

UMTRI  
96421

THE EFFECTS OF DYNAMIC ROUTING  
INFORMATION SIGNS ON ROUTE SELECTION  
AND FREEWAY CORRIDOR OPERATIONS

By

Robert L. Pretty  
Donald E. Cleveland

HSRI Report No. TrS-4

NCHRP Contract 20-3A

OPTIMIZING FREEWAY CORRIDOR OPERATIONS  
THROUGH TRAFFIC SURVEILLANCE,  
COMMUNICATION AND CONTROL

Final Report

Task 4

1971

HIGHWAY SAFETY RESEARCH INSTITUTE  
The University of Michigan  
Huron Parkway and Baxter Road  
Ann Arbor, Michigan 48105

Transportation  
Research Institute



UMTRI  
96421

## ACKNOWLEDGEMENTS

The authors of this report wish to express their appreciation to the many individuals who have given their full support to this phase of the project. Their valuable cooperation has contributed much toward accomplishing this research.

Local government agencies have shown an active interest in all phases of the work through monetary and personnel assistance. Special appreciation is extended to Messers Alger Malo and Anthony Freed, Detroit Department of Streets and Traffic; Messers Harold Cooper, Donald Orne, Herbert Crane, Gordon Paesani, and Terel Cox, Michigan Department of State Highways; Mr. Oscar Gunderson, Wayne County Road Commission; Mr. Howard Cox, Traffic Safety Association of Detroit; and Mr. Edward Wujcik, City of Highland Park Department of Public Works.

Members of the project staff deserving special recognition are Mr. Louis North, Mr. Allen Cook, Mr. Karl Kleitsch, Mrs. Susan Gisting, and Mrs. Cheryl Sills. Mr. Elmer Smith, a communications system engineer at The University of Michigan, was especially helpful in the planning of the dynamic information signs. Dr. David Damkot provided human factor consulting services.

Needed equipment, services, and data were provided by several sources. The Wayne County Road Commission installed and repaired much of the equipment in the field. The Michigan Department of State Highways provided much valuable data including past traffic routing patterns. Also, Control Center equipment from past research was again made available to the project.

The Highway Safety Research Institute merits special thanks for the financial and administrative support they provided as well as their encouragement to undertake this project.

This work was sponsored by the American Association of State Highway Officials, in cooperation with the Bureau of Public Roads, and was conducted in the National Cooperative Highway Research Program which is administered by the Highway Research Board of the National Academy of Sciences - National Research Council.

Transportation  
Research Institute

Local contractual arrangements provided additional support from the City of Detroit, the Wayne County Road Commission, and the Michigan Department of State Highways. Further assistance was provided by the City of Highland Park, Michigan.



## DISCLAIMER

This copy is an uncorrected draft as submitted by the research agency. A decision concerning acceptance by the Highway Research Board and publication in the regular NCHRP series will not be made until a complete technical review has been made and discussed with the researchers. The opinions and conclusions expressed or implied in the report are those of the research agency. They are not necessarily those of the National Academy of Sciences, the Bureau of Public Roads, the American Association of State Highway Officials, or of the individual states participating in the National Cooperative Highway Research Program.



## TABLE OF CONTENTS

	Page
ACKNOWLEDGEMENTS .....	i
DISCLAIMER .....	iii
LIST OF FIGURES .....	vii
LIST OF TABLES .....	xi
SUMMARY OF FINDINGS .....	xv
PART ONE	
CHAPTER ONE: INTRODUCTION AND RESEARCH	
APPROACH .....	3
INTRODUCTION .....	3
THE SITE .....	10
BASIC APPROACH .....	12
THE PRINCIPAL ALTERNATE ROUTE .....	17
THE ALTERNATE ROUTE SYSTEM .....	26
SIGN DESIGN DETAILS .....	39
VARIABLE MESSAGE SIGN .....	39
BLANK-OUT SIGNS .....	42
TRAILBLAZER SIGNS .....	42
SURVEILLANCE AND CONTROL EQUIPMENT .....	50
LOGIC OF SIGN OPERATION .....	54
EVALUATION OF SYSTEM EFFECTIVENESS .....	57
STUDY OF SIGN VISIBILITY .....	57
DRIVER OBSERVANCE STUDY .....	59
TRAFFIC ROUTING AT DECISION POINTS .....	62
OVERALL TRAFFIC RESPONSE .....	63

	Page
CHAPTER TWO: RESEARCH FINDINGS .....	69
SIGN VISIBILITY .....	69
DRIVER SUBJECT RESPONSE .....	73
TRAFFIC ROUTING AT DECISION POINTS .....	86
OVERALL RESPONSE TO DYNAMIC ROUTING SYSTEM .....	96
CHAPTER THREE: INTERPRETATION AND APPRAISAL OF RESEARCH FINDINGS .....	107
SIGN DESIGN AND PLACEMENT .....	112
GENERAL CONSIDERATIONS .....	116
FIELD STUDIES .....	118
DRIVER RESPONSE .....	119
CHAPTER FOUR: CONCLUSIONS AND SUGGESTED RESEARCH .....	121
REFERENCES .....	123
 PART TWO	
APPENDIX A: TECHNICAL EVALUATION OF VARIABLE SIGNS AND SIGN MANUFACTURERS .....	131
APPENDIX B: SPECIFICATIONS FOR THE SUPPLY OF EIGHTEEN VARIABLE SIGNS .....	141
APPENDIX C: DESCRIPTION OF EQUIPMENT USED FOR DATA ACQUISITION AND SURVEILLANCE CONTROL .....	159
APPENDIX D: COMPUTER CONTROL PROGRAMS .....	169
APPENDIX E: DRIVER OBSERVANCE STUDY .....	199
APPENDIX F: PUBLIC INFORMATION ACTIVITIES .....	207
APPENDIX G: DATA FROM TRAFFIC ROUTING STUDY AT TEN DYNAMIC ROUTING INFORMATION SIGNS .....	225
APPENDIX H: PROJECT STATEMENT .....	237

## LIST OF FIGURES

Number	Title	Page
1	RAMP INFORMATION SIGN .....	19
2	NORTHBOUND JOHN C. LODGE FREEWAY CORRIDOR SHOWING ALTERNATE ROUTE AND LOCATION OF RAMP CONDITION INFORMATION SIGNS ...	20
3	EXAMPLE OF CROSS STREET TRAFFIC ROUTING .....	23
4	NODE LINK DIAGRAM OF ALTERNATE ROUTE NETWORK .....	27
5	LOCATIONS OF CORRIDOR DYNAMIC ROUTING INFORMATION SIGNS .....	32
6	UNCONGESTED TREE FORMED BY STATIC AND DYNAMIC SIGNS .....	37
7	TWO STATES OF VARIABLE MESSAGE SIGN .....	41
8	CHICAGO BLANK-OUT SIGN .....	43
9	BLANK-OUT AND STATIC SIGN USED ON DAVISON EXPRESSWAY .....	45
10	TRAILBLAZER AND STATIC GUIDE SIGN .....	47
11	SURFACE STREET DETECTOR LOCATIONS .....	52
12	RELATIVE ABILITY OF SUBJECTS TO SEE AND CORRECTLY USE FIVE SIGN TYPES .....	79

### APPENDIX B FIGURES

B-1	SIGN LOCATIONS .....	142
B-2	VARIABLE MESSAGE SIGN ARROW DISPLAY FOR MESSAGES A, B, C AND D .....	145
B-3	VARIABLE MESSAGE SIGN ARROW DISPLAY FOR MESSAGES E, F AND G .....	146
B-4	TRAILBLAZER SIGN - DESIGN A .....	147

Number		Page
B-5	TRAILBLAZER SIGN - DESIGN B .....	147
B-6	TRAILBLAZER SIGN - DESIGN C .....	148
B-7	TRAILBLAZER SIGN - DESIGN D .....	149

#### APPENDIX C FIGURES

C-1	BLOCK DIAGRAM OF PHYSICAL COMPONENTS OF TRAFFIC CONTROL AND INFORMATION SYSTEM .....	161
C-2	DISPLAY LOGIC FOR VARIABLE MESSAGE SIGN .....	165

#### APPENDIX D FIGURES

D-1	SURVEILLANCE AND CONTROL SYSTEM FLOWCHART PART I .....	174
D-2	SURVEILLANCE AND CONTROL SYSTEM FLOWCHART PART II .....	175
D-3	INTERNAL MALFUNCTION SELF-RECOVERY ROUTINES (RSTAR AND RESTR) .....	176
D-4	SYSTEM INTERNALIZATION ROUTINE FOR CONTINUOUS OPERATION (COLDS) .....	179
D-5	ROUTINE FOR COMPUTATION OF TRAFFIC FLOW DATA (COMP) .....	180
D-6	METERING COMPUTATION AND INFORMATION SIGN CONTROL LOGIC ROUTINE (MTRNG) ....	181
D-7	DETECTOR INTERROGATION ROUTINE (DETEK) .....	182
D-8	OPERATOR COMMUNICATION ROUTINES (MLINE AND DROUT) .....	184
D-9	ROUTINES TO CHECK FOR TASK COMPLETION (CKSYS AND LEVCK) .....	185
D-10	OCCUPANCY DATA COLLECTION AND RAMP METERING ROUTINE (OCCUL) .....	187

Number		Page
D-11	VOLUME DATA COLLECTION ROUTINE (COLMT) .....	188
D-12	DATA TRANSFER ROUTINES (CLTAC AND TAC) .....	189
D-13	SIGN AND SIGNAL POWER CONTROL ROUTINE (POWON) .....	191
D-14	ROUTINE TO ACCEPT MANUAL CHANGES IN METERING RATES AND DIGITAL DISPLAYS (PUSHB) .....	192
D-15	CONSOLE INTERRUPT ROUTINES (CONIN AND CEINT) .....	193
D-16	ROUTINE FOR ONE-AT-A-TIME METERING (MIATM OR MISPC) .....	194
D-17	ROUTINE FOR BULK METERING (TWOCY) .....	195

#### APPENDIX E FIGURES

E-1	DRIVER OBSERVANCE STUDY FIELD SHEET (FIRST SERIES) .....	202
E-2	DRIVER OBSERVANCE STUDY FIELD SHEET (SECOND SERIES) .....	204

#### APPENDIX F FIGURES

F-1	INFORMATIONAL PRESS RELEASE .....	209
F-2	DESCRIPTION OF DYNAMIC ROUTE GUIDANCE SIGNS .....	212
F-3	PRESS ANNOUNCEMENT AND DESCRIPTION OF DYNAMIC ROUTE GUIDANCE SIGNS .....	213
F-4	NEWSPAPER ARTICLE REVIEWING HISTORY OF LODGE FREEWAY RESEARCH .....	214
F-5	EXPLANATORY LEAFLET .....	216
F-6	PRESS RELEASE REVIEWING BASIC CONCEPT OF LODGE RESEARCH .....	221





LIST OF TABLES

Number	Title	Page
1	TRAFFIC PASSING RAMP INFORMATION SIGNS .....	21
2	CROSS STREET TRAFFIC DIVERSION .....	31
3	SIGN LEGIBILITY DISTANCES .....	48
4	SIGNS USED IN SUBJECT DRIVER STUDY .....	64
5	TRAILBLAZER SIGNS EVALUATED IN VISIBILITY STUDY .....	70
6	TRAILBLAZER SIGN LEGEND VISIBILITY DISTANCES .....	71
7	SUBJECTS SIGHTING DYNAMIC ROUTE GUIDANCE SIGNS .....	74
8	CORRECT RESPONSE BY SUBJECTS SIGHTING ROUTE GUIDANCE SIGNS .....	76
9	RESPONSE OF SUBJECTS SIGHTING TRAILBLAZER AND VARIABLE MESSAGE SIGNS .....	78
10	RESPONSE BY SUBJECTS SIGHTING TRAILBLAZERS BY LIGHT CONDITIONS .....	80
11	SUBJECTS SIGHTING TRAILBLAZERS AT EACH LOCATION .....	82
12	RESPONSE OF SUBJECTS SIGHTING TRAILBLAZERS BY SIGN POSITION .....	84
13	PERCENT OF CORRECT RESPONSE BY SUBJECTS SIGHTING THE VARIABLE MESSAGE SIGN FOR TWO SIGN STATES .....	85
14	USAGE OF DIRECT AND ALTERNATE ROUTE .....	87
15	TRAFFIC RESPONSE TO DYNAMIC SIGN DISPLAYS .....	88

Number	Title	Page
16	PERCENT OF TRAFFIC MAKING RECOMMENDED MOVEMENT .....	89
17	TRAFFIC RESPONSE TO DISPLAYS BY LOCATION .....	91
18	TRAFFIC VOLUMES .....	93
19	TIME OF DAY EFFECT ON PERCENT OF DRIVERS USING DIRECT ROUTE .....	94
20	FREEWAY TOTAL TRAVEL AND TOTAL TRAVEL TIME BEFORE AND AFTER THE INTRO- DUCTION OF NEW SIGNS .....	99
21	SURFACE VOLUMES AND AVERAGE AND TOTAL TRAVEL TIMES .....	101

APPENDIX B TABLES

B-1	LOCATIONS OF THE TRAILBLAZER SIGNS .....	144
B-2	LEGIBILITY DISTANCES .....	150

APPENDIX D TABLES

D-1	KEY TO COMPUTER OPERATIONS FLOW CHARTS .....	177
-----	-------------------------------------------------	-----

APPENDIX E TABLES

E-1	INSTRUCTIONS (FIRST SERIES) .....	200
E-2	INSTRUCTIONS (SECOND SERIES) .....	203

APPENDIX G TABLES

G-1	OBSERVATION OF TRAFFIC ROUTING AT SIGN 1: WEST GRAND BOULEVARD AT SECOND .....	225
G-2	OBSERVATION OF TRAFFIC ROUTING AT SIGN 3: SECOND AT SEWARD .....	226

Number	Title	Page
G-3	OBSERVATION OF TRAFFIC ROUTING AT SIGN 4: SEWARD AT SECOND .....	227
G-4	OBSERVATION OF TRAFFIC ROUTING AT SIGN 6: SECOND AT CHICAGO .....	228
G-5	OBSERVATION OF TRAFFIC ROUTING AT SIGN 7: HAMILTON AT CHICAGO .....	229
G-6	OBSERVATION OF TRAFFIC ROUTING AT SIGN 8: CHICAGO AT HAMILTON .....	230
G-7	OBSERVATION OF TRAFFIC ROUTING AT SIGN 12: WOODROW WILSON AT WEBB .....	231
G-8	OBSERVATION OF TRAFFIC ROUTING AT SIGN 13: WEBB AT WOODROW WILSON .....	232
G-9	OBSERVATION OF TRAFFIC ROUTING AT SIGN 14: HAMILTON AT DAVISON SERVICE DRIVE .....	233
G-10	OBSERVATION OF TRAFFIC ROUTING AT SIGN 15: DAVISON SERVICE DRIVE AT HAMILTON .....	234



## SUMMARY OF FINDINGS

A previous report described the design and evaluation of eight Ramp Information signs providing dynamic information on ramp congestion in the northbound direction of the John C. Lodge Freeway, Detroit, Michigan (26).<sup>\*</sup> These signs indicated whether or not a metered ramp should be entered depending on the level of Freeway or ramp congestion and traffic was directed to a parallel surface street route. The percentage passing a dynamic sign was found to be less than 10% for three of the eight ramps.

In this research a further set of 19 variable signs was designed and erected on the cross streets of an Alternate Route Network. This was expected to result in sufficient motorist diversion to reduce ramp congestion. The additional signs directed motorists along a network of surface streets. Thus almost every motorist approaching the Freeway passed a dynamic sign which indicated the appropriate path to the Freeway. The use of more than one parallel route also provided the option of directing as much traffic as possible to the least congested route.

The aims of this particular project task were:

- a. To design suitable signs to divert traffic over a dynamic pattern of routes;

---

<sup>\*</sup> Numbers refer to references at the end of Part One of this report.

- b. To determine suitable logic and hardware to operate these signs from the Control Center;
- c. To devise tests to measure the effectiveness of the signs in diverting traffic; and,
- d. To evaluate the effectiveness of the signs.

The equipment available for operation of the signs and metered ramp signals included

- a. An IBM 1800 digital computer with an input and output interface for field communication located at the Control Center;
- b. Leased telephone cable and lines for communication with the field equipment;
- c. 55 vehicle presence detectors located at 9 locations along the northbound Freeway, on all 9 entrance ramps, including an additional detector on seven of the ramps;
- d. Eight entrance ramp metering signals; and,
- e. Eight ramp information signs.

Equipment installed for this particular task included 19 variable signs and 15 surface street detectors together with the necessary leased telephone lines for communication.

#### SIGN FEATURES

A variable message sign was erected above the west-bound West Grand Boulevard traffic approaching Second Avenue. Seven possible messages were specified. Four pointed straight along West Grand Boulevard for access to

West Grand Boulevard or later ramps. The remainder indicated Second Avenue and then access to the Freeway via Seward, Chicago, or Webb. The sign arrows (when on) were in green neon on a white background. The static message "NORTHBOUND LODGE FREEWAY" was painted in white on a green background, and the variable messages (when on) were in red neon on a white background.

A large blank-out sign was erected for the benefit of westbound Davison Expressway traffic. The purpose of this sign was to divert to Twelfth Street traffic from the entrance to the northbound Lodge Freeway. The static message "LODGE FREEWAY NORTH" and two arrows were painted in white on a green background with the diversion message "DELAY - AVOID RAMP USE 12TH ST" in clear neon tubes on a green background. When this message was activated the neon glowed red. Thus in the off-state, this blank-out sign appeared as a simple guide sign. Another small blank-out sign was erected on Chicago Boulevard at the Freeway to divert eastbound traffic from the Freeway to Hamilton Avenue when warranted.

Finally 16 trailblazer signs were erected at other choice or decision points in the network. Each sign consisted of the static legend "NORTHBOUND LODGE FREEWAY" and two arrows, only one of which was visible at any time. The legend was green and the arrows (when on) showed green.

There was a white background to the whole sign. Four different designs were used, depending on the possible turning movement and the width of the street.

Four tests were devised to measure the effectiveness of the signs in diverting traffic. The first test measured visibility in which the farthest distance that the illuminated trailblazer arrow could be seen was determined. In the second test unfamiliar subjects were asked to drive on selected streets in the network and to follow any variable sign they passed. The two tests revealed defects in sign design and placement. Of particular interest was that the signs with longer messages or more complex design were frequently misread or misunderstood.

The third test to measure the effectiveness of the signs consisted of counting the vehicles taking each specified path from choice points for different states of the signs. It was found that there was a positive response averaging 2.5% and ranging up to eight percent. The response was greater during peak periods and on streets with sharper peak flows.

Finally the overall total travel time was estimated on the Freeway and surface streets for selected before and after days. A reduction of about 300 vehicle hours on the Freeway was measured. An increase in travel time on the surface streets was expected and a total of at least 100



additional vehicle hours was accounted for on a fraction of the links. It seems reasonable, however, to conclude that there was a small reduction in corridor total travel time but of an unknown amount.



**PART ONE**



## CHAPTER ONE

### INTRODUCTION AND RESEARCH APPROACH

#### INTRODUCTION

Among the ways of influencing transportation demand other than changed basic human behavior, changed land use relationships and more extensive transportation systems, improved utilization of existing facilities can be obtained by redistributing the demand for travel in space, time, or both. Redistribution of demand in time would require that other human activities be rescheduled and while there has been some consideration given to staggered hours where there is a substantial opportunity to increase the effectiveness of use of facilities, little attention has been given to redistributing the demand for transportation in space and allocating users to routes other than those that they are currently using.

Beckmann, in his pioneering study, indicated that freedom of choice is a service on which the motorist places a value (2).<sup>\*</sup> He listed four of these freedoms, the freedom of choice of destination, time of departure, route traveled, and speed followed. If a motorist yields one or more of these freedoms it should only be because

---

<sup>\*</sup>Numbers refer to references at the end of Part One of this report.

better service is provided all users of the system as a consequence. Freedom of choice of speed has already been taken from the motorist primarily for safety purposes. It is reasonable to believe that the motorist may similarly be prepared to yield his route choice freedom, particularly if there is little disutility associated with this action.

Observation of peak flows in freeway corridors indicates that while the freeway facilities themselves may be extremely overloaded and provide a low level of service, often there is only a low utilization of parallel streets providing better travel-time service. If some of the freeway traffic could be induced to use part of the unused capacity on the arterial system a higher overall level of peak period service should be achievable for all users.

This leaves the problem of routing traffic to a better advantage (here considered to be measured by travel time divided by miles traveled). Particularly, one is concerned with diverting a small amount of traffic from a popular freeway to surface streets, so that the freeway does not congest. There are three general methods of attack available for this routing problem:

1. Controlling the rate at which traffic is allowed to enter the freeway by traffic signals on the ramp system (ramp metering).
2. Providing alternate routes to the freeway on

which the travel time is almost as good as that on the freeway, and relying on drivers to discover and use these routes.

3. Providing alternate routes with equivalent service as in 2 and providing drivers with information on which routing is currently least congested.

The ramp metering approach has been used in several communities. The general method of this approach is that of unnatural delay. By metering traffic on the ramps, a queue is formed and arriving traffic is delayed. Thus, rather than providing an equivalent route operating at freeway speeds (about 35 miles per hour at optimal velocity) the travel time over the freeway route is increased until some drivers find that surface routes provide better service. This particularly serves to divert traffic which would be using the freeway for only short distances. Because it is this traffic that is diverted it is necessary to control the on-ramps throughout the areas in which congestion develops due to overloads. Ramp metering also actually increases the capacity of the through freeway by reducing the frequency of merge operations and the associated turbulence. The second and third approaches, if drivers can be induced to use alternate routes, offer more promise than the first, since the induced queuing delay at the ramps is not present and thus travel times can be lower. The diversion is more natural, in that it

does not require artificial delays to be introduced. It does require unused surface street capacity, and the ability to provide good surface street service. The third approach is more promising than the second since it would provide appropriate routing even as the alternate surface routes approached capacity, where the second method would always have congestion at lower traffic volumes because of the probabilistic nature of the route decision and thus of the traffic volume on each route.

Potts has explored the interaction among drivers who individually select routes from among a set in which the trip time is the minimum that each could select (25). Those drivers who select minimum time routes are classed as selfish and those who select routes such that the average journey time is not minimized are classed as antisocial. In a road network with uncapacitated roads the selfish driver is also a social driver. However, when the road sections are capacitated and travel times change with flow the selfish driver is not a social driver.

The general effect of ramp metering systems is to increase the travel time for those users for whom the improved travel time on their freeway trip does not equal the additional time spent waiting in the metered ramp queue. It will be to the advantage of all if this traffic can be induced to use an alternate route, if the alternate



route using the surface street network can provide a sufficiently high level of service to attract these users as an alternate to the freeway. Also, variations in demand at metered ramps can make entry at a downstream ramp more attractive to the individual motorist.

It is clear that the key issue under consideration is that of route selection by the motorist in the Corridor. If these benefits are to be achieved with individual drivers being permitted to continue to make their own route choices it is believed necessary that each motorist be provided with information valid for him which will indicate the level of service which he can receive from the system if he does select an alternate route. In recent years there has been a great deal of interest throughout the world in the need for an information system which could provide the highway user with real time or pseudo real time information on the operational status of alternate routes available to him but he (16, 19, 24).

If the motorist selects a heavily congested route his trip takes longer than necessary and also increases the inefficiency of system performance. There may well be better alternative routes available to him but he seldom has sufficient information on which to base an

intelligent choice. Even though the corridor streets may have sufficient total capacity, it is to be expected that congestion will result on some arteries if drivers diverted from the freeway are required to select their own alternate routes. The individual motorist has little information available to him on alternate routes and their state of congestion. Furthermore, the typical motorist rarely examines all feasible alternatives, and his judgement is likely to be subjective and based on erroneous estimates of travel time and distance. For instance, early users of Detroit freeways were found to be more often wrong than right when questioned regarding the relative travel time and distance on alternate routes.

More efficient utilization of available corridor capacity can be achieved by developing a sensing system capable of indicating current levels of service and a computational ability to evaluate possible routes in real time and providing information to drivers indicating which alternate route is currently least congested. If the driving public is to be expected to act on such advice, it is essential that recommended alternate routes provide travel times which are comparable to those on the freeway. Thus, the satisfactory operation of any driver information system designed to distribute traffic over alternate routes requires that service on such alternate routes be upgraded

as much as possible by means of coordinated traffic control and minor geometric improvements, as well as by enforcement of traffic regulations.

In order to achieve optimal flow in a network where the users select their routes voluntarily it is believed that the number of motorists who can be diverted is needed for application desired. It is also believed that this number will generally be only a fraction of those using the network. This fraction can be "controlled" exogenously by the responses of the motorists to the system since many will choose not to follow the suggestion for personal reasons. The fraction will be controlled within the system by displaying the information to a selected set of motorists, probably one or two of several approaches in a spatial context or only part of the time if temporal communication is to be used.

There is a strong belief by other investigators that the prime benefits of a surface street information system are likely to be realized only under unusual circumstances such as major accidents, fires etc.

## THE SITE

Careful study was given to the area served by Detroit's John C. Lodge Freeway and nearby streets. The criteria used in the selection of the corridor to be studied included the availability of unused capacity on the surface street routes, street orientation and continuity considered acceptable to motorists, and likelihood of accomplishment with the time and funds available. Because of these constraints and a desire to communicate with large numbers of drivers using the freeway, it became apparent that studying the northbound movement on the freeway would make it possible to communicate with drivers with origins at prime traffic generators. Afternoon peak period studies would give access to this group as they returned home and provide an opportunity to experiment with the longer and more severe daily peak period.

A study of alternate routes showed that there are several facilities which provided potentially attractive alternate routes to the freeway for longer trips. The major north-south traffic corridor in the city of Detroit is the Woodward Avenue, or John C. Lodge Expressway, Corridor. The Lodge Expressway, originating at the Detroit River in the Central Business District, proceeds approximately 13 miles northwesterly to Eight Mile Road, the northern boundary of Detroit, and beyond into well established

suburban areas. Although there is no single street which parallels it, the freeway is partially supported by its service drives, the newly completed Walter P. Chrysler Freeway, Hamilton Avenue, the one-way streets of Second, Third, John R., Brush, Twelfth, and Fourteenth, the major two-way artery, Woodward Avenue, as well as such minor arteries as Fenkell and Puritan. The corridor must be taken to include all these roads and their natural extensions. It includes much of the city of Highland Park, in addition to large areas of Detroit.

The presence of the old Davison Expressway in the Corridor created an interesting challenge in this study. It provided an opportunity to explore diversion from a freeway to a major street and back to the interchanging freeway rather than using the connecting ramp directly.

Railway grade crossings blocked by frequent switching operations of variable duration created an unusual delay affecting element to this study. A limited set of detectors were added to the Freeway Corridor and used to provide information on traffic flow necessary for the operation of a display system. Dynamic displays capable of providing timely route guidance advice were designed and installed.

Courage concluded that it was of the utmost importance that an alternate route be established throughout the

corridor since the peak demand on the freeway was known to exceed the capacity on all sections from the Edsel Ford Interchange north to Wyoming Avenue, a distance of more than six miles (7).

He recommended the installation of changeable message signs at critical decision points in advance of the alternate route on those streets connecting with the freeway.

A number of traffic engineering improvements were made with the cooperation of the Department of Streets and Traffic of the City of Detroit. These improvements have been described elsewhere (26).

#### BASIC APPROACH

Moskowitz recommended an experiment in rerouting and informing drivers of optimal routine (24). He believed that problems associated with such a system are familiarity with route, unfamiliarity with the travel time on the alternate route, the possibility of too much diversion and the possibility that the information provided to the motorists would not be timely and relevant to their needs.

Heathington structured a systems model of a freeway driver information system in which he attempted to define all elements of the transportation system in a way that

will assist in the voluntary route choice problem (17). He described several characteristics for which criteria can be established to insure maximum efficiency of such a system. These included:

1. Sufficient computing and communication capacity to respond to the demands made upon it by users
2. The quality of information should be at the level and in the form required by the user
3. The information must be provided in a timely fashion
4. The system must be flexible to respond to changed user requirements
5. The system must have a degree of reliability in operating within established performance levels a satisfactory fraction of the time
6. The system should be economical within a cost-effectiveness framework.

Each of the elements received attention in this undertaking to the maximum extent possible.

Traffic engineers have observed that the motorist does not always respond to traffic signs as desired. It is possible to attribute this to one or more of three elements, not seeing the sign, seeing but not understanding it, or understanding it but believing that the information is of no value to him personally. Thus, for a real time freeway information system to effect appropriate

driver response, it must be designed to provide the driver with information which is meaningful, accurate, timely and useful. This study provided the motoring public with an opportunity to play a major role in affecting future real time freeway information system designs.

In a complete Freeway Corridor Dynamic Information and Control System (FCDICS) all travellers in the Corridor would receive relevant information. In this study, the information transmission capabilities existed (changeable message signs) but resources were not adequate to support a system providing information for all users. Hence, a decision was made to provide information for only one destination, those travelling on the northbound Lodge Freeway well beyond Wyoming Road. It was recognized that there would be motorists in the Corridor who desired to use the Freeway, but not that far, and that the information provided them would be erroneous. Fortunately this group is less than 10% of those entering in the six-mile section (26).

Providing a system in which displays are visible to all drivers in the corridor who would be sharing the downstream freeway destination would be extremely expensive. On the other hand, it was important to define a complex network so that the results of the study would be useful in more than the simplest cases.



As a part of the display system developed for this study, consideration was given to various possibilities in the hope that differential responses to the different types of displays could be identified and would be useful in final designs. Among the displays used were:

1. A simple binary display using an arrow indicating which of two directions should be used;
2. Map type presentations giving information on which ramp to use
  - a. Showing two ramps
  - b. Showing three ramps;
3. A complex verbal display including the term "delay" and providing information on more than one decision point.

The strategy adopted in carrying out the Freeway Corridor Dynamic Information and Control System experiment was to implement logical parts of the system and observe the results. Phase one of the experiment involved providing a single Principal Alternate Route for the entire six miles of the Freeway. The results of phase one are described in a separate report (26). Phase two involved providing a more extensive network which in general could be described as consisting of a second alternate route with six or more cross linkages. The resulting system is called the Alternate Network. A third phase will consist of implementing real time traffic control on

many of the traffic signals in the Alternate Network. The results of this 1970 study will be reported in another report.

## THE PRINCIPAL ALTERNATE ROUTE

Eight ramp condition information signs similar to the one shown in Figure 1 and identifying a principal alternate route to the Freeway were placed in operation in the northbound John C. Lodge Freeway Corridor shown in Figure 2 in mid 1969. Each sign provided information for a metered on-ramp. The design, operation and evaluation of that display system are described in detail in Evaluation of a Dynamic Freeway Ramp Entry Guidance System (26) . Three of the sign locations were on the Lodge Service Drive which is adjacent to the Freeway from West Grand Boulevard to Chicago Boulevard. The five other signs were located on the Principal Alternate Route which follows several arterial streets parallel to the Freeway. To reach the Freeway from these five sign sites on the alternate route, a turn must first be made at the appropriate cross street and from one to several blocks traveled on the cross street.

At five of the eight entrance ramps it was possible to approach and enter the Freeway without passing the appropriate information sign, since the signs provided information particularly for those on the principal alternate

route. Since much of the traffic entering the Freeway at these ramps was already on the cross streets, this placed a limit on the effectiveness of these signs. The percent of undiverted traffic entering at each ramp passing the sign was obtained through a license plate study and is shown in Table 1 (26). The small fraction of ramp users passing these signs at the five ramps from Chicago Boulevard to Livernois Avenue is apparent. Hence, if a sign display indicated that its ramp should not be entered, the reduction in entering volumes could not exceed the value shown in Table 1. In practice, the reductions were found to be considerably smaller because many motorists passing signs did not follow the recommended route to the Freeway.

The study of the ramp information signs indicated that there was an overall saving in total travel time of approximately 200 vehicle hours for every afternoon peak period of operation. It seems clear that if more motorists passed the signs, thus having an opportunity to see and obey them, the savings would be even greater. The Freeway cross streets would be the greatest source of additional traffic which might be diverted from the Freeway to a surface street alternate route.



FIGURE 1

RAMP INFORMATION SIGN

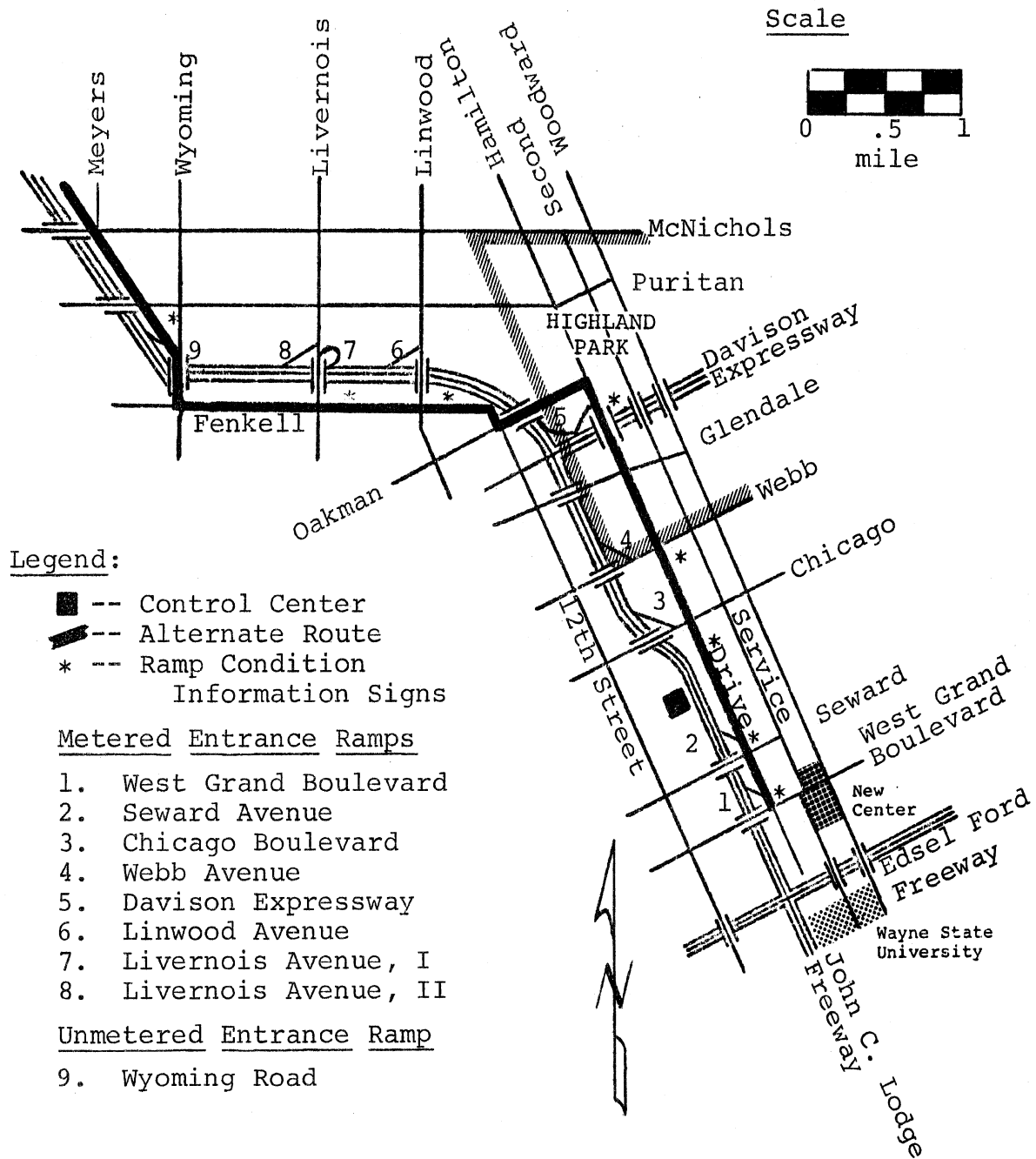

FIGURE 2

NORTHBOUND JOHN C. LODGE FREEWAY CORRIDOR  
SHOWING ALTERNATE ROUTE AND LOCATION  
OF RAMP CONDITION INFORMATION SIGNS

TABLE 1  
TRAFFIC PASSING RAMP INFORMATION SIGNS

RAMP	PERCENT PASSING SIGN
West Grand Boulevard	100.0%
Seward Avenue	100.0
Chicago Boulevard	29.0
Webb Avenue	7.5
Davison Expressway	7.6
Linwood Avenue	11.1
Livernois Avenue	6.3
Wyoming Road	100.0

There are two important considerations associated with the selection of the point of diversion of traffic approaching the Freeway.

1. If the diversion takes place before the cross street traffic reaches the Freeway, additional traffic generated at traffic generators between the Principal Route and the Freeway will not have an opportunity to divert as shown in Figure 3.

2. If the diversion takes place where the cross street traffic reaches the Freeway ramp entrance, the diverted traffic may have to travel a longer distance to enter the Freeway as shown by the linked x lines in Figure 3.

Since these diversion choice point criteria oppose each other, a compromise might be necessary to maximize the number of motorists passing a sign. There are, however, few large traffic generators between the Principal Alternate Route and the Freeway for any of the five cross streets (Chicago, Webb, Davison, Linwood and Livernois) at which this problem exists. On each of these streets except Davison Expressway, northbound traffic approaches the Freeway from either direction. Thus, if early diversion is to be employed, a second alternate route on the western side of the Freeway is necessary. In all cases except Chicago Boulevard, a suitable second alternate route existed and at Chicago the extra distance was minimal.



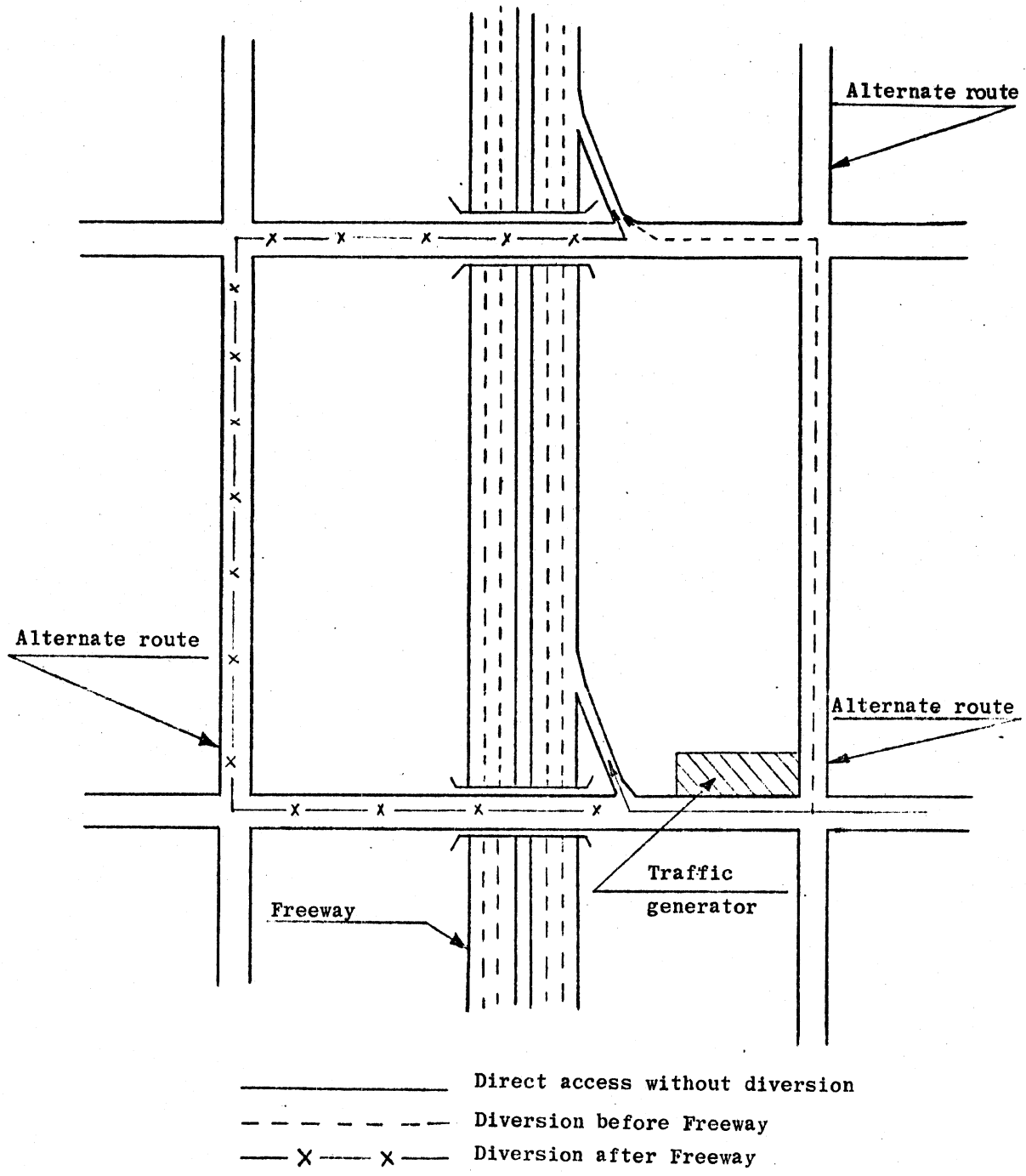

FIGURE 3

EXAMPLE OF CROSS STREET TRAFFIC ROUTING

The Principal Alternate Route, like the Freeway, tends to become congested during the afternoon peak period. Furthermore, any additional diversion from the Freeway may increase the congestion, thus increasing travel time on the alternate route.

There are two major points of congestion on the Principal Alternate Route. The first point is at the southern end of the Corridor at the West Grand Boulevard ramp where traffic from that street and traffic leaving nearby parking areas serving the New Center complex tends to build up at the intersection of the Lodge Service Drive and West Grand Boulevard. In addition, the bulk service metering strategy (more than one vehicle per green cycle) used at this ramp requires only a short waiting time for vehicles well back in the queue, and so the ramp tends to attract much traffic (6). Congestion occurs only occasionally at the second point of congestion, Twelfth Street above Oakman, when the railroad grade crossing barriers crossing Twelfth Street close during the peak period. However, the result is often a long period of closure. Elsewhere, the Principal Alternate Route usually provides a good level of service unless there are numerous illegally-parked cars. This can be a critical factor, especially on Fenkell Avenue, as it has only two westbound through lanes.

In this investigation an additional supporting network of alternate routes to the northbound Freeway was developed. The particular streets were chosen to provide suitable routes for diverted cross street traffic and to provide more than one alternative so that the use of the route with the current minimum travel time could be encouraged. The aims of this project task were, therefore, to design suitable signs to divert traffic to this pattern of alternate routes, determine suitable logic and equipment to operate these signs, and to conduct tests to measure the effectiveness of the signs in diverting traffic and to evaluate the effectiveness of the system.

## THE ALTERNATE ROUTE NETWORK

Figure 4 presents a node-link diagram of the alternate route network selected for implementation. The Principal Alternate Route is identified by the following links: 2-5, 5-8, 8-11, 11-15, 15-18, 18-19, 19-20, 20-21, 21-23, 23-25, 25-31, and 31-32. From this route the Freeway is reached by links 2-3, 5-6, 8-10, 9-10, 11-13, 12-13, 15-14 and 14-16, 21-22, 28-22, 23-24, 29-30 and 25-26.

It is assumed that all traffic originates at nodes and that no traffic originates at the Freeway nodes (3, 6, 10, 13, 16, 22, 24, 30 and 26). The system was designed so that the cross street traffic to be diverted that does not pass a Principal Alternate Route ramp information sign can be diverted by means of additional signs.

The additional alternate routes were selected to divert traffic before it approached the Principal Alternate Route when it became congested and are:

1. Second Avenue from West Grand Boulevard to Webb Avenue and westerly along Webb Avenue to Hamilton Avenue (links 1-4, 4-7, and 7-11). The connecting links for this route are 1-2, 4-5, 7-8, 11-13 and 11-14. In this section, Second Avenue is a one-way, five-lane street in the

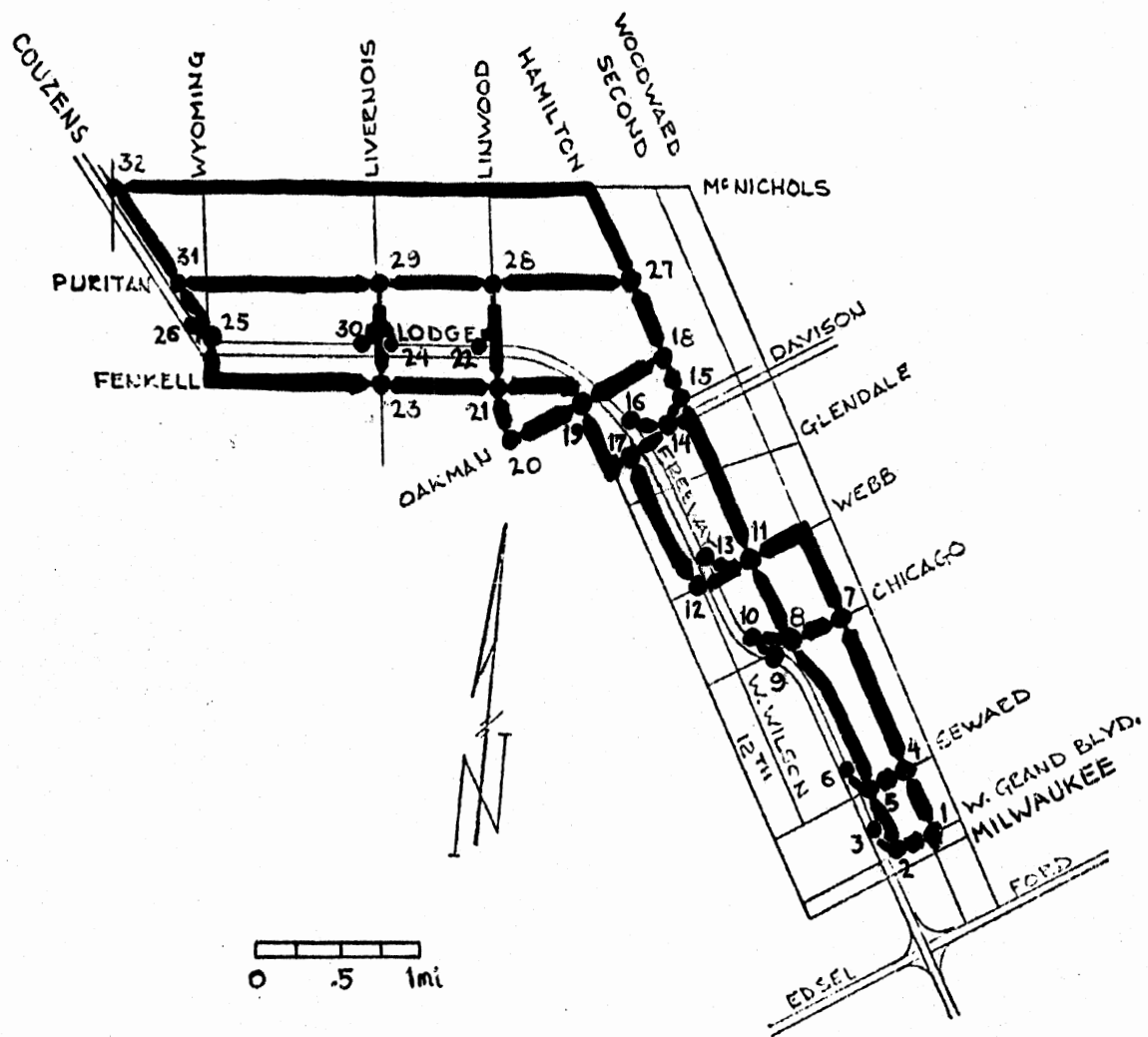

FIGURE 4

NODE LINK DIAGRAM OF ALTERNATE  
ROUTE NETWORK

City of Detroit and usually provides a good level of service. This route is used when the Lodge Service Drive or the southern part of Hamilton Avenue is congested. North of Webb Avenue, Second Avenue is in the City of Highland Park, where it is narrower and not deemed suitable for an alternate route.

2. Hamilton Avenue and Puritan Avenue from Oakman Boulevard to Couzens Drive (18-27, 27-28, 28-29, and 29-31). In the event that Fenkell Avenue is congested, and especially when the Linwood and Livernois ramps are congested, this route can be quicker than the Principal Alternate Route. Since there is also a railroad grade crossing on Hamilton between Oakman and Puritan, this route can only be used when the grade crossing is not in use. Puritan Avenue is approximately the same width as Fenkell with two clear lanes in peak periods. Because left turns are not permitted from Puritan at Linwood, Livernois or Wyoming during peak periods, traffic proceeding north on Hamilton can only be routed to Couzens Drive and beyond Wyoming Road to the Freeway.

3. Hamilton Avenue and McNichols Road from Puritan Avenue to Couzens Drive (27-32). This is a variation of the Puritan Avenue route described above and is indicated when it provides a quicker trip.
4. Oakman Boulevard and Linwood Avenue from Twelfth Street to Fenkell Avenue (19-20 and 20-21). This route is only used to bypass the Twelfth Street railroad grade crossing when the barriers are closed. These crossings are often used for switching movements very close to Twelfth Street, thus making Linwood Avenue a viable alternate route.

The prime purpose for identifying additional alternate routes was to provide Freeway condition information to as many motorists as possible. For the network shown in Figure 4, there are 19 nodes where a motorist has a choice of routes (choice points). These choice points are located at nodes 1, 2, 4, 5, 7, 8, 9, 11, 12, 14, 15, 18, 19, 21, 23, 25, 27, 28 and 29. There are an additional 13 choice points, but these are either Freeway access points (3, 6, 10, 13, 16, 22, 24, 26 and 30) or the junction of two alternate routes (17, 30, 31 and 32). Of the 19 nodes at which the motorist is given a choice of routes, there are eight where northbound Lodge Freeway traffic may approach

from two directions (1, 4, 7, 11, 12, 19, 21 and 23). At the remaining 11 nodes there is only one direction from which northbound Freeway traffic can approach. Second Avenue at Chicago (node 7) was placed in this latter category because it was expected that very little traffic would approach this intersection from the east with the intention of using the northbound Freeway. Table 2 shows the location of the main decision nodes for cross street traffic.

If every reasonable approach to a choice point to the Freeway is to have a sign indicating a suitable route to the Freeway, a total of 27 signs are required, two at each of the eight two-approach nodes and one at each of the 11 one-approach nodes. The existing eight frontage road information signs already indicated which route to take for eight of the nodes. Therefore, an additional 19 signs were required. The locations of these 27 signs are shown in Figure 5.

From each choice point there are never more than two logical paths for a driver to take to the northbound Lodge Freeway. The paths may proceed straight ahead or turn left or proceed straight ahead or turn right, as appropriate. There are no other logical combinations. Therefore, a modified guide sign with two arrows, only one of which is illuminated at any one time, appeared to be a suitable design. This sign is referred to as a Trailblazer in this report.



TABLE 2

## CROSS STREET TRAFFIC DIVERSION

DIRECTION OF TRAFFIC	CROSS STREET	DECISION NODE	DIVERSION TO
Westbound	Chicago	8	Hamilton
Eastbound	Chicago	9	Chicago or Hamilton (8)
Westbound	Webb	11	Hamilton
Eastbound	Webb	12	Woodrow Wilson
Westbound	Davison Service Drive	15	Hamilton
Westbound	Davison Expressway	14	Davison or Twelfth (17)
Northbound	Linwood	21	Fenkell
Southbound	Linwood	28	Puritan
Northbound	Livernois	23	Fenkell
Southbound	Livernois	29	Puritan

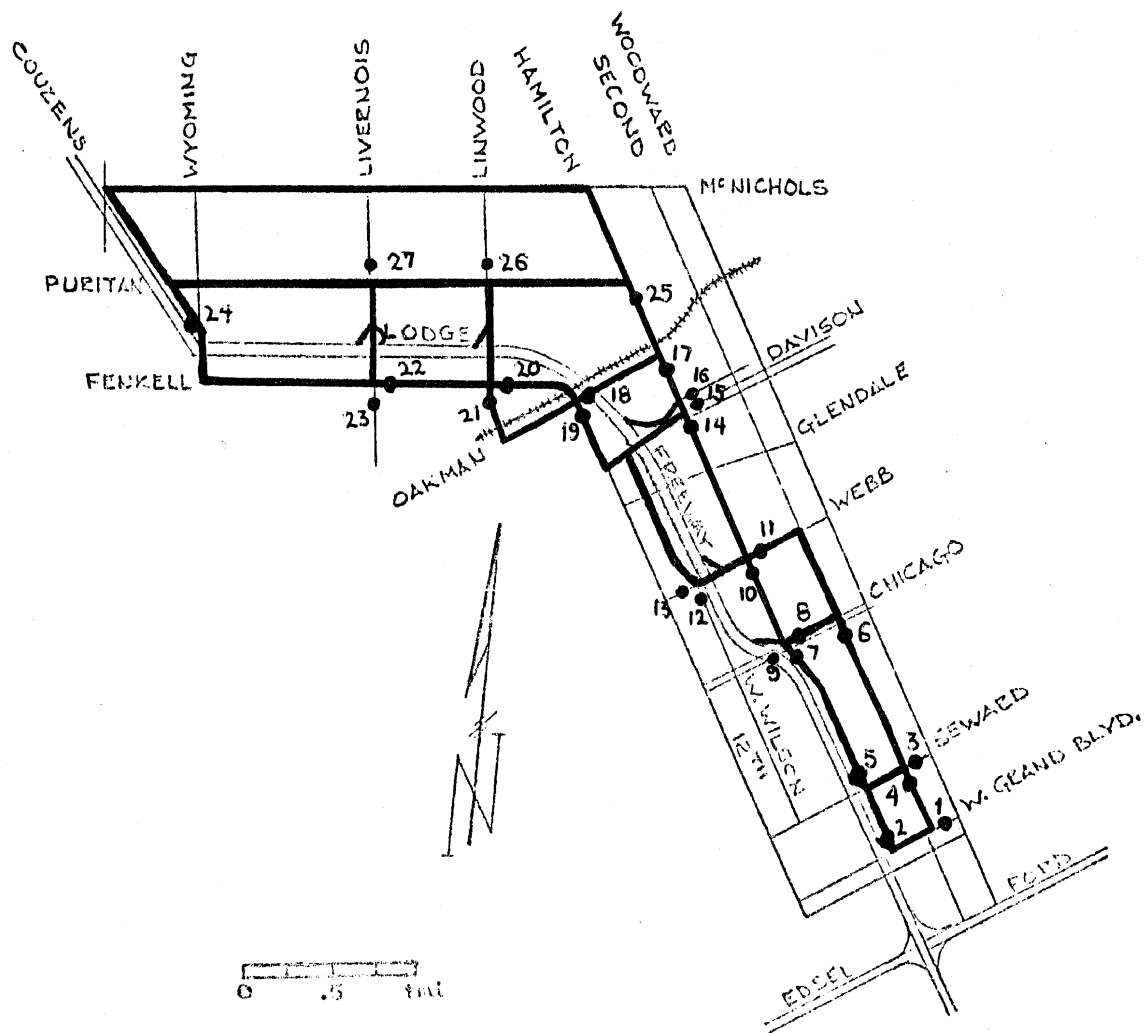

FIGURE 5

LOCATIONS OF CORRIDOR DYNAMIC  
ROUTING INFORMATION SIGNS

The legend "NORTHBOUND LODGE FREEWAY" was selected to accompany the arrows. Other legends such as "TO FREEWAY NORTH," "TO NORTHBOUND JOHN C. LODGE FREEWAY" or "LODGE FREEWAY NORTH," all of which are used on existing standard guide signs, would have been equally appropriate.

For 16 of the 19 approaches, signs based on this principle were designed and manufactured. For the remaining three approaches, however, it was believed appropriate to design a different type of sign.

From the westbound West Grand Boulevard approach to Second Avenue there are two network paths to the Seward ramp, three to the Chicago ramp, four to the Webb ramp and four to continue on Hamilton north of Webb. If turning movements are minimized, a desirable objective, there are still two paths each to the Seward, Chicago and Webb ramps and to Hamilton north of Webb. Since the existing information signs on the Service Drive all can indicate several paths, it seemed logical to design this sign so that it also indicated several paths. This would have the desirable effect of informing motorists of the extent of ramp and Freeway congestion by advising them how far they would have to travel on the alternate route before entrance to the Freeway was recommended. They would then be prepared for the correct maneuvers at the Service Drive as indicated

by the ramp information signs there, and some users could decide at this early point to use the Service Drive or Second Avenue and not enter the Freeway at all.

The position selected for this variable message sign is very close to the point of generation of many of the trips in the Lodge Freeway Corridor. There can be considerable congestion at the West Grand Boulevard intersection with the Lodge Service Drive. Therefore, a sign east of the intersection, giving full corridor information, has the potential to divert many vehicles. Thus, a full message detailing the suggested route was provided motorists at this point.

To further indicate the correct maneuver from this position, a special design was required for the sign arrows. When Second Avenue is an appropriate path, an immediate right turn should be indicated. When the Service Drive is designated as the least congested route, drivers should be asked to take the third road to the right passing Second and Third Avenues. Thus the arrow was designed and constructed to convey two symbolic messages.

The second special sign was required on the westbound Davison Expressway approach to the Lodge Freeway on-ramp. A sign at this location would serve the function of diverting traffic away from a direct entrance to the Lodge Freeway.

It did not seem appropriate to indicate that the Freeway could be reached by not entering via the designated on-ramp. Therefore, the message "DELAY: AVOID RAMP: USE 12TH ST" was selected to divert traffic. This message was illuminated beneath the static message "LODGE FREEWAY NORTH." The painted message "NORTHBOUND LODGE FREEWAY" was not used on this sign. As "LODGE FREEWAY NORTH" is consistent with expressway guide sign terminology, the shorter legend was chosen in an effort to construct the most economical legible sign. Two standard guide signs were erected beyond this sign to indicate the route to Twelfth Street.

The eastbound Chicago Boulevard approach to the Lodge Freeway on-ramp presented the third site which necessitated a unique sign design. As in the case of the westbound Davison Expressway, motorists can be diverted away from a direct entrance to the Freeway. The design and operation of this sign was similar to that of the Davison sign as it was only illuminated when appropriate. This message was placed below a standard guide sign to the Freeway (see lower portion of Figure 10 on page 47 ). Since Hamilton Avenue is only a few hundred feet farther west, it was believed that the street name sign for Hamilton would be sufficient guidance at the intersection with Chicago.

Since not all traffic originated at the nodes, more than 100 static painted guide signs were designed, supplied and erected by the City of Detroit for use in the Detroit City limits and others were purchased by the project for erection in the City of Highland Park (see Figure 10 on page 47 ). These guide signs, together with the dynamic sign displays at "choice points" describe a set of paths for northbound Freeway traffic moving through the corridor. This set of paths is called a tree with flows moving toward the "trunk" formed by the Freeway and Couzens Drive at McNichols Road. Figure 6 shows one of the more than 100 trees which identify paths, this one for the uncongested state displayed during off-peak hours. The general mode of operation was to display indications for the tree currently providing minimum travel time to the northbound Lodge beyond McNichols.

Static signs were placed so that most motorists were first shown the path to the nearest dynamic sign and then the appropriate path from this choice point. Other guide signs were placed for reassurance purposes where the distance between nodes was considerable or where the path changed direction. In one exception to this general rule, it was decided to route northbound Second Avenue traffic at Milwaukee (one block south of West Grand Boulevard) along Milwaukee to the Freeway. This avoided the expense and

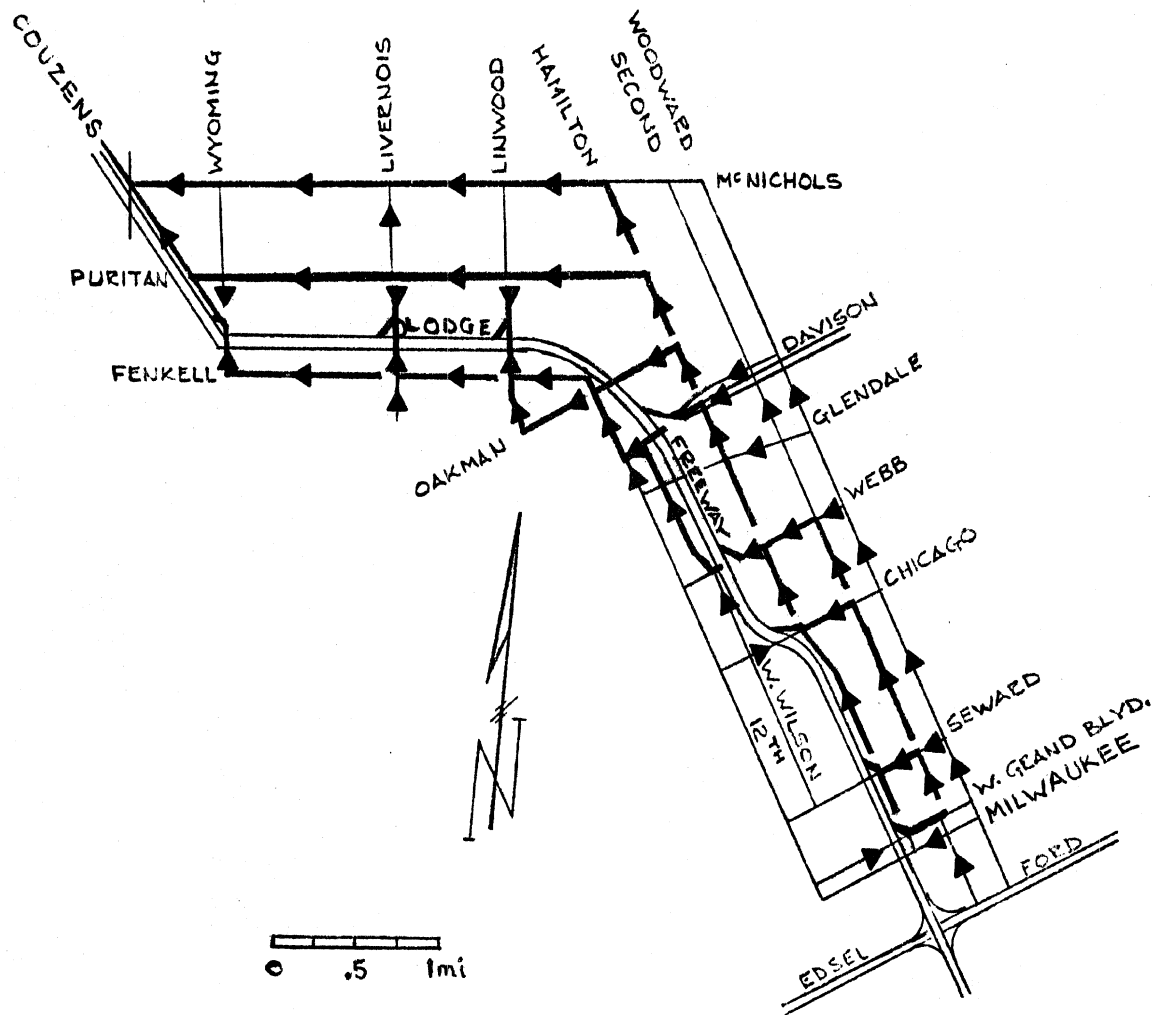

FIGURE 6

UNCONGESTED TREE FORMED BY STATIC AND DYNAMIC SIGNS

difficulty of designing an effective sign for Second Avenue at its complex intersection with West Grand Boulevard.

Two legends were used for the guide signs and both differed from "NORTHBOUND LODGE FREEWAY" as used on the dynamic signs. The legends were "TO NORTHBOUND JOHN C. LODGE FREEWAY" and "TO NORTH LODGE FWY." The colors, legend type and sign size, however, were approximately the same as that of the dynamic signs. This inconsistency was not expected to cause any confusion. As a part of this task, arrangements were made to have the headings on the ramp information signs changed from their original legend of "FREEWAY RAMP CONDITIONS" to "NORTHBOUND LODGE FREEWAY" as shown in Figure 1 on page 19.



## SIGN DESIGN DETAILS

Specifications for 18 variable signs were sent to appropriate manufacturers (Appendices A, B and C). The specifications included conceptual drawings of the signs and the details were left to the manufacturer. As indicated in the previous section, other than for the Chicago Blank-out sign, three types of signs were required.

### VARIABLE MESSAGE SIGN

The variable message sign (Figure 7) was required for westbound West Grand Boulevard traffic approaching Second Avenue. Seven message states were possible (see Appendices B and C for details).

#### State

1. NO MESSAGE (arrows only)
2. USE SERVICE DRIVE AND SEWARD RAMP
3. USE SERVICE DRIVE AND CHICAGO RAMP
4. USE SERVICE DRIVE AND HAMILTON
5. DELAY AHEAD USE SECOND AND SEWARD
6. DELAY AHEAD USE SECOND AND CHICAGO
7. DELAY AHEAD USE SECOND AND WEBB

The message appeared in a panel below the fixed message "NORTHBOUND LODGE FREEWAY."

In the uncongested message state (State 1), a straight ahead directional arrow is illuminated on both sides of the message panel. For all other messages, however, the arrow display appears only on the right side of the sign. This design was adapted from that employed in a recent General Motors study (27).

The messages were designed to support and augment the messages currently displayed on the West Grand Boulevard ramp condition information sign. Of the seven possible message states, four corresponded exactly to the information sign by directing motorists up West Grand Boulevard to the Lodge Service Drive and then along the Service Drive to the recommended ramp of entry, either West Grand Boulevard, Seward or Chicago, or farther along the alternate route if the degree of congestion was severe (States 1, 2, 3, and 4). Two of the remaining three messages recommended usage of the Seward or Chicago ramps, but advised use of Second Avenue rather than the Service Drive (States 5 and 6). State 7, DELAY AHEAD USE SECOND AND WEBB, led the driver to the Webb ramp via another dynamic sign at Hamilton that might indicate the equivalent of State 4. Arrows on the right of the sign indicated the directional equivalents of the street name directions except when entrance at West Grand Boulevard was advised. In this instance an arrow which points straight ahead appeared on both the left and right sides of the sign.

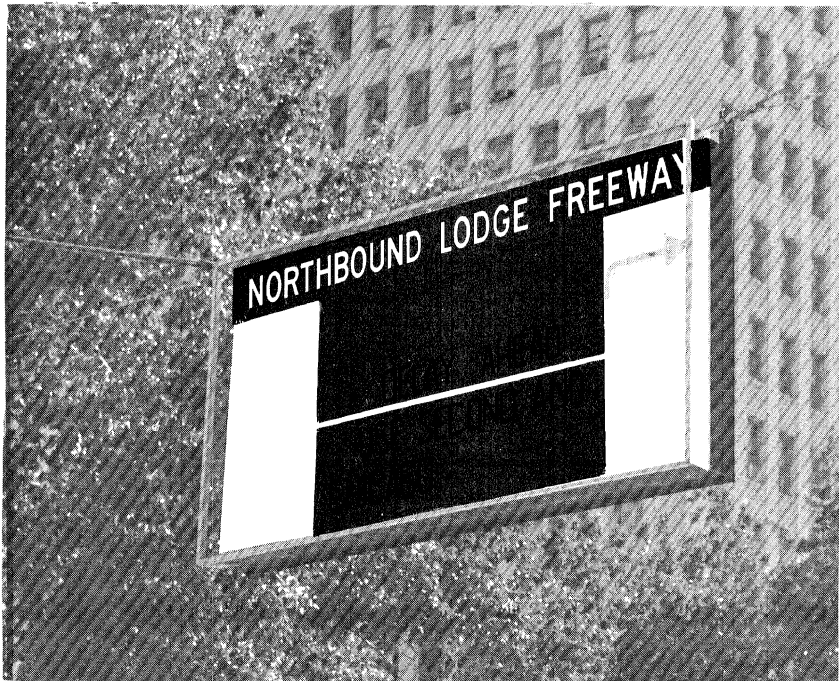
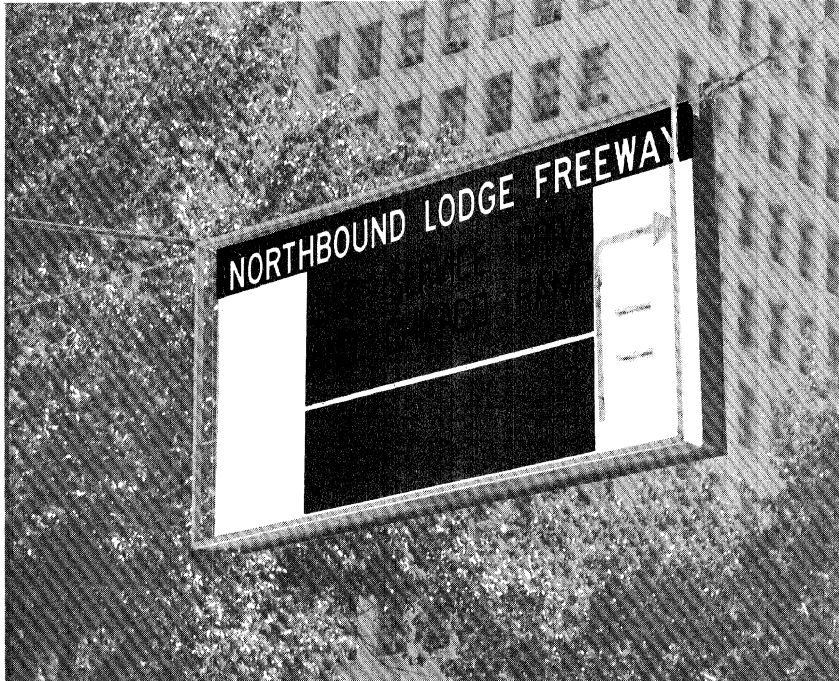

FIGURE 7

TWO STATES OF VARIABLE SIGN MESSAGE

## BLANK-OUT SIGNS

Figure 8 shows the Blank-out sign design used at the Chicago Boulevard ramp terminal. The Blank-out sign shown in the bottom of Figure 9 was centered over the center westbound Davison Expressway traffic lane on the east side of the Hamilton Avenue overpass structure. The message displayed when appropriate was:

DELAY    AVOID RAMP  
USE 12TH ST

As shown in Figure 9, this message was placed under the fixed legend "LODGE FREEWAY NORTH". Two painted arrows at the side of the sign gave it the form of a static guide sign when the message was not activated. Supplemental to this sign, two guide signs were installed downstream of the Hamilton Avenue overpass (see top of Figure 9). They provided directions for either of the two possible routes.

## TRAILBLAZER SIGNS

At the remaining 16 locations variable, Trailblazer signs were designed, supplied and erected (Figure 10, top). These consisted of the fixed legend "NORTHBOUND LODGE FREEWAY" framed by two arrows, only one of which was illuminated at any time. Four different designs were developed

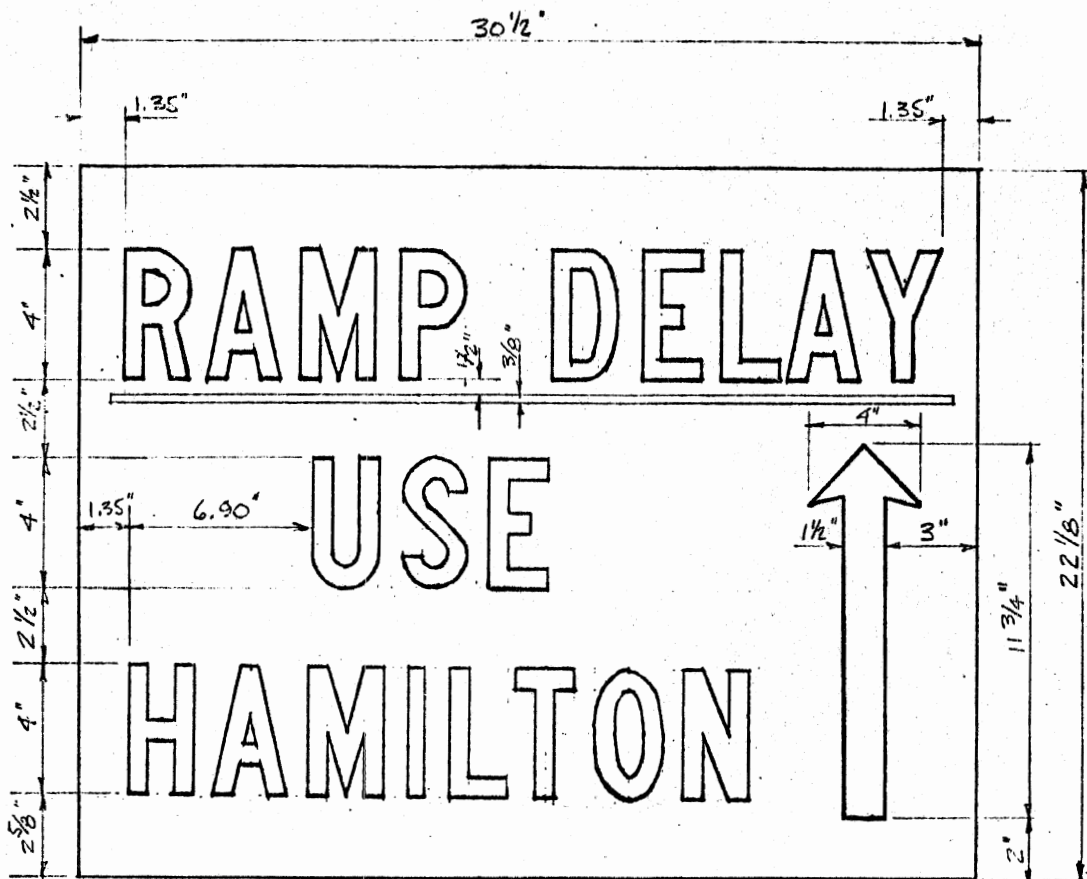

NOTES:

1. LEGEND TO BE STANDARD 4" HIGH SERIES "C" LETTERING.
2. TO BE CONSTRUCTED OF OPAQUE FILM OR PLASTIC WITH LETTERS, UNDERLINE & ARROW CUTOUTS.

THE UNIVERSITY OF MICHIGAN  
FREEWAY CORRIDOR OPERATIONS RESEARCH

DRAWN BY: JFS  
 CHECKED BY:

PRINCIPAL INVESTIGATOR;  
 DATE:

SCALE 1" = 5"

SKETCH # 5

FIGURE 8

CHICAGO BLANK-OUT SIGN

to suit eight right turns (Design A), three left turns from a one-way street (Design B), four left turns from a two-way street (Design C) and one left turn from a one-way street with two-way traffic ahead (Design D). Only the Design C sign was mounted over the roadway. The other signs were erected at the side of the road corresponding with the turning direction and at the lowest height permitted by City of Detroit requirements. In addition to the variable guide signs, more than 100 typical static guide signs were installed along the alternate routes (lower half of Figure 10). These static signs were not, of course, installed at or near choice points where the dynamic guide signs were used.

The possible manufacturers of the dynamic trailblazer signs were permitted to suggest in their bids any form of illumination. One company under consideration uniquely suggested electro-magnetic rotating disks with a black and white face (see Appendix A).

The signs were to have a standard highway green or black background. The messages could be in red, green or white. If any messages or arrows were green, sufficient contrast had to be provided by means of a black background. This last provision, however, was modified by the lowest bidder whose design included a white background. Thus, the



"STATIC SIGN"

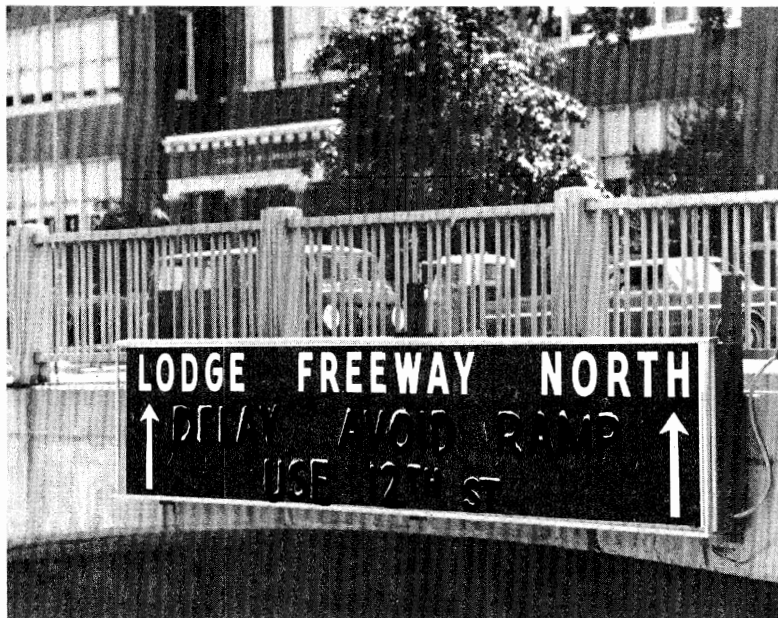

"BLANK-OUT SIGN"

FIGURE 9

BLANK-OUT AND STATIC SIGN USED ON  
DAVISON EXPRESSWAY

signs were done in highway green and white, appropriate colors for freeway guide signs. Also, all dynamic directional arrows were in green. It was believed that the green display by way of its positive nature implies an affirmative action and was best for a guide sign of this type.

Although letter sizes were specified, legibility requirements shown in Table 3 were also given regardless of manufacturing techniques. In addition, for a blanked-out message, it was required that it not be legible from certain distances. (A 20/20 visual acuity was assumed when legibility distances were computed.)

The signs were supplied in September 1969 and erected during that month and the next. Power and telephone lines were supplied and the signs were brought into operation during the week commencing Monday, November 10. The system was fully operational by the following week.

The Public Lighting Commission (PLC) of the City of Detroit took much longer to erect the signs than had been anticipated. One principal cause was that they apparently did not expect that the signs would have exposed neon tubing (nor did the University) and for public safety reasons insisted that each sign have a screen fitted with a lower shelf. This would protect the tubing and also catch most of the debris if a tube shattered. The University immediately



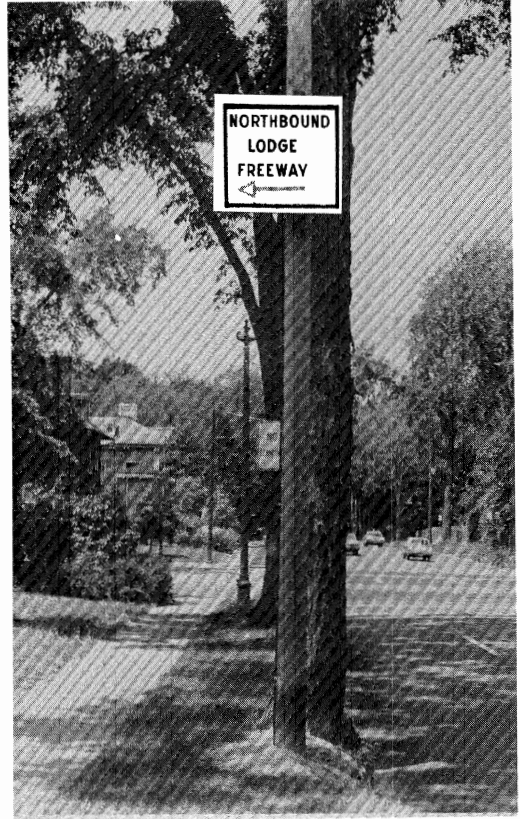
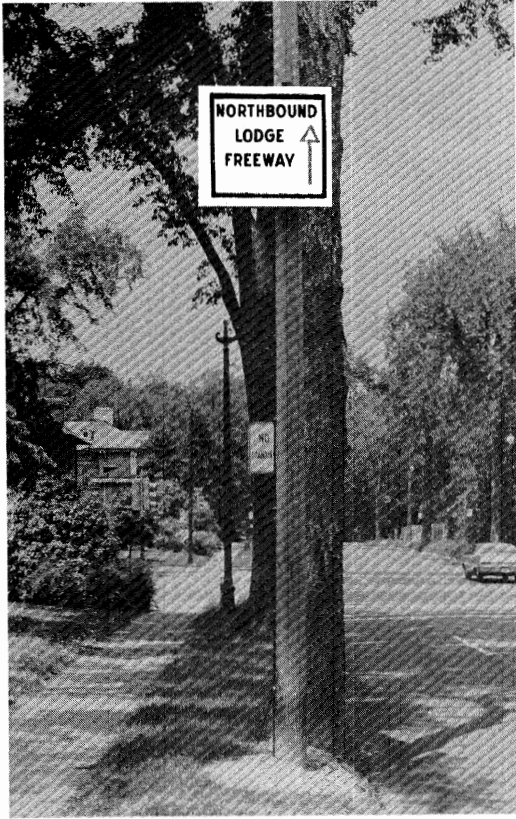

TRAILBLAZER

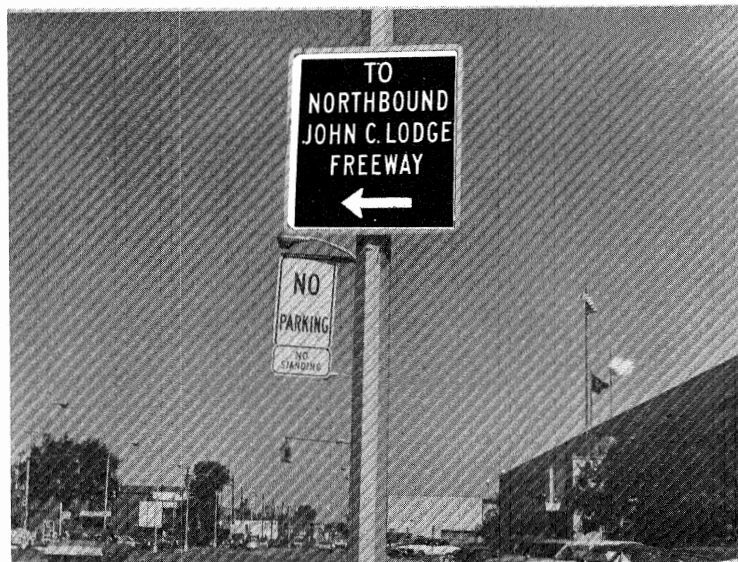

STATIC GUIDE SIGN

FIGURE 10

TRAILBLAZER AND STATIC GUIDE SIGN

TABLE 3

## SIGN LEGIBILITY DISTANCES

SIGN TYPE	LEGIBILITY DISTANCE (FEET)	BLANKED-OUT MESSAGE ILLEGIBLE BEYOND DISTANCE (FEET)
Variable Message Sign (Type 1)	300	75
Davison Blank- Out Sign (Type 2)	400	100
Trailblazer Signs (Types 3A, 3B, 3C)	200	50
Trailblazer Sign (Type 3D)	300	75

arranged for these modifications which were accomplished in less than one week. As a result of this short delay, PLC delayed their work on the erection of the signs. Therefore, the research program had to be completed in winter and even then some activities were accomplished in early 1970.

To publicize the new signs, a press release was forwarded to the Detroit metropolitan newspapers. Examples of coverage received are included in Appendix F. The amount of publicity received was less than for the previous ramp information signs (26). In particular, leaflets were not distributed at ramp entrances. The principal reason for this was that it was considered that the new signs were virtually self-explanatory and it had already been shown that the more complex Ramp Information Signs were well understood (26). In addition, a follow-up questionnaire for the new signs had not been planned and there was no definite first day of operations to coincide with a day for the distribution of leaflets. Nevertheless, it was believed that many motorists would see, understand, and follow the new signs.

## SURVEILLANCE AND CONTROL EQUIPMENT

The corridor under investigation extends along the Lodge Freeway, Detroit, Michigan, from West Grand Boulevard to Meyers Road, a distance of 6.1 miles. The existing equipment available from earlier studies include an IBM 1800 digital computer with an input and output interface for field communication, located at the Control Center at Herman Kiefer Hospital, leased telephone cable and lines for communication with the field equipment, 55 vehicle presence detectors installed at nine stations along the northbound Lodge Freeway, on all nine entrance ramps for use in ramp metering, an additional detector on seven of the on-ramps to detect queueing, and on all ten off-ramps, eight entrance ramp metering signals and eight ramp information signs (details of the computer control system are given in Appendix D).

All of the 55 existing vehicle presence detector installations in the Corridor were located either on the Freeway itself or on the ramps to the Freeway. In order to use the dynamic signs to show the best route to the Freeway, a number of detectors were also required on the relevant surface streets so that Freeway and alternate route volumes could be compared. The quickest route derived

from these volumes would be displayed on the signs. Therefore, nine additional loop detectors were installed on surface streets in the Corridor at locations shown in Figure 11.

The detectors can be categorized as being in three types of positions, left turn lanes, through lanes and railway crossings. Two detectors obtained a count of the number making a left turn towards the Freeway from a particular intersection where an access ramp was available. These sites were located south of both Chicago and Webb. Five other positions obtained a sample "free flowing" count away from a node connecting three or more links in only one lane. The counts obtained from these five detectors could, however, be calibrated by observation with the vehicle counts made for total volume and for the number passing over the loop. With a known ratio between the two, total volume could be estimated based on the count in only one lane. The detectors for the left-turning movements were also used to measure occupancy to give an estimate of the delay in making the left turn. The count obtained in these locations was again a sample as vehicles entered the Freeway from the cross street. Again, prior observation provided the calibration factors for these counts. Finally, two detectors were placed at two grade railway crossings in the Corridor. Their

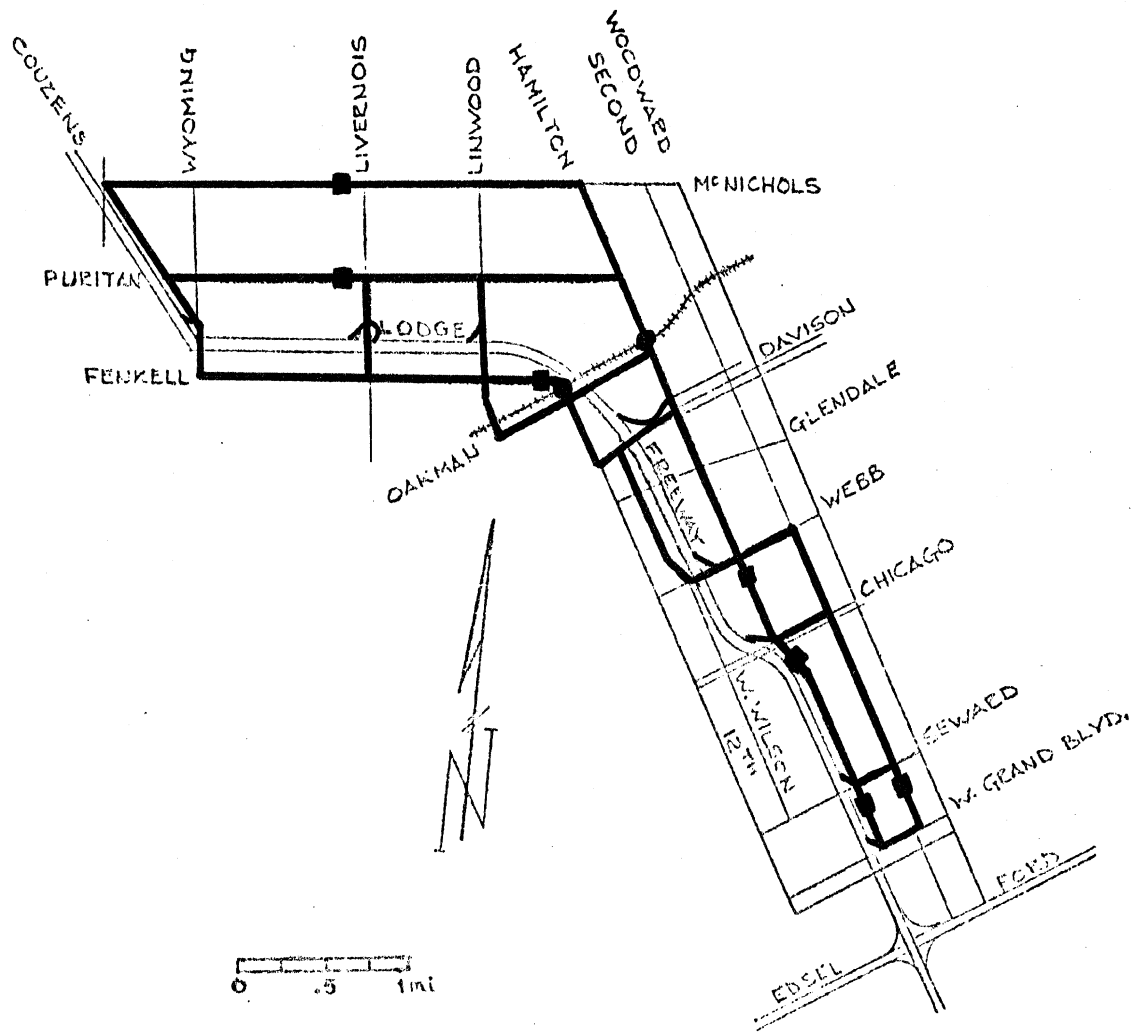

FIGURE 11  
 SURFACE STREET DETECTOR LOCATIONS

function was to determine if the railway gates were closed. Since the two loop detectors at the railway crossing were downstream from the crossings, the detector inputs were inspected for a significant absence of traffic. From this input it could be inferred whether or not there was a delay to surface traffic.

## LOGIC OF SIGN OPERATION

During the northbound off-peak 20 hours, from 6:30 p.m. until 2:30 p.m. of the next weekday, all dynamic sign displays remained fixed in the uncongested mode. For the original eight information signs only the first ramp was illuminated in green. The Trailblazer and Variable Message signs pointed directly to the Freeway and the blankout signs were not activated (Figure 6).

During the 2:30 p.m. to 6:30 p.m. peak period all signs indicated the quickest route to the Freeway or Couzens Drive at McNichols Road. This involved a change in the original mode of operation for the ramp condition information signs. Formerly these signs indicated whether or not a Freeway ramp was congested. Their logic of operation was changed so that the recommended path would be the quickest route for Freeway entrance. Therefore, in some instances ramps not on the shortest path for Freeway entry were shown in red even though they were not congested.

The 19 new signs were required to indicate paths consistent with each other and with the eight original Ramp Information Signs. Thus the total of 27 signs shown in Figure 4 required only 12 independent control signals since



many signs were operated via controls from other signs.

The following listing shows the groupings.

#### GROUPS

1. Sign 1
2. Sign 2
3. Signs 3, 4 and 5
4. Signs 6, 7, 8 and 9
5. Signs 10, 11, 12 and 13
6. Signs 14, 15 and 16
7. Sign 17
8. Signs 18 and 19
9. Signs 20, 21 and 26
10. Signs 22, 23 and 27
11. Sign 24
12. Sign 25

Sign 1 displayed the quicker of the two routes to ramps beyond West Grand Boulevard via the Service Drive or Second when that ramp was congested. Sign 17 showed the shortest of the two routes via Fenkell to the Freeway or Hamilton to Puritan. Signs 18 and 19 always indicated Twelfth Street unless railway crossing activities were taking place at the Twelfth Street crossing but not at the Linwood crossing. Sign 25 showed the faster route, Puritan or McNichols. The remaining signs in the list are the original information signs and the new signs operating on different approaches to an intersection.

Volume information was received from all Freeway on- and off-ramp detectors and the surface street detectors every tenth of a second. (Details of control programming are given in Appendix D which also gives details on the programming for metering control.) At the end of each minute the volumes were totaled for each detector. The value of occupancy was also obtained for each Freeway detector station and for the queue detectors. The computer determined the metering rate based on the Freeway information. Travel time calculations were then made to determine which ramps were to be shown in red. These calculations determined the state of most of the 27 signs. The remaining sign states were determined by comparing travel times on competing surface street routes including a check for railway crossing activity at the Twelfth and Hamilton crossings.

The output to the ramp signals and ramp information signs took place as described in previous reports on this project (6, 26). The relay system used for switching the new variable message sign (Type 1) is described in Appendix C. Operationally, the other signs were all simple in their electrical control since the total possible range of displays was only two. Thus, signs were switched by means of electrical relays upon commands from communication lines. These commands originated either at the Control Center or at other signs (masters) in the systems to change these signs (slaves).

## EVALUATION OF SYSTEM EFFECTIVENESS

Four separate tests were carried out to evaluate the effectiveness of the information system. First, the visibility of the signs was checked for various air temperatures and weather conditions. Second, a human factors study was carried out to measure observance and ability to follow the sign.

The third and fourth evaluation studies were concerned with the response of corridor traffic to the combined information and control system. The two types of studies focused on microscopic behavior of variable display decision points and a macroscopic study of overall performance.

### STUDY OF SIGN VISIBILITY

The lowest bidder for the variable signs proposed green neon arrows on a white background for all arrow displays on the 17 signs utilizing arrows. It was known to the project staff that green neon, unlike red neon, fades badly in cold weather. The proposal of the lowest bidder was accepted, however, because of the limited funds available. Considering the research as a pilot experimental project, it was believed of great value to evaluate the sign design and concept of variable Trailblazers and only subsequently

invest greater amounts of money in signs planned for permanent installation. Additionally, it was planned to evaluate the signs during the month of October with all testing to be completed no later than the end of November, thus avoiding the advent of temperatures cold enough to impair the efficiency of the green neon. Delays in installation, however, altered the original work plan.

The average temperature for October in the Detroit area is 53°F and for November 40°F. With these temperatures, the visibility of the signs should have been satisfactory. The evaluation of the signs, however, was not carried out until December 1969 and January 1970, due to delays in the erection of the signs and in the connection of the telephone lines. The average temperature for December is only 28°F while for January it is 25°F. It was, therefore, decided to check the variation of arrow visibility with air temperature.

Temperature, however, is not the only factor affecting visibility. Ambient light is also an important factor in viewing illuminated signs. The sign orientation, the presence of sunshine and the time of sunset are the major determinants of ambient light. In the Detroit area the mid-month sunset times are 4:35 p.m. in December and 5:00 p.m. in January. Thus, nearly half of the December and January peak periods are not during daylight hours.

The light level was obtained from a Sekonic photograph light meter with the readings recorded in units of exposure value for a film speed of 25 ASA. The temperature was obtained from the local weather station for the nearest possible time to each observation. The time of day was also recorded so that sun position could be determined.

#### DRIVER OBSERVANCE STUDY

A study was conducted by the Human Factors Group at the Highway Safety Research Institute to evaluate subject response to the dynamic route guidance sign system. The variable message sign at West Grand Boulevard, a sample of Trailblazer signs throughout the Freeway Corridor and Blank-out signs were evaluated in terms of their frequency of being seen, understood and obeyed by paid subjects.

Twenty-eight subjects, twenty-three males and five females, were used in this study. They were recruited through the placement services of Wayne State University, Highland Park Junior College and The University of Michigan. Each subject was paid for an average of 3 1/2 hours work, including driving time to the Control Center.

A 1968 Plymouth sedan and a 1970 Ford Falcon sedan both equipped with automatic transmission were used as test vehicles. A Citizen's Band radio installed in the Plymouth

provided communication with the Control Center. Before the beginning of each subject's test, the Control Center personnel set the signs to indicate one of a set of pre-selected displays. The experiment was conducted during off-peak hours so that traffic would be disturbed as little as possible. If traffic was moderate to heavy during a study, the Control Center was notified by radio as soon as a sign was passed so that normal sign operations could be resumed. The route followed in the driving task with the Falcon did not require communication with Control Center.

When each subject arrived at the Control Center he was taken to the test vehicle and told to make the appropriate personal adjustments in seat and mirror positions and to use the seat belt. The experimenter sat in the rear seat. He had prepared data sheets on which to record the subjects' verbal reports of sighting the signs and their behavior in regard to the sign messages.

The tests were carried out in two series. In the first series, each subject was shown a picture of a Trail-blazer sign and read the instructions for the experiment (Appendix E). He was instructed to read and obey all signs directing him to the John C. Lodge Freeway. Verbal instructions were also given when necessary to remain on the study route. The pre-determined sign messages guided him along a selected path although if the first sign was missed or

ignored, he was verbally directed back to the selected route. Each subject first drove past five Trailblazer signs chosen to provide examples of the various situations in which a motorist could encounter one of these signs. He was then directed to the variable message sign at West Grand Boulevard. If directed to the Service Drive, he then followed a route passing one to four ramp information signs. If, however, the subject was directed to Second Avenue, he passed from one to three Trailblazers, all of which had been included in the earlier sample of Trailblazers. Finally, all subjects were routed past the Chicago Blank-out sign which in every instance was illuminated.

In the second series of tests the subjects were again read the instructions for the experiment (Appendix E). Each subject drove past five dynamic signs. These were the

1. Chicago blank-out sign (number 9),
2. the Webb ramp information sign (number 10),
3. the Davison blank-out sign (number 15),
4. the Twelfth Street Trailblazer sign (number 19), and
5. the Linwood ramp information sign (number 20).

The main aim of this study was to test the effectiveness of the Davison Blank-out sign which was not passed during the first series of tests. The sign states remained the same throughout the series of tests. In particular, both blank-out signs were always illuminated. This series of tests was carried out in warmer weather than was the first series.

## TRAFFIC ROUTING AT DECISION POINTS

Of the traffic volume approaching a decision point on any link in the network, it was likely that only a small proportion of motorists would have been considering entry to the northbound Lodge Freeway. Regardless of the weather and traffic conditions, only some of these drivers would have been influenced by the variable signs.

To test whether or not traffic routing changed as the sign states changed, a sample of sign locations where the sign was likely to indicate each path for a reasonable time during the period of study were selected. The study at each location was divided, for the most part, into eight quarter-hour periods from 3:00 p.m. to 5:00 p.m. or 3:30 p.m. to 5:30 p.m. This made it possible to determine if the effects of the signs differed by time of day.

On the first day of a two-day study of each sign, the signs indicated the direct route to the Freeway for the first quarter-hour. Thereafter, the sign alternated between the bypass and the direct routes with changes every quarter of an hour. An observer counted the number of vehicles taking each route for each state of the sign. On the second day, the procedure was identical except that for the first quarter-hour the bypass route was indicated. So that



motorists would not lose faith in the reliability of the signs, if the direct route was favored, the maximum metering rates were used to reduce congestion on the ramp; if the bypass route was indicated, the minimum metering rate was used to increase the direct ramp congestion.

The signs studied are given in Table 4.

Ramp information signs 7 and 14 were located at the same intersections as Trailblazer Signs 8 and 15, respectively. Therefore, simultaneous traffic routing data collected for these signs provided a useful comparison between the two types of sign.

#### OVERALL TRAFFIC RESPONSE

If the signs are obeyed to any extent, there should be a reduction in total travel time on the northbound Lodge Freeway. At the same time, there should be only a fairly small increase in total travel time on the surface street network.

The reduction in Freeway total travel time should be due to a reduction in Freeway travel caused by:

1. some motorists entering at a ramp downstream from their usual entrance due to diversion by the signs (exit ramps can be expected to be unchanged);

TABLE 4  
SIGNS USED IN SUBJECT DRIVER STUDY

SIGN NUMBER	SIGN LOCATION	SIGN TYPE
1	West Grand Boulevard at Second	Variable Message
3	Second at Seward	Trailblazer, Design B
4	Seward at Second	Trailblazer, Design A
6	Second at Chicago	Trailblazer, Design B
7	Hamilton at Chicago	Ramp Information
8	Chicago at Hamilton	Trailblazer, Design A
12	Woodrow Wilson at Webb	Trailblazer, Design A
13	Webb at Woodrow Wilson	Trailblazer, Design C
14	Hamilton and Davison Service Drive	Ramp Information
15	Davison Service Drive at Hamilton	Trailblazer, Design A

2. the diverting motorists entering at less congested ramps; and
3. some motorists deciding not to enter the Freeway at all.

There should be a consequent increase in surface street travel time because of the diverted traffic. For most of the Corridor, however, this traffic can be distributed over more than one surface street. Thus, the diverted traffic, although slightly increasing surface street travel time, is not likely to increase congestion and accompanying long delays. It was expected that there would be an overall reduction in total travel time through the Corridor.

The study was carried out on a before-and-after basis. Freeway travel time was calculated as in Reference (7). In this method, the one-minute volumes  $q^1$  and  $q^{n+1}$  and occupancies  $\theta^i$  and  $\theta_{m+1}$  are known for each of the 240 consecutive minutes in the four-hour peak period for each pair of Freeway detector stations forming the Freeway subsystem. The entering and exiting flows at intermediate ramps,  $q_2, q_3, \dots, q_n$  are also measured for each minute. Then the total vehicle miles of travel (TT) for the four-hour peak period is obtained. The average speed ( $\bar{u}$ ) for a section

is obtained by taking the average of the computed space mean speeds at the end points of the section. Thus;

$$\bar{u} = 1/2 (u_1 + u_{n+1})$$

with  $u_1 = \frac{p_1 q_1}{\theta_1}$

and  $u_{n+1} = \frac{p_{n+1} q_{n+1}}{\theta_{n+1}} ;$

where  $\theta_1$  and  $\theta_{n+1}$  are the values of occupancy at 1 and n+1. Occupancy is measured as the proportion of time that a detector is occupied, while  $p_1$  and  $p_{n+1}$  are constants for the stations 1 and n+1 used to convert occupancy measurements to density.

Therefore, for the four-hour period, total travel time (TTT) for a freeway section is

$$TTT = \frac{TT}{\bar{u}} .$$

Then total travel time for the Freeway is simply the sum of the total travel times for each subsystem. Total travel on the Freeway can also be obtained by summation over the subsystem. Four representative before and after days were chosen with the total travel and total travel time compared.

Considering now the possible increase in surface street travel time, the data suitable for analysis are:

1. link travel times from a project test car;
2. detected volumes from the surface street detectors; and,
3. calibration factors to scale the detected volumes.

The travel times were obtained for each link of the network for each hour of the four-hour peak period. On those links of crucial importance the runs were repeated for the same hour. The computer's records gave the detected volumes, and field observations were used to relate the sample detected to the total volume. Volumes on links without detectors were assumed to change in proportion to the volumes on links with detectors. For the four-hour peak period, the total surface street travel time was obtained by summing over all links the product of average travel time and total volume.

The new signs were considered to have an effectiveness equal to the difference in the reduced travel time on the Freeway and the increased travel time on the surface streets.



## CHAPTER TWO

### RESEARCH FINDINGS

The effectiveness of the Lodge Freeway Corridor dynamic route guidance system installed during this phase of project research was evaluated by means of the following four studies.

1. Sign visibility;
2. Driver subject response;
3. Traffic routing at decision points; and
4. Overall traffic response.

The results of each of these studies will be dealt with separately in this chapter.

#### SIGN VISIBILITY

Visibility readings were taken for the arrows on the Trailblazer Signs at the locations shown in Table 5. It is noted that sun effects are included by using signs pointed in the four cardinal directions. Background visual "noise" differences are also represented in the selection of signs studied.

In Table 6, the visibility distances in feet are given for the five signs under different lighting and temperature conditions. The visibility distances shown identify the

TABLE 5

TRAILBLAZER SIGNS EVALUATED IN VISIBILITY STUDY

SIGN NUMBER	SIGN LOCATION	SIGN FACES*
Sign 13**	Webb at Woodrow Wilson	West
Sign 15	Davison Service Drive at Hamilton	East
Sign 21	Linwood at Fenkell	South
Sign 25	Hamilton at Puritan	South
Sign 26	Linwood at Puritan	North

\* Serves motorists traveling in the opposite direction

\*\* Numbers refer to Figure 5



TABLE 6

TRAILBLAZER SIGN LEGEND VISIBILITY DISTANCES

LOCATION	TIME (p.m.)	LIGHT	TEMPERATURE (°F)	DISTANCE (Feet)	TIME (p.m.)	LIGHT	TEMPERATURE (°F)	DISTANCE (Feet)	TIME (p.m.)	LIGHT	TEMPERATURE (°F)	DISTANCE (Feet)
<u>AFTERNOON</u>												
Webb at Woodrow Wilson	2:58	12.0	28	183	3:38	13.0	26	175	3:35	12.5	8	0
Davison Service Drive at Hamilton	3:04	13.0	28	174	3:42	14.5	26	170	3:40	14.0	8	40
Hamilton at Puritan	3:29	13.5	28	309	3:46	12.5	26	100	3:43	13.0	8	20
Linwood at Puritan	3:13	14.5	28	201	3:58	13.5	26	200	3:46	14.0	8	90
Linwood at Fenkell	3:20	12.0	28	222	3:53	12.5	26	75	3:50	12.0	8	0
<u>EARLY EVENING</u>												
Webb at Woodrow Wilson	5:15	5.0	25	1300	5:16	<5	22	520	5:02	<5	10	75
Davison Service Drive at Hamilton	5:23	<5	25	528	5:20	<5	22	600	5:05	<5	10	150
Hamilton at Puritan	5:25	<5	25	880	5:24	<5	22	800	5:11	<5	10	100
Linwood at Puritan	5:30	<5	25	500	5:28	<5	22	550	5:15	<5	10	135
Linwood at Fenkell	5:33	<5	25	530	5:31	<5	22	525	5:18	<5	10	75
<u>DATE</u>	December 15, 1969				December 22, 1969				January 21, 1970			

point where it could be accurately determined which of the two green neon arrows was activated. The ambient light figures given were obtained by a photographic light meter with the figures in units of exposure value for a film speed of 25 ASA.

Inspection of the values confirms that legibility distance was a function of both ambient light and temperature while the combination of bright lighting and cold temperature resulted in very poor performance in severe cases. Thus, on the coldest day in conditions of sunlight the mean visibility distance for the five signs was only 30 feet, certainly an inadequate distance for driver decision making.

There were also differences among the different signs with legibility distances often varying several hundred feet when other conditions were held constant. It is apparent, however, that despite the severe effects of temperature and lighting conditions the Trailblazers were generally visible at adequate distances for route decisions to be made by motorists desiring to follow the sign system.

## DRIVER SUBJECT RESPONSE

Sign sighting data from the driver observance study were obtained as shown in Table 7. A Chi-square test showed a highly significant difference ( $\alpha = .01$ ) in the relative frequency of sighting of the five signs by attentive subjects. The 50% sighting found at the Chicago Blank-out Sign is the prime contributor to the statistical significance of the results. When the data from this sign were eliminated and another Chi-square test performed, the results remained highly significant. In this second case it was the poor sighting record of the Trailblazer signs, seen less than two thirds of the time, which contributed to the significance of the results. The small differences among the Variable Message, Davison Blank-out and Ramp Information signs were not statistically significant.

For the subjects tested it is concluded that the Variable Message Sign, Davison Blank-out Sign and Ramp Information Signs were much more easily visible, averaging almost 90%, than were either the Trailblazers or the Chicago Blank-out Sign. There are several reasonable explanations for this. First, these three sign types were much larger than the other two types, with the Chicago Blank-out Sign being the smallest of the five signs. Second, the two most frequently seen of these three signs were mounted over the

TABLE 7

## SUBJECTS SIGHTING DYNAMIC ROUTE GUIDANCE SIGNS

SIGN TYPE	SIGHTED BY SUBJECT (Percent)	
	Yes	No
Variable Message (Type 1)	93% (13)	7% (1)
Davison Blank-Out (Type 2)	86% (12)	14% (2)
Ramp Information	86% (24)	14% (4)
Trailblazers (Type 3)	64% (54)	36% (30)
Chicago Blank-Out	50% (14)	50% (14)

Numbers in ( ) indicate number of subjects

roadway and the roadside positions of those sighted less frequently made them increasingly more difficult to see. Third, the messages in the more frequently seen signs were displayed in red neon letters against a dark green background (although the Ramp Information Signs can have green messages) in contrast to the green neon directional arrows against a white background of the Trailblazers; or white message on a black background as used in the Chicago Blank-out Sign. Fourth, contrast with the background related to the complexity of the driving task would also explain the better sighting records of the three most frequently seen sign types.

The route selection response of those driver subjects who sighted the signs is shown in Table 8. The behavior of drivers who did not report sighting the signs has not been considered as in some cases it was possible to coincidentally take the correct action without having seen a sign.

A Chi-square test using Yates correction showed that the difference in turning behavior among the five types of signs is statistically significant at the .05 level. The significantly poorer performance of the Variable Message Sign and the Ramp Information Signs is noted. Only slightly more than half of the willing subjects coming to these signs made the correct turn.

TABLE 8  
CORRECT RESPONSE BY SUBJECTS SIGHTING  
ROUTE GUIDANCE SIGNS

SIGN TYPE	CORRECT BEHAVIOR (Percent)	
	Yes	No
Davison Blank-Out (Type 2)	92% (11)	8% (1)
Trailblazer (Type 3)	87% (47)	13% (7)
Chicago Blank-Out	71% (10)	29% (4)
Variable Message (Type 1)	55% (7)	45% (6)
Ramp Information	54% (13)	46% (11)

Numbers in ( ) indicate number of subjects

Although the large Variable Message Sign and the Ramp Information Signs were more easily seen than the other three sign types tested, a smaller percentage of subjects correctly followed the route instructions. Since the subjects were instructed to obey all traffic signs, it is concluded that this incorrect behavior was the result of not understanding the sign message.

The two Blank-out Signs and the Trailblazer Signs commanded better response than the Variable Message or the Ramp Information Sign because of the relative simplicity of their messages. These three signs provided only a single bit of information (either delay or no delay, or straight or turn movement). The more complex signs provided messages having far more information. Also, the placement of the signs with the best response was better with respect to driver decision and reaction time.

A bar graph (Figure 12) summarizes these results and displays the joint sighting and response to the five types of signs.

Table 9, extracted from Table 8, shows that the difference in response to the Trailblazers and to the Variable Message Sign is highly significant.

TABLE 9

RESPONSE OF SUBJECTS SIGHTING TRAILBLAZER  
AND VARIABLE MESSAGE SIGNS

SIGN TYPE	CORRECT BEHAVIOR	
	Yes	No
Trailblazer (Type 3)	47	7
Variable Message (Type 1)	7	6

Figure 12 summarizes these findings and shows the great differences in both sighting and response, with those signs most frequently seen being those least effective in eliciting the appropriate response by cooperative subject drivers. These were the most complex of the signs, however, and it is believed that an overall effectiveness exceeding 80% for first time viewers is achievable with appropriate design and placement for signs with simple messages.

Table 10 examines the behavior of the subjects who reported sighting the Trailblazer Signs under varying daylight conditions. Fisher's Exact test showed the difference in behavior to be statistically significant at the 0.02 level. Thus, the behavior of subjects tested in sunny weather as compared to those tested in cloudy weather was not the same. These findings are consistent with the previously reported



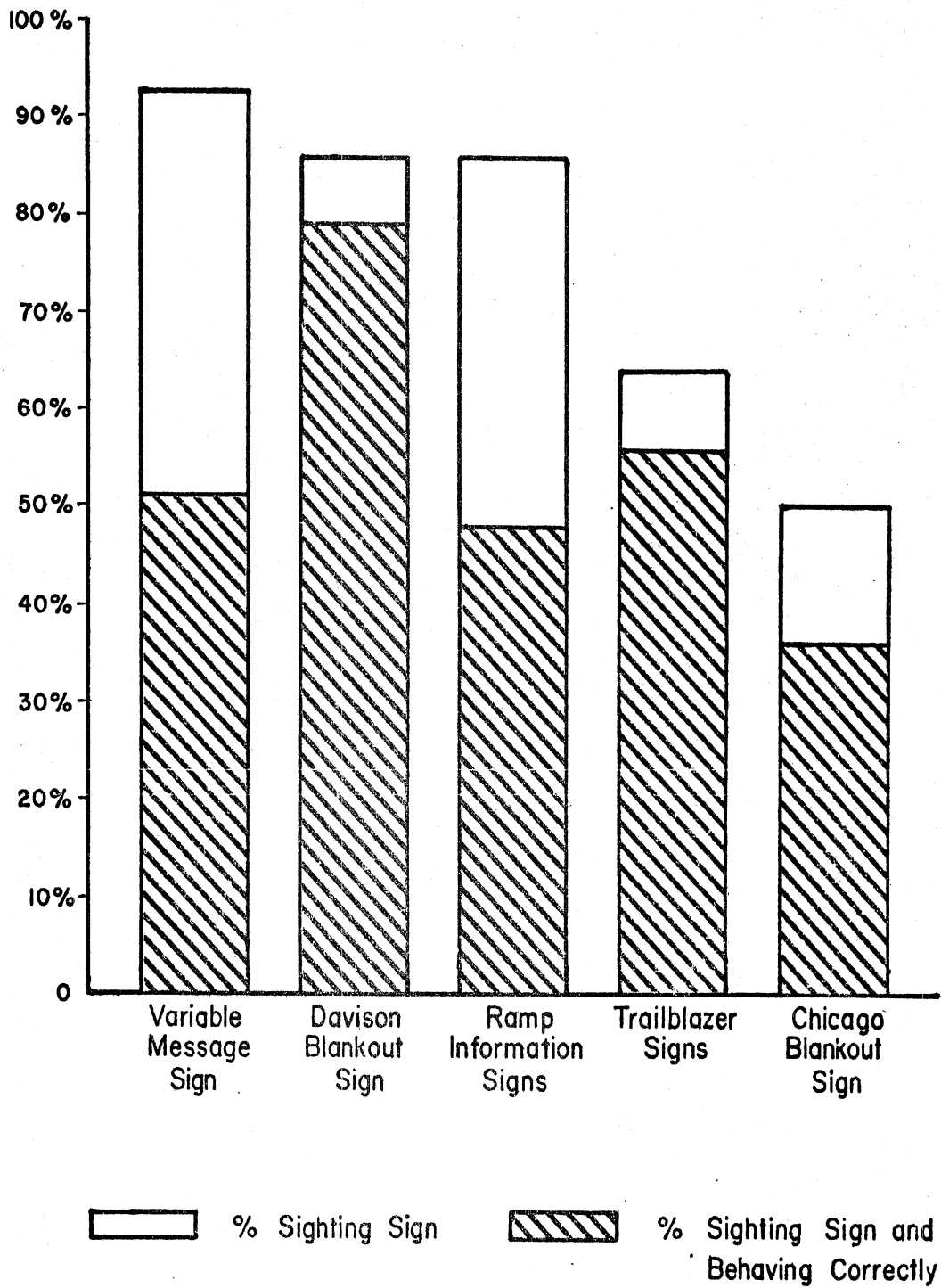

FIGURE 12

RELATIVE ABILITY OF SUBJECTS TO SEE AND  
CORRECTLY USE FIVE SIGN TYPES

TABLE 10

RESPONSE OF SUBJECTS SIGHTING  
TRAILBLAZERS BY LIGHT CONDITIONS

LIGHT CONDITIONS	CORRECT BEHAVIOR	
	Yes	No
Cloudy	35	2
Sunny	12	5

study that showed the decrease in legibility distance under sunny conditions and consequently the inability of the subject to take the correct action because of inadequate distance to respond correctly.

Analysis of driver subject sign sighting at each of the six Trailblazers studied is shown in Table 11. A Chi-square test was performed to examine the significance of the differences in sign sighting at these six Trailblazer locations. Results indicate sign location cannot be shown to significantly affect the sighting of the signs.

The Hamilton and Webb Trailblazer signs are mounted differently than are the other four signs. The signs at Hamilton and Webb are suspended by span wire and centered over the roadway while the other four signs are mounted on posts at the side of the road. Thus, these signs are exposed to the sunlight with no surrounding buildings or trees to provide shade. Under these conditions, not only are the green arrows less distinct but there is also less contrast to the white sign background. On very sunny days, therefore, the signs may be difficult to see and almost certainly difficult to read and consequently obey. A tendency toward supporting such a conclusion is noted although the results are not statistically significant.

TABLE 11

SUBJECTS SIGHTING TRAILBLAZERS  
AT EACH LOCATION

SIGN LOCATION AND DIRECTION OF TRAFFIC	PERCENT	
	SIGHTING	NOT SIGHTING
Woodrow Wilson (North)	71% (10)	29% (4)
Hamilton (North)	43% (6)	57% (8)
Oakman (West)	64% (9)	36% (5)
Webb (East)	64% (9)	36% (5)
Seward (West)	86% (12)	14% (2)
Twelfth (North)	57% (8)	43% (6)

Table 12 shows the differential response to the overhead and roadside mounting of the Trailblazer Signs by those subjects who sighted the sign. Fisher's test was performed to test the significance of the apparent differences. The differential effects of overhead and roadside sign mounting on driver behavior was highly significant.

It was also apparent early in the first series of tests that the placement of the large Variable Message Sign at West Grand Boulevard might affect driver behavior. There is no problem with sign visibility at that location as shown by the fact that all but one subject reported seeing the sign (Table 7). The sign, however, is located very close to Second Avenue, the first intersection at which a turn may be recommended. Therefore, a driver who saw and understood the sign message and who wished to obey it, might be unable to reach the righthand lane in time to turn at Second or may be unaware that right turns are permitted from the second lane. In addition, a driver unfamiliar with the area might not know that Second is the first street to the right past the sign. Table 13 shows the behavior of driver subjects who saw the sign during either of the two state displays. The small sample did not show a significant difference by Fisher's Exact test, but it is believed that with a larger sample it would be found that drivers would not respond to the sign and most often when directed to Second Avenue because of sign placement problems.

TABLE 12

RESPONSE OF SUBJECTS SIGHTING  
TRAILBLAZERS BY SIGN POSITION

SIGN MOUNTING	CORRECT BEHAVIOR	
	Yes	No
Overhead	10	5
Roadside	37	2

TABLE 13

PERCENT OF CORRECT RESPONSE BY SUBJECTS SIGHTING  
THE VARIABLE MESSAGE SIGN FOR TWO SIGN STATES

SIGN STATE	CORRECT BEHAVIOR (Percent)	INCORRECT BEHAVIOR (Percent)
Turn at Service Drive	72% (5)	28% (2)
Turn at Second Avenue	33% (2)	67% (4)

## TRAFFIC ROUTING AT DECISION POINTS

As described in Chapter 1, peak period turning movements were counted at ten selected dynamic sign locations. At each of these locations the dynamic sign alternately indicated one of the two directions leading to the northbound Lodge Freeway. The observations are summarized in Tables G-1 through G-10 in Appendix G. All statistical analyses are based on Chi-square contingency table tests ( $\alpha = .001$ ).

Initially, the results of the studies for the two days at all of the sites were aggregated and these results are presented in Table 14. The usage of the direct or shortest-time route, the route recommended during off-peak hours, versus the usage of the alternate route as a function of the route recommended in the display is shown in the table. While 50.3% of the traffic approached the sign when it was recommending the direct route, there was a differential response to the two displays that can be attributed to the cooperative behavior of some of these motorists. When the direct route was indicated, 52.8% of the traffic followed the indication, but when the alternate route was recommended, an approximate five percent drop took place as only 47.2% of the traffic used the direct route. A similar, but not as strong an effect, was observed for alternate route users when that turn was recommended.



TABLE 14

## USAGE OF DIRECT AND ALTERNATE ROUTE

		ROUTE USED		
		Direct	Alternate	Average
RECOMMEND- ED ROUTE	Direct	52.8% (7,177)	48.9% (12,929)	50.3%
	Alternate	47.2% (6,399)	51.1% (13,486)	49.7%
	Total	100.0%	100.0%	100.0%

$$P_{\chi^2} < .001$$

In an analysis of the sum of the diagonal elements of Table 14 it was found that 20,663 (51.7%) of the motorists followed the route that was displayed as they approached the intersection while 19,328 (48.3%) turned contrary to the recommended display, a difference of 675 vehicles on the two study days. The somewhat larger response to the more direct route indication was again noted.

Table 15 presents the results for the almost 40,000 vehicles observed in this study in still another way. The data for the ten sign locations have been grouped into the heavier and lighter traffic movements for the entire period. It can be seen that when the display indicated that motorists should follow the heavy flow direction, 85.7% of them did this. When the light flow direction was indicated there was a slight reduction to 84.8%. This small difference is statistically significant at the one percent level.

TABLE 15

## TRAFFIC RESPONSE TO DYNAMIC SIGN DISPLAYS

		TURN FOLLOWED	
		Heavy Flow	Light Flow
TURN INDICATED	Heavy Flow	85.7% (17,724)	14.3% (2,961)
	Light Flow	84.8% (16,367)	15.2% (2,939)

$$P_{\chi^2} < .01$$

Table 16 shows the overall response to the recommended movement recorded at each of the ten locations. The most cooperative behavior was recorded at the West Grand Boulevard Variable Message Sign location, where 58.0% of the motorists followed the recommended route. With the exception of the Chicago at Hamilton and Hamilton at Davison Ramp Information Signs which recorded statistically significantly less than 50% usage (49.1% and 47.9%, respectively), the remaining signs recorded similar responses of from 51.0% to 53.3% favorable to the displays. It is believed that the Variable Message Sign and the characteristics of the New Center area personnel who passed that sign explain the good response to it. The poor response to the Hamilton

TABLE 16

PERCENT OF TRAFFIC MAKING  
RECOMMENDED MOVEMENT

SITE	PERCENT MAKING RECOMMENDED MOVEMENT
West Grand Boulevard at Second	58.0%
Second at Seward	51.9%
Seward at Second	52.1%
Second at Chicago	51.0%
Hamilton at Chicago	52.3%
Chicago at Hamilton	49.1%
Woodrow Wilson at Webb	51.9%
Webb at Woodrow Wilson	53.3%
Hamilton at Davison Service Drive	47.9%
Davison Service Drive at Hamilton	53.1%
AVERAGE	51.7%

Avenue Ramp Information Sign at the Davison Expressway was consistent with the poor response to the Principal Alternate Route recorded at this point in other studies (26).

Table 17 presents the data for each of the ten signs by major and minor flows. There was an overall reduction in the percentage using the major route when the minor route was recommended at nine of the ten sites. Only at Site Number 15, the sign displayed to Davison Service Drive traffic at Hamilton, was there an increase in the traffic using the Service Drive when Hamilton was the recommended route. The results for only two of these locations, Webb at Woodrow Wilson and Second at Chicago, were statistically significant. The results at these locations were highly significant with 3.2% and 2.5% of all the traffic, respectively, changing its turning behavior.

At Second and Chicago there is little to choose between the two routes, continuing north on Second to Webb or turning onto Chicago. Both the Webb and Chicago ramps are entered from a side street and there is no continuous service drive available for use. The sign is reasonably well-positioned and with lower traffic volumes on Second Avenue at Chicago than at Seward Avenue, it seems apparent that drivers were able to check which arrow of the Trailblazer was on and make the appropriate maneuver.

TABLE 17

TRAFFIC RESPONSE TO DISPLAYS BY LOCATION

SIGN FACING, LOCATION AND NUMBER	MAJOR MOVEMENT RESPONSE		SAMPLE SIZE
	RECOMMENDED	NOT RECOMMENDED	
West Grand Boulevard at Second, 1	71.5%	68.8%	2243
Second at Seward, 3	91.0%	90.9%	10373
Seward at Second, 4	75.6%	72.7%	1145
Second at Chicago, 6	90.1%	86.9%***	7742
Hamilton at Chicago, 7	77.2%	75.3%	5934
Chicago at Hamilton, 8	89.4%	88.6%	2960
Woodrow Wilson at Webb, 12	84.5%	80.7%	889
Webb at Woodrow Wilson, 13	96.4%	93.9%***	1743
Hamilton at Davison Service Drive, 14	83.6%	81.9%	4063
Davison Service Drive at Hamilton, 15	84.0%	85.1%	2899
			39991

$$P_{\chi^2} < \begin{cases} *, .05 \\ **, .01 \\ ***, .001 \end{cases}$$

The Webb sign at Woodrow Wilson also showed a significant change in traffic routing. The reason is again probably due to the fact that there is little difference in the two routes to the eastbound Davison Expressway, a likely off-ramp for much of the Lodge traffic entering from eastbound Webb. The alternate route to Davison is, of course, north along Woodrow Wilson. It is noted that only very small numbers of vehicles are involved.

The other variations could be entirely due to chance, but application of the Binomial Sign Test indicated that the decrease recorded at nine stations out of ten was statistically significant. Hence, it can be concluded that in general there is an overall effect with a magnitude probably not exceeding three percent of all traffic moving through these decision points, keeping in mind that not all of the vehicles on these streets have the Freeway as their destinations.

A review of the route selections made by time of day was also conducted. The responses of drivers from 3:00 to 4:00 p.m., a period of lesser congestion, were different from those recorded during the peak hour from 4:00 to 5:00 p.m.

Thus, it was believed that there could be a time-of-day effect based on traffic volumes passing the site. The three half-hour periods from 3:30 to 5:00 p.m. were selected for analysis so that an orthogonal analysis could be made at nine of the sites. The two volume differences had to exceed 20% to have the site considered as having a definite peaking effect. Six of the nine sites did not record flow differences this large, while at three locations, Second at both Seward and Chicago and Hamilton at Chicago, there was a large difference in flow during the three periods as shown in Table 18.

TABLE 18  
TRAFFIC VOLUMES

Time of Day	Six Non-Peaking Sites	Three Peaking Sites
3:30 - 4:00 p.m.	3,108 +1%	4,252 +21%
4:00 - 4:30 p.m.	3,157 +21%	5,126 +39%
4:30 - 5:00 p.m.	3,814	7,104

The time of day responses at the two types of sites are shown in Table 19 where the percent of drivers using the direct route is shown for the times when each of the two routes were recommended at the three peaking and six non-peaking sites. Considering first the non-peaking sites, it can be seen that there was a decrease in use of the direct route as the afternoon progressed, regardless of the message displayed.

TABLE 19  
TIME OF DAY EFFECT ON PERCENT OF  
DRIVERS USING DIRECT ROUTE

SITES	TIME		
	3:30-4:00	4:00-4:30	4:30-5:00
Non-Peaking (6)			
Display Recommending			
Direct	60.4%	59.5%	54.6%
Alternate	59.4%	58.8%	52.5%
Peaking (3)			
Display Recommending			
Direct	14.7%	12.2%	13.1%
Alternate	16.6%	14.2%	13.9%

The slightly greater drop in the percent using the direct route when the alternate route was recommended, 6.9% versus 5.8% (59.4% - 52.5%; 60.4% - 54.6%, respectively) is statistically significant ( $\alpha = .001$ ) and indicates that there was a greater response to the alternate route recommendation at these low and relatively constant flow locations as Freeway congestion increased.



At the three sites where peak flows were much greater between 4:30 and 5:00 p.m. than between 3:30 and 4:00 p.m. there was also a significant decrease in the percent using the direct route to the Freeway as the afternoon progressed, regardless of the sign display. However, there was a highly significant interaction between time of day and sign response at these sites and it is concluded that the display of the alternate route recommendation had a greater effect when peak flows existed than earlier in the afternoon.

Further, considering all the figures in Table 19, it can be concluded that the small cooperative response to the displays was greater at the low-flow sites than at the high-flow peaking sites.

The Variable Message Sign study (Table G-1) used two alternate displays to direct traffic to the Seward ramp by two routes. Results showed there was no significant difference between the two directions recommended by the sign and it is concluded that the sign messages themselves did not seem to cause confusion.

In summary, a small but consistent pattern indicating a cooperative response to the sign displays was recorded in these studies. However, since this response was of the order of only a few percent, it was believed unlikely that a necessarily crude macroscopic study of travel and travel time in the Corridor would be able to detect the differences recorded in the microscopic study. The next section of this chapter reviews such a study.

## OVERALL TRAFFIC RESPONSE TO DYNAMIC ROUTING SYSTEM

Because of time constraints, concern with the weather and schedule failures out of the control of the research agency, the expanded dynamic sign system began operation approximately two weeks after the introduction of a new strategy of ramp metering (6). The new metering strategy operation commenced on October 31, 1969 while the new signs were brought into operation during the week beginning November 10, 1969.

It was believed that modest responses to the dynamic route guidance system would be unlikely to affect ramp metering operations since only measured freeway parameters were involved in metering parameter determination. However, the metering parameters directly affected the sign states and potential diversion of traffic. Therefore, the "before" period of study was limited to the week of November 3rd. November 4th, election day, was omitted from the analysis since both total travel and total travel time were considerably larger on this day.

With the onset of harsh weather shortly after the signs became operational on November 17th, it was necessary to postpone the "after" study until early 1970. Coincidentally, before the end of 1969, the Edsel Ford detector station was

moved north to West Grand Boulevard. This gave a definite improvement in measuring input parameters for the Freeway. For compatibility, therefore, the travel and travel time measurements were compared before and after the change between the Seward and Meyers stations, omitting data obtained south of Seward. Data for the month of February 1970 were studied and data for two days were found where the metering strategy at each ramp was identical and where there were no equipment failures.

The following surface street detectors were used to provide traffic flow data on the Alternate Route Network:

1. Second near Pallister;
2. Service Drive near Pallister;
3. Fenkell near Twelfth;
4. McNichols near Livernois; and
5. Puritan near Livernois

The Hamilton near Webb detector was operational during the before study period but not afterwards while those at Hamilton near Chicago and at Hamilton near Puritan were operational during the after period but not before. The data from these detectors were not used leaving the listed five detectors as a data source for surface street volumes for the "before" and "after" conditions. Other surface street volumes were obtained by manual counting.

The total travel time difference between the "before" and the "after" period was estimated by obtaining the product of average travel time and total traffic flow during the afternoon peak for each link for both periods. Since little traffic originated on links between the nodes, the detected traffic volumes were used as the source of data for the determination of both total travel and total travel time. The detected volumes were obtained from only one lane in the direction of flow on the link. However, prior observations had been made to enable these volumes to be adjusted to represent the total volume in the required direction. The calibration factors were different at different times of day usually because of variations in the usage of the curb lane.

To obtain total link travel in vehicle miles, the estimated volumes were multiplied by the measured length of the link. To obtain total travel time, the volumes were multiplied by representative travel times on the link based on several measurements by a test car before and after the introduction of the signs.

Table 20 gives the total travel and total travel time on the Freeway between the Seward and Meyers detectors for the selected "before" and "after" days. All travel shown occurred between the hours of 2:30 p.m. and 6:30 p.m.

TABLE 20

FREEWAY TOTAL TRAVEL AND TOTAL TRAVEL TIME  
BEFORE AND AFTER INSTALLATION OF NEW SIGNS

<u>BEFORE (1969)</u>		
	TOTAL TRAVEL (VEHICLE MILES)	TOTAL TRAVEL TIME (VEHICLE HOURS)
NOVEMBER 3	116,229	3,494
NOVEMBER 5	124,787	3,348
NOVEMBER 6	128,694	3,342
NOVEMBER 7	116,545	3,204
MEAN	121,564	3,372
<u>AFTER (1970)</u>		
	TOTAL TRAVEL (VEHICLE MILES)	TOTAL TRAVEL TIME (VEHICLE HOURS)
FEBRUARY 6	111,210	2,975
FEBRUARY 9	109,567	3,093
MEAN	110,389	3,034

There was a statistically significant decrease of more than 11,000 vehicle-miles from the before period to the after period and also a fall of more than 330 vehicle-hours in the value of the total travel time on the Freeway.

The surface street volumes, and average and total travel times are shown in Table 21 which identifies these values for each link studied.

An examination of the before and after values of volume and average travel time shows increases in the central hours above those recorded in the first and last hours. In most instances, the travel time increased with increasing volumes as would be expected. There was generally an increase in travel time between corresponding hour periods for links in the before and after periods. The four principal exceptions were decreases in travel times but not traffic volumes for the following links:

18-19 Oakman from Hamilton to 12th;

21-23 Fenkell from Linwood to Livernois;

23-25 Fenkell from Livernois to Wyoming; and

27-32 Hamilton and McNichols from Oakman to Couzens Drive.

The reductions in travel times are probably due to improved parking enforcement or better signal timings requested from the City, but are not likely to be caused by the operation

TABLE 21

SURFACE VOLUMES AND AVERAGE  
AND TOTAL TRAVEL TIMES

LINK	STATE	PARAMETERS	HOURS OF THE DAY			
			2:30- 3:30	3:30- 4:30	4:30- 5:30	5:30- 6:30
2-5	Before	q (vehicles)	505	776	875	747
		$\bar{t}$ (minutes)	1.31	1.40	1.10	0.50
		T (minutes)	662	1085	962	374
2-5	After	q (vehicles)	616	817	862	640
		$\bar{t}$ (minutes)	1.34	1.42	1.41	0.55
		T (minutes)	825	1160	1214	352
5-8	Before	q (vehicles)	718	1275	867	915
		$\bar{t}$ (minutes)	2.07	2.20	2.50	2.30
		T (minutes)	1487	2800	2170	2100
5-8	After	q (vehicles)	855	1345	855	780
		$\bar{t}$ (minutes)	2.12	2.23	3.20	2.55
		T (minutes)	1814	3000	2740	1980
8-11	Before	q (vehicles)	385	626	784	670
		$\bar{t}$ (minutes)	1.45	1.80	1.35	0.75
		T (minutes)	558	1125	1159	502
8-11	After	q (vehicles)	496	660	771	572
		$\bar{t}$ (minutes)	1.49	1.83	1.73	0.83
		T (minutes)	739	1208	1332	475

q = surface street volumes

$\bar{t}$  = average travel times on link

T = (q)( $\bar{t}$ ) = total travel time

TABLE 21  
(CONTINUED)

LINK	STATE	PARAMETERS	HOURS OF THE DAY			
			2:30- 3:30	3:30- 4:30	4:30- 5:30	5:30- 6:30
11-15	Before	q (vehicles)	872	926	1300	890
		$\bar{t}$ (minutes)	1.65	1.65	1.75	1.60
		T (minutes)	1440	1528	2270	1425
11-15	After	q (vehicles)	1070	977	1280	760
		$\bar{t}$ (minutes)	1.69	1.68	2.24	1.77
		T (minutes)	1810	1640	2870	1345
15-18	Before	q (vehicles)	935	1084	1438	1225
		$\bar{t}$ (minutes)	0.65	0.62	0.67	0.55
		T (minutes)	608	672	972	674
15-18	After	q (vehicles)	1142	1247	1415	1048
		$\bar{t}$ (minutes)	0.67	0.63	0.86	0.61
		T (minutes)	765	786	1215	639
18-19	Before	q (vehicles)		719		
		$\bar{t}$ (minutes)		1.20		
		T (minutes)		862		
18-19	After	q (vehicles)		728		
		$\bar{t}$ (minutes)		0.78		
		T (minutes)		568		



TABLE 21  
(CONTINUED)

LINK	STATE	PARAMETERS	HOURS OF THE DAY			
			2:30- 3:30	3:30- 4:30	4:30- 5:30	5:30- 6:30
21-23	Before	q (vehicles)		775		
		$\bar{t}$ (minutes)		2.80		
		T (minutes)		2170		
21-23	After	q (vehicles)		784		
		$\bar{t}$ (minutes)		1.81		
		T (minutes)		1420		
23-25	Before	q (vehicles)		925	825	604
		$\bar{t}$ (minutes)		1.90	2.20	2.55
		T (minutes)		1760	1770	1543
23-25	After	q (vehicles)		936	842	602
		$\bar{t}$ (minutes)		1.89	2.14	1.77
		T (minutes)		1770	1800	1030
27-32	Before	q (vehicles)	742		828	761
		$\bar{t}$ (minutes)	9.90		9.55	8.70
		T (minutes)	7340		7900	6620
27-32	After	q (vehicles)	732		853	722
		$\bar{t}$ (minutes)	11.60		9.05	7.67
		T (minutes)	8480		7420	5540

TABLE 21

(CONTINUED)

LINK	STATES	PARAMETERS	HOURS OF THE DAY			
			2:30- 3:30	3:30- 4:30	4:30- 5:30	5:30- 6:30
27-31	Before	q (vehicles)	670	820	855	
		$\bar{t}$ (minutes)	7.35	7.83	8.95	
		T (minutes)	4950	6450	7650	
27-31	After	q (vehicles)	686	820	875	
		$\bar{t}$ (minutes)	7.53	7.97	11.43	
		T (minutes)	5170	6550	10030	

of the system. On the other hand, there were variations in the measurement of both the before and after travel times. Since a reduction of a link's travel time from the before period to the after period appeared to increase the effectiveness of the sign, the conservative assumption is made by eliminating these values from the travel time summation. When this is done, the before and after traffic volumes appear to be quite consistent.

There is a conservative increase of about 100 vehicle-hours of total travel time for the measured links between the before and after periods. The principal links likely to be carrying diverted traffic and for which data was not obtained were

1-4, 4-7 and 7-11 on Second and Webb;

1-19, 19-21 and 21-23 on Oakman, 12th and  
Fenkell to Livernois;

18-27 and 27-32 on Hamilton and McNichols; and

25-31 and 31-32 on Couzens Drive

together with the ramp connections. It is also estimated that the extra surface street vehicle-hours were less than 200 vehicle-hours.

It is concluded that since about 300 vehicle-hours per day were removed from the Freeway there was a small savings in travel time of probably less than 100 vehicle-hours per day.



## CHAPTER THREE

### INTERPRETATION AND APPRAISAL OF RESEARCH FINDINGS

In this study, a set of 19 dynamic signs controlled by a digital computer and designed to recommend dynamically the minimum travel-time route for northbound John C. Lodge Freeway Corridor traffic was planned, designed, installed, operated and evaluated. The evaluation was directed toward the determination of the signs' performance in diverting traffic to one of a series of alternate routes. This dynamic route guidance system operated in close conjunction with an entrance ramp metering system.

During the entire study, ramp signals were utilized to restrict the rate of vehicle entry to the Freeway so that the traffic demand at a bottleneck would not exceed the capacity of that bottleneck. Queuing should not have occurred on the Freeway, but only behind the ramp signals. When there was a long ramp queue it was believed that use of a parallel surface street route and a downstream entry point to the Freeway would result in a lower travel time for the motorist who diverted. Appropriately placed guide signs directing motorists to and along such an alternate route could reduce the demand for a ramp so that the queue would not continue to increase. The ideal result of this

study was envisaged as a state of equilibrium in which the quickest route to a downstream point on the Freeway beyond Wyoming Road alternated between direct Freeway access at the normal point of approach and a surface street alternate route.

The ability to obtain the desired routing response to the dynamic system was not considered necessary for the successful operation of the system or even desirable, because of the possibility of the introduction of surges of traffic resulting in unstable oscillations in usage and a breakdown in street service at the associated higher densities. In the event of ramp congestion, if a sufficient number of motorists could be diverted to prevent a long queue, then a set of information signs would be able to achieve the goal of a state of equilibrium between surface street and freeway travel times. It was hoped that the complete set of signs would be seen by almost all approaching motorists and that there would be sufficient response to create such an equilibrium.

The complete set of signs in the Lodge Freeway Corridor was erected in two stages. A separate report details the design and results obtained on the eight Ramp Information Signs (26). In that study it was found that unless the surface street alternate route was actually the service

drive, the percentage of motorists passing a sign and entering the corresponding ramp was quite small. This meant that even if most motorists obeyed the sign, there would be only a small reduction in the traffic demand at a congested ramp. In all likelihood, the ramp queue and resultant delay would continue to increase.

As described in Chapter One, the additional signs were installed in order to provide guidance to motorists traveling on all logical paths to the Lodge Freeway. With almost all approaching motorists given an opportunity to divert by obeying sign messages, the degree of obedience required to reduce ramp queues was much smaller. In fact, one could visualize quite a rapid cycle of a queue build-up, sign messages directing motorists away from the congested ramp, a reduction in queue length, sign messages guiding motorists directly to the Freeway and finally, another queue build-up. The response time to a queue build-up could be set at any desired length, thus increasing or decreasing stored demand as Corridor conditions dictated.

An example of the importance of providing information to motorists approaching the Freeway from several routes could be exemplified by the situations occurring at the Davison-Lodge Interchange area. If 7.6% of the Davison ramp traffic came from the alternate route on Hamilton, (Figure 2), 50% obedience to the sign would have reduced the demand

for Davison by only 3.8%. If information is given to an additional 50% of the Davison ramp demand which came from the Davison Expressway and an additional 30% from the Davison Service Drive, 50% obedience to all three signs would have reduced the demand for the Davison ramp by as much as 43.8%. This degree of obedience would certainly have been enough to guarantee that the Davison ramp queue would not continue to increase. It should be noted that approximately 12.4% of the traffic approached Davison from southbound Hamilton.

Since monetary and time constraints made it impossible to install a dynamic sign for every approach to a Lodge Freeway ramp, the general principle followed in this study was to place signs on the parallel northbound alternate routes and on the cross streets leading directly to entrance ramps at their intersections with the alternate routes. The parallel alternate routes selected were restricted to those roads capable of carrying a considerable increase in peak-period traffic volumes at existing levels of service. While the function of the dynamic signs was to direct motorists to a parallel surface street route to the Freeway, it was further believed that the selected parallel route would also be the quickest for the motorist at that time. Thus, the signs were designed to indicate to motorists the quickest route, while at any time congestion on other appropriate



routes could be general or local and temporarily ill-suited for diversion. For example, illegal parking could have caused the effective loss of a whole traffic lane in a link or, alternatively, a particular intersection could be oversaturated. A good example of general congestion would have been peak period conditions on Fenkell Avenue which is lined with small businesses, thus inviting stoppages. The West Grand Boulevard Service Drive intersection is frequently a source of local congestion and is a prime example of intersectional oversaturation.

## SIGN DESIGN AND PLACEMENT

The evaluative findings pointed to weaknesses in both the design and placement of the signs. The City of Detroit Public Lighting Commission indicated at a late date that the signs had to be clear of traffic lanes so that they presented no hazard to traffic as well as high enough to minimize the probability of a problem with the high voltages in the neon gas circuits. It is believed that the 17 foot height at which most of the Trailblazer signs were placed above the sidewalk or roadway was too high and increased the problem of viewing the dynamic display. At that height, the signs were intermingled among the advertising signs placed on buildings abutting the road or blended with other types of background (trees, etc.). This helped account for the fact that many of the Trailblazers were not sighted by cooperative subject drivers.

A greater hazard is presented by suspended electrical traffic signs than by painted signs such as those commonly used for center-lane control. This requirement makes the use of Trailblazers over the roadway of doubtful value because of the larger supporting structure and sign required if the sign is to have sufficient impact. Signs directly attached to poles at the side of the road may be less expensive and yet just as effective.

Even for the motorist familiar with the Lodge Freeway Corridor, there was a fundamental difficulty in the sign as the green neon arrows tend to "fade" and become almost invisible in cold weather and bright sunlight. A slight tendency for green to fade could be tolerated, especially when the advantages of a familiar, positive command are weighed against the use of any other color. The extreme fading found in this study, however, confirms the inadequacy of this type of display in the central American environment.

The above discussion has been mainly concerned with the weaknesses of the Trailblazer signs which in reality carry only a very simple message. In contrast, the Variable Message sign used standard white lettering on a green background and red neon messages. The red neon showed no tendency to fade. This sign also used a green arrow to complement the red message and thus minimized the negative connotation of red. Studies also cast doubt on whether or not all seven messages displayed on the Variable Message Sign were necessary. A properly-designed Trailblazer could have been equally satisfactory. The reasons for defining the seven different messages were given in Chapter One, but as a trade-off, the necessary sign was large in size to accommodate all of the messages. Studies showed that it was unnecessary to accept the trade-off. The sign installed was relatively expensive to construct, install and operate.

In the driver behavior study of the Variable Message Sign, only seven out of 13 unfamiliar cooperating driver subjects correctly read it and carried out the appropriate maneuver. Of the other types of signs, only the somewhat complicated Ramp Information Signs had such poor obedience. To test individual messages on this sign it would have been necessary to evaluate, for their route to the Freeway, a sample of motorists passing the sign allowing for the fact that many passing motorists have no intention of using the Freeway.

There were two Blank-out Signs also designed and installed to divert traffic approaching the Lodge Freeway. The sign on the Davison Expressway appeared to be well designed. Since diversion takes place at the Freeway ramp entrance, some explanation for the diversion appeared to be necessary. A Trailblazer sign would simply have read "LODGE FREEWAY NORTH" with an illuminated arrow, and yet it would have been required to direct motorists away from the Freeway. Thus, in this application, a Trailblazer type sign would have been confusing. The message giving the explanation for diversion was in red neon and the remainder of the sign used standard white arrows and lettering on a green background. The second Blank-out sign was at Chicago and was seen by fewer test subjects than any of the other four sign types. This was directly attributable to its size and placement relative to the driver and his task at that time.

In addition to the design and placement problems, disobedience could have been caused by problems enumerated in the earlier report on the Ramp Information Signs (26). These included failure on the part of the driver to see the signs, inability to react in time to the message, unfamiliarity with the Corridor, doubt about travel time savings, disbelief in the sign messages and the environment of the surface streets. All these factors could have been valid in this investigation, and in particular, motorists doubts on travel time savings and disbelief of sign messages. In the study of overall effectiveness, it was found that, due generally to communication problems with lines leased from the Michigan Bell Telephone Company, detector operations could be erratic. This resulted in the signs sometimes showing incorrect messages based on a lack of accurate flow information. Under these circumstances, a motorist diverted in error to a congested link may have lost confidence in the ability of the signs to show the correct paths.

## GENERAL CONSIDERATIONS

Some important items should be considered before a permanent system of information signs is placed in any other corridor.

1. The signs should be carefully placed so as not to compete with other signs and environmental features and at a minimum feasible height above ground level, preferably at the side of a road rather than over it.
2. Trailblazer signs with the simplest possible message rather than a Variable Message sign should be used unless an explanation for diversion or more details are absolutely necessary. This would also be the case at a ramp entrance where some form of Blank-out sign might be required. These should also carry the simplest possible message.
3. The ramp queue lengths necessary to change sign states should be carefully evaluated with allowances made in the event of an accident or other incident occurring on the downstream section of the Freeway.

4. More than one alternate route should not be available to motorists unless the detection system is adequate and reliable and then only if access is available from both sides of the Freeway.
5. If it is decided to divert traffic before reaching the ramp entrances, then an alternate route is required on each side of the Freeway.

It is difficult to make a definite statement from the results of this study on whether or not diversion before or after reaching a freeway service drive is desirable. This is because of the complexity of the Lodge Freeway Corridor. It would appear, however, that if a freeway had a fairly straight alignment, the designation of only one alternate route would be preferable thus reducing the number of signs and the costs. This would necessitate that cross-street traffic from one side of a freeway be diverted to the other side.

Signs to do this might have to be larger than simple Trailblazers. Also, an alternate route of sufficient capacity would have to be available to handle diversion from both sides of a freeway.

## FIELD STUDIES

The tests used to evaluate the effectiveness of the signs should also be altered. If possible, a questionnaire should be distributed at the ramps to determine the percentage of motorists passing choice points. This, or a license plate study for the same purpose, could be carried out before any signs were erected. Alternatively, if this evaluation took place after the signs were in operation, then motorists should be asked whether they saw or used the signs. The traffic routing studies should be used only when it is known that a considerable percentage of traffic intends to enter the freeway. Extensive aerial photography should form the basis of an overall evaluation and be supported by adequate funds spent for moving vehicle studies of travel time and traffic volume counts.



## DRIVER RESPONSE

It is recognized that there were many problems with the design and operation of this experimental system as well as the environment in which it was placed and the lack of a major sustained effort to obtain public acceptance of the concept. A part of the study still under way will ultimately report on the effectiveness after a one year period of operation based on a questionnaire study.

Despite these problems it is believed that the study has shown no strong latent desire on the part of these motorists to make use of a dynamic route guidance system. It is believed that the favorable responses obtained from motorists in hypothetical and questionnaire studies will only be achieved with strenuous efforts, not as a natural response to a well-designed system. Achievement of levels of diversion in the 25% to 40% range is believed to be virtually unattainable.



## CHAPTER FOUR

### CONCLUSIONS AND SUGGESTED RESEARCH

A Freeway Corridor dynamic routing information and control system was designed, installed and evaluated for its ability to divert traffic from congested freeway ramp entrances and to some extent from congested surface streets.

It is concluded that this major effort resulted in a response from less than three percent of the affected motorists and that the most favorable response was on the order of eight percent. The effects of the displays were greater during peak periods on those routes with a marked peak period traffic increase. Overall savings were not detectable at the network level.

Defects were found in sign design, materials, and placement which somewhat impaired their ability to divert traffic. These factors often made it quite difficult for motorists to see the signs. The studies indicated that if the signs had been more visible and legible there would have been little problem understanding their message.

The algorithm for the control of the signs should be reviewed, as an improvement may induce more motorists to follow the signs. Travel time estimates were made for the alternative paths from each sign. However, this was

not necessarily based on accurate information. Freeway detectors in one position were used to estimate Freeway travel time for a whole section of Freeway. Moreover, the queue detectors did not measure queue length and, in any case, the metering rate was not easily predictable so that queue travel time could only be roughly estimated. The possible metering rates could be reduced to perhaps only two, minimum and maximum, and used to try to maintain Freeway capacity but without queueing. Then if the ramp detectors could be modified to monitor queue length, a much more accurate travel time estimate could be made. Sign states could then be based on the critical queue length. The only problem would be whether any strategy change should be made immediately after an accident or other incident is detected on the Freeway.

## REFERENCES

1. ALEXANDER, G. J., KING, G. F. and WARSKOW, M.S. Development of Information Requirements and Transmission Techniques for Highway Users. A condensation of the NCHRP 3-12 Draft prepared by Donna McGlamery. Research Report No. 606-1, Texas Transportation Institute, Texas A & M University, College Station, Texas, July 1970, 62 pgs.
2. BECKMANN, MARTIN, MC GUIRE, C. B. AND WINSTEN, CHRISTOPHER. Studies in the Economics of Transportation. Published for the Cowles Commission for Research in Economics, Yale University Press, New Haven, Connecticut, 1956, 232 pgs.
3. BENSHOOF, J. A. Characteristics of Drivers' Route Selection Behavior. Traffic Engineering and Control, Vol. 11, No. 12, April 1970, pp. 604-606, 609.
4. BERGER, WALLACE G. Criteria for the Design and Deployment of Advanced Graphic Guide Signs. Serendipity, Incorporated, Final Report on Contract No. FH-11-7284, U. S. Department of Transportation, National Highway Traffic Safety Administration, September 1970, 103 pgs., 2 Appendices.
5. CONRADSON, BRUCE A. Detroit Freeway Surveillance and Control Evaluation. Michigan Department of State Highways, July 1968. 17 pgs.
6. COOK, ALLEN R., PRETTY, ROBERT L. AND CLEVELAND, DONALD E. An Evaluation of the Effectiveness of Ramp Metering Operations. Report No. TrS-2, Highway Safety Research Institute, The University of Michigan, Ann Arbor, Michigan, 1970, 122 pgs.
7. COURAGE, KENNETH G. and LEVIN, M. A. A Freeway Corridor Surveillance, Information and Control System Research Report 488-8, Texas Transportation Institute, Texas A & M University, College Station, Texas, December 1968, 349 pgs.
8. DREW, DONALD R., BREWER, KENNETH A., BUHR, JOHANN H. and WHITSON, ROBERT H. Multilevel Approach to the Design of a Freeway Control System. Highway Research Board Record No. 279, 1969, pp. 40-55.
9. DUDEK, CONRAD L., MESSER, CARROLL J. AND MC CASLAND, WILLIAM R. Developments in Real-Time Driver Communications Research. Texas Transportation Researcher, Vol. 6, No. 4, October 1970, pp. 10-12.

10. DUDEK, CONRAD L., MESSER, CARROLL J. and JONES, HAL B. A Study of Design Considerations for Real-Time Freeway Information Systems. Paper prepared for presentation at the 50th Annual Meeting of the Highway Research Board, Washington, D. C., January 1971, 35 pgs.
11. DUFF, J. T. Accomplishments in Freeway Operations Outside the United States. Paper prepared for presentation at the 50th Annual Meeting of the Highway Research Board, Washington, D. C. January 1971, 32 pgs.
12. EBERHARD, JOHN W. Driver Information Requirements and Acceptance Criteria. Highway Research Record No. 265, 1968, pp. 19-30.
13. FENTON, ROBERT E. and OLSON, KARL W. The Electronic Highway. IEEE Spectrum, Vol. 6, No. 7, July 1969, pp. 60-66.
14. FERRANTI-PACKARD ELECTRIC LIMITED. Information Display Systems. Ferranti-Packard Electric Limited, Toronto, Ontario, Canada, Undated, Unpaged.
15. HEATHINGTON, KENNETH W., WORRALL, RICHARD D. and HOFF, GERALD C. An Analysis of Driver Preferences for Alternate Visual Information Displays. Highway Research Record No. 303, 1970, pp. 1-16.
16. HEATHINGTON, KENNETH W., WORRALL, RICHARD D. and HOFF, GERALD C. An Evaluation of the Priorities Associated with the Provision of Traffic Information in Real Time. Highway Research Record No. 336, 1970, pp. 107-114.
17. HEATHINGTON, KENNETH W., WORRALL, RICHARD D. and HOFF, GERALD C. Driver Perceptions Toward Diversion and Their Current Diversionary Behavior. Paper prepared for presentation at the 50th Annual Meeting of the Highway Research Board, Washington, D. C., January 1971, 49 pgs.
18. HOFF, GERALD C. Development and Evaluation of Experimental Information Signs. Chicago Area Expressway Surveillance Project Report No. 8, Chicago, Illinois, December 1965, Revised June 1968, 67 pgs.
19. HOFF, GERALD C. A Comparison Between Selected Traffic Information Devices. Chicago Area Expressway Surveillance Project Report No. 22, October 1969, 62 pgs.

20. KLEITSCH, KARL L. and CLEVELAND, DONALD E. The Effect of Rainfall on Freeway Capacity. Report No. TrS-6, Highway Safety Research Institute, The University of Michigan, Ann Arbor, Michigan, 1971, 34 pgs.
21. MACKIE, A. M. Progress in Learning the Meanings of Symbolic Traffic Signs. RRL Report LR 91, Road Research Laboratory, Crowthorne, England, 1967, 24 pgs.
22. MAY, ANTHONY D. An Economic Assessment of the Ministry of Transport Surveillance and Control System for Urban Motorways. Greater London Council, Transportation Branch, Department of Highways and Transportation, June 1969, 14 pgs.
23. MESSER, CARROLL J. Development and Evaluation of a Multilevel Freeway Control System for the Gulf Freeway. Paper prepared for presentation to the Freeway Operations Committee, 50th Annual Meeting of the Highway Research Board, Washington, D. C., January 1971, 27 pgs.
24. MOSKOWITZ, KARL. Analysis and Projection of Research on Traffic Surveillance, Communication, and Control. National Cooperative Highway Research Program Report 84, Highway Research Board, Washington, D. C., 1970, 48 pgs.
25. POTTS, R. B. The Selfish Driver - Is He Antisocial? Paper No. 695 prepared for presentation at the Fifth Conference of the Australian Road Research Board, 1970, 8 pgs.
26. PRETTY, ROBERT L. and CLEVELAND, DONALD E. Evaluation of a Dynamic Freeway Ramp Entry Guidance System Report No. TrS-3, Highway Safety Research Institute, The University of Michigan, Ann Arbor, Michigan, 1970.
27. ROTHERY, R. W., THOMPSON, R. R. and BUSECK, C. R. A Design for an Experimental Route Guidance System, Vol. III: Driver Display Experimental Evaluation. General Motors Research Laboratories, November 15, 1968, 126 pgs.
28. SURTI, VASANT and GERVAIS, EDWARD F. Peak Period Comfort and Service Evaluation of an Urban Freeway and an Alternate Surface Street. Highway Research Record Number 157, 1967, pp. 144-178.
29. WACHS, MARTIN. Relationships Between Drivers' Attitudes and Route Characteristics. Highway Research Record No. 197, 1967, pp. 70-87.

30. WARDELL, EDWARD J. and MURRAY, ROGER J. Computerized Traffic Signal System Maximizes Roadway Network Capacity and Improves Pedestrian Safety at John F. Kennedy International Airport. Traffic Engineering, Vol. 38, No. 12, September 1968, pp. 26-35.
31. WATTLEWORTH, JOSEPH A. and WALLACE, CHARLES. Evaluation of the Operational Effects of an "On-Freeway" Control System. Research Report 488-2, Texas Transportation Institute, Texas A & M University, College Station, Texas, November 1967, 61 pgs.
32. WEINBERG, MORTON I. Traffic Surveillance and Means of Communicating with Drivers - Interim Report. National Cooperative Highway Research Program Report 9, Highway Research Board, Washington, D. C., 1964, 28 pgs.
33. WEINBERG, MORTON I., DELEYS, NORMAN J. and SCHNEEBERGER, RICHARD F. Surveillance Methods and Ways and Means Of Communicating with Drivers. National Cooperative Highway Research Program Report No. 28, Highway Research Board, Washington, D. C., 1966, 66 pgs.
34. WINKO-MATIC SIGNAL COMPANY. Winko-Matic Signal Company Letter with Enclosures, Avon Lake, Ohio, January 1969, Unpaged.



**PART TWO**



APPENDIX A

TECHNICAL EVALUATION OF VARIABLE  
SIGNS AND SIGN MANUFACTURERS



## APPENDIX A

### TECHNICAL EVALUATION OF VARIABLE SIGNS AND SIGN MANUFACTURERS

An extensive survey of literature and manufacturers was conducted to investigate the availability of variable message signs. After the initial investigation, interest was centered on the capabilities of the three manufacturers who marketed the most promising signs for urban freeway usage--Winko-Matic Signal Company, Ferranti-Packard Limited, and Conrac Corporation. All three manufacturers employ a basic dot matrix module to create alphanumeric characters five dots wide and seven dots high. Characters up to twelve inches in height are possible with this process (14, 32).

The dots on Winko-Matic and Conrac signs are incandescent lamp bulbs. The rating of the bulbs utilized in these signs is usually less than thirty watts. In most instances, however, they are not used to their full capabilities in order to yield improved life spans of up to 10,000 operating hours. The bulbs may be controlled to operate at two different ratings, one for day contrast and a lower one for appropriate night contrast. A bulb matrix sign exceeding ten kilowatts of electrical power for a given message can easily be manufactured.

Instead of bulbs, Ferranti-Packard uses a proprietary electro-mechanical device to make up a matrix of dots. A thin disc is background colored on one side and white on the other side. Power is required only when characters are changed by a magnetic technique. The average power consumption depends on how frequently messages are changed, and usually approximates 200 watts or less.

A fluorescent light can be provided at the bottom and front of the signs when ambient light is insufficient for proper visibility.

For all three manufacturers, the bulbs or discs are on-off binary devices requiring power to actuate them. Power must be controlled so as to actuate the correct set of dots (bulbs or discs) for the given message that is to be displayed on a sign. For all three sign types, controlled power is provided by digital logic circuits which gate 60 hertz alternating electric current through thyristors. These three-terminal, solid-state devices combine the functions of a rectifier and an electronic switch, performing similarly to thyratrons.

Control complexity and communication channel capacity depend on the number of different messages to be displayed and the rapidity with which they must be changed. Since the choice of a suitable message is a part of the project

experiment, infinite message capability initially appeared to be desirable. A fixed set of eight, ten, or twelve messages, however, yields a more simple sign system at less cost. On a short term, cost-effectiveness basis, the fixed message signs were found to be better for this project by a factor varying from 3:1 to 25:1.

A fixed message is achieved by a block rather than a matrix display of characters. The signs consist of cutouts in opaque material so that back lighting displays the characters. The cost differential between matrix and block signs is due largely to the much more sophisticated controls required for matrix signs. The communications costs are currently about the same for either block or matrix signs. However, as traffic control networks become larger and more complex, and as solid-state electronics continue to become less expensive and more versatile in application, it is reasonable to expect that control and communication costs will become more favorable to matrix type signs.

All three of the manufacturers surveyed in detail are prepared to produce fixed message signs. Winko-Matic, however, is about two years away from producing infinite message signs. Before actual writing of specifications for the required signs was undertaken, it was felt advisable to thoroughly study the capabilities of the possible suppliers. A summary for each manufacturer follows:

### Winko-Matic

The design and manufacturing capability of Winko-Matic is concentrated on highway traffic signs. They can produce variable message signs of any desired size in fixed message sets up to eight or twelve messages. It is believed that Winko-Matic is about two years away from production of infinite message signs. Fixed messages permit fixed wiring of printed circuit boards such that only one or two thyristors per message character are required for power control. This fixed logic also simplifies communication channel requirements and message selection at a control center. The four bit code of a number is modulated on a tone carrier frequency for transmission over a teletype, or telephone wire pair, at a rate of five bits per second, for a one-line sign. (The extra bit is available for other purposes such as flashing a message.) Blank printed circuit boards may be purchased by the user so that new messages can be wired and substituted in sign control. Feedback from a sign provides a check on message errors at a central place of control.

### Ferranti-Packard

Although Ferranti-Packard has had some experience with traffic signs, most of their signs have been produced for stock exchange and airport terminal infinite message display systems. The low power required to actuate one of their



signs permits x-y addressing of the dot matrix and a minimum number of thyristors. The addressing technique is similar to that employed in computer ferrite core storage matrices. Since a message is not wired in at the sign, the message rather than a message number must be dispatched over the communications channel from either a teletype console or a computer at a control center. Ferranti-Packard also employs tone carrier modulation. A message is written on a sign line, left to right, at a standard rate of ten characters per second. Messages may be flashed and error checking is provided. For a major sign with controls and communication channels, it appears that Ferranti-Packard prices are only slightly higher than a Winko-Matic fixed message system. This result seems to stem from the ingenious nature of the Ferranti-Packard disc technique as well as the control logic thereby permitted.

### Conrac

Less information was available on the Conrac signs than on the other two. The design of the signs, however, seems to be oriented to sports events. In order to achieve an infinite message capability with a lamp bulb matrix, each bulb is controlled with a thyristor and a four-bit register. Available component pricing data indicate that this design procedure is expensive, perhaps even exorbitant, for the

present experimental purposes. A later check with Conrac on expense failed to produce any justification for using their type of sign on this project.

#### Request for Bids

Conrac Corporation was eliminated from consideration based on the above information. Two manufacturers located in Michigan, Econolite (Smith Sign & Signal Company) and Steel Art (Carrier and Gable) were well known to the project staff from past contacts and did not require further investigation. It was, therefore, decided that specifications and requests for bids would be sent to Winko-Matic, Ferranti-Packard, Steel Art, and Econolite.

At the end of April 1969, the four manufacturers were sent summaries of the requirements for the three types of signs to be used in the project. After additional study and a review of manufacturers' comments, specifications for the signs were prepared and distributed. All of the vendors submitted bids early in June.

Econolite submitted the lowest bid for both the Type 1 and the Type 3 designs. Winko-Matic offered the lowest bid on the Type 2 design. A complete review of the bids by project staff and a University electrical engineering consultant was made to determine whether any factors other than cost should influence the choice of suppliers. A discussion

with a representative of Econolite revealed that their signs would meet the requirements of the research. Thus, contracts were awarded to the lowest bidders in each case. Econolite accepted their contract; however, Winko-Matic, declining to make only one sign, refused their contract. The Type 2 sign was then ordered from Econolite, the second lowest bidder.

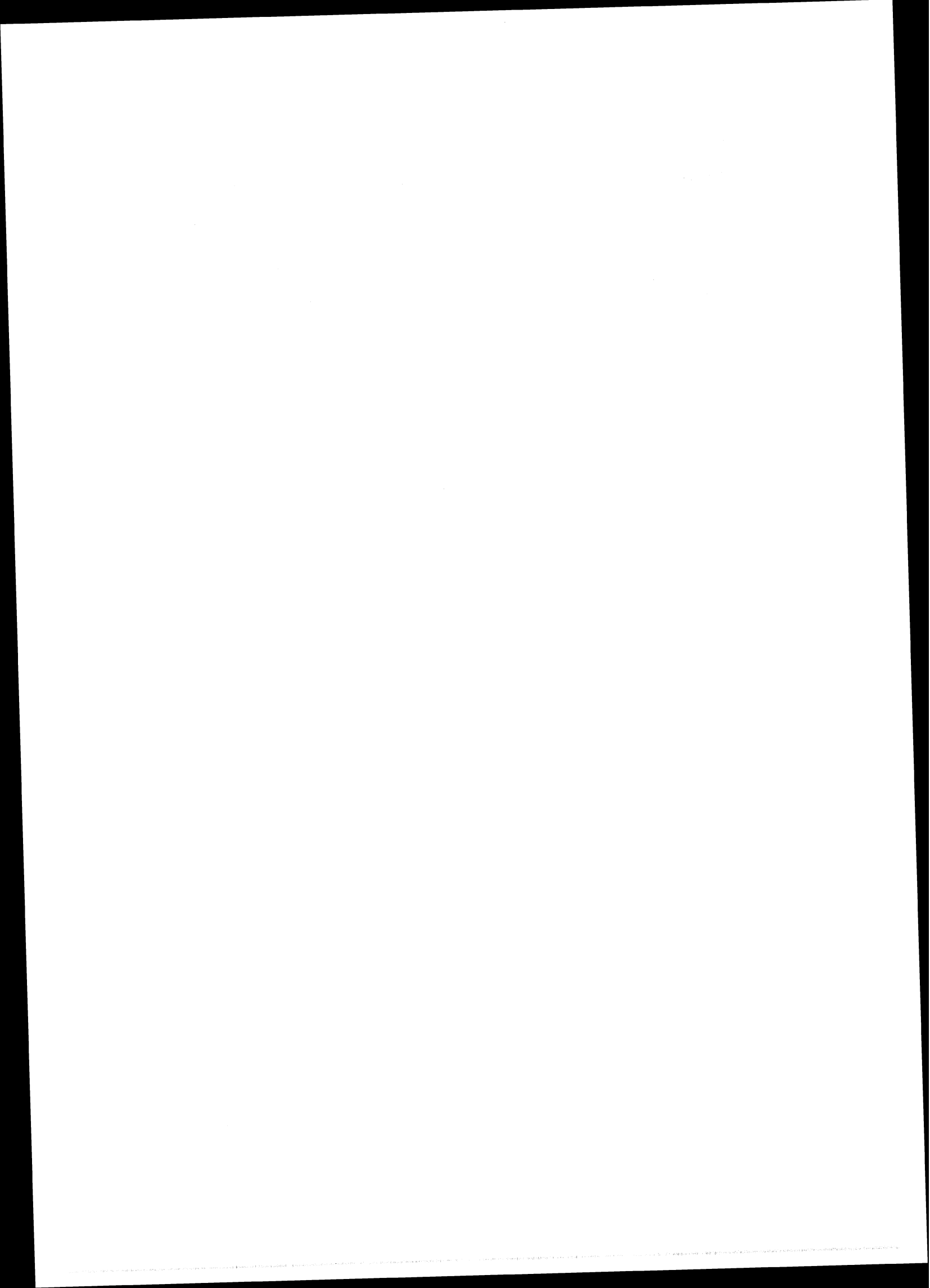

APPENDIX B  
SPECIFICATIONS FOR THE SUPPLY OF  
EIGHTEEN VARIABLE SIGNS



APPENDIX B  
SPECIFICATIONS FOR THE SUPPLY OF  
EIGHTEEN VARIABLE SIGNS

Purpose

The purpose of the signs is to advise motorists using the John C. Lodge Freeway Corridor of the best northbound route to follow in entering the Freeway.

Description

The corridor is displayed in Figure B-1. In terms of use of these signs, the area of interest is bounded by West Grand Boulevard, John C. Lodge Freeway, Webb Avenue, Woodrow Wilson Avenue, Davison Expressway, Twelfth Street, Fenkell Avenue, Wyoming Road, John C. Lodge Freeway, McNichols Road, Hamilton Avenue, Davison Expressway and Second Avenue.

The signs supplied will be erected by The University of Michigan, the Public Lighting Commission of the City of Detroit, the City of Highland Park, or other appropriate authority. The locations for the signs are shown in Figure B-1.

Operation

Three types of signs are required:

1. Variable message
2. Blank-out
3. "Trailblazer"

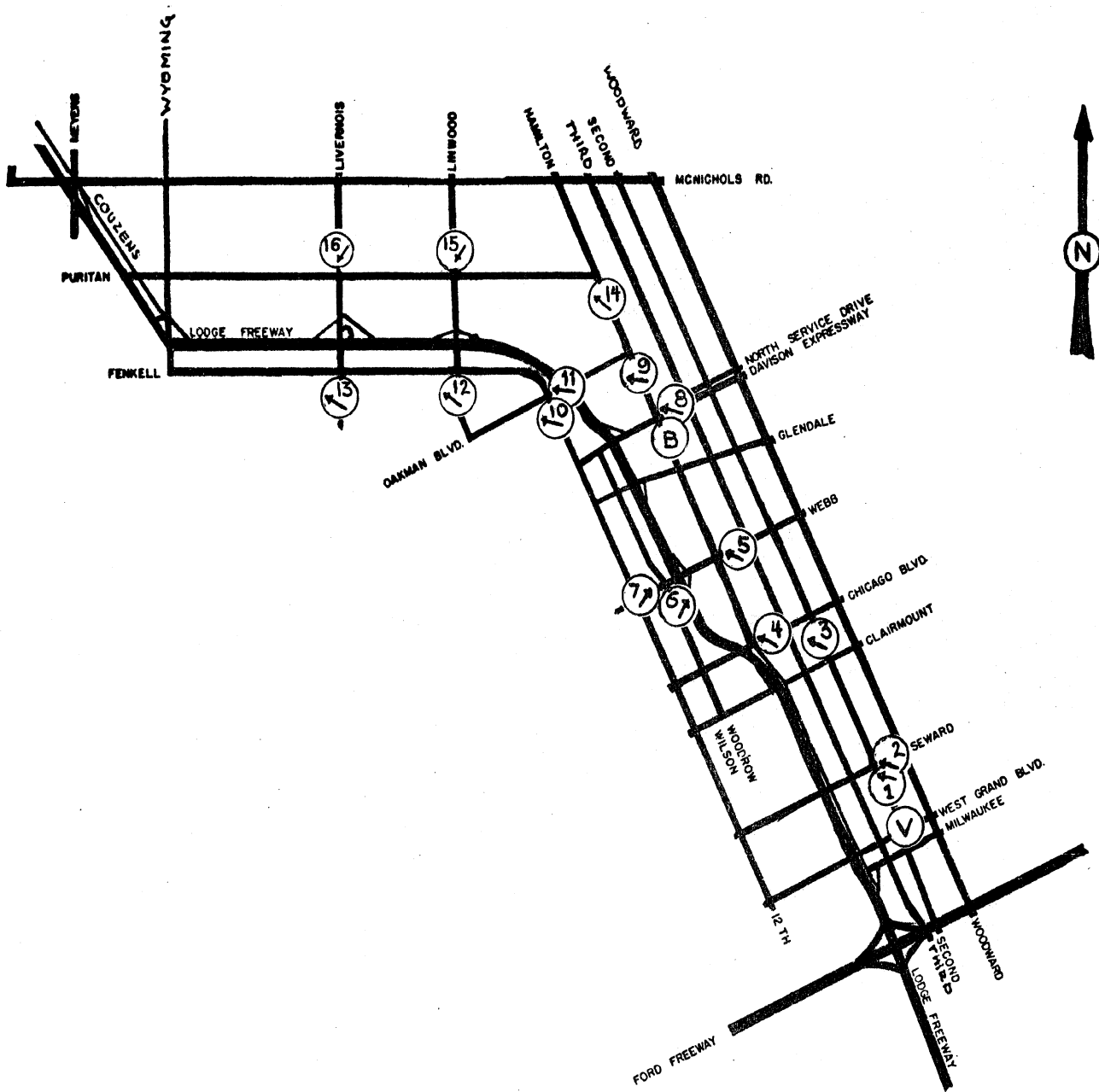

KEY

TRAILBLAZERS:	
	Left Turn or Straight
	Right Turn or Straight
OTHERS (WESTBOUND):	
	Variable Message
	Blank Out

FIGURE B-1  
SIGN LOCATIONS



One type 1 sign is to be located facing westbound traffic on West Grand Boulevard between Cass and Second Avenues. One type 2 sign is to be located facing westbound traffic on the Davison Expressway at the Hamilton Avenue Bridge. The remaining sixteen signs, all type 3, are to be located in various positions throughout the corridor as shown in Figure B-1 and listed in Table B-1. Four different designs are required for type 3 signs.

All eighteen signs will bear the fixed message "NORTHBOUND LODGE FREEWAY." A description of the various required displays follows.

#### Type 1 - Variable Message Sign

Seven word messages are required:

- A. (blank)
- B. USE SERVICE DRIVE  
AND SEWARD RAMP
- C. USE SERVICE DRIVE  
AND CHICAGO RAMP
- D. USE SERVICE DRIVE  
AND HAMILTON
- E. DELAY AHEAD  
USE SECOND AND SEWARD
- F. DELAY AHEAD  
USE SECOND AND CHICAGO
- G. DELAY AHEAD  
USE SECOND AND WEBB

TABLE B-1  
LOCATIONS OF THE TRAILBLAZER SIGNS

NO.	LOCATION - STREET	TRAFFIC DIRECTION	CURB	DESIGN
1	100 ft. S of Seward in Second	N	W	B
2	100 ft. E of Second in Seward	W	N	A
3	100 ft. S of Chicago in Second	N	W	B
4	100 ft. E of Hamilton in Chicago	W	S	A
5	10 ft. E of Hamilton in Webb	W	N	A
6	100 ft. S of Webb in Woodrow Wilson	N	E	A
7	100 ft. W of Woodrow Wilson in Webb	E	--	D
8	100 ft. E of Hamilton in Davison Service Drive	W	N	A
9	100 ft. S of Oakman in Hamilton	N	--	D
10	10 ft. N of Kendall in 12th	N	W	C
11	100 ft. E of 12th in Oakman	W	N	A
12	30 ft. S of Fenkell in Linwood	N	E	B
13	100 ft. S of Fenkell in Livernois	N	--	D
14	100 ft. S of Puritan in Hamilton	N	--	D
15	100 ft. N of Puritan in Linwood	S	W	A
16	100 ft. N of Puritan in Livernois	S	W	A

- Note:
1. All locations are approximate and depend on the convenience of erecting the poles to support the signs.
  2. The curb for sign No. 4 is the S curb of the Westbound roadway.
  3. The position for sign No. 12 is on the traffic island separating right-turning traffic.

Lettering for all varying displays and the fixed message should be a minimum of six inches in height.

The standard of lettering should be the Michigan Department of State Highways Series D or other lettering with at least as good legibility as Series D.

In addition, various arrow displays are required. For message A, the required display is:

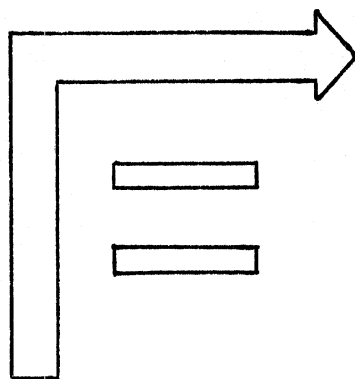

FIGURE B-2  
VARIABLE MESSAGE SIGN ARROW DISPLAY  
FOR MESSAGES A, B, C, AND D

This display will appear on each side of the message panel.

For messages B, C and D, the same arrow display will appear but on only the right-hand side of the message panel.

For messages E, F, and G, the arrow display required is:

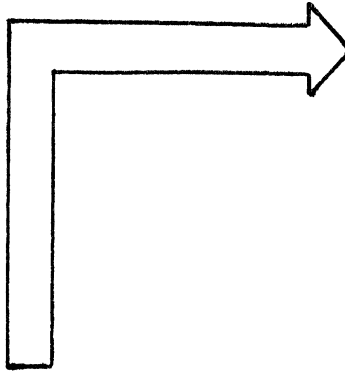

FIGURE B-3  
VARIABLE MESSAGE SIGN ARROW DISPLAY  
FOR MESSAGES E, F, AND G

The width of each arrow display on the sign should be suited to the size of the message panel but should not be less than 18".

#### Type 2 - Blank-Out Sign

The message to be displayed when appropriate is:

"DELAY - AVOID RAMP  
USE 12TH ST"

Size and standard of lettering, including the fixed message, should be 8 inch Series D except for "TH" in "12TH" and "ST" which can be 6 inch Series B.

In addition to the fixed message "NORTHBOUND LODGE FREEWAY," two fixed arrows pointing upward are required on each side of the message panel. The height of each arrow should be suited to the size of the sign or message panel but should not be less than 18".

### Type 3 - Trailblazer Signs

For this type of sign, one of two arrow positions is displayed as traffic conditions dictate. Four designs are required:

Design A (eight signs required) indicates that a through movement or a right turn is recommended.

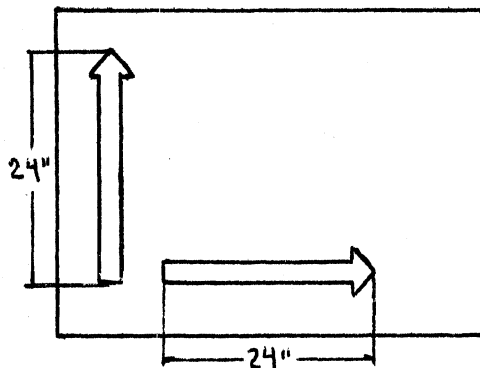

FIGURE B-4

TRAILBLAZER SIGN - DESIGN A

Design B (three signs required) indicates that a through movement or a left turn is recommended.

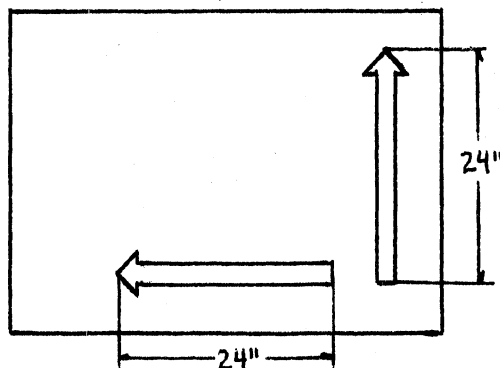

FIGURE B-5

TRAILBLAZER SIGN - DESIGN B

This type of sign is used twice when a left turn is made from a one-way street and once when a left turn is made from a two-way street.

Design C (one sign) also indicates that a left turn is to be made from a one-way street. (It is necessary, however, for this sign to be placed at the intersection immediately before the intersection at which the turn is recommended and therefore a straight through indication is also necessary before the turn arrow.)

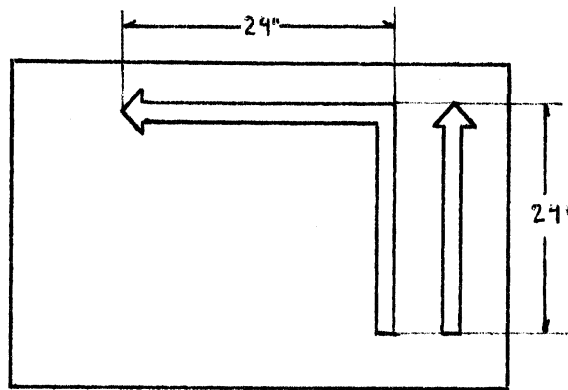

FIGURE B-6  
TRAILBLAZER SIGN - DESIGN C

The size of the lettering of the fixed message in these three designs shall be 4 inch Series D.

Design D (four signs) is similar to Design B except that the lettering is larger, namely, 6 inch Series D letters, and one of the arrows is larger. These signs indicate that a left turn is to be made from a two-way street.

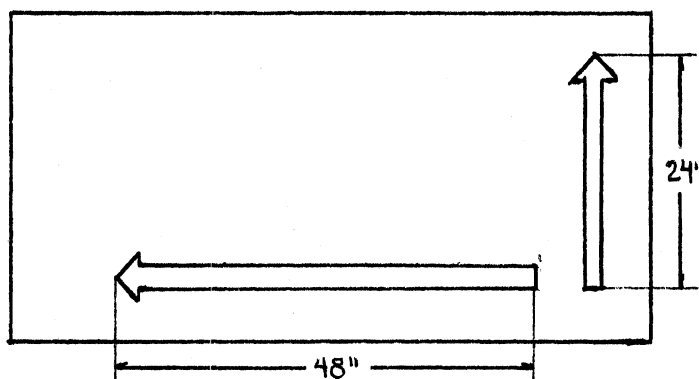

FIGURE B-7

TRAILBLAZER SIGN - DESIGN D

Each arrow dimension given in the four designs is the desirable minimum but the actual size of the arrow should suite the size of the sign.

#### Construction

The sign shall have a general background of either black or standard highway green. The color of the messages may be red, green or white but the arrow display colors may be only green or white. An exception is that red may be used for the "stub arrows," the streets to be avoided in messages A, B, C, and D in the variable message sign. If any of the

messages are colored in green on signs with a green background, sufficient contrast must be provided by means of a black background in the individual message panel. Any message in the three types of signs must be legible to a driver with 20/20 visual acuity at distances given in the table below for all day and night conditions. The sign messages may be internally or externally illuminated. When a message is blanked out, it must not be legible for distances from the sign as given in Table B-2.

TABLE B-2  
LEGIBILITY DISTANCES

Sign Type	Legible Distance (Feet)	Blanked-Out Message Illegible Distance (Feet)
Type 1	300	75
Type 2	400	100
Types 3A, 3B & 3C	200	50
Type 3D	300	75

The shape and size of all arrows shall conform as closely as practicable with the standard sign arrows used by the Michigan Department of State Highways. The width and height of the signs have not been specified. However, it is desirable that all signs be as small as possible while



retaining the minimum lettering and arrow sizes. Preferably, the smaller trailblazer signs shall conform to standard highway sign sizes with dimensions in multiples of six inches. The thickness of all signs shall be no greater than necessary to provide an adequate housing. Any type of material may be used in the construction; however, the finished product must be generally sturdy, weatherproof, and neat in appearance.

#### Sign Faces

The sign faces shall be flat. In addition to the color and illumination requirements given in the previous section, a one-inch reflectorized white border shall be overlaid. Materials used in the sign face shall be equivalent in strength to 3/16 inch plexiglass. The completed sign face shall present an attractive and professional appearance.

#### Mounting

All signs shall be provided with the necessary hardware for direct attachment to existing wooden poles, steel standards, or posts. The University of Michigan will provide the appropriate poles or posts where required, and later erect the signs.

The Type 1 and Type 3 Design D signs will be mounted above the roadway with a minimum clearance of 15 feet above the road surface. In each case, they will be centrally mounted over one of the traffic lanes on the road.

The Type 1 sign is to be mounted over a street 45 feet wide and the center will be 13 feet, 6 inches from the right-hand curb (facing the sign). The Type 3 Design D signs are on streets 52 feet, 74 feet, 74 feet, and 90 feet wide and the center of the sign will be 19 feet, 6 inches, 37 feet, 37 feet, and 45 feet, respectively, from the right-hand curb. In each case, the poles may be assumed to have a 12 inch clearance from the edge of the curb.

The other signs will be directly attached to a pole or post except for the Type 2 sign which will be directly attached to the Hamilton Avenue Bridge. In general, the edge of the sign next to the roadway must be 12 inches clear from the curb.

#### Electrical Requirements

The electrical components in or near the sign shall be designed to operate on 115 volt, 60 cycle, single phase alternating current unless prior approval for departure from this figure is obtained. All components must be approved by Underwriters Laboratories.

All electrical components will be brought to a terminating strip. In the case of the Type 1 and Type 3 Design D signs, this strip will be mounted into a control base on the supporting pole nearest to the center of the sign and about 6 feet above the ground. The University of Michigan will be

responsible for mounting the terminating strip. Thus sufficient internal cable must be provided. For all other signs, the terminating strip can be in, at the back of, or at the side of the sign.

#### Serviceability and Maintenance

It is not intended to develop a permanent operational piece of hardware, but rather to test an operational concept in communication with the motorists. Strict specifications regarding serviceability and maintenance will, therefore, not be imposed; however, the manufacturer shall state the following:

1. Operating temperature range.
2. Anticipated life of light sources.
3. Anticipated useful life of the signs.
4. Power consumption of each sign.
5. General quality of components.
6. Requirements for electrical grounding
7. Any additional features which are likely to affect serviceability of the signs as operational devices.

#### Delivery

Delivery must be completed within ninety (90) days of notification of acceptance of the manufacturer's offer. The

quoted price shall include delivery and unloading at the Public Lighting Commission warehouse, 174 East Atwater, Detroit, Michigan or any other location in the Detroit Metropolitan area specified by The University of Michigan.

#### Guarantee

The supplier shall guarantee satisfactory performance of the units (excluding physical damage) for a period of three months from the date of deliver.

In the event of physical damage to a sign, the manufacturer is asked to quote a labor cost (per hour) and a transportation cost (per call) for returning immediately to Detroit to repair the sign. Replacement materials would be supplied by the manufacturer at current retail prices less sales tax.

#### Working Drawings

Within fourteen days of notification of acceptance of the manufacturer's offer, working drawings for each type of sign shall be submitted to the Principal Investigator for approval. The drawings must show in particular the detailed lay-out of the sign face, the hardware for mounting the signs and the location of the terminal strip if on the sign.

The manufacturer must be prepared to come to the National Proving Ground for Freeway Surveillance Control and Electronic Traffic Aids in Detroit to review the working drawings with the Principal Investigator. This conference will take place within four days after submission of the working drawings.

#### Bids

Tenderers may bid to supply any or all of the types of signs. Alternatively the tenderer may offer to lease any or all of the signs for three months with an option for a twelve-month extension. Variations in the design may be considered and the tenderer is invited to submit alternative bids for any variations. The tenderer shall also include a rough sketch of the layout of the messages for all the signs and state the weight of the Type 1 sign, including the mounting structure.

The bids should be submitted in duplicate with both copies sent to the Principal Investigator, Professor Donald E. Cleveland, whose office is located in the Argus Building, Corner of William and Fourth Streets, Ann Arbor. The mailing address is:

Highway Safety Research Institute  
University of Michigan  
City Center Building  
220 East Huron  
Ann Arbor, Michigan 48108

One copy of the bid should be addressed to The University of Michigan Purchasing Department. The bid must be received no later than 4:00 p.m. on June 2, 1969.

APPENDIX C

DESCRIPTION OF EQUIPMENT USED FOR DATA  
ACQUISITION AND SURVEILLANCE CONTROL





## APPENDIX C

### DESCRIPTION OF EQUIPMENT USED FOR DATA ACQUISITION AND SURVEILLANCE CONTROL

#### Introduction and Relation of Physical Components

The measurement and guidance operations necessary for the real-time information and control system are performed by both field and office equipment. (The reader should also refer to Appendix B of A Freeway Corridor Surveillance, Information and Control System (7) and Appendix A of Evaluation of a Dynamic Freeway Ramp Entry Guidance System (26) for equipment information not detailed here.)

The processing of data acquired through the detector system and the making of control decisions are accomplished by an IBM 1800 digital computer. As the field complex grows in size the computer system can match this growth by appropriate increases in its capabilities. Also, as new traffic flow theories are developed, or as older ones are improved, the decision function can be updated through changes in programming. The computer system is essential to compile and assess the vast quantities of data involved in a real-time freeway control system and also has the flexibility to develop with the control system.

The physical components of the full traffic control and information system are shown in Figure C-1. The traffic detectors are the major source of traffic flow measurements into the system. These detectors are of three types: loop, ultrasonic and transsensor. The loop detectors are used on all of the ramps to detect vehicle presence and to record volumes and on various surface streets in the Lodge Freeway Corridor to record volumes. Transsensor-type detectors are also used for this latter function. The ultrasonic units are utilized on the Freeway, one for each northbound lane at each of nine freeway detector locations. In addition, ultrasonic detectors are used as queue detectors on all on-ramps except one where a loop is used.

Electrical power was provided by either the Public Lighting Commission, a City of Detroit agency which produces power for City services, or the Detroit Edison Company. In all cases power was tapped from existing lines belonging to one of these sources and run to installation sites. All lines were strung overhead and attached to existing poles. Messages are conveyed to and from the field equipment over leased Michigan Bell Telephone lines. This service is tapped at the closest available location by the telephone company and is routed to the field equipment.

**BLOCK DIAGRAM OF PHYSICAL  
COMPONENTS OF TRAFFIC CONTROL AND INFORMATION SYSTEM**

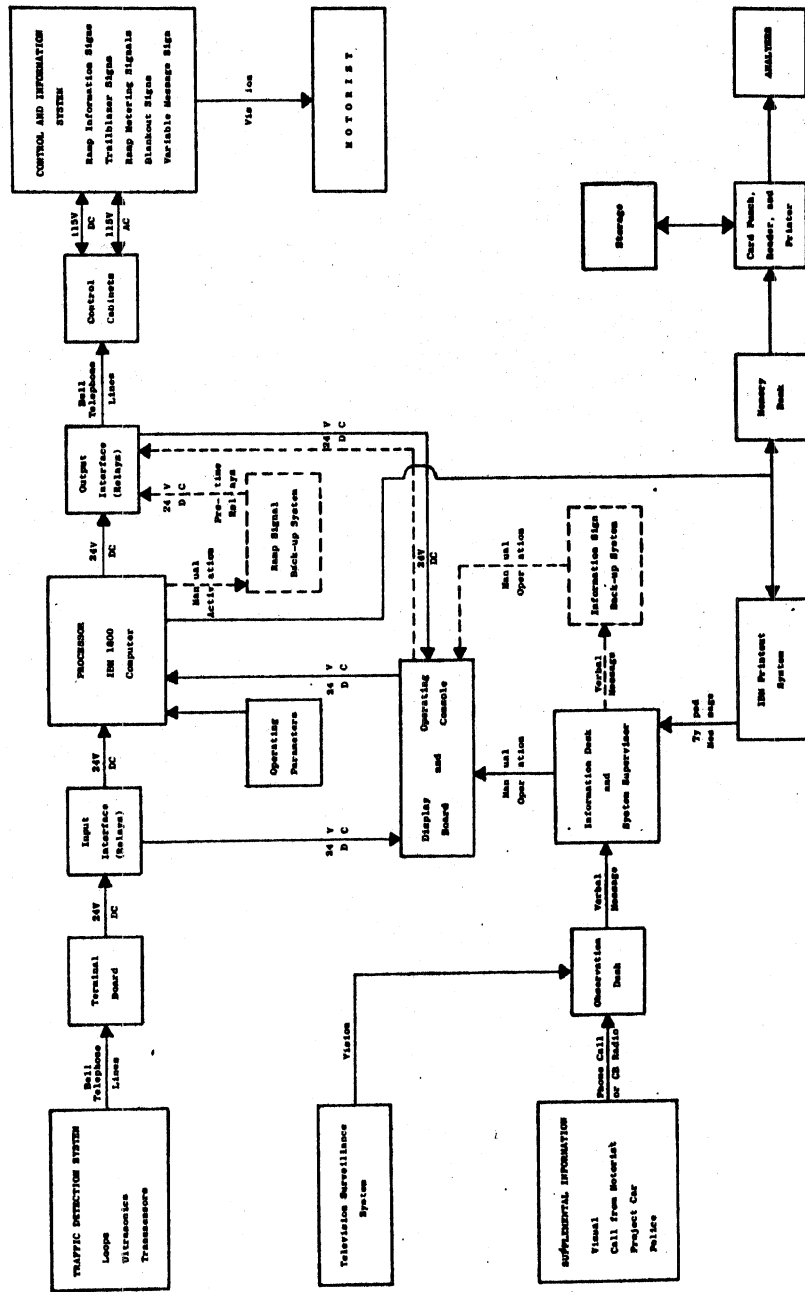

FIGURE C-1

The information received at the Control Center is processed and assessed by the computer in light of operating parameters previously programmed into the system. After assessment, and if appropriate, a call is made for a control function. The necessary command is sent to the field through a second set of leased communication lines.

The control and information systems consist of eight ramp information signs, eight ramp metering signals, 16 trailblazer signs, two blankout signs and one variable message sign. These information devices convey their messages to motorists through the normal visual process.

In summary, the "main line" process described above consists of traffic flow measurements accomplished by detectors; receipt of data from the detector via communication lines; processing of data by the computer; and command output from the computer over communication lines to the control signs and signals in the field. This "main line" process, as can be seen in Figure C-1, is supported by other input information as well as being subject to manual overrides by the system supervisor.

## Description of Dynamic Routing Information Signs

There are 19 new dynamic routing information signs in use in the Lodge Freeway Corridor as a result of this phase of research. All but one of these signs is capable of presenting two messages and one sign can produce as many as seven different messages. These 19 signs, while used for the same purpose, are of two distinct types. The majority, 17, are variable message signs, and two are blank-out signs. Static signs are also utilized to reinforce the directive messages displayed on the dynamic signs.

The large variable message sign on West Grand Boulevard utilizes, as do the smaller trailblazer signs, neon tubes to present the desired message. Since the tubes are clear glass, the ramp names can be "stacked" and yet only the illuminated message can be seen. In the case of the trailblazer signs only the activated arrow can be seen while the other one blends into the sign background.

The blankout sign messages are invisible when not activated but can easily be read when the message is on. The Chicago Boulevard blankout sign has a plexiglass front panel with the appropriate message and is lit by internal lights.

## Electrical Circuiting for Dynamic Routing Information Signs

As mentioned previously, all but one of the 19 signs present only two message states: on or off for the blankout

signs and straight through or turn movements for the trail-blazer signs. Thus the electrical control needed was only a simple switching mechanism accomplished by a relay.

In the case of the variable message sign, however, an electrical control assembly was designed and built by project staff. A schematic of this assembly is shown in Figure C-2. A three digit binary code was developed to provide all of the possible seven messages (with one being redundant). When the appropriate code was called for, electrical relays switched to activate the called for message. As an example, the second message, 100, calls for the first series of switches to be in the "up" position and the second and third series to be "down". The resulting message is "Right Arrow Top" (2); "Right Arrow Bottom" (3); "Use Service Drive" (4); "Seward" (5); and, "Ramp" (8). As a second example the message 001 (first two series of switches in the "up" position and the third series "down") the message becomes: "Right Arrow Top" (2); "Delay Ahead Use Second" (4); and, "Seward" (10).

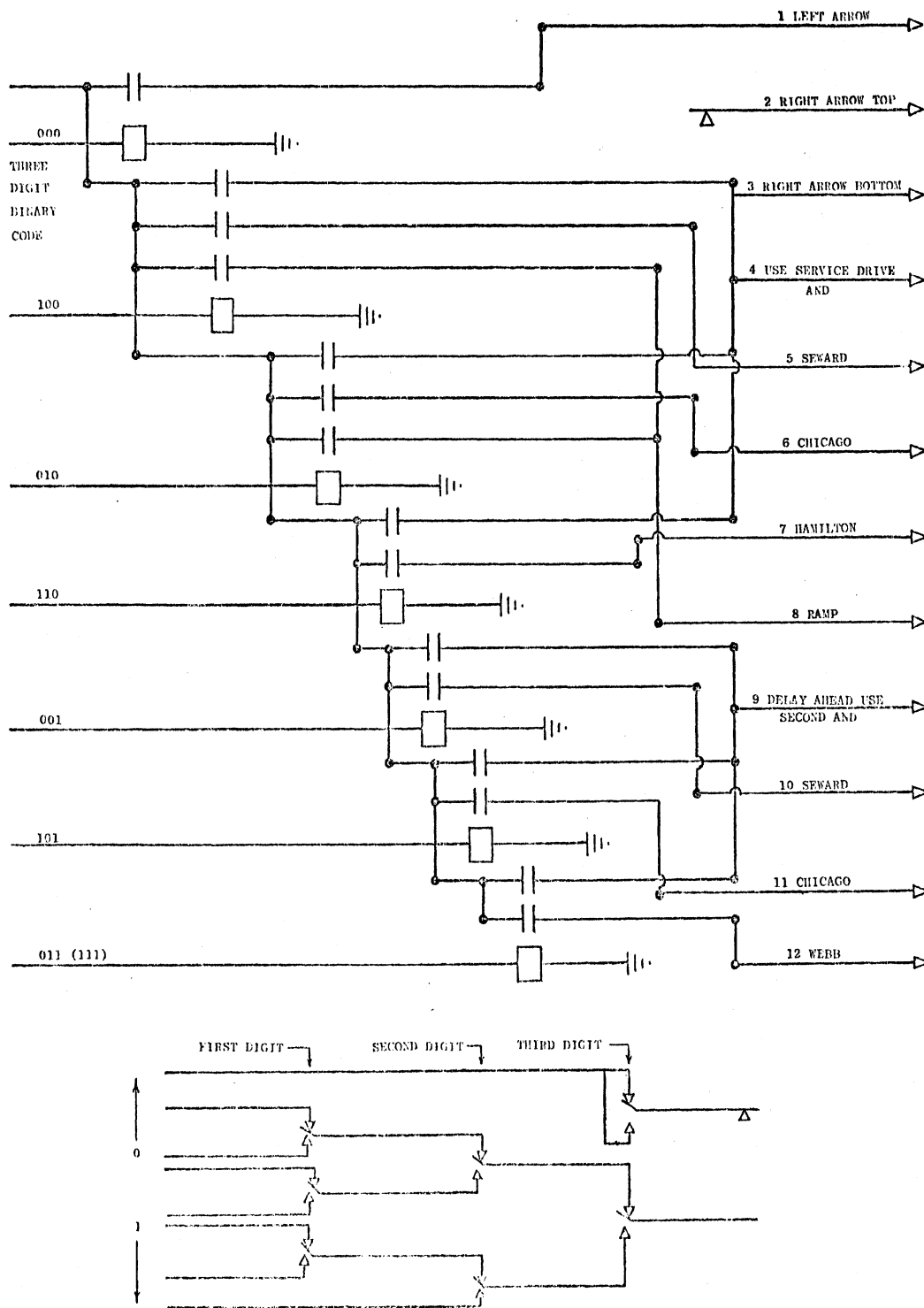

FIGURE C-2  
 DISPLAY LOGIC FOR VARIABLE MESSAGE SIGN





APPENDIX D

COMPUTER CONTROL PROGRAMS



APPENDIX D  
COMPUTER CONTROL PROGRAMS

Introduction

The computer control used for this project had its inception during NCHRP Project 20-3 conducted by the Texas Transportation Institute (TTI). Much of the explanation and documentation contained in Appendix C, "Data Acquisition and Control: Software Methodology," of the TTI final report is still valid and, therefore, will not be duplicated in this appendix ( 7 ). The computer utilized is an IBM 1800 Data Acquisition and Control System.

The primary objectives of the control programming during the 1969 research include metering the eight on-ramps located in the study area, controlling the 27 dynamic routing information signs which lead to the eight metered on-ramps and collecting data from the traffic detection equipment.

Ramp Metering

During 1969 three major changes were made in the ramp metering operation. First, the metering times for all eight ramps were standardized to permit the utilization of just one general metering system ( 6 ). Metering now begins at 2:30 p.m. and ends at 6:30 p.m. The former system had the four southern ramps metered from 2:30 p.m. to 6:30 p.m., while the remaining four were activated at 3:30 p.m.

The second change was a modification in the possible modes of operation (strategies) of the metering system. At the end of 1969 the possible modes are:

1. Fixed one-minute rates (from historical table);
2. Minimum rates;
3. Maximum rates;
4. Constant green;
5. A system model based on a demand/capacity model;
6. A system model based on a storage model; and
7. Off (operationally the same as constant green).

Finally, the Seward on-ramp is now metered with a two-phase (red-green) signal logic replacing the three-phase (red-amber-green) signal logic.

#### Dynamic Routing Information Signs

The eight original University of Michigan driver information signs on the prime alternate route advise the motorist of the most desirable point for him to enter the Freeway in order to avoid congestion (26). The computer control strategy used for these signs was expanded to include the 19 new dynamic routing information signs.

#### On-Line Information

The on-line operation of the computer provides two forms of informational output. The first of these, digital displays

which appear on the display panel, supplies the following information:

1. Ramp volume at a given ramp;
2. Ramp queue detector occupancy;
3. Ramp metering rates;
4. Number of vehicles which can be allowed into a given subsystem;
5. Freeway station volumes;
6. Freeway station occupancies;
7. Net number of vehicles that entered a given subsystem in the past minute; and
8. Current state of variable message sign on West Grand Boulevard.

The second sources of information are the messages printed automatically every minute by the IBM system typewriter.

These messages include information on:

1. A change in metering mode selection;
2. Data to disk messages (suspended, started, overlapped);
3. Detectors down or back in service; and
4. Internal action taken due to detector malfunction (change in metering mode).

## External Controls

The display panel contains various switches which, when manually operated, send an electrical impulse message to override internal program instructions. Eight, eight-position rotary switches are used for selecting the desired metering strategy for each of the metered ramps. There are also eight, three-position rotary switches which provide manual control for the driver information signs. In addition, the display panel has three, eight-position rotary switches available for selection of the type of information desired to be shown on the digital display.

There are also three groups of rotary switches at the lower left of the display panel. Each of these three groups of switches provides external control of the system. External control is defined as a control, other than computer control, and is usually undertaken by the system supervisor. These switches enable the supervisor to override the computer and thus provide manual control of signs and ramp signals. They are generally used during experiments in traffic routing or, in the case of a malfunction, the switches serve as a backup system.

In addition to the switches on the display panel, there are eight, two-position switches on the computer console which, when manually operated, alert the computer to various changes and requests to the system.

## Detailed Description of Control Programs

The entire system is shown in condensed flow chart form in Figure D-1 and D-2. (Table D-1 presents a key explaining technical terms used in these and all remaining Appendix D figures.) The two parts of this figure show how each routine is started and perpetuated, the purpose of each routine and their linkages through the various computer programs that control the operation of the system. There are two types of programs employed in the system. Mainline core loads are stored on disks in core-image format and brought into variable core for execution on call while sub-routines are always in core to enable faster execution.

The following paragraphs contain a detailed discussion of the present routines and programs.

The RSTAR and RESTR routines are presented in Figure D-3. The purpose of these routines is to enable the system to recover from internal malfunctions automatically without any intervention by an operator and, more importantly, without discontinuing the metering system. All variables are reinitialized and all time dependent functions are re-synchronized. (The associated programs are OCCOL, CKSYS, CLTAC, and POWON which are explained below.)

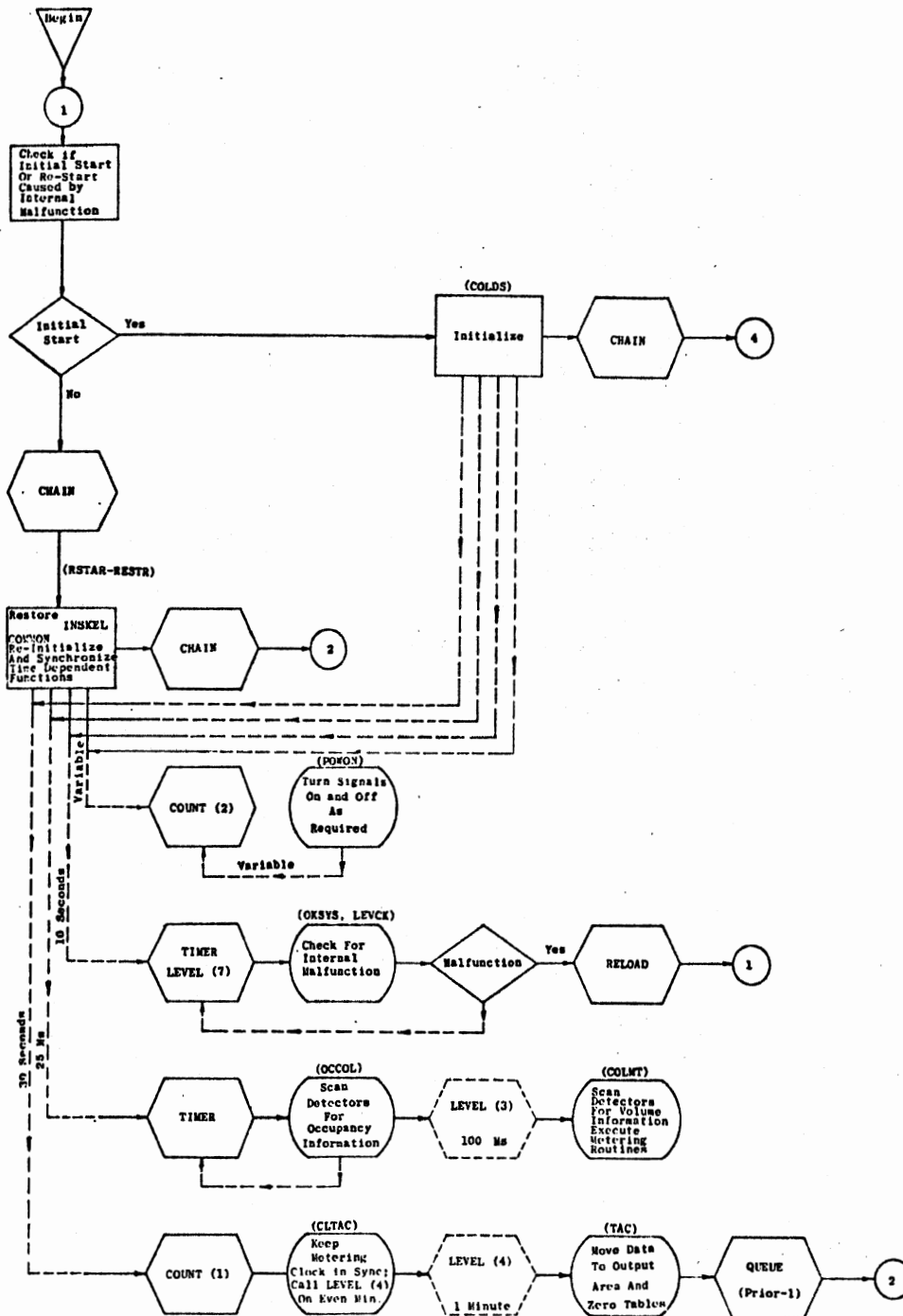

FIGURE D-1

SURVEILLANCE AND CONTROL SYSTEM  
FLOW CHART - PART I



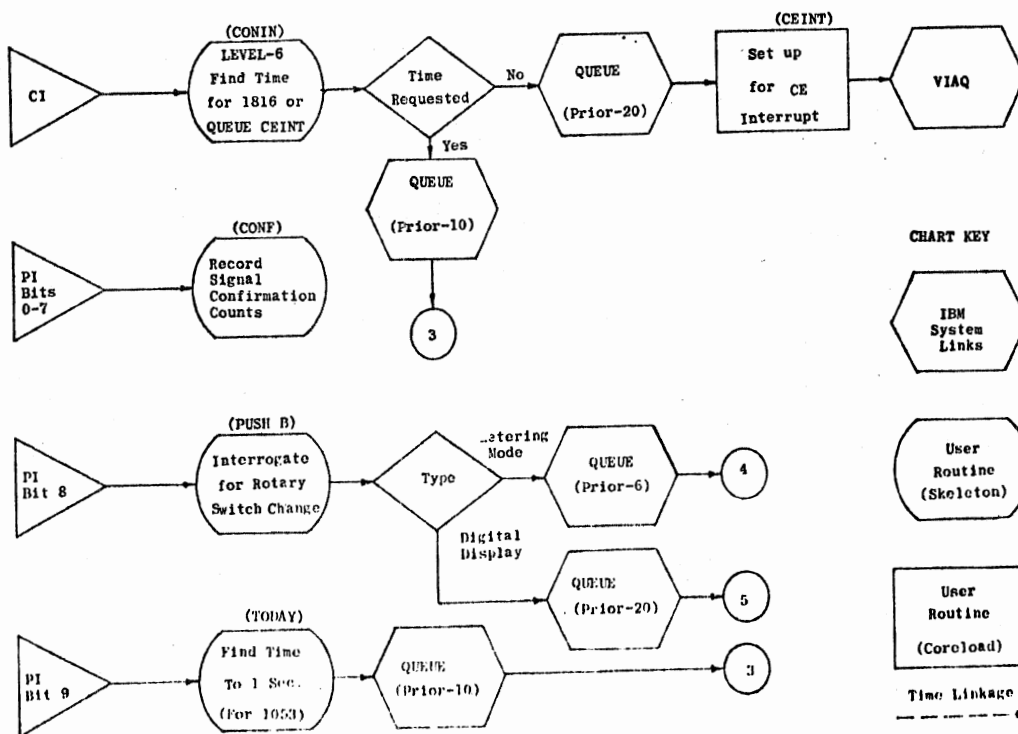
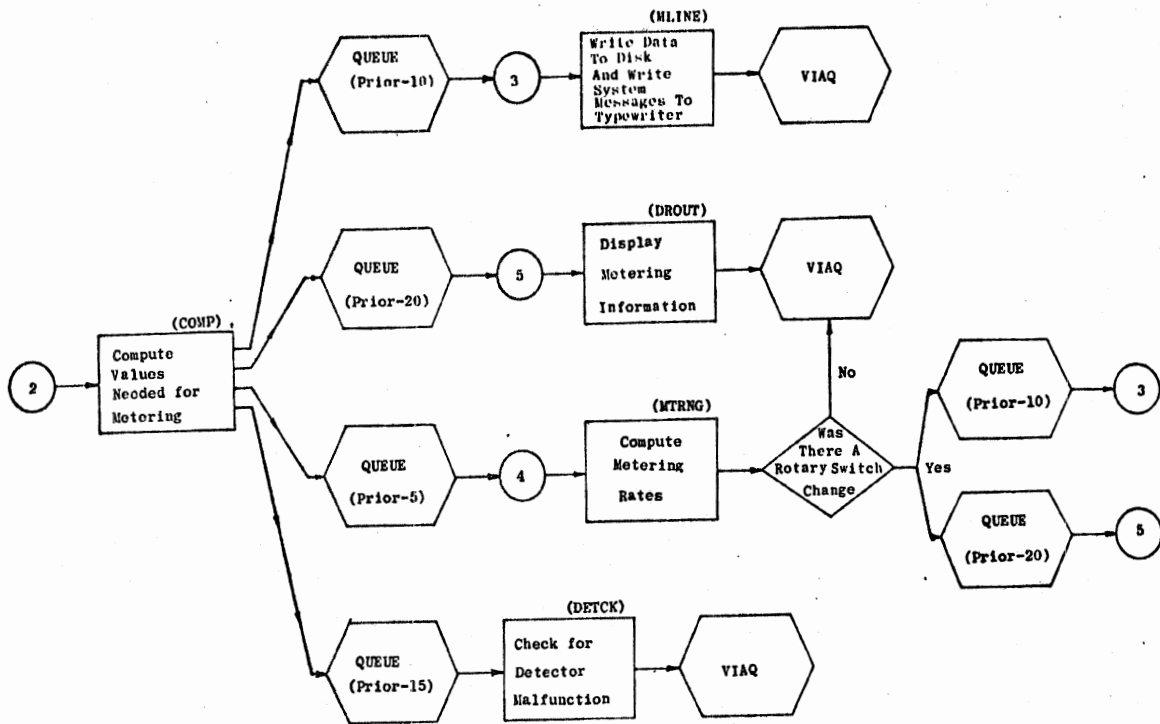

FIGURE D-2

SURVEILLANCE AND CONTROL SYSTEM  
FLOWCHART - PART II

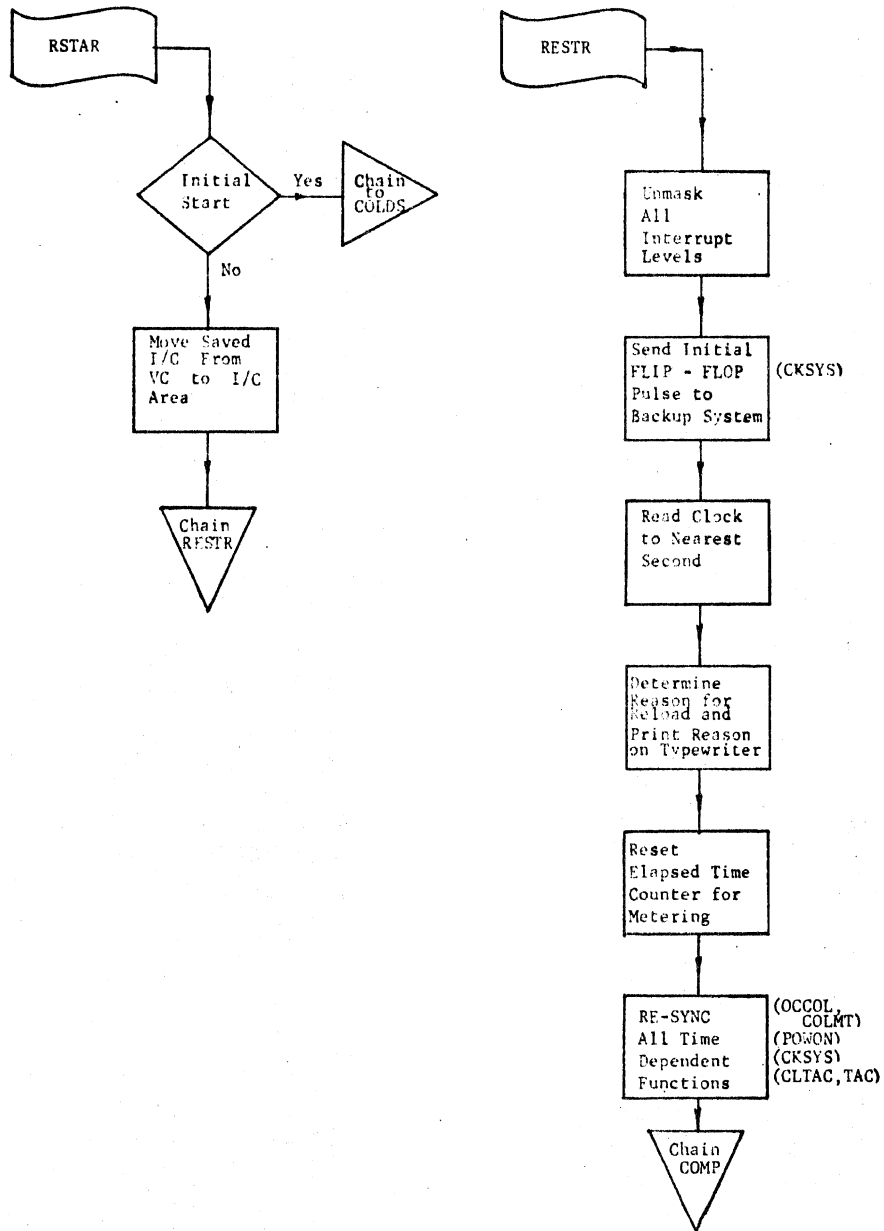

FIGURE D-3

INTERNAL MALFUNCTION SELF-RECOVERY ROUTINES  
(RSTAR AND RESTR)

TABLE D-1

KEY TO COMPUTER OPERATIONS FLOW CHARTS

TERM	DESCRIPTION
CALL CHAIN	This routine allows the user to link two coreloads by overlaying the calling routine.
CALL QUEUE	This call places the named coreload in a queue table for execution when a CALL VIAQ is executed.
PRIOR	This is the priority ranking in the queue.
CALL LEVEL	This call forces a programmed interrupt on the level desired. With the system design, a subroutine is associated with each interrupt level being called by this routine.
CALL VIAQ	This call is used as the last executable statement in a coreload. It will load into variable core in the queue table on a priority basis. If the queue is empty, time sharing is initiated.
ENDTS	End time share. A non-process job is stopped and placed onto disks.
INTEX	Programmed interrupt exit.
INSKEL	Special common area for system programs.

RSTAR is brought into core for execution during an IBM system reload operation. This routine, upon request, can also be made to chain to the COLDS program (Figure D-4) and thus perform a normal system start-up. The COLDS program initializes the system for continuous operation. It is brought into operation by a CALL CHAIN (see Table D-1) from RSTAR.

The COMP program (Figure D-5) makes necessary preliminary computations for use in the metering routine (MTRNG) based on data from the previous minute. COMP also sets up the mainline core load execution priorities and sets a flag to indicate that it has started execution. This program is used to communicate with the system check-out routines.

Figure D-6 presents the MTRNG routine which computes the metering rates for the metered ramps and controls the information sign logic. It also contains special metering override logic, such as that employed at the Davison to Lodge on-ramp, where an excessive ramp queue necessitates a change in metering mode to alleviate congestion on the feeding ramp.

The purpose of the DETCK (Figure D-7) routines is to check for response from each detector in the system. Messages are printed both when a detector malfunction occurs and when it returns to service. Each detector is assigned a maximum

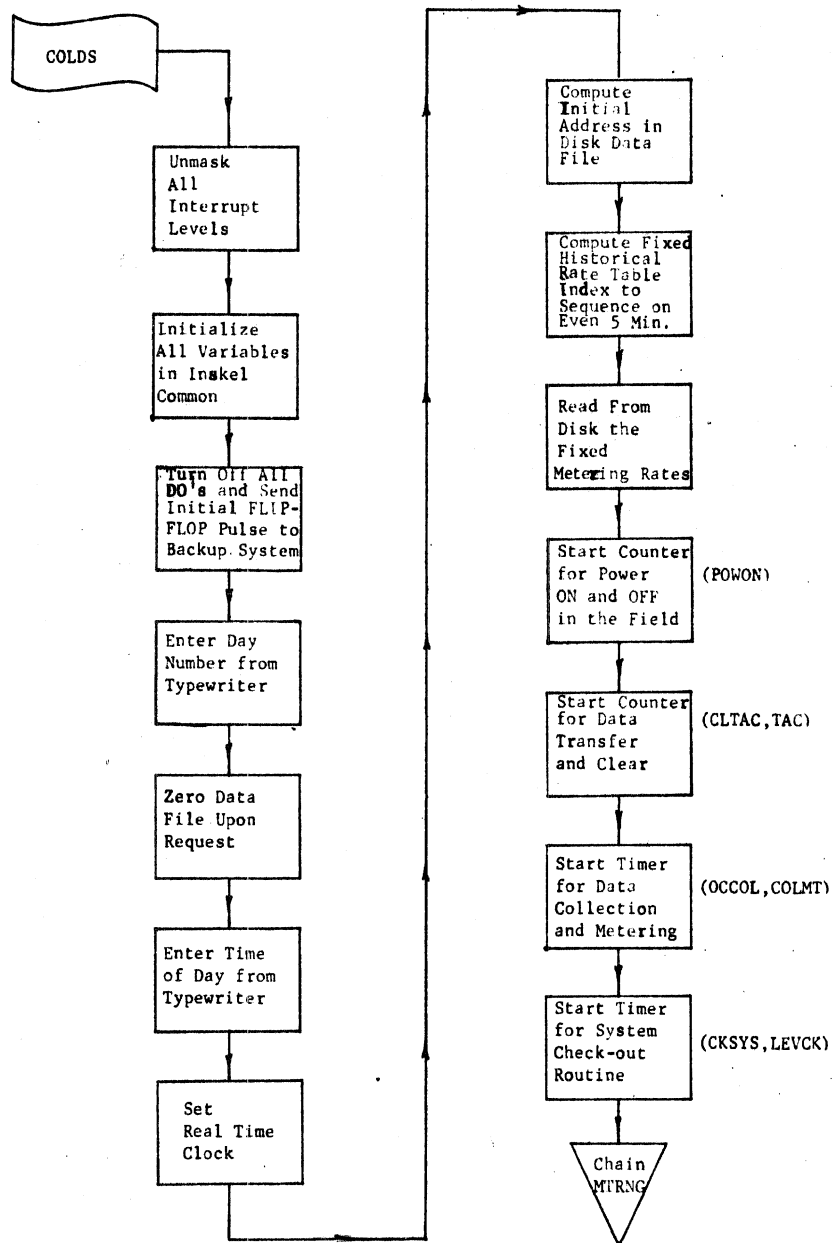

FIGURE D-4

SYSTEM INTERNALIZATION ROUTINE FOR CONTINUOUS OPERATION (COLDS)

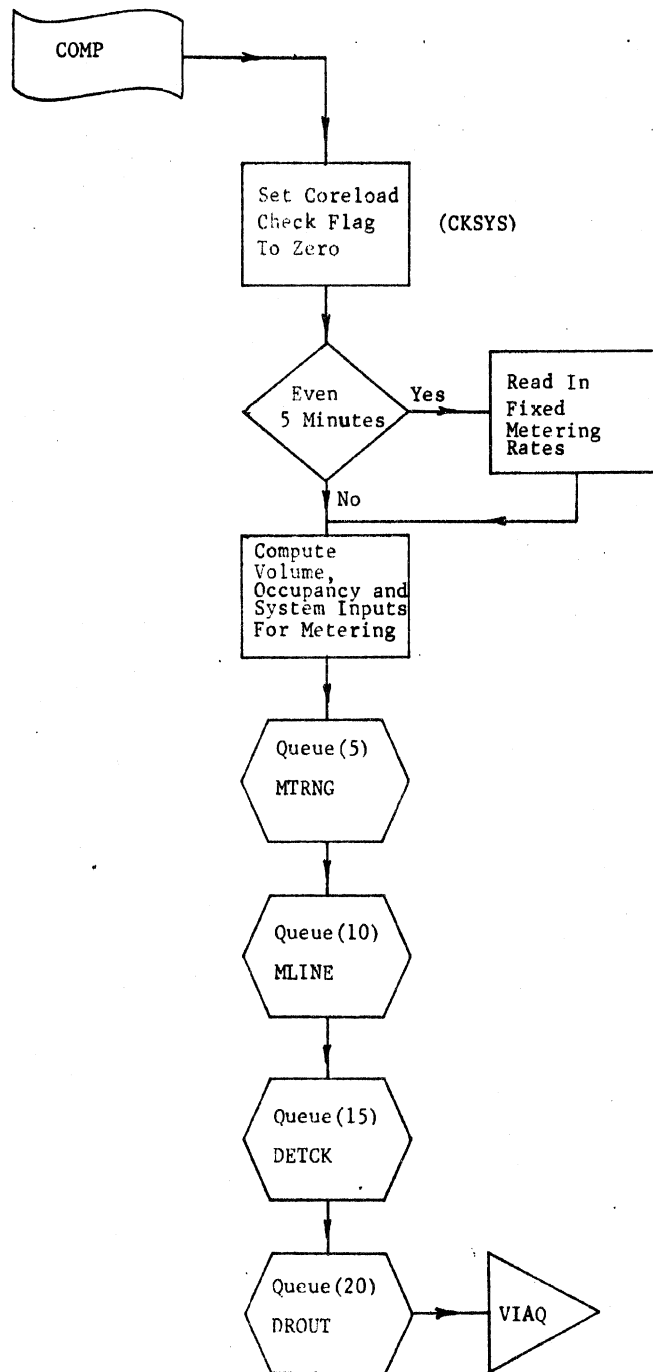

FIGURE D-5

ROUTINE FOR COMPUTATION OF TRAFFIC  
FLOW DATA (COMP)

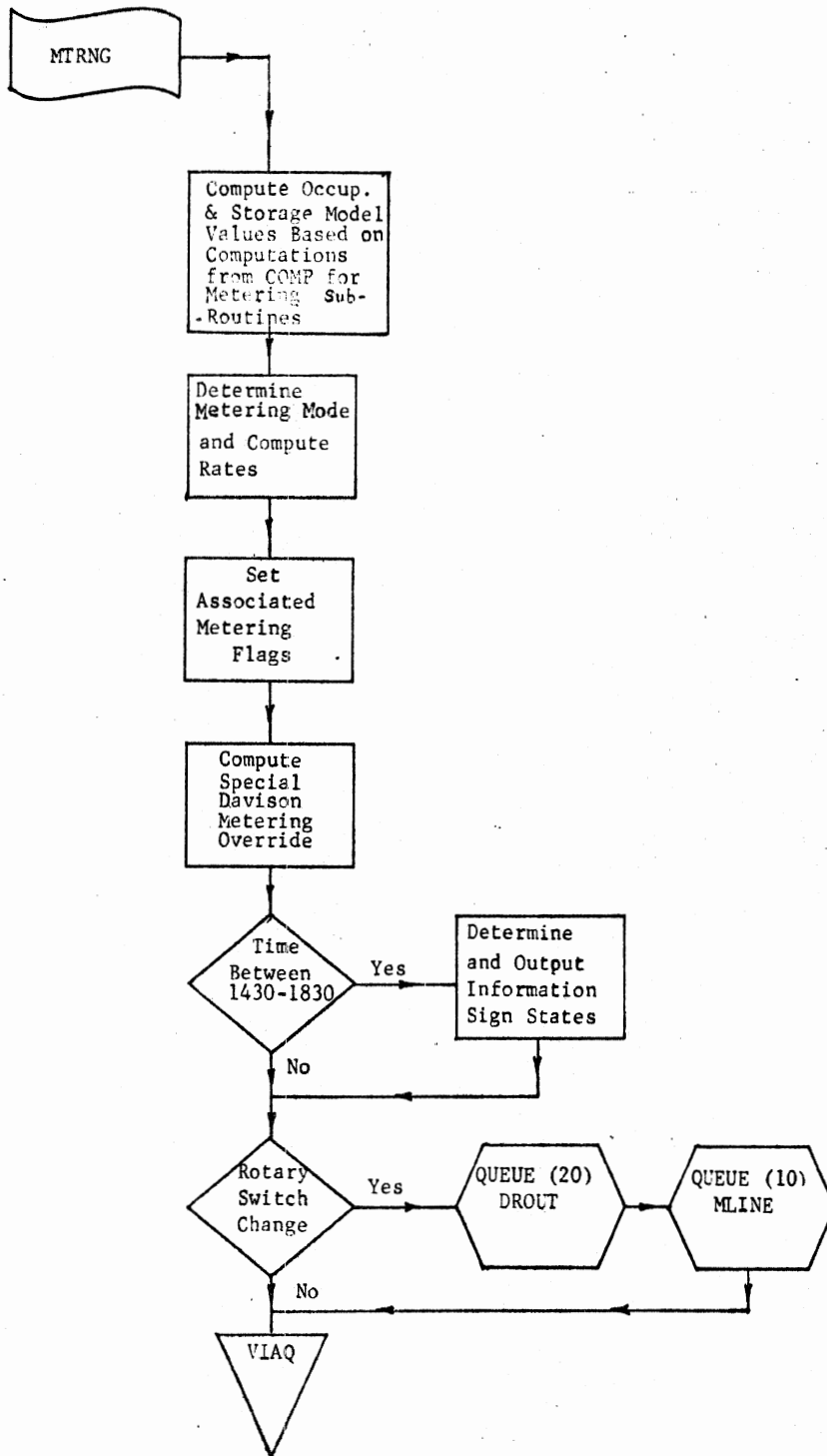

FIGURE D-6

METERING COMPUTATION AND INFORMATION SIGN CONTROL LOGIC ROUTINE (MTRNG)

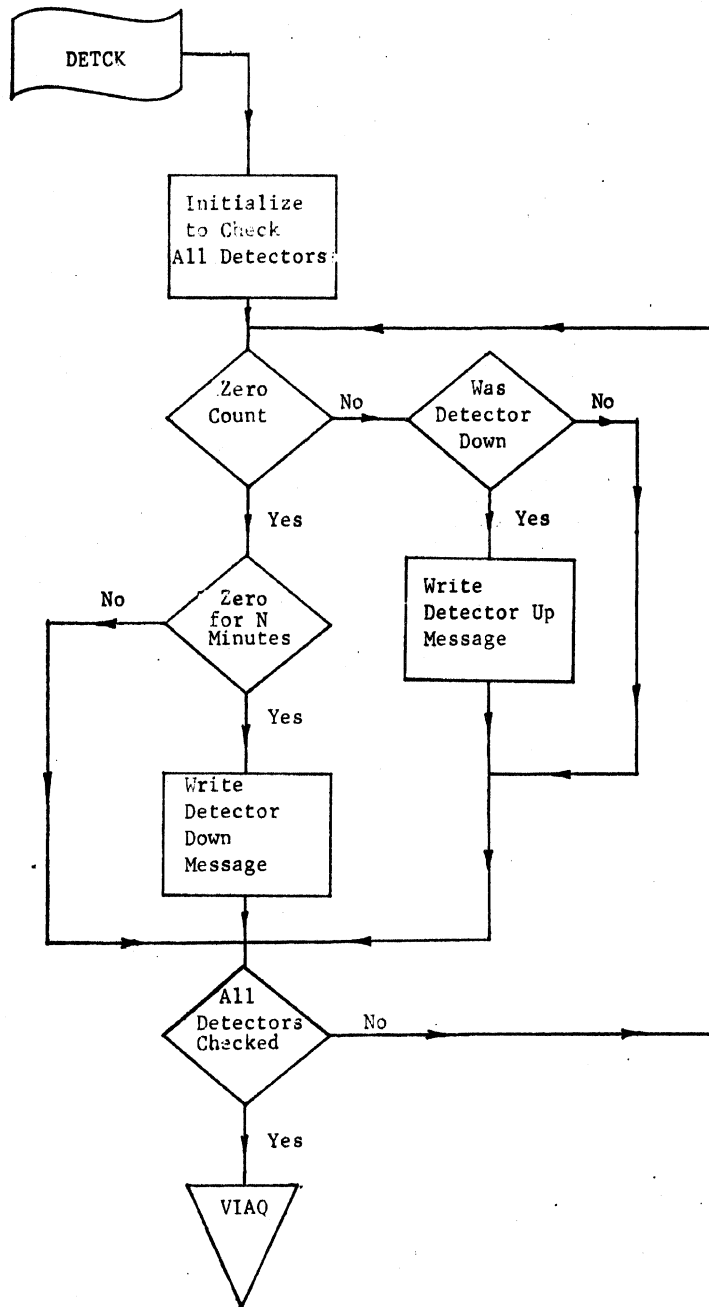

FIGURE D-7

DETECTOR INTERROGATION ROUTINE (DETEK)



allowable number of minutes for no response before corrective procedures are initiated. This same logic is used to check for malfunction of ramp signals.

MLINE (Figure D-8) is the routine which performs all the communication with the operator once the system is operational. It prompts the writing of messages by the typewriter and the writing of data onto the disk, the latter taking place once each minute.

Information desired on the digital display unit is called for by the use of the DROUT routine (Figure D-8). The type of information desired is selected by manually operating the three, eight-position rotary switches on the display panel discussed previously in this appendix.

The CKSYS and LEVCK (Figure D-9) routines check for successful completion of all scheduled tasks. If all tasks were not completed, it is assumed that the computer is out of service and an IBM system RELOAD operation is automatically forced. The following two criteria are used for determining successful completion of all tasks.

1. A flag is set once a minute in one of the skeleton routines (TAC) which must be set to zero in one of the mainline core loads (COMP). This indicates that core loads are being processed and that all skeleton routines are executing.

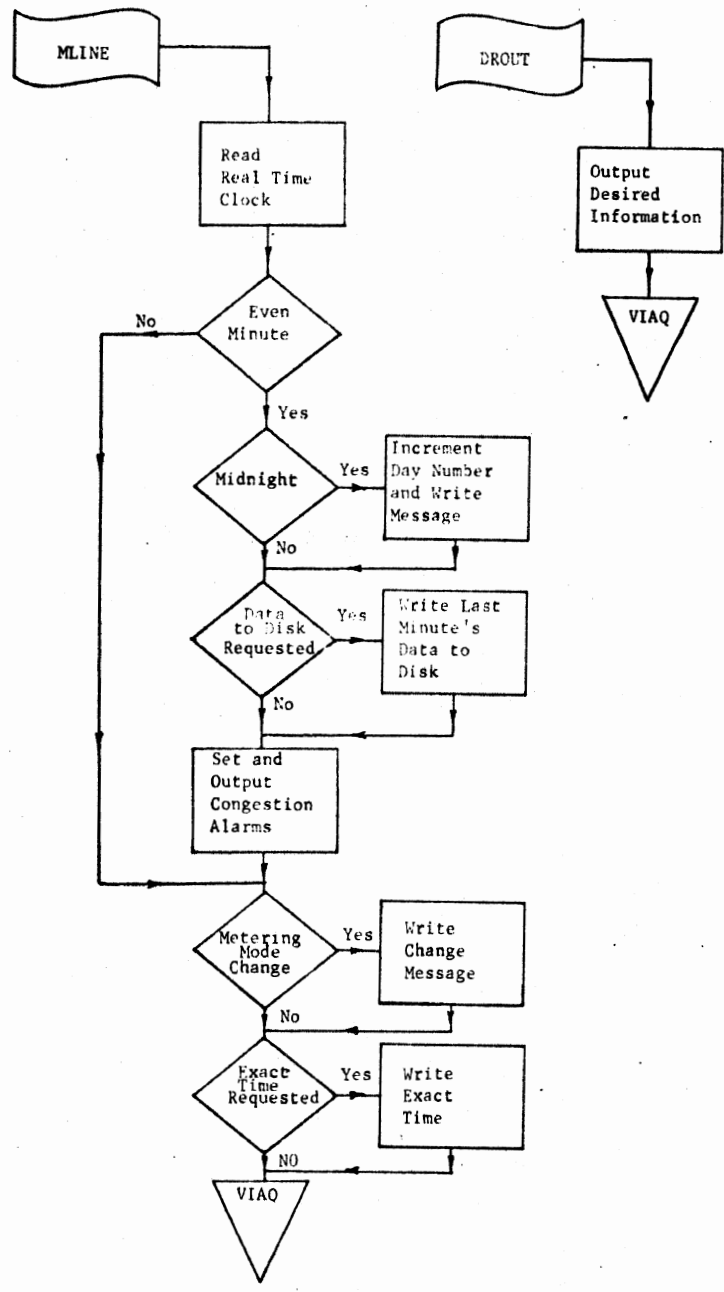

FIGURE D-8  
 OPERATOR COMMUNICATION ROUTINES  
 (MLINE AND DROUT)

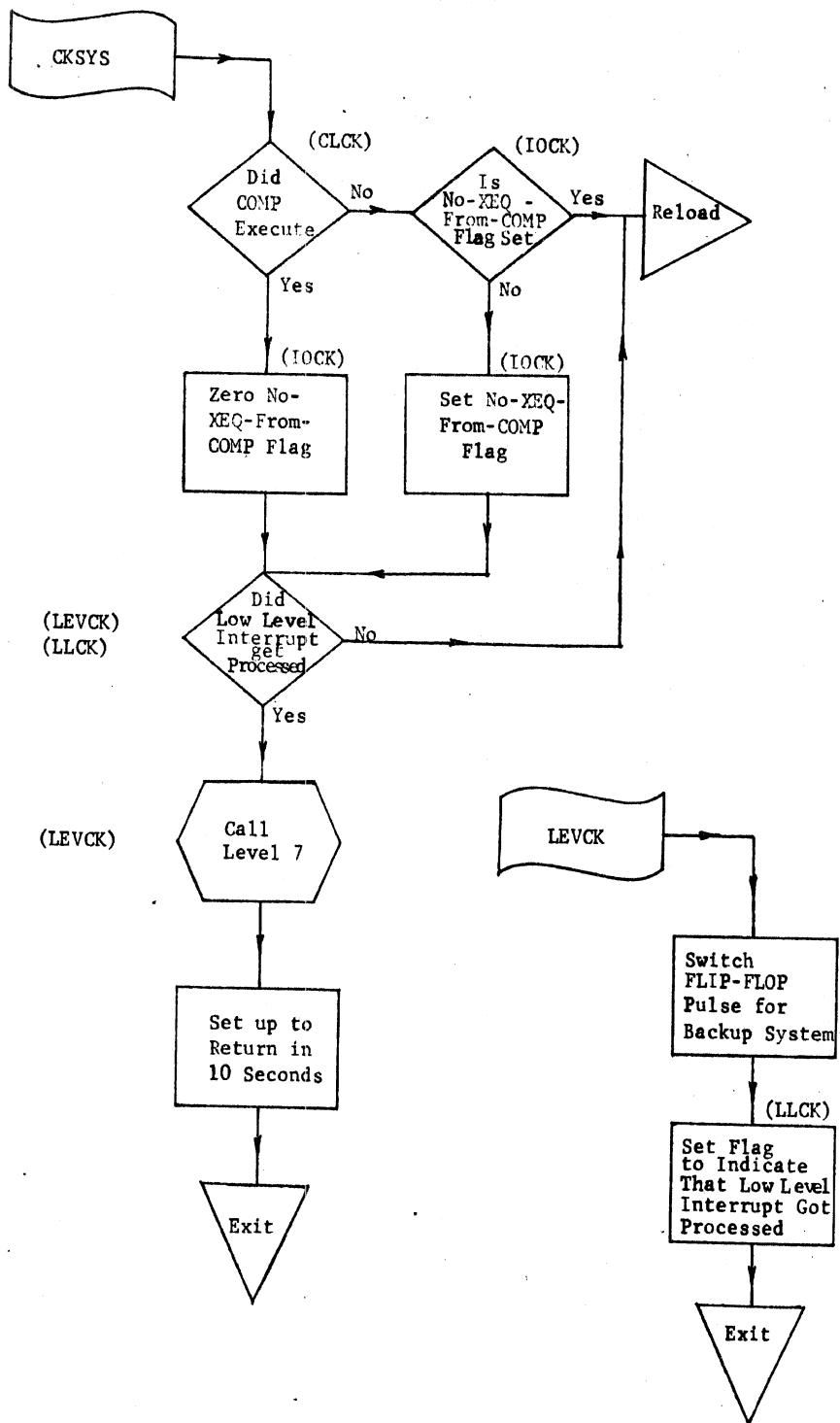

FIGURE D-9

ROUTINES TO CHECK FOR TASK COMPLETION  
(CKSTS AND LEVCK)

2. Response must be received from a low-level interrupt (LEVCK) which indicates that all high level interrupts have been processed.

Sub-routines OCCOL and COLMT (Figures D-10 and D-11) control the actual data collection and ramp metering. OCCOL collects occupancy information from all freeway and queue detectors. COLMT is called from OCCOL every 100 milliseconds through a CALL LEVEL (see Table D-1).

COLMT collects volume information from all the detectors in the corridor and performs the ramp metering operations. Two subroutines are utilized by COLMT, one for the one-at-a-time metered ramps (M1ATM) and one for the bulk service ramps (M1SPC).

After each metered ramp has been processed, a digital word is set up and sent to the field. This word is logically combined with a word from the power-on-and-off routine (see below) to insure that signals are not turned on unless scheduled.

The CLTAC and TAC routines (Figure D-12) control the transfer of the data from the previous minute to a special output table which in turn is transferred to a memory disk by MLINE. Data transferred includes volumes, occupancies, metering rates, number of signal changes, and digital output states. In addition, CLTAC synchronizes all time dependent functions.

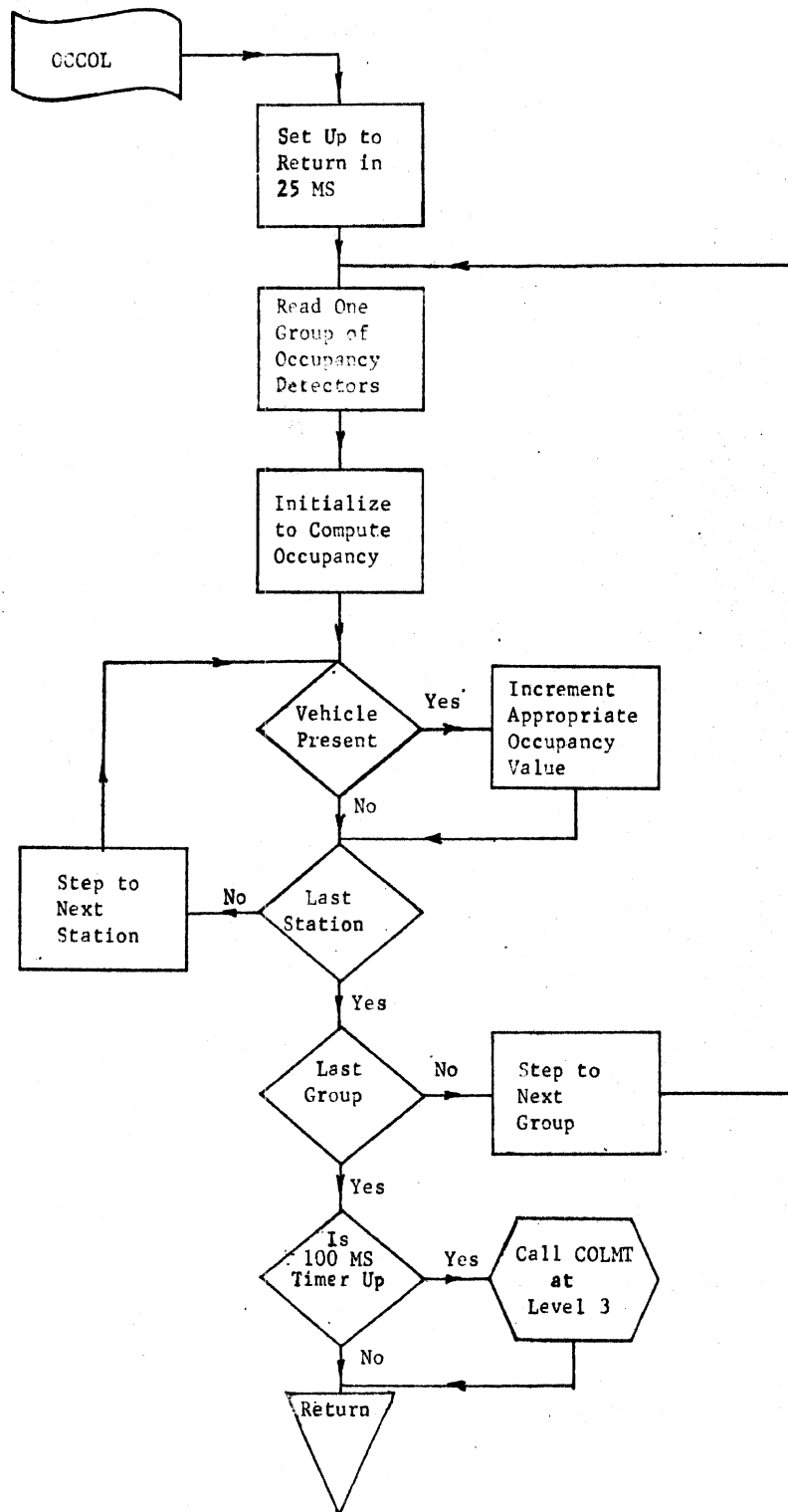

FIGURE D-10

OCCUPANCY DATA COLLECTION AND RAMP METERING ROUTINE  
(OCCUL)

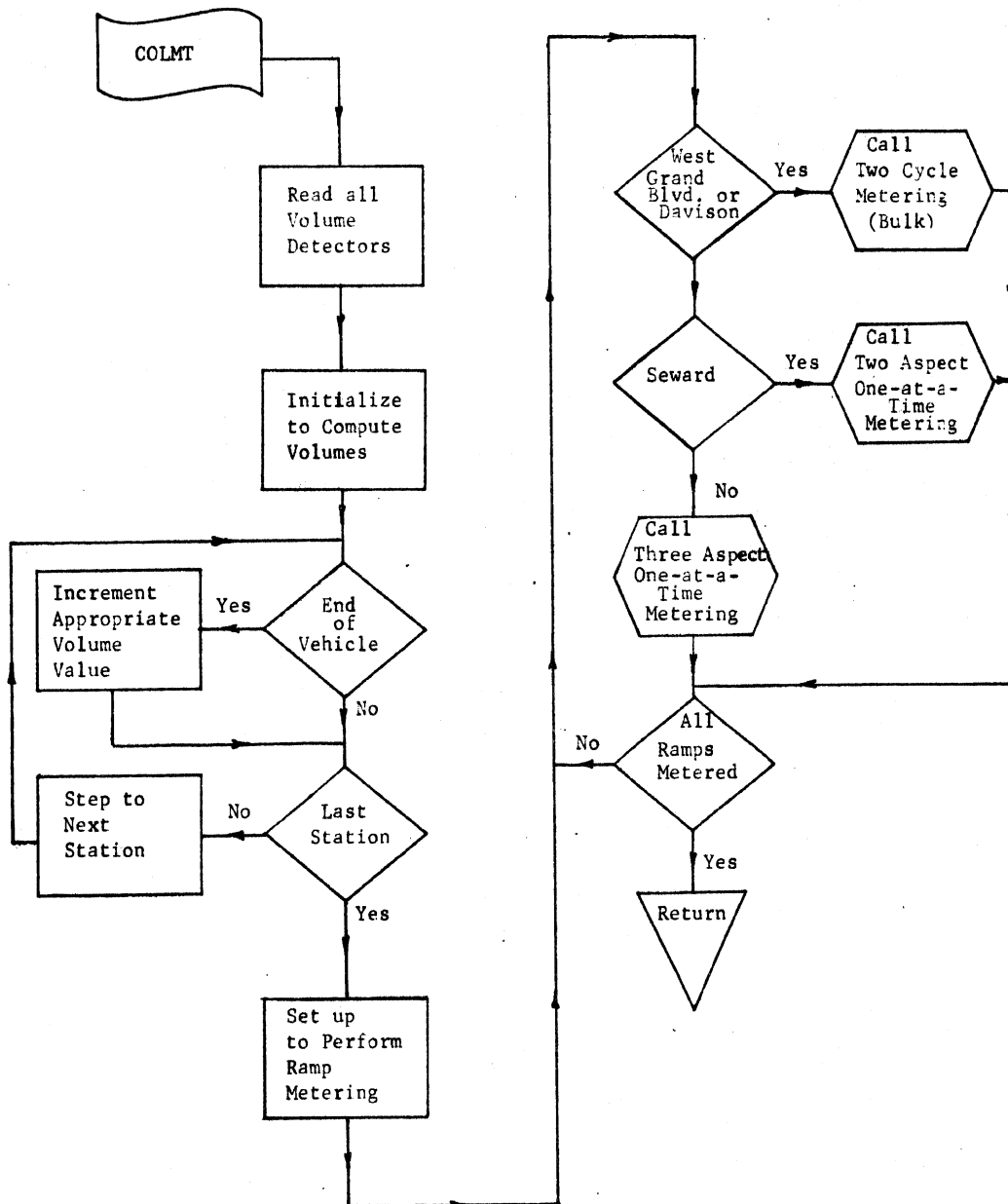

FIGURE D-11  
 VOLUME DATA COLLECTION ROUTINE  
 (COLMT)

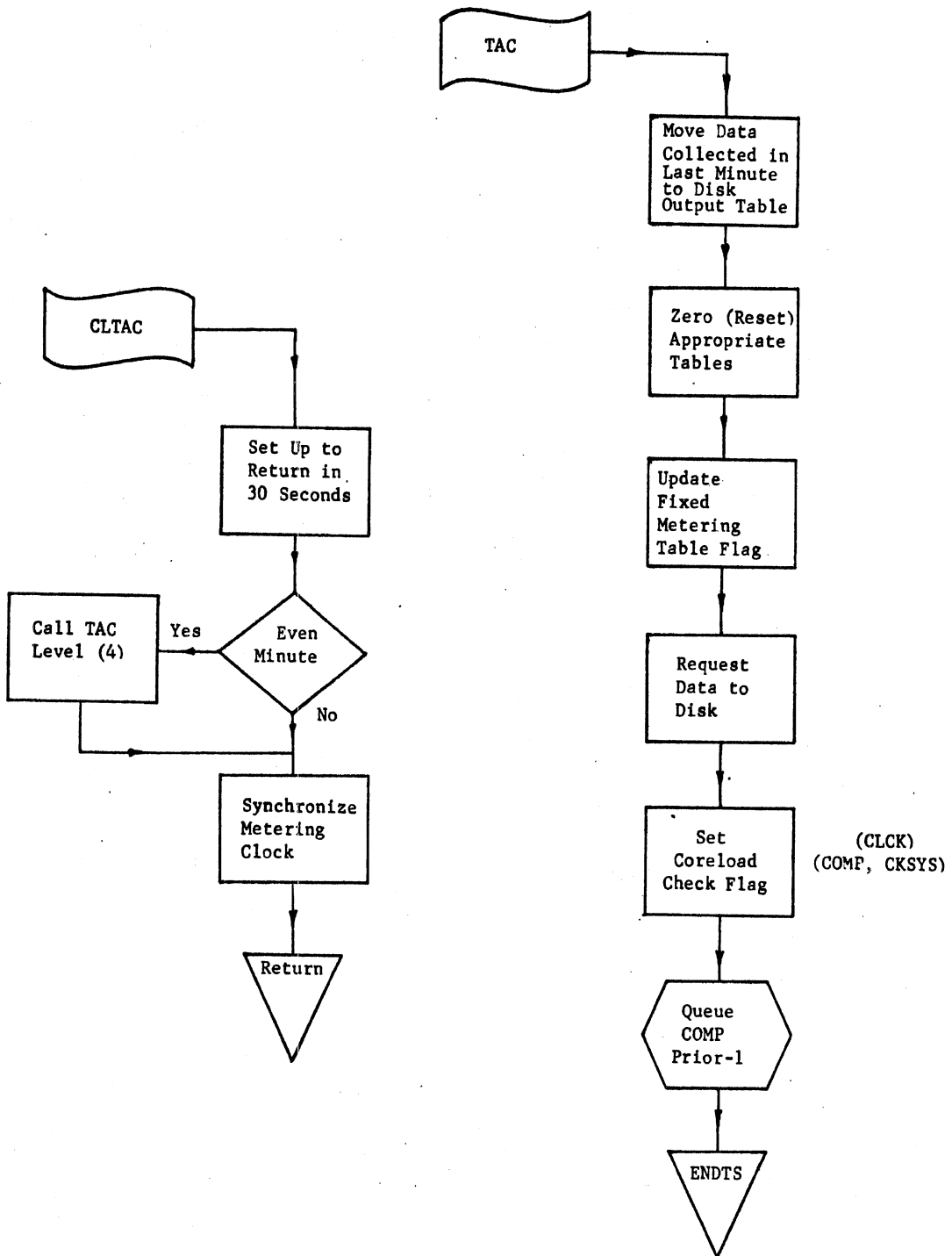

FIGURE D-12  
 DATA TRANSFER ROUTINES  
 (CLTAC AND TAC)

The POWON routine (Figure D-13) is provided to set the mask to control power to the signals and information signs in the field. It is called from a programmed timer at variable intervals. The mask routine is used to perform a mask operation which prevents interrupt recognition on the designated levels. The status of levels not designated is unchanged.

The routine entitled PUSHB (Figure D-14) accepts requests to change metering rates and/or type of information being displayed through the digital display unit. It then queues the appropriate core loads for further action.

When the CE interrupt, an IBM maintenance feature, is employed, the programs associated with it exist with all interrupt levels masked. In order to correct this condition the CEINT is included.

The CEINT routine (Figure D-15) is called from the console interrupt routine CONIN. The CE interrupt is used during the pause in CEINT.

Figures D-16 and D-17, respectively, provide the logic for one-at-a-time and bulk metering.

All of the features presented in this appendix form the total real-time Freeway control and surveillance system. As described, parts of the operation can be performed manually



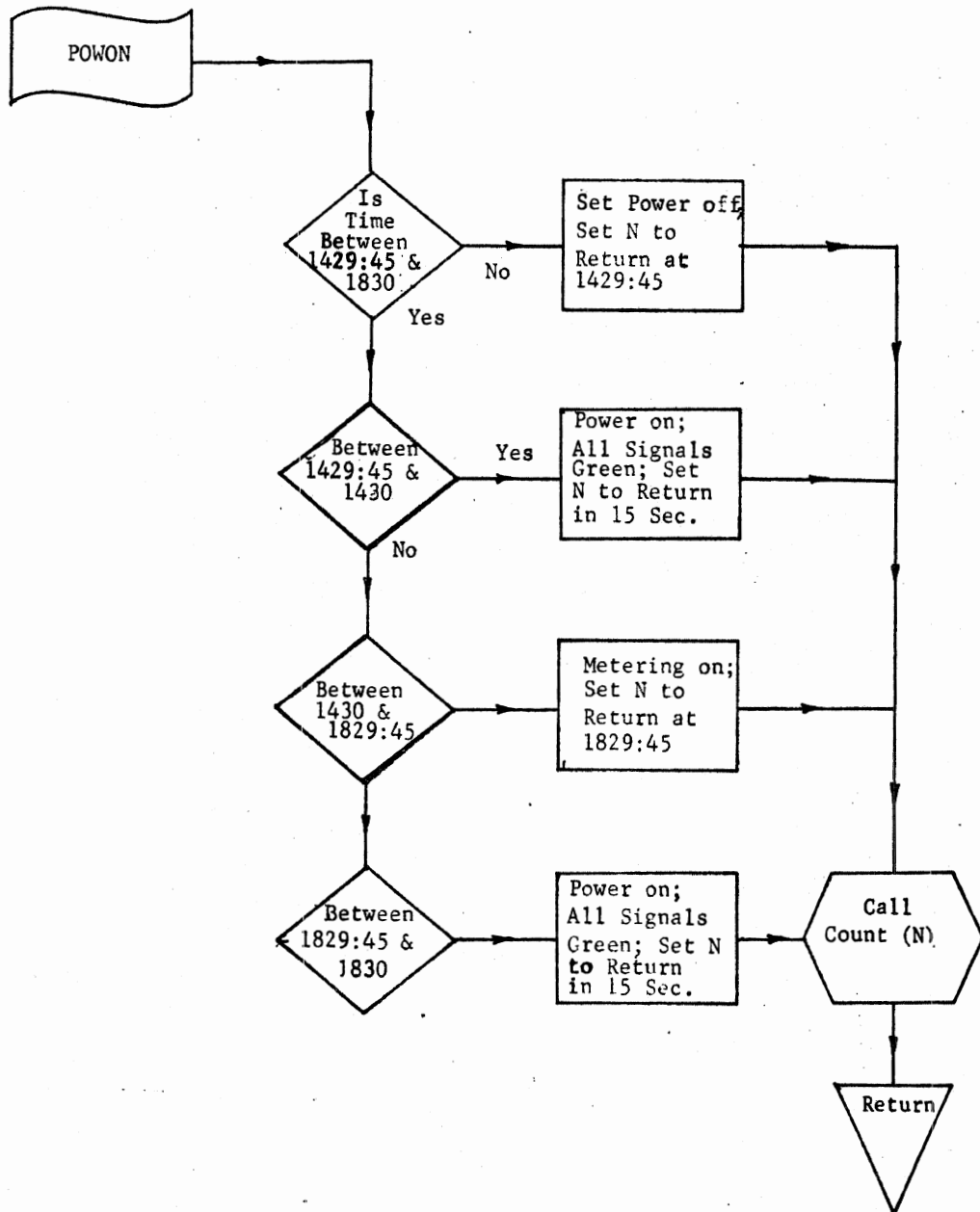

FIGURE D-13

SIGN AND SIGNAL POWER  
CONTROL ROUTINE (POWON)

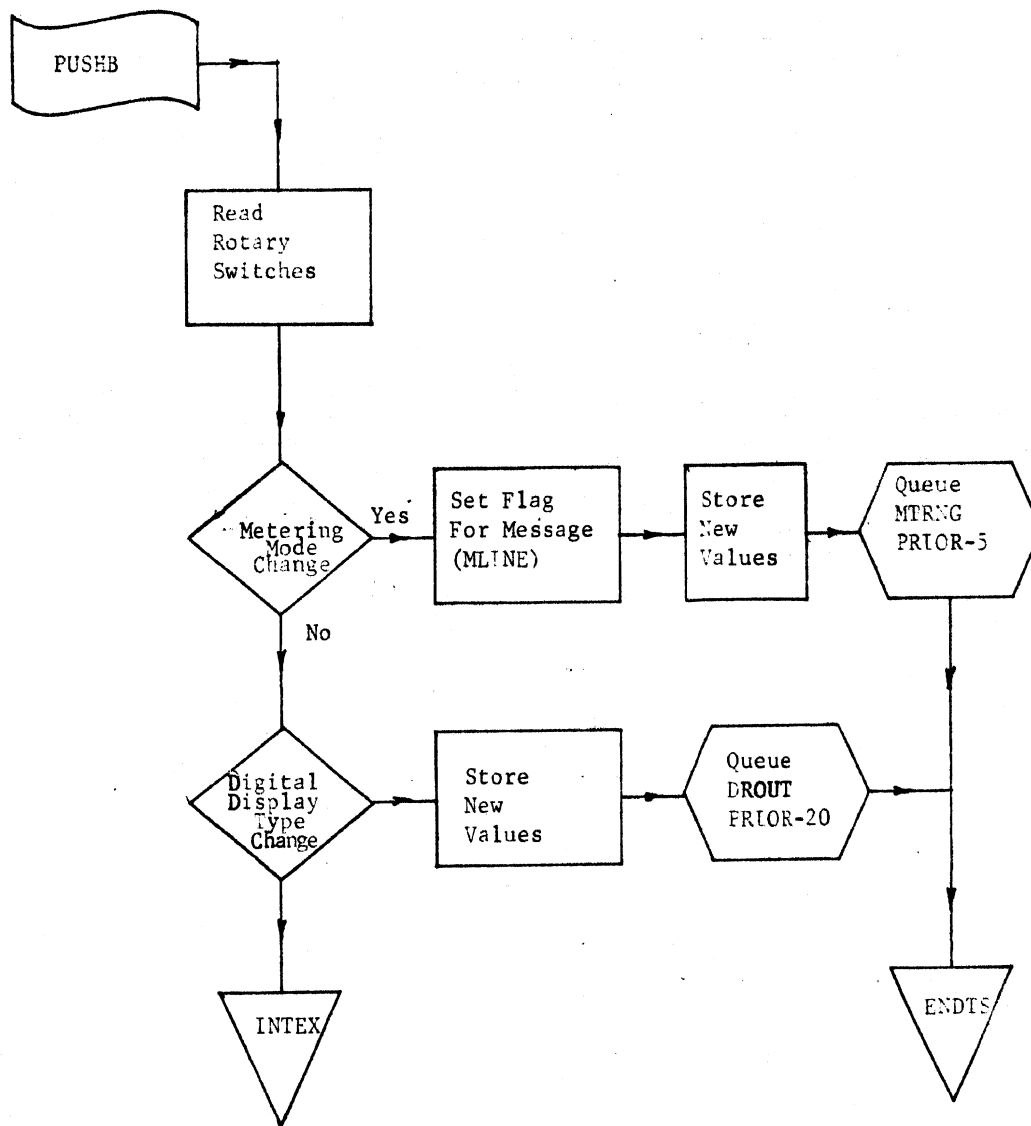

FIGURE D-14

ROUTINE TO ACCEPT MANUAL CHANGES IN METERING RATES AND DIGITAL DISPLAYS (PUSHB)

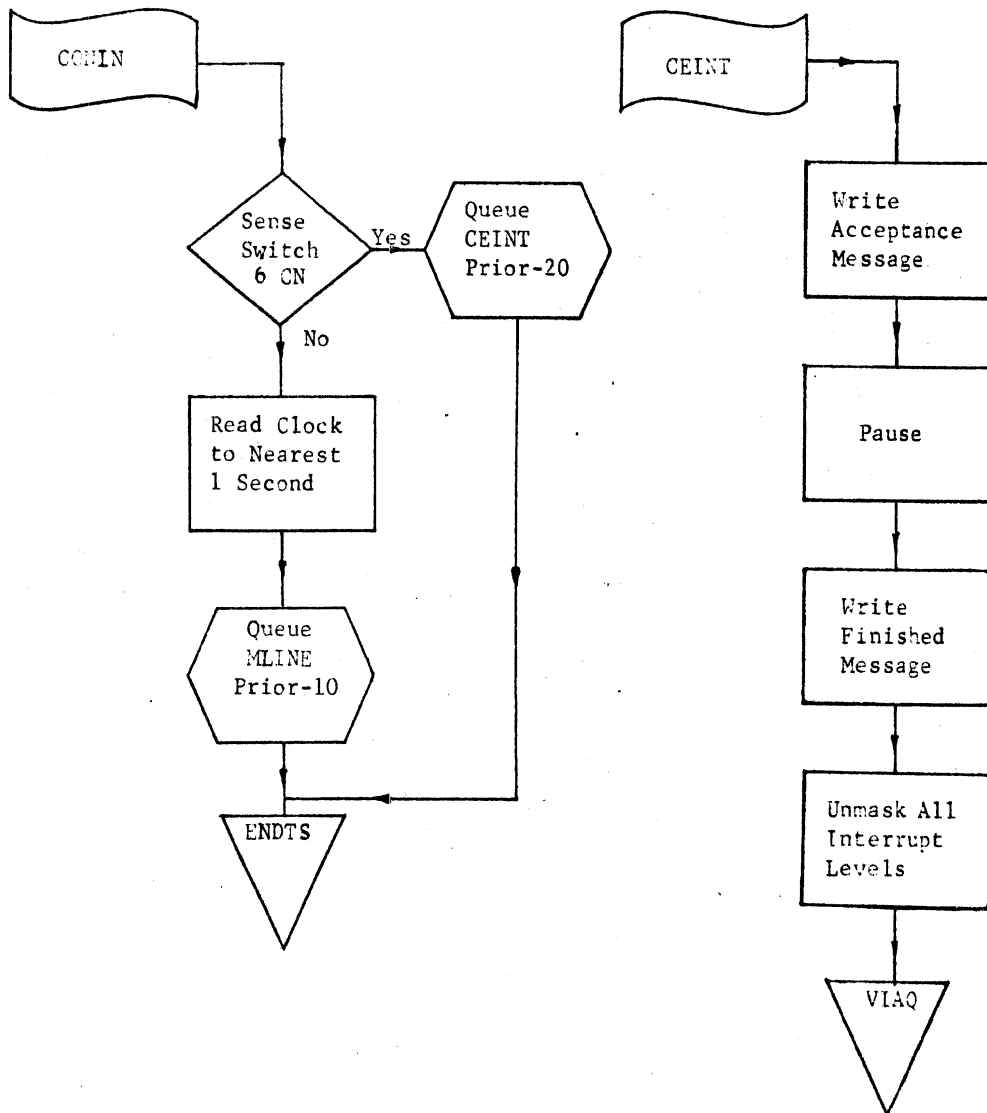

FIGURE D-15  
 CONSOLE INTERRUPT ROUTINES  
 (CONIN AND CEINT)

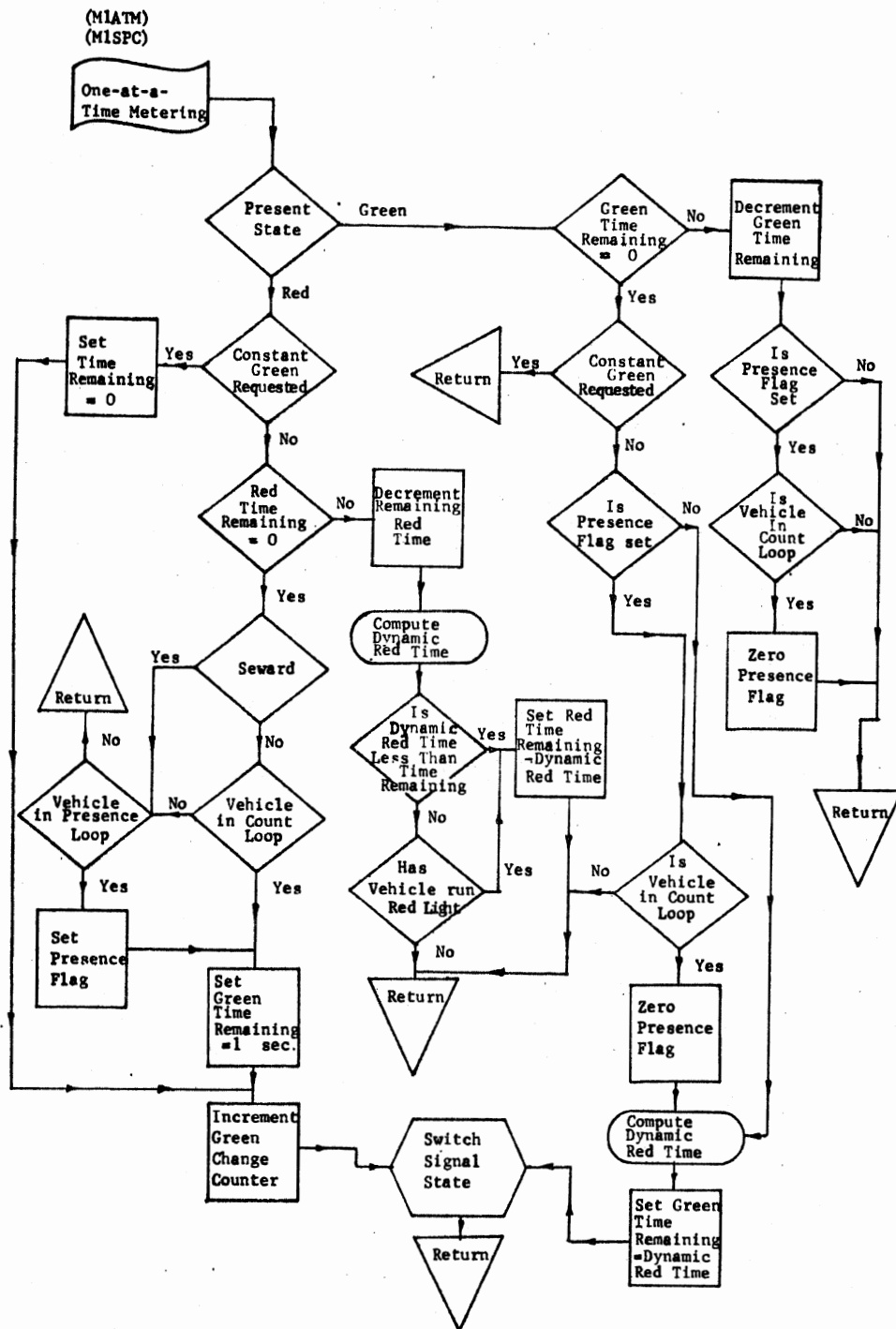

FIGURE D-16

ROUTINE FOR ONE-AT-A-TIME METERING  
(MIATM OR MISPC)

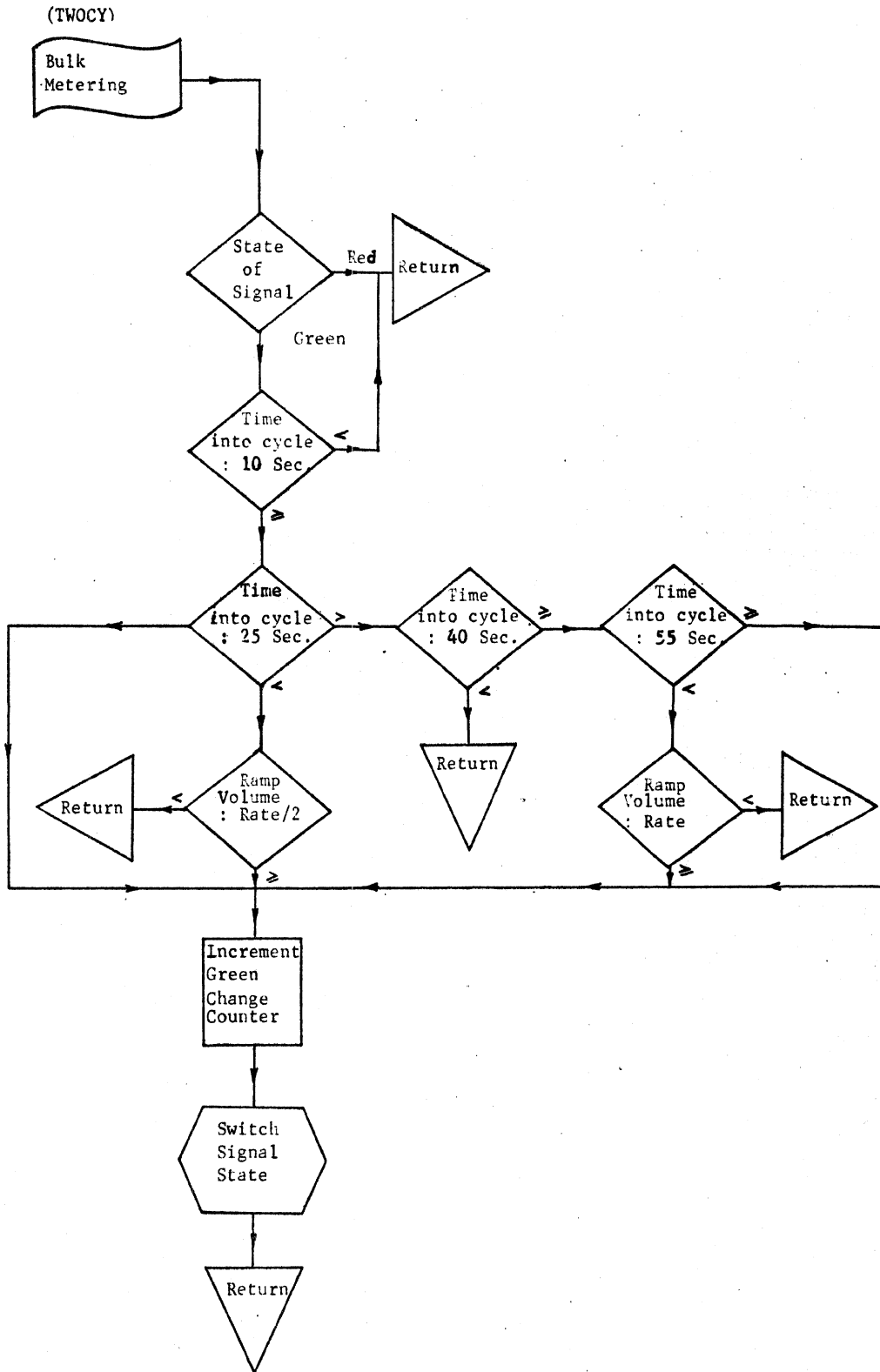

FIGURE D-17

ROUTINE FOR BULK METERING  
(TWOCY)

and in fact, this capability makes it possible for a most reliable back-up system in the event of computer malfunction. This manual back-up system, however, could never be operated so that it would fully and accurately reflect true field conditions.

APPENDIX E

DRIVER OBSERVANCE STUDY





## APPENDIX E

### DRIVER OBSERVANCE STUDY

This appendix briefly discusses the methods utilized to collect data concerning driver sighting and behavior toward the 19 new dynamic route guidance signs installed for this research project. The studies were performed in two separate series; one late in 1969 and the other early in 1970. Both occurred during the winter season.

The first series was conducted under the direction of the Human Factors group of the Highway Safety Research Institute. In it, volunteer test subjects were routed past the Variable Message Sign, Ramp Information Signs, Trailblazer Signs, and the Chicago Boulevard Blank-out Sign. As the subjects were routed through the test route, the study supervisor recorded whether they reported sighting the sign as well as recording their behavior. The instruction read to each subject individually is shown as Table E-1 and the field coding sheet as Figure E-1.

In the second series of observance tests (see Table E-2 and Figure E-2 for instructions and field sheets) additional signs were studied. This study was conducted under the supervision of the project staff since the same procedures and format were utilized as in the first series. The primary additional sign covered in this study was the Davison Expressway Blank-out sign. In addition, Ramp Information and Trailblazer signs and the Chicago Boulevard Blank-out Signs were studied again to increase the sample size.

TABLE E-1

INSTRUCTIONS

(First Series)

The experiment you are taking part in today concerns your ability to read and obey traffic regulation and information signs under normal traffic conditions. The signs we will be most concerned with will be those which direct you to the John C. Lodge Freeway. When you see such a sign, I want you to tell me and then I want you to obey its message. Most of these signs look similar to this. (Show picture of sign.) A lighted arrow on the sign informs you which way to go. It is your responsibility to obey those directions. In addition, we will pass a large information sign which may show any of several messages concerning Freeway entrance. When you see it, read the lighted message to me and obey it. I will also be giving you some verbal directions as we drive which you are expected to follow. At all times, drive within the speed limit and other traffic laws.

Remember; tell me when you see a Freeway directional sign and obey its message, read aloud the lighted portion (if any) on Freeway information signs (if you see an unlighted information sign, tell me) and obey its message,

follow my verbal directions, and obey traffic laws. I will not be able to give you any other information once we have started.

Do you have any questions?

O.K. ignore comments I make over the radio as they are immaterial to your task. They will merely inform the Center of our location.

DRIVER OBSERVANCE STUDY FIELD SHEET  
(First Series)

Name \_\_\_\_\_ Weather \_\_\_\_\_ Traffic \_\_\_\_\_  
Date \_\_\_\_\_ Time \_\_\_\_\_

	Report	Behav.	Comments
Wilson point East			
Hamilton North point West			
Oakman West point West			
Webb East point East			
Seward West point West			

Variable Sign			Info.			
			1	2	3	4
Blank						
Service & Seward						
Service & Chicago						
Service & Hamilton						
Second & Seward			TB1	TB2	TB3	
Second & Chicago						
Second & Webb						

Blankout 

FIGURE E-1  
DRIVER OBSERVANCE STUDY FIELD SHEET  
(FIRST SERIES)

TABLE E-2  
INSTRUCTIONS  
(Second Series)

The experiment you are taking part in today concerns your ability to read and obey traffic regulation and information signs under normal traffic conditions. The signs we will be most concerned with will be those which direct you to the John C. Lodge Freeway (north or north-bound). Some of these signs may be illuminated. When you see such a sign, I want you to tell me and then I want you to obey its message. The message may direct you to take a particular street or streets to reach the Freeway. If so, try to find the particular street or streets. I will also be giving you some verbal directions as we drive which you are expected to follow. At all times, drive within the speed limit and obey other traffic laws.

I will not be able to give you any other information once we have started. Do you have any questions?

DRIVER OBSERVANCE STUDY FIELD SHEET  
(Second Series)

Name \_\_\_\_\_ Weather \_\_\_\_\_ Traffic \_\_\_\_\_  
Date \_\_\_\_\_ Time \_\_\_\_\_

	<u>Report</u>	<u>Behavior</u>	<u>Comments</u>
Chicago Blankout			
Hamilton			
Webb			
Freeway			
Davison Blankout			
Twelfth			
Fenkell			

FIGURE E-2

DRIVER OBSERVANCE STUDY FIELD SHEET  
(SECOND SERIES)

APPENDIX F  
PUBLIC INFORMATION ACTIVITIES





## APPENDIX F

### PUBLIC INFORMATION ACTIVITIES

One of the most vital aspects of a project aimed at providing motorists with road condition and routing information through innovative signing techniques is assuring driver understanding of the sign messages conveyed. An intensive, area-wide campaign utilizing all mediums of communication is essential in accomplishing this purpose.

Appendix B of the report on the Ramp Information signs installed in the John C. Lodge Freeway Corridor describes a rather extensive public relations activity which produced less than satisfactory results (26). The campaign effort (Evaluation of a Dynamic Freeway Ramp Entry Guidance System) included the distribution of an explanatory leaflet at Freeway entrance ramps, the preparation and dissemination of a press release to all major television and radio networks and to the two major daily and all major weekly newspaper publications in the Detroit area, a press conference which resulted in several newspaper articles and television interviews and the appearance of material on the ramp condition information signs in office publications in the New Center area, the largest area of traffic generation for the Lodge Freeway Corridor.

The combined efforts of this campaign reached only approximately half of the Lodge Freeway users as determined through a study conducted by a return mail questionnaire (26). While it was initially planned to carry out a similar, yet slightly less extensive public relations campaign for the dynamic routing signs reported on in this report, the questionnaire results prompted a reevaluation of plans. As the extended campaign necessary to reach more motorists than had been reached through the previous effort would have been too costly, it was decided to limit efforts. This was felt to be justified not only because of the monetary savings involved, but also because of the simpler message conveyed by the majority of the Route Guidance Signs.

Early in November during the installation of the dynamic message signs, an informational report (Figure F-1) was issued to all Detroit and suburban newspapers and to radio and television stations. During this same period, the Principal Investigator participated in a Sunday morning "talk show" sponsored by the Traffic Safety Association of Detroit. The purpose of the program and of the news advisory to local media was to introduce listeners to the concept of an alternate route and to inform them that a new series of signs would soon appear on the Northbound Lodge Freeway to help guide them on the alternate route when the Freeway was congested.

# NEWS . . . FROM THE UNIVERSITY OF MICHIGAN

NEWS SERVICE, 6014 ADMINISTRATION BUILDING

ANN ARBOR, MICHIGAN 48104  
October 6, 1969 (18)  
Contact: Chris Carey  
Phone: 764-7260

## FOR IMMEDIATE RELEASE

EDITORS: Prof. Donald Cleveland, director of the Lodge Freeway information-sign project for U-M's Highway Safety Research Institute, will be available for interviews in Detroit on Wednesday (Oct. 8). You may call him or research engineer Karl Kleitsch in Ann Arbor at 763-1451 or in Detroit at 872-0750.

ANN ARBOR---Eighteen new signs are being installed in the Detroit's John C. Lodge Freeway corridor to help northbound motorists move faster.

The work, being done by the University of Michigan Highway Safety Research Institute, will affect traffic between the New Center area and the Lodge-Wyoming interchange.

Since early last June electronic signs have been guiding motorists onto the Lodge or advising them to avoid it. The signs get the information from a computer, which instantly analyzes traffic flow as measured by buried and overhead sensors.

One of the new signs, on westbound Grand Boulevard near Second Avenue, can display seven different messages. Depending on traffic flow, the sign will advise which ramp provides quickest access to the freeway or which surface streets to use when the freeway is congested.

A second sign, a "blank-out," is attached to the Hamilton Avenue bridge on the westbound Davison expressway. When the Davison-Lodge ramp is congested, the sign advises motorists to continue on Davison to 12th Street, then go north, rather than enter the freeway at Davison. By entering the freeway farther north, the motorist is able to avoid waiting in line.

The remaining 16 signs, known as "trailblazers," guide the motorist on surface streets through the corridor to the freeway. Depending on traffic conditions, one of two arrows on the signs is illuminated to recommend the quickest route to the freeway.

FIGURE F-1  
INFORMATIONAL PRESS RELEASE

In addition to the new signs, the number of detectors in the freeway corridor has been increased. Approximately 30 new detectors, located on the freeway and the streets which offer alternate routes, will supply the computer with information which is then passed on to motorists by the new signs.

The entire system of ramp information signs, the new signs, and detectors will give the northbound motorist up-to-the-minute knowledge of the constantly changing traffic conditions. By following the advice given by the system, northbound motorists will be able to reach their destinations with minimum delay.

Several city, state, and national agencies are assisting the Highway Safety Research Institute with this project. These agencies include the Detroit Department of Streets and Traffic, the Detroit Public Lighting Commission, the City of Highland Park, the Wayne County Road Commission, and the Michigan Department of State Highways. The research is sponsored by the Highway Research Board of the National Academy of Sciences.

#####

(HSRI, Cleveland)(Wayne, Oakland, Detroit Radio & TV)

bjw

FIGURE F-1  
(CONTINUED)

Staff writers of both the Detroit News and Detroit Free Press who had written articles on the Ramp Information Signs, and who had responded to the informational press release, were contacted and were again given information on the signs when they became operational. The operation of the signs and the review of the concept of an alternate route joining the Freeway downstream from the major sites of congestion were the main points of emphasis (Figure F-2). One initial article announcing the inauguration of usage of the new signs resulted from contacts with press representatives. This article appeared in the Detroit Free Press about one week after the signs became operational (Figure F-3). Several days later, the Free Press carried a follow-up article (Figure F-4) which reviewed Lodge Freeway research activities beginning with national Proving Ground research in the mid-1950's and summing up with the formation of the Detroit Freeway Operations Unit Technical Advisory Committee (5).

As stated above, it was initially planned to design and print an explanatory leaflet on the dynamic routing signs similar to that prepared for the ramp condition information signs (26). The high costs of art work and color printing, however, precluded the production of such a leaflet. In its place, a more simple, typed and hand-linked explanation of the signs was prepared by project staff

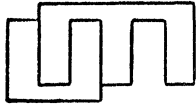

HIGHWAY SAFETY RESEARCH INSTITUTE

Institute of Science and Technology

Huron Parkway and Baxter Road

Ann Arbor, Michigan 48105

THE UNIVERSITY OF MICHIGAN

December 5, 1969

Attention: News Editor

Eighteen new dynamic traffic signs have been installed and are presently being operated in the John C. Lodge Freeway Corridor by the Highway Safety Research Institute of The University of Michigan. The signs are part of a continuing research project studying the effectiveness of providing motorists with information on traffic conditions in an attempt to improve traffic flow. The project has already installed several traffic innovations such as the ramp condition information signs operating at eight northbound entrance ramps.

The new signs, known as variable message signs, display a recommended route for traffic to follow through the Freeway Corridor. If followed, motorists will move through the Corridor with minimum delay. Traffic from the New Center Area north and west to Wyoming will be affected.

One sign displays as many as seven messages, depending on the level of congestion on nearby ramps and the Freeway. Another sign routes drivers away from the Davison to Lodge on-ramp when Lodge traffic is heavily congested. Sixteen other signs guide motorists through the Corridor along the best route to the Freeway itself.

For further information about the new signs and the entire research project, Dr. Donald E. Cleveland, Principal Investigator, or Dr. R. L. Pretty of the Highway Safety Research Institute, will be pleased to be available for interviewing. Arrangements may also be made to photograph the signs in operation.

For information and appointments, please contact Dr. Cleveland or Mr. Karl Kleitsch in Ann Arbor at 313/763-1451 or at 872-0750 in Detroit.

FIGURE F-2

DESCRIPTION OF DYNAMIC  
ROUTE GUIDANCE SIGNS

# Detroit Free Press

ON GUARD FOR 140 YEARS

December 2, 1969

## New Signs Tell Motorists Whether to Use Freeway

BY ROBERTA MACKEY  
Free Press Staff Writer

Eighteen new signs around the Lodge Freeway may help northbound motorists get there faster by going slower.

The signs were installed a week ago in the northbound corridor beginning at W. Grand Blvd. They are designed to tell motorists on surface streets the best route to the far end of the freeway during rush hour.

If there's a tie-up on the freeway or one of its approaches, arrows will advise them to stay on Second, or Puritan, or Fenkell, where the speed limit is lower but traffic is moving.

THE SIGNS are part of an experiment by the Highway Safety Research Institute of the University of Michigan, co-operating with the Detroit and Highland Park street departments.

The goal is to keep traffic moving smoothly by making the best use of all available routes.

Fifty detectors have been installed at key points in the area to monitor traffic conditions and flash the word to a computer installed in one of the Herman Kiefer Hospital buildings.

The computer, the same one which controls the signs at eight entrance ramps, will decide whether arrows on the



Free Press Photo

Lodge Freeway's new look

new signs should direct the motorist left toward a freeway entrance or straight ahead on a less congested street.

The signs are located on W. Grand Blvd. near Cass, where a considerable volume of traffic heads north and west to the freeway, and at "decision points" on Second, Hamilton, the Lodge Service Dr., Puritan, McNichols and Fenkell and on the Davison Freeway at the Lodge interchange.

ALL THE MOTORIST has

to do is follow the signs, but that is not as simple as it sounds.

"It's harder to make the decision to follow the arrow than it is to follow the tried and true way," says Dr. Donald Cleveland, director of the project.

The signs, which operate between 2:30 and 6:30 p.m. and can change about every four minutes, are less complicated than the ones installed last spring at ramp entrances.

FIGURE F-3

PRESS ANNOUNCEMENT AND DESCRIPTION  
OF DYNAMIC ROUTE GUIDANCE SIGNS

# Detroit Free Press

ON GUARD FOR 140 YEARS

December 7, 1969

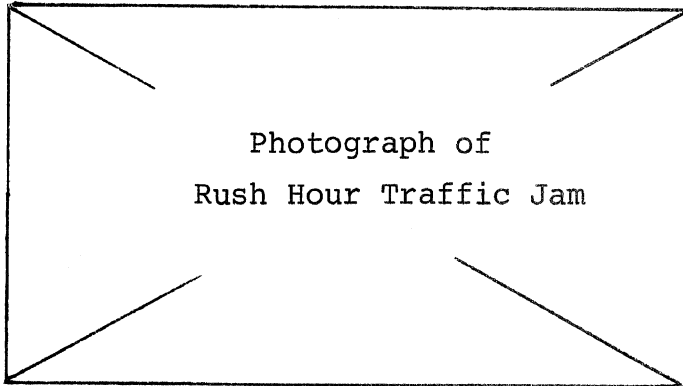

Photograph of  
Rush Hour Traffic Jam

The Lodge--a national proving ground

## Lodge Freeway a Guinea Pig For Traffic Experiments

BY ROBERTA MACKEY  
Free Press Staff Writer

When traffic engineers speak of the John Lodge freeway as the "national proving ground" they are not inviting you to test the top speed on your Corvette.

They are testing ways of keeping traffic moving at reasonable speeds and motorists' reaction to various traffic control devices.

They've been at it for years. Northbound drivers have endured the appearance and disappearance of assorted arrows, flashing lights and other advisories.

Just last week 18 new signs appeared on six streets that parallel the freeway. They advise northbound motorists whether to head for a nearby ramp or continue on the surface street.

The new signs were installed as part of the experimental program being conducted by the University of Michigan Highway Research Center in co-operation with local, county and state highway departments.

THE EXPERIMENTING began in 1955 when the city of Detroit installed television cameras on two overpasses.

City officials gathered in the Veterans Memorial to watch their private road show and declared it a hit.

They learned a lot of useful facts about the flow of freeway traffic, and the two cameras were the forerunner of the first full-blown project.

In 1960, 14 cameras were installed in the 3.2-mile stretch of freeway between W. Grand Blvd. and Davison. They proved that an electronic eye is invaluable in spotting trouble and in helping to clear obstacles out of the way as quickly as possible.

Within a couple more years, signs were installed over each lane, using information from the television to indicate by a green arrow or a red X whether the lane was clear ahead.

Motorists gradually learned to believe the signs, and except for a few incurables they got in the habit of changing smoothly to another lane when theirs was blocked.

Having served their experimental purpose, the lane signs were eventually taken out of service, except for rare occasions when workmen are at work on the freeway.

THE RED AND green lane indicators were soon joined

by the not-so-successful flashers which indicated an acceptable speed limit. Motorists crawling along at 10 miles an hour behind an accident were either enraged or frustrated by the news that they could be going 40 miles an hour.

They never got the signs' real message: That the road ahead would soon be clear, and they might then be able to go as fast as 40.

There was also a time lag between the actual situation and the change in the speed sign, and there was danger of drivers moving too fast for the current traffic condition.

Next, the research team turned their attention to the entry ramps. Big signs that flashed the warning "don't enter" were installed at nine

ramps. They were controlled by a system of electronic sensors, connected to a computer.

They were used mainly when traffic was congested. The experimenters tried for a while using the signs to warn of more congestion, but outraged drivers complained that they were being denied the use of the freeways their tax money had paid for. They ignored the signs.

In 1967, meters that flash red and green, to allow one driver at a time to enter the freeway, were installed on the ramps, and once some kinks were ironed out, they were declared a great success.

According to Dr. Robert Pretty, associate research engineer on the project, the meters have contributed more than anything else to a smooth flow of traffic.

By cutting out the stop-start pattern that results from too many cars trying to enter at once, the meters have speeded up traffic and cut down on accidents.

IN JUNE, AS a stab at curing the ramp congestion cause by the meters, eight map-like signs were erected at the top of the ramps. A complicated arrangement of arrows indicates whether the motorist would be better off to enter the closest ramp or proceed to another one.

The engineers are now trying to evaluate their effectiveness. The results of a questionnaire passed out to drivers on the ramps are being fed into a computer, and the reaction should be available soon.

The latest effort is directed at motorists on Second, Hamilton, the Lodge Service Drive, Fenkell, Puritan and McNichols. It is a simple combination of arrows, one pointing to the freeway, which is turned on if the freeway approach is clear. Another arrow pointing straight ahead flashes if the freeway route is clogged.

Lights have been synchronized on the parallel streets to keep traffic moving as smoothly as possible, and the research team feels that motorists who elect to stay off the freeway may make better time on short trips.

Because the whole effort is experimental, financed largely by a branch of the National Institute of Science, the decision about extending the use of any of the devices rests with local authorities.

The television cameras will be taken out of service this month. They have served their experimental purpose, and they are wearing out.

Meanwhile, state and local authorities have formed the Detroit Freeway Operations Committee to plan how to put the information gained to use throughout the freeway system.

FIGURE F-4

NEWSPAPER ARTICLE REVIEWING HISTORY  
OF LODGE FREEWAY RESEARCH



members (Figure F-5). This "leaflet" was provided to individuals who inquired about or commented on the route guidance signs.

Additional public exposure was received for the project at the time of the dedication of The University of Michigan's Highway Safety Research Institute building which, among many other things, housed the project administrative offices. At this time, The University of Michigan News Service issued press releases on the various activities of the Institute (Figure F-6). One such release dealt with the Lodge Freeway Project and was carried in many local Ann Arbor and Detroit area papers. While the release and subsequent articles did not deal specifically with the dynamic trailblazer signs, it did review the basic idea behind the research and all the signs which were installed in the Lodge Corridor. It is believed that this type of exposure, reminding the public that work is going on to try to alleviate the frustrating dilemma of peak period traffic problems is as valuable as a specific press release in that it serves as a constant reminder making people more conscious and hopefully more willing to obey the experimental sign.

Eighteen new signs have just been installed in the John C. Lodge Freeway Corridor. The signs operate during the 2:30 to 6:30 p.m. peak traffic period. The purpose of these signs is to tell you the best route to follow through the northbound Freeway Corridor to reach your destination with minimum delay.

The new signs are part of a continuing system of innovations in Freeway Corridor travel installed by the Highway Safety Research Institute of The University of Michigan. Already in operation are traffic signals to aid in entering the ramps, driver information signs located at Freeway entrance ramps, electronic detectors which measure the number of cars at various locations, and a computer to calculate the best information to be given to the motorist.

The signs are used to direct motorists to one of several alternate northbound routes. These routes follow streets running close to the Freeway which can accomodate many more cars than they do at present. These streets provide quick travel through the Freeway Corridor, often in less time than on the Freeway when it or the entrance ramps are heavily congested. There are many routing patterns which you can follow to travel north through the Freeway Corridor and the dynamic sign system tells you which route will require the shortest travel time.

Several city, state, and national agencies are cooperating with the Highway Safety Research Institute in finding ways of improving Freeway travel conditions. These agencies include the Highway Research Board of the National Academy of Sciences, the City of Detroit Department of Streets and Traffic and Public

FIGURE F-5  
EXPLANATORY LEAFLET

Lighting Commission, the Michigan Department of State Highways,  
the Wayne County Road Commission, and the City of Highland Park.

The largest and most complex of the new signs (Example 1)

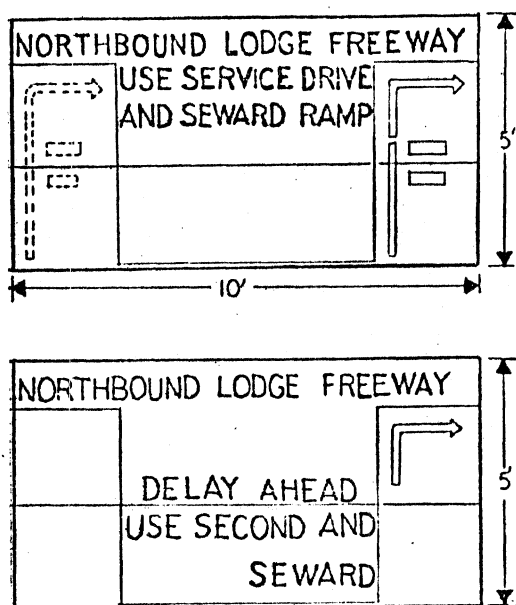

EXAMPLE 1

is located on westbound West Grand Boulevard between Cass and Second Avenues. This sign, capable of displaying seven different messages, tells you the best ramp at which to enter the Lodge Freeway and the best route to follow to arrive at that ramp.

If the ramp at West Grand Boulevard is uncongested and the Freeway is flowing well at this point, two large green arrows, indicating a through and right turn movement, will be illuminated.

FIGURE F-5

(CONTINUED)

In addition, two short bars at the right side of each arrow will be illuminated in green. These bars represent Second and Third Avenues respectively. You are being advised to go past these streets (which are the next two you approach) to make a right turn at the third intersection (the Lodge Service Drive). You can then enter the Freeway by the West Grand Boulevard ramp.

If there is heavy congestion on this ramp, you may be advised to proceed as before to the Service Drive (bypassing Second and Third Avenues as again indicated by short green bars) and then move north on the Service Drive to a specific ramp (Seward or beyond), the best point for entering the Freeway. This information is provided by a red neon message. One large green arrow with the short bars is illuminated to indicate a right turn at the Service Drive.

If there is heavy congestion at the Boulevard and other ramps or on the Southern end of the Freeway, you will be advised to use Second Avenue. Second Avenue has greater capacity than the Service Drive and leads to a network of streets (alternate routes) which direct you to the Freeway or through the Corridor with minimum delay. The sign reads "DELAY AHEAD. USE SECOND AND....", informing you of an uncongested nearby ramp or a recommended street to follow. This message is displayed in red neon lettering, and a large green right-turn arrow is illuminated to indicate a right turn at Second, the next intersection.

This sign gives you, the driver, more information than you really need at this point. It starts you on the route which will lead you to the Freeway at Meyers and beyond in the shortest time. All along your suggested route, you will encounter additional dynamic signs which are constantly up-dated by the computer which is receiving information from over fifty traffic speed and flow

FIGURE F-5

(CONTINUED)

detectors located throughout the Corridor. The most recently seen sign gives you the best possible route at the moment you pass it. Naturally, when the Freeway is flowing freely, you are directed to enter at the first uncongested ramp regardless of your approach to the study area. If, however, portions of the Freeway or entrance ramps are badly congested, you are told the best streets to use to reach a ramp located farther north. Sixteen signs (Example 2)

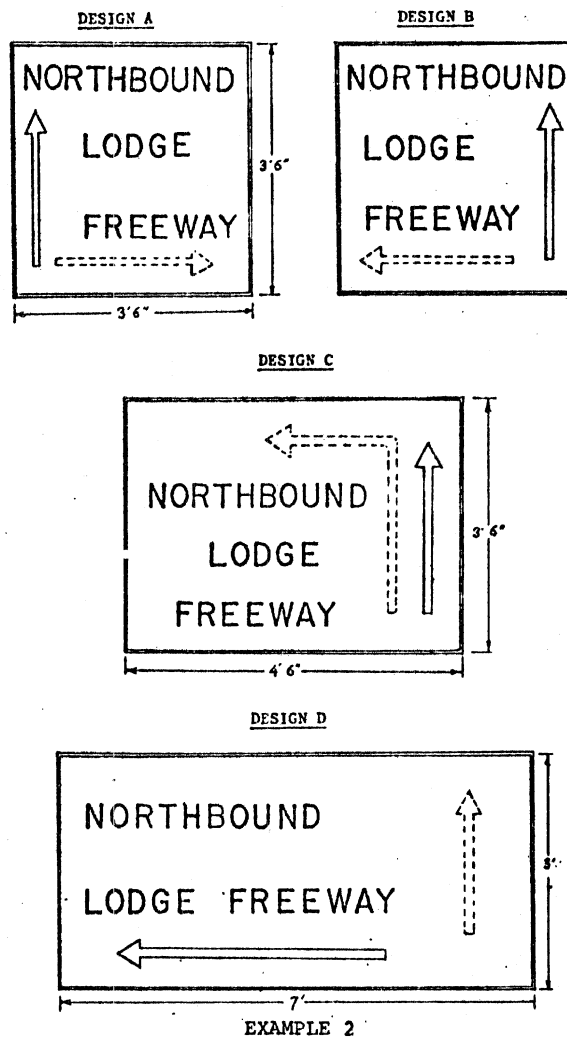
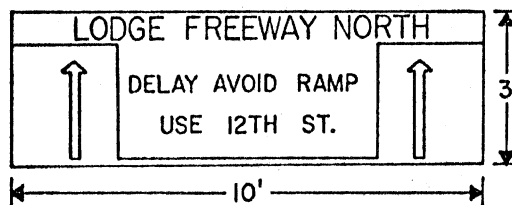

FIGURE F-5  
(CONTINUED)

located at decision points through-out the Corridor and eight signs located near entrance ramps provide up-to-the-minute directions to supplement the information given by the West Grand Boulevard sign. Painted signs confirm that you are on one of the approach routes which is being monitored.

To solve the serious traffic congestion at the Lodge Freeway and the Davison Expressway, a sign (Example 3)



EXAMPLE 3

facing westbound Davison traffic helps you to minimize delays at this point. When the Davison ramp to the Lodge Freeway is congested, you are advised to continue on the Expressway to Twelfth Street. Here you are immediately given further information by the sign system regarding the best ramp to use for entering the Freeway.

FIGURE F-5

(CONTINUED)

# NEWS . . . FROM THE UNIVERSITY OF MICHIGAN

NEWS SERVICE, 6014 ADMINISTRATION BUILDING

ANN ARBOR, MICHIGAN 48104

October 2, 1969 (5)  
Contact: Bill Hampton  
Phone: 764-7260

## FOR IMMEDIATE RELEASE

DETROIT--If five o'clock traffic ever trapped you on the expressway, or if you ever felt you were taking your life in your hands trying to get across a crowded city street, you've probably asked yourself whether there isn't a better way of doing things.

Researchers from the University of Michigan's Highway Safety Research Institute (HSRI) in Ann Arbor think there is a better way. They are now working on two projects in Detroit designed to make life easier for freeway drivers and for city pedestrians.

The HSRI traffic engineering team is led by Prof. Donald E. Cleveland of the U-M's civil engineering department. One of his projects involves testing traffic information and control devices on and around Detroit's John C. Lodge Freeway. A second project tests devices to control pedestrian traffic and to let motorists know where to look for them. The freeway project uses a number of neon "variable information signs" which tell drivers how to get to the Lodge Freeway by the quickest route, and advises them which entrance ramps are least congested.

What the signs say is governed by a computer on the grounds of Herman Keifer Hospital near the freeway. The computer makes its decisions based on data coming in from a network of more than 50 vehicle-counting and speed-measuring sensors located on the Lodge Freeway itself and on adjacent routes in the system.

The first variable information signs were installed at the approaches to eight northbound Lodge Freeway entrance ramps one year ago. This month (September 1969), the HSRI researchers are installing 18 more signs in the area.

Sixteen of these new "trailblazer" signs, including one capable of displaying any of seven messages, will tell motorists the easiest way to get to the Lodge expressway from other freeways and thoroughfares. When the new signs are in operation in early October they'll be able to direct motorists up to six miles along less busy through streets to avoid jammed entrance ramps and crowded freeway conditions.

The current work is sponsored by the Highway Research Board of the National Academy of Sciences and by state and local highway agencies.

FIGURE F-6

PRESS RELEASE REVIEWING BASIC  
CONCEPT OF LODGE RESEARCH





APPENDIX G

DATA FROM TRAFFIC ROUTING STUDY AT TEN  
DYNAMIC ROUTING INFORMATION SIGNS



TABLE G-1

OBSERVATION OF TRAFFIC ROUTING AT SIGN 1:  
WEST GRAND BOULEVARD (WGB) AT SECOND\*

Time of Day	Sign Indication	Route Used		Total Users	Statistical Significance
		WGB	Second		
3:00- 3:45 p.m.	WGB	526	215	741	N.S.
	Second	253	133	386	
	Total	779	348	1127	
3:45- 4:30 p.m.	WGB	542	210	752	N.S.
	Second	263	101	364	
	Total	805	311	1116	

\*Note: This observation was part of a license plate study, with the messages indicated as follows:

3:00 - 3:15 p.m. (WGB)  
 3:15 - 3:30 p.m. USE SERVICE DRIVE AND SEWARD RAMP (WGB)  
 3:30 - 3:45 p.m. DELAY AHEAD USE SECOND AND SEWARD (Second)  
 3:45 - 4:00 p.m. (WGB)  
 4:00 - 4:15 p.m. USE SERVICE DRIVE AND SEWARD (WGB)  
 4:15 - 4:30 p.m. DELAY AHEAD USE SECOND AND SEWARD (Second)

The study was completed in one day.

TABLE G-2

OBSERVATION OF TRAFFIC ROUTING AT SIGN 3:  
SECOND AT SEWARD

Time of Day	Sign Indication	Route Used		Total Users	Statistical Significance
		Seward	Second		
3:30-4:00 p.m.	Seward	102	760	862	N.S.
	Second	76	753	829	
	Total	178	1513	1691	
4:00-4:30 p.m.	Seward	72	876	948	N.S.
	Second	85	896	981	
	Total	157	1772	1929	
4:30-5:00 p.m.	Seward	141	1344	1485	N.S.
	Second	162	1489	1651	
	Total	303	2833	3136	
5:00-5:30 p.m.	Seward	133	1515	1648	N.S.
	Second	168	1801	1969	
	Total	301	3316	3617	
Over-all	Seward	448	4495	4943	N.S.
	Second	491	4939	5430	
	Total	939	9439	10373	

TABLE G-3

OBSERVATION OF TRAFFIC ROUTING AT SIGN 4:  
SEWARD AT SECOND

Time of Day	Sign Indication	Route Used		Total Users	Statistical Significance
		Seward	Second		
3:30-4:00 p.m.	Seward	91	22	113	N.S.
	Second	92	30	122	
	Total	183	52	235	
4:00-4:30 p.m.	Seward	93	24	117	N.S.
	Second	92	23	115	
	Total	185	47	232	
4:30-5:00 p.m.	Seward	112	45	157	N.S.
	Second	111	44	155	
	Total	223	89	312	
5:00-5:30 p.m.	Seward	149	53	202	N.S.
	Second	109	55	164	
	Total	258	108	366	
Over-all	Seward	445	144	589	N.S.
	Second	404	152	556	
	Total	849	296	1145	

TABLE G-4

OBSERVATION OF TRAFFIC ROUTING AT SIGN 6:  
SECOND AT CHICAGO

Time of Day	Sign Indication	Route Used		Total Users	Statistical Significance
		Chicago	Second		
3:30-4:00 p.m.	Chicago	86	533	619	N.S.
	Second	72	541	613	
	Total	158	1074	1232	
4:00-4:30 p.m.	Chicago	100	624	724	H.S.
	Second	83	829	912	
	Total	183	1453	1636	
4:30-5:00 p.m.	Chicago	150	1033	1183	S.
	Second	92	880	972	
	Total	242	1913	2155	
5:00-5:30 p.m.	Chicago	181	1229	1410	S.
	Second	130	1179	1309	
	Total	311	2408	2719	
Over-all	Chicago	517	3419	3936	H.S.
	Second	377	3429	3806	
	Total	894	6848	7742	

TABLE G-5

OBSERVATION OF TRAFFIC ROUTING AT SIGN 7:  
HAMILTON AT CHICAGO

Time of Day	Sign Indication	Route Used		Total Users	Statistical Significance
		Chicago	Hamilton		
3:00-3:30 p.m.	Chicago	156	368	524	N.S.
	Hamilton	173	534	707	
	Total	329	900	1231	
3:30-4:00 p.m.	Chicago	174	523	697	N.S.
	Hamilton	156	476	632	
	Total	330	999	1329	
4:00-4:30 p.m.	Chicago	162	534	696	N.S.
	Hamilton	172	693	865	
	Total	334	1227	1561	
4:30-5:00 p.m.	Chicago	203	697	900	N.S.
	Hamilton	208	705	913	
	Total	411	1402	1813	
Over-all	Chicago	695	2122	2817	N.S.
	Hamilton	709	2408	3117	
	Total	1404	4530	5934	

TABLE G-6

OBSERVATION OF TRAFFIC ROUTING AT SIGN 8:  
CHICAGO AT HAMILTON

Time of Day	Sign Indication	Route Used		Total Users	Statistical Significance
		Chicago	Hamilton		
3:00- 3:30 p.m.	Chicago	220	21	241	N.S.
	Hamilton	310	27	337	
	Total	530	48	578	
3:30- 4:00 p.m.	Chicago	344	37	381	N.S.
	Hamilton	319	40	359	
	Total	663	77	740	
4:00- 4:30 p.m.	Chicago	358	41	399	N.S.
	Hamilton	349	44	393	
	Total	707	85	792	
4:30- 5:00 p.m.	Chicago	371	54	425	N.S.
	Hamilton	375	50	425	
	Total	746	104	850	
Over- all	Chicago	1293	153	1446	N.S.
	Hamilton	1353	161	1514	
	Total	2646	314	2960	



TABLE G-7

OBSERVATION OF TRAFFIC ROUTING AT SIGN 12:  
WOODROW WILSON AT WEBB

Time of Day	Sign Indication	Route Used		Total Users	Statistical Significance
		Webb	W. Wilson		
3:30-4:00 p.m.	Webb	25	65	90	N.S.
	W. Wilson	21	79	100	
	Total	46	144	190	
4:00-4:30 p.m.	Webb	16	79	95	N.S.
	W. Wilson	20	92	112	
	Total	36	171	207	
4:30-5:00 p.m.	Webb	20	88	108	N.S.
	W. Wilson	19	109	128	
	Total	39	197	236	
5:00-5:30 p.m.	Webb	25	127	152	N.S.
	W. Wilson	9	95	104	
	Total	34	222	256	
Over-all	Webb	86	359	445	N.S.
	W. Wilson	69	375	444	
	Total	155	734	889	

TABLE G-8

OBSERVATION OF TRAFFIC ROUTING AT SIGN 13:  
WEBB AT WOODROW WILSON

Time of Day	Sign Indication	Route Used		Total Users	Statistical Significance
		Webb	W. Wilson		
3:30- 4:00 p.m.	Webb	236	8	244	N.S.
	W. Wilson	227	17	244	
	Total	463	25	488	
4:00- 4:30 p.m.	Webb	208	9	217	N.S.
	W. Wilson	193	12	205	
	Total	401	21	422	
4:30- 5:00 p.m.	Webb	220	3	223	H.S.
	W. Wilson	178	13	191	
	Total	398	16	414	
5:00- 5:30 p.m.	Webb	214	13	227	N.S.
	W. Wilson	183	9	192	
	Total	397	22	419	
Over- all	Webb	878	33	911	S.
	W. Wilson	781	51	832	
	Total	1659	84	1743	

TABLE G-9

OBSERVATION OF TRAFFIC ROUTING AT SIGN 14:  
HAMILTON AT DAVISON SERVICE DRIVE

Time of Day	Sign Indication	Route Used		Total Users	Statistical Significance
		Davison	Hamilton		
3:00- 3:30 p.m.	Davison	113	463	576	N.S.
	Hamilton	33	183	216	
	Total	146	646	792	
3:30- 4:00 p.m.	Davison	85	403	488	N.S.
	Hamilton	87	401	488	
	Total	172	804	976	
4:00- 4:30 p.m.	Davison	71	391	462	N.S.
	Hamilton	75	392	467	
	Total	146	783	929	
4:30- 5:00 p.m.	Davison	133	556	689	N.S.
	Hamilton	109	568	677	
	Total	242	1124	1366	
Over- all	Davison	402	1813	2215	N.S.
	Hamilton	304	1544	1848	
	Total	706	3357	4063	

TABLE G-10

OBSERVATION OF TRAFFIC ROUTING AT SIGN 15:  
DAVISON SERVICE DRIVE AT HAMILTON

Time of Day	Sign Indication	Route Used		Total Users	Statistical Significance
		Davison	Hamilton		
3:00- 3:30 p.m.	Davison	313	63	376	N.S.
	Hamilton	115	27	142	
	Total	428	90	518	
3:30- 4:00 p.m.	Davison	337	52	389	N.S.
	Hamilton	346	42	388	
	Total	683	94	777	
4:00- 4:30 p.m.	Davison	348	67	415	N.S.
	Hamilton	323	52	375	
	Total	671	119	790	
4:30- 5:00 p.m.	Davison	347	74	421	N.S.
	Hamilton	321	72	393	
	Total	668	146	812	
Over- all	Davison	1345	256	1601	N.S.
	Hamilton	1105	193	1298	
	Total	2450	449	2899	

APPENDIX H

PROJECT STATEMENT



APPENDIX H

"Excerpts From"

NATIONAL COOPERATIVE HIGHWAY RESEARCH PROGRAM

Highway Research Board  
National Academy of Sciences-National Research Council

FY '67

Project Statement

Research Project Title:

Optimizing Freeway Corridor Operations Through Traffic  
Surveillance, Communication, and Control

General Problem Area:

Special Projects

Research Problem Statement:

To meet present and future traffic demands, the combined freeway and surface street system must operate more efficiently. Freeways through heavily developed areas have limited right-of-way which prevents, on an economic basis, their reconstruction for increased capacity. Practical measures for increasing operational efficiency of these facilities through heavily traveled corridors should be developed by judicious application of traffic surveillance, communication, and control.

Urban freeways comprise a major portion of the traffic-carrying capacity of the total vehicular route system in American cities. It is believed that surveillance, communication,

and control of traffic on freeways as well as on the supplemental street systems can be improved, resulting in better service to the motoring public as a whole.

It is desired to apply the best traffic surveillance, communication, and control techniques in a typical urban freeway corridor and to study the results. Innovations that may be expected to enhance the operational efficiency should be explored.

The National Proving Ground for Freeway Surveillance Control and Electronic Traffic Aids located on the John C. Lodge Freeway in Detroit has been extensively equipped for freeway surveillance, and this freeway and the adjacent corridor is designated as the study site to develop and evaluate improved surveillance, communication, and control techniques.

Objectives:

1. Determine method(s) for increasing the effectiveness of the system which involves the freeway and the adjacent surface street network within the corridor. Evaluate the methods on the study site with or without the use of additional hardware.
2. Recommend equipment configurations (that is, type and location) for the improved system which will represent the optimum balance in cost-effectiveness.





