

**Smart Cruise Platform  
MDOT Contract No. 93-2165  
UMTRI No. 95-30**

**Final Report**

**Robert D. Ervin  
Paul S. Fancher  
Zevi Bareket  
Gregory E. Johnson**

**August 31, 1995**

Technical Report Documentation Page

1. Report No. UMTRI 95-30	2. Government Accession No.	3. Recipient's Catalog No.	
4. Title and Subtitle  Smart Cruise Platform		5. Report Date August 31, 1995	
		6. Performing Organization Code	
		8. Performing Organization Report No. UMTRI-95-30	
7. Author(s) Ervin, R.D., Fancher, P.S., Bareket, Z., Johnson, G.E.		10. Work Unit No. (TRAVIS)	
9. Performing Organization Name and Address The University of Michigan Transportation Research Institute 2901 Baxter Road, Ann Arbor, Michigan 48109-2150		11. Contract or Grant No. MDOT Contract No.93-2165	
		13. Type of Report and Period Covered Final Report August 31, 1995	
12. Sponsoring Agency Name and Address Michigan Department of Transportation 425 West Ottawa Lansing, MI 48909		14. Sponsoring Agency Code	
		15. Supplementary Notes	
16. Abstract  A vehicle-based testbed called the "Smart Cruise Platform" was instrumented, employed in full-scale testing, and augmented with an off-line data processing package for studying the in-use performance of Adaptive (or Intelligent) Cruise Control (ACC). The work was undertaken as a companion effort to two parallel projects that provided the ACC system, itself, and the means for testing 36 lay drivers in the southeast Michigan freeway environment. The test exercise demonstrated the functioning of the Smart Cruise Platform as an experimental tool and the suitability of its data processing package for reducing the exceptionally voluminous data that derive from continuous ACC operation. Test results illustrate a wide range of ACC performance issues and a variety of formats for considering their impact on safe operations, traffic flow, and driver satisfaction.			
17. Key Words Adaptive cruise control, remote sensing, headway control, traffic flow, traffic safety, intelligent transportation systems		18. Distribution Statement  Unrestricted	
19. Security Classif. (of this report) None	20. Security Classif. (of this page) None	21. No. of Pages 56	22. Price

## Table of Contents

1.0	INTRODUCTION .....	1
2.0	THE ADAPTIVE CRUISE CONTROL SYSTEM .....	2
2.1	Interface with the Driver .....	2
2.1.1	Driver Control .....	3
2.1.2	Driver Displays .....	4
2.1.3	Warning Cues .....	5
2.2	Sensor.....	5
2.3	Control Algorithm.....	7
2.4	Control Authority .....	9
2.5	Summary of Operational Boundaries .....	10
3.0	THE INSTRUMENTATION SYSTEM USED FOR DATA COLLECTION .....	11
4.0	THE PROCESSING OF DATA FROM FIELD TESTING USING THE SCP TESTBED .....	14
4.1	Measured (Acquired) Variables .....	15
4.2	Derived (Computed) Variables .....	18
4.3	Processing to Produce a Database of Test Results .....	19
5.0	FIELD TESTING CONDUCTED USING THE SCP .....	20
5.1	Test Method .....	20
5.1.1	The Route .....	20
5.1.2	Control Modes .....	24
5.1.3	Participants .....	24
5.1.4	Instructions to Driver Subjects .....	25
5.2	Findings from the Processing of Objective Data .....	25
5.2.1	Nature of Traffic and Roadway.....	26
5.2.2	Comparison of Driving Modes Based on Freeway Driving .....	27
5.2.3	Differences by Participant Characteristics .....	30
5.2.3.1	Age .....	30
5.2.3.2	Gender .....	33
5.2.3.3	Conventional Cruise Control Usage (Experience) .....	33
5.2.3.4	Interactions between Age, Gender, & Experience .....	35
5.2.4	Observations of Safety Implications Within the Objective Data..	37
5.3	Findings from Subjective Data .....	40
5.3.1	Findings from the Immediate Driving Mode.....	41
5.3.2	ACC Acceptance & Comfort Questionnaire .....	42
6.0	ANCILLARY ANALYSIS OF TRAFFIC FLOW DYNAMICS (Based on AVEC '94 Paper) .....	45
6.1	Traffic Density Modeling .....	45
6.1.1	Relationships Between Velocity & Headway .....	45
6.2	ACC Impact on Traffic Operations .....	48
6.3	Implications Drawn From This Analysis .....	52
7.0	CONCLUSIONS .....	53
	REFERENCES .....	53

**Final Report**  
**Smart Cruise Platform**  
**MDOT Contract No. 93-2165**

**1.0 Introduction**

This document constitutes the final report by the University of Michigan Transportation Research Institute (UMTRI) on a research project entitled, "Smart Cruise Platform," sponsored by the Michigan Department of Transportation under Contract No. 93-2165. The project has addressed the experimental aspects of research on an automotive control system called Adaptive Cruise Control (ACC) —also termed "intelligent" or "smart" cruise control and sometimes "autonomous intelligent" cruise control in certain prior publications by this Institute and others. The term "adaptive" has been increasingly adopted by the community working on this automotive innovation and will be used throughout this report. The ACC system automatically controls the headway between an equipped vehicle and the vehicle ahead, whenever the preset cruise speed causes one to overtake a slower vehicle ahead. Many believe that the market for these systems will grow vigorously in the late nineties, such that this technology may penetrate a large fraction of the motor vehicle population early in the next century. The research issues pertain to the ultimate suitability of ACC usage by individual drivers in a traffic stream that may include few or many other vehicles comparably equipped. The ACC function may also have long-term significance for the highway community since it appears to pose the first logical step for the incremental development toward automated highway systems (AHS).

In the present project, however, the scope of work was limited to meeting the following objective:

To develop and implement a physical testbed called the Smart Cruise Platform (SCP) for evaluating the safety and highway performance impacts of (ACC) systems for passenger cars.

The SCP testbed was realized on a Saab Turbo 9000 passenger car. The installed hardware supported both the ACC functionality, itself, plus a large complement of instrumentation for collecting data on ACC performance and the driver utilization thereof. This project was undertaken as a companion effort to two parallel UMTRI activities involving the study of ACC. The companion studies include a prior partnership between UMTRI and Leica AG, a Swiss manufacturer of laser-based range-measuring products and the provider of the basic ACC sensor. The Leica partnership has provided the ACC system package installed in the Saab plus a continuing series of sensor upgrades as the technology improves. Leica's involvement in sensor development in support of automotive manufacturers in Europe and the U.S. also provides UMTRI with an informed source of consultation on the progress of ACC development and the evolving automotive viewpoint on the configuration of ACC products.

A second companion study, entitled "Forward Collision Avoidance Systems," (FOCAS) is sponsored by the National Highway Traffic Safety Administration (NHTSA). The FOCAS study has provided the considerably greater level of funding needed for actually operating the SCP vehicle in real traffic. A field trial of the SCP,

involving 36 lay subjects and over 100 hours of data collection, was supported by the FOCAS project. With the goal of reducing raw data from these tests, a data processing capability was developed as an element of the SCP testbed capability. The processed results of this test activity are reported here as evidence of SCP capability (i.e., the fulfillment of this project's objective) and as the first substantive documentation of ACC performance in an operating freeway environment.

The final report is arranged to provide descriptions of the SCP testbed elements, themselves, as well as evidence of the testbed's implementation via the field trial program. The ACC system is described in Section 2.0 and the accompanying package of instrumentation is described in Section 3.0. The data processing activity, executed as an off-line process for reducing recorded data, is presented in Section 4.0. The field trial is covered in Section 5, with methodology presented in 5.1, findings of objective data in 5.2, and findings from subjective data in section 5.3. Recognizing that MDOT and any other organization having traffic management responsibility will also be concerned with the long-term impacts of ACC usage on traffic flow, an associated analysis was performed in anticipation of strings of ACC-equipped vehicles operating one behind the other. This analysis is presented in Section 6.0 of the report. Of course, we must await the availability of many SCP-like vehicles before experimental measurement of the ACC-string response characteristics can be made. Correspondingly, we also cannot directly assess the potential impact of large numbers of ACC-equipped vehicles on the behavior of groups of drivers in traffic until substantial numbers are available.

Conclusions of this study are presented in Section 7.0.

## 2.0 The Adaptive Cruise Control System

This section describes the operational properties of the baseline ACC system that was implemented in the initial configuration of the SCP testbed. The functional structure of the system is depicted in a block-diagram form in Figure 1.

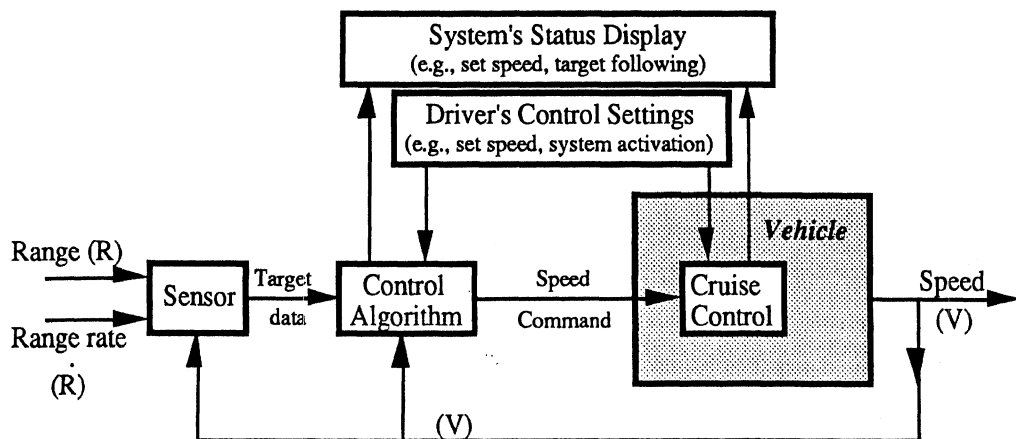

Figure 1. Baseline ACC system structure

## 2.1 Interface with the Driver

The ACC system incorporated three interfaces with the driver. Of the three, two interfaces enable the driver to provide control inputs to the system, while the third interface is informative only (to provide the driver with information regarding the status of the system).

### 2.1.1 Driver Controls

Since the ACC system utilizes the original cruise-control system of the vehicle, its operation depends upon activating the cruise control. Two “main” switches need to be activated for the ACC system to be operative: (1) the original cruise-control toggle switch mounted on the stalk (see Figure 2), and (2) the “on” switch on the ACC control unit. This unit, which is conveniently mounted in the central instruments console, is shown in Figure 3.

Setting and controlling the desired cruising speed is done using the original stalk-mounted switches (see Figure 2). Once the system is engaged, the desired cruising speed is set like a conventional cruise control — by pushing the “SET” button when the vehicle is traveling at that speed. Reengaging the system (if it was disconnected by depressing the brake pedal — much like the conventional cruise control), is done by pushing the “RES” side of the toggle switch. The “SET” and “RES” buttons are also used to incrementally increase or decrease the value of the “set” cruising speed (again, as in the case of a conventional cruise control). During normal operation, the driver does not need to interact with the ACC unit. However, a big, visible red button (on the lower-left side of the unit — see Figure 3) allows for an immediate system shut-off.

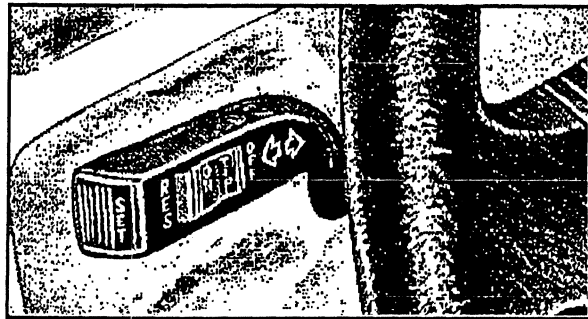

Figure 2. Stalk control switches

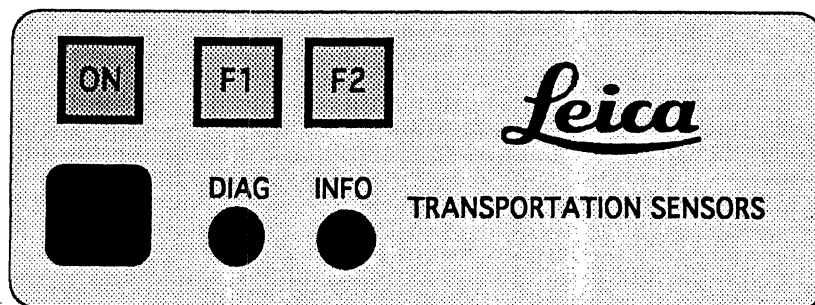

Figure 3. ACC control unit

### 2.1.2 Driver Displays

The driver's display unit is located above the steering column, so that it is well within the driver's view of the instrument panel. The display is shown in Figure 4.

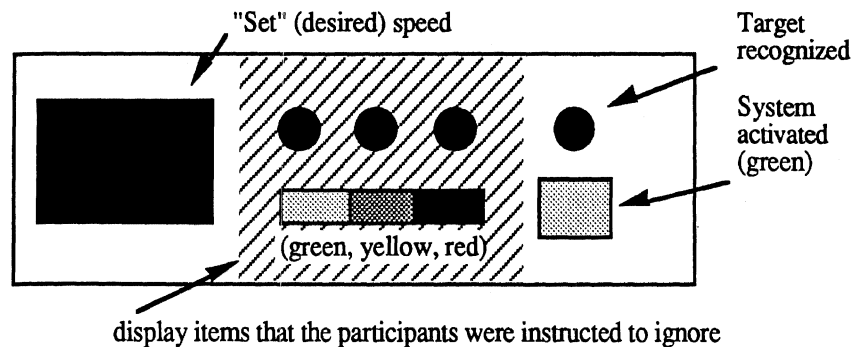

Figure 4. Driver's display unit

The desired speed, or "set" speed, is shown on the left side of the display. While in ACC mode, this speed will never be automatically exceeded by the car. The hatched area in Figure 4 shows, for general information purposes only, additional display items that the participants were instructed to ignore during the deployment exercise. These items include three diagnostic LEDs, and a multicolor illumination that provides some visual cue concerning deviation from the desired headway distance.

The green square LED on the right indicates when the system is engaged, and the red LED above it illuminates when a target that is "valid" to follow is detected by the sensor (see discussion in section 2.3 defining "valid" targets). The system stays active until the brake pedal is pushed, or until it is switched off. The system can be overridden at any time, without being disengaged, by depressing the accelerator pedal.

### 2.1.3 Warning Cues

The baseline system deployed here did not provide any active warning signal to the driver. However, warning was provided implicitly through a kinesthetic cue. Under most operational conditions, the speed of the vehicle was smoothly governed by small modulations of the throttle. When the combination of range and range rate to the preceding vehicle was such that a complete dethrottling (coastdown) was called for, it caused a momentary disruption in the smoothness of the drive, which was altogether noticeable. This initiation of coastdown served as a warning cue, calling the attention of the nonalert driver to all situations challenging the control authority of the ACC system.

## 2.2 Sensor

The infrared headway sensor (Leica-ODIN) measures the distance (range) and relative velocity (range rate) between the ACC-equipped car and the vehicle in front. These two parameters, together with the speed of the car, are imperative for a proper operation of the ACC system.

The ODIN sensor is mounted above the rear-view mirror, behind the front windshield (see Figure 5). The sensor is of a fixed monobeam type, which means that its field of view is fixed in shape and dimensions, and also in its orientation relative to the bearing vehicle. Potential impediments that this characteristic might impose on system's operation are discussed in section 2.5. The view angle of the ODIN is shown in Figure 6.

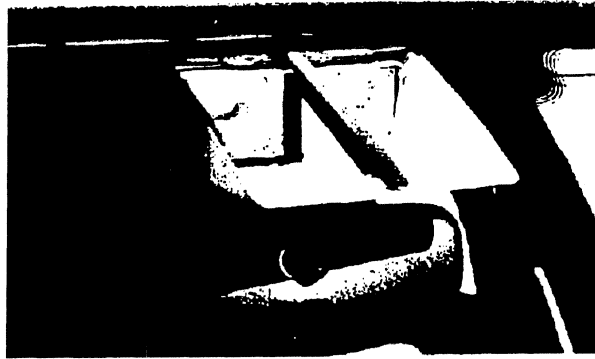

Figure 5. ODIN Infra-red sensor

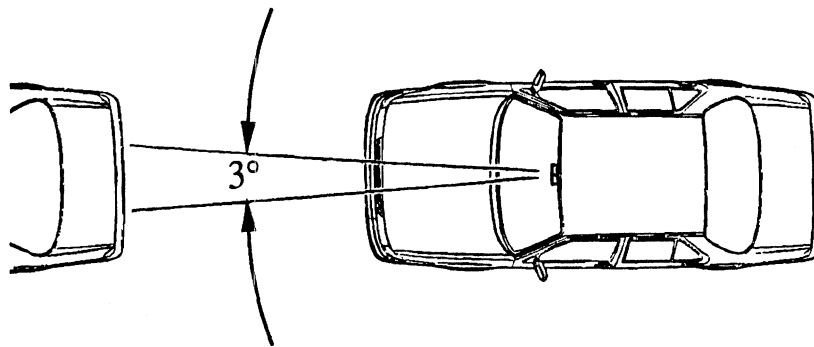

Figure 6. Sensor's field of view

The principle of range measurement employed by the ODIN sensor is called "time of flight." The sensor emits a light pulse, and then measures the time until the echo of this pulse is scattered back from the target. The emitter and receiver lenses of the sensor are clearly shown in Figure 5. Based on the fixed value of the speed of light, the distance to the target can be calculated from the time lapsed between emitting and receiving the light pulse. Digital signal processing that takes place in the sensor unit enhances the reading and improves the sensor's performance. In addition, the range data are also processed to provide relative-speed, or range-rate information.

The sensor is capable of measuring distances from 2 meters (6.56 ft) up to 160 meters (525 ft), and relative speed values between -400 kph (-248 mph) and +200 kph (124 mph). Measuring accuracy varies from  $\pm 0.5$  meter ( $\pm 1.6$  ft) at close ranges, to  $\pm 1.0$  meter ( $\pm 3.2$  ft) at large distances. Range and range-rate data are provided by the sensor to the ACC system at a frequency of 100 Hz (every 10 msec) for targets up to 120 meters (394 ft), and at a frequency of 10 Hz (every 100 msec) for targets that are further than 120 meters.

An additional data item that the sensor reports to the ACC system is "tracking." Conceptually, that information can be regarded as an indication of "target consistency." Momentary targets, which only flash through the sensor's view for a very short interval



(less than 300 milliseconds), will not be reported as tracked, or consistent, targets. Furthermore, since the sensor is of a monobeam type, only one target (the one that is closest) is reported each time. If the range data indicate that the target lacks consistency, that is, the variation between two consecutive readings is too large, that target will also not be reported as tracked. Figure 7 shows two targets that are detected. Only the closer one will be reported, until it drops out of the sensor's view so that the distant target is now reported.

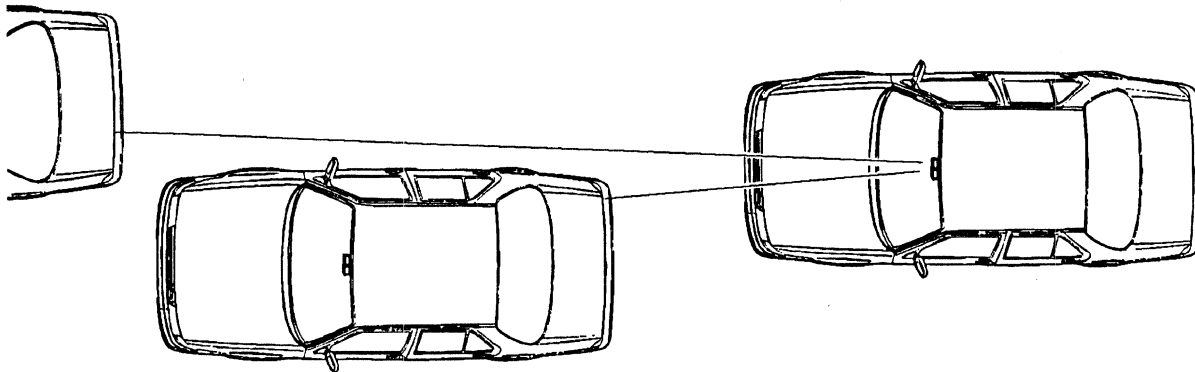

Figure 7. Multiple targets

When a target is detected by the sensor, its range, range-rate (relative speed), and also the tracking information are reported to the ACC control unit. Consequently, those data, together with additional information, is evaluated by the control algorithm to determine the course of action (if any), that is needed to be taken.

### 2.3 Control Algorithm

The control algorithm is a sequential process that begins by assembling data from the various sources, continues through processing the data to make decisions, and it ends by providing an output signal. In the baseline ACC system (see also Figure 1), the input data for the control algorithm include target data (range, range rate, and tracking), driver's setting data (set speed), and vehicle's speed. The output is a commanded speed value, which is the input to the conventional cruise control.

Once the controller assembles the necessary data, the decision-making process commences. Figure 8 describes the control algorithm by way of a schematic. When the information from the sensor indicates that an object was detected within its field of view, the algorithm's first decision needs to address the validity of that target.

The controller discriminates between targets that should be ignored and targets that should be considered. Stationary objects (e.g., road signs), or traffic in the opposite direction, are classified by the algorithm as nonvalid targets. Such targets will cause no control action to be taken. Vehicles that are traveling in the same direction as the host vehicle are classified as valid targets, and the necessity of a subsequent control action is considered by the controller. In addition, target data beyond practical bounds will also classify it as a nonvalid target. These bounds are defined by a combination of range, range rate, and speed.

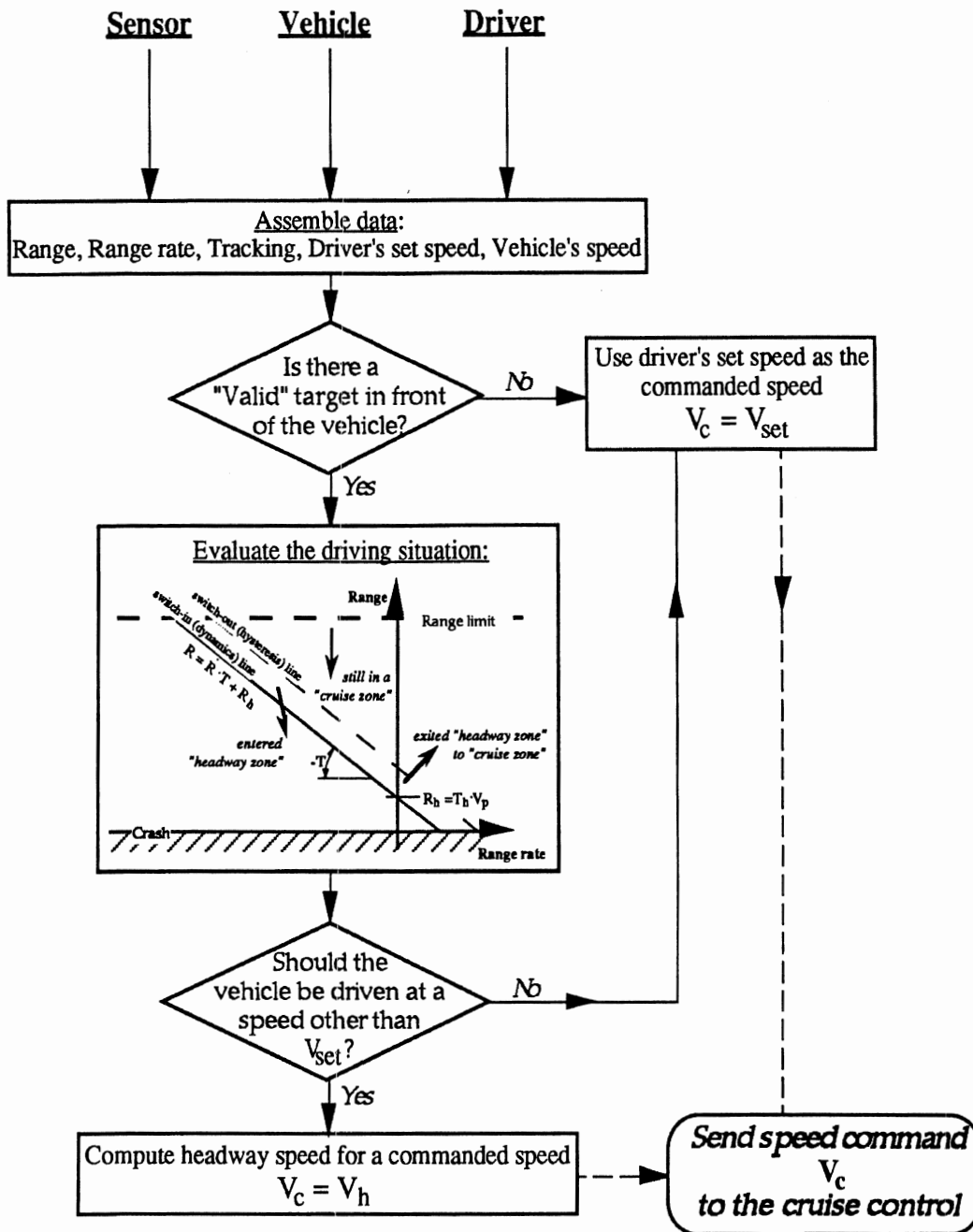

Figure 8. Autonomous Cruise Control algorithm

The process outlined below is used by the control algorithm to determine the validity of a target positioned at a range,  $R$ , in front and traveling at a relative speed, or range-rate,  $R$ :

- compute the speed of the preceding vehicle according to  $V_p = V + \dot{R}$
- if the target is moving at a reasonable speed, and at the same direction as the host vehicle ( $V_p > 0.3 \cdot V$ ), it is a valid target.
- if the target is close enough ( $R < 525\text{ft}$ ), but not so close that it might be an erroneous optical reflection ( $R > 15\text{ft}$ ), it is a valid target.

All other targets are ignored by the controller.

If a valid target is detected by the sensor, the controller evaluates the driving situation, calculates the appropriate headway distance and corresponding speed, and then sends a speed command so that the headway distance is achieved. If no target is detected, or when the vehicle in front either disappears or accelerates above the desired speed, the ACC operates as a normal cruise control according to the speed set by the driver.

As shown in Figure 1, the output of the control algorithm is a speed command to the cruise control system of the vehicle. As shown in Figure 8, the commanded speed can be either the driver's set speed ( $V_{set}$ , as in a conventional cruise control), or some headway speed ( $V_h$ ) that was computed by the controller. If a headway speed needs to be computed, a sliding-control approach is used [7]. Relative to the time it takes for the vehicle to close headway gaps and to reach the desired range, it is assumed that the speed response is significantly faster. That is, it is assumed that in comparison to range changes, speed variations are almost instantaneous ( $V \approx V_C$ ). Therefore, for longitudinal control purposes, the vehicle can be modeled as a first order system. The equation, below, represents such a system.

$$V_h = V_p + \frac{R - R_h}{T}$$

where  $V_p = V + \dot{R}$

and  $R_h = T_h \cdot V_p$

## 2.4 Control Authority

The longitudinal control authority given to the baseline ACC system was limited to throttle manipulation. Brakes are not applied automatically by the system to control speed. Target acquisition, however, is fully automatic. Driver input in selecting a target is not required, and the system autonomously chooses a target to follow.

Since brake activation was not incorporated in the baseline system, the maximum available deceleration rate was the prevailing deceleration during zero-throttle coastdown (approximately 0.05g). During acceleration, however, not all of the available engine power was utilized. Preliminary tests showed that when the vehicle switches from headway operation ( $V_C < V_{set}$ ) to cruise ( $V_C = V_{set}$ ), any large change in commanded speed usually involves a startling level of acceleration because of the high-output engine. For that purpose, a "taming" feature had to be applied during acceleration. This feature was in a form of speed "ramps," or a "moving-window." Namely, when acceleration is required the commanded speed ( $V_C$ ) sent to the cruise control never exceeds a value that is 6 kph (3.7 mph) more than the current speed of the vehicle. This incremental speed increase using 6-kph steps at a time continues until the desired speed is achieved. This taming feature also provides a presumed safety benefit. That is, if the preceding vehicle accidentally drops out of the sensor's view (e.g., when going around a curve) so that the system attempts to resume  $V_{set}$ , the slow acceleration level caused by the 6-kph steps significantly reduces the risk of getting too close before the target is reacquired. Clearly, opposing scenarios also exist. When moving to a vacant lane or in initiating a passing maneuver, drivers might feel that the vehicle is too-lame or not responsive enough. However, safety considerations prevailed in this case. Furthermore, the driver always has the option of overriding the throttle momentarily to get higher acceleration without disconnecting the system.

## 2.5 Summary of Operational Boundaries

This section presents a summary regarding the operation of the ACC system. These boundaries are a result of either the system's design, or its components characteristics, or both. Explanations as to the cause or the rationale behind these boundaries are also provided.

### Following distance:

*Maximum bound* : 160 meters (525 ft).

*Minimum bound* : 4.6 meters (15 ft).

*Rationale* : The maximum bound is determined by a hardware-related limitation. The minimum bound is set deliberately to reflect the fact that the sensor is mounted far behind the bumper (top of windshield) and to minimize the effect of erroneous reflections from the hood.

### Operating speed:

*Maximum bound* : 160 kph (100 mph).

*Minimum bound* : 24 kph (15 mph).

*Rationale* : Both bounds are established for safety reasons. The lower bound, however, is determined by the vehicle's cruise-control system. This system does not operate below 15 mph. Though the cruise-control system can operate above 100 mph, it was decided that for safety reasons the ACC should not be engaged above that value. In any case, the speed commanded by the ACC never exceeds the driver's set speed (see section 2.1.2).

### Acceleration/Deceleration:

*Acceleration bound* : No definitive numerical value. The acceleration level depends on the instantaneous speed and gear, and it can vary between approximately 0.04 and 0.1g.

*Deceleration bound* : Similar to the acceleration, there is no definitive numerical value. Actual limit is the resultant dethrottling coastdown (approximately 0.05g, depending on instantaneous speed and gear).

### Sensor's coverage:

*Maximum bound* :  $\pm 1.5$  degrees relative to the centerline of the ACC vehicle.

*Minimum bound* : none.

*Rationale* : The sensor has a limited field of view (see section 2.2 and Figure 9).

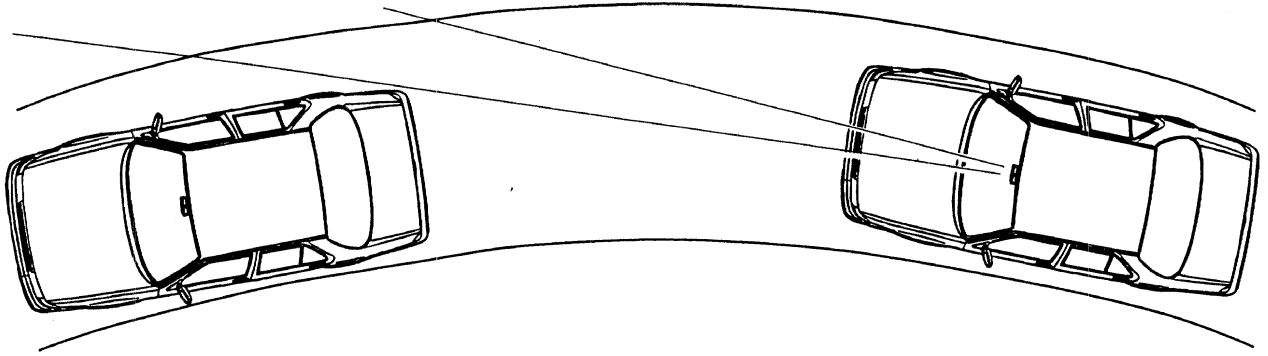

Figure 9. Target outside sensor's view

### **3.0 The Instrumentation System Used for Data Collection**

The instrumentation system for the ACC vehicle gathers data from three separate systems: the ACC controller, a video system, and a set of ancillary transducers. Each system produces an asynchronous serial data stream. The data are collected by a laptop computer. Each system provides distinct information about the vehicle and the environment in which the ACC system is operating.

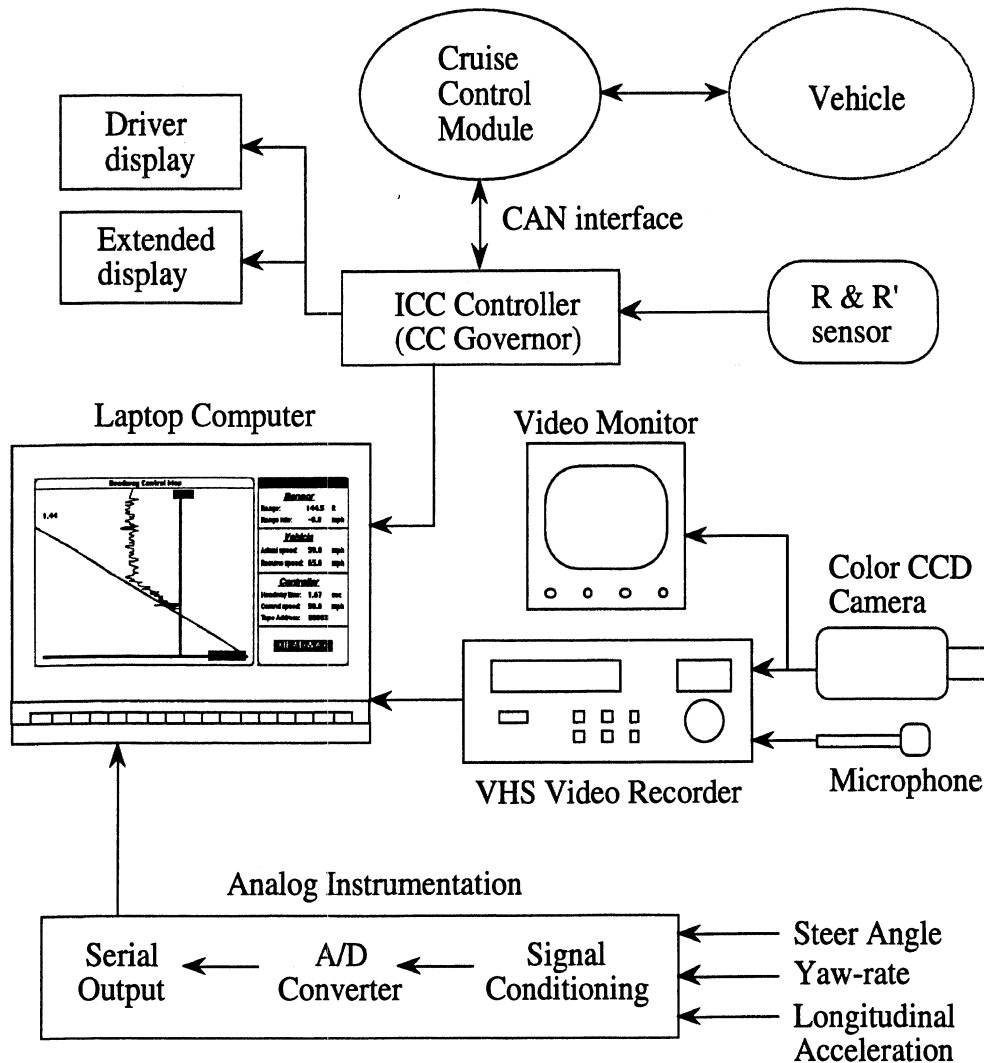

Figure 10. Integrated instrumentation system

Vehicle operating parameters, as well as range and range-rate data, are available from the ACC controller. The controller polls the vehicle's modified cruise control module (via the European standard CAN interface) to obtain data from OEM sensors. These data include vehicle speed, transmission gear, throttle position, accelerator pedal position, and the cruise control set speed. The ACC system also receives asynchronous serial range and range-rate data from the front-mounted, infra-red ODIN sensor. The vehicle information, IR sensor data, and the ACC's internal parameters, such as command speed, computed headway time, Boolean tracking and target acquisition data, and modes of operation, are combined into one continuous serial output stream that the laptop computer collects.

The immediate traffic context is characterized qualitatively by means of a forward-looking video recording on half-inch VHS format tape. The color CCD camera is fitted with a 12.5 mm auto-iris lens and is mounted on a centrally-mounted bracket adjacent to and slightly to the rear of the driver's head. The camera is equipped with an adjustable electronic shutter (currently set to 1/250 seconds) to eliminate blurring caused by vehicle vibrations. It also contains integrated automatic electronic gain control and automatic white balance to counter transient lighting conditions due to shadows, other vehicles, or variations in the vehicle's orientation to the sun. To synchronize the video data with the ACC's information, frame address information is generated by the VCR and transmitted to the data collection computer via an RS232C serial link. The frame address information is also written onto one of the videotape's linear audio tracks using the industry standard

SMPTE time code (Society of Motion Picture and Television Engineers), so that synchronization will not be compromised during later playback and analysis sequences. The time code also supports a limited set of user-defined characters, such that portions of the tape can be labeled with data file names or other useful notations. Audio data, such as experimenter's comments or a test subject's expressions, are recorded on the videotape's hi-fi audio tracks.

The SCP testbed vehicle is also equipped with a number of ancillary analog sensors for transducing longitudinal acceleration, yaw rate, steering wheel angle, and atmospheric pressure. Signal conditioning circuitry are implemented for powering the transducers and filtering the signals prior to conversion through an 8-bit digitizer. These data are transmitted (via RS-232) from the digitizer to the laptop computer for storage.

During the data collection activity, engineering variables are displayed to the engineer/operator in real-time in both numeric form and on the range / range-rate control map. This type of interaction with the experimenter allows the notation (on a log sheet) of transient events or aberrations that demand special attention and analysis at a later date. It also allows for instantaneous field evaluation of controller algorithms, which are currently under development. The algorithms can be modified in the field and evaluated immediately using the real-time data display, allowing efficient development of controller software and user interaction requirements.

Examples of the data display and typical headway scenarios (A, B, and C) are shown in figure 11.

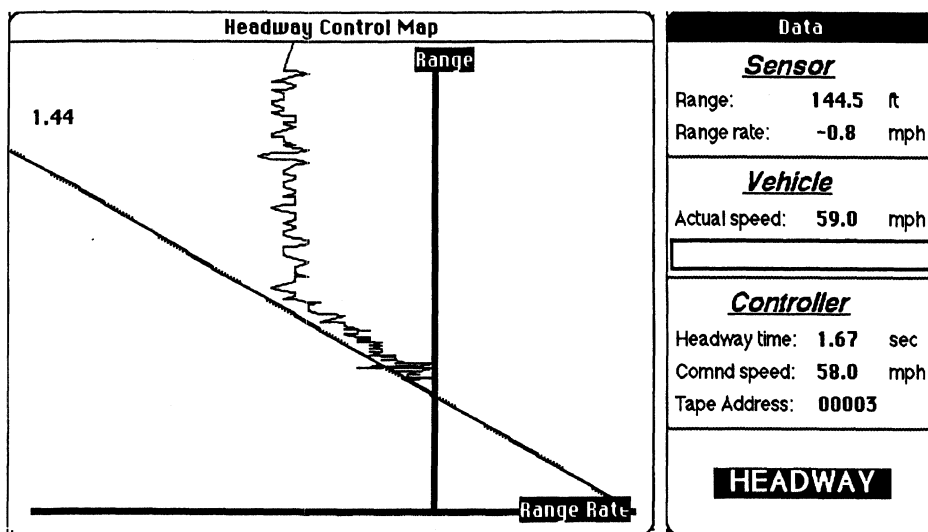

A: Transitioning from a distance

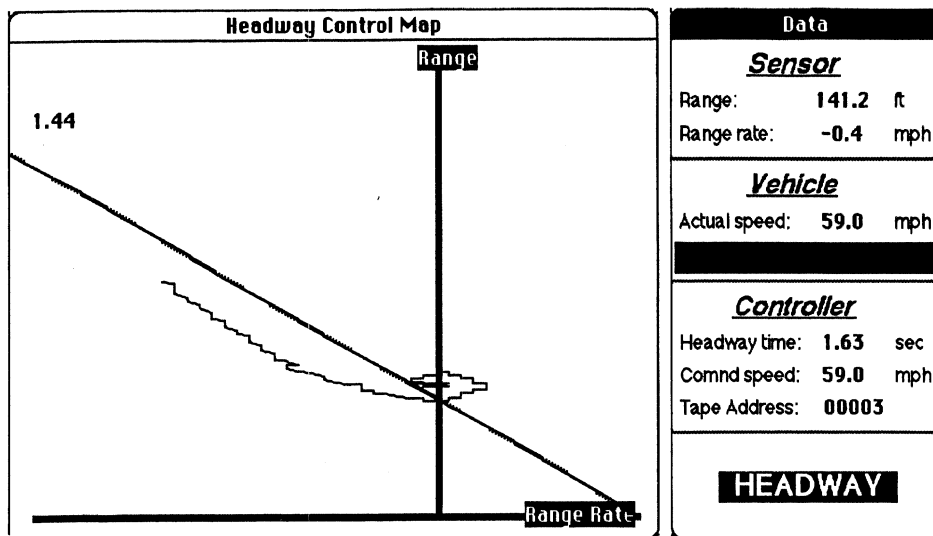

B: Transitioning from close range

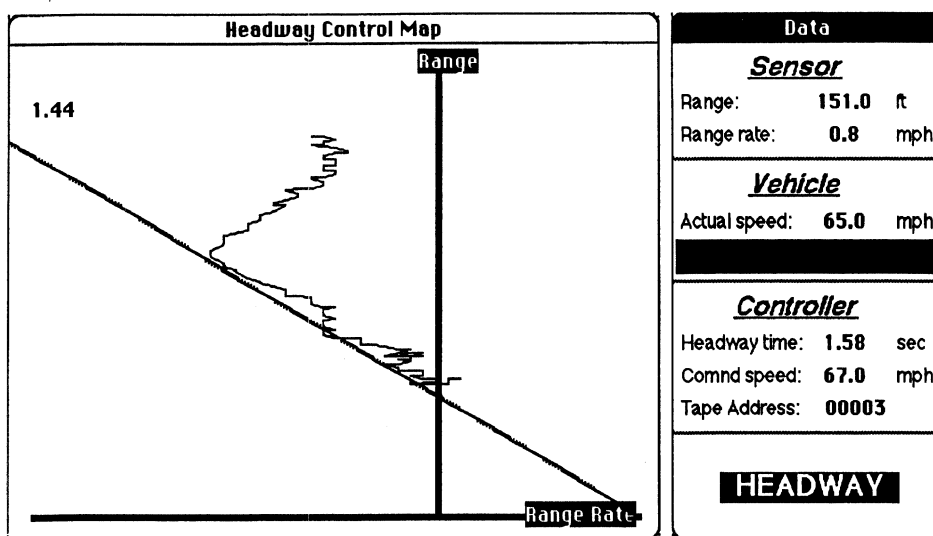

C: Braking by lead vehicle from a distance

Figure 11. Examples of the data display

## 4.0 The Processing of Data from Field Testing Using the SCP Testbed

Evaluation of the ACC system performance and characterization of the driver's behavior requires the generation of a variety of input and response variables. Some of these data variables are needed even when we are simply characterizing the functional baseline, which corresponds to the vehicle being driven under manual control. Note that the outputs of the range-measuring sensor must be employed for characterizing headway keeping behavior even in the manual mode of driving, although the ACC control loop is inactive in that scenario. Covering both the manual and ACC modes of operation, a list of directly-acquired data signals is defined below. Based upon experience with processing data from the field, however, it has also been concluded that additional data items are needed. A set of supplementary variables has therefore been developed based



upon the further processing of the directly-acquired data. These computed data, referred to as auxiliary variables, provide additional information that more explicitly address some of the relational aspects of the inter-vehicle clearance problem and the conflict potential that is intrinsic to vehicle-following.

#### 4.1 Measured (Acquired) Variables

The operation of the ACC system can be regarded as a combination of the following four elements: (1) the sensor, (2) the vehicle, (3) the driver, and (4) the controller. The measured variables are basic data that pertain to each of those elements. These data are used in evaluating driving operations under various modes of automatic-control assistance. Each of the directly-measured data variables are cited below as they derive from each of the four elements of the ACC system. In addition, directly-measured ambient and system-status variables that are intended to aid in the post-test processing are listed.

##### *Sensor Data*

The Leica infra-red sensor measures range (R) and range-rate ( $dR/dt$ ) data regarding objects it detects. That information is fundamental to evaluating and controlling headway.

##### *Vehicle Data*

In the longitudinal direction, the essential vehicle data are velocity and acceleration. Velocity data were available on the communication-bus system of the vehicle. Acceleration data were available from the electronic-throttle system of the vehicle (through the communication-bus). The same system provided data concerning the actual position of the throttle on the engine (from fully open under heavy acceleration to almost closed at idle). In addition, the vehicle was also instrumented with an accelerometer for direct measurement of acceleration and deceleration.

To identify when the vehicle is in a turn, yaw rate was measured. This information is useful in identifying (later when processing the data) whether a target is in the sensor's field of view. These data were acquired by means of a specially-installed rate sensor.

##### *Driver Data*

"Driver data" refers to actions taken by the driver to control the vehicle. The driver can control the forward velocity and the path of motion. For that purpose, measured quantities included accelerator pedal position, brake actuation, and steering wheel angle. The data concerning accelerator pedal position were available from the electronic-throttle system of the vehicle (through the communication-bus), which also provided boolean (yes or no) information about the activation of the brake pedal. Steering wheel angle data were acquired by means of a specially-installed rotary potentiometer.

The desired cruise speed set by the driver and the driver's desired headway-time setting were recorded. It should be noted that even though in this phase of the study drivers did not incorporate a variable headway-time setting, this feature is planned to be incorporated in the future. Therefore the data acquisition and processing system was designed for inclusion of this variable. These data items were available at the communication-bus link.

### *Controller Data*

The controller processes the range and range-rate data from the sensor to discriminate between targets that should be ignored (e.g., road signs), and valid targets for which speed adjustment should be considered. This boolean signal (valid or not valid) was collected from the data serial port on the controller.

The controller's output command to the vehicle's cruise-control system, available at the controller's communication link, was also recorded. This command signal is in the form of a commanded speed.

### *Ambient and Monitoring Data*

To identify when the vehicle is on an uphill slope or a downhill grade, an atmospheric-pressure sensor was installed. This information was intended to support data interpretation—for example, to aid in explaining throttle or brake activation that are occasioned by grade and thus are not fully explained by headway constraints, alone. In addition, visual data were acquired by means of a video camera so that any driving scene could be reviewed. Synchronization between the videotape and the other data that were collected on a laptop computer, was ensured by registering the frame numbers along with the other data.

The complete array of data that were collected is listed in Table 1 below. For each data item listed in the table, its description, units, and the acquisition source are provided.

Table 1. Acquired data

Data Item	Symbol	Definition	Units	Acquisition Source
<b>Sensor Data</b>				
Range	R	Distance from the sensor to a detected object	ft	Sensor
Range Rate	Rdot	Rate of change of distance from the sensor to a detected object	fps	Sensor
<b>Vehicle Data</b>				
Velocity	V	Forward velocity of the headway controlled vehicle	fps	Comm. buss
Acceleration (measured)	Ax	Forward acceleration of the vehicle	g	Accelerometer
Throttle	Cth	Throttle position (on the engine)	%	Comm. buss
Acceleration (calculated)	Vdot	Forward acceleration of the vehicle	g	Comm. buss
Yaw Rate	YR	Yaw rate of the vehicle	deg/sec	Transducer
<b>Driver Data</b>				
Steering	Csw	Rotational position of the steering wheel	deg	Transducer
Accelerator	Cac	Accelerator pedal position	%	Comm. buss
Brake	Lbr	Boolean variable indicating brake pedal status: 0 = brake pedal <b>is not</b> depressed 1 = brake pedal <b>is</b> depressed * note: in the future, when limited braking is incorporated, this data item will contain a continuous variable for brake intensity.	(—)	Comm. buss
Set speed	Vset	Cruise speed set by the driver	fps	Comm. buss
Headway time	Thc	Desired headway time	sec	Controller
<b>Controller Data</b>				
Valid target	Ltv	Boolean variable to filter objects: 1 = detected object <b>is</b> a valid target to consider and to possibly adjust headway to 0 = Otherwise	(—)	Controller
Command speed	Vc	Velocity command for headway control	fps	Controller
<b>Ambient and Monitoring Data</b>				
Grade	Grade	Atmospheric pressure (to indicate altitude changes)	in Hg	Pressure transducer
Frame	Fn	Frame number of the VCR for data playback	(—)	VCR

## 4.2 Derived (Computed) Variables

In addition to the directly-measured data, auxiliary variables were computed and evaluated. These auxiliary variables were derived from the acquired data listed in Table 1. The purpose of the auxiliary variables is to enhance data processing by providing additional information concerning the driver, the vehicle, and a better understanding of driver's operating patterns. Table 2 lists the auxiliary variables that were computed and stored.

Table 2. Derived data

Symbol	Definition	Units	Condition to derive	Expression	Value if cannot be derived
Valid	Valid target	(—)	(—)	=1 if: (525≥R≥15) and (Rdot≥-0.7V) and (V>10) and (Ltv=1) =0 otherwise	
Rnew	Valid range	ft	Valid=1	=R	0
RdotNew	Valid range rate	fps	Valid=1	=Rdot	0
Vp	Speed of preceding vehicle	fps	Valid=1	= V + RdotNew	-10
Rh	Reference headway distance	ft	Valid=1	=Vp·Th	-10
SSPC	Steady-state path curvature	1/ft	V>10	$=\left(\frac{YR}{V}\right)\left(\frac{\pi}{180}\right)$	-0.05
Ays	Steady-state lateral acceleration	g	V>10	$=\left(YR \cdot V\right)\left(\frac{\pi}{180}\right)\left(\frac{1}{32.2}\right)$	0.5
Ta	Available reaction time	sec	Valid=1	$=\frac{Rnew}{V}$	-10
Ti	Time to impact	sec	Valid=1 and RdotNew<-1	$=\frac{-Rnew}{RdotNew}$	-10
Dreq	Deceleration to avoid crash	g	Valid=1 and RdotNew≤0	$=\left(\frac{RdotNew^2}{2 \cdot Rnew}\right)\left(\frac{1}{32.2}\right)$	-0.05
Eh	Headway difference	ft	Valid=1	=Rnew-Rh	-1000
Nh	Normalized headway	(—)	Valid=1	$=\frac{Rnew}{Rh}$	-1
VcRef	Reference speed command	fps	Valid=1	$=Vp+\frac{Rnew-Rh}{T}$	0
Lhind	Hindrance level	(—)	Valid=1 and Vset≥22	$=\frac{V}{Vset}$	0

### 4.3 Processing to Produce a Database of Test Results

Data from the field consisted of a time-sequence of samples from a variety of sources—the Leica circuitry, the Saab's CAN bus, the serial linked instrument package, and the laptop computer—each with its own independent timing system and phase relationship to the system as a whole. Synchronization of all data to within one sample period is possible under such a scheme. Prior to testing the 36 subjects in our field trial activity, the data being transmitted to the laptop computer had been validated to ensure such a phase relationship existed, and that it remained constant over the course of a test. The 10Hz transmission rate was chosen since the controller installed in the vehicle had a preprogrammed output rate of 10Hz. Also, this allows a maximum skew in channel phasing of 100ms—an acceptable synchronization of each subsystem, given the nominal 1Hz bandwidth of the longitudinal mode of whole-vehicle response.

Raw data files were created at a bit depth that varied according to the subsystem from which the data was generated. Digitized analog data from the UMTRI-installed instrumentation package were 8-bits deep, while the controller-generated data signals showed a variety of resolution levels depending upon their internal representations within the microcontroller-vehicle system. The videotape frame numbers appeared as integers and were assumed to be of resolution as specified in the SMPTE standard. Listings of the data items for which time histories are stored in the database were given above, in Tables 1 and 2.

Postprocessing afforded a zeroing of any DC offsets in steering wheel angle and longitudinal acceleration sensors, as well as correction of zero-drift in the yaw-rate sensor. Such analog transducers exhibit classical drift and zeroing problems that tend to be manageable using a high-pass filtering approach. All of the data in the time-histories have been calibrated and corrected for offsets, and these data exist in the files in the appropriate engineering-units.

A first-level reduction approach has been to generate histograms of the raw data covering all of the test subjects. These histograms provide immediate access to the probabilistic distribution of the data and to simple descriptors such as mean, mode, variance, etc. The histograms also lend themselves to easy merging (i.e., cumulative totals across a range of subjects), and they allow a convenient comparative analysis for different subject groups and/or driving modes. The bins selected for the histograms are somewhat arbitrary. When sensor quantization effects were known, attempts were made to locate histogram bin centers at the center of the quantization levels - alleviating re-quantization problems. When the sensor's or subsystem's characterizations were not known, the assignment of bin centers was simply chosen to be uniform between the minimum and maximum values in the time-history. Bin center intervals were, of course, kept constant for a single variable across all subjects and driving modes.

Combined histograms for all 36 subjects and tables of means, standard deviations, variances, modes, and numbers of samples for each subject are available at UMTRI and are the object of continuing study under the FOCAS project.

## **5.0 Field Testing Conducted using the SCP**

As indicated earlier, upon completion of the instrumentation system provided through the SCP project, an initial implementation of the SCP system was undertaken under the companion FOCAS study. The test methods used in this field implementation are described in section 5.1, below, followed by discussion of results in sections 5.2 and 5.3.

### **5.1 Test Method**

The test methodology involved the specification of a variety of sampling and procedural protocols. The items discussed below cover the test route, the variations in control mode in which the subjects drove the vehicle, the participant sample, and the preliminary instructions given to each driver.

#### **5.1.1 The Route**

Each participant drove a predetermined route on local highways (Figure 19 and Table 3). The length of the route was 55 miles, and took approximately 50–60 minutes per trial to complete. This time was believed to be sufficient to allow participants to experience and become accustomed to controlling the vehicle. Participants drove only when weather and road conditions permitted (an experimenter was present at all times to aid participants in route guidance). Test drives took place only between the hours of 9 a.m.– 12:00 p.m. and 1:30 p.m.–4:30 p.m. to avoid large fluctuations in traffic density associated with rush hours. At the end of each experimental trial participants returned to the UMTRI research facility to complete a questionnaire. A ten-minute break was provided to participants at the end of each trial.

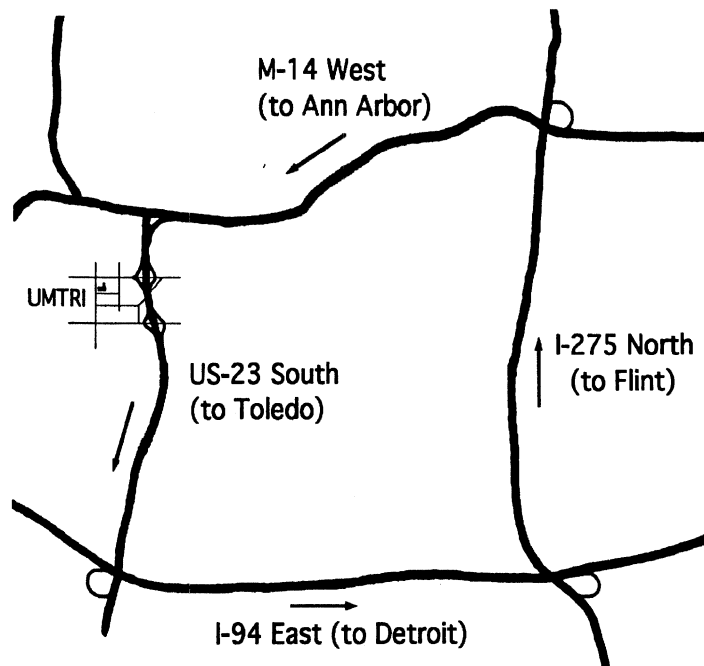

Figure 12. Map of the selected route through Ann Arbor and the Metropolitan Detroit area.

Table 3. Annual average 24-hour traffic volumes for the selected route (Source: Michigan Department of Transportation, 1993 [9])

Segment	Average Volume	Lanes
US 23 (South)	44,000 - 56,000	2
I-94 (East)	60,000 - 91,000	2-3
I-275 (North)	45,000 - 112,000	3-4
M14 (West)	43,000 - 70,000	2-3

The recorded data clearly show the locations of the ramps and the time periods when the vehicles were on the various highways. See Figure 13 for an example of typical data for one subject. To obtain information pertaining to driving at highway speeds, it is convenient to use data when the velocity is greater than 55 mph. As indicated by the velocity time history shown in Figure 13, the velocities on the three low-speed, short-radius, right-turn ramps are below 55 mph although the high-speed, long-radius, left-lane-to-left-lane ramp is included for subject S1.

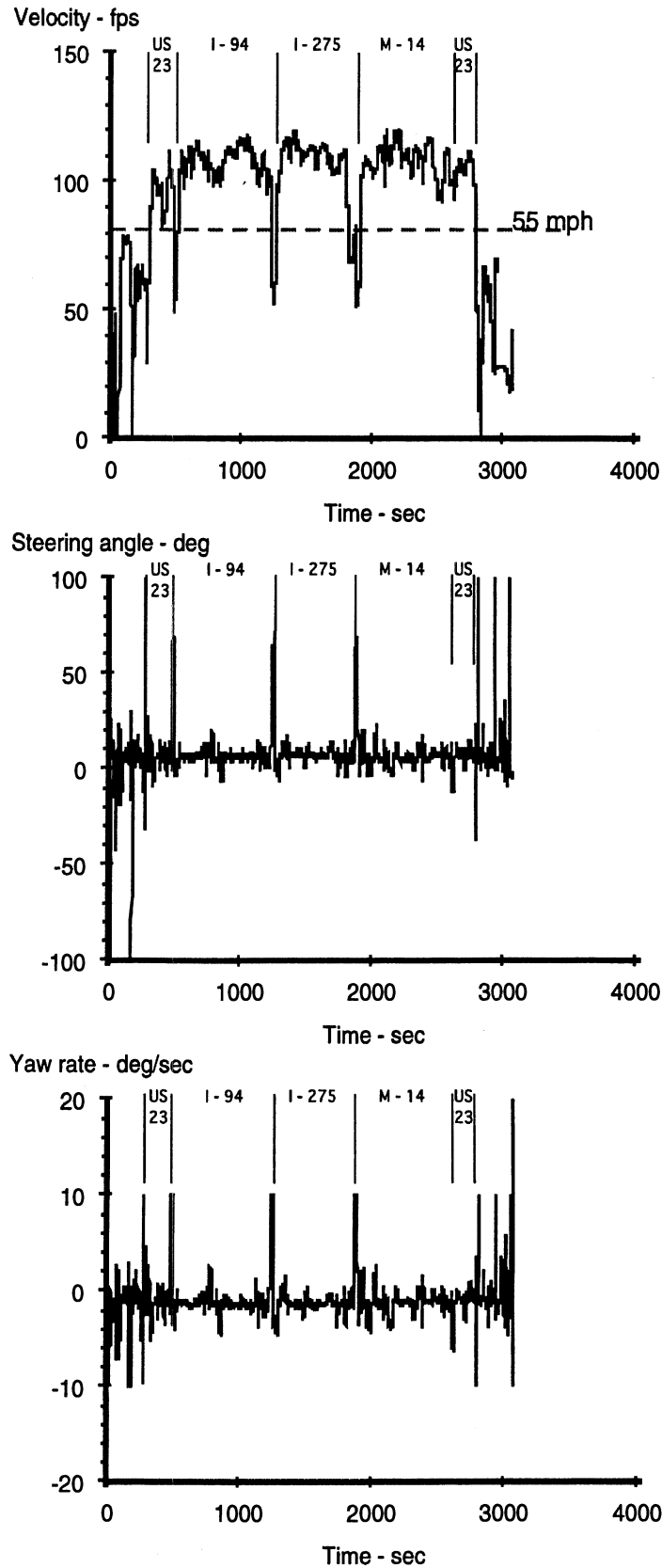

Figure 13. Time histories showing ramp locations

The recorded data also provide an indication of the traffic situation during the tests. There is a subtle way to deduce how much of the time there is a preceding vehicle within range of the sensor. Figures 14 and 15 show histograms of the frequencies of occurrence for various ranges (bins) of velocity and headway range. In these figures, the special information under the bar charts includes a quantity called "Tot," which is the total



number of data points measured for the variable. There are fewer data points for R (that is, Rnew) than there are for V because R is measured only when there is a preceding vehicle within the maximum range of the sensor. If the frequency numbers ("freq") in the tables were divided by the value of Tot, these frequencies would be turned into probability estimates for each bin. While observations of these data are of value as very generalized results, that are especially interesting as a surrogate measure of traffic density—obtained by dividing the value of Tot for R by the value of Tot for V. This ratio gives the fraction of the time in which a preceding vehicle was within 525 feet of the SCP vehicle. When the data from all of the test subjects are combined the ratio is given by  $(289,100)/(453,600) = 0.64$ . That is, the traffic conditions prevailing as an average across all of our test runs can be described by the property that a preceding vehicle was within 525 feet of the SCP vehicle for 64 % of the time. (UMTRI perceives that this surrogate measure will become highly useful as an indicator of traffic condition during ACC Field Operational Testing that is scheduled in the national ITS program for calendar years '96 and '97.)

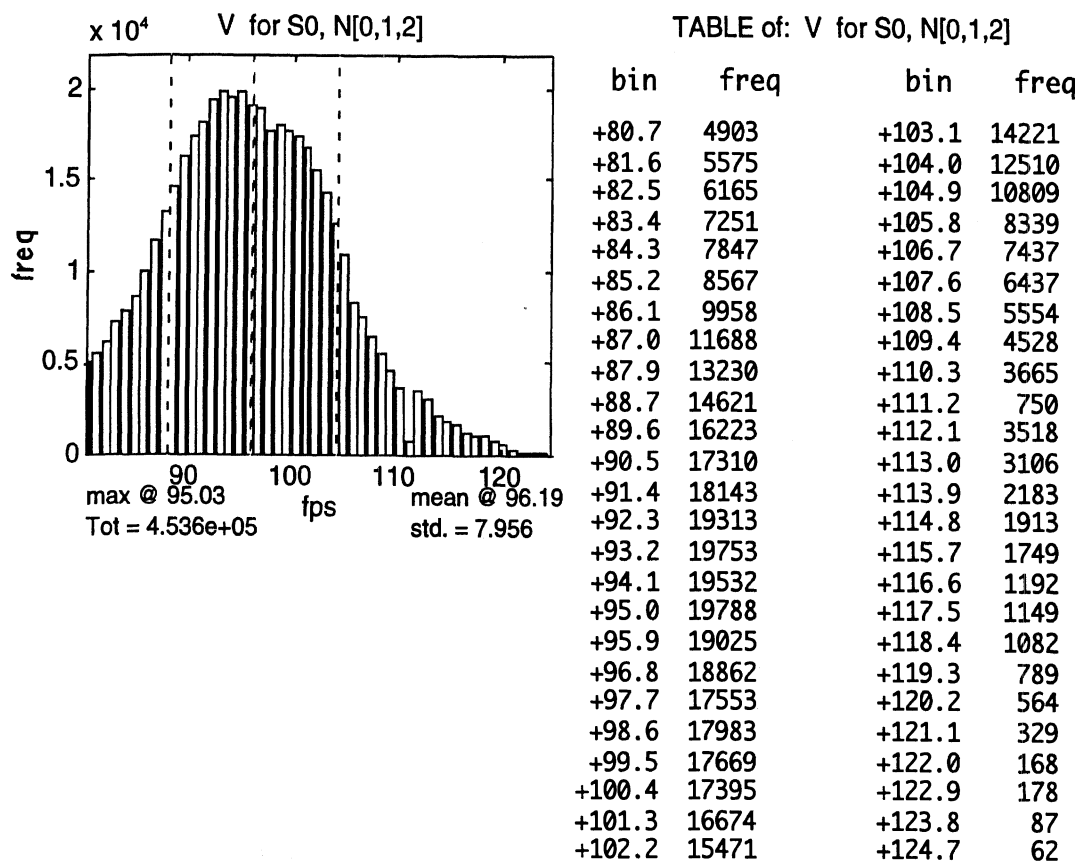

Figure 14. Velocity density histogram

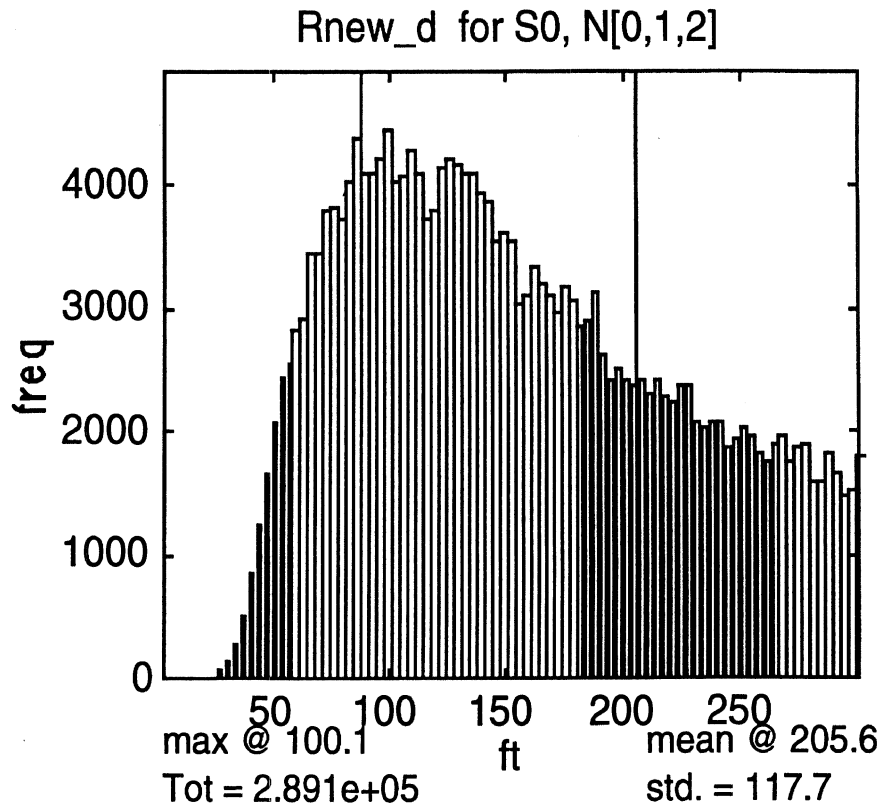

Figure 15. Range density histogram

### 5.1.2 Control Modes

Each of three experimental trials with each subject began and ended at the UMTRI facility. On each trial a different mode of speed assistance (cruise control) was evaluated. The modes included no cruise control (manual), conventional cruise control, and ACC. The same route was followed for testing each of the control modes. The orders in which participants experienced cruise control modes were counter balanced to eliminate order effects in the experimental design.

### 5.1.3 Participants

Thirty-six licensed drivers were recruited from the local Secretary of State's office, as well as through newspaper advertisements, to participate in the study. Prospective individuals were required to meet the following criteria:

- a. possess a valid, unrestricted, driver's license,
- b. have a minimum of two years driving experience,
- c. and appear not be under the influence of alcohol, drugs, or any other substances that could impair their ability to drive.

The participant population was balanced for gender, age, and experience in the use of conventional cruise control. The average yearly mileage driven by participants was 13,500 miles. The three age groups examined were 20 - 30, 40 - 50, and 60 - 70 years of age. Experience with conventional cruise control was divided into two groups; those who frequently used cruise control and those who never, or very rarely, used cruise control. Among those who never, or rarely, used cruise control, having a car that was not equipped with cruise was cited most often as the reason it was not used (57.1%). Among

users of cruise control, reduced workload was cited most often as the reason for its use (64%). When the participants were asked to describe their cruising speed on the open freeway, 57.1% reported that they drove 5 mph above the speed limit, 22.9% reported driving at the speed limit, 2.9% reported driving 5 mph below the speed limit, and 17.1% reported driving at some other speed. In addition, 44.4% of the participants reported regularly driving at speeds consistent with the flow of traffic, while 55.6% drove at a speed with which they felt comfortable.

In the event participants encountered a slower moving vehicle, and the adjacent lane was free, 75% of the participants stated that they would pass the vehicle and return to the lane even if momentary acceleration was necessary. Another 16.7% claimed they would maintain their speed even if it meant moving to another lane and remaining. While 8.3% reported that they would adjust their speed and remain in the lane if the other vehicle were only slightly slower.

#### 5.1.4 Instructions to Driver Subjects

Individuals were briefed as to the nature of the study. Prospective participants were asked to read an information letter describing the study and the associated benefits and risks. Individuals who agreed to participate, and met the previously mentioned criteria, provided informed consent.

Participants were shown the research vehicle, and were instructed on its operation. Specific attention was paid to locating and identifying controls and displays. Instruction on the use of the two cruise-control devices was also provided. Participants were asked to adjust the driver's seat and vehicle mirrors. All participants were required to wear safety belts.

Participants were instructed to drive as they would normally for the existing road and traffic conditions, with the exception that they were asked to employ a specific level of speed assistance (control mode) for each of the three trials. The participants were further instructed to disengage cruise control at any time they felt it was unsafe to use for the existing conditions, but to use the control mode requested as much as possible during the course of the trial. Participants were reminded that as the driver they must remain in control of the vehicle at all times.

## 5.2 Findings from the Processing of Objective Data

The processing of recorded data provides the quantitative means of assessing the performance of the SCP testbed in the context of our sample of drivers and the prevailing traffic on the selected test route, for the times of day indicated earlier. These results are reviewed in this section in terms of both generalized and specific characteristics, all of which aid in forming expectations of the possible impact of ACC products on real-life experience.

### 5.2.1 Nature of Traffic and Roadway

The results presented in section 5.1 showed that during testing there was a preceding vehicle within sensor range 64 % of the time on these routes. Examination of the data also indicates that the mean speed of preceding vehicles ( $V_p$ ) was approximately 66 mph,

with a standard deviation of about 6 mph. The density function for  $V_p$  is not extremely skewed as can be seen by examining Figure 16.

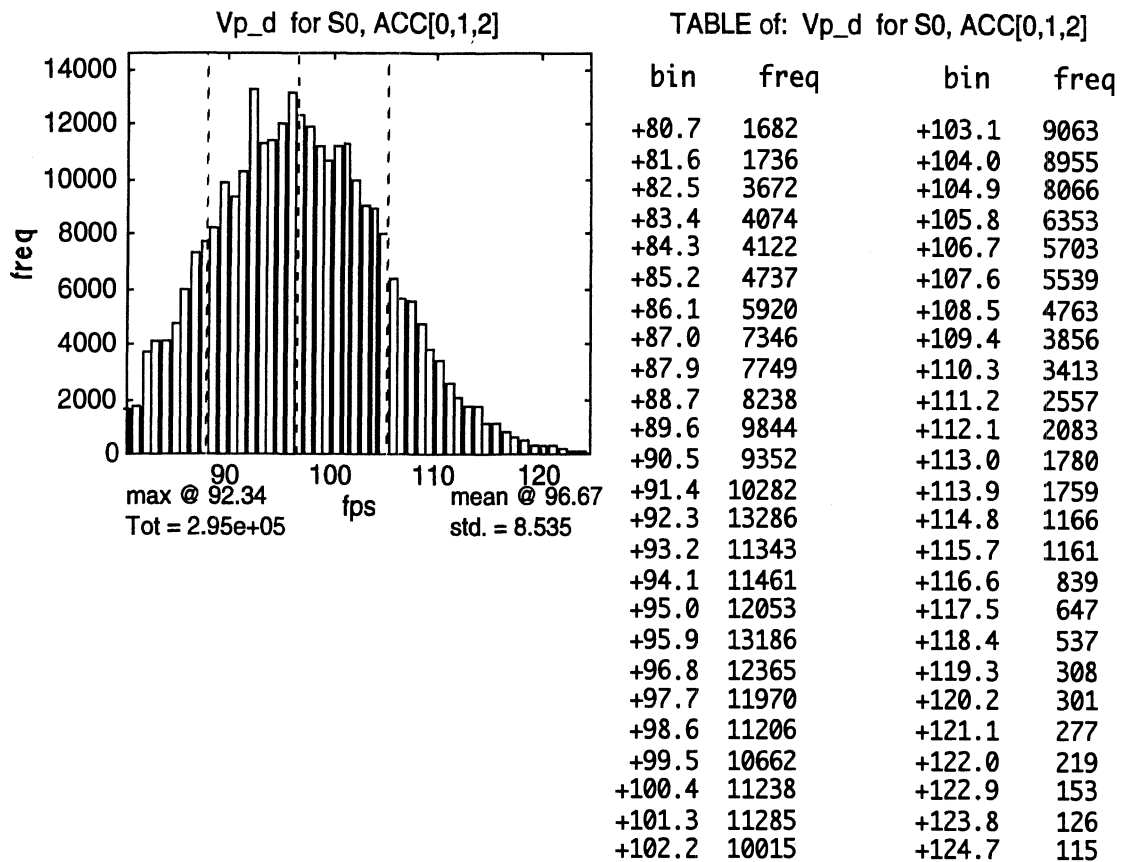

Figure 16. Density of the velocity of the preceding vehicle

The selected roadways are fairly straight and the data tend to show that drivers do not make many sharp turns on these freeways. Figure 17 is a preliminary result that needs to be corrected for drift in the yaw rate sensor. Nevertheless, if one mentally adjusts so that the mean is at zero, these data show that path curvatures more than 0.0005 1/ft (less than 2000 ft radius turn) are very rare. Although more data processing using our computer application for false and missed targets needs to be done, the preliminary finding is that a monobeam sensor, such as the Leica device installed for these tests, will have few missed targets due to road curvature on this set of freeways.

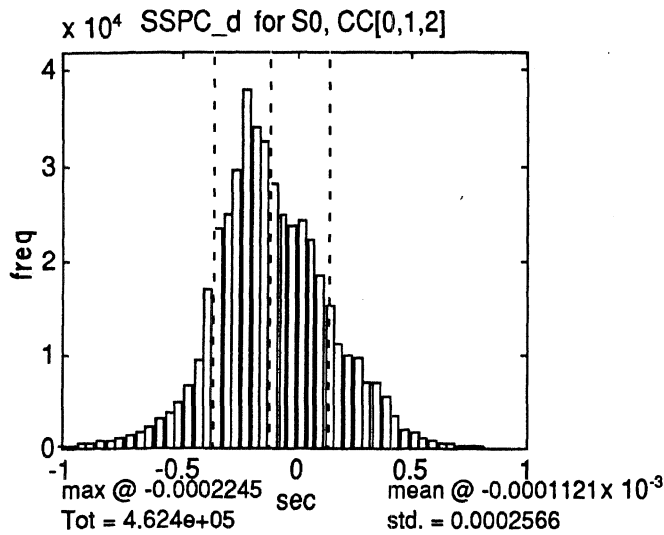

TABLE of: SSPC\_d for S0, CC[0,1,2]

bin	freq	bin	freq
-1.00e-03	354	+2.04e-05	24500
-9.59e-04	415	+6.12e-05	22482
-9.18e-04	514	+1.02e-04	18492
-8.78e-04	498	+1.43e-04	15374
-8.37e-04	757	+1.84e-04	11223
-7.96e-04	976	+2.24e-04	10121
-7.55e-04	1317	+2.65e-04	9612
-7.14e-04	1599	+3.06e-04	7167
-6.73e-04	1852	+3.47e-04	7034
-6.33e-04	2487	+3.88e-04	5735
-5.92e-04	3307	+4.29e-04	3470
-5.51e-04	3980	+4.69e-04	2164
-5.10e-04	4947	+5.10e-04	1637
-4.69e-04	6853	+5.51e-04	1264
-4.29e-04	9466	+5.92e-04	934
-3.88e-04	17239	+6.33e-04	670
-3.47e-04	23749	+6.73e-04	477
-3.06e-04	25082	+7.14e-04	403
-2.65e-04	29942	+7.55e-04	269
-2.24e-04	38106	+7.96e-04	159
-1.84e-04	34372	+8.37e-04	138
-1.43e-04	32873	+8.78e-04	117
-1.02e-04	28316	+9.18e-04	69
-6.12e-05	25059	+9.59e-04	49
-2.04e-05	23835	+1.00e-03	23

Figure 17. Approximate density for path curvature (1/radius)

### 5.2.2 Comparison of Driving Modes Based on Freeway Driving

The differences between driving with normal (manual) control, conventional cruise control, and adaptive cruise control are large. These are different modes of driving not only in name, but also with regard to performance. A good qualitative understanding of these differences may be obtained by inspecting Figures 18 through 20. These figures represent histogram summaries across all miles of freeway operation with all 36 subjects for each of the respective modes of control.

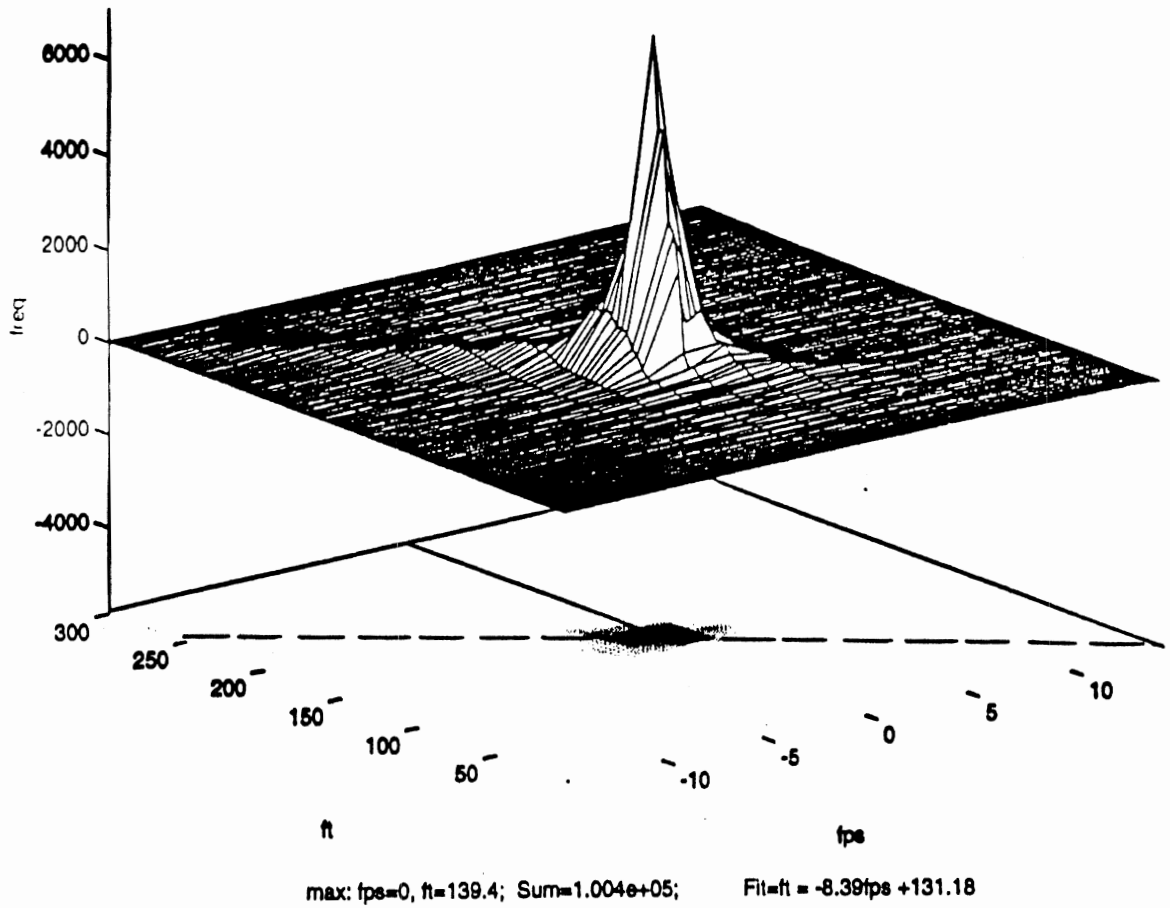

Figure 18. Rdot vs. R histogram, showing ACC operations for miles in which a target was acquired

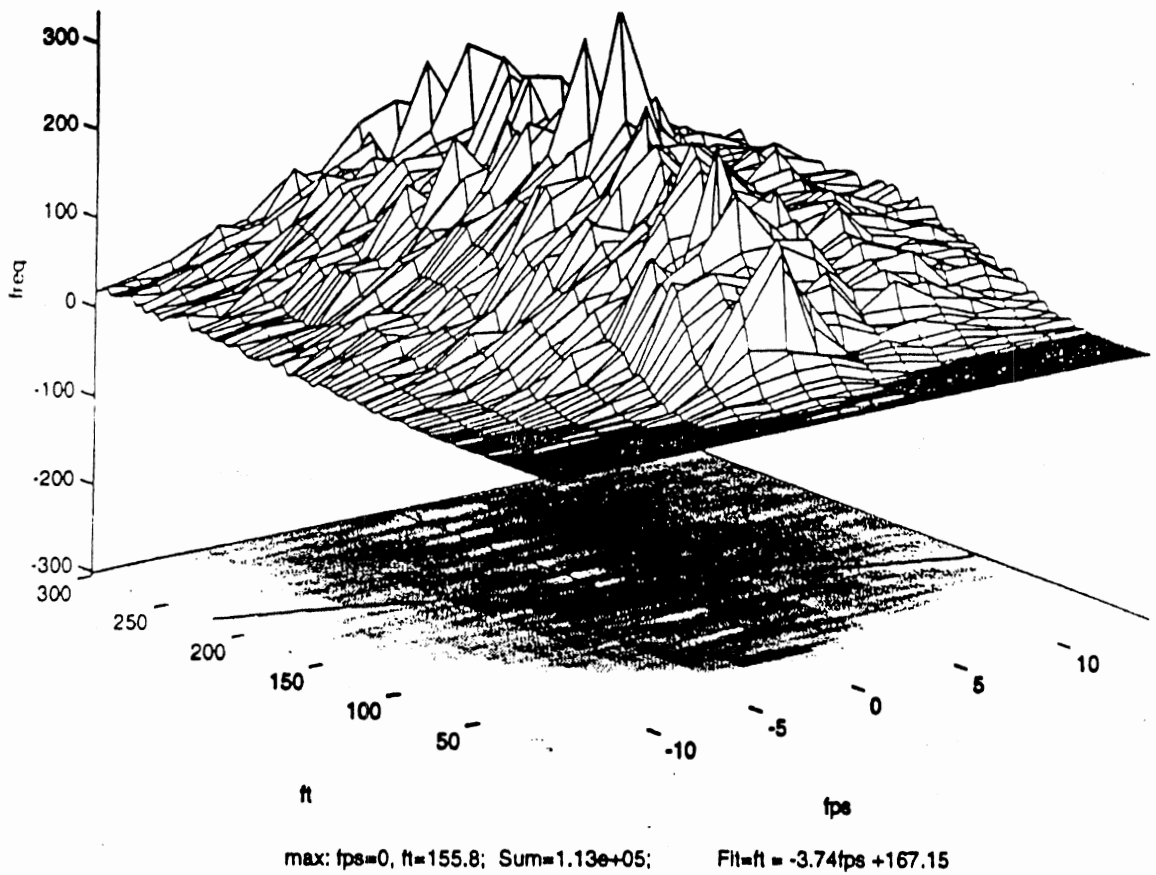

Figure 19 Rdot vs. R histogram, showing CC operations for miles in which cruise control was active

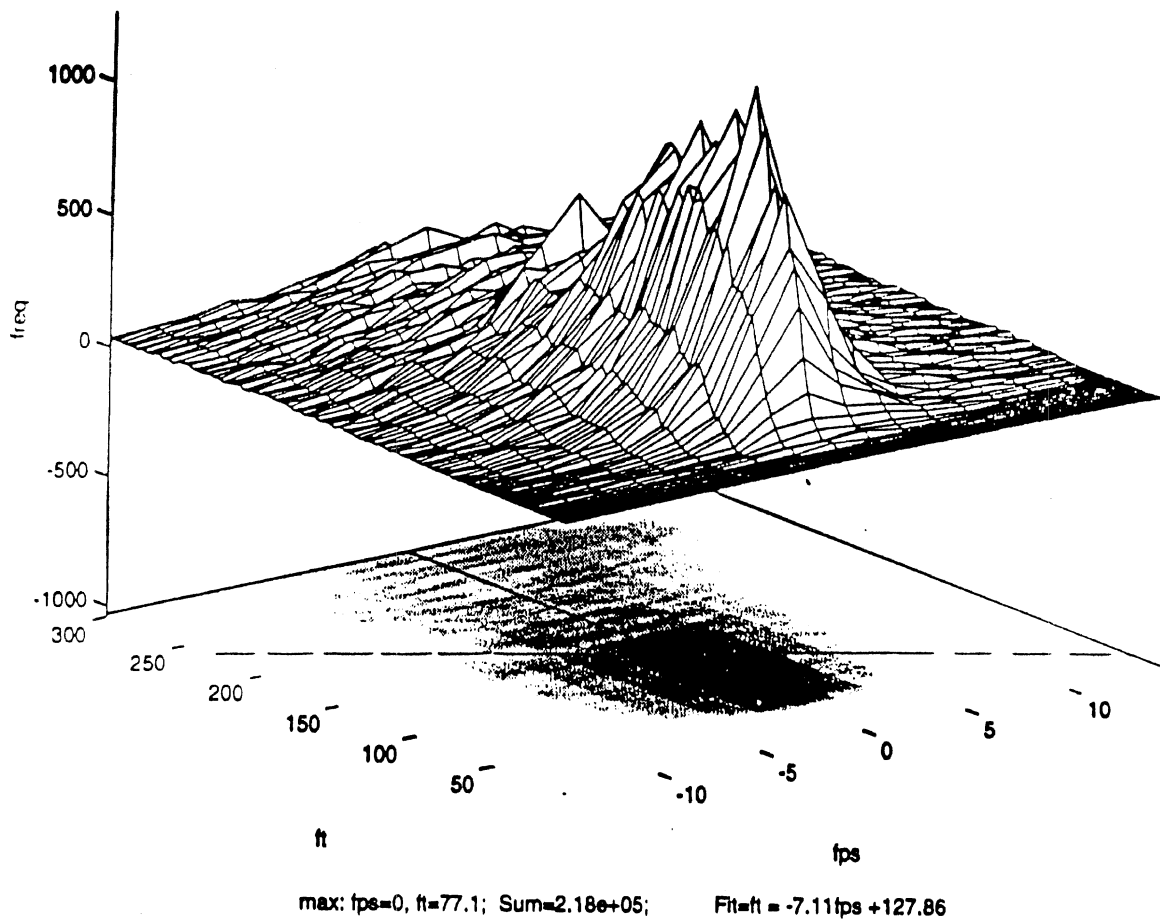

Figure 20. Rdot vs. R histogram, showing Normal (manual) control operations for all freeway miles

Figure 18 shows the form or density of the distribution of R versus Rdot for the case in which the ACC is operating, a target vehicle ahead has been acquired, and the headway algorithm is determining  $V_c$ , the speed command to the cruise control. The pattern of the frequency density plot shows that the ACC system does, indeed, provide a remarkable and sustained regulation of range, thereby also holding range-rate near zero almost all of the time. Clearly, the performance conforms to the control rules embedded within the ACC package.

In contrast, Figure 19 shows an entirely different situation for the case of driving with conventional cruise control engaged. We see that the combined conditions of range and range-rate are distributed broadly across the full dimensions of the plot. There is also a rather dense group of samples evident at small values of R, suggesting that conventional cruise control frequently brings vehicles in very close proximity to one another (presumably while the driver is postponing a braking intervention, hoping that the headway conflict will resolve itself). The CC data also tend to show that a substantial portion of the operating time is, indeed, spent at rather long range, as would be expected.

The appearance of the histogram for the Normal (manual) driving mode, in Figure 20, differs from that of the CC data in that rather little time is spent at very long range and a greater fraction of the operation is at rather close range. The shape of the histogram approaching the shortest range values is very smooth, suggesting that real drivers are attending to headway matters in a continuous and modulated manner as they close in on short range clearances. The CC data, by contrast, were very choppy everywhere—even

in the crucial short range zone, suggesting that driver intervention on the conventional cruise mode is a fitful, variable, type of control procedure.

Further examination of the single-variable histograms has also indicated that there are differences in the form of the range R and Ta data for each of the control modes. These differences show up at close range, as well as elsewhere. Since the density functions are greatly skewed towards zero for R and Ta (the time available for a brake intervention), the mean value is not representative of what is happening at small values of range, which represent very small values of available reaction time. In short, drivers frequently come surprisingly close to the preceding vehicle in either manual control or cruise control driving.

### 5.2.3 Differences by Participant Characteristics

Several four-way, mixed-factor, analyses of variance were performed including the independent variables Age, Gender, and Experience using conventional cruise control. In addition to the three independent variables based upon participant characteristics, the fourth, and final, independent variable examined was Control Mode (a vehicle characteristic). The three independent variables based upon participant characteristics were between-subjects factors in the analyses of variance. The remaining variable, Control Mode, was a within-subjects factor.

The results of analyses for each of the three independent variables based on participant characteristics for the observed cell mean values of the dependent measures Range, Range Rate, Velocity, Accelerator Pedal Position, and Brake Application are presented below. Plots for statistically significant ( $p < 0.05$ ) effects are provided and include standard-deviation error bars.

#### 5.2.3.1 Age

Three ranges of participant age were examined; Young (20-30 yrs), Middle Aged (40-50 yrs), and Older (60-70 yrs). The main effect of participant age was statistically significant ( $p < 0.05$ ) for the following dependent measures: Range, Range Rate, Velocity, Accelerator Pedal Position, and Brake Application (Figures 21 through 24).



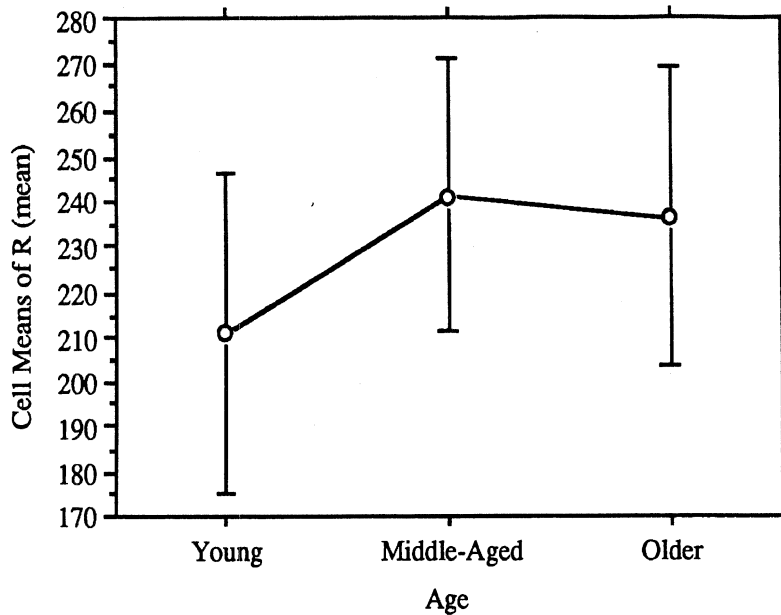

Student-Newman-Keuls post hoc analysis, S = significance level of 0.05

	Vs.	Diff.	Crit. diff.	
Young	Older	25.498	14.265	S
	Middle-Aged	30.495	17.134	S
Older	Middle-Aged	4.997	14.265	

Figure 21. Plot of the main effect of Age for the dependent measure Range (mean) where  $F(2,24) = 10.48$  and  $p \leq 0.01$ , and Student-Newman-Keuls post hoc analysis.

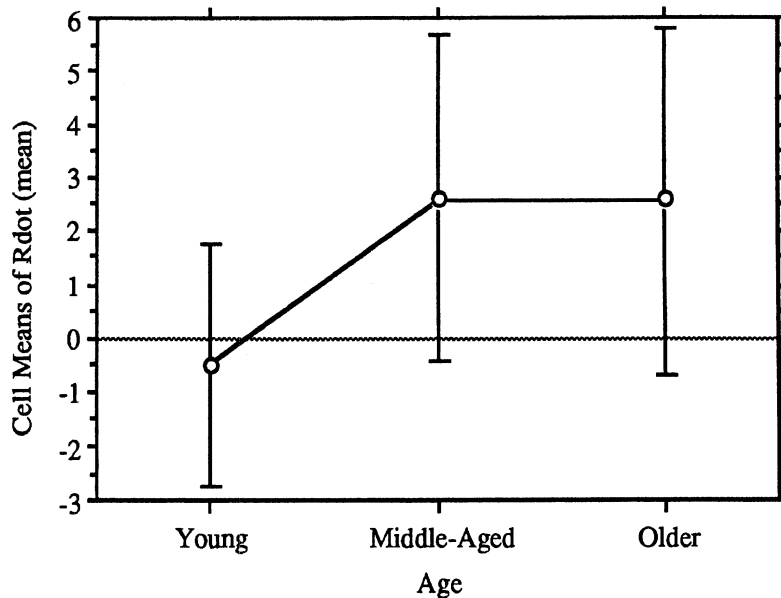

Student-Newman-Keuls post hoc analysis, S = significance level of 0.05

	Vs.	Diff.	Crit. diff.	
Young	Older	3.059	1.310	S
	Middle-Aged	3.097	1.574	S
Older	Middle-Aged	.037	1.310	

Figure 22. Plot of the main effect Age for the dependent measure Range Rate (mean) where  $F(2,24) = 14.67$  and  $p \leq 0.01$ , and Student-Newman-Keuls post hoc analysis.

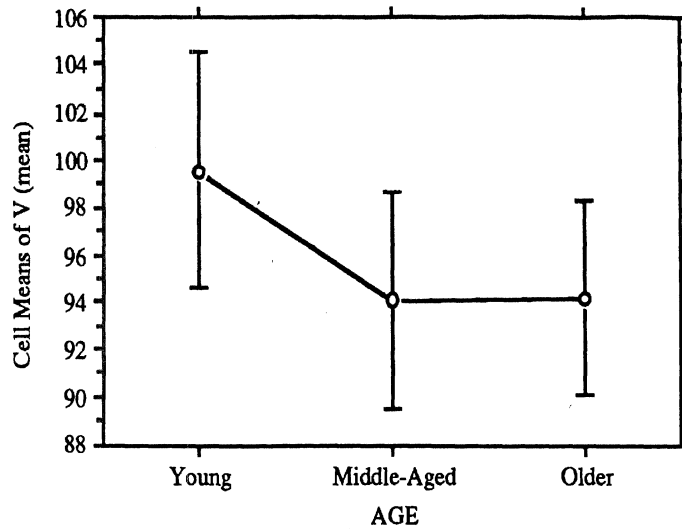

Student-Newman-Keuls post hoc analysis, S = significance level of 0.05

	Vs.	Diff.	Crit. diff.	
Middle-Aged	Older	.101	1.932	
	Young	5.494	2.320	S
Older	Young	5.392	1.932	S

Figure 23. Plot of the main effect Age for the dependent measure Velocity (mean) where  $F(2,24) = 21.11$  and  $p \leq 0.01$ , and Student-Newman-Keuls post hoc analysis.

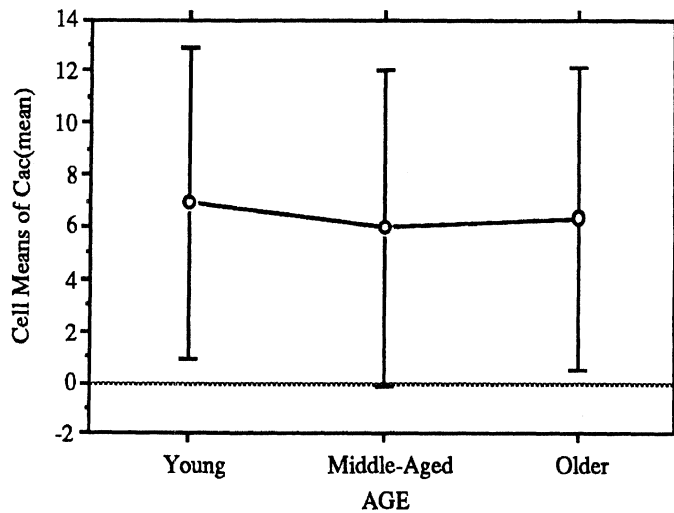

Student-Newman-Keuls post hoc analysis, S = significance level of 0.05

	Vs.	Diff.	Crit. diff.	
Middle-Aged	Older	.358	.635	
	Young	.914	.763	S
Older	Young	.556	.635	

Figure 24. Plot of the main effect Age for the dependent measure Accelerator Pedal Position (mean) where  $F(2,24) = 4.20$  and  $p \leq 0.02$ , and Student-Newman-Keuls post hoc analysis.



Student-Newman-Keuls post hoc analysis, S = significance level of 0.05

	Vs.	Diff.	Crit. diff.	
Middle-Aged	Older	.528	1.897	
	Young	3.056	2.278	S
Older	Young	2.528	1.897	S

Figure 25. Plot of the main effect Age for the dependent measure Brake Application (frequency) where  $F(2,24) = 96.03$  and  $p \leq 0.01$ , and Student-Newman-Keuls post hoc analysis.

### 5.2.3.2 Gender.

Two levels of participant gender were examined; Male and Female. The main effect of participant gender was not statistically significant ( $p < 0.05$ ) for the any of the following dependent measures: Range, Range Rate, Accelerator Pedal Position, or Brake Application.

### 5.2.3.3 Conventional Cruise Control Usage (Experience).

Two levels of participant experience were examined; persons who never, or very rarely, use conventional cruise control and those who use conventional cruise control frequently, or whenever possible. The main effect of participant experience was statistically significant ( $p < 0.05$ ) for the following dependent measures: Range Rate, Velocity, and Accelerator Pedal Position, as shown in Figures 26 through 28.

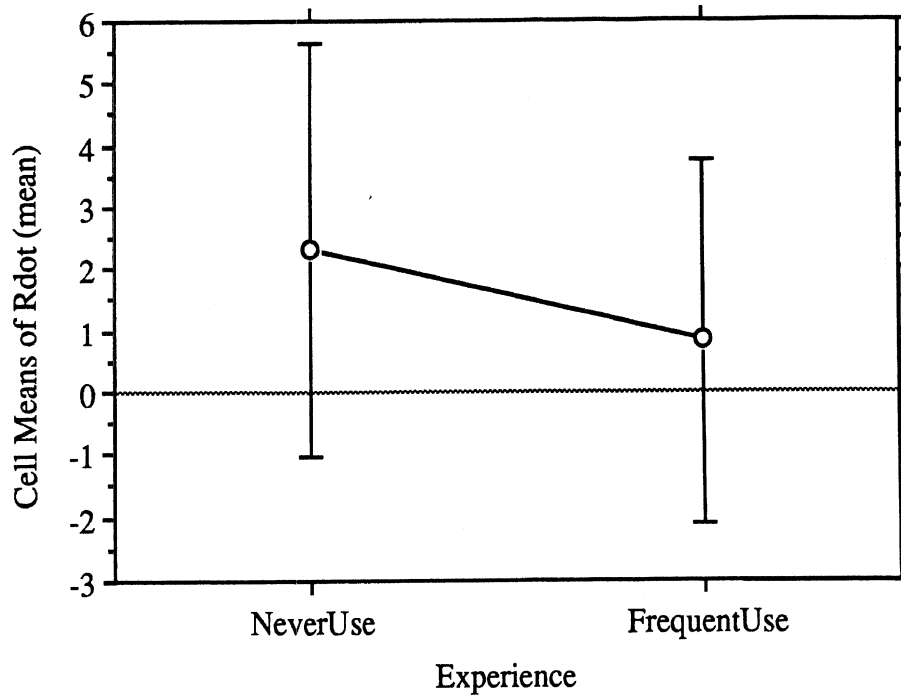

Figure 26. Plot of the main effect Experience for the dependent measure Range Rate (mean) where  $F(1,24) = 7.68$  and  $p \leq 0.01$ .

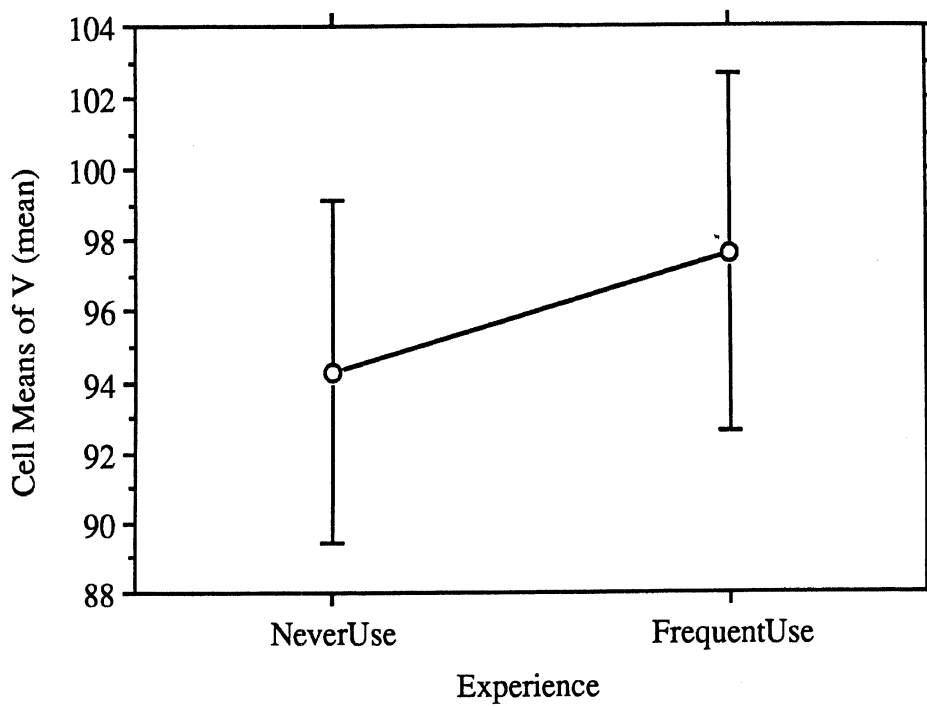

Figure 27. Plot of the main effect Experience for the dependent measure Velocity (mean) where  $F(1,24) = 17.92$  and  $p \leq 0.01$ .

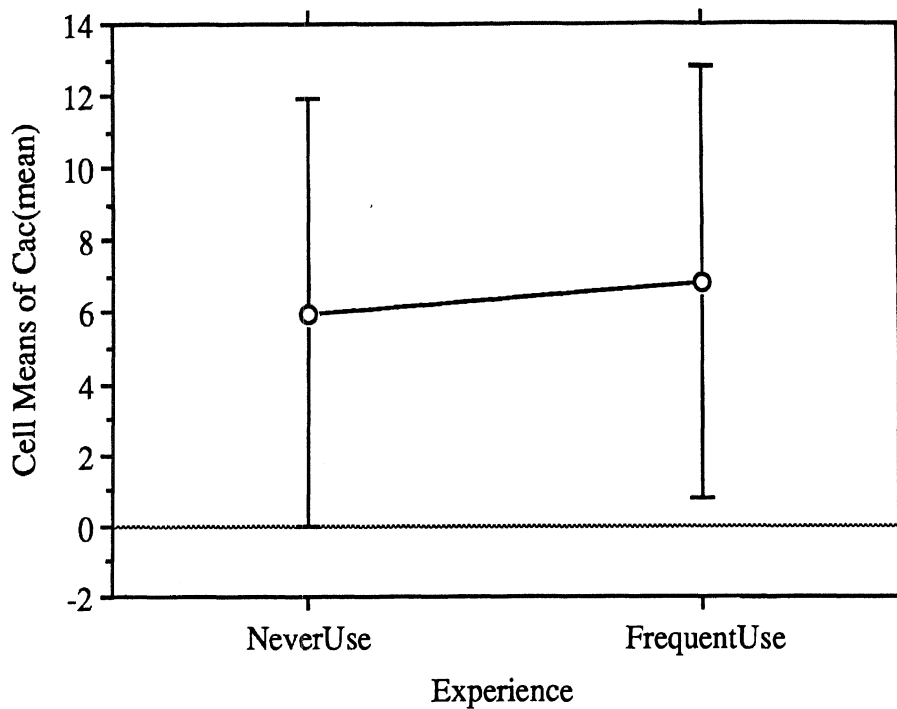

Figure 28. Plot of the main effect Experience for the dependent measure Accelerator Pedal Position (mean) where  $F(1,24) = 10.28$  and  $p \leq 0.01$ .

#### 5.2.3.4 Interactions between Age, Gender and Experience.

Statistically significant ( $p < 0.05$ ) two-way interactions were observed only between the main effects of Age\*Gender for the dependent measure Velocity ( $F(2,24) = 3.22$  and  $p \leq 0.05$ ), and between the main effects of Age\*Experience for the dependent measure Brake Application ( $F(1,24) = 5.09$  and  $p \leq 0.01$ ). These two-way interactions are shown graphically in Figures 29 and 30, respectively.

The only three-way interaction observed was between the main effects of Age\*Experience\*Gender, but this interaction was found to be statistically significant for each of the dependent measures examined. Three-way interactions of this nature are difficult to interpret, particularly due to the fact that no consistent, apparent, relationships exist for this interaction of main effects across the dependent measures. The Age\*Experience\*Gender significant main effect warrants additional examination.

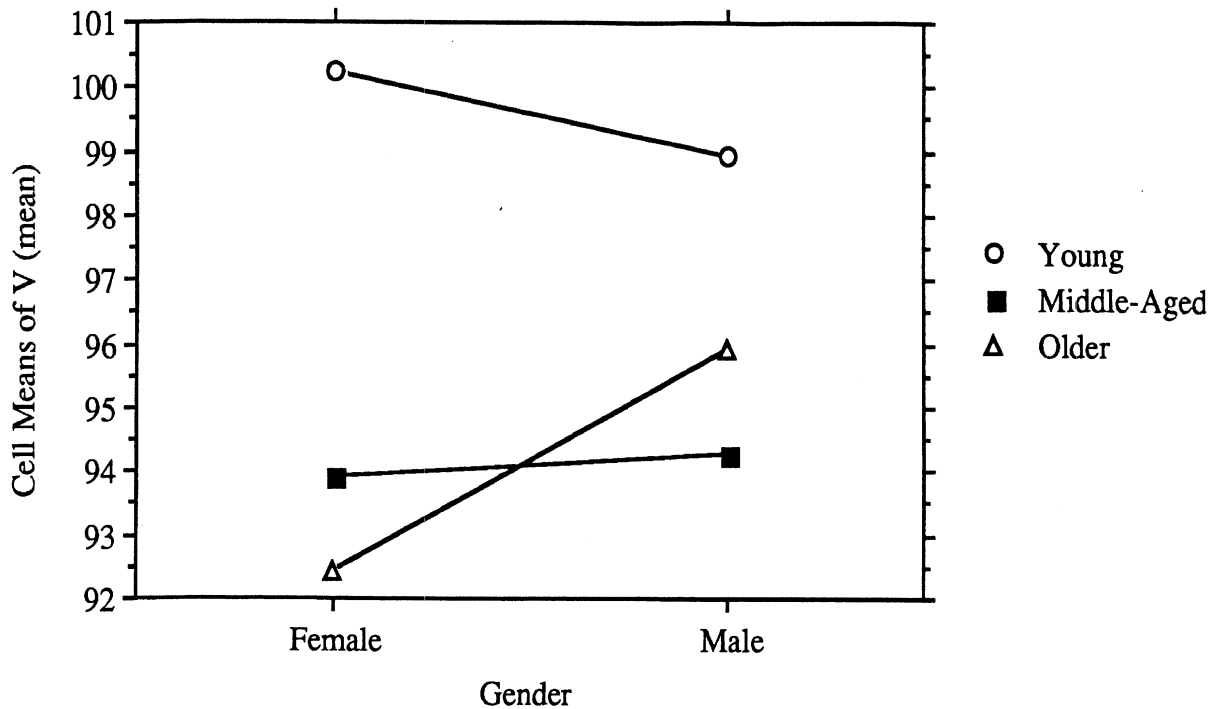

Figure 29. Plot of the interaction Age\*Gender for the dependent measure Velocity (mean) where  $F(2,24) = 3.22$  and  $p \leq 0.05$ .

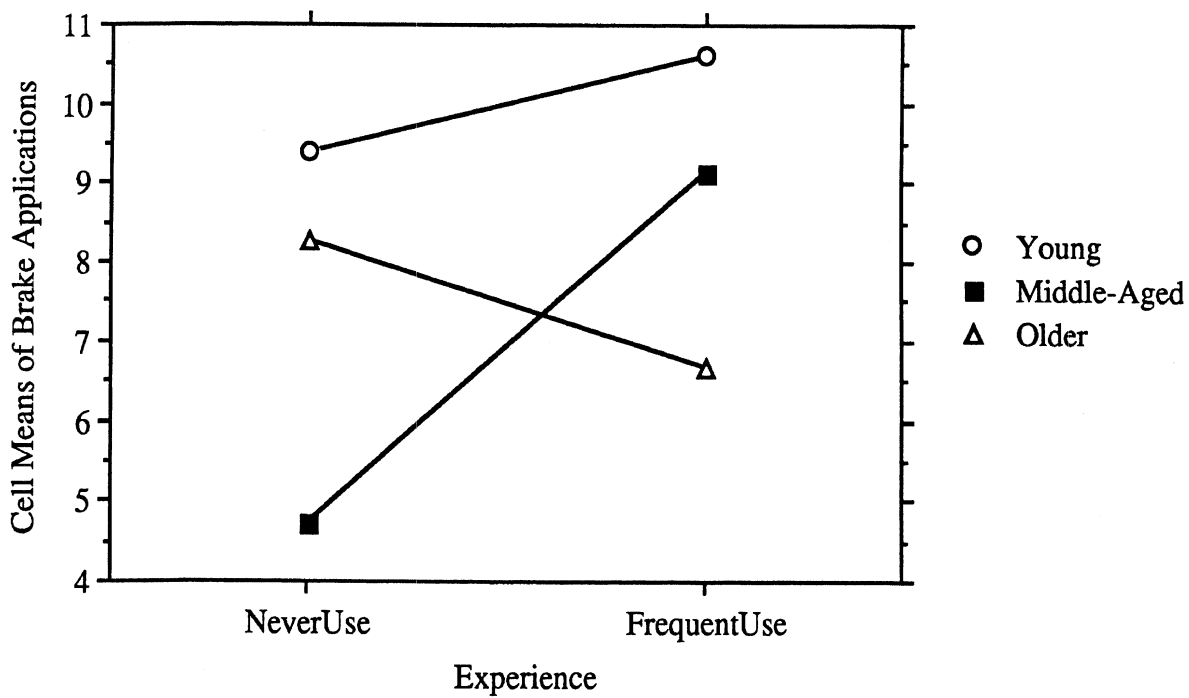

Figure 30. Plot of the interaction Age\*Experience for the dependent measure Brake Application (frequency) for  $F(1,24) = 5.09$  and  $p \leq 0.01$ .

### 5.2.4 Observation of Safety Implications Within the Objective Data

Based on this test experience and previous analysis, it appears reasonable to speculate that ACC systems might have safety benefits related to system characteristics that change the driving situation with respect to driver inattention, available reaction time, and fatigue.

In many rear-end crashes the following vehicle does not slow down at all or perhaps it does not slow down until too late to avoid a collision. Some of these crashes are with stopped cars. As currently configured, ACC systems do not respond to stationary objects in order to eliminate false alarms. Hence, current ACC systems, like the baseline system, will intervene to prevent collisions only with moving vehicles. Nevertheless, there could be a warning given when there is any obstacle in the path of the vehicle at a relatively short range (say less than the stopping sight distance associated with a modest level of deceleration). Whether there would be too many false alarms is not clear.

For moving vehicles, the baseline system provides a warning to drivers through the deceleration that is felt by the driver when the vehicle starts coasting down in speed. This is noticeable and drivers look around to see why the system has decided to slow the vehicle. Based on experience in this study, it appears that decelerations on the order of 0.1g will certainly send a warning message to the driver because deceleration levels at or above 0.1g seldom occur in manual driving on U.S. freeways. See Figure 31. This may have a significant effect upon driver inattention to preceding vehicles.

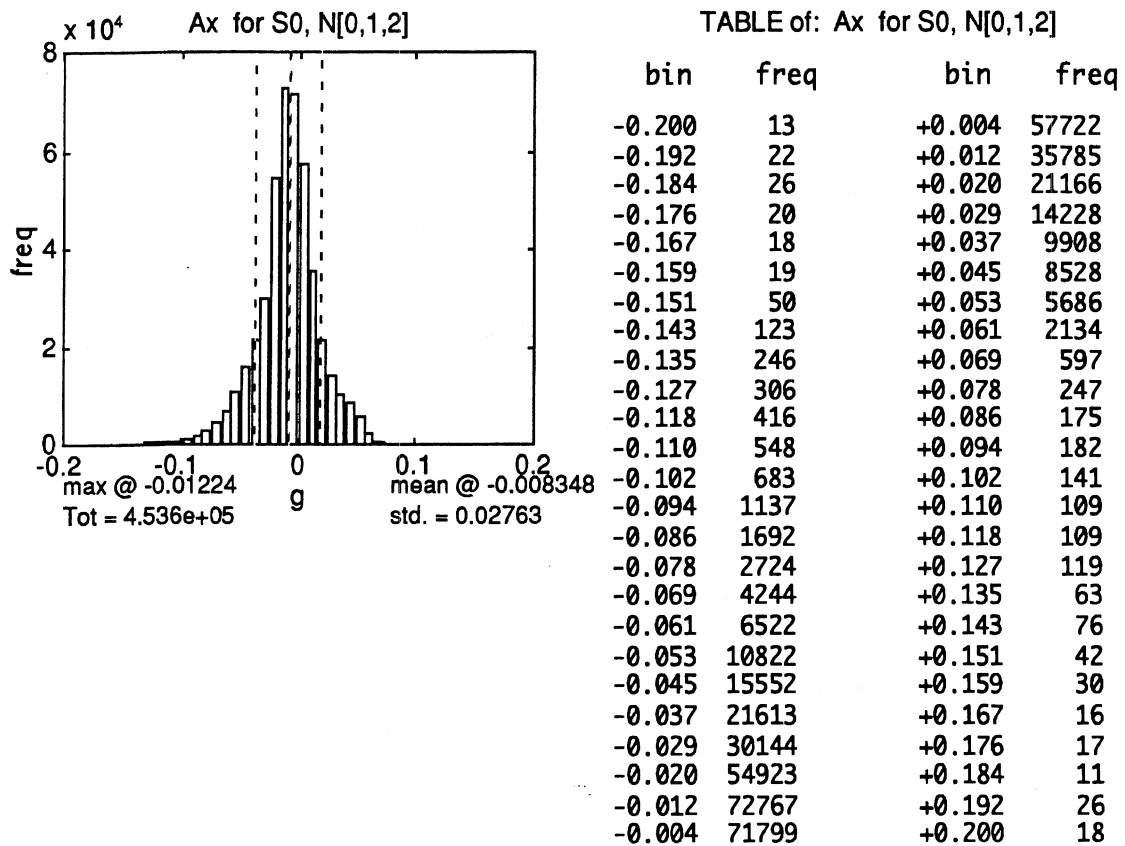

Figure 31. Deceleration and acceleration density

It would seem intuitively reasonable that the derived variable, available reaction time ( $T_a$ ), has a bearing on whether crashes are likely to occur. Test results shown in Figure 32 indicate that drivers often travel at values of  $T_a$  that are much closer than 1.4 seconds, which is the "desired" value of  $T_a$  used in the baseline ACC system. If one knew the relationship between  $T_a$  and the risk of a crash, one could estimate the benefits obtained by maintaining longer ranges (i.e., providing more reaction time when reaction time is less than 2.5 sec). Given a concern with crashes, it is of interest to estimate what might be done with more reaction time. For example, each additional 0.1 sec of available reaction time means a change of relative velocity ( $\Delta V$ ) of 0.322 ft/sec per 0.1 g of relative deceleration between the preceding and following vehicles. This means that a 0.4 sec reduction in  $T_a$  and an available relative deceleration capability of 0.5 g could reduce  $\Delta V$  by 6.44 ft/sec (about 4.4 mph), which could mean a reduction in the number of rear-end crashes and a reduction in the severity of the accidents that did occur.

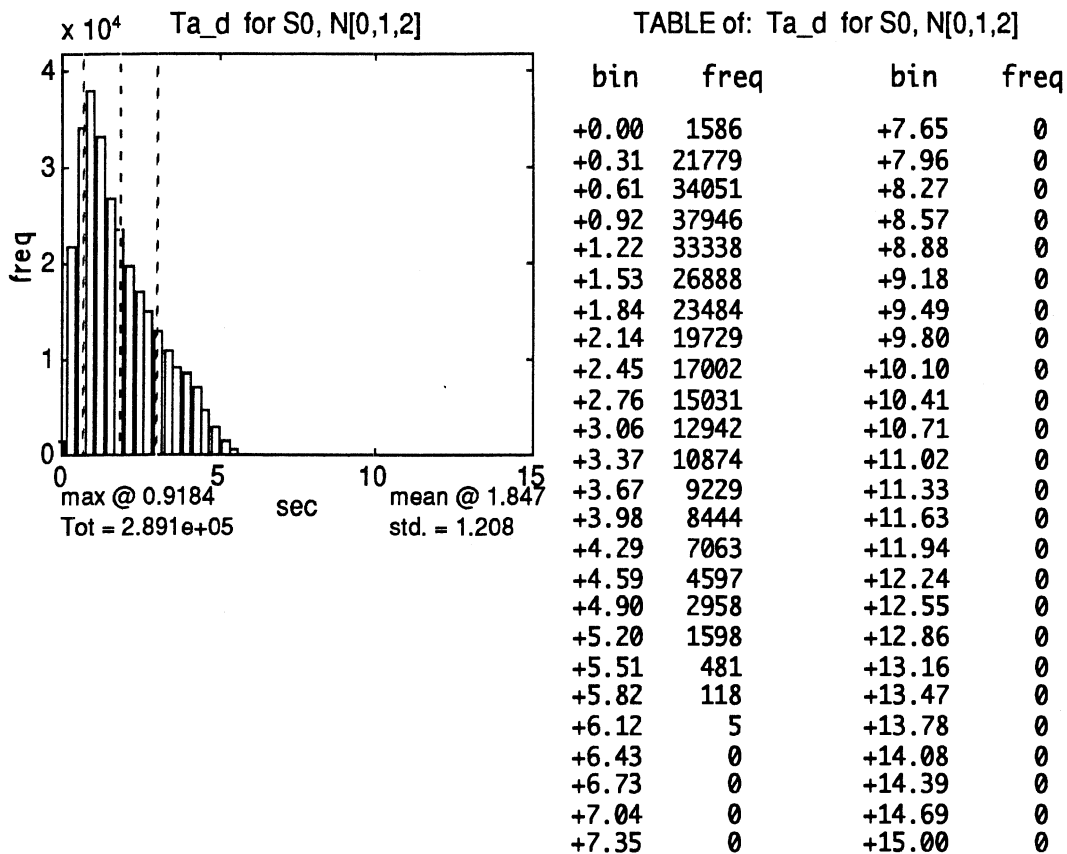

Figure 32. Available reaction time ( $T_a$ ) density

With regard to drivers being able to perceive relative velocity, it has been found that drivers become aware of relative velocity through the looming effect that occurs as an object gets closer. Studies show that people start to distinguish relative speed changes when the angular rate of change of image size exceeds 0.2 deg/sec [8]. For example, the angular width ( $A$  in degrees) of a 6 ft object at a range ( $R$  in feet) is given by:

$$A = 6.57.3/R \quad (6)$$



And the angular rate is:

$$dA/dt = - (344 dR/dt)/R^2 \quad (7)$$

For  $dA/dt$  at the 0.2 sec threshold of resolution, one obtains:

$$dR/dt = - 0.00058 \cdot R^2 \quad (8)$$

This means that at a range of 250 ft, for example, the range-rate needs to be at least 36 ft/sec (25 mph relative velocity) for the driver to notice it. This result for minimum detectable range-rate is so much bigger than one might imagine that it needs further verification. Nevertheless, presuming that the result is at least qualitatively correct, it means that the ACC system has a big advantage over drivers in detecting the rate of closing on a preceding vehicle. In essence, drivers are nearly "blind" to range-rate until they get to within about 100 ft of range when the minimum detectable range rate is 5.8 ft/sec (4 mph). Perhaps this has something to do with why drivers tend to follow at close ranges when the relative velocities are small. In any event, it means that the ACC system is much more responsive to relative velocity than the human driver, and hence the ACC system can be expected to close in on preceding vehicles in a much more orderly and consistent manner.

Now consider fatigue. This is really a nebulous subject, but there is no doubt that ACC (as well as conventional cruise control) greatly reduces the physical and neurological effort that the driver expends in modulating the accelerator pedal. One might think that they put the accelerator pedal at a fixed position and go at the speed they desire. Measurements made in this program show that this is not the case at all. See Figures 33 and 34. Drivers tend to be moving the accelerator pedal continuously with a ratio of standard deviation of the pedal motion about the mean to the mean itself of approximately 0.43 at highway speeds. To the extent that the benefits of removing this effort, and all of the decisions to increase or decrease speed that accompany it, greatly reduces the driver's workload, the ACC system leads to safer, as well as more pleasant, driving.

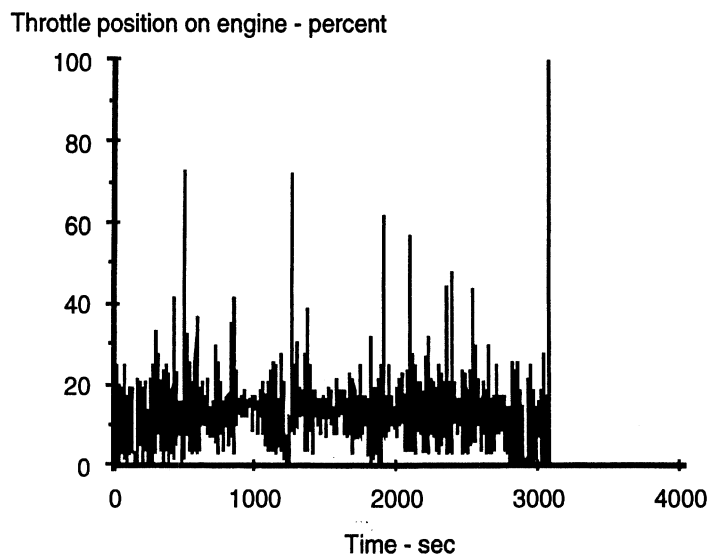

Figure 33. Accelerator pedal position time histories

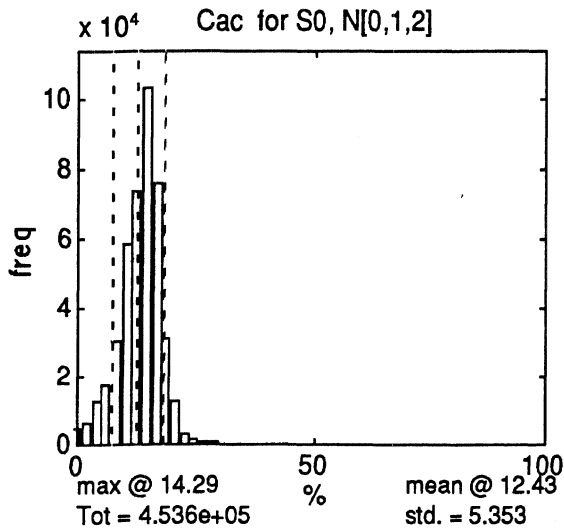

TABLE of: Cac for S0, N[0,1,2]

bin	freq	bin	freq
+0.0	4841	+51.0	14
+2.0	6587	+53.1	7
+4.1	12726	+55.1	19
+6.1	17957	+57.1	11
+8.2	30433	+59.2	4
+10.2	58223	+61.2	6
+12.2	73755	+63.3	1
+14.3	103411	+65.3	2
+16.3	76261	+67.3	3
+18.4	31008	+69.4	0
+20.4	13055	+71.4	4
+22.4	3536	+73.5	3
+24.5	1429	+75.5	0
+26.5	847	+77.6	0
+28.6	478	+79.6	0
+30.6	322	+81.6	0
+32.7	262	+83.7	0
+34.7	145	+85.7	0
+36.7	108	+87.8	0
+38.8	99	+89.8	0
+40.8	64	+91.8	0
+42.9	62	+93.9	0
+44.9	32	+95.9	0
+46.9	39	+98.0	0
+49.0	23	+100.0	0

Figure 34. Accelerator pedal position density

### 5.3 Findings from Subjective Data

Following the completion of each traverse of the predetermined route, once each for the three control modes, a brief questionnaire was completed by each of the participants. The results of this group of questionnaires are presented as section 5.3.1, below. At the end of the entire driving sequence, an additional questionnaire was completed pertaining to the experience with ACC, in particular. Results from the ACC questionnaire are presented in section 5.3.2.

#### 5.3.1 Findings from the Immediate Driving Mode

These questionnaires were used to compare a participant's sense of comfort and safety across control modes. The questions were worded identically, with the exception that reference was made to the control mode most recently experienced by the participant. Each of the questions was followed by a seven-point adjectival rating scale. The questions, and results, are provided below.

1. *How comfortable, from a safety standpoint, did you feel driving the car with no cruise control/conventional cruise control/adaptive cruise control?* The scale was anchored on either end by "Not Comfortable" (1) and "Very Comfortable" (7) respectively, as shown below.

Control Mode	Mean	Std. Dev.
No Cruise	6.17	1.28
Conven. Cruise	5.75	1.05

ACC 6.00 1.22

2. *How easy did you find it to maintain a safe distance between your car and other cars in front of you?* The scale was anchored on either end by “Not Easy” (1) and “Very Easy” (7).

Control Mode	Mean	Std. Dev.
No Cruise	5.86	1.50
Conven. Cruise	5.14	1.62
ACC	6.33	1.17

3. *How comfortable did you feel with the ability to pass other cars while driving with no cruise control/ conventional cruise control/adaptive cruise control?* The scale was anchored on either end by “Not Comfortable” (1) and “Very Comfortable” (7).

Control Mode	Mean	Std. Dev.
No Cruise	6.36	0.96
Conven. Cruise	5.67	1.22
ACC	5.72	1.56

4. *Using no cruise control/ conventional cruise control/adaptive cruise control, do you feel that you drove either faster or slower than you would normally?* The scale was anchored on either end by “Slower than Normal” (1) and “Faster than Normal” (7).

Control Mode	Mean	Std. Dev.
No Cruise	5.17	1.13
Conven. Cruise	3.86	1.15
ACC	3.69	1.43

5. *Using no cruise control/ conventional cruise control/adaptive cruise control, do you feel that you applied the brakes more or less frequently than usual for comparable traffic?* The scale was anchored on either end by “Less than Usual” (1) and “More than Usual” (7).

Control Mode	Mean	Std. Dev.
No Cruise	4.42	1.46
Conven. Cruise	4.39	1.52
ACC	2.47	1.52

6. *In general, how similar was your driving to the way you would normally drive under the same types of road and traffic conditions?* The scale was anchored on either end by “Not at all Similar” (1) and “Very Similar” (7).

Control Mode	Mean	Std. Dev.
No Cruise	5.97	1.36
Conven. Cruise	5.33	1.43
ACC	4.72	1.95

### 5.3.2 ACC Acceptance and Comfort Questionnaire

Following the completion of all three trials, each participant was asked to complete a detailed questionnaire regarding the use of the ACC mode only. The questions, and participant responses, are provided below.

1. *When a difference in vehicle speeds would require you to use the brake, would an audible tone be useful?*

Yes = 17      Not certain = 10      No = 9

2. *Did you like the 2 mph increments for setting and reducing cruise speeds?*

Yes = 34      No = 2 (would prefer 1 and 5 mph increments)

3. *If the headway (distance the adaptive cruise control system maintained between the two vehicles) was adjustable, you would:*

like it shorter (drive closer to others) = 3

like it where it currently is = 17

like it longer (farther from others) = 2

it would depend on traffic conditions = 13

no response = 1

4. *What impact did adaptive cruise control have on your sense of safety?* The scale was anchored on either end by “I felt very unsafe” (1) and “I felt very safe” (7).

Mean = 5.97      Std. Dev. = 1.08

5. *What impact did adaptive cruise control have on your sense of comfort?* The scale was anchored on either end by “I felt very uncomfortable” (1) and “I felt very comfortable” (7).

Mean = 6.25      Std. Dev. = 1.10

6. *Did the system ever make you feel too comfortable, as if someone else had taken control of the car for you?*

Yes = 11      I am not certain = 3      No = 22

7. *How convenient did you find using adaptive cruise control? The scale was anchored on either end by "It was very inconvenient" (1) and "It was very convenient" (7).*

Mean = 6.25      Std. Dev. = 1.23

8. *When closing a gap, or when a lane becomes free, what do you think of the adaptive cruise control system's rate of acceleration? The scale was anchored on either end by "Too Slow" (1) and "Too Fast" (7).*

Mean = 4.22      Std. Dev. = 1.10

9. *How similar to your own driving behavior do you think the adaptive cruise control system operated? The scale was anchored on either end by "Not similar" (1) and "Very similar" (7).*

Mean = 4.91      Std. Dev. = 1.68

10. *Did any aspects of the adaptive cruise control system bother you? If yes, what aspects were bothersome? Values in parentheses represent the number of participants providing the same comment.*

Loss of target on curves (4)

Can't track cars entering the highway (2)

Rate of acceleration during lane change (2)

Location of controls and digital display (2)

Tracks wrong targets on curves

What would indicate malfunction?

Lack of brake lights during deceleration

Uncertain about reliability

Not for use on interchanges

Difficulty in remaining awake

Headway is too short

Headway too long

11. *Please identify any additional concerns or advantages you would associate with owning/using an adaptive cruise control system.*

### **Advantages**

Very safe, reduce risk of accidents  
Good for elderly, minimum leg movement  
Safety for lane changing  
Less driving stress  
Useful and comfortable  
Convenient, unobtrusive  
Less leg cramping, less stress  
Good for elderly & drowsy drivers  
Simple override mechanism  
Improves safety  
  
Less braking required  
Good acceleration, safer than standard cruise  
Comfort on highway trips  
  
Fine for the open road or low traffic

### **Disadvantages**

Over dependence in poor weather  
Concern about quick cut-ins  
Too comfortable on long trips  
Needs sound  
Problem on exit ramps  
Use on exit ramps and curves  
False sense of security  
Over dependency  
Sound when braking needed  
Curves, need to eliminate wrong targets  
Prefer to control car myself  
Over dependence  
Too little acceleration for lane changing

## **6.0 Ancillary Analysis of Traffic Flow Dynamics (based on AVEC '94 Paper)**

Although it was not possible in the time span of the SCP project to examine multiple ACC-equipped vehicles on the highway (since only one prototype existed, to date) an ancillary analysis has been performed to anticipate certain performance characteristics that can be expected from a string of ACC-equipped vehicles operating in succession to one another. This analysis recognizes that, in the design of such systems, there are likely to be trade-offs made between driving comfort (of special interest to vehicle manufacturers, at this stage), the risk of rear-end collisions (obviously of interest to everyone), and the effective levels of highway capacity (of special interest to state DOT) that may prevail when ACC products come into popular usage. Relative to highway capacity, in particular, it recognized that vehicles must travel faster and/or closer together if flow (vehicles/unit time) is to be increased. The following analysis examines whether ACC systems can out-perform unaided drivers with respect to flow, safety, and comfort.

### **6.1 Traffic Density Modelling**

In order to develop an understanding of the ACC influence on intervehicular headway dynamics, we first establish an analytical basis for the conventional car-following problem that is intrinsic to traffic modeling.

#### **6.1.1 Relationships Between Velocity and Headway**

From an analytical point of view, the main difference between driver-control and headway control (ACC-control) lies in the manner in which headway distance (or range between vehicles) is used to control velocity. Figure 1 illustrates the difference between

generic velocity versus distance relationships for both ACC-control and driver-control. In addition, Figure 1 presents basic symbols and equations used in this paper.

Currently used microscopic models for analyzing traffic flow are based on velocity versus distance relationships that are characterized by a rapid decrease in velocity occurring as the distance to the preceding vehicle approaches zero. (See May [1] and Papageorgiou [2]). The form of this relationship is inferred from data obtained by observing the distances chosen by drivers in traffic streams flowing at various velocities [1].

In the driver's eyes the velocity of the trailing vehicle is a function of the distance from the front of the trailing vehicle to the rear of the preceding vehicle. As indicated in Figure 35,

$$d = L + R \quad (1)$$

where:  $d$  is the front-to-front distance between vehicles,  $L$  is the length of the vehicle,  $R$  is the range between vehicles.

In traffic flow analyses, it is conventional to use " $d$ " instead of " $R$ ," but " $R$ " is introduced here to aid in making comparisons with intelligent cruise control systems that employ sensors to measure the headway range ( $R$ ) between vehicles. The slope of the driver-controlled curve, which equals  $\partial V / \partial R$ , is monotonically decreasing as range increases, and the velocity asymptotically approaches the free flow velocity at large headway ranges.

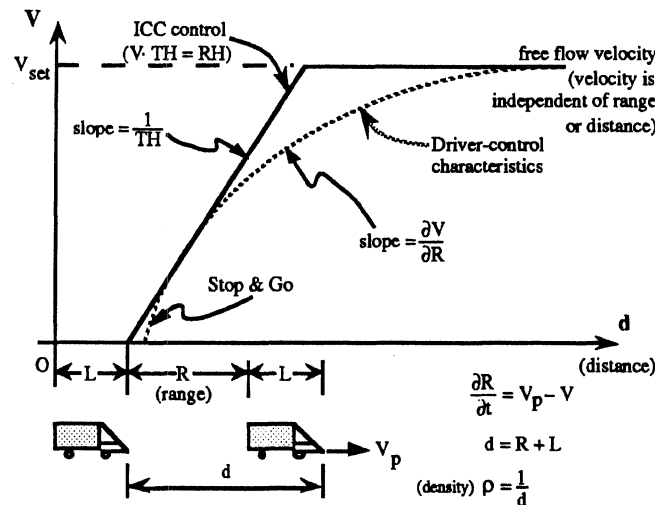

Figure 35. Velocity versus distance relationships.

In the version of ACC discussed here (Fancher, et al [3]), the headway controller changes the trailing vehicle's speed so that the trailing vehicle follows the preceding vehicle at the same speed as the preceding vehicle and at a distance that is proportional to the steady velocity of both the trailing vehicle and the leading vehicle. As illustrated in Figure 35, the slope of the driver-controlled speed vs. distance relationship becomes large as the headway range goes to zero, while in the ACC system, the slope is determined by a quantity TH, called the "time margin."

For the ICC system, the relationship is

$$R = V \cdot TH = RH \quad (2)$$

where: TH = time margin and RH = range margin.

For drivers, the local relationship between velocity and headway range is

$$V = \left( \frac{\partial V}{\partial R} \right) \Big|_{R_0} \cdot (R - R_0) + V_0 \quad (3)$$

where:  $V_0$  and  $R_0$  represent the operating point for the local approximation.

The roles of  $1/TH$  in equation (2) and  $(\partial V/\partial R)$  in equation (3) are critical to maximum flow.

### 6.1.2 Relationships between Density and Flow

The differences between the velocity versus distance relationships given in Figure 35 lead to fundamentally different considerations for determining the conditions for maximum flow in driver-control and ACC-control situations.

In driver-controlled situations, the maximum flow is called the "capacity." Analysis shows that the capacity depends on (1) the slope of the velocity versus distance characteristic and (2) the delay inherent in the driver. Given (1) a delay time,  $T_D$ , for the driver to observe the range to the preceding vehicle, process the information, and perform a speed control action, and (2) the velocity versus headway range of equation (3), the dynamic equation for velocity control is as follows:

$$\frac{d(V_t)}{dt} = \left( \frac{\partial V}{\partial R} \right)_{R_0} \cdot (V_p(t - T_D) - V_t(t - T_D)) \quad (4)$$

Equation (4), while locally stable, can lead to an unstable string of vehicles in that a small disturbance will be amplified from vehicle to vehicle along the string until some vehicle will reach zero velocity and stop and go conditions will prevail. The condition for asymptotic instability of a string of uniform vehicles and drivers is [2]:

$$\left( \frac{\partial V_t}{\partial R} \right)_{R_0} \cdot (T_D) > \frac{1}{2} \quad (5)$$

Inequality (5) means that a region of unstable flow is predicted for speeds and distances (the reciprocal of density) where  $\partial V/\partial R$  is too large. An example of the situation is shown in Figure 36.

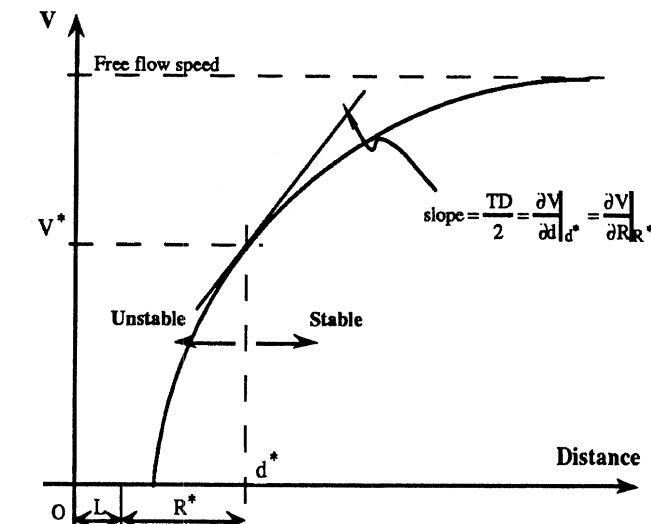

Figure 36. Regions of string instability and stability

According to (5), the critical distance,  $d^*$ , shown in Figure 36, is where

$$\partial V/\partial R = TD/2 \quad (6)$$

Corresponding to  $d^*$ , the critical speed is  $V^*$  and the capacity of flow is  $F_{max}$  and  $\rho^* = 1/d^*$ , where:



$$V^* \text{ (m/sec)} \cdot \rho^* \text{ (veh./m)} = F_{\max} \text{ (veh./sec)} \quad (7)$$

At speeds above  $V^*$ , the ratio  $V/d$  will be less than  $V^*/d^*$ . At speeds less than  $V^*$ , the string is unstable and the situation gets worse rapidly as the distance between vehicles gets to be less than  $R^*$ .

In contrast, the situation for an ACC controlled vehicle is much different as long as TH is much shorter than the principal time constant of the control system plus any delay in the control system.

For the ACC system [4], ideas from nonlinear control are used to convert a vehicle and its cruise control system into a system that operates (to a good approximation) in accordance with the following dynamic equations:

$$T \left( \frac{dR}{dt} \right) + R = TH \cdot V_p \quad (8)$$

where: T is the time constant of the headway control system, TH is the headway time,  $V_p$  is the velocity of the preceding vehicle. And,

$$\left( \frac{dR}{dt} \right) = (V_p - V_t) \quad (9)$$

where:  $V_t$  is the velocity of the trailing vehicle.

As long as

$$T / TH > 1 / 2 \quad (10)$$

a string of identical headway controlled vehicles will be stable (because as long as condition (10) is satisfied, the gain of the gain of  $V_t / V_p$  will be less than 1.0 at all frequencies). Clearly, the control system is to be designed with  $2T > TH$ . (In practice,  $T \approx 12$  sec and  $TH \leq 1.5$  sec.)

Given that stability is no issue for a headway controlled string of vehicles, the maximum flow depends upon constraints set by the choices of TH and maximum speed,  $V_{set}$ . Examination of Figure 1 indicates that the density for ACC-control is given by the following equation:

$$\rho = \frac{1}{L + R} = \frac{1}{L + TH \cdot V} \quad (11)$$

and the flow is

$$F = \rho \cdot V = \frac{V}{L + V \cdot TH} \quad (12)$$

Examination of (12) indicates that the flow approaches  $1/TH$  as  $V$  becomes large.

The implication of (12) with regard to maximizing flow is that TH should be as short as safety considerations allow. For example, if  $L = 6$  m and  $V_{set} = 30$  m/s, then for  $TH = 1.24$  sec.,  $F_{\max} = 2500$  veh/hr and if  $TH = 1$  sec,  $F_{\max} = 3000$  veh/hr. A flow of 2500 veh/hr is very high for a current freeway filled with unaided drivers. Perhaps one could effectively increase the flow to 3000 veh/hr if 1 sec time margins are compatible with driver abilities to supervise ACC systems.

The range between vehicles is critical in determining whether a crash will occur. Crash avoidance depends upon the driver's reaction time, the initial velocity, the range between vehicles, the deceleration rate of the preceding vehicle, and the deceleration capability of the trailing vehicle. The following relationship between these quantities expresses a possible means for determining a desired range for use in an ACC control system:

$$R_D = TD \cdot V + \frac{V^2}{2 a_t} - \frac{V^2}{2 a_p} \quad (13)$$

where:  $R_D$  is the desired range, TD is the driver's response time,  $V$  is the velocity,  $a_p$  is the deceleration of the preceding vehicle, and  $a_t$  is the deceleration of the trailing vehicle. If it is presumed that both vehicles have nearly the same deceleration capabilities (i.e.,  $a_t \approx a_p$ ), then  $R_D$  would be approximately equal to  $TD \cdot V$ . In many driving situations,

drivers' response times are found to average around 1 second with 2 seconds being unusually long, but not uncommon.

In limited experience with an autonomous cruise control system [3], drivers have been operating comfortably with a headway time,  $TH = 1.4$  to  $1.0$  seconds, and a control time constant  $T = 12$  to  $14$  seconds where  $T$  is chosen to be compatible with using natural retardation from rolling resistance and aerodynamic drag (plus engine and transmission drag) to decelerate at about  $0.04g$ . The point is that a time margin,  $TH$ , of less than  $1.4$  seconds may be practical even when using low deceleration to maintain velocity.

## 6.2 ACC Impact on Traffic Operations

The impact of Adaptive Cruise Control on traffic operations was studied using computer simulation methods. Employing the traffic density (or traffic flow) model described earlier, sets of vehicle models representing leading/trailing vehicle pairs have been duplicated to calculate results for strings of vehicles that are operating under headway control. Two vehicle models were exercised: (1) a detailed nonlinear model, and (2) a simplified model. The results from both models are presented and discussed in this section.

The traffic scenario that was used to study how ACC might affect flow was as follows: several individual vehicles, that are moving independently, are converging into a headway-controlled group behind a lead vehicle that is moving at a constant speed, and then, once a steady state is achieved, the lead vehicle changes its speed (slowing down at a constant rate of deceleration).

In previous work rather complete engine and vehicle models were developed [5]. Although the original models represented heavy trucks, they were easily adjusted to represent passenger cars. The engine is modeled as a delayed power plant. The delay is in a form of a torque-growth time lag that represents the combustion process. Peak torque and horsepower values and the corresponding engine speeds are used to compute a mathematical approximation to the power curve. Local linearization is applied to determine the available net engine torque based on throttle setting. In addition to volumetric efficiency, torque losses in the engine are primarily due to friction. With the net available traction torque computed, the longitudinal motion of the vehicle is determined by accounting for inertial properties of the engine and the drivetrain, gear ratios, tire slip, aerodynamics, rolling resistance, and the appropriate grade forces.

A traffic flow simulation that incorporates such a nonlinear vehicle model was derived and used in this work. The simulation consisted of three such individual vehicles coupled together to represent a string of four vehicles including a leading vehicle and three trailing vehicles. Figure 37 illustrates the simulation results in terms of speed changes of the individual trailing vehicles when converging into a headway-controlled group, and responding to a speed change of the lead vehicle. The changes in headway distance (range) between the vehicles are depicted in Figure 38. According to the headway-control algorithm that was used in the simulation, the desired headway time was 2 seconds.

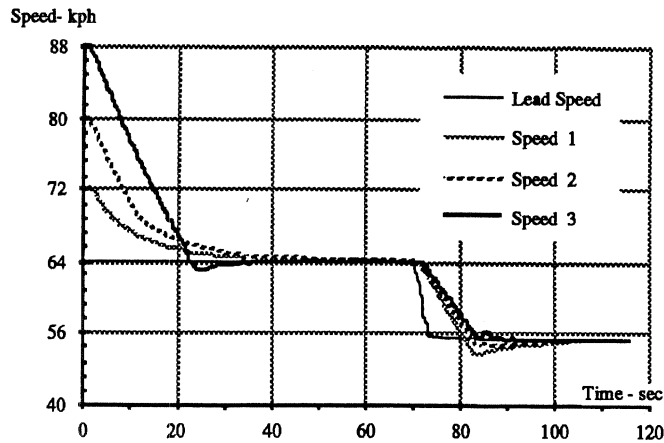

Figure 37. Simulated velocities

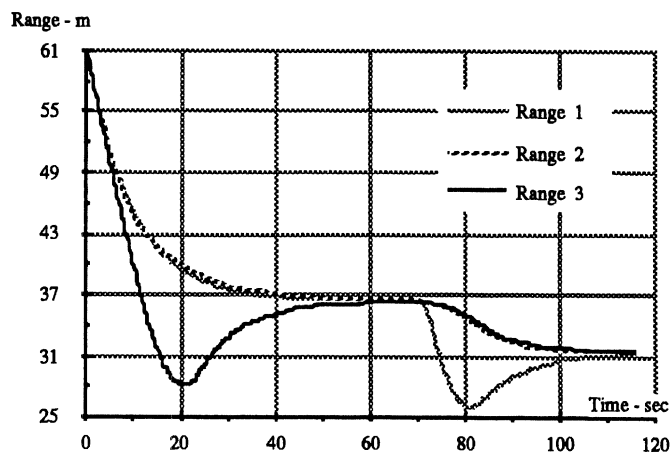

Figure 38. Simulated ranges

During the process of converging, the last vehicle had to go through the most radical speed change (from 88 to 64 kph). Given its initial range and its no-brakes deceleration capabilities (approx. 0.06 g), that vehicle "overshot" the target speed of 64 kph and the desired range of 36 m (2 sec at 64 kph). Since they were traveling at a lower initial speed, the other vehicles were able to adapt their speed more gradually.

When the lead vehicle slowed to 54 kph, the first of the trailing vehicles, which was also capable of only 0.06 g, was not able to keep up, and overshoot both the desired speed and the desired headway. As it had more headway cushion, the second vehicle in the string slightly missed the speed, but was able to maintain headway. The third vehicle was able to properly adjust both its speed and the range to the preceding vehicle.

Next, an attempt was made to study the response of long strings of vehicles (more than 20) to speed disturbances. In order to maintain computing-power requirements to those of desktop computers, some simplifications to the model were necessary. Operation of this simulation model (and previous work in [5]) indicates that the headway-control system effectively cancels most of the nonlinearities, with the exception of the saturation of the braking deceleration, at a level equal to the coast down properties of the vehicle. By using a properly chosen time constant for the headway-control system and introducing a limiter function, it was possible to compensate for this limitation. Simulation parameters were selected based on data recorded from a working AICC vehicle. Experience with both the detailed model and the simplified models that were derived has verified that qualitatively, similar results can be obtained. These models have been implemented in a MATLAB™ environment using SIMULINK™. Currently, we have been using strings consisting of a leading vehicle and 30 trailing vehicles.

Due to the large number of vehicles in the string, and to avoid cluttering of the output plots, results from exercising the SIMULINK™ model are displayed here for : (1) the lead vehicle, the first four individual trailing vehicles, and the last trailing vehicle in the string, and (2) only the response to deceleration is shown. Two combinations of

characteristic properties for the trailing vehicles were studied: (1) headway time of 1 second with a deceleration limit of 0.18 g, and (2) headway time of 1 second with a deceleration limit of 0.09 g. In all cases the trailing vehicles had a time constant of 12 seconds, and the speed disturbance introduced by the lead vehicle was a 0.22 g deceleration.

Results for the first combination of characteristic properties are portrayed in Figures 39 and 40, for the speed response and the changes in headway distance (range) between the vehicles, respectively. It takes a total of approximately 100 seconds for the transient response to diminish, and for the whole group of thirty vehicles to reach a new steady-state flow with the new values of speed and range.

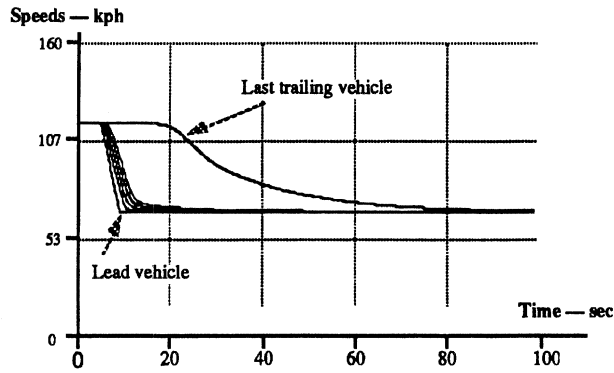

Figure 39. String velocities, 0.18g

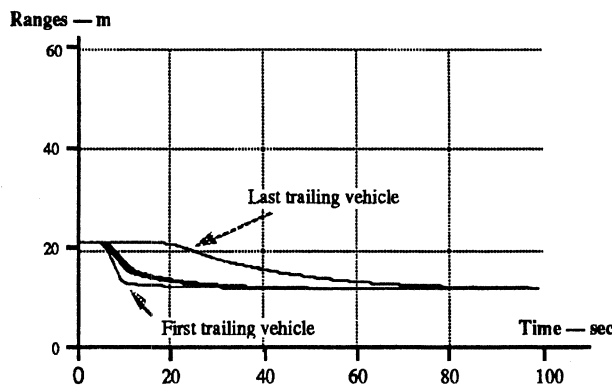

Figure 40. String ranges, 0.18g

Next, a string that consisted of vehicles with substantially lower deceleration characteristics was studied (using the same headway). In contrast to the vehicles in the previous example, which were capable of 0.18 g deceleration, this example incorporates vehicles with a deceleration limit of only 0.09 g. Figures 41 and 42 depict the speed response and changes of headway distance (range), respectively, of the vehicles in the string to a 0.22 g deceleration of the leader.

It is evident that the combination of a short headway distance with a very limited deceleration rate is detrimental for such traffic flow conditions. The vehicle that immediately follows the leader quickly saturates its deceleration capacity, and since it travels closely behind, there is not enough headway distance to cushion and absorb the speed differences, which results in a rear-end collision. However, since all the trailing vehicles have a common limit of deceleration, they successfully follow the first vehicle in the trailing group without rear-ending it.

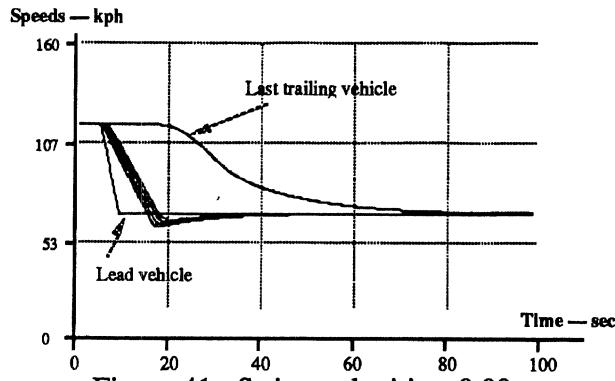

Figure 41. String velocities, 0.09g

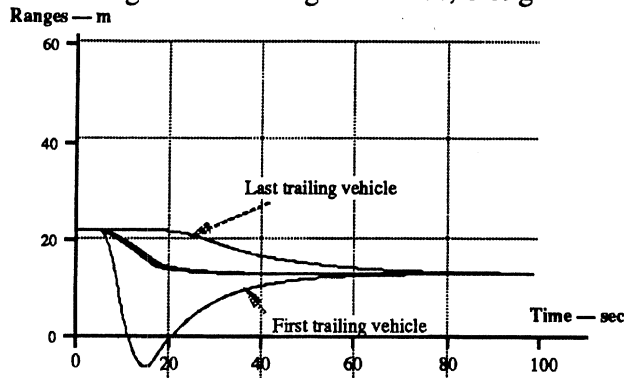

Figure 42. String ranges, 0.09g

Considering the range values portrayed in Figure 42, it is conceivable that by removing the first trailing vehicle such a string of vehicles could be made to handle even a 0.22 g deceleration maneuver. In other words, if a group of vehicles with a very limited deceleration capability follows a vehicle with ample braking power, only the first headway gap needs to be increased. The total length of the group, or the total traffic flow rate, will hardly be affected.

Even if the leading vehicle decelerates at a level such that the first trailing vehicle reaches its saturation level of deceleration, the next trailing vehicle will not need to follow a speed change that takes place at greater than the common level of deceleration saturation. A critical problem is ensuring that preceding vehicles do not decelerate at levels exceeding the deceleration limit. If preceding vehicles decelerate too rapidly, drivers will have to brake their vehicles accordingly, and the string will revert to a driver-controlled string rather than remaining as a headway-controlled string.

The simulation results verify the analytical relationships for spatial instability of the string, as given earlier. In addition, for operation at values of  $T$  and  $TH$  far removed from instability, the results show that if the first trailing vehicle performs well, the rest of the string will have no difficulties.

The simulation results show very stable operation of a headway-controlled string of vehicles. The rules for choosing  $T$  and  $TH$  are clearly known now. A level of deceleration capability of 0.1g is adequate for first trials of normal operation of a headway-controlled string. A deceleration capability of 0.2g would be adequate for handling extraordinarily large decelerations of the leading vehicle, on the order of 0.25g for sufficient time to slow from 80 kph to 48 kph, for example.

It is readily apparent that to achieve high levels of traffic flow rate, the headway time should be minimized. That requirement, however, seems to be at odds with highway safety concepts. Nevertheless, that conflict might be resolved if weakness points (e.g. a low deceleration vehicle traveling behind a more agile one) along the string are identified, and only local increases of headway are applied.

### 6.3 Implications Drawn From This Analysis

The results and findings from the analytical work plus driving experience and the simulation activity reported in this paper support the following ideas:

- Using current ACC-prototypes, steady flows of 2500 to 3000 veh./hour/lane may be feasible.
- ACC systems should reduce the tendency for stop and go driving at low speeds in congested situations. This is because the ACC system will not exhibit the level of asymptotic instability found in manual driving.
- ACC systems may be as safe as manual driving if drivers recognize risky situations and intervene as needed. Driver warnings when range becomes too close may help ensure safer operation.
- ACC systems may employ low levels of deceleration and still maintain suitable time and range margins most of the time. Drivers and passengers are liable to be uncomfortable with high levels of deceleration. Hence customer acceptance may depend upon using low levels of deceleration except in emergency situations.
- Clearly, there is a tradeoff between the level of deceleration used by the ACC and the level of lead vehicle speed change that can be accommodated by the ACC system. The combination of a short time or range margin and limited deceleration capability can be detrimental if the lead vehicle slows rapidly for a long time. Nevertheless, disturbances are not amplified increasingly upstream because the time constant of the ACC has been chosen to be compatible with the level of deceleration to be employed by the ACC [4]. If the first vehicle behind a disturbance in velocity does not experience a problematic situation then the following vehicles will not either.

## 7.0 Conclusions

A platform for experimental examination of the ACC application has been successfully designed, assembled, and tested. The capability represented by the testbed vehicle, and associated data processing tools, enables research at the leading edge of ACC development. Test data gathered during the inaugural usage of the testbed, under the NHTSA-sponsored FOCAS project, have shown that the test system is highly reliable and is able to produce high quality data in extremely large volumes. In fact, a primary need for further development in this area is to develop methods for drastically reducing the raw volume of data gathered from the continuous operation of the testbed vehicle in the field.

The accompanying test program, conducted on a circuit of MDOT trunkline roadways, has shown that the prototyped ACC package represents a feasible automotive product. While a variety of results were presented in this report from objective data recorded during the testing, subjective observations by the participants perhaps serve best to indicate the nominal readiness of ACC technology for general use. We noted that the participants generally felt very comfortable with using the ACC system under the conditions examined. Individuals who were not experienced in the use of conventional cruise control were perhaps initially more reluctant, but none-the-less quickly adapted to the use of ACC. Participants did not have difficulties in understanding the concept of ACC, or the limitations of the ACC system examined (i.e., they understood that there could be missed targets and false targets). Several of the participants, particularly older individuals, stated that an ACC system would make long trips physically more comfortable for them by allowing greater freedom of movement for their legs. However, approximately one-third of the participants stated that the system made them feel too comfortable at times, as if someone else had taken control of the vehicle.

While participants generally reported feeling very comfortable with the ACC system, there were also concerns over the use of ACC in traffic conditions other than those tested ("how might it behave in rush hour traffic," for example). Several participants stated that they would be reluctant to use ACC in many, if not most, traffic settings they encounter due to the density of traffic. When asked, for example, how much they would be willing to spend to purchase an ACC system, all but two stated they would not spend as much money as they believed the manufacturers would be charging. The median amount participants would be willing to spend, above the cost of conventional cruise control, was \$200, whereas the median value participants believed that manufacturers would charge was \$350 above the cost of conventional cruise control. The value participants assigned to an ACC system appears to be, in part, influenced by the amount of use they would receive out of such a system based on the types of traffic settings they normally encounter.

## References

1. May, A. D. *Traffic flow fundamentals*. Englewood Cliffs, N.J., Prentice-Hall, 1990.
2. Papageorgiou, M., and Ioannou, P. *Traffic flow modeling and control and intelligent highway systems (IVHS). Short course notes*. Los Angeles, SSC Systems, June 1993.
3. Fancher, P.S., Ervin, R.D., Bareket, Z., Johnson, G.E., Trefalt, M., Tiedecke, J., and Hagleitner, W. "Intelligent cruise control: performance studies based upon an operating prototype." In *Moving Toward Deployment. Proceedings of the IVHS AMERICA 1994 Annual Meeting. Volume 1*. Washington, D.C., IVHS AMERICA, 1994. Pp. 391-399.
4. Fancher, P. and Bareket, Z. "Evaluating headway control using range versus range-rate relationships." *Vehicle System Dynamics*, Vol. 23, No. 8, Nov 1994, pp. 575-596.
5. Fancher, P., Bareket, Z., and Johnson, G. "Predictive analyses of the performance of a headway control system for heavy commercial vehicles." In Shen, Z., ed. *The Dynamics of Vehicles on Roads and on Tracks. Proceedings of 13th IAVSD Symposium*. Lisse, Swets and Zeitlinger, 1994. Pp. 128-141.