

## ORIGINAL ARTICLES

### *Differential diagnosis of Class II malocclusions*

#### *Part 1. Facial types associated with Class II malocclusions*

**Robert E. Moyers, Michael L. Riolo, Kenneth E. Guire, Robert L. Wainright and Fred L. Bookstein**

*Ann Arbor, Mich.*

*By means of computer-based statistical methods, several types of Class II malocclusion have been discovered with defining horizontal and vertical characteristics. Of the six horizontal types, four are severe syndromes, one is a loose, ill-defined grouping of cases with mild skeletal features, and one has only the dental features of Class II. Five vertical types associated with Class II were also revealed, although each vertical is not associated with all the horizontal types. A simplified simulation of the computerized procedures has been developed for routine use in clinical practice.*

**Key words:** Class II, malocclusion types, cluster analysis, facial types

A common problem in biologic and clinical sciences is the taxonomic one of defining and labeling subgroups of a population. In orthodontics this process has been carried out traditionally by methods that are essentially subjective and, therefore, unable to deal with a whole other set of variables in an efficient, mathematically reliable way. The classic example is the Angle classification of malocclusion.

In recent years, sophisticated multivariate methods have been developed and applied to problems in taxonomy. This was done in an effort to improve the evaluation of an individual as a whole. These methods also make classification schemes easier and more

From The Center for Human Growth and Development, University of Michigan.

The research reported in this study was supported in part by Grant DE-03610 National Institute for Dental Research, National Institutes of Health.

**Table I.** Sources of the sample

Private orthodontic practices	540
Two university orthodontic clinics	100
University of Michigan Growth Study (untreated subjects, serial data)	57
Total	697

objective by means of numerical operations on the data base. These methods derive subgroups which can then be studied further; thus, the methods serve as heuristic tools for the investigator. This article will report on the application of the methods of numerical taxonomy and other statistical and mathematical procedures to the general problem of discovering subgroups within the malocclusion which orthodontists call Class II.

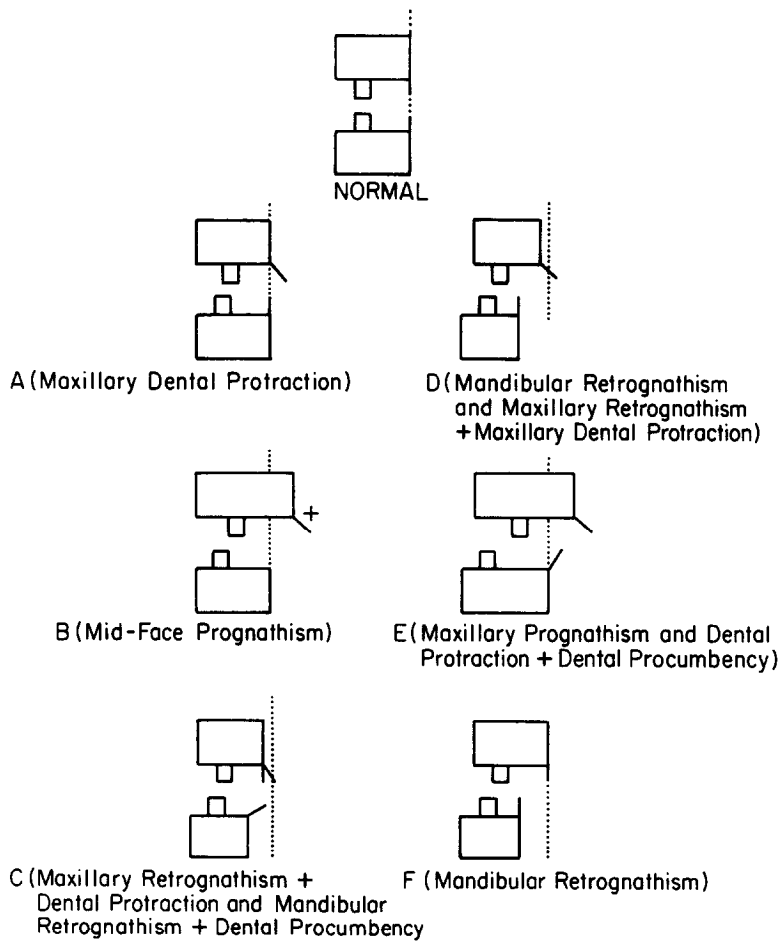
The purpose of this research is to answer the following questions: (1) Is it possible to identify, within a sample of Class II malocclusions, different skeletal facial types? (2) If so, how many types are there, what are their skeletal characteristics, and what is the percentage of subjects in each?

### Previous work

For some time it has been thought that a wide variety of skeletal types are found in the larger population designated Class II. We wished to learn how many such types exist and to find objective ways to identify and describe them. We wanted any subgroups to emerge from within the data as opposed to being imposed on the data by us. Therefore, we began with an approach designed specifically for this purpose, namely, the methods of numerical taxonomy which are known in the statistical literature as *cluster analyses*. The methods of numerical taxonomy which we and others have used are equally and generally applicable to the derivation of groupings in other sorts of anthropologic and anatomic data: body shape, blood groups, electrophoretic patterns, cell shapes, etc. Reviews of the techniques of numerical taxonomy have appeared,<sup>1</sup> and new methods are constantly being developed.

In a previously reported study,<sup>2</sup> we applied cluster analyses to 308 North American children to derive general categories of skeletal facial type and to compare them to the Angle classification. In that initial study we obtained five categories which showed some correspondence to the Angle Classes I, II, and III. We discovered that Angle Class III could be clustered quite unambiguously within the general population, but the relationship between Class I and Class II was far more indistinct. Furthermore, our findings led us to believe that we could identify at least three heretofore undetected subgroups of Angle Class II. By the methods we employed at that time, these three subgroups, while recognizable, were not cleanly and clearly characterized. Nevertheless, we believed that the categories were more realistic and informative than the Angle classes, and we reported them along with the distinguishing skeletal characteristics of each. We were intrigued with the idea of better identification of subsets within the Angle Class II group and decided to attempt to identify their number and characteristics.

The methods of numerical taxonomy and cluster analysis have improved during the period since our first article. Indeed, we have made contributions to the computer implementation of such procedures. Furthermore, there are other procedures which can be used as alternatives, augmentations, or corroborations of cluster analyses. Our experience

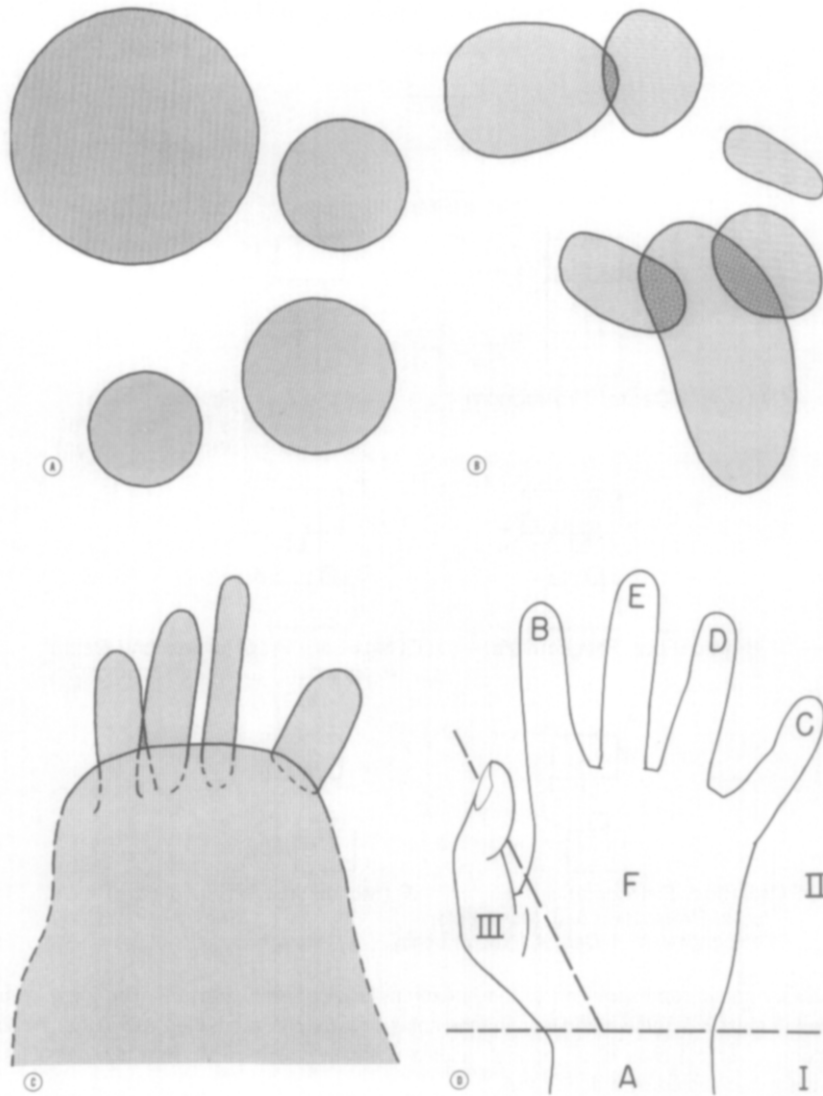


**Fig. 1.** Diagrammatic representation of the horizontal facial types in Class II. The large rectangles symbolize the maxilla and the mandible, and the small squares represent the first molars. Incisors are represented as vertical lines when normal, angled when in labioversion. The ideal profile seen in orthognathism is depicted by a dotted line.

with these methods has given us new insight into their possibilities and limitations. Details of mathematical and statistical analytic methods are not part of this report. They will appear in other articles written for other readers.

### The data base

Within the past several years we have accumulated, digitized, and stored within our computer a rather large sample of treated Angle Class II malocclusions. In addition, our basic data base of longitudinally studied Ann Arbor children includes 57 untreated Class II malocclusions for which we have computer-stored data on both casts and cephalograms for a period of time averaging about 10 years. Our computer methods for casts and cephalograms have been reported previously.<sup>3, 4, 5, 6</sup> All of the data used in the present



**Fig. 2.** Relationship of the horizontal types to each other. Theoretically, clusters should segregate cleanly (A). Biologic data are far more likely to display overlapping clusters (B). Our Class II data look something like C, where there are four fairly well-defined but open-ended clusters which are clearly segregated at one end but seem to merge into a large area which is not at all clustered. A way to visualize these relationships is shown in D. The fingers are the four syndromal types (B, E, D, C) which are all clearly distinct from each other in their extreme forms but blend into type F at the weaker ends of each continuum. Types A and F are not clustered, and the division between them is arbitrary. The location of the broken line between A and F on this drawing betrays a bias from our data to be encountered later in this paper, namely, that Type A, having no abnormal skeletal features, is not properly called Class II. On the other hand, the broken line could fairly be placed beneath the letter A on the diagram, since Type A cases were called Class II by the clinicians classifying the clinical problems used in this research. Perhaps we may think of the thumb as Class III since it does cluster cleanly and overlaps both Classes I and II, but this may be extending the symbolism a bit too much.

study were obtained from lateral cephalograms of 697 North American white children who had undergone treatment by an orthodontist for an Angle Class II malocclusion or who were members of our untreated serial data set ( $n = 57$ ). Table I shows the distribution of cases by source (two university orthodontic clinics, private orthodontic practices, and the untreated serial data from our own growth study). There were obvious differences in the different data sets which comprised our data base. What one orthodontist calls Class II differs significantly from what another labels the same way. The orthodontists designated each treated case as Class II for their own purposes, being unaware at that time that the case would be included in this study, and all treatment was completed prior to the start of this study. Our serial data set includes 208 digitized children's records of varying lengths and completeness of all occlusal categories. At least three orthodontists who have served on our staff (F. P. G. M. van der Linden, W. S. Hunter, and M. L. Riolo) have subjectively designated the Class II cases within the total sample. We included the records of any child considered by any one of these three orthodontists to be Class II. Fifty-seven of the total of 208 children were designated "Class II" by at least one of the three orthodontists.

All cephalograms were traced, digitized, and stored within the computer by methods which we have previously reported.<sup>6, 7</sup>

## Findings

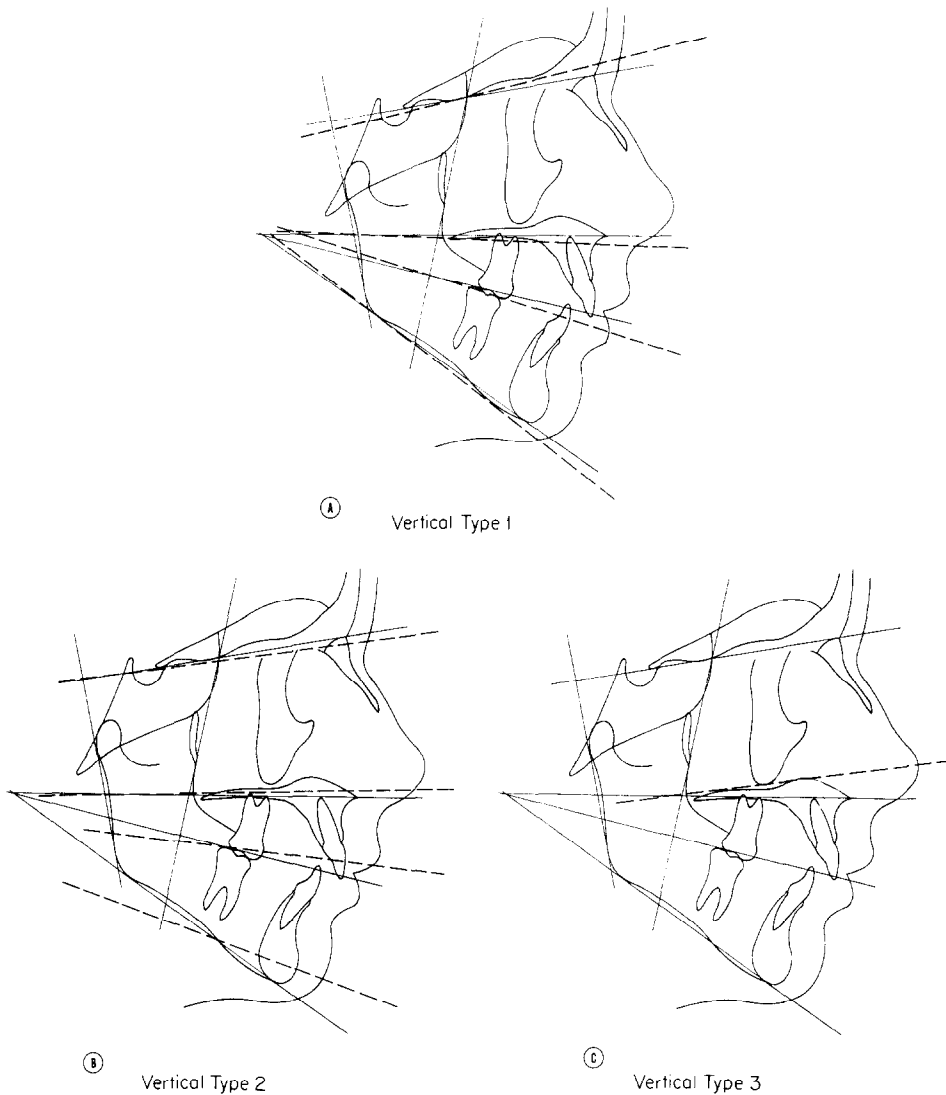
*What is Class II?* Class II apparently is a highly subjective designation, more so than we knew when we started. Nevertheless, we have found some general characteristics of Class II of sufficient interest to be reported in detail in a separate article. At least one of these general findings about Class II is worth mentioning here. Many of the linear measures are smaller than the mean values in our normative data base. In the loosest sense of the word, Class II patients as a rule have smaller faces. Specific quantification of skeletal features of each of the subgroups identified will be described in the second article in this series.

## Horizontal typing

Without describing in detail the analytic steps we have developed and used, our current understanding of Class II taxonomy recognizes six subgroups based on horizontal variables. We identify these six subgroups by the letters A, B, C, D, E, and F and call them "types." Among these, four (Types B, C, D, and E) are true syndromal types of Class II; that is, they have distinctly different skeletal and dental features and their morphologic and growth patterns differ from one another. Type F, the largest subgroup of all, is less well defined, less characteristic of skeletal Class II, and yet clearly not Class I. In this subgroup each individual has some Class II characteristics, although not in sufficient quantity and severity to produce a distinct syndrome. Finally, there is a subgroup (Type A) which has scarcely any Class II skeletal features but, because of its dental characteristics, was designated by the orthodontists as Class II. The paragraphs that follow give brief descriptions of each of these horizontal subgroups. Fig. 1 diagrammatically represents them and Fig. 2 shows their relationships to each other in the "clustering" context.

*Type A* is characterized by a normal\* skeletal profile. The occlusal plane is normal, as

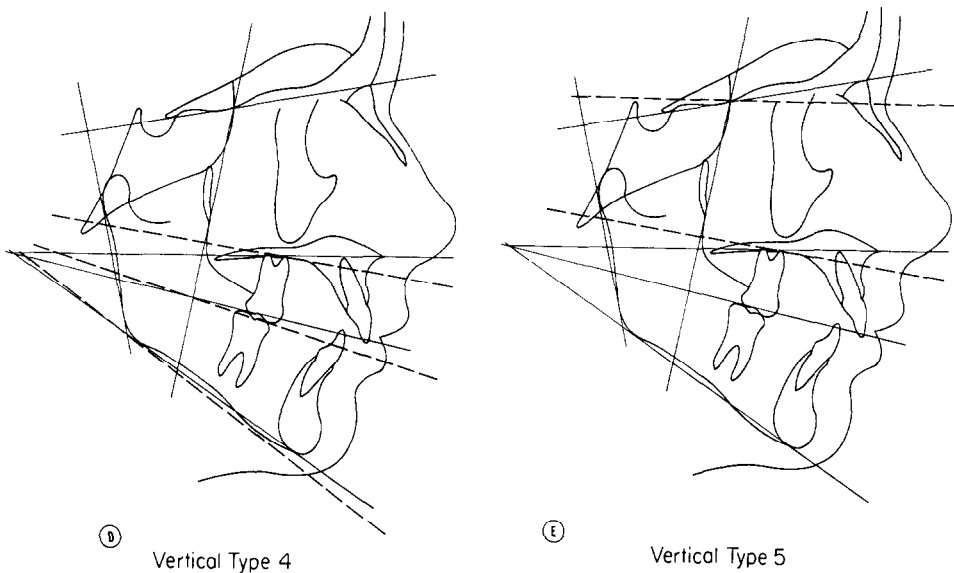
\*All determinants of normality are made by comparisons with our serial data base (Michigan Growth Study).



**Fig. 3.** Vertical Types 1, 2, 3, 4, and 5 compared to the Michigan Growth Study norms. The normal position of the cranial base, palatal, occlusal, and mandibular planes is shown in each drawing by a solid line. The average position for the planes for each of the vertical types is shown as a broken line. **A,** Vertical Type 1. **B,** Vertical Type 2. **C,** Vertical Type 3. **D,** Vertical Type 4. **E,** Vertical Type 5.

is the anteroposterior position of the maxilla and mandible. The mandibular dentition is placed normally on its base, but the maxillary dentition is protracted, resulting in a Class II molar relationship and a greater-than-normal incisal overjet and overbite (Figs. 1 and 6).

*Type B* displays a Class II skeletal profile due to midface prominence associated with a mandible of normal size. Measurements of A-B difference are high because measures of maxillary prognathism are greater than normal, but the mandible is in a normal relation-



**Fig. 3. D and E.** For legend, see facing page.

ship anteroposteriorly. The anterior cranial fossa tends to be flat (Figs. 1, 7, and 8).

*Type C* cases are characterized by generally smaller facial dimensions than other Class II types. There is a markedly Class II profile, even though both the maxilla and the mandible are farther back beneath the anterior cranial base than the normal. The lower incisors are tipped labially, and the upper incisors are either upright or tipped off the base labially according to the vertical category. *Type C* is a severe skeletal Class II with a short mandible, a short maxilla, a squarish gonial angle, and a flat anterior cranial base (Figs. 1 and 9).

*Type D* displays a skeletal profile which is retrognathic, largely because of a small mandible combined with a normal or slightly diminished midface. The mandibular incisors are either upright or lingually inclined, whereas the maxillary incisors are extremely labially inclined. There are few extremes in the gonial angle (Figs. 1 and 10).

*Type E* is characterized by a severe "Class II" profile due to a prominent midface and a normal or even prominent mandible. Bimaxillary protrusion Class II malocclusions are more likely to be horizontal *Type E* than any other, although a few appear as horizontal *Type B*. Both dentitions, in *Type E*, have a tendency to be forward on their bases and the incisors are often in strong labioversion (Figs. 1 and 11).

Horizontal *Type F* is the large heterogeneous subgroup with the mildest Class II tendencies. *Type F* is not a well-defined, rigid syndromal Class II type but, rather, a loose collection of cases displaying some skeletal Class II characteristics. The skeletal profile tends to be less severe than syndromal *Types B, C, D, and E*. The mandible is small, and the midface may be small. The tooth positions reflect the vertical subsets associated with *Type F*. Because there is less homogeneity in this large group, it is more difficult to typify but it is useful to think of each *Type F* as a milder nonsyndromal form of *Type B, C, D, or*

**Table II.** Classification of vertical types for each horizontal type

<i>Class II vertical groups (495 of 610)</i>	<i>A</i>	<i>B</i>	<i>C</i>	<i>D</i>	<i>E</i>	<i>F</i>	<i>Total vertical</i>
Vertical 1	6	0	11	45	0	70	132
Vertical 2	4	51	33	15	36	94	233
Vertical 3	0	0	8	40	0	32	80
Vertical 4	0	13	0	0	0	0	13
Vertical 5	0	20	0	0	17	0	37
Horizontally but not vertically sorted	7	20	12	12	10	54	115
Sorted both vertically and horizontally	10	84	52	100	53	196	495
Total horizontal types	17	104	64	112	63	250	610

Two-way cross tabulation of horizontal and vertical types.

Total sample	697
Unclassified in horizontal clustering	<u>87</u>
Classified into horizontal types	610
Horizontal types unclassified into vertical types	<u>115</u>
Classified into both horizontal and vertical types	495

The 87 who were unclassified in the horizontal clustering include (1) those not fitting into the six large clusters and (2) those rejected by the computer programs for technical reasons, such as missing landmarks. The 115 cases sorted and classified into horizontal but not into vertical types include (1) cases which are horizontally typed but have normal vertical measures and (2) those horizontal types whose vertical morphology is abnormal but does not fit one of the five largest well-identified groups—they “fell through the cracks.”

E (Fig. 1). Type F is the most frequent horizontal type in our sample (Table II, Figs. 1 and 12).

### Vertical types

Five vertical types have been identified by a variety of methods. None are so clearly differentiated operationally as the four syndromal horizontal types. All five vertical types are not seen within each horizontal type; rather, certain vertical types are characteristically associated with certain horizontal groups. It is not necessary for a horizontal type to be associated with any of the described vertical types, for a horizontal type could have normal vertical measures. Indeed, this is frequently the case for horizontal Types A and F and can be true for any horizontal type. We will describe the vertical types and then array them according to their appearance with the several horizontal types (Table II). Fig. 3 depicts the vertical types.

*Type 1.* The characteristic features of vertical Type 1 are a mandibular plane steeper than normal, an even steeper functional occlusal plane, and a palate which is tipped somewhat downward. The anterior cranial base tends to be upward. The result is an anterior face height that is significantly greater than the posterior face height (Fig. 3, A). Type 1 probably is what many orthodontists call a “steep mandibular plane” or a “high angle” case and may be what oral surgeons call the “long face syndrome” (Figs. 3, A, 6, and 10).

*Type 2.* Vertical Type 2 is essentially a square face. The mandibular plane, functional occlusal plane, and palatal plane are all flatter than normal and are nearly parallel. The



CLASS II PLOT, HORIZONTAL

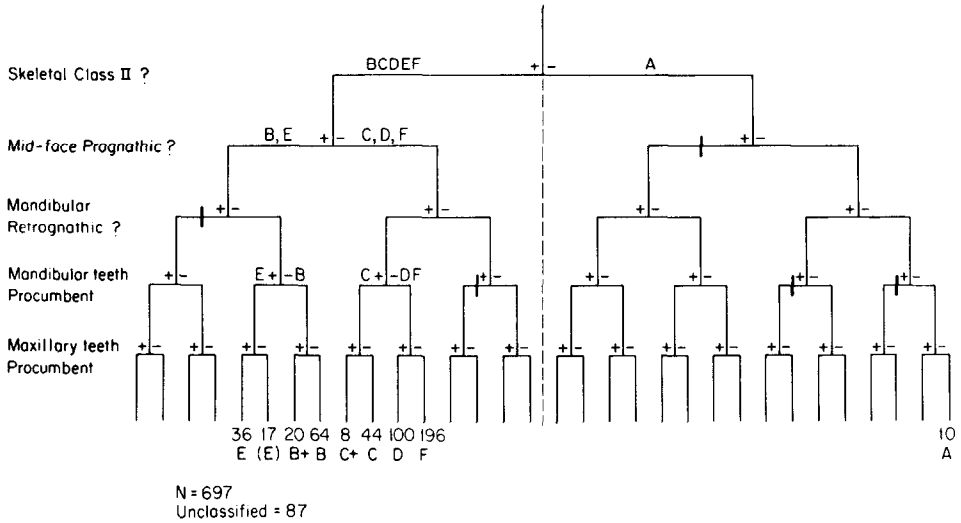


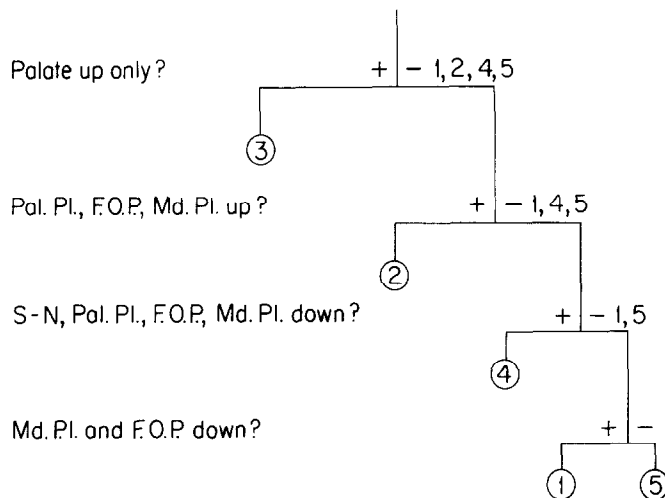
Fig. 4. An arborization for discriminating Class II facial types (see text). + = Yes. - = No.

gonial angle approaches orthogonality, and the anterior cranial base is more horizontal than normal. Under these conditions, the incisors tend to be vertical and in deep-bite (Figs. 3, B, 7, and 9).

*Type 3.* The characteristic feature of vertical Type 3 is a palatal plane which is tipped upward anteriorly. During growth the upper face height does not keep pace with the total face height, resulting in a strong tendency to open-bite. When the mandibular plane is steeper than normal in vertical Type 3, a skeletal anterior open-bite is inevitable. Fig. 3, C shows the features of Type 3, and Fig. 12 shows a patient with F3 features.

*Type 4.* In vertical Type 4 the mandibular plane, the functional occlusal plane, and the palatal plane are all tipped markedly downward (as in Type 1), leaving the lip line unusually high on the alveolar process in the maxilla (Fig. 3, D). The gonial angle is obtuse. Because of the length of the midface in horizontal Type B wherein all vertical Type 4 cases are found, the upper incisors have difficulty coping with the profile and are usually tipped labially whereas upper incisors are vertical in all other Group B Class II cases (Figs. 3, D and 8). In vertical Type 4 the lower incisors are tipped lingually. Vertical Type 4 was seen in only thirteen cases in our sample, but it is a remarkably cohesive, highly describable type. Vertical Type 4 is among the most rare, severe, and anomalous of the vertical types. We have not found it described in the literature.

*Type 5.* Vertical Type 5 is most closely related to vertical Type 2, "the square face syndrome," and is found only in horizontal Subgroups B and E. In Type 5 the mandibular and functional occlusal planes are normal. However, the palatal plane is tipped downward while the gonial angle is the most squarish of all the types, resulting in a skeletal deep-bite of a somewhat different morphology than that seen in vertical Type 2 (Figs 3, E and 11). The lower incisors are found in extreme labioversion, whereas the upper incisors are nearly vertical. Bimaxillary protrusions tend to appear as vertical Type 5.



ARBORIZATION OF VERTICAL TYPES

Fig. 5. An arborization for discriminating the several vertical types of Class II from each other. + = Yes. - = No.

Table III. Characteristic features of the horizontal types

Features	A	B	C	D	E	F
Skeletal class II?	—*	+	+	+	+	+
Midface prognathism?	—	+*	—	—	+*	—
Mandibular retrognathism?	—	—	+*	+*	—	+
I Procumbent?	—	—*	+*	—*	+*	—
I Procumbent?	+	V	V	+	+	V

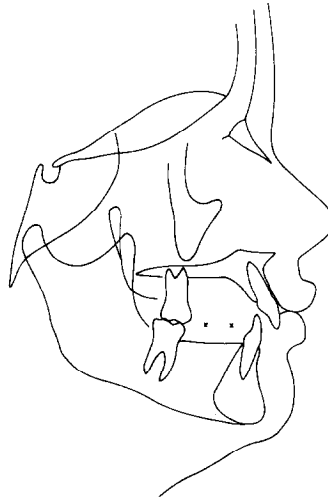
\*Critical discriminators  
V = varies with vertical type

Combining horizontal and vertical types

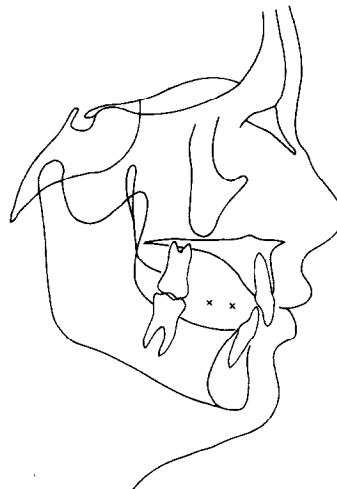
Table II displays the distribution of horizontal and vertical types in matrix form. Several things are of interest in this chart. Note that even though Type A is not truly a skeletal Class II, the two most prominent vertical types tend to appear. There is a strong similarity between horizontal Subgroups B and E, since a high percentage of them are vertical Type 2 and a significant percentage are Type 5. They differ significantly, however, in their dental features, and Group B has the anomalous strange and difficult vertical Type 4 alone. There are similarities in the distribution of vertical types in Groups C, D, and F.

Noncomputer identification of Class II subgroups

Identifying horizontal types. Having defined these groups, we were confronted with the task of determining group membership for individual clinical cases, a classic applica-

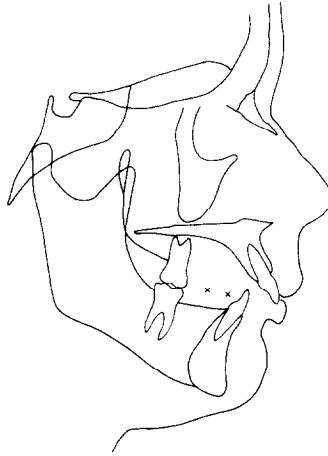


**Fig. 6.** An example of a Type A-1 Class II malocclusion. Note that the maxilla and mandible present a straight skeletal profile, although the maxillary teeth are in labioversion. The anterior face height is a bit greater than the posterior face height. (Compare to Figs. 1 and 3.)

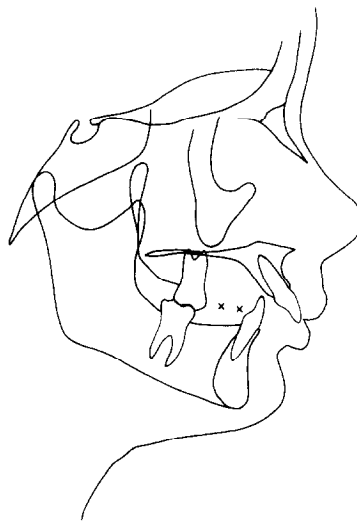


**Fig. 7.** An example of a Type B-2 Class II malocclusion. Note the parallelism of the palatal, occlusal, and mandibular planes, the square gonial angle, and the resultant skeletal deep-bite.

tion of discriminate analysis. In fact, we employed such procedures and found that they work efficiently. However, we have found it useful to devise a simpler procedure for determining group membership. This procedure takes the form of an arborization which segregates horizontal types without resorting to a large computer (Fig. 4). While this method is less sophisticated and uses a limited number of variables, it provides a quick



**Fig. 8.** An example of a Type B-4 Class II malocclusion.



**Fig. 9.** A cephalometric tracing of a Type C-2 Class II malocclusion. Although the vertical descriptors are similar to that in Fig. 7, a Type B-2, note the many differences in factors contributing to the anteroposterior relationship.

sorting of the horizontal clusters which approximates that obtained with the computer. On the left side of the figure are arrayed five questions. Each of these five questions is answered in order by comparing measurements of the individual patient in question with normative standards for "constants," values which display relative invariance through time for each individual. As we have noted in a previous article, measures of pattern, unlike growth measures, show minimal change through time.<sup>7</sup> Constants describe the

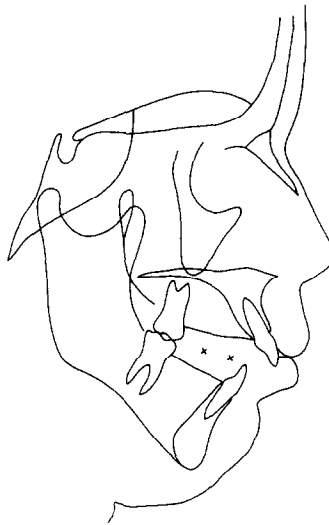


Fig. 10. A Type D-1 Class II malocclusion.

Table IV. Characteristic features of the vertical types

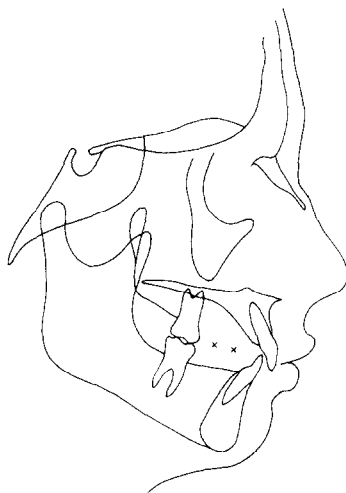
Features	N	1	2	3	4	5
PM vertical/S-N	N	↑	↓*	N	↓*	↓*
PM vertical/palatal plane	N	↓	↑	↑*	↓	↓
PM vertical/occlusal plane	N	↓*	↑	N	↓	N
PM vertical/mandibular plane	N	↓*	↑*	N	↓	N

\*Critical discriminators.

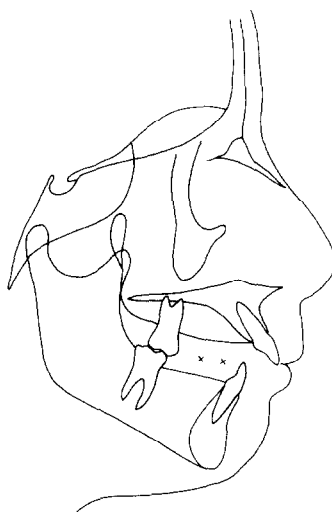
N = normal.

maintenance of pattern; growth measures depict changes in size. It is obvious that pattern measures are needed for this scheme. Through research we have selected the best constants appropriate for each question and the most practical cut-off points to simulate the computer's procedures causing the largest number of cases to be unequivocally sorted. The step-by-step procedure used in clinical practice will be described in the second article in this series. The clinician answers each question in the sequence shown by a simple "yes" or "no" reply. For example, the first question—"Is the subject a skeletal Class II?"—is answered by use of a particular measurement of the A-B relationship comparing the patient's actual A-B relationship with a special graph of Z scores, obviating the need for charts for each sex and all ages. \* If, when the patient is compared to the cut-off point on the chart, the answer is "yes," the orthodontist has eliminated Type A. Now he is on the left half of the diagram, ready for the second question—"Is the midface prognathic?" If the answer is again "yes," Types C, D, and F have been eliminated. In a continuing fashion the remaining questions are answered until one arrives at the bottom, where the

\*Fig. 13, an appendix to this article, depicts a Z score graph used in clinical practice. Its use will be explained in detail in the second article in this series.



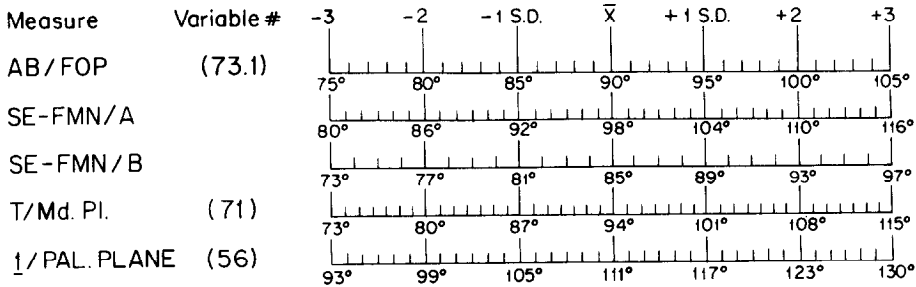
**Fig. 11.** An example of a Type E-5 Class II malocclusion. Study this example with care, comparing it with the Type B-2 shown in Fig. 7 and the Type B-4 shown in Fig. 8. Types B and E are similar in superficial characteristics. The text describes the salient differences among vertical Types 2, 4, and 5.



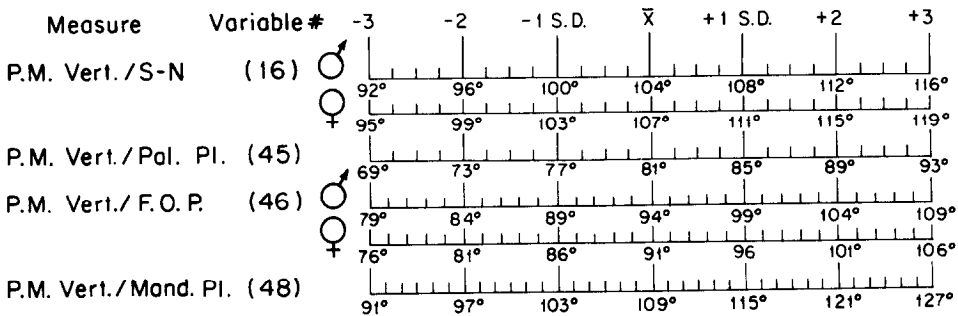
**Fig. 12.** Type F-3 Class II malocclusion. The critical discriminator of vertical Type 3 is the upward cant of the palatal plane. Type 3, when associated with Type F, is less severe than when associated with one of the syndromal malocclusions.

horizontal type is identified. Those positions at the bottom of the arborization which have neither letters nor numbers indicate possibilities which are infrequently associated with any horizontal subgroup. A heavy vertical line within the arborization indicates a point on a path extremely rarely followed in differential diagnosis. Specific details of this procedure, including the charts of Z scores used in clinical practice, comprise the thrust of the second article in this series.

**HORIZONTAL**



**VERTICAL**



Center for Human-Growth and Development, The University of Michigan

**Fig. 13.** Graph of Z scores used in the clinical identification of Class II types. The second article in this series gives the details of the method and illustrates its application in practice.

Table III summarizes the characteristic features of the six horizontal types of Class II.

*Identifying vertical types.* Fig. 3 depicts the five vertical types. The measures used for their discrimination are horizontal plane intersections with the posterior maxillary vertical plane, a plane joining the sphenothmoid points and the bottom of the shadows of the pterygomaxillary fissures. The utility of this vertical plane has been described previously.<sup>8</sup> To identify the vertical type, each of the angles is measured on the subject and entered on the Z score form. The result is compared to the following data to determine the vertical type. Fig. 5 shows an arborization for discriminating the abnormal vertical types from each other and from the normal. Table IV presents a summary of the characteristic features of each of the vertical types.

*Vertical Type 1* is found in significant numbers in Types C, D, and F. Some type A's may also show similarities to the typical vertical type. In Type 1 cases the anterior face height is disproportionately long when compared to the posterior face height. Usually the floor of the anterior cranial fossa is steeper than normal and the palatal and functional occlusal planes are tipped downward while the mandibular plane is steep. This pattern of growth of disproportionate anterior face height seems highly controlled and the predicted future vertical relationships can easily be estimated by extending the cranial base line and

the mandibular plane forward. Dental and alveolar adaptations within this vertical type are dependent upon the horizontal type and the severity of the vertical diversion.

*Vertical Type 2* is found in all horizontal types, although it is the dominant feature of horizontal Types B and E, and a much milder form is the most frequent of F types. In vertical Type 2 the anterior cranial base is more likely to be flat and the palatal plane, the functional occlusal plane, and the mandibular plane tend to be more nearly parallel than is normal. Usually the gonial angle is more orthogonal than normal. These features mean that the palatal plane, the functional occlusal plane, and the mandibular plane will all show negative "Z score" values.

Since *vertical Type 3* is due to an inadequacy of growth in upper anterior face height, it is most easily identified by extreme negative values for the palatal plane angle.

*Vertical Type 4*, as noted earlier, is a severe rare group limited to horizontal Type B. The vertical measures which discriminate vertical Type 4 are the palatal, functional occlusal, and mandibular planes, all of which are steeper than normal. The gonial angle also may be used to discriminate, since vertical Type 4 is the only one of the type B groups which typically has an obtuse gonial angle.

*Vertical Type 5* is found predominantly in horizontal Types B and E. Typically, the mandibular plane is normal, and the functional occlusal plane is nearly normal, but the palatal plane is tipped downward. This downward tipping of the palatal plane and the orthogonality of the gonial angle combine to produce a skeletal deep-bite despite the fact that the mandible is in a normal vertical position.

### Clinical examples

Figs. 6 to 12 illustrate patients who display typical features of several of the horizontal and vertical combinations of Class II just described. The clinical procedure for precise discrimination of all Class II types is the subject of the second article in this series.

### Discussion

It can be posited that if these types are true, persons within a specific type should look alike, grow alike, require similar treatment, and respond to the same treatment in similar fashion. We are persuaded that persons of the same type do, indeed, look alike to the clinician, and the measurable similarities of each group provide the basis for the discrimination of one group from another. The next article in this series will provide more statistical details and examples of use of the arborization method in clinical practice to simulate the results obtained by the computer procedures we used in discovering and identifying the types of Class II.

Very few longitudinal growth studies include a large sample of untreated Class II cases. Our own serial data set has, for example, fifty-seven. Analyses of these fifty-seven cases show that the skeletal characteristics of the type are remarkably persistent through time in each individual. However, a few subjects alter their classification because of changes in their dental features, changes which are mostly seen in cases on the "border" between Type F and Types B, C, D, and E.

Currently we are studying the effects of various treatments of the several types. Our sample was treated prior to the development of this classification scheme, and we have a large number of cases of each type treated by a variety of methods at different age levels.



Through such analysis we are learning the most efficacious therapy for each type as well as the most advantageous times for treatment. Further, we are of the opinion that most current methods of Class II treatment are pointed toward goals which are imprecise or too general. As a simple example, note in Table II that horizontal Types B and E together make up less than 20 percent of the total sample. They are the only types with midface prognathism and thus the most logical on which to use extraoral traction to the maxilla. On the other hand, horizontal types C, D, and F represent almost exactly 50 percent of the total, and they all display mandibular retrognathism with little or no maxillary prognathism. In Types C, D, and F extraoral traction to the maxilla seems contraindicated, for the most part, and treatment should focus on optimizing mandibular growth as is the goal when the various functional jaw orthopedic appliances are used. In the United States of America, at this time, extraoral traction is far more widely used than functional jaw orthopedic appliances. We anticipate that this more precise delineation of Class II types will result in treatments based on the specific type to which the individual patient belongs. It seems also to be easier to make individualized modifications for a single patient's needs within the precise descriptive knowledge about the morphology and growth of each type rather than in the loose context of "Class II."

Finally, we believe that this new knowledge about the subsets within Class II provides an improved base for further research, both basic and clinical, on the most common severe malocclusion with which we must deal in daily practice.

### **Summary and conclusions**

By means of a combination of computer-based programs involving multivariate analyses, cluster analyses, and discriminate functions, we have discovered and described a series of types of Class II malocclusion with defining horizontal and vertical characteristics. Six horizontal groups have been identified. One is essentially a "pseudo-Class II." Another large group consists of cases of mild skeletal Class II with a variety of symptoms. Four different, more severe syndromal Class II horizontal types were revealed. Five less clearly differentiated vertical types can also be described. All vertical types are not found with each horizontal type, but there is a strong relationship between horizontal and vertical features permitting identification of fifteen subtypes with distinguishing features.

We suggest that persons of one type not only look alike, they grow alike, have similar treatment needs, and probably respond to the same treatment in a like fashion.

We are grateful to our colleague, Dr. James A. McNamara, Jr., who collected from his practice and others many of the clinical cases used in this study. The cases from a university clinic were made available by the orthodontic staff of Georgetown University, with whom we are collaborating on several studies.

### **REFERENCES**

1. Sneath, Peter H. A., and Sokol, Robert R.: *Numerical Taxonomy*, San Francisco, 1973, W. H. Freeman and Company.
2. Hirschfeld, W. J., Moyers, R. E., and Enlow, D. H.: A method of deriving subgroups of a population: A study of craniofacial taxonomy, *Am. J. Phys. Anthropol.* **39**:279-290, 1973.
3. Miller, R. L., Dijkman, D. J., Riolo, M. L., and Moyers, R. E.: Graphic computerization of cephalometric data, *J. Dent. Res.* **50**:1363, 1971.

4. Miller., R. L., Hunter, W. S., and Moyers, R. E.: Computer storage and retrieval system for two-dimensional outlines, *J. Dent. Res.* **49**:1176, 1970.
5. Moyers, R. E., van der Linden, F. P. G. M., Riolo, M. L., and McNamara, J. A., Jr.: Standards of human occlusal development, Monograph No. 5, Craniofacial growth series, Ann Arbor, 1976, Center for Human Growth and Development, University of Michigan.
6. Riolo, M. L., Moyers, R. E., McNamara, J. A., Jr., and Hunter, W. S.: An atlas of craniofacial growth. Monograph No. 2, Craniofacial Growth Series, Ann Arbor, 1974, Center for Human Growth and Development, University of Michigan.
7. Moyers, R. E., Bookstein, F. L., and Guire, K. E.: The concept of pattern in craniofacial growth, *AM. J. ORTHOD.* **76**:136-148, 1979.
8. Enlow, D. H., Moyers, R. E., Hunter, W. S., and McNamara, J. A., Jr.: A procedure for the analysis of intrinsic facial form and growth, *AM. J. ORTHOD.* **56**:6-23, 1969.