

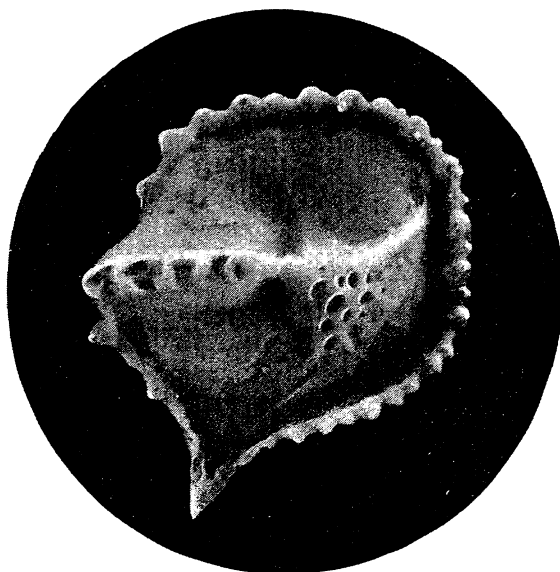

Four Reports of OSTRACOD INVESTIGATIONS

CONDUCTED UNDER
National Science Foundation
Project GB-26



BY

Robert V. Kesling
David G. Darby
Raymond N. Smith
Donald D. Hall



**Four Reports of
OSTRACOD INVESTIGATIONS**

CONDUCTED UNDER
National Science Foundation
Project GB-26



BY

Robert V. Kesling
David G. Darby
Raymond N. Smith
Donald D. Hall

1965



The authors are extremely grateful to
THE SHELL OIL COMPANY
for the generous support used to
bind this volume

CONTENTS

1. ANATOMY AND DIMORPHISM OF ADULT CANDONA SUBURBANA HOFF, by Robert V. Kesling. iv + 56 pages, 15 text-figures, 13 plates.
2. ECOLOGY AND TAXONOMY OF OSTRACODA IN THE VICINITY OF SAPELO ISLAND, GEORGIA, by David G. Darby. vi + 76 pages, 11 text-figures, 33 plates.
3. MUSCULATURE AND MUSCLE SCARS OF CHLAMYDOTHECA ARCUATA (SARS) AND CYPRIDOPSIS VIDUA (O. F. MÜLLER) (OSTRACODA - CYPRIDIDAE), by Raymond N. Smith. vi + 40 pages, 3 text-figures, 11 plates.
4. PALEOECOLOGY AND TAXONOMY OF FOSSIL OSTRACODA IN THE VICINITY OF SAPELO ISLAND, GEORGIA, by Donald D. Hall. vi + 79 pages, 10 text-figures, 20 plates.

ANATOMY AND DIMORPHISM OF ADULT
CANDONA SUBURBANA HOFF

ROBERT V. KESLING

NATIONAL SCIENCE FOUNDATION PROJECT GB-26

REPORT NO. 1

CONTENTS

	PAGE
List of illustrations	iv
Introduction	1
Taxonomic position of <u>Candona suburbana</u> Hoff	2
General anatomy of adult male	4
General anatomy of adult female	15
Non-dimorphic appendages	18
Dimorphic appendages and the furcae	23
Digestive system	27
Nervous system	29
Glandular system	31
Musculature	33
Endoskeleton	35
Sex systems	36
Female system	36
Male system	37
Carapaces	39
Utilization of space within carapaces of male and female	40
Literature cited	43

LIST OF ILLUSTRATIONS

FIGURE	PAGE
1. Male left valve	6
2. Female right valve	7
3. Male appendages in left valve	8
4. Female appendages in right valve	9
5. Appendages and furcae	10
6. Male sex system and glands	12
7. Female sex system	13
8. Male digestive and nervous systems, body framework	14
9. Male musculature and endoskeleton	16
10. Female musculature	17
11. Antennule	19
12. Third thoracic leg	19
13. Male antenna	25
14. Second thoracic leg	26
15. Male Zenker's organ and penis	37
PLATE	FACING PAGE
I. Parasagittal sections of male; Zenker's organs	44
II. Parasagittal sections of male; sex system	45
III. Frontal sections of female; nervous and sex systems	46
IV. Frontal and parasagittal sections of female; various systems	47
V. Parasagittal sections of female; sex system; egg	48
VI. Cross sections of male; nervous, glandular, and sex systems	49
VII. Cross sections of male; digestive, nervous, glandular, and sex systems	50
VIII. Cross sections of male; digestive, nervous, glandular, and sex systems	51
IX. Cross sections of male; digestive, glandular, and sex systems; endoskeleton	52
X. Cross sections of male; digestive, nervous, and sex systems	53
XI. Cross sections of male; digestive, nervous, and sex systems; endoskeleton	54
XII. Male excretory gland B; female seminal receptacles and ovary	55
XIII. Female genital lobes; male oral region; Zenker's organs; live adults	56

INTRODUCTION

FOR A LONG TIME, ostracods have been significant faunal constituents. Today, they are found thriving in ocean depths, shallow ponds, arctic lakes, tropical lagoons, estuaries, brackish swamps, subterranean waters, springs, water holes, and puddles. Whatever its size, salinity, temperature, or depth, nearly every body of water contains ostracods. In the geologic past these tiny crustaceans produced an impressive record. One entire volume of the *Treatise on Invertebrate Paleontology* is devoted to the Ostracoda.

For animals so diverse and numerous, and adapted to so many aqueous environments, one might expect detailed knowledge of their biology and ecology. This is not the case. Remarkably little is known of their life history, tolerances, and relations to other organisms.

Still more regrettable is the poor understanding of their anatomy. Especially during the last half century, taxonomy has proliferated until it has been suggested that ostracodology could stand as a field of study of equal stature with malacology. Realistic evaluation is overdue. Taxonomy should progress with morphology. Even though a multitude of species, genera, families, and higher taxa have been erected, however, no living dimorphic species has been adequately described.

This short contribution concerns the morphology of the adult male and female of *Candona suburbana* Hoff, a freshwater ostracod. I cannot claim that it is a complete treat-

ment of the species. Immature instars are completely ignored. But the valves, appendages, and internal organs of adults of this species are described and illustrated, with special emphasis on dimorphism.

The work is published as part of National Science Foundation project GB-26, entitled "Recent and Fossil Ostracoda from the Vicinity of Sapelo Island, Georgia." Significant parts of the work now underway on the project will deal with the ecology and taxonomy of Recent and fossil species from that area. The present study is based on specimens collected in Illinois, but the information on morphology and dimorphism applies directly to many other ostracods. Because it is deemed fundamental to other parts of the project, it is published first.

My study of *Candona suburbana* started in 1948 at the University of Illinois under the direction of the late Professor Harley J. Van Cleave. The sections illustrated here were prepared by Miss Marion Birkner, his technician. Of the numerous slides made of the species, the most instructive were selected to show the nature, position, and structure of internal organs.

The species was referred to in a non-technical article (Kesling, 1956) and illustrated in a paper on Zenker's organs (Kesling, 1957) and in the *Treatise on Invertebrate Paleontology*. The choice of *Candona suburbana* in these studies was a matter of convenience, not a piecemeal investigation of the species. The following is the first comprehensive report on this ostracod.

TAXONOMIC POSITION OF *CANDONA SUBURBANA* HOFF

In any study of anatomy, the taxonomic position of the subject is important. Whatever characteristics are described affect the concept of the animal in one way or another. The matter of the specific determination also enters into the evaluation of higher taxa -- whether the appendages, systems, and dimorphism are typical for the genus and for the family.

In recent years, *Candona* has been subjected to two very different interpretations. For a long time, the genus was erroneously based on *Cypris candida* O. F. Müller 1776 as the type species, according to the designation of Brady & Norman (1889). The literature on *Candona* expanded under this concept, including such works as Claus (1893), Vávra (1891), G. W. Müller (1912), Sharpe (1918), Sars (1922-28), and Hoff (1942). This was the accepted version of the genus for over half a century, and micro-paleontologists and zoologists learned it this way.

In 1955, however, Howe discovered that *Candona* was really a very different kind of ostracod, one which was familiar to workers as *Herpetocypris*. He pointed out that one year after describing *Candona*, Baird had designated (1846, p. 414) his own earlier species *Cypris reptans* Baird 1835 as its type. Since Brady & Norman (1889, p. 84) had chosen *Candona reptans* Baird (1850, p. 160, pl. 19, figs. 3, 3a) as the type species of their genus *Erpetocypris*, *Candona* became objectively the senior synonym of *Erpetocypris* and Sars' (1890) invalid emendation to *Herpetocypris*. Howe (1955) suggested that the ostracod fitting the current concept of *Candona* might be *Typhlocypris*.

In 1956, Sylvester-Bradley took action to preserve the widespread concept of *Candona* and *Erpetocypris*. He petitioned the International Commission of Nomenclature to have *Cypris candida* O. F. Müller 1776 declared as type of *Candona* and *Cypris reptans* Baird 1835 declared as type of *Erpetocypris*. His suggestion was followed by Wagner (1957) in his important work on detailed carapace descriptions.

Nevertheless, in the *Treatise on Invertebrate Paleontology* volume on Ostracoda (1961, p. Q233), Swain interpreted *Candona* in the light of *Cypris reptans* as the type and *Erpetocypris* as objective junior synonym. He also (1961, p. Q234) set *Eucandona* Daday 1900 as the genus satisfying the content of *Candona* according to Brady & Norman (1889) non Baird (1845).

In this paper, *Candona* is interpreted in the light of *Cypris candida* as the type species.

Order Podocopida Müller 1894

Marine and fresh-water ostracods. Dorsal border curved, or if straight much shorter than total length. No permanent anterior opening between valves. No heart. Two or three pairs of thoracic legs.

Suborder Podocopina Sars 1866

All the fresh-water and some of the marine ostracods. Three pairs of thoracic legs. Exopod of antenna represented by at most a scale and a few setae, never a well-developed branch. Furca rodlike rather than lamelliform. Eyes present in most. Closing-muscle scars discrete, arranged in distinctive group.

Family Cyprididae Baird 1845

Many fresh-water and some marine ostracods. Valves in most species reniform, lacking sulcation; their surface smooth or weakly ornamented. No teeth in hinge. Left valve usually larger than right.

Endopod of antennule long, with well-developed swimming setae. Each of three pairs of thoracic legs different. Anterior part of first thoracic leg modified as accessory food-gathering structure; posterior part in male a clasping organ used in copulation. Second thoracic leg with strong terminal claw. Third thoracic leg adapted to clean body and appendages. Furcal ramus well-developed in most; only in Cypridopsinae small and ending in whiplike process.

Subfamily Candoninae Kaufmann 1900

Valves thin and white or light colored, many translucent and some nearly transparent. Ventral border long, in most species nearly straight or slightly concave. Hinge line considerably shorter than ventral border. Many species exhibiting dimorphism in size and shape of valves, setae on antenna, palp of first thoracic leg, and shape of claws of furca. Males with special setae on antenna. No swimming setae on antenna. Outer masticatory process of maxilla with two or three setae modified as spines. Palp of first thoracic leg in male forming unjointed clasping organ; right and left clasping organs different. Third thoracic leg with three long setae on terminal podomere. Furcal ramus well-developed, two claws at or near the end. Zenker's organ with seven wreaths of chitin spines. Chitin wreaths of Zenker's organs in the male and eggs in the female visible through the thin valves. Creeping forms, unable to swim except for brief intervals. Many species in ponds, a few in streams.

Genus *Candona* Baird 1845

Posterior border in female valve gently convex in some species, nearly straight in others, set at obtuse angle to dorsal border, not evenly rounded between dorsal and ventral borders like that of male; posteroventral border of female sharply round to angular. One closing-muscle scar above, the others forming rosette below.

Antenna with five podomeres in female; penultimate podomere in male not divided, but provided with two large setae on the inner face at the line of demarcation between the two parts. Two terminal podomeres of mandibular palp short, each nearly square in lateral view. Exopod of first thoracic leg rudimentary, two or three setae. Endo-

pod of third thoracic leg with three or four podomeres; second podomere in some species corresponding to second and third in others; in species with four podomeres in endopod, no seta at junction of second and third podomeres. Terminal podomere of third thoracic leg very short, bearing two backwardly directed setae and one long forwardly directed seta, at least one of the backwardly directed setae long. Furca well-developed, its ramus large, with two strong claws and one or two setae; seta on rear border of ramus proximal to subterminal claw by a distance at least twice the narrowest width of the ramus.

Group Acuminata Klie 1938

Valves elongate; height in most species less than half the length. Mandible with four setae in the group near rear distal border of first podomere in endopod, and middle seta at distal edge of second podomere in endopod without secondary setae. Exopod of first thoracic leg consisting of two setae. Genital lobe of female pointed and elongate at rear.

Candona suburbana Hoff 1942

Candona suburbana Hoff, 1942, pp. 88-92, pl. 4, figs. 49-54; pl. 5, figs. 55-57; Kesling, 1956, pp. 82-86, 90-94, 114-15, figs. 1-7; Kesling, 1957, pp. 179-80, figs. 1-5, 8-9.

Length of female valve less than 1.25 mm. Rear part of dorsal border of female valve somewhat angular, not evenly curved at junction with posterodorsal border; posteroventral border not angular. Posterodorsal margin of valve not ornamented. Second podomere in endopod of second thoracic leg as long or longer than the third. Of the two setae on posterodorsal border of terminal podomere of third thoracic leg, the longer less than twice as long as the shorter. Ramus of furca with front border more than eight times as long as its least width and more than twice as long as the subterminal claw. No seta on posterior part of body above furca. Outer lobe of penis undivided. Genital lobe of female a single subconical protuberance, neither bifurcate nor finger-like.

GENERAL ANATOMY OF ADULT MALE

Candona suburbana Hoff is, in general, a typical freshwater ostracod of the suborder Podocopa. The animal may be divided into four parts: carapace, hypodermis, body, and appendages. When closed, the two valves of the carapace completely encase the rest of the animal. The valves are the only calcified parts of the ostracod. The hypodermis, which secretes the valves, is a layer of tissue lining the inner surface of each valve. Dorsally the two parts of the hypodermis are connected to the soft tissues of the body. The body is an elongate sac hanging down from the dorsal part of the carapace. The body contains the digestive system, the central nervous system, the endoskeleton, some excretory glands, certain secreting glands, and parts of the sex system. The appendages are attached to the body.

Valves

The two valves are of nearly equal size. The left is slightly larger than the right and overlaps it around the free edge. The carapace is opened by the contraction of a ligament, which lies along the dorsal border. It is closed by contraction of closing muscles, sometimes called the adductor muscles, which are attached at their ends to the valves and extend through the body (pl. IX, figs. 4-9). When the carapace is tightly closed it is hermetically sealed. When the animal dies, however, the closing muscles relax and the carapace gapes open. The valves not only serve as a protection for the body and appendages, but also as an attachment for muscles operating certain appendages.

The valves show muscle scars and, for some time after the death of the animal, the impressions of the testes (fig. 1).

The valves of *Candona suburbana* are dimorphic. Those of the male are elongate oval in lateral view and have no angulation between the dorsal and posterodorsal borders (fig. 1). They are distinctly larger than those of the female (compare figs. 1 and 2).

Hypodermis

Each half of the hypodermis hangs down from its junction with the body as a curved flap of tissue (pl. I, figs. 1-3). It has the same curvature as the valve to which it is attached. The inner surface of the hypodermis is covered by a thin layer of chitin, which is continuous with the layer covering the body.

Each half of the hypodermis houses testes (fig. 6; pl. I, figs. 2-3), a liver (fig. 8; pl. 8, figs. 2-8), and an excretory gland B or "shell gland" (fig. 6; pl. VI, figs. 1-9). It also contains sensory nerves connected to small hairs or setae, which extend through pores in the valves and warn the animal of external objects near the carapace.

Body

The body of this ostracod is elongate. Although the body has no true segmentation, the cephalic region can be readily distinguished from the thoracic. There is no abdominal region in ostracods. The cephalic region has much greater height than the thoracic.

The cephalic region is made up of a forehead (fig. 3) in the anterodorsal, an upper lip (figs. 3, 8; pl. II, figs. 1-3) in the anteroventral, a mouth in the ventral, and a hypostome (fig. 8; pl. II, fig. 1) in the posteroventral part. The forehead and upper lip are rigid, but the hypostome can be moved back and forth in feeding. The cephalic region has four pairs of appendages attached to it (fig. 3). The antennules are high on the sides of the narrow forehead. The antennae are set below the antennules on the sides of the forehead near its juncture with the upper lip. The mandibles are located at the sides of the mouth, and their palps extend forward along the sides of the upper lip. The maxillae lie along the sides of the hypostome. The cephalic region contains the eye, several glands, the front part of the digestive tract, and most of the central nervous system.

The thoracic region has three pairs of thoracic legs attached to its anterior half and a pair of furcae to its posteroventral end. Between the thoracic legs and the furcae are the penes. The thoracic region contains most of the sex system. Much of this part of the body is occupied by the Zenker's organs or ducti ejaculatorii. The thoracic region also houses the rear parts of the digestive and nervous systems.

Appendages

The antennules (fig. 3) are long, tapering, uniramous appendages. The bases (pl. VI, figs. 1-6) are very broad and set close together on the sides of the forehead. The other podomeres are nearly cylindrical, distally decreasing in diameter, so that the terminal podomere is quite small. The antennules are used mostly as sensory organs in walking. Their long setae feel the area in front of the animal. In use the antennules are concave forward, but when the carapace closes they are curved convex forward to fit along the front of the forehead and upper lip, between the antennae.

The antennae (fig. 3) are strongly constructed appendages of five podomeres each. Their bases (Pl. VI, figs. 1-9; pl. VII, figs. 1-9) are reinforced by thick rims of chitin. From the bases, which are fastened to the sides of the forehead near the upper lip, the antennae project forward, down, and thence posteroventrally to the terminal claws, with sharp angulation between the second and third and between the third and fourth podomeres. The antennae are used in walking. The claws are particularly adapted for crawling over masses of algae on which the animal feeds. On the rear border of the third podomere of each antenna is a modified seta (the "sense club") that is thought to be sensory.

The mandibles (fig. 3; pl. I, fig. 1) have long basal podomeres set at the sides of the mouth. At its dorsal tip, each basal podomere is pivoted to a chitin structure attached to the valve by short muscles. At its ventral end, the podomere has heavily chitinized teeth used in mastication. The teeth of the mandibles are curved inward. In the chewing process the teeth of the two mandibles meet in the center of the mouth (pl. XIII, fig. 3). The palp of each mandible is attached to the lower half of the basal podomere.

mere, and extends forward and down along the sides of the upper lip. By the small claws at its end, the palp drags food particles backward to the mouth. From the first podomere of the palp, an exopod plate extends upward and terminates in long setae.

The maxillae (fig. 3; pl. I, fig. 1) are curiously modified appendages. They are located immediately behind the mandibles and at the sides of the hypostome. The base of each maxilla has more or less the shape of a diagonally truncated cup. It is dorsally acuminate and slants parallel to the basal podomere of the mandible. At the anteroventral end of the base there are four projections of the maxilla (pl. VIII, figs. 3-6), each equipped with several setae. The four projections lie side by side, nearly horizontal along the bottom of the hypostome. The inner three are termed "masticatory" processes and the outer is the palp. The term "masticatory" is not correct, because the processes function only to push food forward to the mouth. The "masticatory" processes are not sharply set off from the rest of the base, but project like the fingers from a glove. The palp, which is the only projection that can be seen in lateral view after removal of the valve, has two podomeres. The "masticatory" processes are nearly rigid, but the palp can move independent of the base. When the animal feeds, the entire maxilla swings back and forth and the setae shove particles into the mouth. From the middle of the base, an exopod plate extends toward the rear. This plate is delicate and bears many setae along its ventral edge. It is sometimes called the branchial plate because its beating motion is assumed to aid respiration.

The first thoracic legs (fig. 3; pl. I, fig. 1) are part of the thoracic region, but are intimately associated with the hypostome. The upper part of each leg is pivoted to a lateral projection from the rear of the hypostome. Each first thoracic leg consists of a vertical protopod or base, an extension of the protopod toward the front, an endopod or palp toward the rear, and a small exopod just above the palp. The front ends of the protopods of the two legs bear many setae, which are used to shove food toward the mouth. They are set close together along the base of the hypostome and are obscured by the maxillae. The palps project outward as well as backward, so that their ends lie along the sides of the second thoracic legs. The palps have their ends modified as grasping organs, which are used in copulation to clasp the edges of the female valves. The left palp differs slightly from the right. The exopod is only a pair of setae extending backward from the base, just above the palp.

The second thoracic legs (fig. 3) are used for walking. They are long uniramous appendages with strong terminal claws. The bases of these legs are set at the sides of the body behind the first thoracic legs (pl. I, fig. 1). Although the base of each leg is vertical, the rest of the leg extends toward the rear. The base of the leg is nearly rigid, but the other four podomeres can be strongly flexed.

The third thoracic legs (fig. 3) are modified for cleaning the inside of the carapace of debris. At rest, the base of each leg is vertical, the second podomere is directed backward, and the last three podomeres are vertical; thus, the leg has nearly a U-shape with the anterior tip of the U fastened to the body above and behind the base of the second thoracic leg and the posterior tip free. In use, however, the long base of each leg can be enrolled on itself a full 180

degrees. The base can also be swung forward or back, so that the tip of the leg can be brought to almost any point on the body. The tip of the leg has three long setae, which are used to sweep foreign particles out of the carapace.

Furcae

The furcae (fig. 3) are attached to the posterior end of the animal. Each furca is very long, more than one-third the length of the carapace. It has a long basal podomere or ramus and two strong terminal claws. When retracted, the furcae extend forward along the genital lobes and their claws lie between the second thoracic legs. When extended, they project from the posteroventral part of the carapace. The furcae are used in walking.

Digestive System

The digestive system is composed of the mouth, the esophagus, the dorsal wulst or pharynx, the stomach, the intestine, the rear gut, and the anus.

The mouth (pl. II, figs. 1-2; pl. VIII, figs. 3-4) is located behind the upper lip and in front of the hypostome. The teeth of the mandibles meet in the mouth in mastication. The mouth is nearly surrounded by appendages which supply it with food. The mandibular palps drag particles back to the mouth, and the maxillae and first thoracic legs shove particles forward to it. Thus, when the animal is grazing, great quantities of algae and diatoms are gathered into the mouth at one time. The action of the hypostome moves the food upward in the mouth and concentrates it.

The esophagus (pl. VII, fig. 9; pl. VIII, fig. 1) is a narrow tube which moves the food upward by peristalsis.

The dorsal wulst (fig. 8; pl. VIII, figs. 1-8) rakes the food particles from the esophagus into the stomach. It is a tongue-shaped organ covered with hard cuticle and fastened to the front part of the stomach. It has several rows of short bristles, which catch the particles and move them into the stomach, in much the same way that hay is conveyed by a mechanical hay-loader.

The stomach (fig. 8; pl. I, fig. 2) is large and nearly reaches the dorsal limit of the body. It is constricted at its posterior end where it joins the intestine. Apparently all digestion takes place in the stomach. When food is present in the stomach, it forms a ball and is covered with a viscous fluid.

The intestine (fig. 8; pl. I, fig. 2) is short and narrow.

The rear gut (fig. 8; pl. I, fig. 2; pl. X, figs. 4-9) is elongate and smaller than the stomach. Usually it contains a fecal pellet made up of diatom skeletons and indigestible macerated fragments of algae.

The anus (fig. 8) is a small opening at the rear of the body a little above the furcae.

Two pairs of secreting glands seem to aid digestion. The first is a pair of small glands in the upper lip, called gland L's (fig. 6; pl. XIII, fig. 3). These glands open into the upper part of the mouth at the base of the esophagus. The second is the livers or hepatopancreases (fig. 8; pl. VIII, figs. 2-8), which empty into the sides of the stomach.

.1 .2 mm.

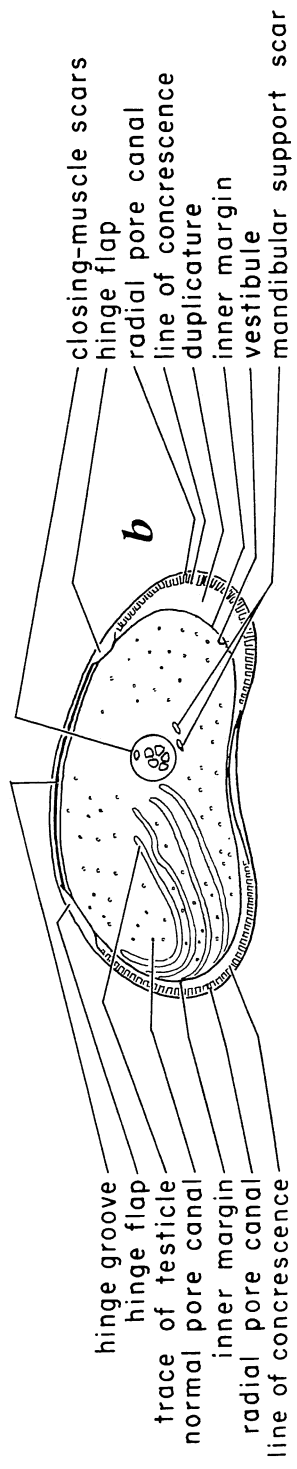
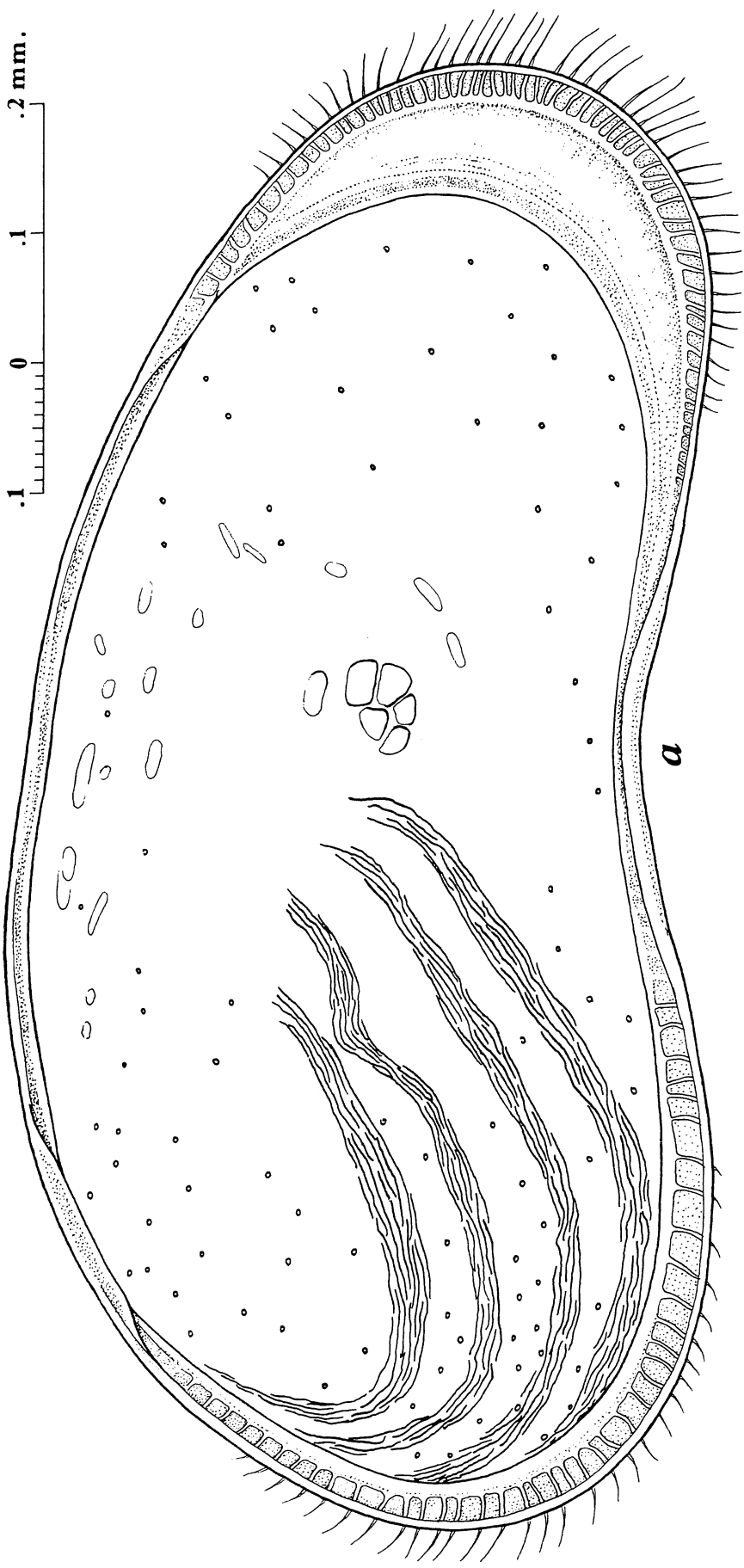

FIG. 1a, b. *Camdonia suburbana* Hoff. Sketch and labeled diagram of inner face of male left valve.

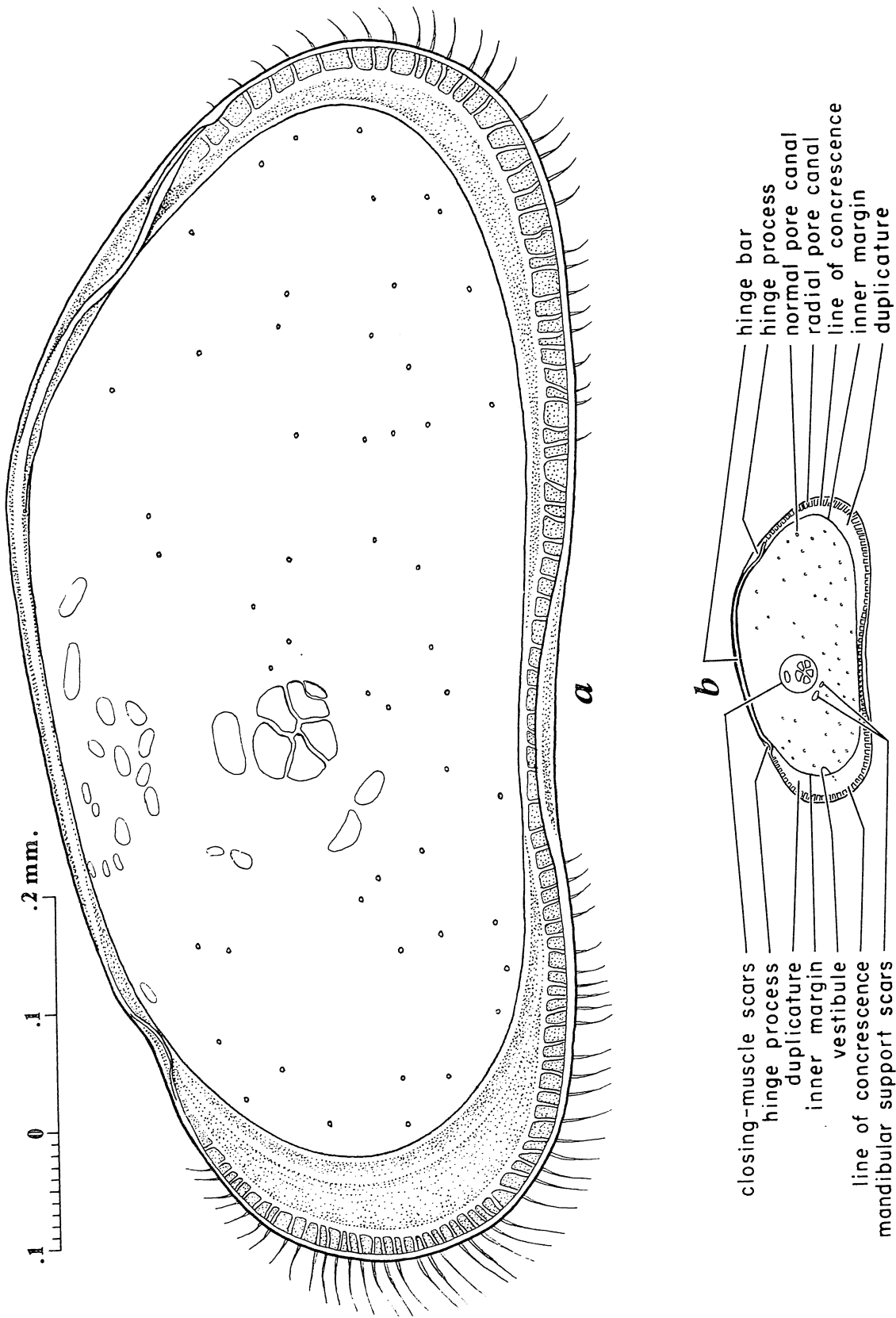

FIG. 2a, b. *Candona suburbana* Hoff. Sketch and labeled diagram of inner face of female right valve.

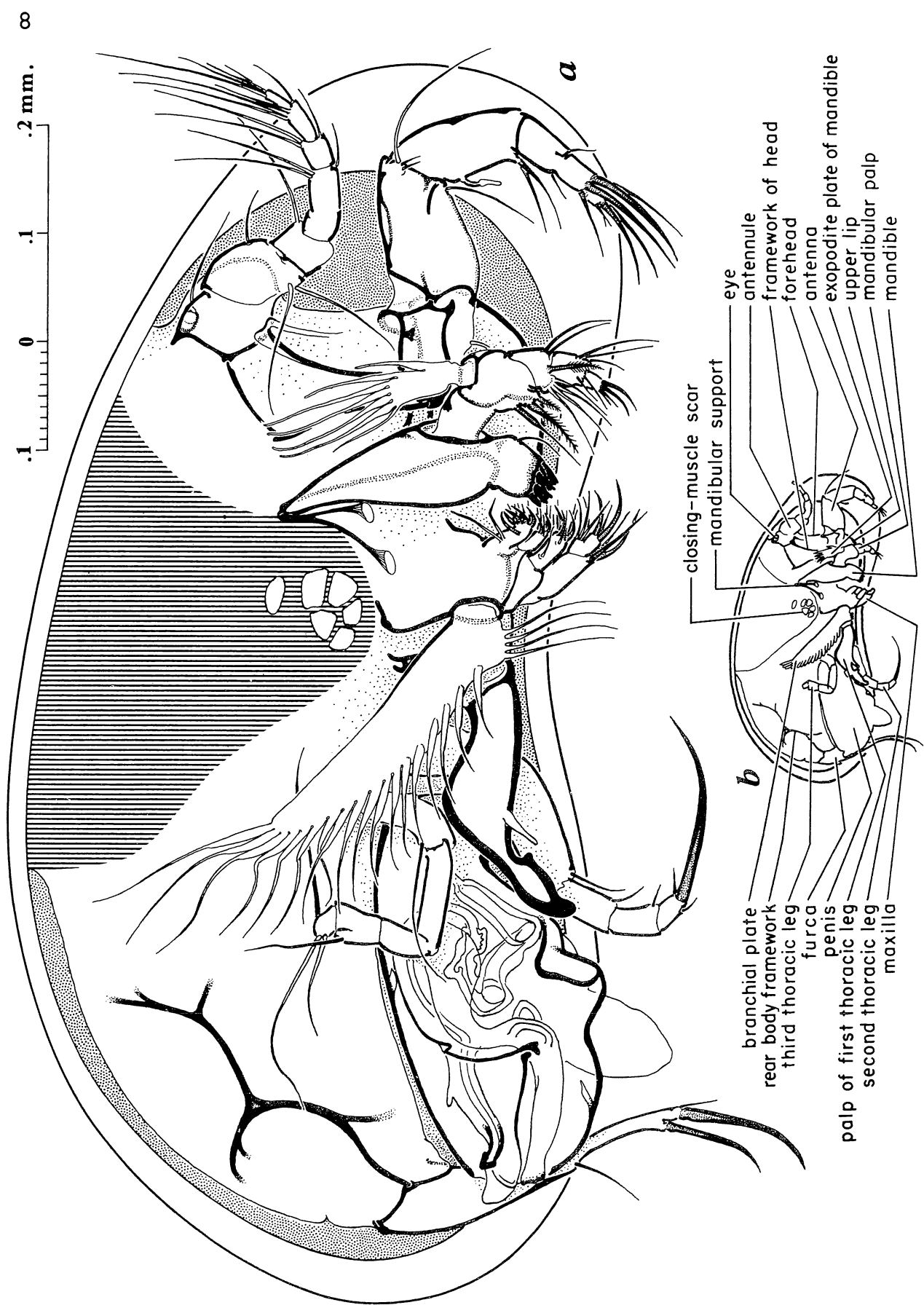
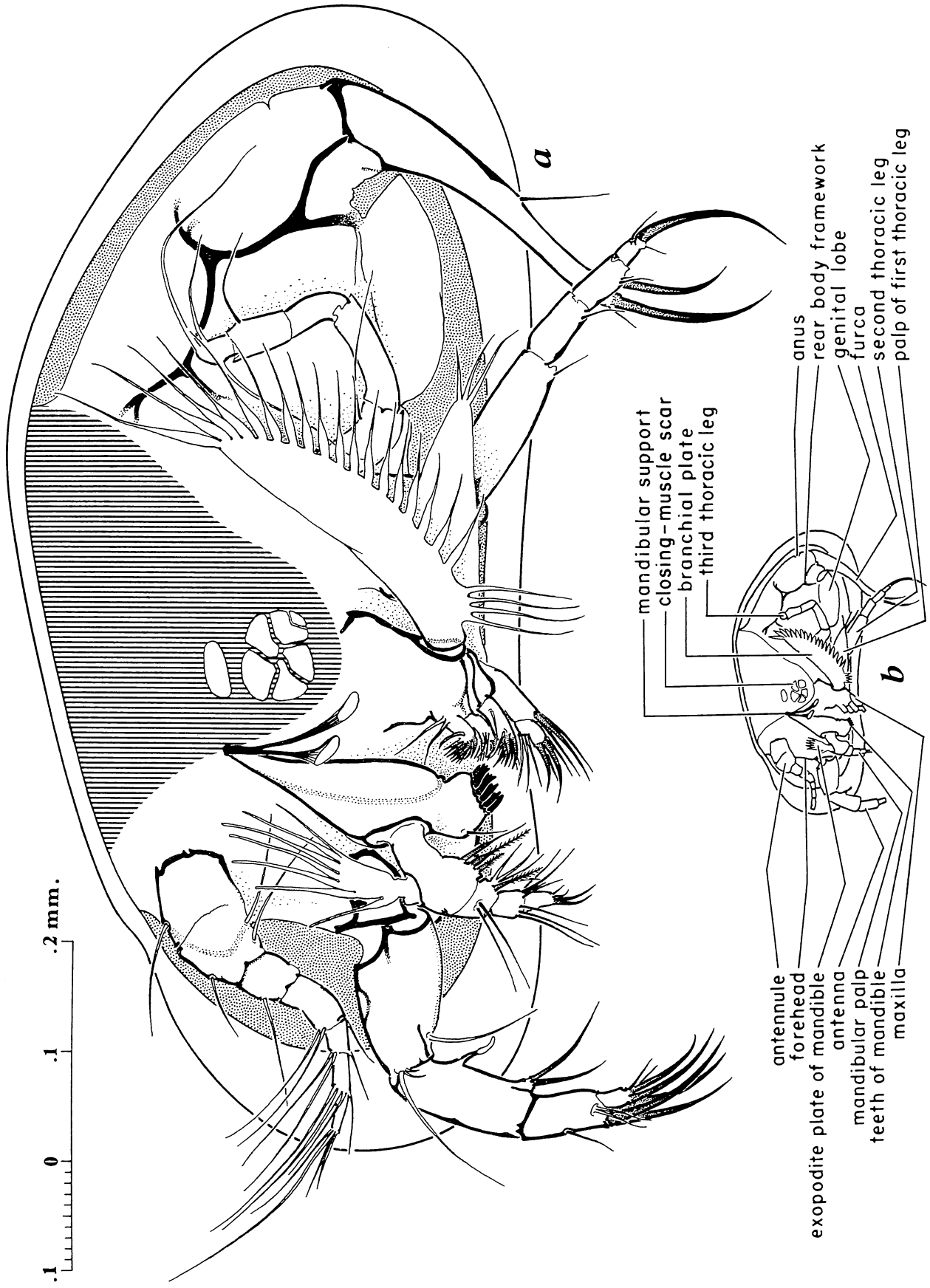

FIG. 3a, b. *Candona suburbana* Hof. Sketch and labeled diagram of male with right valve removed to expose appendages of right side. Vertically-stripped area represents approximately the section through the soft tissues connecting hypodermis of right valve to body. Thick chitin parts of appendages and body shown as solid black. Secondary setae on antennules and branchial plate of maxilla not shown. In sketch, maxilla turned slightly toward the rear and mandible slightly toward the front in order to show their essential features. Scale in upper right corner.



.1
0
.1
.2 mm.

- antennule
- forehead
- exopodite plate of mandible
- antenna
- mandibular palp
- teeth of mandible
- maxilla
- mandibular support
- closing-muscle scar
- branchial plate
- third thoracic leg
- anus
- rear body framework
- genital lobe
- furca
- second thoracic leg
- palp of first thoracic leg

FIG. 4a, b. *Candona subarbana* Hoff. Sketch and labeled diagram of female with left valve removed to expose appendages of left side. Vertically-stripped area represents approximately the section through soft tissues connecting hypodermis of left valve to body. Thick chitin parts of appendages and body shown as solid black. Secondary setae on antennules and branchial plate of maxilla not shown. In sketch, maxilla turned slightly toward the rear and mandible slightly toward the front in order to show their essential features. Scale in upper left corner.

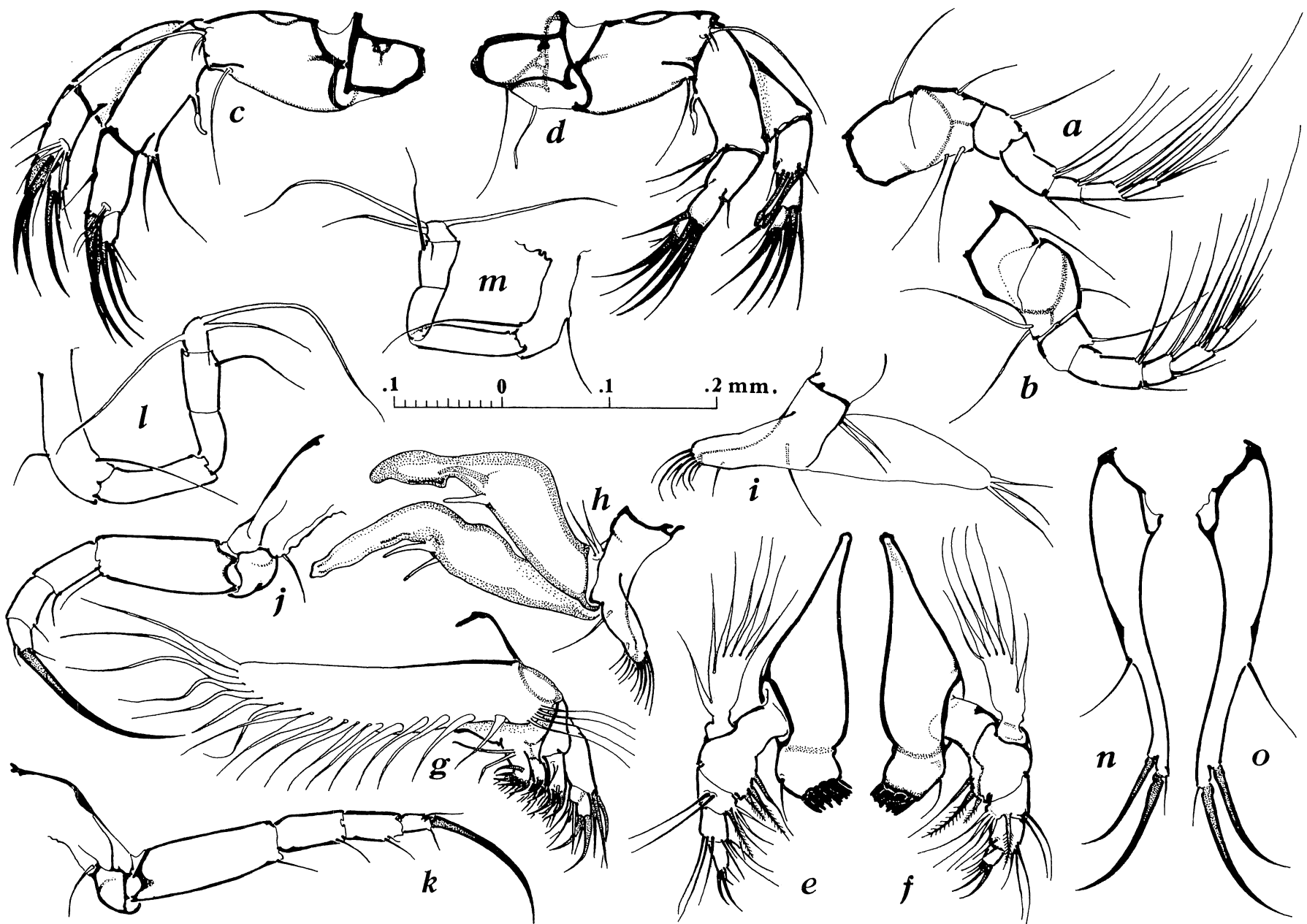

FIG. 5. Sketches of appendages and furcae made with camera lucida from dissections. All to scale near middle of figure. a. Outer face of female right antennule. b. Outer face of male right antennule. c. Outer face of female left antenna and part of inner face of the left. d. Outer face of male right antenna and part of inner face of the left. e. Outer face of female left mandible. f. Outer face of male right mandible. g. Male left maxilla, somewhat twisted. h. Outer face of male right first thoracic leg and inner face of palp of left leg. i. Outer face of female left first thoracic leg. j. Outer face of male right second thoracic leg. k. Outer face of female left second thoracic leg. l. Outer face of female left third thoracic leg. m. Outer face of male right third thoracic leg. n. Outer face of male right furca. o. Outer face of female left furca.

Nervous System

The nervous system is made up of the central nervous system, which includes the cerebrum, circumesophageal ganglia, peribuccal ring, and ventral chain of ganglia, the ganglia of the appendages, sensory nerves, and motor nerves.

The cerebrum (fig. 8; pl. II, figs. 2-3) is the largest unit of the central nervous system. It is located in the forehead. Optic nerves extend upward to the eye, and sensory nerves to the ganglia of the antennules and antennae.

The circumesophageal ganglia (pl. II, fig. 2; pl. VII, figs. 3-9) form a ring around the esophagus. They connect the cerebrum to the ventral chain of ganglia. The peribuccal ring (pl. VII, figs. 4-6) extends from the circumesophageal ganglia into the upper lip.

The ventral chain of ganglia (pl. II, figs. 2-3) extends from its junction with the circumesophageal ganglia to the posterior end of the body. It is very large in the front part (pl. VIII, figs. 4-9) but tapers abruptly behind the maxillae and is very small in the rear half (pl. X, figs. 1-9). It lies below the stomach, intestine and rear gut. Sensory nerves connect the ventral chain of ganglia to the ganglia of the mandibles and post-oral appendages.

Motor nerves are small and difficult to distinguish, even in stained material. They extend from the central nervous system to the appendages, digestive system, closing muscles, genital regions, and the furcae.

Sensory nerves lead from the appendages and the hypodermis to the central nervous system.

Glandular System

There are two kinds of glands in this ostracod, those which secrete and those which excrete. There are four pairs of secreting glands and three pairs of excretory glands.

Two pairs of secreting glands have already been mentioned in the discussion of the digestive system, gland L's and the livers. Secreting gland N's (fig. 6; pl. IX, figs. 7-9) are found in the central part of the body, behind the maxillae. The pair is set close together, and each empties through an opening in one of the first thoracic leg. The use of these glands is unknown.

Excretory gland A's (fig. 6; pl. VII, figs. 8-9) are a pair of elongate sacs which have tubular openings in the forehead just below the antennules. Excretory gland B's (pl. VI, figs. 1-9; pl. VII, figs. 1-7) are found in the hypodermis near the upper part of the forehead. Each gland has three parts: diverticulae, rear sac, and end sac (pl. XII, figs. 1-6). The diverticulae empty into the rear sac. The end sac, which appears to be a secreting gland, also empties into the rear sac. Only the rear sac is connected by a tube with the exterior. It empties through a short narrow conduit to the junction of the forehead and the hypodermis, near the sides of the antennules. Excretory gland C's (pl. IX, figs. 6-9) are saclike, and empty through curved ducts to openings behind the maxillae. These glands lie at the sides of the secreting gland N's.

Endoskeleton

The endoskeleton (pl. VIII, figs. 5-9; pl. IX, figs. 1-5) is a complex piece of chitin situated behind the esophagus, below the stomach, and between the bases of the mandibles. It is connected to the closing muscles. The endoskeleton serves as an apparatus for attachment of muscles to the appendages, the dorsal part of the carapace, the hypostome, the oral region, and two pairs of excretory glands.

Sex System

The male sex system is complicated. Its volume is greater than that of any other system in the ostracod. The system includes testes, vasa deferentia, seminal vesicles, Zenker's organs, and penes. The left and right halves of the sex system are mirror images, but the two are not connected in any part.

Each half of the ostracod contains four tubular testes, located in the hypodermis (fig. 6; pl. I, fig. 3). They are curved parallel to the posteroventral border of the valve and thence extend anterodorsally to their junction with the vas deferens, a little behind the closing muscles. From that place the vas deferens leads forward through the dorsal part of the body. The following section of the vas deferens is known as the "blind" vas deferens (fig. 6; pl. I, fig. 2). It enters the hypodermis at the anterodorsal junction of the hypodermis and the body and runs parallel to the free edge of the valve to the posterodorsal part of the body, where it ends. There is, however, an exit from the "blind" vas deferens. In the ventral part of the hypodermis, the "blind" section is joined to another section of vas deferens in the form of a Y. The latter leads forward parallel to the "blind" section and enters the body at the sides of the forehead. The vas deferens then loops about in the posterior half of the body, encircles the Zenker's organ, and joins the seminal vesicle.

The seminal vesicle (pl. I, fig. 3; pl. VII, figs. 1-9; pl. VIII, figs. 1-9) is a large bladder-shaped storage chamber for spermatozoa in the anterodorsal part of the body. In all specimens examined, the seminal vesicles were distended with spermatozoa. Each vesicle begins as a gradual enlargement of the vas deferens below the Zenker's organ, extends forward along the side of the stomach, and reaches into the forehead. The vesicle empties into the Zenker's organ.

The Zenker's organ or ductus ejaculatorius (pl. I, fig. 2; pl. X, figs. 1-9) is a large complicated cylinder that, during copulation, pumps spermatozoa out through the penis. The left and right Zenker's organs lie side by side in the posterodorsal part of the body. Each consists of a central tube through which the spermatozoa pass (pl. XIII, fig. 4), seven wreaths of chitin spines at right angles to the central tube and extending from the tube to the outer membrane (pl. I, fig. 2), and numerous tiny muscles connecting the wreaths of spines together (pl. XIII, fig. 5). A very narrow tube, the last section of vas deferens, leads from the Zenker's organ to the penis (pl. X, fig. 6).

The penis (pl. II, figs. 1-2; pl. X, figs. 7-10) is very large, complicated, and heavily chitinized. It has several hard plates along the sides and three lobes. The opening of the penis is in the inner lobe.

.1 .2 mm.

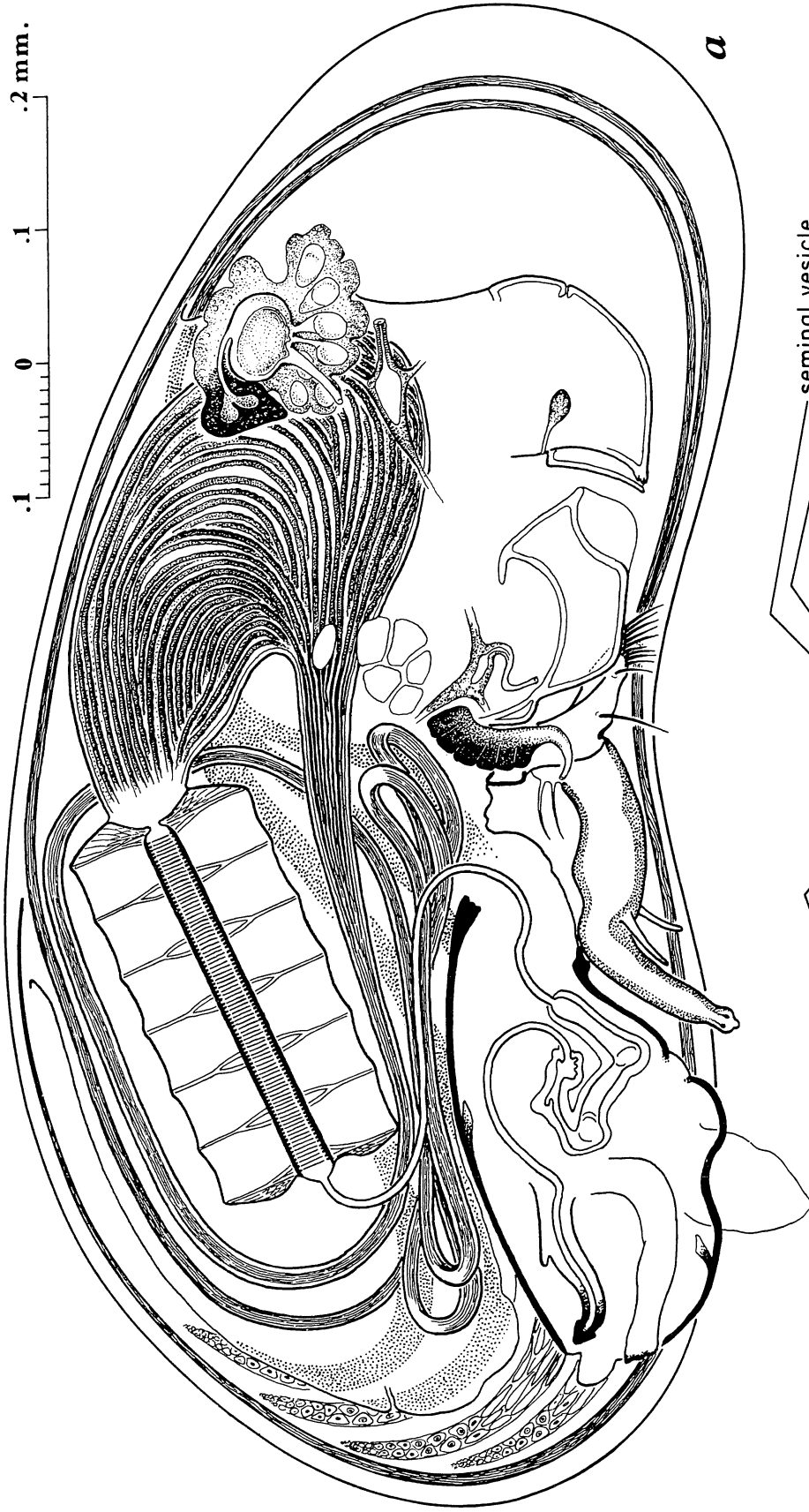

a

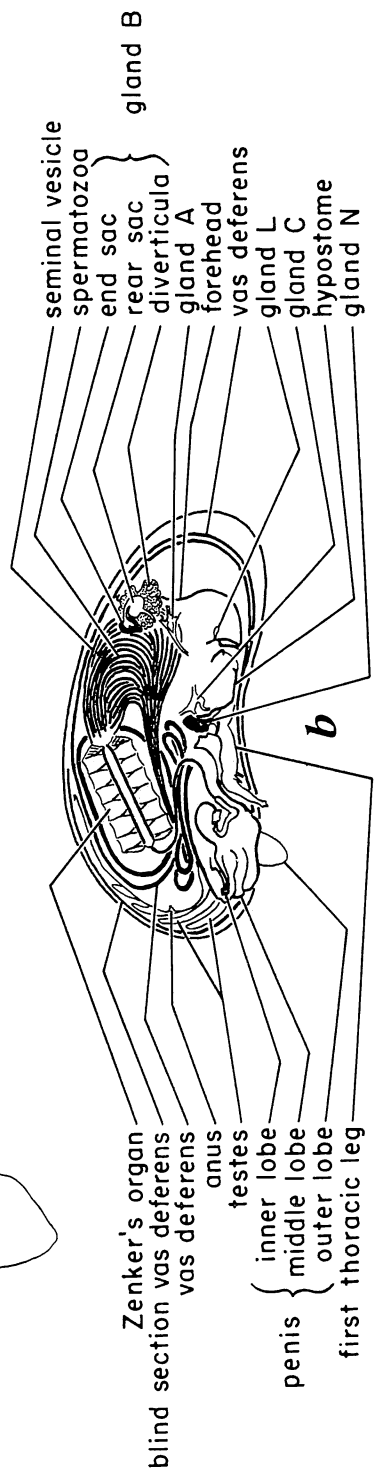

seminal vesicle
 spermatozoa
 end sac
 rear sac
 diverticula
 gland A
 forehead
 vas deferens
 gland L
 gland C
 hypostome
 gland N
 gland B

Zenker's organ
 blind section
 vas deferens
 anus
 testes
 penis { inner lobe
 middle lobe
 outer lobe
 first thoracic leg

FIG. 6a, b. *Candona suburbana* Hoff. Sketch and labeled diagram of male dissected to show sex system and glands. Sex system shown in left half of body, excretory glands in right half, and secreting glands in left half. Outlines of scars of closing muscles drawn for comparison with figure 3. Only left half of Zenker's organ shown. Scale in upper right corner.

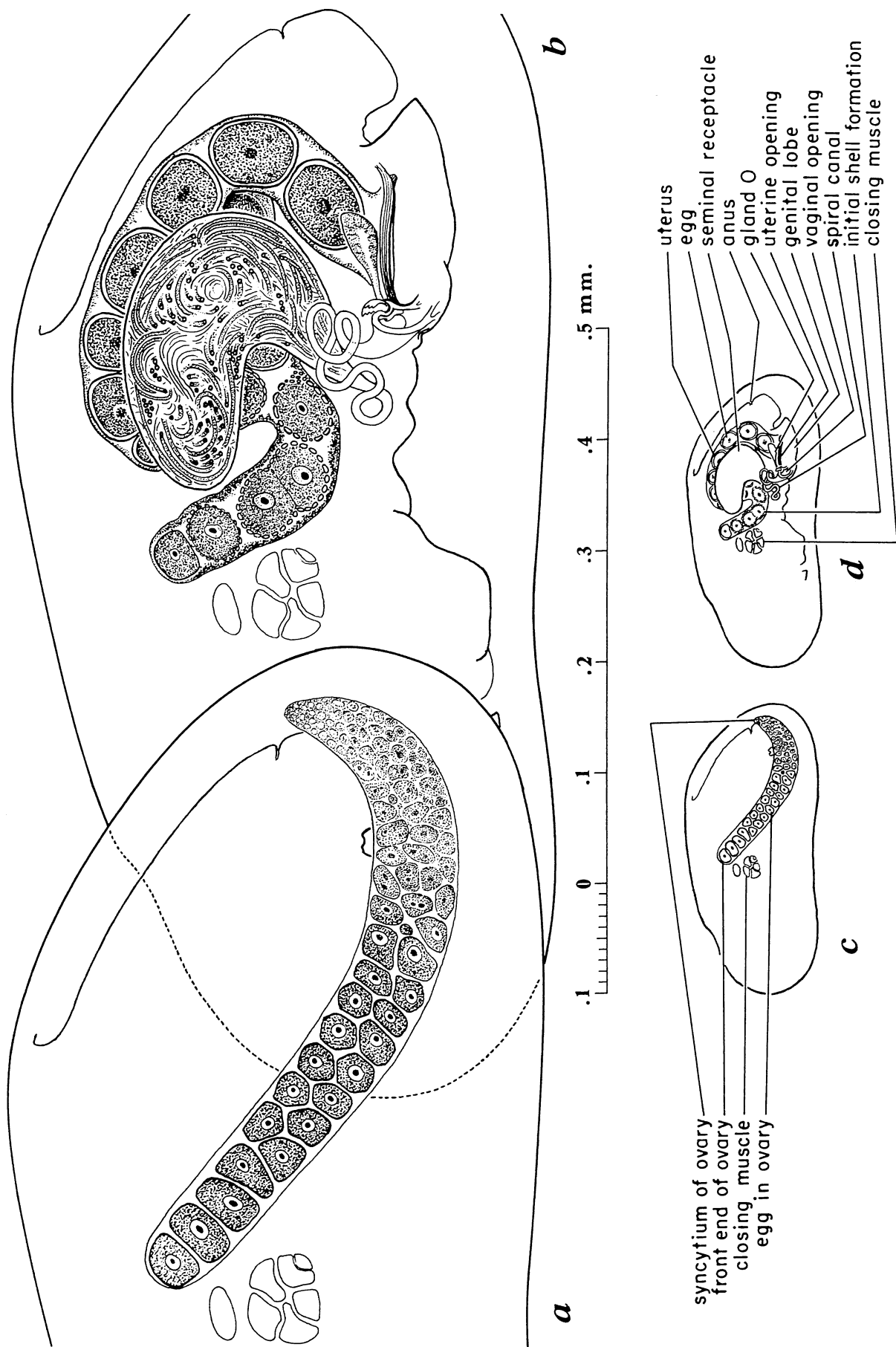
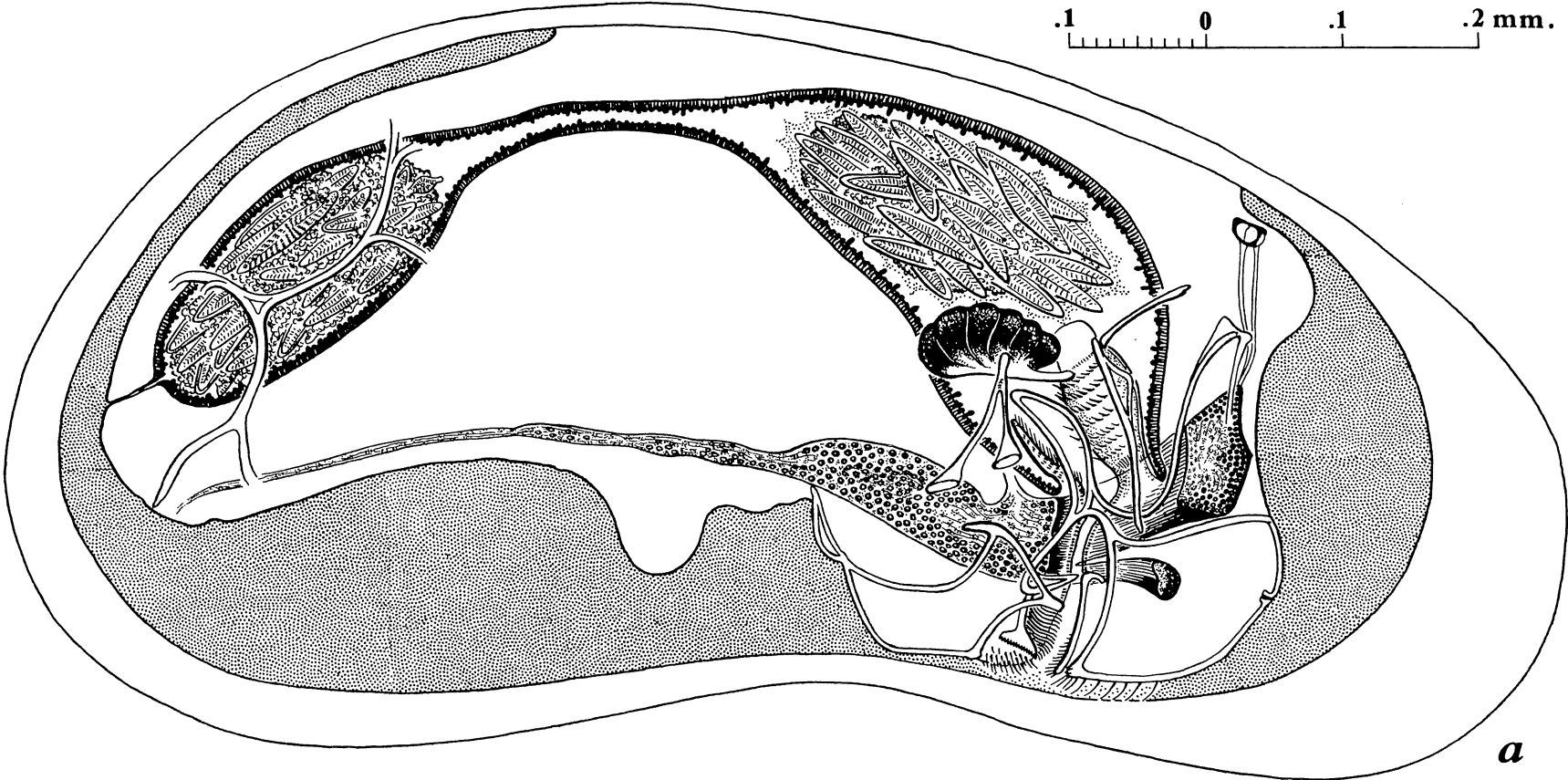
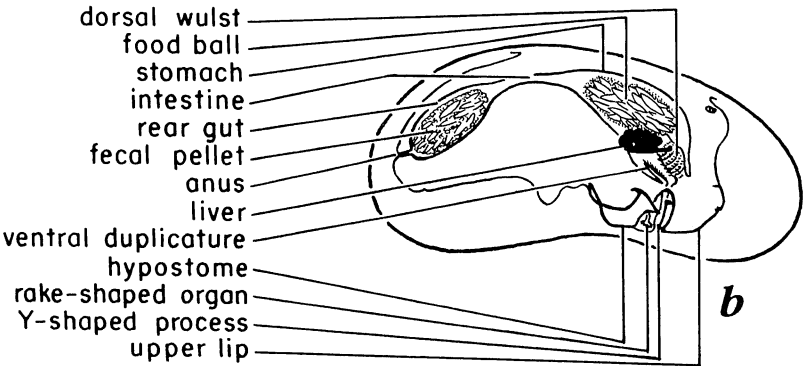

FIG. 7. *Candona suburbana* Hoff. a, c. Sketch and labeled diagram of female dissected to show right half of body as seen from left side. Scale for a and b near center of figure. b, d. Sketch and labeled diagram of female dissected to show left ovary within hypodermis. Scale for c and d near center of figure.

.1 0 .1 .2 mm. 14



a



b

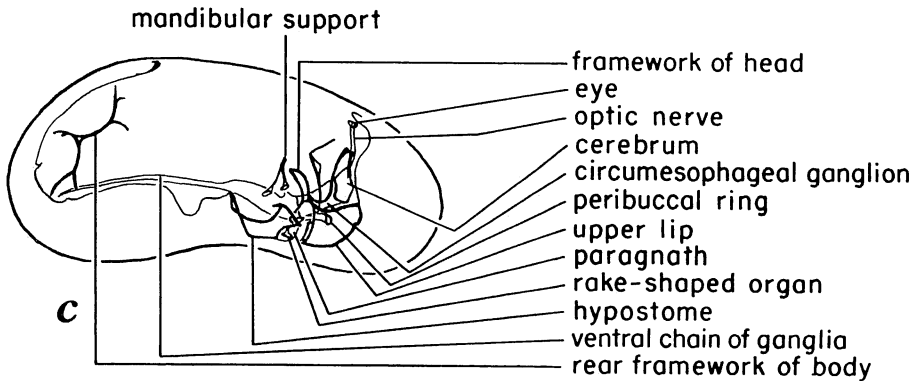

c

FIG. 8. *Candona suburbana* Hoff. a. Sketch of male dissected to show digestive system, nervous system, and framework of the body. Central digestive system and nervous system shown in left half of body, liver and framework of body in the right half. Food ball and fecal pellet contain many remains of diatoms. Scale in upper right corner. b. Labeled diagram of digestive system and part of framework of body. c. Labeled diagram of nervous system and part of framework of body.

GENERAL ANATOMY OF ADULT FEMALE

Except for its sex system, the female of *Candona sub-urbana* is similar to the male. The valves are smaller and have a shape slightly different from that of the male. Some of the appendages and the furcae also differ in details. But the hypodermis, the body, most of the appendages, the digestive system, and the nervous system of the female are the same shape as those of the male although they are slightly smaller.

Valves

The valves of the female have the same arrangement and overlap as those of the male. They are distinctly smaller, however, and have an angulation between the dorsal and posterodorsal borders. The muscle scars of the female valves differ somewhat from those of the male. The valves retain the impressions of the ovaries for some time after the death of the animal. These impressions are evidently only in the chitin lining and not in the calcium carbonate layer of the valves.

Appendages

Each antenna of the female (fig. 4; pl. IV, fig. 1; pl. V, fig. 1) has five distinct podomeres. Each male antenna has a line of demarkation in the chitin of the fourth podomere, so that it appears to be made of six podomeres; in that of the female, there is no such line. The female has a group of four slender setae attached to the fourth podomere. Instead of these setae, the male has two heavy clublike setae on this podomere. The antennae of the male cling to the sides of the female's valves during copulation, and the unusual setae of the male may have a particular sensory function not required in the female.

Each first thoracic leg of the female (fig. 4) has an elongate, acuminate, delicate palp with three slender setae at the end. It is not modified into a grasping organ, as is that of the male. No function of the female palp is known.

Each second thoracic leg of the female (fig. 5k) differs in a few proportions from that of the male. The claw of the female is shorter than that of the male. In addition, the seta on the first podomere of the endopod is shorter in the female than in the male.

Furca

Each furca of the female (fig. 5o) is wider and straighter than that of the male (fig. 5n). The claws also differ slightly in curvature from those of the male.

Gland O

The female has a pair of glands not found in the male. They are the secreting gland O's or copulatory glands (fig. 7). They are located in the genital lobes, and supply a secretion to the vaginae. The precise use of this secretion is not known.

Sex System

The female sex system is composed of two paired parts. The first part includes the ovaries, uteri, and the uterine openings. The second includes the vaginal openings, spiral canals, and seminal receptacles. The first part is not connected to the second within the body of the animal. Furthermore, left and right halves of each part are completely separate.

Each ovary (fig. 7; pl. XII, figs. 8-9) is a curved sac in the posteroventral part of the hypodermis. From its syncytium, each ovary curves down, then forward, and finally anterodorsally to its junction with the uterus, a little behind the closing muscles.

The uteri (pl. III, figs. 1-3; pl. V, figs. 1-2; pl. XIII, figs. 8-9) in the adult female are normally distended with eggs. Each uterus expels eggs through its own opening in the genital lobes (pl. XIII, fig. 2). Thus, eggs originating in the right ovary pass through the right uterus and are laid through the uterine opening of the right genital lobe.

The genital lobes (pl. XIII, figs. 1-2) are a pair of elongate half ellipsoids suspended from the rear part of the body in the same position as the penes of the male. The rear ends of the genital lobes are conical.

There is a vaginal opening (fig. 7) in the front part of each genital lobe. It is near the uterine opening of its lobe, but has no internal connection to it. Each vagina leads to a seminal receptacle through a narrow spiral canal. The two seminal receptacles (pl. IV, fig. 2; pl. XII, fig. 7) are side by side, but each has a distinct wall. In all females that have been examined, the seminal receptacles are distended with spermatozoa.

0.1
0
.1
.2 mm.

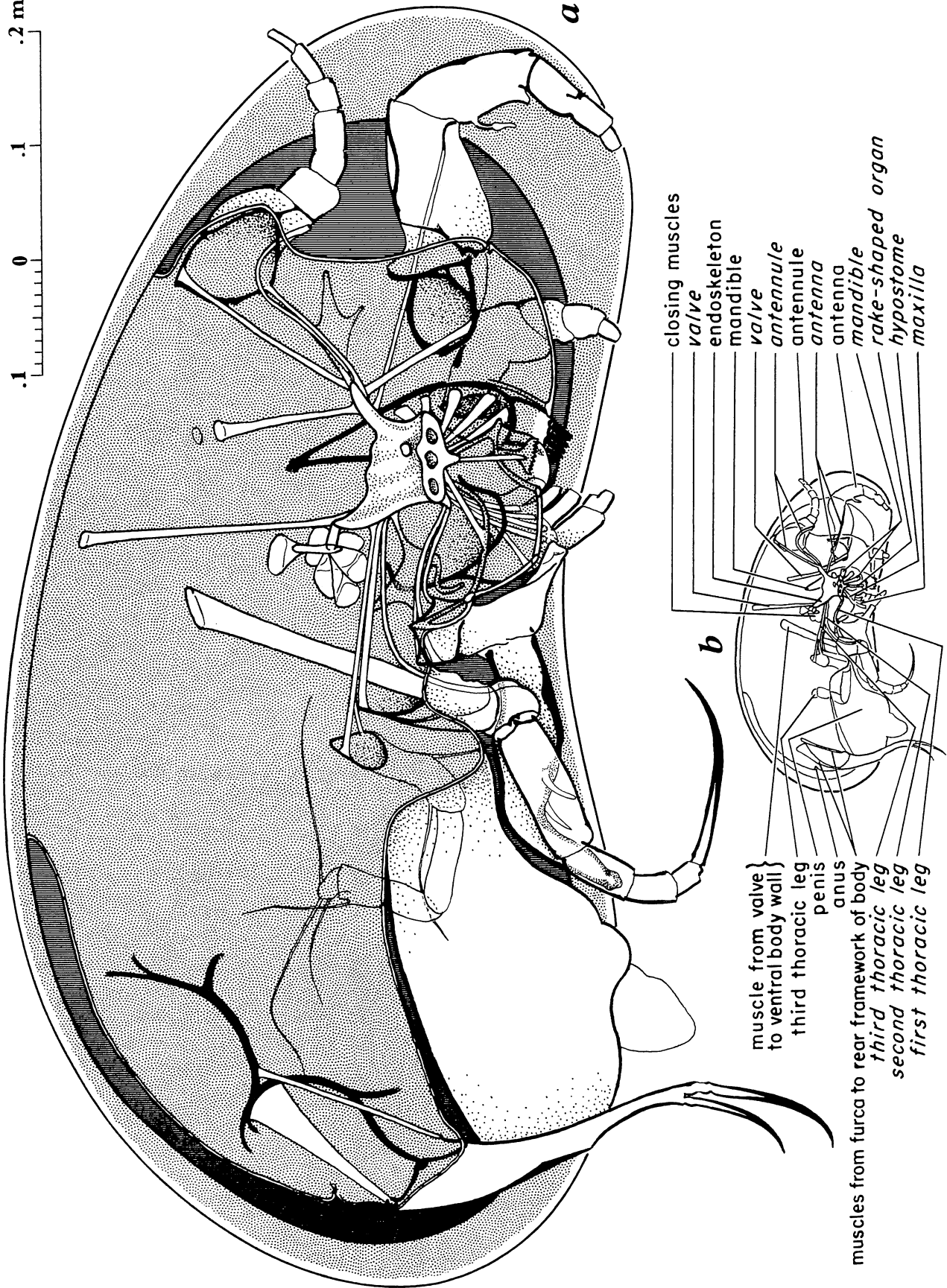

FIG. 9. *Caradonia suburbana* Hoff. a. Sketch of male dissected to show some muscles in left half of body. Only left half of endoskeleton and muscles attached to it are shown. b. Labeled diagram with muscles attached to endoskeleton identified by names of appendages and structures to which they lead (in slant lettering). Structures, appendages, and muscles not attached to endoskeleton labeled in vertical lettering.

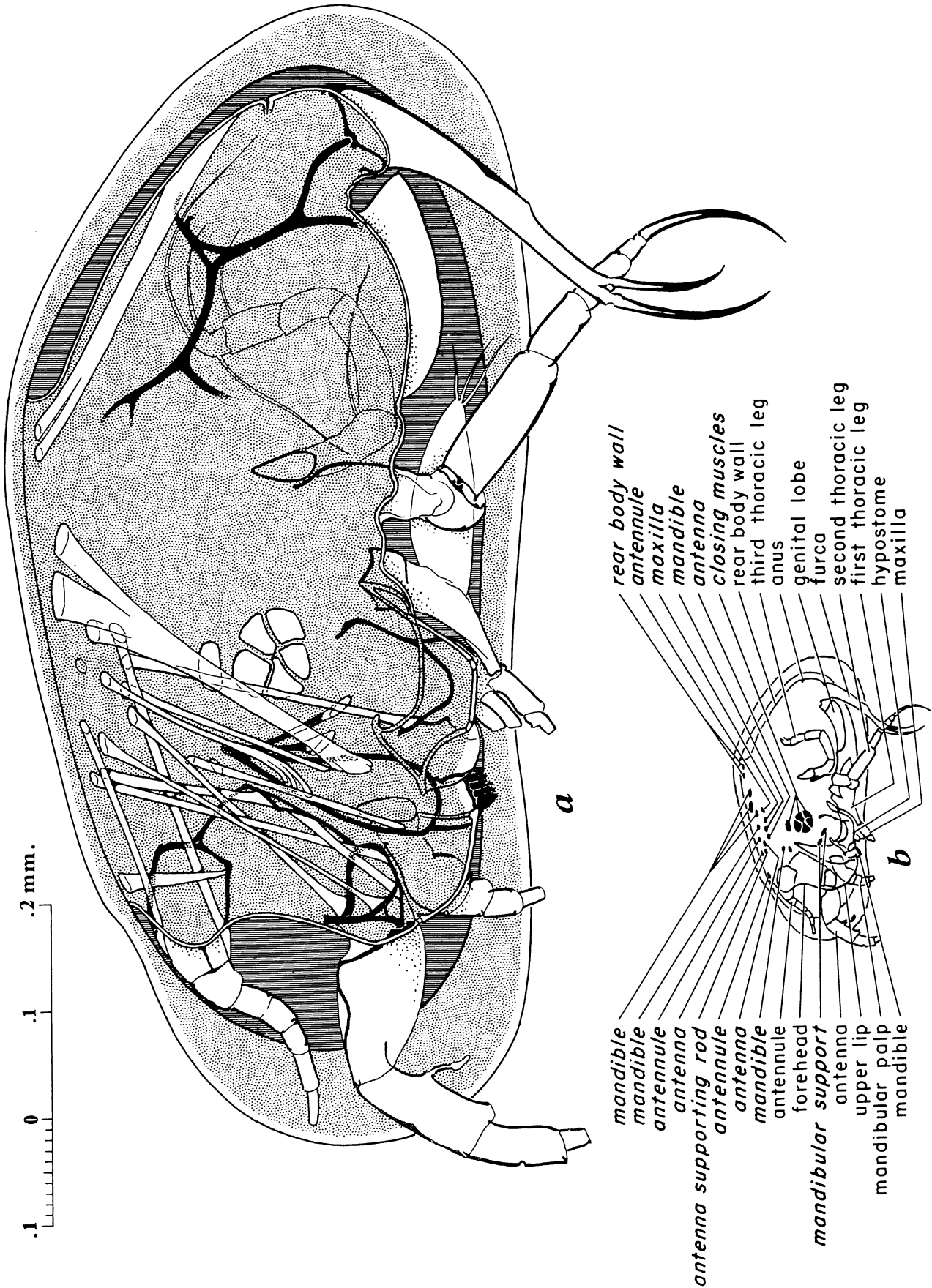

FIG. 10. *Candona subvirbana* Hoff. a. Sketch of female dissected to show some muscles in right half of body. Scars of closing muscles indicated for comparison with figure 4. Scale in upper left corner. b. Labeled diagram with scars of muscles attached to the valve identified by names (in slant lettering) of appendages and structures to which muscles lead; other features labeled in vertical lettering.

NON-DIMORPHIC APPENDAGES

Appendages of this species, like those of other *Candona* species, can be divided into those that are the same in male and female (non-dimorphic) and those that differ (dimorphic). The antennules, mandibles, maxillae, and third thoracic legs are essentially non-dimorphic appendages. They have the same shape and structure in both sexes, although those of the male are slightly larger. The differences are negligible, and the non-dimorphic appendages in the male are at most only a few microns longer than those in the female. Measurements cited in this section are for male appendages.

Because it seems unnecessarily involved to refer to "the articulation of the second podomere of the protopod with the first podomere of the endopod," the podomeres are given letter designations to signify protopod (P) or endopod (E) and numbers to show their positions; the expression then reduces to "the articulation of P2 with E1."

Since the lengths of setae on the appendages are not considered to have taxonomic value as critical as microns, they are here described as extremely long (150 microns or longer), very long (100 to 149 microns), long (80 to 99), medium long (60 to 79), medium (45 to 59), medium short (35 to 44), short (25 to 34), and very short (24 microns or shorter).

Antennules

Unlike many other appendages, the antennules can be readily observed in the living ostracod, extending from the anterodorsal part of the carapace (pl. XIII, fig. 6). Although *Candona suburbana* cannot swim for great distances, it does sometimes skim just above the bottom for a few lengths. In skimming, the animal draws the antennules upward and back over the anterodorsal region, in repeated short thrusts. The long, feathered setae of the appendages act as oars. In walking, the ostracod lowers the antennules so that the long setae explore the area in front of the carapace. The antennules of the female (fig. 5a) are indistinguishable from those of the male (fig. 5b).

The bases of the antennules are set close together near the top of the forehead, above the antennae (figs. 3-4; pl. V, fig. 3), and immediately below the eye (pl. VI, figs. 3-6). Each antennule is long, uniramous, tapering, and extremely flexible. It is composed of seven podomeres, two in the protopod and five in the endopod (fig. 11). The ultimate podomere is directed posteriorly at the conclusion of the skimming stroke and posteroventrally when the antennule is curved downward to lie against the upper lip as the valves are closed; thus, this podomere can be turned almost 360 degrees. Each of the other podomeres can be turned through a smaller angle, with the number of degrees roughly proportional to the distance from the base of the appendage.

The first podomere in the protopod, P1, is rather complex, and appears to be composed of two incompletely separated podomeres. It is broad and subtriangular in lateral view and narrow and subquadrate in dorsal view. It has a large basal opening, subtriangular to subquadrate,

which can be seen on the inner face (fig. 10) and around which the appendage is joined to the rest of the body. Like other podomeres of the ostracod, this one has the chitin covering held in place and reinforced by a frame of thick chitin. The posterior (or proximal) and the lateral parts of P1 bear three rodlike elements of the frame, roughly C-, Y-, and I-shaped. The first two do not lie in one plane; they are articulated on the dorsal border and on the inner face of the podomere. The C-shaped element, the largest of the three, extends along two-thirds of the basal opening. It begins on the outer face, extends to the dorsal border, where it has a short tip articulating with the Y-shaped element, and thence to the posterodorsal corner, where it forms a pronounced projection (fig. 11); along the rear edge of the podomere it is angularly acuminate and has a notch at the posterior apex; at the posteroventral corner it curves inward and continues as one-half of the rear edge of the inner face; the ventral end of this element is pointed, and articulates with one branch of the Y-shaped element. The Y-shaped element lies along the front part of the dorsal border and the dorsal part of the inner face. It bears a prominent notch at the posterior end (the base of the stem of the Y, as it were), which articulates with a tip on the C-shaped element; it extends forward along the dorsal border, and one branch continues to the end of the border, where it bears a concave process that serves as a stop for dorsal movement of P2; the other branch extends from the dorsal border along the inner face to the front edge of the podomere, with a notch near its middle that articulates with the ventral end of the C-shaped process. The I-shaped element is a short, straight rod along the anteroventral border; it reaches the distal edge of the podomere. The anterior opening of P1 is surrounded by an oval of reinforced chitin, which bears two blunt projections toward the front, one on each side, which fit above tips on P2 and control its movement.

P1 articulates with the forehead. The notch on the rear border fits onto the end of a chitin rod along the side of the head (figs. 3-4). The framework of the head has an anterodorsal extension, which fits against the posteroventral edge of the podomere (compare figs. 3 and 8). P1, therefore, pivots on the tip of the chitin rod and cannot be lowered beyond its contact with the extension of the framework of the head. Although two of the chitin elements within P1 are articulated at their ends, it does not appear that parts of the podomere can move independently.

P1 bears four setae. Two, very long, are attached close together in the anteroventral part. The third, very long, projects from the rear part of the dorsal border, and the fourth, medium, from the front part of the dorsal border.

The second podomere, P2, is a short, elliptical cylinder. It has rims around the two ends. Each rim bears two projections, one on each side. Projections on the rear end fit below projections of P1, and those on the front end fit above projections on E1. P2 has very limited movement independent of P1; there are no muscles attached to it. The only seta, very long, is attached to the middle of the dorsal border.

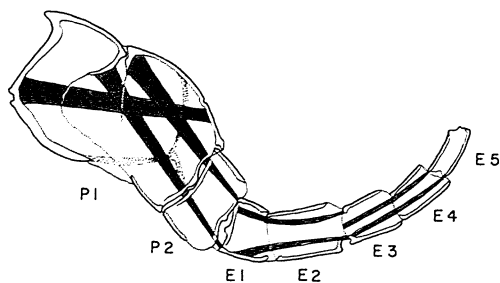

FIG. 11. *Candona suburbana* Hoff. Outer face of antennule showing internal muscles. Compare with figure 3 for scale.

The first two podomeres in the endopod, E1 and E2, have little independent movement, and usually act as one structural unit. Both are cylindrical and about the same diameter. E1 is about 25 microns long and E2 about 35. E1 has a chitin rim around its proximal end; a projection on each side of the rim fits under a projection on the rim of the preceding podomere. The junction of E1 and E2 is marked by only a faint line. E2 has no rim around its distal end. E1 bears no setae, but E2 has three at its distal end, two dorsal and one ventral. The dorsal setae, very long, bear fine secondary setae along their edges except in the basal parts and are said, therefore, to be "feathered." The ventral seta is medium short.

The third podomere of the endopod, E3, is slightly smaller in diameter than the preceding. It is cylindrical and about 30 microns long. There are three setae at its distal end; the two dorsal setae are extremely long and "feathered," and the ventral one is medium. Secondary setae cannot be seen on the ventral setae of the endopod in specimens mounted in diaphane; if present, they are very thin. The fourth podomere in the endopod, E4, is distally about the same diameter as the third, but tapers proximally. It is about 35 microns long. At its distal end it bears four setae; of the three dorsal setae, each "feathered" with secondary setae, two are extremely long and one is long, whereas the ventral seta is only medium.

The terminal podomere in the endopod, E5, is about 30 microns long and 10 microns in diameter. At its end are four setae: extremely long (200 microns), very long, medium long, and medium. Each ventral seta in the endopod extends beyond the distal end of the following podomere, so that, as the antennule is lowered, the ventral setae are the first parts of the appendage to come in contact with foreign objects.

The basal podomere of the antennule, P1, is operated by muscles from the endoskeleton and from the dorsal part of the valve. These muscles can only be worked out in serial sections, and their exact places of attachment are difficult to determine. Apparently, P1 has one extensor and two flexor muscles from the anterodorsal projection of the endoskeleton (fig. 9). It has, in addition, three muscles from the dorsal part of the valve (fig. 10). One, short and almost vertical, is attached to the posteroventral part of the podomere, but acts as an extensor or elevator. The other two muscles are long and almost horizontal; the dorsal one, attached to the anterodorsal part of P1, is an extensor; the ventral muscle, however, attached to the anteroventral part of P1, apparently can act as either an extensor or a flexor, depending on the position of the podomere.

The musculature within the antennule is rather simple (fig. 11). One broad, thin muscle is located entirely within the P1, extending from the posterior to the anterodorsal border. The use of this muscle is unknown. The presence of such a muscle, as well as the articulated chitin frame, suggests that P1 acts as two podomeres. The extensor and flexor muscles that control the endopod originate in P1. The flexor is attached to the dorsal end of the C-shaped chitin element and to the ventral edge of E1; the extensor is attached to the rear end of the Y-shaped element and to the proximal dorsal edge of E1. Within the endopod there are only four muscles, two extensors and two flexors. One extensor and one flexor originate at the proximal rim of E1 and extend to the proximal edge of E3. The other extensor and flexor begin near the proximal edge of E3 and extend to the proximal edge of E5, the terminal podomere.

Within the ventral half of P1 there is a long ganglion, which is connected posteriorly to the deutocerebrum and anteriorly to a sensory nerve bundle leading to the end of the appendage. An "organe chemocepteur," such as Rome (1947, p. 90) described in *Herpetocypris reptans*, has not been found in needle dissections nor in microtomed sections.

Mandibles

The mandibles have two functions, masticating food particles and drawing them into the mouth. The former may be the more important, for the mandibles are the only chewing structures, whereas the maxillae and first thoracic legs are also food gathering appendages. The mandibles lie at the sides of the lower part of the head, behind the antennae and ahead of the maxillae and closing muscles (figs. 3-4; pl. I, fig. 1; pl. III, fig. 3). At their ventral ends the mandibles have strong teeth, which can meet in the atrium of the mouth, behind the upper lip and in front of the hypostome (pl. XIII, fig. 3).

Each mandible consists of a long, nearly vertical basal podomere, with teeth on its lower end, and a palp, which extends forward from the middle of the basal podomere and down along the side of the upper lip. The mandible is a typical crustacean appendage in having a protopod, endopod, and exopod, but it is not typical in the arrangement of these divisions. The protopod includes the long basal podomere and the first podomere of the palp; the endopod is made up of the last three podomeres of the palp;

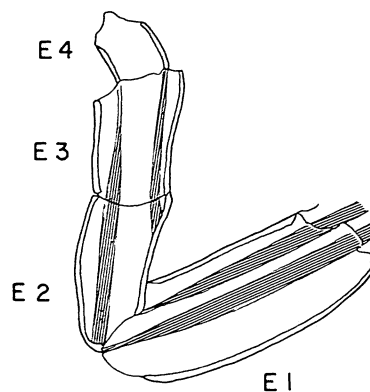

FIG. 12. *Candona suburbana* Hoff. Outer face of third thoracic leg showing internal muscles. Compare with figure 3 for scale.

and the exopod stems from the upper side of the first podomere of the palp. The podomeres in the palp function as a limb and pass particles of food backward to the mouth.

The basal podomere, P1, about 270 microns long, is the longest podomere in the ostracod; its length is greater than one-fifth that of the valve. Its acuminate dorsal tip is articulated with a chitin process shaped like an inverted V, which is attached by two tendons to the side of the valve anteroventral to the closing muscles and which may be called the mandibular support (figs. 3, 4, 8, 10). The ventral end of P1 curves inward and bears the teeth. The inner face is joined to the body around a very large sublanceolate opening, nearly three-fourths as long as the entire podomere, surrounded by a thick chitin rim. On the outer face there is a chitin-rimmed elongate opening to which the palp is attached. On the anterior edge of the podomere, between the palp and the teeth, is a medium short "feathered" seta (figs. 5e, 5f). At the ventral end of the podomere, the five broad, thickly chitinized teeth, with undulating or serrate cutting edges, and three very short setae are set in strong chitin.

P2, the second podomere in the protopod and the first of the palp, is more or less club-shaped; the proximal end is much narrower than the distal. It is joined to P1 by rather thin flexible chitin. On the dorsal side, a chitin-rimmed opening leads to the exopod. The frame of chitin rods is not strongly developed in this podomere. The rods along the dorsal and ventral sides have their distal ends turned sharply inward, and fit against similar ends of the frame of E1 (fig. 5e). Along the distal one-third of the ventral border there are three conspicuous setae. The proximal seta, long, has a long tubular basal section and a thin filamentous end section; the middle, medium long, has a thick base and is "feathered"; and the distal, short, has a wide base, tapers rapidly, and is also "feathered."

The exopod is a very delicate, hand-shaped structure extending upward from the dorsal part of P2. Its seven setae are thin walled, "feathered," and have bulbous bases; one of these setae, medium long, is on the front border and the other six, long to very long, on the distal end. The longest setae are about 125 microns long and extend upward almost as far as the dorsal tip of P1. As has been suggested, the exopod may be a respiratory organ.

E1, the first podomere in the endopod, is short and subcylindrical. It is heavily chitinized along the front and rear borders, but not around the ends. It is provided with seven setae on the distal part; two, long, lie near the front border and five near the rear. Of those near the rear, one is medium, thick, and "feathered" and four are medium long, thin, and spring from a protuberance of the podomere.

E2 is short, cylindrical, and distinctly smaller in diameter than the preceding podomere. On the distal border it has three medium long setae at the front, a medium short and a short on the inner face, and a medium long and a medium at the rear. E3, the terminal podomere, is cylindrical and at the end bears two medium short curved claws and two very short setae.

The musculature of P1 is complex. As noted above, this podomere is pivoted to a chitin support that is fastened to the side of the valve. Through the large basal opening, muscles lead to the podomere from the endoskeleton (fig. 9) and from the dorsal part of the valve (fig. 10). Although P1 usually moves in and out, as in mastication, it can also turn a little on the dorsal pivot. The numerous muscles from the endoskeleton are extremely well developed (pl.

IV, fig. 1; pl. VIII, figs. 3-9; pl. XI, figs. 1-8). Some of the muscles from the dorsal part of the valve are attached to the rear part of the podomere and some to the front part; they probably serve mostly to turn the podomere and adjust the position of the teeth, whereas those from the endoskeleton are powerful adductors.

Within the palp there are very few muscles. A long flexor to the proximal edge of E3 and another to the edge of E1 extend back into P1; because their rear ends are broken loose in all specimens examined, their points of attachment are not known. A large flexor to the proximal edge of E3 traverses E2 and E1 obliquely and is fastened to the anterodorsal end of P2. The exopod is operated by two muscles, which cross within P2; the one to the front edge is from the anteroventral wall of P2 and the one to the rear edge is from the distal end of P2. The endopod is probably extended by the contraction of the chitin at the junction of the podomeres, since none of the muscles to it is an extensor.

The ganglia of the mandible are smaller than those of the antennule, antenna, or maxilla. One lies in the lower part of P1 and receives sensory nerves from the ventral end of the podomere. The other, in the basal part of the palp, is connected to nerves from the claws and setae, which form an irregular cord through the center of the palp. Proximally both are connected to the thick subesophageal part of the ventral chain of ganglia.

Maxillae

The maxillae (figs. 3, 4, 5g) lie at the sides of the hypostome, close behind the mandibles (pl. I, fig. 1), and in front of the first thoracic legs (pl. V, fig. 3). They have accessory food-gathering and respiratory functions. Each maxilla appears to have a protopod, exopod, and endopod, although there is doubt concerning which podomeres belong in the endopod. It is a curiously shaped appendage. The main part of the appendage resembles, so to speak, a glove with one finger and three thumbs. From the basal podomere, which hangs cuplike down along the sides of the hypostome (pl. VIII, figs. 6-9; pl. IX, figs. 1-5; pl. XI, figs. 5-10), there are four cylindrical projections, side-by-side, extending below the hypostome to the mouth. The outermost projection is a palp of two podomeres. Of the inner three projections, called the "masticatory" processes, only the outer two are set off from the basal podomere. The innermost, because it is not separated from the basal podomere, must be regarded as part of the protopod; it is here called the inner "masticatory" process. The middle "masticatory" process may be the second podomere of the protopod, the first of the endopod, or just an outgrowth of the basal podomere; it is difficult to classify a podomere that is not in series with the others. The same problem exists for the outer "masticatory" process. The palp probably represents the endopod, but may not be the whole of it. The three "masticatory" processes and the palp are equipped with setae, which are used to shove food forward to the mouth; the processes are misnamed, therefore, since the mandibles are the only masticatory structures.

The exopod is a large branchial plate projecting posterodorsally from the basal podomere. In the living ostracod this plate is in constant motion, and can be seen to beat rapidly through the valve. It creates a current inside the valve to bring fresh water alongside the body.

The basal podomere, as mentioned above, is connected to the inner "masticatory" process without constriction or

Third Thoracic Legs

line of demarkation. The end of the process is about 160 microns from the outer dorsal tip and only about 80 microns from the inner dorsal edge. The basal podomere has the shape of a beveled cup with the inner "masticatory" process forming a thumblike projection on the inner ventral side. The long outer dorsal tip lies in contact with a chitin rod in the body wall, which leads to the proximal edge of the first thoracic leg; it does not appear to be articulated with the rod. The inner dorsal edge is joined to the upper edge of the hypostome. The outer and inner borders of the podomere are reinforced, but the junction with the body is very thin chitin. As a result, the basal podomere is deformed or torn apart in many needle dissections. On the middle of the outer face is an opening to the exopod or branchial plate (pl. IX, fig. 5), heavily rimmed with chitin. The inner "masticatory" process has two medium slender setae on its proximal part, a short strong curved seta near the middle, and four very short thick and five very short setae at the distal end.

The middle "masticatory" process is short and cylindrical, somewhat smaller than the inner, and lies between the inner and outer processes along the ventral edge of the hypostome (pl. VIII, fig. 5). Distally it has very short setae, three thick and four thin, set close together.

The outer "masticatory" process, sometimes called the "masticatory" process because its setae are taxonomically significant, is longer than the middle and more nearly cylindrical than the inner process. Proximally it bears one short seta and distally seven short, of which three are strong and spinelike and four are thin and delicate.

The two podomeres of the palp are distinctly unequal. The first is long and cylindrical. It is situated outside the "masticatory" processes (pl. VIII, fig. 5). Only the inner part of the distal end is in contact with the second podomere of the palp, and the outer part bears four medium long setae. The second and terminal podomere is short and has a deep notch in its inner border, to which three medium setae are attached. The distal end is provided with two medium curved claws and a short thin seta.

The exopod is a long branchial plate joined to the basal podomere. It extends posterodorsally to posteriorly along the side of the body (figs. 3-4). On the ventral and distal borders are attached eighteen medium long to extremely long, very delicate, "feathered" setae with large bulbous bases, and on the anteroventral border four additional very long, tapering setae with relatively thin bases. Sections of some setae can be seen in plate XIII, figure 1.

Several small muscles from the endoskeleton are joined to the ventral part of the basal podomere (fig. 9). No muscles have been seen from the dorsal part of the valve to the maxilla. The "masticatory" processes have no muscles, and their forward motion, by which food is shoved forward to the mouth, is imparted entirely by the basal podomere.

Within the basal podomere there are four muscles to the branchial plate; two are fastened to its base, moving it back and forth, and two are crossed and attached within the plate, rotating it. Within the palp there are flexor and extensor muscles to the proximal end of the second podomere.

The basal podomere contains a large ganglion (pl. XI, fig. 7), which is connected to the ventral chain of ganglia.

The third thoracic legs are specialized appendages and have retained very few characteristics of a leg. They clean foreign particles from between the body and the valves. They are attached to the sides of the thorax just behind the dorsal tips of the second thoracic legs, and, at rest, lie against the rear part of the body (pls. 3, 4, 9, 10).

Each leg is more or less U-shaped, with only the anterior end joined to the body. It consists of a complex protopod of two partly fused podomeres and an endopod of four. The last podomere is very short. The three well developed terminal setae (figs. 5l, 5m) are used to sweep out the interior of the valve, and the rest of the leg serves as a jointed, swivel-based handle that brings the setae to the desired positions. The leg can be turned forward, extended, and flexed; it is able, therefore, to reach nearly every place within the valve.

The protopod is made of the two most supple podomeres in the ostracod. By a complex musculature, the protopod can not only swing back and forth, but can also twist upon its long axis as much as 180 degrees. By this enrolling action the entire endopod can be swung ahead of the protopod. The two podomeres are not strongly chitinized, and their junction is marked only by the attachment of muscles. On the anterior edge of the protopod, approximately at the junction of the two podomeres, there is a medium long seta. On the posterior edge of the second podomere, near its distal end, is a very long, tapering seta, which extends backward past the end of the first podomere in the endopod.

E1, the first podomere in the endopod, normally lies nearly horizontal. It is long, straight, and cylindrical. Unlike the podomeres of the protopod, it is rigid. It has no setae.

E2 and E3 together correspond to the second podomere in the endopod in some species of *Candona*. Although they are separate in *C. suburbana* and have a distinct line of juncture (figs. 5l, 5m), they are not articulated and move as one unit. E2 is articulated with E1 at about a right angle, and E2 and E3 at rest are carried upright. About 15 microns from the distal end of E3, the podomere has its greatest width and bears a long seta on the posterior border.

E4, the terminal podomere, is short and blocky. It is equipped with three setae used to clean the interior, an extremely long and a long on its posterodorsal border and an extremely long one on its anterodorsal. The setae are tapering and whiplike.

Muscles connect the base of the protopod to the endoskeleton (fig. 9). Within the protopod there are muscles acting as flexors and extensors and some oblique muscles that twist or enroll the protopod. Several muscles are attached at the junction of the two partly fused podomeres. E1 is moved up and down by a flexor and an extensor fastened to its proximal rim and extending back into the protopod. The flexor and extensor to the ventral end of E2 pass back through E1 and are attached to the distal end of the protopod (fig. 12). No muscles are fastened to E3. E4 is operated by a long flexor from the posteroventral end of E2 and a short extensor from the anterodorsal edge of the same podomere. Since no extensor has been described previous-

ly for the terminal podomere of the third leg in a cypridid ostracod, several specimens were examined to check this occurrence. An extensor is present in each third thoracic

leg, but because the muscle is small and lies close to the anterior wall of E3, it is difficult to see unless the terminal podomere is flexed.

DIMORPHIC APPENDAGES AND THE FURCAE

The appendages that differ in the male and female are the antennae, first thoracic legs, and second thoracic legs. The degree of dimorphism is not the same in the three pairs. The first thoracic legs can be easily seen to have radically different palps in male and female, but the antennae must be observed carefully to find the differences in the setae, and the second thoracic legs differ only in relative proportions of the podomeres.

Antennae

Male

The antennae are not difficult to observe in the living animal. They are used in walking and in clinging to surfaces. Because the animal moves about mostly by walking, the antennae may be regarded as the chief appendages of locomotion. They are powerful, strongly constructed, well muscled, and equipped with long claws at the ends.

Each antenna has a protopod of two podomeres and an endopod of three. The protopod and endopod meet at about a right angle (figs. 3, 5d, 13a). The protopod never extends as far as the border of the valve, and only the endopod and the terminal claws can be seen in lateral view of the living animal.

The extended and retracted positions of the antenna are very different. In walking, the end of the protopod is lowered and the endopod is swung forward so that the claws are almost vertical. As a step is taken, the endopod is drawn backward until the claws point posteroventrally. When the valves are closed, however, the end of the protopod is lifted and the endopod is strongly flexed backward to form an acute angle with the protopod. In this position the antennae lie at the sides of the closely set antennules, with the claws resting just below the upper lip.

The bases of the two antennae are attached to the sides of the head near the junction with the upper lip, below the antennules, and in front of the mandibles (figs. 3, 9). In each antenna the basal podomere in the protopod, P1, is shaped somewhat like an elbow joint used in plumbing; the proximal and distal openings lie in intersecting planes. It has limited movement, and serves mostly for hingement and attachment of muscles to P2. It has a girdlelike frame of chitin in one piece, which surrounds both the rear and front openings (fig. 13a). The front half of this frame bifurcates. The frame extends along the rear half of the outer face and has a notch in the middle of the posterior border; at the upper and lower ends this part divides to form two continuous branches. The first makes the front and ventral borders of the outer face; it has a forward projection on the middle of the anterior edge, which articulates with a notch in P2. The second branch forms both the front and rear borders of the inner face, and its ventral half bifurcates to surround a triangular area; at the anteroventral angle, there is an indentation, which fits against the inner posteroventral edge of P2. The length of the podomere at the dorsal border is the thickness of the chitin frame, about 10 microns, and at the ventral border is about 90 microns. The notch on the posterior border

fits onto the end of a chitin rod that lies embedded in the wall of the head. The upper end of this rod is in contact with the rear tip of the chitin rod leading to the antennule (compare figs. 3 and 8). Neither of the chitin rods on the head can move, and they serve as buttressed pivots for the two front appendages. P1 is supplied with three setae along its ventral edge: a very long, tapering, slender seta in the posterior part, and, set close together in the anterior half, a long thin one and a short wide subconical one (not shown in fig. 5d) "feathered" with coarse secondary setae.

The second podomere in the protopod, P2, is elliptical in cross section and elongate subquadrate in lateral view. Its median length is 120 microns. A sloping chitin rim around the posterior edge, dorsally connected to P1 by a wide band of thin flexible chitin, is hinged to P1 at two points: a notch in the middle of the outer face articulates with a projection and a posterior acumination on the ventral edge of the inner face fits against a notch in P1. A rod along the dorsal border of P2 has in its rear half two subelliptical chitin braces on the sides and at its front end a blunt fork, which fits against the outer and proximal edges of a long process of E1. The ventral border is made of rather thin chitin, except for an unusual process at the anterior end, which turns back inside the podomere and seems to reinforce the anteroventral corner. The rim around the anterior edge is rather thin, but has two forward directed tips, one on each side, which articulate with the following podomere. At its distal end, P2 bears four setae. The ventral seta is long. On the outer face near the dorsal border there is a scale with the other three setae; two are very short but the other is very long and projects beyond the end of the following podomere. This last seta may be the vestige of the exopod of the appendage.

The first podomere in the endopod, E1, meets the preceding podomere at about a right angle, and its proximal edge slopes steeply toward the rear. The strong rim around this edge bears four projections: two short tips, one on each side, fit below tips on P2 and act as fulcrum for the endopod; a long dorsal extension has a concave end that abuts against the blunt fork on P2 and serves as a stop for forward movement of the endopod; and a long rod, extending far back inside P2, provides attachment for three muscles (fig. 13a). The front border of E1 has a long chitin rod that is very thick in the middle and near the distal end. The rear border is not strongly chitinized. Its distal extension overhangs the edge of E2. On the rear border a little way below the junction with P2 there is a seta unlike any other in the ostracod. It is often called the sensilla or sense club, and consists of a narrow stem of heavy chitin and an expanded elongate tip of thin chitin (fig. 13a). It may be, as has been suggested, a chemical receptor, but this has not been proved. The distal extension of the rear border has two long wide-based setae.

The second podomere in the endopod, E2, is nearly divided in two. The rear border is sharply indented a little below the middle, and the chitin frame of the front border is divided into two articulating rods; furthermore, there is a flexor muscle connected to the rear indentation and an extensor muscle to the lower of the two articulating

rods. E2 is partly divided in this way only in the male. The proximal edge of the podomere has a chitin rim with front and rear proximal projections to which muscles are attached. The distal edge has a smaller and thinner chitin rim. There are several setae and claws on E2. On the front edge just above the articulation of the two rods there is a short thin seta. On the inner face near the middle of the rear border there is a slightly longer seta. Near the middle of the inner face two large setae are attached, called the male setae because they are found only in that sex. Each male seta extends to the end of the following podomere and is composed of a long, tapering shaft of thick chitin and a thin-walled ovoid tip. The male setae slope across the podomere toward the rear. The distal end is equipped with three very long, heavy claws attached around the front border, a medium long, strong seta at the rear edge of the outer face, and a slightly shorter seta near the rear of the inner face.

The terminal podomere in the endopod, E3, is very small, cylindrical, and short. It is set onto the rear part of the distal end of E2, behind the claws. E3 seems to have very little independent movement. At the distal end are two long claws, curved and strongly chitinized like those of E2; the front claw extends to the tips of the claws on E2 and the rear one is a little shorter (fig. 13b). At the end of the inner face there are three small setae.

P1 is connected by muscles both to the endoskeleton and to the dorsal part of the valve, like a puppet with two sets of controls. It may be that the muscles from the endoskeleton do not produce exactly the same movements as those from the dorsal part of the valve, and some of the muscles may give P1 a lateral or twisting movement. Since these muscles have been studied only in serial sections, their places of attachment are estimated in part and may not be precisely shown in figures 9 and 10. From the endoskeleton a short muscle leads to the posteroventral edge of P1 and a much longer one to the proximal process on E1 (fig. 9). The latter is a flexor for E1, but, because of the unusual relation of P2 and E1, it may at the same time serve as an extensor for P2. From the dorsal part of the valve three long muscles reach down to the anterodorsal and posteroventral edges of the outer face of P1 and to the dorsal edge of the inner face (as in the female valve shown in fig. 10). These muscles act as extensors for P1. Another extensor, leading to the ventral part of P1, is attached to the upper part of the chitin rod in the wall of the head, the ventral end of which is articulated with P1. The dorsal part of this rod is linked by a muscle to the dorsal part of the valve (fig. 10). This is the only part of the body framework known to be connected to the valve.

Within the antenna there are two flexors to the posteroventral end of P2 from the rear edge of P1, and two to the proximal process on E1 from the rear edge of P2 (fig. 13a). A short, broad extensor stretches from the anterodorsal end of P2 to the thick middle part of the front border of E1. E2 has one extensor, from the anterodorsal end of E1, and two flexors, one from the proximal end of E1 and another from the anterodorsal part of P2. Two extensors and two flexors are attached at the front part of the proximal edge of E2; a very thin extensor and a weak flexor lead to the edge of E3, an extensor leads to the lower of the two articulating rods on the front border of the podomere, and a flexor to the indentation on the rear border. E3 seems to have very little movement and the ventral half of E2 none, so that the four muscles in E2 may be ineffective.

The protopod contains two elongate ganglia, one in P1 and another in P2. The first is connected to the deuto-

cerebrum and the second appears to stem from the first. From P2 a bundle of sensory nerves continues to the end of the antenna.

In copulation the antennae of the male are hooked over the dorsal part of the female valve. The male setae have no clasping ability, and they probably are receptors having some special significance in copulation.

Female

The female antenna (figs. 4, 5c; pl. III, fig. 3; pl. IV, fig. 1; pl. V, fig. 1) has P1, P2, and E1 like those in the male.

E2, however, differs considerably from that in the male. The podomere has front and rear borders subparallel throughout the length. The chitin frame along the front border is in one piece. The rear border is nearly straight (fig. 5c). Near the middle of the front border is attached a seta about half as long as the podomere. On the inner face, instead of two male setae, there is a scale on the distal one-third of E2 bearing four unequal, medium to long setae. On the outer face near the end is another scale with two medium, very thin setae. The three claws are slightly longer than those of the male, and there are no distal setae.

E3 is a little more elongate than in the male and distally is provided with two long claws and two medium short setae.

First Thoracic Legs

Male

The first thoracic legs in the male have two uses; they shove food forward toward the mouth and they clasp the ventral borders of the female valves in copulation. The palps differ greatly from those of the female, and are modified as clasping organs. The bases of the first thoracic legs are attached at the sides of the posterior end of the hypostome, where the body narrows abruptly at the beginning of the thorax, close behind the maxillae, and in front of the second thoracic legs (figs. 3, 6; pl. I, fig. 1). Each leg has a protopod, endopod, and exopod. The protopod is L-shaped, with the basal part nearly vertical and the distal part extending forward along the ventral edge of the hypostome. At the angular bend of the protopod, the endopod is attached as a palp extending to the rear. The left and right palps, unlike other podomeres in the ostracod, are not mirror images and have conspicuous differences in shape (fig. 5h). The exopod is very trivial in this species; it consists of two setae on the rear of the protopod just above the palp.

The protopod contains only one podomere, which is bent abruptly near the middle so that the proximal half hangs vertical and the distal half is nearly horizontal. It is about 150 microns long. Only the margin around and near the proximal edge is strongly chitinized. The inner edge is articulated with a lateral extension from the posterodorsal end of the hypostome (fig. 9), and the outer edge is in contact with a chitin rod in the body wall, which leads to the outer dorsal tip of the maxilla (not illustrated). The leg swings back and forth on these fulcra. The palp, or endopod, and the two setae representing the exopod are attached on the rear at the sharp bend. The inner face has one medium long seta, and the distal or front end is provided with a cluster of ten short to medium setae, by which food is passed forward toward the mouth.

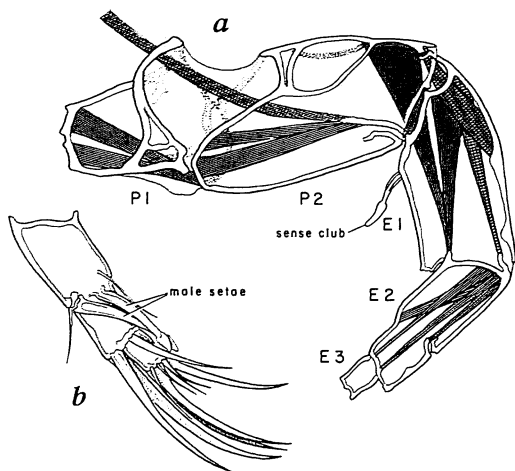

FIG. 13. *Candona suburbana* Hoff. a. Outer face of male antenna showing internal muscles. b. Inner face of male antenna showing male setae on E2. Compare with figure 5d for scale.

The two palps, or endopods, are directed backward and diverge, so that their rear parts lie along the outer sides of the second thoracic legs (figs. 3, 9). Each palp is one podomere, and consists of a long, strongly chitinized shaft, a flexible middle section, and a rather rigid finger-like end section. The palp bends downward at the rear end of the shaft. The chela, or clamping organ is formed by the finger-like end in opposition to two medium short, strong, blunt setae, one on each side, near the ventral border at the rear end of the shaft. The left palp is longer than the right. Its shaft has nearly parallel sides, its ventral border is concave at the setae, and the section behind the setae is narrow and tubular. The right palp, on the other hand, has a wider shaft, its dorsal border forms a hump a little way in front of the setae, its ventral border continues straight beyond the setae, the flexible section is very sharply constricted behind the setae, and the end section is broad and subtriangular. It is more thickly chitinized than the left palp. The shape of each palp is evidently a specific character. In several specimens studied the right palps were all essentially alike as were the left palps. In other *Candona* species examined for comparison, the palps had distinctive shapes different from those in *C. suburbana*.

The exopod is only two medium long setae, and has no trace of a basal plate, such as that found in many genera of the Cyprididae.

The first thoracic leg is swung forward and back by muscles from the endoskeleton. Muscles are attached to the front and rear edges of the proximal margin (fig. 9). A broad band of muscle extends from the chitin rim at the proximal rear edge of the protopod to the ventral proximal end of the palp. Strangely, the palp is void of muscles, and the clamping action appears to result from pressure of the palp against the edge of the female valve.

The vertical half of the protopod contains the efferent end of secreting gland N (fig. 6; pl. I, fig. 1). The opening of the gland is near the exopod. The protopod also contains a ganglion, which is joined to the ventral chain of ganglia by a thin strand of sensory nerves.

Female

The protopod and exopod are about the same size and shape as those in the male, except that the protopod appears to have two setae on the inner face and only eight at the distal end (figs. 4, 5i). The palp, however, is very different. It is a long, delicate, sausage-shaped structure with three medium to long, thin setae on the tip of the tapered distal end. The use of the female palp is not known. Many cells, which appear to be subdermal cells, can be seen through the thin, transparent walls.

Like that of the male, the female protopod contains the efferent part of secreting gland N and a ganglion.

Second Thoracic Legs

Male

The second thoracic legs are long, uniramous appendages used in walking. In use, the distal ends and the long terminal claws are thrust out of the carapace and can be observed in the living ostracod. The second thoracic legs are attached to the ventral sides of the thorax, immediately behind the first thoracic legs and in front of the third (fig. 3; pl. I, fig. 1). The protopods hang down, and their ventral ends lie between the palps of the first thoracic legs (figs. 3, 9). The long endopods are directed backward, diverge, and rest against the sides of the sides of the penes.

When the animal walks, the podomeres in the endopods are flexed so that the tips of the terminal claws point forward and the body is balanced on the convex edge of the claws. As the endopods are extended, the body rocks forward on the claws until the tips of the claws point downward. Then the antennae are extended so that their claws contact the substrate, and flexed to pull the body forward. Thus, the animal walks forward by alternate actions of the second thoracic legs and the antennae.

When the valves are closed, the endopod is extended and the claws point backward with their convex sides up.

The two podomeres in the protopod (fig. 14) are partly fused and do not appear to have independent motion. P1, the long basal podomere, is strongly chitinized only along the posterior border, and is soft and flexible along the front and inner borders. P2 is shaped like an elbow; its front end is subspherical and its posterior is blunt at the junction with E1. The chitin frame at the rear of P2 is continuous with that of P1, and bears a short process on each side that articulates with the proximal rim of E1. On the front edge of P1, just above the junction with P2, there is a medium seta.

E1, the basal podomere in the endopod, is about 130 microns long, a little shorter and wider than that in the female. The sides of the proximal rim articulate with the frame of the ventral part of the protopod, so that the endopod moves mostly up and down. E1 tapers slightly and has a ventral medium short seta at the distal end.

E2 and E3 have about the same shape; each expands a little toward the distal end. E2 is 65 microns long, and E3 about 55. Each has a ventral short seta near its distal end. E3 has no muscles attached to it, and moves relative to E2 only by the flexibility of the chitin at the junction (fig. 14).

E4 tapers distinctly to the claw. It is only about 35 microns long. Near the distal end it has a short dorsal seta and a medium short ventral seta. The claw is firmly

joined to E4. It is 170 microns long and convex dorsally, with the distal half more strongly curved than the proximal.

The protopod is connected to three long muscles from the posterodorsal extension of the endoskeleton. The first is attached to the posterodorsal edge of P1, the second to the anterior part of P2 (fig. 9), and the third to the posterior edge of P2 (fig. 14).

Within the protopod, two muscles extend from P1 to P2; one is attached to the rear dorsal tip of P1 and one to the rear border (fig. 14). The use of these muscles is not known, and P2 appears to be firmly joined to P1. E1 has two short flexor muscles to its anterodorsal edge from the front border of P2; it has no extensor muscle. E2 has a flexor from the proximal edge of E1 and an extensor from the ventral part of P1. E4 has one extensor attached to the middle of the dorsal border of E2. It has three flexors, one to the anterodorsal edge of E2 and two, branching from a long tendon, leading back to the protopod. The last two muscles do not act as flexors in all positions of the leg; when the endopodite is strongly flexed, they touch against the ventral edge and move E4 upward. They are the only muscles within an appendage that pass through three podomeres before they are attached.

Female

The second thoracic leg has the same general shape, musculature, and use as that in the male. The protopod is exactly the same as in the male. E1 is 145 microns long, longer and narrower than in the male. E2 and E3 have the same size and shape as in the male. E4 is only 30 microns long; it is narrow and has subparallel sides. The terminal claw is 140 microns long, rather evenly curved throughout its length.

Furcae

Male

The furcae are long uniramous structures set close together at the posteroventral end of the body, a short distance below the anus and behind the genital region (fig. 3). The furcae are used in locomotion and perhaps in cleaning the posteroventral part of the valve. They lift the animal clear of the substrate by powerful downward kicks. When the valves are closed, they are raised up between the penes.

Each furca consists of a long, sinuous, tapering ramus, two curved claws, and two setae. The ramus is about 210 microns long. Its proximal edge is oblique and rimmed with strong chitin, which forms three projections, one posterior and one on each side. The outer lateral projection is notched and articulates with the posteroventral tip of the rear body framework. The rear border of the ramus (called the dorsal border by some authors) is posteriorly convex in its proximal part and concave in its distal. The front border is similarly curved, but not as strongly (fig. 5n). The distal half of the ramus is only about 15 microns

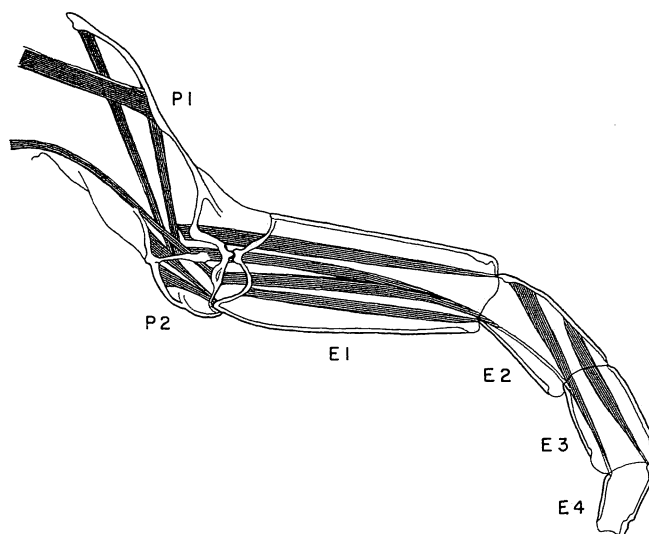

FIG. 14. *Candona suburbana* Hoff. Outer face of second thoracic leg showing internal muscles. Compare with figure 5k for scale.

wide in its narrowest part. The terminal claw is 130 microns long, tapering, nearly straight in its proximal half and curved in its distal. The subterminal claw, attached to a projection near the distal end of the rear border, is about 100 microns long, shaped like the terminal claw but much narrower. On the rear border, where the curvature changes and the ramus becomes much narrower, there is a medium long seta. Immediately in front of the terminal claw is a medium short seta.

The furca is operated by muscles attached to the rear body framework (fig. 9). The front muscle, which elevates the furca, is very thin, but the rear muscle, which lowers it, is broad and powerful.

The narrow nerve cord that extends to the furca is a branch of the ventral chain of ganglia, which splits into two parts in the genital region.

Female

The ramus of the female furca is slightly longer and distally much thicker than in the male, and the claws are longer and less curved (figs. 4, 5o, 10). The distal part of the ramus is about 20 microns wide, the terminal claw is 150 microns long, and the subterminal claw is almost 120 long. The front border of the ramus is 240 microns long, as compared with about 230 in the male. The ramus is nearly straight in both sexes; a straight line from the posterodorsal edge to the short seta does not touch either the front or rear border.

DIGESTIVE SYSTEM

Food Gathering

Although the digestive system by definition starts with the mouth and ends with the anus, the appendages surrounding the mouth play an important role in providing food to the system. The ostracod eats great quantities of algae and diatoms. If the several appendages did not rake up and cram foodstuffs into the mouth, the animal would soon starve on the small amount supplied by the mouth parts alone.

The ends of the mandibular palps, the three "masticatory" processes and palps of the maxillae, and the protopods of the first thoracic legs are equipped with claws and setae, which rake and pitch food to the mouth. The front ends of the first thoracic legs lie close together and shove food to the front of the hypostome. They are flanked by the maxillae, which move food forward to the posterolateral edges of the mouth. The mandibular palps drag particles back past the posterolateral edges of the upper lip.

The motion of these several food-gathering structures is quite rapid, several times a second, as can be observed in a living ostracod by placing it in a watch glass suspended over an inverted microscope.

Mouth

The mouth is an atrium leading to the lower end of the esophagus. In this space the food particles are gathered, masticated, and concentrated. The mandibles lie at the sides of the mouth, the hypostome at the rear, and the upper lip at the front. The teeth of the mandibles meet in the center of the mouth and masticate food.

The mouth is the first part of the stomadaeum, which extends into the stomach. Most of the chitin around the mouth is supple, but some structures are strongly chitinized, such as the Y-shaped process of the upper lip, part of the framework of the head, the rake-shaped organs, and the front edges of the hypostome. From the posteroventral ends of the framework of the head, there are two triangular inwardly-directed processes; their outer edges rest immediately inside the front edges of the hypostome and their tips touch in the upper rear part of the mouth (fig. 8).

Upper Lip

The upper lip is a helmet-shaped structure in the anteroventral part of the head, immediately in front of the mouth (figs. 3, 8, 10). It is firmly attached to the framework of the head and most of it is immovable. It contains secreting gland L (fig. 6), the peribuccal ring of nerves (fig. 8), and numerous muscles to the esophagus and the dorsal wulst. The posteroventral edge of the upper lip is serrate, and the ventral surface has a few setae.

In the rear part of the upper lip is the Y-shaped process (fig. 8), the only movable structure. It is almost vertical. The spatula-like stem of the Y is ventral, and the slender arms extend laterally to the sides of the fixed part of the upper lip. The Y-shaped process is swung back

and forth by muscles connected to the front part of the upper lip. It has several setae along the sides, which appear to move particles back to the middle of the mouth.

The most prominent muscles attached to the upper lip are a pair called the pharynx muscles, which lead to the dorsal wulst or pharynx (pl. III, fig. 3; pl. IV, fig. 3). The muscles to the esophagus are much smaller.

Hypostome

The hypostome is a movable, chitin-framed, sternum-like structure (figs. 6, 8-10), which is situated behind the mouth and between the maxillae in the posteroventral part of the head. The sides of the hypostome converge posteriorly and slope inward ventrally (pl. VIII, fig. 9; pl. IX, figs. 1-9; pl. XI, figs. 5-10). The ventral surface is small, flat, and wedge-shaped. The upper edges, at the contact with the rest of the body, are concave. Ventrally, the front edges are sharply acuminate. At the posterodorsal end, the hypostome has a pair of laterally-projecting chitin loops, which articulate with the inner proximal edges of the first thoracic legs.

The broad front end of the hypostome is deeply indented and lined with setae along the sides of the median groove. It has three parts that are important in feeding: the rake-shaped organs, the paragnaths, and the curtain.

The rake-shaped organs (fig. 8; pl. VIII, fig. 6; pl. XI, fig. 3) are side by side at the front of the hypostome. Each consists of a nearly vertical basal shaft and a horizontal bar, which has about twelve sharp serrations, often called teeth. The inner tips of the horizontal bars touch; it could not be learned if they are fused or independent. The serrations may assist in moving food upward in the mouth. The rake-shaped organs are operated by a pair of muscles from the endoskeleton. The muscles are close together, nearly parallel, and lead from the ventral surface of the endoskeleton (fig. 9; pl. VIII, fig. 8; pl. XI, fig. 7) through a hole in the ventral chain of ganglia (pl. IV, fig. 2; pl. VIII, figs. 7-8; pl. XI, figs. 4-6) to the lower parts of the rake-shaped organs. This is the only occurrence of a hole through part of the nervous system serving only as a passageway for muscles.

The paragnaths are soft, saclike lobes at the outer front edges of the hypostome (fig. 8; pl. VIII, fig. 5; pl. XI, fig. 1). Each paragnath is covered with fine setae directed inward. It has no independent movement, and is used to retain food passed into the mouth.

The curtain is formed by setae extending inward from the front edges of the hypostome in front of the rake-shaped organs. The setae originate in the region of the basal shafts of the rake-shaped organs, but do not seem to be attached to them. On each side, the setae are arranged in fine rows and in clusters within each row; the setae in each cluster converge to a common apex. The left and right setae do not meet in the center of the front surface of the hypostome. The curtain is apparently a kind of filtering apparatus. The arrangement of this part of the hypostome

suggests that food particles gathered between the paragnaths are lifted forward and upward by the rake-shaped organs and pressed against the setae of the curtain before being shoved through them or over them into the mouth.

The entire hypostome is controlled by muscles from the endoskeleton (fig. 9). It moves anterodorsally and posteroventrally, and pivots near its posterodorsal end.

Esophagus

The esophagus is a short vertical tube leading upward from the mouth to the stomach. It is lined with chitin, and is part of the stomadaeum. No setae have been observed on its walls, and all movement of food seems to be by peristaltic action of the strong circular muscles (pl. VII, fig. 9) and several pairs of small muscles connected to the front part of the upper lip.

Dorsal Wulst, or Pharynx, and Ventral Duplicature

The upper end of the stomadaeum lies in the front part of the stomach and consists of two movable projections termed the dorsal wulst, or pharynx, and the ventral duplicature. Both are covered with rather firm chitin and bear many setae. They are used to move food from the esophagus into the stomach.

The dorsal wulst is a large, tongue-shaped structure in the anteroventral end of the stomach (fig. 8; pl. III, figs. 1-2; pl. IV, fig. 3; pl. VIII, figs. 1-8; pl. XI, figs. 1-8). It is attached at its anterior end, and in use bobs up and down. The stiff setae, arranged in several rows around the posteroventral side, are directed toward the free end of the dorsal wulst. They engage the food passing upward through the esophagus and pitch it into the stomach. The dorsal wulst is moved by a pair of short muscles across its base from the front wall of the stomach and by a pair of long pharynx muscles from the front end of the upper lip (pl. III, fig. 3; pl. IV, fig. 3; pl. VI, figs. 3-9; pl. VII, figs. 1-9). In cross section and in frontal section, the rear edge of the dorsal wulst is round, the front surface of the ventral duplicature is concave, and the passageway between them is crescentic.

The ventral duplicature (fig. 8) is much smaller than the dorsal wulst. It is attached to the floor of the stomach immediately behind the front end of the esophagus. It is thin, but wide and curved, like a section of an eaves' gutter. A section of the ventral duplicature can be seen behind the dorsal wulst in plate IV, figure 3. The numerous, upwardly-directed setae on the front surface of the ventral duplicature are not arranged in rows like those of the dorsal wulst, but are evenly spaced.

Stomach

The stomach (fig. 8; pl. I, fig. 2; pl. III, figs. 1-3; pl. IV, fig. 3; pl. V, fig. 3; pl. IX, figs. 1-9) is large, baglike, and tapers posteriorly. It is elastic and expands when filled with food and contracts when empty. The anteroventral end is connected to the esophagus and the posterior to the intestine. The dorsal wulst and the ventral duplicature are situated in the anterior and anteroventral ends. The ducts of the livers empty into the stomach at the sides (pl. VIII, fig. 7; pl. XI, fig. 6).

The food in the stomach forms a compact ball surrounded by a substance presumably secreted by the livers. All or nearly all digestion takes place in the stomach, which appears to be the mesenteron of the ostracod.

Although the stomach exhibits peristaltic motion, which can be seen through the valves, the muscular layer around it is very thin.

Intestine, Rear Gut, and Anus

Behind the stomach is a short narrow section of the alimentary canal called the intestine (fig. 8; pl. I, fig. 2; pl. V, fig. 3; pl. X, fig. 3). This is followed by an expanded section, the rear gut (fig. 8; pl. I, fig. 2; pl. III, figs. 1-3; pl. IV, figs. 1-3; pl. XII, fig. 7). The intestine and rear gut have the same kind of epithelial cells as those in the stomach. The fecal pellets in the rear gut, however, are more compacted than the food balls in the stomach, and are never surrounded by a clinging substance. It is assumed that very little or no digestion takes place here.

The anus (pl. IV, fig. 3; pl. V, fig. 3) is a simple slitlike opening at the posterior end of the body. There is very little proctodaeum.

NERVOUS SYSTEM

Eye

The eye of this species can be more readily discerned in living ostracods than in sections. In living animals it shows up in the anterodorsal part of the valve as a tiny, bright reflector. In sections, however, it is difficult to find and difficult to study because its framework has a translucent pigment.

The eye (figs. 3, 8) contains three elements: a frontal (pl. VI, figs. 3-4) and two lateral (pl. VI, figs. 5-6). The lenses in the elements do not maintain a clear outline in any of eight sectioned specimens. The frontal lens is more clearly defined than the laterals, and is small. Projections from the lateral elements are embedded in the tissues of the head. The eye is connected to the protocerebrum by three thin optic nerves.

Cerebrum

The cerebrum (fig. 8), the largest part of the central nervous system, is situated in the anterior part of the head just above the upper lip. Posteriorly it is confluent with the two branches of the circumesophageal ganglia (pl. II, fig. 2). In cross section the cerebrum is subquadrate (pl. VI, figs. 8-9; pl. VII, figs. 1-2), in frontal section broad and subhexagonal, with a deep indentation at the rear (pl. III, figs. 1-2), and in parasagittal section suboval and dorsally acuminate (pl. IV, fig. 3; pl. V, figs. 2-3). The dorsal, front, and ventral regions of the cerebrum contain numerous nerve cells, clearly defined. The central and posterior regions, on the other hand, are filled with synapses.

The cerebrum can be divided into the protocerebrum, deutocerebrum, and tritocerebrum only by the nerves that lead into it, inasmuch as the divisions are not marked off by separation of ganglia or by constrictions. The protocerebrum is the part connected to the optic nerves. The optic nerves are rather inconspicuous; part of one can be seen extending into the uppermost part of the cerebrum in plate V, figure 3.

The deutocerebrum has one pair of nerves leading from the antennules and another from the hypodermis. The proximal part of one antennular nerve is seen joining the cerebrum in plate V, figure 2. The proximal ends of the two nerves from the hypodermis are clearly shown in plate VII, figure 4, running into the upper sides of the cerebrum. The nerves leave the hypodermis below excretory gland B's and extend downward to the cerebrum.

The tritocerebrum has nerves from the antennae. In plate III, figure 2, the nerve leading into the right side of the cerebrum is an antennal nerve. From the rear inner edges of the tritocerebrum there is a short loop hanging down into the upper part of the upper lip; this has been called the stomatogastric nerve or the labial nerve, and is believed to be the only sympathetic nerve in the ostracod. This nerve can be seen in plate VII, figures 2-3, looped around the paired pharynx muscles. The tritocerebrum is continuous with the circumesophageal ganglia.

Circumesophageal Ganglia and Peribuccal Ring

The circumesophageal ganglia (fig. 8; pl. II, fig. 2; pl. III, Fig. 3; pl. IV, fig. 1; pl. VII, figs. 3-4; pl. VIII, figs. 1-2) connect the tritocerebrum to the ventral chain of ganglia around the esophagus. Each branch is vertically elongate and subquadrate in cross section. Nerve cells are present in the dorsal, distal, and ventral regions, and fibers and synapses in the central and proximal regions.

A little behind and below the junction of the two branches of the circumesophageal ganglia and the ventral chain of ganglia there is attached a ring of nerves from the upper lip, the peribuccal ring (pl. II, fig. 2; pl. IV, fig. 1; pl. VII, figs. 4-6). This ring transmits sensory impulses from the upper lip, the front part of the mouth, and the esophagus.

Ventral Chain of Ganglia

The ventral chain of ganglia (pl. II, figs. 2-3; pl. IV, figs. 2-3; pl. VIII, figs. 4-9; pl. IX, figs. 1-9; pl. X, figs. 1-5; pl. XI, figs. 1-10) is a long chain of fused ganglia in the ventral part of the body, tapering posteriorly to the furcae. The front part, sometimes called the subesophageal ganglion, has a much larger diameter than the rest of the ventral chain. It is joined to the circumesophageal ganglia and the peribuccal ring and lies in the upper region of the hypostome below the endoskeleton and behind the esophagus (pl. IV, fig. 3). This ganglion receives paired bundles of sensory nerves from the dorsal and posterior parts of the body; the flared proximal end of one of these bundles is shown in plate II, figures 1-3, joining the dorsal side of the ventral chain above the front part of the hypostome. At the sides the subesophageal ganglion also has nerves from the mandibles and maxillae. It has a nearly vertical hole through its middle, which forms a conduit for a pair of muscles from the endoskeleton to the rake-shaped organs. A section of one such muscle is shown within the ganglion in plate II, figure 3; frontal sections of both muscles within the ganglion in plate IV, figure 2; and cross sections of both in plate VIII, figures 7-8.

The ventral chain of ganglia is constricted behind the subesophageal ganglion and in front of the section that is joined by nerves from the thoracic legs. It decreases in diameter in the genital region and bifurcates, with separate thin nerves extending to the furcae.

Sensory Ganglia of the Appendages

The appendages contain ganglia within their basal parts. The volume of the ganglia and sensory nerves in all the appendages is nearly as great as that of the central nervous system.

Each antennule has an elongate ganglion more than twice the diameter of the sensory nerve bundle in the distal part of the appendage. It lies in the ventral half of the first podomere of the protopod. It is connected by a so-called nerve, actually a cord containing many fibers, to

the deutocerebrum. Each antenna has two ganglia, one in the first and another in the second podomere of the protopod. The ganglia are long and taper at the ends. Proximally the two join in a nerve leading to the tritocerebrum.

Each mandible contains one ganglion in the lower part of the large basal podomere, connected to the teeth, and a second in the proximal part of the palp, which receives nerves from the claws and setae. Both ganglia are attached by nerves to the subesophageal ganglion of the ventral chain.

The ganglion in the basal podomere of each maxilla is very large; its diameter is nearly as great as that of the subesophageal ganglion to which it is connected (pl. VIII, fig. 9; pl. IX, fig. 1; pl. XI, figs. 5-7). This large ganglion is linked by thick nerve bundles to the "masticatory" processes and to the palp.

Each of the thoracic legs has a narrow, elongate ganglion in its basal podomere. The ganglia are joined by nerves to the central part of the ventral chain of ganglia.

Motor Nerves

The motor nerves are much more difficult to follow in sections than the sensory nerves. They lead from the cen-

tral nervous system to the muscles operating the appendages from the dorsal part of the valve and from the endoskeleton and to the muscles within the appendages. Motor nerves could not be traced back from many muscles.

A pair of nerves from the lateral edges of the protocerebrum and another from the upper surface of the deutocerebrum, behind the sensory nerves from the hypodermis, extend upward to muscles in the dorsal part of the valve that control the antennules and antennae. Whether these pairs also innervate the muscles from the endoskeleton to the antennules and antennae could not be determined.

From the upper edge of each limb of the circumesophageal ganglion there are two motor nerves leading to muscles in the dorsal part of the valve. From the front part of the ventral chain of ganglia there are three pairs of nerves: the uppermost, immediately behind the sensory nerve from the dorsal and posterior part of the valve, activates the mandibular muscles, and the two lower pairs lead to muscles of the mandibles and the closing muscles.

Presumably, there are also motor nerves to the muscles of the maxillae, thoracic legs, furcae, and genital regions, but such could not be discerned in sections or preparations.

GLANDULAR SYSTEM

In this paper the glands are considered in two groups according to their assumed function. The first group includes three pairs thought to be excretory, and the second four pairs thought to be secreting. Because the glands are not directly associated with appendages or segments of the animal, six of the pairs are designated by letters, as in my study of *Cypridopsis vidua* (1951, p. 15, 50-57). Other terms commonly applied to the glands are also given.

Excretory Gland A -- Gland of the Antennule

This pair of glands is located in the head region, a little ahead of the esophagus and at the sides of the cerebrum (pl. III, figs. 1-3; pl. VII, figs. 8-9; pl. VIII, fig. 1). The glands lie in a nearly horizontal position. As seen in frontal sections (pl. III, figs. 1-3), the two glands diverge from their junction with the endoskeleton forward to the ends of their ducts.

My interpretation of the morphology of these glands differs from that of Cannon (1925, p. 7-10). The anterolateral projection, which he regarded as a tendinous supporting strand from the end sac to the lateral ectoderm in the adult, appears to me to be a duct from the end sac.

The end sac of each gland A is more or less bladder-shaped, about 60 microns long, 35 microns wide, and 30 microns high. Its front part is rather blunt and its posterior part tapers regularly to the junction with a tendinous rod leading to the endoskeleton. All cross sections of the end sac are subrectangular. The lumen, about 35 microns long and 20 microns in diameter, contained no fluid in any gland A studied.

The walls of the end sac have an inner thin membrane around the lumen and an outer dense layer embedded in the connective tissues of the head. The inner and outer layers are separated by about 5 microns of clear tissue crossed by numerous irregular membranes. From the front part of the gland, long, tapering, tendinous processes extend into the surrounding tissue, apparently making the gland more rigid. Each of these processes is, at least in part, continuous with the outer layer of the end sac, so that it may be regarded as an apophysis of the end sac. One process extends laterally and down and is attached to the body wall near the base of the antenna. Another projects forward along the side of the cerebrum and is attached to the side of the forehead. A third is directed inward to the region in front of the esophagus. Posteriorly the end sac tapers and is attached to the anterodorsal extension of the endoskeleton by a tendinous process. No muscles have been seen between the end sac and the endoskeleton.

The structure here regarded as an efferent duct is a narrow tube of cuticular tissue leading from the end sac to the base of the antennule.

Excretory Gland B -- "Shell Gland"

This pair of complex glands is located in the anterodorsal region, at the sides of the head (fig. 6; pl. VI, figs. 1-9; pl. VII, figs. 1-7). The glands of males and females

are about the same size. Each gland is embedded in the hypodermis (pl. II, figs. 1-3), and consists of three distinct parts: a glandular section containing several diverticula (pl. XII, figs. 3-6), a large globose rear sac (pl. XII, figs. 2-4), and an elongate end sac (pl. XII, figs. 1-2).

The diverticula of each gland extend forward from the rear sac, to which they connect, as a cluster of about ten subspherical spaces (pl. II, figs. 1-3; pl. V, fig. 1; pl. VI, figs. 1-9). They form the lumen of the glandular section. Each diverticulum is about 30 microns in diameter. It is connected with another diverticulum or with an opening in the base of the rear sac. The cells surrounding the diverticula are composed of a different kind of protoplasm than the rest of the hypodermis; they are vacuolated, have large nuclei (up to 20 microns in diameter), and stain purplish-brown with Ehrlich's haematoxylin and eosin. The cells are held in place by trabecular processes leading to the walls of the hypodermis. There are about ten nuclei in the glandular section (pl. XII, figs. 2-6). Because some nuclei lie distal to the diverticula and some lie between them, it is not known whether each diverticulum has one cell around it or whether some diverticula have two cells and others none. At least five diverticula connect directly to the rear sac through a rather large opening.

The rear sac (pl. VII, figs. 1-3; pl. XII, figs. 2-5) is a hollow globe about 80 microns in diameter, which has an opening to the diverticula of the glandular section, a duct to the end sac, and an efferent duct. It appears to be a central collecting vessel for the products of the glandular section and the end sac. It lies in the hypodermis at the side of the head, a little behind the eye, and above the base of the antennule. The tissue surrounding the rear sac is finely vacuolated, with a hard membranous lining and a dense outer layer. Unlike the protoplasm of the glandular section, that around the rear sac has a smooth outer surface and lacks trabecular processes. The efferent duct is a short, tapering, thin-walled tube that leads from the bottom of the rear sac to the inside of the valve; its distal opening lies at the junction of the inner wall of the hypodermis and the body wall, behind the base of the antennule, and above the base of the antenna. In one specimen (pl. XII, figs. 2-4) the rear sac contains a large quantity of a clear substance that stained orange with Ehrlich's haematoxylin and eosin. Small lobes of this substance project into the adjacent diverticula of the glandular section.

The end sac (pl. VII, figs. 5-7; pl. XII, figs. 1-2) is an elongate bag hanging down along the posterior wall of the rear sac, to which it is attached. It has a lobulate exterior and is embedded in the connective tissue without trabecular processes of any kind. The end sac consists of a cluster of cells around an irregular lumen. The cells are blocky and vacuolated; when stained with Ehrlich's haematoxylin and eosin they strongly resemble those of the liver. The elongate lumen is distally branched and proximally connected by a short efferent duct to the dorsal part of the rear sac (pl. XII, fig. 2). The end sac probably produces some kind of secretion.

Gland B differs greatly from all other glands in the ostracod. It resembles the green gland of higher crustaceans. Its complexity may be the result of fusion of two

glands, one represented by the glandular section and the other by the end sac, with the rear sac developed from the combination of the two efferent ducts. The function remains in doubt, even though Franzl (1940, p. 202-12) contended that these glands in *Cyprinotus incongruens* Ramdohr produce an adhesive substance used to fasten eggs to the substratum. In *Candona suburbana*, the glands are developed equally as well in the male (pl. VI, figs. 1-9; pl. VII, figs. 1-7) as in the female. The classification of the glands as excretory may be questioned.

Excretory Gland C -- Maxillary Gland

This is the most difficult pair of excretory glands to study in *Candona suburbana*. The glands lie in the lower half of the body, below and behind the closing muscles, at the sides of gland N's, and behind the bases of the maxillae (pl. IX, figs. 7-9). The end sac of each gland is subcrescentic in a cross section and elongate in a frontal section, and lies nearly horizontal. Its anterior end is fastened to a posterior branch of the endoskeleton by a short tendinous process, and its posterior end to the body wall near the base of the second thoracic leg by an apophysis; the end sac appears to be suspended between these terminal attachments. The base of the end sac connects to a twisted, more or less S-shaped narrow duct.

The walls of the end sac resemble those of gland A. The long, tubular lumen, only about 7 microns in diameter, is surrounded by a hard membrane. Another dense membrane surrounds the sac. The inner and outer membranes are held apart by numerous irregular partitions throughout the interspace (pl. IX, fig. 8).

The duct that leads from the end sac terminates at the side of the body between the bases of the maxilla and first thoracic leg. The duct is thin and twisted, difficult to follow in serial sections. I have been unable to ascertain whether there is an efferent opening of the duct. No fluid has been found in the end sac or the duct in any specimen.

Liver, or Hepatopancreas

This pair of secreting glands is readily seen in living animals or in sections. Unlike the liver in many other cyprid ostracods, that in *Candona suburbana* is rather short, subpyriform to elongate ovate, and does not extend very far into the hypodermis. Each liver (fig. 8; pl. III, figs. 1-3; pl. VIII, figs. 3-8) lies at the sides of the front part of the stomach, near the dorsal tip of the mandible, and in front of the closing muscles. It is connected to the fore part of the stomach by a short narrow efferent duct (pl. VIII, fig. 7).

The lumen of the liver is narrow and has many short re-entrants. It is filled with a fluid like that surrounding the food ball in the stomach. The surrounding cells are large, and each tapers towards the lumen and the efferent duct (pl. II, figs. 1-3; pl. V, fig. 1; pl. XI, figs. 5-9). They stain dark brownish purple with Ehrlich's haematoxylin and eosin and light reddish purple with triple chrome. The exterior surface of the liver is strongly lobulate.

In living ostracods the liver can be seen through the valve as a golden-yellow mass. Occasionally it shows a peristaltic movement. Inasmuch as there are no muscles attached to the liver, such movement probably results from contractions of the stomach. The secretion of the two livers apparently forms most or all of the digestive juice in the stomach.

Secreting Gland L -- Gland of the Upper Lip

This pair of glands is located in the upper lip (fig. 6; pl. XIII, fig. 3). As compared with gland L's in *Cypridopsis vidua* (see Kesling, 1951, p. 54, fig. 3; pl. 6, no. 21), those in *Candona suburbana* are very small and inconspicuous. The end sac of each gland is elongate oval, about 10 microns in diameter and 20 microns long. It lies in a nearly horizontal position and seems to be held in place only by the connective tissue in the upper lip. A very narrow, thin-walled efferent duct leads back from the end sac to the opening in the fore part of the atrium of the mouth near the beginning of the esophagus. The end sac contains very few cells; it is so small and the cell walls so indistinct that the number of cells is difficult to determine. The lumen is extremely narrow and continuous with the efferent duct.

These glands, by their positions, appear to be salivary glands. The food particles from the esophagus readily combine with those already in the stomach to form a consolidated massive food ball. The secretion of the two gland L's may cause this coagulation.

Secreting Gland N -- Gland of the First Thoracic Leg

This pair of glands, large and easily discernible in microtomed sections, is about the same size in male and female. The dorsal ends of the two glands lie side by side in the ventral half of the body, between the excretory gland C's, above the ventral chain of ganglia, and behind the closing muscles (pl. IX, figs. 8-9). Posteroventrally the two glands diverge, and one enters the protopod of each first thoracic leg (pl. I, fig. 1). Each gland is more or less sausage-shaped, but large and somewhat lobulate in its dorsal half and tapering in its ventral half. The cells have distinct boundaries, and are composed of granular, vacuolated protoplasm. There are about twelve cells in each gland, each with a large nucleus. The lumen, only about 5 microns in diameter, is discernible only in the ventral half of the end sac. The short efferent duct curves back from the end sac to the opening in the rear part of the protopod of the first thoracic leg, near the two setae representing the exopod.

Secreting Gland O -- Copulation Gland of the Female

This is the only pair of glands that is not present in both sexes. It is found only in the female, in which it is part of the sex system. Each gland is located in the anterior part of the corresponding genital lobe, in front of the uterus, and above the vagina (pl. XIII, fig. 1). The end sac is elongate, about 60 microns long and 40 microns in diameter. It is composed of richly vacuolated cells, which are stained by haematoxylin and eosin like those of gland N. Neither the walls nor the nuclei of the cells can be seen. The lumen is narrow and has irregular boundaries. The end sac has only one outlet, a short efferent duct to the vagina.

Gland O is like other glands in the ostracod in that neither one of the pair connects with the other. Each gland apparently supplies a secretion to one of the paired vaginae, but the use of such a secretion is not known.

MUSCULATURE

Closing Muscles

The closing muscles, or adductors (pl. IX, figs. 3-9), are attached to each valve and to a central tendinous structure. When the muscles contract, they draw the two valves together, and when they relax, the ligament above the hinge contracts and spreads the valves apart.

The closing muscles are attached to each valve in a distinctive pattern (figs. 1-4). Five form a rosette near the center of the valve, slightly anterior, and one lies above the rosette. After the animal dies, the positions of muscle attachment are marked by scars. Valves show minor variations in the basic pattern; some have one or more of the five involved in the rosette divided. Parasagittal sections (pl. XII, figs. 1-2) reveal that each closing muscle is made of several discrete bundles of fibers. As many as nineteen bundles have been counted in one section.

In the center of the body, the muscles from each valve join a tendinous band of tissue (pl. IX, fig. 4). The upper edge of this band is reinforced by a long, thin, cordlike tendon (pl. IX, fig. 6) and the lower edge by a short, ventrally concave, rodlike tendon (pl. IX, fig. 5). The ends of the rodlike tendon are attached to the posterodorsal extensions of the endoskeleton (pl. IV, fig. 1). In this manner, the position of the endoskeleton is fixed with reference to the closing muscles.

Appendages

The muscles controlling each of the appendages have already been discussed. They will be reviewed only briefly.

In addition to internal muscles, the antennules each are controlled by six muscles, three from the valve and three from the endoskeleton. All are attached to P1. The terms flexor and extensor are not very appropriate because the appendage is concave upward and elevated when used in swimming movements, depressed and nearly straight when used to explore the area ahead in walking, and depressed and concave downward when folded to fit into the closed carapace. As used in this study, the antennule is said to be flexed when retracted and extended when in the swimming position. Three muscles are definitely extensors, as defined here: one is nearly vertical, connecting the posteroventral corner of the podomere to the anterodorsal margin of the valve; the second is nearly horizontal, connecting the anterodorsal part of P1 to the valve high above the mandible; and the third leads down and back from the posterodorsal corner of the podomere to the anterodorsal tip of the endoskeleton. Two muscles are flexors, from the anterodorsal tip of the endoskeleton to the posteroventral and anteroventral parts of P1. The last muscle operating the antennule may act as a flexor or extensor, depending upon the position of the podomere with relation to the pivot of the base at the middle of the posterior edge of P1.

The antenna is controlled from outside the appendage by six muscles. The strong geniculation of this appendage is associated with an unusual distribution of muscles.

Three muscles from the dorsal part of the valve act as extensors; all are attached to P1. One connects the outer posteroventral edge of P1 to the valve just behind the antennule, the second slopes from the outer anterodorsal edge of P1 to the valve above the mandible, and the third leads from the inner dorsal edge of the podomere to the valve between the positions of the other two extensors. A fourth extensor connects the ventral part of P1 to the antenna supporting rod in the framework of the head (fig. 10), which in turn is connected by a muscle to the dorsal part of the valve. The fifth muscle attached to P1 can apparently act as an extensor or flexor, depending upon the position of the podomere; it leads to the endoskeleton. Another muscle from the endoskeleton extends through the protopod and is attached to the proximal process of E1. This unusual muscle serves as a flexor for E1 or an extensor for P2; it would seem to act in opposition to muscles within the antenna (fig. 13).

The most striking muscles of the mandibles are the adductors converging centrally to the endoskeleton (fig. 9; pl. VIII, figs. 4-9). Muscles from the large basal podomere also extend to the dorsal part of the valve, two from the front edge and two from the rear edge. One of the latter divides dorsally and produces three scars on the valve. The chitinous support of the mandible leaves two scars on the valve anteroventral to the scars of the closing muscles.

The basal podomere of the maxilla is controlled by muscles to both the valve and the endoskeleton. From the front part of the rim a muscle extends vertically to the valve above the closing muscles. From the rear part of the rim, a muscle extends upward to the valve, although its exact place of attachment was not determined. Numerous muscles from within the podomere lead to the posteroventral edge of the endoskeleton. Movement of the maxilla is mostly forward and back. The complexity of the appendages renders the terms extensor and flexor inappropriate.

The first thoracic leg has muscles from the front and rear of the protopod to the posteroventral edge of the endoskeleton. The second thoracic leg has three muscles to the posterodorsal part of the endoskeleton, attached to the posterior edge of P1, the anterior part of P2, and the posterior part of P2. The third thoracic leg has muscles from the posterior and anterior edges of P1 to the posterodorsal process of the endoskeleton.

The furcae are operated by muscles from the front and rear edges to the rear framework of the body.

Digestive System

Muscles were mentioned in the discussion of this system. In addition to the thin layers of muscles in the walls of the stomach, intestine, and rear gut, which allow peristalsis, there are strong circular muscles around the esophagus which also permit peristaltic movement. From the walls of the upper lip, muscles extend to the dorsal wulst (pharynx muscles, pl. III, fig. 3; pl. IV, fig. 3; pl. VII, fig. 6), the esophagus, and the Y-shaped process at the rear of the upper lip.

Endoskeleton

From each half of the endoskeleton (fig. 9), muscles radiate in many directions. Most of these muscles manipulate appendages. There are two to the antennule, two to the antenna, five or more to the mandible (pl. VIII, figs. 5-9), several to the maxilla, two to the first thoracic leg, three to the second thoracic leg, and two to the third thoracic leg; possibly, there are other small muscles undetected. Muscles to the rake-shaped organs in the rear of the mouth are of exceptional interest, inasmuch as they penetrate the ventral chain of ganglia (pl. VIII, figs. 7-8). Another pair of muscles lead to the dorsal rims of the hypostome. A tendinous process from gland A is fastened to the anterodorsal extension of the endoskeleton (fig. 9), and a curved chitin rod attached to the closing muscles is connected to the posterodorsal tips of the endoskeleton (pl. IX, fig. 5). The endoskeleton itself is suspended from each valve by two muscles, one from each of the anterodorsal and posterodorsal tips. The latter can be seen in plate IX, figure 1.

Body

The posterior part of the body is raised by contraction of muscles attached to the posterodorsal part of the valve. In the anterior part of the body, the dorsal part of the valve is connected by a small muscle to a chitin rod forming part of the framework of the head; this rod articulates with the base of the antenna. The anterior part of the body may also be elevated by contraction of muscles from the dorsal part of the valve to the endoskeleton and to the appendages.

Valve

In addition to the scars left by the closing muscles and mandibular support, each valve has numerous small scars in the dorsal region (fig. 10). These are from muscles that extend to appendages, endoskeleton, and body framework. The scars of these small muscles are distributed in four groups.

The first group form a long line subparallel to the dorsal border and close to it. It includes nine muscles. The first is set far forward, attached to the valve just above the antennule to which it leads. The following two scars are situated above the mandible, and are for muscles

leading to antenna and antennule. The fourth, above the maxilla, is made by a small, long muscle to the posterodorsal tip of the endoskeleton (fig. 9). The next three, above and behind the closing-muscle scars, are for muscles which join together and go to the mandible. Well behind these muscles are two small scars of muscles leading to the posterior part of the body and attached dorsal to the anus.

The second group form a row just below the first row and above the mandible. From front to rear they are for muscles leading to the antenna supporting rod of the framework, the antenna, and the mandible.

The third group are in a row below the second and above the mandibles and closing muscles. From the front, they are made by muscles leading to antenna, mandible, maxilla, and antennule. The last group, two small scars just above the mandible and anterodorsal to the closing muscle scars, has erroneously been referred to as the antennal scars. Actually, the dorsal scar leads to the mandible and the ventral to the endoskeleton. The extra muscle found in the male is discussed below.

Copulation Muscles of the Male

From the ventral part of the body at the front end of the penes attachment, large and powerful muscles extend to the body wall (fig. 9; pl. I, figs. 1-3; pl. X, figs. 1-4). These muscles, used in copulation, produce all the action of the complicated penes, which, strangely, contain no muscles. When the copulation muscles contract, the body is sharply constricted, the Zenker's organs are rotated about 90 degrees, the chitin plates of the penes unfold, and the tips of the inner lobes of the penes are thrust forward and out of the carapace.

These are the only muscles found in the male and not in the female. Inasmuch as they lead to the dorsal part of the valve, their scars should offer a means of distinguishing male and female valves in Recent and fossil species. But no scar can be discerned in several male valves stained, and the position of the attachment to the valve can only be determined as posterodorsal to the closing-muscle scars (pl. X, fig. 1).

ENDOSKELETON

The endoskeleton is a complex structure of fused chitin rods. In simple terms, it resembles antlers. From the four major extremities and the base, muscles lead to the dorsal part of the carapace, the appendages, the hypostome, and the rake-shaped organs (fig. 9).

The endoskeleton is suspended from the carapace by four muscles. Two muscles lead from the anterior and posterior extremities on each side to the dorsal part of the corresponding valve. The muscles from the posterior tip forms a small scar in the uppermost row of scars, the fourth from the front; that from the anterior tip is considerably shorter and forms the lower of two small scars above the mandibles. These muscles serve to adjust and control the position of the endoskeleton.

From the anterior extremity three muscles lead to P1 of the antennule. They are attached to the posterodorsal corner, the anteroventral border, and the posteroventral corner of the podomere.

From about the same part of the endoskeleton, two muscles extend to the antenna. The first is relatively short, leading to the posteroventral edge of P1 (pl. IV, fig. 1). The second is much longer, leading to a process on E1; this is a very unusual attachment for a muscle controlling an appendage, and probably evolved as a modification of muscles within the appendage.

The largest and most numerous muscles of an appendage are those of the mandibles. From the lower section of

the endoskeleton, five muscles radiate to the large P1, drawing the teeth together by their contraction (pl. IV, fig. 1; pl. VIII, figs. 2-9; pl. XI, figs. 1-8).

Several muscles extend from the lower part of the endoskeleton. From a small ventral process, small muscles lead to the rake-shaped organs (pl. XI, figs. 3-7). These appear to support and adjust these structures, and not to impart masticatory movements. From the posteroventral part of the endoskeleton, several tiny muscles lead to each maxilla (pl. VIII, fig. 9; pl. XI, figs. 1-3), another pair support the hypostome (pl. XI, fig. 4), and two or three lead to each first thoracic leg.

The posterior extremity on each side of the endoskeleton serves as the origin of muscles to the other two thoracic legs. In the second thoracic leg, they are fastened to the posterodorsal edge of P1 and the anterior and posterior parts of P2. In the third thoracic leg, they are attached to the front and rear of the base. The posterior tip of the endoskeleton is linked to the central process of the band of closing muscles (pl. IV, fig. 1; pl. IX, fig. 5).

Because the enclosing valves extend completely around the appendages in the ostracod, they are not adapted to provide rigid supports for muscles controlling the appendages. The endoskeleton, centrally situated, does provide such supports, and thereby assumes greater importance for the ostracod than for most other crustaceans.

SEX SYSTEMS

Female System

The female system consists of two halves, each complete, with no connection whatsoever between the right and left ovaries, uteri, or seminal receptacles. Each half is a mirror image of the other.

Ovaries

As in other ostracods of the family, the ovaries are elongate curved organs in the hypodermis (fig. 7; pl. XII, figs. 8-9), one on each side of the animal. Each ovary begins in the posterior region, curves down, forward, and up, and enters the uterus near the middle of the valve.

Although Woltereck (1898, pp. 602-608) distinguished the germinal zone, where eggs originate, from the growth zone, where they develop, there is no sharp boundary between zones in the ovary. Instead, from the oocytes in the syncytium to the eggs passing into the uterus, progressive stages are present along the course of the ovary.

Cells in the syncytium are irregular in size and not sharply defined. These oocytes pass through a synapsis and acquire recognizable nuclei. Sections through the ovary (pl. XII, figs. 8-9) show some cells farther along the ovary which are distinctly smaller than the others. These are the "nurse cells" referred to by Woltereck (1898, p. 605) and Claus (1893, p. 21) and thought to be abortive eggs serving to supply vitelline content to the functional eggs. The "nurse cells" do not appear beyond the part of the ovary where the eggs display large, sharply defined nuclei and definite borders.

In the front third of the ovary, that part which leads anterodorsally to the junction with the uterus, the egg cells are crowded together so that their surfaces are beveled against those of adjacent eggs. As a result, the eggs here have angular outlines in cross section (pl. XII, fig. 8). The diameter of this section of the ovary is about 80 microns.

Uteri

Just posterodorsal to the closing muscles on each side of the female, the ovary in the hypodermis passes into the uterus in the body. Both ovary and uterus are thin-walled egg tubes and the boundary set between them is one of convenience.

No conspicuous change in the eggs occurs at the passage from ovary to uterus. Rather, the development of the eggs continues. Within the uterus, the shell is added to each egg. This begins as numerous granules on the surface (pl. V, figs. 4-7), which progressively fuse to form the cuticular wall. The final form of the wall is not apparent until the eggs are nearly to the end of the bladder-like uterus, ready to be laid. In the central part of the uterus, which is normally distended with eggs, the angularity of the eggs disappears and they assume the final spherical shape (pl. III, fig. 3; pl. V, figs. 1-2).

Genital Lobes

The paired genital lobes are elongate ellipsoidal features set close together in front of the furcae (pl. XIII, figs. 1-2). The uterine opening is near the middle and the vagina near the front of each lobe.

Uterine Openings

The two uterine openings, left and right, occur near the middle of the genital lobes. Each opening seems to be a simple, distensible aperture through which eggs can be discharged. No complicated musculature has been noted in association with the openings.

Vaginae

The chitinous framework surrounding the vaginal openings is not nearly as strongly developed in this species as in *Cypridopsis vidua* O. F. Müller (Kesling, 1951, pp. 45-46, figs. 27-29; pl. 49, fig. 240; pl. 59, fig. 272). On the border of the vagina, apparently articulated with the frame, is a "chitin stick" similar to that in *C. vidua* but small and inconspicuous. Muscles attached to this buckle-like structure radiate to the inner wall of the genital lobe (pl. XIII, figs. 1-2). By their contraction, these muscles probably serve to swing each opening into the copulatory position.

The vagina tapers rapidly to a canal that leads to the seminal receptacle. In *Cypridopsis vidua* I found this canal to be very long and wound up in a ball, so that the term spiral canal was quite appropriate. In *Candona suburbana*, however, the canal is relatively short, although somewhat twisted and contorted (fig. 7).

Seminal Receptacles

Each seminal receptacle lies below the corresponding uterus, but no direct connection between them can be found. To date, my observations of serial sections lead me to conclude that each seminal receptacle is a blind end, and that the spiral canal from the vagina is both the adit and exit from it.

Adult females have masses of long spermatozoa in their receptacles (fig. 7; pl. IV, figs. 1-3). As distended, each receptacle is bladder-shaped (pl. V, figs. 1-2).

The male sex products in the receptacles differ drastically from those in the seminal vesicles of the males. In the receptacle of the female, they appear to be true spermatozoa, with a distinct enlargement or "head" and a long filamentous "tail" (pl. V, fig. 1), whereas in the body of the male, they are much wider and have only nodular enlargements to disrupt the longitudinal profile at intervals (pl. I, fig. 3; pl. VII, figs. 8-9; pl. VIII, figs. 1-3). These differences suggest that the sex products within the male are spermatophores, from which the spermatozoa are released prior to their reaching the seminal receptacles in the female. This point needs detailed investigation.

Male System

Like the system within the female, the sex system of the male consists of two halves, each complete in itself, with no connection between the right and left halves. Each half in the male contains elongate testes, circuitous vas deferens, distended seminal vesicle, voluminous Zenker's organ, and complicated, enormous penis.

Testes

Each half of the system has four testes or testicles embedded in the hypodermis. They are subparallel, curving downward along the posterior margin of the valve, then forward and upward to their junction above the closing muscles (fig. 6).

In the syncytium of each testis (pl. I, fig. 3) the developing sex cells begin as irregular bodies, not sharply defined, less than 5 microns in diameter; they do not differ from the oocytes in the syncytium of the ovary in the female in any particular. This section is followed by one in which the cells are well nucleated and subpolygonal, up to 25 microns in diameter (pl. I, fig. 3). This section is only about 200 microns long. Beyond it, the polygonal cells disappear and are replaced by thread-like bodies (pl. I, figs. 2-3). These progressively increase in diameter to the outlets of the testes at their junction.

Vasa Deferentia

The union of the testes is taken as the origin of the vas deferens in each half of the body. The vas deferens follows a curious circuit before enlarging to form the seminal vesicle. From the origin it passes a short distance through the body and enters the hypodermis in the anterodorsal region. There it proceeds forward, down, back, up, and forward, paralleling the edge of the hypodermis (fig. 6). This is the "blind section" of the vas deferens (pl. I, fig. 2; pl. VI, figs. 1-7; pl. XII, figs. 5-6). Actually, of course, this section is not blind, for the exit begins in the ventral section in a Y-junction and extends forward and up parallel to the front half of the "blind section" (fig. 6). The supposed function of this unusual section, once thought to be a fifth testis (Zenker, 1850, p. 195), is to permit the developing spermatozoa (or perhaps spermatophores) to change their direction. These sex products are each longer than the body of the ostracod, and are absolutely the largest known in the animal kingdom.

The vas deferens re-enters the body in the anterodorsal region, parallels the dorsal border, encircles the Zenker's organ (pl. X, figs. 1-5), loops back and forth several times (pl. II, figs. 1-3), and rapidly enlarges to form the seminal vesicle (pl. IX, figs. 1-9). Nearly each section of the vas deferens contains cross sections of several spermatozoa.

Seminal Vesicles

The pair of seminal vesicles nearly fills the anterodorsal region of the body (pl. I, fig. 3; pl. VIII, figs. 1-9; pl. IX, figs. 1-9), extending nearly to the forehead (pl. VI, figs. 7-9). Each is distended with many, many spermatozoa (pl. VIII, figs. 1-9), forming a C-shaped bladder leading into the Zenker's organ. Although the spermatozoa are in places diverted in bundles, they generally follow a course subparallel to the outer wall of the vesicle (pl. I, fig. 3).

Zenker's Organs

These voluminous seminal pumps fill much of the posterodorsal part of the body (pl. II, figs. 1-3; pl. X, figs. 4-5). Their sole known use is to move the extremely large spermatozoa out during copulation.

Each is a complex organ (Kesling, 1957, pp. 175-82). The central tube is composed of numerous chitin rings embedded in tissue (fig. 15a; pl. XIII, fig. 4). Nearly all cross sections of the central tube contain more than one spermatozoon (pl. XIII, fig. 5). Spaced along the central tube are normally seven wreaths of chitin spines (fig. 15a); these wreaths can be seen through the carapace (pl. XIII, fig. 7). Each spine is Y-shaped (pl. XIII, fig. 4), the two prongs attached to the central tube and the tip at the outer limit of the organ. Numerous tiny muscles lace the spines of each wreath together, and others link those of adjacent wreaths (pl. I, figs. 1-3; pl. II, figs. 1-3; pl. X, figs. 3-5). A sheath of tissue covers the outer part of the organ. Thus, the mass of the Zenker's organ is a cylinder of interlaced tiny muscles, given support and rigidity by seven wreaths of chitin spines arranged along a central tube.

The front of the organ is funnel-shaped (pl. I, fig. 3; pl. X, figs. 1-2), serving to direct the spermatozoa into the central tube. At the posterior end, the central tube constricts to a narrow tube curving forward and entering the penis; this may be considered as a continuation of the vas deferens (pl. X, fig. 6).

In use during copulation, the Zenker's organ is rotated about 90 degrees, and ejaculation is accomplished by rhythmic motions through the organ. Thus pulsing proceeds from the front (top) of the organ to the rear (bottom), and can be observed through the carapace by the movement of the chitin wreaths.

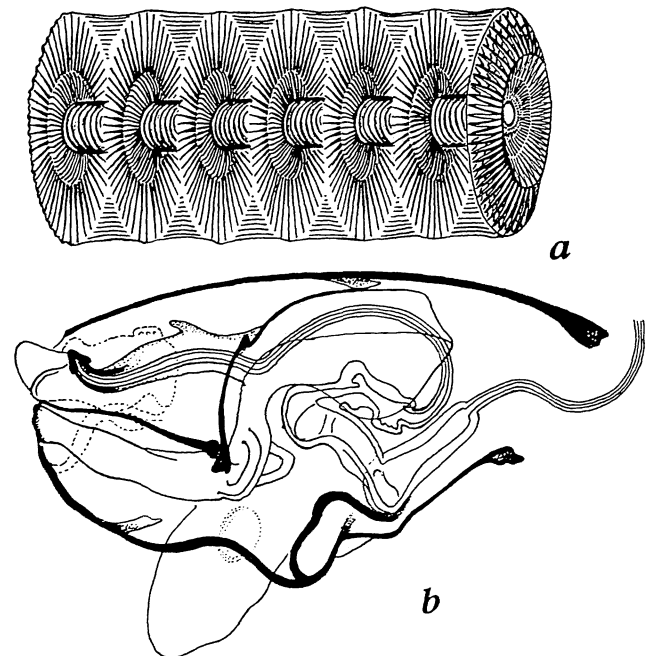

FIG. 15. *Candona suburbana* Hoff. a. Zenker's organ. b. Outer face of penis. Compare with figures 3 and 6 for scale.

Penes

The extremely complicated penes have never been fully understood. They seem to be a necessary adaptation for copulation by a male encased in a carapace with a female encased in another carapace. As compared with other crustaceans, the ostracod has penes that are massive, capable of unfolding for copulation and refolding for retraction within the carapace. In each penis, the chitinous framework forms a sheath around a smaller sheath (pl. X, figs. 7-10). In the passive state, the vas deferens forms a large S within the penis and terminates at the inner of three lobes (fig. 15b; pl. II, figs. 1-2).

Another remarkable feature of the penis is the lack of any musculature within it. Evidently the chitinous parts are intricately hinged, so that erection and unfolding result from the pressure caused by contraction of the copulation muscles (pl. I, fig. 1; pl. X, figs. 1-4), which are attached immediately in front of the penes.

The S-shaped vas deferens within each penis is not a simple tube. There are three successive thick-walled enlargements around the initial curve (pl. II, figs. 1-2). Their function remains a mystery. And nothing is known

of the use of the outer and middle lobes of each penis, which contain no part of the vas deferens. Perhaps they are sensory structures utilized to insure insertion of the inner lobe into the corresponding vagina of the female.

Although I have studied these structures in total mounts and in thin sections, I cannot reconstruct the details of their morphology beyond the sketch presented in figure 15b, nor can I explain their operation.

Powerful muscles (pl. I, fig. 1; pl. X, figs. 1-4) extending from the dorsal part of each valve to the ventral part of the body operate the penis, which contains no muscles. During copulation, these muscles contract. The penis is swung forward and out of the carapace by this action, the plates of the penis spring outward, and the Zenker's organ is rotated to a vertical position. These muscles are not found in the female.

The sex system of the male is complex as a result of the large size of the spermatozoa, the necessity of pumping them out through the penis, and the difficulty of copulation with a female also enclosed by a large bivalved carapace.

CARAPACES

Hingement and Closure

Wagner (1957, p. 18) characterizes the hingement of the genus *Candona* thus: "La charnière est très simple: le bord dorsal de la valve droite s'articule dans une cannelure du bord dorsal de la gauche." Admittedly, the hingement of *Candona* is not as strongly developed as in many of the living marine ostracods, but in my analysis it can scarcely be explained as simple. In each valve, the hinge elements are in very low relief and must be illuminated at low angles to be discerned. Except for the stronger curvature in the male valves (fig. 1), they have the same hingement as the female valves (fig. 2).

The long central part of the hinge consists of a ridge or hinge bar in the right valve and a corresponding hinge groove in the left valve. At each end, however, the ridge turns proximally to curve around an elongate sublunate depression in the right valve (fig. 2), here called the hinge process. In the corresponding positions in the left valve, the groove is terminated by sublunate elevations (fig. 1), which may be termed the hinge flaps. The posterior elements of the hinge are nearly twice the size of the anterior. The terminal parts, although much subdued, appear to me to function as tooth-and-socket arrangements in ostracods having stronger hingement.

Along the remainder of the valve, the free edge of the left valve embraces that of the right in an overlap or overreach. The degree of development varies from weak at the ends to strong at the ventral section.

The selvage and list of each valve are low and inconspicuous, as compared with most other ostracods.

Duplicature

The anterior duplicature is much wider than the posterior, forming a spacious vestibule (figs. 1-2). The adhesive strip maintains about the same width around the free margin. The inner margin has a slight elevation or low ridge. In the anterior duplicature, this is paralleled by another low ridge (figs. 1-2). Numerous radial pore canals pass through the adhesive strip; they are not precisely radial. The proximal ends of the radial pore canals outline the line of concrescence.

Dimorphic Differences

The differences of male and female valves have been noted previously in studies of *Candona*. The posterior region of the male valves are more plenate in lateral view, both from the greater posterodorsal curvature and from the ventral extent. In contrast, the female valves have so little curvature in the posterodorsal part of the border that they seem beveled or truncate. The indentation of the ventral border is much stronger in the male than in the female (figs. 1-2).

The four testes or testicles in the male valve leave traces after removal of the soft parts. The ovary in the female valve may also leave a trace, but it is much fainter than those of the testes in the male.

UTILIZATION OF SPACE WITHIN CARAPACES OF MALE AND FEMALE

Here are presented the first measurements that have been made of the volumes of organs, systems, and other parts of the body in an ostracod. They were computed to determine the relationship between the volume of the carapace and the volume of the sexual system in each adult dimorph of *Candona suburbana* Hoff.

In any problem the quantitative investigation is apt to be more laborious than the qualitative. For small organisms it poses a particular challenge. The minute size of the ostracod's soft parts and their encasement within a hard carapace make measuring of volumes a complex operation.

Method

It seems impossible to measure sizes of body parts in toto. Individual organs cannot be accurately excised from the rest of the body. Even if they could be isolated without shrinkage or swelling, their weight or volume would be difficult to determine because nearly all instruments and procedures are designed for more massive objects.

Volumes of organs in an ostracod can be computed from serial sections of the animal. In microtoming, each organ is sliced into slabs or sections of known thickness. The total volume of the organ is the sum of the volumes of the slabs into which it has been cut. The volume of each slab equals the product of the area and the thickness. Thus, the volume of an organ is determined by slicing it into sections, measuring the area and thickness of each section,

multiplying the area by the thickness for each section, and adding up these products.

The specimens of *Candona suburbana* were cut by a rotary microtome adjusted to produce 10-micron sections. The average thickness of the cross-sections was checked by dividing the total length of the animal by the number of sections.

The area of each section of an organ was more difficult to ascertain. The image of the section was projected onto paper at a known scale by means of a camera lucida attachment on the microscope, the outline traced, the area enclosed by the outline measured by a polar planimeter, and the area of the section computed by applying the necessary reduction for scale.

Measurements of volume by this method are only as accurate as those of the thickness of the sections produced by the microtome, the scale of enlargement of the image by the camera lucida, the outline traced on the paper, and the area registered by the polar planimeter. The significant source of error, however, appears to be not in the accuracy of the instruments nor in their manipulation, but in the assumption that each section of an organ has equal areas on its two sides. For example, the last section of a spherical organ will show a circle on its proximal surface, but at most only a point on its distal surface. The volume is computed for a cylinder, whereas the part of the organ is actually a spherical segment. As a result, the computed volume is larger than the actual. The error is greatly reduced by making thinner sections of the organ.

TABLE 1
VOLUMES OF MALE AND FEMALE SEX SYSTEMS IN *Candona suburbana* HOFF
(in cubic millimeters)

Male system	Female system
Penes 0.0119	Genital lobes. 0.0027
Testes0043	Ovaries0057
Seminal vesicles0106	Seminal receptacles0049
Vasa deferentia0043	Uteri and eggs *0115
Zenker's organs0123	
Muscles operating penes0011	
Total0445	Total0248

* Exclusive of those parts lying within the genital lobes.

TABLE 2
 VOLUMES OF MALE AND FEMALE CARAPACES AND SOFT PARTS IN
Candona suburbana HOFF (in cubic millimeters)

	Male	Female
Carapace	0.1382	0.1127
Total soft parts*1347	.1123
Sex system (see table 1)0445	.0248
Soft parts exclusive of sex system*0902	.0875
Hypodermis0402	.0402
Other soft parts0500	.0473

* Exclusive of distal parts of appendages. Basal parts (protopods) of most appendages included in measurements of the body.

Volumes of Sex Systems

As shown in table 1, the total volume of male sex organs is nearly twice that of the female sex organs. In each adult, the sex system occupies an exceptional proportion of the total body. This is the result of two factors: the size of the spermatozoa, absolutely as well as relatively the largest known in the animal kingdom, and the complexity of copulation between two individuals each encased in a bivalved carapace with narrow opening. Much of the volume of the sex system is concerned, therefore, with storage of spermatozoa and with accommodation of the intricate folding penes.

The male sex system amounts to 0.0445 cubic millimeters, or about one-third of all soft parts (table 2). By far, the largest elements are the Zenker's organs, penes, and seminal vesicles. From selected sections, one might suppose that the size was much greater -- for Zenker's organs (pl. I, figs. 1-3; pl. X, figs. 1-9), for penes (pl. I, figs. 1-3; pl. II, figs. 1-3; pl. X, figs. 6-10), and for seminal vesicles (pl. VII, figs. 1-9; pl. VIII, figs. 1-9). Only in total measurements of volume do these features appear in their correct proportions.

The female sex system comprises 0.0248 cubic millimeters, or only about one-fifth of the soft parts (table 2). Most of the system is made up of uteri, distended with eggs (pl. III, figs. 1-3). The genitalia of the female (genital lobes) are less than one-fourth the volume of those of the male (penes). This is an important factor in the relationship of carapace to sex system, as will be discussed below.

Volumes of Non-Sexual Soft Parts

One of the significant results of these measurements is the discovery that male and female are nearly the same size, apart from the sex systems. Table 2 shows that, excluding the sex system, the male soft parts amount to

0.0902 cubic millimeters and the female soft parts to 0.0875 cubic millimeters. Thus, the male is only slightly larger than the female in non-sexual soft parts. This appears to be a valid conclusion; however, in the animals sectioned and measured the male's stomach was evacuated whereas the female's stomach was occupied by a fairly large food ball. As shown in table 3, the difference amounted to less than 0.004 cubic millimeters for the entire digestive system. From dissections, it is obvious that the male has slightly larger appendages (figs. 3, 5b, 5d, 5f, 5h, 5j, 5m) than the female (figs. 4, 5a, 5c, 5e, 5i, 5k, 5l) and logically might be supposed to have a larger body for their support.

Certain organs were found to have only slightly larger volume in male than in female (table 3). The closing muscles, central nervous system, and gland B are proportionally larger in the male.

Relationship of Carapace and Sex System

The carapace of the male is larger than that of the female, and houses a larger volume of soft parts. The extra volume of soft parts in the male consists mostly of sex organs (table 2). The additional space in the anterior half of the male carapace is utilized primarily for the large seminal vesicles (pl. VI, figs. 7-9; pl. VII, figs. 1-9; pl. VIII, figs. 1-9; pl. IX, figs. 1-9), which have no counterparts in the female.

The most striking dimorphic difference in the carapace, however, lies in the posterior half. The male has a more plicate posterodorsal region and a lobate posteroventral region not found in the female. The posterodorsal region houses the large Zenker's organs (pl. X, figs. 1-9) and the posteroventral region the large penes (pl. X, figs. 7-10). The posterior part of the female carapace accommodates the large uteri, distended with eggs (pl. III, figs. 1-3; pl. V, figs. 1-2). Measurements show that the combined volumes of penes and Zenker's organs is more than twice the

TABLE 3
 VOLUMES OF SOME MALE AND FEMALE ORGANS IN *Candona suburbana* HOFF
 (in cubic millimeters)

	Male	Female
Closing muscles	0.00100	0.00085
Central nervous system00139	.00109
Cerebrum00024	.00023
Circumesophageal ganglia00046	.00030
Peribuccal ring00006	.00004
Ventral chain of ganglia00063	.00052
Digestive system*00218	.00583
Gland B00092	.00084
Diverticula00059	.00051
Rear sac00022	.00021
End sac00011	.00012
Gland C00007	
Gland N00017	
Eye00005	.00005

* Including dorsal wulst and livers. Male stomach evacuated.

volume of the uteri and contained eggs (table 1); if the male carapace were the same size and shape as that of the female, the penes could not be retracted into the carapace (compare figs. 3 and 4). The distribution of the sex organs also has a relationship to the posterior part of the carapace in the female, the uteri are nearly central; but in the male, the Zenker's organs lie above the penes. The

sex system of the male, therefore, requires accommodation dorsally and ventrally in the posterior half of the animal, in contrast to the system of the female, which needs space only centrally.

Obviously, the dimorphic differences in the carapaces are directly related to differences in the sex systems.

LITERATURE CITED

- BAIRD, WILLIAM, 1835, List of Entomostraca found in Berwickshire: Berwickshire Nat. Club Hist., Proc. 1835, pp. 95-100, pl. 3.
- 1845, Arrangement of the British Entomostraca, with a list of species, particularly noticing those which have as yet been discovered within the bounds of the Club: *Ibid.*, Proc. 1845, pp. 145-48.
- 1846, Description of some new genera and species of British Entomostraca: Ann. & Mag. Nat. Hist., ser. 1, vol. 17, pp. 410-16, pl. 9.
- BRADY, G. S., & NORMAN, A. M., 1889, A monograph of the marine and fresh-water Ostracoda of the North Atlantic and of northwestern Europe. Sec. 1, Podocopa: Roy. Dublin Soc., Sci. Trans., ser. 2, vol. 4, pp. 63-270, pls. 8-23.
- CANNON, H. G., 1925, On the segmental excretory organs of certain fresh-water ostracods: Philos. Trans. Roy. Soc. London, ser. B, vol. 214, pp. 1-27, 2 pls., 5 figs.
- CLAUS, CARL, 1893, Beiträge zur Kenntnis der Susswasser-Ostracoden, I. Über den Körper- und Gliedmassenbau der Cypriden: Arb. zool. Instit. Wien, vol. 10, pp. 147-216, 12 pls.
- FRANZL, WALTHER, 1940, Vitale Elektivfärbung und Funktion der "Schalendrüse": Zeitsch. Morph. und Ökol. Tiere (Zeitsch. wiss. Biol., Abt. A), vol. 37, pp. 202-212, 5 figs.
- HOFF, C. C., 1942, The ostracods of Illinois, their biology and taxonomy: Ill. Biol. Monog., vol. 19, nos. 1-2, pp. 1-196, pls. 1-9, 1 fig.
- HOWE, H. V., 1955, Handbook of ostracod taxonomy: La. State Univ. Studies, Phys. Sci. Ser., vol. 1, xiii + 389 pp.
- KAUFMANN, A., 1900, Zur Systematik der Cypriden: Mitt. naturf. Ges. Bern, pp. 103-109.
- KESLING, R. V., 1951, The morphology of ostracod molt stages: Ill. Biol. Monog., vol. 21, nos. 1-3, viii + 324 pp., 96 pls.
- 1956, The ostracod a neglected little crustacean: Turtox News, vol. 34, no. 4, pp. 82-86; no. 5, pp. 90-94; no. 6, pp. 114-15, 7 figs.
- 1957, Notes on Zenker's organs in the ostracod Candona: Amer. Midland Nat., vol. 57, no. 1, pp. 175-82, 9 figs.
- KLIE, WALTHER, 1938, Ostracoda, Muschelkrebse: Die Tierwelt Deutschlands und der angrenz. Meeresteile, vol. 34, pp. 1-230.
- MÜLLER, G. W., 1894, Die Ostracoden des Golfes von Neapel und der angrenzenden Meeresabschnitte: Fauna und Flora des Golfes von Neapel, Monog. 21, viii + 404 pp., 40 pls., figs.
- 1912, Ostracoda: Das Tierreich, vol. 31, pp. 1-434.
- MÜLLER, O. F., 1776, Zool. Danicae Prodromus: Havniae.
- ROME, DOM R., 1947, *Herpetocypris reptans* (ostracode), Étude morphologique et histologique, I. Morphologie externe et système nerveux: La Cellule, vol. 51, pp. 51-152, pls. 1-15, 20 figs.
- SARS, G. O., 1866, Oversigt af Norges marine Ostracoder: Norske Vidensk.-Akad. Forhandl., 1865, pp. 1-130.
- 1890, Oversigt af Norges Crustaceer, med foreløbige Bemaerkninger over die nye eller mindre bekjendte Arter: Forhandl. Norske Vidensk.-akad., Vidensk.-selsk. i Kristiania, 1890, pp. 1-80.
- 1922-28, Ostracoda: An account of the Crustacea of Norway, Bergen Mus., vol. 9, 275 pp., 119 pls.
- SHARPE, R. W., 1918, The Ostracoda, in Ward, H. B., & Whipple, G. C., Fresh-water biology: John Wiley & Sons, N. Y., 1945, pp. 790-827, figs. 1244-1302.
- SWAIN, F. M., et al., 1961, Crustacea, Ostracoda: Treatise on Invertebrate Paleontology (R. C. Moore, edit.), pt. Q, 442 pp., 334 figs.
- VÁVRA, W., 1891, Monographie der Ostracoden Böhmens: Archiv naturwiss. Landesdurchf. Böhmens (Archiv pro přírodovědecký výzkum Čech.), vol. 8, pp. 1-116, figs.
- WAGNER, C. W., 1957, Sur les ostracodes du Quaternaire Récent des Pays-bas et leur utilization dans l'étude géologique des dépôts Holocènes: Thèses présentées à la Faculté des Sciences de l'Université de Paris, sér. A, no. 707, no. d'ordre 733, 259 pp., 50 pls., 26 figs.
- WOLTERECK, RICHARD, 1898, Zur Bildung und Entwicklung des Ostrakoden-Eies: Zeitsch. für wiss. Zool., vol. 64, pp. 596-623, pls. 19-20.
- ZENKER, W., 1850, Über die Geschlechtsverhältnisse der Gattung Cypris: Arch. Anat., Physiol. und wiss. Med., Jahrg. 1850, pp. 193-202, pl. 5.

EXPLANATION OF PLATE I

(All figures enlarged to scale in figure 1)

All sections illustrated on this plate cut 10 microns thick and stained with Ehrlich's haematoxylin and eosin. Sections selected from one male, but not in succession. They are cut parasagittal, slightly inclined; right side of each figure is anterior and top is dorsal. Copulation muscles, operating one of penes, designated by m.

- FIG. 1. Section near left side, cut through left Zenker's organ, muscles operating left penis, and proximal parts of several appendages. Muscle segments in front of muscles operating penis are parts of closing muscles.
- FIG. 2. Section near middle of body, cut through central part of digestive tract, right Zenker's organ, and part of hypodermis. All seven wreaths of chitin spicules in Zenker's organ intersected in this section. Small dark bodies in central tube of Zenker's organ are sections through spermatozoa.
- FIG. 3. Section near right side of body, cut through right Zenker's organ, seminal vesicle, and testes. Parts of the four right testes present in this section. Spermatozoa in seminal vesicle well shown in this section.

PLATE 1

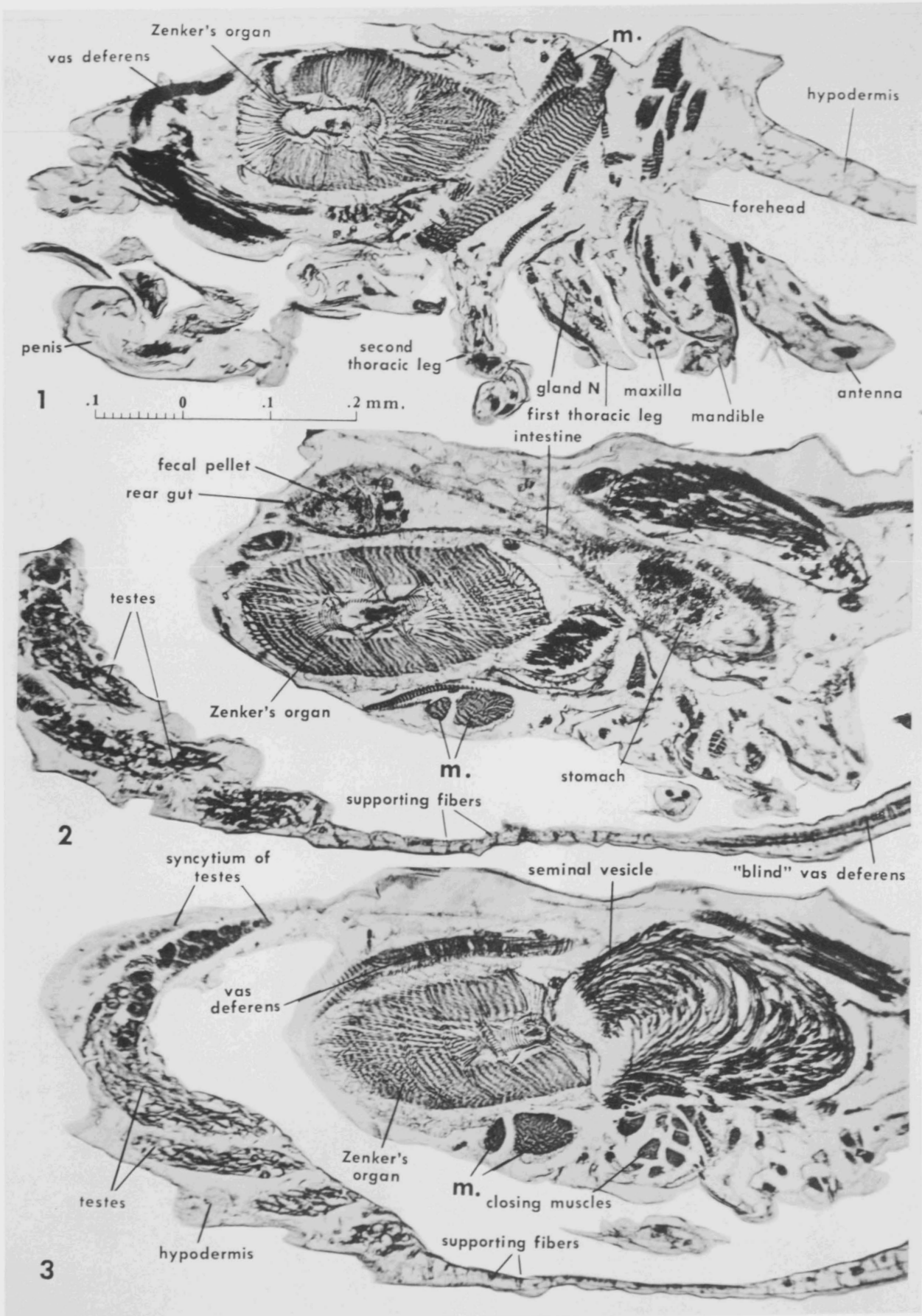

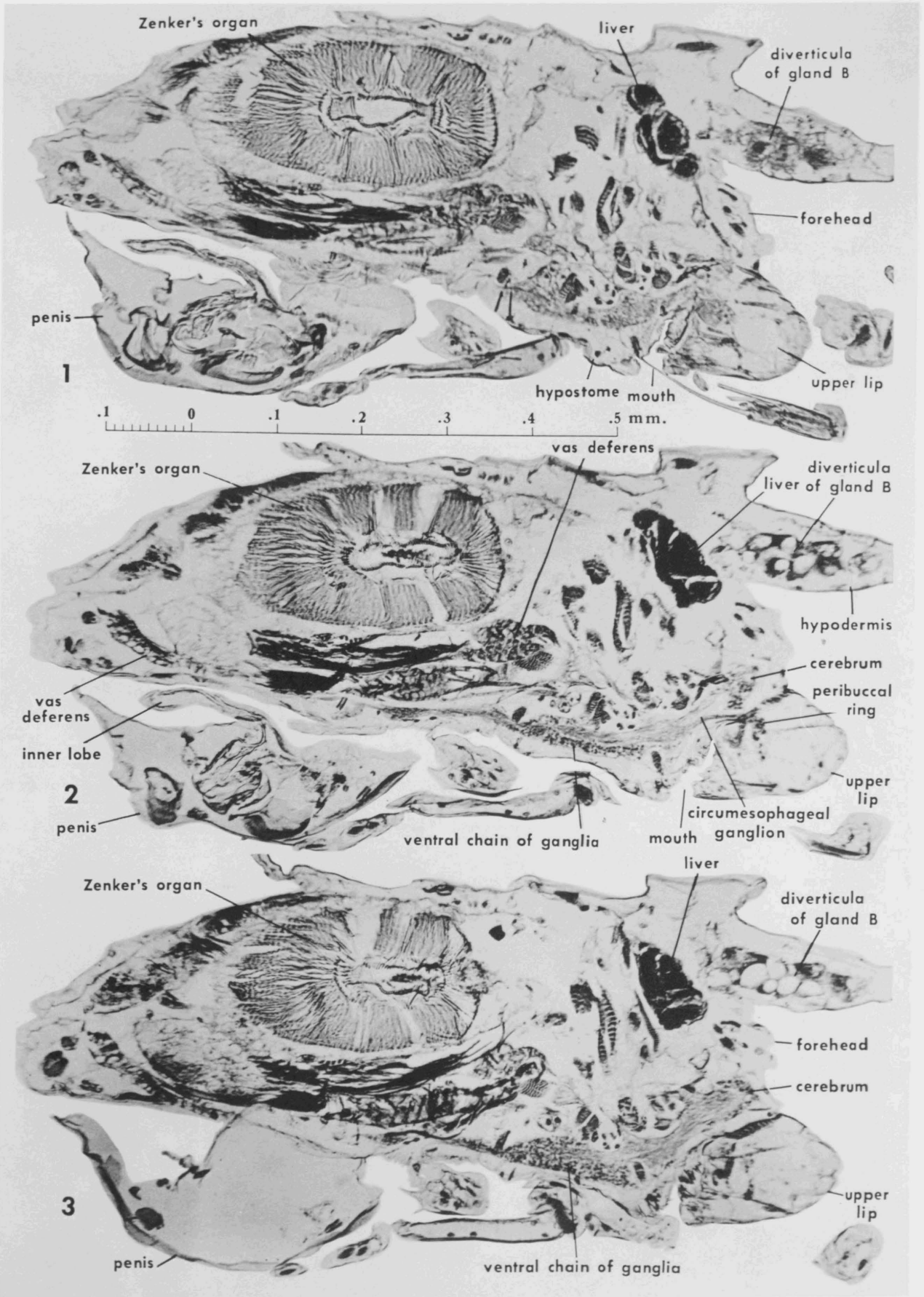

EXPLANATION OF PLATE II

(All figures enlarged to scale in figure 1)

All sections illustrated on this plate cut 10 microns thick and stained with Ehrlich's haematoxylin and eosin. Sections are from one male, the same animal providing sections shown in plate I. They are cut parasagittal, slightly inclined; right side of each figure is anterior and the top is dorsal.

- FIG. 1. Section in left half of body, cut through upper lip, hypostome, left Zenker's organ, penis, and liver. This section shows some of the chitin internal structures of the penis.
- FIG. 2. Section proximal and adjacent to that shown in figure 1. Small dark spots in ventral chain of ganglia, cerebrum and peribuccal ring are nerve cells. Distal end of vas deferens shown in inner lobe of penis.
- FIG. 3. Section proximal and adjacent to that shown in figure 2, containing cerebrum and ventral chain of ganglia of the central nervous system. The two dark objects in front part of ventral chain of ganglia are muscles connecting rake-shaped organs to endoskeleton; these muscles pass through a perforation in the ventral chain of ganglia. Parts of chitin rings can be seen surrounding central tube of Zenker's organ.

EXPLANATION OF PLATE III

(All figures enlarged to scale in figure 1)

All sections illustrated on this plate cut 10 microns thick and stained with Ehrlich's haematoxylin and eosin. Sections are from one female, cut frontal. Right side of each figure anterior.

- FIG. 1. Section near middle of body, cut through stomach and cerebrum. Several eggs shown in the two uteri. Left side of section cuts through liver, and right side through closing muscles and gland A. Small dark spots in cerebrum are nerve cells.
- FIG. 2. Section below that shown in figure 1, but not adjacent to it, showing the dorsal wulst or pharynx in the front part of stomach. Cerebrum intersected near the place where it joins left and right branches of circumesophageal ganglion.
- FIG. 3. Section below that shown in figure 2, but not adjacent to it. Section contains junction of right ovary and uterus, immediately behind closing muscles. It also shows the two pharynx muscles connecting dorsal wulst to upper lip, which pass through the circumesophageal ganglion.

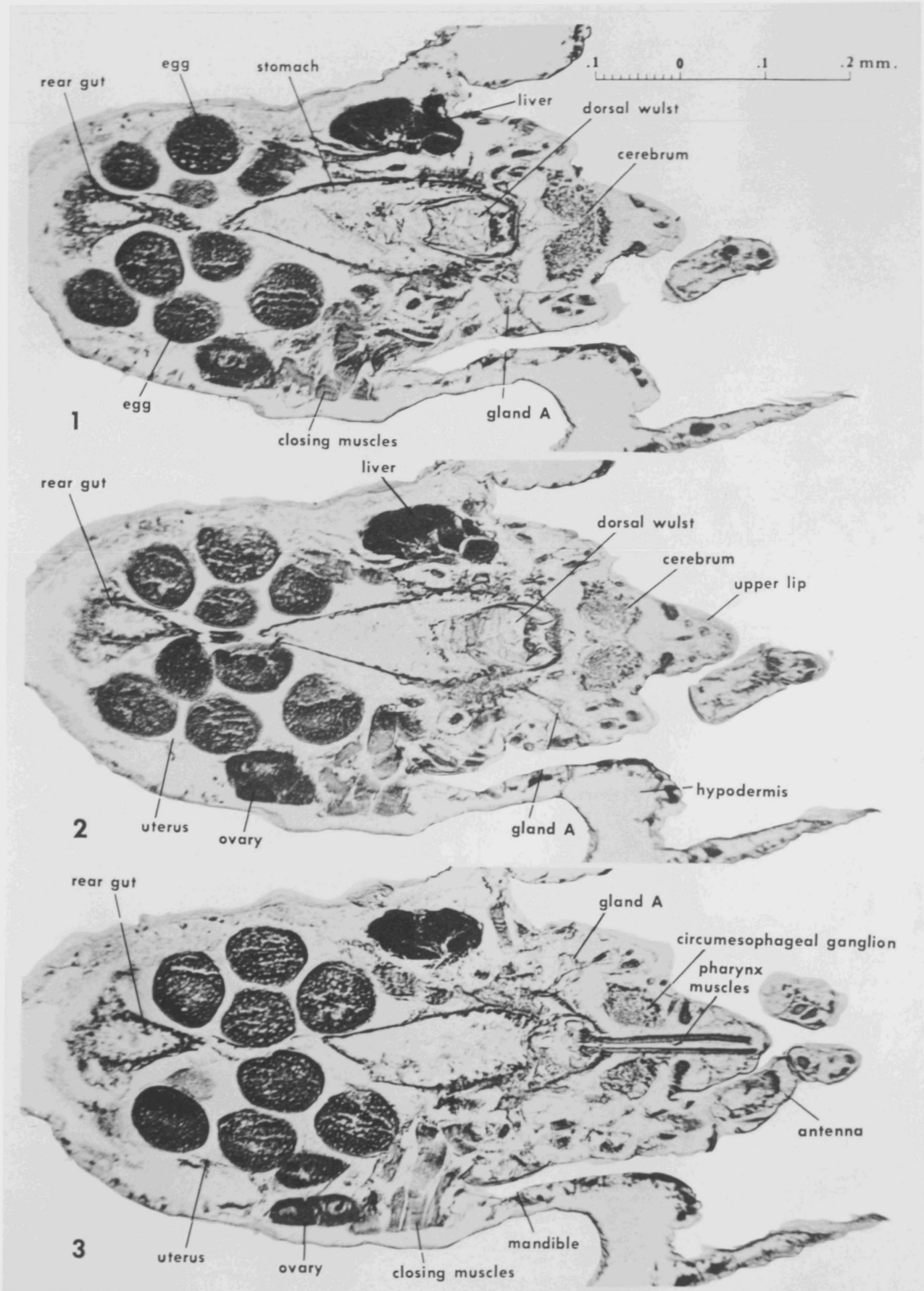

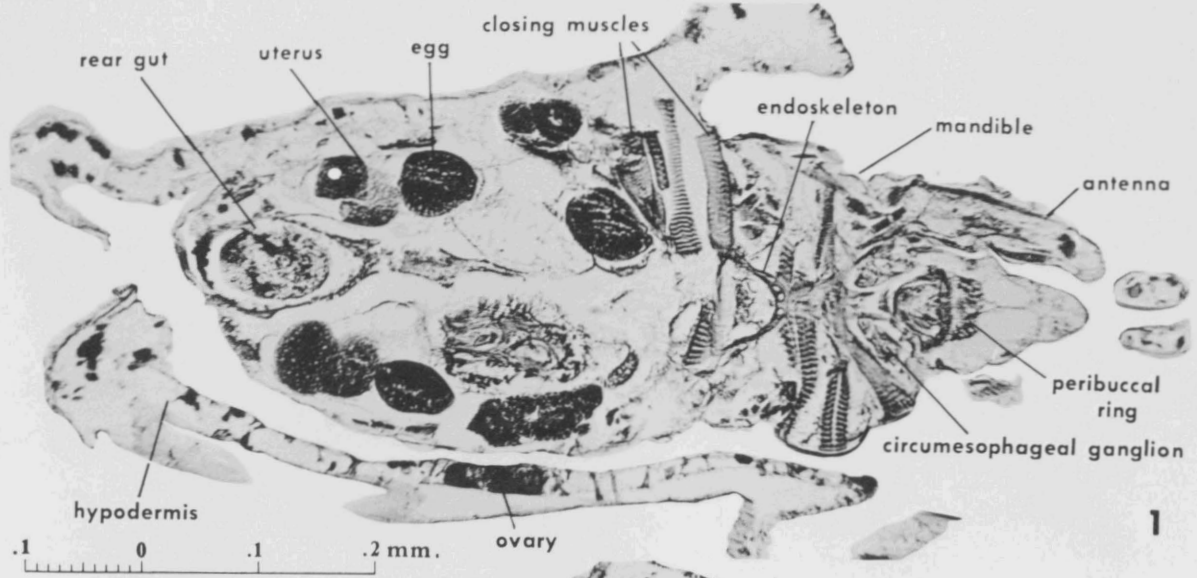

1

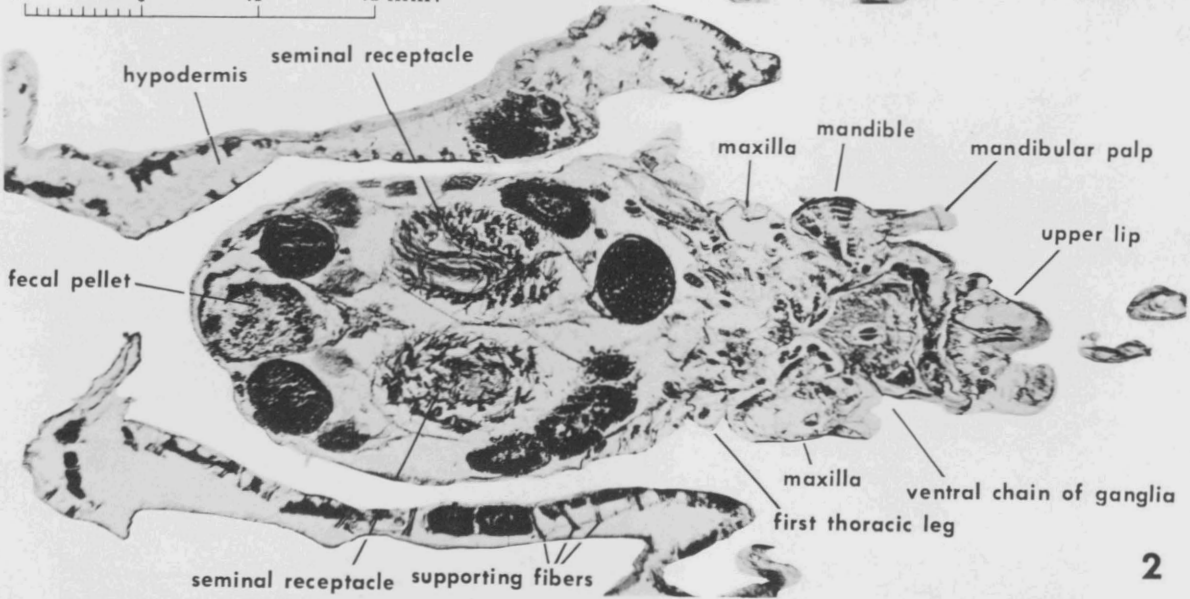

2

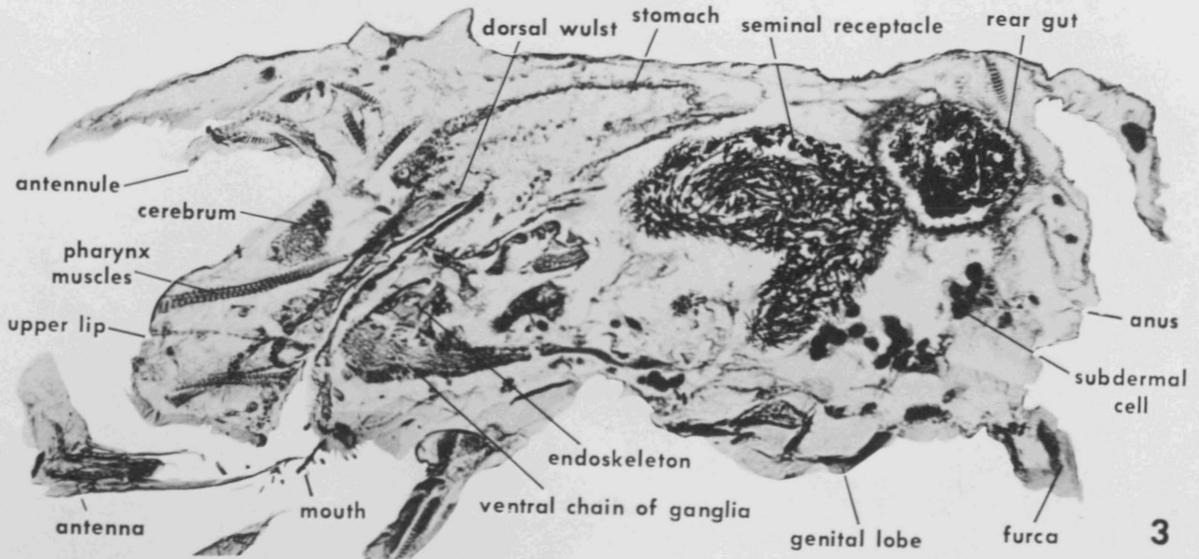

3

EXPLANATION OF PLATE IV

(All figures enlarged to scale in figure 1)

All sections illustrated on this plate cut 10 microns thick and stained with Ehrlich's haematoxylin and eosin. Sections in figures 1 and 2 from same animal as those in plate III, and are cut frontal. Section in figure 3 from another female, and is cut parasagittal. Right side of figures 1 and 2 is anterior; left side of figure 3 is anterior.

FIG. 1. Section below that shown in plate III, figure 3, but not adjacent to it. Section cut through lower part of upper lip, endoskeleton, and lower part of rear gut, showing rear fork of endoskeleton, juncture of left prong of this fork with closing muscles, and muscles connecting endoskeleton with mandibles and antennae.

FIG. 2. Section below that shown in figure 1, but not adjacent to it, cut through mouth and seminal receptacles. The two seminal receptacles contain spermatozoa. Teeth of the two mandibles meet in the mouth between the ventral chain of ganglia and the upper lip. Two elongate objects in center of the ventral chain of ganglia are muscles connecting rake-shaped organs to endoskeleton.

FIG. 3. Section, nearly sagittal, cut through mouth, stomach, rear gut, and anus. Seminal receptacle, filled with spermatozoa, is below stomach and rear gut. Endoskeleton above front part of ventral chain of ganglia. Pharynx muscles connect dorsal wulst to upper lip. Several subdermal cells can be seen in posteroventral part of body.

EXPLANATION OF PLATE V

(Figures 1-3 enlarged to scale in figure 3; figures 4-7 enlarged to 2.4 times that scale)

All sections illustrated on this plate cut 10 microns thick and stained with Ehrlich's haematoxylin and eosin. Sections are from one female, the same that yielded the section shown in plate IV, figure 3. They are cut parasagittal; left side of each figure is anterior. Figure 7 enlarged from figure 3.

FIG. 1. Section through antenna, liver, seminal receptacle, and uterus near left side of body. Eggs below front part of seminal receptacle do not have shell completely formed.

FIG. 2. Section to the right of that shown in figure 1, but not adjacent to it, cut through mouth, seminal receptacle, and left uterus. Masses of subdermal cells behind uterus. Seminal receptacle filled with spermatozoa. Teeth of left mandible are in the mouth, between upper lip and hypostome.

FIG. 3. Section to the right of that shown in figure 2, but not adjacent to it, near that shown in plate IV, figure 3. It cuts through stomach, intestine, rear gut, and anus. The dorsal wulst is in front part of the stomach.

FIGS. 4-7. Successive sections through an egg in the front part of the uterus. This egg surrounded by chitin granules, which have not fused to form the shell. Nucleus shown in figure 7.

PLATE 5

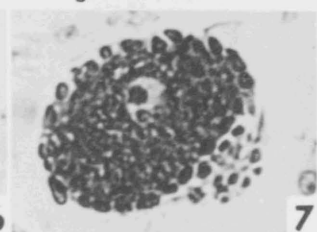
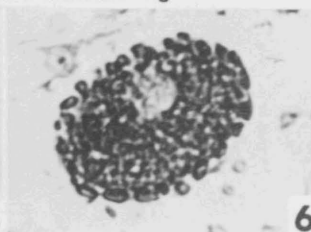
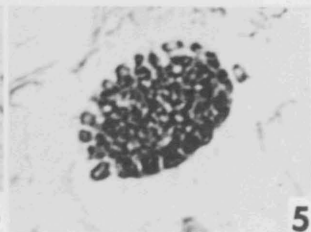
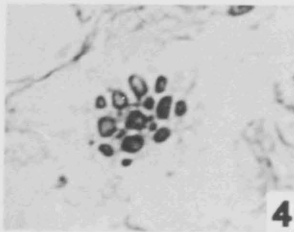
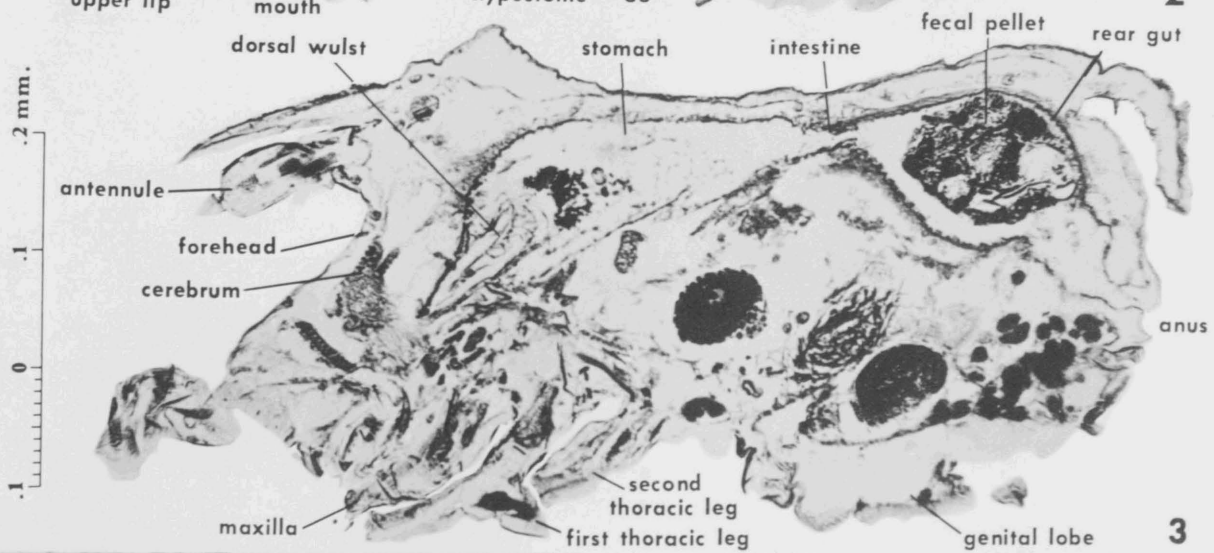
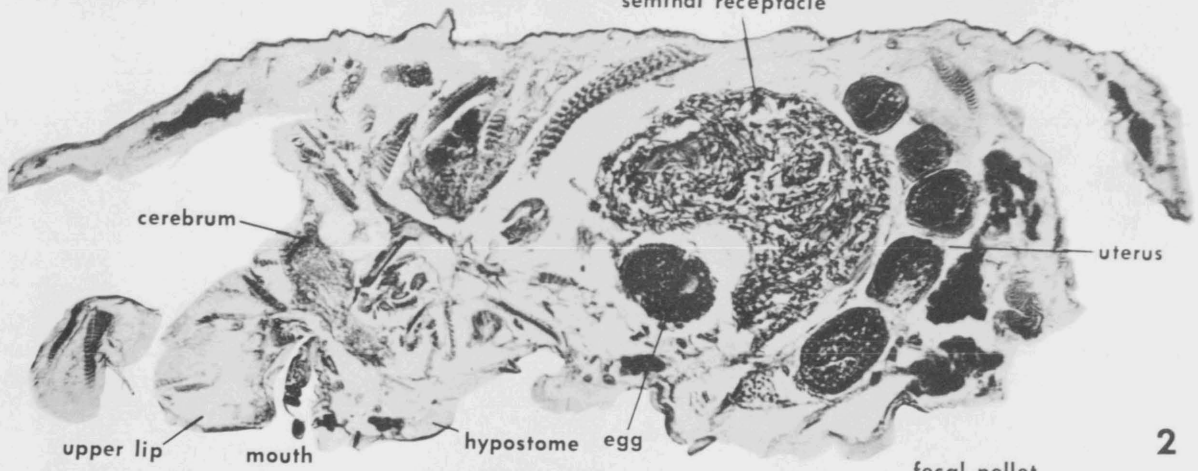
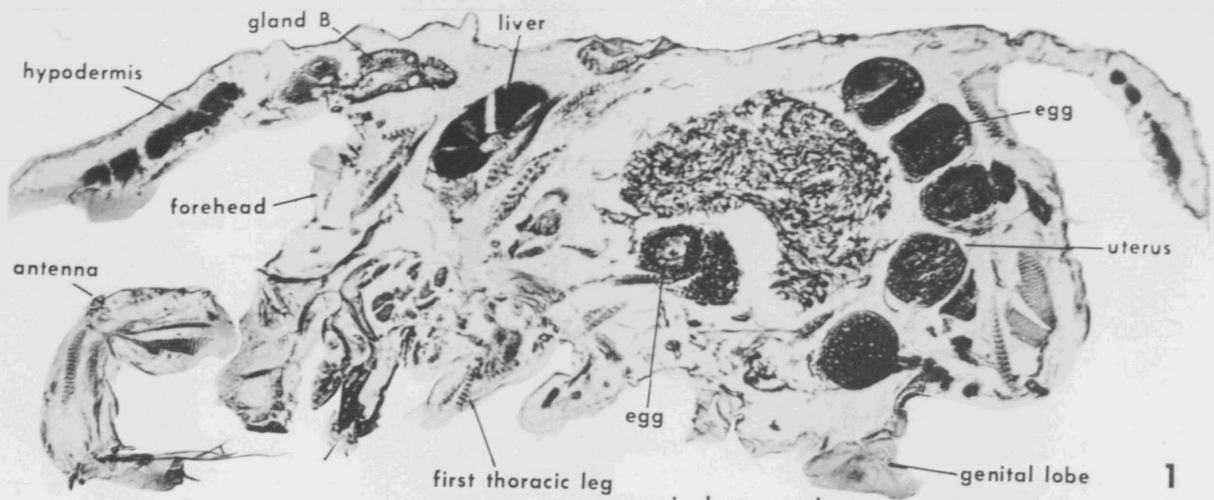
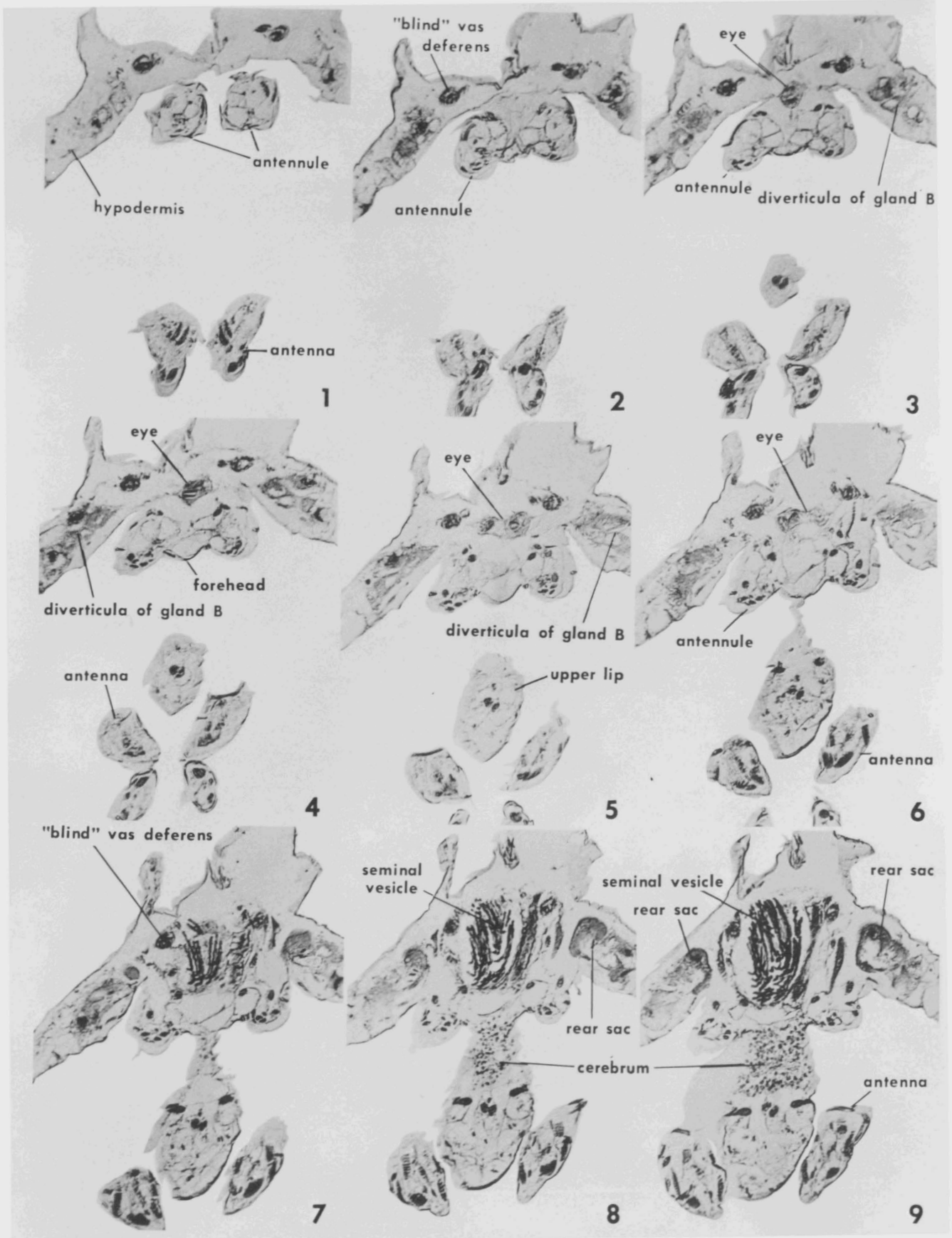

PLATE 6



EXPLANATION OF PLATE VI

(All figures enlarged to scale in plate V, figure 3)

All sections illustrated on this plate cut 10 microns thick and stained with Ehrlich's haematoxylin and eosin. They are successive cross sections through front part of body of a male, in series from front to back. Organs and structures explained by system or group.

Nervous system. The cerebrum (figs. 8-9) contains many nerve cells which appear as dark spots. The eye (figs. 3-6) is above the bases of the antennules and consists of a frontal lens (figs. 3-4) and lateral lenses (figs. 5-6).

Glandular system. Excretory gland B's shown in all figures, as diverticula (figs. 1-7) and rear sacs (figs. 7-9). They extend out into the hypodermis.

Sex system. Seminal vesicle, containing spermatozoa, in the dorsal part of body (figs. 7-9). Sections through proximal parts of the "blind" vasa deferentia in dorsal part of each figure.

Upper lip. The upper lip (figs. 3-9) is below the cerebrum. The two dark objects near its center are cross sections of pharynx muscles.

EXPLANATION OF PLATE VII

(All figures enlarged to scale in plate V, figure 3)

All sections illustrated on this plate cut 10 microns thick and stained with Ehrlich's haematoxylin and eosin. They are successive cross sections of one male, and follow those shown in plate VI, in series from anterior to posterior.

Digestive system. Pharynx muscles are in all figures, lying below the cerebrum (figs. 1-2) and between the two branches of the circumesophageal ganglion (figs. 3-9). Circular and longitudinal muscles in front part of the esophagus (fig. 9).

Nervous system. Cerebrum (figs. 1-3), circumesophageal ganglion (figs. 4-9), and peribuccal ring (figs. 4-7).

Glandular system. Excretory gland B's shown as diverticula (figs. 1-6), rear sacs (figs. 1-4), and end sacs (figs. 4-7). Excretory gland A's above and distal to the circumesophageal ganglion (figs. 8-9).

Sex system. Seminal vesicles, filled with spermatozoa, in all figures. Sections of vasa deferentia above seminal vesicles.

PLATE 7

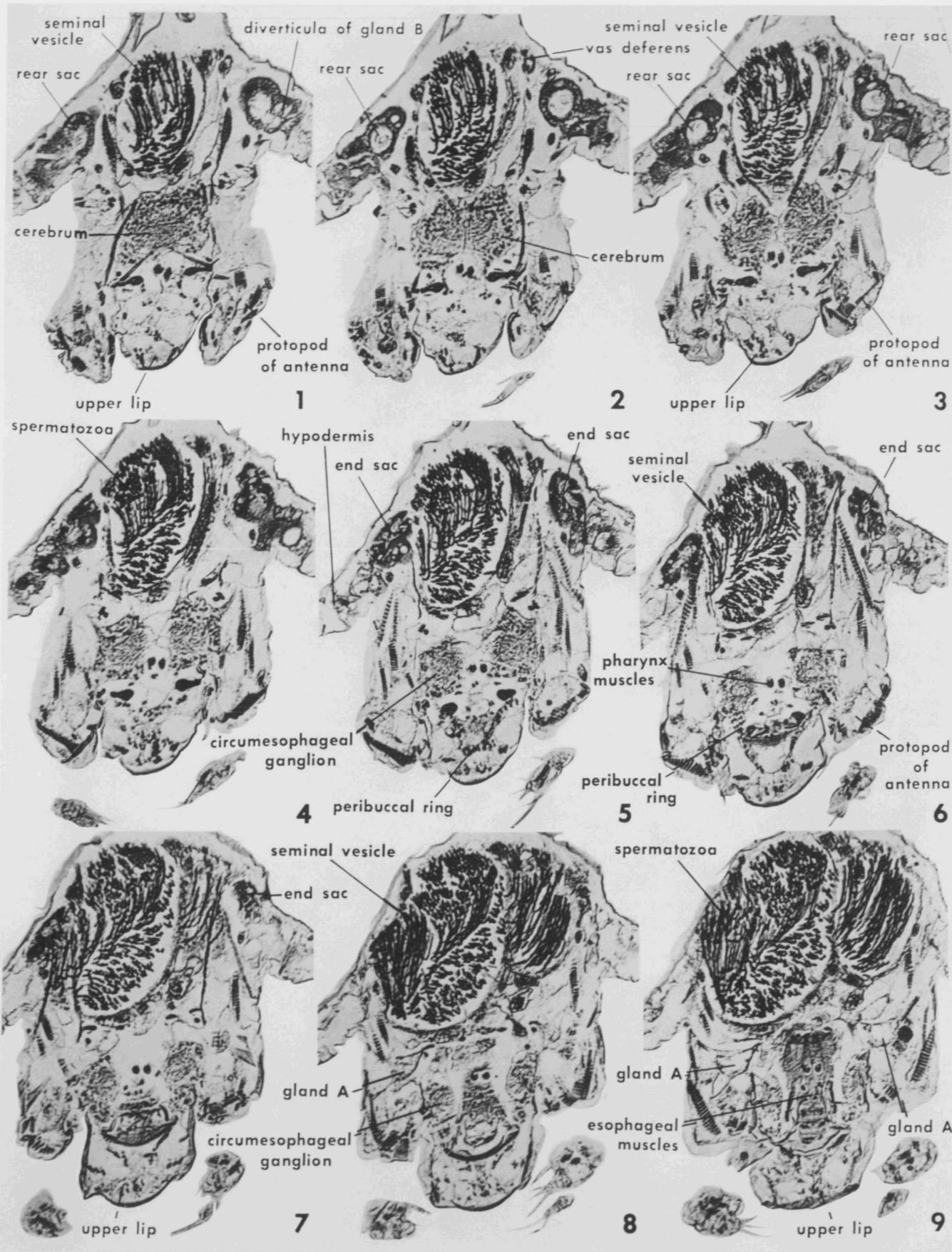

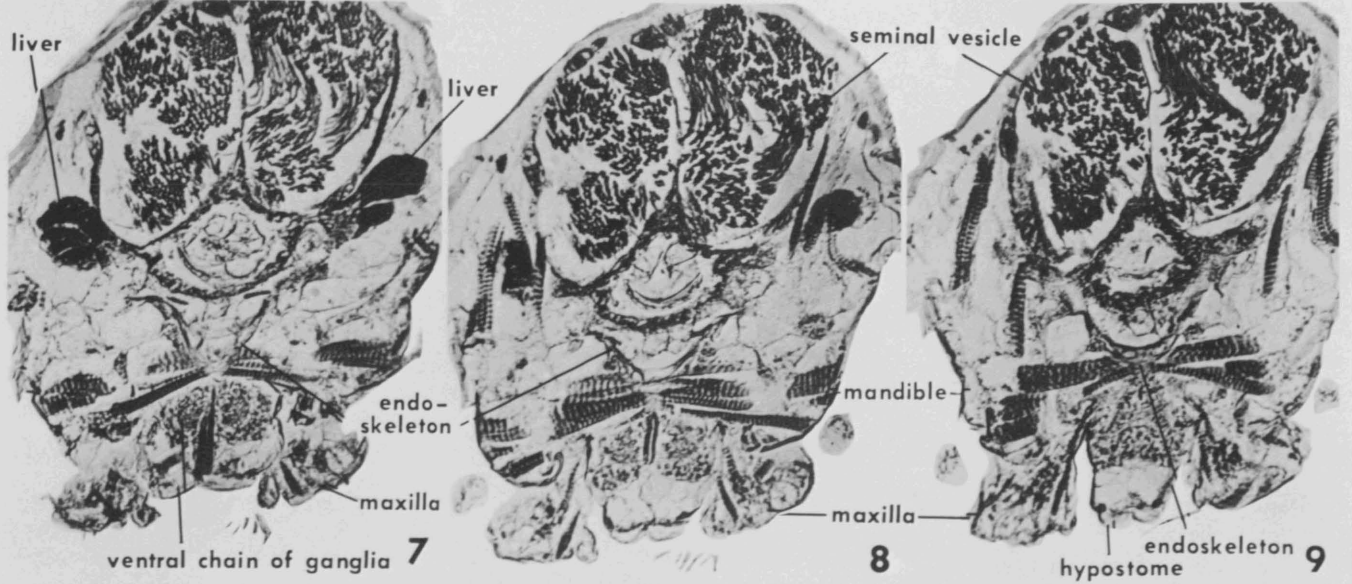
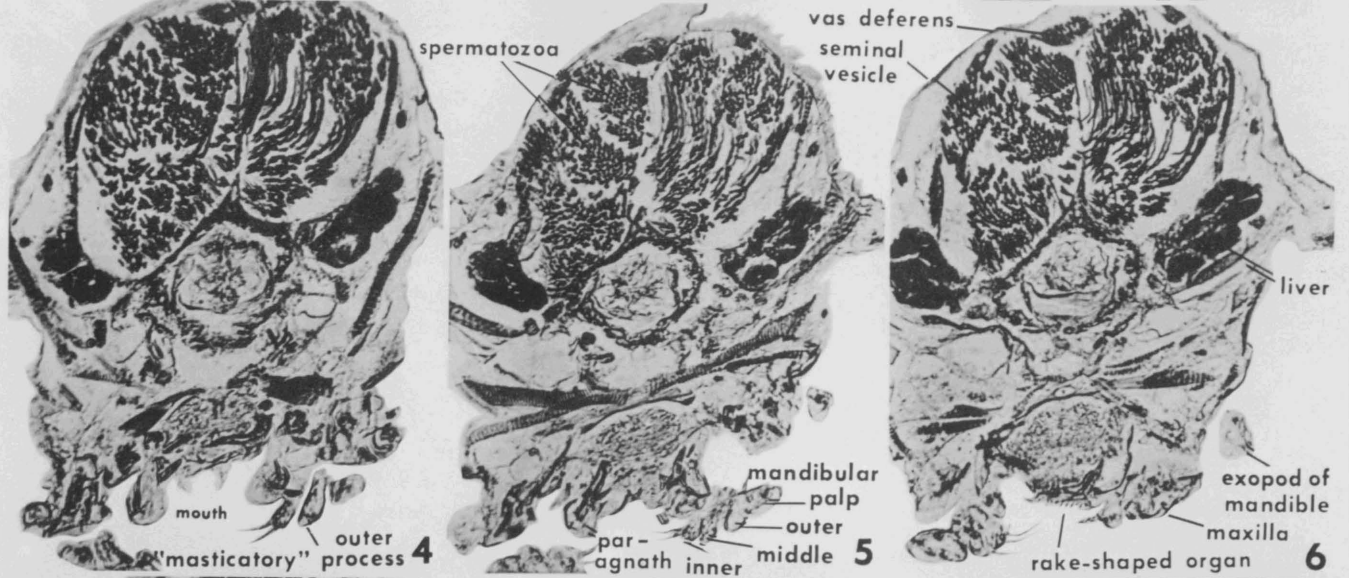
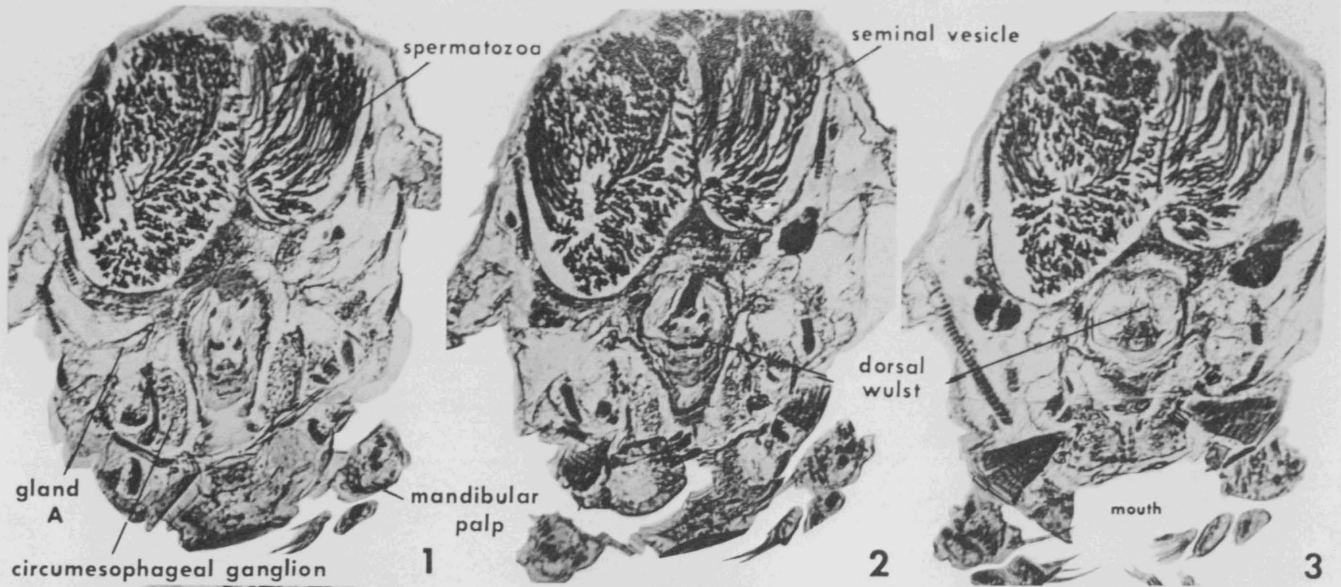

EXPLANATION OF PLATE VIII

(All figures enlarged to scale in plate V, figure 3)

All sections illustrated on this plate cut 10 microns thick and stained with Ehrlich's haematoxylin and eosin. They are successive cross sections of one male, and follow those shown in plate VII, in series from anterior to posterior.

Digestive system. Rear part of the esophagus (fig. 1) extends into front part of stomach (figs. 2-9). Dorsal wulst, or pharynx (figs. 2-9), nearly fills the front part of the stomach. The two livers (figs. 2-8) lie at the sides of the stomach, into which they empty (fig. 7).

Nervous system. The two branches of circumesophageal ganglion (figs. 1-3) unite at their junction with ventral chain of ganglia (figs. 4-9).

Glandular system. Excretory gland A's above and distal to the circumesophageal ganglion (fig. 1).

Sex system. Seminal vesicles, filled with spermatozoa, in all sections. Vasa deferentia above seminal vesicles.

Endoskeleton. This central chitin structure (figs. 5-9) has processes extending forward along outer sides of the circumesophageal ganglion (figs. 1-3), to mandibles (figs. 4-9), and dorsally around lower part of stomach (figs. 7-9). From endoskeleton, a pair of small muscles passes through the ventral chain of ganglia to the rake-shaped organs (figs. 7-8).

Mouth. In this space (figs. 2-4), teeth of mandibles meet (fig. 2). Mouth bounded at front by the upper lip (fig. 1) and at back by the hypostome (fig. 5). Front of hypostome has lateral lobes called paragnaths (figs. 4-5) and central chitin structures called rake-shaped organs (fig. 6). Palp and "masticatory" processes of maxillae (figs. 1-6) extend forward along bottom and side of mouth. Mandibular palps (figs. 1-4) extend forward.

EXPLANATION OF PLATE IX

(All figures enlarged to scale in plate V, figure 3)

All sections illustrated on this plate cut 10 microns thick and stained with Ehrlich's haematoxylin and eosin. They are successive cross sections of one male, and follow those shown in plate VIII, in series from anterior to posterior.

Digestive system. Stomach shown in all figures.

Nervous system. Ventral chain of ganglia (figs. 1-9) in dorsal part of hypostome.

Glandular system. Secreting gland N's (figs. 7-9) lie at sides of the median plane and above the ventral chain of ganglia. They extend into the first thoracic legs (fig. 9). Excretory gland C's (figs. 6-9) distal to secreting gland N's.

Sex system. Seminal vesicles and vasa deferentia in all figures.

Endoskeleton. Dorsal extensions of the central chitin structure (figs. 1-5) connected at their distal tips to a curved chitin rod attached to closing muscles (fig. 5). Muscles extend from the endoskeleton to dorsal part of the carapace (fig. 1) and to maxillae (figs. 1-3).

PLATE 9

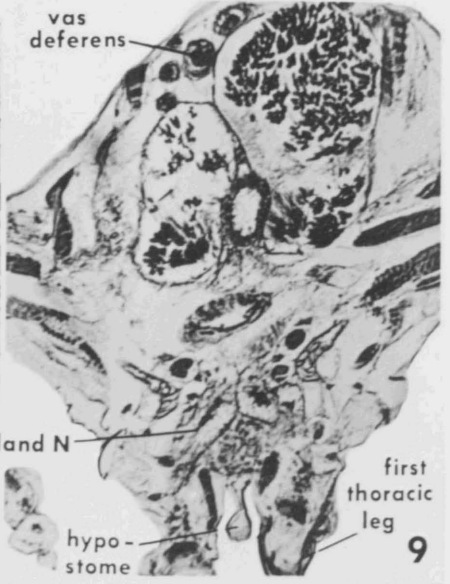
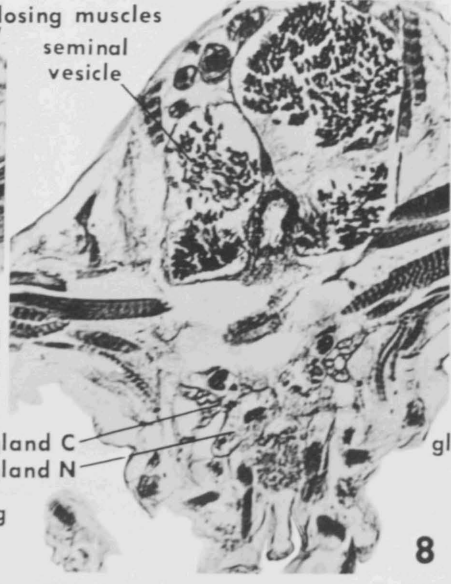
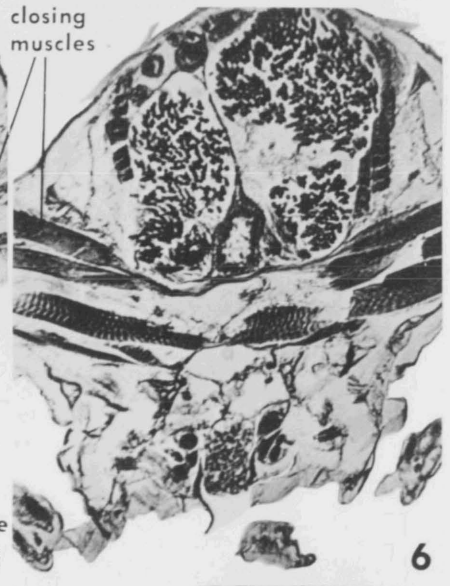
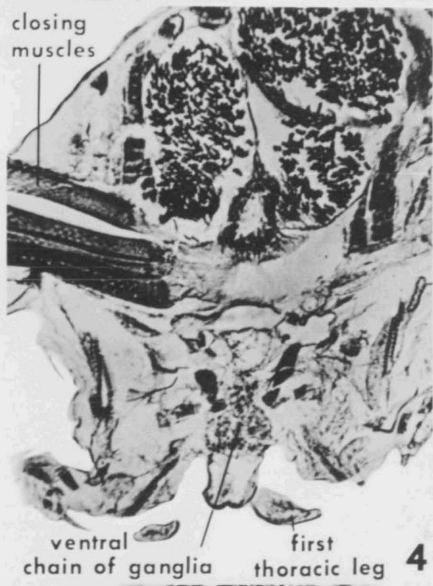
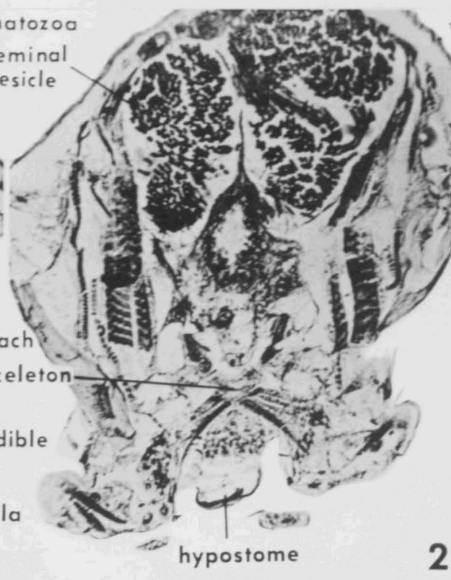
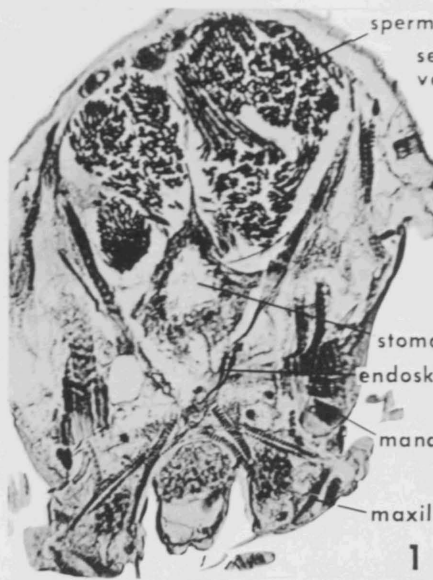

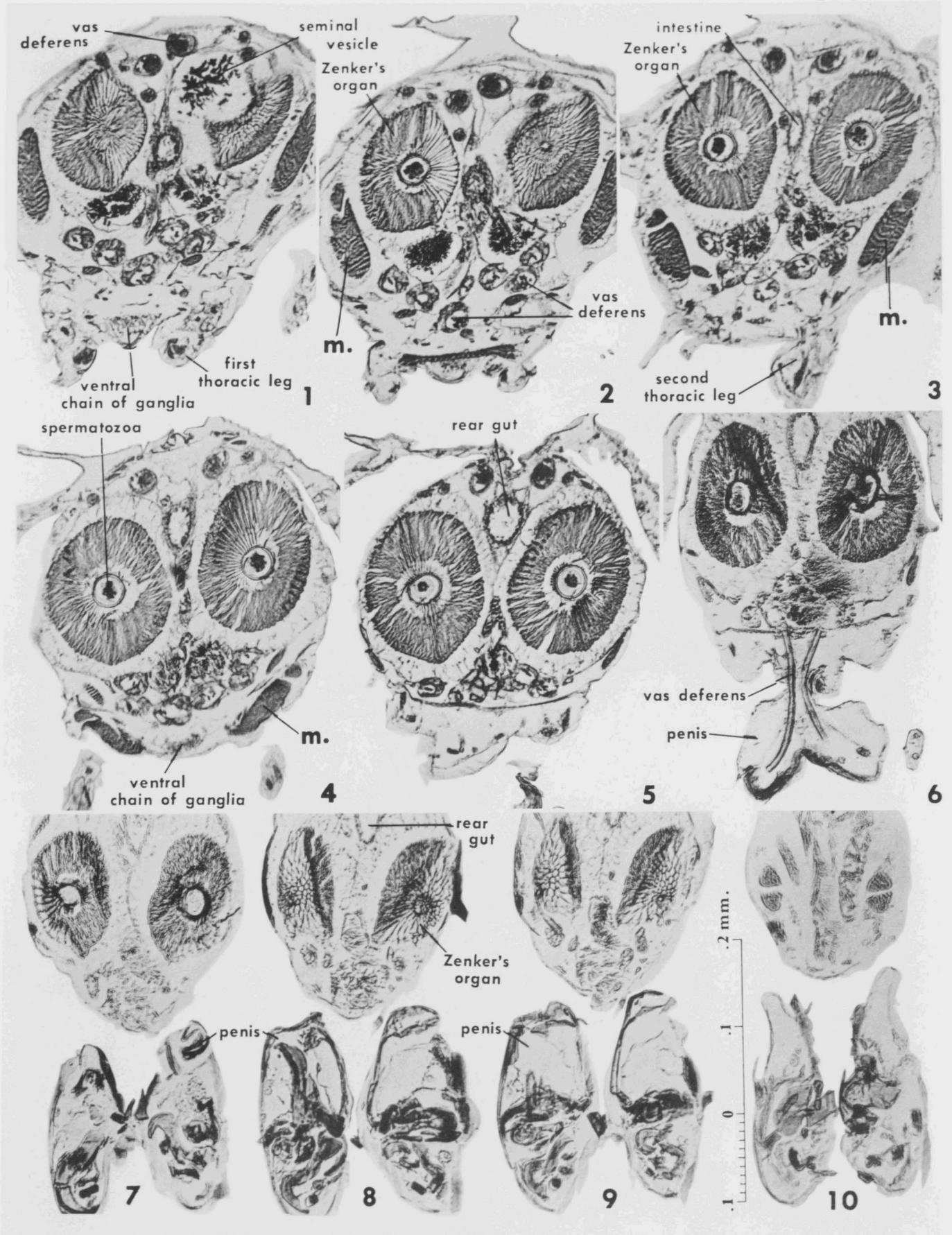

EXPLANATION OF PLATE X

(All figures enlarged to scale between figures 9 and 10)

Sections illustrated in figures 1-5 cut 10 microns thick and stained with Ehrlich's haematoxylin and eosin. They are selected cross sections of the rear part of the body of a male. Sections illustrated in figures 6-10 cut 10 microns thick and stained with polychrome. They are selected cross sections of the rear part of the body of another male.

Digestive system. Intestine (figs. 1-3) extends backward to rear gut (figs. 4-9).

Nervous system. Ventral chain of ganglia (figs. 1-10) becomes smaller toward posterior and bifurcates. The two ends of the ventral chain are the two small objects in the ventral part of the body (fig. 10).

Sex system. Zenker's organs (figs. 1-9) show cross sections of spermatozoa in their central tubes (figs. 3-6). Vasa deferentia (figs. 1-10) appear both below and above the Zenker's organs; those immediately below (figs. 1-4) extend forward to the seminal vesicles. They contain the ends of numerous spermatozoa. Vasa deferentia connect Zenker's organs and penes (fig. 6). Penes connected at their front end (fig. 6) but separated posteriorly (figs. 7-10). Copulation muscles labeled m (figs. 1-4).

EXPLANATION OF PLATE XI

(All figures enlarged to scale in plate X)

Sections illustrated in this plate cut 10 microns thick and stained with polychrome. They are successive cross sections through front part of body of male.

Digestive system. Sections begin just behind esophagus. Paragnaths (fig. 1) and rake-shaped organs (fig. 3) at rear of mouth. Dorsal wulst or pharynx (figs. 1-10) in front part of stomach. Livers (figs. 2-10) empty into front part of stomach from sides (fig. 6).

Nervous system. Ventral chain of ganglia below stomach (figs. 1-10) and in upper part of hypostome (figs. 5-10). It is penetrated (figs. 4-7) by muscles from endoskeleton to rake-shaped organs.

Sex system. Seminal vesicles, filled with spermatozoa, in all figures.

Endoskeleton. Front part (figs. 1-5) is a flat horizontal hub with short spokes extending forward for attachment of muscles to antennules and antennae and laterally for muscles to mandibles. Central part (figs. 6-9) crescent-shaped with vertical struts through middle; from it muscles extend to mandibles (figs. 6-9), maxillae (figs. 8-9), and rake-shaped organs (fig. 7). Rear part (fig. 10) has long dorsal extensions to which muscles are attached leading to dorsal part of carapace.

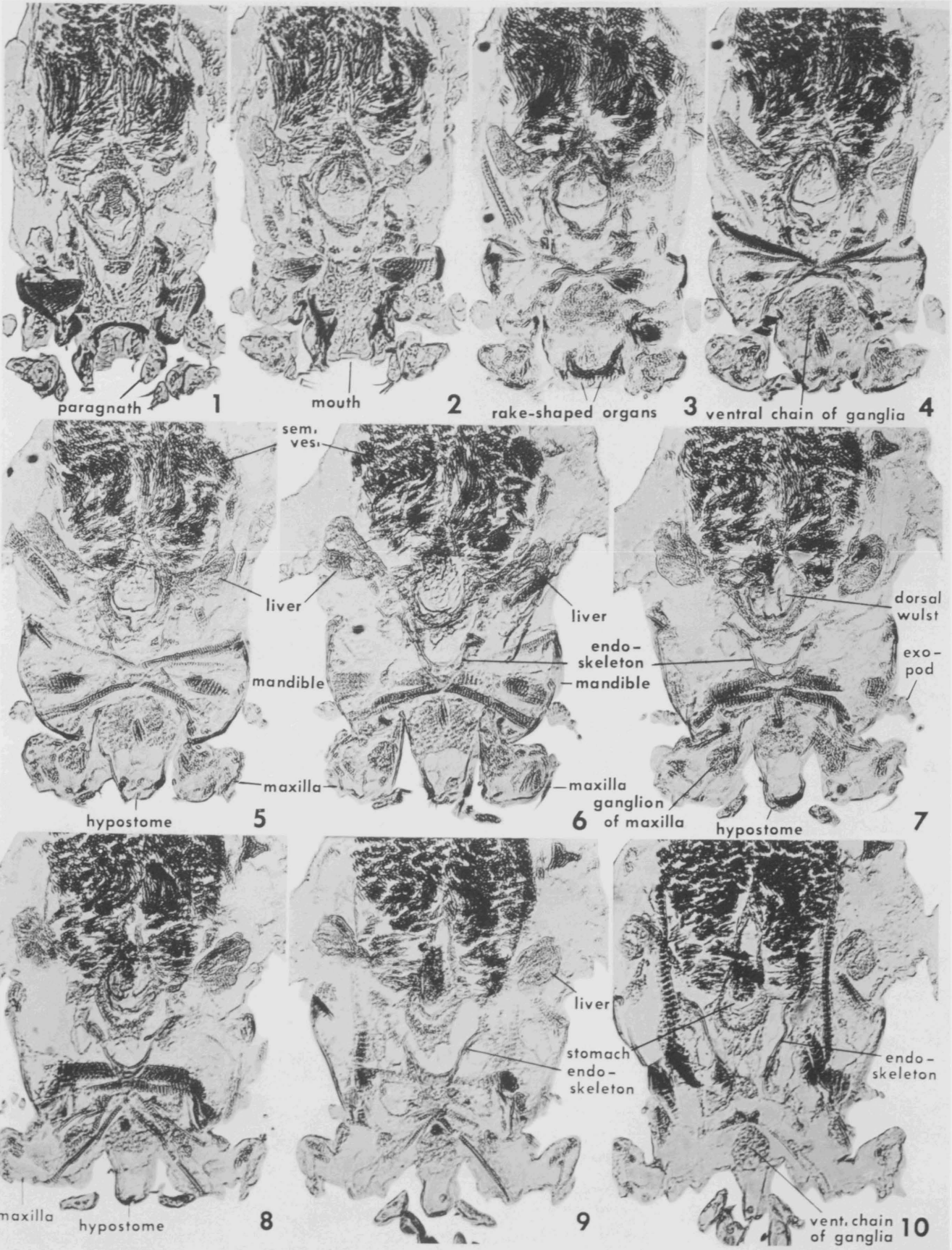

.1 0 .1 .2 .3 .4 .5 mm.

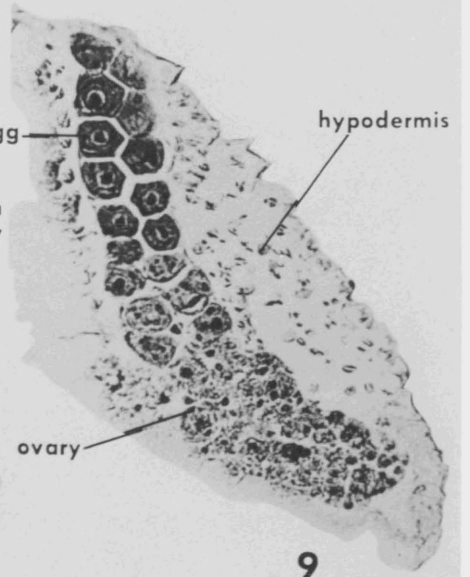
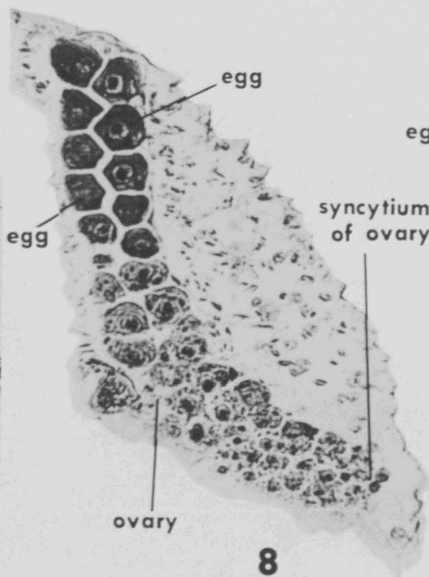
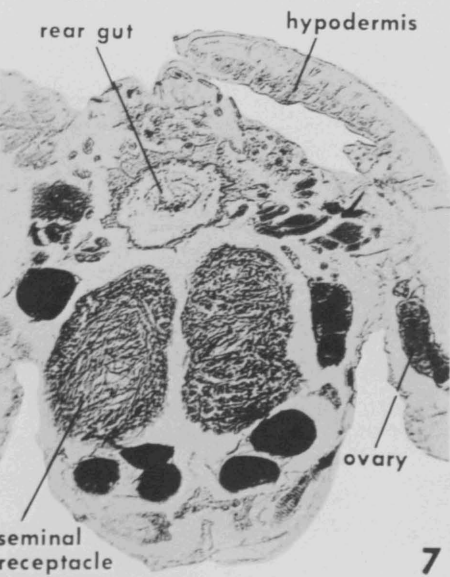
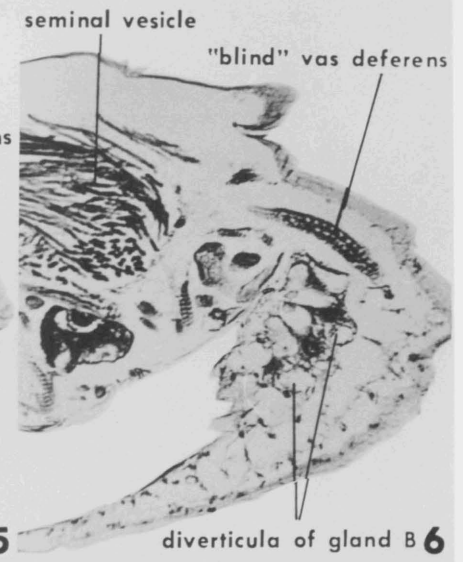
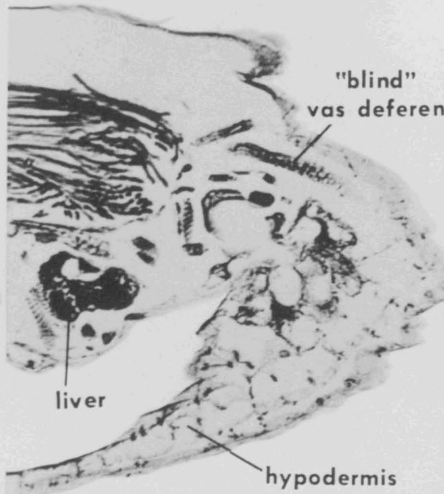
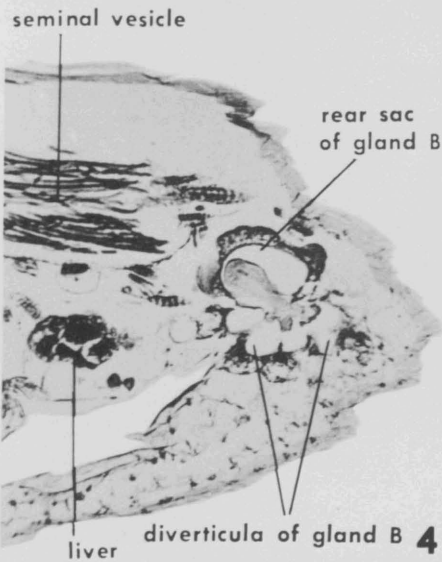
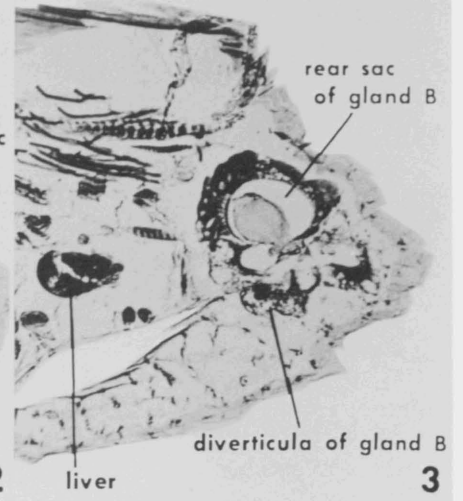
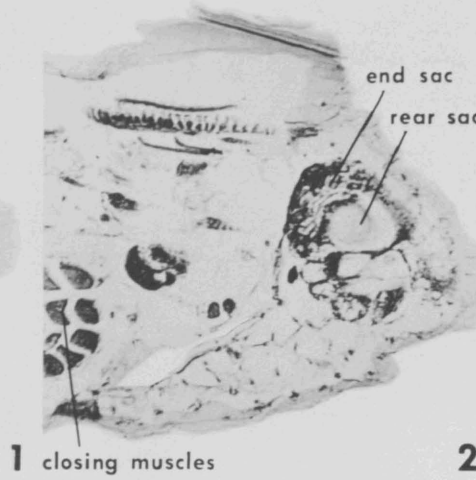
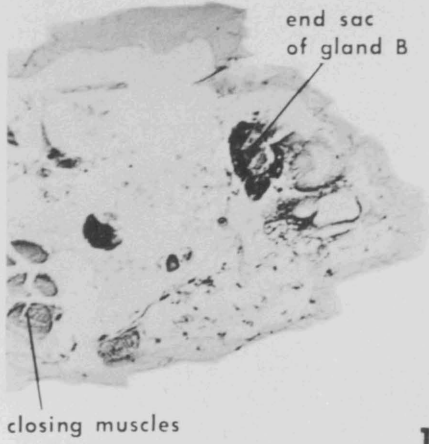

EXPLANATION OF PLATE XII

(All figures enlarged to scale in upper left corner)

Sections illustrated in figures 1-6 and 8-9 cut 10 microns thick and stained with Ehrlich's haematoxylin and eosin. Section illustrated in figure 7 cut 10 microns thick and stained with polychrome.

FIGS. 1-6. Successive parasagittal sections through excretory gland B of a male. Anterior at right in each figure. Fluid in rear sac (figs. 2-4). Rear sac empties between hypodermis and body (figs. 5-6).

FIG. 7. Cross section through rear part of body of female. Seminal receptacles filled with spermatozoa.

FIGS. 8-9. Successive parasagittal sections through ovary of female. Anterior at left in each figure.

EXPLANATION OF PLATE XIII

- FIGS. 1-2. Successive frontal sections through genital lobes of female. Each section 10 microns thick and stained with Ehrlich's haematoxylin and eosin. An egg lies in each uterus (fig. 1). Right uterine opening clear in fig. 2. Approximately x 164.
- FIG. 3. Frontal section through oral region of male, cut 10 microns thick and stained with polychrome. Teeth of mandible extend into mouth between upper lip and hypostome. Approximately x 360.
- FIG. 4. Parasagittal section through Zenker's organ of male, cut 10 microns thick and stained with Ehrlich's haematoxylin and eosin. Approximately x 770.
- FIG. 5. Cross section through Zenker's organ, 10 microns thick and stained with Ehrlich's haematoxylin and eosin. Dark objects clustered near center of figure are cross sections of spermatozoa within central tube of the organ. Approximately x 770.
- FIG. 6. Live female by transmitted light. Approximately x 80.
- FIG. 7. Live male by inclined light from rear. Dark lines in posterodorsal region are wreaths of chitin spines within Zenker's organs. Approximately x 67.
- FIGS. 8-9. Live female by inclined lights from front and rear. Eggs appear as light spots in centrodorsal area (fig. 8). Eggs and muscle scars are dark spots (fig. 9). Approximately x 80.

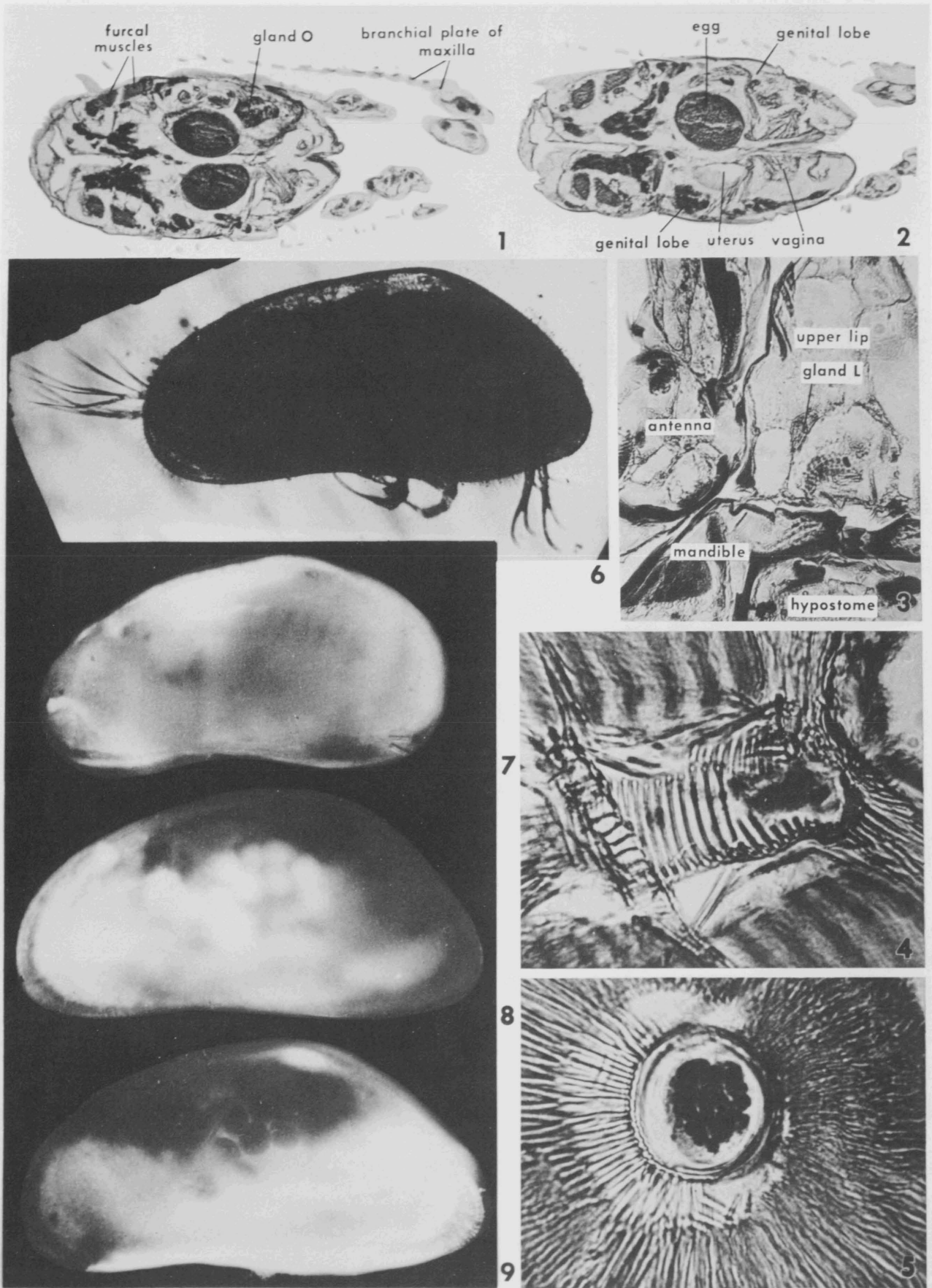

ECOLOGY AND TAXONOMY OF OSTRACODA
IN THE VICINITY OF
SAPELO ISLAND, GEORGIA

DAVID G. DARBY

NATIONAL SCIENCE FOUNDATION PROJECT GB-26

REPORT NO. 2

ACKNOWLEDGMENTS

Thanks are due to the personnel of The Marine Institute, Sapelo Island, Georgia, and its supporters, the University of Georgia and the Sapelo Island Research Foundation. Dr. G. H. Lauff, director during the time of sampling, made available to me vessels, laboratories, offices, vehicles, equipment, etc., without which this work could not have been accomplished. Dr. V. J. Henry, present director of the Marine Institute, subsampled for my use many of the sediment samples he collected during the summer of 1961. He was also generous in supplying the data on grain size from these samples. He and Dr. J. H. Hoyt have given much valuable time and advice to me which contributed much to the worth of the paper. Mr. M. B. Grey collected many of the offshore myodocopid ostracods; he also helped collect other offshore ostracods. During offshore sampling I was also greatly aided by Miss M. A. Horsfall, Miss Masako Satomi, and Mr. J. S. Kier. Mr. James Rouse, Captain of the R. V. KIT JONES, not only took me where I wished to go, but spent many long hours helping with the sampling. Dr. Dirk Frankenberg also took offshore samples for me and generously allowed the use of his dredge and other equipment. Dr. L. R. Pomeroy allowed the use of tidal current data from Doboy Sound. Dr. Hiroyo Kawanabe of the University of Kyoto helped and advised me on certain phases of the sampling. To these people and others of the Marine Institute, who gave so freely of their time and energies without compensation, I extend my great appreciation and thanks.

Mr. Karoly Kutasi of the Museum of Paleontology of the University of Michigan gave valuable advice which saved much time on certain phases of the photography.

Drs. R. V. Kesling, J. C. Ayers, L. I. Briggs, D. B. Macurda, C. F. Powers, and E. C. Stumm of the University of Michigan critically read and edited the paper.

CONTENTS

	PAGE
Acknowledgments	iii
List of illustrations	vi
Introduction	1
Hydrography	2
Sediments	3
Ostracod population	13
Methods of collection and preservation	15
Dissection techniques	16
Staining and mounting techniques	17
Systematic descriptions	18
<u>Cytheromorpha curta</u> Edwards	18
<u>Cytheromorpha warneri</u> Howe & Spurgeon	19
<u>Leptocythere paracastanea</u> Swain	20
<u>Cyprideis floridana</u> (Howe & Hough)	21
<u>Semicytherura elongata</u> (Edwards)	23
<u>Macrocypris sapeloensis</u> , n. sp.	24
<u>Philomedes lilljeborgi</u> (Sars)	25
<u>Pseudophilomedes ferulana</u> Kornicker	26
<u>Rutiderma dinochelata</u> Kornicker	28
<u>Rutiderma mollita</u> , n. sp.	29
<u>Asteropteron oculitristis</u> , n. sp.	29
<u>Cyclasterope biminiensis</u> (Kornicker)	30
<u>Cyclindroleberis psitticina</u> , n. sp.	31
<u>Sarsiella nodimarginis</u> , n. sp.	33
<u>Sarsiella sculpta</u> Brady	34
<u>Sarsiella pilipollicis</u> , n. sp.	35
<u>Sarsiella radiicosta</u> , n. sp.	35
<u>Sarsiella georgiana</u> , n. sp.	36
<u>Sarsiella rousei</u> , n. sp.	37
<u>Sarsiella angusta</u> , n. sp.	38
<u>Sarsiella greyi</u> , n. sp.	38
<u>Sarsiella tubipora</u> , n. sp.	39
<u>Sarsiella disparalis</u> , n. sp.	40
<u>Euconchoecia chierchiaie</u> Mueller	41
References cited	42

LIST OF ILLUSTRATIONS

TEXT-FIGURE	PAGE
1. Map of Sapelo Island and adjacent part of mainland	4
2. Areas seasonally sampled	6
3. Tidal currents	7
4. Cross-sectional current flow in Doboy Sound	8
5. Percentages of organic material in sediments	9
6. Percentages of calcium carbonate in sediments	10
7. Median phi values of sediments	11
8. Modified Forster-Anchor dredge	12
9. Areas sampled and examined for ostracods in summer, 1961	14
10. Fifth limb of <u>Pseudophilomedes ferulana</u>	27
11. <u>Euconchoecia chierchiaie</u>	41
PLATE	FACING PAGE
1. <u>Cytheromorpha curta</u> Edwards	44
2. <u>Cytheromorpha curta</u> Edwards, <u>C. warneri</u> Howe & Spurgeon	45
3. <u>Leptocythere paracastanea</u> Swain	46
4. <u>Leptocythere paracastanea</u> Swain	47
5. <u>Cyprideis floridana</u> (Howe & Hough)	48
6. <u>Cyprideis floridana</u> (Howe & Hough)	49
7. <u>Semicytherura elongata</u> (Edwards)	50
8. <u>Macrocypris sapeloensis</u> , n. sp.	51
9. <u>Macrocypris sapeloensis</u> , n. sp.	52
10. <u>Philomedes lilljeborgi</u> (Sars)	53
11. <u>Pseudophilomedes ferulana</u> Kornicker	54
12. <u>Pseudophilomedes ferulana</u> Kornicker	55
13. <u>Rutiderma dinochelata</u> Kornicker	56
14. <u>Rutiderma dinochelata</u> Kornicker	57
15. <u>Rutiderma mollita</u> , n. sp., <u>Asteropteron oculitristis</u> , n. sp.	58
16. <u>Asteropteron oculitristis</u> , n. sp.	59
17. <u>Cyclasterope biminiensis</u> (Kornicker)	60
18. <u>Cyclasterope biminiensis</u> (Kornicker)	61
19. <u>Cyclasterope biminiensis</u> (Kornicker), <u>Cylinderoleberis psitticina</u> , n. sp.	62
20. <u>Cylinderoleberis psitticina</u> , n. sp.	63
21. <u>Sarsiella nodimarginis</u> , n. sp.	64
22. <u>Sarsiella nodimarginis</u> , n. sp., <u>S. sculpta</u> Brady	65
23. <u>Sarsiella sculpta</u> Brady, <u>S. pilipollicis</u> , n. sp.	66
24. <u>Sarsiella radiicosta</u> , n. sp.	67
25. <u>Sarsiella radiicosta</u> , n. sp., <u>S. georgiana</u> , n. sp., <u>S. rousei</u> , n. sp.	68
26. <u>Sarsiella rousei</u> , n. sp., <u>S. angusta</u> , n. sp.	69
27. <u>Sarsiella greyi</u> , n. sp.	70
28. <u>Sarsiella greyi</u> , n. sp.	71
29. <u>Sarsiella tubipora</u> , n. sp.	72
30. <u>Sarsiella disparalis</u> , n. sp.	73
31. <u>Sarsiella disparalis</u> , n. sp.	74
32. <u>Euconchoecia chierchiaie</u> Mueller	75
33. <u>Euconchoecia chierchiaie</u> Mueller	76

INTRODUCTION

The following work describes podocopid ostracods inhabiting a complex estuarine-lagoonal environment between the mainland and Sapelo Island, Georgia, and the myodocopid ostracods offshore from the island. Twenty-four species were found, thirteen of which are new.

Sampling was carried out in June through September, 1961; December, 1961; April, 1962; December, 1962; and March through June, 1963.

Most work on Recent Ostracoda was done during the last century and the early part of the present one by Baird, Brady, Mueller, and Sars. With few exceptions, contemporary work has been undertaken by paleontologists who wish to extend information on these stratigraphically useful microfossils which are common in all periods from Ordovician to Recent. Interpretation of fossil occurrences must be firmly based on modern ecology. Much of the ecological data is the product of work by paleontologists. Two factors have contributed to the still separate ostracod classifications used in zoology and paleontology. The first is the inadequate description of carapace morphology, e. g. hinge structure, normal and marginal pore canals, and central muscle scars, by zoologists. The second is the description of only the carapace by paleontologists working on Recent faunas. Both approaches are understandable, but unfortunate. If a more functional classification is to develop, it will probably be based upon a classification of Recent forms utilizing both carapace and internal morphology. The erection of genera, indeed families, upon soft parts only, and the subsequent injection of these taxa into a classification based wholly upon characteristics of the carapace make for some very unusual affinities. Certain features of internal morphology, such as gills or mandibular pinchers apparently have no expression in the carapace of the animal; these occur, however, in Myodocopida only, which are uncommon as fos-

sils. The Podocopida is the group most split by the dual classification.

The present work was undertaken to describe an estuarine fauna. Initially, over 50 species were found as empty carapaces. For most of these species, specimens were never found alive, and carapaces were rare. They were brought into the area by tidal currents and do not make up any significant portion of the death assemblage. Time did not allow a detailed analysis of these forms. The death assemblage is complicated in this area by submarine erosion of deposits as old as Miocene and the distribution of this material to Recent sediments (Darby and Hoyt, 1964). The living ostracod fauna in the areas sampled inshore proved to be unusual in that it was composed mainly of one extremely prolific species: *Cytheromorpha curta*. First described from the Miocene by Edwards (1944), this species has rightly been thought to be characteristic of brackish water environments; it has been reported before from the Recent in San Antonio Bay by Swain (1955, p. 567, etc.). Better than any other ostracod of the Sapelo Island area, it is able to withstand turbid waters, large and rapid daily salinity ranges, and large seasonal temperature range. The great amount of organic matter in the water and substrate and the high oxygen content of the water support the large population. Geologic formations containing numerous specimens of only one or two species may have been deposited in such an environment as described herein; at least the possibility should be considered.

It is hoped that the simple techniques described for the dissection and staining of the soft parts will prove useful to others in examination of internal morphology of ostracods.

All specimens described are deposited in the University of Michigan Museum of Paleontology (UMMP).

HYDROGRAPHY

Sapelo Island, a remnant barrier island, lies parallel to the Georgia coast about five miles offshore (text-fig. 1). The island has wide, relatively deep tidal channels at its northern and southern boundaries, separating it from similar islands. An elongate area of salt marsh dissected by open and blind tidal channels lies between the island and the coast, forming an irregular lagoonal estuary. Fresh water from the Darien and Altamaha rivers, to the south of the island, dilutes the saline water in complex patterns. Mixing of fresh and saline waters is relatively rapid and areas other than Doboy Sound are only slightly stratified (table 1). Measured salinities are lowest up the Darien River (less than 1.8 ‰) and highest in Doboy and Sapelo sounds (nearly 30 ‰). The effects of the fresh water from the rivers near Sapelo Island and others along the coast are evident over 60 miles offshore where the salinities may still be less than 35 ‰.

Tides along the Georgia coast are relatively higher than adjacent areas either north or south, averaging about seven feet (U. S. Coast and Geodetic Survey, 1964). The tides in the estuarine-lagoonal area take the form of a standing wave, the currents being lowest at high and low tides.

Tides are essentially concurrent in Doboy and Sapelo sounds. The hydrodynamic pressure from the fresh water entering Doboy Sound from the two rivers to the south causes the tidal flow in back of the island to be directed northward. The confluence of the tidal currents is, therefore, not approximately midway between the two sounds, but near Sapelo Sound; one area is in the vicinity of points 17-21 (text-fig. 2). The opposing currents during the flood cause a velocity decrease in this area and consequent sediment deposition in the channel. This situation results in fresh water being carried northward during the flood, with

a consequent effect on the biota. The tidal current map (text-fig. 3) shows the relative lengths and directions of tidal flow from the northern and southern sounds. Text-figure 4 shows the tidal current pattern through a cross section of Doboy Sound. The greater velocities on the ebb are the result of the additional fresh water emptying from the estuary. The current pattern in this area is typical of estuaries, and current reversal occurs near high and low tides. The current on the southern side of the sound begins the ebb first, due to the pressure from the fresh water reinforced by the effect of Coriolis force which tends to direct the flow to the right in this hemisphere.

Table 1 shows typical salinity measurements up the Darien River, in back of the island, and in Doboy Sound. Sapelo Sound, with no direct influx of fresh water, does not exhibit the stratification found in Doboy Sound. Salinity values there seldom vary more than 1 ‰ between the surface and five meters deep. Water temperatures measured in back of the island varied from about 8°C in January to 31°C in July.

The water is always turbid, and typical Secchi disc readings are approximately 60 cm. The turbidity does not decrease noticeably at the outlets of the estuary due to the high velocities of the tidal currents through the restricted channels (sounds), where a maximum speed of over three miles per hour was measured. As discussed in the section following, this clastic suspended material is introduced principally by the rivers.

The waters are well oxygenated, although reducing conditions exist a few millimeters below the surface of the finer sediments. Typical values near the bottom varied from 3.14 to 4.17 ml/liter of oxygen.

SEDIMENTS

Inshore. - The waters of the estuarine-lagoonal complex contain large amounts of clastic and organic suspended material. Some of the suspended matter is derived from the salt marshes, some from the reworking of the tidal channels themselves, but the greatest portion is directly from the mainland. Both rivers emptying near Sapelo Island are turbid, and the rate of allocthonous sedimentation varies seasonally with their flow. During times of heavy rainfall many small intermittent streams probably contribute a significant amount of clastic material. The clay fraction from the fresh water sediment undoubtedly flocculates upon encountering brackish water. This increases the effective particle size and contributes to the sedimentation of the clays. Experiments have shown that clays in fresh water for 30 months may settle less than the same amount of clay in salt solution (percent not given) in 30 minutes (Grabau, 1913). Without flocculation, much more of the clay fraction would be carried out to sea. The flushing time of this estuary is not known, but the morphological complexity of the area and the high degree of mixing indicate it is not rapid.

The material in suspension contains a large percentage of organic matter. The predominantly clay and silt deposits also contain a relatively large percent of organic matter, mainly in the form of plant detritus derived from the salt marsh. The salt marsh deposits are the result of deposition of fine sediments in areas of low current velocity, their subsequent stabilization by vegetation (chiefly *Spartina alterniflora*), and the further supplementation during flooding at atypically high tides when additional sediment is trapped by the vegetation. The typical salt marsh deposit stands a foot or two above normal high water.

The organic content of some of the sediment was determined by finding the percentage of organic carbon using the chromic acid reduction technique. The percent organic carbon was multiplied by a factor of 1.8, a recommended figure based on an assumed 56 percent organic carbon of the total organic matter (Trask, 1939). The results are shown in text-figure 5. These data are taken from approximately the upper ten centimeters of sediment as brought up in a grab sampler.

Tidal flat sediments have little interstitial migration of water, hence little diffusion of dissolved gases. The salinity of water about one foot away from a recently exposed tidal flat was measured and compared to that of water seeping into a 6 inch hole dug into the sediment (a technique described by Alexander et al., 1932). At sample point 7 (text-fig. 2) interstitial water was 22.05 ‰, that of the adjacent channel water 18.86; at sample point 18 the salinity of the interstitial water was 22.94 ‰, that of the channel 19.22; at sample point 24, interstitial water was 25.23 ‰, that of the channel 22.75. At high tide the salinities over these same areas are higher than those of the interstitial water: 25.53 ‰ at point 7, and 27.18 ‰ at sample point 18.

Teal and Kanwisher (1961) have studied some of the sediments of areas still inundated by normal high tides. Nearly all were oxygen-free within a few millimeters of the surface, and had pH values varying from 6.5 to 7.4. Hydrogen sulfide was present in the more reduced sedi-

ments of lower pH. Water samples taken over similar areas just before exposure at lower tide levels at stations 4, 11, and 25 (text-fig. 2) in 1963 showed dissolved oxygen contents of from 3.14 to 4.17 ml/liter (standard Winkler method).

Carbonate content of some samples was measured. Large pieces of mollusc shell were removed, but shell fragments comparable to the sediment size were included. In effect, the results are a measure of the carbonate content of the clastic sediment in equilibrium with the environment. The results are shown in text-figure 6.

Grain size was determined for sediments at the stations shown in text-figure 7. These were done by the standard pipette method; results are from as yet unpublished data by V. J. Henry of the University of Georgia. Median phi values are high in tidal flat areas, indicating slower current action and consequent deposition of fine sediments. They are generally lower in the sounds and open channels where tidal currents keep the clay-silt fraction in suspension. The series of values along the Darien River indicates an increasing grain size upstream, with the last three stations over 95 percent sand. The series along the tidal channel along the western border of Sapelo Island shows a large variation in grain size, owing, no doubt, to the supply of sand from the island. Sediments sampled from area A (text-fig. 7) across the channel had median phi values varying from 9.73 on the side away from the island (73.73 % clay) to 2.16 on the side nearest the island (88.66 % sand). These conditions are capable of rapid change. At areas B and C samples were taken one week apart. The median phi value at B changed from 7.45 to 9.08, and that at C 2.74 to 7.25! Dr. Henry (personal communication) has pointed out that the resampling was not done in the precise spot and debris from oyster reefs could be responsible for the change rather than currents. This does, however, indicate the extreme complexity and variability of the sediment patterns.

When lithified these sediments would probably result in dark grey to black shale with varying amounts of carbonate and arenaceous material. Due to the very high organic content, the area is a likely source of future petroleum.

Offshore. - The benthonic podocopid ostracods living offshore are not included in this work. The offshore mydocopids are primarily nektonic, swimming close to the sediment-water interface. I do not believe there is a close relationship between the substrate and the nektonic ostracods. With the exception of one planktonic species, the mydocopids are not prolific and if there is a preference for substrate in any species, it was not evident. For these reasons no detailed analysis of the offshore sediments is included.

In general, the shelf off Sapelo Island is very gently sloping, about 2.2 feet per mile. The continental slope begins approximately 73 miles out from the island. Sediment samples were taken with the modified Forster-Anchor dredge shown in text-figure 8. The data are shown in Table 2. The sediments are nearly all predominantly sand although areas do occur where the sediments are very silty. The turbidity from the river-borne clastic sediments is noticeable ten to fifteen miles offshore.

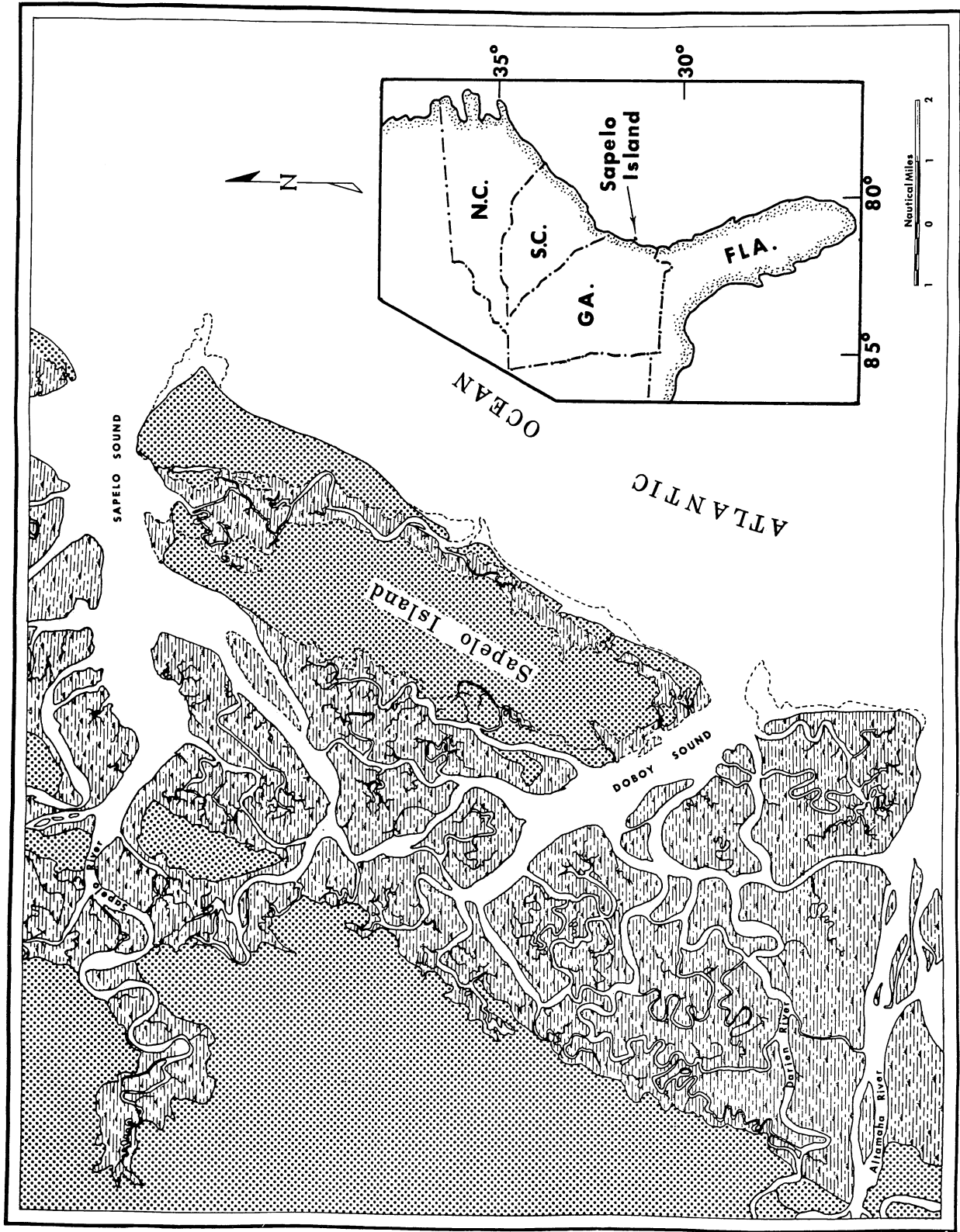

TEXT-FIGURE 1

Map showing location of Sapelo Island and configuration of the salt marsh area between the island and mainland.

	Station	Stage	Depth	Salinity ‰	Temp. °C	Date			
BACK OF ISLAND	7	High	bottom	26.1	12	12/16/61			
			surface	25.9					
	8	"	b	25.5					
			s	25.4					
	9	"	b	26.3					
			s	26.3					
	10	"	b	26.2					
			s	26.8					
	11	"	b	25.7					
			s	25.6					
	DARIEN RIVER	7	Low	b			13.2	21	4/9/63
				s			13.1		
8		"	b	13.2					
			s	13.1					
9		"	b	13.6					
			s	13.4					
10		"	b	13.9					
			s	13.9					
11		"	b	13.9					
			s	13.8					
DOBOY SOUND		1	Mid Flood	b	14.9	16.5	12/19/61		
				s	14.1				
	2	"	b	13.7					
			s	13.7					
	3	"	b	12.5					
			s	12.5					
	4	"	b	4.1					
			s	3.8					
	5	"	b	2.8					
			s	2.7					
	6	"	b	<1.8					
			s	<1.8					
25	Low	s	10.6	8.5	2/7/63				
		5 meters	19.2						
	High	s	25.7	9.5	1/11/63				
		5 meters	28.3						
25	High	10 meters	29.2	9.0					

TABLE 1

Depths, salinities, and temperatures from selected sample points shown in text-fig. 2.

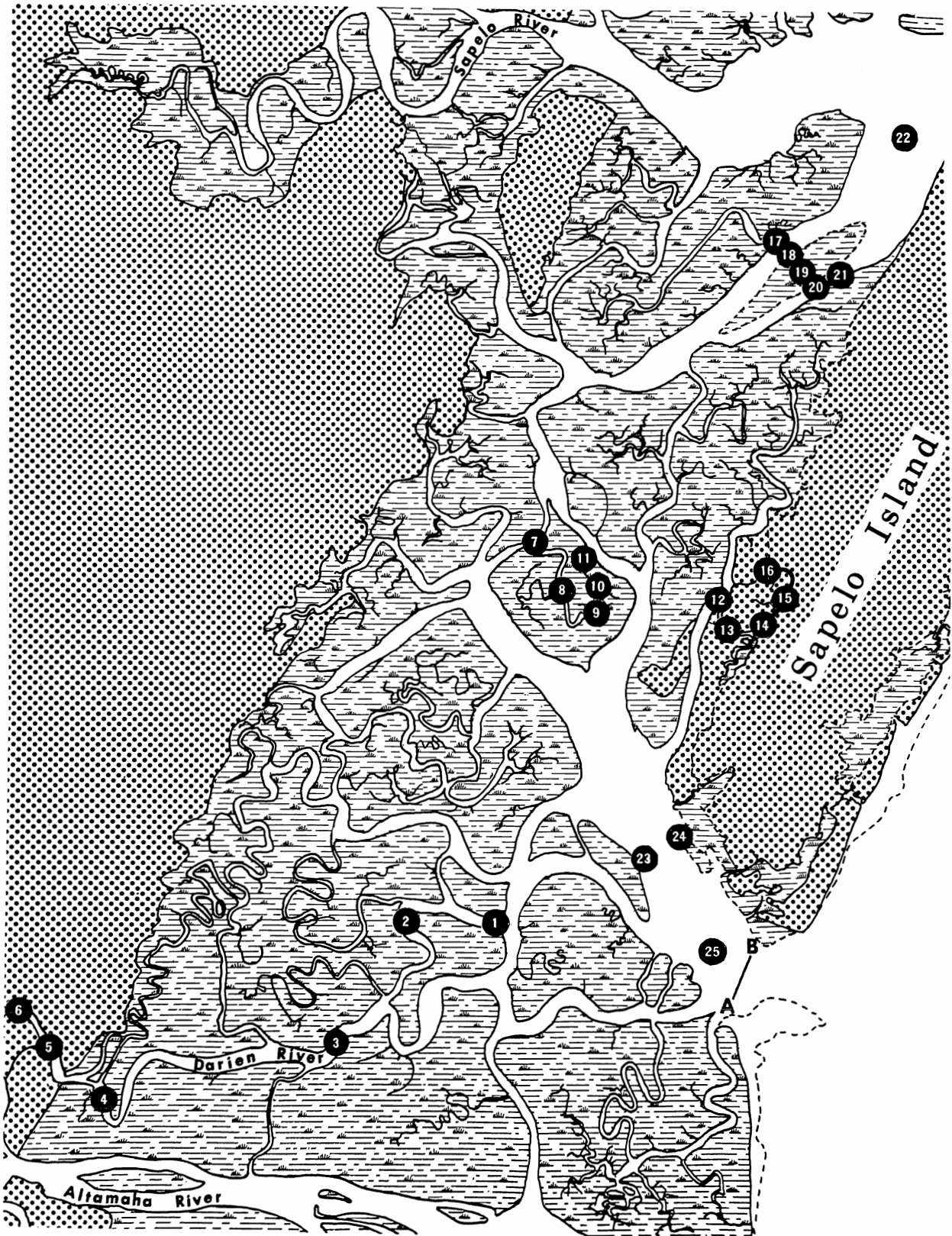

TEXT-FIGURE 2

Map showing areas which were seasonally sampled. Line A-B refers to cross-section shown in text-fig. 4.

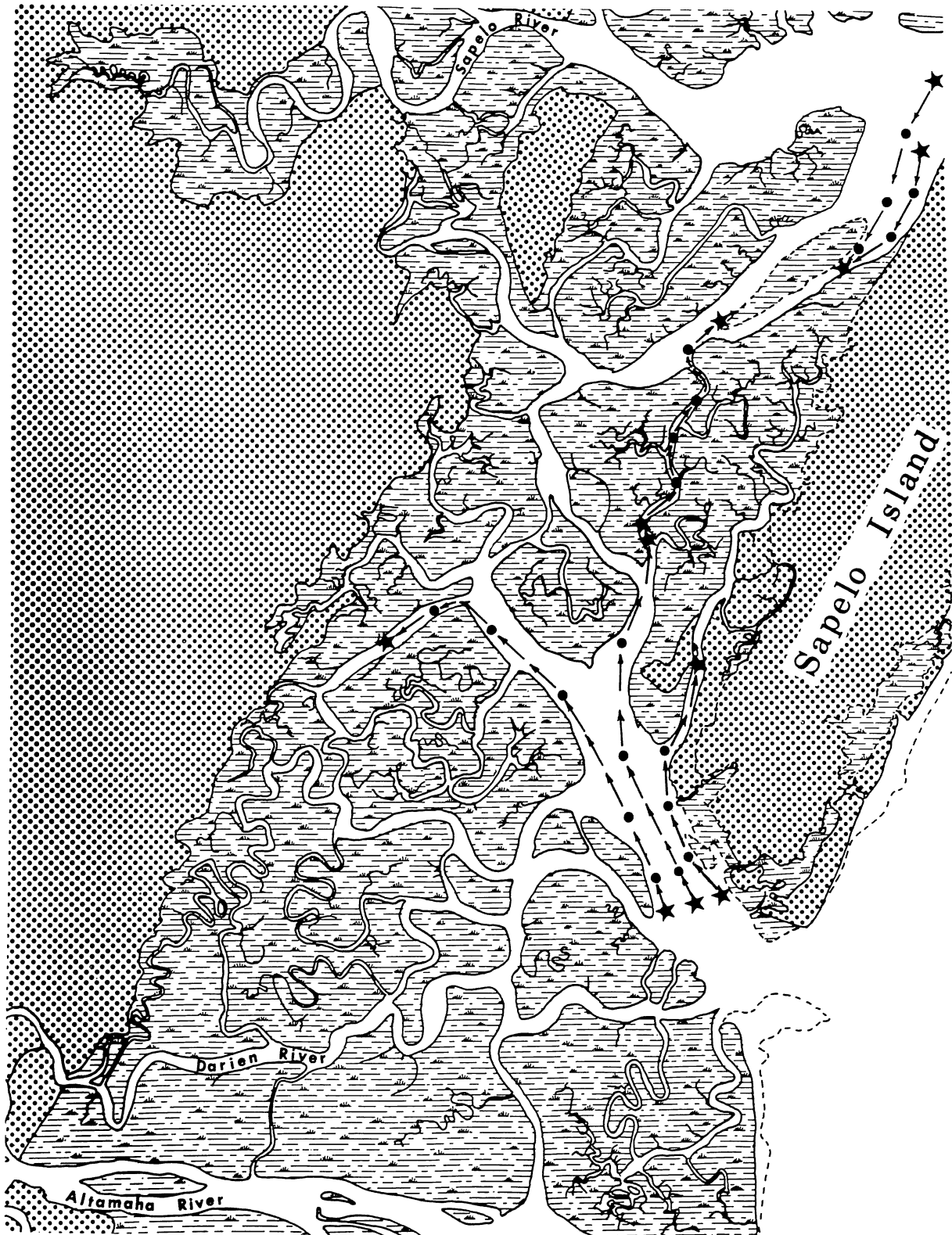

TEXT-FIGURE 3

Map of tidal currents. All data taken with drogues released at low tide. Stars indicate beginning and end of movement during flood, dots indicate approximate hour intervals. Note difference in length of tidal flow between north and south.

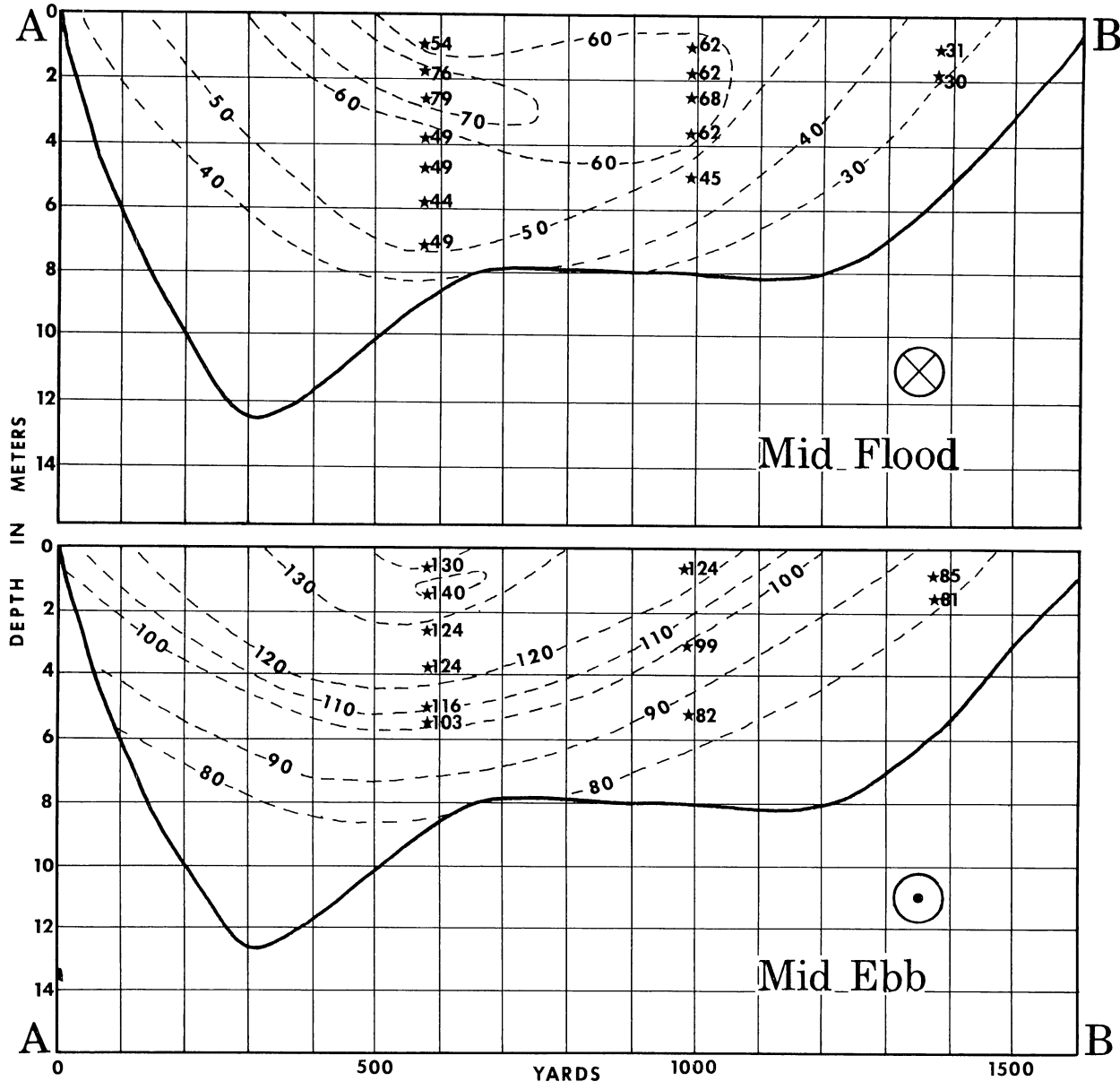

TEXT-FIGURE 4

Diagram of cross-sectional current flow in centimeters per second along line A-B of text-fig. 2 across Dobby Sound. From unpublished data by Dr. L. R. Pomeroy and students, University of Georgia.

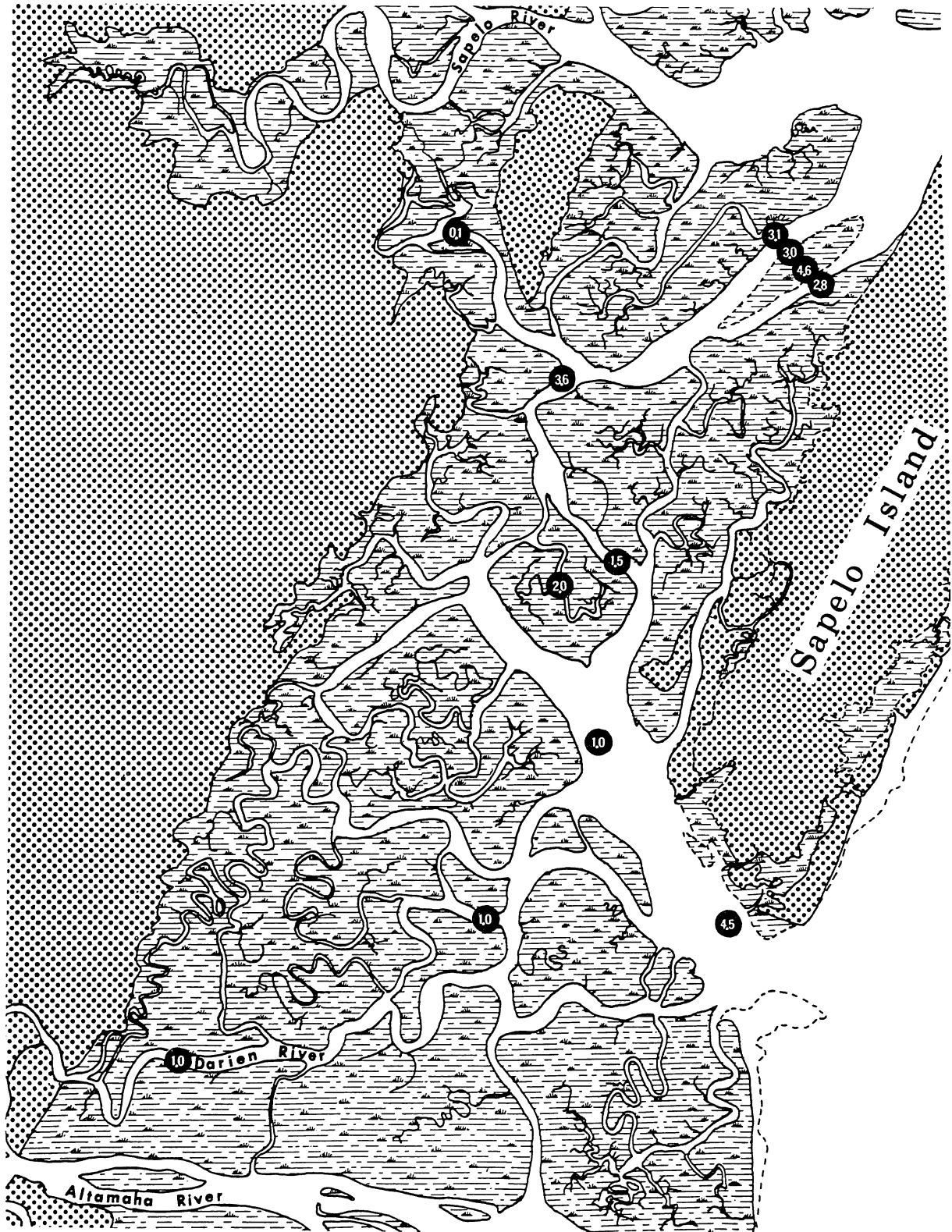

TEXT-FIGURE 5

Map showing approximate percentages of organic material in sediments.

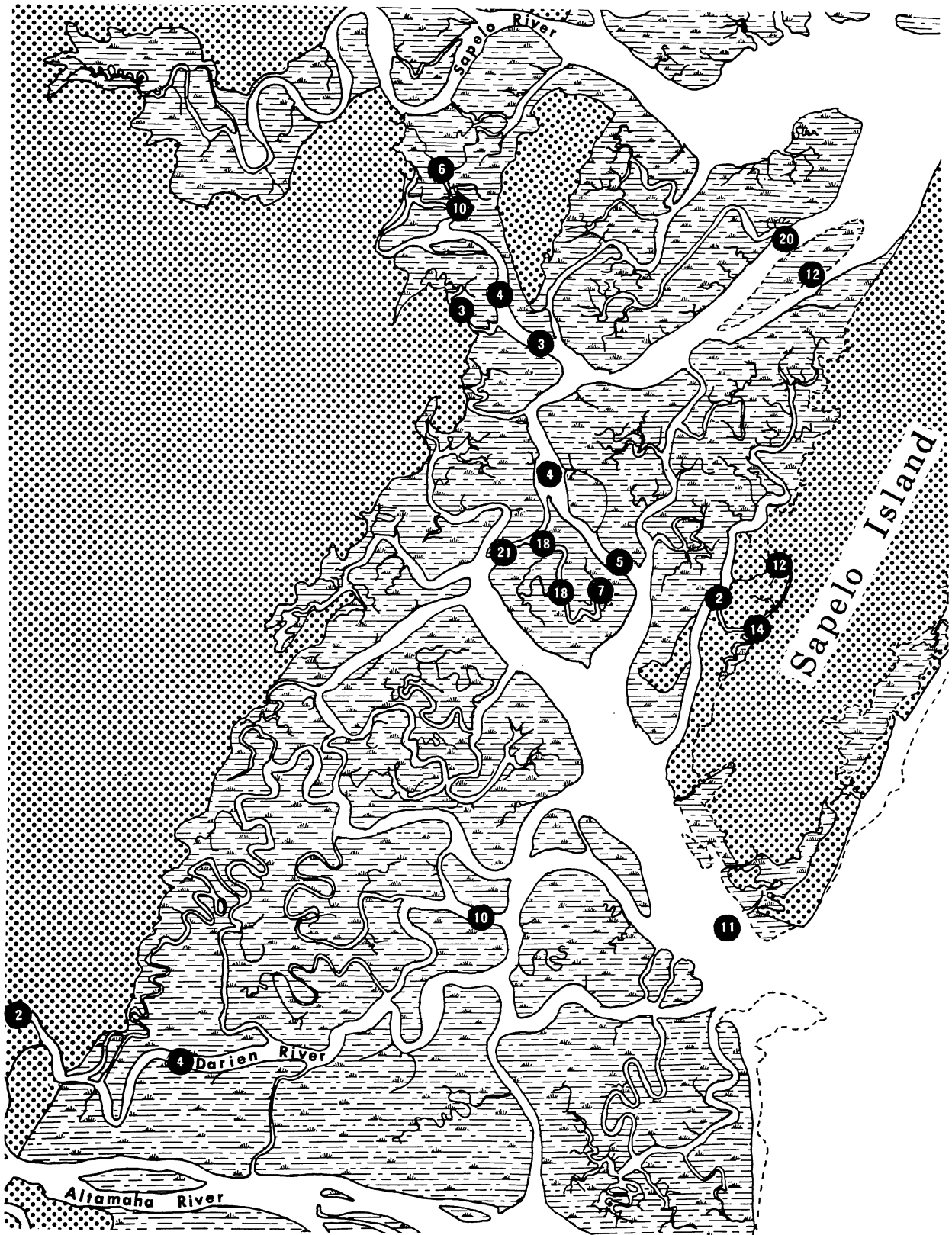

TEXT-FIGURE 6

Map showing approximate percentages of calcium carbonate in sediments.

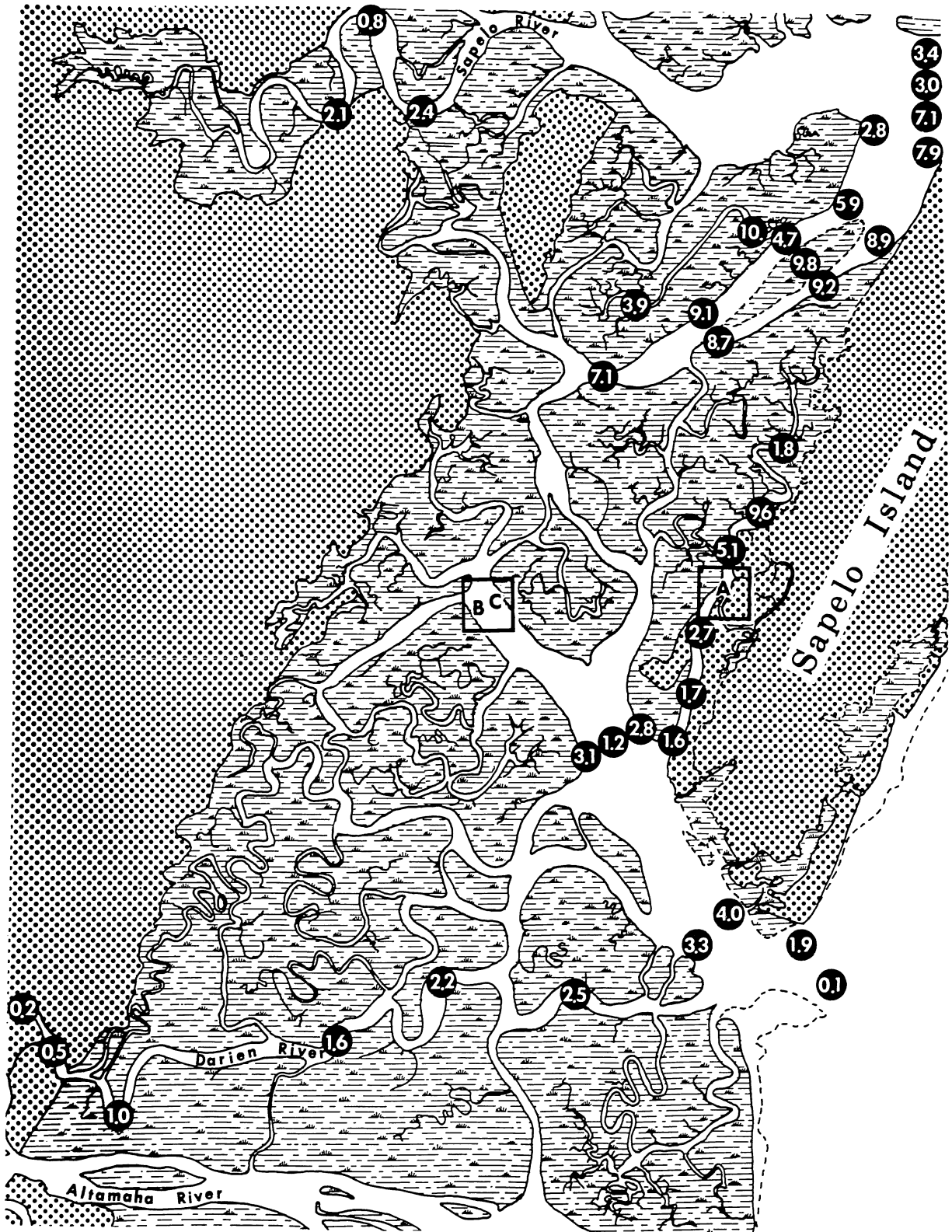

TEXT-FIGURE 7

Map showing median phi values of sediments. Areas A and B-C are referred to in Sediment section of text.

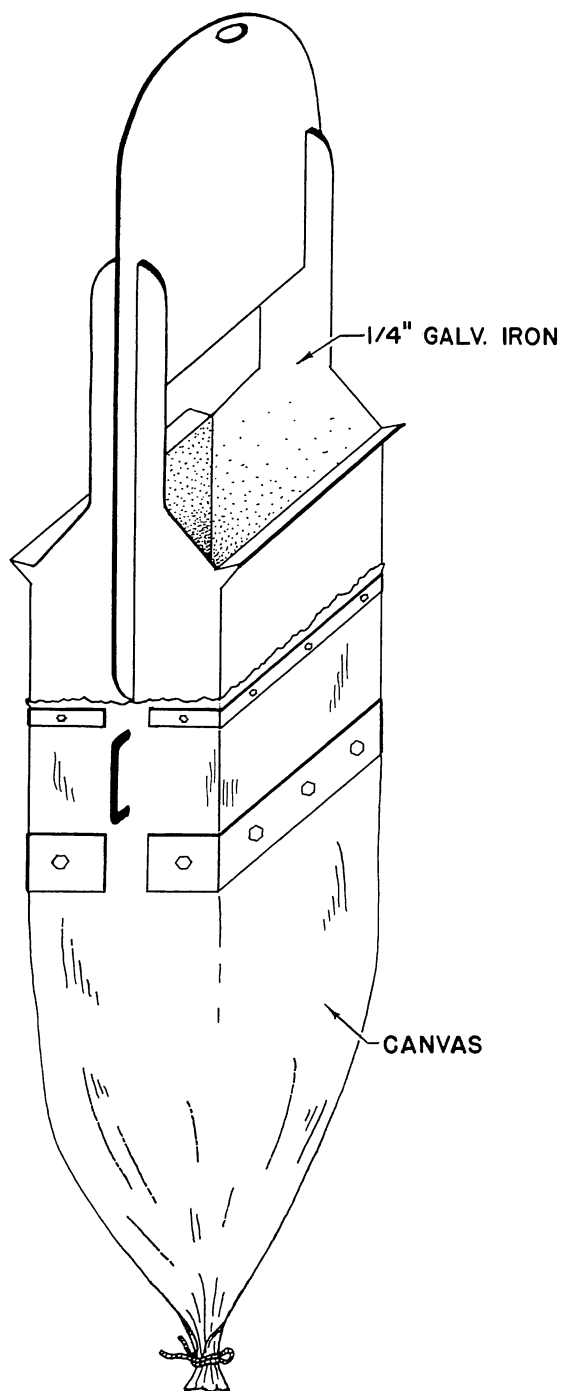

Naut. Mi. From Is.	Depth in ft.	Phi Median	Carbonate Percent
29	81	1.2	5.5
38	85	1.2	6.5
43	96	1.2	7.0
55	115	1.3	7.0
65	142	1.1	9.5
72	161	1.4	27.0
74	381	1.4	36.0
75	625	2.4	59.0

TABLE 2

Data from offshore sample stations, taken May, 1963.

TEXT-FIGURE 8

Sketch of modified Forster-Anchor dredge
used in offshore sampling.

OSTRACOD POPULATION

To my knowledge, no ostracod fauna has been described previously which is so completely dominated by a single species existing in such large numbers. From a total of 209 samples examined from the estuarine-lagoonal facies in back of Sapelo Island (text-fig. 9), 4,550 ostracods were found alive and identified. About 85 percent were of one species, Cytheromorpha curta. Of the remaining 15 percent, ten percent were obtained from one sample area, stations 17-21 (text-fig. 2), where the less euryhaline species seem to be concentrated.

For the ostracod fauna, the limiting factor in this environment is salinity. The currents generated by semi-diurnal tides attain such velocities in the sounds and channels that the ostracod population is in nearly constant flux, moving to and fro with each tidal cycle. Reducing conditions which exist a few millimeters beneath the sediment-water interface prevent the ostracods from burrowing deeply enough to escape the current. The fresh water from the rivers entering south of the island mixes with the marine water and a daily salinity range of over 15 ‰ is common in many areas. C. curta was found alive and active in salinities varying from less than 2 to over 30 ‰.

An extremely dense summer population is supported by the relatively high organic content of the water and substrate, principally in the form of plant detritus, and the large oxygen content of the well-mixed water. As many as 277 specimens of C. curta were found in 5 cc of sediment.

The population boundary between the extremely euryhaline Cytheromorpha curta and the other inshore podocopids lies in the zone of tidal confluence along the southern boundaries of Sapelo Sound. One such zone is in the vicinity of sample points 17-21 (text-fig. 2), where opposing current from Sapelo Sound prevents larger amounts of fresh water from being carried northward. Conflicting currents and the consequent reduced velocity in this area cause much of the suspended load to be deposited in the channel near these sample points. The ostracods from Sapelo Sound are also deposited, and may be concentrated in larger numbers here than in the sound. An interesting relationship between Cytheromorpha curta and Cyprideis floridana exists in this region and is described in the discussion of the latter species.

Additional information on the habits and habitats of each species, including the offshore myodocopids, may be found in the discussion sections in the taxonomic descriptions.

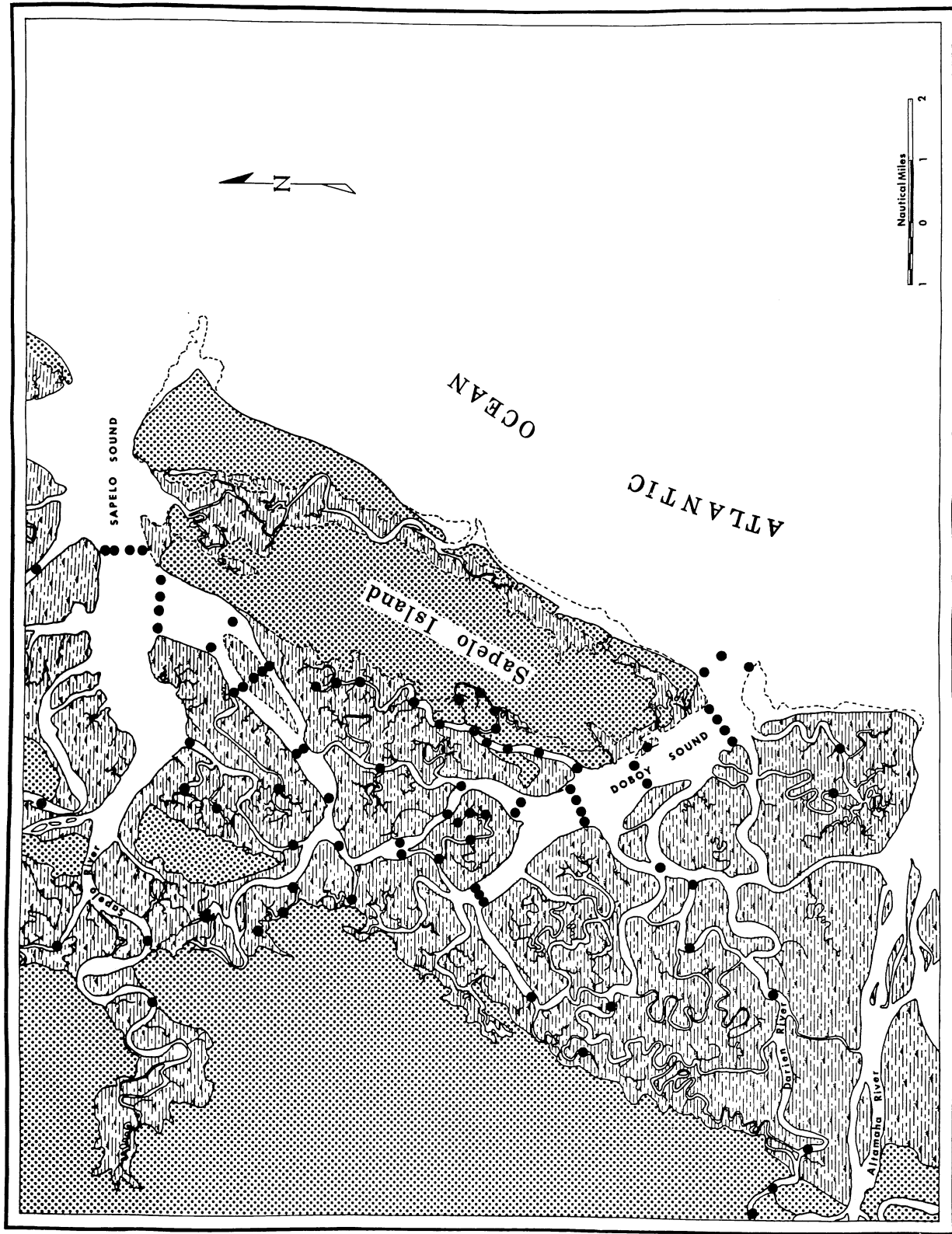

TEXT-FIGURE 9

Map showing areas sampled (some more than once) and examined for ostracods during summer (1961).

METHODS OF COLLECTION AND PRESERVATION

Inshore ostracods. - The ostracods were usually collected from the sample points shown in text-figure 9 by means of a modified Van Veen grab sampler mounted on a small inboard or outboard motorboat. An "A" frame was fitted to the thwarts of the boat and the grab lowered and raised with a winch. The Van Veen sampler has a useful feature for sampling animals living at the sediment-water interface: a small door in the flattened top of the grab enables the investigator to subsample the full grab without dumping out its contents. This preserves, to an extent dependent upon bottom conditions, the stratification between the substrate and the overlying water. Subsamples were taken by reaching with a small jar into the top of the grab as it rested, filled but unopened, on a thwart. If sediments are free from large shells, sponges, etc., a quantitative subsample could be taken through the door by means of a small plastic tube fitted with a piston and operating like a typical piston corer; in this turbid environment, however, this proved impractical, because of the small cross sectional area measured no consistent count of living ostracods could be obtained. For example, in five samples taken within a few minutes over a square meter of bottom, the count of *C. curta* varied by over 200 percent.

The jars, each containing about 25 cc of sediment, were filled with seawater, capped and taken back to the laboratory. The greater part of a day could be spent sampling, and the ostracods collected in the morning were still alive and active in the evening. The filled jars were kept out of direct sunlight.

In the laboratory a 5 cc subsample was taken from a jar and placed on a large sieve of about 200-micron mesh size. If the ostracod population was low, the entire contents of the jar were used. The sample was then gently washed with a small hose. Sea water or fresh water can be used without ill effects on an estuarine population. When the sediment was broken up and the fine fraction washed away, the remainder was transferred, with the aid of a wash bottle, to a counting tray. The ostracods were then removed, alive, by means of a small brush. A certain amount of practice is needed to become proficient at picking out ostracods, since the sediments usually also contain a large quota of decapods, worms, etc., all moving vigorously. The movement of most ostracods is quite characteristic, even when burrowing beneath the saturated sediment; that of other arthropods of similar size tends to be much more jerky. When teased with a needle, the ostracod withdraws within its shell, whereupon the surrounding sediment can be pushed aside and the animal removed with a brush. It is then placed in a depression square filled with distilled water. Although estuarine ostracods will eventually die in a relaxed position in distilled water, this takes a very long time due to their salinity tolerance. A quicker method is to kill them by means of the addition of a crystal or two of chloral hydrate or menthol; this leaves them with the shell agape and the appendages relaxed, making dissection and slide mounting easier. The animals can then be transferred to a preserving medium or immediately dissected.

If necessary the samples can be preserved prior to examination; a small amount of alcohol is added to the jar,

which should contain only a small amount of water in addition to the sediment. As soon as the animals relax more alcohol can be added to bring the solution up to 70 percent concentration. The addition of preservative prior to examination was avoided whenever possible, because dead ostracods were extremely difficult to find and remove from the washed inshore samples which still contained large amounts of organic detritus. Staining with rose bengal, which has proved useful for separating live from dead foraminifers, was tried. This proved completely ineffective due to the high quantity of organic detritus which also took the stain, so that the ostracods were still inconspicuous. Examination of samples while the ostracods are still living is not only far easier, but the living and dead populations can be determined accurately.

Ostracods which could not be dissected immediately were placed, after being killed gently, in 70 percent alcohol in a small vial which was taped around the cap or dipped in paraffin and taped to prevent evaporation. Experimentally, some were placed in neutral formalin of four percent, and a small amount of magnesium carbonate buffer, enough to cover the bottom of the small vial, was added. Both of these methods proved adequate, although both seemed to cause hardening of the appendages after two years. This inhibited the appendage from leveling itself in the slide mounting medium so it could be photographed well. I found it always easier to dissect specimens within a few months.

A suggested, but not personally tried, preservative is a solution of equal amounts of glycerine, water, and alcohol.

Offshore ostracods. - Collection offshore was done in depths up to 625 feet. This requires a well-equipped, fairly large vessel. All collections were made from the 65 foot research vessel KIT JONES. To dredge at these depths required a cable of nearly 1000 feet. The dredge used was a modified Forster-Anchor, as shown in text-figure 8. With a 12 cm bite on either side, it was 40 cm wide and 50 cm long; it was equipped with a canvas bag about 50 cm in length. This particular dredge was constructed for obtaining a representative benthonic fauna including molluscs, etc., which may have burrowed several inches into the substrate. Were a dredge of this type to be designed expressly to collect ostracods, one with a lesser bite, perhaps three or four centimeters, would be preferable. This would permit the dredge to be dragged over a greater surface area before filling; because the littoral ostracod fauna is not dense, this is an important factor.

After the dredge was dragged a few feet and filled, it was brought over the side of the vessel and suspended over a large bucket which had a rectangular spout a few inches below the rim. A galvanized corrugated garbage container of about 30 gallons capacity serves this purpose well. The canvas bag was then slowly opened by releasing the slip knot in the tying cord, emptying the contents of the dredge into the bucket. A hose with running sea water was shoved down into the sediments, the elutriant carrying the micro-fauna passing through the spout onto a sieve or series of

sieves held beneath. Two or three persons can adequately carry out this procedure and work a great quantity of sediment for its fauna. Upon filling, the sieves (the smallest of about 200 micron mesh) were washed out into a liter bottle. Decay of a marine microfauna begins relatively rapidly, especially in warm weather, and except when the vessel was heading directly for the laboratory, preservative was added to most of the samples. The best method of preservation was to add neutral formalin to the jar slowly until a 3-4 percent solution was reached. This requires only small amounts of preservative, and when added in small doses over an hour period, no contraction of appendages was noted. To adequately preserve the samples with alcohol requires not only large amounts of alcohol but the mixing with sea water may form precipitates. Inasmuch as sea water will additionally buffer the neutral formalin, no extra amount of buffer compound need be added if the storage period for the samples is brief. To keep the fauna alive in selected samples, the

water was oxygenated and the jars immersed in covered basins of sea water to maintain nearly normal temperature.

Upon reaching the laboratory, the same procedures were used as for inshore samples. The dead ostracods are generally easily picked out with a brush since there is not obscuring organic detritus and fine sediments such as are present in the inshore samples.

Plankton tows were taken at each station where dredging was carried out. The tows were usually of about fifteen minutes duration, about 3000 liters passing through the Clarke-Bumpus sampler. All were carried out close to the surface, about ten meters of wire being let out. This procedure not only collects the planktonic ostracod fauna, but it reveals whether planktonic forms are being introduced into the benthonic fauna during elutriation by running sea water.

DISSECTION TECHNIQUES

The ostracod was removed from the preserving medium, placed in distilled water for a few minutes, and transferred to a drop of glycerine on a depression square. The animal was then removed from the shell with a pair of needles which were made by the following method. While held with a forceps, a piece of tungsten wire about as thick as a normal commercial dissecting needle and about three to five inches long is quickly dipped about an inch into molten sodium nitrite which has been melted in a small crucible over a bunsen burner. Initially the flame is strong enough to heat the sodium nitrite such that the immersed wire incandescens. The wire is then slowly drawn from the seething crucible, tapering itself by the loss of oxidized tungsten. A number of wires are given this initial taper, the quick immersion and slow withdrawal being done five or ten times for each, then the flame is lowered. After the sodium nitrite has cooled somewhat, each wire is given its final taper; it should not incandesce at this point. A microscope should be at hand for checking the points during the process. Extremely fine dissection needles can be cheaply and quickly produced by this method. They can be made finer than insect mounting pins usually used, do not rust, and are not springy. The wire can be mounted in a dissecting needle holder, a dowel, or left as is.

After the shell has been removed from the ostracod, it is mounted in glycerine jelly, if it is lightly or noncalcareous, on a depression slide. If calcareous it is transferred to a 50 percent Clorox solution for only a minute or two to remove excess organic matter. It is then washed in distilled water and placed on a micropaleontology slide which has been lightly coated with a gum tragacanth solution. Occasionally it was necessary to remove the small amount of calcium carbonate of some myodocopid ostracods so that the shell could be mounted in a combination staining-mounting medium, which is acid. Decalcification was done in a five percent acetic acid solution.

Bubbles which lodge inside the vestibule or elsewhere in the shell inhibit mounting the shell in glycerine jelly or stain-mountant; they can be removed by placing the shell in glycerine on a slide warmer for an hour.

Appendages are removed from the animal, one by one, with the needles, and each is mounted on a separate slide. Usually some whole mounts are made to confirm the appendage orientation of a species. Dissections are performed under magnifications of 25 to 80 X, depending upon the size of the animal. After a little practice, one can remove appendages quite accurately and rapidly.

STAINING AND MOUNTING TECHNIQUES

As each appendage is removed, it is mounted. Only a few stains work well with chitin, and nearly all involve difficulties due to the minuteness of the appendages and the necessity of dehydrating and fixing. All ostracods used in this study were stained and mounted with the water-soluble staining-mounting medium CMC-S, manufactured by General Biological Supply House (Turtox) of Chicago, Illinois. This medium is ideal for this use and even if the soft parts are not to be photographed, the staining greatly facilitates observation of morphological details.

A good working container for the medium is a small weighing bottle, a glass rod being used for a dropper. After an appendage has been removed, a drop of the medium is placed on a clean glass slide; the appendage is picked out of the glycerine with a needle; the depression square removed from beneath the microscope and the slide put in its place; the microscope is focused on the drop and the appendage placed in the medium with the needle. When the appendage is pushed to the bottom of the drop its contact with the slide prevents lateral movement; then the slide is removed from beneath the microscope. A coverslip is slowly placed on the staining-

mounting medium and the whole returned to the microscope stage. With the appendage in focus the coverslip is gently pressed to spread the medium and shifted as necessary to orient the appendage. Some practice will facilitate orientation of the appendage. A high-power microscope is used to check the setae and other features to see they are well displayed. When the appendage is satisfactorily displayed, the slide is set aside and the next appendage dissected off. After each slide has set about 24 hours the stain within the mounting medium has been absorbed by the appendage, coloring it carmine. The coverslip may then be ringed.

If a particular structure absorbs too much stain, or internal structures of a whole mount are being studied, the stain-mountant may be diluted with water. This is seldom necessary.

Since this stain-mountant is acid, no calcareous test should be placed in it. Additional care must be taken if the ostracod has been eating foraminifers or if calcareous algae have grown on its appendages. If this is the case, the soft parts may be placed in a 5 percent acetic acid solution prior to mounting.

SYSTEMATIC DESCRIPTIONS

Phylum ARTHROPODA

Class CRUSTACEA

Subclass ENTOMOSTRACA

Order OSTRACODA

Suborder PODOCOPIDA

Superfamily Cytheracea Baird, 1850

Family Loxoconchidae Sars, 1925

Genus *Cytheromorpha* Hirschmann, 1909*Cytheromorpha curta* Edwards (emended herein)

Pl. 1, figs. 1-12; pl. 2, figs. 1-6

Cytheromorpha curta Edwards, 1944, p. 516, pl. 86, figs. 19-22; Swain, 1951, p. 49, pl. 7, fig. 22.(?) *Cytheromorpha pascacoulaensis* Mincher; Swain, 1955, p. 630, pl. 63, fig. 4; pl. 64, fig. 5; text-fig. 34c.

Carapace. - Female: calcareous, short, highest anteriorly. Broadly rounded anteriorly, dorsally nearly straight, steeply sloped toward rounded posterior; ventral margin essentially straight, slightly concave anterior to midpoint, more strongly so on right valve. Length about 1.5 times height.

Surface nearly smooth in adult, slightly punctate; earlier instars conspicuously reticulate. Valves not inflated posteriorly, more gently sloped anteriorly. Normal pore canals sieve-type, sparse.

Inner lamella forming anterior vestibule about twice as wide as adhesive strip, a very narrow vestibule postero-ventrally. Radial pore canals tapering distally, straight, simple -- about 18.

Central muscles forming a ventrally forward curved vertical row of 4 adductor scars in mid-ventral region, and an irregularly crescent-shaped scar anteriorly. Mandibular fulcral point a circular scar just anterior to top-most adductor scar.

Hinge amphidont. Right valve with a distinct rounded tooth in a curved negative area which forms a more prominent socket anterior to tooth, entire element overhung by a thin "locking" bar; median portion with a narrow groove; posterior element a crescent-shaped tooth, anterior extremity being smaller than posterior, mid-portion depressed, serving as a distinct socket; left valve complement of right, anterior element a crescent-shaped tooth, anterior end much more toothlike than posterior, mid-portion depressed, serving as a distinct socket; median element a narrow ridge; posterior element a crescentic socket with a central tooth, entire element overhung with a thin "locking" bar.

Indistinct eye spot may be present close to anterior cardinal angle.

Male: slightly dimorphic. Shell nearly always somewhat smaller, but size overlap occurs in adults. Height/

length ratio about same. Slightly reticulate on posterior two-thirds as adult.

Antennule. - Six segments; basal podomere largest, no setae; second podomere dorsoproximally coarsely hirsute, a thin ventrodistal seta; third podomere short, a long dorsodistal spine with a short very thin seta off distal portion of spine, extending beyond point; fourth podomere as preceding, in addition a flagellum off lateral distal margin; fifth podomere slightly elongated, bearing a spine as on third and fourth podomeres, and two additional distal flagella; sixth (terminal) podomere elongated, distally bearing a long spine as on preceding three segments, two flagella-like setae, and a long distally expanded sensory seta; latter may not be well developed in every adult.

No dimorphism observed.

Antenna. - Protopod elongate, no setae. Exopod reduced to a long dorsally situated rodlike flagellum of three indistinct segments, distal portion bent downward. Endopod of three segments; first podomere short, one to four dorsoproximal setae and a ventrodistal seta; second podomere long, probably a fusion of two segments, proximal half dorsally hirsute, two mid-dorsal setae, three mid-ventral setae (one quite large), and one large ventrodistal seta; third (terminal) podomere very short, one ventroproximal and one dorsodistal clawlike spine.

No dimorphism observed.

Mandible. - Protopod elongate, heavily chitinous, gnathobase of basal podomere with short blunt teeth, a few short setae between teeth. Exopod reduced to an anterodorsally directed seta. Endopod of three segments; first podomere with about four ventrodistal setae, one dorso-distal seta; second podomere with one ventrodistal seta, two long dorsodistal setae; third (terminal) podomere with two or three coarse distal clawlike setae.

Dimorphic. Endopodal setae of male more numerous, longer; masticatory portion of basis of protopod wider.

Maxilla. - Basal podomere with four distal rami, the anteriormost (maxillary palp) of two segments, first segment with one or two long distal setae, second segment short, distally tipped with three short clawlike setae and three or four thinner setae; three other rami similarly distally equipped. Exopod a lobate process with about 18 long pinnate "branchial" setae.

No dimorphism observed.

Fifth limb. - Elongate crusiform, four segments; basal podomere with two or three proximal setae, two anterodistal setae; second podomere with an anterodistal seta; third podomere with a very short anterodistal spine; fourth (terminal) podomere tipped with a long stout forward curved claw which is somewhat segmented about one-third of way from proximal end. No dimorphism observed.

Sixth limb. - As fifth limb but longer and with only one anterodistal seta on basal podomere. No dimorphism observed.

Seventh limb. - As sixth, but larger. No dimorphism observed.

Furca. - Very reduced, bilobate pair, hirsute with few setae.

Copulatory appendage. - Paired, very large, complex. Capable of being extended well below shell such that attachment point of thoracic limbs is also out of shell.

Eye. - Paired, situated near anterior cardinal angle. Shiny under reflected light. A mass of irregularly grouped granules.

Habitat. - Estuarine-lagoonal; less than 2 to over 29 ‰ salinity.

Size. - See discussion.

Range. - Miocene to Recent.

Types. - Hypotypes UMMP nos. 48754, 48755, 48756, 48757, 48758, 48759, 48760, 48761, and 48762.

Remarks. - Males of this genus have generally been found to be distinctly larger than the females, e.g. *C. fuscata* (Brady, 1869a); however there is no sure way to determine the males of the species herein without observation of internal morphology.

The young are so distinctly reticulate that a separate species could easily be erected if fossil remains were the sole evidence.

The species is distinguished from *C. fuscata* (Brady) by its smaller size, adults being about 390 microns long in this environment while those found in the Miocene by Edwards varied from 380 to 440 microns. The species assigned by Swain (1955, p. 630) to *C. pascagoulaensis* Mincher vary from about 413 to 420 microns. *C. fuscata* (female) is generally over 550 microns in length, while the male is about 700 microns (see Schaefer, 1953, p. 373). The exopod of the mandible is much more reduced in *C. curta*. In other respects the internal morphology of the two species is very similar.

C. curta is very similar in carapace outline to *C. pascagoulaensis* Mincher (1941, p. 344) from the Miocene of Mississippi. Although Mincher states the greatest height is at center, his figures indicate it is anterior. He saw no normal pore canals or muscle scars. His description of the hinge is borne out by his figure, and the right valve has no distinct posterior tooth, while the left has no crescentic-shaped posterior tooth.

The genus is typical of brackish water environments.

Discussion. - This species makes up, by far, the greatest percentage of the estuarine-lagoonal ostracod assemblage. It is extremely well adapted to the harsh environment of salinities ranging from less than 2 ‰ at sample point 6 (text-fig. 2) up the Darien River to salinities of about 30 ‰ at the northern and southern ends of Sapelo Island in the sounds. The water temperature in which the species lives varies from 7.7° C (45.8° F) in December to 31° C (87.8° F) in July. The tidal currents are of such a magnitude that in most areas it is unlikely the animal can withstand being swept along. The entire population probably fluctuates to-and-fro with the tidal motion. The ability of this one species to withstand such ecological rigors accounts for its predominance over all others.

The population varies in number considerably, being quite low in winter, e.g. in December, 1961, 25 samples were taken over a period of ten days at sample points 1-25 (text-fig. 2) - a total of 102 specimens was found alive; in July of 1961, 277 specimens were found alive in one 5 cc sample, and counts of over 100 specimens per 5 cc were common.

The sampling was done during June-September, 1961; December, 1961; April, 1962; December, 1962; March-June, 1963. Adults were found of both sexes at all periods. During April the instars far outnumbered the adults, in the ratio of 50 to one. These instars were 195-230 microns long. In March the young did not significantly outnumber the adults - neither were found in great numbers, although very small instars may have been overlooked in the clay-silt and organic sediments. The instars were commonly only 120 microns long at this time. It appears that the animals hatch in the early spring, mature throughout the summer, breed either in the fall, winter, or very early spring (no eggs were ever found), and those adults which survive the winter may reach 429 microns in length. Most female adults, at least they have a full complement of appendages, are about 380 microns in length, with a range of 343-429 microns. Males are usually 340-380 microns long. The adult size range of 343 to 429 microns is so large as to inhibit the use of growth statistics unless one assumes post-maturation molting that still increases the size of the animal by a significant ratio, i.e. on the order of 1.2 - 1.25. Since no appendages are being added, this is improbable. Since the adults are so variable in size, the growth formulae of Kesling (1951), Anderson (1964), and others do not appear applicable here for the determination of number of instars.

Instars with only one pair of thoracic limbs developed were 195 and 200 microns long, one pair and anlagen of the second 215 microns long, and two pair 235 and 240 microns long. It may take two molts for the complete development of some appendages, and the well-developed copulatory organs in males about 350 microns in length may not yet be functional until another molt.

The life span appears to be one year.

Specimens of this species were found in all areas of the estuarine-lagoonal province in back of the island described in the environmental discussion of the area.

Cytheromorpha warneri Howe & Spurgeon

(emended herein)

Pl. 2, figs. 7-10

Cytheromorpha warneri Howe & Spurgeon, in Howe et al., 1935, p. 11, pl. 2, figs. 5, 8, 9; pl. 4, fig. 4; Van den Bold, 1946, p. 105; Van den Bold, 1950, p. 86; Malkin, 1953, p. 787, pl. 80, figs. 18, 19; Puri, 1953, p. 277, pl. 6, figs. 5-7, text-figs. 11f, g; Puri & Hulings, 1957, p. 187, fig. 11, no. 10 (bottom); Puri, 1960, p. 114, pl. 3, figs. 11, 12, text-fig. 36.

Carapace. - Entire surface of valves punctate, indistinct posteriorly, reticulations more distinct posteriorly. Marginal pore canals simple, straight; normal pore canals sieve type, sparse. Central muscle scars a vertical row of four adductor scars, a V-shaped frontal scar.

Antennule. - Typical of genus (cf. *C. curta*, pl. 2, fig. 2). Six segments; basal podomere largest, no setae; second podomere dorsoproximally hirsute, a thin ventrodistal seta; third podomere short, a long dorsodistal spine

with one or two short very thin setae off distal portion of spine extending beyond point; fourth podomere short with two long dorsodistal spines each bearing a distal flagella; fifth podomere short bearing two dorsodistal spines with a distal flagella and two laterodistal setae (one longer); sixth (terminal) podomere elongated, distally bearing a long spine as on preceding three podomeres, a flagellumlike seta, and a long distally expanded sensory seta.

No dimorphism observed.

Antenna. - Typical of genus. Protopod elongate, no setae. Exopod reduced to a long dorsally situated rodlike flagellum, distally bent downward. Endopod of three segments; first podomere short, four to six thin hairlike dorsoproximal setae and a long ventrodistal seta; second podomere long, probably of two fused podomeres, two mid-dorsal setae of unequal length, two mid-ventral setae of unequal length, a mid-ventral sensory seta with distal expansion, and one ventrodistal large seta; third (terminal) podomere very short, one ventroproximal and one dorso-distal clawlike spine.

No dimorphism observed.

Mandible, maxilla, fifth, sixth, and seventh limbs, labrum, and copulatory appendages. - As in *C. curta*, but proportionally larger in adult.

Eye. - Not seen.

Habitat. - Brackish water, salinities of 13 to 28 ‰.

Size. - Length of adult 500-585 microns.

Types. - Hypotypes UMMP nos. 48763, 48764, and 48765.

Remarks. - The animal is easily distinguished from others of its genus by the shell structure. It is not easily distinguished from *Leptocythere paracastanea* Swain (see herein) by its gross shell features. Under normal viewing with a dissecting microscope of approximately 80 power, very close examination did not always serve to distinguish the two - especially males. The internal morphology is very alike, and grossly the two are homeomorphs. They may easily be differentiated under high magnification with transmitted light. *Leptocythere* has polyfurcate radial pore canals, open type normal pore canals, and different dentition. *C. warneri* has simple radial pore canals and sieve type normal pore canals.

Discussion. - Adults were found in March in Sapelo Sound and adjacent areas and were not common.

Family Leptocytheridae Hanai, 1957

Genus *Leptocythere* (*Leptocythera*, errore) Sars, 1925

Pl. 3, figs. 1-10; pl. 4, figs. 1-9

Leptocythere paracastanea Swain (emended herein)

Leptocythere paracastanea Swain, 1955, p. 640, pl. 62, fig. 7; pl. 63, figs. 1a-c; text-figs. 39, 5a, b.

Carapace. - Female: calcareous, somewhat tumid, greatest height slightly anterior of mid-line, greatest width nearly central. Anterior broadly rounded, dorsally gently curving to a less broadly rounded posterior, the posterior cardinal corner protruding, more so on left valve. Ventral margin nearly straight, sinuous near mid portion. Two short shallow sulci anterodorsally; a postero-

ventral groove creating an indistinct lobe. Anterior two-thirds punctate, posterior portion coarsely reticulate. Inner lamella usually fused with inner surface of shell forming pseudomarginal pore canals, occasionally a narrow anterior and posteroventral vestibule. Normal pore canals open type, radial pore canals polyfurcate, each with a short marginal seta.

Central muscle scars a nearly vertical row of four adductors, a curved frontal scar anterior to topmost adductor, very indistinct.

Teeth of right valve: anterior tooth distinct, slight lateral crenulations, indistinct sockets on both sides of tooth; median element a long ridge; posteriorly a distinct tooth with dorsal crenulations, an indistinct shallow socket posterior to tooth; left valve: anterior elements a small tooth followed by a slightly crenulate socket and a posterior larger elongate tooth which grades into the lower positive portion of a median groove; posterior elements a crenulate socket bordered by two teeth and overhung and reinforced by extension of upper positive portion of median element.

Male: longer in relation to height, punctations over whole surface, reticulations more subdued. Median hinge element of left valve dorsally crenulate, more so posteriorly. Posteroventral groove less distinct.

Antennule. - Five segments; stout; basal podomere largest, no setae; second podomere thinner, nearly as long, a thin ventrodistal seta; third podomere short, a stout dorsodistal curved claw; fourth podomere with two dorsomedian claws (one small, more distal large with a flagellum), three dorsodistal claws (two small, more distal one large with a flagellum), and a thin dorsodistal seta; fifth (terminal) podomere narrow elongate with a short dorsomedian spine, terminated with a stout claw bearing a short distal flagellum, a long thin spine, and a long sense club (cf. *Cytheromorpha warneri*, pl. 2, fig. 10), usually distally expanded.

No dimorphism observed.

Antenna. - Protopod elongate, no setae. Exopod reduced to a long thin dorsally situated rodlike flagellum, distally bent downward. Endopod of three segments; first podomere short, a long pinnate ventrodistal seta; second podomere long, probably two fused segments, a dorso-median seta, three ventromedian setae (one heavy, one a sense club, and one ventrodistal heavy pinnate seta with a flagellum); third (terminal) podomere short with two terminal claws, the dorsal claw off an extended base.

No dimorphism observed.

Mandible. - Protopod elongate, heavily chitinous, gnathobase of basal podomere with approximately eight short teeth and two or three short spines; second podomere of protopod with two posteriorly directed marginal spines. Exopod not seen, probably very reduced. Endopod of three segments; first podomere with two small distal setae off lateral edge and two large pinnate posterodistal setae; second podomere with one long pinnate seta, two short posterodistal setae, two anteromedian setae, and one anterodistal seta; third (terminal) podomere with three terminal setae.

No dimorphism observed.

Maxilla. - Basal podomere with four distal rami, anteriormost (maxillary palp) of two segments, first with

three long distal pinnate setae, second with three long pinnate terminal setae; three other rami similarly distally equipped; exopod a lobate process with about 18 long pinnate "branchial" setae.

No dimorphism observed.

Fifth limb. - Elongate crusiform, four segments. Basal podomere with anteromedian seta, posteromedian pinnate seta, and two anterodistal setae; second podomere with anterodistal seta; third podomere with very short distal spines; fourth (terminal) podomere with short distal spines, terminated with a long stout anteriorly curved claw with a constriction one-third out from base.

No dimorphism observed.

Sixth and seventh limbs. - As fifth limb but increasingly larger, with only one anterodistal seta on basal podomere.

No dimorphism observed.

Furca. - Reduced, lobate, hirsute. Dorsally straight on female.

Genital lobe. - Spinose, vaginae two chitinous rings.

Copulatory appendage. - Very large, complex. Distal extension broad, quickly tapered, lightly chitinous.

Eye. - Paired, well forward. Observed to move forward and backward.

Habitat. - Brackish water, salinities of 13 to 28 ‰.

Size and types. - Hypotypes: UMMP 48769, male, 445 microns long, 195 microns high; UMMP 48767, female, 445 microns long, 235 microns high; UMMP nos. 48766, 48768, 48770, and 48771.

Remarks. - The genus Leptocythere differs from Cytheromorpha in the dentition, the presence of open vs. sieve type normal pore canals, and in polyfurcate vs. straight radial pore canals. The internal morphology of the two genera is nearly the same; the antennule of Cytheromorpha has six podomeres, while that of Leptocythere has five, the fourth and fifth equivalents of Cytheromorpha being fused. In all other respects the appendages are essentially alike.

This species differs from L. castanea Sars (1925, p. 174, pl. 80, fig. 1) by the presence of reticulations on the shell surface, in addition to the punctae, and by the more blunt distal process of the copulatory organ. The length of L. castanea is given as 690 microns, the specimens of L. paracastanea described by Swain from San Antonio Bay, Texas, as male: 560 microns, female 490 microns; the specimens described herein are smaller, usually 445 microns long.

All other species of the genus may be easily distinguished by the shell.

Discussion. - This species is typically found in brackish water. It is not as euryhaline as Cytheromorpha curta and has a general salinity range of 13 to 28 ‰. It is found in Sapelo Sound, and occasionally behind the island adjacent to the sound.

Adults have been found in the winter, but are uncommon. The greatest numbers appear to occur in March and April. The appendages are quite yellow in appearance. The shell is a close homeomorph of Cytheromorpha warneri, but smaller.

The male is capable of extending the copulatory organs such that the entire thoracic region is outside of the shell. No eggs were found in any female.

Occurrence uncommon.

Family CYTHERIDEIDAE Sars, 1925

Genus Cyprideis Jones, 1856

Cyprideis floridana (Howe & Hough)

(emended herein)

Pl. 5, figs. 1-8; pl. 6, figs. 1-8

Cytheridea floridana Howe & Hough, 1935, in Howe et al., 1935, p. 10, pl. 2, figs. 15, 16, 18; pl. 4, figs. 6, 10.

Anomocytheridea floridana (Howe & Hough), Stephenson, 1938, p. 142, pl. 23, fig. 15; pl. 24, figs. 7, 8; text-figs. 2, 6, 19, 20. Edwards, 1944, p. 510, pl. 85, figs. 16, 17. Puri, 1953, p. 229, pl. 2, fig. 10, text-figs. 3a, b. Howe, 1961, Q 273, fig. 203, no. la-e.

(?) Cytheridea ? (Anomocytheridea) floridana Hough & Hough, Van den Bold, 1946, p. 82.

Cyprideis littoralis Brady; Swain, 1955, p. 615, pl. 59, figs. 11a-c; text-figs. 38, 5a, b.

non Cyprideis floridana Puri, 1960, p. 110, pl. 2, fig. 5, text-figs. 1-3.

Carapace. - Normal pore canals sieve type.

Antennule. - Five segments; basal podomere large, nearly as wide as long, distally hirsute; second podomere long, medially hirsute, a long distally segmented ventrodistal seta; third podomere short with a dorsodistal long pinnate spine; fourth podomere short, consisting of two fused segments, two spines dorsomedially (one pinnate), two spines dorsodistally (one pinnate), and a short laterodistal seta; fifth (terminal) podomere narrow, long, with three thin terminal setae.

No dimorphism observed.

Antenna. - Protopod somewhat smaller than basal podomere of antennule, no setae. Exopod reduced to dorsally situated rodlike flagellum, distally bent downward. Endopod of three segments; basal podomere short, hirsute in areas, with a comparatively long ventrodistal seta; second podomere long, two dorsal setae of unequal length, a long pinnate ventral spine; two long distomedial setae, and a ventrodistal pinnate spine; third (terminal) podomere very short, bearing two large clawlike spines.

Dimorphic. One distomedial ventral seta on second podomere of male is longer, reaching as far as terminal spines of distal podomere.

Mandible. - Basal podomere of protopod heavily chitinous, gnathobase broad, tipped with long blunt spines

and one or two blunt setae, a short seta off the anterior portion proximal from the tip; second podomere of proto-pod short with a long pinnate median seta directed posteriorly. Exopod of four setae, one very small, three large and very pinnate similar to branchial setae of maxilla. Endopod of two segments, basal podomere longest, with an anteromedian long distally segmented seta, a long posteromedian seta, two lateral median setae, six anterodistal setae, a lateral distal seta, and a long posterodistal seta; second (terminal) podomere very reduced with two long heavy terminal setae.

No dimorphism observed.

Maxilla. - Basal podomere with four rami, anterior most (mandibular palp) of two segments; first segment with four long distally segmented anterodistal setae, one posterodistal seta; second (terminal) segment with three terminal setae; other three rami with about six heavy terminal setae. Exopod with about 16 long pinnate "branchial" setae.

No dimorphism observed.

Fifth limb. - Elongate, crusiform, four segments; basal podomere large, an anteromedian distally segmented seta, two anterodistal segmented setae and a large posterior segmented very pinnate seta one-fourth way from proximal end; second podomere narrow, one short seta and one long pinnate anterodistal seta; third podomere with two or three small distal spinules; fourth (terminal) podomere with a long anteriorly curved claw as long as last two podomeres.

Dimorphic. Right fifth limb of male has three distal podomeres thicker, the anterodistal seta of second podomere larger and clawlike, distal claw heavier.

Sixth limb. - As fifth limbs of female and left fifth limb of male, but larger and only one anterodistal seta on basal podomere.

Dimorphic. Right sixth limb of male with normal basal podomere, last three podomeres very reduced, weakly developed; terminus a small node, not a claw.

Seventh limb. - As sixth limb but longer and with the proximally situated posterior seta of basal podomere distinctly smaller, not as pinnate; last three podomeres with spinules around distal peripheries.

Dimorphic. Male has about eight thin, nearly hair-like setae along anterior margin of second podomere and a like clump of these on proximal portion of basal podomere. Both appendages symmetrically developed.

Furca. - Reduced; nodular with two small setae.

Copulatory appendage. - Paired; very large, quadrate; lobate extensions, a "copulatory string" of three-fourths whorl. Basal quadrate portion of figured male (pl. 5, fig. 2), 390 microns across.

Eye. - Paired, stalked, no lenses. Visual area a mass of darkly pigmented granules. Situated near dorsal border 275 microns from anterior end of female 890 microns in length.

Habitat. - Brackish water of salinities from 13 to 28 ‰.

Size and types. - Hypotypes: UMMP 48772, female, 890 microns long, 475 microns high; UMMP 48773, male,

975 microns long, 500 microns high; UMMP nos. 48774, 48775, and 48776.

Range. - Upper Miocene to Recent.

Remarks. - The internal morphology differs from that of *C. torosa* (Jones) (= *C. littoralis* Brady) in only a very minor way, if at all. The mandible of that species has an exopod with three large and two small setae (as figured by Sars, 1925, pl. 71), while *C. floridana* has three large setae and only one small seta. *C. torosa* possesses a spine on the posteroventral corner of the right valve, and the uppermost adductor muscle scar is not directed upward at an angle as in the species herein, hence the carapaces are easily distinguished.

Discussion. - Young instars were found in December and throughout the spring and summer. Adults, the females bearing eggs, were first found in April. The males were comparatively rare. The young instars are not readily assigned to the species since they taper considerably toward the posterior, needing no carapace room for penes or eggs.

It appears that eggs are developed and hatch during the early spring. The new-born may only reach maturity early the next spring since none were found in winter. Too few adults were found, even in spring, to state categorically that this is the life cycle.

The species is confined to Sapelo Sound and directly adjacent areas where the salinity ranges are not as great as in the marsh areas. An interesting occurrence was noted in June, 1961, when sampling at points 17-20 (text-fig. 2). At sample point 17, off the tidal bar, 98 specimens of *Cytheromorpha curta* were obtained from 5 cc of sample at the sediment-water interface; at sample point 18, on the flank of the bar, 62 specimens of that species were found in 5 cc of sediment plus 50 specimens of *Cyprideis floridana*; at sample point 19, on the bar, three specimens of *C. curta* were found in 5 cc of sediment and 67 specimens of *C. floridana*; at sample point 20, off the tidal bar near shore, 6 specimens of *C. floridana* were found in 5 cc of sediment, and no *C. curta*. This was thought at first to be a classic ecological situation wherein *Cyprideis floridana* preferred the type of substrate and the shallower water of the tidal bar, while *Cytheromorpha curta* preferred the deeper water and its coarser substrate. This was the first time I had been to this area, and was unaware of the current situations and the fact that the bar was exposed at low tide - leaving only 100 feet or so navigable along the western bank of the tidal river. When the tidal currents were understood, it was found that an opposing action occurs in this area, and is responsible for the deposition of sediments forming the bar. The tidal map (text-fig. 3) shows the incoming tide from Sapelo Sound is not strong in this area (note length of movement of drogue for incoming tide) and is confined to the eastern bank of the channel. The tide from the south is much greater and actually causes opposing current flows on either side of the bar for a period of time. Note the median phi diameters (text-fig. 7), which reflect the tidal currents in this area. *C. floridana* is brought onto the bar by the tidal current and is deposited there, just as are the fine sediments which make up the bar, when the current velocity drops off due to opposing currents. In fact, there may be some increase in concentration of number of specimens per unit area higher than in the sound. *C. curta* occurs in very high concentrations within the tidal channels in back of the island, and is brought from this area to the sound by the tidal current from the south, the resultant being the lateral stratification of species in a short distance.

Sampling on the bar when exposed at low tide showed that nearly all specimens were carried back into the sound, the population being very reduced. There is generally enough moisture to maintain these reduced populations during the exposure period. The sediment is saturated to the point that during sampling of the bar the investigator nearly disappears. Capillary action keeps some moisture at the surface even under the summer sun.

An adult female placed in a small cup of brackish water was noticed to be gravid. After 13 days two young were born (April 19) and molts were already noticed. The young were 195 microns long at this time. On April 25 six young were seen, and the adult was still alive. The contents were observed on April 29 and the adult was quite weak, doubtless not being fed properly, and only three of the six young were seen. To my surprise, the shell of the female opened and the other three swam out! At least in this case some post-birth parental care exists. All young died within the following week.

The thoracic legs of this female were observed to act in cleaning the outside of the carapace as well as the inside.

Family CYTHERURIDAE Mueller, 1894

Genus Semicytherura Wagner, 1957

Semicytherura elongata (Edwards)
(emended herein)

Pl. 7, figs. 1-12

Cytherura elongata Edwards, 1944, p. 526, pl. 88, figs. 21-25; Swain, 1951, p. 50, pl. 7, figs. 24, 25; Swain, 1955, p. 628, pl. 64, figs. 12a, b.

(?) Cytherura johnsoni Mincher; Benson & Coleman, 1963, p. 31, pl. 6, figs. 3-5 (non 1, 2), text-fig. 18b.

Carapace. - Teeth; right valve: anterior tooth slightly crenulate, followed by a socket; median element a strong bar overhanging a narrow groove; posteriorly a socket followed by a slightly crenulate reduced tooth; left valve; anterior and posterior elements sockets; median bar expanded at both ends into crenulate teeth (see remarks). Right valve overlaps left in median dorsal region, left valve with overlapping flanges distally both anterior and posteriorly.

Male expanded posteriorly, somewhat more elongate; lateral ornamentation much more distinct than cross ribs, some specimens with cross ribs very indistinct.

Normal pore canals few, widespread, open. Very rarely a sievelike area exists, no borders as in a sieve-type pore, function unknown. Marginal pore canals few, long, not all reaching margin, somewhat grouped.

Antennule. - Six segments, distal four long and narrow; basal podomere largest, no setae; second podomere with a long thin ventromedian seta; third podomere with one dorso-distal seta; fourth podomere with three dorsodistal setae; fifth podomere with three dorsodistal setae; sixth (terminal) podomere with three thin terminal setae (one blunt).

Dimorphism. The seta of the third podomere, and one of those of the fourth and fifth podomeres is heavier in the male.

Antenna. - Protopod with no setae. Exopod reduced to a dorsally situated rodlike flagellum distally bent down-

ward. Endopod of four segments, penultimate one a fusion of two; basal podomere short with two ventrodiscal setae; second podomere elongate tapering with a ventrodiscal seta; third podomere long with a short dorsomedian and a ventrodiscal seta; fourth (terminal) podomere short with a dorsodistal short spine and long clawlike seta, a ventrodiscal clawlike seta, and a small inner lateral seta.

Essentially no dimorphism, male has two bulbous glands in back of labrum with tubule into antennae - probably leading to sensory setae.

Mandible. - Basal podomere of protopod heavily chitinous, gnathobase with heavy blunt teeth; second podomere of protopod relatively short. Exopod a long thin seta. Endopod with three segments; basal podomere relatively long with one anterodistal seta and one posterodistal seta; second podomere with three or four anterodistal and four or five posterior setae; third (terminal) podomere short, narrow, with three or four relatively short terminal setae.

No dimorphism observed.

Maxilla. - Terminal segments of basal podomere relatively elongate, "palp" of two segments, the proximal about five times the length of the distal. All four rami terminated with four to six setae; branchial plate of exopod with about 16 long pinnate setae.

No dimorphism observed.

Fifth limb. - Elongate, crusiform, four segments; basal podomere somewhat ovate, two anterodistal setae, one anteromedian seta, and one posteromedian seta; second podomere with one anterodistal seta; third podomere with no setae; fourth (terminal) podomere with a terminal claw anteriorly curved, as long as podomere.

No dimorphism observed.

Sixth limb. - As fifth limb but larger, basal podomere with only one anterodistal and two anteromedian setae.

No dimorphism observed.

Seventh limb. - As sixth limb but larger.

No dimorphism observed.

Copulatory appendage. - Paired, very large, complex; "copulatory string" of only one loop. Much like that of C. (?) intumescens Sars (1925, p. 96).

Habitat. - Found in or adjacent to Sapelo Sound during spring; salinities from 13 to 28 ‰, usually in upper range. Uncommon.

Types. - Hypotypes UMMP nos. 48777, 48778, and 48779.

Size. - Adults from 460 to 520 microns in length.

Range. - Miocene to Recent.

Remarks. - In all respects described by Edwards, the valves of this species agree with his Cytherura elongata. The inner lamella are not as wide, especially posteriorly, as in those species which Wagner lists for his genus Semicytherura (1957, p. 80-89). The terminal teeth of the

median element of the left valve are crenulate in the species herein (pl. 7, figs. 8, 9) and this is the principal difference from the genus *Cytherura*. The crenulations are not easily seen. By orienting the shell in glycerine jelly with a hot needle, they may be observed from within nearly on the plane between the valves, and under a magnification of 400-500.

No differences in internal morphology were noted between *Cytherura* and *Semicytherura*.

Discussion. - One female specimen taken in April was put in a Nembutal solution and several days later observed. Prior to death the animal had laid eggs, all but one of the six laid had hatched. The antennules and antennae were observable, the young were approximately 190 microns long.

Superfamily BAIRDIACEA Sars

Family MACROCYPRIDIDAE Mueller, 1912

Genus *Macrocypris* Brady, 1868a

Macrocypris sapeloensis, n. sp.

Pl. 8, figs. 1-9; pl. 9, figs. 1-9

Carapace. - Male: calcareous, elongate, dorsal margin curved, ventral margin slightly concave. Greatest height slightly anterior; anterior end broadly rounded, posterior sub-acute, rounded, apex nearly on a line with ventral margin. Surface smooth. Inner lamella wide anteriorly and posteriorly, narrow ventrally; anteriorly inner lamella curves close to inner shell surface, posteriorly more parallel to plane of valve contact. Large posterior and anterior vestibula.

Radial pore canals numerous, non-branching, nearly all reach anterior edge. Line of conrescence very irregular, following thick pore canals toward edge. Normal pore canals simple, open, sparse, most numerous postero-ventrally.

Central muscle scars a large group of about 12 adductors circularly arranged, located slightly ventral of mid-point. Two smaller scars anteroventrally, two smaller scars anterodorsally.

Right valve larger, overlapping left ventrally. Hinge advanced merodont/entomodont; right valve: anteriorly a crenulate elongate socket becoming a positive crenulate element toward mid-line, from mid shell to posterior portion slightly curved, essentially acting as a positive ridge curving outward into a more positive comparatively short crenulate element which posteriorly becomes an elongate crenulate socket; left valve: complementary, the area opposite the median element of the right valve correspondingly slightly concave, a long positive ridge overlaps the right valve.

Antennule. - Seven segments; basal podomere about as wide as long; second podomere fused to basal, two long ventrodiscal setae with very finely saw-toothed distal margins; third podomere short, fused to second, one ventrodiscal seta, distal margins finely toothed, and one dorso-distal seta of like structure; fourth podomere articulated with third, shorter setae in same arrangement as preceding podomere; fifth podomere with a large dorsodistal

seta, distally nearly smooth, and a smaller ventrodiscal seta; sixth podomere with two ventrodiscal setae, nearly smooth; seventh (terminal) podomere with four essentially smooth stout setae.

Antenna. - Similar to antennule, six segments; basal podomere with a short sagittal seta directed ventrally; second podomere with a long sagittal seta; third podomere with two long, one short dorsoproximal setae, dorsodistal edge with three or more very short spines, ventroproximally a cluster of six long setae; fourth podomere with two dorsodistal setae, one ventroproximal seta, two short setae, one long seta, and two sensory setae ventrodistally, the latter distally broadened and spinose; fifth podomere with one short and one long stout setae ventrodistally, dorsodistally four long stout setae, one shorter; sixth (terminal) podomere overhung by dorsodistal portion of fifth, one or two long stout and two shorter setae terminally.

Mandible. - Basal podomere of protopod elongated for leverage of gnathobase. Gnathobase terminated with approximately eight chitinous spines posteriorly decreasing in size, numerous short setae between spines; second podomere of protopod with three distal setae. Exopod reduced to about six long pinnate setae, not heavily chitinized, off a raised base. Endopod of four segments; basal podomere with approximately six long distal setae; second podomere with four laterodistal setae, about six marginal distal setae; third podomere short, about two distal setae; fourth (terminal) podomere very short with approximately four terminal setae, one larger and more heavily chitinized.

Maxilla. - Basal podomere with two long setae directed anteriorly off lateral portion, one short seta off posterior margin; terminus of four rami, anteriormost (maxillary palp) of two segments, all rami distally equipped with numerous setae, posterior ramus with a long marginal proximal seta. Epipod lobate, about 10 long pinnate marginal setae, three or more short proximal setae.

Fifth limb. - Short, non-crusiform. Protopod low, moundshaped; palp (exopod ?) small, elongate, two or three segments, two long proximal setae, three terminal setae; endopod essentially two segments, basal podomere large with one seta and two blunt stout spines distally, second podomere heavily chitinous, curved forward for grasping.

Sixth limb. - Elongate crusiform, five, possibly six, segments; basal podomere with three long seta on anterior margin and one posterodistal seta; second podomere long, one seta just inside posterior margin somewhat proximal of mid-point, distally very finely pinnate, and one long anterodistal seta; third podomere long, one long anterodistal seta; fourth podomere elongate with one long and one short anterodistal seta; fifth (terminal) podomere long, distally a possible segmentation, terminus with one short and two long, very stout clawlike setae.

Seventh limb. - Elongate crusiform, five segments; basal podomere with four or five setae off anterior margin, one off posterior; second podomere long, one anterodistal seta; third podomere as second, shorter; fourth podomere with two anterodistal setae, both shorter than preceding setae; fifth (terminal) podomere with two anteriorly directed setae and one posterodorsally directed large cleaning seta, distal two-thirds of which is toothed on both edges.

Furca. - Each branch with two segments; first segment elongate, with a few very small setae in two spots along one edge; second segment a curved claw as long as preceding segment.

Copulatory appendage. - Paired, simple, triangular, acute end proximal, affording the entrance for vas deferens.

Sperm and ejaculatory system. - Sex system paired. Sperm very long, no complete one could be determined because they are so intertwined. No expanded "head" bearing a nucleus was seen. Testes not distinct. Vas deferens begins tightly coiled, enters an ampulla (probably for sperm storage although sperm seem too long for much storage capacity), continues through a muscular ejaculatory apparatus (Zenker's organ), and coils again upon emerging. It tapers prior to entering the penis and its exit is so narrow that only a few, possibly only one, sperm may exit at a time. Entire system was tightly packed with sperm.

Eye. - None present in genus.

Habitat. - Taken from 625 feet of water, salinity approximately 35 ‰, water temperature 23°C, 75 miles offshore near edge of Gulf Stream; one living specimen from Sapelo Sound.

Size and type. - Holotype UMMP no. 48780, male, length 1.56 mm, height 0.60 mm.

Remarks. - The genus Macrocypris differs from Macrocyprina Triebel (1960, p. 118) by the nature of the sperm ejaculatory system, Zenker's organ being thicker and the vas deferens looped about it in Macrocyprina, and a three rather than two segmented maxillary palp. Triebel also states that Macrocyprina has a rounded posterior rather than pointed, however the species herein, and others, seem to bridge that gap.

This species differs from M. minna (Baird, 1850a, p. 171) by the non-pointed posterior and the shape of the penes. The internal morphology of that species is figured by Sars (1923, pls. 26, 27). M. schmitti Tressler (1949, p. 341) differs in the setation of the seventh limb, has a shorter terminal segment on the sixth limb, and a somewhat more curved shell.

The shells of the following species are incompletely described and no internal morphology is considered, affinities are in doubt: M. decora (Brady, 1866, pl. 57, fig. 13a), the figure shows muscle scars that make generic assignment to Macrocypris, as Brady later did (1880, p. 44), questionable; M. maculata (Brady, 1866, p. 367) the anterior appears to have a much more narrow adhesive strip; M. orientalis Brady (1868, p. 61) appears to have a different hinge line shape; M. hieroglyphica Brady (1868, p. 62) appears to have a different hinge line shape; M. canariensis Brady (1880), M. setigera Brady (1880), M. similis Brady (1880, p. 42), and M. tumida Brady (1880, p. 43) are too poorly described; M. tenuicauda Brady (1880, p. 41) appears to have a more drawn out posterior and the palp of the fifth limb is unsegmented as shown in pl. 3, fig. 2a; M. turbida Mueller (1908, p. 94) has a higher shell, different adductor muscle scars, one of the fifth limbs has a distal spine elongated, and the furcae have shorter terminal claws; M. inaequalis Mueller (1908, p. 95) has different adductor muscle scars, a narrower anterior adhesive strip, the fifth limbs have one, rather than two, blunt distal spines on the penultimate segment, and the furcae are unsymmetrical in length; M. tensa Mueller (1908, p. 96)

has different adductor muscle scars and short terminal claws on the furcae; M. dispar Mueller (1908, p. 96) has different adductor muscle scars, and the terminal claws of the furcae do not appear to be well differentiated; M. africana Mueller (1908, p. 97) has different adductor muscle scars and short terminal claws on the furcae; M. succinea Mueller (1894, p. 242) has been placed in the genus Macrocyprina Triebel (1960) by virtue of the three segmented maxillary palp (maxillartaster) and the arrangement of the coils of the vas deferens.

Suborder MYODOCOPIDA

Superfamily CYPRIDINACEA Baird, 1850

Family Cypridinidae Baird, 1850

Genus Philomedes Liljeborg, 1853

Philomedes lilljeborgi (Sars) (emended herein)

Pl. 10, figs. 1-10

Bradycinetus lilljeborgi, Sars, 1866, p. 112.

Philomedes lilljeborgi, Skogsberg, 1920, p. 402, figs. 70-73 and synonymy therein; Poulsen, 1962, p. 346, fig. 151, and synonymy therein.

(?) Philomedes levis Mueller, 1894, p. 211, pl. 3, figs. 4, 18, 22, 29-31.

Carapace. - Female: noncalcareous, subovate, tumid. Rostrum very pronounced, anteriorly and posteriorly pointed, ventrally concave, lined with broad setae, each terminated with approximately five smaller round setae ("selvage" of Skogsberg, 1920, pl. 70, figs. 1, 2, 4). Inner portion of rostrum with a prominent row of setae. Incisure rounded. Shell posteroventrally produced. Surface essentially smooth, checkered with pentagonal "cracks", very sparsely covered with either short broad setae similar to those of rostrum or long setae. Vestibule wide posteriorly and anteriorly, narrow along mid-portion.

Radial pore canals occasionally branching.

Adductor muscle scar pattern a circular group of over ten scars anteroventrally of mid-point.

See Skogsberg, 1920, for complete description of internal morphology.

Antennule. - Six, possibly seven, segments; basal podomere longest, no setae; second podomere nearly as long, articulated with basal, margins hirsute, three ventrodiscal setae with secondary setae and one dorsodiscal seta; third podomere very short, fused to second and fourth, two dorsodiscal and one ventrodiscal seta; fourth podomere with one dorsodiscal and three ventrodiscal setae, all bearing secondary setae (one very long extending beyond terminus); fifth podomere articulated with fourth, bearing a very long ventrodiscal seta whose distal portion is divided into four or five secondary setae, this seta appears to originate from the terminal podomere unless closely observed; sixth (terminal) podomere very short, possibly two fused podomeres, distally bearing two short or medium and five long setae (two thinner and blunt, three distally split with secondary setae along length). All setae striated normal to length.

Antenna. - Protopod large, ovoid. Endopod reduced, apparently of two segments, basal podomere short bearing six setae; second podomere proximally bearing a long seta with subsetae, at about two-thirds way from proximus bearing two setae off a nodose area, and a long thin seta

just short of terminus. Exopod of nine segments; basal podomere about as long as all succeeding, no setae; second through eighth podomeres each bearing a long pinnate natatory seta; ninth (terminal) podomere bearing four long natatory setae and three smaller setae. All but two natatory setae on each antenna broken.

Mandible. - Protopod with forked pinnate process at distal end, not heavily chitinous for mastication. Exopod reduced, dorsally directed, two segments; basal podomere terminated in two setae, one pinnate; second podomere obliquely off first, terminated in a very short spine. Endopod of four segments; basal podomere with six lateral setae on proximal portion, three large with several teeth along one margin, three dorsodistal pinnate setae, and seven or eight ventral pinnate setae; second podomere with about four ventrodistal setae (three long and pinnate); third podomere long, approximately five ventrodistal pinnate setae in two groups, approximately four dorsoproximal setae, and five long dorsal setae at about mid-point; fourth (terminal) podomere with two smooth curved claws and several shorter setae at terminus.

Maxilla. - Protopod with three endites; first with ten distal pinnate setae, second with about four distal pinnate setae; third terminated with about four pinnate setae, others laterally. Endopod with approximately 12 setae and three curved claws.

Fifth limb. - Exopod with about four heavily chitinous teeth, one larger, several with secondary spines, many setae proximally. Epipod of approximately 50 broad, lightly chitinous very pinnate setae.

Sixth limb. - Crescent shaped, terminus of essentially four lobes, anterior three small, each with a lateral seta, anteriormost with three terminal pinnate setae, middle with seven, posterior with about eight; posterior lobe very broad, lined with about 22 broad heavily pinnate setae.

Seventh limb. - Typical of superfamily, vermiform, segmented. Terminus with opposing rows of short setae which have a short oblique branch short of terminus (Skogsberg, 1920, fig. 72, no. 14), four or five typical terminal setae with typical cone-in-cone distal portions, four to six more proximally.

Furca. - Ten claws distally increasing in length, larger with secondary spines along concave margin; margin hirsute.

Frontal organ. - Unsegmented, comparatively long, thin, straight, end rounded.

Eye. - Very reduced or absent in females.

Habitat. - Taken from 405 feet of water, salinity approximately 35 ‰. September.

Size and types. - Hypotype UMMP no. 48781, female: length 1.74 mm, height 1.62 mm.

Remarks. - The checkered pattern of the shell has not been reported for this species, but has for *P. rotunda* Skogsberg (1920, p. 414, pl. 75, fig. 2) and *P. interpuncta* Baird (in Mueller, 1894, p. 210, pl. 3, figs. 2 & 38).

This species differs from its closest affinity *P. interpuncta* Baird (1850b), by the absence of a rostral beak, different setation of antennules and maxillae, and the absence of stout setae between the furcal claws. *P. inter-*

puncta was so incompletely described by Baird as to leave some question as to assignment. *P. levis* Mueller (1894), may not be a valid species, internally the differences do not appear to be of greater magnitude than individual variations in *P. lilljeborgi* reported by Skogsberg; the shell is somewhat different in the shape of the rostrum, but not more so than in specimens of *P. lilljeborgi* reported by Sars (1922, p. 14-15, pl. 8).

The broken antennal natatory setae probably indicate the female is a mature specimen, even if somewhat shorter than others described, and had completed a planktonic phase of the sexual cycle (see Skogsberg, 1920, p. 348-368). Skogsberg's proposal that colder water might be causal in the loss of setae, rather than as a part of a sexual cycle, would be doubtful in the case of present occurrence.

Discussion. - What appear to be developing eggs were seen inside the animal. Remains of a diatom and a *Globigerina* type foraminifer were in the stomach. The adductor muscle scar pattern was obscured since the chitinous shell broke at the attachment point upon dissection.

Genus *Pseudophilomedes* Mueller, 1894

Pseudophilomedes ferulana Kornicker
(emended herein)

Pl. 11, figs. 1-9; pl. 1, 12, figs. 1-8

Pseudophilomedes ferulana Kornicker, 1958, p. 235, figs. 46, 1a, b, 2a, b; 56, a-d.

Carapace. - Female: weakly or irregularly calcareous, ovoid, a blunt non-downcurved rostrum overhanging a slight incisure, four or five long setae on inner face. A blunt broad caudal process slightly ventral to mid-line. Greatest height central. Shell very tumid. Margins somewhat nodose, with long setae in several rows. Surface reticulate, a sulcus slightly anterior to mid-line extends dorsally from mid shell. Surface sparsely covered by inter-reticulate setae. About six nodes along the contact margin of both valves slightly dorsal to caudal process.

Radial pore canals appear straight. Adductor muscle scar pattern indistinct, anterior to sulcus.

Antennule. - Six segments; basal podomere longest, articulated distally, four or five very small spines on the ventral margin; second podomere with one dorsal sensory spine, a few very small spines on both margins; third podomere short, nearly fused to second, a dorsodistal sensory spine with a few secondary setae and a similar ventrodistal spine, both margins bearing a few very small spines; fourth podomere with one dorsodistal sensory spine bearing secondary setae, two similar ventrodistal sensory spines, both extending well beyond terminus, ventral margin bearing a few very small spines; fifth podomere distally articulated, bearing a short dorsodistal spine; sixth (terminal) podomere with seven long and one medium spine, two of long spines smooth and flattened and more finely segmented than others which have sparse secondary spines and forked tips.

Antenna. - Protopod large, no setae. Endopod a verruciform process bearing two lateral spines and a distinctive long terminal spine with secondary setae distally. Exopod of nine segments; basal podomere nearly as long as succeeding ones, no setae; second through eighth podomeres each bearing a long heavily pinnate natatory seta proximally

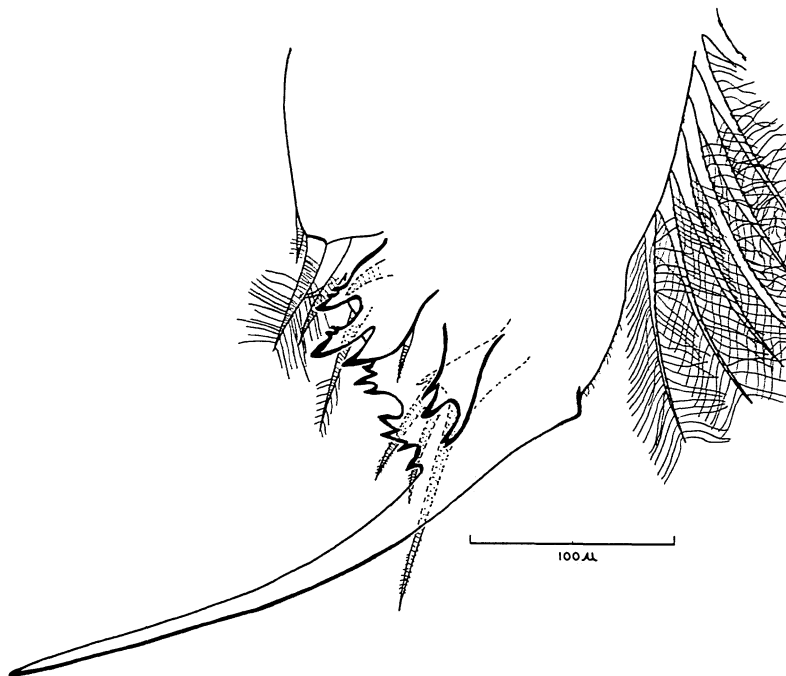

TEXT-FIGURE 10

Drawing of fifth limb of *Pseudophilomedes ferulana*

spinose on one margin; ninth (terminal) podomere bearing two long and one medium very pinnate setae, no marginal spines.

Mandible. - Basal podomere of protopod with a large distinctive forked masticatory process dorsally off distal end, each fork with three or four spines along margin; second podomere with two ventral setae, one proximal, one comparatively large heavily pinnate distal, and 3 large setae dorsally. Exopod reduced to two sparsely pinnate setae off a comparatively large basal ramus, and several small lateral spines. Endopod of three segments; basal podomere with two ventrodorsal pinnate setae; second podomere long, narrow, apparently a fusion of two segments, three large dorsal setae, one proximally, two at mid-point, and several small marginal setae and spines; third (terminal) podomere with about six terminal spines, one longer, more clawlike with distal subsetae.

Terminal portion protrudes from shell just beneath rostrum.

Maxilla. - With three principal rami, the proximal with three heavy spines bearing subspines and a sensory pinnate seta, easily broken off, middle ramus with two heavy spines bearing subspines and three setae; distal ramus with about seven pinnate basal setae of varying lengths, about four more distal pinnate setae and a large blunt distally segmented terminal process with sensory (?) granules on distal margin, curved forward. Dorsal margin of appendage hirsute.

Fifth limb. - Distinct for genus. Terminated in a long claw anteriorly directed; proximal margin of claw's base with three or four pronged elements, generally many

spinose elements at base of claw (text-fig. 10). Epipod with about 45 long very pinnate setae.

Sixth limb. - Essentially four lobed, anterior small, bearing one or two pinnate setae; second with two smaller pinnate setae and two long pinnate setae; third lobe with three or four smaller and two larger pinnate setae; posterior lobe relatively wide bearing five to seven typically pinnate setae along the margin and two posteriorly directed extremely pinnate setae, latter not striated normal to length, also with very fine secondary setae covering entire rounded surface rather than being in two rows as on others. A small posterior seta on the margin of basal podomere.

Seventh limb. - Typical of superfamily, vermiform, segmented; six setae of various lengths on terminal segment, five or six more proximally, generally shorter. The terminus typical opposing rows of very small setae.

Furca. - Terminated in seven to ten claws followed by a short broad spine (more an outgrowth of border chitin than with a distinct attachment as have claws). Distal claw with a secondary claw sagittally off the mid portion, not easily observed laterally. All claws with distinct secondary spines along exsagittal edge, larger proximally. Fourth claw broader and more blunt than others relative to length, this typical of genus. Number of claws not always equal on both sides.

Frontal organ. - Long, arising from a more-or-less bifid frontal ganglion; proximal half segmented; mid portion expanded; distal half smooth except for occasional small sensory hairs, tip sharply pointed and covered with sensory hairs.

Eye. - Paired; situated near base of antennule - anten-

na. Appear to have three or four large lenses separated around the central area of nerve tissue. Other globules attached to outside of anterior portion of ocular membrane, of unknown function. Tissue more granular than in large lenses.

Egg. - Not separate within posterior portion of shell, but encased within a transparent membrane, four to ten observed.

Habitat. - Taken from 141 to 429 feet of water, off-shore, salinity approximately 35 ‰.

Types. - Hypotypes UMMP nos. 48785, 1.404 mm long, 0.975 mm high; 48782, 1.404 mm long, 0.936 mm high; 48783, 1.52 mm long, 0.97 mm high; 48784; all females.

Remarks. - The specimen figured by Kornicker differs slightly in regards to the setae of the maxilla. The furca as drawn shows no secondary spines on the claws, nor the large secondary claw of the largest distal claw. This latter is difficult to see in lateral view. The furca has eight claws, and this is mentioned as a specific guide, however, in the specimens from the Sapelo Island area the number of claws is variable. The principal likeness is the blunt sensory distal process of the maxilla. There is no detailed description of shell features or soft parts given.

Three species of this genus have previously been described: P. foveolata Mueller (1894); P. angulata Mueller (1894); P. inflata (Brady & Norman, 1896) (= Paramekodon inflatus Brady & Norman). Males have been described only for P. foveolata (Philomedes foveolata, Brady & Norman, 1896), they were taken by net tows rather than from bottom samples; the planktonic occurrence may be connected with the sexual cycle as is known in species of Asterope and Philomedes. The males do not have the large distal claw on the fifth limb, although the fourth claw on the furca is enlarged as in the case of the female. Some species of Philomedes e.g. P. interpuncta Baird, as well as species of Cypridina and Sarsiella also exhibit the enlargement of the fourth furcal claw.

The two flattened antennular setae and the forked terminus of the other antennular setae are not exclusive generic characters, occurring in Philomedes and Sarsiella. The large claw of the fifth limb of the female is the most distinguishing generic character; the unusual distal maxillary process of P. ferulana is probably, as Kornicker states, of subgeneric value.

Discussion. - There is a pair of very pinnate long setae extending downward to the shell's edge from the vicinity of the base of the fifth limb, I was unable to ascertain the point of articulation.

The eggs were cellular clusters and showed no recognizable development at the date of capture.

The muscle-scar pattern was not distinct on the nearly non-calcareous specimens found; it appears to consist of three rows, the two posterior ones curved convexly toward the rear; the posterior row is of about five scars, the middle and anterior of about three. The lack of calcium carbonate in most of the shell prohibited mounting the specimens dry, and the removal of the body tends to tear the inner chitinous layer where the adductors attach. There is still enough calcium carbonate present to prevent mounting in CMC-S, an acid medium, so the whole mounts must be decalcified in 5 percent acetic acid.

Family RUTIDERMATIDAE Brady & Norman, 1896

The family is characterized by the presence of an articulating pincher (chela) on the mandible.

Genus Rutiderma Brady & Norman, 1896

Rutiderma dinochelata Kornicker (emended herein)

Pl. 13, figs. 1-9; pl. 14, figs. 1-7

Rutiderma dinochelata Kornicker, 1958, p. 236, figs. 46, 8a, b; 57, a-f; 58, a-d; 86, b, f, j.

Carapace. - Female: calcareous or noncalcareous, oval in lateral outline with a nodose margin. Posterior truncate with a caudal process. Rostrum downcurved, not overhanging incisure. Surface coarsely punctate, two prominent longitudinal ribs joined by a posterior vertical rib; faint radial ribs anteroventrally. Anterior and ventral margins with two sets of setae, one long emerging from thin radial pore canals, other a margin of very thin setae, so close as to form a nearly solid chitinous border extending outward about one-half the length of the major setae.

Interior of caudal process with an unusual hirsute, setiferous flange. Flange with a set of radial pore canals. A "reverse vestibule" exists beneath the flange. No portion of the main body mass of the animal extends into this area.

Adductor muscles form an anteroventral circular group of about 12 well spaced ovoid scars.

Antennule. - Five segments; basal podomere largest, no setae; second podomere with a dorsomedian seta, a distolateral seta; third podomere with two dorsoproximal setae, one dorsodistal seta, a ventroproximal seta, and two ventrodistal setae (one medium, other long) extending nearly as far as setae off terminal podomere; fourth podomere with one long ventrodistal seta; fifth (terminal) podomere very short, with five long setae with occasional secondary setae, three or four short setae.

Antenna. - Protopod large, ovoid. Endopod reduced to three or four short setae on a node (verruca). Exopod of nine segments; basal podomere with no setae; second through fifth podomeres each with a non-pinnate long seta with faint dorsal dentition; sixth through eighth podomeres each with a long pinnate natatory seta, ninth (terminal) podomere with four heavily pinnate setae.

Mandible. - Protopod of two segments; basal shortest with a small forked process off distal end; second podomere with four proximal setae, one median seta, and three distal setae. Endopod (?) of two segments, the distal podomere equipped with a very heavily chitinized pair of articulated claws. Claws with dentition along inner margins, a large spine in between claws, five or six short setae off distal podomere.

Maxilla. - Two principal endites, the proximal shortest, distally equipped with many spines, some with heavy subspines; second endite larger, of two segments; basal with two distal setae curving around terminus; second podomere short, distally equipped with about five short pinnate setae and two stout spines with sub-spines. Related in form to Sarsiella.

Fifth limb. - Distal portion of protopod equipped with about six heavily chitinized broad spines with broad multi-forked tips; a small lobe posterior to distal end of protopod (endopod ?) with about eight distal setae; a large "branchial" plate (exopod ?) with about 42 large pinnate setae.

Sixth limb. - Reduced. Platelike, lightly chitinized. Each plate of about four lobes, all with distal setae, the posterior lobe largest with about seven setae, the posterior setae becoming shorter and very hirsute.

Seventh limb. - Vermiform, segmented, bearing six terminal setae, four more proximally, all with typical cone-in-cone structure distally.

Furca. - Bearing four claws followed by two spines, hirsute proximally. Secondary spines on claws prominent, occurring in a series of alternating lengths.

Frontal organ. - Long, an expanded area at about mid-point.

Eye. - Only one seen. Four lenses, some bifid.

Habitat. - Taken from depths of 57 to 441 feet, offshore, salinities of 25 to 35 ‰. June through September.

Types. - Hypotypes UMMP nos. 48786, 48787, 48788, 48789, 48790; all females.

Remarks. - Although these animals differ somewhat from the photographs, drawings and descriptions of Kornicker, I have placed them in his species. The specimens from the vicinity of Sapelo Island have a stronger caudal process, the margin is more nodose, and the inner dentition of the mandibular chelae differs, note the proximal tooth and the spines (pl. 13, fig. 9); this particular dentition of the chela is the same in all specimens captured and is the same for both the right and left.

Kornicker uses the furcal claws as a specific character, stating (1958, p. 236): "The caudal furca bears three strong claws which show distinct demarcation lines at their bases, followed by two weak claws." Yet his drawing (fig. 57a) shows four strong claws followed by two weak ones. All specimens from near Sapelo Island have four strong and two weak claws.

Any variances between the populations at Bimini and Sapelo Island appear to be subspecific.

Discussion. - All specimens taken were bearing four eggs, each approximately 200 microns in diameter.

The

The stomach contents showed the remains of annelids, diatoms, and nearly whole large copepods, attesting to the use to which the mandibular chelae are put.

Rutiderma mollita, n. sp.

Pl. 15, figs. 1, 2

Carapace. - Female: weakly or noncalcareous, nodose margins, reduced rostrum and caudal process; longitudinal ribs faint. Surface lightly punctate, radial pore canals very thick and prominent, many branching. Flange on interior of caudal process much reduced.

Internal morphology. - The same as for R. dinochelata Kornicker, herein, except furca which has three strong claws followed by three reduced spines.

Habitat. - Taken from 65 feet of water of about 30 ‰ salinity, offshore. August.

Size and types. - Holotype UMMP 48791, female, length 1.44 mm, height 1.02 mm; paratype UMMP 48792, female, length 1.45 mm, height 1.05 mm.

Remarks. - Differs from R. compressa Brady & Norman (1896) in the nodose margin, the configuration of the ribs, the dentition of the mandibular chelae, and the secondary spines of the furca.

The morphology of the appendages is strikingly similar to R. dinochelata, even down to the position of individual setae. The character of the dentition on the claw of the mandibular chelae is the same, as well as the number and position of setae on the seventh limb. Only the furca differs.

Discussion. - Both females were bearing four eggs each.

Genus Astroteron Skogsberg, 1920

Astroteron oculitristis, n. sp.

Pl. 15, figs. 3-7; pl. 16, figs. 1-8

Carapace. - Male: weakly and irregularly calcareous; elliptical in outline, greatest height nearly at mid-point. Large rostrum directed ventrally, overhanging incisure. Principal sculpture a ridge paralleling margin, anterodorsally narrow and low, posterodorsally and ventrally becoming wide, high, steep with heavy irregular nodes which may project over margin. Distinctly incurved around rostral region. Surface essentially smooth with slightly raised porous (?) areas of irregular size, generally larger posteriorly, the pores (?) appear as irregular squarish patterns within the raised areas.

Anterior and ventral margins lined with setae, other rows on inner face of rostrum, along posterior contact margin.

Vestibule present. Radial pore canals thin, straight. Adductor muscle pattern circular, about 15 closely spaced scars slightly anteroventral to mid-point.

Antennule. - Six segments; basal podomere largest, no setae; second podomere articulated with basal, three or four setae along dorsal margin, distal two pinnate, margin hirsute; third podomere very short, fused at both ends, one ventrolateral seta, three comparatively large pinnate dorsal setae; fourth podomere with one dorsodistal pinnate seta, one ventrodistal pinnate seta, the latter projecting well beyond terminus of appendage; fifth podomere with one very long ventrodistal seta with striae ceasing at about mid-point, seta becoming smooth and forking, the forks also dividing; sixth (terminal) podomere with six long setae, two thinner and blunt, four larger and segmented, with numerous subsetae and a short heavy blunt spine, slightly curved dorsally.

Antenna. - Protopod large, ovoid. Endopod of three segments; basal podomere with four or five proximal setae; second podomere elongate with two small laterodistal

setae; third (terminal) podomere elongate, narrow, terminus bluntly rounded, a comparatively long thin seta off the proximal portion. Exopod of nine segments; basal podomere about as long as succeeding, one proximal seta; second through eighth podomeres each with a long heavily pinnate natatory seta, occasionally spinose along margin; ninth (terminal) podomere with two long natatory setae as preceding, one medium length pinnate seta, one short pinnate seta. All setae striated normal to length.

Mandible. - Protopod with nine distally pinnate ventral setae, four very short proximal setae not projecting beyond margin, four short dorsoproximal setae, three or four dorsodistal setae (one or two short, two long and pinnate). Exopod reduced, dorsally directed, two long setae off distal portion, tip pointed, hirsute. Endopod of three segments; basal with five ventral pinnate setae increasing in length proximally; second podomere with two or three ventrodistal setae and about 12 to 15 dorsal setae, generally increasing in length distally; third (terminal) podomere short, three or four short or medium setae and two long heavy nonpinnate setae. All setae striated normal to length.

Maxilla. - Protopod with six or more ventroproximal setae, two or three short setae ventrodistally, entire ventral margin lined with long distally flattened "baleen" bristles, two dorsoproximal setae, three dorsodistal setae (two short, one long). Endopod (?) with two to three short dorsal setae, terminus with five long pinnate setae and one short nonpinnate seta.

Fifth limb. - Highly modified. Comb ventrally lined with distally pinnate setae; a large pinnate seta (exopod ?) pointing forward from the mid-lateral area of comb. Epipod curved, ventral margin lined with very pinnate setae, broader and longer than those of comb.

Sixth limb. - Highly modified, flat, axe-shaped; rounded anteriorly, two endites, one with thin pinnate setae and other with heavier pinnate setae continuing along curved margin toward posterior which is pointed and hirsute with no terminal setae.

Seventh limb. - Vermiform, segmented, with about 20 typical setae, with distal cone-in-cone structure.

Furca. - Three principal claws increasing in size distally, all with spines of cyclical size along concave margin, hirsute on convex; followed by four pinnate setae decreasing in size proximally.

Gills. - Seven pairs.

Frontal organ. - Gently tapering distally to a rounded, slightly expanded tip. Central ganglion essentially bi-lobed.

Eye. - Paired, stalked, very strongly pigmented central area. Multifaceted, marginal lenses of variable size, the larger being directed ventrally toward substrate.

Habitat. - Taken from 59 feet of water, offshore, of salinity of about 25 ‰. August.

Size and types. - Holotype UMMP 48793, male, length 1.74 mm, height 1.08 mm, width 1.02 mm; paratype UMMP 48794, male, dimensions as holotype.

Remarks. - Both sexes were described for *A. fuscum* (Mueller, 1890a) and *A. agassizii* (F. Mueller, 1870); in both, the antennal endopod of the male differs from that of

the female, and strongly resembles that of the species herein. Only the female of *A. monambon* Kornicker is known. For the first two species there is no mention of sexual dimorphism in the shell, hence the species herein stands little chance of being the male of *A. monambon*, since it is readily distinguished from that and the other two species by the sculpture of the shell.

The unusual, but very functional, distribution of marginal lenses of the eyes has been noticed for *A. agassizii* (F. Mueller, 1870, pl. 9, figs. 15, 16, 20) in both sexes. Only the downward pointing larger lenses are drawn in these figures by Mueller. No eyes were found in *A. fuscum*; eyes are present, but not described in the case of *A. monambon*.

Genus *Cyclasterope* Brady, 1897

Cyclasterope biminiensis (Kornicker)
(emended herein)

Pl. 17, figs. 1-8; pl. 18, figs. 1-7;
pl. 19, figs. 1, 2

Cycloberis (misprint for *Cycloleberis*) *biminiensis*, Kornicker, 1958, p. 243, figs. 67a-d; 68a-f; 85a-e.

(?) *Cyclasterope brevis* (Mueller), Brady, 1902, p. 183, pl. 24, figs. 16-22, non *Asterope brevis* Mueller, 1890a, p. 239, pl. 25, fig. 10; pl. 26, fig. 7; pl. 27, figs. 7-10, 15, 16.

Carapace. - Male; slightly and irregularly calcareous; smooth, translucent, subcircular, rostrum downcurved over incisure. Margin of shell lined on inner edge with relatively widely spaced setae; two inner marginal rows, one approximately along edge of inner lamella, other in between in anterior portion - dorsally more or less merging with outer row. Probable line of concrescence close to outer margin posteriorly; radial pore canals straight, unbranched, profuse. Adductor muscle scar pattern of many (30-40) elongate scars arranged in a near-spiral pattern, typical of genus.

Antennule. - Six segments; basal podomere largest, comparatively wide, no setae; second podomere articulated with basal, no setae, slightly hirsute on borders; third podomere short with five or six dorsal setae, one very small ventrodistal seta; fourth podomere short, one dorsodistal seta and a long thin ventrodistal seta extending beyond end of appendage; fifth podomere longer, with three to five prominent dorsal nodes and a ventrodistal heavy distally branching seta; sixth (terminal) podomere very short, with a dorsodistal heavy curved claw, generally seven additional distal setae, some of which branch distally or along their margin into relatively large secondary setae which in turn terminate in smaller short setae.

Antenna. - Large protopod. Endopod reduced, three segments, generally three setae near base; second podomere with none or one seta; third (terminal) podomere bluntly rounded with a short curved seta at tip, a long smooth seta originating about half way back on segment (exception in largest specimen, four setae on basal podomere, no short terminal seta, long seta off tip; possibly a secondary sexual character, see remarks). Exopod of nine segments; basal podomere approximately the length of the succeeding eight, overlapping the second with a lateral toothlike process; second through eighth podomeres each with a marginal slightly curved blunt toothlike spine dis-

tally directed, the ninth occasionally with two. Second podomere with a segmented pinnate curved seta; third through eighth each with long segmented grossly pinnate natatory setae proximally bearing marginal spines; ninth (terminal) podomere usually with four pinnate setae, in adult two are long and toothed as in third through eighth podomeres.

Dimorphism. - See remarks.

Mandible. - Protopod with "scythe-shaped" process proximally directed off basal podomere (Skogsberg, 1920, p. 452); second podomere with a proximally directed process set with setae, some of which are distally pinnate, ventral margin with six to eight distally pinnate setae. Exopod reduced, non-muscular, dorsally directed, with two major distal setae. Endopod of three segments; first podomere with about five posterior setae; second podomere with about ten anterior setae and three posterodistal setae; third (terminal) podomere with two small setae, one long thin seta, and three long heavy setae-spines.

Maxilla. - Two endites on protopod with approximately five setae each. Exopod (?) dorsal, non-muscular, reduced, non-segmented; basal endite elongated generally bearing over 100 flattened, pinnate, long bristles ("baleen") distally along ventral margin, some secondary bristles ventrally and dorsally. Endopod with about five lightly pinnate distal setae.

Fifth limb. - Highly modified, comb ventrally lined with marginal pinnate setae, a large pinnate seta (exopod ?) pointing forward from mid area of comb; epipod curved, margin lined with thick very pinnate setae.

Sixth limb. - Highly modified, flat, axe-shaped, rounded anteriorly, pointed posteriorly; ventral margin rowed with short thick pinnate setae.

Seventh limb. - Vermiform, dorsally directed, segmented, distally equipped with varying numbers of setae, generally increasing in number with size of animal, distally with cone-in-cone structure; terminus surrounded by opposing rows of short blunt setae.

Furca. - Carried tucked up under body; four main pairs of curved claws with one or more rows of teeth along concave borders; a pinnate seta usually between third and fourth claw; fourth claw followed by three to six pinnate setae, depending on size of animal; margins of furcae hirsute.

Frontal organ. - Long, thin, probably unsegmented, non-muscular; base the so-called median eye (here no pigment seen).

Gills. - Seven pairs, posterodorsal.

Eye. - Stalked, oval, multifaceted, outer facets unpigmented. Covered with thin membrane.

Habitat. - Taken from 53 to 121 feet of water, offshore, salinity about 35 ‰. May and August.

Size and types. - Length of six specimens 1.59 - 3.20 mm; hypotypes UMMP nos. 48795, 48796, 48797, 48798, 48799, and 48800.

Remarks. - Mueller (1890a, p. 240) in a discussion of Cyclasterope (Asterope) brevis states that the differences of the endopod of the antennae are secondary sexual charac-

teristics. He believed those with a distal short seta, or none, and a long seta emerging further back on the terminal podomere indicate the male, and that the long seta originating at the tip indicates a female. He was, however, unable to describe or figure the sex organs "(Ich zweifle nicht daran, dass es sich hier um sekundäre Geschlechtsmerkmale handelt, obwohl ich mir über die Beschaffenheit der Geschlechtsorgane wegen mangelfafter Conservierung kein Urteil bilden konnte.)" C. brevis (Mueller) and C. biniensis (Kornicker) are very similar, and the form of the antennal endopod indicates this is the male. This relationship appears to be the same in other genera of the family, Asteropteron and Cylindroleberis. In the case of the species of Cylindroleberis described on the following pages, the vaginae could be seen on the specimen with the typical female antennal endopod.

Brady (1902, p. 183) describes ostracods from the West Indies, referring them to Cyclasterope brevis. He erred in stating that Mueller erected the species from a female specimen from off the South American coast. Brady undoubtedly got this idea from the stated source of C. americana, on the same page. Mueller had 16 specimens of C. brevis from off Enosima, Japan, which he divided, as just discussed, into male and female. Further complicating this is the fact that C. americana has five nodes on the fifth podomere of the antennule - as does the species Brady considered conspecific with C. brevis. C. americana has three furcal claws and Brady states the West Indies' specimens have four, therefore it is probable that he misread the source of Mueller's material, rather than the species name, and had no intention of assigning material to C. americana.

Mueller stated that C. brevis, from off Japan, has one node on the fifth podomere of the antennule; he does not figure this but says: "Erste Antenne mit einem stumpfen Zahn an dem fünften Glied (vergl. Fig. 9, Taf. xxvi, von A. dentata, wo 5 derartige Zähne vorhanden)." Mentally concerned with teeth, he called the figured antennule of C. (Asterope) americana "A. dentata," since this is the referred to figure; no such species as A. dentata exists.

C. biniensis differs from C. brevis in the presence of three to five nodes on the margin of the fifth podomere of the antennule, the presence of distal clawlike setae on the mandible, and probably in other ways since Mueller's description of the maxilla is incomplete, and the first and second thoracic legs are not mentioned. The setae arrangement on the seventh limb is too variable with growth to be a specific feature between these two species.

Discussion. - All specimens but the largest have an irregularly calcareous shell. They are, without exception, partially covered with calcareous spots. Mueller, 1890a, p. 239, also mentions this on the Japan specimens: "... , besteht aus derbem Chitin mit geringer Kalkablagerung."

Genus Cylindroleberis Brady, 1868b

Cylindroleberis psitticina, n. sp.

Pl. 19, figs. 5, 6; pl. 20, figs. 1-9

Carapace. - Oblong, rostrum curved downward overhanging narrow, comparatively deep, incisure. Surface smooth, no ornamentation. Short setae line interior of rostrum and inner side of anterior and ventral margins. Inner lamella wide anteriorly and posteriorly. Adductor muscle scar pattern apparently about ten round scars in circular area slightly anteroventrally of mid-point.

Dimorphism. The female is longer in relation to height.

Antennule. - Female: six segments, basal podomere with no setae; second podomere with a long dorsodistal pinnate seta, a very short ventrodistal seta, a short laterodistal seta; third podomere with seven dorsal pinnate setae, two shorter ventrodistal setae; fourth podomere with a large ventrodistal seta distally divided into about six bare sensory setae; fifth podomere with one laterodistal seta; sixth (terminal) podomere with a chitinous claw curved upward, five long setae, four with heavy subsetae.

Dimorphism. Male with six rather than seven dorsal pinnate setae on third podomere.

Antenna. - Female: protopod large, ovoid. Endopod of three weakly developed segments; a long seta off tip. Exopod of nine segments; basal podomere nearly as long as succeeding eight, no setae; second podomere with a comparatively short pinnate seta; third through eighth podomeres each with a long pinnate natatory seta, occasionally slightly spinose along proximal margin; ninth (terminal) podomere with one natatory seta, two shorter setae. Inner distal margin (margin opposite natatory setae) of each podomere with a very small spine.

Dimorphism. Male antenna heavier; third podomere of endopod with pointed tip, a long seta proximally off inner margin; ninth podomere (terminal) of exopod with four setae, two natatory, rather than three setae, one natatory, as in female.

Mandible. - Female: protopodite large, about seven ventral pinnate setae directed proximally, two long dorso-distal setae. Exopod reduced, tip hirsute with one small forked seta. Endopod of three segments; basal podomere with three long pinnate ventroproximal setae; second podomere with six long and three short dorsal setae, one long and two medium ventrodistal setae; third (terminal) podomere with a nearly straight chitinous claw, one or two stout setae, two shorter, thinner setae.

Dimorphism. Male mandible heavier, but essentially non-dimorphic. This individual has one more distal stout seta on terminus of endopod.

Maxilla. - Female: protopod with approximately six ventroproximal larger setae, one ventrodistal seta, two dorsoproximal seta and one dorsodistal seta, entire ventral margin lined with long distally flattened "baleen" bristles. Endopod (?) with one long proximal seta, terminus with two setae. Exopod (?) dorsal, reduced, unsegmented, pointed.

Dimorphism. Male with only one terminal seta on endopod (?).

Fifth limb. - Highly modified, comb ventrally lined with distally pinnate setae, a long forward directed lateral seta at mid-point (exopod?). Epipod curved, margin lined with many (45-50) long very pinnate setae.

No dimorphism observed.

Sixth limb. - Female: highly modified, axe shaped, flat, rounded anteriorly, tipped with approximately six short setae, one lateral and one dorsal setae proximally; ventral margin lined on posterior half with short pinnate setae; posterior not seen.

Dimorphism. Males not seen.

Seventh limb. - Female: vermiform, segmented, six setae on distal segments, six others proximally, all distally with cone-in-cone structure. Terminus with opposing rows of short blunt setae.

Dimorphism. Male with setae as in female, terminus appears "closed" rather than two opposing rows of short setae.

Furca. - Female. Six pairs of claws decreasing in size proximally, the larger with secondary spines along concave margin; a short seta follows claws. Claws easily broken out of sockets.

Dimorphism. Distal three claws of male more distinct in size from following, which are more spinelike.

Frontal organ. - Comparatively long and straight, simple, terminus rounded; a slight constriction proximal to mid-point. Male's possibly slightly shorter and thicker.

Gills. - Seven pairs (cf. *Cyclasterope biminiensis*, pl. 19, fig. 3).

Eye. - Female: absent or very reduced.

Dimorphism. Very prominent in male. About 20 separate lenses, some bifid, the larger marginal ones directed downward toward substrate. Stalked.

Habitat. - Taken from 45 to 405 feet of water, offshore, salinity about 25 to 35 ‰. September.

Size and types. - Holotype UMMP no. 48801, female, length 1.80 mm, height 0.57 mm; Paratype UMMP no. 48802, male, length 1.29 mm, height 0.59 mm.

Remarks. - The species may be differentiated from others whose shell shape is similar by the following: *C. setisparsa* (Kornicker, 1958, p. 239) possesses two short spines on the mid portion of the male antennal endopod (fig. 63b), the anterior of the sixth limb bears long setae, and the ventral margin has only one seta; only three long dorsal setae are on the second endopodal segment of the mandible. Although Kornicker states that the male of this species is unknown, he figures a male antennal endopod. Other figures of this same specimen are of the mandible, seventh limb, antennule, and an outline drawing of the shell. This latter figure shows the eyes. Since the absence of eyes in the female of this genus is so evident due to their prominence in the male, it is unlikely Kornicker would miss this dimorphism were it present. The female of *C. oblonga* as figured by Mueller (1894, pl. 8, fig. 4) (= *C. mariae* [Baird] 1850b, p. 257) also shows eyes. It is therefore probable that not all species of the genus exhibit this ocular sexual dimorphism.

The species herein differs from *C. oblonga* in the lack of eyes in the female, in the lack of two extremely long terminal setae on the antennule of the male, and the non-grasping form of the male antennal endopod.

C. elliptica (Philippi, 1840, p. 186) has a less elongate shell and different setation on the antennule.

C. grimaldi (Skogsberg, 1920, p. 510) has posterior setae on the shell of the male, and an antennal exopod with basal spines on the distal podomeres.

Discussion. - The female carried nine eggs within the shell.

Family Sarsiellidae Brady & Norman, 1896

Genus Sarsiella Norman, 1869

Characteristics of genus. - Carapace noncalcareous to strongly calcareous, heavily ornamented to nearly smooth; circular or subcircular in outline, with pronounced caudal process, rostrum generally present in males, generally absent in females (pl. 22, fig. 1, 2; pl. 25, fig. 3).

Antennule generally of five podomeres, possibly four in some species (pl. 21, fig. 2); male with sensory hairs off third podomere (Pl. 25, fig. 4).

Antenna with large protopod, heavily muscled for use in locomotion. Endopod in female reduced to a small verruca (node) with or without spines, in male less reduced, may be altered for grasping. Exopod of nine podomeres, distal eight with pinnate natatory setae (pl. 31, figs. 3, 4; pl. 25, fig. 7).

Mandible distinctive; basal podomere of protopod with a heavy internal chitinous support rod; last three podomeres (endopod ?) each usually with a distinctive curved claw off distal portion (pl. 24, fig. 4).

Maxilla distinctive; terminal podomere of endopod with five stout spines, usually with secondary spines, these are articulated to move as a unit sagittally, functioning as a feeding "hand"; penultimate podomere with two long setae curving around terminus (pl. 24, fig. 5; pl. 23, fig. 4).

Fifth and sixth limbs distinctive (pl. 31, figs. 5, 7).

Seventh limb vermiform in female, absent or reduced in male (pl. 30, fig. 5).

Frontal organ simple, blunt, club-shaped (pl. 21, fig. 1).

Eye paired, generally with five separated usually bifid lenses; male possibly dimorphic, up to ten lenses (pl. 21, fig. 1).

Habitat benthonic-nektonic, littoral.

Sarsiella nodimarginis, n. sp.

Pl. 21, figs. 1-8; pl. 22, figs. 1, 2

Carapace. - Female: calcareous. Circular with a prominent caudal process and a very nodose margin. An alar extension begins slightly anterior to mid-line, the anterior portion is rounded and enlarged, affording the base for adductor muscles. Ala widens posteriorly and is nodose on its margin; posterior portion abruptly truncated. Surface smooth, free margin lined with setae. Inner lamella narrow, radial pore canals thickened, apparently simple.

Antennule. - Five segments; basal podomere with no setae; second podomere with one dorsal seta; third podomere with one dorsoproximal seta, one ventroproximal seta, one dorsodistal seta, and three ventrodistal setae;

fourth podomere with one short distal seta; fifth (terminal) podomere with six long setae, one medium seta and one short seta, all nonpinnate, long setae tipped with a very small spine. All setae striated normal to length.

Antenna. - Protopod large, ovoid. Endopod a verruca with two lateral setae and a very small central seta. Exopod of nine segments; basal podomere long, no setae; second through eighth podomeres each with a long very pinnate natatory seta, some becoming proximally spinose along one margin; ninth (terminal) podomere with one long natatory seta as preceding plus a second shorter non-pinnate seta.

Mandible. - Typical of genus. Protopod with two segments; basal podomere elongate with a strong chitinous support rod; second podomere short, rounded, with four setae on inner margin, one seta on median outer margin, two distal setae on outer margin; last three podomeres (endopod ?) each with a long claw and two very small proximal setae on outer margin.

Maxilla. - Typical of genus. Terminus of endopod bearing five short blunt spines bearing secondary spines; three short setae more proximally on posterior portion; penultimate podomere with two long marginal setae curved around terminus. Coxa, pre-coxa essentially bilobate, larger lobe with about 10 spines, smaller with about six.

Fifth limb. - Typical of genus. Essentially asymmetrically bilobed, larger lobe with about eight setae, smaller with two; epipod with about 35 long thick very pinnate "branchial" setae.

Sixth limb. - Typical of genus. Terminal lobe with 15 to 26 faintly pinnate setae; posteriorly two long wide very pinnate setae.

Seventh limb. - Vermiform, segmented; terminus opposing rows of very short setae; terminal segment bearing six setae of varying lengths, four more setae 11 to 15 segments proximally - all with distal cone-in-cone structure.

Furca. - Five, occasionally four, major claws, larger with secondary spines along concave margin, claws followed by three or four minor spines. Gradation from major to minor claws is fairly constant, upon further growth animal might have more major ones.

Frontal organ. - Simple, comparatively short, club-shaped.

Eye. - Paired, medially situated, each with five bifid lenses; whole covered by a membrane.

Habitat. - Taken from 99 to 373 feet of water, offshore, of salinities from 25 to 35 ‰. August, September.

Size and types. - Holotype UMMP 48803, female, length 1.68 mm, height 1.44 mm; paratype UMMP 48804, female.

Remarks. - The species is readily distinguished by its shell characteristics.

Discussion. - The specimens each bore ten eggs of about 230 microns.

Sarsiella sculpta Brady (emended herein)

Pl. 22, figs. 3-8; Pl. 23, fig. 1

Sarsiella sculpta Brady, 1890, p. 516, pl. 1, figs. 17, 18 non 19, 20; Kornicker, 1958, p. 252, figs. 47 - 6a, b, 82d, e, 88d, k, e, o, s; (?) Brady, 1897, p. 93, pl. 17, figs. 12, 13.

Carapace. - Female: weakly and irregularly calcareous; subcircular, a broad caudal process posteroventrally. Contact margin slightly crenulate, occasionally with small secondary crenulations. Anterior and ventral margins with long setae which disappear posteriorly, except on caudal process. Highest point posterior of mid-line, wider posteriorly, abruptly sloped dorsally - posterodorsally. A distinct depression beginning anterior of mid-point, elongated toward caudal process. Surface coarsely and irregularly reticulate. Adductor muscle scar pattern slightly anterior to mid-line, consisting of about 12 circular or elongate scars which may be divided, spacing irregular. Radial pore canals straight.

Antennule. - Typical of genus. Five segments; basal podomere largest, distally articulated, no setae; second podomere with one dorsal seta; third podomere with one dorsoproximal seta, one dorsodistal seta, one ventroproximal seta, and three ventrodistal setae (two longest extending past terminal podomere); fourth podomere with one short distal seta; fifth (terminal) podomere very short, one short and six long setae. All setae striated normal to length.

Antenna. - Protopod large, ovoid. Endopod verruciform, one seta near base, directed toward base of exopod. Exopod of nine segments; basal podomere nearly as long as succeeding podomeres, no setae; second through eighth podomeres each with a long pinnate natatory seta, occasionally marginally spinose proximally; ninth (terminal) podomere with one long natatory seta as preceding and one short very finely pinnate seta. All setae striated normal to length.

Mandible. - Typical of genus. Protopod with two segments, basal large with heavy chitin support rod; second podomere with three or four spines on inner margin, one on outer; last three segments (endopod ?) each with a strong curved claw and a small distal spine on outer side.

Maxilla. - Typical of genus. Terminus of endopod with five short blunt very stout spines, each with two rows of secondary spines; two short setae proximally on posterior half of podomere; penultimate podomere with two long marginal slightly pinnate setae curving around terminus. Coxa, pre-coxa rounded, bearing about 15 spines, some with secondary spines.

Fifth limb. - Typical of genus. Terminal segment with three lobes, anterior bearing two spines distally; middle bearing three distal and one posterolateral spine; posterior division bearing two distal and one very short proximal spine. Epipod with about 35 long very pinnate "branchial" setae.

Sixth limb. - Typical of genus. Short, rounded, terminus bearing about 12 spines ventrally directed; two long pinnate posterior setae.

Seventh limb. - Vermiform, segmented, with six terminal setae of variable length, four more proximally,

all with distal cone-in-cone structure. Terminus with opposing rows of very short setae.

Furca. - Five major claws with secondary spines along concave margin, a small spine at posterior base of fourth and fifth claws; the two plates of the furcae somewhat more separated than usual.

Frontal organ. - Simple, club-shaped, the basal ganglion comparatively large.

Eye. - Paired, each with about five separated bifid lenses; whole covered by a membrane.

Habitat. - Taken from 121 feet of water, offshore, of salinity of about 34 ‰. July.

Size and types. - Holotype UMMP 48805, female, length 1.20 mm, height 0.96 mm.

Remarks. - The shell is less calcareous than other specimens reported by Brady and by Kornicker. It also has a less prominent caudal process, possibly due to the lack of CaCO₃. Since only one specimen was found, and it is very like descriptions of S. sculpta, I have tentatively placed the specimen found off Sapelo Island in that species.

The original description by Brady (1890) was only of the shell, and what appear to be two species were figured; I consider the first two drawings only as of S. sculpta. The original was taken in water of two to four fathoms in the South Seas (Noumea, etc.). Subsequently (1897) Brady figured a seventh limb and furca of a specimen from Flinder's Passage (off northeastern Australia ?), but did not figure the shell; hence there is no way of knowing which of the two sets of figures of the original description, 17-18 or 19-20, this specimen resembled. Kornicker figures these same two parts from a specimen from the Bahama Islands. The specimen from off Sapelo Island has less setae on the seventh limb than that of Kornicker, and the furca does not have proximal short spines following the major claws as do the specimens of both other authors.

Discussion. - Six eggs were found inside the specimen. Some were very near to hatching, but still within a membrane. No calcium carbonate was formed (the adult was only weakly calcified). The marginal setae of the shell and, remarkably, nearly all the appendages were well-developed. Only the sixth and seventh limbs were not seen, either because they had not been formed, or, in the case of the seventh limb, because they were males. The appendages did not stain well, since there was little muscle development; I noted that the antenna had all of its segments and setae. This is important in the identification of young instars, since in most species of the genus the young have antennae similar to those of the adult. The antennules have six long setae extending beyond the terminus, as does the adult, but they appear to originate within more proximal segments. Segmentation is difficult to ascertain in the antennules, but all appear to be there, although not in the precise form of the adult. The epipod of the fifth limb was noticed on several unborn specimens.

The chitinous outer lining of the vaginae were unusual in that the left one was only 42 microns in diameter while the right was 68 microns.

Sarsiella pilipollicis, n. sp.

Pl. 23, figs. 2-9

Carapace. - Female: slightly and irregularly calcareous. Elliptical outline, a very prominent posteroventral caudal process, ventrally directed. Shell prominently nodose. Nodes form three prominent lateral rows, dorsal row with additional nodes posteriorly, margin nodose. Nodes bear many sensory setae, generally one more prominent. Surface reticulate, small sensory hairs border reticules. Anterior and ventral margins with long setae, entire margin and submargin with short setae. Radial pore canals straight, thin, profuse. Adductor muscles attach anteroventrally of central area, seven to ten scars, some bifid, no distinct pattern.

Antennule. - Five segments; basal podomere longest, no setae; second podomere articulated with basal, one dorsodistal seta; third podomere fused to second, one dorsodistal seta, one dorsoproximal seta, one ventroproximal seta, and two ventrodistal setae extending beyond terminus of appendage; fourth podomere articulated with third, three or four short distal setae; fifth (terminal) podomere with six long terminal seta, four pointed, rarely with secondary setae, and two blunt. All setae striated normal to length.

Antenna. - Protopod large, ovoid. Endopod a verruca bearing two lateral spines directed toward base of exopod. Exopod of nine segments; basal podomere about as long as succeeding, no setae; second through eighth podomeres each bearing a long pinnate natatory seta; ninth (terminal) podomere with one long natatory seta as preceding and one short nonpinnate seta.

Mandible. - Typical of genus. Basal segment of protopod large, elongate, with a heavy chitinous support rod; second podomere with about four short spines on inner margin. Last three podomeres (endopod ?) each with a large curved terminal claw and a very short spine on the outer distal edge of each podomere.

Maxilla. - Typical of genus. Terminus of endopod with five stout spines, each with heavy secondary spines, the anterior one curved distally toward posterior, more pointed; two short spines more proximally on posterior inner portion; penultimate podomere with two long marginal spines curving around terminus; coxa, pre-coxa bilobate with about 12 spines.

Fifth limb. - Typical of genus. Terminus rounded, asymmetrically bilobed, larger lobe with approximately nine setae, smaller, anterior, lobe with two setae; a short seta more proximally off anterior portion; epipod with about 33 long very pinnate broad "branchial" setae.

Sixth limb. - Typical of genus. Terminus broadly rounded, very asymmetrically bilobed, smaller anterior lobe bearing three short setae, larger bearing about 12 finely pinnate setae ventrally directed; posteriorly with two broad, less chitinous, very pinnate setae.

Seventh limb. - Vermiform, segmented, terminus with opposing rows of very small setae; six terminal setae,

some very reduced, two other setae about ten segments proximally, all with distal cone-in-cone structure.

Furca. - Five major claws, distal one very large, distal three with secondary spines along concave margin; followed by three or four small marginal spines.

Frontal organ. - Short, club-shaped, off an essentially bilobed ganglion.

Eye. - Not observed.

Habitat. - Taken from 373 feet of water, offshore, of salinity of about 35 ‰. September.

Size and types. - Holotype UMMP 48806, female, length 1.37 mm, height 1.17 mm.

Remarks. - The species is easily distinguished from others of the genus by the setiferous nodes on the shell.

Discussion. - The specimen bore ten eggs. It had portions of several copepods in its stomach, one about one-third the body size of the ostracod, and relatively complete!

Sarsiella radiicosta, n. sp.

Pl. 24, figs. 1-11; pl. 25, fig. 1

Carapace. - Female: calcareous, subcircular, a blunt caudal process posteroventrally; caudal process with interior vestibule. Anterior and ventral margins very slightly crenulated. Two principal positive areas, one slightly ventral of mid-point, other posterodorsal of mid-point. Anteroventral region marked by faint radial ribs originating from a more ventral positive area. Entire surface slightly punctate. Setae approximately 30 microns long along anterior and ventral margins.

Radial pore canals not evident.

Adductor muscle pattern a group of about 12 circular comparatively widely spaced scars.

Antennule. - Five (?) segments; setation variable with age; basal podomere largest, no setae; second podomere with a dorsomedian seta; third podomere with one long and one short ventrodistal setae, one short ventroproximal seta, one dorsodistal seta, and one dorsoproximal seta; fourth podomere with two short distal setae; fifth (?) (terminal) podomere very short, indistinctly separated, possibly not a real podomere, seven terminal setae, two medium, five large and nonpinnate. All setae striated normal to length.

Antenna. - Protopod large, ovoid. Endopod verruciform, no setae observed. Exopod with nine segments; basal nearly as long as succeeding podomeres, no setae; second through eighth podomeres each with a long very pinnate natatory seta, subsetae becoming spinose along proximal margin. Ninth (terminal) podomere with two setae, one as preceding, other short and apparently nonpinnate.

Mandible. - Typical of genus. Basal podomere elongate, large, with a heavy chitinous support; second podomere short with a small dorsodistal seta, a small ventrodistal seta. Last three podomeres (endopod ?) each with a long terminal claw, distal longest, each with a short distal seta off outer margin.

Maxilla. - Typical of genus. Terminus of endopod with five stout claws, each with heavy secondary spines, the anterior one curved distally toward posterior, and two short spines more proximally on posterior inner margin; penultimate podomere with two long marginal setae curving around terminus; coxa, pre-coxa essentially bilobate with about 15 spines.

Fifth limb. - Typical of genus. Terminus rounded with about five spines distally; epipod with over 30 large very pinnate "branchial" setae.

Sixth limb. - Typical of genus. Terminus broadly rounded, asymmetrically bilobed, larger lobe bearing about ten ventrally directed setae, smaller lobe with about four short setae; posteriorly with two broad, less chitinous very pinnate setae.

Seventh limb. - Vermiform, segmented, generally four setae near terminus, four to others eight to twelve segments proximally, all somewhat blunt and stout, with typical cone-in-cone distal structure. Terminus with opposing rows of very short setae.

Furca. - Five curved principal claws, larger with irregularly sized secondary spines along concave margin; none to two very small spines proximally follow claws.

Eye. - Paired, not generally visible through shell, appear red under reflected light, six separated lenses.

Habitat. - Taken from 81 feet of water, offshore, of a salinity of about 25 ‰. April, May.

Size and types. - Holotype UMMP 48807, female, length 0.975 mm, height 0.775 mm; paratypes UMMP nos. 48808, female; 48809, female.

Frontal organ. - Comparatively thick, medium length, simple, rounded terminus.

Remarks. - The most diagnostic features of this species are the shape of the shell, the length and position of the anteroventral ribs, and the lack of setae on the antennal endopod. The species is closely allied to both *S. capsula* Norman (1869) and *S. costata* Kornicker (1958), but does not have the long dorsal ridge of either; when viewed dorsally the species herein shows two positive areas, not a lateral ridge.

Sarsiella georgiana, n. sp.

Pl. 25, figs. 2-9

Carapace. - Male: chitinous, ovoid, a blunt rostrum and large caudal process. Ventral margin nodose, anterior most node largest. Ventral margin and inner margin of inner lamella lined with large setae. Three posterior marginal nodes, two prominent, one at mid-line, other dorsal, third much reduced, posteroventral. Each tipped with a long sensory seta. Surface essentially smooth. Ornamentation consists of a three part lateral extension, central

juncture slightly posteroventral to mid-point; one extension directed anteriorly, one posteroventrally, and a third postero dorsally, latter expanded into a dorsally directed ala with a process terminally bearing a long sensory seta.

Radial pore canals not easily observed, apparently straight.

Adductor muscles attach within central portion of lateral ornamentation, scars therefore spread over a curved surface, not prominent.

Antennule. - Five segments; basal podomere with no setae; second podomere with one dorsodistal seta; third podomere with one dorsoproximal seta, one dorsodistal seta and two ventrodistal units - one a very long non-pinnate seta extending as far as terminal setae of appendage, other, typical in males of the genus, a mass of hundreds of sensory hairs depending like medusoid tentacles; fourth podomere with a short distal seta; fifth (terminal) podomere with two short, one medium, and five long nonpinnate setae with secondary setae along their length. All setae striated normal to length.

Antenna. - Protopod typically large, ovoid. Endopod with three segments; basal podomere with two very short lateral spines; second podomere with three comparatively large stout spines; third (terminal) podomere curved as a clasping organ and tipped with a small spine. Exopod of nine segments; basal nearly as long as succeeding eight, no setae; second through eighth podomeres each with a long pinnate natatory seta, proximal secondary setae being somewhat spinose on one margin of second podomere's seta; ninth (terminal) podomere with two setae, one as preceding, other much shorter and nonpinnate.

Mandible. - Typical of genus. Three terminal segments (endopod ?) each with a stout claw. Comparatively smaller than in female. A stout seta on convex margin of penultimate podomere, a small seta on concave margin of terminal podomere.

Maxilla. - None seen.

Fifth limb. - Only epipod seen; typical of genus, with about 35 very pinnate "branchial" setae.

Sixth limb. - Typical of genus. Subcircular ventrally, about ten long and eight shorter very pinnate setae on margin in two rows; two typical long very pinnate setae extended posteriorly.

Seventh limb. - Not present on male.

Copulatory appendage. - Paired, highly modified, terminated by one large and one smaller chitinous claw both curved anteriorly; a small spine between them. A tubule and some glandular tissue visible just proximal to claws. A large muscle along anterior margin.

Furca. - Five major claws with secondary spines of cyclical size along concave margin; claws followed by a few very small marginal spines.

Frontal organ. - Short, simple, club-shaped.

Eye. - Paired, each with about ten bifid lenses of different sizes, generally not in contact and forming no distinct pattern. Whole covered by a thin membrane.

Habitat. - Taken from 81 feet of water, offshore, salinity about 25 ‰. July.

Size and types. - Holotype UMMP 48810, male, length 1.09 mm; height 0.62 mm.

Remarks. - Only a male was found. The specimen did not bear any seventh appendage that could be seen. As Skogsberg (1920, p. 88) has stated: "... we know that in the males of this genus [*Sarsiella*] the 7th limb is quite absent." Mueller (1894, p. 72) commented that the seventh appendage is rudimentary to the point of uselessness for cleaning, and the posterior portion of the shell and the appendages become fouled.

I was unable to observe even vestigial traces of a male seventh appendage.

Kornicker (1958, p. 286, fig. 75c) figured a seventh appendage of a male of *S. carinata* Scott (1905) which is very typical of the female seventh appendage except for the absence of the terminal opposing rows of very short spines. There is no doubt of it being a male, since a penis is also figured. Unfortunately Kornicker did not describe or figure the internal anatomy of the male of his new species, *S. gigacantha*, although he found three and the line drawing of the shell shows close affinities with the species herein. Kornicker may have been unaware that males have, to my knowledge, never been found with a developed seventh limb, and does not comment upon his finding one.

S. gigacantha Kornicker has a less nodose ventral margin, and the juncture point of the lateral ornamentation is somewhat anterodorsal to the mid-point, whereas it is posteroventral in the species herein. Kornicker did not describe the maxilla of his species, nor can I; it is probably very reduced.

The male differs principally from *S. carinata* Scott in having a complex antennal endopod as compared with the simple one of that species, in having three mandibular claws rather than two, and in having a non-segmented frontal organ.

The posterior nodes and the nodose margin separate this species from *S. zostericola* Cushman (1906) although the appendages are quite similar.

Sarsiella rousei, n. sp.

Pl. 25, figs. 10-12; pl. 26, figs. 1-3

Carapace. - Female: subcircular, rounded caudal process posteroventrally. A very slight anterior rostrum, more evident on left valve, presence atypical of female of genus. Tumid, steeply sloped posteriorly. Surface reticulate, interstices covered with raised hollow tubercules. Margin hispid, ventrally bordered with long setae. Radial pore canals straight, apparently unbranched. Adductor muscle scar pattern not seen.

Antennule. - Five segments; basal podomere with no setae; second podomere articulated with basal, with one dorsal seta; third podomere with one dorsoproximal seta, one dorsodistal seta, one ventroproximal seta, and two or three long ventrodistal setae extending past terminus; fourth podomere articulated with third, two dorsal setae; fifth (terminal) podomere short, with six long setae, two blunt (sensory?), four pointed. All setae striated normal to length.

Antenna. - Protopod large, ovoid. Endopod verruciform, a comparatively long finely pinnate seta distally, two short lateral setae directed toward base of exopod. Exopod of nine segments; basal podomere nearly as long as succeeding podomeres, no setae; second through eighth podomeres each with a long pinnate natatory seta which is proximally spinose along one margin; ninth (terminal) podomere with two terminal setae, one long pinnate natatory and one short nonpinnate.

Mandible. - Typical of genus. Basal podomere elongate, large, with a heavy chitinous support; second podomere with about three short setae off inner margin; last three podomeres (endopod?) each terminated with a long claw, each with a short distal seta off outer margin.

Maxilla. - Typical of genus. Terminus of endopod with five stout claws, each with heavy secondary spines, the anterior one curved distally toward posterior and more pointed, two short spines more proximally on posterior inner margin; penultimate podomere with two long marginal setae curving around terminus; coxa, pre-coxa essentially bi-lobate with about 12 spines.

Fifth limb. - Typical of genus. Terminus rounded, asymmetrically bilobed, the larger with five setae, smaller with two; a short spine more proximally off anterior portion; epipod with about 30 very pinnate broad "branchial" setae.

Sixth limb. - Typical of genus. Terminus broadly rounded, asymmetrically bilobed, larger bearing about ten ventrally directed setae, smaller with about three short setae; posteriorly with two broad, less chitinous, very pinnate setae.

Seventh limb. - Vermiform, segmented; terminus opposing rows of very small spines, six terminal setae of varying lengths, two more about seven segments proximally, all with distal cone-in-cone structure.

Furca. - Five principal claws decreasing in size proximally, each bearing small spines along concave margin, followed by about three very small marginal spines.

Frontal organ. - Short, club-shaped, off a subspherical somewhat bilobed ganglion.

Eye. - Paired, each with five separate lenses, all somewhat bifid. Whole encompassed by a membrane. Comparatively large.

Habitat. - Taken from 77 to 96 feet of water, offshore, salinity of about 32 ‰. July and August.

Size and types. - Holotype UMMP 48811, female, length 1.26 mm, height 0.96 mm, width 0.78 mm maximum; paratype UMMP 48812, female, length 1.13 mm, height 0.94 mm.

Remarks. - The species is easily differentiated from other known species of the genus by the structure and hispid nature of the shell. The presence of a slight rostral incisure, probably not providing any permanent opening in the shell in this species, is atypical of females of the genus. The female is often generically described as having no antennal sinus or rostrum (e.g. Treatise, 1961, p. Q403) although Scott (1905, p. 368, pl. 1, fig. 3) described and figured a female, *S. gracilis*, with a small, but distinct, rostrum.

Discussion. - The holotype had four eggs inside the posterior of the carapace.

The species is named for Mr. James Rouse, Captain, R. V. KIT JONES.

Sarsiella angusta, n. sp.

Pl. 26, figs. 4-6

Carapace. - Female: chitinous, elliptical in outline, very thin. A posteroventral caudal process. Surface smooth, sole ornamentation a ridge just inside and parallel to margin. Margin finely nodose. Long setae along anterior and ventral margin. Adductor muscle scars indistinct, apparently eight or more circular, occasionally bifid or trifid scars in irregular pattern.

Antennule. - Five segments; basal podomere largest, no setae; second podomere articulated with basal, with one dorsodistal seta, three or four very small dorsal marginal spines; third podomere fused to second, with two dorsal setae, one proximal - one distal, two ventrodistal setae extending beyond terminus; fourth podomere articulated with third, with two distal setae; fifth (terminal) podomere very short, with six long setae, four pointed, two blunt. All setae striated normal to length.

Antenna. - Protopod large, ovoid. Endopod verruciform with two lateral setae directed toward base of exopod. Exopod of nine segments; basal approximately as long as succeeding, no setae; second through eighth podomeres each with a long pinnate natatory seta; ninth (terminal) podomere with two setae, one long natatory as preceding, one short, non-pinnate.

Mandible. - Typical of genus. Basal podomere large, elongate with a heavy chitinous support; second podomere with about four short setae off inner margin, two off outer margin. Last three podomeres (endopod ?) each terminated with a long claw, each with a short distal seta on the outer margin.

Maxilla. - Typical of genus. Terminus of endopod with five stout claws, each with heavy secondary spines, two short spines more proximally off posterior inner surface; penultimate podomere with two long marginal setae curving around terminus; coxa, pre-coxa essentially bilobate with about 12 spines.

Fifth limb. - Terminus rounded, asymmetrically bilobed, the smaller anterior, with two terminal setae, the larger with seven setae; a short seta more proximally off anterior portion; epipod with over 20 long very pinnate broad "branchial" setae.

Sixth limb. - Terminus broadly rounded, very asymmetrically bilobed, the smaller anterior lobe bearing three short setae, larger bearing about seven finely pinnate setae ventrally directed; posterior with two broad, less chitinous, very pinnate setae.

Seventh limb. - Vermiform, segmented, terminus with two opposing series of short spines, six terminal setae of varying lengths, four more setae seven to ten segments proximally, all with distal cone-in-cone structure.

Furca. - Five curved claws increasing in size distally, each with secondary spines along concave margin.

Frontal organ. - Short, club-shaped, off an essentially bilobed ganglion.

Eye. - Paired. Five separate lenses, whole encased by a membrane.

Habitat. - Taken from 41 feet of water, offshore, salinity about 25 ‰. September.

Size and types. - Holotype UMMP no. 48813, female, length 1.44 mm, height 1.08 mm, width 0.45 mm maximum.

Remarks. - The thinness and simplicity of the shell suffices to differentiate this from other known species.

Sarsiella greyi, n. sp.

Pl. 27, figs. 1-10; pl. 28, figs. 1-7

Carapace. - Weakly or irregularly calcareous. Subcircular, somewhat flattened along hinge line; a comparatively long caudal process posteroventrally. Anterior and ventral margins somewhat nodose, occasionally nodes on posterior. Surface smooth to slightly reticulate; gently sloped laterally, expanded posterodorsally into a hollow "wing," the interior acting as a brood pouch. Free margin lined with numerous long setae, occasional setae on lateral surface. Adductor muscle scar pattern central, apparently seven or eight rounded subdivided scars in irregular pattern.

Dimorphism. Alar extension (brood pouch) reduced in male (?).

Antennule. - Five segments; basal podomere longest, no setae; second podomere with one dorsal seta; third podomere with one dorsoproximal seta, one dorsodistal seta; one small ventroproximal seta, and two ventrodistal setae; fourth podomere with two distal setae; fifth (terminal) podomere with six long nonpinnate setae with occasional secondary setae, four pointed and two blunt. All setae striated normal to length.

No dimorphism observed.

Antenna. - Female: protopod large, ovoid. Endopod a verruciform process terminated by a small spine, two lateral setae directed toward base of exopod. Exopod of nine segments; basal podomere nearly as long as succeeding, no setae; second through eighth podomeres each with a long pinnate natatory seta, proximally becoming spinose along margin; ninth (terminal) podomere with one natatory seta as preceding, one short nonpinnate seta.

Dimorphism. Endopod of male (?) a verruciform process as in female, also with two lateral setae. Terminus a node with two setae, right and left alike, apparently not fitted for grasping.

Mandible. - Typical of genus. Basal podomere of protopod large, with heavy chitinous support rod, a hirsute bulge posterodistally; second podomere with four short and one large setae along inner margin, two short setae on outer distal edge. Last three podomeres (endopod ?) each terminated with a large claw, each with a small spine on outer distal edge.

No dimorphism observed.

Maxilla. - Typical of genus. Terminus of endopod with five stout spines with heavy secondary spines, proximally two setae off posterior half; penultimate podomere with two long marginal setae curving around terminus; coxa, pre-coxa of about three nodes, each very spinose, some with secondary spines.

No dimorphism observed.

Fifth limb. - Typical of genus. Terminal podomere bilobate, posterior lobe with five setae, anterior with three; penultimate podomere directed anteriorly, terminated with two long setae; epipod with about 35 broad very pinnate "branchial" setae.

No dimorphism observed.

Sixth limb. - Typical of genus. Terminus rounded with about 14 setae in two longitudinal rows; posteriorly two broad, less chitinous, very pinnate setae.

No dimorphism observed.

Seventh limb. - Female: vermiform, segmented; terminal segment with six setae of varying length, two to four more ten to fifteen segments proximally, all with distal cone-in-cone structure. Terminus with opposing rows of very short setae. In central portion of distal third of appendage are chitinous vertebraelike supports.

Dimorphism. Appendage not observed in male (?).

Furca. - Five major claws, larger with secondary spines along concave margin followed by three to five marginal spines.

No dimorphism observed.

Frontal organ. - Short, club-shaped, off a somewhat bifid basal ganglion.

No dimorphism observed.

Eye. - Female: paired, each with five separated distinctly bifid lenses. Whole covered by a membrane.

Dimorphism. Male (?) has non-bifid lenses.

Habitat. - Taken from 81 feet of water, offshore, salinity of about 25 ‰. July.

Size and types. - Holotype UMMP 48814, female, length 1.14 mm, height 1.02 mm; paratypes UMMP 48816, male (?) length 1.09 mm, height 0.936 mm; UMMP 48815, female, length 0.90 mm, height 0.84 mm.

Remarks. - The structure of the carapace serves to differentiate this from other known species.

Discussion. - The male, if it is the male, is quite unusual for the genus. There is no rostrum and no setiferous process on the antennule which are characters of all previously described *Sarsiella* males known to the author. Neither antennal endopod is formed for clasping. The only masculine features are the absence of a seventh limb and the possession of what appear to be near-vestigial copulatory appendages. Conceivable, the latter could be the posterior portion of a parasitic degenerative isopod, similar to one described by Sars (1889, pl. 97, fig. 5). The growth of the seventh limbs would have been inhibited by the parasite.

Both females were bearing eggs, the larger holotype had eight in each brood pouch, the smaller paratype had four in each; the size difference in these mature adults may indicate post-maturation molting.

The species is named for Mr. Milton S. Grey, who collected and gave it to the author.

Sarsiella tubipora, n. sp.

Pl. 29, figs. 1-11

Carapace. - Female: irregularly calcareous; subcircular in outline, somewhat flattened along hinge line; a distinct posteroventral caudal process. Central portion of valve essentially flat, posteriorly steeply sloping to margin, otherwise gently sloped. Surface very reticulate. Inter-reticulate area covered with large pores which are raised above the surface as tubes with a distal expansion. Margin edged with tube-pores and with large setae anteriorly extending ventrally and disappearing posteriorly except at caudal process. Adductor muscles attached anteroventral to mid-point, appear to be below reticules, about 12 ovoid, occasionally divided, scars in irregular pattern.

Antennule. - Five segments; basal podomere largest, no setae; second podomere with one dorsal seta; third podomere with one dorsodistal seta, one dorsoproximal seta, one ventroproximal seta, and two ventrodistal long setae extending beyond terminus of appendage; fourth podomere with one distal seta; fifth (terminal) podomere short, with six long terminal setae, one shorter on right appendage, two shorter on left. All setae striated normal to length.

Antenna. - Protopod large, ovoid. Endopod verruciform, two short spines near base directed toward base of exopod, a comparatively long very finely pinnate spine off the terminus. Exopod of nine segments; basal podomere nearly as long as succeeding, no setae; second through eighth podomeres each with a long pinnate proximally spinose natatory seta; ninth (terminal) podomere with one long and one short pinnate setae.

Mandible. - Typical of genus. Large ovoid basal segment of protopod with heavy chitinous support rod; second podomere with two medial spines on posterior margin and one distal spine on posterior margin; last three podomeres (endopod ?) each with a long curved distal claw and a small distal spine on outer margin.

Maxilla. - Typical of genus. Terminal podomere of endopod with five broad blunt spines bearing two rows of strong secondary spines, distal portion of anteriormost spine thinner and finely pinnate; two more proximal setae on posterior portion. Penultimate podomere with two long finely pinnate setae curving around terminus.

Fifth limb. - Typical of genus. Terminus rounded, lobate. A small anterior lobe off penultimate podomere with a short terminal seta; a larger anterior lobe off terminus with two setae, principal lobe with four distal setae, one proximal. Epipod with more than 20 long broad, weakly chitinous very pinnate "branchial" setae.

Sixth limb. - Typical of genus. Rounded, lobate; small anterior lobe with one to three setae, large terminal lobe with about 12 smooth to finely pinnate setae extending downward; two broad, less chitinous very pinnate setae posteriorly. Posterior margin hirsute.

Seventh limb. - Vermiform, segmented; distal segment with six setae, two other setae about eight segments proximally, all with cone-in-cone structure distally. Terminus with opposing rows of very small setae.

Furca. - Five major claws with secondary spines along concave margin, followed on left plate by about eight smaller spines; on right three smaller spines between claws three and four, about five follow fifth claw.

Frontal organ. - Simple, club-shaped.

Eye. - Paired, with five separated bifid lenses. Whole covered by a membrane.

Habitat. - Taken from 121 feet of water, offshore, of salinity of about 30 ‰. July.

Size and types. - Holotype UMMP 48817, female, length 1.55 mm, height 0.98 mm.

Remarks. - The species is easily recognized by its unusual pores.

Discussion. - The specimen bore a cluster of six eggs, mutually attached, one in center bounded by five others.

Sarsiella disparalis, n. sp.

Pl. 30, figs. 1-7; pl. 31, figs. 1-8

Carapace. - Female: very weakly calcareous. Sub-circular, anterior and ventral margins slightly crenulate. A posteroventral caudal process. Surface comparatively smooth. Ornamentation of valves extremely variable in degree, not so much in morphology; consists of a large median horizontal ridge with anterior and posterior alar projections, a shorter dorsal ridge also with anterior and posterior extensions, and a ventral ridge with an extension at about mid-point. A median posterior node usually occurs at margin. Dorsal and ventral marginal ridges may be lacking and median ridge reduced to a low elongate mound. This may occur on only one valve of a specimen. Some specimens fairly symmetrical; on very asymmetrical ones, lack of ornamentation was on left valve. Anterior and ventral margins bear setae. Inner lamella slightly spinose posteriorly. Radial pore canals simple, unbranching. Adductor muscles attach in hollow of anterior alar portion of median ridge, difficult to distinguish scar pattern; apparently a small central cluster of about seven closely spaced scars with about eight more, some bifid, around these.

Antennule. - Five (?) segments; basal longest, no setae; second podomere with one dorsal seta; third podomere with one dorsoproximal seta, one dorsodistal seta, and two ventrodistal long setae extending past terminus of appendage; fourth podomere with one short distal seta; fifth (terminal) podomere very short, indistinctly separated, possibly not a true podomere, usually four long pointed setae, two shorter blunt setae, and two short setae. All setae striated normal to length.

Antenna. - Protopod large, ovoid. Endopod a verruciform process with two short lateral setae pointing toward base of exopod, a very short seta on terminus. Exopod of nine segments; basal podomere nearly as long as succeeding, no setae; second through eighth podomeres each with a long pinnate natatory seta; ninth (terminal) podomere with two terminal setae, one as preceding, other shorter, only slightly pinnate. All setae striated normal to length.

Mandible. - Typical of genus. Basal podomere of protopod large, with a heavy chitinous support rod; second podomere with two or three setae on outer margin, three or four on inner. Last three podomeres (endopod ?) each with a long distal claw and a short distal spine on outer margin.

Maxilla. - Typical of genus. Terminal podomere with five heavy blunt spines with coarse secondary spines, two smaller setae proximally off posterior half; penultimate podomere with two finely pinnate marginal setae curving around terminus; coxa, pre-coxa rounded terminally with a total of about 15 spines.

Fifth limb. - Typical of genus. Terminus asymmetrically bilobed, smaller lobe with two long setae, larger with about five. Epipod with about 40 long very pinnate "branchial" setae.

Sixth limb. - Typical of genus. Terminus asymmetrically bilobed, rounded, distally bearing about 12 faintly pinnate stout setae, posteriorly bearing two large less chitinous pinnate setae.

Seventh limb. - Vermiform, segmented; six terminal setae, four proximally at intervals, all with distal cone-in-cone structure. Terminus with opposing rows of very short setae.

Furca. - Five major claws with secondary spines along concave margin, followed by about two very minute spines.

Frontal organ. - Simple, club-shaped, basal ganglion large with pigmented tissue.

Eye. - Paired, each with five separated bifid lenses. Whole covered by a membrane.

Habitat. - Taken from 41 to 61 feet of water, offshore, of salinities of about 25 ‰. August, September.

Size and types. - Holotype UMMP 48819, female, length 1.50 mm, height 1.26 mm; paratypes UMMP 48818, female, length 1.44 mm, height 1.20 mm; 48820. Five specimens found.

Remarks. - The unusual features of shell morphology serve to differentiate this from other known species.

Discussion. - Both females dissected bore six eggs which appeared to be in various stages of development. About five more eggs were still within the body mass.

Superfamily Halocypridacea Dana, 1852

Family Halocyprididae Dana, 1852

Genus *Euconchoecia* Mueller, 1890b

Euconchoecia chierchiae Mueller

Pl. 32, figs. 1-9; pl. 33, figs. 1-9

Euconchoecia chierchiae Mueller, 1890b, p. 277, pl. 28, figs. 1-10; Skogsberg, 1920, p. 740, figs. 148-151.

Carapace. - Noncalcareous. Rostrum pointed, deeply incised, female with spine on tip of left rostrum. Right posterior spine on both sexes. Posterior gland openings symmetrical, slightly ventral to posterior corner. Dorsal area depressed near mid-line, possibly due to adductor muscle tension on noncalcareous shell. Normal pore canals evident upon staining, unaltered test appears smooth.

Internal morphology. - See Skogsberg (1920) for complete description; Iles (1961) gives functions of appendages of a halocyprid.

Habitat. - Planktonic. Occurrences variable, all off-shore, population generally increasing further from shore, maximum number taken on edge of Gulf Stream, 75 miles from land; water of 20-26° C., salinities 25 to over 35 ‰. Tows taken both day and night at three to five meters depth.

Size and types. - Length of adults 1.1 to 1.28 mm; height of males about one-half length, females slightly less. Hypotype UMMMP nos. 48821, 48822, 48823, 48824, 48825, 48826, and 48827.

Remarks. - This genus differs from *Conchoecia* Dana (1848) in that the posterior glands (Drusengruppen of Mueller) open symmetrically near the posterodorsal corners of the shell, and, according to Skogsberg (1920, p. 738) by the distal node (verruca) on the second podomere of the male antenna. Mueller erected the genus and described the species on the basis of males found off the coast of Brazil; I found females predominant, from 60 to 80 percent of each sample; these were collected in May.

Discussion. - The setae of the fourth podomere of the antennule were seen to be used for rowing the animal through the water. All appendages were seen to be moved rapidly, even the furca, as the animal swam. The action is jerky, much like some copepods.

Upon placing a freshly killed specimen in distilled water, occasionally the inner and outer chitin layers of the shell would expand apart as osmotic transfer of water occurred. It is possible that some degree of regulation of fluid between these two layers may aid the animal in buoyancy maintenance.

The eggs of the living female have a greenish blue cast; nearly all females were bearing eggs.

The stomach contents revealed diatoms as the major food source, and what appeared to be portions of arthropod appendages were also seen.

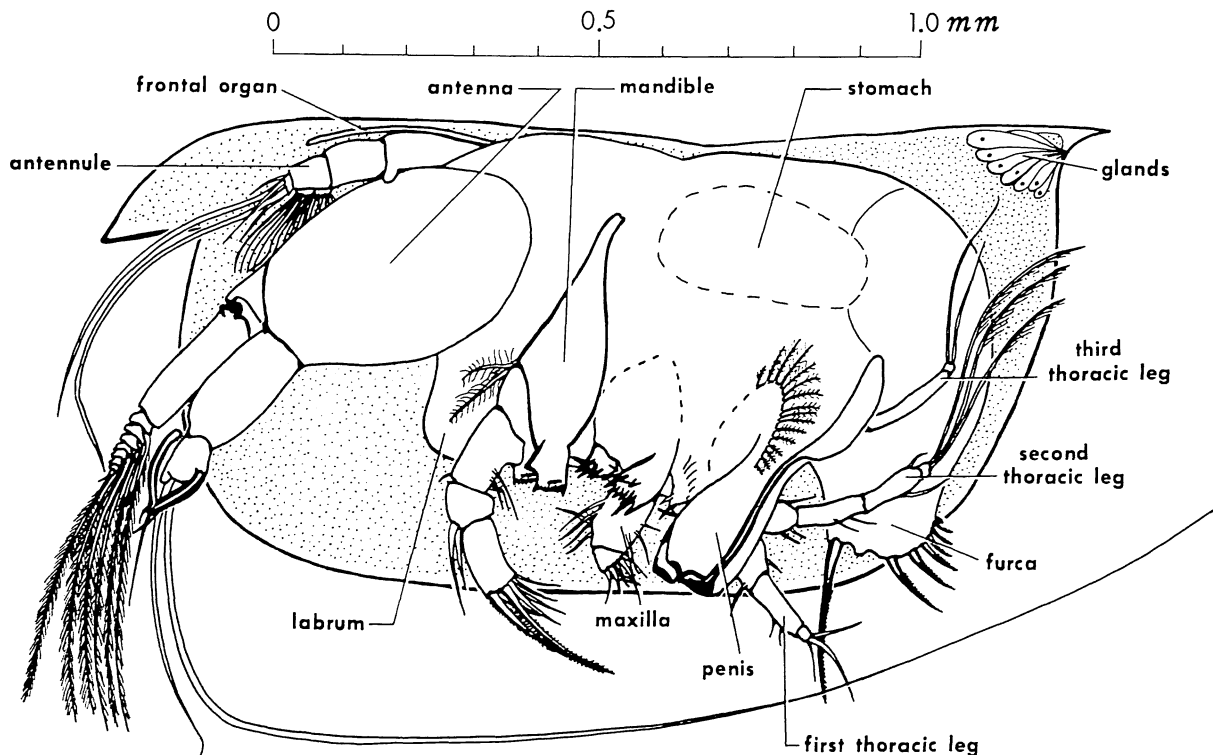

TEXT-FIGURE 11

Drawing of planktonic species *Euconchoecia chierchiae*; penis is unpaired in this group.

REFERENCES CITED

- ALEXANDER, W. B., SOUTHGATE, B. A., & BASSINDALE, R., 1932, The Salinity of the Water Retained in the Muddy Foreshore of an Estuary: *Mar. Biol. Ass. Jour.*, N.S. 18, p. 297-298.
- ANDERSON, F. W., 1964, The Law of Ostracod Growth: *Palaeontology*, vol. 7, pt. 1, p. 85-104, 1 text-fig., 28 tabs.
- BENSON, R. H., & COLEMAN, G. L., 1963, Recent Marine Ostracodes from the Eastern Gulf of Mexico: *Univ. Kansas Paleontol. Contrib.*, Arthropoda, Art. 2, 52 p., 8 pls., 33 figs.
- BAIRD, WILLIAM, 1850a, The Natural History of the British Entomostraca: Ray Society, London, p. i-viii + 364, 36 pls.
- , 1850b, Description of Several New Species of Entomostraca: *Proceedings Zool. Soc. London*, part 18, p. 254-257, 2 pls.
- BRADY, G. S., 1866, On New or Imperfectly Known Species of Marine Ostracoda: *Trans. Zool. Society*, London, vol. 5, p. 359-394, 6 pls.
- , 1867-1871, in *Les Fonds de la Mer*, Folin, L. de and Perier, L., vol. 1, Paris, Savy.
- , 1868a, A Synopsis of the Recent British Ostracoda: *Intell. Observer*, vol. 12, p. 110-130, 2 pls.
- , 1869a, Contributions to the study of Entomostraca. IV, Ostracoda from the river Scheldt and the Grecian Archipelago: *Ann. Mag. Nat. History*, ser. 4, vol. 3, p. 45-50, 2 pls.
- , 1880, Report on the Ostracoda Dredged by H. M. S. Challenger During the Years 1873-1876: Report *Sci. Results Voyage H. M. S. Challenger*, Zoology, pt. 3, 184 p., 44 pls.
- , 1890, On Ostracoda Collected by H. B. Brady, Esq., LL.D. F.R.S., in the South Sea Islands: *Trans. Roy. Soc. Edinburgh*, vol. 35, part 2, p. 489-526, 4 pls.
- , 1897, A Supplementary Report on the Crustaceans of the Group Myodocopa Obtained During the Challenger Expedition, with Notes on Other New or Imperfectly Known Species: *Trans. Zool. Soc. London*, vol. 14, no. 7, p. 85-100, 3 pls.
- , 1902, On New or Imperfectly Known Ostracoda, Chiefly from a Collection in the Zoological Museum, Copenhagen: *Trans. Zool. Soc. London*, vol. 16, pt. 4, no. 1, p. 179-210, 5 pls.
- , & NORMAN, A. M., 1896, A Monograph of the Marine and Freshwater Ostracoda of the North Atlantic and of North-Western Europe - Part 2, Sections 2 to 4: Myococopa, Cladocopa, and Platycopa: *Sci. Trans. Royal Dublin Society*, vol. 5, ser. 2, p. 621-784, 28 pls.
- CUSHMAN, J. A., 1906, Marine Ostracoda of Vineyard Sound and Adjacent Waters: *Proc. Boston Soc. Nat. History*, vol. 32, no. 10, p. 359-386, 12 pls.
- DANA, J. D., 1848, *Conspectus Crustaceorum quae Orbis Terrarum Circumnavigatione, Carolo Wilkes e Classe Reipublicae Foederatae Duce, Lexit et Descripsit, Pars 2: Proc. Amer. Academy of Arts and Science*, 1852, vol. 2, p. 9-61.
- DARBY, D. G., & HOYT, J. H., 1964, An Upper Miocene Fauna Dredged from Tidal Channels of Coastal Georgia: *Jour. Paleontology*, vol. 38, no. 1, p. 67-73, 2 pls., 2 text-figs.
- EDWARDS, RICHARD A., 1944, Ostracoda from the Duplin marl (Upper Miocene) of North Carolina: *Jour. Paleontology*, vol. 18, no. 6, p. 505-528, 4 pls.
- GRABAU, A. W., 1913, *Principles of Stratigraphy*, 1185 p., 264 figs., A. G. Seiler & Co., New York, N. Y.
- HIRSCHMANN, NIKOLAJ, 1909, Beitrag zur Kenntnis der Ostracodenfauna des Finnischen Meerbusens: *Societas pro Fauna et Flora Fennica, Meddelanden*, vol. 35, p. 282-296, 1 pl., 12 figs.
- HOWE, H. V., 1961, Systematic Descriptions, in *Treat. Invertebrate Paleontology*, part Q, Arthropoda 3, Ostracoda, i-xxiii + 442 p., 334 figs.
- , et al., 1935, Ostracoda of the Arca Zone of the Choctawhatchee Miocene of Florida: *Fla. Geol. Survey, Geol. Bull.* 13, 47 p., 4 pls.
- ILES, E. J., 1961, The Appendages of the Halocyprididae: *Discovery Reports*, vol. 31, p. 299-326, 14 figs.
- JONES, T. R., 1856, A Monograph of the Tertiary Entomostraca of England: *Palaentographical Soc. of London*, 68 p., 6 pls.
- KESLING, R. V., 1951, Mechanical Solution of Formulas for Growth Rates: *Contrib. Mus. Paleontology Univ. Mich.*, vol. 8, no. 10, p. 231-237, 3 figs.
- KORNICKER, L. S., 1958, Ecology and Taxonomy of Recent Marine Ostracodes in the Bimini Area, Great Bahama Bank: *Publ. of the Institute of Marine Science, Univ. Texas*, vol. 5, p. 194-300, 89 figs.
- LILJEBORG, W., 1853, De Crustaces ex Ordinibus Tribus: Cladocera, Ostracoda, et Copepoda, in *Scania Occurrentibus. Om de Inom Skane Forekommande Crustaeer af Ordningere Cladocera, Ostracoda och Copepoda*; Lund, xvi + 222 p., 27 pls.
- MALKIN, D. S., 1953, Biostratigraphic Study of Miocene Ostracoda of New Jersey, Maryland, and Virginia:

- Jour. Paleontology, vol. 27, no. 6, p. 761-799, 5 pls., 14 figs.
- MINCHER, ALBERT R., 1941, The fauna of the Pascagoula Formation: Jour. Paleontology, vol. 15, no. 4, p. 337-348, 2 pls., 4 figs., 1 tab.
- MUELLER, FRITZ, 1870, Bemerkungen uber Cypridina: Jenaische Zeitschrift für Medicin und Naturwissenschaft, band 5, p. 255-276, 2 pls.
- MUELLER, G. W., 1890a, Neue Cypridiniden: Zoologische Jahrbucher, Abtheil. für Syst., Geog. und Biol. der Thiere, band 5 (1891), p. 211-252, 3 pls.
- , 1890b, Ueber Halocypriden, Zoologische Jahrbucher, Abtheil. für Syst., Geog. und Biol. der Thiere, band 5 (1891), p. 253-280, 3 pls.
- , 1894, Die Ostracoden des Golfes von Neapel und der Angrenzenden Meeres-Abschnitte: Fauna und Flora des Golfes von Neapel, Zool. Sta. Neapel, mono. 21, p. i-viii + 404, 40 pls.
- , 1908, Die Ostracoden der Deutschen Sudpolar Expedition, 1901-1903: Deutsche Sudpolar Expedition, band 10, zool. band 2, p. 51-181, 16 pls., 45 text-figs.
- NORMAN, A. M., 1869, Shetland Final Dredging Report - Part 2. On the Crustacea, Tunicata, Polyzoa, Echinodermata, Actinozoa, Hydrozoa, and Porifera: Report of 38th Meeting Brit. Assoc. Adv. Science (1868), p. 247-336 (Ostracoda, p. 289-295).
- PHILIPPI, A., Zoologische Bemerkungen, III, Asterope, ein neues Genus der Ostracopoden: Archiv. für Naturgeschichte, Jahrgang 6, band 1, p. 186-188, 1 pl.
- POULSEN, E. M., 1962, Ostracoda - Myodocopa, part 1, Cypridiniformes - Cypridinidae: Dana Report 57, The Carlsberg Foundation's Oceanographical Expedition Round the World 1928-30, vol. 10, 414 p., 181 figs., 26 tabs.
- PURI, H. S., 1953, Contribution to the Study of the Miocene of the Florida Panhandle: Fla. Geol. Survey, Geol. Bull. 36, 345 p., 17 pls., 14 text-figs., 12 tabs.
- , 1960, Recent Ostracoda from the West Coast of Florida: Trans. Gulf Coast Geol. Societies, vol. 10, p. 107-149, 6 pls., 46 text-figs., 1 fig.
- , & HULINGS, N. C., 1957, Recent Ostracode Facies from Panama City to Florida Bay Area: Trans. Gulf Coast Assoc. Geol. Societies, vol. 7, p. 167-190, 11 figs.
- SARS, G. O., 1866, Oversigt af Norges Marine Ostracoder: Videnskabs-Selskabet, I Christiania, Forhandlinger, p. 1-130.
- , 1889, An Account of the Crustacea of Norway, vol. 2, Isopoda, parts 1-14, 270 p., 104 pls.
- , 1922-1928, An Account of the Crustacea of Norway, vols. 1-9, Ostracoda, 277 p., 119 pls.
- SCHAEFER, H. W., 1953, Uber Meeres- und Brackwasser-Ostracoden aus dem Deutschen Kustengebiet: Hydrobiologia, vol. 5, no. 4, p. 351-389, 15 figs.
- SCOTT, ANDREW, 1905, Report on the Ostracoda Collected by Professor Herdman, at Ceylon, in 1902: Report to the Government of Ceylon on the Pearl Oyster Fisheries of the Gulf of Mannaar, Part 3, Supplementary Report 12, p. 365-384, 2 pls.
- SKOGBERG, TAGE, 1920, Studies on Marine Ostracods, part 1, Cypridinids, Halocyprids and Polycopids: Uppsala Universitat, Zoologiska Bidrag från Uppsala, Suppl. band 1, 784 p., 153 figs.
- STEPHENSON, M. B., 1938, Miocene and Pliocene Ostracoda of the Genus Cytheridea from Florida: Jour. Paleontology, vol. 12, no. 2, p. 127-148, 2 pls., 20 text-figs.
- SWAIN, F. W., 1951, Ostracoda from Wells in North Carolina, part 1, Cenozoic Ostracoda: U.S. Geol. Survey Prof. Paper 234-A i-ii + 58, 7 pls., 3 figs.
- , 1955, Ostracoda of San Antonio Bay, Texas: Jour. Paleontology, vol. 29, no. 4, p. 561-646, 6 pls., 39 text-figs.
- TEAL, J. M., & KANWISHER, JOHN, 1961, Gas Exchange in a Georgia Salt Marsh: Limnology and Oceanography, vol. 6, no. 4, p. 388-399, 5 figs., 3 tabs.
- TREATISE ON INVERTEBRATE PALEONTOLOGY, 1961, R. C. Moore Ed., part Q, Arthropoda 3, Crustacea, Ostracoda, 442 p., 334 figs., Univ. Kansas Press.
- TRIEBEL, ERICH, 1960, Die taxionomische Stellung und die Gattungen der Unterfamilie Macrocypridiniae (Ostracoda): Senckenbergiana Biol., vol. 41, no. 1/2, p. 109-124, 8 pls.
- TRESSLER, W. L., 1949, Marine Ostracoda from Tortugas, Florida: Jour. Wash. Acad. Sciences, vol. 39, no. 10, p. 335-343, 25 figs., 1 tab.
- U. S. Coast and Geodetic Survey, 1964, Tidal Current Tables, Atlantic Coast of North America.
- VAN DEN BOLD, W. A., 1946, Contribution to the Study of Ostracoda with Special Reference to the Tertiary and Cretaceous Microfauna of the Caribbean Region: Amsterdam, 167 p., 18 pls. text-figs.
- , 1950, Miocene Ostracoda from Venezuela: Jour. Paleontology, vol. 24, no. 1, p. 76-88, 2 pls., 4 figs.
- WAGNER, C. W., 1957, Sur les Ostracodes du Quaternaire Récent des Pays-Bas et leur Utilization dans L'Étude Géologique des Dépôts Holocènes, 158 p., 50 pls., 26 figs.; Mouton & Co., The Hague, Netherlands.

EXPLANATION OF PLATE 1

FIGS. 1-12 Cytheromorpha curta Edwards

1, 3-5 UMMP 48754, female; 1, left valve exterior, x100; 3, right valve interior, x100; 4, left valve interior, x100; 5, dorsal view of teeth, AL anterior left, AR anterior right, PL posterior left, PR posterior right, x500.

2, 11 UMMP 48755, male; 2, left valve exterior showing more reticulate pattern and smaller size, x100; 11, internal morphology, penes on left, x120.

6, 12 UMMP 48756, female; 6, right valve, transmitted light showing adult lack of reticulation, dark spots are normal pores, x100; 12, internal morphology, dark spots in upper right are eyes, x120.

7 UMMP 48757, male; right valve, transmitted light showing reticulations and smaller size of adult, x100.

8 UMMP 48758, immature specimen, transmitted light showing reticulate pattern. x100.

9 UMMP 48759, adductor muscle scars, exterior left valve, anterior to right. x500.

10 UMMP 48760, anterior of left valve from inside - showing radial pore canals and vestibule, x500.

PLATE 1

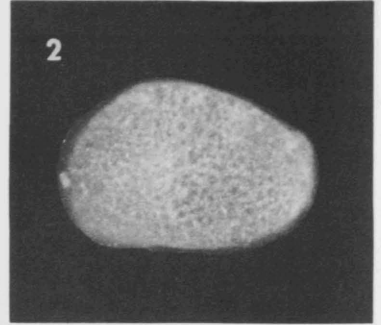
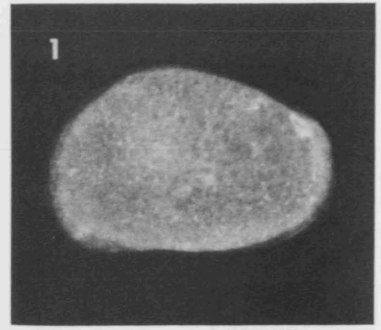
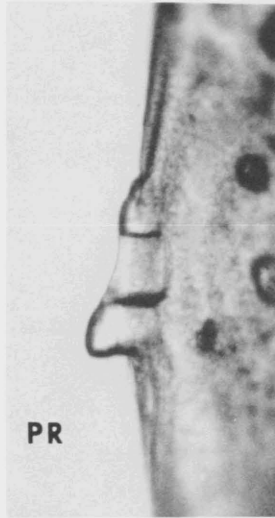
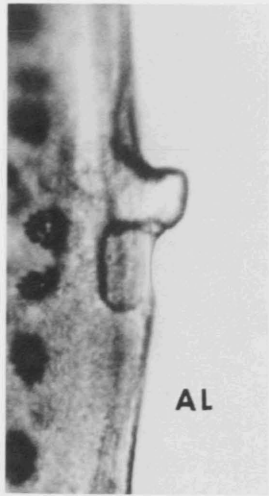
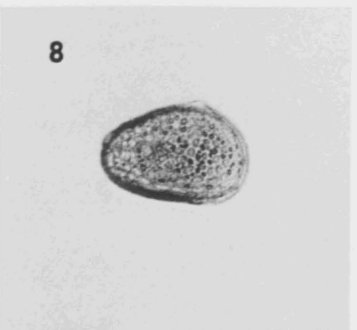
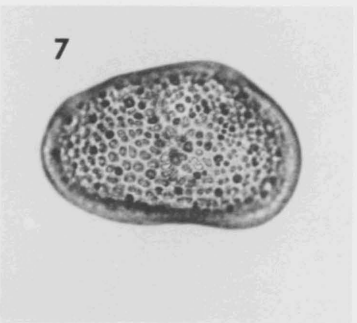
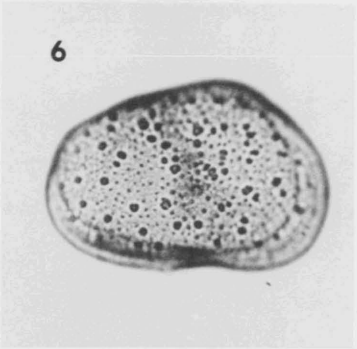
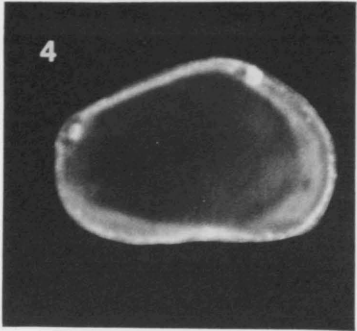
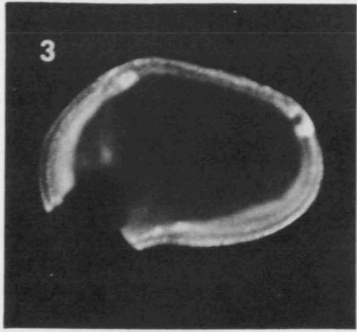
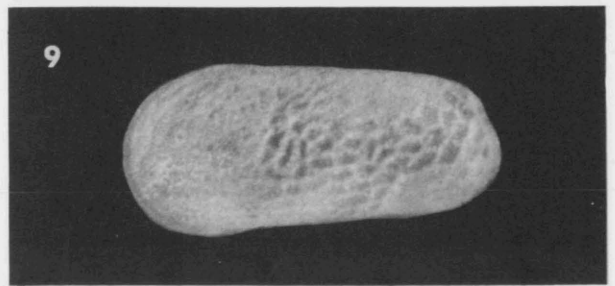
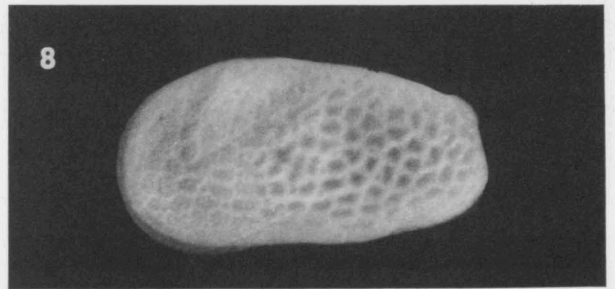
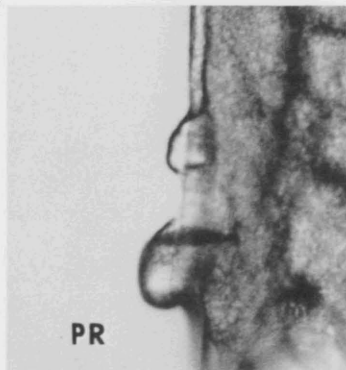
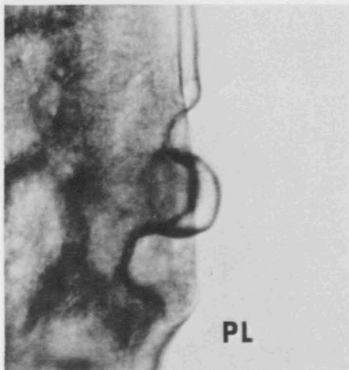
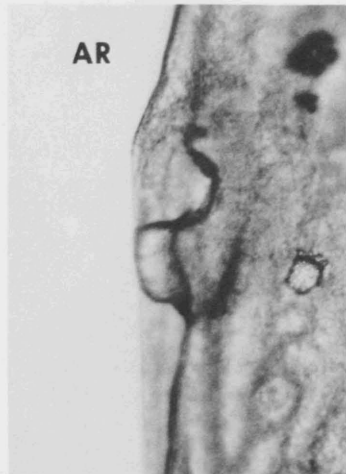
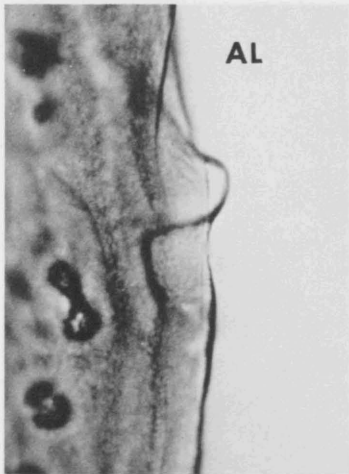
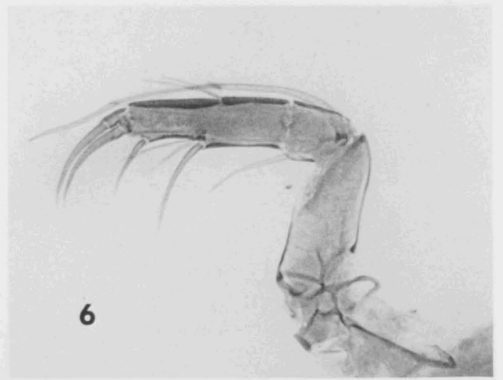
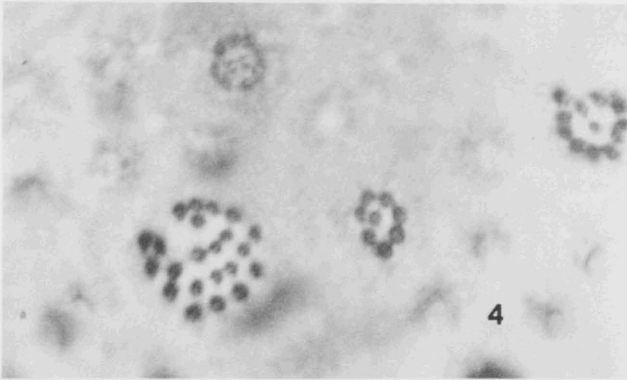
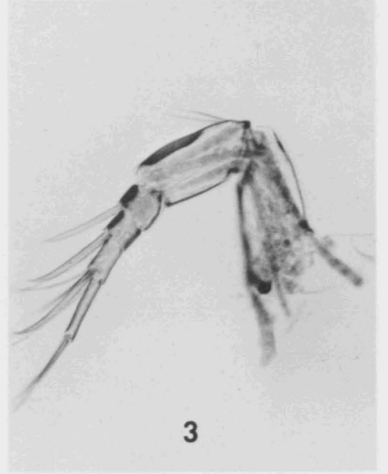

PLATE 2



EXPLANATION OF PLATE 2

FIGS. 1-6 Cytheromorpha curta Edwards

- 1 UMMP 48755, male, showing penes, x300.
- 2, 6 UMMP 48761, male; 2, mandible, x300; 6, antenna, exopod the dorsal rod, x300.
- 3 UMMP 48762, female, antennule, x300.
- 4 UMMP 48754, female, normal sieve type pores, x1200.
- 5 UMMP 48760, female, maxilla (exopod with branchial setae out of focal plane), x300.

FIGS. 7-10 Cytheromorpha warneri Howe & Spurgeon

- 7, 8 UMMP 48763, female; 7, dorsal view of teeth, AL anterior left, AR anterior right, PL posterior left, PR posterior right, x500; 8, left valve exterior, x100.
- 9 UMMP 48764, left valve exterior, x100.
- 10 UMMP 48765, male, sensory distal seta of antennule, x1300.

EXPLANATION OF PLATE 3

FIGS. 1-10 Leptocythere paracastanea Swain

1, 3-6, 8 UMMP 48766, male; 1, left valve interior, x100; 3, left valve exterior, x100; 4, left valve, dorsal view, tipped outward to show teeth, anterior toward top, x200; 5, right valve, dorsal view, anterior toward top, x200; 6, dorsal view of teeth, AL anterior left, AR anterior right, PL posterior left, PR posterior right, x500; 8, left valve, posterior portion of median hinge element, dorsal view, posterior to left, x500.

2, 7, UMMP 48767, female; 2, left valve exterior, x100; 6, dorsal view of teeth, Al anterior left, AR anterior right, x500.

9, UMMP 48768, female, internal morphology, dark posterior spot is vaginae, x150.

10, UMMP 48769, male, internal morphology, note diatoms in stomach, just above penes, x150.

PLATE 3

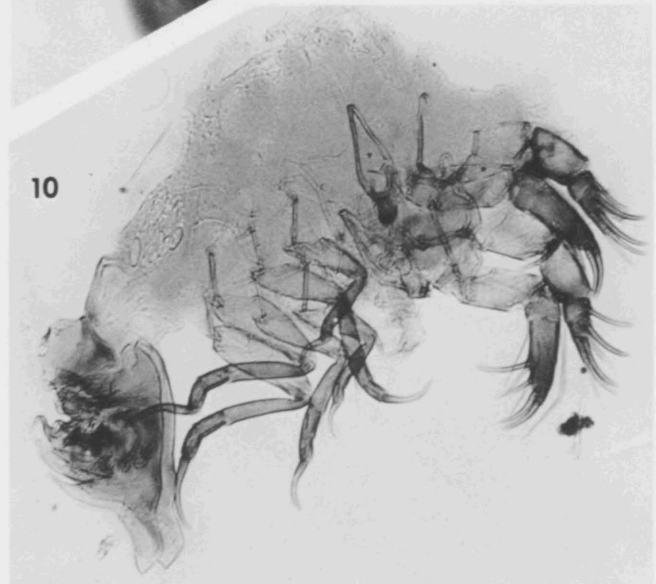
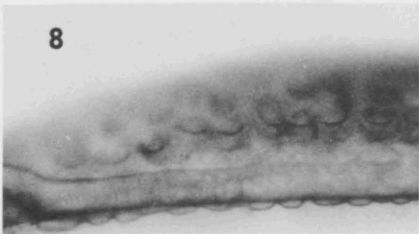
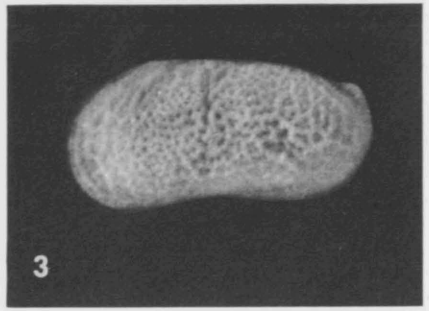
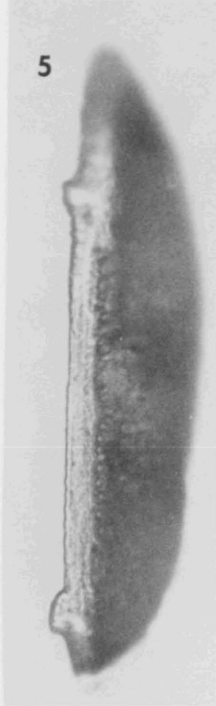
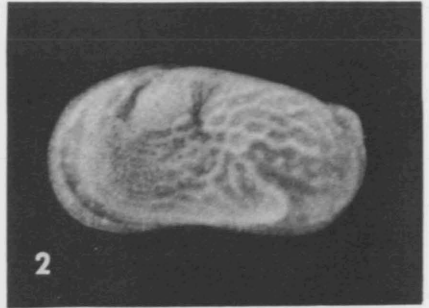
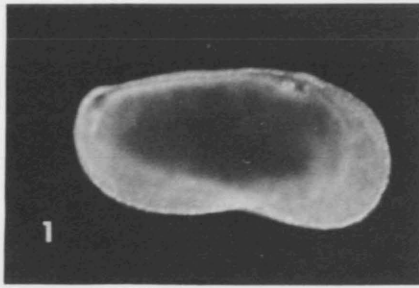
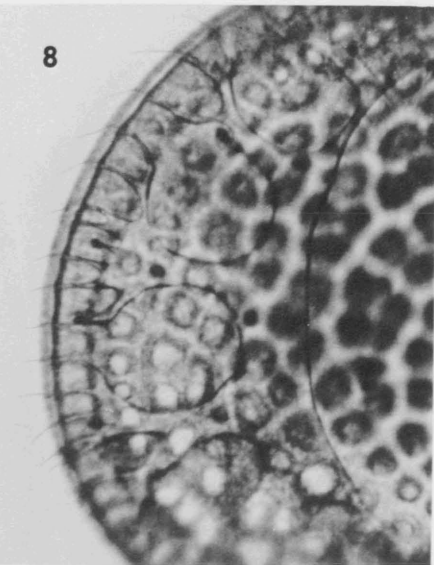
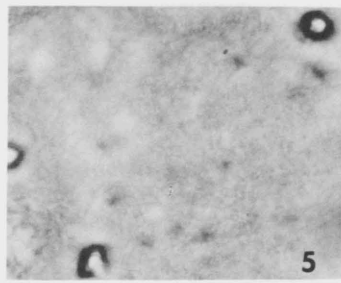
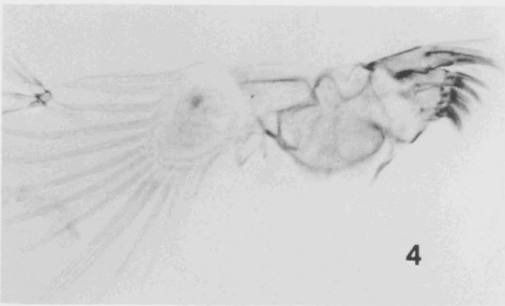
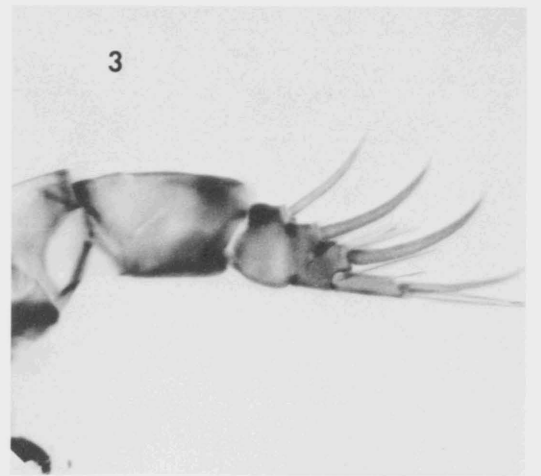
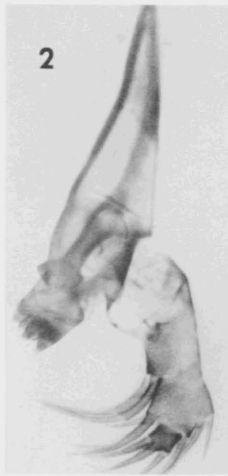
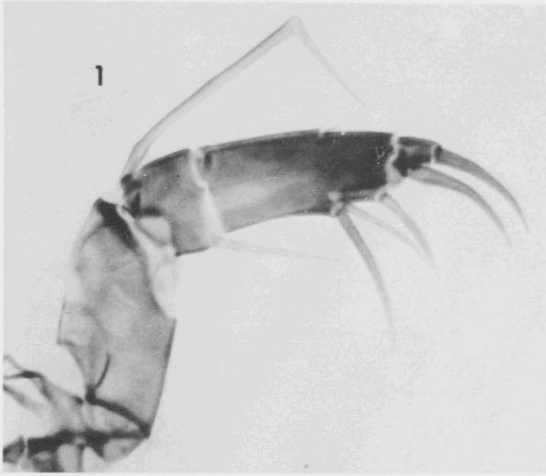

PLATE 4



EXPLANATION OF PLATE 4

FIGS. 1-9 Leptocythere paracastanea Swain

1-4 UMMP 48770, female; 1, antenna, x400; 2, mandible, x400; 3, antennule, x400; 4, maxilla, x400.

5-7 UMMP 48767, female; 5, normal pore canals, exterior view, x1000; 6, fifth, sixth and seventh limbs, anterior to right, x400; 7, gut with diatoms, x400.

8 UMMP 48766, male, anterior of right valve from inside showing polyfurcate radial pore canals, x500.

9 UMMP 48771, male, copulatory appendages, x500.

EXPLANATION OF PLATE 5

FIGS. 1-8 Cyprideis floridana (Howe & Hough)

1, 3-4, 6 UMMP 48772, female; 1, left valve exterior, x100; 3, left valve interior, x100; 4, right valve interior, x100; 6, dorsal view of teeth, anterior toward top, x200.

2, 5 UMMP 48773, male; 2, left valve exterior, x100; 5, dorsal view of teeth showing slight variation within species, anterior toward top; x200.

7 UMMP 48774, sieve type normal pores, note larger main pore in upper central region, x1200.

8 UMMP 48775, adductor muscle scars of left valve exterior, note distinctive angle of upper scar of row, dark area between upper scar of row and V-shaped scar is mandibular fulcral point, x500.

PLATE 5

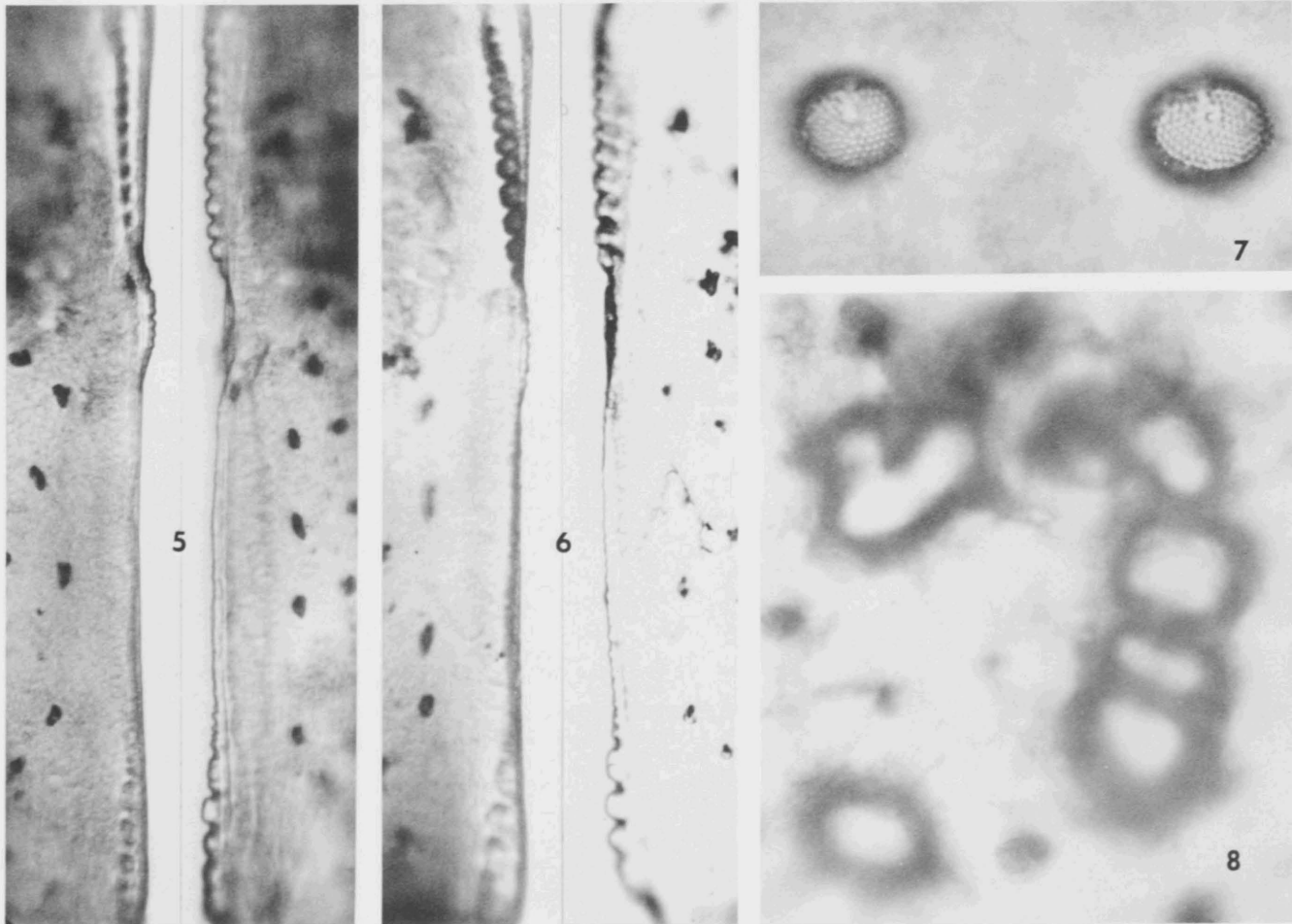
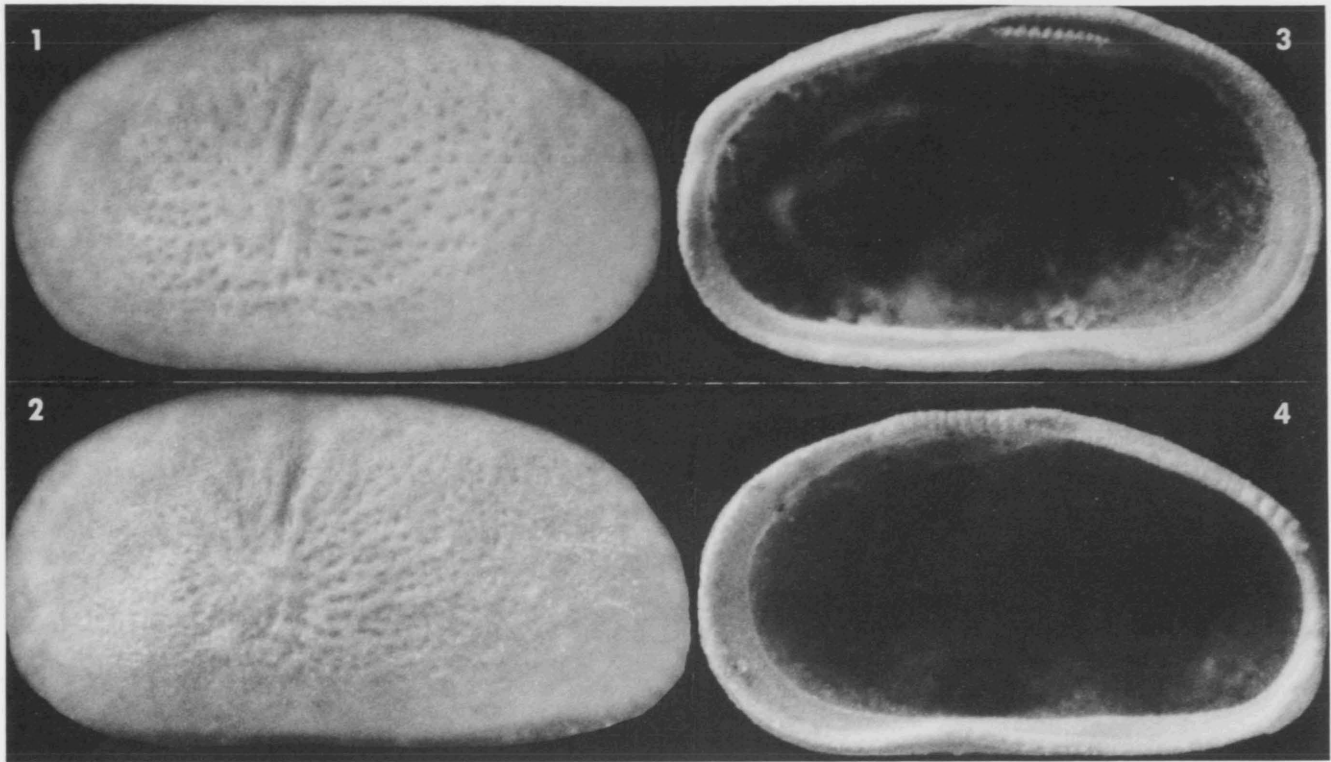
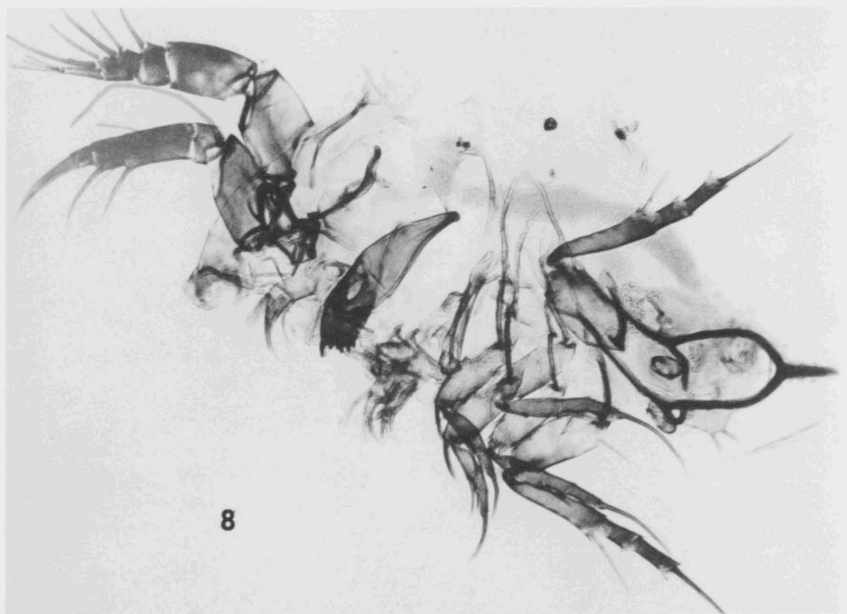
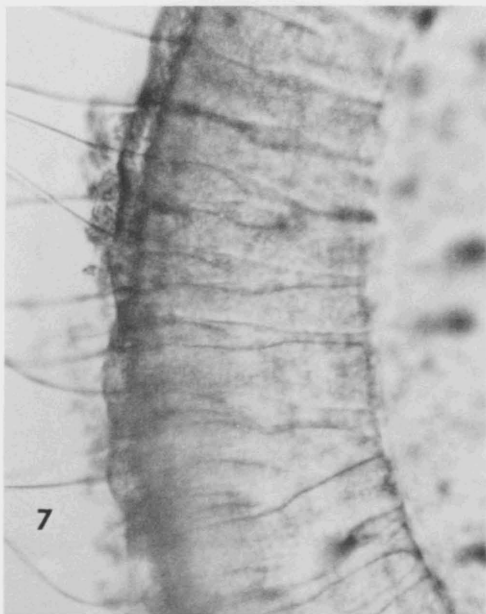
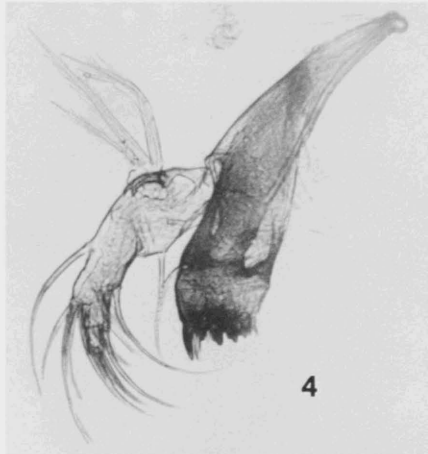
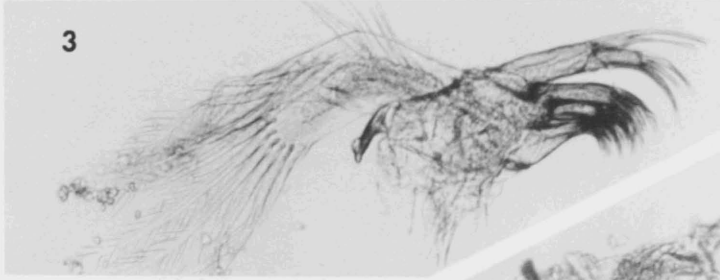
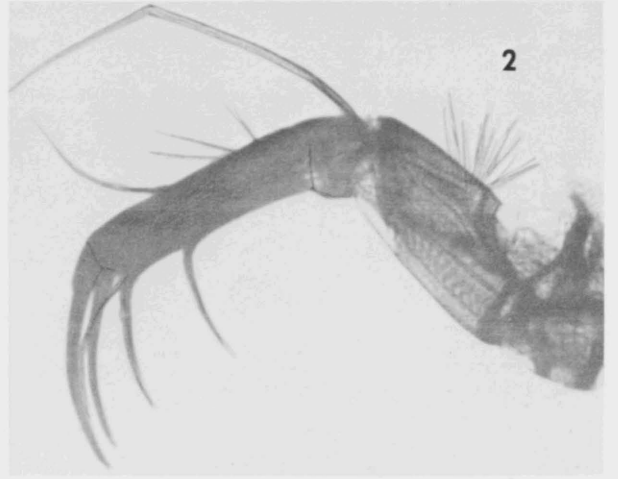
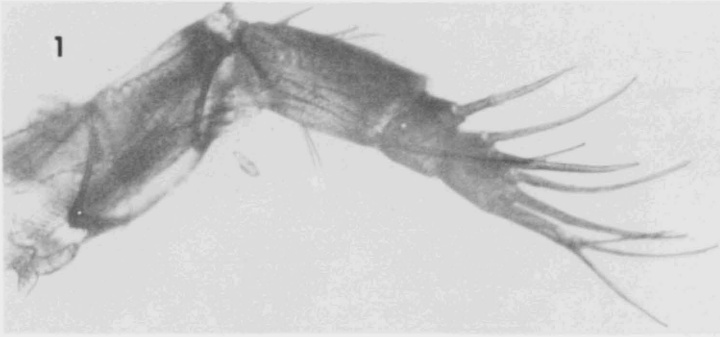

PLATE 6



EXPLANATION OF PLATE 6

FIGS. 1-8 Cyprideis floridana (Howe & Hough)

1, 2, 7 UMMP 48773, male; 1, antennule, x200; 2, antenna, x200; 7, radial pore canals, inside right valve, x500.

3-5 UMMP 48776, female; 3, maxilla, x200; 4, mandible, x200; 5, sixth limb, x200.

6, 8 UMMP 48772, female; 6, genital region showing a vagina and tubules, x500; 8, whole mount showing arrangement of appendages, an antennule and antenna have been removed, furca at right angles to normal position, x100.

EXPLANATION OF PLATE 7

FIGS. 1-12 Semicytherura elongata (Edwards)

1 UMMP 48777, female, dorsal view of valves, anterior to left, note overlap by left valve anteriorly, x100.

3, 4 UMMP 48778, male; 3, dorsal view of valves, anterior to left, note overlap by left valve anteriorly, x100; 4, left valve exterior, x100.

2, 5-12 UMMP 48779, female; 2, left valve exterior, x100; 5, right valve interior, x100; 6, left valve interior, x100; 7, dorsal view of teeth, AL anterior left, AR anterior right, PL posterior left, PR posterior right, x500; 8, posterior left tooth from inside, showing crenulations, x500; 9, anterior left tooth from inside showing crenulations, x500; 10, normal open type pore canal, area to left is not a sieve pore, x1200; 11, radial pore canals, x500; 12, whole mount showing internal morphology, x200.

PLATE 7

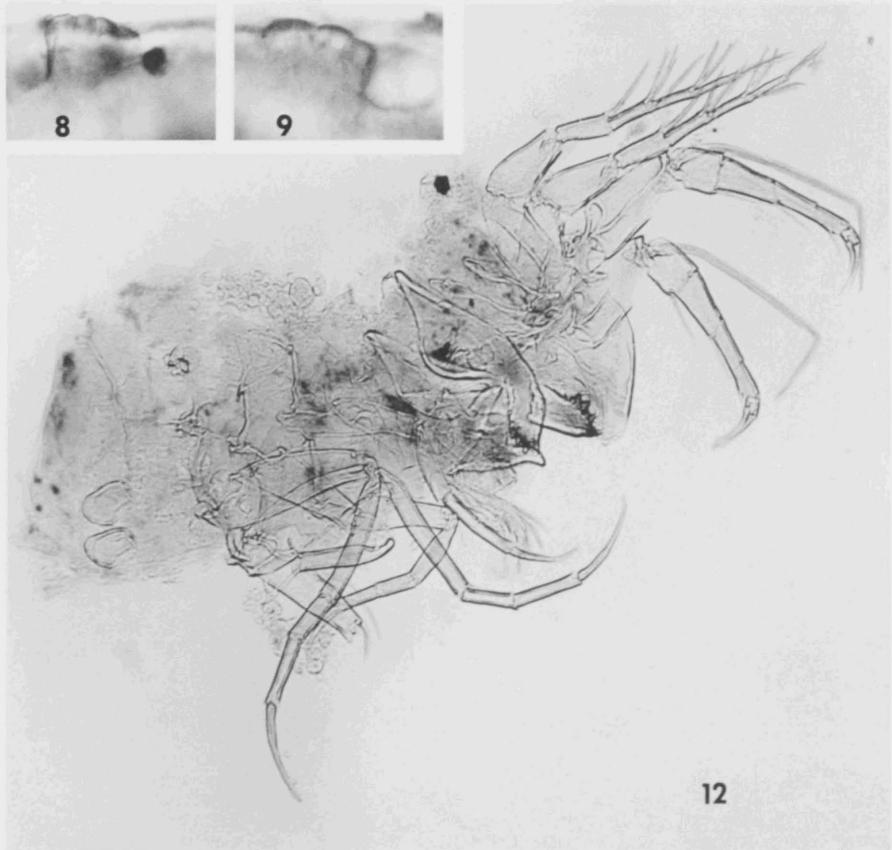
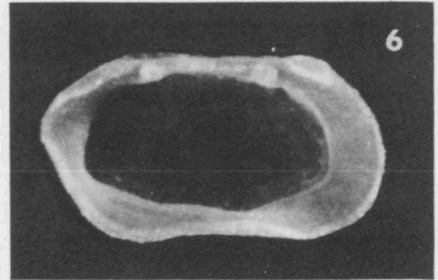
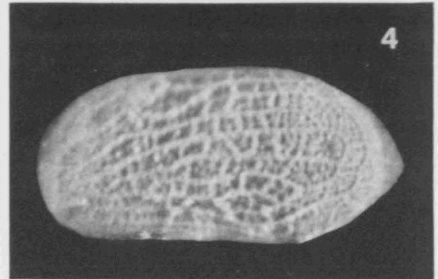
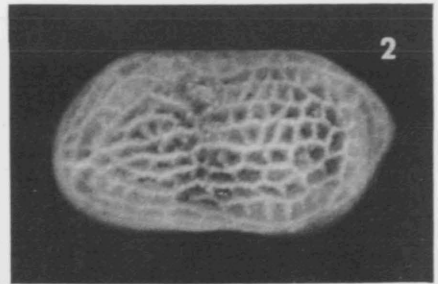
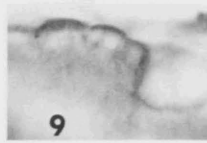
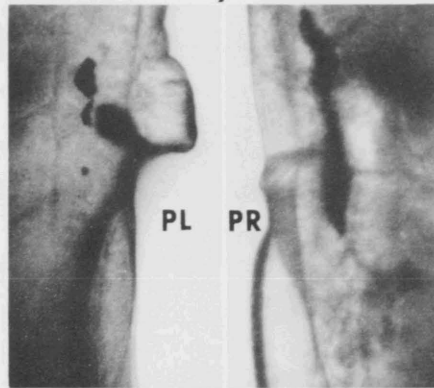
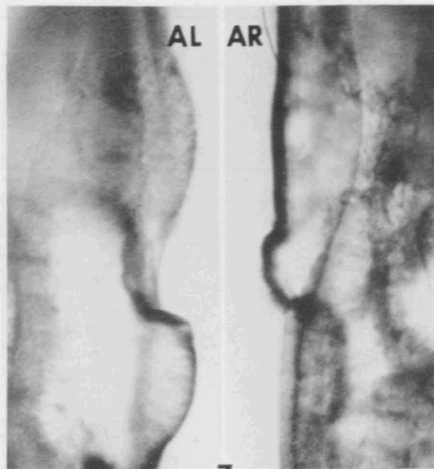
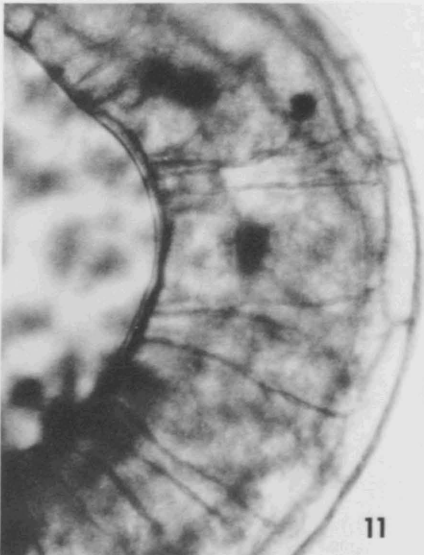
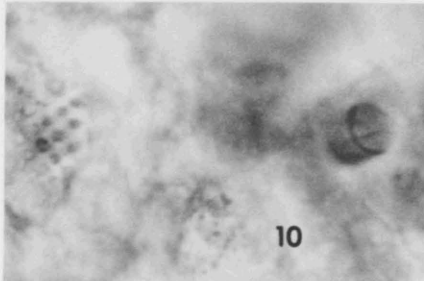
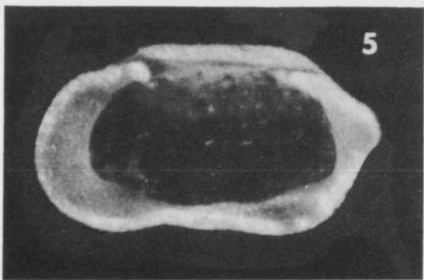
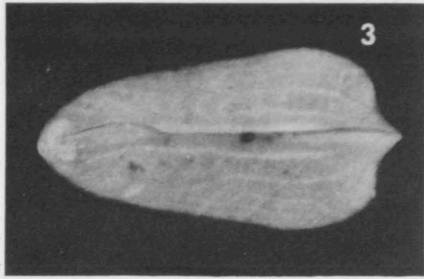
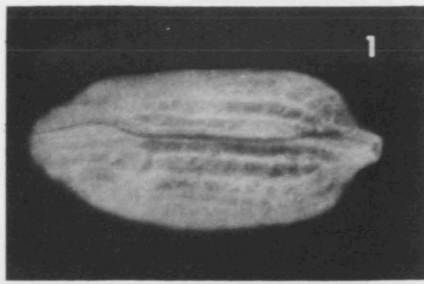
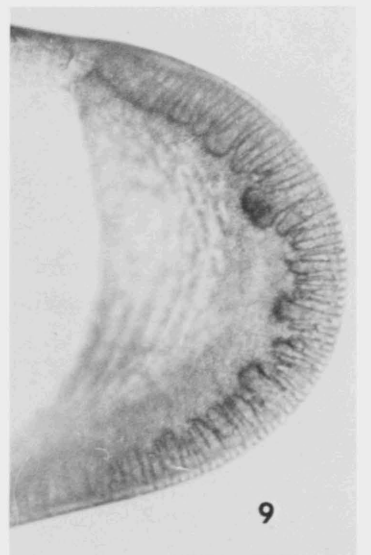
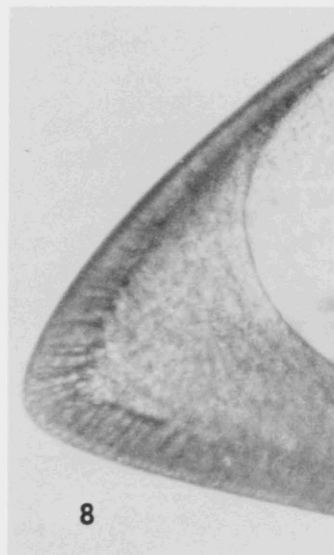
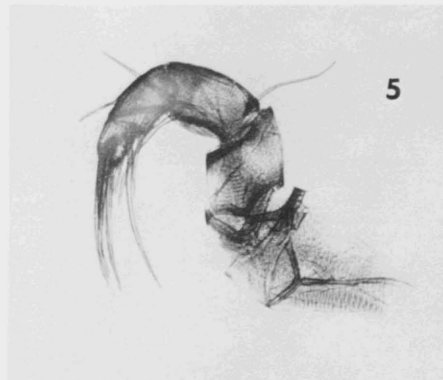
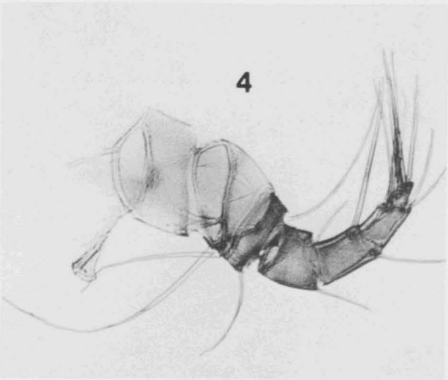
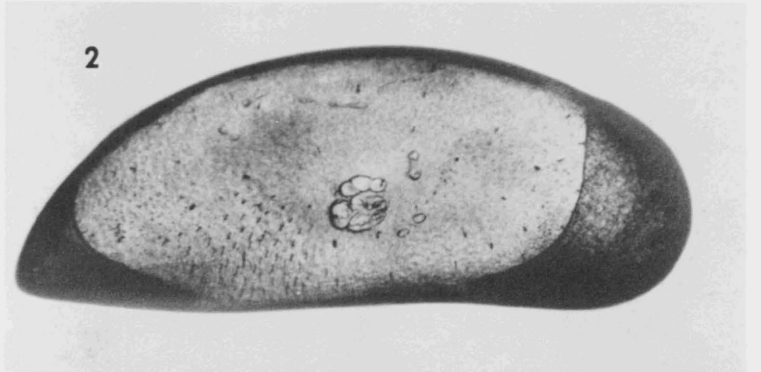
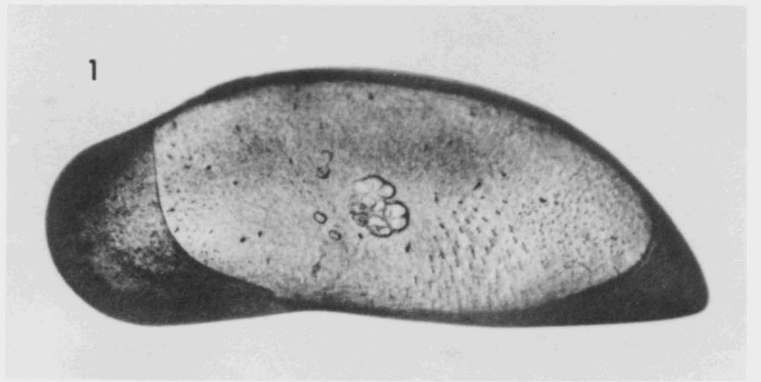

PLATE 8



EXPLANATION OF PLATE 8

FIGS. 1-9 Macrocypris sapeloensis, n. sp.

1-9 UMMP 48780, holotype, male; 1, left valve, exterior view, x60; 2, right valve external view, x60; 3, hinge elements, dorsal view, anterior is upward, x100; 4, antennule, x100; 5, antenna, x100; 6, adductor muscle scars, inside right valve, anterior to left, x200; 7, mandible, distal portion, x100; 8, posterior of right valve, external view, showing radial pore canals and vestibule, x200; 9, anterior of right valve, external view, showing radial pore canals and vestibule, x125.

EXPLANATION OF PLATE 9

FIGS. 1-9 Macrocypris sapeloensis, n. sp.

1-9 UMMP 48780, holotype, male; 1, distal portion of maxilla, x300; 2, sixth limb, x100; 3, seventh limb, x100; 4, labrum and fifth limbs, x200; 5, furca and copulatory organ, x100; 6, sperm, x100; 7, furca, x300; 8, distal seta of seventh limb, x600; 9, vas deferens (detached from ampullae at top of photomicrograph) and Zenker's organs, x100.

PLATE 9

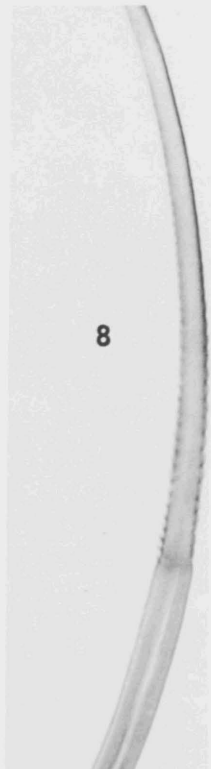
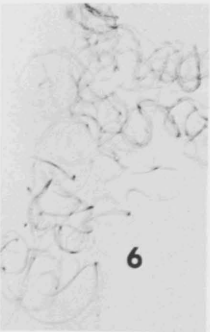
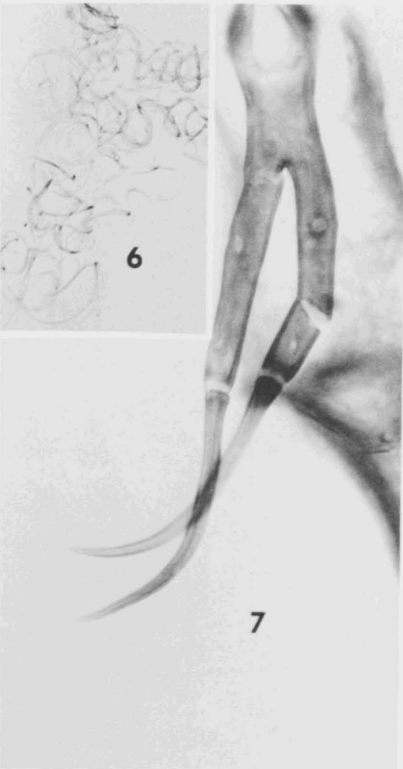
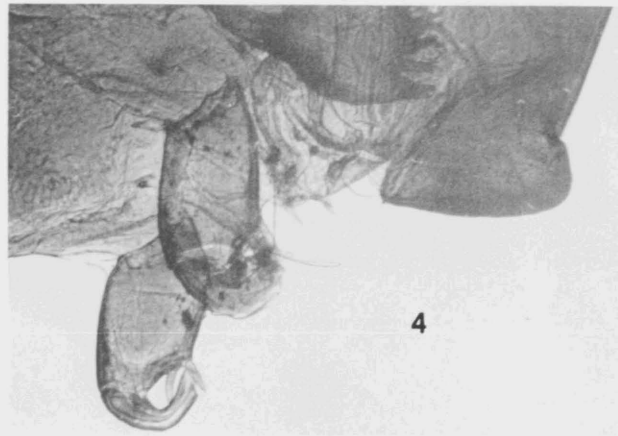
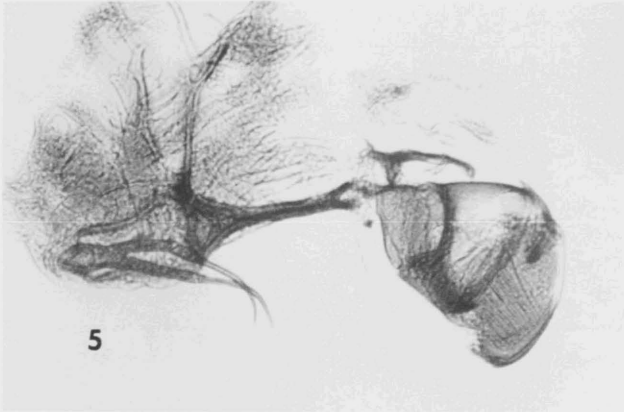
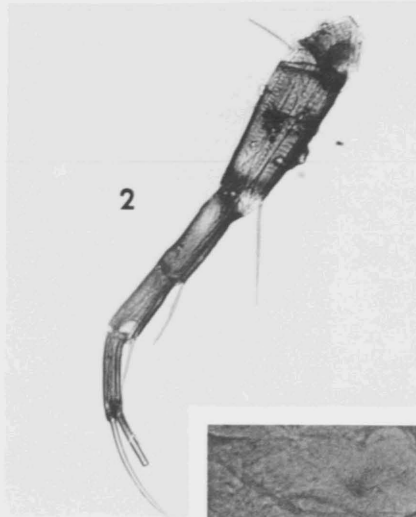
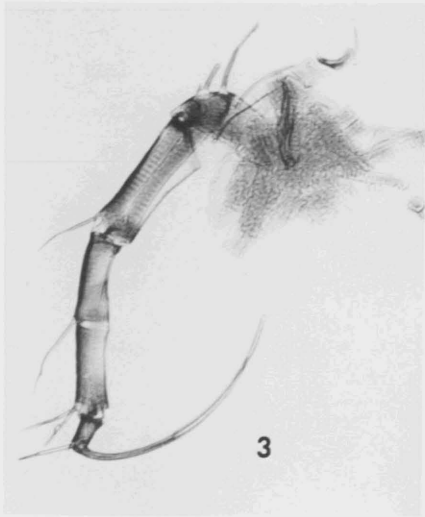

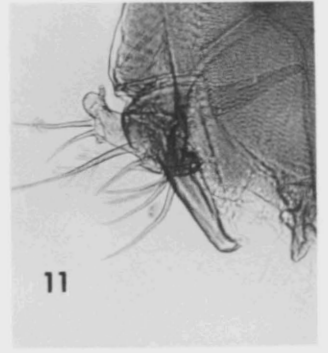
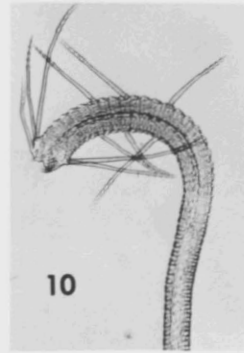
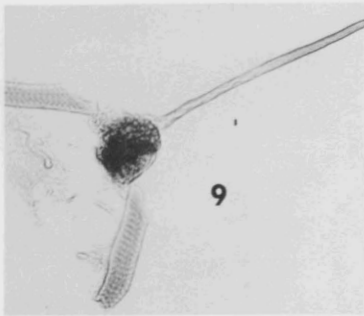
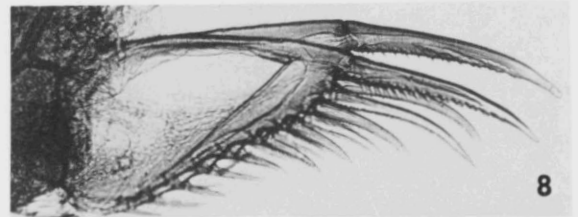
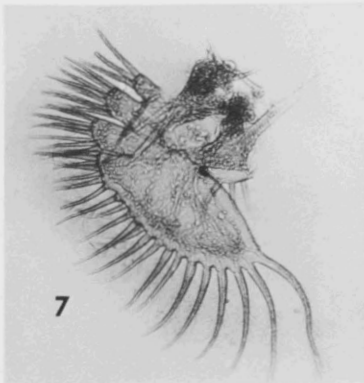
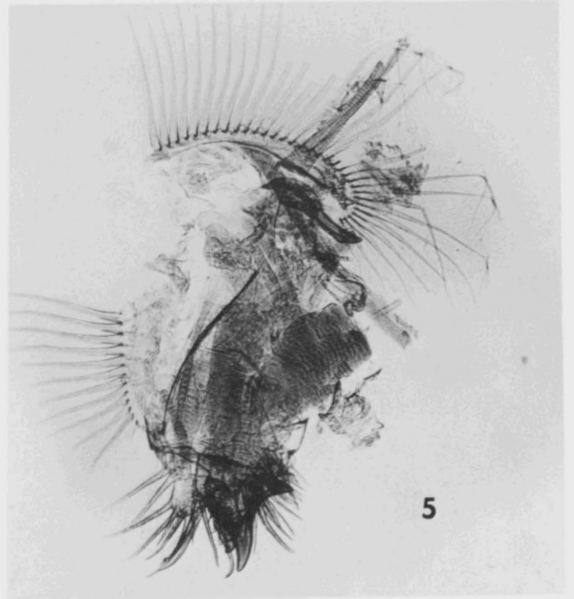
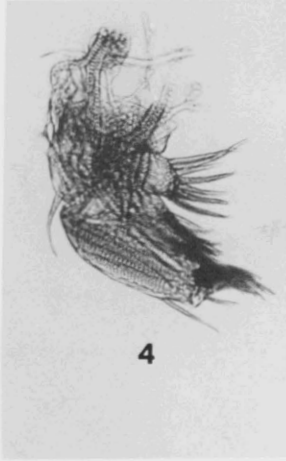
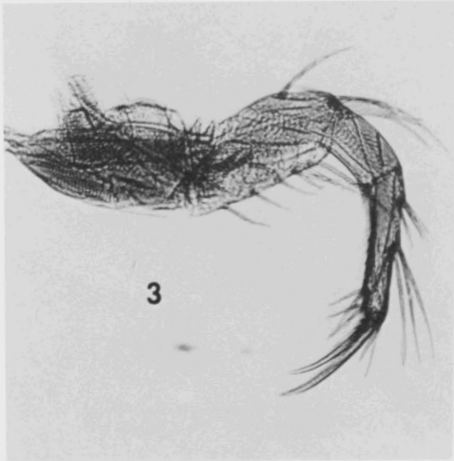
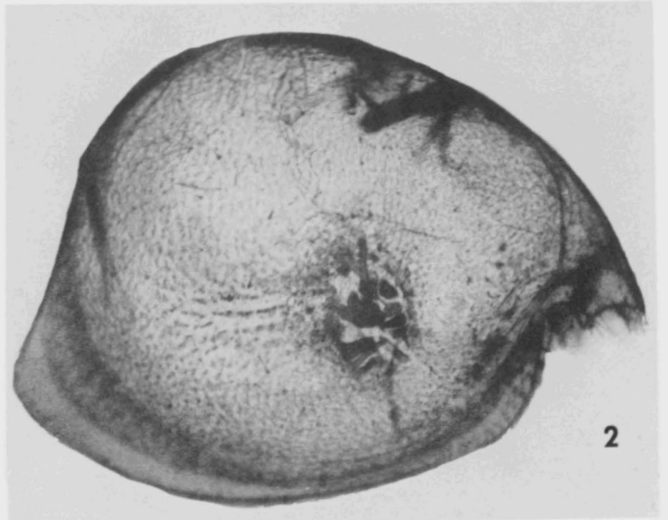
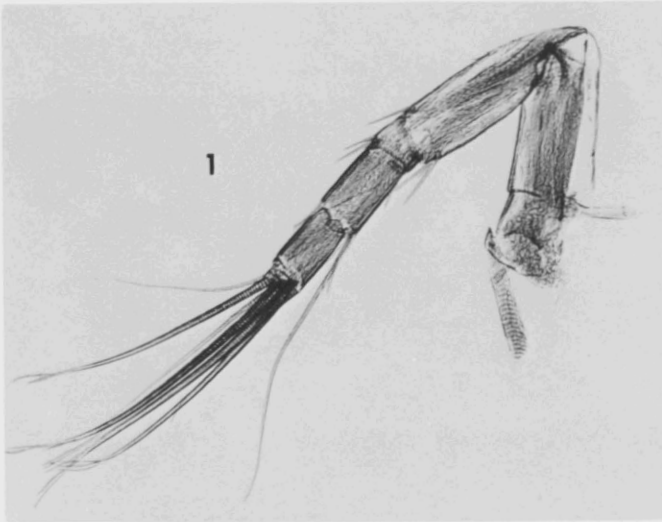

EXPLANATION OF PLATE 10

FIGS. 1-11 Philomedes lilljeborgi (Sars)

1-11 UMMP 48781, female; 1, antennule, x100; 2, right valve exterior, x50; 3, mandible, x100; 4, maxilla, x100; 5, fifth limb, x100; 6, rostrum, internal view, x100; 7, sixth limb, x100; 8, furca, x100; 9, frontal organ, x100; 10, seventh limb, x100; 11, endopod of antenna, a distal seta is broken off, x150.

EXPLANATION OF PLATE II

FIGS. 1-9 Pseudophilomedes ferulana Kornicker

1, 3, 4, 8 UMMP 48782, female; 1, dorsal view of furca, showing small lateral spines off principal claws, x100; 3, tip of distal process of maxilla, x1000; 4, tip of distal seta of antennule, x1000; 8, left valve from exterior, x50.

2, 6, 9 UMMP 48783, female; 2, distal portion of mandible showing palp, x200; 6, internal view of caudal process showing row of nodes, x150; 9, antenna, note verruciform endopod with terminal seta coming from behind basal podomere of exopod, x200.

5 UMMP 48784, female, furca, x100.

7 UMMP 48785, female, dorsal view of carapace showing sulci, x50.

PLATE 11

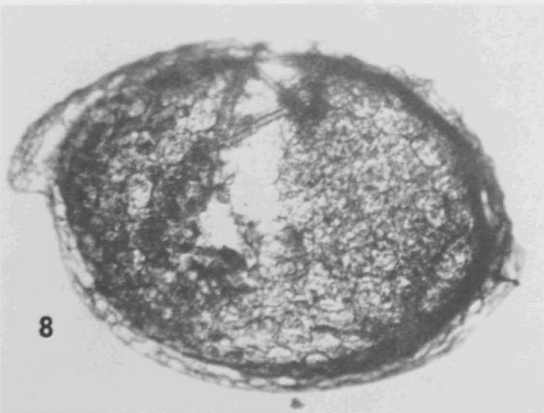
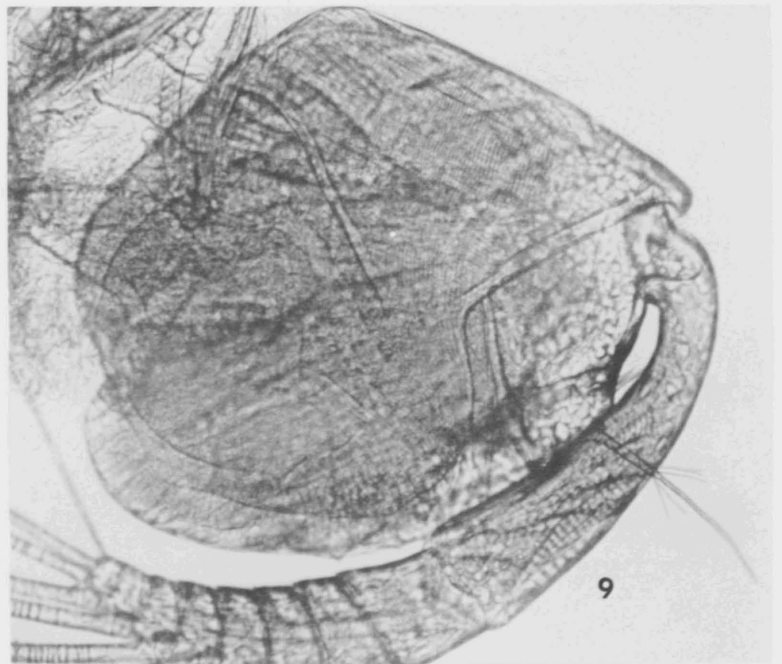
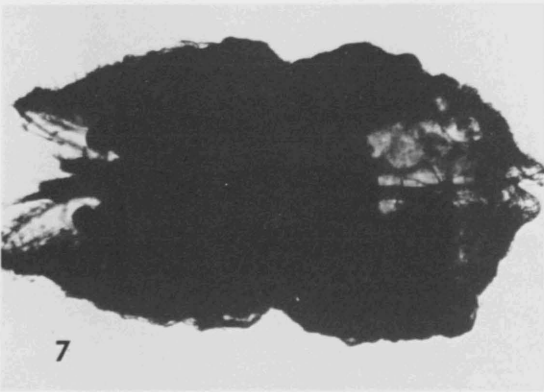
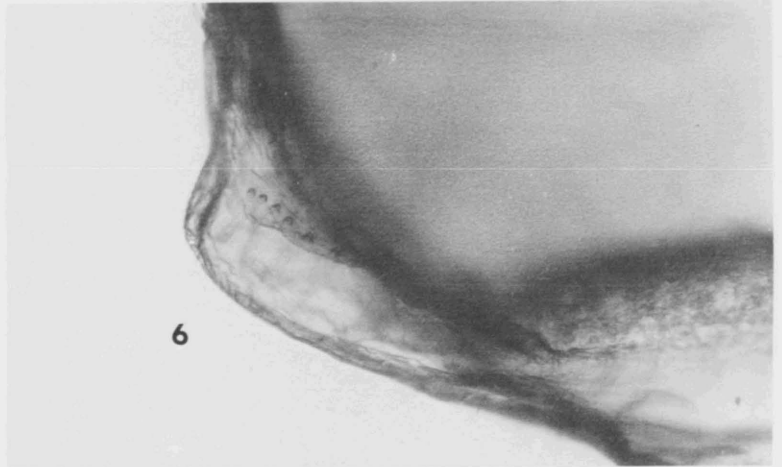
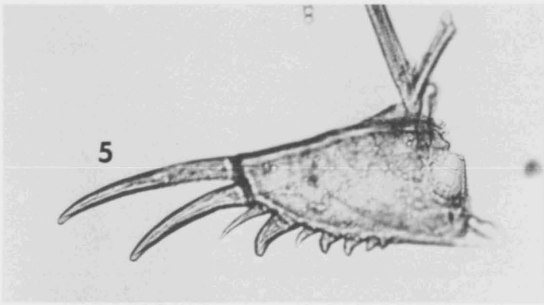
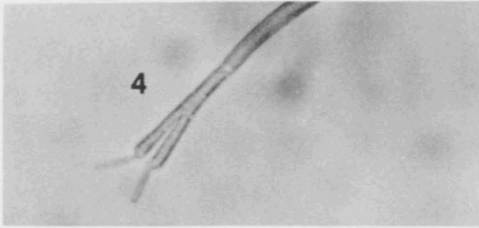
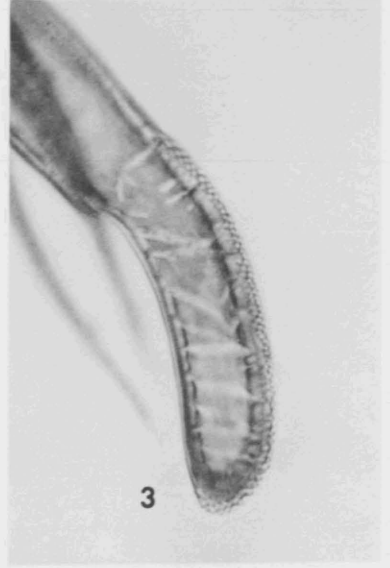
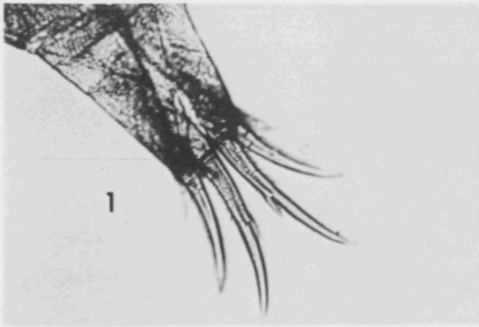

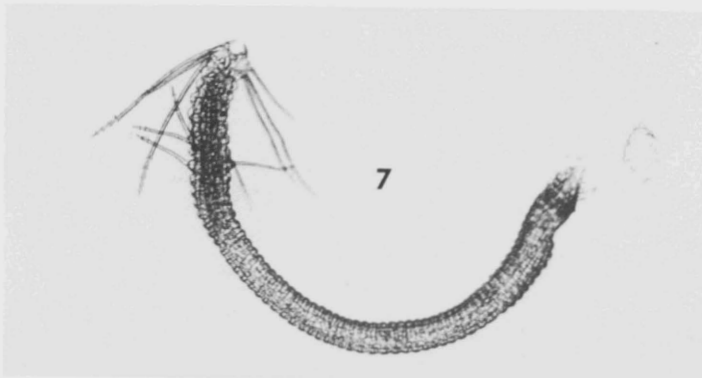
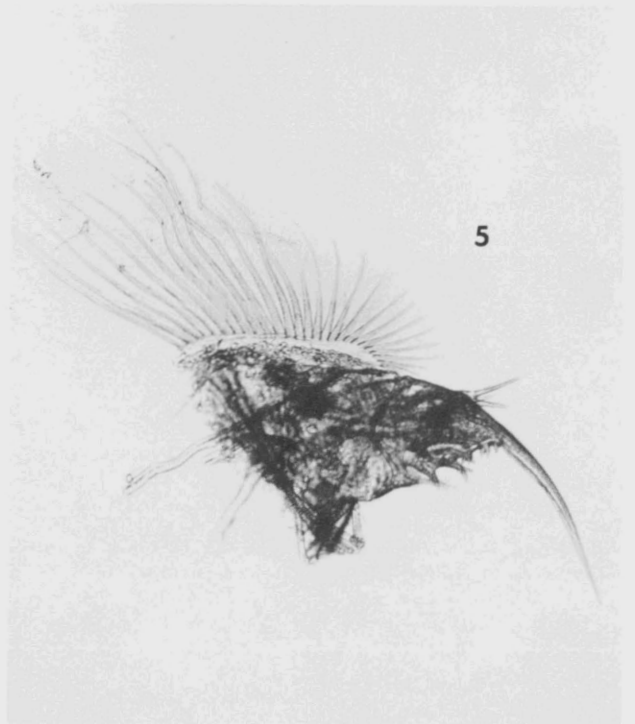
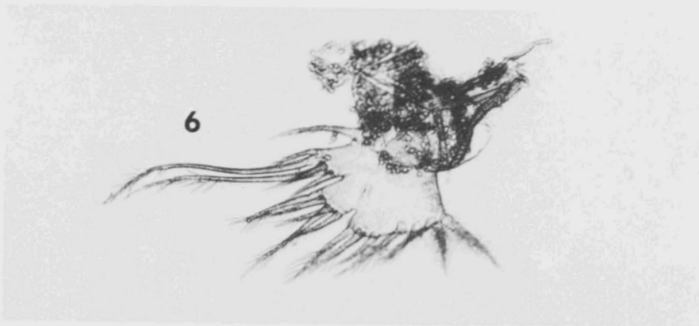
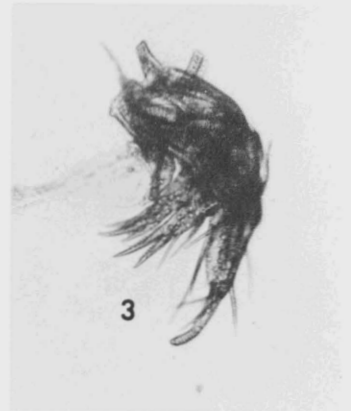
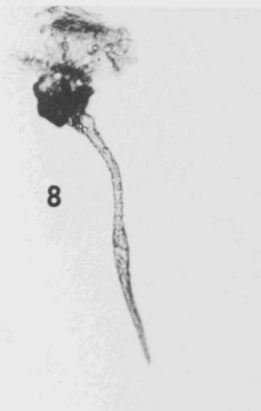
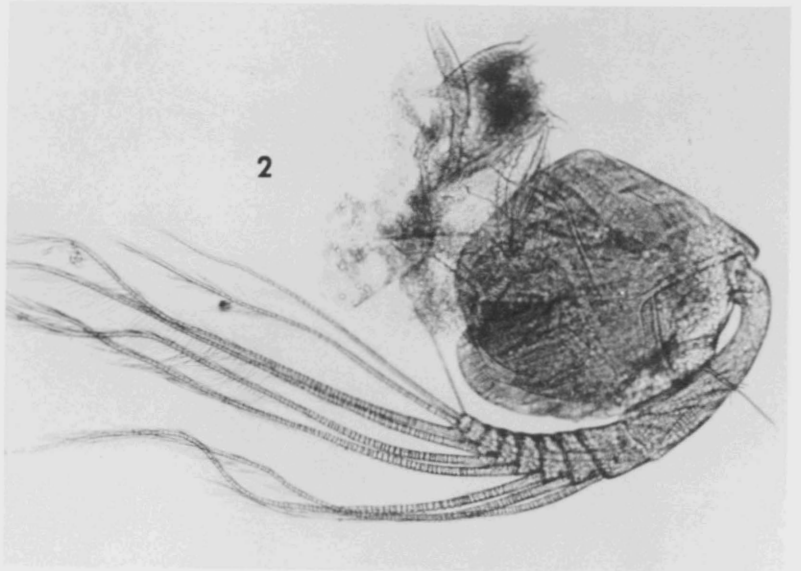

EXPLANATION OF PLATE 12

FIGS. 1-8 Pseudophilomedes ferulana Kornicker

1, 3, 4, 8 UMMP 48782, female; 1, antennule, dark spot near base is eye, x100; 3, maxilla, x100; 4, mandible, x100; 8, frontal organ, x100.

2, 5-7 UMMP 48783, female; 2, antenna, x100; 5, fifth limb, x100; 6, sixth limb, x100; 7, seventh limb, x100.

EXPLANATION OF PLATE 13

FIGS. 1-9 Rutiderma dinochelata Kornicker

1-4, 6-9 UMMP 48786, female; 1, antennule, x100; 2, antenna, x100; 3, mandible and maxilla, x100; 4, seventh limb, x100; 6, furcae, x100; 7, "toothed" portion of margin of antennal seta, x1000; 8, frontal organ and eye, x200; 9, articulating chela, x500.

5 UMMP 48787, female; mandible, maxilla and fifth limb, x100.

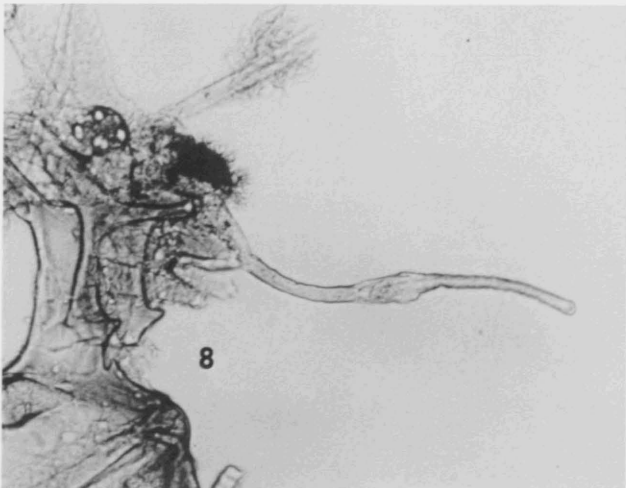
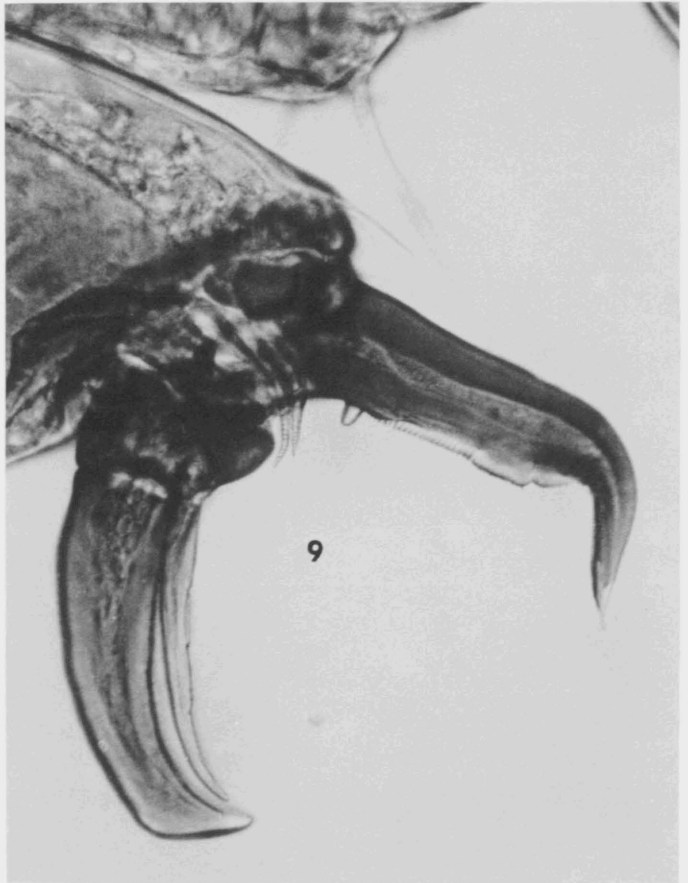
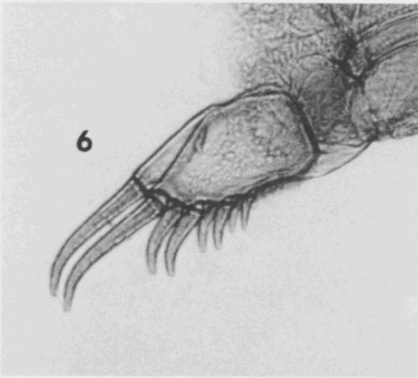
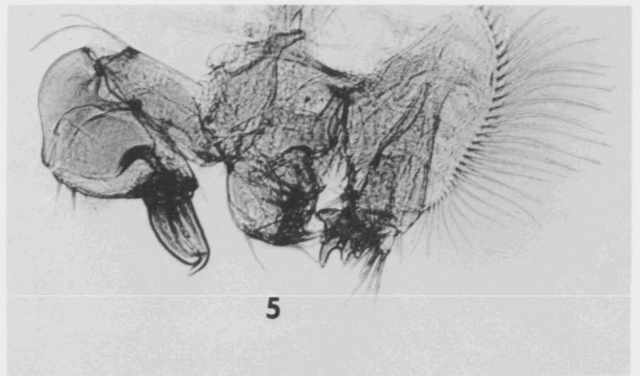
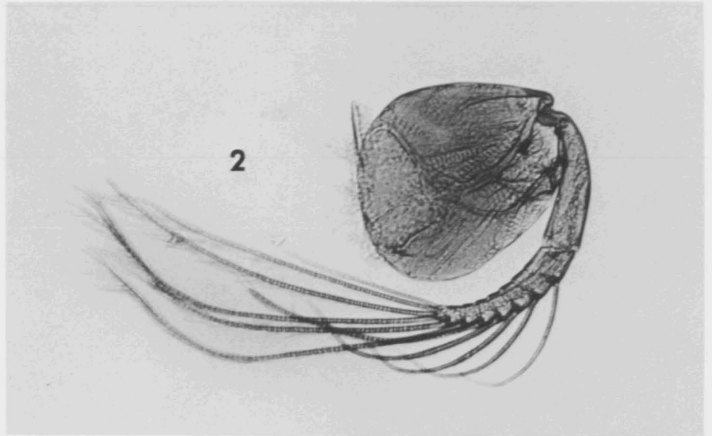
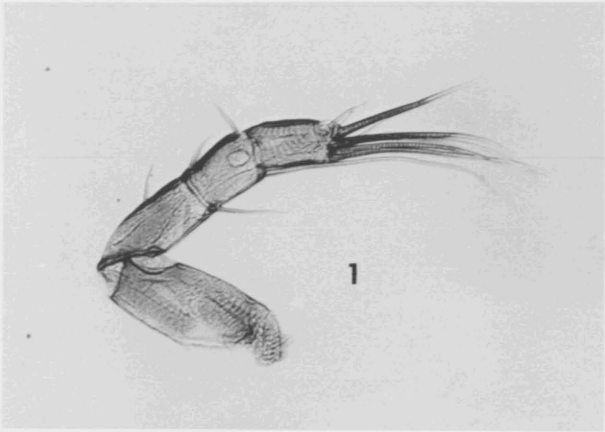

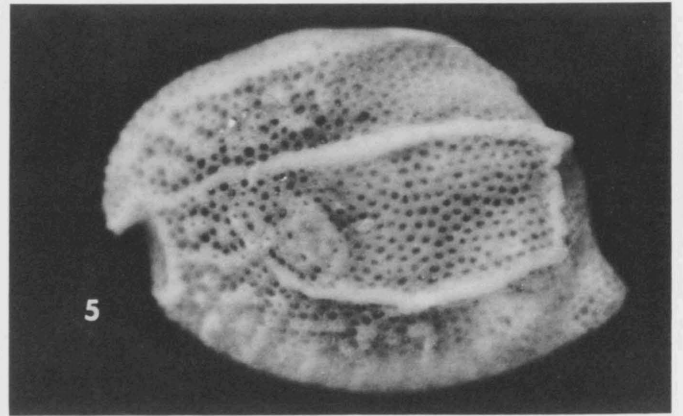
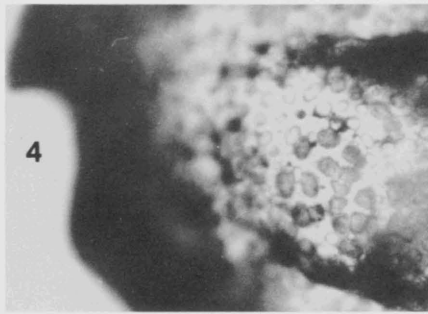
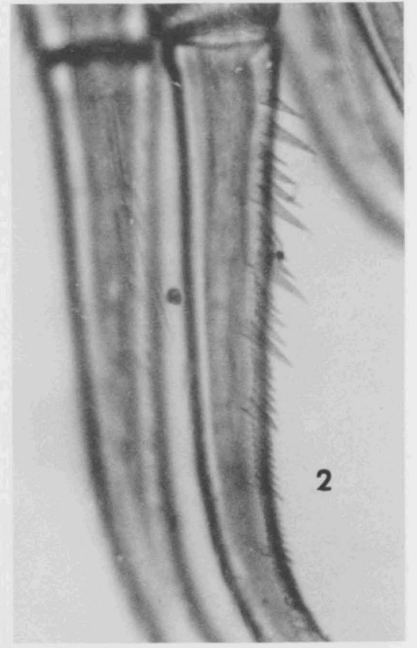
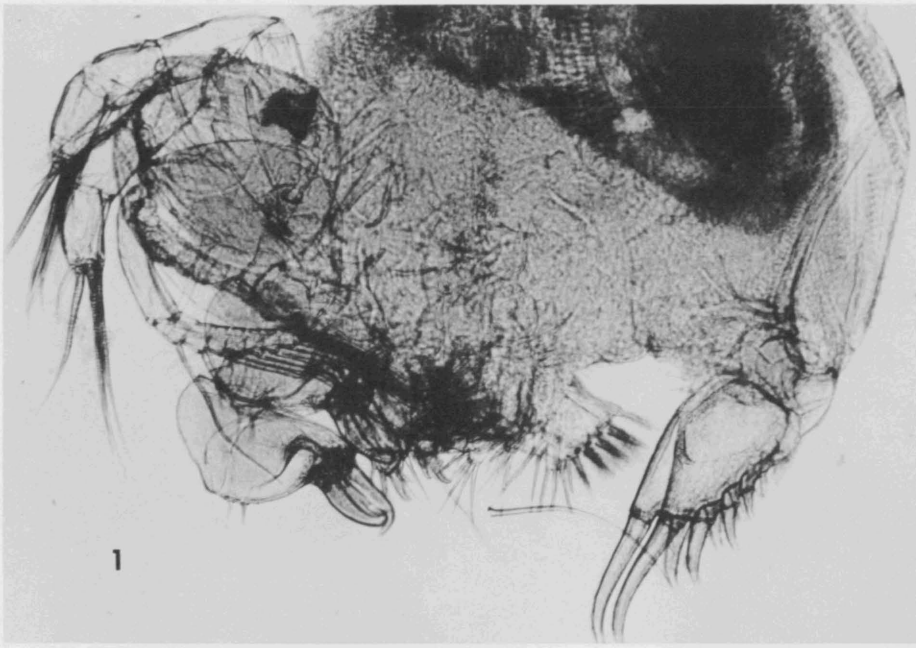

EXPLANATION OF PLATE 14

FIGS. 1-7 Rutiderma dinochelata Kornicker

- 1 UMMP 48788, female, whole mount showing appendage orientation, note sixth limb by furcae, x100.
- 2 UMMP 48786, female, major claws of furcae showing secondary setation, x500.
- 3-5 UMMP 48789, female; 3, adductor muscle scar pattern, right valve exterior, x100; 4, adductor muscle scar pattern, left valve exterior, x100; 5, left valve exterior, x60.
- 6 UMMP 48790, female, copepod in stomach, x500.
- 7 UMMP 48787, female, inside view left caudal process showing setiferous flange, x500.

EXPLANATION OF PLATE 15

FIGS. 1, 2 Rutiderma mollita, n. sp.

1 UMMP 48791, female, holotype; right valve exterior, x60.

2 UMMP 48792, female, schematic of adductor muscle scar pattern, arrow indicates anterior.

FIGS. 3-7 Asteropteron oculitristis, n. sp.

3, 5-7 UMMP 48793, male, holotype; 3, seventh limb, x100; 5, left valve exterior, x50; 6, adductor muscle scar pattern, inside left valve, anterior to right, x100; 7, raised pore cluster, x500.

4 UMMP 48794, male, paratype, furca, x60.

PLATE 15

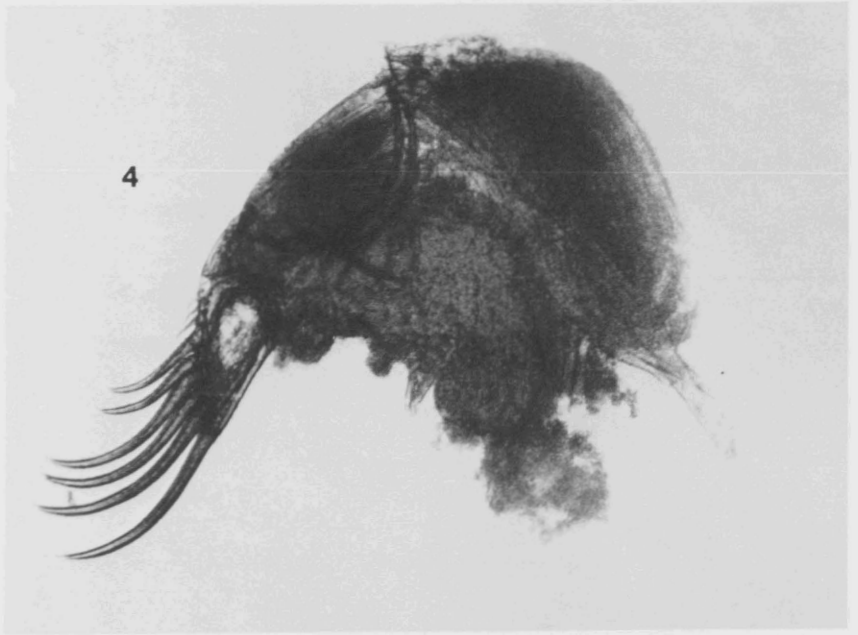
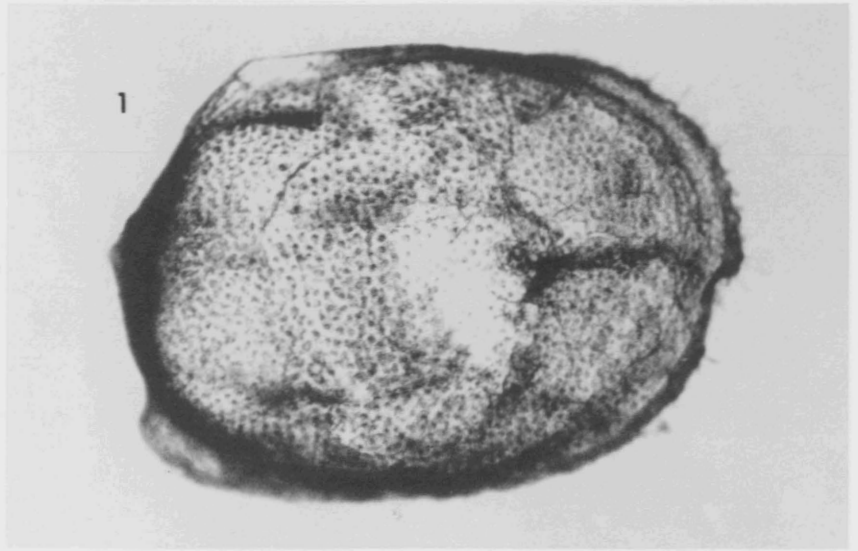
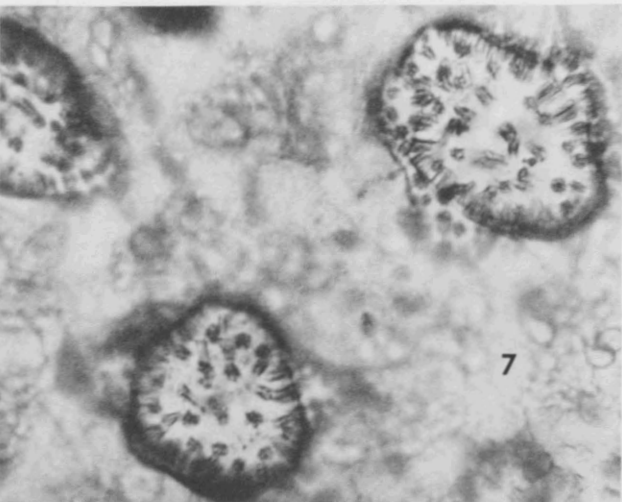
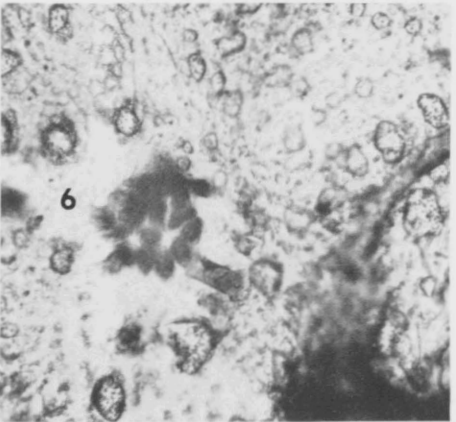
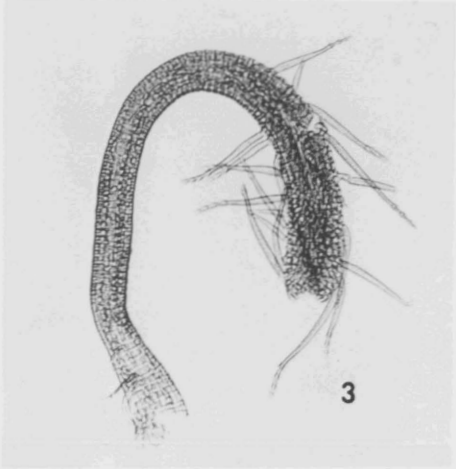
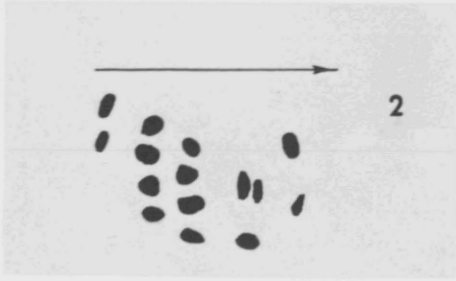

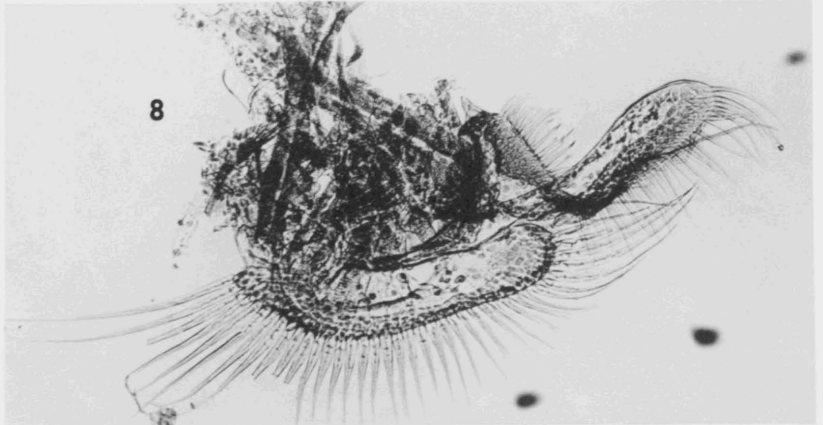
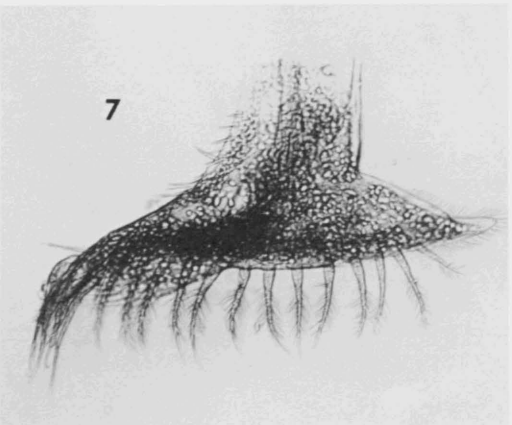
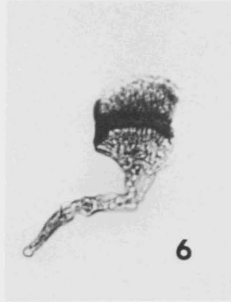
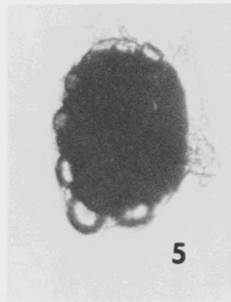
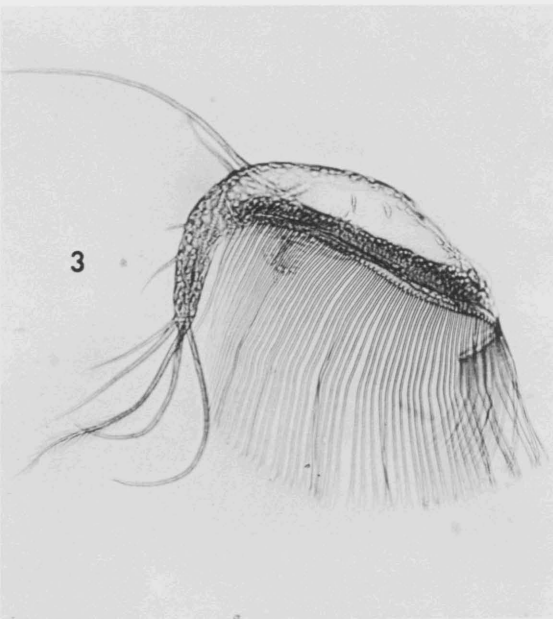
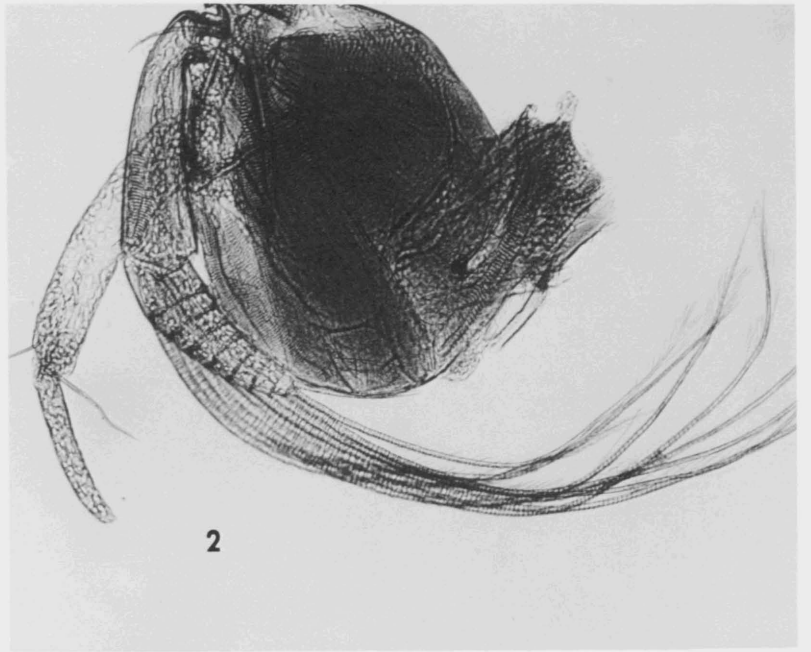
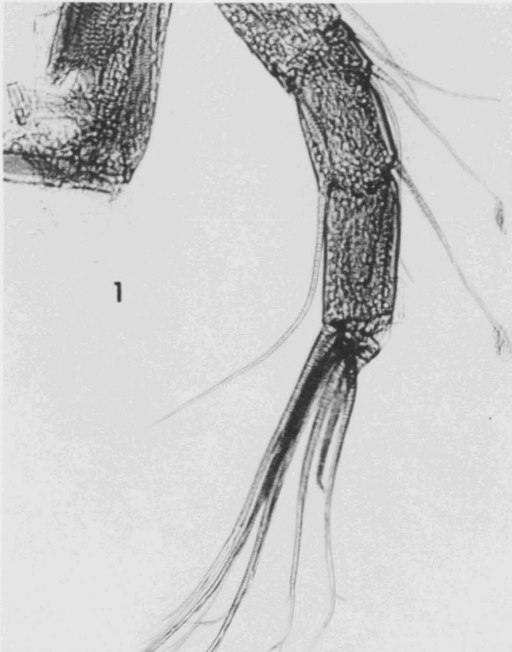

EXPLANATION OF PLATE 16

FIGS. 1-8 Asteropteron oculitristis, n. sp.

1, 2, 5, 7 UMMP 48794, male, paratype; 1, portion of antennule, x100; 2, antenna, note endopod on left, x100; 5, eye, note position of larger lenses - downward toward substrate, x200; 7, sixth limb, x100.

3, 4, 6, 8 UMMP 48793, male, holotype; 3, maxilla, X87; 4, mandible, x100; 6, frontal organ, x100; 8, a pair of fifth limbs, x100.

EXPLANATION OF PLATE 17

FIGS. 1-8 Cyclasterope biminiensis (Kornicker)

1 UMMP 48795, male, antennule, x75.

2, 8 UMMP 48796, male; 2, antenna, x50; 8, showing form of endopod of male, note short basal spines (somewhat masked by natatory setae) of exopod podomeres, x200.

3 UMMP 48797, left valve exterior, showing irregular calcareous pattern, x30.

4, 7 UMMP 48798, male; 4, frontal organ, note bilobation of basal ganglion, x100; 7, natatory setae of antenna, showing spinose pattern and subsetae, x500.

5, 6 UMMP 48799, male; 5, eye lense pattern, x300; 6, inner view of rostrum, x500.

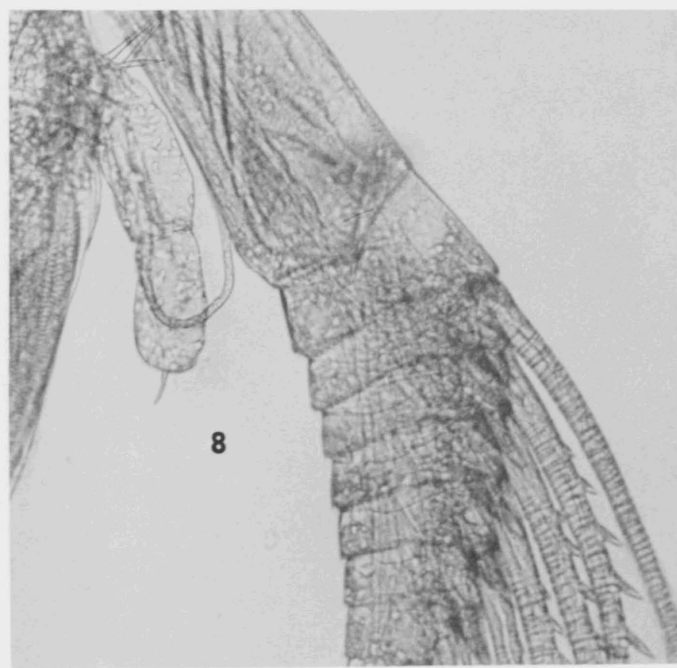
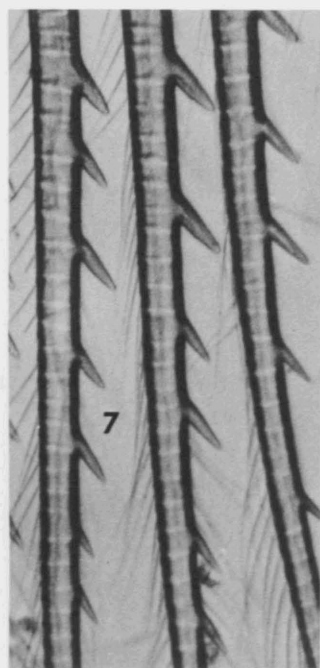
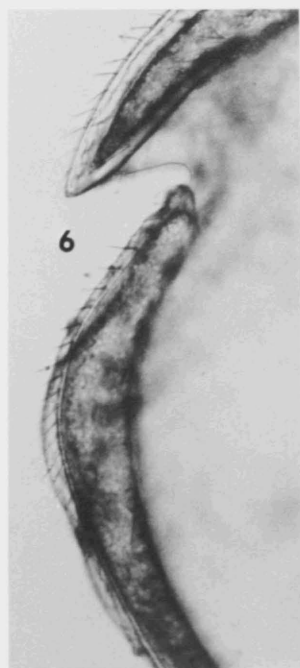
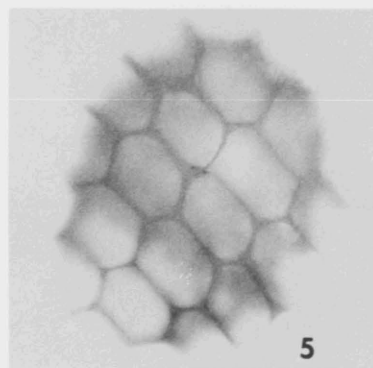
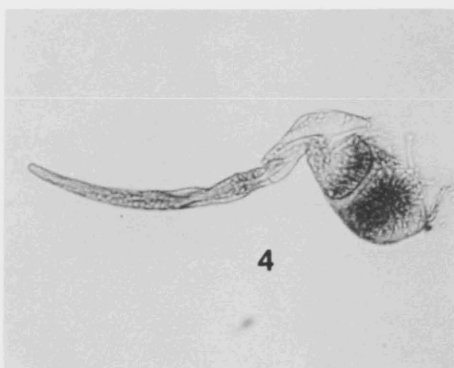
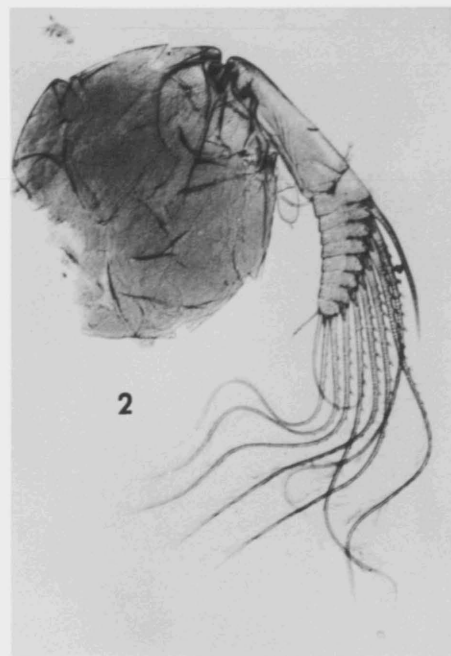
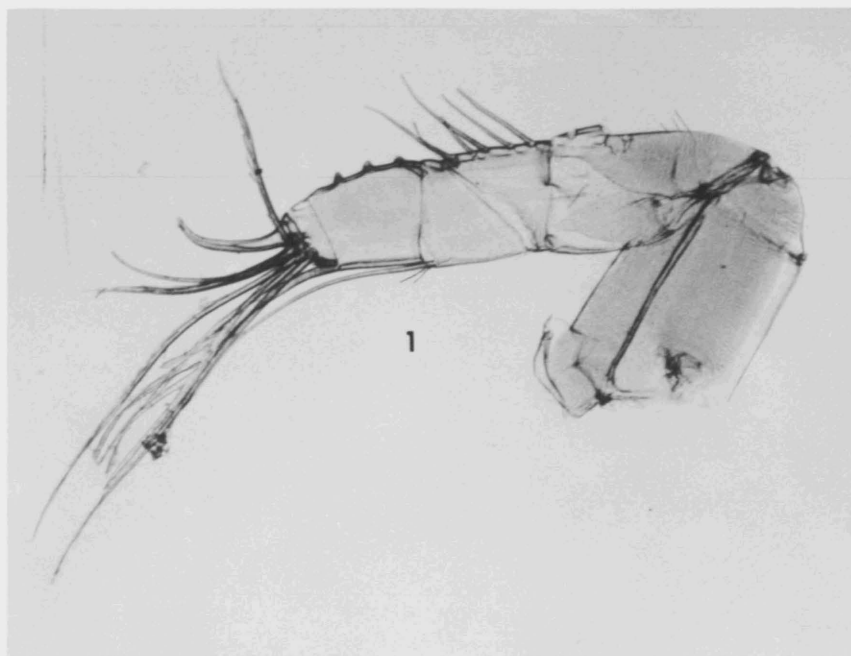

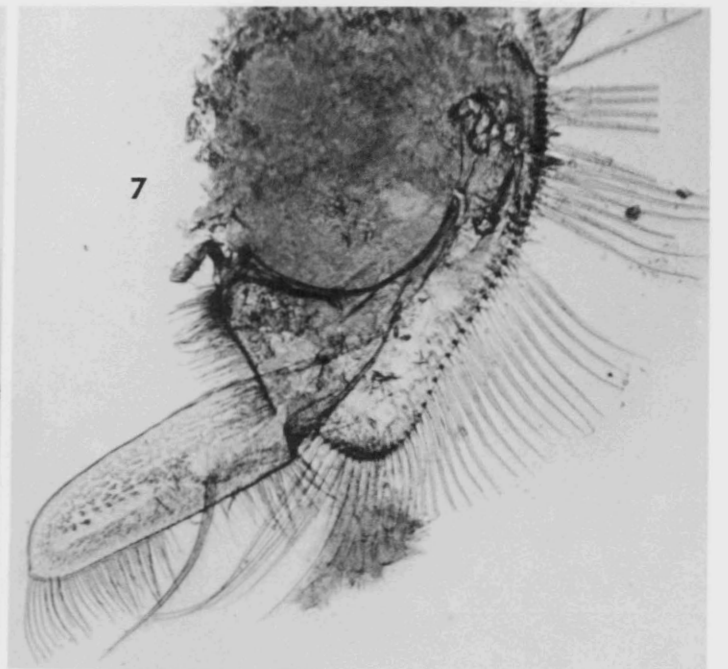
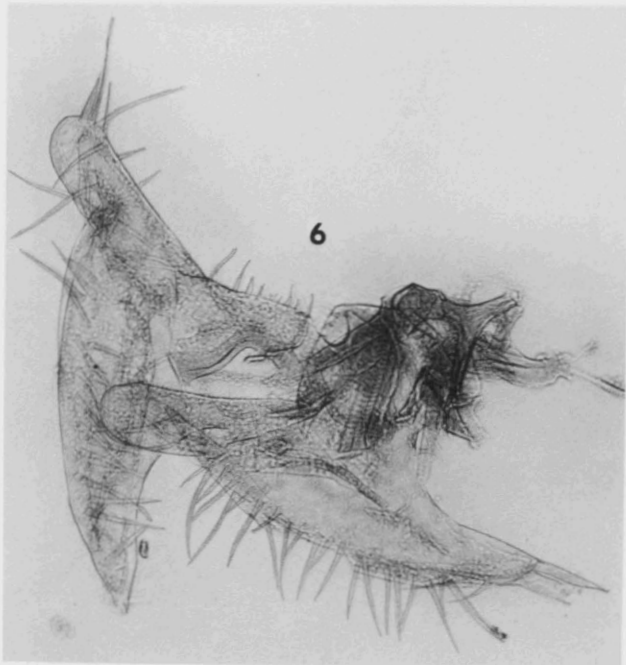
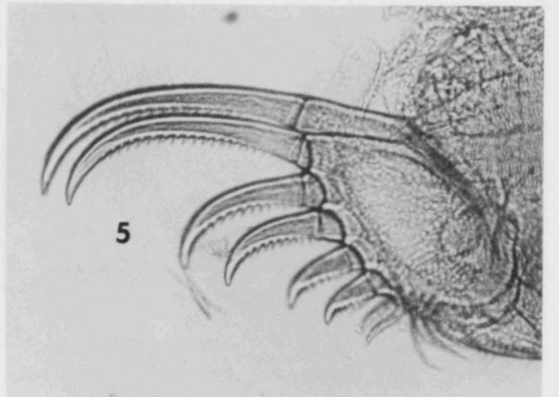
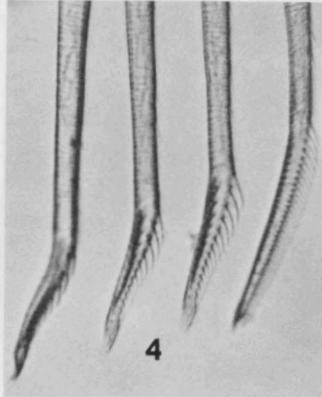
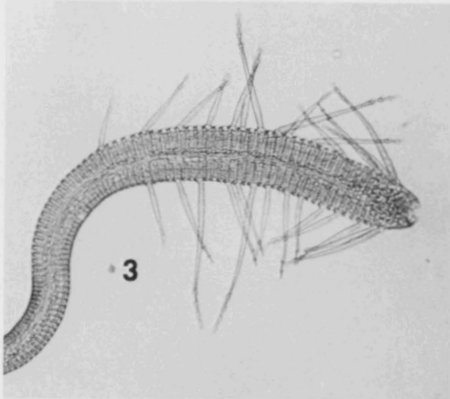
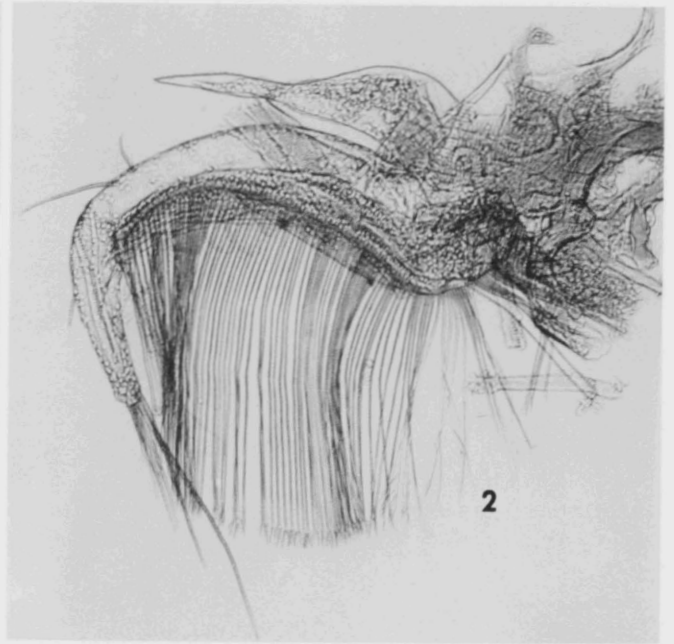
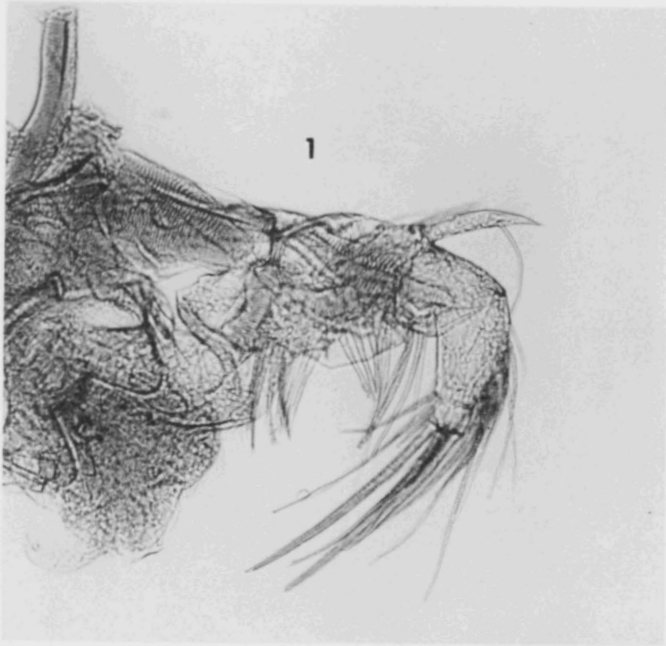

EXPLANATION OF PLATE 18

FIGS. 1-7 Cyclasterope biminiensis (Kornicker)

1, 5, 6 UMMP 48798, male; 1, mandible, x100; 5, furcae, x100; 6, sixth limbs, x100.

2 UMMP 48795, male, maxilla, x100.

3 UMMP 48799, male, seventh limb, x100.

4 UMMP 48796, male, setae from ventral portion of second podomere of protopod of mandible, x500.

7 UMMP 48800, male, fifth limb, x75.

EXPLANATION OF PLATE 19

FIGS. 1-4 Cyclasterope biminiensis (Kornicker)

- 1 UMMP 48795, male, setae of seventh limb showing calcareous algae growth, x500.
- 2 UMMP 48800, male, seventh limb, x100.
- 3 UMMP 48799, male, gills, anterior to right, x100.
- 4, schematic drawing of adductor muscles scar pattern, arrow indicates anterior.

FIGS. 5, 6 Cylindroleberis psitticina, n. sp.

- 5 UMMP 48802, male, antenna, x100.
- 6 UMMP 48801, female, holotype, left valve exterior, x60.

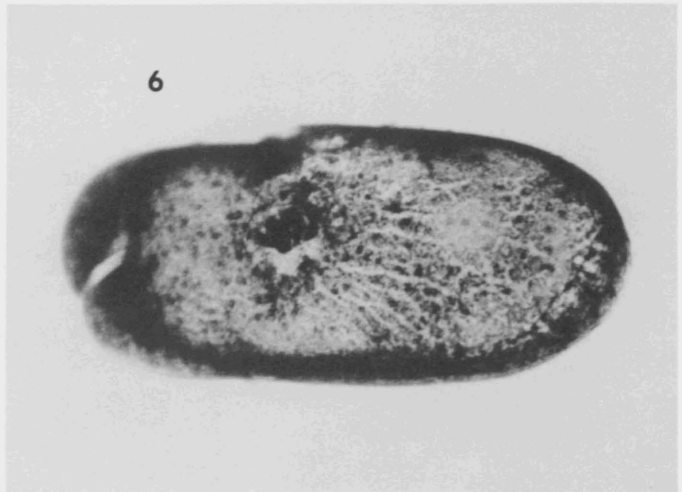
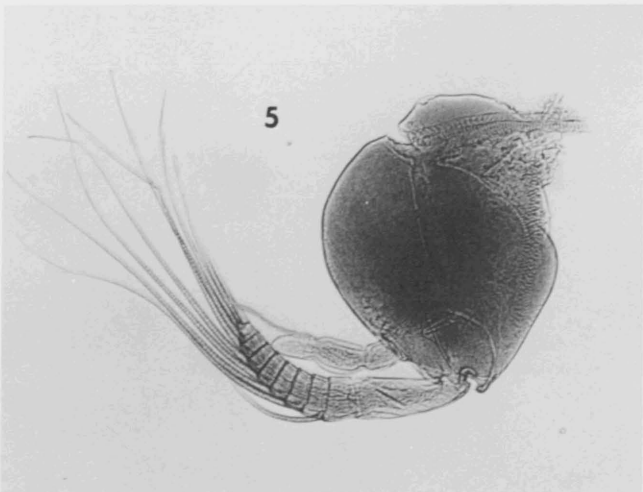
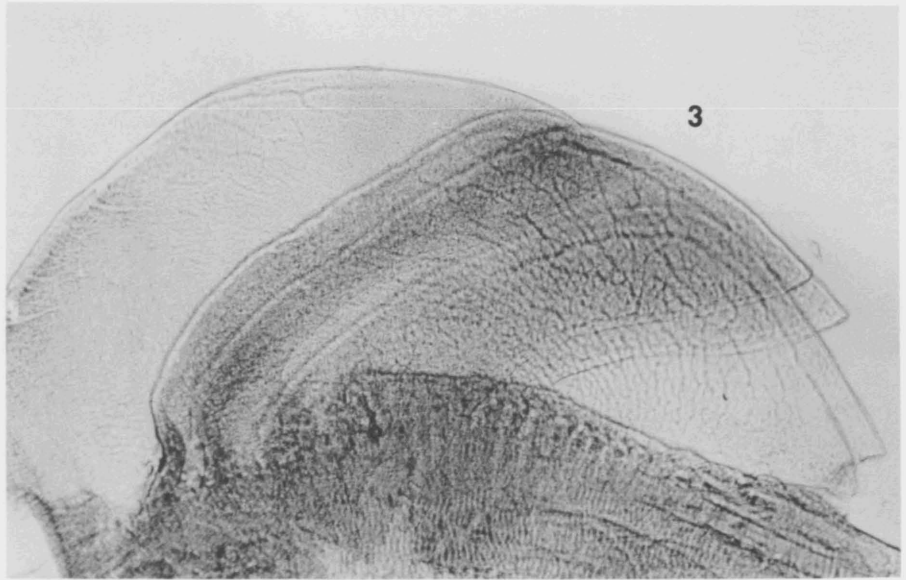
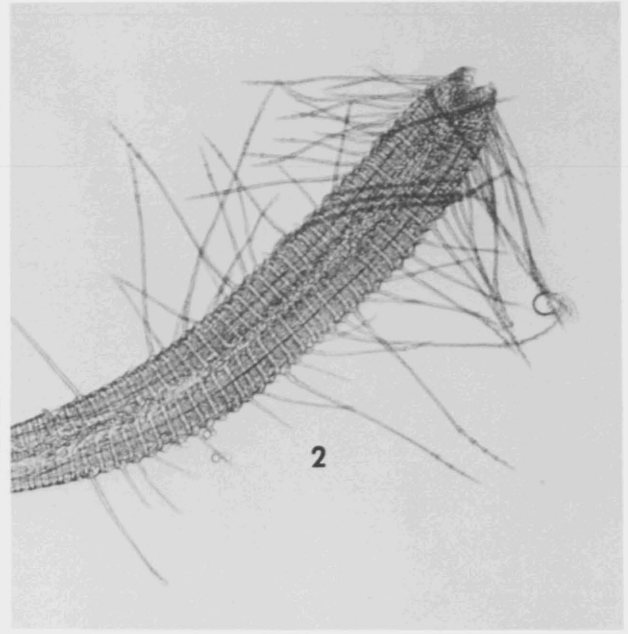
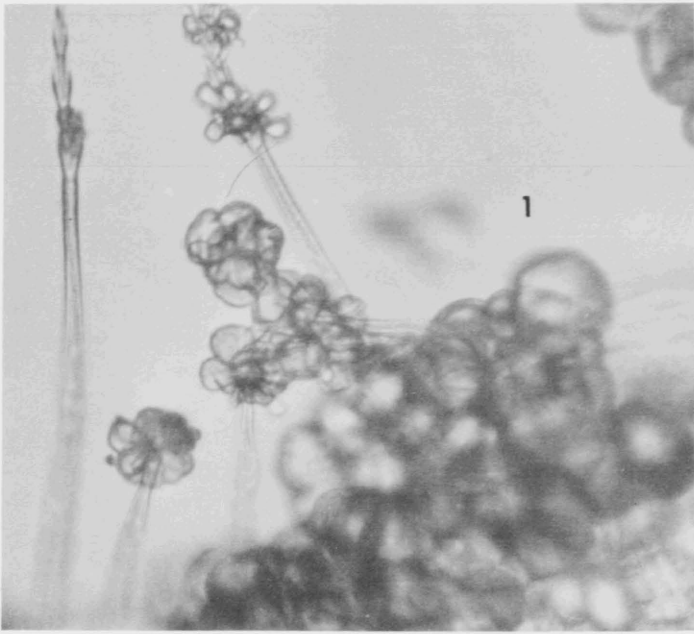

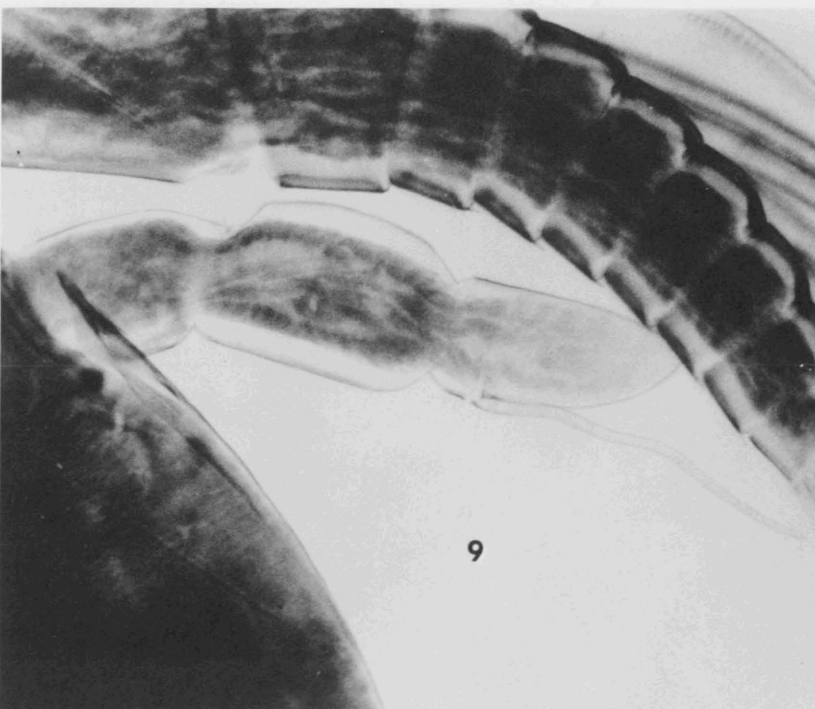
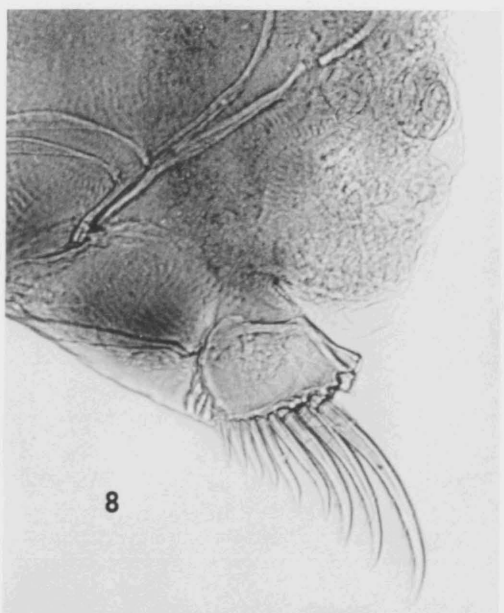
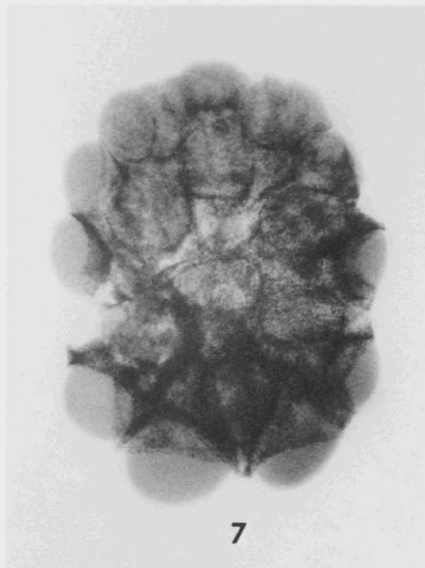
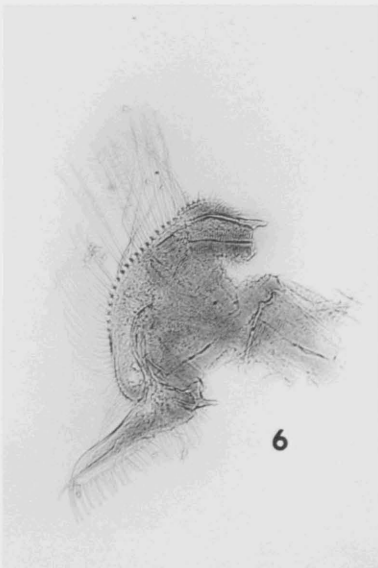
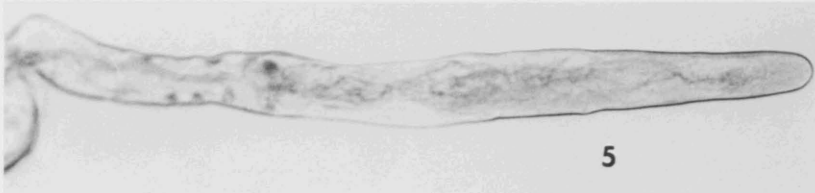
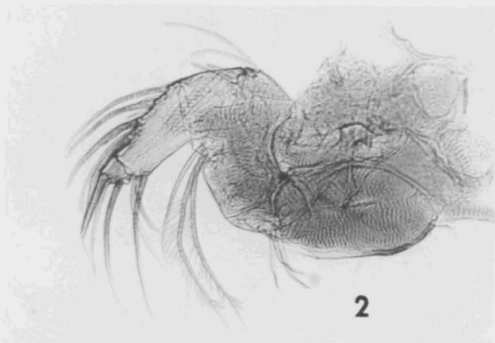
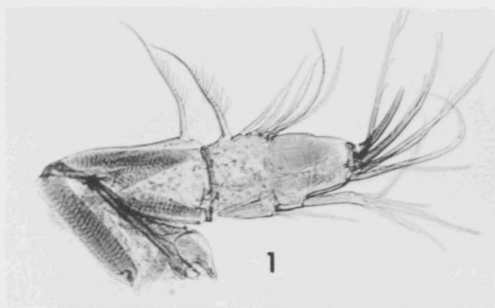

EXPLANATION OF PLATE 20

FIGS. 1-9 Cylindroleberis psitticina, n. sp.

1, 2, 5, 8 UMMP 48801, female, holotype; 1, antennule, x100; 2, mandible, x100; 5, frontal organ, x500; 8, furcae, largest distal pair of claws broken off at bases, x200.

3, 4, 6, 7, 9 UMMP 48802, male; 3, maxilla, x100; 4, frontal organ, x500; 6, fifth limb, x100; 7, eye, x500; 9, antennal endopod, x500.

EXPLANATION OF PLATE 21

FIGS. 1-8 Sarsiella nodimarginis, n. sp.

1-8 UMMP 48803, female, holotype; 1, frontal organ and eye, x200; 2, antenna, x50; 3, antennule, x100; 4, mandible, x100; 5, maxilla and sixth limb, x100; 6, furcae, x100; 7, fifth limb, x100; 8, antennal endopod, on left is elongate basal podomere of exopod, x500.

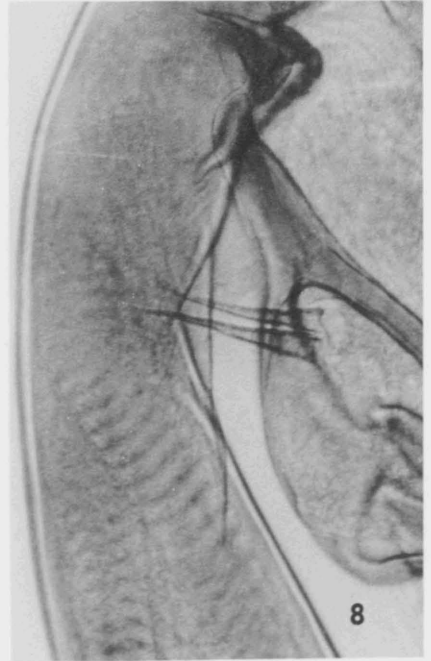
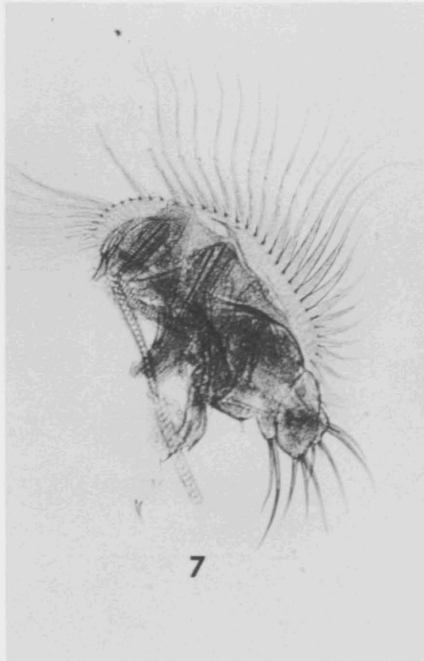
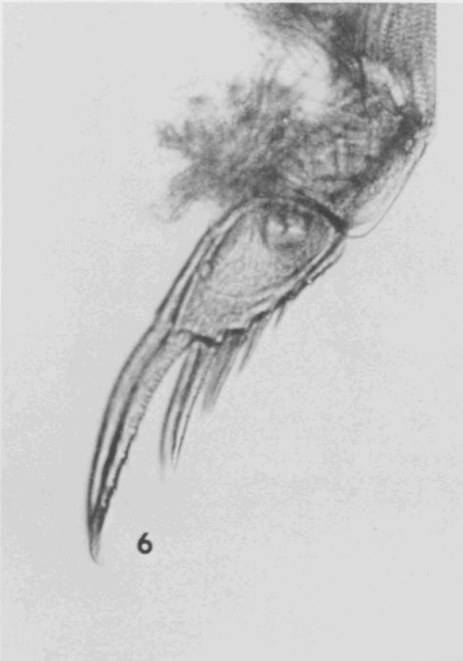
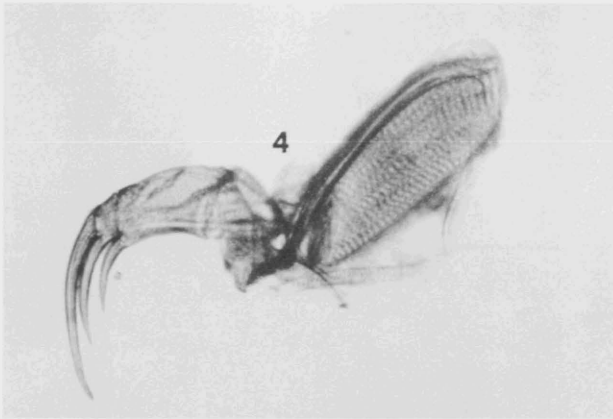
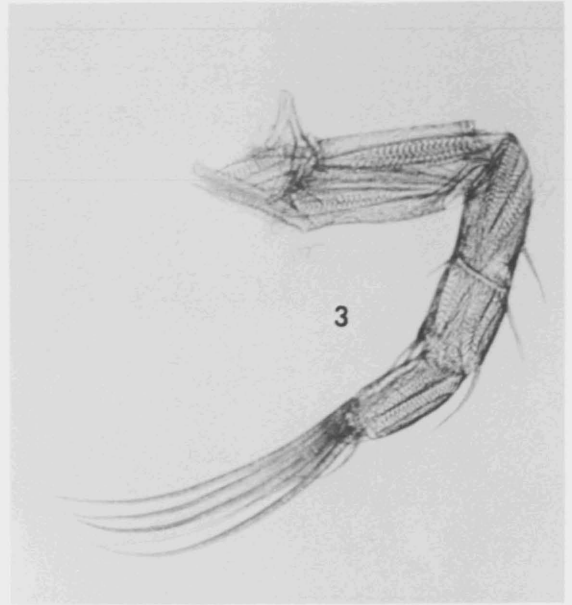
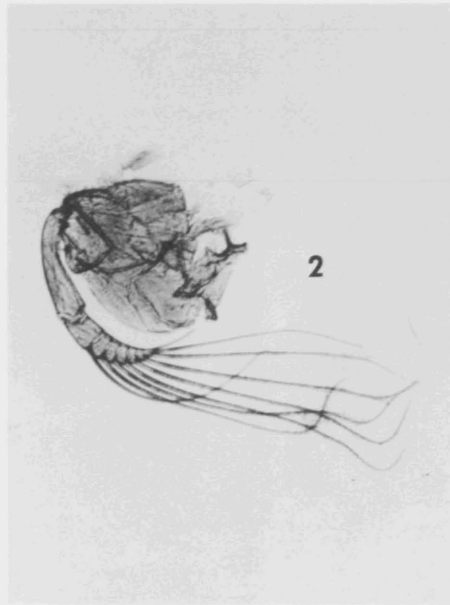

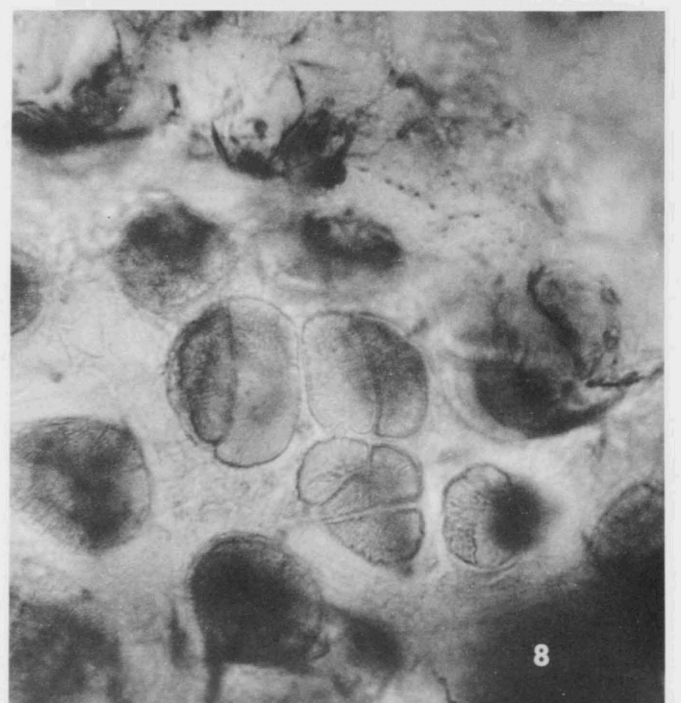
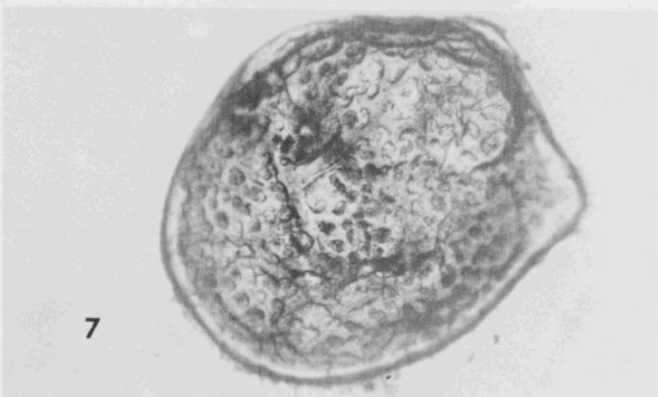
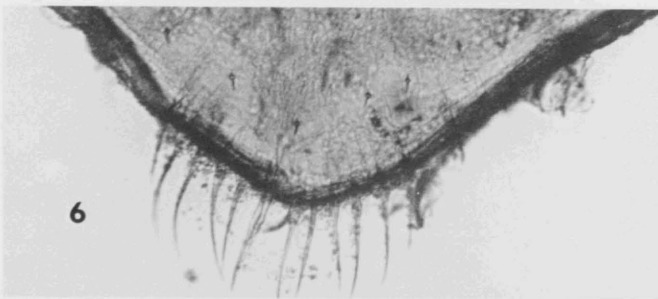
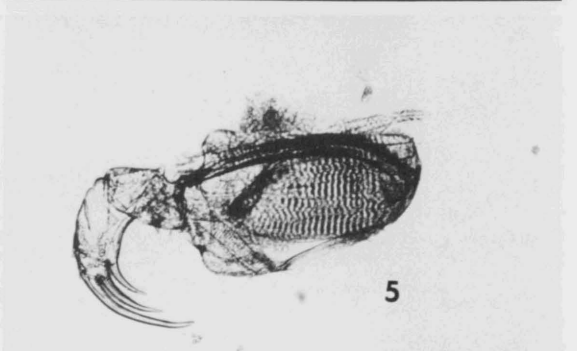
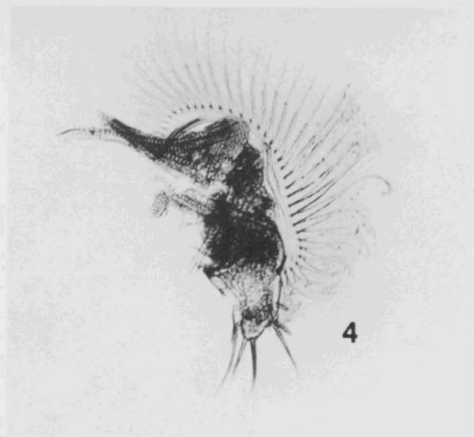
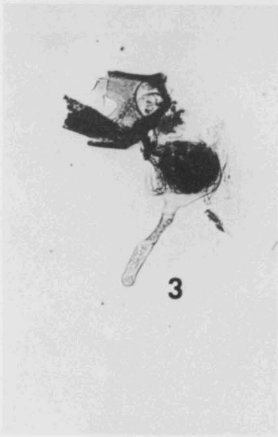
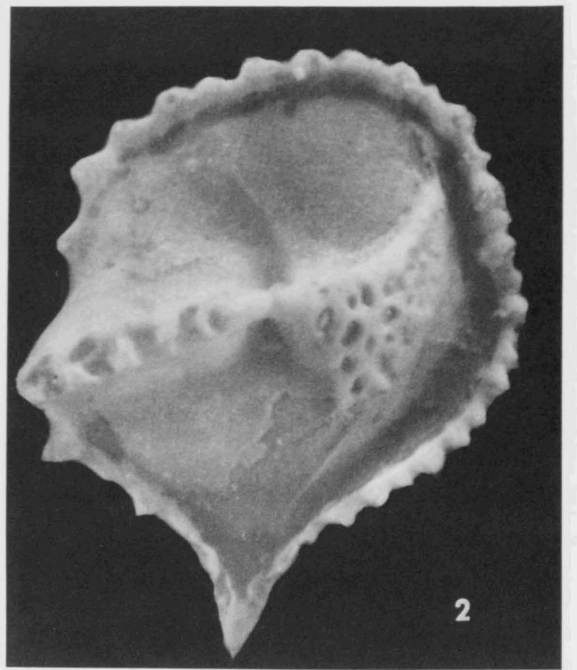
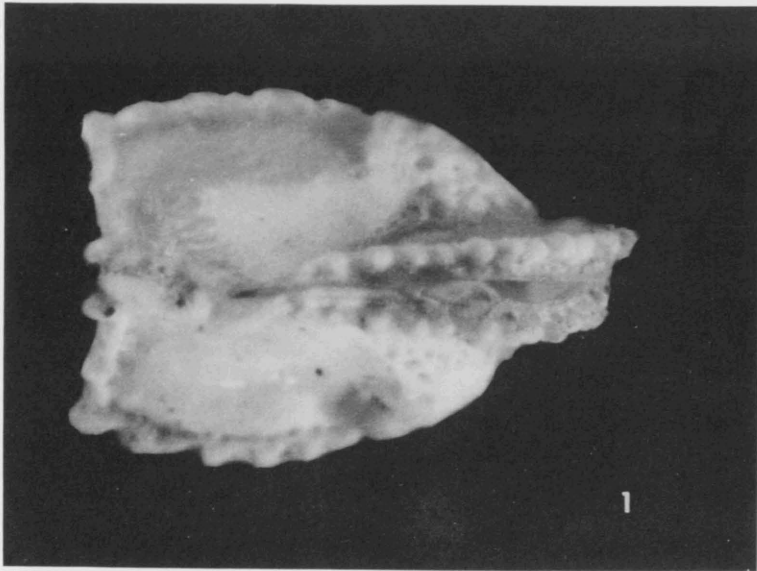

EXPLANATION OF PLATE 22

FIGS. 1, 2 Sarsiella nodimarginis, n. sp.

1, 2 UMMP 48804, female; 1, dorsal view of valves showing alae, x50; 2, right valve exterior, x50.

FIGS. 3-8 Sarsiella sculpta Brady

3-8 UMMP 48805, female; 3, frontal organ, x100; 4, fifth limb, x100; 5, mandible, x100; 6, caudal process, x500; 7, left valve exterior, x50; 8, adductor muscle scars, anterior to left, x500.

EXPLANATION OF PLATE 23

FIG. Sarsiella sculpta Brady

1 UMMP 48805, newborn emerging from egg capsule, x100.

FIGS. 2-9 Sarsiella pilipollicis, n. sp.

2-9 UMMP 48806, female, holotype; 2, end of seventh limb, x500; 3, antennule, x100; 4, maxilla, x100; 5, adductor muscle scars, right valve, anterior to right, x100; 6, furcae, note two vaginae at upper right, x100; 7, nodes, x200; 8, carapace surface, x500; 9, left valve exterior, x60.

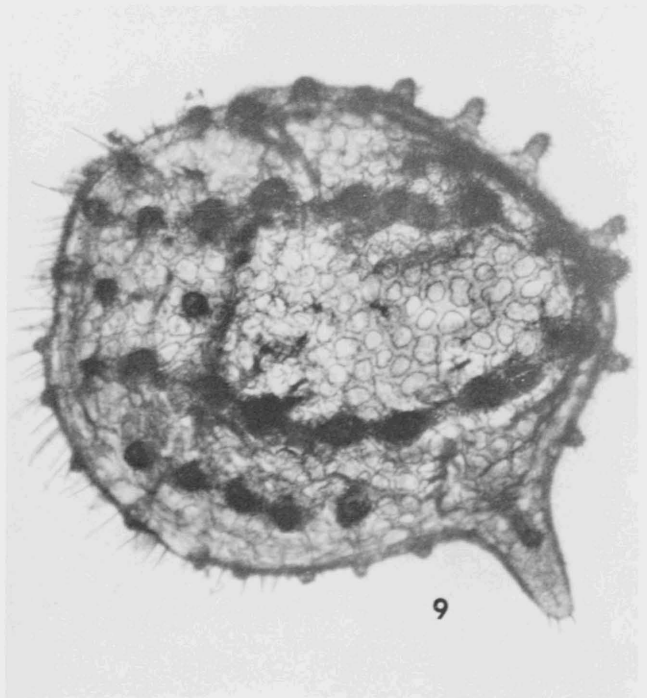
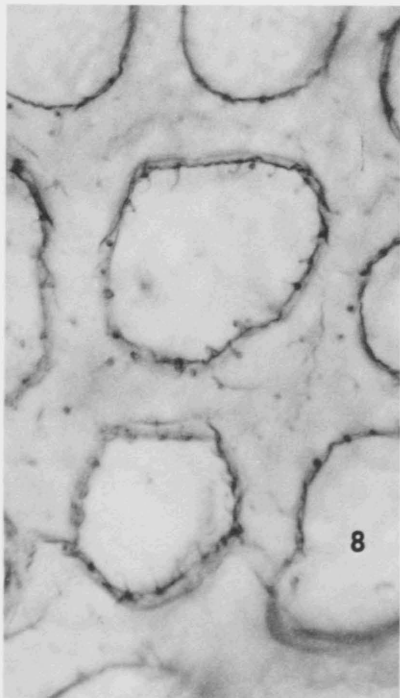
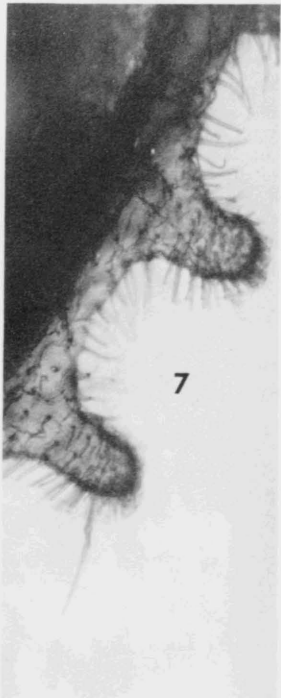
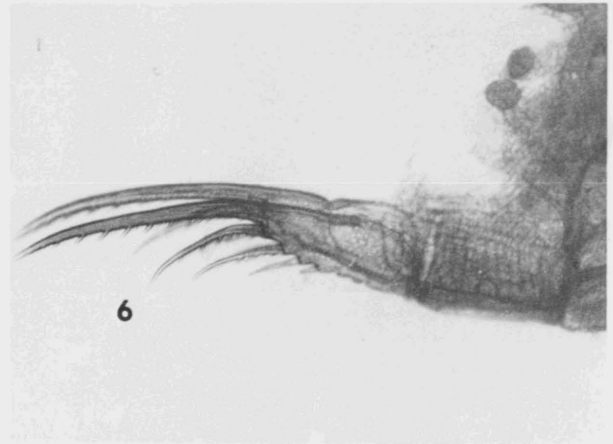
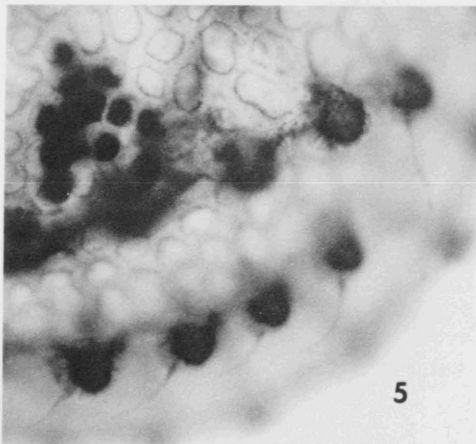
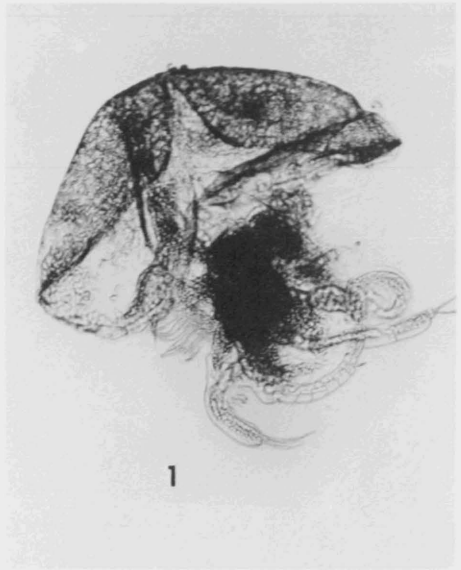
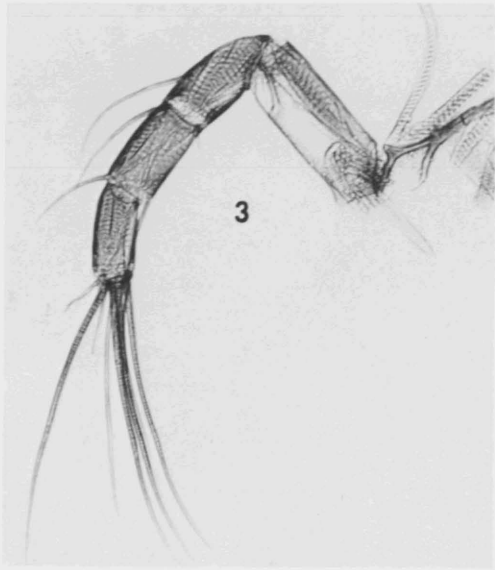

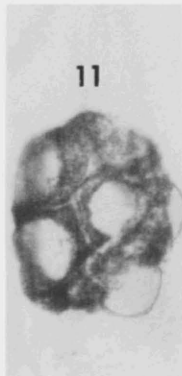
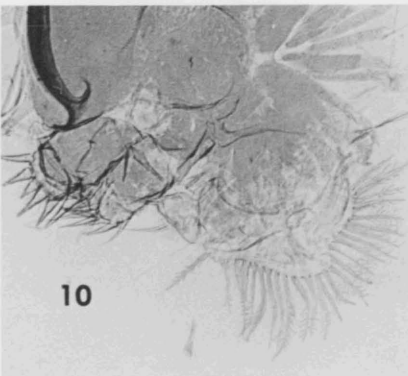
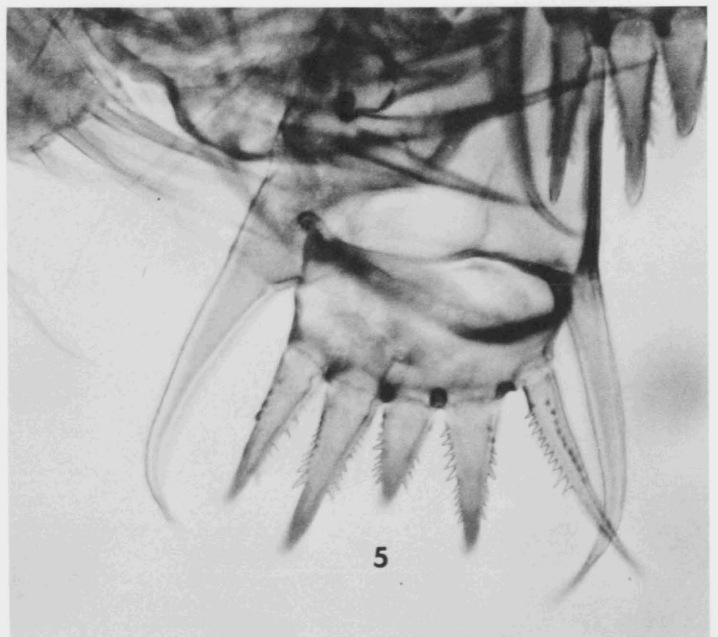
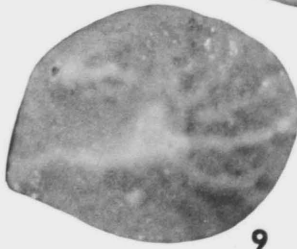
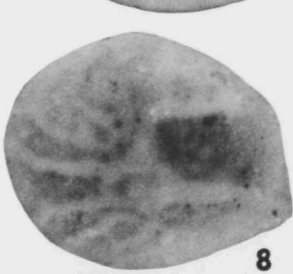
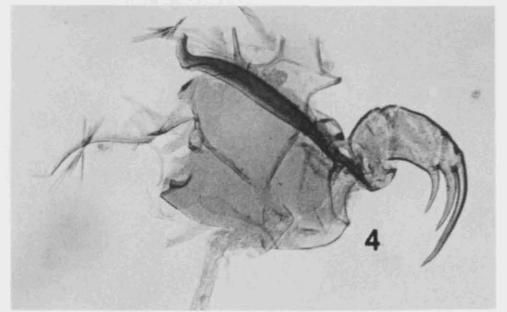
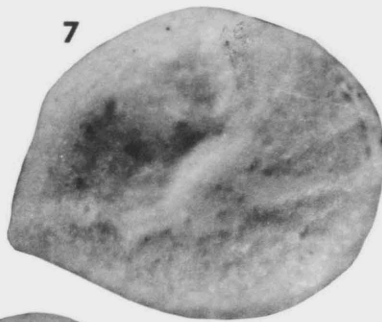
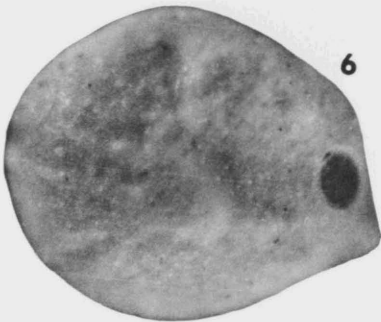
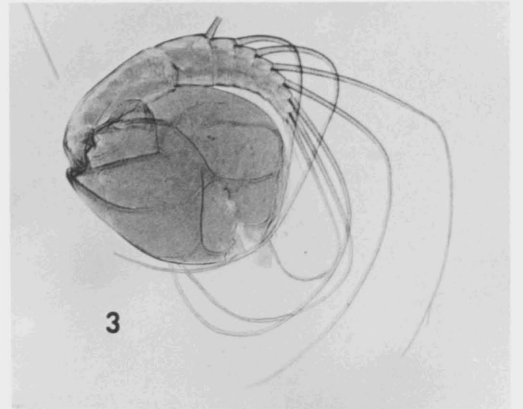
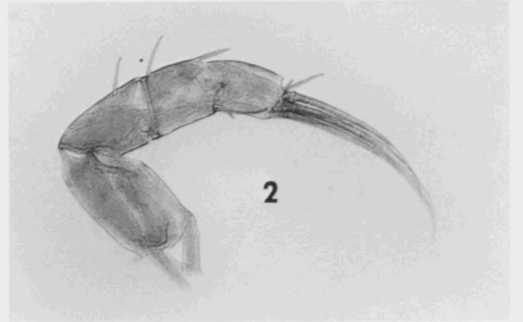
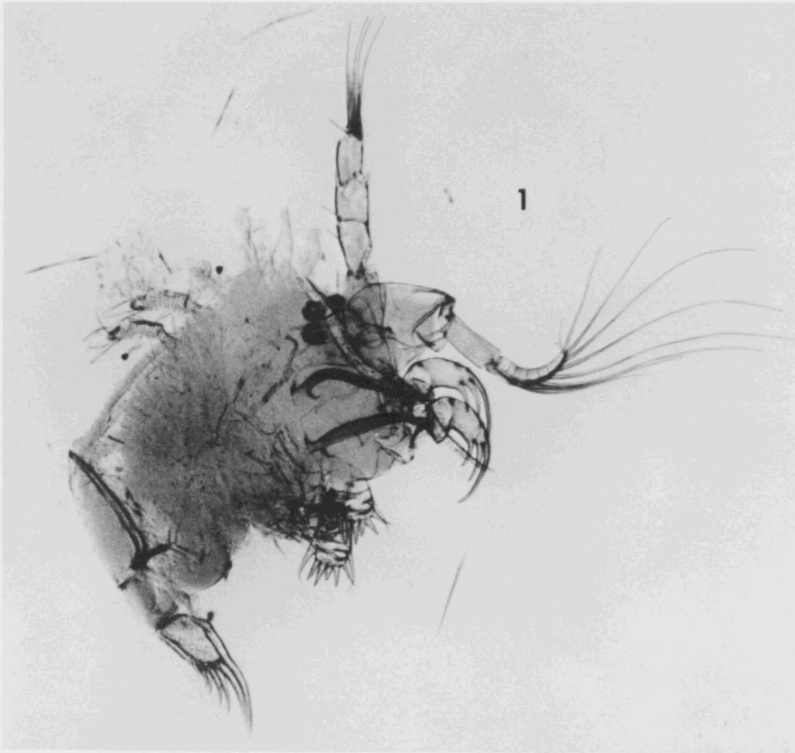

EXPLANATION OF PLATE 24

FIGS. 1-11 Sarsiella radiicosta, n. sp.

1, 5 UMMP 48807, female, holotype; 1, whole mount showing appendage orientation, an antennule and antenna have been removed, note two eyes, seventh limbs projecting dorsally, x60; 5, two terminal podomeres of maxillary endopod, typical of genus, x500.

2-4, 6, 7, 10, 11 UMMP 48808, female; 2, antennule, x100; 3, antenna, x100; 4, mandible, x100; 6, left valve exterior, x60; 7, right valve exterior, x60; 10, maxilla and fifth limb, x100; 11, eye, x500.

8, 9 UMMP 48809, female; 8, left valve exterior, x60; 9, right valve exterior, x60.

EXPLANATION OF PLATE 25

FIG. 1 Sarsiella radiicosta, n. sp.

1 UMMP 48808, female, adductor muscle scars, left valve, anterior to left, x300.

FIGS. 2-9 Sarsiella georgiana, n. sp.

2-9 UMMP 48810, male, holotype; 2, frontal organ, dark mass is an eye, x100; 3, left valve exterior, x60; 4, antennule, note bristles "baleen" off third podomere, typical of males of genus, x100; 5, endopod (?), x200; 6, antenna, x100; 7, antenna showing grasping form of endopod, x200; 8, sixth limb, x100; 9, furcae and penis, x100.

FIGS. 10-12 Sarsiella rousei, n. sp.

10-12 UMMP 48811, female, holotype; 10, furcae, x100; 11, frontal organ, x100; 12, antennule, x100.

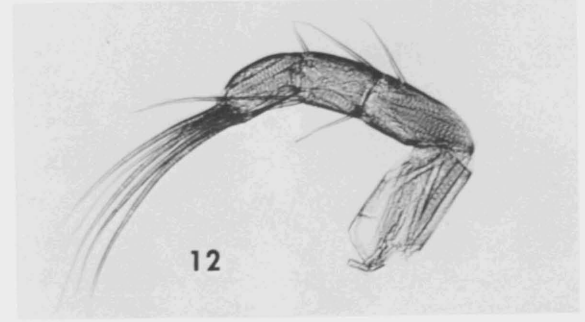
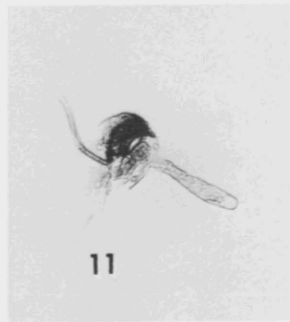
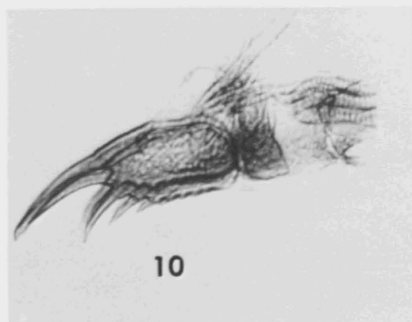
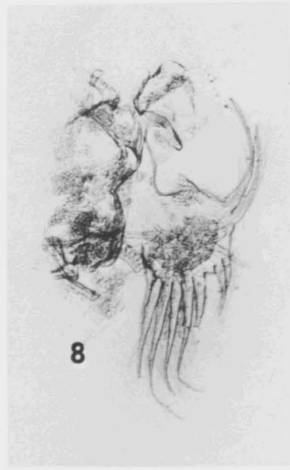
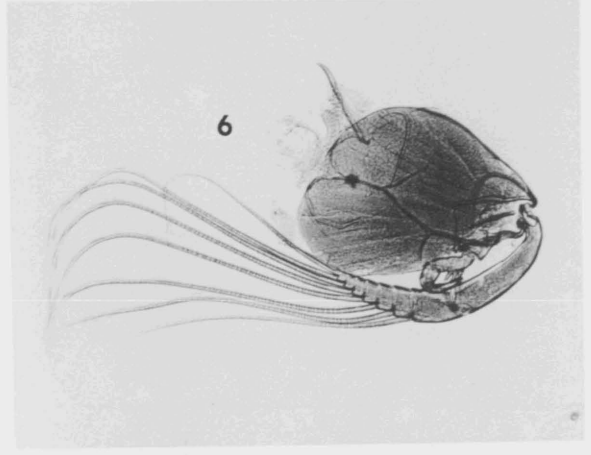
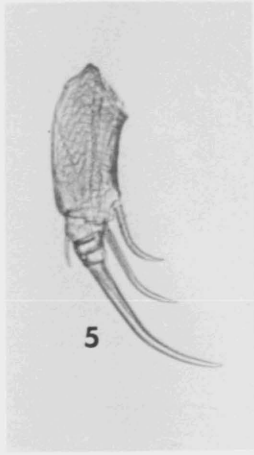
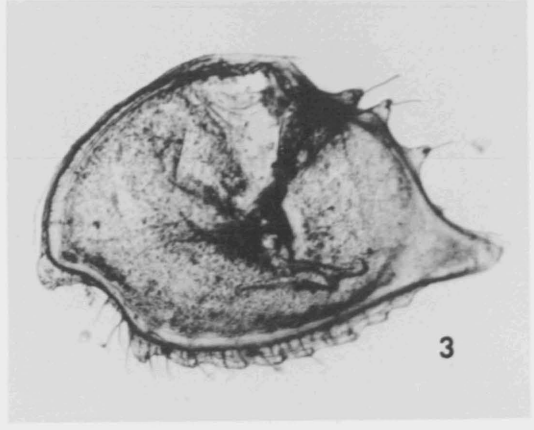
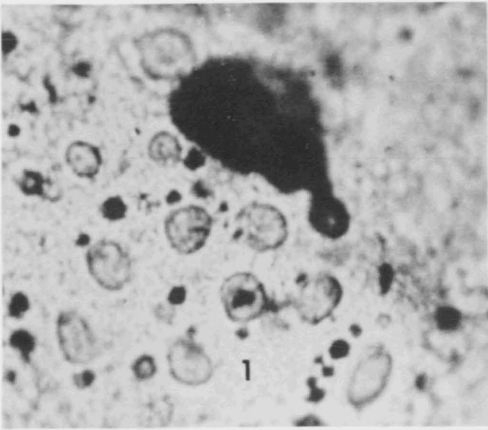

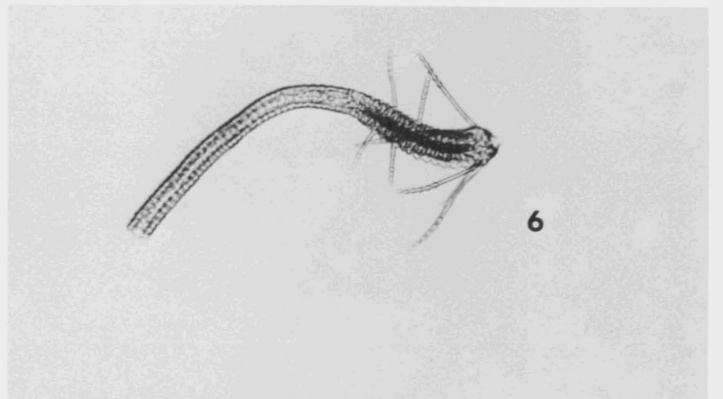
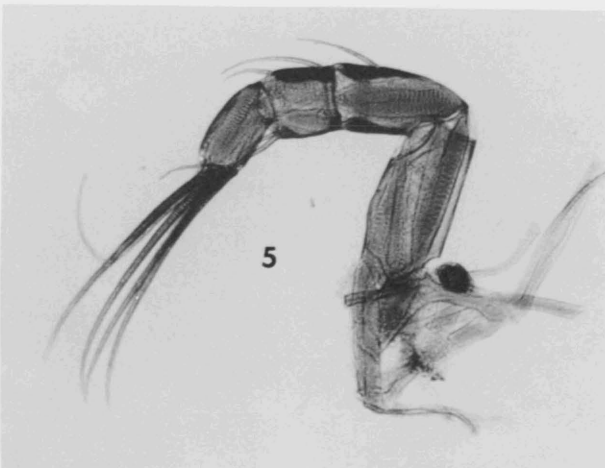
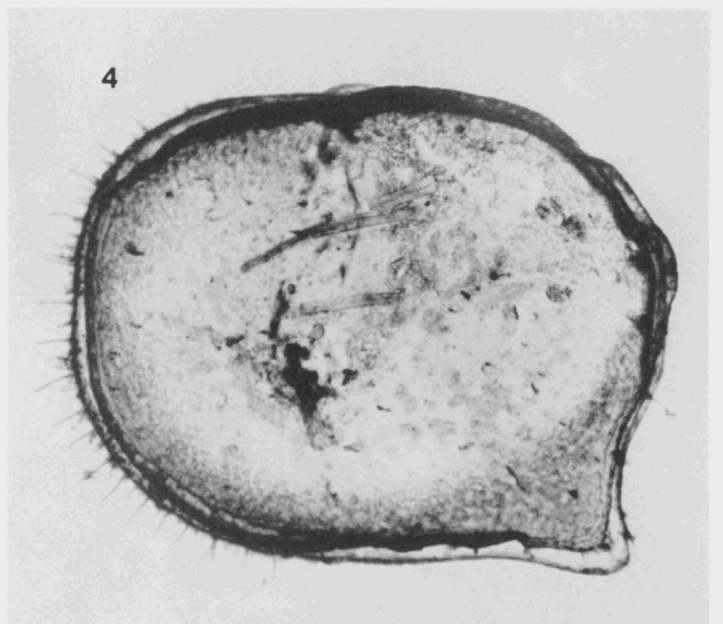
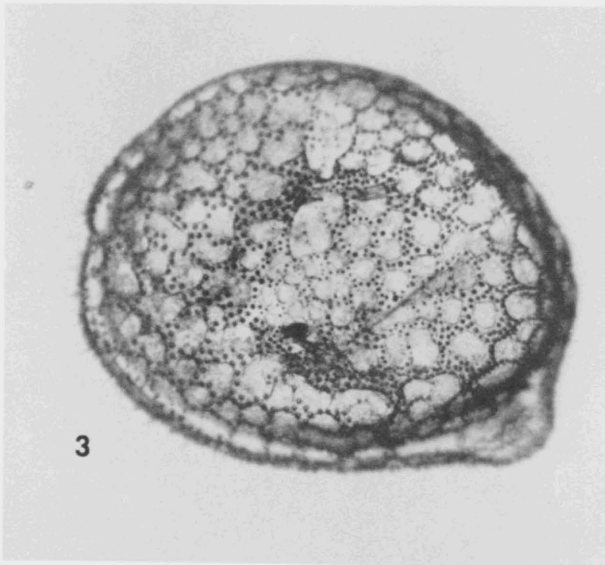
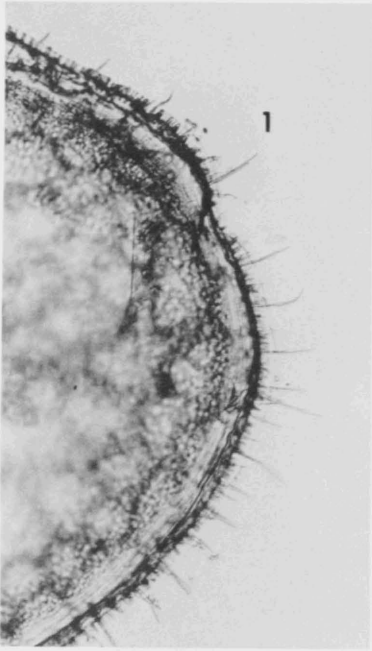

EXPLANATION OF PLATE 26

FIGS. 1-3 Sarsiella rousei, n. sp.

1-3 UMMP 48811, female, holotype; 1, left valve interior showing slight rostrum, atypical of female of genus, x100; 2, whole mount both antennae removed, note arthropod remains in gut, x100; 3, left valve exterior, x60.

FIGS. 4-6 Sarsiella angusta, n. sp.

4-6 UMMP 48813, female, holotype; 4, left valve exterior x60; 5, antennule, x100; 6, seventh limb, x100.

EXPLANATION OF PLATE 27

FIGS. 1-19 Sarsiella greyi, n. sp.

1-9 UMMP 48814, female, holotype; 1, antennule, x100; 2, fifth limb, x100; 3, mandible, x100; 4, frontal organ, x100; 5, seventh limb, x100; 6, sixth limb, x100; 7, furcae, x100; 8, copepod in stomach, x200; 9, right valve exterior showing irregular growth of calcium carbonate, x50.

10 UMMP 48815, female, right valve exterior, noncalcareous specimen, note the posterodorsal outpouching serving as brood space, x50.

PLATE 27

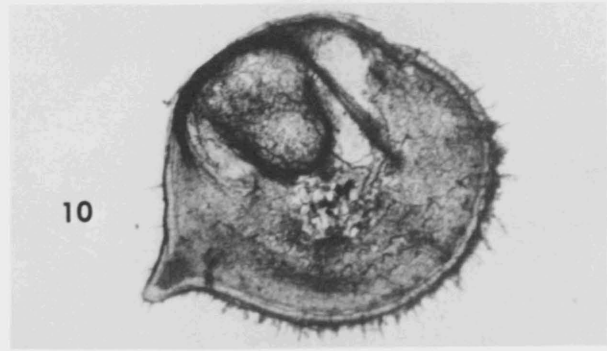
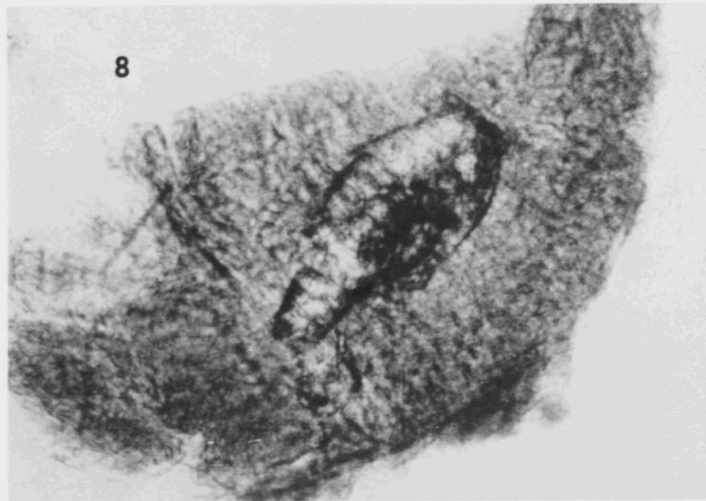
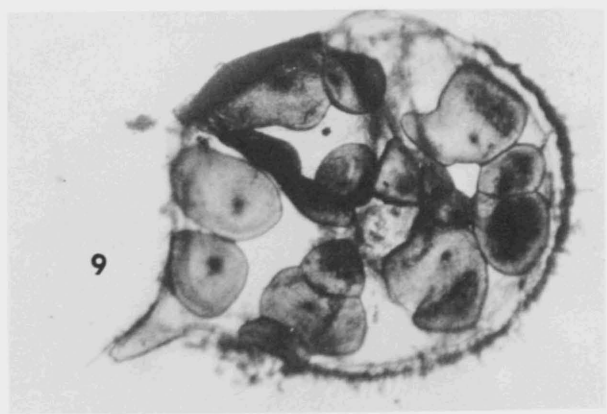
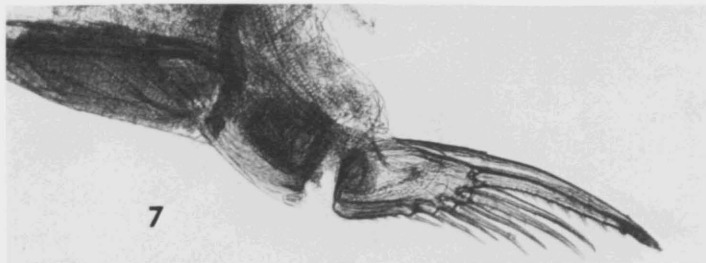
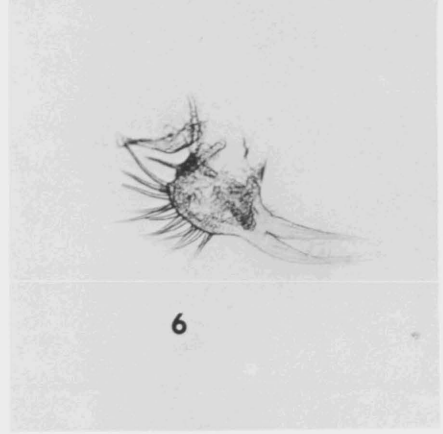
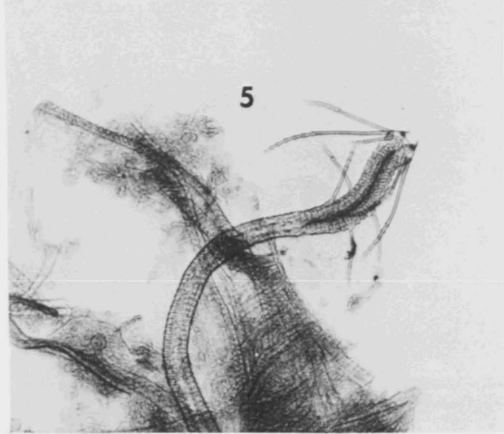
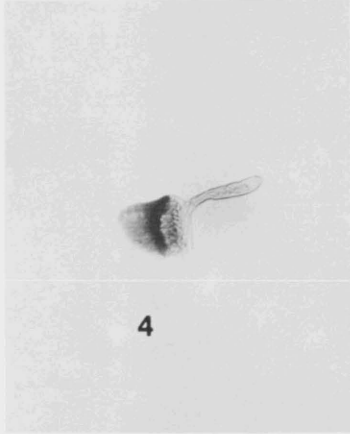
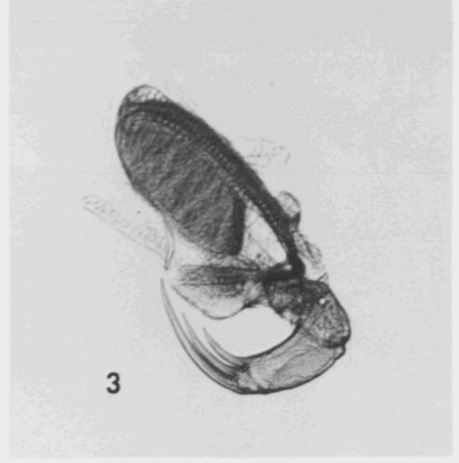
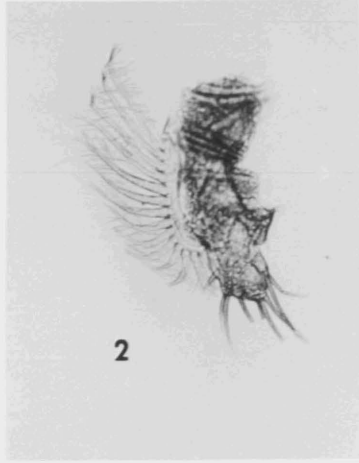
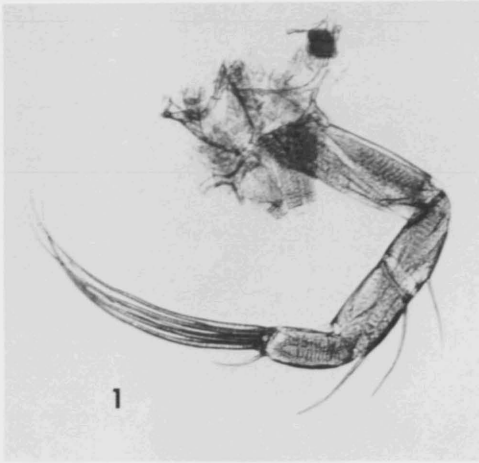

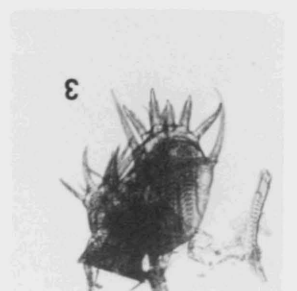
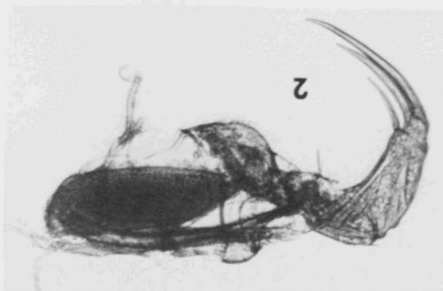
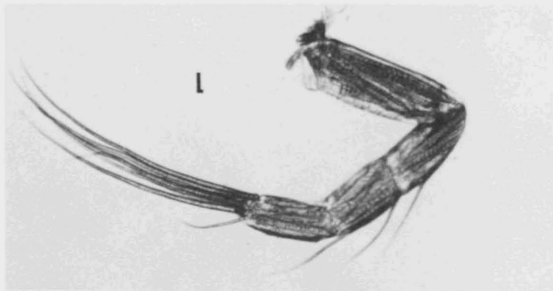
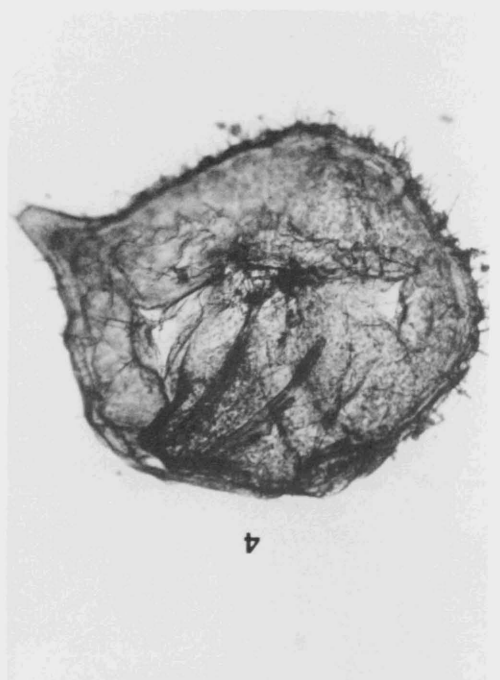
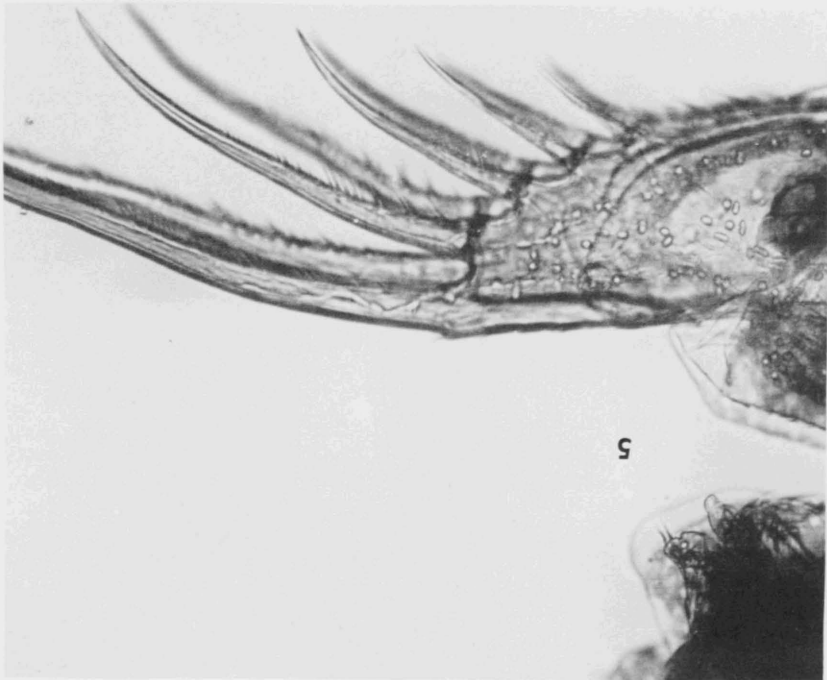
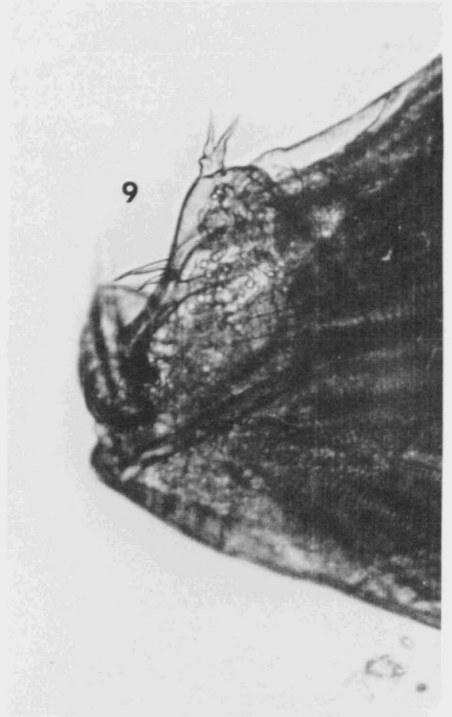
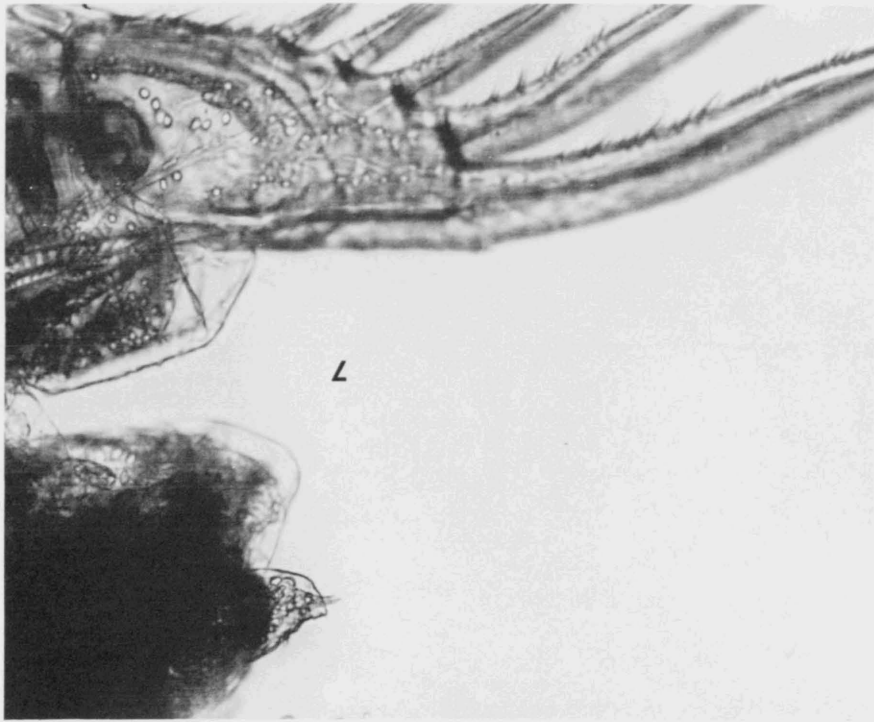

PLATE 28

EXPLANATION OF PLATE 28

FIGS. 1-7 Sarsiella greyi, n. sp.

1-7 UMMP 48816, male; 1, antennule, x100; 2, mandible, x100; 3, maxilla, x100; 4, left valve exterior, x50; 5, furca and what may be a reduced copulatory organ, x300; 6, antennal endopod, exopod has been removed, x300; 7, furcae and possible copulatory organ, reverse view of figure 5, x300.

EXPLANATION OF PLATE 29

FIGS. 1-11 Sarsiella tubipora, n. sp.

1-11 UMMP 48817, female, holotype; 1, antennule, x100; 2, mandible, x100; 3, antenna, x100; 4, maxilla, x100; 5, sixth limb, x100; 6, fifth limb, x100; 7, antennal setae, x500; 8, furcae, x200; 9, shell surface showing tube-pores surrounding reticules, x500; 10, edge of shell surface showing tube-pores, x500; 11, left valve exterior, x50.

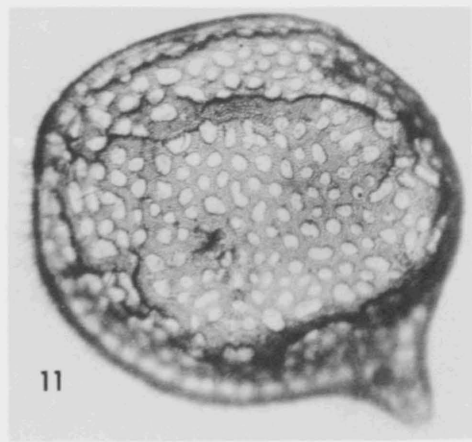
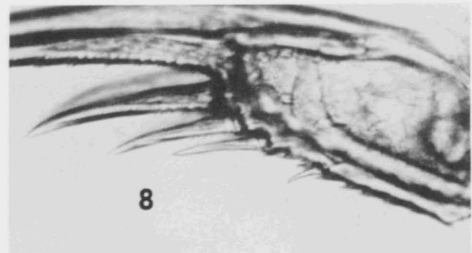
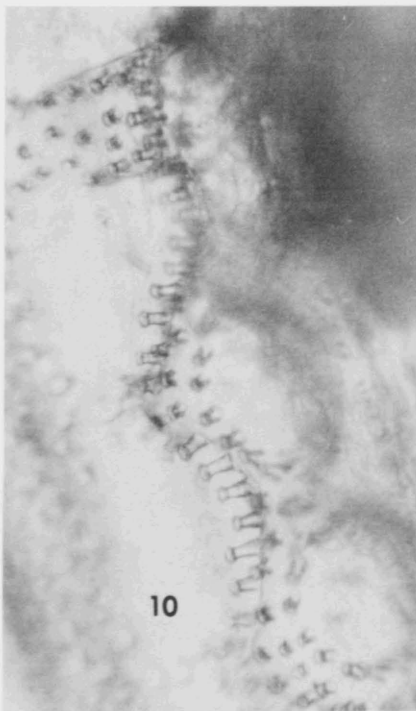
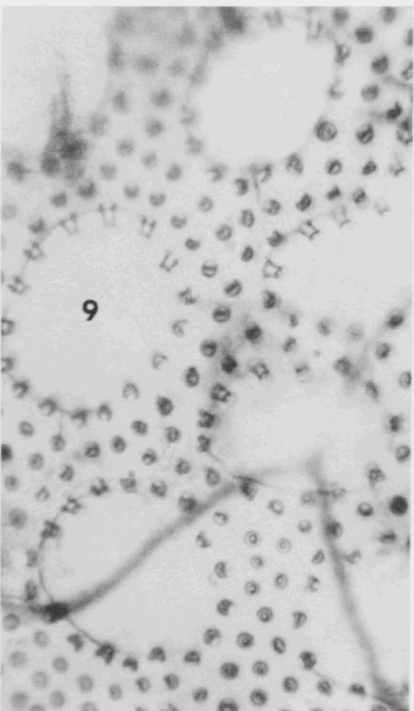
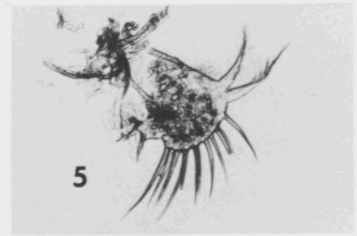
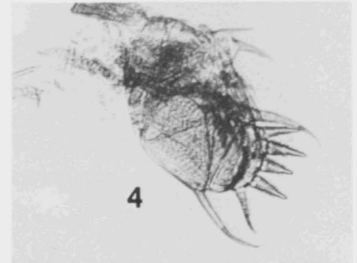
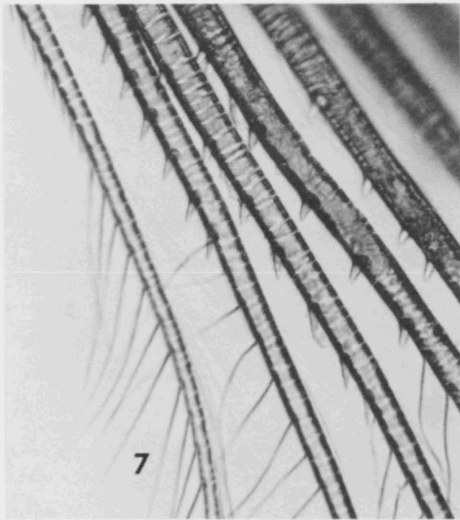
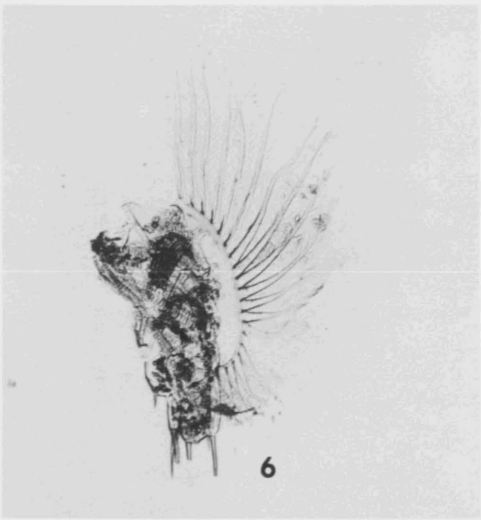
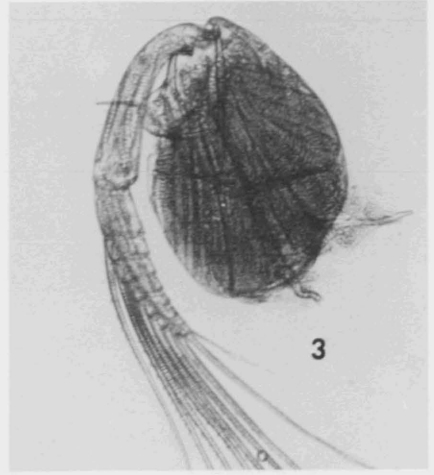
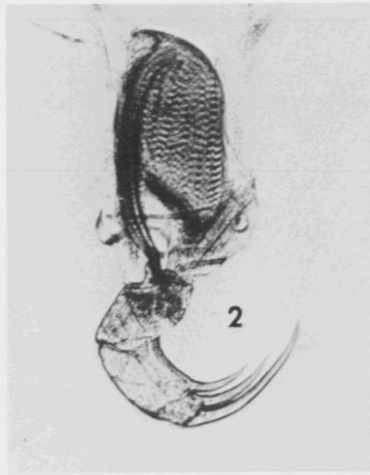
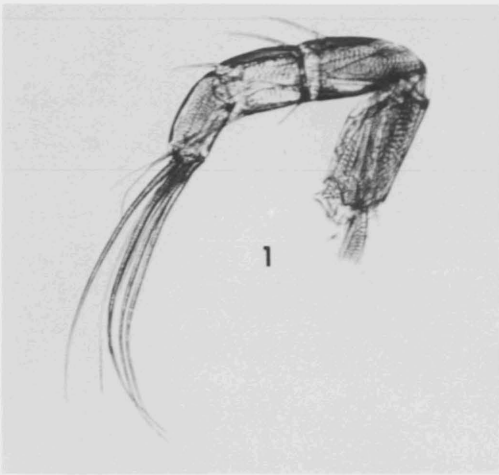

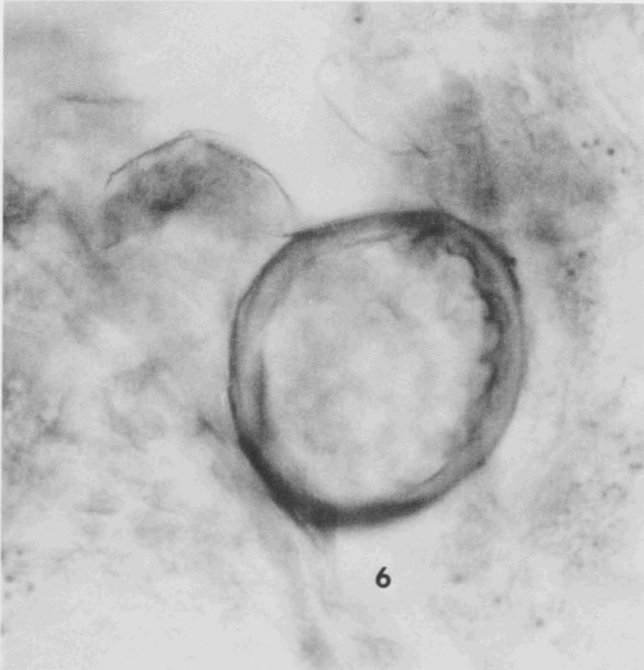
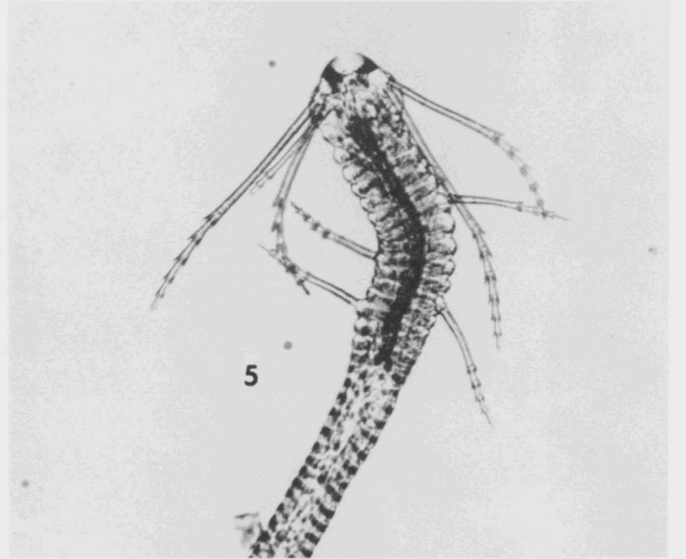
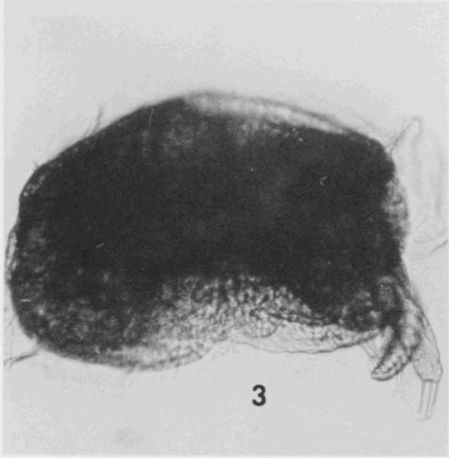
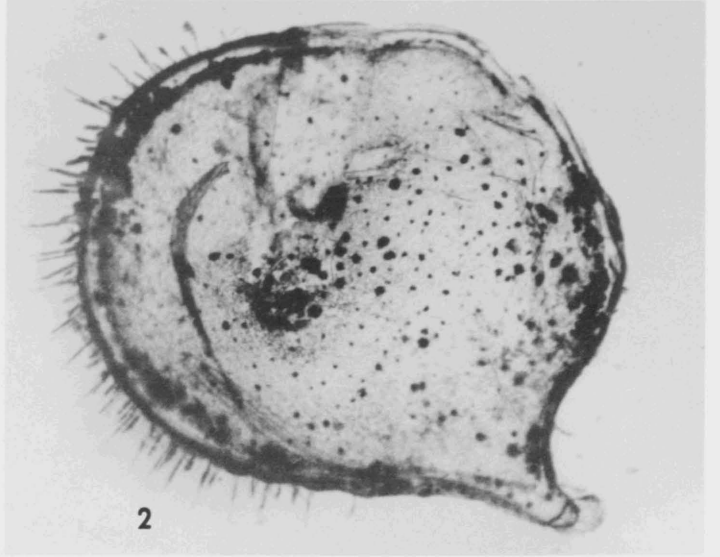
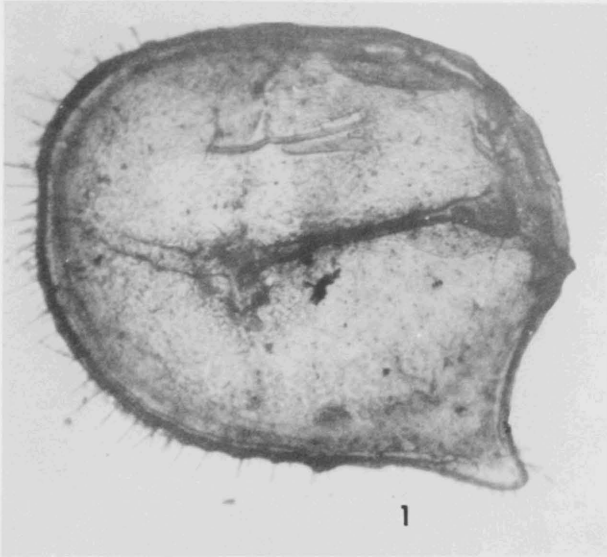

EXPLANATION OF PLATE 30

FIGS. 1-7 Sarsiella disparalis, n. sp.

1 UMMP 48818, female, left valve exterior showing median lateral ridge, dorsal and ventral alar projections are present but do not stand out; x50.

2-6 UMMP 48819, female, holotype; 2, left valve exterior showing lack of ornamentation, cf. figure 2, plate 31, the right valve of this specimen has alae as does figure 1, this plate, x50; 3, egg with first instar emerging, note rudimentary antennule and antenna, x200; 4, frontal organ, x100; 5, seventh limb, x200; 6, vagina, x1000.

7 UMMP 48820, female, glands in proximal portion of furca, x200.

EXPLANATION OF PLATE 31

FIGS. 1-8 Sarsiella disparalis, n. sp.

1, 2, 4-7 UMMP 48819, female, holotype; 1, antennule, x100; 2, silhouette, ventral view, of valves showing extreme asymmetrical ornamentation, x50; 4, antennal endopod, exopod broken off, x300; 5, sixth limb, x100; 6, furcae, x100; 7, fifth limb, x100.

3, 8 UMMP 48818, female; 3, antenna, x100; 8, mandible, maxilla, portion of fifth limb, x100.

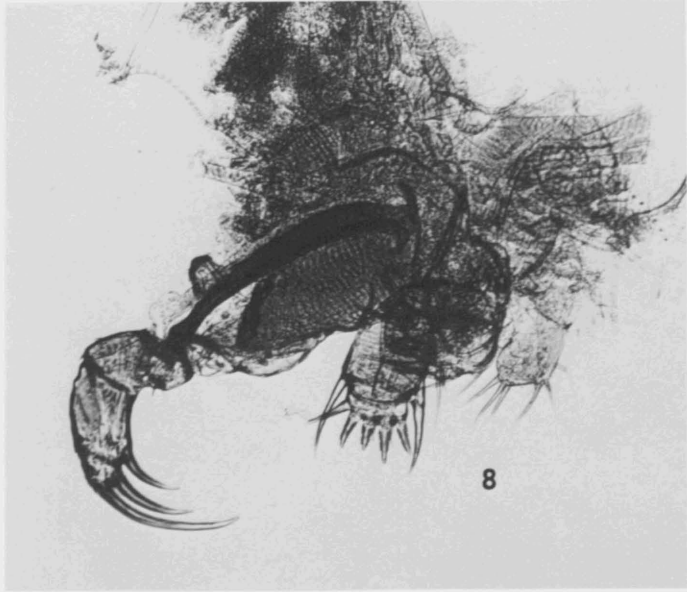
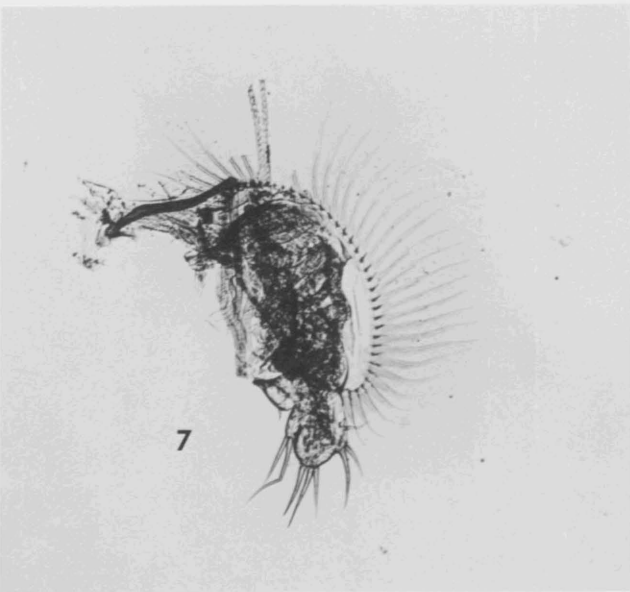
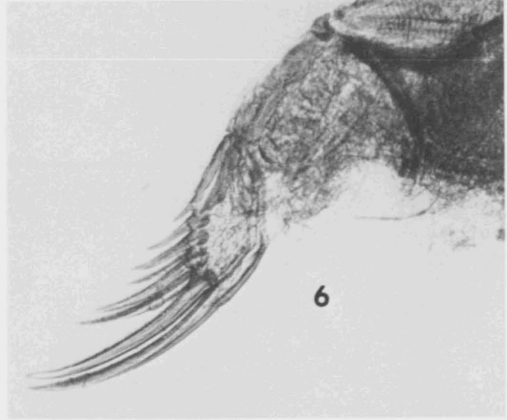
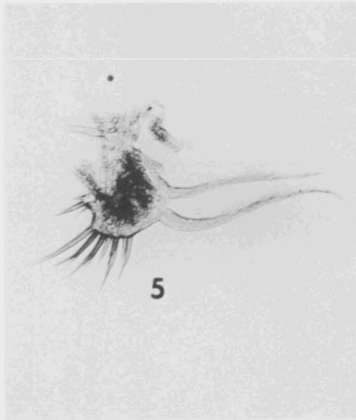
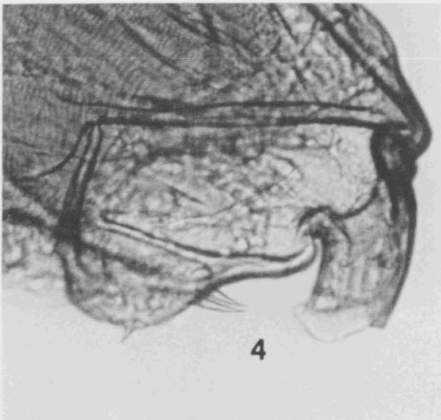
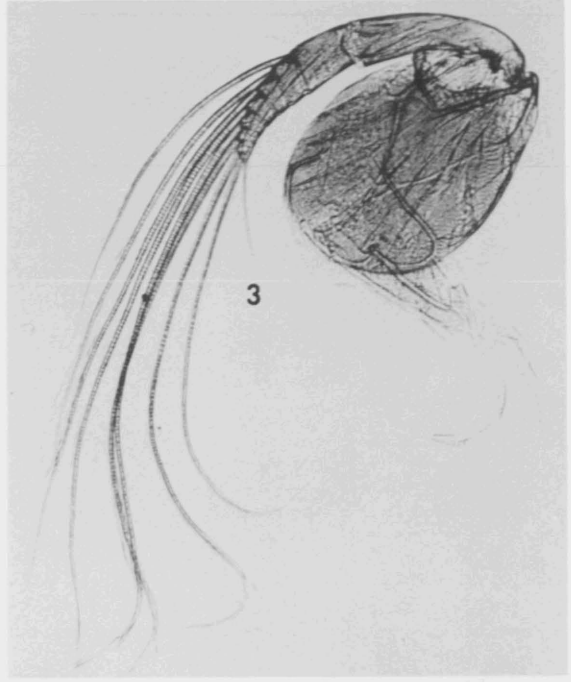
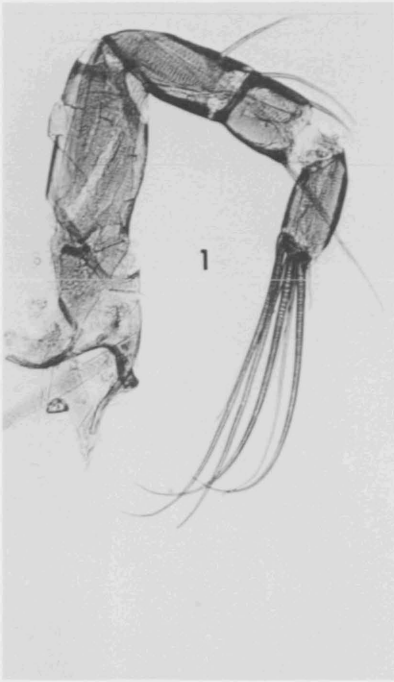

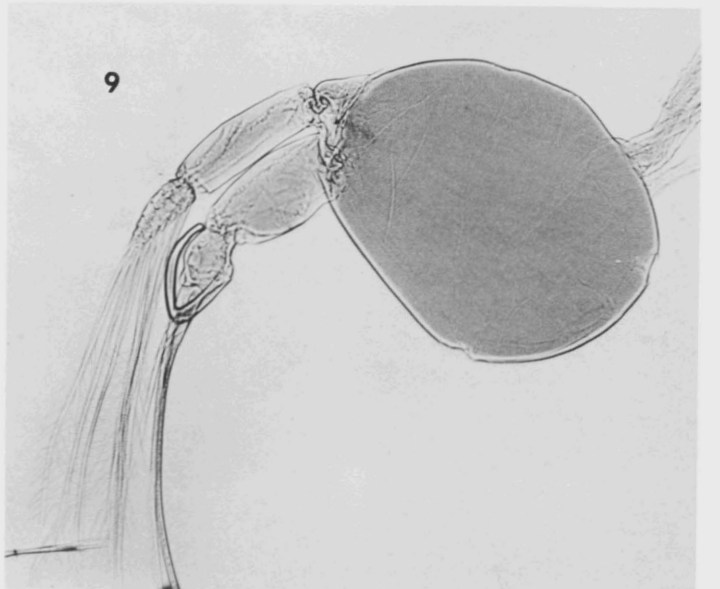
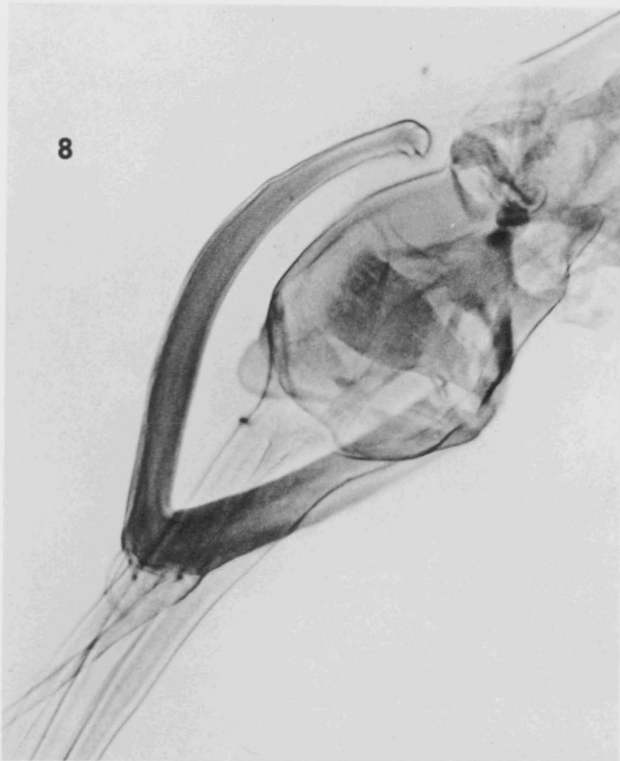
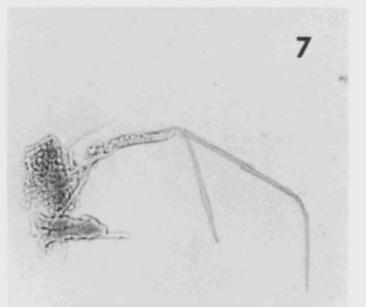
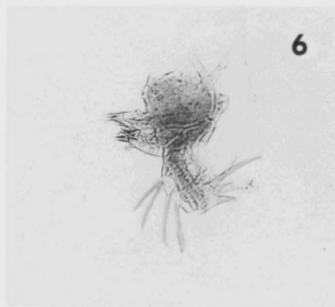
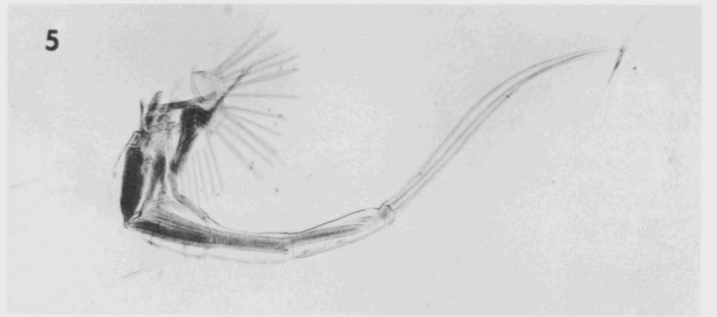
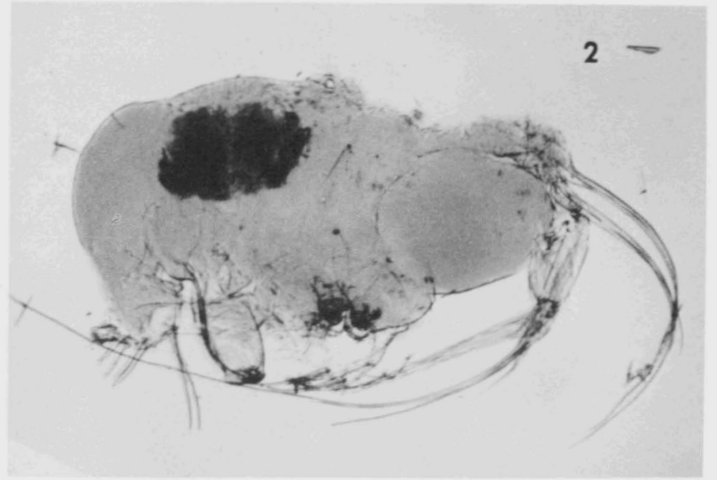

EXPLANATION OF PLATE 32

FIGS. 1-9 Euconchoecia chierchia Mueller

1, 3, 4, 6, 7 UMMP 48821, male; 1, antennule and labrum, x100; 3, fifth limb, x100; 4, mandible, x100; 5, sixth limb, x100; 6, maxilla, x100; 7, seventh limb, x100.

2 UMMP 48822, male, whole mount, an antennule and antenna have been removed, note long sexually distinctive antennal seta, dark mass in main body is stomach, x60.

8 UMMP 48823, male, grasping organ of right endopod of antenna, x500.

9 UMMP 48824, male, antenna, x100.

EXPLANATION OF PLATE 33

FIGS. 1-9 Euconchoecia chierchia Mueller

1 UMMP 48825, female, complete animal bearing eggs, x60.

2 UMMP 48826, female, diatom entering mouth, maxillae aiding, x500.

3 UMMP 48827, female, antennule, x100.

4, 7-9 UMMP 48824, male; 4, dorsal view of posterior of valves showing glands and spine off right valve, x100; 7, adductor muscle scar of right valve, anterior toward top, dorsal to left, cf. fig. 6, x500; 8, adductor muscle scar of left valve, anterior toward top, dorsal to right, cf. fig. 6, x500; 9, external view of valves, central overlap caused by flattening the chitinous test, x60.

5 UMMP 48821, male, penis, x100.

6 UMMP 48822, male, adductor muscle scar of left valve, internal view, anterior toward top, dorsal to left, note variance with the more common type scars of figs. 7 & 8, x500.

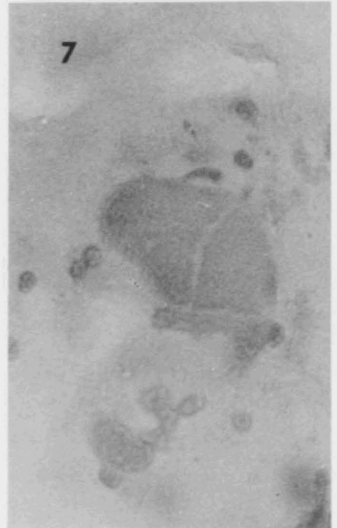
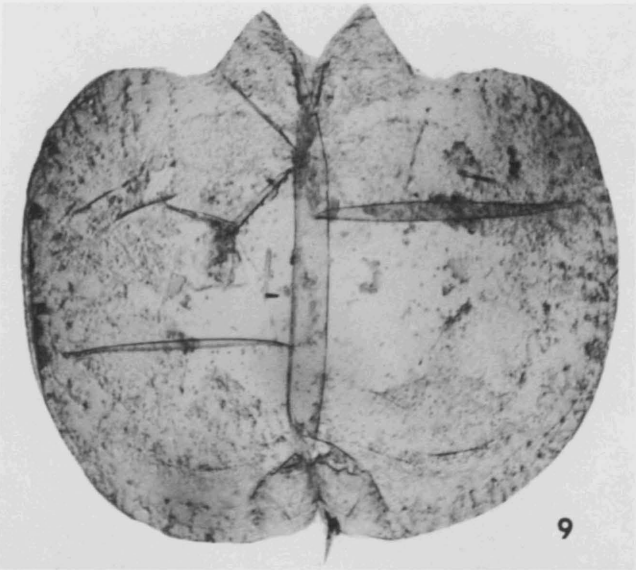
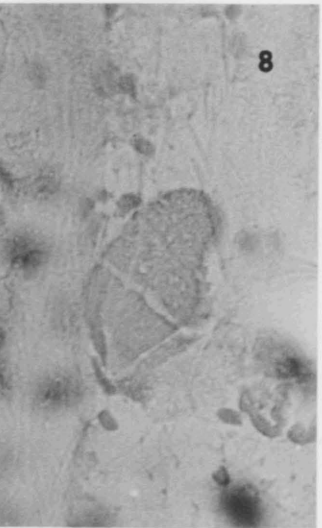
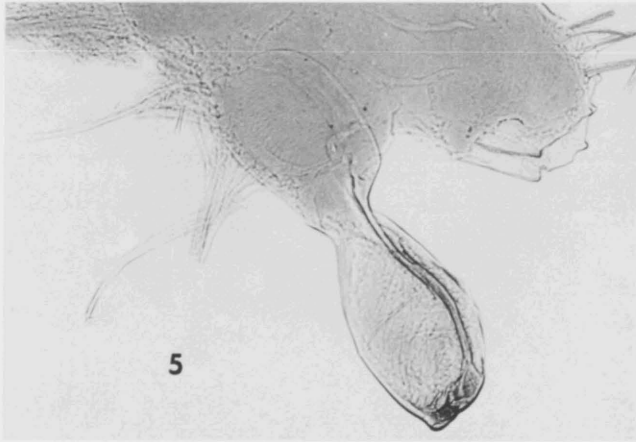
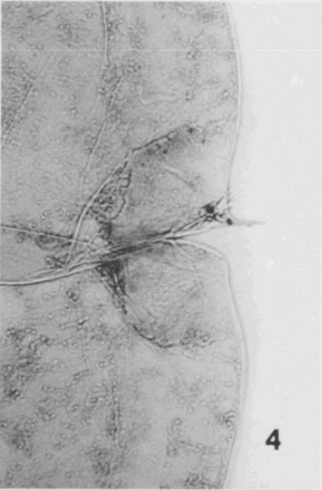
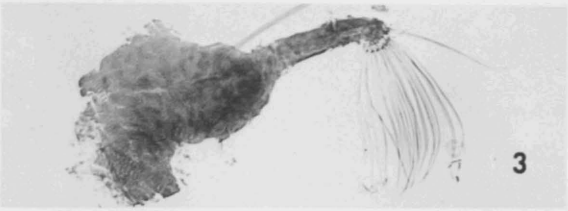
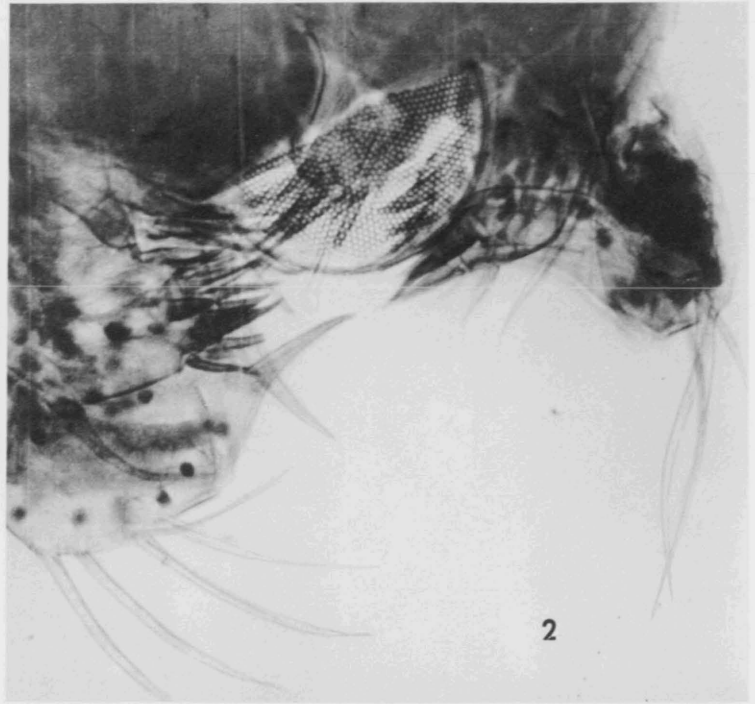
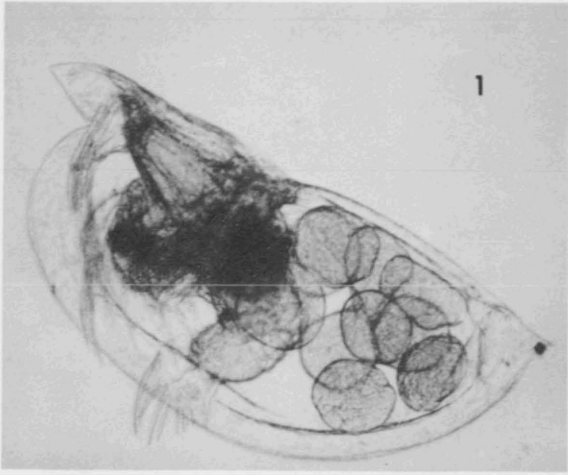

MUSCULATURE AND MUSCLE SCARS OF CHLAMYDOTHECA
ARCUATA (SARS) AND CYPRIDOPSIS VIDUA (O. F. MÜLLER)
(OSTRACODA - CYPRIDIDAE)

RAYMOND NEWTON SMITH

NATIONAL SCIENCE FOUNDATION PROJECT GB-26

REPORT NO. 3

ACKNOWLEDGMENTS

This study was supported by funds made available from National Science Foundation Grant GB - 26, entitled "Recent and Fossil Ostracoda in the Vicinity of Sapelo Island, Georgia." The work was carried out under the direction of Dr. Robert V. Kesling, the Principal Investigator of the project.

The writer is indebted to Dr. Robert V. Kesling for his suggestions and guidance throughout the study. For the use of the microtechnique laboratory in the Museum of Zoology, University of Michigan, the writer would like to thank Dr. Theodore H. Hubbell and Dr. Henry van der Schalie. A particularly strong vote of thanks goes to Dr. Henry van der Schalie. A particularly strong vote of thanks goes to Dr. Henry van der Schalie for his advice and encouragement, and for the use of his personal facilities while the writer was investigating micro and biological techniques; and also to Mrs. van der Schalie for her instruction on the preparation of microtome thin sections. Mr. Karoly Kutasi of the University of Michigan, Museum of Paleontology, offered valuable advice and assistance on some aspects of the photography. The courtesies and use of facilities extended to the writer by the personnel of the Division of Marine Invertebrates of the United States National Museum is gratefully acknowledged. Thanks are also offered to the many members of the Geology and Zoology Departments of the University of Michigan who gave freely of their time and advice. Last, but not least, the writer would like to thank his wife, Jacqueline, for her untiring patience and understanding during the time this work was being carried out.

CONTENTS

	PAGE
Acknowledgments	iii
List of illustrations	vi
Introduction	1
Previous work	2
Biological techniques	2
Preparation of specimens for dissection and sectioning	3
Needle dissection	4
Whole mounts	4
Microtome-serial sectioning	5
Free-hand sectioning and mounting	5
Polarized light for study of muscles	6
Staining molted valves	6
Muscle-scar terminology	7
Previous work	7
Muscle fields	9
Instar determination	11
Attachment of muscles to the valves	14
Closing muscles	15
Appendage and other body muscles	15
Musculature and muscle scars of <u>Chlamydotheca arcuata</u> (Sars)	16
Musculature and muscle scars of the adult	16
Musculature and muscle scars of immature instars	20
Summary of the muscle-scar patterns of the nine instars of <u>Chlamydotheca arcuata</u> (Sars) ...	21
Musculature and muscle scars of <u>Cypridopsis vidua</u> (O. F. Müller)	21
Musculature and muscle-scars of the adult	22
Musculature and muscle-scars of immature instars	24
Summary of the muscle-scar patterns of the nine instars of <u>Cypridopsis vidua</u> (O. F. Müller)	24
Taxonomic evaluation of muscle scars	25
Dorsal-muscle field	25
Central-muscle field	26
Bibliography	28

LIST OF ILLUSTRATIONS

FIGURE	PAGE
1. Diagrammatic drawing of interior right valve of cypridid ostracod illustrating proposed muscle-scar terminology	8
2. Right half of <i>Chlamydotheca arcuata</i> (Sars)	17
3. Right half of <i>Cypridopsis vidua</i> (O. F. Müller)	23

PLATE	FACING PAGE
1. <i>Chlamydotheca arcuata</i> , adult sectioned along median plane, posterior mandibular muscle, forehead region	30
2. <i>Chlamydotheca arcuata</i> , adult, ventral thoracic area, muscles from thoracic legs, closing muscles	31
3. <i>Chlamydotheca arcuata</i> , eighth instar, dorsoanterior area of adult	32
4. <i>Chlamydotheca arcuata</i> , posterior region of eighth instar, dissected mandible of adult	33
5. <i>Chlamydotheca arcuata</i> , adult closing muscles, sagittal section of seventh instar, transverse sections of eighth instar	34
6. <i>Chlamydotheca arcuata</i> , right half of adult, right half of eighth instar, right half of seventh instar, right half of sixth instar, left half of fifth instar, left half of fourth instar	35
7. <i>Cypridopsis vidua</i> , right half of adult	36
8. <i>Chlamydotheca arcuata</i> , valves of adult, eighth instar, seventh instar, first instar	37
9. <i>Chlamydotheca arcuata</i> , valves of sixth, fifth, fourth, third, and second instars	38
10. <i>Cypridopsis vidua</i> , valves of adult, eighth instar, seventh instar, sixth instar	39
11. <i>Cypridopsis vidua</i> , valves of first through sixth instars, eighth instar, and adult	40

INTRODUCTION

The classification of recent ostracods is based primarily upon the morphology of their appendages and other soft body parts. As the appendages are very rarely preserved, fossil ostracods are classified on features of the carapace such as hinge, shape, lobation, sulcation, ornamentation, and muscle scars. The result is a dual system of classification; the paleontologic and the zoologic. The two systems of classification are not mutually exclusive, however, as many fossil Mesozoic and Cenozoic genera have been related to their living relatives on the basis of hinge structure and muscle-scar patterns.

The importance of ostracods as stratigraphic markers and paleoecologic indicators has greatly increased within the past few decades. In some sediments ostracods are more abundant than foraminifera, as ostracods inhabit fresh-water and brackish environments in which foraminifera are lacking or greatly restricted. If ostracods are to be of increasing value in paleoecologic and stratigraphic studies, the two systems of classification must be made more compatible. The closer fossil ostracods can be related to their living counterparts, the more reliable will be the paleoecologic and stratigraphic interpretations.

The lack of correlation of fossil ostracods to their living counterparts can be explained in several ways. Zoologists studying recent ostracods are primarily concerned with the soft part morphology and only rarely do they give an adequate description of the carapace. On the other hand paleontologists working with recent forms have been known to describe a new living species on the basis of the valve without any description of the soft parts or appendages.

Very little is known about the barest essentials of morphology of this group of organisms which is so common and prolific in all types of aquatic environments. Much of what is known about ostracod morphology has been written by paleontologists seeking a better understanding of Recent forms in order to find solutions to pressing paleontological problems. Excellent examples of these types of studies are to be found in the works of Alexander (1933), Bradley (1941), Triebel (1941), and Kesling (1951).

The difficulty of understanding fossil and recent ostracods is compounded by their life cycle and sexual characteristics. Ostracods pass through eight instars between the egg and adult stages. At the time of each molt new appendages are added and/or the existing appendages are changed in their structure and function. Changes also occur in the size, shape, and configuration of the valves at the time of each molt. Although many fresh-water species are parthenogenetic, the majority of ostracods are thought to be syngamic. In these species, sexual dimorphic differences in the appendages and body as well as differences in the size, shape, and other features of the carapace are common. Due to these many variables it is often difficult, if not impossible, to determine if the species that are being studied are immature instars of known species, adults, or male and female valves of one species.

By plotting the height and length of a series of specimens it is possible to determine, with some assurance,

the various instars of a species. Much of the classification, however, is based on features which are fully developed only on the valves of the adults. Little or nothing is known about the development through the instars of such important classification features as the hinge, ornamentation, marginal characters, canals, pores, and muscle-scar patterns. Because of this lack of knowledge new species have been erected on late instars which show a partial development of adult characters.

Obviously, if ostracods are to be of increasing value in paleoecological and stratigraphic studies, a fuller understanding of their life history, soft parts, and hard-part relationships must be made known. All available features must be utilized in determining specific, generic, and higher taxonomic levels, and also for determining instars and sexual dimorphs. The development of characters and the trend of their change throughout the ontogeny of ostracods must be understood. It also is equally important to determine the characters which remain constant throughout the ontogeny. Until much more work has been done on all the major groups of ostracods, specific patterns of characters and character changes present in one group probably should not be indiscriminately applied to other groups.

The muscle-scar patterns found on ostracod valves provide one of the few common meeting grounds between the paleontologic and zoologic systems of classification. Muscles originating in various parts of the body terminate on the valve where they form muscle scars which are often preserved on the valves of fossil ostracods. The morphology of the soft body of the various groups of ostracods is quite different. The number, function, and structure of the appendages is variable. Therefore, the muscle-scar patterns of the various groups also differ.

The scars which lie in the central area of the valve and form the central-muscle field have been widely used with varying degrees of importance in the classification of orders, suborders, superfamilies, families, and genera. Muscle scars are generally poorly preserved in Paleozoic forms; and in these they are used primarily to distinguish orders. In Mesozoic forms muscle scars are commonly well preserved and, when used in conjunction with hinge structures, some fossil genera can be related to their living relatives. Many genera of the suborders Platycopina, Metacopina, and Podocopina are distinguished on the basis of the pattern of the central-muscle field.

In contrast, the scars which lie in the dorsal area of the valve and form the dorsal-muscle field, with one exception, have not been used in the classification of ostracods. These scars are formed by extensor and flexor muscles which operate the appendages and also by muscles which support other internal parts of the body. Very little data have been published on the arrangement, number, and taxonomic importance of the scars of the dorsal-muscle field.

Present Study

The musculature and muscle-scar patterns on the valves of two species of fresh-water cypridid ostracods,

Chlamydotheca arcuata (Sars), and *Cypridopsis vidua* (O. F. Müller) were studied. Primary importance was attached to the muscles which form the scars of the dorsal-muscle field. The musculature and muscle scars were studied in the adults as well as the complete instar series for each species. The object of the study was to determine if any taxonomic importance can be attached to the scars of the dorsal-muscle field.

The two species were chosen because they are both parthenogenetic, so that any observed differences in the immature instars cannot be attributed to sexual dimorphism. Both species are easily cultured in the laboratory, insuring a plentiful supply of living specimens and valves of all growth stages.

In addition to the primary study of the muscles which form the scars of the dorsal-muscle field, other problems were also considered. The method of attachment of the closing and other body muscles was studied, and the determination of instars investigated. A revised terminology for the classification of the muscle scars found on the valves is proposed. Some of the biological techniques that are particularly well adapted to the study of ostracod

morphology are reviewed and a simple, easy method for the study of the internal morphology in its natural relationship to the valve is presented. The development of the muscle-scar pattern of the central-muscle field of both species is discussed in conjunction with the development of the muscle-scar pattern of the dorsal-muscle field.

The morphology of the living specimens was studied by the use of microtome thin sections, dissections, and free-hand sections. Many specimens were permanently mounted in Canada balsam for further study. Measurements of the valves for instar determination were made with a binocular microscope fitted with a micrometer eyepiece. Photographs of the valves and soft parts were taken on Adox K.B. 14 film utilizing an A. O. Spencer compound binocular microscope with an attached 35-mm. camera.

Because of their delicate nature many of the valves used to illustrate the muscle scars were destroyed in handling. The permanent slides of the soft parts are deposited in the Museum of Paleontology of the University of Michigan.

PREVIOUS WORK

Few attempts have been made to correlate the muscles which extend from the body to the dorsal region of the valve with the dorsal-muscle scars. The development of the muscle-scar patterns of the dorsal- and central-muscle fields throughout the ontogenetic series of a species has never been adequately investigated.

In his study of the nervous system of *Herpetocypris reptans* Baird, Rome (1947) described muscles extending from the appendages and other body parts to the dorsal area of the valve. In addition, he was the first to identify muscles which extend from the maxillae and thoracic legs to the dorsal area of the valve. He did not, however, relate the muscles to the scars found on the dorsal area of the valve. In his complete morphological and ontogenetic study of *Cypridopsis vidua* (O. F. Müller), Kesling (1951,

Figs. 5, 5a) identified and figured muscles extending from the cephalic region and furca to the dorsal region, but did not correlate the muscles with their muscle scars. Later, Kesling (1956, Figs. 3, 7a) figured the musculature and the dorsal-muscle scars of an adult female of *Candona suburbana* Hoff.

Benson and MacDonald (1963) first utilized the patterns of the dorsal-muscle scars as an aid in taxonomy. They used the dorsal-muscle-scar pattern as an aid in distinguishing three fossilized Pleistocene species of *Candona*. They also used the dorsal-muscle-scar pattern to identify the instars of the three species as well as to identify the male dimorphs of the species. Their utilization of dorsal-muscle-scar patterns was based on the consistency within a species, which has been corroborated in part by this present study.

BIOLOGICAL TECHNIQUES

The study of ostracod morphology and anatomy often requires special techniques because of the size and construction of the short, laterally compressed body enclosed within a bivalve carapace. Many of the organs and all of the appendages are paired. The body is firmly attached to the calcareous part of the valves and held in place by the chitinous lamella. Numerous muscles from the appendages and other parts of the body are attached to the valves. With the exception of some members of the suborder Myodocopa, the carapace is calcified. The adults of many species are commonly less than a millimeter in length.

In the study of living forms, the purpose dictates the types of techniques to be used. If the study is aimed at

identification and classification, then it is necessary to remove the valves and appendages, inasmuch as the classification of recent forms is based primarily on the morphology of the appendages. Detailed study of the internal anatomy requires more refined techniques. Microtome thin sectioning has been used almost exclusively for this purpose but the preparation of thin sections is exacting and time-consuming, and requires a great deal of expensive equipment.

Needle dissection and thin-section methods have their limitations. Needle dissection requires removal of the valve to expose the body. Removal of the valve is often difficult because of the firm attachment of the centrally

located closing muscles and the muscles in the dorsal region of the valve. In many attempts, the body is mangled during the removal of the valves. Once the valve is removed the appendages can be separated from the body, but the remainder of the ostracod is usually completely distorted.

The study of ostracod anatomy by the use of microtome thin sections has several disadvantages. Sections are generally cut 10 microns thick which may produce as many as a hundred sections for a single specimen. Many features traverse much of the body, and they can be identified and traced through a series of sections only with great difficulty. Orientation of the specimens in the embedding media is difficult and specimens are usually sectioned at an angle to the plane desired. Three-dimensional reconstruction of portions of the anatomy from a series of slides is possible, but it is laborious and not precise. The mechanics of serial sectioning provides no guarantee that the sections will be the same thickness. The reagents and processes used in the preparation of the specimens result in appreciable shrinkage and distortion of the body. The ostracod body contains a great deal of chitin, which, because it becomes quite brittle during the preparation processes, results in torn and flaked sections. The posterior region of adult females, in particular, are often completely shattered because of the extreme hardness of the chitin-coated eggs.

In this investigation, many previously described techniques were utilized and a new one devised to determine the relationship between the musculature of the body and the muscle scars found on the valves. Since very few zoologists work on ostracods, little has been published on the biological techniques adaptable to their study. Consequently, a great deal of effort was expended in both searching the literature for methods and experimenting to determine suitable biological techniques. In order to facilitate work by others, a brief review is given of some of the techniques that were tried in this study.

Preparation of Specimens for Dissection and Sectioning

Relaxation of specimens. -- Specimens may be killed suddenly by the addition of a fixative solution to the water. However, ostracods killed in this manner usually die with their valves tightly closed. While some specimens will partially open their valves within a few minutes, a large number remain tightly closed after death. Dissection of a specimen with tightly closed valves is nearly impossible as the chitin coating of the ostracod body resists penetration of fixing solutions and other reagents. Instead, the greater the gape of the valves after death, the more efficient is the penetration of chemical solutions.

It is, therefore, desirable to relax or narcotise ostracods before the addition of the fixing agent. Three methods of relaxation were tried. In the first method, add a few drops of a 10% solution of sodium nebutol to the specimen dish. Add more of the solution over a period of hours until the specimens are relaxed.

In the second method, add a few drops of a solution of 96 parts water, 3 parts 95% alcohol, and 1 part propylene-phenoxytol to the specimen dish. This will lead to relaxation in about thirty to forty minutes.

The most consistent and simplest method is the use of

a mixture of menthol and chloral hydrate crystals. Sprinkle a mixture of 3 parts menthol crystals and one part chloral hydrate crystals in the specimen dish. Remove the dish from strong light or the ostracods may swim to the surface and become trapped in the surface film of the dissolving crystals. By this method most specimens are completely relaxed in about twenty minutes. Menthol alone will relax the ostracods quickly but may not be sufficient to prevent contraction when exposed to the fixing agent; the addition of chloral hydrate paralyzes the closing muscles so that they are unable to contract.

The preceding methods of relaxation are convenient only in the laboratory. For a simple and useful field method, use a mixture of equal parts of 95% alcohol and water. According to Hoff (1942, p. 19), this method will kill the individuals of most species with their valves agape. After a few hours transfer the specimens to 70% alcohol. If the specimens are to be sectioned, fixation in 30-35% alcohol is preferable, providing the specimens are transferred to 70% alcohol within a half hour. Fixation with intermediate grades of alcohol causes excessive distortion while higher concentrations of alcohol and formalin induce many specimens to seal their valves tightly.

Fixation, washing, and preservation. -- Fixation consists of using chemical means to arrest the life processes and to preserve and harden tissue. Preservation is simply storage of specimens in a medium that will prevent deterioration. The processes of fixation and preservation are the same in many cases, but in others they are distinct. The choice of fixation and preservation methods is governed by the purpose of the study. If the specimens have been relaxed before fixation, they should be fixed as soon as they are unable to contract. Washing is used to rid the specimen of the fixation chemicals in those procedures where the fixing and preservative agents are different.

Ethyl alcohol is a common fixative and preservative. Except for special purposes, such as needle dissection, alcohol alone is a second-class agent in that it shrinks soft tissue extensively. If specimens are placed into intermediate or high grades of alcohol, violent diffusion currents are set up between the water in the tissues and the alcohol causing extreme distortion of the body so changes in the percentage of alcohol must be gradational. A series of 30, 50, 70, 95, and 100% grades of alcohol is recommended. Fifteen or twenty minutes in each grade is required to prevent violent-diffusion currents. If the specimens are left in less than 70% alcohol for more than a few hours, the tissues will start to macerate.

Biological specimens are commonly preserved in 70-80% alcohol for long periods of time. After an interval of several weeks or months, however, the tissues begin to lose their staining capacity. Specimens which are to be stored for long periods of time are better preserved in a solution of 95% ethyl alcohol, glycerine, and distilled water in equal parts. Specimens preserved in this solution may later be used for dissection or thin sectioning and the tissue retains its capacity for staining.

A 10% solution of buffered-neutral formalin may be used for fixation and preservation but if the solution is not neutralized, the ostracod valves will decalcify. Formalin tends to harden tissue and chitin more rapidly than alcohol but often does not harden the tissues sufficiently to ensure good results when embedded in paraffin for serial sectioning. If formalin solutions are not kept in a dark or cool place the formaldehyde may decompose and coat the specimens with a white deposit of paraformaldehyde. Storage

of ostracods for long periods of time in formalin is not recommended. Formalin is highly soluble in alcohol and easily washed out during dehydration.

Bouin's fluid (picric acid, commercial formalin, and glacial acetic acid) is an excellent fixing agent for ostracods. Picric acid penetrates the chitin rapidly, formalin hardens, and acetic acid reduces shrinkage. Because the solution is acid, ostracods should not be allowed to remain in Bouin's fluid for extended periods of time. One hour is sufficient to fix ostracods. Ostracods fixed in Bouin's fluid should never be exposed to water or alcohol of less than 50% until the fixing solution is washed out. Gradually add 50% alcohol to the fixed specimens and change the solution until the dish contains 50% alcohol. Then add 70% alcohol, and change several times until every trace of yellow color is removed from the specimens and the liquid. The only disadvantage in the use of Bouin's fluid is the care that must be exercised in quickly bringing the specimens to a concentration of 50% alcohol without creating violent diffusion currents in the liquid.

AFA (alcohol-formalin-acetic acid) is another excellent fixative for ostracods. A solution of 85 parts 70% alcohol, 10 parts commercial formalin, and 5 parts glacial acetic acid is satisfactory. This solution fixes rapidly and penetrates well because of the formalin. The acetic acid counteracts shrinking of the tissues. Again, because of the alcohol, add the solution gradually to avoid diffusion currents. One hour in full strength AFA is sufficient to fix ostracods. Wash by transferring the specimens to 70% alcohol and change the alcohol at least once within an hour.

Dehydration. -- Specimens which are to be mounted in balsam or other resinous media, or embedded in paraffin for thin sectioning must have all water removed from the tissues. This is usually accomplished by changing the 70% alcohol to 95% and then 100%, allowing twenty or thirty minutes between changes. The 100% alcohol should be changed at least once more to ensure complete dehydration.

There is considerable shrinkage of the tissues somewhere between the grades of 60-90% alcohol. Higher grades of alcohol also harden the tissue as well as the chitin. If the specimens are to be simply dissected in balsam, then this hardening is no great disadvantage. However, excess hardening and shrinkage are disadvantages when specimens are to be sectioned.

In the past few years cellosolve (ethylene glycol monoethyl ether) has come into use as a dehydrating agent. Cellosolve is a much less violent dehydrating agent than alcohol and it does not excessively harden the tissue or chitin. Cellosolve also causes less tissue shrinkage than high grades of alcohol. Specimens in any grade of alcohol may be directly transferred to solution of equal parts of cellosolve and the grade of alcohol from which the specimens were taken. After about a half hour, change the solution to 100% cellosolve. A second change of 100% cellosolve is desirable. The use of cellosolve is particularly recommended for thin section preparation.

Clearing. -- Clearing agents are liquids that replace the dehydration agents in the tissues and also facilitate the infiltration of the tissue by the embedding media or resinous mounting media such as balsam. Of the several clearing agents available, the most commonly used is xylol, but it tends to harden the tissues and chitin. Toluol is more expensive than xylol, but does not harden the tissue and chitin as much. The use of cellosolve and toluol for dehydrating and clearing ostracods for thin-section work is

strongly recommended. Glycerine is a good clearing agent for studying unstained ostracods on temporary slides as it clears enough to permit study of the parts, but not to the point where unstained structures are rendered invisible.

Needle Dissection

The majority of ostracod dissection is done in glycerine as it renders the body soft and pliable. Small amounts of glycerine jelly may be dissolved in the glycerine to increase its viscosity and facilitate the dissection. After fixation, run the specimens down through the grades of alcohols to water and then transfer to glycerine, or transfer the specimens to a solution of 10% glycerine in 70% alcohol and allow the alcohol to evaporate.

Because of its fluidity glycerine is unsuited for permanent mounts of dissected ostracods, but glycerine jelly is practical. Remove the dissected parts from glycerine with a warm needle and transfer them to a slide on which a small drop of glycerine jelly has been spread out. Arrange appendages in their proper order on the glycerine jelly and cover them with another small drop of glycerine jelly. Place a heated cover slip on the second drop of jelly and gently heat the slide. The heat will cause the glycerine jelly to spread out evenly without seriously disarranging the parts.

Permanent mounts of dissected ostracods are made in balsam. After fixation, dehydration, and clearing infiltrate the specimens with balsam. Place a specimen in a drop of balsam on a slide and dissect off the valves. The valves may be placed in a second drop of balsam on the same slide but the cover slip should be supported by bits of glass to prevent crushing them. Leave the dissected parts in the first drop of balsam and cover with a cover slip.

Staining the specimen before dissection and mounting greatly increases its value. Several staining methods work well. Hoff (1942, p. 20) described a method of staining with acid fuchsin. Borax-carmine is a useful stain for ostracods; the formula and directions for this stain are given by Pantin (1948, p. 23). Acid fuchsin and borax-carmine stain the body and appendages bright red.

Another stain which has been used with great success is chlorazol black E which will stain chitin as well as tissue. Stain the specimens for thirty or forty minutes in a saturated solution of chlorazol black E in a 70% alcohol. Wash in 70 or 90% alcohol until the alcohol becomes clear.

Needle dissection of ostracods requires very small needles. Insect pins mounted in a match stick are very useful, but, when dissecting small ostracods even the smallest of the insect pins, the minuten nadeln, seem huge

Very fine dissecting needles tapered to a point of a few tens of microns are easily made. When dipped into a crucible of boiling or nearly boiling sodium nitrite, tungsten wire is rapidly oxidized. Repeated dipping of the wire in hot sodium nitrite produces a needle with a point as fine as desired. Dulled or bent points are easily resharpened by the same method. Mount the needles in a wooden handle for convenience.

Whole Mounts

Whole mounts of many animals have the advantage of showing the general topography of the specimen. In the case of ostracods whole mounts are of little value, even

with the valves decalcified. The body of an ostracod is much too compact and complicated to be able to observe or trace any feature more than a fraction of a millimeter from the surface of the valve.

Microtome-Serial Sectioning

Good serial sections of ostracods are very difficult to obtain. In the first place, correct orientation of ostracods in the embedding media is difficult because of their small size. In addition, decalcification of the valve usually causes distortion of the body. If the chitin has been hardened, the sections tear and split.

Bouin's fluid or AFA are good fixatives when preparing ostracods for microtome-serial sectioning. Decalcify the specimens in 70% alcohol by adding a few drops of a solution of 0.25% HCl in 70% alcohol to the dish daily for several days. An attempt to decalcify rapidly will cause the formation of CO₂ bubbles, which become trapped in the valves and completely distort the body. Placing the dish in a partial vacuum reduces the formation of CO₂ bubbles in the body and valves. Chelating agents such as versene or sequestrene (ethylenediaminetetracetic acid) may be used in place of HCl for decalcification. These chelating agents are supposedly a less violent treatment than HCl. As chelating agents must be dissolved in an aqueous solution of 10% formalin, the specimens must be run back to water after they have been washed and fixed. As much distortion can occur in the ostracods by running them back to water and then back to alcohol as can occur when decalcifying with HCl in 70% alcohol.

Heavily pigmented forms should be bleached before serial sectioning. Add a few drops of clorox to the 70% alcohol and change the solution each day until the pigment is reduced and then wash in several changes of 70% alcohol. Final dehydration and clearing should be done with cello-solve and toluol for the reasons previously mentioned. Orientation of the specimens in the embedding media is facilitated by the addition of a drop or two of a weak aqueous solution of acid fuchsin (0.5%) to the dish after bleaching.

Paraffin Method. -- Bioloid paraffin is commonly used for serial-section embedding, but tissuemat is preferred to paraffin because it ribbons better and allows cutting and ribboning of thicker sections. Two changes of paraffin allowing thirty minutes in the oven for each change is sufficient for infiltrating ostracods.

Several specimens may be embedded and oriented in the same box. Small boxes are made from heavy non-porous paper. During embedding, place several glass plates or flat dish covers in the oven. Place a warmed plate or cover on the stage of a low-power binocular microscope. Pipette the specimens and paraffin by means of a heated eyedropper into a box and place it on the warmed plate. The warmed plate will sufficiently retard the hardening of the paraffin so that the specimens may be orientated with heated needles. Keep the surface of the paraffin liquid with the heated needles until paraffin at the bottom of the box congeals enough to retain the orientation of the specimens and then gently blow on the surface of the paraffin to form a congealed layer. Then carefully immerse the plate and box in a dish of cold water to harden the paraffin quickly.

Ostracods dehydrated in alcohol and cleared in xylol do not section well and the tearing and flaking render many specimens worthless. The use of cello-solve, toluol, and

tissuemat cannot be recommended too strongly. With the use of these reagents, excellent ribboned sections were obtained at thicknesses of 25 to 50 microns.

Specimens may also be sectioned as thick as 100 or 150 microns but ribboning of the sections is impossible at these thicknesses. Stain specimens in toto before sectioning. Set the microtome at its maximum advance. After each section is cut, remove the blade and advance the specimen the desired number of microns and then replace the blade to cut the section. Sections obtained in this manner are too thick to adhere to a slide, but may be deparaffinized in a dish and mounted in balsam.

Celloidin-paraffin double embedding. -- The celloidin-paraffin double embedding method was also tried utilizing celloidin concentrations of 4, 6, and 8%. Embed the specimen in the celloidin block, harden with chloroform, and run the block down to a solution of 70% alcohol. Since the celloidin block is permeable, the specimen may be decalcified after embedding. Place the block in a solution of 0.25% HCl in 70% alcohol under a vacuum. Add a few drops of the solution daily. The specimen will decalcify in several days with little distortion. After decalcification, dehydrate with alcohol, clear with chloroform and then xylol, and embed the block in paraffin according to normal embedding procedures. Celloidin-paraffin sections ribbon well and the valves and body retain their shape. However, chloroform causes extreme hardening of the tissue and chitin, which results in tearing and flaking of the sections, so that this method of sectioning for ostracods is worthless.

Gauthier (1939, p. 209) described a somewhat similar method of celloidin-paraffin embedding, except that he did not decalcify the valves before sectioning. This method was tried and only resulted in a well dulled blade, and shattered and otherwise useless sections.

Thin sections stain well in Harris haematoxylin and eosin for six to eight minutes.

Free-Hand Sectioning and Mounting

Free-hand sectioning and mounting is preferred to microtome sectioning or needle dissection, because it permits the study of the internal organs and other structures in their natural orientation. The anatomy along any given plane through the body is easily exposed and studied. It is simple and does not require the elaborate equipment and techniques necessary for microtome work. Organs and muscles may be traced through the body without the intricate reconstruction that is necessary when using thin sections. Using this method the body is not disarranged as in needle dissection. While this method is more exacting and time-consuming than standard needle dissection, the value of the results far exceeds the extra time and effort required.

Specimens are relaxed, fixed, decalcified, bleached, stained, dehydrated, and then cleared. The use of cello-solve is again recommended to reduce shrinkage and distortion of the body. Either xylol or toluol may be used for clearing. Xylol hardens the body so that it better retains its shape during handling after deparaffinization, but also makes dissection more difficult. Next, embed the specimens in paraffin. Infiltration with paraffin is not as critical in this method as it is for the serial section method. If an oven is not readily available, melt the paraffin on a hot plate. Paraffin may be kept liquid during infiltration simply by placing the embedding dish on a table under a goose-

neck table lamp. After embedding the specimens in paper boxes and hardening the paraffin in cold water, peel the box from the paraffin block. Attach the block to a small rectangle of wood, which has had one end previously infiltrated with paraffin, gently heat the ends of the wooden and paraffin blocks and join them together.

Trim the paraffin until a specimen becomes visible. Place the specimen block under a low-power dissecting microscope and hold the block with one hand. Carefully trim the paraffin with a sharp razor blade, until the orientation of the specimen becomes clear. Rotate the block and continue trimming until the trim plane corresponds to the desired plane of sectioning.

The specimen may be sectioned by two methods. In the first method, continue trimming the paraffin block by thin slices. Rotate the block to maintain the desired section of the specimen. Cease trimming when the desired position is reached. This method, of course, results in loss of part of the specimen. If the specimen is trimmed from the side this loss is not serious because ostracods are bilaterally symmetrical.

In the second method, carefully estimate the desired plane of section and make one quick slice through the specimen. In most cases both sections of the specimen remain intact. Large specimens may be sectioned into two or three pieces by this method.

Then cut the specimen from the paraffin block and, along with any other pieces worth saving, deparaffinize and clear in two or three changes of xylol. Sections may either be mounted in balsam as permanent mounts or they may be run down to 70% alcohol or glycerine for further dissection and study.

Specimens as small as .6 mm. in length have been successfully sectioned by this method. Figures 1 and 2 on Plate 7 show sections of a specimen of Cypridopsis vidua prepared by this method.

Polarized Light for Study of Muscles

Striated muscle tissue exhibits a high degree of birefringence when polarized. Unstained muscle produces the best results, but lightly stained muscle will polarize to some extent. The internal musculature of unstained ostracods sectioned by the free-hand method and mounted in balsam is strikingly displayed in polarized light.

Any microscope may be easily adapted for the study of muscle by polarized light. Place a small piece of Polaroid plastic (the polarizer) on top of a slide. Cut out and tape circular pieces of Polaroid plastic (the analyzers) over the eyepieces in such a manner so as not to interfere with the rotation of the eyepieces. Bring the axes of the polarizer and the analyzer into proper orientation by turning the eyepieces.

Staining Molted Valves

The valves of many recent ostracods, especially the younger instars, become quite transparent and difficult to see when immersed in a liquid. The calcium carbonate of the valves may be stained by appropriate methods, but the valves of the younger instars are lightly calcified and calcium carbonate staining methods are then of little value. A method has been devised to stain the chitin of the valves, rather than the calcium carbonate.

Immerse the valves in a solution of equal parts of water and clorox for about thirty minutes, and then rinse with several changes of water. If the valves are not thoroughly rinsed, the stain will not take and the valves will deteriorate in time. Decant the last rinse water and add a saturated solution of chlorazol black E in 70% alcohol. The necessary length of time in the stain depends on the species, but twenty or thirty minutes is usually sufficient. Wash out the stain by repeated changes of 95% alcohol.

This method will stain the valves of most species a medium greenish-black color. The clorox converts the chitin of the valve to chitosan enabling it to pick up the stain. Because muscle scars stain differently from the chitin on the rest of the valve, they are easily distinguished even in the young instars. Immature valves which otherwise are impossible to handle in water or glycerine because of their transparency become plainly visible.

MUSCLE-SCAR TERMINOLOGY

A review of the literature reveals inconsistencies in the terminology for the groups of scars found on the interior of ostracod valves. For the most part, these groups of scars are formed by the termination of various body muscles. With one or possibly two exceptions, the origins of the scar groups have been correctly identified. However, the terminology used for the various groups of scars has varied from author to author.

After a discussion of the position and origin of the groups of scars and a review of some of the previous terminology, a revised terminology is proposed. In order to avoid confusion, the revised terms are used in the following discussion of the location and origin of the scar groups.

Muscle scars represent the points of attachment of various body muscles on the valve of an ostracod. Muscles are connected to the outer chitin coating of the hypodermis layer of the valve. When soft parts are no longer present, the former points of muscle attachment are represented by depressions or raised areas on the calcareous layer of the valve. Other parts of the soft body also form scars or imprints on the valves. As will be seen, some of these scars very closely resemble the scars formed by muscles.

The closing- or adductor-muscle scars are imprints formed by the termination of the closing or adductor muscles, which traverse the ostracod body from valve to valve. Except in the family Conchoeciidae of the suborder Myodocopa, the closing muscles are situated somewhat in front of the middle of the valve. Though quite variable in size, number, and arrangement, this group of scars is easily identified, and is usually the most prominent scar feature on the interior of the valve.

Anterior and ventral to the closing-muscle scars lie the mandibular scars, which are elongated and often somewhat elliptical in shape. The mandibular scars are usually paired, but in some groups of ostracods only a single mandibular scar can be discerned. Such a single scar probably represents the fusion of two scars. The mandibular scars represent the point of attachment on the valve of a pair of chitinous rods which extend dorsally and attach to the dorsal apex of the basal podomere of the mandible. These scars are often referred to in the literature as the mandibular-muscle scars or the mandibular-adjustor-muscle scars.

Another group of scars located near the center of the valve is the frontal group. In most of the literature these scars have been erroneously called the antennal group or antennal scars. The frontal scar group is located anterior to the closing muscles and dorsal to the mandibular scars. In the Cyprididae the frontal scars are often anterodorsal to the closing-muscle group. According to Van Morkhoven (1962), the frontal scars are inconspicuous or appear to be lacking in the suborder Cladocopa, the family Cytherellidae of the suborder Platycopa, and the family Darwinulidae of the suborder Podocopa. The group is prominent in the Cyprididae where they form a pair of closely related scars, which, however, may coalesce to a single scar. In the Cytheridae the frontal group is usually represented by a

single V-shaped scar, or, occasionally by two or three separate small scars. The origin of this group is further considered under the discussion of the revised terminology.

In addition to the mandibular scars, the mandible occasionally leaves another mark of its presence on the valves. The dorsal apex of the basal podomere of the mandible tapers to a heavily chitinized, rounded point. The pointed dorsal apex lies in close proximity to the interior of the valve. As the mandible performs its function of mastication, the dorsal apex pivots against the body wall and the valve. Thus the apex of the mandible acts as a fulcrum and a spot or scar may be formed on the valve at this point. Triebel (1960, p. 111) described the formation of this scar in a species of the genus *Chlamydotheca*. He shows (1960, Pl. 18, Fig. 33) a piece of valve with the mandible still attached. The dorsal apex of the mandible and the scar which it has formed are quite apparent. Triebel (1960, p. 111) called this scar the mandibular "Stutzfleck" (mandibular support scar). The two chitinous rods which form the mandibular scars are also shown.

The mandibular fulcral scar is generally poorly developed on the valves and often goes unnoticed. Its position is variable. The scar may lie anterior to the dorsalmost of the closing-muscle scars, or anterior to and closely associated with the closing muscles. In any event, it invariably lies between the closing-muscle scars and the frontal scars. The mandibular fulcral scar is well developed in most members of the families Cyprididae and Cytheridae of the suborder Podocopa.

The dorsal-muscle scars occupy the dorsal part of the valve, with the exception of its posterior and anterior extremes. In relation to the closing-muscle scars, the dorsal-muscle scars are quite small and are usually difficult to observe. As most of the dorsal-muscle scars are situated on the dorsolateral curvature of the valve, the valve must be tilted in order to study them. The dorsal-muscle scars represent a complex array of muscles connecting the appendages and other parts of the body to the valve.

Previous Work

A brief review of a few pertinent papers in which the muscle scars have been considered will illustrate the lack of a consistent terminology for the various groups of scars.

Triebel (1941, p. 297) recognized four groups of scars: the closing muscles, mandibular, antennal, and the dorsal group of scars. He stated (p. 297) that the closing muscle and mandibular groups correspond to the central-muscle field of Zálányi (1929, p. 11), and the antennal and dorsal groups correspond to Zálányi's peripheral group of scars.

In 1949 Triebel (p. 205) referred to the lateral muscle field of *Candona candida* (O. F. Müller) as being composed of the closing-muscle scars, mandibular scars, and of a pair of scars formed by insertion of the chitinous "Stutzleisten" or support ridge of the antenna. The pair of scars formed by the antennal "Stutzleisten" correspond to the position of the frontal scars.

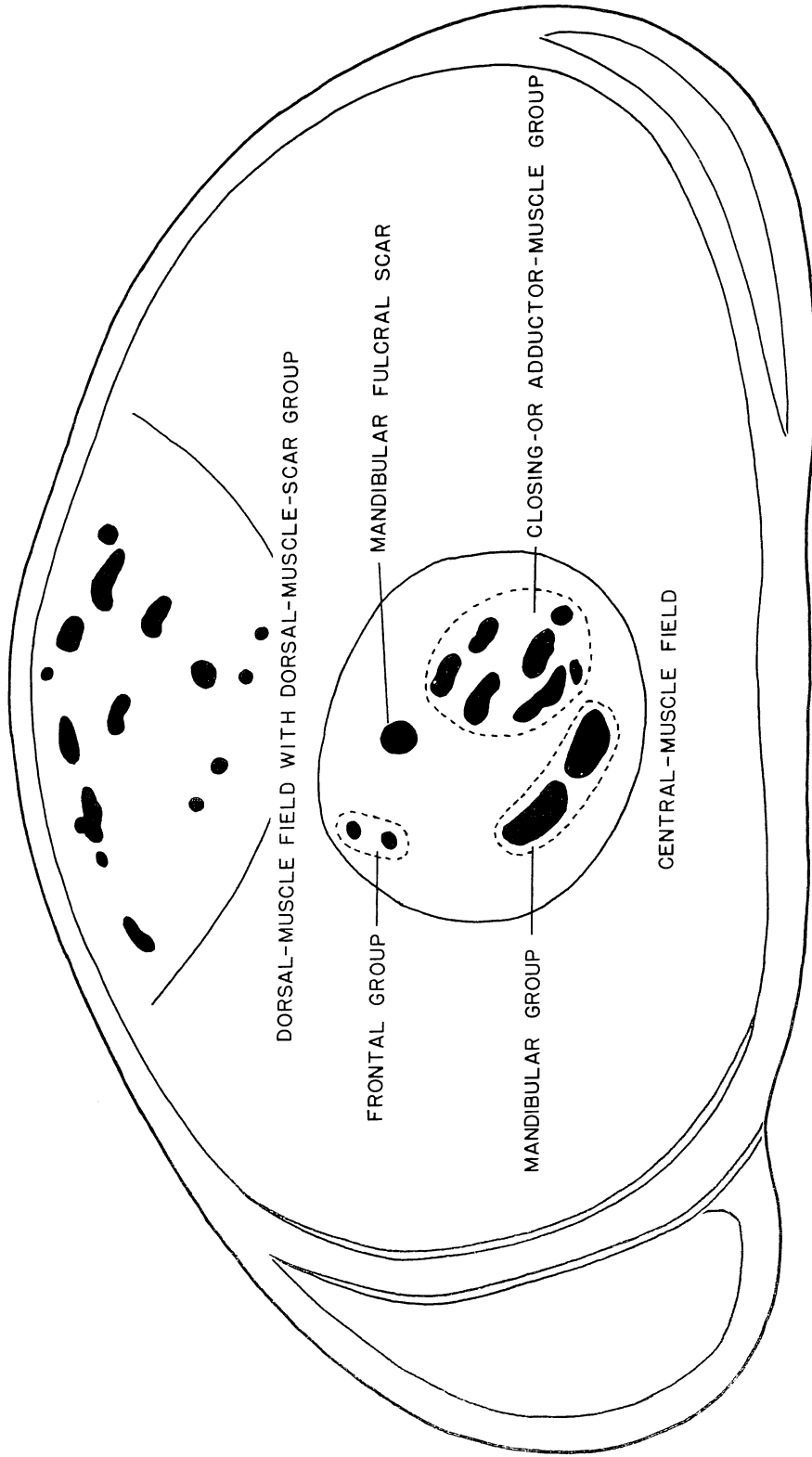

TEXT-FIGURE 1. Diagrammatic sketch of interior of right valve of cypridid ostracod with muscle scars labeled in proposed terminology.

Pokorný (1958, p. 89-91) divided the scars into two areas of the valve. The first area, located nearly in the center of the valve, he designated the central group or central-muscle field. He assigned three groups of scars to the central-muscle field; the closing muscles, mandibular scars, and the antennal scars. The second scar area which he termed the peripheral group is located in the dorsal area of the valve. The peripheral group contains only the dorsal-muscle scars. However, on Pokorný's diagram of the muscle scars (Fig. 629, p. 89) the group which he termed the peripheral group in the text, is labeled as the dorsal group of muscle scars. The three groups which comprise the central-muscle field are not clearly set off as the central-muscle field. No mention is made of the mandibular fulcral point.

Triebel in 1960 (p. 110) referred to the closing muscles as the closing-muscle field and then shortly thereafter (p. 111) he called the closing muscles a group. The pair of scars which he described in 1949 (p. 205) as being formed by the insertion of the chitinous Stutzleisten of the antenna he termed the frontal scars.

In the *Ostracod Volume of the Treatise on Invertebrate Paleontology* (1961), the groups of scars mentioned are the adductor or closing muscles, mandibular-adjustor muscles, dorsal-muscle scars, and the antennal scars. The mandibular-adjustor muscle scars are also called the mandibular scars. It is noted (p. Q17) that the mandibular scars are often included in the closing-muscle group.

In his recent volume on *Post-Paleozoic Ostracoda*, Van Morkhoven (1962, p. 47-49) recognized two distinct groups of muscle scars, which he termed the central- (or adductor-) muscle scars, and the dorsal-muscle scars. In addition, he distinguished the mandibular scars, (the two scars anteroventral to the closing-muscle scars) and indicated that the scars are formed by chitinous rods from the apex of the mandible rather than true muscles. He also introduced the term fulcral point for the scar formed on the valve by the pivoting motion of the dorsal apex of the basal podomere of the mandible. Van Morkhoven proposed the term frontal scar for the single V-shaped scar or the occasional two or three separate small scars which are present just anterior to the vertical row of closing-muscle scars in the family Cytheridae of the suborder Podocopa. He also used the term frontal scar for the scars in other groups of ostracods which lie in a similar position.

On a diagram of a cytherid ostracod, Van Morkhoven (1962, Fig. 3) illustrated the scars in two areas of the valve. The dorsal area included only the dorsal-muscle scars. The central area is designated as the central-muscle-scar area and includes the adductor and mandibular scars, frontal scar, and fulcral point. In the text the central-muscle-scar area is often simply referred to as the central-muscle scars. This is the same term that was used to designate the closing- or adductor-muscle scars.

Benson and MacDonald (1963, p. 7; Pl. 4) designated the scar groups as the adductor, antennal, mandibular-muscle scars, and the dorsal-body scars. The dorsal-body scars are further subdivided by them into the major dorsal-body scars and the minor dorsal-body scars.

The lack of a uniform terminology of the scars and their groups is apparent in the foregoing discussion. With this in mind, the author proposes a revision of the terminology of the scars and their groups. This revision attempts to encompass the existing knowledge of the origin

and the variation in the scar groups. Further investigations may alter this terminology, but even at our present state of knowledge there is a need for a more uniform set of terms. The introduction of new terms is avoided as much as possible by the clarification and use of those existing.

Text-figure 1 is a diagrammatic presentation of the scar patterns of a recent cypridid ostracod. The figure and the arrangement of the scars are only intended to illustrate the proposed terminology. While there is a great variation in the scar patterns of ostracod groups, the author believes that this terminology may be applied to all groups of ostracods.

Muscle Fields

The terms central- and dorsal-muscle fields refer to the areas of the valves which contain prominent groups of scars. The muscle fields are composed of one or more separate groups of scars. This use of the term, "muscle field," as being composed of separate and identifiable groups of scars conforms to the sense of the term, "muscle field," as used by Zalányi (1929, p. 11), Pokorný (1958, pp. 89-91), and Triebel (1949, p. 205). It also corresponds to the term, "area," as used by Van Morkhoven (1962, Fig. 2) in designating the central-muscle-scar area.

At the risk of introducing further ambiguity in the terminology, the use of the word muscle in the terms central- and dorsal-muscle fields is retained, even though some of the scars of the central-muscle field are, or may not be, formed by muscles. The alternative to this usage would be to introduce some new terms such as, "dorsal- and central-scar fields," but this would lead to other complications.

The muscle scars and other scars referred to in this discussion are, strictly speaking, merely the traces or imprints of various soft parts of the body left on the interior of the valve of the ostracod. If the term, "scar field," were to be used, then the definition should include other imprints, which heretofore have never been included by any worker in the distinction of scar groups or fields, such as the liver, ovaries, testes, and eyespots. The scars or imprints of these organs would in many cases traverse the two fields. The liver imprint of *Chlamydotheca arcata* (Sars) is visible on Figures 1, 2, 3, 4, 5, and 6 of Plate 8. The anterior end of the liver scar lies dorsal to the closing-muscle group and ventral to the dorsal-muscle field. It traverses the area of the central-muscle field and terminates near the posteroventral margin of the valve. Van Morkhoven (1962, Fig. 18) illustrated the imprints or scars of testes on the left valve of *Candona studeri* Kaufmann. The testes scars loop through the central- and dorsal-muscle fields as well as over other extensive areas of the valve.

For these reasons the terms central- and dorsal-muscle fields as used in the revised terminology include only the scars which are formed by individual muscles or support structures of the body. The scars formed by entire organs are not included in this category.

In most cases the scars can be readily separated into the two fields. The ventralmost scars of the dorsal-muscle field are usually far enough removed from the scars of the central-muscle field to allow a clear distinction between the two fields. However, in a few genera of

the family Cytheridae of the suborder Podocopa, there are some small scars closely associated with the dorsalmost scars of the closing-muscle group. Van Morkhoven (1962, p. 58) thought that these small scars probably represent unusually centrally placed dorsal-muscle scars.

Central-muscle field. -- The central-muscle field (Fig. 1), located in the central area of the valve, is composed of four more or less distinct groups of scars: the closing- or adductor-muscle scars, mandibular scars, frontal scars, and the mandibular fulcral scar. The four groups occupy approximately the same relative position to each other in all groups of ostracods.

Both the terms, "closing muscles," and "adductor muscles," are widely used in the literature. The terms are synonymous and no misunderstanding ever arises from the use of either of these terms. Therefore, the scars formed by these muscles may be termed the closing- or adductor-muscle scars with equal validity.

The mandibular-scar group should definitely not include the word muscle in its terminology as the scars are not formed by true muscles, but rather by the chitinous support rods which were previously described. The scars should be simply referred to as the mandibular scars.

The term mandibular fulcral scar is introduced here in preference to the terms "Stutzleisten" and fulcral point for the scar formed by the pivoting motion of the dorsal apex of the mandible against the body wall and valve. It is felt that this term best expresses the origin of its formation.

The mandibular fulcral scar should be given careful attention as it is often included in the closing-muscle group. As this scar is often only distinguished with difficulty, it should be noted whenever it occurs and clearly excluded from the closing-muscle group. The mandibular fulcral scar is visible on the right valve of Chlamydotheca arcuata (Sars) (Pl. 8, Fig. 1) as an irregularly rounded scar between the dorsalmost scars of the closing-muscle group and the frontal group. It is also faintly visible in the same position on the left valve of the adult Chlamydotheca arcuata (Pl. 8, Fig. 2). The mandibular fulcral scar is not visible on the valves of the instars of Chlamydotheca arcuata (Pl. 8, Figs. 3, 4, 5, 6; Pl. 9, Figs. 1-10). No mandibular fulcral scar is apparent on any of the valves of Cypridopsis vidua O. F. Muller (Pls. 10-11).

The frontal scar group poses a problem in terminology. With the exception of Triebel (1960, p. 111) and Van Morkhoven (1962, p. 48), authors have designated these as antennal scars. The author has been unable to determine from the literature who first related these scars to the antennae and designated them as antennal scars, but the term "antennal scar," has been carried in the literature for at least several decades and is still the most commonly

used term today.

The term frontal scars or frontal-scar group is best suited for these scars for several reasons. During the investigation of the musculature of Chlamydotheca arcuata, it was determined by thin sections and dissection that the frontal scars are formed by two separate muscles. One of the muscles has its origin on the ventral area of the mandible and the other muscle originates on the anterior portion of the endoskeleton. In addition, Kesling (in press) has reached the same conclusion in the study of the anatomy of the anatomy of Candona suburbana Hoff. No evidence was found that the frontal scars represent the point of insertion on the valves of the chitinous support rods (Stutzleisten) of the antenna as suggested by Triebel (1949, p. 205) for Candona candida (O. F. Muller). Therefore, at least in the family Cyprididae of the suborder Podocopa, these scars are in no way related to the antenna.

As far as can be determined, the frontal scars when observed in all groups of ostracods occupy the same relative position with respect to the other groups of scars in the central-muscle field. The origin of these scars in the other groups of ostracods is unknown. In the case of the family Cytheridae of the suborder Podocopa, Van Morkhoven (1962, p. 48) stated that the origin of these scars is not known, but they do not seem to represent places of muscle attachment. Certainly only a morphological investigation of living cytherids and other groups of ostracods will provide an answer to this problem. However, it seems likely that the frontal scars in other ostracods will be found to be similar to those in the Cyprididae. Therefore, the best term for this group is simply the frontal scars but the origin of the frontal scars should not be referred to except in the groups where it is definitely known.

Dorsal-muscle field. -- The dorsal-muscle field is composed of a single group of scars, the dorsal-muscle scars. With a few exceptions, they are easily distinguished from the scars of the central-muscle field by their position on the dorsal area of the valve. The term dorsal-muscle scars is preferred for this group because of its widespread usage.

The origin of the individual dorsal-muscle scars is known for only a few species. There appears to be a great variation in the patterns between different species. As the patterns are known for only a few species, and they vary greatly, it is not felt advisable at this time to attempt to subdivide the dorsal-muscle scars into groups. There does, however, appear to be some trend in the patterns of the few species in which they are known. When the origin of the individual scars in the dorsal-muscle-scar group is determined for more species, then perhaps a more refined classification of the dorsal-muscle scars will be possible. The dorsal-muscle scars and their origins in two species of fresh-water ostracods is discussed in detail in another section of this paper.

INSTAR DETERMINATION

During the investigation of ostracod musculature and muscle scars it was necessary to determine the instars of the two species, both in the living specimens and in the molted valves. *Chlamydotheca arcuata* (Sars) was the first species studied, and it was during work on this species that some of the problems of instar determination became apparent.

Chlamydotheca arcuata (Sars)

The adult is easily recognized by the conspicuous anterior flange on both valves (Pl. 8, Figs. 1, 2). This flange is completely lacking on the valves of all the instars. Spines are present on the margin of the posteroventral corner of the valves of the fifth, sixth, seventh, and eighth instars (Pl. 8, Figs. 3-6, Pl. 9, Figs. 1-4).

The instar determination of large numbers of living specimens and molted valves was accomplished by measuring the height and length of the specimens or valves and plotting the results on a graph. Kesling (1953) discussed and reviewed the basis and the validity of this method for the determination of ostracod instars. The assignment of a living specimen to its correct instar may be easily confirmed by examination of the soft parts. However, the correct determination of the instar of a molted valve was found to present unsuspected problems.

Two hundred and ninety-seven valves were collected from the bottom of a culture tank on August 8, 1962. The height and length of the valves were measured and plotted on a graph to determine the limits of each instar. The results are recorded on Chart 1 as population 1. The instars of population 1 can be readily distinguished on the basis of their height and length. The separation of the instars on the basis of measurements was confirmed by a check of the soft parts of various instars. Due to the extremely fragile nature of the first instar valve, only one valve of the first instar was found and measured.

A year later it was necessary to collect another group of valves of all the growth stages for the purpose of photographing the muscle scars on the valves. The valves were collected from the bottom of the same tank from which the valves of population 1 were collected. During the initial stages of the photographic work it suddenly became apparent that the instar limits calculated for population 1 did not apply to the instars of the second population. Three hundred and two valves were then measured and plotted on a graph. The results are recorded on Chart 1 as population 2. No valves of the first instar were found intact in the second population.

As shown on Chart 1, the height and length limits and the averages of the height and length are quite similar for the second and third instars of the two populations. Starting with the fourth instar and proceeding toward the adult the differences in the limits and the averages of the height and length for corresponding instars of the two populations becomes more and more pronounced. If the two populations of the single species shown on Chart 1 were to be considered as a single population, then the limits of height

between adjacent instars would overlap, and the limits of length would be near the point of overlap. Kesling (1951, p. 101) pointed out that in *Cypridopsis vidua* (O. F. Müller) there is also a similar overlap in the height of adjacent instars.

Immediately after the second group of valves was measured, about 100 adults were removed from the tank and placed in a clean tank with a clean sand bottom and a plentiful supply of filamentous green algae. The ostracods were allowed to reproduce for several generations in the clean tank. About five months later a group of valves was collected from the bottom of the tank. Although the ostracods had passed through several generations in the tank, few valves other than the last two growth stages were found. The other younger instar valves were destroyed in the organic sediment which had formed on the bottom of the tank as a result of an accidental overfeeding of fish food about a month before the valves were collected. Fifty adult valves and eighty-four immature valves were collected and measured. Seventy-six of the eighty-four immature valves were thought to be of the eighth instar. The adult valves ranged in height from 1.33 to 1.63 mm, and in length from 2.25 to 2.73 mm. The valves assumed to be of the eighth instar ranged in height from 1.11 to 1.24 mm, and in length from 1.89 to 2.07 mm. The average height-length of the adults and the eighth instar was 1.51-2.60 mm and 1.18-1.98 mm respectively.

If these measurements for the incomplete instar series are superimposed on those for the first two populations on Chart 1, then the three populations for the single species overlap in length as well as height. Of the total measured specimens, the adult and the eighth instar range in length from 2.03 to 2.73 mm and from 1.53 to 2.07 mm respectively. If a complete series of instars were available for the third population, and their measurements plotted on the chart, the height-length limits of all of the growth stages would probably overlap. In the absence of other criteria such as ornamentation, change in shape, and change in outline of the valve, the three populations plotted together on the same chart would be difficult to separate into proper instars.

The implications of this observed overlap in the length, as well as the height, between adjacent instars in an ostracod population are numerous. In a cultured population over an extended period of time, the size limits of each instar change. Particularly, when using predetermined size limits for molted valves, the population size limits should be periodically checked to insure that the valves are assigned to the correct instar. If the size limits of population two had been applied to the incomplete third population many valves would have been undoubtedly assigned to the incorrect instar.

A large number of specimens or valves should be measured when determining the limits of the instars. If the specimens or valves are used for study an added precaution is selection of only specimens or valves which fall near the average for the instar. Other characters such as ornamentation, and change in outline and shape should be noted for each instar and used as a check against the measured limits.

CHART 1

Comparison of size distribution of approximately 300 valves each of two populations of *Chlamydotheca arcuata* (Sars).

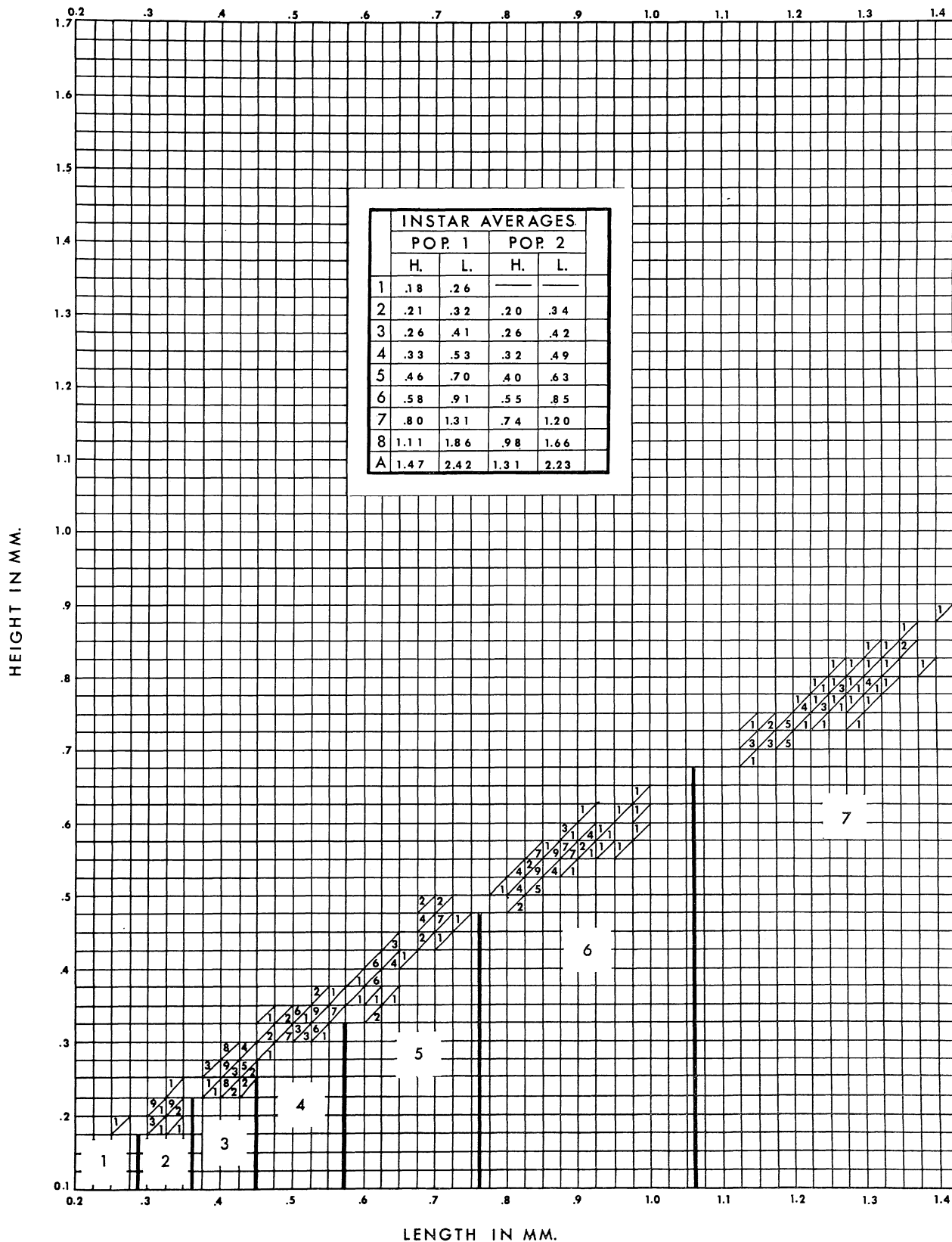

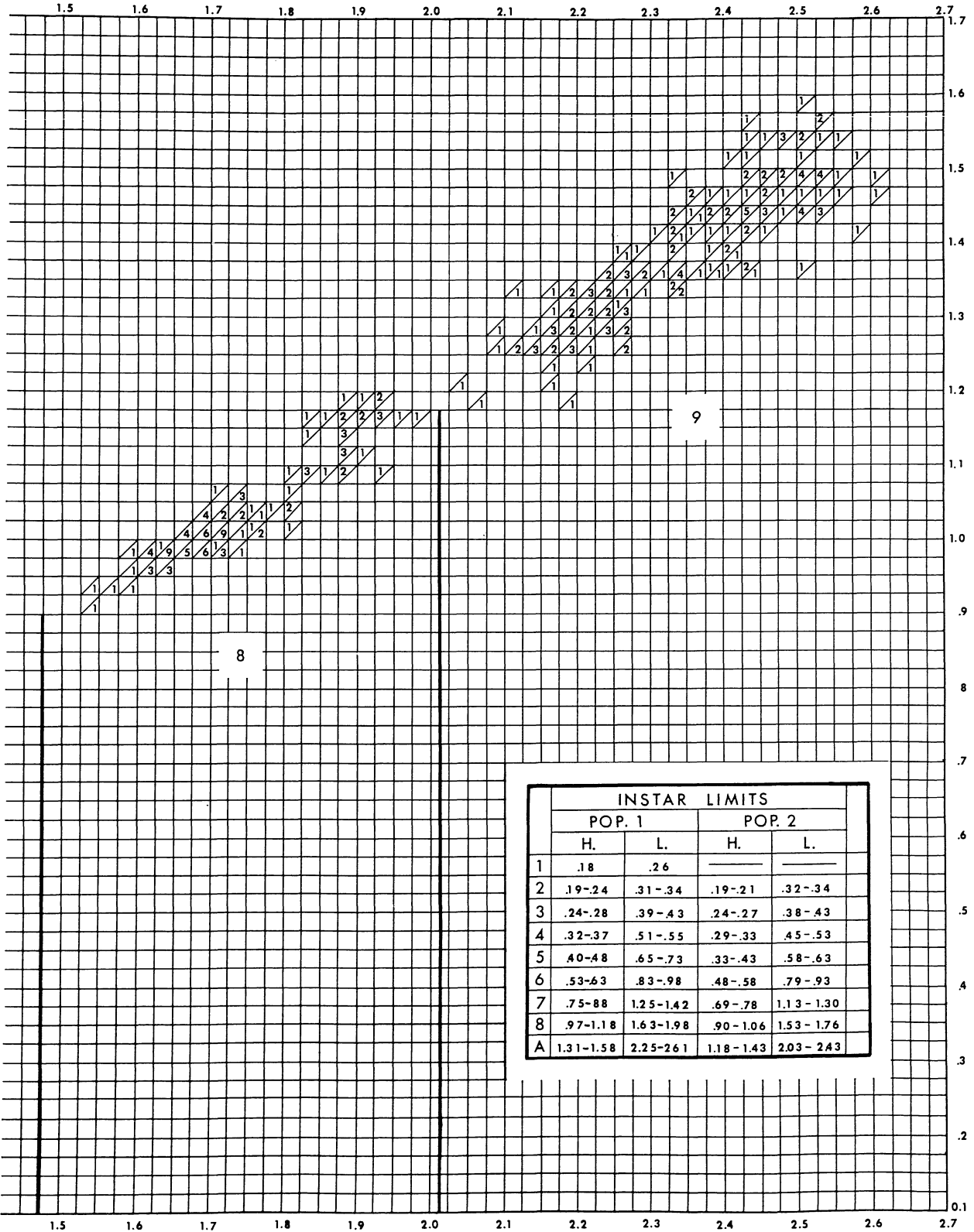

Descriptions of species should include the observed size range of all specimens available, rather than just an average size for the species. In the literature the lengths given for *Chlamydotheca arcuata* are 2.68, 2.70, and 2.60 mm. Very few of the specimens cultured in the tanks attained those lengths.

The sizes of the male and female of many ostracod species are known to differ. If the valves of a group of fossil ostracods is measured and plotted on a graph and there appears to be no natural break between the instars, this may indicate either the population contains male and female members or that it is only a series of valves from a parthenogenetic population with an extremely wide range of size for each instar. Both the adult and the eighth instar of *Chlamydotheca arcuata* exhibit a variation in length of 26%.

Several reasons have been proposed for the variation of size within an instar of a living ostracod species. Kesling (1953, p. 103) listed five reasons: (1) sex, (2) individual variation, (3) diet, (4) parasitism, and (5) temperature. No accurate records were kept of the environmental conditions in the tanks because of lack of control facilities and the problem of variation only became apparent in the latter stages of the study. However, it is felt that a few general conclusions may be drawn from the available information.

In this study the tanks were supplied with a calcareous sand bottom, city tap water, and aeration. Food consisted of filamentous green algae, small spherical algae, tropical fish food, and crushed snails. Water was added to replace that lost by evaporation. The tanks were kept near a window, and the water temperature approximated that of the room throughout the year.

Sexual variation may be ruled out as a cause of variation, as *Chlamydotheca arcuata* is parthenogenetic. Several dozen living specimens of each population were checked to insure that the species had not become syngamic, as this change has been known to occur in some species of freshwater ostracods. Individual variation occurred within each instar, but there was also variation in the size between the instars of different populations. The food supply of the cultures was adequate at all times, though somewhat variable. Kesling (1952, p. 268) concluded that deficiencies in

the diet of an immature ostracod merely prolong the period of time until molting and do not cause a dwarfing of the animal. No evidence of parasitism was found in the many specimens that were studied. Elofsen (1941, p. 399) suggested that temperature may cause a variation in the size. The author believes that temperature variation in the cultures of *Chlamydotheca arcuata* was not significant enough to induce the variation found in the different populations.

Reyment and Brännström (1962) conducted experiments on cultures of *Cypridopsis vidua* and found that specimens raised in either a calcareous or stagnant environment were smaller than those raised in a normal environment. Stunting of snails in laboratory cultures is a common phenomenon. The stunting of snails has been attributed to the accumulation of excretory products.

The variation found in the different populations of *Chlamydotheca arcuata* may be due in part to the accumulation of excretory products, inasmuch as the tanks were never cleaned. During the period between the collection of the first and second population from the same tank, the bottom of the tank had become quite foul. Organic material had collected to a depth of several millimeters. The ostracods collected from this environment had the smallest average adult size. When specimens were transferred from this environment to a clean tank the average adult size increased to 2.60 mm within five or six generations. The bottom of the tank was foul at the time of collection of the valves of the third population, but this fouling was caused by an accidental overfeeding of fish food only a few weeks before the tank was sampled.

Cypridopsis vidua (O. F. Müller)

Kesling (1951, Chart 1) plotted the size distribution of five hundred valves of *Cypridopsis vidua* and found that the adult valves ranged in length from .585 to .655 mm. The author had several laboratory cultures of *C. vidua* throughout this study. Because of the differences that were observed in the cultures of *Chlamydotheca arcuata*, a population which approximated the size of the population measured by Kesling was selected for study. Only specimens which fell near the average measurements for each instar were studied to insure correct instar determination.

ATTACHMENT OF MUSCLES TO THE VALVES

The valve of a living ostracod is composed of many layers. Progressing from the outside toward the inside of the valve the following layers are encountered: (1) chitin, (2) calcium carbonate, (3) chitin, (4) hypodermis, and (5) chitin. The calcareous layer is lacking in some groups of ostracods. The chitin layer on the outside of the valve is called the chitin coating of the calcareous layer. The chitin which lies between the calcareous layer and the hypo-

dermis is termed the chitin coating of the hypodermis. The innermost layer of chitin, which hangs in a fold from the dorsal area of the body and completely encases the soft parts of the body, is termed the chitin lining of the hypodermis. A recently molted ostracod valve is composed of three layers: (1) the chitin coating of the calcareous layer, (2) the calcareous layer, and (3) the chitin coating of the hypodermis.

The closing muscles, as well as muscles from the appendages and other parts of the body, penetrate the hypodermis layer and terminate on the chitin coating of the hypodermis. There is a distinct difference between the closing muscles and the muscles from other parts of the body near their point of termination. These differences were found in both species of fresh-water Cyprididae that were studied.

Closing Muscles

At the outer ends of the closing muscles, the hypodermis is greatly reduced in thickness. In these areas the hypodermis is composed of granular protoplasm, and as the closing muscles pass through these areas, they lose their striated character (Pl. 5, Figs. 1, 3, 5). The distal tips of the myofibrille of the striated muscle are interlaced with unstriated tonofibrille. The tonofibrille extend through the chitin coating of the hypodermis. At their point of termination, the ends of the muscles diverge to cover a slightly larger surface area (Pl. 5, Figs. 1, 5). Because the hypodermis is in close contact with the chitin coating of the hypodermis, the unstriated portion of the muscle is very short (Pl. 5, Figs. 1, 3, 5).

A low, flat boss is developed within or on the chitin coating of the hypodermis at the point where the end of the muscles are in contact (Pl. 5, Figs. 1, 3-5). The boss extends into the calcareous layer of the valve. It is within this chitin boss that the tonofibrille are developed. Schreiber (1922, p. 533) stated that in the case of *Cyprinus inconguens* Ramdohr, the myofibrille of the closing muscles are continuous with the tonofibrille. However, Richards (1951, p. 240) pointed out that careful observation of good preparations shows that muscle attachments in both crayfish and dragonfly larvae are not continuous, but that the tonofibrille split and interlace with the ends of myofibrille. According to Dennell (in Waterman, 1960, p. 452), the tonofibrilles are formed during the deposition of the cuticle and are renewed at each molt.

On several transverse serial microtome sections through the closing muscles of *Chlamydotheca arcuata* (Sars) the ends of the closing muscles were pulled away from the chitin bosses (Pl. 5, Fig. 3). Under very high magnification the tonofibrille are plainly visible in the chitin boss. On some of the sections where the muscle was pulled away from the boss, the base of the boss was fringed with protruding tonofibrille, which had evidently extended and interlaced with the ends of the myofibrille of the closing muscle. The individual tonofibrilles within the boss are very small in comparison to the diameter of the closing muscle myofibrilles. Interlacing of the tonofibrille of the boss with the ends of the myofibrille of the muscle provides a strong attachment between the muscle and rigid valve. The interlacing with the non-striated tonofibrille at the end of the muscles evidently obscures the striated character of the muscle myofibrille.

Kesling (1951, p. 73) stated that he believed the bosses at the ends of the closing muscles are molted with the hard parts of the valves. This opinion is confirmed by the writer's observations on recently molted valves, which were stained by the previously mentioned technique. The muscle scars of stained valves stand out in great contrast to the rest of the valve, because the chitin bosses which were molted with the chitin coating of the hypodermis, are thicker and pick up a greater amount of the stain. It was also observed, on specimens that had been left for too

long a time in clorox, that chitin bosses of the closing muscles had actually lifted and pulled away from the muscle scars.

The situation of the tonofibrille of the chitin boss interlacing with the tips of the closing muscle myofibrille is compatible with the fact that the bosses are shed with the valve during molting. If the myofibrille were continuous with the tonofibrille, then the fibers would have to be broken or disassociated at the point of junction between the muscle and boss and following the molt the ends of the fibers would have to grow or otherwise be extended through the newly formed bosses.

Appendage and other Body Muscles

According to Richards (1951, p. 241), one of the most common methods of muscle attachment in arthropods is the extension of the muscle to the basement membrane of the integument and its continuation by tonofibrille. This is essentially the method of attachment of the closing muscles in the two species of ostracods that were studied. However, the method of attachment of the other body muscles is quite different.

The terminal-distal portion of the body muscles completely lose their striated character and are transformed into a band of translucent, unstriated connective tissue (Pl. 5, Fig. 3). The relative distance from the chitin coating of the hypodermis that this transformation of the muscles takes place is different for each muscle. In the case of *Chlamydotheca arcuata*, the distal, terminal third of the ventral antennal muscle is connective tissue, whereas the dorsal antennal muscle is striated tissue for nearly its entire length (Pl. 1, Fig. 2). The muscles leading to the dorsal area from the thoracic legs and the maxilla are connective tissue for nearly half their length (Pl. 4, Fig. 3). On the other hand the connective tissue on the distal, terminal ends of the dorsal antennule, posterior-body wall, and furcal rod muscles is extremely short (Pl. 1, Fig. 1).

At the point of attachment of the body muscles on the valves, the translucent, unstriated connective tissue passes through the granulated hypodermis and flares out to cover a wider area (Pl. 1, Fig. 3). Chitin bosses with tonofibrille are present in the chitin coating of the hypodermis at the point of attachment. The tonofibrille of the chitin boss interlace with the ends of the connective tissue fibers at the end of the muscle.

The major difference between the attachment of the closing muscles and the body muscles is presence of the band of translucent, unstriated connective tissue at the terminal ends of the body muscles. The presence of the sometimes lengthy band of translucent connective tissue on the distal ends of the body muscles often makes it very difficult to determine their point of termination on the valves. This is particularly true for the very small muscles extending from the thoracic legs and maxillae to the dorsal area, as approximately their distal half is composed of this connective tissue.

No evidence was found that any fibers of any sort penetrate through the chitin boss of the chitin coating of the hypodermis into the calcareous layer. The bosses which penetrate the calcareous layer probably decay during fossilization and leave depressed areas which are called muscle scars on fossilized valves.

MUSCULATURE AND MUSCLE SCARS OF CHLAMYDOTHECA ARCUATA (Sars)

The species of *Chlamydotheca* used in this study was identified as *Chlamydotheca arcuata* (Sars). Identification was based on the original description by Sars (1901, pp. 23-24; Pl. 5, Figs. 10-12), and subsequent additions by Furtos (1933, pp. 440-441; Pl. 2, Figs. 5-8), and Tressler (1949, p. 70; Fig. 13h-i). These adequately cover the general morphology of the soft parts and valves, so that no further description of these features is necessary for the purpose of the study.

The musculature of ostracods is very complex. Several dozen muscles are found in the body of an ostracod. The majority of these do not connect to the valve, but rather join and operate individual parts of the anatomy. A description of all the muscles of the ostracod body is beyond the scope of this study. The complex musculature of the appendages and other internal parts of *Chlamydotheca arcuata* (Sars) generally corresponds to that described by Kesling (1951) in his study of *Cypridopsis vidua* (O. F. Müller). The muscles considered here are primarily those which originate in the appendages and other parts of the body and terminate on the valves to form muscle scars. Several muscles which operate and support the furca, as well as those which extend to the furcal rod from the thoracic appendages, are also described in this study, because the origin and function of these muscles is not well known. The origin and function of the adductor or closing muscles of ostracods is well known and will not be further commented on in this paper. However, the developmental pattern of the closing-muscle-scar group is considered.

Figure 2a is a diagrammatic drawing of the right half of an adult specimen, viewed through the external surface of the valve. Consequently, some of the muscles that are connected to the inner surface of the appendages are represented by dashed lines. This drawing was constructed from a specimen that was sectioned along the median plane by the freehand method. All of the muscles illustrated have corresponding muscles in the other half of the body. In the following discussions it is understood that each muscle and feature discussed is duplicated on the other half of the body.

Figure 2b is an overlay of the same valve indicating the muscle origin of the scars of the dorsal-muscle field and the frontal scars of the central-muscle field.

In the following discussions of the muscles, the function of several muscles is noted. Following Kesling's suggestion (1951, p. 44), the muscles which move podomeres or appendages ventrally are labeled as flexors, and those which move podomeres or appendages dorsally are labeled as extensors. The same system is followed in the discussion of the musculature of *Cypridopsis vidua*.

Musculature and Muscle Scars of the Adult

Except where noted, the following discussion of the musculature and muscle scars is limited to those muscles which terminate and form a scar in the dorsal-muscle field. The arrangement of the muscle scars in the dorsal-muscle field. The arrangement of the muscle scars in the

dorsal-muscle field does not lend itself to a description of the scars in any particular order. Therefore, the muscles and the scars formed by these muscles are described for each appendage or body part. The general order of discussion starts with the antennular muscles and proceeds from the anterior toward the posterior of the animal. The scars formed by endoskeletal muscles and the muscles which form the scars of the frontal group are discussed last.

Antennular muscles and muscle scars. -- Five muscles originate from each antennule and terminate on the dorsal area of the valve. Three of these form individual scars, while the other two merge at their termination with muscles from other parts of the body to form a single large scar (Fig. 2a-b).

The dorsal antennular muscle is the largest and most prominent (Pl. 1, Fig. 1; Pl. 3, Fig. 4; Pl. 4, Fig. 2; Pl. 5, Fig. 1). It originates on the dorsal rim of the basal podomere of the antennule (Pl. 3, Fig. 4) and extends at a low angle toward the posterodorsal part of the body. The dorsal antennular muscle acts as an extensor for the antennule. Its termination forms the most posterior muscle scar in the dorsal-muscle field. The scar lies just behind the large oval scar formed by the large posterior mandibular muscle (Fig. 2a-b; Pl. 8, Figs. 1-2).

A small muscle, which also acts as an extensor, arises on the dorsal rim of the basal podomere (Fig. 2a-b) close to the origin of the dorsal antennular muscle. The exact point of origin of this muscle is difficult to discern, but it appears to originate either just dorsal or ventral to the dorsal antennular muscle. On Pl. 5, Fig. 4, this small muscle is faintly visible where it bisects the right angle formed by the crossing of the dorsal antennular and endoskeletal muscles. This small muscle from the dorsal rim of the antennule does not form a distinct scar but merges at its termination with the large anterior muscle from the mandible and other smaller muscles to form a single, large scar (Fig. 2a-b; Pl. 8, Figs. 1-2).

A third small muscle originates on the medioproximal rim of the basal podomere (Fig. 2a-b) and extends at a high angle to the dorsal area where it forms a distinct muscle scar. This small, rounded muscle scar lies just anterior to the large, elongate scar formed by muscles from the mandible and other body parts (Fig. 2a-b; Pl. 8, Figs. 1-2). The function of this muscle is not known.

A fourth muscle, which acts as a flexor, originates within the ventral part of the basal podomere of the antennule (Fig. 2a-b). It extends out through the opening of the basal podomere and terminates just anterior to the large anterior mandibular muscle. Its scar is not distinct, but rather merges with the scars of the mandible and other muscles to form a large ovate scar (Fig. 2a-b; Pl. 8, Figs. 1-2).

Another small, yet important muscle, which acts as a flexor, originates on the ventroproximal rim of the antennule (Fig. 2a-b). It extends posteriorly and terminates near the midline of the valve (Fig. 2a-b). The terminal

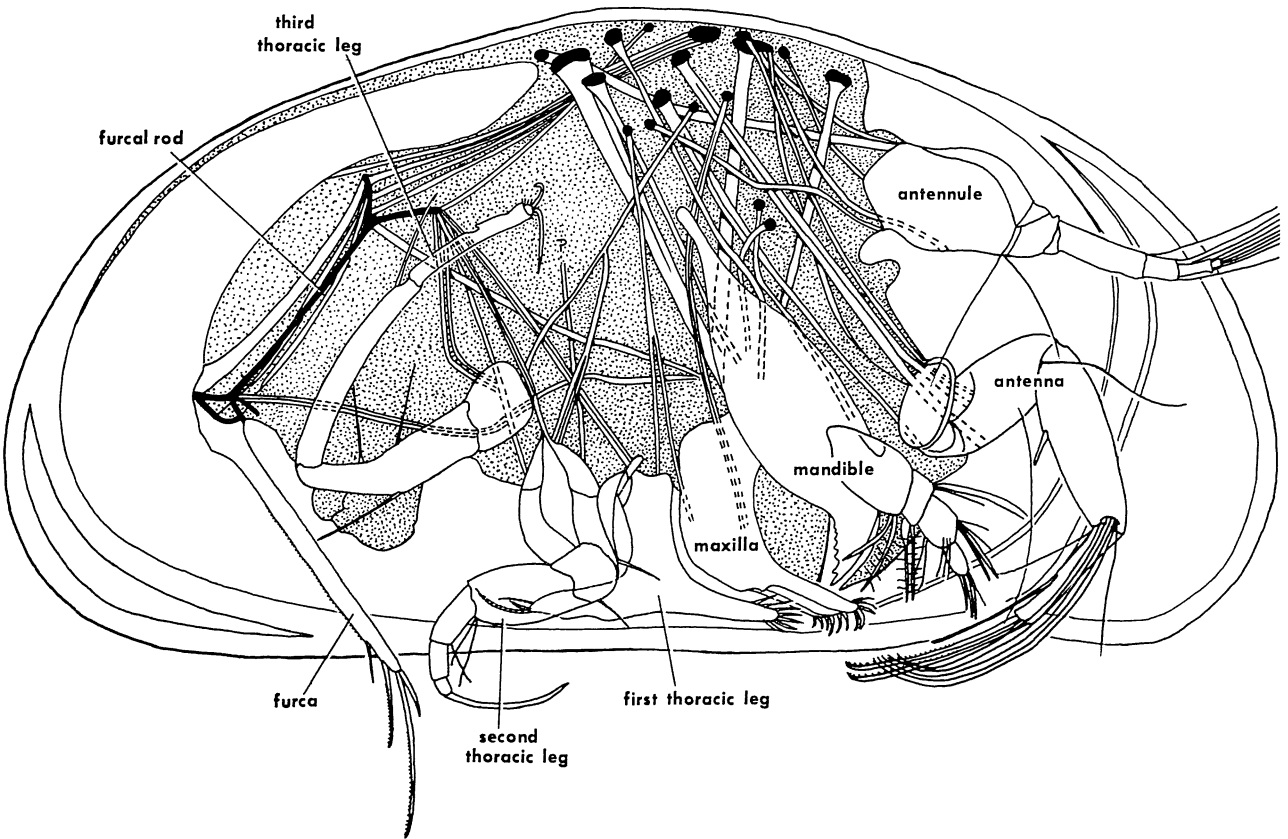
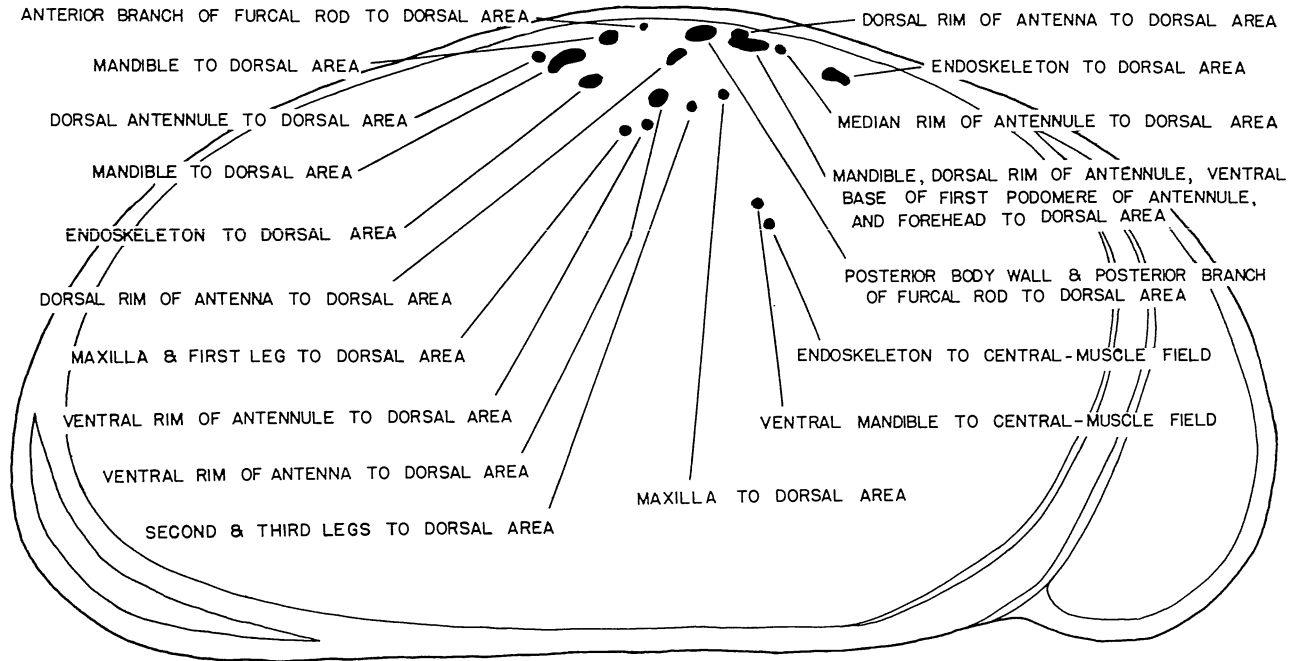

TEXT-FIGURE 2. *Chlamydotheca arcuata* (Sars). Musculature of right side (below) and muscle scars of left valve (above) labeled with origin of muscles in dorsal-muscle field.

half of this muscle is labeled on Pl. 2, Fig. 1. Figure 4 of the same plate is an enlargement of its terminal area. It forms a distinct scar, which is the anteriormost scar of the small pair in the ventroposterior area of the dorsal-muscle field (Fig. 2a-b; Pl. 8, Figs. 1-2).

Antennal muscles and muscle scars. -- The basal podomere of the antenna is attached to the head region by a chitin framework, so that its movement is restricted. Consequently, the extensor and flexor muscles which raise and lower the antenna pass through the basal podomere and attach to the proximal portion of the second podomere. One small and three large muscles originate from the second podomere of each antenna. Two of the large muscles are closely associated for nearly their entire length and form a single muscle scar. The other two form individual scars.

The dorsalmost of the muscles extending from the antenna is a small extensor muscle. It originates on the dorsoproximal rim of the second podomere and extends through the basal podomere, terminating just above the large scar formed by the mandible muscle and the other small muscles (Fig. 2a-b). The scar formed by this small muscle from the dorsal rim of the antenna is sometimes difficult to distinguish, as it may merge with the large scar just below it (Fig. 2a-b; Pl. 8, Figs. 1-2).

The point of origin of the two muscles which are closely associated for most of their length lies just ventral to the point of origin of the small dorsal muscle. The dorsalmost of this pair originates near the dorsal rim of the second podomere of the antenna. The ventral muscle of the pair originates on the ventral floor of the second podomere. As these two muscles pass through the basal podomere they merge and appear as a single muscle (Fig. 2a-b; Pl. 1, Fig. 2; Pl. 3, Fig. 4; Pl. 6, Fig. 1). Even though they are very closely associated throughout their length and form a single scar, each muscle probably has a separate function. The dorsal muscle of the pair probably acts as an extensor and the ventral muscle as a flexor. The single scar formed by these two muscles lies near the center of the dorsal-muscle field (Fig. 2a-b; Pl. 8, Figs. 1-2).

The third large muscle from the antenna, which acts as a flexor, originates on the ventroproximal rim of the second podomere (Fig. 2a-b; Pl. 1, Fig. 2). The ventral antennal muscle terminates near the center of the dorsal-muscle field slightly posterior and ventral to the dorsal antennal muscle (Fig. 2a-b; Pl. 8, Figs. 1-2).

Forehead muscle and muscle scar. -- The forehead region is connected to the dorsal area of each valve by a single muscle (Fig. 2a-b; Pl. 1, Figs. 1, 4; Pl. 3, Fig. 1). It lies just anterior to the pharynx and may appear as if it actually attaches to the pharynx and may appear as if it actually attaches to the pharynx, but as shown on Pl. 1, Fig. 4, the forehead muscle does not attach to the pharynx. On this figure the forehead muscle appears as a dark band of muscle tissue extending dorsally from the area of the dorsal wulst. Ventrally from the dorsal wulst, it appears as a chitinous tendon, extending beyond the cerebrum and attaching to the forehead just above the upper lip. This is the only muscle observed which is attached at its point of origin by a chitinous tendon. The forehead muscle probably functions as a retractor for the forehead and upper lip. It extends dorsally and merges at its termination with other muscles to form a single scar (Fig. 2a-b, Pl. 8, Figs. 1-2).

Mandibular muscles and muscle scars. -- Each mandible is connected to the valve by four muscles and three of these terminate on the dorsal region of the valve. The smallest of the four muscles terminates on the lateral surface of the valve forming a scar in the frontal group of the central-muscle field. Discussion of this small muscle is deferred to the discussion on the origin of the scars of the frontal group.

The two largest mandibular muscles form a V, with its point of origin on the inner face of the large, canoe-shaped basal podomere (Fig. 2a-b; Pl. 1, Fig. 2; Pl. 2, Fig. 1; Pl. 3, Figs. 2-3; Pl. 4, Fig. 3; Pl. 6, Fig. 1). Kesling (1951, p. 26) suggested that these two muscles act as retractors and also perhaps as diductors. They form large, prominent scars on the valve (Fig. 2a-b; Pl. 8, Figs. 1-2). As previously noted, several smaller muscles merge at their termination with the anterior muscle of this pair to form a single large scar. The posterior muscle of the pair does not merge with other muscles at its termination (Fig. 2a-b).

The third muscle leading from the mandible to the dorsal area is about one-third the diameter of the V-shaped pair (Fig. 2a-b). It originates on the inner face, near the distal end, of the basal podomere (Pl. 3, Fig. 2). As shown on this figure the other two large muscles from the mandible extend vertically upward. This third muscle extends at an angle to the dorsal area, and evidently functions to draw the apex of the mandible toward the center of the body, which would then swing the basal parts of the mandible outward from the side of the mouth. Its scar is just dorsal and anterior to the scar formed by the posterior muscle of the large V-shaped pair (Fig. 2a-b; Pl. 8, Figs. 1-2).

Maxilla and first thoracic leg muscles and muscle scars. -- The muscles of the maxilla and the first thoracic leg are discussed as a unit, because a single scar in the dorsal-muscle field appears to be formed by muscles which arise from the maxilla and the first thoracic leg (Fig. 2a-b).

As indicated on figure 2a-b, a muscle from the rear part of the maxilla and a muscle from the front part of the first thoracic leg appear to merge and form a single muscle extending to the dorsal area of the valve. Whether or not these two muscles actually fuse, which seems unlikely, they are at least so intimately associated for most of their length that they are indistinguishable as individual muscles. The scar formed by the combined muscles of the maxilla and the first thoracic leg is the posterior scar of the small pair which lies in the ventroposterior area of the dorsal-muscle field (Fig. 2a-b; Pl. 8, Figs. 1-2).

A pair of closely associated muscles, not associated with muscles from the thoracic legs, originates in the basal podomere of the maxilla. The exact point of origin and the function of this pair is not obvious. They extend to the dorsal area in a position just in front of the transverse closing muscles and behind the basal podomere of the mandible (Pl. 2, Fig. 5). The maxilla muscle pair forms a single scar, which is the anterior scar of the small pair located in the ventroanterior area of the dorsal-muscle field (Fig. 2a-b; Pl. 8, Figs. 1-2). Perhaps the muscles which are attached to the anterior and posterior of the maxilla serve to move the maxilla backward and forward.

The thoracic legs are unique in that they have not only a direct muscle connection to the valve, but also have

muscles which attach to the anterior branch of the furcal rod. The anterior furcal-rod branch in turn has a direct muscle connection to the valve (Fig. 2a-b). A pair of closely associated muscles extends from the dorsal rim of the basal podomere of the first thoracic leg and attaches to the anterior branch of the furcal rod (Fig. 2a-b; Pl. 1, Fig. 2; Pl. 2, Fig. 3; Pl. 4, Fig. 3). The exact point of origin of these muscles on the basal podomere is difficult to determine, but if they are attached in slightly different positions, then the muscles may serve to rotate the first thoracic leg.

Second and third thoracic leg muscles and muscle scars. -- The second and third thoracic legs also appear to share a common muscle which connects to the dorsal area of the valve (Fig. 2a-b; Pl. 2, Figs. 1, 3; Pl. 4, Fig. 3). Again, in much the same manner as the muscles of the first thoracic leg and the maxilla, these individual muscles become indistinguishable as they extend toward the dorsal area. The muscles from the basal podomeres of the second and third thoracic legs merge near the center of the body and continue to the dorsal area where they form a single scar (Fig. 2a-b; Pl. 8, Figs. 1-2). The scar is the rear one of the small pair in the anteroventral area of the dorsal-muscle field. The exact nature of the function of these muscles is not clear, but they probably aid in the movements of the appendages.

The second thoracic leg also has a pair of muscles leading to the anterior branch of the furcal rod (Fig. 2a-b; Pl. 4, Fig. 3). In addition, a single muscle extends toward the posterodorsal area of the body; in Figure 2a, the uncertainty of the termination of this muscle is indicated by a question mark. Determination of the muscles in the posterior area of the body is difficult because they are very small and usually obscured by the rear gut, liver, ovaries, and other body tissues.

The third thoracic leg also has a pair of muscles extending from its basal podomere to the anterior branch of the furcal rod (Fig. 2a-b).

Furca and posterior-body-wall muscles and muscle scars. -- The musculature which operates the furca is complex. The furca, as well as the whole posterior part of the body, is capable of a great deal of movement. The base of the furca is supported by a rod embedded in the posterior-body wall. The furcal rod acts as a fulcrum for the base of the furca. The furcal rod branches on its dorsal end with one branch extending backward and the other forward. In Figure 2a the furcal rod is drawn in solid black.

As previously mentioned, muscles from the thoracic legs attach to the anterior branch of the furcal rod. The anterior branch of the furcal rod is in turn connected to the dorsal area of the valve by a single muscle (Fig. 2a-b; Pl. 4, Fig. 3), which evidently adds stability to the anterior branch when the muscles from the thoracic appendages pull against the rod. Some of the thoracic leg muscles which attach to the anterior branch of the furcal rod are shown on figure 1 of Plate 4.

Three muscles which aid in the operation and extension of the furca attach to the posterior branch of the furcal rod (Fig. 2a; Pl. 1, Fig. 2; Pl. 2, Fig. 1; Pl. 4, Fig. 2). The largest of the three lies posterior to the furcal rod and attaches to the posterior base of the furca. This muscle acts as an extensor, as its contraction extends the furca out of the opened valves. A pair of smaller muscles, which act as flexors, connect near the anterior base of furca (Fig. 2a-b).

The posterior branch of the furcal rod is supported by at least three muscles which extend to the dorsal area of the valve. There is also at least one muscle originating in the dorsoposterior-body wall just above the posterior branch of the furcal rod. These form a loosely knit group extending to the dorsoanterior area of the valve (Fig. 2a-b; Pl. 1, Fig. 1; Pl. 3, Fig. 3; Pl. 4, Figs. 1-2; Pl. 6, Fig. 1). The posterior part of the body is not firmly attached to the valve. The muscles connecting the posterior branch of the furcal rod to the valves compensate for the forces created by the operation of the furca. Scars of muscles from the posterior branch of the furcal rod and the posterior-body wall lead to the dorsocentral area of the dorsal-muscle field (Fig. 2a-b; Pl. 8, Figs. 1-2).

The furcal rod is also connected to the endoskeleton by two muscles (Fig. 2a-b; Pl. 1, Fig. 2; Pl. 2, Fig. 3). One muscle connects to the dorsal end of the rod at a point near where it branches. Contraction of this muscle draws the apex of the furcal rod forward and forces the base of the furca backward. A pair of muscles extend within the ventral part of the body from the endoskeleton to the base of the furca. They probably act to draw the base of the furca forward.

Endoskeletal muscles and muscle scars. -- The endoskeleton of *Chlamydotheca arcuata* is a chitinous, saddle-shaped structure. It lies in the center of the body between the mandibles (Pl. 3, Fig. 2; Pl. 5, Figs. 7-8). There are two dorsal prongs on each side of the endoskeleton; one prong points anteriorly and the other points posteriorly (Pl. 5, Figs. 7-8). A large muscle originates on each prong. The endoskeleton is not shown in the diagram on figure 2a in order to avoid confusion, but the muscles which extend from the endoskeleton are shown in their approximate position on the diagram.

The muscles supporting the right and left side of the anterior end of the endoskeleton are shown on Fig. 2, Pl. 3, and the muscles supporting the right and left sides of the posterior end of the endoskeleton are shown in the same relative position on Fig. 3, Pl. 3.

The muscle from the anterior end of the endoskeleton forms the anteriormost scar in the dorsal-muscle field (Fig. 2a-b; Pl. 8, Figs. 1-2). The muscle from the posterior of the endoskeleton forms a scar just anteroventral to the scar of the posterior muscle of the large V-shaped mandibular muscles (Fig. 2a-b; Pl. 8, Figs. 1-2).

In addition to the two large muscles which support each side of the endoskeleton, there is a third small muscle which extends laterally to the area of the central-muscle field. Discussion of this small muscle is deferred to the following section on the muscles and origin of the frontal group.

Muscles which form frontal scars of central-muscle field. -- As previously mentioned in the discussion of muscle-scar terminology, two distinct and unrelated muscles form the frontal scars of the central-muscle field. In the literature, the origin of these scars almost exclusively has been attributed to antennal muscles. During this study it was found that these two muscles are in no manner associated with the antenna. The area from which these muscles arise is exceedingly complex and a quick or casual observation could easily lead to the conclusion that these two muscles are associated with the antenna.

The two muscles that form the scars of the frontal group originate in two different parts of the body. The dorsal scar of the frontal group (Pl. 8, Figs. 1-2) is

formed by a small muscle which is attached to the ventral inside face of the basal podomere of the mandible (Fig. 2a-b; Pl. 2, Fig. 2). The ventral scar of the frontal group (Pl. 8, Figs. 1-2) is formed by a small muscle which is attached to the endoskeleton (Fig. 2a-b; Pl. 2, Fig. 2; Pl. 5, Figs. 7-8). The ventral mandibular muscle draws the mandible toward the body wall. The muscle to the endoskeleton serves to stabilize the position of the endoskeleton in the center of the body. The two muscles are shown on Figs. 2, 5 of Pl. 2, as they penetrate the body in a position between the anterior edge of the mandible and the posterior edge of the basal podomere of the antenna.

The mandibles were dissected from several adult specimens. The mandibles are firmly attached to the endoskeleton by several muscles, and during the dissection several mandibles were obtained which were still associated with portions of the endoskeleton. Figures 4-5 of Plate 4 show a dissected mandible, part of the body wall, and part of the endoskeleton, which retain the two muscles that form the frontal scars. Figure 6 of Plate 4 shows another mandible dissection with the two muscles.

These muscles are also well shown in their natural position on transverse thin sections (Pl. 5, Figs. 7-9). Figures 8-9 shows two successive sections cut through a specimen. The center part of the ventral mandibular muscle missing on Fig. 9 is present in its correct position on Fig. 8.

Closing-muscle scars. -- There are five large and two small scars in the closing-muscle group. One small scar is located just behind the middle scar of the posterior row, and the other is ventroposterior to the large ventral scar (Pl. 8, Figs. 1-2). The large ventral scar on the right valve (Pl. 8, Fig. 1) is strongly constricted in its center but the constriction is not complete and the scar is not actually divided. This scar on the left valve is much less constricted (Pl. 8, Fig. 2).

Musculature and Muscle Scars of Immature Instars

The soft parts and the valves of the instars were studied to determine the changes that occur in the musculature and resulting muscle-scar patterns found on the valves of the instars. The entire muscle system will not be reviewed for each instar. Only the important differences in the musculature and the muscle-scar patterns including the central-muscle field are considered. The instars are discussed in their reverse order proceeding from the oldest to the youngest so that the instars may be compared to the adult.

Eighth instar. -- All of the appendages and most of the body is in its final form. The sexual organs are in the anlagen stage of development. The musculature of the eighth instar (Pl. 6, Figs. 2-3) is identical to that of the adult (Pl. 6, Fig. 1).

The dorsal-muscle-scar pattern of the eighth instar (Pl. 8, Figs. 3-4) is identical to the adult (Pl. 8, Figs. 1-2). With one exception, the central-muscle field of the eighth instar (Pl. 8, Figs. 3-4) is the same as the adult (Pl. 8, Figs. 1-2). The mandibular fulcral scar present on the valves of the adult (Pl. 8, Figs. 1-2) is missing on the valves of the eighth and younger instars (Pl. 8, Figs. 3-8; Pl. 9, Figs. 1-10). The ventral closing-muscle scar is smaller than that of the adult and is not constricted (Pl. 8, Figs. 3-4).

Seventh instar. -- All of the appendages are well de-

veloped and the musculature (Pl. 6, Fig. 4) corresponds to the musculature of the adult.

The dorsal-muscle-scar patterns (Pl. 8, Figs. 5-6) are similar to those of the eighth instar and the adult (Pl. 8, Figs. 1-4). The closing-muscle scars are grouped more closely and the two dorsal scars lie close together.

Sixth instar. -- All of the appendages are present even though many are not fully developed. The third thoracic leg is in the anlagen stage. The muscles extending to the valve (Pl. 6, Figs. 5-6) are similar to those of the adult.

The muscle scar in the dorsal-muscle field formed in the adult by the merging of the second and third thoracic legs (Fig. 2a-b) is present on the valve of the sixth instar (Pl. 9, Figs. 1-2). The author was unable to determine whether this scar was formed by muscles from both the second and third leg or only by muscles from the second leg. In any event, the overall dorsal-muscle-scar pattern of the sixth instar (Pl. 9, Figs. 1-2) still corresponds to the pattern of the older growth stages (Pl. 8, Figs. 1-6). The dorsal-closing muscles form only one scar (Pl. 9, Figs. 1-2).

Fifth instar. -- The muscles which form the most prominent scars in the dorsal-muscle field are well developed (Pl. 6, Figs. 7-8). However, in the younger instars, it was impossible to determine the small muscles which extend dorsally from the thoracic legs, maxilla, and ventral rim of the antennule. The presence or absence of these muscles can only be inferred by the muscle scars found in the dorsal-muscle field. The scars formed by the small muscles from the thoracic legs, maxilla, and ventral rim of the antennule are difficult to recognize on the valves of the older growth stages. On the valves of the fifth and younger instars, these small muscle scars approximate the size and appearance of the normal pore canals. Therefore, no conclusions may be drawn with certainty about the presence or absence of the muscles which form these scars.

The valves of the fifth instar (Pl. 9, Figs. 3-4) exhibit the first departure from the dorsal-muscle-scar pattern found in the older growth stages. The two scars formed by the muscles from the dorsal-body wall and the furcal rod (Fig. 2a-b) are conspicuously absent. No scar of the large dorsal antennular muscle (Fig. 2a-b) can be seen in the valve of the fifth instar (Pl. 9, Figs. 3-4), but it is definitely present on the valves of the fourth and third instars (Pl. 9, Figs. 5-8). The dorsal antennular muscle is well developed in the fifth instar (Pl. 6, Figs. 7-8). The absence of its scar on the valve photographed is probably due to a quirk of preservation. As previously noted, the two pairs of small scars in the ventral area of the dorsal-muscle field are indistinguishable on the valves of the fifth and younger instars.

The closing-muscle scars resemble those of the sixth instar.

Fourth instar. -- With the exception of the anlagen of the first thoracic appendage, only the appendages of the head region are present. The muscles extending from the head appendages to the dorsal region (Pl. 6, Figs. 9-10) are still remarkably similar in arrangement to those of the adult.

The pattern of the muscle scars in the dorsal-muscle field (Pl. 9, Figs. 5-6) closely resembles that of the fifth instar (Pl. 9, Figs. 3-4). The two middle scars of the

closing-muscle group are nearly joined (Pl. 9, Figs. 5-6).

Third instar. -- The musculature of the third instar resembles that of the fourth instar. The musculature of the third instar was observed through the transparent valve.

The dorsal-muscle-scar pattern (Pl. 9, Figs. 7-8) is similar to the pattern of the fourth instar (Pl. 9, Figs. 5-6). The two small closing-muscle scars present on the valves of all older growth stages (Pl. 8, Figs. 1-6; Pl. 9, Figs. 1-6) are lacking on the valves of the third and younger instars (Pl. 9, Figs. 7-10).

Second instar. -- All the head appendages are present in the second instar. The musculature of the second instar was not clearly observed, but the muscle-scar pattern of the dorsal-muscle field (Pl. 9, Figs. 9-10) is similar to the pattern of the third instar (Pl. 9, Figs. 7-8).

An important difference is noted in the central-muscle field. The chitinous supporting rods joining the mandible to the lateral surface of the valve are not developed, so that the mandibular scars are absent (Pl. 9, Figs. 9-10). The two middle closing-muscle scars no longer appear to be nearly joined as they are on the valves of the third and fourth instars.

First instar. -- No living specimens of the first instar were observed, and only a single molted carapace of the first instar was found (Pl. 8, Fig. 7). The valves of the first instar are weakly calcified, if at all. No scars of any sort were found on the single valve that was studied (Pl. 8, Fig. 8). However, judging from the relationships of the second instar, the scars, if found on the valve of the first instar would probably be much the same as those of the second instar.

Summary of the Muscle-scar Patterns of the Nine Instars of *Chlamydotheca arcuata* (Sars)

The muscle-scar patterns were studied on many valves, both right and left, of all the instars and the adult with the exception of the first instar. The patterns are the same on both right and left valves of each growth stage. The muscle-scar patterns are constant on all of the valves within each growth stage.

On some valves all of the scars do not appear to be present at first glance or if they are present the shape of the scars appears to be different. Careful observation in such cases confirms that the scar patterns are complete.

The apparent differences are merely due to the preservation or the lack of it on the different valves.

Dorsal-muscle field. -- The muscle scars formed by the posterior-body wall and the furcal rod do not appear until the sixth instar. The presence of the two pairs of small scars in the ventral area of the dorsal-muscle field is uncertain until the sixth instar. From the sixth instar to the adult the pattern of the dorsal-muscle field is constant. Each dorsal-muscle scar retains its position relative to other scars in the dorsal-muscle field and to scars of the central-muscle field throughout the part of the ontogeny in which it is developed.

Central-muscle field. -- The pattern of the closing-muscle group changes through the instars. In their order of appearance in life, from the first to the ninth or adult instar, individual scars become more complex by division. The closing-muscle scars were not observed on the valve of the first instar. There are four large scars in the second and third instars. A pair of small scars are added in the fourth instar, and the closing-muscle group then consists of four large and two small scars. This pattern is maintained through the sixth instar. In the seventh instar the dorsal scar is nearly divided into two separate scars. This division is complete in the eighth instar so that the closing-muscle group then consists of five large and two small scars. In the adult the ventral large scar is elongated and often so sharply constricted at its center that it appears to be two separate scars. However, the ventral scar usually retains its identity as a single, but constricted scar. Because of this more or less continuous change, the final closing-muscle-scar pattern is only attained in the adult stage.

With the exception of the first instar, which was not observed, two frontal scars are present in all of the instars and the adult.

Two mandibular scars are present from the third instar to the adult. These scars are missing on the valves of the second and perhaps the first instar. With their first appearance in the third instar, the mandibular scars are approximately equal in length to the large scars of the closing-muscle group (Pl. 9, Figs. 7-8). The mandibular scars become progressively more elongate with respect to the large scars of the closing-muscle group from the third instar to the adult. In the adult the mandibular scars are approximately twice the length of the large scars of the closing-muscle group (Pl. 8, Figs. 1-2).

The mandibular fulcral scar is apparent only in the adult stage.

MUSCULATURE AND MUSCLE SCARS OF *CYPRIDOPSIS VIDUA* (O. F. MÜLLER)

The identification of this species was based on the description given by Kesling (1951, pp. 1-3) in his monograph on *Cypridopsis vidua* (O. F. Müller). The musculature and many other features of the species were worked out in great detail in this monograph, so that no further comment on the morphology of *Cypridopsis vidua* is necessary for the purpose of this study.

The major muscles which extend from the appendages and other body parts were described and figured by Kesling (1951), but the attachment of the muscles was not correlated with the muscle scars found on the dorsal area of the valve. However, with specimens prepared by the previously described method of free-hand sectioning, it was possible to correlate the muscles with their scars of attachment.

Several muscles from the head region, furca, endoskeleton, and posterior-body wall were correlated with their muscle scars. Several dozen free-hand sections were prepared of adult specimens and in the thoracic region of a few of these specimens, muscles that appeared to extend to the dorsal region of the body were found. Because these muscles are very small and difficult to trace even in the best prepared specimens, no positive comment concerning their origin, function, position, or termination may be made. However, the author has little doubt that a system of thoracic leg muscles somewhat comparable to that observed in *Chlamydotheca arcuata* (Sars) exists in the body of *Cypridopsis vidua*. No scars in the ventral region of the dorsal-muscle field were found that might indicate the presence of these muscles, but this is not surprising in view of the extremely small size of the muscles which probably form scars about the size of the normal pores, and thus would be indistinguishable.

Figure 3a is a modification of Kesling's (1951, Fig. 5, p. 10) diagram of the left half of an adult viewed from the median plane toward the exterior of the valve. As in the case of the drawing of *Chlamydotheca arcuata* the muscles represented on the drawing are duplicated on the other half of the valve. Figure 3b is an overlay of the same valve indicating the muscle origin of the scars of the dorsal-muscle field.

The adult valve of *Cypridopsis vidua* has a coarse surface texture which tends to obscure the muscle scars when viewed in transmitted light (Pl. 10, Fig. 1; Pl. 11, Fig. 12). The muscle-scar pattern was studied on several adult valves and was found to be identical to the pattern on the valves of the eighth instar (Pl. 10, Figs. 2-4; Pl. 11, Fig. 11). Therefore, in the following discussion of the adult muscle scars reference is also made to the left valve of the eighth instar (Pl. 10, Fig. 2), as well as the adult left valve (Pl. 10, Fig. 1).

As in the case of other ostracods, the nature of the closing muscles is well known, so that only the development of their pattern is considered in the following discussions. Only the muscles which form scars in the dorsal area of the valve plus the two that form the frontal scars of the central-muscle field are discussed. The discussion of the muscles and muscle scars follows the sequence used for *Chlamydotheca arcuata*.

Musculature and Muscle Scars of the Adult

Antennular muscles and muscle scars. -- Four muscles extend from the proximal region of the basal podomere, but the point of termination is known for only three of the muscles. The largest, most prominent muscle attaches to the dorsal rim of the basal podomere, and extends directly toward the posterior of the body (Fig. 3a-b; Pl. 7, Figs. 1-2). This muscle acts as a flexor for the antennule, and forms the most posterior scar in the dorsal-muscle field (Fig. 3a-b; Pl. 10, Figs. 1-2).

A small muscle, which acts as flexor, originates on the rim of the antennule just dorsal to the large flexor muscle described above (Fig. 3a-b). This small muscle forms a distinct scar in the dorsal-muscle field (Fig. 3a-b; Pl. 10, Figs. 1-2).

A small muscle from the median rim of the antennule merges at its termination with muscles from the mandible and other body parts to form a single, large muscle scar (Fig. 3a-b; Pl. 10, Figs. 1-2).

A muscle originating on the ventral rim of the antennule can be traced toward the mid-dorsal area of the body (Fig. 3a-b). The termination of this ventral antennular muscle is obscure, but comparison to a similar muscle found in *Chlamydotheca arcuata* (Fig. 2a-b) suggests that this muscle terminates near the ventrocentral part of the dorsal-muscle field.

Antennal muscles and muscle scars. -- Three muscles extend from the inner surface of the basal podomere rim to the dorsal area (Fig. 3a-b). The dorsalmost of these three muscles, which acts as a flexor, forms a muscle scar directly dorsal to the large anterior scar of the mandible and other muscles (Pl. 10, Figs. 1-2). Occasionally these two muscles form a single scar.

Another, larger muscle also originates in the dorsal region of the antenna (Pl. 7, Figs. 1-2). It is shown in Figure 3a-b as a single muscle, but it may actually be a pair of closely associated muscles. The muscle or muscles function as flexors. The muscle scar lies just ventral to a line between the scars of the two large mandibular muscles (Fig. 3a-b; Pl. 10, Figs. 1-2).

The third muscle, which acts as an extensor, originates in the ventral area of the basal podomere (Fig. 3a-b; Pl. 7, Figs. 1-2) and terminates to form a muscle scar ventral and slightly posterior to the scar formed by the large flexor muscle from the dorsal area of the antenna (Fig. 3a-b; Pl. 10, Figs. 1-2).

Forehead muscle and muscle scar. -- The forehead region is connected to the dorsal area of each valve by a single muscle. It merges at its termination with muscles from the mandible and other parts to form a single scar (Fig. 3a-b; Pl. 10, Figs. 1-2).

Mandibular muscles and muscle scars. -- Two large muscles, which form a V, connect the mandibles to the dorsal area of the valve (Fig. 3a-b; Pl. 7, Figs. 1-2). The third muscle from the mandible to the dorsal area, which is present in *Chlamydotheca arcuata*, was not observed. At its termination, the anterior muscle of the pair merges with several other muscles to form a large scar (Fig. 3a-b; Pl. 10, Figs. 1-2). The termination of the posterior muscle forms a single large scar in the posterior area of the dorsal-muscle field (Fig. 3a-b; Pl. 10, Figs. 1-2).

Furca and posterior-body-wall muscles and muscle scars. -- The arrangement of the muscles and the furcal rod in the posterior end of the body is quite similar to that of *Chlamydotheca arcuata*. Because of the small size of *Cypridopsis vidua* the details of the area are not apparent, but the muscles which extend toward the dorsal area are visible. Muscles supporting the body wall and the dorsal end of the furca form a common muscle scar in the posterior end of the dorsal-muscle field (Fig. 3a-b; Pl. 10, Figs. 1-2).

Endoskeletal muscles and muscle scars. -- The endoskeleton is a saddle-shaped structure with projecting prongs. Supporting muscles extend from anterior and posterior prongs on each side of the endoskeleton to the dorsal area (Fig. 3a-b). The muscle from the anterior prong forms the most anterior muscle scar of the dorsal-muscle field (Fig. 3a-b; Pl. 10, Fig. 1-2). The posterior muscle forms a scar just ventral to the scar formed by the posterior mandibular muscle (Fig. 3a-b; Pl. 10, Figs. 1-2).

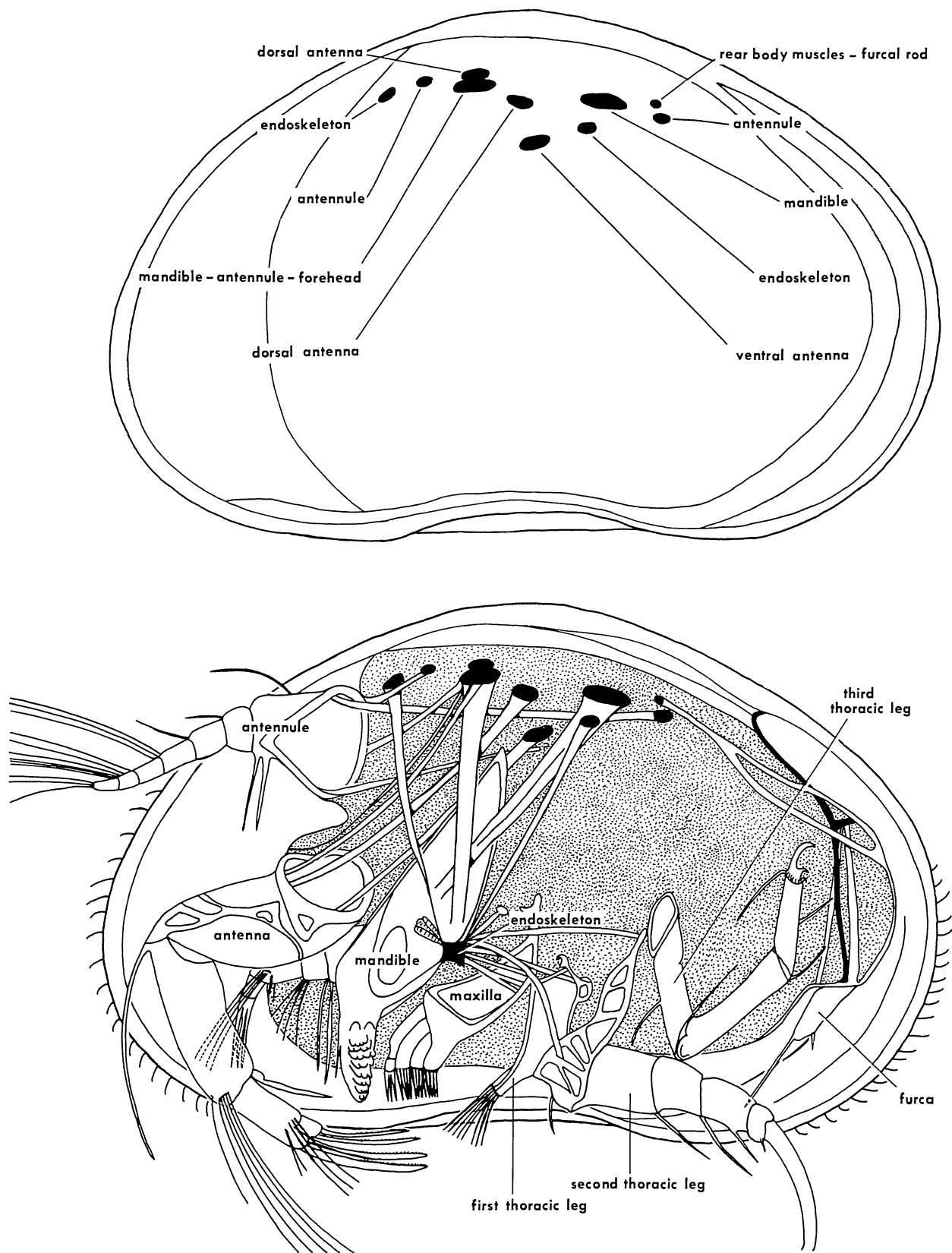

TEXT-FIGURE 3. *Cypridopsis vidua* (O. F. Müller). Musculature of right side as viewed from median plane (below) and muscle scars of right valve (above) labeled with origin of muscles in dorsal-muscle field.

Muscles which form frontal scars of central-muscle field. -- Because of their small size and location, it is difficult to determine the exact origin of the two small muscles which form the frontal scars. However, the author feels certain that these two muscles are not associated with the antenna but very likely have the same origin as the two muscles which form the frontal scars of *Chlamydotheca arcuata*.

Closing-muscle scars. -- The closing-muscle group consists of four large and two small scars. Three of the large scars are arranged in an anterior, curved vertical row. The fourth large scar lies directly posterior to the ventral scar in the anterior row (Pl. 10, Figs. 1-2). One of the small scars lies just below the two ventralmost large scars, and the other posteroventral to the most posteroventral large scar (Pl. 10, Figs. 1-2).

Musculature and Muscle Scars of Immature Instars

Free-hand sections were made of specimens of the seventh and eighth instars, and the muscles which lead to the valve were found to be similar to those of the adult. The younger instars are too small to be sectioned by the free-hand technique, and their valves too opaque to allow a view of the muscles. Kesling (1951), described the ontogeny of the instars of *Cypridopsis vidua* in detail. The details of development are similar to those of *Chlamydotheca arcuata*. Therefore, it is assumed that the individual muscle scars in the dorsal-muscle field of the instars, which are in the same relative position as those in the adult valve, represent the point of attachment of the same muscle or muscles.

As the musculature of all the instars was not studied, only the muscle scar patterns of the instars are reviewed.

Eighth through sixth instars. -- The arrangement of the scars in the dorsal- and central-muscle fields (Pl. 10, Figs. 2-6; Pl. 11, Figs. 11, 13) is identical to that of the adult (Pl. 10, Fig. 1; Pl. 11, Fig. 12).

Fifth instar. -- The scars formed by the posterior-body wall and the furcal rod are absent or unrecognizable. The two small closing-muscle scars in the posteroventral area of the closing-muscle group are not present (Pl. 11, Figs. 1-2).

Fourth and third instar. -- The dorsal-muscle-scar pattern (Pl. 11, Figs. 3-6) is similar to the pattern of the fifth instar (Pl. 11, Figs. 1-2). The scars of the frontal group are present but obscure.

Second and first instar. -- The scars of the dorsal-muscle field and the frontal scars are nearly unrecognizable (Pl. 11, Figs. 7-10). In the central-muscle field only the four closing-muscle scars are visible (Pl. 11, Figs. 7-10). The mandibular scars are lacking on the valves of both the second and first instar.

Summary of the Muscle-Scar Patterns of the Nine Instars of *Cypridopsis vidua* (O. F. Müller)

The muscle-scar patterns on many valves of each of

the nine growth stages were studied. As in the case of *Chlamydotheca arcuata*, the muscle-scar pattern was found to be constant on all of the valves studied within each growth stage, and the same on both the right and left valves of each growth stage. The coarse texture of the valves of all growth stages tended to obscure the muscle scars, particularly when immersed in glycerine and viewed through transmitted light.

No scars that might be interpreted as being formed by muscles from the maxilla or thoracic legs were found. However, there is reason to believe that these muscles and muscle scars do exist, but are too small to be recognized. A small muscle from the ventral rim of the antennule forms one of the scars in the two small pairs of scars located in the ventral area of the dorsal-muscle field of *Chlamydotheca arcuata*. A similar muscle is known to exist in *Cypridopsis vidua*. Yet the termination of this muscle, which is quite apparent in *Chlamydotheca arcuata*, is not visible in *Cypridopsis vidua*. Therefore, it is felt that the muscles from the maxilla and thoracic legs, which are very difficult to find in the large specimens of *Chlamydotheca arcuata*, may exist in *Cypridopsis vidua*, but are too small to be recognized.

Dorsal-muscle field. -- Muscle scars are unrecognizable in the first and second instars. Scars formed by muscles from the posterior-body wall and furcal rod appear to be lacking on the valves of the first through fifth instar. The patterns are identical on the valves of the sixth instar through the adult. No scars were observed that could be correlated with muscles that originated from the thoracic legs or the maxilla. The relative position of the muscle scars that were observed was constant throughout the growth stages.

Central-muscle field. -- From the first through the fifth instar the closing-muscle-scar group is composed of four large scars arranged with a dorsal and ventral scar separated by two scars in a horizontal row. Two small scars are added in the sixth instar. In the sixth and seventh instar the position of the posterior scar of the horizontal row shifts to a more ventral position, so that in the last three growth stages the pattern is a somewhat curved, anterior, vertical row of three scars with a fourth scar nearly posterior to the ventral scar of the vertical row.

The two mandibular scars are not present on the valves of the first and second instar. They first appear in the third instar and are present on valves of all successive growth stages. The scars are approximately equal in length to the dorsalmost closing-muscle scar from their first appearance in the third instar through the adult.

The recognition of the frontal scars is uncertain in the first and second instars, but they are definitely present in the third and fourth instar even though obscure. The frontal scars are easily recognized on the valves of the fifth instar through the adult.

No mandibular fulcral scars were recognized on the valves of any growth stage.

TAXONOMIC EVALUATION OF MUSCLE SCARS

This study of the musculature and muscle-scars patterns of *Chlamydotheca arcuata* (Sars) and *Cypridopsis vidua* (O. F. Müller) has provided answers or partial answers to several questions. It has also established a foundation on which more comprehensive and conclusive studies may be made. The musculature and muscle-scar patterns were carefully investigated in all of the growth stages of both species. The results are valuable in both zoological and paleontological advances, even though seldom, if ever, are all instars of a species preserved as fossils.

It has been established that the muscles and muscle-scar patterns follow a definite pattern of development. Future studies on ostracod musculature and muscle-scar patterns need not be concerned with the study of their development throughout all the growth stages. If the muscles of an adult specimen are identified and correlated with the muscle scars on the valves, it may be reasonably assumed that corresponding muscle scars were left on the valves on the immature instars by the same muscle which formed the scars on the valves of the adult.

This study also indicates that there is a similarity in the overall configuration of the body muscles which terminate on the valves of these two species. Although the species studied belong to two different genera of the same family, the configurations of the body muscles which connect to the valves are remarkably similar. This is not surprising in view of similarity of the morphological structures of the ostracods of this family. As the classification of Recent ostracods is based primarily on the differences in their morphology, there are probably major differences in the configuration of the muscles which attach to the valves of different groups on the basis of the configuration of the dorsal-muscle field.

Both species studied are fresh-water cypridid ostracods. To what extent the conclusions reached in this study may apply to other groups of ostracods is not known. Nevertheless, it is felt that some of the conclusions are generally valid, because certain morphological consistencies are present in each group of ostracods. It must be understood, however, that the conclusions reached here are primarily directed to fresh-water cypridid ostracods.

When this study was conceived, the author knew of no other investigation in which the dorsal-muscle scars were seriously considered for any reason, but during the time of this investigation a paper was published by Benson and MacDonald (1963) on the postglacial ostracods from Lake Erie. In their paper Benson and MacDonald analysed the dorsal-muscle-scar patterns on the fossilized valves of three species of *Candona*, and reached the conclusion that the dorsal-muscle scars are a taxonomically significant feature in the classification of fresh-water ostracods.

The evolutionary trends of ostracods are not well known. The dorsal-muscle scars offer a direct means of correlation between the hard and soft structures of ostracods. A study of the dorsal-muscle-scar patterns of ostracods with respect to evolutionary trends may offer interesting possibilities. In fact, Benson and MacDonald (1963, p. 9, Fig. 4) discussed and illustrated the changes in the valve in the evolution of *Candona caudata* Kaufmann to *Candona novacaudata* Benson and MacDonald. The evolution

of these two species is evidenced in sediments of a thirty-five foot core from the bottom of Lake Erie. In the evolution of these species, the dorsal-muscle-scar pattern remained relatively unchanged while the shape of the valve underwent definite and recognizable changes.

Benson and MacDonald arrived at their conclusions from the study of fossilized valves, but the conclusions reached in this study are derived from living forms. Because these have been the only studies on the taxonomic significance of the dorsal-muscle scars, the results of both investigations are compared in an attempt to assess the dorsal-muscle-scar patterns. In addition, a few comments are made concerning the scars of the central-muscle field.

Dorsal-Muscle Field

Taxonomic evaluation of the dorsal-muscle scars involves several factors. Fresh-water ostracods have nine different growth stages with right and left valves; some are parthenogenetic and others syngamic. Syngamic species often exhibit dimorphic differences between the valves of the male and female.

Both *Chlamydotheca arcuata* and *Cypridopsis vidua* are parthenogenetic species so there is no question of dimorphic differences in the valves of the immature instars. It was found that the dorsal-muscle scars are identical on the right and left valves of each growth stage within each species, but the muscle-scar pattern is not the same on the valves of all growth stages. In each of the two species the dorsal-muscle-scar pattern is identical on all valves from the sixth instar through the adults. This fact is particularly significant as the valves of younger growth stages are seldom found as fossils. However, even though instars younger than the sixth have a different dorsal-muscle-scar pattern, there are enough similarities so that if all features are utilized, the instars can be related to the species.

The consistency of the dorsal-muscle-scar pattern is a taxonomically significant feature for relating instars of a given species to the adult. The adult valve of *Chlamydotheca arcuata* is radically different from those of the instars. The adult valves have a well developed anterior flange and lack spines on the margins, whereas the late instars lack the well developed anterior flange but possess spines on the posteroventral margin. The dorsal-muscle-scar pattern provides a positive means of relating the instars to the adult. The valves of the late instars of *Cypridopsis vidua* are also quite different in shape and structure, but, like those of *Chlamydotheca arcuata*, possess a common dorsal-muscle-scar pattern by which they may be related. However, when relating instars to a known adult species, the dorsal-muscle-scar pattern should be used in conjunction with other characters such as the central-muscle scars and the plotted size limits of the instars and adult valves.

Benson and MacDonald statistically analyzed three hundred valves for each of three syngamic species of *Candona* by graphically comparing the carapace height-length ratio with the ontogenetic development of the muscle-scar pattern. They (p. 7) divided the dorsal-muscle scars into two groups, which they termed the minor and major dorsal body scars. This division of the dorsal-muscle scars was considered in a previous section on the terminology of mus-

cle scars, but for the purpose of this discussion the terms used by them will be retained. The minor scars are designated by them as the scars which form an irregular row along the dorsal margin of the valve. The major scars consist of two more or less parallel rows situated ventral to the minor scars in the center of the dorsal-muscle field.

Benson and MacDonald (1963) also found that the dorsal-muscle-scar pattern is a valuable aid for relating instars to the adults of known species. However, before discussing this aspect of their work it is necessary to consider their recognition of the adults on the basis of the dorsal-muscle-scar patterns. They stated (p. 7) that the minor dorsal body scars of the candonid species examined remain relatively unchanged in their distribution, number, and pattern within a species; however, the major dorsal body scars change significantly between species. This statement is interpreted to mean that the configuration of the entire dorsal-muscle-scar pattern was relatively constant within each species, yet different between species. Comparison of the entire dorsal-muscle-patterns along with the shape of the valves of *Candona novacaudata* Benson and MacDonald (their Pl. 2, Figs. 1-4; Fig. 6, p. 15), *C. nyensis* Gutentag and Benson (their Pl. 1, Figs. 7-10; Fig. 7, p. 17), and *C. subtriangulata* Benson and MacDonald (their Pl. 2, Figs. 6-8; Fig. 8, p. 19) reveals differences between the three species. However, the author does not feel that the major scars are more important taxonomically than the other scars. The configuration of the entire dorsal-muscle-scar pattern along with other differences in the character of the valve may be utilized to separate these three species of *Candona*.

Benson and MacDonald (1963) related the instars of the three species just discussed to the adults on the basis of the dorsal-muscle-scar patterns. They stated (p. 7) that the early instar stages (not possessing taxonomically important adult characteristics) of one species can be distinguished from similarly shaped carapaces of another species on the basis of the configuration of the dorsal body scars. They illustrate, by means of outline drawings, the valve shape and dorsal-muscle scars of the late instars and adults of *Candona novacaudata* (Fig. 6, p. 15), *C. nyensis* (Fig. 7, p. 18), and *C. subtriangulata* (Fig. 8, p. 19). Along with differences in the shape of the immature valves between the three species, the instars of the three species can be identified by the position and configuration of the dorsal-muscle scars. However, the reported development of the dorsal-muscle-scar patterns on these three species of *Candona* differs from that observed in *Chlamydotheca arcuata* and *Cypridopsis vidua*. In the case of *Chlamydotheca arcuata* and *Cypridopsis vidua* the final dorsal-muscle-scar pattern was developed in the sixth instar and remained unchanged in all later growth stages. According to the illustrations of the three *Candona* species, however, the final dorsal-muscle-scar pattern is not achieved until the seventh or eighth instar. It is not known if this difference in the development of the final patterns of the three species of *Candona* as compared to the two species studied by the author is real, or if the interpretation was influenced by poor preservation of the scars in the candonid species.

The musculature and muscle-scar-patterns have not been studied in living specimens of syngamic species. There are differences in the structure and function of some appendages in the male and female of the same species. Whether these differences are manifested in the musculature and muscle scars is unknown. Kesling (1956, p. 86) described a large muscle which extends dorsally from the copulatory apparatus of *Candona suburbana* Hoff, but he

was unable to correlate the muscle with any scar on the valve.

Valves of adult males and females of many syngamic species differ conspicuously in shape and outline. The male valves may be elongated and deepened in the posterior half in order to accommodate the copulatory apparatus. The posterior of the female body is often distended by a large number of eggs and the valves are inflated in the posterior region. However, these differences in the shape and outline between male and female are thought to be exhibited only in the adult stage because the sexual characteristics are not developed in immature stages.

Benson and MacDonald (1963) in their study of the three candonid species stated (p. 8) that the differences in shape between male and female specimens of a single species exhibiting dimorphism, which usually makes identification difficult, can now be more accurately resolved. They found that the dorsal-muscle-scar patterns of the adult male and female valves of *Candona novacaudata* appear to be identical (their Pl. 2, Figs. 1, 2, 4; Fig. 6, p. 15). They stated (p. 7) that the minor scars of candonid species such as *C. subtriangulata* consists of seven to eight individual scars. On their figure 6, p. 15, the patterns of the male and female are identical, but on their plate 2, figures 7-8, the number of scars is the same but there is a slight variation in the configuration of the pattern. The pattern of *C. nyensis* as shown on their figure 7, p. 17, has one less minor scar on the female valve than on the male valve, but on their plate 1, figures 8-9, the number of scars on the valves of the male and female are the same. The configuration of the pattern is also the same.

An exact analysis of the variation of the seven or eight minor scars was not given, and whether this variation is caused by differences in preservation or sexual characteristics is not known. In any event, the evidence given by Benson and MacDonald seems to confirm their opinion that the dorsal-muscle-scar pattern is of significant value in assigning male and female valves to the same species.

As a final note it should be pointed out that the preceding conclusions are based on detailed studies of the configurations of the dorsal-muscle-scar patterns. Observable differences in the position of the various scars are valid criteria, but differences in the exact shape of the individual scars are not important. The exact shape of the muscle scars is often only a matter of preservation.

A careful study of the details of the dorsal-muscle-scar pattern reveals specific differences. However, based on a limited range of observations, the author believes that the general configuration of the dorsal-muscle-scar pattern is also a valid taxonomic character at the generic level. This may be a valuable aid in working with older fossil forms where many of the precise details of the dorsal-muscle-scar patterns are sometimes obscured by poor preservation.

Central-Muscle Field

The central-muscle field is an important taxonomic feature in the classification of ostracods. There is considerable variation in the number, shape, and relative position of the scars in different groups. According to Van Morkhoven (1962, p. 49) certain basic patterns appear to be restricted to higher systematic categories (such as

suborders, families, and subfamilies) of the classification based on soft parts, whilst the finer details often appear to be characteristic for a genus, and more rarely for a species.

Although a study of the variation of the scars of the central-muscle field was not the major purpose of this study, a few comments may be made on the closing-muscle scars of the two species studied. The development of the closing muscles of the two species has been described; but it is not known if all species of the two genera follow similar developmental patterns.

However, comparison of the closing-muscle-scar pattern of the adult valves of a few species of Chlamydotheca indicates that it is variable. The final closing-muscle-scar pattern of Chlamydotheca arcuata is developed by splitting of the previous scars, and this seems to be the case in other species of the genus.

The closing-muscle-scar pattern of C. incisa (Claus) (Triebel, 1960, Pl. 18, Fig. 35c) resembles that of C. arcuata (Pl. 8, Figs. 1-2), except that the large middle scar of the anterior row and the large ventral scar are constricted to the point of appearing to form separate scars. Triebel (1961, Pl. 11, Figs. 34-35) illustrated the closing-muscle scars of two left valves of C. hummelincki hummelincki. On one valve the two dorsal scars are situated very close to each other, the anterior and poster-

ior scars of the middle horizontal row are both clearly divided into separate scars, and the ventral scar is also divided into two separate scars. In addition all of the scars form a compact group. The two dorsal scars of C. unispinosa (Baird, 1862) (Triebel, 1961, Pl. 16, Fig. 67), are nearly in contact, and the other three scars are sutured, but not divided.

Hence, it appears that the closing-muscle scars of species of Chlamydotheca are quite variable. There even seems to be variation with a single species such as C. hummelincki hummelincki and yet others such as C. arcuata are relatively constant.

From superficial evidence, the closing-muscle scars of Cypridopsis vidua seem to be more constant than those of Chlamydotheca arcuata. The closing-muscle-scar pattern of Cypridopsis vidua is developed by a shifting of the position of the scars, whereas the final closing-muscle-scar pattern of Chlamydotheca arcuata is developed by a splitting of the scars.

The author believes that the possibility of slight individual variation, when combined with the vagaries of preservation does not make exact details of the closing-muscle-scars of great value for specific taxonomic determination. However, the overall developmental pattern of the closing-muscle-scars, when established, may prove to be an aid in relating instars of a species or genus.

BIBLIOGRAPHY

- ALEXANDER, C. I., 1933, Shell Structure of the Ostracode Genus *Cytheropteron*, and Fossil Species from the Cretaceous of Texas. *Journ. Paleontol.*, Vol. 7, No. 2, pp. 181-214, pls. 25-27.
- AMBROGI, L. P., 1957. *Manual of Histologic and Special Staining Technics*: vi + 206 pp., 4 pls., Washington, D. C., Armed Forces Institute of Pathology.
- BAKER, J. R., 1958, *Principles of Biological Micro-technique*: xv + 357 pp., 29 figs., New York, John Wiley & Sons, Inc.
- 1960, 4th ed. *Cytological Technique*: xv + 150 pp., 7 figs., New York, John Wiley & Sons, Inc.
- BARTH, RUDOLPH, 1945, Untersuchungen am Hautmuskelschlauch der Raupen von *Catacola*-Arten, zugleich ein Beitrag zur Frage der Insertion des Arthropodenmuskels. *Zoologische Jahrbücher; Anatomie und Ontogenie*, Vol. 69, Part 3, pp. 405-434, 18 figs.
- BENSON, R. H., AND MCDONALD, H. C., 1963, Post-glacial (Holocene) Ostracodes from Lake Erie. *Univ. Kansas Paleont. Contrib., Arthropoda*, Art. 4, pp. 1-26, 4 pls., 8 figs.
- BRADLEY, P. C. S., 1941, The Shell Structure of the Ostracoda and its Application to their Paleontological Investigation. *Annals and Magazine Natural History*, Ser. 11, Vol. 8, No. 43, pp. 1-33, 18 figs.
- CANNON, H. G., 1925, On the Feeding Mechanism of a Freshwater Ostracod, *Pionocypris vidua* (O. F. Müller). *Jour. Linnean Soc. London*, Vol. 36, pp. 325-335, Pl. 11, 5 figs.
- 1940, On the Anatomy of *Gigantocypris mtilleri*. *Discovery Reports*, Vol. 19, pp. 185-244, Pls. 39-42, 17 figs.
- CLAUS, C., 1893, Beitrag zur Kenntniss der Süßwasser-Ostracoden: 1. Ueber den Körper- und Gleidmassenbau der Cypriden nebst Bemerkungen über einzelne innere Organe derselben. *Arbeiten aus dem Zoologischen Institut der Universität Wien und der Zoologischen station in Triest*, Vol. 10, pp. 147-216, Pls. 1-12, 3 figs.
- COLTON, H. S., 1908, Some Effects of Environment on the Growth of *Lymnea columella* Say. *Proc. Acad. Nat. Sci. Phil.*, Vol. 60, Part 3, pp. 410-448, 5 figs., 23 tables.
- DAVENPORT, H. A., 1960, *Histological and Histochemical Technics*: xxii + 401 pp., 25 figs., 5 tables, Philadelphia, W. B. Saunders Co.
- ELOFSON, OLOF, 1941, Zur Kenntniss der marinen Ostracoden Schwedens mit besonderer Berücksichtigung des Skageraks. *Zoologiska Bidrag från Uppsala Universitet*, Vol. 19, pp. 215-534, 52 figs., 42 charts.
- FORBES, G. S., AND CRAMPTON, H. E., 1942, The Effects of Population Density Upon Growth and Size in *Lymnaea palustris*. *Biol. Bull.*, Vol. 83, No. 2, pp. 283-289, 3 tables.
- FURTOS, N. C., 1933, The Ostracoda of Ohio. *Ohio Biological Survey*, Vol. 5, No. 6, Bull. 29, pp. 413-524, 16 pls.
- 1947, On the Ostracoda from the Cenotes of Yucatan and Vicinity, in *Pearse, A. S., Creaser, E. P., and Hall, F. G., Carnegie Institution of Washington*, Pub. No. 457, pp. 89-115, 127 figs.
- GALIGHER, A. E., 1934, *The Essentials of Practical Microtechnique in Animal Biology*: 298 pp., 58 figs., Berkeley, California, Albert E. Galigher, Inc., Laboratory of Microtechnique.
- GAUTHIER, HENRI, 1939, Sur la Structure De La Coquille Chez Quelques Cypridopsides A Furca Réduite Et Sur La Validité Du Genere *Cyprilla* (Ostracodes). *Société Zoologique de France, Bull.* 64, pp. 203-228, 6 figs.
- GUYER, M. F., 1941, *Animal Micrology, Practical Exercises in Zoological Micro-technique*: xvi + 331 pp., 76 figs., 1 table, Chicago, Univ. Chicago Press.
- HARTMANN, GERD, 1953, Zur Morphologie der Polycopiden. *Zeitschrift für Wissenschaftliche Zoologie*, Vol. 158, No. 2/4, pp. 193-248, 43 figs.
- HOFF, C. C., 1942, The Ostracods of Illinois: Their Biology and Taxonomy. *Illinois Biological Monographs*, Vol. 19, Nos. 1-2, pp. 1-196, pls. 1-9.
- HOWE, H. V., AND LAURENCICH, LAURA, 1958, *Introduction to the Study of Cretaceous Ostracoda*. iii + 536 pp., Louisiana State Univ. Press.
- ILES, E. J., 1961, The Appendages of the Halocyprididae. *Discovery Reports*, Vol. 31, pp. 299-326, 14 figs.
- KESLING, R. V., 1951a, The Morphology of Ostracod Molt Stages. *Illinois Biological Monographs*, Vol. 21, Nos. 1-3, vii + 324 pp., 96 pls., 36 figs., 8 tables, 5 charts.
- 1951b, Mechanical Solution of Formulas for Growth Rates. *Contrib. Mus. Paleontol. Univ. Mich.*, Vol. 8, No. 10, pp. 231-237, 3 figs.
- 1951c, Terminology of Ostracod Carapaces. *Contrib. Mus. Paleontol. Univ. Mich.*, Vol. 9, No. 4, pp. 93-171, 18 pls., 7 figs., 5 charts.
- 1952a, A Study of *Ctenoloculina cicatricosa* (Warthin). *Contrib. Mus. Paleontol. Univ. Mich.*, Vol. 9, No. 8, pp. 247-290, 3 pls., 5 figs., 2 charts.
- 1952b, Doubling in Size of Ostracod Carapaces in Each Molt Stage. *Jour. Paleontol.*, Vol. 26, No. 5, pp. 772-780, 1 fig., 6 charts.
- 1953, A Slide Rule for the Determination of Instars in Ostracod Species. *Contrib. Mus. Paleontol. Univ. Mich.*, Vol. 11, No. 5, pp. 97-109, 2 figs.
- 1956, The Ostracod. A Neglected Little Crustacean. *Turtox News*, Vol. 34, No. 4, pp. 82-86, 7 figs.

- KLIE, WALTER, 1930, Ostracoden aus dem paraguayischen Teile des Gran-Chaco. *Archiv. für Hydrobiologie*, Vol. 22, pp. 221-258, 40 figs.
- 1939, Süßwasserostracoden aus Nordostbrasilien 11: Die Gattung *Chlamydotheca*. *Zoologischer Anzeiger*, Vol. 128, No. 5/6, pp. 153-159, 13 figs.
- LEE, A. B., 1937, *The Microtomist's Vade-Mecum*, 10th ed., xi + 784 pp., 3 figs., Philadelphia, P. Blakiston Son & Co. Inc.
- MCCLUNG, C. E., 1950, *McClung's Handbook of Microscopical Technique for Workers in Animal and Plant Tissues*, 3rd. ed., Ruth McClung Jones, editor. xix + 790 pp., 142 figs., New York, Paul B. Hoeber, Inc., Medical Book Dept. of Harper & Brothers.
- MOORE, R. C., editor, 1961, *Treatise on Invertebrate Paleontology: Part Q, Arthropoda 3, Crustacea, Ostracoda*, xxiii + 442 pp., 334 figs., Lawrence, Kansas, Univ. Kansas Press and Geol. Soc. America.
- MÜLLER, G. W., 1912, *Ostracoda. Das Tierreich im Auftrage der Akademie der Wissenschaften zu Berlin*, Part 31, xxxiii + 434 pp., 92 figs.
- PANTIN, C. F. A., 1948, *Notes on Microscopical Technique for Zoologists: viii + 79 pp., 9 pls.*, London, Cambridge Univ. Press.
- POKORNÝ, VLADIMÍR, 1958, *Gründzuge der Zoologischen Mikropalaontologie; Band II*, viii + 455 pp., 528 figs., Berlin, Veb Deutscher Verlag Der Wissenschaften.
- REYMENT, R. A., AND BRÄNNSTRÖM, B., 1962, *Certain Aspects of the Physiology of Cypridopsis (Ostracoda, Crustacea)*. *Acta Universitatis Stockholmiensis; Stockholm Contributions in Geology*, Vol. 9, No. 5, pp. 207-242, 16 figs.
- RICHARDS, A. G., 1951, *The Integument of Arthropods*. xvi + 411 pp., 65 figs., Minneapolis, University of Minnesota Press.
- ROME, DOM REMACLE, 1947, *Herepetocypris reptans* Baird (Ostracode), *Etude Morphologique et Histologique: 1. Morphologie Externe et Système Nerveux*. *La Cellule*, Vol. 51, No. 1, pp. 51-152, Pls. 1-15, 15 figs.
- SARS, G. O., 1901, *Contributions to the Knowledge of the Fresh-water Entomostraca of South America as Shown by Hatching from Dried Material*. *Archiv. Math. Naturv.*, Vol. 24, No. 1, pp. 1-52, Pls. 5-6.
- SCHREIBER, ERNA, 1922, *Beiträge zur Kenntnis der Morphologie, Entwicklung und Lebensweise der Süßwasser-Ostracoden: Zoologische Jahrbücher, Abteilung für Anatomie und Ontogenie der Tiere*, Vol. 43, pp. 485-538, 24 figs.
- TRESSLER, W. L., 1947, *A Checklist of the Known Species of North American Freshwater Ostracoda*. *American Midland Naturalist*, Vol. 38, No. 3, pp. 698-707.
- 1949, *Fresh-water Ostracoda from Brazil*. *Proc. U.S. Nat. Mus.*, Vol. 100, No. 3258, pp. 61-83, Figs. 12-14.
- 1954, *Fresh-water Ostracoda from Texas and Mexico*. *Jour. Washington Acad. Sci.*, Vol. 44, No. 5, pp. 139-149, 48 figs., 1 table.
- TRIEBEL, ERICH, 1941, *Zur Morphologie und Ökologie der fossilen Ostracoden: Mit Beschreibung einiger neuer Gattungen und Arten*. *Senckenbergiana*, Vol. 23, No. 4/6, pp. 294-400, pls. 1-15, 2 figs.
- 1947, *Methodische und Technische Fragen der Mikropalaöntologie*. *Senckenberg-Buch 19*. 47 pp., 35 figs., Frankfurt am Main, W. Kramer & Co.
- 1949, *Das Narbenfeld der Candoninae und seine palaontologische Bedeutung*. *Senckenbergiana*, Vol. 30, No. 4/6, pp. 205-212, 1 pl.
- 1960, *Die taxionomische Stellung und die Gattungen der Unterfamilie Macrocypridinae (Ostracoda)*. *Senckenbergiana*, Vol. 41, No. 1/2, pp. 109-124, Pls. 13-20.
- 1961, *Süßwasser-Ostracoden von den Karibischen Inseln: 1. Cypridini*. *Senckenbergiana*, Vol. 42, No. 1/2, pp. 51-74, Pls. 6-17.
- Van Morkhoven, F. P. C. M., 1962, *Post-Paleozoic Ostracoda, Their Morphology, Taxonomy, and Economic Use*; Vol. 1, vii + 204 pp., 79 figs., 7 tables, 1 chart, New York, Elsevier Publishing Co.
- WARD, B. W., & WHIPPLE, G. C., 1918, *Fresh Water Biology*. ix + 1111 pp., 1547 figs., New York, John Wiley & Sons, Inc.
- WATERMAN, T. H., editor, 1960, *The Physiology of Crustacea; Vol. 1, Metabolism and Growth*. xvii + 670 pp., 6 pls., 76 figs., 52 tables, New York, Academic Press, Inc.
- WINKLER, E. M., 1955, *A Study of the Variation of Recent and Fossil Ostracods*. *Jour. Paleontol.*, Vol. 29, No. 6, pp. 1059-1065, 4 figs.
- Zalányi, Bela, 1929, *Morpho-systematische Studien über Fossile Muschelkrebse*. *Geologica Hungarica, Series Palaeontologica*, Fasc. 5, pp. 1-153, 53 text-figs.

EXPLANATION OF PLATE 1

Chlamydotheca arcuata (Sars)

- Figs. 1-2. Right half of adult sectioned by free-hand method along median body plane. Specimen photographed at four levels of focus starting near median plane (Fig. 1) and proceeding toward exterior surface of valve (Fig. 2; Pl. 2, Figs. 1-2). Each level photographed in four quadrants and composite photograph constructed for each of four levels. Various muscles and body structures come into focus in each of four levels. Figure 1 shows dorsal antennule, forehead, posterior-body wall, and posterior branch of furcal-rod muscles, and digestive tract with large fecal pellet in rear gut. Mature egg apparent as dark circle above fecal pellet (Figs. 1-2). Large V-shaped pair of mandibular muscles faintly visible in Figure 1; plainly visible in Figure 2. Figure 2 shows dorsal and ventral antennal muscles extending at high angle to dorsal region, posterior endoskeletal muscle terminating anteroventral to posterior mandibular muscle, spiral canals in genital lobe, and muscles of first and second thoracic legs extending toward furcal rod and dorsal area. Furcal rod branched at dorsal end; muscle bands extend from base of furca to posterior branch of furcal rod (Fig. 2). X 75.
- Fig. 3. Enlargement of termination of posterior mandibular muscle. Striated muscle tissue changes to translucent, unstriated connective tissue near point of termination. Unstriated connective tissue diverges at point of termination. X 600.
- Fig. 4. Enlargement of forehead region showing pharynx, dorsal wulst, stomach, intestine, rear gut, and cerebrum. Forehead muscle originates as slender tendon ventrally to cerebrum and changes to striated muscle tissue anterior to dorsal wulst. X 100.

PLATE 1

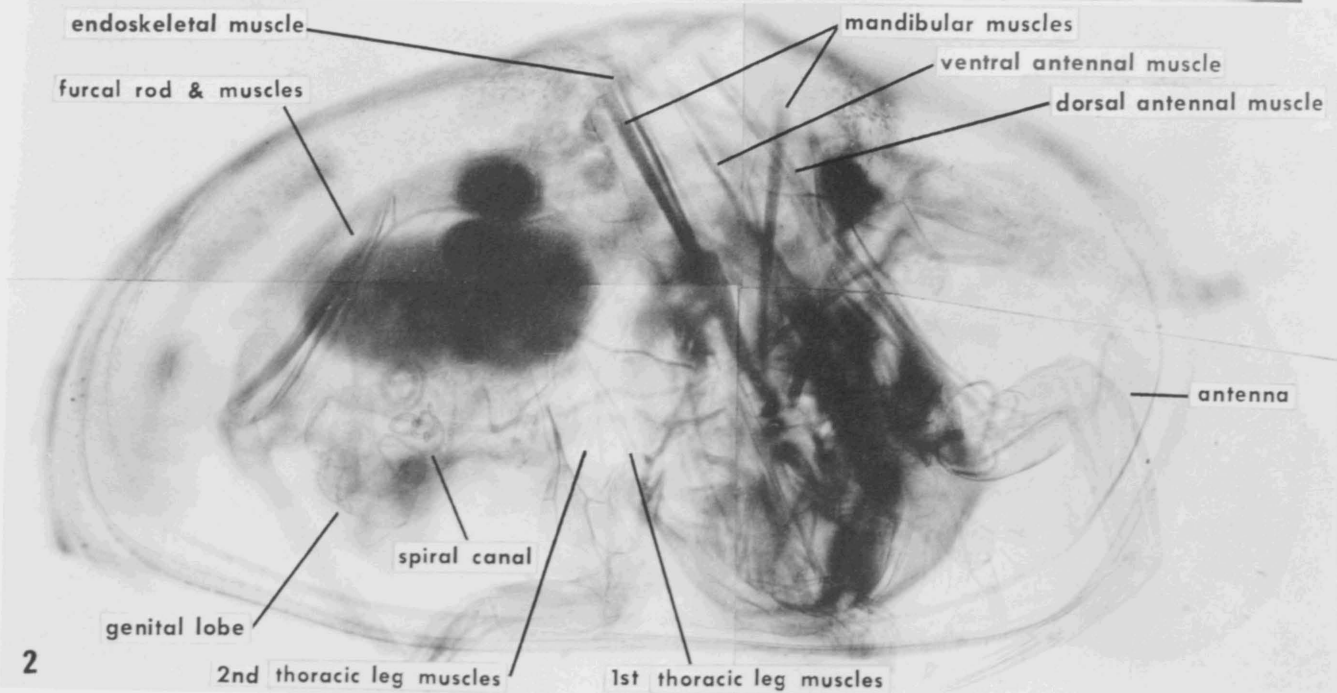
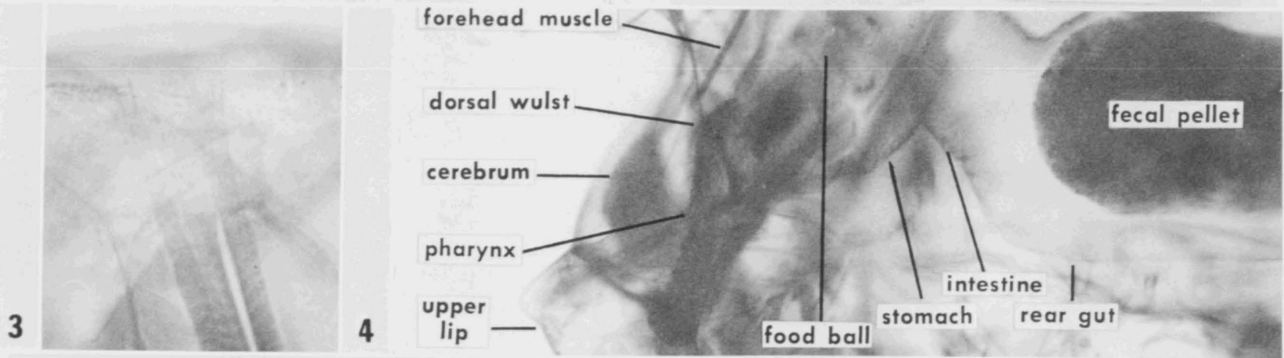
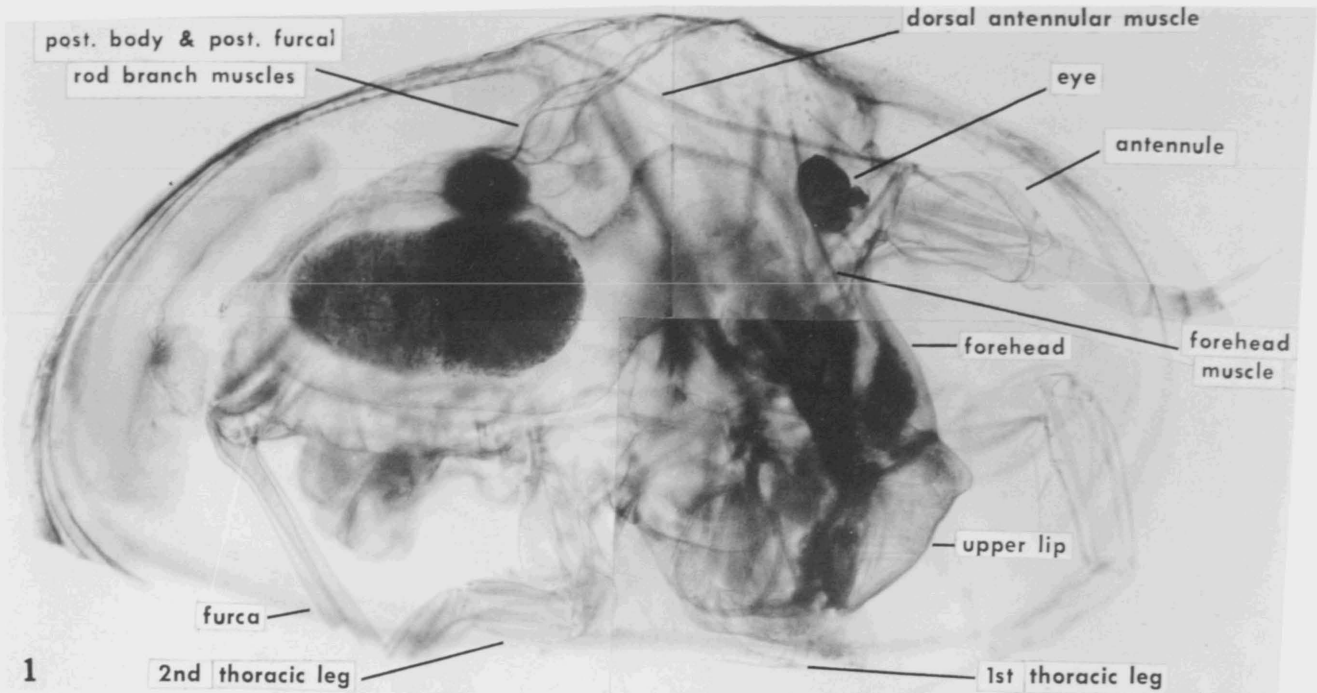

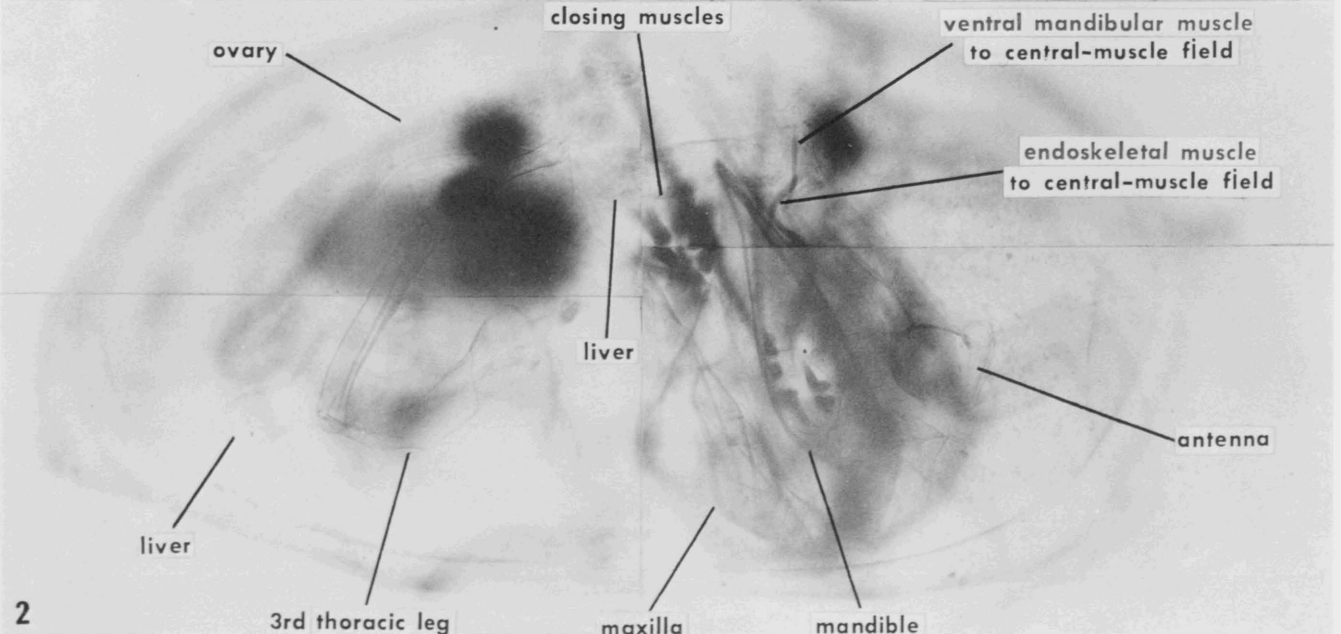
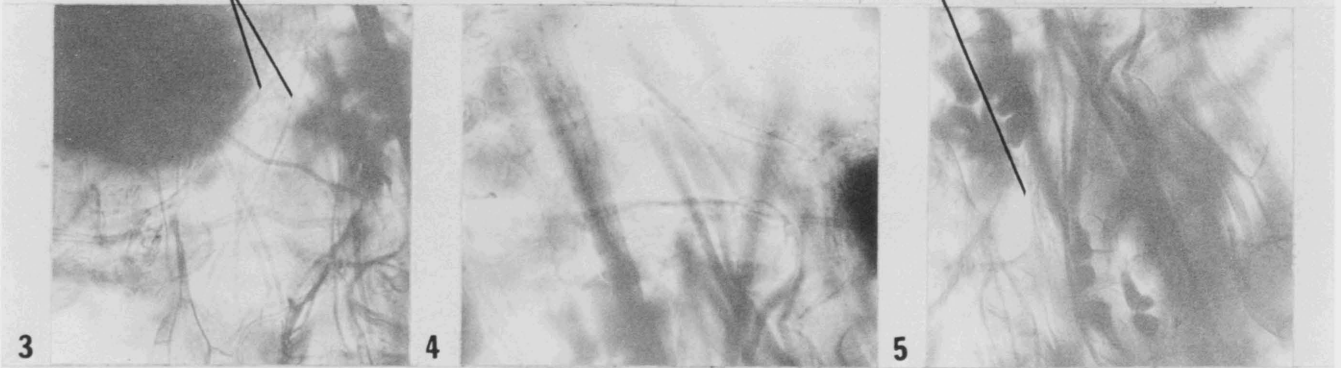
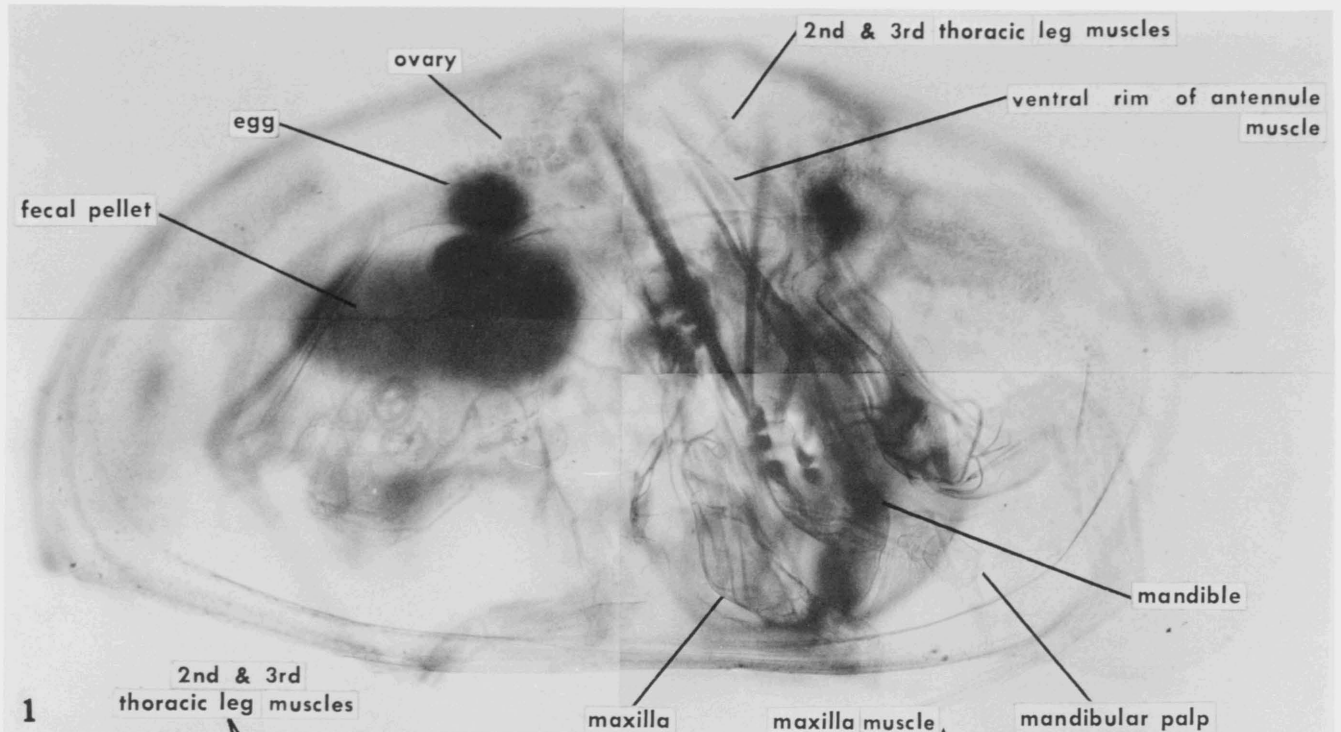

EXPLANATION OF PLATE 2

Chlamydotheca arcuata (Sars)

Figs. 1-2. Continuation from Plate 1, Figures 1 and 2, of series of right half of adult photographed at successive levels; Figure 2 focused near surface of valve. Figure 1 shows large pair of V-shaped mandibular muscles attached to inner surface of basal podomere, ovary with immature and mature eggs, second and third leg muscles merging near their distal end, and muscle from ventral rim of antennule terminating posterior to second and third leg muscles. Maxilla situated posterior to mandible (Figs. 1-2). Closing muscles located near center of valve (Figs. 1-2). Figure 2 shows pointed and rounded apex of mandible, liver in hypodermis close to surface of valve, and ventral mandibular muscle and endoskeletal muscle which form frontal scars of central-muscle field visible at point anterior to basal podomere of mandible and behind basal podomere of antenna. X 75.

Fig. 3. Enlargement of ventral thoracic area just behind closing muscles. Muscles from basal podomeres of second and third thoracic legs merge posterodorsal to closing muscles and continue to point of termination as single muscle strand (also see Fig. 1). Pair of closely associated muscles extend from first thoracic leg (lower center) toward anterior branch of furcal rod (obscured by fecal pellet at upper left). Pair of muscles extend from endoskeleton (right center) toward base of furca (left center) and apex of furcal rod (upper left). X 100.

Fig. 4. Enlargement of terminal area of muscles from second and third thoracic legs, ventral rim of antennule, maxilla and first thoracic leg. X 125.

Fig. 5. Enlargement of closing muscle and mandibular area. Maxillary muscle passes dorsally in position anterior to closing muscles and posterior to basal podomere of mandible. Ventral mandibular and endoskeletal muscles (labeled on Fig. 2) visible at upper right. X 125.

EXPLANATION OF PLATE 3

Chlamydotheca arcuata (Sars)

- Figs. 1-3. Thick transverse section of eighth instar photographed at successive levels proceeding from anterior (Fig. 1) toward posterior (Fig. 3) to show muscles and structures. Figure 1 shows part of basal podomere of antenna on each side of body, forehead muscle extending at angle toward dorsolateral surface of valve, and mandibular palps in position alongside mouth. Figure 2 shows masticatory rake-shaped organs posterior to mouth, and endoskeleton in center of body, dorsal to mouth and ventral to closing muscles. Figures 2 and 3 show several transverse muscles connecting mandibles to endoskeleton, large mandibular support muscles extending vertically toward dorsal area, chitinous adjustor rod extending from dorsal apex of basal podomere of mandible to lateral wall, and liver within hypodermis close to surface of valve. X 100.
- Fig. 4. Enlargement of dorsoanterior area of adult specimen shown on Pls. 1-2. Note muscles from antennule, mandible, and endoskeleton extending toward dorsal area of valve. X 175.

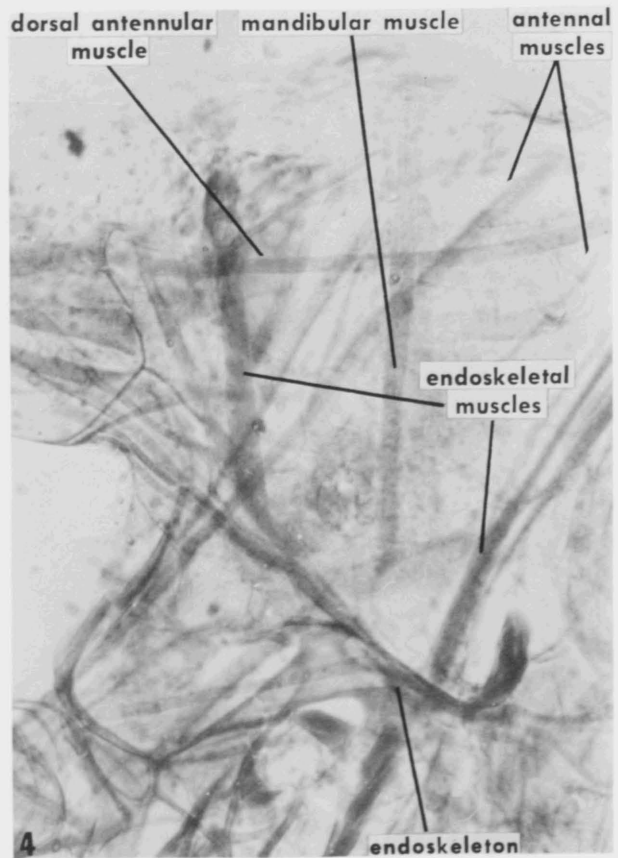
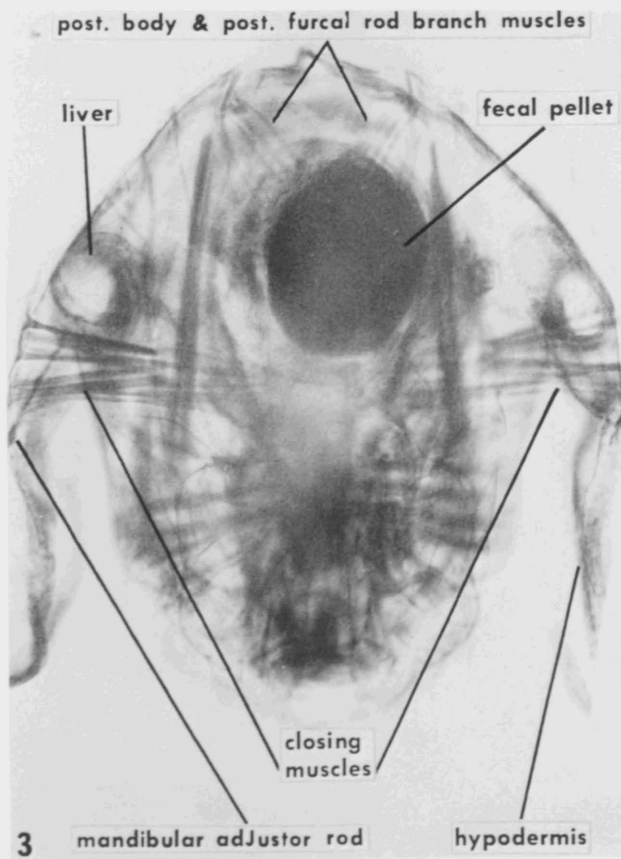
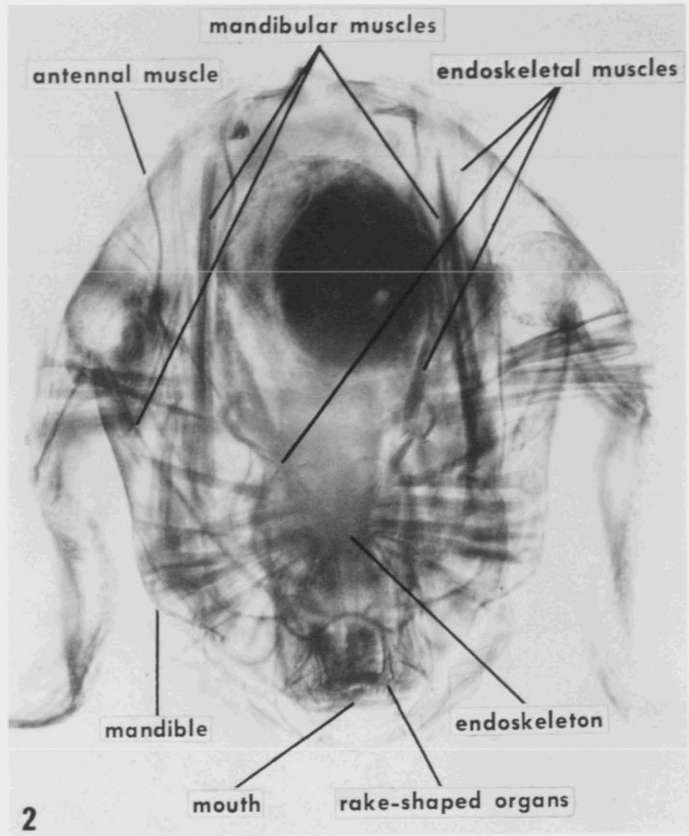
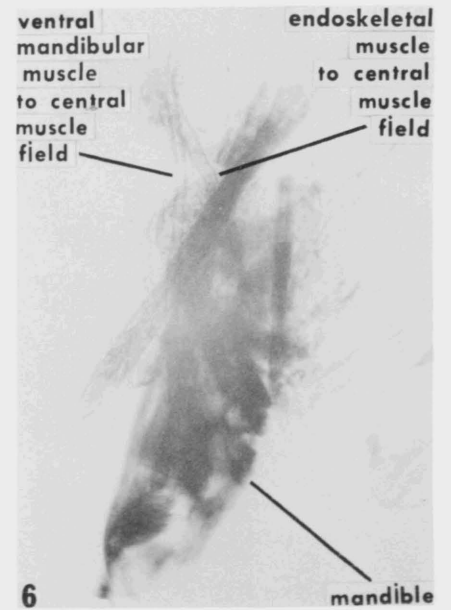
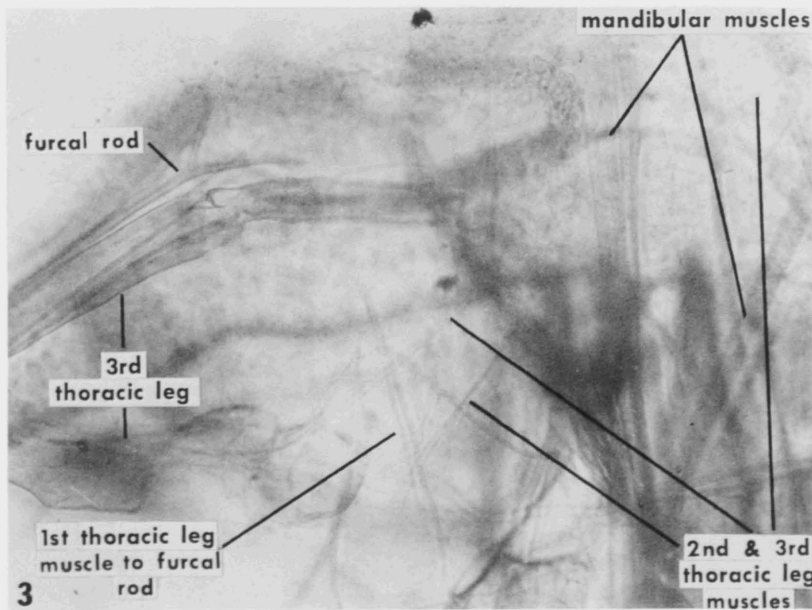
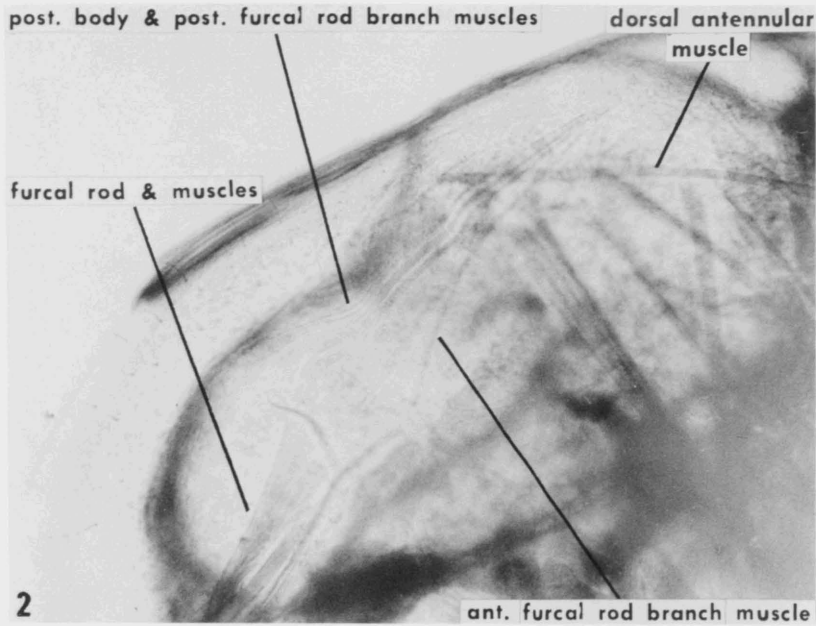
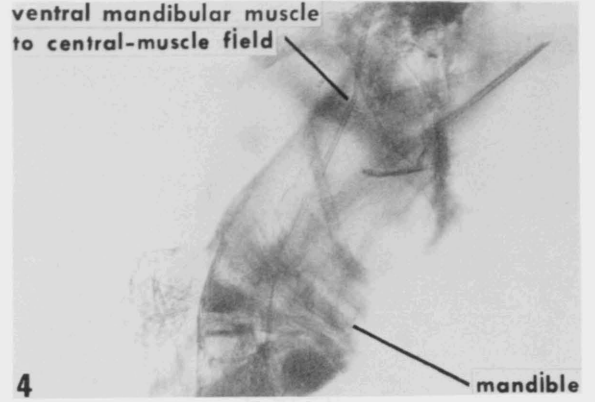
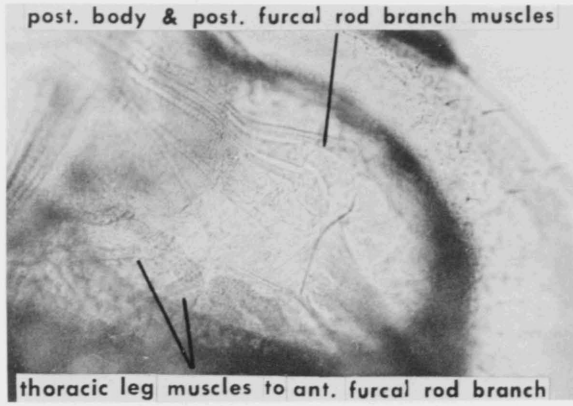

PLATE 4



EXPLANATION OF PLATE 4

Chlamydotheca arcuata (Sars)

- Fig. 1. Lateral view of posterior region of eighth instar. Thoracic leg muscles connected to anterior branch of furcal rod. Anterior branch of furcal rod supported by single muscle from dorsal area. Posterior branch of furcal rod supported by three muscles from dorsal area. Single muscle, above muscles supporting posterior branch of furcal rod, supports posterior-body wall. X 100.
- Fig. 2. Lateral view of posterior region of eighth instar showing furcal rod and muscles which connect to dorsal area. X 100.
- Fig. 3. Lateral view of posterior region of eighth instar. Muscles from second and third thoracic legs merge and terminate on dorsal area as single muscle band. Pair of closely associated muscles extend from base of first thoracic leg to anterior branch of furcal rod. X 150.
- Figs. 4-5. Dissected mandible and part of body wall of adult showing muscles which form frontal scars of central-muscle field. Ventral mandibular muscle extends from inside ventral area of mandible basalppodome at low angle to valve wall (Fig. 4). Section of endoskeletal muscle extends from valve wall toward endoskeleton at nearly ninety degree angle from valve wall (Fig. 5). X 100.
- Fig. 6. Dissected mandible and part of body wall of adult showing muscles which form scars of frontal group of central-muscle field. X 100.

EXPLANATION OF PLATE 5

Chlamydotheca arcuata (Sars)

- Fig. 1. Adult, 10- μ transverse section. Lateral view of closing muscle termination on wall of decalcified valve. Chitin boss of chitin coating of hypodermis extends into area occupied by calcareous layer. Chitin boss and closing muscle firmly joined. Chitin coating of calcareous layer (dorsalmost layer) thickened in area of closing-muscle attachment. X 700.
- Fig. 2. Adult, 10- μ sagittal section of distal end of closing muscle at point of termination on chitin coating of hypodermis. Muscle split into groups of fibers. X 400.
- Fig. 3. Adult, 10- μ transverse section. Distal end of closing muscle torn away from chitin boss as result of chemical preparation. Chitin boss remains firmly attached to chitin coating of hypodermis. Chitin coating of calcareous layer collapsed onto boss after decalcification. Note enlargement of distal tips of muscle fibers and their lack of striation. X 400.
- Fig. 4. Adult, 10- μ transverse section. Closing muscle attached to chitin boss. Chitin coating of calcareous layer collapsed onto chitin coating of hypodermis after decalcification. Faint vertical striations in chitin boss are tonofibrills. X 400.
- Fig. 5. Adult, 10- μ transverse section. Note enlargement of distal tips of closing-muscle fibers and their lack of striation at distal tips. Closing muscles slightly enlarged at distal termination to cover wider area. X 300.
- Fig. 6. Thick sagittal free-hand section of seventh instar. Arrangement of anterior section of body similar to that of adult. Section through mouth area shows mouth, pharynx and cerebrum. Ventral chain of ganglia extends from mouth region to base of furca. X 100.
- Fig. 7. Eighth instar, 50- μ transverse section. Endoskeleton with prongs extending dorso-laterally from each side. Small muscle extends from endoskeleton to lateral wall of valve to form frontal scar of central-muscle field. Transverse muscles from mandibles attached to lateral surface of endoskeleton. Mandibles attached to dorsal area of valve by vertical muscles. Duct from liver to stomach partially exposed on left side. X 150.
- Figs. 8-9. Eighth instar, 50- μ transverse sections through endoskeleton, mandible, and area of attachment of muscles of frontal group of central-muscle field. Section of Fig. 9 posterior to section of Fig. 8. Small endoskeletal muscle extends to valve wall to form ventralmost scar of frontal group of central-muscle field (Fig. 8). Ventral mandibular muscle extends to valve wall to form dorsal frontal scar of central-muscle field (Fig. 9). Careful examination reveals terminal end of endoskeletal muscle of Fig. 8 just ventral to terminal end of ventral mandibular muscle on Fig. 9. X 200.

PLATE 5

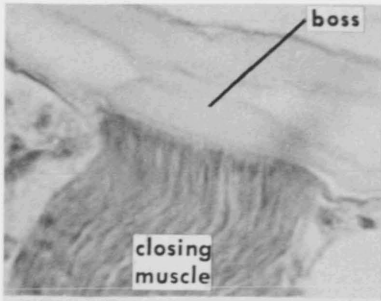

1

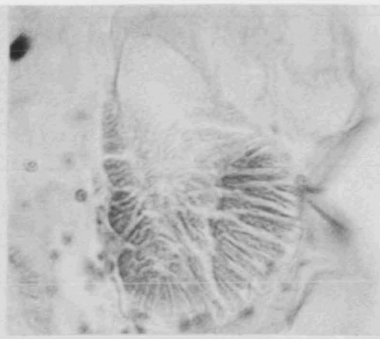

2

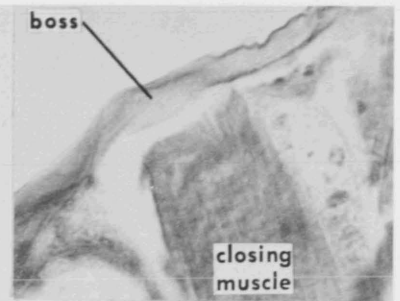

3

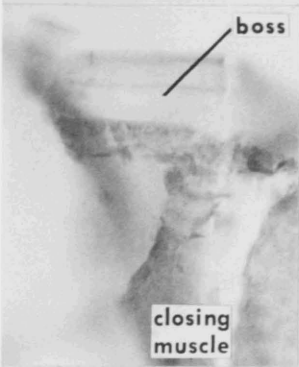

4

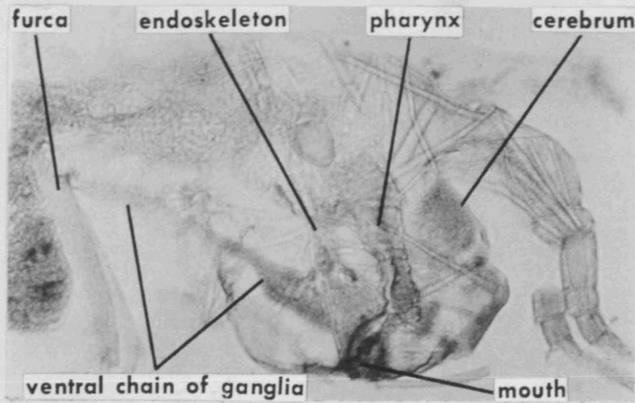

6

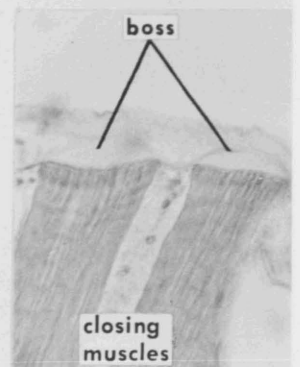

5

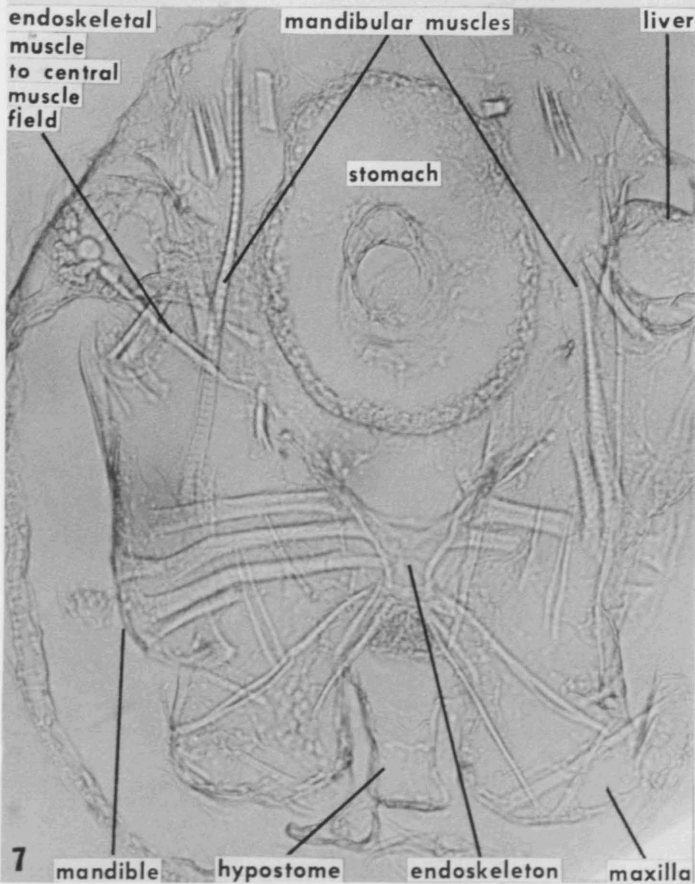

7

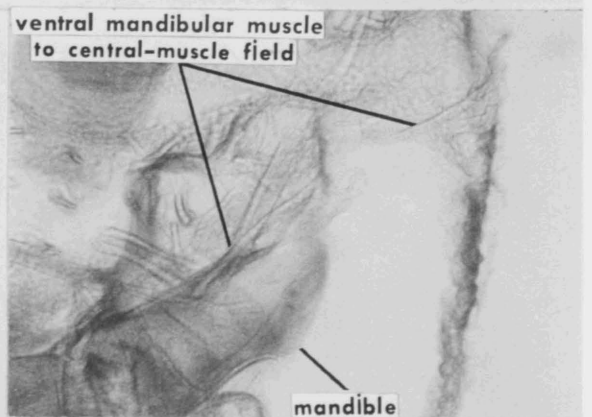

9

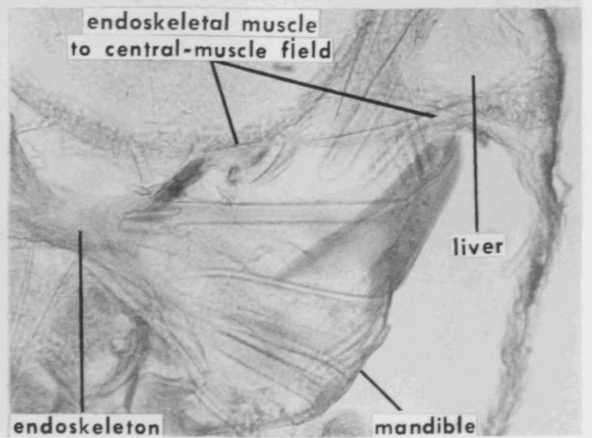

8

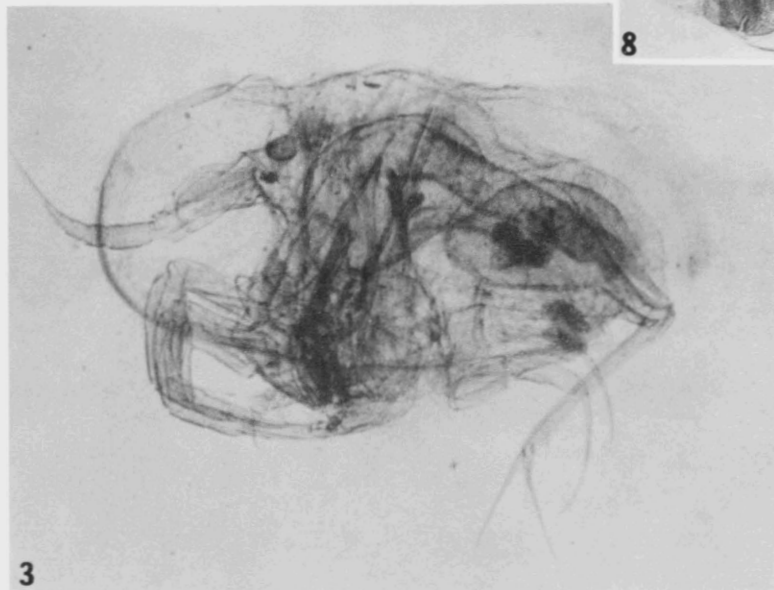
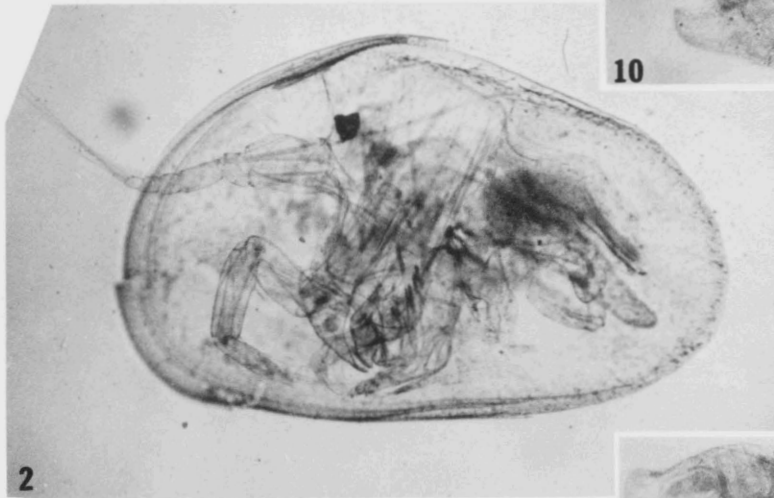
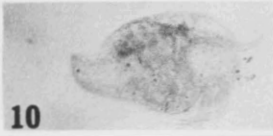
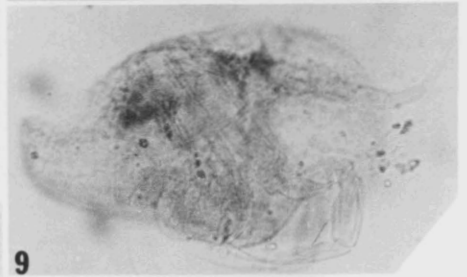
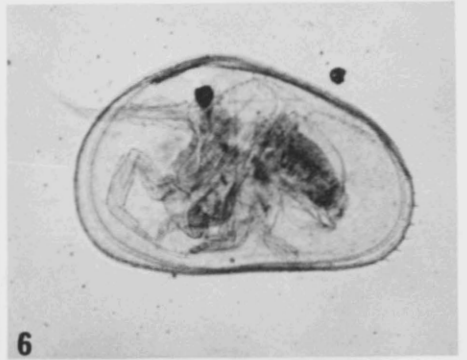
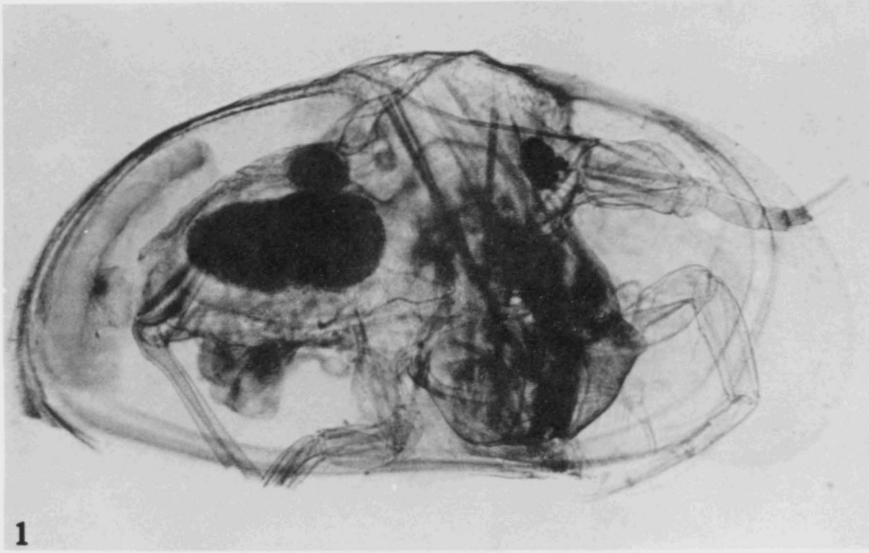

EXPLANATION OF PLATE 6

Chlamydotheca arcuata (Sars)

Free-hand sections along or near median body plane of fourth instar through adult specimens. All figures X 50 except as noted.

Fig. 1. Right half of adult. Same specimen as shown on Pl. 1, Figs. 1-2; Pl. 2, Figs. 1-2. Photograph taken through exterior of right valve. Details of head region obscured by complexity of structures. Specimen used as model for diagrammatic text-figure drawing of muscles and muscle scars (Figs. 2a-b).

Fig. 2. Right half of eighth instar. Photograph taken near median plane of specimen. Valve not completely decalcified. Note similarity of body morphology and muscle arrangement as compared to adult (Fig. 1), but difference in shape of valves. Liver extends diagonally from near center of body toward posteroventral margin of valve.

Fig. 3. Right half of eighth instar. Specimen sectioned oblique to midline.

Fig. 4. Right half of seventh instar. Photographed near median plane of specimen. Configuration of muscles leading to dorsal area similar to those of the eighth instar and adult.

Figs. 5-6. Right half of sixth instar. Valve not decalcified. Photographed near midline of specimen. Posterior portion of body reduced. Note spines on posteroventral margin of valve. Note remarkable similarity structure and musculature of head region to that of older growth stages. Fig. 5, X 55.

Figs. 7-8. Left half of fifth instar. Photographed near median plane of specimen. Posterior of body reduced. Structure and musculature of head region still quite similar to that of older growth stages. Fig. 7, X 83.

Figs. 9-10. Left half of fourth instar. Photographed near median plane of specimen. Head region located more toward center of the valve. No thoracic appendages fully developed. Fig. 9, X 111.

EXPLANATION OF PLATE 7

Cypridopsis vidua (O. F. Müller)

Figs. 1-2. Right half of adult sectioned by free-hand method along median body plane. Specimen photographed at two levels; Fig. 1 near median plane; Fig. 2 between median plane and exterior surface of valve. Note similarity of structures and position of muscles of anterior and head region to those of Chlamydotheca arcuata (Sars) (Pl. 1, Figs. 1-2; Pl. 2, Figs. 1-2). Figure 1 shows dorsal antennal muscle, and anterior muscle of V-shaped pair that support mandible from dorsal region. Figures 1 and 2 show dorsal antennular muscle extending horizontally toward posterior of body, and posterior and anterior muscles supporting endoskeleton from dorsal area. Figure 2 shows ventral antennal muscle, and posterior muscle of V-shaped pair that supports mandible from dorsal area. Because of small size and complexity of specimen other muscles not well shown. X 255.

PLATE 7

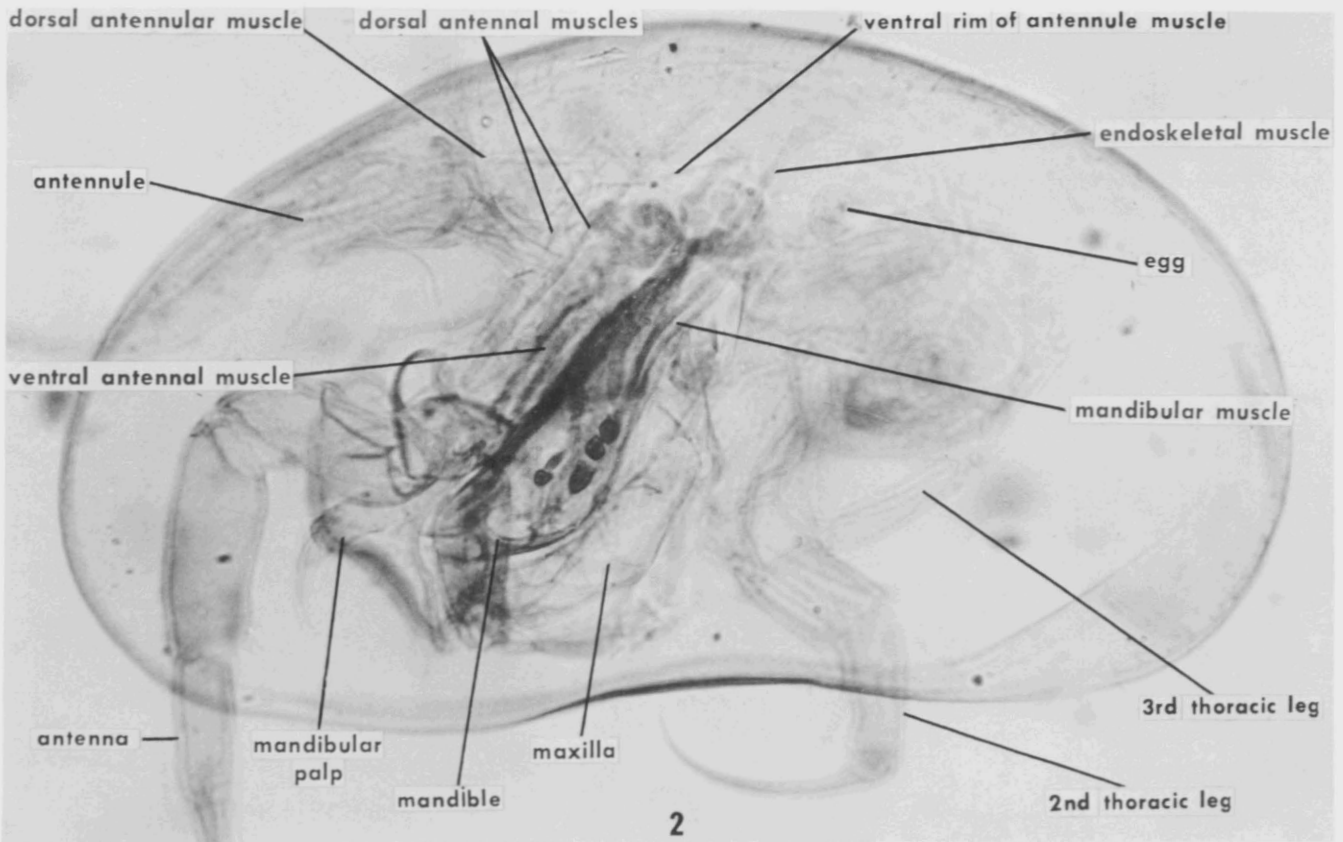
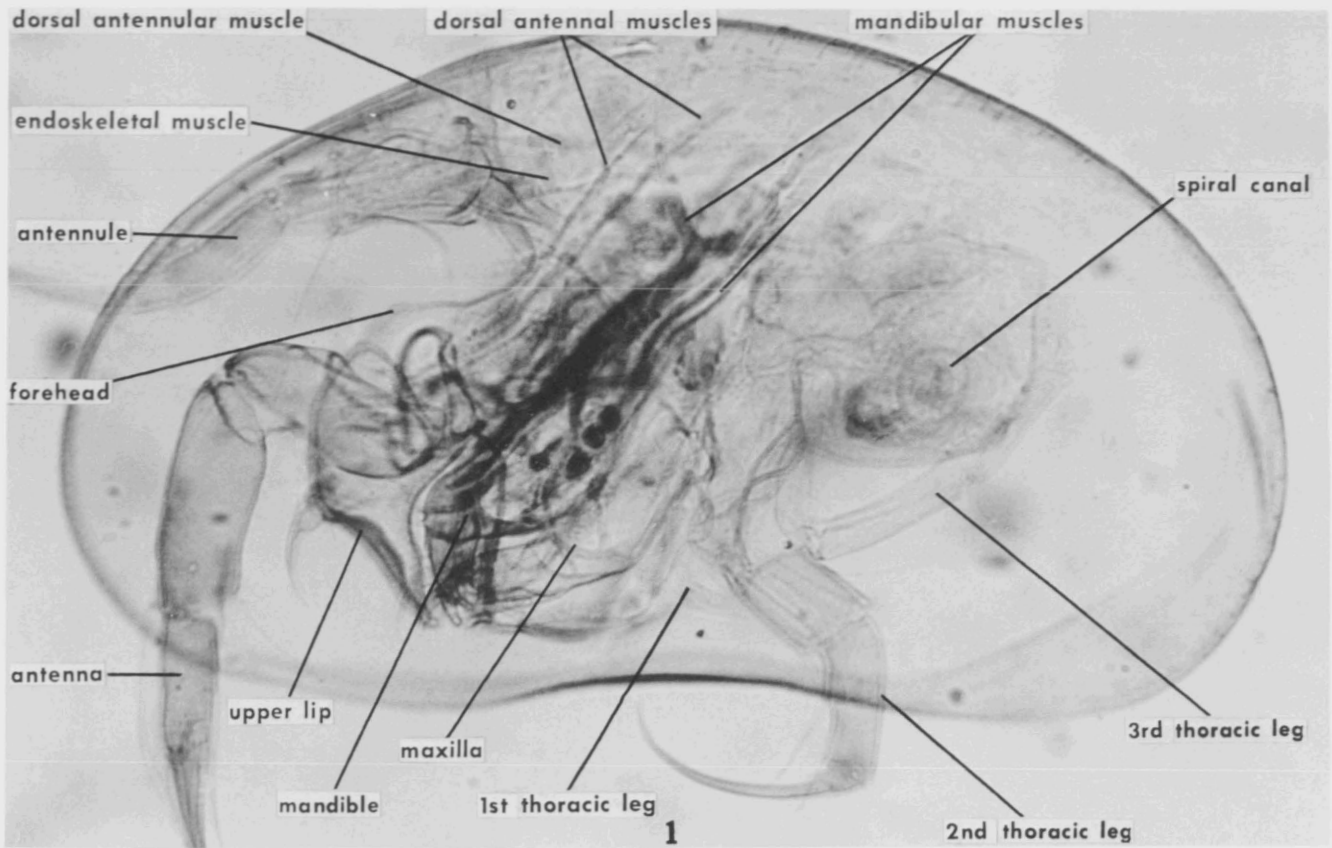

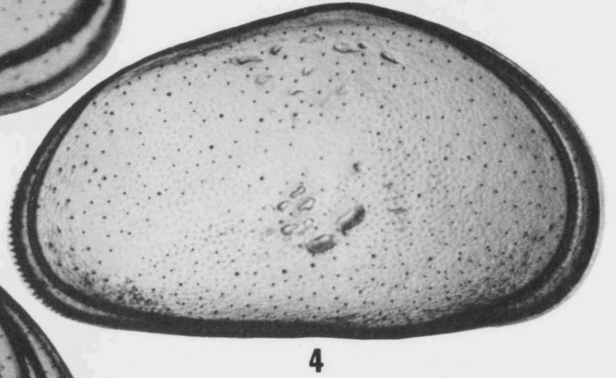
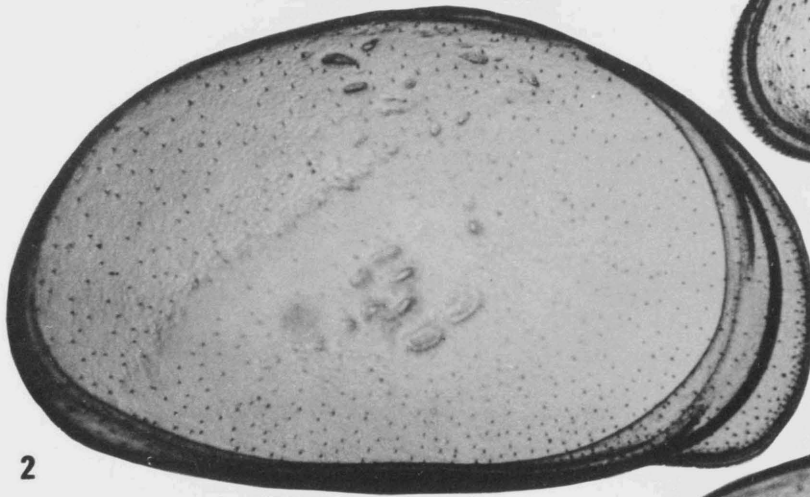
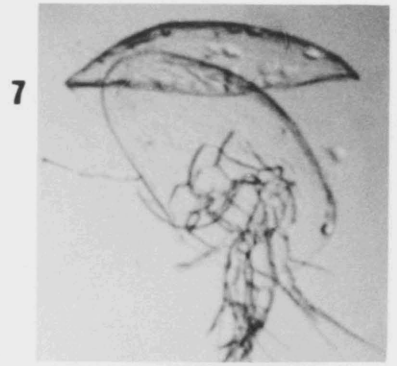

2

5

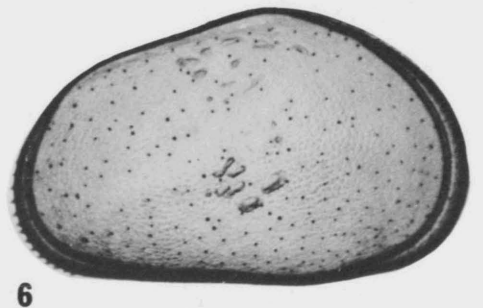
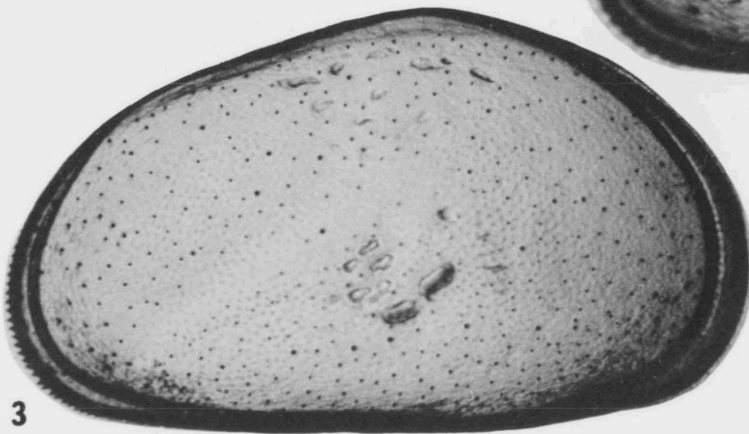
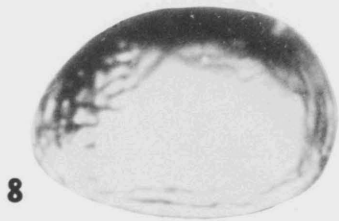

EXPLANATION OF PLATE 8

Chlamydotheca arcuata (Sars)

All figures X 50 except as noted.

- Fig. 1. Adult, interior right valve. All dorsal-muscle scars well developed. Irregularly rounded mandibular fulcral scar located between frontal and closing-muscle scars. Ventral closing-muscle scar severely constricted, but not completely divided. Liver scar represented by sinuous band lacking normal pore canals. Anterior end of scar located dorsal to closing-muscle scars in area between central- and dorsal-muscle fields. Radial pore canals visible on anterior margin.
- Fig. 2. Adult, interior left valve. Scars of dorsal- and central-muscle fields correspond to scars of adult right valve. Ventral closing-muscle scar not as constricted as corresponding scar on right valve. Mandibular fulcral scar poorly defined. Anterior flange of valve not as long as flange on right valve.
- Figs. 3-4. Eighth instar; interior left valve. Two pairs of small scars faintly visible in ventral region of dorsal-muscle field. Dorsal frontal scar present, but faintly visible. Dorsal antennular scar situated close to large mandibular scar in postero-dorsal area of dorsal-muscle field. Mandibular fulcral scars not visible on valves of eighth and younger instars. Ventral closing-muscle scar reduced and not constricted. Numerous, short spines on posteroventral margin. Anterior flanges lacking on eighth instar and all younger instars. Fig. 3, X 63.
- Figs. 5-6. Seventh instar; interior left valve. Dorsal-muscle-scar pattern similar to eighth instar and adult. Two dorsal-closing-muscle scars nearly fused. Fewer spines on posteroventral margin than on eighth instar. Fig. 5, X 82.
- Fig. 7. Molted valves and appendage covering of first instar. Valves very lightly calcified if at all. X 155.
- Fig. 8. Right exterior valve of first instar. No muscle scars or structures visible. X 155.

EXPLANATION OF PLATE 9

Chlamydotheca arcuata (Sars)

All figures X 50, except as noted.

Figs. 1-2. Sixth instar; interior right valve. Two small pairs of scars only faintly visible in ventral area of dorsal-muscle field, but overall pattern of dorsal-muscle field corresponds to that of older growth stages. Two dorsal-closing-muscle scars fused to single scar. Fewer spines on posteroventral margin than on seventh instar, but spines longer and more stout. Fig. 1, X 123.

Figs. 3-4. Fifth instar; interior right valve. Because of their small size two pairs of small scars in ventral region of dorsal-muscle field cannot be recognized with any certainty on valves of fifth and younger instars. Scars formed by muscles from dorsal-body wall and posterior branch of furcal rod absent on valves of fifth and younger instars. Dorsal antennular scar absent on valve photographed, but probably due to quirk of preservation. Closing-muscle scars resemble those of sixth instar. Few, obtuse spines on posteroventral margin. Fig. 3, X 156.

Figs. 5-6. Fourth instar; interior right valve. Arrangement of larger scars of dorsal-muscle field still similar to those of sixth instar. Dorsal-muscle field located more toward posterior of valve than in older growth stages. Two middle scars of closing-muscle group partially fused. Spines on posteroventral margin lacking on fourth and all younger instars. Fig. 5, X 200.

Figs. 7-8. Third instar; interior left valve. Dorsal-muscle-scar pattern resembles that of fourth instar. Frontal scars still visible on valve. Two minor closing-muscle scars absent on valves of third and younger instars. Fig. 7, X 232.

Figs. 9-10. Second instar; interior left valve. Dorsal-muscle-scar pattern somewhat similar to third instar. Mandibular scars lacking. Outline of valve somewhat ovate. Fig. 9, X 310.

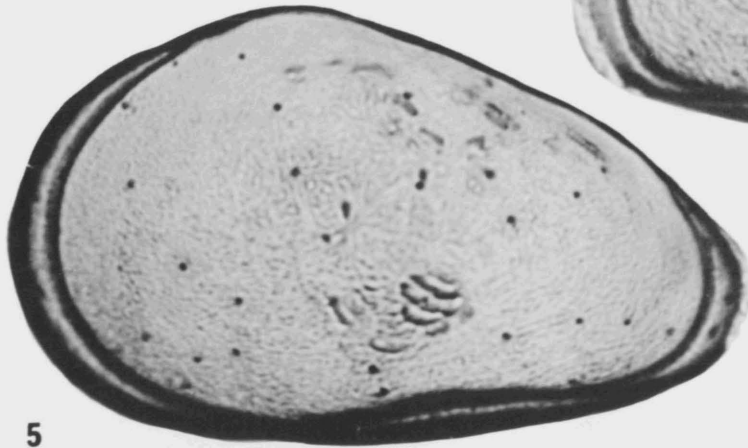
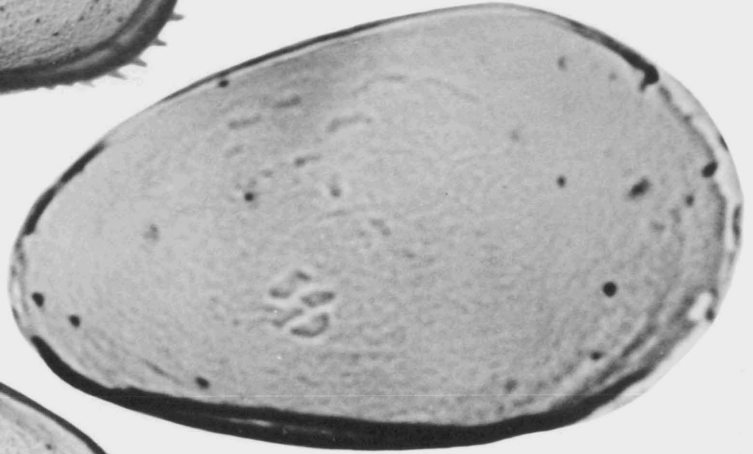

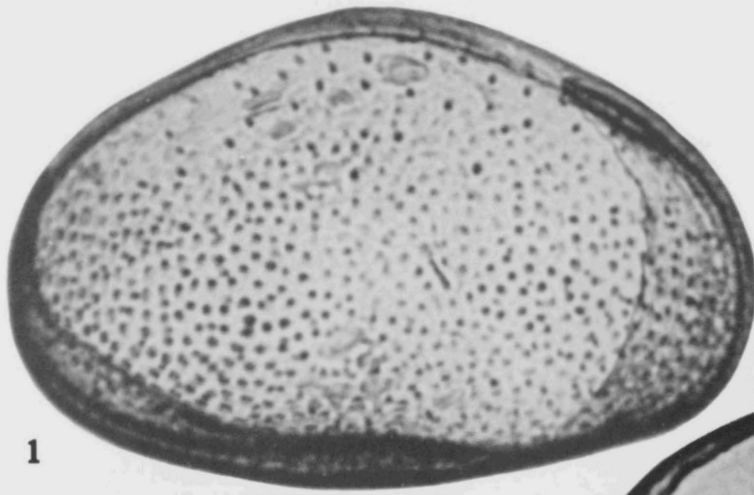

1

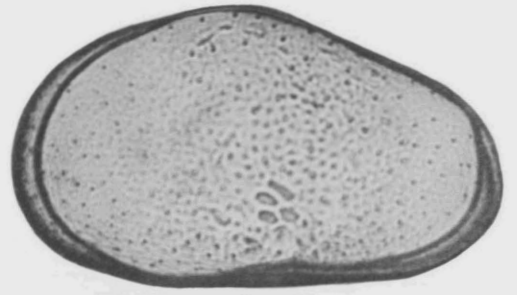

4

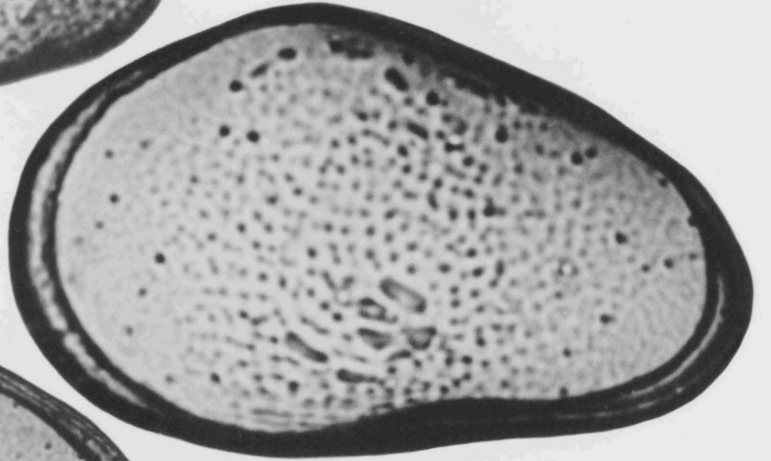

7

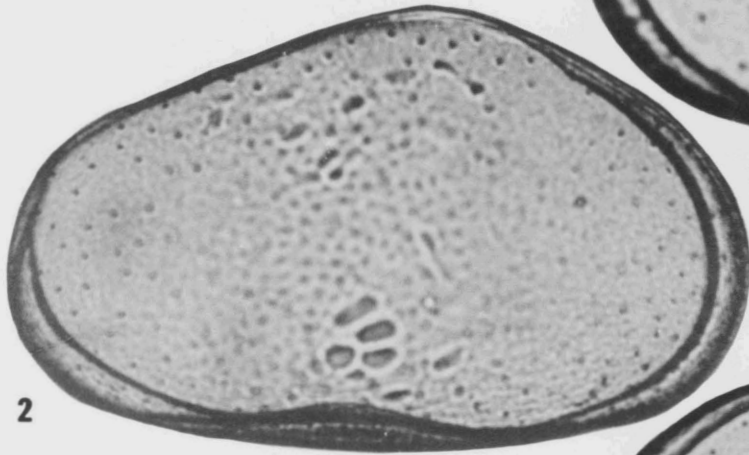

2

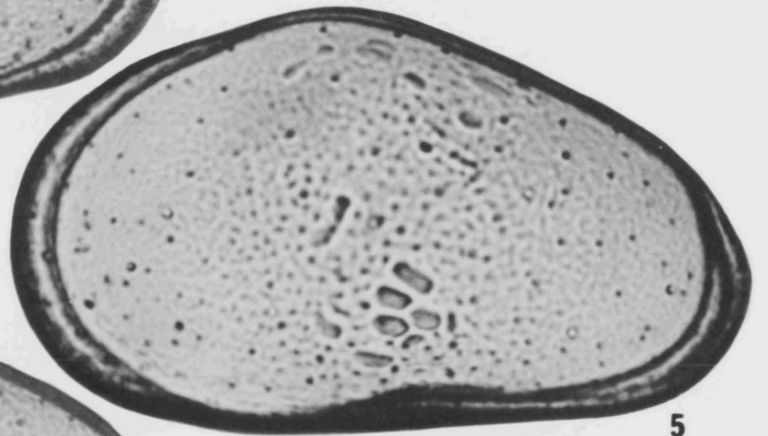

5

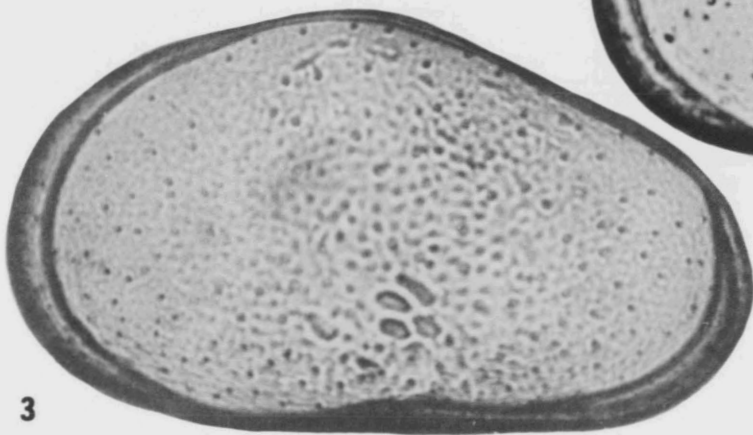

3

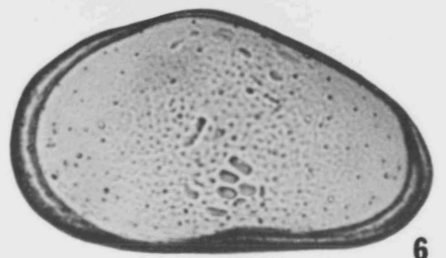

6

EXPLANATION OF PLATE 10

Cypridopsis vidua (O. F. Müller)

All figures X 130, except as noted.

Fig. 1. Adult; interior left valve. Dorsal-muscle scars difficult to photograph in transmitted light; only largest of scars discernible. Surface texture of valve coarse. Two frontal scars appear as dark line anterodorsal to closing-muscle scars. Patterns of dorsal-muscle field and central-muscle field identical to those of eighth instar (Fig. 2). Duplicature wide along anterior margin; narrow along ventral and posteroventral margin. X 155.

Fig. 2. Eighth instar; interior left valve. Dorsal-muscle-scar pattern well developed. Central-muscle field consists of two frontal, two mandibular, and six closing-muscle scars. No mandibular fulcral scars apparent on valves of any instar of adult. Duplicature reduced on valves of all instars. X 182.

Figs. 3-4. Eighth instar; interior right valve. Scars of dorsal- and central-muscle fields correspond to those of left valve. Fig. 3, X 194.

Figs. 5-6. Seventh instar; interior right valve. Scars of dorsal- and central-muscle field correspond to those of eighth instar and adult. Fig. 5, X 230.

Fig. 7. Sixth instar; interior right valve. Scars of dorsal- and central-muscle fields correspond to those of older growth stages, except closing-muscle scars in a more circular arrangement. X 324.

EXPLANATION OF PLATE 11

Cypridopsis vidua (O. F. Müller)

All figures X 130, except as noted.

- Figs. 1-2. Fifth instar; interior right valve. Size of normal pore canals approximates that of smaller dorsal-muscle scars making recognition difficult. Scars formed by muscles from posterior-body wall and posterior branch of furcal rod absent on valves of fifth and younger instars. Circular arrangement of closing-muscle scars; two small ventral scars no longer present. Fig. 1, X 396.
- Figs. 3-4. Fourth instar; interior left valve. Pattern of dorsal- and central-muscle fields similar to that of fifth instar. Frontal scars present, but not well shown on valve. Fig. 3, X 465.
- Figs. 5-6. Third instar; interior left valve. Pattern of dorsal- and central-muscle fields similar to that of fourth and fifth instars, but dorsal-muscle field located in posterodorsal area of valve. Fig. 5, X 562.
- Figs. 7-8. Second instar; interior right valve. Dorsal-muscle scars nearly unrecognizable. Four closing-muscle scars in circular arrangement. Mandibular scars absent. Frontal scars absent or unrecognizable. Fig. 7, X 329.
- Figs. 9-10. First instar; interior left valve. Valve ovate, lacking well defined margins. Four closing-muscle scars located in posterior half of valve. Dorsal-muscle scars unrecognizable. Fig. 9, X 385.
- Fig. 11. Eighth instar; interior left valve. Photograph of same valve as Fig. 2, Pl. 10.
- Fig. 12. Adult; interior left valve. Photograph of same valve as Fig. 1, Pl. 10.
- Fig. 13. Sixth instar; interior right valve. Photograph of same valve as Fig. 7, Pl. 10.

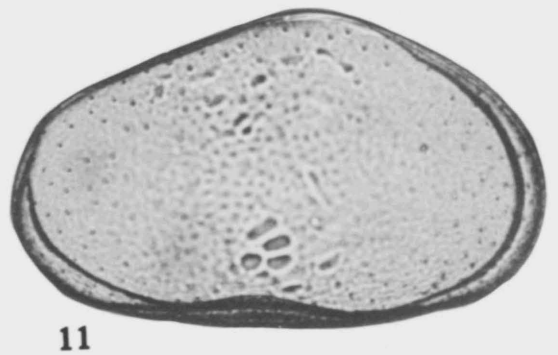
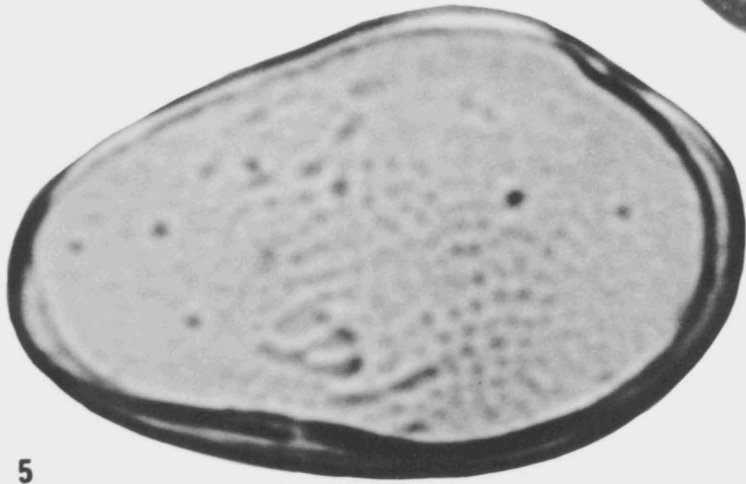
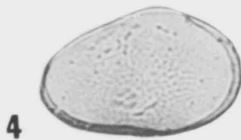
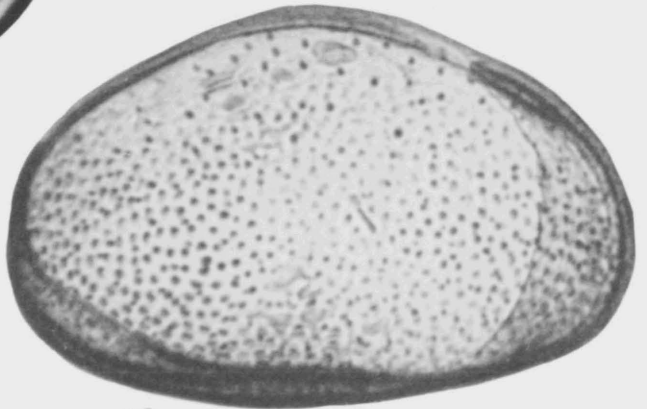
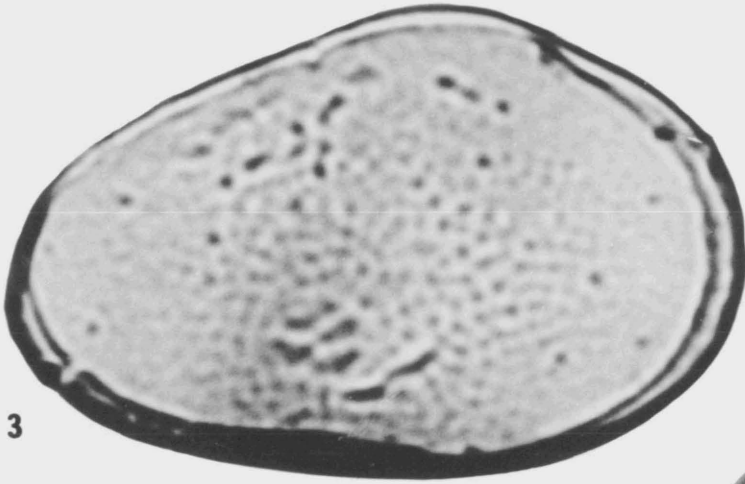
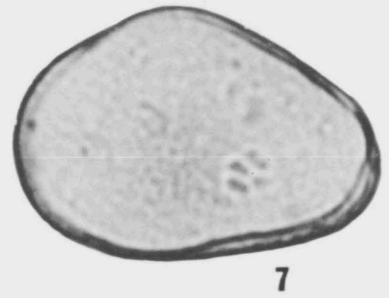
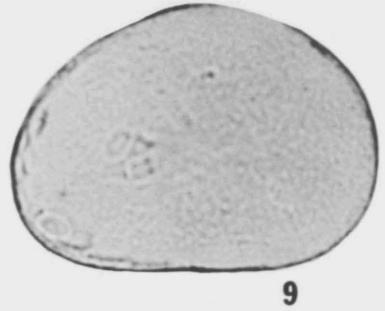
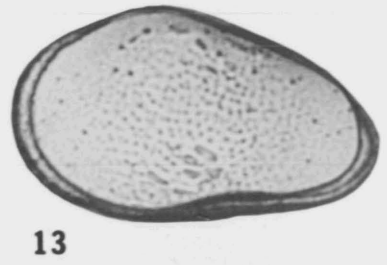
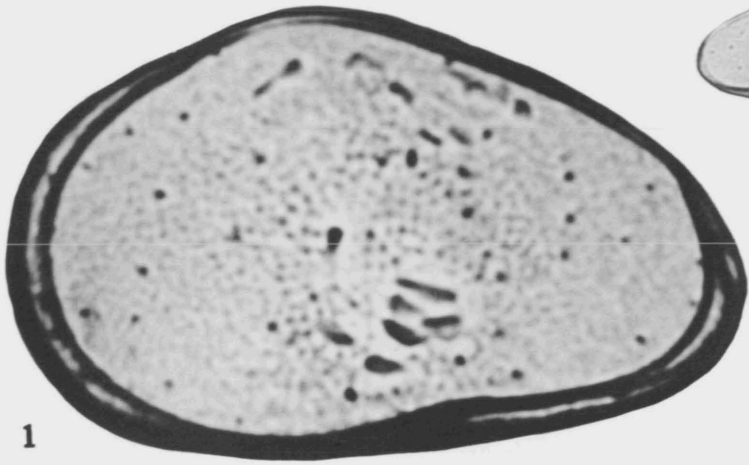

PALEOECOLOGY AND TAXONOMY
OF FOSSIL OSTRACODA IN THE VICINITY OF
SAPELO ISLAND, GEORGIA

DONALD D. HALL

NATIONAL SCIENCE FOUNDATION PROJECT GB-26

REPORT NO. 4

ACKNOWLEDGMENTS

I wish to thank Dr. Robert V. Kesling, under whose guidance this work was done. Particular gratitude is due the staff of the University of Georgia Marine Institute at Sapelo Island, where part of the work was done, for their full cooperation in allowing access to the core material and use of their laboratory facilities. Without the cooperation of Drs. G. E. Lauff, J. H. Hoyt, and J. V. Henry, this work could not have been done. I found the two volumes of Van Morkhoven (1962, 1963) on Post-Paleozoic Ostracoda most helpful, and made full use of them, particularly in my diagnoses of genera in the systematic portion.

CONTENTS

	PAGE
Acknowledgments	iii
List of illustrations	vi
Introduction	1
Laboratory procedures	1
Geologic setting	1
Previous work on east coast Upper Miocene Ostracoda	2
Community concept	4
Ecology of Recent Ostracoda from Gulf of Mexico and Sapelo Island	5
Paleoecology	23
Systematic descriptions	27
<i>Bairdia laevicula</i> Edwards, 1944	27
<i>Bairdia</i> sp.	27
<i>Candona</i> (?) sp.	28
<i>Pontocypris</i> sp.	28
<i>Acutocythereis laevis</i> Edwards, 1944	29
<i>Acutocythereis multipunctata</i> Edwards, 1944	29
<i>Acutocythereis gigantea</i> (Edwards, 1944)	30
<i>Acutocythereis tenmilecreekensis</i> (Puri, 1953)	30
<i>Campylocythere laeva</i> Edwards, 1944	31
<i>Aurila amygdala</i> (Stephenson, 1944)	32
<i>Aurila conradi conradi</i> (Howe & McGuirt, 1935)	32
<i>Aurila conradi</i> (Howe & McGuirt), 1935, <i>floridana</i> Benson & Coleman, 1963	32
<i>Actinocythereis exanthemata</i> (Ulrich & Bassler, 1904) <i>gomillionensis</i> (Howe & Ellis, 1935) ..	33
<i>Costa triplistriata</i> (Edwards, 1944)	33
<i>Costa</i> sp. aff. <i>C. triplistriata</i> (Edwards, 1944)	33
<i>Echinocythereis garretti</i> (Howe & McGuirt, 1935)	34
<i>Murrayina martini</i> (Ulrich & Bassler, 1904)	34
<i>Orionina vaughani</i> (Ulrich & Bassler, 1904)	35
<i>Pterygocythereis</i> sp. cf. <i>P. americana</i> (Ulrich & Bassler, 1904)	35
<i>Pterygocythereis</i> sp.	36
<i>Puriana rugipunctata</i> (Ulrich & Bassler, 1904)	36
<i>Puriana mesacostalis</i> (Edwards, 1944)	36
<i>Triginglymus whitei</i> (Swain, 1951)	37
<i>Triginglymus sapeloensis</i> , n. sp.	37
<i>Clithrocytheridea virginensis</i> Malkin, 1953	38
<i>Cushmanidea ashermani</i> (Ulrich & Bassler, 1904)	39
<i>Cushmanidea tuberculata</i> (Puri, 1958)	39
<i>Cushmanidea echolsae</i> (Malkin, 1953)	39
<i>Cushmanidea glabra</i> , n. sp.	40
<i>Cushmanidea magniporosa</i> , n. sp.	40
<i>Cushmanidea</i> sp.	41
<i>Haplocytheridea bradyi</i> (Stephenson, 1938)	41
<i>Cyprideis floridana</i> (Howe & Hough, 1935)	42
<i>Cyprideis swaini</i> , n. sp.	42
<i>Eucythere</i> sp. cf. <i>E. declivis</i> (Norman, 1865)	43
<i>Eucythere triangulata</i> Puri, 1953	43
<i>Sahnia</i> sp.	44
<i>Cytherura forulata</i> Edwards, 1944	45
<i>Cytherura reticulata</i> Edwards, 1944	45
<i>Cytherura vestibulata</i> , n. sp.	46
<i>Cytheropteron talquinensis</i> Puri, 1953	47
<i>Cytheropteron yorktownensis</i> (Malkin, 1953)	47
<i>Hemicytherura ? sablensis</i> Benson & Coleman, 1963	47
<i>Kangarina howei</i> Puri, 1953	47
<i>Megacythere johnsoni</i> (Mincher, 1941)	48
<i>Paracytheridea vandenboldi</i> Puri, 1953	49
<i>Paracytheridea</i> (?) <i>shattucki</i> Malkin, 1953	49
<i>Loxococoncha australis</i> Brady, 1880	50
<i>Loxococoncha metagordensis</i> Swain, 1955	50
<i>Loxococoncha purisubrhomboidea</i> Edwards in Puri, 1953	50
<i>Loxococoncha reticularis</i> Edwards, 1944	51
<i>Cytheromorpha curta</i> Edwards, 1944	51
<i>Cytheromorpha warneri</i> Howe & Spurgeon, 1935	51
<i>Paradoxostoma</i> (?) <i>delicata</i> Puri, 1953	52
<i>Pellucistoma magniventra</i> Edwards, 1944	52
<i>Pellucistoma atkinsi</i> , n. sp.	53
Bibliography	54

LIST OF ILLUSTRATIONS

FIGURE	PAGE
1. Map showing areas where ecology of Recent Ostracoda has been studied in the Gulf of Mexico and Sapelo Island, Georgia	6
2. Map of Sapelo Island, Georgia, showing location of sediment cores studied	7
3. Cross section through Sapelo Island and Georgia mainland	8
4. East Mississippi Delta area studied by Curtis	9
5. Rockport, Texas, (San Antonio Bay) area studied by Swain	10
6. Panama City area studied by Puri & Hulings	11
7. Alligator Harbor area studied by Puri & Hulings	12
8. Diagram of relationships of ostracod assemblages	22
9. Cross section of Sapelo Island	24
10. Cross section of Sapelo Island	25

PLATE	FACING PAGE
1. <u>Pontocypris</u> sp., <u>Bairdia laevicula</u> Edwards, <u>B. sp.</u> , <u>Candona</u> (?) sp.	60
2. <u>Eucythere</u> sp. cf. <u>E. declivis</u> (Norman), <u>E. triangulata</u> Puri, <u>Campylocythere laeva</u> Edwards	61
3. <u>Sahnia</u> sp., <u>Paradoxostoma</u> (?) <u>delicata</u> Puri, <u>Acuticythereis multipunctata</u> Edwards	62
4. <u>Acuticythereis laeivissima</u> Edwards, <u>A. gigantea</u> Edwards	63
5. <u>Acuticythereis tenmilecreekensis</u> (Puri), <u>A. gigantea</u> Edwards	64
6. <u>Aurila amygdala</u> (Stephenson), <u>A. conradi conradi</u> (Howe & McGuirt), <u>A. conradi floridana</u> Benson & Coleman	65
7. <u>Pterygocythereis</u> sp. cf. <u>P. americana</u> (Ulrich & Bassler), <u>Orionina vaughani</u> (Ulrich & Bassler), <u>Costa triplistriata</u> (Edwards), <u>C. sp. aff. C. triplistriata</u> (Edwards), <u>Actinocythereis exanthemata gomillionensis</u> (Howe & Ellis)	66
8. <u>Puriana rugipunctata</u> (Ulrich & Bassler), <u>P. mesacostalis</u> (Edwards), <u>Echinocythereis garretti</u> (Howe & McGuirt)	67
9. <u>Murrayina martini</u> (Ulrich & Bassler), <u>Triginglymus whitei</u> (Swain), <u>T. sapeloensis</u> , n. sp. ..	68
10. <u>Clithrocytheridea virginensis</u> Malkin, <u>Cyprideis swaini</u> , n. sp.	69
11. <u>Cyamocytheridea</u> (?) <u>probosciduala</u> (Edwards), <u>Cyprideis floridana</u> (Howe & Hough)	70
12. <u>Cushmanidea magniporosa</u> , n. sp., <u>C. ashermani</u> (Ulrich & Bassler)	71
13. <u>Cushmanidea tuberculata</u> (Puri), <u>C. echolsae</u> (Malkin)	72
14. <u>Cushmanidea echolsae</u> (Malkin), <u>C. glabra</u> , n. sp.	73
15. <u>Cytheropteron yorktownensis</u> Malkin, <u>Cytherura reticulata</u> Edwards, <u>Kangarina howei</u> Puri, <u>Cushmanidea</u> sp.	74
16. <u>Cytherura forulata</u> Edwards, <u>C. vestibulata</u> , n. sp., <u>Hemicytherura sablensis</u> Benson & Coleman	75
17. <u>Pellucistoma atkinsi</u> , n. sp., <u>P. magniventra</u> Edwards, <u>Megacythere johnsoni</u> (Mincher) ..	76
18. <u>Cytheropteron talquinensis</u> Puri, <u>Paracytheridea</u> ? <u>shattucki</u> Malkin, <u>P. vandenboldi</u> Puri	77
19. <u>Loxoconcha reticularis</u> Edwards, <u>L. australis</u> Brady, <u>L. purisubrhomboidea</u> Edwards, <u>L. metagordensis</u> Swain	78
20. <u>Cytheromorpha curta</u> Edwards, <u>C. warneri</u> Howe & Spurgeon	79

INTRODUCTION

This dissertation is the result of study of the ostracod fauna from a series of thirteen cores which penetrate a maximum depth of 56 feet into mostly unconsolidated sediments on Sapelo Island, Georgia. It is part of an investigation of Ostracoda, both living and fossil, in the vicinity of Sapelo Island sponsored by the National Science Foundation Grant No. GB-26.

The study was undertaken to determine the usefulness of ostracods as indicators of paleoenvironments. Since the majority of species found in the cores are still living, it was anticipated that the fossil forms could be directly compared with the living to interpret paleoecological conditions and reconstruct some of the history of Sapelo Island.

Several difficulties, however, were encountered in proceeding toward this goal. First, the identification of species from literature is a major problem. Descriptions of many species are sketchy and the illustrations, as most, of limited value. Although this situation is not universal, even authors recognized as authorities on Cenozoic Ostracoda have paid little attention to type and configuration of marginal pore canals, type of normal pores, and other important morphological features.

A second and much more serious difficulty is the lack of published data on ecology of living ostracods. Some excellent work has been done, but not nearly enough to provide reliable environmental controls on species. As Benson & Coleman point out (1963, p. 6), ecological inferences must be based on species, since not nearly enough is known to attempt generalities about the environmental limits of genera or higher taxonomic groups.

Other troublesome problems were met. What does the fossil assemblage represent in relation to the living population? Do bottom sediments, which comprise the geologic record, influence the living population and can the two be correlated? If they can be correlated, do they represent a selective depositional phenomenon or a significant ecological record? Is carapace morphology related to the environment in which the ostracod lives? These problems are by no means unique to the interpretation of the fossil records of the ostracods in the late Pleistocene of Sapelo Island, but are universal in studying the fossil record. The literature on paleoecology, unfortunately, offers no standard guide for their solution.

Specimens are designated UMMP, and deposited in The University of Michigan Museum of Paleontology.

LABORATORY PROCEDURES

Seventy-five samples were taken from twelve cores at the University of Georgia Marine Institute. The samples were chosen at intervals of apparent significant changes in lithology as judged from a megascopic examination of the cores. These were then divided into subsamples. Part of each subsample was utilized for sediment analysis and part was searched for the microfauna. The results of the sediment analysis are not yet available. The part of the sample used for ostracod study was not quantitatively controlled, although approximately the same amount of material was searched through for each sample. It was found that soaking in water was adequate for disaggregation, since almost all the samples were unconsolidated. In the samples studied first all the material that failed to pass through a 220-mesh screen was searched; later, because ostracods were found to be practically absent in the material which passed through the 100-mesh screen was examined. Both ostracods and foraminifers were picked; although they are very numerous and well-preserved the foraminifers were not identified. Samples which yielded a large fauna were supplemented by

more material to provide for detailed study of the morphology of the species.

The photographic methods were quite simple. Specimens were cleaned for a short period, usually not exceeding 30 seconds, in a 50% solution of commercial clorox, then washed with alcohol and finally with water. All views of the exterior of the carapace and some views of the hinge were taken on Adox KB-14 35 mm film after the specimens were coated lightly with sublimated ammonium chloride. Most photographs were magnified x20 on the film and printed to x54 with an enlarger. The photographs which show details of muscle scars, marginal pore canals and normal pores were taken by transmitted light with the specimen immersed in glycerin. Dorsal views of the hinge were taken by transmitted light with the specimen held firmly in position in glycerin jelly. Valves were removed from the glycerin jelly by heating slightly and placing them in a 50% solution of alcohol. The same film, Adox KB-14, was used for these photographs.

GEOLOGIC SETTING

Sapelo Island, Georgia, is one of a series of barrier islands paralleling the eastern coast of the United States from North Carolina to Florida. According to Hoyt, Weimer, & Henry (1964, p. 170) it is "... the result of a complex history of development from the Late Pleistocene to the present." The island proper consists of fine to coarse sand and is separated from the mainland by an extensive salt marsh, cut by numerous meandering tidal channels (see text-figs. 1 & 2). That the shore line has varied considerably throughout the Late Pleistocene is shown by different sets of dune ridges which parallel the

present shoreline. The ocean bottom slopes very gently and reaches depths of only 34 to 45 feet ten miles offshore. The tides are above average for the southeastern Atlantic coast, attaining a diurnal range of seven feet.

The following brief history of the island is summarized from Hoyt, Weimer & Henry (1964). Three distinct shorelines can be distinguished in addition to the present one which correspond to stillstands of the sea. No absolute dates have been established; hence the time of deposition is tentative even though the sequence is definite. The old-

est shoreline in the region is the Pamlico, which occupies a position 6 to 10 miles inland from the present shoreline. This sand barrier island was formed during the Mid-Sangamon interglacial stage when sea-level was 20 to 25 feet higher than at present. The second represented shoreline is the Princess Anne, consisting of deposits about 10-15 feet above the present sea-level and dated as late Mid-Sangamon. A narrow lagoon-salt marsh is developed between these two ancient shorelines. The Silver Bluff shoreline formed during late Sangamon time and it was then that most of Sapelo Island was formed. The Silver

Bluff shoreline is separated by an extensive salt marsh from the Princess Anne shoreline deposits. Recent build-up of the island has been by accretion on the shoreward side, which is separated from the Silver Bluff deposits by a one-fourth mile wide salt marsh. Each of the barrier islands has been shifting southward by erosion of its north end and deposition on its south end. The cores from which the samples were taken for this study represent sections through approximately sixty feet of this complex of barrier sands, dune sands, off-shore marine sands and salt marsh deposits.

PREVIOUS WORK ON EAST COAST UPPER MIOCENE OSTRACODA

The first paper of importance concerned with Miocene ostracods in the eastern United States was that of Ulrich & Bassler, 1904. They described and illustrated a great number of species from the Middle and Upper Miocene of Maryland and Virginia, particularly the Calvert and Yorktown Formations. Since most species in the paper were new, it forms the basic systematic work to which subsequently described east coast ostracod faunas must be compared. Howe, et al., 1935, described the ostracods of the Arca zone of the Choctawhatchee Formation (Upper Miocene) of Florida. This paper was concerned only with descriptions of species and no attempt was made to work out any correlation on the basis of the ostracods.

The next important paper was that of Edwards, 1944, in which he described the ostracod fauna of the Duplin Marl (Upper Miocene) of North Carolina. Like the previous papers mentioned, this was primarily descriptive in nature, and as in the others the samples studied were from surface exposures. The faunas studied were from only three localities. On the basis of the ostracods, Edwards considered the Duplin Marl to be the stratigraphic equivalent of the Yorktown Formation of Virginia. Swain, 1948, studied cores that penetrated the subsurface Miocene of Maryland, described the ostracods, and gave tentative age values to the different depths of the core. In 1951 he wrote a more extensive paper in which he described the ostracod fauna of several cores taken in North Carolina which penetrated through the Cenozoic and into the Cretaceous deposits.

Malkin (1953) restudied the Middle and Upper Miocene of Virginia, Maryland, and New Jersey, and set up stratigraphic zonations primarily on the basis of the ostracod fauna, supplemented by the foraminifers. She erected four substages and six faunozones. Her paper is actually the first concerned with the upper Tertiary stratigraphic correlation in the eastern United States based on the occurrence of ostracods. Malkin (1953, p. 771) considered the Yorktown faunas to be similar to those of the Duplin Marl and Choctawhatchee Formation and that: "Differences in the faunules may be attributed to ecologic or facies differences."

In the same year Puri (1953a) wrote a detailed paper on Miocene stratigraphy and facies relationships in western Florida. Earlier workers in that area recognized four zones in the Choctawhatchee Formation of western Florida, which were named for the predominant mollusc in each: Yoldia, Arca, Ecphora, and Cancellaria zones, from oldest to youngest. Puri considered that these represent facies relationships, and rather than representing a sequence were in many instances deposited within the same time span, but in different environments. He considered the Yoldia facies to be the updip equivalent of the Ecphora facies, while the Arca facies is the updip equivalent of the Cancellaria facies. The Yoldia facies underlies in part the Arca facies and the Ecphora facies underlies in part the

Cancellaria facies.

Although Puri studied both the ostracod and the foraminifer faunas of the entire Miocene, only that of the upper part is discussed here. He considered the Yoldia facies to represent (1953a, p. 40): "... the westernmost shallow water marine sediments of the Choctawhatchee Stage deposited in the vicinity of the type locality." It contains a sparse microfauna. The Arca facies, lying for the most part above the Yoldia facies is considered to have been "... deposited offshore under outer neritic conditions." The Ecphora facies was "... deposited under conditions similar to those of the Arca facies, but the fauna is from deeper water." Puri then stated concerning the Cancellaria facies that it "... is in part contemporaneous with the Arca and Ecphora facies and in part younger. The succeeding advance of the Choctawhatchee sea deposited the Cancellaria facies."

Puri (1953a, p. 48-50) gave the following environmental limitations to these facies: Yoldia, 30-100 meters, inner neritic, offshore muddy bottom; Arca, 30-100 meters, outer neritic; Ecphora, maximum depth 100 meters, outer neritic; Cancellaria facies, the lower part the same as the Ecphora facies, the upper part "... under more shallow conditions during a transgressive sea." The greatest similarity between facies insofar as the ostracod fauna is concerned are the Ecphora and Cancellaria facies which have in common 22 species that are not present in the other facies in the Miocene of western Florida. Puri also discussed the correlation of the Choctawhatchee Formation in relation to the stratigraphy of the Gulf Coast states, but not with regard to its relationship to the Yorktown Formation and Duplin Marl.

McLean (1957) wrote a paper about the ostracods of the Yorktown Formation, but only from localities in the York-James Peninsula region of Virginia. He described 30 species, one new, and discussed possible correlations of the Yorktown Formation in relation to the Duplin Marl and the Choctawhatchee Formation. He concluded (1957, p. 62) that the three formations are stratigraphic equivalents and that the differences in faunal characteristics are due to changing environments; further that the Yorktown Formation was deposited in an open sea environment in relatively shallow waters. He stated that the faunas vary greatly from sample to sample and probably represent constantly changing, but local, environmental conditions.

The above discussion constitutes a brief summary of the Miocene ostracod work done to date in the eastern United States and into the western portion of Florida. No detailed stratigraphic discussion is intended, but on the basis of the few ostracod faunas described there would appear to be little significant differences between the Upper Miocene formations of western Florida, North Carolina, and Virginia. Table 1 shows the ranges of species encountered in the present work.

TABLE 1. REPORTED OCCURRENCES OF OSTRACOD SPECIES DESCRIBED HEREIN.

	Miocene		Pleis- tocene	Recent
	Lower	Middle Upper		
<u>Actinocythereis exanthemata</u> <u>gomillionensis</u> (Howe & Ellis, 1935).....		X	X	?
<u>Acuticythereis laevis</u> Edwards, 1944		X	X	X
<u>A. gigantea</u> (Edwards, 1944).....			X	
<u>A. multipunctata</u> Edwards, 1944			X	
<u>A. tenmilecreekensis</u> (Puri, 1953) ..			X	
<u>Aurila amygdala</u> (Stephenson, 1944)..	X	X		X
<u>A. conradi conradi</u> (Howe & McGuirt, 1935).....	X	X	X	
<u>A. conradi floridana</u> Benson & Cole- man, 1963				X
<u>Bairdia laevicula</u> Edwards, 1944		?	X	
<u>Campylocythere laeva</u> Edwards, 1944..			X	
<u>Clithrocytheridea virginensis</u> Malkin, 1953.....			X	
<u>Costa triplistriata</u> (Edwards, 1944).			X	
<u>Cushmanidea ashermani</u> (Ulrich & Bassler, 1904)		X	X	X
<u>C. echolsae</u> (Malkin, 1953).....			X	X
<u>C. tuberculata</u> (Puri, 1958)				X
<u>Cyamocytheridea</u> (?) <u>probiscidiala</u> (Edwards, 1944)			X	X
<u>Cyprideis floridana</u> (Howe & Hough, 1935)			X	X
<u>C. swaini</u> , n. sp.				X
<u>Cytheromorpha curta</u> Edwards, 1944 ..			X	
<u>C. warneri</u> Howe & Spurgeon, 1935 ...		X	X	X
<u>Cytheropteron talginensis</u> Puri, 1953			X	
<u>C. yorktownensis</u> (Malkin, 1953).....			X	
<u>Cytherura forulata</u> Edwards, 1944 ...			X	X
<u>C. reticulata</u> Edwards, 1944			X	X
<u>Echinocythereis garretti</u> (Howe & McGuirt, 1935)		X	X	X
<u>Eucythere</u> cf. <u>E. declivis</u> (Norman, 1865)			X	
<u>E. triangulata</u> Puri, 1953			X	
<u>Hemicytherura</u> ? <u>sablensis</u> Benson & Coleman, 1963				X
<u>Kangarina howei</u> Puri, 1953			X	
<u>Loxococoncha australis</u> Brady, 1880 ...				X
<u>L. metagordensis</u> Swain, 1955				X
<u>L. purisubrhomboidea</u> Edwards, 1953..	X	X	X	
<u>L. reticularis</u> Edwards, 1944		X	X	
<u>Megacythere johnsoni</u> (Mincher, 1941)				X
<u>Murrayina martini</u> (Ulrich & Bassler, 1904)	X	X	X	
<u>Orionina vaughani</u> (Ulrich & Bassler, 1904)		X	X	?
<u>Paracytheridea</u> ? <u>shattucki</u> Malkin, 1953		X	X	
<u>P. vanboldeni</u> Puri, 1953			X	X
<u>Paradoxistoma</u> (?) <u>delicata</u> Puri, 1953			X	
<u>Pellucistoma magniventra</u> Edwards, 1944			X	X
<u>Pterygocythereis</u> sp. cf. <u>P.</u> <u>americana</u> (Ulrich & Bassler, 1904).....		X	X	X
<u>Puriana mesacostalis</u> (Edwards, 1944)			X	?
<u>P. rugipunctata</u> (Ulrich & Bassler, 1904)	X	X	X	X
<u>Triginglymus whitei</u> (Swain, 1951)...		X	X	X

COMMUNITY CONCEPT

The term "Community" is often used when characterizing an assemblage of organisms, but it is not always clarified. An elucidation of community and related terms is offered here to avoid confusion in the comparison of the Sapelo Island fossil assemblages with the several described assemblages from the Recent ostracods in the Gulf of Mexico. The concept of a community as employed here is based upon the excellent discussions of Newell et al. (1959), and Johnson (1962, 1963). Careful consideration of terms is judged necessary because of the concepts inherent in their usage. As Newell et al. (1959, p. 197), point out, there are several different meanings which may be understood from the term "community" when it is used to define a group of organisms found together. First is the "habitat community," which is defined as "... a natural association of organisms set apart according to certain defined features of the environment." In order to recognize the habitat community, the organisms living in a particular environment are analysed and for example, an estuarine community is differentiated. The term community is used theoretically for the entire biota present, but in actual practice it is limited to selected taxonomic groups. The types of organisms considered is limited by a number of factors, and almost never are all living organisms studied. Here only the benthic ostracods have been considered. Even though "community" as generally used represents only part of the theoretical community, it seems unwise to use it as a description of only one taxonomic group such as the ostracods. The term "biofacies" has been used with essentially the same connotation as habitat community by Swain (1955) and by Puri & Hulings (1957), as restricted to the ostracods.

A second way of using the term community is as an "organic community," which is the conception of a community as "... a regular occurring combination of certain types of organisms." In this usage the species are grouped in recurring assemblages without regard to habitat and then an attempt is generally made to fit the groupings into a physical environment. This grouping of species into like assemblages which occur together consistently to the partial exclusion of others is in reality what is generally done in paleoecology. The concept of an organic community has been used as in the explanation given by Hoskins (1964, p. 1680). The term biofacies has also been used in this sense and it is important to differentiate the two terms. In fact, Hoskins uses the terms biofacies and assemblage as synonymous in the sense of an organic community of molluscs.

The third concept is that of the "ecological community" in which "... emphasis is given to the mutual dependence of animals and plants which not merely exist in geographic proximity but are bound together by their ecological functions. For this sort of community the term 'biocoenosis' is properly employed." There is a wide difference of opinion about the importance of the interdependence of the organic constituents of an ecological community. Johnson (1964, p. 128) states: "Individuals of two or more species might live together because they interact with one another and/or have similar responses to the local environment. They may occur together by chance." He further states, "The viewpoint that is developed here, and perhaps overstated is that benthic communities are commonly associations of largely independent species occurring together because of similar responses to the physical environment." Granted, this is a somewhat controversial question which is far from being solved, but the view of

Johnson is certainly convenient for one attempting to utilize a specific taxonomic group for the re-creation of depositional environments. Since it is impossible for a paleontologist to confront the entire ecological community and consider the interrelationships, the idea of primary dependence on the physical environment, rather than the interdependence of organisms, allows one to consider more confidently those organisms that happen to be preserved.

Three kinds of evidence for the recognition of ancient communities are suggested by Johnson (1964) as follows:

1. field evidence of burial in situ,
2. taxonomic analogy with a modern community,
3. recognition of recurring suites of species analogues to the recurrences observed among modern communities."

All three concepts have been considered in the determination of the paleoecological environment of the Sapelo Island sediments to a greater or lesser degree. While no direct field observations were made, the assumption has been made that ostracods buried together were more likely to have lived in the same habitat than those which were not found together. Furthermore, that they are found in assemblages that would approximate closely the assemblages that could be distinguished if they had been collected as living organisms. An attempt has been made to compare the assemblages found in the sediments with those living today in the vicinity of Sapelo Island and also with those recorded in the Gulf of Mexico. The forms from the Sapelo Island sediments are considered as ostracod organic communities (assemblages and sub-assemblages), since the habitat can only be inferred. On the other hand, the groupings of Recent ostracods are in reality ostracod habitat communities (biofacies of Swain, 1955, and Puri & Hulings, 1957). That two different types of assemblages are to be compared should be understood.

One of the major problems encountered in paleoecology is the tendency for a partial analysis of morphology and taxonomy. Whittington (1964, p. 20) recently issued this pertinent warning:

"Taxonomy cannot be avoided because it is difficult, nor ignored as 'out-of-date' in the flush of enthusiasm for the present fashion for paleoecology. Here the term 'taxonomy' means classification of fossils resulting from detailed morphological studies of carefully collected material that has been prepared with the utmost care and thoroughness -- we cannot afford to neglect any information that new or old techniques may derive from fossils. The aim of systematic paleontology is a classification of fossils embodying knowledge of morphology, ecology, geographical distribution, and evolution. Thus systematic and paleoecological work are not separate disciplines; they must go hand-in-hand, and one cannot be done effectively without the other. To some extent the present enthusiasm for paleoecology is a reaction against a type of descriptive paleontology that treats a fossil more or less as an inorganic object unrelated to other fossils and the rocks that contained it. Such a reaction is as ill-conceived as its cause."

ECOLOGY OF RECENT OSTRACODA FROM GULF OF MEXICO AND SAPELO ISLAND

Ecology of Recent ostracods has been studied in certain areas in the north and western Gulf of Mexico (text-fig. 1). In each paper the author has indicated assemblages which are theoretically controlled by the physical environment in the area with which they were encountered. In this paper I have attempted to compare the assemblages from one locality to another. The area to be considered extends from Florida Bay, at the southern tip of Florida, to San Antonio Bay, Texas, located in the northwestern part of the Gulf of Mexico. Ecological studies have actually touched only a small portion of the intervening shoreline. The sampling was done at different times of the year in the separate studies along the coast, and in most instances a particular sampling station was manned only once. Hence, the possibility must be considered that the absence of a particular form at a station may mean that they are absent at that time of the year only, rather than being always absent. This disadvantage is offset by the fact that most of the studies did not differentiate between living specimens and empty carapaces. In fact, in some of the papers it is not clear whether, of all species reported, even one specimen was found living.

Nevertheless, by using the reported occurrences of ostracods found in the Recent sediments, it should be possible to differentiate some generalized assemblages from the six areas considered here. The environments studied are briefly discussed, and the species which the various authors considered diagnostic are tabulated. The environments in which Curtis (1960) placed her biofacies units (ostracod habitat community) provide a framework into which the biofacies units of the other authors have been placed with exception of the Estuarine subfacies (IIb). There is no doubt that the areas discussed are not precisely the same, and somewhat different assemblages could be expected. The judgment of whether forms are conspecific based upon an assessment of a single published illustration is necessarily subjective and at times probably in error.

As a part of the American Petroleum Institute Project 51 (API 51), Curtis (1960) studied the ostracod fauna in the southeastern portion of the Mississippi River delta area (text-fig. 4). The specimens studied and evaluated were almost exclusively empty carapaces, since very few living forms were found. The area studied was a portion of the distributaries of the Mississippi River, an open lagoon (Breton Sound), and a portion of the offshore open shelf to the depth of almost 600 feet. A wide variety of environments was encountered with the following biofacies units delineated by Curtis:

- I. Offshore (middle and outer neritic) biofacies
- II. Inshore (paralic) biofacies
 - a. Nearshore (inner neritic) subfacies
 - b. Estuarine subfacies
 - c. Open lagoonal subfacies
 - d. Interdistributary subfacies

The offshore biofacies represents an environment of open marine influence. There is little contamination from terrestrial sources in this environment, and it is believed to be characteristic of the shallow, open shelf of the Gulf of Mexico. The inshore biofacies are all influenced to a greater or lesser extent by the influx of fresh water and the consequent mixing with marine water. The near-

shore subfacies (IIa), with a maximum depth of 60 feet, is open to the Gulf proper, but is influenced by freshwater influx and has a distinct assemblage, which is more closely related to the other inshore biofacies than to the offshore biofacies. The estuarine subfacies (IIb) is an environment strongly influenced by fresh water. According to Curtis it is a typical estuarine environment, in that it is oriented normal to the shoreline and the circulation is two-layered, the fresh water lying above the more saline water. However, it does not have a restricted circulation and is open to the Gulf. As discussed later, the ostracod assemblages of IIa and IIb are indistinguishable. For these reasons IIa and IIb are lumped together for purposes of comparison. The open lagoonal subfacies (IIc), represented by Breton Sound, is oriented parallel to the shoreline, has lower than normal salinity, and is influenced much less directly by the influx of fresh water, than the estuarine subfacies. The interdistributary subfacies (IId), is one under strong freshwater influence, and has very low salinity. It is within this framework of biofacies units, which occur in the environments, briefly characterized, that the assemblages which have been designated for the other areas in the Gulf of Mexico will be fitted.

Also as a part of the API 51 project, Swain (1955) studied an area on the northwest coast of the Gulf of Mexico (text-fig. 5). Most of his samples were taken in San Antonio Bay, which is a combination of estuary in the upper portion, and a partially open lagoon in the lower part. The two environments are mixed to a certain degree since they are open to one another. Barrier islands (Matagordo and St. Joseph), broken only by narrow, deep inlets, serve to separate the Bay from the open Gulf. The circulation of the Bay is thus restricted from the open Gulf water, particularly in the upper, estuarine portion. A few samples were taken offshore to a maximum depth of 60 feet. The ostracod biofacies which were differentiated are as follows:

River and Prodelta facies

- River subfacies (IId of Curtis)
- Prodelta subfacies (IId of Curtis)

Bay facies

- Midbay subfacies
- Marginal subfacies
- Lower bay subfacies (IIc of Curtis)

Open Gulf facies

- Nearshore subfacies (IIa of Curtis)
- Offshore subfacies (No fauna reported)

The river and prodelta facies are strongly influenced by freshwater influx and the assemblage is that of fresh- or brackish-water forms (IId of Curtis). The bay facies is divisible into the upper portion which is estuarine and the lower part which is lagoonal. The estuarine portion is influenced by the influx of the Guadalupe River and Swain further subdivided it into a midbay and a marginal subfacies. The midbay subfacies is that portion of the estuary in which the sediments consist of fine muds, which are a part of the delta built by the inflowing Guadalupe River. The marginal subfacies is that portion along the margins of the estuary, in which the sediments are more

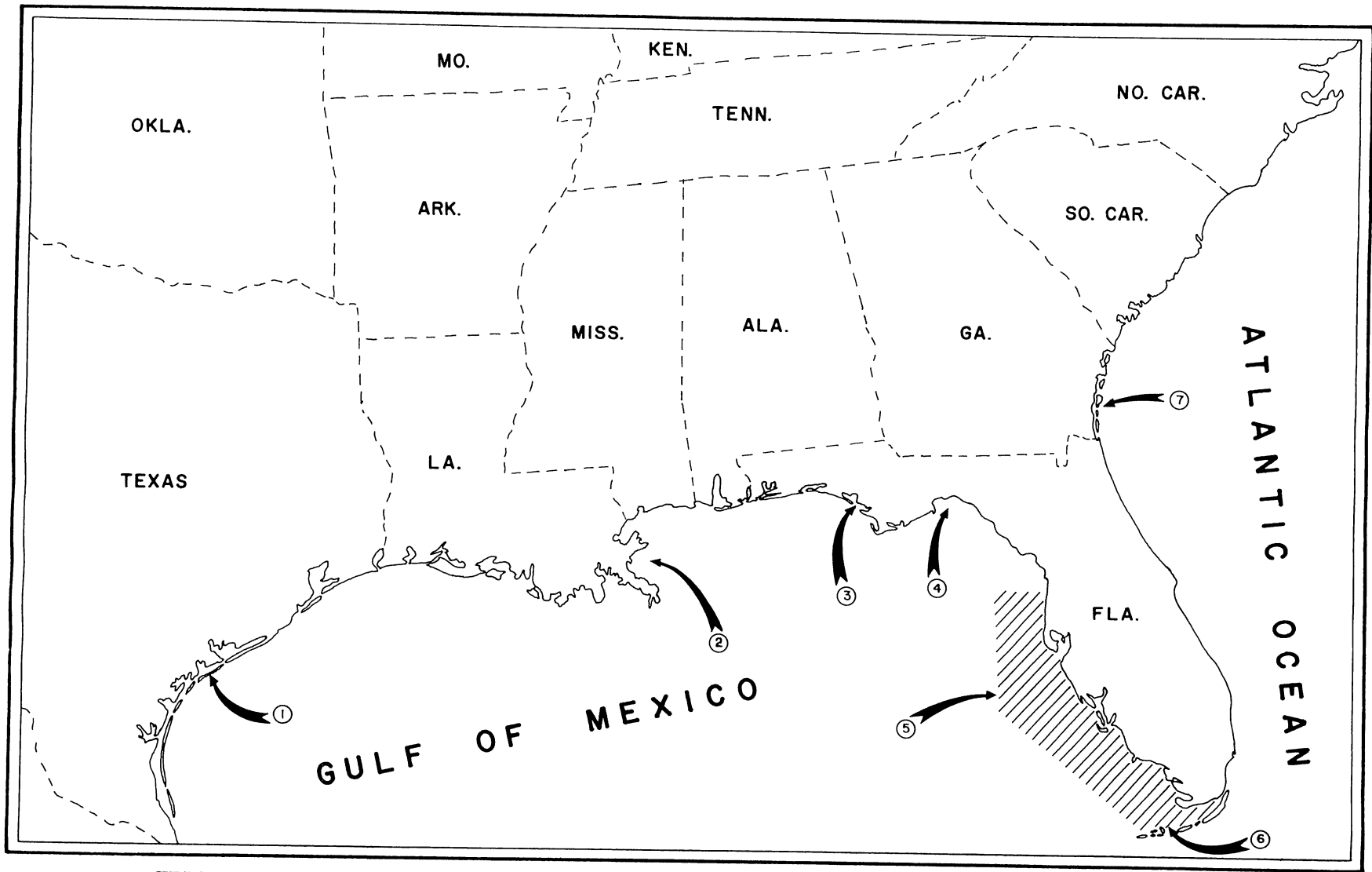

TEXT-FIG. 1. Location map showing areas where ecology of Recent Ostracoda has been studied in the Gulf of Mexico and Sapelo Island, Georgia: 1 - San Antonio Bay (Swain, 1955); see text-fig. 5. 2 - Mississippi Delta area (Curtis, 1960); see text-fig. 4. 3 - Panama City area (Puri & Hulings, 1957); see text-fig. 6. 4 - Alligator Harbor area (Puri & Hulings, 1957); see text-fig. 7. 5 - Offshore, west coast of Florida (Benson & Coleman, 1963). 6 - Florida Bay and Florida Keys area (Puri & Hulings, 1957). 7 - Sapelo Island, Georgia (Darby, 1964); see text-fig. 2.

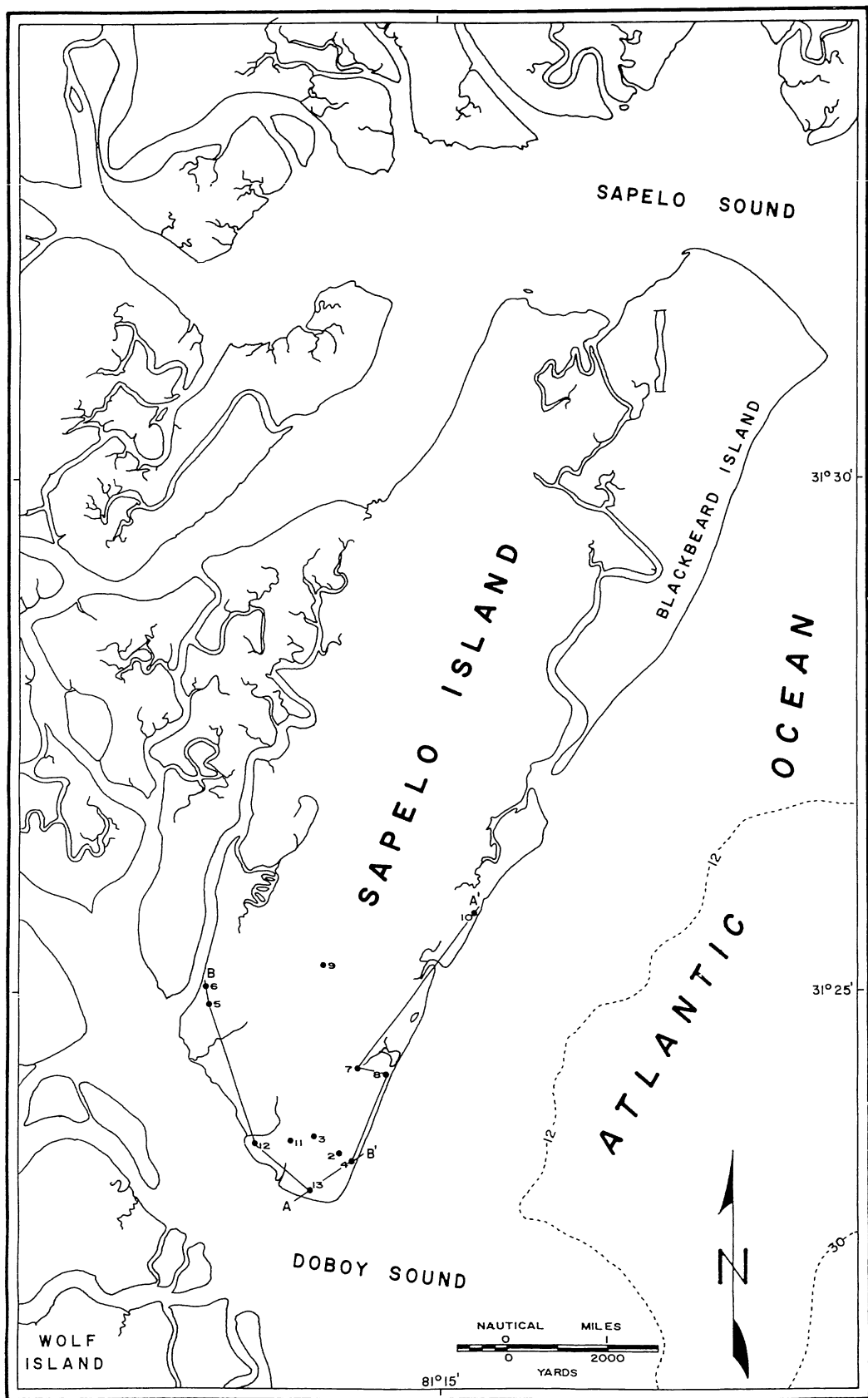

TEXT-FIG. 2. Map of Sapelo Island, Georgia, showing location of sediment cores studied. Numbers refer to designation assigned each core as used in text.

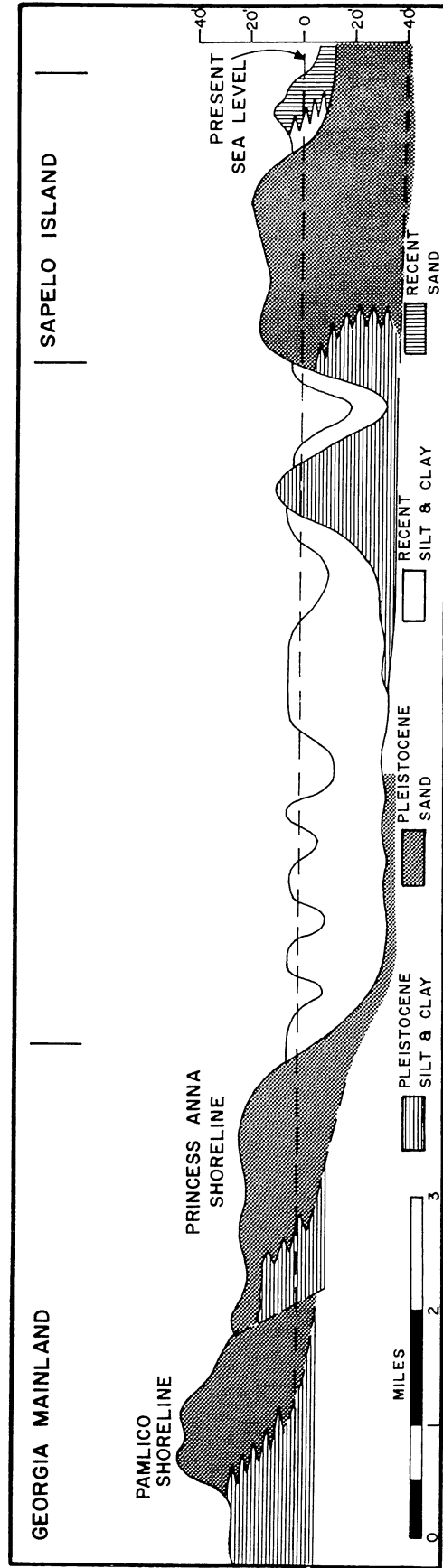

TEXT-FIG. 3. Cross section through Sapelo Island and Georgia mainland (modified after Hoyt, Weimer, & Henry, 1964).

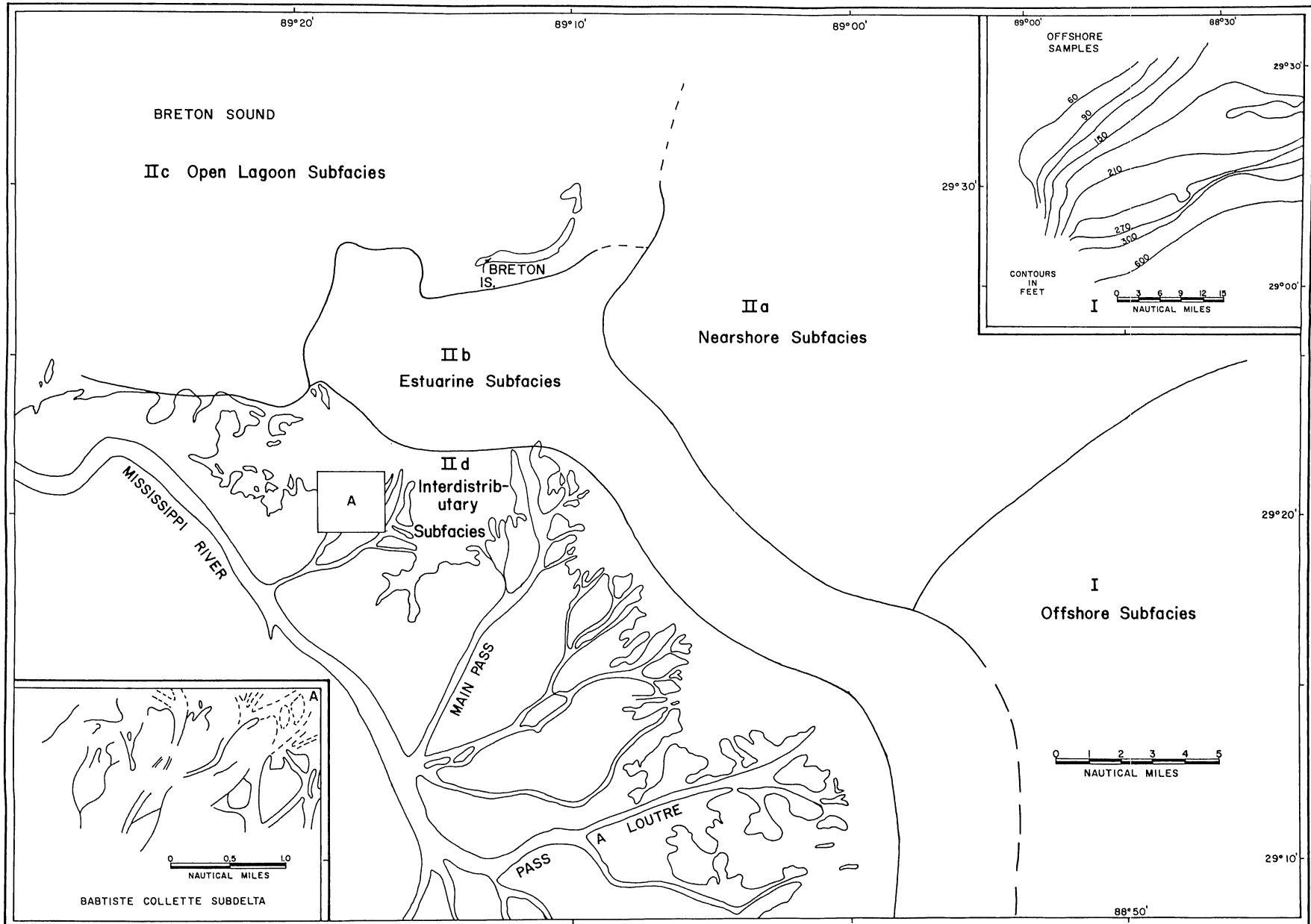

TEXT-FIG. 4. East Mississippi Delta area studied by Curtis (1960). Biofacies designations are those of Curtis which are referred to in the text (after Curtis, 1960).

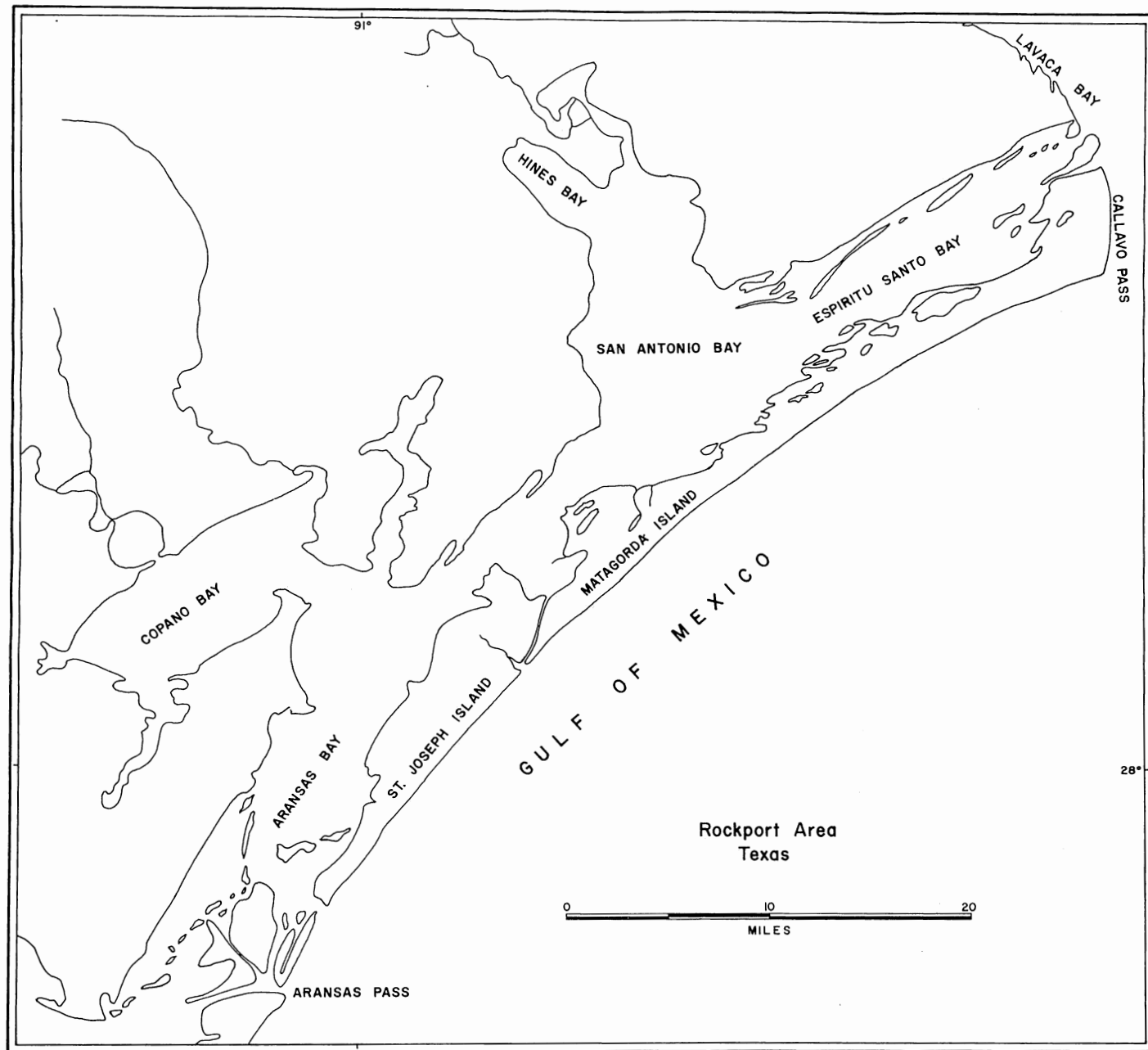

TEXT-FIG. 5. Rockport, Texas (San Antonio Bay) area studied by Swain (after Swain, 1955).

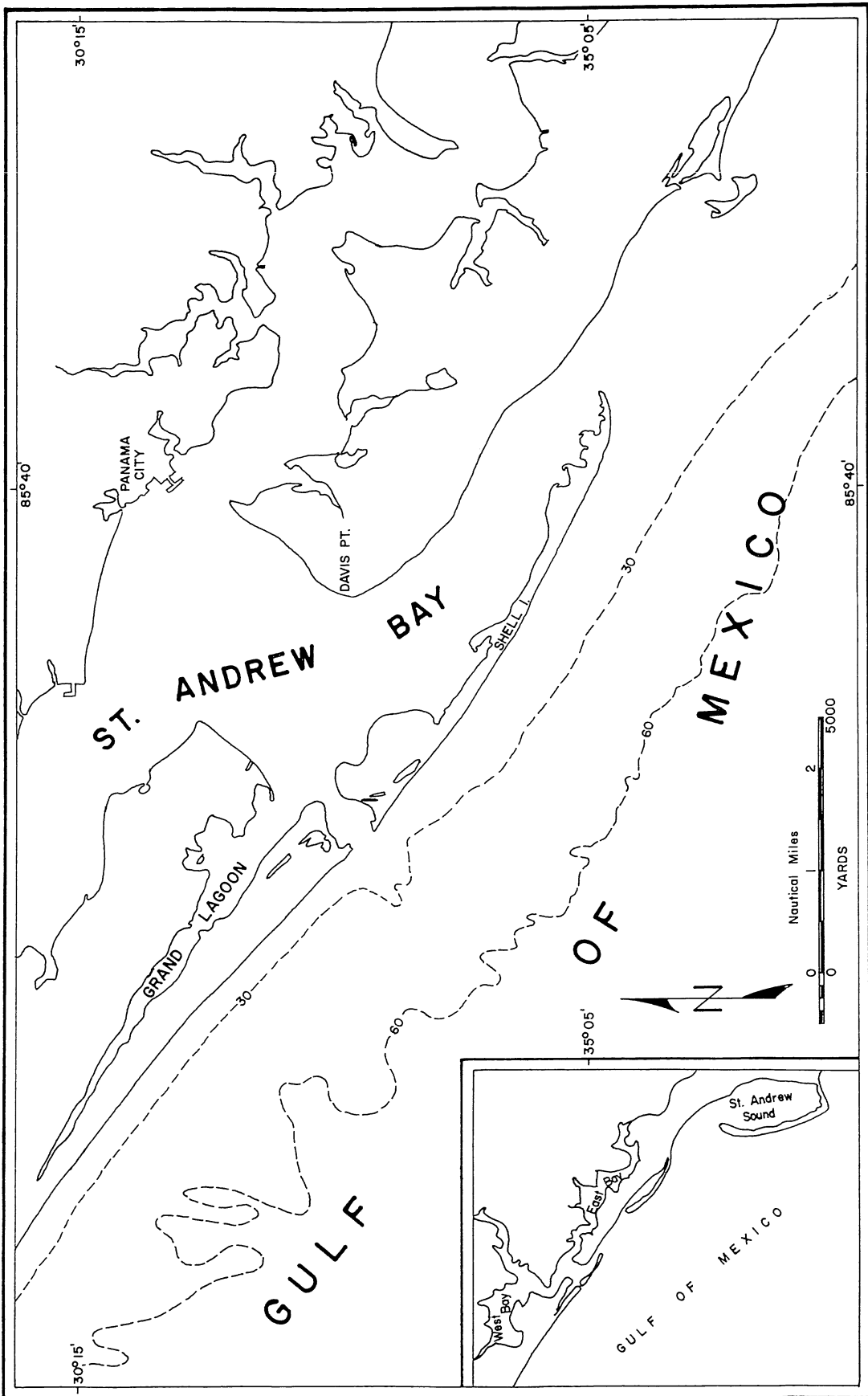

TEXT-FIG. 6. Panama City area studied by Puri & Hulings (1957).

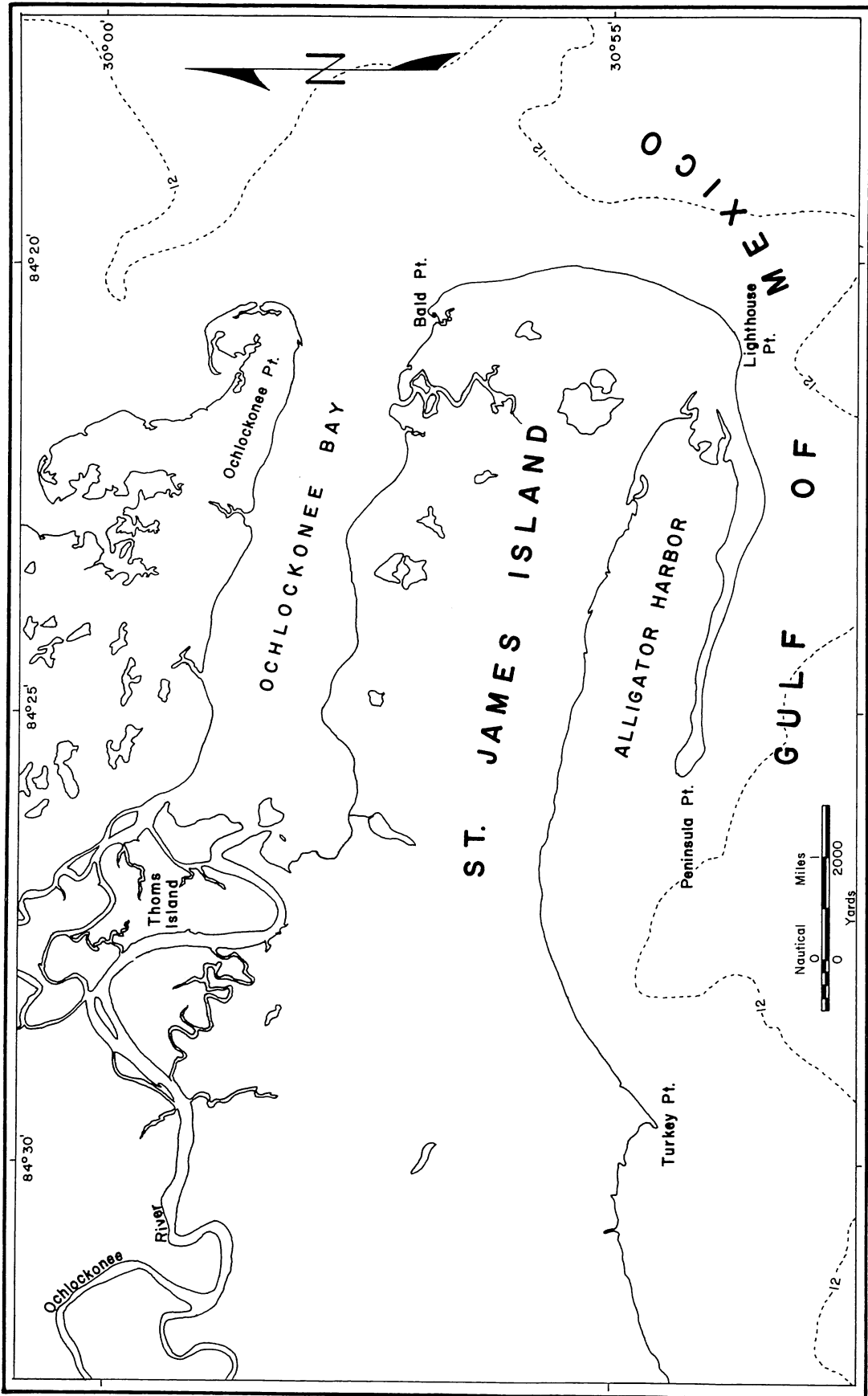

TEXT-FIG. 7. Alligator Harbor area studied by Puri & Hulings (1957).

TABLE 2. COMPARISON OF PHYSICAL CHARACTERISTICS OF OFFSHORE OSTRACOD SAMPLING AREAS.

<u>Environmental Unit</u>	<u>Depth (in ft.)</u>	<u>Salinity (parts per thousand)</u>	<u>Temperature (Centigrade)</u>	<u>Bottom Sediments</u>
Offshore, Curtis, 1960 Miss. R. delta area	more than 60	34.3-36.1	avg. 20 avg. range 2.5	offshore clays & marginal deposits (mixture of river clays with older deposits)
Offshore, Benson & Coleman, 1963 West coast of Florida	about 70-239	36.2-37.4	no bottom temp. given	angular, fine to medium size carbonates

TABLE 3. COMPARISON OF OSTRACOD SPECIES REPORTED AS DIAGNOSTIC OF OFFSHORE SAMPLING AREAS (See table 2).

Curtis (1960) (Outer neritic, more than 60 feet)	Benson & Coleman (1963) (Outer neritic, more than 70 feet)
<u>Basslerites</u> cf. <u>B. berchoni</u> (Brady)	<u>Bairdia victrix</u> Brady, 1869 <u>Bairdoppilata triangulata</u> Edwards, 1944
<u>Cushmanidea</u> cf. <u>C. agricola</u> (Howe & Hadley, 1935)	<u>Cytherella grossmani</u> Benson & Coleman, 1963
<u>Cytheropteron</u> aff. <u>C. alatum</u> , Sars	
<u>Cytheropteron</u> aff. <u>C. leonensis</u> Puri, 1953	
<u>Echinocythereis</u> <u>margaretifera</u> (Brady)	* <u>Echinocythereis garretti</u> (Howe & McGuirt, 1935)
<u>Hemicythere</u> cf. <u>H. convexa</u> (Baird)	<u>Loxocorniculum fischeri</u> (Bradey, 1869)
<u>Krithe producta</u> Brady	
<u>Microxesteleberis</u> sp.	
<u>Paracypris polita</u> Sars	<u>Perissocytheridea laevis</u> Benson & Coleman, 1963
<u>Pterygocythereis</u> sp.	<u>Pterygocythereis</u> sp. aff. <u>P. americana</u> (Ulrich & Bassler, 1904)

* Taxonomic name consistent with current usage.

TABLE 4. COMPARISON OF PHYSICAL CHARACTERISTICS OF INNER NERITIC SAMPLING AREAS.

<u>Environment Unit</u>	<u>Depth</u> (in ft.)	<u>Salinity</u> (parts per thousand)	<u>Temperature</u> (Centigrade)	<u>Bottom Sediments</u>
Inner neritic, Curtis, 1960 Miss. R. delta area	less than 60	34.2-36.1	Avg. 24 avg. range 9	sands, silts, clays & reworked older sands
Estuarine, Curtis, 1960 Miss. R. delta area	0-30	25.3-34.3	avg. 24 avg. range 15	prodelta silty clays & delta front silts and clays
Open gulf, Swain, 1955 San Antonio Bay	to 60	36	not given	silt, sand
Inner neritic, Puri & Hulings, 1957 Alligator Harbor area	2-12	-----	-----	-----
Inner neritic, Puri & Hulings, 1957 Panama City area	23-65	35.6-36.8	10-30	medium to fine-grained well-sorted sands
Inner neritic, Benson & Coleman, 1963 West coast of Florida	23- about 70	34.19-39.92	avg. summer surface- 29 Feb. 18-24	angular, fine to medium size car- bonates

sandy for the most part, but it also includes some marsh areas. The ostracod assemblages of the two subfacies are similar, with the exception that relatively more specimens of *Perissocytheridea* are found in the marginal subfacies, and more of *Cytherura* occur in the midbay subfacies. These two genera are the dominant ones of the two bay subfacies. It is also interesting to note that no specimens of *Perissocytheridea* were found in the Sapelo Island sediments. The Midbay subfacies may be compared directly to the estuarine environment studies by Darby, to the west of Sapelo Island, Georgia. The lower bay subfacies is an open lagoon, oriented parallel to the shoreline, with the major circulation entering from the northeast through Espiritu Santo Bay, bringing open gulf water. This lower bay subfacies is equivalent to the open lagoonal subfacies (IIc) of Curtis. Swain's sampling area extended to a depth of approximately 60 feet into the open gulf, beyond the barrier islands. Since the nearshore subfacies (IIa of Curtis) had as its depth limit 60 feet, the offshore subfacies of Swain is comparable to it. As will be seen in the discussion of the biofacies units of Benson & Coleman (1963), the depth level at approximately 60 to 70 feet appears to be a significant boundary between ostracod assemblages.

Puri & Hulings (1957) studied several areas along the eastern and northeastern limits of the Gulf of Mexico. Biofacies units were differentiated within two of the areas, the vicinity of Panama City (text-fig. 6), and near Alligator Harbor, Florida (text-fig. 7). They reported three genera from Tampa Bay, Florida, but no other information was provided, and that area is not considered here. The fourth area sampled by Puri & Hulings included two localities in shallow water near Crane Key and Bahia Honda, Florida Keys. No other information was given, but the following brief characterization provided by Gors-

line (1963, p. 131) describes Florida Bay as: "... a shallow, compartmented evaporation pan receiving fresh water inflow from the continental margin and open-ocean from the western and southern sides." Widely diverse environments exist in near proximity to one another, so that the particular physical conditions where the samples of Puri & Hulings were taken is not known. The Florida Bay area is not directly comparable to any of the other environments studied in the Gulf of Mexico. It has been termed a "back-reef lagoonal facies" by Benson & Coleman (1963, p. 11), but that description was based upon the limited sampling of Puri & Hulings and not on any collecting by Benson & Coleman. In addition to other features which serve to make the Florida Bay environment unique among those already considered is the accumulation of carbonate muds and shell sands at the present time. The carbonates are predominantly silt and clay size aragonite (Gorsline, 1963, p. 136). The deposit accumulating in the area was called by Puri & Hulings (1957, p. 188) a major distinctive biofacies unit of the west coast of Florida and termed the "carbonate province" as opposed to the "clastic province" which included the Panama City and Alligator Harbor areas. Much more sampling is required before it can be ascertained whether there is actually a consistent assemblage present in the Florida Bay carbonate environment. It would then be meaningful to compare the assemblages to those found in the Bahamas where active carbonate deposition is also taking place.

In the Panama City area, the sampling was done between the depths of 23 and 65 feet in the open Gulf of Mexico. According to Puri & Hulings there is little fresh-water dilution of the sampling area and the salinity is close to normal marine. Three biofacies units were designated by Puri & Hulings (1957, p. 176) as follows:

TABLE 5. COMPARISON OF OSTRACOD SPECIES REPORTED AS DIAGNOSTIC OF INNER NERITIC ENVIRONMENTS
(See table 4).

Curtis (1960) IIA & IIB	Benson & Coleman (1963) (less than 70 feet)	Puri & Hulings (1957) (Panama City, 23-65 ft.)	Puri & Hulings (1957)(Alligator Harbor Inner neritic)
	<u>Aurila amygdala</u> (Stephenson, 1944)		
	* <u>Aurila conradi floridana</u> Benson & Coleman, 1963	----- <u>Hemiothere conradi</u> Howe & McGuirt, 1935 <u>Hemiothere</u> cf. <u>H. confragosa</u> Edwards, 1944	----- <u>Hemiothere conradi</u> Howe & McGuirt, 1935
	<u>Bairdia gerda</u> Benson & Coleman, 1963		
<u>Campylocythere laevissima</u> (Edwards, 1944)	----- <u>Campylocythere laevissima</u> (Edwards, 1944)	----- <u>Campylocythere laevissima</u> (Edwards, 1944)	----- <u>Campylocythere laevissima</u> (Edwards, 1944)
* <u>Acuticythereis laevissima</u> Edwards, 1944			
<u>Cushmanidea</u> cf. <u>C. anderseni</u> (Puri, 1953)			
<u>Cushmanidea</u> cf. <u>C. echolsae</u> (Malin, 1953)			
		<u>Pontocythere</u> n. sp. 1 = (<u>Cushmanidea sulcata</u> Puri, 1960)	
		<u>Pontocythere</u> n. sp. 2 = (<u>Cushmanidea elongata</u> (Brady, 1868))	
			<u>Cytherella</u> n. sp. 1 <u>Cytherelloidea</u> n. sp. 1 = (<u>C. sarsi</u> Puri, 1960)
<u>Cytheretta daniana</u> (Brady, 1869)	-----* <u>Protocytheretta daniana</u> (Brady, 1869)		
	<u>Cytheretta ? sahani</u> Puri, 1952		
<u>Cytherura forulata</u> Edwards, 1944			----- <u>Cytherura forulata</u> Edwards, 1944 <u>Cytherura johnsoni</u> Mincher, 1941 <u>Cytherura wardensis</u> Howe & Brown, 1935
	<u>Haplocytheridea gigantea</u> Benson & Coleman, 1963	-- <u>Haplocytheridea bassleri</u> Stephenson, 1938	
	*= <u>H. setipunctata</u> (Brady)	= <u>H. setipunctata</u>	
	<u>Haplocytheridea proboscoidala</u> Edwards, 1944		
	*= <u>H. bradyi</u> Stephenson, 1938		
<u>Hermanites ? sp.</u>			
<u>Loxococoncha australis</u> Brady, 1880		----- <u>Loxococoncha australis</u> Brady, 1880	
<u>Loxococoncha</u> cf. <u>L. puri-subrhomboida</u> Edwards, 1944	<u>Loxococoncha sarasotana</u> Benson & Coleman, 1963		
		<u>Loxococoncha</u> aff. <u>L. guttata</u> (= <u>L. ochlockenensis</u> Puri, 1960)	
	* <u>Loxocorniculum postdorsoalatum</u> (Puri, 1960)	<u>Loxococoncha postdorsoalatum</u> Puri, 1960	
<u>Luvula</u> cf. <u>L. palmerae</u> Coryell & Fields, 1937			
		<u>Microcythere</u> n. sp. 2 = (<u>Megacythere robusta</u> Puri, 1960)	
	<u>Paracypris ? sablensis</u> Benson & Coleman, 1963		
	<u>Pellucistoma magniventra</u> Edwards, 1944		
<u>Pellucistoma</u> aff. <u>P. howei</u> Coryell & Fields, 1937			
<u>Perissocytheridea brachyforma</u> Swain, 1955			
	<u>Puriana rugipunctata</u> (Ulrich & Bassler, 1904)	----- <u>Puriana rugipunctata</u> (Ulrich & Bassler, 1904)	
<u>Puriana</u> sp.			<u>Puriana</u> n. sp. 1 = <u>P. floridana</u> Puri, 1960

* Taxonomic name consistent with current usage.

TABLE 6. COMPARISON OF PHYSICAL CHARACTERISTICS OF OPEN LAGOONAL OSTRACOD SAMPLING AREAS.

<u>Environmental Unit</u>	<u>Depth (in ft.)</u>	<u>Salinity (parts per thousand)</u>	<u>Temperature (Centigrade)</u>	<u>Bottom Sediments</u>
Open Lagoonal, Curtis, 1960 Miss. R. delta area	0-18	18.2-32.5	avg. 22 avg. range 21	silty clay to sandy silt and 'marginal deposits' (sands, silts, clays)
Lower bay sub-facies, Swain, 1955 San Antonio Bay	avg. 5.5	29.8-37.9	-----	gyttja-silt-sand, shell marl sand, silt, clay
Bay biofacies, Puri & Hulings, 1957 Alligator Harbor area	less than 10	range 28-34	range 10-30	sand to sandy mud

TABLE 7. COMPARISON OF OSTRACOD SPECIES REPORTED AS DIAGNOSTIC FOR OPEN LAGOONAL ENVIRONMENTS (See table 6).

<u>Curtis (1960) IIC (Open lagoonal)</u>	<u>Swain (1955) (Lower bay)</u>	<u>Puri & Hulings (1957) (Alligator Harbor)</u>
<u>Actinocythereis exanthemata</u> (Ulrich & Bassler, 1904)	<u>Actinocythereis aff. A. exanthemata</u> (Ulrich & Bassler, 1904) <u>Campylocythere concinnoidea</u> Swain, 1955	
<u>Cytherura forulata</u> Edwards, 1944	<u>Cytherura costata</u> Muller, 1894 <u>Cytherura gibba</u> Muller, 1894	<u>Cytherura forulata</u> Edwards, 1944 <u>Cytherura wardensis</u> Howe & Brown, 1935 <u>Cytherura johnsoni</u> Mincher, 1941 <u>Pontocythere n. sp. 1</u> = <u>Cushmanidea sulcata</u> Puri, 1960 <u>Pontocythere n. sp. 2</u> = <u>Cushmanidea elongata</u> (Brady, 1868) <u>Cyprideis n. sp. 1</u> = <u>C. floridana</u> of Puri
<u>Haplocytheridea cf. H. walt-onensis</u> (Stephenson) * <u>H. setipunctata</u> Brady <u>Hemicythere cf. H. cymba</u> (Brady) --- * <u>Aurila conradi floridana</u> Benson & Coleman, 1963	<u>Haplocytheridea bassleri</u> (Stephenson, 1938) <u>Hemicythere conradi</u> Howe & McGuirt, 1935 <u>Hemicytherideis sp.</u>	
<u>Leptocythere bacescoi</u> (Rome) <u>Leptocythere cf. L. porcellanea</u> (Brady) <u>Loxococoncha subrhomboidea</u> Brady	<u>Loxococoncha metagordensis</u> Swain, 1955	<u>Microcythere n. sp. 2</u> = <u>Megacythere robusta</u> Puri, 1960
<u>Microcythere johnsoni</u> Mincher, 1941 * <u>Megacythere johnsoni</u>	<u>Microcythere johnsoni</u> Mincher, 1941 <u>Paracytheridea vandenboldi</u> Puri, 1953	
<u>Perissocytheridea brachyforma</u> Swain, 1955	<u>Perissocytheridea brachyforma excavata</u> Swain, 1955	<u>Puriana rugipunctata</u> (Ulrich & Bassler, 1904) <u>Puriana n. sp. 1</u> = <u>P. floridana</u> Puri, 1960

*Taxonomic name consistent with current usage.

TABLE 8. COMPARISON OF PHYSICAL CHARACTERISTICS OF ESTUARINE OSTRACOD SAMPLING AREAS.

<u>Environmental Unit</u>	<u>Depth</u> (in ft.)	<u>Salinity</u> (parts per thousand)	<u>Temperature</u> (Centigrade)	<u>Bottom Sediments</u>
Midbay subfacies, Swain, 1955 San Antonio Bay	avg. 3	2-28.9	-----	peat-clay, gyttja-clay, silt, sand
Marginal subfacies, Swain, 1955 San Antonio Bay	avg. 5	27.1-36.1	-----	sand, silt, clay
Estuary, Darby, 1964 Sapelo Island area	0-30	1.8-29.2	avg. 7.7 Dec. avg. 31 July	clay, silt with 4.5% organic matter

- | | | |
|----------------------------|--|----------------------------|
| 1. Inner neritic biofacies | 1. (depth range 23-47 feet and may extend into shallower water). | 2. Bay biofacies |
| 2. Inner neritic biofacies | 2. (depth range 47-60 feet). | a. Ochlochonee Bay |
| 3. Inner neritic biofacies | 3. (depth range 60-65 feet). | b. Alligator Harbor |
| | | 3. Inner neritic biofacies |

The three inner neritic biofacies units are compared directly to the nearshore subfacies (IIa) of Curtis (1960).

The Alligator Harbor area sampled by Puri & Hulings is more complex environmentally than the Panama City area and the following biofacies units were designated (1957):

1. River biofacies

The River biofacies needs little explanation. It is strongly influenced by the influx of fresh water. The ostracod assemblage has strong fresh-water affinities and is compared to the Interdistributary subfacies (IIc) of Curtis (1960). The two bays included in the Bay biofacies are described by Puri & Hulings as a "neutral estuary," but are here considered separately. Ochlochonee Bay (see text-fig. 7) appears to be a typical estuary strongly influenced by fresh-water rivers entering at the upper end, but since only two sampling stations were used, both near-shore and one near the mouth, the Ochlochonee Bay assemblages are not considered herein. On the other hand,

TABLE 9. COMPARISON OF OSTRACOD SPECIES REPORTED AS DIAGNOSTIC OF ESTUARINE ENVIRONMENTS (See table 8).

<u>Swain (1955)</u> Estuarine environment	<u>Darby (1964)</u> Estuarine environment
<u>Cyprideis littoralis</u> Brady -----	* <u>Cyprideis floridana</u> Howe & Hough, 1935
<u>Cyprideis torosa</u> (Jones) (<u>C. swaini</u> n. sp.)	
<u>Cyprideis locketti</u> (Stephenson)	
<u>Cytherura elongata</u> Edwards, 1944 --	* <u>Semicytherura elongata</u> (Edwards, 1944)
<u>Cytherura forulata</u> Edwards, 1944	
<u>Cytherura johnsoni</u> Mincher, 1941	
<u>Cytheromorpha curta</u> Edwards, 1944 --	<u>Cytheromorpha curta</u> Edwards, 1944
	<u>Cytheromorpha warneri</u> Howe & Spurgeon, 1935
<u>Leptocythere paracastanea</u> Swain, 1955 --	<u>Leptocythere paracastanea</u> Swain, 1955
<u>Limnocythere sanctipatricii</u> Brady & Robertson, 1869	
	<u>Macrocypris sapeloensis</u> Darby, 1964
<u>Monoceratina</u> ? sp.	
<u>Paracytheridea troglodyta</u> Swain, 1955	
<u>Paradoxostoma atrum</u> Müller, 1894	
<u>Perissocytheridea brachyforma</u> Swain, 1955	

*Taxonomic name consistent with current usage.

TABLE 10. COMPARISON OF PHYSICAL CHARACTERISTICS OF RIVER OSTRACOD SAMPLING AREAS.

<u>Environmental Unit</u>	<u>Depth</u> (in ft.)	<u>Salinity</u> (parts per thousand)	<u>Temperature</u> (Centigrade)	<u>Bottom Sediments</u>
Interdistributary sub- facies, Curtis, 1960 Miss. R. delta area	less than 6	0-28.9	avg. 20 avg. range 25	sandy & clayey silts of delta front deposits
River & Prodelta sub- facies, Swain, 1955 San Antonio Bay	avg. 2.5	2-12.7	-----	peat-clay, clay silt, very fine sand
River biofacies, Puri & Hulings, 1957 Alligator Harbor	----	----	-----	-----

Alligator Harbor receives little fresh water directly and is compared to the Open lagoonal subfacies (IIc) of Curtis (1960). The Inner neritic biofacies unit is represented by five samples taken at a maximum depth of approximately 12 feet. It is equated with the Nearshore subfacies (IIa) of Curtis (1960). Only 10 sampling stations are indicated on Figure 9 (Puri & Hulings, 1957) for the entire Alligator Harbor area and most of these are located very close to the shore; the central portions of the bays are essentially unsampled.

Unlike those previously considered, the study of Benson & Coleman (1963) was made exclusively offshore in open gulf environments. The area (see text-fig. 1) is situated between the Alligator Harbor and Florida Bay areas studied by Puri & Hulings. The depths sampled were between 19 and 239 feet. Benson & Coleman (1963, p. 12) state, "Even with a limited number of widely separated localities a distribution pattern of ostracods based primarily on depth of water is indicated." As would be expected there is no abrupt change of species assemblage at any one depth, but from Figure 3 (Benson & Coleman, 1963, p. 11) there does appear to be a transition from one assemblage to another at about the depth of 70 feet. Benson & Coleman have approached the grouping problem from the concept of an organic community as described above. That is, they have not previously set up environmental limits within which the species are considered,

but rather grouped the species on the basis of their affinities to one another. The species which occur predominantly in water of less than about 70 feet are compared to the Nearshore subfacies (IIa) and those occurring in depths of greater than 70 feet to the Offshore biofacies (I) of Curtis (1960).

Physical properties of the environmental units from which the ostracod assemblages are compared in tables 2, 4, 6, 8, 10. The facies have been chosen as being comparable, particularly with regard to salinity and depth. Admittedly, many other physical parameters affect the environment of an organism, but since these represent the most available data from the reports considered, they have been chosen as the controlling factors. Species considered diagnostic by the authors referred to for the particular environments are compared in tables 3, 5, 7, 9, 11. Those species appearing opposite one another in the tables are considered synonymous, either by the latest references in the literature or in some cases by the present author. The taxonomic names listed are those used by the author at the head of the column. The taxonomic name which is considered consistent with current usage is indicated by an asterisk.

It is immediately apparent that only a few species that have been reported by more than one author occur consistently within a particular environmental unit. The

TABLE 11. COMPARISON OF OSTRACOD SPECIES REPORTED AS DIAGNOSTIC OF RIVER ENVIRONMENTS (See table 10).

<u>Curtis (1960)</u>	<u>Swain (1955)</u>	<u>Puri & Hulings (1957)</u>
Interdistributary IID	River & prodelta	River- Alligator Harbor
<u>Candona marchica</u> Hartwig, 1899	<u>Candona marchica</u> Hartwig, 1899	<u>Candona</u>
<u>Candona</u> spp.	<u>Candona lactea</u> Baird, 1850 <u>Candona caudata</u> Kaufmann, 1900	<u>Darwinula</u>
<u>Paracytheridea trogodyta</u> Swain, 1955	<u>Darwinula aurea</u> (Brady & Robertson, 1870)	
<u>Perissocytheridea matsoni</u> (Stephenson)	<u>Potamocypris smargdina</u> (Varva, 1891)	
	<u>Physocypris pustulosa</u> (Sharpe, 1897)	

TABLE 12. DISTRIBUTION OF SELECTED SPECIES. Top figure refers to absolute numbers of specimens, lower figure to percent of specimens of a species in the sample.

Sample No.	2-50	6-45	6-52	5-42	8-45	3-47	10-26	13-30	13-32	13-26	7-25	7-42	4-23	4-27	4-29	4-30	4-34	12-5	12-26	12-44	5-36	8-20	8-28	Total (No.)	Total (%)
1. <u>Actinocythereis exanthemata</u>	3	2	-	-	-	-	-	-	-	-	-	-	-	-	-	-	-	-	-	-	-	-	-	5	0.1
<u>gemillionensis</u>	1.5	2.8	-	-	-	-	-	-	-	-	-	-	-	-	-	-	-	-	-	-	-	-	-	-	-
2. <u>Aurila conradi</u>	15	2	2	-	3	-	-	-	-	-	-	-	-	-	-	-	-	-	-	-	-	-	-	22	0.6
<u>conradi</u>	7.8	2.8	6.4	-	1.6	-	-	-	-	-	-	-	-	-	-	-	-	-	-	-	-	-	-	-	-
3. <u>Cytheropteron talquinensis</u>	14	3	2	-	6	-	-	-	-	-	-	-	1	-	-	-	-	-	-	-	-	-	-	26	0.7
<u>talquinensis</u>	7.2	4.2	6.4	-	3.2	-	-	-	-	-	-	-	2.5	-	-	-	-	-	-	-	-	-	-	-	-
4. <u>Cytheropteron yorktownensis</u>	14	2	5	-	-	-	-	-	-	-	-	-	-	-	-	-	-	-	-	-	-	-	-	21	0.5
<u>yorktownensis</u>	7.2	2.8	16.1	-	-	-	-	-	-	-	-	-	-	-	-	-	-	-	-	-	-	-	-	-	-
5. <u>Echinocythereis garretti</u>	2	2	-	1	-	-	-	-	-	-	-	-	-	-	-	-	-	-	-	-	-	-	-	5	0.1
<u>garretti</u>	1.0	2.8	-	3.1	-	-	-	-	-	-	-	-	-	-	-	-	-	-	-	-	-	-	-	-	-
6. <u>Loxococoncha australis</u>	7	5	1	1	-	-	4	-	1	-	2	-	-	-	-	-	-	1	-	-	-	-	-	22	0.6
<u>australis</u>	3.6	7.1	3.2	3.1	-	-	0.4	-	0.3	-	0.2	-	-	-	-	-	-	12.5	-	-	-	-	-	-	-
7. <u>Murrayina martini</u>	46	22	9	7	3	-	-	-	-	-	-	-	-	-	-	-	-	-	-	-	-	-	-	87	2.4
<u>martini</u>	23.9	31.4	29.0	21.8	1.6	-	-	-	-	-	-	-	-	-	-	-	-	-	-	-	-	-	-	-	-
8. <u>Paracytheridea shattucki</u>	36	8	1	3	6	-	3	-	-	-	-	-	-	-	-	-	-	-	-	-	-	-	-	57	1.5
<u>shattucki</u>	18.7	11.4	3.2	9.3	3.2	-	0.3	-	-	-	-	-	-	-	-	-	-	-	-	-	-	-	-	-	-
9. <u>Puriana rugipunctata</u>	41	22	-	3	-	-	-	-	-	-	-	-	-	-	-	-	-	-	-	-	-	1	-	66	1.8
<u>rugipunctata</u>	21.3	31.4	-	9.3	-	-	-	-	-	-	-	-	-	-	-	-	-	-	-	-	-	20.0	-	-	-
10. <u>Triginglymus whitei</u>	14	1	-	2	1	4	-	-	-	-	-	-	-	-	-	-	-	-	-	-	-	-	-	22	0.6
<u>whitei</u>	7.2	1.4	-	6.2	0.5	7.0	-	-	-	-	-	-	-	-	-	-	-	-	-	-	-	-	-	-	-
11. <u>Acuticythereis giganteus</u>	-	-	-	2	-	-	46	-	15	5	10	-	2	7	13	-	-	-	-	-	-	-	-	100	2.7
<u>giganteus</u>	-	-	-	6.2	-	-	5.0	-	5.1	83.3	1.4	-	5.0	1.3	3.0	-	-	-	-	-	-	-	-	-	-
12. <u>Acuticythereis laevisima</u>	-	-	3	17	5	26	-	11	-	5	4	3	18	7	-	1	-	-	-	-	-	-	-	100	2.7
<u>laevisima</u>	-	-	9.3	9.3	8.7	2.8	-	3.7	-	0.7	8.8	7.5	3.3	1.6	-	4.0	-	-	-	-	-	-	-	-	-
13. <u>Aurila conradi floridana</u>	-	-	-	3	3	53	-	6	-	23	3	4	9	3	-	-	-	4	-	-	-	-	-	111	3.0
<u>floridana</u>	-	-	-	1.6	5.2	5.8	-	2.0	-	3.3	6.6	10.0	1.6	0.7	-	-	-	14.8	-	-	-	-	-	-	-
14. <u>Cushmanidea echolsae</u>	-	-	3	37	17	328	3	126	-	255	-	19	88	87	4	-	2	14	-	2	-	-	-	985	27.3
<u>echolsae</u>	-	-	9.3	20.3	29.8	36.1	60.0	43.4	-	37.4	-	47.5	16.4	20.4	13.3	-	25.0	51.8	-	40.0	-	-	-	-	-
15. <u>Cushmanidea tuberculata</u>	-	-	-	5	-	36	-	3	-	21	1	-	27	27	1	2	-	-	-	-	-	-	-	123	3.4
<u>tuberculata</u>	-	-	-	2.7	-	3.9	-	1.0	-	3.0	2.3	-	5.0	6.3	3.3	8.0	-	-	-	-	-	-	-	-	-
16. <u>Haplocytheridea bradeyi</u>	-	-	2	68	12	148	2	38	1	46	36	-	81	97	4	-	2	-	-	2	-	-	-	537	14.8
<u>bradeyi</u>	-	-	6.2	37.3	21.0	16.3	40.0	13.1	16.7	6.7	80.0	-	15.1	22.7	13.3	-	7.4	-	-	7.4	-	-	-	-	-
17. <u>Cyprideis floridana</u>	-	-	-	2	-	12	-	3	-	5	-	-	67	34	2	13	-	-	-	-	-	-	-	138	3.8
<u>floridana</u>	-	-	-	1.0	-	1.3	-	1.0	-	0.7	-	-	12.5	7.9	6.6	52.0	-	-	-	-	-	-	-	-	-
18. <u>Cyprideis swaini</u>	-	-	-	-	-	41	-	8	-	51	-	-	133	109	7	6	2	1	-	1	3	-	-	362	10.0
<u>swaini</u>	-	-	-	-	-	4.5	-	2.7	-	7.4	-	-	24.8	25.5	23.3	24.0	25.0	3.7	-	20.0	75.0	-	-	-	-
19. <u>Cytheromorpha curta</u>	-	-	-	-	-	13	-	-	-	25	-	-	8	9	-	3	1	-	5	-	1	-	-	65	1.8
<u>curta</u>	-	-	-	-	-	1.4	-	-	-	3.6	-	-	1.4	2.1	-	12.0	12.5	-	71.4	-	25.0	-	-	-	-
20. <u>Cytherura forulata</u>	-	-	-	-	-	-	-	10	-	74	-	6	43	3	3	-	1	2	-	1	-	-	-	143	3.9
<u>forulata</u>	-	-	-	-	-	-	-	3.5	-	10.8	-	15.0	8.0	0.7	10.0	-	12.5	7.4	-	20.0	-	-	-	-	-
21. <u>Cytherura vestibulata</u>	-	11	-	-	-	18	-	2	-	20	-	1	3	-	-	-	-	1	-	-	-	-	-	56	1.5
<u>vestibulata</u>	-	35.4	-	-	-	1.9	-	0.6	-	2.9	-	2.5	0.7	-	-	-	-	3.7	-	-	-	-	-	-	-
22. <u>Loxococoncha reticularis</u>	-	-	-	-	-	12	-	-	-	7	-	-	1	-	-	-	-	-	-	-	-	-	-	20	0.5
<u>reticularis</u>	-	-	-	-	-	1.3	-	-	-	1.0	-	-	0.1	-	-	-	-	-	-	-	-	-	-	-	-
23. <u>Megacythere johnsoni</u>	-	-	1	-	2	12	-	5	-	13	-	1	15	14	2	-	-	-	-	-	-	-	-	65	1.8
<u>johnsoni</u>	-	-	3.1	-	3.5	1.3	-	1.7	-	1.9	-	2.5	2.8	3.2	6.6	-	-	-	-	-	-	-	-	-	-
24. <u>Paracytheridea vandenboldi</u>	-	1	-	7	5	76	-	15	-	58	1	1	15	4	-	-	-	-	-	-	-	-	-	184	5.1
<u>vandenboldi</u>	-	1.4	-	3.8	8.7	8.3	-	5.1	-	8.5	2.2	2.5	2.8	0.9	-	-	-	-	-	-	-	-	100	-	-
25. <u>Paradoxostoma (?) delicata</u>	-	-	1	-	-	10	-	12	-	2	-	-	2	3	-	-	1	-	-	-	-	-	-	31	0.8
<u>delicata</u>	-	-	3.1	-	-	1.1	-	4.2	-	0.2	-	-	0.4	10.0	-	-	3.7	-	-	-	-	-	-	-	-
26. <u>Puriana mesacostalis</u>	-	-	-	23	6	8	-	7	-	5	-	-	2	-	-	-	-	-	-	-	-	-	-	52	1.4
<u>mesacostalis</u>	-	-	-	12.6	10.5	0.8	-	2.4	-	0.7	-	-	0.3	-	-	-	-	-	-	-	-	-	-	-	-
27. <u>Triginglymus sapeloensis</u>	-	-	-	-	-	35	-	26	-	54	-	2	13	9	1	-	1	-	1	-	-	-	-	142	3.9
<u>sapeloensis</u>	-	-	-	-	-	3.8	-	8.9	-	7.9	-	5.0	2.4	2.1	3.3	-	12.5	-	14.2	-	-	-	-	-	-
28. <u>Kangarina howei</u>	-	-	3	-	1	1	-	2	-	1	-	-	-	-	-	-	-	2	-	-	-	-	-	10	0.2
<u>howei</u>	-	-	9.3	-	1.7	0.1	-	0.6	-	0.1	-	-	-	-	-	-	-	7.4	-	-	-	-	-	-	-
29. <u>Campylocythere laeva</u>	-	-	-	1	-	4	-	-	-	-	-	-	1	2	3	-	-	-	-	-	-	-	-	11	0.2
<u>laeva</u>	-	-	0.5	-	0.4	-	-	-	-	-	-	-	0.1	0.4	10.0	-	-	-	-	-	-	-	-	-	-
30. <u>Acuticythereis multipunctata</u>	-	-	-	-	-	15	-	-	-	3	-	-	7	1	-	-	-	-	-	-	-	-	-	26	0.7
<u>multipunctata</u>	-	-	-	-	-	1.6	-	-	-	0.4	-	-	1.3	0.2	-	-	-	-	-	-	-	-	-	-	-
31. <u>Acuticythereis temilecreekensis</u>	-	-	-	-	2	6	-	-	-	1	-	-	2	-	-	-	-	-	-	-	-	-	-	11	0.2
<u>temilecreekensis</u>	-	-	-	-	3.5	0.6	-	-	-	0.1	-	-	0.4	-	-	-	-	-</							

TABLE 13. GROSS LITHOLOGIC DESCRIPTION OF THE SEDIMENT CORES.

Core # 2				
0-12.5	Fine-grained, light tan to white, well-sorted sand.		35-40	Fine- to coarse-grained sand with some green mud; shells present.
12.5-17.5	Fine-grained, light tan, angular sand; small shells & shell fragments.		40-42	Fine-grained gray sand with some coarse grains.
17.5-30	Fine-grained, tan to brown, angular sand with abundant gray, silty mud; shells abundant.	Core # 8		
30-42.5	Fine- to coarse-grained, tan to brown sand with some gray mud; shells abundant.	0-9		Fine-grained, well-sorted, light gray sand.
42.5-55	Medium- to coarse-grained, light tan sand with some gray, silty mud; shells and shell fragments.	9-20		Gray marsh mud, sandy toward base.
		20-25		Fine-grained, well-sorted, tan sand with some mud layers; some shell fragments.
		25-45		Fine- to coarse-grained, poorly-sorted, gray sand with some mud; shells present sometimes in layers.
Core # 3		45-49		Fine-grained, gray, muddy, poorly-sorted sand.
0-5	Fine-grained, yellow sand.			
5-11	Marsh mud.	Core # 9		
11-25	Fine-grained, tan sand with stringers & blobs of clay & fresh mica.	0-2		Fine-grained, white & gray sand.
25-29	Fine-grained, sand with mud layers; broken shells.	2-4		Fine-grained, dark brown & black sand.
29-30	Clay & silt.	4-10		Fine-grained, well-sorted, yellow-brown sand; brown, oxidized shell layer in lower part.
30-35	Fine-grained silty sand with mud stringers & coarse sand with shell layers.	10-20		Fine-grained, well-sorted, yellow-brown sand with some coarse particles.
35-41	Alternating fine-grained silty sand with mud stringers & coarse sand with shell layers.	20-25		Fine-grained, light yellow to tan sand with some clay layers.
41-42	Fine-grained, well-sorted, gray sand.	25-43		Fine-grained, well-sorted, gray sand with gray sandy mud stringers.
42-46	Fine-grained sand with some coarse grains; shells present.			
46-52	Coarse-grained, poorly-sorted, gray sand with silt matrix.	Core # 10		
Core # 4		0-5.5		Fine-grained, light gray sand with mud matrix.
0-17.5	Fine-grained to very fine-grained, light gray sand with some mud & shell layers.	5.5-10.5		Dark gray marsh mud.
17.5-24.5	Fine-grained, gray sand with some mud matrix; abundant marine shells.	10.5-25		Fine-grained, light gray to brown sand with clay stringers.
24.5-29.5	Fine- to coarse-grained, light gray sand with silt & mud matrix; abundant marine shells.	25-30		Fine-grained, gray-green muddy sand; shells present.
29.5-33	Fine-grained sand with small shells.	30-45		Fine- to coarse-grained, poorly-sorted, gray sand; shells abundant.
33-47	Fine-grained gray clay & sand.	45-47		Fine-grained sand with mud layers; shell layers present.
47-55	Fine-grained sand with clay matrix & shell layers.	Core # 11		
Core # 5		0-5		Fine-grained, light gray to tan sand.
0-7	Brown & gray marsh mud.	5-10		Marsh mud.
7-17	Fine-grained, well-sorted, tan & light brown & yellow sand.	10-48		Alternating fine-grained to medium-grained sand & layers of mud less than 1 inch thick; sand size shells from 32-38 feet, coarse shell fragments from 32-45 feet.
17-40	Fine-grained, gray sand with mud layers.			
40-42	Fine- to coarse-grained, poorly-sorted, clayey sand with mica & pebbles to $\frac{1}{2}$ inch in diameter.	Core # 12		
Core # 6		0-5		Fine-grained, light tan sand; shells present.
0-18	Marsh mud.	5-27.5		Fine-grained, gray, well-sorted sand with mica.
18-27.5	Very fine-grained, gray, silty, clayey sand.	27.5-30		Fine-grained, gray sand alternating with layers of mud.
27.5-30	Fine- to coarse-grained, poorly sorted, silty, clayey sand; numerous broken shells.	30-42		Marsh mud.
30-42	Fine- to medium-grained, poorly-sorted sand; some shell fragments.	42-47.5		Coarse-grained, poorly-sorted sand with mud in $\frac{1}{2}$ inch layers; shells abundant.
		47.5-62.5		Coarse-grained, poorly-sorted, gray sand with little mud & no shells.
42-52	Fine- to coarse-grained, gray sand with mud matrix; pebbles to $\frac{1}{2}$ inch in diameter, abundant shells.	Core # 13		
Core # 7		0-10		Fine-grained, light gray sand with minor clay stringers; shells present.
0-17.5	Fine- to medium-grained, light brown to brown sand with mud matrix.	10-30		Fine-grained, light gray sand with thin clay layers; abundant small shells & shell fragments.
17.5-20	Fine-grained, well-sorted, gray sand with abundant mica.	30-35		Fine- to coarse-grained, light gray sand; shells present.
20-22	Alternating, fine-grained, gray sand & mud.	35-55		Fine- to coarse-grained, gray sand with mud matrix; few shells.
22-35	Fine-grained, gray sand with mud layers; abundant shells.			

TABLE 14. LISTING OF SAMPLES SEARCHED FOR MICROFAUNA. First digit is core number designation; second number is depth in feet below surface of sample. O - s - other shell material; C - coarse sand present.

<u>Core 2</u>	<u>Core 3</u>	<u>Core 4</u>	<u>Core 5</u>	<u>Core 6</u>
2-52 O S C	3-10	4-3	5-1	6-7
	3-15	4-12 S	5-5	6-16
	3-26	4-18	5-15	6-22
	3-26 S	4-23 O S	5-21	6-31 S C
	3-36	4-29 O S	5-24	6-37 S C
	3-47 O	4-30 O S	5-36	6-45 O S C
	3-52 S C	4-34 O	5-42 O S C	6-52 O S C
		4-46 SS		
		4-56 C		
<u>Core 7</u>	<u>Core 8</u>	<u>Core 9</u>	<u>Core 10</u>	<u>Core 11</u>
7-6	8-4	9-2	10-10	11-3
7-12	8-10	9-4	10-13	11-10
7-20	8-20 O S	9-21	10-21	11-15
7-24 O S	8-25 S		10-26 O S	
7-35 S	8-28 O S		10-37 S	
7-42 O S C	8-36 S		10-47	
	8-46 S		10-50	

following species are known only from a single environment as characterized in the tables.

Offshore (Tables 2, 3; + 70 feet)

Pterygocythereis americana (Ulrich & Bassler, 1904)

Echinocythereis garretti (Howe & McGuirt, 1935)

Inner neritic (Tables 4, 5; 0-7 feet)

Acuticythereis laevisima (Edwards, 1944)

Haplocytheridea bradeyi

Protocytheretta daniana (Brady, 1869)

Estuarine (Tables 8, 9)

Cyprideis floridana

Cytheromorpha curta

Leptocythere paracastanea

Open lagoon (Tables 6, 7)

Actinocythereis exanthemata (Ulrich & Bassler, 1904)

Megacythere johnsoni (Mincher, 1941)

River (Tables 10, 11)

Candona marchica

Darwinula sp.

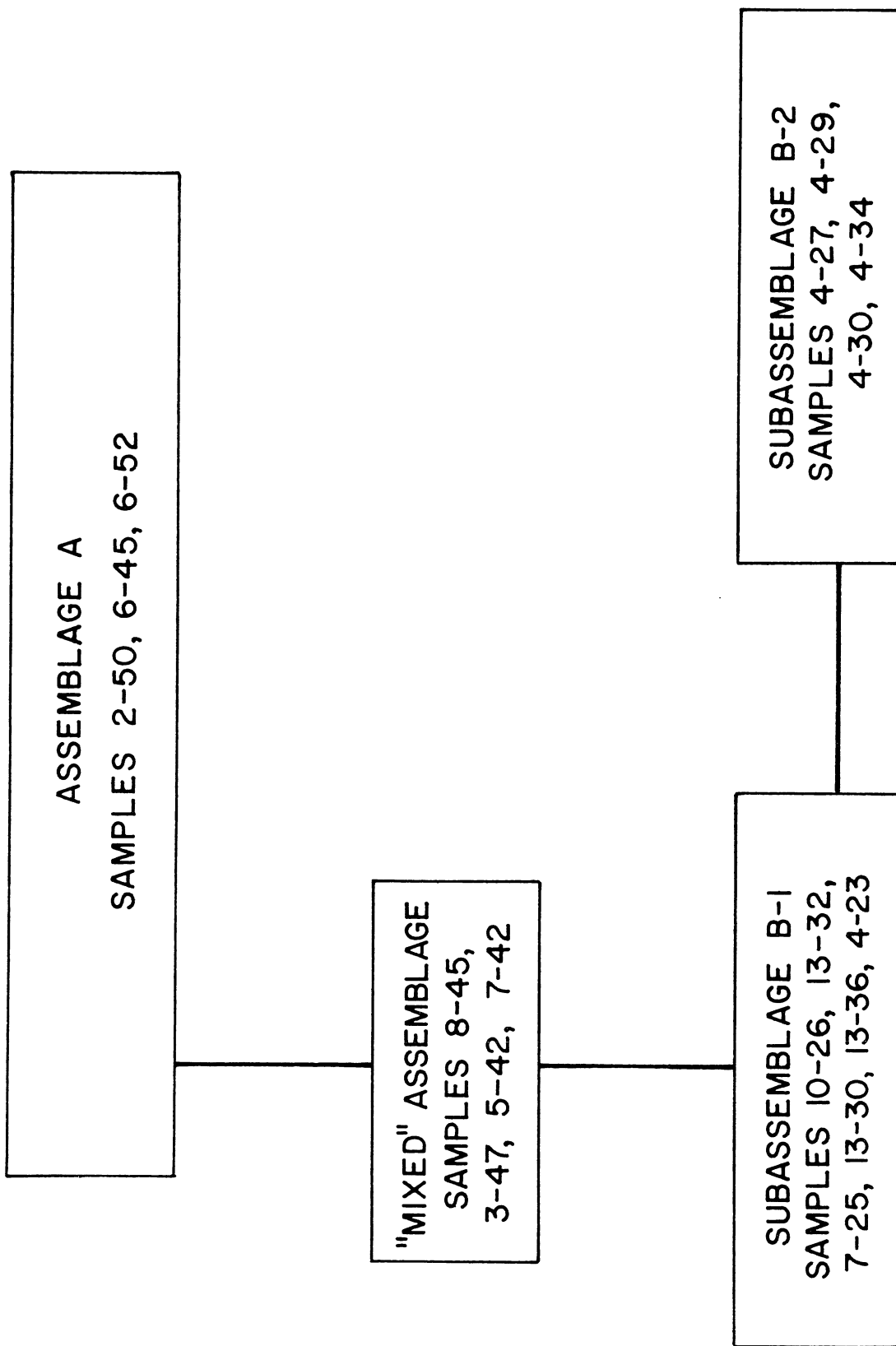

TEXT-FIG. 8. Diagram of relationships of ostracod assemblages. Samples shown represent those containing enough forms for a reliable evaluation.

PALEOECOLOGY

Location of the shallow core holes which were drilled into the sediments of Sapelo Island is shown in text-fig. 2. The samples chosen for sediment analysis were split into subsamples, part of which were searched for ostracods. The samples were originally selected at intervals where an apparent change of lithology occurred. Altogether some 56 species of ostracods were identified, photographed, and described. Of these, 31 were chosen as comprising a significant part of the entire ostracod population utilized for the interpretation of the paleoecology. The samples in which ostracods were present and the absolute numbers and percentage of each of the 31 species considered significant are listed in table 12. Single valves and carapaces were each counted as one. Table 13 lists the gross lithologic character of the cores. Table 14 lists those samples searched for ostracods with an indication of whether ostracods were present or absent. Table 1 lists all species of ostracods found and their reported ranges as determined from the literature.

As can be seen from table 12 there are two distinct groupings of samples based upon the presence or absence of particular species. Clearly, species numbered 1 through 10 occur consistently together. The three samples 2-50, 6-45, and 6-52 are composed almost entirely of this group of species. The species in this grouping are designated Assemblage A, and include the following:

Actinocythereis exanthemata gomillionensis
Aurila conradi conradi
Cytheropteron talquinesis
Cytheropteron yorktownensis
Echinocythereis garretti
Loxoconcha australis
Murrayina martini
Paracytheridea shattucki
Puriana rugipunctata
Tringlymus whitei

Samples 5-42 and 8-45 each contain six species from Assemblage A but also contain many species from Assemblage B as characterized below. These two samples are considered mixtures of the two primary assemblages. Six of the ten species in Assemblage A have been reported exclusively from the Upper Miocene and older, while the remaining four have been reported previously from both Recent and the Miocene. In addition, the three "pure" samples are conspicuous in that the carapaces of all species tend to be large and heavily calcified. No young instars are present in those samples and the median grain size is larger than most other samples in which ostracods were present. Although not identified to species, the foraminifera also tend to be larger than was typical of other samples. Some shells are abraded and a few of the carapaces are dark gray to almost black in color. The dark carapaces are particularly worn.

From the evidence outlined, it is considered probable that Assemblage A represents reworked Miocene deposits. Darby & Hoyt (1964, p. 68) have described a fauna dredged from Sapelo Sound which they consider to be Upper Miocene (probably Duplin Marl) (see text-fig. 2). All samples which contain many species of Assemblage A occur below 40 feet in the cores, but even so the Miocene is not as deeply buried here by younger sediments as it is elsewhere. As the situation now exists in the vicinity of Sapelo Island, it is certainly conceivable that "pure" Mio-

cene deposits, such as found in samples 2-50, 6-45, and 6-52, could be and probably are being formed. The strong currents, in this case probably tidal, scour deeply enough to expose Miocene (as they evidently have in Sapelo Sound) would also be adequate to transport selectively and redeposit coarse sediment grains and heavily calcified ostracod carapaces and large foraminifer tests. It is also reasonable that "mixed" assemblages of Miocene and indigenous Pleistocene ostracods were formed. In places where the current was not as strong (samples 5-42 and 8-45) mixing would occur. Into these areas of lower current velocity, some of the Miocene species undoubtedly were transported, but the indigenous fauna lived and was deposited along with them. Based upon living representatives of Assemblage A, the original Miocene depositional environment was probably in depths of approximately 60 feet or more. This is based solely on 5 specimens of Echinocythereis garretti which has been reported by Curtis (1960) and by Benson & Coleman (1963) as being diagnostic of relatively deep water (more than 60 feet). The remainder of the species either has not been reported from the Recent or has been found in too wide a variety of environments to be considered diagnostic.

The second grouping, designated Assemblage B, is assumed to be essentially indigenous to the samples in which they are found. The sediments are finer-grained than those discussed above, many young thinly calcified instars are present, and none of the carapaces show evidence of abrasion. Considering only the presence or absence of species, the remainder of the samples show little difference. The vast majority of specimens occur in five samples: 7-25, 10-26, 13-32, 4-27, and 4-29. Within these samples, almost all of the remaining 21 selected species (see table 12) occur at least once, so that the Assemblage B cannot be subdivided on that basis. However, when the relative number of specimens of particular species is considered, it then becomes possible to subdivide Assemblage B into two paleoecologically meaningful subassemblages. Samples 7-25, 10-26, and 13-32 are designated as subassemblage B-1, while samples 4-27 and 4-29 are designated as subassemblage B-2.

In subassemblage B-1, the larger percentages of Cushmanidea echolsae, Cytherura restibulata, Paracytheridea vandenboldi, and Tringlymus sapeloensis distinguish it from subassemblage B-2. T. sapeloensis is a new species and consequently not helpful as an environmental indicator, although it may be useful in future studies. The remaining three species characterize open lagoon and inner neritic environments (Swain, 1955; Curtis, 1960). Subassemblage B-2 is characterized by larger percentages of Cyprideis floridana and Cyprideis swaini than were found in the samples making up subassemblage B-1. Both of these species have been found by Darby (1964) and by Swain (1955) in an estuarine environment. In addition, there is a small but consistent increase in the percentages of Megacythere johnsoni, Cushmanidea tuberculata, and Haplocytheridea johnsoni in subassemblage B-2. For the seven species used to subdivide Assemblage B, two important factors should be noted. First of all, five of the seven have been reported in Recent sediments; and secondly, in the samples considered, they include all of the most commonly encountered species. The fact that they have been reported from the Recent sediments allows paleoecological interpretations to be based upon the known life environments of the species. Since they include the most

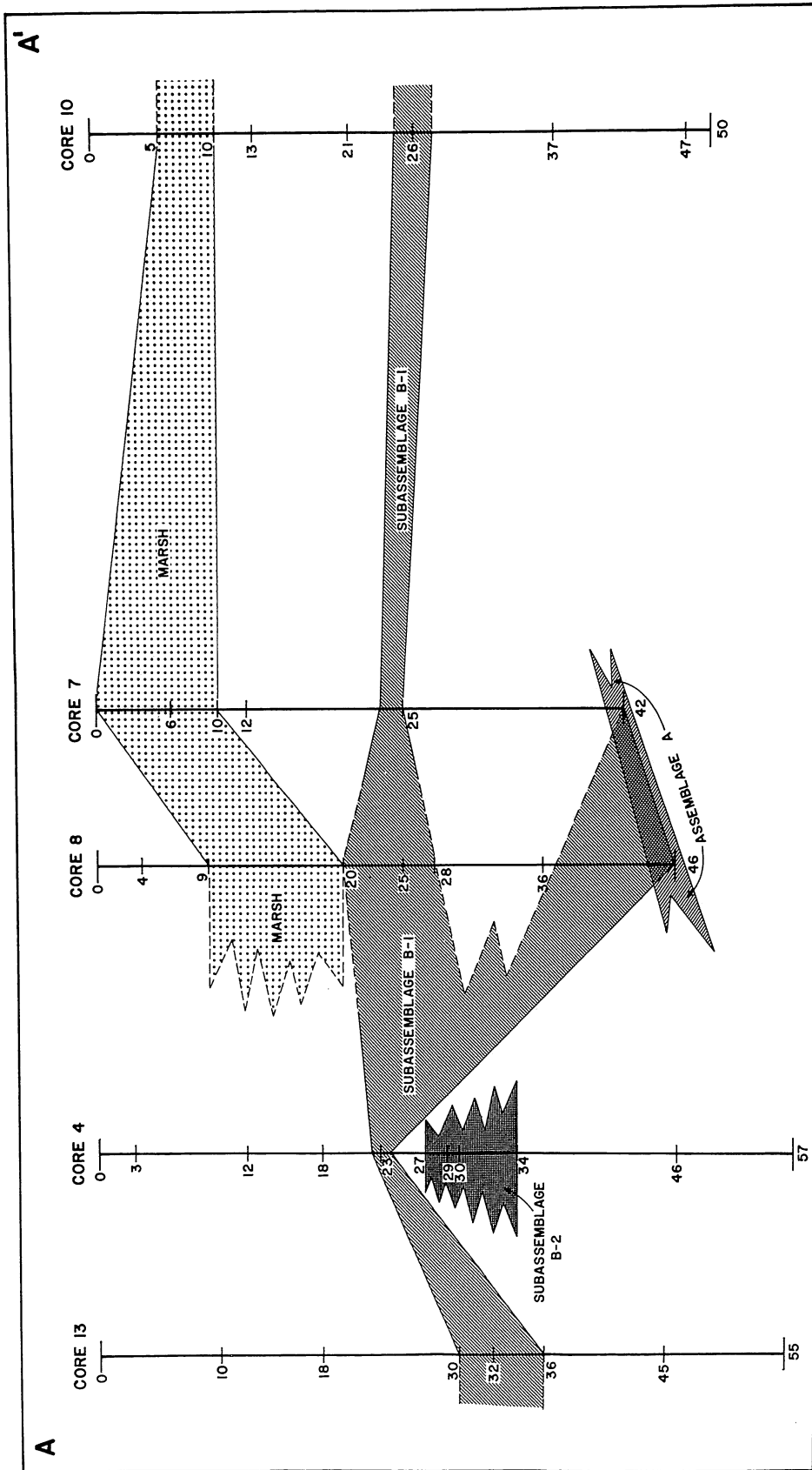

TEXT-FIG. 9. Cross section A-A' of Sapelo Island (text-fig. 2). Zero-foot datum is ground level, which varies approximately 10 to 20 feet above mean sea level. Exact elevations not available.

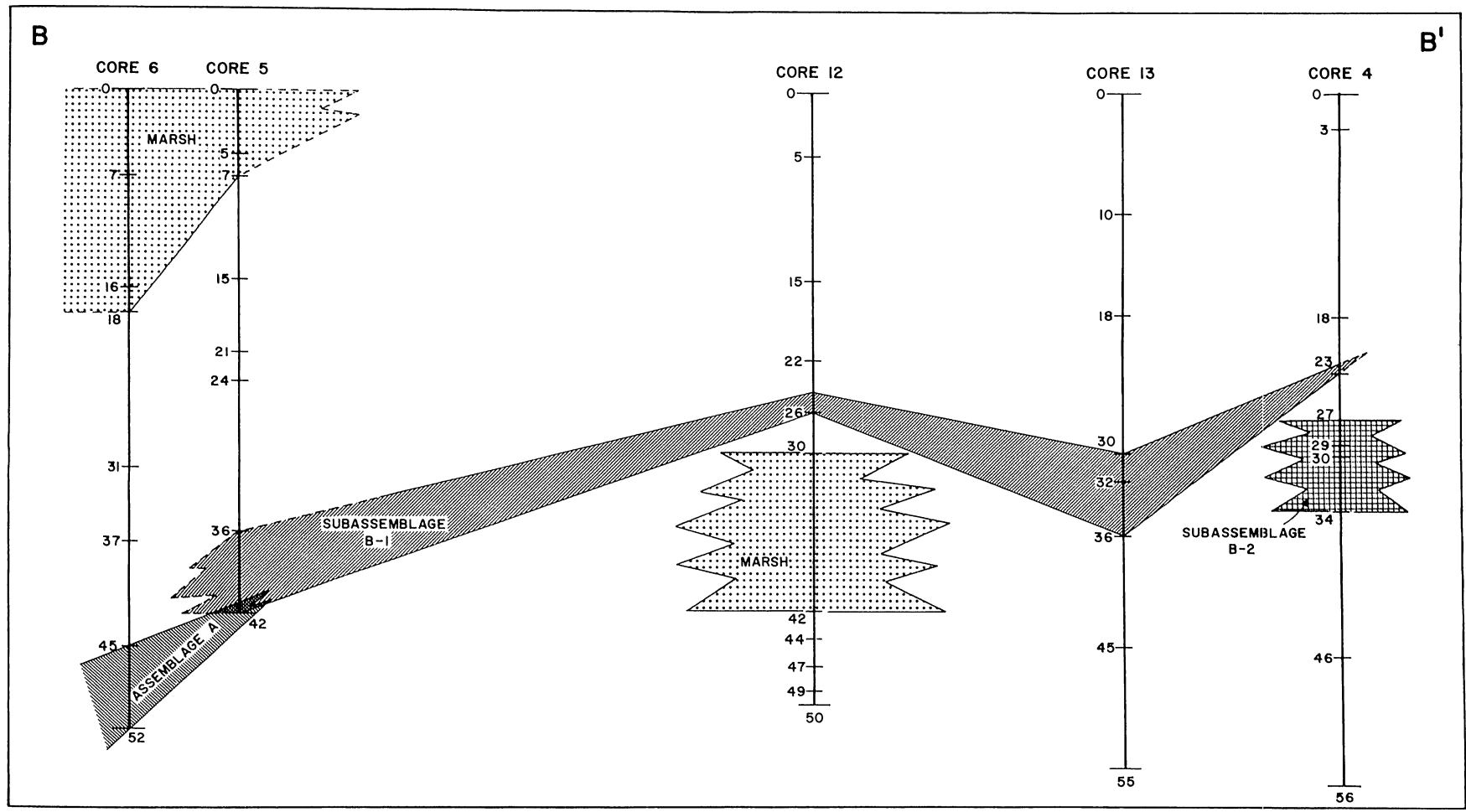

TEXT-FIG. 10. Cross section B-B' of Sapelo Island (text-fig. 2). Zero-foot datum is ground level, which varies approximately 10 to 20 feet above mean sea level. Exact elevations not available.

common species, the chance that they were deposited in near proximity to the environment in which they lived seems very strong.

Of the 21 species which characterize Assemblage B, all those which have been reported from Recent sediments were found in either shallow neritic (less than 60 feet), open lagoonal, or estuarine conditions. On the basis of the work on Recent ecology, this serves to eliminate the outer neritic (greater than 60 feet) and river environments from further consideration. The boundaries between an open lagoon, estuary, or the inner neritic environment are often difficult to determine, and in many areas of the present oceans one is open to another. One would not expect, therefore, to find the assemblage of species in an estuarine environment entirely absent from the inner neritic environment into which the estuary empties.

In fact, Darby (p. 20, 1964) found only 6 living species of ostracods in the estuaries behind Sapelo Island, yet he reports the occurrence of empty carapaces of 50 other species. It is important to consider that he made collections throughout the year which supports his assertion that those 50 species were deposited by current action and are not indigenous to the area sampled. The relative abundance is a good basis for separating indigenous species from those carried in by currents.

First to be considered is the life habitat and probable depositional environment of subassemblage B-2. Two significant species in samples 4-27 and 4-29, *Cyprideis floridana* and *Cyprideis swaini*, are relatively much more abundant than in subassemblage B-1. *C. floridana* was found by both Swain (1955) and Darby (1964) in an estuarine environment. Darby reported that *C. floridana* occurred in the areas where conditions were not as extreme as in the upper regions of the Sapelo Island estuaries and this would seem to be about the same environment in which Swain reported them from upper San Antonio Bay. The depositional environment suggested for subassemblage B-2 is primarily based on these two species along with the relatively fewer specimens of those four species characteristic of subassemblage B-1. The salinity could have varied from 2 to 28 parts per thousand with a possible diurnal range of 10 parts per thousand. The water depth was less than 25 feet.

Subassemblage B-1 is characterized by the greater percentages of four species, three of which have been reported from Recent sediments. *Cytherura vestibulata*, *Paracytheridea vandenboldi*, and *Cushmanidea echolsae* are not restricted to either the inner neritic (tables 4, 5) or the open lagoonal (tables 6, 7) environments. Based on the life habitats of those three species, it is thus impossible to determine whether subassemblage B-1 was deposited in an open lagoon or inner neritic environment. However, the presence of *Cyprideis floridana* and *Cyprideis swaini* would indicate that the salinity was less than normal marine. The depositional environment suggested for subassemblage B-1 is a salinity of 25-34 parts per thousand and water depth of 20 to 60 feet.

There are several other samples which are indistinguishable as far as these two subassemblages are concerned. The "mixed" samples, 5-42, 8-45, and 3-47, are composed of Assemblage A (Miocene components) and subassemblage B-1. If the ten Miocene species are removed their species composition conforms closely to that of subassemblage B-1. Text-fig. 8 shows the relationships believed to exist between the various groupings.

Some radiocarbon dating has been performed by the Exploration Department and the Geochemical Laboratory, Humble Oil and Refining Company, Houston, Texas, on shell material from the cores under consideration. Three of these dates are significant in determining the age of the ostracod assemblages described above. They are as follows:

Core 4, 7-10 ft. = $1,475 \pm 105$ yrs. B. P.
 Core 4, 25 ft. = $3,375 \pm 115$ yrs. B. P.
 Core 12, 43 ft. = $29,925 \pm 2000$ yrs. B. P.

The dating of Core 4 at 25 feet of 3,375 years Before Present indicates that sedimentation took place at an average of one inch per 5.5 years. Based upon the generalized sea level curve of Shepard (1960) for the past 15,000 years that deposition took place during the marine transgression which followed the last glacial climax placed at 18,000 years B. P. (Merrill, et al., 1965, p. 398). Core 4 was drilled near the beach into Recent sands. Both subassemblage B-1 (samples 4-27, 4-29, 4-30, 4-34) and subassemblage B-2 (sample 4-23) were evidently deposited within this last marine transgression. All samples containing these two subassemblages are here considered to have been deposited in the last transgression and would thus be considered post-Wisconsin in age.

Core 12 was dated from a sample of shell material from a depth of 43 feet as $29,925 \pm 2000$ years B. P. Cur-ray (1961, p. 1711) concluded that there was a high stand of sea level at approximately 30,000 years B. P. Based on the dating of Core 12, the Silver Bluff shoreline and the major portion of Sapelo Island formed at about that time. In most of the cores coarse-grained sand with shell material is encountered at about 30 to 49 feet below the present surface of the island (Table 14). Since most of the cores were made at elevations of about 15 feet above sea level, the coarse sand is at about 35 feet below present sea level. The dated sample (12-43) is a coarse-grained sand which evidently forms a part of a fairly uniform blanket beneath the island. These coarse sands contain Assemblage A. Since the coarse sands lie at approximately the same depth in Core 12 as in the other cores they are considered as generally contemporaneous. If this is correct it places the deposition of Assemblage A somewhere within the high stand of sea level postulated by Curry at approximately 30,000 years B. P. This does not, however, alter the suggestion made herein that they are redeposited Miocene forms.

Summary. - Paleoenvironments proposed for portions of the sedimentary deposits which underlie Sapelo Island, Georgia, are based almost entirely upon the comparison of the ostracods found in the Pleistocene sediments to those previously reported from Recent sediments in the Sapelo Island area and the Gulf of Mexico. An evaluation of studies pertaining to Recent ostracod ecology in the Gulf of Mexico has revealed that relatively few species are known to be consistently restricted in their life habitat to such a limited set of physical conditions as to be useful as paleoecological indicators. The fact that relatively few known species are ecologically restricted is probably due more to the lack of ecological studies than to the nature of the organisms. For the most part, ecological research has not been based upon living specimens, nor has the sampling been adequate for definitive results.

Nevertheless, comparison of several studies has revealed a few species that have been reported in more than one geographical area from similar environments. Some of these occur in the Sapelo Island Pleistocene sedi-

ments and one can utilize them for making paleoenvironmental interpretations. Using presence or absence of a species as the major criterion, two primary groupings were distinguished which have been called Assemblage A and Assemblage B. Assemblage A is considered to be a reworked Miocene fauna based upon apparent affinities of the species to known Miocene faunas from the eastern United States coupled with the physical character of the sediments in which they occur. Using relative percentages of specimens of particular species in a sample, Assemblage B was subdivided into subassemblages B-1 and B-2. The consistently greater percentages of *Cyprideis floridana* Howe & Hough, 1935, and *Cyprideis swaini*, n. sp., indicate that subassemblage B-2 is an estuarine fauna and was probably deposited in that type of an environment. The presence of *Cushmanidea echolsae* Malkin, 1953, *Cytherura vestibulata*, n. sp., and *Paracytheridea vandenboldi* Puri, 1953, in relatively greater numbers suggest that subassemblage B-1 could have been deposited in an open lagoonal or inner neritic environment.

Several samples contain elements of both Assemblage A and subassemblage B-1. These were deposited in

environments in which the currents were strong enough to transport the reworked Miocene fauna, but not strong enough to make it impossible for an indigenous fauna to live. The depositional environment for all of the samples in which Assemblage B is found was probably less than 60 feet, and for subassemblage B-2 considerably less. The salinity for subassemblage B-2 was from 25-34 parts per thousand and for subassemblage B-1, 2-28 parts per thousand.

The times of deposition of samples in which ostracods occur are correlated with the last two marine transgressions which according to Curray (1961, p. 1711) took place before (about 30,000 years B.P.) and after (post-18,000 years B.P.) the latest major Wisconsin glacial advance. Based upon radiocarbon dating, the samples containing Assemblage B were deposited about 3,500 years B.P., which places them within the time of the latest marine transgression. Another radiocarbon date reveals that Assemblage A was deposited about 30,000 years B.P., the time at which Curray placed the marine transgression which preceded the latest major Wisconsin glacial advance.

SYSTEMATIC DESCRIPTIONS

Subclass Ostracoda Latreille, 1806

Order Podocopida Sars, 1866

Suborder Podocopina Sars, 1866

Superfamily Bairdiacea Sars, 1888

Family Bairdiidae Sars, 1888

Genus *Bairdia* M'Coy, 1844

Bairdia M'Coy, 1844, p. 164; Edwards, 1944, p. 506; Sylvester-Bradley, 1950, p. 751; Pokorný, 1958, p. 225; Benson, 1959, p. 42; Shaver, 1961, Q 202; Benson & Coleman, 1963, p. 17; Van Morkhoven, 1963, p. 32.

Type species. - *Bairdia curta* M'Coy, 1844, p. 164, pl. 23, fig. 6.

Diagnosis. - Lateral outline ovate to subtrapezoid; anterior end "boat-shaped," greatest height in anterior half; posterior end more broadly rounded; dorsal margin very convex, ventral margin less so. Surface smooth or punctate; may have anterior and/or posterior marginal denticulations. Size medium to large, length 0.50 to 1.00 mm. Inner lamella wide, widest anteriorly; anterior and posterior vestibule present. Marginal pore canals numerous, simple, straight. Normal pores numerous, small, scattered, open. Hinge adont. Central muscle scars consist of about 7 to 15 distinct scars, arrangement constant within each species.

Bairdia laevicula Edwards, 1944

Pl. 1, fig. 7

Bairdia laevicula Edwards, 1944, p. 506, pl. 85, figs. 3, 4; Puri, 1953a, p. 223, pl. 1, fig. 1, text-fig. 1 d.

[?] *Bairdia* cf. *B. laevicula* Edwards, Swain, 1951, p. 17.

Material. - Three valves.

Dimensions. - Figured hypotype, UMMP 48680: length .68 mm., height .36 mm.

Former occurrences. - Edwards (1944, p. 506) reported this species from the Upper Miocene Duplin Marl of North Carolina. Puri (1953a, p. 223) has stated that it occurs frequently in the Upper Miocene Arca facies of western Florida. Swain (1951, p. 17) listed, with no description or illustration, a form as *Bairdia* cf. *B. laevicula* Edwards from the subsurface Middle Miocene of North Carolina. If this form of Swain is *B. laevicula*, it is the only known occurrence older than Upper Miocene.

Bairdia sp.

Pl. 1, fig. 8-11

Material. - Five valves, three of them broken.

Dimensions. - Figured hypotype, UMMP 48681: length .64 mm., height .36 mm.

Remarks. - Only two well-preserved single valves of this species were found and the specimens are tentatively assigned to the genus Bairdia. The posteroventral marginal spines (pl. 1, fig. 10) are characteristic of many species of Bairdia, but the central muscle scars are actually more characteristic of the genus Bythocypris. Insufficient material was found to make a more definite assignment.

Superfamily Cypridacea Baird, 1845

Family Cyprididae Baird, 1845
[nom. correct. Baird, 1850 (pro Cypridae
Baird, 1845)]

Subfamily Candoninae Brady, 1900

Genus Candona Baird, 1845

Candona Baird, 1845, p. 152; Wagner, 1957, p. 18; Pokorný, 1958, p. 231; Swain, 1961, Q233; Van Morkhoven, 1963, p. 58; Staplin, 1963, p. 762; Swain, 1963, p. 802.

Type species. - Cypris candida O. F. Müller, 1776, p. 199.

Diagnosis. - Lateral outline variable, bean-shaped, triangular or elongate; maximum height in posterior half or at mid-length. Surface smooth, punctate or with faint reticulations. Size variable. Inner lamella moderately wide; wide anterior vestibule, smaller posterior vestibule; marginal zone narrow. Normal pores small, scattered, open. Hinge adont. Muscle scars consist of elongate scar above a group of five subtriangular equal-sized scars.

Candona (?) sp.

Pl. 1, fig. 12 - 19

Material. - Six valves, two of them broken.

Dimensions. - Figured hypotype, UMMP 48683: length .64 mm, height .34 mm.

Remarks. - This form is tentatively placed in the genus Candona, primarily on the basis of the muscle scar pattern, lateral outline, and hinge. There are, however, important morphologic characters which make the assignment tenuous. The scarcity and preservation of specimens oppose erection of a new species.

The normal pores are particularly interesting in these forms (pl. 1, figs. 12, 13). When viewed from the exterior at a magnification of x1000 it can be seen that each pore is divided into four discrete portions. Evidently each of the four portions was an opening for a seta. The anterior vestibule is narrower than in most Candona and the posterior vestibule is very narrow. These features make it doubtful that the species belongs to Candona, but no other assignment seems possible at this time. Other species that have the Candona-type muscle scar pattern should be examined carefully to determine the nature of their normal pores; if there is a group of Candona-like forms with this type of normal pores a new genus or subgenus should be erected.

Subfamily Pontocypridinae G. W. Müller, 1894

[Nom. correct. Kaufmann, 1900 (pro Pontocyprinae
G. W. Müller 1894)]

Genus Pontocypris Sars, 1866

Pontocypris Sars, 1866, p. 13; G. W. Müller, 1894, p. 246; Sars, 1923, p. 47; Pokorný, 1958, p. 228; Swain, 1961, Q247; Van Morkhoven, 1963, p. 72.

[?] Erythrocypris G. W. Müller, 1894, p. 256.

Type species. - Cythere (Bairdia) mytiloides Norman, 1862, p. 50, pl. 3, figs. 1-3 subsequent designation, Brady & Norman, 1889, p. 107.

Diagnosis. - Lateral outline elongate; maximum height slightly anterior to mid-length; posteroventral margin of right valve with spines, anterior margin sometimes with spines. Surface smooth or punctate. Size medium to large, length 0.60 to 1.20 mm. Inner lamella wide with large vestibules present both anteriorly and posteriorly; marginal zone narrow throughout. Marginal pore canal details not known. Normal pores small, numerous, open. Hinge adont. Central muscle scars not known in detail.

Pontocypris sp.

Pl. 1, fig. 1-6

Material. - One specimen, a left valve.

Dimensions. - Figured hypotype, UMMP 48679: length .79 mm., height .29 mm.

Remarks. - This species is known only from a left valve. It appears to belong definitely to the genus Pontocypris Sars. Since little is known of the morphology of the carapace of this genus, I have fully illustrated the marginal pore canals and central muscle scars in order to provide a basis for comparison of species known to belong to this genus. As can be seen in the photographs (pl. 1, figs. 1-6) both the muscle-scar pattern and marginal pore canals are unusual. Central muscle scars consist of only two elongate semi-oval shaped marks, located directly ventral to the point of greatest convexity of the dorsal margin. Marginal pore canals are necessarily short because the marginal zone is narrow; they are evenly spaced, very wide at the line of concrescence and narrowing gradually and evenly toward the outer margin. One of the characteristics of Pontocypris is the presence of posteroventral marginal denticles on the right valve, but since only the left valve of this form was found this criterion could not be applied. Hinge is adont, conforming, along with lateral outline, to the genus Pontocypris.

Superfamily Cytheracea Baird, 1850

Family Campylocytheridae Puri, 1960

[nom. transl. Benson & Coleman (pro Campylocytherinae Puri, 1960)]

Genus Acuticythereis Edwards, 1944

Acuticythereis Edwards, 1944, p. 519; Van den Bold, 1946, p. 31; McLean, 1957, p. 90; Howe, 1961, Q307; Puri, 1960, p. 128.

Campylocythere Edwards, Malkin, 1953, p. 784 [in part]; Pokorný, 1958, p. 271 [in part]; Benson & Coleman, 1963, p. 23 [in part]; Van Morkhoven, 1963, p. 128 [in part].

Type species. - Acuticythereis laevisissima Edwards, 1944, p. 519, pl. 87, figs. 4-11.

Diagnosis. - Lateral outline elongate-oval to elongate subtriangular; anterior end broadly rounded, posterior end less so; ventral margin slightly convex. Surface smooth, punctate or reticulate. Medium size, length 0.6 to 0.8 mm. Inner lamella of medium width, widest anteriorly; inner margin and line of conrescence diverge anteriorly and posteriorly, forming small vestibules. Marginal pore canals numerous in anterior end, about 25 in number, some simple, others bifurcating and sinuous, less numerous in posterior portion, about 4 to 8, non-bifurcating. Normal pores large, sieve-type. Hinge amphidont/heterodont, any of the hinge elements may be crenulates. Central muscle scar field consists of four elongate adductor scars with the frontalscars consisting of two clearly differentiated scars, the dorsal one tending to separate into two more scars.

Remarks. - Edwards (1944, p. 514, 519) erected two genera, Acuticythereis and Campylocythere, which several authors (Malkin, 1953, p. 784; Benson & Coleman, 1963, p. 23; Van Morkhoven, 1963, p. 128) have subsequently considered synonymous. I regard the hinges of the two type species, A. laevisissima and C. laeva, as sufficiently distinct to uphold the original generic separation of Edwards. A complete description of the hinge of Campylocythere laeva is given in the remarks section under that species.

Two species are here referred to the genus Acuticythereis, A. giganticus and A. tenmilecreekensis, which have previously been placed in the genus Basslerites Howe (in Coryell & Fields, 1937, p. 11). According to Van Morkhoven (1963, p. 209) Basslerites giganticus probably belongs to a new genus, but at least is not referable to Basslerites as understood by him on the basis of comparison to its type species of B. miocenica Howe, 1935. Significant differences are compared below.

	<u>Basslerites</u>	<u>A. giganticus</u> , <u>A. tenmilecreekensis</u>
Length	0.4-0.5 mm.	0.70-0.90 mm.
Normal pores	open	sieve
Carapace	thinly calcified	heavily calcified
Frontal scars	V-shaped	two discrete scars, dorsal one sometimes separated.

On the basis of the above listed differences these species clearly cannot be included in the genus Basslerites. Their hinge is the same type as in other species assigned to the genus Acuticythereis, although none of the elements is crenulated (like those in most other species in that genus). Other features, such as normal pores, marginal pore canals, and muscle-scar patterns, are very close to those of the type species, A. laevisissima.

Acuticythereis laevisissima Edwards, 1944

Pl. 4, fig. 1-13, 17-18

Acuticythereis laevisissima Edwards, 1944, p. 519, pl. 87, figs. 4-11; McLean, 1957, p. 90, pl. 12, figs. 4 a-g; Puri, 1960, p. 128, pl. 2, figs. 16, 17; Howe, 1961, fig. 233, 1.

[?] Acuticythereis laevisissima punctata Edwards, 1944, p. 520, pl. 87, figs. 12, 13.

Campylocythere laevisissima (Edwards), Malkin, 1953, p. 785, pl. 80, figs. 4-6; Puri and Hulings, 1957, p. 174, 176, 183, fig. 11 (bottom); Curtis, 1960, p. 479, pl. 2, fig. 1 (bottom); Benson & Coleman, 1963, p. 24, pl. 4, figs. 6, 8, 9, text-fig. 11.

Campylocythere laeva Edwards, Malkin, 1953, p. 784, pl. 80, figs. 1, 3 [non pl. 80, fig. 2 - Campylocythere laeva Edwards]; Puri & Hulings, 1957, p. 187, figure 11; Puri, 1960, p. 128, figs. 1, 2, text-figs. 12, 13.

Material. - Eleven carapaces and 89 valves.

Dimensions. - Figured hypotypes, UMMP 48696: length .58 mm, height .26 mm, UMMP 48697: length .60 mm, height .26 mm, UMMP 48699: length .61 mm, height .29 mm.

Former occurrences. - Reported from the Upper Miocene and Recent sediments of the Gulf of Mexico and eastern United States. Edwards (1944, p. 519) recorded this species from the Upper Miocene Duplin Marl of North Carolina; Malkin (1953, p. 785) and McLean (1957, p. 90) reported it from the Yorktown Formation of Virginia, Maryland, and New Jersey. Puri & Hulings (1957, p. 174), Puri (1960, p. 128), Curtis (1960, p. 479), and Benson and Coleman (1963, p. 24) have all reported it from the Recent sediments of the Gulf of Mexico. Benson & Coleman (1963, p. 24) give the depth range as 19 to 95 feet, with greater numbers at less than 25 feet, and salinity range from 34.86 to 39.92 parts per thousand.

Remarks. - Inasmuch as this species has been well described in previous papers, only additional morphological observations are made here. The normal pores (pl. 4, fig. 13) are sieve-type and number about 30. The marginal pore canals (pl. 4, figs. 10, 11, 17, 18) number about 25 anteriorly and 5 posteriorly; the anterior ones branch and are sinuous, but the posterior ones are simple and more nearly straight. The anterior margin has many false marginal pore canals, while those present posteriorly almost invariably extend to the outer margin. Plate 4, figs. 17, 18 shows the relationship between the marginal pore canals and the false canals, which are actually sieve-type normal pores which exit through the outer lamella rather than between the outer and inner lamella. The four adductor muscle scars (pl. 4, fig. 12) are elongate, about three times as long as high; the upper of the two frontal scars is elongate, while the lower one is oval-shaped. No mandibular or dorsal muscle scars were observed, but the fulcral point is visible lying between the frontal and adductor scars.

A. laevisissima varies considerably in lateral outline. Plate 4, figs. 2, 3 shows an elongate specimen, but about one-third of those found were higher in relation to their length and do not converge as acutely posteriorly, but are more evenly rounded. In all other respects the two general types are identical, and they may be dimorphs.

Acuticythereis multipunctata Edwards, 1944

Pl. 3, figs. 15-24

Acuticythereis multipunctata Edwards, 1944, p. 520, pl. 87, figs. 14-16.

[?] Acuticythereis multipunctata Edwards, Puri, 1960, p. 128, text-figs. 14, 15.

[?] Acuticythereis multipunctata parva Edwards, 1944, p. 520, pl. 87, figs. 17, 18.

Material. - One carapace and 25 valves.

Dimensions. - Figures hypotype, UMMP 48695: length .66 mm, height .36 mm.

Former occurrences. - Originally described from the Upper Miocene Duplin Marl by Edwards, (1944, p. 520) from North Carolina, and questionably from Recent sediments of the eastern Gulf of Mexico by Puri (1960, p. 128).

Remarks. - The specimens from Sapelo Island agree closely in all details with those described by Edwards (1944, p. 520, pl. 87, figs. 14-16). The following can be added to the description of Edwards. The normal pores are numerous, large, and of the sieve type (pl. 3, fig. 21), the crenulations of the posteromedian bar in the left valve become coarser toward the posterior portion (pl. 3, fig. 22) and the posterior tooth in the right valve is crenulate (pl. 3, fig. 20). The muscle scars were not observed in the present specimens, but according to Edwards they are typical for the genus (see above).

Puri (1960, p. 128, text-figs. 14, 15) has assigned Recent material from the west coast of Florida to this species, but they do not appear to be conspecific. Puri's specimens are conspicuously smaller, 0.50 mm in length as opposed to those of Edwards which are listed as from 0.66-0.74 mm; Puri's are much higher in proportion to the length, and the drawings (text-figs. 12a, 15b) show quite clearly that the inner margin and line of concrecence are coincident throughout, and therefore lack vestibules. These features taken together, particularly the size and outline, make it seem doubtful that they belong to A. multipunctata and no other description is given.

Acuticythereis gigantea (Edwards, 1944)

Pl. 4, figs. 14-16, 19-22; pl. 5, figs. 9-19

Basslerites giganteus Edwards, 1944, p. 521, pl. 87, figs. 19-23.

Basslerites cf. B. giganteus Edwards, Puri, 1953a, p. 280, pl. 8, fig. 12, text-fig. 11 L.

Material. - Three carapaces and 97 valves.

Dimensions. - Hypotypes, UMMP 48700 (immature instar): length .67 mm, height .32 mm, UMMP 48705: length .81 mm, height .38 mm.

Former occurrences. - Edwards (1944, p. 521) reported this species from the Upper Miocene Duplin Marl of North Carolina. Puri (1953a, p. 280) has also reported a closely related form from the Upper Miocene of Florida.

Remarks. - This species was originally assigned to the genus Basslerites (see discussion under genus above), but has here been placed in the genus Acuticythereis. The frontal muscle scars consist of two separate scars, the lower one of which has a tendency to be divided. The normal pores are large and of the sieve type (pl. 5, figs. 18, 19).

It is placed in the species A. giganticus although there is a slight difference in the general outline of the specimens from Sapelo Island from those illustrated by Edwards. In particular the posterior margin of both valves is more pointed than those in Edwards' figures. He does state, however, that he had less blunt forms which are not shown. There is also a small, projecting structure anterior to the anterior socket of the left valve (pl. 5, fig. 14) which is not mentioned by Edwards.

Puri (1953, p. 280, pl. 8, fig. 12, text-fig. 11L) tentatively placed a form in this species. It appears very similar in outline and hinge, but is somewhat larger, the length being given as 0.878 mm as opposed to 0.80 mm given by Edwards for the holotype.

Acuticythereis tenmilecreekensis (Puri, 1953)

Pl. 5, fig. 1-8

Basslerites tenmilecreekensis Puri, 1953a, p. 280, pl. 8, figs. 13-15, text-fig. 11 M.

Material. - One carapace and 10 valves.

Dimensions. - Figured hypotypes, UMMP 48701: length .77 mm, height .38 mm; UMMP 48702: length .76 mm, height .38 mm; UMMP 48703: length .78 mm, height .40 mm; UMMP 48704: length .64 mm, height .34 mm.

Former occurrences. - Puri (1953a, p. 280) reported this species from the Middle Miocene Chipola facies and questionably from the Upper Miocene Arca facies of western Florida.

Remarks. - The specimens from Sapelo Island appear to be conspecific with that of Basslerites tenmilecreekensis Puri, 1953a, but the lateral outline and hinge are the only diagnostic morphologic features described by Puri. The posterior inner lamella of the forms described here (pl. 5, figs. 3, 5) is expanded into a striated bulge which is not shown in Puri's photograph (1953a, pl. 8, fig. 14), but details in that photograph are poor. Normal pores are sieve-type, large and scattered. Marginal pore canals are moderate in number, about 25 anteriorly, 6 posteriorly; anteriorly they branch, posteriorly they are simple, straight. Small anterior vestibule is present, while no posterior vestibule appears to be present, but it is difficult to observe because of the thickening of the inner lamella. The central muscle scar field consists of four elongate adductor muscle scars in a vertical row; frontal scars consist of an oval upper scar and one elongate lower one, which in some specimens is almost separated into two discrete scars. Fulcral point visible between adductor and frontal scars. No mandibular muscle scars observed.

As discussed above, this species is here placed in the genus Acuticythereis because of the muscle-scar pattern, nature of the marginal pore canals, hinge and the presence of sieve-type normal pores.

Genus Campylocythere Edwards, 1944

Campylocythere Edwards, 1944, p. 514; Van den Bold, 1946, p. 31; Malkin, 1953, p. 784 [in part]; Pokorný, 1958, p. 271 [in part]; Howe, 1961, Q307; Benson & Coleman, 1963, p. 23 [in part]; Van Morkhoven, 1963, p. 128 [in part].

Type species. - Campylocythere laeva Edwards, 1944, p. 515, pl. 86, figs. 8-14.

Diagnosis. - Lateral outline elongate; anterior end rounded, dorsal half acute, posterior end bluntly rounded, with prominently projecting posterior cardinal angle at position of posterior terminal hinge element; dorsal margin convex, ventral margin slightly sinuous. Size medium length about 0.70 mm. Inner lamella of medium width, widest anteriorly, with wide vestibule anteriorly and narrow one posteriorly. Marginal pore canals numerous anteriorly, sparse posteriorly, all short, straight, simple, evenly spaced, some not reaching outer margin. Normal pores moderate in size, sieve type. Hinge amphidont/heterodont, posterior element crenulated, hinge convex dorsally. Central muscle scar pattern consists of four elongate adductor scars with two distinct frontal scars lying anterior to adductor scars.

Remarks. - As has already been stated (see remarks under genus Acuticythereis) the two genera Acuticythereis and Campylocythere are clearly separable despite the fact that they have been considered synonymous by several authors. No other species has been assigned to the genus Campylocythere other than the type species C. laeva, therefore the above diagnosis is based upon this species.

Differences that separate it from Acuticythereis are primarily the hinge (discussed below) and the inner lamella area. While the inner lamella has about the same width in relation to the carapace size in the two genera, the line of concrescence is much closer to the outer margin in Campylocythere. As a result the marginal pore canals are considerably shorter. They are also simple, straight and tend to be evenly spaced as opposed to those in all four species of Acuticythereis described herein which have branching marginal pore canals which do not appear evenly spaced. These features can be clearly seen in the various photographs shown on plates 2, 3, 4, and 5.

Campylocythere laeva Edwards, 1944

Pl. 2, figs. 12-22

Campylocythere laeva Edwards, 1944, p. 515, pl. 86, figs. 14-16; Malkin, 1953, p. 784, pl. 80, fig. 2 [non pl. 80, figs. 1, 3 = Acuticythereis laeivissima Edwards].

[non] Campylocythere laeva Edwards, Puri & Hulings, 1957, p. 187, fig. 11 [= Acuticythereis laeivissima Edwards]; Puri, 1960, p. 128, pl. 2, figs. 1, 2, text-figs. 12, 13 [= Acuticythereis laeivissima Edwards].

Material. - Eleven isolated valves.

Dimensions. - Figured hypotypes, UMMP 48689: length .72 mm, height .30 mm, UMMP 48690: length .73 mm, height .30 mm.

Former occurrences. - It is here believed that only those specimens described by Edwards and possibly one specimen illustrated by Malkin belong to this species. Edwards (1944, p. 515) reported it from the Upper Miocene Duplin Marl of North Carolina, and Malkin (1953, p. 784) from the Upper Miocene Yorktown Formation of Maryland, Virginia, and New Jersey.

Remarks. - On the basis of the hinge that Edwards (1944, pl. 86, figs. 9, 10, 12, 13) figured for this species it is felt that this is the first time it has been reported since his original description. The hinge that Edwards illustrated is distinctly different for this species as compared to that for the species he assigns to the genus Acuticythereis in the same paper. In the right valve of C. laeva the posteromedian element which is a groove is considerably wider anteriorly and narrows abruptly about midway toward the posterior. At the point where it narrows is a change of direction so that the groove is convex dorsally. This characteristic is shown in both the figures of Edwards (1944, p. 86, figs. 9, 10) and in this paper on plate 2, figure 14. In the species Edwards assigned to Acuticythereis on the other hand the anteromedian element is straight and there is no abrupt widening of the groove.

In all other respects the specimens here under consideration appear to be identical to those of Edwards. In particular, the posteroventral swelling that is both mentioned and illustrated by Edwards (1944, p. 515, pl. 86, figs. 8, 11) is shown here on plate 2, figures 12, 13. The central muscle scar pattern, marginal pore canals and the size and configuration of the vestibules are also identical to those shown by Edwards.

In addition to features shown or mentioned by Edwards the following observations were made on the specimens from Sapelo Island. The normal pores are sieve-type, although considerably smaller than in the species here assigned to Acuticythereis. Two mandibular muscle scars are present below and anterior to the central muscle scar field (pl. 2, fig. 21). Two scars were observed dorsal to the central field and are shown on plate 2, figure 19. The dorsal view of the hinge on plate 2, figure 22 shows a peculiar tooth-like projection adjacent, but slightly ventral to the median bar in the left valve, with a corresponding shallow negative element in the right valve. There is a small anterior positive element in the left valve, which projects anteroventrally, followed by a deep bounded socket, a positive bar with the above mentioned tooth-like structure, and a posterior crenulate socket. In the anterior portion of the left valve there is a large flange developed which overlaps the right valve. Complimentary structures are present in the right valve and can be seen in the figures on plate 2.

It is very doubtful that the forms assigned by Puri (1960, p. 128, pl. 2, figs. 1, 2, text-figs. 12, 13) to this species rightfully belong here. Benson & Coleman (1963, p. 24) place them in Campylocythere laeivissima Edwards, 1944, where they belong in all probability. Malkin (1953, p. 784, pl. 80, figs. 1, 2, 3) also places some specimens in this species. Only figure 2 conforms in outline to those of Edwards and the hinge line in figure 3 definitely does not.

Family Hemicytheridae Puri, 1953

[nom. transl. Howe, 1961 (pro Hemicytherinae Puri, 1953)]

Genus Aurila Pokorný, 1955

Cythereis, gruppo Auris Neviani, 1928, p. 72.

Aurila Pokorný, 1955, p. 17; Howe, 1961, Q302; Benson & Coleman, 1963, p. 34; Benson & Kaesler, 1963, p. 22.

Mutulis (Aurila) Pokorný, Ruggieri, 1956, p. 133; Ruggieri, 1958, p. 168; Pokorný, 1958, p. 268; Van Morkhoven, 1963, p. 138.

Type species. - Cythere convexa Baird, 1850, p. 174, pl. 21, fig. 3.

Diagnosis. - Lateral outline almond-shaped, dorsal margin strongly convex, ventral margin sinuate; anterior margin broadly rounded, posterior margin forming caudal process. Surface pitted or reticulated, but not as strongly ornamented as Mutulis Neviani, 1928. Valves heavily calcified. Very numerous marginal pore canals, mostly simple, straight. Normal pores sieve type. Hinge amphidont/heterodont, posterior tooth in right valve incised to receive a small tooth in left valve. Frontal muscle scars appear to be constantly three where mentioned.

Aurila amygdala (Stephenson, 1944)

Pl. 6, figs. 1-9

Hemicythere amygdala Stephenson, 1944, p. 158, pl. 28, figs. 8, 9; Puri, 1953b, p. 176, pl. 1, fig. 3; Puri, 1953a, p. 266, pl. 11, fig. 14; Puri & Hulings, 1957, p. 174; Puri, 1960, p. 129, text-figs. 31, 32.

Aurila amygdala (Stephenson), Butler, 1963, p. 73, pl. 2, fig. 16, pl. 6, fig. c; Benson & Coleman, 1963, p. 36, pl. 8, figs. 6, 8, 9, text-fig. 22.

Material. - Three carapaces.

Dimensions. - Figured hypotypes, UMMP 48706: length .56 mm, height .35 mm, UMMP 48707: length .51 mm, height .29 mm.

Former occurrences. - This species was originally described from the Oligocene Discorbis, Heterostegina, and Marginulina zones from the Gulf coast of Texas by Stephenson (1944, p. 158). Puri (1953a, p. 266) has reported it from the Middle Miocene Chipola, Oak Grove, and Shoal River facies of western Florida. It has also been found in the Recent marine sediments of the Gulf of Mexico by Puri (1960, p. 129) and Benson & Coleman (1963, p. 36). Benson & Coleman give a depth range of from 19 to 76 feet and the salinity range as 36.91 to 39.21 parts per thousand.

Aurila conradi conradi (Howe & McGuirt, 1935)

Pl. 6, figs. 10-19, 23

Hemicythere conradi Howe & McGuirt in Howe et al, 1935, p. 27, pl. 3, figs. 31-34, pl. 4, fig. 17; Edwards, 1944, p. 518, pl. 86, figs. 17, 18; Swain, 1951, p. 42, pl. 6, figs. 9-12; Puri, 1953b, p. 176, pl. 2, figs. 1, 2; Malkin, 1953, p. 796, pl. 82, figs. 16-18.

[non] Hemicythere conradi Howe & McGuirt, Swain, 1955, p. 635, pl. 62, fig. 3 a-c; Puri & Hulings, 1957, p. 174, 183, 188, fig. 11, no. 4 (bottom).

Aurila conradi (Howe & McGuirt), McLean, 1957, p. 94, pl. 11, fig. 7 a-b.

[non] Aurila conradi (Howe & McGuirt), Puri, 1960, p. 129, pl. 3, figs. 9, 10.

Aurila conradi conradi (Howe & McGuirt), Benson & Coleman, 1963, p. 35; Benson & Kaesler, 1963, p. 23.

Material. - Seven carapaces and 15 valves.

Dimensions. - Figured hypotypes, UMMP 48708: length .59 mm, height .37 mm, UMMP 48709: length .64 mm, height .38 mm.

Former occurrences. - This species has been reported from the Arca zone of the Upper Miocene Choctawhatchie Formation of Florida by Howe, et al. (1935, p. 27); Upper Miocene Duplin Marl of North Carolina by Edwards (1944, p. 518); throughout the entire Miocene by Swain (1951, p. 42) from wells in North Carolina; Upper Miocene Yorktown Formation of Maryland, Virginia, and New Jersey by Malkin (1953, p. 796) and McLean (1957, p. 94).

Aurila conradi (Howe & McGuirt, 1935) floridana Benson & Coleman, 1963

Pl. 6, figs. 20-22, 24-29

Hemicythere conradi Howe & McGuirt, Swain, 1955, p. 635, pl. 62, fig. 3 a-c; Puri & Hulings, 1957, p. 174, 183, 188, fig. 11, no. 4 (bottom).

Aurila conradi (Howe & McGuirt), Puri, 1960, p. 129, pl. 3, figs. 9, 10.

[?] Hemicythere cf. H. cymba (Brady), Curtis, 1960, p. 484, pl. 3, fig. 11 (top).

Aurila conradi (Howe & McGuirt) floridana Benson & Coleman, 1963, p. 35, pl. 8, figs. 8-10, text-fig. 21; Benson & Kaesler, 1963, p. 23.

Material. - One carapace and 110 valves.

Dimensions. - Figured hypotypes, UMMP 48710: length .64 mm, height .46 mm; UMMP 48711: length .66 mm, height .43 mm; UMMP 48712: length .59 mm, height .37 mm.

Former occurrences. - This species has been previously reported only from the Recent sediments of the Gulf of Mexico. It has been found by Swain (1955, p. 635), Puri & Hulings (1957, p. 174), Puri (1960, p. 129), questionably by Curtis (1960, p. 484), and Benson & Coleman (1963, p. 35). Benson & Coleman give a depth range of 19 to 131 feet, with a salinity range of 36.17 to 39.92 parts per thousand.

Family Trachyleberididae Sylvester-Bradley, 1948

[nom. correct. Sylvester-Bradley & Harding, 1954 pro Trachyleberididae Sylvester-Bradley, 1948]]

Genus Actinocythereis Puri, 1953

Actinocythereis Puri, 1953d, p. 178; Puri, 1953a, p. 252; Pokorný, 1958, p. 262; Sylvester-Bradley, 1961, Q334; Benson & Coleman, 1963, p. 47.

Trachyleberis (Actinocythereis) Puri, Van Morkhoven, 1963, p. 178.

Type species. - Cythere exanthemata Ulrich & Bassler, 1904, p. 117, pl. 36, figs. 1-5.

Genus Costa Neviani, 1928

Diagnosis. - Lateral outline elongate, subrectangular; dorsal and ventral margins nearly straight, converging slightly posteriorly; anterior end broadly rounded, posterior end obliquely rounded; highest portion near anterior end. Surface with strong anteromarginal ridge; three distinct longitudinal rows of spiny tubercles; anterior end with short marginal denticulations; posterior end strongly denticulate. Size medium to large, length 0.70 to 1.0 mm. Inner lamella moderately wide, line of conrescence and inner margin coincide throughout and parallel the outer margin. Marginal pore canals numerous, straight, simple, most of them paired. Normal pores few, scattered, small, open. Hinge amphidont/heterodont. Muscle scar field consists of four oval-shaped adductor scars, with U-shaped frontal scar.

Actinocythereis exanthemata (Ulrich & Bassler, 1904) gomillionensis (Howe & Ellis, 1935)

Pl. 7, figs. 12-17

Cythereis exanthemata var. gomillionensis Howe & Ellis, in Howe et al., 1935, p. 19, pl. 1, figs. 6-12, pl. 4, fig. 3; Van den Bold, 1946, p. 88, pl. 9, fig. 19; Van den Bold, 1950, p. 83.

Cythereis exanthemata gomillionensis Howe & Ellis, Edwards, 1944, p. 521, pl. 87, figs. 31, 32.

Trachyleberis exanthemata gomillionensis (Howe & Ellis), Malkin, 1953, p. 792, pl. 81, figs. 15, 17, 18.

Actinocythereis exanthemata gomillionensis (Howe & Ellis), Puri, 1953d, p. 181, pl. 2, figs. 1, 2; McLean, 1957, p. 83, pl. 10, figs. 2 a-d; Darby & Hoyt, 1964, p. 70, pl. 18, figs. 12, 13.

Actinocythereis exanthemata var. gomillionensis (Howe & Ellis), Puri, 1953d, p. 181, pl. 2, figs. 1, 2; McLean, 1957, p. 83, pl. 10, figs. 2 a-d; Darby & Hoyt, 1964, p. 70, pl. 18, figs. 12, 13.

Actinocythereis exanthemata var. gomillionensis (Howe & Ellis), Puri, 1953a, p. 253, pl. 13, figs. 16, 17.

[?] Actinocythereis sp. aff. A. exanthemata (Ulrich & Bassler) Benson & Coleman, 1963, p. 48, pl. 6, fig. 12, text-fig. 31.

Material. - One carapace and 4 valves.

Dimensions. - Figured hypotypes, UMMP 48721: length .85 mm, height .45 mm; UMMP 48723: length .88 mm, height .58 mm.

Former occurrences. - This subspecies was originally described from the Arca zone of the Upper Miocene Choctawhatchie Formation of Florida by Howe & Ellis (in Howe, et al., 1935, p. 19). It has since been widely reported from the Upper Miocene of eastern United States by Edwards (1944, p. 521), Malkin (1953, p. 792), McLean (1957, p. 83), and Darby & Hoyt (1964, p. 70); and from the Upper Miocene of western Florida by Puri (1953a, p. 253). One closely related form has been described from the Recent sediments of the Gulf of Mexico by Benson & Coleman (1963, p. 48).

Costa Neviani, 1928, p. 72; Howe, 1955, p. 36; Ruggieri, 1956, p. 162; Sylvester-Bradley, 1961, Q336.

Costa (Costa) Neviani, Van Morkhoven, 1963, p. 198.

Trachyleberis (Costa) Neviani, Keij, 1957, p. 93.

Rectotrachyleberis Ruggieri, 1952, p. 38; Ruggieri, 1956, p. 163.

Costa (Rectotrachyleberis) Ruggieri, Van Morkhoven, 1963, p. 200.

Type species. - Cytherina edwardsii Roemer, 1838, p. 518, pl. 6, fig. 27 subsequent designation, Howe, 1955, p. 36.

Diagnosis. - Lateral outline subrectangular; maximum height at anterior cardinal angle; dorsal and ventral margins nearly straight, converging slightly posteriorly; anterior end broadly rounded, posterior end less so. Surface with three prominent ridges; anterior marginal ridge present; anterior and posterior marginal denticulations present. Size medium, length 0.65 to 0.90 mm. Inner lamella wide, line of conrescence and inner margin coincide throughout. Marginal pore canals moderately numerous, straight, simple. Normal pores few, scattered, small, open, hinge amphidont/heterodont. Central muscle scar field consists of four adductor scars in vertical row and V-shaped frontal scar.

Costa triplistriata (Edwards, 1944)

Pl. 7, figs. 6, 9, 10

Cythereis triplistriata Edwards, 1944, p. 522, pl. 87, figs. 24-26.

non Trachyleberis ? T. ? triplistriata (Edwards), Swain, 1951, p. 37, pl. 6, figs. 2, 3.

? Rectotrachyleberis cf. R. triplistriata (Edwards), 1953a, p. 264, pl. 11, figs. 1, 2.

Material. - Two isolated valves.

Dimensions. - Figured hypotypes, UMMP 48717: length .78 mm, height .36 mm; UMMP 48718: length .67 mm, height .32 mm.

Former occurrences. - Edwards (1944, p. 522) originally described this species from the Upper Miocene Duplin Marl of North Carolina, Swain (1951, p. 37) and Puri (1953a, p. 264) have each illustrated forms closely related to C. triplistriata, but neither appears to be con-specific (see Costa cf. C. triplistriata below).

Costa sp. aff. C. triplistriata (Edwards, 1944)

Pl. 7, fig. 8

Trachyleberis ? cf. T. ? triplistriata (Edwards), Swain, 1951, p. 37, pl. 6, figs. 2, 3.

Material. - One valve.

Dimensions. - Figured hypotype, UMMP 48719: length .64 mm, height .32 mm.

Former occurrences. - Since only one valve has been found, and this one slightly broken, no precise assignment could be made. It is, however, very similar to a form illustrated by Swain (1951, p. 37, pl. 6, figs. 2, 3), from the subsurface Upper Miocene of North Carolina. As Swain states this pitted form may be an immature molt of C. triplistriata.

Genus Echinocythereis Puri, 1953

Echinocythereis Puri, 1953a, p. 259; Sylvester-Bradley, 1961, Q336; Benson & Coleman, 1963, p. 46; Van Morkhoven, 1963, p. 171.

Type species. - Cythereis garretti Howe & McGuirt, in Howe et al., 1935, p. 20, pl. 3, figs. 17-19, pl. 4, figs. 5, 15.

Diagnosis. - Lateral outline subovate; valves inflated; dorsal margin almost straight, ventral margin sinuate; anterior end broadly rounded, posterior end more narrowly drawn out. Surface covered with spines, arranged more or less concentrically. Generally large, length up to 1.25 mm. Inner lamella wide, inner margin and line of concrescence coincide throughout. Marginal pore canals numerous, straight, mostly simple. Normal pores small, open. Hinge amphidont/heterodont, all elements smooth. Two separate frontal muscle scars.

Echinocythereis garretti (Howe & McGuirt, 1935)

Pl. 8, figs. 15, 16, 18-23

Cythereis garretti Howe & McGuirt, in Howe et al., 1935, p. 20, pl. 3, figs. 17-19, pl. 4, figs. 5, 15; Puri, 1953c, p. 751.

Buntonia ? cf. B. ? garretti (Howe & McGuirt), Swain, 1951, p. 39, pl. 3, fig. 6, pl. 4, figs. 4-6.

Echinocythereis garretti (Howe & McGuirt), Puri, 1953a, p. 260; pl. 12, figs. 2-5, text-fig. 9 a, b; Sylvester-Bradley, 1961, Q336, fig. 261, 3; Benson & Coleman, 1963, p. 46, pl. 4, figs. 4, 5, text-fig. 30.

[?] Echinocythereis margaretifera (Brady), Curtis, 1960, p. 481, pl. 1, fig. 19.

Material. - Two carapaces and 3 isolated valves.

Dimensions. - Hypotypes, UMMP 48731: length .94 mm, height .58 mm; UMMP 48732: length .91 mm, height .58 mm; UMMP 48733: length .94 mm, height .57 mm; UMMP 48734: length .94 mm, height .58 mm.

Former occurrences. - This species was originally described by Howe et al. (1935, p. 20) from the Arca zone, Upper Miocene of western Florida. Swain (1951, p. 39) described a form which appears conspecific with E. garretti from the subsurface Middle and Upper Miocene of North Carolina and Puri (1953a, p. 260) reported it from the Arca, Ecphora and Cancellaria facies, Upper Miocene of Florida. It has been found in Recent sediments from the Gulf of Mexico by Benson & Coleman (1963, p. 46) and questionably by Curtis (1960, p. 481). Benson & Coleman give a depth range of greater than 60 feet and salinity from 36.17 to 37.39 parts per thousand.

Genus Murrayina Puri, 1953

Murrayina Puri, 1953a, p. 255; Pokorný, 1958, p. 263; Sylvester-Bradley, 1961, Q 339.

Type species. - Murrayina howei Puri, 1953a, p. 255, pl. 12, figs. 9, 10, text-figs. 8 g, h (= Cythere producta Ulrich & Bassler, 1904, p. 115, pl. 36, fig. 17, pl. 38, figs. 28-30) [non Cythere producta Brady, 1866, p. 368, pl. 59, fig. 7].

Diagnosis. - Lateral outline elongate, subrectangular; dorsal and ventral margins sinuous to almost straight and parallel; anterior end broadly rounded, oblique dorsally. Surface pattern reticulate, with well-developed sub-central tubercle; marginal ridges present, but no well-defined longitudinal ridges. Inner lamella moderately wide; vestibule present anteriorly. Marginal pore canals numerous, straight, simple, closely spaced, sometimes occurring in groups of two or three. Normal pores unknown in type species. Hinge amphidont/lophodont. Central muscle scars consist of two vertical rows of three scars each, with two oblique frontal scars anterior to adductor scars; other muscle scars unknown in type species.

Murrayina martini (Ulrich & Bassler, 1904)

Pl. 9, figs. 1-10, 13

Cythere martini Ulrich & Bassler, 1904, p. 112, pl. 36, figs. 11-15.

Cythere micula Ulrich & Bassler, 1904, p. 116, pl. 36, figs. 18-20.

Cythereis martini (Ulrich & Bassler), Swain, 1948, p. 196, pl. 12, figs. 16, 17; Puri, 1953c, p. 750.

Trachyleberis ? martini (Ulrich & Bassler), Swain, 1951, p. 29, pl. 3, figs. 8, 15.

Trachyleberis ? cf. T. micula (Ulrich & Bassler), Swain, 1951, p. 29, text-fig. 3 L.

Trachyleberis martini (Ulrich & Bassler), Malkin, 1953, p. 793, pl. 82, figs. 6-13.

Murrayina martini (Ulrich & Bassler), Puri, 1953a, p. 256, pl. 12, figs. 11-13, text-figs. 8 e, f; McLean, 1957, p. 86, pl. 11, figs. 1 a-c, 2 a-b, 3 a-d.

Material. - Twenty carapaces and 67 isolated valves.

Dimensions. - Figured hypotypes, UMMP 48735: length .71 mm, height .34 mm; UMMP 48736: length .72 mm, height .38 mm; UMMP 48737: length .74 mm, height .40 mm; UMMP 48738: length .68 mm, height .38 mm; UMMP 38739: length .42 mm, height .22 mm; UMMP 48740: length .72 mm, height .37 mm; UMMP 48741 (immature instar): length .48 mm, height .27 mm.

Former occurrences. - Originally described from the Middle and Upper Miocene of Maryland and Virginia by Ulrich & Bassler (1904, p. 112). Swain (1951, p. 29) reported it from the entire Miocene subsurface of North Carolina, and both Malkin (1953, p. 793) and McLean (1957, p. 86) from the Yorktown Formation of Virginia, Maryland,

and New Jersey. Puri (1953a, p. 256) has reported it from the Upper Miocene Arca, Ecphora and Cancellaria facies of western Florida.

Genus Orionina Puri, 1953

Orionina Puri, 1953a, p. 253; Pokorný, 1958, p. 264; Sylvester-Bradley, 1961, Q339; Van den Bold, 1963, p. 39; Benson & Coleman, 1963, p. 45; Van Morkhoven, 1963, p. 165.

Type species. - Cythere vaughani Ulrich & Bassler, 1904, p. 109, pl. 38, figs. 25-27.

Diagnosis. - Lateral outline elongate-subquadrate; anterior end broadly rounded, oblique dorsally, posterior end drawn out ventrally; posterior margin convex dorsally; dorsal margin almost straight, ventral margin sinuous. Surface bearing three longitudinal ridges, the lowermost divides into two branches which are superimposed on weaker reticulation. Inner lamella wide anteriorly; peripheral part fused to outer lamella; posteroventral margin finely denticulate. Marginal pore canals numerous, evenly spaced in some species, branched in others. Hinge amphidont/heterodont. Normal pores numerous, small, open.

Orionina vaughani (Ulrich & Bassler, 1904)

Pl. 7, figs. 4, 5, 7

Cythere vaughani Ulrich & Bassler, 1904, p. 109, pl. 38, figs. 25-27.

Cythereis vaughani (Ulrich & Bassler), Howe et al., 1935, p. 25, pl. 3, figs. 24-26, pl. 4, fig. 13; Edwards, 1944, p. 552, pl. 87, figs. 27, 28; Van den Bold, 1946, p. 88 (in part), pl. 10, fig. 1; Van den Bold, 1950, p. 83 (in part).

Trachyleberis vaughani (Ulrich & Bassler), Swain, 1951, p. 37, pl. 6, figs. 6, 7; Malkin, 1953, p. 794, pl. 82, fig. 14.

Orionina vaughani (Ulrich & Bassler), Puri, 1953a, p. 254, pl. 12, figs. 15, 16, text-figs. 8 a-c; McLean, 1957, p. 88, pl. 11, figs. 6 a, b; Brown, 1958, p. 64, pl. 3, fig. 2; Puri & Vernon, 1959, p. 135, 142, 146; Van den Bold, 1963, p. 41, pl. 3, figs. 1-5, text-fig. 5, figs. 1-4.

Orionina bermudae (Brady), Van den Bold, 1957, p. 242 (in part), Table 1 [non pl. 1, figs. 12 a, b = Orionina similis Van den Bold, 1963]; Van den Bold, 1958, p. 403 (in part) [non pl. 5, fig. 9 = Orionina serrulata (Brady), 1869]; Puri & Vernon, 1959, p. 151, 154, 156, 182, 197, 406 [non p. 243 = Orionina bradyi Van den Bold, 1963].

[?] Orionina burmadae (Brady), Benson & Coleman, p. 45, pl. 8, fig. 7, text-fig. 29.

Material. - Three isolated valves.

Dimensions. - Figured hypotypes, UMMP 48715: length .78 mm, height .32 mm; UMMP 48716: length .75 mm, height .35 mm.

Former occurrences. - Widely reported from Miocene of the eastern United States and the Caribbean.

Genus Pterygocythereis Blake, 1933

Cythereis (Pterygocythereis) Blake, 1933, p. 239; Triebel, 1941, p. 385; Van den Bold, 1946, p. 29; Sylvester-Bradley, 1948, p. 793.

Pterygocythereis Blake, Keij, 1957, p. 94; Pokorný, 1958, p. 262; Howe, 1961, Q267; Benson & Coleman, 1963, p. 21.

Pterygocythereis (Pterygocythereis) Blake, Van Morkhoven, 1963, p. 215.

Type species. - Cythereis jonesii Baird, 1850, p. 175, pl. 20, fig. 1.

Diagnosis. - Lateral outline subrectangular; broadly rounded anteriorly, more acute posteriorly; marginal spines often present around anteroventral and posterior areas. Surface tends to be smooth except for prominent wing-like projection which gives carapace arrow-like shape when viewed dorsally. Size large, length 0.80 to 1.10 mm. Inner lamella moderately wide; line of confluence and inner margin coincide throughout, and run parallel to outer margin. Marginal pore canals moderate in number, nearly straight, simple, thickened in distal half. Normal pores few, small open. Hinge amphidont/heterodont. Central muscle scars of vertical row of four adductor scars, with V- or U-shaped frontal scar.

Pterygocythereis sp. cf. P. americana (Ulrich & Bassler, 1904)

Pl. 7, figs. 1-3

Cythereis cornuta var. americana Ulrich & Bassler, 1904, p. 122, pl. 37, figs. 29-33.

Cythereis (Pterygocythereis) cornuta var. americana (Ulrich & Bassler), Howe et al., 1935, p. 26, pl. 2, figs. 19, 21-24, pl. 4, fig. 24; Swain, 1948, p. 206, pl. 14 (labeled as plate 13), fig. 4.

Pterygocythereis cornuta americana (Ulrich & Bassler), Swain, 1951, p. 41; Puri, 1953a, p. 261, pl. 13, figs. 1-5, text-figs. 9 d-f.

Pterygocythereis americana (Ulrich & Bassler), Malkin, 1953, p. 795, pl. 80, figs. 26-29; McLean, 1957, p. 80, pl. 9, figs. 5 a-d, 6 a-e.

[?] Pterygocythereis sp. aff. P. americana (Ulrich & Bassler), Benson & Coleman, 1963, p. 22, pl. 5, figs. 1-3, text-fig. 10.

[?] Pterygocythereis sp. Curtis, 1960, p. 478, pl. 1, fig. 32.

[?] Pterygocythereis cf. P. americana (Ulrich & Bassler), Curtis, 1960, p. 478, pl. 1, fig. 33.

Material. - Three isolated valves.

Dimensions. - Figured hypotypes, UMMP 48713: length .93 mm, height .51 mm; UMMP 48714: length .78 mm, height .40 mm.

Former occurrences. - This species was originally described from the Miocene of Maryland by Ulrich & Bassler (1904, p. 122), and has since been reported from the Upper Miocene by Howe et al. (1935, p. 26), Swain

(1948, p. 206; 1951, p. 41), Puri (1953a, p. 261), Malkin (1953, p. 795), and McLean (1957, p. 80). It has tentatively been identified from the Recent sediments of the Gulf of Mexico by Curtis (1960, p. 478) and Benson & Coleman (1963, p. 22).

Pterygocythereis ? sp.

Pl. 7, fig. 11

Material. - Nine isolated valves.

Dimensions. - Figured hypotype, UMMP 48720: length .58 mm, height .42 mm.

Remarks. - Several specimens were found which are believed to be immature instars of a Pterygocythereis species, possibly, P. ? americana.

Genus Puriana Puri, 1953

Favella Coryell & Fields, 1937, p. 8; Edwards, 1944, p. 523 (non Favella Jorgenson, 1925).

Puriana Puri, 1953c, p. 751; Sylvester-Bradley, 1961, Q341; Benson & Coleman, 1963, p. 42; Van Morkhoven, 1963, p. 200.

Type species. - Favella puella Coryell & Fields, 1937, p. 8, fig. 8 a-c, juvenile (= Cythereis rugipunctata gatunensis Coryell & Fields, 1937, p. 10, fig. 11 a, adult).

Diagnosis. - Lateral outline subquadrate; anterior end broadly rounded, posterior end truncate; ventral margin concave, dorsal margin straight. Valves tumid, with a narrowly compressed zone at the posterior margin in dorsal view. Surface covered with ridges and knobs, those ridges present in the posterior half tending to be aligned in a dorsal-ventral direction; subcentral tubercle present. Weak anterior and about five strong posterior tubercles present. Size medium, length 0.60 to 0.85 mm. Marginal pore canals few, straight, simple. Normal pores few in number, open. Hinge amphidont/heterodont.

Remarks. - Considerable confusion exists concerning the type species of this genus, and therefore the species which belong to it. In the original description Coryell & Fields (1937, p. 8) designated Favella puella Coryell & Fields, 1937, as the type species. They also named a new variety in the same paper, Cythereis rugipunctata gatunensis Coryell & Fields. Subsequently most authors have considered F. puella to be a young molt of C. rugipunctata gatunensis and therefore the two forms have been listed as synonymous under the name F. puella (= Puriana puella) since it appears first in the publication. Van Morkhoven (1963, p. 201) considers F. puella to be a young molt of Cythere rugipunctata Ulrich & Bassler, 1904, and it is therefore assumed he considers all three of the named species synonymous. However, Benson & Coleman (1963, p. 43) state that they have studied the type material in the American Museum and have determined that Puriana puella is in fact a young molt of Cythereis rugipunctata gatunensis and that P. rugipunctata Ulrich & Bassler is a distinct species from P. puella, but congeneric with it. Therefore Favella puella remains the type species of Puriana.

Sylvester-Bradley (1961, Q336, Q341) places Cythere rugipunctata Ulrich & Bassler, and presumably its

allies, which would include Puriana puella, in the genus Carinocythereis Ruggieri, 1956, on the basis of hinge and ornamentation. I agree with Benson & Coleman (1963, p. 43) that this does not seem consistent with the characters of the two genera, and here retain the species in the genus Puriana.

Puriana rugipunctata (Ulrich & Bassler, 1904)

Pl. 8, figs. 1-5, 7

Cythere rugipunctata Ulrich & Bassler, 1904, p. 118, pl. 38, figs. 16, 17.

Cythereis rugipunctata (Ulrich & Bassler), Howe et al., 1935, p. 23, pl. 1, figs. 20-22, pl. 4, figs. 22, 23.

Favella rugipunctata (Ulrich & Bassler), Edwards, 1944, p. 524, pl. 88, figs. 5, 6; Van den Bold, 1946, p. 100, pl. 10, fig. 3; Van den Bold, 1950, p. 86; Malkin, 1953, p. 797, pl. 82, fig. 24.

Trachyleberis ? rugipunctata (Ulrich & Bassler), Swain, 1951, p. 38, pl. 6, fig. 8.

Puriana rugipunctata (Ulrich & Bassler), Puri, 1953c, p. 750; Puri, 1953a, p. 257, pl. 12, figs. 18, 19, text-fig. 8 k; Puri and Hulings, 1957, p. 174, 176, 183; McLean, 1957, p. 89, pl. 11, figs. 5 a-d; Puri, 1960, p. 126, pl. 6, fig. 18; Benson & Coleman, 1963, p. 43, pl. 8, figs. 1, 2, text-fig. 27 [non pl. 8, fig. 5 (= P. mesacostalis)].

Carinocythereis rugipunctata (Ulrich & Bassler), Sylvester-Bradley, 1961, Q336.

Material. - Eleven carapaces and 55 isolated valves.

Dimensions. - Figured hypotypes, UMMP 48724: length .77 mm, height .37 mm; UMMP 48725: length .70 mm, height .35 mm; UMMP 48726: length .66 mm, height .34 mm.

Former occurrences. - This species was originally described by Ulrich & Bassler (1904, p. 118) from the Miocene of Maryland. It has been reported from the Upper Miocene Arca zone of Florida (Howe et al., 1935, p. 23), Upper Miocene Duplin Marl of North Carolina (Edwards, 1944, p. 524), entire Miocene from the subsurface of North Carolina (Swain, 1951, p. 38), Upper Miocene Arca, Ecphora and Cancellaria facies of western Florida (Puri, 1953a, p. 257), and the Yorktown Formation of Virginia (McLean, 1957, p. 89). It has also been found in the Recent sediments of the eastern Gulf of Mexico by Puri & Hulings (1957, p. 174), Puri (1960, p. 126), and Benson & Coleman (1963, p. 43). A depth range of 19 to 239 feet, and salinity range of 35.01 to 39.92 parts per thousand is given by Benson & Coleman.

Puriana mesacostalis (Edwards, 1944)

Pl. 8, figs. 6, 8-14, 17

Favella mesacostalis Edwards, 1944, p. 524, pl. 88, figs. 1-4.

[?] Favella cf. F. mesacostalis Edwards, Swain, 1951, p. 41.

"Favella" mesacostalis Edwards, Puri, 1953c, p. 751.

[in part] Puriana rugipunctata (Ulrich & Bassler), Benson & Coleman, 1963, p. 43, pl. 8, fig. 5 [non pl. 8, figs. 1, 2 (= P. rugipunctata)].

Material. - Four carapaces and 48 isolated valves.

Dimensions. - Figured hypotypes, UMMP 48727: length .75 mm, height .34 mm; UMMP 48728: length .75 mm, height .35 mm; UMMP 48729 (immature instar): length .48 mm, height .27 mm; UMMP 48730 (immature instar): length .48 mm, height .27 mm.

Former occurrences. - Originally described from the Upper Miocene Duplin Marl of North Carolina by Edwards (1944, p. 524). Also questionably reported from the subsurface Miocene of North Carolina by Swain (1951, p. 41). Benson & Coleman (1963, p. 44, pl. 8, fig. 5) comment that they found some specimens that were like P. rugipunctata, except that spines replaced the posterior dorsal-ventral oriented ridges, which would appear to be conspecific with the forms from Sapelo Island.

Genus Tringinglymus Blake, 1950

Tringinglymus Blake, 1950, p. 181; Keij, 1957, p. 127; Pokorný, 1958, p. 271; Howe, 1961, Q307; Van Morkhoven, 1963, p. 175.

Type species. - Tringinglymus hyperochus Blake, 1950, p. 181, pl. 30, figs. 4-9.

Diagnosis. - Lateral outline elongate, subrectangular; anterior end broadly rounded, oblique dorsally, posterior end less broadly rounded also oblique dorsally; dorsal and ventral margins somewhat sinuous. Surface ornamented with reticulations, low ridges with a prominent antero-ventral ridge generally present. Inner margin moderately wide, with inner margin and line of concrescence not coinciding in type species, but no vestibule present in species assigned by Keij (1957, p. 127) to the genus. Marginal pore canals numerous at anterior end, less so ventrally and posteriorly; apparently straight, simple in type species. Normal pores unknown in type species. Hinge amphidont/lophodont; subtriangular projection below hinge of both valves. Central muscle scar field consists of vertical row of four elongate-ovate scars, with two oblique frontal scars anterior to dorsalmost adductor scars.

Tringinglymus whitei (Swain, 1951)

Pl. 9, figs. 11, 12, 14-19

Leguminocythereis whitei Swain, 1951, p. 43, pl. 3, figs. 14, 16-18, pl. 4, fig. 1; Malkin, 1953, p. 785, pl. 80, figs. 7-12.

Leguminocythereis (?) whitei Swain, McLean, 1957, p. 80, pl. 9, figs. 4 a-b.

Material. - Six carapaces and 16 isolated valves.

Dimensions. - Figured hypotypes, UMMP 48742: length .72 mm, height .38 mm; UMMP 48743: length .74 mm, height .38 mm; UMMP 48744: length .80 mm, height .42 mm; UMMP 48745: length .78 mm, height .43 mm.

Former occurrences. - Originally described by Swain (1951, p. 43) from the entire Miocene and Pleistocene from the subsurface of North Carolina. Also reported from the Yorktown Formation of Virginia, Maryland, and New Jersey by Malkin (1953, p. 785) and McLean (1957, p. 80).

Remarks. - This species has previously been placed in the genus Leguminocythereis Howe, 1936 (in Howe & Law, p. 61). It differs from that genus in lateral outline, ornamentation and hinge. It seems to conform very closely to the type species, T. hyperochus, of the genus Tringinglymus, particularly in the ornamentation, lateral outline, and the presence of the subtriangular projection at about mid-length, below the hinge of both valves.

Tringinglymus sapeloensis n. sp.

Pl. 9, figs. 20-27

Description. - Lateral outline elongate, subrectangular; dorsal and ventral margins almost straight; anterior margin rounded, oblique in dorsal half, posterior margin narrowly rounded in ventral half, short concave portion present at posterior cardinal angle.

Surface with irregular, sub-rounded reticulate pattern; prominent anteromarginal ridge; anterior blunt marginal spines.

Inner lamella moderately wide anteriorly and posteriorly, narrowing abruptly ventrally, no vestibule present. Marginal pore canals numerous, approximately 25 anteriorly, 10 ventrally, 6 posteriorly, straight, simple, tending to thicken in central portion.

Normal pores small, open, few scattered.

Hinge amphidont/lophodont; in right valve anterior smooth tooth higher anteriorly, smooth median groove, smooth posterior tooth higher posteriorly, with sharp ventrally directed projection below hinge at about mid-length; in left valve anterior socket, smooth median ridge, posterior socket, and similar projection below hinge as described in right valve.

Material. - Nine carapaces and 133 isolated valves.

Dimensions. - Holotype, UMMP 48747: length .61 mm, height .34 mm. Paratypes, UMMP 48746: length .59 mm, height .30 mm; UMMP 48748: length .42, height .22; UMMP 48749: length .53 mm, height .26 mm; UMMP 48750: length .59 mm, height .37 mm.

Remarks. - This species differs from T. whitei in being smaller, but most noticeable in having decidedly less prominent raised ornamentation.

Family Cytherideidae Sars, 1925

[nom. transl. Sylvester-Bradley & Harding, 1953 (ex. Cytherideinae Sars, 1925)]

Genus Clithrocytheridea Stephenson, 1936

Cytheridea (Clithrocytheridea) Stephenson, 1936, p. 702; Van den Bold, 1946, p. 80.

Clithrocytheridea Stephenson, Stephenson, 1944, p. 449;

Stephenson, 1946, p. 326; Keij, 1957, p. 57; Pokorný, 1958, p. 247; Howe, 1961, Q275; Van Morkhoven, 1963, p. 281.

Cytheridea (Leptocytheridea) Stephenson, 1937, p. 156 [in part].

Type species. - Cytheridea (?) garretti Howe & Chambers, 1935, p. 14, pl. 1, figs. 4, 5, pl. 2, figs. 11, 12, pl. 6, figs. 10, 11.

Diagnosis. - Lateral outline elongate, subquadrangular, highest portion lies anterior of mid-length; anterior end broadly rounded, posterior end narrowly so. Surface usually coarsely pitted, with ridges often present; the ornamentation pattern usually arranged concentric to margins. Size medium, length 0.60 to 0.80 mm. Inner lamella moderate in width, anterior vestibule often formed. Marginal pore canals numerous, straight, simple. Normal pores numerous, sieve-type. Hinge merodont/entomodont, all elements crenulate.

Remarks. - Van Morkhoven (1963, p. 281) lists the upper range of the genus as Eocene and states (p. 284) that any younger described species differ in one or more features from the true Clithrocytheridea. Keij (1957, p. 57) lists the range as extending to the Recent and Howe (1961, Q276) as questionably to the Recent. The specimens considered below conform in all details to the features listed by Van Morkhoven (1963, p. 281) for the genus Clithrocytheridea, and is therefore treated as such.

Clithrocytheridea virginensis Malkin, 1953

Pl. 10, figs. 1-4

Clithrocytheridea virginensis Malkin, 1953, p. 783, pl. 79, figs. 23, 25-28; McLean, 1957, p. 74, pl. 8, figs. 2 a-g.

[?] Haplocytheridea sp. aff. H. israelskyi Stephenson, Swain, 1951, p. 20, pl. 1, figs. 15-17.

Material. - Two valves, a left and a right.

Dimensions. - Figured hypotypes, UMMP 48751: length .81 mm, height .38 mm; UMMP 48752: length .85 mm, height .46 mm.

Former occurrences. - Malkin (1953, p. 783) described C. virginensis from the Upper Miocene Yorktown Formation of Virginia, and McLean (1957, p. 74) reported it from the same area. Swain (1951, p. 20) described a form, Haplocytheridea sp. aff. H. israelskyi, which appears identical to this species from the subsurface Upper Miocene of North Carolina, with one specimen found in the Lower Miocene.

Genus Cushmanidea Blake, 1933

Cushmanidea Blake, 1933, p. 233; Puri, 1957, p. 193; McLean, 1957, p. 77; Puri, 1958, p. 172 [in part (non Pontocythere Dubovsky, 1939, or Hemicytherideis Ruggieri, 1952)]; Pokorný, 1958, p. 248; Howe, 1961, Q290 [in part (non Pontocythere Dubovsky, 1939, or Hemicytherideis Ruggieri, 1952)]; Van Morkhoven, 1963, p. 329.

Hulingsina Puri, 1958, p. 173; Howe, 1961, Q290; Benson & Coleman, 1963, p. 30.

Type species. - Cytheridea seminuda Cushman, 1906, p. 374, pl. 33, figs. 62-64.

Diagnosis. - Elongate carapace, curved, convex dorsal margin. Surface smooth, reticulate, pitted or tuberculate. Inner lamella moderately wide, vestibules formed both anteriorly and posteriorly; line of concrescence irregular, indented toward the outer margin at origin of marginal pore canals. Marginal pore canals moderate in number, straight, simple, originating at indentation of line of concrescence in bunches of two, three, or four. Type of normal pores unknown in type species, but in most species, medium size, sieve-type, may be constant in position within a species. Hinge merodont/lophodont. Central muscle scar field of four elongate-ovate adductor scars with V- or heart-shaped frontal scar; two elongate mandibular scars near ventral margin.

Remarks. - There has been much discussion concerning the validity of a group of closely related genera: Cushmanidea Blake, 1933, Pontocythere Dubovsky, 1939, Hemicytheridea Ruggieri, 1952, and Hulingsina Puri, 1958 (see Oertli, 1956, p. 56; Wagner, 1957, p. 44; Puri, 1958, p. 171; Howe, 1961, Q290; Van Morkhoven, 1963, p. 329). It has been established by Oertli (1956, p. 56) that Pontocythere and Hemicytheridea are synonymous on the basis of the fact that their type species are congeneric, and therefore the name Hemicytheridea must be suppressed in favor of Pontocythere.

Puri (1958, p. 171) restudied the genus Cushmanidea and placed Pontocythere (including Hemicytheridea) in synonymy with Cushmanidea. He includes the species Cytheridea elongata Brady (1868, p. 421) in Cushmanidea based on material sent him from the Adriatic Sea. This species is the type of Hemicytherideis, and is therefore included in the concept of the genus Pontocythere. Puri describes and illustrates all of the hinge elements as being smooth, while Wagner (1957, p. 44) shows the median and posterior elements as crenulate for the same species. This is an important distinction since Puri (1958, p. 172) in redefining the genus Cushmanidea states: "Hinge nondenticulate, valves articulate by means of three pairs of flanges." Therefore it would seem that the two genera, Pontocythere and Cushmanidea are separable on the basis of the hinge elements. In some species of Cushmanidea, however, the posterior, short hinge element is faintly crenulate. In addition Van Morkhoven states (1963, p. 329): "The type species of Cushmanidea (Cytheridea seminuda Cushman, 1906) and Pontocythere, however, show some marked differences in soft parts (mandibles, copulation organs) as well as in valve structure (hinge), and for the moment they are therefore better kept apart."

Puri (1958, p. 173) erected the genus Hulingsina with the type species H. tuberculata also described in the same paper (not Cytheridea americana Cushman, 1906, as stated by Van Morkhoven, 1963, p. 329). Nowhere in the paper did Puri actually designate H. tuberculata as the type species, but it is listed first under the genus and also described first under Hulingsina, therefore it must take priority as the type species. This genus as originally described differs from Cushmanidea by being more heavily ornamented, consisting of tubercles, reticulations or coarse pits. Since the type species of both Cushmanidea and Hulingsina are living forms, slight differences in surface ornamentation without any mention of soft parts are insufficient for generic distinctions. Therefore in agreement with Van Morkhoven (1963, p. 329) I recognize Pontocythere (including Hemicytherideis) and Cushmanidea (including Hulingsina) as valid genera.

Cushmanidea ashermani (Ulrich & Bassler,
1904)

Pl. 12, figs. 14-17

Cytherideis ashermani Ulrich & Bassler, 1904, p. 126, pl. 37, figs. 10-16; Howe, et al., 1935, p. 14, pl. 3, figs. 8-10; Edwards, 1944, p. 514, pl. 86, figs. 1-4; Van den Bold, 1946, p. 87, pl. 12, fig. 8; Swain, 1948, p. 195, fig. 1 [plates 13 and 14 are reversed]; Swain, 1951, p. 19; Puri, 1952, p. 910, pl. 130, figs. 4-8, text-figs. 1, 2; Puri, 1953a, p. 286, pl. 9, figs. 4-8; Malkin, 1953, p. 778, pl. 78, figs. 1-13.

Cytherideis longula Ulrich & Bassler, 1904, p. 128, pl. 37, figs. 21-27; Swain, 1948, p. 195, pl. 14, fig. 2 [plates 13 and 14 are reversed]; Swain, 1951, p. 19.

Cytherideis agricola Howe & Hadley, Malkin, 1953, p. 779, pl. 28, figs. 24, 25.

Cytherideis semicircularis Ulrich & Bassler, 1904, p. 127, pl. 37, figs. 18-20.

Cushmanidea ashermani (Ulrich & Bassler), McLean, 1957, p. 77, pl. 8, fig. 5 a-f.

Hulingsina ashermani (Ulrich & Bassler), Puri, 1958, p. 173; Benson & Coleman, 1963, p. 30, pl. 4, figs. 1-3 [numbers 3 and 4 are reversed on plate 4], text-fig. 17.

Hulingsina sulcata Puri, 1960, p. 118, pl. 2, figs. 6, 7, text-figs. 43-46.

Material. - Five isolated valves.

Dimensions. - Figured hypotypes, UMMP 48764: length .84 mm, height .38 mm; UMMP 48765: length .83 mm, height .38 mm.

Former occurrences. - This species has been widely reported from the Miocene sediments of the eastern and Gulf Coast states of the United States. It has also been reported from the Recent sediments of the Gulf of Mexico by Benson & Coleman (1963, p. 30). They give a depth range of 32 to 239 feet, being most abundant at greater than 60 feet.

Remarks. - There is much confusion pertaining to the correct identification of this species. Only 5 specimens were found in the Sapelo Island material and they conform very closely to those shown by Ulrich & Bassler (1904, p. 126, pl. 37, figs. 10-16) and Edwards (1944, p. 514, pl. 86, figs. 1-4). The synonymy shown above follows closely that of Benson & Coleman (1963, p. 30), but reexamination of many of the forms is necessary before it will be possible to separate them accurately. No attempt is made here to do that.

Cushmanidea tuberculata (Puri, 1958)

Pl. 13, figs. 1-10

Hulingsina tuberculata Puri, 1958, p. 173, pl. 2, figs. 5-9; Howe, 1961, Q290, fig. 217, no. 1 a-e.

Description. - Lateral outline elongate, entire carapace curved, convex dorsally; anterior end rounded evenly,

posterior end bluntly rounded in left valve, much more pointed in right valve.

Surface with prominent tubercles covering entire carapace, tending to be arranged parallel to margins; dorsal sulcus present slightly anterior of mid-length and oriented in anteroventral direction.

Inner lamella moderately wide, greatest width in anterior end; line of concrescence and inner margin coincident except in small area in anterior portion, thus forming small anterior vestibule.

Marginal pore canals about 25-30 anteriorly, 15 ventrally and 10-15 posteriorly; originating at line of concrescence in groups of two, three or four and diverging toward the outer margin in anterior; tend to be paired posteriorly and subparallel rather than divergent as in anterior.

Normal pores large, sieve-type, few in number, not coinciding with surface tubercles.

Hinge merodont/lophodont, same as in C. echolsae (see below). Muscle scar pattern same as in C. echolsae (see below).

Material. - Five carapaces and 118 isolated valves.

Dimensions. - Figured hypotypes, UMMP 48766: length .72 mm, height .29 mm; UMMP 48767: length .67 mm, height .27 mm; UMMP 48768: length .69 mm, height .29 mm; UMMP 48769: length .67 mm, height .29 mm.

Former occurrences. - Reported previously by Puri (1958, p. 173), where it was originally described from his locality 5, in six feet of water off the west coast of Florida. It is assumed that the species was found living, although no mention is made by Puri of this fact.

Remarks. - As stated above, this species was the type of the genus Hulingsina, which is not considered a valid genus in this paper. A full description has been included since many details of the interior of the valve were not originally given by Puri.

Cushmanidea echolsae (Malkin, 1953)

Pl. 13, figs. 11-22; pl. 14, figs. 1-8

Cytherideis echolsae Malkin, 1953, p. 778, pl. 78, figs. 14-17; Puri, 1958, p. 175; McLean, 1957, p. 78, pl. 9, figs. 1 a-c, 2 a-d.

[?] Cushmanidea cf. C. echolsae (Malkin), Curtis, 1960, p. 483, pl. 2, fig. 7 (top), fig. 8 (bottom).

Description. - Lateral outline elongate, entire carapace curved, convex dorsally; anterior end evenly rounded, posterior end bluntly rounded in left valve, much more pointed in right valve.

Surface with prominent pits; dorsal sulcus slightly anterior of mid-length which trends in an anterodorsal direction; sometimes second less prominent sulcus, parallel to and posterior to the first.

Inner lamella moderately wide, greatest width in anterior end; vestibules present both anteriorly and posteriorly, the widest at anterior end; line of concrescence and inner margin coincide ventrally; line of concrescence

irregular anteriorly, bending toward outer margin at position where marginal pore canals originate.

Marginal pore canals about 30 anteriorly, 15 ventrally, and 10 posteriorly; always originate at line of concrescence in groups of two, three or four and diverge toward outer margin; straight, simple in ventral and posterior portions; frequent normal pores visible through inner lamella which give impression of being marginal pore canals.

Normal pores large, sieve-type; appear to be constant within this species, particularly in vicinity of central and mandibular muscle scar field.

Hinge merodont/lophodont. Right valve with anterior elongate flange, formed of outer lamella which bends ventrally, where extension of carapace forms exterior limits of median groove with internal flange paralleling this to form interior limit of median groove, posterior, short, crenulate tooth-like projection which continues posteriorly as short flange.

Left valve has anterior internal flange forming groove when combined with extension of outer lamella, median bar and oblique groove for reception of posterior tooth-like projection of right valve.

Central muscle-scar pattern of four adductor scars, one dorsal and slightly anterior to the remaining three; frontal U-shaped scar, three mandibular scars near ventral margin, the two which lie ventral to the third touching; three dorsal scars visible, dorsal and anterior to the central muscle scar field.

Material. - Forty-two carapaces and 943 isolated valves.

Dimensions. - Figured hypotypes, UMMP 48770: length .66 mm, height .27 mm; UMMP 48771: length .66 mm, height .27 mm; UMMP 48773: length .72 mm, height .32 mm; UMMP 48774: length .64 mm, height .29 mm; UMMP 48775: length .67 mm, height .29 mm; UMMP 48776: length .59 mm, height .27 mm.

Former occurrences. - Originally described from the Upper Miocene Yorktown Formation of Virginia, Maryland, and New Jersey by Malkin (1953, p. 778) and again from the Yorktown of Virginia by McLean (1957, p. 78). A form was questionably assigned to this species by Curtis (1960, p. 483) from the Recent sediments of the Gulf of Mexico, near the Mississippi River delta.

Remarks. - A complete description is here included based on the Sapelo Island specimens since this is the most important species present in the sense of quantity. One interesting aspect of the forms found is the seemingly consistent position of the normal pores. Three photographs (pl. 14, figs. 4, 6, 7) are shown of left valves taken in transmitted light from the interior of the valves, and it can be seen that all of the normal pores, which show as black dots, are in almost identical position in relation to the muscle scars and the line of the median sulcus. Locations were checked closely and found to be the same on ten valves, five right and five left.

Cushmanidea glabra, n. sp.

Pl. 14, figs. 9-21

Description. - Lateral outline, carapace curved

convex dorsally; anterior end narrowly rounded, posterior end bluntly rounded in left valve, more narrowly in right valve.

Surface entirely smooth, no ornamentation and no dorsal sulcas developed.

Inner lamella wide anteriorly, moderate ventrally and posteriorly; wide vestibule present anteriorly, narrow vestibules posteroventrally and posteriorly; line of concrescence and inner margin coincide elsewhere; high flange present near line of concrescence both anteriorly and posteriorly in right valve and anteriorly only in left valve.

Marginal pore canals about 25-30 in anterior, 15 ventrally and 10 posteriorly, sinuous, simple, tend to widen near outer margin in bulge; in anterior portion originate in groups of two, three or four, and then diverge sinuously toward outer margin.

Normal pores moderate in size, scattered, sieve-type, with large opening in center and sieve structure surrounding.

Hinge merodont/lophodont. Right valve with elongate anterior flange which is posterior extension of projecting flange inside of and parallel to anterior outer lamella, extending slightly past mid-length, with posterior, elongate, finely crenulate projection at posterior extremity; shallow median groove; high, short, thin, posterior tooth which is projection of flange which continues inside of and concentric to posterior outer margin.

Left valve has elongate anterior flange which is extension of projecting flange which is parallel to and inside of anterior outer margin; elongate, negative, finely crenulate area anterior to median, thin, smooth bar; short posterior socket.

Central muscle-scar field of four adductor scars, three of which are relatively large and in a row trending in an anteroventral direction, the fourth much smaller and dorsal to the others; frontal U-shaped scar anterior to adductor scars and at mid-height; fulcral point lying between adductor and frontal scars; no mandibular or dorsal muscle scars visible.

Material. - One carapace and 5 isolated valves.

Dimensions. - Holotype, UMMP 48777: length .54 mm, height .29 mm. Paratype, UMMP 48778: length .59 mm, height .27 mm.

Remarks. - This species is placed in the genus *Cushmanidea* on the basis of its elongate carapace, hinge type and muscle scar pattern. It differs from other Miocene to Recent members of the genus in having a completely smooth exterior carapace surface.

Cushmanidea magniporosa, n. sp.

Pl. 12, figs. 1-13

Description. - Lateral outline elongate, carapace curved convex dorsally; anterior end nearly evenly rounded, somewhat oblique above, posterior end rounded dorsally with posteroventral truncation.

Surface smooth dorsally and posterodorsally, with series of low ridges concentric to outline of outer margin, stronger ones nearer outer margin.

Inner lamella moderately wide, widest anteriorly, narrowing anteroventrally, widening again posteroventrally, narrowing abruptly at posteroventral extremity, widening somewhat at posterior end; wide anterior vestibule, narrow posterior one; line of concrescence irregular at both anterior and posterior ends, bending toward outer margin at origin of marginal pore canals.

Marginal pore canals about 25 anteriorly, 15 posteriorly, 10 ventrally; grouped in bunches of two, three, or four anteriorly, bunched occasionally ventrally and posteriorly; not branching.

Normal pores frequent, large, scattered and sieve-type.

Hinge merodont/lophodont. Right valve has anterior high flange which bends ventrally and forms interior boundary of median groove, while outer boundary formed by extension of outer lamella, high posterior flange, slightly crenulate and shorter than similar anterior flange.

Left valve has anterior groove, exterior boundary of which is formed by outer lamella and interior boundary formed by flange which ends about two-thirds of length of groove, followed by second flange which forms median, smooth bar and whose anterior lower portion forms inner boundary of posterior third of anterior groove; posterior ill-defined socket and platform for reception of posterior high flange of right valve.

Central muscle-scar pattern consists of four adductor scars, three of which lie close together in a vertical row, while the fourth lies dorsal and slightly anterior to the other three, a frontal U-shaped scar anterior to the dorsal adductor scar, three mandibular scars near ventral border, two of which lie close together and are nearest the ventral edge, and three dorsal scars visible dorsal and anterior to the central muscle-scar field.

Material. - One carapace and 5 isolated valves. Only one specimen mature.

Dimensions. - Holotype, UMMP 48763: length .92 mm height .38 mm.

Remarks. - This species is placed in *Cushmanidea* with some doubt. The hinge line appears to be unique in its possession of the notch in the left valve (pl. 12, figs. 5, 8) of the anterior anti-slip bar which has no apparent complementary structure in the right valve. In addition, the normal pores are somewhat different from those of *C. echolsae*, *C. tuberculata*, and *C. glabra* (compare pl. 12, fig. 9, to pl. 13, figs. 21, 22).

Cushmanidea sp.

Pl. 15, figs. 17-23

Material. - Three valves.

Dimensions. - Figured specimen, UMMP 48783: length .71 mm, height .34 mm.

Remarks. - Only two unbroken and one broken valves of this form were found. Because the hinge conforms closely to that in other species of *Cushmanidea*, it is put in that genus.

Genus *Haplocytheridea* Stephenson, 1936

Haplocytheridea Stephenson, 1936, p. 700; Sandberg, 1964, p. 359.

Cytheridea (*Haplocytheridea*) Stephenson, Van Morkhoven, 1963, p. 278.

Type species. - *Cytheridea montgomeryensis* Howe & Chambers, 1935, p. 17, pl. 1, fig. 1; pl. 2, figs. 1-3, 7, 9; pl. 6, figs. 17, 18.

Diagnosis. - Lateral outline elongate to subtriangular; carapace heavily calcified generally; dorsal margin rounded gently, ventral margin typically concave in posterior half. Surface with shallow small to medium sized pits. Size medium, length 0.65 to 0.90 mm. Inner lamella moderately wide, more narrow ventrally and posteriorly; vestibule sometimes present anteriorly. Marginal pore canals moderate in number, mostly simple, straight, some bifurcating. Normal pores correspond to surface pits, small, sieve-type. Hinge merodont/entomodont, all elements positive in smaller valve, negative in larger valve.

Haplocytheridea bradyi (Stephenson, 1938)

Pl. 11, figs. 1-11

Cytheridea (*Haplocytheridea*) *bradyi* Stephenson, 1938, p. 129, pl. 23, fig. 22; pl. 24, figs. 5, 6; text-fig. 10.

Haplocytheridea bradyi (Stephenson), Swain, 1955, p. 618, pl. 59, fig. 12a-b; Puri, 1960, p. 110, pl. 2, figs. 3-4; pl. 6, fig. 19; text-figs. 4, 5; Sandberg, 1964, p. 362, pl. 2, figs. 7-16.

Haplocytheridea wadei (Stephenson), Puri, 1953, p. 231, pl. 3, figs. 5, 6; text-fig. 3g.

Cytheridea (*Haplocytheridea*) *wadei* Stephenson, 1941, p. 428, text-figs. 3, 4, 14-18.

Cytheridea (*Haplocytheridea*) *probosciduala* Edwards, 1944, p. 508, pl. 85, figs. 8-11.

Haplocytheridea probosciduala (Edwards), Benson & Coleman, 1963, p. 28, pl. 3, figs. 4-9; text-fig. 15.

[not] *Haplocytheridea* cf. *H. probosciduala* (Edwards), Puri, 1953, p. 234, pl. 2, figs. 17, 18, text-fig. 3e-f [= ?*Haplocytheridea subovata* (Ulrich & Bassler, 1904)].

[?] *Haplocytheridea probosciduala* Malkin, 1953, p. 783, pl. 79, figs. 16, 20.

Material. - Seven carapaces and 530 isolated valves.

Dimensions. - Figured hypotypes, UMMP 48757: length .74 mm, height .38 mm; UMMP 48758: length .72 mm, height .38 mm; UMMP 48759: length .77 mm, height .35 mm.

Former occurrences. - Reported from the Upper Miocene of Florida, and North Carolina. It has been found in the Recent sediments of the Gulf of Mexico by Benson & Coleman within a depth range of 20 to 70 feet, with most specimens found at less than 35 feet.

Remarks. - The following features were observed in addition to those previously described by other authors for this species. The normal pores (pl. 11, figs. 4, 8) are large, sieve-type which correspond in position to the pits visible externally (pl. 11, figs. 2, 3). The normal pores spread abruptly upon reaching the exterior of the carapace. The central muscle-scar field (pl. 11, fig. 7) consists of four adductor scars, the ventral three of which are elongate with the long axis parallel to the dorsal margin, while the dorsal-most one lies at right angles to the other three. Two mandibular scars are present, one ventral to the adductor scars and paralleling the ventral margin, the other lying below the U-shaped frontal scar and oriented in an antero-dorsal direction.

Malkin (1953, p. 783, pl. 79, figs. 16, 20) mentions and illustrates a form which has anterior marginal spines, a feature which neither Edwards nor Benson & Coleman mentions, and which the present specimens lack altogether. Puri (1953a, p. 234) tentatively refers forms from the *Ecphora* and *Cancellaria* facies, Upper Miocene of western Florida to this species and he also shows anterior marginal spines, and the positive hinge elements in the right valve, which is the reverse of the hinge elements in this species.

Genus *Cyprideis* Jones, 1857

Cyprideis Jones, 1857, p. 20; Goerlich, 1952, p. 185; Pokorný, 1958, p. 247; Benson, 1959, p. 44; Howe, 1961, Q276; Van Morkhoven, 1963, p. 289.

Anomocytheridea Stephenson, 1938, p. 141; Edwards, 1944, p. 509; Howe, 1961, Q273.

Cytheridea (*Anomocytheridea*) (Stephenson), Van den Bold, 1946, p. 82.

Type species. - *Candona torosa* Jones, 1850, p. 27, pl. 3, fig. 6 a-e. (See also Wagner, 1957, p. 39, pl. 14, figs. 1-5).

Diagnosis. - Lateral outline oval; dorsal margin slightly convex, dorsal and ventral margins almost parallel; anterior and posterior ends both broadly rounded. Surface smooth or pitted, anterodorsal sulcus sometimes present. Size large, 0.75 to 1.00 mm in length. Inner lamella narrow; inner margin and line of concrecence coincide throughout and parallel outer margin. Marginal pore canals numerous, often bifurcating. Normal pores numerous, sieve-type, often long slit-like. Hinge amphidont/archidont, the median element is divided, the anteromedian portion consisting of a projecting crenulate bar in the left valve.

Cyprideis floridana (Howe & Hough, 1935)

Pl. 11, figs. 12-22

Cytheridea floridana Howe & Hough in Howe et al., 1935, p. 10, pl. 2, figs. 15, 16, 18, pl. 4, figs. 6, 10.

Anomocytheridea floridana (Howe & Hough), Stephenson, 1938, p. 142, pl. 23, fig. 15, pl. 24, figs. 7, 8, text-figs. 2, 6, 19, 20; Edwards, 1944, p. 510, pl. 85, figs. 16, 17; Puri, 1953a, p. 229, pl. 2, fig. 10, text-figs. 3a, b; Howe, 1961, p. Q273, fig. 203, no. la-e.

[?] *Cytheridea* ? (*Anomocytheridea*) *floridana* Howe & Hough, Van den Bold, 1946, p. 82.

[?] *Cyprideis littoralis* Brady, Swain, 1955, p. 615, pl. 59, figs. 11a-c, text-figs. 38, 5a, b.

[non] *Cyprideis floridana* Puri, 1960, p. 110, pl. 2, fig. 5, text-figs. 1-3.

Material. - One carapace and 137 isolated valves.

Dimensions. - Figured hypotypes, UMMP 48760: length .90 mm, height .45 mm; UMMP 48761: length .93, height .51 mm; UMMP 48762: length .91 mm, height .45.

Former occurrences. - Originally described from the *Arca* zone of the Upper Miocene Choctawhatchie Forma-

tion of Florida by Howe & Hough (in Howe et al., 1935, p. 142) as the most common ostracod occurring in the *Arca* zone and restricted to marine beds. Edwards (1944, p. 510) reported it from the Upper Miocene Duplin Marl of North Carolina, and Puri described it from the *Arca* facies of western Florida. Swain (1955, p. 615) assigned a form to *Cyprideis littoralis* (see also remarks below) from the Recent sediments of San Antonio Bay in the Gulf of Mexico which appears to belong to this species, although in his plate 59, figure 11c, the surface pits seem to be coarser than in the Sapelo Island forms.

Remarks. - *Cyprideis floridana* is very closely related to the type species of *Cyprideis*, *C. torosa*. The single prominent posteroventral spine on the right valve present on *C. torosa* which is mentioned and illustrated by Wagner (1957, p. 39, pl. 14, fig. 4) is lacking in *C. floridana*, and the uppermost adductor muscle scar is elongate in a vertical direction in *C. floridana*, whereas it is elongate in a horizontal direction as are the other three adductor scars in *C. torosa*.

Cytheridea floridana was chosen by Stephenson (1938, p. 141) as the type of his new genus *Anomocytheridea*. But this species is so closely related to *C. torosa* that it is practically impossible to place them in separate genera or even separate subgenera as has been suggested by Howe (1961, p. Q273). Howe (1961, p. Q273) characterizes the genus *Anomocytheridea* as follows: "Like *Cyprideis* in all characters except anterior portion of median hinge element which forms short blunt smooth bar instead of crenulate ridge, and antennal scars distinct instead of forming a V." Then in figure 203 (p. Q276) of the same volume are shown drawings of *Anomocytheridea floridana*, the type species, reproduced from Stephenson (1938, pl. 23, fig. 15, pl. 24, figs. 7, 8), which clearly show the anteromedian element of the hinge as being crenulate and the frontal or antennal muscle scar as forming a U-shaped scar. Therefore, all the differences between the two genera disappear and *Anomocytheridea* becomes a junior synonym of *Cyprideis*.

Swain (1955, p. 615-617) described two forms from the Recent sediments of San Antonio Bay, Gulf of Mexico, using the names *Cyprideis littoralis* and *C. torosa*. It has since been well-established (Wagner, 1957, p. 39; Van Morkhoven, 1962, p. 45) that the two species are identical, differing only in the presence or absence of phenotypic marginal tubercles caused by a decrease in salinity. In addition, none of the forms shown by Swain exhibit the prominent posteroventral spine mentioned above, and except for the somewhat coarser surface pits the ones listed under *C. littoralis* appear conspecific with *C. floridana*. The forms Swain lists under *C. torosa* are evidently the same species as the new species *C. swaini* described in this paper.

Puri (1960, p. 110) has recently described a new species of *Cyprideis* to which he gave the name *C. floridana*. The transference of *Anomocytheridea floridana* to the genus *Cyprideis* makes a new name necessary for the species described by Puri.

Cyprideis swaini, n. sp.

Pl. 10, figs. 5-17

[?] *Cyprideis torosa* (Jones), Swain, 1955, p. 616, pl. 59, figs. 8a, b, text-fig. 32c.

Description. - Lateral outline subtriangular, highest portion in anterior third; ventral margin almost straight, slight concavity in posterior third, dorsal margin evenly and strongly convex, only break in curve at posterior cardinal

angle; anterior end broadly and evenly rounded, posterior end bluntly rounded.

Surface almost smooth to reticulate; prominent dorsomedian sulcus, with weaker one anterior to the first; in three immature specimens was found two prominent nodes in posterior third of valve and in several others less prominent nodes in same position. This feature was always observed on immature forms.

Inner lamella narrow; line of concrescence and inner margin coincide throughout, with the possible exception of the central posterior portion where the thickening of inner lamella makes observation of the inner margin difficult.

Marginal pore canals short, straight, simple, evenly spaced, about 25 anteriorly, 8 posteriorly.

Normal pores moderate in number, large sieve-type varying in shape, some are circular, some slit-like and others are three-cornered slits.

Hinge amphidont/heterodont. Right valve consists of anterior bar, in most specimens coarsely crenulate, in others very finely crenulate, anteromedian element a finely crenulate short socket; posteromedian element a smooth groove and posterior, short bar with about 6 crenulations.

Left valve with anterior crenulate socket, anteromedian finely crenulate bar, posteromedian smooth bar and posterior crenulate socket.

Central muscle-scar pattern of four adductor scars lying close together in vertical row, all oval-shaped, the topmost being smaller than the other three and more elongate; frontal scar V-shaped, lying anterior to topmost adductor scar; two mandibular scars present, both elongate, one near ventral margin and parallel to it, the other larger than the first, dorsal to it and trending in an antero-dorsal direction; fulcral point visible between adductor and frontal muscle scars.

Material. - Three hundred sixty-two isolated valves.

Dimensions. - Holotype, UMMP 48754: length .82 mm, height .48 mm, paratypes, UMMP 48753: length .74 mm, height .45 mm; UMMP 48755: length .77 mm, height .48 mm; UMMP 48756: length .74 mm, height .45 mm.

Former occurrences. - Swain (1955, p. 616) described forms from the Recent sediments of San Antonio Bay, Gulf of Mexico which are here placed in this species.

Remarks. - This species is here placed in the genus *Cyprideis* because of the muscle scar pattern, hinge, and sieve-type normal pores. However, it differs from the type species of *Cyprideis*, *C. torosa* in the type of marginal pore canals. In *C. torosa* and *C. floridana* they are more numerous and branching, while in *C. swaini* they are simple, straight and evenly spaced.

Genus *Eucythere* Brady, 1868

Eucythere Brady, 1868, p. 429, nom. nov. for *Cytheropsis* Sars, 1866 [non. M'Coy, 1849]; Müller, 1894, p. 362; Lienenklaus, 1900, p. 524; Müller, 1912, p. 333; Sars, 1925, p. 161; Alexander, 1934, p. 226; Alexander, 1936, p. 689; Howe, 1936, p. 143; Triebel, 1940, p. 161; Edwards, 1944, p. 513; Puri, 1953a, p. 299; Wagner, 1957, p. 43; Pokorný, 1958,

p. 282; Howe, 1961, Q285; Van Morkhoven, 1963, p. 337.

Type species. - *Cythere declivis* Norman, 1865, p. 16, pl. 5, figs. 9-12 subsequent designation, Brady and Norman, 1889, p. 178.

Diagnosis. - Lateral outline triangular, highest toward anterior end; anterior end broadly rounded, posterior end narrowly rounded. Surface smooth, pitted, lightly reticulated or with irregular wrinkles. Size medium, length 0.40 to 0.80 mm. Inner lamella wide anteriorly where inner margin and line of concrescence are widely separate, more narrow vestibule developed posteriorly. Marginal pore canals few in number, straight, evenly spaced, simple. Normal pores large, sieve-type. Hinge merodont/entodont. Central muscle-scar field consists of four arcuate adductor scars and U-shaped frontal scar.

Eucythere sp. cf. *E. declivis* (Norman, 1865)

Pl. 2, figs. 1-7

Cythere declivis Norman, 1865, p. 16, pl. 5, figs. 9-12.

Cythere tenuitesta Sars, 1866, p. 57.

Eucythere declivis (Norman), Brady, 1868, p. 430, pl. 27, figs. 22-26, 52-55; Brady & Norman, 1889, p. 178; Müller, 1894, p. 27, pl. 29, figs. 5, 13; Blake, 1933, p. 233; Alexander, 1934, p. 227, pl. 35, figs. 27; Wagner, 1957, p. 43, pl. 15, figs. 1-5; Pokorný, 1958, p. 282, fig. 975; Howe, 1961, Q285, fig. 212, 2 a-b; Van Morkhoven, 1963, p. 338, fig. 547.

Material. - One carapace.

Dimensions. - Figured hypotype, UMMP 48686: length .58 mm, height .32 mm.

Former occurrences. - *E. declivis* has been widely described from Recent marine waters off the coasts of western Europe, and Wagner also reports it from the Pleistocene.

Remarks. - According to Wagner (1957, p. 44), who redescribed the carapace of this species in great detail, there has been considerable confusion concerning its identification. Since only one specimen was found in the Sapelo Island sediments only a tentative identification is made here. This specimen is remarkably close to the one shown by Wagner, in particular the central muscle-scar field and the position of the large sieve-type normal pores.

Eucythere triangulata Puri, 1953

Pl. 2, figs. 8-11

Eucythere triangulata Puri, 1953a, p. 300, pl. 16, figs. 7, 8, text-fig. 13j.

Material. - Two valves, a left and a right.

Dimensions. - Figured hypotypes, UMMP 48687: length .75 mm, height .37 mm; UMMP 48688: length .64 mm, height .34 mm.

Former occurrences. - Described by Puri (1953a, p. 300) from the Upper Miocene *Arca* and *Ecphora* facies of western Florida.

Genus Sahnia Puri, 1952

Sahnia Puri, 1952, p. 912; Puri, 1958, p. 174; Van Morkhoven, 1963, p. 335.

Neocytherideis Puri, Sylvester-Bradley & Harding, 1953, p. 755 [in part]; Howe, 1961, Q290 [in part].

Type species. - Cytherideis subulata Brady, 1868 [non Cytherideis subulata Brady, 1867], p. 454, pl. 35, figs. 43-46 (see remarks.).

Diagnosis. - Outline elongate, the posterior more broadly rounded than the anterior end, which is drawn out, ventral margin nearly straight, dorsal margin broadly curved. Surface nearly smooth, faint concentric ridges sometimes present, stronger near margins, anterior marginal denticles sometimes present, valves weakly calcified. Size medium, length about 0.60 mm. Inner lamella broad throughout, widest in anterior end, where narrow vestibule is present. Marginal pore canals moderate in number, curved, non-branching, swelling often present in distal third. Normal pores large, sieve-type. Hinge merodont/lophodont. Central muscle-scar field with four adductor scars lying close together and forming curved pattern, oval-shaped frontal scar and usually well-defined fulcral point.

Remarks. - Sahnia was erected by Puri (1952, p. 912) and the type species was chosen as Cytherideis subulata Brady. However, according to Sylvester-Bradley & Harding (1953, p. 754) Puri incorrectly identified that species. The type specimens of C. subulata are lost, but material from the type localities, Cockburnspath, Berwickshire, Scotland, and Torquay, Devon, England, and they say that the species is well-represented in the British Museum. Puri's specimens were from a different locality, Swanage, Dorset, England. In the same paper Puri erected another genus, Neocytherideis, with the species Neocytherideis elongatus, which is described as new in the same paper, as the type species. The specimens upon which N. elongatus is based, are also from Swanage (spelled Swange by Puri), Dorset, England. All of the material from Swanage is reported by Puri as being from the "shore sand." Presumably the specimens were found alive, although no mention of this fact is made, nor is any mention made of whether or not the "soft-parts" were available for study.

Unfortunately, there is considerable disagreement among authors as to the standing of these species and genera which Puri erected. To begin with, as mentioned above, Sylvester-Bradley & Harding (1953, p. 754) consider the specimens upon which Puri based the genus Sahnia, i. e. his Cytherideis subulata as misidentified. In addition they consider the species Neocytherideis elongatus Puri, 1952, the type species for the genus Neocytherideis, to be synonymous with Cytherideis subulata var. fasciata Brady & Robertson, 1874.

Brady described two species which differ in outline as Cytherideis subulata. The first, which must be the valid Cytherideis subulata was named by him in 1867 and was based on specimens originally described by Baird in 1850 as Cythere flavida (not O. F. Müller, 1785). Brady (1868) then figured another form as Cytherideis subulata. Puri listed both of these forms under his synonymy for Sahnia subulata, but Van Morkhoven (1963, p. 332) considered them separable. Van Morkhoven therefore considers the genus Neocytherideis, based upon the valid Cytherideis subulata, and the genus Sahnia to be valid and based upon the second and invalidly named Cytherideis

subulata of Brady. If the idea of Van Morkhoven is followed, the new species of Puri (1952, p. 912), Neocytherideis elongatus, is a junior synonym of the valid C. subulata, and Van Morkhoven does designate it as the type species of Neocytherideis. He therefore considers Puri's Sahnia subulata (type species of Sahnia) as a junior synonym of Brady's invalidly named second C. subulata. The type species of Sahnia, therefore, is left without a name.

On the other hand, Sylvester-Bradley & Harding (1953, p. 754) considered the two type species designated by Puri as congeneric and therefore recognize only the genus Neocytherideis, with the type species N. elongatus Puri as being synonymous to Cytherideis subulata var. fasciata Brady & Robertson, 1874. Unfortunately, they did not indicate whether they considered this latter variety of Brady & Robertson synonymous with any of the above mentioned species of Brady.

It would seem impossible at this time to unscramble this problem without first examining type material in order to decide whether the two genera should be recognized, or, as Sylvester-Bradley believes, only Neocytherideis is valid. Secondly if, as Van Morkhoven believes, the type species of Sahnia is without a valid name in the original designation, it is questionable if the generic name is valid. For the purposes of this paper I have followed the concept of Van Morkhoven (1963, p. 332) and recognized both genera. The species Puri (1952, p. 913) used as the type species should be renamed and possibly the genus should also be renamed, but retaining the concept of the genus as originally erected. But not having seen the type material and particularly the specimens in the British Museum, the name Sahnia is used herein for fear that the introduction of another name at this time will only add to the confusion.

Sahnia sp.

Pl. 3, figs. 1-9

Material. - Seven isolated valves.

Dimensions. - Figured hypotypes, UMMP 48692: length .62 mm, height .20 mm; UMMP 48691: length .60 mm, height .22 mm.

Description. - Lateral outline elongate, broadly rounded posteriorly, much more narrowly rounded anteriorly, with longest extent of anterior end lying in ventral half of valve. Ventral margin slightly sinuous, dorsal margin gently and evenly curved. Surface smooth except for faint ridges subparallel to margins in anteroventral portion. Carapace thinly calcified and fragile.

Inner lamella moderate in width, widest in anterior. Line of concrescence coincident with inner margin except in anterior where small vestibule is present.

Marginal pore canals simple, curved, enlarged in distal third in anterior; straight, simple, and evenly spaced in ventral and posterior portions.

Normal pores sieve-type, large.

Hinge merodont/lophodont. All elements smooth. Right valve consists of median groove limited by outer margin of valve and with thickening of outer margin of valve at either end forming hinge elements which fit into grooves of left valve. Left valve has thickened central portion opposite median groove of right valve with long anterior and short posterior grooves.

Central muscle-scar field of four adductor scars, the smallest being the dorsal one and each succeeding one toward the ventral margin being larger; an oval-shaped frontal scar lying anterior and ventral to the ventral-most adductor scar, and indistinctly outlined, but large and prominent fulcral point. Dorsal muscle scars not observed.

Remarks. - This species does not appear to be conspecific with that considered by Puri (1952, p. 912) as *Cytherideis subulata* Brady and designated by him as the type species of *Sahnia*. It differs particularly in possessing a much narrower inner lamella. In most other characters it is similar, but the above-mentioned character would seem to warrant the erection of a new species. However, in view of the tremendous nomenclatural difficulties surrounding this genus it is felt it is better for the time being to give only a full description of this species and await a complete assessment of the type material.

Curtis (1960, pl. 1, fig. 34) illustrated, with no discussion a form which she called *Sahnia* aff. *S. subulata* (Brady) which differs in lateral outline from this species in possessing a much sharper anterior cardinal angle. Since only the lateral outline is shown no further comparison can be made.

Family Cytheruridae G. W. Müller, 1894

[nom. transl. Reyment, 1961 (ex Cytherurinae G. W. Müller, 1894)]

Genus *Cytherura* Sars, 1866

Cytherura Sars, 1866, p. 69; Müller, 1894, p. 286; Edwards, 1944, p. 525; Hornibrook, 1952, p. 50; Swain, 1955, p. 626; Keij, 1957, p. 144; Hanai, 1957, p. 16; Pokorný, 1958, p. 285; Benson, 1959, p. 51; Reyment, 1961, Q291; Benson & Coleman, 1963, p. 31; Benson & Kaesler, 1963, p. 22; Van Morkhoven, 1963, p. 344; Swain, 1963, p. 815.

Type species. - *Cythere gibba* O. F. Müller, 1785, p. 66, pl. 7, figs. 7-9 (female) = *Cythere gibbera* O. F. Müller, 1785, p. 66, pl. 7, figs. 10-12 (male) subsequent designation, Brady & Norman, 1889, p. 190; see also Wagner, 1957, p. 74, pl. 33, figs. 1-5.

Diagnosis. - Lateral outline oblong; anterior end broadly rounded, caudal process developed posteriorly. Surface almost smooth, punctate to reticulata; marginal denticulations absent. Size medium, length 0.35 to 0.65 mm. Inner lamella narrow; line of concretion and inner margin are coincident throughout. Marginal pore canals number about 12 anteriorly, simple, sinuous; posteriorly from two to four present. Normal pores few in number, scattered, small, open. Hinge merodont/entomodont.

Cytherura forulata Edwards, 1944

Pl. 16, figs. 1-14

Cytherura forulata Edwards, 1944, p. 526, pl. 88, figs. 17-20; Swain, 1951, p. 50; Malkin, 1953, p. 789, pl. 80, figs. 22-24; Swain, 1955, p. 628, pl. 64, figs. 10 a-c, text-figs. 35 c, 39-2 a, b; Puri, 1960, p. 115, pl. 4, figs. 16, 17.

Cytherura elongata Edwards, 1944, p. 526, pl. 88, figs. 21-25; Swain, 1951, p. 50, pl. 7, figs. 24, 25; Swain, 1955, p. 628, pl. 64, figs. 12 a, b.

Cytherura johnsoni Mincher, Benson & Coleman, 1963, p. 31, pl. 6, figs. 1-5, text-fig. 18.

[?] *Cytherura johnsoni* Mincher, Van den Bold, 1963, p. 395, pl. 9, fig. 3.

[?] *Cytherura johnsoni* Mincher, Benson & Kaesler, 1963, p. 22, pl. 3, figs. 7, 8, text-fig. 11.

[?] *Cytherura forulata* Edwards, Curtis, 1960, p. 478, pl. 1, fig. 18, pl. 2, fig. 4 (top), fig. 5 (bottom).

[?] *Cytherura forulata* var. Edwards, Curtis, 1960, p. 478, pl. 3, fig. 6 (top).

Material. - Twenty-one carapaces and 122 isolated valves.

Dimensions. - Figured hypotypes, UMMP 48784: length .46 mm, height .23 mm; UMMP 48785: length .47 mm, height .24 mm; UMMP 48786: length .53 mm, height .23 mm.

Former occurrences. - Originally described from the Upper Miocene Duplin Marl of North Carolina by Edwards (1944, p. 526). Although confusion exists in the correct identification of this species it seems certain that it occurs in the Yorktown Formation of Virginia, Maryland, and New Jersey (Malkin, 1953, p. 789) and the subsurface Upper Miocene of North Carolina (Swain, 1951, p. 50). In addition, this species has been reported by Benson & Coleman (1963, p. 31) from the Recent sediments of the Gulf of Mexico. They give a depth range of 31 to 131 feet.

Remarks. - This is a variably shaped species with apparent sexual dimorphism reflected in the lateral outline. The presumed females (pl. 16, figs. 1, 2) are relatively shorter and higher than the males (pl. 16, fig. 5). The development of the posterior caudal process varies considerably and has been discussed previously (Malkin, 1953, p. 789; Benson & Coleman, 1963, p. 31). *C. forulata* and *C. elongata* are here considered synonyms. It is believed that these two species represent the two extremes of shape variation within one species. However, I do not consider *C. johnsoni* Mincher as synonymous with *C. forulata* and *C. elongata* as do Benson & Coleman (1963, p. 31). The antero-dorsal outline of *C. johnsoni* has a definite concave portion at the cardinal angle of the right valve (see Mincher, 1941, pl. 47, fig. 1a) as does *C. reticulata* Edwards (see Edwards, 1944, pl. 88, fig. 15). This seems distinctive and a constant enough criterion to enable separation of these species. For a discussion of *C. johnsoni* and *C. reticulata* see remark section under *C. reticulata*. Therefore, since the species of Benson & Coleman lack this distinctive concavity they are here considered to be *C. forulata*. In addition to the features already described for this species, the normal pores are small, scattered, and open.

Cytherura reticulata Edwards, 1944

Pl. 15, figs. 5-8, 11, 12

Cytherura reticulata Edwards, 1944, p. 526, pl. 88, figs. 13-16.

[?] *Cytherura johnsoni* Mincher, Swain, 1955, p. 627, pl. 64, figs. 8 a-c, text-figs. 35b, 39-1 a, b, c; Puri & Hulings, 1957, p. 174, 176, 183, 187, fig. 11, no. 2 (center); Puri, 1960, p. 114, pl. 4, fig. 14, 15.

[?] *Cytherura reticulata* Edwards, Swain, 1951, p. 50.

[?] *Cytherura reticulata* Edwards, McLean, 1957, p. 73, pl. 7, figs. 7 a, b.

Material. - One carapace and 15 isolated valves.

Dimensions. - Figured hypotypes, UMMP 48780: length .40 mm, height .26 mm; UMMP 48781: length .42 mm, height .23 mm.

Former occurrences. - This species was originally described from the Upper Miocene Duplin Marl of North Carolina by Edwards (1944, p. 526). Other closely allied forms which probably belong to *C. reticulata* have been reported from the Recent sediments of the Gulf of Mexico (Swain, 1955, p. 627; Puri, 1960, p. 114). Swain (1951, p. 50) mentioned, but with no description or illustration, a form from the subsurface Upper Miocene of North Carolina and McLean (1957, p. 73) described a form which very questionably belongs to this species from the Yorktown Formation of Virginia.

Remarks. - *C. johnsoni* Mincher (1941, p. 343) and *C. reticulata* Edwards (1944, p. 526) are possibly synonymous, but there is one significant morphologic difference in the original descriptions of the two species. *C. johnsoni* has a posterior vestibule, as stated in the original description, which is absent in *C. reticulata* and absent in the forms here assigned to *C. reticulata*. No posterior vestibule is shown in the forms Swain (1955, p. 627) found in the Recent sediments of San Antonio Bay, and they are tentatively considered as *C. reticulata*. No judgment can be made concerning this feature in the forms Puri & Hulings (1957, p. 187) or Puri (1960, p. 114) placed in *C. johnsoni*. The holotype of *C. johnsoni* has a length of 0.80 mm, while the holotype of *C. reticulata* is 0.40 mm which is the approximate length of the other forms that have been assigned to *C. johnsoni* by various authors.

Both *C. johnsoni* and *C. reticulata* have a prominent concave outline at the anterodorsal cardinal outline, which clearly differentiates them from the forms variously identified as *C. forulata* and *C. reticulata* (see remark section under *C. forulata*). In addition to the features already described for this species, the normal pores are small, scattered, and open.

Cytherura vestibulata, n. sp.

Pl. 16, figs. 15-23

Cytherura rara Müller, Swain, 1955, p. 628, pl. 64, fig. 9.

[?] *Cytherura rara* Müller, Curtis, 1960, p. 482, pl. 2, fig. 5 (top), figs. 2, 6 (bottom).

Description. - Lateral outline subpyriform; dorsal margin slightly convex; anterior end broadly rounded ventrally, oblique dorsally; posterior pointed caudal process slightly ventral to mid-height; highest portion in anterior third.

Surface with irregular reticulate pattern, longitudinal ribs about ten in number, sinuous.

Inner lamella moderately wide, paralleling outer margin except posteriorly where it abruptly widens considerably across caudal process; vestibule present both anteriorly and posteriorly, widest in posterior portion.

Marginal pore canals straight, simple, about ten observed at anterior end, none ventrally and about five posteriorly.

Normal pores few, scattered, open; do not occur in any regular pattern as related to surface reticulation.

Hinge merodont/entomodont. Right valve with elongate, crenulate tooth, median finely crenulate groove, weak posterior trilobed tooth.

Left valve with anterior flange which overlaps right valve, anterior oblique socket, median crenulate bar, with crenulated low toothlike thickenings at both extremities of that median bar, posterior shallow, oblique socket.

Muscle-scar pattern consists of four arcuate adductor scars, which were the only scars observed.

Material. - Fifty-six isolated valves.

Dimensions. - Holotype, UMMP 48791: length .39 mm, height .20 mm. Paratypes, UMMP 48790: length .41 mm, height .21 mm; UMMP 48792: length .41 mm, height .21 mm.

Former occurrences. - Swain (1955, p. 628) described a form which is certainly conspecific with the present one from the Recent sediments of San Antonio Bay in the Gulf of Mexico. Curtis (1960, p. 478) has also reported a form from the Recent sediments near the Mississippi River Delta in the Gulf of Mexico, which does not appear conspecific with the Sapelo Island specimens.

Remarks. - Swain (1955, p. 628) described and illustrated a form which is conspecific to the present one, which he assigned with some doubt to *Cytherura rara* Müller. He stated that the ornamentation was not as strong as in *C. rara*. A form was figured by Curtis (1960, p. 482) and assigned to *C. rara* which appears from the illustration to be more coarsely reticulate than the present ones or that of Swain and since no text comments were made it is only tentatively placed in this new species.

This species is placed with some reservations in the genus *Cytherura*. *C. vestibulata* has both anterior and posterior vestibules, which the type species *Cytherura gibba* lacks, and the marginal pore canals are straight and evenly spaced, whereas those of *C. gibba* are sinuous and grouped in pairs. In other features *C. vestibulata* agrees closely enough to *C. gibba* to be considered congeneric.

Genus *Cytheropteron* Sars, 1866

Cytheropteron Sars, 1866, p. 79; Brady & Norman, 1889, p. 207; Sars, 1925, p. 223; Alexander, 1933, p. 187; Martin, 1939, p. 176; Stephenson, 1946, p. 318; Hanai, 1957, p. 26; Pokorný, 1958, p. 287; Benson, 1959, p. 54; Reymont, 1961, p. Q292; Swain, 1963, p. 816; Van Morkhoven, 1963, p. 382.

Type species. - *Cythere latissima* Norman, 1865, p. 19, pl. 6, figs. 5-8 (= *Cytheropteron convexum* Sars, 1866, p. 79, non *Cythere convexa* Baird, 1850).

Diagnosis. - Lateral outline ovate to subrhomboidal, valves generally inflated ventrolaterally and strong wing-like extensions often present; dorsal margin strongly convex. Surface smooth, punctate or reticulate, wing-like extensions sometimes denticulate at their posterior edge. Size variable. Inner lamella moderately wide, vestibule present in anterior end; marginal pore canals few in number, simple and straight. Normal pores small, open. Hinge merodont/entomodont.

Cytheropteron talquinensis Puri, 1953

Pl. 18, figs. 1-11

Cytheropteron talquinensis Puri, 1953a, p. 243, pl. 5, figs. 5-7; McLean, 1957, p. 73, pl. 7, figs. 6a-c.Material. - Four carapaces and 22 isolated valves.Dimensions. - Figured hypotypes, UMMP 48802: length .59 mm, height .35 mm; UMMP 48803: length .62 mm, height .35 mm.Former occurrences. - Originally described from the Upper Miocene of Florida by Puri (1953a, p. 243), and also from the Upper Miocene Yorktown Formation of Virginia by McLean (1957, p. 73).Remarks. - In addition to the morphologic features described by Puri (1953a, p. 243), the following observations were made. The hinge which is merodont/entomodont, consists of terminal bilobed teeth in the right valve of almost equal size at each end, with corresponding sockets in the left valve. The median bar in the left valve is coarsely crenulate in the anterior and posterior portions and much more finely crenulate in the middle third. The inner lamella is wide both anteriorly and posteriorly with a wide vestibule and narrow marginal zones at both ends. The marginal pore canals are simple, straight and evenly spaced. The muscle scars were not observed, evidently because of the heavy surface reticulation. Normal pores small, scattered and open.The surface shown by McLean (1957, pl. 7, fig. 6b) indicates a form with no surface reticulation, but in all other respects appears to be conspecific with C. talquinensis.Cytheropteron yorktownensis (Malkin, 1953)

Pl. 15, figs. 1-4, 9, 10

Eocytheropteron yorktownensis Malkin, 1953, p. 780, pl. 79, figs. 1-4.Eocytheropteron ? sp. Swain, 1951, p. 47, pl. 7, fig. 16.Material. - Five carapaces and 16 isolated valves.Dimensions. - Figured hypotype, UMMP 48779: length .42 mm, height .24 mm.Former occurrences. - Originally described from the Upper Miocene Yorktown Formation of Virginia, Maryland, and New Jersey by Malkin (1953, p. 780). Swain (1951, p. 47) reported a form which appears to be conspecific to C. yorktownensis from the subsurface Upper Miocene of North Carolina, but he found only one specimen.Genus Hemicytherura Elofson, 1941Cytheropteron (Hemicytherura), 1941, p. 314.Hemicytherura Elofson, Hornbrook, 1952, p. 58; Wagner, 1957, p. 75; Pokorný, 1958, p. 286; Benson, 1959, p. 52; Reymont, 1961, Q293; Benson & Coleman, 1963, p. 32.Hemicytherura (Hemicytherura) Elofson, Van Morkhoven, 1963, p. 349.Type species. - Cythere cellulosa Norman, 1865, p. 22, pl. 5, figs. 17-20, pl. 6, fig. 17 (see also Wagner, 1957, p. 76, pl. 34, figs. 1-5).Diagnosis. - Lateral outline subrectangular to subtriangular; anterior end oblique in dorsal half, rounded below, subcentral caudal process at posterior end. Surface with reticulation or coarse pits; prominent ventral ridge. Size small to medium, length 0.35 to 0.65 mm. Inner lamella wide anteriorly, narrower ventrally and posteriorly; vestibule sometimes present anteriorly and posteroventrally. Marginal pore canals sinuous in anterior, grouped in bunches of two to four; all are simple. Normal pores 20 to 30, scattered, small, open. Hinge merodont/entomodont.Remarks. - In the type species, H. cellulosa, the median element in the right valve hinge is crenulate at both ends, but is not in this species. According to Van Morkhoven (1963, p. 351) some of the species in this genus have the entire median bar crenulate, but all have at least crenulated portions at the ends. Therefore the assignment of this species to Hemicytherura must be considered tentative.Hemicytherura? sablensis Benson & Coleman, 1963

Pl. 16, figs. 24-30

Hemicytherura sablensis Benson & Coleman, 1963, p. 33, pl. 6, figs. 6, 8, text-fig. 19.Material. - Four isolated valves.Dimensions. - Figured hypotypes, UMMP 48793: length .51 mm, height .27 mm; UMMP 48794: length .51 mm, height .27 mm.Former occurrences. - Originally described by Benson & Coleman (1963, p. 33) from Recent sediments of the eastern Gulf of Mexico. They reported a depth range of 19 to 27 feet.Genus Kangarina Coryell & Fields, 1937Kangarina Coryell & Fields, 1937, p. 13; Pokorný, 1958, p. 287; Reymont, 1961, Q293.Hemicytherura (Kangarina) Coryell & Fields, Van Morkhoven, 1963, p. 353.Type species. - Kangarina quellita Coryell & Fields, 1937, p. 13, figs. 15 a, b, c.Diagnosis. - Differs from Hemicytherura in having anterior marginal pore canals not grouped in bunches and a sinuous ventral outline as opposed to an almost straight one in Hemicytherura.Remarks. - Very little difference exists between Kangarina and Hemicytherura, and Van Morkhoven (1963, p. 349) considers Kangarina as a subgenus of Hemicytherura.Kangarina howei Puri, 1953

Pl. 15, figs. 13-16

Kangarina howei Puri, 1953a, p. 246, pl. 4, fig. 7, text-figs. 6i, j.

Material. - One carapace and 11 isolated valves.

Dimensions. - Figured hypotype, UMMP 48782: length .39 mm, height .23 mm.

Former occurrences. - Puri (1953a, p. 246) described this species from the Upper Miocene Ecphora facies of western Florida.

Remarks. - The Sapelo Island specimens are placed in this species primarily on the basis of similarity of the lateral outline, since with the exception of the hinge, no other details of the interior of the carapace are given by Puri. The lateral outline of the left valve is more blunt posteriorly and the right valve more convex dorsally than the left. The marginal pore canals are simple, and curved anteriorly, most not reaching the outer margin; posteriorly two curved ones are present on the caudal process. Line of conrescence and inner margin are coincident throughout although irregular in anterior. Normal pores small, open.

Genus Megacythere Puri, 1960

Microcythere Mincher, 1941 (non Müller, 1894), p. 344; Puri, 1953a, p. 290; Swain, 1955, p. 641; Van den Bold, 1957, p. 237.

Megacythere Puri, 1960, p. 119; Benson & Kaesler, 1963, p. 27.

Type species. - Megacythere robusta Puri, 1960, p. 122, pl. 2, figs. 14, 15, text-figs. 10, 11.

Remarks. - The genus Megacythere was erected by Puri (1960, p. 119) to encompass several Miocene to Recent species of southeastern United States, among which is Microcythere johnsoni, that were formerly assigned to Microcythere Müller, 1894. The genus is tentatively recognized here although it has not been adequately characterized. Several important morphological features were not mentioned in the original description. Particularly lacking are the nature of the normal pores, whether open or sieve-type and whether the line of conrescence and inner margin are coincident throughout or diverge to form a vestibule. This latter feature differs in the original description of at least two of the species Puri assigned to the genus, Microcythere moresiana Stephenson, 1935, and Microcythere johnsoni Mincher, 1941.

The median groove of the genus is defined (Puri, 1960, p. 119) as being: "... flanked on the dorsal side by two denticulate bars and on the ventral side with one denticulate bar that does not extend as far as the postjacent socket." This feature is not mentioned, nor illustrated by other authors when dealing with the species indicated by Puri as belonging to the genus Megacythere. It has not been observed in the species here under consideration.

There are several other genera which are closely allied to Megacythere Puri, but no decision as to which ones are valid can be made until the types are described in detail with all morphological features discussed. Seemingly closely related genera are Paracytheroma Juday, 1907, which was described entirely on the basis of soft parts, Microcytherura Muller, 1894, Tetracytherura Ruggieri, 1952, and Boldella Keij, 1957. According to Van Morkhoven (1963, p. 367), in Microcytherura the ornamentation consists of characteristic irregular reticulations, the normal pores are sieve-type, and the hinge-bar in the left

valve lacks any terminal teeth. It is similar to M. johnsoni in lacking any vestibules and the type of marginal pore canals. M. johnsoni is like Tetracytherura in the hinge being pentadont, marginal pore canals, muscle scar pattern, but Tetracytherura has an anterior vestibule. It most closely resembles Boldella in all features except the presence of an anterior vestibule in Boldella. Puri states that the hinge of Megacythere and Boldella are different, but the main difference is in the presence of the three denticulate bars in the right valve. It is doubtful if this is important enough for a generic distinction and the characteristic does not seem consistent within the species Puri assigned to Megacythere. Therefore it appears highly probable that the two genera are synonymous.

Megacythere johnsoni (Mincher, 1941)

Pl. 17, figs. 16-25

Microcythere johnsoni Mincher, 1941, p. 344, pl. 47, figs. 4 a-d; Puri, 1953a, p. 290; Van den Bold, 1957, p. 237, pl. 4, fig. 1.

[?] Microcythere johnsoni Mincher, Swain, 1955, p. 641, pl. 63, fig. 2 a-c, pl. 64, fig. 7, text-fig. 39, 3.

[?] Megacythere johnsoni (Mincher), Benson & Kaesler, 1963, p. 28, pl. 3, figs. 3, 4, text-fig. 16.

[?] Paracytheroma johnsoni (Mincher), Van den Bold, 1963, p. 412, pl. 10, fig. 10, pl. 11, fig. 7 a, b.

Material. - Six carapaces and 59 isolated valves.

Dimensions. - Figured hypotypes, UMMP 48800: length .42 mm, height .26 mm; UMMP 48801: length .41 mm, height .25 mm.

Description. - Lateral outline subquadrate, modified by a ventroposterior extension of margin resulting in highest portion of valve lying in posterior third; dorsal margin slightly convex, ventral margin sinuous, concave portion lying in anterior third; anterior end evenly rounded, slightly oblique in dorsal half, slightly drawn out posteriorly in some specimens.

Surface with sinuous longitudinal ridges, which tend to join at both posterior and anterior ends of valves and diverge medially; ridges are from 9-14 in number in mature specimens.

Inner lamella moderately wide, more narrow in posterior end; posteroventrally corresponding to bulge seen in lateral view; inner margin and line of conrescence coincident throughout.

Marginal pore canals moderate in number, about 16 anteriorly, 10 ventrally and 8 posteriorly, simple, sinuous, tending to occur in bunches of two or three; about half do not reach outer margin.

Normal pores about 25 in number, scattered, small, open.

Hinge of left valve with anterior socket, bounded dorsally by flange, median non-crenulate bar bearing low crenulate tooth on anterior extremity and stepped tooth posteriorly, with highest portion being posterior, and posterior shallow socket bounded by low dorsal flange which extends some distance posteriorly and appears to overlap right valve.

Hinge of right valve with anterior crenulate tooth, median groove which deepens at both extremities to accommodate teeth on ends of median bar of left valve, and posterior pointed tooth bounded dorsally by flange which fits inside posterior dorsal flange of left valve.

Muscle-scar pattern consists of four adductor scars in almost straight line perpendicular to dorsal margin, with crescent-shaped frontal scar, two mandibular scars near ventral margin and fulcral point visible anterior to topmost adductor scar.

Remarks. - The Sapelo Island specimens differ very little from the original descriptions and illustrations of Mincher (1941, p. 344). The marginal pore canals are said to be straight by Mincher, but are sinuous in the forms here placed in his species. In other regards they appear synonymous. However, most of the forms which have been assigned to *M. johnsoni* appear to have important enough differences from the original description to question whether they belong to that species. These forms and their comparison to Mincher's are discussed below. The forms that Puri (1953a, p. 290) and Van den Bold (1957, p. 237) are so briefly treated that no comparison can be made; therefore, they have been tentatively left in *M. johnsoni* in the above synonymy.

The forms assigned by Swain (1955, p. 641), Van den Bold (1963, p. 412), and Benson & Kaesler (1963, p. 28) all show large vestibules developed in the anterior and smaller ones posteriorly. This is not in accord with the illustrations of Mincher (1941, pl. 47, figs. 4, b, d). He shows the line of concrescence and inner margin to be coincident throughout. In addition the illustration of Benson & Kaesler (1963, text-fig. 16) shows branching marginal pore canals much like those present in the genus *Pellucistoma*. Mincher states (1941, p. 344): "Radial pore canals are moderate in number, straight, simple, and are present on anterior, ventral and posterior margins."

Genus *Paracytheridea* G. W. Müller, 1894

Paracytheridea G. W. Müller, 1894, p. 340; Edwards, 1944, p. 511; Van den Bold, 1946, p. 26; Keij, 1957, p. 158; Pokorný, 1958, p. 252; Benson, 1959, p. 49; Reymont, 1961, Q299; Benson & Coleman, 1963, p. 33; Van Morkhoven, 1963, p. 376.

Type species. - *Paracytheridea depressa* G. W. Müller, 1894, p. 341, pl. 26, figs. 16-26, pl. 29, figs. 4, 8 (= *Cytheropteron bovetensis* Seguenza, 1880, p. 65, pl. 17, fig. 54).

Diagnosis. - Lateral outline elongate; ventrally directed swelling on valves moderately to strongly developed; anterior end obliquely rounded above, broadly rounded below; posterior caudal process developed. Surface ornamented with ridges and/or tubercles, with reticulations sometimes superimposed on these. Size medium, length 0.50 to 0.75 mm. Inner lamella moderate in width, inner margin and line of concrescence coincide throughout. Marginal pore canals few and tend to be evenly spaced, usually only two present in posterior caudal process. Hinge merodont/entodont, but poorly understood (see Van Morkhoven, 1963, p. 378).

Paracytheridea vandenboldi Puri, 1953

Pl. 18, fig. 22-30

Cytheropteron nodosum Ulrich & Bassler, 1904, p. 129, pl. 38, figs. 37-40 non *Cytheropteron nodosum* Brady, 1868, p. 448, pl. 34, figs. 31-34.

Paracytheridea nodosa (Ulrich & Bassler), Howe et al., 1935, p. 37, pl. 3, fig. 7; Van den Bold, 1946, p. 86, pl. 16, fig. 14; Swain, 1951, p. 51, pl. 3, figs. 19-22.

Paracytheridea vandenboldi Puri, 1953d, p. 751; Malkin, 1953, p. 780, pl. 79, fig. 5; Puri, 1953a, p. 238, pl. 3, fig. 7, text-fig. 5 a, b; Swain, 1955, p. 625, pl. 62, fig. 2 a, b; McLean, 1957, p. 75, pl. 8, fig. 4 a, b.

[?] *Paracytheridea altila* Edwards, 1944, p. 512, pl. 85, figs. 20, 21.

Material. - One hundred eighty-four isolated valves.

Dimensions. - Figured hypotypes, UMMP 48806: length .53 mm, height .26 mm; UMMP 48807: length .53 mm, height .25 mm.

Former occurrences. - Described originally by Ulrich and Bassler (1904, p. 129) from the Miocene of Virginia on the basis of only one valve. It has since been reported by Howe, et al., (1935, p. 37) from the Arca zone of the Upper Miocene Choctawhatchie Formation of Florida; Swain (1951, p. 51) from subsurface Middle Miocene of North Carolina, Malkin (1953, p. 780) from the Yorktown Formation of Virginia, Maryland, and New Jersey, and McLean (1957, p. 75) from the Yorktown Formation of Virginia. Swain (1955, p. 625) reported *P. vandenboldi* as rare in the Recent sediments of San Antonio Bay, Gulf of Mexico.

Paracytheridea? shattucki Malkin, 1953

Pl. 18, figs. 12-21

Paracytheridea? wetherelli Jones, Swain, 1951, p. 51, pl. 7, figs. 2-4.

Paracytheridea shattucki Malkin, 1953, p. 780, pl. 79, figs. 6-9.

Paracytheridea shattucki curta Malkin, 1953, p. 781, pl. 79, figs. 10-12.

[?] *Paracytheridea similis* Malkin, 1953, p. 781, pl. 79, figs. 13, 14.

[?] *Cytheropteron choctawhatcheensis* Puri, 1953a, p. 242, pl. 5, figs. 1, 2.

Loxoconcha wetherelli Jones, Puri, 1953d, p. 751.

Material. - Ten carapaces and 47 isolated valves.

Dimensions. - Figured hypotypes, UMMP 48804: length .65 mm, height .35 mm; UMMP 48805: length .64 mm, height .35 mm.

Former occurrences. - Malkin (1953, p. 780) described this species from the Middle and Upper Miocene of Virginia, Maryland, and New Jersey. Swain (1951, p. 51) described a form from the subsurface Middle Miocene of North Carolina under the name of *P. ? wetherelli*, which appears conspecific with *P. shattucki*. Puri (1953a, p. 242) described a species, *Cytheropteron choctawhatcheensis* which may be conspecific with this species from the Upper Miocene *Ecphora* and *Cancellaria* facies of western Florida.

Remarks. - Malkin (1953, p. 780-782) described two species and one subspecies of Paracytheridea which are very closely related and would seem to be one continuous series and thus one species. They are separated primarily on the basis of the relation of hinge length to overall length of the valve. A diagram is given (p. 788, fig. 11) with the ratio of length to length of hinge shown on the ordinate and the stratigraphic position from Calvert through upper Yorktown shown on the abscissa. While there is a smaller ratio (1.4 to 1.8) for the upper Yorktown forms Malkin calls P. similis the gradation of actual ratios is essentially continuous from 1.4 to 2.6. The present specimens have a ratio of from 1.6 to 2.2 and therefore conform to P. shattucki, which is limited to the middle Miocene Calvert Formation. P. shattucki curta has a given ratio of from slightly less than 2.2 to 2.6 and ranges from Choptank to Yorktown. Assuming that each dot on the diagram represents a single specimen, only 9 specimens are shown for P. similis and 6 for P. shattucki. I have placed the Sapelo Island specimens in the species P. shattucki, placed P. shattucki curta in synonymy with it, and tentatively placed P. similis also in the synonymy with P. shattucki.

Family Loxoconchidae Sars, 1925

[nom. transl. Howe, 1961 (ex Loxoconchinae Sars, 1925)]

Genus Loxoconcha Sars, 1866

Loxoconcha Sars, 1866, p. 61; Sars, 1926, p. 217, Alexander, 1936, p. 693; Murray, 1938, p. 586; Edwards, 1944, p. 526; Van den Bold, 1946, p. 32; Pokorný, 1958, p. 292; Howe, 1961, Q312; Benson & Coleman, 1963, p. 36; Benson & Kaesler, 1963, p. 26; Swain, 1963, p. 819; Van Morkhoven, 1963, p. 385.

Normania Brady, 1866, p. 832 [= Loxoconcha by Brady, 1868, p. 432].

Loxoleberis Sars, 1866, p. 130 [= Loxoconcha by Howe, 1962, p. 137].

Type species. - Cythere impressa Baird, 1850 (non McCoy, 1847) [= Cythere rhomboidea Fisher, 1855, p. 61, subsequent designation by Brady & Norman, 1889, p. 183].

Diagnosis. - Lateral outline sub-rhomboidal, anterior end rounded, posterior end more narrowly rounded tending to point posterodorsally; some species have marginal genotypic tubercles. Surface smooth to coarsely reticulate or pitted, ornamentation often arranged concentric to margins, marginal denticles rare. Size variable, length from 0.45 to 1.00 mm. Inner lamella wide anteriorly, narrower in ventral and posterior margins; wide anterior vestibule, line of concrescence nearly parallel to outer margins. Marginal pore canals few, simple, evenly spaced. Normal pores large, sieve-type. Hinge amphidont/pentodont. Central muscle-scar field consists of four adductor scars in arc which is open toward the anterior, and variably shaped frontal scar.

Loxoconcha australis Brady, 1880

Pl. 19, figs. 6-8, 11

Loxoconcha australis Brady, 1880, p. 119, pl. 28, fig. 5 a-f, pl. 29, fig. 3 a-d; Swain, 1955, p. 630, pl. 63,

fig. 11, pl. 64, fig. 2; Puri & Hulings, 1957, p. 187, fig. 11, no. 3 (left side); Curtis, 1960, p. 482, pl. 2, fig. 15 (bottom); Puri, 1960, p. 111, text-figs. 33, 34, 38.

Material. - Three carapaces and 19 isolated valves.

Dimensions. - Figured hypotypes, UMMP 48811: length .54 mm, height .32 mm; UMMP 48812: length .56 mm, height .35 mm.

Former occurrences. - Previously reported from the Recent of western Europe and the Gulf of Mexico.

Loxoconcha metagordensis Swain, 1955

Pl. 19, figs. 15-18

Loxoconcha metagordensis Swain, 1955, p. 629, pl. 63, figs. 9 a, b, pl. 64, figs. 1 a, b, text-figs. 36 b and 39, no. 7 a, b.

[?] Loxoconcha metagordensis Swain, Puri, 1960, p. 111, pl. 3, figs. 15, 16.

Material. - Three isolated valves (one broken).

Dimensions. - Figured hypotypes, UMMP 48815: length .54 mm, height .37 mm; UMMP 48816: length .66 mm, height .37 mm.

Former occurrences. - Swain (1955, p. 629) described this species from Recent sediments of San Antonio Bay, Gulf of Mexico. It has also been reported by Puri (1960, p. 111) from the Recent sediments off the west coast of Florida, but his illustrations appear more closely related to L. purisubrhomboidea Edwards in Puri (1953c, p. 750).

Loxoconcha purisubrhomboidea Edwards in Puri, 1953

Pl. 19, figs. 9, 10, 12-14

Loxoconcha purisubrhomboidea Edwards in Puri, 1953d, p. 750; Puri, 1953a, p. 274, pl. 10, fig. 8, text-fig. 10 h; McLean, 1957, p. 71, figs. 4a-e.

Loxoconcha subrhomboidea Edwards, (non Brady, 1880, p. 121, pl. 28, figs. 4a-d) 1944, p. 527, pl. 88, figs. 28-32; Swain, 1951, p. 25, pl. 2, figs. 18, 19; Malkin, 1953, p. 787.

Loxoconcha reticularis Edwards, Malkin, 1953, pl. 80, figs. 13, 14 non figs. 15-17

[?] Loxoconcha metagordensis Swain, Puri, 1960, p. 111, pl. 3, figs. 15, 16.

Material. - Two carapaces and 3 isolated valves.

Dimensions. - Figured hypotypes, UMMP 48813: length .62 mm, height .40 mm; UMMP 48814 (broken): length approximately .70 mm, height .42 mm.

Former occurrences. - Originally described by Edwards (1944, p. 527) from the Upper Miocene Duplin Marl of North Carolina. Reported by Malkin (1953, p. 787) from the Upper Miocene Yorktown Formation of Virginia, and from the same formation by McLean (1957, p. 71); Swain (1951, p. 25) from the subsurface of the entire Mio-

cene of North Carolina and by Puri (1953a, p. 274) from the Upper Miocene Ecphora and Cancellaria facies of western Florida.

Loxoconcha reticularis Edwards, 1944

Pl. 19, figs. 1-5

Loxoconcha reticularis Edwards, 1944, p. 527, pl. 88, figs. 26, 27; Malkin, 1953, p. 786, pl. 80, figs. 15, 16, 17 [non figs. 13, 14 = L. purisubrhomboidea Edwards, in Puri, 1953d]; McLean, 1957, p. 72, pl. 7, figs. 5a, b.

[?] Loxoconcha reticularis Edwards, Puri, 1953a, p. 274, pl. 10, fig. 7, text-fig. 10c.

[?] Loxoconcha cf. L. reticularis Edwards, Swain, 1951, p. 26.

Material. - Four carapaces and 16 isolated valves.

Dimensions. - Figured hypotypes, UMMP 48808: length .46 mm, height .27 mm; UMMP 48809: length .48 mm, height .32 mm; UMMP 48810: length .38 mm, height .29 mm.

Former occurrences. - Described originally by Edwards (1944, p. 527) from the Upper Miocene Duplin Marl of North Carolina. Reported by Malkin (1953, p. 786) and McLean (1957, p. 72) from the Upper Miocene Yorktown Formation of Virginia, and questionably by Puri (1953a, p. 274) from the Upper Miocene Ecphora and Cancellaria facies of western Florida.

Genus Cytheromorpha Hirschmann, 1909

Cytheromorpha Hirschmann, 1909, p. 290; Sars, 1925, p. 177; Alexander, 1934, p. 222; Edwards, 1944, p. 515; Swain, 1955, p. 630; Keij, 1957, p. 88; Pokorný, 1958, p. 280; Howe, 1961, Q313; Swain, 1963, p. 818.

Type species. - Cythere fuscata Brady, 1868, p. 47, pl. 7, figs. 5-8 [= Cytheromorpha albula Hirschmann, 1909, p. 292, figs. 7, 8] subsequent designation, Sars, 1925, p. 177; see also Wagner, 1957, p. 49, pl. 19, figs. 1-5.

Diagnosis. - Lateral outline elongate to almost oval; both anterior and posterior margins broadly rounded, anterior end more so; ventral margins sinuous, dorsal margin almost straight. Medium size, length 0.5 to 0.7 mm. Inner lamella, marginal pore canals and hinge like Loxoconcha. Normal pores large and sieve-type.

Cytheromorpha curta Edwards, 1944

Pl. 20, figs. 1-15

Cytheromorpha curta Edwards, 1944, p. 516, pl. 86, figs. 19-22; Swain, 1951, p. 49, pl. 7, fig. 22.

Material. - Twelve carapaces and 53 isolated valves.

Dimensions. - Figured hypotypes, UMMP 48817: length .35 mm, height .22 mm; UMMP 48818: length .38

mm, height .26 mm; UMMP 48819: length .34 mm, height .29 mm.

Former occurrences. - Originally described by Edwards, (1944, p. 516) from the Upper Miocene Duplin Marl of North Carolina. Also reported by Swain (1951, p. 49) from the subsurface Upper Miocene of North Carolina.

Remarks. - There are two very closely related species, C. pascagoulaensis, as described and illustrated by Mincher, lacks the posterior tooth of the left valve, which is surrounded by the posterior socket in C. curta. This serves to separate the two species, but in other respects they are very close. The immature instars of the Sapelo Island specimens of C. curta tend to be more coarsely pitted than the mature forms. This species has large sieve-type normal pores, which were not mentioned by either Edwards or Swain.

Cytheromorpha warneri Howe & Spurgeon, 1935

Pl. 20, figs. 16-25

Cytheromorpha warneri Howe & Spurgeon, in Howe et al., 1935, p. 11, pl. 2, figs. 5, 8, 9, pl. 4, fig. 4; Van den Bold, 1946, p. 105; Van den Bold, 1950, p. 86; Malkin, 1953, p. 787, pl. 80, figs. 18, 19; Puri, 1953a, p. 277, pl. 6, figs. 5-7, text-figs. 11f, g; Puri & Hulings, 1957, p. 187, fig. 11, no. 10 (bottom); Puri, 1960, p. 114, pl. 3, figs. 11, 12, text-fig. 36.

Cytheromorpha cf. C. warneri Howe & Spurgeon, Swain, 1951, p. 49, pl. 7, figs. 18, 19.

Material. - Two carapaces and 6 isolated valves.

Dimensions. - Figured hypotype, UMMP 48821: length .56 mm, height .26 mm.

Former occurrences. - Originally described from the Arca zone of the Upper Miocene Choctawhatchie Formation of Florida by Howe & Spurgeon (in Howe et al., 1935, p. 11). Also reported from the Upper Miocene Yorktown Formation of Virginia by Malkin (1953, p. 787), from the subsurface Upper Miocene of North Carolina by Swain (1951, p. 49), the Upper Miocene Ecphora and Cancellaria facies of western Florida by Puri (1953a, p. 277), and the Miocene of the Caribbean area by Van den Bold (1950, p. 86). Puri (1960, p. 114) has also reported it from the Recent sediments off the west coast of Florida in the Gulf of Mexico.

Family Paradoxostomatidae Brady & Norman, 1889

Genus Paradoxostoma Fischer, 1855

Paradoxostoma Fischer, 1855, p. 654; Müller, 1894, p. 312; Sars, 1928, p. 255; Van den Bold, 1946, p. 35; Wagner, 1957, p. 96; Pokorný, 1958, p. 299; Sylvester-Bradley & Howe, 1961, p. Q315; Van Morkhoven, 1963, p. 429.

Type species. - Cythere variabilis Baird, 1835, p. 98, figs. 7a, b.

Diagnosis. - Lateral outline elongate-oval; greatest height in posterior third; dorsal margin convex, ventral margin variable; anterior end acutely rounded below, posterior end more broadly rounded, usually with slight caudal

process. Surface smooth; valves thinly calcified. Size medium, length 0.35 to 0.70 mm. Inner lamella moderately wide anteriorly, narrower elsewhere; marginal zone narrow throughout; line of concrescence and inner margin coinciding only at anteroventral margin, in some species not at all. Marginal pore canals few, short, simple, evenly spaced. Normal pores few, scattered, small open. Hinge merodont/lophodont. Muscle scars in most species are vertical row of four adductor scars; frontal scars poorly known, but apparently never a V-shaped scar.

Paradoxostoma (?) delicata Puri, 1953

Pl. 3, figs. 10-14

Paradoxistoma (?) delicata Puri, 1953a, p. 288, pl. 14, figs. 1, 2, 3, pl. 15, fig. 3, text-fig. 12f.

[?] Xestoleberis curta Brady, Curtis, 1960, p. 482, pl. 2, fig. 14 (top).

Material. - Thirty-one isolated valves.

Dimensions. - Figured hypotypes, UMMP 48693: length .46 mm, height .22 mm; UMMP 48694: length .46 mm, height .22 mm.

Description. - Lateral outline elongate, subtriangular, highest part in posterior third; posterior end broadly rounded, anterior end acutely rounded; dorsal margin convex, ventral margin concave.

Surface smooth, no ornamentation, no dorsal sulcus.

Inner lamella wide anteriorly, moderately wide ventrally and posteriorly; vestibule present along entire margin except dorsally; line of concrescence everywhere close to outer margin so that marginal zone narrow.

Marginal pore canals short, simple, evenly spaced, rather wide relative to length; about 10 anteriorly, 15 ventrally, 10 posteriorly, many along ventral and posterior margins are normal pores which do not reach outer margin.

Normal pores in central portion scattered, small sieve-type, with open central pore surrounded by sieve structure; along remainder of valve, particularly dorsal margin and at ends, linear-shaped sieve type pores which in some cases are as large as central adductor-muscle scars; appear to be constant in number and position for the species. Hinge merodont/lophodont. Right valve: small, thin anterior and posterior terminal teeth, connected by long, smooth median groove.

Left valve: small terminal sockets connected by thin, smooth median ridge.

Four adductor-muscle scars, slightly arcuate, ventral three are linear-shaped, dorsalmost one oval; one presumably mandibular scar, oval-shaped, near ventral margin; fulcral point anterior to adductor scars; no frontal scars visible.

Remarks. - This species was placed tentatively in Paradoxostoma by Puri (1953a, p. 288), but he made no comment concerning the reason for the questionable assignment. The current forms appear conspecific with his, at least the lateral outline is identical and it conforms to the remainder of Puri's description. A somewhat more complete description is included above. P. (?) delicata

conforms well to the concept of Paradoxostoma except for the presence of the large, linear trending, sieve-type normal pores described above. Since other species assigned to the genus have open normal pores according to Morkhoven (1963, p. 431) it is possible that a new genus should be erected on the basis of this species. However, it is felt that other species should be investigated in more morphological detail before any splitting of the genus is undertaken.

Curtis (1960, p. 482, pl. 2, fig. 14) illustrated a form with no text comment, which she assigned to Xestoleberis curta Brady (originally named as Cytheridea (?) curta Brady, 1865, p. 370, pl. 58, figs. 7a, b). Curtis' form appears considerably lower in height in relation to the length than the species illustrated by Brady, and is probably not conspecific with it. The lateral outline is the same as the present form and therefore is questionably placed in P. (?) delicata.

Genus Pellucistoma Coryell & Fields, 1937

Pellucistoma Coryell & Fields, 1937, p. 17; Edwards, 1944, p. 528; Van den Bold, 1946, p. 35; Pokorný, 1958, p. 299; Benson, 1959, p. 58; Sylvester-Bradley & Howe, 1961, Q317; Benson & Coleman, 1963, p. 40; Benson & Kaesler, 1963, p. 28; Van Morkhoven, 1963, p. 435.

Type species. - Pellucistoma howei Coryell & Fields, 1937, p. 17, figs. 18a, b, c.

Diagnosis. - Lateral outline subovate; dorsal margin straight to gently convex, ventral margin sinuous; anterior margin obliquely rounded in ventral half, more broadly rounded in dorsal half, posterior end with caudal process. Surface smooth to finely punctate; marginal denticulations, sulci and lateral extensions absent. Size medium, length 0.45 to 0.60 mm. Inner lamella wide anteriorly and posteroventrally, more narrow elsewhere; line of concrescence bends toward outer margin at the inner extent of marginal pore canals. Marginal pore canals wide at line of concrescence, branching toward outer margin anteriorly, most are simple posteriorly and ventrally, but some bifurcate. Normal pore open. Hinge merodont/entomodont, all elements in left valve are positive; the anterior tooth better developed than the posterior.

Pellucistoma magniventra Edwards, 1944

Pl. 17, figs. 9-15

Pellucistoma magniventra Edwards, 1944, p. 528, pl. 88, figs. 33-35; Puri, 1953a, p. 289, pl. 15, fig. 4, text-fig. 12a; Puri & Hulings, 1957, p. 174, 176, 183, 187, fig. 11, no. 6 (left side); Puri, 1960, p. 119, pl. 2, figs. 10, 11, text-figs. 8, 9; Benson & Coleman, 1963, p. 41, pl. 6, fig. 11, text-fig. 26; Van den Bold, 1963, p. 404, pl. 10, fig. 6.

[?] Pellucistoma sp. cf. P. magniventra Edwards, Swain, 1951, p. 52.

Paradoxistoma ensiforme Brady, Swain, 1955, p. 633, pl. 63, fig. 7.

Material. - Eight isolated valves.

Dimensions. - Figured hypotypes, UMMP 48797: length .50 mm, height .26 mm; UMMP 48798: length .48 mm, height .24 mm.

Remarks. - The present forms are somewhat smaller, length about 0.50 mm as opposed to the holotype which is 0.63 mm and those of Benson & Coleman (1963, p. 41) which are 0.71 mm, but they appear identical in all respects. In addition to former descriptions the following observations were made. The normal pores are the open type and while the marginal pore canals are branching at both ends they differ somewhat. Anteriorly all of the branches reach the outer margin, while posteriorly in all observed cases only one of the two or three branches reach the outer margin, the others exiting through the outer lamella. There is present in the anteroventral margin of the right valve of the inner lamella a groove which accommodates a complementary positive structure of the left valve.

Pellucistoma atkinsi, n. sp.

Pl. 17, figs. 1-8

[?] Paradoxostoma atrum Müller, Swain, 1955, p. 632, pl. 63, figs. 6a-d, text-figs. 36c, 39-4 a, b, c; Puri & Hulings, 1957, p. 187, fig. 11, no. 13 (left side); Puri, 1960, p. 119, pl. 2, figs. 12, 13.

Material. - Eight isolated valves.

Dimensions. - Holotype, UMMP 48795: length .51 mm, height .27 mm. Paratype, UMMP 48796: length .51 mm, .26 mm.

Description. - Lateral outline subquadrate, dorsal margin slightly convex, ventral margin sinuous, concave in anterior third of valve; anterior margin broadly rounded, somewhat oblique in dorsal half, posterior blunt caudal process present.

Surface smooth; carapace thin.

Inner lamella broad anteriorly, narrower elsewhere, almost disappearing at posterior concavity of ventral lateral outline; large vestibule present anteriorly, smaller one posteriorly; line of conrescence irregular anteriorly, bends toward outer margin at point of origin of marginal pore canals.

Marginal pore canals present with about equal frequency anteriorly, ventrally and posteriorly; branching, almost all branches reach outer margin.

Hinge merodont/entomodont. Right valve has anterior anti-slip tooth developed as extension of inner lamella at cardinal angle, median groove which deepens at anterior end and very slightly at posterior end, flange situated ventral to termination of median groove continuing to dorsal portion of caudal process. Left valve has anterior ill-defined socket for reception of anti-slip tooth, median bar, very finely crenulate, with thickenings developed at both extremities, the larger one at anterior end, oblique groove posterior to median bar which accommodates posterior flange of right valve.

Normal pores are few, scattered and open.

Muscle scar pattern of four adductor scars, slightly arcuate, two frontal scars anterior to topmost adductor scar, two mandibular scars near ventral margin and fulcral point anterior to two center adductor scars.

Remarks. - This species differs from P. magniventra most conspicuously in lateral outline, being nearly subquadrate with a relatively poorly developed caudal process, while P. magniventra has a more sinuous ventral margin and more convex dorsal outline. In addition the antislip tooth in the right valve is somewhat larger in P. atkinsi and nearly all marginal pore canals in the posterior portion reach the outer margin, whereas in P. magniventra only one branch of a set reaches the outer margin, the others exiting through the outer lamella. In addition, P. atkinsi possesses two individual frontal scars, but P. magniventra has a single crescent-shaped scar.

P. atkinsi differs from Paradoxostoma atrum Müller (1894, p. 320, pl. 23, figs. 15, 46, 50) in having prominent branching marginal pore canals, whereas P. atrum has simple straight ones. This feature is one of the distinguishing characteristics used (Van Morkhoven, 1963, p. 437) to separate the genera Paradoxostoma Fischer, 1855, and Pellucistoma Coryell & Fields, 1937. It is possible on the basis of lateral outline that the species questionably placed in the above synonymy belong in this new species, but not enough is known about the hinge and marginal pore canals to form a definite conclusion.

BIBLIOGRAPHY

- ALEXANDER, C. I., 1929, Ostracoda of the Cretaceous of North Texas: Texas Univ. Bull., No. 2907, p. 1-137, 10 pls.
- , 1933, Shell structure of the ostracode genus *Cytheropteron* and fossil species from the Cretaceous of Texas: Jour. Paleontology, v. 7, no. 2, p. 181-214, pls. 25-27.
- , 1934, Ostracoda of the Midway (Eocene) of Texas: *Ibid.*, v. 8, no. 2, p. 206-237, pls. 32-35.
- , 1936, Ostracoda of the Genera *Eucythere*, *Cytherura*, *Eucytherura*, *Loxoconcha* from the Cretaceous of Texas: *Ibid.*, v. 10, no. 8, p. 639-694.
- BAIRD, WILLIAM, 1835, List of Entomostraca found in Berwickshire: Proc. Berwickshire Naturalists Club, p. 95-100, pl. 3.
- , 1845, Arrangement of the British Entomostraca, with a list of species: *Ibid.*, for 1842-1849, p. 145-158.
- , 1850, The natural history of the British Entomostraca: London, Ray Society, viii + 364 p.
- BENSON, R. H., 1959, Ecology of Recent Ostracodes of the Todos Santos Bay region, Baja California, Mexico: Univ. Kansas Paleont. Contr., Arthropoda, Art. 1, 80 p., 11 pls., 20 text-figs.
- , & COLEMAN, G. L., 1963, Recent marine ostracodes from the eastern Gulf of Mexico: *Ibid.*, Art. 2, p. 1-52, pls. 1-8.
- , & KAESLER, R. L., 1963, Recent marine and lagoonal ostracodes from the Estero de Tastiota Region, Sonora, Mexico (Northeastern Gulf of California): *Ibid.*, Art. 3, p. 1-34, pls. 1-4.
- , & MADDOCKS, R. F., 1964, Recent ostracodes of Knysna Estuary, Cape Province, Union of South Africa: *Ibid.*, Art. 5, p. 1-39, pls. 1-6.
- BLAKE, C. H., 1933, Order Ostracoda, in Biological Survey of the Mount Desert Region conducted by William Proctor, pt. 4, p. 229-241, figs. 39, 40. Philadelphia, Pa., Wistar Inst. of Anatomy & Biology.
- BLAKE, D. B., 1950, Gosport Eocene Ostracoda from Little Stave Creek, Alabama: Jour. Paleontology, v. 24, no. 2, p. 174-184, pls. 29, 30.
- BOLD, W. A. VAN DEN, 1946, Contribution to the study of Ostracoda: 167 p., pls. 1-18, Amsterdam, J. H. de Bussy.
- , 1950, Miocene Ostracoda from Venezuela: Jour. Paleontology, v. 24, no. 1, p. 76-88, pls. 18-19.
- , 1957, Ostracoda from the Paleocene of Trinidad: Micropaleontology, v. 3, no. 1, p. 1-14.
- , 1958, Ostracoda of the Brasso Formation of Trinidad: *Ibid.*, v. 4, no. 4, p. 391-418.
- , 1963, The ostracode genus *Orionina* and its species: Jour. Paleontology, v. 37, no. 1, p. 33-50.
- BOSQUET, J., 1852, Description des Entomostraces Fossiles des Terrains Tertiaires de la France et de la Belgique: Acad. Roy. Soc., Lettres, Beaux-Arts de Belgique, v. 24, p. 1-142.
- BRADY, G. S., 1866, On new or imperfectly known species of marine ostracoda: Trans. Zool. Soc. London, v. 5, p. 359-393, pls. 57-62.
- , 1867, A synopsis of the Recent British Ostracoda: Intellectual Observer, v. 12 (for 1868), p. 110-120.
- , 1868, A monograph of the Recent British Ostracoda: Trans. Linnean Soc. London, v. 26, p. 353-495.
- , 1869, Contributions to the study of the Entomostraca. No. IV. Ostracoda from the River Scheldt and the Grecian Archipelago: Ann. & Mag. Nat. History Ser. 4, v. 3, p. 45-50, pls. 7, 8.
- , 1880, Challenger Reports, Zoology, v. 1, pt. 3, Ostracoda, p. 1-184.
- , & NORMAN, A. M., 1889, A monograph of the marine and fresh-water ostracoda of the North Atlantic and of northwestern Europe. Section 1, Podocopa: Sci. Trans. Royal Dublin Soc., ser. 2, v. 4, p. 63-270, pls. 8-23.
- , & ROBERTSON, D., 1874, Contributions to the study of the Entomostraca. No. IX, On Ostracoda taken amongst the Scilly Islands, and on the anatomy of *Darwinella stevensoni*: Ann. & Mag. Nat. History, Ser. 4, v. 13, p. 114-118.
- BUTLER, E. A., 1963, Ostracoda and correlation of the Upper and Middle Frio from Louisiana to Florida: Dept. of Conservation, La. Geol. Survey, Geol. Bull. no. 39, xvii + 100 p., 6 pls.
- CORYELL, H. N., & FIELDS, SUZANNE, 1937, A Gatun ostracode fauna from Cativa, Panama: Amer. Mus. Novitates, no. 956, p. 1-18, figs. 1-18.
- CURRAY, J. R., 1960, Sediments and history of Holocene transgression, continental shelf, northwest Gulf of Mexico in Recent Sediments, Northwest Gulf of Mexico, p. 221-266, publ. by Amer. Assoc. Petr. Geol.
- , 1961, Late Quaternary sea level: a discussion: Bull. Geol. Soc. Amer., v. 72, p. 1707-1712.
- CURTIS, D. M., 1960, Relation of environmental energy levels and ostracod biofacies in east Mississippi delta area. Bull. Am. Assoc. Petr. Geol., v. 44, no. 4, p. 471-494, pls. 1-3.

- CUSHMAN, J. A., 1906, Marine Ostracoda of Vineyard Sound and adjacent waters. Boston Soc. Nat. History, Proc., v. 32, no. 10, p. 359-385, pls. 27-38.
- DARBY, D. G., 1964, Ecology and taxonomy of Ostracoda in the vicinity of Sapelo Island, Georgia. Univ. Michigan Ph.D. Thesis, viii + 194 p.
- , & HOYT, J. H., 1964, An Upper Miocene fauna dredged from tidal channels of coastal Georgia. Jour. Paleontology, v. 38, no. 1, p. 67-73, pls. 17, 18.
- DEEVEY, E. S., 1965, Environments of the geologic past, review of, IMBRIE, JOHN, & NEWELL, N. D., editors, 1964, Approaches to Paleocology: Science, v. 147, no. 3658, p. 592-594.
- DUBOWSKY, N. W., 1939, Zur Kenntniss der Ostracoden Fauna des Schwarzen Meer. Trav. Sta. Biol., Karadagh, v. 5, p. 3-68.
- EDWARDS, R. A., 1944, Ostracoda from the Duplin Marl (Upper Miocene) of North Carolina. Jour. Paleontology, v. 18, no. 6, p. 505-528, pls. 85-88.
- ELOFSON, OLAF, 1941, Zur Kenntnis der marinen Ostrakoden Schwedens mit besonderer Berücksichtigung des Skageraks. Upsala Univ., Zool. Bidrag från Upsala, v. 19, p. 215-534.
- FAIRBRIDGE, R. W., 1961, Eustatic changes in sea level, in AHRENS, L. H., editor, Physics & Chemistry of the Earth, v. 4, p. 99-185. Pergamon Press, New York.
- FISHER, SEBASTIAN, 1855, Beitrag zur Kenntnis der Ostracoden. Abhandl. Math. Phys. Class Bayer. Akad. Wiss., Munich, v. 7, no. 3, p. 635-666, pls. 1, 2.
- GOERLICH, FRANZ, 1953, Ostrakoden der Cytherideinae aus der Tertiären Molasse Bayerns. Senckenbergiana, v. 34, p. 117-148.
- GORSLINE, D. S., 1963, Environments of carbonate deposition, Florida Bay and Florida Straits, in BASS, R. O., editor, Shelf Carbonates of the Paradox Basin, a Symposium, p. 130-143. Four Corners Geological Society.
- HANAI, TETSURO, 1957, Studies on the Ostracoda from Japan, Part III; Subfamilies Cytherurinae G. W. Müller (emend. G. O. Sars 1925) and Cytheropterinae n. subfam. Jour. Faculty of Sci., Sec. 2, v. 11, pt. 1, p. 11-36, pls. 2-4, 10 text-figs.
- HARDING, J. P., & SYLVESTER-BRADLEY, P. C., 1953, The ostracod genus *Trachyleberis*. Bull. Brit. Mus. (Nat. Hist.), Zoology, v. 2, no. 1, p. 1-15, pls. 1, 2.
- HENRY, V. J., & HOYT, J. H., 1963, Geologic history and development of the Pleistocene and Recent barrier islands of the Georgia coast. Unpubl. Guide for Georgia Geol. Soc. Field trip, Sapelo Island, Georgia, Sept. 21-22, 1963.
- HIRSCHMANN, NIKOLAJ, 1909, Beitrag zur Kenntnis der Ostracoden fauna des finnischen Meerbusens. Societas pro Fauna et Flora Fennica, Meddelanden, v. 35, p. 282-297, pls., figs. 1-12.
- HORNIBROOK, N. DE B., 1952, Tertiary and Recent marine Ostracoda of New Zealand. New Zealand Geol. Survey, Paleont. Bull. 18, p. 1-82, pls. 18, 4 text figs.
- HOWE, H. V., 1955, Handbook of Ostracod Taxonomy. Louisiana St. Univ. Press, Baton Rouge, La., p. 1-368.
- , 1961, in Treatise on Invertebrate Paleontology, R. C. Moore, editor, Part Q, Arthropoda 3. Lawrence, Kansas, Univ. Kansas Press and Geol. Soc. America.
- , 1962, Ostracod Taxonomy, p. xix + 366, Baton Rouge, La., La. St. Univ. Press.
- , & Graduate Students, 1935, Ostracoda of the Arca zone of the Choctawhatchee Miocene of Florida. Fla. Board of Cons. Geol. Dept. Bull., no. 13, p. 1-37, pls. 1-4.
- , & Chambers, Jack, Louisiana Jackson Eocene Ostracoda. Dept. Conservation, La. Geol. Survey, Geol. Bull. no. 5, p. vii - 65, 6 pls.
- , & LAW, JOHN, 1936, Louisiana Vicksburg Oligocene Ostracoda, *Ibid.*, no. 7, p. 1-96.
- HOYT, J. H., WEIMER, R. J., & HENRY, V. J., 1964, Late Pleistocene and Recent sedimentation, central Georgia coast, U.S.A., p. 170-176, in Dev. in Sedimentology, v. 1, Deltaic & shallow marine deposits, Proc. Sixth Intern. Sed. Congr., 1963, L. M. J. V. van Straaten, editor; Elsevier Publ. Co., New York.
- JOHNSON, R. G., 1960, Models and methods for the analysis of the mode of formation of fossil assemblages: Bull. Geol. Soc. Amer., v. 71, p. 1075-1086.
- , 1962, Interspecific association in Pennsylvanian fossil assemblages: Jour. Geology, v. 70, p. 32-55.
- , 1964, The community approach to paleoecology in Imbrie, J., & Newell, N. D., editors, Approaches to Paleocology, p. 107-134, John Wiley, New York.
- JONES, T. R., 1850, Description of the Entomostraca of the Pleistocene beds of Newbury, Copford, Clacton and Grays. Ann. & Mag. Nat. Hist., Ser. 2, v. 6, p. 25-28, pl. 3.
- , 1857, A monograph of the Tertiary Entomostraca of England. Palaeontographical Soc. London, p. 1-68, pls. 1-6.
- JUDAY, CHAUNCEY, 1907, Ostracoda of the San Diego region: II. Littoral Forms. Univ. Calif. Publication, Zoology, v. 3, no. 9, p. 135-150.
- KELJ, A. J., 1957, Eocene and Oligocene Ostracoda of Belgium. Inst. Royal des Sci. Naturelles de Belgique, Mem. no. 136, p. 1-210, pls. 1-23.
- KELLETT, BETTY, 1935, Ostracodes of the Upper Pennsylvanian and Lower Permian strata of Kansas: III Bairdiidae, Entomoconchidae, Cytheridae, and Cypridae. Jour. Paleontology, v. 9, no. 2, p. 132-166, pls. 16-18.

- KESLING, R. V., 1951, Terminology of ostracod carapaces. *Mich. Univ., Mus. Paleontology, Contributions*, v. 9, no. 4, p. 93-171.
- LATREILLE, P. A., 1806, *General Crustaceorum et Insectorum, Tomus I*, p. I - XVIII + 303.
- LEROY, L. W., 1943, Pleistocene and Pliocene Ostracoda of the coastal region of southern California. *Jour. Paleontology*, v. 17, no. 4, p. 354-373, pls. 58-62.
- MALKIN, D. S., 1953, Biostratigraphic study of Miocene Ostracoda of New Jersey, Maryland, and Virginia. *Jour. Paleontology*, v. 27, no. 6, p. 761-799, pls. 78-82, 14 text-figs.
- MARTIN, J. L., 1939, Claiborne Eocene species of the ostracode genus *Cytheropteron*. *Jour. Paleontology*, v. 13, no. 2, p. 176-182, pl. 22.
- MCCLEAN, J. D., 1957, The Ostracoda of the Yorktown formation in the York-James Peninsula of Virginia. *Bull. Am. Paleontology*, v. 38, no. 167, p. 52-103, pls. 7-12, 3 charts.
- M'COY, FREDERICK, 1844, A synopsis of the characters of the Carboniferous Limestone fossils of Ireland, Dublin University Press, p. 1-207, 29 pls.
- MERRILL, A. S., EMORY, K. O., & RUBIN, MEYER, 1965, Ancient oyster shells on the Atlantic continental shelf, *Science*, v. 147, no. 3656, p. 398-400.
- MINCHER, A. R., 1941, The fauna of the Pascagoula formation. *Jour. Paleontology*, v. 15, no. 4, p. 337-348, pls. 46-47.
- MORKHOVEN, F. P. C. M. VAN, 1962, *Post-Paleozoic Ostracoda*, v. 1, General. vii + 204 p., 79 figs., New York, Elsevier Publ. Co.
- , 1963, *Post-Paleozoic Ostracoda*, v. 2, Generic Descriptions, p. 1-478, 763 figs., New York, Elsevier Publ. Co.
- MÜLLER, G. W., 1894, Die ostracoden des Golfes von Neapel und der Angrenzenden Meeres-Abschnitte. *Naples Sta. Zool., Fauna und Flora des Golfes von Neapel, Monograph.* 21, p. 1-404, pls. 1-40.
- , 1912, *Ostracoda in Das Tierreich. Im Auftrage der Königl. Preuss. Akad. Wiss. zu Berlin.* 31 Lieferung, p. 1-434.
- MÜLLER, O. F., 1776, *Zoologiae Danicae Prodomus, Seu Animalium Daniae et Norvegiae Indigenarum Characters, Nomina, et Synonyma Imprimis Popularium*, F. F. Havniae, p. 1-282.
- , 1785, *Entomostraca Seu Insecta Testacea, Quae in Aquis Daniae et Norvegiae Reperit, Descripsit et Iconibus Illustravit.* Lipsiae et Havniae, p. 1-135.
- NEVIANI, A., 1928, *Ostracodi fossil d'Italia. I. Valle-biaja (Calabriano).* Pontificia Acad. delle Sci., Rome Memoire, Ser. 2, v. 11, p. 1-120, 2 pls.
- NEWELL, N. D., IMBRIE, JOHN, PURDY, E. G., & THURBER, D. L., 1959, *Organism communities and bottom facies, Great Bahama Bank: Bull. Amer. Mus. Nat. History*, v. 117, art. 4, p. 181-228.
- NORMAN, A. M., 1862, *Contributions to British Carcinology. II. On Species of Ostracoda new to Great Britain.* Ann. & Mag. Nat. History, Ser. 3, v. 9, p. 43-55.
- , 1865, *Report of the Crustacea in Nat. Hist. Northumberland and Durham, Trans.*, v. 1, p. 12-29, pls. 5-7.
- OERTLI, H. J., 1956, *Ostracoden aus der Oligozänen und Miozänen Molasse der Schweiz.* Schweizerischen Naturf. Gesell., Schweiz Paläont. Abh., Bd. 74, p. 1-116.
- PHLEGER, F. B., 1960, *Ecology and Distribution of Recent Foraminifera.* The Johns Hopkins Press, Baltimore, p. 1-297.
- POKORNÝ, VLADIMÍR, 1955, *Contribution to the morphology and taxonomy of the subfamily Hemicytherinae Puri.* Acta Universitatis Carolinae, III, p. 1-35, 19 text figs.
- , 1958, *Gründzüge der zoologischen Mikropaläontologie*, Bd. II, viii + 453 p., 1077 text figs.
- PURI, H. S., 1952, *Ostracode genus Cytherideis and its allies.* *Jour. Paleontology*, v. 26, no. 6, p. 902-914, pls. 130-131.
- , 1953a, *Contribution to the study of the Miocene of the Florida panhandle.* Fla. Geol. Survey, Bull. 36, p. 1-345.
- , 1953b, *The ostracode genus Hemicythere and its allies.* *Jour. Wash. Acad. Sci.*, v. 43, no. 6, p. 169-179, pls. 1, 2.
- , 1953c, *Taxonomic comment on: "Ostracoda from wells in North Carolina, Part 1: Cenozoic Ostracoda," by F. M. Swain.* *Jour. Paleontology*, v. 27, no. 5, p. 750-752.
- , 1953d, *The ostracode genus Trachyleberis and its ally Actinocythereis.* *Amer. Midl. Nat.*, v. 49, no. 1, p. 171-188, pls. 1, 2.
- , 1957, *Stratigraphy and zonation of the Ocala group.* Fla. Geol. Survey, Bull. 38, pt. 3, *Ostracoda*, p. 186-244, 15 pls.
- , 1958, *Ostracode genus Cushmanidea.* *Gulf Coast Assoc. Geol. Soc., Trans.*, v. 8, p. 171-181, 2 pls.
- , 1960, *Recent Ostracoda from the west coast of Florida.* *Gulf Coast Assoc. Geol. Soc. Trans.*, v. 10, p. 107-149, pls. 1-6.
- , & HULINGS, N. C., 1957, *Recent ostracode facies from Panama City to Florida Bay area.* *Gulf Coast Assoc. of Geol. Soc., Trans.*, v. 7, p. 167-190, 11 text figs.
- REYMENT, R. A., 1961, *in Treatise on Invertebrate Paleontology*, R. C. Moore, editor, Part Q, Arthropoda 3, Lawrence, Kansas, Univ. Kansas Press and Geol. Soc. America.

- ROEMER, F. A., 1938, Die Cytherinen des Molasse-Gebirges. *Neus Jahrbuch fur Min., Geol., Pal.*, p. 514-519.
- RUGGIERI, GIULIANO, 1952a, Nota Preliminare Sugli Ostracodi Di Alcune Spiagge Adriatiche. *Bologna Universiat, Inst. Zool., Note del Lab. Biol. Marina di Fano*, v. 1, no. 8, p. 57-64.
- , 1952b, Gli Ostracodi Delle Sabbie Grigie (Milaziano) Di Imola, Parte II. *Giorn. Geologia, Bologna, Ser. 2*, v. 22, p. 59-115.
- , 1956, La Subdivisione Degli Ostracodi Già Compresi Nel Genere *Cythereis* Proposta da Neriani Nel 1928. *Società Italiana di Scienze Naturali, Atti*, v. 95, Fasc. II, p. 161-175.
- , 1958, Alcuni Ostracodi del Neogene Italiano, *Ibid.*, v. 97, Fasc. II, p. 127-146, 30 figs.
- SANDBERG, PHILIP, 1964, Larva-adult relationships in some species of the ostracode genus *Haplocytheridea*: *Micropaleontology*, v. 10, no. 3, p. 357-368.
- SARS, G. O., 1866, Oversigt af Norges Marine Ostracoder. *Norske Vidensk-Akad. forhandling*, p. 1-130.
- , 1888, Nye Bidrag til Kundskaben om Middlehavets Invertebratfauna. 4. Ostracoda Mediterranea. *Archiv. for Mathematik og Naturvidenskab, Oslo*, v. 12, p. 173-234, pls. 1-20.
- , 1922-28, An account of the Crustacea of Norway, v. 9, Ostracoda, pts. 1-16, p. 1-277, pls. 1-119.
- SEQUENZA, G., 1880, Le formazioni terziarie nella provincia de Reggio. *Atti R. Acad. dei Lincei, ser. 3, mem. 6 (Rome)*, p. 3-443, pls. 4-17.
- SHARER, R. H., 1961, in *Treatise on Invertebrate Paleontology*, R. C. Moore, editor, Part Q, Arthropoda 3, Lawrence, Kansas, Univ. Kansas Press and Geol. Soc. America.
- SHEPARD, F. P., 1960, Rise at sea level along northwest coast Gulf of Mexico in Shepard, F. P., et al., editors, *Recent sediments, Northwest Coast Gulf of Mexico*, p. 338-381, *Amer. Assoc. Petr. Geol.*
- STAPLIN, F. L., 1963, Pleistocene Ostracoda of Illinois. *Jour. Paleontology*, v. 37, no. 4, p. 758-797.
- STEPHENSON, M. B., 1935, Some microfossils from the *Potamides matsoni* zone. *La. Geol. Survey Bull.*, no. 6, p. 187-197, pl. 5.
- , 1936, Shell structure of the ostracode genus *Cytheridae*: *Jour. Paleontology*, v. 10, no. 8, p. 695-703, pl. 94.
- , 1937, Middle Tertiary Ostracoda of the genus *Cytheridea*. *Ibid.*, v. 11, no. 2, p. 145-159, pls. 26, 27, 27 text-figs.
- , 1938, Miocene and Pliocene Ostracoda of the genus *Cytheridea* from Florida: *Ibid.*, v. 12, no. 2, p. 127-148, pls. 23, 24.
- , 1941, Notes on the subgenera of the ostracode genus *Cytheridea*. *Ibid.*, v. 15, no. 4, p. 424-429, 20 text figs.
- , 1943, *Haplocytheridea bassleri* Stephenson, new name for *Cytheridea subovata* Ulrich and Bassler. *Ibid.*, v. 17, no. 2, p. 206-207.
- , 1944, New ostracoda from subsurface Middle Tertiary strata of Texas, *Ibid.*, v. 18, no. 2, p. 156-161, pl. 28.
- , 1946, Weches Eocene Ostracoda from Smithville, Texas, *Ibid.*, v. 20, no. 4, p. 297-344, pls. 42-45.
- SUTTON, A. H. & WILLIAMS, J. R., 1939, Ostracoda from the Weches formation at Smithville, Texas. *Jour. Paleontology*, v. 13, no. 6, p. 561-574, pls. 63, 64.
- SWAIN, F. M., 1948, Ostracoda, Hammond Well in Anderson, J. L. et al., *Cretaceous and Tertiary subsurface geology. Maryland Dept. of Geol., Mines and Water Resources, Bull. 2*, p. 187-213, pls. 12-14.
- , 1951, Ostracoda from wells in North Carolina, Part 1, Cenozoic Ostracoda. *U.S. Geol. Survey, Prof. Paper 234-A*, p. 1-58, pls. 1-7.
- , 1955, Ostracoda of San Antonio Bay, Texas. *Jour. Paleontology*, v. 29, no. 4, p. 561-646, pls. 59-64, 39 text figs.
- , 1961, in *Treatise on Invertebrate Paleontology*, R. C. Moore, editor, Part Q, Arthropoda 3, Lawrence, Kansas, Univ. Kansas Press and Geol. Soc. America,
- , 1963, Pleistocene Ostracoda from the Gubik Formation, Arctic Coastal plain, Alaska. *Jour. Paleontology*, v. 37, no. 4, p. 798-834, pls. 95-99.
- SYLVESTER-BRADLEY, P. C., 1948, The Ostracode genus *Cythereis*. *Jour. Paleontology*, v. 22, no. 6, p. 792-797, pl. 122.
- , 1950, The shall of the ostracod genus *Bairdia*. *Ann. & Mag. Nat. Hist.*, ser. 12, v. 3, p. 751-756.
- , 1961, in *Treatise on Invertebrate Paleontology*, R. C. Moore, editor, Part Q, Arthropoda 3, Lawrence, Kansas, Univ. Kansas Press and Geol. Soc. America.
- , & HARDING, J. P., 1953, The nomenclature of the Ostracode genus *Cytherideis*. *Journ. Paleontology*, v. 27, no. 5, p. 753-755.
- , & -----, 1954, Postscript notes on the ostracode *Trachyleberis*, *Ibid.*, v. 28, no. 5, p. 560-562.
- REICHERT, CURT, 1937, Ordovician and Silurian faunas from Arctic Canada. *Copenhagen Univ. Min.-Geogomst. Mus. Communications paleont.* no. 59, p. 1-169, pls. 1-24.
- , 1939, New names for ostracode homonyms. *Jour. Paleontology*, v. 13, no. 6, p. 622.
- TRIEBEL, ERICH, 1940, Die Ostracoden der Deutschen Kreide. 3. *Cytherideinae und Cytherinae der unteren Kreide. Senckenbergiana, Bd. 22*, p. 160-227.
- , 1941, Zur morphologie und Ökologie der Fossilen Ostracoden, mit Beschreibung einiger neuer Gattungen und Arten. *Ibid.*, Bd. 23, p. 294-400.

- ULRICH, E. O., & BASSLER, R. S., 1904, Systematic Paleontology of the Miocene deposits of Maryland Ostracoda. Maryland Geol. Survey Miocene Report, Part 1 (text), p. 98-130; Part 2 (plates), Pls. 35-38.
- WAGNER, C. W., 1957, Sur les Ostracodes du Quaternaire Recent des Pays-Bas et leur utilisation dans l'étude geologique des dépôts Holocènes. 259 p., pls. 1-50, The Hague, Mouton and Co.
- WALTON, W. R., 1964, Recent foraminiferal ecology and paleoecology, in Approaches to Paleoecology, Imbrie, John, & Newell, N. D., editors. John Wiley & Sons Inc., New York.
- WHITTINGTON, H. B., 1964, Taxonomic basis of paleoecology, in Imbrie, J. & Newell, N. D., editors, Approaches to Paleoecology, p. 19-27, John Wiley, New York.
- ZIEGLER, J. M., 1959, Origin of the Sea Islands of the Southeastern United States, Geographical Review, v. 49, p. 222-237.

PLATES

EXPLANATION OF PLATE 1

(Figures x60 except as noted)

FIGS. 1-6 Pontocypris sp.

1-6, left valve, UMMP 48679; 1, interior view, transmitted light; 2, exterior; 3, posterior marginal area, transmitted light, x215; 4, 5, posterior and anterior marginal pore canals respectively, transmitted light, x590; 6, central muscle-scar field, transmitted light, x 215.

FIG. 7 Bairdia laevicula Edwards. Right valve, exterior, UMMP 48680.FIGS. 8-11 Bairdia sp.

8, 10, 11, left valve, UMMP 48681; 8, exterior; 10, posterior marginal area, transmitted light, x215; 11, anterior marginal area, transmitted light, x120; 9, right valve, central muscle-scar field, transmitted light, UMMP 48682, x215.

FIGS. 12-19 Candona (?) sp.

12-15, 18, 19, left valve, UMMP 48683; 12, 13, sieve-type normal pores, x1475; 14, interior view, transmitted light, x 72; 15, exterior; 18, 19, posterior and anterior marginal areas, transmitted light, x215. 16, right valve, central muscle-scar field, transmitted light, UMMP 48684, x 215. 17, left valve, central muscle-scar field, transmitted light, UMMP 48685, x215.

PLATE 1

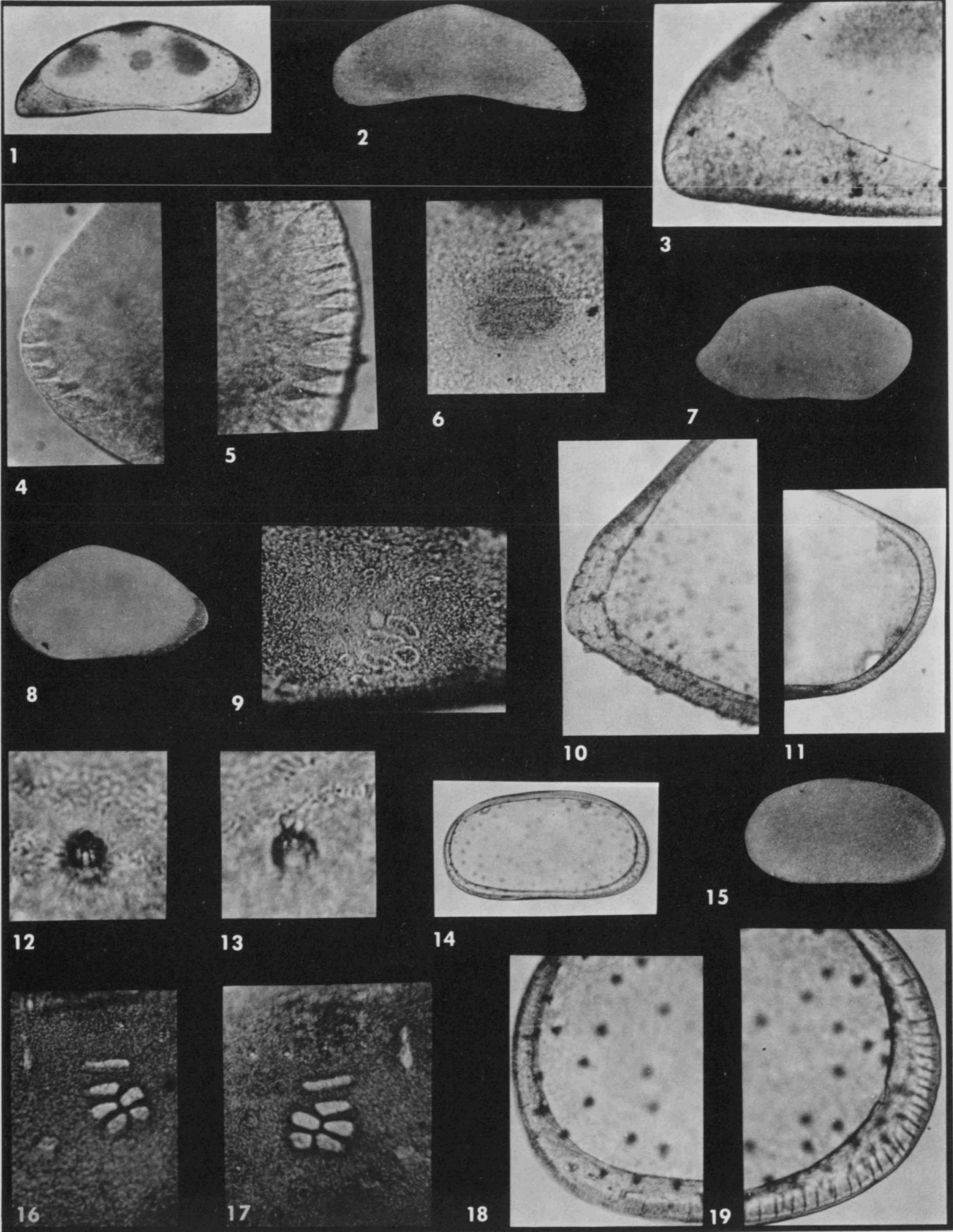

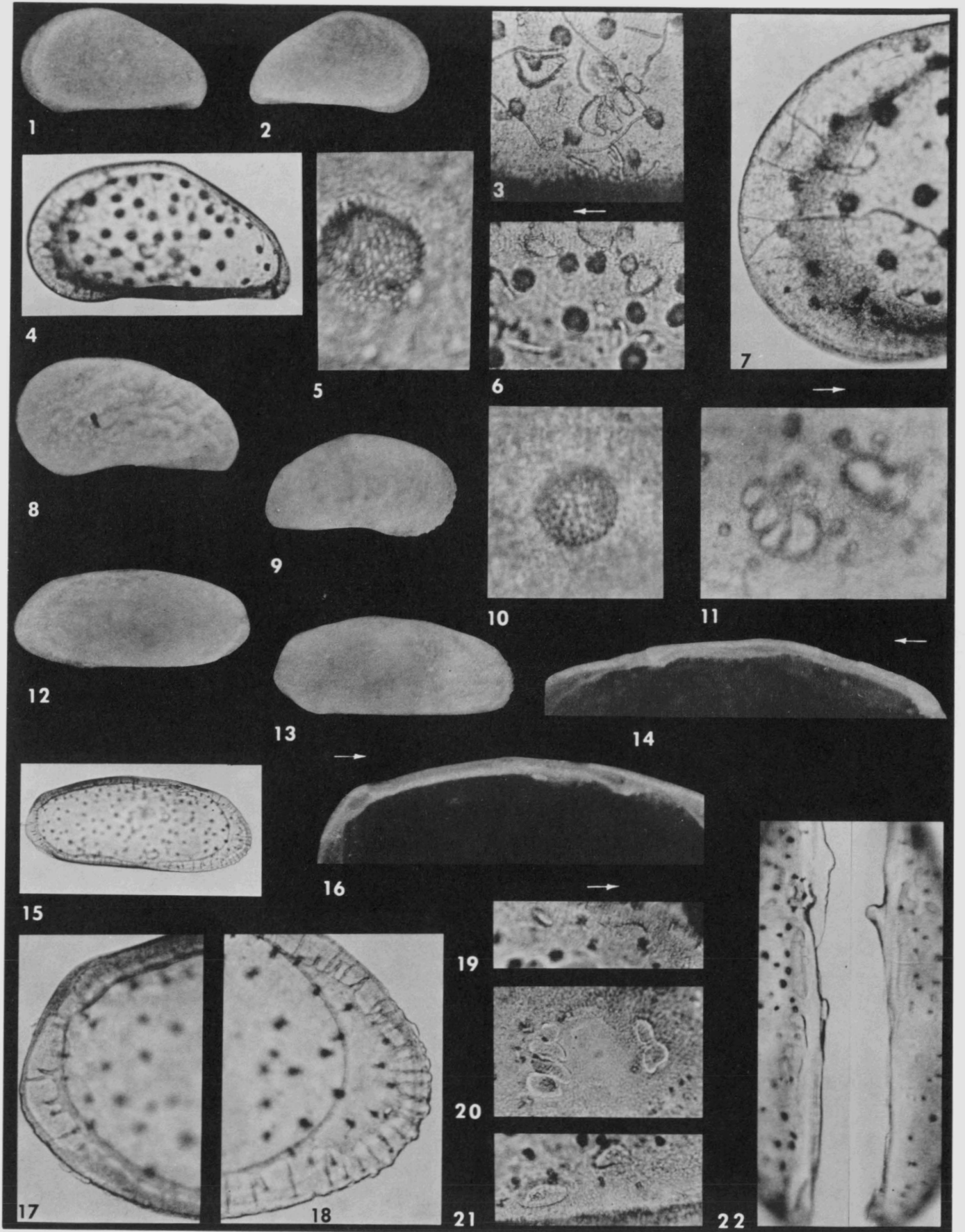

EXPLANATION OF PLATE 2

(Figures x60 except as noted)

FIGS. 1-7 Eucythere sp. cf. E. declivis (Norman)

1-7, UMMP 48686 (one specimen); 1, left valve, exterior; 2-7, right valve; 2, exterior; 3, central muscle-scar field, transmitted light, x215; 4, interior view, transmitted light, x90; 5, sieve-type normal pore, transmitted light, x1475; 6, dorsal muscle-scar field, transmitted light, x215; 7, anterior marginal area, transmitted light, x215.

FIGS. 8-11 Eucythere triangulata Puri

8, 10, left valve, UMMP 48687; 8, exterior; 10, sieve-type normal pore, transmitted light, x1475. 9, 11, right valve, UMMP 48688; 9, exterior; 11, central muscle-scar field, transmitted light, x215.

FIGS. 12-22 Campylocythere laeva Edwards

12, 15-21, left valve, UMMP 48689; 12, exterior; 15, interior view, transmitted light; 16, hinge, interior view, x120; 17, 18, posterior and anterior marginal areas respectively, transmitted light, x215; 19, 20, 21, dorsal, central and mandibular muscle fields respectively, transmitted light, x215, 13, 14, right valve, UMMP 48690; 13, exterior, x72; 14, hinge, interior view, x120. 22, hinge, dorsal view, transmitted light, left valve UMMP 48689, right valve UMMP 48690, x120.

EXPLANATION OF PLATE 3

(Figures x60 except as noted)

FIGS. 1-9 Sahnia sp.

1, 2, 6-8, right valve, UMMP 48692; 1, anterior marginal area, transmitted light, x215; 2, exterior; 6, hinge, dorsal view, transmitted light, x120; 7, central muscle scar field, transmitted light, x430; 8, hinge, interior view, x120. 3, 4, 5, 9, left valve, UMMP 48691; 3, exterior; 4, interior view, transmitted light, x90; 5, hinge, dorsal view transmitted light, x120; 9, hinge, interior view, x120.

FIGS. 10-14 Paradoxostoma (?) delicata Puri

10, 12, 13, 14, left valve, UMMP 48693; 10, exterior; 12, posteroventral marginal pore canals, transmitted light, x1475; 13, anterior marginal areas showing wide vestibule and narrow marginal zone, transmitted light, x215; 14, adductor muscle scars, transmitted light, x215, 11, right valve, exterior, UMMP 48694.

FIGS. 15-24 Acuticythereis multipunctata Edwards

15-24, UMMP 48695 (one specimen); 16, 17, 19, 20, 21, 24, right valve; 16, exterior; 17, hinge, interior view, x120; 19, 20, anterior and posterior marginal areas respectively, transmitted light, x215; 21, sieve-type normal pore, transmitted light, x1475; 24, hinge, dorsal view, transmitted light, x120; 15, 18, 22, 23, left valve; 15, exterior; 18, hinge, interior view, x120; 22, posteromedian hinge element to show coarse crenulation of posterior portion of median ridge, dorsal view, transmitted light, x295; 23, hinge, dorsal view, transmitted light, x120.

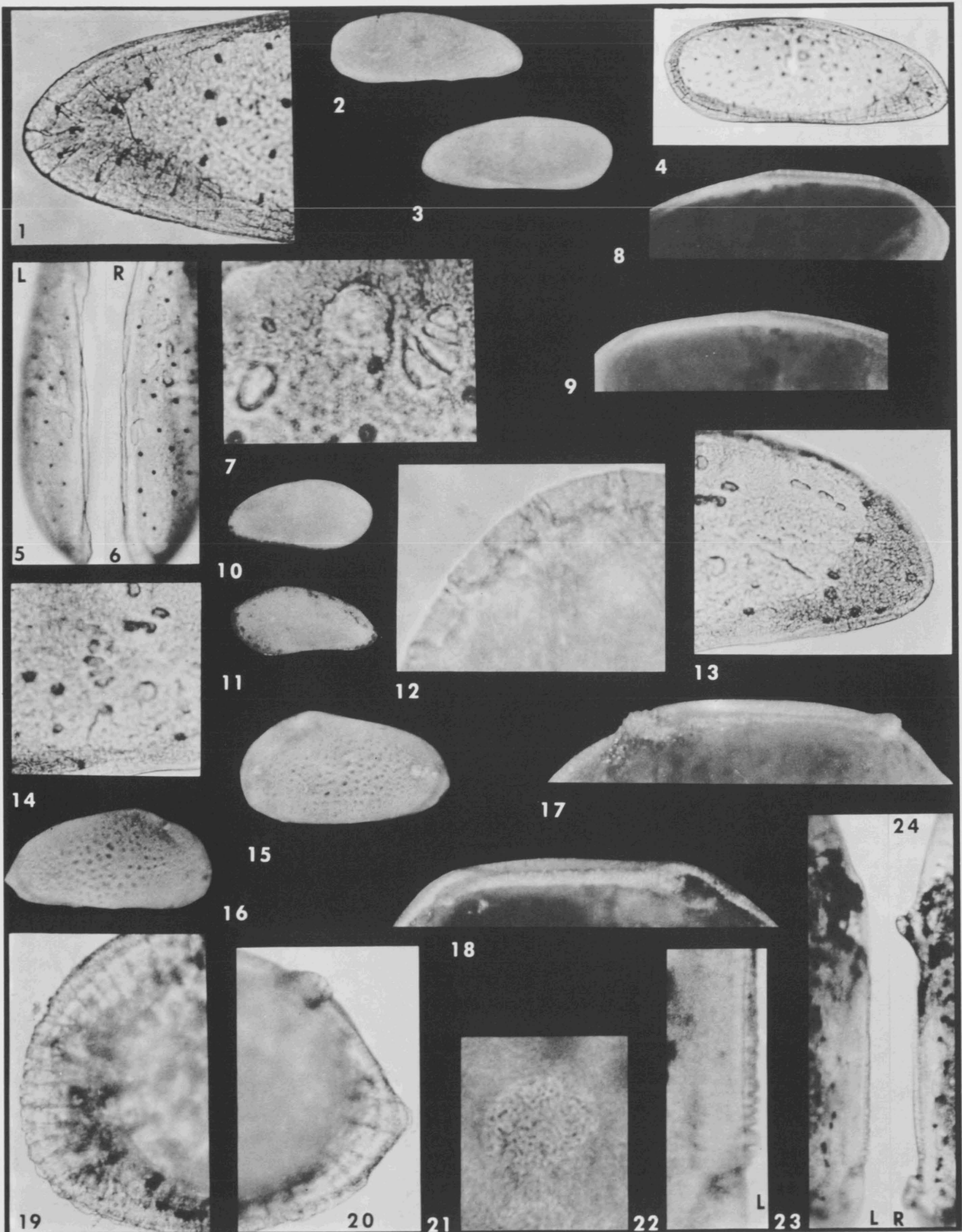

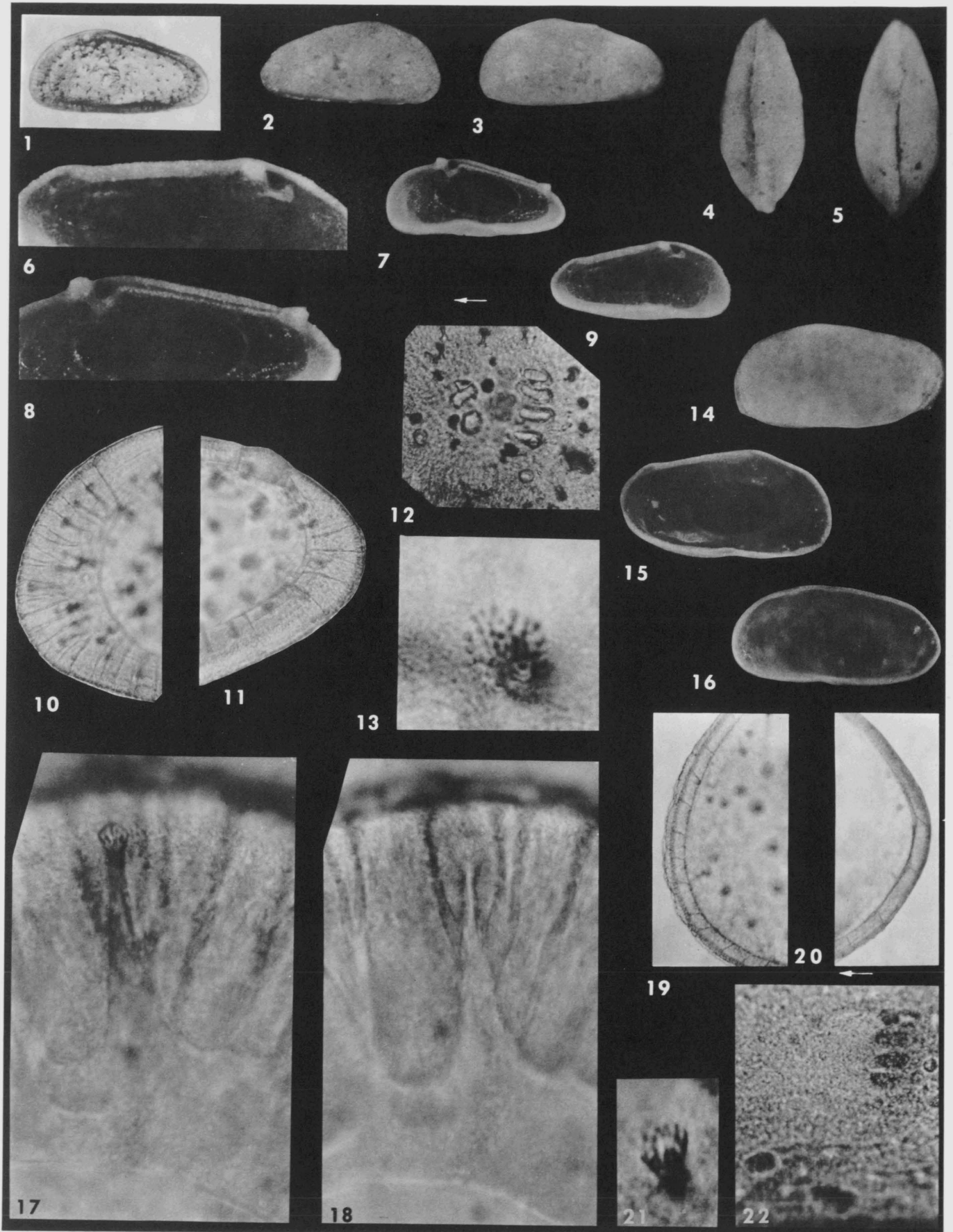

EXPLANATION OF PLATE 4

(Figures x50 except as noted)

FIGS. 1-13, 17, 18 Acuticythereis laevissima Edwards

1, 2, right valve, UMMP 48696; 1, interior view, transmitted light; 2, exterior. 3, left valve, exterior, UMMP 48697. 4, 5, UMMP 48698; 4, ventral view; 5, dorsal view. 6-13, 17, 18, UMMP 48699 (one specimen); 6, 9, left valve; 6, hinge, interior view, x120; 9, interior view; 7, 8, 10-13, 17, 18, right valve; 7, interior view; 8, hinge, interior view, x120; 10, 11, anterior and posterior marginal areas respectively, transmitted light, x215; 12, central muscle scar field, transmitted light, x215; 13, sieve-type normal pore, transmitted light, x1475; 17, 18, two photographs taken at same position in two planes of focus from exterior, 18 focused deeper, showing relation of anterior marginal pore canals which reach outer margin, and a "false canal" which is in reality a sieve-type normal pore which also originates at line of concrescence, but exits through outer lamella, rather than between outer and inner lamella, x960.

FIGS. 14-16, 19-22 Acuticythereis gigantea Edwards

14-16, 19-22, UMMP 48700 (one specimen); 14, 15, left valve; 14, exterior; 15, interior view; 16, 19-22, right valve; 16, interior view; 19, 20, anterior and posterior marginal areas respectively, transmitted light, x215; 21, sieve-type normal pore, transmitted light, x1475; 22, central and mandibular muscle field, transmitted light, x215.

EXPLANATION OF PLATE 5

(Figures x60 except as noted)

FIGS. 1-8 Acuticythereis tenmilecreekensis (Puri)

1, 4, 5, 6, UMMP 48701 (one specimen); 1, 5, 6, right valve; 1, exterior; 5, posterior marginal area, transmitted light, x215; 6, hinge, interior view, x120; 4, left valve, hinge, interior view, x120. 2, left valve, exterior, UMMP 48702. 3, 7, right valve, UMMP 48703; 3, posterior marginal area, x120; 7, interior view. 8, central muscle-scar field, transmitted light, UMMP 48704, x215.

FIGS. 9-19 Acuticythereis gigantea Edwards

9-19, UMMP 48705 (one specimen); 9, 10, 12-14, 17-19, left valve; 9, 10, posterior and anterior marginal areas respectively, transmitted light, x215; 12, exterior; 13, central muscle scar field, transmitted light, x215; 14, hinge, interior view, x120; 17, interior view; 18, 19, two views of sieve-type normal pores, x1475; 18, looking down long axis of pore, 19, at an angle to long axis; 11, 15, 16, right valve; 11, exterior; 15, hinge, interior view, x120; interior view.

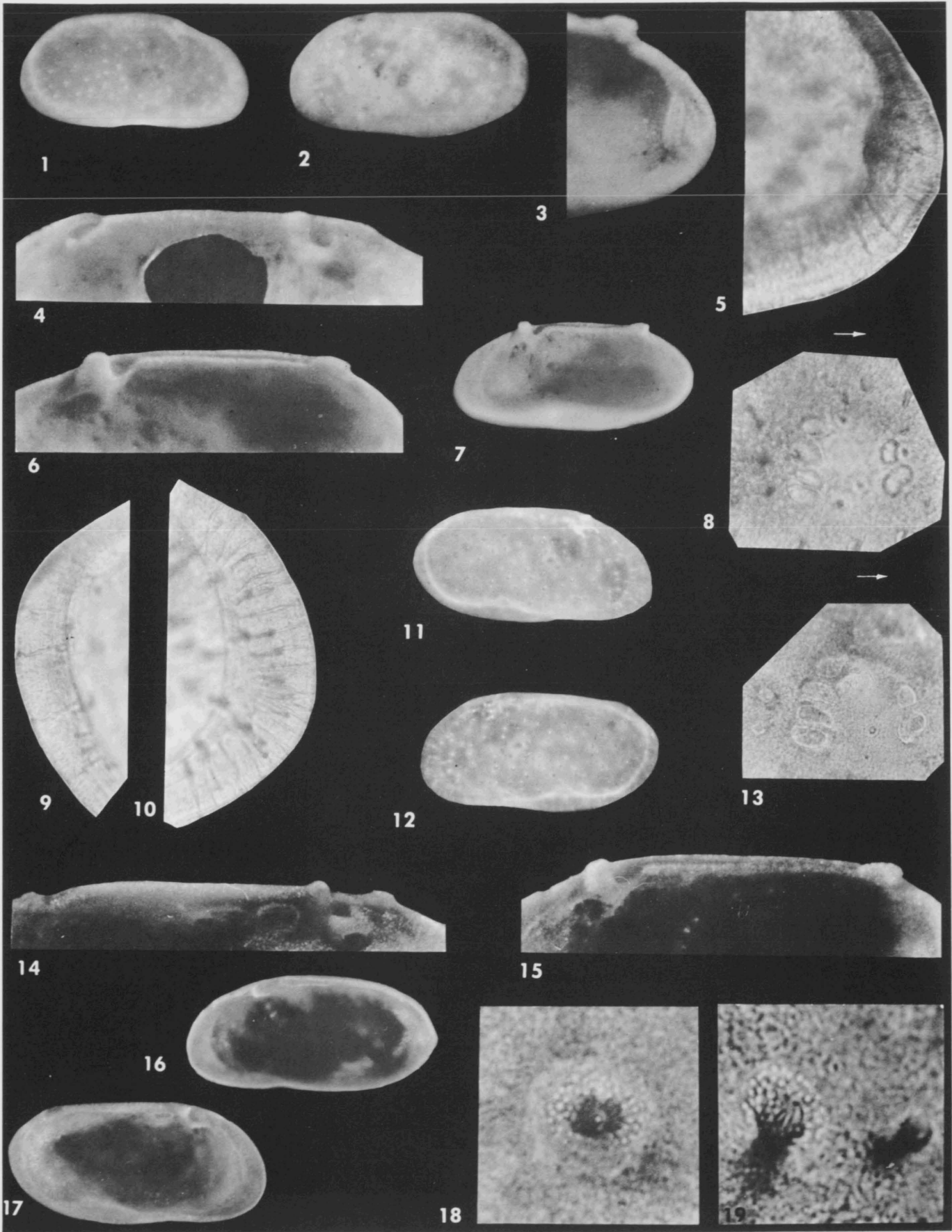

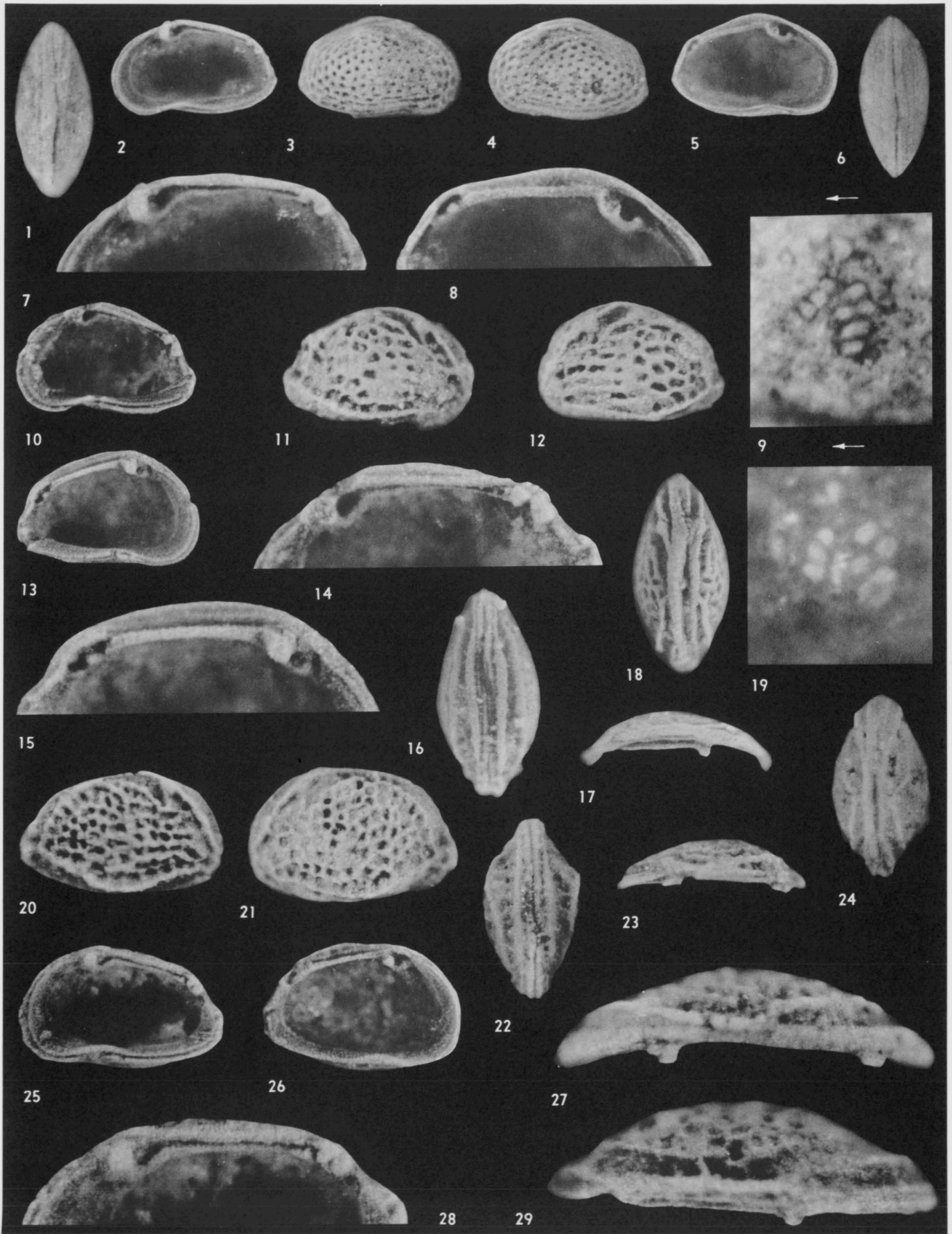

EXPLANATION OF PLATE 6

(Figures x60 except as noted)

FIGS. 1-9 Aurila amygdala (Stephenson)

1, 9, UMMP 48706; 1, exterior, ventral view; 9, right valve, central muscle scar field, transmitted light, x215. 2-8, UMMP 48707 (one specimen); 2, 3, 7, right valve; 2, interior view; 3, exterior; 7, hinge, interior view, x120; 4, 5, 8, left valve; 4, exterior; 5, interior view; 8, hinge, interior view, x120; 6, exterior, dorsal view.

FIGS. 10-19, 23 Aurila conradi conradi (Howe & McGuirt)

10-15, 17, 19, 23, UMMP 48708 (one specimen); 10, 11, 14, 19, 23, right valve; 10, interior view; 11, exterior; 14, hinge, interior view, x120; 19, central muscle-scar field, transmitted light, x215; 23, hinge, dorsal view, x215; 12, 13, 15, 17, left valve; 12, exterior; 13, interior view; 15, hinge, interior view, x120; 17, hinge, dorsal view. 16, 18, UMMP 48709; 16, exterior, ventral view; 18, exterior, dorsal view.

FIGS. 20-22, 24-29 Aurila conradi floridana Benson & Coleman

20, 25, 27, 28, right valve, UMMP 48710; 20, exterior; 25, interior view; 27, hinge, dorsal view, x120; 28, hinge, interior view, x120. 21, 26, 29, left valve, UMMP 48711; 21, exterior; 26, interior view; 29, hinge, dorsal view, x120. 22, 24, UMMP 48712; 22, exterior, ventral view; 24, exterior, dorsal view.

EXPLANATION OF PLATE 7

(Figures x60 except as noted)

FIGS. 1-3 Pterygocythereis sp. cf. P. americana (Ulrich & Bassler).

1, left valve, exterior, UMMP 48713. 2, 3, right valve, UMMP 48714; 2, exterior;
3, ventral view.

FIGS. 4, 5, 7 Orionina vaughani (Ulrich & Bassler)

4, right valve, exterior, UMMP 48715. 5, right valve, exterior, UMMP 48716. 7, right
valve, hinge, interior view, UMMP 48715, x120.

FIGS. 6, 9, 10 Costa triplistriata (Edwards)

6, left valve, exterior, UMMP 48717. 9, 10, right valve, UMMP 48718; 9, exterior,
UMMP 48717. 9, 10, right valve, UMMP 48718; 9, exterior; 10, hinge, interior view,
x120.

FIG. 8 Costa sp. aff. C. triplistriata (Edwards). 8, right valve, exterior, UMMP 48719.FIG. 11 Pterygocythereis ? sp. 11, left valve, UMMP 48720.FIGS. 12-17 Actinocythereis exanthemata gomillionensis (Howe & Ellis).

12, left valve, exterior, UMMP 48721. 13, left valve, hinge, interior view, UMMP 48722,
x120. 14-17, UMMP 48723 (one specimen); 14, 15, right valve; 14, interior view; 15,
hinge, interior view, x120; 16, 17, left valve; 16, interior view; 17, hinge, interior view,
x120.

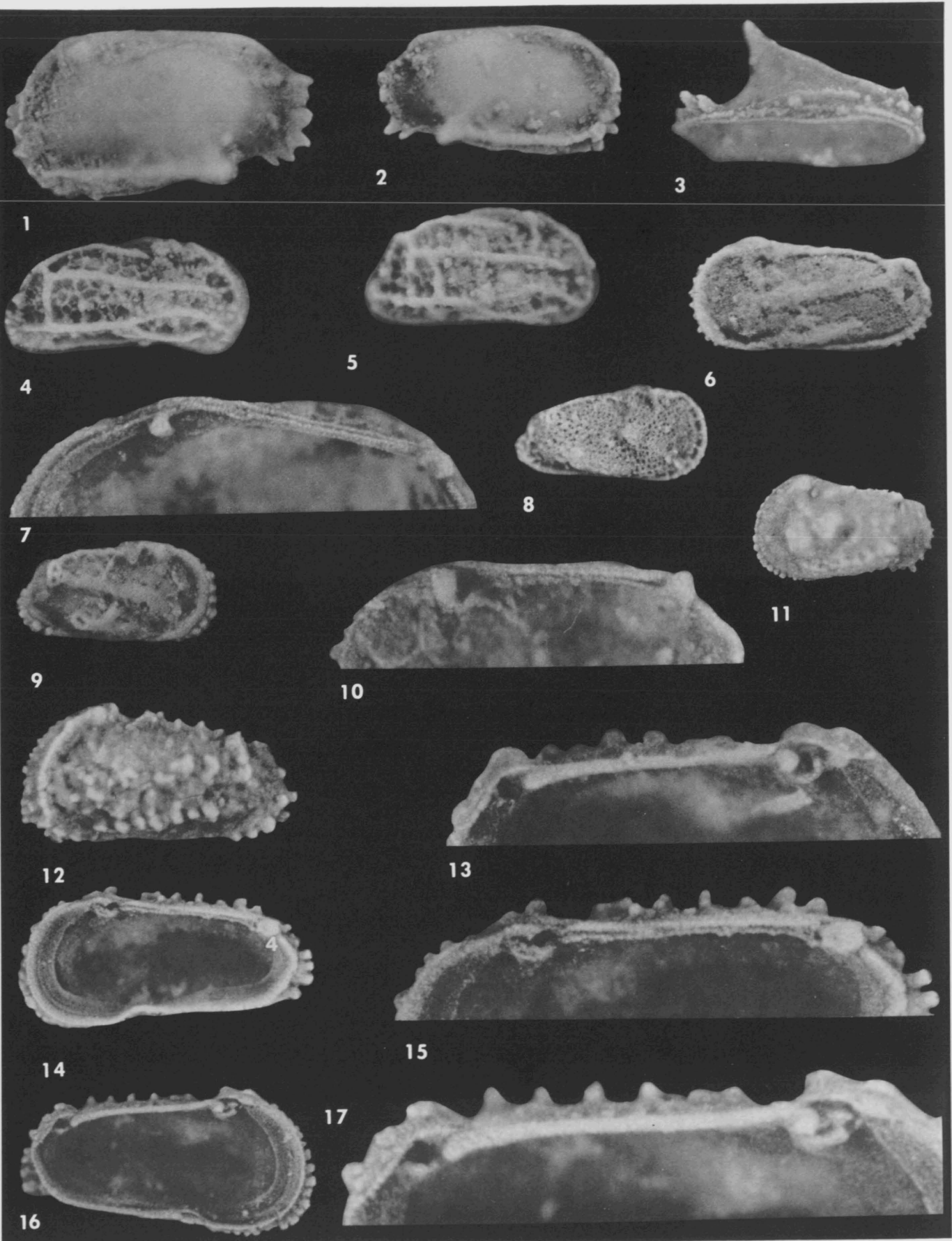

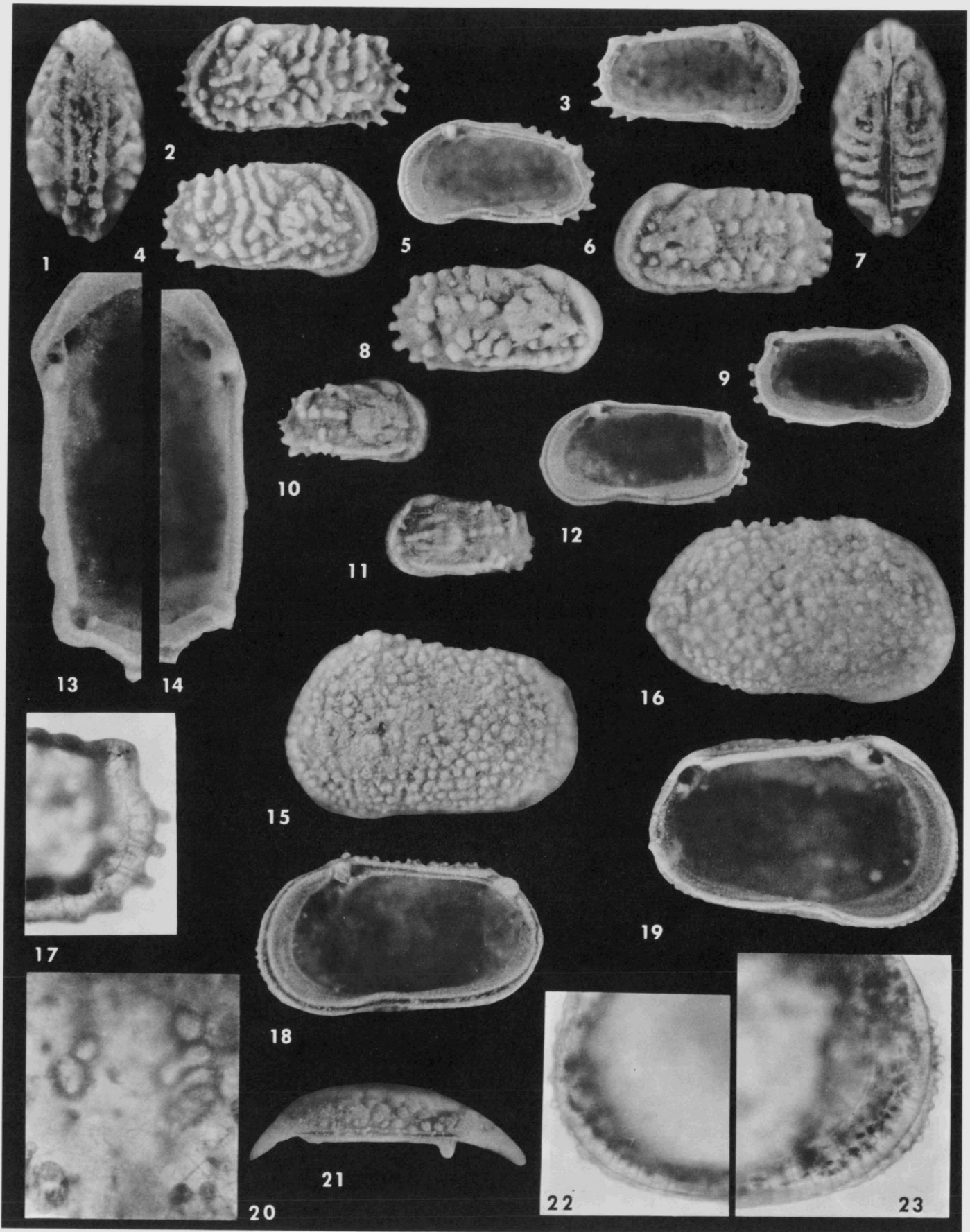

EXPLANATION OF PLATE 8

(Figures x60 except as noted)

FIGS. 1-5, 7 Puriana rugipunctata (Ulrich & Bassler)

1, 7, UMMP 48724; 1, exterior, ventral view; 7, exterior, dorsal view. 2, 3, left valve, UMMP 48725; 2, exterior; 3, interior view. 4, 5, right valve, UMMP 48726; 4, exterior; 5, interior view.

FIGS. 6, 8-14, 17 Puriana mesacostalis (Edwards)

6, 9, 13, 17, left valve, UMMP 48727; 6, exterior; 9, interior view; 13, hinge, interior view, x120; 17, posterior marginal area, transmitted light, photo taken from exterior, x215. 8, 12, 14, right valve, UMMP 48728; 8, exterior; 12, interior view; 14, hinge, interior view, x120. 10, right valve, UMMP 48729, immature, exterior. 11, left valve, UMMP 48730, immature, exterior.

FIGS. 15, 16, 18-23 Echinocythereis garretti (Howe & McGuirt)

15, 20, 22, 23, UMMP 48731 (one specimen); 15, 22, 23, left valve; 15, exterior; 22, 23, posterior and anterior marginal areas respectively, transmitted light, x120; 20, right valve, central muscle-scar field, transmitted light, x120. 16, right valve, exterior, UMMP 48732. 18, right valve, interior view, UMMP 48733. 19, 21, left valve, UMMP 48734; 19, exterior; 21, hinge, dorsal view.

EXPLANATION OF PLATE 9

(Figures x60 except as noted)

FIGS. 1-10, 13 Murrayina martini (Ulrich & Bassler)

1, 2, 9, 10, UMMP 48735 (one specimen); 1, 9, left valve; 1, exterior; 9, hinge, interior view, x120; 2, 10, right valve; 2, exterior, 10, interior view. 3, left valve, UMMP 48736, exterior. 4, right valve, UMMP 48737, exterior; 5, left valve, UMMP 48738, interior view. 6, 7, UMMP 48739 (one specimen); 6, left valve, exterior; 7, right valve, exterior. 8, exterior, ventral view, UMMP 48740. 13, right valve, hinge, interior view, UMMP 48741, x120.

FIGS. 11, 12, 14-19 Tringinglymus whitei (Swain)

11, 18, left valve, UMMP 48742; 11, exterior; 18, hinge, interior view, x120. 12, 15, 19, right valve, UMMP 48743; 12, exterior; 15, interior view; 19, hinge, interior view, x120. 14, right valve, exterior, UMMP 48744. 16, 17, left valve, UMMP 48745; 16, interior view; 17, exterior.

FIGS. 20-27 Tringinglymus sapeloensis, n. sp.

20, left valve, exterior, UMMP 48746. 21, 23, left valve, UMMP 48747; 21, exterior; 23, interior view. 22, 27, right valve, UMMP 48748; 22, interior view; 27, hinge, interior view, x120. 25, 26, UMMP 48749; 25, exterior, ventral view; 26, exterior, dorsal view. 24, right valve, exterior, UMMP 48750.

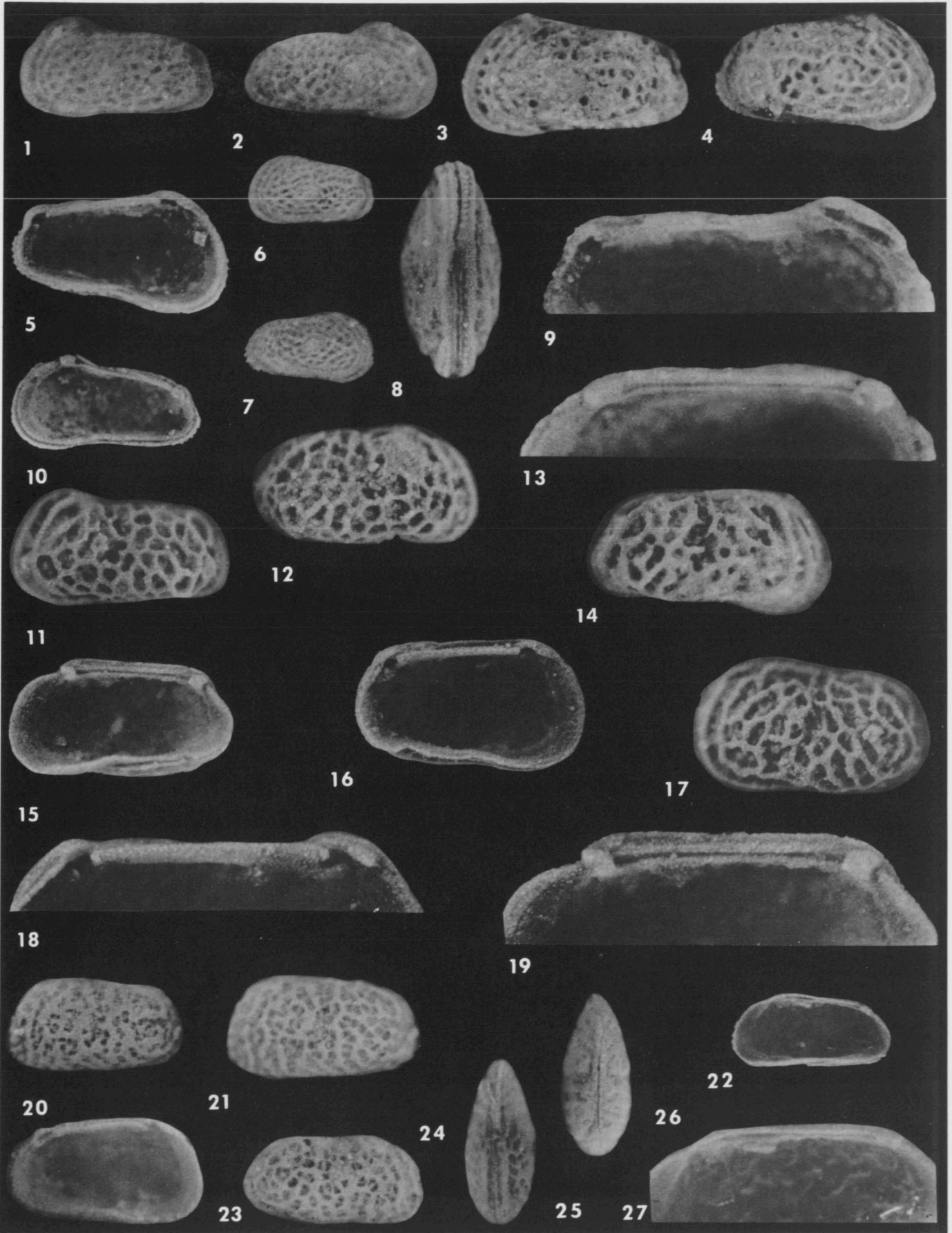

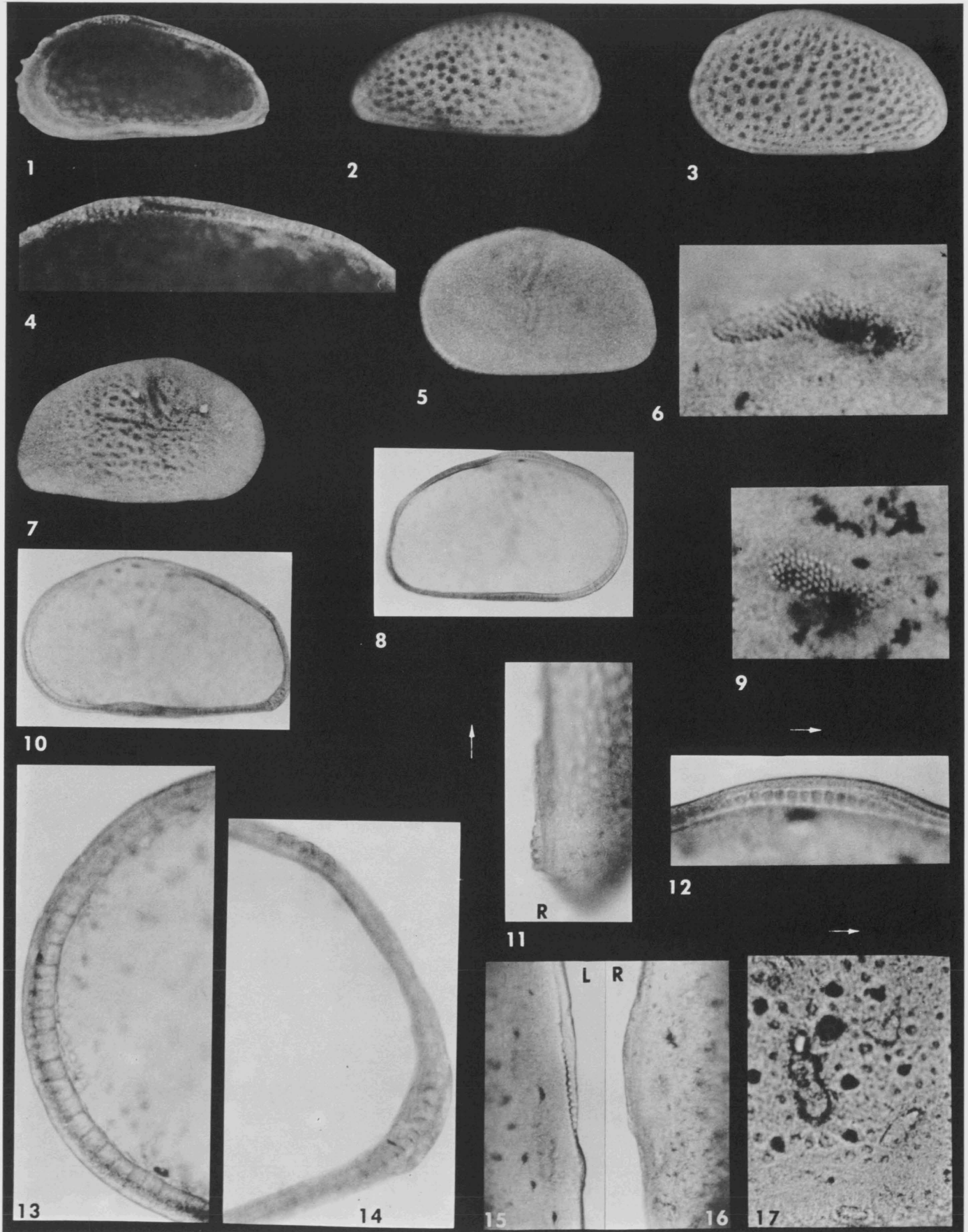

EXPLANATION OF PLATE 10

(Figures x60 except as noted)

FIGS. 1-4 Clithrocytheridea virginensis Malkin

1, 2, 4, right valve, UMMP 48751; 1, interior view; 2, exterior; 4, hinge, interior view, x120. 3, left valve, exterior, UMMP 48752.

FIGS. 5-17 Cyprideis swaini, n. sp.

5, 8, 12, 15, 17, left valve, UMMP 48753; 5, exterior; 8, interior view, transmitted light; 12, anterior hinge element, interior view, transmitted light, x215; 15, anterior and anteromedian hinge elements, dorsal view, transmitted light, x120; 17, central muscle-scar field, transmitted light, x215. 6, 7, 10, 11, 13, 14, right valve, UMMP 48754; 6, sieve-type normal pore, transmitted light, x1475; 7, exterior; 11, posterior hinge elements, dorsal view, transmitted light, x120; 13, 14, anterior and posterior marginal areas respectively, transmitted light, x215. 9, sieve-type normal pore, transmitted light, UMMP 48755, x1475; 16, anterior and anteromedian hinge elements, dorsal view, right valve, UMMP 48756, x120.

EXPLANATION OF PLATE 11

FIGS. 1-11 Cyamocytheridea (?) probosciduala (Edwards)

1-3, 5-7, 9, 10, UMMP 48757 (one specimen); 1, 2, 6, 10, right valve; 1, interior view, transmitted light, x60; 2, exterior, x60; 6, hinge, interior view, x120; 10, anterior hinge element, dorsal view, transmitted light, x215; 3, 5, 7, 9, left valve; 3, exterior, x60; 5, hinge, interior view, x120; 7, central and mandibular muscle-scar field, transmitted light, x215; 9, anterior hinge element, dorsal view, transmitted light, x215. 4, 8, sieve-type normal pores, UMMP 48758, x1475. 11, left valve, anterior marginal area, transmitted light, UMMP 48759, x215.

FIGS. 12-22 Cyprideis floridana (Howe & Hough)

12, 13, 18, 19, UMMP 48760 (one specimen); 12, 18, left valve; 12, hinge, anterior view, x120; 18, anterior and median hinge elements, dorsal view, transmitted light, x120; 13, 19, right valve; 13, hinge, interior view, x120; 19, anterior and median hinge elements, dorsal view, transmitted light, x120. 14, 16, 17, 20-22, left valve, left valve, UMMP 48761; 14, exterior, x72; 16, sieve-type normal pore, transmitted light, x1475; 17, central and mandibular muscle field, transmitted light, x215; 20, 21, posterior and anterior marginal areas respectively, transmitted light, x215; 22, anterior marginal pore canals, transmitted light, x490, 15, right valve, UMMP 48762, exterior, x60.

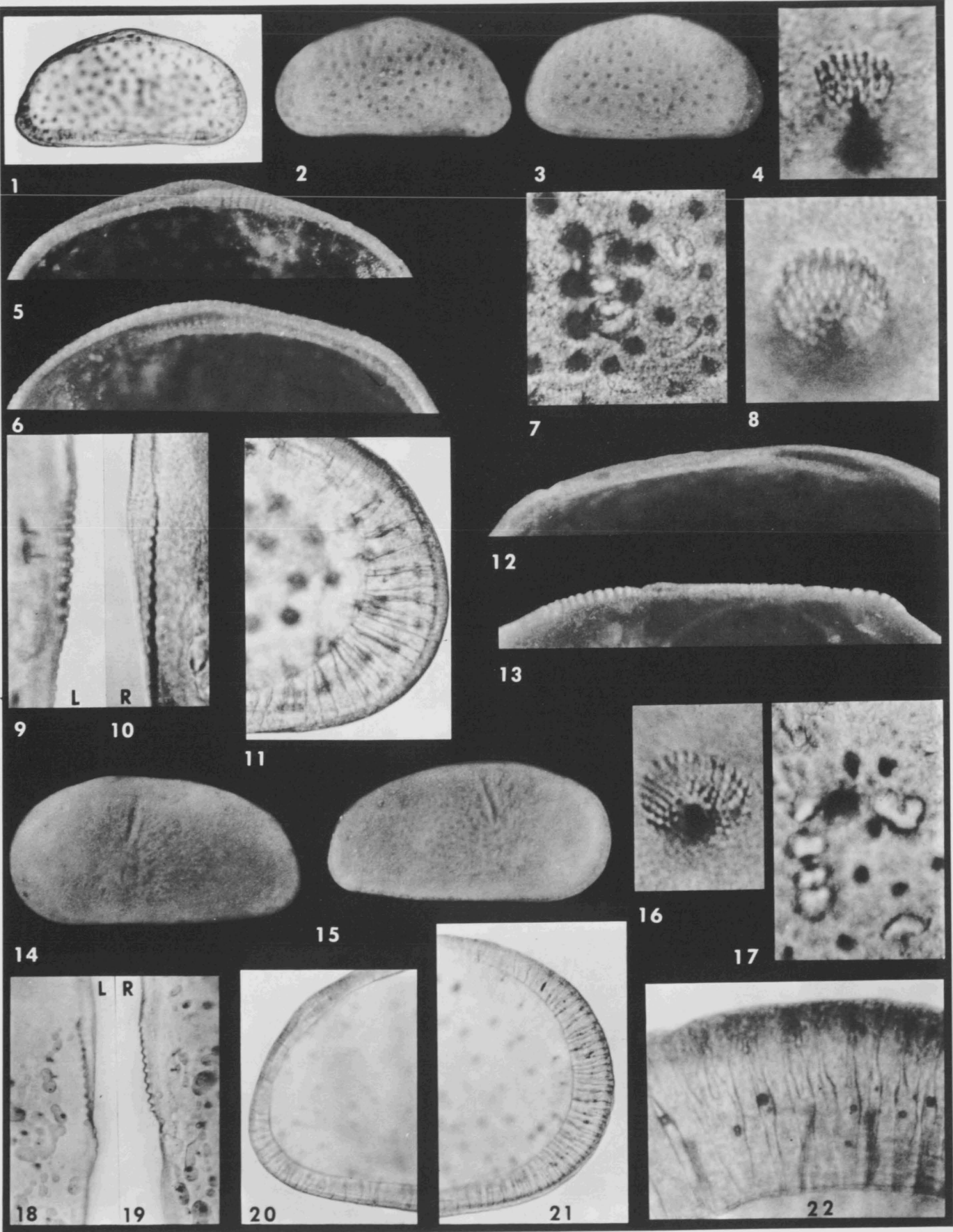

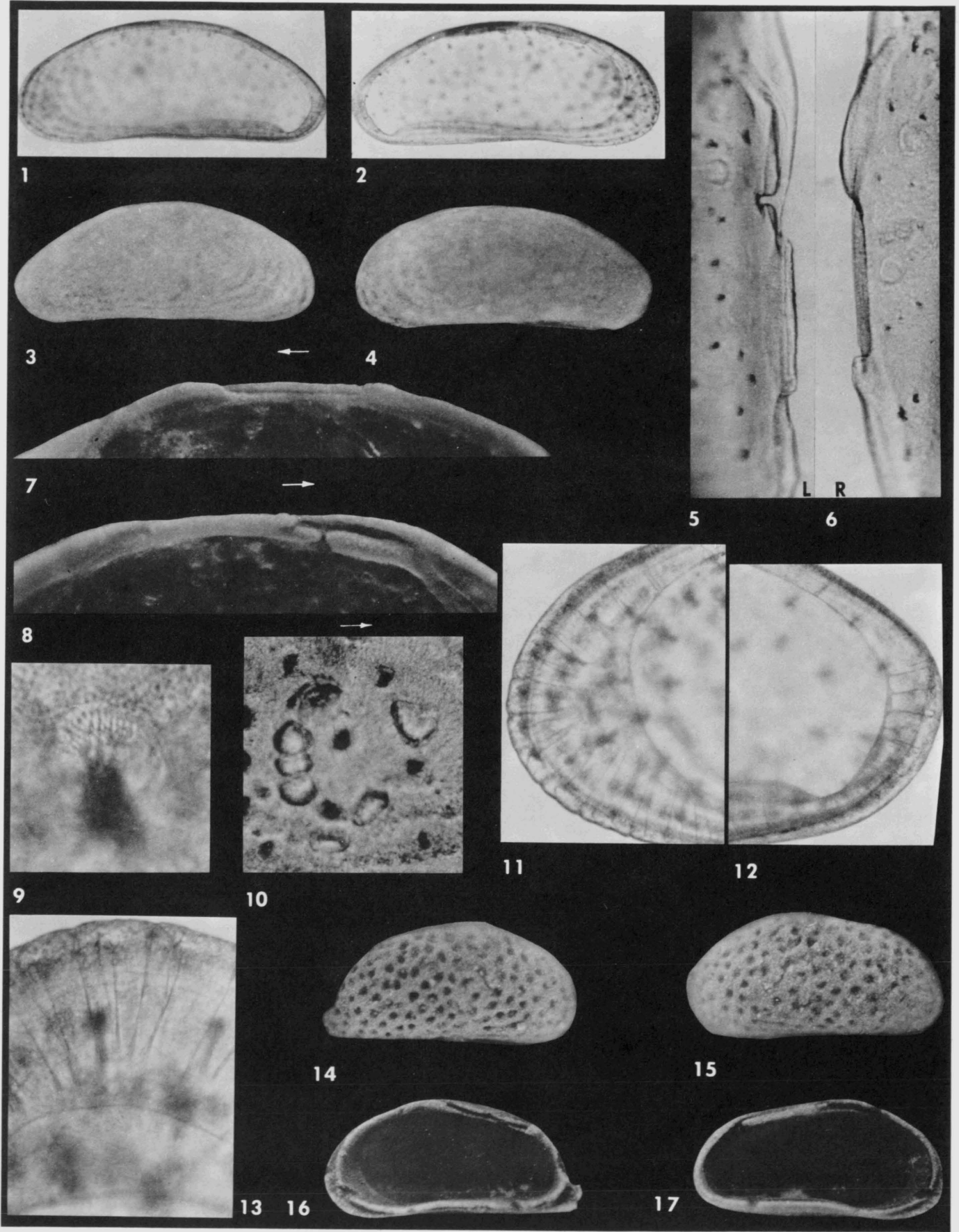

EXPLANATION OF PLATE 12

(Figures x60 except as noted)

FIGS. 1-13 Cushmanidea magniporosa, n. sp.

1-13 UMMP 48763 (one specimen); 1, 3, 6, 7, 9, 11-13, right valve; 1, interior view, transmitted light; 3, exterior; 6, hinge, dorsal view, transmitted light, x120; 7, hinge, interior view, x120; 9, sieve-type normal pore, transmitted light, x1475; 11, 12, anterior and posterior marginal areas respectively, transmitted light, x215; 13, anterior marginal pore canals, transmitted light, x430; 2, 4, 5, 10, left valve; 2, interior view, transmitted light; 4, exterior; 5, hinge, dorsal view, transmitted light, x120; 10, central and mandibular muscle scar field, transmitted light, x215.

FIGS. 14-17 Cushmanidea ashermani (Ulrich & Bassler)

14, 16, left valve, UMMP 48764; 14, exterior; 16, interior view. 15, 17, right valve, UMMP 48765; 15, exterior; 17, interior view.

EXPLANATION OF PLATE 13

(Figures x60 except as noted)

FIGS. 1-10 Cushmanidea tuberculata (Puri)

1, right valve, exterior, UMMP 48766. 2, 3, left valve, UMMP 48767; 2, exterior; 3, hinge, interior view, x120. 4-9, UMMP 48768 (one specimen); 4, 6, right valve; 4, central and mandibular muscle-scar field, transmitted light, x215; 6, hinge, dorsal view, transmitted light, x120; 5, 7, 8, 9, left valve; 5, hinge, dorsal view, transmitted light, x120; 7, 8, posterior and anterior marginal areas respectively, transmitted light, x215; 9, anterior marginal pore canals, transmitted light, x490. 10, UMMP 48769, sieve-type normal pore above, interior view of surface tubercle below, transmitted light, x1475.

FIGS. 11-22 Cushmanidea echolsae (Malkin)

11-13, 15, 17, 21, 22, UMMP 48770 (one specimen); 11, 13, 21, 22, left valve; 11, interior view, transmitted light; 13, hinge, interior view, x120; 21, 22, sieve-type normal pores, x1475; 12, 15, 17, right valve; 12, interior view, transmitted light; 15, hinge, interior view, x120; 17, anterior half of valve showing dorsal muscle-scar field, dorsal view, transmitted light, x120. 14, right valve, exterior, UMMP 48771. 16, left valve, exterior, UMMP 48772. 18, 19, UMMP 48773 (one specimen); 18, left valve, hinge, dorsal view, transmitted light, x120; 19, right valve, hinge, dorsal view, transmitted light, x120. 20, UMMP 48774, sieve-type normal pore near anterior margin perpendicular to long axis of pore, x1475.

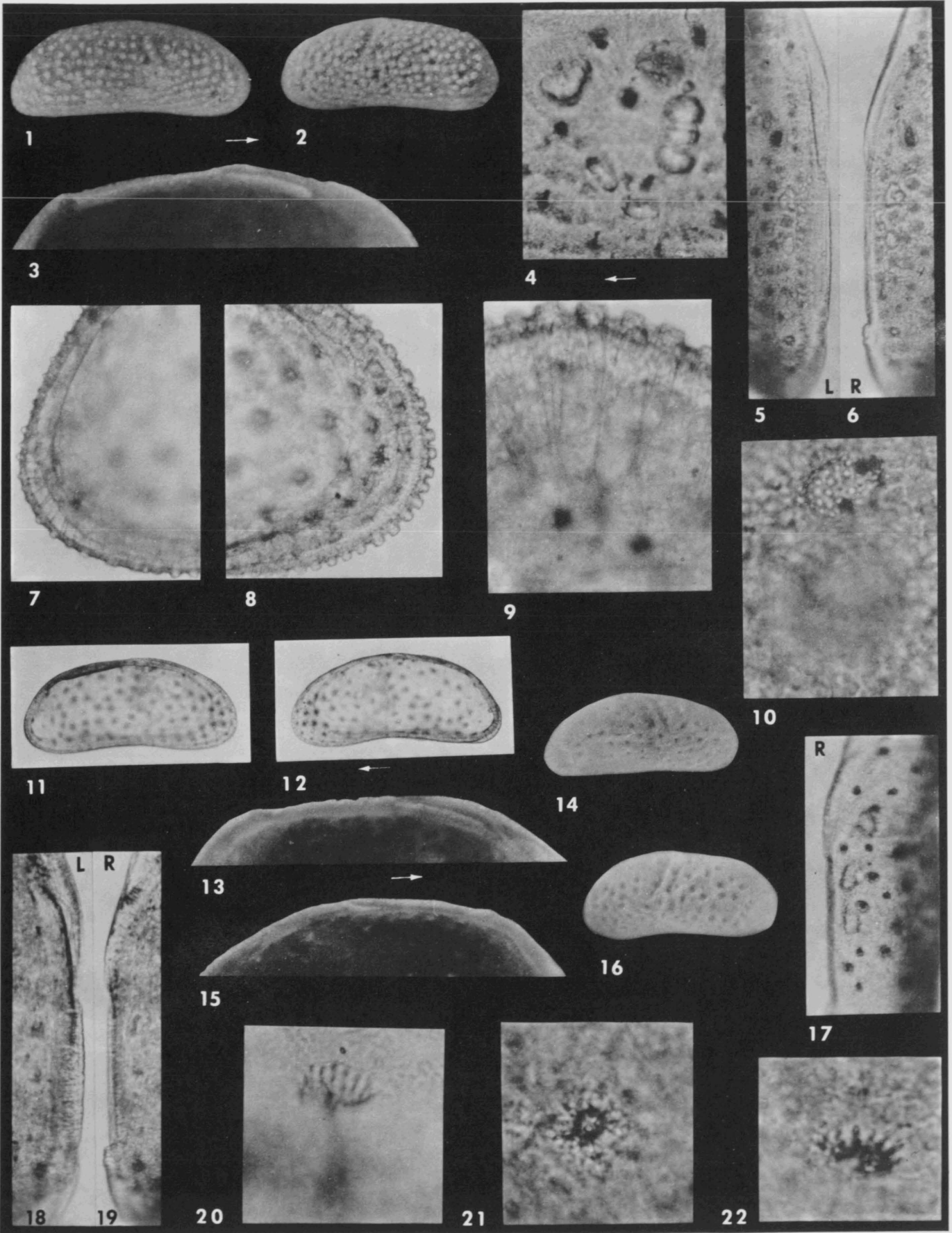

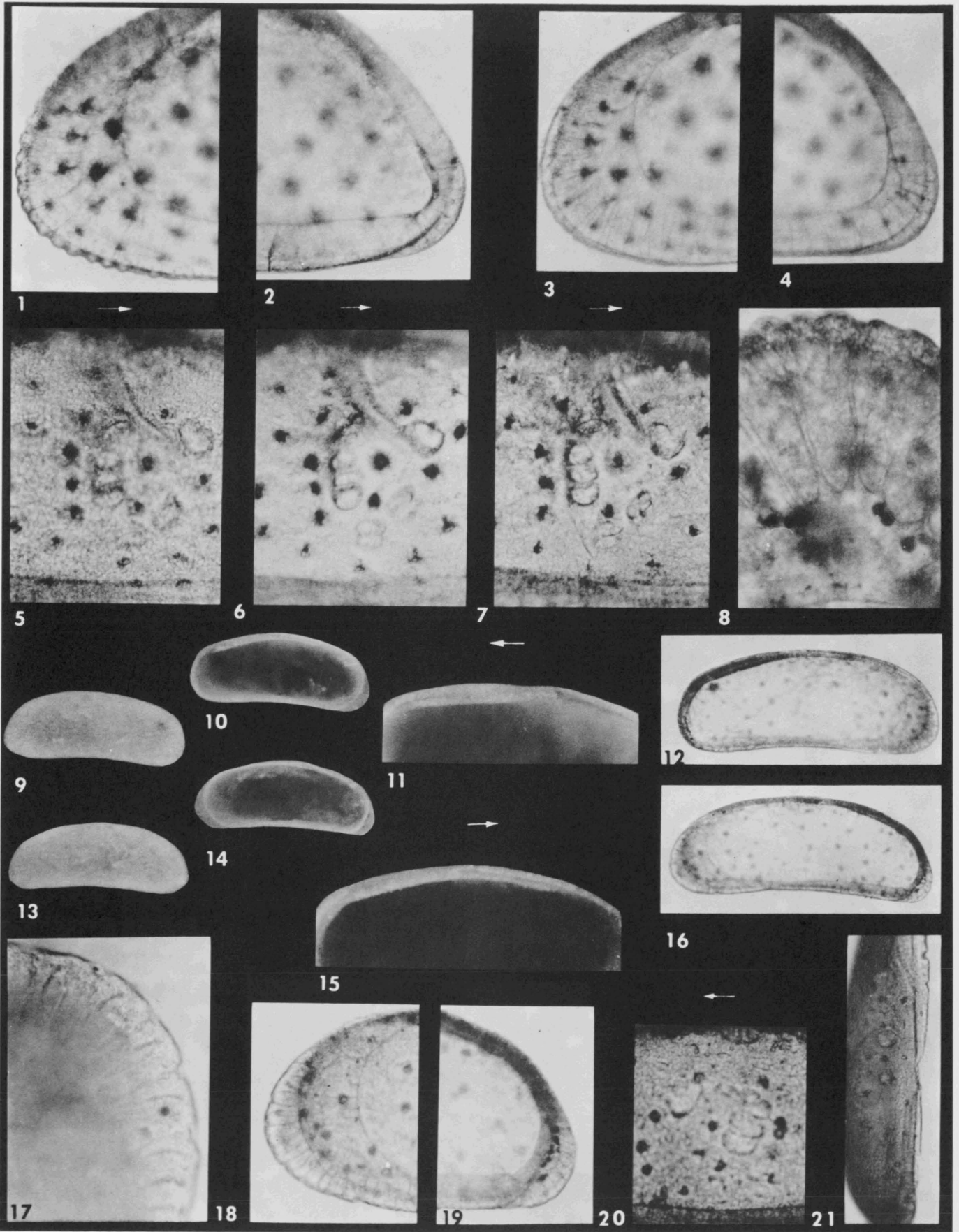

EXPLANATION OF PLATE 14

FIGS. 1-8 Cushmanidea echolsae (Malkin)

1, 2, right valve, UMMP 48775, anterior and posterior marginal areas, transmitted light, x215. 3, 4, right valve, UMMP 48776, anterior and posterior marginal areas, transmitted light, x215. 5, 6, 7, central and mandibular muscle scar field of three left valves, transmitted light, UMMP 48770, 48772, 48773, respectively, showing exact position of normal pores in relation to the central muscle scars and dorsal sulcus. 8, right valve, anterior marginal pore canals, transmitted light, UMMP x215.

FIGS. 9-21 Cushmanidea glabra, n. sp.

9, 10, 12-21, UMMP 48777 (one specimen); 9, 10, 12, 15, 17, 21, left valve; 9, exterior, x60; 10, interior view, x60; 12, interior view, transmitted light, x90; 15, hinge, interior view, x120; 17, anterior marginal pore canals, transmitted light, x590; 21, hinge, dorsal view, transmitted light, x120; 13, 14, 16, 18, 19, 20, right valve; 13, exterior, x60; 14, interior view, x60; 16, interior view, transmitted light, x90; 18, 19, anterior and posterior marginal areas, transmitted light, x215; 20, central muscle scar field, transmitted light, x215. 11, right valve, hinge, interior view, UMMP 48778, x120.

EXPLANATION OF PLATE 15

FIGS. 1-4, 9, 10 Cytheropteron yorktownensis Malkin

1-4, 9, 10, UMMP 48779 (one specimen); 1, 3, 10, right valve; 1, exterior, x60; 3, hinge, interior view, x120; 10, hinge, dorsal view, transmitted light, x215; 2, 4, 9, left valve; 2, exterior, x60; 4, hinge, interior view, x120; 9, hinge, dorsal view, transmitted light, x215.

FIGS. 5-8, 11, 12 Cytherura reticulata Edwards

5, 6, 12, right valve, UMMP 48780; 5, interior view, x90; 6, posterior marginal area, transmitted light, x215; 12, hinge, dorsal view, transmitted light, x215. 7, 8, 11, UMMP 48781 (one specimen); 7, right valve, exterior, x90; 8, 11, left valve; 8, exterior, x90; 11, hinge, dorsal view, transmitted light, x215.

FIGS. 13-16 Kangarina howei Puri

13-16, UMMP 48782 (one specimen); 13, 14, 16, right valve; 13, 14, anterior and posterior marginal areas respectively, transmitted light, x215; 16, exterior, x90; 15, left valve, exterior, x90.

FIGS. 17-23 Cushmanidea sp.

17-23, left valve, UMMP 48783; 17, exterior, x60; 18, hinge, interior view, x120; 19, hinge, dorsal view, transmitted light, x120; 20, 21, posterior and anterior marginal areas respectively, transmitted light, x215; 22, central muscle scar field, transmitted light, x215; 23, anterior marginal pore canals, transmitted light, x430.

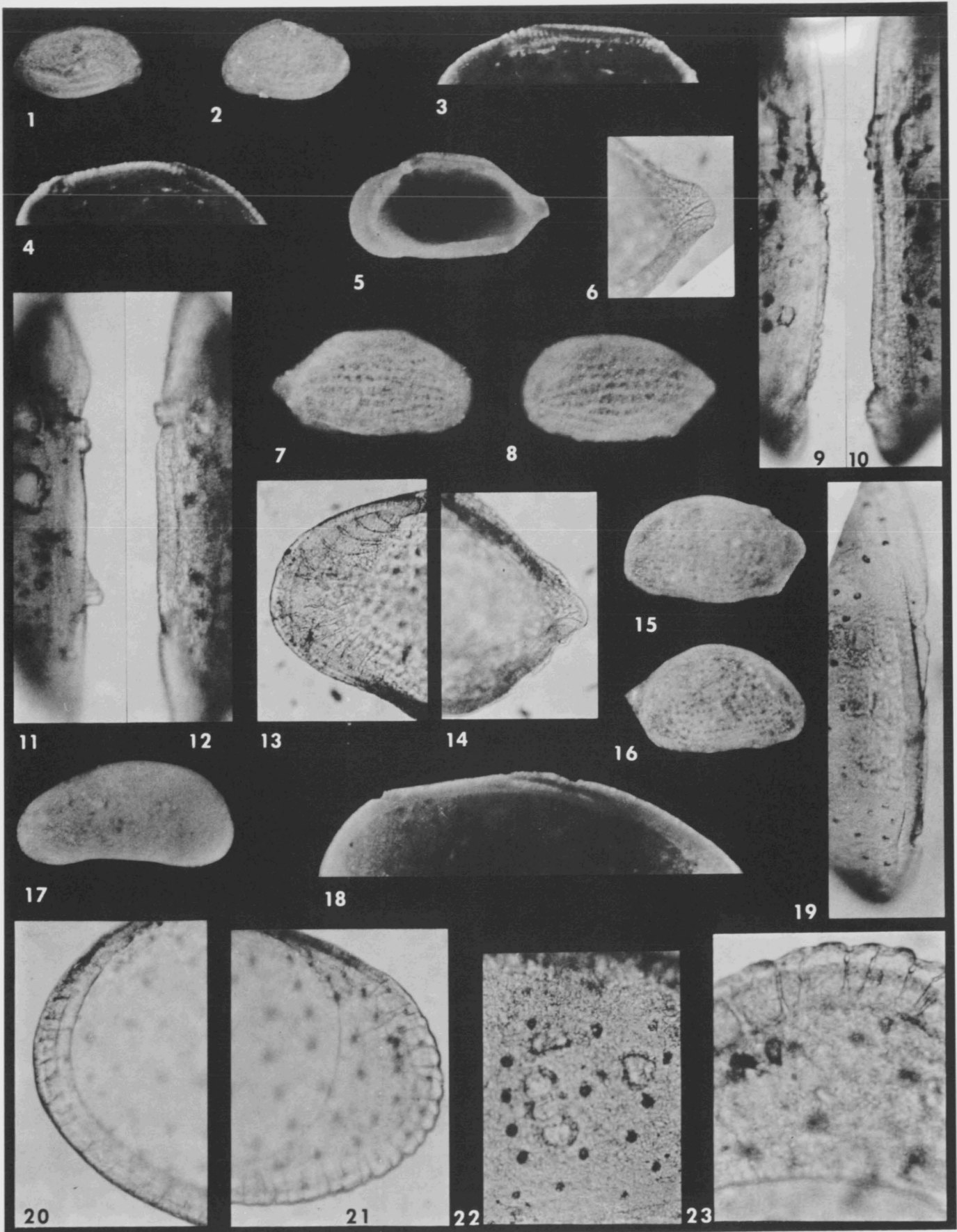

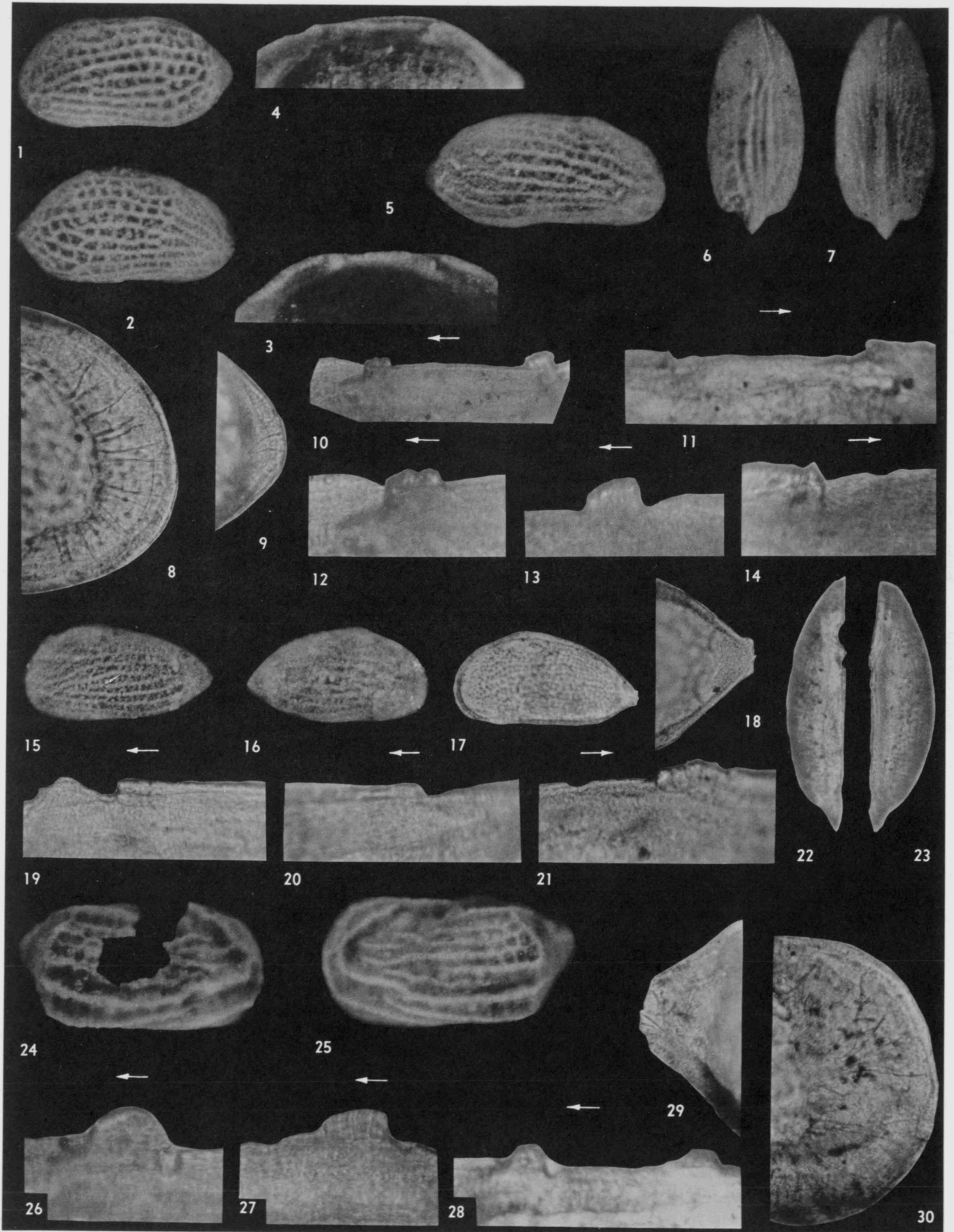

EXPLANATION OF PLATE 16

(Figures x90 except as noted)

FIGS. 1-14 Cytherura forulata Edwards

1, 3, 10, 12, 13, left valve, UMMP 48784; 1, exterior; 3, hinge, interior view, x120; 10, hinge, dorsal view, transmitted light, x215; 12, hinge, anterior elements, dorsal view, transmitted light, x430; 13, hinge, posterior element, dorsal view, transmitted light, x430. 2, 4, 11, 14, right valve, UMMP 48785; 2, exterior; 4, hinge, interior view, x120; 11, hinge, dorsal view, transmitted light, x215; 14, hinge, posterior element, dorsal view, transmitted light, x430. 5, right valve, exterior, UMMP 48786. 6, 7, UMMP 48787; 6, exterior, dorsal view; 7, exterior, ventral view. 8, left valve, anterior marginal area, transmitted light, UMMP 48788, x215. 9, right valve, posterior marginal area, transmitted light, UMMP 48789, x215.

FIGS. 15-23 Cytherura vestibulata, n. sp.

15, left valve, exterior, UMMP 48790. 16-18, 21, 23, right valve, UMMP 48791; 16, exterior; 17, interior view, transmitted light; 18, posterior marginal area, transmitted light, x215; 21, hinge, anterior element, dorsal view, transmitted light, x430; 23, hinge, dorsal view, transmitted light, x120. 19, 20, 22, left valve, UMMP 48792, 19, hinge, anterior element, dorsal view, transmitted light, x430; 20, hinge, posterior element, dorsal view, transmitted light, x430; 22, hinge, dorsal view, transmitted light, x120.

FIGS. 24-30 Hemicytherura sablensis Benson & Coleman

24, right valve, exterior, UMMP 48793. 25-30, left valve, UMMP 48794; 25, exterior; 26, hinge, anterior element, dorsal view, transmitted light, x430; 27, hinge, posterior element, dorsal view, transmitted light, x430; 28, hinge, dorsal view, transmitted light, x215; 29, 30, posterior and anterior marginal areas respectively, transmitted light, x215.

EXPLANATION OF PLATE 17

(Figures x90 except as noted)

FIGS. 1-8 Pellucistoma atkinsi, n. sp.

1, 2, 8, left valve, UMMP 48795; 1, interior view, transmitted light; 2, exterior; 8, hinge, dorsal view, transmitted light, x120. 3-7, right valve, UMMP 48796; 3, exterior; 4, 6, anterior and posterior marginal areas respectively, transmitted light, x215; 5, central and mandibular muscle scar field, transmitted light, x215; 7, hinge, anterior "anti-slip" tooth, dorsal view, transmitted light, x430.

FIGS. 9-15 Pellucistoma magniventra Edwards

9, 13-15, left valve, UMMP 48797; 9, exterior; 13, 15, posterior and anterior marginal areas respectively, transmitted light, x215; 14, central and mandibular muscle scar field, transmitted light, x215. 10, 11, right valve, UMMP 48798; 10, exterior; 11, interior view, transmitted light. 12, left valve, UMMP 48799, hinge, dorsal view, transmitted light, x120.

FIGS. 16-25 Megacythere johnsoni (Mincher)

16, 19-25, left valve, UMMP 48800; 16, exterior; 19, hinge, dorsal view, transmitted light, x120; 20 interior view, transmitted light; 21, 23, posterior and anterior marginal areas respectively, transmitted light, x215; 22, central and mandibular muscle scar field, transmitted light, x215; 24, posterior hinge element, dorsal view, transmitted light, x430; 25, anterior hinge element, dorsal view, transmitted light, x430. 17, right valve, exterior, UMMP 48801. 18, right valve, hinge, dorsal view, transmitted light, x120.

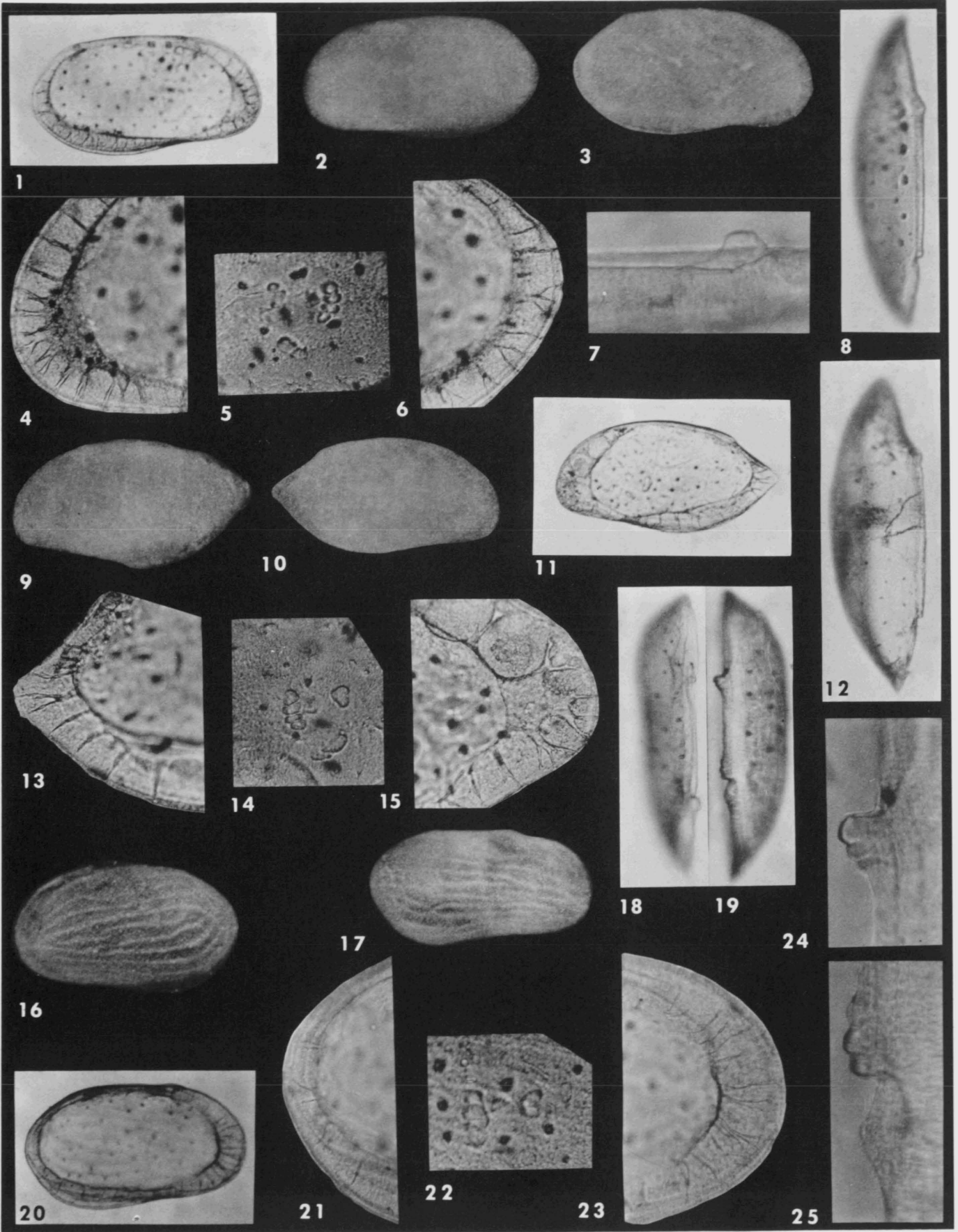

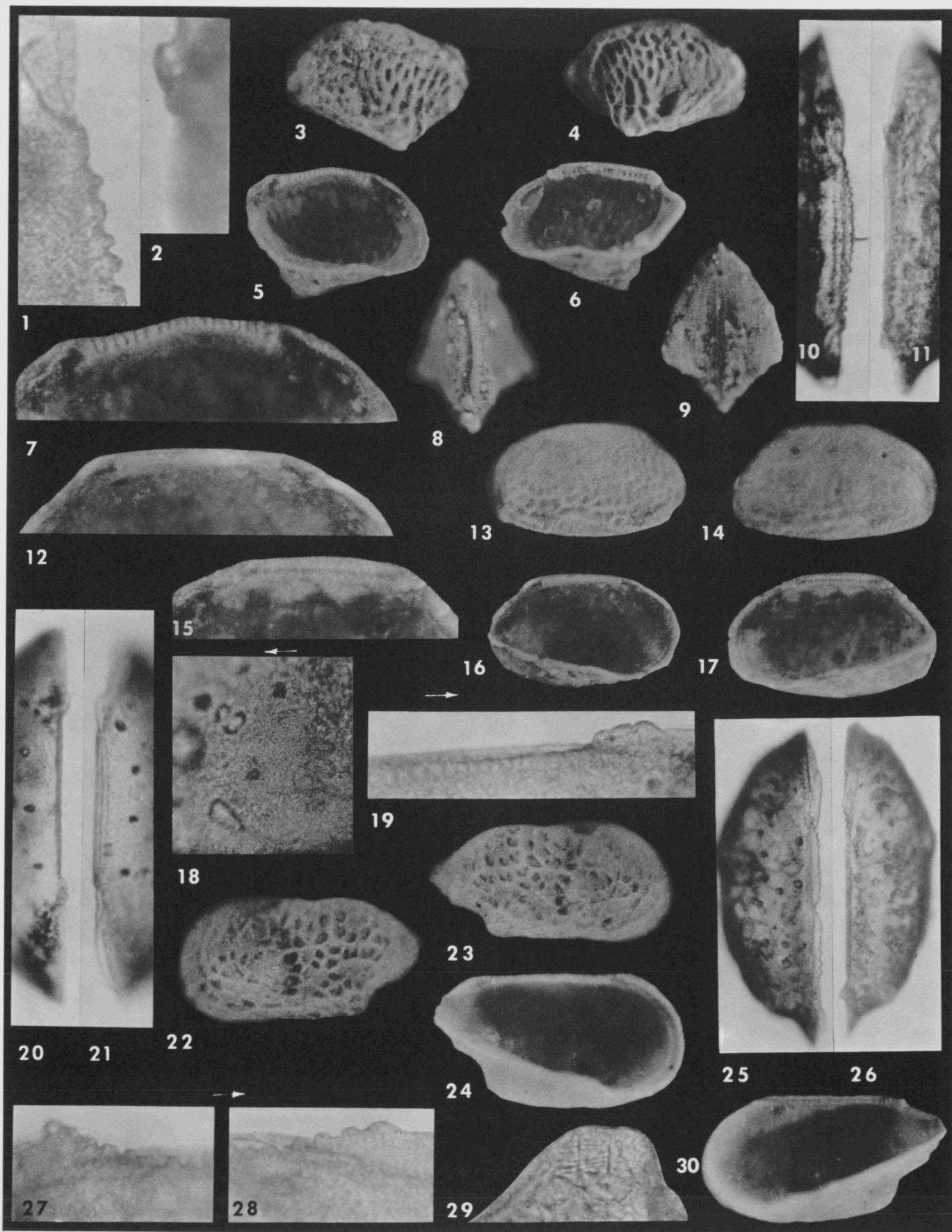

EXPLANATION OF PLATE 18

(Figures x60 except as noted)

FIGS. 1-11 Cytheropteron talquinensis Puri

1, 2, 3, 5, 7, 10, 11, UMMP 48802 (one specimen); 1, 3, 5, 7, 10, left valve; 1, anterior hinge element, dorsal view, transmitted light, x430; 3, exterior; 5, interior view; 7, hinge, interior view, x120; 10, hinge, dorsal view, transmitted light, x120; 2, 11, right valve; 2, anterior hinge element, dorsal view, transmitted light, x430; 11, hinge, dorsal view, transmitted light, x120. 4, 6, 8, 9, UMMP 48803 (one specimen); 4, exterior; 6, interior view; 8, exterior, dorsal view; 9, exterior, ventral view.

FIGS. 12-21 Paracytheridea ? shattucki Malkin

12, 13, 16, 21, left valve, UMMP 48804; 12, hinge, interior view, x120; 13, exterior; 16, interior view; 21, hinge, dorsal view, transmitted light, x120. 14, 15, 17-20, right valve, UMMP 48805; 14, exterior; 15, hinge, interior view, x120; 17, interior view; 19, anterior hinge element, dorsal view, transmitted light, x430.

FIGS. 22-30 Paracytheridea vandenboldi Puri

22, 24, 25, 29, left valve, UMMP 48806; 22, exterior, x90; 24, interior view, x90; 25, hinge, dorsal view, transmitted light, x120; 29, posterior marginal area, transmitted light, x215. 23, 26, 27, 28, 30, right valve, UMMP 48807; 23, exterior, x90; 26, hinge, dorsal view, transmitted light, x120; 27, posterior hinge element, dorsal view, transmitted light, x430; 28, anterior hinge element, dorsal view, transmitted light, x430; 30, interior view, x90.

EXPLANATION OF PLATE 19

(Figures x90 except as noted)

FIGS. 1-5 Loxoconcha reticularis Edwards

1, right valve, exterior, UMMP 48808. 2-4, left valve, UMMP 48809; 2, exterior; 3, 4, posterior and anterior marginal areas respectively, transmitted light, x215. 5, right valve, median hinge element, interior view, transmitted light, UMMP 48810, x430.

FIGS. 6, 7, 8, 11 Loxoconcha australis Brady

6, 7, right valve UMMP 48811; 6, interior view; 7, exterior. 8, 11, left valve, UMMP 48812; 8, interior view; 11, exterior.

FIGS. 9, 10, 12-14 Loxoconcha purisubrhomboidea Edwards in Puri

9, 10, 12, 13, left valve, UMMP 48813; 9, 10, posterior and anterior marginal areas respectively, transmitted light, x215; 12, interior view; 13, exterior. 14, right valve, interior view, UMMP 48814.

FIGS. 15-18 Loxoconcha metagordensis Swain

15, left valve, exterior, UMMP 48815. 16-18, right valve, UMMP 48816; 16, interior view; 17, exterior; 18, anterior marginal area, transmitted light, x215.

PLATE 19

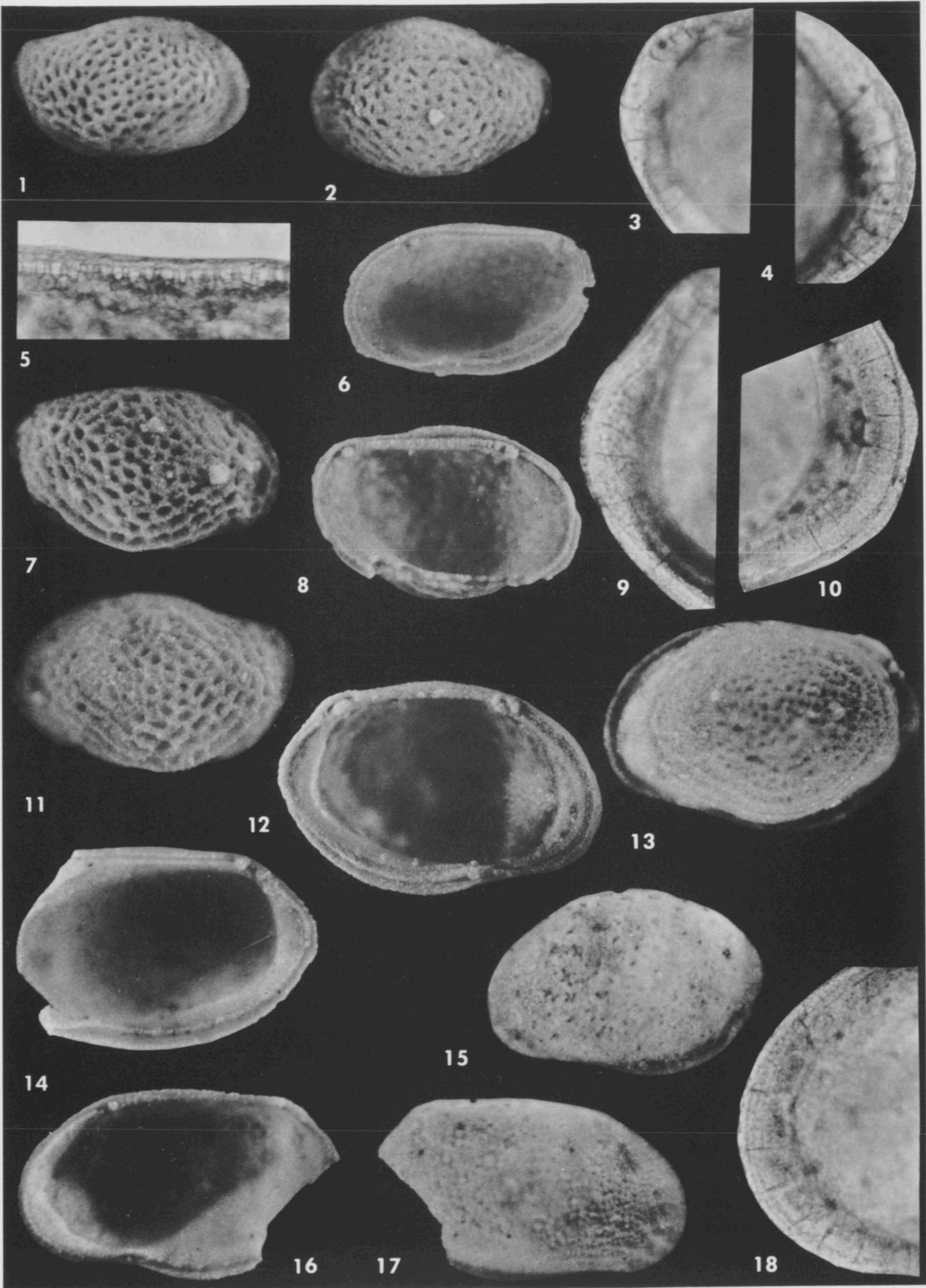

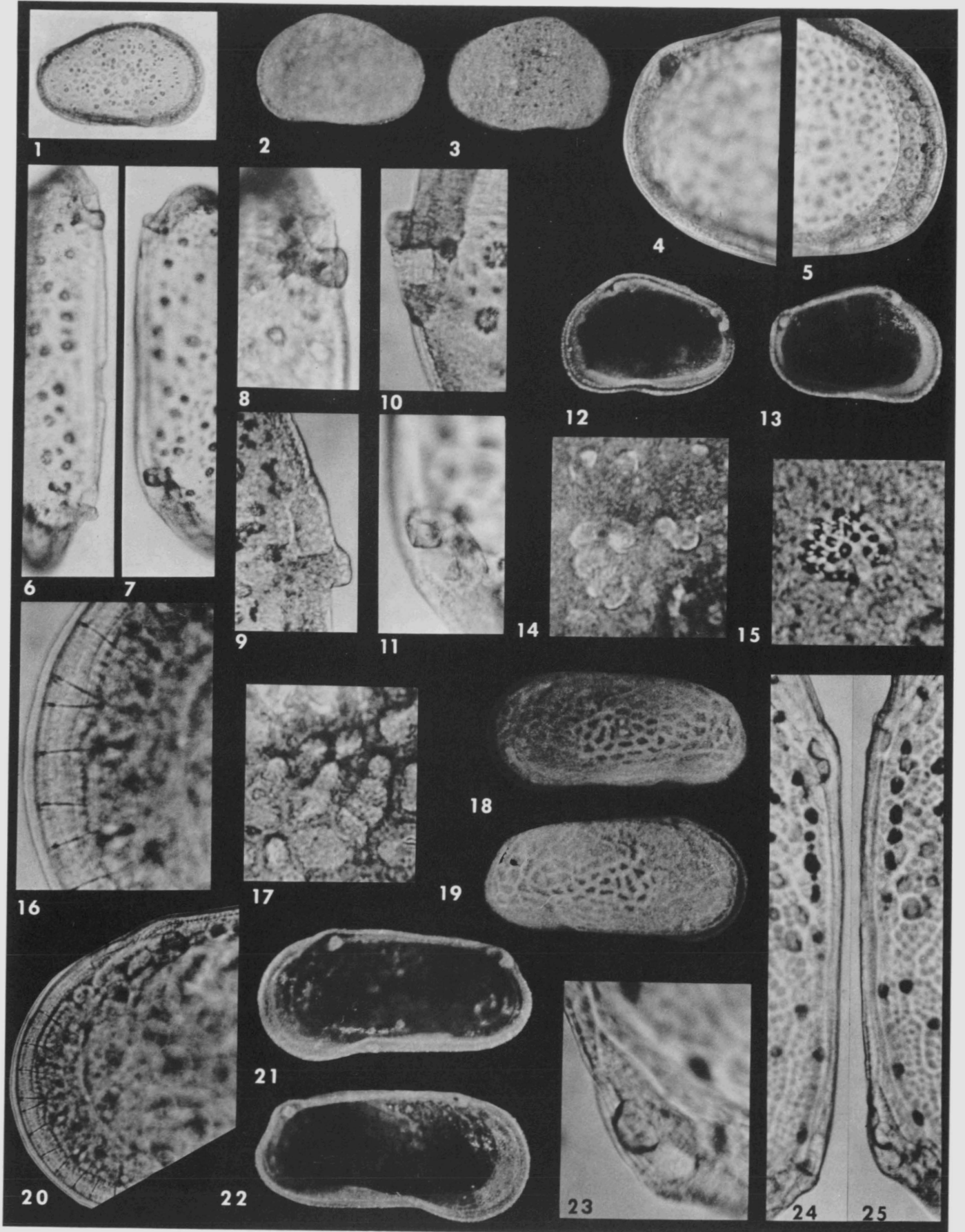

EXPLANATION OF PLATE 20

(Figures x90 except as noted)

FIGS. 1-15 Cytheromorpha curta Edwards

1, 6-11, UMMP 48817 (one specimen); 1, interior view, transmitted light; 6-11, hinge elements, transmitted light, viewed from ventral direction; 6, right valve, x215; 7, left valve, x215; 8, right valve, anterior element, x430; 9, right valve, posterior element, x430; 10, left valve, anterior element, x215; 11, left valve, posterior element, x215. 2-5, 12, 13, UMMP 48818 (one specimen); 2, 4, 5, 13, left valve; 2, exterior; 4, 5, posterior and anterior marginal areas respectively, transmitted light, x215; 13, interior view. 14, right valve, central muscle-scar field, transmitted light, UMMP 48819, x430; 15, sieve-type normal pore, transmitted light, UMMP 48820, x1475.

FIGS. 16-25 Cytheromorpha warneri Howe & Spurgeon

16-25, UMMP 48821 (one specimen); 16, 17, 19, 20, 21, 24, right valve; 16, anterior marginal area, transmitted light, x215; 17, central muscle scar field, transmitted light, x430; 19, exterior; 21, interior view; 24, hinge, taken from ventral view, transmitted light, x215; 18, 22, 23, 25, left valve; 18, exterior; 22, interior view; 23, posterior hinge element, ventral view, transmitted light, x430; 25, hinge, ventral view, transmitted light, x215.

