

**UMTRI-2005-31**

# **PRIORITIZING IMPROVEMENTS TO TRUCK DRIVER VISION**

**Matthew P. Reed  
Daniel Blower  
Michael J. Flannagan**

**University of Michigan  
Transportation Research Institute**

**May 2006**

**PRIORITIZING IMPROVEMENTS TO TRUCK DRIVER VISION**

Matthew P. Reed  
Daniel Blower  
Michael J. Flannagan

The University of Michigan  
Transportation Research Institute  
Ann Arbor, Michigan 48109-2150  
U.S.A.

May 2006







**Technical Report Documentation Page**

1. Report No. UMTRI-2005-31		2. Government Accession No.		3. Recipient's Catalog No.	
4. Title and Subtitle Prioritizing Improvements to Truck Driver Vision			5. Report Date May 2006		
			6. Performing Organization Code		
7. Author(s) Reed, Matthew P., Blower, D.F., and Flannagan, M.J.			8. Performing Organization Report No.		
9. Performing Organization Name and Address University of Michigan Transportation Research Institute 2901 Baxter Rd. Ann Arbor MI 48109			10. Work Unit No. (TRAIS)		
			11. Contract or Grant No.		
12. Sponsoring Agency Name and Address International Truck and Engine Corporation			13. Type of Report and Period Covered		
			14. Sponsoring Agency Code		
15. Supplementary Notes					
<p>16. Abstract</p> <p>This report presents the results of a three-part study of truck driver exterior vision and its safety consequences. In part one, crash data are analyzed to document vision-related truck crash issues. About 20% of truck-initiated crashes occur in configurations in which limitations to truck driver vision may have been an important factor contributing to the crash. Right-going lane changes and turns account for more than half of these crashes. On average, right-going truck-initiated crashes are about 4.5 times more likely than left-going crashes. Non-motorists killed in startup and right-turn crashes were nearly all adults and tend to be older the pedestrians struck in other crash modes, suggesting that near-field truck vision analyses should focus on adults rather than children. Over half of pedestrians involved in start-up crashes are over age 65. An experimental study showed that driver performance in detecting lane-change conflicts was directionally consistent with the findings from the crash data. Drivers took longer to detect conflicts on the right side of the vehicle than on the left. The longest reaction times were observed when the target vehicle was directly to the right of the cab, suggesting that detecting a conflict in this area is most difficult for drivers. Drivers also made more errors on the right side of the vehicle, including several failures to detect a vehicle directly to the right of the cab. Based on these findings, a prioritized set of vision zones was developed. The highest priority for improvements to driver vision is the area directly to the right of the truck cab. This area represents the most likely position of a crash partner at the truck driver's decision point in right lane-change crashes and is also the pre-crash position of many non-motorists involved in <i>right turn</i> and <i>start up</i> crashes. This report presents a new approach to evaluating exterior vision from truck cabs. The method differs from previous approaches, e.g., SAE J1750, by providing an aggregate score that is related to a specific crash-safety issue. The method is based on the visibility of standing adult pedestrians, and hence addresses the specific problem of pedestrian involvement in <i>start up</i> and <i>right turn</i> crashes. The experimental paradigm presented in Section 3 also represents a promising approach to evaluating the quality of exterior vision provided by alternative vision systems. The time drivers require to determine if a conflict exists provides a sensitive measure of the difficulty of the task. The parallels between the findings of the experimental study and the crash data analysis support the validity of the experimental approach. This method could be applied to evaluate alternative mirror systems, camera-based systems, and other technologies that might be developed to address the priorities established in this report.</p>					
17. Key Word Truck drivers, vision, mirrors, safety			18. Distribution Statement		
19. Security Classif. (of this report)		20. Security Classif. (of this page)		21. No. of Pages 85	22. Price



## **ACKNOWLEDGMENTS**

This research was funded by International Truck and Engine Corporation. The authors thank Brandon Schoettle, Omer Tsimhoni, and Sheila Ebert for their assistance.





## CONTENTS

ACKNOWLEDGMENTS .....	iii
1.0 INTRODUCTION .....	1
2.0 ANALYSIS OF CRASH DATA .....	3
3.0 EMPIRICAL TEST OF MIRROR SYSTEMS.....	45
4.0 PRIORITIZATION OF ZONES FOR DRIVER VISION IMPROVEMENT .....	63
5.0 A METHOD FOR EVALUATING NEAR-CAB VISIBILITY .....	67
6.0 SUMMARY AND CONCLUSIONS .....	81
7.0 REFERENCES .....	85



## 1.0 INTRODUCTION

Although a view of the environment surrounding a vehicle is critical for driving, little effort has been directed at quantifying the quantity and quality of the field of view that is required. A small aperture affording a view of the forward scene a few degrees wide might be considered the minimum possible exterior view, but most vehicles provide drivers with a much wider field of view, encompassing nearly 360 degrees around the vehicle. The total field of view is achieved by indirect vision using mirrors as well as by direct vision. Driver head motions allow a range of vantage points and further expand the fields of view.

Drivers of heavy trucks (10,000 lb and larger) rely to a greater extent than drivers of smaller vehicles on indirect vision. Most heavy trucks provide no view through the rear of the vehicle, so vision to the rear is restricted to the view provided by exterior mirrors. Often the geometry of the truck obstructs the view of the area adjacent to the truck behind the cab. The higher driving position typical of heavy trucks increases the size of the zone around the vehicle within which vision is obstructed by the vehicle.

Regulatory requirements for truck driver vision are minimal. The only standard that bears directly on driver fields of view is Federal Motor Vehicle Safety Standard (FMVSS) 111, which regulates mirror systems. Trucks over 10,000 lb are required to have planar mirrors with an area of at least 323 cm<sup>2</sup> on each side of the cab. Direct vision is unregulated.

Any increase in the visibility of the exterior environment could be viewed as an improvement in driver vision, and any decrease could be viewed as negative. But all increases or reductions are unlikely to have the same effects on safety. For example, raising the hood by 10 cm might have a larger effect on safety than lowering the top of the windshield by 10 cm. But whether either change would have a significant impact on safety would depend on the baseline condition. Raising the hood would not matter if the potential crash partners remained visible, but lowering the top of the windshield could reduce the visibility of traffic control signals if the starting point were sufficiently low.

Similarly, the potential effects of changes in mirror configurations are difficult to determine. Nearly all heavy trucks currently have mirrors that exceed the FMVSS 111

requirements, primarily by the addition of convex mirrors near the mandated planar mirrors. Recently the National Highway Traffic Safety Administration (NHTSA) has requested information on whether fender-mounted convex mirrors should be required (NHTSA XX) and has proposed new rules that would mandate indirect vision systems to view the area behind certain straight trucks (NHTSA XX). The potential benefits of the rear-view requirement are more apparent because the area immediately behind the truck is currently not viewable by the driver. The potential benefits of fender-mounted convex mirrors, which are already present on the right front of about two-thirds of tractor-trailers, are more difficult to determine.

This report presents the results of a study designed to address the contributions of the quantity and quality of the field of view to truck safety. The study was conducted in three complementary tasks. First, an extensive analysis of crash data from several sources examined the role of driver vision in truck-initiated crashes (Section 2 of the report). Second, an experimental study of truck drivers' conflict detection in a lane-change scenario was conducted (Section 3). Third, a quantitative method for evaluating truck cab designs with respect to near-cab visibility was developed (Section 5). As part of the work, a prioritized set of vision zones around the truck were established to guide improvements to direct and indirect vision (Section 4).

## 2.0 ANALYSIS OF CRASH DATA

### 2.1 Data and Analysis Methods

Two sources of crash data were used to characterize the crash environment of medium and heavy trucks: nationally representative computerized crash files and supplementary data collected specifically for this project for selected crash types.

*Nationally Representative Crash Data* — The computerized crash files used were the Trucks Involved in Fatal Accidents (TIFA) file, which is compiled by UMTRI, and the National Automotive Sampling System General Estimates System file (NASS GES, referred to simply as GES hereafter), compiled by the National Highway Traffic Safety Administration. Data files for seven years, 1994-2000, were aggregated for the analysis. Multiple years of data were used to improve the resolution of the analysis and to produce statistically reliable results.

The TIFA file is a survey of all medium and heavy trucks<sup>1</sup> involved in a fatal traffic accident in the United States. A fatal accident includes any traffic accident in which one or more persons are fatally injured; the fatality may occur to a truck occupant, an occupant of another vehicle, or a nonmotorist. For 1999 and 2000, TIFA is a census file, meaning there is a record for each truck involved in a fatal crash. For 1994-1998, trucks were sampled to reduce the number of cases processed. For those years, about 60 percent of trucks involved in a fatal crash were sampled. Weights were determined that allow correct national estimates of population totals. The TIFA file provides the most accurate and detailed data on trucks involved in a fatal crash available.

The GES crash file is a nationally representative sample of police-reported crashes, covering all vehicles involved in a traffic accident, not just trucks. GES data are coded entirely from police-reports. GES is the product of a complex sample survey with clustering, stratification, and weighting that allows calculation of national estimates.

The GES data are used to cover nonfatal truck accidents. The GES file is known to underestimate fatal crashes by approximately 20-30 percent. Since the TIFA data are

---

<sup>1</sup> The term *trucks* will be used hereafter to refer to all class 3 and above vehicles.

known to be a substantially more accurate representation of fatal truck crash involvement, for this analysis TIFA data are used to cover fatal crashes and GES data are used to represent nonfatal crashes. To facilitate analysis, an analytical file was built that combines TIFA and GES data, with TIFA data covering fatal involvements and GES nonfatal. Care was taken to ensure that the variables combined were compatible, or recoded to be compatible. In particular, the TIFA file includes an accident type variable that codes the relative position and movement of the vehicles prior to the crash. The TIFA accident type variable is modeled on the accident type variable in the GES file, so they are fully compatible. This variable is of particular use in the present effort since it provides critical information on how the crash occurred and, accordingly, the direction to the conflict prior to collision.

**Error!**

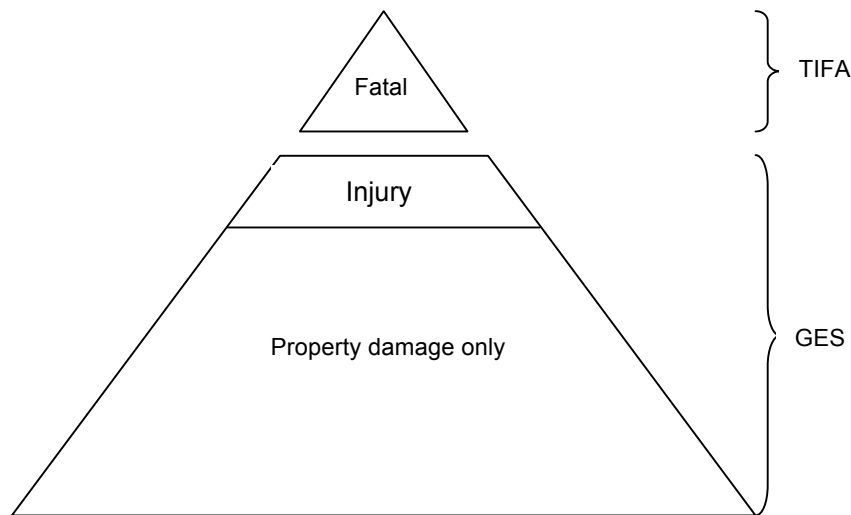

Figure 1. Composition of analysis file: TIFA and GES, 1994-2001.

Figure 1 shows schematically the composition of the analysis data file: the near census TIFA file covers fatal crash involvements while the nationally-representative GES sample file covers all other crash severities. The shapes are not to scale; fatal crashes account for only 1.3 percent of truck crash involvements. However, given their severity and the additional detail the TIFA file supplies, it is important to use the most accurate data available.

*Supplemental Data Collection for Selected Crash Types* — Supplementary data were collected for this project to provide greater detail on the events and positions for specific crash types. The source of these data was a review of police reports for a set of crashes. Such police reports were available because as part of the TIFA data collection protocol, UMTRI acquires from the states the original crash reports on all fatal crashes involving trucks. These police reports are currently available for 1999 and later (early years have been discarded because of storage limitations), and provide a resource to examine in some detail specific crash types.

Three crash types were identified for supplementary data collection. They are: 1) *start up* crashes in which the truck starts from a stopped positions and strikes a nonmotorist; 2) *right turn* crashes in which the truck collides with a nonmotorist while making a right turn; and, 3) *lane change/merge right*<sup>2</sup> crashes in which the truck collides with another vehicle while merging or changing lanes to the right. In the *start up* crash type, the truck starts from a stopped position and collides with a nonmotorist<sup>3</sup>, usually but not always with the front of the truck. The *right turn* crashes considered here are those in which the truck is turning right, either at an intersection or into a driveway or alleyway, and collides with a nonmotorist. In *lane change/merge right* crashes, the truck changes lanes to the right or merges to the right and collides with another vehicle. Note that for each crash type, the truck driver initiates the maneuver that leads to the crash.

The supplemental data collection provides more detailed information about the position and movement of the other party—vehicle, pedestrian, or bicyclist—with respect to the truck to determine critical vision zones around the truck. The two primary pieces of data collected were the position of the other party three to five seconds prior to the collision and the position at the decision point for the truck, that is, at the point where the truck driver initiated the maneuver. In addition, the general crash type was coded, along with the line of travel of the other party, the location of contact, and the point of contact on the truck. Information on the use of mirrors prior to the crash was also collected, but

---

<sup>2</sup> We will italicize crash types in the text to make the references more clear. Many of the crash types have long names because they are very specific. It is hoped that italicizing the names will make it more clear when we are referring to a specific crash type.

<sup>3</sup> Nonmotorist is a somewhat awkward term that encompasses pedestrians, bicyclists, and any other person not occupying a motorized vehicle, such as roller-bladers, children in strollers, skateboarders, and so on.



the use of mirror was mentioned in only ten of 160 cases reviewed, and in none did the truck driver report seeing the other party in the mirror prior to the collision.

Figure 2 shows the interface used in collecting the data. The database was developed in Microsoft Access, which provides convenient and flexible tools for entering and reviewing data.

Year:	2000	Other LineOfTravel:	Road	CrashType:	LCM right
State:	6	LocationOfContact:	Road	<input type="checkbox"/> Miscode	
FARS:	2879	Other's Motion:	Same direction	<input type="checkbox"/> NotApplicable	
Veh N:	2	Relative Motion:	Constant		
Config:	TS	AccTrk:	46		
AdjustedMirror:	Unknow	AccPedBike:	45		
CheckedMirror:	Unknow	ContactPoint:	1		
SawInMirro:	Unknow	Position, 3-5:	2		
Comment:		Decision point:	2		

Reconstruction concluded the car was in the truck's blindspot, moving at constant relative velocity when truck changed lanes into car. Driver asked why he couldn't see the headlights of the car in the dark, but the area was lighted. No fender mirror! P 56

Record: 10 of 40 (Filtered)

Figure 2. Data collection interface for supplementary crash data.

A total of 160 cases were identified for review. One case was discarded because it had been miscoded: vehicle maneuver was coded as turning right, but the narrative on the police report indicated that the truck moved to the right as part of an unsuccessful evasive maneuver. Another ten cases were considered not applicable to the intended crash type; for example, a case where the driver stops his truck to work on the brakes and it rolls over him does not belong in the *start up* crash type, because there is nothing useful to be learned about the role of truck driver vision in the crash. After deleting the miscoded and not applicable cases, 148 cases yielded usable information.

Table 1  
Cases Reviewed for Supplemental Data Collection,  
TIFA 1999-2000

Crash Type	N
LCM right	40
Start up (struck nonmotorist)	38
Turn right (struck nonmotorist)	70
Total	148

## 2.2 Results

In this section, we discuss the results of the crash data analysis, both the mass crash files—TIFA and GES—as well as the supplemental data collected for specific crash types. Figure 3 shows the flow of the crash data analysis. The crash data analysis has a number of objectives. The initial goal is to classify truck crash involvements into crash types that are meaningful in terms of driver vision, that is, the direction and proximity to the conflict. Analysis of the mass crash data in the analytic file built from TIFA and GES is used to accomplish this step. Neither direction nor distance to the conflict is directly coded in the crash data, but the crash configuration can provide very rough approximations for both. Accordingly, crashes are aggregated into categories from which inferences where the truck driver should have been looking can be drawn. Within those categories, crash configuration in which the truck driver would have to rely on his mirrors are identified as “mirror-relevant.” In these crashes, the conflict with the other party to the collision occurred in areas around the truck where the driver would have to rely on the mirrors to view. In addition, the effect of factors such as weather and light condition are considered. Certain crash types of interest were selected to collect additional data on the location of the other party around the truck. These cases were selected from the fatal (TIFA) data because police reports on them are readily available. The supplementary data are analyzed to determine critical points around the vehicle.

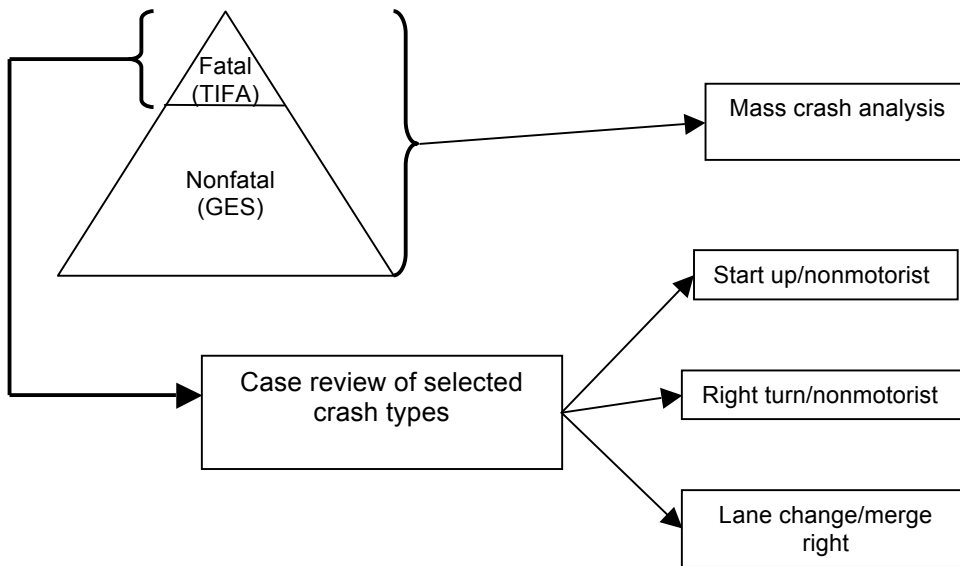

Figure 3. Analysis of mass crash data and selected crash types.

*Analysis of TIFA and GES* — The first step in developing the crash configuration classification tabulated in Table 2 was to identify crashes in which the truck driver initiated the action and in which the driver would have to rely on mirrors to view the area in which the conflict occurred. In other words, these are crashes for which the truck driver’s use of mirrors is of primary relevance to avoiding the crash. In each case, the truck driver is performing the maneuver. For example, in *lane change/merge right* crashes, the truck driver was changing lanes or merging with traffic to the right of the truck. Cases in which the other vehicle changed lanes into the truck are excluded, because the truck driver’s mirrors are not primarily at issue. Clearly there can be cases where the truck driver may view the impending conflict and maneuver to avoid the crash; those cases are not included here but rather are captured in the *sideswipe, same direction, other encroaching* category.

Crash configurations labeled “not truck-mirror-relevant” encompass crash types in which the driver would not normally have to rely on the mirrors to view the area of impending conflict. The categories used are from a typology developed for crash-avoidance applications, and provide general information about the nature of the conflict that led to the collision. For example, *rear-end, truck striking* crashes includes all crashes

in which the truck struck another vehicle that was stopped or going slower in front of the truck. In these crashes, clearly the conflict is in front of the truck and the response of the truck is the primary crash avoidance mechanism, either by slowing, steering around the conflict, or both. In *sideswipe, same direction, other vehicle encroaching* crashes, both vehicles are proceeding in the same direction and the other vehicle encroaches into the truck's lane. In these crashes, the conflict is to the side of the truck, but the other vehicle initiated the crash by moving into the truck's lane. The other crash types can be subjected to a similar analysis.

In Table 2 the crashes are organized to put similar crash types together. The first three crash types are all single vehicle, so they involve primarily the action of the truck driver. The others are organized as logical pairs, to group complementary crash types together, depending on the role of the truck. For example, *rear-end, truck striking* and *rear-end, truck struck*, or *head-on, truck encroaching* and *head-on, other encroaching*.

Table 2  
 Classification of Truck Involvements in Crashes in  
 Relation to Truck Driver Vision Zones  
 TIFA/GES 1994-2000

	Crash type	N	%
Not truck mirror-relevant	No collision	109,949	4.1
	Ran off road	219,762	8.2
	Hit object* in road	173,708	6.5
	Rear-end, truck striking	296,154	11.1
	Rear-end, truck struck	198,580	7.4
	Sideswipe, same direction, truck encroaching†	16,604	0.6
	Sideswipe, same direction, other encroaching	193,827	7.3
	Head-on, truck encroaching	3,489	0.1
	Head-on other encroaching	12,652	0.5
	Sideswipe, opposite direction, truck encroaching	37,522	1.4
	Sideswipe, opposite direction, other encroaching	55,348	2.1
	Truck turns across other's path	143,516	5.4
	Other vehicle turns across truck's path	118,091	4.4
	Both going straight, truck into other's side	53,088	2.0
	Both going straight, other vehicle into truck's side	51,466	1.9
	Truck backs into other vehicle†	695	0.0
	Other vehicle backs into truck	18,447	0.7
	Untripped rollover	17,446	0.7
Truck mirror-relevant	Truck, lane change/merge right into other vehicle	180,797	6.8
	Truck, lane change/merge left into other vehicle	41,067	1.5
	Truck turns right, other vehicle in blind spot	94,771	3.5
	Truck turns left, other vehicle in blind spot	22,515	0.8
	Truck starts up from stop	215	0.0
	Truck backs into other vehicle	186,350	7.0
	Other crash type	411,352	15.4
	Unknown crash type	14,314	0.5
	<b>Total</b>	<b>2,671,729</b>	<b>100.0</b>

\* "Objects" are typically pedestrians, bicyclists, or other nonmotorists.

† Cases are anomalous on impact location, collision, or prior move.

Overall Table 2 shows that mirror-relevant crashes account for 19.7 percent of all truck crash involvements. That is, crashes occurring in areas where the truck driver would have to rely on mirrors to determine if it is safe to maneuver account for almost one out of five crashes in which trucks are involved. In all of these crashes, the truck

initiates the crash through a maneuver. In most of these crashes, the conflict is relatively close to the truck, since the truck is either in a low speed maneuver, as in the *start up*, *backing*, or *turning* crashes, or the relative speeds of the vehicles is low, as in the *lane change/merge* crash types. Among the mirror-relevant crashes, note the dominance of crashes where the truck is moving to the right, particularly in *lane change/merge* (LCM). LCM right crashes occur 4.4 times more frequently than LCM left crashes. Similarly, *right turn* crashes are significantly more frequent than *left turn* crashes. There are 4.2 *right turn* (mirror-relevant) crashes for every mirror-relevant crash while turning left. Clearly drivers are having much more trouble in maneuvers to the right than to the left. *Start-up* crashes were very hard to identify using available variables. The number is likely to be an underestimate.

While it may be useful to compare complementary crash types, Table 3 shows the crash types sorted from most common to least, within the mirror-relevant and other crash types. Among the crash types considered not mirror-relevant, *rear-end, truck striking* was the most common, with 11.1 percent of all truck crash involvements. *Ran off road, rear-end, truck struck*, and *sideswipe, same direction, other encroaching*, are all of similar magnitude. The most common mirror-relevant crash type is *truck backs into other vehicle* with 7.0 percent of all truck involvements. *Lane change/merge right* accounts for about the same percentage, with 6.8, and is in the top quarter of all crashes. Note that the *other* category actually is the most frequent. The *other* category includes a wide variety of crashes that do not fit into any of the named categories.

Table 3  
Ranking of Crash Types in Relation to Truck Driver Vision Zones  
TIFA/GES 1994-2000

	Crash Type	N	%
Not truck mirror-relevant	Rear-end, truck striking	296,154	11.1
	Ran off road	219,762	8.2
	Rear-end, truck struck	198,580	7.4
	Sideswipe, same direction, other encroaching	193,827	7.3
	Hit object* in road	173,708	6.5
	Truck turns across other's path	143,516	5.4
	Other vehicle turns across truck's path	118,091	4.4
	No collision	109,949	4.1
	Sideswipe, opposite direction, other encroaching	55,348	2.1
	Both going straight, truck into other's side	53,088	2.0
	Both going straight, other vehicle into truck's side	51,466	1.9
	Sideswipe, opposite direction, truck encroaching	37,522	1.4
	Other vehicle backs into truck	18,447	0.7
	Untripped rollover	17,446	0.7
	Sideswipe, same direction, truck encroaching†	16,604	0.6
	Head-on other encroaching	12,652	0.5
	Head-on, truck encroaching	3,489	0.1
	Truck backs into other vehicle†	695	0.0
	Truck mirror-relevant	Truck backs into other vehicle	186,350
Truck, lane change/merge right into other vehicle		180,798	6.8
Truck turns right, other vehicle in blind spot		94,771	3.5
Truck, lane change/merge left into other vehicle		41,067	1.5
Truck turns left, other vehicle in blind spot		22,515	0.8
Truck starts up from stop		215	0.0
Other crash type	411,352	15.4	
Unknown crash type	14,314	0.5	
Total		2,671,729	100.0

\* "Objects" are typically pedestrians, bicyclists, or other nonmotorists.

† Cases are anomalous on impact location, collision, or prior move.

Table 4 shows the definitions for the mirror-relevant crash types. While developing this set of crash types, the goal was to identify crashes that occurred in an area where the truck driver would have to use his mirror to successfully complete a maneuver. Each bullet point essentially corresponds to a set of code values for a particular variable. Since crashes as they actually occur on the roads do not readily sort

themselves into neat categories, and since crash investigators can make mistakes, consistency was required across multiple variables to increase the probability that crashes assigned to a particular category were roughly similar. For example, in the case of *lane change/merge right*, certain codes in the accident type variable define the crash type, but in some cases the first contact was on the left or rear of the vehicle, and where movement prior to the crash was a left turn. Such cases might be genuine inconsistencies or the crash itself may have been anomalous. But whatever the explanation, the crashes were excluded to avoid contaminating the category. Note that in both the left and right turn categories, the vehicle collided with was approaching from the rear of the truck.

Table 5 shows the categories of driver vision zones that can be reasonably inferred from the crash types and other information available in the crash files, and provides the reasoning supporting the classification. The goal is to identify the direction from the driver to the impending conflict. The classification was developed using the crash types developed above, along with the more detailed accident type information and information about the location of the first impact on the vehicle. The table describes the locations identified by each category.



Table 4  
 Identification of Mirror-Relevant or Indirect Driver Vision Crashes

Crash Type	Definition
Lane change/merge right	<ul style="list-style-type: none"> <li>• Same trafficway, same direction accident type move to right</li> <li>• First impact on right side</li> <li>• Prior move is lane change, merge, or going straight</li> </ul>
Lane change/merge left	<ul style="list-style-type: none"> <li>• Same trafficway, same direction accident type move to left</li> <li>• First impact on left side</li> <li>• Prior move is lane change or merge</li> </ul>
Right turn	<ul style="list-style-type: none"> <li>• Change trafficway, accident type is turn to right, with other vehicle approaching from behind</li> <li>• First impact on right</li> </ul> <p style="text-align: center;"><i>or</i></p> <ul style="list-style-type: none"> <li>• First harmful event is collision with pedestrian or pedalcyclist</li> <li>• First impact on right side</li> <li>• Prior move is right turn</li> </ul>
Left turn	<ul style="list-style-type: none"> <li>• Change trafficway, accident type is turn to left, with other vehicle approaching from behind</li> <li>• Prior move is left turn</li> <li>• Impact point on left</li> </ul>
Backing	<ul style="list-style-type: none"> <li>• Accident type is backing</li> <li>• First harmful event is collision</li> </ul>
Start up	<ul style="list-style-type: none"> <li>• Prior move is stopped or starting up in traffic lane</li> <li>• First harmful event is collision with pedestrian or pedalcyclist</li> <li>• At intersection or intersection-related</li> </ul>

Table 5  
Driver Vision Zone Definitions

Direction to Conflict	Definition
Forward	Straight in front of vehicle. For example, rear-ends where the truck is the striking vehicle, or start-up collisions with pedestrians.
Right forward	Conflict is in right adjacent lane, for example, striking a parked vehicle in the parking lane. Also includes same direction sideswipes where the contact point was on the front right corner.
Right	These are mostly crashes that occur when the vehicles are on intersecting roadways. As an example, for the vehicle coded 87 in the diagram here, the conflict is coming from the right. Actually, it is to the right only at the point of impact. Prior to that (i.e., when the view might have been relevant to the driver), the direction would be more like 60°. The right and left categories are used only for cases where the vehicles pre-crash were on intersecting roads.
	
Right rear	Direction to the other vehicle is on the right side, toward the rear of the vehicle. Most of these cases are from the mirror-relevant group.
Right, general	Conflict was to the right of the vehicle, but it cannot be determined if it was forward, rear, or in the middle. Many of these are same direction sideswipes. The contact information is not detailed enough to know whether the other vehicle was to the right front of the truck, roughly in the middle, or toward the rear.
Rear	Directly to the rear of the truck. Includes mostly rear-end struck and truck backed into other vehicle.
Left, rear	Consistent with right rear
Left	Consistent with right
Left forward	Consistent with right forward: these are mostly head-ons and opposite direction sideswipes. It is assumed they are all cases of conflicts with vehicles initially in the adjacent lane. Some fraction are actually cases where the vehicle is already in the truck's lane, such as cases where the other vehicle used an exit ramp as an entrance ramp. There is no way to identify such cases in the data, but it is likely the fraction is very small.
Left, general	Consistent with right, general.
No conflict	These are cases, as far as can be determined, where driver vision to whatever it is he is hitting, is not of primary relevance to the crash. Includes untripped rollovers, for example, and cases where the driver drove or skidded off the road and was not maneuvering to avoid something in the road. Category also includes noncollision events, such as fires, explosions, falling from vehicle, and so on.
Unknown	Insufficient information to deduce direction to the conflict from the configuration of the crash and impact point the direction to the conflict. Many are coded unknown or other on accident configuration. Point of impact on the truck does not imply the vector of the collision, so that is not enough.

Table 6 shows the results of aggregating truck crash involvements into the categories described in the table above. Note that directly forward and directly to the rear are both about the same magnitude, and directly right and directly left are both about the same magnitude. Table 6 includes all crashes, not just those the truck driver initiated by maneuvering.

Table 6  
Classification of Crashes by Direction to Conflict  
TIFA/GES 1994-2000

Direction to Conflict	N	%
Forward	419,569	15.7
Right forward	50,887	1.9
Right	132,134	4.9
Right rear	94,839	3.5
Right, general	315,557	11.8
Rear	395,725	14.8
Left, rear	23,739	0.9
Left	146,362	5.5
Left forward	206,649	7.7
Left, general	162,438	6.1
No conflict	319,611	12.0
Unknown	404,220	15.1
Total	2,671,729	100.0

The distribution may be more readily seen in Figure 4. In this figure, the no conflict and unknown categories are dropped, and the percentages recalculated for all cases with known conflicts. The percentages at the corners on the front and rear of the truck identify right forward and right rear, left forward and left rear. The percentages for crash involvements in which the direction to the conflict was more or less directly to the left or right, as at an intersection, are labeled as intersection crashes. The “general” categories show the percentages of crash involvements in which the conflict was to the left or right, but for which there was insufficient information to classify the direction more precisely.

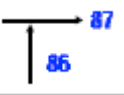
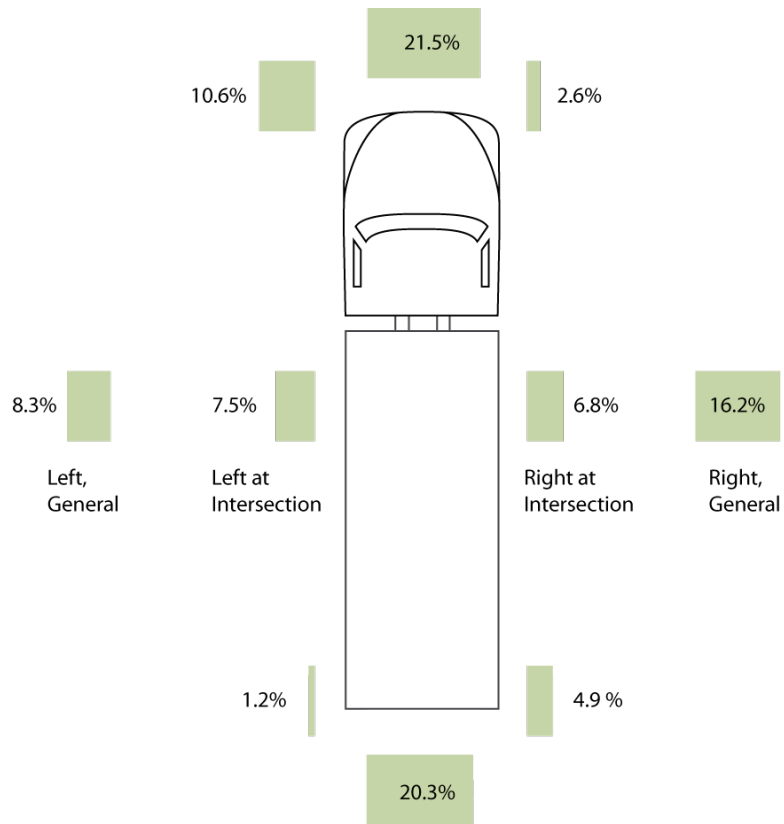

Figure 4. Distribution of direction to conflict, TIFA/GES 1994-2000.

Again, the proportion of conflicts to the front and rear are nearly equal, as are conflicts directly to the left and right. Left forward is significantly higher than right forward, 10.6 percent to 2.6 percent. Conflicts to the left forward in this classification result in head-on collisions or sideswipes in which the vehicles are moving in opposite directions. These occur primarily on roads with two-way traffic.

However, the figure also depicts the limits of attempting to determine with confidence the direction to the conflict using the computerized record alone. For many crash types it was not possible to classify the direction to the conflict in other than general terms, i.e., left general or right general.

Table 7 shows distribution of vision zones by crash severity. Crashes are divided between more serious (fatal, A-injury, or B-injury) and the less serious (C-injury or no injury) crash involvements, and the distribution of the driver vision zone is shown for each. Since most crash involvements include only minor or no injury, fatal, A-injury, and

B-injury involvements are combined to accumulate sufficient sample size for meaningful comparisons. Crashes in which the vehicles were going in opposite directions are much more serious than those in which they were going in the same direction, because closing speeds prior to impact are typically much lower. Note that the left forward zone accounts for 24.1 percent of the more serious involvements, but only 8.6 percent of the less serious. Head-on collisions and sideswipes in which the vehicles are going in opposite directions account for many of the involvements in the left forward zone. The right, general zone tends to include less severe crash involvements: only 8.2 percent of serious but 16.9 percent of less serious involvements. Many involvements assigned to the right, general zone are same direction sideswipes, where closing speeds are low. In contrast, crashes in which the conflict was to the left or right—these crashes typically occur at intersections where the vehicles are crossing paths—are overrepresented among serious crash involvements. Overall, the left and right zones account for 21.7% of more serious truck involvements and only 13.5 percent of the less serious.

Table 7  
Distribution of Crash Severity by Direction to Conflict  
TIFA/GES 1994-2000

Direction to Conflict	Fatal, A-, and B-Injury		C-injury and No Injury	
	N	%	N	%
Forward	45,695	18.8	357,646	22.1
Right forward	2,654	1.1	44,760	2.8
Right	26,569	10.9	101,060	6.2
Right rear	5,311	2.2	87,458	5.4
Right, general	20,036	8.2	272,930	16.9
Rear	43,336	17.8	339,795	21.0
Left forward	58,477	24.1	139,484	8.6
Left	26,247	10.8	117,196	7.2
Left, rear	2,242	0.9	21,366	1.3
Left, general	12,399	5.1	136,972	8.5
Total	242,966	100.0	1,618,667	100.0

Examination of specific crash types can shed more light on the role of driver vision in truck crashes and certain factors that affect it. Table 2 above showed significant

disparity in crash involvements when the truck was maneuvering to the left in comparison with maneuvers to the right. Specifically, in maneuvers where the truck driver must use the mirrors to determine if the maneuver is safe, LCM crashes to the right are 4.4 times more frequent than LCM crashes to the left. Crashes in which the truck was executing a right turn at an intersection and collided with something to the truck's right are 4.2 times more frequent than analogous left turn crash involvements. In both crash types, (LCM right/left and turning left/right), the driver must use mirrors to determine if the maneuver is safe. Moreover, the driver's view to the right generally is more difficult, because the passenger side mirror is farther away than the driver side mirror, so the image will be smaller and more difficult to interpret.

Both weather and light condition may affect the driver's ability to use the mirrors effectively. In this section, the effect of weather and light condition on two crash types will be considered.

In rainy or wet weather, splash and spray can coat the mirror and windows, obscuring the driver's view. In dark conditions, the driver will be able to see less in the mirror than in daylight. On the other hand, headlamps of other vehicles in the mirror will be particularly salient and the driver may be able to see light reflected on the road from the headlamps of vehicles traveling alongside the truck. Thus, weather and light condition both affect driver vision and may have an effect on the types of crashes that occur by making certain types more likely.

The presumed effect of weather with respect to mirrors is that precipitation and spray may obscure the image in the mirror, making it more difficult for the driver to judge if the way is clear. Thus, mirror-relevant crashes may be more likely in adverse weather. The table shows that crashes in which truck drivers rely on mirrors are actually relatively less frequent in adverse weather (precipitation or fog) than in good weather. "No adverse conditions" accounted for 89.4 percent of mirror-relevant involvements, but only 82.0 percent of non-mirror-relevant crash involvements.

Table 8  
Mirror-Relevant Involvements and Weather Condition  
TIFA/GES 1994-2000

Weather	Mirror-relevant		Non-mirror relevant	
	N	%	N	%
No adverse condition	469,765	89.4	1,747,132	82.0
Precipitation	48,672	9.3	328,792	15.4
Fog	978	0.2	13,339	0.6
Other	1,220	0.2	16,904	0.8
Unknown	5,088	1.0	25,526	1.2
Total	525,723	100.0	2,131,693	100.0

The data tabulated in Table 8 consider all types of mirror-relevant crashes together and shows that they are not more likely in adverse conditions than other crashes. However, the presumed effect of precipitation and spray on mirrors may operate differently in different types of crashes, and may be detected by considering pairs of complementary crash types. In both lane change and turns, the driver's reliance on the mirrors depends on the direction of the maneuver. Similarly, LCM maneuvers to the right are more difficult than LCM maneuvers to the left.

Table 9 shows how adverse weather in the form of rain, snow, or sleet changes the relationship between maneuvers to the left and right. The numbers in the cells are the ratio of right to left crash involvements for the two crash types in two conditions. Where there are no adverse weather conditions, LCM right involvements occur 4.40 times more frequently than LCM left. In rain, snow, or sleet conditions, where splash or spray might obscure the mirror, one might expect an even higher ratio of right to left. In fact, the ratio is somewhat higher, 4.86 to 4.40, which is an increase of about 10 percent. However, for the turning crash type, the ratio of right to left is actually lower in rain, snow, or sleet, by about 10 percent. Thus for one crash type, adverse weather seems to raise the ratio slightly and for the other it seems to decrease it, equally slightly.

Table 9  
Involvement Ratios of LCM and Turning Crashes by Weather Condition  
TIFA/GES 1994-2000

	No adverse conditions	Rain, snow, or sleet
Ratio right to left lane change/ merge	4.40	4.86
Ratio right to left turns	4.33	3.88

The interpretation of this result is not clear, but note that the effect is small. Adverse weather accounts for only about a 10 percent change in the ratio, while the ratio itself, which is the effect of using mirror to maneuver left and right, shows increases of several hundred percent. The underlying data—from TIFA and GES—is a combination of seven years from a near-census file and a complex, stratified sample, so calculating confidence intervals for this result would be very difficult and indeed cost-prohibitive. However, the effect of weather appears to be relatively small, and may not exist. Weather is taken as a surrogate for splash and spray, and it is assumed that spray on the mirrors would reduce the driver’s ability to use them. It seems likely, in light of the result, that either adverse weather does not obscure the mirrors or that the spray is not sufficient to hinder their use.

Light condition may also affect mirror-relevant crashes. However, Table 10 shows that the overall distribution of mirror-relevant crashes by light condition differs only somewhat from the same distribution for other truck crash involvements. Non-mirror-relevant involvements have a somewhat lower proportion of the daylight condition, 78.7 percent compared with 84.3 for the mirror-relevant involvements. This difference is consistent with an elevated proportion of non-mirror-relevant crashes in the dark condition, 9.7 percent compared with 4.7 for mirror-relevant crashes. If anything, crashes in which the driver had direct vision of the conflict are more likely in dark conditions than are mirror-relevant crashes.



Table 10  
Light Condition and Mirror-Relevant Crashes  
TIFA/GES 1994-2000

Light condition	Mirror-relevant		Non-mirror-relevant		Unknown		Total	
	N	%	N	%	N	%	N	%
Daylight	443,058	84.3	1,677,070	78.7	10,346	72.3	2,130,474	79.7
Dark/lighted	39,708	7.6	162,421	7.6	1,111	7.8	203,239	7.6
Dark	24,824	4.7	207,596	9.7	1,324	9.2	233,745	8.7
Dawn/Dusk	13,162	2.5	63,686	3.0	672	4.7	77,519	2.9
Unknown	4,964	0.9	20,926	1.0	862	6.0	26,752	1.0
Total	525,715	100.0	2,131,699	100.0	14,315	100.0	2,671,730	100.0

However, Table 11 shows that the distribution of crash types varies by light condition, particularly when the two pairs of complementary crash configurations are considered. In the daylight condition, 6.6 percent of involvements are *LCM right*, compared with 1.6 percent *LCM left*. The relative percentages are similar in dark conditions, but in dark/lighted conditions 9.6 percent are *LCM right* and only 1.3 percent are *LCM left*. *LCM right* crashes are even more over-involved in dark/lighted conditions. A similar pattern may be observed for *right turn* and *left turn* mirror-relevant crashes.

Table 11  
Mirror-Relevant Crash Types by Light Condition  
TIFA/GES 1994-2000

Crash type	Daylight	Dark/ lighted	Dark	Dawn/ Dusk	Unk.	Total
LCM, right	140,399	19,564	14,613	5,152	1,069	180,797
LCM, left	34,481	2,550	2,588	545	904	41,067
Right turn	82,893	6,590	2,252	2,795	241	94,771
Left turn	20,551	741	452	447	323	22,515
Start up	175	36	4	0	0	215
Backing	164,559	10,227	4,916	4,222	2,427	186,351
Non-mirror-relevant	1,677,070	162,421	207,596	63,686	20,926	2,131,699
Unknown	10,346	1,111	1,324	672	862	14,315
<b>Total</b>	<b>2,130,474</b>	<b>203,239</b>	<b>233,745</b>	<b>77,519</b>	<b>26,752</b>	<b>2,671,730</b>
Column percentages						
LCM, right	6.6	9.6	6.3	6.6	4.0	6.8
LCM, left	1.6	1.3	1.1	0.7	3.4	1.5
Right turn	3.9	3.2	1.0	3.6	0.9	3.5
Left turn	1.0	0.4	0.2	0.6	1.2	0.8
Start up	0.0	0.0	0.0	0.0	0.0	0.0
Backing	7.7	5.0	2.1	5.4	9.1	7.0
Non-mirror-relevant	78.7	79.9	88.8	82.2	78.2	79.8
Unknown	0.5	0.5	0.6	0.9	3.2	0.5
<b>Total</b>	<b>100.0</b>	<b>100.0</b>	<b>100.0</b>	<b>100.0</b>	<b>100.0</b>	<b>100.0</b>

Table 12 displays how light condition affects the ratio of right to left for these crash types. It appears that lower visibility significantly increases the difficulty of maneuvering safely to the right, as compared with the left. There are also interesting differences between the categories of light condition. (The dawn/dusk category includes only about three percent of involvements.) The dark condition increases the ratio of *right* to *left* LCM involvements by about 37 percent, compared with the daylight condition (4.1 to 5.6). This increase is expected since it is likely that darkness in general degrades driver vision, particularly when using mirrors. However, note that in dark/lighted conditions, the ratio of right to left increases to 7.7, or by almost 88 percent, compared to the daylight condition. One interpretation of these results is that darkness exacerbates the problem of using the right-side mirror to determine if a maneuver to the right is safe, but that there

may be some help from the other vehicle’s headlamps. However in the dark/lighted condition, the roadside lights in essence wash out or mask the backscatter from the other vehicle’s headlamps, resulting in the significant increase in the ratio. The results are similar for *right* and *left turn* mirror-relevant crashes, and the interpretation would also be similar.

Table 12  
Involvement Ratios of LCM and Turning Crashes by Light Condition  
TIFA/GES 1994-2000

Crash comparison	Daylight	Dark/ lighted	Dark	Dawn/ Dusk	Unk.	Total
Ratio right-to-left lane change	4.1	7.7	5.6	9.5	1.2	4.4
Ratio right-to-left turns	4.0	8.9	5.0	6.2	0.7	4.2

*Supplemental Data Collection on Selected Crash Types* — Three crash types were identified for supplemental data collection. Each crash type was “mirror-relevant,” meaning that the conflict occurred in an area that the driver would have to use the mirror system to see. The three crash types were *LCM right*, *right turn* involving a pedestrian or other nonmotorist, and *start up* involving a pedestrian or other nonmotorist. Both the *start up* and *right turn* crash types involve low speed maneuvers, typically in urban areas, since they involve collisions with pedestrians or other nonmotorists. The *LCM right* crashes are primarily crashes on high-speed roads, usually involving two or more travel lanes in the same direction.

*LCM right* crash involvements account for 6.8% of all truck involvements, which is a significant portion of the truck crash population and sufficient justification for selection for the more detailed case review. The *start up* and *right turn* crash involvements selected for review both are limited to those with pedestrians and other nonmotorists and account for a much lower proportion of the truck crash problem. For all crash severities, about 7.8 percent of truck involvements are collisions with nonmotorists.

It is difficult to estimate with confidence the proportion of involvements covered by the nonmotorist crash types reviewed. In the crash typology developed for this project, the *start up* and *right turn* crash types account for about 10.0 percent of

truck/nonmotorist crash involvements, and 6.3 percent of fatal involvements, but both are likely underestimates. About 470 nonmotorists are killed annually in collisions with trucks, so those two crash types account for at least 30 fatalities per year. This figure is likely an underestimate. The mass crash data files have significantly less information about nonmotorists than they do about motor vehicles. In both the TIFA and the GES file, the crash type for most nonmotorist involvements is “hit object in road,” with the nonmotorist being the object. There is no further information about the movement of the nonmotorist, as there is for motor vehicles. So the tools available to specify nonmotorist crash types are limited.

In addition, there has been limited research on truck/nonmotorist crashes so it is difficult to determine a better estimate. Retting, in a study of truck/pedestrian fatal crashes, found that 47.5 percent of truck/pedestrian occurred when the truck started from a stopped position (Retting 1993). Another 14.4 percent occurred in right turns by the truck. Retting manually reviewed 202 fatal truck/pedestrians crash reports in four cities. Since he reviewed crashes only from four urban areas, it is not appropriate to extend those percentages to the whole population. Crash types are likely to be different in rural and suburban areas. The correct answer likely lies somewhere between the Retting finding and the proportions in the analysis here.

The typology here is about as detailed as possible, using the information in the mass crash data. Given the limited information about pedestrian movements in the mass crash files, it would be necessary to do something like what Retting did, but in a nationally representative set of cases. In the scope of the current project, that is not possible. However, in both the *start up* and *right turn* crash types, the critical points occur in areas around the truck where the truck driver cannot see, either directly or by the use of mirrors. Therefore, in low speed maneuvers in urban areas with nonmotorists present, the onus of collision avoidance is of necessity on the nonmotorist. Improved vision in these areas would aid the driver in these situations, by giving him a chance of seeing the nonmotorist. Moreover, addressing the problem with nonmotorists in low speed maneuvers would likely help in other crash types that do not involve nonmotorists but where the conflict is in the same area.

The supplemental data were collected by reviewing police accident reports (PARs). UMTRI collects PARs as part of its TIFA program, and these PARs were used for the review. Since the cases were selected from the TIFA file, all the cases involve fatal crashes. All qualifying crashes from 1999 and 2000 (years for which TIFA can supply PARs) were taken.

The primary purpose of the data collection was to determine the position of the other party at two points: three to five seconds before the collision and at the decision point for the truck driver. Note that all three crash types are those that the truck driver initiated by turning, changing lanes, or starting up. Accordingly, the positions of the other party prior to the maneuver and at the time when the driver decides to make the maneuver are important. Choosing three to five seconds as the position to code prior to the collision is somewhat arbitrary, but the combination of that position and the decision point does provide a view of the motion of the other party relative to the truck.

The interface for the data collection is shown above in **Error! Reference source not found.** The primary source for the information is the scene diagram, reporting officer's narrative, and any witness statements included in the police report of the accident. These items are of course of varying quality, both within a state and between states. Some reports included fairly detailed crash reconstructions. Other reports are very sketchy, with little usable detail.

The positions of the other party are of necessity estimates based on available information and deductions from the nature of the parties. An older pedestrian is assumed to move slowly, while bicyclists move more quickly. If overtaking speed is given in an *LCM right* crash, the position prior can be determined by tracking back from the impact point on the truck to where the other vehicle was prior to the crash. For example, a 10 mph differential in travel speed implies a difference of 14.7 feet per second. If a truck is 65 feet long and the impact point was the front right quarter of the tractor, the other vehicle would have been 44 to 73 feet behind the front of the tractor three to five seconds prior to impact. Where available, such information was taken into account, but for most cases coding is a best estimate. Missing data is high for some crash types. For the *LCM right* crash type, for example, it was not possible to estimate the prior position for 15 of the 40 cases.

Table 13 shows the distribution of truck configuration for the reviewed crash types. The dominant truck configurations are straight trucks and tractor-semitrailers. Straight trucks are somewhat overinvolved in these crashes: straight trucks account for 28.2 percent of trucks in fatal truck crashes and tractor-semitrailers account for 59.6 percent. But both types are well represented here, with 38.5 percent and 52.7 percent respectively. Even in the *start up* and *turn right* crash types, tractor-semitrailers account for almost half the involvements.

Table 13  
Truck Configuration by Crash Type for Cases Reviewed  
TIFA 1999-2000

Truck configuration	LCM right		Start up/ nonmotorist		Turn right/ nonmotorist		Total	
	N	%	N	%	N	%	N	%
Bobtail	2	5.0	2	5.3	4	5.7	8	5.4
Straight truck	10	25.0	15	39.5	32	45.7	57	38.5
Straight & trailer	1	2.5	4	10.5	0	0.0	5	3.4
Tractor- semitrailer	27	67.5	17	44.7	34	48.6	78	52.7
Total	40	100.0	38	100.0	70	100.0	148	100.0

To code the position of the other vehicle, the area around the truck was divided into a grid, and the other vehicle was placed in one of the cells. The position along the truck was divided into thirds, with the front third essentially encompassing the tractor or cab portion of a straight truck. The other vehicle was then located either in the lane to the right, the lane to the left, in front or to the rear of the truck. For *start up* and *right turn* crashes, the nonmotorist could be coded on the sidewalk or shoulder and areas were also included for parties more than 20 feet to the right. This area was also used in the case of *LCM right* crashes to locate vehicles that merged left as the truck merged right into the lane between them. It was also used in *start up* and *right turn* crashes to locate parties (usually bicyclists) that were moving on the road intersecting with the one the truck was on initially.

*Lane Change/Merge to Right* — Figure 5 shows the position of the other vehicle three to five seconds prior to the collision. The position could not be estimated for 15 of

the 40 cases reviewed, so the rate of missing data is high. The percentages shown in the table were calculated after excluding the unknown cases. This procedure assumes that the true position for the missing cases follows the same distribution as those for which the position could be estimated. This seems a reasonable assumption, since there is no reason to think that vehicles in some positions would be less likely to be identified than those in other positions.

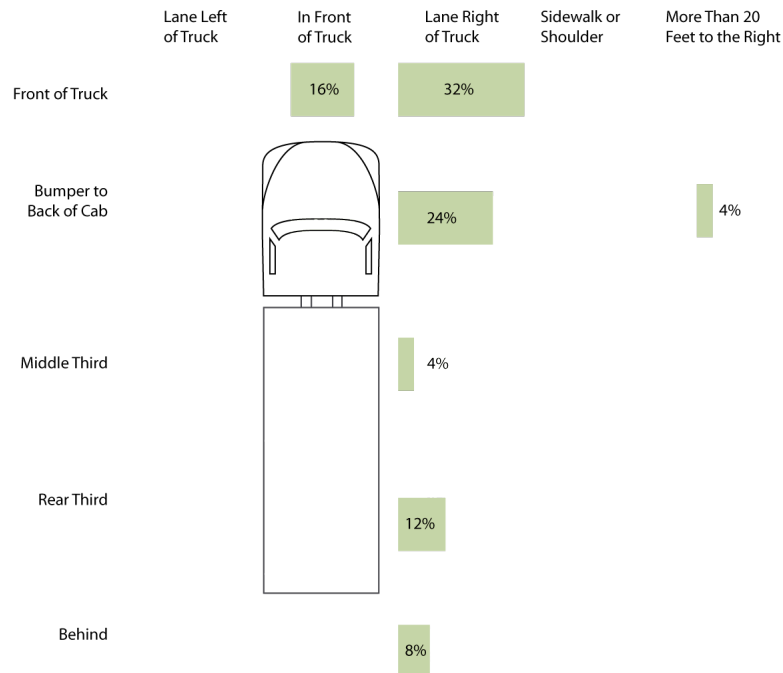

Figure 5. Position of other vehicle 3-5 seconds prior to truck driver's decision point, Lane Change/Merge to Right Crashes, N=40, TIFA 1999-2000. Fifteen of 40 cases were excluded from the calculation of percentages because the position could not be determined.

The number of cases in Figure 5 is small (40), but the cases include all *LCM right* fatal crash involvements for 1999 and 2000. Three more years, with potentially sixty more cases, are available but could not be reviewed within the constraints of time and funding. Also the additional years were subsequent to the period covered by the mass crash data analysis. Because the number of cases reviewed is small, confidence intervals for the proportions are relatively large. For example, the 95 percent confidence interval for the estimate that 32 percent of the other vehicles were to the front right of the cab is  $\pm 18$  percent. (Adding three more years of cases would cut the confidence intervals almost in half.)

The size of the confidence intervals is a concern. However, many of the findings discussed below are consistent with expectations and with experimental results. The experiments described in Section 3 of this report identified the front right of the truck as a concern. The fact that the results from crash analysis are consistent with the experimental finding boosts confidence the results reported here are real, even if confidence in the statistical sense is not high.

Over half of the vehicles for which the prior position could be estimated were either along side the front of the truck or in front of the truck. A total of 40 percent of the other vehicles actually were along side the truck three to five seconds prior to the crash, and most of these were to the front. The vehicles coded directly to the front of the truck were being overtaken by the truck, which sideswiped them while maneuvering back into the lane. Only two cases were found in which the other vehicle was overtaking the truck rapidly on the right; and there was only one case (4 percent here) in which the other vehicle changed lanes left into the same space into which the truck was moving. In most of the *LCM right* crashes, the conflict is to the immediate right of the truck or slightly in front.

The position of the other vehicle at the decision point, that is the point at which the truck initiates the maneuver, was significantly easier to determine. The position at decision point could not be determined for only three of the 40 cases. As shown in Figure 6, in almost half the cases (48.6 percent,  $\pm 16.1$ ) the other vehicle was to the right of the cab at the decision point. An additional 21.6 percent were alongside the truck behind the cab. The cases coded in the lane next to the truck but still forward of the truck at the decision point included cases in which traffic suddenly slowed and the truck maneuvered unsuccessfully to avoid a collision and one case of reckless driving by the truck driver. However, the primary finding is that in these crashes the other vehicle is most frequently along side the front right of the truck when the driver decides to change lanes to the right.



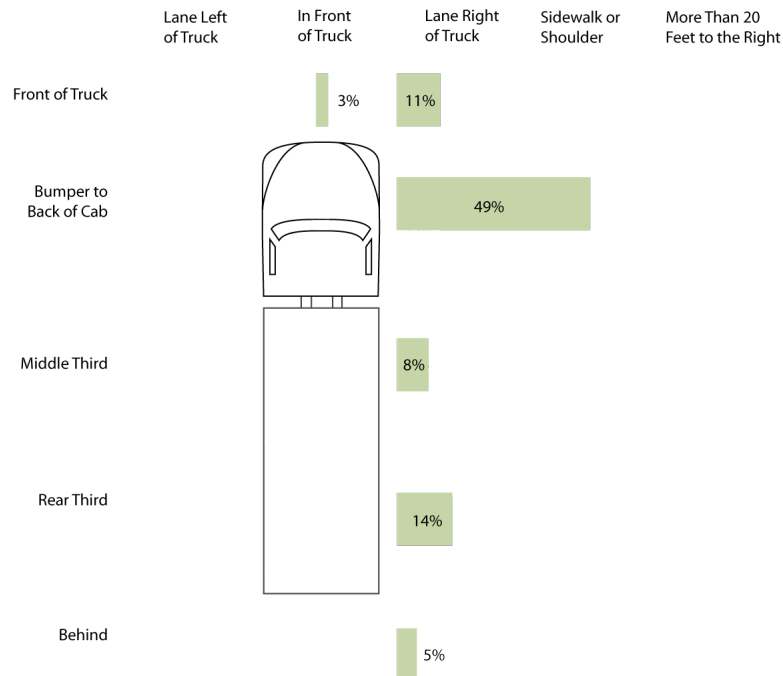

Figure 6. Position of other vehicle at decision point, Lane Change/Merge to Right Crashes. TIFA 1999-2000, N=40. Not applicable: 10.8%. Three unknowns were excluded from percentage calculations.

The position three to five seconds prior to the crash could not be determined for half of the cases that were next to the cab at the decision point, so whether those vehicles had been pacing along side the truck in its forward blind spot cannot be determined. However, for cases along side the cab at the decision point that could be located prior to the crash, all but one were along side the truck prior to the crash and the one exception was just forward of the truck. None were rapidly overtaking from the rear.

Findings from the analysis of mass crash data reinforce the point. The TIFA data includes a variable that identifies the initial point of impact on the truck. Figure 7 is based on analysis of seven years of the TIFA file, not the case review. It shows the distribution of initial impact point on the truck in fatal crashes in which the truck was making a lane change or merging either to the right or left. (Nonfatal crash involvements could not be included because the GES file includes only the side of impact, not the location on the side.) The figures of the trucks are adapted from the coding manual used by FARS analysts to record the data. Both straight trucks and tractor-semitrailers are included in the data. It is important to remember that only the first contact point is recorded, so the movement of the other vehicle prior to impact is not reflected. Thus, we do not know if

the other vehicle was moving alongside the truck at a steady state or rapidly overtaking the truck. Nevertheless, the distribution of contact points is strikingly and suggestively different when the truck is moving left than when the truck is moving right.

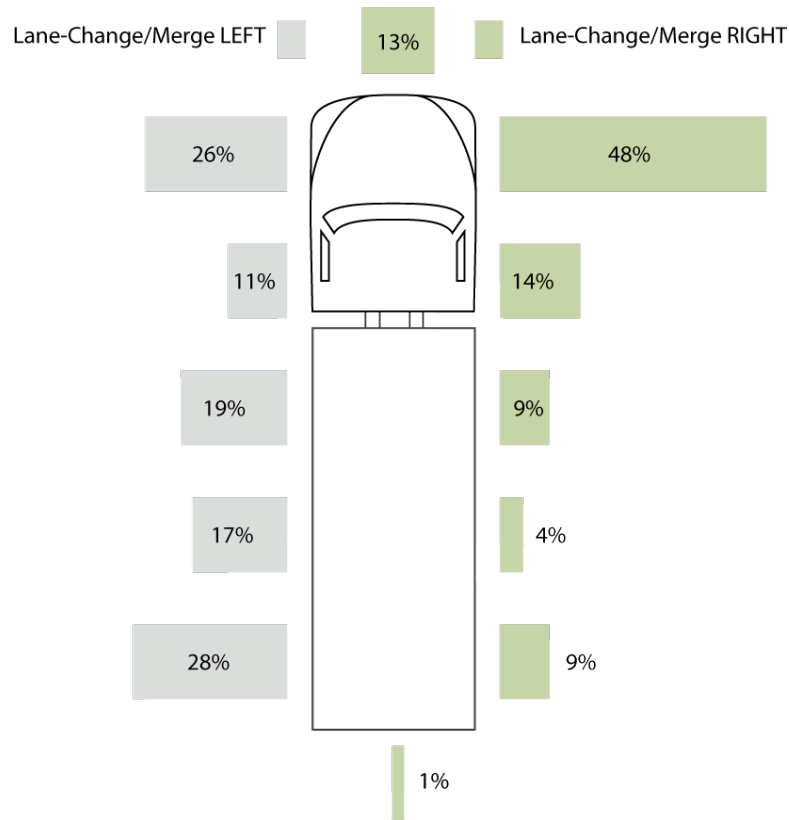

Figure 7. Distribution of initial impact on the truck in two crash types. Fatal crashes only, Total N=200, TIFA 1994-2000.

When the truck changed lanes or merged to the right, almost 48 percent of the contact points were in the cab area, compared with only 25.5 percent of left movements. And when moving right, an additional 13.0 percent were in the front of the truck, which is at least consistent with the scenario of the other vehicle moving at the same speed as the truck in the truck's forward blind zone. In total, over 60 percent of contact points on the truck in fatal crashes in which the truck changed lanes to the right occurred on the front of the truck, including the front plane and the right side of the cab. Proportionally fewer of the contact points on the truck in movements to the right were to the rear of the vehicle, with only 8.9 percent in the rear fifth of the truck. Contact points were more evenly distributed along the left of the vehicle in lane changes to the left, while in lane

changes to the right, contact occurred more frequently to the front of the vehicle. This suggests that, in lane changes to the left, the other vehicle more frequently was overtaking and contacted the truck at an essentially random point. But in lane changes to the right, about half the time the other vehicle was pacing alongside the truck to the right of the cab.

*Start Up Crashes* – *Start up* crashes include all crashes in which the truck was starting from a stopped position on the roadway and collided with a pedestrian, bicyclist, or other nonmotorist. Most often the truck was stopped at an intersection and was the lead vehicle. The pedestrian crossed in front of the vehicle and was struck by the front of the truck as it started forward. This crash type also includes cases in which the truck was stopped on the roadway and a pedestrian attempted to cross between the truck and trailer. Note that *start up* crashes can include both pedestrians and bicyclists. Pedestrians are typically close to the vehicle prior to the crash, but bicyclists can be some distance away since they typically travel much faster than people on foot.

Table 14 shows the relative motion of the other party prior to the crash. In most cases, the other party was crossing the intended path of the truck, most frequently from the right to the left, but sometimes from the truck's left to its right. In six of the 38 cases reviewed, the other party was essentially stationary. In two of these, there had been a prior collision between the truck and another vehicle (of which the truck drivers were unaware) and the pedestrian was the other driver inspecting damage or calling for help. In another three instances, the pedestrian was a worker around the truck or a passenger who had exited the truck and was retrieving possessions from behind the cab. And in one case, a pedestrian had suffered a seizure and had collapsed in front of the truck when it pulled forward.

Table 14  
Motion of Nonmotorist Relative to Truck, Start Up Crashes  
TIFA 1999-2000

Nonmotorist Motion	N	%
Crossing Right to Left	16	42.1
Stationary	6	15.8
Crossing Left to Right	5	13.2
Same direction	1	2.6
Unknown	10	26.3
Total	38	100.0

Figure 8 shows the position of the other party three to five seconds prior to the collision. The most frequent position is in front of the vehicle, typically older pedestrians moving slowly, but it is interesting to note the diversity of positions. In the cases immediately in front of the truck, it is likely that they were close enough to the truck to be hidden by the hood. In all cases where it was mentioned, the truck driver said he did not see the pedestrian prior to the collision, or did see the pedestrian (not in front of the truck) but assumed that the pedestrian had cleared the truck's path. For example, in one crash the driver saw a 72-year old pedestrian attempting to cross in front. He waited until he thought the pedestrian had cleared, but the pedestrian had fainted and was struck as the truck pulled forward. But in most cases, the driver said that he never saw the other party, whether pedestrian or bicyclist.<sup>4</sup>

---

<sup>4</sup> The claim by the driver that he did not see the nonmotorist prior to the crash is of course self-protective. But the drivers who did not stop immediately continued normally after the crash, i.e., betrayed no consciousness of having just struck someone.

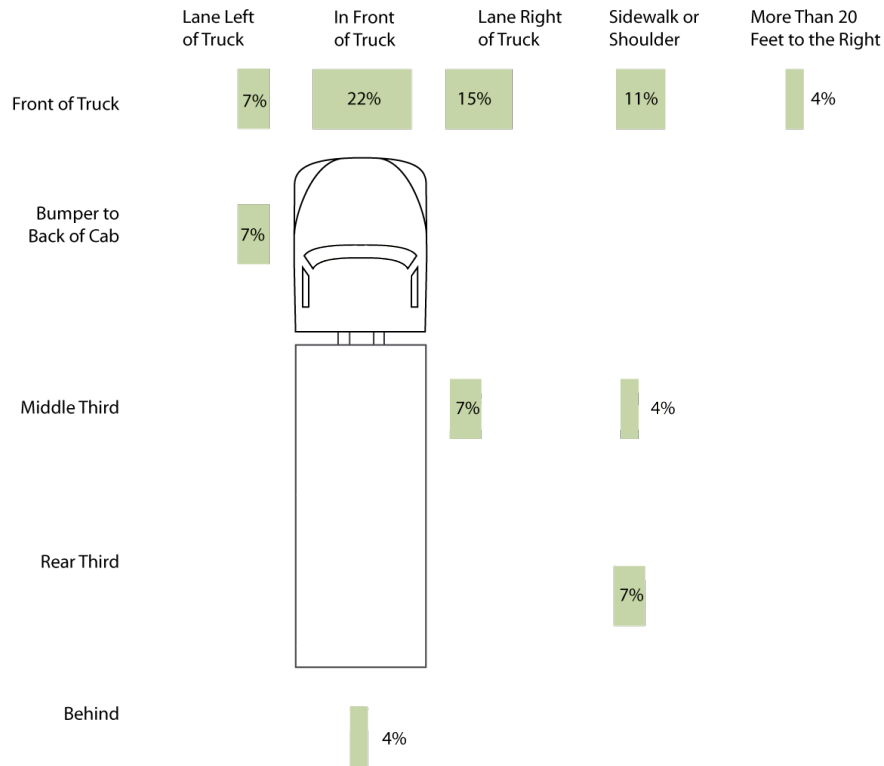

Figure 8. Position of nonmotorist 3-5 seconds prior to crash, Start Up Crashes, TIFA 1999-2000, N=38. Other (underneath truck): 3.7%. Unknowns account for 28.9% of the 38 cases and are excluded from the percentage calculations.

At the decision point, in over half the cases the pedestrian or bicyclist was either to the left or right of the truck or directly in front of it (Figure 9). In almost 58 percent of the crashes, the other party was directly in front of the vehicle. An additional 9.1 percent were in the lane to the right in front of the truck, and 9.1 percent were to the left. The cases coded behind the truck include two in which the pedestrian attempted to cross between the truck and trailer and one in which the pedestrian was a worker crushed when the truck rolled backward. Two cases coded at the side of the truck toward the rear or on the sidewalk toward the rear were likely suicides.

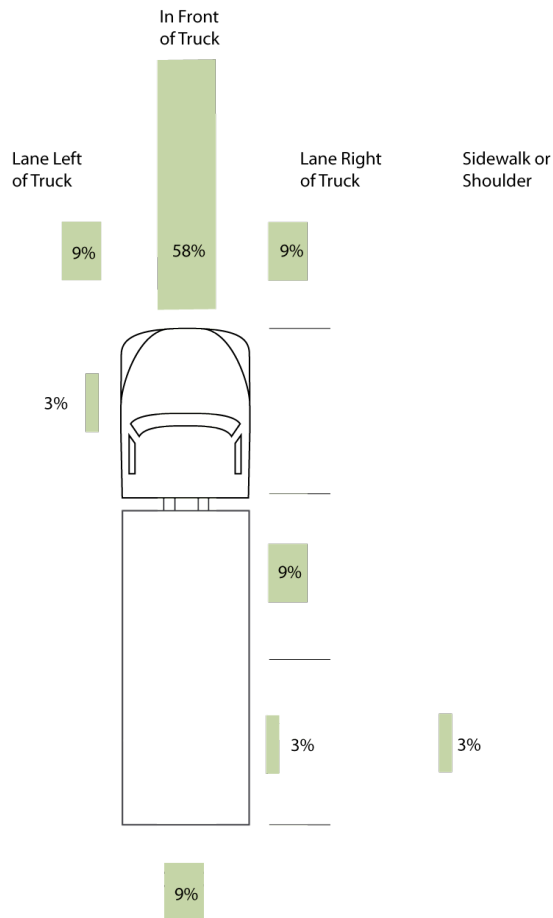

Figure 9. Position of nonmotorist at truck decision point, Start Up Crashes, TIFA 1999-2000, N=38. Other (underneath truck): 3.0%. Position could not be coded for 13.2% of the 38 cases, and are excluded from the percentage calculations.

As in the *LCM right* crash type, the number of cases available for review is small, resulting in relatively large confidence intervals. For example, the estimate that 57.6 percent of the nonmotorists were directly in front of the truck at startup has a 95 percent confidence interval of  $\pm 16.9$  percent. On the other hand, even with that large uncertainty, it is clear that directly in the front of the truck is the primary point of concern.

Older pedestrians are overrepresented in truck *start up* crashes. Older pedestrians tend to move more slowly and take longer to clear the path of the truck. They also are less agile and less able to move out of the way of the truck when it starts unexpectedly. Figure 10 shows the distribution of pedestrian age in fatal crashes. Only pedestrians are included in the figure and separate distributions are shown for the *start up* crash type and all other crash types. Note that the distribution of pedestrian age is significantly shifted to

the right (higher ages) in *start up* crashes compared with pedestrians in all other truck crash types.

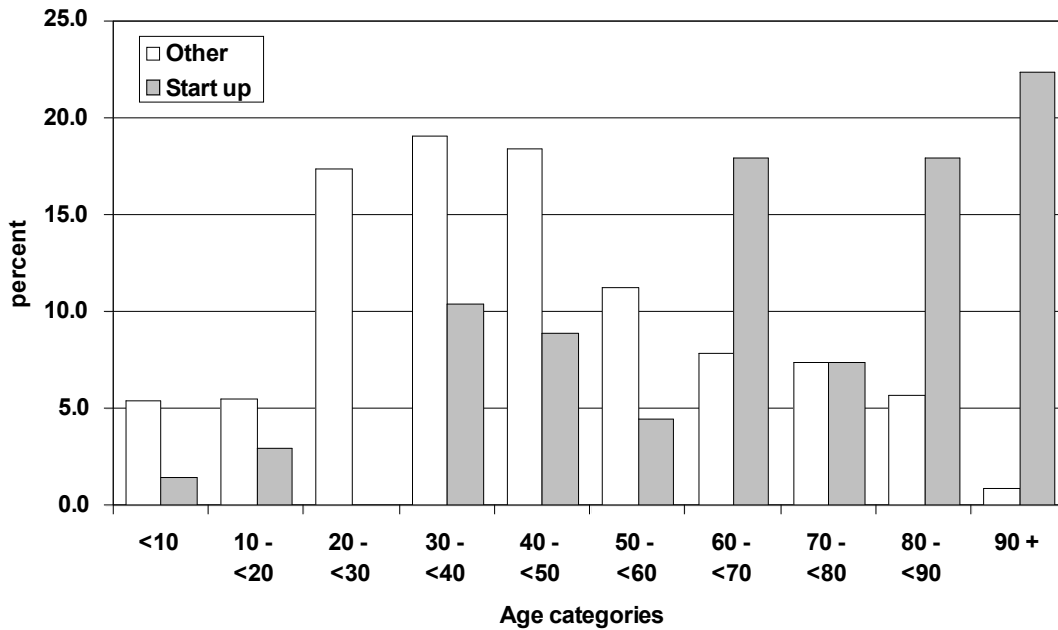

Figure 10. Distribution of pedestrian age in fatal *start up* and other truck crashes. TIFA 1994-2000.

Table 15 is also restricted to pedestrians involved in truck crashes and compares the percentage of pedestrians in three age categories for *start up* and other truck crashes. In fatal truck *start up* crashes, fully 52.2 percent of pedestrians struck are over 65 years old, compared with only 16.5 percent of other truck/pedestrian crashes. Only 3.0 percent are under 17. It appears that older pedestrians are much more vulnerable to this crash type than other pedestrians. Given the fact that the truck driver is largely unable to view the immediate vicinity of the vehicle, in low speed maneuvers the burden of avoiding a collision is largely borne by the other parties around the truck. Populations that are less mobile are especially vulnerable.

Table 15  
 Percentage Distribution of Age of Pedestrians in Start Up  
 and Other Fatal Truck Crashes  
 TIFA 1994-2000

Pedestrian age	Crash type		Total
	Start up	Other	
< 17	3.0	8.2	8.0
17 to 65	43.3	74.4	73.5
> 65	52.2	16.5	17.5
Unknown	1.5	1.0	1.0
Total	100.0	100.0	100.0
N	67	2,252	2,319

*Turn Right Crashes with Nonmotorists* — Turn right crashes involving a truck making a right turn and colliding with a pedestrian or other nonmotorist actually occur in a variety of configurations. Seventy cases were reviewed. Figure 11 shows the most common configurations. In each diagram, the turning arrow represents the truck and the straight arrow represents the movement of the pedestrian, bicyclist, or in one case, a skater on rollerblades. The number of cases is shown for each configuration.

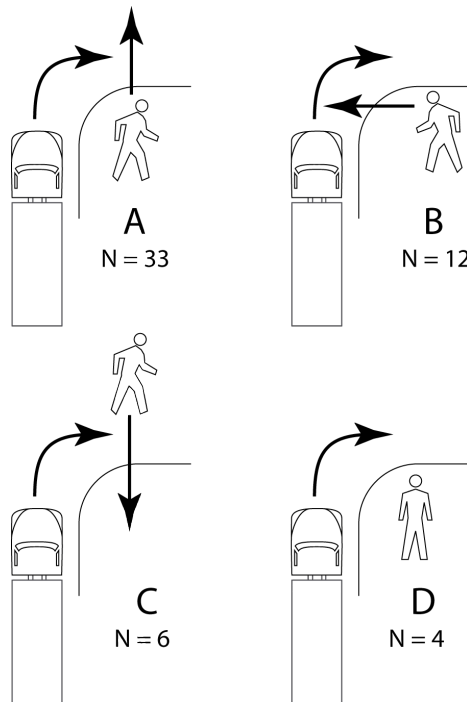

Figure 11. Selected right turn/nonmotorist crash configurations, TIFA 1999-2000.



Most *right turn*/nonmotorist crashes occurred when the truck attempted a right turn and the pedestrian or nonmotorist went straight. Many of these crashes involved a bicycle, either in the lane next to the truck, or riding on the sidewalk next to the truck. Similarly, some of the crashes depicted in diagram B involved a bicycle riding along the side of the road against traffic, on the roadway onto which the truck was turning. Relatively few of the crashes involved off-tracking to the extent that the trailer axles encroached onto the sidewalk during the turn. Diagram D depicts one set, in which the pedestrians were stationary on the corner when struck by the trailer axles. The diagrams depicted in Figure 11 are the primary *right turn*/nonmotorist configurations identified in the case review.

While the number of crashes in which the trailer axles off-tracked up onto the curb and sidewalk is relatively small, off-tracking even when the axles stayed in the road was a factor in many of these accidents. For example, in one case an older woman was crossing the road onto which the truck was turning. The driver stopped to allow the woman to pass in front and waited until he thought she should have made it to the curb. He checked his mirror, did not see the woman, and proceeded. But the woman had paused in the road, and when the truck moved forward, the trailer swung into her, knocked her down, and she was struck by the rear axles.

In a similar case, but a different configuration, an older pedestrian intended to cross the street, as in diagram B in Figure 11. The truck pulled forward to make the turn and in fact swung wide to avoid off-tracking onto the curb. The pedestrian stepped out into the street anticipating the truck clearing, but was taken by surprise as the trailer swung toward him as the truck completed the turn. He attempted to get out of the way, but stumbled and was struck.

Figure 12 shows the position of the nonmotorist prior to the decision point in *right turn* fatal truck crashes. The position could not be determined in 12 of the 70 cases reviewed, or 17.1 percent. Cases coded unknown on prior position are excluded when calculating percentages. About 43 percent of the nonmotorists were on the sidewalk next to the truck prior to the turn. Most of these are about level with the cab or somewhat in front of the cab. The cases coded more than 20 feet to the right are typically bicyclists either on the sidewalk (3.4 percent here) or riding along the curb against traffic in the

roadway (8.6 percent). Another 8.6 percent were on the sidewalk but behind the truck. These cases were bicyclists riding on the sidewalk and overtaking the truck.

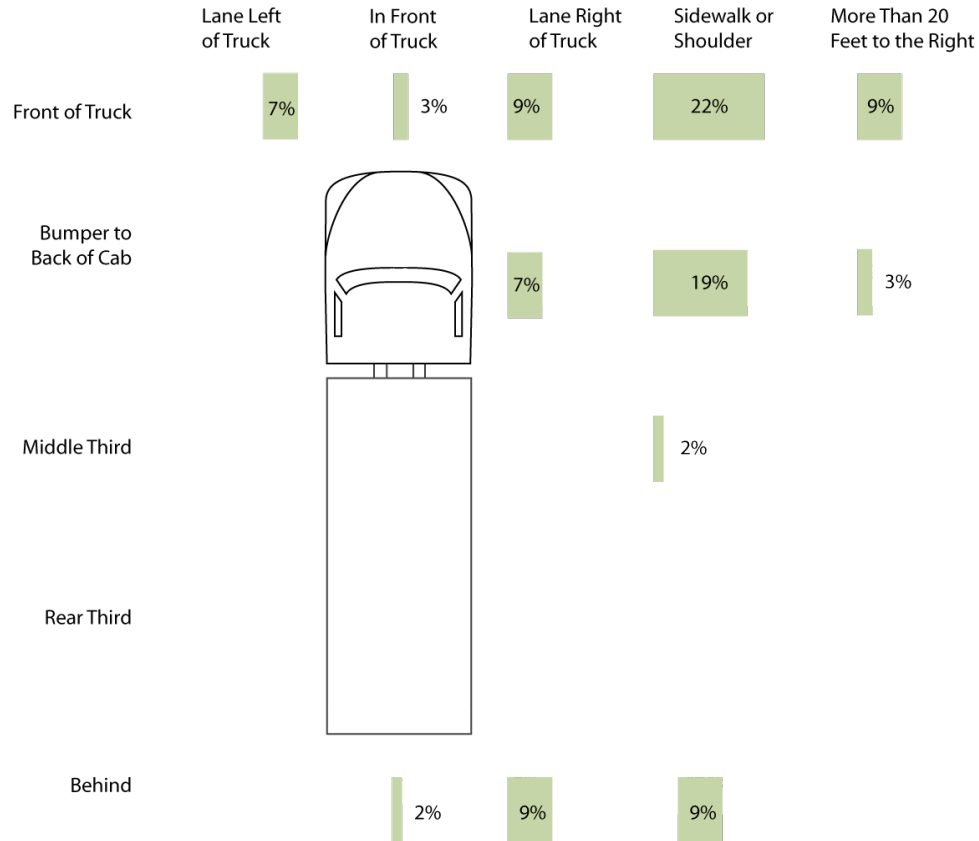

Figure 12. Position of nonmotorist 3-5 seconds prior to decision point, Turn Right/Nonmotorist Crashes, TIFA 1999-2000, N=70. Twelve of 70 cases are excluded from calculation of percentages because the position could not be coded.

About a quarter of the cases coded in the lane next to the truck were bicyclists. The ones behind the truck were overtaking it, while the ones next to the cab or slightly ahead were typically stopped next to the truck, waiting for the traffic signal to change and intending to proceed straight ahead. In virtually all cases, the truck driver reported not seeing the bicyclist. In one such case, a man and a woman on bicycles had stopped next to a concrete mixer, with the man in the lead. When the light changed, the truck started forward to turn but paused to allow the man to clear. The driver did not see the following woman, who collided with the side of the truck as it executed the turn.

Figure 13 shows the position of the nonmotorist at the decision point for the truck. This is the point at which the driver initiated the turn. A third of the nonmotorists for whom this position could be estimated were on the sidewalk or shoulder and even with the cab of the truck. While a few were struck when the truck off-tracked up onto the sidewalk or shoulder, in most cases the nonmotorist proceeded into the street where they were struck. Only 14.8 percent were estimated to be just in front of the truck at turn initiation. Almost 20 percent were in the road and slightly ahead of the truck, but likely still in the forward blind zone.

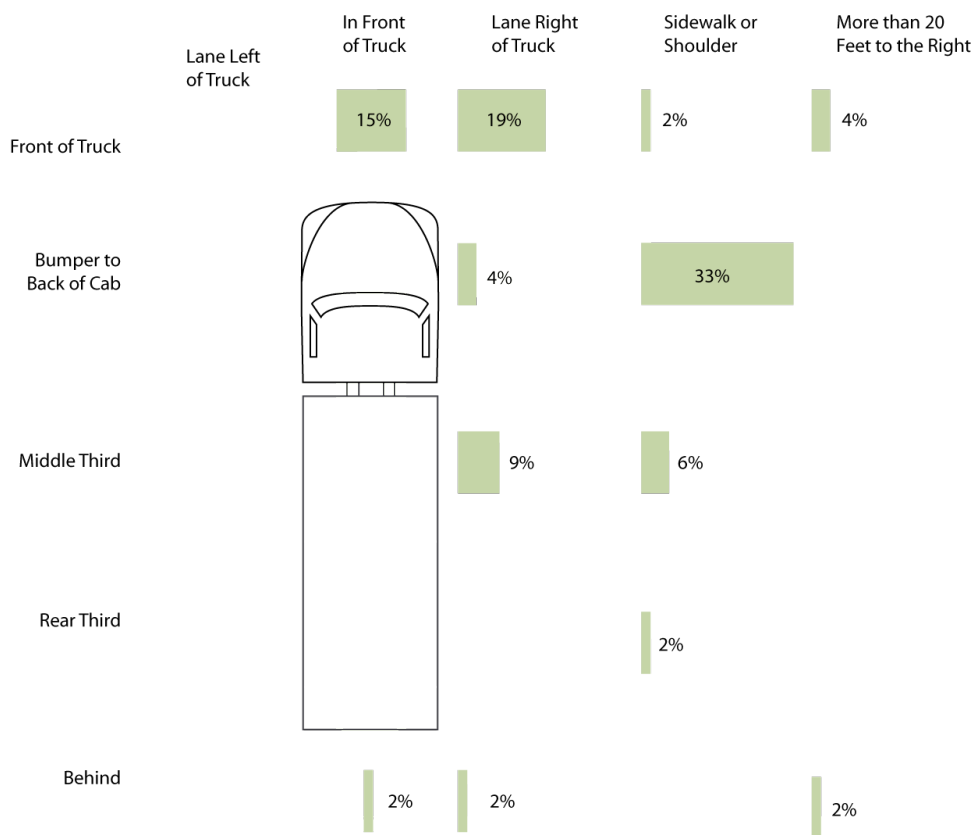

Figure 13. Position of nonmotorist at truck driver's decision point, Turn Right/Nonmotorist Crashes, TIFA 1999-2000, N=70. One case was not applicable (driver lost control due to a medical emergency). Sixteen of 70 cases were excluded from the calculation of percentages because the position could not be coded.

As in *start up* crashes, older pedestrians are significantly overrepresented in *right turn* truck fatal crashes. Almost 42 percent of pedestrians struck in *right turn* crashes were over 65, compared with only 17.0 percent of pedestrians struck in other crash types. From the review of the events of specific crashes it appears that some are similar to *start*

*up* crashes, in that the older pedestrians proceeded more slowly than other pedestrians and the driver's vision was blocked by the hood. But many were related to off-tracking, even when the truck stayed entirely in the road. In these crashes, the pedestrian stepped into the street as the truck started forward, anticipating the truck's movement. But they were taken by surprise when the trailer axles tracked inboard of the tractor, and were unable to move out of the way. It appears that the truck driver had no way to see the crucial areas while making the turn and so had no idea that there was a problem until after the event, either by sensing a thump as the wheels passed over the pedestrian or when alerted by others that an accident had occurred.

Table 16  
Percentage Distribution of Age of Pedestrians in Right Turn  
and Other Fatal Truck Crashes  
TIFA 1999-2000

Pedestrian age	Crash type		Total
	Right turn	Other	
< 17	4.7	8.1	8.0
17 to 65	53.5	73.9	73.5
> 65	41.9	17.0	17.5
Unknown	0.0	1.0	1.0
Total	100.0	100.0	100.0
N	43	2,276	2,319

### 2.3 Summary and Discussion

Mirror-relevant crashes account for almost 20 percent of all crash involvements. That is, crashes in which the truck driver needed to use mirrors to maneuver safely accounted for about one in five truck crash involvements. In most of the mirror-relevant crash types, the crashes involved relatively low closing speeds, either because the truck was moving slowly, as in *start up* and the *turning* crashes, or because both vehicles were moving in the same direction on the same roadway and the truck maneuvered into the other vehicle, as in the *lane change* crashes. In these crashes, the conflict was close to the truck and the driver had to rely on the truck mirrors to determine where the other vehicle or nonmotorist was.

Truck crashes in which the driver must rely on mirrors to move the right are significantly overrepresented in comparison with left moves. *LCM right* crashes occurred over four times more frequently than *LCM left* crashes. Similarly, turn at intersection crashes (*turn right* crashes) in which the conflict comes from the rear are over four times more frequent in right turns than in left. The distance from the driver to the right-side mirror and the relatively smaller image in the mirror makes maneuvers to the right more risky than similar maneuvers to the left.

Given the over-representation of mirror-relevant crashes to the right, it was hypothesized that factors that might further obscure the image would affect the relative frequency. Darkness and weather were both considered. Weather condition was used as a surrogate for splash and spray that may coat the mirrors and obscure the image. Only a relatively small effect was found. When there was precipitation, the over-representation of *right to left LCM* crashes increased by about 10 percent. But in turns at intersection, the ratio of right to left actually decreased by about 10 percent. Possibly splash and spray on the mirrors is not a problem or if it is, it is relative small.

Light condition, however, plays a larger and consistent role. Darkness increased the right/left ratio for *LCM* crashes by about 37 percent. The dark/lighted condition further increased the relative frequency of lane changes to the right. Apparently darkness obscured the view, and when there were streetlights, those lights washed out reflectance from the headlamps of the other vehicle, making it very difficult for the truck driver to detect other vehicles to the right.

Supplemental data on selected crash types reinforced the findings from the analysis of the computerized crash files, and identified the right front as a significant problem area. A sample of police reports on fatal crashes were reviewed for three types: *LCM right*, *start up*, and *right turn*.

In *LCM right* crashes, the area to the right of the cab or just in front appeared to be a significant problem. In over half of the crashes reviewed, the other party was in that area three to five seconds prior to the collision. And in almost half of the collisions, the other vehicle was to the front right of the truck's cab when the truck driver initiated the move to the right. Identification of front right as major area of concern is reinforced in

the mass crash data by the findings on the initial impact point. Where the *LCM* was to the right, there was a concentration at the front of the vehicle with almost 61 percent of the impacts. In contrast, where the *LCM* was to the left, impact point distribution was bimodal, with about 25 percent to the front left, about 25 percent to the rear left and the remainder distributed in between.

In *start up* crashes where the other party was a pedestrian and was struck by the front, it is likely that in most cases the driver's view was obstructed by the hood. Most drivers said they never saw the pedestrian, while some drivers said they saw the pedestrian crossing and paused until they thought the pedestrian had cleared. For most pedestrian *start up* crashes, the pedestrian was either in front of or near the front of the truck three to five seconds prior to the collision. Almost 60 percent were in front of the truck at the decision point, and an additional 18.2 percent were either immediately to the left or right of the front of the truck. In the remainder, the pedestrian was behind the truck and it rolled back, or the pedestrian was attempting to cross between the truck and trailer. Clearly the primary zone is immediately in front of the truck.

Older pedestrians were significantly overrepresented in *start up* crashes. Over half of the pedestrians struck were over 65, compared with only 16.5% for other types of truck/pedestrian fatal crashes. In many of the collisions with older pedestrians, their shorter stature and slower foot speed were factors mentioned in the police reports. The truck drivers who saw the pedestrian prior to the collision waited until they thought it was safe to proceed. But without cross-view mirrors, the driver has no way of seeing the area in front of the vehicle, so the burden of crash avoidance falls largely on the pedestrians.

*Right turn* crashes are more complex, and involved off-tracking as well as blind spots. When the crashes involved bicyclists stopped alongside the truck in the street, the driver frequently stated that he could not see them. These crashes were like *start up* crashes in that typically the bicyclist was waiting along side the truck, unseen by the driver, and when the truck started forward, the bicyclist did also and was struck when the truck turned. In most cases in which the bicyclist was initially on the sidewalk, the bicyclist attempted to cross in front of the truck without stopping. In all such cases, the truck driver reported not having seen the bicyclist prior to making the turn.

There were a few cases of classic off-tracking, in which the trailer or truck rear axles mounted the curb and encroached on the sidewalk or shoulder. But much more common were collisions in which the truck initiated its turn—in some cases swinging wide so as to avoid running up on the curb—and the pedestrian stepped out into the street, anticipating the truck clearing out. But when the trailer swung toward them as the trailer axles tracked inboard of the tractor path, the pedestrian was unable to get out of the way in time and was struck. Older pedestrians were also over-represented in *right turn* crashes, with pedestrians over 65 accounting for almost 42 percent of the involvements, compared with 17 percent of other crash types.

In sum, the area to the right of the truck, particularly right forward, is clearly significantly overrepresented in certain crash types. In lane change crashes, movement to the right is overrepresented by over four times compared to movement to the left, and the problem is exacerbated at night and in dark/lighted conditions. In low speed maneuvers involving pedestrians and other nonmotorists, the fact that the truck driver is largely unable to view the immediate vicinity of the vehicle places the burden of avoiding a collision largely on the other parties around the truck. Populations that are less mobile are especially vulnerable. The critical areas are immediately in front and to the right of the truck.

## 3.0 EMPIRICAL TEST OF MIRROR SYSTEMS

### 3.1 Introduction

In this section, we describe a pilot experiment that was designed to quantify the difficulty of a driver's visual scanning task for various locations around a heavy truck and for different mirror systems. The purpose of this experiment was to develop a method and to provide preliminary data on visual difficulty.

The method was implemented in a static, parking lot setting, but it is intended to be extendable to fully dynamic driving situations in actual traffic. Making this extension will require further work, and presumably will require some modifications of the procedure.

Crash data, described in Section 2 of this report, provide one source of information about the areas in which a driver experiences visual difficulty. The right side appears to present more of a problem than the left, and this difference appears to be higher at night than during the day. Data from the current experiment can be compared to the findings from the crash data. This approach will allow us to develop a model of visual difficulty to account for the major findings in the crash data, and, more importantly for practical considerations, make valid predictions about the efficacy of various countermeasures, such as innovative mirror systems, to reduce problems with visual difficulty.

### 3.2 Methods

An outdoor, parking lot situation was used to simulate statically the most important visual circumstances that a driver would be presented with in traffic that is moving at a common speed on a multilane road.

*Subjects* — Six professional truck drivers were paid to participate in the study. All were male and ranged in age from 39 to 63, with an average age of 51.8 years. Gender and age were not explicitly selected in determining the sample. Subjects were recruited through e-mail messages that were sent to truck drivers in the southeast Michigan area who were members of the Owner-Operator Independent Drivers



Association (OOIDA). By self-report, the subjects ranged in years of professional driving experience from 5 to 45, with an average of 17.2 years.

*Vehicles* — Two vehicles were used: a tractor-trailer and a passenger car. The tractor-trailer consisted of an International tractor and an UMTRI box trailer. As shown in **Error! Reference source not found.**, the entire combination was 19.5 m (64 ft) long. The trailer itself was 13.7 m (45 ft) long. The passenger car was a 1993 Nissan Altima.

*Mirrors and Fields of View* — Three mirrors were mounted on each side of the tractor: a flat (west coast) mirror, a window-mounted convex mirror, and a fender-mounted convex mirror. All mirrors were left in place throughout the experiment, but black covers were placed over one or the other of the convex mirrors during blocks of trials when they were not to be used. The mirrors were aimed using the guidelines developed by Liberty Mutual (1998). The convex mirrors were aimed for a typical driver's eye position and were not reaimed for individual drivers. This proved to be satisfactory for all drivers, primarily because of the wide fields of view of those mirrors. The west coast mirrors were reaimed for each driver. The visibility of the passenger car in the fields of view of the three mirrors is characterized in Table 17, and the fields of view are shown in Figure 14.

Table 17  
 Visibility of the Passenger Car in the Three Rearview Mirrors, Right Side  
 (empty cell = no visibility, x = partial visibility, xx = full visibility)

Distance aft of Front Bumper (m)	Mirror		
	Flat (west coast)	Window Convex	Fender convex
0		x	xx
1		x	xx
3		x	xx
5		x	xx
10		xx	xx
15	x	xx	xx
20	xx	xx	xx
25	xx	xx	xx
30	xx	xx	xx
35	xx	xx	xx

*Field Setup* — The study was conducted in a flat, open area of the UMTRI parking lot. The setup is diagrammed in Figure 14. The tractor-trailer was parked at one end of the area, so that the passenger car could be placed in a variety of positions alongside or behind it. Using visual reference marks that were not visible from the cab of the tractor-trailer, the car could be placed at 0, 1, 3, 5, 10, 15, 20, 25, 30, or 35 m behind the tractor-trailer (measured from the front of the tractor to the front of the car). The car could be one lane to the left, one lane to the right, or two lanes to the right of the tractor-trailer. Lanes were 3.7 m (12 ft) wide. The parking lot was equipped with fixed lighting, but that lighting was turned off for the night condition.

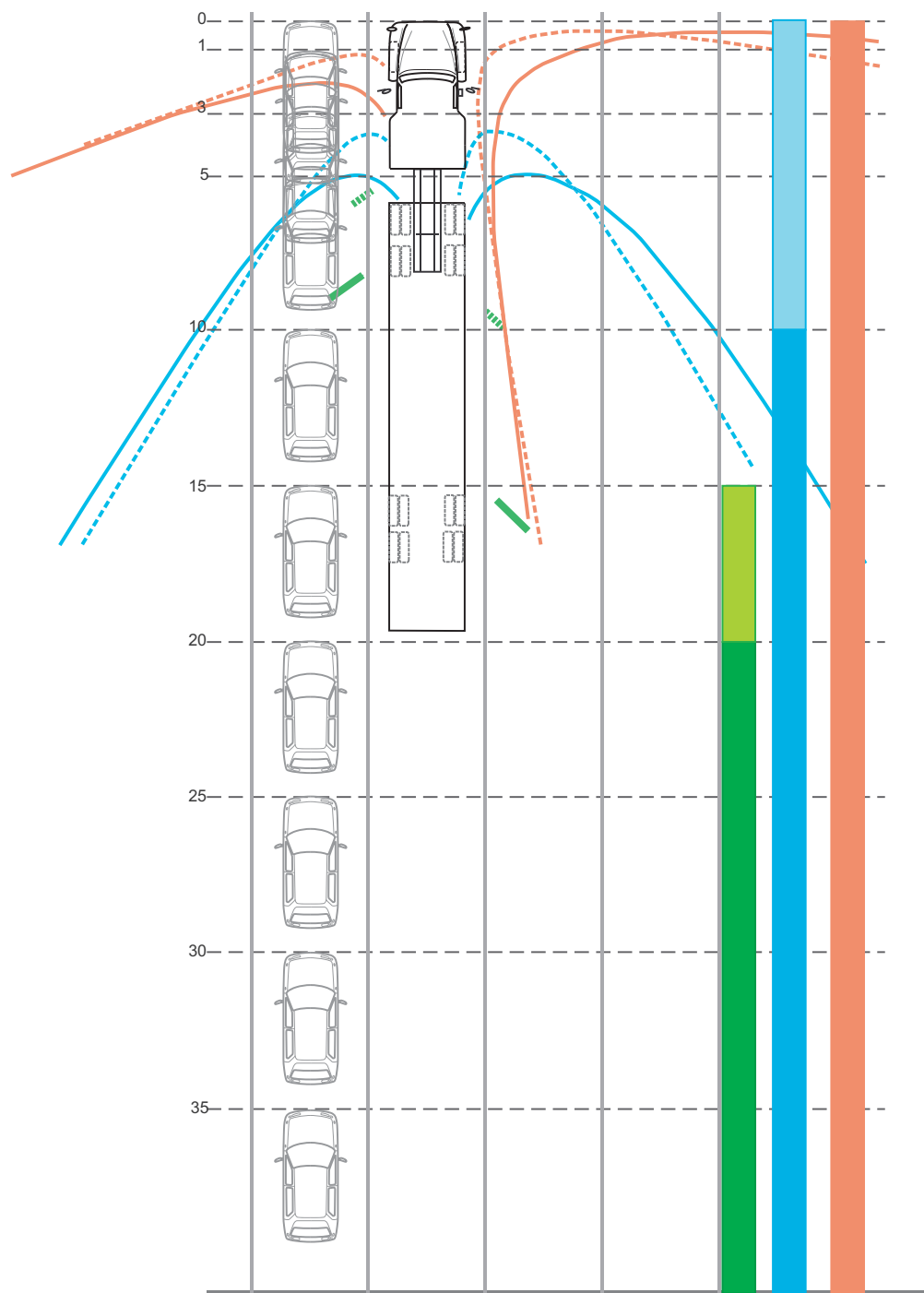

Figure 14. The field setup, showing the position of the tractor-trailer and the potential positions of the passenger car one lane to the left (similar positions could be occupied in the first or second lane to the right of the tractor-trailer). Approximate mirror fields of view are shown for the planar mirrors (green), door-mounted convex (blue) and fender-mounted convex (orange) on the ground plane (solid lines) and 1.2-m plane (dotted lines). The colored bars to the right show the approximate visibility of the target vehicle in each of the right-side mirrors as a function of distance aft of the front bumper. For example, the vehicle was partially visible in the planar mirror at the 10-m mark and fully visible at the 20-m mark.

*Procedure* — Each subject participated individually. For each subject, there were two sessions, each about two hours long. The first was always a day session and the second was a night session. At the beginning of the first session, each subject filled out a brief questionnaire about his professional driving experience and use of rearview mirrors on heavy trucks. He was also given a vision test. He was then seated in the tractor-trailer and the west coast mirrors were aimed.

The procedure was the same for the night and day sessions. For the night sessions, all fixed lighting was turned off before the session began. During each session, 8 blocks of trials were run. Each trial began with the driver looking at a designated point inside the cab. This allowed the passenger car to be moved into position without the subject seeing it. During nighttime sessions, the car was moved into position with the headlamps off so that the subject could not sense the position of the car by direct or reflected light from the headlamps. The headlamps were turned on after the car was in position. So that the headlamps would not make it possible to discern the location of the car after they were turned on, different visual fixation points were used for the day and night sessions. During daytime sessions, the subject looked at a small indicator lamp on the lower part of the instrument panel, below the steering wheel. During nighttime sessions, the subject looked at a position on either the right or left interior of the cab (opposite the side on which the car might be positioned for that trial). At the end of each session, the subject completed a short debriefing questionnaire. At the beginning of each trial, an experimenter in the rear of the cab warned the subject that a trial was about to begin.

The experimenter then initiated a trial by pressing a button on a computer that kept track of trials and collected responses from the subject. The computer then either turned on the indicator light (during daytime sessions) or made an audible signal (during nighttime sessions). These signals indicated to the subject that he should look to a predesignated side of the truck (right or left), and, using any combination of direct and mirror fields of view, determine whether the car was present on that side in a location that would be in conflict with a lane change to that side. He was to make that determination as quickly as possible and indicate his decision by pushing one of two buttons on a small hand-held box: one marked “Go” (indicating that the car was either not present, or was

present in a position that did not conflict with a lane change), and one marked “No go” (indicating that the car was present and in a position that conflicted with a lane change). The computer recorded which button was pushed, and the time between the signal to the subject (the indicator light or audible signal) and the button push.

During each block, the car, if present, was always on the same side of the truck. The subject was therefore always aware of which side to look to on each trial. During each of the first 6 blocks, the car, if present, was always either one lane to the left or right of the truck. The first six blocks each consisted of 15 trials, including 5 on which the car was not present and 10 on which the car was present at each of the longitudinal positions (0, 1, 3, 5, 10, 15, 20, 25, 30, or 35 m). The seventh and eighth blocks each consisted of 12 trials, including 4 on which the car was not present and 8 on which the car was present at each of four longitudinal positions (5, 15, 25, or 35 m) one or two lanes to the right of the truck. On trials when the car was not present, it was positioned in the blind zone behind the truck so that it would not be visible to the subject in any direct or mirror field of view. Within each block, the order of trials was randomized so that the subject could not predict whether the car would be present, or in what position it might appear.

It was left to the subject’s judgment to decide whether the car was in a position that would be in conflict with a lane change. This was true for both longitudinal position (in all blocks of trials) and lane position (in the last two blocks of each session, during which the car might be either one or two lanes to the right).

The availability of mirrors was changed between blocks of trials, and remained fixed within each block of trials. For each session, the first six blocks of trials included the following three sets of available mirrors, once on each side: (1) flat, window-mounted convex, and fender-mounted convex; (2) flat and window-mounted convex; (3) flat and fender-mounted convex. For each session, the seventh and eighth blocks included the following two sets of mirrors: (1) flat, window-mounted convex, and fender-mounted convex; (2) flat and window-mounted convex.

### 3.2 Results and Discussion

Results are reported in terms of response type and then reaction time. Finally, we discuss the relationship between response type (coded as correct or incorrect) and reaction time.

*Proportion “go” responses* — The proportion of “go” responses is shown in Figure 15 as a function of distance behind the front of the tractor-trailer, for the left and right sides. There were very few go responses for positions within the first 20 m, as might be expected because there was overlap between the vehicles for all positions back to 15 m, and there was so little clearance at 20 m (see Figure 15) that many people would consider “no go” to be the correct response for that position as well. There are a few go responses at very short distances, but only on the right side. All go responses at short distances can be considered mistakes, because the passenger car was clearly in conflict with a lane change by the tractor-trailer when it was in those positions.

The same data are shown in Figure 16 broken down by night and day. The increase in go responses with distance is shifted to higher distances at night, as if drivers were more conservative at night, perhaps because the task was more difficult in the more limited viewing conditions of nighttime. Figure 16 shows that the go responses at the very short distances occur primarily at night.

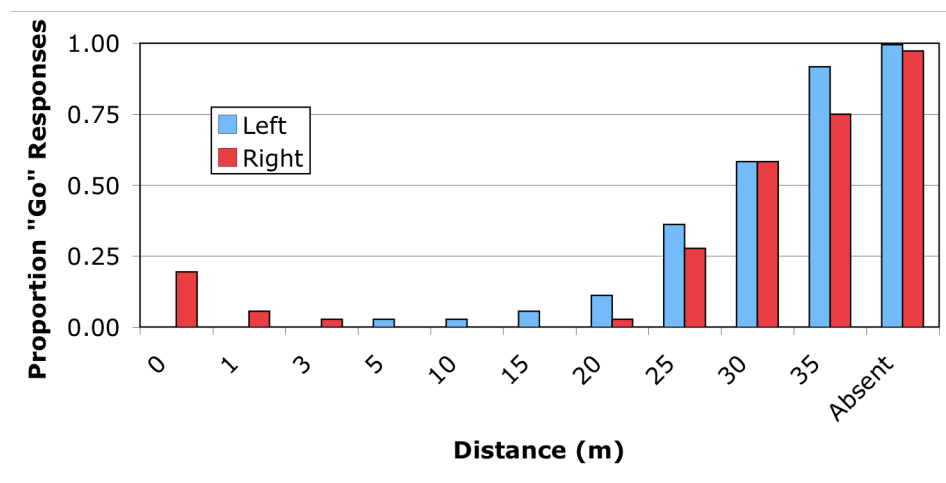

Figure 15. Proportion “go” responses by side and distance of the target passenger car.

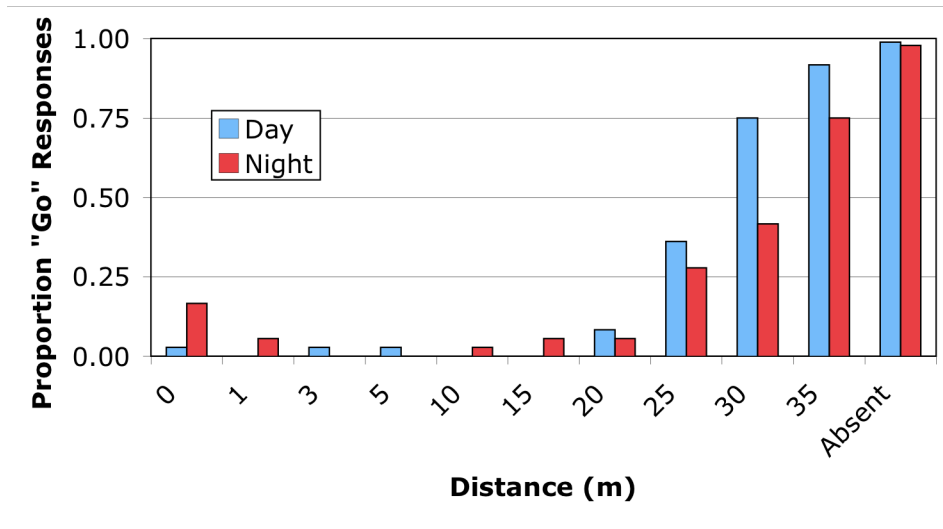

Figure 16. Proportion “go” responses by light condition and distance of the target passenger car. Right and left sides combined.

Figure 17 shows the data for the right side only to emphasize the effects on that side. It is clear that the go responses at very short distances are primarily limited to the night condition on the right side. That combination of conditions could be expected to be the most difficult, given that direct views out the window are more limited on the right side, and that partial visibility of the passenger car, near the edge of the window-mounted convex mirror, may be less useful in the limited viewing conditions of nighttime.

Figure 18 shows a breakdown of responses by side and time of day simultaneously. This view of the data makes it clear that the go responses at short distances are in fact primarily limited to the right side at night. This corresponds well to the crash data, which indicate that crashes are overrepresented for the same combination of conditions. Figure 18 also illustrates that the tendency to shift go responses to higher distances that is evident in Figure 15 and Figure 16 is mostly restricted to the combination of right side and night. Because this could be considered conservative behavior, it would not be expected to lead to more crashes if it were happening in actual driving, but it is also consistent with the hypothesis that there is an interaction of the difficulties that drivers experience in seeing to the right and the reduction in visibility caused by night conditions, such that the combination of right side and night is particularly difficult.

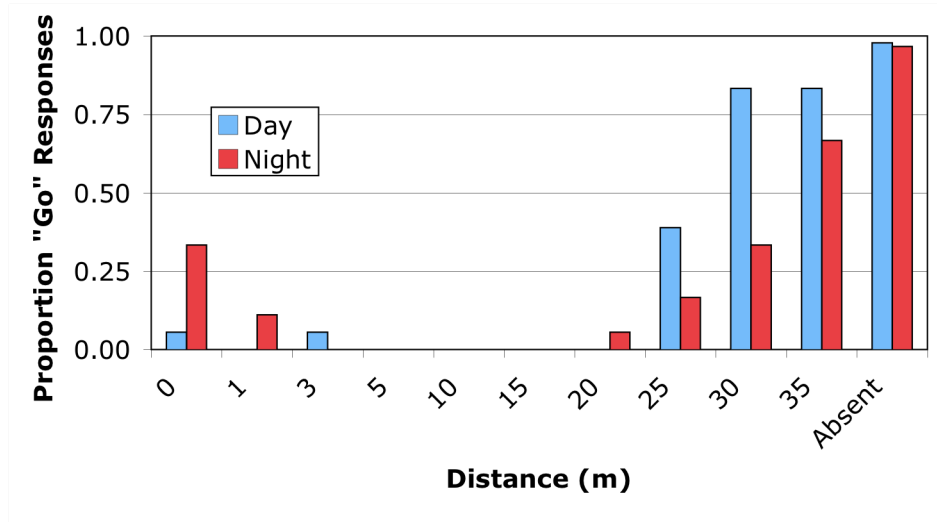

Figure 17. Proportion “go” responses by light condition and distance of the target passenger car. Right-side data only.

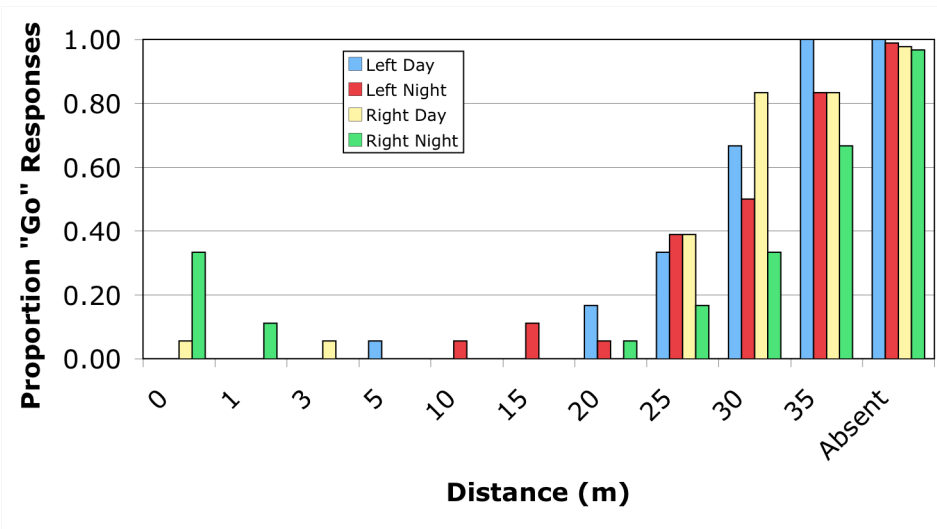

Figure 18. Proportion go responses by distance for each combination of side and light condition.

Although it was left to the subjects to decide which positions of the passenger car were in conflict with a lane change by the tractor-trailer, some patterns in the data are best illustrated by imposing a rule that allows us to classify responses as right or wrong. First, it is reasonably clear that all go responses at distances less than 20 m should be considered errors. A distance of 20 m is more ambiguous, but certainly lane change maneuvers in that configuration would be risky by many drivers. **Error! Reference source not found.** shows responses coded as error rates, using the assumption that no go is the correct response at all distances of 20 m or less, and that go is correct at all distances of 25 m or more. Using that assumption, the error rates at 25 m are particularly high, and it might be argued that the criterion for the no go response should be pushed



back to 30 m. However, the patterns of errors highlighted by this analysis, and which we will relate to reaction time data below, would not be critically different if the criterion were shifted to 30 m.

Figure 19 illustrates and highlights several aspects of the subjects' responses that can be considered errors. First, there are errors on the right side at night at short distances. Second, there are many nominal errors when the passenger car is just behind the end of the trailer, a circumstance that perhaps should be viewed mainly as an indication of the ambiguity of those situations. Third, whatever distance is used as the criterion for when there is enough clearance to allow a lane change, there will be a particularly large number of trials on the right at night that can be considered errors in a conservative direction.

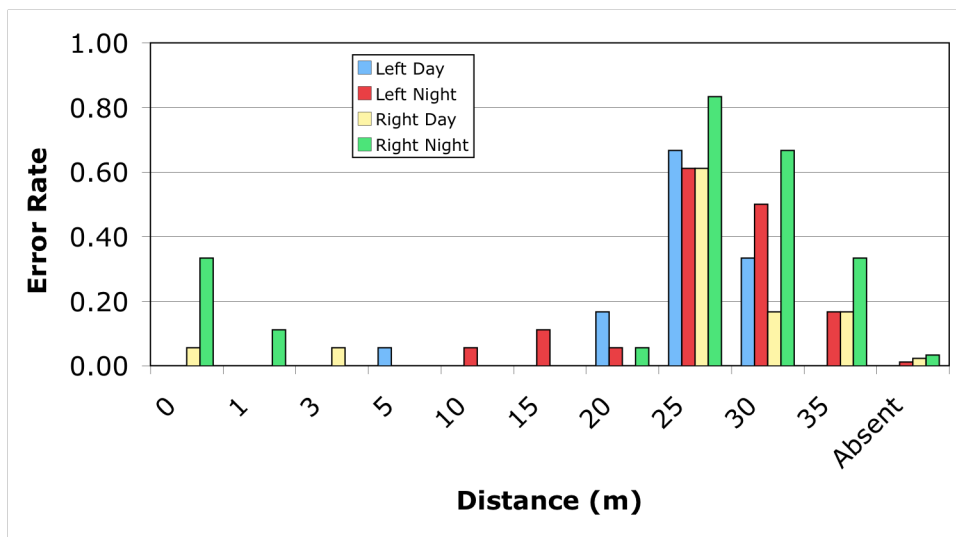

Figure 19. Responses recoded as error rates, based on 25 m as the criterion for adequate separation for a lane change.

Figure 20 shows the error rates in Figure 19 referenced to the condition with the fewest nominal errors (the left side in the daytime). This emphasizes the relative difficulty of the various conditions, showing the previously noted pattern in which the right side at night is especially difficult.

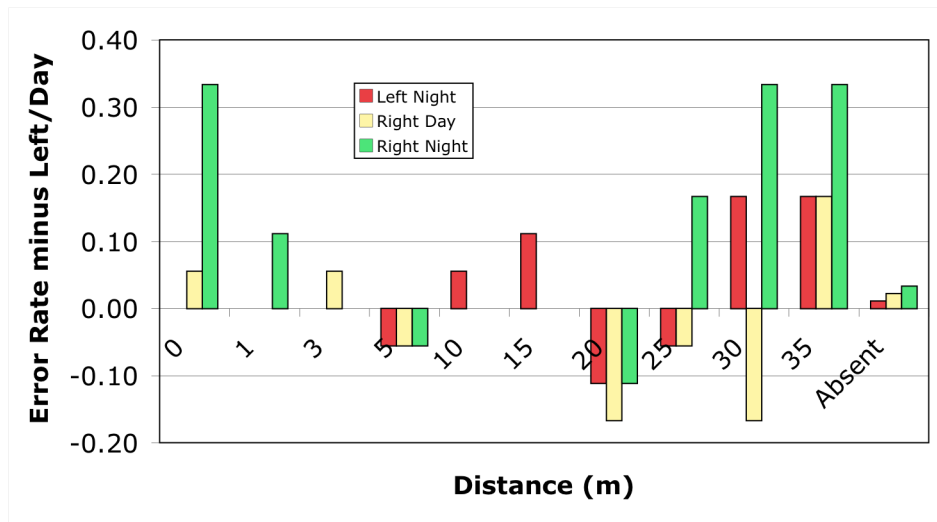

Figure 20. Error rates referenced to the left-day condition.

Figure 21 shows a summary of responses from the blocks of trials in which the passenger car could appear either one or two lanes to the right of the tractor-trailer. In those blocks, subjects had to decide not only whether the passenger car was clear of the rear end of the trailer, but which lane it was in. For the most part, they could decide the lane location reliably. The proportions of cases in which the car was two lanes to the right but subjects indicated no go may be attributable to conservative decision making, to avoid a possible conflict with a car that might itself change lanes, rather than to a misperception of which lane the car was in. Lane location and distance to the rear clearly interact in the final decisions made by these subjects, but the extent to which this pattern reflects their intended strategy (or a normative strategy) and the extent to which it reflects any errors in their perceptions of the location of the passenger car are difficult to separate in these data.

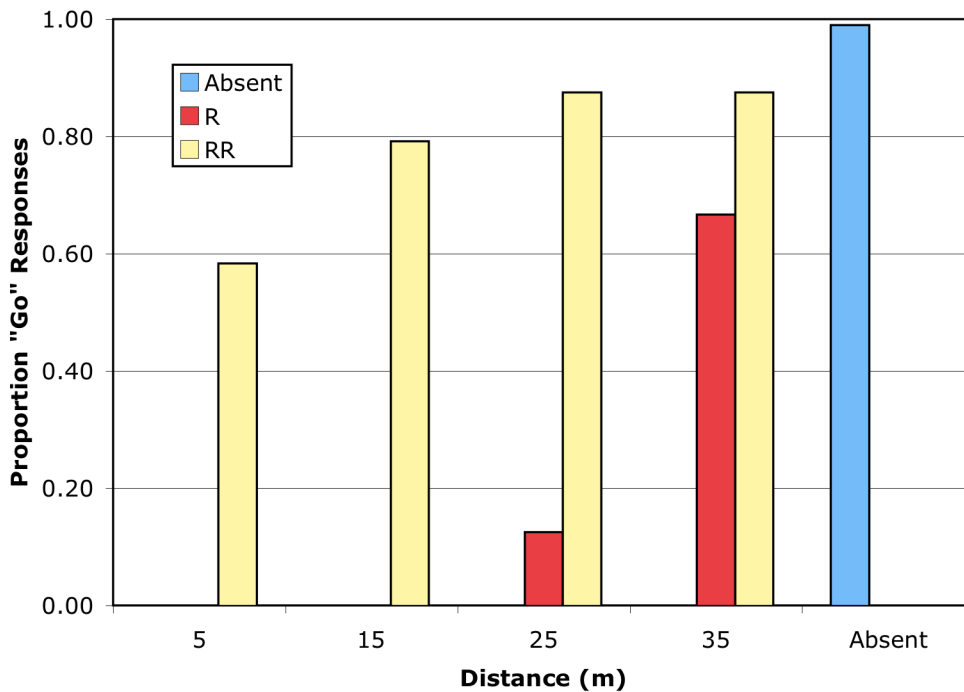

Figure 21. Proportion “go” responses by lane and distance of the target passenger car, for trials in the blocks using two lanes to the right of the truck (R indicates one lane to the right, RR indicates two lanes to the right).

*Reaction Time* — Figure 22 shows reaction times for each distance on the left and right sides. The times were mostly between 1 and 2 seconds—on the slow side but not out of line with decisions that drivers may make in real traffic when anticipating a lane change. Reaction times are consistently higher on the right side, and the difference is particularly large for the very short distances, at which there were a substantial number of trials that can be considered errors. There also appears to be a rise in reaction times when the passenger car is near the end of the trailer (about 20 m). The extra time is presumably associated with the need to make finer discriminations, or perhaps to take into account strategic considerations, when the clearance with the end of the trailer is marginal.

Figure 23 shows the reaction time data further broken down by time of day. As might be expected on the basis of the results for response type and errors, the high reaction times for short distances on the right side are particularly high at night. Interestingly, there is not a general increase of reaction times at night. Rather, the increase at night appears to be limited to the short distances on the right. However, interpretations of the overall effect of night versus day have to be considered tentative, given that in the design of this study all subjects completed the day condition before the

night condition. Practice effects could therefore be expected to cause a general improvement in the night condition.

Figure 24 shows reaction times referenced to the condition that had the shortest reaction times (and the lowest error rates, as shown in Figure 20). This highlights the relative difficulty of the various conditions. As with the error rates, it indicates that the combination of the right side and nighttime is particularly difficult. The right side during the day is also difficult by the reaction time measure. At least in terms of reaction time, the left side at night is not much more difficult than during the day.

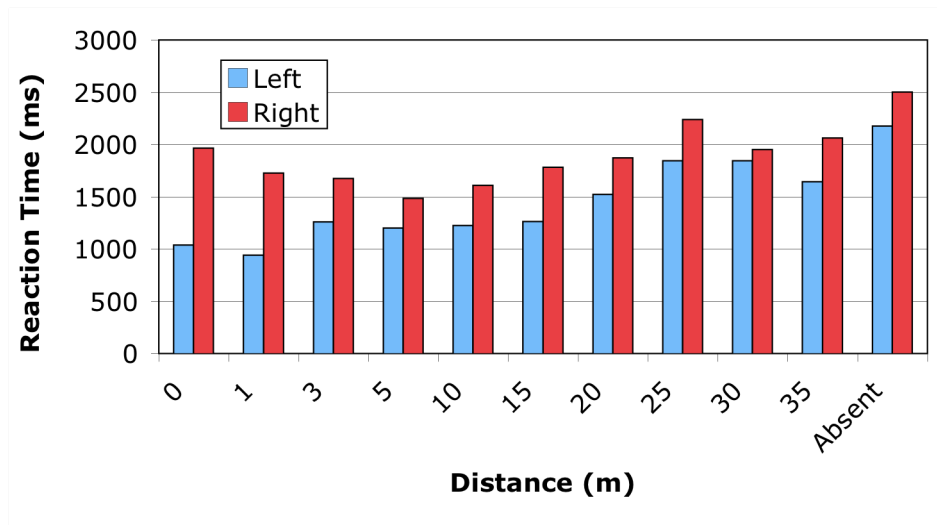

Figure 22. Reaction time by side and distance of the target passenger car.

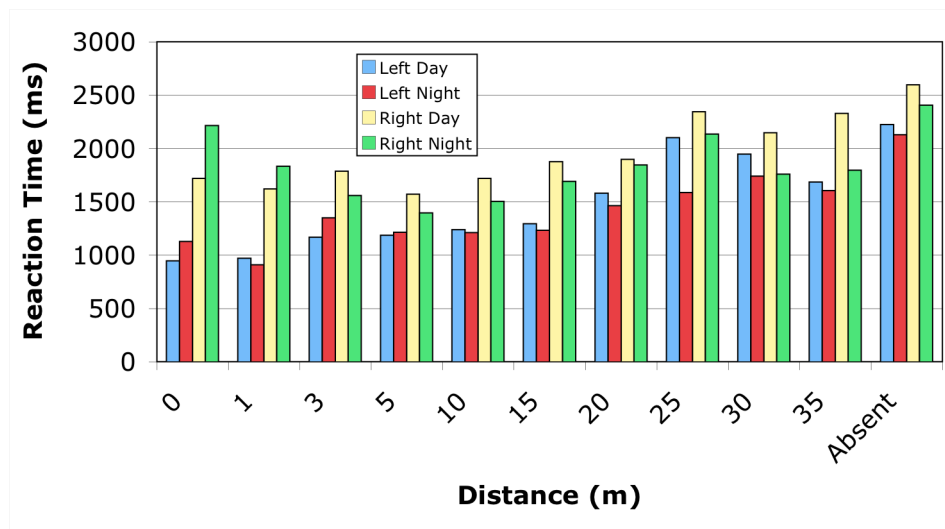

Figure 23. Reaction time by side, light condition, and distance of the target passenger car.

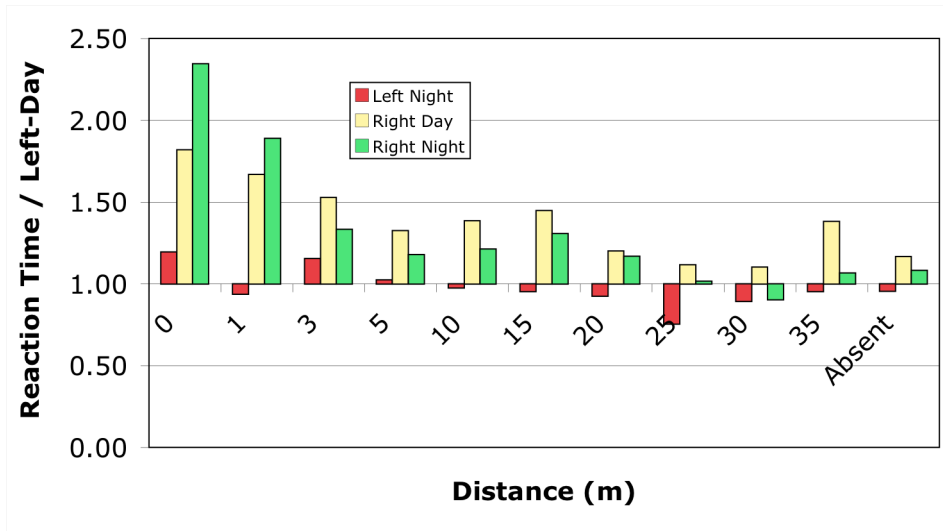

Figure 24. Reaction times referenced to the left-day condition.

Figure 25 shows the relationship between reaction times and error rates (as shown in Figure 19) for all combinations of side and distance. There is a clear positive relationship, with the conditions that lead to more errors also requiring the longest reaction times. This relationship makes interpretation of both the reaction time and error rate results relatively straightforward, because both measures lead to similar conclusions. The opposite relationship, a tradeoff between reaction time and error rate, is sometimes observed and is usually considered an indication of relatively complex strategic effects on the part of subjects.

Figure 26 shows the relationship between reaction time and error rates for the three different mirror conditions. The best performance, in terms of both speed and accuracy (at least as quantified here) was for the innovative condition in which there was a fender-mounted convex mirror, but no window-mounted convex mirror. Although these pilot data cannot be considered conclusive, the favorable results for this condition suggest that the possibility of substituting a fender-mounted convex mirror for the currently standard window-mounted convex mirror should be further investigated.

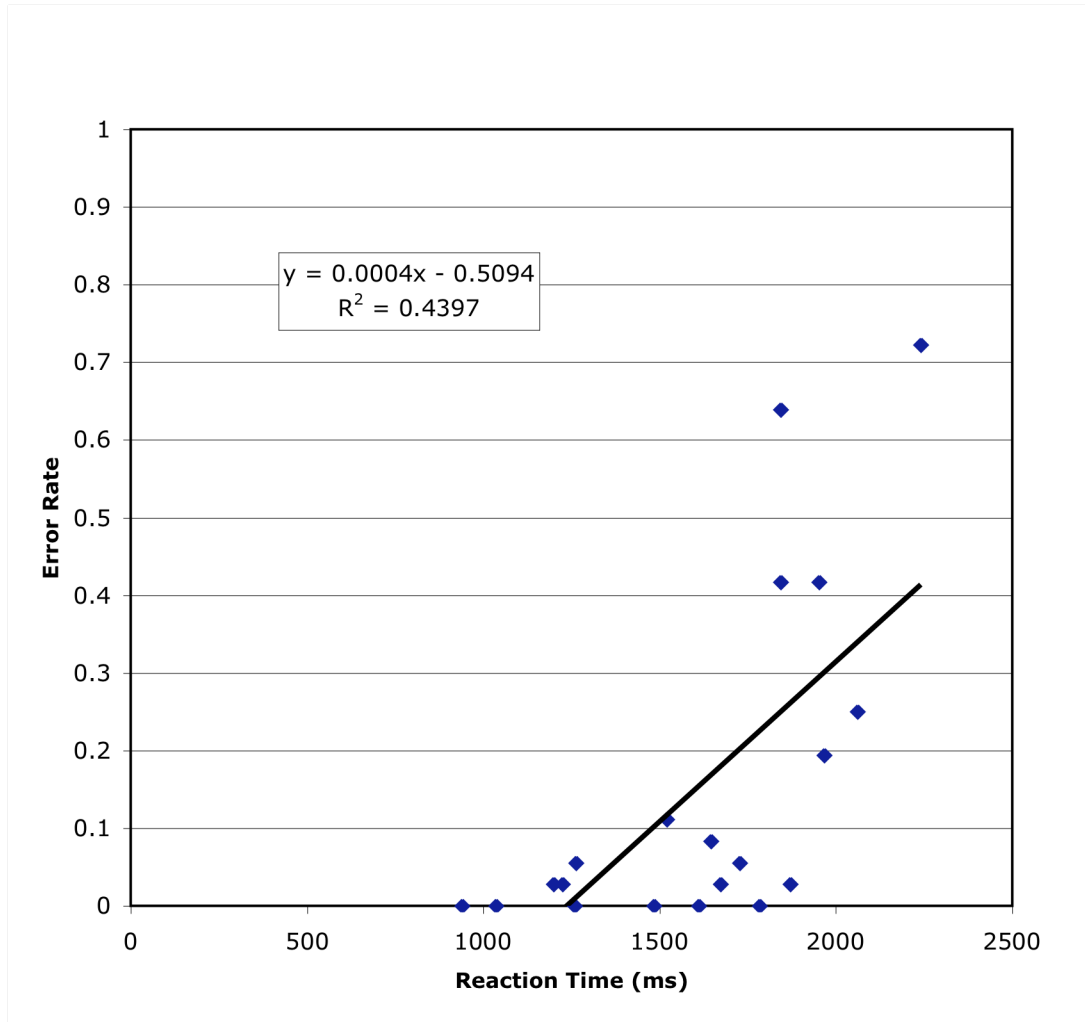

Figure 25. The relationship between reaction time and error rate for the 20 combinations of side (L/R) and distance. Conditions in which the passenger car was absent are not included.

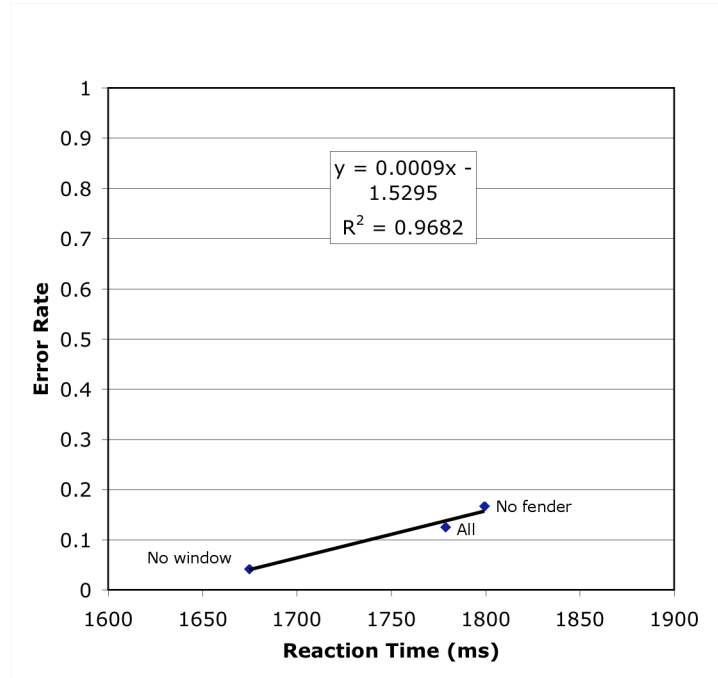

Figure 26. Speed and accuracy by mirror condition. For right, night, and distances of 5 m and lower.

Figure 27 shows a histogram of responses to a question about the overall value of fender-mounted mirrors. This group of drivers was generally positive about these mirrors.

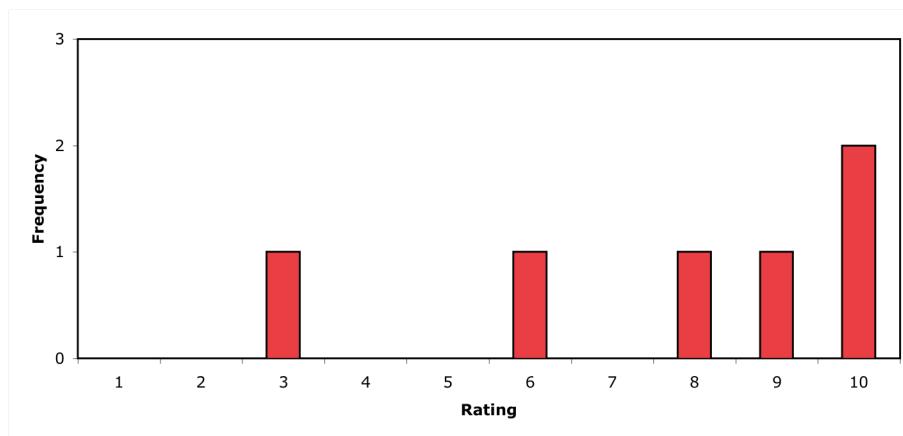

Figure 27. Ratings of the value of fender-mounted mirrors by the six subjects (10 is better).

### 3.4 Summary and Conclusions

The empirical results for driver visual performance are consistent with the crash data described in Section 2. There appears to be converging evidence for a visibility

problem on the right side, toward the front of tractor-trailers. Preliminary results for three different mirror systems are not conclusive, but suggest that the best visual performance may result from an innovative system in which a fender-mounted convex is used to replace, rather than supplement, the currently standard window-mounted convex mirror.





## 4.0 PRIORITIZATION OF ZONES FOR DRIVER VISION IMPROVEMENT

### 4.1 Zone Definition and Rationale

One objective of this study was to determine which aspects of driver vision most required improvement. Based on the crash data results presented in Section 2, and the supporting findings from the pilot study of driver performance presented in Section 3, a set of four plan-view zones has been developed and prioritized. Figure 28 presents these zones, which lie forward, rearward, and to the right of the truck.

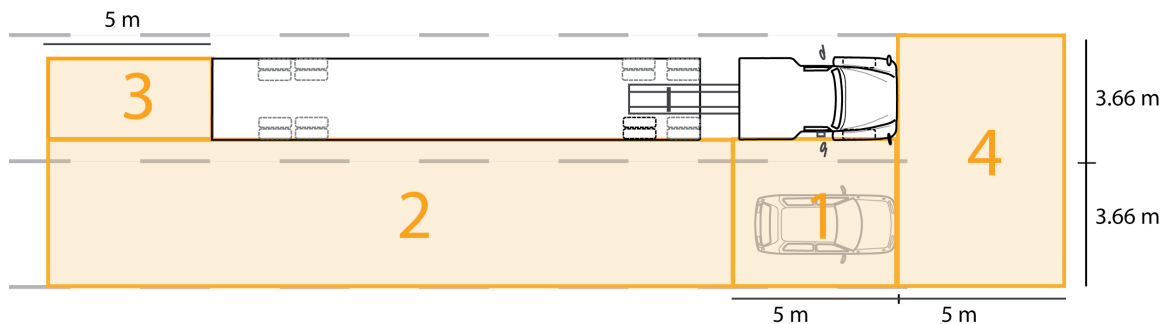

Figure 28. Prioritized zones for driver vision improvement. The highest priority zone is indicated with numeral 1.

**Priority 1 (highest): The area immediately to the right of the cab, extending to the far side of the adjacent lane and 5 m rearward from the front bumper.**

The crash analysis presented in Section 2 shows that the area immediately to the right of the cab is the area of highest concern. This is the most common location for contact with another vehicle during truck-initiated lane-change/merge crashes. This zone also encompasses the most common initial (pre-maneuver) positions for non-motorists struck during start-up and right-turn crashes. In the pilot study (Section 3), drivers took the longest to detect lane-change conflicts in this area. The geometric analysis of direct and indirect fields of view for an exemplar cab showed that a small vehicle in this location could be completely obstructed from direct view and not visible with door-mounted mirrors. The driver's only view of objects in this area was provided by the fender-mounted convex mirror.

**Priority 2 (second highest): The area immediately to the right of the truck, extending to the far side of the adjacent lane, beginning 5 m from the front bumper and extending to a line 5-m rearward of the back of the truck (including trailer).** Right-going, truck-initiated lane-change/merge crashes are approximately 4.5 times more

likely than left-going crashes. Even after accounting for the substantial percentage of these crashes in which the struck vehicle is in zone 1 immediately prior to the truck-initiated maneuver, the area adjacent to the right side of the truck and extending one car-length behind the back of the truck remains a high priority. Although vehicles that are centered in the adjacent lane in this zone are usually partially or wholly visible in the door-mounted planar mirror, the door-mounted convex mirror is the only means most drivers have to view the entirety of the zone. The difference in response times between the left and right sides in the area rearward of the cab (see section 3) suggests that the combination of mirrors available on the right side is less effective than the mirrors on the left side.

**Priority 3 (third highest): The area immediately behind the truck.** The crash analysis in Section 2 shows that backing crashes are the most common type of truck-initiated crash. The data used in this analysis were limited to crashes that occur on a public motorway, so the actual number of backing crashes would probably be considerably higher if crashes that occurred on private property (parking lots, loading docks, shipping terminals, etc.) were included. Backing crashes have recently been addressed by NHTSA in a Notice of Proposed Rulemaking that outlines changes to FMVSS 111 that would require an indirect vision system covering the area immediately behind certain straight trucks (NHTSA 2005). NHTSA estimated that about 13 on-road fatalities each year are caused by backing crashes, whereas approximately 66 off-road fatalities in backing crashes occur during the same time period. Because backing crashes tend to occur at low speeds, the fatalities are mostly non-motorists.

**Priority 4 (fourth highest): The area immediately in front and to the right-front of the truck, extending through the truck's lane across the right adjacent lane and extending 5 m forward of the front bumper.** Start-up and right-turn crashes account for perhaps 40 to 60 on-road non-motorist fatalities in the U.S. each year. In most of these cases, the pedestrian or cyclist is in front of or to the right front of the cab immediately prior to the event (i.e., in zones 1 or 4). Crashes into non-motorists initially located in zone 4 are those most likely affected by direct vision obstructions, since few U.S. trucks have mirrors covering this zone. Methods to assess visibility in zones 1 and 4 are the subject of section 5.

## 4.2 Discussion

As noted above, these zones are intended to prioritize improvements to driver vision above the current de-facto standard, i.e., door-mounted planar and convex mirrors on both sides of the cab. The lack of inclusion of a particular area (say, the left-front of the cab) in these zones should not be interpreted as implying either that the driver vision in those areas would not benefit from improvement, nor that decrements in vision in those areas would be acceptable. For example, expanding the width of the direct-vision obstruction posed by the driver-side A-pillar would not be desirable, but the current analysis is not able to estimate the safety effect of such a change.

The vision zones described above are defined only in plan view. Because the potential crash partners in these areas typically have a vertical extent of a meter or more, suggesting that the primary plane of interest may not be the ground. Section 5 addresses the issue of the relevant target height.

The vision zones described above span only areas relatively close to the vehicle. Some crashes due to limitations of driver direct indirect vision involve partners who are outside of the priority zones when the truck driver begins the maneuver, but the importance of driver vision in such crashes is difficult to quantify from crash data. Hence, the data do not provide a good justification for making A-pillar obstructions (or direct-vision obstructions due to mirrors) a high priority, except as they affect visibility of targets located within 5 m of the vehicle.

The vision zones prioritization implicitly addresses the relative importance of improvements in direct and indirect vision. The top three priority areas are areas with minimal or no direct visibility, meaning that improvements to driver vision in these areas will come through improvements in indirect vision systems. Vision zone 4, directly in front of the truck, may be addressed on some vehicles through improvements in direct vision (changes in the hood design, for example) but other trucks will require an indirect vision component (e.g., a front cross-view mirror) to improve driver vision in this zone. The highest priority zone directly to the right of the cab is already addressed on the majority of trucks by a convex mirror mounted on the hood or fender near the front of the truck. However, even with a mirror in this location, drivers' reaction times with targets in zone 1 are still longer than for targets in the equivalent location on the left side of the truck. This suggests that vision improvement above that provided by the fender-mounted convex mirror should be examined for this zone.



## **5.0 A METHOD FOR EVALUATING NEAR-CAB VISIBILITY**

### **5.1 Introduction**

The crash data analysis in Section 2 demonstrated that crashes due to limitations of driver vision occur most frequently in the areas directly behind the vehicle, along the right side of the vehicle, particularly adjacent to the cab, and immediately forward of the cab. The experimental study reported in Section 3 demonstrated that the time required for drivers to detect a lane-change conflict was greatest immediately to the right of the cab. Section 4 presented a set of zones, ordered by priority, in which improvements in driver vision could yield safety improvements.

Driver vision can be improved in a variety of ways. The preferred approach should always be to provide direct vision of the area of interest. If direct vision is not feasible, then a high-quality view of the area should be provided by an indirect vision system. The quality of the view afforded by an indirect vision system is difficult to quantify meaningfully, but the methods used in the pilot study provide a potential performance-based approach. That is, the relative amount of time required to determine the presence or absence of a conflict might be a useful measure of the relative quality of the view. In the pilot study, the target was a vehicle, but a pedestrian or pedal cyclist might provide a more rigorous test of an indirect vision system, particularly for targets relatively far rearward along the vehicle or close to the cab.

Two standardized methods are currently available for comparing the driver vision provided by alternative cab designs. SAE J1750 presents two methods for generating graphical depictions of the visual field by raytracing from an eye point, usually the centroid of the J941 cyclopean eyellipse. The polar plot depicts vision obstructions due to the cab, mirrors, and other vehicle structures in angle (azimuth, elevation) space. The horizontal projection plot shows the visible and obstructed areas on a horizontal plane, often the ground plane. Figure 29 shows a sample horizontal projection plot from J1750.

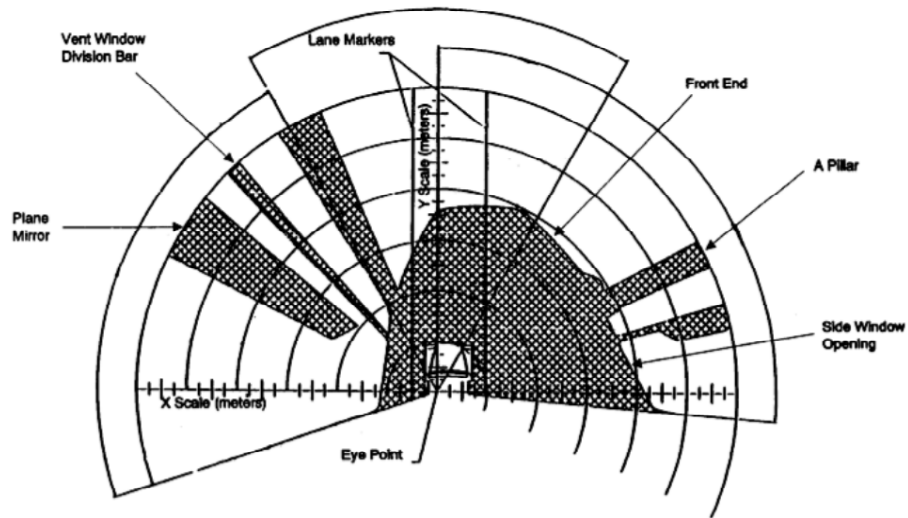

Figure 29. Sample horizontal projection plot from SAE J1750.

The J1750 visibility plots, and other graphical depictions of driver visibility, are valuable for comparing among vehicles. However, the SAE Recommended Practices do not provide guidance on the importance of improvements in the size of the visible field. Intuitively, the importance of a particular increase or decrease in the field of view depends on the area that is obstructed or revealed. A decrement in visibility in one area may have no meaningful safety effect, whereas a decrement in another area may have an important effect.

This report section presents a calculation procedure for evaluating of the relative safety of alternative truck cab designs with respect to near-cab visibility. The method is based on the following observations:

- The primary safety problem in the area affected by obscuration caused by the hood and cab greenhouse, i.e., the area directly in front and to the right of the truck, is crashes with non-motorists (pedestrians and pedal-cyclists).
- Most of the non-motorists struck by trucks are adults.

- Start-up and right-turn crashes occur at low speeds.

A method for evaluating cab obstruction is therefore proposed that evaluates the percentage of the standing adult pedestrian population that is visible at a range of target points near the cab. The goal of the evaluation method is to provide a meaningful *relative* measure of the direct and indirect fields of view in the area near the cab. An ideal measure will be

- scaled such that a score that is twice as high represents approximately twice as much risk;
- calculated in such a manner that credit is not given for additional visibility beyond that required to address the problem; and
- selected such that attention to the measure will tend to produce safer designs.

The method presented here evaluates the percentage of the adult population that would be obscured from a representative driver eye point at a large number of sample points on the ground plane near the cab. Summing obscured fractions across the sample points gives a quantitative measure of the vision obstruction posed by the cab.

## **5.2 Evaluation Method**

### *1. Obtain a computer model of the vehicle to be evaluated.*

Although it would be technically feasible to perform these measurements and calculations with an actual vehicle, the procedure is intended to be performed using computer-aided design (CAD) software. A CAD model of the vehicle that includes all relevant vision obstructions is needed. For the current purposes, that includes the hood and the “greenhouse,” i.e., the outlines of the window openings on the cab. All mirrors should be included, since they provide indirect vision and also obstruct direct vision. Figure 30 shows the minimum information based on measurements of an example truck cab. The CAD data must include an appropriate ground plane for the vehicle. Since some cabs are used in multiple configurations with different grounds, separate analyses will need to be performed for each condition.



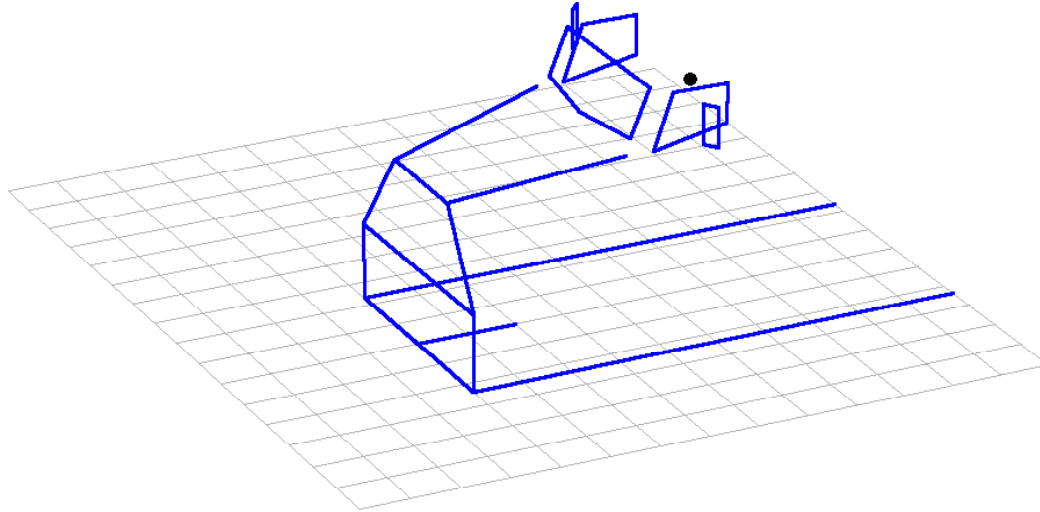

Figure 30. Computer model of vision obstructions for the example vehicle, including window perimeters and the hood. The viewing point (representative driver eye point) is shown with a black dot.

2. *Establish a viewing point.*

These calculations are performed from a single viewing point. Unlike some vision analyses intended to assess a worst case (e.g., the mirror viewing tasks for school buses in FMVSS 111, which use a small-female eye location), the intent of the current procedure can be readily fulfilled using an average eye location. The recommended approach is to use the centroid of an appropriately positioned cyclopean driver eyellipse for each vehicle, which is an estimate of the average driver eye location on the driver lateral centerline. The SAE J941 Class-B eyellipse (SAE 2005) or a newer eyellipse (Reed 2005) could be used. To preserve the comparability of the analyses across vehicles, the same procedure should be used to locate the viewing point in each vehicle.

2. *Establish a grid of sample points.*

Figure 31 shows the layout of the sample points. Beginning at the front bumper and vehicle centerline, a grid is constructed with 0.5 m pitch. The grid wraps around the sides of the vehicle to the back of the cab. The sample points are at the centers of the 0.5-x-0.5-m squares defined by the grid. The grid is 10 m wide and 10 m long, with the

center of the grid at the projection of the front bumper onto the ground at the lateral centerline of the vehicle. The 10-m width was chosen to approximately span the width of three lanes ( $3 \times 3.7 \text{ m} = 11.1 \text{ m}$ ). The fore-aft length is more arbitrary, but extends approximately one car length in front of the bumper and rearward past the back of the cab for most trucks. (See section 5.4 for more discussion of the choice of sampling points.)

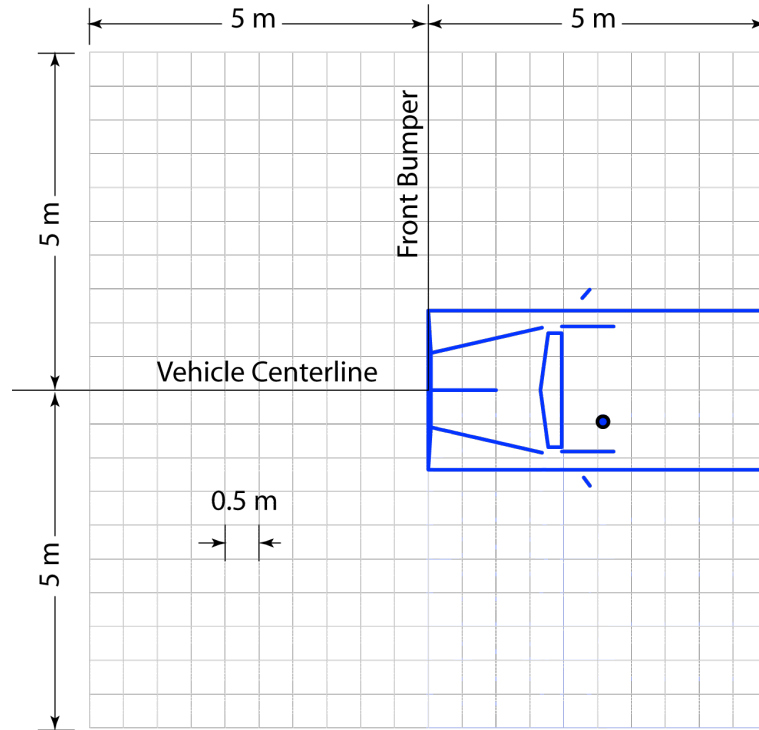

Figure 31. Laying out sample points (plan view). Each intersection point on the grid is a sample point.

3. *Compute the minimum view height at each sample point.*

This procedure determines the minimum height that is visible at each sample point. Determine the point on a vertical line through the sampling point such that a line from the viewing point intersecting any lower point on the vertical line would also intersect the cab. Figure 32 shows the calculation schematically.

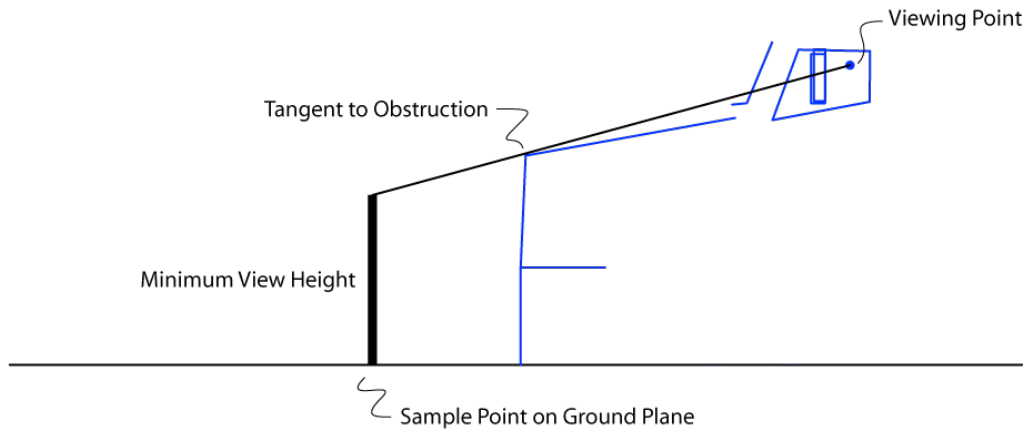

Figure 32. Establishing the minimum view height (schematic in side view).

Figure 33 shows the results of calculating minimum view heights on the grid for the example cab geometry. For the areas in front of the hood, the lines indicate the minimum height of an object that would be visible at the corresponding ground-plane location. Sampling points at which a vertical line is completely obscured area shown with red vertical lines. The A-pillars create noteworthy three-dimensional effects. Because the A-pillar slopes rearward in this geometry, there are sampling points within the ground-plane A-pillar obscuration at which an object of a sufficient height is visible. In the direction of the right A-pillar, sufficiently tall objects are visible across most of the sampling grid.

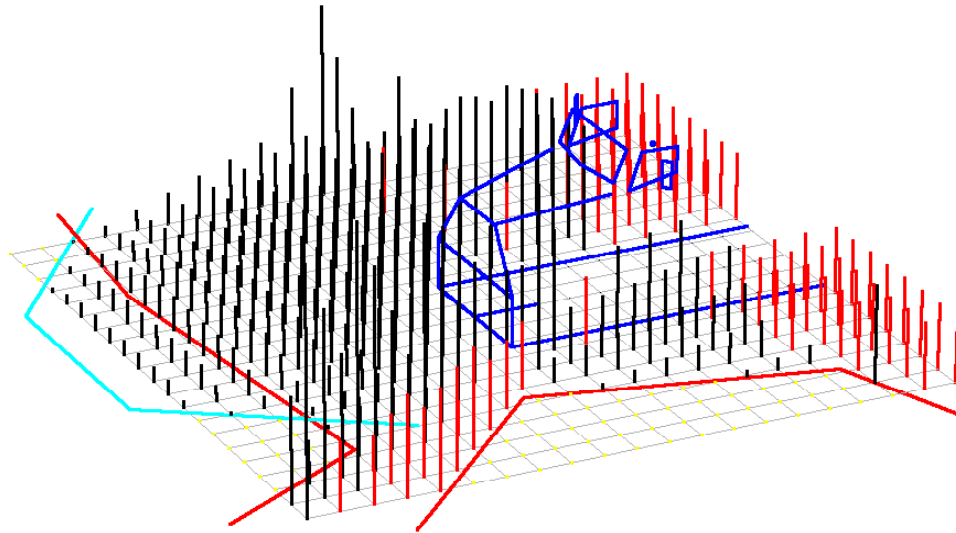

Figure 33. Illustration of direct view heights on sampling points. A vertical red line indicates that a vertical line through the sampling point is completely obscured. A black line indicates that the view is partially obscured and shows the minimum height that is visible. The obstruction perimeters on the ground plane are shown for the windows and windshield (red lines) and hood (cyan line).

4. *Compute the fraction of the pedestrian population visible at the view height.*

The pedestrian population is modeled as a 50/50 male/female population having the distribution given by the 1990 National Health and Nutrition Examination Survey, known as NHANES III (NCHS 1994). Male stature is modeled as a normal distribution<sup>5</sup> with mean 1755 mm and standard deviation 74.2 m. The female stature distribution has mean 1618 mm and standard deviation 68.7 m. An adjustment of 25 mm is added to account for shoes, and a multiplier of 0.82 is used to estimate shoulder height from stature. The result is the adult pedestrian viewing height distribution shown in Figure 34. To simplify the calculations, the distribution is approximated using a linear function between the 1st and 99th percentiles:

---

<sup>5</sup> The mean and standard deviation have been selected to obtain a good fit in the tails of an approximating normal distribution. The actual mean and standard deviation are somewhat different.

$F(Z) =$

$$\begin{aligned}
 Z < 1.19 \text{ m} &\quad \rightarrow \quad 0 \\
 1.19 \text{ m} \leq Z \leq 1.54 \text{ m} &\quad \rightarrow \quad (z - 1.19)/(1.19 - 1.54) \\
 Z > 1.54 \text{ m} &\quad \rightarrow \quad 1
 \end{aligned}
 \tag{1}$$

where  $Z$  is the viewed height and  $F(Z)$  is the fraction of the pedestrian population that is obscured. Under the approximation, the adult pedestrian population is fully visible for viewing heights at or below 1.19 m, and fully obscured for viewing heights above 1.54 m.

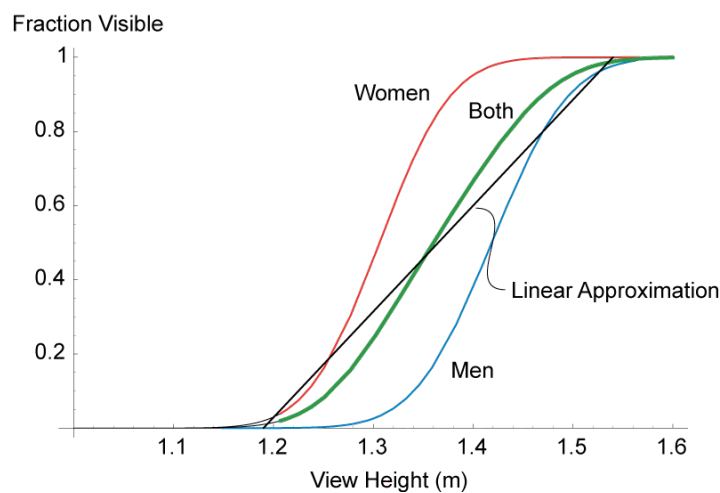

Figure 34. Fraction of adult pedestrian population that is visible as a function of view height from the ground.

Figure 35 shows the obscured fraction as a set of vertical lines at the sampling points. A vertical line 1 m tall indicates that the population is fully obscured at that point. No vertical line indicates that the population is fully visible (or that the sampling point is under the vehicle, and hence not included).

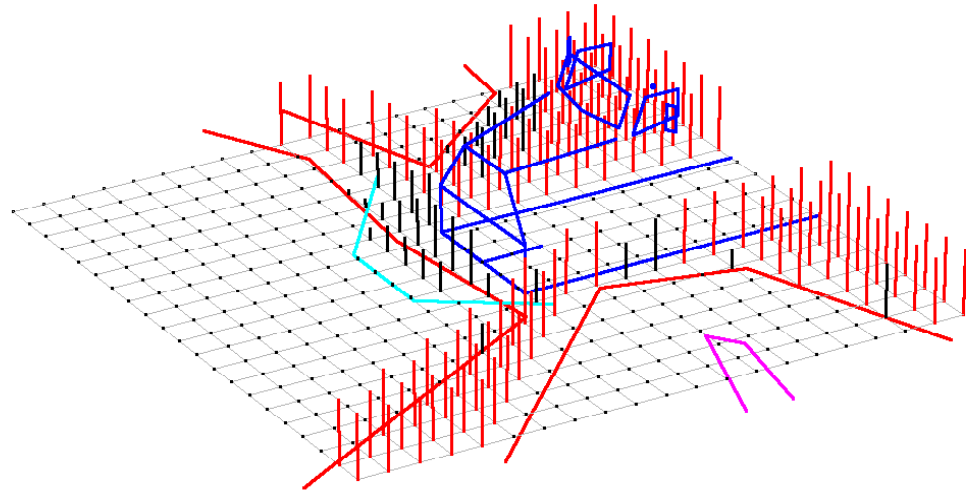

Figure 35. Depiction of the fraction of the population that is obscured for direct vision for the example vehicle geometry. A vertical red line (all are 1-m tall) indicates that the population is completely obscured and a vertical black line indicates fractional obscuration (height is fractional obscuration times one meter). The obscuration boundaries at the 1.2 m plane are shown. Pedestrian obscuration calculations were not performed for mirrors.

Figure 35 shows that most of the obscuration on the sample grid is due to the greenhouse rather than the hood for the example vehicle. In some circumstances, it might be valuable to evaluate only the hood or the A-pillars. Figure 36 shows the results of considering only obscuration due to the hood in the area forward of the bumper.

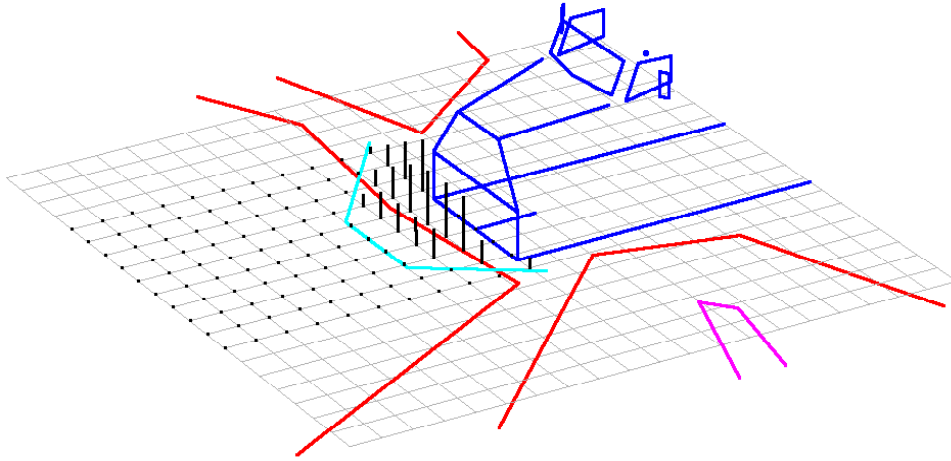

Figure 36. Fraction of the pedestrian population obscured by the hood. A vertical black line indicates fractional obscuration (height is fractional obscuration times one meter). The obscuration boundaries at the 1.2 m plane for the hood (cyan) and greenhouse (red) are shown.

##### 5. *Compute an Aggregate Obscuration Score*

For comparing across cab designs, a single score may be desirable. One approach is to multiply the fractional pedestrian population obscurations by the plan-view area represented by each sample point ( $0.25 \text{ m}^2$  in the current example) and sum across the sample points. A lower score is better, indicating less obscuration. Using this approach, the aggregate score for the analysis in Figure 36 (hood obscuration only) is  $3.2 \text{ m}^2$ . Lowering the front hood points by  $0.2 \text{ m}$  improves the score to  $1.0 \text{ m}^2$ . Figure 37 shows the analysis with the lowered hood points. In this case, the obscuration caused by the bottom of the windshield becomes more important on the right side of the cab than the hood obscuration.

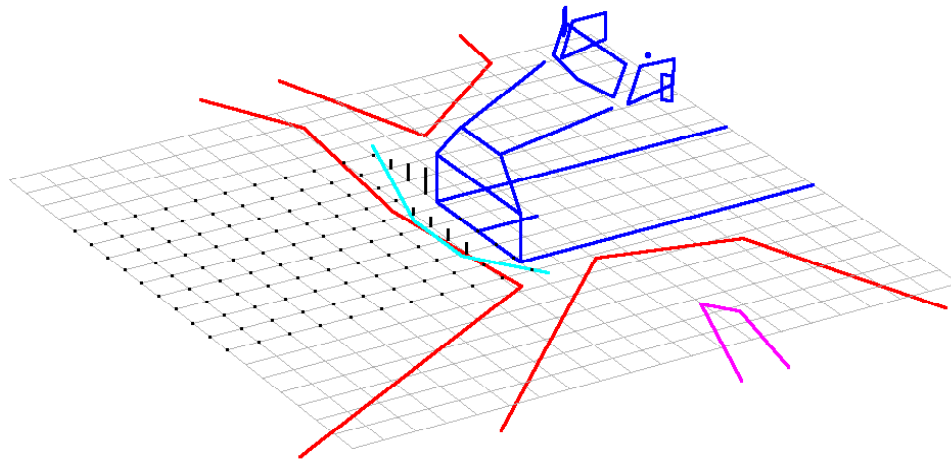

Figure 37. Fraction of the pedestrian population obscured by the hood, using the example cab geometry with front hood points lowered by 0.2 m. A vertical black line indicates fractional obscuration (height is fractional obscuration times one meter). The obscuration boundaries at the 1.2 m plane for the hood (cyan) and greenhouse (red) are shown.

### 5.3 Discussion

This method provides a numerical evaluation of cab obscuration that is based on detection of adult pedestrians near the cab. This method is designed specifically to address start-up and right-turn crashes with nonmotorists. As shown in Section 3, the nonmotorist involved in these types of fatal crashes is usually directly in front of or to the right-front of the truck at the time the truck driver begins the maneuver. Hence, improving driver vision in these areas may reduce the incidence of these crashes.

Some parameters of the method have been set somewhat arbitrarily. For example, the 0.5-m pitch on the sampling grid corresponds roughly to the plan-view volume occupied by a standing pedestrian, but a finer grid would produce smoother measures of the effects of changes in cab geometry and would reduce the likelihood of missing the effect of a potentially important geometric feature. Of course, sampling at more points increases the effort required to perform an assessment. The overall grid size (10 m x 10 m) is also somewhat arbitrary. A larger grid would provide a better gage of pillar



obscuration, and a grid that extended further to the rear might be valuable for assessing mirror fields of view. Regardless of the sampling points used, comparable values can only be obtained across vehicles designs if the same grid is used.

The practicality of the procedure depends substantially on the time required to evaluate the view height at a plan view location. The sample calculations used in this report were performed in *Mathematica* using highly abstract vehicle geometry, and the calculations could be performed essentially instantaneously. However, for use with existing CAD geometry it may be more feasible to program the calculations as CAD macros. For most analyses, it would not be necessary to evaluate the view height at all of the sample points in the grid. For example, the results in Figure 36 could be obtained by evaluating only 40 sample points.

The proposed procedure is somewhat analogous to computing the obscuration area on a plane 1.2 m above the ground plane. The area within the 1.2-m obscuration boundary will be roughly proportional to the score obtained by the proposed procedure. For complex cab geometry, computing the projected area may be more difficult than computing the view height at sampling points on a grid. Further investigation of the relative merits of the two approaches should be conducted.

The example calculations focused exclusively on direct vision, but indirect vision assessments could be made using the same method. In this case, the three-dimensional mirror fields of view would be included in the calculations of visible area. Viewing an area with a mirror is less desirable than a direct view of the area, and hence it would be desirable to “penalize” mirrors when comparing designs that combine direct and indirect view of an area. The appropriate penalty should be related to the performance of people using the mirror system to detect targets of interest, e.g., vehicles and nonmotorists. Intuitively, performance might be expected to be a function of the curvature of the mirror (convex mirrors providing worse performance than planar mirrors) and the distance from the driver to the mirror. Other factors, such as the size of the mirror and weather conditions, might also be important.

The experimental study presented in Section 3 provides one approach to comparing detection performance with direct view and convex mirrors. For example,

the drivers took approximately twice as long to detect a vehicle directly to the right of the cab using a convex mirror as they did on the left side of the vehicle using predominantly direct vision. This suggests that, as a starting point, vision near the cab using a convex mirror should be discounted 50% relative to direct vision. So, if the entire pedestrian population were obscured for direct vision at a particular sample point, but fully visible using a convex mirror, the score would be 0.5. Further experimental work could quantify the relative value of direct and indirect vision (particularly using convex mirrors) for detecting pedestrians using the reaction-time measure.

The proposed method does not take into account the effects of head movements or binocular vision, both of which can alter the effective obscuration, particularly for the left-side A-pillar and mirror. However, since the goal is to produce a relative measure that is useful across vehicles, a single representative viewing point is probably sufficient. To take into account the effects of binocular vision and head movement, the analysis could be performed for each sample point using two eye locations, with the better value used for the aggregate calculation. For example, if the pedestrian population would be completely obscured at a sample point from the right eyellipse centroid, but visible from the left eyellipse centroid, the population could be considered to be completely visible at that point.

The method could be extended to cover all areas around the vehicle, but the meaning of the analysis would be strongly dependent on the appropriateness of the penalty used for indirect vision systems. Anecdotally, a convex mirror has a “sweet spot” corresponding to a distance from the mirror at which a pedestrian is most readily detected. If the pedestrian is closer, the distortion creates problems with identification. If the pedestrian is further from the mirror, the distortion and minification may make the pedestrian difficult to detect. An appropriate performance-based scoring system is needed that would appropriately account for the differences in quality of field of view for different indirect vision systems. This will be particularly important for evaluating the potential benefits of camera based systems over mirrors and for comparing alternative camera locations, display characteristics, etc. As noted above, the reaction-time paradigm, using direct-vision or planar-mirror detection time as a control, may be a good metric for establishing the relative quality of view provided by different systems.



## 6.0 SUMMARY AND CONCLUSIONS

### 6.1 Primary Findings

About 20 percent of crashes initiated by trucks occur in configurations in which limitations to truck driver vision may have been an important factor contributing to the crash. Right-going lane changes and turns account for more than half of these crashes. In contrast, lane changes and turns to the left account for only about 12 percent. Data on crash contact points also show more frequent contacts on the right side of the truck than on the left. The locations of contact points in lane-change/merge scenarios show a strong bias toward the front of the vehicle (adjacent to the cab) for right-going crashes, whereas left-going crashes are more evenly distributed. On average, right-going truck-initiated crashes are about 4.5 times more likely than left-going crashes.

Using an in-depth analysis of police accident reports (PARs), the pre-crash positions of the crash partners were determined for a subset of potentially vision-related crashes. The analysis further implicates vision along the right side of the truck, and particularly directly adjacent to the cab, in lane-change/merge crashes into other vehicles. Data from the PAR analysis showed that nonmotorists killed in *start up* and *right turn* crashes were usually in front of or to the right of the cab immediately prior to the crash. Nonmotorists killed in start up and right turn crashes with trucks were nearly all adults and tend to be older than pedestrians struck in other crash modes. Over half of pedestrians involved in *start up* crashes are over age 65.

The experimental study presented in Section 3 showed that driver performance in detecting lane-change conflicts was directionally consistent with the findings from the crash data. Drivers took longer to detect conflicts on the right side of the vehicle than on the left. The longest reaction times were observed when the target vehicle was directly to the right of the cab, suggesting that detecting a conflict in this area is most difficult for drivers. Drivers also made more errors on the right side of the vehicle, including several failures to detect a vehicle directly to the right of the cab.

Based on these findings, a prioritized set of vision zones was developed (Section 4). The highest priority for improvements to driver vision is the area directly to the right

of the truck cab. This area represents the most likely position of a crash partner at the truck driver's decision point in right lane-change crashes and is also the pre-crash position of many nonmotorists involved in *right turn* and *start up* crashes. The entire area on the right side of the truck, and the area to the rear of the truck, also merit additional attention, based on the relatively large percentage of crashes in which truck drivers fail to detect conflicts in these areas. An additional priority zone was established directly in front of the vehicle to address *start up* crashes involving nonmotorists. Although these crashes occur at low speeds, the vulnerability of the nonmotorists makes these crashes particularly lethal.

## **6.2 Evaluating Direct and Indirect Exterior Vision from Truck Cabs**

Section 5 presents a new approach to evaluating exterior vision from truck cabs. The method differs from previous approaches, e.g., SAE J1750, by providing an aggregate score that is related to a specific crash-safety issue. The method is based on the visibility of standing adult pedestrians, and hence addresses the specific problem of pedestrian involvement in *start up* and *right turn* crashes. Quantitative comparisons between vehicle designs with respect to exterior vision can be conducted using the new method.

The experimental paradigm presented in Section 3 also represents a promising approach to evaluating the quality of exterior vision provided by alternative vision systems. The time drivers require to determine if a conflict exists provides a sensitive measure of the difficulty of the task. The parallels between the findings of the experimental study and the crash data analysis support the validity of the experimental approach. This method could be applied to evaluate alternative mirror systems, camera-based systems, and other technologies that might be developed to address the priorities established in this report.

## **6.3 Future Research**

Given the scope of the problem documented by the crash data analysis, considerably more work is needed to address truck driver vision. Additional analysis of crash data would help to quantify the problem more completely and with greater precision. A relatively small effort would be required to double or triple the number of

PARs analyzed to address the pre-crash configurations in *LCM*, *right turn*, and *start up* crashes. Adding more data to these analyses would narrow the confidence bounds and provide a more complete picture of the vision improvement needs near the cab.

Data from the Large Truck Crash Causation Study (LTCCS) have become available this year. The LTCCS dataset includes highly detailed information on a nationally representative sample of 963 crashes involving heavy trucks. The data are much richer than those in GES or TIFA, and include considerably more detail than is found in typical PARs. Although the total number of cases is small, these data are expected to be valuable for addressing vision-related questions. For example, the LTCCS contains specific information on mirror configurations that is lacking from other datasets. In addition, each crash investigation is documented with numerous photographs, including the interior of the cab from the driver's point of view. A study of vision-related factors in the LTCCS should be conducted to complement the analyses presented in the current report.

The experimental investigation reported in Section 3 used only six subjects but nonetheless yielded some valuable results. More experimental work should be conducted along similar lines with the dual objectives of (1) developing a robust experimental methodology for quantifying the quality of the view provided by an indirect vision system, and (2) evaluating the performance of alternative indirect vision systems that may help to address the substantial driver vision issues documented in this report. Elements that should be included in future studies include:

- alternative targets, including motorcyclists, pedestrians, and pedalcyclists; and
- alternative indirect vision systems, including various combinations of the current planar and convex mirrors, aspheric convex mirrors, and camera-based systems.

Older drivers will be an important cohort in future studies because of cognitive and perceptual differences with younger drivers and because they represent an increasing percentage of truck drivers.

The parking-lot experimental approach also should be validated in a dynamic setting. One naturalistic approach would be to examine the time that drivers use to make

right-going and left-going lane-change judgments in traffic. Consistency between the right/left ratios on-road and in the static situation would support the validity of the static approach.

On-road data collection would also be valuable to understand more completely how drivers use their mirrors. Many trucks are currently equipped with five, six, or more mirrors. How do drivers use these mirrors, many of which have partially redundant fields of view? It is possible that having fewer but more-optimal mirrors would provide improved performance by reducing scanning demands. In-vehicle studies with alternative mirror configurations could address this issue.

Experimental studies should also be conducted to address the detection of pedestrians with direct vision. The analysis method presented in Section 5 assumes that the pedestrian must be fully visible above the shoulders to be seen by the driver. A reaction-time approach to detection might be a useful way to quantify the amount of a pedestrian that must be visible to provide reliable detection. As with the other conflict-detection studies, consideration of background contrast and target position will be important.

The CAD-based vision evaluation method presented in Section 5 should be applied to a number of truck cabs to determine its feasibility and utility. Determining whether the calculations are best performed in CAD software or in an external program will be an important first step. More research is needed to establish an appropriate method for balancing A-pillar and hood obstruction. The current method, based solely on pedestrian obscuration, does not take into account the distance from the truck. Any pedestrian obscuration directly in front of the hood is problematic, but pedestrians obstructed by the A-pillar are not directly in danger. Any relative motion of the truck and pedestrian that increased the likelihood of conflict may also increase the likelihood that the pedestrian will become visible to the truck driver. Further analytical studies of truck motions in right-turn scenarios may provide a means to quantify the relative importance of hood and A-pillar obstructions for pedestrian protection. Combined with further analysis of crash data, these analytic studies might yield an appropriate metric for addressing the contribution of A-pillar and mirror obscuration to crashes with other vehicles.

## 7.0 REFERENCES

- Gordon, C. C., Churchill, T., Clauser, C. E., Bradtmiller, B., McConville, J. T., Tebbetts, I., & Walker, R. A. (1989). 1988 Anthropometric Survey of U.S. Army Personnel: Methods and Summary Statistics. Final Report. (NATICK/TR-89/027). Natick, Massachusetts: U.S. Army Natick Research, Development and Engineering Center.
- Liberty Mutual (1998). *Mirrors for trucks and tractor-trailers, LP 226 R2 [loss prevention reference note]*. Hopkinton, Massachusetts: Liberty Mutual Group.
- National Center for Health Statistics (2005). National Health and Nutrition Examination Survey III. <http://www.cdc.gov/nchs/>.
- National Highway Traffic Safety Administration (2003). New Rearview Technology and Federal Motor Vehicle Safety Standard No. 111; Rearview Mirrors; Request for Comments. Docket No. NHTSA-2002-12347. *Federal Register*, Vol. 68, No. 14.
- National Highway Traffic Safety Administration (2005). Notice of Proposed Rulemaking: Federal Motor Vehicle Safety Standards; Rearview Mirrors. Docket No. NHTSA 2004-19239. *Federal Register*, Vol. 70, No. 175.
- Reed, M.P. (2005). Development of a New Eyellipse and Seating Accommodation Model for Trucks and Buses. Technical Report UMTRI-2005-30. University of Michigan Transportation Research Institute, Ann Arbor, Michigan.
- Retting, R.A. (1993). A Study of Fatal Crashes Involving Pedestrians and Trucks in Four Cities. *Journal of Safety Research*, Vol. 24, pp 195-203.
- SAE International (2005). *SAE Handbook*. SAE International, Warrendale, PA.
- Sweatman, P.F., Ogden, K.W., Haworth, N., Corben, B., Rechnitzer, G., Diamantopoulou, K. (1995). *Heavy vehicle crashes in urban areas*. Roaduser Research Pty Ltd., Australia/ Monash University, Melbourne, Australia.