

archive
84289

July, 1993
NSRP 0371

CON COMMITTEE
ENVIRONMENTAL EFFECTS
PROTECTION AND COATINGS
TECHNOLOGY INTEGRATION
PROCESS INNOVATION THE NATIONAL
QUALITY STANDARDS SHIPBUILDING
RESEARCH
PROGRAM
OPERATION

**North American
Shipbuilding Accuracy
Phase II**

U. S. DEPARTMENT OF THE NAVY
CARDEROCK DIVISION, NAVAL SURFACE
WARFARE CENTER

in cooperation with

Newport News Shipbuilding

This report / manual was prepared as an account of U.S. government sponsored work. Neither the United States, nor the Carderock Division, Naval Surface Warfare Center (CDNSW) – formly The David Taylor Research Center-DTRC, nor any person acting on behalf of the CDNSW (a) makes any warranty or representation, expressed or implied, with respect to the accuracy, completeness or usefulness of the information contained in this report / manual, or that the use of any information, apparatus, method, or process disclosed in this report may not infringe privately owned rights; or (b) assumes any liabilities with respect to the use of or for damages resulting from the use of any information, apparatus, method, or process disclosed in the report / manual. As used in the above, "persons acting on behalf of the CDNSW" includes any employee, contractor, or subcontractor to the contractor of the CDNSW to the extent that such employee, contractor or subcontractor to the contractor prepares, handles, or distributes, or provides access to any information pursuant to his employment or contract or subcontract to the contractor with the CDNSW. ANY POSSIBLE IMPLIED WARRANTIES OF MERCHANTABILITY AND / OR FITNESS FOR PURPOSE ARE SPECIFICALLY DISCLAIMED.

THE NSRP NEEDS YOUR EVALUATION OF THIS REPORT!

PLEASE RETURN A RESPONSE CARD AFTER READING REPORT.

NSRP READER RESPONSE CARD

We would appreciate your comments on this report. Please take a few minutes to complete and return this postage-paid card. Thank you.

Name _____

Organization _____

Phone _____

• **Overall Quality of Report**

Excellent Good Fair Poor

• **Useful to You/Your Organization**

Very Useful Moderately Useful N/A

• **Did/Will your organization implement the results of this project?** Yes No

If not, why? _____

• **How Did You Receive Report?**

Mailed directly to you

Referred to you by someone else

• **Did/Will You Pass Report On To Someone Else?** Yes No

• **In Your Opinion, Is Anything Missing That Would Make This Report Better?**

Yes _____

• **General Comments**

NSRP 0371

NSRP READER RESPONSE CARD

We would appreciate your comments on this report. Please take a few minutes to complete and return this postage-paid card. Thank you.

Name _____

Organization _____

Phone _____

• **Overall Quality of Report**

Excellent Good Fair Poor

• **Useful to You/Your Organization**

Very Useful Moderately Useful N/A

• **Did/Will your organization implement the results of this project?** Yes No

If not, why? _____

• **How Did You Receive Report?**

Mailed directly to you

Referred to you by someone else

• **Did/Will You Pass Report On To Someone Else?** Yes No

• **In Your Opinion, Is Anything Missing That Would Make This Report Better?**

Yes _____

• **General Comments**

NSRP 0371

**NO POSTAGE
NECESSARY
IF MAILED
IN THE
UNITED STATES**

BUSINESS REPLY MAIL

FIRST CLASS MAIL PERMIT NO. 1 NEWPORT NEWS, VA

NSRP PROGRAM MANAGER
W. G. BECKER
NEWPORT NEWS SHIPBUILDING
NEWPORT NEWS, VA 23607

**NO POSTAGE
NECESSARY
IF MAILED
IN THE
UNITED STATES**

BUSINESS REPLY MAIL

FIRST CLASS MAIL PERMIT NO. 1 NEWPORT NEWS, VA

NSRP PROGRAM MANAGER
W. G. BECKER
NEWPORT NEWS SHIPBUILDING
NEWPORT NEWS, VA 23607

FINAL REPORT

**NORTH AMERICAN
SHIPBUILDING ACCURACY
PHASE II**

Submitted to the:
Maritime Administration
through
Newport News Shipbuilding
Newport News, VA

July 9, 1993

Project Director:
Howard M. Bunch
Principal Investigator:
Albert W. Horsmon, Jr.

The University of Michigan
Transportation Research Institute
Marine Systems Division
Ann Arbor, Michigan

1. Report No. NSRP 0371		2. Government Accession No.		3. Recipient's Catalog No.	
4. Title and Subtitle North American Shipbuilding Accuracy Phase II				5. Report Date July 9, 1993	
				6. Performing Organization Code	
7. Author(s) The Marine Systems Division				8. Performing Organization Report No. UMTRI-93-27	
9. Performing Organization Name and Address The University of Michigan Transportation Research Institute 2901 Baxter Road, Ann Arbor, Michigan 48109-2150				10. Work Unit No. (TRAIS)	
				11. Contract or Grant No. P.O. #POM-23034-R	
12. Sponsoring Agency Name and Address Newport News Shipbuilding 4101 Washington Ave Newport News, VA 23607				13. Type of Report and Period Covered Technical October 6 - December 31, 1992	
				14. Sponsoring Agency Code Maritime Administration	
15. Supplementary Notes					
16. Abstract <p>This report was developed as part of the National Shipbuilding Research Program SP-4 Panel initiative to increase the understanding and use of accuracy control methods and standards in the U.S. shipbuilding industry. This project was undertaken to continue the research started under the North American Shipbuilding Accuracy Phase I (1986) project. The main purpose of this project was to update the steel-fabrication and assembly-process accuracy documented in the Phase I report, and to compile accuracy figures for new processes which were not addressed in the previous project. The completion of this project will provide benchmarks for shipyards to assess their current level of accuracy, as well as standards against which future process improvements can be measured.</p>					
17. Key Words Accuracy, Accuracy Control, Shipbuilding Standards			18. Distribution Statement		
19. Security Classif. (of this report) Unclassified		20. Security Classif. (of this page) Unclassified		21. No. of Pages 22	22. Price

EXECUTIVE SUMMARY

This report was developed as part of the National Shipbuilding Research Program (NSRP) SP-4 Panel initiative to increase the understanding and use of accuracy control methods and standards in the North American shipbuilding industry. This project was undertaken to continue the research started under the U.S. Shipbuilding Accuracy Phase I project. The main purpose of the Phase II project was to update the steel-fabrication and assembly-process accuracy information documented in the Phase I report, and to compile normal variances for processes that were not addressed in the previous project. This project provides benchmarks for shipyards to assess their current levels of process variance, as well as standards against which future process improvements can be measured.

The Phase II report was developed under the direction of the NSRP and Panel SP-4¹ of SNAME,² through a contract from MarAd³ administered by Newport News Shipbuilding. It was developed from survey responses from North American shipyards related to process variation normally achieved in various ship construction processes. Only a small number of yards queried responded to the requests for data, so the results are not statistically significant in representing the whole of the North American shipbuilding industry. However, four of the yards that did respond have recent experience in commercial construction, so the results represent, to some extent, the accuracy likely to be achieved as North American shipyards get back into the commercial market.

¹Panel SP-4, Design Production Integration

²Society of Naval Architects and Marine Engineers

³The Maritime Administration of the U.S. Department of Transportation

NORTH AMERICAN SHIPBUILDING ACCURACY PHASE II

TABLE OF CONTENTS

Report Documentation Page	i
Executive Summary	ii
Table of Contents	iii
I. Introduction.....	1
II. Definitions.....	3
III. Discussion	5
IV. Conclusions	5

Appendix

A. North American Shipbuilding Accuracy Data.....	A-1
---	-----

I. INTRODUCTION

In the past twelve years, accuracy control programs have been implemented by many U.S. shipyards following the methodology used successfully in Japan. The goals of these programs have been to reduce production costs through less rework, improve performance of the finished products as a result of higher quality workmanship, reduce construction time, utilize material more efficiently, and continuously improve processes through statistical methods. Most applications of accuracy control in U.S. shipyards have focused on structural steel fabrication, assembly, and erection processes, because controlling these processes can greatly reduce the cost and duration of structural *and* outfitting work.

In order to successfully implement an accuracy control program, it is necessary to verify that processes are under control, and to determine the "normal" accuracy of these processes. If processes are not under control, steps must be taken to eliminate identifiable influences. To verify accuracy of processes, sampling plans must be developed that define the measurements to be taken, how these measurements will be made, the sample size desired, and how standard ranges and tolerance limits will be established. Once this data is collected and analyzed, shipyards can assess their own quality levels and initiate improvement actions where necessary. If industry averages for equivalent processes are known, shipyards can compare their process variations with these average or normal process variation levels to help judge the success of their accuracy control programs.

The U.S. Shipbuilding Accuracy Phase I project was developed to both monitor the accuracy levels of various steel construction processes and to provide industry averages for these processes against which U.S. shipyards could compare their own accuracy levels. While Phase I obtained data for some of the steel processes identified in the Japanese Shipbuilding Quality Standard (JSQS), others process averages were not determined prior to project completion due to a lack of data. In these cases, the JSQS standard ranges and tolerance limits were reported. In addition, statistically valid data were received from only three shipyards. This created the need for a Phase II project, which attempted to reverify the accuracy levels presented in Phase I, carry out accuracy measurements for additional processes, and broaden the base of shipyards participating in this accuracy survey.

The survey that was used to request the accuracy data was divided into three sections: 1) questions pertaining to data already collected for the Phase I report; 2) questions pertaining to data that was copied from the Japan Shipbuilding Quality Standard for the Phase I report, and which was desired from North American shipyards for this report; and 3) questions pertaining to

new process areas, such as pipe bending and painting. This survey was sent to twenty-eight shipyards including all eight U.S. Navy yards.

Only eight of the twenty-eight yards queried responded to the requests for data. One of those yards, however, was Saint John Shipbuilding of New Brunswick Canada, a regular member of the SP-4 Panel, so the report has been retitled "*North American Shipbuilding Accuracy Phase II.*" *Phase II* was used to refer back to the Phase I project. The following yards supplied data and have their input included in the data sets in Appendix A:

Avondale Industries, Inc., New Orleans, LA
Bath Iron Works Corporation, Bath, ME
BethShip, Sparrows Point, MD
Leevac Shipyards, Inc., Jennings, LA
National Steel & Shipbuilding Co., San Diego, CA
Newport News Shipbuilding, Newport News, VA
Ingalls Shipbuilding, Pascagoula, MS
Saint John Shipbuilding, New Brunswick, Canada

Due to the limited number of responses to the survey and the resulting small sample sizes for process data, the results are not statistically significant in representing the whole of the North American shipbuilding industry. However, four of the eight yards that responded are key, large yards with recent experience in commercial construction, so the results are at least somewhat representative of the accuracy likely to be achieved as the U.S. industry attempts to reenter the commercial market.

The remainder of this report is divided into three sections. Section II contains the basic definitions for data in the blocks of the appendix. Section III is a discussion of the data and a commentary on some of the data that did not fit directly onto the data report form. Section IV is the conclusion, which describes the benefits from the project. The actual accuracy figures are in Appendix A.

II. DEFINITIONS

The following definitions are similar to those presented on each survey data sheet *key*. These keys were provided as a basic guide to filling out the survey. These definitions apply to the data presented in Appendix A.

Process Description - A description of the process that was used to make the part or assembly.

Example: N/C Flame Burning for flat panel parts.

Manufacturing Level - A pictorial description of the item being measured and the dimensions desired.

Measurement Device and Accuracy - A description of the measurement device and the accuracy that is expected of it.¹

Example: Steel Tape at + or - 1/32"

Measurement Device & Accuracy	Measurement # Responded	Standard Range	Tolerance Limit
		JSQS(mm)	JSQS(mm)
Steel Tape 1/32" or 1/16"	Length - L # respond:6	± .083 in	± .134 in
		± 2.11 mm	± 3.40 mm
		J: ± 3.5	J: ± 5.0

Figure 1

¹ An excerpt from page A-1 of the Appendix is shown as Figure 1 to better define these categories of data.

Measurement - A description of the measurement indicated in the diagram.

#Responded - This is the number of shipyards that actually presented data for that particular measurement.

Standard Range - The standard range is that part of the process variation that falls within two standard deviations of the average measured dimension, representing a 95.44% probability of occurrence for a process with a normal statistical distribution. Most ranges provided were in inches; those that were not provided in inches have been converted to inches.

Tolerance Limit - The tolerance limit is that part of the process variation that falls within three standard deviations of the average measured dimension, representing a 99.73% probability of occurrence for a process with a normal statistical distribution.

JSQS - For reference purposes, accuracy standards from the Japanese Shipbuilding Quality Standard (1991) are listed for each measurement that compares to a JSQS measurement. All JSQS numbers are listed in millimeters below the dotted line on the data sheets in the Appendix. For the part fabrication figures on page A-2, "PI" numbers are listed. The PI numbers refer back to data gathered for the Phase I report for the "Deviation from fitted length" area. In the "Squareness of end cut" area, very little data was gathered and it was not in a consistent form, so no data has been reported.

S.P.C. used: Y / N - Indicates whether Statistical Process Control has been used as a regular part of the process for measuring that particular level of manufacturing.

III. DISCUSSION

The data received from the survey is presented in Appendix A. Only eight of the twenty-eight yards queried responded to the requests for data, so the results are not statistically significant in representing the whole of the North American shipbuilding industry. Some of the data areas have no responses, many have only one or two and are listed for interest, not from a statistical significance.

In the original survey, the values for pipe bending asked for were t_1 , t_2 , and the ratio of t_1 to t_2 . The responses received were in many different forms and the data was very difficult to compare. To consolidate the responses and make the data easier to compare, the data presented on page A-10 in the Appendix has been converted into percentage wall thinning for bending of pipes. The formula used for this is: $(1 - t_2/t_1) \times 100$. The pipe sizes reported in the survey ranged in diameter from 22.5 mm (2 in) to 90.2 mm (8 in). Materials reported were Cu, CuNi, Stainless Steel, and Steel.

Two interesting aspects of the data stand out. First, very few of the responding yards are actually using statistical process control, at least not on the processes surveyed. Second, a steel tape is still the most common form of measurement tool, but the accuracy of measurements achieved range from $\pm 1/16$ inch to $\pm 1/64$ inch. Only one form of advanced measurement is listed for the processes surveyed, and that is a simple transit.

For comparison purposes, accuracy standards from the Japanese Shipbuilding Quality Standard, produced by the Society of Naval Architects of Japan,² are listed where measurements are comparable.

IV. CONCLUSIONS

The accuracy data in this report provide a representation of process variances normally achieved in normal shipbuilding practice. Perhaps more importantly, it represents a benchmark against which shipyards can judge accuracy of their processes. Even yards that did not participate can get an idea of which dimensional measurements may be taken to better understand accuracy control problems; these yards may also be able to contribute to a Phase III survey.

² The Society of Naval Architects of Japan, 15-16, Toranomom 1 Chome, Minato-ku, Tokyo 105, Japan

APPENDIX A

**NORTH AMERICAN SHIPBUILDING
ACCURACY DATA**

NORTH AMERICAN SHIPBUILDING ACCURACY PHASE II

FLAT PANEL

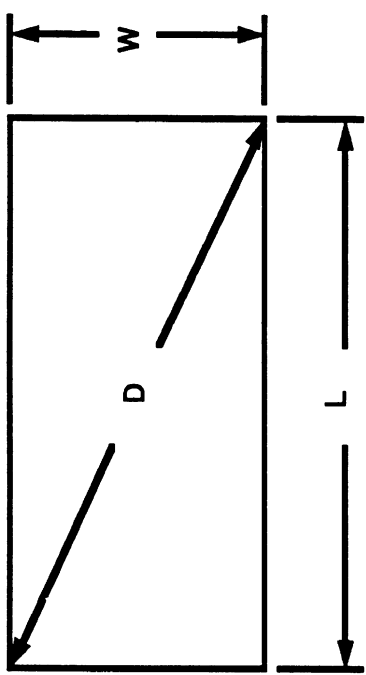
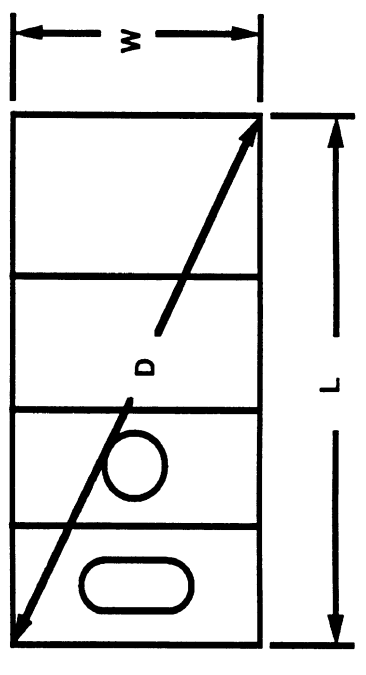
Process Description	Manufacturing Level	Measurement Device & Accuracy	Measurement # Responded	Standard Range JSQS(mm)	Tolerance Limit JSQS(mm)
4 of 6 NC Flame 2 of 6 NC Plasma	 <p>PART FABRICATION</p>	Steel Tape 1/32" or 1/16"	Length - L # respond:6	± .083 in ± 2.11 mm J: ± 3.5	± .134 in ± 3.40 mm J: ± 5.0
		Same	Width - W # respond:6	± .042 in ± 1.06 mm J: ± 3.5	± .080 in ± 2.04 mm J: ± 5.0
S.P.C. used: 2Y/4N	 <p>FLAT PANEL ASSEMBLY</p>	Same	Diagonal - D # respond:4	± .117 in ± 2.97 mm N/A	± .173 in ± 4.40 mm N/A
S.P.C. used: 1Y/3N		Same	Length - L # respond:4	± .126 in ± 3.20 mm J: ± 4.0	± .183 in ± 4.64 mm J: ± 6.0
		Same	Width - W # respond:5	± .228 in ± 5.78 mm J: ± 4.0	± .336 in ± 8.54 mm J: ± 6.0
		Same	Diagonal - D # respond:3	± .246 in ± 6.24 mm J: ± 4.0	± .358 in ± 9.10 mm J: ± 8.0

STRUCTURAL SHAPES

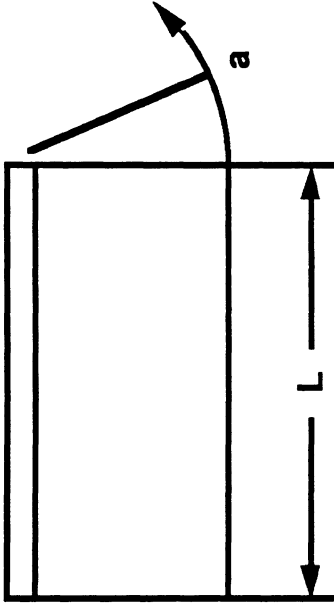
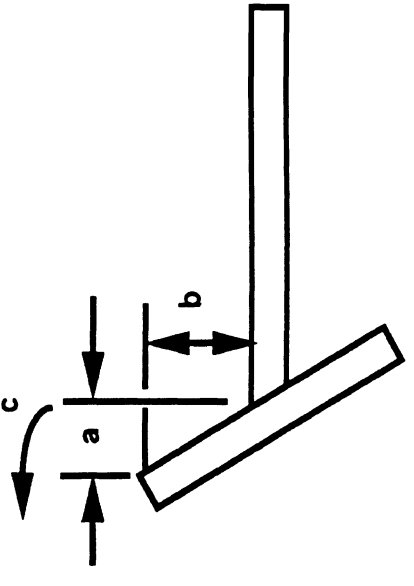
Process Description	Manufacturing Level	Measurement Device & Accuracy	# Responded	Standard Range JS/PI(mm)	Tolerance Limit JS/PI(mm)
NC Plasma and Shears	<p>PART FABRICATION</p> 	Steel Tape 1/32" or 1/16"	Deviation of Fitted Length - L #respond: 3	± .073 in ± 1.86 mm PI:±3.3	± .127 in ± 3.21 mm PI:±5.0
S.P.C. used: 0Y/2N	<p>BUILT UP MEMBERS</p> 	Same + Straight Edge and Square	Squariness of End cut Angle a #respond: 2	N/A N/A	N/A N/A
S.P.C. used: Y / N			Angular Deviation of Face Plate Ratio a/b #respond: 0 OR Angle c #respond: 0	N/A N/A	N/A N/A

Section 1

Section 2

NORTH AMERICAN SHIPBUILDING ACCURACY PHASE II

FLAT PANEL

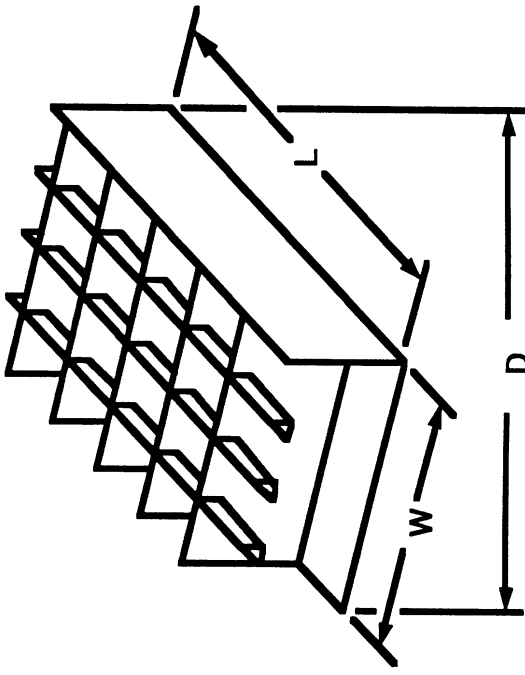
Process Description	Manufacturing Level	Measurement Device & Accuracy	Measurement # Responded	Standard Range JSQS (mm)	Tolerance Limit JSQS (mm)
NC and manual marking, plate panels set and tacked, flux core manual welding	SEMI-BLOCK AND BLOCK ASSEMBLY:		Length - L	± .190 in ± 4.83 mm	± .283 in ± 7.19 mm
			#respond:5	J: ± 4.0	J: ± 6.0
S.P.C. used: 2Y/3N			Width - W	± .325 in ± 8.26 mm	± .498 in ± 12.6 mm
			#respond:6	J: ± 4.0	J: ± 6.0
			Diagonal-D	± .139 in ± 3.52 mm	± .296 in ± 5.82 mm
			#respond:3	N/A	N/A

Section I

Section II

NORTH AMERICAN SHIPBUILDING ACCURACY PHASE II

CURVED PLATE

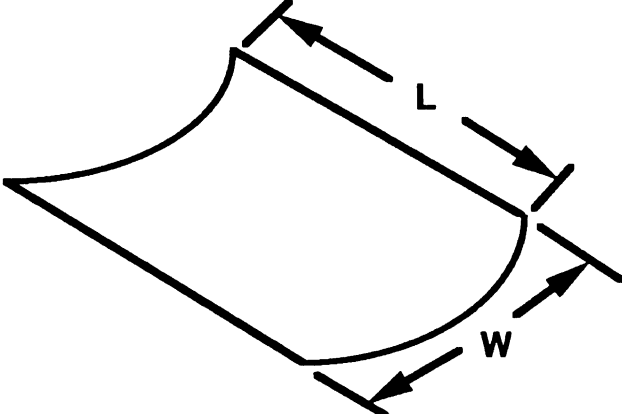
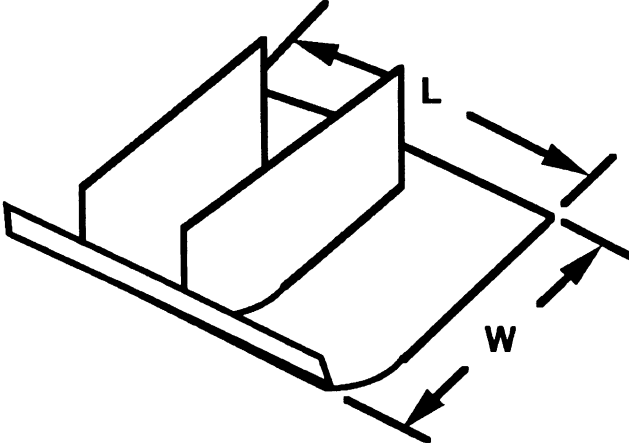
Process Description	Manufacturing Level	Measurement Device & Accuracy	Measurement # Responded	Standard Range	Tolerance Limit
				JSQS (mm)	JSQS (mm)
Plate Rolls	PART FABRICATION 	Steel Tape 2 at 1/32" 1 at 1/16'	Length - L #respond:3	± .299 in	± .347 in
				± 5.82 mm	± 8.82 mm
				J: ± 4.0	J: ± 8.0
				± .184 in	± .312 in
				± 4.67 mm	± 7.92 mm
				J: ± 4.0	J: ± 8.0
S.P.C. used: 0Y/2N					
NC and manual marking, fitted and tacked, manual flux core welding	SUB-BLOCK ASSEMBLY 	Steel Tape 2 at 1/32" 1 at 1/16'	Length - L #respond:4	± .182 in	± .317 in
				± 4.61 mm	± 8.05 mm
				J: ± 4.0	J: ± 8.0
				± .213 in	± .347 in
				± 5.41 mm	± 8.81 mm
				J: ± 4.0	J: ± 8.0
S.P.C. used: 1Y/2N					

NORTH AMERICAN SHIPBUILDING ACCURACY PHASE II

CURVED PLATE

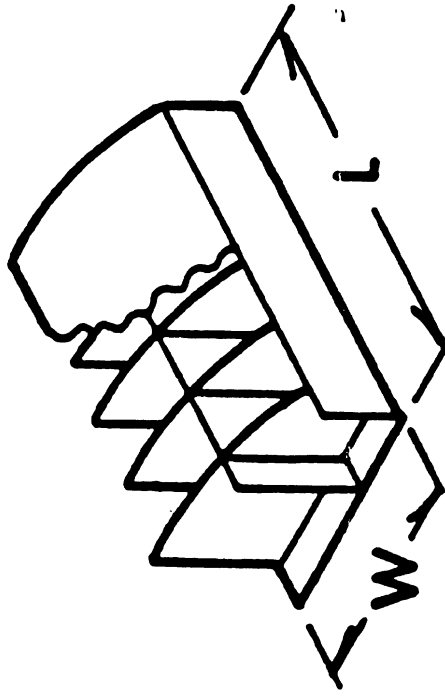
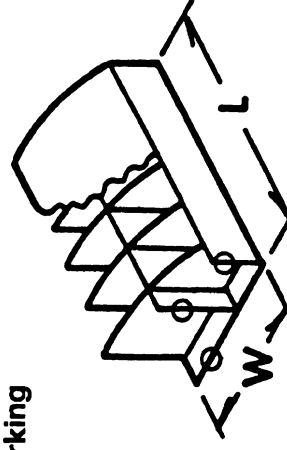
Process Description	Manufacturing Level	Measurement Device & Accuracy	Measurement # Responded	Standard Range JSQS (mm)	Tolerance Limit JSQS (mm)
Bulkheads fitted and welded to flat plate then set into curve plate which is on pin jigs	SEMI-BLOCK AND BLOCK ASSEMBLY 	Steel Tape 2 at 1/16" 1 at 1/32"	Length - L #respond:3	± .200 in ± 5.08 mm J: ± 4.0	± .305 in ± 7.75 mm J: ± 8.0
S.P.C. used: 1Y/2N N/A	Ref: for page 9 Block Marking 	Same N/A	Width - W #respond:3 N/A	± .199 in ± 5.05 mm J: ± 4.0	± .303 in ± 7.69 mm J: ± 8.0 N/A

NORTH AMERICAN SHIPBUILDING ACCURACY PHASE II

FLANGED PLATE

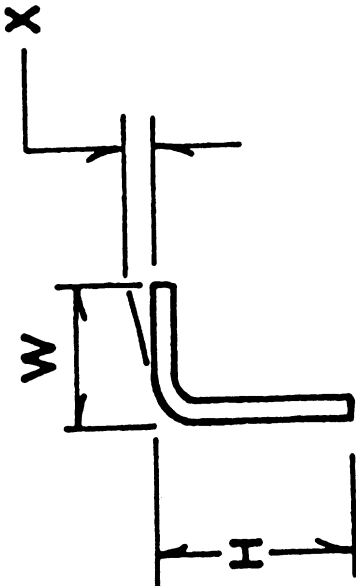
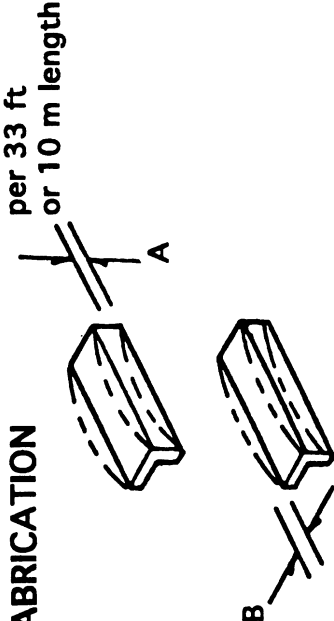
Process Description	Manufacturing Level	Measurement Device & Accuracy	# Responded	Standard Range JSQS (mm)	Tolerance Limit JSQS (mm)
Hydraulic press 1 with radius corner dies	<p>PART FABRICATION</p> 	Steel Tape 2 at 1/16" 1 at 1/32"	Flange Width - W #respond:3	± .177 in ± 4.50 mm J: ± 3.0	± .292 in ± 7.42 mm J: ± 5.0
S.P.C. used: 0Y/3N	<p>PART FABRICATION</p> 	Same + Template	Accuracy of Bend - X inches per 4 in or mm per 100mm #respond:3	± .112 in ± 2.4 mm J: ± 2.5	± .225 in ± 4.8 mm J: ± 4.5
S.P.C. used: 0Y/1N			Curvature A in Plane of Flange in per 33 ft mm per 10m #respond:2	± .745 in ± 18.9 mm J: ± 10	± 1.18 in ± 29.9 mm J: ± 25
			Curvature in Plane of Web - B #respond:2	± 1.06 in ± 2.69 mm J: ± 10	± 1.65 in ± 41.9 mm J: ± 25

NORTH AMERICAN SHIPBUILDING ACCURACY PHASE II

PART FABRICATION

Process Description	Manufacturing Level	Measurement Device & Accuracy	Measurement # Responded	Standard Range JSQS (mm)	Tolerance Limit JSQS (mm)
NC plasma cut 500T Press Break	<p>CORRUGATED PLATE</p>	Steel Tape 1/16"	Depth of Corrugation D #respond:1	± .188 in ± 4.76 mm J:± 3.0	± .375 in ± 9.53 mm J:± 6.0
		Steel Tape 1/16"	Width of Corrugation B1 B2 #respond:1	± .250 in	± .375 in
		Steel Tape 1/16"	Pitch of Corrugation P #respond:1	± 6.35 mm	± 9.53 mm
S.P.C. used: 0Y/1N				J:± 3.0	J:± 6.0
Plate Roller	<p>ROLLED PLATE</p>	Steel Tape 1/32"	Diameter D #respond:1	± .062 in ± 1.57 mm J:± D/200	± .125 in ± 3.18 mm J:± D/150
		S.P.C. used: 1Y/1N			
S.P.C. used: 1Y/1N	<p>BUILT-UP PLATE SECTION</p>	Steel Tape 1/16"	Face Plate Misalignment X #respond:1	± .125 in ± 3.18 mm J:± 1.5	± .188 in ± 4.76 mm J:± 3.0
		S.P.C. used: 1Y/1N			

NORTH AMERICAN SHIPBUILDING ACCURACY PHASE II

MARKING: Cutting and fitting lines
lines for general Hull Members

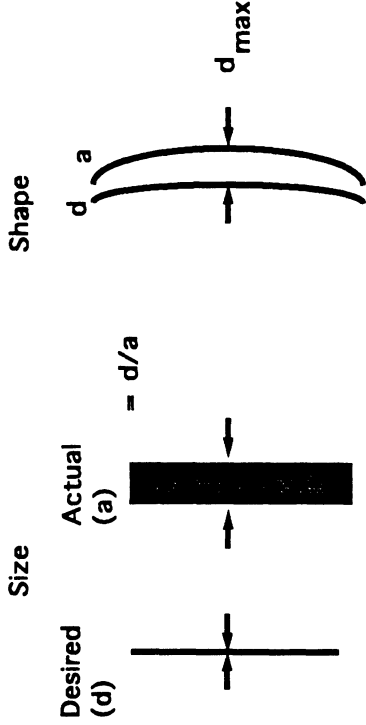
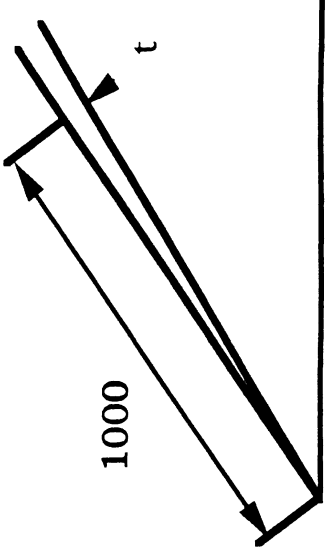
Process Description	Manufacturing Level	Measurement Device & Accuracy	Measurement # Responded	Standard Range JSQS (mm)	Tolerance Limit JSQS (mm)
<p>NC Scribe Air Driven Punch</p>	<p>SIZE AND SHAPE OF LINES</p> 	<p>Steel Tape Straight Edge 1/16"</p>	<p>Size #respond:1</p>	<p>± .063 in ± 1.59 mm J:± 2.0</p>	<p>± .063 in ± 1.59 mm J:± 3.0</p>
<p>S.P.C. used: OY/1N</p>	<p>ANGLED LINES</p> 	<p>Steel Tape Straight Edge 1/16"</p>	<p>Shape d #respond:1</p>	<p>± .063 in ± 1.59 mm J:± 1.5</p>	<p>± .063 in ± 1.59 mm J:± 2.5</p>
<p>S.P.C. used: OY/1N</p>			<p>Corner Angle - t #respond:1</p>	<p>± 2.6 in ± 6.60 mm J:± 1.5</p>	<p>± 5.2 in ± 13.2 mm J:± 2.0</p>

NORTH AMERICAN SHIPBUILDING ACCURACY PHASE II

MARKING: Cutting and fitting lines
lines for general Hull Members

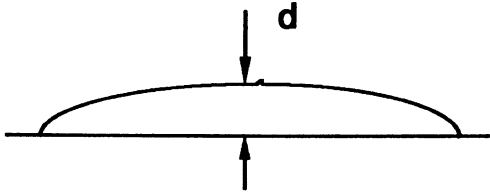
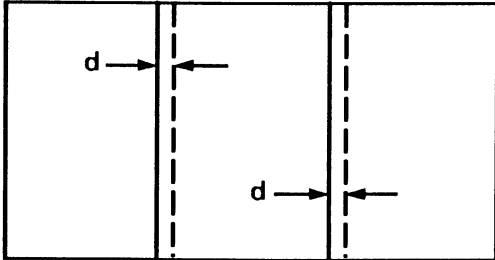
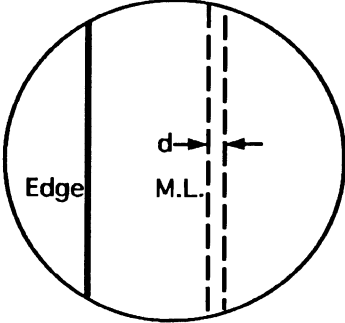
Process Description	Manufacturing Level	Measurement Device & Accuracy	Measurement # Responded	Standard Range JSQS (mm)	Tolerance Limit JSQS (mm)
S.P.C. used: Y / N	<p>CURVATURE</p> 		<p>Curvature d #respond:0</p>	<p>N/A J:± 1.0</p>	<p>N/A J:± 1.5</p>
S.P.C. used: 2Y/1N	<p>MEMBER LOCATION</p> 	<p>Steel Tape 1 at 1/16" 2 at 1/32" 1 at 1/64"</p>	<p>Member Location d #respond:4</p>	<p>± .152 in ± 3.87 mm J:± 2.0</p>	<p>± .198 in ± 5.02 mm J:± 3.0</p>
S.P.C. used: Y / N	<p>BLOCK CUTOFF MARKING (Field) Ref. Page 5</p> 		<p>Block Edge Cut-Off Marking d #respond:0</p>	<p>N/A J:± 2.5</p>	<p>N/A J:± 3.5</p>

NORTH AMERICAN SHIPBUILDING ACCURACY PHASE II

PIPE BENDING

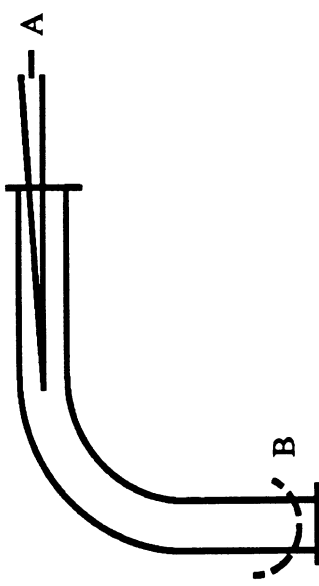
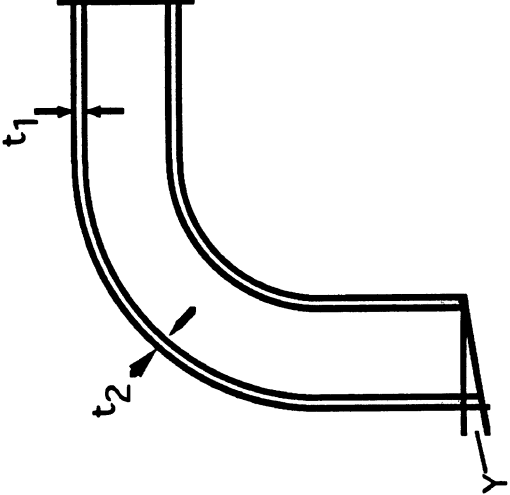
Process Description	Manufacturing Level	Measurement Device & Accuracy	Measurement # Responded	Standard Range JSQS (mm)	Tolerance Limit JSQS (mm)
Rotary Draw Bender	Simple Bends Specify Bend Diameter 	Protractor $\pm .5^\circ$ Steel Tape 1/64"	Deviation from desired bend angle Angle A #respond:2	$\pm 1.12^\circ$ N/A	$\pm 1.41^\circ$ N/A
S.P.C. used: 2Y/0N		N/A	Torsion along Length Angle B	N/A	N/A
Same		Ultrasound $\pm 3\%$	Thickness - t_1	N/A	N/A
		Same	Thickness - t_2	N/A	N/A
		Same	Wall Thinning* $1 - \frac{t_2}{t_1} \times 100$ #respond:3	$\pm 12.4\%$ N/A	$\pm 15.8\%$ N/A
S.P.C. used: 0Y/3N		Same	Pipe Flange Distortion Angle Y	N/A	N/A

NORTH AMERICAN SHIPBUILDING ACCURACY PHASE II

PIPE BENDING

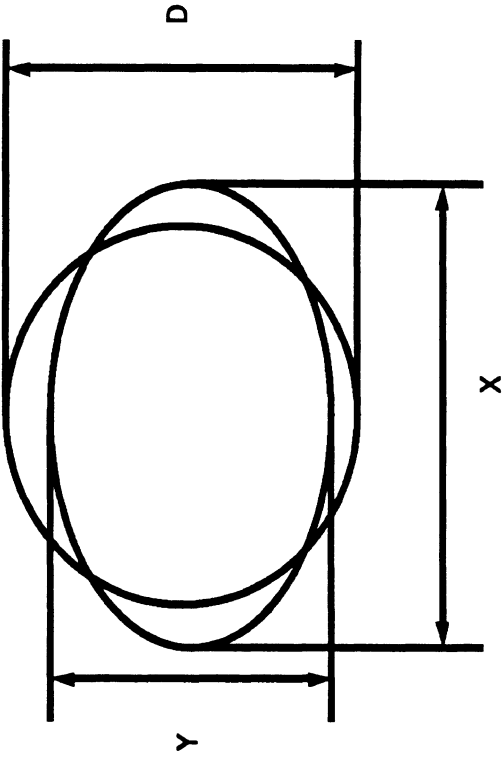
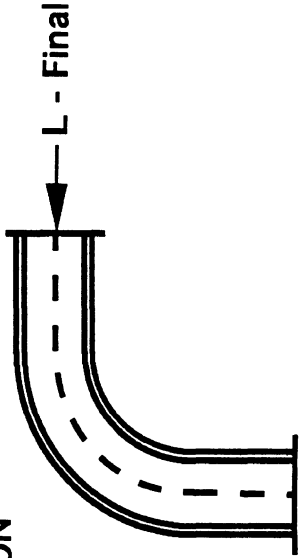
Process Description	Manufacturing Level	Measurement Device & Accuracy	Measurement # Responded	Standard Range JSQS (mm)	Tolerance Limit JSQS (mm)
Rotary Draw Bender	 <p>CIRCULARITY</p>	Calipers 1/16"	Diameter across Major Axis X #respond:1	± 1.92 in ± 48.7 mm N/A	N/A N/A
		Same	Diameter across Minor Axis Y #respond:1	± 1.86 in ± 47.3 mm N/A	N/A N/A
S.P.C. used: 1Y/N	 <p>ELONGATION</p>	Same	Diameter of undistorted Pipe D #respond:1	± 1.90 in ± 48.2 mm N/A	N/A N/A
Same		Steel Tape 1/64"	Elongation due to bending L - original L - final #respond:2	± .510 in ± 1.30 mm N/A	± .036 in ± .91 mm N/A
S.P.C. used: Y/2N					

EDGE PREPARATION

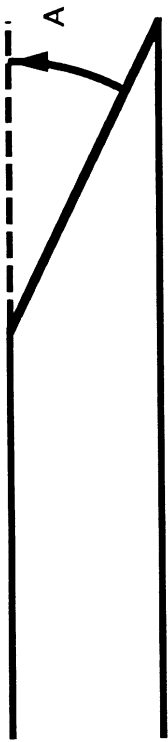
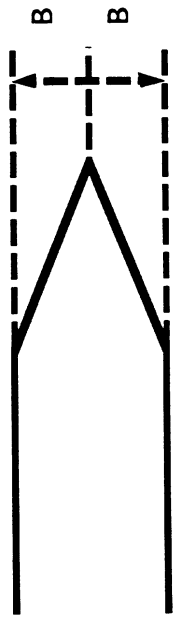
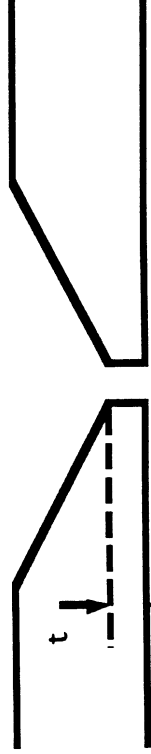
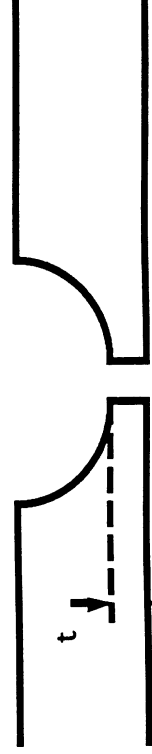
Process Description	Manufacturing Level	Measurement Device & Accuracy	Measurement # Responded	Standard Range JSQS (mm)	Tolerance Limit JSQS (mm)
NC Flame Planing		Bevel Gauge ± .5°	Angle - A #respond:1	± 1.00° J:± 2.0°	± 3.00° J:± 4.0°
S.P.C. used:1Y/N					
Same		Steel Tape 1/32"	Length - B #respond:1	± .031 in ± .79 mm J:± 1.5	± .063 in ± 1.59 mm J:± 2.0
S.P.C. used:1Y/N					
Same		Steel Tape 1/32"	Thickness - t #respond:1	± .031 in ± .79 mm N/A	± .063 in ± 1.59 mm N/A
S.P.C. used:1Y/N					
Same			Thickness-t #respond:0	N/A N/A	N/A N/A
S.P.C. used: Y / N					

NORTH AMERICAN SHIPBUILDING ACCURACY PHASE II

PAINT THICKNESS

Dimensional Units: Mils

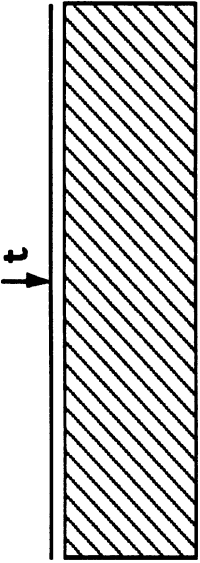
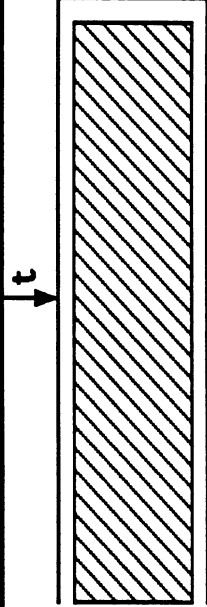
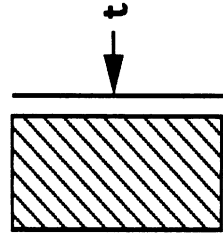
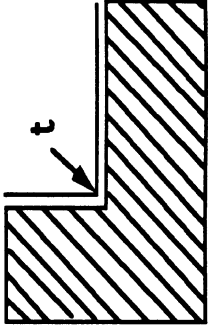
Process Description	Manufacturing Level	Measurement Device & Accuracy	Measurement # Responded	Standard Range JSQS (mm)	Tolerance Limit JSQS (mm)
Air Spray		Electric or Magnetic Gauge $\pm 5\%$ Wet Film Gauge	Thickness - t #respond:3	± 12.0 N/A	± 23.9 N/A
S.P.C. used: 1Y/2N					
Same		Same	Thickness - t #respond:2	± 16.1 N/A	± 20.2 N/A
S.P.C. used: 0Y/2N					
Same		Wet Film Gauge	Thickness - t #respond:1	± 7.6 N/A	± 20.2 N/A
S.P.C. used: 1Y/0N					
Same		Electric or Magnetic Gauge $\pm 5\%$ Wet Film Gauge	Thickness - t #respond:2	± 16.1 N/A	± 20.2 N/A
S.P.C. used: 0Y/2N					

