

REFASHION LIVERNOIS

by

Angela Cesere
Nolan Sandberg
Peter Widin
Lauren Yelen

A Master's Project submitted
in partial fulfillment of the requirements
for the degree of
Master of Landscape Architecture
(Natural Resources and Environment)
at the University of Michigan
April 2015

Faculty advisor:
Professor MaryCarol Hunter, PhD

ABSTRACT

Urban revitalization has traditionally taken the shape of outside developers dictating the form and usage of spaces. In contrast, our client Chad Dickinson of I'm Here Detroit looks to create a mixed use development (including retail, restaurant and residential spaces) which is not only profitable but fulfills the needs of the surrounding community. The site occupies a historic stretch of Livernois Avenue in Detroit, known as the Avenue of Fashion. Like much of Detroit, the retail district has suffered from hard times, but has recently seen greater economic investments due to the strength of the nearby residential communities. The neighborhoods surrounding this area have retained their architectural integrity and identity, and are a highly desirable place to live. Longtime homeowners maintain a strong sense of community, but lack for a place to gather and relax outdoors within walkable distance.

On the face of things we were tasked with designing the outdoor courtyard of this development. However, the design process was founded on community engagement and respect for sense of place. To address this we a) gathered information on preferences for how the space might be used from community members during a public festival held along the Avenue; b) applied community feedback to design a courtyard space that serves commercial goals while offering an inviting and accessible gathering space for the neighborhood; c) created a design with built in spatial flexibility that accommodates a diverse programming schedule; and d) developed a design that showcased the use of local materials and sustainability best management practices into this design to serve as a precedent for other urban redevelopment projects. As a community hub, the resulting design has the potential to serve as a catalyst for further revitalization of the Avenue of Fashion.

ACKNOWLEDGEMENTS

We would like to thank all those who assisted and supported us during our project.

MaryCarol Hunter, Advisor, Professor of Landscape Architecture at the University of Michigan School of Natural Resources and Environment

Chad Dickinson, Client, I'm Here Detroit

Kirsten Lyons, Professional Advisor, Green Garage Detroit

Friends and family.

Contents

- PART I: INTRODUCTION** 1
 - CLIENT INFORMATION AND PROJECT GOALS..... 1
 - REFASHION LIVERNOIS TEAM PROFILE 2
 - SITE HISTORY AND CONTEXT 3
- PART 2: COMMUNITY FEEDBACK**..... 9
 - INTRODUCTION 9
 - INSTITUTIONAL REVIEW BOARD APPROVAL..... 9
 - RESEARCH INTO SURVEY METHODS 10
 - SURVEY CREATION 10
 - RESULTS 14
 - WHAT WE LEARNED 17
- PART 3: DESIGN PROCESS** 19
 - SITE INVENTORY AND EXISTING CONDITIONS..... 19
 - SITE ANALYSIS: SITE CONSTRAINTS AND OPPORTUNITIES..... 19
 - CONCEPT DEVELOPMENT 23
 - DESIGN..... 25
 - Courtyard Planting Design 29
 - Green Roof 31
- PART 4: CONCLUSIONS & REFLECTIONS ON OUR DESIGN PROCESS**..... 38

APPENDIX A.I: MAP OF LIVERNOIS BUSINESSES	41
APPENDIX A.II: FLYER FOR TABLING EVENT	42
APPENDIX B.I: SURVEY QUESTIONS	43
APPENDIX B.II SURVEY RESULTS	44
APPENDIX B.III	45
APPENDIX B.IV: PREFERENCE RECORDING SHEET	63
APPENDIX B.V: IMAGE PREFERENCE RESULTS	64
APPENDIX C.1: PERMEABLE PAVER DETAILS	66
APPENDIX C.1I: BENCH PLAN DETAILS	67
APPENDIX C.1II: BENCH ELEVATION	68
APPENDIX C.1V: RAMP PLAN DETAIL	69
APPENDIX C.V: RAMP ELEVATION DETAIL	70
APPENDIX C.VI: RAILING ELEVATION DETAIL	71
APPENDIX C.VII: WATER FEATURE DETAIL	72
APPENDIX C.VIII: COURTYARD PLANTING PLAN ALONG WALL	73
APPENDIX C.IX: COURTYARD PLANTING PLAN ALONG RAMP AND SIDEWALK	74
APPENDIX C.X: PLANTING BED DETAIL ALONG RAMP	75
APPENDIX C.XI: GREEN ROOF MIX DETAILS	76
APPENDIX C.XII: GREEN ROOF IRRIGATION DETAIL	77
APPENDIX C.XIII: GREEN ROOF ROOFSTONE DETAIL	78
APPENDIX C.XIV: GREEN ROOF STANDARD SYSTEM I	79
APPENDIX C.XV: GREEN ROOF STANDARD SYSTEM II	80
WORKS CITED	81

PART I: INTRODUCTION

The troubles of Detroit, Michigan, are well-documented. However, amidst blight and bankruptcy exist pockets of revitalization. One such area stretches along Livernois Avenue from McNichols (6 Mile Road) to the northern city border at Eight Mile Road. Known as the "Avenue of Fashion," in its heyday during the 1950's through 70's, this area bustled with customers eager to shop at boutiques and high end department stores like B. Siegel Company, or go out for a night on the town at hotspots like Baker's Keyboard Lounge. Although the historic neighborhoods adjacent to the Avenue of Fashion are still well-maintained, the retail district itself is no longer a regional shopping destination. The primary issues affecting the revitalization efforts are vacant and unkempt buildings, lack of visual cohesion and appeal, and poor urban design (Urban Land Institute, 2011).

Recognizing the potential for commercial corridors to both stabilize and revitalize areas, several agencies have focused their efforts on supporting retail development along Livernois, including Detroit Economic Growth Club, Revolve, and Hatch Detroit. The potential for this area has prompted young entrepreneurs and even a former Detroit Lions cornerback to purchase derelict properties and open up new shops and restaurants. One such property is the former Hunter's Supper Club, purchased by Chad Dickinson of I'm Here Detroit, a local development company.

CLIENT INFORMATION AND PROJECT GOALS

Our client, Chad Dickinson, is an architect, developer, furniture maker and a member of the Livernois Avenue community. His development company, I'm Here Detroit, provides thoughtful community driven solutions to local interior architecture and design problems while aiding with business development. We also collaborated with Kirsten Lyons, a Sustainability Support Services Provider for the Green Garage who holds degrees in architecture, horticulture, and design. She served as our key contact for the courtyard design project and is assisting Dickinson with design and sustainability of the buildings onsite.

Dickinson's property on Livernois includes three architecturally distinct but connected buildings opening out to a 52' x 50' courtyard. The buildings will be converted into a mixed use space, including a restaurant, special events space, and second-story residential loft. With its historic façade and prominent location along the corridor, this building complex has the potential to greatly impact the new Avenue of Fashion aesthetic identity. In particular, the courtyard space facing Livernois Avenue offers the perfect opportunity to create a destination space for not only retail and restaurant customers, but local residents. According to Dickinson, "We're focused on development based around viable communities rather than traffic patterns" (Crain's Detroit, 2013). Dickinson knew he wanted this space serve the community's needs by providing a gathering space for the people living in the surrounding neighborhoods. He also had a few ideas about outdoor programming, including a seasonal beer garden and special events like music and performances. However, he did not have a clear vision of how this space would look or function spatially.

2

The goal of this project was to create an outdoor space that contributes to the ongoing commercial revitalization efforts along Livernois Avenue, and also fulfills the needs of the surrounding community. By helping to create a destination public/private space at the former Hunter's Supper Club, our project engages in neighborhood placemaking. Using research from Project for Public Spaces (Power of Ten), our goal was to reassert Livernois Avenue as a Detroit destination. A revitalized space at the Supper Club site can provide a solid anchor location within the avenue and provide many things to do, something essential in attracting people and driving foot traffic to local businesses. This increased interest along the corridor will provide not only social but economic vitality to the area. The unique role of the Hunter's Supper Club site as a neighborhood hub provides the opportunity to introduce a large audience to sustainable design and materials, with the goal of these features being adapted as a standard for building. In particular, we sought to showcase green stormwater management practices, and the use of local and recycled materials and site amenities. We also expanded the courtyard visual footprint to the streetscape to improve the pedestrian experience.

REFASHION LIVERNOIS TEAM PROFILE

Our team was excited to bring our individual talents and perspectives to this project:

Angela Cesere - Angela holds a Bachelor of Fine Arts with an emphasis on photography from the University of Michigan. As a former photojournalist, Angela has contributed to the documentation of the collaborative design process. She also has a lot of experience finding information and building relationships with contacts. She is very interested in creating urban spaces centered around community needs.

Nolan Sandberg - Nolan holds a Bachelor of Science in Engineering in Mechanical Engineering from the University of Michigan. Nolan's interests include placemaking, sustainable development and community driven urban design inspired by his time in Honduras as a Water Engineer with the Peace Corps.

Pete Widin - Pete has a B.S. in Applied Ecology and plans to incorporate more urban work as a Landscape Architect; to revitalize urban spaces and incorporate ecology into the greater context of high-use areas.

Lauren Yelen - Lauren holds a B.S. in Biology from Arizona State University, and an M.S. in Ecology and Evolutionary Biology from the University of Michigan. Lauren is inspired by ecological processes, and intrigued by the perceived interface between man-made and "natural" environment. She hopes to create spaces that meld both ecological and urban functionality.

Though our team is diverse in background and professional ambition, we all align under the flags of sustainability and social responsibility.

SITE HISTORY AND CONTEXT

Through the 1950's through 1970's, the stretch of Livernois Avenue between 7 and 8 Mile Roads in Detroit was one of the top regional destinations for luxury shopping, and affectionately referred to as "The Avenue of Fashion." Along the Avenue, upscale department stores like B. Siegel Co., Woolworths, and Grinnell (a famous piano manufacturer), were widely regarded for the highest levels of quality and customer service. (See Fig. 1.) Like Hudson's department store in downtown Detroit, many people enjoy fond memories of outings to the Avenue. Shopping there was a grand and exciting experience; with shop after shop of beautiful goods, and in its heyday Livernois achieved an ambience akin to modern day Rodeo Drive.



Fig. 1: Advertisement in Vogue, 1952



Fig. 2: Photo by Jim Hendin, Marvin Gaye walking by his home in Detroit in 1971

Additionally, Livernois Avenue has a rich musical legacy, and in particular was known as a jazz hotspot. Baker's Keyboard Lounge, America's oldest operating jazz club, has anchored the Avenue since 1933. Famous jazz performers like Art Tatum, Dave Brubeck, Louis Armstrong, Ella Fitzgerald, John Coltrane, Miles Davis, and countless others have graced Baker's stage through the years. Baker's piano-shaped bar is rumored to have inspired Liberace to install his famous piano-shaped swimming pool at his home in Beverly Hills (Detroit News, 2015). Marvin Gaye also used to live in the neighborhood, as did Barry Gordy, founder of Motown Records. (See Fig. 2.)

Our site houses another notable historic building on the Avenue, referred to as the old Hunter's Supper Club. The oldest building in the Livernois area, it was originally a European style farmhouse constructed in the late 1890's by a European landowner. Later,

a carriage house was added onto the back side of the home, and eventually in the 1950's brick clad shops popped up on either side of the original buildings. The farmhouse itself had a diverse series of occupants, including a dance studio and the aforementioned Hunter's Supper Club, which hosted many special events over the years for local residents. However, in recent years the building has been unoccupied and fallen into disrepair. (Fig. 3)



Fig. 3: Image of current site and former Hunter's Supper Club building

Despite its storied past, in the past few decades the Avenue has experienced many of the same woes as the rest of Detroit, including high levels of vacancies and retail leakage. However, the Livernois area stands distinct from the overall city in its capacity to leverage extraordinary local historic and economic assets. Adjacent to the avenue are some of the city's most stable and architecturally distinctive neighborhoods. Sherwood Forest, a residential neighborhood immediately east of Livernois, is home to an older, highly educated and affluent population. Predominantly African-American, many of the residents have lived in the area for decades, establishing a strong sense of community within the neighborhood. With median home values of \$196,900, and very few vacancies, Sherwood Forest is a highly desirable place to live. A little further east is Palmer Woods, and to the north is Green Acres, both similar in demographics to Sherwood Forest. To the west of Livernois are the Pembroke and Badgely neighborhoods, where home values are more modest (median price of \$87,607), but still above the Detroit average (\$59,700) (data compiled by Areavibes.com using 2012 U.S. Census Data, see Fig. 4-7). Less than two miles south of the main retail area is the University District neighborhood, dominated by the University of Detroit Mercy and Marygrove College, with a combined student population of 6,000. (See Appendix A.I for a map of Livernois Ave.)

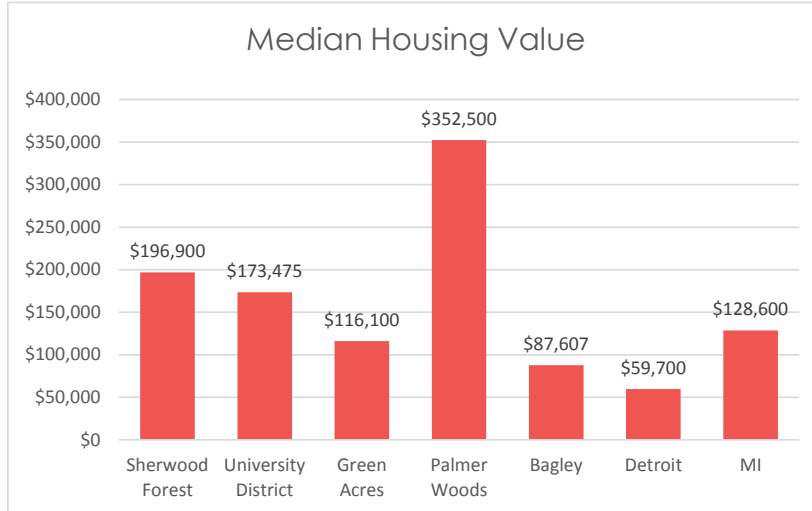

Fig. 4

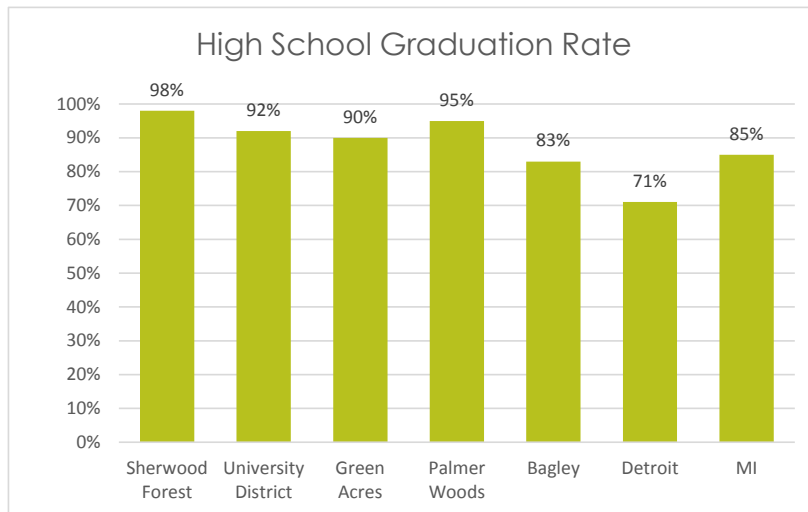

Fig. 5

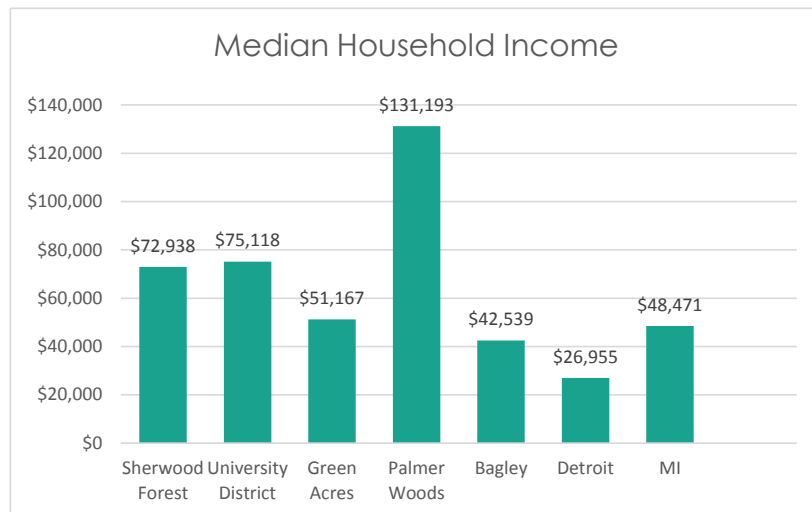

Fig. 6

	Sherwood Forest	University District	Green Acres	Palmer Woods	Bagley	Detroit	MI
Population (2013)	1,129	2,109	991	808	12,488	721,459	9,895,622
Population density (sq mi)	5,264	4,178	6,977	2,459	10,017	5,200	175
Median age	45.3	44.0	47.9	51.5	38.7	34.7	38.8
Caucasian	4%	9%	10%	14%	1%	12%	79%
African American	96%	90%	90%	82%	97%	82%	14%
Asian	0%	0%	0%	0%	0%	1%	2%
Median Household Income	\$72,938	\$75,118	\$51,167	\$131,193	\$42,539	\$26,955	\$48,471
Median Housing Value	\$196,900	\$173,475	\$116,100	\$352,500	\$87,607	\$59,700	\$128,600
High School Graduation Rate	98%	92%	90%	95%	83%	71%	85%

Fig. 7

According to Revolve Detroit, an organization working to foster the evolution and vibrancy of Detroit's neighborhood business districts, the Livernois area harbors tremendous consumer power: within approximately one mile of the district, there are nearly 9,000 households, with average incomes of around \$50,000. Income density (the concentration of spending power) is nearly seven times higher than the regional average. However, nearly 50% of local resident consumer spending (approximately \$140 million) is on retail purchases made outside of the area (Revolve Detroit, 2015). Regarding his choice to redevelop the Hunter's Supper Club property on Livernois Avenue, Dickinson noted "This northwest side of Detroit has a lot of money to spend, but it's not spent in the city. You have money bleeding out of the city into Ferndale and Royal Oak instead of staying in Detroit. We want to be able to offer people a viable commercial enterprise" (Crain's Detroit, 2013).

Recognizing economic potential of the area, many other local agencies and investors are seizing the opportunity to develop a vibrant local retail market on Livernois, and are working to revitalize the Avenue. Rather than rely on big box anchors that fail to reflect the flavor of a place, revitalization efforts have focused on small, locally owned businesses. In spring 2013, the Detroit Economic Growth Corporation won a \$200,000 prize from ArtPlace to install art in the vacant storefronts and medians along the Avenue. Its Revolve Detroit program also worked with neighborhood groups to place pop-up shops in vacant storefronts. Some of those



Fig. 8: Good Cakes and Bakes

businesses became permanent, including Good Cakes and Bakes, a shop filled with delectable sweet treats. (See Fig. 8.) According to the shop's young owner, April Anderson, "Livernois has this buzz like Midtown [Detroit] used to have — everything doesn't have to be downtown or in Midtown," she said. "We're starting to coin the

phrase 'uptown.' Come uptown to shop. Come uptown to eat. People want something different, and they want it in their neighborhoods" (Crain's Detroit, 2014). Revolve Detroit's "Community Storefront" on Livernois continues to serve as a business incubator for entrepreneurs just starting out. (See Fig. 9, Livernois Community Storefront)



Fig. 9: Livernois Community Storefront

Another burgeoning Livernois business receiving a great deal of publicity is Kuzzo's Chicken and Waffles, owned by former Detroit Lions football player Ron Bartell (see Fig. 10). Bartell, who grew up in the area, said of his decision to open the restaurant,



Fig. 10: Kuzzo's Chicken and Waffles, view from Courtyard

"Hopefully it's a spark that brings other businesses around here, whether it's other diners, restaurants, lounges. This area needs so many different things yet can support so many different things. I hope this really shows that in order to be successful you don't have to go downtown or Midtown; you can actually stay in the neighborhood and do good business and hire people and service the community" (Model D Media, 2015).

Along with the Dickinson's redevelopment project and Good Cakes and Bakes, Kuzzo's was one of the Avenue businesses profiled during a recent press conference announcing a new program called Motor City Match. Speaking inside the old Hunter's Supper Club, Detroit Mayor Mike Duggan, himself a member of the Livernois community, explained that the initiative will award \$500,000 in three month cycles to entrepreneurs interested in setting up shop in Detroit. (See Fig. 11.) According to Duggan, "The Motor City Match program is designed to expand the growth we are seeing downtown, Midtown, and Corktown to key neighborhood corridors across our city" (Michigan Radio, 2015).

Investments in the Avenue are not limited to individual business development. In 2013 Hatch Detroit, another program “supporting independent retail businesses in Detroit through funding, exposure, education, and mentoring,” launched its neighborhood initiative on the Avenue, which brought new pedestrian scale signage to five businesses on Livernois as well as a district-wide cleanup sponsored by the Detroit Lions (Hatch Detroit, 2015).



Fig. 11: Chad Dickinson at the Motor City Match press conference, April 2015

Further beautification efforts and streetscape upgrades are occurring along the Avenue. Thanks to efforts from the Detroit Economic Growth Corporation (DEGC), in 2014 the Michigan Department of Transportation conditionally committed nearly \$1 million in federal dollars for landscaping and other beautification for the 2.5 mile stretch of Livernois between McNichols and 8 Mile Rd. That money was matched by city and private dollars, bringing the total investment in the Avenue to \$1.7 million. Additionally, the DEGC is currently working with its partners to secure funding for a second phase that would include public amenities like new sidewalks, lighting, and bike lanes.

PART 2: COMMUNITY FEEDBACK

INTRODUCTION

The hallmark of any successful public space is how active it is on any given day of the week. When we first met with Chad Dickinson to discuss the project, he made it clear to us that this was to be a space for the community. He is a resident of the neighborhood, and it was important to him to create a space that the neighborhood would take ownership of as a central hub, a place where they could gather as a community for workshops, entertainment, or simply socializing. After seeing the site and neighborhood context, we understood Dickinson's desire to serve the neighborhood and saw a community-based design as the only way forward for this site. As such, it was necessary to engage with the residents of the surrounding neighborhoods and record their desires for the space.

INSTITUTIONAL REVIEW BOARD APPROVAL

After agreeing that we should survey community members in the neighborhood on what preferences they had, we began looking into the Health and Behavioral Sciences Institutional Review Board (IRB) process for human research conducted by students at the University of Michigan. This review process was set in place for the protection of human subjects due to past incidents of physically or emotionally harmful studies. Reading through the IRB student guide and talking with the School of Natural Resources representative on the IRB board led us toward seeking exempt status for our research. This meant a much shorter application process, and no need for ongoing IRB review and approval for our project.

Our project fell under exemption #2 of the 45 CFR 46.101.(b):

“Research involving the use of educational tests (cognitive, diagnostic, aptitude, achievement), survey procedures, interview procedures or observation of public behavior, unless: (i) information obtained is recorded in such a manner that human subjects can be identified, directly or through identifiers linked to the subjects; and (ii) any disclosure of the human subjects' responses outside the research could reasonably place the subjects at risk of criminal or civil liability or be damaging to the subjects' financial standing, employability, or reputation.” (“Public Welfare” 2009.)

Because the subject matter of our survey was centered on preferences for what should be in a courtyard, it involved minimal risk for those being surveyed. To stay within the exempt status, we also decided not to collect or record survey takers' names and background information in connection with their preferences. We discovered during the process of filling out the exemption form that we could not survey anyone under 18 years of age and still be exempt. This was a disappointment to us because we had hoped to get a range of suggestions from all ages in the community. After careful thought, we decided to exclude surveying anyone under 18 with the knowledge that parents could also voice suggestions with children's interests in mind.

As a part of the IRB process, each member of our team went through Program for Education and Evaluation in Responsible Research and Scholarship (PEERS) certification. This was valuable in understanding why the IRB process is in place and how to survey people responsibly.

RESEARCH INTO SURVEY METHODS

As leaders in the realm of “placemaking”, much of our research into methods was derived from the work of Project for Public Spaces (PPS), a non-profit urban planning firm based in New York City. The most basic element of placemaking, according to PPS is the idea that “The Community is the Expert” (“Eleven Principles for Creating Great Community Places” 2015). Leveraging local knowledge of a site’s history, perceived shortcomings and potential are essential to creating a meaningful and active public space. A successful place has four key qualities – it is accessible, there are plenty of activities for users, it is a comfortable place to be and it fosters social interaction (“What Makes a Successful Place” 2015)(see Fig. 12). It was important for us to transform the courtyard into a place that exhibited all of these qualities, and as such, we began to create a way to gather information and perceptions about the site from the community as well as their desires for what would bring them to the space regularly. We used PPS’ place diagram to focus our questions on these important factors.



Fig. 12: PPS' Place Diagram (“What Makes a Successful Place” 2015)

SURVEY CREATION

To make this courtyard into an attractive community space, we really needed to understand not only the desired components and activities for the space, but also the aesthetic preferences of the potential users. We decided to create a two-part survey: part one held multiple choice and open response questions,

and part two held images of spaces and amenities where survey takers could indicate preferences. (See Appendix A and B for actual surveys.) The surveys were deliberately made short to avoid overwhelming the survey taker, but extra space was provided for additional comments.

The multiple choice questions addressed what activities and amenities people wanted to participate in at the space. This place-specific distinction was made to provoke people into thinking not only about activities and amenities they enjoy in general, but what they felt would make sense specifically at the site. We tried to include a large range of activities that would appeal to a variety of age groups and interests, some of which our client had suggested in previous conversations. For the question on amenities, we listed a variety that could feasibly work at the site.

Part one concluded a couple of important open-ended questions. The first one addressed what people disliked about other spaces and did not want to see in the courtyard, and the other asked what activities or amenities were missing in the survey taker's neighborhood that the space could potentially provide. These questions were important to us to understand what drives people away from spaces and what community needs the courtyard could fulfill.

For the visual preferences portion of the survey, we put together a list of categories of amenities we thought could imaginably work in the space (e.g. awnings) and also included things that we knew the space would have to include in order to function (e.g. a ramp). The categories we came up with were as follows:



Fig. 13: Precedent of a trellis

Trellises, Pergolas and Awnings: Many outdoor spaces use these features to provide shade or to make a space more intimate. We also liked the potential to use these elements in conjunction with lighting or plantings.



Fig. 14: Precedent of lighting

Lighting: Our client expressed the desire to use the courtyard for restaurant and bar seating, so it was clear to us that lighting was essential for making the space outside usable in the evening hours.



Fig. 15: Precedent of ramp with stairs

Stairs and Ramps: The main courtyard area and several building entrances are located more than six inches above the sidewalk and require stairs and a ramp to enter the space and meet accessibility guidelines. We included images of designs that kept these elements separate and some that combined them into the same space.



Fig. 16: Precedent of railing

Railings: The stairs and ramp will require railings to meet accessibility requirements of the site. We included images of simple and ornate railings, along with varying levels of transparency and types of materials.



Fig. 17: Precedent of seating

Seating: People will need comfortable places to sit in the courtyard in order to make good use of the space. Included in the images were both moveable and permanent seating options with a variety of colors, materials, and styles.



Fig. 18: Precedent of water feature

Water: We explored adding fountains or other types of water features to our site to dampen noise from the street and for aesthetic value. This group of images also included potential decorative stormwater features.



Fig. 19: Precedent of paving

Paving: To meet accessibility needs, we knew we needed to pave the courtyard. We provided examples of different paving patterns, types and styles.



Fig. 20: Precedent of a bench

Planters: We knew we wanted to brighten the space with plantings, and that we would likely need planters to accomplish this goal. We found a variety of planters in many shapes, colors, and sizes from large standalone planters to those with built-in-seating and other creative designs.

During the survey creation process we determined that we would get the most beneficial feedback by conducting our surveys in-person, at the site. We wanted an opportunity to talk with the community directly about their needs and gauge how they felt about our project. We also thought that it would be more helpful for people to visualize what could happen in the courtyard while sitting inside the actual space.

When we found out that Light Up Livernois (an event held as a part of the Detroit Design Festival) was scheduled to occur right outside of our site in the fall of 2014 it seemed a perfect opportunity to get feedback from residents. To prepare for this event, we made and posted flyers with event details on light posts and inside business windows within a block of our site, about a week before the event date. (See Appendix A.II for an image of the flyer.) We also put together a tri-fold board with information about our team and the courtyard that we could display at the site. We drew attention to ourselves at the site with balloons and by engaging with passers-by on the sidewalk. We also offered doughnuts, soft drinks and gave out flowers to



Fig. 21: Fashion show during Light Up Livernois

incentivize people to come talk with us and take the survey.

The Light Up Livernois event drew mostly community members and some visitors out to the Avenue of Fashion with art installations and a fashion show (see Fig. 21). The event was well attended, and many people stopped by our site to talk with us and fill out surveys. A reporter from MLive Detroit, a news organization, stopped by to take our photo and ask us questions about our project. Overall, there was a high level of excitement and amiable conversation from neighbors and local business owners at the event.



Fig. 22: Photo during survey event

RESULTS

During the three hours that we spent in the courtyard during the Light Up Livernois event, we talked to over 60 people (see Fig. 22). Sixty people completed Part A of the survey (desired activities) and 6 people completed Part B, the visual preference portion of the survey.

We received the most responses to the two questions asking people to simply check which activities they would like to see at the site and what amenities would be more likely to attract them. We received between 9 and 51 votes for each activity option, but there were distinct favorites. Figure 23 and 24 below show the results. The majority of respondents said that they would like to listen to live music, meet friends or neighbors to socialize, eat, and just people watch. In addition to activities, people said they would like to see flowers and trees, seating, shelter, and artwork. (See Appendix B for full survey tally results.)

Fig. 23: **What amenities would make you want to come to this space?**

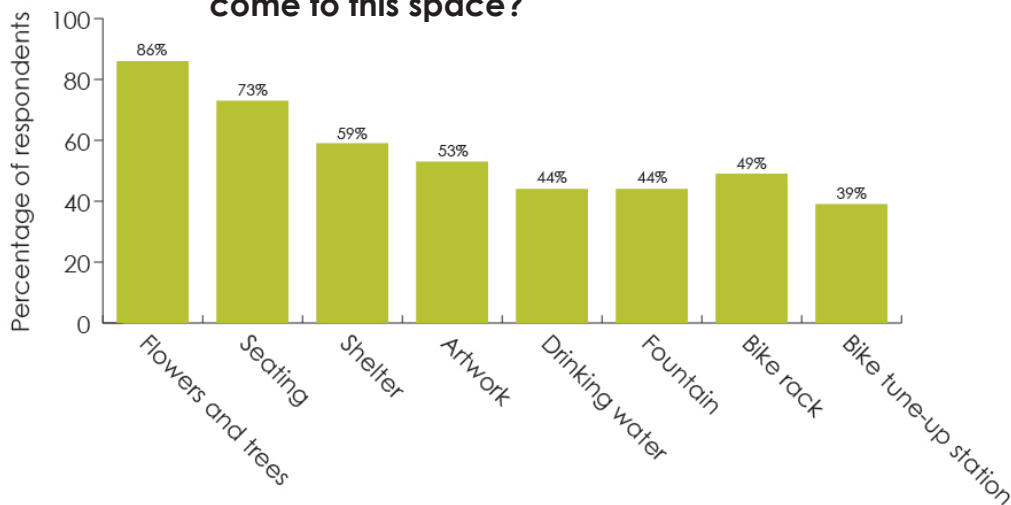
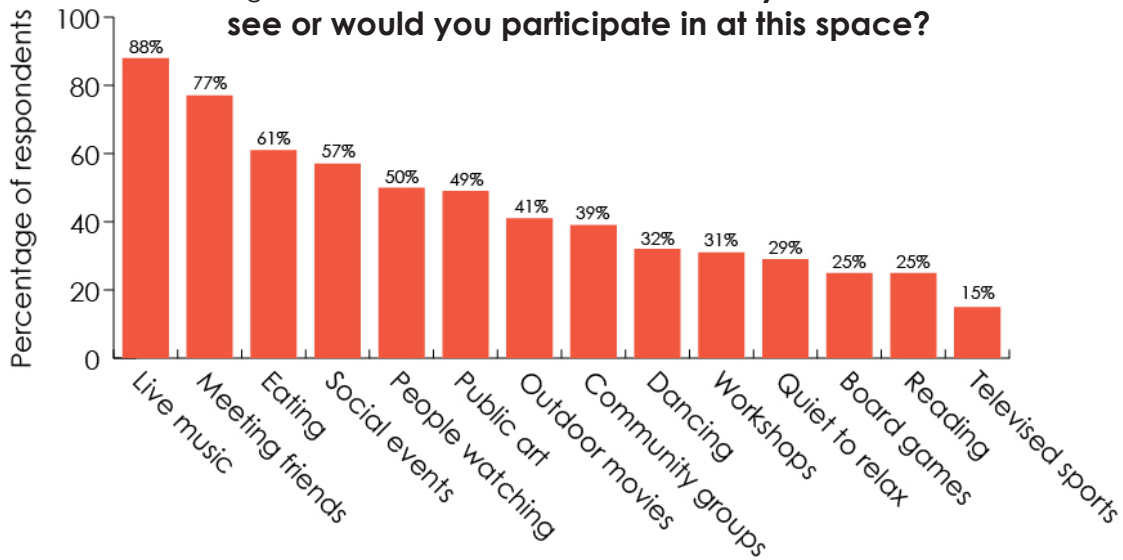

Fig. 24: **What sort of activities would you like to see or would you participate in at this space?**



Due to the fact that we only had a few people fill out the visual preference survey, there was less of a consensus on favorites. Some images received no votes, but most received between 1 and 4 votes. The most preferred images in each category are shown below (Fig. 25-33). (See Appendix B.V for full visual preference results.)



Fig. 25: Top choice for green wall



Fig. 26: Top choice for planter



Fig. 27: Top choice for paving



Fig. 28: Top choice for trellis



Fig. 29: Top choice for ramp/stairs



Fig. 30: Top choice for lighting

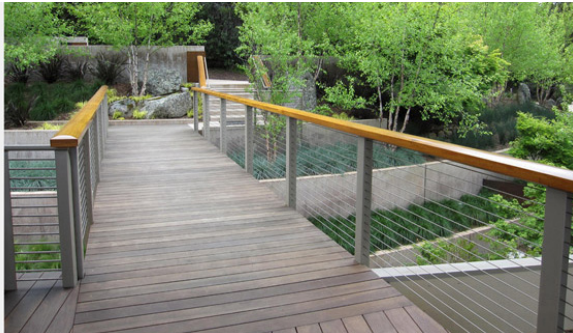

Fig. 31: Top choice for railing



Fig. 32: Top choice for seating



Fig. 33: Top choice for water feature

In addition to checkbox questions and image preferences, there were several areas for open comment. The answers we received here, plus notes that we took while talking to community members provided immense value. Many people had memories of the old Hunter's Supper Club. There had been many Sweet 16 parties held there as well special dinners. Some people remembered it as a dance studio after the supper club closed. Responses to questions varied, but mostly uniform. One person thought that food should be prohibited because it would attract pests, while almost everyone else wanted both the restaurant as well as a place to eat outside food. Security was an issue for several people. Bars on the windows and large objects to hide behind were opposed but there was suspicion that benches would attract vagrants and large groups of young people. Below are some of our favorite quotes.

What amenities would make you want to come to this space?

“People are the number one attraction, second is music, dancing and other activities. A comfortable place to sit in the shade completes the picture!”

What do you dislike about other spaces that you DO NOT want to see here?

“Thoughtless commercial development. Places unwelcoming to multiple, diverse, economic classes.”

“I dislike public spaces that lack hands on elements/public engagement. I also dislike public spaces that separate themselves from the street”

What sort of activities would you like to see or participate in this space?

“JAZZ!!”

WHAT WE LEARNED

Responses overall made it clear that there was a lack of communal public spaces in the surrounding area. The neighborhood wanted a place to gather and meet their friends, a space that didn't cater to one demographic but was open to everyone. The neighborhood tends toward an older demographic so a space that is family friendly during the day was important, while it was recognized that young people needed a safe place to hang out in at night. Due to its history as one such place, the people we talked to were very excited to see it come back and become that type of gathering space again. The European character was much beloved, but the lack of vegetation along in the space and along the avenue was highlighted as a shortcoming. The respondents wanted the softer, more natural feel of plants in the courtyard, something that would be more welcoming than solely the hard lines of the building. The most recurrent thing, on almost every survey, was the mention of music. Memories of parties and events in the supper club and the history of Livernois as a jazz destination colored the responses such that the use incorporation of live music in some way was imperative to our design.

Through the event, we learned a great deal about the needs and desires of the community. While we didn't ask questions about demographics, the people we talked to largely conformed to neighborhood census demographics. They were generally older, african american, and long-time residents of the area.

We also learned a lot about the process of community engagement. Piggybacking on the Light Up Livernois event greatly increased our foot traffic. Despite our balloons and flyering of the street a few days beforehand, we would not have gotten the same response rate without the established event. Offering cider and doughnuts as an additional incentive was appreciated, but did not draw in passers-by in and of themselves. Setting our table in the courtyard itself was very helpful for people answering questions. There was a lot of gazing around and pointing. It was clear that the respondents were picturing different elements in the courtyard.

The survey was well received, but the visual preference test using printed images

was not as successful. We printed several copies of tabloid sized (11" x 17") image sheets, which turned out to be a mistake because the size was unwieldy. It was determined upon reflection that dot voting on a central board containing the images would have been easier and probably would have gotten more responses.

PART 3: DESIGN PROCESS

Since the project site was purchased in a vacant state, we began with a fairly clean but derelict slate. The central design and planning challenges are addressed in the Inventory and Analysis sections that follow. Our approach was to first identify and detail existing site conditions. With our community-informed design goals in mind, we were able to transform the site's limitations into a design scheme that is socially functional and aesthetically anchored in the French-influenced style of the historical Avenue of Fashion. The design process used for this project is detailed below.

SITE INVENTORY AND EXISTING CONDITIONS

Outdoor and Indoor Elements:

In the spring-fall of 2014, our team made several site visits to document existing conditions at the project site. Initially, we visited the site to get an overall feel for the immediate physical and historical context of the property. This involved a tour of the outdoor and indoor aspects of the site lead by our client, Chad Dickinson and Kirsten Lyons of the Green Garage. As we moved through the buildings and courtyard, they discussed the plans and ideas for each area. This helped us develop initial conceptual ideas about how the site could be used, and understand special needs requiring attention. On the right, in Fig. 34 and 35, are pictures of the site in its existing condition. Some restoration work has been done on the roof of the central building during the time we were working on design for the site.



Fig. 34: 1890's construction



Fig. 35: 1950's construction

SITE ANALYSIS: SITE CONSTRAINTS AND OPPORTUNITIES

Courtyard:

Since the existing courtyard was a gravel pad, we knew that it would need a complete facelift from the ground up (see Fig. 36). The gravel gives the site a very utilitarian feel and renders the courtyard inaccessible to wheelchairs and walkers. We were told by the client that an engineer had surveyed the site and noted that

the subsoil underneath the gravel surface would drain very well and accommodate stormwater runoff. It was important to maintain permeable surfaces within the courtyard while improving the aesthetics of the space because this area is the main sink for rainwater running into the site from the surrounding roofs.



Fig. 36: Gravel courtyard

Planting Needs:

There are currently no plants on site (with the exception of street trees). There were likely more plants present at some point in history, but we weren't able to learn where or what these might have been. Currently the only area of the site that could hold plants in the ground without much modification is the area along the south-facing wall of the courtyard. Our number one community suggestion for the site was to add beautiful plants, so we knew this was a priority we needed to address with care. We felt there was a great opportunity for the courtyard and entrances to have vibrant and welcoming plantings. While in-ground plantings could be placed along the edges of the site, we needed a less permanent solution for the inner courtyard area in order to keep the space flexible. Plants would need to be low maintenance and also provide aesthetic appeal throughout the four seasons. These traits would also limit plantcare time and costs, and maximize the value of the plants as an attractive feature throughout the year. Salt tolerance for winter runoff was also a factor included in our choice of plant species.

Green Roof:

A semi-accessible rooftop of about 500 square feet is present outside of the second-floor windows of the 1950's era building on the south side of the site (see Fig. 37). The roof was reinforced to carry a load of 50 lbs/square foot, which provided a great design opportunity for an added feature. The intended use of the second-story space above the restaurant varied between a bar area or separate loft apartment space [currently, April 2015, the loft apartment is the intended use].



Fig. 37: Existing second-floor roof space

This rooftop space presented an opportunity for adding green space to the site, especially since the west-facing windows of the loft all look out onto this space. One important consideration for this area was potential safety hazards and accessibility difficulties.

Accessibility:

Currently at the site the only access into some building entrances are via a stairway or up a driveway and across gravel, because the entire courtyard is above sidewalk grade (see Fig. 38). It was necessary to keep this elevation to maintain easy access into building entrances on the courtyard side. The site required special care and attention to make it ADA accessible and inviting to people of all abilities. The grade change also provided the opportunity for a soft division of space between the street side of the courtyard and the more intimate inner courtyard experience. One challenge that we faced while designing this space was how to design a ramp that doesn't take away too much space from inside the small courtyard and doesn't obstruct views into the space.



Fig. 38: Stairs to courtyard above sidewalk grade

Circulation and Entrances:

Fig. 39

■ Building Entrances
 ← Site Entrances

The indoor uses on-site demanded that we provide direct access to northern (1890's) building entrances through the courtyard from the street, while maintaining an intimate and comfortable feeling for patrons within the courtyard itself. Along with ADA accessible entrances to the site, access to these entrances form the main circulation pattern within the site itself (see Fig. 39). The main body of the courtyard is a "free roaming" space where circulation is designated only by the arrangement of seating and other special use components such as a performance space during live

events. Restaurant uses on the south side of the site will include both patron/server access to the patio through a centrally located door.

An existing concrete walkway with community members' birthdays written on it was marked for removal during this process. This walkway is in poor condition which would ultimately hamper winter maintenance. It also doesn't fit well with the overall site aesthetic we were aiming for, though there is potential for pieces of the sidewalk to be used as decorative items within the building.

Stormwater:

As part of a sustainable redevelopment project, the ecological management of stormwater runoff is essential to create an holistic example of urban sustainability in Detroit. As mentioned above, our team was told that the site's subsoils are able to drain the amount of runoff coming into the site from the surrounding rooftops. The image below shows the general sources of rainwater that will drain into the courtyard surface. Permeability was necessary across a majority of the site to allow this drainage to continue, which informed our hardscape design and selection of materials on site.

After talking with the client and community members, our team felt there was an opportunity to showcase this sustainable stormwater management on-site in an artful and engaging way. It was decided that some sort of water feature would be an intriguing addition to fill this role.

Programming:

Since the site is relatively small and confined, it was crucial to understand intended programming at the outset of concept development. During our analysis, this consisted of synthesizing how various activities such as live music, afternoon chatting, and seasonal fluctuations in use affect the feel and spaciousness of the courtyard (see Fig. 40). The courtyard needed to be very flexible to

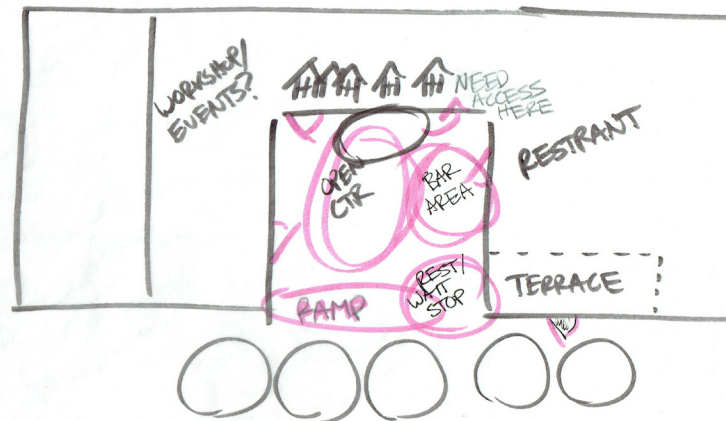

Fig. 40: Process diagram of programming

accommodate a variety of activities, but we also wanted to have some permanent elements as well. Indoor uses including the restaurant, and central and north retail/ event spaces also needed special consideration to ensure they function smoothly with the courtyard during various events on site. The courtyard provides a great opportunity to have outdoor seating for the restaurant within the south (1950's) building, but also presented a challenge of how to keep restaurant patrons separate from other courtyard patrons without creating large barriers that would obstruct views into the courtyard. While working through these challenges we gained a lot of insight into how we wanted the site to perform under different uses, which helped greatly going into concept development.

Sun/Shade:

It was important to conduct a sun/shade analysis to inform our planting design (see Fig. 41). Using Google SketchUp, the following images were generated using the four annual equinoxes to simulate sun and shade patterns using our original 3D model.



Fig. 41: (Clockwise from top left) Sun/shade analysis of site in December, March, June, September, at noon. Dark grey areas indicate shade during that time.

CONCEPT DEVELOPMENT

Our site concept was developed with three main goals in mind :

- Create flexible space for diverse activities/programming
- Demonstrate sustainable urban design practices
- Provide space where interaction with friends and strangers is fun, comfortable, and natural.

During concept development, we relied heavily on our community feedback to inform spatial arrangement and initial design choices. Special consideration was given to the site's need for flexibility. Components such as a rollout bar (stored within middle building), seating, and planters are all movable to accommodate various uses within the site.

Division of Space, with Unity:

Throughout the warm season, the courtyard is divided into the use areas seen below (see Fig. 42). Our client was interested from the outset in having a restaurant space on site with the 1950's era building on the eastern side of the site slated to house this food and drink establishment. Part of the courtyard was desired to be patio space

for the restaurant, and thus we designated an outdoor dining area specifically for this establishment. Having this relatively permanent use of one side of the courtyard necessitated a soft division between the restaurant area and the greater courtyard. This soft division serves to create unity in the site while also maintaining distinct areas of use. This allows the greater community to enjoy the courtyard center as a public space while people dining at the outdoor patio have an enhanced atmosphere for their dining experience.

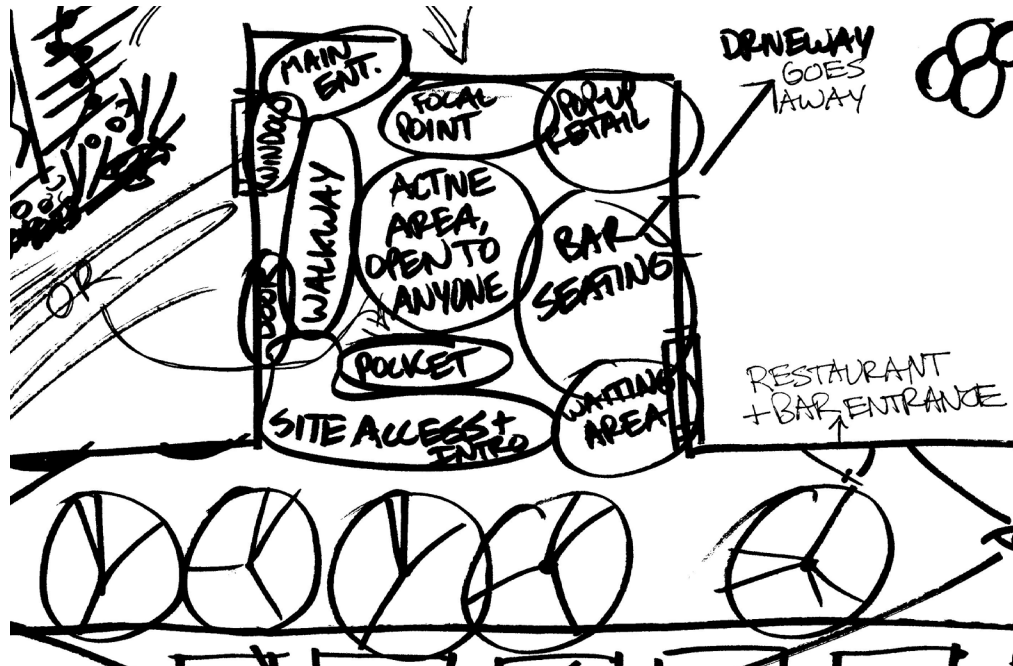

Fig. 42: Preliminary example of site programming diagram

The few spatial divisions within the site are permeable – such as the restaurant patio and greater courtyard. Permeability means that they separate spaces physically but not visually. This helps maintain the overall aesthetic unity of the site. Spatial divisions are created by a planting strip along the street side face of the site, by the architectural awnings over the restaurant patio and rollout bar, and by the large permanent benches and movable planters.

Our design process involved spending a few weeks working out spatial arrangements that would be optimal for our intended open site programming (see Fig 43).

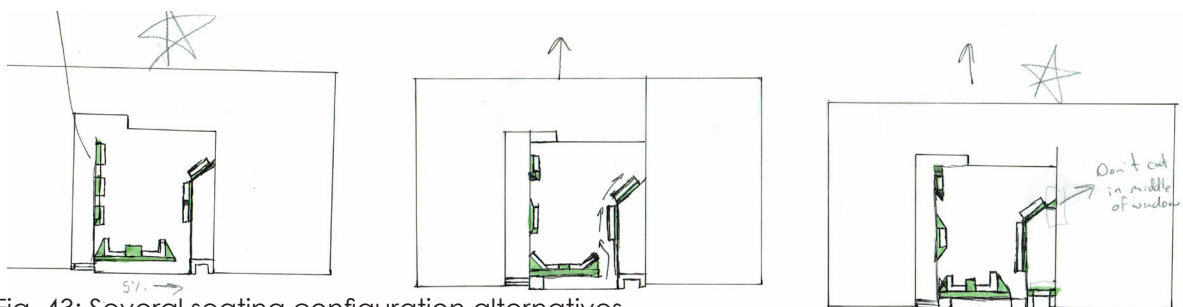

Fig. 43: Several seating configuration alternatives

DESIGN

Overall configuration:

Our analysis and design concept resulted in the overall site configuration you see below (Fig. 44). The design responds to circulation and programming needs, and also preserves and further develops the intimate European feel of the site.

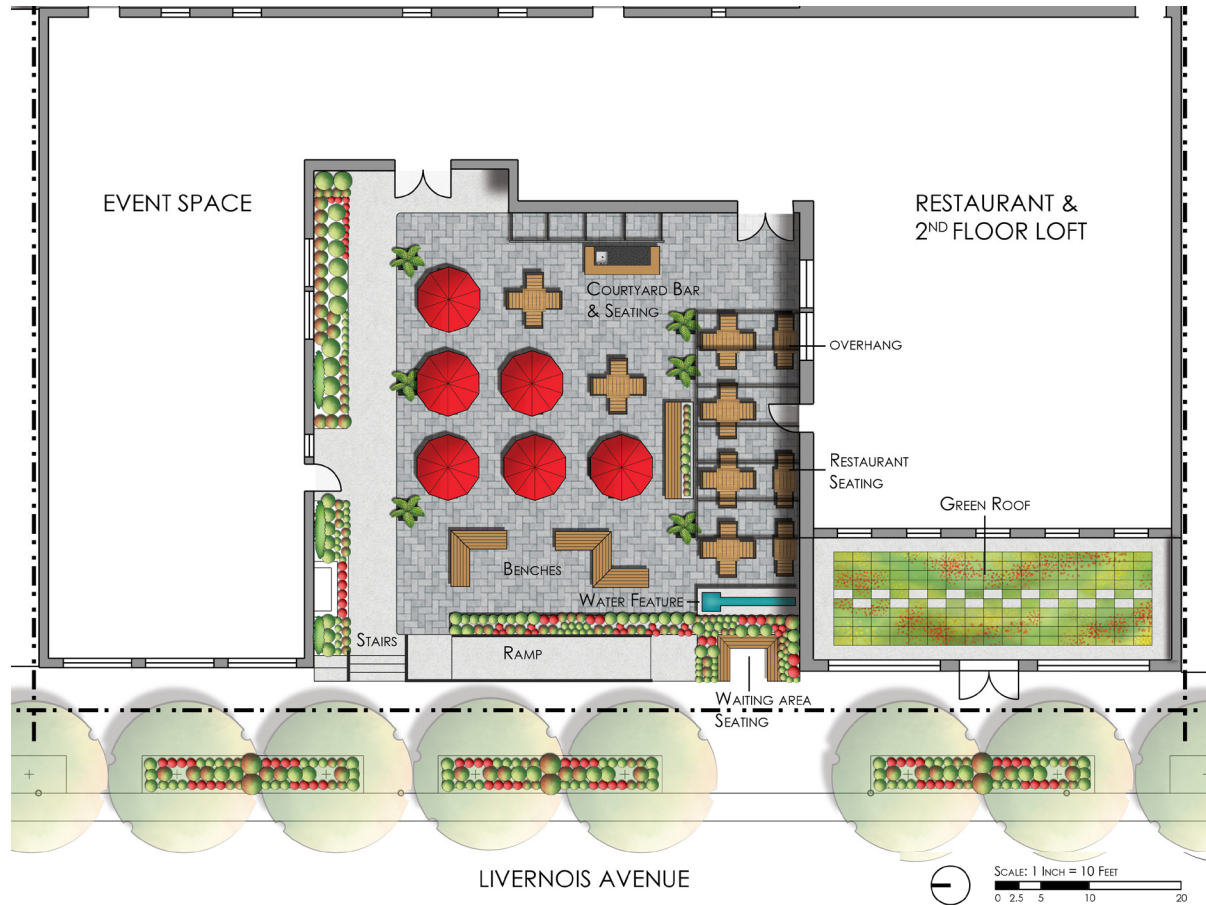

Fig. 44: Plan view of courtyard design

Ramp and Railing, Entering the Site:

At street side, we provided both stairs and an ADA-accessible ramp for universal access to the site. This configuration also gives patrons a choice of access points. Studies have shown that visitors often appreciate the experience of a ramp when entering a site, even if they are physically fully capable of using stairs (Kaplan and Kaplan, 1978).

Railings for the stairs and adjacent ramp are stylistically matched, and were chosen specifically in response to visual preferences of surveyed Livorno community members. Railings were specified as metal with a dark-grey finish that matches other metal elements on site (awnings, bench fastenings, etc.) The railing selection adheres to the goal of a sleek, European aesthetic, while also being visually permeable. It is important to have a clear view through the railing in this situation

so that visitors can freely and comfortably interact with views, and people from between courtyard and sidewalk. This type of community interaction is a highlight of the site, and the chosen railings are an integral yet subdued piece of this atmosphere.

Permanent Custom Seating:

This design decision resulted from the initial need to have a welcoming and engaging entrance to the courtyard, and evolved into a permanent set of focal benches. Site seating elements were selected based on their flexibility for different programming options. The large benches near the ramp were designed to allow visitors to sit facing either the inner courtyard or the sidewalk (see Fig. 45). This arrangement enables people watching, greeting, and community building. The configuration of the benches themselves create a semicircular, intimate feel to the courtyard entrance, and is also conducive to keeping an eye on small children. Studies and human history itself show that circular seating arrangements, where friends and strangers can face each other, inspire more creative interaction and a sense of comfort and familiarity (Kaplan and Kaplan, 1978).



Fig. 45: Rendering of west side permanent benches

The seating area at sidewalk-level next to the restaurant is intended for patrons waiting to be seated for dining. It also serves as an inviting rest stop for dog walkers and people waiting to meet friends. This sitting area also enhances the effect of the soft division (via planting beds) created between the greater courtyard and dining area on site. The broad (18" deep) wooden seating surface brings a sense of warmth and comfort to this space. The bench is embraced by a shade garden of ferns, iris, and wild ginger among others, creating a low, green backdrop that offers

a sense of refuge along the sometimes busy sidewalk and open street. The cubby bench feature also creates a memorable and recognizable landmark, enhancing pedestrian navigability to the site and improving the streetside experience for the local community.

All permanent seating options will be made with wood to match the aesthetic of the spruce or clear cedar paneling that our client plans to add to the west-facing wall in the courtyard. Metal attachments to the ground will reflect the dark grey finish of the awnings and railings we designed.

Movable Seating:

Creative seating arrangements are possible for various events/programming. All tables and chairs are movable, including the standing planters within the courtyard. The only permanent seating elements are the dual-direction permanent benches near the sidewalk and the planter bench along the long edge of the restaurant patio. This planned flexibility allows the courtyard to be cleared for larger, more active events, or to be a more intimate setting for a poetry night or jazz trio.

New Sidewalk Within Courtyard:

Our sidewalk design is based upon our analysis of an optimal hierarchy of circulation for the courtyard. The sidewalk that runs from front to rear of the courtyard itself is a replacement for the existing walk. Its resurfacing was deemed a necessary change for aesthetic reasons and in consideration of site durability and winter maintenance. The new sidewalk is concrete and is the only large area of impermeable paving on site. Angled turns in the sidewalk at the courtyard entrance and also at the rear building entrance allow for a comfortable walking space while maintaining the formal layout of the courtyard itself, and complementing the geometry of other site features.

Permeable Paving:

Old World Eco Pavers from Fendt Builder's Supply in Ann Arbor were specified as our permeable paver of choice (see Fig. 46). The area of the permeable paving is about 1,848 square feet, and if built as designed (see Appendix C.I for paver section) can hold up to about 1,184 cubic feet of water before exfiltration into the soil subgrade. This translates into being able to hold about 3.5 inches of rainfall before exfiltration, which includes rain falling directly on the pavers and runoff from the rooftop, walkway, and other non-permeable surfaces that drain into the courtyard space. Fendt was contacted regarding their Old World Eco Pavers for advice on use as the main courtyard surface.



Fig. 46: Fendt Old World Eco Pavers

Architectural Awnings:

Based on our site analysis, it would be aesthetically pleasing to place architectural awnings over both the restaurant patio area and rollout bar area to both create a soft division between patio and courtyard, and also to bring the visitor experience

down to the more intimate, human scale. Shading needs were not part of this consideration since the largest awning coverage occurs in an area that is in full shade throughout the year. Rather, the awnings serve as the aforementioned spatial division and also as an artistic frame for lighting and potential planting (vines) needs. It should be noted that the patio awning will likely require some type of overhead guy wire supports to take undue strain off of the building where the awning itself connects at a right angle. The awning will be finished with the same dark-grey as the railings and other metal features on-site.

Water Feature:

Our team included the fountain feature to draw attention to stormwater management on site. This feature also enhances patio atmosphere by distracting visitors from sounds of the nearby street. Our placement of the fountain is related to the convenient location of rainwater runoff coming off of the adjacent restaurant/loft roof.

Rollout Bar and Accent Wall:

Restaurant uses on the South side of the site will include both patron/server access to the patio from inside, and also the rollout bar storage area. A challenge for us was to create a lively setting while maintaining space for the bar to move in and out of the double doors on the South end of the central site building. (See Fig. 47).



Fig. 47: Rendering of courtyard in the evening

Our client decided to create an accent wall centered in the back of the courtyard directly behind the rollout bar. This wall will be faced with spruce or clear cedar wood siding, and complement images that surveyed community members responded to very positively. Since the visual preference images also showed wall plantings of kitchen herbs, our team decided to add hanging wooden herb boxes to this wall. The natural look of wood and herbs appeals to the senses, and warms and softens the rear wall of the courtyard, providing contrast between the white walls of the farmhouse and the hard red brick of the restaurant. The herb wall will provide a warm backdrop for the rollout bar during courtyard happy hours and other open bar events. This further serves to bring the open courtyard experience down to the human scale, and provide a sense of novelty for the space.

COURTYARD PLANTING DESIGN



Fig. 48: Rendering of plantings in the courtyard

According to our survey results, the most-wanted amenity on the site was plants. We took care throughout our design process to note places that could be enlivened with greenery in order to make the courtyard a thriving and attractive space. (See Fig. 48 for rendering of courtyard plantings.)

Courtyard:

We were delighted to have existing planting space on site, and went a step further to provide more color and life for unification of the entire courtyard. Labeled planting plans are available in Appendix C.VIII and Appendix C.IX. (Also see Fig. 49.)

Entrance Plantings:

The approach to the site was designed to create intrigue. Entrance plantings running across the face of the site invite and attract visitors with the novelty of nature at play in the city. Anchoring plants such as Prairie Dropseed grass and Coral Bells weave among Nasturtium and Creeping Thyme. This rhythmical arrangement creates a visual focus and brings the initial experience of the courtyard space down to eye level.

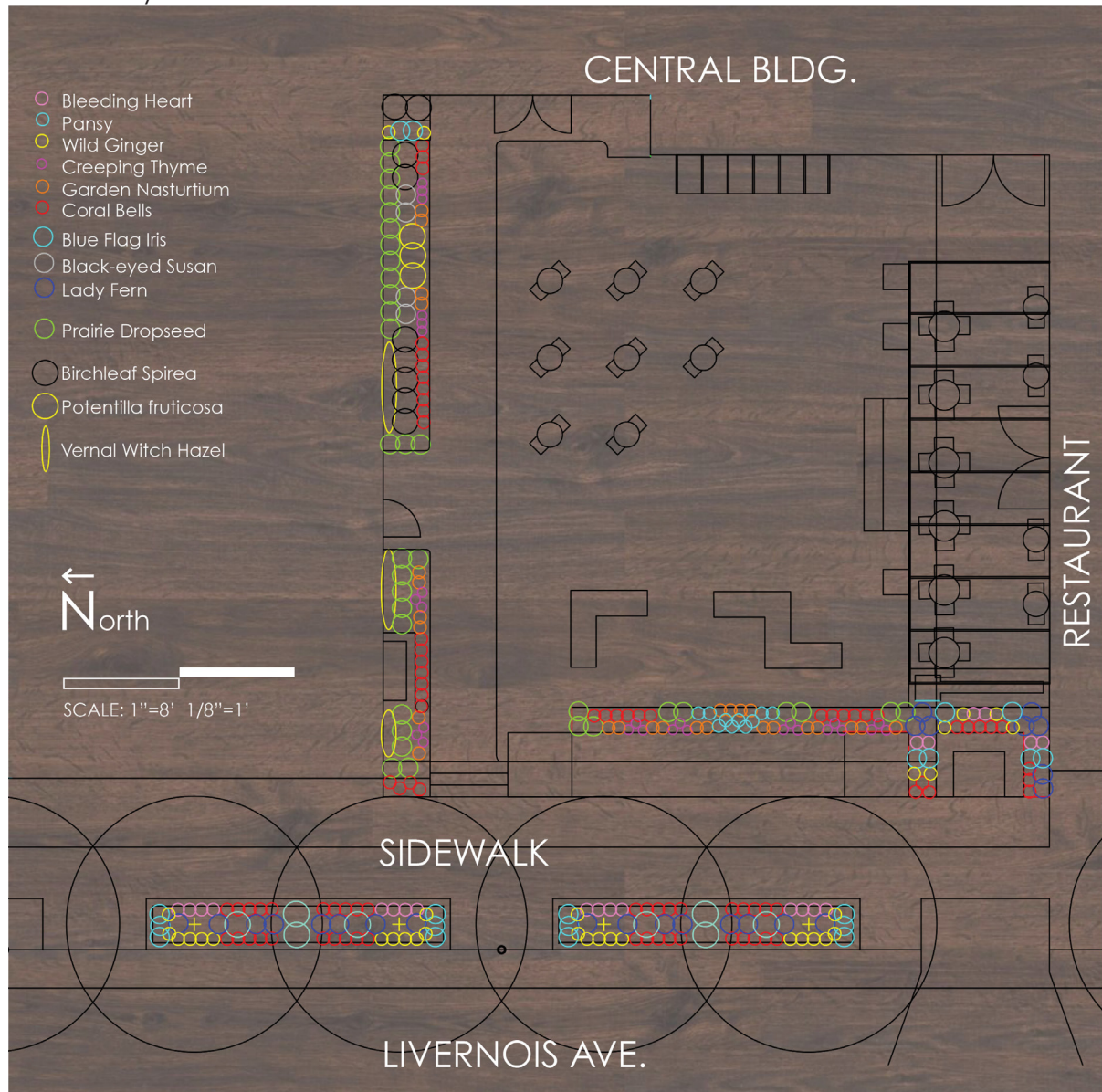

Fig. 49: Planting plan

Microclimates:

Based on our site analysis, we used the site's warm and bright north side and cool and dark south side microclimates to drive our plant selections.

Shade Garden (Cubby Sidewalk Bench Garden):

This garden serves as a continuation of the entrance plantings that run across the

face of the site. Aesthetics of the shade plantings are matched with those of the sunnier areas along this strip and in the courtyard itself. Verticality and movement are provided by grasses in sunny areas and by ferns and iris in shady areas. . This further serves to keep the baseline energy of the site on a welcoming plane, and thus enlivens the space.

Sensory Appeal:

To improve the already uncommon experience of nature in the city, sensory stimuli were incorporated into planting design and selection. This attracts visitors and provides welcoming intrigue. Visual aspects of texture, color, and form with olfactory hints of kitchen herbs (herb wall, Creeping Thyme) and edible flowers (Nasturtium). Plants at visitor's fingertips will engage the senses to create a memorable and relaxing experience.

Seasonality:

The courtyard planting uses both native plants and common cultivars to create four-season beauty in the space. Perennials make up the majority of plants, allowing for season extension. This results in an earlier green-up in the spring (along with Vernal Witch Hazel bloom) and extended color in the fall. See the Seasonality Chart below for species-specific seasonal interest. (See Fig. 50 on next page.)

Movable Planters:

Large, upright planters are arranged around the courtyard (see site plan). These serve to anchor the courtyard and provide an intimate feeling in the space. Pennisetum grass with its height, softness and movement acts as the focal plant. Sweet Potato Vine and Garden Nasturtium serve as accents. These plantings are annuals. Seasonal decorations such as gourds/stalks for fall and garlands/small trees in winter can serve in the off seasons.

Streetside Plantings:

We were eager to beautify the street side planting beds, which currently hold Honey Locust trees but are without any plants for visual interest at street level. Plant selections were made based on tolerance of partial shade and road/sidewalk salt. Aesthetic choices were aligned with the courtyard's welcoming theme of texture, color and movement. Dwarf Holly provides additional winter interest with its clusters of bright red berries.

GREEN ROOF

In our initial design concept, we designated the area on the rooftop outside of the second-floor loft as an outdoor patio, but due to issues regarding safety and access to this space, we decided that a green roof was better suited to this area.

There are a variety of companies that operate in and just outside of Michigan that grow and/or install green roofs. Our team member Angela Cesere had a chance to meet with several different companies during the 2014 Grey to Green conference in Toronto and the 2014 Grand Rapids Green Roof Market Development Symposium. She was able to ask questions about green roof products and talk about what might work in relation to the space we were designing. It was also a great opportunity to

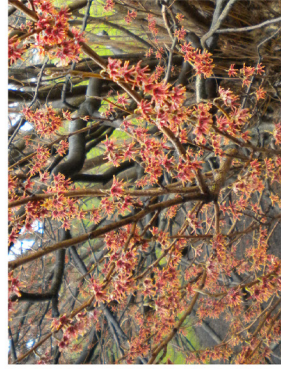
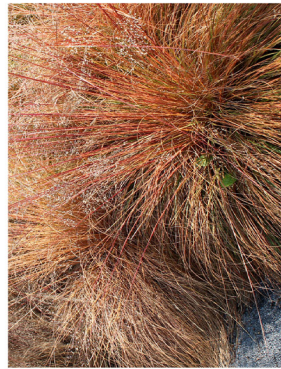

Fig. 50: Seasonality chart

see green roofs projects that other professionals had designed and installed. After talking with professionals in the Ann Arbor area who had worked with green roof companies, we decided to design with LiveRoof products in mind. They have a strong reputation of outperforming other companies in terms of service and overall quality of the product. Because LiveRoof is headquartered in Spring Lake, Michigan, this also means that plants are grown in similar conditions to Detroit's.

After evaluating LiveRoof materials, we decided to go with the LiveRoof Standard system. (See Appendix C.XIV-XV.) The rooftop where the green roof would be located was reinforced to carry a load of 50 lbs/square ft. The LiveRoof Standard system weighs about 27-29 lbs/square foot when saturated and vegetated (LiveRoof, LLC 6). This option also offered a variety of plant types to choose from .

For our green roof design, we wanted to avoid extremely geometric, monochromatic designs in favor of a more dynamic, natural sort of aesthetic. We looked at Michigan State University's Children's Garden green roof for inspiration. (See Fig. 51.)

Plants come in 1' x 2' trays. We chose three mixes of plants and spread them out in a non-symmetric pattern where mixes appear to flow into one another and across the rooftop. Along the border of the roof we put Beach Sand colored RoofStone™, which served for easy maintenance access and offered an aesthetically pleasing edge bordering walls and windows, an area where plants would not grow well. A step-stone pathway of RoofStone™ also exists through the center of the design for maintenance purposes. RoofStone™ was chosen for its ease of integration with the LiveRoof system. (See Fig. 52: green roof plan on next page.)

We decided to make our own custom mixes of plants instead of going with LiveRoof's pre-designed mixes for added control over color and bloom times. The plant color palette was chosen to reflect similar colors as the courtyard plants with yellows, reds, whites, and a variety of greens hues being emphasized. The mixes created are divided into color groups and each contain a plant that is present in another mix for the appearance of continuity across the rooftop. Blooms extend from April to October, with the majority of plants blooming in June and July. The foliage of the plants change color throughout the year, and consists of mostly evergreen and semi-evergreen plants with a couple of deciduous accent plants. (See Fig. 53 for seasonality chart.) Studying other green roofs revealed that a variety of textures and heights made for a more exciting and natural look. Each mix includes skinny- and broad-leaved plants, and mixes contain plants with height variations that will create depth. (See Fig. 54 for plant mixes.) See Appendix C.XI for a planting detail of each mix.



Fig. 51: MSU Children's Garden green roof

PLAN VIEW OF ROOF

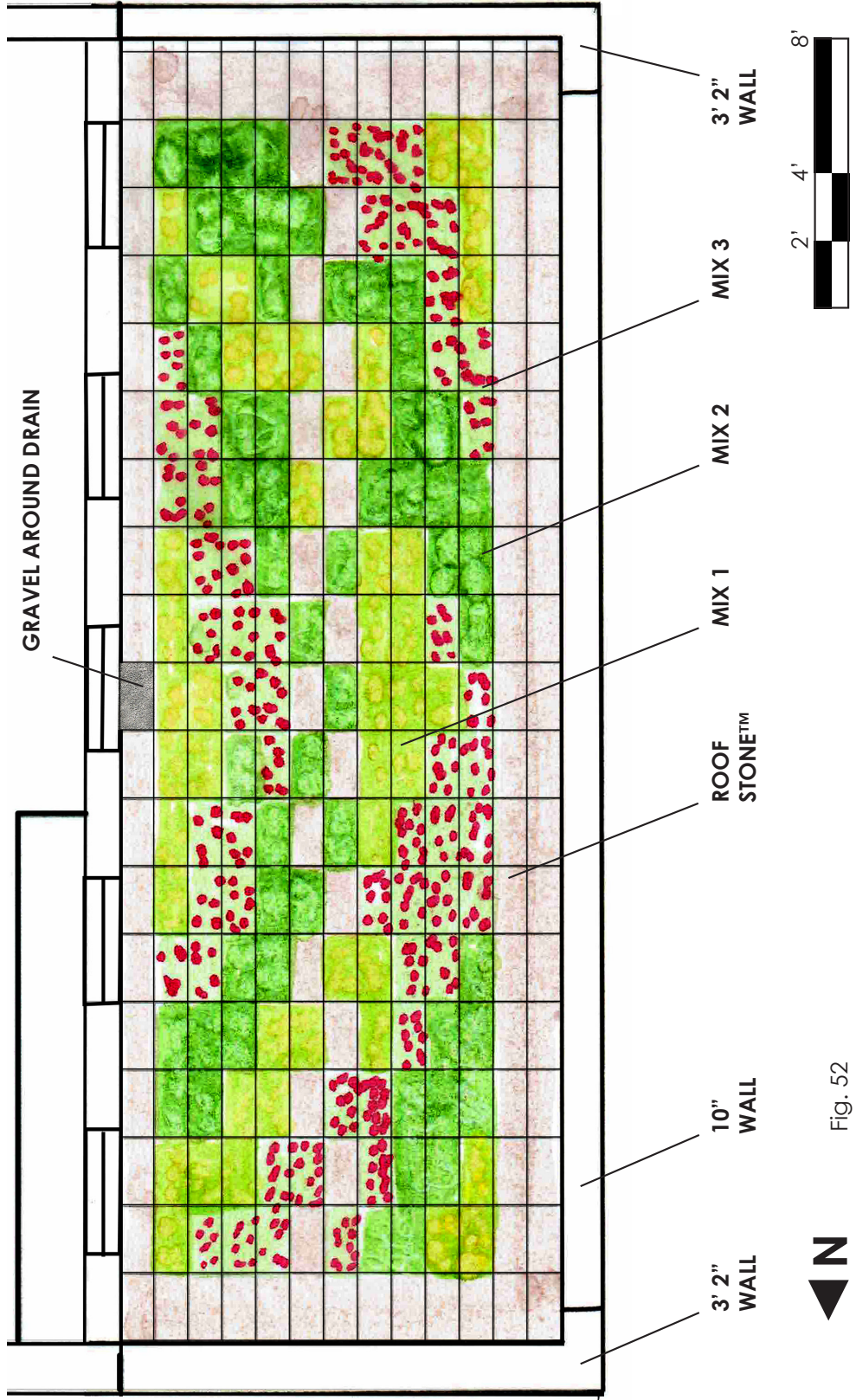

Fig. 52

FOLIAGE + BLOOM COLOR PHENOLOGY

BOTANICAL NAME	JAN	FEB	MAR	APRIL	MAY	JUNE	JULY	AUG	SEPT	OCT	NOV	DEC
Allium stellatum BLOOM FOLIAGE												
Sedum acre 'Aureum' BLOOM FOLIAGE												
Sedum album 'Chlorificum' BLOOM FOLIAGE												
Sedum album 'Purple Ice' BLOOM FOLIAGE												
Sedum hybridum 'Immergrunchen' BLOOM FOLIAGE												
Sedum reflexum Solar Spice® BLOOM FOLIAGE												
Sedum sexangulare 'Elatum' BLOOM FOLIAGE												
Sedum spurium 'Album Superbum' BLOOM FOLIAGE												
Sedum spurium 'Dragon's Blood' BLOOM FOLIAGE												
Sedum spurium 'Green Mantle' BLOOM FOLIAGE												
Sedum spurium Guacamole® BLOOM FOLIAGE												
Sempivivum 'Silverine' BLOOM FOLIAGE												

Fig. 53

Mix 1: Custom Yellow and Green

Base Plants



Sedum acre 'Aureum'



Sedum album 'Chloroticum'



Sedum hybridum 'Immergrunchen'



Sedum reflexum 'Solar Spice'

Accent Plant:



Sedum spectabile 'Star Dust'

Mix 2: Custom Yellow/Red/Green

Base Plants



Sedum acre 'Aureum'



Sedum album 'Purple Ice'



Sedum spurium 'Green Mantle'

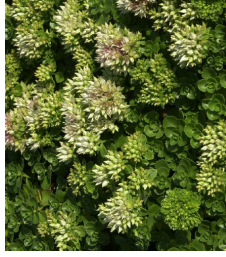

Sedum spurium 'Album Superbum'

Accent Plant:

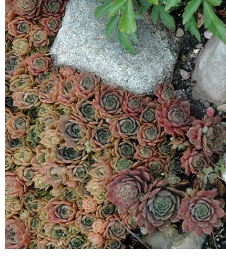

Sempivivum 'Silverine'

Mix 3: Custom Reds and Greens

Base Plants



Sedum album 'Purple Ice'

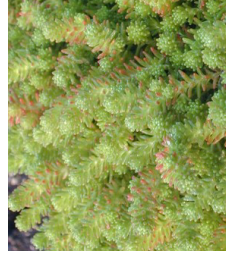

Sedum sexangulare 'Elatum'



Sedum spurium 'Dragon's Blood'

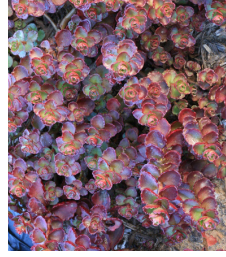

Sedum spurium 'Guacamole'

Accent Plant:



Allium stellatum

Fig. 54

Green Roof Benefits:

Green roofs tout a host of benefits, ranging from environmental to cost to psychological benefits. Vegetated roofs have been shown to retain up to around 69% of rainfall, thus decreasing the amount of rainwater that flows directly into the sewer system, often picking up chemicals from hard surfaces along the way (Oberndorfer et al. 828). Green roofs have been shown to reduce street noise, which would be important for anyone taking up residence in the second floor loft space because Livernois Avenue gets quite a bit of motor vehicle traffic (Oberndorfer et al. 829). Research has shown that exposure to nature reduces stress much more effectively than exposure to urban environments, so adding planted material outside of a loft window could potentially benefit a person living in that space (Ulrich et al. 222).

When installed correctly and irrigated properly (refer to Appendix C.XII for irrigation specifications), green roofs can increase a roof's longevity by reducing the roof's exposure to UV rays and decreasing temperature variability so the roof won't expand and contract as much as a non-vegetated roof (Oberndorfer et al. 828). Rooftop temperature is greatly decreased in the summer on green roofs compared to black-top roofs, which has the effect of lowering the cost of cooling the building below (Oberndorfer et al. 828).

PART 4: CONCLUSIONS & REFLECTIONS ON OUR DESIGN PROCESS

Throughout this process we gained a great deal of insight into how design can be used as a tool for urban revitalization and place-making. Engaging with the Livernois community and hearing their insights about what they envisioned for the look and programming at our site was invaluable. Although the surveys and precedent image questionnaires we provided to people were useful, it was through talking directly to the residents that we gained a much deeper understanding of their needs. For example, many of the older residents were adamant that the space caters to multiple generations, one that they as well as their grandchildren could enjoy. Senior residents in particular wanted a space where they could relax during the day, lounging with a book or watching the passers-by on Livernois. Based on this feedback and in order to accommodate people-watching we designed our benches to allow for seating in either direction, facing the street or the courtyard interior. Most of our primary design features and decisions were informed by the verbal and written feedback we received during the community engagement process, which we married with our knowledge of ecological landscape design.

Although speaking to community members individually proved the most useful for our design process, we see ways that we could have improved our method of gathering formal feedback from the community. In the future, we would recommend a less cumbersome method of displaying precedent images. In lieu of individual sheets, large boards that multiple people could view at one time would be more efficient, as well as visually appealing. All images within a particular category should fit on one board to avoid confusion. Individuals could either rank images on a separate form, or place marks or stickers of images they prefer on the boards themselves. On the surveys we handed out, in retrospect we wished we had included space for individuals to recount memories or anecdotes about the Avenue of Fashion or Hunter's Supper Club. Some general questions about the person's connection to the Livernois community (for instance: did they live in the neighborhood, for how many years, what was their age bracket?) would have been useful as well.

It was through speaking with the community that we fully began to realize the implications of implementing this design. Their excitement for a beautiful outdoor space on Livernois was palpable. There is an enormous body of evidence showing that people in urban areas crave green space, and our community preference research confirmed those studies. The introduction of a vibrant, lush courtyard to Livernois Avenue will not only improve the aesthetic value of the area, but will draw people in and establish the old Hunter's Supper Club site as a destination.

Through our engagement with the community and research on place-making, we learned what makes for a successful place, and designed with those qualities in mind. Artfully incorporating a ramp into the design ensures the courtyard will be a highly accessible place to all ages and abilities. The flexibility in the courtyard layout, achieved through a mix of permanent and movable seating, will allow for many types of programming that appeal to a wide range of people, and in particular accommodate the music events that many residents were excited about. The bench seating configuration fosters social interaction, both with other courtyard

users, as well passers-by on the sidewalk. Colorful and fragrant plantings invite people into the courtyard space, and evoke a sense of relaxation that encourages people to linger. The courtyard design is intended to feel equally welcoming to patrons of the future restaurant and local residents just wanting a nice place to sit and relax. (See Fig. 55.)

It was important to our client to create a space that the neighborhood would take ownership of as a central hub, a place where they could gather as a community for workshops, entertainment, or simply socializing. In designing with the Livernois community in mind, we hope that the built courtyard will achieve Dickinson's vision of establishing his development as a community hub and catalyst for urban revitalization along Livernois, a place that truly *refashions* the Avenue of Fashion for the better.



Fig. 55: Community gathering at the courtyard space.

APPENDIX A.I: MAP OF LIVERNOIS BUSINESSES

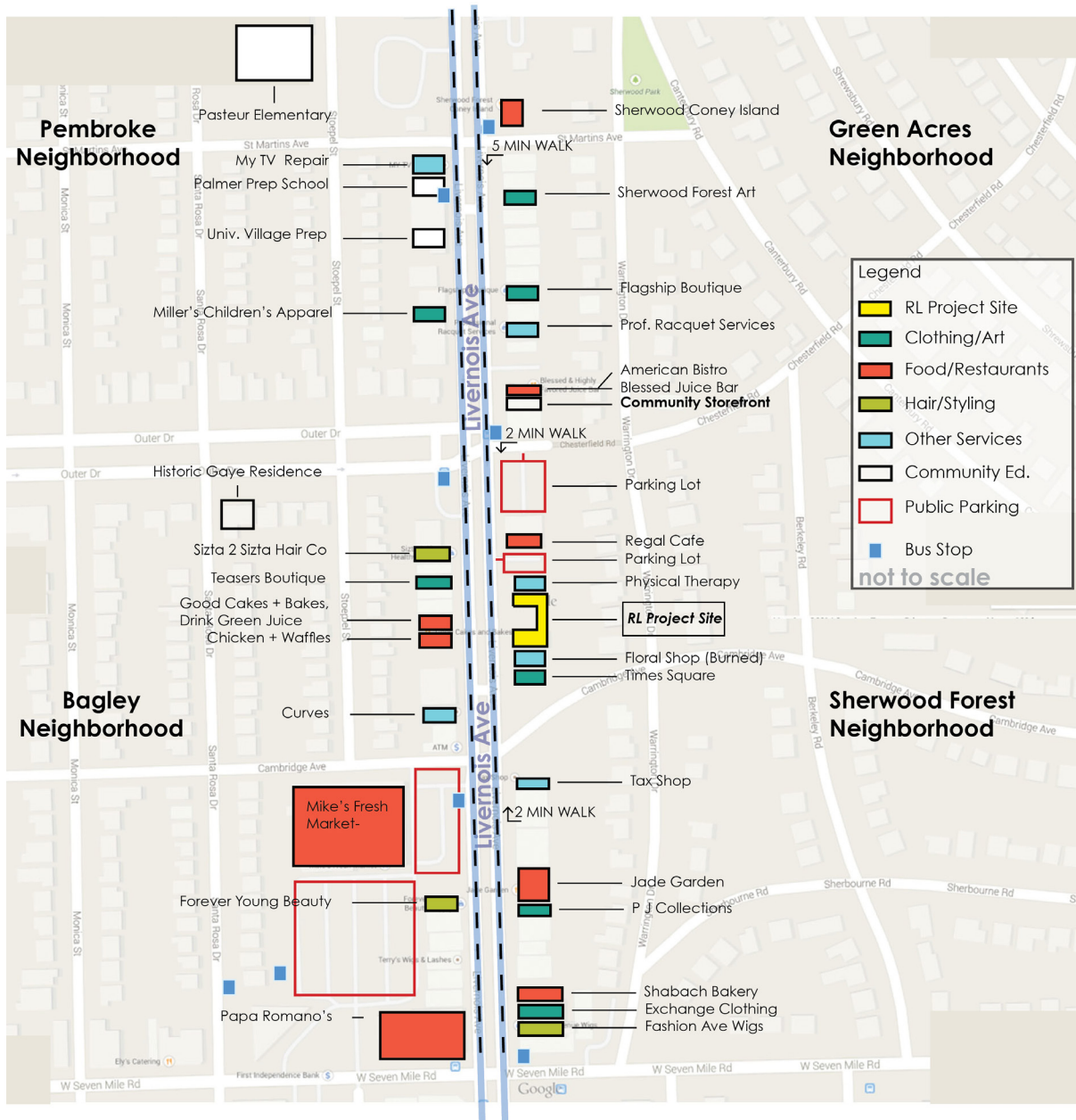

REFASHION LIVERNOIS

*How would you re-design the courtyard
at the former Hunter's Supper Club?*



LET YOUR VOICE BE HEARD! JOIN US FOR SNACKS, BEVERAGES,
& THE OPPORTUNITY TO GIVE FEEDBACK ON THE FEATURES YOU
WOULD LIKE TO SEE IN A NEW GATHERING PLACE ON THE
AVENUE OF FASHION. 19350 LIVERNOIS AVE, DETROIT.

SUNDAY, SEPT 28, 4-6:30 PM
DETROIT DESIGN FESTIVAL

APPENDIX B.I: SURVEY QUESTIONS

What sort of activities would you like to see or would you participate in at this space? (check all that apply)

- Meeting friends and neighbors to socialize
- Social events
- Listening to live music
- Reading
- Dancing
- People-watching
- Public art - creative spaces
- Watching an outdoor movie
- Watching televised sporting events
- Space to play table-top games ex) board games, card games, chess
- Quiet place to relax
- Meeting with community/social group
- Eating (either food bought on site or made elsewhere)
- Participating in a workshop or educational activity
- Other (use the space below to share other ways you would like to see this space used)

What amenities would make you want to come to this space? (check all that apply)

- Flowers and trees
- Lots of seating
- Shelter from the elements (rain, sun, wind)
- Artwork on display
- Access drinking water
- A water feature - ex) a fountain
- Bike rack
- Bike tune-up station
- Other (describe below)

APPENDIX B.II SURVEY RESULTS

What sort of activities would you like to see or would you participate in at this space? (check all that apply)

- 77% __46__ Meeting friends and neighbors to socialize
 - 57% __34__ Social events
 - 88% __52__ Listening to live music
 - 25% __15__ Reading
 - 32% __19__ Dancing
 - 50% __30__ People-watching
 - 49% __29__ Public art - creative spaces
 - 41% __24__ Watching an outdoor movie
 - 15% __9__ Watching televised sporting events
 - 25% __15__ Space to play table-top games ex) board games, card games, chess
 - 29% __17__ Quiet place to relax
 - 39% __23__ Meeting with community/social group
 - 61% __36__ Eating (either food bought on site or made elsewhere)
 - 31% __18__ Participating in a workshop or educational activity
 - ___ Other (use the space below to share other ways you would like to see this space used)
-
-
-
-

What amenities would make you want to come to this space? (check all that apply)

- 86% __51__ Flowers and trees
 - 73% __43__ Lots of seating
 - 59% __35__ Shelter from the elements (rain, sun, wind)
 - 53% __31__ Artwork on display
 - 44% __26__ Access drinking water
 - 44% __26__ A water feature - ex) a fountain
 - 49% __29__ Bike rack
 - 39% __23__ Bike tune-up station
 - ___ Other (describe below)
-
-
-
-

What do you dislike about other public spaces that you DO NOT want to see here?

APPENDIX B.III

PLANTED WALLS

Which types of planted walls do you prefer and might work well in this space?

page 1

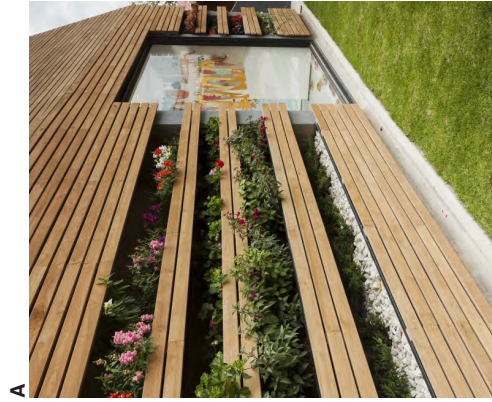

PLANTED WALLS Which types of planted walls do you prefer and might work well in this space? page 2

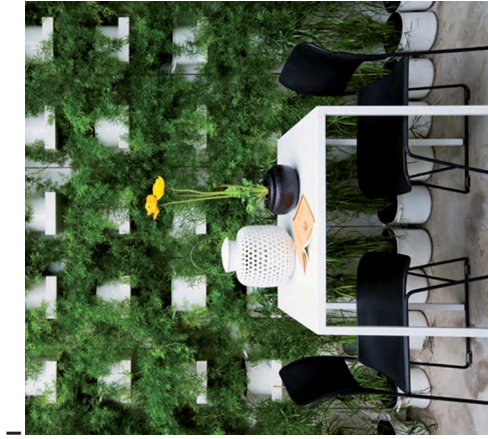
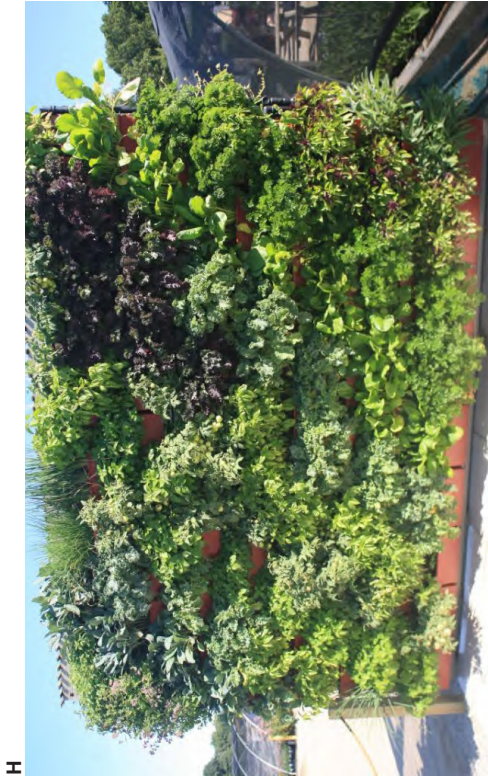
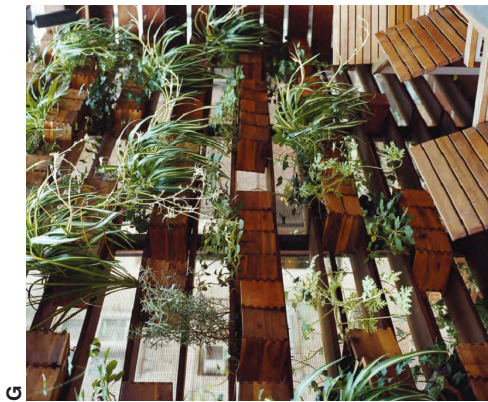

LIGHTS Which types of lights do you prefer and might work well in this space?

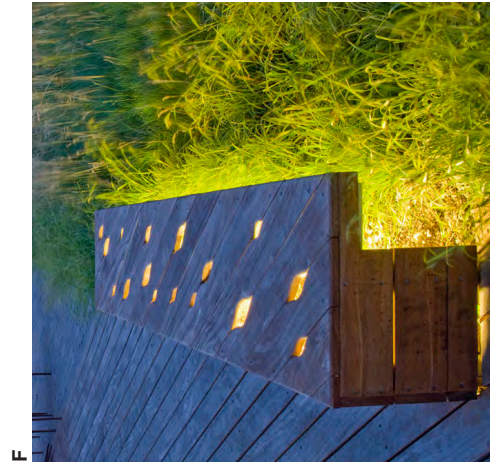
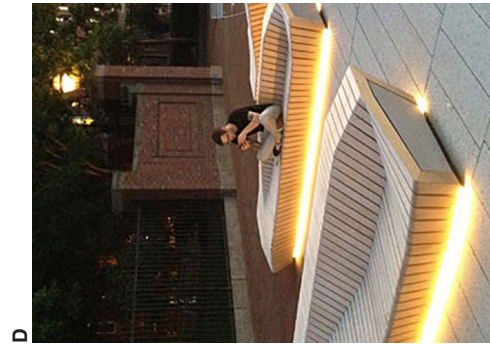
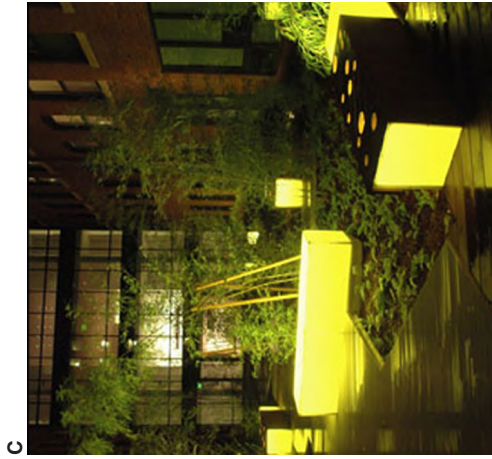
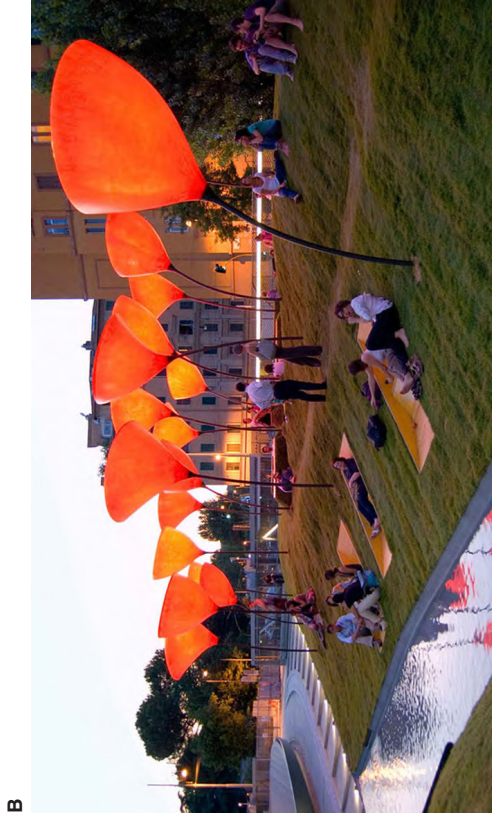

LIGHTS Which types of lights do you prefer, and might work well in this space?

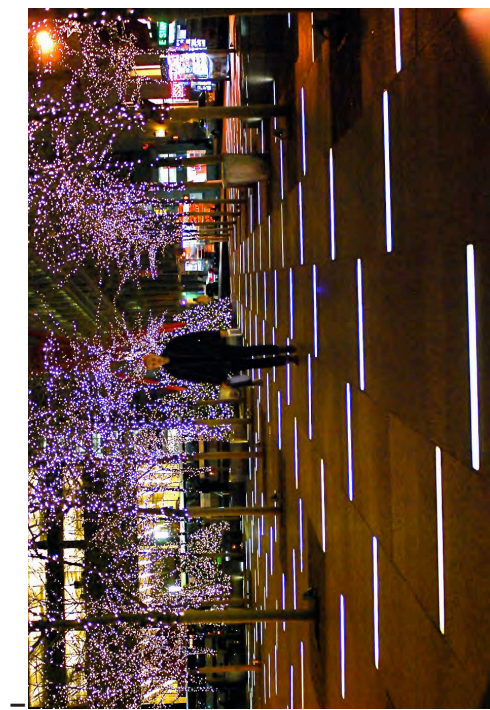
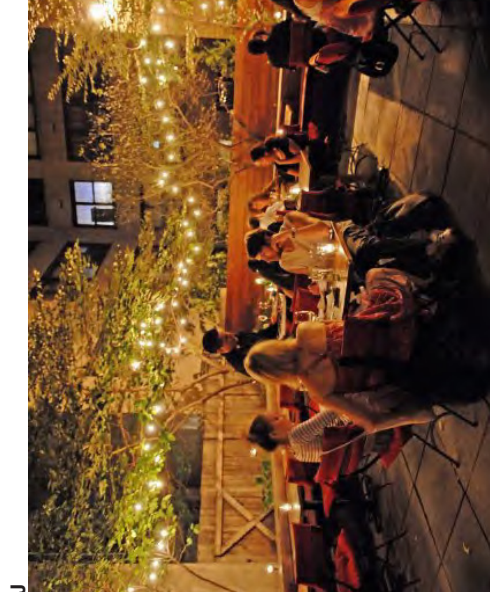
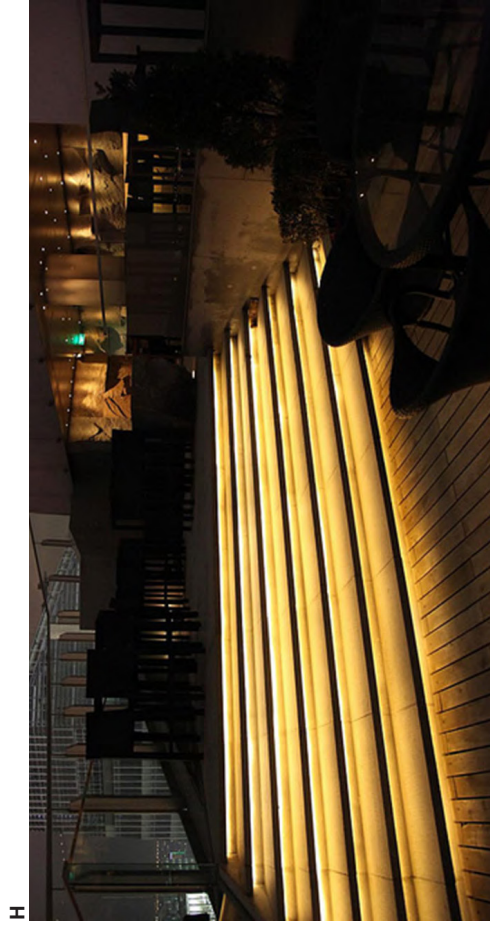

RAILINGS Which types of railings do you prefer, and might work well in this space?

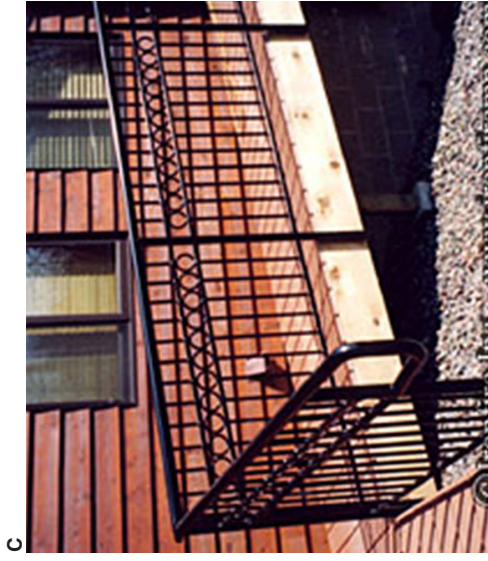
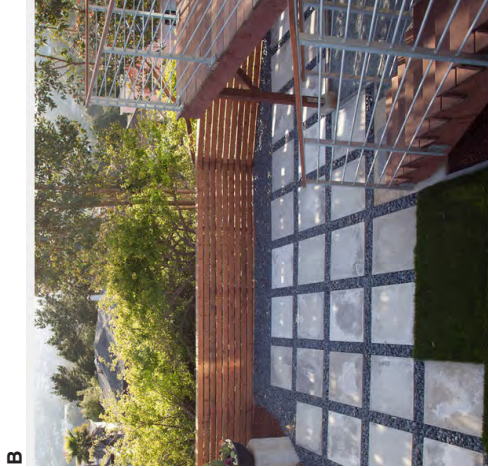
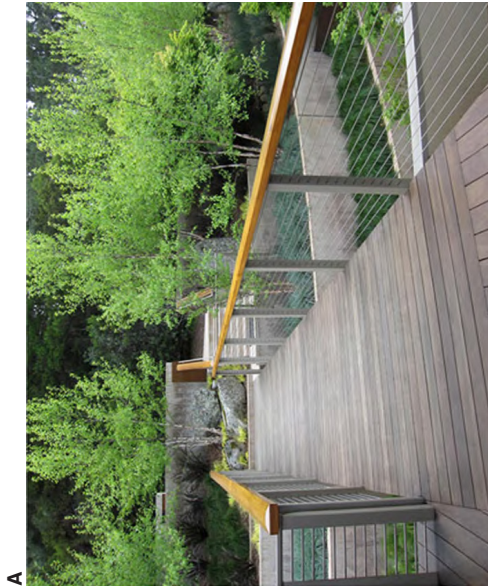

SEATING Which types of seating do you prefer and might work well in this space?

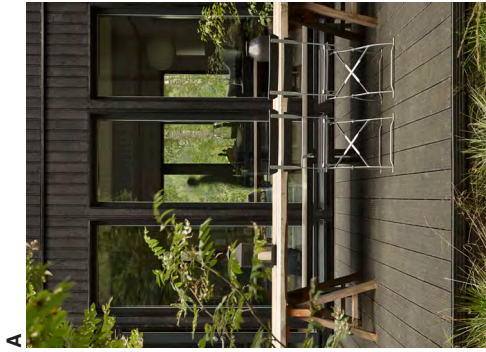

SEATING Which types of seating do you prefer and might work well in this space?

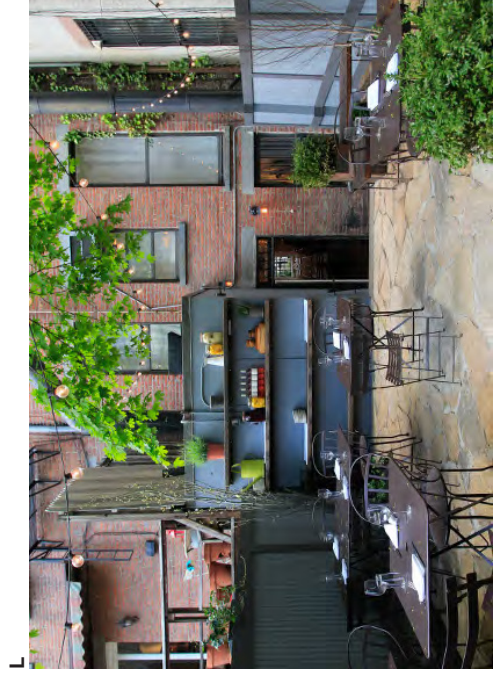
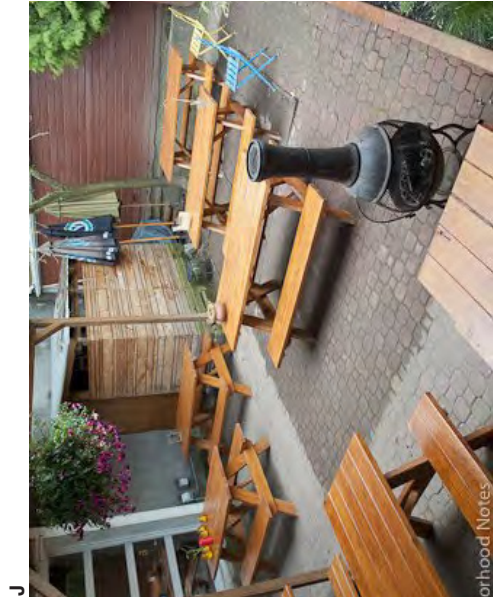

SEATING Which types of seating do you prefer and might work well in this space?

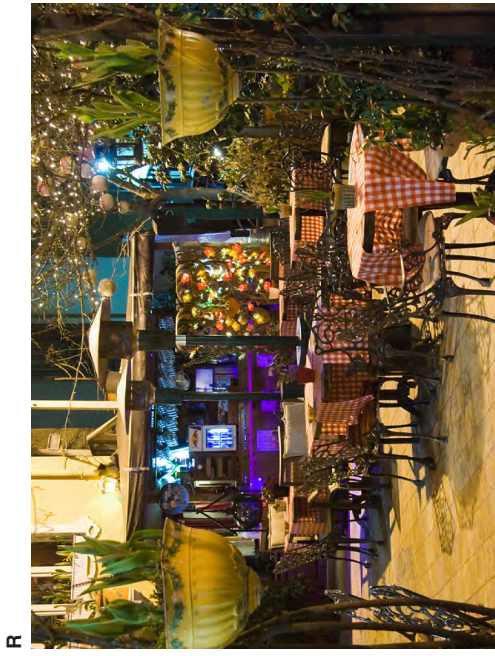
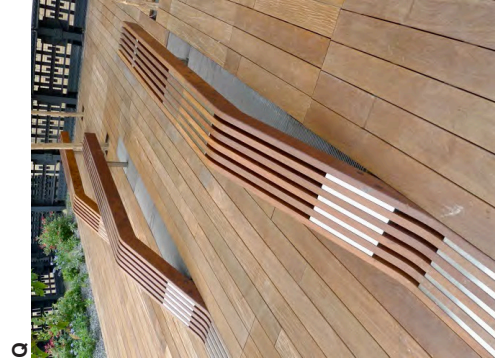
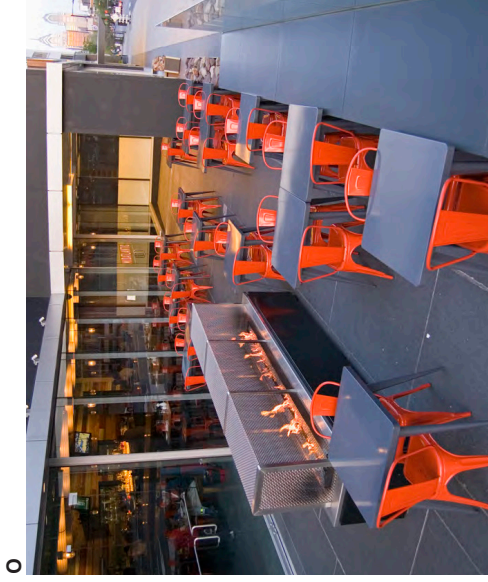
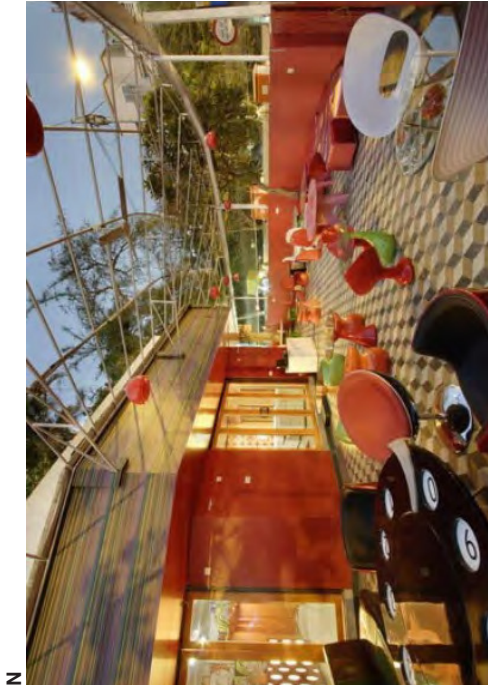
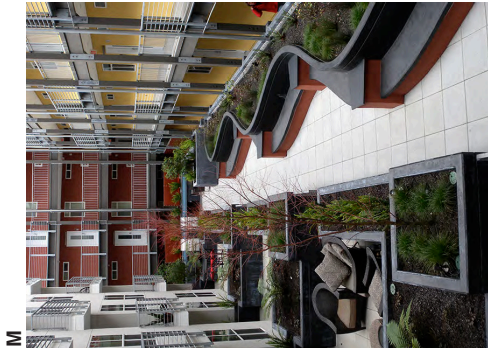

SEATING

Which types of seating do you prefer and might work well in this space?

page 4

S



T

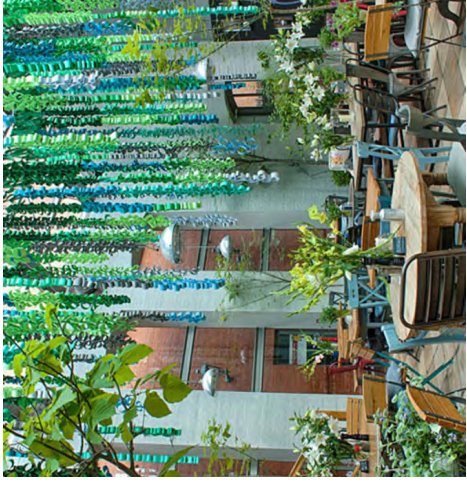

U



V



W



TRELLIS/PERGOLAS/AWNING

Which types of trellises, awnings and pergolas do you prefer and might work well in this space?

page 1

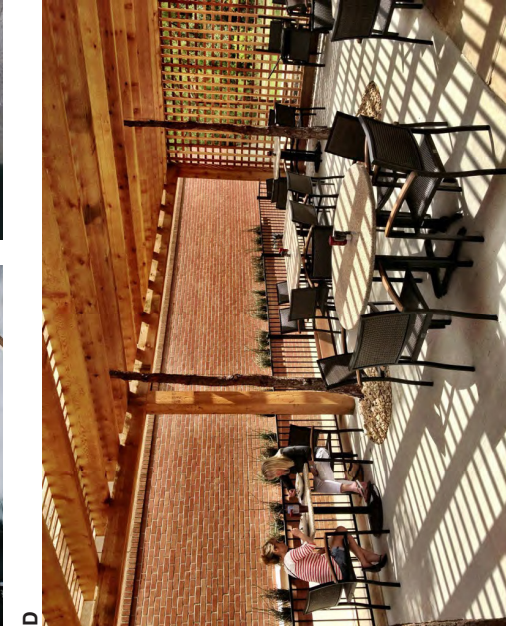
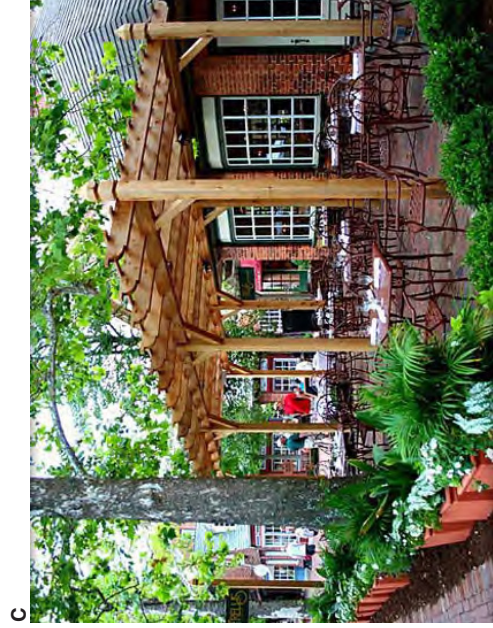
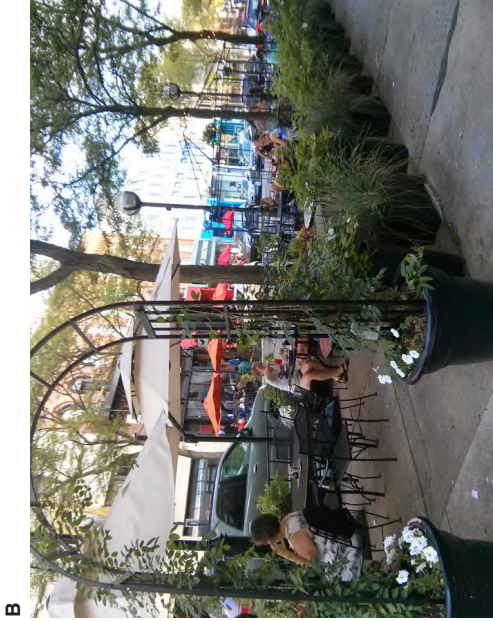
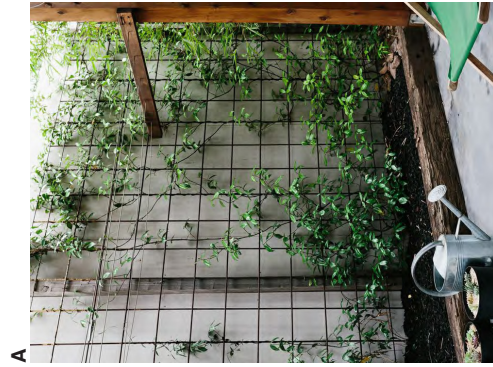

TRELLIS/PERGOLAS/AWNING

Which types of trellises, awnings and pergolas do you prefer and might work well in this space?

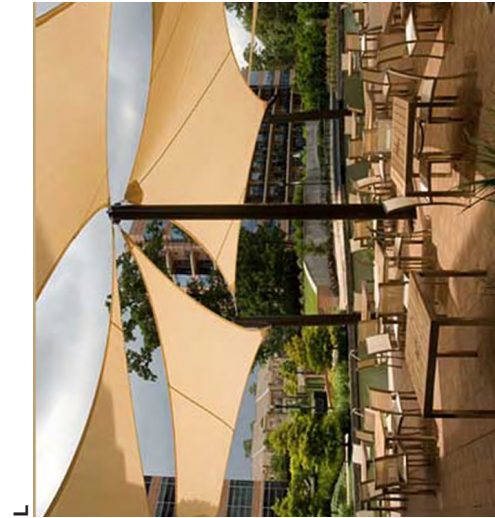
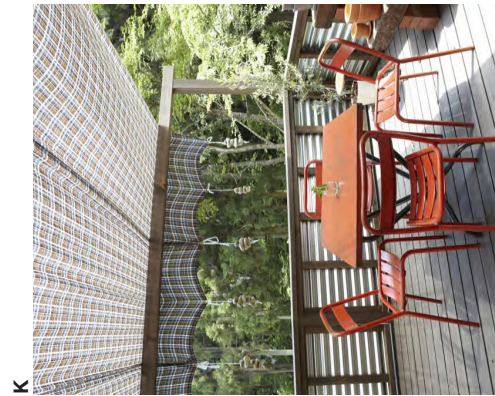

WATER FEATURES

Which types of water features do you prefer and might work well in this space?

page 1

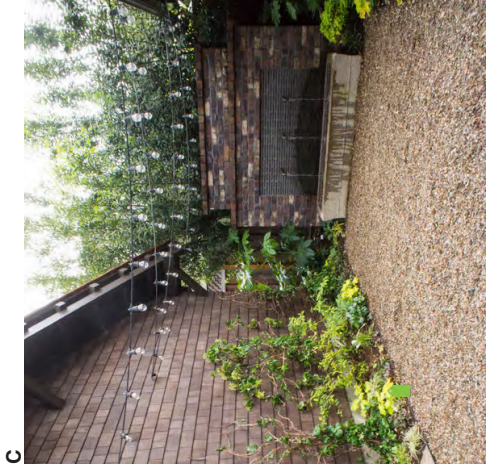
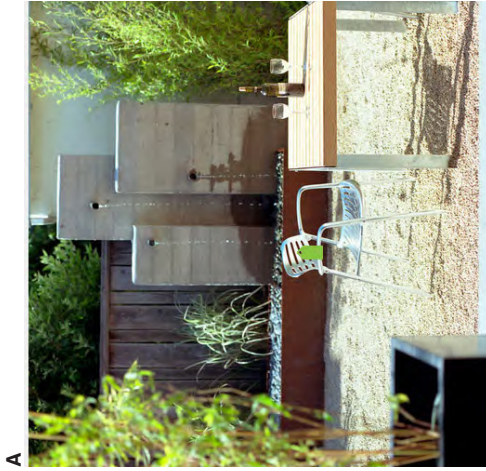

WATER FEATURES

Which types of water features do you prefer and might work well in this space?

page 2

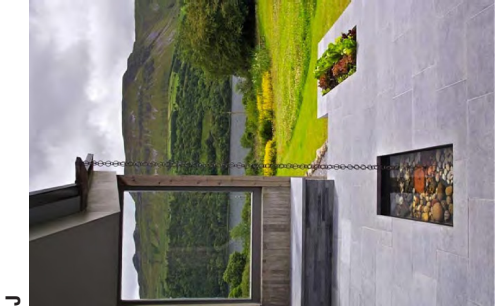
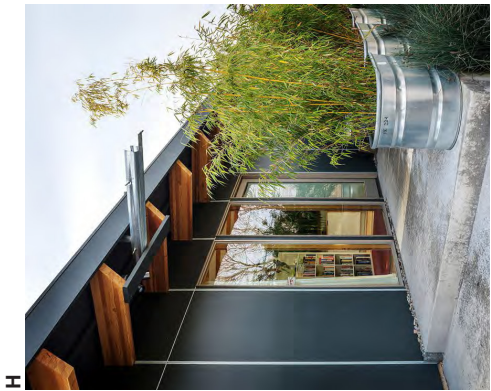

H

G

F

K

J

I

PAVING Which types of paving do you prefer and might work well in this space?

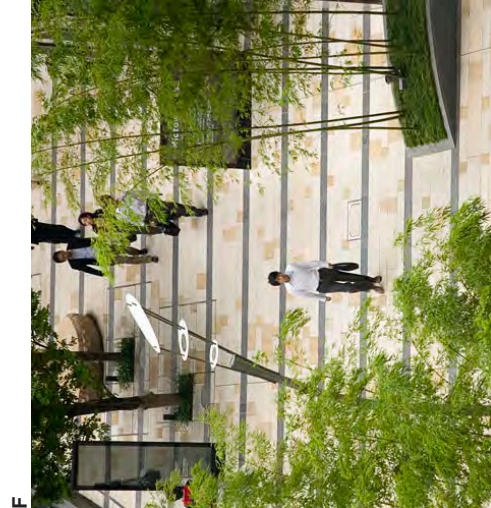
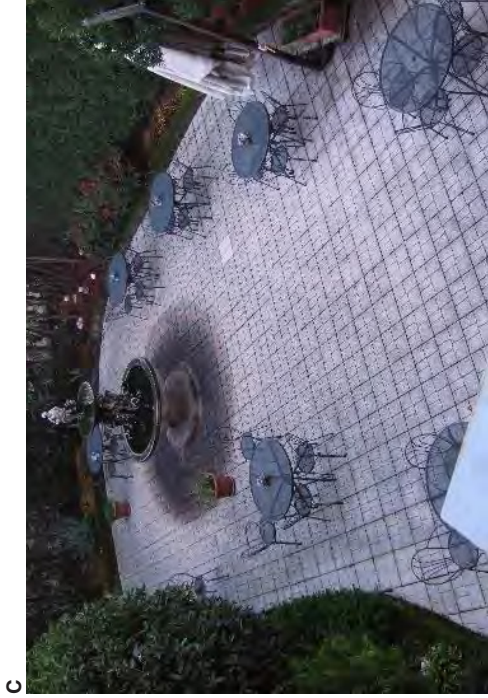

PAVING Which types of paving do you prefer and might work well in this space?

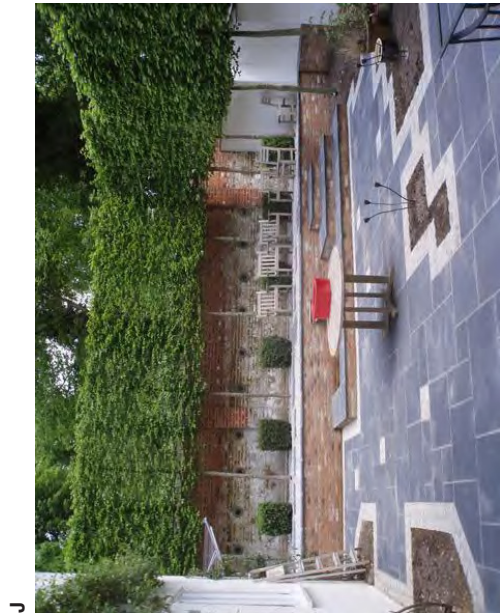
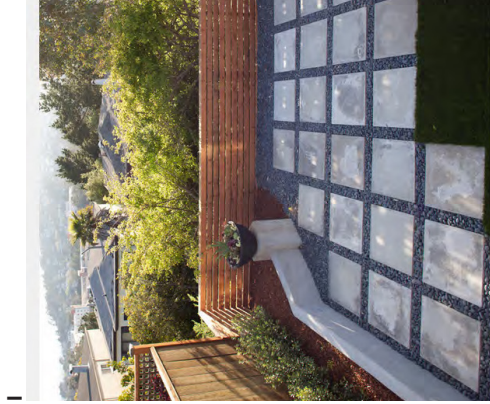
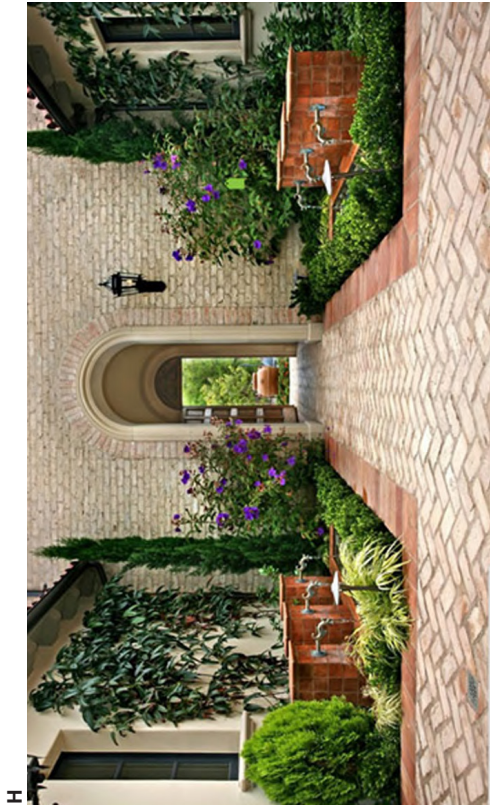
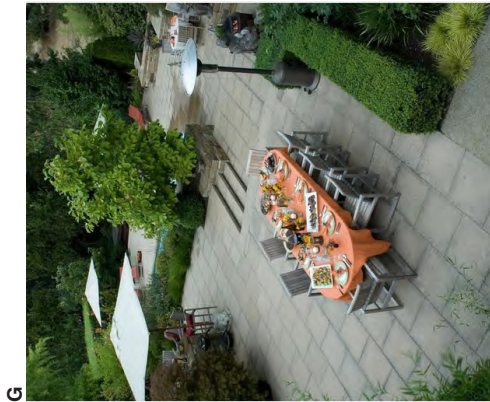

STAIRS & RAMPS

Which types of stair and ramp designs do you prefer and might work well in this space?

page 1



STAIRS & RAMPS

Which types of stair and ramp designs do you prefer and might work well in this space?

page 2

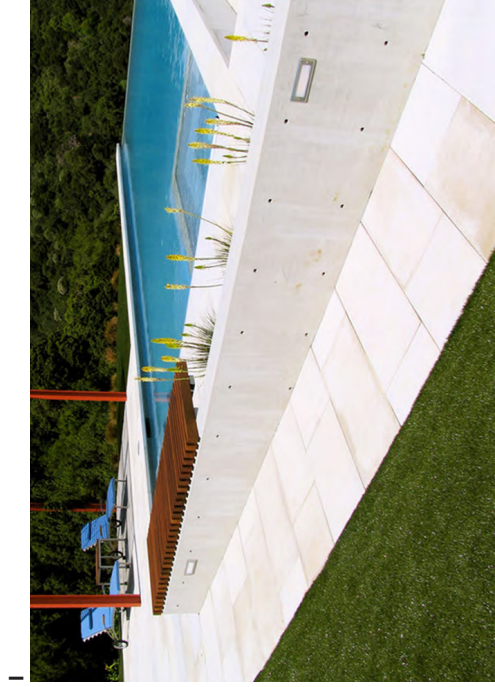
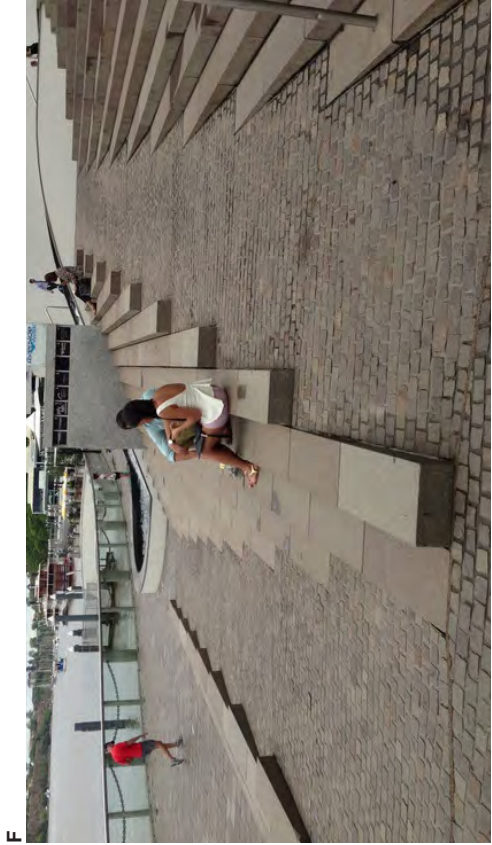

PLANTERS

Which types of planters do you prefer and might work well in this space?

page 1

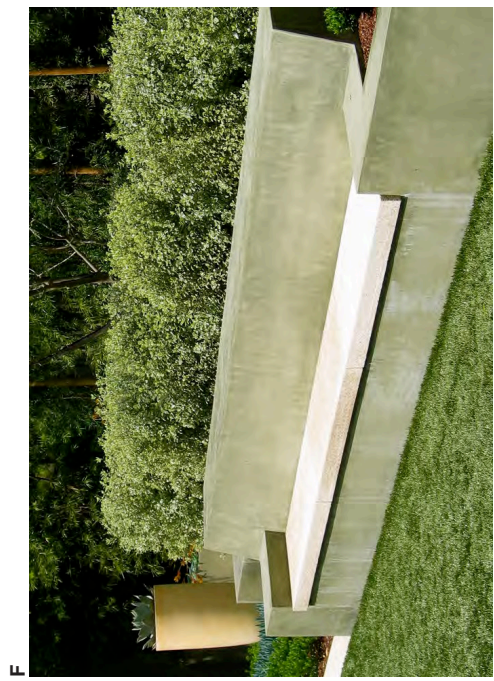
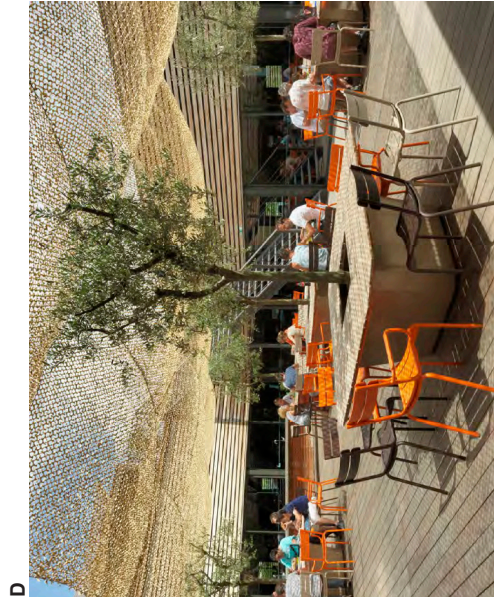

APPENDIX B.IV: PREFERENCE RECORDING SHEET

Take a look at the sheets with images on them. Each of the sheets has a category at the top left which will tell you what to pay attention to in each photo. Above each image is a letter that is associated with that image. For each category, circle the letter(s) ON THIS SHEET of images that you prefer and that you feel would fit well in this courtyard.

Planted walls:

A B C D E F G H I J K L

Lighting:

A B C D E F G H I J K

Railings:

A B C D E F

Seating:

A B C D E F G H I J K L M N O P Q R S T U V W

Trellis/Pergola/Awning:

A B C D E F G H I J K L

Water:

A B C D E F G H I J K

Paving:

A B C D E F G H I J K L

Stairs and Ramps:

A B C D E F G H I J

Planters:

A B C D E F

APPENDIX B.V: IMAGE PREFERENCE RESULTS

Planted walls:

B: 3



D: 1



Railings:

A: 3



D: 2



I: 1



F: 1

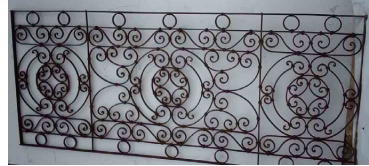

Lighting:

A: 1



C: 2



Seating:

A: 1



I: 2



D: 1

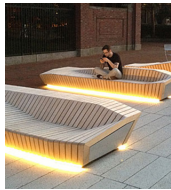

E: 1



K: 1

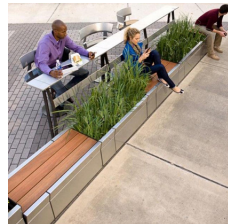

N: 1

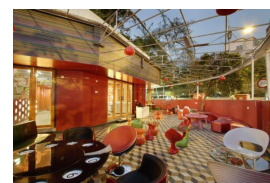

F: 1

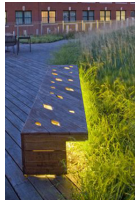

G: 2



P: 1



R: 2



H: 1

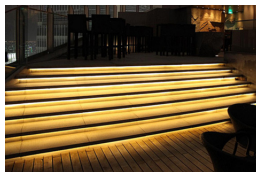

I: 1

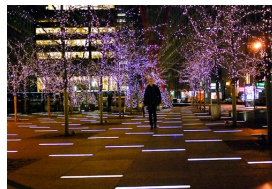

T: 3



U: 2 - one person particularly liked the lighting here



W: 2



Trellis/Pergola/Awning

B: 1

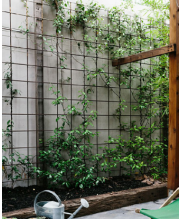

D: 3

C: 2

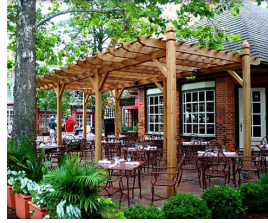

F: 2

Paving

A: 1



D: 1

C: 1



H: 2



J: 1



L: 1



H: 2



J: 4



Stairs

B: 4



D: 1



L: 2



F: 2



I: 1



J: 1



Water:

B: 1



G: 1

C: 1



F: 2

Planters

B: 2



D: 2

C: 1



E: 1



F: 1



APPENDIX C.1: PERMEABLE PAVER DETAILS

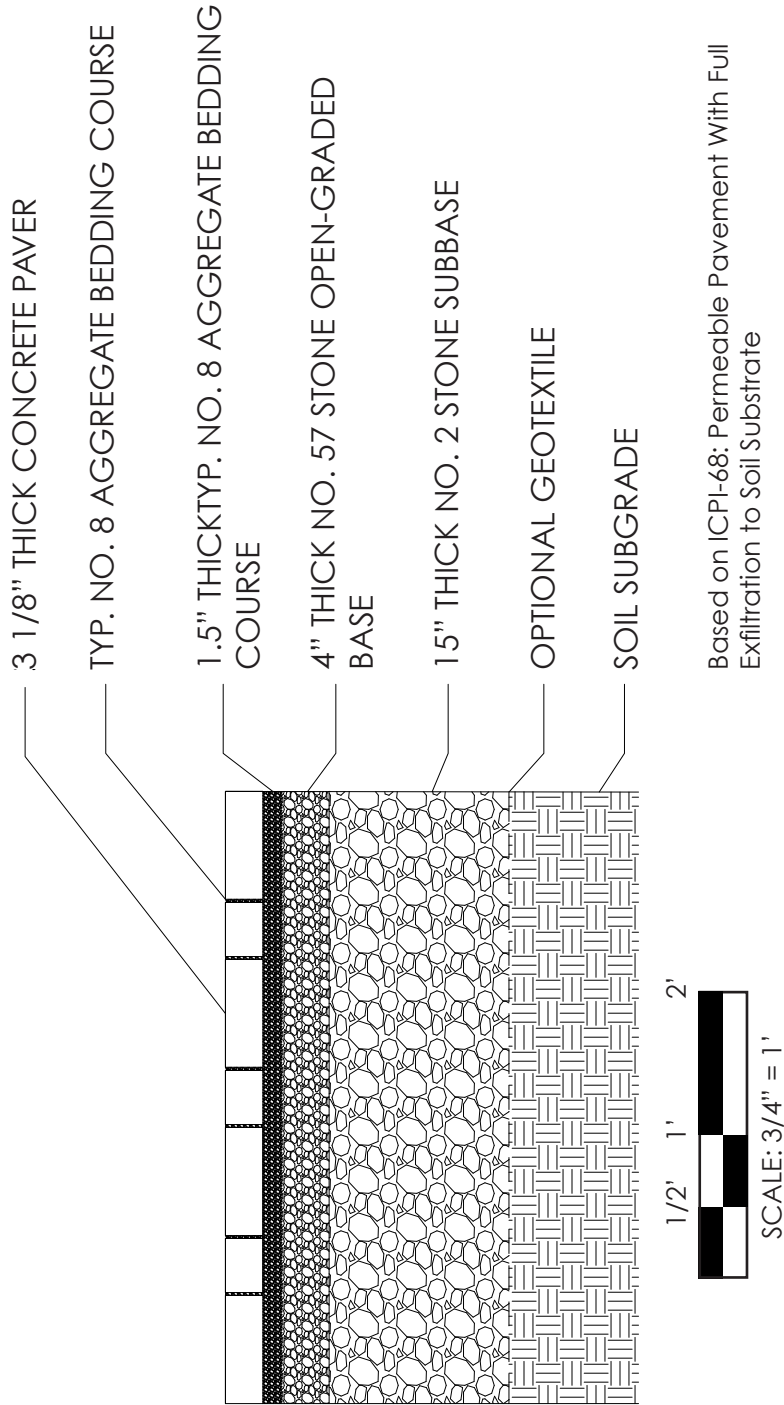

APPENDIX C.11: BENCH PLAN DETAILS

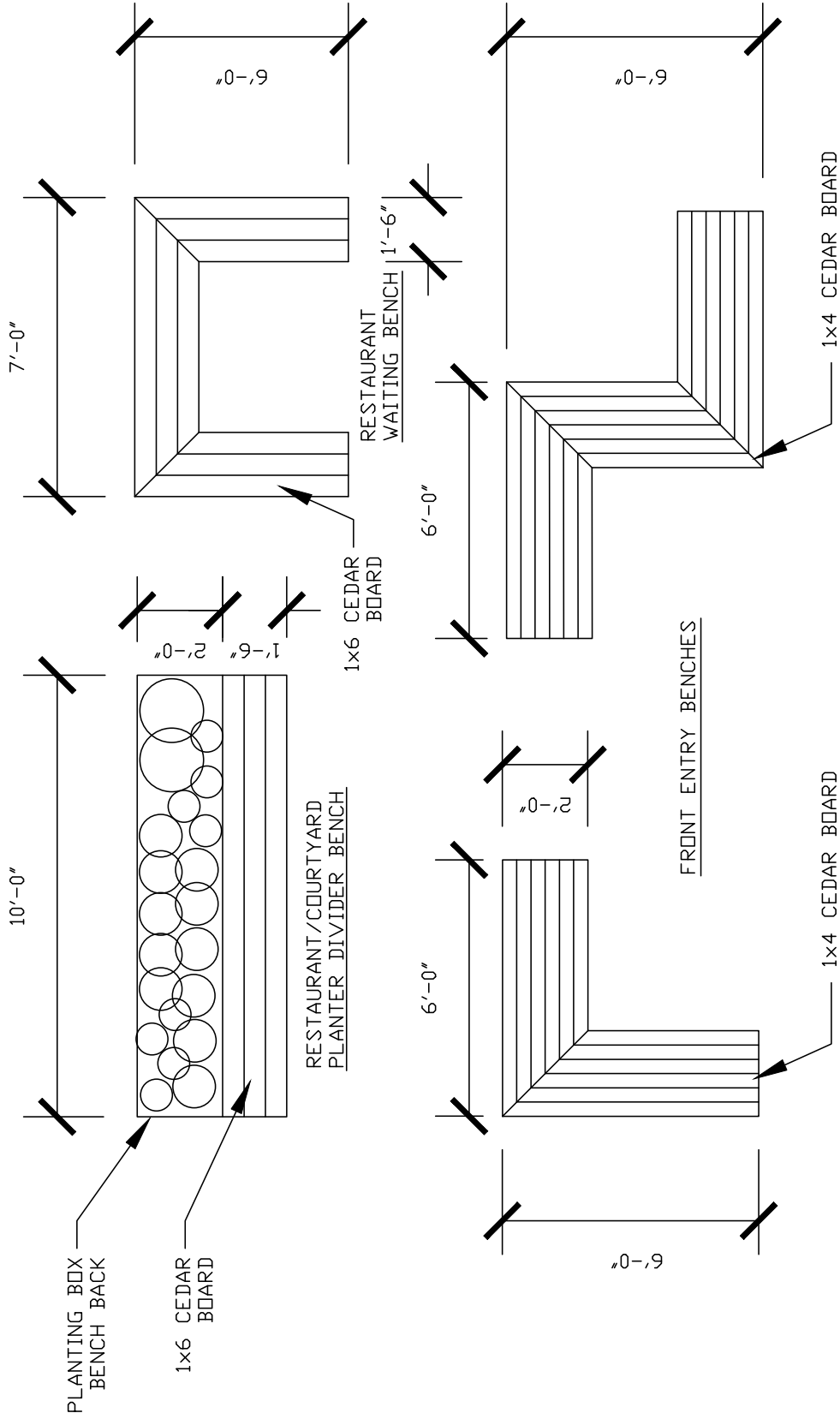

BENCH PLAN DETAILS

N.T.S.

APPENDIX C.III: BENCH ELEVATION

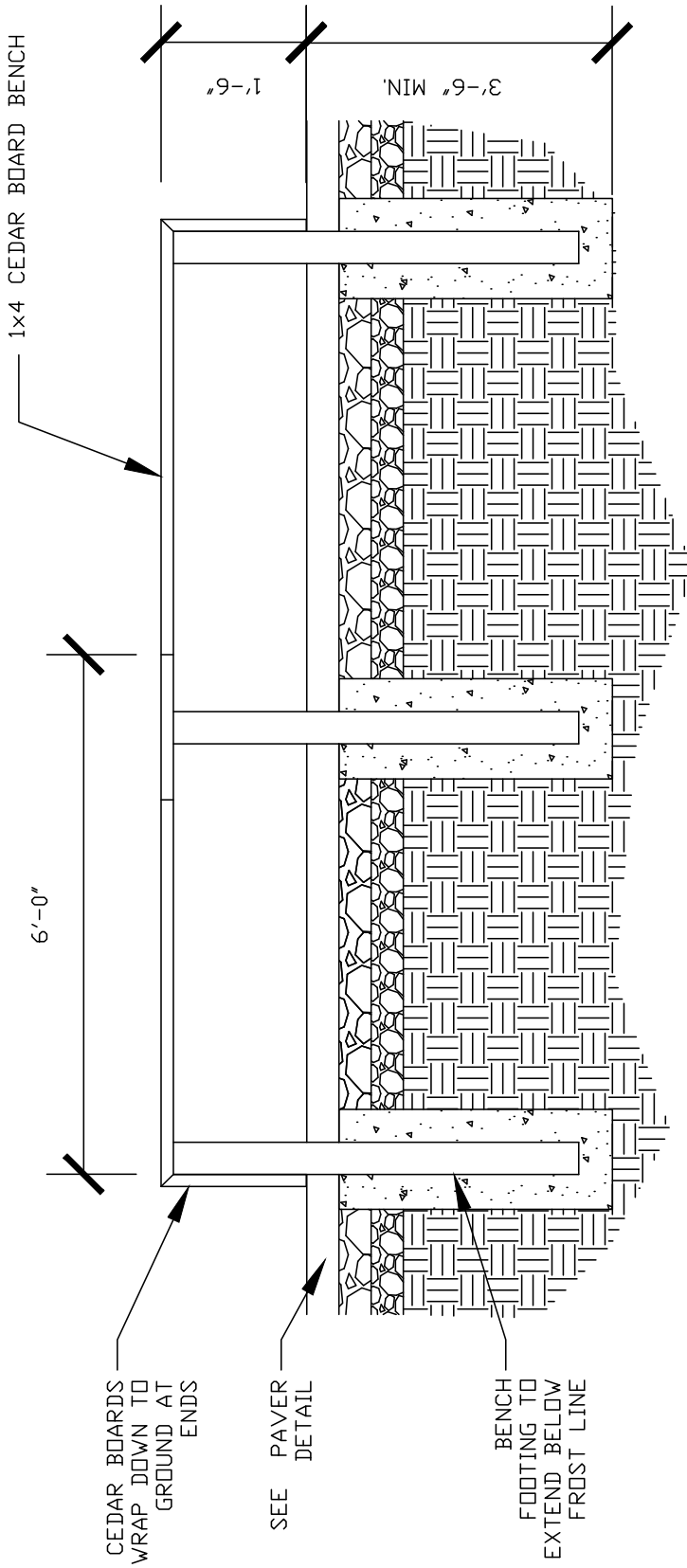

BENCH ELEVATION DETAIL, TYP.

N.T.S.

APPENDIX C.1V: RAMP PLAN DETAIL

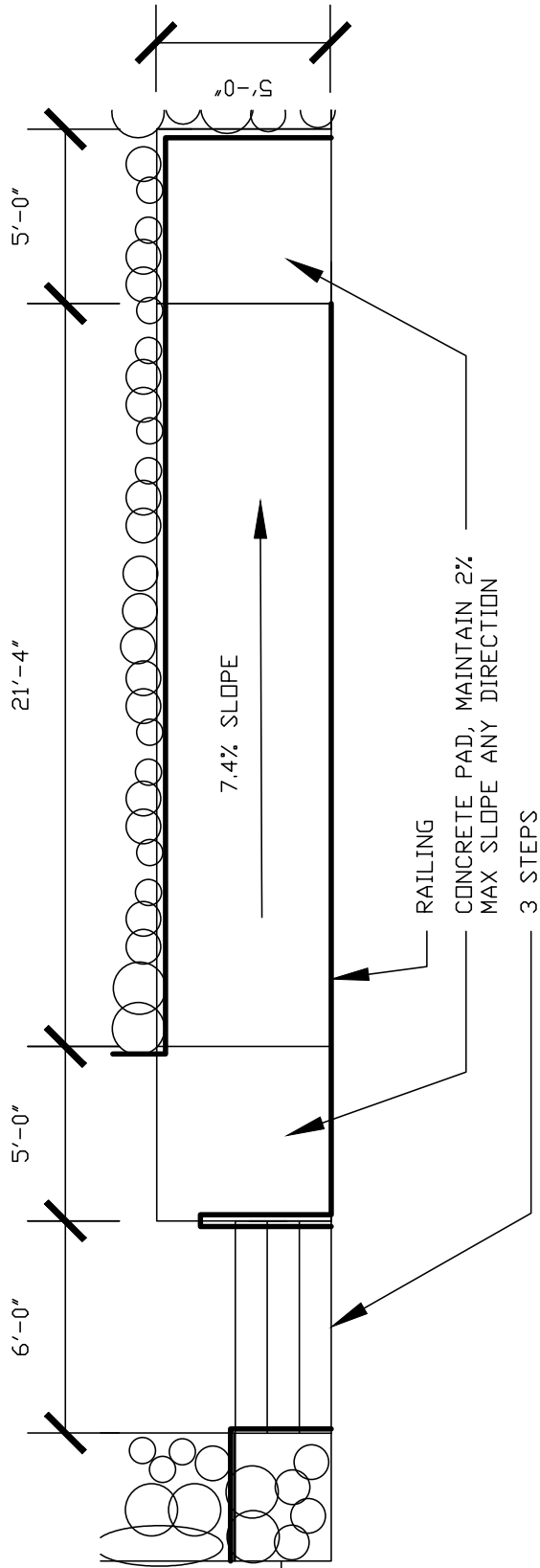

RAMP PLAN DETAIL

N.T.S.

APPENDIX C.V: RAMP ELEVATION DETAIL

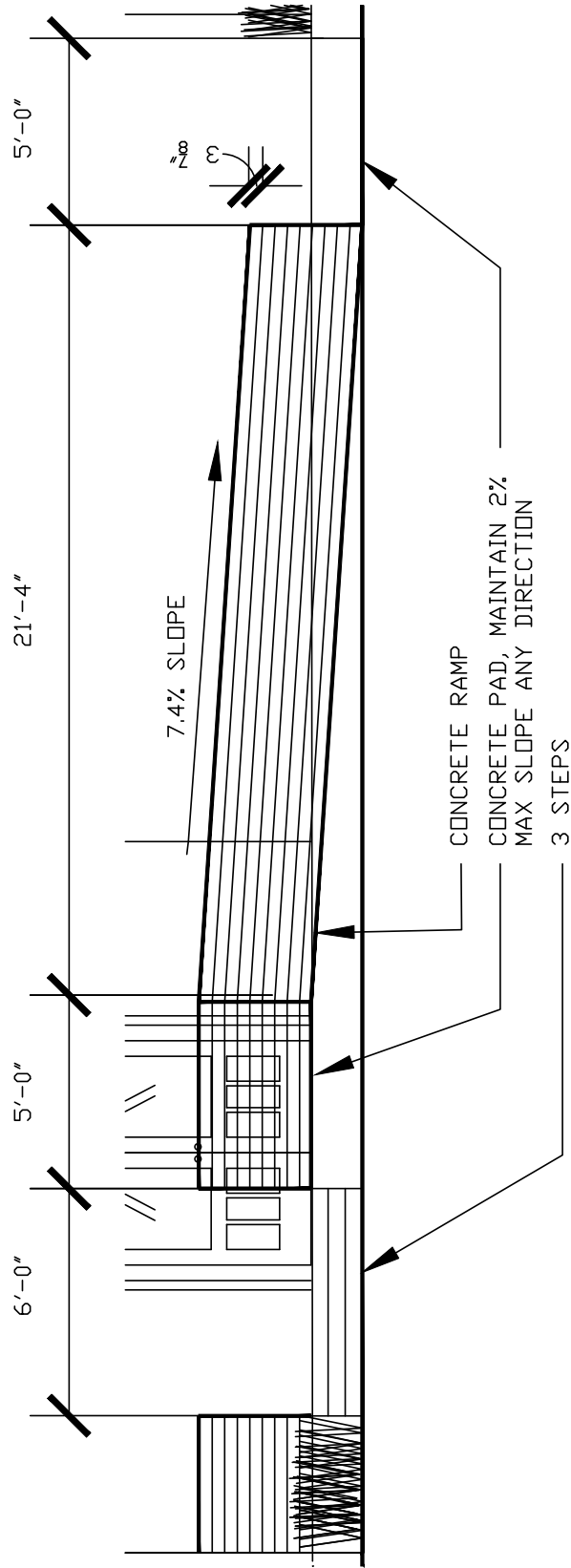

RAMP ELEVATION DETAIL

N.T.S.

APPENDIX C.VI: RAILING ELEVATION DETAIL

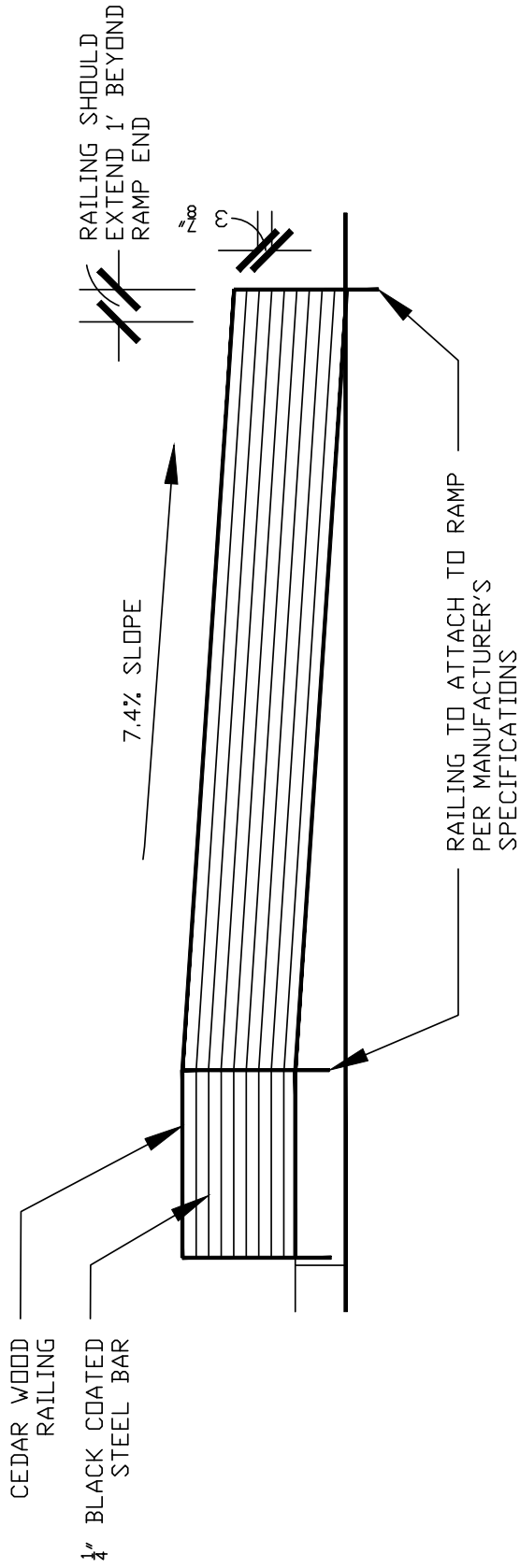

RAILING ELEVATION DETAIL

N.T.S.

APPENDIX C.VII: WATER FEATURE DETAIL

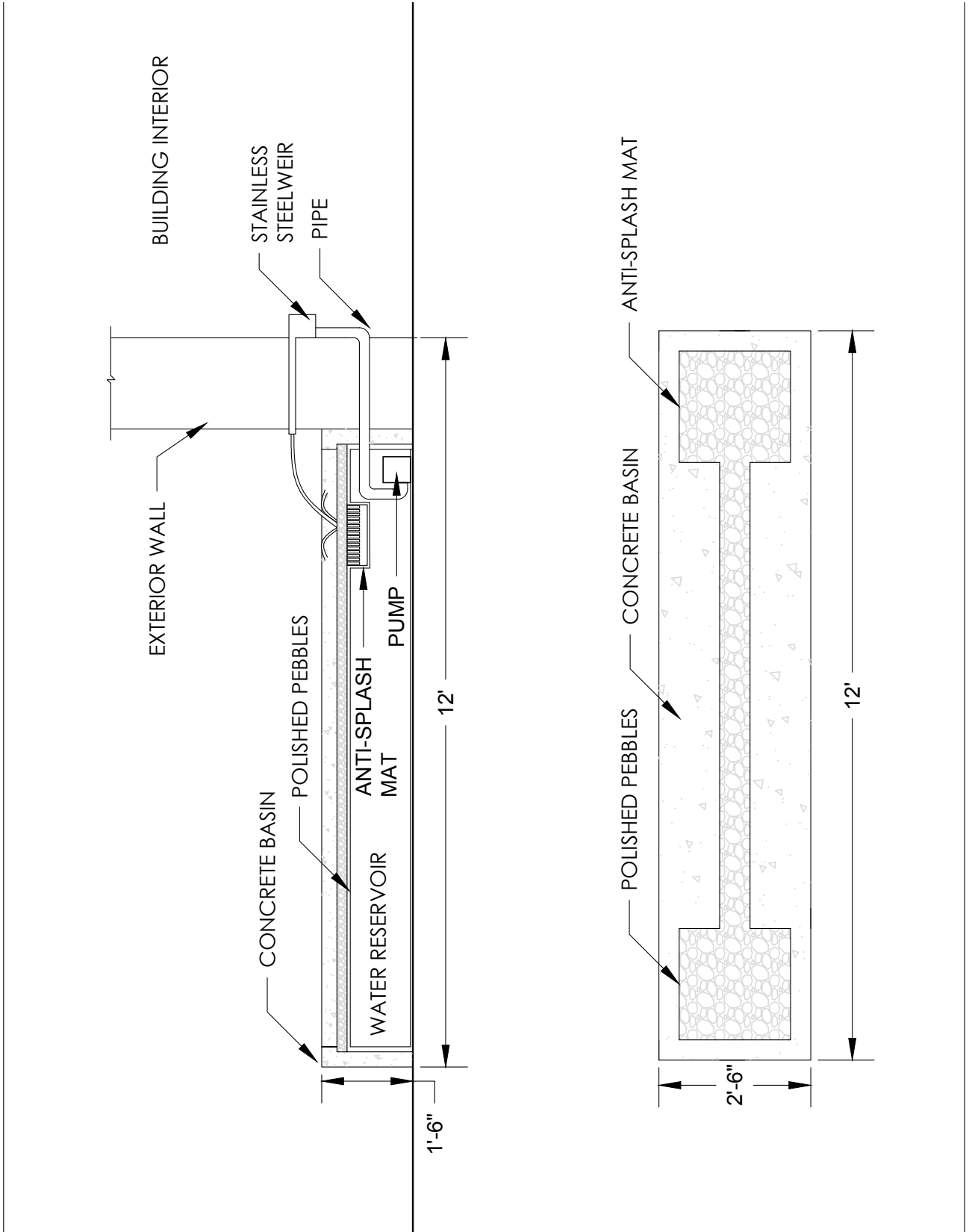

APPENDIX C.VIII: COURTYARD PLANTING PLAN ALONG WALL



- Bleeding Heart
- Pansy
- Wild Ginger
- Creeping Thyme
- Garden Nasturtium
- Coral Bells
- Blue Flag Iris
- Black-eyed Susan
- Lady Fern
- Prairie Dropseed
- Birchleaf Spirea
- Potentilla fruticosa
- ◡ Vernal Witch Hazel

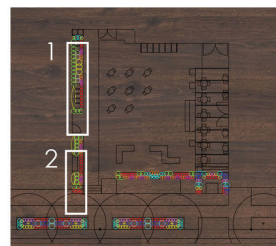

←
North

APPENDIX C.IX: COURTYARD PLANTING PLAN ALONG RAMP AND SIDEWALK

-  Bleeding Heart
-  Pansy
-  Wild Ginger
-  Creeping Thyme
-  Garden Nasturtium
-  Coral Bells
-  Blue Flag Iris
-  Black-eyed Susan
-  Lady Fern
-  Prairie Dropseed
-  Birchleaf Spirea
-  Potentilla fruticosa
-  Vernal Witch Hazel

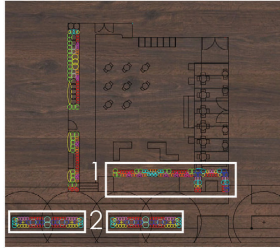

←
North

SCALE: 1"=6'

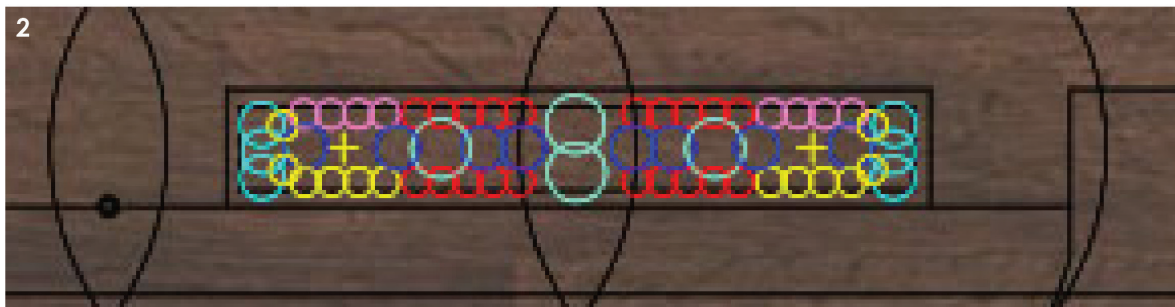
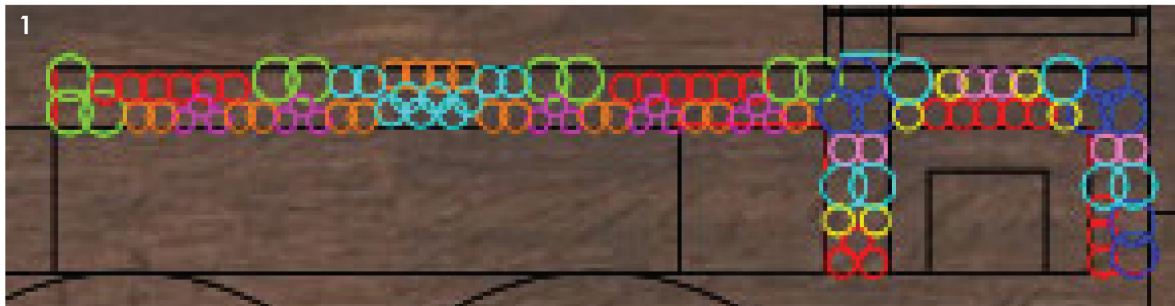

Both Streetside Planters have identical planting design.

APPENDIX C.X: PLANTING BED DETAIL ALONG RAMP

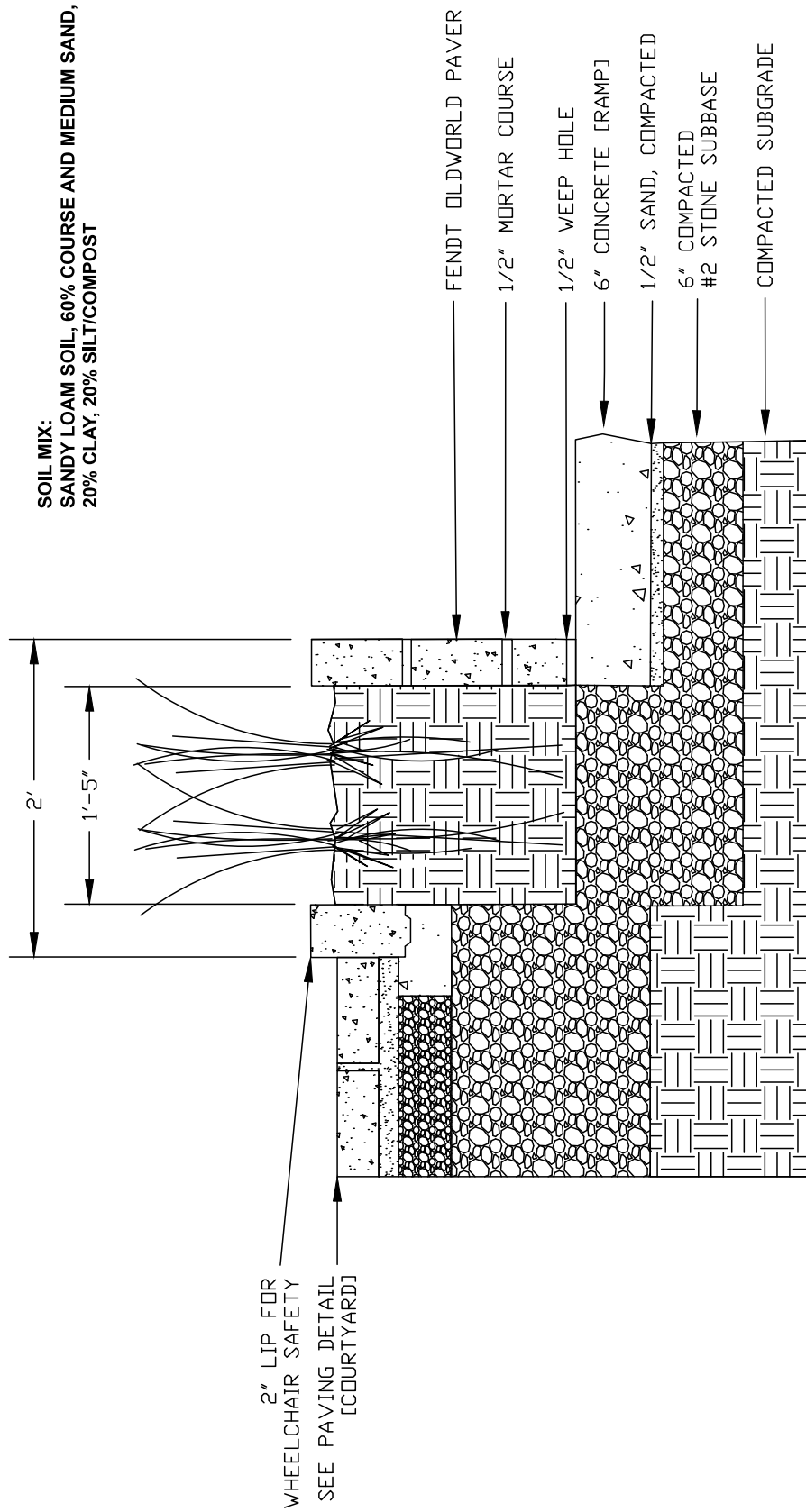

APPENDIX C.XI: GREEN ROOF MIX DETAILS

Mix 1: Custom Yellow and Green

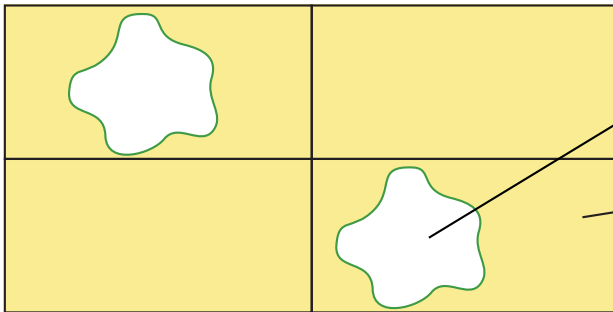

Sedum spectabile 'Star Dust' accents planted randomly in every other module

Base plants
Mixed together and planted for full, even coverage

Mix 2: Custom Yellow/Red/Green



Sempivivum 'Silverine' accents planted randomly, 2 in each module

Base plants
Mixed together and planted for full, even coverage

Mix 3: Custom Reds and Greens

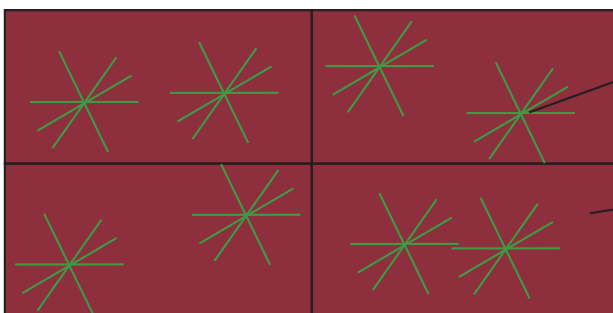

Allium stellatum accents planted randomly, 2 in each module

Base plants
Mixed together and planted for full, even coverage

APPENDIX C.XII: GREEN ROOF IRRIGATION DETAIL

Subterranean Irrigation

Trenched in Modules
 Recommended for LiveRoof Standard (4.25"), Deep (6"), and Maxx 8"

SIDE VIEWS

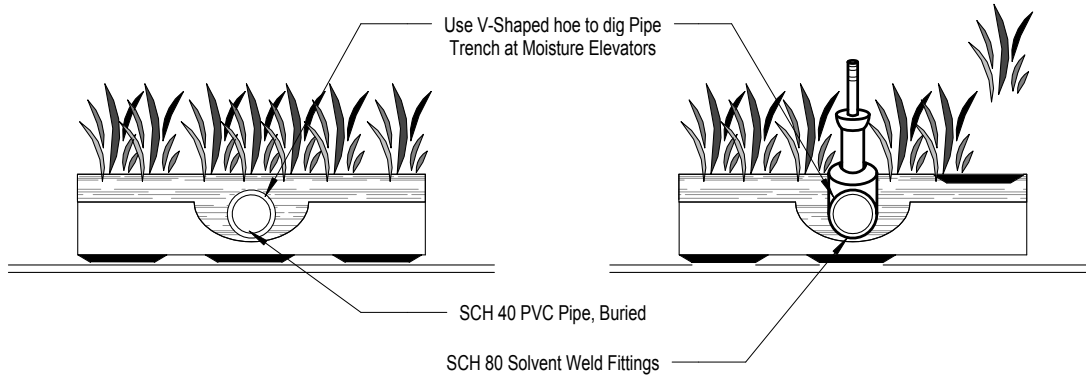

TOP VIEW

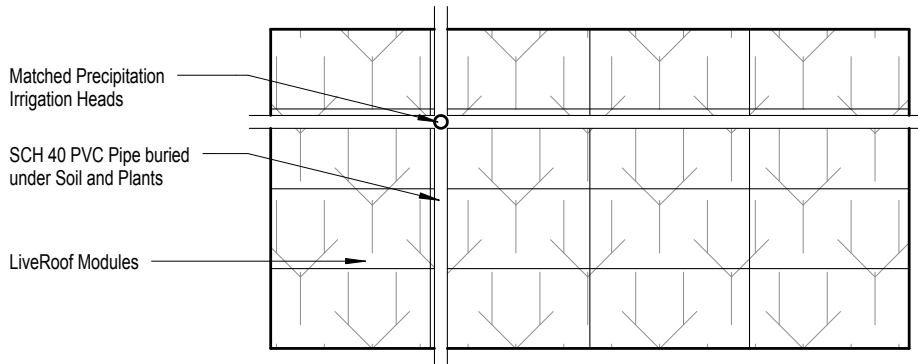

NOT TO SCALE

SLOPE, REFLECTIVE SURFACES, SHADE, BUILDING HEIGHT AND WIND EXPOSURE AFFECT IRRIGATION NEEDS. CONSULT LIVEROOF LICENSED GROWER FOR APPROPRIATE PLANT SELECTIONS BASED ON SITE CONDITIONS. CONSULT A QUALIFIED IRRIGATION SPECIALIST TO DETERMINE APPROPRIATE DESIGN CONFIGURATION OF IRRIGATION, INCLUDING PIPE DIAMETER, LAYOUT, HEAD STYLE AND SPACING.

IRRIGATION A
 v2011-04-13

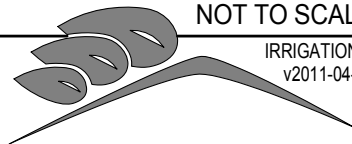

LiveRoof

LiveRoof, LLC
 P.O. Box 533
 Spring Lake, MI 49456

(800) 875-1392
 www.liveroof.com

APPENDIX C.XIII: GREEN ROOF ROOFSTONE DETAIL

ROOFSTONE

LiveRoof Integrated Paver System
 Recommended for LiveRoof Standard (4.25") and Deep (6") Systems

COLORS	SIZE	
	1' x 2' x 4" STANDARD	1' x 2' x 6" DEEP
<input type="checkbox"/> BEACH SAND	<input type="checkbox"/> 4"	<input type="checkbox"/> 6"
<input type="checkbox"/> CHARCOAL	<input type="checkbox"/> 4"	<input type="checkbox"/> 6"
<input type="checkbox"/> LIGHT REFLECTIVE	<input type="checkbox"/> 4"	<input type="checkbox"/> 6"
<input type="checkbox"/> MOCHA	<input type="checkbox"/> 4"	<input type="checkbox"/> 6"
<input type="checkbox"/> RED BRICK	<input type="checkbox"/> 4"	<input type="checkbox"/> 6"
<input type="checkbox"/> NATURAL	<input type="checkbox"/> 4"	<input type="checkbox"/> 6"

SIDE VIEWS

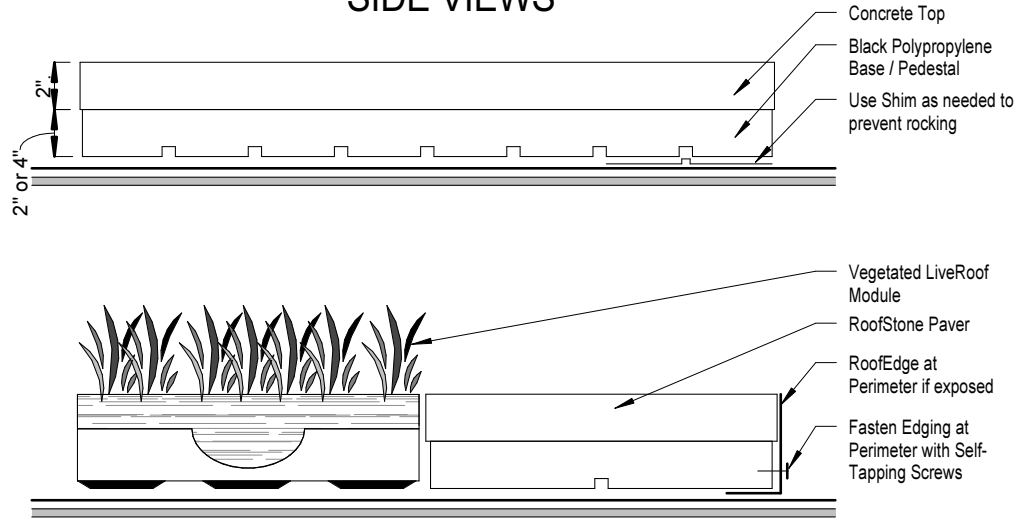

TOP/BOTTOM VIEW

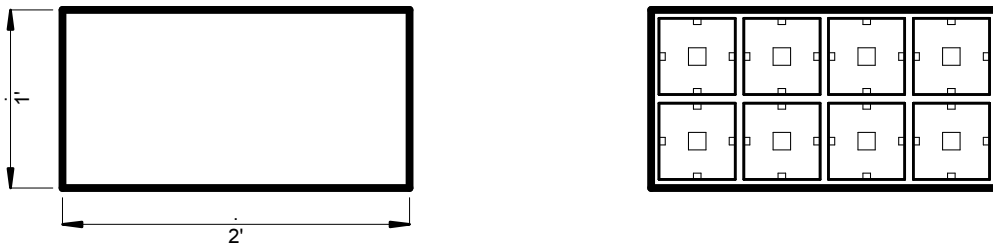

Paver Weight = 50 lbs (4") or 53 lbs (6")

NOT TO SCALE

ILLUSTRATIONS ARE TO CONCEPTUALLY ASSIST PROFESSIONALS IN DESIGN OF LIVEROOF APPLICATIONS. LIVEROOF DOES NOT ACCEPT RESPONSIBILITY FOR ENGINEERING BASED ON ILLUSTRATIONS. A QUALIFIED STRUCTURAL ENGINEER SHOULD BE CONSULTED TO DETERMINE APPROPRIATE AND SUITABLE DESIGN. PAVER WALKWAYS NEAR PARAPETS SHOULD BE DESIGNED FOR SAFE USE, TAKING INTO ACCOUNT WIND FACTORS.

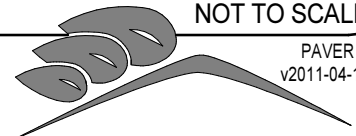

PAVER A
 v2011-04-18

LiveRoof, LLC
 P.O. Box 533
 Spring Lake, MI 49456

(800) 875-1392
 www.liveroof.com

LiveRoof

APPENDIX C.XIV: GREEN ROOF STANDARD SYSTEM I

LiveRoof STANDARD SYSTEM

Over Conventional Roofing Assembly

SIDE VIEW

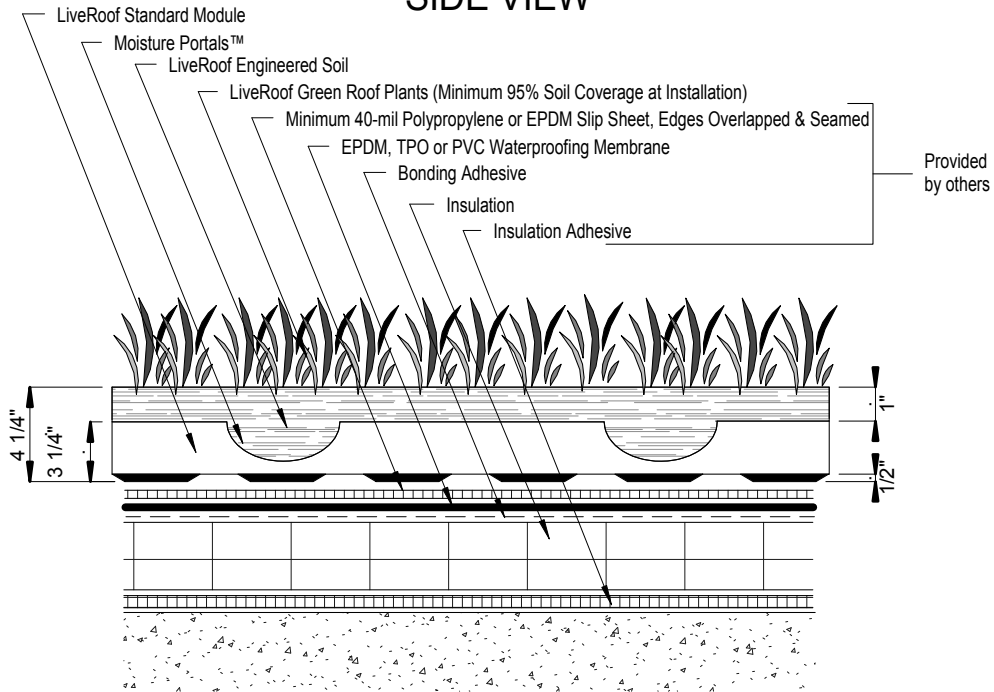

TOP VIEW

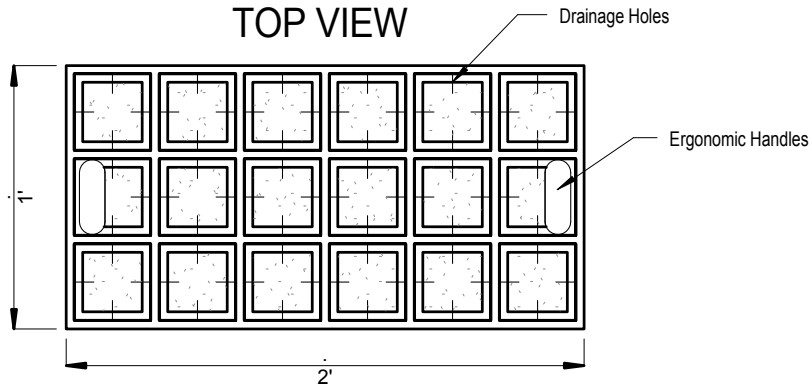

LiveRoof System Saturated Weight: 27-29 lbs / sf

NOT TO SCALE

STANDARD A

ILLUSTRATIONS ARE TO CONCEPTUALLY ASSIST PROFESSIONALS IN DESIGNING LIVEROOF INSTALLATIONS. LIVEROOF DOES NOT ACCEPT RESPONSIBILITY FOR ENGINEERING BASED ON ILLUSTRATIONS. A QUALIFIED ROOFING SPECIALIST SHOULD BE CONSULTED TO DETERMINE APPROPRIATE WATERPROOFING AND ROOF DECK MATERIALS AND SUITABLE DESIGN.

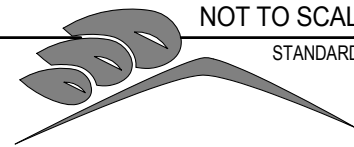

LiveRoof

LiveRoof, LLC
P.O. Box 533
Spring Lake, MI 49456

(800) 875-1392
www.liveroof.com

APPENDIX C.XV: GREEN ROOF STANDARD SYSTEM II

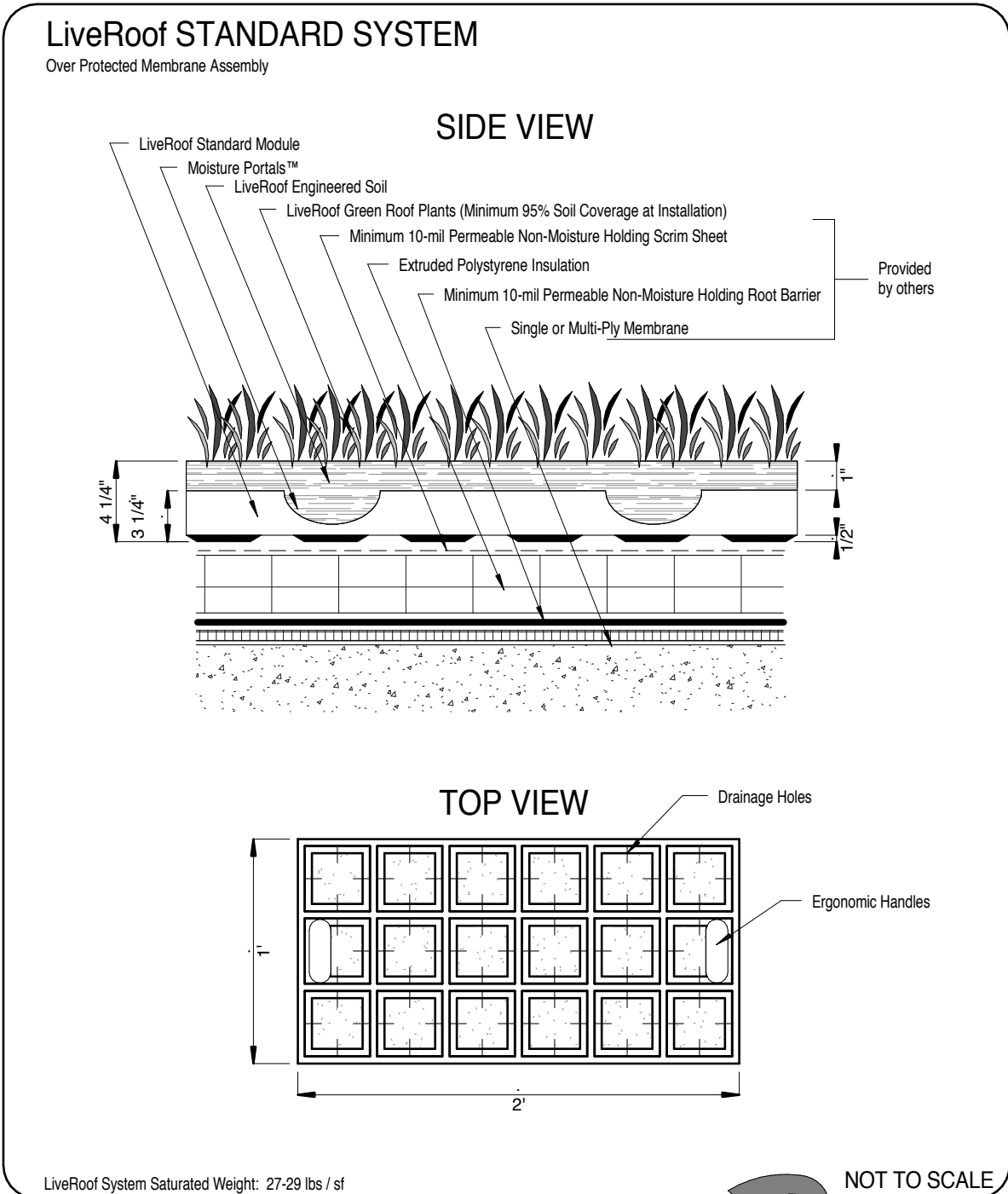

ILLUSTRATIONS ARE TO CONCEPTUALLY ASSIST PROFESSIONALS IN DESIGNING LIVEROOF INSTALLATIONS. LIVEROOF DOES NOT ACCEPT RESPONSIBILITY FOR ENGINEERING BASED ON ILLUSTRATIONS. A QUALIFIED ROOFING SPECIALIST SHOULD BE CONSULTED TO DETERMINE APPROPRIATE WATERPROOFING AND ROOF DECK MATERIALS AND SUITABLE DESIGN.

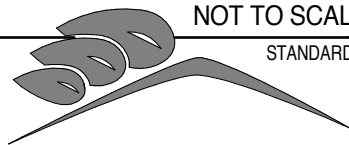

LiveRoof

LiveRoof, LLC
P.O. Box 533
Spring Lake, MI 49456

(800) 875-1392
www.liveroof.com

WORKS CITED

Aguilar, Louis. "Baker's Keyboard Lounge seeks official landmark status." *The Detroit News*, 6 Feb. 2015. Web. 10 Apr. 2015.

Anderson, April. Interview by Suzette Hackney. "Livernois' Avenue of Fashion district overcomes hard times." *Crains Detroit*, 19 Oct. 2014. Web. 10 Apr. 2015.

Bartell, Ron. Interview by MJ Galbraith. "Kuzzo's Chicken and Waffles opens on the Avenue of Fashion." *Development News*. Model D Media, 27 Jan. 2015. Web. 10 Apr. 2015.

Dickinson, Chad. Interview by Amy Haimerl. "Livernois Avenue in the fast lane for \$1.7 million face-lift." *Crain's Detroit*, 20 May 2013. Web. 10 Apr. 2015.

Duggan, Mike. Interview by Virginia Gordon. "Detroit launches new business expansion program for city's neighborhoods." *Michigan News*. Michigan Radio, 1 Apr. 2015. Web. 10 Apr. 2015.

"Eleven Principles for Creating Great Community Places." *Project for Public Spaces*. Web. 15 Apr. 2015.

Kaplan and Kaplan. *Humanscape: environments for people*. Duxbury Press, 1978. Print.

Livernois Avenue of Fashion. Revolve Detroit, 2015. Web. 10 Apr. 2015

LiveRoof, LLC. *LiveRoof: Hybrid Green Roof System Catalog*. 2015. Print.

Oberndorfer, Erica, et al. "Green Roofs as Urban Ecosystems: Ecological Structures, Functions, and Services." *BioScience* 57 Nov. 2007: 823-833. Print.

"Public Welfare." *Title 45 Code of Federal Regulations*, Pt. 46. 2009 ed., Web.

"The Avenue of Fashion." *Neighborhoods*. Hatch Detroit, 2015. Web. 10 Apr. 2015.

Ulrich, Roger S., et al. "Stress recovery during exposure to natural and urban environments." *Journal of Environmental Psychology* 3 Sept. 1991: pgs 201-230. Print.

Urban Land Institute: Daniel Rose Center for Public Leadership in Land Use. "Reviving Livernois Avenue as a Thriving Urban Main Street." *A ULI Daniel Rose Fellowship Program City Study Visit Report*. Urban Land Use Institute, January 18–21, 2011. Web. 10 Apr. 2015.

"What Makes a Successful Place." *Project for Public Spaces*. Web. 15 Apr. 2015.

