

3687-1-F = RL-2110

LOCATION OF CREVASSES IN GLACIAL ICE BY  
DETECTION OF MICROWAVE PASSIVE THERMAL RADIATION

Weston E. Vivian

July 1960

- I. Introduction
- II. Radiation from a ~~Dissipative~~ Dielectric Layer
- III. Dielectric and ~~Thermal~~ Structure of a Crevasse
- IV. Anticipated Radiation Contrast Patterns
- V. Feasibility of Crevasse Location

## I. Introduction

The deep glacial ice layers which cover large areas of the Arctic and Antarctic are fractured by frequent crevasses in those local areas where underlying terrain irregularities induce high tensile stress in the flowing ice.

The crevasses, typically a meter or so in width and up to tens of meters in depth, normally become bridged by a shelf of surface snow deposited by wind. The snow bridge may be strong or weak, depending on age and local conditions. Travel through crevassed areas by men or vehicles is notoriously slow. Extreme care is taken to probe every step for a possible crevasse covered by a weak bridge. While certain animals are believed capable of sensing such bridges without probing, man has not yet succeeded in developing a comparable capability.

Recent detailed studies of the physical structure and properties of crevasses indicate that different sub-surface temperature gradients exist between snow-covered solid glacial ice and snow-bridged crevasses. It has been suggested that a system for rapid external measurement of subsurface temperature may provide a useful means of crevasse location not dependent on deep mechanical probing. Of the types of temperature sensors available, only microwave radiometers currently appear potentially utilizable. Shorter-wavelength radiometers tend to indicate only surface temperature; long-wavelength radiometers of sufficient

size to provide adequate spatial resolution are not practicable in most situations foreseen.

Whether or not an effective system is devisable is not well established, however. No quantitative experimental or analytical evaluation of the capabilities and limitations of microwave radiometers for this application has been undertaken as yet, to the author's knowledge. Many pertinent questions remain to be settled. A preliminary survey of the key problems is presented here. The physical phenomena governing the potential performance of a microwave radiometer sensor are outlined, Contrast patterns which should be observed are estimated. The information presented indicates that there is a reasonable probability that crevasses can be located by this sensor technique during appropriate weather, and that some information on the depth and state of the snow bridge possibly may be deduced from the sensor records.

## II. Radiation from a Dissipative Dielectric Layer

The density and temperature of the snow covering glacial ice areas vary appreciably and to some extent periodically with depth, a consequence of compacting from weight load and of seasonal variation of temperature and wind at the exposed surface at time of deposition. In the vicinity of crevasse walls and in crevasse snow bridges, the otherwise horizontally-stratified density and temperature contours are distorted by local convection and regelation effects. The lower surfaces of snow bridges are very irregular in shape and composition.

For non-crevassed areas an accurate calculation of the microwave passive radiation transmitted into the air from the snow is feasible. An accurate knowledge of the density and temperature distributions, determined either experimentally or analytically, is, of course, a prerequisite. The emission of each stratum, and the absorption, refraction and reflection of this radiation component by underlying and overlying strata and the snow-air interface are required and can be calculated. Provided the internal density and temperature gradients are small, in particular that no abrupt variations occur within a wavelength of propagation in the medium except at the snow-air interface, a much-simplified approximate calculation accommodating only temperature and absorption variations is appropriate. In this approximation, the radiation intensity, measured in terms of apparent temperature, is given by:

$$T_{OS} = \left\{ 1 - R(\theta') \right\} \int_0^{\infty} \left[ \exp - \int_0^x \alpha(x_1) \sec \theta' dx_1 \right] T(x) \alpha(x) \sec \theta' dx$$

where  $R(\theta)$  is the power reflection coefficient at the snow-air interface,  $x = 0$ ;  $T(x)$  is the temperature;  $\alpha(x)$  is the absorption coefficient, a function of density, temperature

and frequency (and of free water content, if present); and  $\theta'$  is the angle of incidence inside the dielectric, as shown below:

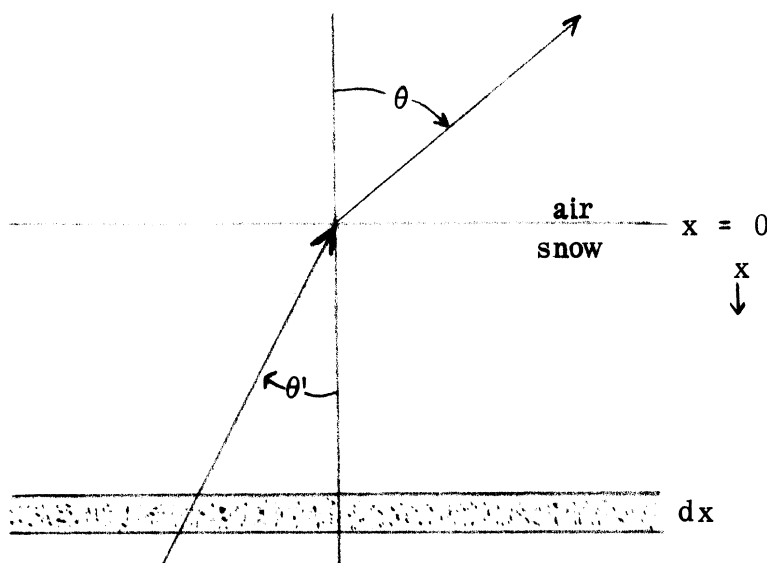

Figure 1.

The absorption coefficient  $\alpha$  is related to the dielectric constant, for  $\tan \delta$  small as in snow, as:

$$\alpha \approx \frac{\omega}{c} \eta \tan \delta \approx 2\pi \lambda_m^{-1} \tan \delta$$

where  $\omega$  is the radian radiation frequency, with  $c$  the velocity of light in vacuum; and where  $\eta^2 = \epsilon'$  and  $\tan \delta = \frac{\epsilon''}{\epsilon'}$ , where  $\epsilon = \epsilon' - j\epsilon''$  is the complex (relative) dielectric coefficient; here  $\lambda_m$  is the radiation wavelength in the medium. Also, from the laws of refraction, for  $\tan \delta$  small,  $\sin \theta = \eta \sin \theta'$ .

While this approach is acceptable for smooth-surfaced non-crevassed areas, it is too simplified to be accurate as presented above for crevasses. First, the internal cavity of the crevasse constitutes a complex scatterer. Second, the density and temperature distributions in the snow adjacent to the crevasse as mentioned above are no longer simply horizontally stratified. By inclusion of additional snow-air interfaces at the crevasse faces, including snow bridge faces, and ray-tracing of multiple reflections inside the crevasse, one can extend the model sufficiently to develop an estimate of the local

radiation. The effort required to carry out such calculations is sufficient to deter extensive analysis of representative crevasses except for illustrative purposes (see IV below).

One particular case which is easily estimated, however, is the solution for a snow bridge sufficiently thick that the contribution from the bottom face will be negligible. In this case the above simple solution for horizontal stratification is satisfactory.

The reflection  $R$  which occurs at the air-snow interface is strongly dependent on incidence angle. Methods of computing the reflection-coefficient for dielectric interfaces are well known. A crude graph of  $R(\theta)$  for an air-snow interface for a typical value of dielectric constant for snow is given in Figure 2.

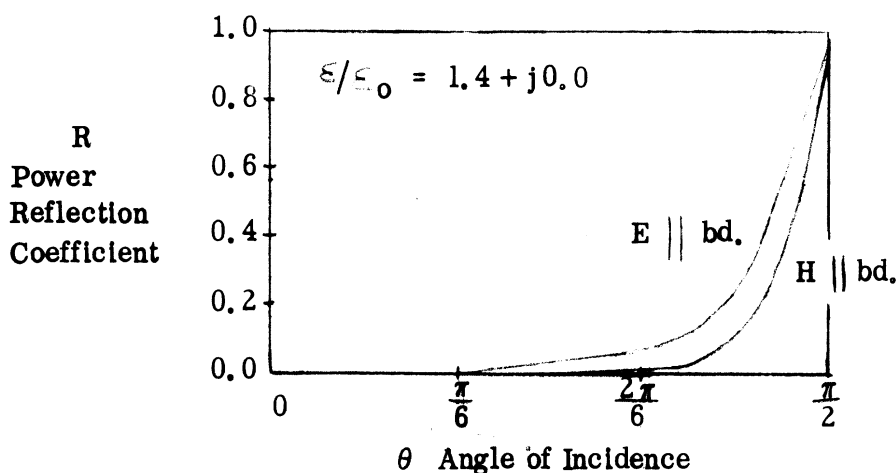

If any radiation from the sky is incident on the snow-air interface, it, of course, also will be reflected and add to the total observed intensity. The component so contributed will be  $T_{0a} = R(\theta)T_a$ , where  $T_a$  is the apparent temperature of the atmospheric source. In clear weather in the microwave region in frigid zones the apparent sky temperature will be well below ambient ground temperature, and approach absolute zero. Furthermore, for near-vertical incidence, the reflection coefficient shown above is near zero. Hence the sky component will be very small under such conditions. Conversely, in wet weather and for near-grazing incidence, the sky component can be dominant. Specification of the sky condition is thus essential.

### III. Dielectric and Thermal Structure of Crevasses

Evaluation of the above radiation integral requires a precise knowledge of subsurface temperature and dielectric constant. Quantitative information available on these parameters is summarized below.

#### A. Thermal Distribution

As indicated earlier, the temperature of the snow above solid ice and in crevasse snow bridges varies with depth, season and crevasse geometry. In non-crevassed area the temperature distribution can be estimated by solution of the one-dimensional heat equation. Assuming for simplicity uniform heat capacity and transmittance coefficients, infinite depth, and a surface temperature excitation which is periodic with a period of one year with all higher harmonics ignored, the temperature vs depth and time of year will be:

$$T(x, t) = T_m + T_p \cos(\omega t - \beta x) e^{-\beta x}$$

where  $T_m$  is the yearly mean temperature;  $T_p$  is the peak excursion;  $\omega = 2\pi$  (duration of year) $^{-1}$ ; and  $\beta = \left(\frac{\omega}{2k}\right)^{1/2}$  is the thermal attenuation coefficient, where  $k = \frac{K}{C}$ , with  $K$  the thermal conductivity and  $C$  the volumetric specific heat. With  $K_{\text{snow}}$  assumed approximately one-tenth of  $K_{\text{ice}}$ , then  $\beta_{\text{snow}} \approx 0.7 \text{ meter}^{-1}$ , whence the thermal wavelength is about 10 meters, the thermal excursion being attenuated by  $e^{-1}$  in 1.3 meters. A typical value for  $T_{\text{ex}}$  might be  $40^\circ \text{K}$ . This illustrative calculation, though not unrepresentative, is at best only indicative of the range of variables of interest.

The temperature distribution in a crevasse is far more complex. Current evidence indicates that convective as well as conductive heat transfer is important. No attempt will be made here to find or delineate the mathematical form of the temperature profile. (Initial attempts led to results inconsistent with the experimental profiles below.)

Sample experimental temperature profiles are shown in Figures 3A and 3B (deep profiles) and Figure 4 (shallow profile). In the samples of Figure 3, the upper crevasse region is 2° to 4° warmer than the nearby undisturbed region at the same depth. In the sample of Figure 4, the snow bridge is about 4° warmer. The author is advised that such differences are not uncommon, perhaps typical.

Because the surface temperatures shown in the samples are near 0° C., the melting point of snow, the samples by implication are governed by more complicated heat transfer mechanisms, arising from the phase change, than used in the simple formula earlier discussed. Also the equality of temperature at the air-snow interface at both locations in Figure 4 again is in all likelihood a consequence of phase change effects at the melting point. Even at surface temperatures below the melting point, however, a uniform surface temperature is expected, for wind motion strongly influences the temperature of the first few centimeters depth.

#### B. Dielectric Distribution

The dielectric constant of snow varies with density. It is approximately given by the simple proportional form (see Reference 2):  $(\epsilon_s - 1) = \left( \frac{\text{snow density}}{\text{ice density}} \right) (\epsilon_{\text{ice}} - 1)$ .

The real part of the dielectric constant for ice is essentially 3.15 over the range of frequency and temperature of interest here. The dissipative part however is strongly dependent on frequency and temperature. While no well-established detailed model exists for prediction of the dissipative part, sufficient empirical evidence has been gathered to characterize its dependence on temperature over the range of interest. In particular, at a frequency of 10 Kmc. the following empirical formula fits experimental data to within a few percent, for  $1^\circ < (T_m - T) < 50^\circ$ :

$$\tan \delta \approx 1.05 \times 10^{-3} (T_m - T)^{-0.53}$$

where  $T_m$  is the melting point temperature of ice.

Experimental data for 24 Kmc. indicate a similar though not identical dependence (see Reference 1). The crude evidence to date suggests that, in the microwave range,  $(\omega \tan \delta)$



remains relatively constant vs.  $\omega$ .

The above remarks apply to (supposedly) pure ice. Presence of impurities, especially salts, can cause a marked increase of absorption. However, it appears plausible that glacial ice and snow formed from deposited and compressed snowfall will be very pure.

Examination of typical density profiles indicates that the density of glacial snow within a few meters of the surface is of the order of 0.5, as a working approximation (see Reference 3). Thus radiation at a frequency of 10 Kmc. entering a uniform layer at  $-3^{\circ}$  C would decay by  $e^{-1}$  at a distance of about 5 meters. At 24 Kmc., the  $e^{-1}$  penetration would be somewhat smaller, about 3 meters.

#### IV. Anticipated Contrast Patterns

From examination of the reflection coefficient graph for snow (or ice, as a limit value), one can see that very little snow radiation is lost by reflection at the surface, and that little sky reflection interference occurs out to incidence angles of about  $\frac{\pi}{3}$ , provided the snow at the surface is dry. For radiation polarized such that the electric vector is in the plane of incidence this behavior is virtually guaranteed out to the Brewster angle. In the remarks that follow therefore, R will be assumed zero as a first approximation.

To illustrate the magnitude of radiation contrast which should be observable, the radiation temperature difference between the two locations of Figure 4 (one away from the crevasse, one in the snow bridge) now will be calculated, assuming the snow density to be 0.5 in both, and accepting the empirical  $\tan \delta$  data of Reference 1. In order to avoid inappropriate use of the empirical curve, the surface temperature will be assumed not over  $-1^{\circ}$  C., instead of the  $0^{\circ}$  C. shown in the figure.

The charted temperature profiles for the two locations, which are given only to a limited depth, will be continued to  $x \rightarrow \infty$  as follows. For the out-crevasse location, the dashed curve will be followed. For the snow bridge location, the unknown true curve will be approximated by continuation at the lowest value shown, down to the base of the bridge, followed by a jump to the asymptotic value for the out-crevasse location. This latter assumption is admittedly very crude. However no other better assumption is evident. The assumption can be interpreted as replacement of the crevasse cavity with contacting snow having a temperature close to that of the lower cavity walls (the cavity itself is loss free transmitter of radiation, and the radiation temperature in the deep, irregular cavity should be close to average wall temperature). Subject to these postulations, the difference in apparent temperature at normal incidence,  $\theta' = 0$ , at 10 Kmc. is  $1.1^{\circ}$  K, and at 24 Kmc.,  $0.9$  K.

These differences are relatively insensitive to angle of incidence,  $\theta$ , from  $\theta = 0$  up to about  $\theta = \frac{\pi}{4}$ , the vicinity of the Brewster angle. (Over this range the internal ray remains nearly vertical.)

The radiation temperature differences, furthermore, are quite evidently much smaller than the horizontal snow temperature difference. The absorption constant at both 10 Kmc. and 24 Kmc. is so small that the net contribution of the bridge depth zone to the radiation integral is distinctly limited (the argument of the transmission exponent rises only to 0.5 at the base of the bridge in this sample). Whether selection of some much higher frequency would cure this problem or not is not determinable on the basis of the very limited data available on variation of  $\omega \tan \delta$  vs.  $\omega$ .

These radiation temperature differences indicate the range of radiometer sensitivity necessary to detect such subsurface snow temperature differences. What comparable variations in temperature may occur over surrounding non-crevassed areas because of local variations in snow density, temperature profile, surface condition or other parameters is not known. While it is possible to analyze radiation temperature perturbations caused by such variations, particularly through crude estimates based on the simple heat transport equation, no useful data exists suitable for defining what magnitude of local parameter variations are probable. Hence even qualitative evaluation of this key question is not possible at this time.

The data above do suggest that crevasse snow bridges should be visible as long narrow regions of slightly elevated radiation temperature. Other glacial snow objects or surface conditions may or may not produce similar patterns. So long as the snow surface is dry, wind-caused surface roughness should have little effect on the patterns, since  $R$  is very low. If sheets or ridges of dense ice occur at the surface, particularly of near-resonant thickness, the increase of  $R$  resulting conceivably could cause comparable patterns. While it was mentioned above that  $R$  was small and would be ignored as a first approximation, it is evident on

examination of the smallness of the radiation temperature differences calculated above that a very small change of incidence angle, such as from varying snow surface tilt resulting from snow windrows, may be of serious consequence. More specifically, R varies from about 0.01 at  $\theta = 0$ , to nearly zero at  $\theta = \frac{\pi}{4}$ , for vertical polarization (E in plane of incidence). The net radiation temperature integral always will be close to  $273^{\circ}$  K. Thus tilt angles of the order of magnitude of  $\frac{\pi}{12}$  could produce temperature fluctuations comparable to the difference sought. Quantitative study of this point clearly is necessary; surface roughness data will be a necessary prerequisite.

The above calculations ignored presence of any water layer at the surface. Such layers often occur for days after light rain or warm sunshine. During such periods R may be materially accentuated, and useful operation thereby inhibited. Fortunately, more interest has been expressed in operation in dry cold days, when the crevasse hazard is considered greatest.

## V. Feasibility of Crevasse Location

The magnitude of radiation temperature difference indicated in the example above is a range which can be measured with precision by microwave radiometers, provided advanced equipment is employed. Hence further development of the proposed technique appears well worth consideration.

Extensive research remains to be done, however, to ascertain whether the crevasse example used here is representative or not. The range of thickness of snow bridge detectable needs to be established. Sensitivity of the technique to seasonal weather variations is a key question. Other potential problems were pointed out above. Initiation of exploratory field research appears in order.

At a later stage, when more complete knowledge of the natural phenomena exists, it will be necessary to examine with care the technical design problems entailed in constructing and providing for field use radiometers of sufficient thermal and angular resolution and speed of response to accomplish worthwhile field missions. The probability that practical equipment can be developed appears good provided the estimates made above prove representative.

Because the penetration of 10 Kmc. and 24 Kmc. radiation appears in excess of that desired for the particular task at hand, and because penetration may decrease slowly with frequency, use of much higher frequency radiation should be investigated. Design of compact fine resolution radiometer instruments will be aided by use of a high frequency.

References

1. "The Dielectric Properties of Ice at 1.25 cm. Wavelength," J. Lamb and A. Turney Proc. Phys. Soc. London, 62B : 272 (1949).
2. "Reflection Coefficient of Snow and Ice at V. H. F." J. A. Saxton, Wireless Eng. Jan. 1950.
3. "Preliminary Study of Crevasse Formation," S. I. P. R. E. Report 38. July, 1957

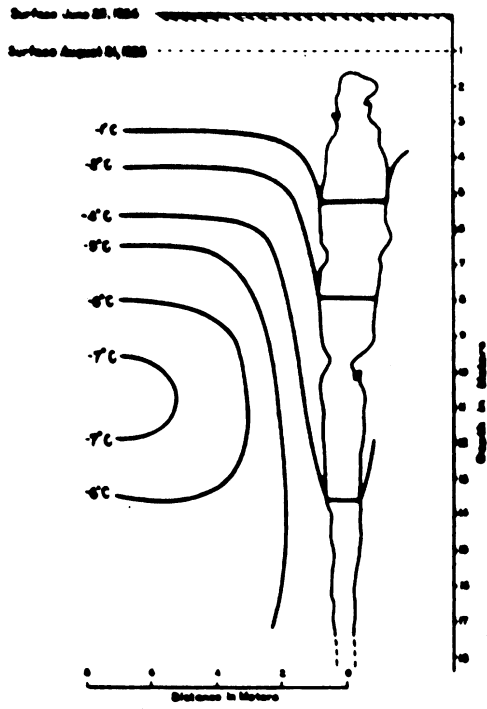

August 15, 1955

(a)

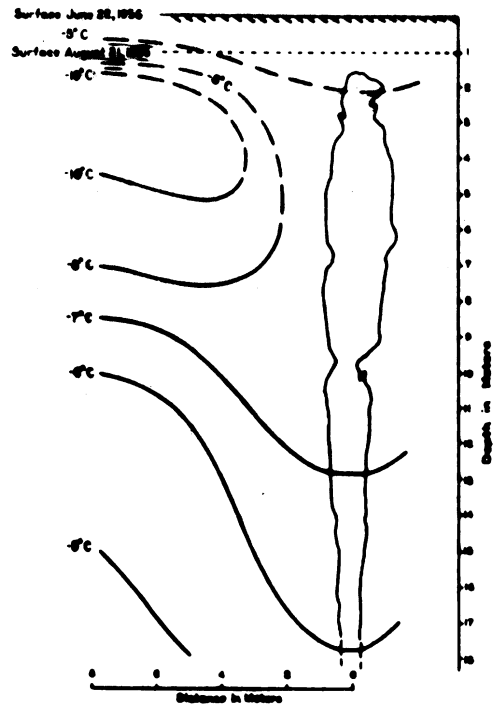

June 21, 1956

(b)

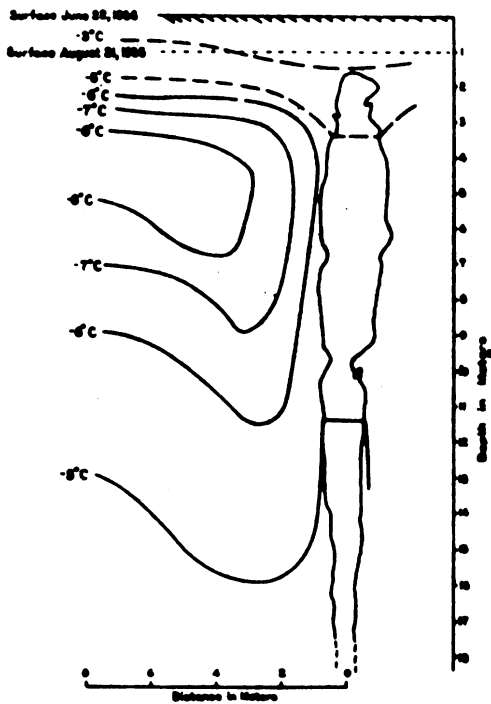

June 29, 1956

(c)

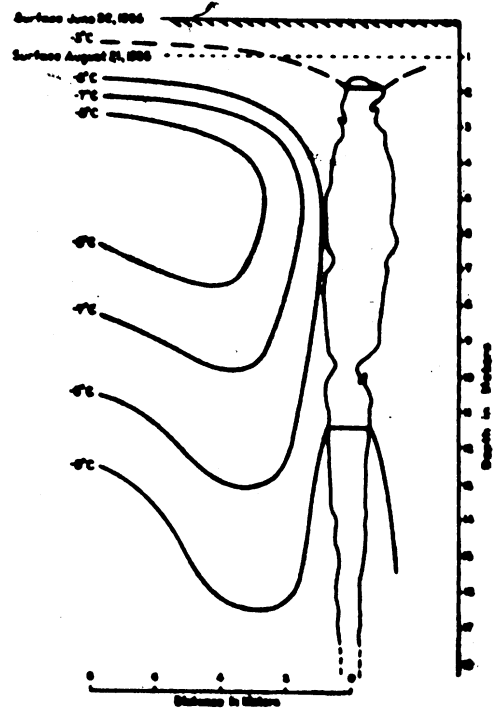

June 27, 1956

(d)

Example of Temperature Distribution in Crevasse

Figure 3A

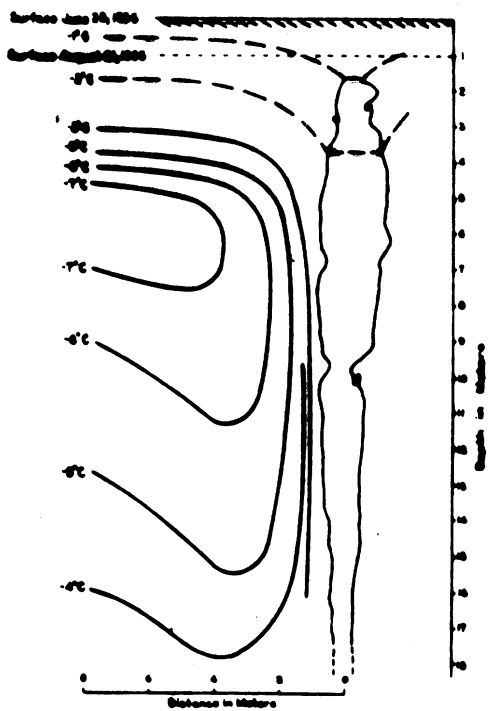

July 6, 1956

(e)

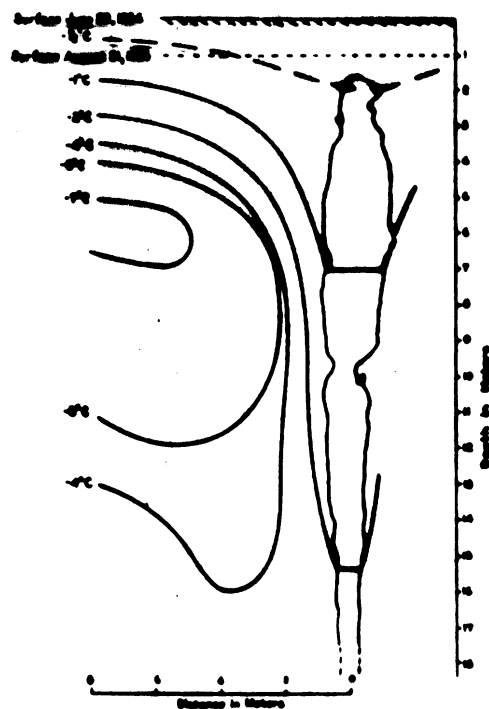

July 19, 1956

(f)

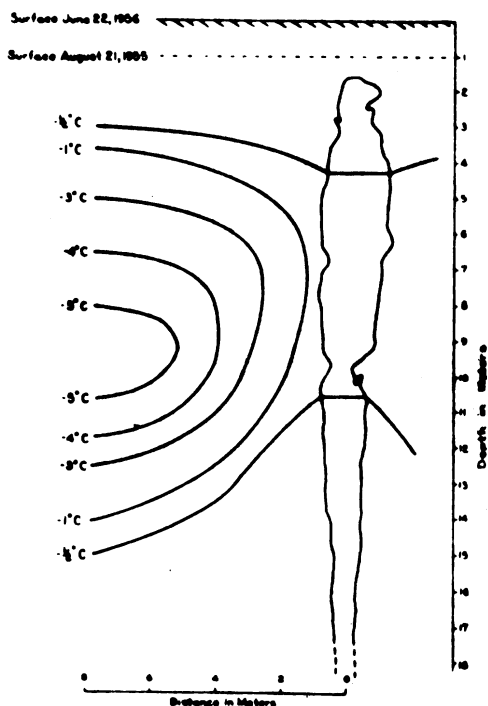

August 13, 1956

(g)

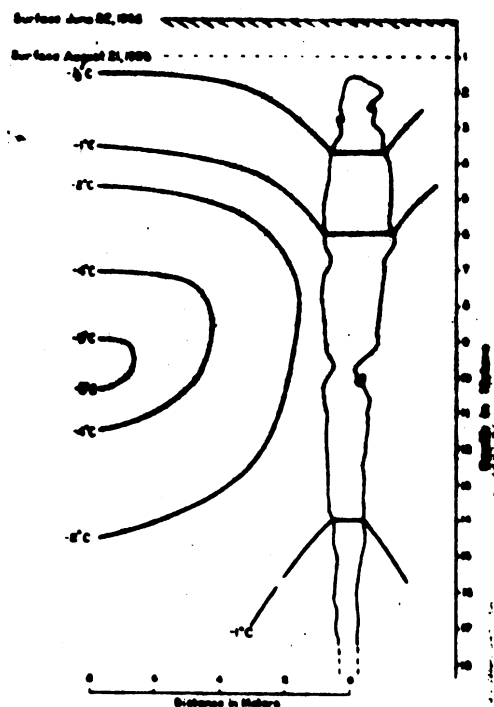

August 23, 1956

(h)

Example of Temperature Distribution in Crevasse

Figure 3B



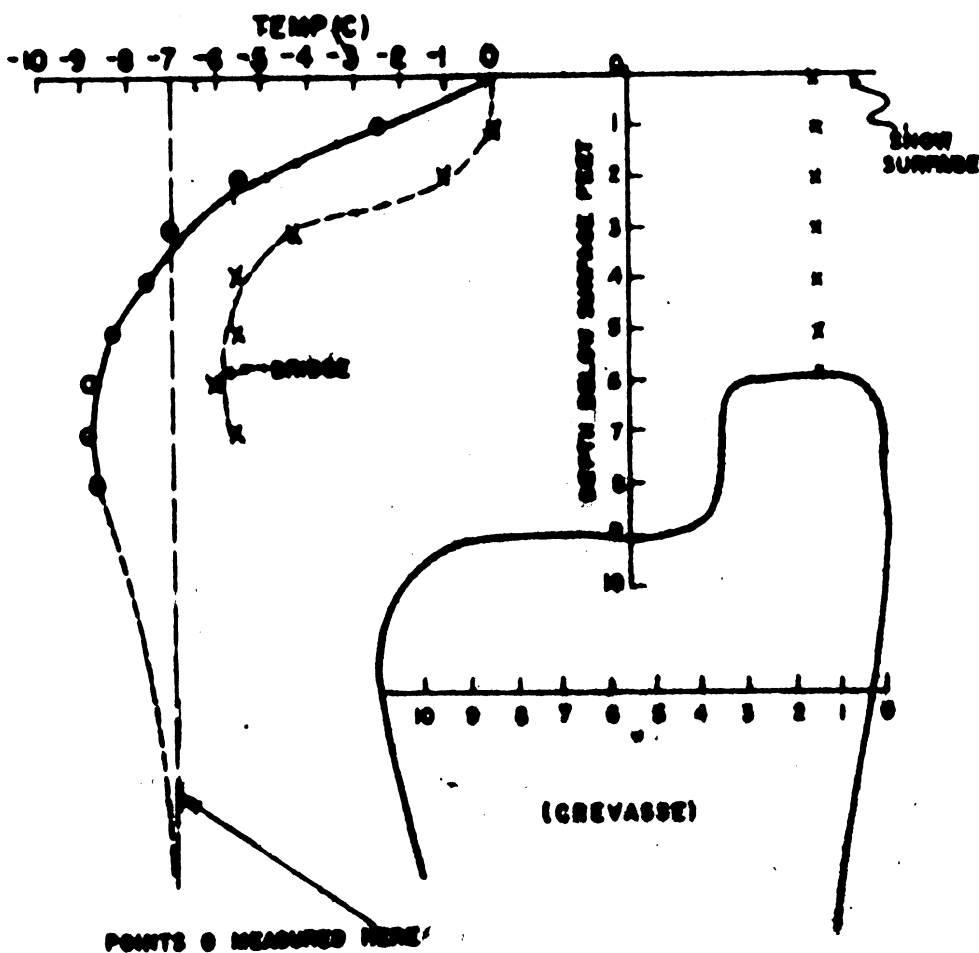

Example of Temperature Distribution in Crevasse Snow Bridge

Figure 4