

UMTRI-83-3

Biomechanical Accident
Investigation Methodology

D. H. Robbins
J. W. Melvin
D. F. Huelke
H. W. Sherman

Transportation Research Institute
Institute of Science and Technology
The University of Michigan
Ann Arbor, Michigan 48109

Final Report
February 1983

Prepared for
Motor Vehicle Manufacturers Association
320 New Center Building
Detroit, Michigan 48202

1. Report No. UMTRI-83-3	2. Government Accession No.	3. Recipient's Catalog No.	
4. Title and Subtitle Biomechanical Accident Investigation Methodology		5. Report Date February 1983	
		6. Performing Organization Code 301721	
7. Author(s) D.H.Robbins, J.W.Melvin, D.F.Huelke, H.W.Sherman		8. Performing Organization Report No. UMTRI-83-3	
9. Performing Organization Name and Address Transportation Research Institute Institute of Science and Technology The University of Michigan Ann Arbor, Michigan 48109		10. Work Unit No.	
		11. Contract or Grant No. 1135	
		13. Type of Report and Period Covered Final Report July 1981 - January 1983	
12. Sponsoring Agency Name and Address Motor Vehicle Manufacturers Association 320 New Center Building Detroit, Michigan 48202		14. Sponsoring Agency Code	
15. Supplementary Notes			
16. Abstract <p>The purpose of this project was to combine state-of-the-art detailed accident investigation procedures, computerized vehicle crash and occupant modeling, and biomechanical analysis of human injury causation into a method for obtaining greatly enhanced biomechanical data from vehicle crashes. Four accident cases, out of eighteen investigated, were selected for detailed reconstruction. Three were frontal impacts while the fourth was lateral. The CRASH II and MVMA2D analytical models were used in the reconstruction process. Biomechanical analysis of the predicted results led to the conclusion that such procedures, when used carefully, could estimate the level of force applied to vehicle occupants during accidents.</p>			
17. Key Words		18. Distribution Statement	
19. Security Classif.(of this report)	20. Security Classif.(of this page)	21. No. of Pages 98	22. Price

TABLE OF CONTENTS

	<u>Page</u>
List of Figures	i
1.0 Introduction	1
2.0 Background and Methods	1
3.0 Summary of Preliminary Case Investigations	4
4.0 The Reconstructions	10
4.1 Case No. 9. 1981 Mercury Lynx (Frontal Impact. 22.9 mph).	10
4.2 Case No. 10. 1977 Oldsmobile Cutlass (Frontal Pole Impact. 28.6 mph).	28
4.3 Case No. 13. 1980 Volkswagen Rabbit (Frontal Impact. Passive Restraint. 36.7 mph).	42
4.4 Case No. 14. 1980 Chevrolet Chevette. (Lateral Impact. 35 mph).	56
5.0 Biomechanical Review of Reconstructions	76
5.1 Case No. 9	76
5.2 Case No. 10	77
5.3 Case No. 13	78
5.4 Case No. 14	78
6.0 Conclusions	80
7.0 References	82
Appendix	83

LIST OF FIGURES

	<u>Page</u>
1. Schematic of Accident Scene (Case No. 9)	11
2. Vehicle Damage (Case No. 9)	12
3. Occupant Injuries (Case No. 9)	13
4. Subject in Car in Typical Driving Position	15
5. Subject and Reconstruction (Case No. 9)	16
6. Identification of Vehicle Interior Contact Surfaces (Case No. 9)	17
7. Occupant Position. 0 ms. (Case No. 9)	19
8. Occupant Position. 70 ms. (Case No. 9)	20
9. Occupant Position. 90 ms. (Case No. 9)	21
10. Occupant Position. 110 ms. (Case No. 9)	22
11. Occupant Position. 140 ms. (Case No. 9)	23
12. Force on Head Due to Interior Contacts (Case No. 9)	24
13. Force on Chest and Abdomen from Steering Wheel (Case No. 9)	25
14. Force on Knee and Tibia from Instrument Panel (Case No. 9)	26
15. Head and Chest Acceleration (Case No. 9)	27
16. Schematic of Accident Scene (Case No. 10)	29
17. Vehicle Damage (Case No. 10)	30
18. Occupant Injuries (Case No. 10)	31
19. Identification of Vehicle Interior Contact Surfaces and Occupant Position. 0 ms. (Case No. 10)	33
20. Occupant Position. 50 ms. (Case No. 10)	34
21. Occupant Position. 60 ms. (Case No. 10)	35
22. Occupant Position. 80 ms. (Case No. 10)	36
23. Occupant Position. 100 ms. (Case No. 10)	37
24. Force on Head Due to Interior Contacts (Case No. 10)	38
25. Force on Chest and Abdomen from Steering Wheel (Case No. 10)	39
26. Force on Knee and Tibia from Instrument Panel (Case No. 10)	40
27. Head and Chest Accelerations (Case No. 10)	41
28. Schematic of Accident Scene (Case No. 13)	43

LIST OF FIGURES CONTINUED

	<u>Page</u>
29. Vehicle Damage (Case No. 13)	44
30. Occupant Injuries (Case No. 13)	45
31. Identification of Vehicle Interior Contact Surfaces and Occupant Position. 0 ms. (Case No. 13)	47
32. Occupant Position. 30 ms. (Case No. 13)	48
33. Occupant Position. 60 ms. (Case No. 13)	49
34. Occupant Position. 80 ms. (Case No. 13)	50
35. Occupant Position. 160 ms. (Case No. 13)	51
36. Force on Forearm from Steering Wheel (Case No. 13)	52
37. Belt Force (Case No. 13)	53
38. Force on Tibia from Bolster (Case No. 13)	54
39. Head and Chest Accelerations (Case No. 13)	55
40. Schematic of Accident Scene (Case No. 14)	57
41. Vehicle Damage (Case No. 14)	58
42. Occupant Injuries (Case No. 14)	59
43. Vehicle Interior, Occupant Ellipses, Joint Locations, and Occupant Position. 0 ms. (Case No. 14)	64
44. Occupant Position. 40 ms. (Case No. 14)	65
45. Occupant Position. 60 ms. (Case No. 14)	66
46. Occupant Position. 80 ms. (Case No. 14)	67
47. Occupant Position. 200 ms. (Case No. 14)	68
48. Force on Head from Window (Case No. 14)	69
49. Belt Force (Case No. 14)	70
50. Force on Arm/Shoulder from Door (Case No. 14)	71
51. Force on Right Upper Leg from Transmission Housing (Case No. 14)	72
52. Force on Leg Due to Shift Lever (Case No. 14)	73
53. Head and Chest Vertical Accelerations (Case No. 14)	74
54. Head and Chest Lateral Accelerations (Case No. 14)	75

1.0 INTRODUCTION

The purpose of this project was to combine presently available advanced computer modeling techniques for reconstructing a crash sequence to the development of methods for determining occupant contact velocities, impact forces and occupant responses in passenger car accidents. This was a preliminary study which was intended to develop a methodology to analyze real-world accidents and to investigate the applicability of computerized vehicle crash and occupant motion simulation modeling techniques to the improvement of accident investigation-based biomechanics data and staged laboratory collision tests.

2.0 BACKGROUND AND METHODS

For the past 13 years, the MVMA has supported field accident investigation under the direction of Dr. Huelke. That investigation program had the potential to incorporate biomechanically specialized additions to the ongoing program and to provide a trained team for additional accident investigations. The gathering of these specialized data from Washtenaw County accidents could also be enhanced by the medical alert system used in the present accident investigation program. Thus, the specialized injury notification and data gathering needs of this project could be added to the existing emergency room program in the county with a small additional effort.

In Europe this type of detailed investigation has been supplemented by actual crash tests with dummies and cadavers to obtain biomechanical data. This type of approach is relatively costly and only a limited number of tests have been performed. This project was to substitute computer simulations for both the vehicle crash and the occupant motion phases of the study. This approach was expected to be:

- more flexible in studying the variables associated with the cases,
- less costly, and
- ultimately of much greater general utility in advancing knowledge of injury causation, tolerance and protection of occupants in crashes.

The goal of the project was to combine state-of-the-art detailed accident investigation data, computerized vehicle crash and occupant motion modeling, and biomechanical analysis of human injury into a method for obtaining greatly enhanced biomechanical data from vehicle crashes. The findings of the investigations, in the form of probable occupant contact velocities, impact forces and occupant impact responses, were compared with existing biomechanical knowledge for the purpose of demonstrating the utility of the methods.

Protocol for the computer simulation procedures and specialized investigation techniques was developed prior to initiation of the active accident investigation.

The following criteria were the primary factors in choosing an accident for in depth investigation:

1. Occupant injuries of particular biomechanical significance;
2. Type or direction of impact;
3. Reconstructibility of the crash in terms of vehicle factors and kinematics;
4. Comparability to accidents representative of national accident statistics.

The focus of the project was to understand, as well as possible, the injuries sustained by the occupant, the sources of the injury and the occupant kinematics that were responsible for the injury-producing contact. Since occupant injuries were the primary concern, initial identification of a prospective case was through notification that specific types of injuries had been sustained by a person who was an occupant in a crashed motor vehicle. Following this notification, the vehicle and the accident site were investigated in a preliminary manner. Based on the medical factors, vehicle factors and accident site factors, a review of the case was made by the principal investigators. If the predetermined criteria of injury type, source of injury, crash type and probability of accurate reconstruction were met, then the investigation proceeded.

The basic field investigation was carried out by the Huelke team. Dr. Melvin directly assisted in the investigation from the standpoint of injury sources, contact points, injury mechanisms and other biomechanical factors.

Dr. Robbins was directly involved in assessing the reconstructibility of the occupant kinematics, including occupant anthropometry and pre-crash geometry.

Following the gathering of the accident data, work commenced on reconstructing the vehicle crash factors using the CRASH II computer model. When suitable simulation of the vehicle crash was obtained, the resulting dynamic data were available as input for two- or three-dimensional dynamic occupant motion computer simulation models such as those used in other MVMA-sponsored studies at HSRI. The MVMA-2D occupant motion simulation (1) was used in this preliminary study. The computerized reconstruction of the occupant kinematics and contact points were compared with the case data and judgements made as to the realism of the simulation.

3.0 SUMMARY OF PRELIMINARY CASE INVESTIGATIONS

Eighteen actual crashes were identified as being of possible interest through the screening of ongoing crash investigation information. The preliminary accident data were reviewed and, in some cases, the team inspected the vehicles and the crash scene, before coming to a decision in regard to the utility of the crash. Six of the eighteen cases were judged to have sufficient merit to be of further interest to this project. A capsule description of each accident and the reasons for rejection from further investigation or inclusion for further study are given in the following:

Case #1

On July 20, 1981 a 1980 VW Scirocco was struck in the left side by a 1980 Oldsmobile Omega in an intersection type collision.

After impact the Oldsmobile swung completely around with the Scirocco going over a curb and down a slight embankment to come to rest against a hedge. Injuries were not of a high AIS.

Reason for Discontinuance:

After impact, the VW hit a curb and then went down an embankment into a hedge. This cannot be accounted for in the computer accident reconstruction program.

Case #2

On August 20, 1981 a four-door Chevrolet Impala went off the road, crossed a private driveway and struck a tree head-on.

From the accident report this crash looked like a possible case for the model simulation study but upon visiting the scene of the crash it was found that the car first struck a driveway culvert before continuing on and striking a tree.

Reason for Discontinuance:

The impact with the culvert preceding the tree impact.

Case #3

On August 24, 1981 a 1979 Pontiac Grand Prix went off the road and hit a tree head-on.

From the accident report this looked like a good candidate for the study.

Reason for Discontinuance:

Front center impact with the tree was at a relatively low speed indicated by the minor damage. In addition, the injuries to the driver were AIS-1. Examination of the interior of the car showed that there were no occupant contact marks visible anywhere on the interior with the exception of a light smudge on the windshield glass.

Case #4

On September 1st there was an intersection collision between two vehicles in Ann Arbor. Injuries to both parties were minor but had the potential, based on the police report, for modeling.

Reason for Discontinuance:

Damage was relatively minor - the injuries were minor. In addition, the rest positions of the vehicles indicate that the illustration by the police was incorrect.

Case #5

This was an unusual accident which had the potential for reconstruction. On Saturday, August 23rd a Buick was traveling thru an intersection when tree removers accidently dropped a tree into the roadway crushing the roof of the car and burying it underneath the tree. The lap-shoulder belted occupants of the automobile were trapped within the car for about an hour and a half. The intersection was closed for seven hours.

Reason for Discontinuance:

To extricate the car occupants the fire department cut the A-pillars and peeled the roof back so that adequate crush measurement could not be obtained. Also, it was not representative of national accident data statistics.

Case #6

This was a cross median crash involving a 1978 Renault and a 1976 Oldsmobile. Injury severity of the Renault driver was AIS-3.

Reason for discontinuance:

Oblique crash not easily reconstructed by either of the computer models. Some invasion and compromise of passenger compartment. Exact rest position of vehicle not precisely known. Vehicle damage modified in extraction of occupant.

Case #7

This case involved a 1980 Chevrolet Blazer that ran off the road and back on striking an approaching 1980 Chevrolet Citation head-on. The force of the impact drove the Citation rearward and the Blazer rolled over it. The Blazer caught on fire.

On-scene photographs and measurements are available.

The driver of the Citation was dead at the scene while the driver of the Blazer was transported to the hospital.

Reason for Discontinuance:

Extreme crush and intrusion of the Citation. Cannot reconstruct Blazer rollover onto Citation.

Case #8

A 1981 Chevrolet Citation went off the west side of the road, hit a raised driveway, bounded over it and struck a large tree. Injuries were AIS-1.

Reason for Discontinuance:

Double frontal impact (driveway, tree). Low injury level.

Case #9

A 1981 Mercury Lynx driven by a 35-year-old male was on the expressway when it struck the rear of a 1972 Chevrolet Nova that was stopped on the paved right shoulder of the roadway. The driver of the Nova was looking for something in his glove box. The driver of the Lynx apparently fell asleep and rear-ended the Nova directly in the rear.

Useful Case

Point of impact and point of rest of the vehicles are known. This was a direct frontal collision with the full rear-end of the Nova. Detailed injury description was available.

The driver was extremely cooperative and volunteered to come in for anthropometric measurement and photography.

Case #10

A 1977 Oldsmobile Cutlass S was forced off the roadway and struck a 56 cm diameter tree directly head-on. Frontal crush of the car was 93 cm.

Useful Case

Point of impact and vehicle deformation as well as detailed injury description are available.

Driver indicated that he would cooperate fully in this study.

Case #11

A 1980 VW Rabbit went off the road and struck a tree in the right front corner at approximately a 45 degree angle. The 73-year-old male was wearing the passive restraint system. The driver had multiple frac-

tures of the right ribs, multiple contusions, a fracture of the right femur, a contusion of the right kidney as well as other minor injuries. He died 54 hours later due to cardiac arrest.

Reason for Discontinuance:

This was an oblique right frontal collision with the vehicle spinning away from the tree after impact but the exact position of rest was unknown.

Case #12

A 2-vehicle intersection collision occurred between a 1969 Cadillac 4-door DeVille and a 1981 3-door hatchback Escort. The approximate rest position of the Escort is known. The Cadillac was left at the scene and the owner/driver picked it up or had it picked up sometime later and driven out of the county.

The Escort driver had minor injuries including contusions and lacerations of the top of the head and lacerations about the forehead from striking the sunvisor, header and windshield. The damage to the Escort was concentrated in the right front corner area.

Reason for Discontinuance:

The occupant dynamics were fairly obvious but, as indicated above, the rest position of the Cadillac and the damage to the Cadillac were not available.

Case #13

This was a two-vehicle offset head-on crash between a 1979 Blazer and a 1980 VW Rabbit. The Blazer was traveling downhill in an area that was covered with ice near a right hand curve in the road. The Blazer slid over the centerline and impacted the Rabbit, severely damaging the left front area hood and the wheel. Both occupants in the VW were wearing their automatic shoulder belts.

The male driver had extensive injury to both knees from contact with the lower instrument panel/knee bolster area.

The female passenger flexed forward to strike her left cheek on the instrument panel causing a depressed and displaced fracture of the left zygoma along with other minor injuries.

Useful Case

Very specific details on the injuries were available, although the rest position of the vehicles was not well documented. The nature of the injuries and the type of crash were judged to be interesting enough to retain this case for further investigation.

Case #14

A 1980 Chevrolet Chevette was struck broadside by a 1977 Chevrolet C/20 Chevy Van. Intrusion on the passenger's side was extensive. The driver was wearing a lap-shoulder belt and sustained but minimal (AIS-1) injuries.

Useful Case

The point of impact and point of rest can be determined. Significant crush with lap-shoulder belt being worn makes this an ideal case for reconstruction.

Case #15

On March 12, 1981 a 1982 Plymouth TC-3 was involved in a rear-end collision with another car. The driver's injuries were multiple but primarily of AIS-1. However her unconsciousness raises the level to AIS-2.

Reason for Discontinuance:

Although this was a good flush barrier type frontal collision, the exact point of impact and point of rest of the vehicles cannot be determined.

Case #16

This case involved a 1980 Mercury Capri running off the roadway and striking the left rear corner of a parked 1974 Dodge van. There were no skid marks prior to the impact. The unrestrained driver of the Capri sustained minor and moderate injuries.

Useful Case

The rest position of the vehicles and the detailed injury information are available.

Case #17

A 1974 Mustang struck the hooper wheels of a slow moving train. The car damage was of the barrier type. The driver was killed.

Reason for Discontinuance:

No autopsy performed on the driver and no medical investigation available.

Case #18

This accident involved an intersection type collision of a 1981 Buick Skylark 4-door and a Ford pickup truck. This was a broadside collision to the left of the pickup truck. Injuries were multiple and extensive to both driver and passenger of the Skylark and all injury descriptions are available.

Useful Case

Details on the point of impact, point of rest, and crush profiles of the vehicles are available.

4.0 THE RECONSTRUCTIONS

The following four sub-sections describe the reconstruction of occupant kinematics for the four accident cases which were selected. In each case information is presented in the following order:

- Accident description including vehicle damage and injuries;
- Geometric definition of the subject in the vehicle;
- Occupant kinematics during the crash sequence;
- Occupant dynamics including forces of interaction and accelerations of the head and chest.

4.1 Case No. 9. 1981 Mercury Lynx (Frontal Impact. 22.9 mph).

In this case a 1981 Mercury Lynx driven by a 35 year old male was driving on a freeway when it struck the rear of a 1972 Chevrolet Nova which was stopped on the paved right shoulder of the roadway. Figure 1 is a schematic of the accident scene showing the square rear-end impact as well as the well-defined resting points of the vehicles. Figure 2 shows the damage to the front end of the Lynx.

The lone male driver was unrestrained and upon impact is estimated to have continued forward and struck the left sunvisor and header with his forehead, the windshield with his face, the steering wheel with his throat and chest, and the lower panel with his knees.

Interior damage to the vehicle was moderate. Driver contact deformed the left sunvisor and contiguous windshield header. After the windshield was starred, continued head travel caused a jagged tear in the laminate of about 20 cm (7.87 in) and an outward bulge of 4 cm (1.57 in). Chest contact with the steering wheel caused it to fold around the hub and forward nearly to the instrument cluster eyebrow. The vehicle steering column was configured to include a V-joint flexible coupling and the right shear capsule was separated about 35 mm (1.38 in). Also, there was obvious upward rotation and lateral right movement of the column. Although they did not appear to be damaged, the driver may have had his left hand between the steering wheel rim and the two control levers on the left of the steering column or the left side of the instrument cluster eyebrow. The left end of the lower panel below the headlight switch was deformed by the driver's

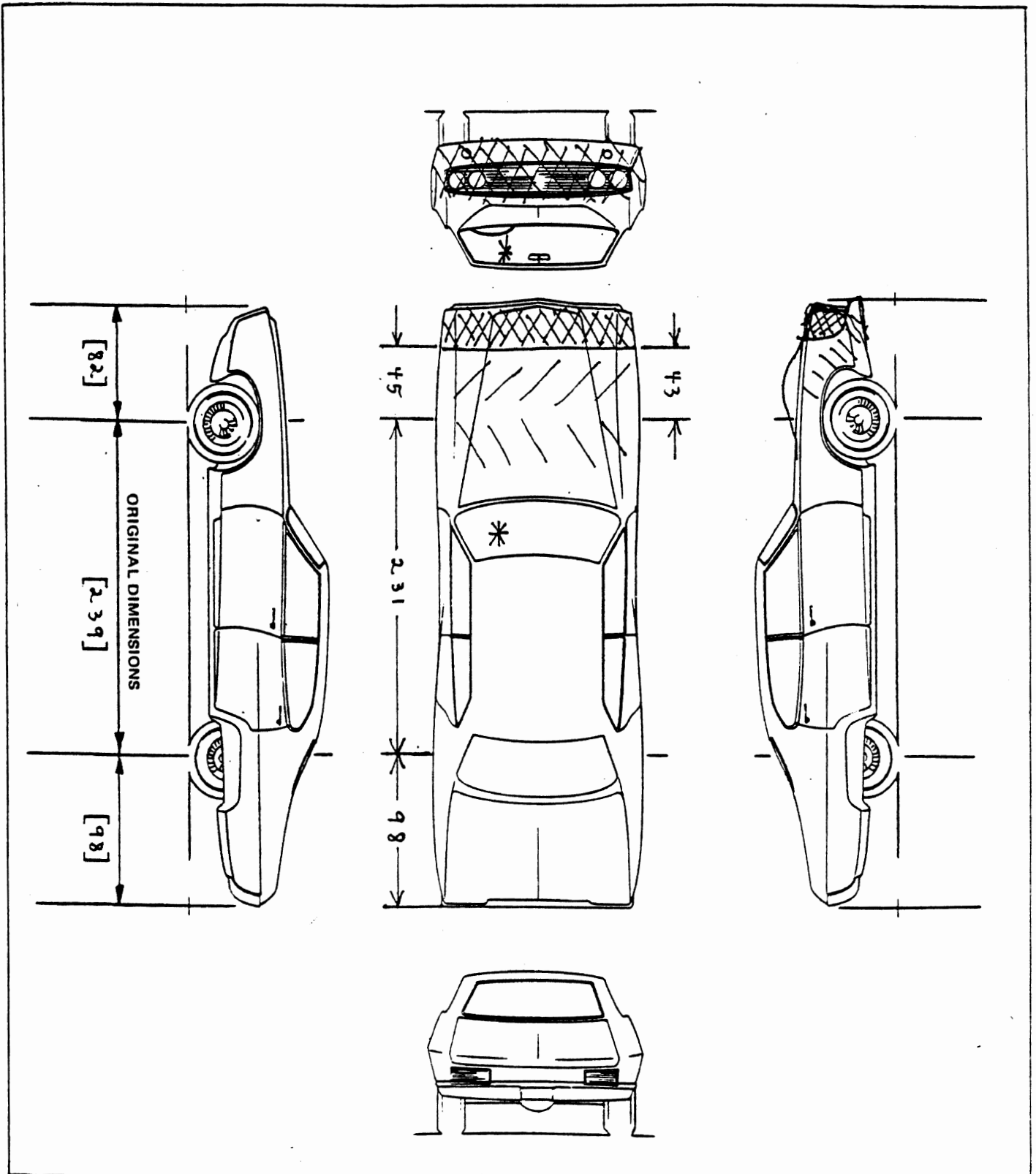
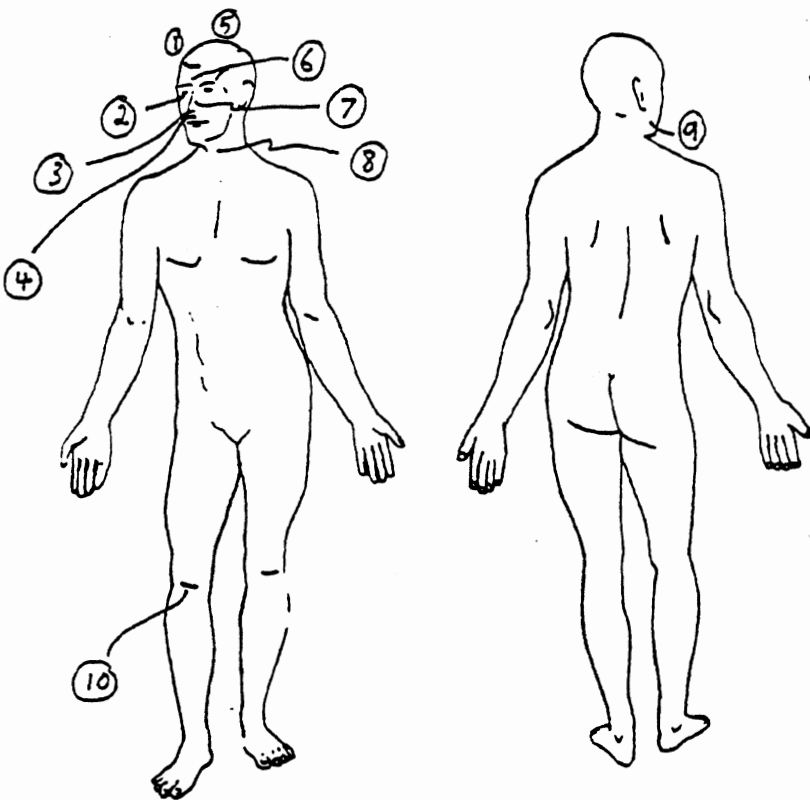

Figure 2. Vehicle Damage (Case No. 9).

INDICATE LOCATION OF INJURIES, INCLUDING MAJOR BRUISES



1. Abr. Rt. Forehead
2. Abr. Rt. Cornea
3. 2 cm. Lac. Rt. Nostril
4. 6 cm. Vert. T+T Lac. Rt. Upper Lip
5. Unconscious (2-3 min)
6. Abrs. Both Eyelids
7. Abr. Nose
8. Possible Fx. Larynx with pneumolarynx + hemorrhage Rt. Vocal Cord
9. Abr. Rt. Jaw
10. Cont. + Abr. Rt. Knee

SOFT TISSUE INJURIES

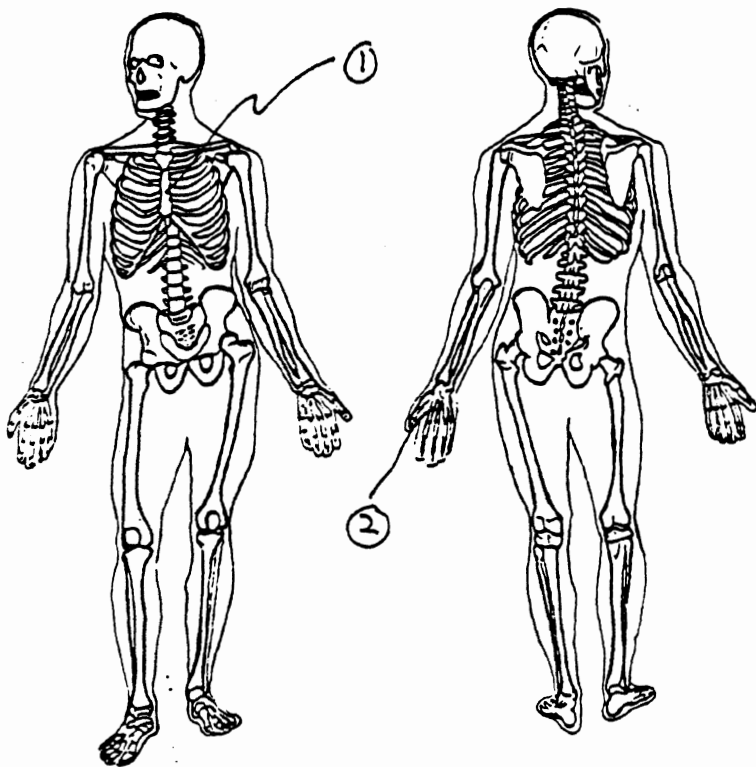

- ① Cracked Sternum
- ② Comminuted Fxs. Proximal and mid portion 4th and 5th Lt. Metacarpals

SKELETAL INJURIES

Figure 3. Occupant Injuries (Case No. 9).

left knee while his right knee deformed the lower panel to the right of the right shear capsule location.

The unrestrained driver sustained a variety of injuries during contact with the vehicle interior which were concentrated on the upper chest, neck, and head as defined in Figure 3.

Use of the CRASH II program yielded a velocity change of 22.9 mph along the axis of the Lynx. This was represented as an acceleration in the form of a trapezoid with a total duration of 80 milliseconds and rise and decay times of 5 milliseconds.

The first step in reconstruction of occupant dynamics using the MVMA-2D occupant motion simulation was to develop an estimate of vehicle geometry and location of the occupant within the vehicle. The key information used were engineering drawings of the vehicle plus information gathered during an interview with the victim of the crash. During the interview simple anthropometric measurements were made documenting his size as:

- 72.24 in. (183.5 cm.) stature
- 200.5 lb. (91.1 kg.) weight
- 39.13 in. (99.4 cm.) sitting height
- 24.09 in. (61.2 cm.) knee to buttock length

To develop the estimate of the posture of the occupant in the vehicle, photographs were taken showing his normal driving position in a vehicle essentially geometrically identical to the one involved in the accident. Figure 4 is an example photograph. A schematic of the vehicle interior cross-section was then made for a plane through the center-line of the occupant using vehicle scale drawings. The photographic slide of the seated occupant was then projected onto the schematic taking account, insofar as possible, distortions based on camera placement. An outline of the occupant was then sketched onto the schematic. This result is shown in Figure 5. A linkage for the occupant was then superimposed using the anthropometry of the driver. The dimensions of this linkage were obtained by scaling known 50th percentile data to fit the four basic measurements made on him. Figure 6 identifies the various contact surfaces defining the vehicle interior. Because of the lack of force-



Figure 4. Subject in Car in Typical Driving Posture.

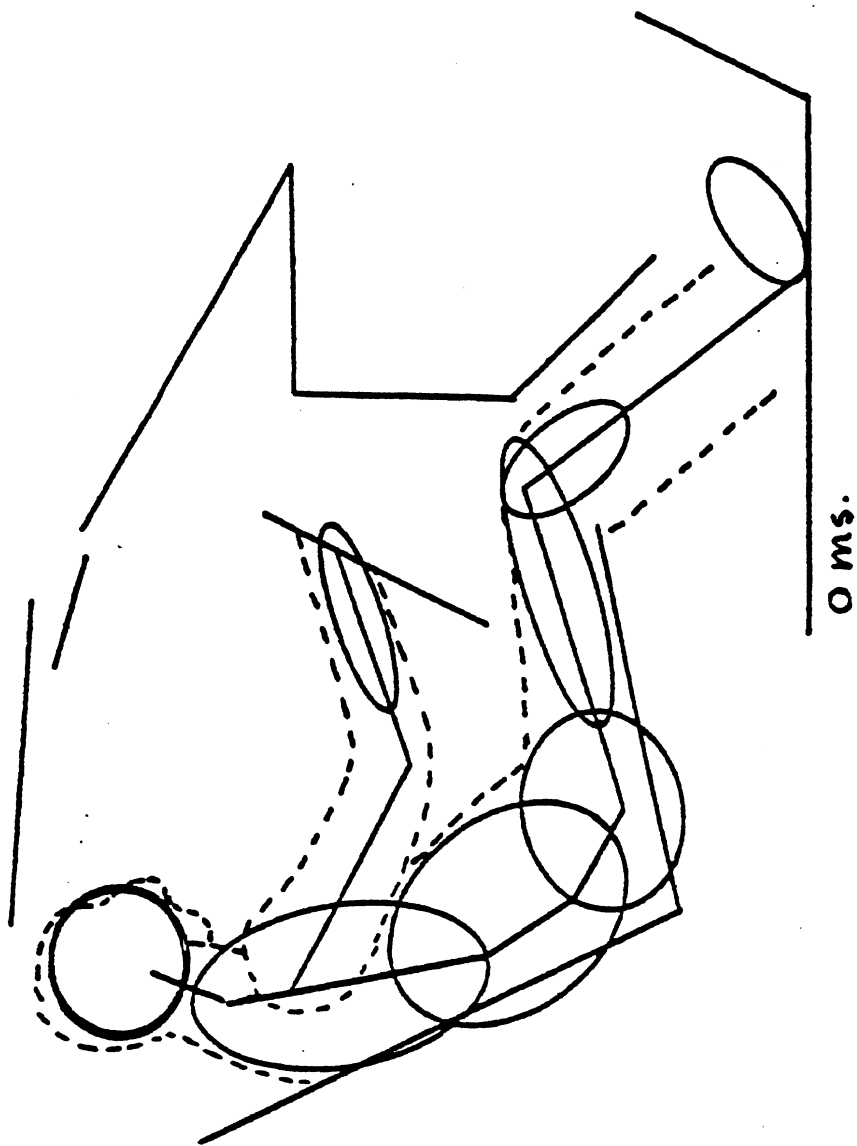

Figure 5. Subject and Reconstruction (Case No. 9).

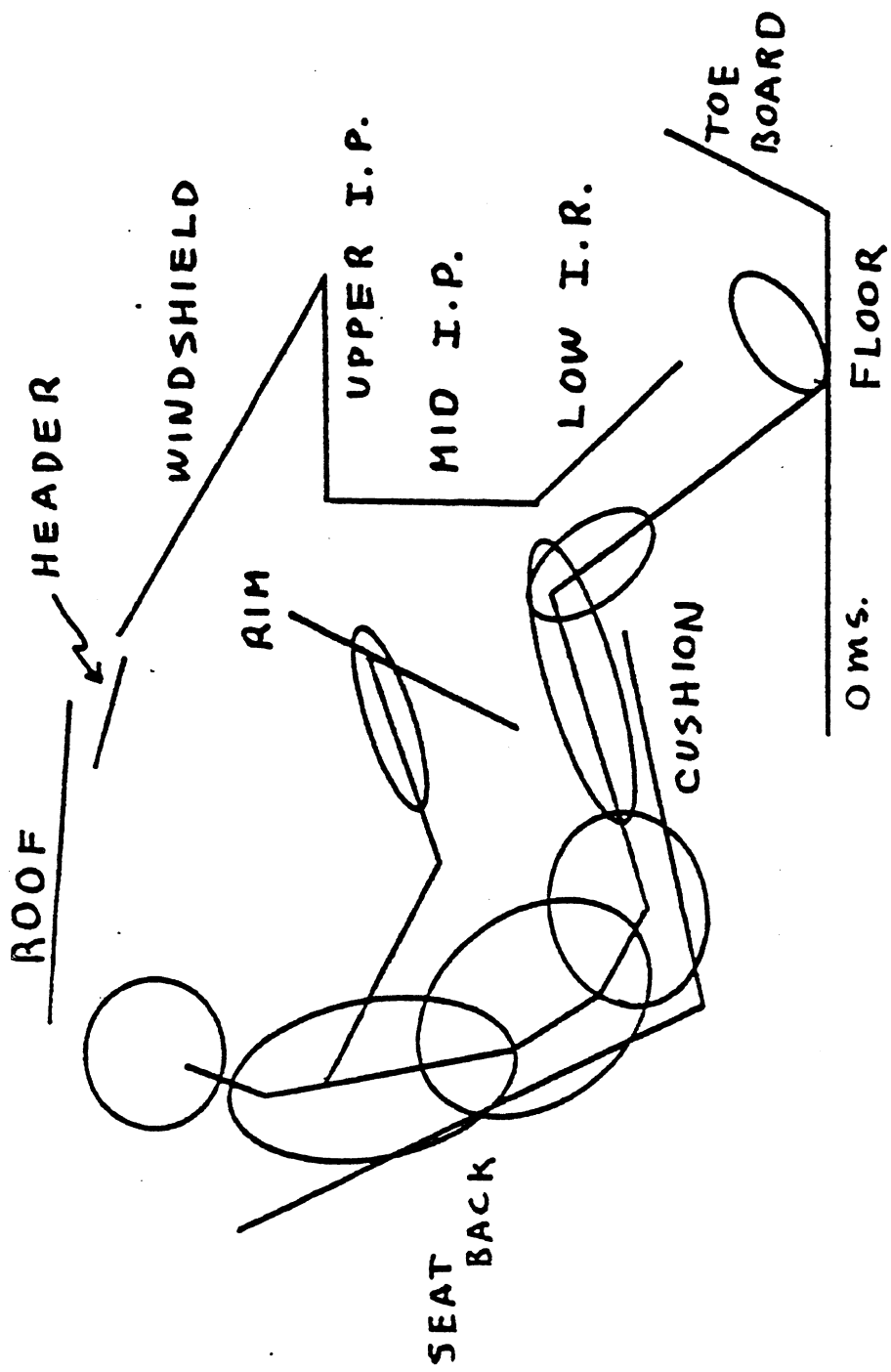

Figure 6. Identification of Vehicle Interior Contact Surfaces (Case No. 9).

deflection data for the specific vehicles studied and the exploratory nature of the project, engineering estimates based on available information were used for these quantities. The complete data set used in the simulation is included in Appendix A along with those for the other three reconstructions.

Figures 7-11 show tracings of the simulated occupant positions for several points in time during the simulation. Figure 7 shows the initial position at 0 milliseconds. At 70 milliseconds (Figure 8) the subject has moved forward and shows substantial contact with the lower instrument panel while contact with the header has just begun. Figure 9 shows compression of the neck resulting from the header contact and initiation of column/thorax interactions. Figure 10 shows the head rotating over the column and into the windshield. It is possible that the larynx contact may have occurred at this point or possibly later during the contact with the upper instrument panel shown in Figure 11. By 140 milliseconds the column/rim combination has collapsed several inches in the simulation. This approximates the deformations observed in the crashed vehicle. It should also be noted that by 140 milliseconds the knees and tibias are no longer interacting with the lower instrument panel. This represents the beginning of the rebound phase with the remainder of the body following during the remaining phases of the simulation.

Figures 12-15 show some of the dynamic output results produced by the simulation. Figure 12 shows the sequence of interactions between the head and, successively, the header, windshield, and upper instrument panel. Figure 13 shows the chest and abdomen interactions with the steering wheel/column. Interaction between the lower part of the steering wheel rim and the abdomen leads the chest/column contact by about 10 milliseconds. Substantial normal forces are generated on both the femur (at the knee) and the tibia (just below the knee) during their contact with the lower instrument panel as shown in Figure 14. Because of the two-dimensional nature of the MVMA-2D occupant motion simulation, the numbers shown represent the sum of the loadings to both legs. Vehicle/occupant interactions observed as actual contact points in the crashed vehicle indicate that this assumption is reasonable. Head and chest accelerations are shown in Figure 15.

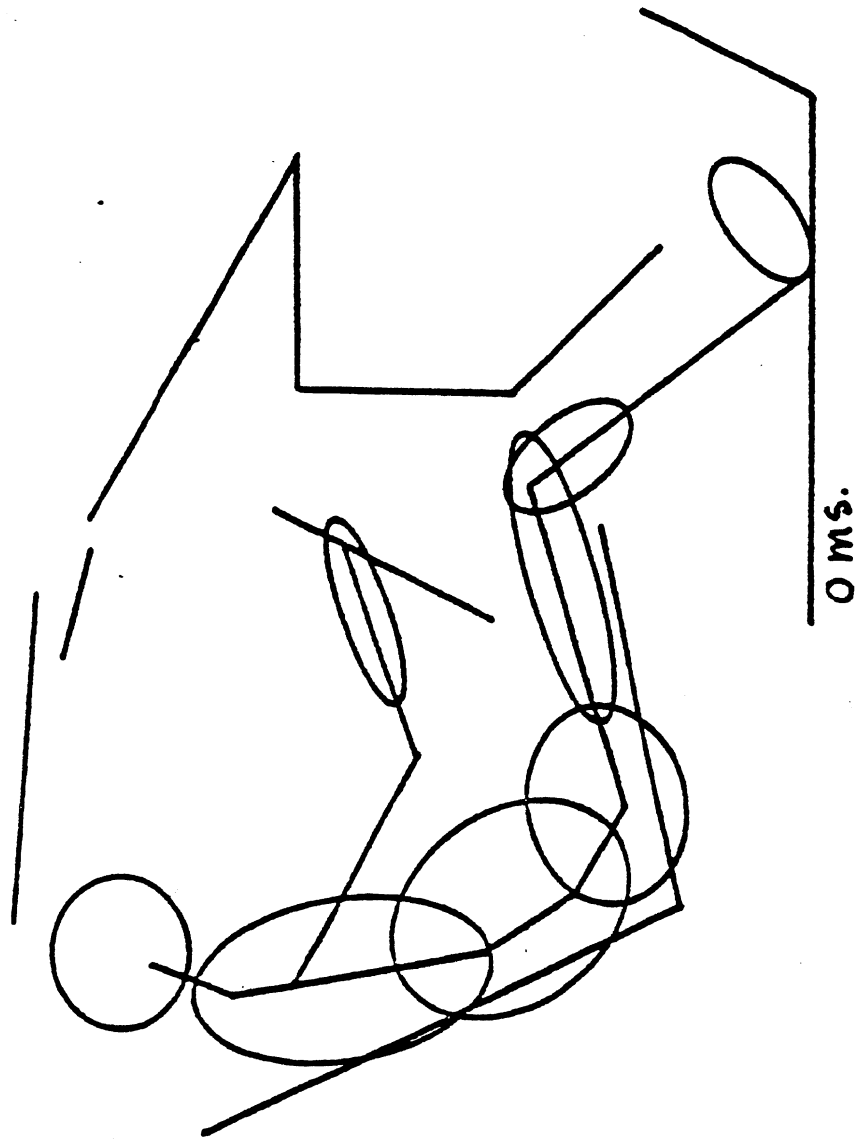

Figure 7. Occupant Position. 0 ms. (Case No. 9).

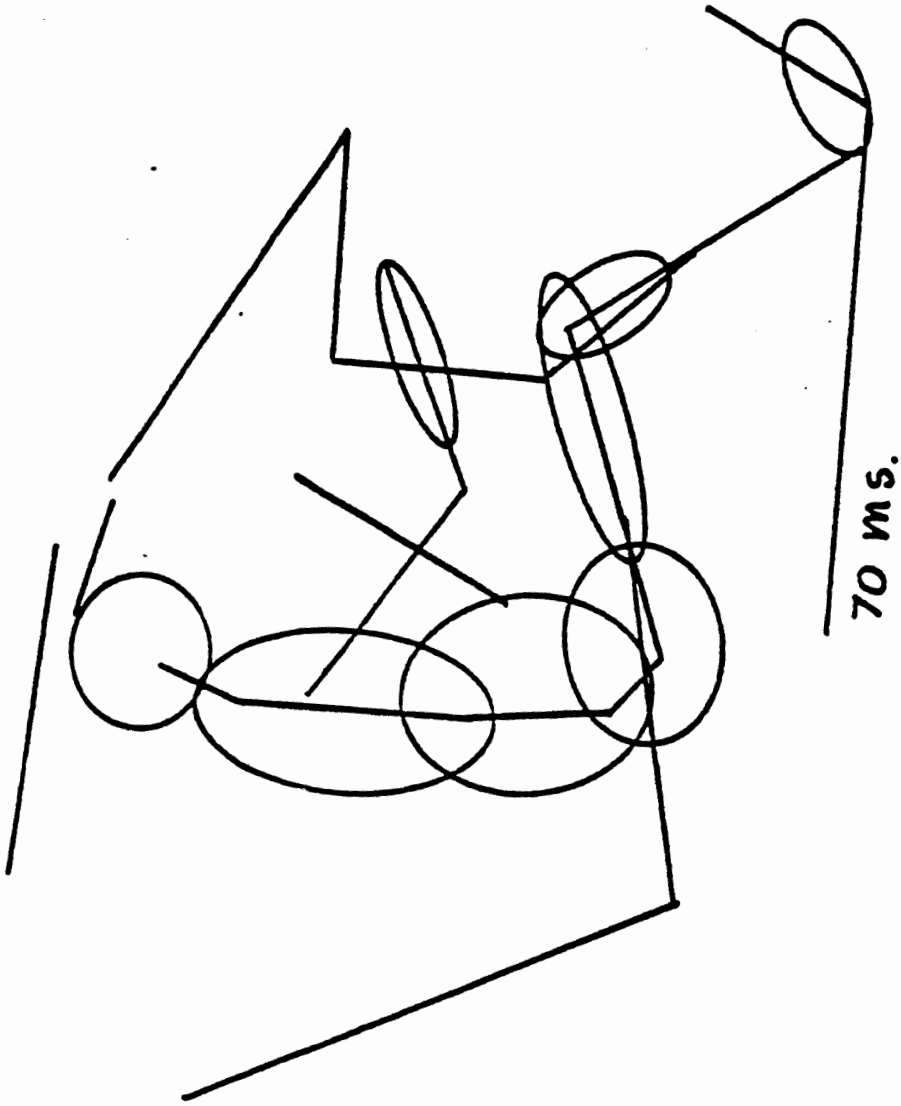

Figure 8. Occupant Position. 70 ms. (Case No. 9).

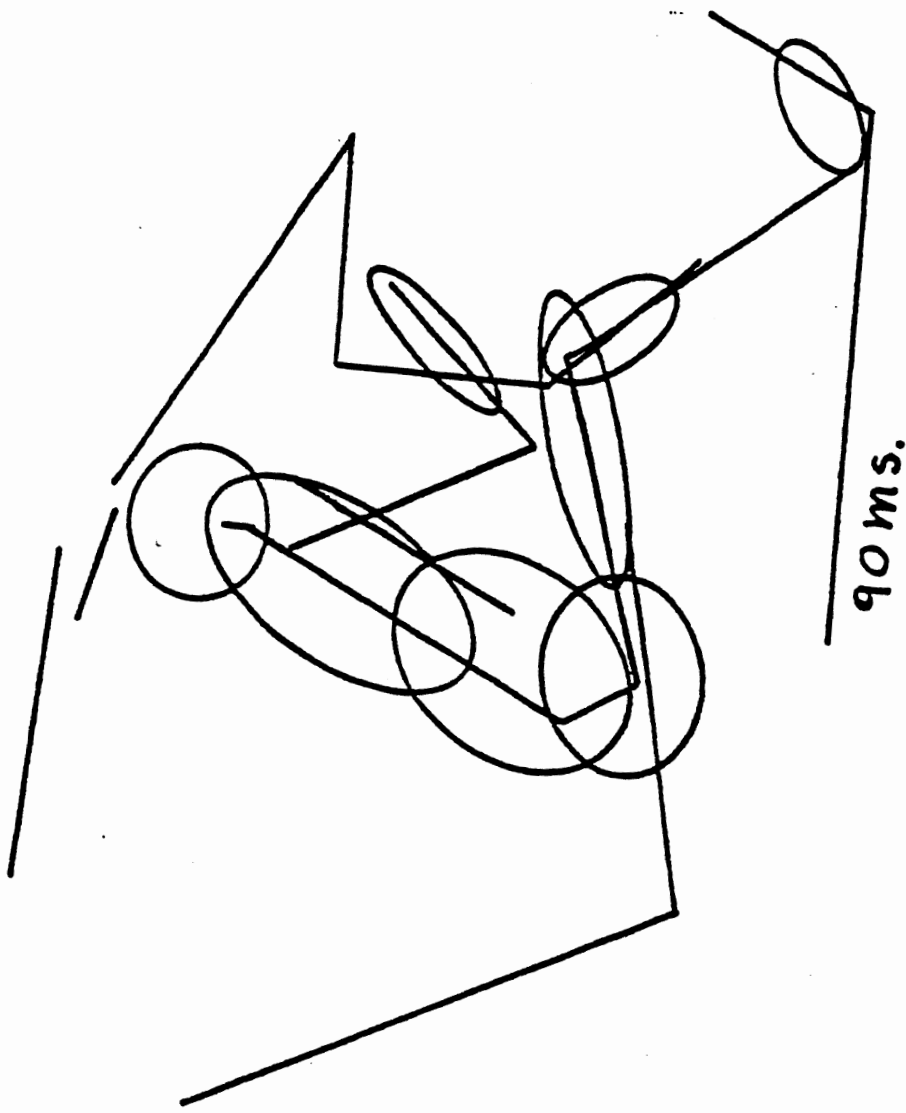

Figure 9. Occupant Position. 90 ms. (Case No. 9).

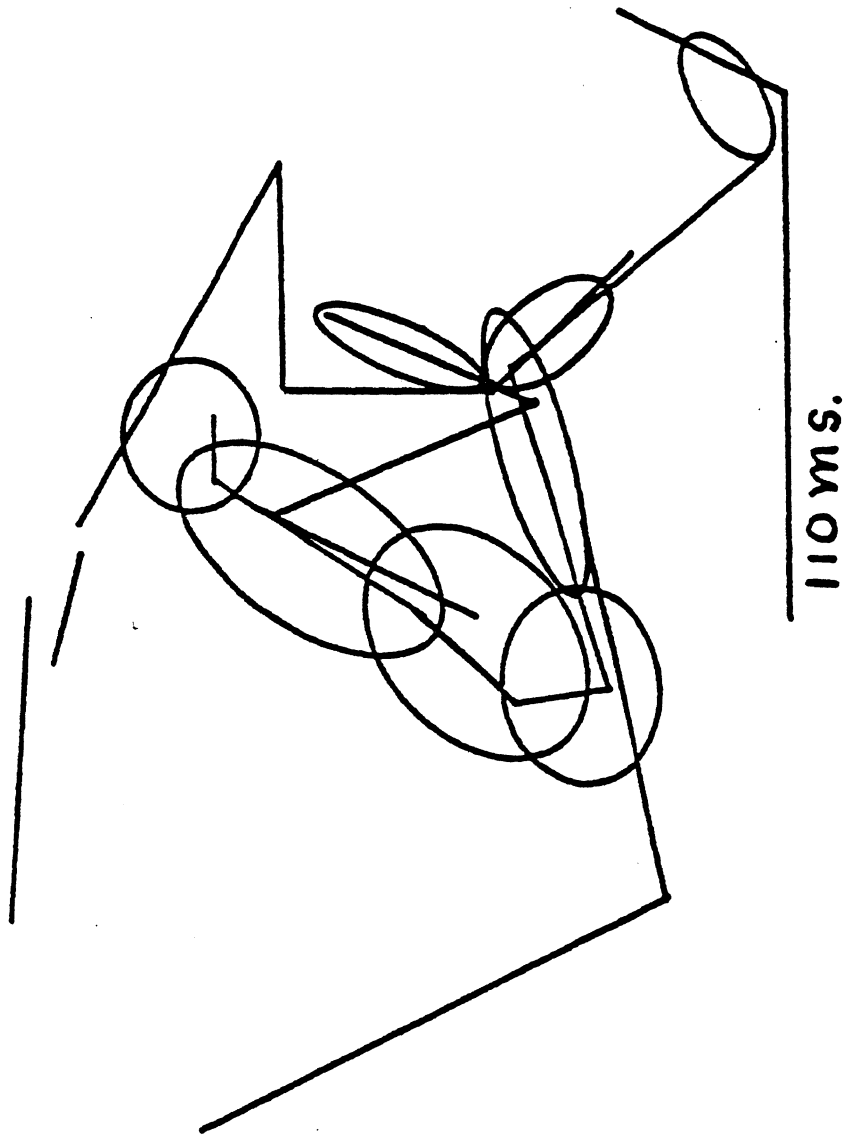

Figure 10. Occupant Position. 110 ms. (Case No. 9).

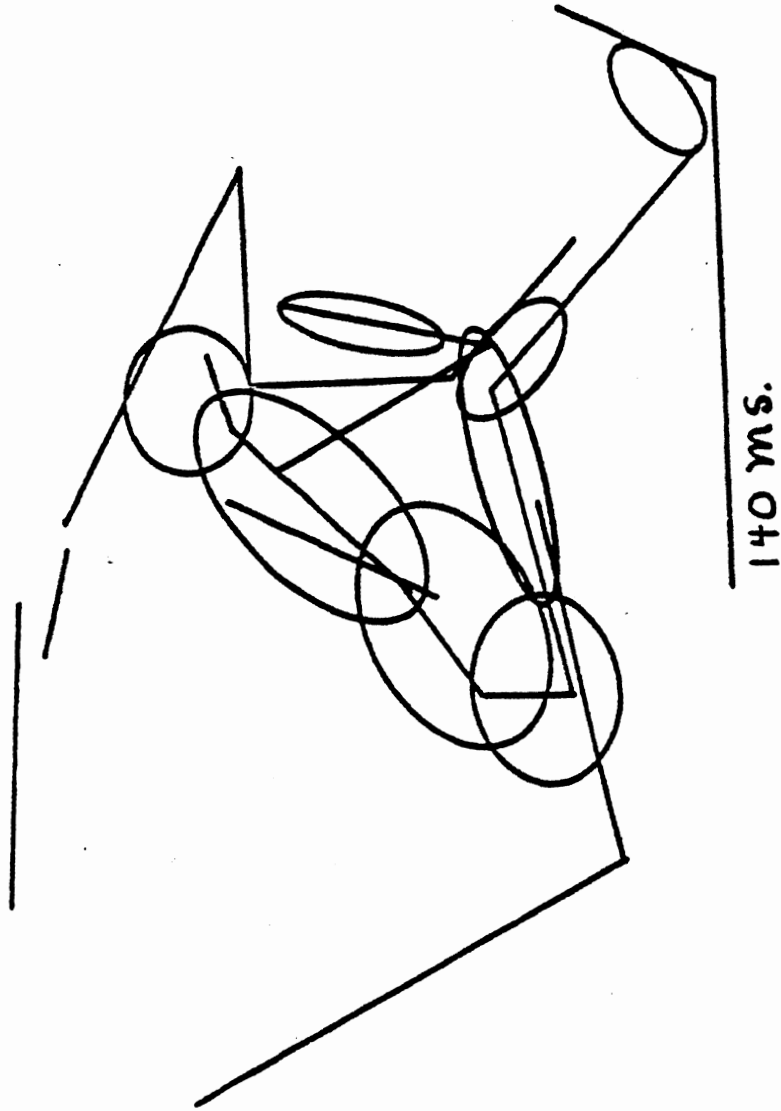

Figure 11. Occupant Position. 140 ms. (Case No. 9).

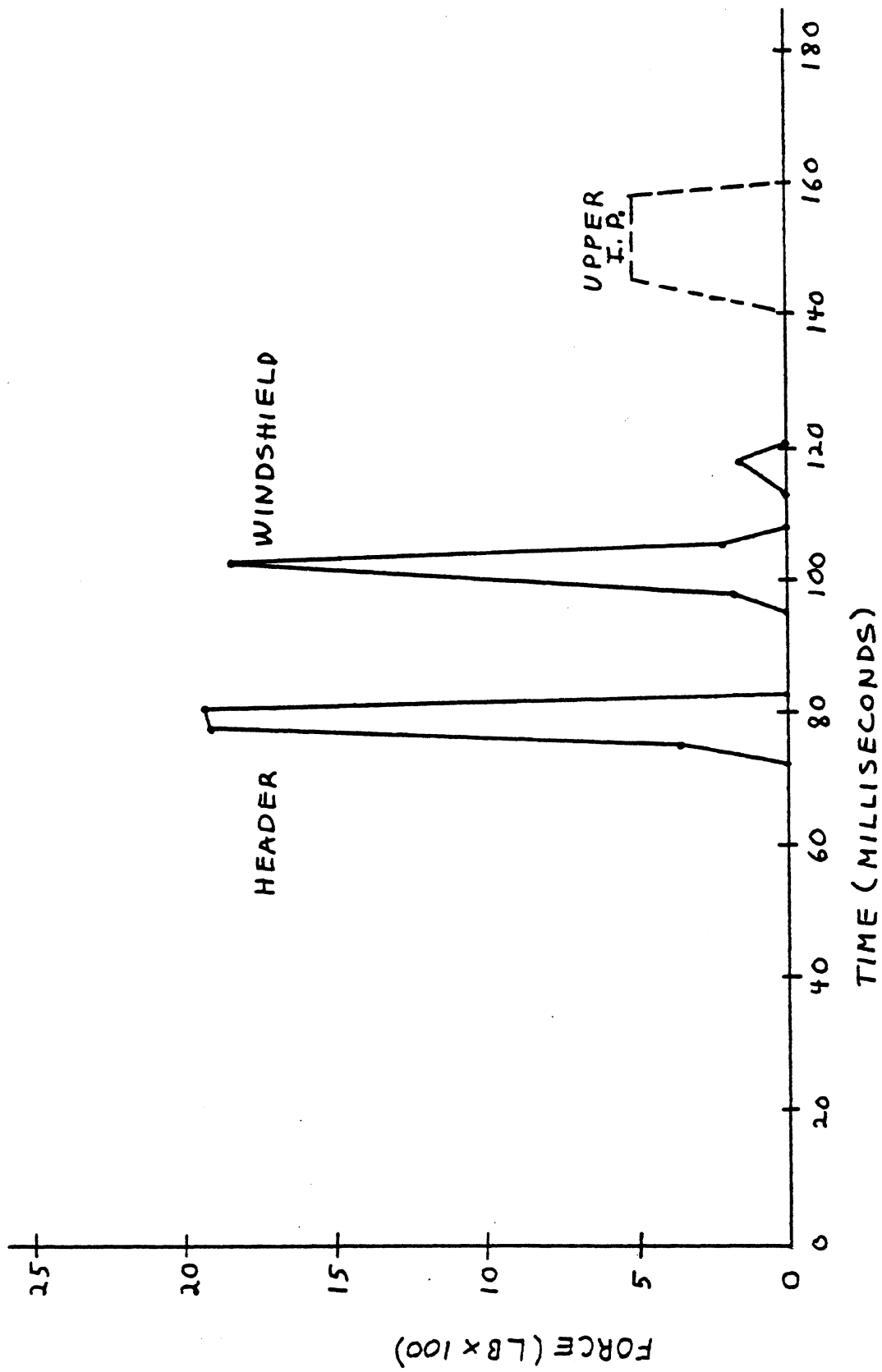

Figure 12. Force on Head Due to Interior Contacts (Case No. 9).

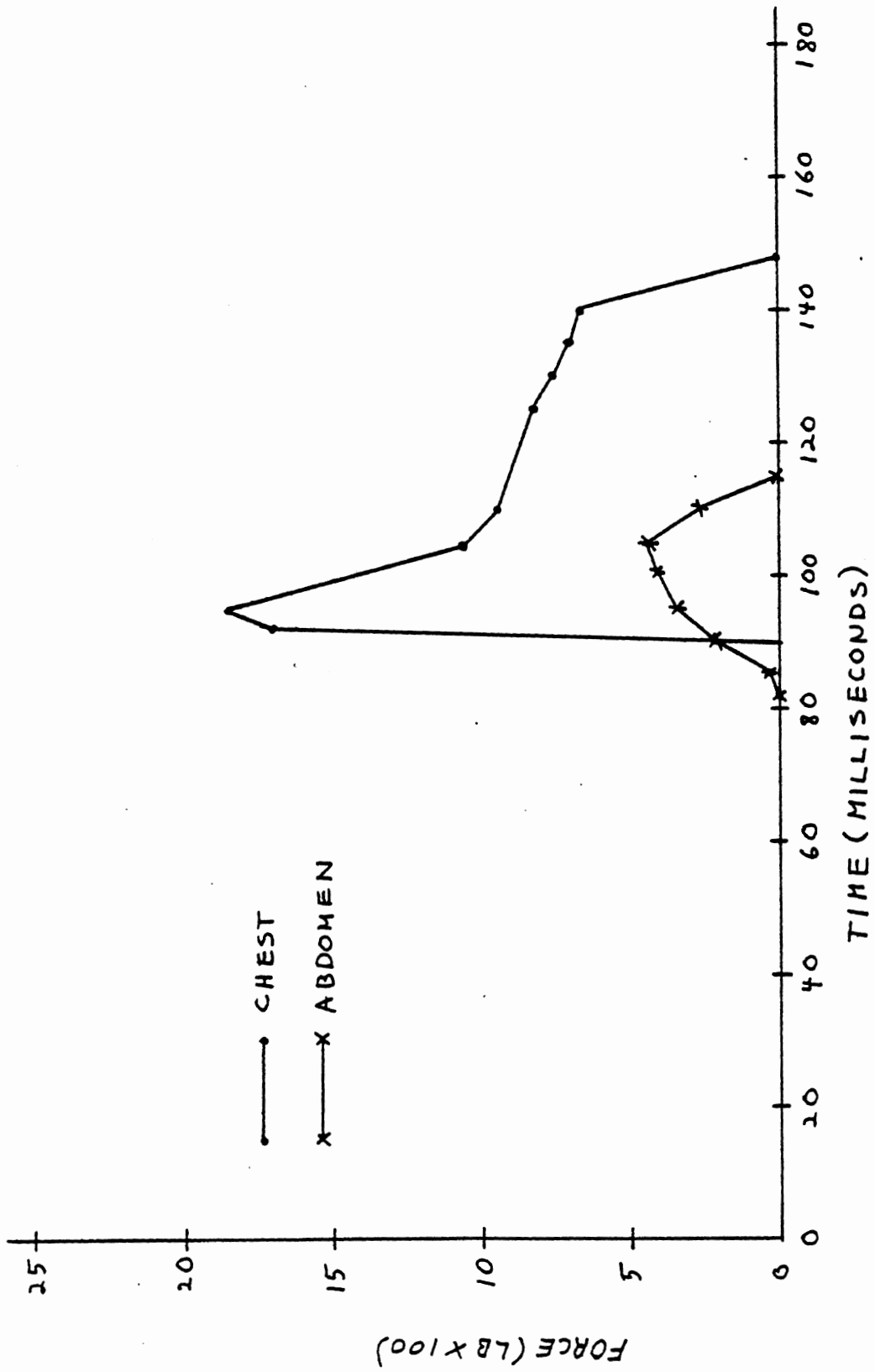

Figure 13. Force on Chest and Abdomen from Steering Wheel (Case No. 9).

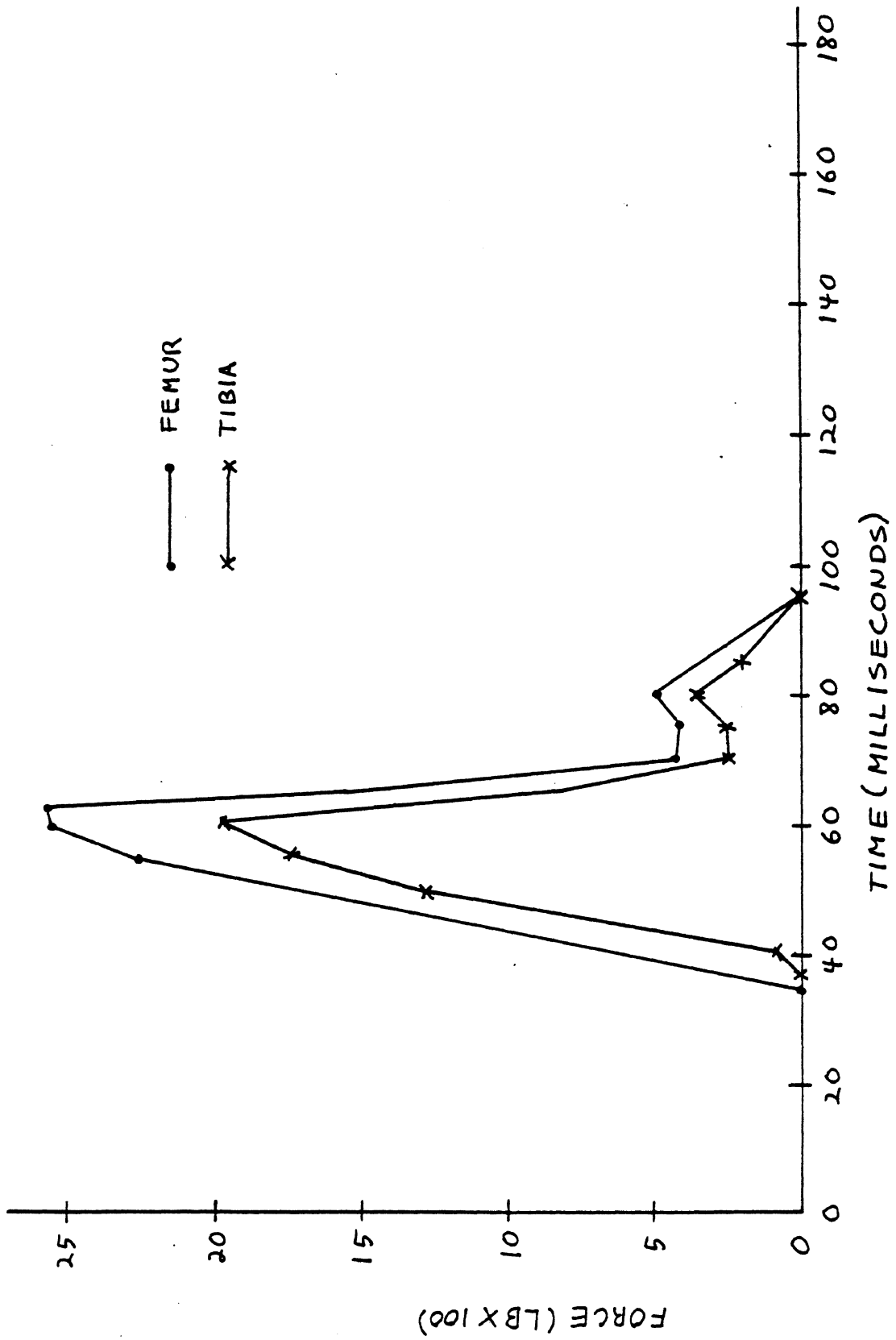

Figure 14. Force on Knee and Tibia from Instrument Panel (Case No. 9).

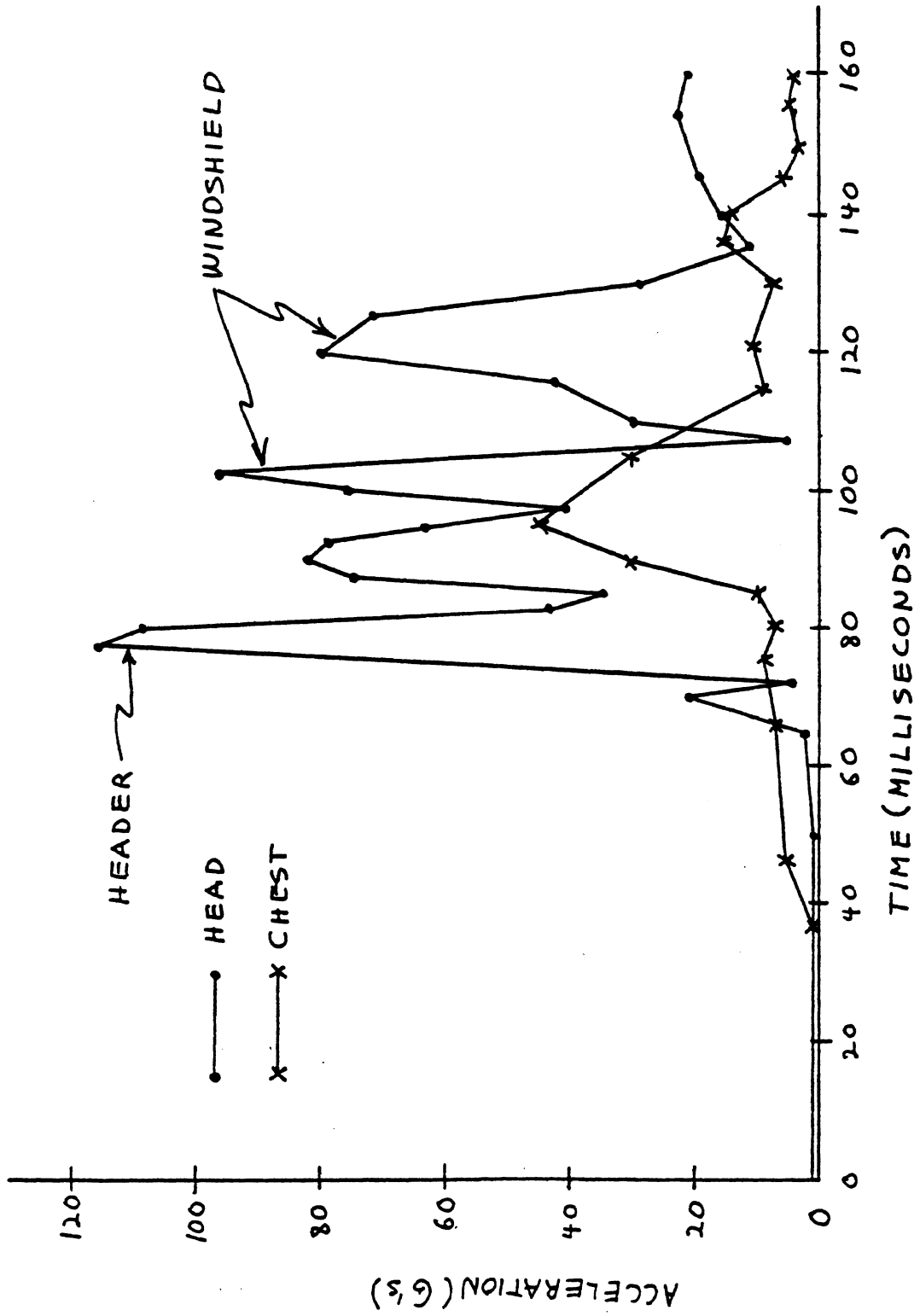

Figure 15. Head and Chest Accelerations (Case No. 9).

For the most part the peaks correspond with the peak force loadings shown in the previous figures.

4.2 Case No. 10. 1977 Oldsmobile Cutlass (Frontal Pole Impact. 28.6 mph).

In this case a 1977 Oldsmobile Cutlass S was forced off the roadway and struck a 56 cm diameter tree directly head-on. Frontal crush of the car was 93 cm. Figure 16 is a schematic of the accident showing the well-defined vehicle motions. Figure 17 shows the severe and almost perfectly symmetric damage sustained by the vehicle.

The lone male driver was unrestrained and upon vehicle impact with the tree is estimated to have continued forward and upward contacting the sunvisor, header, and windshield with his forehead; the steering wheel rim with his throat; the steering wheel rim and spokes with his chest; the lower panel with his knees; and possibly the mid panel with his right shoulder and forearm.

Interior damage to the vehicle was moderately heavy. The left sunvisor and header were damaged and the windshield was starred by the driver. The lower half of the steering wheel rim was severely bent and the spokes were slightly deformed. This caused the energy absorbing device to be compressed about 123 mm (4.84 in) and the shear capsules were separated. Upward force by the driver caused the steering column to rotate upward, but separation of the shear capsules necessitated its final state to be down. Driver contact broke the mid and lower panel areas to both the left and right of the column.

The unrestrained driver sustained a variety of injuries, during contact with the vehicle interior, to the head, neck, rib cage, hip, lower legs, and lower arms. These are detailed in Figure 18.

Use of the CRASH II program yielded a velocity change of 28.6 mph along the axis of the Oldsmobile. This was represented as an acceleration in the form of a sine curve with a total duration of 80 ms.

Procedures similar to Case 9 were used to define the vehicle interior geometry and occupant position. During an interview, the simple anthropometric measurements on the driver yielded:

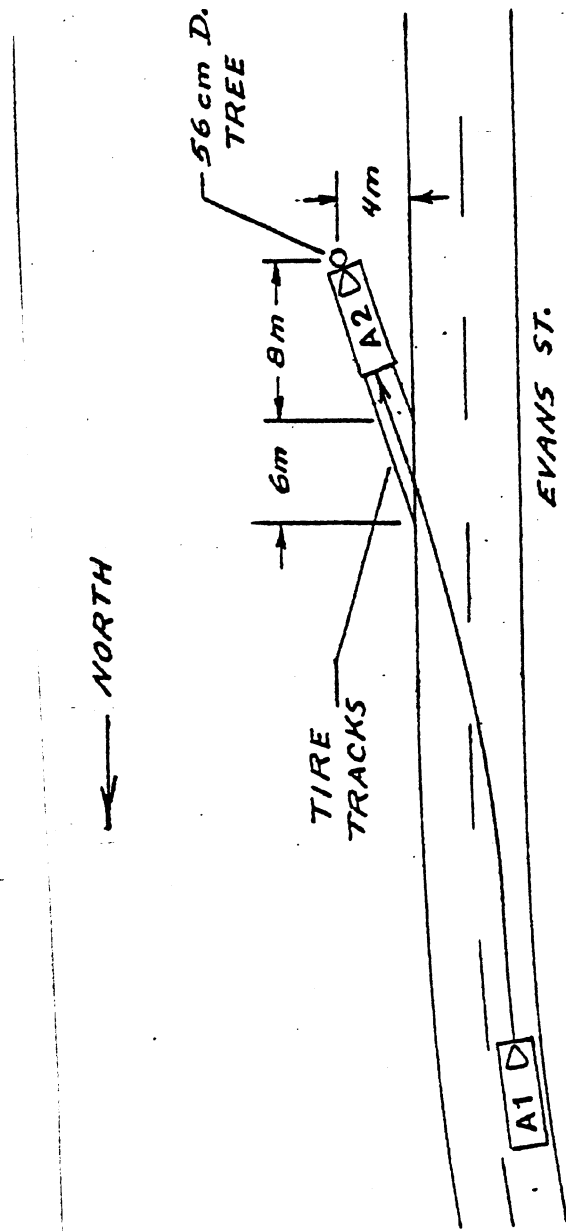

Figure 16. Schematic of Accident Scene (Case No. 10).

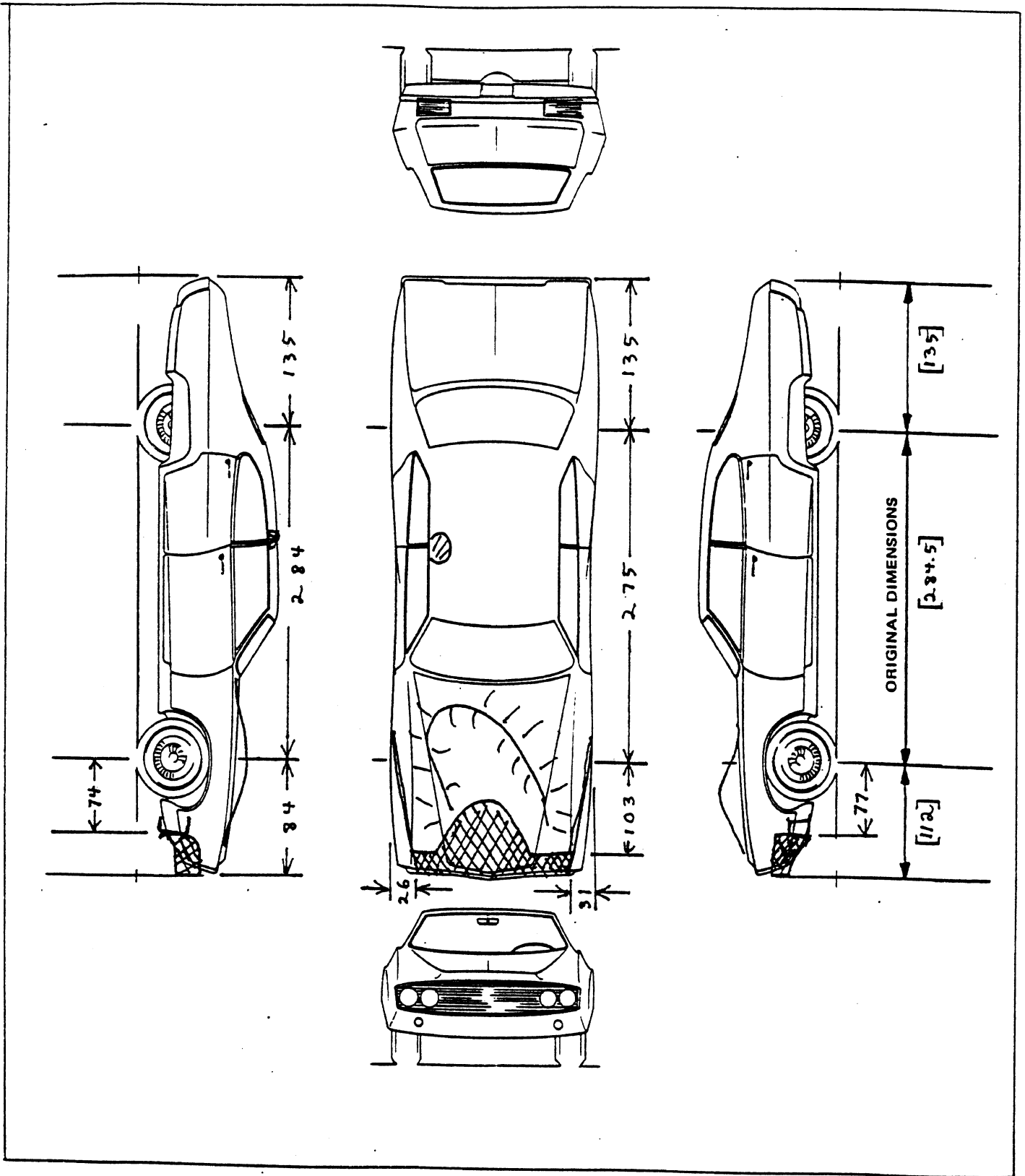
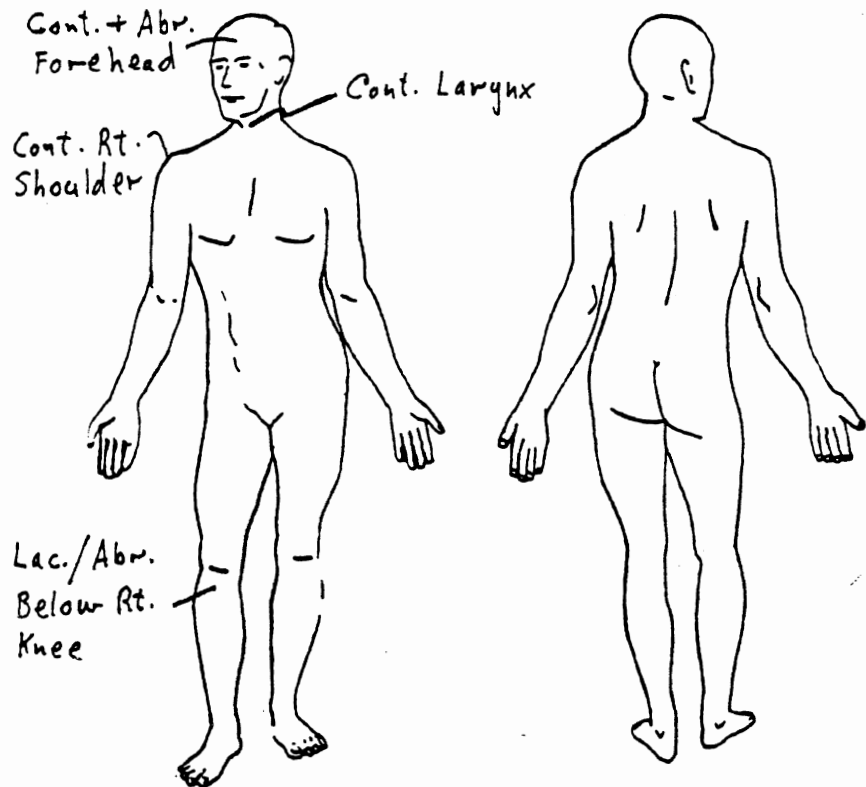

Figure 17. Vehicle Damage (Case No. 10).

INDICATE LOCATION OF INJURIES, INCLUDING MAJOR BRUISES



Briefly Unconscious

SOFT TISSUE INJURIES

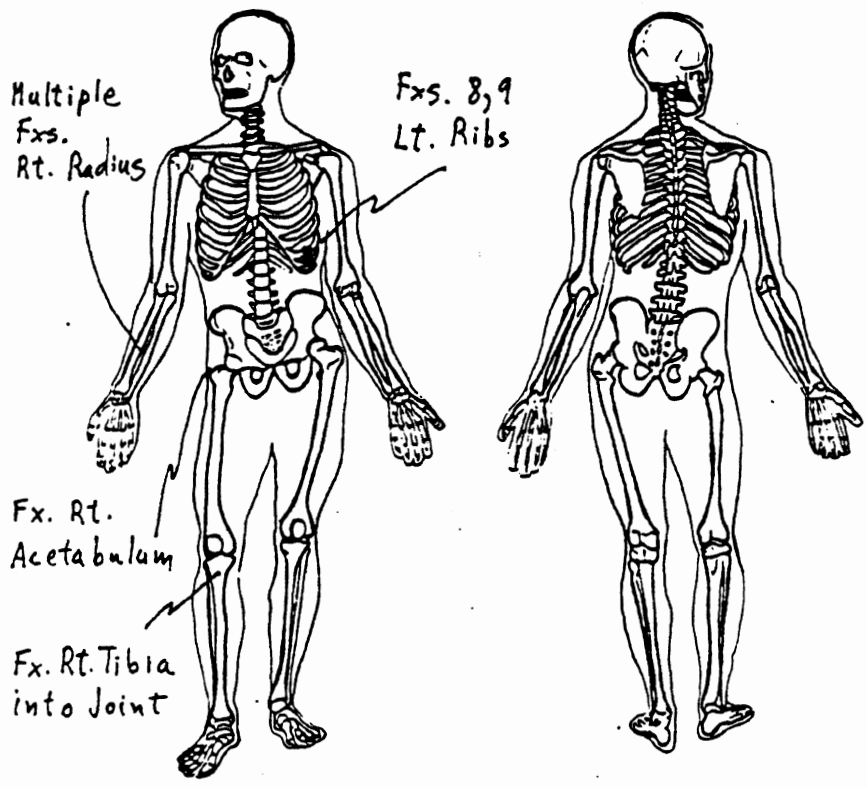

SKELETAL INJURIES

Figure 18. Occupant Injuries (Case No. 10).

- 50 years old
- 69.2 in. (175.8 cm.) stature
- 182 lb. (82.7 kg.) weight
- 37.2 in. (94.4 cm.) sitting height

Photographs were taken of the subject in a vehicle essentially identical to that involved in the accident. Figure 19 shows the occupant linkage at 0 milliseconds and vehicle geometry assembled from the vehicle drawings, subject photographs, and the limited anthropometric measurements. The contact surfaces and ellipses which were included were those believed to be active in the subject/vehicle dynamic interactions.

Figure 19-23 show tracings of occupant position for several points in time during the simulation. Figure 20 shows the beginning of knee/tibia interactions with the lower instrument panel at about 50 ms. Also, the lower rim of the steering wheel is just beginning to contact the abdomen. Figure 21 at 60 milliseconds shows several interactions imminent or just beginning. The lower rim of the steering wheel is interacting with the lower region of the chest contact ellipse. At the same time the lower arm has moved forward and has penetrated the planes of the instrument panel (No Contacts were allowed for this segment in the simulation, however this view represents a plausible location for the arm/panel interactions documented in the accident reconstruction). The head, at this point in time, is just about ready for a contact with the header. It was necessary to add a small circle to the top of the head (shown in the figures) in order to sense this contact due to the short length of the header, the relatively large size of the main head ellipse, and the relatively small penetration of the head into the header. Figure 22 shows the primary interaction with the windshield while Figure 23 shows the predicted position of most forward excursion with the head and neck contacting the steering wheel rim and the instrument panel. It should be noted in Figure 23 that rebound has been initiated in the areas of the lower extremities. This rebound is transmitted on up the linkage as the simulation continues.

Figures 24-27 show some of the dynamic output results produced by the simulation. Figure 24 shows the predicted force loadings applied to the head. The three primary interactions are with the header, windshield, and instrument panel. Interactions of the chest and abdomen with the steering

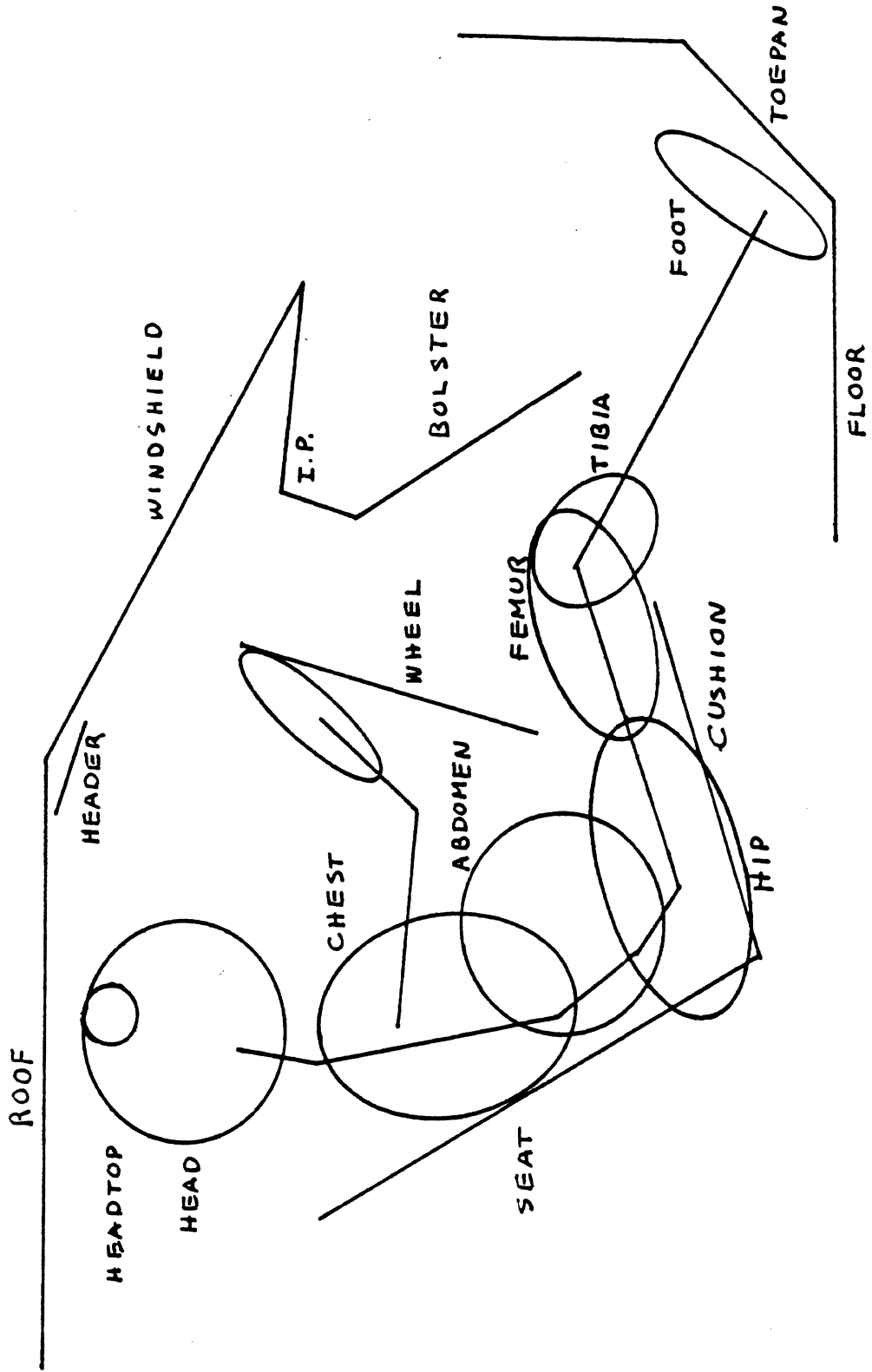

Figure 19. Identification of Vehicle Interior Contact Surfaces and Occupant Position. 0 ms. (Case No. 10).

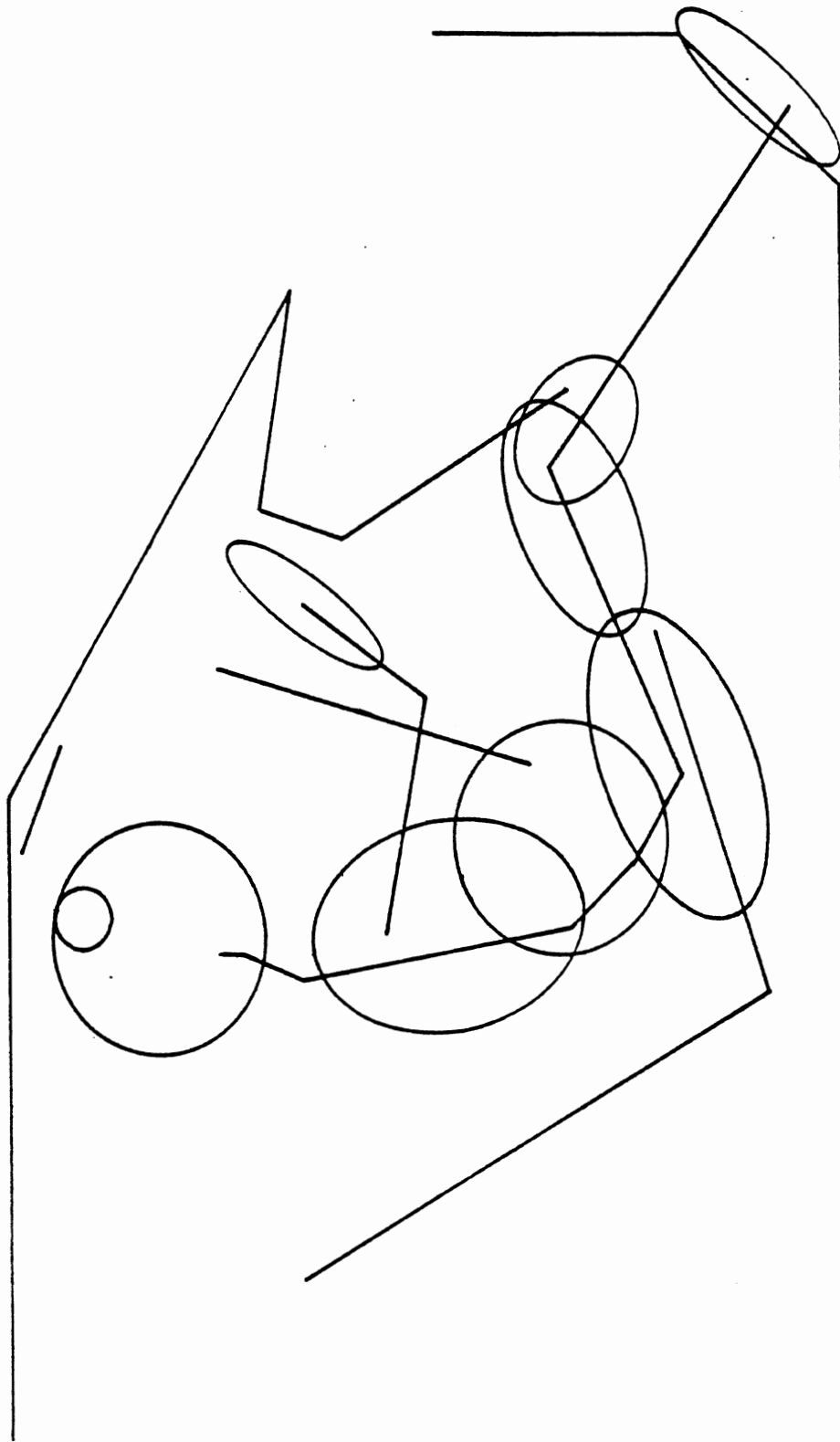

Figure 20. Occupant Position. 50 ms. (Case No. 10).

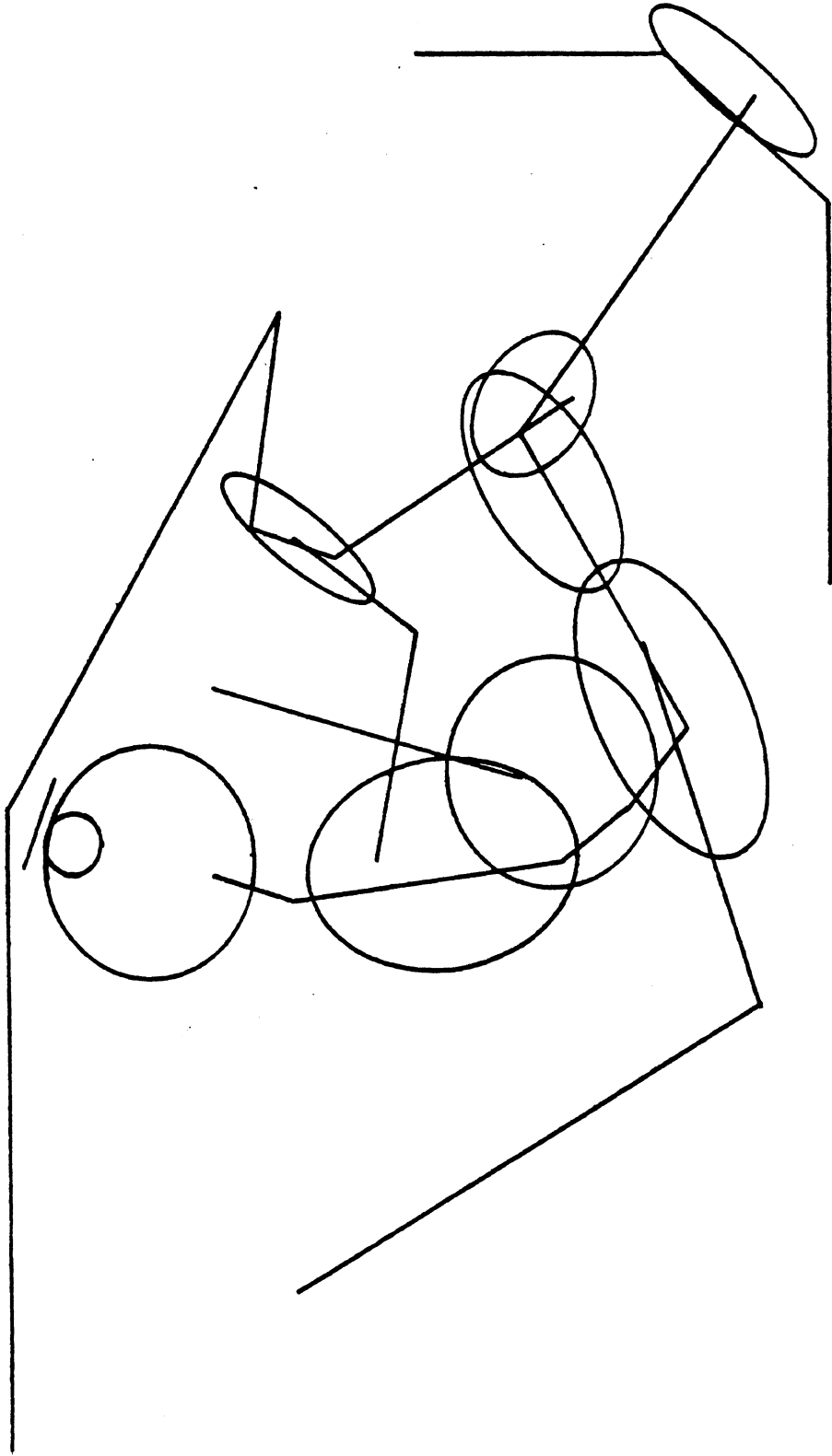

Figure 21. Occupant Position. 60 ms. (Case No. 10).

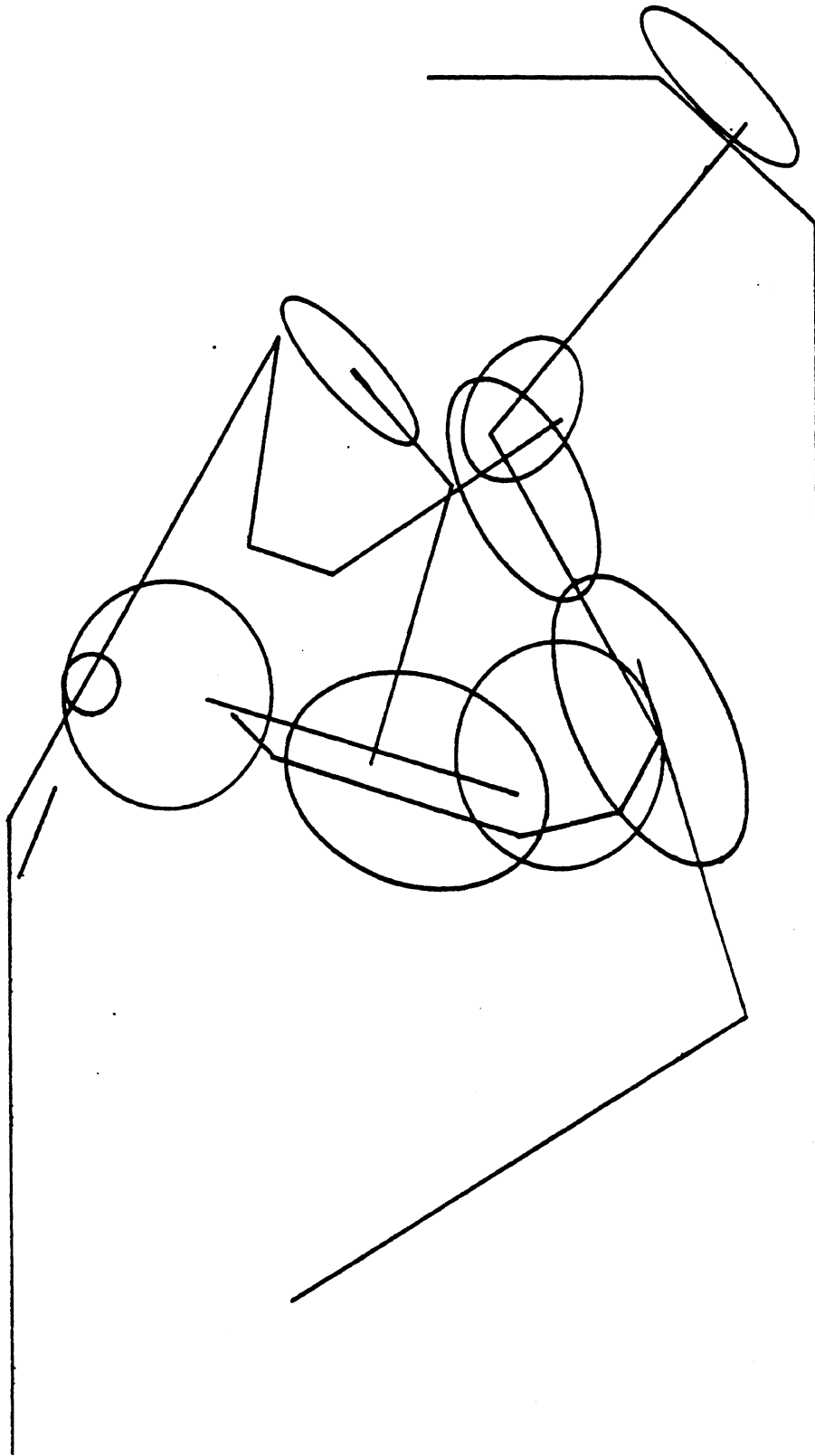

Figure 22. Occupant Position. 80 ms. (Case No. 10).

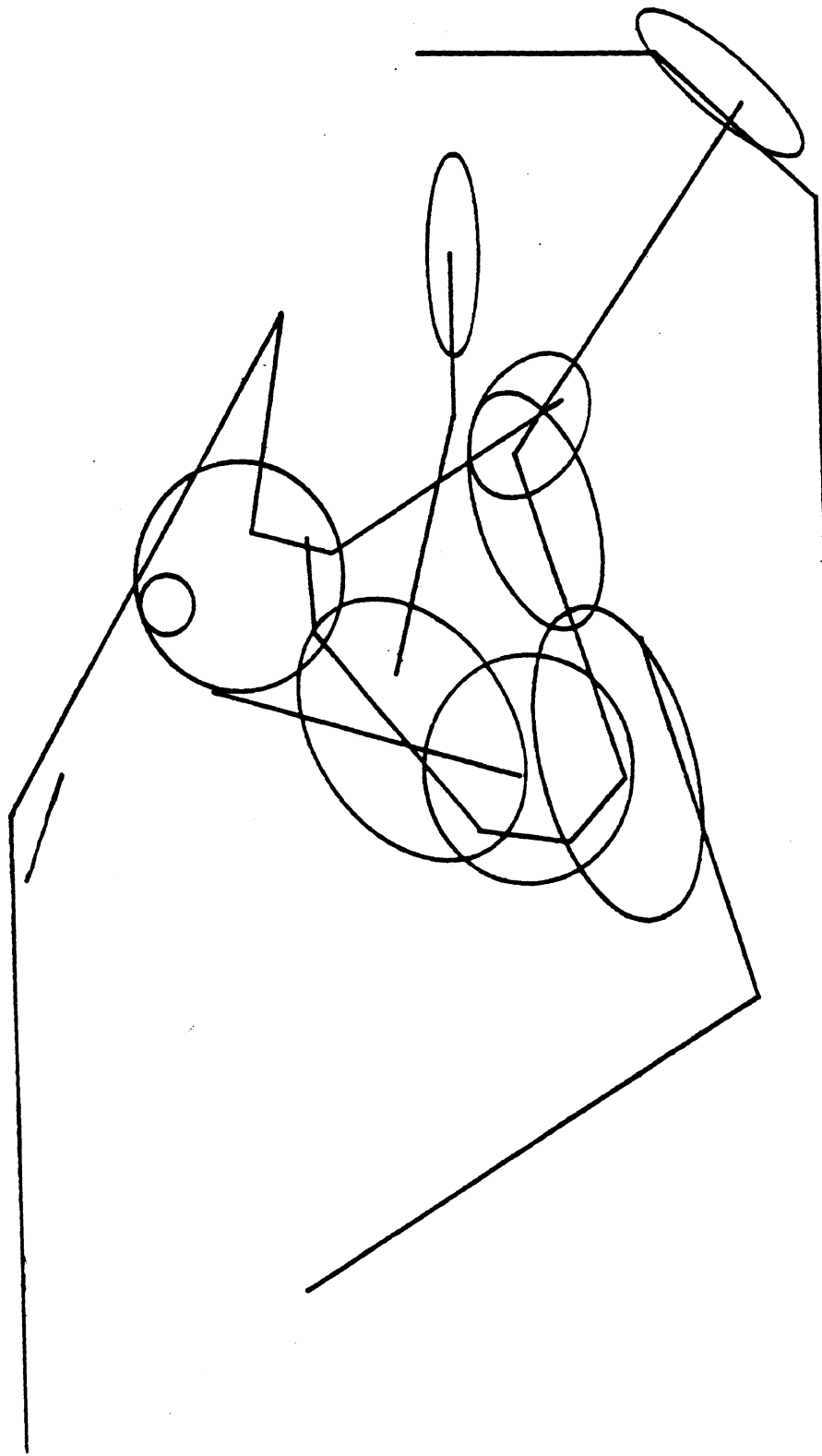

Figure 23. Occupant Position 100 ms. (Case No. 10).

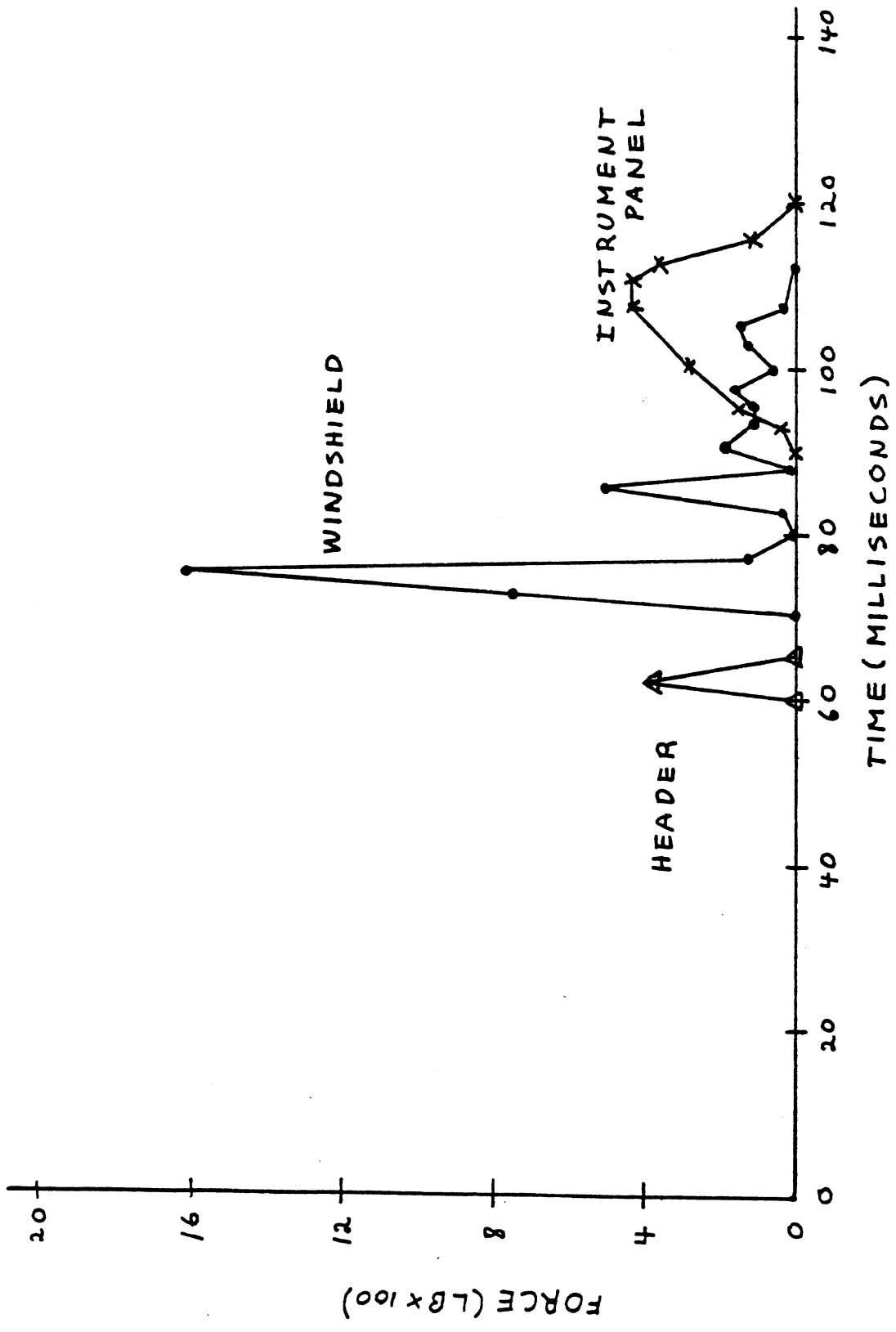

Figure 24. Force on Head due to Interior Contacts (Case No. 10).

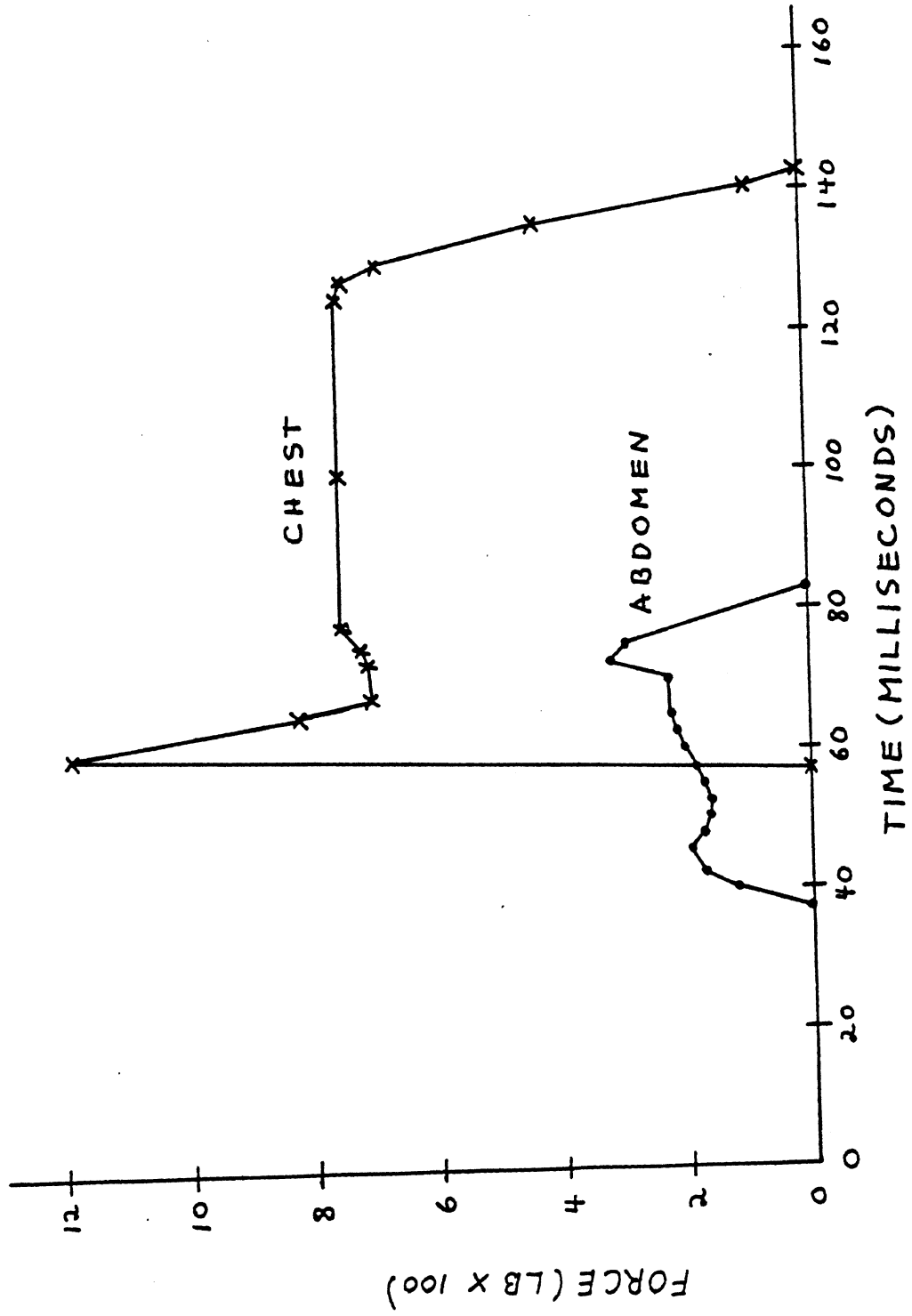

Figure 25. Force on Chest and Abdomen from Steering Wheel (Case No. 10).

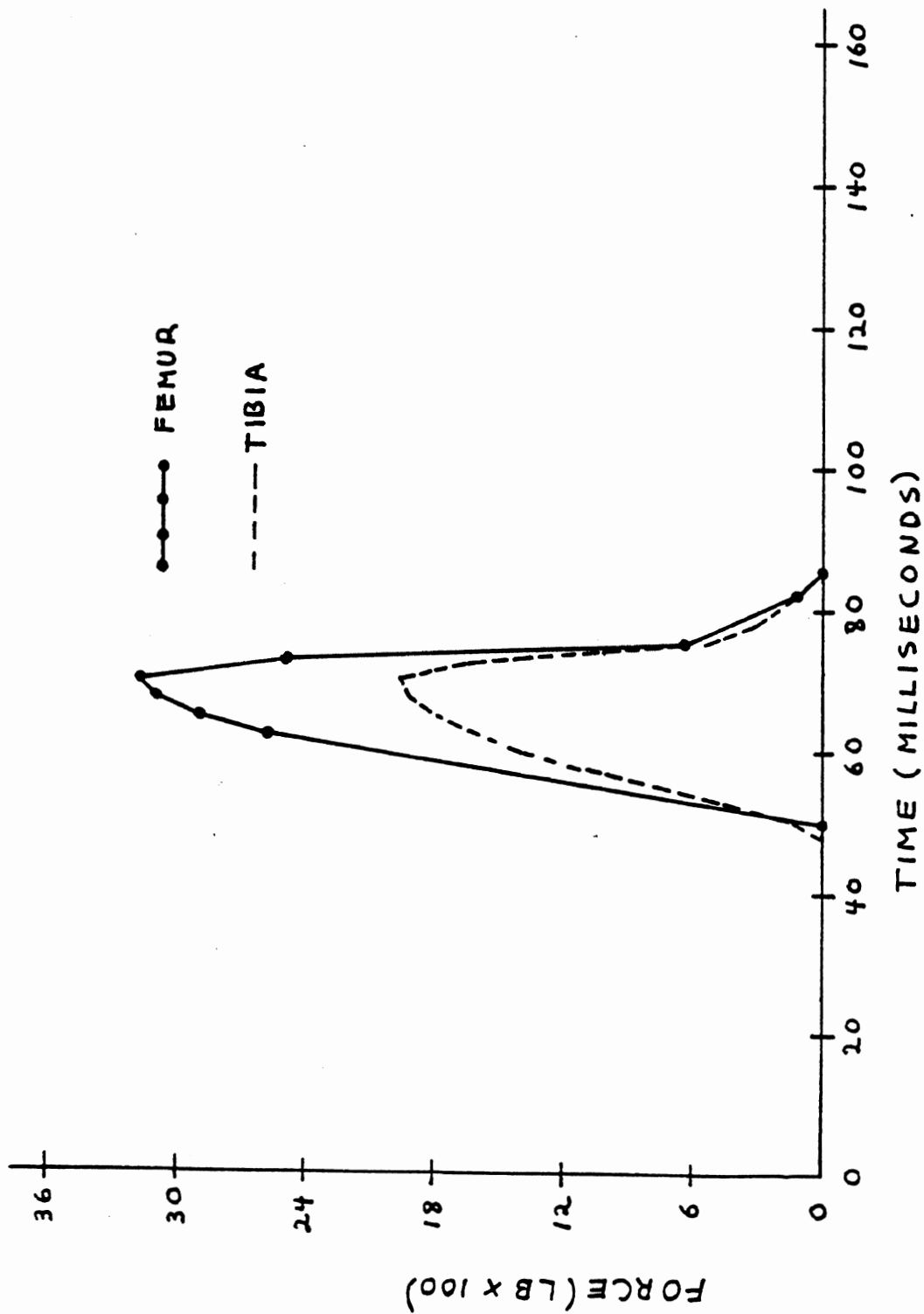

Figure 26. Force on Knee and Tibia from Instrument Panel (Case No. 10).

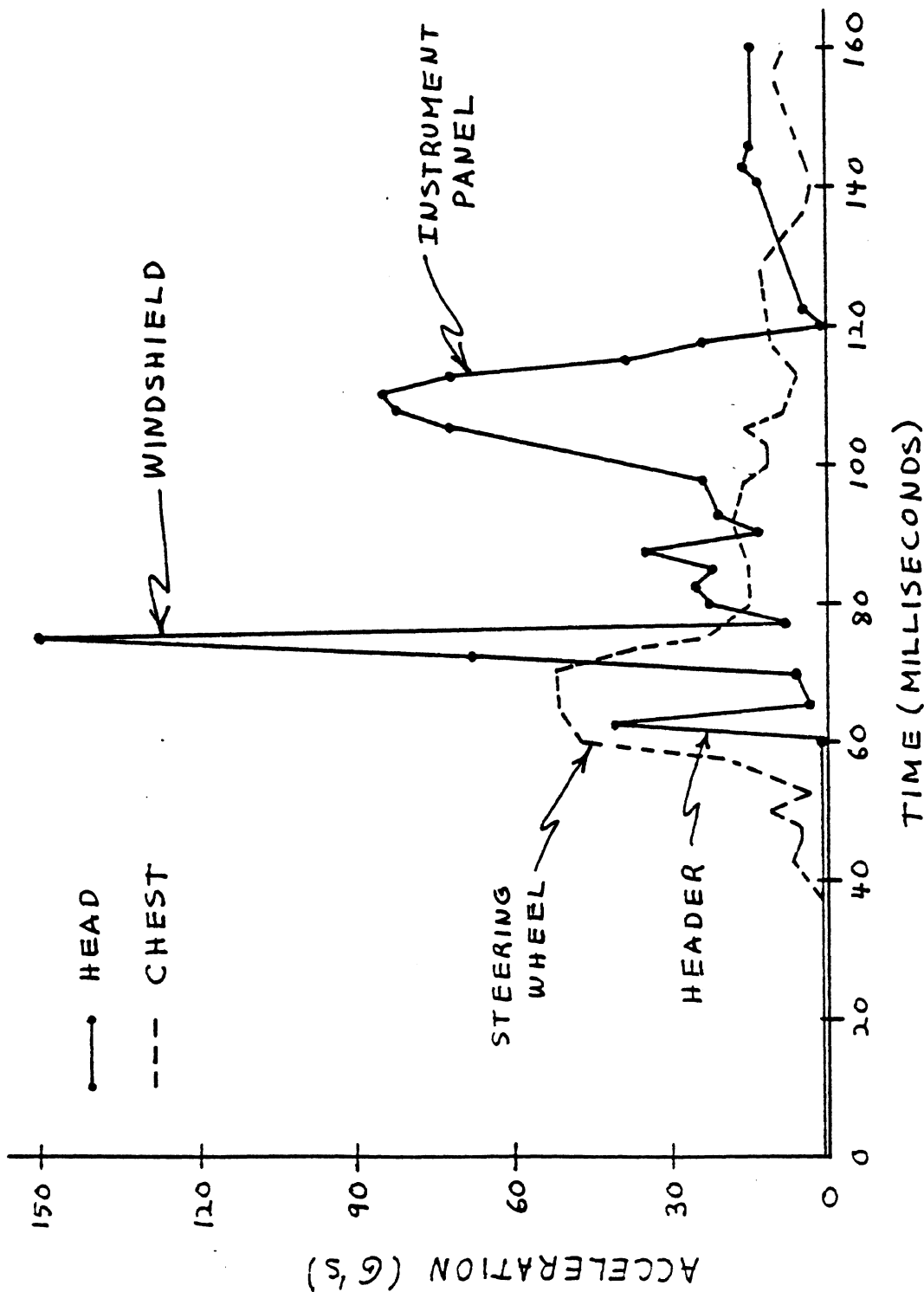

Figure 27. Head and Chest Accelerations (Case No. 10).

wheel/column are shown in Figure 25. The abdomen is in contact for approximately 20 ms before the rib cage becomes substantially involved in the dynamics. The tibia and femur loads shown in Figure 26 show the considerable force which was likely transmitted to the acetabulum. Figure 27 shows head and chest accelerations which are, as happened in Case No. 9, well correlated with the phasing of the loadings shown in the previous figures. It should be noted that the G-loading to the head due to the header contact is relatively low. This is a case where small changes in input data could dramatically change the simulation. If the occupant sat 1/2 inch lower, the contact would not occur. If he were 1/2 inch higher, the size of the force spike would likely be larger than that for the windshield. The effect of vehicle pitch during the tree impact was not investigated due to the limited nature of the project and could also be a major factor in the relative position of the head with respect to the vehicle in the timing of this important contact.

4.3 Case No. 13. 1980 Volkswagen Rabbit (Front Impact. Passive Restraint. 36.7 mph.)

In this case a 1980 Volkswagen Rabbit was driving on a two-lane road. A Chevrolet Blazer crossed the centerline on an icy turn. The impact energy transfer was nearly "head-on" for the Rabbit. Figure 28 is a schematic of the accident scene. Figure 29 shows the damage to the vehicle.

The male driver was restrained by a passive belt system. Upon impact he continued forward against the shoulder belt and his knees contacted the knee bolster. He stated that he braced himself by straightening both legs and slamming both feet against the floorpan. There was no evidence of contact between the driver and his right front passenger.

The fairly extensive damage to the vehicle interior was concentrated in the left front corner of the passenger compartment. The left end of the instrument panel was partially separated from the deformed left A-pillar. The steering wheel rim was slightly deformed from the driver apparently bracing his hands against it. There was some evidence of steering column movement to the left and slightly upward. The interior of the left door was deformed and the glass broken out due to impact but it is unknown if there was contact by the driver. There was intrusion of the instrument

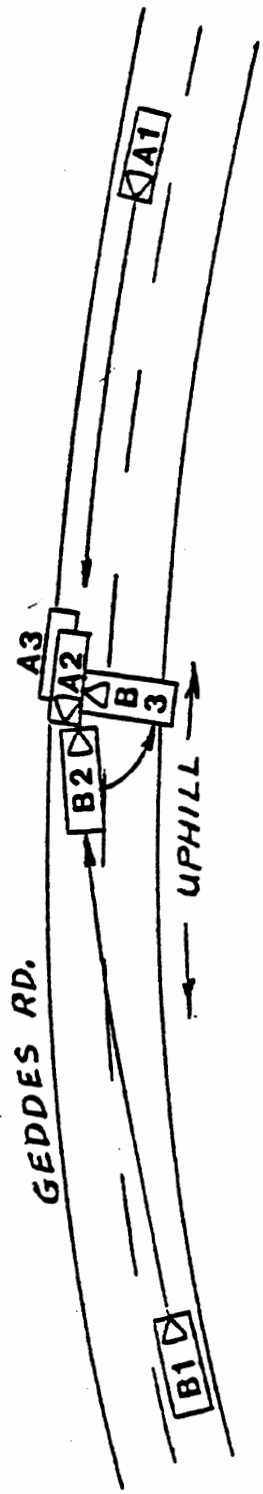

Figure 28. Schematic of Accident Scene (Case No. 13).

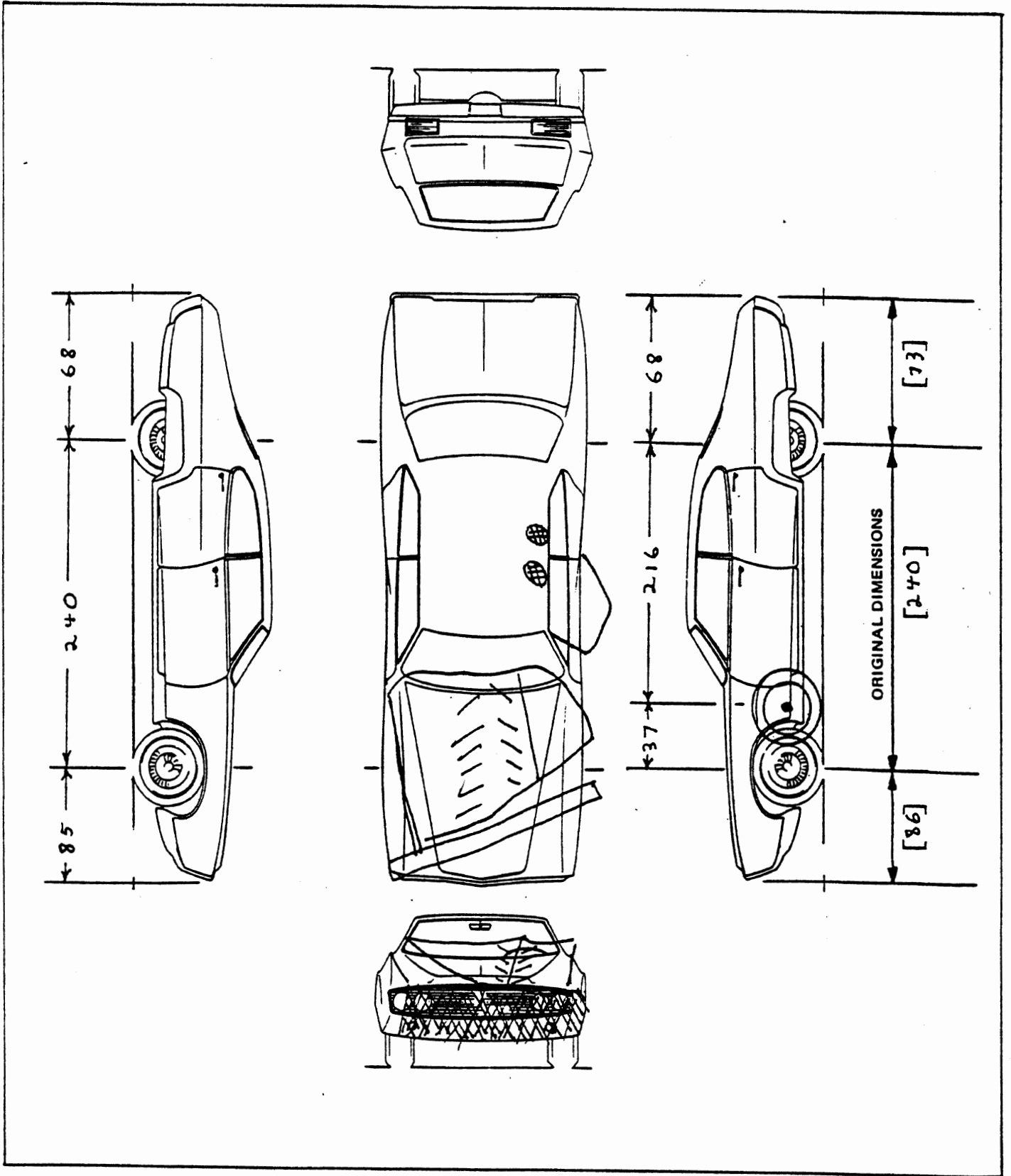
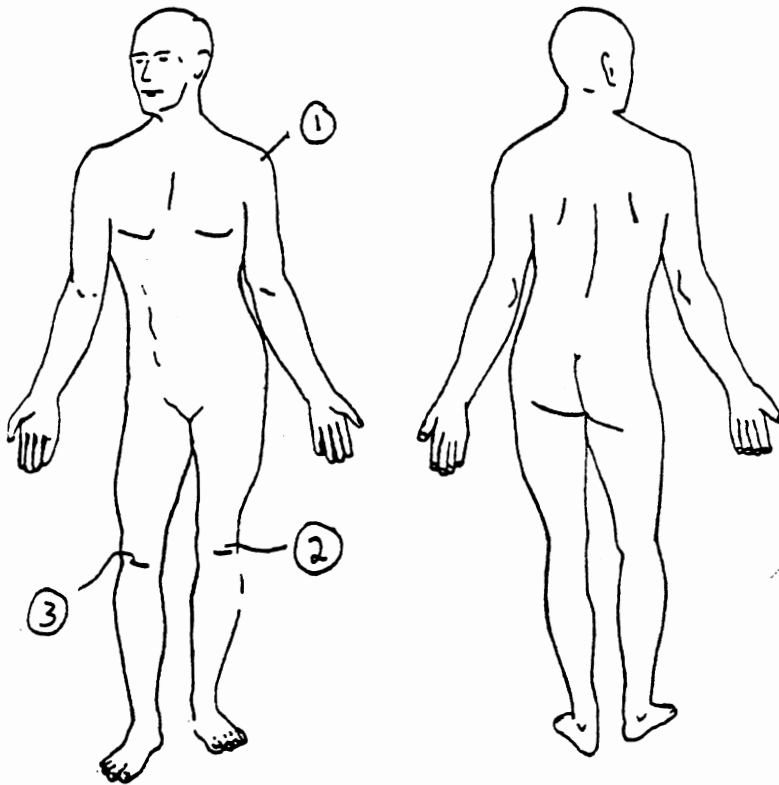

Figure 29. Vehicle Damage (Case No. 13).

INDICATE LOCATION OF INJURIES, INCLUDING MAJOR BRUISES



1. Cont. Left Shoulder
2. Partial tear. Lt. Posterior Cruciate Ligament
3. Tear, Rt. Anterior Cruciate Ligament

SOFT TISSUE INJURIES

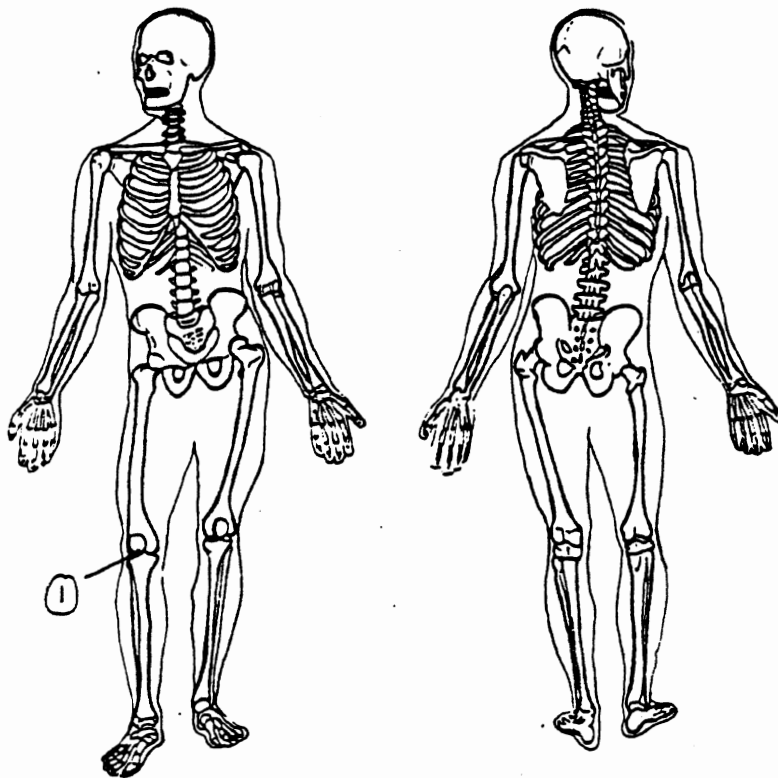

1. Split Fx. Rt. Tibial Plateau, Crushing Lateral Plateau, Avulsion Tibial Spine

SKELETAL INJURIES

Figure 30. Occupant Injuries (Case No. 13).

panel which forced the knee bolster back toward the driver's knees. The floorpan was buckled and the driver's seat adjuster deformed. The instrument panel around the instrument cluster was damaged and the damaged rear-view mirror was dislodged from the severely crazed windshield, but it is unknown if there was any occupant contact.

The driver sustained only a contusion on the left shoulder due to the restraining force of the shoulder belt but suffered relatively severe knee injuries. The details are presented in Figure 30.

Use of the CRASH II program yielded a velocity change of 36.7 mph along the axis of the Volkswagen. This was represented as an acceleration in the form of a trapezoid with a total duration of 80 milliseconds and rise and decay times of 10 milliseconds.

Procedures similar to the previous two cases were used to define the vehicle interior geometry and occupant position. It was necessary to supplement vehicle drawings with direct measurements on the geometry of the knee bolster. During an interview, the simple anthropometric measurements on the driver yielded:

- 47 years old
- 69.6 in. (176.7 cm.) stature
- 184 lb. (83.6 kg.) weight
- 35.3 in. (89.7 cm.) seated height

Photographs were taken of the driver in a Rabbit essentially identical to that involved in the accident. Figure 31 shows the initial occupant linkage and contact ellipse configuration in relation to the schematic of the vehicle interior. Included in this case are the torso belt locations. The hand was allowed to interact with the steering wheel in this case. Because the impact forces resulting from contact with the bolster appeared to be applied to the tibia, the knee ellipse used in the previous cases was deleted.

Figures 31-35 show tracings of the simulated occupant positions for several points in time during the impact. The tibia was in contact with the bolster by 30 milliseconds as shown in Figure 32. Figure 33 shows the beginnings of effects due to the upper torso restraint. Figure 34 shows

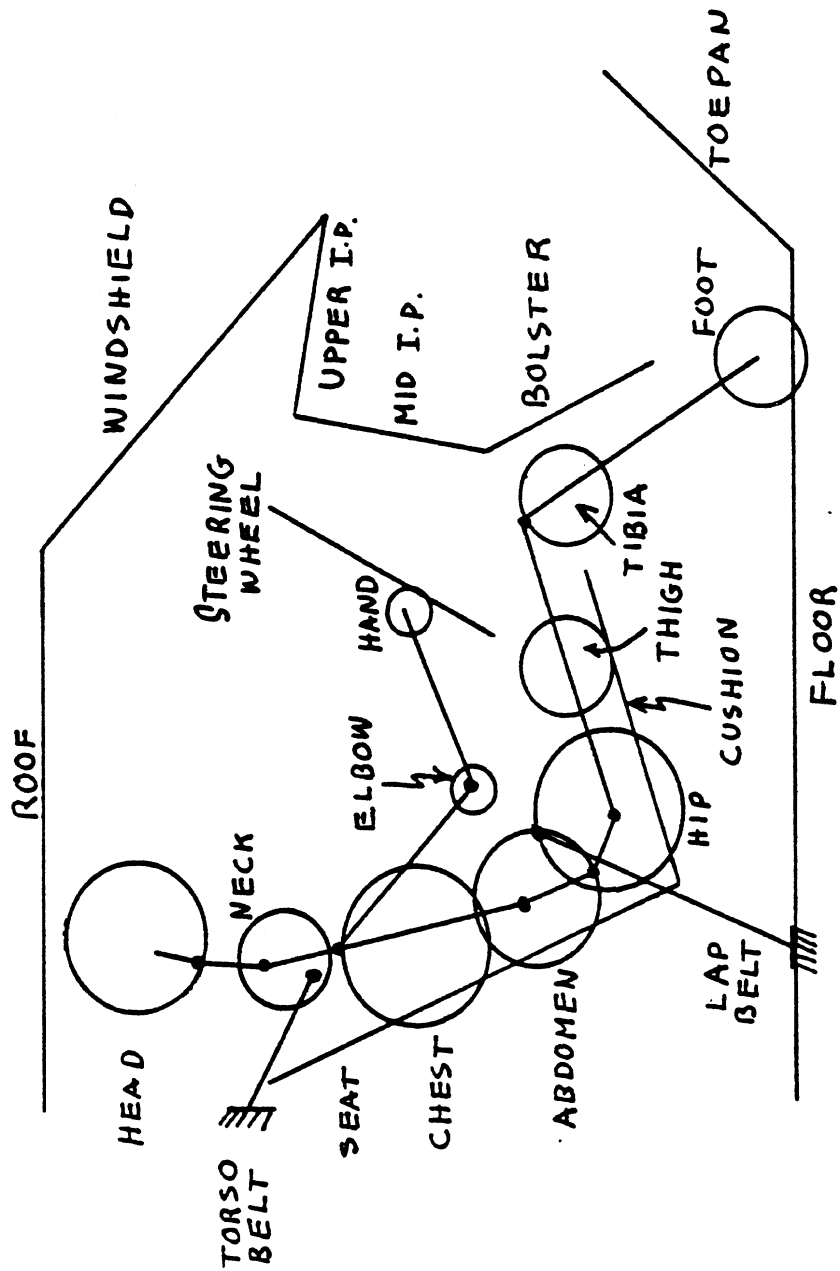

Figure 31. Identification of Vehicle Interior Contact Surfaces and Occupant Position. 0 ms. (Case No. 13).

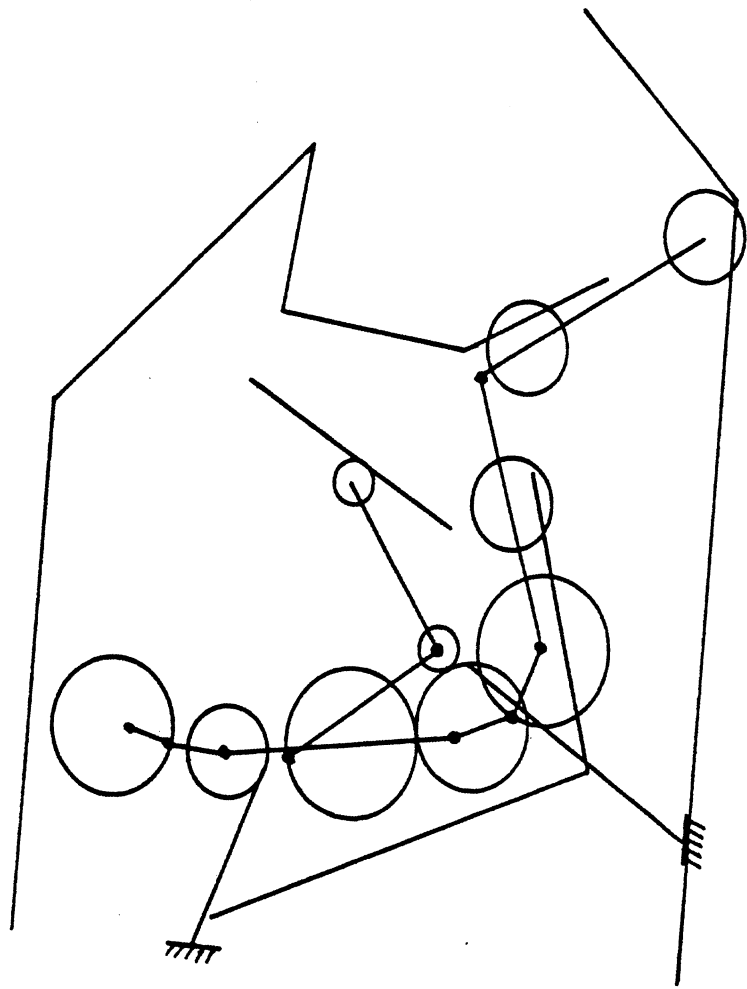

Figure 32. Occupant Position. 30 ms . (Case No 13).

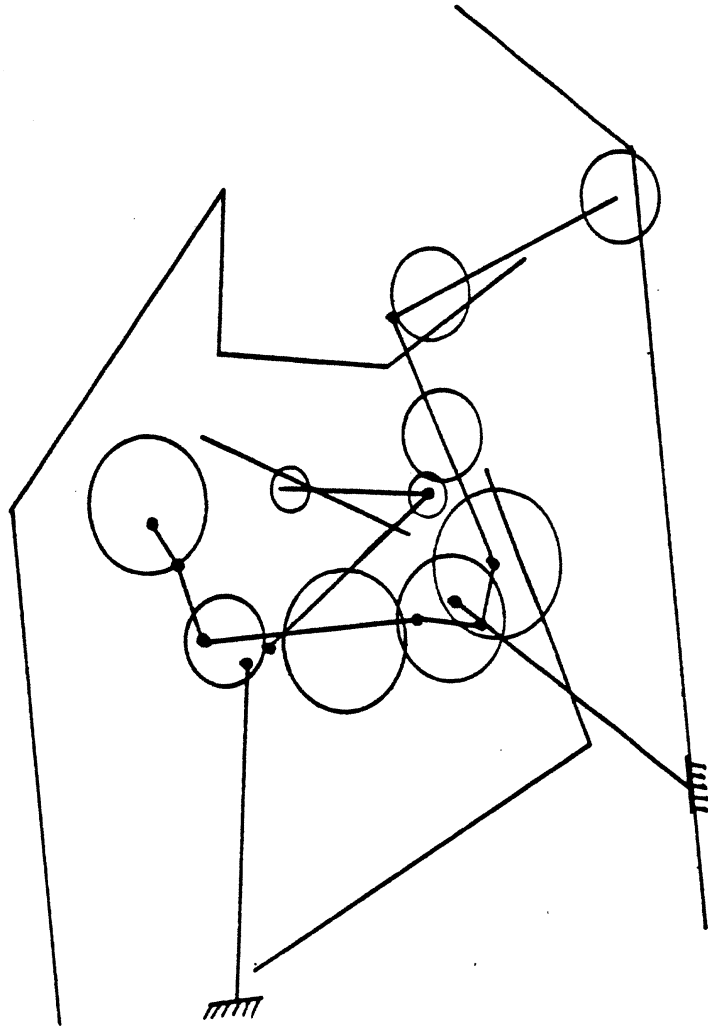

Figure 34. Occupant Position. 80 ms. (Case No. 13).

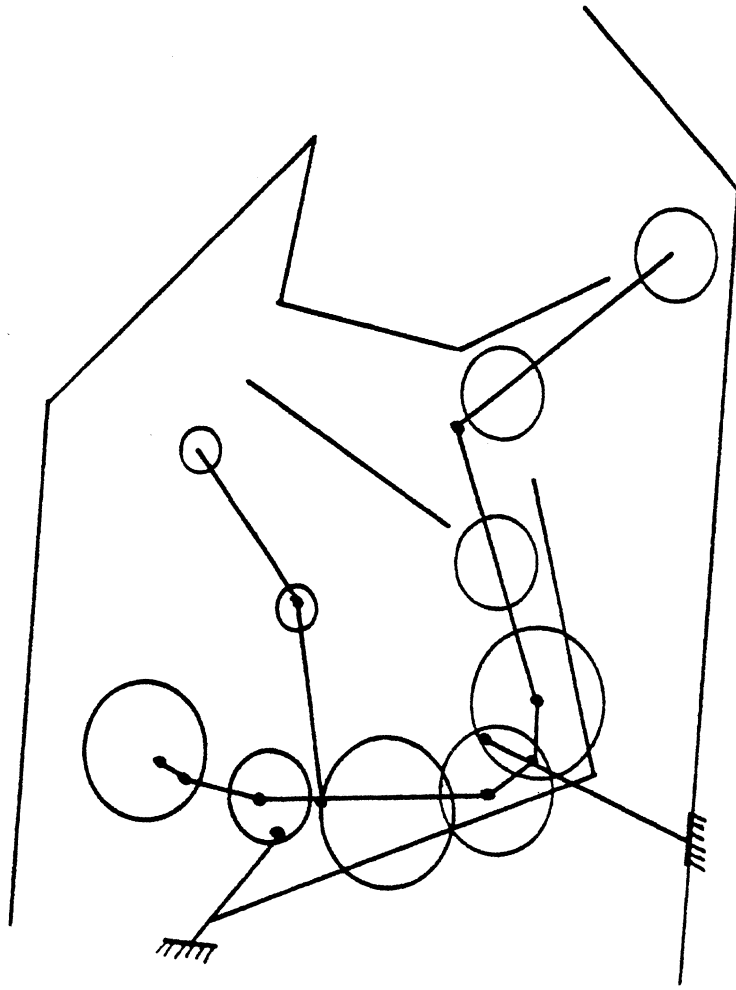

Figure 35. Occupant Position. 160 ms. (Case No. 13).

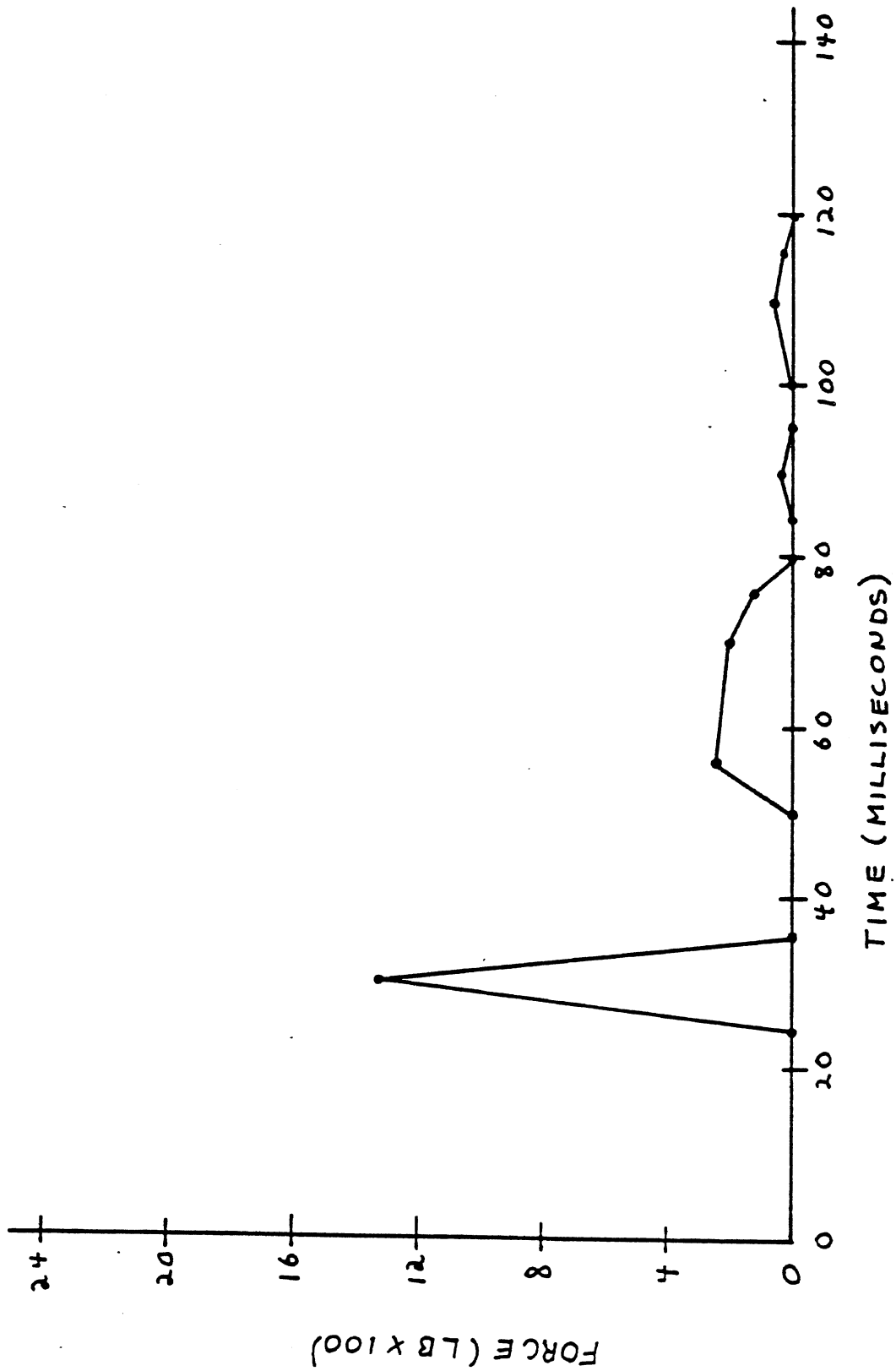

Figure 36. Force on Forearm from Steering Wheel (Case No. 13).

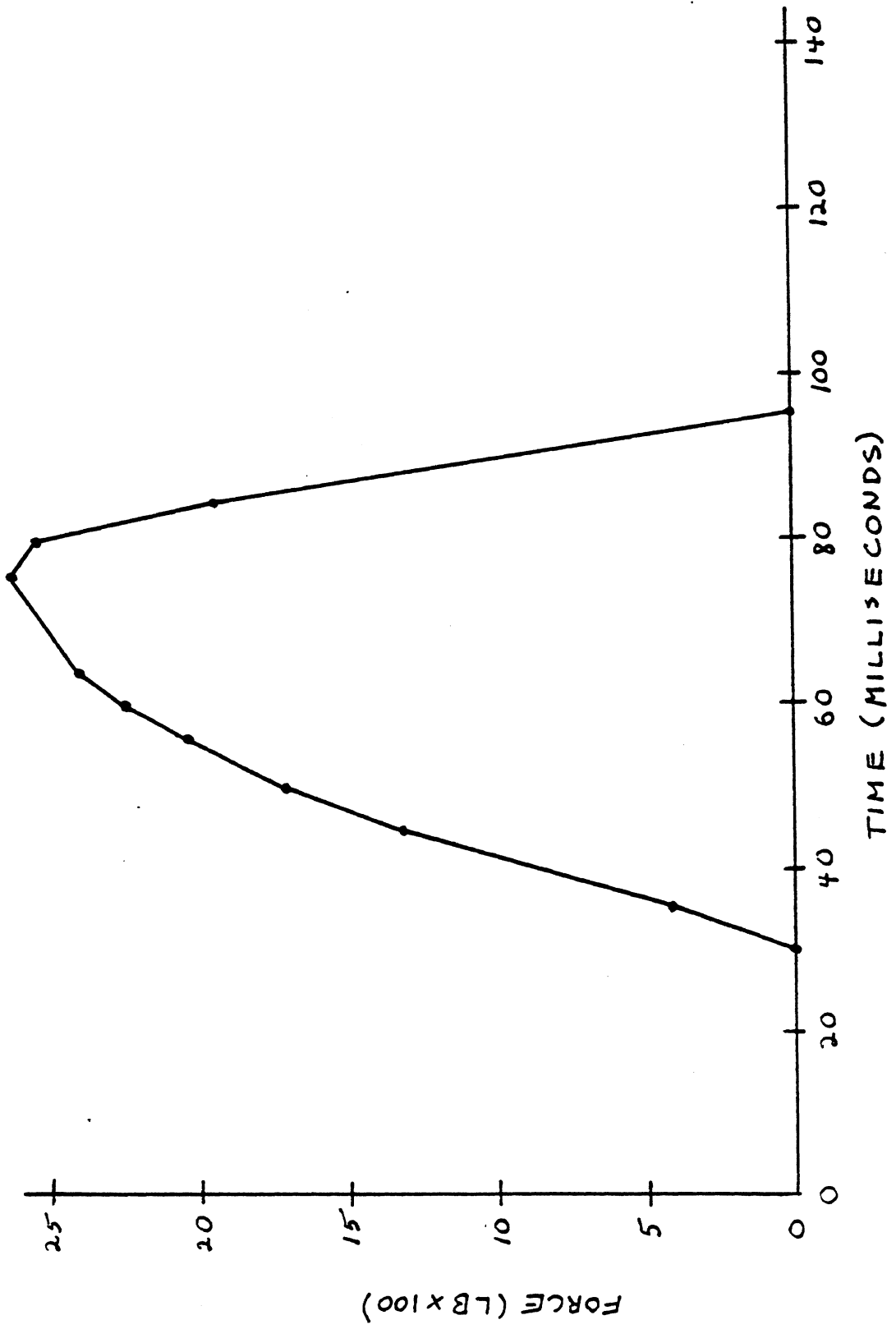

Figure 37. Belt Force (Case No. 13).

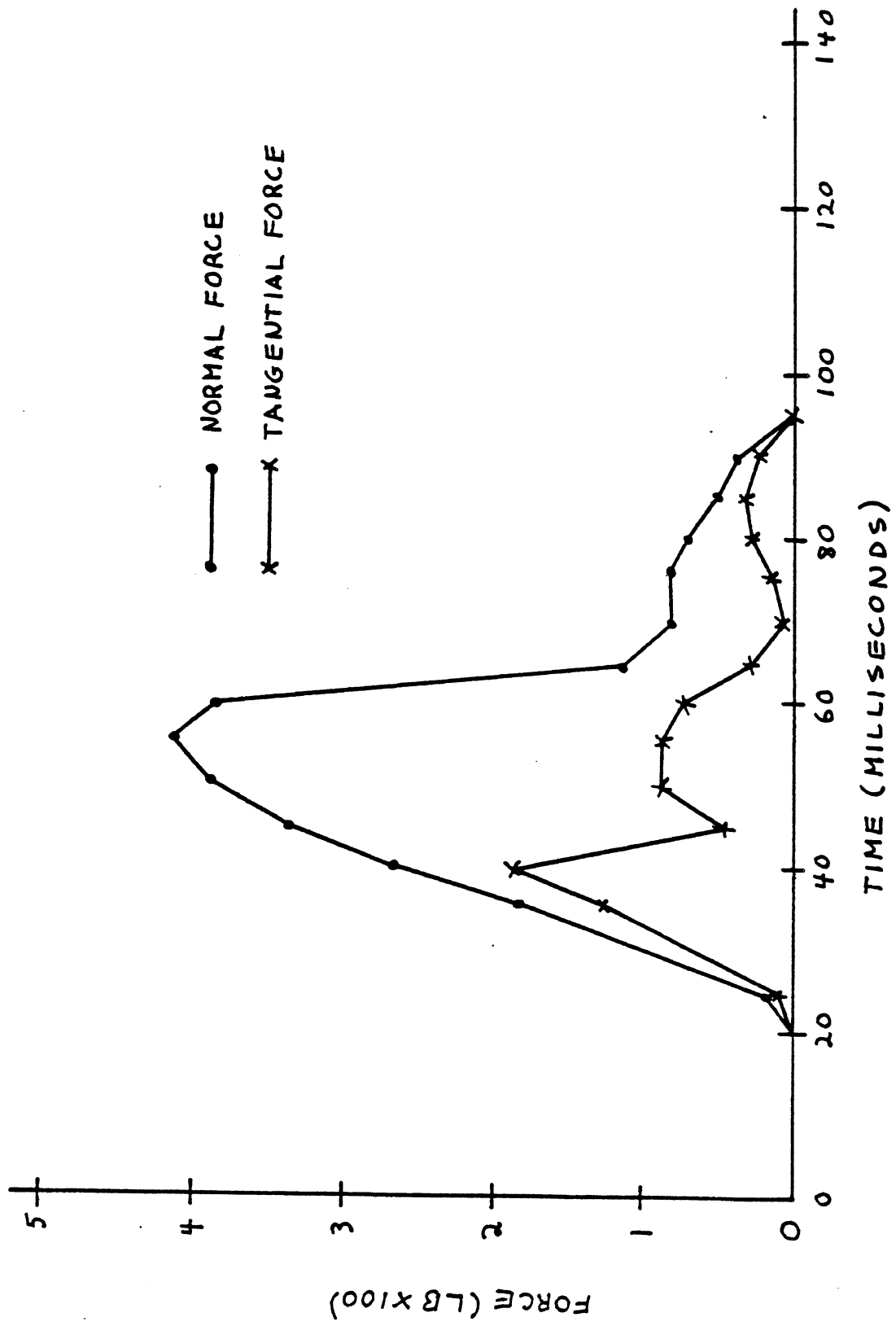

Figure 38. Force on Tibia from Bolster (Case No. 13).

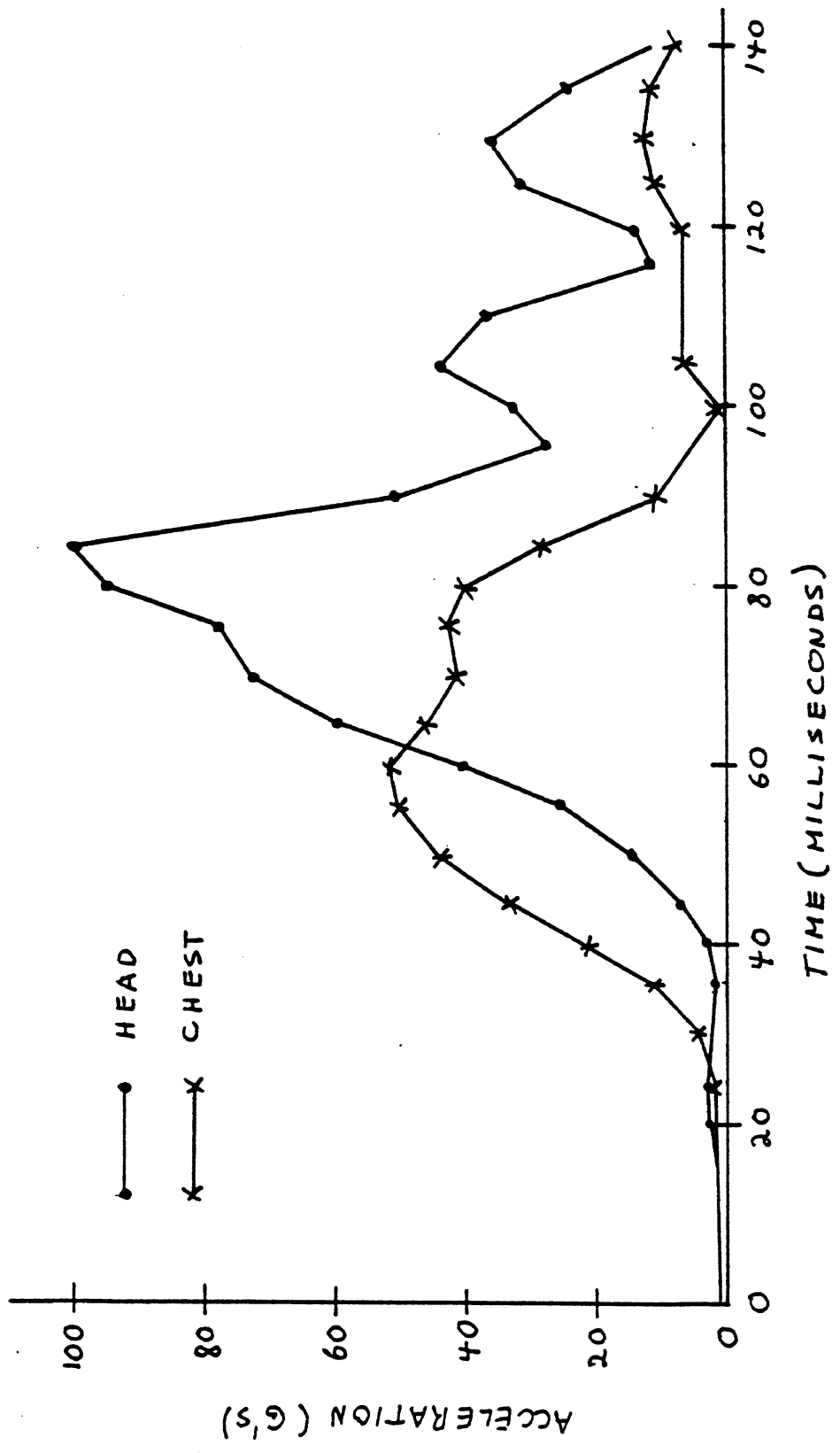

Figure 39. Head and Chest Accelerations (Case No. 13).

the farthest forward excursions of the body with the beginnings of rebound in the lower legs. The location of the arms and hands throughout the sequence should also be noted. The final drawing, Figure 35, shows complete rebound at a time of 160 milliseconds.

Figures 36-39 show some of the dynamic output results produced by the simulations. Interactions between the forearm and the steering wheel are shown in Figure 36. Although the magnitude of the initial spike is probably unrealistic from a human response point of view, the ability to feed force and energy into the body through this part in the linkage in a relatively continuous manner has been demonstrated. Refinement of the force-deflection curve for the steering column, which was used for this simulation, to reflect a softer material property for wheel rim deformation, would probably solve much of the problem. Similarly, the properties of elbow and shoulder joints could be refined, to include muscle tension effects and the mobility of the shoulder girdle. No well-researched data have been developed to this point in time for definition of shoulder girdle mobility. Figure 37 shows the major restraint effect on the chest due to the upper torso belt. Figure 38 shows the forces on the tibia due to contact with the bolster. This force is transmitted into the knee joints as a shear force. Within the limited scope of this project it was not possible to explore the intrusion of the knee bolster into the occupant compartment. This intrusion could have had a marked effect on the results. Figure 39 is a plot of head and chest accelerations. The peak head accelerations follow the peak chest accelerations which appear to be directly related to the application of the belt forces. This phasing relation is related to the pitching down of the head with respect to the upper torso. No evidence of contact of the head with the vehicle is evident.

4.4 Case No. 14. 1980 Chevrolet Chevette (Lateral Impact. 35 mph).

In this case a 1980 Chevrolet Chevette was struck in the side by a C/20 Chevy Van. Intrusion was extensive on the passenger's side. The female driver of the Chevette was wearing a lap-shoulder belt and sustained minimal injuries. A schematic of the accident scene is shown in Figure 40. Damage to the Chevette is shown in Figure 41. Although there was a spin by the subject vehicle, it appeared that the primary force vector was

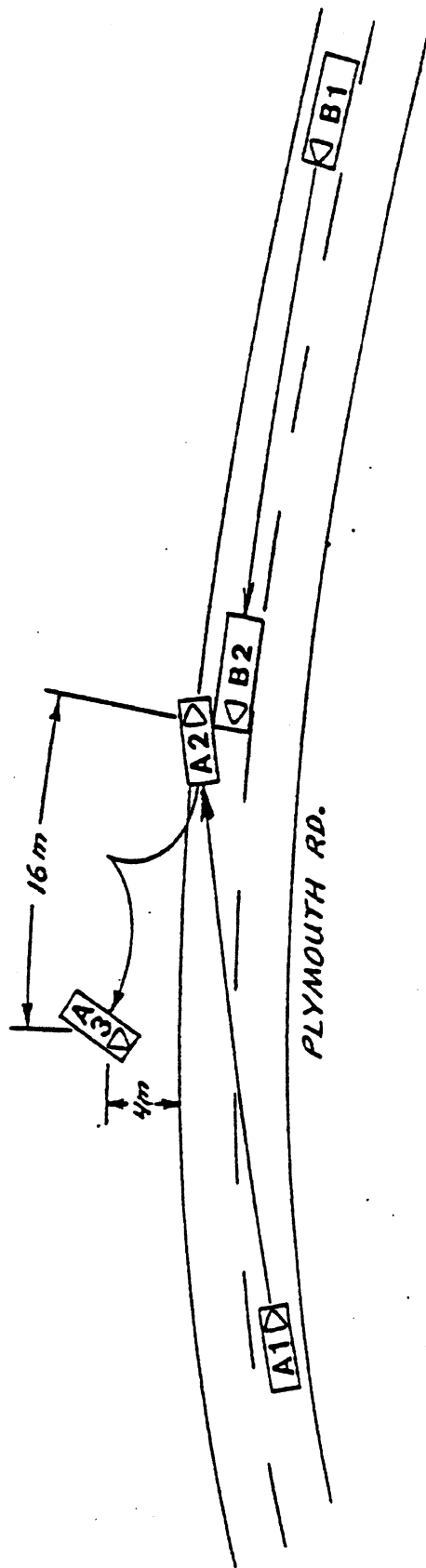

Figure 40. Schematic of Accident Scene (Case No. 14)

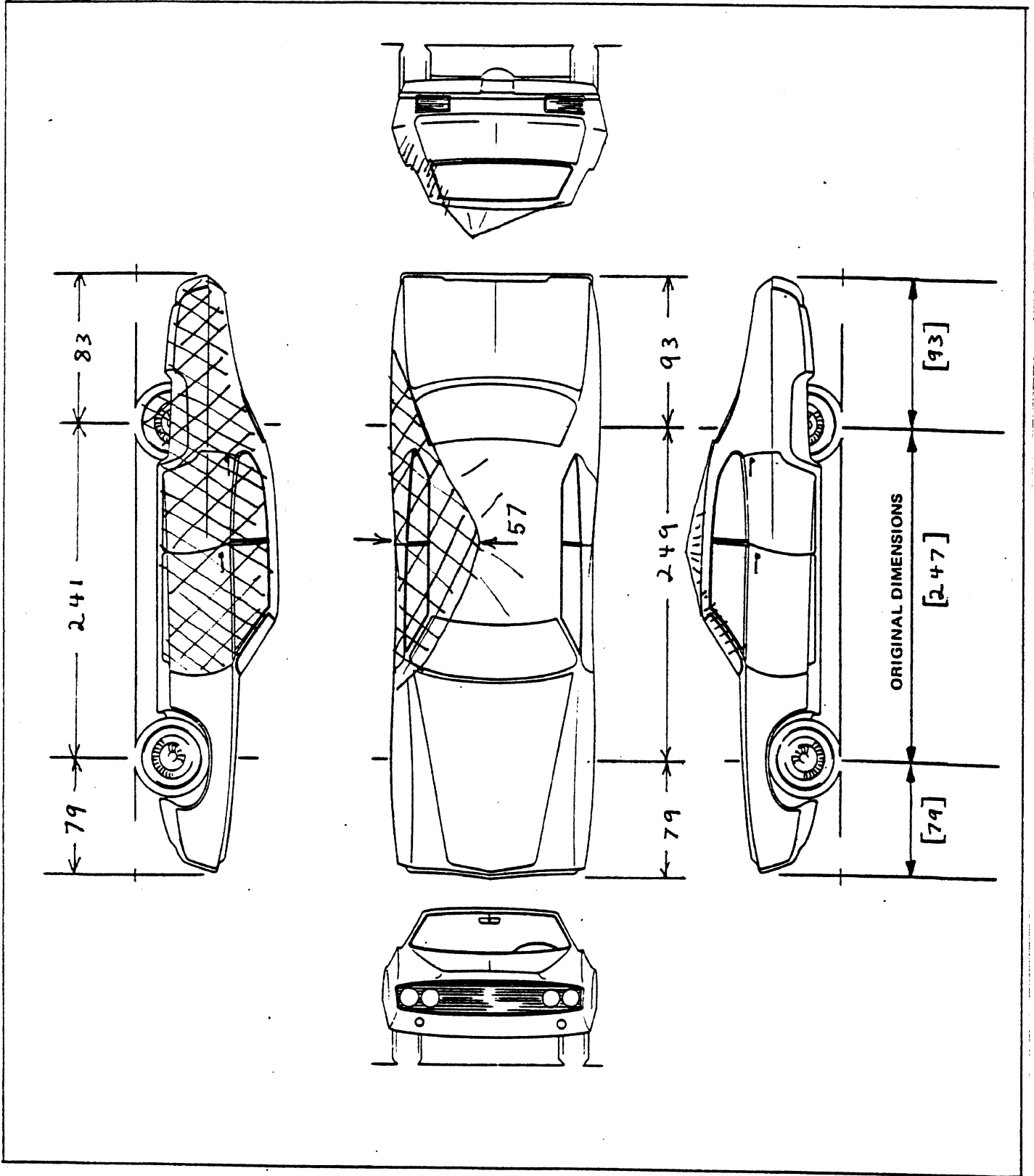
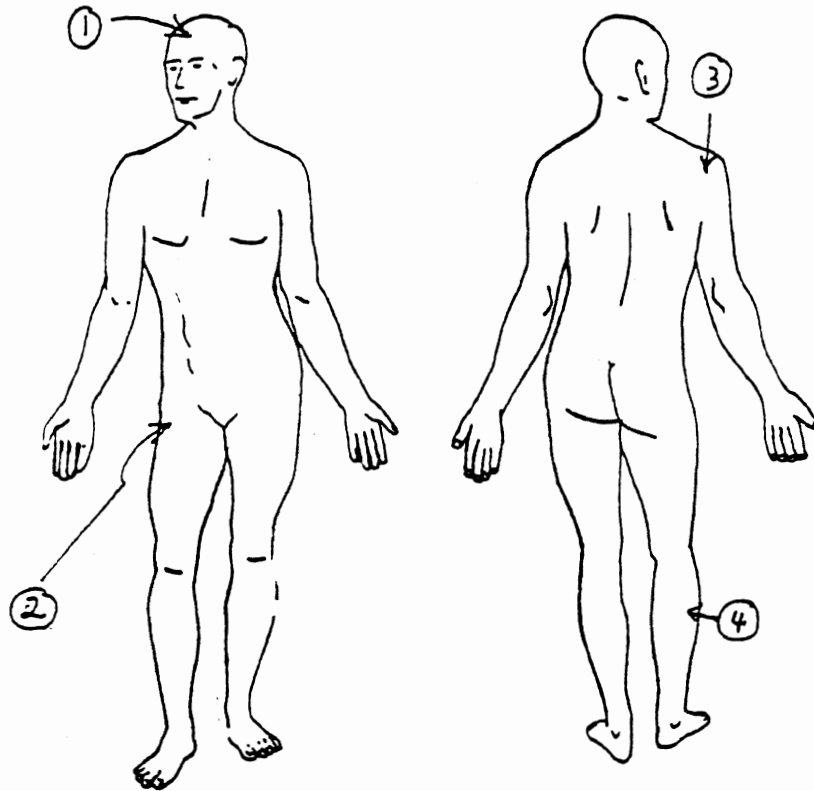

Figure 41. Vehicle Damage. (Case No. 14).

INDICATE LOCATION OF INJURIES, INCLUDING MAJOR BRUISES



1. Lac. Rt. Frontal Scalp
2. Cont. Rt. Proximal Anterior and Medial Thigh
3. Lac. Posterior Rt. Shoulder.
4. Cont. Rt. Calf

SOFT TISSUE INJURIES

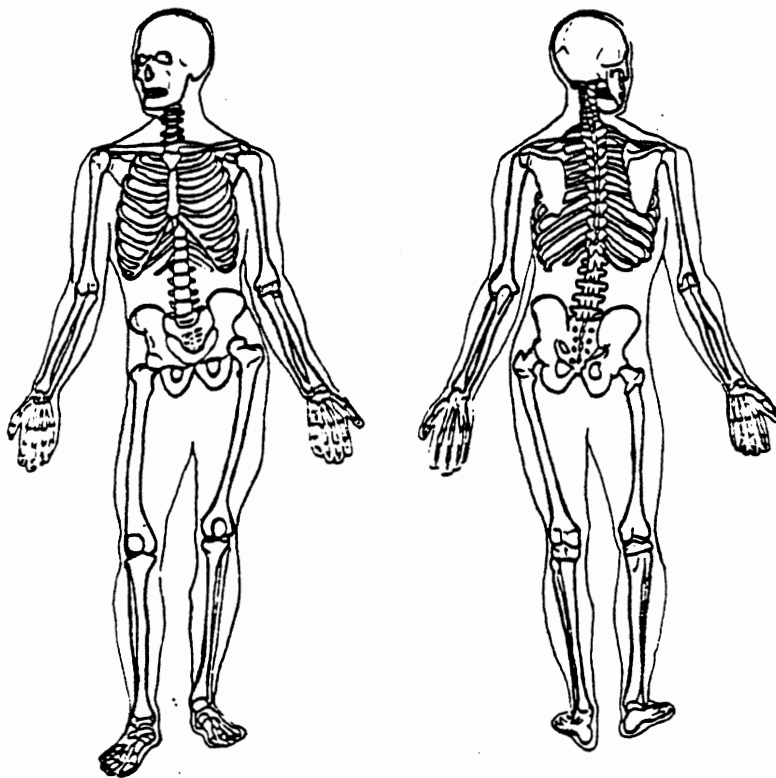

SKELETAL INJURIES

Figure 42. Occupant Injuries (Case No. 14).

lateral as judged by the exterior damage. The accident occurred on snow-covered and slippery surfaces. Based on the assumed lateral force vector, it was decided to attempt simulation of this case also using the MVMA-2D occupant motion simulation.

The lone female driver was wearing the 3-point restraint system. Upon impact she flexed to the right contacting the front right door and floor-mounted shift lever.

Damage was extensive to the right side of the passenger compartment. The floor-mounted T-bar shift lever was bent to the right by the driver causing its plastic housing to crack. Deformation of the right upper A-pillar crazed the right half of the windshield, deformed the header, bowed the right sunvisor and deformed the roof in the front right corner. The front right door intruded about 41 cm (16.14 in) damaging its latch housing and the front right seat cushion and seat adjuster. Its window sill was also contacted by the driver. The right B-pillar intruded about 46 cm (18.11 in) damaging the front right seat back and causing it to bend to the left behind the driver's seat back. Intrusion of the right roof side rail deformed the roof.

The driver sustained only minimal injuries as illustrated in Figure 42. These were apparently due to contacts with the right door, T-bar shift lever, and seat belt buckle.

Use of the CRASH II program yielded a lateral velocity change of 35 mph. This was represented as an acceleration in the form of a trapezoid with a total duration of 60 milliseconds and rise and decay times of 5 milliseconds. This was based on an estimate of the amount of time for the impacting vehicle to cause the intrusion and transfer its motion.

Procedures similar to the previous cases were used to define the vehicle interior geometry. Some direct vehicle measurements were necessary due to the unusual vehicle cross-section required for use in the simulation. Although the subject was not interviewed, height and weight were obtained from medical records:

- 21 years old
- 66 in. (167.6 cm.) stature
- 125 lb. (56.8 kg.) weight

In order to establish the occupant linkage, the baseline data included in the report by Robbins, et al (2) were used. The linkage dimensions, mass, and inertial properties were scaled to the size of the female driver. The door and window planes were located in the intruded position as contacts were believed to occur after the intrusion had taken place. A total of 12 inches of intrusion was included. This is an estimate based on the fact that maximum intrusion was located in the region of the B-pillar which is behind the simulated occupant motion plane. Figure 43 shows the resulting subject and vehicle geometry. The contact surfaces are labelled while the occupant ellipses and joint centers are defined in a table included in the figure. To begin to take account of the three-dimensional aspects of this problem using a projection of the rearview of the subject in a plane, the mobility of the body linkage has been defined as is shown in the sketch in the upper middle section of the figure. The elements of this linkage are:

- 1-2, the neck
- 2-3, chest
- 3-4, abdomen
- 4-5, pelvis
- 5-6, upper legs
- 6- , lower legs
- 2-9, shoulder girdle (Rigid link. The point 9 is mobile at the end of the link)
- 9-8, upper arm
- 8- , lower arm

It should be noted that contact between occupant ellipses and vehicle surfaces is selective. In other words, parts of the driver which are anticipated to contact vehicle components are allowed to generate force while others are not allowed. For example, the leg ellipses are allowed to contact the shift lever while this component is transparent to the torso ellipses. This flexibility of the contact algorithm in the MVMA-2D code makes it easier to account for the resulting quasi-three-dimensional effects.

Figures 43-47 show tracings of the simulated driver's position for several points in time during the impact. By 40 milliseconds (Figure 44), the legs and torso have contacted the transmission housing and/or the shifter. The belt is just beginning to exert force (It has been assumed that the driver slipped from under the upper torso portion of the 3-point belt system). Also, she is just beginning to pivot down toward the intruded door. Figure 45 shows that the driver has pivoted toward the door. The arm has just initiated contact which will peak in about 10 milliseconds. The belt is effectively restraining the torso from riding over the transmission housing. Figure 46 shows the occupant at 80 milliseconds. The torso has pitched over completely and the head has contacted the window. By the end of the simulation (Figure 47), the subject has rebounded showing the effects of the belts.

Figures 48-54 show some of the dynamic output results produced by the simulations. Figure 48 shows the force on the head produced during the window contact. The restraining effect of the belt forces is shown in Figure 49. The effect of the belts is to prevent the lower torso and extremities from completely riding over the transmission housing. The arm/shoulder interaction with the door is shown in Figure 50. Computer exercises using either more or less intrusion of the door resulted in higher or lower to no force of interaction. Figure 51 documents the interaction of the thighs and upper legs at the hip with the transmission housing. The location of the 3-point belt stalk by the housing and the minor injury suffered by the driver most likely resulted from this interaction. The interaction between the leg and shift lever is shown in Figure 52. It also occurs early in the dynamic event. Figures 53 and 54 show the lateral and vertical accelerations experienced by the dynamic linkage. In many cases the peaks correlate well with observed kinematic or dynamic events. Chest accelerations shift from lateral (40-60 milliseconds) to vertical (60-80 milliseconds) as the belt system and shift housing causes the torso to pitch toward the side. A clean spike shows up in the head lateral acceleration which correlates well with the interaction with the window. Head vertical accelerations appear to be larger than would be expected for a human. This could probably be corrected by including better data (if it

exists) for lateral bending of the neck and the effects of elongation caused by pitching violently toward the side of the vehicle.

Occupant Ellipses

- A = Head
- B = Upper Torso
- C = Center Torso
- D = Lower Torso
- E = Left Upper Leg
- F = Right Upper Leg
- G = Left Lower Leg
- H = Left Foot
- I = Right Foot
- J = Right Lower Leg
- K = Right Upper Arm
- L = Right Lower Arm

Occupant Joints

- 0 = Head C.G.
- 1 = Upper Neck Joint
- 2 = Lower Neck Joint
- 3 = Upper Spine Joint
- 4 = Lower Spine Joint
- 5 = Hip Joint
- 6 = Knee Joint
- 8 = Elbow Joint
- 9 = Shoulder Joint

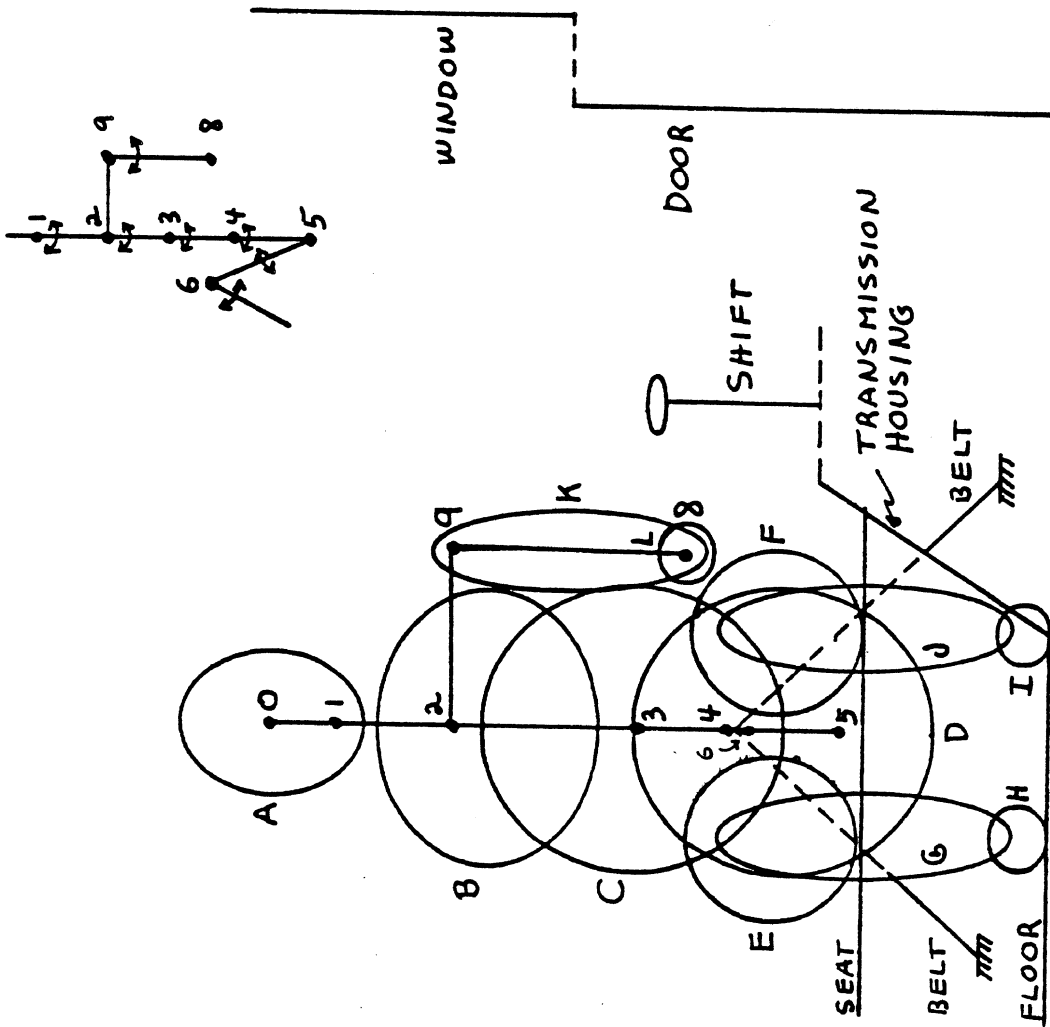

Figure 43. Vehicle Interior, Occupant Ellipses, Joint Location, and Occupant Position. 0 ms. (Case No. 14).

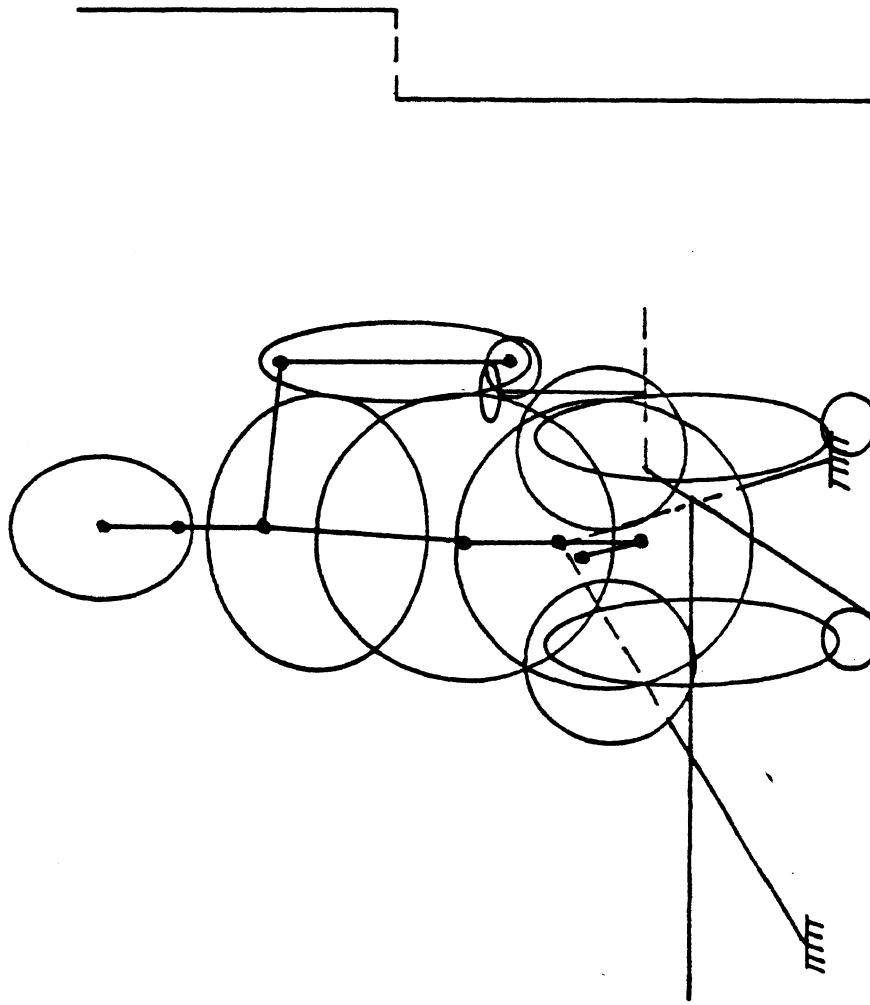

Figure 44. Occupant Position. 40 ms. (Case No. 14).

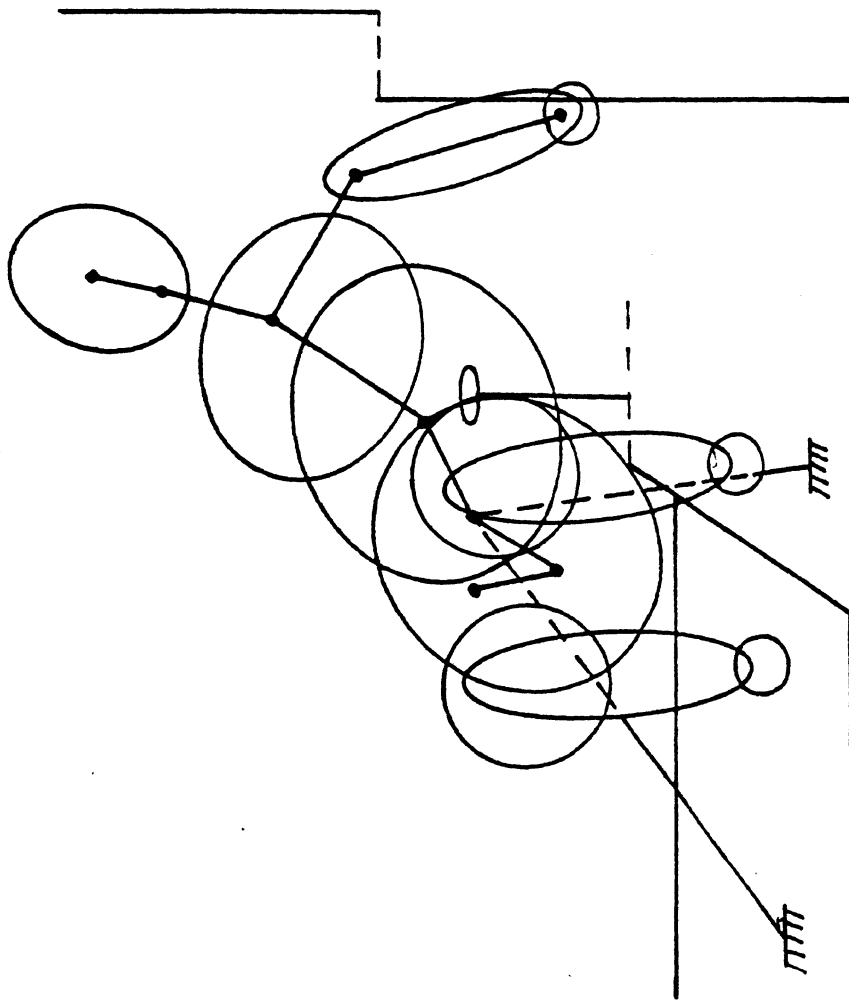

Figure 45. Occupant Position. 60 ms. (Case No. 14).

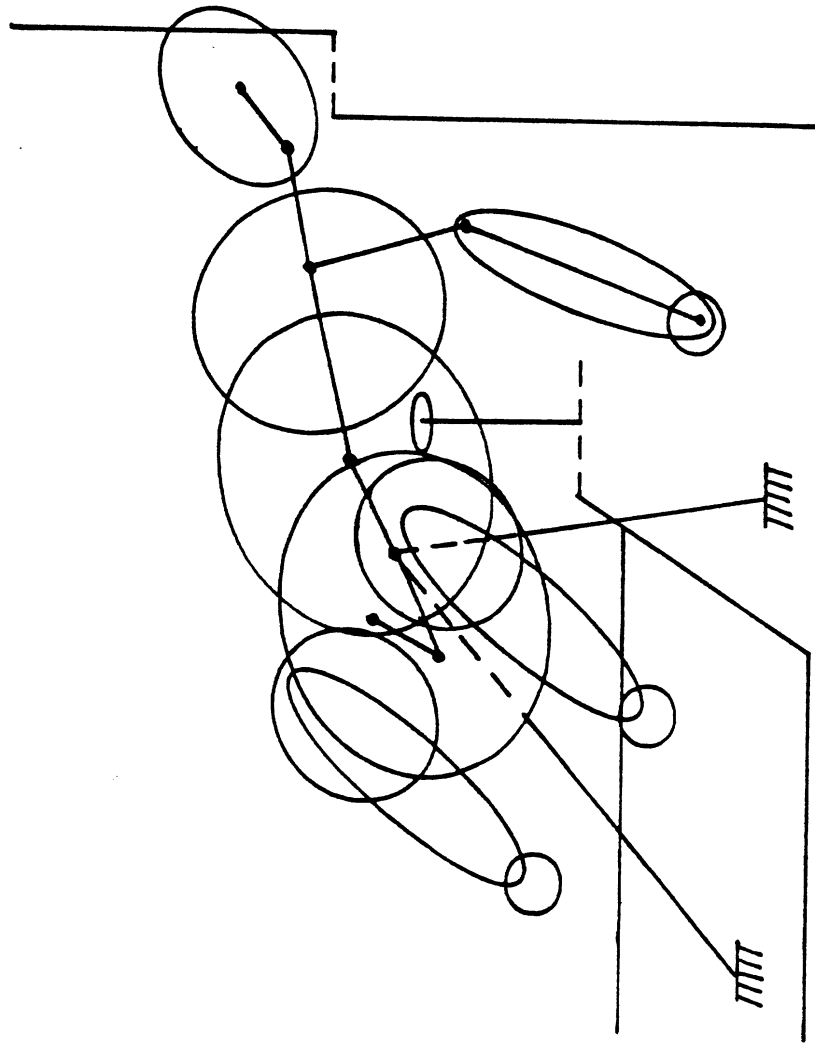

Figure 46. Occupant Position. 80 ms. (Case No. 14)

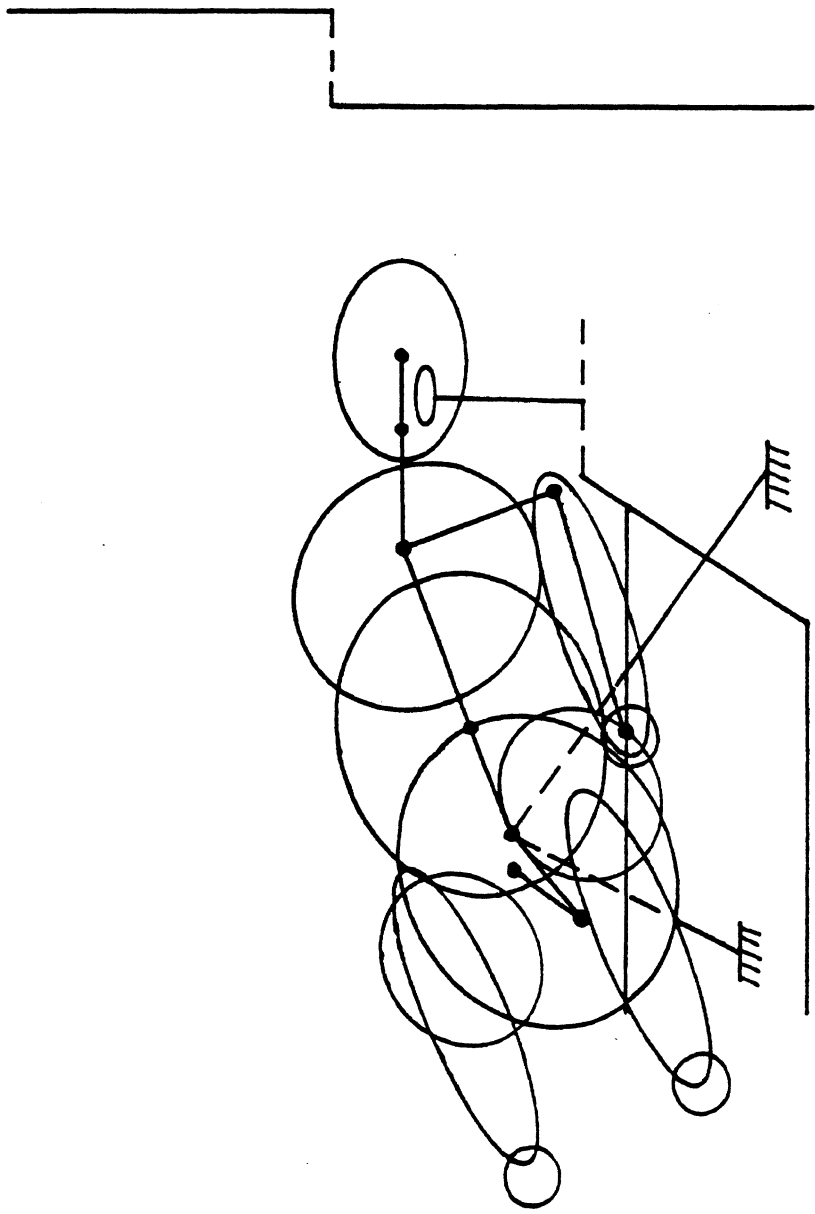

Figure 47. Occupant Position. 200 ms. (Case No. 14).

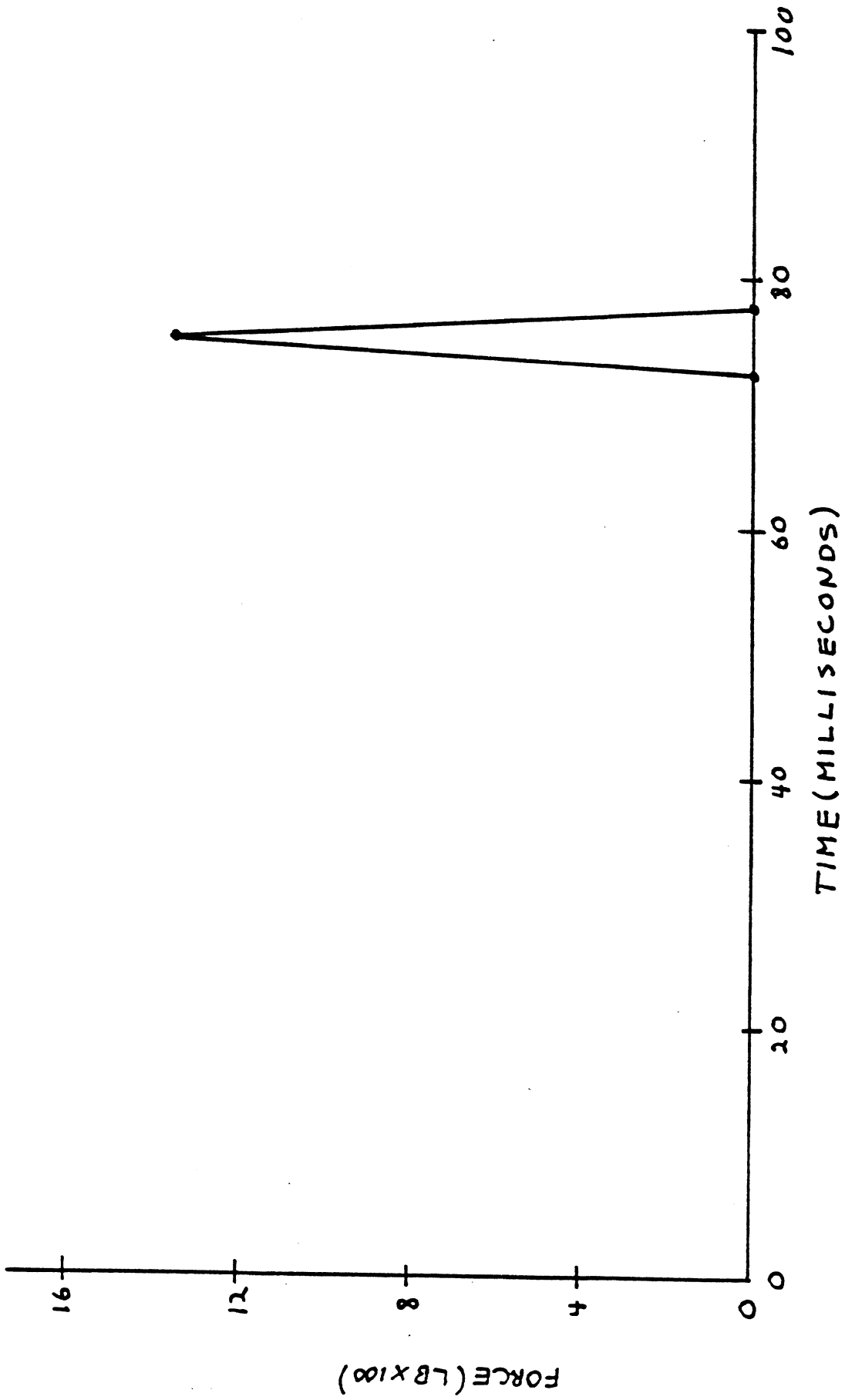

Figure 48. Force on Head from Window (Case No. 14)

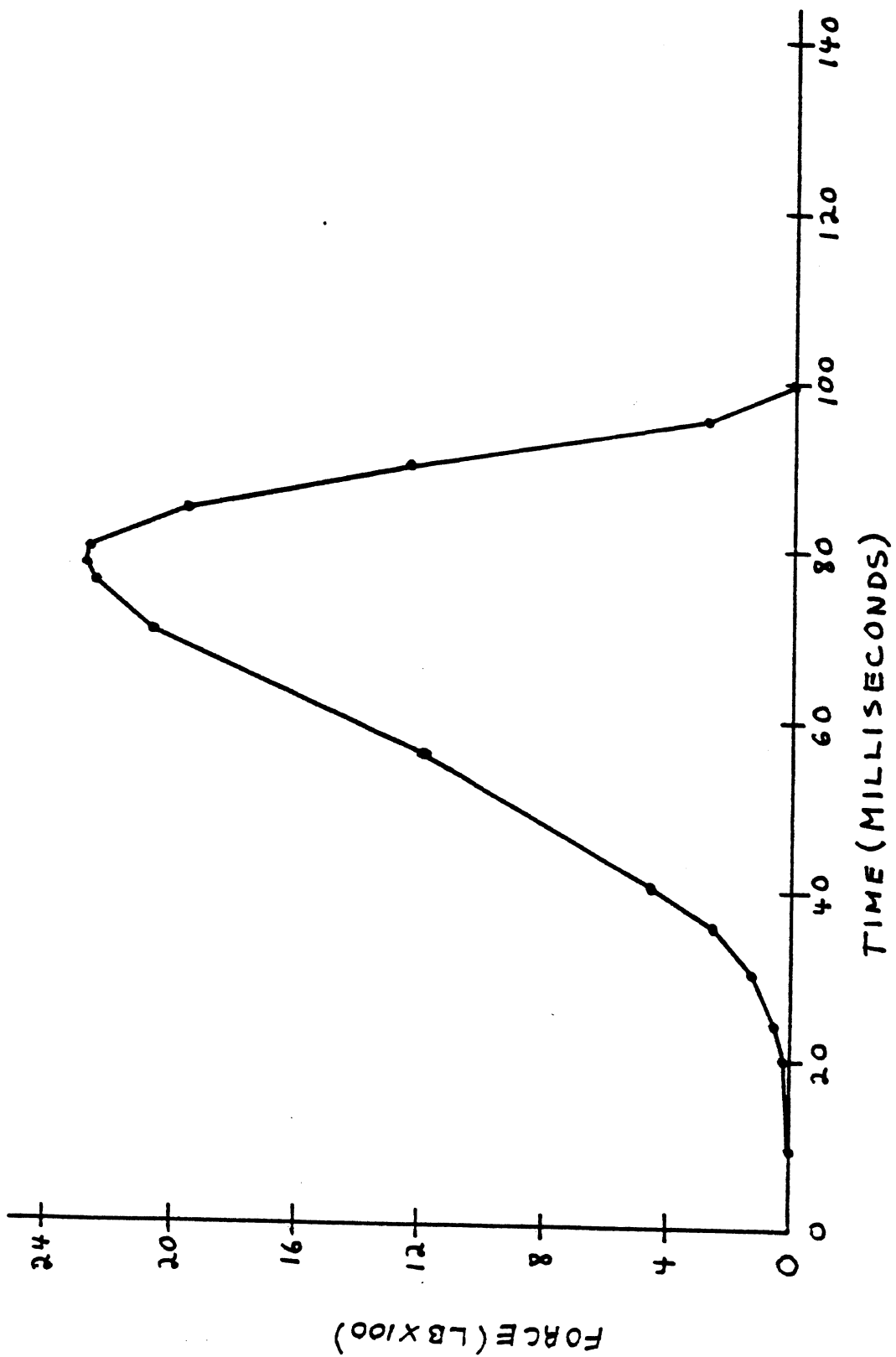

Figure 49. Belt Force (Case No. 14)

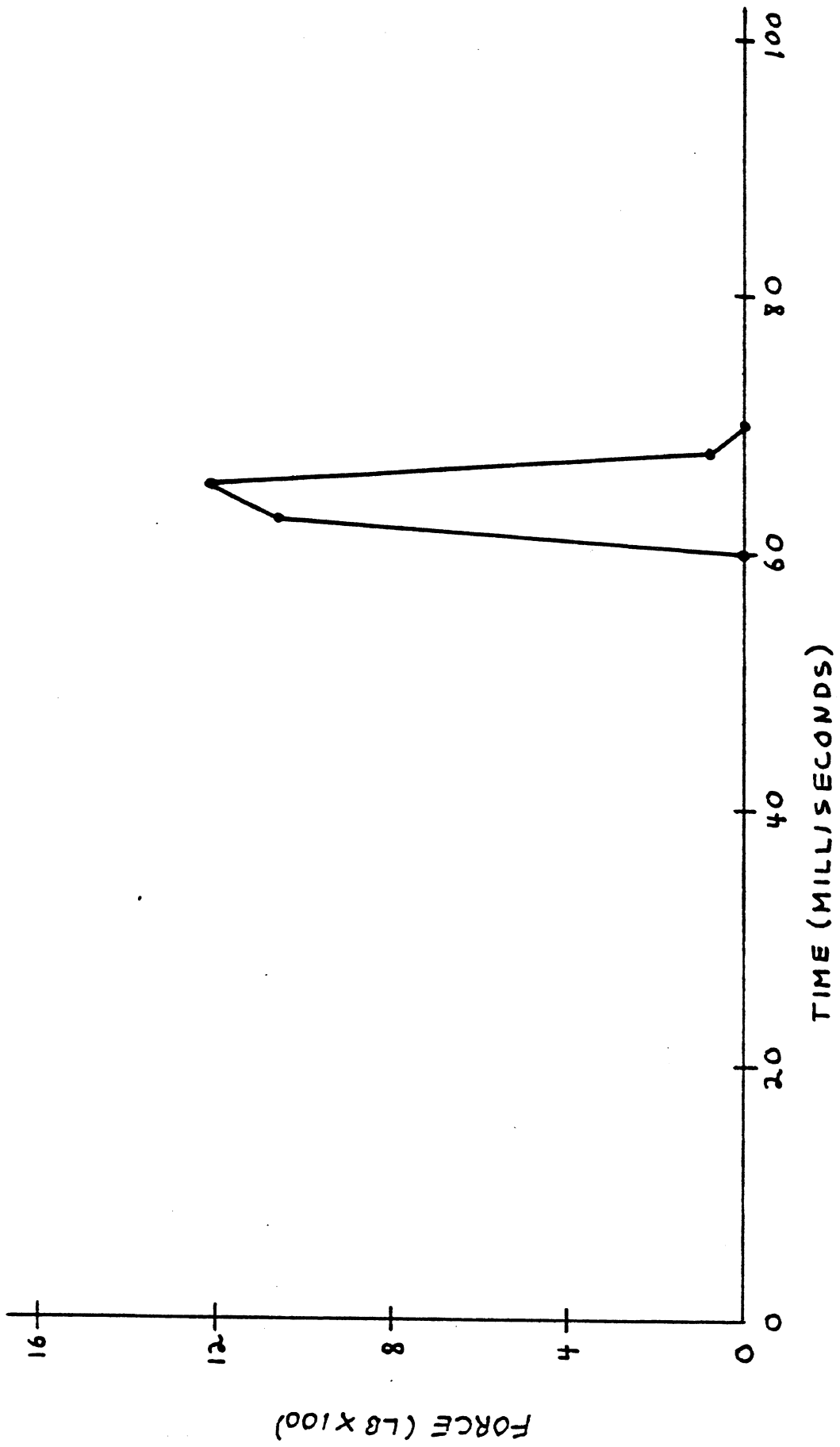

Figure 50. Force on Arm/Shoulder from Door (Case No. 14).

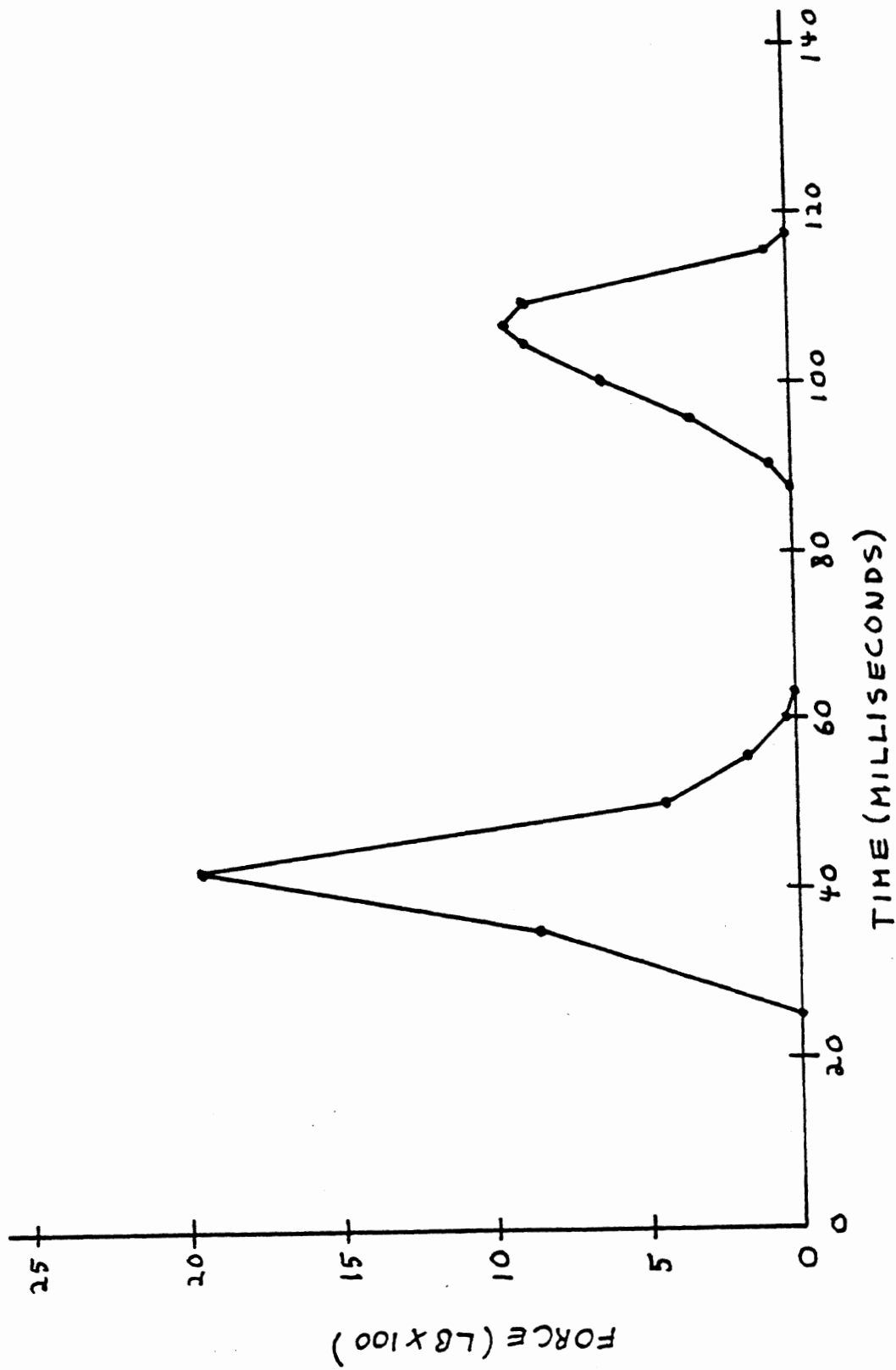

Figure 51. Force on Right Upper Leg from Transmission Housing (Case No. 14)

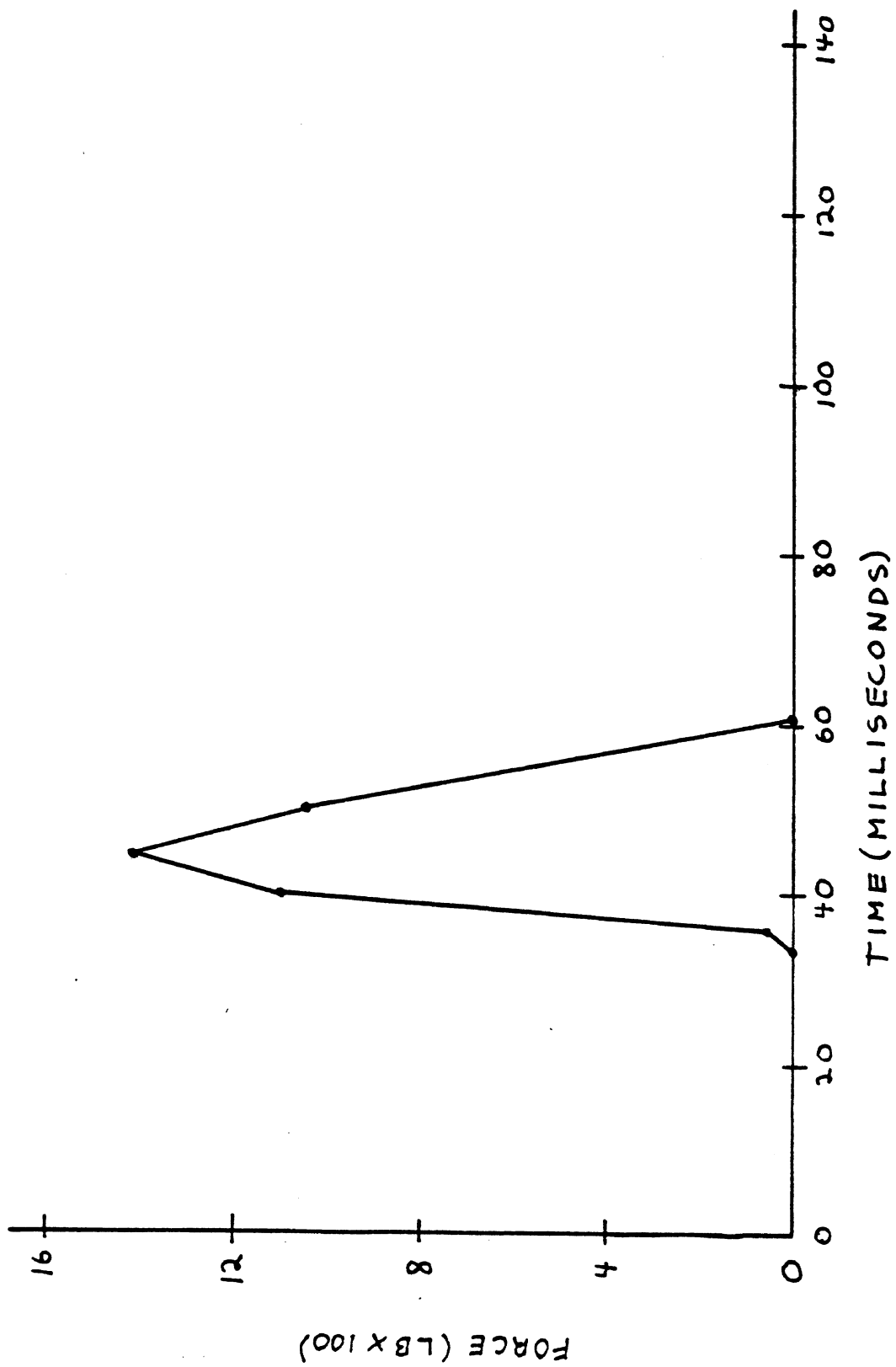

Figure 52. Force on Leg due to Shift Lever (Case No. 14).

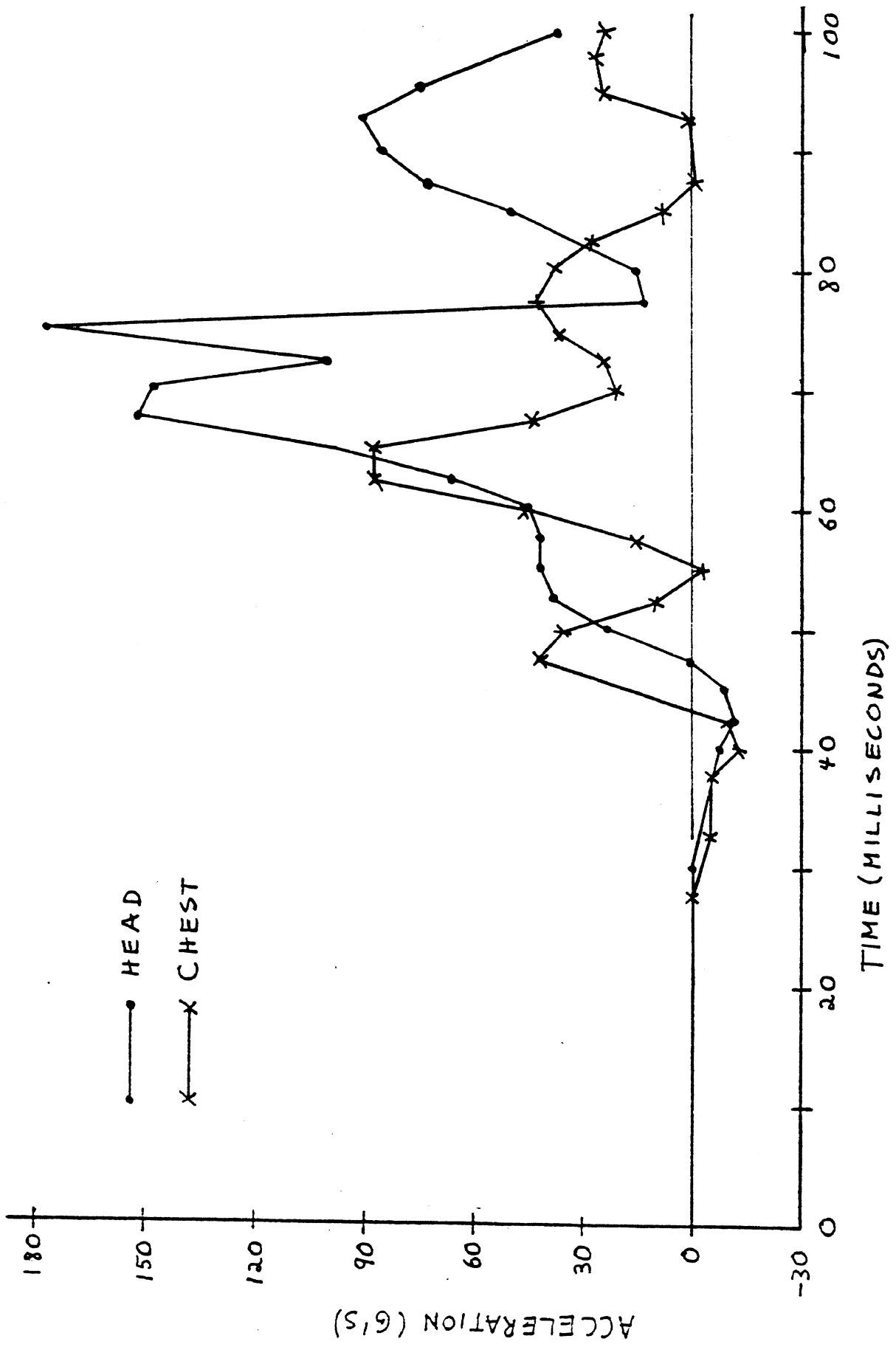

Figure 53. Head and Chest Vertical Accelerations (Case No. 14).

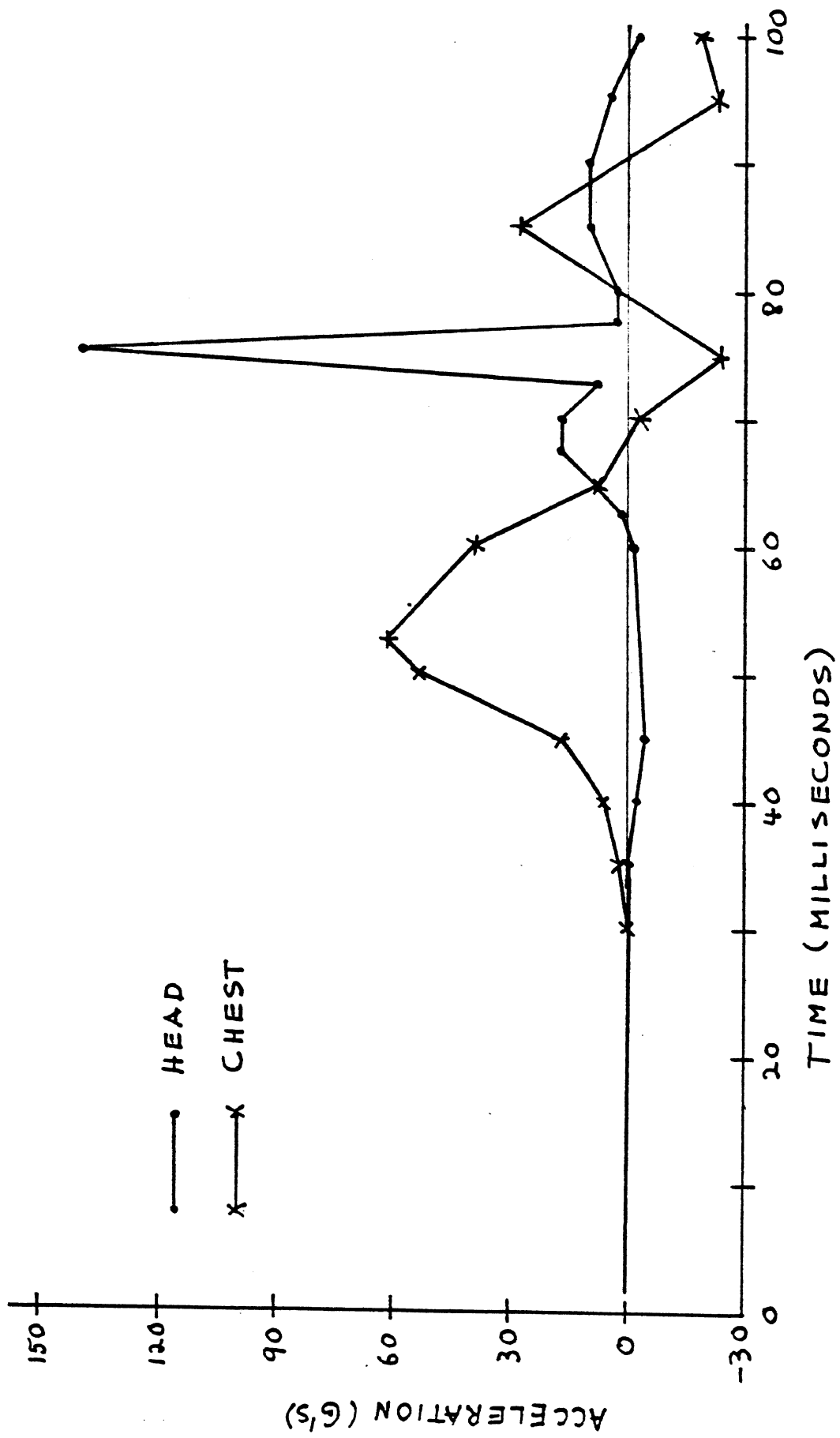

Figure 54. Head and Chest Lateral Accelerations (Case No. 14).

5.0 BIOMECHANICAL REVIEW OF RECONSTRUCTIONS

This section discusses the biomechanical aspects of the four reconstructions in terms of the accelerations of body regions, contact forces and resulting injuries. Comparisons are made between the results of the various reconstructions to highlight differences and similarities.

5.1 Case No. 9

This large, 35 year old male sustained significant head impacts against the header and windshield. The force levels of 1800-1900 lbs. associated with these impacts would not be expected to cause frontal bone skull fractures although they approach the lower limits of frontal fracture tolerance for flat impact surfaces. Similarly, the head accelerations associated with these two impacts are moderately severe (peaks near 120 G's). Additional head acceleration peaks around 80 G's are also present, and the entire head acceleration-time history (Figure 15) is characterized by significant time durations as well as acceleration magnitudes. This subject was concussed for 2-3 minutes.

The size and position of the subject and the vehicle interior geometry combined to produce a uniform contact of the chest squarely with the steering wheel. Although uniform, the loading was severe enough to fracture the sternum. The predicted load peak was approximately 2000 lbs. which is similar in magnitude to those produced by experimental studies on chest impact with cadavers. The chest accelerations associated with the impact were less than 50 G.

The contact of the subject's legs with the instrument panel produced an average force of 1300 lbs. in each femur and 1000 lbs. into each lower leg. This resulted in a total femur load of approximately 2300 lbs. in each leg as the lower leg force would be transmitted by shear to the upper leg. The lower leg load was close to tolerable values for knee joint ligamentous damage in cadavers. The subject was tall and had robust legs. Neither the average lower leg loads of 1000 lbs. nor the total femur loads of 2300 lbs. were likely near the tolerance of this subject.

The most severe injury sustained by the subject was a possible fractured larynx which has an AIS rating of 4. However, the forces and ac-

celerations generated in the head and chest impacts and the initiation of temporary brain dysfunction and chest structural integrity are indicative that the thresholds of severe injury for the subject's head and chest were being approached in this crash.

5.2 Case No. 10

This case involves a more severe frontal crash than in Case 9 (28.6 mph versus 22.9 mph) with an older, smaller male driver (50 years old) of a larger car. The contact of the head with the header was not as severe as the windshield contact, which produced a peak of 1600 lbs.--well below frontal bone fracture tolerance. The head acceleration associated with the windshield contact was higher than that of Case 9 (150 G peak) but with a lesser duration. Similar longer duration acceleration peaks around 80 G occurred late in both crashes. The subject was only briefly unconscious.

The contact of the subject's chest with the steering wheel was not as uniform or aligned as in Case 9 due to configurational differences in the vehicle interior and the subject positioning. A peak chest load of 1200 lbs. was produced. The fractures of the 8th and 9th ribs on the left side may have been due to the interaction of the bottom half of the steering wheel as shown in Figure 21. The age of the subject may also have had an influence on the production of skeletal damage at the lower load of 1200 lbs. Despite the lower load, the peak chest accelerations were slightly higher (55 G) than in Case 9.

The average femur contact force was 1550 lb. on each leg. The average tibial force was 900 lb. per leg and the total average femur load would be 2450 lb. per leg. The deformation of the instrument panel due to knee contact was greater on the left side and may have contributed to more of the load being carried by the right leg. The fracture of the right tibia occurred with a predicted load of at least 900 lbs. Both the age and the lesser lower leg development of their subject may have also influenced the initiation of this fracture at loads successfully sustained in Case 9. The subject also sustained a fracture of the right acetabulum, again at a load of at least 2450 lbs. but most likely greater than that. Both of these

load level ranges (900-1800 lbs. and 2450-4900 lbs.) are consistent with the tolerance limits derived from cadaver leg impacts.

5.3 Case 13

Unlike the previous two cases, this frontal crash involved a passively restrained driver (47 years old) at a much greater impact severity (36.7 mph). Due to the upper torso restraint belt, the head acceleration-time history was quite different from those of the previous cases. It was less abrupt in nature and had no contact spikes, although the peak reached 100 G. The duration of the waveform was much greater than the other two cases. No loss of consciousness was noted.

The upper torso belt loads reach 2600 lbs. during the crash without skeletal damage. This value is significantly greater than cadaver based limits for rib fracture due to belt loading.

The subject's lower leg geometry produced significant loading to the lower legs by contact with the knee bolster. The peak average force acting on each tibia was 2100 lbs., well above the level for ligamentous damage to cadaver knee joints. Both knee joints received ligament damage with the right tibial plateau sustaining a split fracture at these high load levels.

5.4 Case 14

This was a severe far-side impact involving a female driver restrained by a three-point belt system. The intrusion of the right side of the vehicle provided a significant head contact point which produced an abrupt 1350 lb. peak force to the head. The contact resulted in a laceration to the right frontal scalp of the subject. The load peak was well below skull fracture tolerance for a flat surface impact to the frontal bone. The lateral head accelerations were low except for the abrupt contact spike with a peak of 140 G. The vertical head accelerations were equally as high but with much greater duration during this contact. The subject was not concussed.

A significant impact force (1220 lbs. peak) was produced by contact of the right shoulder with the intruded vehicle interior. There are no biomechanical shoulder force data to compare this with, however.

This contact also produced very high chest accelerations although the realism of lateral shoulder response data for the model can not be validated at this time. Large loads were also predicted against the upper leg (2000 lbs.) and lower leg (1400 lbs.) by interaction with interior components. No significant injuries were produced, however.

6.0 CONCLUSIONS

1. A primary goal of this project was to combine state-of-the-art detailed accident investigation procedures, computerized vehicle crash and occupant motion modeling, and biomechanical analysis of human injury causation into a method for obtaining enhanced biomechanical data from vehicle crashes. This method involved organization of a multi-disciplinary team which investigated and analytically reconstructed four accident cases. The reconstructions, using largely preliminary data, were evaluated and the dynamic loadings predicted for application to the vehicle occupants yielded injury results which were generally within accepted ranges of known tolerance data.

2. Vehicle trajectories and resting positions after the accident must be documented completely, insofar as is possible, to allow a reasonable prediction of velocity change during impact, and hence, to allow a reasonable approximation for vehicle acceleration or position to be made as a function of time. Use of CRASH and SMAC programs are not reliable if this information is not available.

3. Improved force - deformation data for both vehicle components and the occupant would improve predictions of force and acceleration magnitudes, energy absorbed by segments of the human body, and as a result, the rebound.

4. The use of the interview of the injured vehicle occupant was very informative with respect to:

- details of the accident
- his or her physical size
- additional medical details of the injuries
- estimated driving posture in a vehicle essentially the same as the one involved in the crash

The subjects were very interested in the project and much more cooperative and useful than was originally estimated.

5. A data bank on human anthropometry should be established for use in studies such as this based on human dimensions, mass distribution, inertial properties, joint locations, joint mobility, and joint strength. Most of

the data available to the project was based on definitions and measurements made on anthropomorphic test devices. These data were particularly suspect for neck and shoulder mobility, flexibility, and elongation.

6. The analytical methodology provides a technique for adjusting parameters as new data become available. For example, these parameters, all required in the analytical reconstruction, could represent quantities relating to the vehicle dimensions, the accident definition, vehicle damage definitions, occupant anthropometry, and physical properties (strength, force-deformation) of the occupant or vehicle. In other words, a reconstruction is not lost after the first attempt. It can be improved upon either by the original team or, later, by others with more complete data.

7.0 REFERENCES

1. Bowman, B.M., Bennett, R.O., and Robbins, D.H., "MVMA Two-Dimensional Crash Victim Simulation, Version 4," 3 Vols., Report No. UM-HSRI-79-5, Highway Safety Research Institute, University of Michigan, Ann Arbor, June 1979.
2. Robbins, D.H. and Becker, J.M., "Baseline Data for Describing Occupant Side Impacts and Pedestrian Front Impacts in Two Dimensions," Report No. UM-HSRI-81-29, Highway Safety Research Institute, University of Michigan, Ann Arbor, June 1981.

APPENDIX

DATA SETS USED IN MVMA2D SIMULATIONS

1	MVMA ACCIDENT DATA RECONSTRUCTION. CASE NO. 1.									100
2	1.	1.	32.174	0.	0.	200.	.5	2.5	10.	101
3	0.	0.	0.	0.	0.	0.	.1	.000001	5.	102
4	FOOT		FLOOR							106
5	CHEST		STEERING WHEEL							106
5.5	CHEST		SEATBACK							106
6	ABDOMEN		STEERING WHEEL							106
7	HIP		CUSHION							106
8	FEMUR		CUSHION							106
8.2	FOREARM		BOLSTER							106
8.5	FOREARM		WINDSHIELD							106
9	ABDOMEN		SEATBACK							106
9.1	HEAD		ROOF							106
9.2	HEAD		HEADER							106
9.3	FOREARM		DASH							106
9.4	CHEST		RIMTOP							106
9.5	HEAD		RIMTOP							106
9.6	FEMUR		BOLSTER							106
9.7	TIBIA		BOLSTER							106
9.8	HEAD		DASH							106
9.9	HEAD		WINDSHIELD							106
10	0.	1.	1.	0.	0.	0.	0.	0.	0.	107
11	0.	0.	0.	0.	0.	0.	0.	0.	0.	108
12	0.	0.	0.	0.	0.	0.	0.	0.	0.	109
13	0.	0.	0.	0.	0.	0.	0.	0.	0.	110
14	0.	0.	0.	0.	0.	0.	0.	0.	0.	111
15	VICTIM NO. 1									200
16		13.9	6.75	5.0	17.5		13.6	4.69	.5	201
17	1.0	8.35	3.0	3.19	9.02	12.75	5.83	7.5	.5	202
18	.0267	.1320	.0225	.0741	.1237	.0568	.0275	.0280	.0100	203
19	.369	4.020	.725	2.738	2.227	2.932	.384	.792	.040	204
20	4.5	.014	0.	.0065	40.	.3	45.	-45.	.75	205
21	4.5	.014	0.	.0065	40.	.3	45.	-45.	.75	215
22	6.	.014	0.	.0065	40.	.3	50.	-90.	.75	206
23	6.	.014	0.	.0065	40.	.3	50.	-90.	.75	216
24	40.	.01	0.	.75	45.	.3	0.5	-44.5	.75	207
25	50.	.01	0.	.75	90.	.3	-6.5	-51.5	.75	208
26	15.	.03045	.00053	0.	300.	.3	0.	-105.	.75	209
27	.5	8.	0.	0.	100.	.3	144.	0.	.75	210
28	25.	0.	.006457	0.	400.	.3	155.	-60.	.75	211
29	12.2	0.	.006457	0.	100.	.3	0.	-134.	.75	212
30	100.	0.	0.	.059						242
31	500.	0.	0.	.100						213
32	20.	230.	0.	1.			1.		.75	214
33	0.	-27.	-22.	-29.	-46.5	67.5	-52.5	-52.		217
34	1.91	8.22		2.95	1.67	5.21	0.	2.23	0.	218
35	HIP				5.	1.				219
35.1	ABDOMEN				3.	1.				219
35.2	CHEST				2.	1.				219
37	HEAD				1.	1.				219
38	FEMUR				5.	1.				219
39	TIBIA				6.	1.				219
40	FOOT				6.	1.				219
40.5	FOREARM				8.	1.				219
41	HIP		-8.52	-1.	5.5	4.0				220
41.1	ABDOMEN		0.	-1.	7.	5.				220
41.2	CHEST		-2.19	0.	8.	4.25				220
43	HEAD		-1.5	0.	4.	4.				220
44	FEMUR		3.98	0.	7.5	2.				220
45	TIBIA		-9.75	-.5	3.75	2.				220

Case No. 9 Lynx Front Impact (1 of 4)

46	FOOT	6.	-3.	2.	3.75					220
46.2	FOREARM	0.	0.	5.	1.25					220
46.5										300
47	71.5	98.5	120.5	149.5	16.	-51.5	-29.	23.	71.5	301
48	-4.25	0.	-21.5	0.	4.25	0.				303
49	VEHICLE	INTERIOR								400
50	FLOOR	MATFL		0.	1.	1.	1.			401
51	DASH	MATDASH		0.	1.	1.	1.			401
52	BOLSTER	MATBOL		0.	1.	1.	1.			401
53	WINDSHIELD	MATWD		0.	1.	1.	1.			401
54	CUSHION	MATCH		0.	1.	1.	1.			401
55	SEATBACK	MATSB		0.	1.	1.	1.			401
55.1	HEADER	MATHD		0.	1.	1.	1.			401
55.2	ROOF	MATRF		0.	1.	1.	1.			401
55.5	STEERING WHEEL	MATSTW		0.	1.	1.	1.			401
55.6	RIMTOP	MATSTW		0.	1.	1.	1.			401
56	FLOOR	3.	4.	1.	0.	0.				402
57	DASH	2.	2.	1.	0.	0.				402
58	BOLSTER	1.	2.	1.	0.	0.				402
59	WINDSHIELD	1.	1.	1.	0.	0.				402
60	CUSHION	1.	3.	1.	0.	0.				402
61	SEATRACK	1.	2.	1.	0.	0.				402
61.1	HEADER	1.	6.	1.	0.	0.				402
61.2	ROOF	1.	2.	1.	0.	0.				402
61.5	STEERING WHEEL	1.	5.	1.	0.	0.				402
61.6	RIMTOP	1.	5.	1.	0.	0.				402
62	MATFL	0.	0.	0.	1000.	2000.	2400.	8000.		403
63	MATDASH	0.	0.	0.	1000.	2000.	0.	0.		403
64	MATBOL	0.	0.	0.	1000.	2000.	0.	0.		403
65	MATWD	0.	0.	0.	1000.	2000.	0.	0.		403
66	MATCH	0.	0.	0.	1000.	2000.	0.	0.		403
67	MATSB	0.	0.	0.	1000.	2000.	0.	0.		403
67.1	MATHD	0.	0.	0.	1000.	2000.	0.	0.		403
67.2	MATRF	0.	0.	0.	1000.	2000.	0.	0.		403
67.5	MATSTW	0.	0.	0.	1000.	2000.	0.	0.		403
68	MATFL	2.	0.	0.	0.	FLSTAT	INERZ	FLGR		404
69	MATDASH	2.	0.	0.	0.	DASHSTAT	INERZ	DASHGR		404
70	MATBOL	2.	0.	0.	0.	BOLSTAT	INERZ	BOLGR		404
71	MATWD	2.	0.	0.	0.	WDSTAT	INERZ	WDGR		404
72	MATCH	2.	0.	0.	0.	CHSTAT	INERZ	CHGR		404
73	MATSB	2.	0.	0.	0.	SBSTAT	INERZ	SBGR		404
73.1	MATHD	2.	0.	0.	0.	HDSTAT	INERZ	HDGR		404
73.2	MATRF	2.	0.	0.	0.	RFSTAT	INERZ	RFGR		404
73.5	MATSTW	2.	0.	0.	0.	STWSTAT	INERZ	STWGR		404
74	FLGR	-1.	.2							405
75	FLGR	-1.	.2							406
76	DASHGR	-1.	.8							405
77	DASHGR	-1.	.08							406
78	BOLGR	-1.	.8							405
79	BOLGR	-1.	.08							406
80	WDGR	-1.	.95							405
81	WDGR	-1.	.01							406
82	CHGR	-1.	.1							405
83	CHGR	-1.	.85							406
84	SBGR	-1.	.1							405
85	SBGR	-1.	.85							406
85.1	HDGR	-1.	.5							405
85.2	HDGR	-1.	.5							406
85.3	RFGR	-1.	.5							405
85.4	RFGR	-1.	.5							406

Case No. 9 Lynx Front Imnact (2 of 4)

85.5	STWGR	-1.	.95							405
85.6	STWGR	-1.	.05							406
86	FLSTAT	-1.	800.							407
87	DASHSTAT	-1.	441.24	-109.64	9.3813	0.17045				407
88	BOLSTAT	0.	0.							407
89	BOLSTAT	6.	5400.							407
90	WDSTAT	-1.	2000.							407
91	CHSTAT	-1.	147.	37.6	-74.48	22.16				407
92	SBSTAT	-1.	78.	-65.4	67.4	-29.4	4.28			407
92.05	STWSTAT	0.	0.							407
92.1	STWSTAT	.1	1562.							407
92.15	STWSTAT	.49	1875.							407
92.2	STWSTAT	.51	2500.							407
92.25	STWSTAT	.75	1875.							407
92.3	STWSTAT	1.5	1562.							407
92.35	STWSTAT	2.4	1000.							407
92.4	STWSTAT	3.9	750.							407
92.45	STWSTAT	8.	750.							407
92.5	STWSTAT	10.	10000.							407
92.6	HDSTAT	-1.	4000.							407
92.7	RFSTAT	0.	0.							407
92.8	RFSTAT	2.	2000.							407
92.9	RFSTAT	3.	13000.							407
93	INERZ	-1.	0.							408
94	FLOOR		FLOOR	20.	.25	1.	1.			409
95	TOEBOARD		FLOOR	20.	.25	1.	2.			409
96	TOEPAN		FLOOR	20.	.25	1.	3.			409
97	BOLSTERD		BOLSTER	4.	.25	1.	1.			409
98	MIDDLEDH		DASH	4.	.25	1.	1.			409
99	UPPERDH		DASH	4.	.25	-1.	2.			409
100	WINDSHIELD		WINDSHIELD	1.	.25	1.	1.			409
101	CUSHION		CUSHION	20.	.25	-1.	1.			409
102	SEATBACK		SEATBACK	20.	.25	-1.	1.			409
102.1	HEADER		HEADER	4.	.25	1.	1.			409
102.2	ROOF		ROOF	4.	.25	-1.	1.			409
102.5	STEERING WHEEL		STEERING WHEEL	2.	.25	1.	1.			409
102.6	RIMTOP		RIMTOP	2.	.25	1.	1.			409
103	FLOOR		1.							410
104	TOEBOARD		1.							410
105	TOEPAN		1.							410
106	BOLSTERD		1.							410
107	MIDDLEDH		1.							410
108	UPPERDH		1.							410
109	WINDSHIELD		1.							410
110	CUSHION		1.							410
111	SEATBACK		1.							410
111.1	HEADER		1.							410
111.2	ROOF		1.							410
111.5	STEERING WHEEL		1.							410
111.6	RIMTOP		1.							410
112	FLOOR	-1.	14.5	3.25	39.0	3.25				411
113	TOEBOARD	-1.	39.0	3.25	42.86	2.07				411
114	TOEPAN	-1.	42.86	2.07	46.2	-7.02				411
115	BOLSTERD	-1.	23.58	-16.83	36.22	-3.59				411
116	MIDDLEDH	-1.	26.2	-25.72	25.73	-14.54				411
117	UPPERDH	-1.	37.42	-25.72	23.0	-24.46				411
118	WINDSHIELD	-1.	18.64	-37.93	40.92	-24.46				411
119	CUSHION	-1.	20.9	-9.12	-1.1	-4.5				411
120	SEATBACK	-1.	-1.1	-4.5	-13.	-31.27				411
120.1	HEADER	-1.	12.0	-40.0	17.0	-37.93				411

Case No. 9 Lynx Front Impact (3 of 4)

120.2	ROOF		-1.	-1.95	-41.71	15.0	-40.53			411
120.5	STEERING WHEEL		-1.	20.02	-27.93	14.2	-15.09			411
120.6	RIMTOP		-1.	20.02	-27.93	19.19	-25.94			411
121	1.	1.	0.							412
122	1.	2.	.7							412
123	1.	3.	.2	0.						412
124	1.	4.	.8	.15						412
124.5	1.	5.	1.							412
124.6	1.	6.	.1							412
125	CRASH	22.9 MPH								600
126	0.	33.59	0.	0.	0.	0.	0.	0.	0.	601
127	5.	1.	0.							602
128	0.	0.	5.	-13.92	75.	-13.92	80.	0.		
129	200.	0.								
133										700
134										800
200										1000
1001	0, 1, 4-17, 21-32, 37, 40, 46-50, 45									1001
1002	0.	0.	0.	13.5	0.015					1003
1003	40.	60.	110.3	1.	0.85	201.	5.	5.		1004
1004	0.	0.	-30.	60.	-50.	20.	5.	0.		1500
1005	21.	0.	6.	0.	0.	0.	1.	0.	10.	1501
1006										1600

End of file

1	MVMA ACCIDENT DATA RECONSTRUCTION. CASE NO. 2.									100
2	1.	1.	32.174	0.	0.	200.	.5	2.5	10.	101
3	0.	0.	0.	0.	0.	0.	.1	.000001	5.	102
4	FOOT		FLOOR							106
5	CHEST		STEERING WHEEL							106
6	CHEST		SEATBACK							106
7	ABDOMEN		STEERING WHEEL							106
8	HIP		CUSHION							106
9	FEMUR		CUSHION							106
10	FOREARM		BOLSTER							106
11	FOREARM		WINDSHIELD							106
12	ABDOMEN		SEATBACK							106
13	HEAD		ROOF							106
14	HEAD		HEADER							106
15	FOREARM		DASH							106
16	CHEST		RIMTOP							106
17	HEAD		RIMTOP							106
17.5	HEADTOP		HEADER							106
18	FEMUR		BOLSTER							106
19	TIBIA		BOLSTER							106
20	HEAD		DASH							106
21	HEAD		WINDSHIELD							106
22	0.	1.	1.	0.	0.	0.	0.	0.	0.	107
23	0.	0.	0.	0.	0.	0.	0.	0.	0.	108
24	0.	0.	0.	0.	0.	0.	0.	0.	0.	109
25	0.	0.	0.	0.	0.	0.	0.	0.	0.	110
26	0.	0.	0.	0.	0.					111
27	SUBJECT NO. 2									200
28		12.6	4.6	4.2	15.8		10.3	3.5	1.4	201
29	.96	7.6	2.04	2.68	8.12	12.24	4.43	7.2	.5	202
30	.0232	.1148	.0196	.0645	.1076	.0494	.0239	.0244	.0087	203
31	.295	3.216	.58	2.19	1.782	2.346	.307	.634	.040	204
32	4.5	.014	0.	.0065	40.	.3	45.	-45.	.75	205
33	4.5	.014	0.	.0065	40.	.3	45.	-45.	.75	215
34	6.	.014	0.	.0065	40.	.3	50.	-90.	.75	206
35	6.	.014	0.	.0065	40.	.3	50.	-90.	.75	216
36	40.	.01	0.	.75	45.	.3	0.5	-44.5	.75	207
37	50.	.01	0.	.75	90.	.3	-6.5	-51.5	.75	208
38	15.	.03045	.00053	0.	300.	.3	0.	-105.	.75	209
39	.5	8.	0.	0.	100.	.3	144.	0.	.75	210
40	25.	0.	.006457	0.	400.	.3	60.	-155.	.75	211
41	12.2	0.	.006457	0.	100.	.3	0.	-134.	.75	212
42	100.	0.	0.	.059						242
43	500.	0.	0.	.100						213
44	20.	230.	0.	1.			1.		.75	214
45	0.	-24.4	-24.2	-19.4	-53.2	49.2	-70.8	-59.4		217
46	1.91	8.22		2.95	1.67	5.21	0.	2.23	0.	218
47	HIP				5.	1.				219
48	ABDOMEN				3.	1.				219
49	CHEST				2.	1.				219
50	HEAD				1.	1.				219
50.5	HEADTOP				1.	1.				219
51	FEMUR				5.	1.				219
52	TIBIA				6.	1.				219
53	FOOT				6.	1.				219
54	FOREARM				8.	1.				219
55	HIP		-7.2	-.2	7.2	3.8				220
56	ABDOMEN		.5	-3.4	4.8	4.8				220
57	CHEST		-.7	-1.	6.9	4.7				220
58	HEAD		-3.	0.	5.15	5.15				220

Case No. 10 Oldsmobile Front Pole Impact (1 of 4)

58.5	HEADTOP	-8.5	0.	.5	.5					220
59	FEMUR	5.	0.	5.7	2.7					220
60	TIBIA	-10.4	0.	3.4	2.5					220
61	FOOT	7.5	-1.9	1.2	4.5					220
62	FOREARM	0.	0.	4.8	1.3					220
63	SLUMPED HUMAN									300
64	78.	102.4	126.6	146.	19.2	-30.	-6.8	52.6	78.	301
65	-3.9	0.	-23.8	0.	4.	0.				303
66	VEHICLE INTERIOR									400
67	FLOOR	MATFL		0.	1.	1.	1.			401
68	DASH	MATDASH		0.	1.	1.	1.			401
69	BOLSTER	MATBOL		0.	1.	1.	1.			401
70	WINDSHIELD	MATWD		0.	1.	1.	1.			401
71	CUSHION	MATCH		0.	1.	1.	1.			401
72	SEATBACK	MATSB		0.	1.	1.	1.			401
73	HEADER	MATHD		0.	1.	1.	1.			401
74	ROOF	MATRF		0.	1.	1.	1.			401
75	STEERING WHEEL	MATSTW		0.	1.	1.	1.			401
76	RIMTOP	MATSTW		0.	1.	1.	1.			401
77	FLOOR		3.	4.	1.	0.	0.			402
78	DASH		2.	2.	1.	0.	0.			402
79	BOLSTER		1.	2.	1.	0.	0.			402
80	WINDSHIELD		1.	1.	1.	0.	0.			402
81	CUSHION		1.	3.	1.	0.	0.			402
82	SEATBACK		1.	2.	1.	0.	0.			402
83	HEADER		1.	6.	1.	0.	0.			402
84	ROOF		1.	2.	1.	0.	0.			402
85	STEERING WHEEL		1.	5.	1.	0.	0.			402
86	RIMTOP		1.	5.	1.	0.	0.			402
87	MATFL		0.	0.	0.	1000.	2000.	2400.	8000.	403
88	MATDASH		0.	0.	0.	1000.	2000.	0.	0.	403
89	MATBOL		0.	0.	0.	1000.	2000.	0.	0.	403
90	MATWD		0.	0.	0.	1000.	2000.	0.	0.	403
91	MATCH		0.	0.	0.	1000.	2000.	0.	0.	403
92	MATSB		0.	0.	0.	1000.	2000.	0.	0.	403
93	MATHD		0.	0.	0.	1000.	2000.	0.	0.	403
94	MATRF		0.	0.	0.	1000.	2000.	0.	0.	403
95	MATSTW		0.	0.	0.	1000.	2000.	0.	0.	403
96	MATFL		2.	0.	0.	0.	FLSTAT	INERZ	FLGR	404
97	MATDASH		2.	0.	0.	0.	DASHSTAT	INERZ	DASHGR	404
98	MATBOL		2.	0.	0.	0.	BOLSTAT	INERZ	BOLGR	404
99	MATWD		2.	0.	0.	0.	WDSTAT	INERZ	WDGR	404
100	MATCH		2.	0.	0.	0.	CHSTAT	INERZ	CHGR	404
101	MATSB		2.	0.	0.	0.	SBSTAT	INERZ	SBGR	404
102	MATHD		2.	0.	0.	0.	HDSTAT	INERZ	HDGR	404
103	MATRF		2.	0.	0.	0.	RFSTAT	INERZ	RFGR	404
104	MATSTW		2.	0.	0.	0.	STWSTAT	INERZ	STWGR	404
105	FLGR	-1.	.2							405
106	FLGR	-1.	.2							406
107	DASHGR	-1.	.8							405
108	DASHGR	-1.	.08							406
109	BOLGR	-1.	.8							405
110	BOLGR	-1.	.08							406
111	WDGR	-1.	.95							405
112	WDGR	-1.	.01							406
113	CHGR	-1.	.1							405
114	CHGR	-1.	.85							406
115	SBGR	-1.	.1							405
116	SBGR	-1.	.85							406
117	HDGR	-1.	.5							405

Case No. 10 Oldsmobile Front Pole Impact (2 of 4)

118	HDGR	-1.	.5							406
119	RFGR	-1.	.5							405
120	RFGR	-1.	.5							406
121	STWGR	-1.	.95							405
122	STWGR	-1.	.05							406
123	FLSTAT	-1.	800.							407
124	DASHSTAT	-1.	441.24	-109.64	9.3813	0.17045				407
125	BOLSTAT	0.	0.							407
126	BOLSTAT	6.	5400.							407
127	WDSTAT	-1.	2000.							407
128	CHSTAT	-1.	147.	37.6	-74.48	22.16				407
129	SBSTAT	-1.	78.	-65.4	67.4	-29.4	4.28			407
130	STWSTAT	0.	0.							407
131	STWSTAT	.1	1562.							407
132	STWSTAT	.49	1875.							407
133	STWSTAT	.51	2500.							407
134	STWSTAT	.75	1875.							407
135	STWSTAT	1.5	1562.							407
136	STWSTAT	2.4	1000.							407
137	STWSTAT	3.9	750.							407
138	STWSTAT	8.	750.							407
139	STWSTAT	10.	10000.							407
140	HDSTAT	-1.	4000.							407
141	RFSTAT	0.	0.							407
142	RFSTAT	2.	2000.							407
143	RFSTAT	3.	13000.							407
144	INERZ	-1.	0.							408
145	FLOOR		FLOOR	20.	.25	-1.	1.			409
146	TOEBOARD		FLOOR	20.	.25	1.	2.			409
147	TOEPAN		FLOOR	20.	.25	1.	3.			409
148	BOLSTERD		BOLSTER	4.	.25	1.	1.			409
149	MIDDLEDH		DASH	4.	.25	1.	1.			409
150	UPPERDH		DASH	4.	.25	-1.	2.			409
151	WINDSHIELD		WINDSHIELD	1.	.25	1.	1.			409
152	CUSHION		CUSHION	20.	.25	-1.	1.			409
153	SEATBACK		SEATBACK	20.	.25	-1.	1.			409
154	HEADER		HEADER	4.	.25	1.	1.			409
155	ROOF		ROOF	4.	.25	1.	1.			409
156	STEERING WHEEL		STEERING WHEEL	2.	.25	1.	1.			409
157	RIMTOP		RIMTOP	2.	.25	1.	1.			409
158	FLOOR		1.							410
159	TOEBOARD		1.							410
160	TOEPAN		1.							410
161	BOLSTERD		1.							410
162	MIDDLEDH		1.							410
163	UPPERDH		1.							410
164	WINDSHIELD		1.							410
165	CUSHION		1.							410
166	SEATBACK		1.							410
167	HEADER		1.							410
168	ROOF		1.							410
169	STEERING WHEEL		1.							410
170	RIMTOP		1.							410
171	FLOOR	-1.	20.	-4.73	35.84	-4.73				411
172	TOEBOARD	-1.	35.84	-4.73	44.	-13.				411
173	TOEPAN	-1.	44.	-13.	44.	-25.				411
174	BOLSTERD	-1.	21.36	-29.9	28.03	-18.6				411
175	MIDDLEDH	-1.	21.36	-29.9	22.5	-33.4				411
176	UPPERDH	-1.	22.5	-33.4	31.65	-32.1				411
177	WINDSHIELD	-1.	10.65	-45.2	31.65	-32.1				411

Case No. 10 Oldsmobile Front Pole Impact (3 of 4)

178	CUSHION	-1.	16.5	-14.5	-3.2	-8.				411
179	SEATBACK	-1.	2.	-5.	-13.	-31.27				411
180	HEADER	-1.	7.7	-45.2	9.7	-44.3				411
181	ROOF	-1.	-20.	-46.5	7.25	-46.5				411
182	STEERING WHEEL	-1.	15.15	-35.4	10.35	-20.6				411
183	RIMTOP	-1.	15.15	-35.4	14.53	-33.5				411
184	1.	1.	0.							412
185	1.	2.	.7							412
186	1.	3.	.2	0.						412
187	1.	4.	.8	.15						412
188	1.	5.	1.							412
189	1.	6.	.1							412
190	CRASH 28.6 MPH									600
191	0.	41.95	0.	0.	0.	0.	0.	0.	0.	601
192	18.	1.	0.							602
193	0.	0.	5.	-5.02	10.	-9.85	15.	-14.3		
194	20.	-18.2	25.	-21.4	30.	-23.78	35.	-25.25		
195	40.	-25.74	45.	-25.25	50.	-23.78	55.	-21.4		
196	60.	-18.2	65.	-14.3	70.	-9.85	75.	-5.02		
197	80.	0.	200.	0.						
198										700
199										800
200										1000
1001	0, 1, 4-17, 21-32, 37, 40, 46-50, 45									1001
1002	0.	0.	0.	13.5	0.015					1003
1003	40.	60.	110.3	1.	.85	201.	5.	5.		1004
1004	0.	0.	-30.	50.	-50.	0.	5.	0.		1500
1005	21.	0.	0.	0.	0.	0.	1.	0.	10.	1501
1006										1600

End of file

1	MVMA ACCIDENT DATA RECONSTRUCTION. CASE NO. 13.									100
2	1.	0.	32.174	0.	0.	200.	.5	5.	10.	101
3	3.	0.	0.	0.	0.	0.	10.	.000001	5.	102
4	FOOT		FLOOR							106
5	CHEST		STEERING WHEEL							106
6	CHEST		SEATBACK							106
7	ABDOMEN		STEERING WHEEL							106
8	HIP		CUSHION							106
9	FEMUR		CUSHION							106
10	FOREARM		STEERING WHEEL							106
11	ABDOMEN		SEATBACK							106
12	HEAD		ROOF							106
13	FOREARM		INST.PANEL							106
14	HEAD		STEERING WHEEL							106
15	FEMUR		BOLSTER							106
16	TIBIA		BOLSTER							106
17	HEAD		INST.PANEL							106
18	HEAD		WINDSHIELD							106
19	0.	1.	1.	0.	0.	0.	0.	0.	0.	107
20	0.	0.	0.	0.	0.	0.	0.	0.	1.	108
21	1.	1.	0.	0.	0.	0.	0.	0.	0.	109
22	0.	0.	0.	0.	0.	1.	1.	1.	1.	110
23	0.	0.	0.	0.	0.	0.	0.	0.	0.	111
24	SUBJECT NO. 13									200
25	14.5	4.15	3.6	16.35		11.55	4.5	-.3		201
26	2.4	8.5	1.4	.7	8.3	9.2	5.	6.3	.5	202
27	.0265	.1454	.0142	.069	.1077	.0593	.0223	.0266	.0059	203
28	.22	3.211	.105	1.048	2.593	.609	.244	.616	.019	204
29	25.	.500	0.	.0065	40.	30.		-45.	.75	205
30	25.	.500	0.	.0065	40.	30.	45.		.75	215
31	25.	.500	0.	.0065	40.	30.		-45.	.75	206
32	25.	.500	0.	.0065	40.	30.	45.		.75	216
33	40.	.01	0.	.75	45.	30.	0.5	-44.5	.75	207
34	50.	.01	0.	.75	90.	90.	-6.5	-51.5	.75	208
35	15.	.03045	.00053	0.	300.	200.	0.	-105.	.75	209
36	.5	8.	0.	0.	100.	100.	144.	0.	.75	210
37	25.	0.	.006457	0.	400.	300.	155.	-60.	.75	211
38	12.2	0.	.006457	0.	100.	100.	0.	-134.	.75	212
39	500.	0.	0.	.1						242
40	500.	0.	0.	.100						213
41	20.	230.	0.	1.			1.		.75	214
42	-15.1	-11.2	-14.2	-39.	-43.6	74.	-38.3	-63.		217
43	2.4	8.5	0.							218
44	HIP			5.	1.					219
45	ABDOMEN			3.	1.					219
46	CHEST			2.	1.					219
47	HEAD			1.	1.					219
48	NECK			2.	1.					219
49	FEMUR			5.	1.					219
50	TIBIA			6.	1.					219
51	FOOT			6.	1.					219
52	ELBOW			7.	1.					219
53	FOREARM			8.	1.					219
54	HIP	-8.3	0.	4.65	4.65					220
55	ABDOMEN	0.	0.	3.75	3.75					220
56	CHEST	0.	.8	4.35	4.35					220
57	HEAD	-1.5	0.	4.	4.					220
58	NECK	-7.85	0.	2.8	2.8					220
59	FEMUR	0.	0.	2.75	2.75					220
60	TIBIA	-6.	0.	2.5	2.5					220

Case No. 13 Rabbit Front Impact (1 of 4)

61	FOOT	7.75	0.	2.5	2.5					220
62	FOREARM	4.1	0.	1.	1.					220
63	ELBOW	6.5	0.	1.	1.					220
64	SEATED HUMAN.									300
65	74.9	101.2	115.4	154.4	18.	-56.	-40.5	22.5	90.	301
66	-6.15	0.	-11.15	0.	4.15	0.				303
67	VEHICLE INTERIOR									400
68	FLOOR	MATFL		0.	1.	1.	1.			401
69	INST.PANEL	MATDASH		0.	1.	1.	1.			401
70	BOLSTER	MATBOL		0.	1.	1.	1.			401
71	WINDSHIELD	MATWD		0.	1.	1.	1.			401
72	CUSHION	MATCH		0.	1.	1.	1.			401
73	SEATBACK	MATSB		0.	1.	1.	1.			401
74	ROOF	MATRF		0.	1.	1.	1.			401
75	STEERING WHEEL	MATSTW		0.	1.	1.	1.			401
76	FLOOR		2.	4.	1.	0.	0.			402
77	INST.PANEL		2.	2.	1.	0.	0.			402
78	BOLSTER		1.	2.	1.	0.	0.			402
79	WINDSHIELD		1.	1.	1.	0.	0.			402
80	CUSHION		1.	3.	1.	0.	0.			402
81	SEATBACK		1.	2.	1.	0.	0.			402
82	ROOF		1.	2.	1.	0.	0.			402
83	STEERING WHEEL		1.	5.	1.	0.	0.			402
84	MATFL		0.	0.	0.	1000.	2000.	2400.	8000.	403
85	MATDASH		0.	0.	0.	1000.	2000.	0.	0.	403
86	MATBOL		0.	0.	0.	1000.	2000.	0.	0.	403
87	MATWD		0.	0.	0.	1000.	2000.	0.	0.	403
88	MATCH		0.	0.	0.	1000.	2000.	0.	0.	403
89	MATSB		0.	0.	0.	1000.	2000.	0.	0.	403
90	MATRF		0.	0.	0.	1000.	2000.	0.	0.	403
91	MATSTW		0.	0.	0.	1000.	2000.	0.	0.	403
92	MATFL		2.	0.	0.	0.	FLSTAT	INERZ	FLGR	404
93	MATDASH		2.	0.	0.	0.	DASHSTAT	INERZ	DASHGR	404
94	MATBOL		2.	0.	0.	0.	BOLSTAT	INERZ	BOLGR	404
95	MATWD		2.	0.	0.	0.	WDSTAT	INERZ	WDGR	404
96	MATCH		2.	0.	0.	0.	CHSTAT	INERZ	CHGR	404
97	MATSB		2.	0.	0.	0.	SBSTAT	INERZ	SBGR	404
98	MATRF		2.	0.	0.	0.	RFSTAT	INERZ	RFGR	404
99	MATSTW		2.	0.	0.	0.	STWSTAT	INERZ	STWGR	404
100	FLGR	-1.	.2							405
101	FLGR	-1.	.2							406
102	DASHGR	-1.	.8							405
103	DASHGR	-1.	.08							406
104	BOLGR	-1.	.8							405
105	BOLGR	-1.	.08							406
106	WDGR	-1.	.95							405
107	WDGR	-1.	.01							406
108	CHGR	-1.	.1							405
109	CHGR	-1.	.85							406
110	SBGR	-1.	.1							405
111	SBGR	-1.	.85							406
112	RFGR	-1.	.5							405
113	RFGR	-1.	.5							406
114	STWGR	-1.	.95							405
115	STWGR	-1.	.05							406.
116	FLSTAT	-1.	800.							407
117	DASHSTAT	-1.	441.24	-109.64	9.3813	0.17045				407
118	BOLSTAT	0.	0.							407
119	BOLSTAT	6.	5400.							407
120	WDSTAT	-1.	2000.							407

Case No. 13 Rabbit Front Impact (2 of 4)

121	CHSTAT	-1.	122.	37.6	-74.48	22.16				407
122	SBSTAT	-1.	14.	-9.	14.	-4.	1.			407
123	STWSTAT	0.	0.							407
124	STWSTAT	.1	1562.							407
125	STWSTAT	.49	1875.							407
126	STWSTAT	.51	2500.							407
127	STWSTAT	.75	1875.							407
128	STWSTAT	1.5	1562.							407
129	STWSTAT	2.4	1000.							407
130	STWSTAT	3.9	750.							407
131	STWSTAT	8.	750.							407
132	STWSTAT	10.	10000.							407
133	RFSTAT	0.	0.							407
134	RFSTAT	2.	2000.							407
135	RFSTAT	3.	13000.							407
136	INERZ	-1.	0.							408
137	FLOOR		FLOOR	20.	.25	1.	1.			409
138	TOEBOARD		FLOOR	20.	.25	1.	2.			409
139	BOLSTERD		BOLSTER	4.	.25	1.	1.			409
140	MIDDLEDH		INST.PANEL	4.	.25	1.	1.			409
141	UPPERDH		INST.PANEL	4.	.25	-1.	2.			409
142	WINDSHIELD		WINDSHIELD	1.	.25	1.	1.			409
143	CUSHION		CUSHION	20.	.25	1.	1.			409
144	SEATBACK		SEATBACK	20.	.25	1.	1.			409
145	ROOF		ROOF	4.	.25	1.	1.			409
146	STEERING WHEEL		STEERING WHEEL	2.	.25	1.	1.			409
147	FLOOR		1.							410
148	TOEBOARD		1.							410
149	BOLSTERD		1.							410
150	MIDDLEDH		1.							410
151	UPPERDH		1.							410
152	WINDSHIELD		1.							410
153	CUSHION		1.							410
154	SEATBACK		1.							410
155	ROOF		1.							410
156	STEERING WHEEL		1.							410
157	FLOOR	-1.		-15.	11.3	29.7	11.3			411
158	TOEBOARD	-1.		29.7	11.3	39.2	0.			411
159	BOLSTERD	-1.		17.5	-10.	24.7	2.5			411
160	MIDDLEDH	-1.		19.7	-6.3	21.1	-18.8			411
161	UPPERDH	-1.		21.1	-18.8	32.	-16.2			411
162	WINDSHIELD	-1.		32.	-16.2	15.3	-30.9			411
163	CUSHION	-1.		-8.	5.	16.5	-2.5			411
164	SEATBACK	-1.		-3.4	5.	-14.2	-20.			411
165	ROOF	-1.		16.	-32.9	-16.	-32.9			411
166	STEERING WHEEL	-1.		9.7	-6.7	16.6	-20.			411
167	1.	1.	0.							412
168	1.	2.	.7							412
169	1.	3.	.2	0.						412
170	1.	4.	.8	.15						412
171	1.	5.	1.							412
172	1.	6.	.1							412
173	CRASH	53.8	FT/SEC							600
174	0.	53.8	0.	0.	0.	0.	0.	0.	0.	601
175	5.	1.	0.							602
176	0.	0.	10.	-23.89	70.	-23.89	80.	0.		
177	200.	0.								
178	PASSIVE	TORSO	BELT							700
179	BELT	0.	0.	0.	0.	1000.	2000.	0.	0.	704
180	BELT	2.	0.	0.	0.		BLTST	BINERZ	BLTGR	705

Case No. 13 Rabbit Front Impact (3 of 4)

181	BLTGR	-1.	.75							706
182	BLTGR	-1.	.25							707
183	BLTST	-1.	234.							708
184	BINERZ	-1.	0.							709
185	2.15	-1.5	-16.3	-21.3	2.	BELT				710
186	1.3	2.6	-7.2	10.6	2.	BELT				711
187	0.	0.	4.	24.2	0.	1.	1.			717
188				1.		0.	0.			719
189	3.	3.	3.	3.	1.	1.	0.	0.		720
190	0.	0.	0.	0.	0.	0.	0.			725
191										800
192										1000
1001	0, 1, 4-17, 21-32, 37, 40, 46-50, 45									1001
1002	0.	0.	0.	13.5	0.015					1003
1003	40.	60.	110.3	1.	0.85	201.	5.	5.		1004
1004	0.	0.	-30.	60.	-50.	20.	5.	0.		1500
1005	21.	0.	6.	0.	0.	0.	1.	0.	10.	1501
1006										1600

End of file

Case No. 13 Rabbit Front Impact (4 of 4)

1	MVMA ACCIDENT DATA RECONSTRUCTION. CASE NO. 14.	100
2	SUBJECT NO. 14.	200
3	SEATED HUMAN. REAR VIEW.	300
4	VEHICLE INTERIOR. SIDE STRUCTURES.	400
5		500
6	SIDE IMPACT. 35 MPH.	600
7	LAP BELT USED. TORSO BELT SLID OFF.	700
8		800
9	1. 1. 32.174 .0001 0. 200. .5 2.5 10.	101
10	3. 0. 0. 0. 0. 0. 10. .000001 3.	102
11	.2 .02 600. 500. 20. .05 10. 1. 1.	103
12	HEAD DOOR	106
13	HEAD SEAT	106
14	HEAD WINDOW	106
15	UPPER TORSO DOOR	106
16	UPPER TORSO WINDOW	106
17	UPPER TORSO SEAT	106
18	LOWER TORSO SEAT	106
19	LOWER TORSO TRANS.HOUS	106
20	LOWER TORSO SHIFT	106
21	RIGHT UPPER LEG SEAT	106
22	RIGHT UPPER LEG TRANS.HOUS	106
23	RIGHT UPPER LEG SHIFT	106
24	RIGHT FOOT FLOOR	106
25	LEFT FOOT TRANS.HOUS	106
26	LEFT UPPER LEG SEAT	106
27	LEFT FOOT FLOOR	106
28	RIGHT UPPER ARM DOOR	106
29	RIGHT UPPER ARM WINDOW	106
30	RIGHT UPPER ARM SEAT	106
31	RIGHT LOWER ARM DOOR	106
32	RIGHT LOWER ARM WINDOW	106
33	RIGHT LOWER ARM SEAT	106
34	0. 0. 0. 0. 0. 0. 1. 0. 1.	107
35	0. 0. 0. 0. 0. 0. 0. 0. 1.	108
36	1. 1. 0. 0. 0. 0. 0. 0. 0.	109
37	0. 0. 0. 0. 0. 1. 1. 1. 1.	110
38	0. 0. 1. 0. 0. 0. 0. 0. 0.	111
39	HEAD 1. 1.	219
40	HEAD 0. 0. 4.31 2.98	220
41	UPPER TORSO 2. 1.	219
42	UPPER TORSO 0. 0. 4.64 6.51	220
43	CENTER TORSO 3. 1.	219
44	CENTER TORSO -1.88 0. 6.6 6.1	220
45	LOWER TORSO 4. 1.	219
46	LOWER TORSO 0. 0. 7.14 6.66	220
47	LEFT UPPER LEG 5. 1.	219
48	LEFT UPPER LEG .75 -4.27 3.58 3.59	220
49	LEFT LOWER LEG 6. 1.	219
50	LEFT LOWER LEG -.35 4.27 7.04 2.14	220
51	LEFT FOOT 6. 1.	219
52	LEFT FOOT 7.01 4.27 1.25 1.	220
53	RIGHT UPPER LEG 5. 1.	219
54	RIGHT UPPER LEG .75 4.27 3.58 3.59	220
55	RIGHT FOOT 6. 1.	219
56	RIGHT FOOT 7.01 -4.27 1.25 1.	220
57	RIGHT UPPER ARM 7. 1.	219
58	RIGHT UPPER ARM 0. 0. 6.6 1.57	220
59	RIGHT LOWER ARM 8. 1.	219
60	RIGHT LOWER ARM 0. 0. .78 1.07	220

Case No. 14 Chevette Lateral Impact (1 of 3)

61	RIGHT LOWER LEG				6.	1.				219
62	RIGHT LOWER LEG	-.35	-4.27	7.04	2.14					220
63	0.	8.45	4.51	4.69	4.07		10.27	1.51	7.3	201
64	3.1	2.06	2.16	2.35	2.11	5.81	5.04	.55	.76	202
65	.0185	.0703	.0229	.0725	.0665	.037	.00888	.00888	.00348	203
66	.202	1.48	.211	1.21	.524	.68	.0932	.184		204
67	31.2	5.	0.	0.	200.	300.	0.	-30.	.5	205
68	31.2	5.	0.	0.	200.	300.	0.	-30.	.5	206
69	50.	5.	0.	0.	200.	300.	30.	-30.	.5	207
70	50.	5.	0.	0.	200.	300.	30.	-30.	.5	208
71	16.	5.	0.	0.	200.	300.	-150.	-210.	.5	209
72	16.	5.	0.	0.	200.	300.	210.	150.	.5	210
73	16.	5.	0.	0.	200.	300.	10.	-90.	.5	211
74	16.	5.	0.	0.	200.	300.	30.	-30.	.5	212
75	751.	0.	757.	1.98						213
76	1000.	0.	800.	2.5			0.		.5	214
77	31.2	5.	0.	0.	200.	300.	30.	0.	.5	215
78	31.2	5.	0.	0.	200.	300.	30.	0.	.5	216
79	751.	0.	757.	1.98						242
80	0.	0.	0.	0.	-180.	180.	0.	0.		217
81	3.188	2.125	0.							218
82	90.	90.	90.	90.	90.	-90.	-90.	-90.	90.	301
83	0.	0.	-15.59	0.	4.69	0.				303
84	SHIFT		PANEL MATERIAL	0.	1.	1.	1.			401
85	TRANS.HOUS		PANEL MATERIAL	0.	1.	1.	1.			401
86	WINDOW		GLASS MATERIAL	0.	1.	1.	1.			401
87	DOOR		DOOR MATERIAL	0.	1.	1.	1.			401
88	FLOOR		FLOOR MATERIAL	0.	1.	1.	1.			401
89	SEAT		SEAT MATERIAL	0.	1.	1.	1.			401
90	SHIFT	1.	1.	1.	0.	1.				402
91	TRANS.HOUS	1.	1.	1.	0.	1.				402
92	WINDOW	1.	1.	1.	0.	1.				402
93	DOOR	1.	1.	1.	0.	1.				402
94	FLOOR	1.	1.	1.	0.	1.				402
95	SEAT	1.	1.	1.	0.	1.				402
96	PANEL MATERIAL	0.	0.	50.	100.	101.	0.	0.		403
97	DOOR MATERIAL	0.	0.	50.	100.	101.	0.	0.		403
98	FLOOR MATERIAL	0.	0.	50.	100.	101.	0.	0.		403
99	SEAT MATERIAL	0.	0.	50.	100.	101.	1500.	2500.		403
100	GLASS MATERIAL	0.	0.	.001	.5	.6	0.	0.		403
101	PANEL MATERIAL	1.				PANEL	ZERO	GRRATIO		404
102	DOOR MATERIAL	1.				DOOR	ZERO	GRRATIO		404
103	FLOOR MATERIAL	1.				FLOOR	ZERO	GRRATIO		404
104	SEAT MATERIAL	1.				SEAT	ZERO	GRRATIO		404
105	GLASS MATERIAL	1.				GLASS	ZERO	GRRATIO		404
106	GRRATIO	-1.	0.							405
107	GRRATIO	-1.	1.							406
108	PANEL	0.	0.							407
109	PANEL	3.	3000.							407
110	PANEL	4.	13000.							407
111	DOOR	-1.	1000.	-562.5	1031.25	-562.5	93.75			407
112	FLOOR	-1.	860.							407
113	SEAT	0.	0.							407
114	SEAT	2.8	125.							407
115	SEAT	4.	400.							407
116	SEAT	5.	1000.							407
117	SEAT	5.5	2000.							407
118	GLASS	-1.	10000.							407
119	ZERO	-1.	0.							408
120	SHIFT		SHIFT	5.	.5	1.	1.			409

121	TRANS.HOUS		TRANS.HOUS	5.	.5	1.	1.			409
122	WINDOW		WINDOW	5.	.5	1.	1.			409
123	DOOR		DOOR	5.	.05	1.	1.			409
124	FLOOR		FLOOR	5.	.5	1.	1.			409
125	SEAT		SEAT	5.	.5	1.	1.			409
126	SHIFT		1.							410
127	TRANS.HOUS		1.							410
128	WINDOW		1.							410
129	DOOR		1.							410
130	FLOOR		1.							410
131	SEAT		1.							410
132	SHIFT		-1.	13.5	10.	13.5	-8.			411
133	TRANS.HOUS		-1.	4.5	10.	10.5	-1.			411
134	WINDOW		-1.	30.	10.	30.	-26.			411
135	DOOR		-1.	26.5	10.	26.5	-12.			411
136	FLOOR		-1.	-11.5	10.	33.	10.			411
137	SEAT		-1.	-11.5	2.	33.	2.			411
138	1.	1.	.05							412
139	0.	51.33	0.	0.	0.	0.	0.	0.	0.	601
140	5.	1.								602
141	0.	0.	5.	-29.	55.	-29.	60.	0.		
142	200.	0.								
143	2.	1.								603
144	0.	0.	200.	0.						
145	2.	1.								604
146	0.	0.	200.	0.						
147	BELT		0.	0.	0.	1000.	2000.	0.	0.	704
148	BELT		2.	0.	0.		BLTST	BINERZ	BLTGR	705
149	BLTGR	-1.	.5							706
150	BLTGR	-1.	.5							707
151	BLTST	-1.	234.							708
152	BINERZ	-1.	0.							709
153	4.69	0.	10.5	8.	0.	BELT				712
154	4.69	0.	-9.5	7.	0.	BELT				713
155	3.	0.	4.	0.	0.	1.	1.			717
156				1.		0.	0.			719
157	3.	3.	3.	3.	1.	1.	0.	0.		720
1000										1000
1001	1.	1.	-15.	50.	15.	-40.	5.	0.		1500
1002	21.	0.	0.	1.	1.	0.	1.	0.	0.	1501
1003										1600

End of file