

UMTRI-82-49

SAFETY ANALYSIS OF TRIDENT MISSILE TRANSPORTATION
EQUIPMENT

R.D. ERVIN

C.B. WINKLER

L. SEGEL

FINAL REPORT

SPONSORED BY:

STRATEGIC SYSTEMS PROJECT OFFICE
DEPARTMENT OF THE NAVY

CONTRACT No. N00163-82-C-0267

DECEMBER 1982

UMTRI The University of Michigan
Transportation Research Institute

Technical Report Documentation Page

1. Report No.		2. Government Accession No.		3. Recipient's Catalog No.	
4. Title and Subtitle SAFETY ANALYSIS OF TRIDENT MISSILE TRANSPORTATION EQUIPMENT				5. Report Date December 1982	
				6. Performing Organization Code 020038	
7. Author(s) R.D. Ervin, C.B. Winkler, L. Segel				8. Performing Organization Report No. UMTRI-82-49	
9. Performing Organization Name and Address Transportation Research Institute The University of Michigan 2901 Baxter Road Ann Arbor, Michigan 48109				10. Work Unit No.	
				11. Contract or Grant No. N00163-82-C-0267	
12. Sponsoring Agency Name and Address Strategic Systems Project Office Department of the Navy Missile Branch, SP27323 Washington, D.C. 20376				13. Type of Report and Period Covered Final 7/14/82-12/15/82	
				14. Sponsoring Agency Code	
15. Supplementary Notes					
16. Abstract <p>The turning behavior of specialized tractor-semitrailers was studied to define and subsequently resolve a problem involving loss of steerability in tight-radius curves. The tractor of these combination vehicles incorporated four axles, with one front steering axle and three heavily loaded rear axles. In this configuration, the tires on the steering axle were called upon to provide large levels of lateral forces in order to establish a curved path for the three aft-located axles. Computerized analyses were performed to evaluate the conditions under which loss of steering control would develop and to identify changes in vehicle design or operating practices by which steering control could be assured.</p> <p>One version of the vehicle included a "self-steering" or "castering" axle at the No. 2 axle position on the tractor as a partial countermeasure to the tight-radius cornering problem. The inability of this axle design to caster easily, however, due to coulomb friction in the caster-steering system, was shown to combine with other features in limiting the vehicle's turning capability on low-friction surfaces. Improvements in the low-speed cornering behavior of the vehicle were attained when: a) the coulomb friction present in the self-steer axle was reduced, b) load was distributed more toward the tractor front axle, and c) when the aft-located tires on the tractor were of bias-ply rather than radial construction.</p>					
17. Key Words tractor-semitrailer, low-speed turning, steering control, surface friction			18. Distribution Statement UNLIMITED		
19. Security Classif. (of this report) NONE		20. Security Classif. (of this page) NONE		21. No. of Pages 40	22. Price

TABLE OF CONTENTS

CHAPTER

1	INTRODUCTION.	1
2	THE BASIC LOW-SPEED TURNING PROBLEM	2
3	PRESENTATION OF SIMULATION RESULTS.	8
	Results	8
	High-Speed Turning Performance.	23
4	CONCLUDING REMARKS REGARDING THE C-4 TRANSPORTATION EQUIPMENT	27
5	ISSUES CONCERNING THE DYNAMIC RESPONSE OF THE CONCEPT D-5 TRANSPORTATION EQUIPMENT.	29
	Under/Oversteer Gradient.	29
	High-Speed Offtracking.	32
	Articulation Stability of the Overall System.	32
	Basic Roll Stability.	35
	Tractor Tractive Capabilities	35
	Design Details Involving the Trailer Axle Steering Controller	35
	Trailer Motions Following Jackknife of the Tractor.	36
	Pitch Response of Semitrailer	37
	REFERENCES	38

1. INTRODUCTION

This document constitutes the final report on a study entitled "Safety Analysis of Trident Missile Transportation Equipment," which was conducted by The University of Michigan Transportation Research Institute (UMTRI). The project was sponsored by the Strategic Systems Project Office of the Department of the Navy. The study consisted of computerized analysis of the turning behavior of existing tractor-semitrailers used to transport the C-4 Trident missile and also involved review of dynamic performance issues pertaining to a design concept for transporting the advanced, D-5, missile.

Two versions of the existing tractor-semitrailer systems were evaluated. One of these vehicles involved a Mack tractor having four axles, of which the first axle aft of the front axle incorporated a self-steering or castering function. The second vehicle involved a Kenworth tractor having four conventional axles on a longer-wheelbase layout. Analysis of the turning behavior of these vehicles was accomplished using a simplified, zero-speed, computer model of the vehicle and employing tire data from previous UMTRI measurements. The data describing the mechanical properties of the self-steering axle employed on the Mack tractor were made available from UMTRI measurements obtained in a coincident study sponsored by the National Research Council of Canada.

The report describes, first, the basic nature of the low-speed turning problem which is exhibited by the four-axle tractors cited above. Next, in Section 3, the results of the computerized analysis addressed to this problem are presented. In Section 4, conclusions and recommendations regarding the current vehicles used to transport the C-4 Trident missile are presented. Finally, in Section 5, the dynamic performance issues pertaining to the advanced D-5 transportation system are discussed.

2. THE BASIC LOW-SPEED TURNING PROBLEM

In this section, the basic nature of the low-speed turning problem encountered with the four-axle tractor will be discussed. While this "problem" exists also in any vehicle having more than one non-steering axle (such as a conventional highway tractor having a two-axle tandem rear suspension), the phenomenon of interest is more exaggerated with the vehicles being studied here. In order to properly explain the mechanics of low-speed turning behavior, we will first refer to the basic nature of the pneumatic tire's response to lateral slip.

Shown in Figure 1 is a plot of the lateral force produced by a truck tire in response to the lateral slip condition which is illustrated at the bottom of the figure. We define a slip angle, α , as the angle subtended between the wheel plane and the direction of travel. (At speed, we would define this "direction of travel" arrow as the resultant velocity vector.) As shown, the slip angle condition develops whenever the wheel center is caused to travel along a path which is not lined up with the wheel plane orientation. We will show shortly that this condition occurs on the four-axle tractor even during cornering for which the lateral, or centripetal, acceleration of the turn is negligible.

The plot shows that the lateral force produced by the tire initially rises steeply with slip angle and then "saturates" at higher values of slip angle. The initially steep lateral force response is known to derive from the essentially elastic behavior of the tire in which the carcass and tread rubber are deformed as they come into ground contact but in which no sliding of tread rubber with respect to the ground is occurring. In this regime, the lateral forces are produced entirely as a function of (a) the tire's construction and (b) the vertical load imposed upon the tire.

As the slip angle increases, an increasing fraction of the tread rubber elements in the "contact patch" begin to slide with respect to the pavement. Since the sliding phenomenon is determined by interfacial

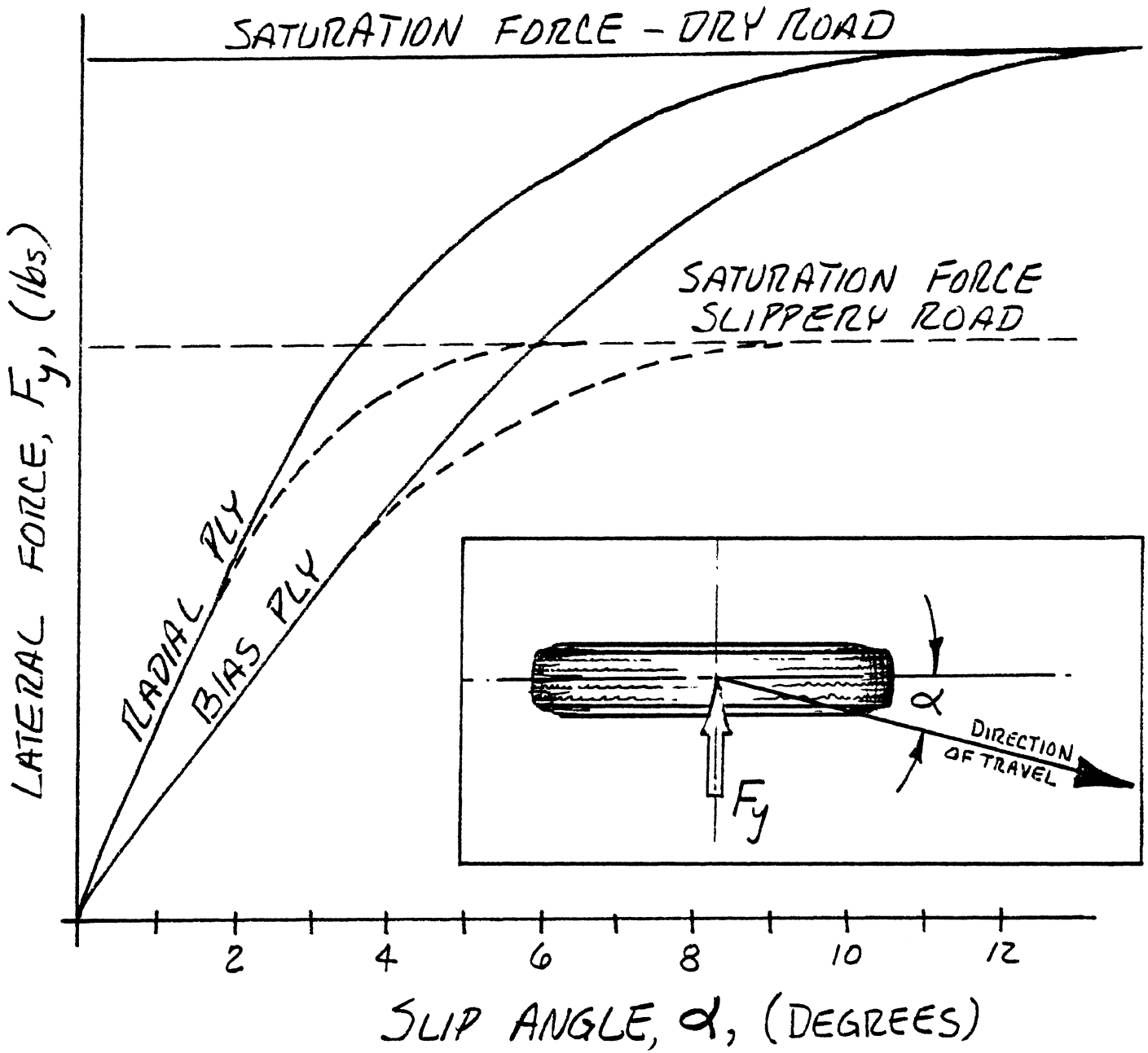

Figure 1. Typical Lateral Force vs. Slip Angle Diagrams for a Given Vertical Load.

friction, the lateral force behavior of the tire at high slip is controlled by the frictional interaction between the tread rubber and the surface of the pavement. Accordingly, the figure illustrates the solid and dashed lines depicting tire behavior on high and low friction surfaces, respectively. We see that the curves are coincident on both surfaces when the slip values are low, but that the saturation level lateral forces are directly limited by the friction level. (It should be noted that lateral force data are customarily presented in a form which normalizes for vertical load— F_y/F_z —thus incorporating the first-order influence of load directly into the results.)

Figure 1 also illustrates a typical distinction in the lateral force behavior of radial and bias-ply tires. The radial tire is higher in its apparent "cornering stiffness" characteristic such that it produces higher values of lateral force at slip values short of the saturation condition. When saturation is achieved, however, there is little distinction between tires of radial and bias-ply construction. (Note that the higher cornering stiffness of the radial tire may go counter to the intuition of the layman if he has observed the greater "flexing" of the radial's sidewall and if he has noted that the vertical stiffness of such tires is typically lower than with bias-ply tires. The fact is that the radial-ply truck tire is constructed with a very stiff—often steel-plyed—belt section which is flexible in the radial direction but which is extraordinarily stiff in response to the slip angle condition.)

Having illustrated the basic nature of the tire's lateral force response to slip angle, it is instructive to observe the slip angle conditions imposed on the four-axle tractor when negotiating a small-radius curve at low speed. Shown in Figure 2 is a schematic of the four-axle vehicle, collapsed into single-tired axles, and traveling around a steady curve. The steady-state requirement of a single turn center imposes the slip angle condition on the three aft-located tires, as a function of the longitudinal spacing of these axles. Further, we see that the tires on the No. 2 and No. 4 axles experience slip angles having opposite signs. Thus, tire No. 2 experiences a side force to the left and tire No. 4 experiences a side force to the right. The net effect

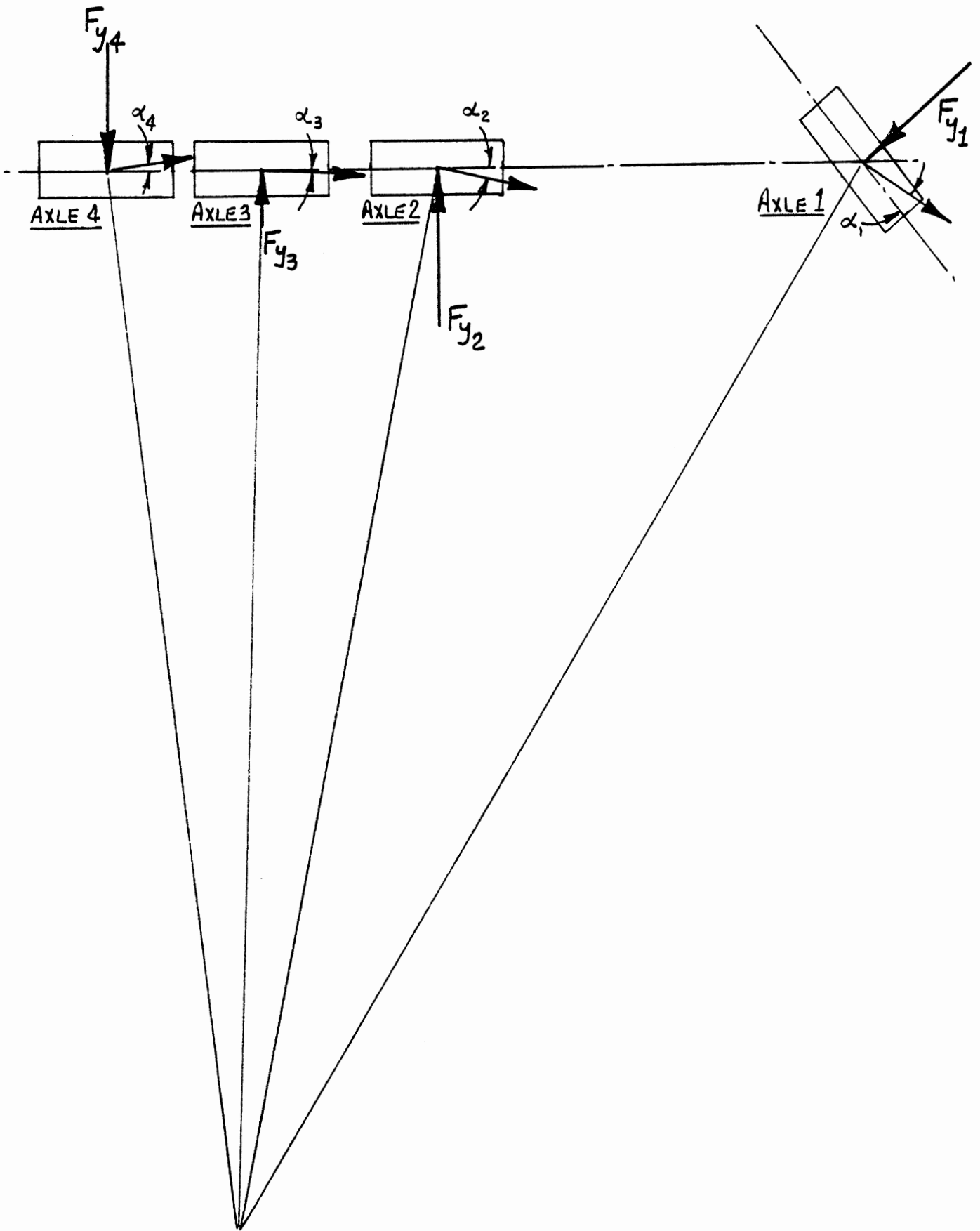

Figure 2. Tire Side Forces and Slip Angles Developed on Four-Axle Tractor in Tight-Radius Turn at Zero Speed.

of the slip angles appearing at axles 2 through 4 is that a moment is produced resisting the curvilinear motion of the overall vehicle. Thus, the curved path is only achieved because the front, or steering, tires are themselves operating at a slip angle such that a side force is produced as shown in the figure. It is this demand for a substantial side force on the steering axle tires that is the crux of the special problem imposed during tight-radius cornering of the four-axle tractor.

This "problem" can be summarized in the following observations:

- The spread three-axle set on the rear of the tractor produces a large turn-resisting moment when the vehicle operates through a tight-radius turn.
- The value of the radius establishes the size of the tire slip angles on these three aft axles.
- The tire forces in response to these slip angles depend primarily upon tire load and carcass construction.
- The net moment must be balanced through development of a large side force on the steering (front) axle tires.
- Because front-axle load is small relative to rear loads, the front tires must run at large slip angles to generate the needed level of lateral force.
- The large levels of front tire slip angle cause these tires to operate near the saturation end of the slip regime, thus rendering the vehicle's turning capability dependent upon the prevailing tire-road friction condition (while the rear tires are all operating in the more-or-less elastic range of the tire, with relatively low values of slip angle).
- The vehicle will be unable to tighten its turn radius below a fixed value whenever:
 - a) the front tires reach saturation, or,
 - b) the front wheels have been steered to the full-lock position.

-If front tire saturation is encountered at a steer level which is less than the full-lock steering position, further steering input will actually increase the turn radius since the component of front tire side force which is normal to the vehicle's centerline will be decreasing. (Note that this "normal" component, F_{y_n} , is defined by the relation, $F_{y_n} = F_y \cos \delta$ where δ is the front wheel steer angle.)

-Given that the "problem" occurs, then, when the vehicle becomes turn-radius-limited prior to reaching its mechanical steering stop, the following categories of countermeasures can be identified:

- a) The turn-resisting moment can be reduced by:
 - incorporating a castering axle at the No. 2 position, thereby reducing α_2 and F_{y_2}
 - putting bias tires on axles No. 2, 3, and 4, thus reducing the levels of rear tire side force produced at the given values of slip angle
 - reducing the magnitudes of the loads carried on the tractor's rear axles, especially on the extremity axles, No. 2 and 4.
- b) The vehicle's wheelbase can be lengthened, thereby increasing the lever arm at which the front tire side forces act.
- c) The load can be redistributed toward the front such that front tire side force capacity increases.

In the next section, a quantitative analysis of the turning problem will be presented, and the improvements in performance afforded by the various countermeasures cited, conceptually, above will be illustrated.

3. PRESENTATION OF SIMULATION RESULTS

Two kinds of simulation were conducted for evaluation of the turning behavior of the C-4 transportation equipment. One type, used most extensively, involved a simplified zero-speed model of the vehicle, with the right- and left-side tires collapsed into a single wheel plane, and with the tire lateral force response represented as a nonlinear function of slip angle. The calculation method was based upon a generalized analysis presented in Reference [1]. This model was exercised by solving for the achievable path radius at each value of steering-wheel angle, from 0 to 800 degrees. The model permitted evaluation of the problem which was of greatest interest, namely, the turning capability of the vehicle around tight radius corners. The second analysis method involved a comprehensive simulation of the yaw and roll dynamics of the vehicle. This multi-purpose model was employed to examine the implication of vehicle modifications on the yaw stability of the unit. This model is documented in Reference [2].

Shown in Figure 3 are layout drawings for both of the vehicle configurations which were considered. At the top is a long wheelbase tractor employing three conventional (non-steering) axles at the rear—although the No. 2 axle happens to be outfitted with an air-supported "pusher" suspension. At the bottom of the figure is a shorter wheelbase tractor whose No. 2 axle position is considered to be equipped with either a non-steering pusher as above or with a self-steering, or castering axle design. The No. 2 axle in the bottom case is also considered to be air-spring-supported such that variations in air pressure can be introduced to effect a redistribution of loading.

Results

Shown in Figure 4 is a plot of the turn radius achieved as a function of steering-wheel input angle for two configurations of the short wheelbase tractor. Table 1 lists parameters for each vehicle configuration and cites the "configuration number" such as is also shown next to each curve in Figure 4. The figure shows that increasing steer

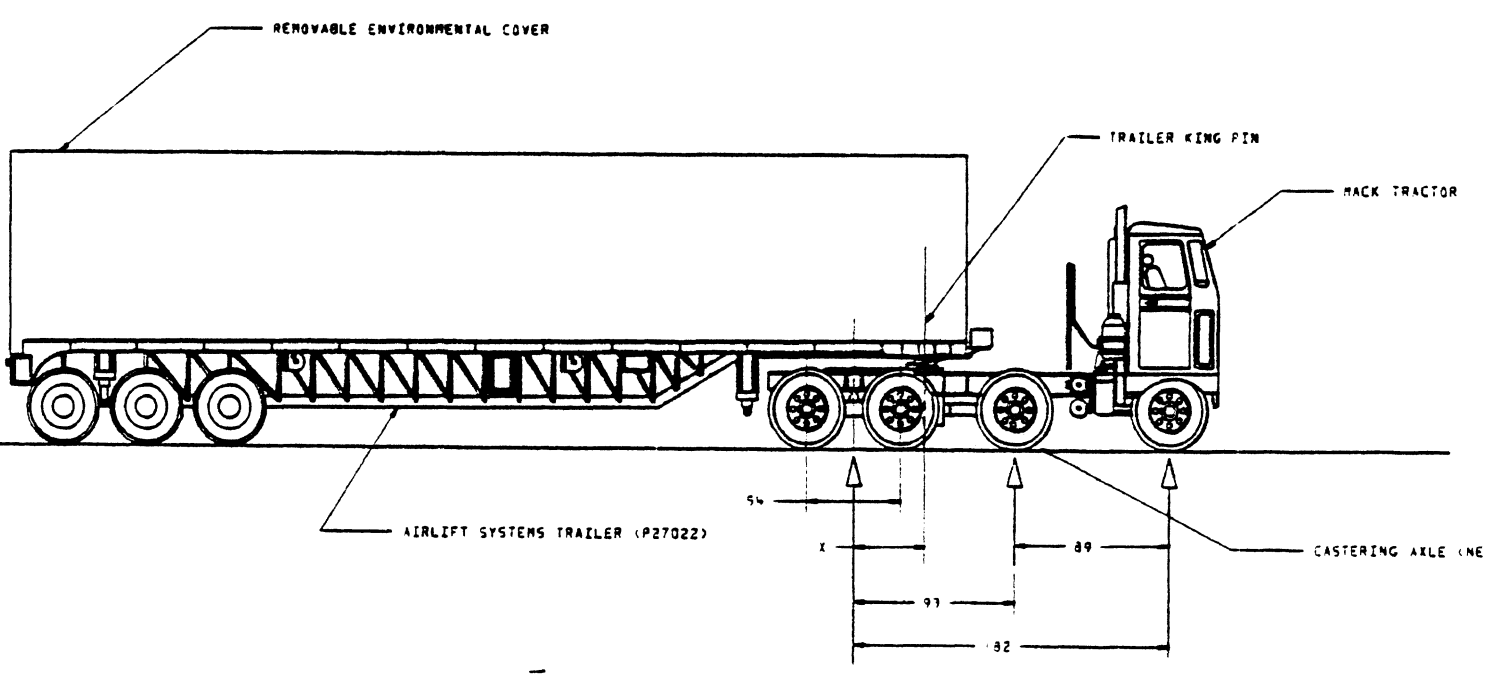
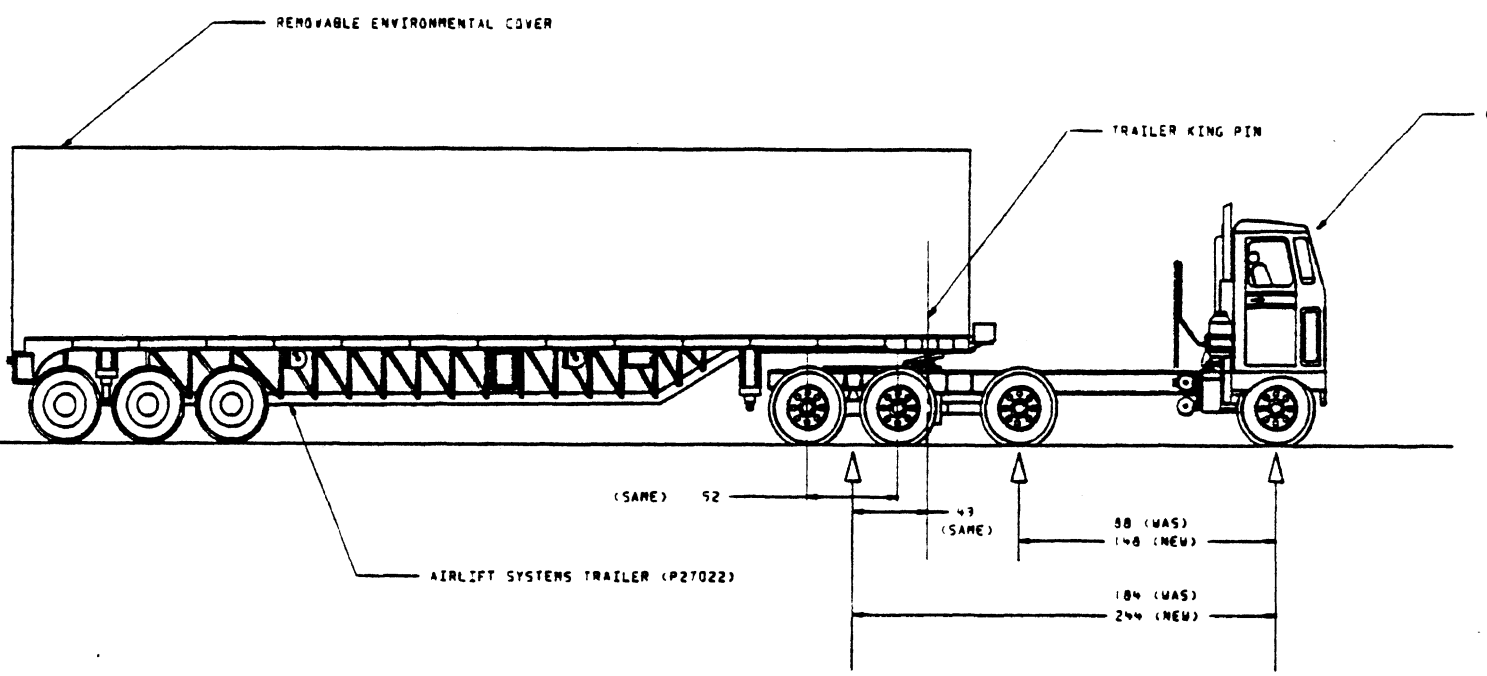

FIGURE 3 C-4 TRACTORS

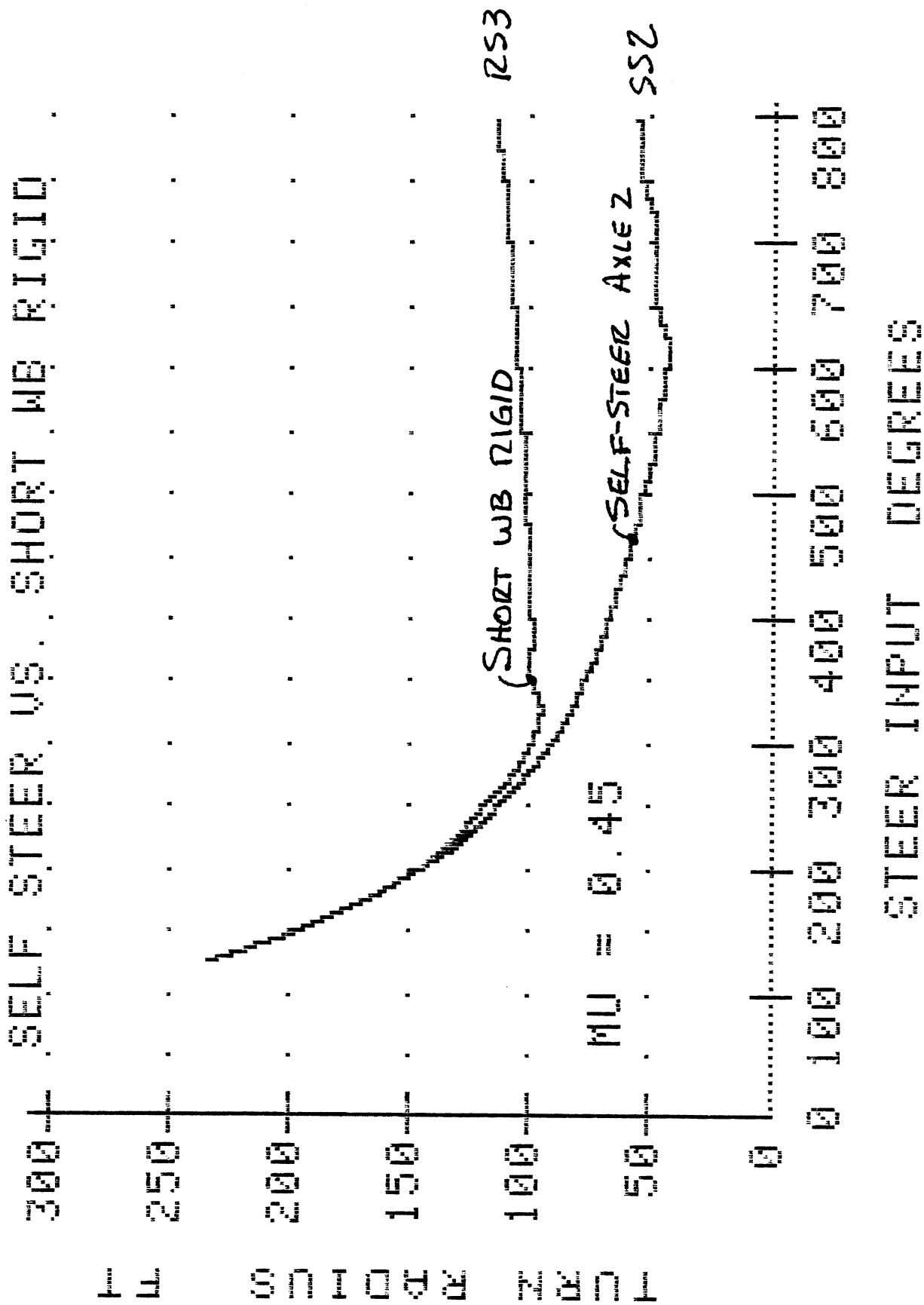

Figure 4. Turn Radius vs. Steering-Wheel Input at Zero Speed.

Table 1. Parameters Describing Vehicles Which Were Evaluated Using a Zero-Speed Turning Analysis.

	Configuration Number	Nominal Vehicle Configuration	Tires*		Axle Loads				Self-Steer Axle Friction lbs	Tire/Road Friction Limit	
			Front	Rear	#1	#2	#3	#4		Front	Rear
Baseline Short WB Tractor, Variable Pavement Friction	SS1 (Mack)	Short WB, Self-Steer on Axle No. 2	R	R	13650	21500	21385	21385	6700	.8	.8
	SS2	"	R	R	13650	21500	21385	21385	6700	.45	.45
	SS3	"	R	R	13650	21500	21385	21385	6700	.40	.40
	SS4	"	R	R	13650	21500	21385	21385	6700	.30	.30
Radial/Bias Mix	SS5	"	R	B	13650	21500	21385	21385	6700	.40	.40
	SS6	"	R	B	13650	21500	21385	21385	6700	.30	.30
Radial/Bias Mix with Low Friction Axle No. 2	SS7	"	R	B	13650	21500	21385	21385	1500	.40	.40
	SS8	"	R	B	13650	21500	21385	21385	1500	.30	.30
Forward Weight Bias (50 psi Air Susp.)	SS10	"	R	B	15285	18300	22166	22166	5700	.30	.30
	SS11	"	R	R	15285	18300	22166	22166	5700	.30	.30
Short WB with No. 2 Axle Rigid	RS1 (Mack)	Short WB, Rigid Axle No. 2	R	R	13650	21500	21385	21385	NA	.80	.80
	RS2	"	R	R	13650	21500	21385	21385	NA	.70	.70
	RS3	"	R	R	13650	21500	21385	21385	NA	.45	.45
Long WB with Variable Pavement Friction	RL1 (Kenworth)	Long Wheelbase	R	R	14800	18500	22000	22000	NA	.80	.80
	RL2	"	R	R	14800	18500	22000	22000	NA	.70	.70
	RL3	"	R	R	14800	18500	22000	22000	NA	.60	.60
	RL4	"	R	R	14800	18500	22000	22000	NA	.50	.50
	RL5	"	R	R	14800	18500	22000	22000	NA	.40	.40
	RL6	"	R	R	14800	18500	22000	22000	NA	.30	.30
Long WB, Front Tires on Sand	RL7	"	R	R	14800	18500	22000	22000	NA	.40	.70
	RL8	"	R	R	14800	18500	22000	22000	NA	.40	.60
	RL9	"	R	R	14800	18500	22000	22000	NA	.30	.70
	RL10	"	R	R	14800	18500	22000	22000	NA	.20	.70
D-5 Tractor	ADV1	Long Wheelbase, D-5 Concept	R	R	16000	15400	15400	15400	NA	.30	.30

*R - Radial Ply
B - Bias Ply

input results in a decreasing turn radius until some minimum turn is achieved. The upper curve represents the behavior of the short wheelbase tractor with its No. 2 axle "rigid"; i.e., employing the conventional pusher axle arrangement. The lower curve represents the same tractor with the "self-steer" or castering axle at the No. 2 position. A sample of the self-steering axle in question was tested at the UMTRI laboratory and was found to exhibit a large level of coulomb friction in the self-steer function. Accordingly, in Table 1 a value of 6700 lbs is indicated as the "self-steer axle friction" for the case of a 21,500-lb load on axle No. 2. Also note that a relatively low value of tire/road friction ($\mu = 0.45$) is represented in the calculations for Figure 4.

At the indicated value of tire/road friction, which represents, perhaps, a polished pavement in a rain-covered condition, the "short WB rigid" tractor is seen to achieve a minimum radius of only 100 feet while the tractor equipped with the self-steer axle achieves a minimum radius of approximately 40 feet. In both cases, the vehicle exhibits a minimum radius behavior prior to reaching the mechanical steering stops. (The mechanical stops typically limit front wheel angle to approximately 40 degrees, or, in this case, approximately 1000 degrees of steering wheel angle for the assumed value of 25 for the steering system ratio.)

This plot illustrates the basic nature of the turning limitation which is imposed by the four-axle tractor arrangement. If a driver were attempting to operate these two vehicle configurations around typical right-angle intersection turns on the indicated rainy surface, the "rigid" vehicle would be incapable of making such turns while the self-steer adaptation would render the vehicle marginally capable of the needed maneuvers. Note from Table 1 that the cases shown in this figure involve the reference distribution of axle loads which provide for heavy loading of the three rear axles and a relatively light loading of the front axle.

Referring back to the generalized discussion of Section 2, it is interesting to observe that the data of Figure 4 confirm that the turn radius rises again after a minimum radius has been reached as a consequence of the "cosine loss" in the orientation of the front tire side force vector.

Shown in Figure 5 is a plot of the behavior of the same "self-steer," short wheelbase tractor on pavements spanning the tire/road friction range of $\mu = 0.3$ to 0.8 . The 0.3 condition represents, perhaps, a slippery road condition prevailing as the result of a light dusting of snow. The 0.8 condition represents a typical dry road. The figure shows that, on a dry road, the vehicle is able to achieve a radius of approximately 30 feet within the 800-degree steer angle. The vehicle is seen to begin suffering a minimum radius problem when $\mu = 0.45$ and to then become dramatically reduced in performance as friction level decreases further. When the friction level is equal to 0.3 , the vehicle is incapable of making turns having a radius less than approximately 150 feet. (It should be noted that the small "saddle" appearing in the response curve at $\mu = 0.3$ and at a steer input of approximately 200 to 250 degrees is an anomaly of the computation method—the actual vehicle would exhibit a response more like the dashed line drawn across the top of the saddle.)

In Figure 6, the dry-road turning capability of the short wheelbase, self-steer, tractor is compared with that of the long wheelbase tractor. We see that both vehicles are rather similar in behavior except that:

- a) the short wheelbase tractor can achieve a somewhat tighter radius turn at the highest steer inputs, and
- b) the short wheelbase tractor requires considerably less steering input for the same turn, especially in short radius curves. (For example, 28% greater steering input is required for the long wheelbase tractor to negotiate a 50-foot radius curve.)

Since truck drivers are often sensitive to the amount of steering required, it is likely that the short wheelbase, self-steer tractor would be found preferable for maneuvering on a dry roadway. When a low friction road condition is represented, however, the relative attractiveness of the two vehicles reverses, as shown in Figure 7. Here we see that the self-steer tractor is limited to a minimum radius turn of 150 feet, while the long wheelbase vehicle exhibits virtually the same behavior as was seen on the dry road condition. Examination of the detailed simulation results

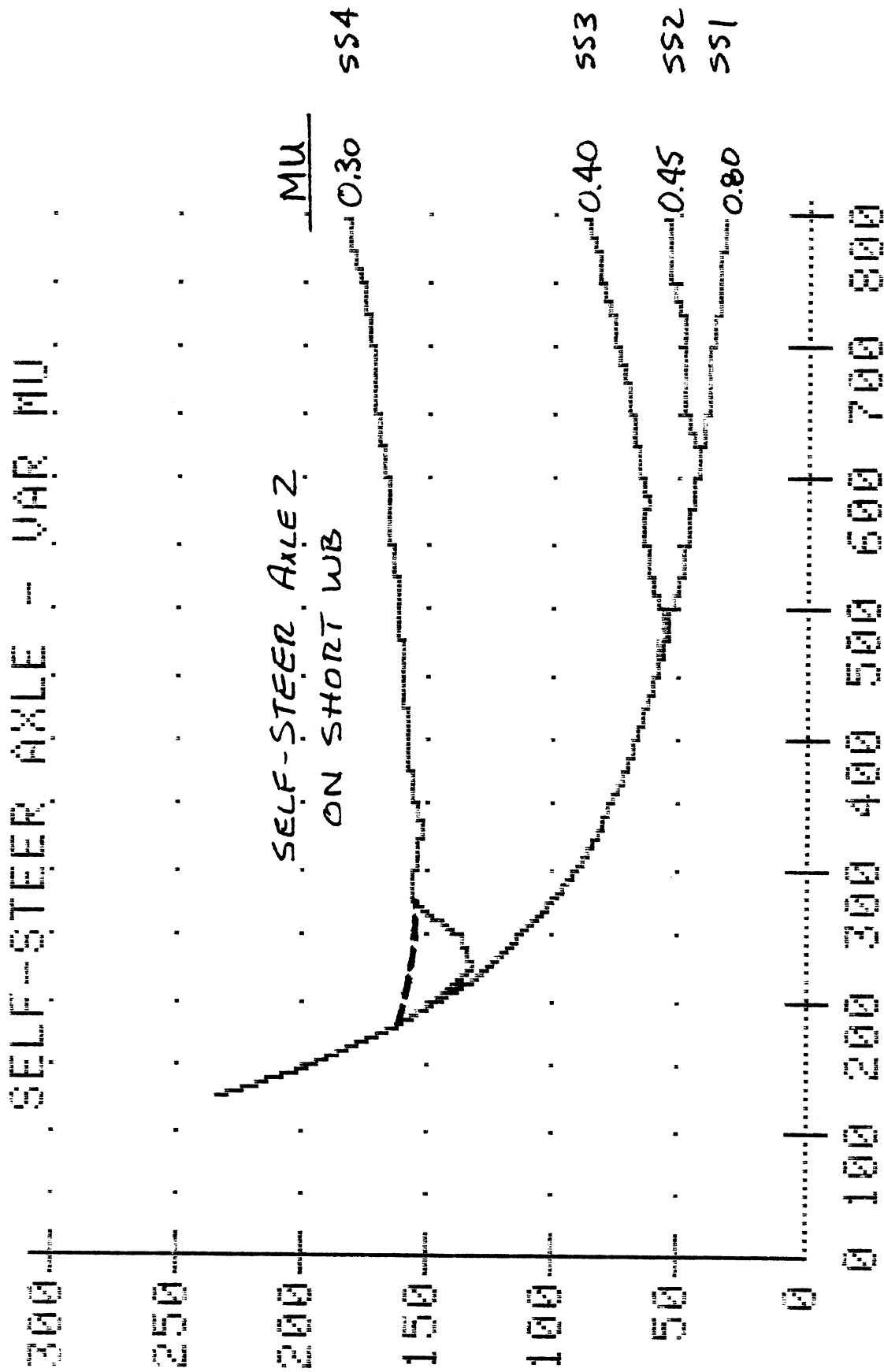

Figure 5. Turn Radius vs. Steering Wheel Input for Various Surface Friction Levels—Short Tractor with Self-Steering No. 2 Axle.

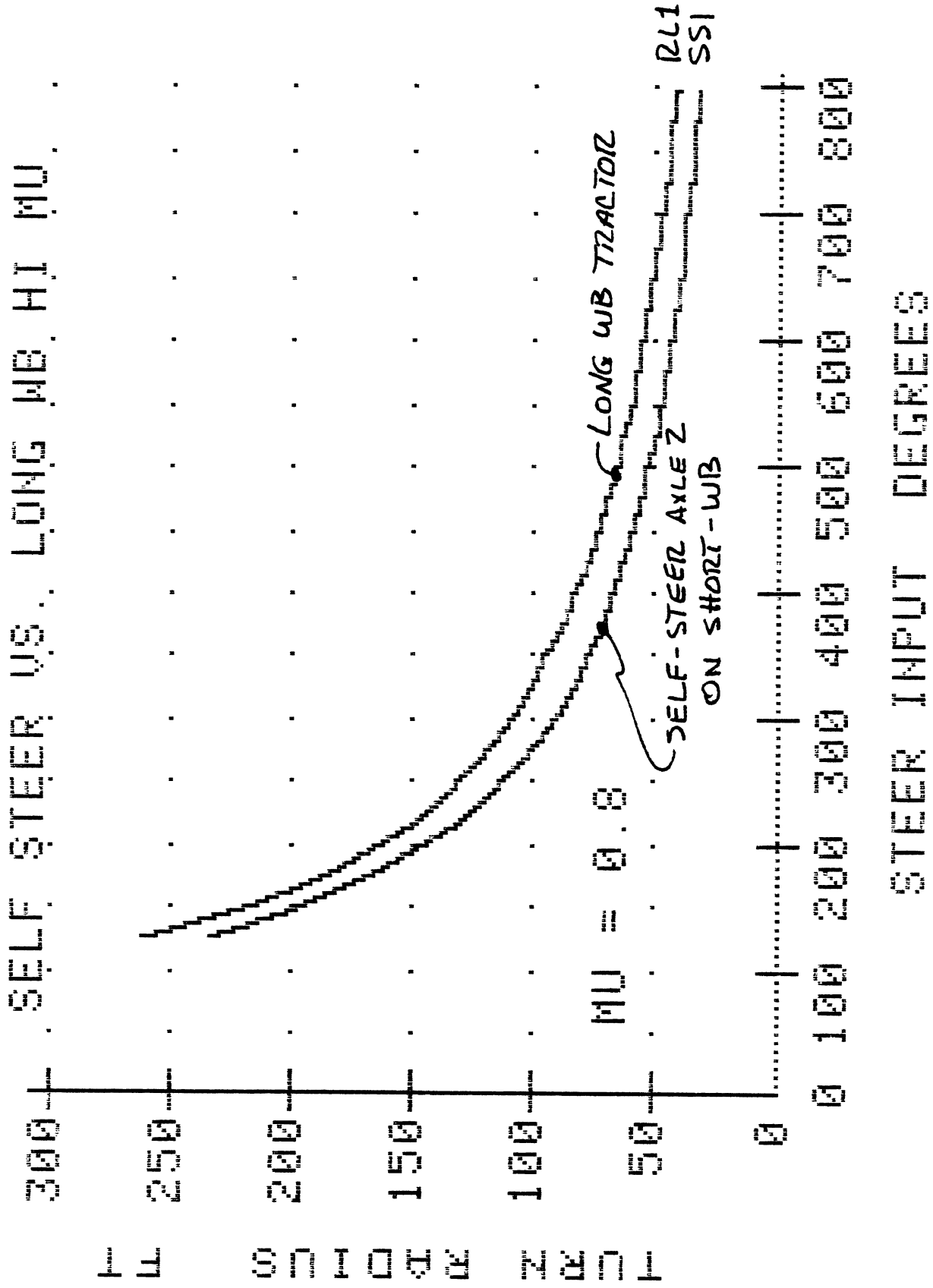

Figure 6. Turn Radius vs. Steering Wheel Input—The Two Basic C-4 Tractors on a Dry Pavement.

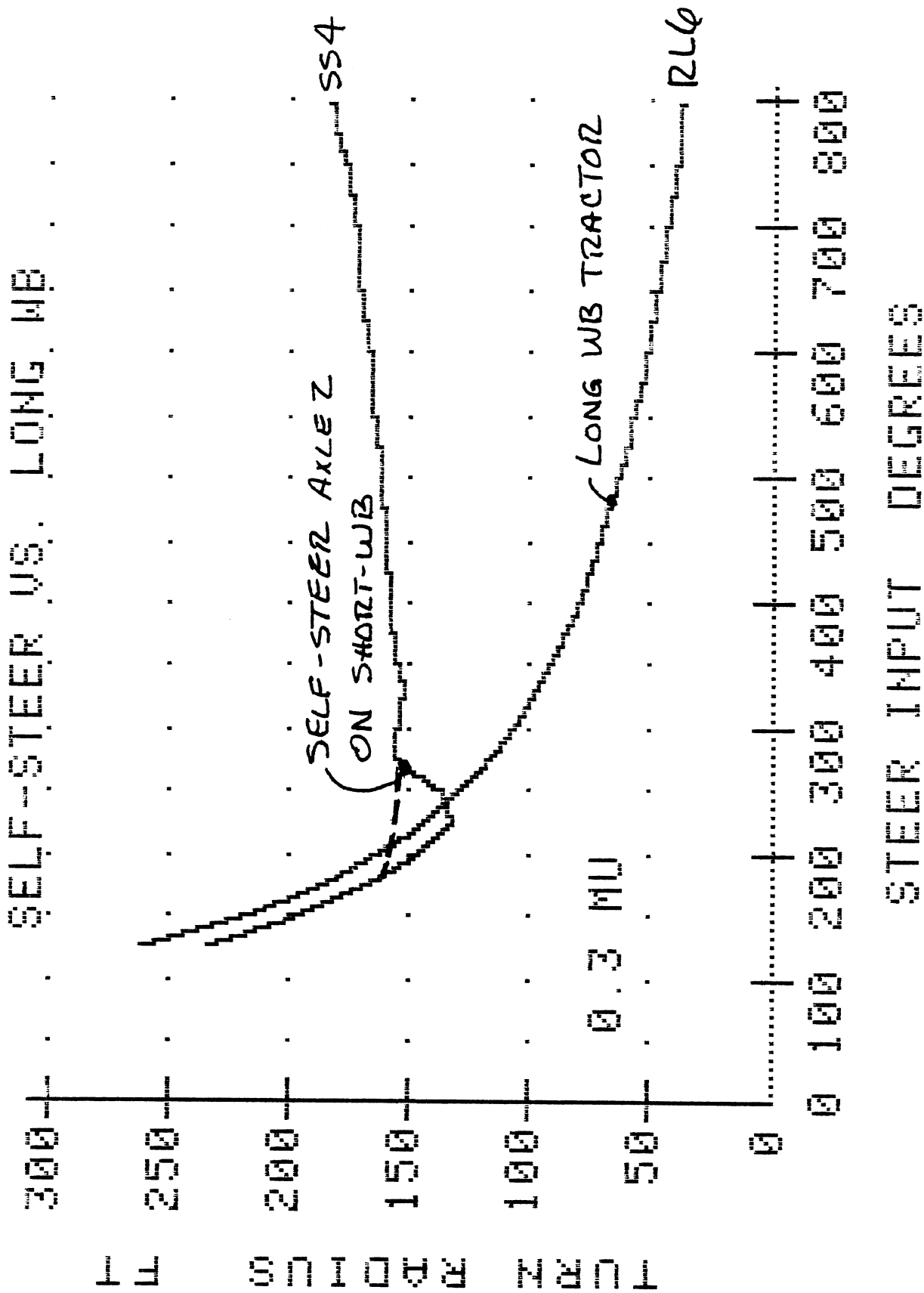

Figure 7. Turn Radius vs. Steering Wheel Input—The Two Basic C-4 Tractors on a Rather Low-Friction Surface.

has revealed that while the short wheelbase, self-steer tractor suffers side force saturation at the tires on the front axle, making tighter turning impossible, the long wheelbase vehicle experiences saturation in the tires on the No. 2 axle, thus limiting the turn-resisting moment so that tight radius curves can be negotiated. Accordingly, it would appear that for these reference cases of vehicle setup, the long wheelbase unit would be more attractive for operation on low friction surfaces.

An additional case that was examined involved an unusual surface friction condition such as may arise in areas where the roadway had been previously sanded during a snowfall. After the snow has melted, the residual sand remains on the surface and is effectively brushed by the vehicular traffic into two "ridges" as shown in Figure 8. When a vehicle with sufficiently long wheelbase traverses roadway curves having such a distribution of sand, it is supposed that the fore and aft tire sets tend to track in such a way that the front tires run on a sand-covered pavement while the majority of the rear tires run on a more-or-less clear pavement. By such a scenario, the front tires experience a lower frictional limit than do the rear tires such that a deficiency in front tire lateral force capability develops. Figure 9 illustrates the turning performance of the long wheelbase tractor for cases involving differing frictional representations of this condition. It is seen that the "front tires on sand" condition is capable of producing the same generic behavior of the long wheelbase unit as was shown previously for the short wheelbase, self-steer tractor. That is, lateral forces at the front tires are caused to saturate while the rear tires are still resisting the negotiation of a curved path.

In addition to analyzing the behavior of the existing vehicles under differing pavement conditions, analyses were also performed to evaluate various countermeasures which might be implemented to cause the short wheelbase, self-steer tractor to exhibit acceptable turning performance on a low friction surface. Shown in Figure 10 are a set of calculated results for the short wheelbase vehicle on a slippery surface, with $\mu = 0.3$. At the top, the performance of the baseline vehicle is shown again, establishing a 150-foot minimum turning radius.

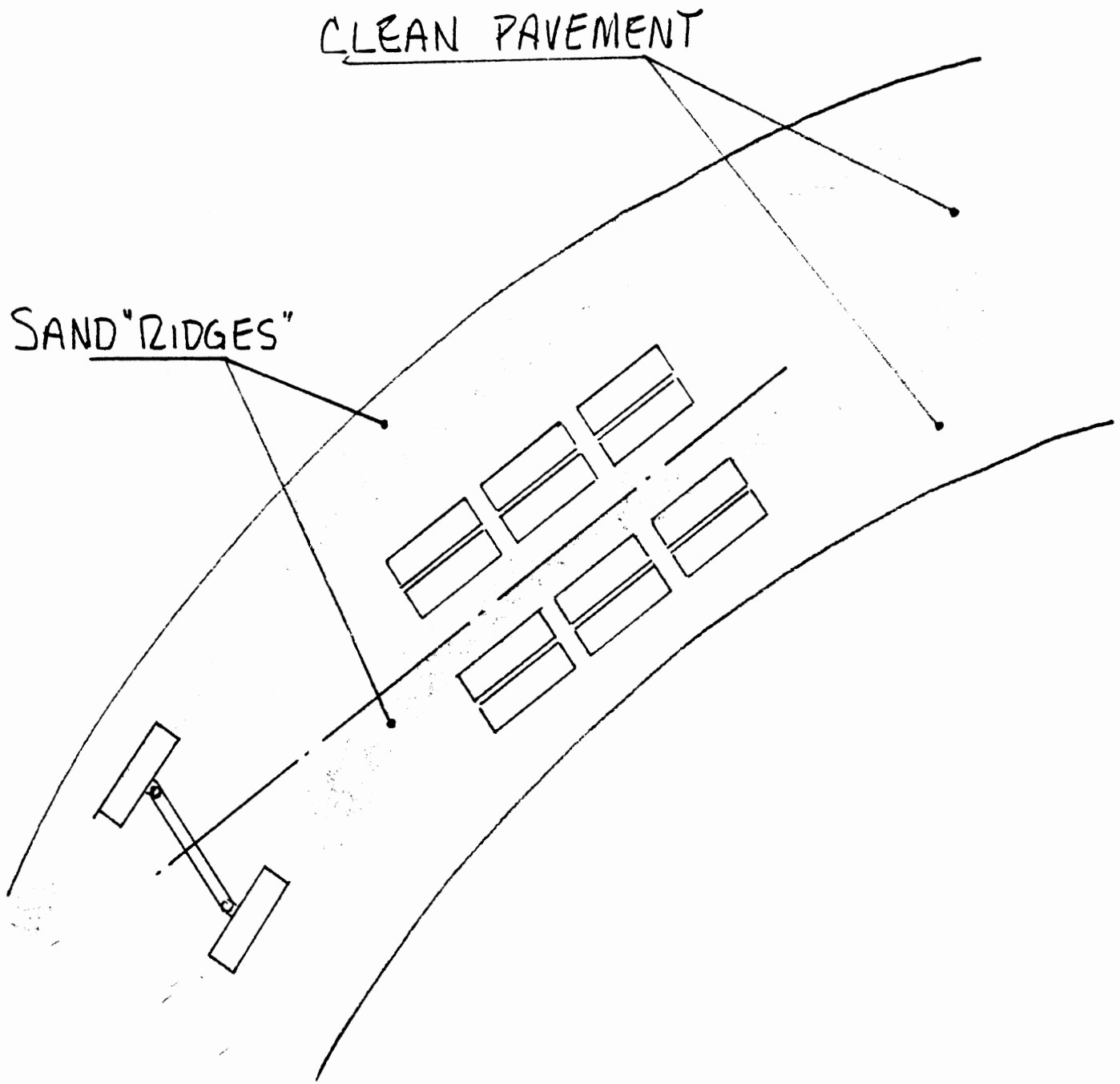

Figure 8. Sketch Illustrating the Anomalous Matching of Front and Rear Tire Paths with "Sanded" and "Clean" Pavement.

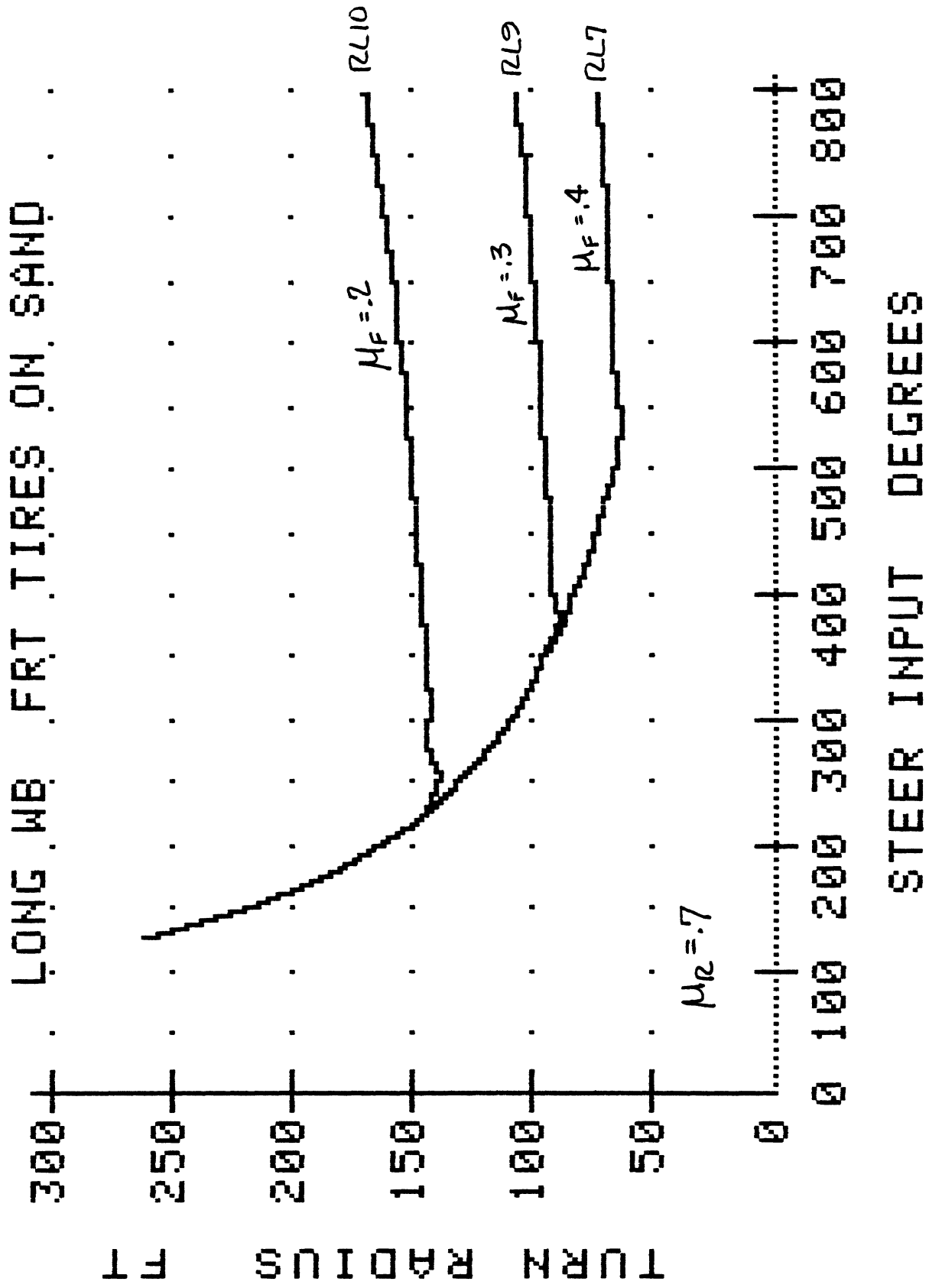

Figure 9. Turn Radius vs. Steering Wheel Angle for Long Wheelbase Tractor on the Anomalous "Sanded" Pavement.

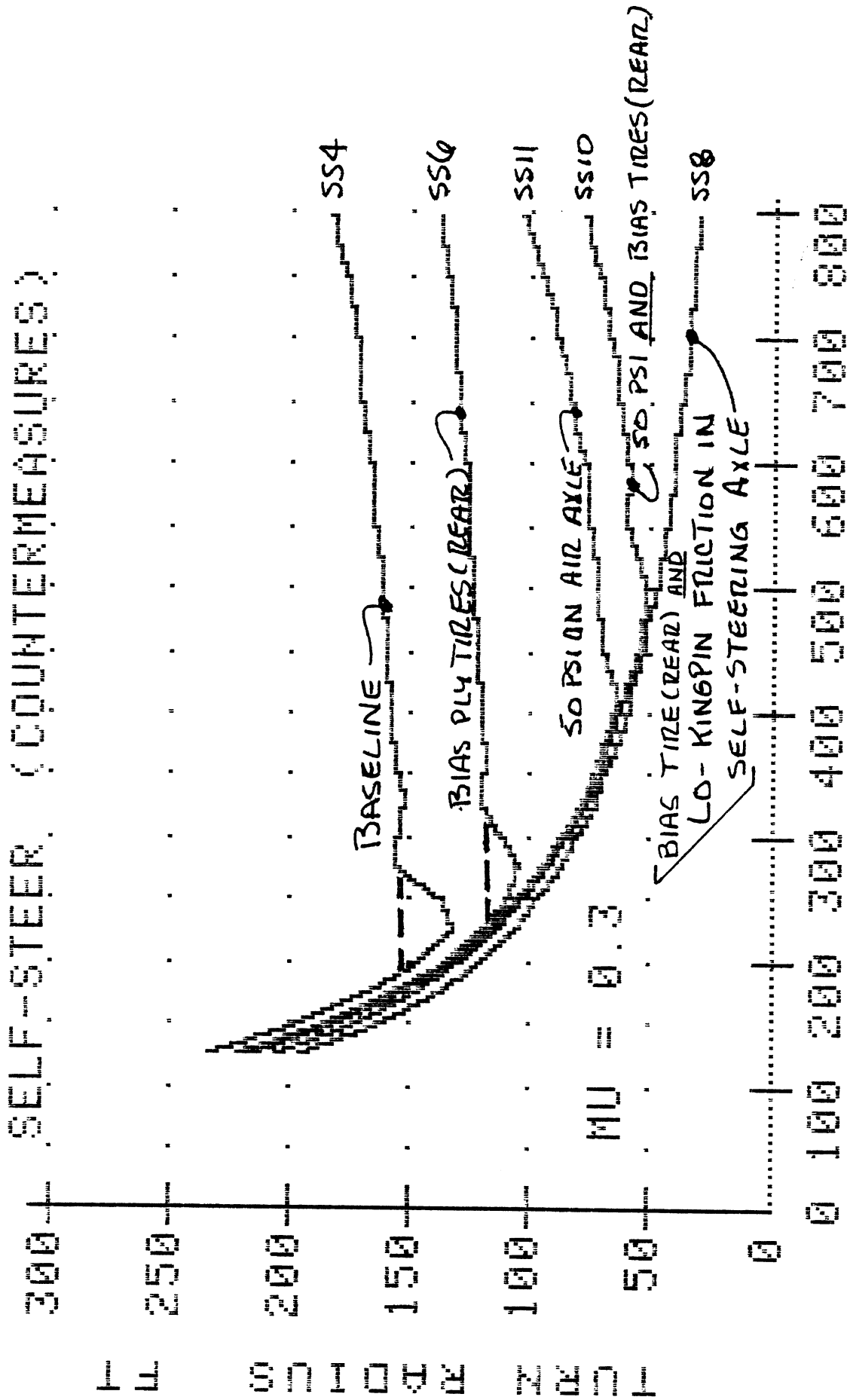

Figure 10. Turn Radius vs. Steering Wheel Input for the Short Wheelbase Tractor Incorporating Various Possible Countermeasures to the Tight Radius Turning Problem.

Just below the baseline curve is the result obtained when the baseline radial tires are replaced, on the three rear axles, by typical bias-ply tires. The minimum turning radius is seen to reduce to approximately 120 feet as a result of the smaller turn-resistive moment produced at the rear axle set. That is, since the bias tire has a lower effective "cornering stiffness," for the same vertical load condition, than the reference radial tire, the rear tire slip angles (which were shown earlier to derive simply from the curved-path condition) produce proportionately lower lateral forces and, thus, a proportionately lower moment resisting the turning motion. As a consequence, the front tires are called upon to produce a lower level of lateral force in negotiating a given turn such that a tighter "minimum" radius can be achieved before saturation of the front tires occurs.

Looking now at the curve labeled "50 psi on air axle" in Figure 10, we see the effect of a substantial redistribution of load among the tractor axles (with the original all-radial tire installation). Listed below are the baseline and redistributed loads which pertain to the cases of differing inflation of the air springs on axle No. 2.

<u>Condition</u>	<u>Air Spring Pressure</u>	<u>Axle Loads, lbs</u>			
		<u>1</u>	<u>2</u>	<u>3</u>	<u>4</u>
Baseline	65 psi	13,650	21,500	21,385	21,385
Modified	50 psi	15,285	18,300	22,166	22,166

Note that the load on axle No. 2 has reduced by 3,200 lbs, in the "50 psi" case, and that the load on the front axle has increased by some 1,600 lbs. Figure 10 reveals that this load distribution provides a large improvement in the minimum radius turning capability of the vehicle. It should be apparent that the improvement derives from the combined reduction in the turn-resistive moment imposed by the rear tires and the improved lateral force capability of the front tires.

In the next curve on Figure 10 (second from the bottom), the combined effect of the bias tire installation on the rear axles plus the 50 psi air spring inflation on axle No. 2 yields an even better performance.

We see that the limit-turning capability approaches a minimum radius of 50 feet.

The best performance in Figure 10 is achieved by the vehicle in the baseline loading and bias-rear tire conditions, but with a self-steering No. 2 axle which has been modified to yield a much lower level of coulomb friction in its self-steer function. To elaborate, the self-steering axle employs a pair of wheel spindles which are castered about vertical kingpins. The frictional resistance of these spindles to rotation about the kingpins has been reduced, in the subject case, from an equivalent 6,700 lbs of lateral tire force to 1,500 lbs of lateral force. That is, the modified case requires only a total of 1,500 lbs of side force on the tires of axle No. 2 before the castering action proceeds to limit the slip angle prevailing on those tires. In the figure, we see that the "low-kingpin-friction" case yields a minimum turning radius performance on the 0.3- μ surface which is essentially identical to that achieved by the baseline vehicle on dry pavement.

Moreover, the examined set of potential countermeasures illustrate that various means are available for improving the minimum radius performance of the vehicle. In practice, it may be that some of these schemes of vehicle modification are more readily implemented than others such that performance gains may have to be tempered by other considerations.

To conclude the examination of tight radius cornering behavior, Figure 11 presents a comparison of the performances of the two previously-described vehicles with that of the D-5 concept tractor which will be described in Section 5. This four-axle tractor is comparable in layout to the long wheelbase version considered above, but is loaded more favorably, with lighter rear loads and higher front axle loading than in the reference case. The figure shows that on the low friction surface, the two long wheelbase tractors behave virtually identically, with respect to low-speed turning performance.

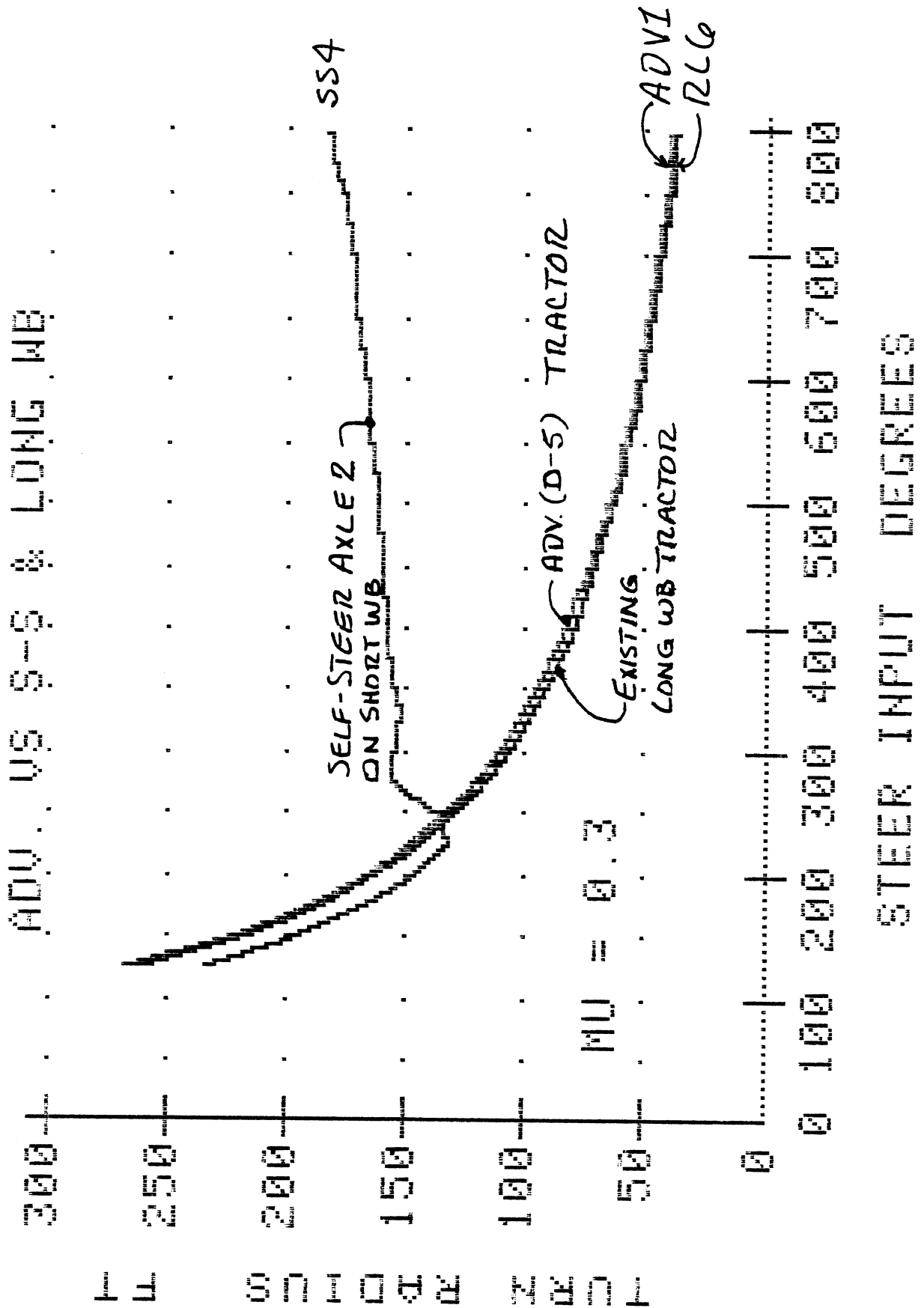

Figure 11. Turn Radius vs. Steering Wheel Input for Three Different Tractor Types on a Low Friction Pavement.

High-Speed Turning Performance

The peculiar turning problem which was identified above was seen to derive from the resistance of the multiple-rear-axle tractor to traveling around tight radius curves. It was seen that non-zero slip angles prevailed even when the vehicle speed was virtually zero simply as a result of the kinematics of vehicle motion around a fixed turn center. When a tight radius turn is negotiated at a higher value of speed, however, a non-zero centripetal acceleration condition prevails, such that new levels of tire side force, and thus slip angles, are needed to establish static equilibrium. The result of increasing speed was examined by means of a single check of vehicle turning response at 10 mph, using a comprehensive simulation of the vehicle. The results showed that the short wheelbase, self-steer tractor required a minimum μ value of 0.65 in order to achieve a 50-foot radius turn at 10 mph, in comparison with a minimum μ of 0.42 needed to negotiate the 50-foot turn at zero speed. Clearly, the 0.13 g level of centripetal acceleration accompanying the 10-mph turn results in a considerably larger demand on front tire side force level such that a higher friction level is needed.

A similar calculation conducted for a 150-foot radius curve, however, showed no significant influence of the 10-mph speed on the vehicle's turning capability. This result, of course, is understandable since at the larger radius, the turn-resistive moment developed at the rear axles is much smaller, as is the centripetal acceleration implied by the selected speed condition. Indeed, it is quite apparent that no limitations in turning capacity (such as described in the preceding analyses) will arise during normal travel of the four-axle tractor at highway speeds, given the large path radii which are involved. (Of course, this is not to say that the vehicle can safely negotiate any conceivable turning maneuver since every heavy truck exhibits roll and yaw stability limits which will serve to rather severely constrain the outer boundary of maneuver severity.)

In order to explore the possibly negative influence of one of the countermeasures to the low-speed turning problem on the high-speed stability behavior, a separate set of simulations was conducted at 55 mph.

In these calculations, the short wheelbase, self-steer tractor and semi-trailer combination was examined in both the baseline and in the "low-kingpin-friction" configurations. The purpose of the calculations was to determine whether the "low-kingpin-friction" case, which essentially assures that very low levels of tire side force will be developed at axle No. 2, would cause a reduction in the yaw stability of the tractor. In this context, yaw stability involves the resistance of the tractor to divergent rotation around its vertical axis, such as may promote a loss of control situation in higher severity turns at highway speeds.

The simulation runs were made using a linearly increasing steer input, to provide a sweep in turn severity, at 55 mph. Shown in Figure 12 are plots of the time response of both vehicle configurations, in terms of the yaw rate, lateral acceleration, and tractor body sideslip angle variables. Looking at the lateral acceleration signals, we see that the described steering input results in an increasing lateral acceleration response which appears to be diverging late in the simulation run. Thus we can say that the simulation shows yaw instability to be possible for both vehicle configurations, but it appears as a prominent aspect of the response only for lateral acceleration levels above 0.4 g, or so.

Of immediate importance to the evaluation of countermeasures, however, we see that the vehicle does not exhibit any greater degree of yaw instability, at a given level of lateral acceleration, in the "low-kingpin-friction" case than in the baseline case. This conclusion is reached by examining the levels of yaw rate and body sideslip angles attained in both vehicle cases at, say, the 0.4 g level of lateral acceleration. We note that virtually no change in yaw rate and sideslip response have occurred (although we note, of course, that the low-kingpin-friction case has lengthened the effective wheelbase of the vehicle, thereby rendering a lower gain in its lateral acceleration response to the steadily increased steering input). Moreover, it appears that the reduction in the friction of the kingpins on the self-steering axle does not introduce any noticeable reduction in the yaw stability of the vehicle combination at highway speeds.

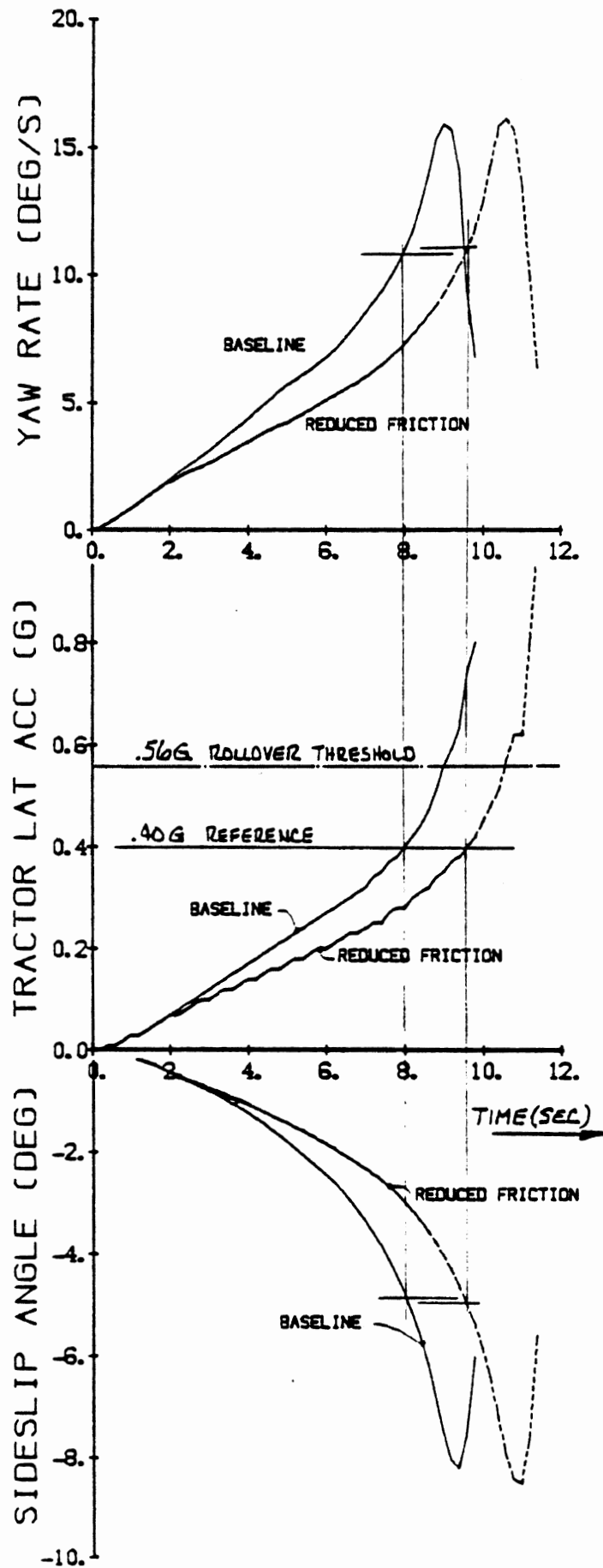

Figure 12. Time Histories of Response to Ramp Steer Input at 55 mph, for Short Wheelbase Tractor in Its Baseline Configuration and also with a Low-Friction Kingpin Treatment in the No. 2 Self-Steering Axle.

It may also be of interest that the roll stability limit of the vehicle was calculated to be at a lateral acceleration level of 0.56 g. Given the overall levels of roll and yaw stability assessed here, it appears that this vehicle very substantially exceeds the stability performance of tractor-semitrailers in general commercial service.

4. CONCLUDING REMARKS REGARDING THE C-4 TRANSPORTATION EQUIPMENT

The short wheelbase, four-axle tractor is clearly a vehicle which needs special treatment to solve its tight radius turning problem. The use of the self-steering axle, in its "off the shelf" version, appears to provide a partial solution, although it renders only a marginally-acceptable performance when the pavement friction level begins to decrease. Additional improvement is attained when the axle loads are redistributed by means of reducing the air spring inflation pressure on axle No. 2. A further benefit accrues from the installation of bias-ply tires on the vehicle. If this latter change is employed, it is advisable to install bias tires on the front as well as rear axles to assure the retention of a reasonable understeer level in the vehicle.

The single most beneficial step appears to derive from a modification of the self-steer axle hardware to achieve a wholesale reduction in the level of the coulomb friction which resists the steering motion of the castered wheels. (It should be recognized that reduction of this coulomb friction characteristic to a near-zero level may then necessitate the use of a steering damper device to prevent shimmy oscillations.) Notwithstanding the special effectiveness of the modification to the self-steer axle hardware, it appears that a nearly comparable level of improvement is achieved, for nearly all operating conditions, by the combination of the cited redistribution of load and the installation of bias-ply tires.

The long wheelbase tractor is clearly superior to the short, self-steer-equipped tractor in its ability to achieve tight radius curves on low friction surfaces. With adoption of the countermeasures cited above, however, the tight-radius turning capability of the short wheelbase tractor can be made comparable to that of the long wheelbase unit. In fact, drivers may then prefer the shorter tractor since considerably less steering activity will be needed in negotiating the vehicle through intersections, etc.

Although it was shown that the longer wheelbase tractor could negotiate turns having less than 50-foot radii even on surfaces having very low friction levels, a peculiar condition was defined in which this vehicle did exhibit a marked loss in turning capability. This condition involved turning at low speed on a pavement having areas of sand concentrated at the shoulder edge of the lane and in the center of the lane. Under such a condition, which tends to prevail following the use of sand to enhance traction when the pavement was snow-covered, the tractor is unable to achieve sufficiently high levels of front tire side force and thus becomes limited in the minimum achievable turn radius.

Regarding the importance of speed on the tight-radius cornering problem, it was shown that a 10-mph speed would seriously compromise the ability of the short wheelbase tractor to negotiate a 50-foot radius turn on a medium-friction surface. When the turn radius was 150 feet, however, the 10-mph condition was of negligible influence. Thus, we observe that tight-radius cornering, under low-friction conditions, should be done at very low speeds (say, less than 5 mph for turn radii of 50 feet or so). Alternatively, there is no apparent reason for concern over the vehicle's ability to achieve the large turn radii which are encountered, at normal posted speeds, on the highway.

Finally, there appear to be no unusual problems in the area of vehicle yaw stability, either in the baseline vehicle cases, or in cases involving any of the examined countermeasures.

5. ISSUES CONCERNING THE DYNAMIC RESPONSE OF THE CONCEPT D-5 TRANSPORTATION EQUIPMENT

The following sections present a list of issues concerning the dynamic performance of the tractor-semitrailer intended for transporting the D-5 missile. These issues have been identified from a brief review of an eight-axle trailer concept, shown in Figures 13 and 14. The vehicle concept is especially notable for the high gross weight, the multiple and independently-steered trailer axles, and by the peculiar interactions between trailer axle loads due to an active suspension system. The issues, to be discussed below, are not presented in order of priority, but are each seen as demanding some degree of engineering analysis. It appears that the types of analysis needed to study each issue are amenable to computerized simulation, given the current state of vehicle mechanics technology. Further, these analyses should be looked upon as part of the design development process since it appears that various parameters of the basic system will need adjustment to achieve suitable overall performance.

Under/Oversteer Gradient

The steady-path curvature response of the tractor-semitrailer combination to steer inputs by the driver can be expressed in an under/oversteer gradient. This characteristic is of interest since it is generally held that the ease of steering control is related to the achievement of a reasonable level of understeer. It is apparent that a number of design features on the subject vehicle may play a role in determining the understeer quality of the vehicle. Among these "determinants" is the fifth wheel placement, selection of tractor tires, and perhaps most importantly here, the behavior of the trailer axle steering system insofar as the trailer may impose an anomalous force reaction at the tractor's fifth wheel during steady turning. The collection of the vehicle design features influencing understeer should be evaluated to assure that the vehicle exhibits acceptable steady-cornering behavior.

ADVANCED SLBM MISSILE TRANSPORTATION SYSTEM

AXLE LOAD CRITERIA			
LOAD PER AXLE	R1	R2	R3
	16,000 (5,000)	29,750	

NOTES

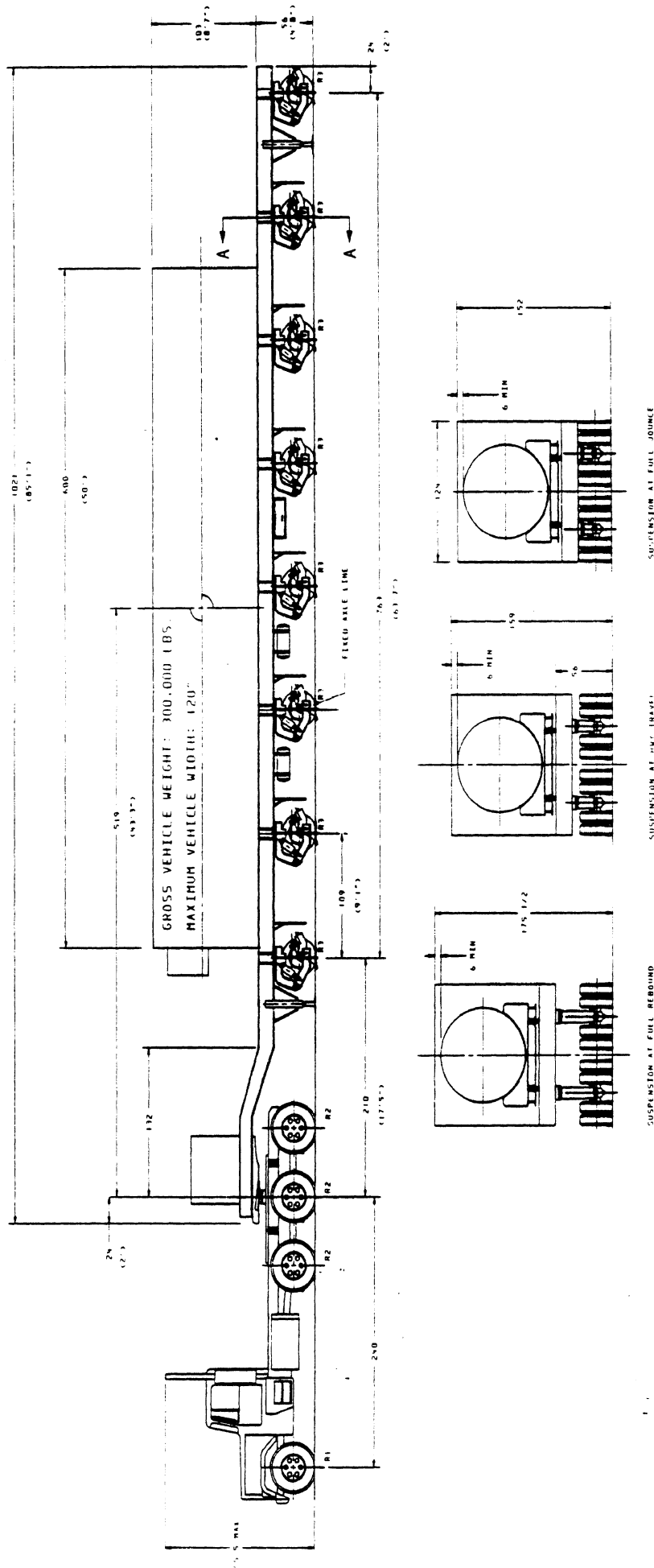

Figure 13. Concept of Tractor-Semitrailer for Transporting D-5 Missile.

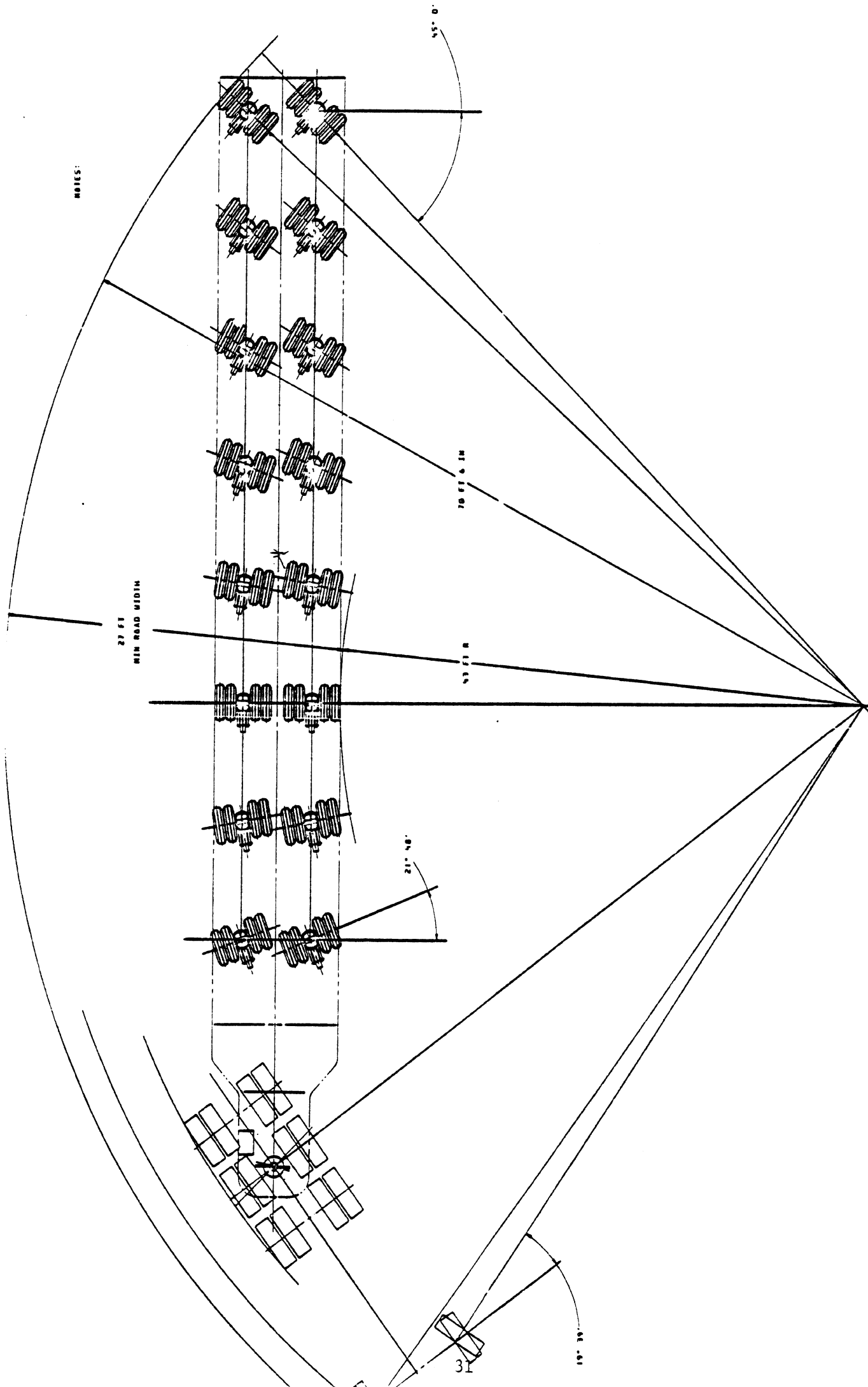

Figure 14. Plan View of Automatically-Steered Trailer in Concept D-5 Transportation System.

High-Speed Offtracking

When the vehicle goes through a freeway exit ramp or some other short-radius curve, the scheme by which trailer axles are steered (a scheme intended to enhance low-speed turning) will act to exaggerate the high-speed offtracking behavior. The result will be that the trailer will "hang out" in the turn, thus subtending a greater path radius. The question will be, "How much does it hang out at reasonable turn radii and levels of lateral acceleration?" The permissible extent of this outboard type of offtracking is established by highway geometric constraints involving lane widths and the near proximity of guardrails.

In order to investigate this phenomenon, the vehicle must be modeled fairly thoroughly in regard to "yaw plane" characteristics. If axle roll-steer interactions are significant, the roll-induced steer effects can probably be handled quasi-statically.

Articulation Stability of the Overall System

Articulation stability embraces the broad set of characteristics which determine whether (a) trailer swing oscillations will be sustained, (b) perturbations in trailer articulations will be followed by unacceptable disturbances to the tractor, or (c) excessive trailer articulation levels will begin to accrue while cornering on lower friction road surfaces. It is apparent that design analysis is needed in order to identify the means for attaining acceptable performance in each of these areas, as outlined below.

a) Trailer Swing Oscillations - With the automatic steering of trailer axles, the eight-axle vehicle foils the application of even the most rudimentary rules of thumb for predicting trailer swing behavior. For example, one can reduce any conventional semitrailer to an equivalent single-axle trailer and then determine properties of the nominal swing behavior by comparing location of this trailer axle with the longitudinal position of the trailer mass center. If the axle is at or ahead of the mass center, lightly damped or unstable swing oscillations can be expected. For the case of the eight-axle vehicle, however, the automatic

steering action of the trailer axles is expected to so dominate the mechanics of side force generation at the trailer tires that no such simplification is useful, and thus a complete systems response analysis must be performed.

One thing which seems quite clear is that the design of the automatic axle steering functions will have everything to do with the character of swing oscillations. The selection of which trailer axle is to be non-steering, for example, is expected to have a distinct influence upon the dynamic behavior of the trailer.

The analysis of such matters requires complete treatment of the yaw plane dynamics of the system, although a linear analysis should suffice since articulation angles and tire slip angles are small. Some consideration should also be given to combined yaw/roll interactions if it appears that the roll-springing is relatively soft and if the suspension roll-steer properties are relatively strong.

b) Trailer Perturbations Inducing Tractor Disturbances - This subject involves the general matter of the degree of dynamic coupling which prevails between yaw motions of the tractor and trailer. The most important issue seems to be whether perturbations to the trailer, such as derive from road irregularities, wind gusts, etc., will induce motions which inordinately disturb the tractor. Accordingly, the natural modes of yaw response must be evaluated and the degree of coupling assessed.

Given that the trailer weights some 270,000 lbs, with only 46,000 lbs of tire load present on the tractor tandem axle set, the trailer can be looked upon as able to "make the tractor go wherever it wants." Thus, if the trailer is not caused to articulate, dynamically, about the fifth wheel center, thereby rendering a dynamic decoupling, dynamic yaw motions of the trailer may introduce powerful lateral motions at the rear of the tractor, perhaps making steering control difficult.

Such phenomena can be studied using the same linear dynamics model suggested in Item (a), above.

c) Yaw Stability Problems on Low-Friction Surfaces - As a derivative of the high-speed offtracking phenomenon cited earlier, the reduced-friction case deserves attention because of the peculiarities of the trailer axle layout arrangement. The following observations are pertinent:

- 1) Contrary to the design of conventional semitrailers in which the total trailer load is concentrated upon tires which are situated at the fore and aft extremities of the vehicle, the eight-axle trailer distributes its load at axle locations all along its length. Since axle load establishes the level of tire side forces which can be generated, it is noteworthy that the tires occupying the important "outer extremity" positions bear only a small portion of the total load.
- 2) For the automatic steering arrangement illustrated in Figure 14, the largest slip angles achieved during steady turning at some speed will occur on the aft-most trailer axles. Thus, as we consider surface friction level going down, such as due to rainfall or other surface contamination, the rearmost trailer tires will be the first to saturate in shear force.
- 3) With saturation in the side force output of the vital rearmost tires, the development of a yaw moment on the trailer as a whole is strongly deteriorated. The remaining, non-saturated, axles are placed at less effective moment arms with respect to the c.g. such that considerably larger tire slip angles are needed to establish yaw moment equilibrium. The net outcome is that increasingly large levels of outboard offtracking would accrue as friction level is reduced.

This phenomenon can be examined suitably using a static yaw (-and possibly roll) model which employs an authentic treatment of the steering mechanisms as well as nonlinear tire characteristics.

Basic Roll Stability

The basic static roll stability of the vehicle should be assessed, given the roll-reaction characteristics of the suspensions. Although the overall vehicle width is very large (124 inches), the spread between each of the two adjacent suspension struts on each trailer axle appears rather narrow. Depending upon the roll moment exhibited across a four-wheel set (on each strut), the total roll stability of the vehicle could either be quite high or relatively low. The roll stability issue can be fruitfully studied with the aid of a static model, given an adequate characterization of the suspension parameters involved.

Tractor Tractive Capabilities

The tractor tandem is loaded to an unusually small fraction of the gross vehicle weight. If only two of the tractor tandem axles are driven, for example, a maximum tractive effort of about ($0.8\mu \times 30,800$ lbs = 24,640 lbs) is available on a dry pavement. With a gross weight of 300,000 lbs, and considering an "ideal" tractor suspension, the maximum grade achievable without sliding the tractor drive wheels on a dry pavement would be about 8%. For typical commercial tractor suspensions, however, having a substantial degree of inter-axle load transfer in response to driving forces, the maximum achievable grade would be more like 6%. (Here it was assumed that the load transferred between the tandem axles was equal to 0.18 times the sum of the drive forces.) If the vehicle were negotiating a tight-radius curve while ascending a grade, a somewhat lower grade value would constitute the limit condition. Moreover, this vehicle will place great demands on tractor tractive capability such that special design attention to tractive performance is warranted.

Design Details Involving the Trailer Axle Steering Controller

Considering a purely passive mechanical linkage arrangement for achieving the steer actuation of the trailer axles, it is conceivable that the actuation element which directly "picks up" the tractor-to-semitrailer articulation angle might impose an excessive reaction moment about the fifth wheel coupling. Thus, the analysis of vehicle yaw

response as suggested above, should also serve to determine the maximum tolerable moment about the fifth wheel. It seems quite possible that such a determination would indirectly rule out mechanical solutions to the steer-actuation system, thus leaving only active (powered) systems as the feasible alternatives.

On the other hand, if such an analysis indicates that an active, say hydraulic, steer actuation system is needed, the dynamic properties of this system must be considered. At the very least, for example, a slew rate specification should be developed to assure that the trailer can "keep up with the tractor" even in an emergency evasive type of maneuver. Without such a provision, it is conceivable that a sufficiently rapid steering maneuver could result in an irrational set of trailer axle steer angles, and thus some anomalous loss of control event.

Trailer Motions Following Jackknife of the Tractor

In the jackknifing of conventional tractor-semitrailers, the trailer goes virtually straight ahead while the tractor rotates rapidly around the fifth wheel—finally striking the cab against the side of the trailer. In the case of the envisioned eight-axle trailer, tractor jackknife would tend to actuate the trailer axle-steering system (as if the vehicle were in a curved path), inducing the fully-steered axle motions. While it is not clear, at this juncture, just how the combination vehicle would respond to this set of conditions, a very dramatic form of monotonic instability can be envisioned. By this scenario, the sharply-steered trailer would take off on a very tightly-curved path and would probably roll over. Thus, tractor jackknife with an articulation-steered array of trailer axles might result, not simply in a jackknife, but in a disaster. Accordingly, the vehicle design should reflect a rigorous level of attention to the tractor jackknife contingency, endeavoring to prevent it entirely.

Pitch Response of Semitrailer

Depending upon the manifolding of the suspension struts on the trailer axles, the trailer will achieve some effective level of "pitch stiffness" which, together with inertial properties, will establish the pitch vibrational modes. One concern regarding pitch mode behavior involves the hard-braking case, in which the tractor might experience a gross overload if the pitch stiffness is very low. The other issue simply involves the natural pitch oscillations which may prevail during on-highway travel. Again, given the tremendous ratio of trailer weight to tractor weight, the motion behavior of the trailer is of primary significance since the trailer has plenty of "power" to push the tractor around and thus distress the driver.

REFERENCES

1. Gillespie, T.D. and Winkler, C.B. "On the Directional Response Characteristics of Heavy Vehicles." IUTAM Symposium, 1977.
2. Gillespie, T.D. and MacAdam, C.C. "Constant Velocity Yaw/Roll Program User's Manual." Rept. No. UMTRI-82-39, University of Michigan Transportation Research Institute, October 1982.