

UM-HSRI-PF-76-2-1

The Noise and Traction Characteristics of Bias Ply Truck Tires

Volume 1 of 2

Noise and Dry Traction Findings

by

Robert D. Ervin

Robert E. Wild

January 1976

Highway Safety Research Institute / University of Michigan

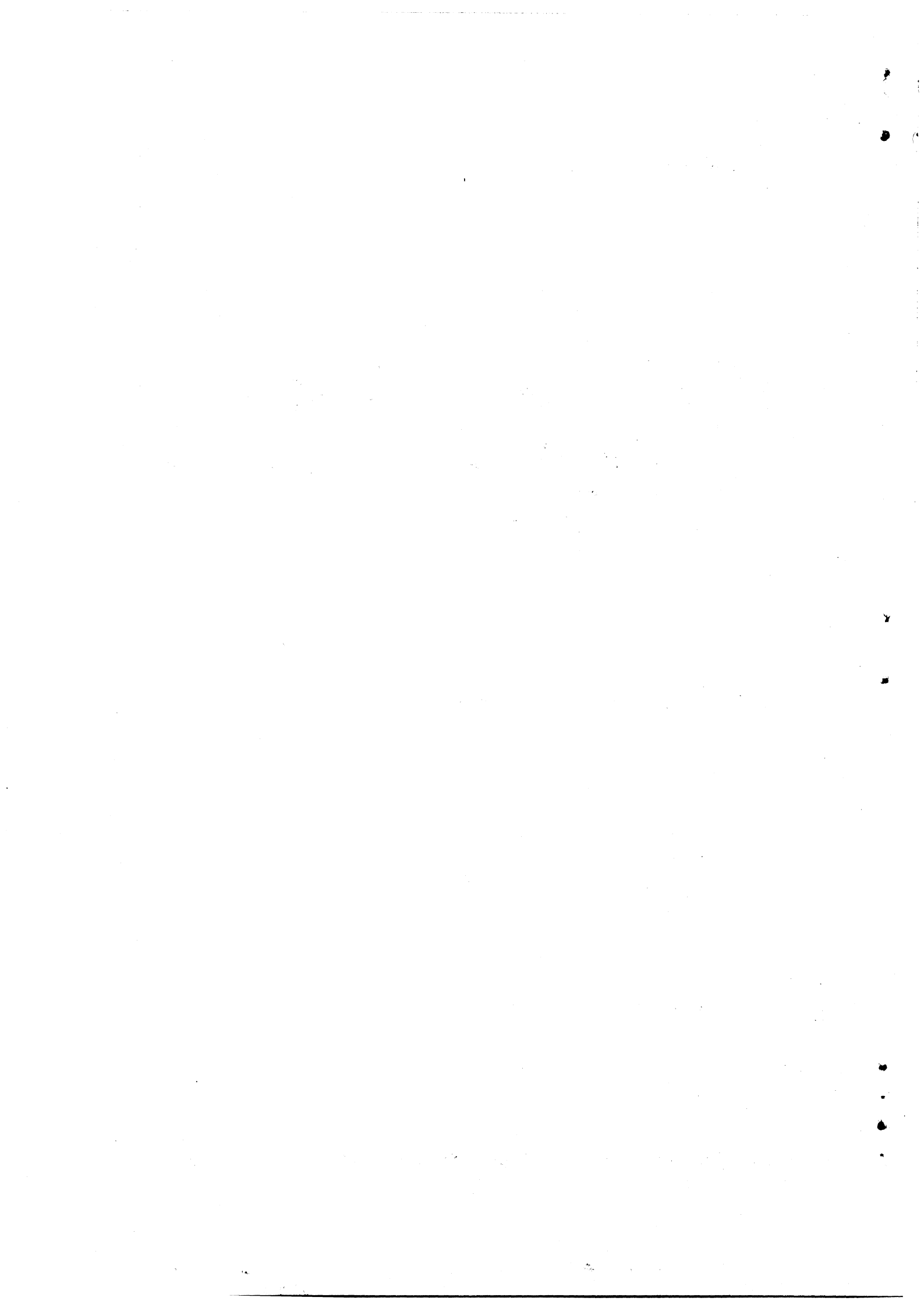

Technical Report Documentation Page

1. Report No. UM-HSRI-76-2-1		2. Government Accession No.		3. Recipient's Catalog No.	
4. Title and Subtitle NOISE AND TRACTION CHARACTERISTICS OF BIAS-PLY TRUCK TIRES Vol. 1 - Noise and Dry Traction Findings				5. Report Date January 1976	
				6. Performing Organization Code	
7. Author(s) R. D. Ervin & R. E. Wild				8. Performing Organization Report No. UM-HSRI-76-2-1	
9. Performing Organization Name and Address Highway Safety Research Institute The University of Michigan Huron Parkway & Baxter Road Ann Arbor, Michigan 48109				10. Work Unit No. (TRAIS)	
				11. Contract or Grant No. 361048	
12. Sponsoring Agency Name and Address Motor Vehicle Manufacturers Association 320 New Center Building Detroit, Michigan 48202				13. Type of Report and Period Covered Final	
				14. Sponsoring Agency Code	
15. Supplementary Notes					
16. Abstract This project has established a data base of noise and traction characteristics for a sample of bias-ply heavy truck tires. The tire sample, representing both "rib" and "lug" type tread patterns, was tested according to the SAE J-57 tire noise procedure and in a variety of laboratory and over-the-road traction experiments. Dry-pavement traction results show that the noisier lug-type tires exhibit traction properties which are generally less desirable from the viewpoint of their influence on vehicle response to steering and braking.					
17. Key Words			18. Distribution Statement UNLIMITED		
19. Security Classif. (of this report) UNCLASSIFIED		20. Security Classif. (of this page) UNCLASSIFIED		21. No. of Pages 154	22. Price

Form DOT F 1700.7 (8-72)

Reproduction of completed page authorized



UM-HSRI-76-2-1

THE NOISE AND TRACTION CHARACTERISTICS OF
BIAS-PLY TRUCK TIRES

Volume 1 of 2

Noise and Dry Traction Findings

Project 361048

Robert D. Ervin
Robert E. Wild

January 1976

Sponsored by
The Motor Vehicle Manufacturers Association

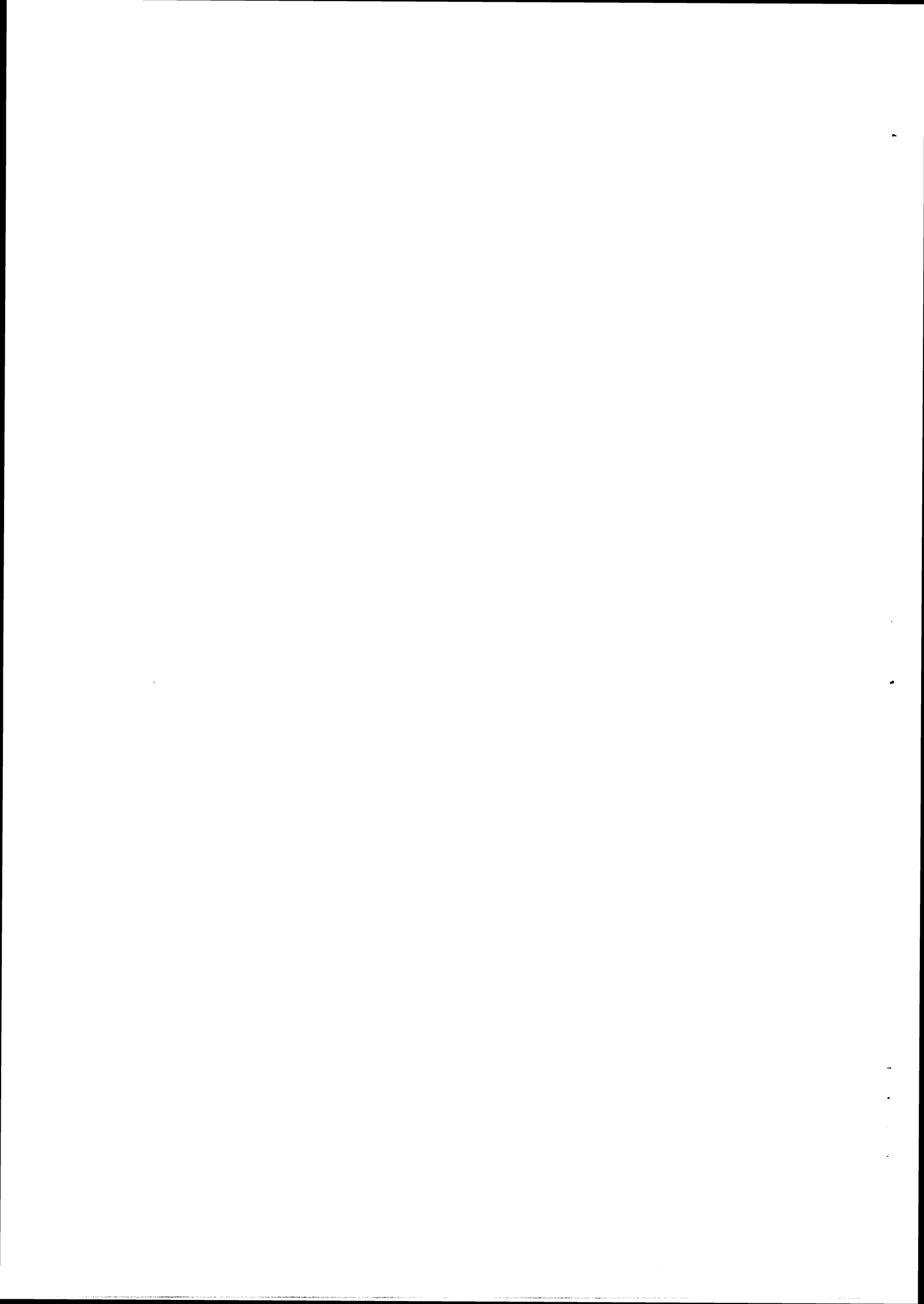

TABLE OF CONTENTS

1.	INTRODUCTION.	1
2.	RESEARCH METHODOLOGY.	3
	2.1 Tire Sample.	3
	2.2 Noise Level Measurements	7
	2.3 Traction Measurements.	8
3.	RESULTS	17
	3.1 Noise Test Results	17
	3.2 Traction Test Results.	22
4.	CONCLUDING REMARKS.	47
	REFERENCES	49
	APPENDIX A - DETAILED NOISE TEST RESULTS FROM REPORT PREPARED FOR HSRI BY INTERNATIONAL HARVESTER COMPANY	51
	APPENDIX B-I - TABULAR FLAT-BED TEST RESULTS	109
	APPENDIX B-II - INDIVIDUAL LONGITUDINAL FORCE PLOTS FROM MOBILE TRACTION TESTS	111
	APPENDIX B-III - INDIVIDUAL LATERAL FORCE PLOTS FROM MOBILE TRACTION TESTS.	119
	APPENDIX C - TRACTION TEST APPARATUS	139



1.0 INTRODUCTION

This document reports on an experimental program conducted by the Highway Safety Research Institute (HSRI) of The University of Michigan under grant support from the Motor Vehicle Manufacturers Association. The project had as its primary objective the gathering of data descriptive of the noise and traction characteristics of lug- and rib-type truck tires of bias-ply construction. The terms "lug" and "rib" are meant to denote two basic tread configurations which differ in the orientations of the major elements in the tread pattern. The "lug"-type tread is one in which the major elements in the tread pattern are oriented in the transverse direction and are separated from one another by significant transverse grooves. The "rib"-type tread is characterized by tread elements oriented primarily in the circumferential direction and which are separated from one another by circumferential grooves.

Lug- and rib-type truck tires have been shown to contrast markedly in their noise generating properties while in the freely rolling state [1]. The study reported herein, while reconfirming that "lugs" are significantly noisier than "ribs," endeavored to further compare these two tire types in terms of their highway traction qualities. It should be noted, however, that the restriction of this examination to noise and traction properties in no way presupposes a priority of these two topics in the evaluation of tire quality. Rather, the study reflects the fact that truck tire traction data are exceedingly scarce and are needed, in accompaniment with noise data, to factor vehicle safety considerations into the tire noise controversy.

"Traction" measurements, such as are reported herein, refer specifically to the tire's ability to generate shear forces during contact with a highway pavement. Thus the reported measures are discussed in terms of their significance to vehicle controllability in the context of steering and braking maneuvers on the highway. On the other hand, a second dimension of tire traction behavior, while presumably important to the lug versus rib comparison, has not been investigated here, namely, the tractive effort which can be sustained by tires operating on deformable surfaces such as mud and snow. These so-called "mobility" properties remain largely unexamined for highway-type truck tires to date.

The main body of Volume 1 of the report is organized into "methodology" and "results" sections in which are presented summaries of methods and findings. Appendices are provided as elaborations on both topics. The traction test results presented in Volume 1 pertain to experiments conducted on a dry pavement surface. Volume 2 presents and discusses the results of traction tests conducted on a wetted pavement surface.

2.0 RESEARCH METHODOLOGY

The methodologies employed in this study addressed the characterization of two diverse aspects of tire behavior. Measurements were conducted to describe both the noise and traction performance qualities of a sample of six truck tires, under conditions which were seen as relevant to the respective noise and traction interests arising from environmental and safety issues. With regard to noise generation, measurements were made according to an existing standard practice, recommended by the Society of Automotive Engineers. Traction measurements were conducted according to procedures developed at HSRI, since a standardized methodology has yet to be established.

2.1 TIRE SAMPLE

Six heavy truck tires were selected to conduct the noise and traction experiments. The sample was selected to reproduce as closely as possible the set of tires which were employed in a pioneering noise measurement effort [1] conducted by the U.S. National Bureau of Standards. The test tires are identified in Table 1. (All tires were 10.00 x 20/F, where the "F" designation indicates a Tire & Rim Association (T&RA) rated load of 5430 lbs at a cold inflation pressure of 85 psi.) The test sample, as illustrated in Figure 1, contains three tires with "circumferential rib"-type tread patterns and three tires configured with tread patterns of the "cross lug" variety. A seventh tire, as listed in Table 1, was employed only as a quiet reference tire in the noise measurements; it was not traction tested.

Four specimens of each tire in Table 1 were procured directly from the respective manufacturers in common production lot sets.

TABLE 1
TIRE SAMPLE

Tread Type	Manufacturer	Model	Contained in Reference 1 Sample?
Hwy. Rib	Goodyear	Super Hi Miler	No
	Firestone	Transport 1	Yes, but in a now-obsolete version-Transport 150
	General	GTX	Yes, but in a now-obsolete version-Power Jet
Lug	Goodyear	Custom Cross Rib	Yes
	Uniroyal	Fleet Master Super Lug	Yes
	Firestone	Transport 200	Yes
"Quiet" Reference Tire	General	HCR	Yes

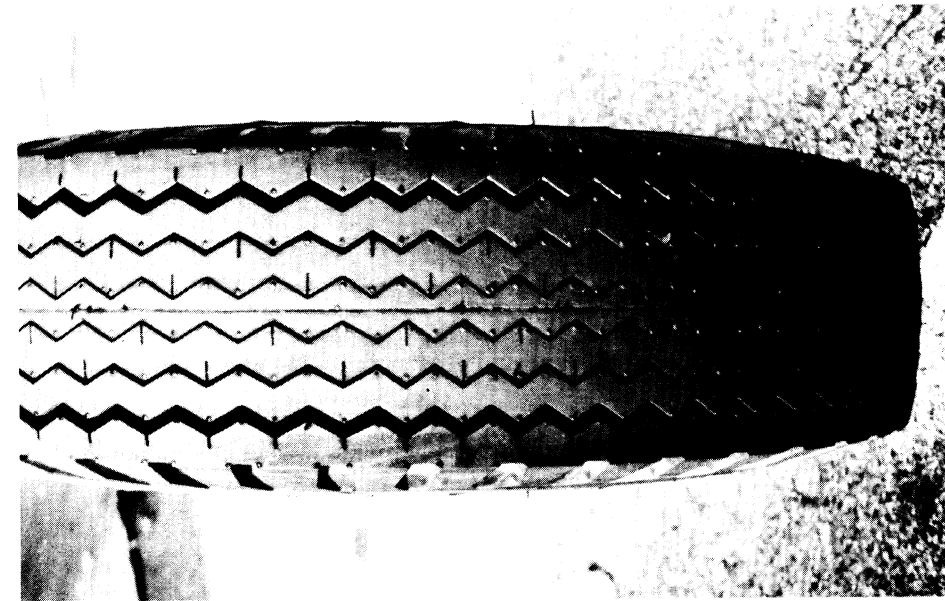

Goodyear Super
Hi Miler

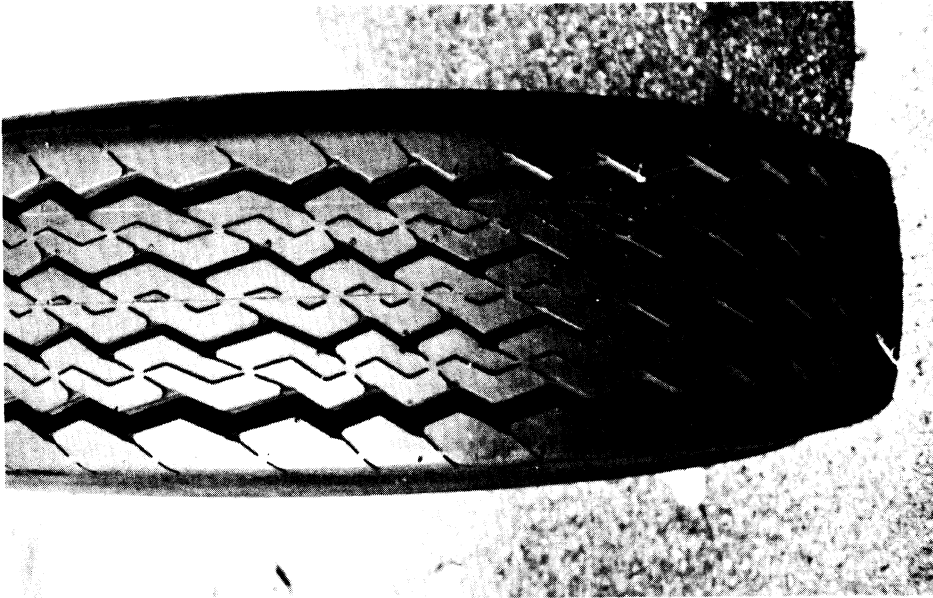

General
GTX



Firestone
Transport 1

Figure 1a. Photos of rib-type tread patterns represented in the noise/traction test sample.

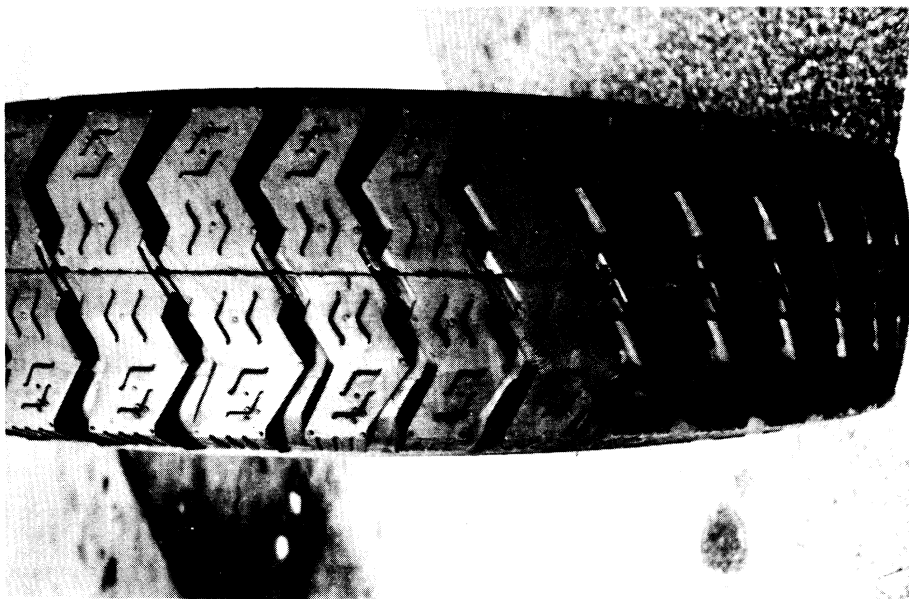

Uniroyal
Fleetmaster
Super Lug

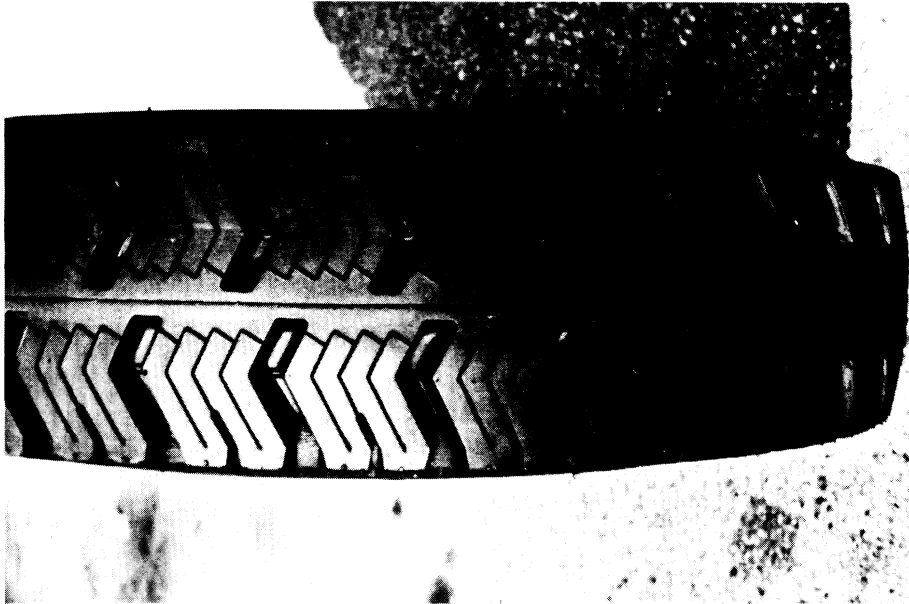

Goodyear
Custom Cross Rib

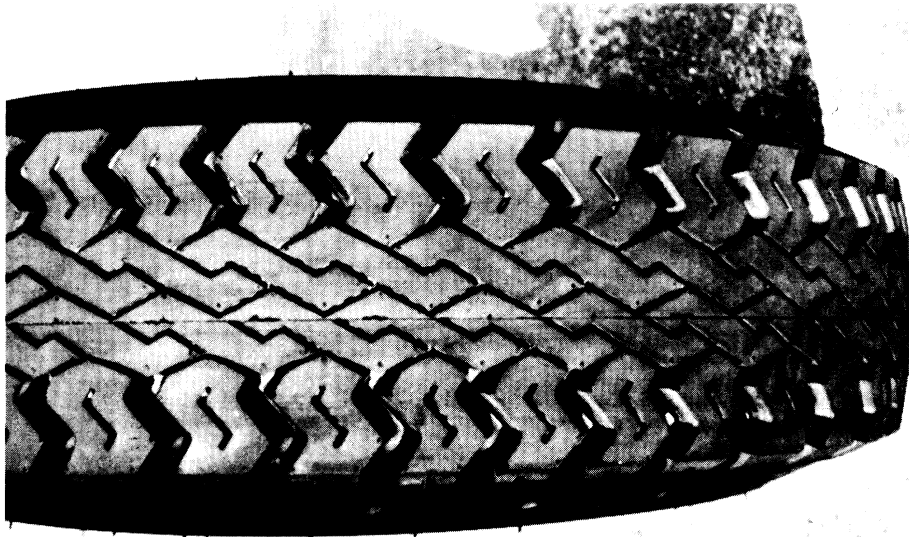

Firestone
Transport 200

Figure 1b. Photos of lug-type tread patterns represented in the noise/traction test sample.

2.2 NOISE LEVEL MEASUREMENTS

Noise level measurements were conducted by the International Harvester Corporation at its Noise Test Facility in Fort Wayne, Indiana. The noise level measurements were made according to the procedures prescribed in "Sound Level of Highway Truck Tires—SAE J57." Although a detailed description of the test procedure, test facilities, and data processing methods are given in Appendix A, a brief summary of the method will be given here.

The basic procedure requires, first, the installation of the subject tires on the rear axle of a loaded, two-axle truck. The front axle of the vehicle is outfitted for these tests with a so-called "quiet" tire. The vehicle is coasted by the noise measurement site at a speed of 50 mph, while a measurement of the peak A-weighted noise level is made using a sound level meter set for "slow" dynamic response. In addition to sound level measurements, per se, recordings were also made in this study on magnetic tape, permitting a subsequent 1/3 octave spectral analysis—a step which is not required by SAE J57. As a further addition to the J57 method, tests were conducted using 35 mph as the "coast-by" speed and also with the sound level meter set to the "fast" as well as the "slow" dynamic response.

Only fully treaded tire samples were subjected to the matrix of coast-by measurements. Noise tests were conducted first, following which the four tire specimens were utilized in the various traction experiments.

2.3 TRACTION MEASUREMENTS

Traction measurements were made on each of the six sample tires using three different test devices. The first machine, the HSRI Flat-Bed Tester, is a low-speed laboratory dynamometer which was used to obtain precision measurements of the "cornering stiffness" parameter (C_α), defined as the slope of the side force (F_y) versus slip angle (α) relationship through the origin, viz.,

$$C_\alpha = \left. \frac{\partial F_y}{\partial \alpha} \right|_{\alpha=0}$$

In addition to measuring C_α , a tire property bearing on the directional response of trucks in normal driving maneuvers, other traction tests were conducted to characterize tire properties relevant to emergency braking and steering maneuvers. These other tests involved the use of two mobile traction dynamometers which were developed at HSRI. One machine measures a tire's longitudinal force (F_x) response to longitudinal slip (s), while another device measures the F_y versus α relationship, comparable to the flat-bed machine, but now obtaining data on real pavements at actual highway speeds. All mobile tests were conducted on a Portland cement concrete track at the Dana Automotive Test Facility in Ottawa Lake, Michigan. This surface is characterized by an ASTM skid number (dry) of 87, as measured with the E-501 standard tire.

2.3.1 FLAT-BED TESTS. The HSRI Flat-Bed Tire Tester, shown in Figure 2, mounts a single tire specimen within an instrumented support assembly from which force and moment reactions are measured. The tire is caused to



Figure 2. HSRI Flat-Bed Tire Tester

operate at the desired slip angle on a flat plate at a velocity of 1.44 mph. The vertical load condition is maintained constant throughout the traverse of the flat plate, while a computerized data acquisition system samples the output of various measurement transducers. Detailed description of the flat-bed machine is presented in Appendix C.

In tests performed for this study, each tire was operated at $\pm 1^\circ$ slip angle orientations, and at vertical load (F_z) values of:

$$F_z = 1.0 \times \text{Rated Load} = 5430 \text{ lbs}$$

$$F_z = 0.6 \times \text{Rated Load} = 3260 \text{ lbs}$$

$$F_z = 0.3 \times \text{Rated Load} = 1630 \text{ lbs}$$

Varying F_z conditions were chosen to cover tire loadings such as prevails over the empty to fully-loaded usage of commercial vehicles. Since F_z is known to have a first-order influence on C_α , it is pertinent to examine this sensitivity as it signifies a sensitivity of vehicle directional behavior to loading.

One specimen of each tire was employed in the flat-bed tests; all tires were tested at their rated cold inflation pressure of 85 psi.

2.3.2 MOBILE TRACTION TESTS-LONGITUDINAL. The HSRI Mobile Longitudinal Force Tester, shown in Figure 3, is a semi-trailer device which mounts a single tire sample along its centerline. The test wheel is braked by a large commercial air-actuated brake as the trailer is towed at various velocities over the test pavement. The test wheel suspension incorporates a multi-component force transducer and an air spring loading system. The rotational velocity of the test wheel is transduced by a DC tachometer, which output signal is used in computing longitudinal slip.

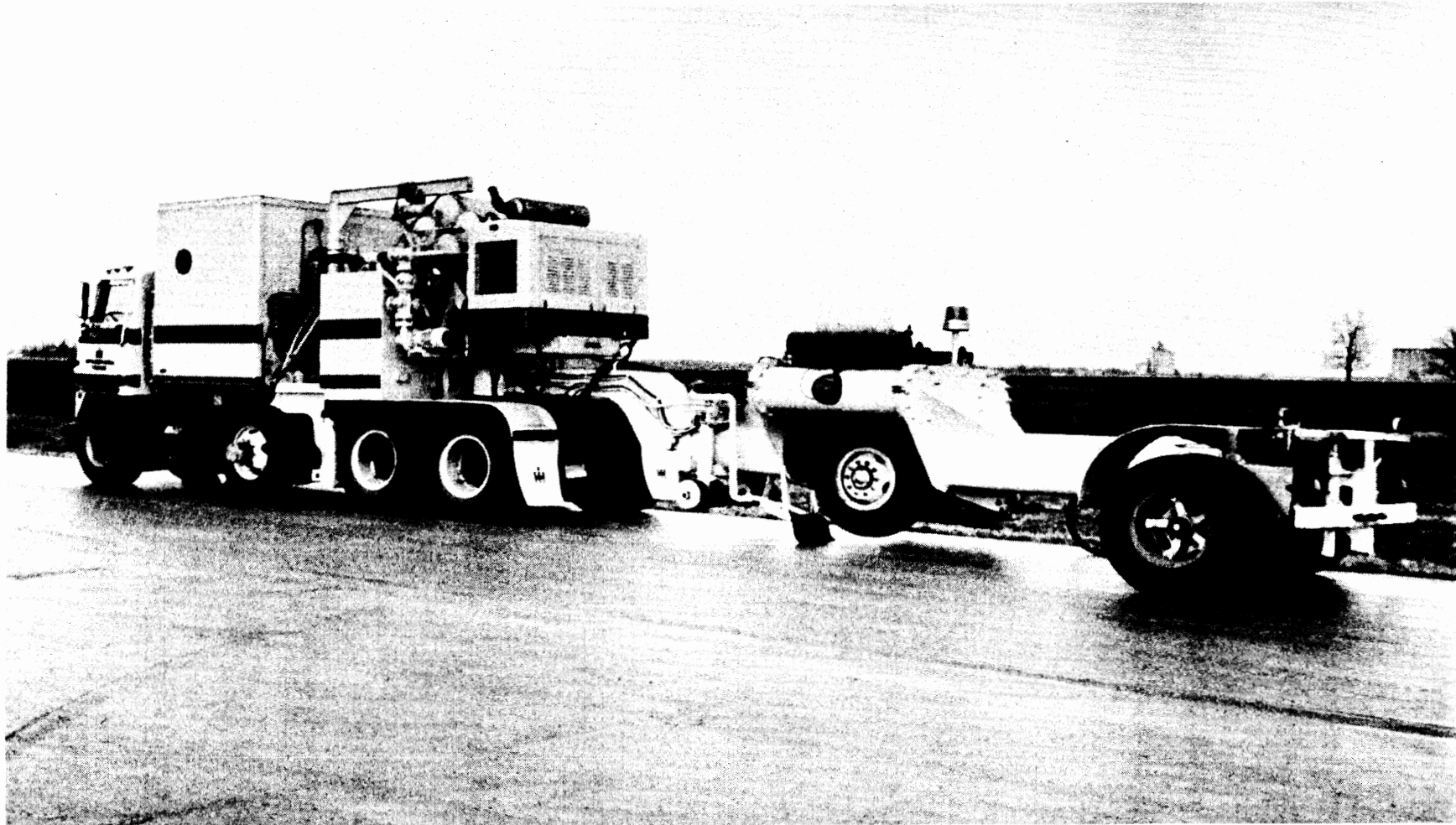

Figure 3. HSRI Mobile Truck Tire Dynamometer - trailer-mounted longitudinal force machine and tractor-mounted lateral force machine.

Signals from transducers on the trailer are conditioned and recorded in a data acquisition module located on the towing tractor. The tractor also incorporates all other services needed in the operation of hydraulic, pneumatic, and electrical systems.

In this study, each tire specimen was subjected to a sequence of velocity and load conditions per the following test matrix:

TABLE 2

<u>Run No.</u>	<u>Vertical Load Rated Load</u>	<u>Velocity, mph</u>	<u>Brake Application</u>
1 (REF)	1.0	40	Six Lockup Cycles - Each Run
2	0.5	20	
3	1.0	20	
4 (REF)	1.0	40	
5	1.5	20	
6	0.5	40	
7 (REF)	1.0	40	
8	1.5	40	
9	0.5	55	
10 (REF)	1.0	40	
11	1.0	55	
12	1.5	55	
13 (REF)	1.0	40	

For each "run" in the sequence, the test-wheel brake is applied so as to approximate a ramp input of torque. The wheel is braked until "lockup," ($s=100\%$) is achieved, following which the brake is automatically released. This "lockup cycle" is repeated six times at each test condition.

In later processing of the tape recorded data, the F_x versus s function is determined as an average of the tire's behavior over the six cycles.

The 13-run test sequence provides the means for examining the tire's sensitivity to both load and velocity over a range of conditions such as can apply to the limit stopping of trucks from any legal highway speed in either the empty or fully-loaded condition. The "reference" conditions of $F_z = 1.0 \times \text{Rated Load}$ and $V = 40 \text{ mph}$ are repeated periodically to provide a means of assessing the statistical quality of the experiment as well as the basic stability of the traction behavior of the tire specimen. As will be shown later, however, the constancy of a specimen's behavior is primarily of concern only in the conduct of side force tests on dry surfaces.

One specimen of each tire was subjected to the indicated matrix of test runs on a dry concrete surface. A second specimen was tested per the same test matrix, but on a concrete surface which was wetted by a water film of 0.020 in. nominal thickness. The method for wetting the test surface is described in Section 2.3.4. Additional details on the mobile dynamometer machine are presented in Appendix C.

2.3.3 MOBILE TRACTION TESTS-LATERAL. A second mobile device, namely a tire side force dynamometer, is incorporated within the tractor-trailer system described previously. This dynamometer assembly is attached to the frame of the tractor which was shown in Figure 3 and applies two test tires to the roadway at a controlled slip angle. Lateral and vertical reaction forces are transduced through a load cell mounted in the test-wheel spindle. The test tire is loaded by an air spring system, as with the trailer device. The slip angle is servo-controlled through a program of "slew and pause"

increments, causing the test wheel to experience a pre-determined set of steady-state levels of α . In later reduction of the data from magnetic tape, the time history of recorded signals is sampled and averaged over each of the "pause" intervals, yielding a set of F_y , F_z , and α numerics characterizing the tire's lateral traction response to the stated conditions. A more detailed description of the mobile side force dynamometer is presented in Appendix C.

Lateral traction measurements at slip angles ranging from 0 to 20° were conducted on specimens of each tire under both dry and wet pavement conditions. The matrix of vertical loads and velocities duplicated the test run sequence shown previously in Table 2, with the exception that a slip angle program was substituted for the lockup cycle process used in longitudinal force tests. Slip angle was incremented in each lateral force run to cover the values $\alpha = -1^\circ, +1^\circ, 2^\circ, 4^\circ, 6^\circ, 12^\circ, 20^\circ$. Each α level was maintained for a period of 1.0 second, while velocity and vertical load were held constant. As with the longitudinal measurements, one specimen was employed in tests on dry concrete and a second specimen was employed on concrete which was wetted with a water film of 0.020 in. thickness.

2.3.4 WET SURFACE TESTING. The wet pavement condition was achieved by means of an on-board watering system delivering a calibrated flow of water ahead of the test tire. Separate nozzles are employed just ahead of either the longitudinal or lateral test wheel positions to deliver flow rates which are adjusted at each test velocity condition to yield a nominal 0.020 in. thickness to the deposited film. Each nozzle is segmented to assure a uniform flow distribution across an 18-in. swath. The

wet test process, itself, involves an initial pass over the test course to provide a preliminary wetting of the test pavement. On successive passes, the water delivery system is activated about two seconds prior to the initiation of the slip process (either longitudinal or lateral). The elapsed time between runs is maintained reasonably constant throughout the test sequence.

Results obtained from wet surface testing were unavailable at the time of printing Volume 1 of this report and thus are provided in Volume 2.

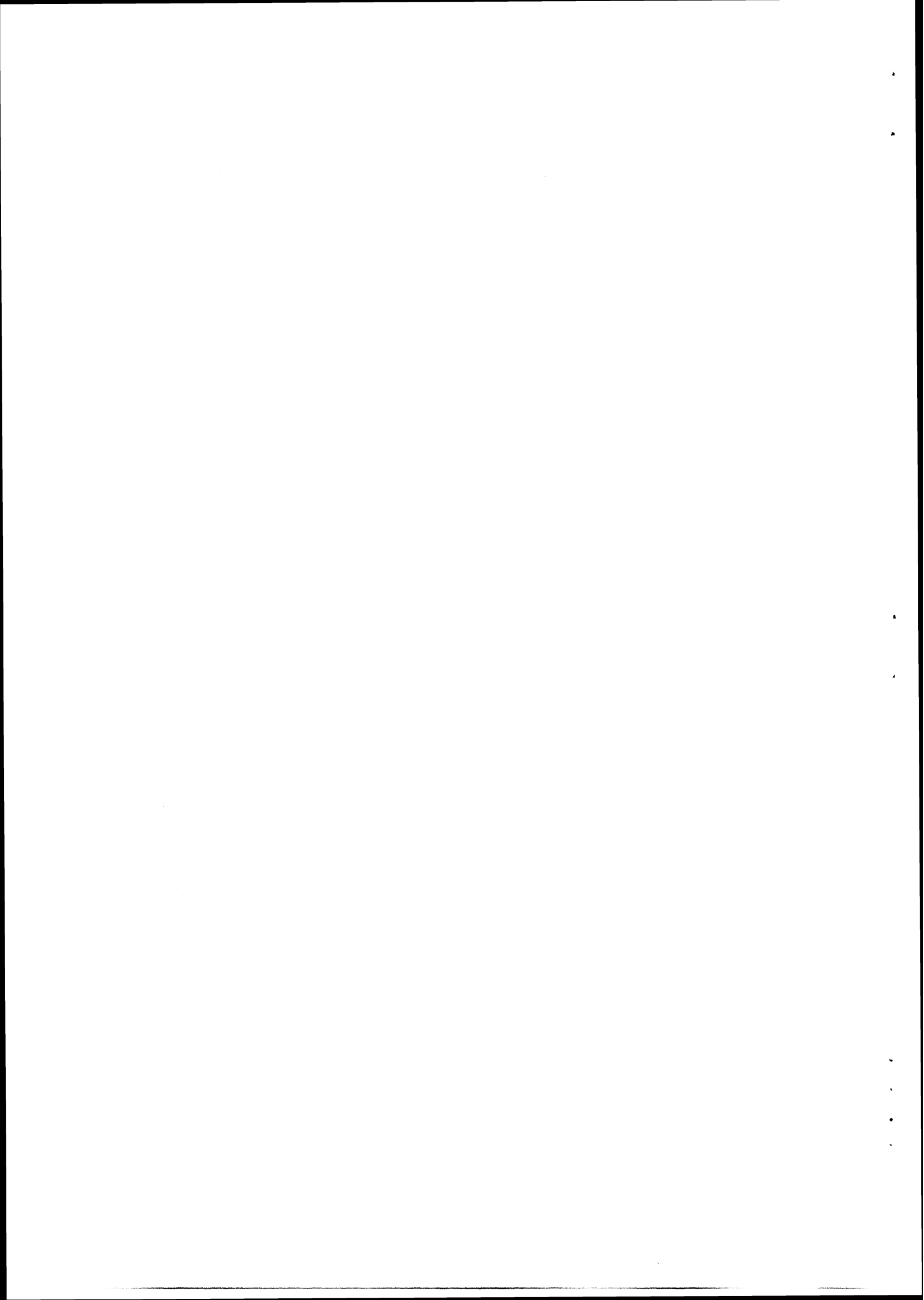

3.0 RESULTS

In this section, the noise and (dry) traction findings obtained on the six-tire sample are summarized. Although an interpretation of these data will be offered, it is recognized that many diverse analyses may be conducted for purposes of extracting a generalized meaning from the measurements. Given the limited state of knowledge on the relationship between vehicle dynamic properties and accident avoidance quality, it must be stated that interpretations of traction data offered here are based mainly upon fundamental axioms of vehicle mechanics and not upon proven relationships to highway safety. An equal level of candor concerning interpretation of noise data would suggest that the evaluation of dbA noise level differences rests ultimately upon a solid understanding of the relationship of community noise fields (however characterized) to the nuisance and health reactions of humans to that noise.

3.1 NOISE TEST RESULTS

Noise level measurements obtained according to SAE J57 are shown in terms of peak levels of dbA in the bar graph of Figure 4. These results, shown for both the 35 mph and the 50 mph (per J57) velocity, agree quite well with the sound level results reported in Reference 1. In general, the lug-type tires are seen to be an average of 6.7 db higher in sound level than the rib tires in the 50 mph test, and 4.2 db higher in the 35 mph test. These differences confirm the results of Reference 1 to within about 1 db, when comparing measurements obtained on concrete surfaces. The three lug-type tires which were included in the sample of Reference 1, as well as in the sample reported here, are seen to have been ranked

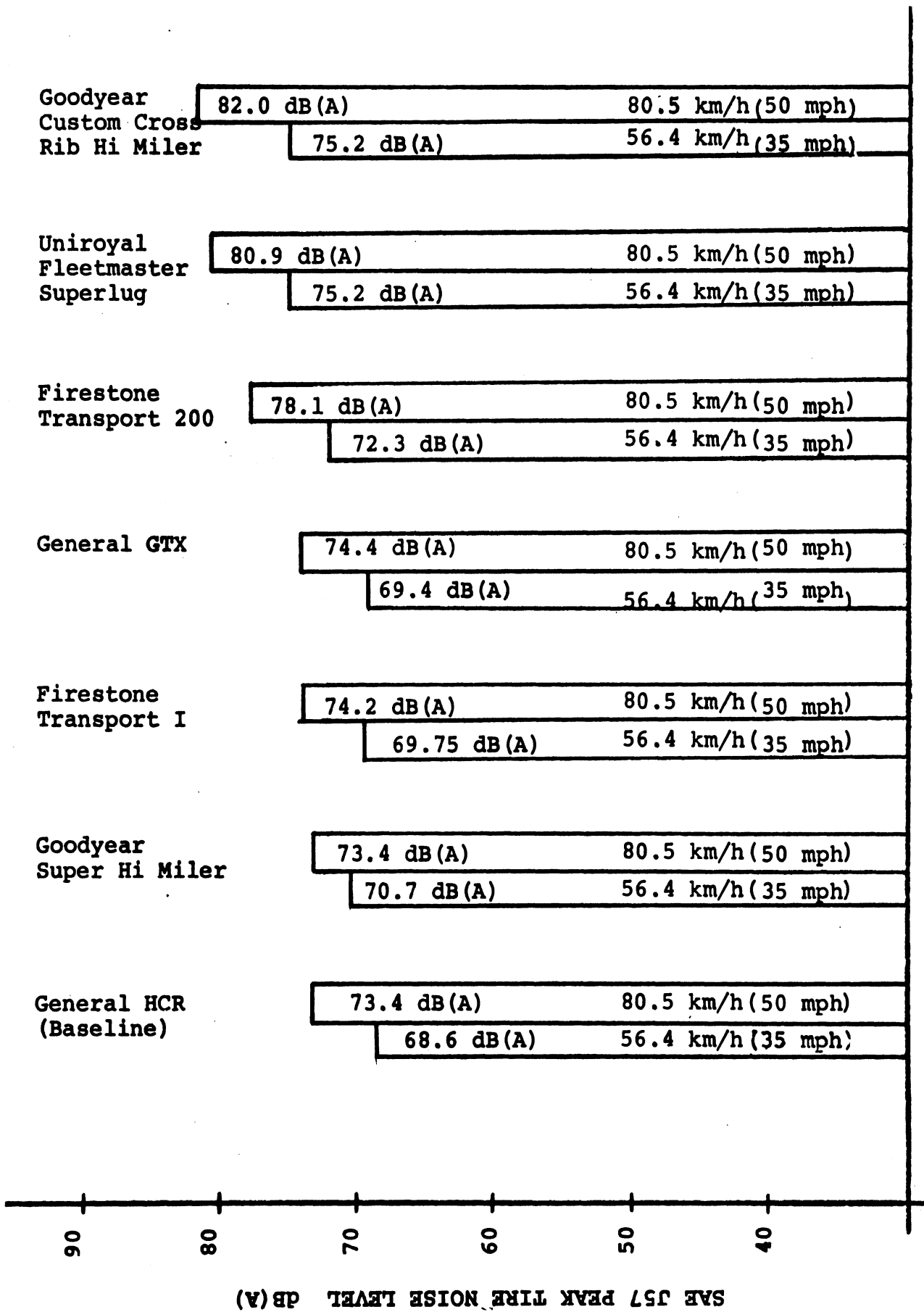

Figure 4. Peak db(A) Levels measured at 50 ft. for passby speeds of 35 and 50 mph.

identically in both studies at 50 mph, with only a slight rearrangement at 35 mph.

The results shown in Figure 4 correspond to the dbA peaks recorded with a sound meter set to the "slow" response condition. In Table 3, these data are augmented by measurements made at the "fast" response setting. It is interesting to note that the difference between readings taken at the fast and slow settings is generally greater for the 50 mph runs than for the 35 mph runs—clearly due to the more condensed sound level transient deriving from the higher velocity passby. Additionally, of course, the fast readings are characteristically higher than slow readings since the fast meter setting imposes less attenuation on the peak level, itself.

The tape recorded data taken for each tire was further processed by International Harvester to provide a 1/3 octave analysis of the noise spectrum corresponding to the time in the passby test at which the maximum A-weighted sound level was observed. Figure 5 is an example spectral analysis, as produced from the 35 and 50 mph tests on the Uniroyal Fleetmaster Superlug. As has been reported by many sources [2, 3, 4], the spectrum of tire-generated sounds is dominated in most cases by a narrow band peak in the vicinity of 300 to 400 Hz. This tonal contribution derives from the periodic passage of the fundamental tread elements through the contact patch. Specifically, the spectrum of Figure 5 shows a peak at a center frequency of 315 Hz. This peak derives from the nearly pure tone character of this tire, which passes its major lug elements through the contact patch at a nominal rate of 319/sec when operating at a velocity of 50 mph [2]. It appears that first and second harmonics are also evident in the spectrum of Figure 5. Third-octave spectra are presented in Appendix A for each tire in the sample.

TIRE TYPE	S P E E D	SLOW RESPONSE A-WEIGHTED PEAK	FAST RESPONSE A-WEIGHTED PEAK	DIFFERENCE (FAST-SLOW)
GENERAL HCR	35	68.6	69.0	0.4
	50	73.4	74.3	0.9
UNIROYAL FLEETMASTER SUPERLUG	35	75.2	76.4	1.2
	50	80.9	82.8	1.9
GOODYEAR CUSTOM CROSS RIB HI MILER	35	75.2	76.0	0.8
	50	82.0	83.2	1.2
FIRESTONE TRANSPORT 200	35	72.3	72.8	0.5
	50	78.1	80.2	2.1
GENERAL GTX	35	69.4	70.2	0.8
	50	74.4	75.8	1.4
GOODYEAR SUPER HI MILER	35	70.7	72.2	1.5
	50	73.4	73.9	0.5
FIRESTONE TRANSPORT I	35	69.8	70.6	0.8
	50	74.2	75.6	1.4

TABLE 3. PEAK db(A) LEVELS OBTAINED USING "FAST" AND "SLOW" METER RESPONSE SETTINGS.

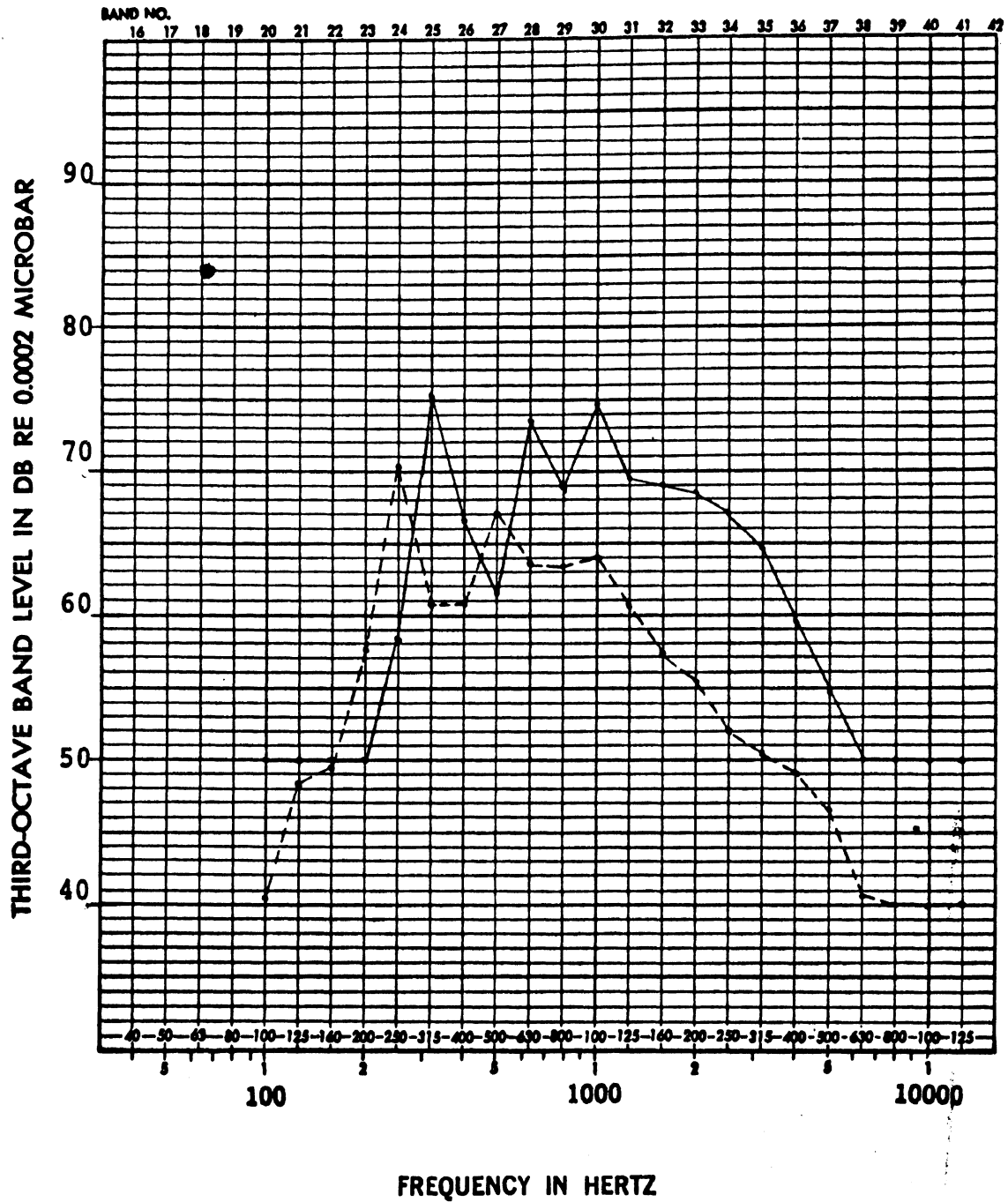

Figure 5. Example of third-octave tire noise level spectrum, in dB(A) vs. frequency. (Uniroyal Fleetmaster Superlug tire)

----- 35 mph
 ————— 50 mph

The final presentation of noise data involves spectral signatures of each tire as evaluated at various times, and thus at various positions of the test truck, during the passby test. These data, such as shown for the example lug tire in Figure 6 (and presented for each tire in the sample in Appendix A), indicate A-weighted sound level measures versus distance (along the truck's path relative to the microphone location). The plot shows both the total sound level (at the bottom of the figure) and the 1/3 octave band levels over the range of truck positions covering plus and minus 100 feet from the microphone position. The curve at each 1/3 octave level represents the sound level measured above a 65 db(A) threshold at each center frequency over the 200-foot passby. Third-octave bands registering less than a 65 db sound level are omitted. Thus, for example, the sound level curve shown at the 315 Hz center frequency shows a value of 66 db at a distance of -100 feet and rises to its peak of 77 db at +20 feet.

The data shown in Figure 6 provide a more comprehensive view of the tire's noise signature to the extent that the elements of directionality are represented. The passby test, however, involves the observance of noises emanating from multiple tire sources and thus requires that the sound level/position data be interpreted with due regard to the complex system that is involved.

3.2 TRACTION TEST RESULTS

A summary of traction test results is presented in this section. Detailed data presentations for each tire are provided in Appendix B.

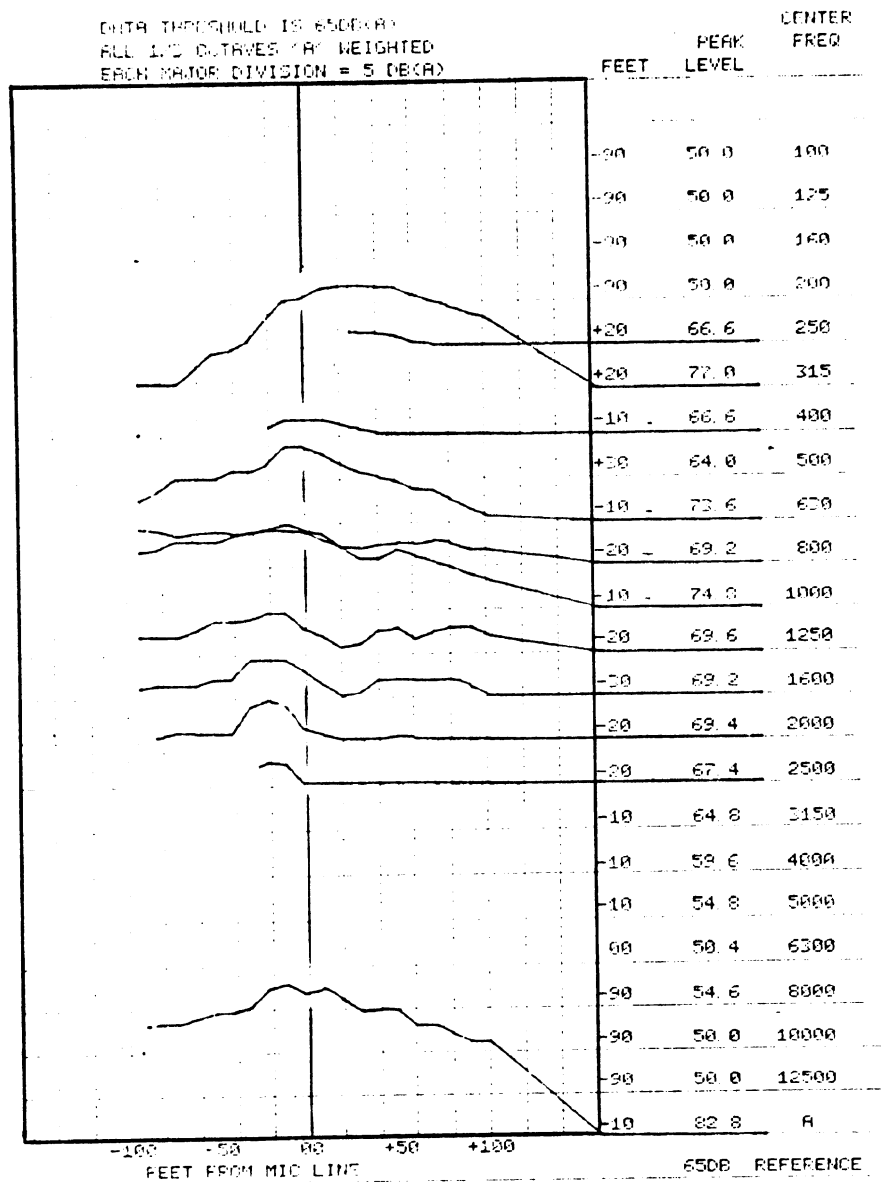

Figure 6. 1/3 octave band noise level signatures as recorded vs. distance along the path of the test vehicle.

3.2.1 FLAT-BED RESULTS. Cornering stiffness (C_{α}) as a function of normal load (F_z) for each of the six selected tires is shown in Figure 7. These data clearly discriminate between the rib-type and lug-type tread patterns in the sample, showing the rib tires to be an average 20% higher in their C_{α} values than the lug tires tested.

Some insight into the meaning of these data can be obtained through a simple analysis of the sensitivity of the "understeer" quality of a typical straight truck to the installation of tires of varying cornering stiffness. A pertinent measure can be derived from the expression of the path curvature, $1/R$, response of a vehicle to a front-wheel steering input, δ , at any velocity, V , as shown below:

$$\delta = \frac{\ell}{R} \left(1 - \frac{V^2 U}{g \ell} \right) \quad (1)$$

where

ℓ is the vehicle's wheelbase

R is the radius of path curvature

g is the acceleration due to gravity

and U is the understeer coefficient, determining the vehicle's basic linear range yaw behavior as a function of certain parameters of the tire/vehicle configuration, per the relation:

$$U = \frac{W}{\ell} \left(\frac{a}{C_{\alpha_2}} - \frac{b}{C_{\alpha_1}} \right) \text{ deg/g} \quad (2)$$

where

W = vehicle weight

a = longitudinal position of mass center aft of the front axle

- Goodyear Custom Cross Rib
- Uniroyal Fleet Master Super Lug
- ▲ Firestone Transport 200
- ▲ Goodyear Super Hi Miler
- General GTX
- Firestone Transport 1

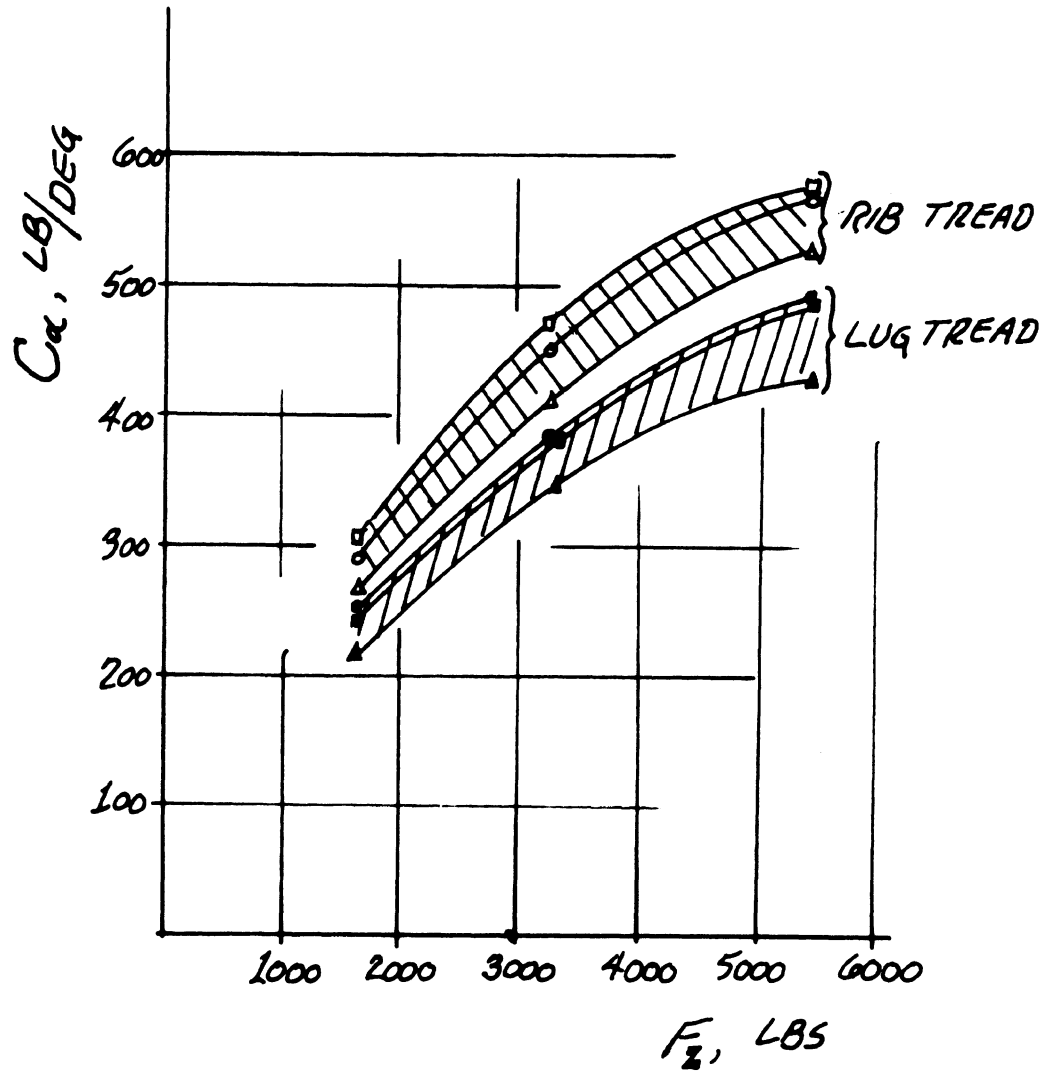

Figure 7. Cornering Stiffness, C_{α} , as Influenced by Vertical Load, F_z , for the Six-Tire Sample.

$$b = l - a$$

C_{α_1} = sum of the cornering stiffnesses of all tires mounted on the front axle

C_{α_2} = sum of the cornering stiffnesses of all tires mounted on the rear axle.

For purposes of evaluating the C_{α} measurements shown in Figure 7, the usage of (a) lug-type tires on the drive axle (only) of a 2-axle truck can be compared with the usage of (b) rib-type tires at both axle positions. The influence of these tire installations can be expressed in terms of the difference in U which derives, considering that:

$$C_{\alpha(\text{Lug Tire})} \approx 0.8 C_{\alpha(\text{Rib Tire})}$$

Let us consider the installation of lug tires as duals on the rear axle, with single rib tires on the front axle, such that,

$$C_{\alpha_2} = 4C_{\alpha(\text{Lug Tire})} = 3.2C_{\alpha(\text{Rib Tire})}$$

and

$$C_{\alpha_1} = 2C_{\alpha(\text{Rib Tire})}$$

As a further simplification, let us consider a perturbation in U about a configuration in which $a = 2b$ —a configuration yielding a neutral steer behavior (i.e., $U=0$) for case (b), when tires with the same value of C_{α} are installed at all wheel positions. Evaluating

Equation (2) using these parameters, we see that the usage of lug tires at the rear results in a 2 deg/g reduction in the understeer level which otherwise would derive from common tire installations all around. This worst case reduction occurs in the case of the fully-loaded vehicle, $W=30,000$ lbs. A reduction in understeer level of this magnitude is indeed significant, given that heavy trucks commonly exhibit a value of U in the range of 3 to 6 deg/g understeer.

Thus the common usage of lug-type tires on (rear) drive axles can be expected to degrade a response property which is generally regarded as pertinent to vehicle control. Alternatively, we might conclude that the increased noise level characterizing lug-type tires is not offset by a beneficial influence on the path curvature response characteristic of vehicles.

3.2.2 MOBILE TRACTION RESULTS - LONGITUDINAL.

Measurements of the longitudinal traction properties of the six-tire sample were obtained according to the 13-run sequence of load and velocities conditions described earlier. For each tire and test condition, a graphic display of the so-called " μ -slip" behavior was obtained, as shown for an example tire in Figure 8. The μ -slip curve shape illustrates the classic features of longitudinal force generation. The initially-steep increase of longitudinal force with increasing slip reflects the circumferential elasticity of the tire's carcass and tread structure. Beyond the elastic region, the force output reaches a peak as all of the tread elements traversing the contact patch begin to slide relative to the roadway. As slip increases further, the frictional coupling between tire and road degrades due to rubbing speed and heating effects, hence the characteristically negative slope at high slip.

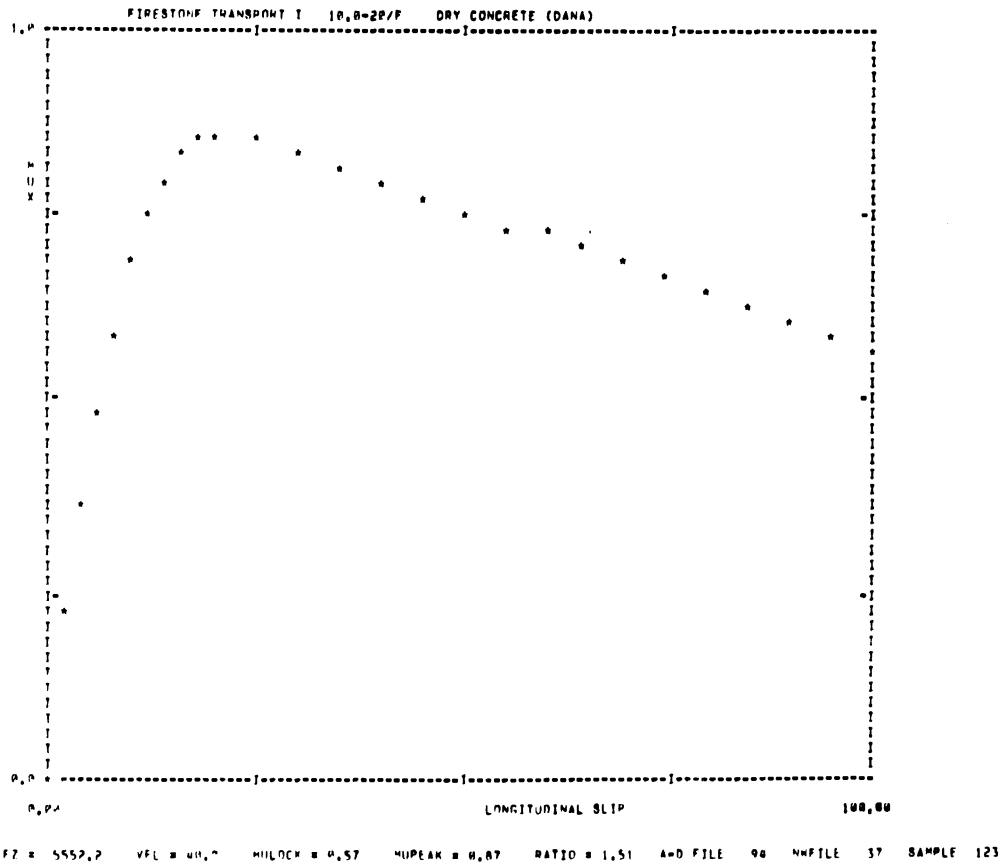

Figure 8. Example print plot of the F_x/F_z vs. slip behavior of a heavy truck tire on a dry concrete pavement.

The slope of the force/slip relationship through the origin, termed longitudinal stiffness, C_s , is directly analogous to the cornering stiffness property, C_α , which was discussed in relation to lateral forces. It is clear that rib- and lug-type tread patterns are sharply differentiated in their C_s parameter, as is illustrated in Figure 9. This plot, summarizing the μ -slip behavior of the three rib and three lug tires, represents normalized longitudinal force responses as measured under the reference condition of 40 mph and rated load. Referring to initial slopes, these data show the average rib tire as obtaining a $C_s = 49,000$ lb/unit slip while the average for the three lug tires is 30% less, with $C_s = 34,000$ lb/unit slip. Putting this observation into a vehicle control context, C_s values are of primary interest insofar as they influence vehicle response to braking in a curved path. To understand this influence, one must first consider that a vehicle employing lower C_s tires will experience greater excursions in longitudinal slip to effect the same deceleration levels as a comparable vehicle equipped with higher C_s tires. Since as longitudinal slip increases, the tire's ability to generate lateral forces decreases, there exists a mechanism by which the longitudinal properties of tires can influence the cornering response of vehicles to braking inputs. Thus, as a vehicle is negotiating a turn, at a given level of lateral acceleration and thus, tire side forces, it will experience a perturbation in centripetal force and/or yaw moment as a consequence of a braking input. The severity of this disturbance will be determined by:

- a) the initial level of lateral acceleration,
- b) the level of braking force generated at each of the various tire positions,

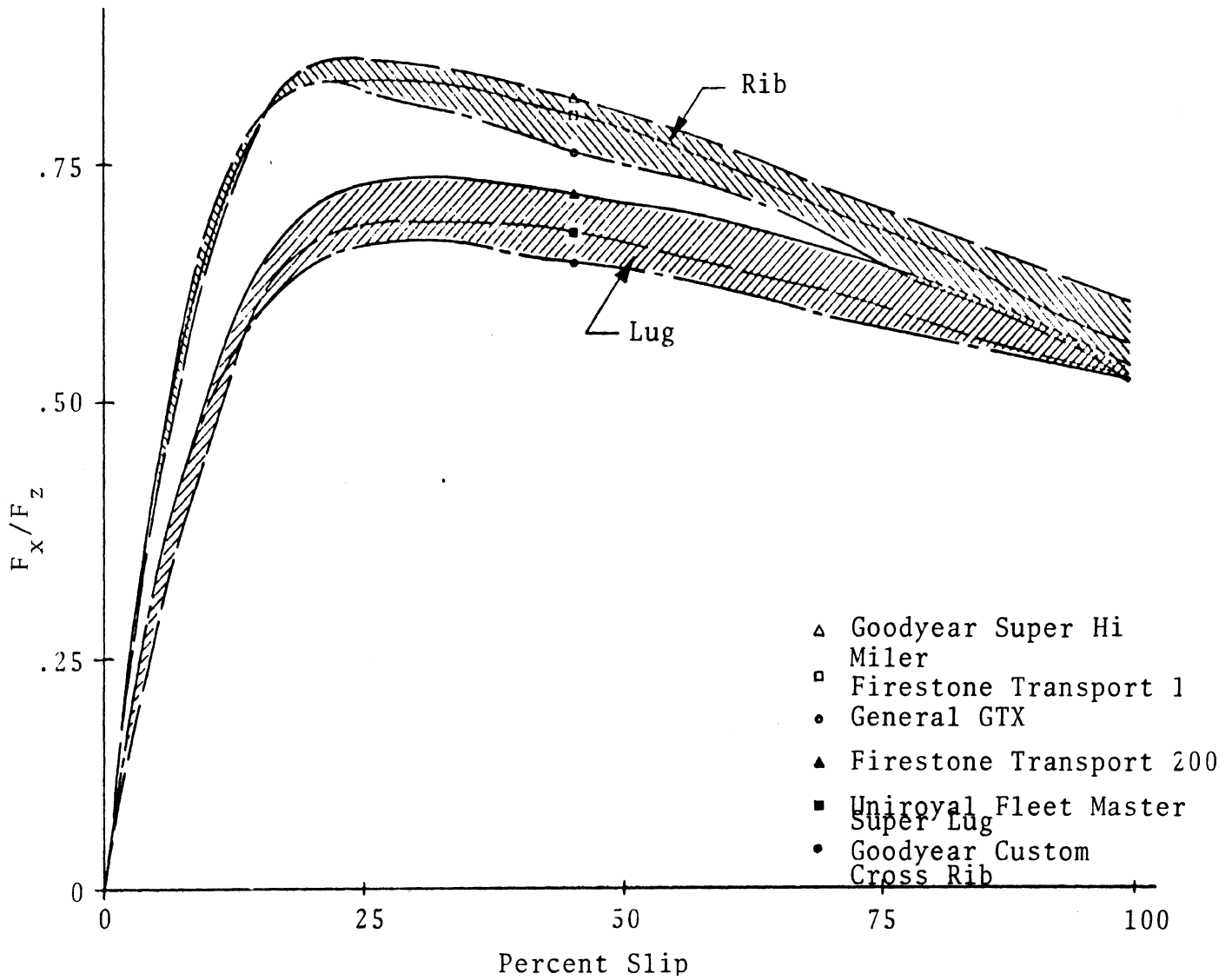

Figure 9. Characteristic μ -slip curve shapes at the reference condition of 40 mph and $1.0 \times$ Rated Load.

- c) the level of longitudinal slip accompanying the braking forces (where slip level is related to the tire's C_s parameter, for sub-limit braking), and
- d) the tire's lateral traction response to longitudinal slip.

The tire with a lower value of C_s will, for a given braking input, suffer a large instantaneous change in side force and thus will serve to more severely disturb the vehicle's curvilinear motion. For heavy trucks in which lug (low C_s) and rib (high C_s) tires are methodically distributed to rear and front axle positions, respectively, the potential for yaw moment disturbances deriving from braking applications in a turn are enhanced. Since heavy trucks typically "overbrake" their rear axles in favor of "underbraking" the steering axle, the cited yaw moment influence of rear-mounted lug tires is further aggravated.

As no reliable data is yet available describing the behavior of heavy truck tires under combined lateral and longitudinal slip, a quantitative determination of the implications of high and low values of C_s is not possible. Nevertheless, we can conclude that the measured values of C_s for lug-type tires constitute a less favorable behavior than is found for rib-type tires.

Additionally, the C_s distinctions between lug- and rib-type tires can be interpreted in terms of their implications on the understeer behavior of the cornering vehicle, in the absence of braking. By a subtle but well-known mechanism, the longitudinal stiffness of tires which are mounted in pairs, as a dual set, is directly involved in determining the yaw moment balance on a

cornering truck. The mechanism is simply understood by considering that the yaw rotation of a clamped pair of tires (for which no relative spin rotation is permitted) results in relative fore and aft translations of the two adjacent wheel centers, and thus of the ground-plane projections of those wheel centers. Accordingly, one of the dual tires experiences a positive longitudinal slip and the other experiences an equal value of negative longitudinal slip. The resulting shear force reactions to these slip conditions begets a yaw couple whose magnitude is proportional to the product of longitudinal slip level, s , times longitudinal stiffness, C_s . The polarity of this couple is such as to oppose yawing; thus it is an "understeering" influence.

The installation of either lug or rib tires at the dual positions thus implies a difference in the dual's yaw resistive moment which is proportional to the difference in the value of lug and rib C_s parameters, that is, the resulting yaw moments are approximately 30% higher for the rib tire.

A simplified analysis of the steady turning behavior of a typical two-axle truck shows that the vehicle equipped with lug tires on its rear duals is characterized by a lower understeer coefficient, U (as was defined in Eq. (4)). The difference in understeer level deriving from the described dual tire moment (comparing lug with rib) is closely approximated by the expression:

$$\Delta U = \frac{\Delta C_s y^2 g}{a C_{\alpha_1} V^2} \quad \text{deg/g} \quad (3)$$

where

ΔC_s = difference in C_s values exhibited by
typical lug and rib tires, that is,
 $C_{s_{rib}} - C_{s_{lug}} \approx 15,000 \text{ lb/unit slip}$

y = lateral spacing between wheel centers
of a dual-mounted pair (typically
about 12")

and g , a , C_{α_1} , and V are as defined earlier.

Accordingly, a typical lug tire installation on a rear axle employing dual tire sets would yield an understeer level which is lower than that for the corresponding installation of a typical rib tire by amounts such as:

0.29°/g at 10 mph

0.07°/g at 20 mph

0.03°/g at 30 mph

Thus, while the influence of C_s on understeer level represents an interesting aspect of vehicle mechanics, it provides a negligible degree of discrimination between the properties of lug- and rib-type tires for operating speeds above 10 mph.

With regard to limit braking capability, the pertinent features of the μ -slip curve are the peak value of F_x/F_z and the value which accrues under the locked-wheel condition, at $s = 100\%$. Accordingly, the longitudinal traction data obtained for the six-tire sample has been reduced to plots of "peak" and "slide" values of F_x/F_z at the various conditions of load and velocity. Figures 10, 11, and 12 illustrate the ranges of peak and slide data, as a function of loading, for the rib and lug tire classes at 20, 40, and 55 mph, respectively.

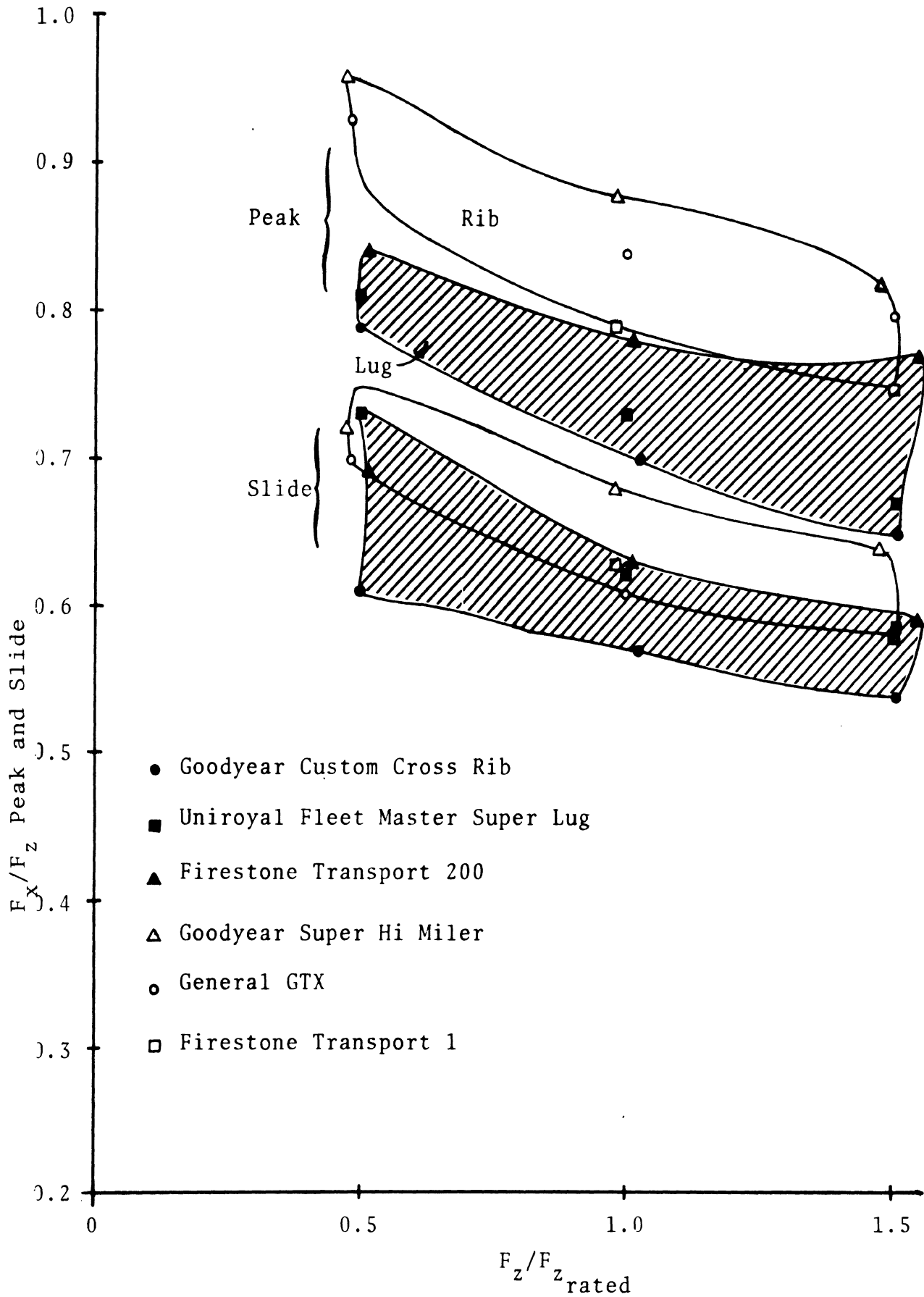

Figure 10. Peak and slide values of F_x/F_z at 20 mph for the six-tire sample.

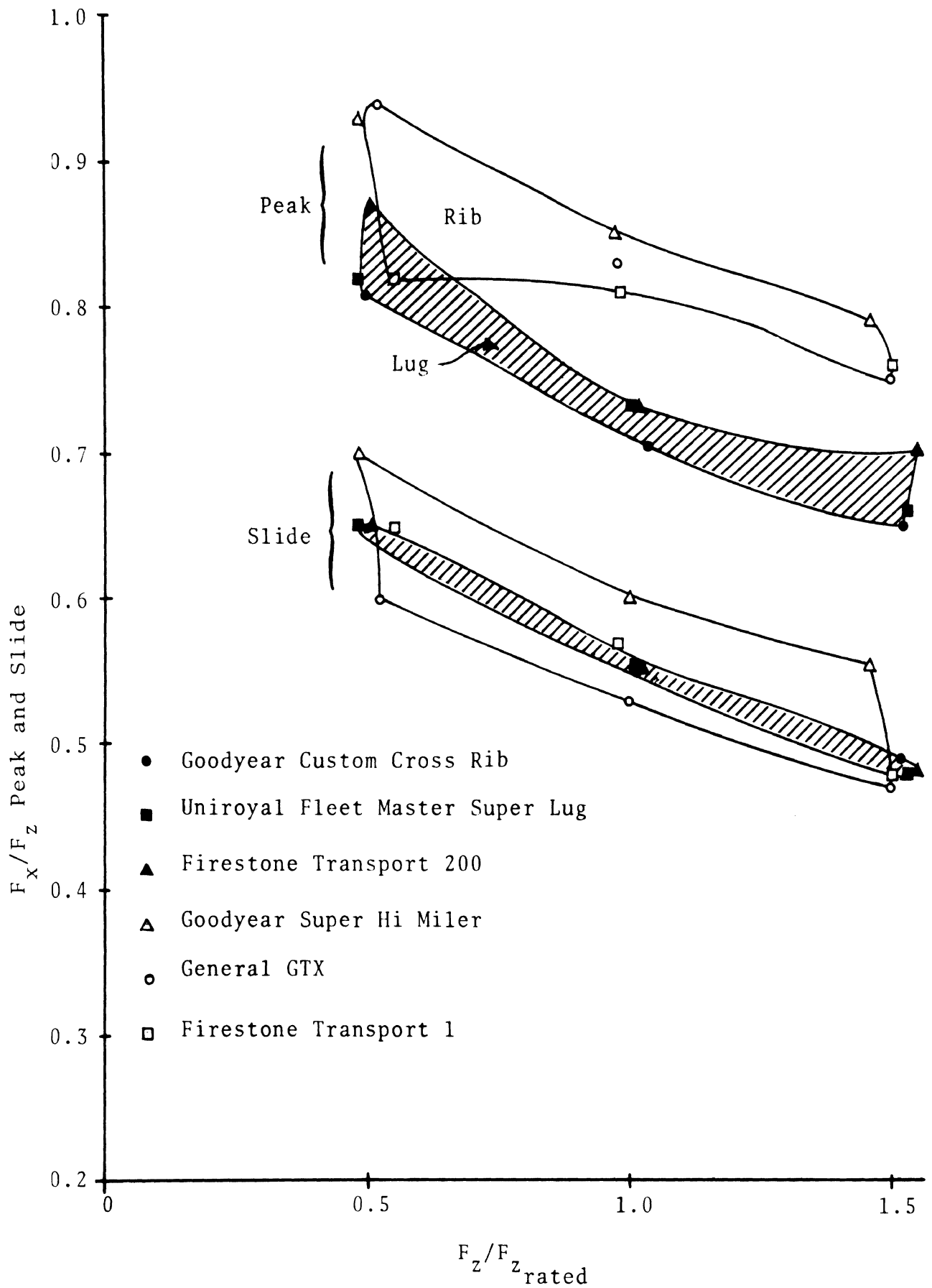

Figure 11. Peak and slide values of F_x/F_z at 40 mph for the six-tire sample.

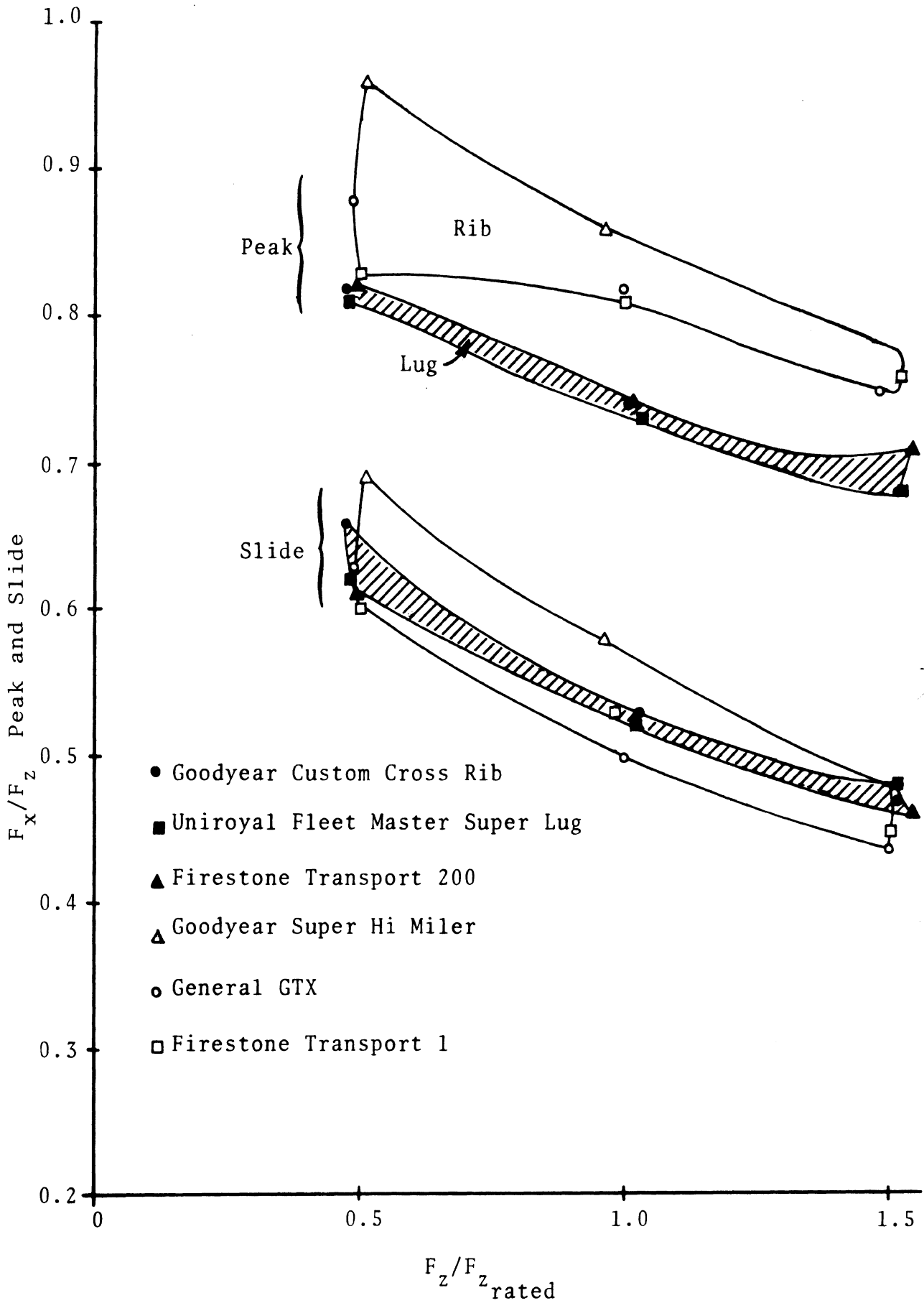

Figure 12. Peak and slide values of F_x/F_z at 55 mph for the six-tire sample.

These measures show, in general, a reduced peak traction capability among the three lug tires, in comparison with the three rib selections. The peak value of F_x/F_z for the average lug tire is 13% below that of the average rib tire at 20 mph. This differential appears to reduce at the higher velocities to 9-10%. The "slide" traction measures are much less discriminating, yielding no significant average differences at 40 and 55 mph and only a 4% lower performance of the average lug tire at 20 mph.

The implications of contrasting values of limit longitudinal traction can be cited more quantitatively than was possible for properties in the elastic range of tire behavior. With regard to traction peaks, for example, an approximation of the stopping distance constraints imposed by lug versus rib tires can be obtained through analogy to a sensitivity analysis recently reported by Fancher and MacAdam [2]. Through computerized simulation of a three-axle antilock-equipped heavy truck, these researchers found that a 10% reduction in peak traction capability on all 10 installed tires resulted in 8% and 3% increases in stopping distance for the unloaded and loaded configurations, respectively. Taking into account certain peculiarities of the brake system, these findings suggest that a lug-rear and rib-front tire distribution might be expected to increase stopping distances on the order of 3% unloaded and 3% loaded in comparison with a baseline, rib-only tire distribution. While this approximation applies to an example antilock-equipped truck, such as represents an increasing portion of the truck fleet since promulgation of FMVSS 121, the larger (non-antilock-equipped) percentage of the truck population is more directly effected by the lug tire/rib tire traction differences. Most significantly, the use of lug tires on

the more heavily braked drive axle(s) imposes a lower ceiling on the controllable braking range of such trucks—an effective reduction in deceleration capability which would appear to be on the order of the 8 to 13% range of difference between the peak traction performances of rib and lug tires.

In summary, then, lug- and rib-type tires of cross-bias construction are clearly differentiable in both the elastic and friction-limited regimes of their longitudinal traction behavior. Further, the differentials in both regimes render the rib tire more beneficial, particularly when the commonly-rearward (drive axle) installation of lug tires is considered. It should be noted that the context of these remarks is that of longitudinal traction on dry pavements and does not imply any conclusions for deformable surfaces or for contaminated, non-deformable surfaces.

Since mobile measurements, similar to those reported in this section, have historically been of low statistical quality, it is appropriate to cite measures of the repeatability of data gathered here. As shown in Table 4, the standard deviations of peak and slide traction values, as measured over the five "repeat" runs, indicates a relatively low random content for all six tires in the sample. Additionally, it is important to note that the sequence of repeat runs indicates no monotonic trend in traction modification as a result of accumulated test-induced wear.

3.2.3 MOBILE TRACTION RESULTS - LATERAL. Tests were conducted on the lateral traction dynamometer to permit examination of the friction-limited lateral force behavior of the six-tire sample. Data resulting from

TABLE 4

PEAK AND SLIDE VALUES OF F_x/F_z AS OBTAINED
OVER THE FIVE REPEAT RUNS FOR EACH OF
THE SIX SAMPLE TIRES

<u>Goodyear Super Hi Miler</u>			<u>Firestone Transport 200</u>		
Run	μ_p	μ_s	Run	μ_p	μ_s
1	.86	.60	1	.74	.56
4	.85	.61	4	.75	.55
7	.87	.63	7	.79	.59
10	.85	.60	10	.73	.56
13	.85	.60	13	.72	.54
Avg.	.856	.608	Avg.	.746	.56
σ	.00800	.0117	σ	.0242	.0167

<u>Firestone Transport 1</u>			<u>Goodyear Custom Cross Rib</u>		
Run	μ_p	μ_s	Run	μ_p	μ_s
1	.85	.57	1	.67	.53
4	.83	.56	4	.70	.56
7	.82	.58	7	.74	.55
10	.81	.56	10	.73	.55
13	.80	.57	13	.73	.55
Avg.	.822	.568	Avg.	.714	.548
σ	.0172	.00748	σ	.0258	.00980

<u>General GTX</u>			<u>Uniroyal Fleetmaster Super-Lug</u>		
Run	μ_p	μ_s	Run	μ_p	μ_s
1	.83	.54	1	.70	.54
4	.83	.52	4	.71	.55
7	.83	.53	7	.73	.55
10	.80	.53	10	.74	.56
13	.82	.53	13	.74	.55
Avg.	.822	.53	Avg.	.724	.55
σ	.0117	.00632	σ	.01625	.00632

these tests were reduced to a plotted format such as shown in Figures 13 and 14. These examples indicate the basic sensitivity of the F_y/F_z versus α relationship to velocity and vertical load, respectively. As with longitudinal traction measurements, the tire exhibits a steeply rising (elastic) behavior followed by a friction-determined saturation. In the case of lateral traction, the angular slip range of interest is limited to about $\alpha=20^\circ$, thereby eliminating any need to characterize performance at high slip velocities such as are relevant to longitudinal traction. Accordingly, it is not surprising that the example of Figure 13 indicates a rather limited sensitivity of (F_y/F_z vs. α) to velocity. Indeed, as summarized in Figure 15, the performance of all six lug and rib tires over the 20 to 55 mph velocity range and at their common rated load, is contained within a relatively narrow band. Figure 15 serves to support the conclusion that no appreciable differentiation can be made between the lug- and rib-type samples on the basis of their lateral force sensitivity to velocity. In addition, Figure 15 illustrates that the absolute levels of lateral traction capability do not serve to distinguish lug from rib tires in the sample tested. Figure 16 serves to confirm this observation even further, by illustrating that the entire sample of six tires is closely packed in its lateral traction behavior over the load range, as well.

Thus we find, somewhat surprisingly, that the ability of the lug-type, cross-bias tire to generate lateral forces, at elevated slip angles and on a dry pavement, is comparable to the capability of its rib-type counterpart.

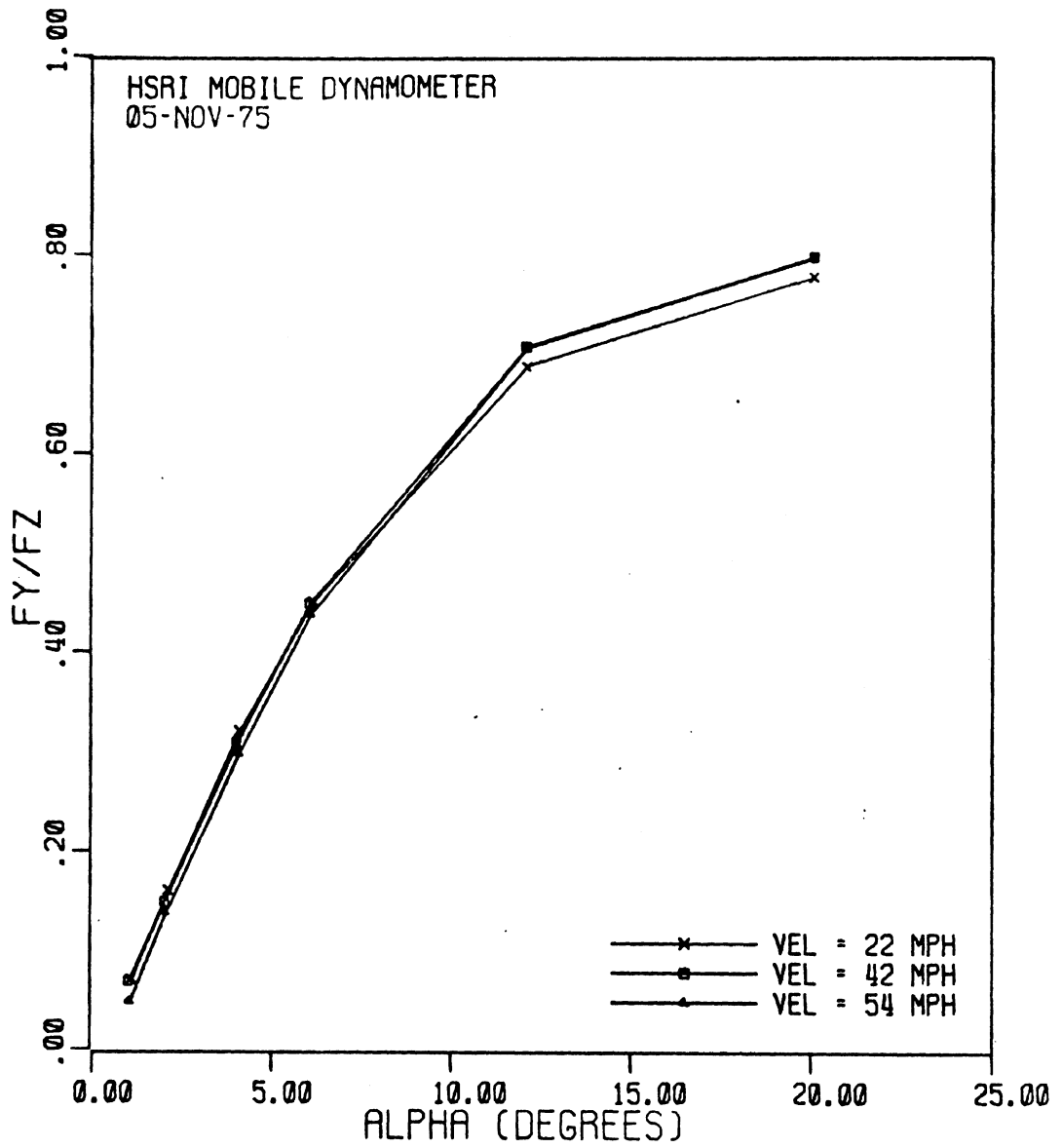

FIRESTONE TRANSPORT 200 10.00X20/F
 FZ = 5437 LB

Figure 13. Example velocity sensitivity of normalized lateral force response to slip angle.

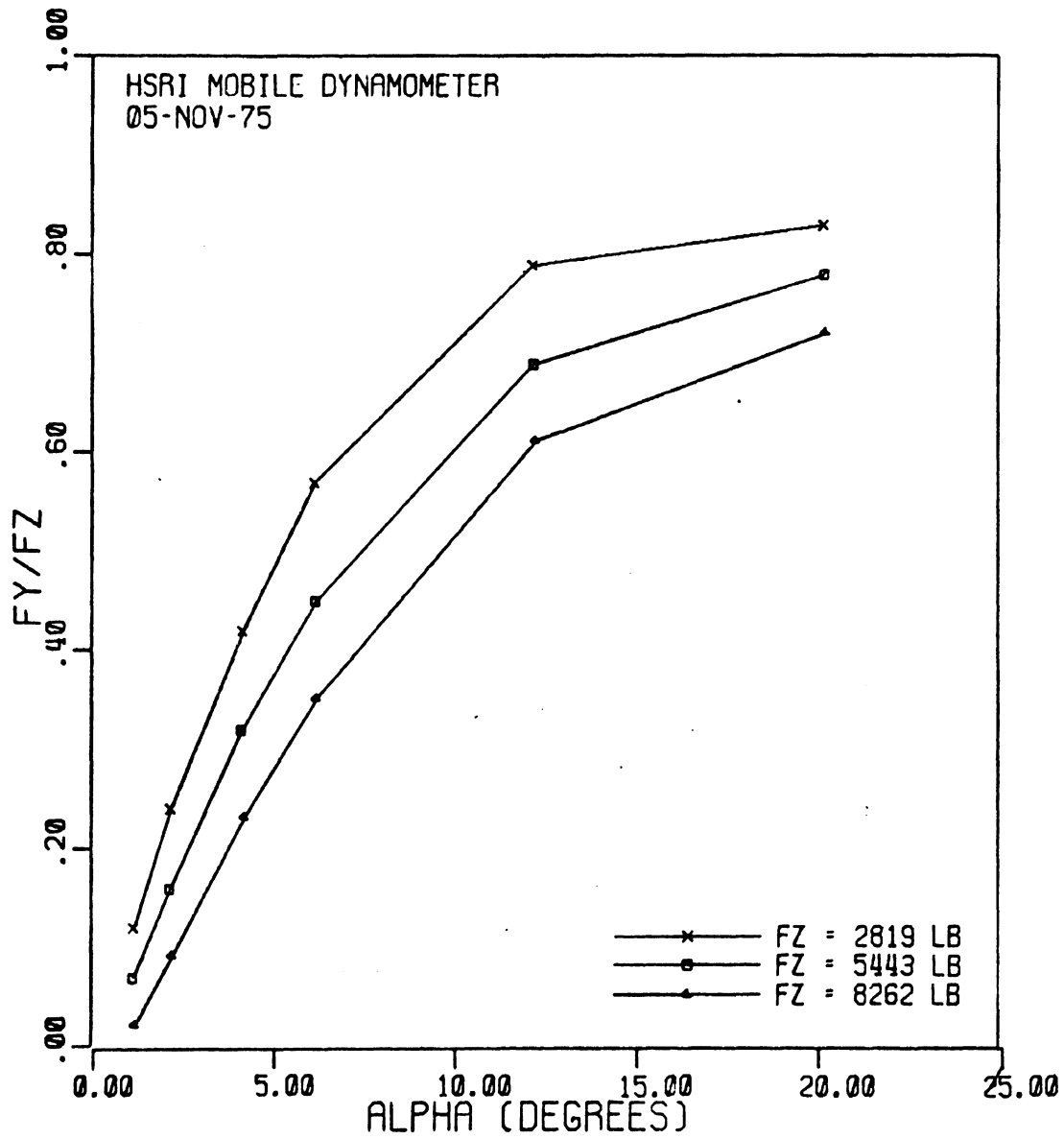

FIRESTONE TRANSPORT 200 10.00X20/F
VEL = 22 MPH

Figure 14. Example load sensitivity of normalized lateral force response to slip angle.

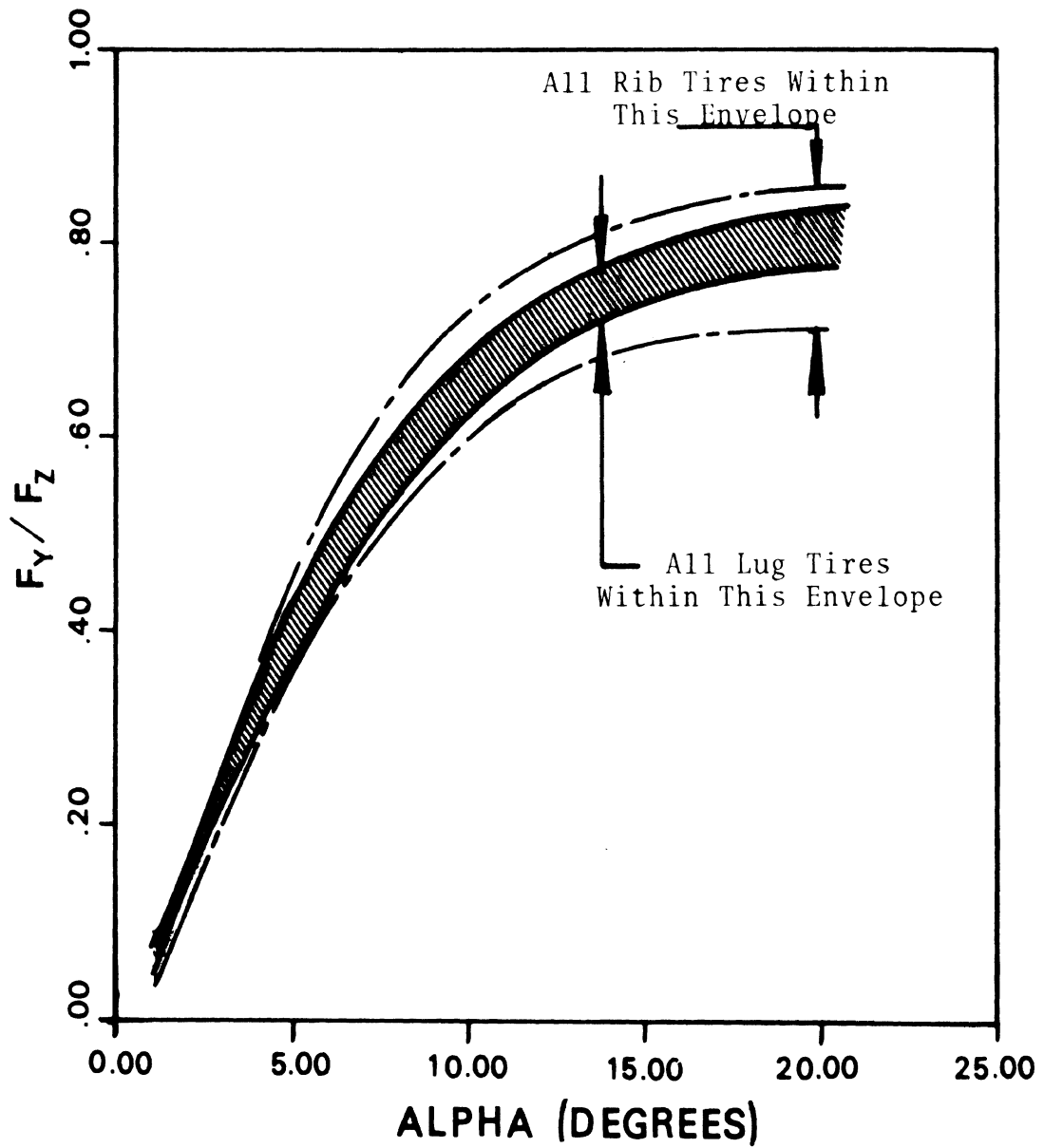

Figure 15. Envelopes of F_y/F_z vs. α data obtained at test velocities of 20, 40, and 55 mph and at rated load for all six tires in the sample.

- Uniroyal Fleet Master Super Lug
- Goodyear Custom Cross Rib
- ▲ Firestone Transport 200
- Firestone Transport 1
- General GTX
- ▲ Goodyear Super Hi Miler

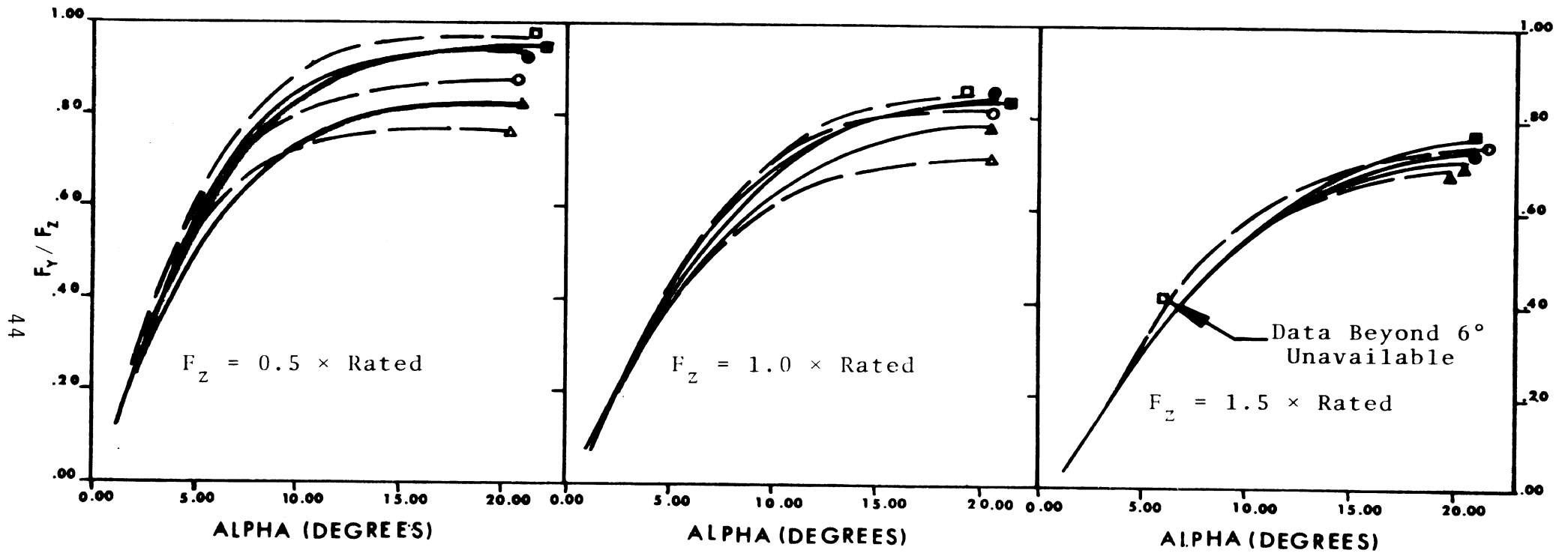
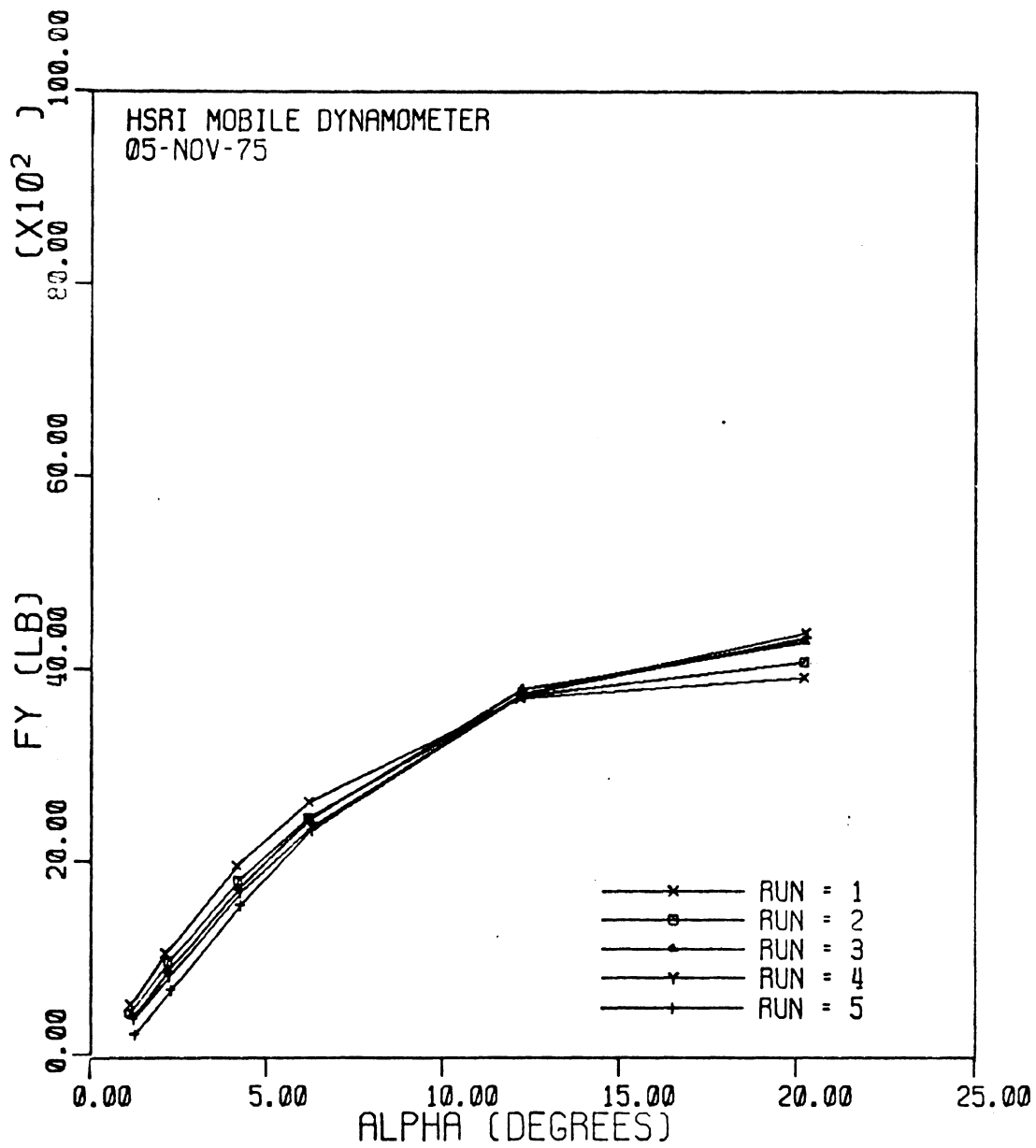

Figure 16. Summary of the F_y/F_z vs. α behavior of the six-tire sample at each of three loads, and at 20 mph.

In contrast to the repeatability appreciated in mobile longitudinal experiments, the mobile lateral test is characterized by less than an ideal level of repeatability. This situation derives from a deterministic, rather than random, process arising out of the "destructive" character of the test. As pneumatic tires are operated at large slip angles and at highway-type velocities, they accrue a peculiar and very concentrated pattern of treadwear which causes, generally, a significant increase in the maximum side force capability. As the treadwear continues throughout a sequence of traction tests, the side force at $\alpha=20^\circ$ may typically increase by 10% as shown in Figure 17. This figure illustrates the changing F_y versus α response over the course of the five repeat runs. In addition to the increasing F_y at high slip, an increasingly negative F_y offset at $\alpha=0$ is also obtained as a consequence of the "induced camber" influence of an asymmetric wear pattern.

The treadwear anomaly, while bothersome, is felt to have a negligible influence on the lateral traction findings expressed earlier. The load sensitivity data, for example, which were presented in Figure 16, represent the 20 mph test condition which was examined immediately following the first check run, and thus can be viewed as representing the virtually new tire.



FIRESTONE TRANSPORT 200 10.00X20/F
FZ = 5469 LB VEL = 41 MPH

Figure 17. Example of changing lateral traction behavior as a consequence of test-induced wear.

4.0 CONCLUDING REMARKS

This study has served to provide a common data base of noise and traction properties for bias-ply truck tires. As such, it has provided an objective set of information to assist the decision making of those who are concerned with the contrast in these characteristics.

Measurements of peak db(A) noise levels per SAE J-57 have shown lug-type tires to be an average of 6 db higher in noise level than tires with rib-type patterns.

Insofar as dry traction is concerned, it has been shown that tires exhibiting improved traction performance are generally those whose tread patterns yield lower noise output. Conversely, the tire which exhibits characteristically less desirable traction properties has been found to be noisier as well. Regarding both directional and longitudinal traction properties, the common usage of lug-type tires on rear driving axles (only) results in a typically disadvantageous arrangement, from a vehicle control point of view. The degree of disadvantage, however, cannot be objectified within current technology. Indeed, it might be argued that the professional truck driver is quite capable of maintaining an acceptable level of control over his vehicle when it is configured with the common rib-front, lug-rear tire installations. It cannot be argued, however, that such a configuration, per se, promotes controllability. Rather, it would seem that the trucking community opts for lug tires on driving axles for reasons other than can be justified on the basis of the resulting influences on vehicle control quality.

While it is not the intent of this study to discuss the relative merits of lug and rib tires beyond the

context studied here, the reader should note that significant other areas of tire performance do exist and should be duly accounted for in any program which seeks a comprehensive comparison.

REFERENCES

1. Leasure, W.A., Jr., Corley, D., Farrer, J., and Flynn, D., Truck Noise - I; Peak A-Weighted Sound Levels Due to Truck Tires. Addendum, National Bureau of Standards Report, July 1972.
2. Leasure, W.A., Jr. and Corley, D.M., Truck Noise - 1B; Spectral and Directional Characteristics of Noise Generated by Truck Tires. Final Report, National Bureau of Standards, September 1974.
3. Reiter, W.F., Eberhardt, A., Harper, L., and Atkinson, T., Truck Noise VII-A; Experimental Investigation of Truck Tire Sound and Vibration. Report on Contract No. DOT-OS-20105, December 1974.
4. Truck Tire Noise. Society of Automotive Engineers, Report No. SAE SP-373, October 1972.
5. Fancher, P.S. and MacAdam, C.C., "Computer Analysis of Antilock System Performance in the Braking of Commercial Vehicles." To be presented at the Institution of Mechanical Engineers Conference on Braking of Road Vehicles, University of Technology, Loughborough, England, March 1976.



APPENDIX A

DETAILED NOISE TEST RESULTS FROM REPORT
PREPARED FOR HSRI BY
INTERNATIONAL HARVESTER COMPANY

TRUCK TIRE NOISE TESTING
THE UNIVERSITY OF MICHIGAN
PURCHASE ORDER NO. R-192856

FOR
HIGHWAY SAFETY RESEARCH INSTITUTE
ANN ARBOR, MICHIGAN
BY
INTERNATIONAL HARVESTER COMPANY
VEHICLE DYNAMICS GROUP
FORT WAYNE, INDIANA

PREPARED BY R. W. Glotzbach
R. W. GLOTZBACH
APPROVED BY N. A. Miller
N. A. MILLER

SUBJECT: Truck Tire Noise Testing

OBJECT: To determine the objective scaling of the noise levels which are associated with various truck tire tread configurations.

CONCLUSIONS: 1. The tires rank in the following order with regards to noise level generated at the speeds listed with 1 having lowest level and 7 having the highest.

80.5 km/h 56.4 km/h
(50 MPH) (35 MPH)

1	1	General HCR (Baseline)
2	4	Goodyear Super Hi Miler
3	3	Firestone Transport I
4	2	General GTX
5	5	Firestone Transport 200
6	6	Uniroyal Fleetmaster Superlug
7	7	Goodyear Custom Cross Rib Hi Miler

2. All the tires tested have higher peak noise levels when measured using "fast response" versus "slow response" meter settings. Also, the difference between the fast and slow response levels is, in general, greater at 80.5 km/h (50 mph) than 56.4 km/h (35 mph).
3. All the tires tested generate higher noise levels at 80.5 km/h (50 mph) than at 56.4 km/h (35 mph) with some being more sensitive to the speed increase than others with respect to increasing noise level generation.

REMARKS: 1. The test work reported herein was done between May 6, 1975 and May 20, 1975.

2. All calculation sheets, test data, lists, and data sheets are included in the Appendicies of this report.

3. Data recording tapes are included along with this report in case further reduction would be desired on the raw data.

REMARKS: (continued)

4. The calibration of all data collection and reduction instrumentation is traceable to the National Bureau of Standards.

METHOD:

The tire test project was carried out in five distinct phases or tasks as listed below.

TASK I The vehicle on which the tires were tested was prepared for compliance to the specifications as stated in "Sound Level of Highway Truck Tires - SAE J57". This was done by mounting a load rack to a Loadstar 1800 series 4x2 truck which complied with SAE J57 as shown in Figure 1. The load was applied such that the tires under test were loaded to their maximum for continuous running at highway speeds according to the Tire and Rim Association Year Book. For the 10.00-20F tires used, the maximum load specified per tire when used as a dual was 21,170 nt (4760 pounds) at 516.8 kPa (75 psi) tire pressure. Thus, the chassis was loaded such that the rear axle loading was 84,700 nt (19,040 pounds). Specifications for the test vehicle are given in Figure 2.

TASK II Noise level tests on the baseline "quiet" tires and on the six test tires were performed in accordance with J57 procedures. The test site was located at the International Harvester Truck Test Center with a layout of the test site shown in Figure 3. The test site was in full compliance with SAE J57 recommendations.

Tire noise data was recorded on magnetic tape for all the tires tested so that the data could be further reduced by 1/3 octave means. Figure 4 illustrates in block form the instrumentation used and the method of collecting the data. The data was recorded on a NAGRA III tape recorder via a B & K 2203 Sound Level Meter using a 2.54 cm (1") condensor microphone while the vehicle traversed a 61 m (200 foot) measurement zone. In order to locate the test vehicle on the measurement zone for later data reduction, an 8 KHz tone was recorded on the tape 61 m (200 feet) ahead of the microphone point. This was done by the vehicle running over a pressure sensitive switch located 61 m (200 feet) ahead of the microphone point. This switch activated a tone burst generator which fed to the recorder an 8 KHz tone of one-half second duration. Since the

METHOD: (continued)

vehicle speeds for the various tests were constant and of a known value, the vehicle position on the test site could be correlated to the time on the tape recording following the 8 KHz tone. A second B & K model 2203 Sound Level Meter with a 2.54 cm (1") condenser microphone was also used to obtain a live reading in A weighted Slow Response to be used to correlate with the recorded value. See Appendix I for specification data on the collection and reduction instrumentation. The data sheets from the collection portion of the project showing the test conditions and live noise level readings are shown in Appendix II.

Noise tests were then made following SAE J-57 Recommended Practice for testing truck tire noise (see Appendix III). This involved measuring the tire noise levels 15 m (50 feet) from centerline of travel while the vehicle coasted through the measurement zone with the engine off. In addition to the J-57 speed of 80.5 km/h (50 mph), tests were also run on each of the tires at 56.4 km/h (35 mph). The vehicle speedometer was calibrated at 56.4 km/h (35 mph) and 80.5 km/h (50 mph) to assure the correct test speeds. Test run speeds were kept within + 1.6 km/h (+ 1 mph) tolerances throughout the testing phase.

The tires were tested in the following order.

1. General - HCR (Straight rib) - Baseline
2. Uniroyal - Fleetmaster Superlug)
3. Goodyear - Custom Cross Rib) "Traction"
4. Firestone - Transport 200)
5. General - GTX)
6. Goodyear - Super Hi Miler) Hwy. Rib
7. Firestone - Transport I)

Each set of tires was "warmed up" by running approximately 16 to 24 km/h (10 to 15 miles) just prior to noise level testing to ensure the absence of flat spots, etc. Tire pressures were checked under a cold condition as recommended in the Tire and Rim Association Yearbook prior to warm up. Tires were tested in a new, as received, condition without prior "run-in" mileage other than the actual tire warm up as per instructions from HSRI.

METHOD: (continued)

TASK III Following testing, the test vehicle was returned to pre-test condition. This involved removing the test tires from the vehicle and mounting standard tires as well as the removal of the weight rack used for the noise testing phase.

TASK IV The data collected in Task II was reduced to provide information in both overall levels and in 1/3 octave analysis. Data reduction was accomplished with the use of the International Harvester Noise Data Acquisition and Reduction System shown in Appendix IV. In brief, the data reduction system consists of two B & K 1/3 octave real time analyzers controlled by a mini computer. Data for this test was inputted from magnetic tape into one of the real time analyzers. The computer was programmed to begin sampling after detecting the 8 KHz tone put on each data run during the collection portion of the testing. Triggering on the tone, the computer-controlled analyzer sampled the data for every 3.28 m (10 foot) interval over the 61 m (200 foot) test zone used. This sampling interval corresponds to a time interval between samples of 0.195 sec/sample at a speed of 56.4 km/h (35 mph) and 0.137 sec/sample at a speed of 80.5 km/h (50 mph).

The overall SAE J57 average levels were determined from the passes recorded on each set of tires, and a representative pass was reduced in 1/3 octave with the information printed on data output sheets from the computer. The data sheets (Appendix V) contain information pertaining to the test conditions, 1/3 octave levels vs. truck position and overall levels.

The overall level data was reduced by playing back the recorded runs through the real time analyzer using both fast random response and slow random response in the reduction process. Thus, the differences between responses for tire testing could be compared. The data summary sheet containing the reduced overall levels for each pass along with the computed SAE averages is found in Appendix VI.

TASK V The final task was summarization of the reduced data. This involved generating the appropriate graphs and charts to adequately summarize the data generated. These are covered in the Conclusions and Results portions of the report.

RESULTS:

1. The ranking of the noise levels of the tires per SAE J57 measurement techniques was as follows for 80.5 km/h (50 mph). The levels listed are in peak "A"-weighted slow response.

SAE J57 Average

General HCR (Baseline)	73.4 dB(A)
Goodyear Super Hi Miler	73.4 dB(A)
Firestone Transport I	74.2 dB(A)
General GTX	74.4 dB(A)
Firestone Transport 200	78.1 dB(A)
Uniroyal Fleetmaster Superlug	80.9 dB(A)
Goodyear Custom Cross Rib Hi Miler	82.0 dB(A)

The ranking for the test tires evaluated at 56.4 km/h (35 mph) were as follows. The levels were reduced using peak "A" weighted slow response.

SAE Average

General HCR (Baseline)	68.6 dB(A)
General GTX	69.4 dB(A)
Firestone Transport I	69.8 dB(A)
Goodyear Super Hi Miler	70.7 dB(A)
Firestone Transport 200	72.3 dB(A)
Uniroyal Fleetmaster Superlug	75.2 dB(A)
Goodyear Custom Cross Rib Hi Miler	75.2 dB(A)

These levels are illustrated in bar graph form in Figure 5. It can be seen that the differences between levels within a tread family (ie traction or highway rib) were not of a large magnitude, while there were significant level differences between the traction and the highway rib groups.

2. The peak noise levels attained using "slow" versus "fast" meter responses were investigated by reducing the recorded runs using both types of response. Figure 6 lists the SAE averages for all the tire runs made both in slow response and fast response. In all cases, the fast response values were greater than the slow response ones.
3. The effect of vehicle speed was examined by testing each of the sets of tires at both 56.4 km/h (35 mph) and 80.5 km/h (50 mph). By again examining Figure 6, the affect of vehicle speed can be observed. In all cases, the peak noise levels experienced increased with increasing vehicle speed. It can also be noted, that some tires are more speed sensitive than others. In general, the "traction"

RESULTS: (continued)

type tires yielded larger increases in peak noise level at the higher vehicle speeds than did the highway rib tires.

4. One-Third octave analysis was used during the data reduction process to yield output that could be used for a further analysis tool at a later date to help more clearly analyze the tire noise generation mechanism. The complete 1/3 octave levels versus vehicle position in both a graphical "waterfall" type display and also in numerical matrix form for a representative pass of each of the tire types tested are contained in Appendix V.

Figures 7 through 13 show the plots of noise levels versus 1/3 octave frequencies at the position where the maximum "A" weighted peak occurred for each of the tire groups tested. Both the 80.5 km/h (50 mph) and 56.4 km/h (35 mph) speed data is presented. All third-octave reduction was done using fast response settings on the analyzer to get a more responsive analysis of the data.

LOADSTAR 1800 4 x 2 LOADED FOR SAE J57 RUNS
ON TIRE NOISE

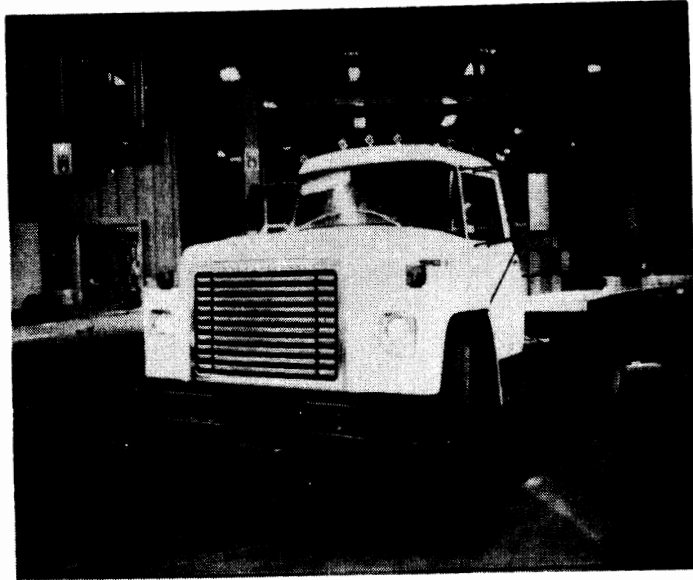

Figure 1

CHASSIS

EQUIPMENT:

CHASSIS: Loadstar 1800 4x2, 27,500 GVW, DHA 37353

WHEELBASE: 383 cm (151 inch)

ENGINE: V-392 Gas

TRANSMISSION: T-496 IH 5 Speed

FRONT AXLE: FA-109 IH 40,034 nt (9000 lb.)

REAR AXLE: RA-186

RATIO: 5.57-7.60

FRONT SPRINGS: Standard 40,034 nt (9000 lb.)

REAR SPRINGS: Variable #383167-C91 97,860 nt (22,000 lb.)

STEERING: Power

MISCELLANEOUS: Cast Wheels

Test Weight:

Front	-	18,593 nt (4,180 lbs.)
Rear	-	84,693 nt (19,040 lbs.)
Total	-	103,287 nt (23,220 lbs.)

Figure 2

BRINDING AREA

THIS PRINT IS PROVIDED ON A RESTRICTED BASIS AND IS NOT TO BE USED IN ANY WAY DETRIMENTAL TO THE INTEREST OF THE INTERNATIONAL HARVESTER COMPANY.

PERMANENT I.M. IDENTIFICATION SHALL INCLUDE THE FOLLOWING WITHOUT INTERFERING WITH FUNCTION OF THE PART:
 1. I.M. TRADEMARK PER I.M. STD 143
 2. I.M. PART NUMBER
 3. VENDOR CODE NO. (PURCHASING DEPT. TO ADVISE VENDOR HIS CODE NO.)
 4. VENDOR'S NAME, PART NO. OR TRADEMARK NOT TO APPEAR ON PART.

TIRE TEST SITE Located At IHC TRUCK TEST CENTER
 Fort Wayne, Indiana

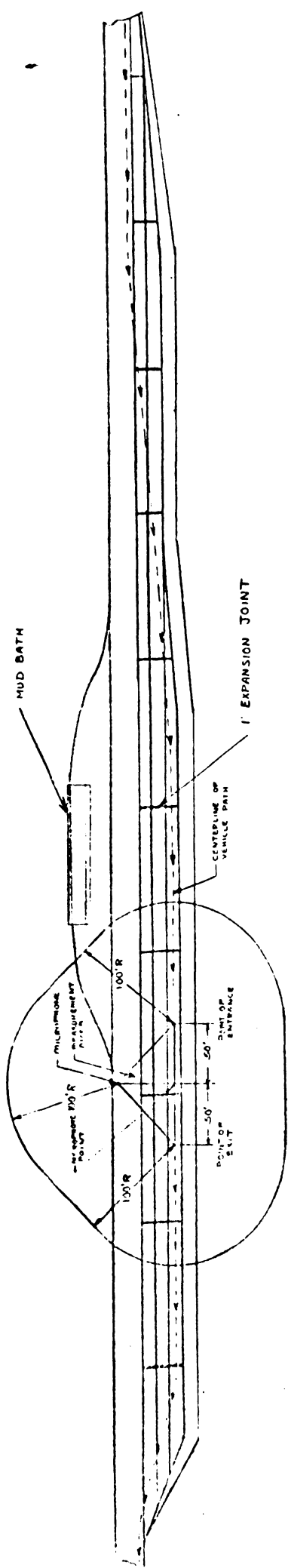

WT. APPROX. /

PTC

UNLESS SPECIFIED DIM. TOLERANCES ARE: ALL PLACES IN INCHES TWO PLACES (FRACTIONS) ±.005 THREE PLACES (DECIMALS) ±.002 ANGLES ±.5°		TWO HOLE PROJECTION		INTERNATIONAL HARVESTER COMPANY MOTOR TRUCK DIVISION FORT WAYNE ENGINEERING	
ONE	DATE	ENGINEER	REV.	REFERENCE	NAME (TRANSLATION)
					NOISE MEASUREMENT AREA AT TTC
					CONTROL E50
					VEHICLE E
					APPROVED
					MATERIAL
					DATE 1-10-75
					CHECKED
					VISION MATERIAL
					DATE
					APPROVED
					PRELIM CODE SCALE 1" = 80'
					PART NO.
					RELEASE NO.
REFERENCE:					

Figure 3

DATA COLLECTION SYSTEM

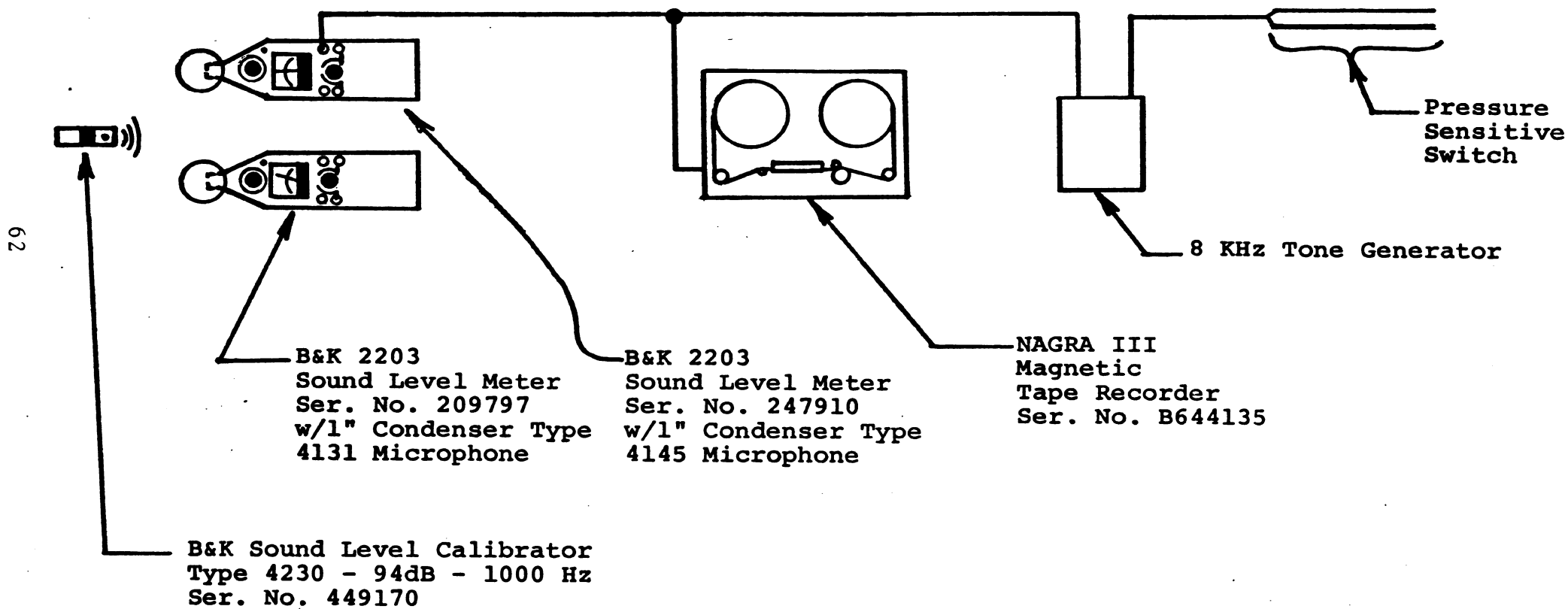
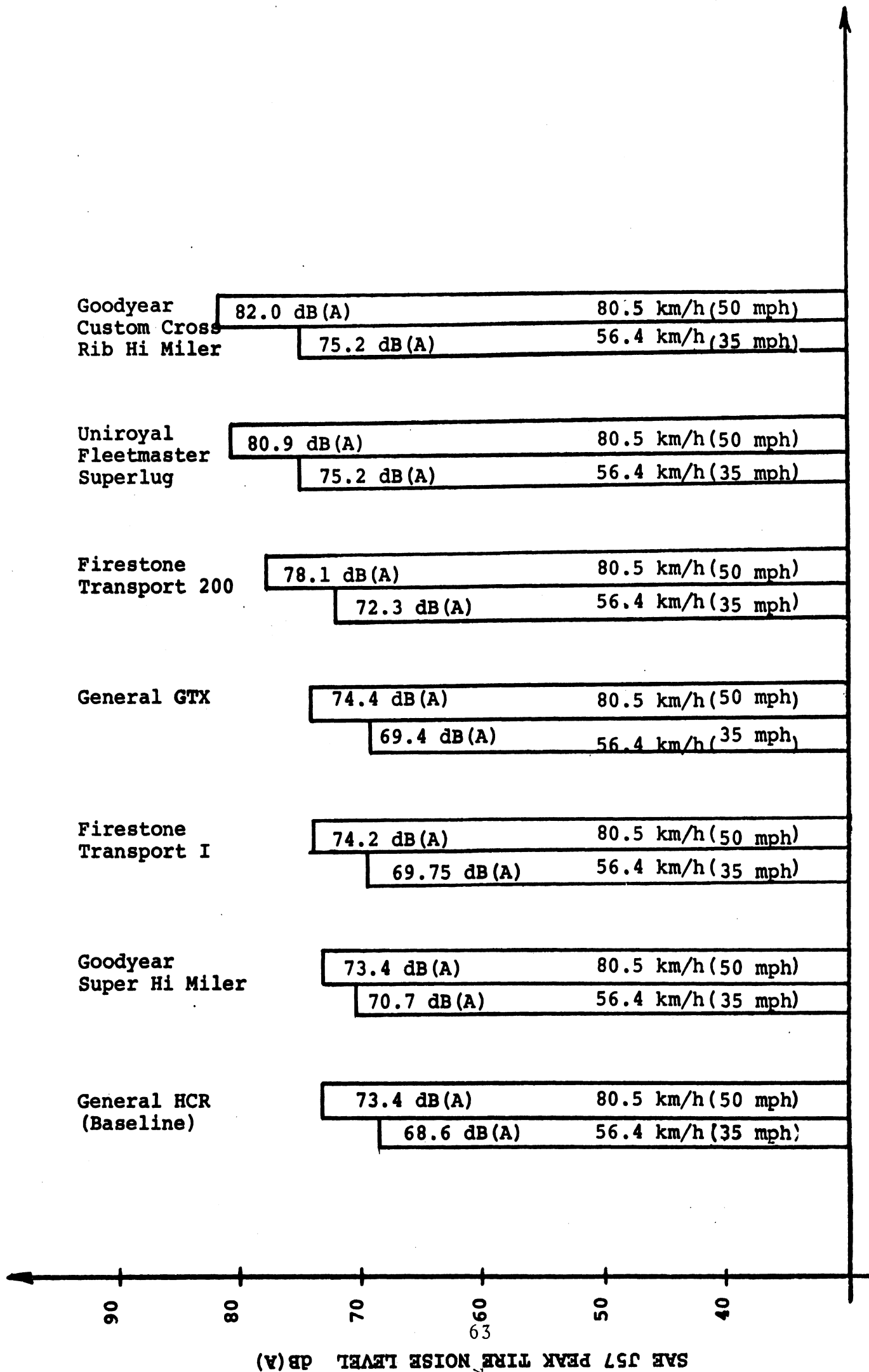

Figure 4

PEAK SAE J57 TIRE NOISE LEVELS FOR SEVEN TIRE TYPES AT 35 AND 50 MPH



Note: Levels shown were measured at 50 ft. with 'A' weighting and slow response.

Figure 5

FAST VS. SLOW RESPONSE DURING DATA REDUCTION

TIRE TYPE	S P E E D	SLOW RESPONSE A-WEIGHTED PEAK	FAST RESPONSE A-WEIGHTED PEAK	DIFFERENCE (FAST-SLOW)
GENERAL HCR	35	68.6	69.0	0.4
	50	73.4	74.3	0.9
UNIROYAL FLEETMASTER SUPERLUG	35	75.2	76.4	1.2
	50	80.9	82.8	1.9
GOODYEAR CUSTOM CROSS RIB HI MILER	35	75.2	76.0	0.8
	50	82.0	83.2	1.2
FIRESTONE TRANSPORT 200	35	72.3	72.8	0.5
	50	78.1	80.2	2.1
GENERAL GTX	35	69.4	70.2	0.8
	50	74.4	75.8	1.4
GOODYEAR SUPER HI MILER	35	70.7	72.2	1.5
	50	73.4	73.9	0.5
FIRESTONE TRANSPORT I	35	69.8	70.6	0.8
	50	74.2	75.6	1.4

Figure 6: Slow and Fast Response data for the SAE Average peak A-weighted tire noise levels along with the numerical differences between the two types of response levels.

ADD 4.9 DB TO OBTAIN OCTAVE BAND LEVEL

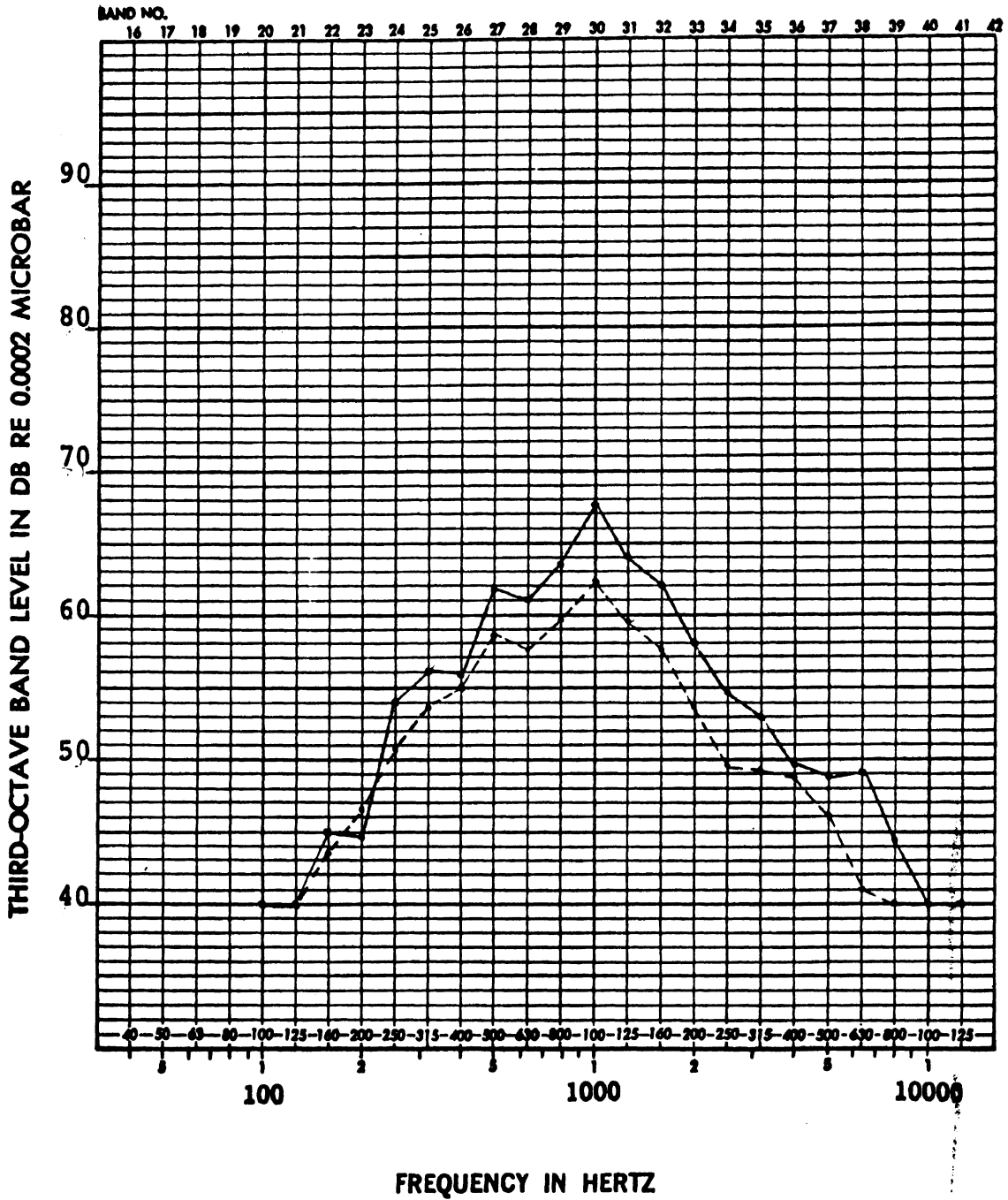

Third-Octave Tire Noise Level in dB(A) vs. Frequency

GENERAL HCR Tires

----- 35 mph,
-10 ft. vehicle position at 68.8 dB(A) overall peak level

———— 50 mph,
-10 ft. vehicle position at 73.2 dB(A) overall peak level

ADD 4.9 DB TO OBTAIN OCTAVE BAND LEVEL

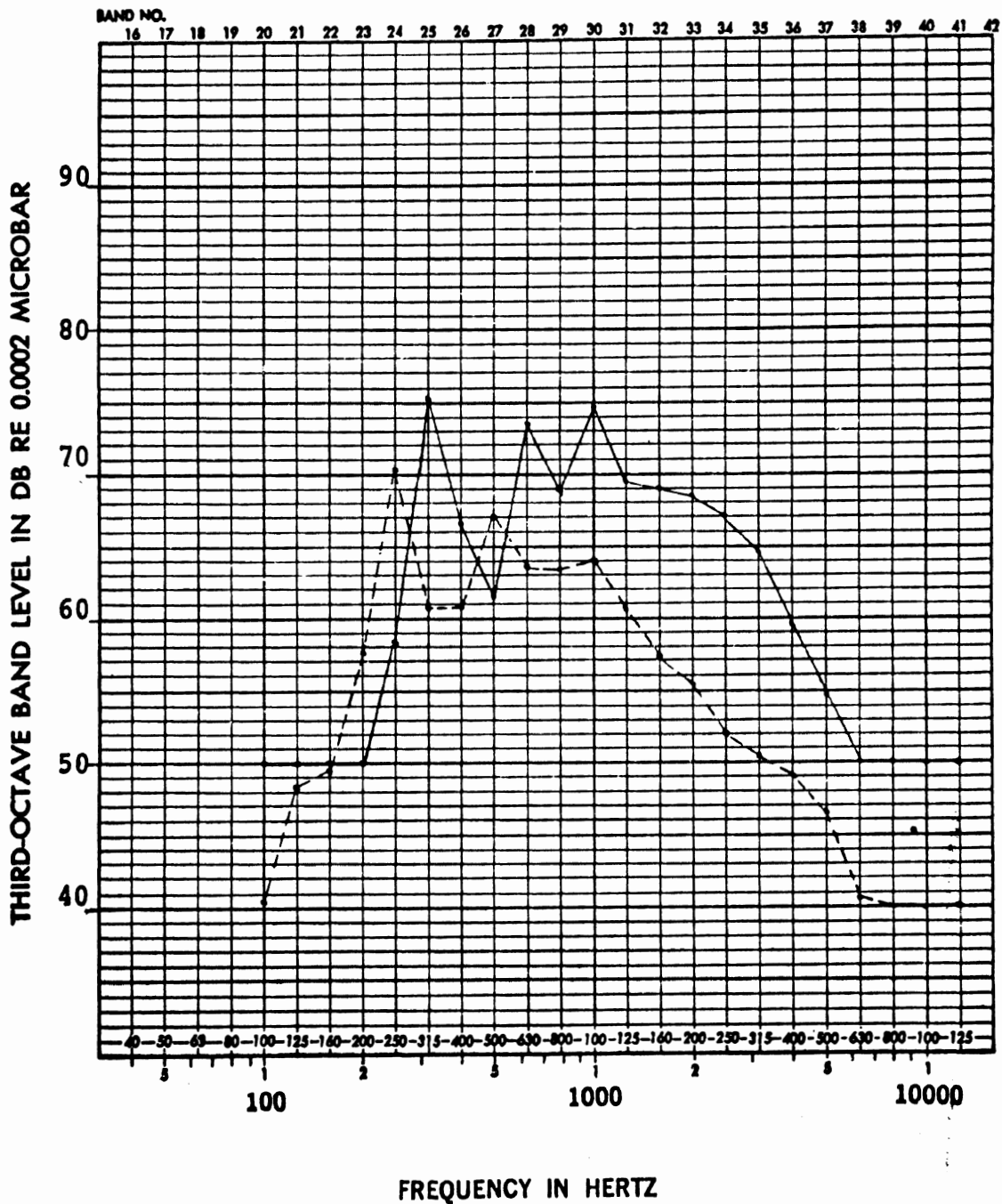

Third-Octave Tire Noise Level in dB(A) vs. Frequency

UNIROYAL Fleetmaster Superlug Tires

---- 35 mph,
+10 ft. vehicle position at 76.0 dB(A) overall peak level

— 50 mph,
-10 ft. vehicle position at 82.8 dB(A) overall peak level

Figure 8

NO. 31,462. SOUND ANALYSIS BY THIRD-OCTAVE BANDS. IN STOCK DIRECT FROM CODEX BOOK CO., NORWOOD, MASS. 02062
 1961 U.S.A.

ADD 49 DB TO OBTAIN OCTAVE BAND LEVEL

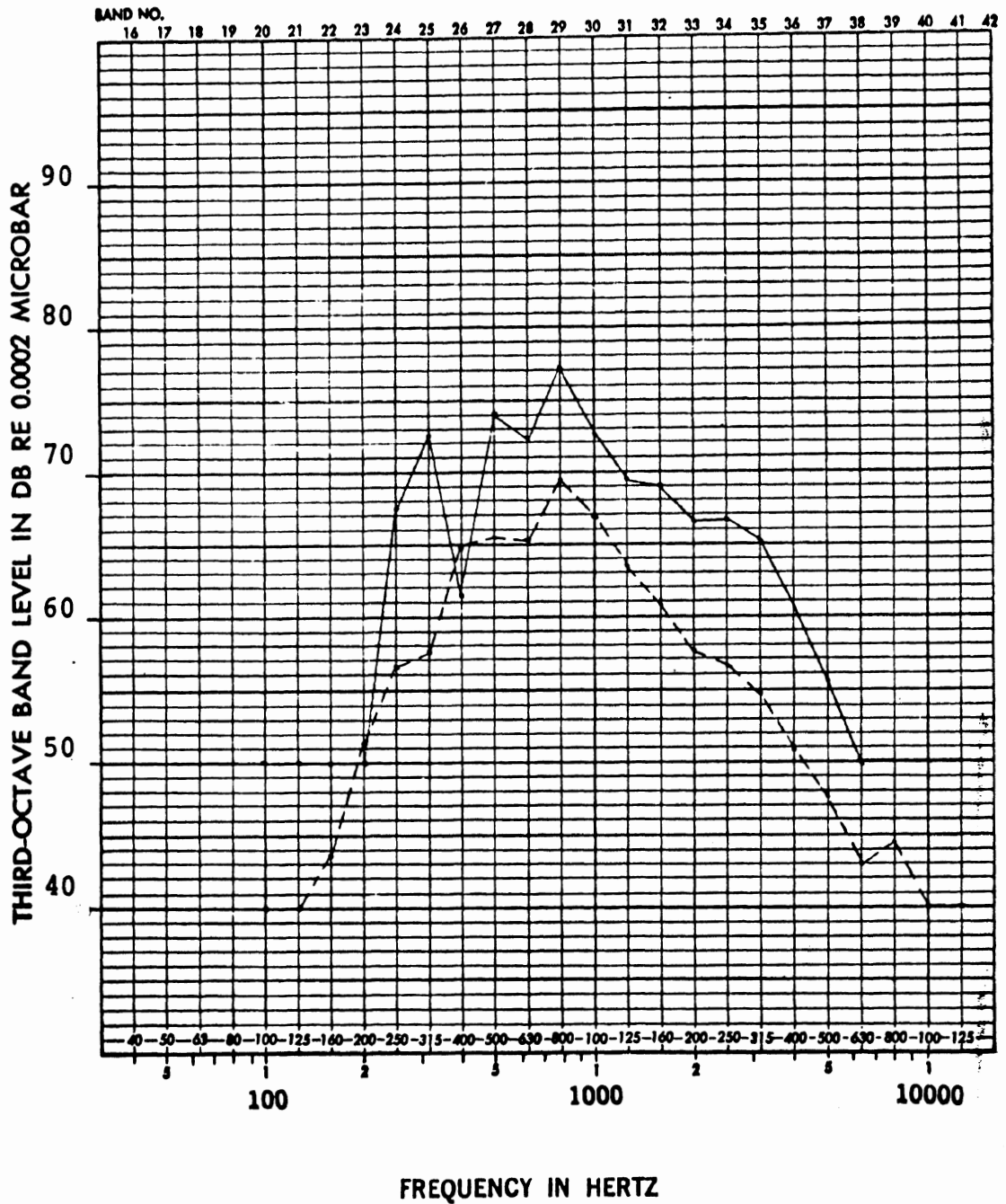

Third-Octave Tire Noise Level in dB(A) vs. Frequency

GOODYEAR Custom Cross Rib Hi Miler Tires

--- 35 mph,
 -10 ft. vehicle position at 75.6 dB(A) overall peak level

— 50 mph,
 -10 ft. vehicle position at 83.2 dB(A) overall peak level

Figure 9

ADD 4.9 DB TO OBTAIN OCTAVE BAND LEVEL

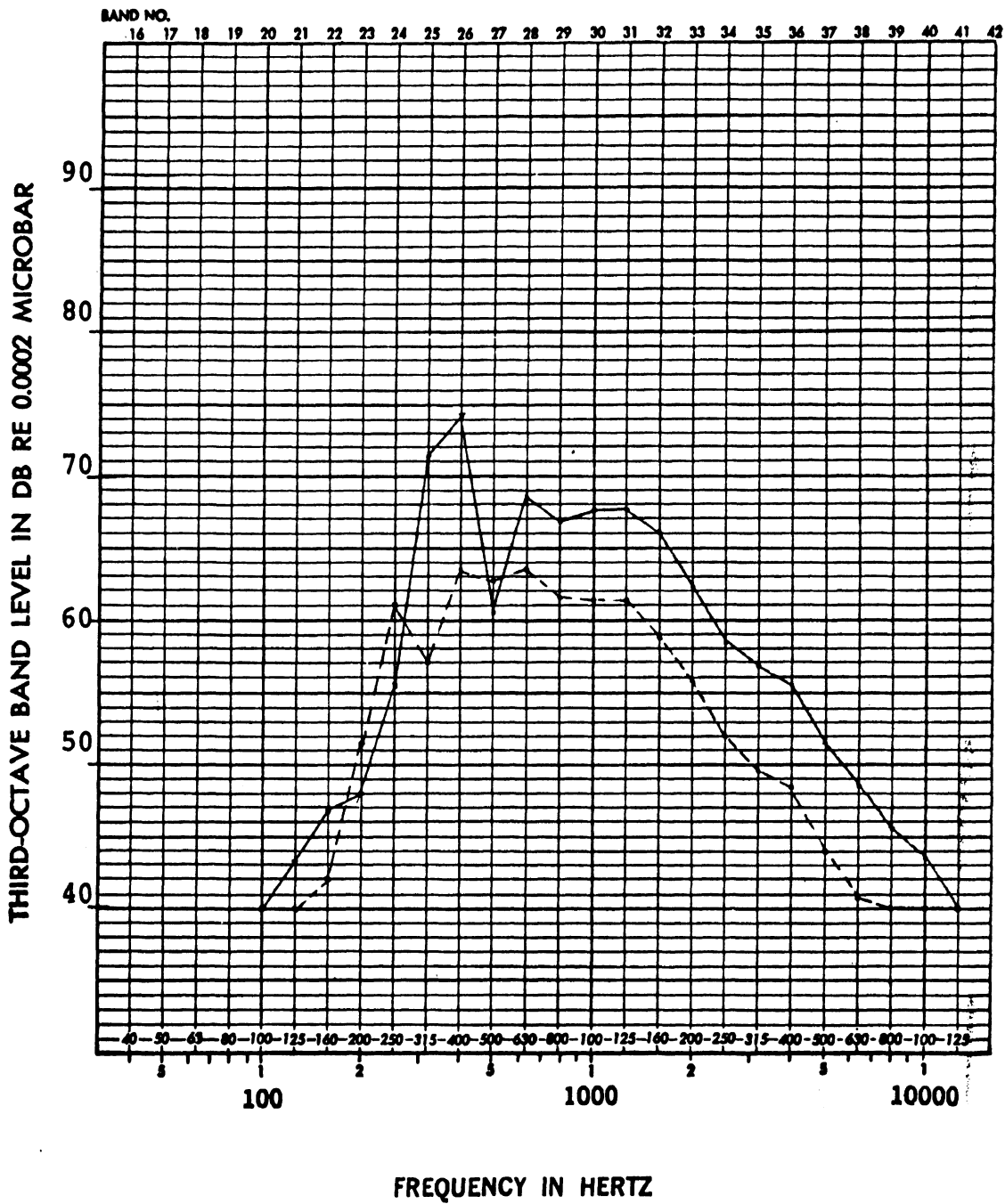

Third-Octave Tire Noise Level in dB(A) vs. frequency

FIRESTONE Transport 200 Tires

---- 35 mph,
0 ft. vehicle position at 72.8 dB(A) overall peak level

— 50 mph,
0 ft. vehicle position at 80.2 dB(A) overall peak level

Figure 10

ADD 49 DB TO OBTAIN OCTAVE BAND LEVEL

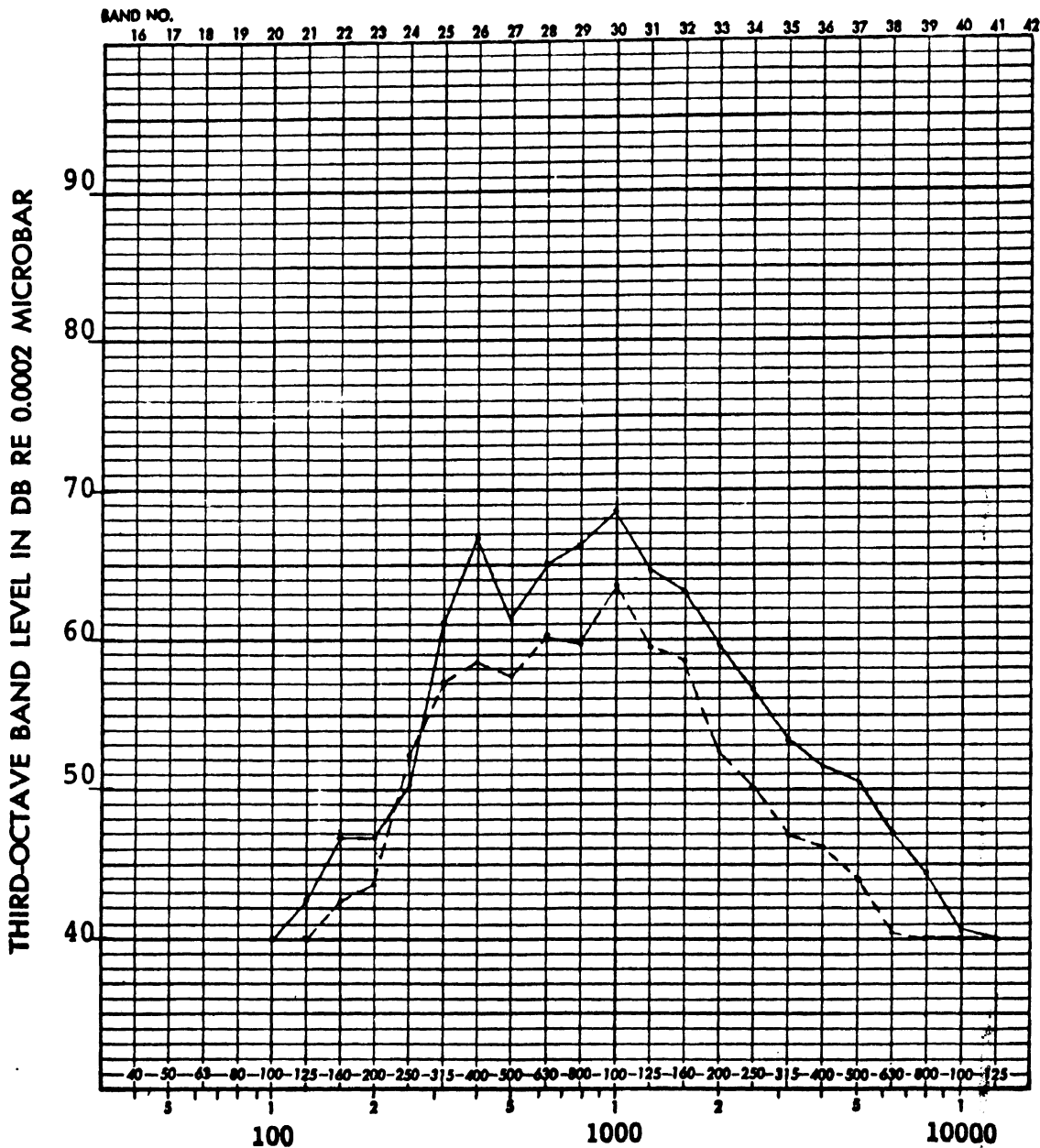

THIRD-OCTAVE BAND LEVEL IN DB RE 0.0002 MICROBAR
 FREQUENCY IN HERTZ
 Third-Octave Tire Noise Level in dB(A) vs. frequency
 GENERAL GTX Tires
 ---- 35 mph,
 -20 ft. vehicle position at 70.4 dB(A) overall peak level
 ——— 50 mph,
 -10 ft. vehicle position at 75.8 dB(A) overall peak level

Figure 11

NO 162.
 ND AI
 S BY
 OCTA
 108.
 CK DII
 TOM C
 BOOK
 3RWO
 55.02
 PRINTED IN U.S.A.
 GRAPH PAPER

ADD 4.9 DB TO OBTAIN OCTAVE BAND LEVEL

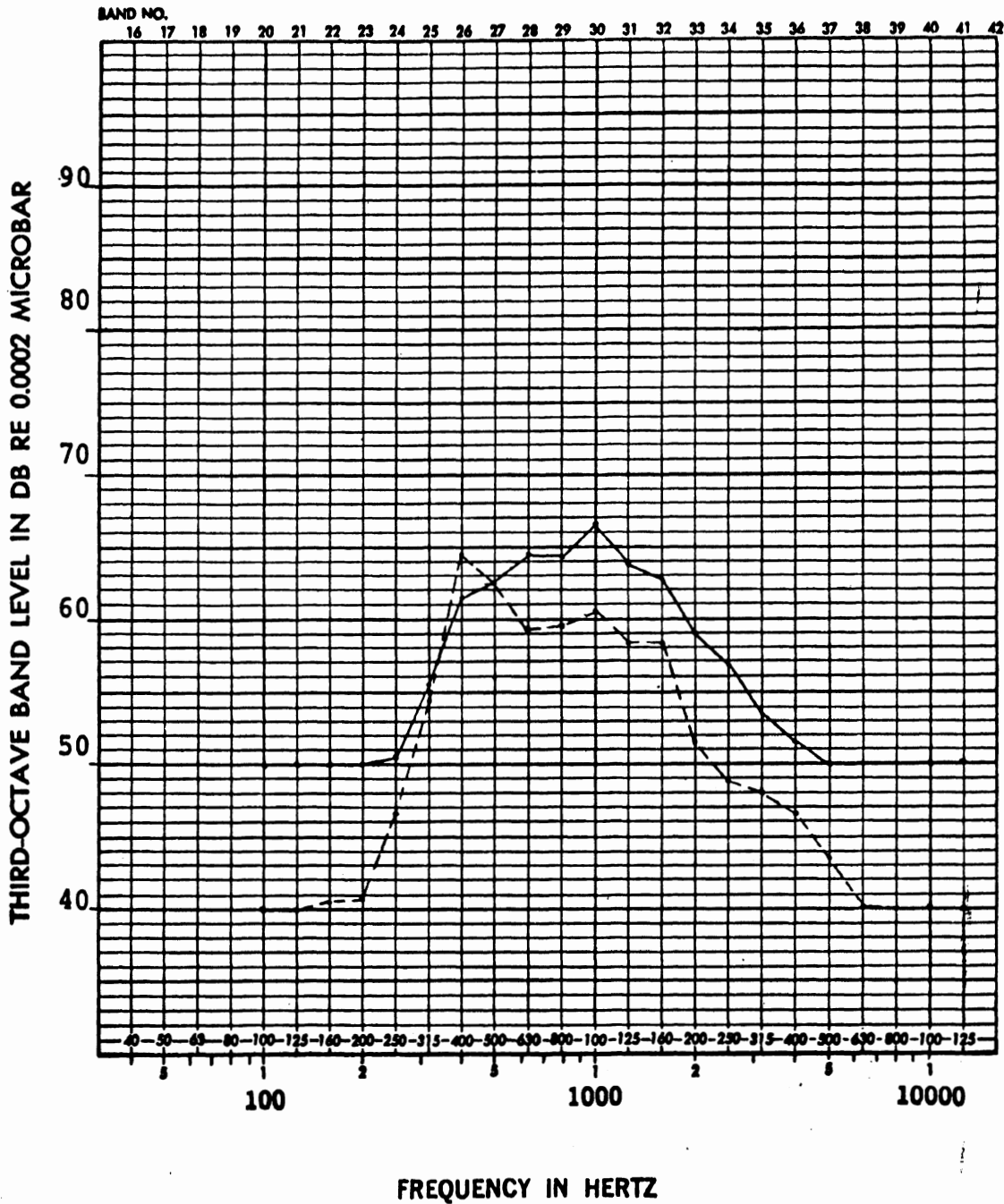

Third-Octave Tire Noise Level in dB(A) vs. frequency

GOODYEAR Super Hi Miler Tires

- 35 mph,
-20 ft. vehicle position at 71.2 dB(A) overall peak level
- 50 mph,
-10 ft. vehicle position at 73.6 dB(A) overall peak level

ADD 4.9 DB TO OBTAIN OCTAVE BAND LEVEL

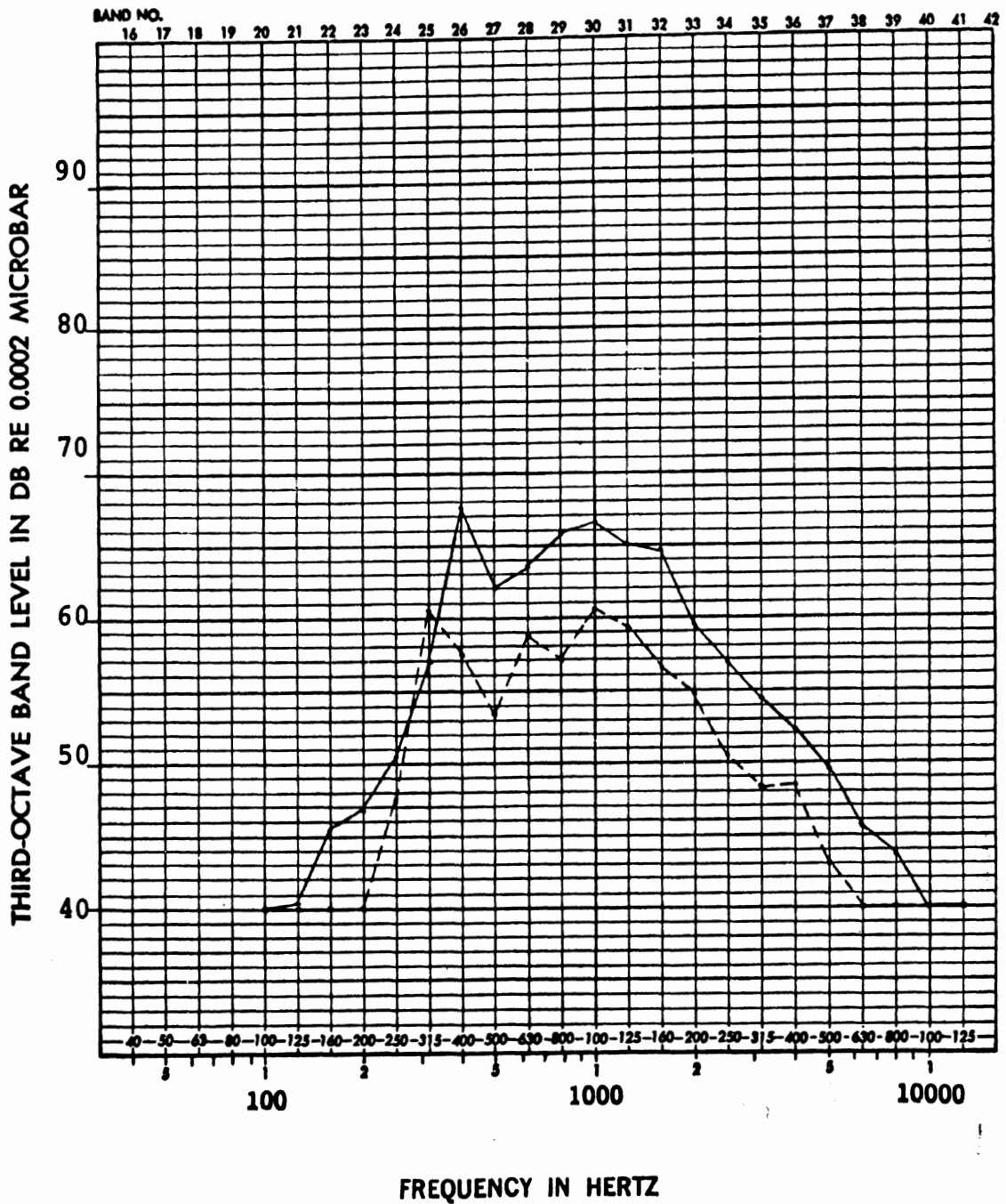

Third-Octave Tire Noise Level in dB(A) vs. frequency

FIRESTONE Transport I Tires

---- 35 mph,

-40 ft. vehicle position at 69.2 dB(A) overall peak level

— 50 mph,

-10 ft. vehicle position at 75.4 dB(A) overall peak level

Contained in this appendix are the data output sheets from the 1/3 - octave analysis portion of the tire noise data reduction and analysis phase. The following is a detailed discussion explaining how to read the format used on the output sheets so as to be able to understand all of the information which they contain.

The output sheets for this test consist of a first sheet which has a graphical display of the data in a "waterfall" type plot along with numerical values for peak levels in each third-octave and overall and what position they occurred at on the measurement area along with headings pertaining to the test conditions. The second data sheet consists of a numerical matrix which contains all of the data points used to plot the graphic "waterfall" curves on the first sheet. Each sheet will be discussed as to how to read its format.

First Data Sheet: For the following discussion, refer to Figure IV-1. Each line and column will be discussed and referred to by number.

- Line 1: This is a title line which states the type of test involved along with a test number which is assigned by the computer.
- Line 2: This line has the vehicle identification number along with a description of the test being reduced.
- Line 3: This line gives the data threshold level in dB(A) which the computer uses to establish baselines for the graphic plots during reduction.
Levels below the threshold level are not plotted.
- Line 4: This is a statement that during the 1/3-octave reduction, all 1/3 octaves were 'A' weighted. Thus, all the levels listed on the output sheets have 'A' weighted values.
- Line 5: Line five states that for the graph portion of the output, each major vertical grid mark has a value of 5 dB(A).
- Line 6: This is a statement of the temperature, in degrees Fahrenheit, and the wind speed, in miles per hour, recorded at the time the data was collected.
- Line 7: Line seven is a statement of the time at which the computer reduced the run. The time is in a 24-hour clock format.
- Line 8: This line(s) states the horizontal axis information for the plot. Each division equals 20 feet of vehicle position in the measurement zone. Positive values denote position of the vehicle after the microphone point while negative values denote positions ahead of the microphone point.

Line 9: This states the value of the horizontal grids where the plots for the third octaves cross under the numbers in the columns in the center of the sheets. This establishes a base reference value for each curve in the "waterfall" display to enable one to read values directly from the plots.

Line 10: This is the same as line 8, except that since only one channel of data was reduced, it was not used.

Column 1: This column contains the vehicle position in feet (from the microphone point) at which the levels for each of the 1/3-octaves and overall level was at maximum.

Column 2: This column gives the peak level attained during the test for each 1/3-octave and the overall level in dB(A). Values below the dynamic range level are printed as the value of the dynamic range at which the analyzer was set at the time of the reduction.

Column 3: This is the column containing the center frequency of each of the 1/3-octave bands used in the analyzer. The bottom-most member of the column reads 'A' and is the overall 'A' weighted level.

Columns 4 & 5: Not used since only one channel of data was reduced.

Second Data Sheet: Refer to figure IV-2 for the discussion of the data presentation format of the second sheet. Each line is discussed along with the numerical data matrix.

Line 1: This line states the test number given on the first data sheet so as to identify the second sheet.

Line 2: Line two is a restatement of the vehicle identification given on the first data sheet.

Line 3: This is a restatement of the test condition description also contained on the first data sheet.

Line 4: This identifies the 1/3 octave analyzer being used. In this case, Left Side Data indicates that the left analyzer in the control console was used and not that the data was taken on the left side of the vehicle.

The columns and rows for the numerical matrix are labeled as to what they are. Vertical columns refer to 1/3 octave center frequencies while the horizontal rows refer to the vehicle position relative to the microphone point with the same notation as discussed previously. The numbers in the matrix are the noise levels in dB(A) at a particular frequency and position as defined by the particular column and row in which it is located. Values below the "dynamic range" are assigned a value equal to the dynamic range when printed.

SAE J-57 TIRE NOISE TEST-1/3 OCTAVE REDUCTION TEST NO. SN052775-003 ← Line 1

VEHICLE ID LOADSTAR TIRE TEST DESCRIPTION SAMPLE DATA SHEET ← Line 2

DATA THRESHOLD IS 60DB(A) ← Line 3
ALL 1/3 OCTAVES 'A' WEIGHTED ← Line 4
EACH MAJOR DIVISION = 5 DB(A) ← Line 5

TEMP 60 WIND ← Line 6

TIME 16:51 ← Line 7

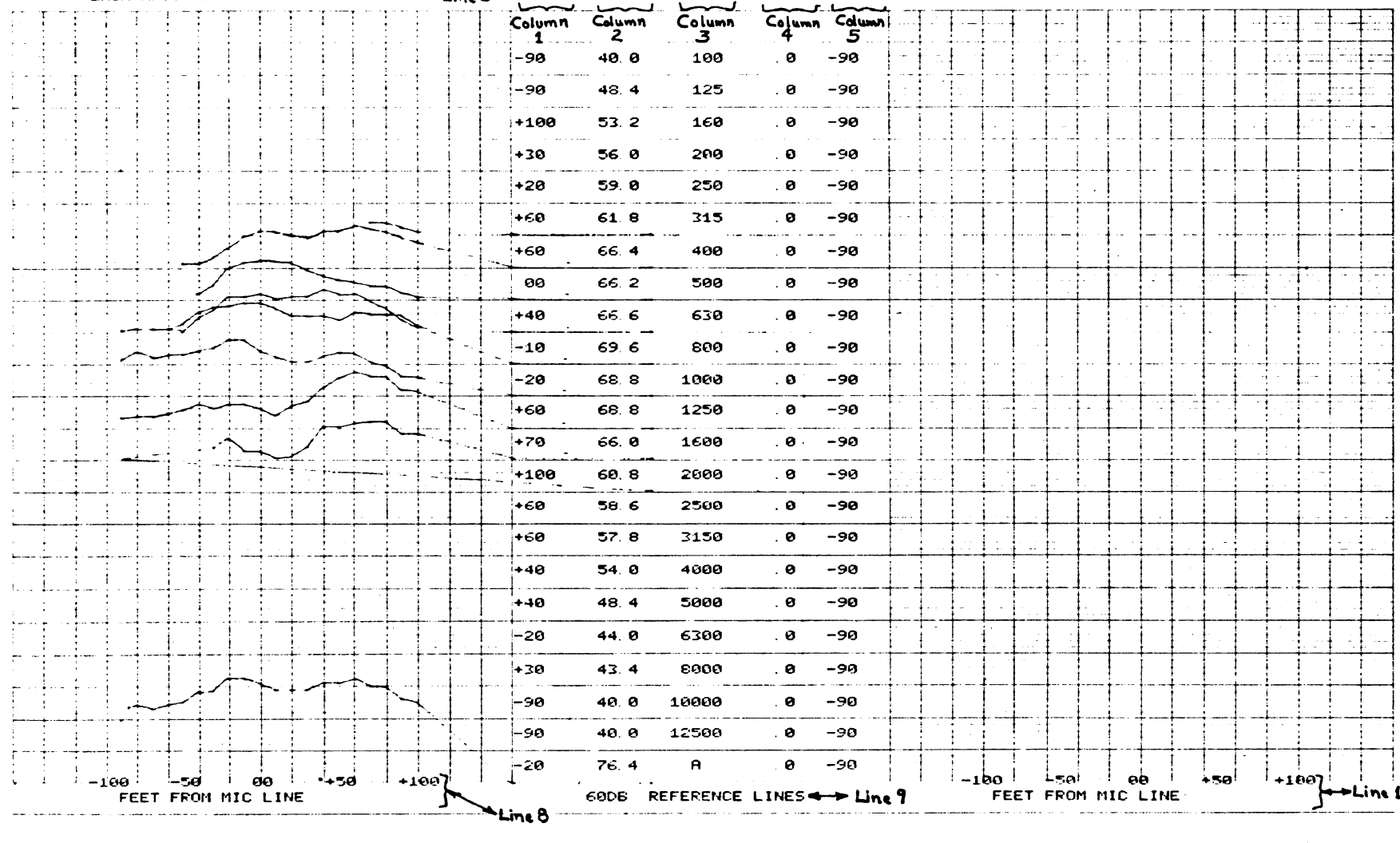

FIGURE IV - 1

74

PRINTED BY THE STANDARD REDUCED COMPANY U.S.A.

TEST # SMO52775-003 → Line 1
 VEHICLE ID LORDSIR IRE IESI → Line 2
 DESCRIPTION SAMPLE DATA SHEET → Line 3

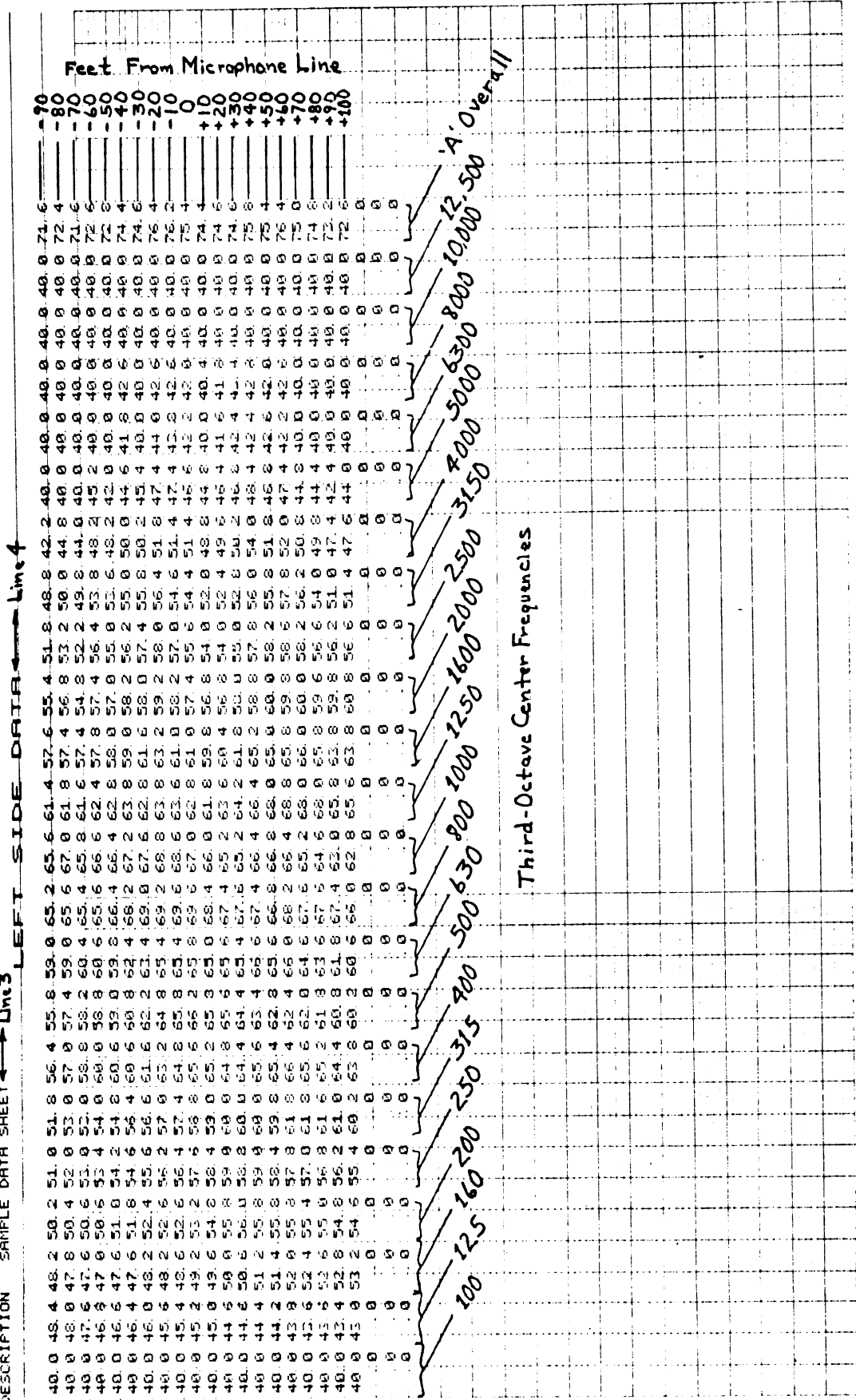

FIGURE IV-2

SAE J-57 TIRE NOISE TEST-1/3 OCTAVE REDUCTION TEST NO. SN052175-005

VEHICLE ID LOADSTAR 146 TIRE NOISE DESCRIPTION BASELINE: GENERAL HCR TIRES AT 35MPH

TEMP 58 WIND 5-6

TIME 20.32

DATA THRESHOLD IS 50DB(A)
ALL 1/3 OCTAVES "R" WEIGHTED
EACH MAJOR DIVISION = 5 DB(A)

LEFT PEAK LEVEL
CENTER FREQ
RIGHT PEAK LEVEL

FEET

FEET

FEET

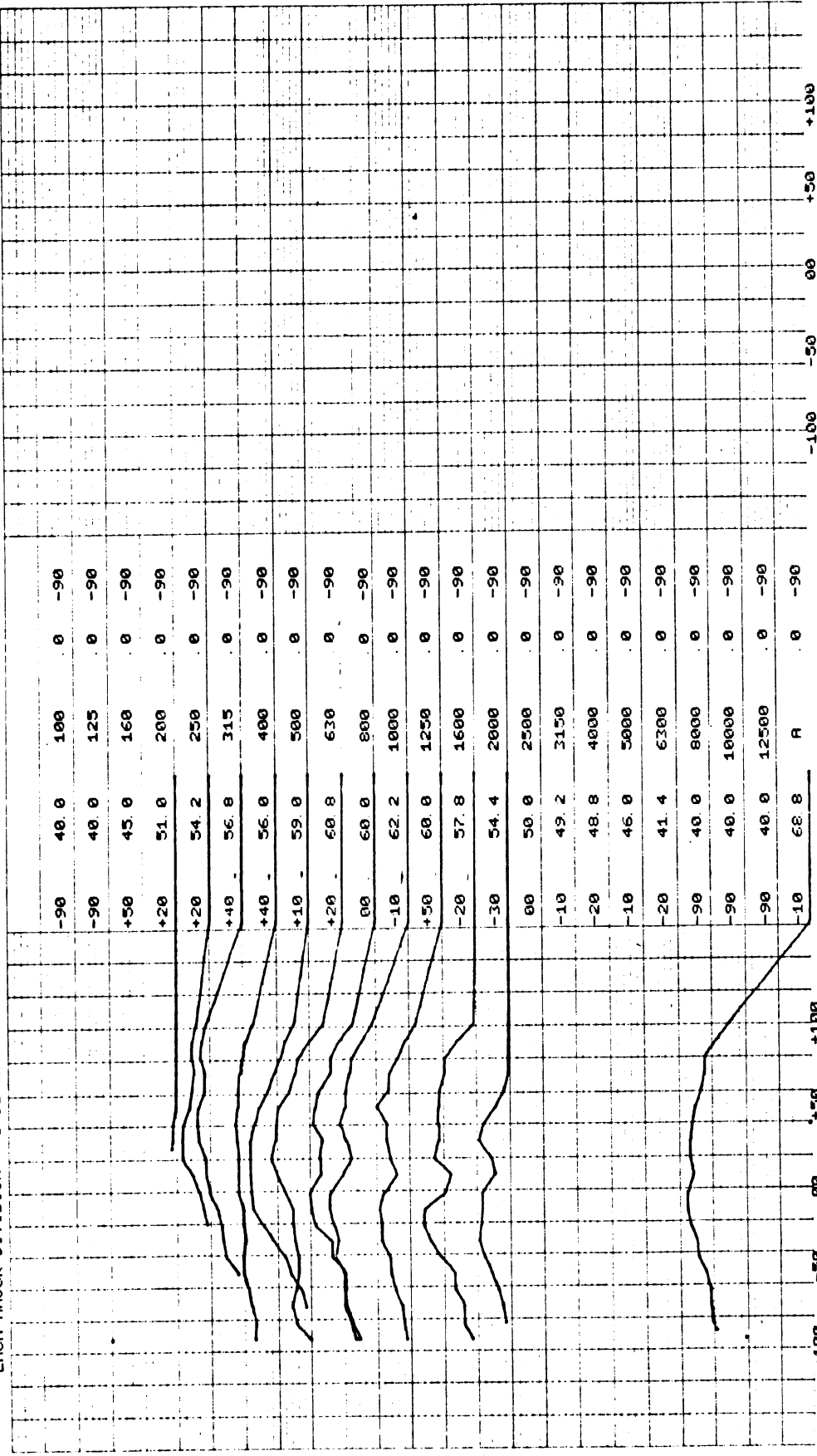

FEET FROM MIC LINE

500B REFERENCE LINES

FEET FROM MIC LINE

SAE J-57 TIRE NOISE TEST-1/3 OCTAVE REDUCTION TEST NO. SN052175-006

VEHICLE ID LOADSTAR 146 TIRE NOISE DESCRIPTION BASELINE: GENERAL HCR TIRES AT 50MPH

DATA THRESHOLD IS 55DB(A)
 ALL 1/3 OCTAVES "R" WEIGHTED
 EACH MAJOR DIVISION = 5 DB(A)

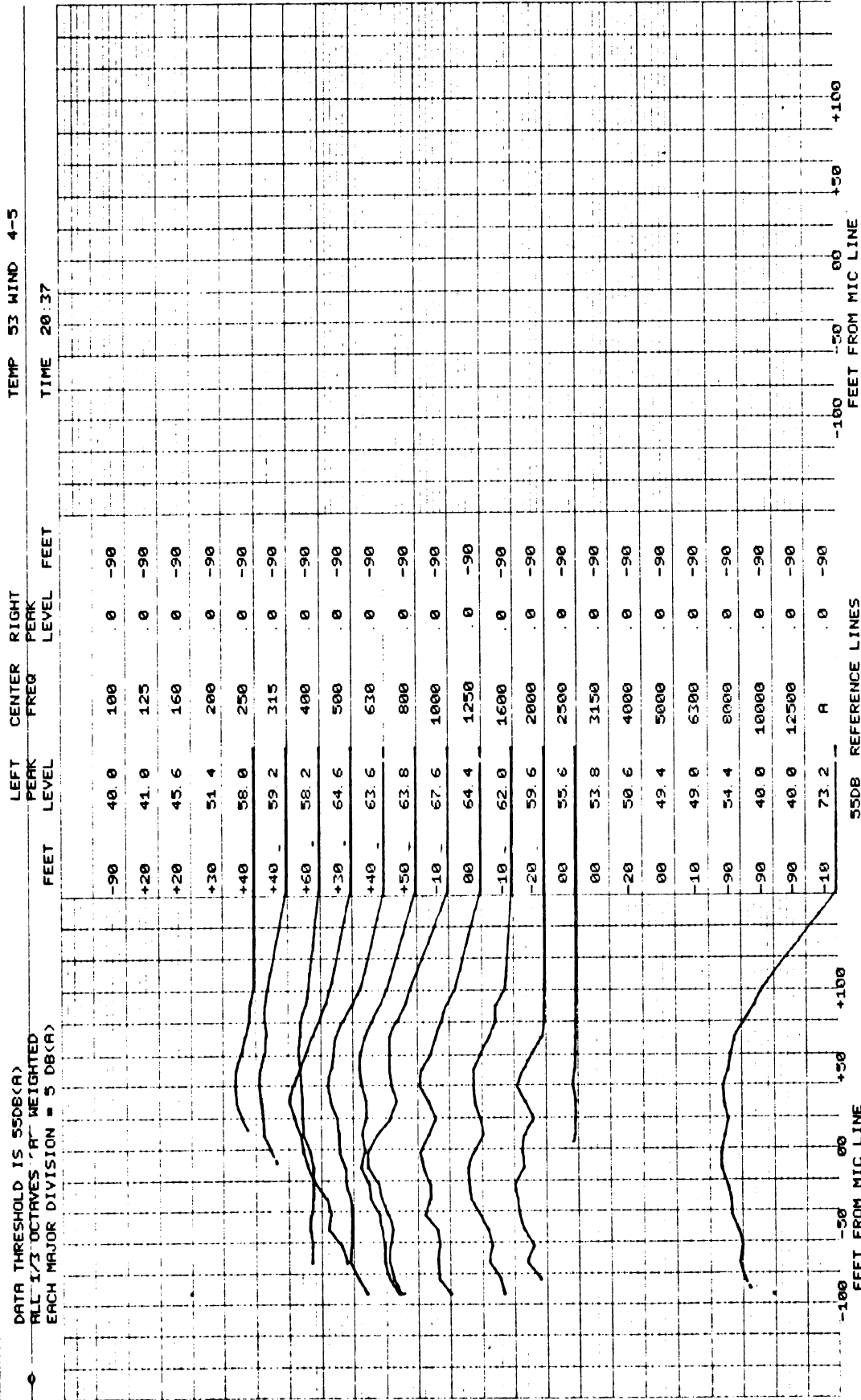

TEMP 53 WIND 4-5 TIME 20.37

SAE J-57 TIRE NOISE TEST-1/3 OCTAVE REDUCTION TEST NO. SN852175-008

VEHICLE ID LOADSTAR 146 TIRE NOISE DESCRIPTION UNIROVAL FLEETMASTER SUPER LUG @35MPH

TEMP 60 WIND 0

TIME 20.46

DATA THRESHOLD IS 60dB(A)

ALL 1/3 OCTAVES 'A' WEIGHTED

EACH MAJOR DIVISION = 5 DB(A)

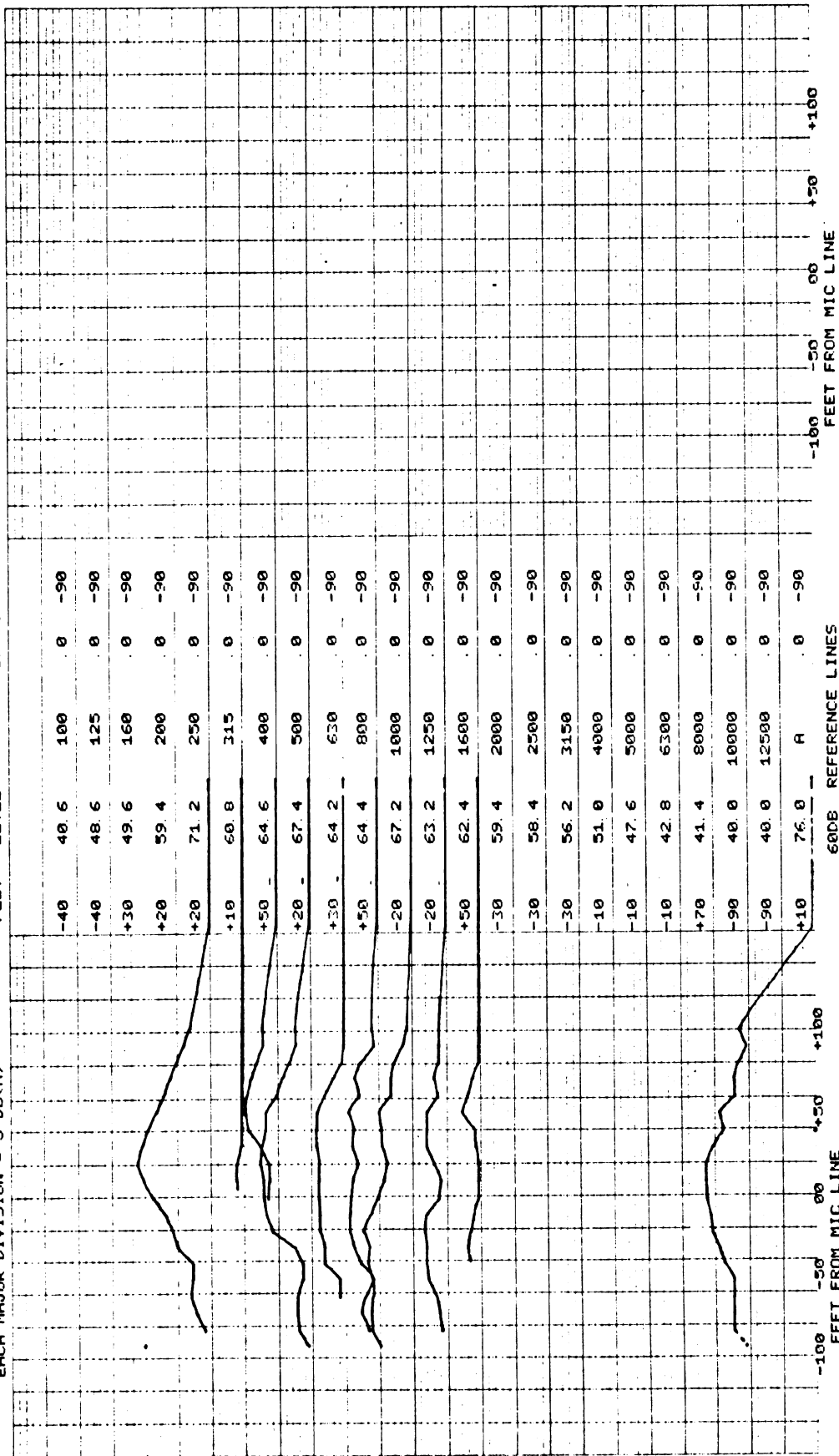

FEET FROM MIC LINE

60DB REFERENCE LINES

TEST # SN052175-008
 VEHICLE ID LOADSTAR 146 TIRE NOISE
 DESCRIPTION UNIROYAL FLEETMASTER SUPER LUG @35MPH

LEFT SIDE DATA

40.4	48.4	48.2	45.2	60.0	49.6	52.8	60.2	57.0	59.4	64.6	59.6	56.6	54.0	49.4	48.0	41.8	40.0	40.0	40.0	40.0	40.0	70.0
40.4	48.4	47.8	45.4	60.6	50.2	54.0	61.6	59.6	61.2	65.8	60.6	57.8	54.8	50.8	48.2	42.6	40.0	40.0	40.0	40.0	40.0	72.0
40.4	48.2	47.8	46.2	62.9	51.4	55.2	61.8	59.8	62.4	66.0	61.0	58.2	55.2	51.8	48.8	43.6	40.0	40.0	40.0	40.0	40.0	72.0
40.4	48.2	48.2	46.8	62.8	53.6	55.6	61.6	60.6	61.6	65.4	61.4	59.2	56.8	53.8	51.4	47.0	42.6	40.0	40.0	40.0	40.0	71.8
40.4	48.4	48.6	47.8	62.2	55.0	57.6	60.8	60.6	60.4	65.8	62.6	59.8	56.6	55.4	51.8	48.0	45.2	40.0	40.0	40.0	40.0	71.0
40.6	48.6	48.4	48.0	62.6	55.0	57.4	61.0	63.0	62.6	66.4	62.8	61.2	57.4	57.0	54.0	50.0	45.4	40.0	40.0	40.0	40.0	73.2
40.6	48.6	48.6	50.0	64.8	56.6	57.2	62.2	62.8	63.4	66.0	62.6	61.6	59.4	58.4	56.2	50.4	44.6	40.4	40.0	40.0	40.0	74.0
40.4	48.6	49.0	50.8	65.6	57.6	59.0	65.6	63.6	64.2	67.2	63.2	61.0	58.0	56.8	54.6	50.4	46.0	41.6	40.4	40.0	40.0	75.0
40.4	48.4	48.8	52.4	66.8	59.6	60.2	66.6	63.6	64.0	65.8	62.6	60.6	58.2	56.6	53.4	51.0	47.6	42.8	40.4	40.0	40.0	75.2
40.4	48.4	49.0	54.2	68.4	60.4	61.2	67.0	63.8	63.0	65.0	61.0	58.2	56.6	53.6	50.8	49.8	46.0	41.0	40.0	40.0	40.0	75.8
40.4	48.2	49.4	57.6	70.2	60.8	60.8	67.0	63.6	63.4	64.0	60.6	57.2	55.4	52.0	50.4	49.0	46.6	40.6	40.0	40.0	40.0	76.0
40.4	48.4	49.4	59.4	71.2	60.6	61.2	67.4	63.6	62.8	63.4	61.8	59.0	55.6	52.6	51.6	50.0	46.4	41.0	40.4	40.0	40.0	76.0
40.4	48.4	49.6	58.8	70.2	60.0	62.4	67.0	64.2	63.8	64.4	62.8	60.4	57.6	55.8	52.8	49.8	45.8	42.6	40.8	40.0	40.0	74.6
40.2	48.2	49.6	58.0	69.2	59.0	64.2	66.6	64.4	64.0	63.2	64.4	62.6	60.6	57.6	55.4	52.0	48.8	44.4	42.2	40.6	40.0	73.2
40.0	48.4	49.2	57.4	68.0	58.4	64.6	66.4	64.0	63.0	64.4	64.0	62.6	62.4	57.8	55.6	52.6	48.6	44.6	42.4	41.0	40.0	74.0
40.0	48.4	49.0	56.8	67.0	57.6	64.2	64.0	62.0	62.6	63.0	61.2	61.4	57.0	54.2	51.4	48.6	42.4	40.0	40.0	40.0	40.0	71.6
40.0	48.4	49.0	57.0	66.0	56.0	63.6	64.0	61.4	63.4	63.0	61.8	60.8	56.6	53.6	49.6	47.6	43.4	40.0	41.4	40.0	40.0	72.0
40.0	48.4	48.0	56.6	64.0	56.4	62.0	62.0	60.2	62.2	62.4	61.0	59.6	57.4	52.8	49.4	45.6	40.0	40.0	40.0	40.0	40.0	71.0
40.0	48.0	48.4	56.2	63.0	55.4	62.0	62.0	58.8	60.8	61.2	61.0	57.8	54.4	50.2	47.4	42.8	40.0	40.0	40.0	40.0	40.0	69.0
40.0	48.0	48.2	56.8	63.0	54.4	62.2	62.2	58.8	61.0	60.6	61.0	57.6	56.4	50.6	46.6	42.6	40.0	40.0	40.0	40.0	40.0	71.2
0	0	0	0	0	0	0	0	0	0	0	0	0	0	0	0	0	0	0	0	0	0	0
0	0	0	0	0	0	0	0	0	0	0	0	0	0	0	0	0	0	0	0	0	0	0

SAE J-57 TIRE NOISE TEST-1/3 OCTAVE REDUCTION TEST NO. SN052175-009

VEHICLE ID LOADSTAR 146 TIRE NOISE DESCRIPTION UNIROYAL FLEETMASTER SUPER LUG @50MPH

DATA THRESHOLD IS 65DB(A)
ALL 1/3 OCTAVES 'A' WEIGHTED
EACH MAJOR DIVISION = 5 DB(A)

LEFT PEAK FREQ RIGHT PEAK LEVEL FEET

TEMP 60 WIND 0
TIME 20:50

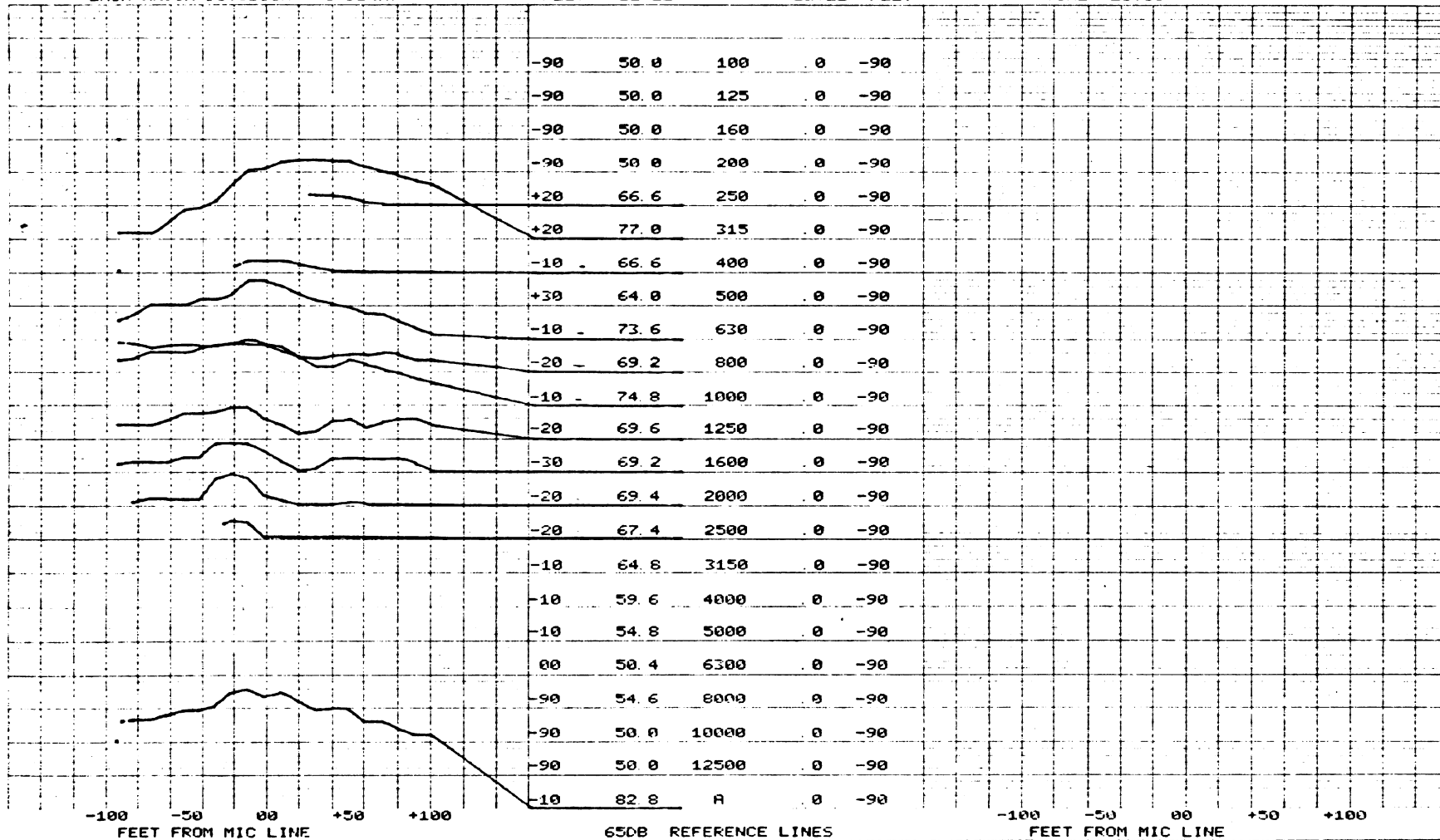

82

SAE J-57 TIRE NOISE TEST-1/3 OCTAVE REDUCTION TEST NO. SN052775-002

VEHICLE ID LOADSTAR 146 TIRE NOISE DESCRIPTION GOODYEAR CUST. CROSS. RIB HIMILER@35MPH

TEMP 55 WIND 0
TIME 16:47

DATA THRESHOLD IS 60DB(A)
ALL 1/3 OCTAVES 'A' WEIGHTED
EACH MAJOR DIVISION = 5 DB(A)

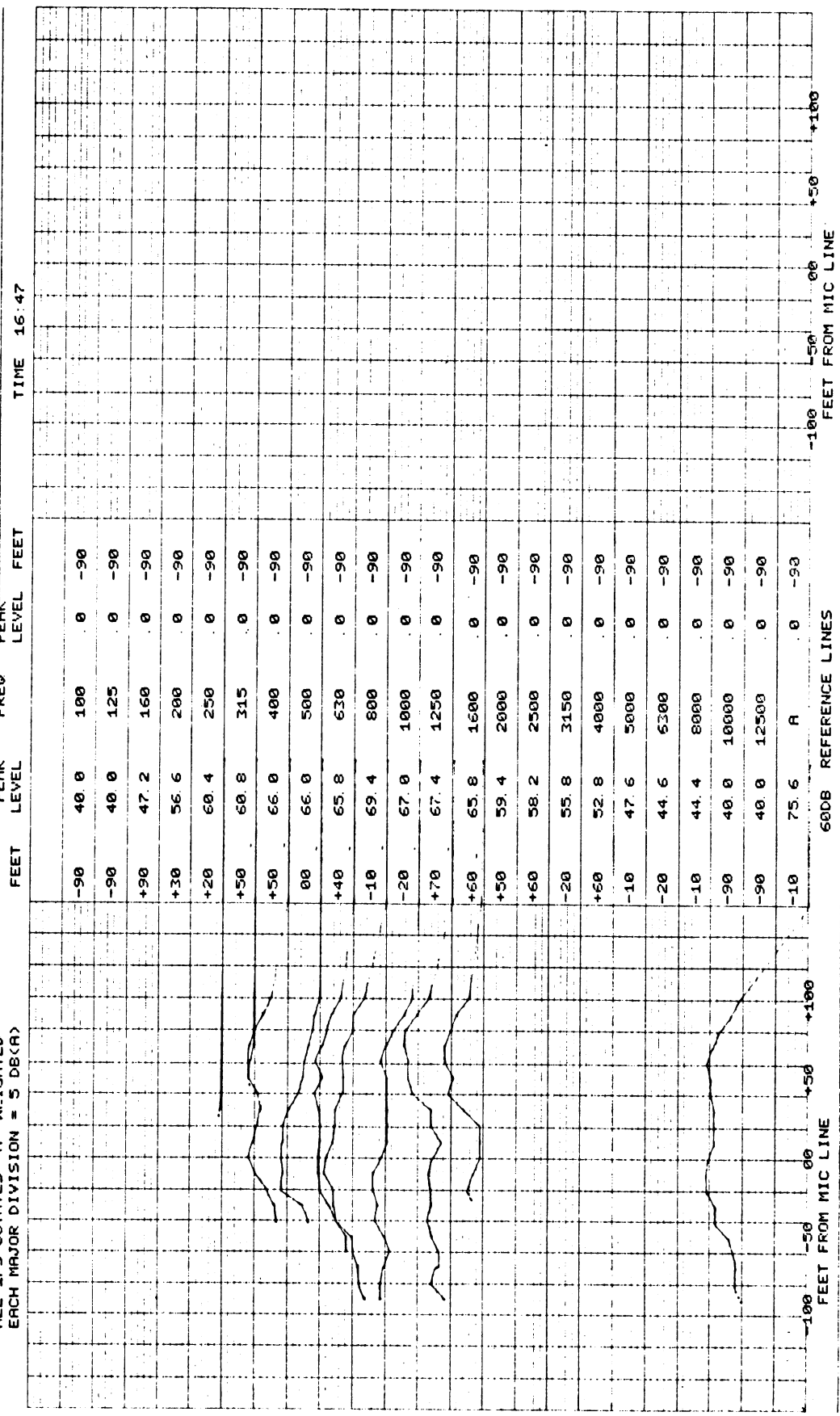

60DB REFERENCE LINES
FEET FROM MIC LINE

SRE J-57 TIRE NOISE TEST-1/3 OCTAVE REDUCTION TEST NO. SN052775-004

VEHICLE ID LOADSTAR 146 TIRE NOISE DESCRIPTION GOODYEAR CUST. CROSS. RIB HIMILERS@50MPH

DATA THRESHOLD IS 65DB(A)
 ALL 1/3 OCTAVES ARE WEIGHTED
 EACH MAJOR DIVISION = 5 DB(A)

TEMP 55 WIND 0
 TIME 16:55

LEFT PEAK LEVEL
 CENTER FREQ
 RIGHT PEAK LEVEL

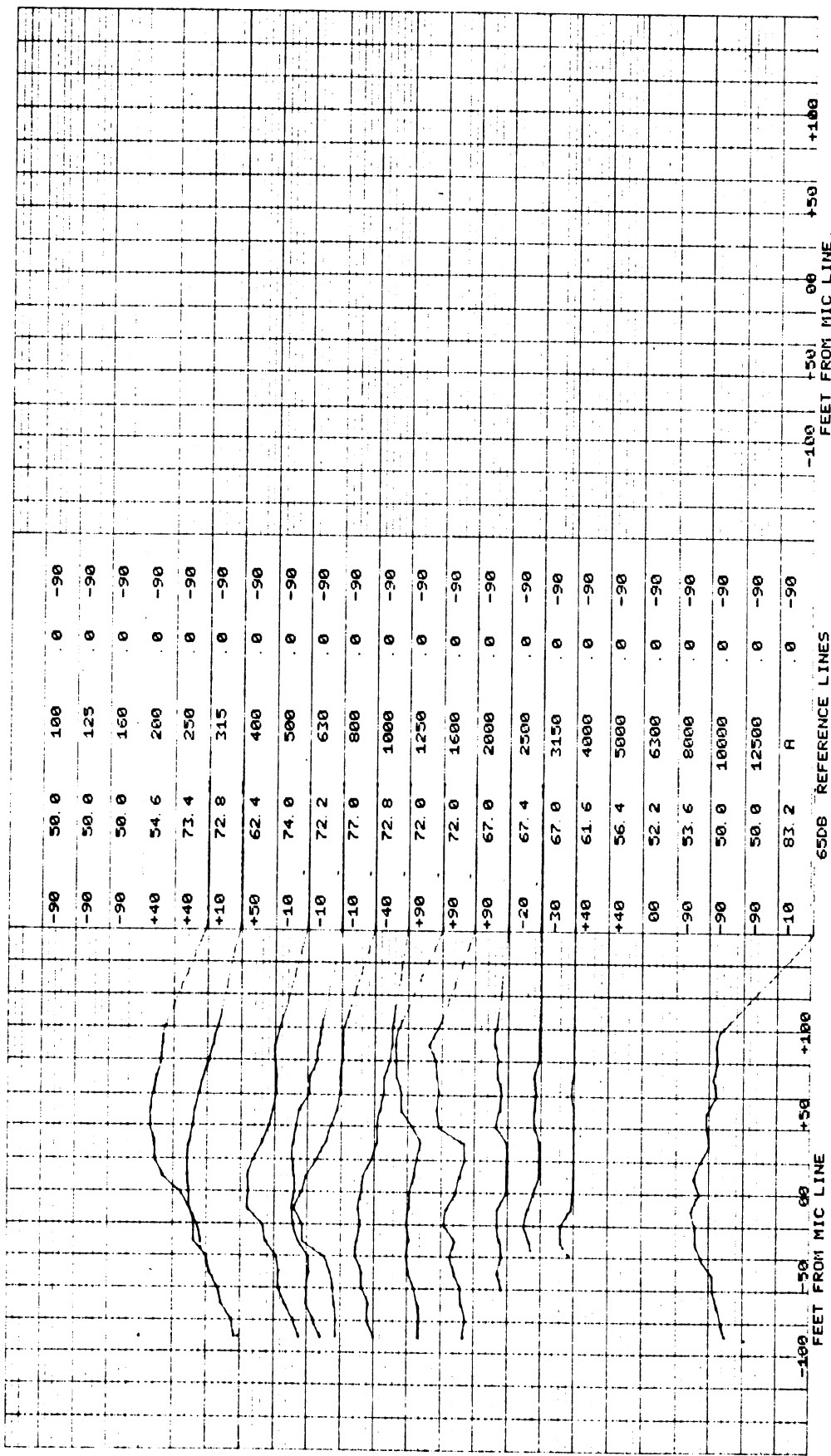

65DB REFERENCE LINES
 FEET FROM MIC LINE

SAE J-57 TIRE NOISE TEST-1/3 OCTAVE REDUCTION TEST NO. SN052775-005

VEHICLE ID LOADSTAR 146 TIRE NOISE DESCRIPTION FIRESTONE TRANSPORT 200035MPH

TEMP 88 WIND 4-6

TIME 17:00

DATA THRESHOLD IS 55DB(A)
 ALL 1/3 OCTAVES 'A' WEIGHTED
 EACH MAJOR DIVISION = 5 DB(A)

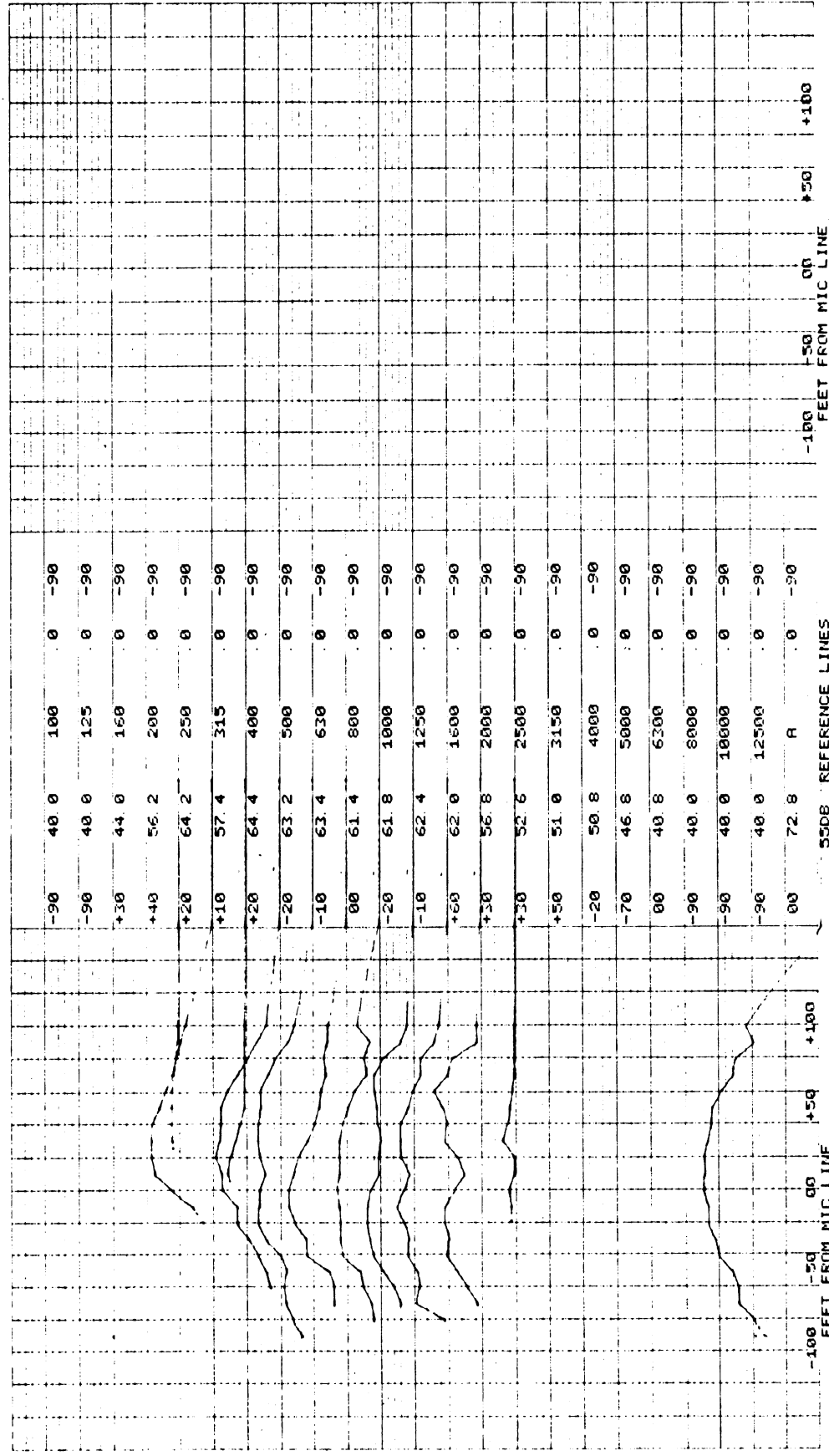

SAE J-57 TIRE NOISE TEST-1/3 OCTAVE REDUCTION TEST NO. SN032775-006

VEHICLE ID LOADSTAR 146 TIRE NOISE DESCRIPTION FIRESTONE TRANSPORT 200 AT 50MPH

DATA THRESHOLD IS 650B(A)
 ALL 1/3 OCTAVES 'A' WEIGHTED
 EACH MAJOR DIVISION = 5 DB(A)

TEMP 88 WIND 3-5

TIME 17:05

LEFT PEAK LEVEL FEET CENTER FREQ LEVEL FEET RIGHT PEAK LEVEL FEET

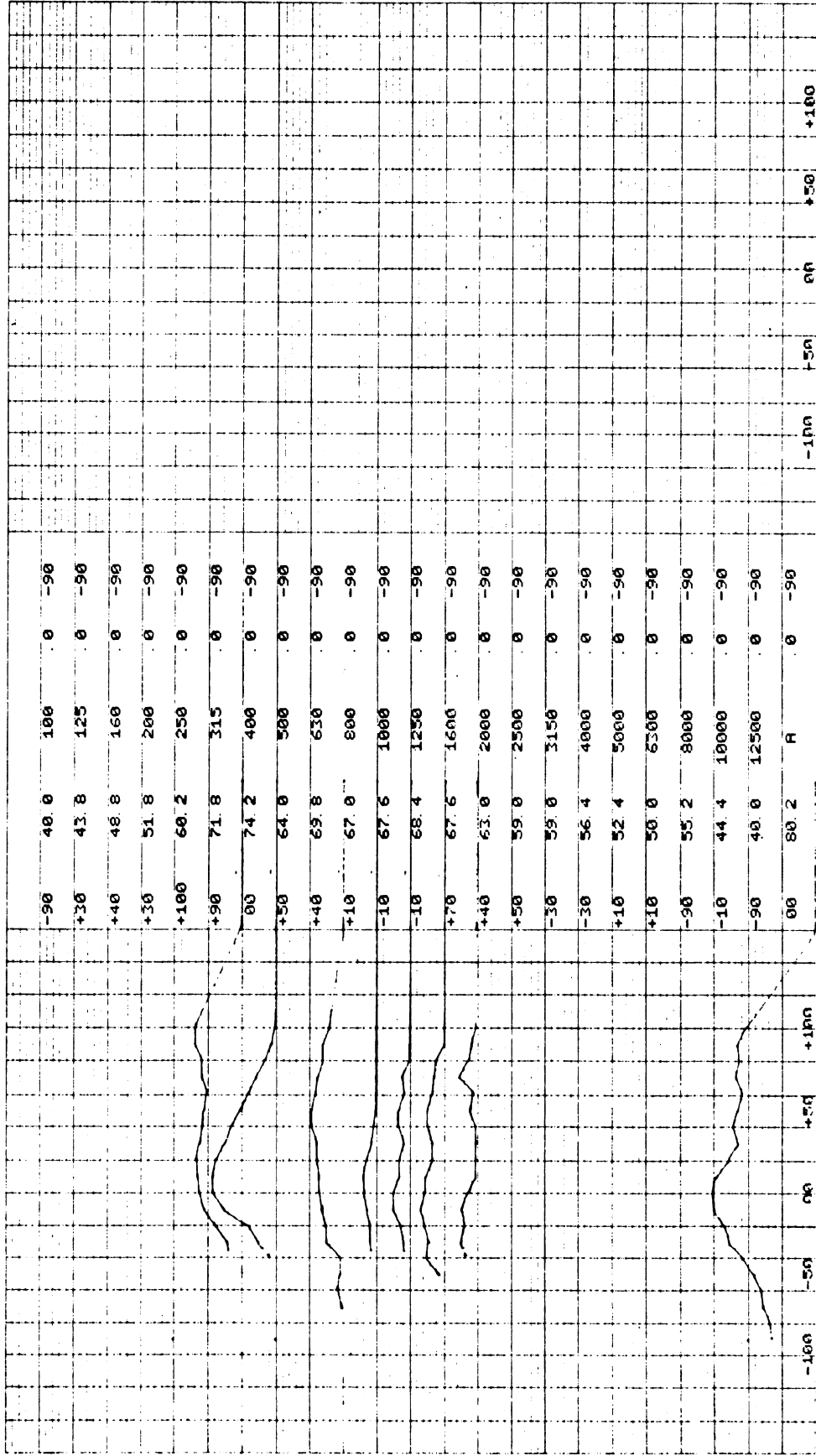

650B REFERENCE LINES
 FEET FROM MIC LINE

SAE J-57 TIRE NOISE TEST-1/3 OCTAVE REDUCTION TEST NO. SN052775-007

VEHICLE ID LOADSTAR 146 TIRE NOISE DESCRIPTION GENERAL GTX TIRES AT 35 MPN

DATA THRESHOLD IS 55DB(A)
 ALL 1/3 OCTAVES "R" WEIGHTED
 EACH MAJOR DIVISION = 5 DB(A)

TEMP 82 WIND 5-6
 TIME 17:10

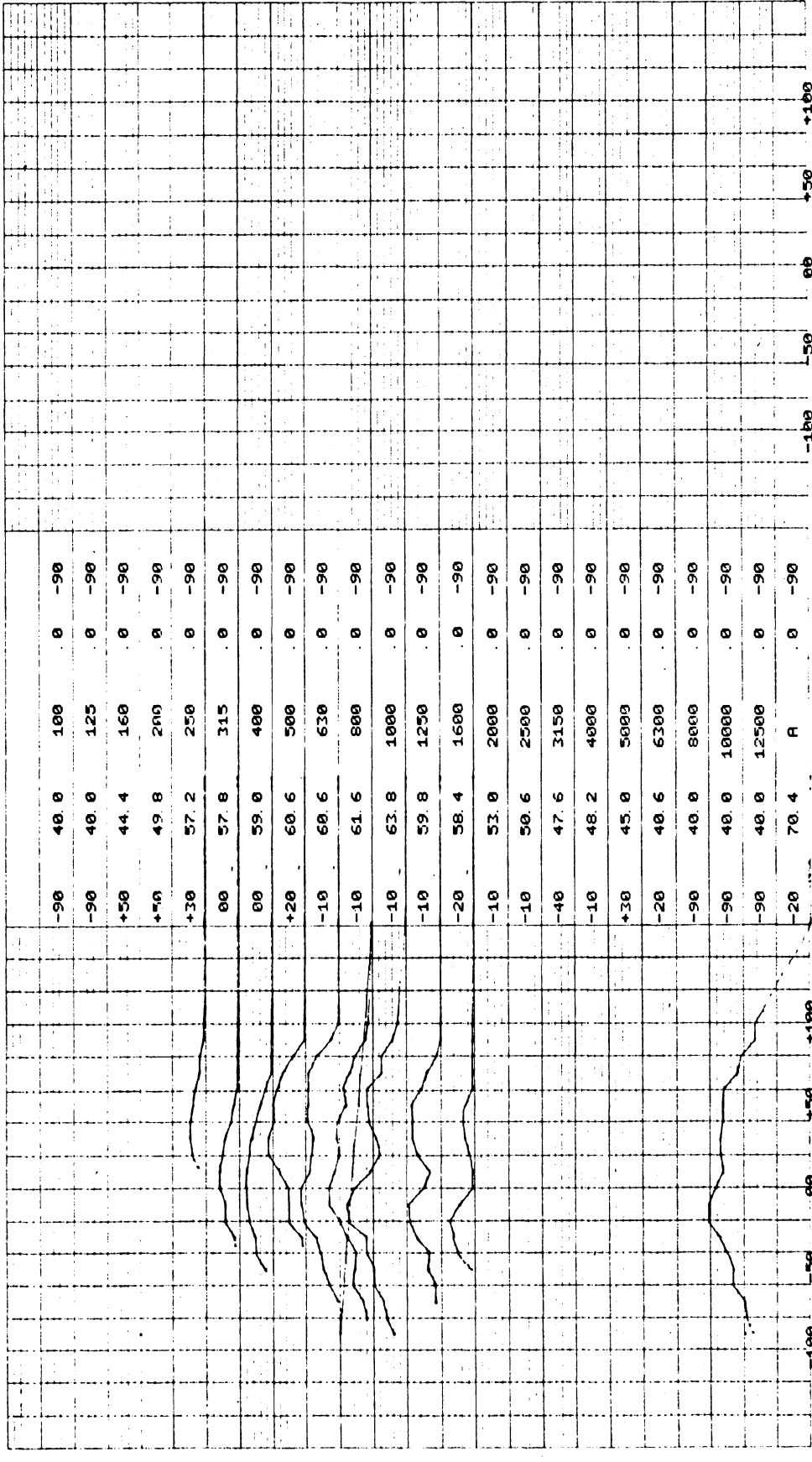

FEET FROM MIC LINE -100 -50 00 +50 +100
 55DB REFERENCE LINES
 -90
 -80
 -70
 -60
 -50
 -40
 -30
 -20
 -10
 00
 10
 20
 30
 40
 50
 60
 70
 70.4

SAE J-57 TIRE NOISE TEST-1/3 OCTAVE REDUCTION TEST NO. SN052775-008

VEHICLE ID LOADSTAR 146 TIRE NOISE DESCRIPTION GENERAL GTX TIRES AT 50MPH

DATA THRESHOLD IS 60DB(A)
 ALL 1/3 OCTAVES / A- WEIGHTED
 EACH MAJOR DIVISION = 5 DB(A)

TEMP 82 WIND 5-6

TIME 17:14

LEFT CENTER RIGHT
 PEAK FREQ PEAK FREQ PEAK FREQ
 FEET LEVEL FEET LEVEL FEET LEVEL

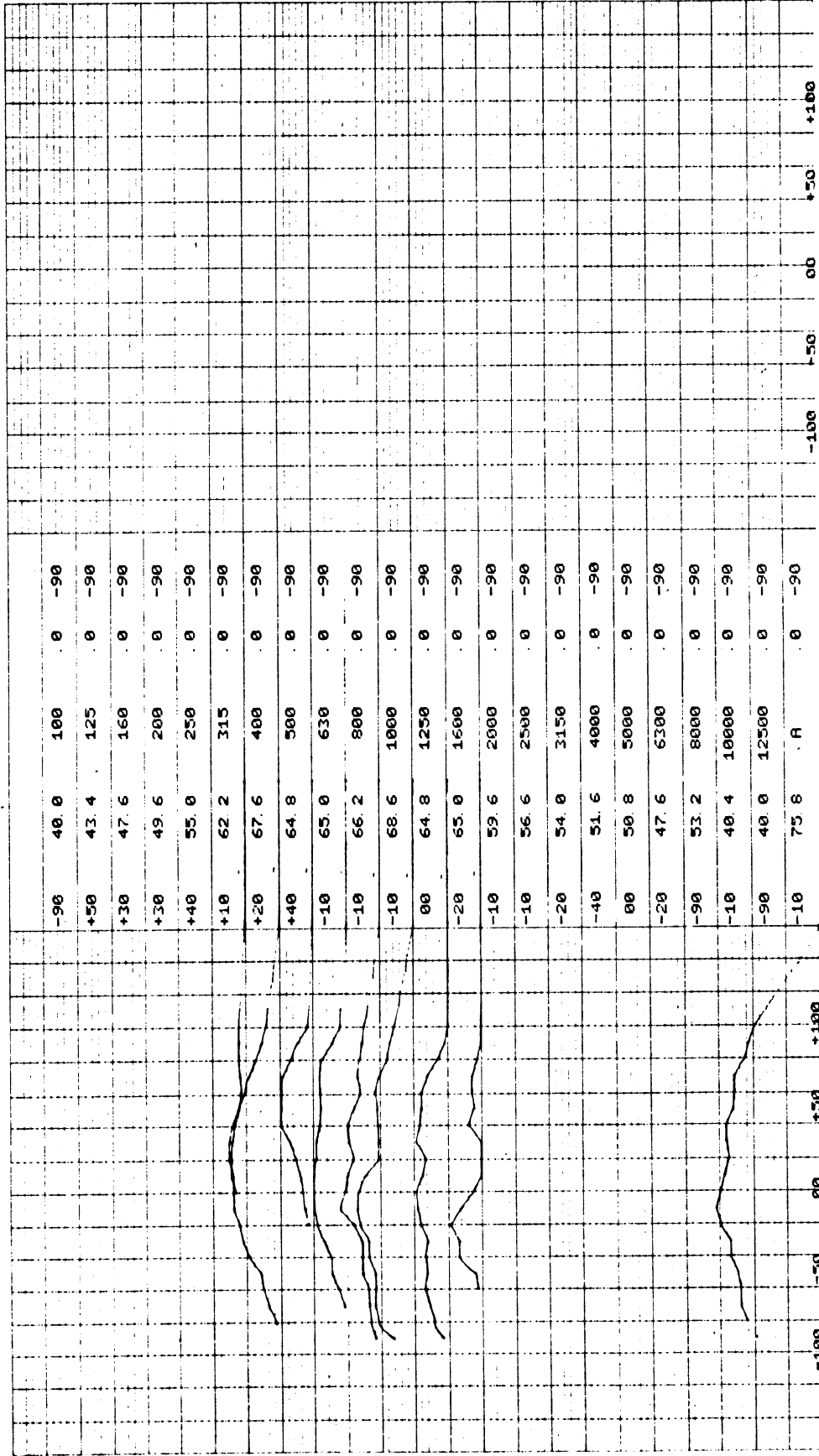

600B REFERENCE LINES
 -100 -50 00 +50 +100 FEET FROM MIC LINE

TEST # SN052775-008
 VEHICLE ID: LOADSTAR 146 IIRE NOISE
 DESCRIPTION GENERAL GTX TIRES AT 50MPH

LEFT SIDE DATA

40.0	40.0	44.0	43.8	45.4	50.2	59.2	56.6	58.4	60.8	63.2	61.0	58.2	56.2	51.6	49.6	46.0	47.8	43.6	53.2	40.0	40.0	40.0	70.4
40.0	40.0	44.0	44.0	45.8	52.0	60.6	56.4	59.0	61.6	65.4	62.2	59.4	57.4	53.4	49.0	47.0	46.2	45.0	47.6	40.0	40.0	40.0	71.6
40.0	40.0	44.0	44.0	46.2	53.6	61.8	57.6	60.6	61.8	66.0	62.8	60.0	57.8	53.4	49.0	48.0	46.8	42.4	42.6	40.0	40.0	40.0	72.4
40.0	40.0	45.0	44.0	46.8	54.8	62.6	58.4	61.4	62.0	65.6	63.0	60.0	57.8	54.0	49.0	48.0	46.8	42.4	42.6	40.0	40.0	40.0	72.8
40.0	41.0	46.2	45.4	48.2	56.0	64.6	59.2	62.6	62.8	66.8	63.6	61.0	57.4	53.0	49.0	48.0	46.8	42.4	42.6	40.0	40.0	40.0	73.8
40.0	42.0	46.8	46.8	49.6	58.0	65.4	59.4	63.4	62.8	66.6	63.2	58.6	55.0	51.0	48.0	47.0	46.0	42.4	42.6	40.0	40.0	40.0	73.8
40.0	42.0	46.8	46.8	50.2	51.0	66.8	60.6	64.6	64.0	68.2	64.2	58.6	55.0	51.0	48.0	47.0	46.0	42.4	42.6	40.0	40.0	40.0	75.2
40.0	43.0	47.0	47.0	51.4	61.4	67.8	61.6	65.6	65.2	69.6	64.8	59.0	55.0	51.0	48.0	47.0	46.0	42.4	42.6	40.0	40.0	40.0	75.8
40.0	43.0	48.4	48.4	52.8	62.2	67.8	62.0	66.0	65.2	69.6	64.8	59.0	55.0	51.0	48.0	47.0	46.0	42.4	42.6	40.0	40.0	40.0	74.8
40.0	42.8	47.4	49.2	54.0	62.0	67.6	62.6	66.4	64.8	65.2	63.2	59.4	58.6	54.4	50.0	47.8	46.8	42.4	42.6	40.0	40.0	40.0	74.4
40.0	42.8	47.4	49.2	54.0	61.8	67.4	63.4	64.8	64.0	65.2	63.2	59.4	58.6	54.4	50.0	47.8	46.8	42.4	42.6	40.0	40.0	40.0	74.4
40.0	43.2	47.4	49.2	55.0	61.4	66.8	64.8	64.8	64.0	65.0	62.0	58.4	56.2	52.8	51.0	48.0	47.0	42.4	42.6	40.0	40.0	40.0	74.2
40.0	43.4	47.4	49.2	54.0	60.8	66.0	64.6	63.8	63.8	65.6	63.8	61.0	57.8	55.0	51.0	48.0	47.0	42.4	42.6	40.0	40.0	40.0	73.2
40.0	43.2	47.4	49.2	54.0	64.6	64.6	64.6	64.6	64.6	64.6	64.6	64.6	64.6	64.6	64.6	64.6	64.6	64.6	64.6	64.6	64.6	64.6	73.0
40.0	43.0	47.0	49.0	54.0	61.0	63.0	63.0	64.0	64.0	64.0	64.0	64.0	64.0	64.0	64.0	64.0	64.0	64.0	64.0	64.0	64.0	64.0	73.0
40.0	42.8	46.8	49.6	53.6	61.0	62.6	62.6	63.2	63.2	63.2	63.2	63.2	63.2	63.2	63.2	63.2	63.2	63.2	63.2	63.2	63.2	63.2	71.6
40.0	42.6	46.6	49.6	53.6	60.8	62.0	62.0	62.0	62.0	62.0	62.0	62.0	62.0	62.0	62.0	62.0	62.0	62.0	62.0	62.0	62.0	62.0	70.8
0	0	0	0	0	0	0	0	0	0	0	0	0	0	0	0	0	0	0	0	0	0	0	0
0	0	0	0	0	0	0	0	0	0	0	0	0	0	0	0	0	0	0	0	0	0	0	0
0	0	0	0	0	0	0	0	0	0	0	0	0	0	0	0	0	0	0	0	0	0	0	0

SAE J-57 TIRE NOISE TEST-1/3 OCTAVE REDUCTION TEST NO. SN052775-009

VEHICLE ID LOADSTAR 146 TIRE NOISE DESCRIPTION GOODYEAR SUPER HILMILER TIRES AT 35MPH

TEMP 82 WIND 2-3

TIME 17:18

DATA THRESHOLD IS 55DB(A)
ALL 1/3 OCTAVES "A" WEIGHTED
EACH MAJOR DIVISION = 5 DB(A)

LEFT PEAK LEVEL
CENTER FREQ.
RIGHT PEAK LEVEL

FEET

FEET

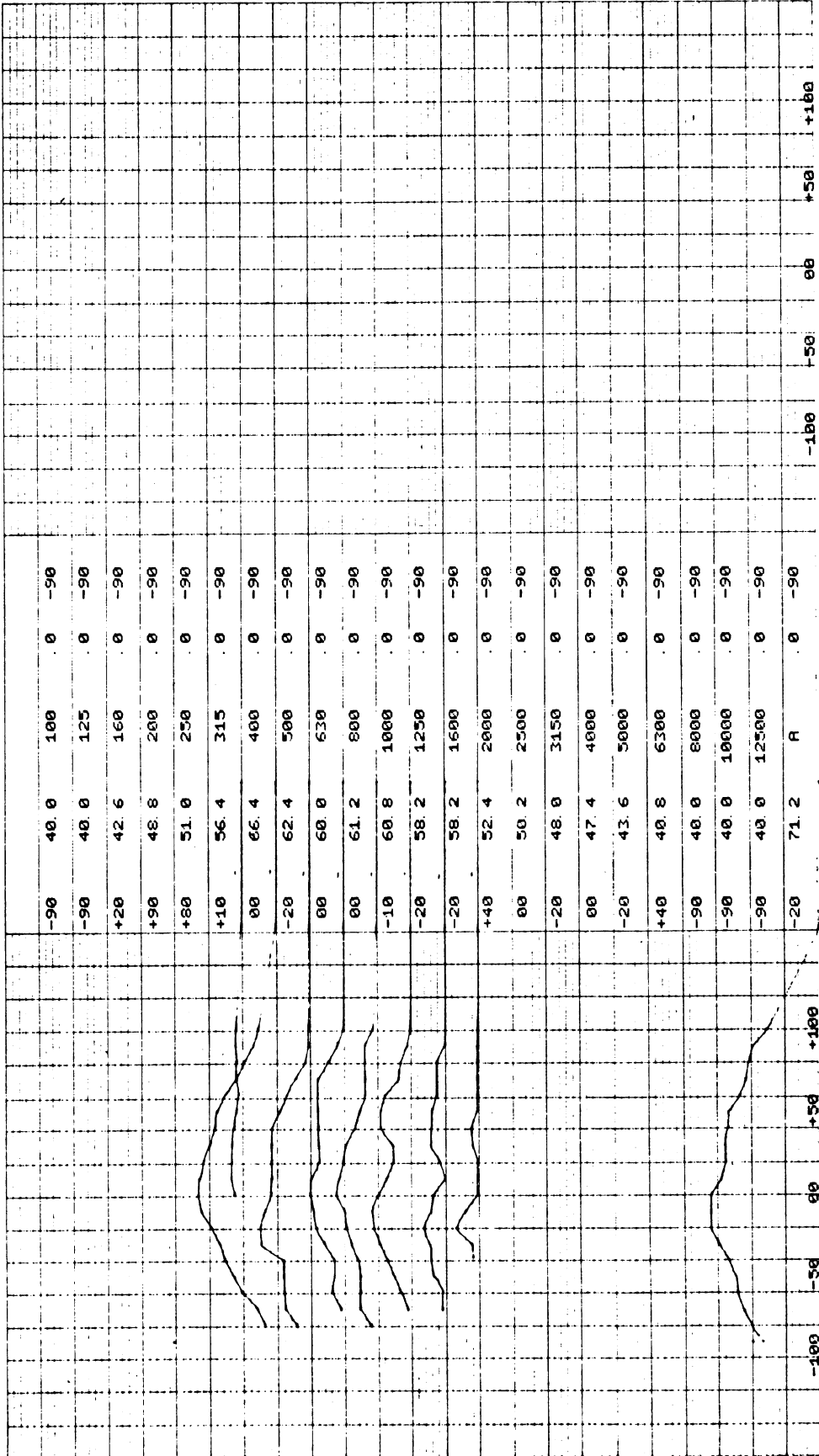

-100 -50 00 +50 +100
FEET FROM MIC LINE

-100 -50 00 +50 +100
FEET FROM MIC LINE

550B REFERENCE LINES

SAE J-57 TIRE NOISE TEST-1/3 OCTAVE REDUCTION TEST NO. SN052775-011

VEHICLE ID LOADSTAR 146 TIRE NOISE DESCRIPTION GOODYEAR SUPER HILMILER TIRES AT 50MPH

DATA THRESHOLD IS 55DB(A)
 ALL 1/3 OCTAVES 'A' WEIGHTED
 EACH MAJOR DIVISION = 5 DB(A)

TEMP 82 WIND 2-3
 TIME 17:24

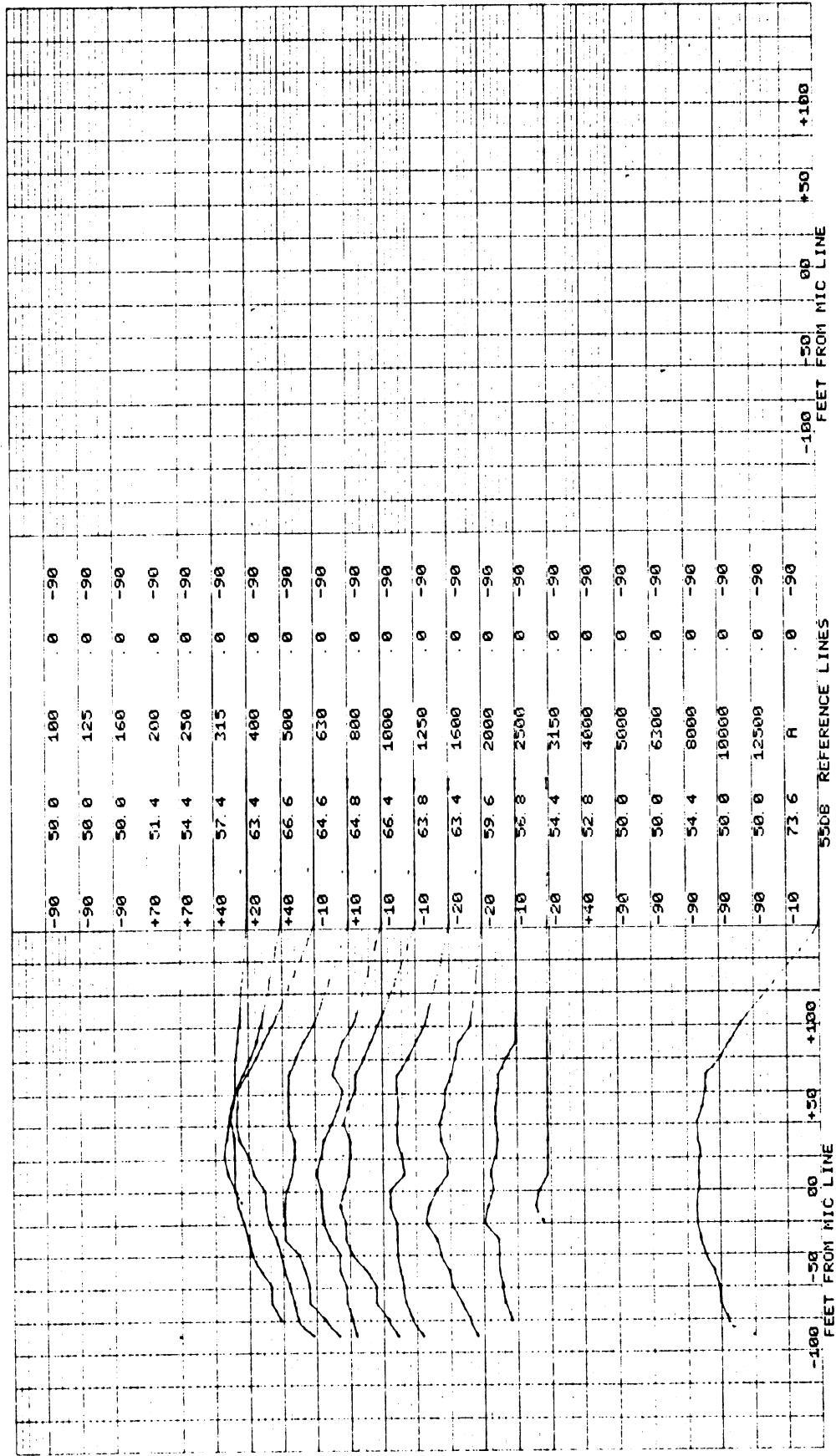

SAE J-57 TIRE NOISE TEST-1/3 OCTAVE REDUCTION TEST NO. SN032775-012

VEHICLE ID LOADSTAR 146 TIRE NOISE DESCRIPTION FIRESTONE TRANSPORT I TIRES AT 35MPH

DATA THRESHOLD IS 50DB(A)
 ALL 1/3 OCTAVES - A - WEIGHTED
 EACH MAJOR DIVISION = 5 DB(A)

TEMP 82 WIND 0-2

TIME 17:53

LEFT CENTER RIGHT
 PEAK FREQ PEAK LEVEL

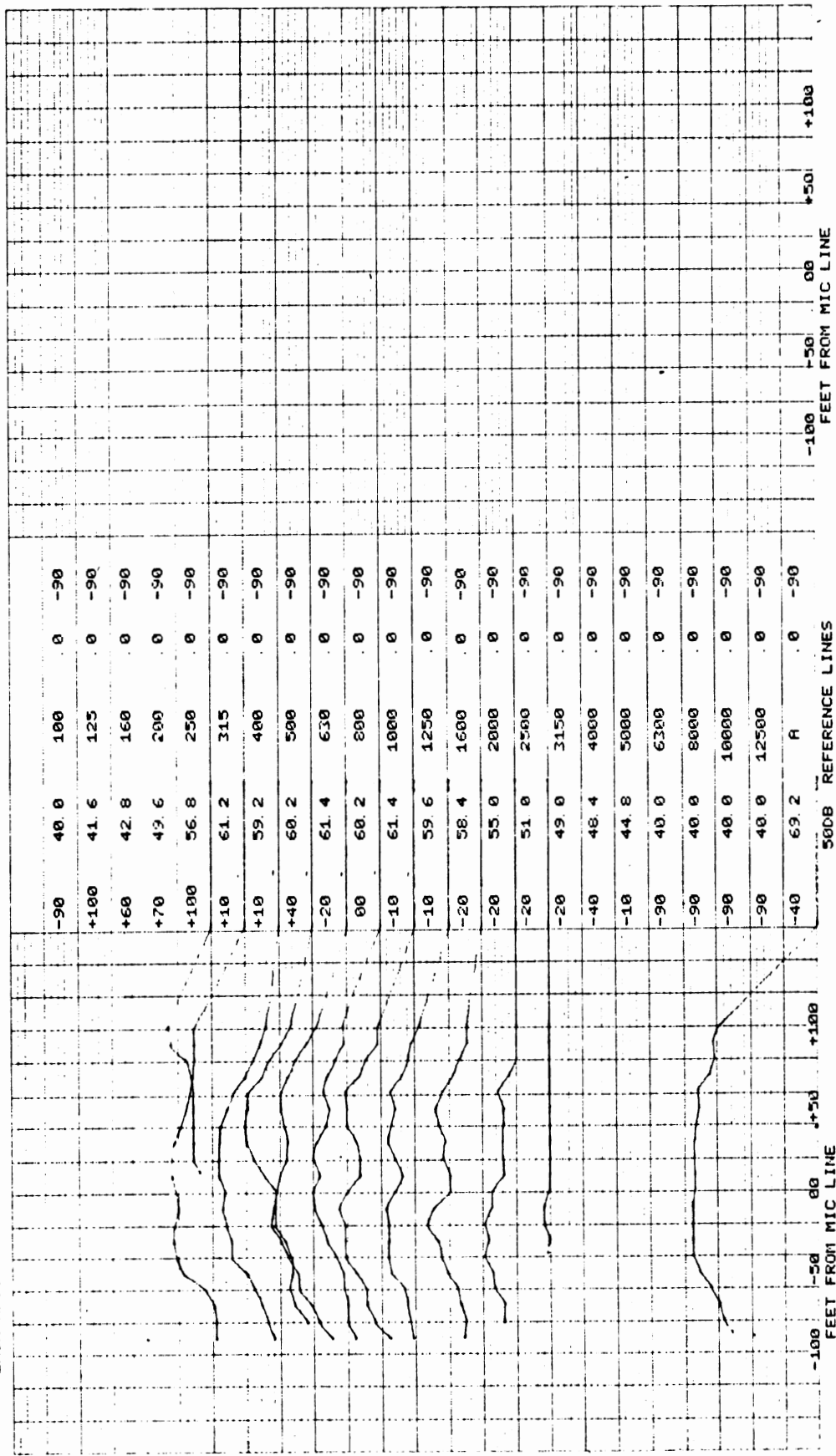

-100 -50 00 +50 +100
 FEET FROM MIC LINE
 50DB REFERENCE LINES

SAE J-57 TIRE NOISE TEST-1/3 OCTAVE REDUCTION TEST NO. SN052775-013

VEHICLE ID L0DSTAR 146 TIRE NOISE DESCRIPTION FIRESTONE TRANSPORT 1 TIRES AT 50MPH

LEFT CENTER RIGHT
PEAK FREQ PEAK FREQ PEAK FREQ
TEMP 82 MIND 0-2

TIME 17:57

DATA THRESHOLD IS 60DB(A)
ALL 1/3 OCTAVES / A-WEIGHTED
EACH MAJOR DIVISION = 5 DB(A)

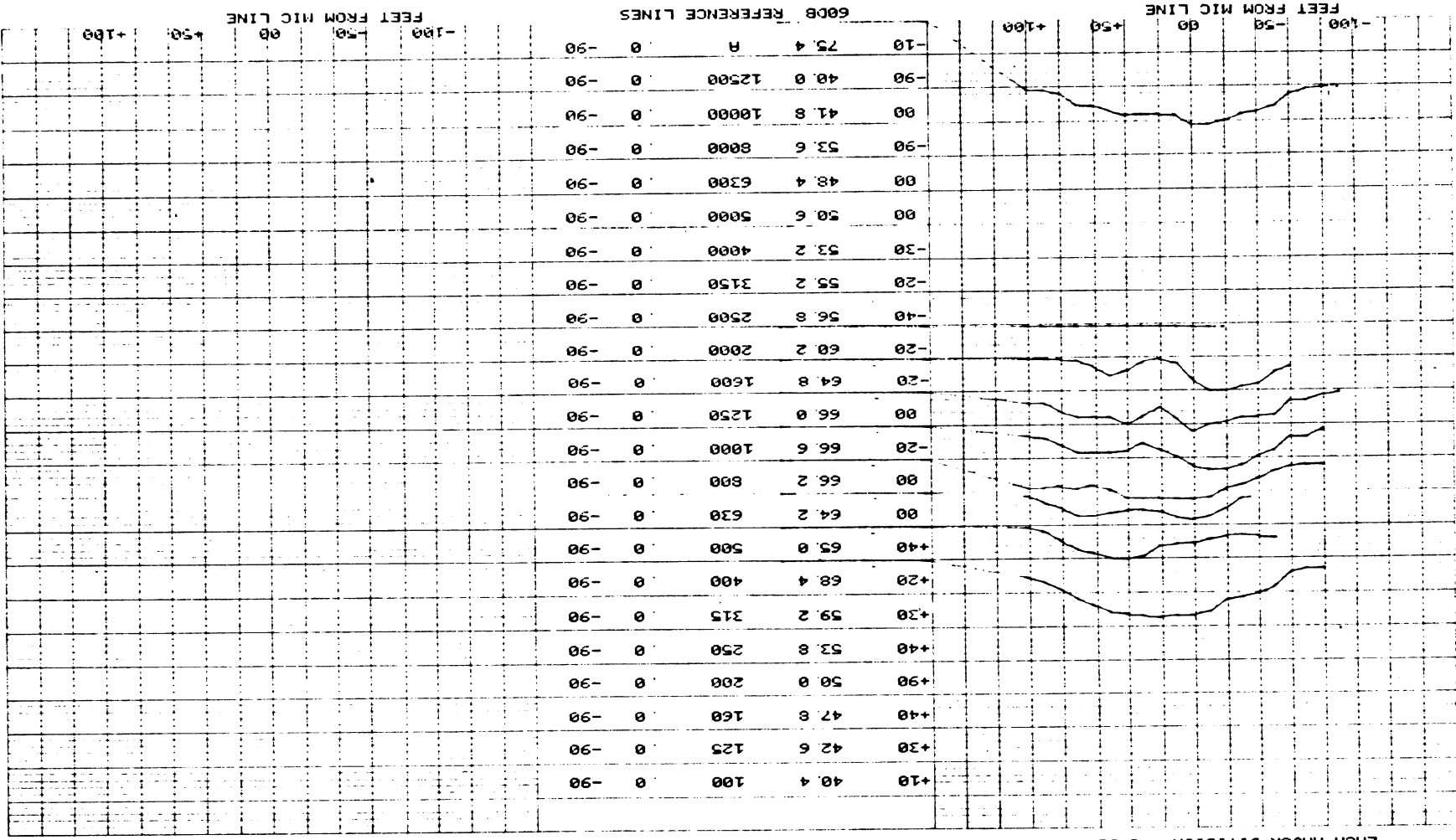

TEST # SN052775-013
 VEHICLE ID LOGSTAR 146 TIRE NOISE
 DESCRIPTION FIRESTONE TRANSPORT I TIRES AT 50MPH
 LEFT SIDE DATA

40.0	40.0	42.4	43.4	45.4	48.8	60.0	59.2	55.2	59.8	55.0	50.8	47.4	45.6	43.4	40.2	53.6	40.0	40.0	40.0	69.8	
40.0	40.0	42.8	43.6	45.4	50.0	61.2	59.4	56.4	60.8	60.6	59.8	57.4	52.0	48.0	45.8	44.2	40.0	40.0	40.0	70.2	
40.0	40.0	42.8	44.0	45.4	50.0	61.2	59.4	56.4	60.8	60.6	59.8	57.4	52.0	48.0	45.8	44.2	40.0	40.0	40.0	71.2	
40.0	40.0	43.6	44.2	46.4	52.0	61.2	61.0	61.4	61.0	61.4	61.0	58.4	53.4	49.0	48.0	45.6	40.0	40.0	40.0	72.0	
40.0	40.0	43.6	44.4	46.4	52.0	61.2	61.0	61.4	61.0	61.4	61.0	58.4	53.4	49.0	48.0	45.6	40.0	40.0	40.0	73.0	
40.0	40.0	43.8	44.4	46.4	52.0	61.2	61.0	61.4	61.0	61.4	61.0	58.4	53.4	49.0	48.0	45.6	40.0	40.0	40.0	74.0	
40.0	40.0	44.0	44.4	46.4	52.0	61.2	61.0	61.4	61.0	61.4	61.0	58.4	53.4	49.0	48.0	45.6	40.0	40.0	40.0	74.8	
40.0	40.0	45.0	46.0	46.0	55.0	61.4	62.4	64.4	66.6	64.6	60.2	56.8	53.2	48.6	45.6	42.6	40.0	40.0	40.0	74.8	
40.0	49.4	47.6	46.8	50.4	57.0	67.6	62.0	61.6	65.8	65.0	56.8	54.4	52.2	49.6	45.6	43.8	40.0	40.0	40.0	75.4	
40.2	41.0	46.0	46.8	50.4	57.0	68.2	62.4	64.4	66.2	65.8	58.0	56.4	52.2	49.0	45.8	43.8	40.0	40.0	40.0	74.0	
40.4	41.4	47.0	47.8	51.4	58.0	68.4	62.0	64.4	66.2	65.8	58.0	56.4	52.2	49.0	45.8	43.8	40.0	40.0	40.0	72.8	
40.4	42.0	47.4	48.4	53.0	59.0	68.4	62.0	64.4	66.2	65.8	58.0	56.4	52.2	49.0	45.8	43.8	40.0	40.0	40.0	74.2	
40.4	42.6	47.6	48.6	53.0	59.0	68.4	62.0	64.4	66.2	65.8	58.0	56.4	52.2	49.0	45.8	43.8	40.0	40.0	40.0	73.2	
40.4	42.4	47.6	48.6	53.4	59.2	67.0	64.4	64.4	64.4	64.4	64.4	61.8	57.0	54.4	51.0	47.4	44.0	40.0	40.0	72.6	
40.4	42.4	47.4	48.6	53.4	59.2	67.0	64.4	64.4	64.4	64.4	64.4	61.8	57.0	54.4	51.0	47.4	44.0	40.0	40.0	72.6	
40.4	42.4	46.8	48.4	53.4	57.0	65.4	63.8	63.8	63.8	63.8	62.6	57.0	54.4	51.0	47.4	44.0	40.0	40.0	40.0	70.8	
40.4	42.4	46.8	48.4	53.4	57.0	65.4	63.8	63.8	63.8	63.8	62.6	57.0	54.4	51.0	47.4	44.0	40.0	40.0	40.0	70.8	
40.4	42.4	46.8	48.4	53.4	57.0	65.4	63.8	63.8	63.8	63.8	62.6	57.0	54.4	51.0	47.4	44.0	40.0	40.0	40.0	70.2	
40.4	42.4	46.8	48.4	53.4	57.0	65.4	63.8	63.8	63.8	63.8	62.6	57.0	54.4	51.0	47.4	44.0	40.0	40.0	40.0	70.2	
40.2	42.2	46.4	49.6	53.4	57.4	65.4	64.4	64.4	64.4	64.4	64.4	61.8	57.0	54.4	51.0	47.4	44.0	40.0	40.0	69.0	
40.2	42.2	46.4	49.6	53.4	57.4	65.4	64.4	64.4	64.4	64.4	64.4	61.8	57.0	54.4	51.0	47.4	44.0	40.0	40.0	69.0	
40.0	40.0	40.0	40.0	40.0	40.0	40.0	40.0	40.0	40.0	40.0	40.0	40.0	40.0	40.0	40.0	40.0	40.0	40.0	40.0	40.0	69.0
40.0	40.0	40.0	40.0	40.0	40.0	40.0	40.0	40.0	40.0	40.0	40.0	40.0	40.0	40.0	40.0	40.0	40.0	40.0	40.0	40.0	69.0
40.0	40.0	40.0	40.0	40.0	40.0	40.0	40.0	40.0	40.0	40.0	40.0	40.0	40.0	40.0	40.0	40.0	40.0	40.0	40.0	40.0	69.0
40.0	40.0	40.0	40.0	40.0	40.0	40.0	40.0	40.0	40.0	40.0	40.0	40.0	40.0	40.0	40.0	40.0	40.0	40.0	40.0	40.0	69.0

OVERALL LEVEL DATA SUMMARY SHEET

TIRE NOISE DATA SUMMARY SHEET

TIRES TESTED	S P E E D	SLOW 'A'-WEIGHT LEVELS					FAST 'A'-WEIGHT LEVELS				
		Pass 1	Pass 2	Pass 3	SAE Avg	Pass 1	Pass 2	Pass 3	SAE Avg		
		35	68.9	68.1	68.3	68.60	69.0	68.6	69.0	69.00	
50	72.9	72.4	74.0	73.45	74.0	73.7	74.6	74.30			
35	75.1	75.2	74.9	75.15	76.8	76.0	75.6	76.40			
50	80.5	81.0	80.8	80.90	82.6	82.7	82.8	82.75			
35	75.0	74.8	75.4	75.20	75.9	75.6	76.2	76.05			
50	81.7	81.8	82.2	82.00	83.1	83.2	83.2	83.20			
35	72.2	72.4	72.1	72.30	72.6	73.0	72.5	72.80			
50	78.4	77.7	77.8	78.10	80.4	79.4	80.1	80.25			
35	69.5	69.2	69.0	69.35	70.2	70.3	69.7	70.25			
50	73.6	74.3	74.5	74.40	75.6	75.6	75.9	75.75			

TIRES TESTED	S P E E D	SLOW 'A'-WEIGHT LEVELS				FAST 'A'-WEIGHT LEVELS			
		Pass 1	Pass 2	Pass 3	SAE Avg	Pass 1	Pass 2	Pass 3	SAE Avg
Goodyear Super Hi Miler on rear axle	35	70.4	70.3	71.0	70.70	71.8	71.1	72.6	72.20
	50	73.2	73.6	72.8	73.40	73.8	74.0	73.7	73.90
Firestone Transport I's on rear axle	35	68.3	69.0	70.5	69.75	69.3	64.4	71.8	70.60
	50	74.3	74.2	74.0	74.25	75.7	75.5	75.5	75.60

SOUND LEVEL OF HIGHWAY TRUCK TIRES—SAE J57

SAE Recommended Practice

Report of Vehicle Sound Level Committee approved July 1973.

1. Introduction—This SAE Recommended Practice establishes a test procedure for measuring the sound level produced by tires intended primarily for highway use on motor trucks, truck tractors, trailers and semitrailers, and buses. The procedure provides for the measurement of the sound generated by a set of test tires, mounted on the rear axle operated at 50 mph (80 km/h) and at maximum rated tire load.

Specifications for the instrumentation, the test site, and the operation of the test vehicle are set forth to minimize the effects of extraneous sound sources and to define the basis of reported levels.

Reference to sound levels is given in the Appendix.

2. Instrumentation—The following instrumentation shall be used for the measurements as required:

2.1 A sound level meter which satisfies the Type 1 requirements of ANSI S1.4-1971, Specification for Sound Level Meters.

2.1.1 As an alternative to making direct measurements using a sound level meter, a microphone or sound level meter may be used with a magnetic tape recorder and/or a graphic level recorder or indicating meter, providing the system meets the requirements of SAE J181, with "slow" response specified in place of "fast" as applicable in paragraph 3.6 therein.

2.2 An acoustical calibrator for establishing the calibration of the sound level meter and associated instrumentation.

2.3 An anemometer.

3. Test Site

3.1 The test site shall be located on a flat area which is free of reflecting surfaces (other than the ground), such as parked vehicles, trees, or buildings within 100 ft (30 m) of the measurement area.

3.2 The vehicle path shall be relatively smooth, semipolished, dry, Portland concrete which is free of extraneous surface material.

3.3 The microphone shall be located 50 ft (15 m) from the centerline of the vehicle path at a height of 4 ft (1.2 m) above the ground plane. The normal to the vehicle path from the microphone shall establish the microphone point on the vehicle path. See Fig. 1.

3.4 The test zone extends 50 ft (15 m) on either side of the microphone point along the vehicle path. The measurement area is the triangular area formed by the point of entrance into the test zone, point of exit from the test zone, and the microphone.

3.5 The measurement area should be surfaced with concrete, asphalt, or similar hard material and, in any event, shall be free of powdery snow, grass, loose soil, ashes, or other sound-absorbing materials.

3.6 The ambient sound level (including wind effects) at the test site shall be at least 10 dB below the level of the test vehicle operated in accordance with the test procedure.

3.7 The wind speed in the measurement area shall be less than 12 mph (19 km/h).

4. Test Vehicle

4.1 The vehicle shall be a motor truck equipped with two axles (a nonpowered steering axle and a powered axle).

4.2 The vehicle shall have a platform, rack, or van body capable of retaining the loading or ballast. This body shall have an essentially flat and horizontal undersurface, and be mounted such that this surface has a 5 ± 1 in (127 ± 25 mm) minimum clearance with the tire fully loaded. This body shall be nominally 96 in (2440 mm) in width and extend a minimum of 36 in (910 mm) rearward of the rear (powered) axle centerline.

4.3 Mud flaps should be removed at the test site, if permissible.

5. Tires

5.1 Tires used for dual installations shall be dual mounted (four tires) on the rear axle for testing. Tires used in single installations (wide base) shall be mounted singly. A tire used as both duals and singles may require test at both dual and single mounting. The sound level reported must be identified as to type of mounting.

5.2 The tires shall be inflated to the maximum pressure and loaded to the maximum load specified by the Tire and Rim Association for continuous operation at highway speeds exceeding 50 mph (80 km/h).

5.2.1 If local load limits will not permit full rated load, the test may be conducted at the local load limit with inflation pressure reduced to provide a tire deflection equal to the maximum load and inflation pressure, provided the load is not less than 75% of the maximum rated load.

As an alternative, the pressure in the tires can be adjusted to correspond to the actual load following the appropriate load/pressure tables in the Tire and Rim Association Yearbook. Because the choice of procedure may cause small differences in level, such levels may not be reported as absolute unless they are identified with the percent load used.

5.3 Quiet tires are recommended for use on the front axle.

6. Procedure

6.1 The test vehicle shall be operated in such a manner (such as coasting) that the sound level due to the engine and other mechanical

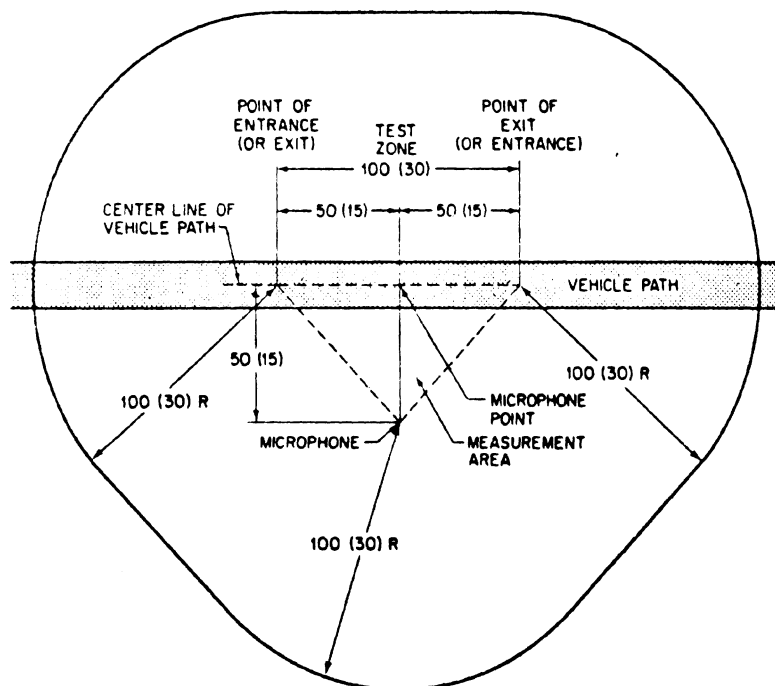

NOTE: DIMENSIONS ARE FT (m)

FIG. 1—TEST SITE (SEE PARAGRAPH 3). (VEHICLE MAY BE RUN IN EITHER DIRECTION)

sources is minimized throughout the test zone. The vehicle speed at the microphone point shall be 50 mph (80 km/h).

6.2 The sound level meter shall be set for "slow" response and the A-weighting network. The observer shall record the highest level attained during each pass of the test vehicle, excluding readings where known acoustical interferences have occurred.

6.2.1 Alternatively, each pass of the test vehicle may be recorded on magnetic tape and subsequently analyzed with a sound level meter and/or graphic level recorder.

6.3 There shall be at least three measurements. The number of measurements shall equal or exceed the range in decibels of the levels obtained.

6.4 The sound level reported shall be the average of the two highest readings which are within 2 dB of each other.

7. General Comments

7.1 It is recommended that technically competent personnel select the equipment to be used for the test measurements and that these tests be conducted only by persons familiar with the current techniques of sound measurement.

7.2 All instrumentation should be operated according to the practices recommended in the operating manuals or other literature provided by the manufacturer. All stated precautions should be observed. Some specific items for consideration are:

7.2.1 Specifications for orientation of the microphone relative to the ground plane and the source of sound should be adhered to. (Assume that the sound source is located at the microphone point.)

7.2.2 Proper signal levels, terminating impedances, and cable length should be maintained on all multi-instrument measurement systems.

7.2.3 The effect of extension cables and other components should be taken into account in the calibration procedure.

7.2.4 The position of the observer relative to the microphone should be as recommended.

7.3 Instrument manufacturer's recommended calibration procedure and schedule for individual instruments should be employed. Field calibrations should be made immediately before and after testing each set of tires.

7.4 Not more than one person, other than the observer reading the

meter, shall be within 50 ft (15 m) of the vehicle path or the microphone, and that person shall be directly behind the observer reading the meter, on a line through the microphone and the observer.

7.5 The sound level of the tires being tested is valid only when the sound level of the vehicle equipped with quiet tires is at least 10 dB below that of the vehicle equipped with test tires. The sound levels obtained with this procedure may be used for a relative ranking of the test tires, if the sound level of the vehicle equipped with the quietest tires available is 3-10 dB lower than when equipped with the tires being tested.

8. *Reference Material*—Suggested reference material is as follows:

8.1 ANSI S1.1-1960, Acoustical Terminology

8.2 ANSI S1.2-1962, Physical Measurement of Sound

8.3 ANSI S1.4-1971, Specification for Sound Level Meters

8.4 SAE J184, Qualifying a Sound Data Acquisition System

8.5 Tire and Rim Association Yearbook

Applications for copies of the ANSI documents should be addressed to the American National Standards Institute, Inc., 1430 Broadway, New York, New York 10018.

APPENDIX

A1. An A-weighted sound level exceeding 85 dB, determined in accordance with this recommended practice, is not consistent with present best current practice for cross ribbed tires in normal states of wear. It is general experience that the sound level of unworn tires is significantly less than that of worn tires.

A2. Road surfaces are known to significantly affect the sound level exhibited by truck tires. The vehicle path surface specified herein is not sufficiently defined to eliminate variations in sound level due to surface (see paragraph 3.2).

A3. Persistence of tire sounds after the passage of the vehicle and the tonal components of these sounds are properties of certain types of tires which tend to occur concurrently. Both are factors that direct attention to the sound, and are important determinants of the acceptability of the sound.

Insufficient data are available concerning the measurement of the sound from distant truck tires and the significance of these sounds compared to the sound levels measured with this procedure.

APPENDIX B-I

TABULAR FLAT-BED TEST RESULTS

The following table indicates lateral force measurements which were obtained with each tire at slip angles of $\pm 1^\circ$ and at 0° for each of three values of vertical load. The cornering stiffness parameter, C_α , is then listed as the average of the lateral forces obtained at $+1^\circ$ and -1° .

Tire	Vertical Load, lbs.	Lateral Force, lbs at Slip Angles, α			Cornering Stiffness C_α lbs/deg
		$+1^\circ$	-1°	0°	
Goodyear Super Hi Miler	1630	-291	234	-31	263
	3260	-459	363	-60	411
	5430	-606	444	-73	525
General GTX	1630	-326	260	-37	293
	3260	-503	392	-65	448
	5430	-643	492	-80	568
Firestone Transport 1	1630	-346	267	-49	306
	3260	-540	403	-76	471
	5430	-670	486	-106	578
Uniroyal Fleetmaster Super Lug	1630	-268	215	-26	242
	3260	-430	340	-47	385
	5430	-559	417	-64	483
Goodyear Custom Cross Rib	1630	-270	224	-36	247
	3260	-433	337	-56	385
	5430	-572	418	-77	495
Firestone Transport 200	1630	-259	178	-30	219
	3260	-403	289	-51	346
	5430	-538	315	-84	426

APPENDIX B-II

INDIVIDUAL LONGITUDINAL FORCE PLOTS FROM MOBILE TRACTION TESTS

The following plots represent the "peak" and "slide" values of normalized longitudinal force obtained during the braking traction testing of the six-tire sample on a dry Portland cement concrete pavement. Each plot illustrates the influence of both load and velocity on the values of F_x/F_z obtained at the peak of the " μ -slip" curve and at the 100% slip condition. Additionally, data from the five repeats of the reference condition run, at $F_z = 1.0 \times$ rated load and $V = 40$ mph, are plotted as an indicator of the basic repeatability of the experiments. Tabular data from the repeat runs, together with computed standard deviations, were presented in the text, Table 3.

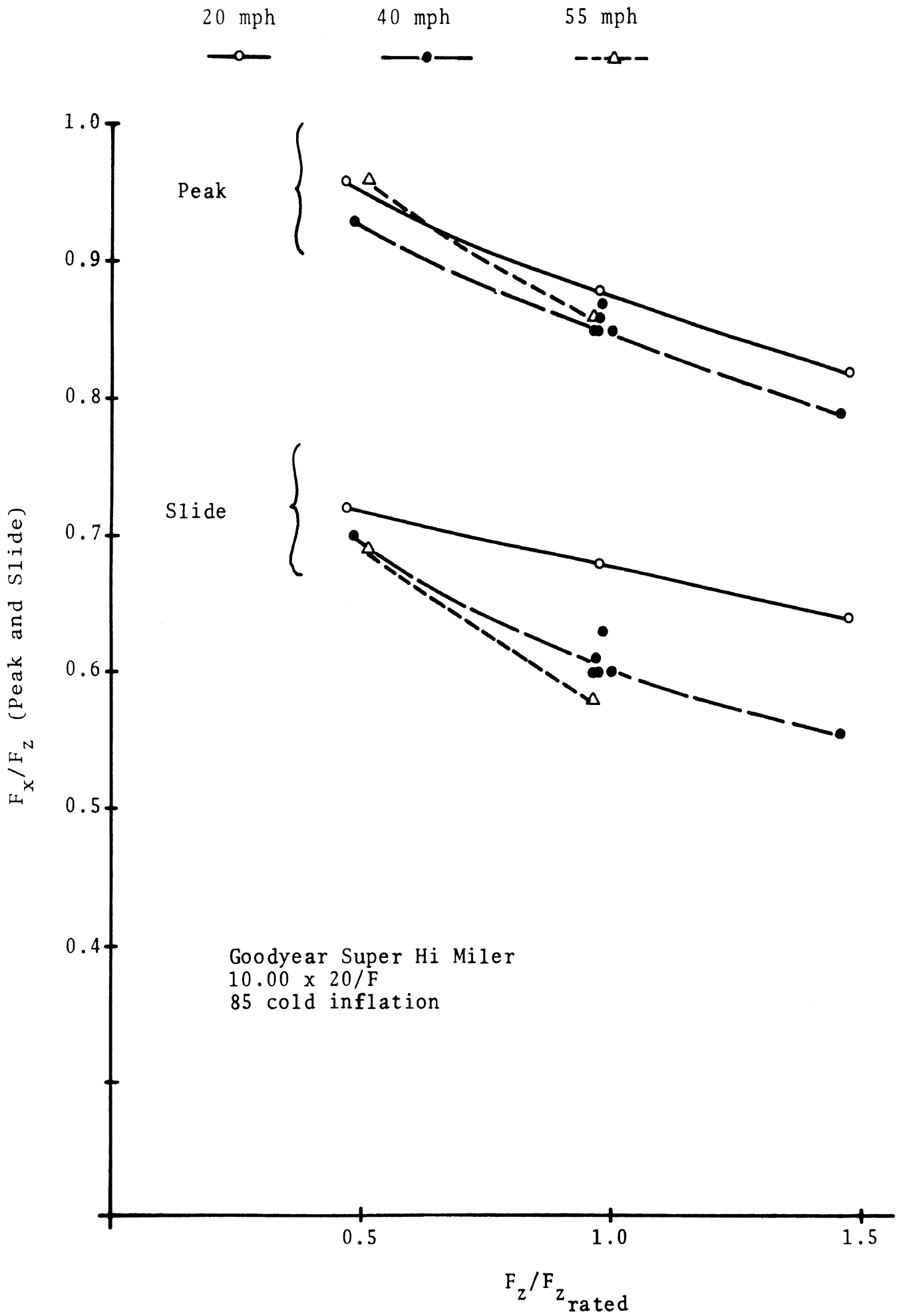

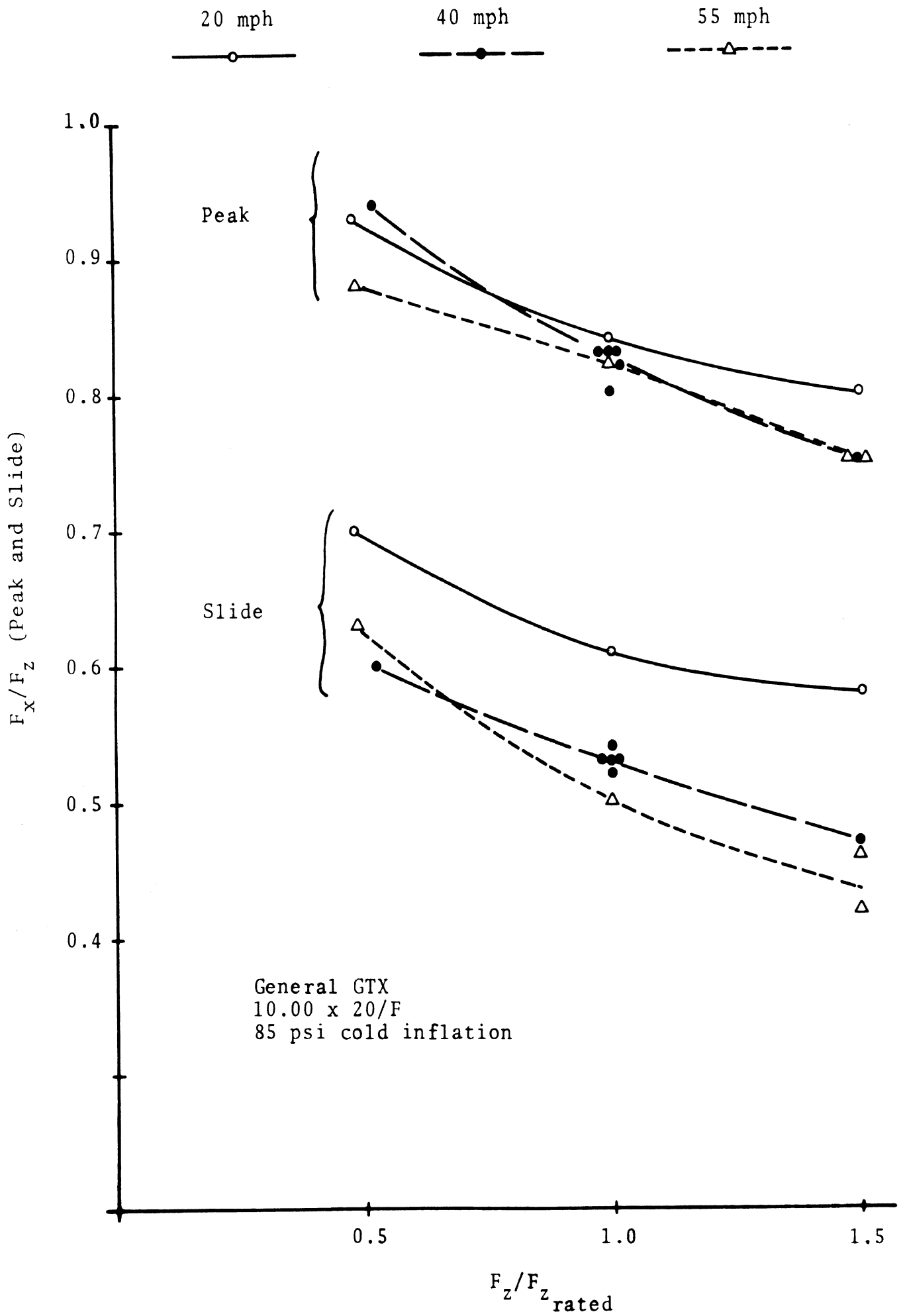

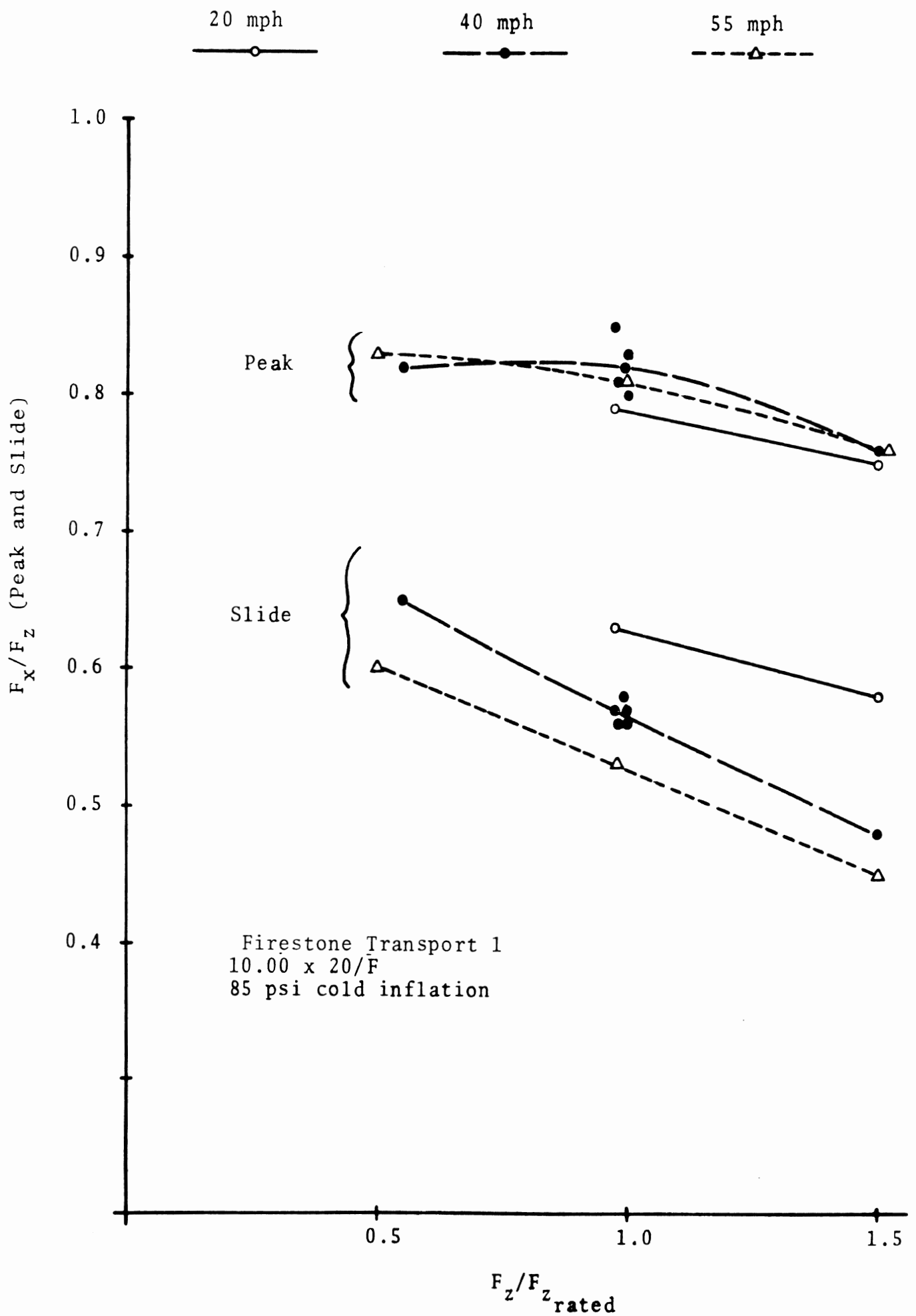

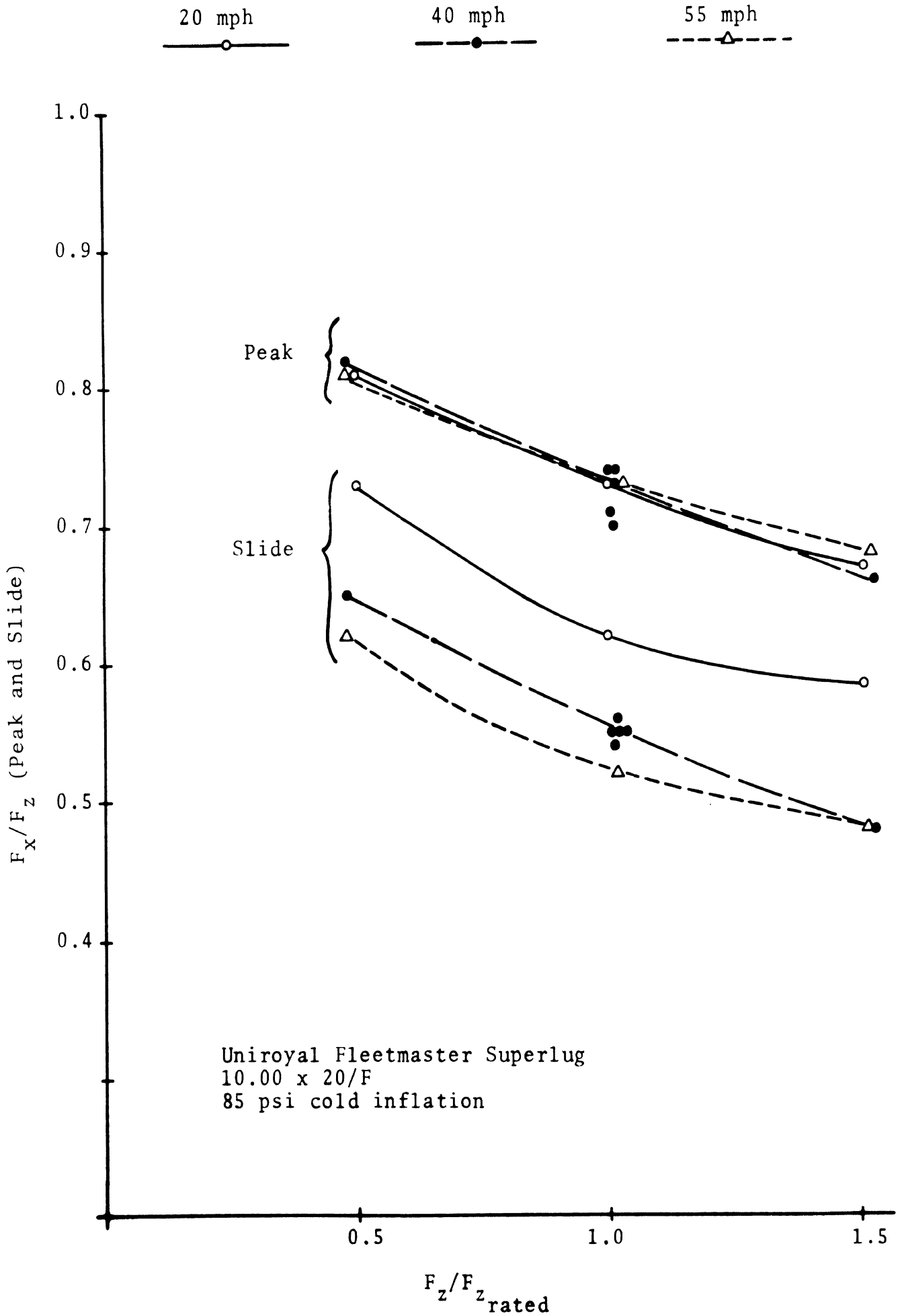

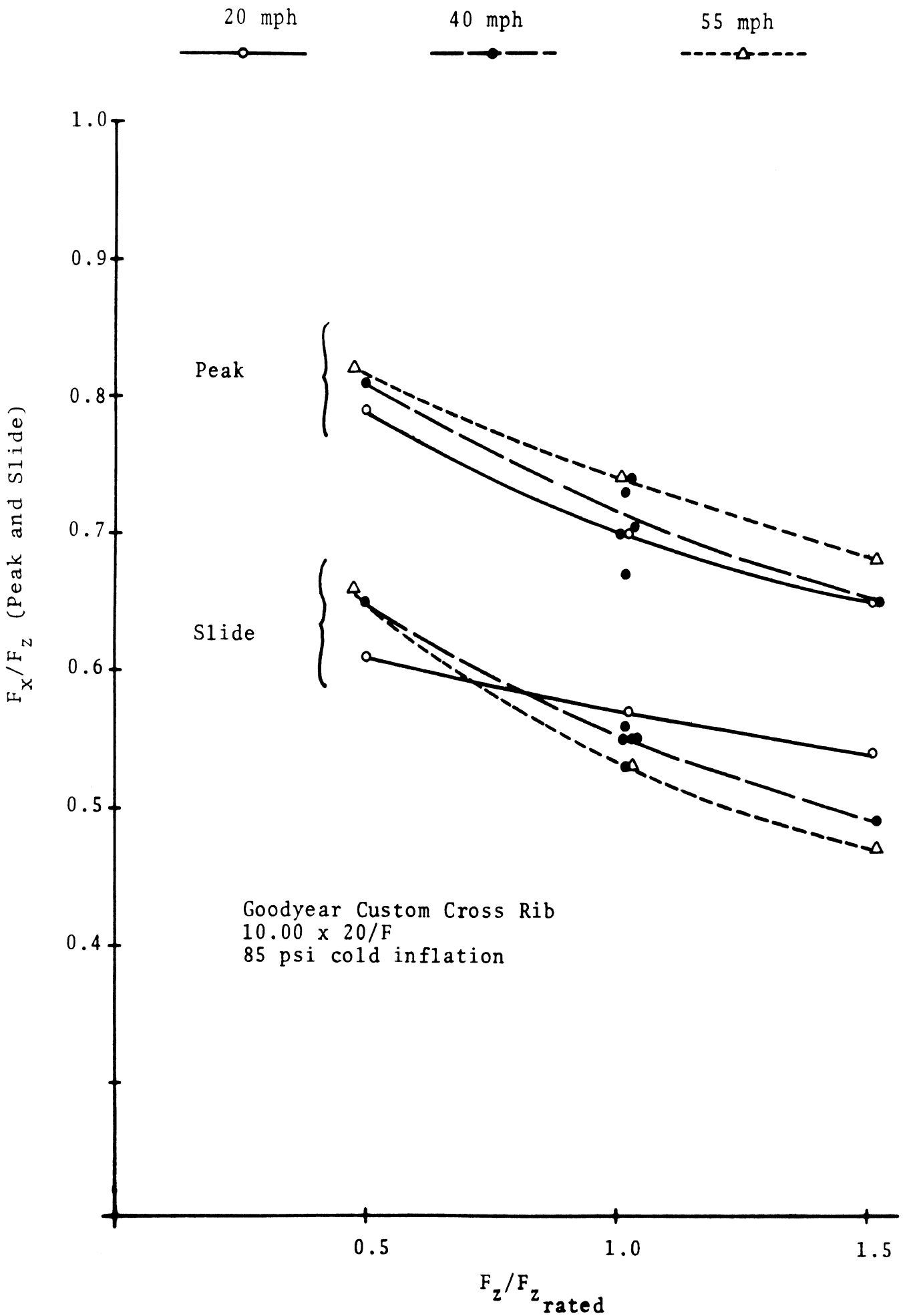

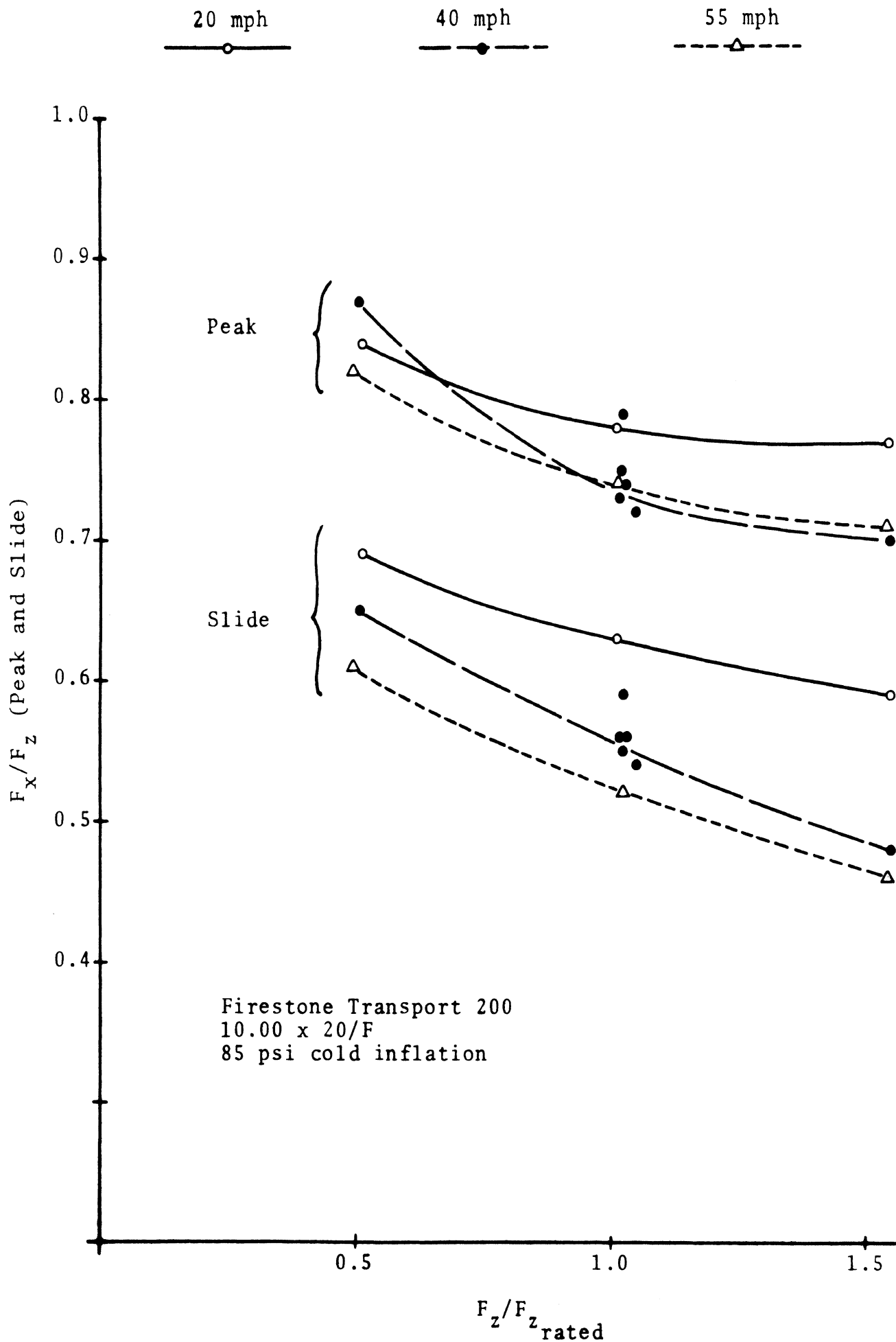

APPENDIX B-III

INDIVIDUAL LATERAL FORCE PLOTS FROM MOBILE TRACTION TESTS

The following plots represent the lateral force, F_y , or the normalized lateral force, F_y/F_z , versus slip angle, α , behaviour of each tire in the test sample. These data were obtained using the HSRI mobile dynamometer on a dry Portland cement concrete pavement. Each tire is represented by three plots indicating the influence on lateral traction of

- 1) velocity
- 2) load
- 3) repeated test runs

Accordingly, the first plot for each tire represents tests conducted all at rated load, but at velocities of nominally 20, 40, and 55 mph.

Similarly, the second plot for each tire represents tests conducted at 40 mph and at vertical loads of $F_z = 0.5, 1.0, \text{ and } 1.5$ times the T&RA rated load. The final plot serves to document the stability of the tire specimen as a force-producing mechanism over the sequence of test runs. These data indicate the tire's F_y/α behaviour as measured during each of five "spot checks" at conditions of $F_z = \text{rated load}$ and $V = 40 \text{ mph}$.

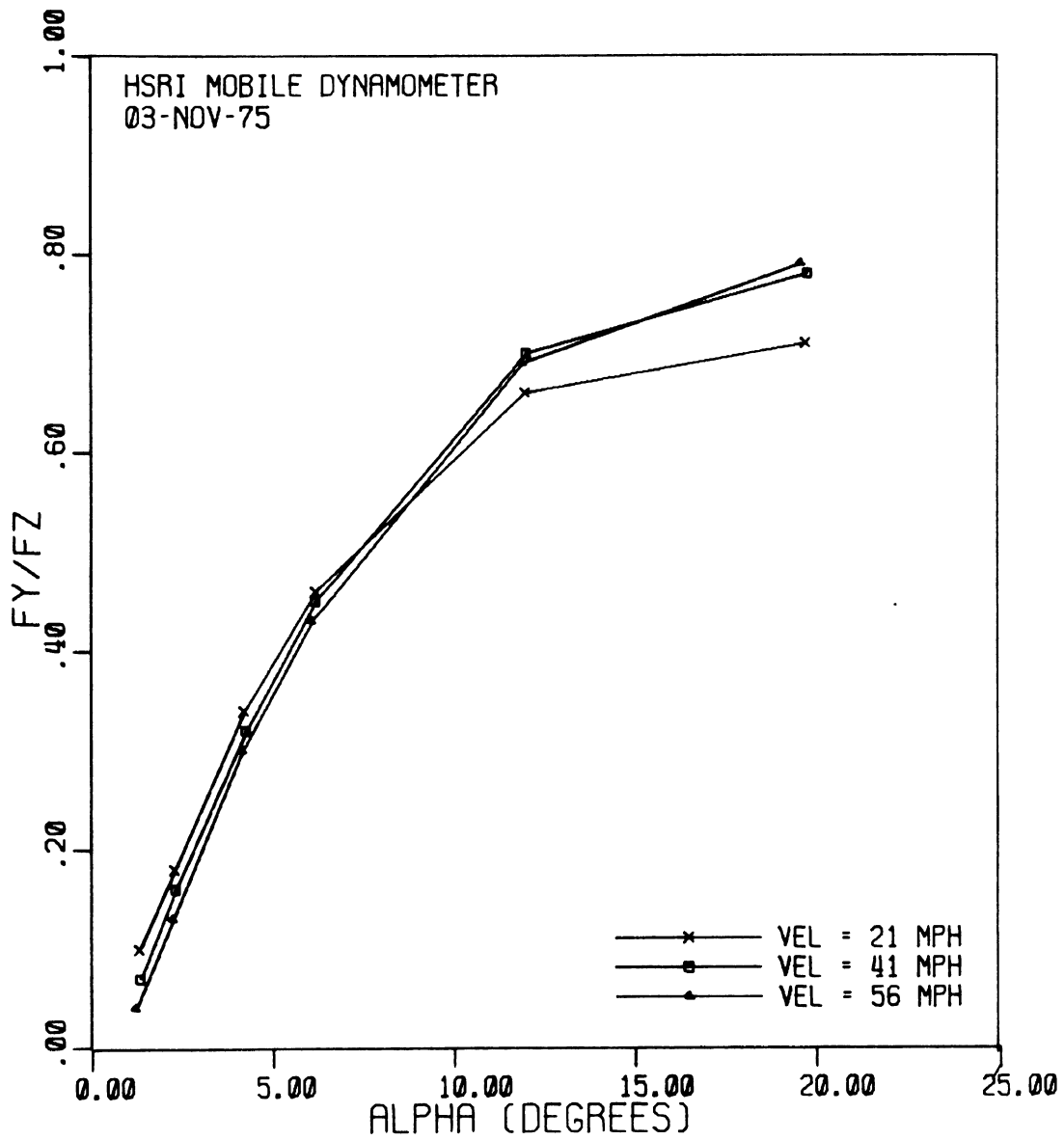

GOODYEAR SUPER HI MILER 10.00X20/F
FZ = 5530 LB

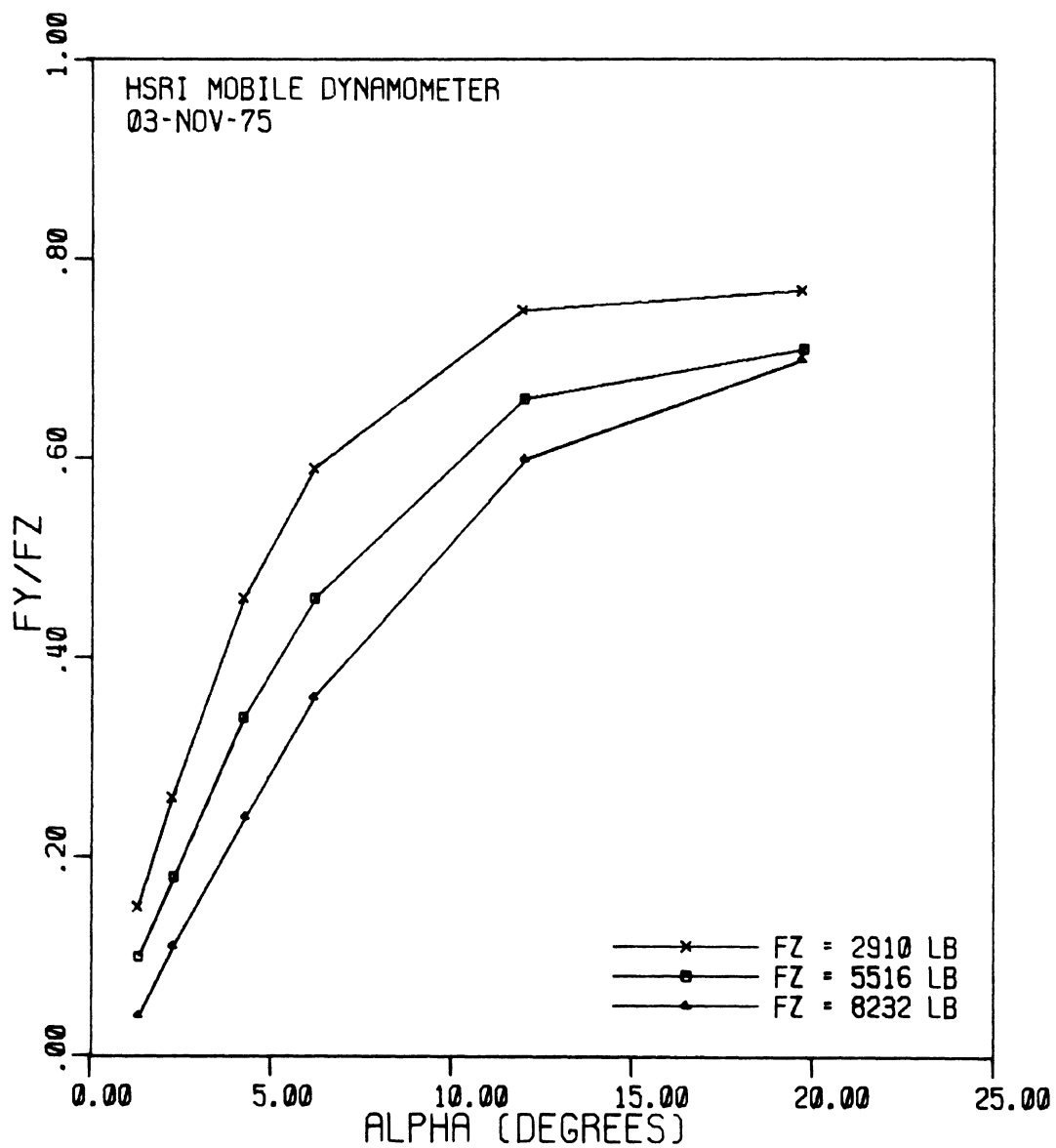

GOODYEAR SUPER HI MILER 10.00X20/F
VEL = 22 MPH

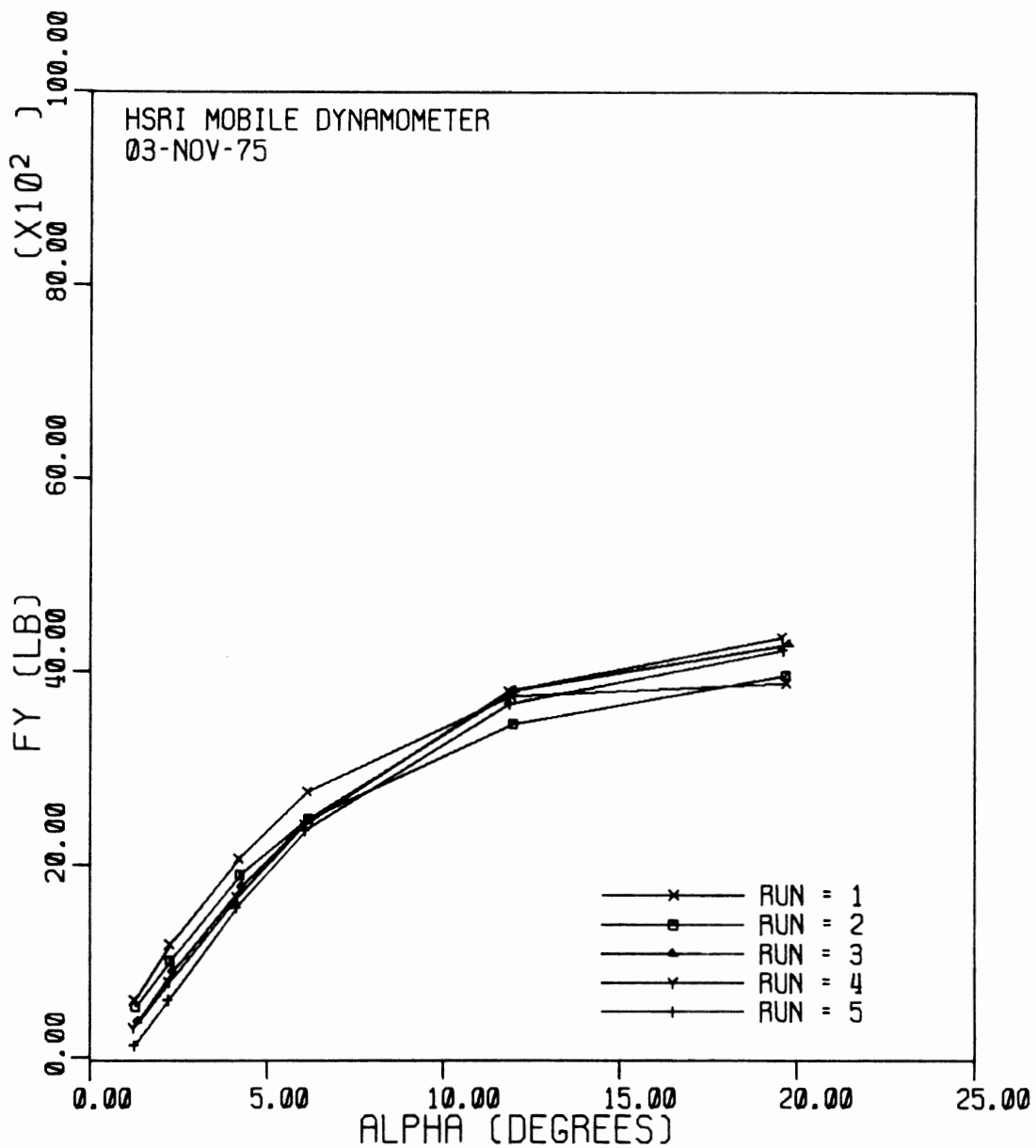

GOODYEAR SUPER HI MILER 10.00X20/F
FZ = 5535 LB VEL = 41 MPH

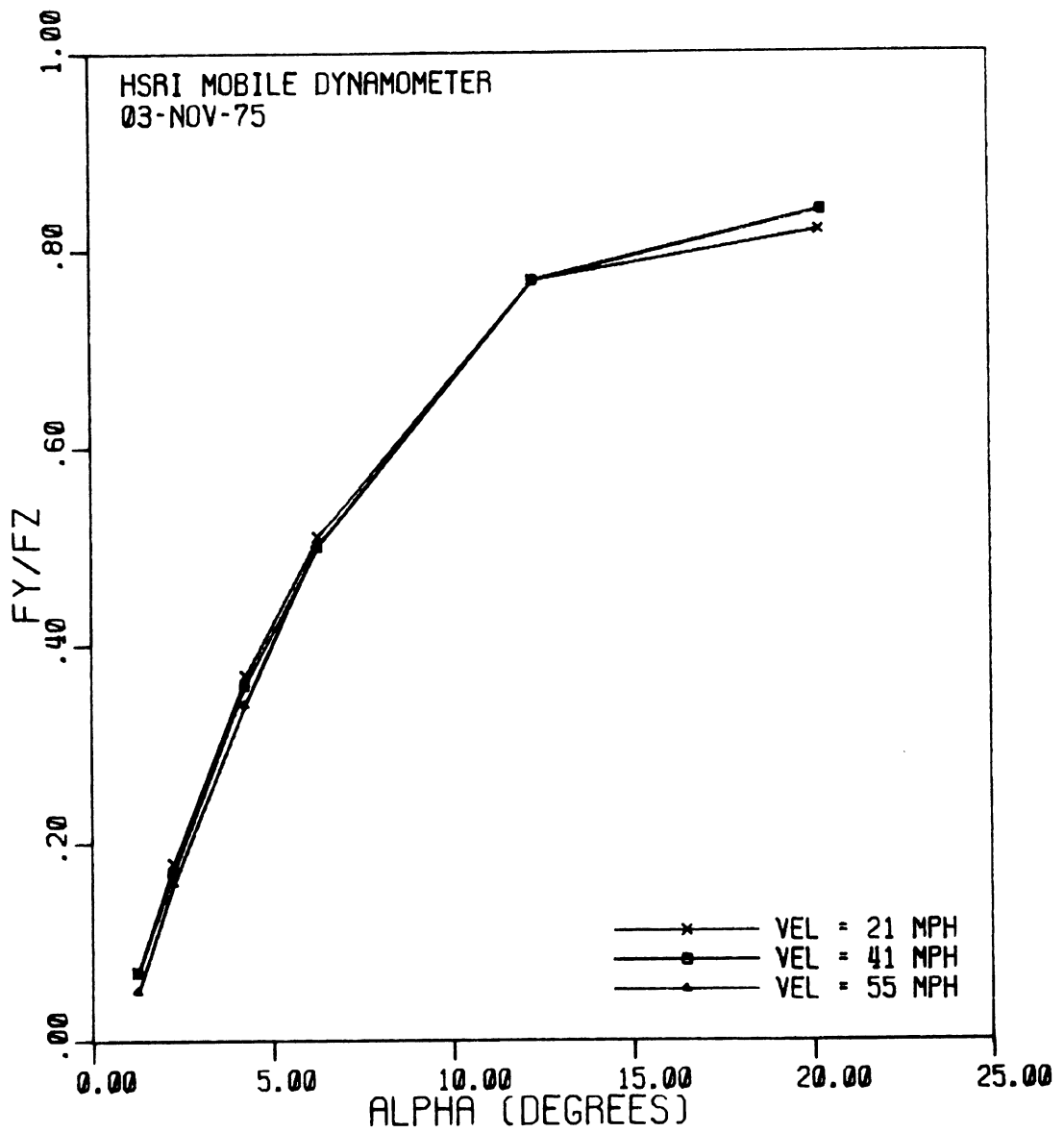

GENERAL GTX 10.00X20/F
FZ = 5515 LB

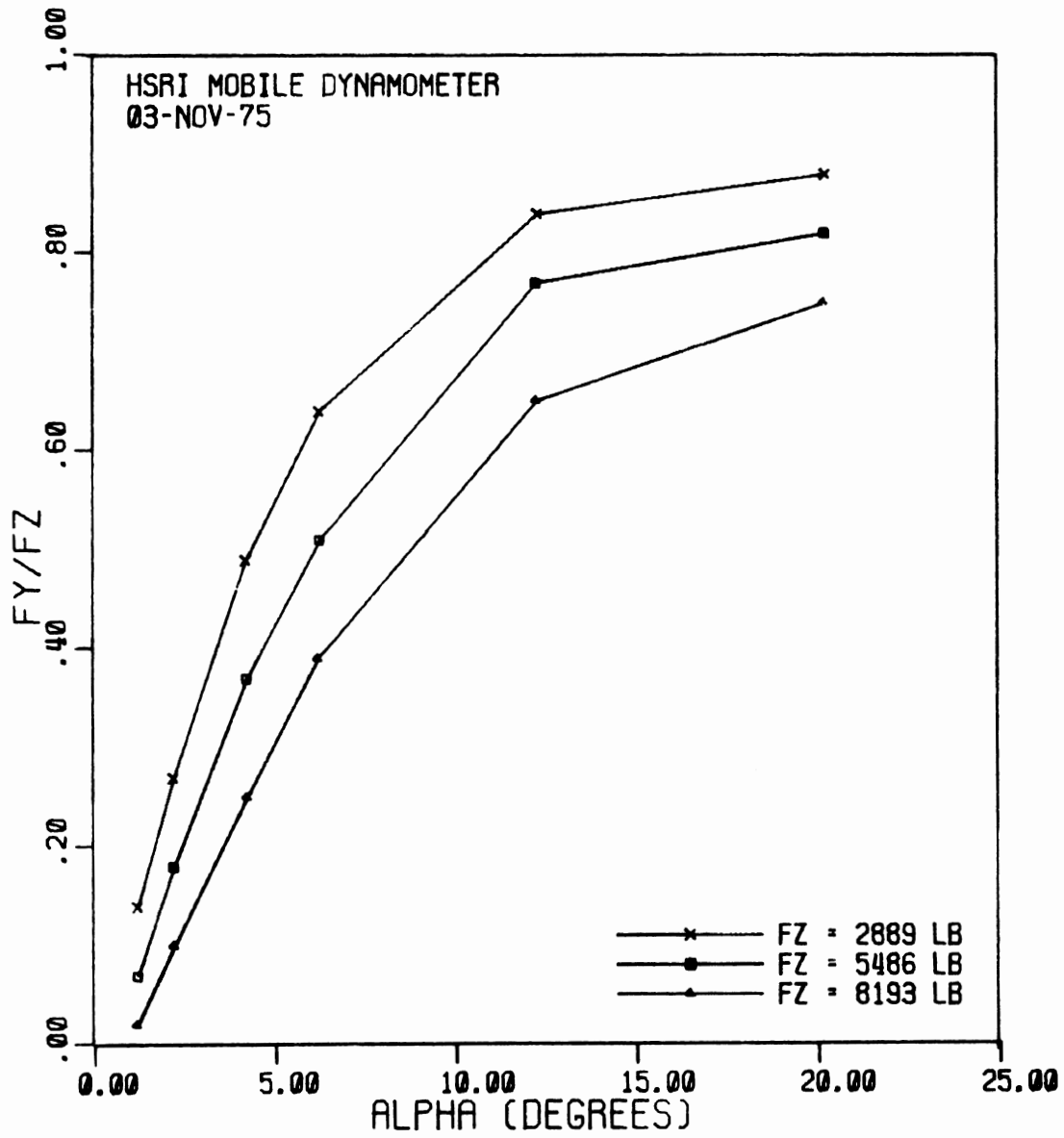

GENERAL GTX 10.00X20/F
VEL = 22 MPH

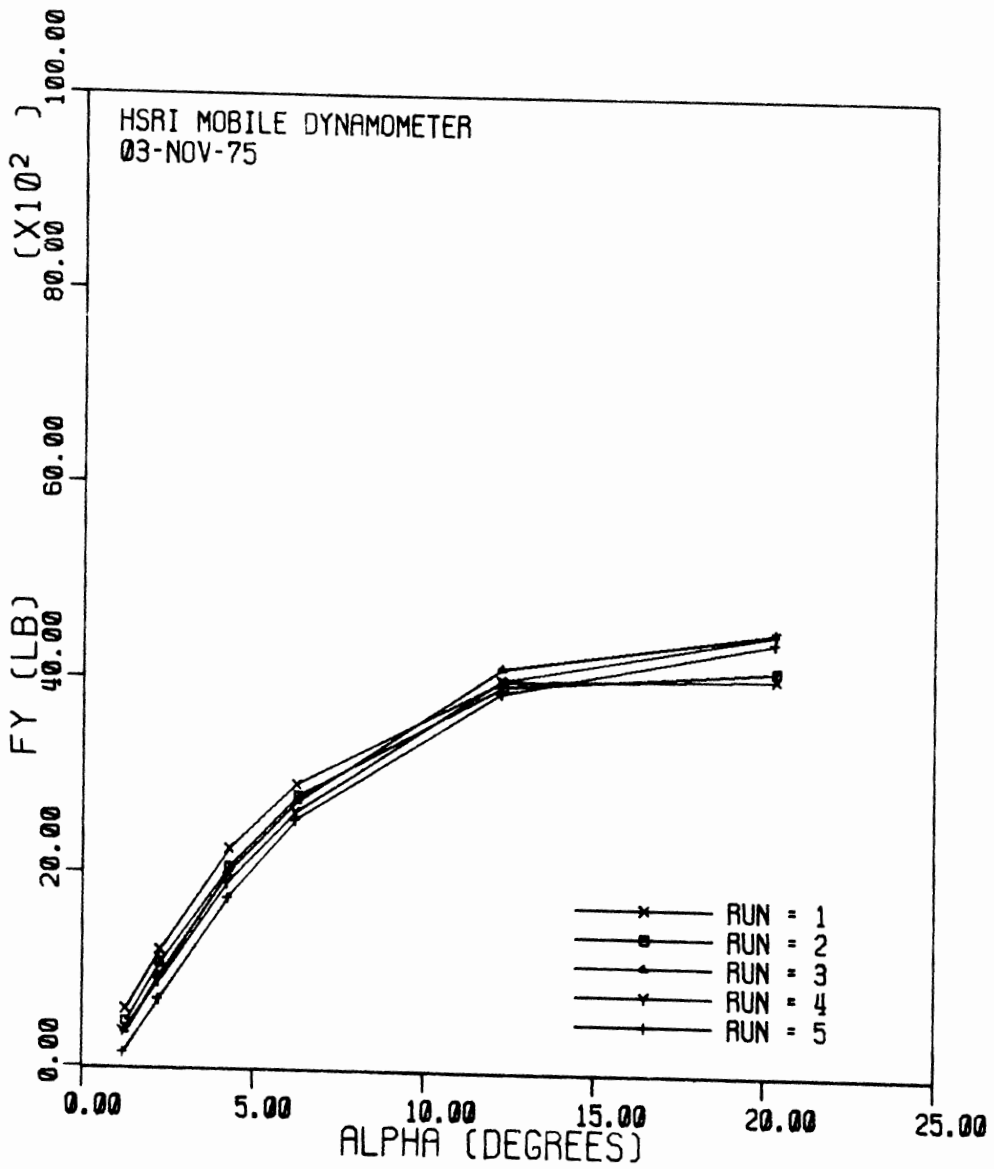

GENERAL GTX 10.00X20/F
FZ = 5533 LB VEL = 41 MPH

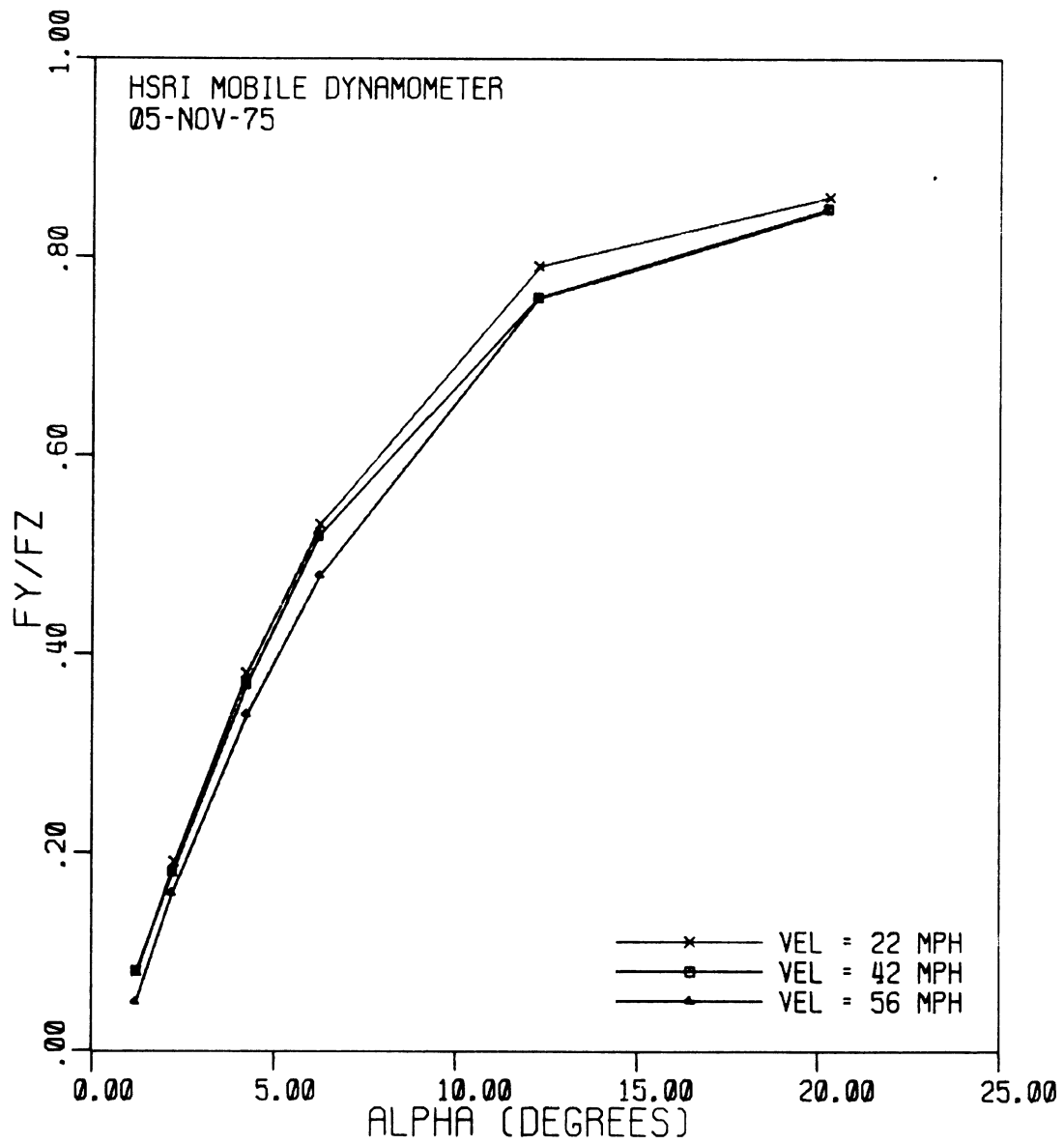

FIRESTONE TRANSPORT 1 10.00X20/F
FZ = 5527 LB

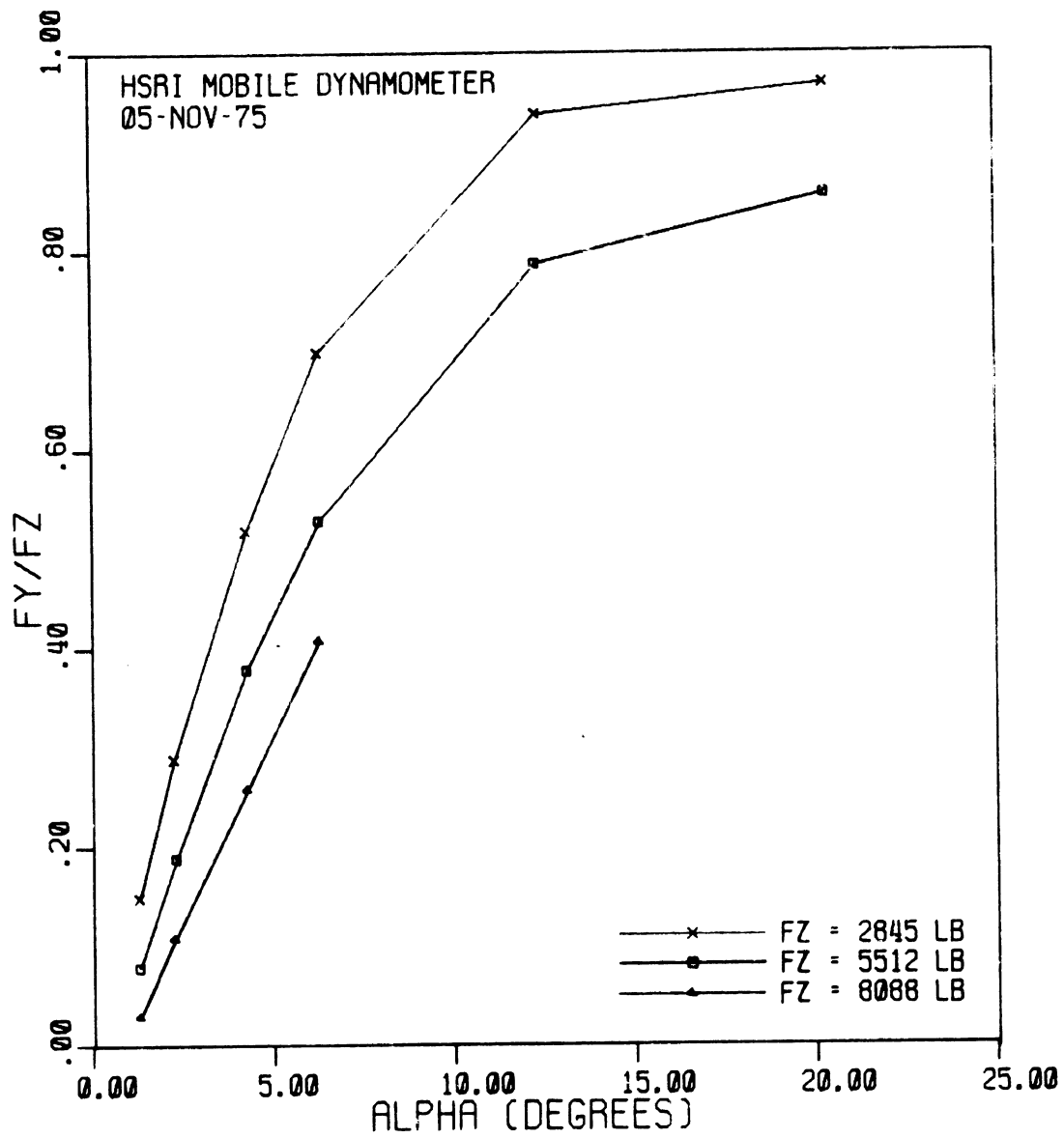

FIRESTONE TRANSPORT 1 10.00X20/F
VEL = 22 MPH

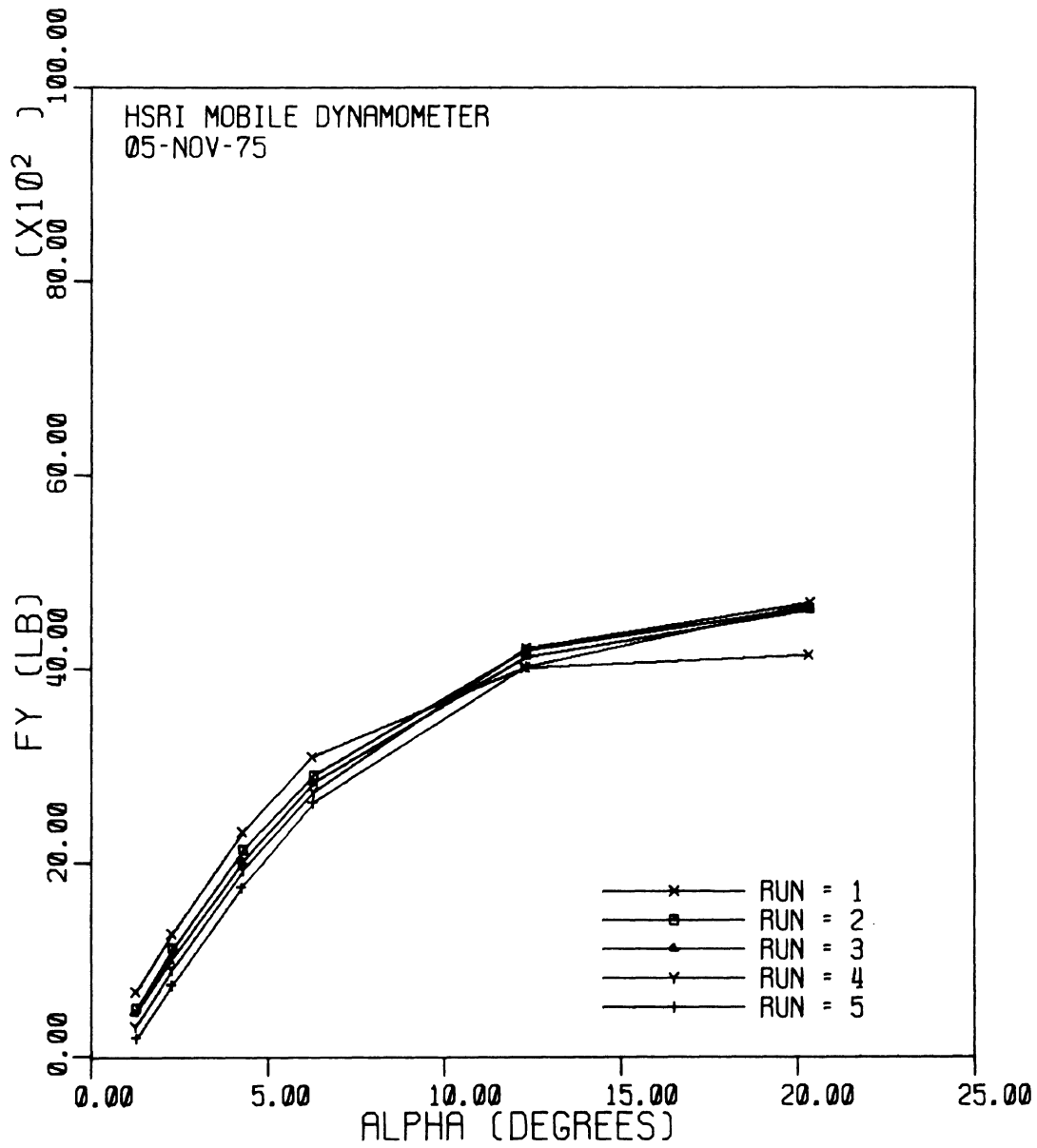

FIRESTONE TRANSPORT 1 10.00X20/F
FZ = 5510 LB VEL = 41 MPH

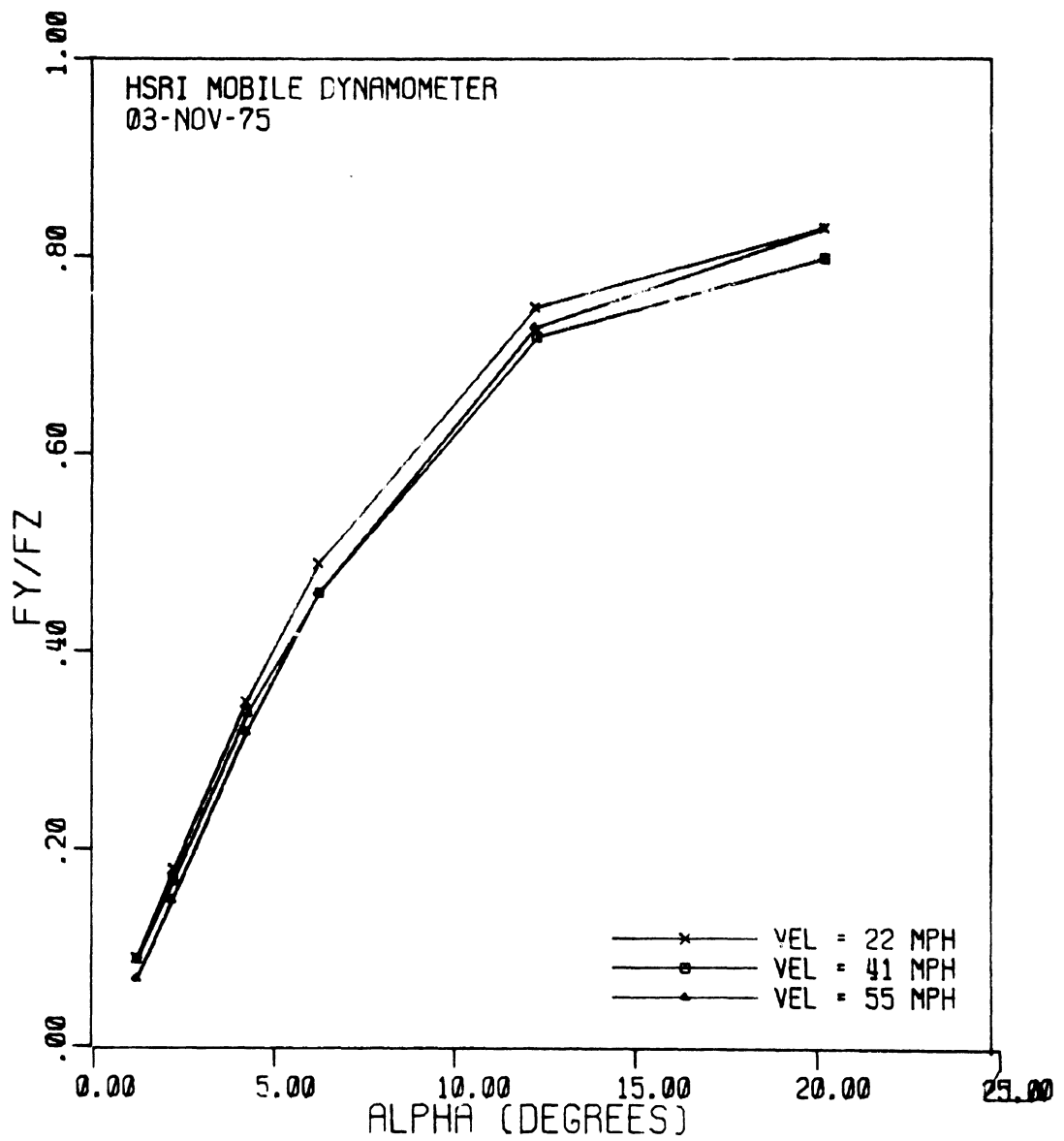

UNIROYAL FLEETMASTER SUPER LUG 10.00X20/F
FZ = 5512 LB

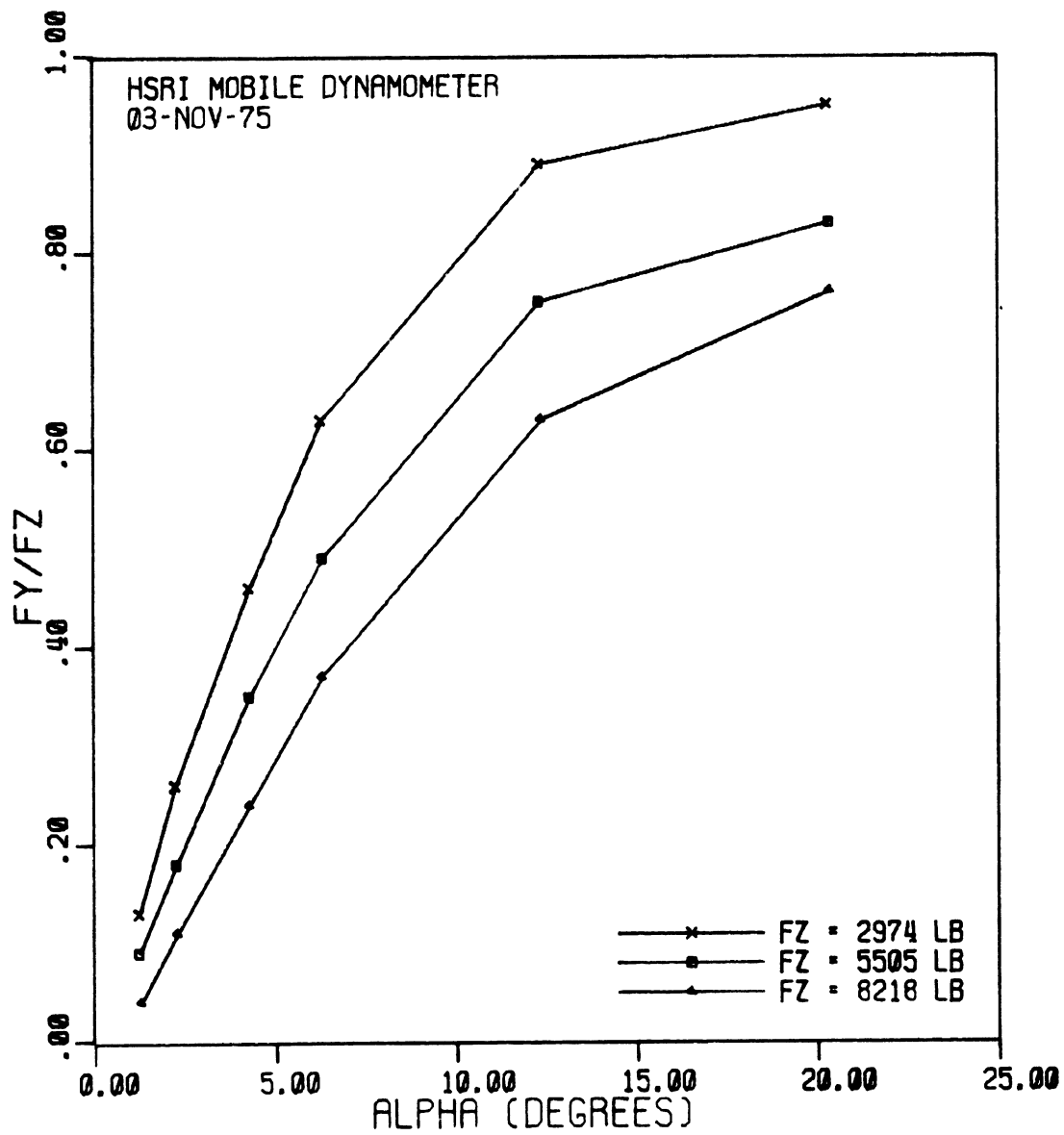

UNIROYAL FLEETMASTER SUPER LUG 10.00X20/F
VEL = 21 MPH

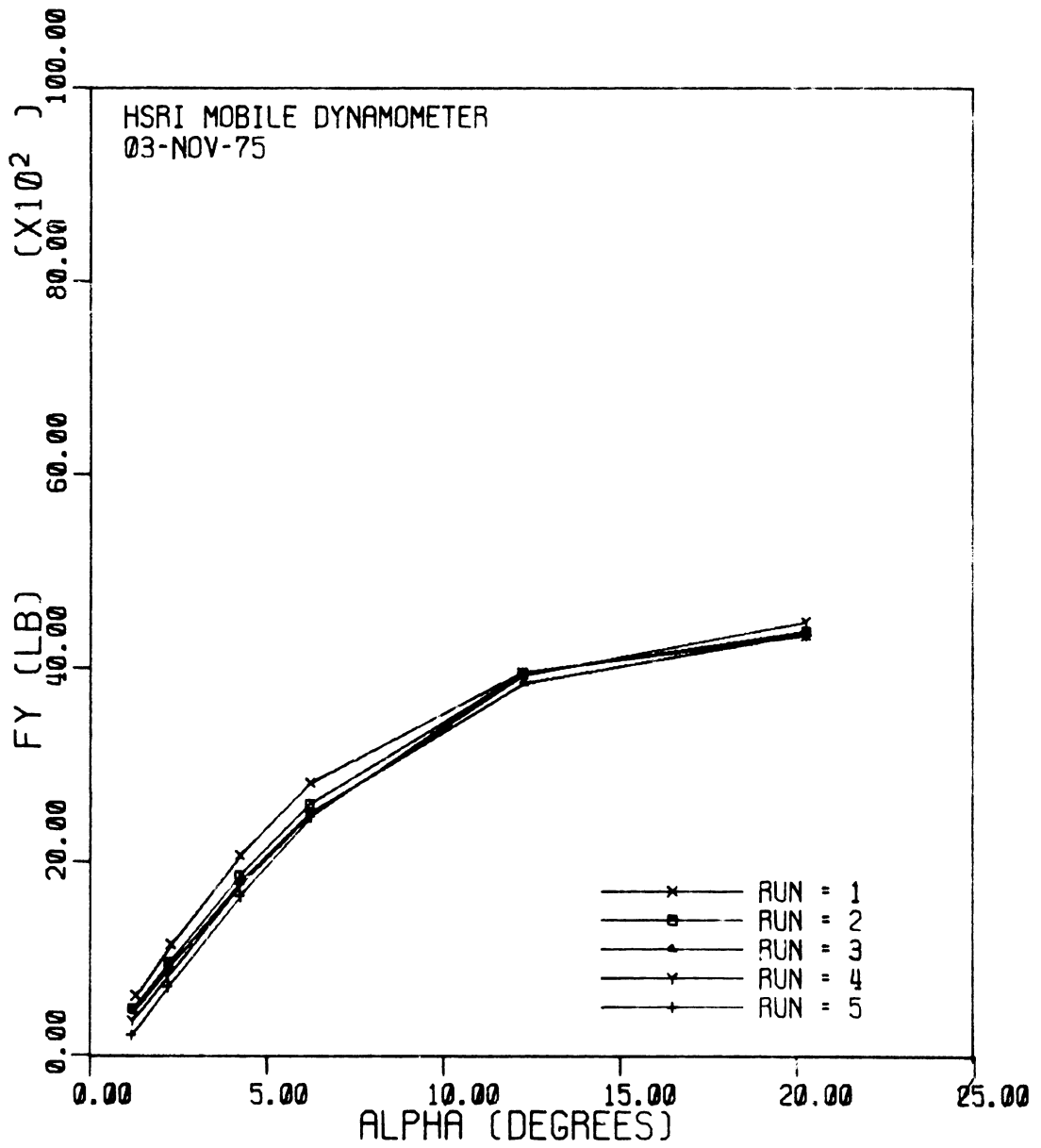

UNIROYAL FLEETMASTER SUPER LUG 10.00X20/F
FZ = 5523 LB VEL = 41 MPH

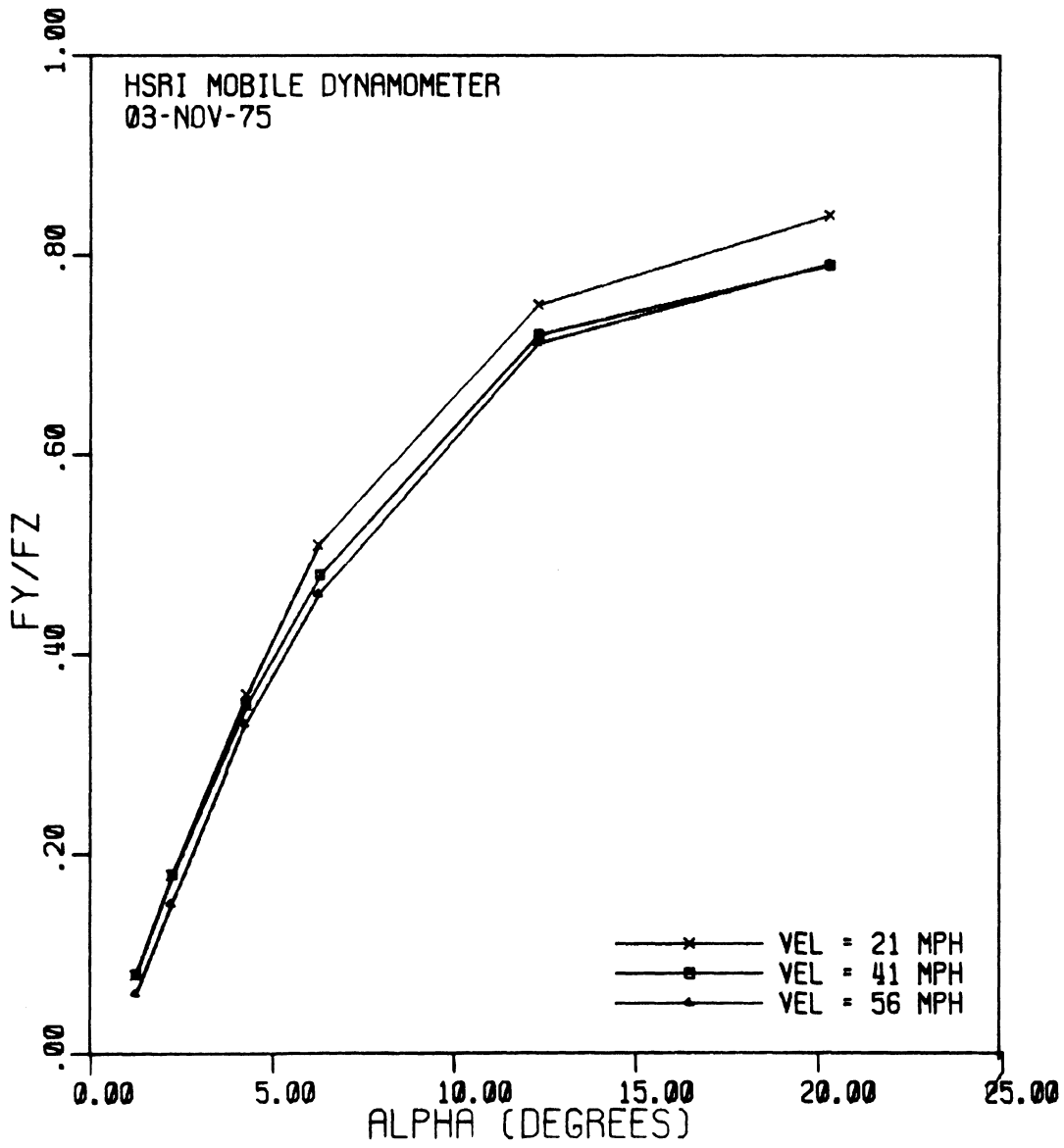

GOODYEAR CUSTOM CROSS RIB HI MILER 10.00X20/F
FZ = 5526 LB

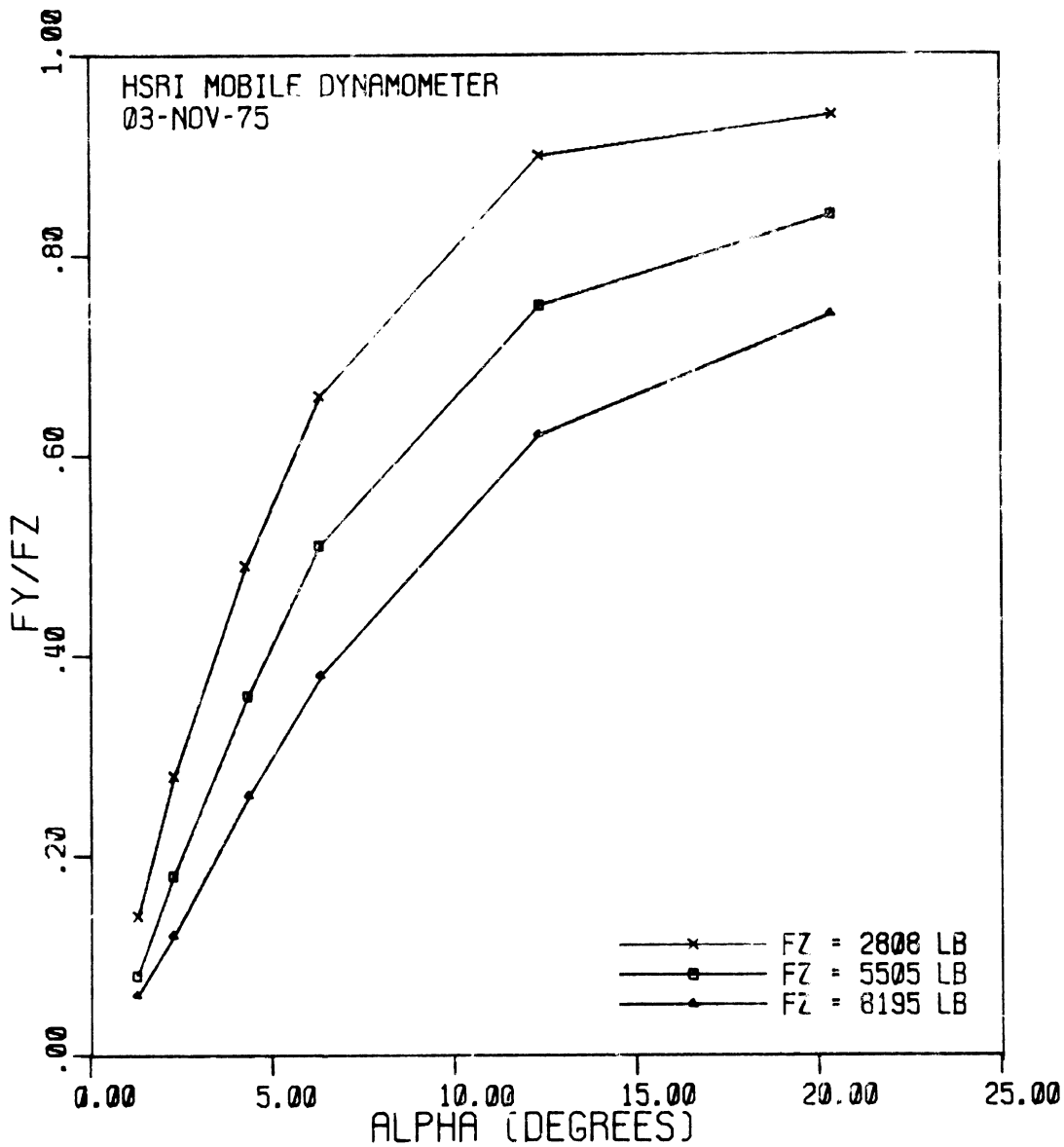

GOODYEAR CUSTOM CROSS RIB HI MILER 10.00X20/F
VEL = 21 MPH

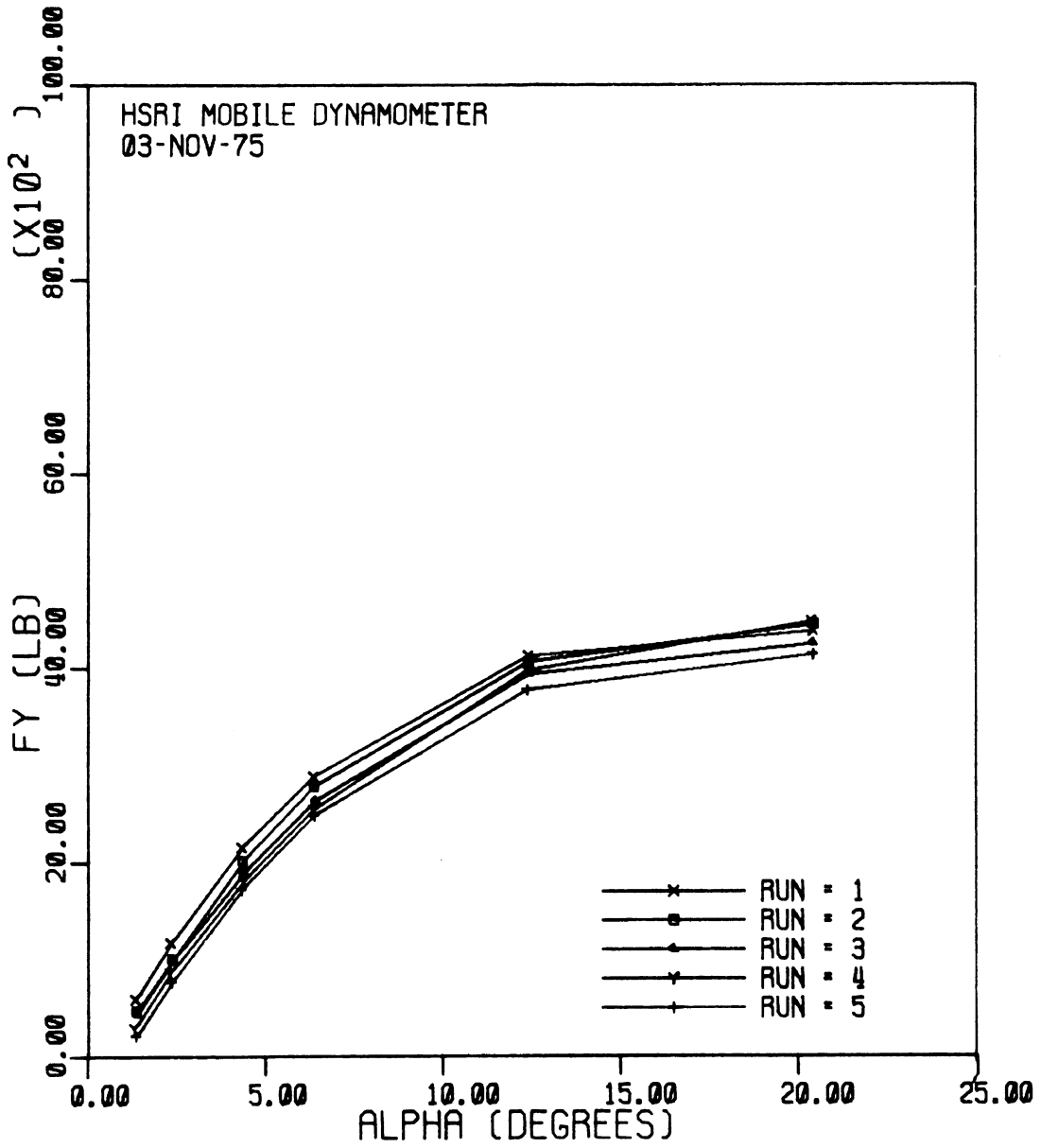

GOODYEAR CUSTOM CROSS RIB HI MILER 10.00X20/F
FZ = 5611 LB VEL = 41 MPH

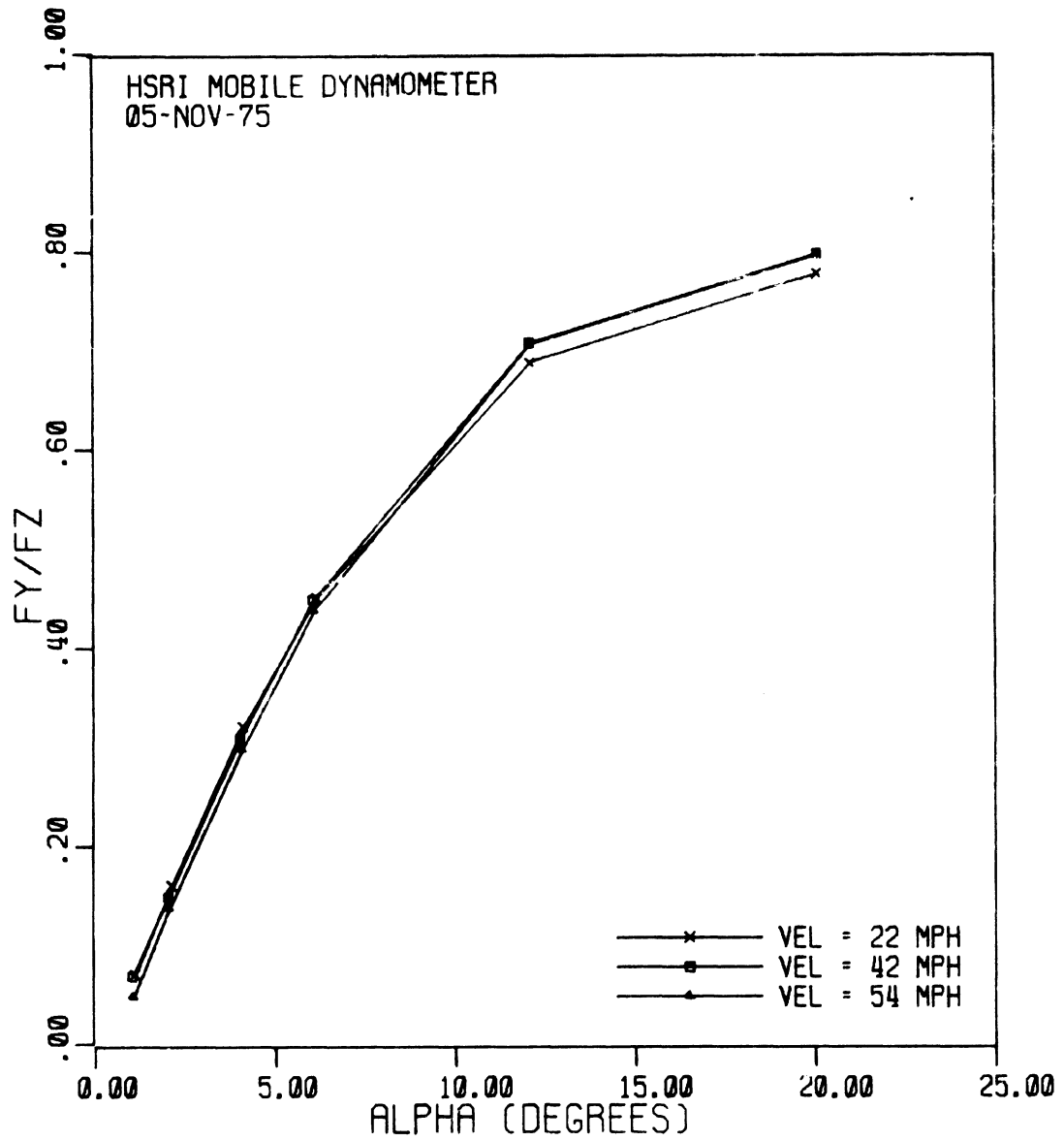

FIRESTONE TRANSPORT 200 10.00X20/F
FZ = 5437 LB

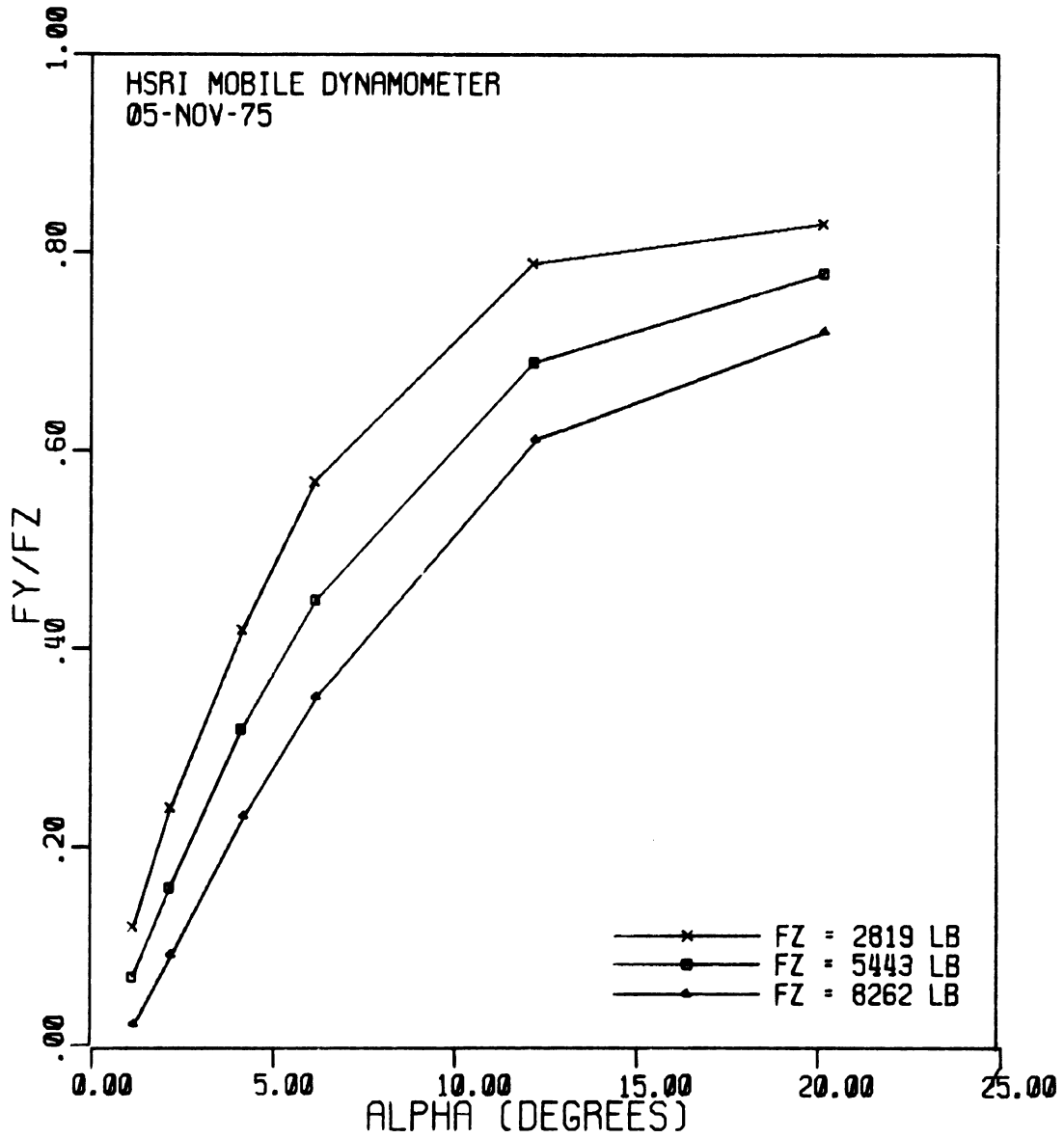

FIRESTONE TRANSPORT 200 10.00X20/F
VEL = 22 MPH

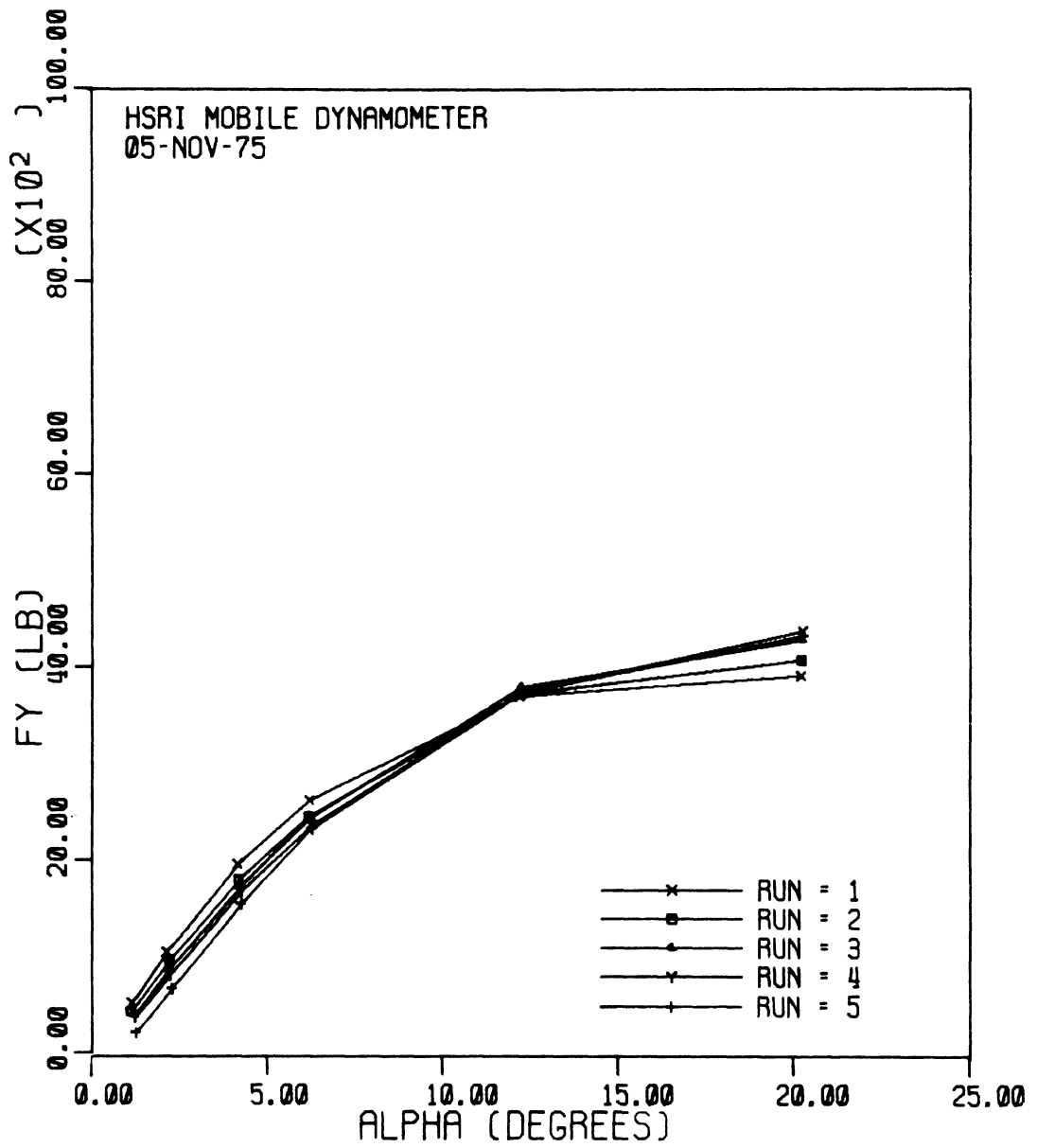

FIRESTONE TRANSPORT 200 10.00X20/F
FZ = 5469 LB VEL = 41 MPH

APPENDIX C

TRACTION TEST APPARATUS

HSRI FLAT-BED MACHINE

The HSRI flat-bed tire tester provides precise laboratory measurements of the mechanical properties of standing, rolling, and slipping tires. It can accommodate tires up to 44 inches outside diameter with vertical loads to 10,000 lbs. The slip angle is adjustable in 1° increments from 0° to ±30° and in 15° increments on out to +90°. Camber angles can be varied from -10° to +20° in 1° increments. The test wheel is powered by a 13,000 ft-lb hydraulic system which is driven independently of the flat-bed table to create longitudinal slip conditions.

The machine is instrumented to measure the three force and three moment components developed by the tire, in addition to test wheel drive torque (T), rolling height (R_h), and wheel angular velocity (ω). The positions of the six load cells used to measure the forces and moments are shown in Figure C-1.

The bed surface is 100 grit* tungsten carbide bonded directly to the aluminum table with no intervening paper or glue. The bed velocity is 2.11 feet per second or 1.44 mph. Thus the flat-bed machine is useful for exploring the small slip or "elastic" mechanical properties of tires, which are essentially speed independent, and for measuring the ultimate force and moment capabilities of tires at higher slip conditions.

DATA ACQUISITION

During a test, the analog output of the transducers is recorded continuously on a chart recorder and at discrete

*100 grit = 100 particles per square inch.

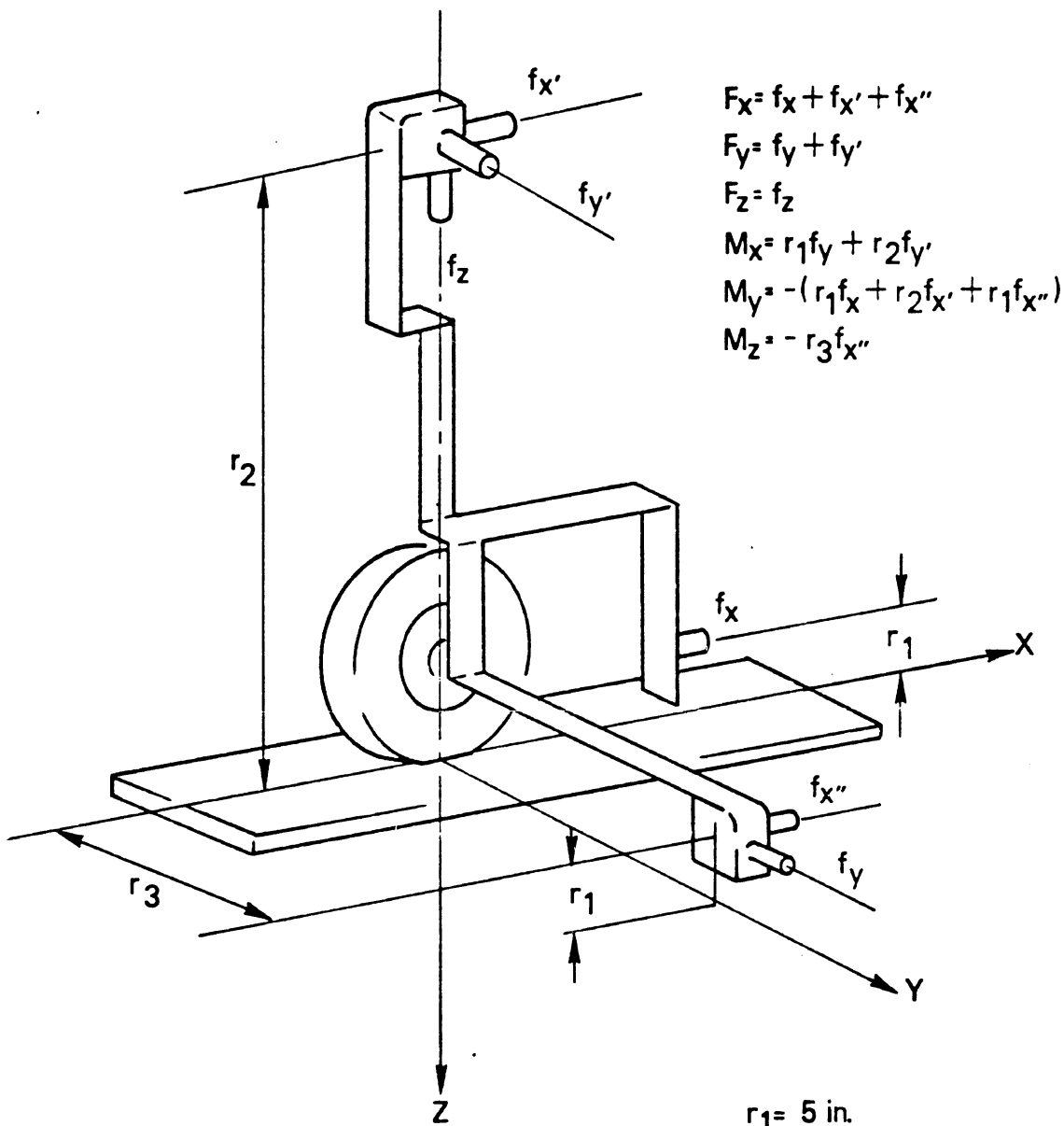

$r_1 = 5 \text{ in.}$
 $r_2 = 75 \text{ in.}$
 $r_3 = 30 \text{ in.}$

intervals is digitized onto magnetic tape. This periodic sampling of analog data, which is the main source of data acquisition, is done ten times during the constant velocity portion of a pass of the flat-bed table. The samples are spaced in time to cover approximately one revolution of the test tire.

The samples of analog data are routed to a tape recorder interface unit which digitizes and formats the data for printing onto magnetic tape along with such information as slip angle, specified load, and test number. The digital tape (the end product of a test series) is processed on the HSRI IBM 1800 digital computer. Here the data from the six load cells is multiplied by a 6×6 calibration matrix which provides the proper scale factors and removes interaction caused by test frame distortion. The ten samples obtained during a pass of the bed are now averaged. The result is a table of the forces and moments produced by the tire at each of the various test parameter combinations. The data processing to this point is illustrated in C-2.

Data listed in tables such as described above is put through a final processing to combine and average the four values of each force and moment which results from making both left and right passes at both positive and negative angles of the same magnitude.

MOBILE TRACTION MEASUREMENT APPARATUS

The HSRI mobile dynamometer in its current stage of development consists of a tractor, semi-trailer vehicle which permits investigation of either longitudinal or lateral traction characteristics of heavy truck tires. The system, shown in Figure C-3, permits measurement of longitudinal properties by way of the trailer-configured dynamometer as it is towed and serviced by the instrumented tractor. Mounted on the same tractor is a structure supporting a lateral traction measurement system, as diagrammed in the plan view of Figure C-4. Each test system is basically designed to expose a truck tire

REAL-TIME DATA ACQUISITION

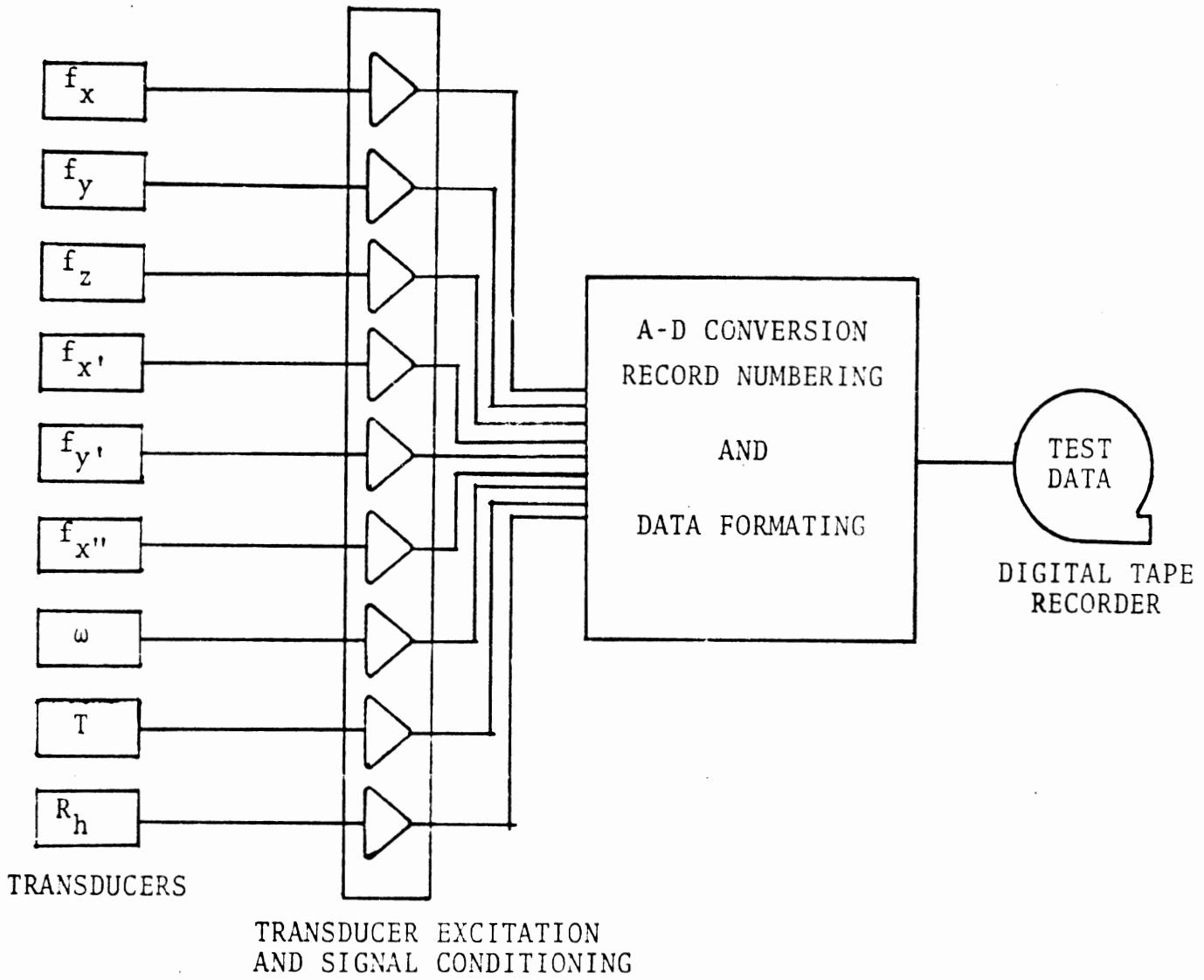

FINAL PROCESSING BY IBM 1800

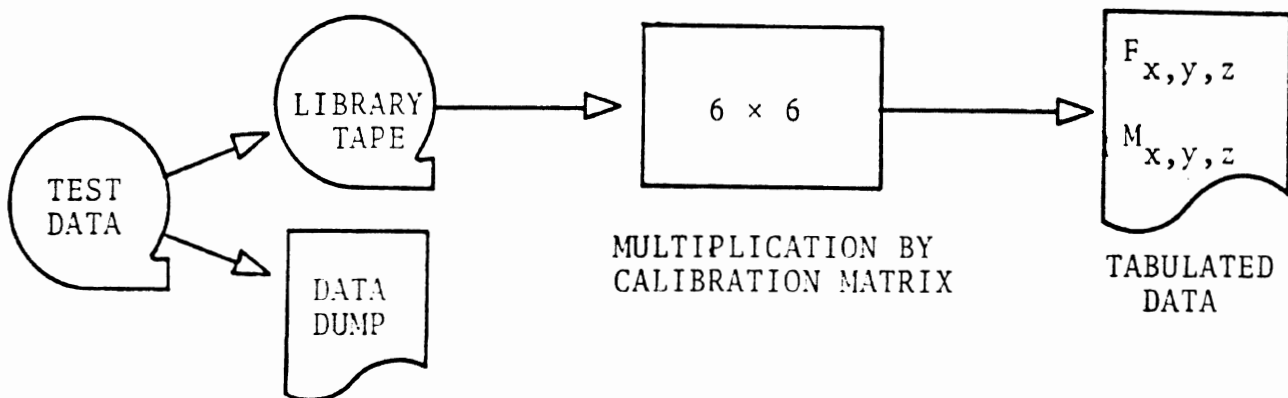

TAPE DUPLICATION ONTO
MASTER LIBRARY TAPE
AND RAW DATA DUMP

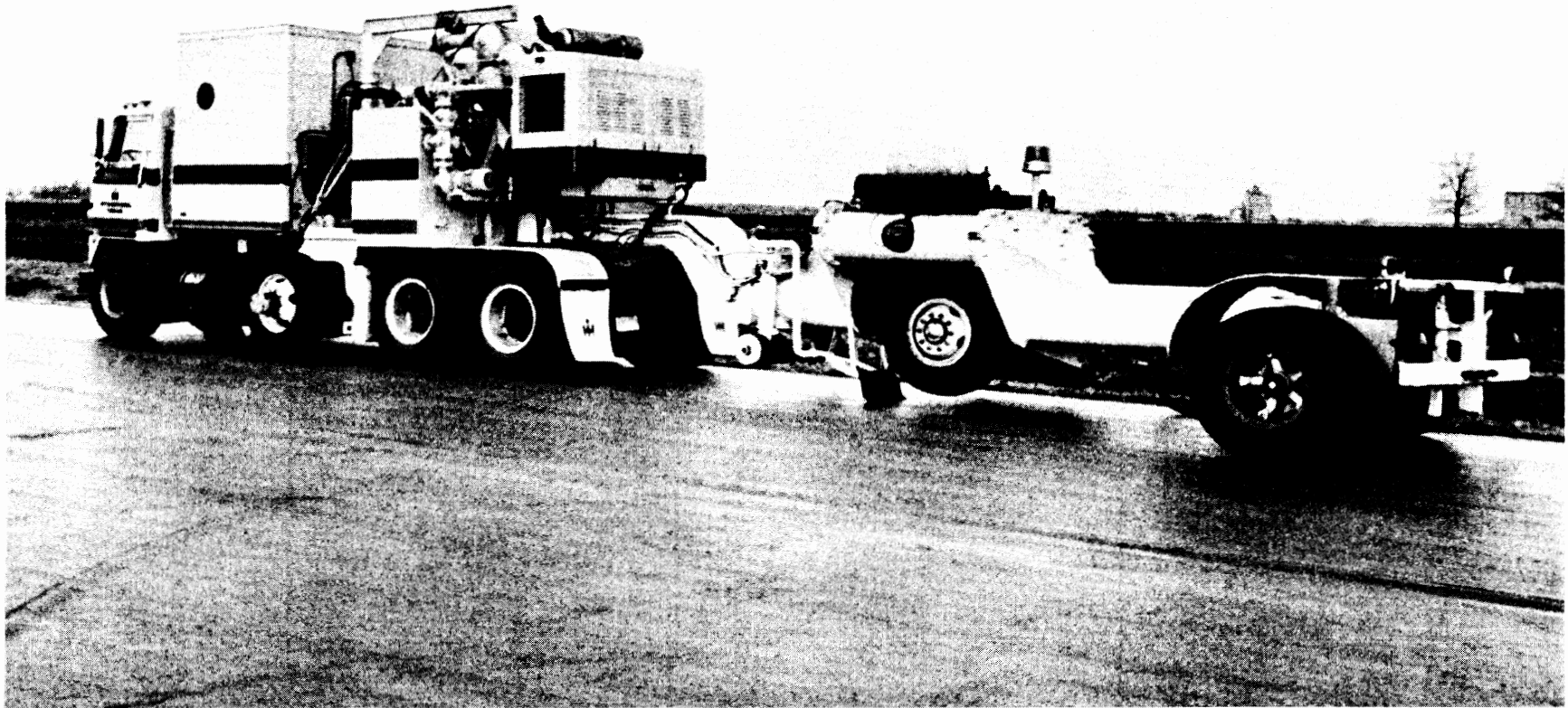

Figure C-3. HSRI Mobile Truck Tire Dynamometer - trailer-mounted longitudinal force machine and tractor-mounted lateral force machine.

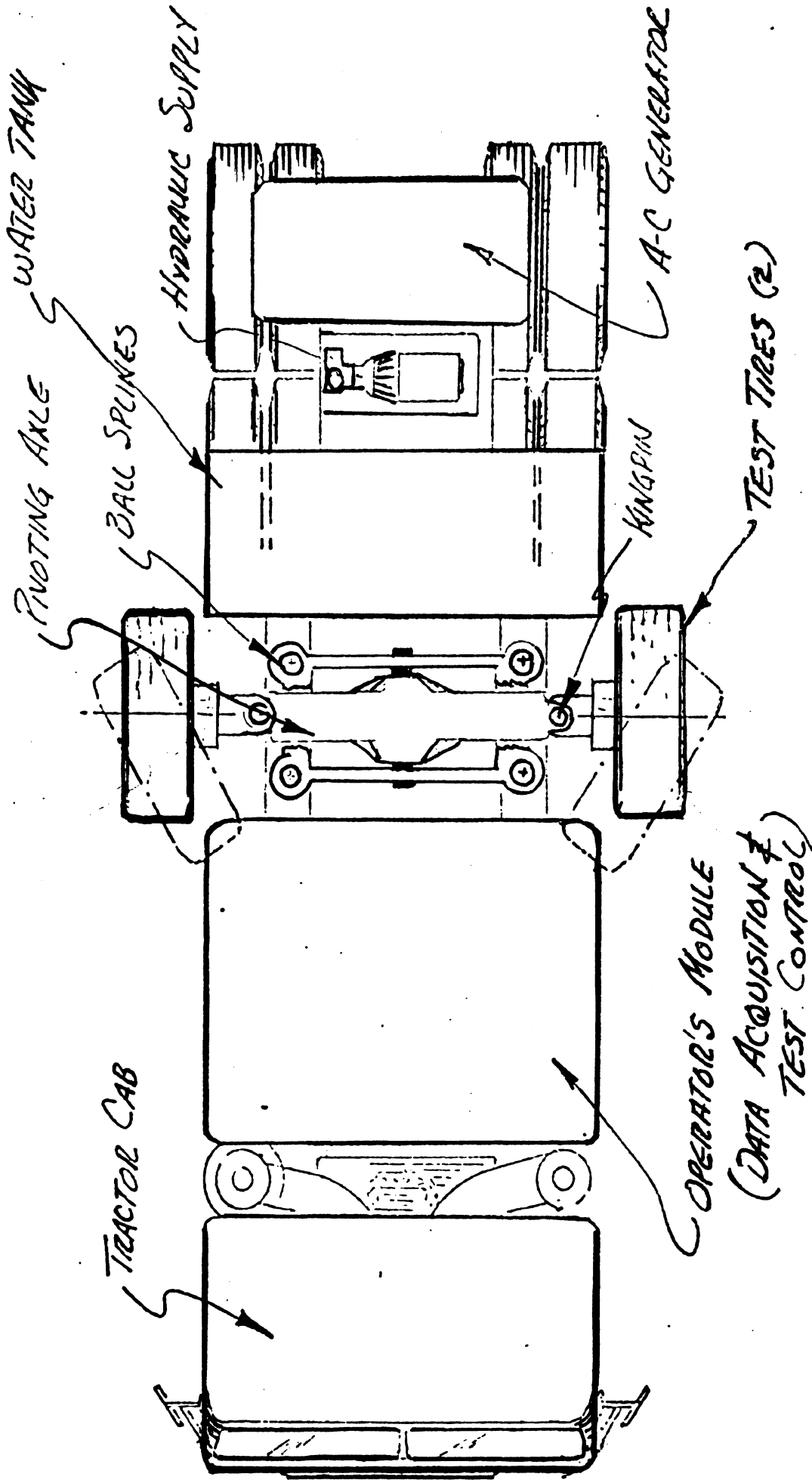

Figure C-4 Plan View of Mobile Truck Tire Side Force Dynamometer

specimen to a set of operating conditions which cover the full range of possible loads, velocities, longitudinal or angular slip, and pavements such as can be encountered under either normal or emergency situations on the highway.

The longitudinal traction dynamometer, shown in Figure C-5, is a welded trailer structure of pipe and plate sections, designed for economy of construction and for stiffness. The test wheel is situated approximately at the trailer c.g. position and is supported by a parallelogram suspension. This suspension configuration, shown in Figure C-6, derives from attempts to achieve three fundamental qualities in a mobile traction measurement machine, viz.,

- 1) The elimination of kinematic interactions between the loads applied to the test wheel and resulting shear forces and moments.
- 2) The employment of a low-spring rate loading mechanism (an air spring), to assure the attainment of the desired load levels while neither (a) sacrificing frequency response in the vertical degree of freedom of the test wheel, nor (b) imposing a significant through-coupling of the vibrations of the foundation vehicle to the test wheel.
- 3) The minimization of the value of the "unsprung" mass, i.e., the mass which is displaced with the vertical motion of the test wheel spin axis.

The parallelogram linkage suspension is thus provided to assure kinematic isolation of forces while assuring a zero inclination (camber) of the test wheel plane.

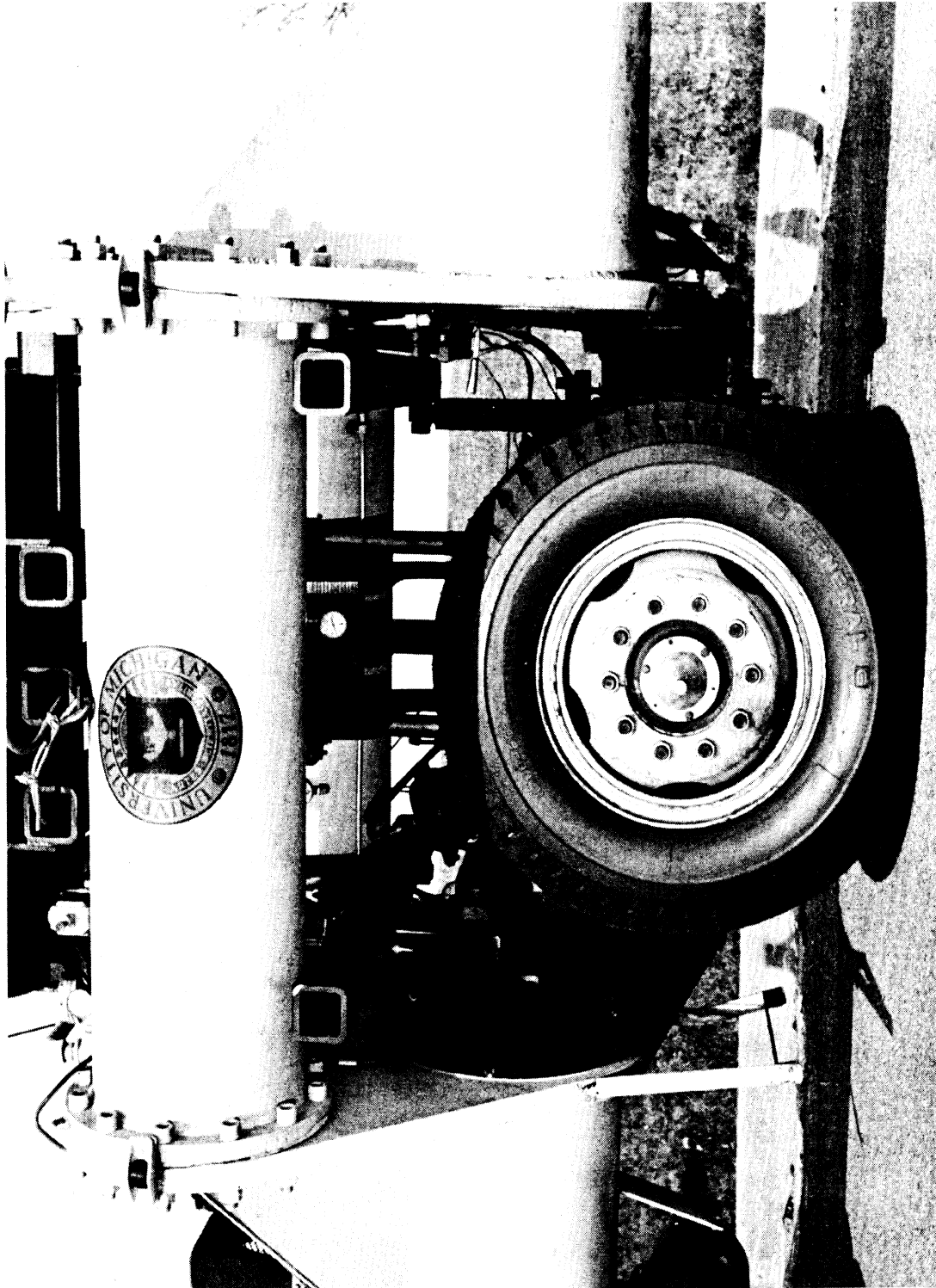

Figure C-5. Test Tire on Longitudinal Force Trailer

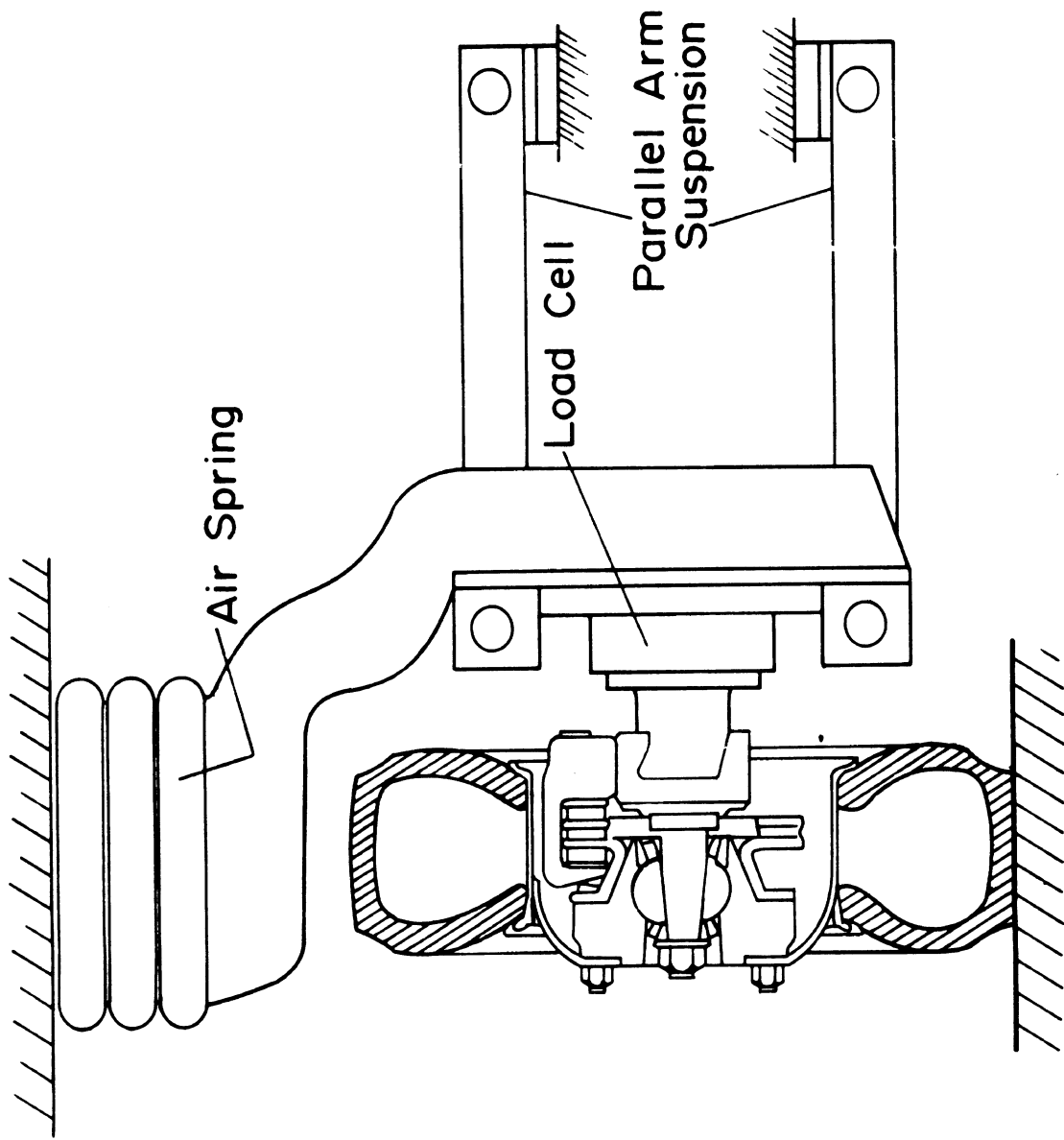

Figure C-6. Test wheel suspension.

The use of an air spring loading mechanism permits a controllable vertical load condition and, in the case of the HSRI machine, imposes a nominally 350 lb/in coupling between the trailer and the test wheel—while operating at a common mid-range load of 5000 lb., F_z . At higher loads, the spring rate rises to a maximum value of 1000 lb/in at a load of 20,000 lbs., while the spring rate, of course, diminishes to zero at zero inflation of the air spring. These spring rates contrast with corresponding leaf suspension rates of trucks which are five to eight times stiffer at comparable rated wheel loads.

The basic design principle behind air spring loading, then, is that the machine incorporates a relatively "soft" loading member (which is also virtually frictionless) and thereby attains features which serve to enhance the quality of the vertical load condition which is imposed upon the test tire. With such a mechanism, it is then straightforward to obtain precision selections of vertical load through the use of commercially available precision regulators.

The unsprung mass which is associated with the vertical degree of freedom of the test wheel on the HSRI machine weighs 1850 lbs., when outfitted with a 10.00 x 20/F tire and the corresponding 20 x 7.50 disc wheel rim. By such a configuration, the "wheel hop" system indicates a natural frequency of approximately 5 Hz (for an effective radial spring rate of the tire of 5000 lb/in). In general, a high frequency wheel hop system permits a minimal vertical load fluctuation as the tire follows the varying profile of the test surface. In the design of HSRI's longitudinal force

dynamometer, the "quality" deriving from a reduced size of the unsprung mass was compromised with the obvious needs of strength, stiffness, and economy of construction of the wheel support assembly. The longitudinal force, F_x , vertical load, F_z , and brake torque, T_b , are transduced by way of a serial-mounted load cell. These signals, together with wheel angular velocity and vehicle velocity, constitute the primary data channels for the machine.

The nominal pitch and jounce trim of the HSRI trailer are controlled through the use of self-leveling air suspensions on both the trailer rear axle and the tractor rear tandem. Thus, as a given vertical load is transferred from the two respective axle sets to the test wheel, through inflation of the test wheel air spring, the tractor and trailer leveling systems adjust to a running equilibrium at which the trailer assumes its design trim attitude. The use of air suspensions on both ends of the trailer also contributes to attenuation of ride motions, thus further assuring quality in the vertical load condition.

The test trailer is capable of mounting any tire in the 20-inch rim size, and above, which is:

- a) less than 46 inches in free diameter, and
- b) 18 inches or less in maximum section width.

Tires can be loaded to a maximum level of 20,000 lb., although, to date, brake torque limitations have prevented the lockup of tires on high friction surfaces at loads exceeding about 15,500 lbs.

The lateral traction dynamometer shown schematically in Figure C-7, mounts two tire samples on opposing steerable spindles outboard of the tractor's wheel

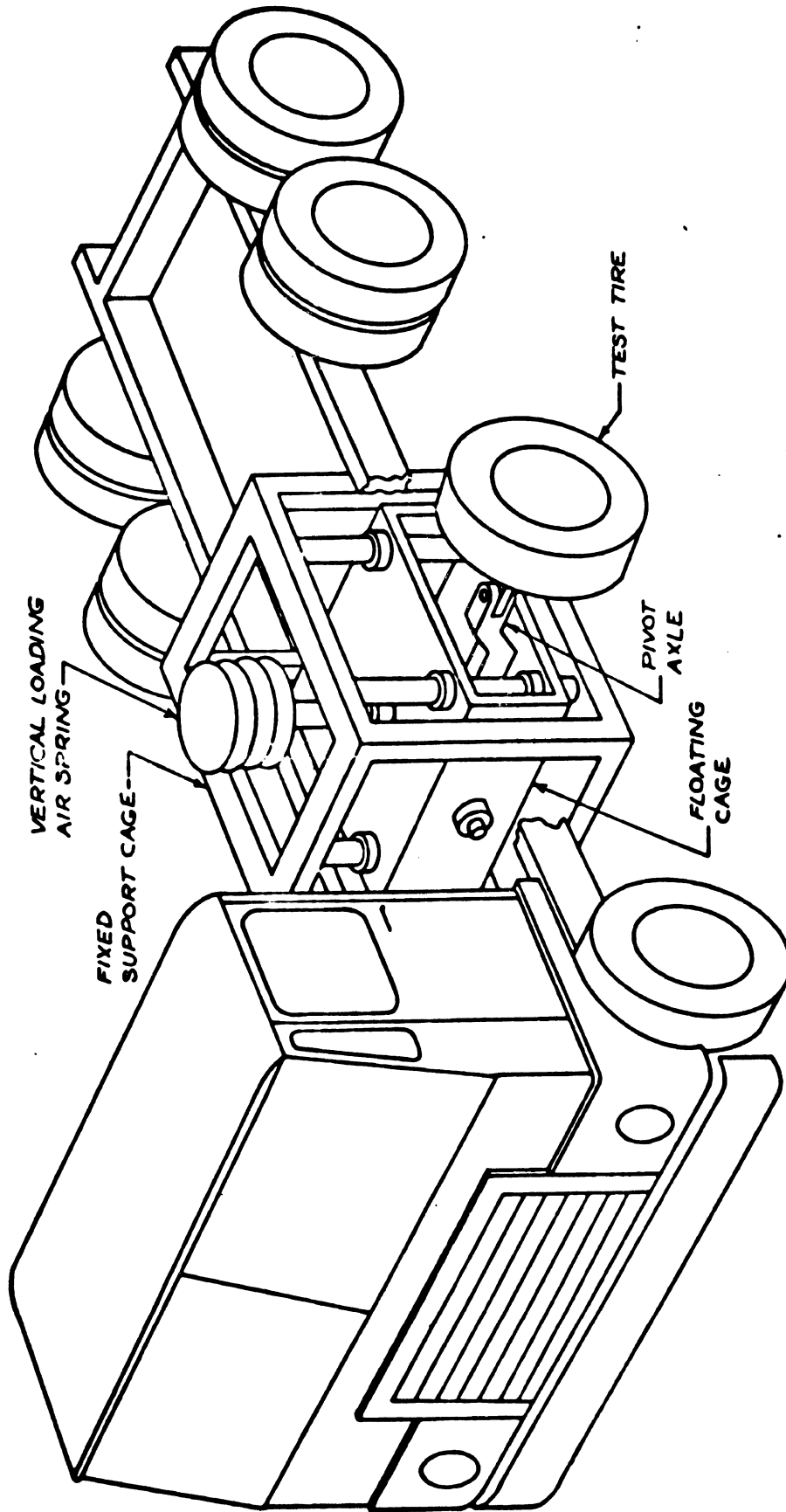

Figure C-7. Major Components of the Side Force Dynamometer Assembly.

tracks. The two tires are "toed-in" together by an electrohydraulic servo system covering a slip angle range from -1° to $+30^{\circ}$. The test wheel spindles are mounted upon a solid cross-axle which is constrained by a single longitudinal pivot pin.

The pin itself is fastened within a cage which can move only vertically, as constrained by a set of four ball-spline bearings. The vertically-"floating" cage is then loaded through inflation of a set of air springs. This machine thus incorporates a suspension designed to maximize the three "fundamental virtues" of mobile measurement described earlier—but for the more complicated case in which two tires are needed to achieve a side force equilibrium on the foundation vehicle. Clearly, the "pivot axle" arrangement provides for a load equalization between both tires while also providing a higher frequency response to road profile irregularities which are uncorrelated, side-to-side. The "floating cage" provides the needed kinematic isolation of the vertical load from forces in the ground plane by virtue of its rectilinear antifriction constraints. The air spring loading configuration again provides for precision load selection while incorporating a low spring rate coupling between the unsprung mass(es) and the foundation vehicle.

The two wheel spindles are "steered" to equal but opposing slip angles by an electrohydraulic servo system which incorporates two sets of actuating cylinders as shown in Figure C-8. The linkage arrangement which mechanically couples both spindles together permits the use of a single control loop, operating on the feedback signal from the one instrumented wheel while assuring common slip angles, side to side, even in the event of a servo power failure.

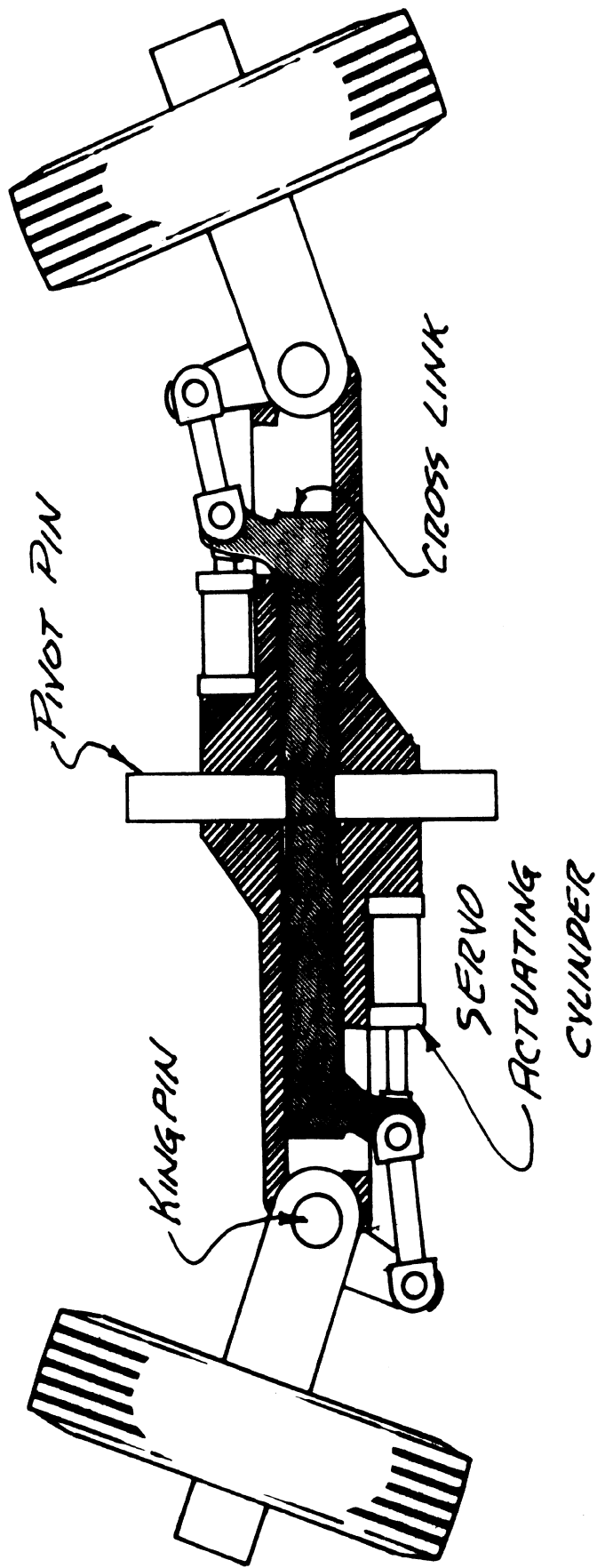

Figure C-8 Section View of Pivot Axle with Steering Servo Linkage.

The system permits mounting of any tire within the 30" to 48" range of free diameters and which is less than 18" in cross-section width. The measurement of tire force and moment conditions is achieved by way of a serial multicomponent load cell which transduces lateral and vertical force components as well as aligning moment.

Data signals from either the longitudinal or lateral test apparatuses are conditioned and recorded within a tractor-mounted module. The module serves as a self-contained data acquisition laboratory as well as the operator's station for selecting and initiating test control functions. As shown in Figure C-9, the operator's module provides an array of hard-wired electrical controls in addition to certain pneumatic and hydraulic control elements.

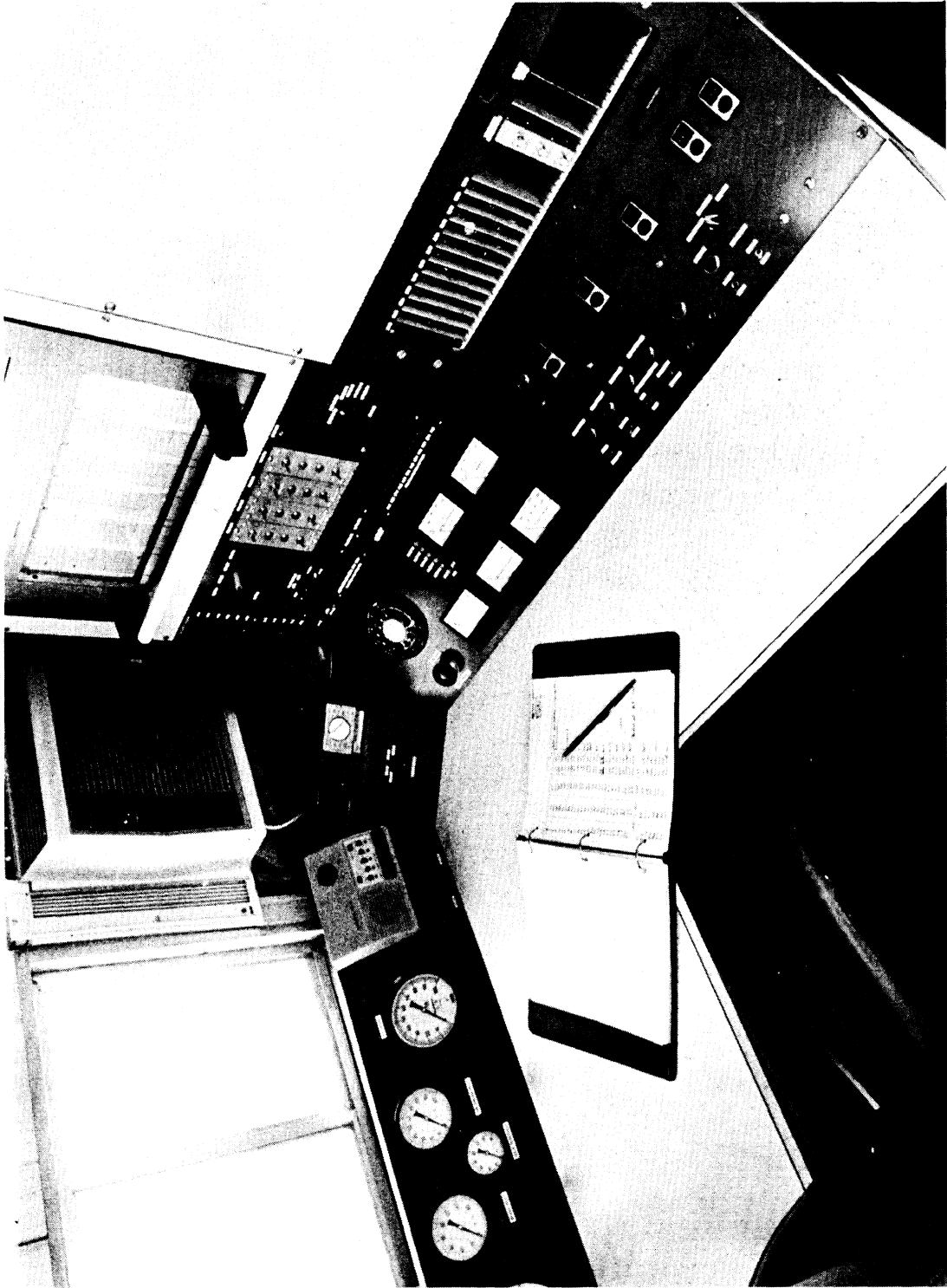

Figure C-9. Data Acquisition Module