



U.S. Department
of Transportation
**National Highway
Traffic Safety
Administration**

www.nhtsa.dot.gov
nhtsa
people saving people

DOT HS 809 900

August 2005

Automotive Collision Avoidance System Field Operational Test Report

Methodology and Results

This publication is distributed by the U.S. Department of Transportation, National Highway Traffic Safety Administration, in the interest of information exchange. The opinions, findings and conclusions expressed in this publication are those of the author(s) and not necessarily those of the Department of Transportation or the National Highway Traffic Safety Administration. The United States Government assumes no liability for its content or use thereof. If trade or manufacturer's names or products are mentioned, it is because they are considered essential to the object of the publication and should not be construed as an endorsement. The United States Government does not endorse products or manufacturers.

1. Report No. DOT HS 809 900		2. Government Accession No.		3. Recipient's Catalog No.	
4. Title and Subtitle Automotive Collision Avoidance System Field Operational Test Report: Methodology and Results				5. Report Date August 2005	
				6. Performing Organization Code	
7. Author(s)				8. Performing Organization Report No.	
9. Performing Organization Name and Address University of Michigan AND General Motors Transportation Research Institute Research and Development Center 2901 Baxter Rd. 30500 Mound Road Ann Arbor, MI 48109 Warren, MI 48090				10. Work Unit No. (TRAIS)	
				11. Contract or Grant No. DTNH22-99-H-07019	
12. Sponsoring Agency Name and Address National Highway Traffic Safety Administration U.S. Department of Transportation 400 Seventh Street S.W. Washington D.C.				13. Type of Report and Period Covered Final research report	
				14. Sponsoring Agency Code	
15. Supplementary Notes Work conducted by the University of Michigan Transportation Research Institute under contract and in collaboration with General Motors.					
16. Abstract The Automotive Collision Avoidance System field operational test (or ACAS FOT) project was led by General Motors (with Delphi playing a major supporting role) under a cooperative agreement with the U.S. Department of Transportation. The work conducted by the University of Michigan Transportation Research under this project is the subject of this two-volume report. This work involved developing the FOT methodology, gathering the FOT data, and the analysis and interpretation of this massive dataset. The FOT involved exposing a fleet of 11 ACAS-equipped Buick LeSabre passenger cars to 12 months of naturalistic driving by lay drivers from southeastern Michigan. The ACAS system included both a forward crash warning (FCW) system and an adaptive cruise control (ACC) system. The goal of the FOT was to examine the suitability of the ACAS system for widespread deployment from the perspectives of both driving safety and driver acceptance. Ninety-six drivers participated in the project, with an accumulation of 137,000 miles of driving. Data included over 300 data signals collected at 10 Hz with corresponding samples of video of the forward driving scene and the driver's face. A set of subjective instruments were used to capture information about the driver and their self-reported tendencies, as well as post-drive questionnaires, interviews (which included video replays of alert experiences), and focus groups. Results indicated that ACC was widely accepted by drivers, whereas the acceptance of FCW was mixed (due to false alarms) and was not found to be significantly related to FCW alert rate. ACC was found to be benign from a traffic safety perspective, with possible benefits resulting from the marked reduction in short (<1 second) headways and reduced passing behavior observed during ACC driving. While incidents were found in which the FCW may have contributed to a timely driver response to an emerging rear-end crash conflict, the frequency or magnitude of such conflicts in manual driving was unchanged when FCW was enabled. In addition, headways in manual driving with FCW enabled were found to increase on freeways and also during daytime driving.					
17. Key Word Forward crash warning, adaptive cruise control, crash avoidance, crash warning, FCW, ACC, ACAS, longitudinal control, rear-end crash, driver assistance systems			18. Distribution Statement Unrestricted		
19. Security Classif. (of this report) None		20. Security Classif. (of this page) None		21. No. of Pages 928	22. Price

Table of Contents

Executive Summary	1
1 Introduction.....	1-1
2 Structure of the FOT	2-1
2.1 Overview of the FOT Learning Stream	2-2
2.2 Three Days in the Life of an ACAS FOT Subject.....	2-4
2.3 ACAS Algorithms A, B, C	2-5
3 Test Method.....	3-1
3.1 Test Vehicle with ACAS System.....	3-1
3.1.1 2002 Buick LeSabre.....	3-1
3.1.2 ACAS System Overview	3-3
3.1.3 Threat-Assessment Algorithm Overview	3-5
3.1.4 Adaptive Cruise Control (ACC) System Overview.....	3-8
3.2 FOT Pilot Testing and Experimental Design.....	3-10
3.2.1 FOT Pilot Testing	3-10
3.2.1.1 Stage 1 Pilot Test	3-10
3.2.1.2 Stage 2 Pilot Test	3-11
3.2.1.3 Stage 2.5 Pilot Test	3-12
3.2.1.4 Stage 3 Pilot Test	3-12
3.2.2 FOT Experimental Design	3-13
3.3 Data Acquisition System.....	3-14
3.3.1 DAS Package	3-14
3.3.2 Collected Variables.....	3-18
3.3.3 Video Data	3-19
3.3.4 Trip-Summary Data by Cellular Modem.....	3-20
3.3.5 Data Download from a Returned Vehicle.....	3-21
3.3.6 Tool for Debriefing of Returning Participants.....	3-22
3.4 Management of Test Participants.....	3-23
3.4.1 Human Use Approval	3-23
3.4.2 Recruitment and Screening.....	3-24
3.4.3 Pre-launch Orientation.....	3-26
3.4.4 Communication in Contingencies.....	3-27
3.4.5 Post-return Debriefing	3-27
3.4.6 Focus groups	3-28
3.5 Management of Test Vehicles	3-28
3.5.1 Schedule for Validating and Dispatching Vehicles	3-28
3.5.2 Preparations for Vehicle Launch	3-32
3.5.3 Vehicle Maintenance	3-32
3.5.4 ACAS System Maintenance	3-33

4	The ACAS data set.....	4-1
4.1	Overview of the data archive	4-1
4.2	The ACAS FOT database	4-2
4.3	Invalid data and known anomalies.....	4-5
4.3.1	Overall FOT distance summary per vehicle	4-6
4.3.2	Invalid Trips.....	4-8
4.3.3	Low-level data-validity problems	4-9
4.4	Subjective Data	4-10
4.4.1	Driver Biographic Data.....	4-10
4.4.2	Behavior and Style Questionnaires.....	4-10
4.4.2.1	Driver Behavior Questionnaire (DBQ).....	4-10
4.4.2.2	Driver Style Questionnaire (DSQ).....	4-11
4.4.3	Debrief Questions – Written	4-12
4.4.4	Debrief Questions – Live Discussion	4-12
4.4.5	Focus Group Sessions	4-13
5	Data Processing Methods	5-1
5.1	On-Board Data Processing.....	5-1
5.1.1	CAN Message List.....	5-2
5.1.2	Histograms	5-2
5.1.3	Summary Numerics	5-3
5.1.4	Customized Functions.....	5-5
5.2	Post-Facto Data Processing.....	5-5
5.2.1	Time-History Channels.....	5-5
5.2.2	Event Table Generation	5-5
5.2.3	Multi-Dimensional Histograms	5-7
5.3	Identifying FCW Driving Scenarios From Video Data	5-8
5.3.1	Motivating The Use Of Scenarios.....	5-8
5.3.2	Driving Scenarios Used In The Conflict Analysis.....	5-11
5.3.3	Identifying FCW Driving Scenarios From FOT Data	5-11
5.3.3.1	Using Video To Identify FCW Driving Scenarios	5-11
5.3.3.2	Automatic Processing To Identify In-Host-Path Driving Scenarios... 5-13	
5.4	Processing To Identify Road Type	5-13
5.5	Combining Vs. Segregating Data From Algorithms A, B, C	5-16
5.6	Processing to Characterize Driving Style	5-16
5.6.1	Methodology and Background.....	5-16
5.6.2	Clustering the ACAS Drivers	5-16
5.7	Identifying levels of forward conflict	5-24
5.8	Characterizing the Traffic Environment	5-26
6	Presentation of Descriptive Results.....	6-1
6.1	Descriptive Statistics On Driving Exposure	6-1
6.1.1	Overall Exposure	6-1
6.1.2	Exposure By Driver	6-4
6.1.3	Exposure By Driving Environment	6-6
6.1.4	Exposure By Driving Style	6-8

6.1.5	Exposure By Week	6-12
6.2	Descriptive Statistics And ACAS Activity	6-12
6.2.1	Activity Involving FCW	6-13
6.2.1.1	Availability Of FCW.....	6-13
6.2.1.2	FCW Imminent Alerts.....	6-14
6.2.1.3	Driver Adjustment Of FCW Sensitivity Setting.....	6-31
6.2.1.4	FCW Cautionary Alerts	6-47
6.2.2	Activity Involving ACC And CCC.....	6-52
6.2.2.1	Utilization Of Cruise Control, ACC And CCC	6-52
6.2.2.2	Adjustment Of Set Speed And Headway Time	6-57
6.2.2.3	ACC Alerts.....	6-68
6.3	Characterization Of ACAS Performance From FOT Data	6-74
6.3.1	FCW Alert Performance	6-75
6.3.1.1	FCW Imminent Alert Performance.....	6-75
6.3.1.2	FCW Cautionary Alert Performance	6-81
6.3.2	ACC Alert Performance.....	6-81
6.3.2.1	Type Classification And Counts Of ACC Alerts.....	6-82
6.3.2.2	Road Types Associated With ACC Alerts.....	6-84
6.3.2.3	Stationary ACC Alerts	6-84
6.3.2.4	Moving-Target ACC Alerts:.....	6-86
6.3.2.5	Speeds Associated With In-Path ACC Alerts.....	6-86
6.3.2.6	Set Speeds Associated With In-Path ACC Alerts.....	6-87
6.3.3	ACC Control Performance.....	6-90
7	Presentation of Results – FCW Theme	7-1
7.1	FCW Safety Results.....	7-1
7.1.1	FCW Safety Hypotheses.....	7-2
7.1.2.	The Influence of ACAS ¹ on Headway Keeping during Manual Driving ..	7-3
7.1.3	Identifying Levels of Conflict in Forward Closing Situations.....	7-12
7.1.3.1	FCW Conflict Study Set	7-13
7.1.3.2	Braking Behavior and Maximum Conflict Levels Associated with the Conflict Set	7-15
7.1.4	FCW Effect on Conflict Resolution.....	7-17
7.1.4.1	Rate of Conflict-Zone Events	7-18
7.1.4.2	Braking Responses to Conflict Events:.....	7-20
7.1.4.3	Conflict Levels at Braking Onsets – Effect of Enabling ACAS.....	7-21
7.1.4.4	Highest Conflict Level during Conflict Events – effect of enabling ACAS.....	7-23
7.1.4.5	Change in the Rate of FCW Alerts as an Indicator of Changes in Conflict Incidence.....	7-25
7.1.5	Driver Response to FCW Alerts	7-28
7.1.5.1	Driver Actions Following Imminent Alerts.....	7-28
7.1.5.2	Driver Responses to Cautionary Alerts.....	7-42
7.1.6	Potentially Useful FCW alerts	7-43
7.1.6.1	Analyst Safety Ratings of Selected FCW Alerts	7-44

7.1.6.2	Comparing Alert-Event Ratings: Drivers' Utility Ratings vs. Analyst's Safety Rating.....	7-47
7.1.7	Evaluation of Secondary Behaviors with FCW.....	7-49
7.1.7.1	Secondary Behaviors with Manual Driving.....	7-49
7.1.7.2	FCW Imminent-Alert Scenarios Involving Secondary Behaviors.....	7-55
7.1.7.3	Secondary Behaviors Observed During Commutes.....	7-58
7.1.8	Summary of FCW Safety Analyses.....	7-61
7.2	FCW Acceptance.....	7-63
7.2.1	Drivers' Perceptions and Evaluations of FCW.....	7-64
7.2.1.1	FCW Post-Drive Questionnaire Results.....	7-64
7.2.1.2	Results of the FCW Take-Home Questionnaire.....	7-75
7.2.1.3	FCW Debriefing Questions.....	7-79
7.2.1.4	Review of FCW Key Events for Utility.....	7-81
7.2.1.5	Synopsis of the Responses from Focus Groups Regarding FCW.....	7-88
7.2.2	FCW Acceptance by System Exposure.....	7-98
7.2.2.1	Acceptance by Cautionary-Alert Exposure.....	7-98
7.2.2.2	FCW Acceptance by Imminent-Alert Exposure.....	7-99
7.2.4	Driver Profiles Corresponding to FCW Acceptance.....	7-101
7.2.4.1	Acceptance of FCW by Age.....	7-101
7.2.4.2	Acceptance of FCW by Gender.....	7-102
7.2.4.3	Acceptance of FCW by Income.....	7-102
7.2.4.4	Acceptance of FCW by Education.....	7-106
7.2.4.5	Acceptance of FCW by Driver Self-Characterization.....	7-106
7.2.5	Summary of FCW Acceptance Analyses.....	7-111
8	Presentation of Results – ACC Theme.....	8-1
8.1	ACC Safety Results.....	8-1
8.1.1	Basic Headway-Keeping in ACC Driving.....	8-4
8.1.2	Cases of ACC Throttle Override into Headway Intrusion.....	8-10
8.1.3	Cases of Reverse Cut-in Leading to Headway Intrusions in ACC Driving.....	8-17
8.1.4	Passing Other Vehicles Under ACC Control.....	8-24
8.1.5	Lane Selection with ACC Engaged.....	8-39
8.1.6	Other Vehicles Cutting in Ahead of the ACC Host.....	8-45
8.1.7	Secondary Task Activity with ACC Engaged.....	8-55
8.1.8	Intervention by Braking.....	8-58
8.1.9	Staying Engaged up to the 0.3-g Deceleration Limit.....	8-75
8.1.10	ACC Driving Corresponding to Owner's Manual Advisories.....	8-81
8.1.11	Summary of ACC Safety Analyses.....	8-84
8.2	Results of ACC Acceptance.....	8-86
8.2.1	Driver's Perceptions and Evaluations of ACC.....	8-86
8.2.1.1	ACC Post-Drive Questionnaire Results.....	8-86
8.2.1.2	ACC Take-Home Questionnaire Results.....	8-92
8.2.1.3	Review of ACC Key Events for Utility.....	8-95
8.2.1.4	Synopsis of Focus Group Responses Regarding ACC.....	8-96
8.2.2	ACC Interactions Connoting Acceptance.....	8-102
8.2.2.1	Acceptance of ACC by Utilization.....	8-103

8.2.2.2	Acceptance of ACC by Headway Selection	8-109
8.2.3	Driver Profiles Corresponding to ACC Acceptance.....	8-120
8.2.3.1	Acceptance of ACC by Age.....	8-120
8.2.3.2	Acceptance of ACC by Gender.....	8-121
8.2.3.3	Acceptance of ACC by Income	8-121
8.2.3.4	Acceptance of ACC by Education.....	8-121
8.2.3.5	Acceptance of ACC by Driver Self-Characterization.....	8-122
8.2.3.7	Acceptance of ACC by Driving Style.....	8-125
9	Analyses Examining Differences in Acceptance between Algorithms A, B and C	9-1
9.1	Differences in Driver Characteristics.....	9-1
9.1.1	Differences in DBQ Scores between Algorithms A, B and C	9-2
9.1.2	Differences in DSQ Scores between Algorithms A, B and C.....	9-2
9.2	Differences in Acceptance of ACAS	9-3
9.2.1	Drivers' Perceptions and Evaluations of FCW in the Post-Drive Questionnaire	9-4
9.2.2	Drivers' Perceptions and Evaluations of FCW in the Take-Home Questionnaire	9-6
9.2.3	Drivers' Perceptions and Evaluations of ACC in the Post-Drive Questionnaire	9-8
9.2.4	Drivers' Perceptions and Evaluations of ACC in the Take-Home Questionnaire	9-10
9.3	Summary of Acceptance Differences by Algorithm.....	9-11
10	Conclusions.....	10-1
10.1	Conclusions Pertaining to FCW Safety	10-2
10.2	Conclusions Pertaining to FCW Acceptance.....	10-5
10.3	Conclusions Pertaining to ACC Safety.....	10-7
10.4	Conclusions Pertaining to ACC Acceptance	10-14
10.5	Overall Conclusions from the ACAS FOT.....	10-15
	References.....	Ref-1
	Acknowledgments	
	Glossary	a

Appendices

- Appendix A:.....Data Signals List
- Appendix B:.....Information Letter
- Appendix C:.....Informed Consent
- Appendix D:.....Instructional Video Transcript
- Appendix E:.....Post-Drive Questionnaire With Descriptive Statistics
- Appendix F:.....Take-Home Questionnaire
- Appendix G:.....Driver Characteristics And Biographical Data
- Appendix H:.....Detailed Contents Of The Driver Related Database
- Appendix I:.....Coding Key For Imminent Alerts And Secondary Behaviors
- Appendix J:.....Imminent Alert Counts And Distance Traveled For Individual Drivers
- Appendix K:.....Four Multifactor, Repeated-Measures Analyses Of Variance Of The Percentile Of Following Time At 1-Second Headway Time Margin
- Appendix L:.....Evaluation Of Secondary Behaviors With ACC
- Appendix M:.....ACC Driving Corresponding To Owner's Manual Advisories
- Appendix N:.....Post-Drive Questionnaire Free-Response Summary Algorithm C Drivers
- Appendix P:.....Multifactor Analysis Percentile Of Following Time At 1-Second Headway Time Margin
- Appendix Q:.....Data Fields In Fot Database Tables
- Appendix R:.....Various Pivot Table Results On Exposure
- Appendix S:.....Driver Behavior Questionnaire
- Appendix T:.....Driver Style Questionnaire
- Appendix U:.....Photo Anecdotes Of Throttle-Override, Reverse Cut-In Incidents, and Flying Pass Incidents

Table of Figures

Figure 1.1. The matrix of FOT analysis themes and the ACAS subsystems.....	1-3
Figure 3.1. Buick LeSabre with ACAS	3-2
Figure 3.2. ACAS functional schematic	3-3
Figure 3.3. Head up display configuration.....	3-4
Figure 3.4. Forward collision warning system threat level icons	3-5
Figure 3.5. DAS package.....	3-14
Figure 3.6. DAS with sides unfolded.....	3-15
Figure 3.7. A block diagram depiction of the DAS	3-16
Figure 3.8. DAS FOT functional diagram	3-17
Figure 3.9. Forward video capture.....	3-19
Figure 3.10. Face video capture.....	3-20
Figure 3.11. Phone view diagnostic form	3-21
Figure 3.12. Data download connection	3-22
Figure 3.13. Debrief viewer	3-23
Figure 3.14. Original scheduling design for the FOT	3-30
Figure 3.15. Monitoring fleet deployment during the FOT	3-31
Figure 4.1. Overview of the ACAS data handling paths	4-2
Figure 4.2. Labeling of the four test-segment groups.....	4-5
Figure 5.1. Scenario taxonomy	5-10
Figure 5.2. Driving scenarios: examples of in-host-path (IHP) scenarios.....	5-10
Figure 5.3. Driving scenarios: examples of transitioning-host-path (THP) scenarios..	5-10
Figure 5.4. Road class derivation for paved surfaces	5-14
Figure 5.5. Fraction of time spent at different speeds for four major road type classifications.....	5-15
Figure 5.6. Within-cluster variation of variables	5-21
Figure 5.6. (<i>continued</i>) Within-cluster variation of variables.....	5-22
Figure 5.7. Importance by variable for <i>Reserved</i> drivers.....	5-23
Figure 5.8. Importance by variable for <i>Assertive</i> drivers.....	5-23
Figure 5.9. Fraction of distance for the different lane-positions, along with the Not- mapped and Insufficient-data categories	5-28
Figure 5.10. Examples of the three traffic-density designations	5-29
Figure 5.11. Traffic count as a function of time of day for freeways.....	5-30
Figure 5.12. Traffic count as a function of time of day for surface roads	5-30
Figure 6.1. Accumulation of all FOT travel distance by calendar time and by algorithm	6-1
Figure 6.2. Distribution of valid trips and distance travel by algorithm.....	6-2
Figure 6.3. Relative number of trips and relative distance traveled with ACAS disabled and enabled, by algorithm.....	6-3
Figure 6.4. Histogram of distances for valid algorithm-C trips.....	6-3
Figure 6.5. Histogram of travel distance during valid trips by all drivers and algorithm-C drivers	6-4
Figure 6.6. Histogram of the average trip distance for algorithm-C drivers.....	6-5

Figure 6.7. Distances traveled in valid, algorithm-C trips by driver gender and age with ACAS enabled and disabled	6-5
Figure 6.8. Distances traveled in valid, algorithm-C trips by road class with ACAS enabled and disabled	6-6
Figure 6.9. Relative distances traveled in valid, algorithm-C trips by road class with ACAS enabled and disabled	6-7
Figure 6.10. Relative distances traveled in valid, algorithm-C trips by driving-environment factors with ACAS disabled and enabled	6-7
Figure 6.11. Distance exposure by driving-style type with ACAS disabled and enabled	6-8
Figure 6.12. Relative distances (algorithm-C) by road class and driving style with ACAS enabled and disabled	6-9
Figure 6.13. Relative engaged distances (algorithm-C) by road class and driving style with ACAS enabled and disabled	6-10
Figure 6.14. Relative exposure to traffic conditions by driver type and road class.....	6-11
Figure 6.15. Repeated trips portion by driving style with ACAS enabled and disabled	6-12
Figure 6.16. Counts of drivers as a function of the ratio of omitted ACAS-enabled alerts to the number of recorded ACAS-enabled alerts (driver 1 – 96).....	6-16
Figure 6.17. ACAS-enabled alert rates for algorithms A, B, and C, expressed as the sum of rates for targets that are stationary and moving.....	6-17
Figure 6.18. Alert rate by unit time, compared to alerts per 100 miles	6-18
Figure 6.19. Cruise-engaged alerts, as a fraction of all ACAS-enabled alerts (algorithms A, B, and C)	6-20
Figure 6.20. Histogram of the number of drivers with various alert rates (includes all ACAS heard alerts, algorithms A, B, and C).....	6-22
Figure 6.21. Histogram of the number of algorithm C drivers with various alert rates	6-23
Figure 6.22. FCW alert rate per 100 miles for ACAS-enabled driving: by algorithm and by road type (excluding ramps)	6-24
Figure 6.23. Variation among drivers of the number of ACAS-enabled alerts occurring on known road types, with the number of alerts on surface roads also shown.	6-25
Figure 6.24. Variation among drivers of the number of ACAS-enabled alerts, and the variation in the relative fraction of the alerts that are associated with stationary targets.....	6-27
Figure 6.25. Stationary-target alerts, as a fraction of all ACAS-enabled alerts (for algorithm A, B, C)	6-28
Figure 6.26. Variation of alert rate per 100 miles in ACAS-enabled driving (algorithm C), by road type and cruise-engaged status. Alerts include ACC and manual driving alerts.....	6-28
Figure 6.27. Travel distance in miles during algorithm C ACAS-enabled driving, broken down by road type and cruise-engaged status.....	6-29
Figure 6.28. Speed at time of FCW imminent alert onset – cruise not engaged, algorithm C.....	6-30
Figure 6.29. Traffic density and road type effect on FCW imminent alert rate (algorithm C, ACAS enabled, includes ACC alerts)	6-31

Figure 6.30. Traffic density exposure: miles traveled by road type and traffic density (algorithm C, ACAS enabled, includes ACC mileage)	6-31
Figure 6.31. Fraction of time and distance by sensitivity setting (FCW-only).....	6-32
Figure 6.32. Fraction of time by week, age and gender for each sensitivity setting.....	6-33
Figure 6.33. Mean number of FCW sensitivity adjustments per week by gender.....	6-35
Figure 6.34. Mean number of FCW sensitivity adjustments by week.....	6-36
Figure 6.35. Mean number of FCW sensitivity adjustments by the interaction of gender and week	6-36
Figure 6.36. Mean frequency of FCW sensitivity-setting selection per week.....	6-37
Figure 6.37. Mean frequency of FCW sensitivity-setting selection by driver age group.	6-38
Figure 6.38. Mean frequency of FCW sensitivity-setting selection by driver gender.	6-39
Figure 6.39. Mean frequency of FCW sensitivity selection by setting by week	6-40
Figure 6.40. Mean frequency of FCW sensitivity-setting selection by wiper use.	6-41
Figure 6.41. Mean frequency of FCW sensitivity-setting selection by ambient light conditions.....	6-42
Figure 6.42. Mean frequency of FCW sensitivity-setting selection by traffic density.	6-43
Figure 6.43. Mean frequency of FCW sensitivity-setting selection by road type	6-44
Figure 6.44 Visual alert icons: Time icons are displayed, as a fraction of the FCW-active time (algorithm C drivers)	6-47
Figure 6.45. Visual alert icons: How often icons were displayed to individual drivers (algorithm C).....	6-48
Figure 6.46. Visual alert icons: How often icons were displayed, as function of FCW sensitivity selection by drivers (algorithm C).....	6-48
Figure 6.47. Visual alert icons: How often the different icons were displayed, as a function of FCW sensitivity selection (algorithm C).....	6-49
Figure 6.48. Visual alert icons: Effect of age on the fraction of FCW active time that the visual alert icons were displayed (algorithm C)	6-50
Figure 6.49. Visual alert icons: Effect of gender on the fraction of FCW active time that the visual alert icons are displayed (algorithm C)	6-51
Figure 6.50. Fraction of visual alert icon time on different road types (algorithm C drivers).....	6-51
Figure 6.51. Comparison of the use of CCC and ACC by algorithm-C drivers.....	6-53
Figure 6.52. Comparison of the use of CCC and ACC by driver gender and age group (algorithm-C drivers)	6-53
Figure 6.53. Comparison of the use of CCC and ACC by road class (algorithm-C drivers).....	6-54
Figure 6.54. Comparison of the use of CCC and ACC by traffic density on freeways and on other road types (algorithm C drivers).....	6-55
Figure 6.55. Comparison of the use of CCC and ACC by driving-environment factors (algorithm C drivers).....	6-56
Figure 6.56. Use of cruise control by algorithm-C drivers by driving style.....	6-56
Figure 6.57. Histograms of set speeds with CCC and ACC (algorithm C drivers).....	6-58

Figure 6.58. Histogram of ACC headway (gap) setting (ACC engaged), algorithm-C driving	6-59
Figure 6.59. Histograms of the drivers' average set speed with CCC and ACC, algorithm-C driving	6-60
Figure 6.60. Histogram of drivers' average ACC headway time (gap) setting with ACC engaged, algorithm-C driving	6-61
Figure 6.61. Average cruise-control set speed by gender and age group (CCC and ACC, algorithm-C drivers).....	6-62
Figure 6.62. Average ACC headway (gap) setting by gender and age group with ACAS enabled (ACC), algorithm-C driving	6-62
Figure 6.63. Average set speed (mph) by functional road class for CCC and ACC, algorithm-C driving	6-63
Figure 6.64. Average ACC headway time (gap) setting (seconds) by road class, algorithm-C driving	6-64
Figure 6.65. Average cruise-control set speeds (mph) for CCC and ACC by road type and traffic density, algorithm-C driving	6-65
Figure 6.66. Average cruise-control set speeds by driving-environment factors with CCC and ACC, algorithm-C driving	6-65
Figure 6.67. Average ACC headway (gap) setting by driving-environment factors, algorithm-C driving	6-66
Figure 6.68. Average set speed by driving style, algorithm-C driving.....	6-67
Figure 6.69. Average ACC headway (gap) setting by driving style, algorithm-C	6-67
Figure 6.70. ACC alert rates per 100 miles for moving and stationary targets for travel with ACC engaged with moving alerts suppressed (system version 7) and not suppressed (system version 8), algorithm-C driving	6-69
Figure 6.71. Percent of drivers with various ACC alert rates, algorithm-C driving.....	6-70
Figure 6.72. ACC alert rates per 100 miles for moving and standing targets by ACC headway (gap) setting for travel with ACC engaged, algorithm-C driving.....	6-71
Figure 6.73. ACC alert rates per 100 miles for moving and standing targets by driver gender and age group for travel with ACC engaged, algorithm-C driving	6-72
Figure 6.74. ACC alert rates for moving and standing targets by road class for travel with ACC engaged, algorithm-C driving.....	6-72
Figure 6.75. ACC alert rates per 100 miles for moving and standing targets by traffic density on freeways and on other roads for travel with ACC engaged, algorithm-C driving.....	6-73
Figure 6.76. ACC alert rates per 100 miles for moving and standing targets by lighting condition and by windshield-wiper use for travel with ACC engaged, algorithm-C driving.....	6-74
Figure 6.77. FCW imminent alerts during manual driving.....	6-75
Figure 6.78. Number of false alerts and non-false alerts for individual drivers (algorithm C, manual driving). Number of drivers is indicated on the vertical axis.....	6-78
Figure 6.79. Decel-to-avoid at onset of FCW imminent alerts (algorithm C, manual driving).....	6-79
Figure 6.80. Decel-to-avoid and projected decel-to-avoid at onset of FCW imminent alerts (algorithm C, manual driving).....	6-80

Figure 6.81. Enhanced TTC at FCW imminent alert onset (algorithm C, manual driving)	6-81
Figure 6.82. Breakdown of ACC alerts by target type	6-83
Figure 6.83. ACC alerts on different road types	6-84
Figure 6.84. Kinematic conditions at the onset of stationary-target ACC alerts experienced by algorithm-C drivers	6-85
Figure 6.85. Kinematic conditions at onset of ACC moving-target alerts (algorithm C)	6-86
Figure 6.86. Host speed at onset of ACC in-path alerts. Bins have equal sizes, but labels have been rounded	6-87
Figure 6.87. Set speed at onset of ACC in-path alerts. Bins have equal sizes, but labels have been rounded	6-88
Figure 6.88. Set speed versus host speed at onset of ACC in-path alert	6-88
Figure 6.89. Time histories showing the ACC response to lead-vehicle braking	6-91
Figure 6.90. Time histories showing the ACC response to a cut-in episode	6-93
Figure 7.1. Histograms of headway time margin while following for the <i>closest follower</i> and the <i>farthest follower</i> , respectively, with ACAS disabled	7-4
Figure 7.2. Histograms of headway time margin while following for the <i>closest follower</i> and the <i>farthest follower</i> , respectively, with ACAS disabled and enabled	7-5
Figure 7.3. Means and differences of the cumulative histograms of headway time margin while following for driving with ACAS disabled and ACAS enabled	7-6
Figure 7.4. Mean percentiles for the two-way effects of ACAS x age group and ACAS x traffic density	7-10
Figure 7.5. Comparison of the strengths of factors influencing the tendency to tailgate	7-11
Figure 7.6. Kinematic conditions used to identify potential forward conflicts	7-13
Figure 7.7. Driver braking behavior computed over IHP-scenario event set (baseline, algorithm C)	7-15
Figure 7.8. Driver braking behavior computed over the set of mixed-scenario events (baseline, algorithm C)	7-16
Figure 7.9. Histogram of time-to-collision/decel-to-avoid at brake onsets – IHP cases without recent braking (from algorithm-C drivers)	7-16
Figure 7.10. Histogram of the minimum time-to-collision / minimum decel-to-avoid in all IHP scenarios (algorithm-C only)	7-17
Figure 7.11. Cumulative distribution among drivers of the rate of IHP-scenario events, by week (algorithm C drivers, excluding driver 52)	7-18
Figure 7.12. Rate of conflict-study events by driver week (algorithm-C drivers): mean of individual driver's rates	7-19
Figure 7.13. Driver braking behavior in IHP-scenario events (ACAS-enabled, algorithm C)	7-20
Figure 7.14. Driver braking behavior in mixed-scenario events (ACAS-enabled, algorithm C)	7-21
Figure 7.15. Distribution of individual drivers' mean values of decel-to-avoid at brake onset within the conflict zone (algorithm C drivers)	7-22
Figure 7.16. Distribution of individual drivers' mean values of enhanced TTC at brake onset within the conflict zone (algorithm C drivers)	7-22

Figure 7.17. FCW imminent alert rates by week for manual driving (algorithm-C drivers)	7-26
Figure 7.18. FCW imminent alert rates by week for manual driving on surface roads – moving-target alerts only (algorithm-C drivers)	7-27
Figure 7.19. Comparing the conflict scenario breakdown for alerts in manual baseline driving (left) with that for manual ACAS-enabled driving (right). Algorithm-C drivers only.	7-27
Figure 7.20. Driver actions following FCW imminent alerts during ACAS-enabled weeks 2, 3, and 4 (algorithm-C drivers)	7-29
Figure 7.21. Mean fraction of FCW alert events with driver braking	7-31
Figure 7.22. Cumulative distribution of brake duration following alerts	7-33
Figure 7.23. Brake reaction time across forward conflict scenarios.	7-35
Figure 7.24: Brake reaction time across forward conflict scenarios and system exposure	7-36
Figure 7.25: Mean brake reaction times as a function of scenario type and gender	7-37
Figure 7.26. Net change in driver speed across forward conflict scenarios 2 s after alert.	7-38
Figure 7.27. Driver changes in speed 2s after alert for (a) OHP, (b) IHP, and (c) THP scenarios.	7-39
Figure 7.28. Amber 2 cautionary alert icon maximum headway time margin events persisting for 10 seconds or more at speeds greater than 55 mph	7-43
Figure 7.29. Overall mean ratings of alert utility	7-84
Figure 7.30. Mean ratings of alert utility by gender	7-85
Figure 7.31. Mean ratings of alert utility by age	7-85
Figure 7.32. Mean ratings alert utility by type	7-86
Figure 7.33. Mean ratings of utility for moving and stationary alerts by age group	7-87
Figure 7.34. Mean ratings of utility for moving alerts judged to be unnecessary	7-87
Figure 7.35. Mean ratings of utility by alert type, age group, and gender	7-88
Figure 7.36. Distribution of median household incomes for algorithm-C drivers	7-103
Figure 7.37. Distribution of median family incomes for algorithm-C drivers	7-104
Figure 7.38. Distribution of per capita incomes (PCI) for algorithm-C drivers	7-104
Figure 7.39. Distribution of years of formal education of algorithm-C drivers	7-106
Figure 8.1. Headway-time histograms in heavy and sparse freeway traffic for all driving over 50 mph	8-5
Figure 8.3. Tails of the decel-to-avoid histograms for all driving in heavy and sparse freeway traffic over 50 mph	8-7
Figure 8.4 Headway-time vs. range-rate histograms, manual driving on freeways	8-8
Figure 8.5. Headway-time vs. range-rate histograms, ACC driving on freeways	8-9
Figure 8.6. Peak decelerations reached in 42 cases of autobraking response following a headway intrusion provoked by throttle-override	8-12
Figure 8.7. Distribution of Htm/Th minima provoked by throttle override	8-12
Figure 8.8. Distribution of ACC gap setting during throttle-override-into-conflict	8-13
Figure 8.9. Plot of all minimum Htm/Th values, and the averages thereof, attained by individual persons whose driving contained such data	8-14
Figure 8.10. Ranking of 34 drivers according to the total number of “throttle-override conflicts” that they cultivated	8-14

Figure 8.11. Ranking of 34 drivers according to the average value of $(H_{tm}/Th)_{min}$ that they each cultivated by means of throttle override	8-15
Figure 8.12. Ranking of 34 drivers according to the minimum value of H_{tm} that they each cultivated by means of throttle override	8-16
Figure 8.14 Distribution of minimum values of H_{tm}/Th reached in reverse cut-in conflicts.....	8-19
Figure 8.15. Distribution of minimum A_x (maximum deceleration) during the autobraking response to a reverse cut-in conflict	8-20
Figure 8.16. Distribution of the duration of autobraking in response to reverse cut-in conflicts.....	8-21
Figure 8.17. Rank order of drivers who encountered reverse cut-in conflict, according to the total number of such episodes experienced.....	8-21
Figure 8.18. Rank order of drivers who encountered reverse cut-in conflict, according to the maximum deceleration level experienced from ACC autobraking.....	8-22
Figure 8.19. Rank order of drivers who encountered reverse cut-in conflict, according to the minimum H_{tm}/Th value experienced in any such episode	8-23
Figures 8.20. Flying pass rate in each of three modes of longitudinal control	8-26
Figure 8.21. Cumulative distribution of the time spent driving behind an individual, preceding vehicle that has been identified by radar as the CIPV target	8-27
Figure 8.22. Distribution of speed during flying passes in three alternative modes of control	8-28
Figure 8.23. Distribution of range values upon transitioning the lane in flying passes during ManBase driving	8-29
Figure 8.24. Distribution of range values upon transitioning the lane in flying passes during ACC driving	8-29
Figure 8.25. Distribution of range values upon transitioning the lane in flying passes during CCC driving.....	8-30
Figure 8.26. Overlaid distribution of range values in flying passes under three differing modes of longitudinal control	8-30
Figure 8.27. Distribution of range-rate values upon transitioning the lane in flying passes manual driving	8-31
Figure 8.28. Distribution of range-rate values upon transitioning the lane in flying passes during ACC-engaged driving.....	8-32
Figure 8.29. Distribution of range-rate values upon transitioning the lane in flying passes during CCC-engaged driving.....	8-32
Figure 8.30. Overlay of the range-rate distributions from flying passes	8-32
Figure 8.31. Distribution of times-to-collision upon transitioning the lane in-flying pass maneuvers during ManBase driving	8-33
Figure 8.32. Distribution of times-to-collision upon transitioning the lane in flying passes during ACC-engaged driving.....	8-33
Figure 8.33. Distribution of times-to-collision upon transitioning the lane in flying passes during CCC-engaged driving.....	8-34
Figure 8.34. Overlay of times-to-collision from flying-passes in each of three modes of longitudinal control.....	8-34
Figure 8.35. Distribution of deceleration-to-avoid values (m/s^2) upon transitioning the lane in flying-passes during ManBase driving.....	8-35

Figure 8.36. Distribution of deceleration-to-avoid values (m/s^2) upon transitioning the lane in flying-passes during ACC driving	8-36
Figure 8.37. Distribution of deceleration-to-avoid values (m/s^2) upon transitioning the lane in flying-passes during CCC driving.....	8-36
Figure 8.38. An overlay of deceleration-to-avoid distributions from flying-passes in three modes of longitudinal control.....	8-36
Figure 8.39 A rank ordering of the 44 drivers who conducted at least one flying pass during ACC driving, by the event count of each individual, under algorithm C.	8-38
Figure 8.40. The average fraction of individual's freeway driving distances at speeds above 50 mph, distributed among lane positions and modes of control.....	8-41
Figure 8.41. Distributions of average traffic counts at speeds above 50 mph, distributed among lane positions and modes of control.....	8-42
Figure 8.42. Cumulative values of decel-to-avoid $< -1.0 m/s^2$ for each of the three control modes in each of the three nominal lane positions	8-43
Figure 8.43. Cut-in rates vs. initial headway time margin for each of three levels of traffic density, combining all modes of control.....	8-47
Figure 8.44. Cut-in rates at the low end of the headway-time scale.....	8-47
Figure 8.45. Overall cut-in rates experienced in each of three driving control modes.....	8-48
Figure 8.46. Cut-in rates within bins of constant initial headway time and traffic density, for manual and ACC modes of control.....	8-49
Figure 8.47. Total number of cut-ins observed at each of the ACC gap settings	8-49
Figure 8.48. Cut-in rates observed at each of the ACC gap settings	8-50
Figure 8.49. Distributions of the headway times posed by arriving cut-in vehicles, for each of the three modes of control.....	8-50
Figure 8.50. Distributions of the range rate values with which cut-in vehicles arrived ahead of the host, for each of the three modes of control.....	8-51
Figure 8.51. Distributions of the host-vehicle speed values at the moment of cut-in, for each of the three modes of control.....	8-52
Figure 8.52. Comparison of cut-in events under manual and ACC control, according to the average cut-in range value that was seen in each 0.5 m/s bin of range-rate	8-53
Figure 8.53. Rates of brake apply under the stated query condition, case-1	8-60
Figure 8.54. Rates of brake apply under the stated query condition, case-2	8-61
Figure 8.55. Peak decelerations reached during ACC braking intervention under case-2 of the stated query condition in medium traffic.....	8-63
Figure 8.56. Peak decelerations reached during CCC braking intervention under case-2 of the stated query condition in medium traffic.....	8-63
Figure 8.57. Peak decelerations reached in ManBase brake applications under case-2 of the stated query condition in medium traffic	8-64
Figure 8.58. Peak decelerations overlaid for all three control modes under case-2 of the stated query condition in medium traffic	8-64
Figure 8.59. Speed changes derived from ACC braking intervention under case-2 of the stated query condition in medium traffic	8-66
Figure 8.60. Speed changes derived from CCC braking intervention under case-2 of the stated query condition in medium traffic	8-66

Figure 8.61. Speed changes derived from ManBase brake applications under case-2 of the stated query condition in medium traffic	8-67
Figure 8.62. Overlaid speed changes under case-2 of the stated query condition in medium traffic.....	8-67
Figure 8.63. Headway time values at onset of ACC braking intervention under case-2 of the stated query condition in medium traffic	8-68
Figure 8.64. Headway time values at onset of CCC braking intervention under case-2 of the stated query condition in medium traffic	8-68
Figure 8.65. Headway time values at onset of ManBase braking application under case-2 of the stated query condition in medium traffic.....	8-69
Figure 8.66. Overlay of headway time values at braking onset, under case-2 of the stated query condition in medium traffic	8-69
Figure 8.67. Distribution of $(H_{tm}/Th)_{min}$ that was reached within 5 seconds after ACC braking intervention under query case-2 and medium traffic.....	8-70
Figure 8.68. Decel-to-avoid values at onset of ACC braking intervention under case-2 of the stated query condition in medium traffic	8-71
Figure 8.69. Decel-to-avoid values at onset of CCC braking intervention under case-2 of the stated query condition in medium traffic	8-72
Figure 8.70. Decel-to-avoid values at onset of ManBase brake application under case-2 of the stated query condition in medium traffic.....	8-72
Figure 8.71. Overlay of Decel-to-avoid values at onset of braking under case-2 of the stated query condition in medium traffic.....	8-73
Figure 8.72. Distribution of longitudinal acceleration under ACC control just prior to brake onset under case-2 of the stated query condition in medium traffic.	8-74
Figure 8.73. Distribution of the sixty total events of 0.3-g autobraking by road type..	8-77
Figure 8.74. Distribution of 0.3-g autobraking events by speed at the time of 0.3-g onset	8-77
Figure 8.75. Distribution of 0.3-g autobraking events by whether the driver intervened by application of the brake pedal.....	8-78
Figure 8.76. Distribution of the elapsed time between onset of the 0.3-g autobraking and driver intervention by application of the brake pedal	78
Figure 8.77. Weekly count of 0.3-g autobraking events over the period of ACAS-enabled driving.....	8-79
Figure 8.78. Percent of cruise utilization by ACAS enablement and week.....	8-104
Figure 8.79. Overall mean cruise utilization by gender.....	8-104
Figure 8.80. Overall mean cruise utilization by age group.....	8-105
Figure 8.81. Percent Cruise Utilization on Freeways by Week.....	8-106
Figure 8.82. Effect of gender on cruise utilization percent by week.....	8-107
Figure 8.83. Effect of age group on cruise utilization percent across week	8-108
Figure 8.84. Mean number of headway adjustments by gender and age group.....	8-110
Figure 8.85. Mean number of adjustments of headway by week	8-111
Figure 8.86. Mean number of adjustments to a particular headway setting by week.	8-111
Figure 8.87. Mean number of adjustments to a particular headway setting by week and gender.....	8-112

Figure 8.88. Mean number of adjustments to a particular headway setting by week and age group.....	8-113
Figure 8.89. Mean number of adjustments to a particular headway setting by week.	8-113
Figure 8.90. Mean number of headway adjustments on limited access roads per week by age and gender	8-114
Figure 8.91. Mean number of headway adjustments on limited access roads per week by gender.....	8-116
Figure 8.92. Mean number of headway adjustments on limited access roads per week by age group.....	8-117
Figure 8.93. Mean number of headway adjustments on limited access roads per week to particular settings by gender	8-118
Figure 8.94. Mean number of headway adjustments on limited access roads per week to particular settings by driver age group.....	8-118
Figure 8.95. Mean number of headway adjustments on limited access roads per week to particular settings by week.....	8-119

Table of Tables

Table 2.1. Seven stages of test driving activity in the ACAS FOT project	2-3
Table 2.2. ACAS algorithms A, B, and C.....	2-5
Table 3.1. Threat-assessment function states.....	3-6
Table 3.2. DAS file types.....	3-19
Table 3.3. Vehicle-turnaround activities.....	3-32
Table 4.1. Files/tables generated for each trip in the FOT.....	4-3
Table 4.2. Overall FOT distance summary per vehicle in miles	4-6
Table 4.3. Summary of invalid trips	4-9
Table 5.1. List of histograms generated on board each vehicle.....	5-4
Table 5.2. Samples of event tables generated from the ACAS database.....	5-6
Table 5.3. Multi-dimensional histograms	5-7
Table 5.4. Driving scenarios used in FCW analyses	5-12
Table 5.5. Complete road-class designation in the ACAS FOT database	5-14
Table 5.6. List of all driver-level variables extracted for Cluster Analysis.....	5-18
Table 5.7. List of driver-level variables meaningful for clustering	5-19
Table 5.8. List of driver-level variables not meaningful for clustering.....	5-19
Table 5.9. Distribution of clusters.....	5-19
Table 5.10. Centroids of clusters	5-20
Table 5.11. Frequency of clusters by driver age.....	5-22
Table 6.1. Terminology used to denote ACAS imminent alerts in different control modes	6-14
Table 6.2. ACAS alerts omitted from the analyses.....	6-15
Table 6.3. Number of usable FCW imminent alerts – broken down by FOT algorithm and whether ACAS displays were enabled (includes cruise-engaged alerts).....	6-16
Table 6.4. Number of ACAS alerts provided to individual drivers during ACAS-enabled driving by algorithm (includes FCW imminent alerts and ACC alerts).....	6-21
Table 6.5. Alert rate per 100 miles for driver during ACAS-enabled driving. Means and standard deviations (in parentheses) are shown, and rates are normalized by miles driven in the associated control mode.....	6-22
Table 6.6. FCW imminent alert rates per 100 miles with the ACAS system enabled, algorithm C, broken down by road type and cruise-engaged status	6-26
Table 6.7. Paired comparisons: mean frequency per week of sensitivity setting selection events	6-38
Table 6.8. Driver most-likely-value (MLV) of FCW-sensitivity setting selection.....	6-45
Table 6.9. Breakdown of ACC alerts by the 3 weeks of ACAS-enabled driving.....	6-69
Table 6.10. FCW imminent alert events: breakdown of in-host path (IHP) scenario alerts (algorithm C, ACAS enabled, manual driving)	6-76
Table 6.11. FCW imminent alert events: breakdown of transitioning-host path (THP) scenario alerts (algorithm C, ACAS enabled, manual driving)	6-77
Table 6.12. Visual alert icons are almost always triggered by headway considerations.....	6-81
Table 6.13. Forward conflict scenarios associated with CCC and ACC alerts.....	6-83

Table 7.1. Main effects on the cumulative percentile of headway time margin of 1 second	7-9
Table 7.2. Two-way effects of ACAS on the cumulative percentile of headway time margin of 1 second.....	7-9
Table 7.3. Number of conflict-study events occurring on freeways and surface roads (algorithm-C drivers)	7-18
Table 7.4. Means of conflict metrics at braking onset for selected IHP-scenario events	7-23
Table 7.5. Testing ACAS effect on means of peak-conflict levels (algorithm C drivers)...	7-24
Table 7.6. Steering associated with imminent-alert events (excluding host-initiated steering).....	7-34
Table 7.7. Driving scenarios associated with FCW imminent-alert events with driver steering (manual driving, algorithm-C)	7-34
Table 7.8. FCW imminent alert events with apparently-startled driver response (algorithm C).....	7-40
Table 7.9. Selected criteria for analyst’s ratings of alert safety value	7-46
Table 7.10. Analyst’s rating of utility of FCW alerts from a sample of 65 algorithm-C alerts.....	7-46
Table 7.11. Comparing results of driver’s utility ratings and an analyst’s safety judgments for 51 FCW alert events	7-48
Table 7.12 Counts of exposure clips reviewed by gender	7-50
Table 7.13 Counts of exposure clips reviewed by age group	7-50
Table 7.14 Counts of exposure clips reviewed by gender and age group.....	7-50
Table 7.15 Counts of clips containing secondary behaviors by driver gender and age group during week 1 (ACAS disabled and no conventional cruise control in use).....	7-51
Table 7.16 – Counts of clips containing secondary behaviors by driver gender and age group during weeks 2-4 (ACAS enabled but no adaptive cruise control in use)...	7-53
Table 7.17 Counts of exposure clips containing secondary behaviors by week 1-4 (disengaged).....	7-54
Table 7.18. Imminent-alert clips containing secondary behaviors by week and cruise control engagement.....	7-56
Table 7.19. Imminent-alert clips containing secondary behaviors by age group	7-57
Table 7.20. Imminent-alert clips containing secondary behaviors by gender	7-57
Table 7.21. Imminent-alert clips containing secondary behaviors by gender and age group.....	7-58
Table 7.22. Imminent-alert clips containing secondary behaviors by conflict scenario.....	7-59
Table 7.23. Secondary behaviors observed during commutes by week	7-60
Table 7.24. Post-drive questionnaire differences by age for FCW (Algorithm C).....	7-66
Table 7.25. Post-drive questionnaire differences for FCW of age-by-gender (Algorithm C).....	7-68
Table 7.26. Total variance explained by each factor	7-69
Table 7.27. Take-home-questionnaire differences across age for FCW (Algorithm C).....	7-75

Table 7.28. Total variance explained by each factor	7-76
Table 7.29. Mean ratings of alert utility by scenario type and precipitator	7-83
Table 7.30 Predictive values of driver age on FCW acceptance	7-101
Table 7.31 Predictive values of the DBQ violation scores on FCW acceptance	7-108
Table 7.32. Predictive values of the DSQ planning scores on FCW acceptance.....	7-109
Table 7.33. Predictive values of the DSQ social resistance scores on FCW acceptance	7-110
Table 7.34. Predictive values of the DSQ focus scores on FCW acceptance.....	7-110
Table 7.35. Predictive values of the DSQ speed scores on FCW acceptance	7-111
Table 8.1. Overall summary table for throttle-override intrusions	8-11
Table 8.2. Summary table of acc reverse cut-in events	8-18
Table 8.3. Summary table of flying pass with ACC engaged.....	8-26
Table 8.4. High-level summary of CIPV durations when driving on freeways	8-27
Table 8.5. Mileages supporting analyses that relate lane position to control mode	8-40
Table 8.6. Summary table for ACC	8-46
Table 8.7. Counts of secondary task activity seen during CCC and ACC driving.....	8-56
Table 8.8. Driver's secondary task activity in all three alternative control modes.....	8-57
Table 8.9. Summary table of ACC braking intervention, case 1	8-60
Table 8.10. Summary table for ACC brake interventions, case-2 in medium traffic only ..	8-62
Table 8.11. Summary table of cases of the limit-autobraking response by ACC	8-76
Table 8.12. ACC utilization and 0.3-g events on freeways	8-80
Table 8.13. ACC utilization and 0.3-g events on surface roads	8-80
Table 8.14. ACC's 0.3-g autobraking events by traffic density	8-81
Table 8.15. Summary from studying owner's manual precautions using FOT data	8-83
Table 8.16. Post-drive questionnaire differences across age for ACC	8-89
Table 8.17. Post-drive questionnaire differences across age x gender for ACC	8-90
Table 8.18. Take-home questionnaire ranking mean differences across age for ACC.....	8-93
Table 8.19. Effect of gender on cruise usage by week	8-107
Table 8.20. Mean number of adjustments to a particular headway setting by week ..	8-112
Table 8.21. Mean number of adjustments to a particular setting across weeks on limited access roads.....	8-117
Table 8.22. Predictive values of driver age on ACC acceptance.....	8-121
Table 8.23. Predictive values of DSQ planning scale scores on ACC acceptance.....	8-122
Table 8.24. Predictive values of DSQ social resistance scale scores on ACC acceptance	8-123
Table 8.25. Predictive values of DSQ speed scale scores on ACC acceptance.....	8-124
Table 8.26. Predictive values of DSQ deviance scale scores on ACC acceptance.....	8-124
Table 8.27. Predictive values of DBQ error scale scores on ACC acceptance.....	8-125
Table 8.28. Predictive values of DBQ violation scale scores on ACC acceptance	8-125
Table 9.1. Differences between DBQ subscale scores by algorithm.....	9-2
Table 9.2. Differences between DSQ subscale scores by algorithm	9-3
Table 9.4. Differences between algorithms for specific take-home FCW questions.....	9-7
Table 9.5. Differences between algorithms for specific post-drive ACC questions.....	9-9
Table 9.6. Differences between algorithms for specific take-home ACC questions....	9-10

Executive Summary

Overview of the ACAS FOT Project and Key Findings

The Automotive Collision Avoidance System Field Operational Test (ACAS FOT) has exposed a fleet of ten specially-equipped Buick LeSabre passenger cars to 12 months of naturalistic driving by laypersons recruited from the general driving population in Southeastern Michigan. The ACAS system that was installed on each car included both a Forward Crash Warning (FCW) system and an Adaptive Cruise Control (ACC) system. Both of these systems are supported by a forward-looking radar device, plus several other sensing, actuating, and threat-prediction features.

The goal of the FOT was to examine the suitability of the ACAS system for widespread deployment, from the dual perspectives of driving safety and driver acceptance. Since both aspects of evaluation involve tremendously complex interactions between the driver, vehicle, and roadway/traffic elements of the driving process, the requirement for naturalistic testing was considered appropriate. As expected, given the limited driving exposure involved, no crashes occurred in the FOT.

The FCW system is intended to warn the driver of an emerging conflict that could lead to a rear-end crash. On the one hand, a small set of incidents did occur during the FOT in which the FCW alert may well have helped the driver in avoiding a crash. Each of these involved an initial state of apparent distraction or misjudgment of the situation and culminated in a corrective response by the driver. On the other hand, the majority of alerts were perceived by the driver to have been either unnecessary or something of a nuisance. Accordingly, driver ratings of FCW acceptance were mixed, showing a guarded degree of acceptance of the system.

The ACC system constitutes an enhancement to conventional cruise control. In addition to controlling speed at the so-called set-speed value selected by the driver, the system also automatically manages the distance to a preceding vehicle. The ACC system performed very well in the field test and received high acceptance ratings by most participants. The consistent performance of the ACC system was seen to be effective in managing almost all conflicts, thereby enabling extended periods of engagement without the need for driver intervention. Although drivers used ACC prudently with respect to many of the details of its operation, an initially-high rate of ACC usage on surface roads did give rise to conflicts until drivers adapted their behavior to effectively moderate the risk.

The development and fabrication of the ACAS system was led by the General Motors Corporation in partnership with the Delphi Corporation. The project was operated under a cooperative agreement with the United States Department of Transportation. GM and Delphi conducted an extensive program of engineering tests and evaluations throughout the development process, following which the University of Michigan Transportation Research Institute (UMTRI) executed several stages of pilot testing with lay drivers that led up to the year-long FOT that is reported here. Each vehicle in the FOT fleet was equipped with UMTRI's on-board data acquisition system, yielding a large archival database that has been analyzed to determine the suitability of ACAS in terms of driving safety and driver-acceptance. The database is believed to have long-term value for the study of the driving process.

The scope of the field test was such that 96 individuals who had been recruited from the general driving population completed a prescribed period of naturalistic driving. A total of 81 persons drove a total of four weeks and an additional 15 persons drove for three weeks during an algorithm-refinement stage of testing (see below.) In all cases, the participant was simply asked to use the ACAS vehicle as their personal car.

Participants were sampled in three age bands, with equal numbers of men and women in their 20s, 40s, and 60s. In the first week of driving by any participant, the vehicle operated in a baseline mode corresponding simply to the production version of the 2002 Buick LeSabre. The first week of a person's driving thereby provided a reference data sample against which to later evaluate driving with ACAS enabled. After the baseline period, the vehicle switched over automatically to the ACAS functionality, as anticipated by the driver based upon instructions that were provided by a researcher when the vehicle was picked up.

While testing the first 15 drivers in the FOT, it was determined that changes were needed to better calibrate the FCW algorithm to the context of naturalistic driving and improve FCW system acceptance. In the end, three versions of the FCW algorithm (termed A, B, and C) were subjected to FOT driving. This summary addresses the most mature version of the system (algorithm C), which was experienced by a total of 66 persons.

The remaining portion of the executive summary is structured in four parts that expand upon this overview. Firstly, the ACAS functions are briefly described. Secondly, a summary is presented of the test operation, itself, and the general success attained in data collection. Next, the scope of the test exposure is summarized to show how the test miles were distributed across the different factors that strongly influence the resulting

data. Finally, for both of the respective FCW and ACC subsystems, the results are discussed in terms of their potential impacts on driver acceptance and driving safety.

Functionality of the ACAS FCW and ACC Systems Evaluated

The FCW and ACC functions both draw upon the same basic sensing and processing elements and employ a head-up display (HUD) that projects images low on the windshield, with a focal plane at the distance of the front bumper, to show the related FCW and ACC information to the driver. Both subsystems also provide the driver with steering-wheel buttons for adjusting the system to personal preference—permitting the driver to vary either the sensitivity level by which a cautionary stage of FCW warning is displayed or the desired gap-setting by which the ACC system controls headway following time. Both subsystems have identical rules for alerting the driver to the threat posed by a stationary object and different rules for alerting to the threat of what is termed a “movable” target (i.e., a moving vehicle or one that was previously seen by radar to have been moving but is currently stopped). The ACC system employs only the movable-target detections when controlling headway to a preceding vehicle. In any case, it is salient to distinguish the FCW alerts that occur during manual driving from the alerts that occur during ACC driving, the former of which constitute the great majority of all alert activity actually experienced during the FOT.

The FCW function provides visual warnings when following within a driver-adjustable headway time, when following very closely (tailgating), or when approaching a vehicle too rapidly (closing). For closing situations, a final imminent alert consists of both a flashing visual display and an auditory warning. In contrast to cautionary alerts, the timing of the imminent alert is not adjustable by the driver.

The ACC function is primarily that of a speed-and-headway controller, once this subsystem has been engaged. The controller modulates speed at or near the driver-adjusted set-speed value and employs the throttle and brakes to manage the driver-adjusted gap, or headway following time, behind the preceding vehicle. The maximum braking authority of the ACC controller is 0.3g. Any headway conflict calling for the full, 0.3g, braking response of the ACC system triggers an imminent alert. Because the ACC system is tuned to provide smooth control that minimizes jerk, the 0.3-g braking level is never applied by means of an abrupt step in deceleration. The lack of tight, instantaneous control over headway is intentional, seeking to ensure both driver comfort and a readiness to take over in the case of a quickly-rising threat.

Figure 1 below shows the layout of the HUD. Vehicle speed is at the upper left. System status and the level of FCW sensitivity (or ACC gap-setting, not shown) appear as the car-following icons at the lower right. Vehicle-detected and collision-warning icons are displayed at the upper right. (At times, the HUD displays additional information not shown in the figure, such as ACC set speeds and text alerting the driver to conditions when ACAS is not functioning normally.)

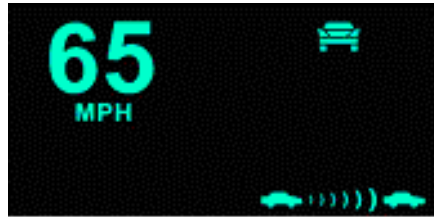

Figure 1. Head up display configuration

The sequence of icons for the FCW alert is shown in the figure below. On the left, the small blue-green icon representing the back end of a vehicle is displayed when the system determines that there is a vehicle in the host vehicle's path. If the degree of conflict with this obstacle is growing, the icon turns to an amber color and grows in size, providing a looming image to help prompt the driver's response. If the driver does not respond and the host vehicle continues to approach the obstacle, the icon progresses to the imminent-alert icon at the far right. The red vehicle icon flashes with a yellow crash symbol overlaid. When the imminent alert condition involves a closing situation, an audio beeping accompanies the flashing icon. For an extreme tailgating situation, the red and yellow alert icon flashes but no beeping occurs. FCW alerts are suppressed while, and shortly after, the driver applies the brakes. FCW is also not available below a minimum speed of 20 or 25 mph, depending upon whether speed is going down or up, respectively.

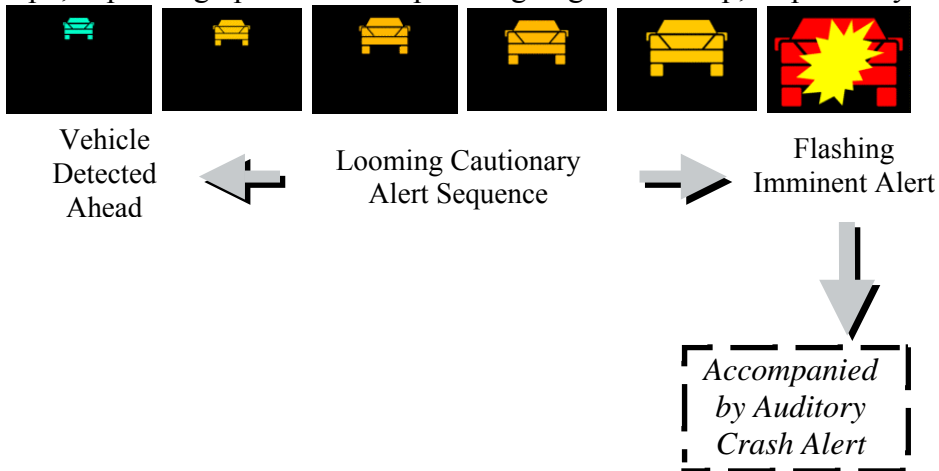

Figure 2. Visual crash alert icons

The Field Operational Test Methodology

The ACAS FOT was broadly successful both in terms of fielding a reliable test vehicle and recovering the desired data. Of the 96 individual drivers who were given an ACAS vehicle and launched as FOT subjects, all successfully completed the multi-week term of the driving assignment. In 13 cases, some problem with a deployed vehicle was resolved by substituting a replacement car for the faulty one in the field.

Measured against the designed scope of the FOT, 94% of the intended data was successfully collected and compiled into a relational database. The resulting database of engineering variables is 164 GB in volume and contains up to 400 engineering variables that were sampled at 10-Hz, as well as subjective assessments. The companion set of video files is fully synchronized with the quantitative database.

The video record was derived from forward-looking- and driver's-face-oriented cameras. The forward scene was recorded on a continuous basis at 1 Hz while the driver's face was sampled at 5 Hz for 4 seconds every 5 minutes. When an ACAS-alert event occurred, the forward and face-oriented cameras were recorded at 10Hz over an 8-second window that straddled the moment of alert-onset.

Subjective data were collected using several questionnaires as well as an interactive debriefing that was done on the day the car was returned from the field by a participant. The live debriefing involved a replay of approximately a dozen alert events, as seen through the forward- and face-looking cameras. Subjects were asked to rate each of the selected alerts, given their own recollection and observation of the driving circumstances in which the alert occurred. Later, four focus groups were held, each gathering several individuals for a structured discussion and evaluation of their ACAS-driving experience.

Overall Scope of ACAS FOT Exposure

Over the twelve-month period of testing, the vehicle fleet covered 137,000 miles. Of that amount, 101,000 miles were traveled with the ACAS system in its algorithm-C configuration from which the principal findings of the FOT have been drawn. The mean trip-length was 12 miles, although many trips were shorter than one mile in length and a few exceeded a hundred miles. The average total distance driven by a subject was 1500 miles, of which 1200 miles was in the ACAS-enabled state.

On average, the primary exposure variables were rather well-balanced between the baseline and the ACAS-enabled periods. This is an important fact supporting the many FOT analyses in which the baseline data from the first week of driving are used as a

reference for evaluating the ACAS data from the subsequent three weeks of driving.

Among the various factors of test exposure, the following is worthy of note:

- Males and females traveled almost equal total distances.
- The older age group traveled 38% of the total miles, versus 31% each for both the younger and middle-aged groups.
- Roughly 50% of travel was on freeways, 50% on surface roads.
- Roughly 75% of travel was in well-lit conditions, 25% in dark.
- Roughly 10% of travel was with windshield wipers on, 90% with wipers off.
- Roughly 40% of travel was in sparse traffic, 45% in medium, 15% in dense.

The above exposure summary indicates that several significant driving conditions did vary across the FOT. What is not portrayed in these aggregate numbers is that individual drivers tend to differ significantly from one another by the peculiar distributions of the miles that they travel, especially with respect to the road type, traffic density, and the light/dark conditions that prevail. Since the individuals also differ greatly in the total distances they cover, it has been necessary to perform statistical analyses on the objective FOT data in ways that prevent the particular exposure patterns of the high-mileage individuals from unduly skewing the results. In analysis areas where the data are sparse, altogether, some degree of ambiguity from such effects is unavoidable. Where the data volumes are higher, however, other kinds of analysis can remove the undue weighting that otherwise occurs from large differences in total driving exposure.

Of the 101,000 miles traveled in the algorithm-C portion of the FOT, 78,000 miles were traveled during the weeks in which the ACAS system was enabled. The ACAS-enabled miles were distributed such that 63% of the driving was under manual control and 37% was under ACC control. As suggested above, many aspects of the FOT results are tracked according to the manual versus ACC modes of driving because the outcomes are strongly differentiated by the functional expressions of the system that prevail in each. Since ACC driving is more prevalent in less-conflicted driving conditions, such as freeway environments and light traffic, manual driving (and the FCW function that applies to the manual mode of control) becomes exposed to what is the more conflicted end of the spectrum of traffic densities and road types.

Apparent Driver Experimentation with the System

Most drivers, when asked, acknowledged having experimented with the ACAS system to some degree. While they had been asked to limit their experimentation to the first few days after the ACAS system first became enabled, there were nonetheless instances in

which drivers appeared to “probe” the functionality over a longer period, presumably in order to better understand its capabilities and limitations. The data indicate that during the first week of FCW availability, there was a short-lived but substantial jump in the rate of imminent alerts associated with the most obvious forward conflicts—those involving a vehicle ahead in the same lane—which strongly suggests experimentation with the FCW system. In none of these cases did the experimentation seem patently unsafe. Instead, it was often the case that drivers reporting probing the system unsuccessfully by tailgating—a maneuver that will not, in fact, trigger an imminent alert sound.

The ACC system was used on surface streets during the first and second week of its availability in such a way that a distinctly-higher incidence of limit-autobraking by the ACC controller was observed, although this kind of ACC driving activity had greatly subsided by the third week of system usage. In addition, several instances of experimentation were noted when drivers were attempting to demonstrate the functionality to passengers. Drivers reported having had ample opportunity to explore the ranges of FCW and ACC settings such that the rate of variation in setting had also subsided substantially by the third week of system availability.

The Issue of Large Individual Differences

The first principle that connects driver attributes to the FOT results is that differences between individuals tend to have the largest influence among all factors that are identified in the data. This is not to say that important influences of the ACAS system, itself, were not seen in the test data, but rather that such influences are embedded within the tremendous importance of individual effects. Among the factors by which individual drivers affect the FOT data, the principle influences are believed to result from the combination of 1) the relative assertiveness of the person’s driving style, 2) the mileage traveled by the individual during the FOT (especially the corresponding mileage exposures to FCW and ACC functionality), and 3) the distribution of road types and traffic conditions that establish the ‘conflict potential’ of the particular environments within which the individual traveled. Extensive use has been made of statistical techniques to minimize bias in the FOT findings that might derive from the differences that accompany individuals. Nonetheless, such differences have tended to limit the range of findings that can be stated with high statistical confidence.

Introduction to Results from the ACAS FOT

The FOT results are organized and presented below according to the respective FCW and ACC subsystems, using several themes and situational issues that are pertinent to the

respective functions that are involved. For each of the subsystems, the summary of FOT results begins by describing the conditions and extent to which the function was manifest to the test drivers and how they interacted with the individual features of the system. While the first level of interaction involved driver adjustment of the ACAS system, the more complex interactions lie in the specific maneuvering activities by which drivers tended to cultivate and/or respond to an ACAS warning or control function. When considering the details of such interaction, potential implications for driving safety and driver acceptance are highlighted.

The principal safety inferences are drawn from analyzing the objective data and the answers that drivers gave when asked about their perceptions of safety. The assessment of driver acceptance comes overwhelmingly from questionnaire responses, although focus-group sessions have added a degree of clarity in seeking to explain the apparent viewpoint lying behind driver responses.

In general, results were deemed worthy of inclusion in this executive summary wherever it is believed that they relate to the long-term potential for FCW and ACC functions as automotive products.

Results Addressing Forward Crash Warning

FCW-related results are presented under 11 different sub-headings and then summarized in a brief statement of the key findings.

Conditions Under Which FCW Was Experienced

In the 49,000 miles that were driven in the manual mode during the Algorithm-C portion of the field test, some stage of the cautionary alert was present approximately 9% of the FCW-available driving time over a speed of 25 mph although only the first three stages of the four looming-image icons were commonly encountered. Noting that driver's could adjust the sensitivity of the cautionary alert even to a lowest setting that suppresses cautionary icons altogether, it is notable that many drivers retained sensitivity settings that yielded cautionary alerts so frequently.

The total rate of exposure to cautionary alerts varied greatly among drivers, with 57% of the drivers receiving cautionary icons less than 7.5% of the driving time over 25 mph, and 20% of drivers receiving them more than 20% of the driving time over 25 mph. Cautionary alerts occurred far more frequently when the driver had adjusted the FCW system to its most sensitive settings, although this result is also conditioned by the combinations of driving style, traffic environment, and sensitivity settings for the

individual. The overwhelming majority of cautionary alerts are associated with following within the driver-adjustable headway time, with less than 2% of the cautionary alert time due to closing situations or tailgating.

Overall, imminent FCW alerts were encountered at a rate of 1.1 alerts per 100 miles for drivers using Algorithm C, but the alert rate varies greatly by the manual vs. ACC control mode of driving. Thus, the typical FOT participant experienced a total of about 10 imminent alerts, given the average exposure of 1200 miles of driving during the three weeks that ACAS was enabled. Imminent alerts appeared at a rate of 1.44 per 100 miles in manual driving and 0.38 per 100 miles in ACC driving. The lower alert rate in ACC driving may reflect in part the higher use of ACC in the less-conflicted freeway environments as well as the ability of the ACC controller, to manage headway time, further reducing the likelihood of forward conflicts (note that the ACC-related issues are the focus of a later section in this executive summary.) Approximately 40% of the imminent-alert events involved a stationary object that did not actually lie in the path of the host vehicle.

Results showed that the imminent alert rate for drivers using Algorithm C:

- varied greatly across individuals, from 0.08/100 miles to 4.34/100 miles;
- was six times higher on surface roads than freeways;
- was 20% higher when freeway traffic was heavy rather than sparse.

Driving scenarios were defined as a means of breaking down imminent alert events according to the relationship between the object triggering the alert and the actual path of the host vehicle. The scenarios included, for example, following behind a vehicle that brakes while remaining in the same lane as the host, approaching a vehicle as a prelude to passing it, approaching a vehicle that is braking to turn out of the host's lane, and so forth. These scenarios have been, in turn, grouped into categories that provide a useful overview of the distribution of imminent alerts in manual driving. The imminent alerts break down according to the following scenarios:

1. stationary target that is never in the host's path (36%)
2. moving vehicle that is in the same lane as the host at some point in the approach episode, and is in a different lane at other times in the episode (32%)
3. moving vehicle that is always in the same lane as the host during the approach episode (27%)
4. moving vehicle that is never in the host's path (3%)
5. moving vehicle that crosses more-or-less normal to the host's path (2%)
6. other, including a stopped vehicle in the same lane as the host (less than 1%)

Examples of the scenarios in the second item above include a host passing maneuver and, most commonly, a lead vehicle turning left or right. As this breakdown implies, any critique of the FCW function unavoidably encounters the complex temporal/spatial domain of inter-vehicle conflict. That is, the way that vehicles are actually driven in proximity to one another reflects the driver expectations of how each conflict is about to be resolved (and, thus, how much utility might be attributed to an alert, given these expectations.)

Usage of FCW Sensitivity Settings

Drivers made liberal use of the full range of six FCW sensitivity settings available for varying the extent of presentation of cautionary icons. Approximately the same nominal amount of driving was done in the least-sensitive setting, the two middle ones, and the most sensitive one. Basically the younger drivers preferred low sensitivity settings and the older drivers preferred the high end of the sensitivity range. Women were seen to use the two lowest-sensitivity settings twice as often as men. This, along with ACC utilization rates discussed above, may suggest that men seek more interaction with the system than women.

The FCW sensitivity adjustment was also changed rather frequently from one setting to the next by most participants in the field test, with the typical individual making thirty choices over the three weeks of ACAS-enabled driving. One individual made only three changes in adjustment while another changed it 92 times. On average, the sensitivity was adjusted two or three times during every hour of driving. Such adjustment activity was more than two times as frequent during the first week of ACAS-enabled driving than in the following two weeks, suggesting a period of acclimation to the FCW function and to the preferred adjustment setting. Those who preferred sensitivity values around the top-two setting values were about twice as active in varying the sensitivity level as those who preferred the low-sensitivity zone around the bottom-two settings. Males were considerably more active in making sensitivity adjustments than were females.

Discrimination of Alerts by Moving versus Stationary Lead Vehicles

The majority of imminent FCW alerts were either triggered by stationary, non-vehicle objects, such as signs, mailboxes, and overpasses, or occurred in traffic situations in which the forward conflict with a moving vehicle was ultimately resolved by lateral motions of the vehicles. In most of these situations, drivers generally perceived the alert to be a nuisance and did not rate it as having a positive utility.

There were a minority of the alerts, however, in which the scenario type rendered the alert more compelling for assisting drivers in avoiding rear-end crashes. This group involved the host vehicle approaching a slower vehicle in its lane or one that was decelerating in the same lane such that the host driver needed to apply brakes in order to resolve the developing conflict. These events led to 27% of all imminent alerts, and in these alert events, drivers responded with braking 88% of the time. These were also rated by drivers as the most useful type of alerts.

Only one case in manual driving was found where an imminent alert was provided for a vehicle that had been stopped in the lane ahead during the entire episode (and had never before been observed to move.) The most common situation in which the FCW could conceivably address a potential stopped-lead-vehicle crash is when the imminent alert sounds while the lead vehicle is still moving but is decelerating. In this stereotypical crash-threat scenario, the lead vehicle often would have been stopped by the time an inattentive driver, without FCW, would have impacted the vehicle. Clearly, this function can be covered without the need to alert on stationary targets, since the target can be detected while still moving.

FOT results make it clear, however, that FCW system effectiveness was compromised by its marginal fidelity in issuing an alert for the rare case of a genuine threat from an in-path, stationary vehicle that has never been observed to have moved. In the FOT, less than 1% of all alerts corresponded to this case. The impact of this design requirement on the FCW system performance was that 36% of all alerts in the FOT were of the nuisance type that became triggered by non-threatening, stationary targets. The tradeoff in designing FCW to manage the stationary-target threat is further complicated by the desire to maintain a simple mental model of functionality, (i.e., where it is simpler to conceive the function if the FCW system responds to both moving and stationary vehicles) as another factor impacting driver acceptance of FCW. (On the other hand, if FCW were to be combined with any of the current ACC products that ignore the always-stationary object, the simplest mental model would require that both functions ignore such objects.)

In any case, since drivers became quite aware that FCW alerts often occurred in situations in which braking was not required, they certainly did not brake reflexively to imminent FCW alerts. Braking occurred in 88% of shared-lane situations, but only 30% of situations in which lane changes or turns constitute the common means of resolving the conflict.

Effects of FCW on Following (or Headway-Keeping) Behavior

The ability of FCW to reduce the number and severity of rear-end crashes was examined through the use of surrogate metrics, with emphasis given on identifying changes in driving patterns that occurred with versus without ACAS enabled. The influence of FCW on headway time margins was selected as a central portion of such examination because an increase in headway could provide a driver with additional time to react to an event ahead. When ACAS is enabled, headway time is found to increase by statistically significant amounts during periods of quasi-steady-state vehicle-following. Across the 66 drivers, the average fraction of time spent following at less than 1-second headway times constituted 30% of all vehicle-following time during the baseline week, but only 25.5% when ACAS was enabled. Statistically-significant reductions in following were seen from headways ranging from 0.4 to 1.6 seconds.

More specifically, significant effects of FCW on headway times were found in two conditions. In daytime conditions, the average percentage of time under 1-second headway was reduced approximately 13% (from an average percentile value of 30% to approximately 26%) under manual driving with FCW available. Second, longer headways were found to occur while driving manually on limited-access roads with FCW available. For this case, the average time under 1-second headway changed with a magnitude similar to that seen in daytime conditions.

Two possible mechanisms that may explain the observed increase in headways with ACAS enabled are (1) an influence of the FCW cautionary alerts, which are predominately headway-based, and/or (2) an increase in driver awareness of headway times when driving. It is possible that the combined exposure to FCW and ACC may have caused some drivers to increase their headway during manual driving with FCW support. The influence of cautionary alerts was studied, and there was a significant effect of ACAS on influencing middle-aged drivers to reduce the frequency of prolonged-following events (i.e., a scenario that is addressed by cautionary alerts.) However, this difference was seen to erode over time. Therefore, the observed headway-distance effect appears more likely to be due to a more general awareness of headway fostered by the ACAS system.

Effects of FCW on Closing-Type (or Approach) Behavior

ACAS does not appear to change the frequency or the magnitude of approach (or closing-type) conflicts that drivers experience in manual driving, regardless of the conflict metric employed. This is examined in parallel using two data sets: the set of imminent alert events, and a set of 44,827 conflict-study events in which forward conflict metrics exceed

a modest threshold. The rate of events in which the imminent alert criteria is satisfied provides a straightforward measure of drivers' experience of forward conflicts. The alert rate was not affected by the availability of ACAS, except for a short-lived jump in alert events when the system first becomes available. This is presumably due to drivers' experimentation with the system. In addition, ACAS does not affect the types of scenarios in which these imminent alert events occur.

The conflict-study events were sampled in a way that was independent of the FCW computations. Results showed that the availability of FCW did not change the rate of such conflict events, nor did it affect the fraction of the events that were identified as same-lane situations. In addition, the peak conflict levels associated with these conflicts were not affected by ACAS. Overall, approach-conflict levels appear unaffected by FCW in the manual driving mode.

Overall, there is no compelling evidence that ACAS influences the way drivers manage the closing-type conflicts with preceding traffic, but instead they appear to adjust their following distances to allow extra distance on limited-access roads, and during daytime.

Effects of FCW on Braking Behavior

There was no statistically-significant evidence indicating that FCW induced a change in driver-braking response to conflict. Given several metrics for defining and scaling conflicts, driver response-to-conflict during baseline manual driving were compared with responses that occurred following an FCW alert, for commonly-scaled conflicts. Although many analyses were conducted to search for such changes, only secondary effects were seen. Results showed no significant changes in either the frequency of driver braking, conflict levels at the time of brake onset, or the time that elapsed from alert onset to brake onset.

When FCW became available, a decrease was seen in the magnitude of speed changes that occurred within the first two seconds after alert-level conflicts in manual driving. However, when the larger set of 44,000 events constituting the conflict study set were analyzed, there was no change in the rate of braking, nor in the ultimate conflict level.

Effect of FCW on Secondary-Task Behavior

One context in which drivers can be said to have interacted with the ACAS-equipped vehicle involved the liberty that they took to indulge in so-called "secondary-task behaviors", for example, brushing one's hair, eating, and talking on a cell phone, while driving. A review of video images showed that the rate of secondary-task behaviors

during manual driving had only a slight degree of variation over the four-week period, with no statistically-significant difference between week 1 (18%) and weeks 2 – 4 (19%).

Overall, there was no significant relationship observed between the occurrence of FCW alerts and secondary-task behavior, although a slight increase was observed in the first week of ACAS-enabled driving during which drivers appeared to be conversing more frequently with passengers (perhaps regarding the FCW system.) Other than the conversations with passengers, which are hypothesized to be associated with the novelty of the ACAS system, the pattern and frequency of other common secondary-task behaviors (e.g., talking on a cell phone) did not change while ACAS was enabled, except for a slight drop in such behaviors that was observed in the final two weeks of exposure.

Identification of FCW Alerts with Safety Potential

Several specific events were identified in which an FCW alert appeared to assist drivers. In order to search for such evidence, a set of 65 candidate events were identified for inspection. Candidate events were those in which a driver received an imminent alert and at least one of the following criteria held as well:

1. the driver's eyes were not on the driving task at the time of the alert,
2. the driver's face appeared to show a startled expression following the alert,
3. the braking level reached at least 0.4 g within three seconds after the alert, or
4. drivers chose to steer in response to the alert (indicating a possible urgency in response).

Of the 65 candidate events, 13 were identified where the imminent alert was considered to be valuable because it was associated with one or more of the criteria above. Although the statistics on rear-end crashes suggest that it is very unlikely that all of these events would have precipitated a crash without the FCW system, the events nevertheless demonstrate that the FCW system did have an alerting capability that appears to have assisted at least some drivers in some circumstances.

In contrast, only 1 out of 240 stationary-target alerts was observed to involve a true, in-path vehicular target for which the alert was kinematically justified—and this single event did not qualify among the set of 65 candidates, above. Thus, none of the stationary-target alerts was seen as credible, in the sense of safety-potential as discussed here.

Perceived Safety and Driver Acceptance of FCW

In terms of the perceived safety of the FCW system, the results were somewhat mixed. While the majority of drivers acknowledged some safety benefits associated with FCW,

most, aside from the majority of older drivers, felt that they themselves did not need the system—yet could think of others who did. There were numerous instances in either debriefing or focus groups where drivers would report that *they* did not need to receive imminent warnings, as they were attentive drivers, but that they could see where the FCW system would be good for *others*. In particular, young and old drivers were frequently mentioned as those that might benefit most, although typically by the opposing age group. The relative infrequency of a true, rear-end crash threat was cited several times in the focus groups as being of concern, as the possibility existed for drivers to become insensitive to imminent alerts if the frequency of false alerts was too high. Nonetheless, a number of drivers in the focus groups stated that the FCW system made them more cognizant of the surrounding traffic conditions—even to the degree that they drove more conservatively than normal in order to avoid imminent alerts or because they recognized that their driving was being examined as part of the study. This was supported by questionnaire results in which the majority of drivers stated that they drove at least as safely with the system as compared with their normal driving behavior. However, when asked if they believed that an FCW system would increase their driving safety, approximately 1/3 either disagreed or were neutral on the matter (mean rating of 4.6 on a 7-point scale). Lastly, several drivers, mostly from the older group, stated that the system reaffirmed their beliefs in what constitutes “safe” driving. They felt that an infrequent occurrence of imminent alerts meant they must be a good driver. However, there were no strong relationships between objective measures (i.e., frequency of alerts) and the subjective perceptions of FCW system safety.

In terms of the perceptions that were indicative of driver acceptance, most drivers saw some limited benefit in the FCW system, but primarily for drivers other than themselves. Drivers frequently commented that they received more FCW alerts than they believed were necessary and that the additional alerts were deemed to be nuisances or false alarms. This point of view seemed to contribute significantly to the negative ratings of the usefulness of the FCW system. Nevertheless, 45% of the FOT subjects indicated that they *probably* or *definitely would* purchase FCW if they were purchasing a new car today.

Predicting FCW Acceptance

FCW acceptance differed among drivers due largely to age rather than gender. The majority of age effects were constituted in the dissociations between older drivers’ ratings of FCW and their middle-age and younger counterparts. In general, the obtained age differences resulted in older drivers viewing the FCW system more favorably than either the middle-age or younger driving groups. Consistent with the value they ascribed to the

FCW system, older drivers selected the most-sensitive setting significantly more frequently than did either the younger and middle-aged drivers.

Suggested Modifications of the FCW System

The FOT participants had a wide variety of suggestions for improving the FCW system in behalf of driver acceptance. The two statements most frequently associated with FCW system attributes that needed improvement were first, reduce the frequency of nuisance and false alarms, and second, to provide a means to permit the FCW system to be turned off in certain types of traffic conditions.

Some drivers were interested in having the system be more readily adjustable. Some commented that they wanted the freedom to choose from a variety of warning beeps, the colors and types of the icons displayed on the HUD, to turn off the cautionary alerts and perhaps the system altogether, and to adjust for different driving environments (i.e., city verses freeway driving). One suggestion was that the driver might be allowed to indicate to the system what they deemed to be a false alarm after one was experienced, allowing the system to more readily adapt to their personal driving style. Drivers also wanted FCW to work in poor weather conditions, as this is when many thought the concept could be most helpful (the ACAS system was disabled upon use of the highest setting of wipers). Other suggestions included having the system functional at lower speeds (below 25mph) and having the system detect targets such as pedestrians or deer.

In terms of an objective appraisal of all the FCW data from the FOT, the most compelling change for improving the system, given the current state of the technology, would be the elimination of stationary-target alerts, while still retaining the potential to warn on a ‘movable’ object that may have stopped in the vehicle’s path.

Summary of Key FCW Results Pertaining to Driving Safety and Driver Acceptance

Results from analysis of the FCW-related data showed that:

- ◇ Driver response to the ACAS FCW system was mixed. Older drivers were more likely to view the system favorably, and middle-age drivers the least likely. Most drivers saw some limited benefit associated with the FCW system, but typically reported that the benefit would be greater for drivers other than themselves.
- ◇ After experiencing the FCW feature for three weeks, most of the FOT subjects were not willing to purchase such a system at a \$1000 cost.
- ◇ The most important factor influencing the frequency and conditions in which individual drivers experienced alerts were the individual driver themselves,

with the type of road (and therefore, traffic dynamics) being the second most important factor.

- ◇ Drivers frequently commented that they received more FCW alerts than they believed were truly necessary, with the additional alerts being deemed as nuisances or false alarms. This seemed to contribute significantly to the negative perceptions of the FCW system.
- ◇ The two statements most frequently associated with FCW system attributes that needed improvement were first, reduce the frequency of nuisance and false alarms, and second, to provide a means to permit the FCW system to be turned off in certain types of traffic conditions.
- ◇ At least 13 situations were identified where FCW appeared to contribute to the driver's proper awareness of a potential rear-end crash, and/or the encouragement of an appropriate, firm braking response to the situation.
- ◇ The headway distances during periods of vehicle-following in manual, daytime driving were also seen to increase on all road types (with no corresponding impact on nighttime driving.)
- ◇ No change in the rate or the severity of conflicts was observed when driving with versus without FCW.
- ◇ No consistent set of results suggested that driver braking responses to conflicts was either positively or negatively affected.
- ◇ A majority of FCW imminent alerts were either false alerts triggered by objects not on the roadway or alerts occurring in scenarios in which the forward conflict is typically resolved through a divergence in the paths of the two vehicles rather than through braking by the host driver. This aspect of system performance appears to have negatively influenced driver acceptance of FCW.
- ◇ The current state of sensor processing leaves FCW operating with much less information than an alert driver has regarding anticipated vehicle movements and the detection of vehicles that are stopped in one's own path. Therefore, the most compelling change for improving the system, given the current state of the technology, would be the elimination of stationary-target alerts while still retaining the potential to warn on a 'movable' object that came to a stop in the vehicle's path.

Results Addressing Adaptive Cruise Control

ACC-related results are presented under 13 different sub-headings and then summarized in a brief statement of the key findings.

Conditions Under Which ACC Was Experienced

The ACC function is, of course, manifest when the driver engages it. Thus the ACC driving experience always traces to the conscious choice made by FOT drivers to turn the system on, given their judgment of the suitability of ACC engagement under the prevailing driving conditions.

The percentage of driving distance over which ACC is engaged is termed the utilization level. It was seen that ACC was utilized in 37% of the total distance driven with ACAS enabled, compared to a 20% utilization of conventional cruise control (CCC) during the baseline week of driving. ACC was utilized more frequently than CCC in all driving conditions, including all the variations in road type, traffic density, and day/night illumination, as well as the wet/dry condition that is deduced by whether the wipers are on or off. On interstate highways, ACC was utilized in 60% of the total distance compared to 37% with CCC. The largest differences seen between CCC and ACC utilization rates occurred under dense traffic conditions and on surface streets, as follows:

- ACC was utilized at 3.5 times the rate of CCC under dense traffic conditions. Presumably because ACC has the remarkable ability to manage headway, thereby relieving the driver of much of the stress imposed by this task, it is perhaps not surprising that ACC would be employed at a higher rate under dense traffic conditions. Since dense traffic also poses the higher likelihood of unstable flow, however, braking interventions lasting 2 seconds or more were employed by the ACC driver three and a half times more frequently than under the medium traffic condition. Thus, the higher rate of ACC use in dense traffic appears to pose a greater requirement upon the driver's readiness to intervene. On the other hand, the data suggest that drivers were attentive to the greater demand for intervention.
- ACC was also utilized at 2.1 times the rate of CCC in the surface-road environment that tends to pose more intense and more frequent conflicts requiring a driver response. Nevertheless, drivers appeared to be adapting their ACC-utilization choices as time went on, since the ACC utilization rate on surface roads declined by a quarter over the three weeks of ACAS usage.

Older males utilized ACC a third more than the younger or middle-aged males, and older females utilized ACC at more than twice the rate of younger or middle-aged

females. Since older drivers, as a total group, also accumulated approximately 15% greater travel mileage, the ACC driving data represents a significantly greater expression of older-driver patterns of behavior. Males in the younger and middle-aged groups used ACC at least 50% more than females of the same age, although female usage of ACC was about 10% above that of males in the older-age group. While older drivers tended to select lower set-speeds and longer gap-settings with ACC relative to their younger counterparts, they experienced higher alert rates with ACC engaged.

As a final observation on ACC usage conditions, approximately 1.5% of ACC driving mileage was traveled on curves whose radii were tight enough to reduce the active range of the radar to less than 100 meters. On the one hand, this constraint does suggest a diminished lead time for providing both the headway control and alert functions during ACC driving. On the other hand, tight-radius geometries are most pronounced on lower-speed roads such that the effects of the diminished range of the ACC radar on curves appear to be largely compensated by the more moderate speeds.

Usage of ACC Set-Speed and Headway-Gap Settings

The ACC system affords a means for adjusting both the cruise set-speed and the preferred time-gap setting to accord with driver preferences under the prevailing road and traffic conditions. Since the ACC system also controls for headway, however, drivers often left the cruise speed set at a level that was above the speed of traffic, thereby depending upon the headway controller to find the speed that is achievable under the prevailing conditions. One notable feature in the ACC set-speed data is that the maximum-adjustable speed, 80 mph, was among the three most-likely values selected by drivers under ACC control, whereas that value was selected one-tenth as much under CCC control. In both ACC and CCC driving, the average set speed values selected over all driving by an individual driver varied widely, from about 50 mph to 78 mph.

The ACC gap setting was adjusted over the whole available range of values in almost the same pattern as was seen in FCW sensitivity adjustments. Of the six values of gap-setting corresponding to headway times of 1.0 seconds to 2.0 seconds in 0.2-second increments, the shortest and longest were almost equally popular, but among different age segments of the driver sample. The younger group was much more likely to prefer the 1.0-second setting and the older group was substantially more likely to prefer the 2.0-second setting. The value of 1.4 second was the next most popular after those two extreme values. The selected gaps tended to be shorter on freeways than on surface roads, with wipers off rather than on, and in dark rather than lighted conditions. This

suggests that drivers adjusted the gap settings in response to conditions, although the dark/light contrast seems counterintuitive.

The ACC gap setting was changed much less frequently by most participants than was the FCW sensitivity level. The typical individual changed the ACC gap setting only on the order of two or three times during the three weeks of ACAS-enabled driving. Males altered the ACC gap setting about twice as frequently as females.

Rate and Conditions Surrounding ACC Alerts/Maximum-Deceleration Braking

As indicated earlier, imminent alerts were presented much less frequently during ACC driving than during manual driving. Of the 0.38 alerts per 100 miles cited earlier for ACC driving, the breakdown by conflict scenario is as follows:

- moving vehicle that is always in the same lane as the host during the approach episode (49%)
- stationary target that is never in the host's path (42%)
- stationary vehicle that is in the host's path (6% of total)
- moving vehicle that is in the same lane as the host at some point in the approach episode, and is in a different lane at other times in the episode (2%)
- other (less than 1%)

ACC alerts are notable in that those listed under the 1st and 3rd bullet, above (i.e., 55% of the total) match the kinematic profile for which the system was designed, compared to approximately 28% for imminent FCW alerts that were generated during manual driving.

The fact that the overall rate of imminent alerts under ACC control is well below that of manual driving is partially explained by the fact that the ACC system is a reliable, continuous controller of the headway variable. Although the rules for generating imminent alerts under manual and ACC driving differ in certain important ways, it is apparent that the great difference in alert rates is primarily the reflection of a relatively conservative strategy for ACC control along with drivers' decisions to employ ACC in generally more benign driving environments.

Another important context for ACC manifesting itself to the driver is in the braking response of its controller. The so-called 'autobraking' response of the ACC system constitutes both a haptic cue to the host driver and a direct action by the controller to address forward conflict. A total of 60 episodes occurred in which the ACC controller reached its nominal 0.3-g deceleration limit, for a rate of approximately once every 200 miles of ACC driving, overall. These incidents showed what appeared to be a distinct novelty effect and took place primarily on surface streets. The rate of limit-autobraking

events in the surface-street environment was approximately once every seventy miles compared to a rate of only once every two-thousand miles of ACC driving on freeways. Drivers appeared to have progressively adopted a more cautious approach toward using the full-autobraking capability of ACC on surface streets, however, since the rate of such events dropped by three quarters over the three weeks of ACAS driving. Similarly, even the more rare but observable incidence of limit-autobraking events on freeways had essentially vanished by the final week of ACAS driving. Extrapolating these data, it would appear that drivers would not tend to depend upon limit-autobraking as a common facet of ACC driving, over the long term.

Effects of ACC on Following (Headway-Keeping) Behavior

ACC driving was generally differentiated from manual and CCC control by the interesting phenomenon of more-sustained following. In freeway driving, where the opportunity for following another vehicle persists for rather long periods of time, it was seen that drivers stayed behind any given preceding vehicle for approximately twice as long when ACC was engaged as occurred when driving in either of the other two control modes. This result aligns well with a focus-group comment by one participant who said, (ACC) “made me able to relax...and let the thing drive.” The evidence for prolonged-following episodes also links to the observation that ACC driving induces the practice of staying in one’s own lane. It is recognized that this practice may well be beneficial for both calming traffic and for reducing the prospect of lane-change crashes.

As can be anticipated simply from the ACC system design, ACC driving is transacted at headway times that are substantially longer than those employed in manual driving under the same conditions. In heavy freeway traffic, for example, ACC driving has one third the prevalence of travel at shorter than 1.0 second headway times than does manual driving. As traffic density reduces, the distribution of headway times under ACC control tends to become more like that of the manual and CCC driving modes, although still lacking in the very-short headway values that arise from tailgating behavior in manual driving.

Effects of ACC on Approach (or Closing-Type) Conflicts

It had been hypothesized that FOT participants would sometimes apply the throttle manually during ACC driving as a means of encroaching upon the preceding vehicle so that, upon throttle release, the automatic ACC control response would be provoked. Such a technique might be used to probe, and thus learn, the full range of the ACC braking response, up to its deceleration limit of 0.3 g. FOT data showed, however, that although

approximately half of the test subjects did, indeed, use the “throttle-override” technique at one time or another to intrude substantially within the selected ACC control gap, no individual ever provoked the full, 0.3 g, braking response of the controller by this means. Several drivers appeared to have employed this tactic as a means of coercing the preceding driver out of the fast lane of the freeway so that the host driver could pass.

Generalizing on the effects of ACC on approach conflicts, the FOT data were analyzed to reveal the ability of the ACC controller to manage approach-type conflicts with the preceding vehicle under both dense and sparse levels of freeway traffic. Results indicate that ACC driving encounters virtually the same distribution of conflicts as in manual driving under dense traffic but is much less likely than the case of manual driving to encounter conflict when the traffic density level is sparse. It appears that the ACC system provides a strategy of control which is rather conservative relative to common manual-control behavior, especially when the host is approaching another vehicle at a substantial overtaking speed. In such cases, the ACC controller decelerates sooner in the approach transient and generally avoids substantial overshoots in headway time.

Effect of ACC on Manual Braking Behavior

ACC driving was examined in order to determine the frequency and severity of manual braking that is applied for intervening upon ACC control. It was seen that the frequency with which the driver applies the service brake is much lower in ACC driving than in either manual or CCC driving under the same driving conditions. Typically, the brake is applied approximately 20 times more frequently per distance traveled in manual driving and 3 times more frequently in CCC driving than when driving under ACC control.

When the driver does apply the brake to intervene upon ACC control, the peak decelerations achieved and the conflict levels prevailing at the moment of brake application were not significantly different from those observed when driver braking occurred in manual driving or as a means of intervening upon CCC control. The fact that the brake was not applied more aggressively when the driver intervened upon ACC control suggests that other drivers following behind the ACC-equipped vehicle encountered little difference in the severity of conflicts posed by ACC braking interventions than were experienced when following either CCC- or manually-controlled vehicles.

Since ACC does not decelerate in response to stationary-type targets, it was of also interest to observe whether drivers would act expeditiously to disengage ACC by means of braking intervention upon encountering an in-path stationary vehicle, under ACC

control. Results showed that stationary and very-slow-moving vehicles were encountered only rarely as an obstacle that provoked ACC disengagement by the driver. While no such cases occurred on freeways, a total of 32 events of this kind took place on surface streets. Since rather little total mileage was traveled on surface streets, the rate of such encounters was relatively high—approximately once every 80 miles of ACC engagement on surface roads. Nevertheless, when manual braking was applied to disengage ACC and resolve conflict posed by such targets, the relatively short values of driver brake-reaction times that were observed suggest that drivers had been reasonably attentive to the threat of these obstacles.

Effect of ACC on Secondary-Task Behavior

ACC driving was examined relative to that of manual- and CCC-driving, to determine the extent of any difference in secondary-task behaviors. It was observed that the rate of secondary-task behaviors in ACC driving was significantly higher than in CCC driving, but not significantly different from that of manual driving. Since the higher incidence of secondary-task behavior with ACC primarily involved the driver conversing with other occupants of the vehicle, it has been hypothesized that the novelty of the ACC system may have stimulated both the situation of driving with occupants present (in order to demonstrate the novel system) and the prospect of a sustained conversation on the matter. The declining rate of such activity from week-2 through week-4 tends support this view.

Sustained Following/Lane-Dwelling, Passing, and Cut-In Behavior

Because ACC driving involves an approximate doubling of the characteristic time that drivers choose to spend following behind any other specific vehicle, ACC driving is sustained for longer periods of time within the same lane, compared to manual driving. The resulting reduction in passing rates suggests that the ACC driver is substantially less exposed to hazards associated with the lane-changing that typically initiates the pull-out-to-pass sequence. The resulting rate of passing other vehicles on freeways under ACC control was about 50% of that seen during manual driving and 70% of the rate under CCC control.

ACC driving was compared to the other control modes for the specific case of the so-called ‘flying-pass’ maneuver (i.e., an overtaking maneuver that is begun by a driver who is approaching at a significant overtaking-speed from directly behind the vehicle that is to be passed.) When the flying pass was conducted during ACC driving, the lane-change phase of the maneuver was initiated at considerably longer range than under manual or CCC control, thus leaving more clearance to the preceding vehicle at the time of crossing

over into the adjacent lane. As a result, the levels of conflict (expressed by time-to-collision) that arise during flying passes in ACC driving are considerably more benign than when driving manually or under CCC control. The practice in ACC driving of pulling out at longer range from the preceding vehicle is believed to reflect the driver's awareness that if the ACC vehicle were to be driven closer before pulling out, the headway controller would activate to slow down the host vehicle. If slowing were to occur while the passing maneuver is underway, it would tend to foil the timing of the maneuver and perhaps provoke conflict with faster-moving traffic in the adjacent lane that is being entered.

The rate of cut-in that occurs ahead of the ACC driver on freeways is intermediate between the rates experienced during manual driving and CCC control. It is clear that the experience of cut-in, for any mode of control, is powerfully influenced both by the headway gap that the host driver maintains and by the nominal traffic density that prevails. The fact that the ACC driver cannot select a gap setting shorter than 1 second does result in a considerably higher cut-in rate than would be experienced at the shorter headways that are commonly sustained under manual control. The higher cut-in rate with ACC is particularly pronounced when driving in dense traffic. Focus-group participants did observe that the longer gap values obtained with ACC certainly would 'allow cars to cut in front of you.' On the other hand, the limitation of the minimum gap-time to 1 second does act to strongly reduce the extent of short-headway driving, thereby reflecting the design trade-off that was made between driving-safety and driver-acceptance qualities of the system.

Identification of ACC Alerts with Compelling Justification

Of 25 moving-target alerts that were produced while under ACC control, 24 of them appeared to have been justified by the presence of a vehicle that impeded travel in the host vehicle's established path. Taking the set of 17 of these cases in which the driver reacted with a brake application lasting two seconds or more, the braking inputs all began within 1.1 seconds of the alert onset. Thus, the moving-target alerts that were presented during ACC driving were deemed to be highly credible as a warrant for brake intervention.

Considering stationary-target alerts, the total of 47 such incidents that were encountered in ACC driving included 6 incidents in which the alert was credible, i.e., a stopped vehicle was indeed in the ACC vehicle's path. These six incidents were all among a total of only 18 stationary-target alerts that were encountered on surface streets

and all of them were followed by manual brake interventions within 0.5 seconds of the alert onset. Thus, while stationary targets were the source of a large group of false alerts by the FCW system, overall, they were much more likely to have entailed a genuine threat when appearing as an alert under ACC control, especially on surface streets.

Perceived Driving Safety and Driver Acceptance of ACC

The perceived safety of the ACC system was largely favorable. When asked if they believed that an ACC system would increase their driving safety the majority of drivers agreed, with a mean rating of 5.5 on a 7-point scale (where 1= strongly disagree and 7= strongly agree), which is considerably higher than the ratings for FCW. Ratings of perceived safety of ACC were particularly common from older drivers relative to their younger and middle-aged counterparts. As a group, middle-aged drivers were least likely to agree that ACC would increase their driving safety. Several focus-group participants acknowledged that the ACC system increased the following distances that they would typically maintain under manual control and that they tended to drive less aggressively when ACC was engaged. Nonetheless, there were comments made during the focus groups that raised concerns about the possibility of diminished attention to the task of driving while ACC was engaged (even though video review of secondary-task behaviors did not support these concerns). Some comments by participants related to slowness to intervene by using the brake at times and the need to use the accelerator more when attempting a passing maneuver.

Overall, drivers showed a high level of acceptance of the ACC system. Responses to several key ACC acceptance questions showed that only a few drivers rated the ACC system as unacceptable. Over the bulk of the ACC acceptance data, there was clear consensus that ACC was a desirable system. When asked if they would consider purchasing an ACC system if they were buying a new car today, 73% of the FOT subjects indicated that they *probably* or *definitely would*. The overall satisfaction with the ACC system received a means score of 6.0 on a 7-point scale (where 1 = very dissatisfied and 7 = very satisfied.).

Factors Predictive of ACC Acceptance

Differences in ACC acceptance amongst drivers was again largely due to age rather than gender. In general, the age differences resulted in older drivers viewing the ACC system more favorably. This finding was consistent in both the post-drive and take-home questionnaires and was obtained regardless of gender. Attempts to determine how characteristics of individual drivers would seem to serve as practical predictors of driver

acceptance of ACC were modestly successful. Driver age, in particular, was more likely to predict ACC system acceptance than was driver gender, education or income. Overall satisfaction level received a mean value of 6.6 on a 7-point scale among the older-drivers who, as a group, had also exhibited a distinctly higher level of ACC utilization than either of the other two age groups.

Suggested Modifications of the ACC System

The only substantive suggestions for improvement of the ACC system related to the available ranges of speed and gap-setting adjustments. Noting that some 8% of all ACC mileage was traveled with the ACC set speed adjusted to its 80 mph maximum value, it is not surprising there was feedback from some participants that the 80-mph limit was set too low. Also, noting that approximately one quarter of all ACC mileage was traveled at the shortest-available gap setting and another quarter was traveled at the longest-available gap setting, the prospect of extending upper and lower gap-time limits is likely to be of interest to some (but, of course, not the same) drivers.

Clearly, any decisions to extend either the upper limit on set speed or the lower limit on gap-time must address the apparent safety trade-offs that are implied. With regard to the kind of precautionary information that might be included in an ACC owner's manual, or perhaps in training materials provided to drivers, it seems prudent to counsel strongly against the use of ACC on surface streets, given the high potential for conflicts that are sufficiently severe as to require limit-autobraking responses of the ACC system (which serve as something of a surrogate for conflict severity.)

Summary of Key ACC Findings Relating to Driving Safety and Driver Acceptance

Results from analysis of the ACC-related data showed that:

- The ACAS ACC system was widely used and favorably regarded by most participants.
- After experiencing the ACC feature for three weeks, most of the FOT subjects seemed genuinely willing to purchase such a system.
- The ability of this ACC controller to provide smooth, effective management of speed and headway over a very broad range of driving conditions is believed to account for its wide utilization and acceptance by FOT drivers.
- ACC driving was basically benign in all of its safety implications for freeway driving.

- The rather popular usage of ACC in dense, but flowing, freeway traffic does result in more cut-in activity ahead of the ACC vehicle due to the somewhat longer headway times that are managed by the system.
- The converse effect of longer headway-times, as well as the continuous control action of the ACC system is that ACC driving affords more headway clearance and lower levels of kinematic conflict on an ongoing basis.
- ACC can be kept continuously engaged over long distances on freeways, especially when traffic density is sparse.
- ACC driving on surface streets appears to pose a possible safety concern for the neophyte ACC user who will become exposed to the stronger conflicts that may arise in this environment.
- The fact that drivers adapted within only a three-week test window to significantly contain their exposure to conflict-laden driving conditions, such as surface streets, would seem to bode well for the long-term adoption of prudent practices of ACC supervision by the driver.
- All evidence indicates the FOT drivers managed the ACC system with a rather high state of attentiveness, especially as reflected in short driver braking reaction times and modest levels of deceleration, when braking interventions did occur.
- Although the tested ACC system was capable of automatically decelerating at up to 0.3g, the deliberately-retarded delivery of this response by the ACC controller is believed to have been an effective characteristic in discouraging drivers from depending upon it.

1 Introduction

This document constitutes the Final Technical Report on the conduct of the Automotive Collision Avoidance System (ACAS) Field Operational Test (FOT). ACAS is a package of advanced electronic sensors, processors, and displays/controls that provide forward crash warning (FCW) and adaptive cruise control (ACC) functionality. For this FOT, the ACAS package was implemented on a fleet of 2002 Buick LeSabre sedans. The field operational testing of ACAS-equipped vehicles was conducted by the University of Michigan Transportation Research Institute (UMTRI), under a subcontract from the General Motors (GM). GM, in turn, served as the prime contractor under a Cooperative Agreement with the U.S. Department of Transportation (USDOT) as part of its Intelligent Vehicle Initiative program. The Delphi Corporation served as another subcontractor to GM. Although GM has prepared a report on the entire ACAS project, this document reports only on the operational testing and subsequent analysis aspects covering UMTRI's portion of the work.

The basic design of the project involved development of the integrated, ACAS driver-assistance system by GM and Delphi, testing and evaluation of intermediate versions of this system by UMTRI, and eventual build-up of a fleet of 13 vehicles by GM and Delphi. UMTRI then subjected the vehicle fleet to naturalistic driving exposure by recruiting 96 laypersons from the southeast Michigan area to drive an ACAS vehicle for an extended period as their personal car. Data were recorded using UMTRI's on-board data acquisition system and were later analyzed to examine the suitability of the system for widespread deployment from a safety and acceptance point of view.

While brief reference is made here to the several stages of pilot testing that preceded the FOT, the great preponderance of this report deals with the FOT, itself, and the analysis of its measured data. The full-scale phase of testing covered a 12-month period thereby encompassing the seasonal weather variations characteristic of Michigan. During the first portion of this period, changes were made in the FCW algorithm to better calibrate it to the naturalistic driving and warning-acceptance behaviors that drivers were seen to exhibit when operating an ACAS vehicle in normal use. Due to this extension of the development process, three versions of the FCW algorithm (termed A, B, and C) were subjected to FOT driving. All reporting of collected data, herein, indicates the version of the system that was being employed at the time in which testing occurred.

This document addresses both subjective and objective forms of data recovered from the test-participation of the 96 laypersons who drove in the FOT. Certain aspects of the

results are quite straightforward, including, for example, the reporting of questionnaire responses by the test subjects and the mileage and time exposures of individuals to the driving environment. Most of the results, however, involve the deliberate investigative process of formulating queries for extracting relevant data from the data archive, through which very specific time-records of the driving experience can be accessed. In such cases, one seeks insight into specific driving phenomena that are believed to have been extracted by the query. These include such matters as longitudinal conflicts provoked by lead-vehicle-braking, the influence of traffic density on ACC engagement, the steering and braking responses of drivers to FCW alert events, and so forth.

Moreover, the database that resulted from the ACAS FOT provides a rich characterization of the driving process, both under the baseline condition in which the ACAS functions are turned off and later when they are engaged. It must be admitted at the outset that this report provides only a rather high-level review of the contents of this massive database. Indeed, the ACAS FOT data represent such an extensive resource that the authors believe its utility extends far beyond the immediate desire to evaluate the ACAS package, per se. Because the ACAS test platform contains one of the most complete characterizations of the driving process ever conducted using on-board instruments, the database is seen as an authoritative source for studying a host of issues related to the operational reality of driving.

This reporting document is constructed to present both the method and the results of the ACAS FOT. Sections 1 and 2 introduce the project and outline the FOT as the essential empirical element of this study. Section 3 explains the methodology of the FOT, including the ACAS system and the procedures used in testing it. Sections 4 and 5 address the FOT database and the methods employed for enhancing the raw data in order to derive additional variables and establish certain conventions for measuring the performance of ACAS and the driving behavior of its users.

The presentation of results begins in Section 6. A large set of graphs are presented in Sections 6.1 and 6.2 for breaking down the ACAS driving exposure by factors that were present when the driving took place. Since many important factors must be left uncontrolled in a naturalistic driving experiment, it is axiomatic that a field operational test of this kind must be reported in light of the exposure that actually takes place. Together, the exposure data portray the rich array of conditions that contributed to the accrued mileage, but for the most part they do not speak to the response of the driver/vehicle system. Section 6.3, however, does provide an accounting, together with descriptive analyses, of the system responses that were measured.

Section 7 and 8, respectively, examine the interactions between the test participants and the FCW and ACC subsystems. Each of these two sections is further broken down into the two evaluative themes of the study: safety and driver acceptance. These two major portions of the report thus analyze the FOT results according to the two-by-two matrix shown in Figure 1.1.

		Themes for ACAS Analysis	
		Safety	Acceptance
ACAS Subsystems	FCW	FCW Safety Section 7.1	FCW Acceptance Section 7.2
	ACC	ACC Safety Section 8.1	ACC Acceptance Section 8.2

Figure 1.1. The matrix of FOT analysis themes and the ACAS subsystems

Section 7.1 addresses FCW safety and 7.2 addresses FCW acceptance. Likewise, Section 8.1 addresses ACC safety while 8.2 addresses ACC acceptance. Recognizing that algorithm C represents the most-mature version of the FCW function and thus the premium block of FOT test data, almost all of the results in Sections 7 and 8 are presented using the data from driving with algorithm C.

Section 9 presents a high-level analysis of certain differences in ACAS driving that were observed for the three different FCW algorithms used during the FOT. Section 10 summarizes the conclusions that have been drawn from the FOT.

2 Structure of the FOT

The field operational test is an empirical investigation that provides for very open observation of the driving process. As a methodological type, it contrasts markedly with the following test techniques that are commonly used for vehicle development and the study of driver/vehicle interaction:

Scripted maneuvers run on a proving ground

Testing of this kind is typically conducted on private facilities, such as a proving grounds, per a very strict definition of speeds, control inputs, path constraints and the like. The detailed form of the data is known ahead of time, as are the means by which the results will be analyzed from collected data. By contrast, all maneuvering activity in the FOT occurs without any foreknowledge on the part of the researcher of where, when, how, or why the maneuvers take place. Thus, the FOT design contains no pre-established markers in the data record that point to maneuvers of a particular kind. Likewise, there is no experimental control over the time histories that the data may take when FOT participants are engaged in the driving process.

Free-form driving over a defined roadway

Here, the vehicle's path is prescribed by a set of road constraints, (most likely on a proving grounds, again) but the test participant is generally free to negotiate the road per the personal style that the driver chooses. FOT participants engage in essentially unconstrained use of the public road system such that the routes reflect each driver's own discretion and travel needs. Thus the FOT design contains no prescription of either the roads to be used, the times-of-day, or the traffic or weather or any other aspect of the driving conditions under which to travel. Since the manifestation of ACAS functionality is profoundly affected by the road and traffic environment, each participant's experience of ACAS is strongly conditioned by the driving exposure that they elect to give it.

Accompanied driving on public roads

The test participant drives on public roads, accompanied by a researcher. If the subject is being asked to interact with a specifically-prepared display or control device, the researcher is available to ensure that the interaction is conducted per the test protocol. In the FOT, the unaccompanied participants are on their own following a brief orientation period when first picking up the car. Although participants are provided both VCR and CD copies of an orientation video for their later review, any

remaining misconceptions of the system must be resolved through the trial-and-error process of direct observation since there is no expert along in the car to ask. Since the opportunity for a person's observation of the system function is often situational, the system may be readily exercised by one driver to produce the needed observations while differing route choices and maneuvering behavior by another driver can leave any misconception uncorrected throughout the whole term of FOT driving.

The comparisons above emphasize that the FOT approach is overwhelmingly unstructured when compared to other empirical techniques for studying driving activity. Clearly, the desire for maximizing the realism of the human driving experience has been given the premium weighting when the FOT type of experiment is chosen. On the other hand, a good deal of structure has been provided in the sampling of participants and in the methodical collection of data, as discussed in Section 3 of this report.

2.1 Overview of the FOT Learning Stream

Several steps were taken to provide increasing test realism and opportunities for system refinement in going from the more controlled, pilot stages of investigation to the final stage of ACAS testing in the FOT. Before any test vehicle was provided for use in any of the pilot or final-FOT stages of testing, GM and Delphi conducted extensive forms of test driving as well as scripted verification tests to explore and eventually document the performance of the installed systems. Recognizing the iterative character of the GM/Delphi and UMTRI stages of testing, these combined activities provided a learning stream by which a relatively complex automotive application became increasingly understood in terms of key design parameters and phenomena in the driving process that provoke its response and determine its acceptance by laypersons. It is clear that the design and response issues that became key to ACAS success arose from a) the physical environment that is sensed, b) the maneuvering behaviors by which drivers choose to move through that environment, and c) the perceptions that drivers have of the ACAS function, once it has been encountered during driving.

Table 2.1 outlines seven stages of testing that occurred in this project. The first four steps are termed pilot testing since they provided a preliminary form of experiment by which to qualify the ACAS system and certain subject-management procedures as ready and suitable for full-scale operations in the FOT.

Table 2.1. Seven stages of test driving activity in the ACAS FOT project

Test Activity	System employed	Purpose/Description	Outcome
Pilot Test 1 (the ACC segment)	Delphi ACC car	<ul style="list-style-type: none"> - Explore issues in ACC measurement and data analysis; - Several UMTRI drivers operating over a mixed route. 	Successful demonstration of data collection and analysis plus evaluation of ACC
Pilot Test 1 (the FCW segment)	Delphi FCW car	<ul style="list-style-type: none"> - Explore issues in FCW measurement and data analysis; - Several UMTRI drivers operating over a mixed route. 	Successful demonstration of data collection and analysis plus evaluation of FCW
Pilot Test 2	GM's ACAS Prototype Vehicle	<ul style="list-style-type: none"> - Evaluate system in driving by laypersons; - 6 lay drivers <i>accompanied</i> by a researcher over a defined route. 	Judgment made that driver acceptance levels and alert rates necessitated wide changes in ACAS algorithms
Pilot Test 2.5	FOT-intended vehicle, pre-Algorithm-A	A repeat of Pilot Test 2 to examine layperson driving in <i>accompanied</i> mode following extensive changes in ACAS algorithms following PT2	Successful use by accompanied laypersons cleared the way for unaccompanied tests
Pilot Test 3	ACAS system for FOT, almost the same as Algorithm A	<ul style="list-style-type: none"> - Dress rehearsal for the FOT; - 6 laypersons each driving unaccompanied over 2 days of baseline driving and 4 days of ACAS-enabled driving 	Success in this mini FOT yielded approval to proceed with the FOT
FOT Algorithm A	ACAS FOT system w/Algorithm A	<ul style="list-style-type: none"> - Formal conduct of FOT; - 15 laypersons driving ACAS-A as their personal car; - 1-week baseline, 3-weeks ACAS enabled 	Judgment made to terminate ACAS-A testing and develop Algorithm C to improve acceptance
FOT Algorithm B	ACAS FOT system w/Algorithm B	<ul style="list-style-type: none"> - Formal conduct of FOT; - 15 laypersons driving ACAS-B as their personal car; - 1-week baseline, 2-weeks ACAS enabled 	While Algorithm C was being prepared, FOT data were obtained using FCW Algorithm B that ignored <i>never-before-seen-moving</i> stationary targets
FOT Algorithm C	ACAS FOT system w/Algorithm C	<ul style="list-style-type: none"> - Formal conduct of FOT; - 66 laypersons driving ACAS-C as their personal car; - 1-week baseline, 3-weeks ACAS enabled 	Main FOT dataset was produced covering the final, C-level configuration of the FCW Algorithm

2.2 Three Days in the Life of an ACAS FOT Subject

Clearly, the core intent of the ACAS operational-test method was to provide a driving experiment by which the collected data serve to portray naturalistic behavior with and without the ACAS system enabled. Nevertheless, it must be acknowledged that the subjects were not living their normal driving life, in a strict sense: their driving activity was part of somebody's test. Before taking a test vehicle, of course, each subject made a conscious choice to call UMTRI and to undergo the screening questions for candidacy as a test subject. Then they made an appointment to come for orientation and to pick up an ACAS car. The date of this appointment then marked the first of three rather salient experiences that took place in the participation of each subject. These experiences constitute an important part of the naturalistic (as opposed to 'natural') character of the FOT, as follows:

- Day 1: The subject experienced the entire orientation procedure of approximately 2-hours duration, as described in Section 3, and then drove off in the 2002 Buick LeSabre with ACAS disabled. In contrast to a strictly-normal driving experience, the subject had driven with another person who demonstrated the unconventional warning and control functionality of the ACAS system and had then proceeded to drive from the UMTRI site to their personal driving environment using the unfamiliar but otherwise-conventional vehicle as their personal car. The ensuing first-week use of the vehicle was to provide what the researchers would regard as baseline data, although it is recognized that familiarization with the Buick, per se, was also underway.
- Day 7: As had been advised during the orientation session, the test car first manifested ACAS functionality to the driver at the beginning of the second trip on the seventh calendar day of participation. The fact that the ACAS-enabled state had been activated was made apparent by additional content of the head-up display on the windshield. Thus, beginning with that trip, the driver began the process of familiarization as a naturalistic user of the Buick with ACAS functionality.
- Day 26: Instead of normal trip-taking on the twenty-sixth day, the subject drove from their personal driving environment to the UMTRI site. An extensive debriefing process produced additional data elements and served to conclude the subject's participation in the study as an ACAS driver.

Accordingly, each subject had their attention drawn directly to the test protocol on three occasions during their test participation. Some of the subjects also experienced one or more additional incidents that deviated from their own driving pursuits, due to a

system breakdown that required direct intervention by UMTRI staff. Thirteen subjects saw their test car swapped with a replacement in order to address an in-field problem.

Notwithstanding these episodes that called the subject’s attention to the fact that their driving activity was part of a test, this report takes the general point of view that the naturalistic driving behavior that has been measured in the ACAS FOT gives a generally-useful estimate of how the ACAS system would perform in truly-natural use.

2.3 ACAS Algorithms A, B, C

The three versions of ACAS — referred to as algorithms A, B, and C — differ in the way targets are identified as crash threats and by the level of alert that is provided given the measured relative motions of the vehicles.

The decision to introduce three algorithms into the test came after the first subset of drivers of the FOT provided unexpectedly-negative feedback about the nuisance alerts that the FCW system presented to them. While such feedback was valuable in itself, it was considered necessary to conduct the bulk of the FOT using a system that would stimulate a more balanced mix of driver-acceptance results. This, in turn, would lead to better understanding of driver-acceptance issues while ensuring that at least a nominally-acceptable system was being provided for the study of the safety issues.

Therefore a plan was developed to revise the FCW function in three steps: the original FCW system, algorithm A, would be used for the first 15 drivers; algorithm B would be quickly introduced thereafter for the next 15 drivers and would include modifications simple enough to significantly reduce the nuisance rate while allowing for rapid validation; and algorithm C would follow after that, with significant modifications to reduce the nuisance rates. The remaining aspects of the test protocol were basically the same, except for resulting adjustments in the driver-training information to match each version of the system.

Table 2.2 below summarizes the main features and driver subsets of each of the three FCW algorithms. More details regarding the differences in algorithms will be included in Section 3.1.2, which describes the FCW system.

Table 2.2. ACAS algorithms A, B, and C

Algorithm	Description	Driver set
A	Original FCW, including alerts for both stopped and moving objects.	15 (drivers 1 – 15)
B	No alerts to <i>never-before-seen-moving</i> stopped objects in both FCW and ACC.	15 (drivers 16 – 30)
C	Alerts to <i>never-before-seen-moving</i> objects reinstated. Path prediction improved. Threat assessment revised. Tailgating alert modified.	66 (drivers 31 – 96)

3 Test Method

This section presents the FOT test methodology. Section 3.1 presents features of the ACAS-equipped vehicle fleet that are salient to the understanding of the experiment and the meaning of the results. This includes an overview of the test vehicle, the FCW, and the ACC. Section 3.2 presents the experimental design of the FOT pilot tests and the FOT itself. This includes the sampling of test participants (drivers), comments on statistical power analysis, and the sampling frame itself. The fleet was equipped with a sophisticated data acquisition system observing more than 250 signals at rates of 10 or 20 Hz. Sections 3.3 gives an overview of the data collected on-board the vehicle and describes the data acquisition system. That section also describes the process of monitoring the fleet and the automatic loading of data into relational databases. The recruitment and handling of the subjects is found in Section 3.4, and the process of managing the vehicle fleet is covered in Section 3.5.

3.1 Test Vehicle with ACAS System

FOT subjects were provided with a 2002 Buick LeSabre that was equipped with an ACAS system to drive as their own vehicle. This section provides a brief overview of the vehicle platform and the ACAS system developed by GM and Delphi.

3.1.1 2002 Buick LeSabre

The FOT was conducted with a fleet of ten vehicles (plus a backup vehicle). These were drawn from the 13 vehicles fabricated by GM with Delphi's assistance. The vehicle platform selected by GM was the Buick LeSabre, model year 2002. These vehicles were virtually identical, having the same production options including a silver-metallic paint. On the vehicle's outside, there were very few items that differentiated the test vehicle from ordinary LeSabres, so that these cars did not particularly stand out in traffic. Figure 3.1 shows an FOT vehicle with visible antennas for GPS and the data acquisition system's cellular modem. The radar fascia can be seen in the center of the grill in the figure.



Figure 3.1. Buick LeSabre with ACAS

Inside, the vehicle differed from the stock LeSabre as well:

- A head-up display (HUD) was installed in front of the driver to project ACAS visual displays and vehicle speed within the driver’s field of view. Extra driver control switches were installed in the dashboard to the left of the steering column to control HUD brightness and vertical position.
- Existing buttons located on the steering wheel that were used for HVAC and radio functions were re-wired for use by the ACAS system. These allowed drivers to set the ACC gap (distance) and adjust the sensitivity (lateness) of the FCW visual cautionary alerts.
- A driver-face camera was mounted on the A-pillar.
- Two forward-looking cameras were installed near the top of the windshield on the passenger’s side of the rear-view mirror. A shroud shielded them from view of the passengers.
- A “comment button” was installed on the dash to the right of the steering wheel column, so that drivers could dictate comments on specific ACAS experiences when they so desired.

The driver would also note that the forward portion of the LeSabre’s trunk was closed off by a panel. Behind this panel was most of the ACAS processors and power-management systems. Despite these extra features, extensive care had been taken by GM and Delphi to minimize a driver’s sense that they were in a research vehicle.

3.1.2 ACAS System Overview

The ACAS system consists of the FCW and ACC systems developed and integrated by GM and Delphi. Figure 3.2 shows a functional schematic of the ACAS system. The forward-looking radar is a scanning frequency-modulated, continuous-waveform (FMCW) radar using a 77 GHz frequency to track up to 15 targets, returning a set of outputs for each, including range, its time derivative (range-rate), relative acceleration, azimuth, and others. Four separate methods are used to estimate the geometry of the road ahead of the vehicle, and these each use different primary sensors: yaw rate, differential GPS and digital maps, vision-based lane tracking, and radar-based tracking of the vehicles ahead. Figure 3.2 shows that results of these individual estimates of road geometry are combined by a data fusion function. A target selection function uses this output along with other information to select up to two (i.e., zero, one, or two) of the radar tracks for the ACAS functions.

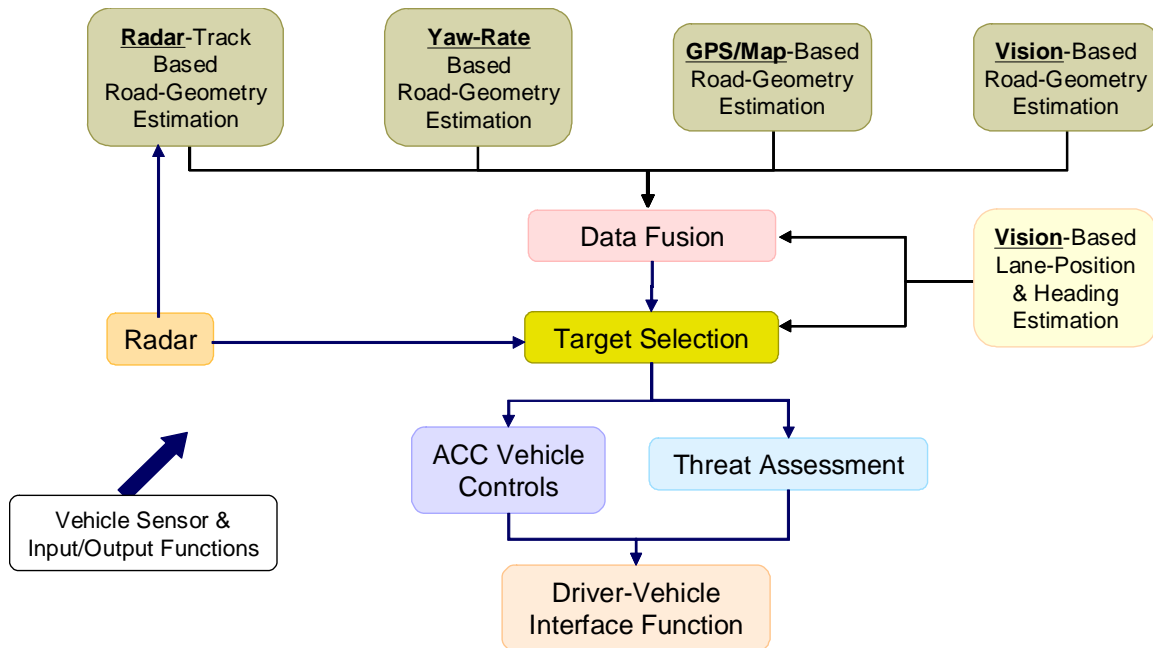

Figure 3.2. ACAS functional schematic

A closest in-path vehicle (CIPV) may be selected from the radar tracks. The CIPV is a “movable” target, that is, one that either is moving or has been observed to move. The range and range-rate from the host vehicle to the CIPV are the primary variables used by the ACC system when controlling headway by modulating the throttle and the brakes. The maximum braking authority of the ACC controller is 0.3g. The CIPV is also considered as the relevant movable target for computing the crash-alert threat level. The other potential track selected is called the closest-in-path stationary object (CIPS). The

CIPS is an object that has not been observed to move, but is considered a potential threat for a forward crash. At any time, there may be both a CIPV and a CIPS, only a CIPV, only a CIPS, or neither.

Both the CIPV and the CIPS are used by the threat assessment function to control the FCW output. The ACC controller does not respond to a CIPS target, although such a target can provoke an imminent crash alert while ACC is engaged. Driver application of the brake always suppresses an FCW alert and disengages ACC.

The driver vehicle interface (DVI) subsystem uses outputs of the ACAS processors to control the HUD and issue auditory warnings when necessary. The DVI also includes driver controls for the ACC operation, to adjust the cautionary alert timing (sensitivity setting) of the FCW, and to adjust brightness and vertical position of the HUD.

Figure 3.3 shows the layout of the head up display. Vehicle speed is displayed in the upper left. System status is displayed on the lower right. Icons in the upper right are used to display information that either a vehicle has been detected or that a cautionary alert applies. Cautionary alerts are caused by following closely (headway-based) or approaching a target rapidly (closing-based). The timing of these cautionary alerts is adjustable by the driver. A final, imminent alert consists of both a flashing visual and an auditory warning. The timing of the imminent alert is not adjustable by the driver.

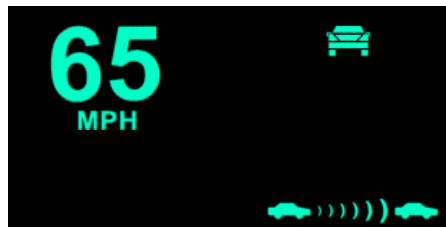

Figure 3.3. Head up display configuration

Cautionary alerts involve the presentation of one of several possible icons in the upper right corner of the HUD. A “looming” effect will occur in certain approach situations, where a sequence of icons of increasing size is displayed. The sequence of icons for the FCW alert as implemented in the FOT is shown in Figure 3.4 for an approach which escalates from detecting a non-threatening vehicle ahead, through each stage of the cautionary alert, culminating in an imminent alert. On the left, a small blue-green icon representing the back end of a vehicle is displayed when the system determines there is an obstacle in the host vehicle’s path. As the obstacle is approached the icon turns amber and grows in size, providing a looming image to indicate that the driver may need to take action soon to avoid a crash. If the driver does not respond and the host vehicle continues to approach the obstacle, the icon changes to an imminent-alert

icon consisting of a red vehicle with a yellow crash symbol on it. The imminent alert consists of an auditory tone and the flashing of the red/yellow icon. For an extreme tailgating situation, the imminent-alert icon flashes but no beeping occurs. The auditory component of the imminent alert is played through the front speakers while the radio is temporarily muted.

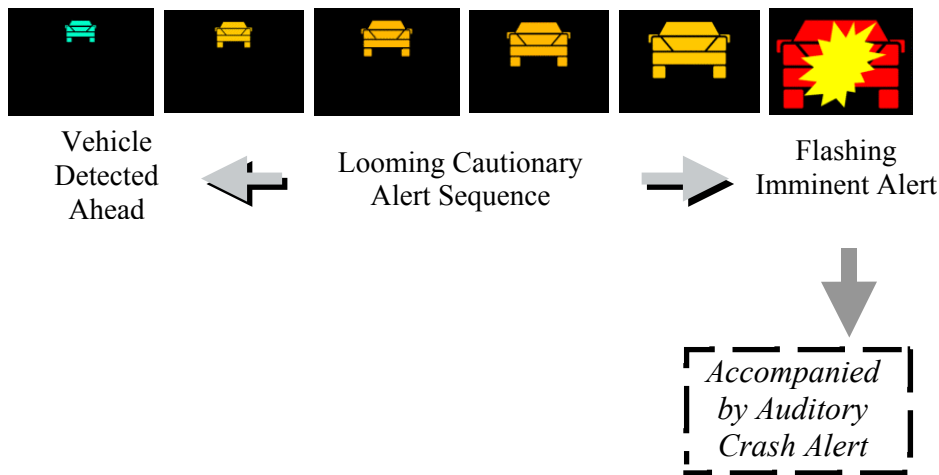

Figure 3.4. Forward collision warning system threat level icons

3.1.3 Threat-Assessment Algorithm Overview

The inputs to the threat-assessment algorithm are received and the results are produced ten times per second. The inputs include:

- CIPV and CIPS information,
- Host vehicle motions and driver controls (speed, accelerations, yaw rate, throttle, brake), and
- Ancillary information (wiper stalk switch position, outside temperature, ACC state).

To implement the multi-stage warning system, the threat-assessment algorithm produces an alert level from 0 to 100 that is used by the DVI. An alert level of 0 is produced when there is no lead vehicle or the lead vehicle is beyond the range requiring a cautionary display. An alert level of 100 indicates the imminent alert audio and visual outputs should be produced by the driver vehicle interface. An alert level of 98 causes the imminent flashing alert without audio. Values from 1 through 98 produce the Looming Cautionary Alert Sequence to display.

The output from the threat-assessment algorithm includes:

- GM threat-assessment level (value from 0 to 100) for display,

- Threat level for several alternative algorithms including the NHTSA Threat-Assessment Algorithm,
- Target ID associated with the alert level (i.e., either the CIPV or CIPS track ID)
- Crash avoidance range, R_{ca} ,
- Cautionary warning onset range, R_o ,
- Indices indicating which radar and target selection computation cycles were used as input for the current threat-assessment output.

The GM threat-assessment algorithm analyzes the kinematic conditions between the host vehicle and objects selected by target selection. There are two modes: one is used when ACC is not engaged; the other is used when ACC is engaged. In both modes the threat-assessment algorithm is the same for stationary objects. However, there is a difference in how movable objects are treated.

When ACC is engaged there are no visual cautionary alerts for movable objects. The braking that occurs in response to slower lead vehicles serves as a prominent haptic cue to draw the driver’s attention to the situation ahead. With ACC engaged, imminent alerts for movable objects are produced when the maximum braking authority of the ACC has been reached. In this situation, the imminent flashing visual and auditory alerts indicate that the driver may need to take control and brake at a level that is higher than the ACC can provide.

When ACC is not engaged the threat-assessment for movable objects is based upon kinematic equations similar to those used all the time for stationary objects. These modes are summarized in Table 3.1.

Table 3.1. Threat-assessment function states

Alerts Generated	ACC State	
	Engaged	Not Engaged
Stationary Objects	Based on vehicle kinematics	Based on vehicle kinematics
Movable Vehicles	Based on requested ACC braking level	Based on vehicle kinematics

Calculation of the alert level proceeds in stages:

1. Prediction of driver reaction time, T_r , and braking intensity, a_f , after the reaction time,
2. Calculation of an imminent crash avoidance alert range, R_{ca} , and a cautionary alert onset range, R_o ,

3. Calculation of a tentative alert level, AL, then,
4. Modification of the alert level using nuisance-alert reduction heuristics.

The predicted braking intensity, a_f , is a function of the host vehicle speed, lead vehicle speed, and lead vehicle deceleration. It is modified by an estimate of road conditions derived from inputs such as temperature and wiper activity.

The imminent crash-alert range, R_{ca} , is a function of the kinematic conditions and the expected response by the driver.

$$R_{ca} = f(V_f, V_l, a_l, T_r, a_f)$$

Where

V_f = following vehicle speed

V_l = lead vehicle speed

a_l = lead vehicle acceleration

a_f = host (following) vehicle acceleration

The cautionary alert onset range, R_0 , is calculated two ways, one appropriate for closing situations and the other associated with tailgating situations.

For closing situations R_0 is calculated so that the cautionary warnings begin at a driver-selected time before the imminent alert begins.

$$R_{01} = R_{ca} + (V_f - V_l)\tau_i$$

Where τ_i ; $i=1 \dots 6$ are values determined by the driver's chosen FCW sensitivity setting, i .

For tailgating situations, R_0 , is calculated so that the cautionary warnings begin at a time-headway that is also determined by the drivers selected FCW sensitivity, i ,

$$R_{02} = R_{ca} + V_f \tau_i / 2$$

producing cautionary alerts that begin from 0 to 2 seconds headway. Finally the alert onset range is calculated from:

$$R_0 = \max(R_{01}, R_{02})$$

The tentative alert level, AL, is calculated using the following equation:

$$AL = 0 \quad \text{if } R > R_0$$

$$AL = 100 \quad \text{if } R < R_{ca}$$

$$AL = 100 * (R - R_{ca}) / (R_0 - R_{ca}) \quad \text{if } R_{ca} \leq R \leq R_0$$

Where R is the observed range to the target.

To reduce nuisance alerts, a set of heuristic rules modify the tentative alert level. These heuristics identify situations in which the assumption is made that the driver is

intentionally maneuvering close to another vehicle or that the target object is not actually in the path the driver intends to take. One of two modifications can occur:

1. Set the alert to some lower level (e.g. set $AL = 98$ or $AL = 0$)
2. Delay displaying the alert until it has persisted for a predetermined amount of time ($AL(t) = \min(AL(t), \dots, AL(t-N))$ where N is a function of the situation)

An example of the first approach is to suppress alerts if the driver has applied the brake pedal recently, as mentioned earlier. The rationale behind this rule is the assumption that drivers who are already braking at a significant level are cognizant of the driving situation ahead, and therefore, a warning is not appropriate. Thus, it is believed that an FCW alert during braking would be perceived by the driver as a nuisance.

An example of the second approach is in tailgating situations, where the alert level displayed is the minimum of the alert levels generated in the last few seconds. The rationale behind this rule is that tailgating is not a situation that requires immediate action by the driver (i.e., a crash is not imminent) and drivers sometimes get into tailgating-like situations when preparing to pass or when a vehicle cuts in front of them. Therefore, the tailgating warning is only presented if the driver has been in the situation for several seconds without acting to increase the gap to the preceding vehicle.

Once the modified alert level is calculated, the result is sent to the DVI. The DVI uses the alert level to determine which icon is displayed. If a vehicle is detected but the alert level is zero, then the smallest, blue-green icon vehicle-detected icon is displayed. If the alert level is 100 then the imminent alert icon is displayed. Values between 0 and 100 are evenly divided for presentation of the intermediate icons shown in Figure 3.4.

3.1.4 Adaptive Cruise Control (ACC) System Overview

The Adaptive Cruise Control (ACC) system is designed as a comfort-enhancing system, which is an extension of conventional cruise control (CCC). Whereas the FCW system described above is designed to strictly deliver warnings, the ACC system relieves the driver from some of the longitudinal-control tasks by actually controlling speed and headway keeping. Another significant difference between the two systems is the fact that drivers had no choice with regard to the activation of the FCW system — it was always *on* — but they could choose to engage or to disengage the ACC system.

As described in Section 3.2 (*Experimental Design*), during the first week the ACC system was not available. That is, if the driver engaged the cruise control, it simply maintained speed just like the conventional system (CCC). During the next three weeks, if the driver chose to engage the cruise control, it functioned as ACC.

The ACC system provided operational modes that were not unlike a conventional cruise control. However, utilizing information (from the front-mounted radar) about vehicles and other objects in the host vehicle's path ahead, the list below provides details about features that were incorporated into the ACC design. It should be emphasized that, the features described below were functioning and in effect, if *and only if* the ACC system was engaged. Although it may have been available for the driver, no ACC feature or functionality was active if the system was in a state of *off* or *standby*:

- The driver could select and adjust the desired cruising speed, the *set speed*, anywhere from 25 to 80 mph;
- The set speed was shown to the driver at all times on the HUD;
- When no impeding object was detected in the host's path, the system maintained the set speed selected by the driver, thus operating similarly to conventional cruise control;
- If a stationary target (a stopped vehicle or a roadside object) was detected and the threat level was high enough, the imminent-alert icon (see Figure 3.4) was displayed, accompanied 0.3 seconds later by the audio alert;
- When a moving vehicle was detected ahead (slower or faster) by the radar, the vehicle-detected icon was displayed on the HUD;
- When a slower-moving vehicle was detected within the effective range, the speed of the host vehicle was automatically reduced as needed by retarding the throttle or by activating the brakes, if necessary, to match that of the vehicle ahead;
- Under the conditions described above, the steady-state following gap (i.e., time headway) behind the slower car (in terms of headway time) was determined by the driver through selection of any of six available settings ranging from 1 to 2 seconds in 0.2 second steps;
- The selected following gap was shown to the driver at all times on the HUD;
- When the vehicle ahead changed its speed, the host vehicle also changed its speed to match (bounded by the set speed and the designed acceleration limits);
- If in the course of maintaining the desired gap, the deceleration requested by the ACC controller exceeded 0.3 g, the imminent icon was displayed, the audio alert was sounded (regardless of whether the limit-autobraking deceleration level, 0.3 g, had been reached already);
- If the conditions led to the host slowing down below 20 mph, a different audio tone was sounded and a "Driver-Control-Required" message was displayed on the HUD, intended to prompt the driver to take control of the vehicle's speed;

- After following a vehicle, when the road opened up (either by the headway gap widening, the impeding vehicle departing the host's lane, or the host moving to an open lane) – the ACC system automatically increased the speed back to the set speed (but in any case, the system never automatically accelerated above the set speed).

Note that regarding messages displayed to the driver, some prioritization scheme was in effect at all times. So, depending on the circumstances, a message may have been suppressed in order to allow the presentation of one that had a higher priority.

3.2 FOT Pilot Testing and Experimental Design

In Section 3.2.1, the sequence of pilot testing leading up to the FOT is briefly summarized. Section 3.2.2 presents the deliberately-controlled aspects of subject-sampling and system deployment that were governed by the experimental design.

3.2.1 FOT Pilot Testing

Pilot testing was a multi-stage process that helped to influence the final development of the ACAS system. The pilot-testing sequence commenced with UMTRI professionals evaluating the ACAS system and its components on public roads, as well as a proving ground environment, and concluded with unaccompanied laypersons driving ACAS-equipped vehicles for a six-day period.

3.2.1.1 Stage 1 Pilot Test

The first of two Stage-1 experiments evaluated an ACC system in isolation. Eight UMTRI staff members, all of whom participated in the ACAS project, drove a Delphi Opel Vectra development vehicle that was equipped with an ACC system. Each driver completed a two-hour, 94-mile route which consisted of mostly freeways and major arterials to provide maximum opportunity for ACC usage. Drivers were encouraged to use ACC as much as possible and to explore the range of available headway-time settings.

Prior to beginning the route, each person was given an orientation drive of approximately twenty minutes in order to learn the system operation. All drives were completed during the day between the hours of 9AM and 3 PM to avoid rush hour traffic. After the drive, a questionnaire was completed by each staff member. The questionnaire explored the areas of perceived safety of the ACC system, satisfaction with the system characteristics, and predicted ACC utilization after a month of exposure. The results of

the preliminary investigation of ACC were reported to GM and Delphi for consideration in ongoing development.

A second Opel Vectra, equipped with a modified ACC system, was adapted by UMTRI to also include an FCW function that sought to approximate the the ACAS threat-assessment algorithm. The principal test activity conducted with the second Opel involved normal driving on public roads. Seven UMTRI staff members drove the test vehicle over a 76-mile route during daytime, non-rush-hour periods. Prior to beginning the route, an orientation drive was taken so that each driver was familiar with the controls for the ACC and FCW systems as well as the operation of each system. The route consisted of freeways, major arterials, and surface streets in urban, suburban and rural settings. ACC usage was restricted to the freeway environment. The route was planned so that each driver had the opportunity to experience FCW functionality under both ACC and manual driving modes.

Drivers were instructed to drive as they normally would with the exception that ACC was to be utilized as much as possible on the freeway segments. Drivers were free to adjust the ACC headway time and set speed as well as the FCW sensitivity level. As with the earlier ACC-only experiment, drivers completed a questionnaire about their experiences with the systems.

The ACC/FCW equipped-Opel was also used to execute scripted scenarios in a proving ground setting. The objectives of these tests were to experience the FCW alerts in developing rear-end conflicts, with and without ACC; to study the likely behavior in specific scenarios of the ACAS system and to gain additional engineering exposure of the UMTRI staff to the workings of the FCW/ACC system. Testing over a two-day period was conducted at the Transportation Research Center (TRC) in Ohio. The tests were performed by four UMTRI staff members, all of whom participated in the public road driving experiment described earlier. The proving ground tests employed two vehicles, a “leading” vehicle and the Opel as a “following” vehicle.

Overall, Stage 1 pilot testing was felt to be quite successful as a preparatory introduction of UMTRI staff for field-testing the ACAS function. The public-road driving experiment revealed an FCW alert rate that was higher than expected, and this was additional input to GM’s development effort.

3.2.1.2 Stage 2 Pilot Test

The Stage-2 pilot test introduced lay drivers into ACAS vehicles for the first time. This test involved a mixed-factors design in which the between-subjects variables were driver

age and gender and the within-subject variable was the state of the ACAS system (i.e. ACAS disabled, FCW only, FCW and ACC). Three levels of age were examined, 20 to 30, 40 to 50 and 60 to 70. Gender was balanced in each age group.

An ACAS prototype-phase vehicle, a 2002 Buick LeSabre, was employed for Stage 2 testing. Twelve layperson drivers, accompanied by a researcher, made three traversals of the same 55 mile route. ACAS was disabled for the first trip; the second trip was driven with only FCW enabled; and for the final trip the ACAS system was fully functional. The majority of the route consisted of interstate roads and state highways (approximately 75%), with local and arterial roadways accounting for the balance.

A 20-minute orientation drive preceded the beginning of the route driving. Drivers were able to select ACC set speeds and headway time settings as well as adjust the FCW in accordance with their normal driving preferences.

All of the driving was completed during daytime, non-rush-hour periods. A detailed questionnaire was completed by each driver at the conclusion of the third traversal of the route. The results of Stage 2 pilot testing were further input for ongoing development work.

3.2.1.3 Stage 2.5 Pilot Test

In order to evaluate the modifications to the ACAS system, especially the HUD display redesign, six of the twelve layperson drivers from Stage 2 participated in Stage 2.5. The between-subject factors were age and gender. Only one treatment, ACAS enabled, was investigated. Drivers were once again accompanied by a researcher and they drove the same route and were given the same instructions as described in Stage 2 above. They drove the route once during the day and once at night to verify acceptance of the night-time HUD displays. At the conclusion of testing, a detailed questionnaire was completed by each driver.

With minor subsequent changes to the ACAS design, it was determined that the system was suitable for unaccompanied driving by laypersons, as the final step in pilot testing prior to the launch of the FOT.

3.2.1.4 Stage 3 Pilot Test

As in Stages 2 and 2.5, the experimental design for Stage 3 was a mixed-factors design in which the between-subjects variables were driver age and gender, and the within-subject variable was the experimental treatment (i.e. driving with and without ACAS).

Each of six participants drove the ACAS vehicle for a period of approximately six days and experienced the same order of treatments, namely two days of an ACAS disabled state followed by four days of the ACAS system being enabled. After an extensive orientation and an accompanied test drive, drivers took the vehicle for unsupervised use. At the end of their use of the vehicle, they returned for a debriefing.

3.2.2 FOT Experimental Design

The FOT experimental design was a mixed-factors design in which the between-subjects variables were driver age and gender, and the within-subject variable was the experimental treatment (i.e. ACAS-disabled and ACAS-enabled). The disabled period lasted approximately 6 days, and the enabled period lasted approximately 20 days. Algorithm-B drivers had less time with the vehicles, so that both their baseline and ACAS durations were proportionally reduced. The disabled period is treated as a baseline measure, since the research vehicle operated like a conventional passenger vehicle. Consenting drivers operated the test vehicle in an unsupervised manner, simply pursuing their normal trip-taking behavior using the ACAS test vehicle as a substitute for their personal vehicle. Use of the test vehicles by anyone other than the selected individuals was prohibited.

A driver sample was selected based upon an experimental design in which 96 drivers participated in the ACAS FOT. The primary emphasis in the experimental design was to roughly mirror the population of registered drivers, but with simple stratification for age and gender, variables previously seen to interact with headway-keeping behavior and, presumably, forward conflicts portending the risk of rear-end crash. No attempt was made to control for vehicle ownership or household income levels. Thus, it should be stressed that ACAS FOT participants may not be fully representative of drivers who will initially purchase such a system.

The age groups examined were 20-30, 40-50, and 60-70 years of age. Previous UMTRI research results have shown that car-following behavior does, indeed, follow a strong trend with age such that stratification by age will substantially distribute the headway-keeping-behavior characteristic across the sample. Although gender was not found previously to be a correlate to these phenomena, a gender balance (i.e., half men, half women) was applied in the sample.

Because, ultimately there were three algorithms examined in the FOT, the drivers were further divided into three groups. Again, 15 drivers took part in Algorithm A, 15 in Algorithm B, and 66 drivers took part in Algorithm C. It is this final group of drivers on

which the analyses which follow are concentrated. For drivers in Algorithms A and B, age was balanced, but gender was not. Both age and gender were balanced in Algorithm C. Because of constraints in the overall FOT schedule, drivers in Algorithm B were limited to only five days of baseline driving and two weeks of ACAS-enabled driving.

3.3 Data Acquisition System

In addition to the ACAS functionalities of ACC and FCW, the FOT vehicles included a UMTRI data acquisition system (DAS). The sections below describe the design and the operation of the DAS.

3.3.1 DAS Package

The DAS package consists of four subsystems comprising a main computer, video computer, power controller, and multi-mode wireless radio modem. Figure 3.5 is a front view of the package (10" x 10" x 10"). A bar of ten green LEDs indicates the states of the different subsystems (e.g., computer power, modem power, ACAS enable relay, etc.)



Figure 3.5. DAS package

The two computers have keyboard and mouse eliminators that permit operation while a subject has the vehicle without these I/O devices, but allow hot-pluggable keyboard, mouse, and VGA monitor for maintenance and trouble-shooting activities. The round connector at the center provides for external power, on/off switching, and mode setting.

Figure 3.6 shows the system with the sides folded down and Figure 3.7 shows a block diagram of the system.

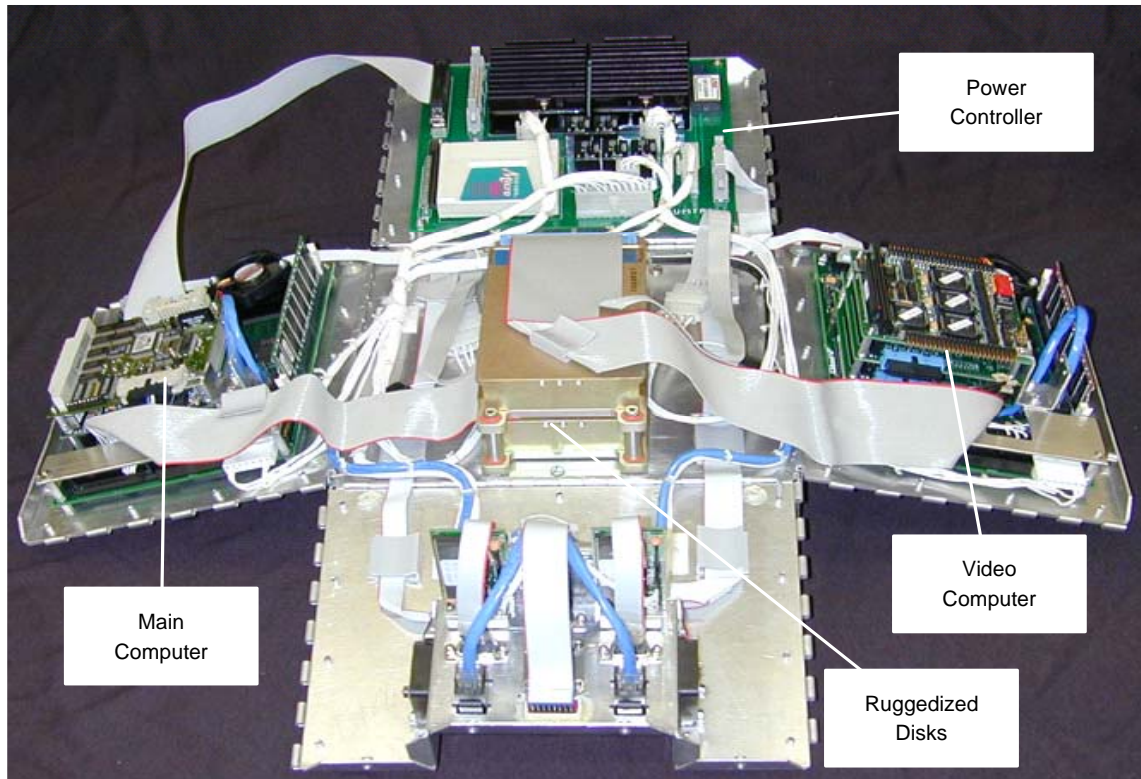

Figure 3.6. DAS with sides unfolded

The main DAS computer consists on an EBX form-factor single-board computer (including display, and Ethernet controllers), a PC104-plus CAN controller card, a PC104-plus analog and digital interface card, and a ruggedized hard disk. The video computer consists on an EBX form-factor single-board computer (including display, audio, and Ethernet controllers), two PC104-plus frame grabber cards, digital interface card, and a ruggedized hard disk (a specially selected, laptop-type disk in an evacuated enclosure with built-in heater and temperature control system). A microcontroller supervises power sequencing. The normal operating temperature range of this system is constrained by the hard disk that operates from -18°C to $+55^{\circ}\text{C}$. When power is applied, the microcontroller senses the input voltage and the hard-disk temperatures. If the voltage is too low, the system waits for it to increase to 12.5 volts which is usually true once the engine has started. If the disk temperatures are below -10°C , the microcontroller enables the heating system provided in the disk enclosures. The normal disk and computer power is applied and the heaters are disabled when the disks reach -10°C .

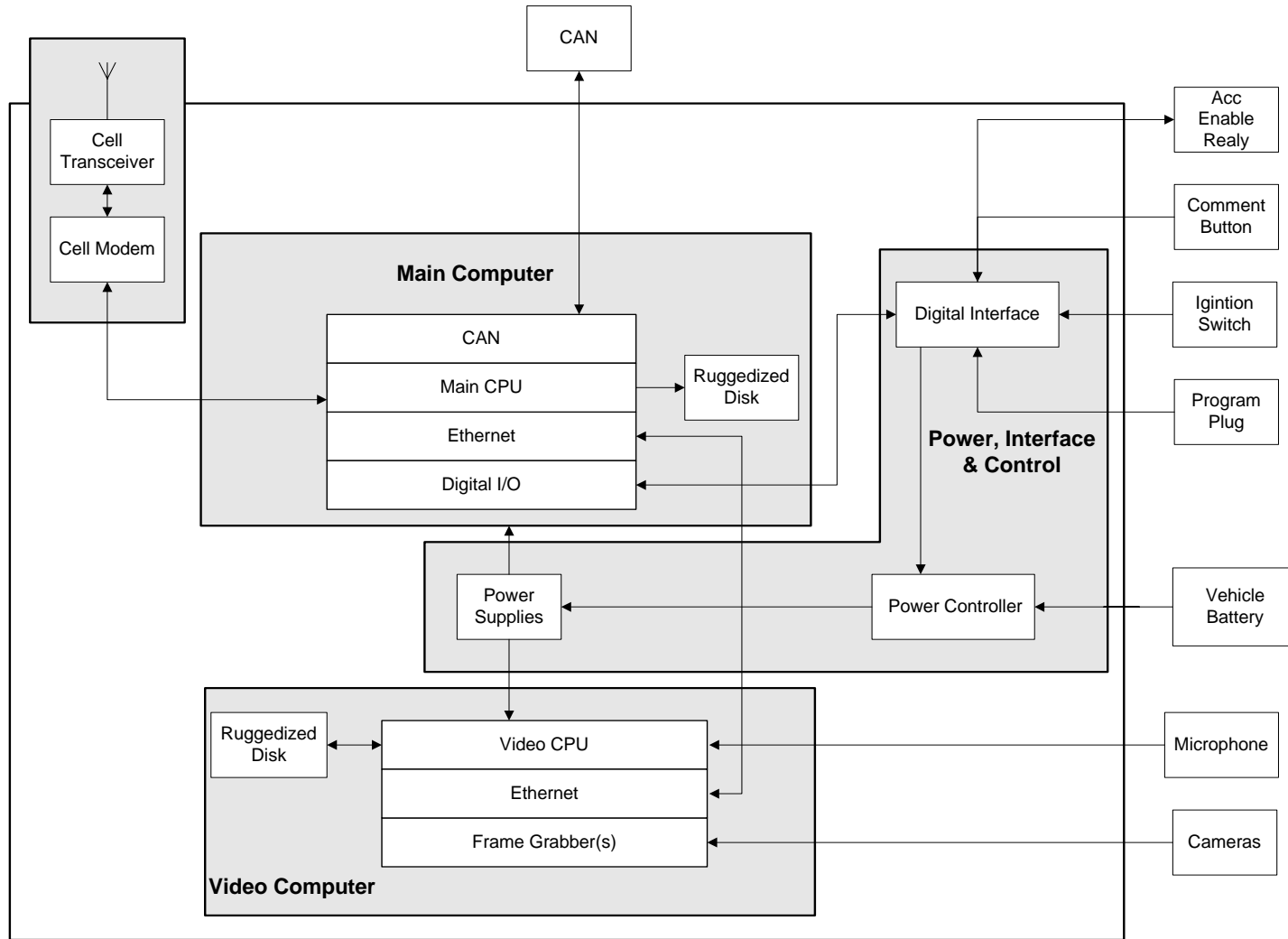

Figure 3.7. A block diagram depiction of the DAS

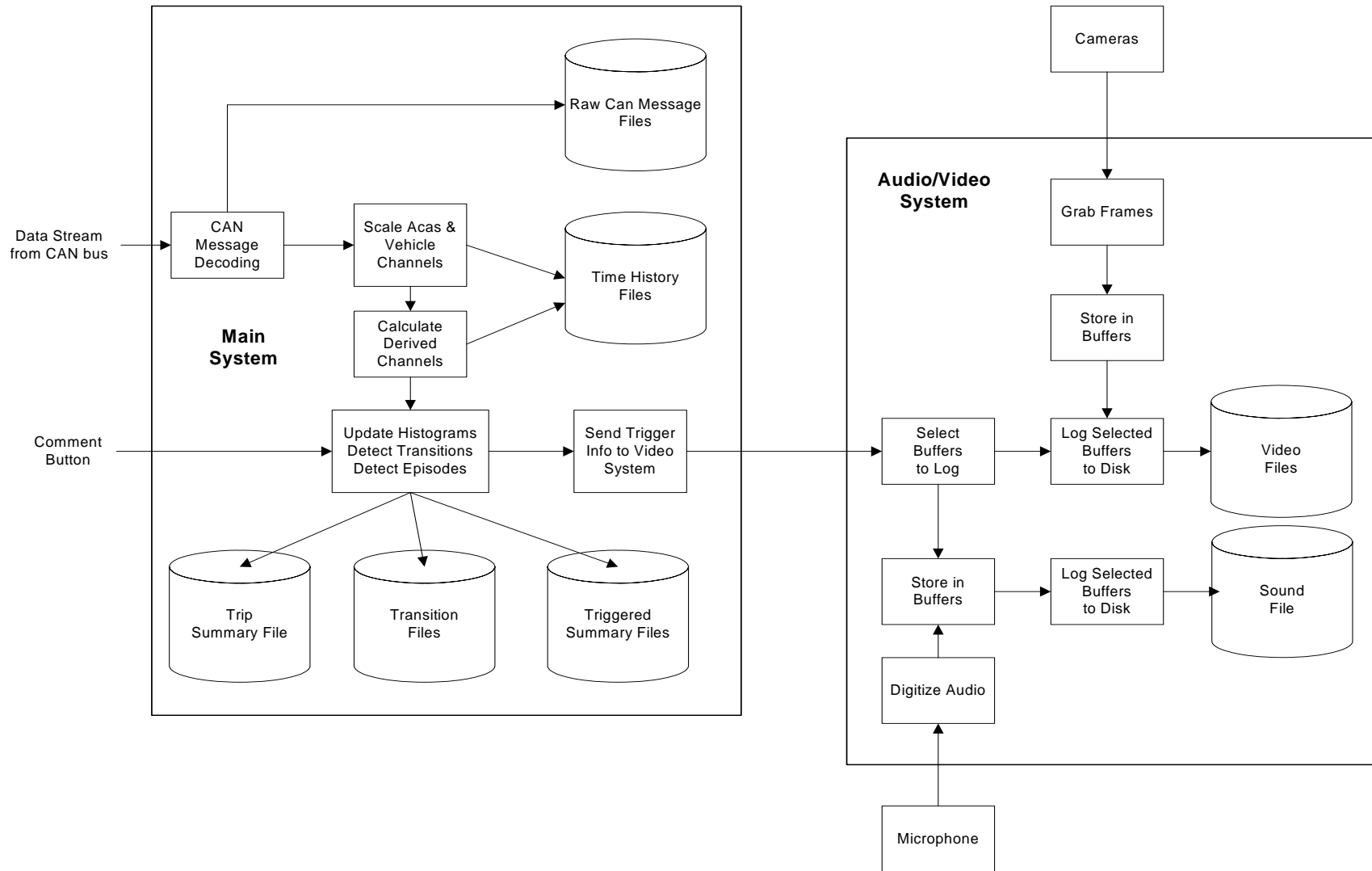

Figure 3.8. DAS FOT functional diagram

Figure 3.8 illustrates the DAS operation when in FOT mode. The software organizes all of the data by trip (that is, into data files whose time stamps extend from the moment of ignition-on to the moment of ignition-off). The main system reads, buffers, and decodes the CAN messages and extracts the appropriate vehicle and ACAS signals, and scales and converts the data as necessary. Derived channels are then calculated and all parsed information is logged to several time-history files. Raw CAN messages from each ACAS subsystem are also logged to separate files. Slowly-changing or intermittent channels are logged transitionally. That is, a transition log is created, capturing transition events by their channel identification, timestamp, and data values.

An episode-processing task monitors the incoming primary and calculated channels for the occurrence of significant episodes (e.g., ACC engagements, collision warnings, hard braking, manual presses of a “comment” button, etc.). The main system sends a small (seven-channel) data record to the video system (via Ethernet) continuously at a rate of 20 Hz. When an alert is detected, the main system logs it to the so-called Fcws triggered summary file and the video system is notified. The video system then captures a retrospective clip of video data. Transition counts, histograms, errors, and other trip-summary information are recorded to a trip-summary log at the end of each trip. When a trip ends, the main system checks the current date against the programmed ACAS-enable date and sets the ACAS-enable relay appropriately. It then activates the cellular system to transfer data via modem to UMTRI. Once the transfer is complete, all systems are turned off.

The audio/video system continuously digitizes and buffers the output of two video cameras and one microphone. When an alert trigger is received from the main system, both the video and audio are saved to disk. Exposure video is also saved (see timing and duration details in Section 3.3.3.)

3.3.2 *Collected Variables*

The DAS stores data in seven different kinds of files as listed in Table 3.2. Appendix A contains a list of channel names and descriptions. All of the filenames created by the DAS contain the record name, driver number, and trip number. Thus the summary file for the second driver’s (driver 2) first trip (trip 1) would be named “Summary_002_0001.bin”.

Table 3.2. DAS file types

File Type	Description	Example
Time History	Synchronous, sampled at 10 Hz. Each record has a time and one or more data samples (bytes, integers, floats, etc.)	Data_002_0001
Transition	Each record includes a time, channel id, and a value	Bytes_002_0001
Summary	End-of-trip summary including trip duration, counts, histograms, etc.	Summary_002_0001
Triggered Summary	Each record is a summary of an episode (FCW alert, Acc engagement, etc.) including start time, end time, latitude, longitude, speed, etc.	Fcws_002_0001
Raw CAN	Contains buffered CAN packets with test time and CAN time. Recorded when a full message is received	RawRadar_002_0001
Video	Each record contains a time and the bitmap image from the frame grabber	Forward_002_0001
Audio	Each record contains a time and a half of a second of 48 KHz, one byte/sample audio (i.e., 24,000 samples)	Audio_002_0001

3.3.3 Video Data

The 20-Hz clock that provides the main computer synchronization is divided by two and then used to hardware-trigger the two frame grabbers to capture the next even fields of video. The cameras output two interlaced fields per frame. Thus, only every other horizontal line is sampled and stored. The lines are doubled on playback to restore the bitmap to its original aspect ratio.

Figure 3.9 illustrates the capture of forward-scene video. Sixty-four lines of the even field are sampled at the 10 Hz rate and buffered in memory for up to thirty seconds.

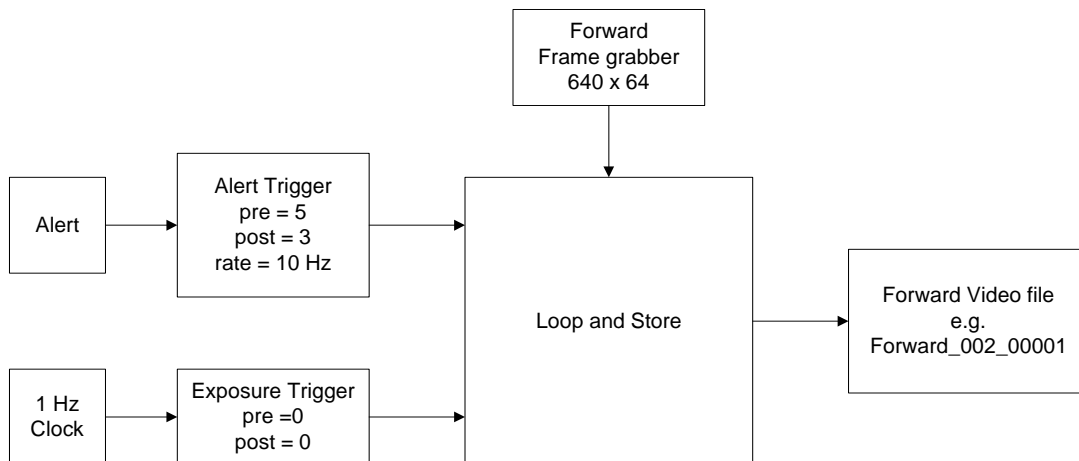

Figure 3.9. Forward video capture

Either an alert or exposure trigger will cause the bitmaps to be stored in the forward video file. An alert trigger sends eight seconds (from five seconds prior to the event to three seconds after) of forward video to the file. An exposure trigger causes just one field

to be recorded every second, except when the host vehicle is not moving. A particular field is only written once, even if the triggers overlap.

The face-video capture details are shown in Figure 3.10. This grabber crops the face camera to a 448 by 168 image and 300 fields are buffered (thirty seconds at 10 Hz). An alert triggers the storing of eight seconds (four before and four after) of 10 Hz video. The exposure trigger causes four seconds of 5 Hz video to be stored at five-minute intervals. Face video is collected even when the vehicle is stopped.

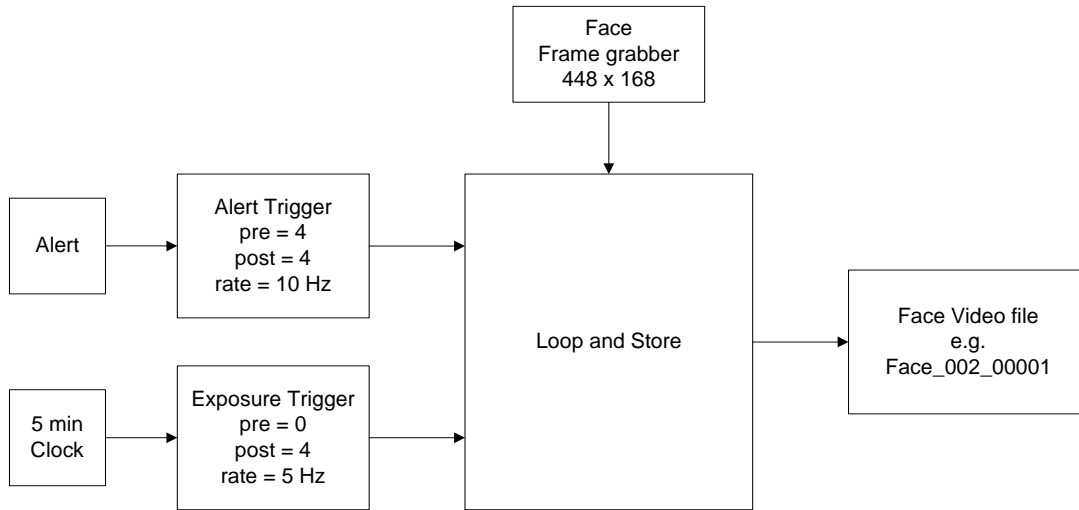

Figure 3.10. Face video capture

The cropping values (for both face and forward video) were selected via trial-and-error after viewing the full-frame video images and determining which of the image area holds the interesting and necessary details.

3.3.4 Trip-Summary Data by Cellular Modem

After a trip is over, the main computer turns the modem on and places it in CDPD (Cellular Digital Packet Data) mode and attempts to contact the UMTRI FTP (File Transfer Protocol) server. If a CDPD connection is unavailable (busy urban tower or if the car is in a rural area, not supported for CDPD), the modem is switched to CSC (Circuit Switched Cellular) mode. The files indicated for copying in the database catalog are then transferred and the corresponding catalog records are updated. If the driver turns the car back on, or if five minutes have elapsed, the file transfer is aborted.

At 15-minute intervals, a SQL Server job executes and transfers the files from the FTP server to the ACAS file server and then loads the records from the files into the appropriate tables in the ACAS-phone database. Next a stored procedure calculates

summary statistics from several health histograms. The fleet was monitored by using an Access Project form to display the statistics as shown in Figure 3.11.

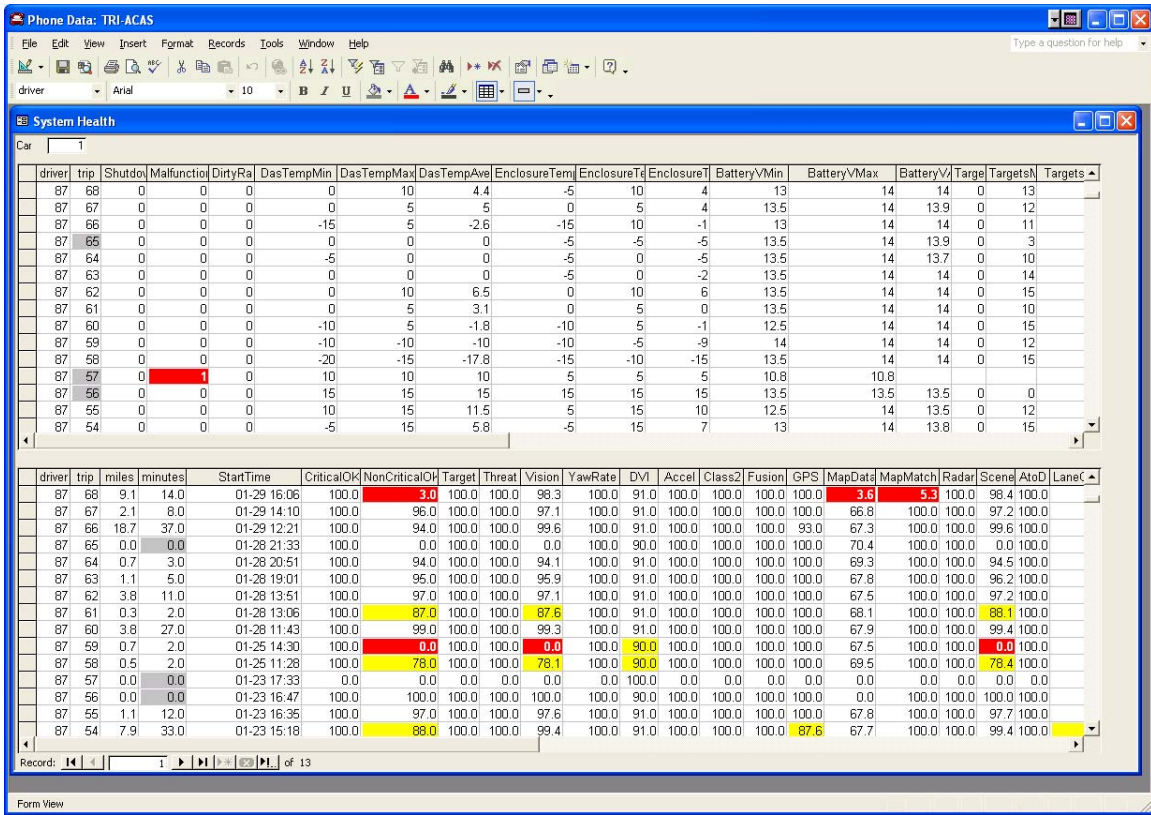

Figure 3.11. Phone view diagnostic form

Each page of the form displays the trips of a car, ordered with the most recent first. Values that are out of normal range are color-coded to indicate the severity of a possible problem. Very short trips are not checked (but are indicated by a grey background on trip number in the top form or on duration in the bottom form).

3.3.5 Data Download from a Returned Vehicle

Carts equipped with a 13.8 volt DC power supply, network switch, mode control switch, keyboard, mouse and LCD monitor were assembled to provide maintenance and download facilities at UMTRI for the ACAS vehicles. Figure 3.12 shows the network, power, and mode connections to the DAS via the small access door in the trunk-enclosure panel.



Figure 3.12. Data download connection

Each computer in the DAS maintains a database that includes a table that catalogs the names and sizes of all data files. Once the cart is connected to the DAS and the UMTRI building network, a program copies the files to the ACAS file server and then loads the numeric data into the ACAS SQL Server FOT database. This database also contains a catalog that is updated as files are moved and loaded.

3.3.6 Tool for Debriefing of Returning Participants

The following files are sent to UMTRI via cell modem for the purpose of preparing and facilitating the participant debrief:

- Hard-braking episodes;
- ACC engagements;
- FCW alerts;
- Comment-button presses.

The data from these files are combined into an event-facts table in the phone database. When the vehicle returns to UMTRI, the DAS computers are connected to the building network as described in Section 3.3.5.

The tool in Figure 3.13 uses the event-facts table and pulls the corresponding video data from the DAS to show the selected episodes of forward video, face video, and map location to the participant to elicit their comments on the performance of the ACAS system in a particular event.

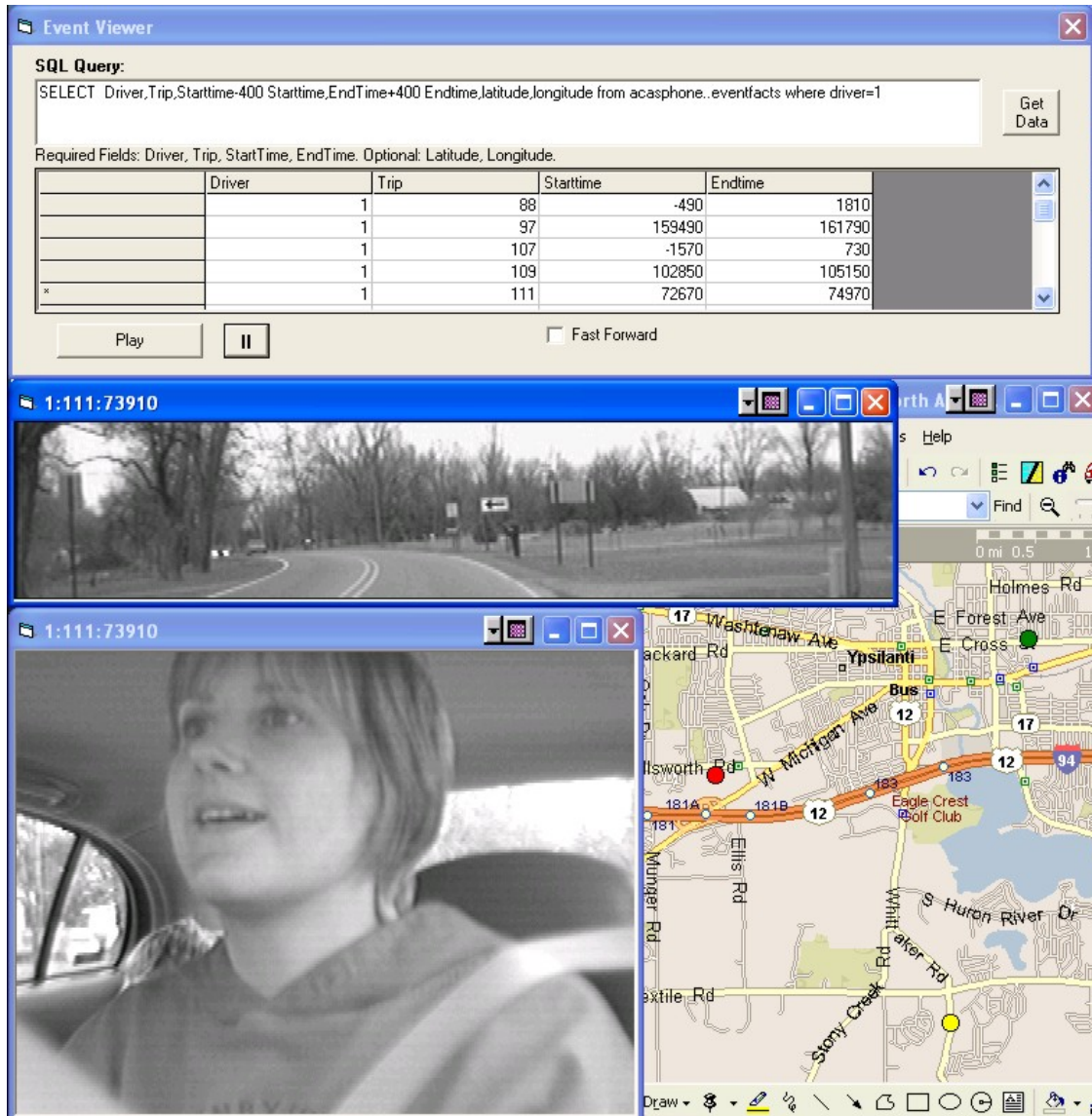

Figure 3.13. Debrief viewer

3.4 Management of Test Participants

3.4.1 Human Use Approval

Approval for the use of human subjects in research for pilot testing required review by three bodies: the University of Michigan Behavioral Sciences Internal Review Board (IRB), the General Motors IRB and the NHTSA Human Use Review Panel (HURP).

Ultimately, only the University and General Motors IRB were required to review and approve the application for the FOT. A separate approval from the University's IRB was obtained in order to perform focus groups.

3.4.2 Recruitment and Screening

With the assistance of the Michigan Secretary of State's office, 4000 licensed drivers were selected at random for possible participation in the FOT. The drivers were selected from among the licensed population living in the following nine counties in southeastern Michigan: Ingham, Jackson, Lenawee, Livingston, Macomb, Monroe, Oakland, Washtenaw, and Wayne. From this random pool of 4000 drivers, smaller random samples of names were selected to receive informational postcards. The postcards did not give specific details about the study, but stated that the recipient had met some of the criteria necessary to participate in the study. Additionally, the postcard stated that drivers would have the use of a new car and would be compensated for their time. A toll-free number was provided for interested persons to learn more about the study and determine if they qualified.

A total of 2900 postcards were mailed resulting in 356 people (12.3%) calling to inquire about the study. A research associate provided these callers with an overview of the study and screened all interested persons. A minimum-annual-mileage threshold was required for a driver to qualify. This minimum value was determined using mean values reported in the year 2001 National Personal Transportation Survey (NPTS). The NPTS reports average annual mileage by driver age and gender for U.S. drivers. The qualifying criterion was to report mileage not less than 25% below the NPTS reported average for an age and gender category. In addition, the following were grounds for excluding individuals from participating in the field operational test, at the time of the follow-up phone call:

- They or their spouse/partner work for an OEM or Tier 1 supplier (automotive manufacturer or parts supplier).
- They have been driving less than two years.
- They are unable to drive a car equipped with an automatic transmission without assistive devices or special equipment.
- They have been convicted of any of the following in the past 36 months:
 - a. Driving while their operator's license is suspended, revoked, or denied.
 - b. Vehicular manslaughter, negligent homicide, felonious driving or felony with a vehicle.

- c. Operating a vehicle while impaired, under the influence of alcohol or illegal drugs, or refusing a sobriety test.
 - d. Failure to stop or identify under a crash (includes leaving the scene of a crash; hit and run; giving false information to an officer).
 - e. Eluding or attempting to elude a law enforcement officer.
 - f. Traffic violation resulting in death or serious injury.
 - g. Any other significant violation warranting suspension of license.
- They acknowledge the need for, but fail to use, corrective devices such as eye glasses or hearing aids.
 - They are currently taking any drugs or substances which may impair their ability to drive.
 - They agree to abstain from drinking alcohol for at least 12 hours prior to any trip with the ACAS vehicle, with abstention for 24 hours preferred.
 - They have symptomatic heart disease with chest pain; shortness of breath or light-headedness which they have experienced at rest or when walking one block or less; rhythm disturbances associated with light-headedness or fainting; require defibrillation; or have experienced a heart attack within the past six (6) months.
 - They have suffered brain damage from a stroke, tumor, head injury, or infection; have visual loss, blurring, or double vision; weakness, numbness, severe tremors or funny feelings in the arms, legs, or face; trouble swallowing, slurred speech; uncoordination or loss of control; trouble walking, trouble thinking, remembering, talking, or understanding.
 - They have had a stroke within the past 3 months, have an active tumor, or have lingering effects of a stroke or transient ischemic attack suffered in the past year.
 - They have ever been diagnosed with seizures or epilepsy and have experienced a seizure in the past 12 months.
 - They suffer from a respiratory disorder such as asthma or chronic bronchitis which results in obvious or continuous shortness of breath, especially if oxygen therapy is required.
 - They often suffer from motion sickness under mild to moderate conditions or the sickness results in severe symptoms.
 - They have suffered from inner ear, dizziness, vertigo, or balance problems in the past 12 months or have Meniere's disease.
 - They suffer from diabetes and, as a result, are required to take insulin, or have had symptomatic hypoglycemia in the past three months.

- They have migraine or tension headaches greater than two times a month, or if they take narcotic medications for the headaches.
- They are, or there is a possibility that they are pregnant.

Individuals that met all qualifications and were needed to satisfy the experimental design received a brief overview of the field test. The final selection of drivers was dependent upon the person's availability per the test schedule. If individuals found the conditions of participation to be generally agreeable, a specific date and time was arranged for the driver to visit UMTRI to pick up the ACAS vehicle and go through an orientation.

3.4.3 Pre-launch Orientation

Prior to a driver's arrival at UMTRI, they received a mailing containing several items. Each driver received, and was required to read, an information letter that outlined the study procedures, protocol, risks, and benefits. The information letter is in Appendix B. Furthermore, drivers were required to acknowledge their awareness and acceptance of these conditions by signing an informed-consent form, attached as Appendix C. Drivers also received a background questionnaire, a driver behavior questionnaire, and a driving style questionnaire. The driver behavior and driver style questionnaires are included as Appendices HF3 and HF4, respectively. Each driver provided written consent at the beginning of the orientation session. Drivers were introduced to the ACAS-equipped vehicle as well as the FCW and ACC functions and controls via a 17-minute training video.

Drivers were then given a hands-on overview of the test vehicle and the ACAS system. A HUD demonstration prior to the test drive afforded each person the opportunity to observe the FCW warning icons and system-state messages before actually experiencing them in real traffic. The accompanied test drive lasted about 20 minutes and included both local roads and expressways so that drivers were exposed to the FCW system as well as being able to engage ACC on the expressway. A copy of the training video and written instructions about the use of the ACAS system was placed in each test vehicle's glove compartment so that drivers could review the materials if needed. (See Appendix D for the transcript of the orientation video.) After the test drive, seated-eye-height measurements were taken while each driver sat in the test vehicle. Lastly, drivers were reminded to page an on-call researcher with any problems or questions.

3.4.4 Communication in Contingencies

During the FOT, two researchers carried pagers which shared a common number. Researchers were available 24 hours per day. Drivers were instructed to contact a researcher if they were involved in a crash, had mechanical or ACAS system problems, or simply had questions about the ACAS system. A cell phone was placed in each test vehicle so that drivers could conveniently contact researchers.

On a limited number of occasions, UMTRI researchers had to initiate contact with drivers. A driver was contacted in the event of one of the following conditions:

- An ACAS system component failure was detected by remote monitoring by ACAS researchers. If a component failure was detected while the vehicle was in the field, the driver was contacted to make arrangements to provide him or her with another ACAS vehicle.
- System software upgrades were required. Drivers were contacted and software upgrades were completed by UMTRI personnel at the ACAS vehicle's location.
- Lack of cell modem activity. If data were not being transmitted via the cellular modem in the ACAS vehicle, drivers were contacted to inquire whether the ACAS vehicle was being driven.

3.4.5 Post-return Debriefing

At the conclusion of their 26-day ACAS driving experience, drivers returned the test vehicle to UMTRI. During a 2-hour debriefing session, drivers completed an extensive questionnaire (Appendix E). The questionnaire specifically addressed primarily the FCW and ACC systems, and included a limited set of questions which addressed the HUD. While the driver completed the questionnaire, a researcher prepared to show the driver the video from a sample of alerts from their time with the ACAS vehicles. The researcher accessed the on-board data record to determine the amount of and type of ACAS imminent alerts that had been received by the driver during their ACAS driving experience. Additionally, the researcher reviewed the accompanying forward camera and face camera video for these alerts. Between 12 and 15 alerts were selected to be replayed to the returning driver. When possible, a driver was shown an equal number of stationary and moving alerts. The presentation order of the type of the alert (moving versus stationary) was balanced across all drivers.

Once drivers had completed the questionnaire, the researcher discussed their responses with them and drivers were provided an opportunity to offer further amplification and clarification where necessary. Seven additional questions which were

not included in the final version of the post-drive questionnaire were asked. Next, the selected alert-event videos were shown and detailed feedback concerning the usefulness of each of the shown alerts was elicited. At the end of the debriefing session, drivers were given an additional take-home questionnaire (Appendix F) and a postage-paid envelope to return it. They were asked to complete this additional questionnaire within ten days of the completion of their ACAS driving experience. All drivers were paid \$250 for their participation at the end of the debriefing session. Drivers who completed and return the take-home questionnaire received an additional \$50.

3.4.6 Focus groups

Upon completion of their participation in the FOT, the 66 Algorithm-C drivers were invited to participate in a single focus group session. The focus group provided drivers with the opportunity to expand on their answers to the detailed questionnaire and provide additional information about their experience with the ACAS system. Additionally, conversations with other focus-group members often supplied added insights into their experiences with the ACAS system. Each of four separately-held focus groups lasted approximately two hours. The same 35 questions about FCW and ACC were asked each time. A complete list of the questions may be found in Section 4.4.5. Drivers were paid \$45 for taking part in a focus group.

3.5 Management of Test Vehicles

Maintenance and monitoring of the FOT fleet, from both the automotive and the ACAS-system aspects, were vital to the success and safety of the FOT. Careful monitoring of the fleet was required given the experimental system installed in the vehicles, as well as the mileage expected for them. This section provides details regarding the overall management of the test fleet including vehicle scheduling, launch and routine maintenance of vehicle and system health.

3.5.1 Schedule for Validating and Dispatching Vehicles

Over the course of the operational field test, each vehicle underwent two types of tests: characterization tests and checkout tests. The characterization tests were performed once per vehicle, and occurred between the time that the vehicle was received by UMTRI from GM and its release to the first participant. (Prior to this delivery, GM executed more thorough validation tests of the ACAS functions.) Checkout tests, as the name implies, were performed each time a vehicle was released for use by a participant. The checkout tests were much more limited in scope than the characterization tests. Various aspects of

the system were exercised, and, based on the response, adjustments or corrections were made. If the needed adjustments were relatively minor (e.g., camera focus, camera aim) they were done by UMTRI's staff, however, when the required repairs were more substantial (e.g., HUD that is dimmed or with a limited range of motion), they were made by GM and/or Delphi personnel. Data were collected during these exercises primarily for documentation purposes. The primary means to evaluate the success or failure of the tests was the experimenter's subjective evaluation. Unless a problem presented itself, these data were unlikely to be actually examined. Throughout the checkout process, the experimenter also observed the display interface and ensured that the proper settings and warnings were shown.

The original FOT design called for either two or three vehicles to be returned at the beginning of the week and to be sent out again with new participants at the end of that week. The FOT startup was staggered as shown in Figure 3.14 such that the deployed fleet was built up to a total of ten vehicles (plus a spare vehicle) over the first six weeks. Similarly, at the end of the FOT the circulation pattern tapered off such that the last weeks involved only the receiving of test vehicles.

Note that the original nominal design outlined in Figure 3.14 for dispatching vehicles addressed the original goal of 78 drivers over 39 weeks. During the course of the FOT, the goals were changed to 96 drivers over 49 weeks. This extension is not incorporated into the figure. The original design was based on achieving a 73 percent efficiency in deployment: 78 drivers out of a possible 107 duty cycles (10 cars, 43 weeks, 4 weeks per driver). In reality, 96 drivers were launched, which over a period of 49 weeks result in an achieved efficiency of 78 percent. During the FOT a planning program was used to track the fleet deployment. Figure 3.15 shows a screen snapshot of the program in use.

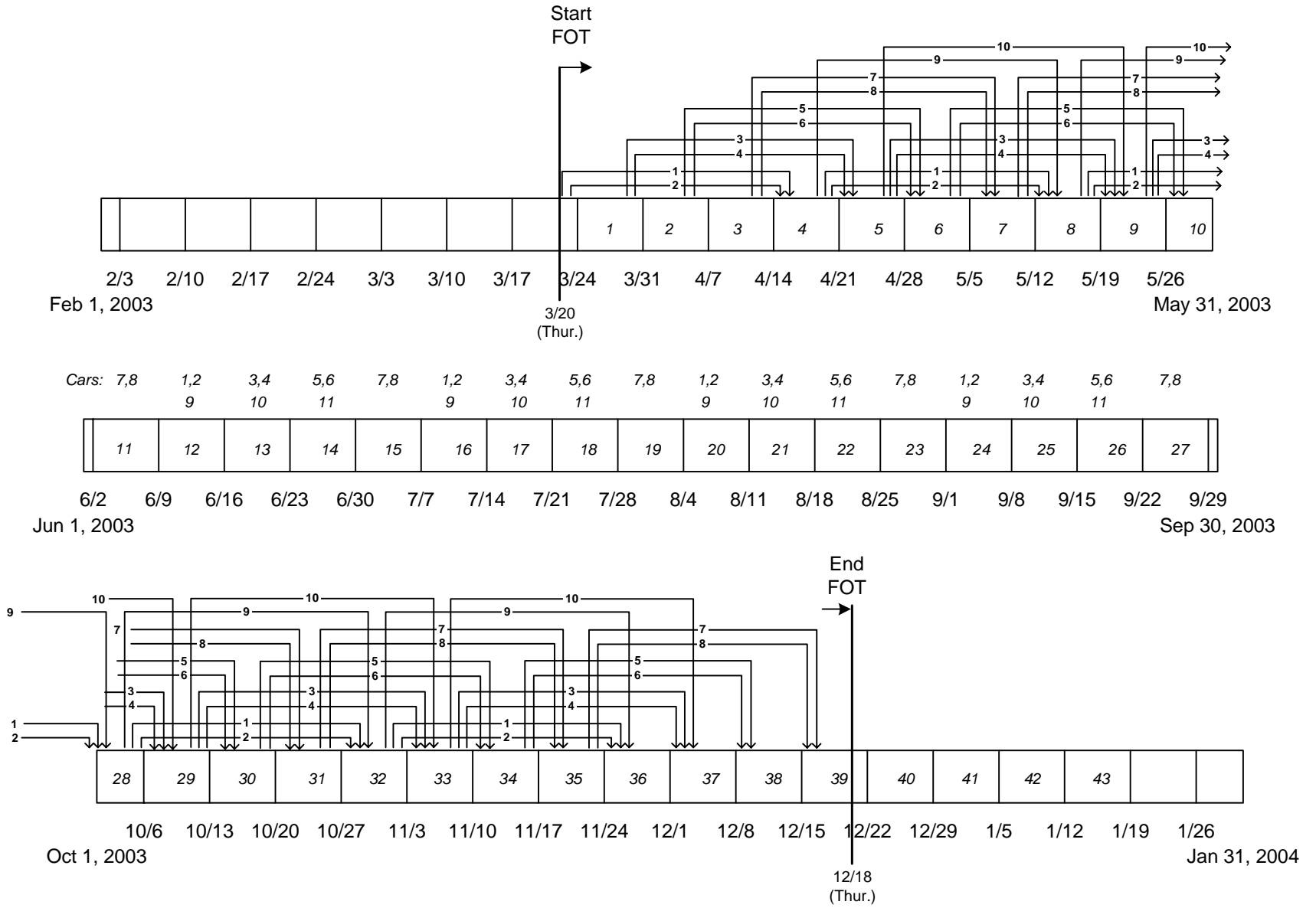

Figure 3.14. Original scheduling design for the FOT

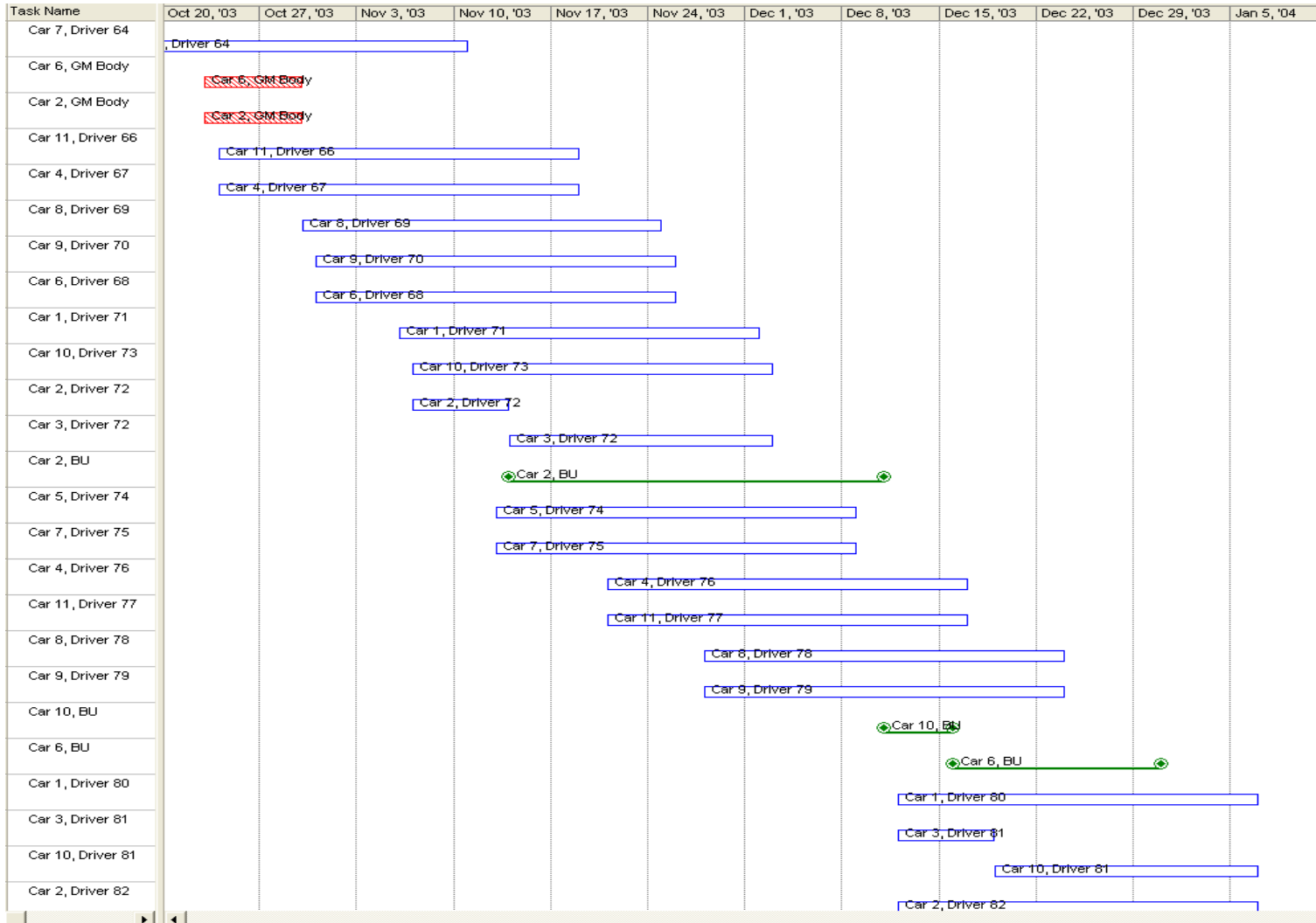

Figure 3.15. Monitoring fleet deployment during the FOT

3.5.2 Preparations for Vehicle Launch

During each week of the FOT, a rotation of two or three vehicles took place. Vehicles were received at the beginning of the week, and they were sent out on Thursdays and Fridays. Occasionally, special arrangements were made to accommodate schedule conflicts of the participants.

Typically, the turnaround period for a vehicle (from one driver’s return to UMTRI until the next driver was sent out in the same vehicle) was two to three days. The nominal plan was based on an available time period of two days (16 work hours) for turnaround completion. A detailed list of tasks, addressing both the automotive aspects and the system and data aspects, was followed during that period to ensure a consistent and complete preparation. The list included items to be completed before a subject was assigned an FOT vehicle. Overall, the list covered activity items and procedures as given in Table 3.3 below.

Table 3.3. Vehicle-turnaround activities

<i>Task description</i>	<i>Duration (Hours)</i>																																																			
<p>(1) Data from first driver is uploaded onto server.</p> <p>(2) Vehicle maintenance tasks. A checklist was followed to cover items such as:</p> <ul style="list-style-type: none"> — safety, readiness, and functionality of all automotive systems; — ensuring content of driver equipment (e.g., emergency tools, maps, etc.); — ensuring content of documentation (e.g., instructions, insurance, etc.); — performing periodic maintenance per OEM schedule; — cleaning. <p>(3) System maintenance tasks</p> <p>(4) Verification of the functionality of the system and creation of a permanent record of the system behavior using a predefined set of driving maneuvers.</p> <p>(5) Verification that the DAS was working correctly and re-initialization of the system for the next driver.</p>	<table border="1" style="width: 100%; border-collapse: collapse;"> <tr><td style="text-align: right;">(1)</td><td style="width: 20px;"> </td><td style="text-align: right;">0</td></tr> <tr><td></td><td style="border-left: 1px solid black;"> </td><td style="text-align: right;">1</td></tr> <tr><td></td><td style="border-left: 1px solid black;"> </td><td style="text-align: right;">2</td></tr> <tr><td></td><td style="border-left: 1px solid black;"> </td><td style="text-align: right;">3</td></tr> <tr><td style="text-align: right;">(2)</td><td style="width: 20px;"> </td><td style="text-align: right;">4</td></tr> <tr><td></td><td style="border-left: 1px solid black;"> </td><td style="text-align: right;">5</td></tr> <tr><td></td><td style="border-left: 1px solid black;"> </td><td style="text-align: right;">6</td></tr> <tr><td></td><td style="border-left: 1px solid black;"> </td><td style="text-align: right;">7</td></tr> <tr><td></td><td style="border-left: 1px solid black;"> </td><td style="text-align: right;">8</td></tr> <tr><td style="text-align: right;">(3)</td><td style="width: 20px;"> </td><td style="text-align: right;">9</td></tr> <tr><td style="text-align: right;">(4)</td><td style="width: 20px;"> </td><td style="text-align: right;">10</td></tr> <tr><td></td><td style="border-left: 1px solid black;"> </td><td style="text-align: right;">11</td></tr> <tr><td></td><td style="border-left: 1px solid black;"> </td><td style="text-align: right;">12</td></tr> <tr><td></td><td style="border-left: 1px solid black;"> </td><td style="text-align: right;">13</td></tr> <tr><td></td><td style="border-left: 1px solid black;"> </td><td style="text-align: right;">14</td></tr> <tr><td></td><td style="border-left: 1px solid black;"> </td><td style="text-align: right;">15</td></tr> <tr><td style="text-align: right;">(5)</td><td style="width: 20px;"> </td><td style="text-align: right;">16</td></tr> </table>	(1)		0			1			2			3	(2)		4			5			6			7			8	(3)		9	(4)		10			11			12			13			14			15	(5)		16
(1)		0																																																		
		1																																																		
		2																																																		
		3																																																		
(2)		4																																																		
		5																																																		
		6																																																		
		7																																																		
		8																																																		
(3)		9																																																		
(4)		10																																																		
		11																																																		
		12																																																		
		13																																																		
		14																																																		
		15																																																		
(5)		16																																																		

3.5.3 Vehicle Maintenance

Routine vehicle maintenance and repair work combined UMTRI staff effort and work that was done at authorized GM service shops. For special needs, GM or Delphi was involved directly. The maintenance tasks were carried out through the following sub-tasks:

- UMTRI inspection — complete automotive check to ensure safe and proper functionality of the vehicle. At that time, conformance with standard maintenance schedule and procedures set by the manufacturer were verified.
- OEM maintenance — any repairs, if needed, and dealer-level periodic maintenance (e.g., recall campaigns) were performed by authorized GM service shops in Ann Arbor, Michigan. Given the unique aspects of the test fleet relative to the OEM configuration, UMTRI arranged for dedicated points of service. That is, maintenance personnel at the dealer were specially acquainted with the nature of the vehicles. Some maintenance issues that were determined (mainly by GM) to be beyond the dealer's capability, were addressed at the GM Technical Center in Warren, Michigan

3.5.4 ACAS System Maintenance

Prior to release of a vehicle to the next participant, the integrity of the ACAS system was tested via the checkout tests to ensure both the safety and proper functioning of the system. When problems were found, UMTRI staff attempted to solve them and make repairs under GM's and Delphi's guidance. When necessary, the more complicated repairs were made by GM or Delphi.

4 The ACAS data set

The data set used as the basis for all the analyses that follows in this report can be divided into four major subsets: primary data, derived or secondary data, subjective data and video/audio data. The primary data set consists of those data collected on-board the test vehicles as they were being driven by the test subjects. These data are considered primary because they were meaningful as received and required little or no processing prior to being loaded into the FOT databases. Secondary data, on the other hand, have been derived from the primary data using some substantial form of processing or analysis. Some secondary data are collected in “real-time” on-board the vehicles, mostly in the form of histograms, while the bulk of these data are derived and stored after the vehicles have been returned by the subjects. (See Section 5 for a discussion of the data processing methods used in this study.) Subjective data are those that describe the characteristics of the test participants themselves (i.e., age, gender, income, etc.) as well as their opinions and preferences. Lastly, the video/audio data consists of forward video images that capture the forward driving scene for each driver on each trip at all times, and the driver’s face image which is captured in an exposure- and event-triggered mechanism. This section of the report outlines the content and structure of the primary data, on-board audio recording triggered by alerts or comment-button presses, and subjective data. Video was discussed in Section 3.3, and secondary data are covered in Section 5.

4.1 Overview of the Data Archive

To explain the various components of the ACAS data archive, it is helpful to see an overview of the data path that shows how the archive relates to the other important elements of the data processing and handling methods used during and after the FOT. This overview is shown in Figure 4.1 below. In the broadest sense, the figure shows that data are generated by the test vehicle and stored on the DAS. Then, at the end of every trip and when the vehicle returns to UMTRI these data are moved to the data server. Customized executables running on the data server load the data files into the ACAS database. (Data files coming over the cell phone were also loaded into the ACAS phone database for vehicle/system diagnostic- and health-monitoring.)

The analysis/processing and visualization of the data were done using a variety of tools with the results of these processes being stored in databases that were separate from the main ACAS database (called Analyst’s DB in Figure 4.1). Also, subjective data from the various forms and questionnaires provided by each subject were loaded into a participant database. Lastly, tying together most of the data generation and handling

processes is the ACAS *project database*. Because the project database contains all the necessary information to document the data as it was collected on the DAS, it serves as a reference to document the object data archive as it was collected on the test vehicles. A description of the project database can be found in Section 3.3 which covers the data acquisition system.

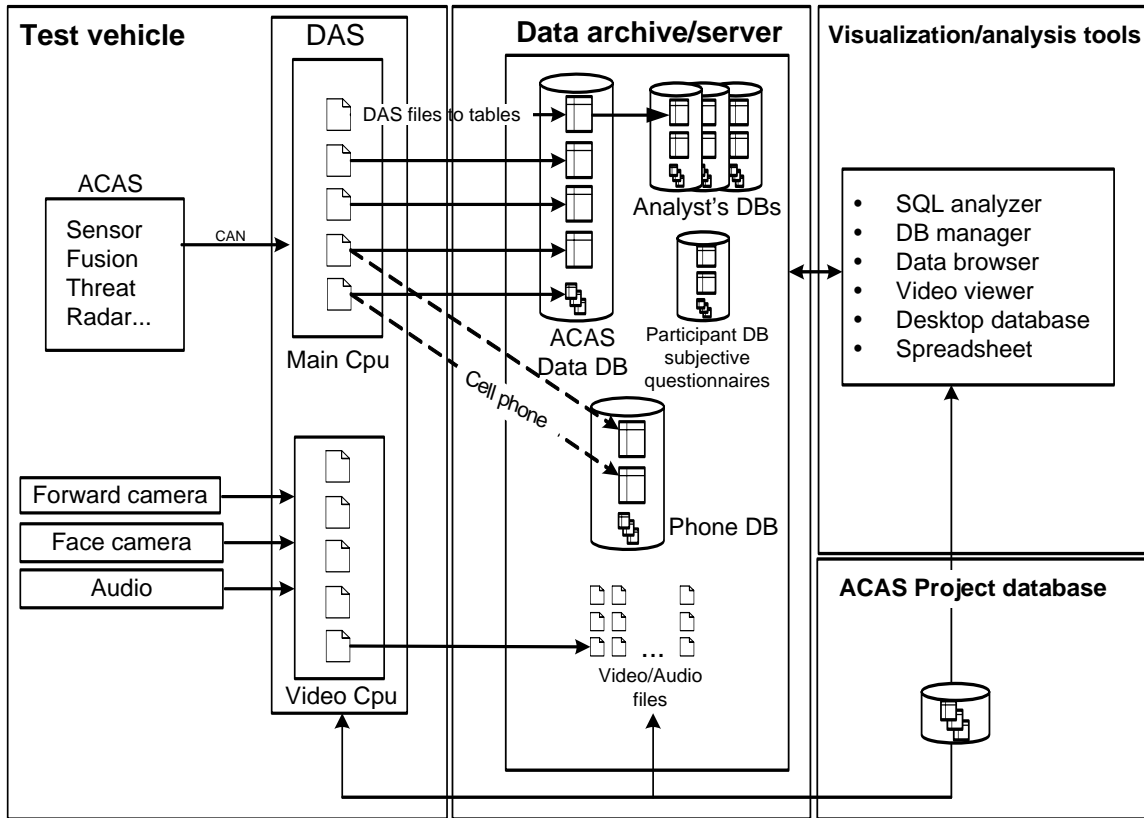

Figure 4.1. Overview of the ACAS data handling paths

4.2 The ACAS FOT Database

The ACAS FOT database contains approximately 164 GB of data and is a collection of 72 tables ranging in size from hundreds to over 400 million records (most time-history or triggered series tables contain approximately 133 million records). The table structure in the database is a direct mapping between files collected on-board the vehicles and the tables in the database. The general format of the tables/files is summarized in Table 4.1 below. This table also shows an example file name (for driver 9, trip 25) for each of the on-board files. (Note: unlike other tables, the summary file also contains histogram information and hence maps to multiple tables in the database.) The format of each file is given in the table and a short description of each format follows:

Table 4.1. Files/tables generated for each trip in the FOT

<i>Table name</i>	<i>Format</i>	<i>Example DAS File Name</i>
Summary	Summary	Summary_9_0025.bin
AccBraking	Triggered Series	AccBraking_9_0025.bin
Data	Triggered Series	Data_9_0025.bin
DFTh	Triggered Series	DFTh_9_0025.bin
Map	Triggered Series	Map_9_0025.bin
Sensor	Triggered Series	Sensor_9_0025.bin
STVRc	Triggered Series	STVRc_9_0025.bin
Comms	Triggered Summary	Comms_9_0025.bin
Engs	Triggered Summary	Engs_9_0025.bin
Fcws	Triggered Summary	Fcws_9_0025.bin
Hbs	Triggered Summary	Hbs_9_0025.bin
Bytes	Triggered Transition	Bytes_9_0025.bin
Doubles	Triggered Transition	Doubles_9_0025.bin
Floats	Triggered Transition	Floats_9_0025.bin
RadarInfo	Customized	RawRadar_9_0025.bin
Targets	Customized	RawRadar_9_0025.bin

Summary—these files contain histograms and trip-summary numbers. The data in the summary-formatted files are stored as one record and are only saved to disk at the end of a trip. The structure and mapping of a summary file is complex as this type of file contains a mixture of data types.

Triggered series—these files are time-history in nature (i.e., records are written to the file at a constant frequency). The data written to these file types were sampled at 20 Hz, but written to disk at 10 Hz. Only the AccBraking triggered series file was gated and not collected all the time. The channels in this file were only saved to disk when the ACAS system commanded automatic braking. Data for the other triggered series files were written to disk at all time.

Triggered summary—these files are event based. Similar to a summary file that contains information about an entire trip, a triggered summary contains information about an event that occurs within a trip. The four triggered summaries collected on-board each vehicle recorded information regarding: 1) Comms—driver comment button events, 2) Engs—CCC and ACC engagement events, 3) Fcws—forward collision warning events, and 4) Hbs—hard braking events.

Triggered transition—data are logged to these files upon a transition in a signal’s value.

The name of the transition file indicates the format of the logged value. Byte-transition events can have a value between 0 and 255, Float transitions can have values between $-3.40E+38$ and $3.40E+38$, while the Doubles transitions are precision number data from $-1.79E + 308$ to $1.79E + 308$. The data actually logged for each transition event are the channel signal identification number, the transition value, and the time that the value changed.

Customized—the radar data was not completely parsed on-board the vehicles as they were being driven during the study. Instead, a post-processing routine was established that parsed through each of the raw CAN radar files and mapped them directly into the Targets and RadarInfo tables. (Note: all CAN data was saved in its original format during the test for use by the partners. Their customized tools require that this portion of the dataset be formatted for direct CAN-message input.)

Regardless of the table format, all tables share similar fields that constitute the primary indices of the database. These primary indices are *Driver*, *Trip*, and *Time*¹ where *Driver* is a number from 1 to 96, *Trip* is a sequential number indicating the ignition on/off cycle, and *Time* is an integer number representing the number of centi-seconds since the start of the DAS. The fact that relationships can be formed between similar fields such as these allows data from different tables to be *connected*. This connection is the backbone of the relational database concept and is a powerful analysis technique with large datasets containing millions of records.

Since this report was not intended to be a primer on the use of relational databases, the level of detail regarding the implemented structure of all the tables and other objects in the ACAS database is limited. However, it is intended that this report document the content of the objective data set so that it can be used as a reference for further analyses of these data.

Test-Segment Groups Labeling

All of the time-domain data gathered from each participant ultimately becomes distinguished by one of four nominal test-segment groups that subsequently, afford a key distinction for analyzing the data archive. Figure 4.2 identifies the four test-groups by

¹ Most tables have a *Time* field; however, the name used for the field does vary for different tables, but always includes the word time. As a rule, the data were collected at 10 Hz which means that each centi-second time value is a multiple of 10. However, to ensure that all radar data were recorded, the DAS sampling frequency was set to 20 Hz. In some rare instances, the Time recorded by the DAS was between 10 Hz samples. In these cases, the time value would be a multiple of 5.

name, as they associate with both the state of ACAS enablement and the state of the prevailing cruise-mode's engagement. The following definitions apply:

- CCC: data from 1st-week driving in which the conventional cruise control (CCC) system is engaged;
- ManBase: data from 1st-week driving in which the CCC system is not engaged;
- ACC: data from 2nd-through-4th-week driving in which the ACC system is engaged;
- ManACAS: data from 2nd-through-4th-week driving in which the ACC system is not engaged;

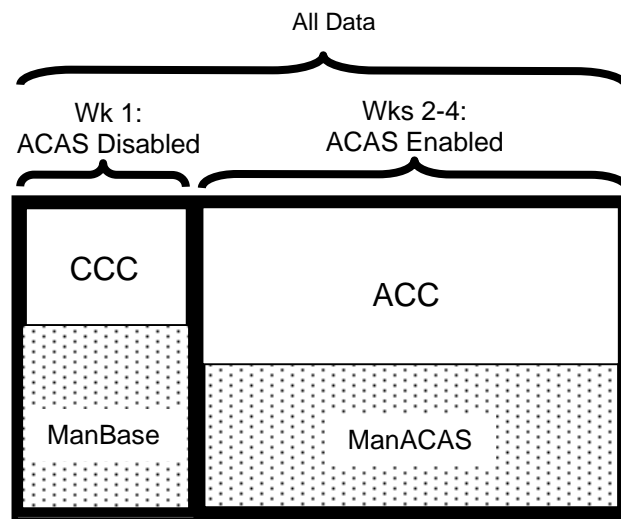

Figure 4.2. Labeling of the four test-segment groups

Subjective Data

All information collected regarding each driver was entered into an SQL database. This included all of the data outlined in Section 4.4: biographical information, responses to driving behavior and style questionnaire, and all post-drive and take-home questionnaire responses. This database could in turn be merged with those containing vehicle-based data in order to better characterize drivers and their perceptions and behaviors.

4.3 Invalid Data and Known Anomalies

This section of the report addresses, in a broad sense, the overall quality of the objective data collected by the DAS during the FOT. Three levels of data scrutiny are used to address this issue. The first is an accounting of the mileage traveled and logged by the DAS. The second is a trip level evaluation of the data quality that results in characterizing entire trips as being valid or invalid. The implications of this characterization are presented in terms of miles and exposure relative to the entire FOT experience. The third

is a general discussion of low-level data issues that are addressed on an individual basis during a specific analyses and area of study. This third section is conceptual in nature due to the fact that these problems tend to be specific to a particular channel. In some of these cases, data were corrected across all drivers regardless of the type of analysis done while in other cases, the problems were identified and simply excluded from further analysis based on the premise that sufficient remaining ‘good’ data existed to provide meaningful findings from the database overall.

4.3.1 Overall FOT Distance Summary Per Vehicle

In general, the collection and logging of data during operations by the subject drivers was robust, with approximately 96 percent of all miles driven recorded by the DAS. Table 4.2 shows an accounting of the distance accumulated on each vehicle as compared to the driving distance as measured by the DAS². Data for twelve vehicles are shown in the table. Each of these vehicles was driven by a subject at some point during the study, although at any given time the maximum number of vehicles in the field was ten. The meaning of the columns is explained below.

Table 4.2. Overall FOT distance summary per vehicle in miles

<i>Vehicle number</i>	<i>DAS distance</i>	<i>Missed on start-up</i>	<i>ACAS malfunction</i>	<i>Skipped Trips</i>	<i>Total</i>	<i>Odometer (truth)</i>	<i>Difference</i>
1	16054	259	1269	10	17592	17600	8
2	9089	216	112	10	9427	9438	11
3	8191	136	121	40	8488	8492	3
4	11851	246	57	1	12156	12171	16
5	12947	301	164	109	13520	13536	15
6	11917	232	276	13	12439	12452	14
7	14503	383	269	37	15192	15209	17
8	10492	220	232	5	10949	10958	9
9	16056	235	85	11	16388	16409	21
10	10309	230	110	7	10657	10661	5
11	14069	215	158	41	14483	14501	18
12	3601	86	74	0	3761	3767	6
Total	139078	2760	2928	284	145050	145194	144

² Due to corrupted hard-disks, the DAS malfunctioned on two drivers (81 and 92) during the FOT, which resulted in the loss of at most 880 miles of driving. (We know the mileage when the DAS failed, and we know the mileage when we sent the next subject. We do not know which portion of the *missing miles* were actually driven by the participant driver.) These miles are not included in the table due to the fact that odometer values were not manually recorded when the vehicles (6 and 5) were retrieved from these subjects.

The odometer miles shown in the table were derived by taking the difference between the last and first recorded odometer values for each driver and summing them per vehicle. This represents the best estimate of the actual distance each vehicle was driven by the subjects during the field test operations and excludes any distance that might have accumulated on the vehicles between drivers when engineers or technicians operated the cars. Based on these data and for the twelve vehicles used in the FOT, a total of 145,194 miles were traveled by the 96 subjects. The column labeled DAS distance represents the total distance traveled by the subjects for each vehicle, as measured by the DAS. The total of this column for all vehicles is 139,078 miles which is 5,972 miles less than that measured by the fleet's odometer records. This difference in measured distance can be accounted for by considering the three main causes of missed distance, as measured by the DAS, which were:

- 1) Missed start-up distance. In the event of a "cold start," that is, when the DAS has to perform a full boot-up, the vehicle is often moving before the DAS begins to process and record the vehicle performance data (the magnitude of this missed distance depends on how quickly the driver begins moving following the ignition-on event and how fast he drives in the first minutes of the trip). The missed start-up distance, as shown in the table, accounts for approximately 2,760 miles or about 46 percent of the 5,972 mile difference between the actual distance and the DAS recorded distance. This distance is estimated using recorded GPS locations.
- 2) ACAS malfunction distance. There were a number of reasons for an ACAS system malfunction. A primary one was the malfunction of the sensor processor (an essential component of the ACAS system). Sensor malfunctions result in no data being written to the CAN bus and hence, no vehicle speed or calculated distance by the DAS is derived for the entire time of the malfunction. Another ACAS malfunction occurred when a software license, resident in each car, expired during the test period creating a significant event in which all fielded cars malfunctioned within a 24 hour time period. These malfunctions constitute a loss of approximately 2,928 miles or about 49 percent of the 5,972 mile difference between the actual distance and the DAS recorded distance.
- 3) DAS skipped trips. Depending on the timing and sequence of events related to a series of ignition cycles, it was possible that the DAS logic could arrive at a state that resulted in the loss of data for an entire trip. This was an unlikely event, but nevertheless, it accounted for 284 miles of missed data and occurred on all the vehicles with the exception of vehicle 12 (note: vehicle 12 had the fewest miles

and drivers of the fleet). This skipped distance constitutes approximately 5 percent of the difference between the actual distance and the DAS recorded distance.

Overall, there remains 144 odometer miles that were unaccounted for by the DAS or the three main reasons for lost distance outlined above. This represents a difference of less than 0.1 percent of the actual distance (which is notable, given that the resolution on the odometer-recorded data is 0.5 miles)

4.3.2 Invalid Trips

For the purpose of this report and the analysis and findings herein, an assessment of the validity of the data were done at the trip level, identifying eight areas of problematic or extraneous data that were deemed unacceptable for the exposure and analysis sections of this report. The eight classifications for excluding entire trips were:

1. Zero distance—Trips with no logged distance by the DAS were excluded. These were trips in which the vehicle did not move, there was a ACAS system malfunction (and hence no recorded distance), or trips that ended before the DAS was fully operational.
2. Low-speed—Trips with a maximum speed of 20 mph (9 m/s) or less were excluded regardless of distance traveled.
3. System health not okay—Trips for which none of the ACAS system health flags were operational during the entire time of the trip were excluded.
4. Critical okay < 90 percent—Trips wherein the critical ACAS systems were inoperable more than 10 percent of the time were considered invalid.
5. Frozen threat index—Trips that showed significant instances of repeated threat assessment index values were considered invalid.
6. Radar malfunction—Trips for which the data showed that there were no radar targets for the entire trip were considered invalid
7. Non-FOT subject driving—Trips taken by non-FOT drivers were excluded. This distinction was based on a visual/manual analysis of the center exposure frame from each trip of each subject.
8. Premature system enabling—Driver 91 was mistakenly released into the field with the ACAS system enabled. This problem affected only the driver's first trip since the DAS evaluates and toggles (if necessary) the system state at the end of each ignition cycle.

In total, there were 1,761 trips and 2259 miles of driving excluded based on these seven classifications. Table 4.3 summarizes these results.

Table 4.3. Summary of invalid trips

<i>Invalid trip distinction</i>	<i>Distance, miles</i>	<i>Percent of all logged distance</i>	<i>Number of trips</i>
Zero distance trips	0	0	1096
Maximum trip speed < 20 mph	39	0.03	470
System health histogram not okay	69	0.05	14
Critical okay < 90 percent	983	0.71	124
Frozen threat index	754	0.54	15
Radar malfunction	178	0.13	32
Non-FOT subject driving	236	0.17	10

4.3.3 *Low-level Data Validity Problems*

The third level of scrutiny is identification of low-level problems. These problems tend to be specific to a particular channel, such as the missed transition in the brake signal or a numerical instability in a calculated field. Because these problems tend to present themselves in specific analyses, they are handled on an individual basis using the following considerations:

- careful validation of culled subsets,
- expert opinion of what is reasonable from the perspective of vehicle dynamics,
- an understanding of driving and the ACAS system, and
- experience in dealing with FOT datasets.

These problems fall into three general categories, namely those that are either:

- a) Transitional—The general character of these problems can be described as being *missed* transitional events. The cause of these problems was not specifically identified during the study because they are rare and seem to be intermittent in nature. In some cases, these problems can be corrected using other synchronous data channels.
- b) Discrete—The character of a discrete problem is best described as a wrong or invalid number. A good example is the odometer values from the vehicles which were reported for every 0.5 miles of travel. In a number of cases (with all vehicles showing the same behavior) the odometer data field showed a mileage decrease for the reported number (the value was then reported correctly at the next 0.5 mile value). In this specific example, the erroneous odometer data was simply ignored in any distance calculation using the odometer field.
- c) Continuous—These problems are found in the 10- or 20-Hz time-history channels and tend to be short in duration and easily found by searching for extreme values

in the field of interest. An example is the filtered longitudinal acceleration (AxFiltered) channel. During the normal sequence of start-up events the data in this channel is accurate. However, there were times when the startup sequence was different, and the DAS began recording data before the ACAS system began writing to the data bus (called a ‘warmstart’). In these cases, if the vehicle was moving, a large step function would occur in vehicle speed channel. Of course, when this channel was differentiated to derive longitudinal acceleration the values corresponding in time with the large change in velocity would be erroneously large and an extreme spike is recorded in the acceleration channel.

4.4 Subjective Data

4.4.1 Driver Biographic Data

Appendix G includes a table that contains much of the biographical data acquired from each driver. This data includes information such as age, zip code, estimated income, education, occupation, and primary vehicle make and model. This information was also contained in an SQL database in order to allow it to be merged with vehicle and event-based data. Detailed information regarding how all of the driver-related data were recorded can be found in Appendix H.

4.4.2 Behavior and Style Questionnaires

The driver behavior and driving-style questionnaires were administered to each driver to support analyses reported in Sections 7.2 and 8.2 to better understand driver acceptance results.

4.4.2.1 Driver Behavior Questionnaire (DBQ)

The DBQ was developed in Great Britain and evaluates features of drivers’ self-reported behaviors while driving. The DBQ, in the current ACAS study, was modified to better reflect the spelling, grammar, and driving situations present in the United States. This version of the DBQ is a 24-item questionnaire (Parker, Reason, Manstead, and Stradling, 1995) which examines three types of behaviors: errors, lapses, and violations (Reason, Manstead, Stradling, Parker, and Baxter, 1991). Errors are failures or misjudgments of an unintentional nature or the failure of a planned action to achieve its desired consequence. Errors are sometimes dangerous for other drivers. Lapses are more harmless events which result from inattention or slips in memory. Violations are deliberate acts which break social norms such as speeding or running a stop sign (Parker,

et al., 1995). Errors and violations are the two that are theorized to contribute to road accidents (Reason et al., 1991).

Scale scores for lapses, errors, and violations were developed by summing the scores for the questions that referred to a particular factor and then dividing by the number of questions relating to the particular factor. Four subjects left a question blank. In order to calculate a scale score for these subjects, an average of the remaining questions in that particular factor was taken and used in place of the missing data. Though the DBQ is anchored at 0 (never) and 5 (nearly all the time), the actual range of responses from subjects was small. This information, by driver, was also contained in an SQL database in order to allow it to be merged with vehicle and event-based data.

4.4.2.2 Driver Style Questionnaire (DSQ)

The DSQ was developed in Great Britain and evaluates features of drivers' self-reported style while driving. The DSQ, in the current study, was modified to better reflect the spelling, grammar, and driving situations present in the United States. The DSQ is a 15-item questionnaire which evaluates six factors of drivers' styles: focus, calmness, social resistance, speed, deviance, and planning. Focus relates to one's ability to drive cautiously and ignore distractions. Information about the ability to stay calm in dangerous and quick-paced situations is in the calmness scale. The social resistance scale addresses a driver's like or dislike for being given advice about driving abilities. The scale of speed contains questions related to whether one drives fast and over the posted limit. The deviance scale relates to behaviors that are inconsiderate of other drivers and often dangerous, like passing on the right or running a red light. Planning contains questions regarding a driver's tendency to plan ahead before setting out for a trip (French, West, Elander, and Wilding, 1993). The DSQ was constructed to include questions about behaviors related to accidents, decision-making styles, and reactions to advice that others give (West, Elander, and French, 1992).

The six factors above were distinguished after the questionnaire's original factor analysis. The six factors were scored in the same manner as the DBQ with averages resulting in scaled scores of the six factors, though there were no missing data for the DSQ. The DSQ is anchored at 0 (never) and 5 (nearly all the time). Some items were reversed-coded in order to score the items in such a way that "5" represents a lot of the quality (calmness, deviance, etc.) and "0" represents none of that quality. For instance, question 8 reads: "Do you become flustered when faced with sudden dangers while driving?" A score of "5" on this item would indicate no calmness. Therefore the

question was reversed coded such that a “5” would indicate great levels of calmness. The range in scores for the individual questions and for the overall factors with the DSQ is much larger than that for the DBQ. This information, by driver, was also contained in an SQL database in order to allow it to be merged with vehicle and event-based data.

4.4.3 Debrief Questions – Written

Appendix E contains the complete post-drive questionnaire, along with descriptive statistics, which each driver completed immediately upon returning the research vehicle. Most of the questionnaire took the form of 7-point Likert-type questions, with a few multiple choice and fill-in type questions. Once completed, a research associate reviewed many of the questions with the driver. The purpose was to receive clarification where written responses might have been ambiguous and to ensure that drivers responded to each of the questions. All of these responses are contained in an SQL database to allow for comparison with vehicle and event-based data.

4.4.4 Debrief Questions – Live Discussion

A researcher held an in-depth discussion with each driver regarding his or her responses to the questionnaire. Seven additional FCW questions (Appendices HF9 and HF10) which were not in the post-drive questionnaire were also discussed at the end of the FCW section and prior to the discussion about ACC. Drivers provided clarification and additional insights into their experiences with and impressions of the ACAS system.

As part of the debriefing discussion, drivers viewed both forward-camera and face-camera video for the FCW imminent alerts that they received. If drivers received more than 12 alerts, then only 12 alerts from among the total were shown to them. Each driver evaluated the alerts and rated them on their degree of usefulness. After viewing each video clip, drivers were asked whether or not the alert was useful in the given situation. If the alert was found to be useful, the driver was asked to provide specific details testifying to the usefulness of the alert. Finally, using the five-point scale below, they were asked to rate how useful the alert was perceived to be.

1	2	3	4	5
Not at all Useful	Slightly Useful	Somewhat Useful	Fairly Useful	Quite Useful

If an alert was rated as not being useful (i.e., a “1” rating), drivers provided insight as to why they found the alert to be unnecessary in the specific instance. A rating scale

similar to the one used to rate usefulness was employed to rate how unnecessary a particular alert was. Each alert was evaluated according to the method outlined above.

1	2	3	4	5
Completely Unnecessary	Fairly Unnecessary	Somewhat Unnecessary	Slightly Unnecessary	Not at all Unnecessary

4.4.5 Focus Group Sessions

Only Algorithm-C drivers were invited to attend a focus group after they had completed their entire driving experience and debriefing session. Four focus groups spaced approximately six weeks apart were each held on weekday evenings at UMTRI. Each focus group consisted of six or seven drivers, an UMTRI moderator, and a court transcriptionist. Of the 26 drivers who attended, ten were female and sixteen were male. Eight ranged in age from 20 to 30 years, eight ranged in age from 40 to 50 and 10 ranged in age from 60 to 70. During each focus group the same 35 questions were asked. Below is the series of questions. Responses to these questions are summarized in FCW Section 7.2.1.5 and ACC Section 8.2.1.4 of this report.

- How often did you encounter situations where you felt the FCW system was useful?
- How often do you get into a situation where an FCW system could help prevent a rear-end accident?
- How often do you come close to having a rear-end accident?
- Were there situations when you got an alert when you were not paying enough attention?
- Were there situations when FCW prevented a rear-end accident?
- When (if ever) did you find false alarms annoying?
- Did you tend to not pay much attention to FCW due to false alarms?
- What false alarm situations did you find most/least annoying?
- Were there situations when you did not get an alert when you felt one was required?
- Overall, did you think FCW warnings were useful?
- When (if ever) were the FCW warnings useful?
- Would you have turned FCW off if you could have?
 - ◊ If so, when and why?
 - ◊ When you got an imminent FCW alert, what did you typically do?

- ◇ Apply the brakes, check the traffic, or simply ignore the alert?
- ◇ Did your response change depending on the scenario?
- ◇ Did the way you responded to the alerts change with more FCW experience?
- ◇ If so, how?
- Do you think the FCW cautionary alert (amber icons that changed size) affected how you followed vehicles in normal traffic?
 - ◇ If so, how?
- What did you think of the timing of the FCW imminent alert?
 - ◇ Was it too early, just right, too late?
 - ◇ Describe what led you to this conclusion?
- Do you think that FCW will reduce harm caused by rear-end accidents?
- Do you think FCW made you a safer driver?
 - ◇ Did you drive more or less aggressively?
 - ◇ Are there other ways you think FCW may have changed the way you drove?
- Did FCW perform in the way you would expect it to if you bought this feature?
 - ◇ If not, how should FCW perform differently?
- Do you think FCW is ready for production?
- Would you buy an FCW system?
 - ◇ If not, why not
 - ◇ If so, why
- How would you suggest improving the FCW system?
- Overall, did you find ACC useful?
 - ◇ In what traffic conditions did you like using ACC?
 - ◇ In what conditions did you prefer not to use ACC?
- Compare your overall driving experience with ACC versus conventional cruise control.
- Did you make any errors when using ACC?
 - ◇ If so, what types?
- Were there situations when ACC prevented a rear-end accident?
- Were there situations when you were uncomfortable with the ACC behavior?
- Were there situations when ACC behaved such that it could have led to a rear-end accident?
- How do you think the ACC responded to stopped vehicles?
- How about slow-moving vehicles?
- How often did you override the ACC braking?
 - ◇ You applied the brakes harder than ACC would.

- What do you think about the maximum level of ACC braking?
 - ◊ Did you get a good sense of the maximum braking level?
 - ◊ Did you experiment to find this level of braking?
 - ◊ Too high, just right, too low?
 - ◊ Were you comfortable with this level of braking?
- What did you think of the range of settings for adjusting the distance to the vehicle ahead?
 - ◊ Were there enough settings?
 - ◊ What about the closest distance setting, was it too close, just right, too far?
 - ◊ What about the farthest distance setting, was it too close, just right, too far?
- Do you think that ACC will reduce harm caused by rear-end accidents?
- Do you think this ACC made you a safer driver?
 - ◊ Did you drive more or less aggressively?
- Are there other ways you think ACC may have changed the way you drove?
- Did ACC perform in the way you would expect it to if you bought this feature?
 - ◊ If not, how should ACC perform differently?
- Do you think ACC is ready for production?
- Would you buy an ACC system?
- How would you improve the ACC system?

5 Data Processing Methods

The previous section described the four types of data that constitute the FOT archive – primary data, secondary (derived) data, subjective data, and video/audio data. This section describes some of the more important secondary data. Secondary data are data resulting from substantial processing of the primary (un-processed) data. The data processing for the study can be thought of as falling into two distinct phases. The first phase was defined by the processing that occurs as the vehicles were being driven by the subjects. This processing was done by the DAS and included processes such as: histogram generation, event triggering, event counting, aggregating, integrating, etc. The second phase involved processing of data by analysts after the vehicle returned to UMTRI. This processing occurred while the field test was underway and after its conclusion.

A description of the data processing for these two phases is covered in Sections 5.1 and 5.2. The remainder of Section 5 discusses the specific methods of data processing used to address some of the major distinctions in the data archive that serve as the primary controlling variables that were not intentionally part of the experimental design. These include discussion of:

- driving conflict scenarios (Section 5.3);
- road-type designations and their simplification in the analysis (Section 5.4);
- treatment of the different FCW algorithms in analyses (Section 5.5);
- characterization of driver style (Section 5.6);
- levels of forward-conflict assessment (Section 5.7); and
- characterization of the traffic environment and vehicle lane position on the roadway (Section 5.8).

5.1 On-Board Data Processing

Any research project that involves data archives as large as the one collected here needs to make optimal use of all available computational resources. Accordingly, during this test, as much data processing as possible was done on-board the vehicles as they were being driven in the field. The primary role of the DAS was to gather data elements from the ACAS data bus at the most basic level, convert them, and save them in a format that would be meaningful to the engineers and researchers. The primary elemental tasks of this process were to read, parse, convert to engineering units, and save (in a format compatible with the FOT relational database) the hundreds of data signals that appeared

on the ACAS CAN bus on-board the vehicle. However, beyond this primary function, the DAS was also used to performed many processing tasks that contributed to:

- a) monitoring the health of the ACAS system while in the field,
- b) summarizing the exposure and activity of the vehicles and their drivers,
- c) and reducing the amount of data processing required after the vehicles and drivers returned from the field.

Not all data processing was possible by the DAS on-board the vehicle. The unique character of the data archive, i.e., that data is saved for all driving time means that certain processing methods are more easily done after the fact. A good example and one that was done using the ACAS data archive involved differentiating the speed signal to produce an accurate measure of vehicle acceleration without inducing any phase-lag in the measure. This was easily done post facto because at any time in the data archive there was the ability to use both future and past data values for the computation.

Sections 5.1.1 to 5.1.4 outline the on-board data processing that was implemented during the ACAS FOT.

5.1.1 CAN Message List

There were over 400 DAS channels created to support the data-collection process done by the DAS. Many of these channels were simple conversions of CAN messages to engineering units. Some of the channels were created for intermediate storage of information that could then be further parsed into meaningful data elements. Creating a byte channel and reading enumerated bits from it is a good example of such intermediate processing. A complete list of the channels that were derived directly from the ACAS CAN-message list is given in Appendix A. Furthermore, to support other diagnostic and data-analysis tools, the DAS also recorded and saved all the raw CAN messages for the entire FOT.

5.1.2 Histograms

Histograms can provide great insight and be an efficient method of summarizing large amounts of data, regardless of the underlying format of the particular channel being sampled. Histograms were used extensively in this project for analysis, sensor and channel validation, and monitoring overall system health. Many of the channels associated with the system and sub-system health were made into histograms for easy interpretation during the field test. Other histograms served as a very efficient source for first-order approximations of the exposure characteristics of each driver or groups of drivers. A good example of this would be the derivation of distance above a minimum

speed threshold from a speed histogram. Since a speed histogram contains the amount of time (counts) that each driver spent in each of the speed bins for every trip, it is numerically efficient to estimate the distance traveled by summing over all bins above the minimum speed threshold, the product of time in the bin and the center speed of the bin. In a relational database this can be done very efficiently regardless of the number of trips or drivers.

Table 5.1 on the next page summarizes the histograms produced by the DAS in real time during the FOT. It shows the name of the histogram (which directly maps into the database table name), a brief description of the histogram and the related gate channel. This channel would control when counts are added to the histogram bins.¹ Not shown in Table 5.1 is the histogram sort channel. Sort channels effectively increase the number of dimensions of the histogram. A good example of this is the SpeedRoadHist. Here a speed histogram was generated for each road class category, effectively producing nine separate histograms of speed, one for each road-class designation. Multi-dimensional histograms offer the added possibility of aggregating some or all of the categorical sorting values. That is, with any histogram, it is possible to combine columns and rows to make a smaller, less refined, representation of the underlying data. Other histograms, produced after-the-fact are discussed in Section 5.2.3.

5.1.3 Summary Numerics

On-board processing of summary numerics was also important both for diagnostics and driver-exposure considerations. After each trip, or at the end of a triggered summary, the DAS would count and record summary numbers such as counts of transitions, minimum or maximum values of a given field or the last value of a particular channel. Some examples of count channels include: *Abs*, *Alert*, *AccCleanSensor*, *Comment*, *DriverControlRequired*, *AutoBrake*, etc. A good example of a minimum, maximum values of a channel were found in the auto alignment of the radar. The integration of *Speed*, gated by other channels like *Dark*, *Wiper*, *FcwActive* and *Engaged* provided the summary distance statistics for each of these different conditions.

¹ In many cases, the gate channel is EvenTime. Since the DAS parsed CAN data at 20 Hz, this channel was necessary to reduce the counts in each bin to a frequency of 10 Hz., which is consistent with data logging in the time-history format.

Table 5.1. List of histograms generated on board each vehicle

Name	Description	Gate
SystemHealthHist	System Health Histogram	EvenTime
RRDotEngagedHist	Range Rate Histogram - engaged	EngagedTarget
SensitivityRoadHist	Sensitivity by road class histogram	FcwActiveEven
GapRoadHist	Gap by road class Histogram	EngagedEven
GapSpeedHist	Gap by speedHistogram	EngagedEven
RangeSpeedHist	Range and speed histogram	ValidTarget
VisionHealthHist	Vision health counts	EvenTime
SceneHealthHist	Scene health counts	EvenTime
SensorAtoDHealthHist	SensorAtoD health counts	EvenTime
Class2HealthHist	Class2 health counts	EvenTime
RadarHealthHist	Radar health counts	EvenTime
AccelerometerHealthHist	Accelerometer health counts	EvenTime
GpsHealthHist	Gps health counts	EvenTime
YawRateHealthHist	YawRate health counts	EvenTime
FusionHealthHist	Fusion health counts	EvenTime
TargetHealthHist	Target health counts	EvenTime
ThreatHealthHist	Threat health counts	EvenTime
MapINSHealthHist	MapINS health counts	EvenTime
MapDataHealthHist	Map Data health counts	EvenTime
MapMatchHealthHist	Map Matchhealth counts	EvenTime
TcSwitchHist	Traction control histogram	EvenTime
WiperHist	Wiper Histogram	EvenTime
DarkHist	Dark histogram	EvenTime
HudMessageHist	Hud Message Histogram	EvenTime
VehicleIconSpeedHist	HUD Vehicle Icon Histogram	FcwActiveEven
TransitionTypeSpeedHist	Transition Type Histogram	EvenTime
OutsideTemperatureHist	Outside temperature Histogram	EvenTime
HtmEngagedHist	Headway time margin histogram - ccc/acc	EngagedTarget
HtmNotEngagedHist	Headway time margin histogram - not ccc/acc	NotEngagedTarget
RangeHist	Range histogram	ValidTarget
SpeedHist	Trans Speed histogram	EvenTime
BatteryVoltageHist	Battery Voltage Hist	EvenTime
DasVoltageHist	Das Voltage Hist	EvenTime
YawRateSpeedHist	Yaw rate and speed histogram	EvenTime
SteerSpeedHist	Steer and speed histogram	EvenTime
SetSpeedHist	Set speed histogram	EngagedEven
PrndlHist	Prndl histogram	EvenTime
BridgeTargetsHist	Bridge Targets Histogram	SaveRadar
AllTargetsHist	All Targets Histogram	SaveRadar
StoppedTargetsHist	Stopped Targets Histogram	SaveRadar
MovingTargetsHist	Moving Targets Histogram	SaveRadar
StationaryTargetsHist	Stationary Targets Histogram	SaveRadar
FarConfHist	Far confidence histogram	EvenTime
NearConfHist	Near confidence histogram	EvenTime
HeadingConfHist	Heading confidence histogram	EvenTime
LaneOffsetConfHist	Lane offset confidence histogram	EvenTime
LaneChangeHist	Lane change histogram	EvenTime
AxFilteredHist	Ax filtered histogram	WasMoving
SpeedRoadHist	Trans Speed and road class histogram	EvenTime
RRDotNotEngagedHist	Range Rate Histogram - not engaged	NotEngagedTarget
HUDFaultHist	HUD fault histogram	EvenTime
DVIHealthHist	DVI Health Histogram	EvenTime

5.1.4 Customized Functions

Also incorporated in the DAS architecture is the ability to perform sophisticated data processing. Example of these customized functions include the identification of hard-braking events and the derivation of road class from the sub-system channels provided by the Map module in ACAS. What is important to note about the customized on-board processing that was done by the DAS is the flexibility it provides in terms of having access to all other data channels as well as the vast array of tools, such as conditional statements, data-type conversions, and numerical assignments.

5.2 Post-Facto Data Processing

In the broadest sense the post processing done in this study falls into three categories: a) the generation of newly created time-history channels for each driver and every trip in the field study; b) the generation of event tables which are critical in the analysis of a large dataset because they provide explicit pointers into the data archive marking the beginning and ending of particular events, and c) the creation of multi-dimensional histograms that were not generated on-board the vehicles.

5.2.1 Time-History Channels

A number of different time-history tables were generated to support the analysis and exposure sections of this report. Many of these tables are mentioned below in the sections that describe the data processing used to address some of the major distinctions in the data archive that serve as the primary controlling variables. Generally, the time-history data generated after the FOT included the following:

- Conflict metrics—Time-to-collision, headway-time-margin, etc.
- Kinematics of the host and target vehicles—Speed, smoothed accelerations, closing, following, near, separating, and cut-in.
- Environmental metrics—Road class, traffic count and density, host-vehicle lane position, etc.

5.2.2 Event Table Generation

Event tables or triggered summary tables were an integral part of the database. Some of them were generated on-board the vehicles during the FOT, but most of them were generated directly from the ACAS database. Table 5.2 lists some of the important event tables. There are five critical fields in an event table. They are Driver, Trip, StartTime, EndTime, and Value. The Driver, Trip, and the two time fields uniquely identify a discrete period of time within the ACAS database and serve as primary pointers for

accessing sub-sets of the time-history data. The value field indicates the state of the variable that is the basis for the table.

Table 5.2. Samples of event tables generated from the ACAS database

<i>Table Name</i>	<i>Description</i>
AbsSpeedEvents	Duration of constant AbsSpeed values
AbsSpeedLt3Events	Pointers to data records with AbsSpeed < 3 m/s
AbsSpeedLt9Events	Pointers to data records with AbsSpeed < 9 m/s
AutoBrakeEvents	Start and end times of all auto braking events in ACC
BrakeEvents	Start and end times of all manual braking events
CipsEngagedEvents	Pointer to time with current in path stationary object (CIPS) while engaged in ACC or CCC
CIPVEvents	Identification of all persistent and mature current in path vehicle (CIPV) radar tracks with a fix to minimize target switching
CutInEvents	Start and end times of cut-in events as defined Section 8
DarkEvents	Explicit pointers to time with dark flag was true
FcwTargetIdEvents	Start and end times for all mature FcwTargetid tracks along with their flags indicating stationary, movable, or moving
flyingPassEvents	Flags instances of flying passes as defined in Section 8
GapEvents	Identifies all gap setting values
HtmEvents	Start and end times of times when Htm is below threshold values from 0.1 to 3.0 seconds
HudVehicleIconEvents	Start and end times of the various HUD vehicle icon events
LanePositionEvents	Start and end times of the host vehicle lane position as outlined in the section that characterizes the traffic environment
RoadClassEvents	Identification of constant road class designations
SensitivityEvents	Identifies all sensitivity setting values
StraightRoadEvents	Start and end times of travel with minimal yaw-rate
TargetEvents	Start and end radar indices of all persistent and mature targets as recorded by the radar during the FOT
ThreatIndexEvents	Identification of events when the threat index did not change
ThrottleEvents	Start and end times for throttle-off events
ThrottleOverrideEvents	Pointers to times when the driver over-rides ACC using the throttle pedal
TrafficDensityEvents	Pointers to Sparse, Medium, and Heavy traffic events as outlined in the traffic characterization section
TTCLT3Events	Pointers to times when time-to-collision is less than 3 seconds
TTCLT4Events	Pointers to times when time-to-collision is less than 4 seconds
TTCLT5Events	Pointers to times when time-to-collision is less than 5 seconds
TurnsignalEvents	Pointers to times when the turn-signal usage (includes direction)
UnknownRoadClassEvents	Start and end times of the unknown road class designation
WiperEvents	Start and end time of wiper usage (includes wiper setting)

An associated statistics table was also created along with many event tables. The purpose of the so-called Stats table was to save summary information about each event in the corresponding event table. These tables also had a set of core fields along with additional customized fields that were added to specifically characterize some aspect of the event. The core fields of each Stats table were: Driver, Trip, StartTime, Distance, DistanceFcwActive, DistanceEngaged, CntFcwActive, and CntEngaged. The Driver, Trip and StartTime fields are used to merge the Stats table to its partner event's table. The Distance and Count fields are often aggregated to characterize the exposure of the events

in the context to the entire FOT. The customized fields of the Stats tables generally include summary information that describe the kinematic state of the host vehicle such as average speed, maximum yaw-rate, or peak deceleration.

5.2.3 Multi-Dimensional Histograms

There were additional histograms generated in the post-processing of the database archive. Several are shown in Table 5.3. All of these histograms were multi-dimensional in the sense that for every source channel (the basis for the histogram), there were three separate categorical channels. The combination of these categorical channels, along with the fact that there is a row in the table for each driver and trip makes the size of these histograms approximately 3.5 million records each.

Table 5.3. Multi-dimensional histograms

<i>Name</i>	<i>Source Channel</i>	<i>Categorical Channels</i>
CIPVAzRHist	Azimuth	Range, engaged, Sensitivity/Gap
DecelAvoidVHist	Decel-to-avoid	Speed, engaged, Sensitivity/Gap
HtmVFollowingHist	Headway-time-margin	Speed, Engaged, Sensitivity /Gap (Rdot between -2.0 and 2.0 m/s)
HtmRdotHist	Headway-time-margin	Rdot, Engaged, Sensitivity/Gap
HtmVHist	Headway-time-margin	Speed, Engaged, Sensitivity/Gap
RdotVHist	Range-rate	Speed, Engaged, Sensitivity/Gap
RdotVNBHist	Range-rate	Speed, Engaged, Sensitivity/Gap (non-braking)
RRdotHist	Range	Range-rate, Engaged, Sensitivity/Gap
RVHist	Range	Speed, Engaged, Sensitivity/Gap
TTCVHist	Time-to-collision	Speed, Engaged, Sensitivity/Gap
VRoadClassHist	Speed	Road class, Engaged, Sensitivity/Gap

Creating, populating and updating these histograms required a two-step procedure. First, a time-history table was generated that contains a “time-history” of bin numbers corresponding to the original real values. That is, given a bin-center value and a bin-width value, a simple calculation yields the appropriate bin that the count for the value belongs in. Hence a table of bin positions and the corresponding categorical values was constructed which has a one-to-one relationship with the time history of the source channel. Then, using a specialized program that generates appropriate Structured Query Language (SQL) statements, the histogram table is created, populated with the default values and updated with counts for all the records in the bin-number time-history. This specialized code was critical since, to update any one of the eleven histograms requires the appropriate SQL statement for loading each bin, and hence, the generation of thousands of these statements. Automation provides the only reasonable method that ultimately ensures accuracy and leverages the computational optimization and efficiency

of SQL. (There are over eleven thousand lines of SQL in the procedure that creates and updates these eleven histograms.)

5.3 Identifying FCW Driving Scenarios from Video Data

This section defines a set of labels called *driving scenarios* which are attached to certain events within the FOT. These labels are useful for characterizing events within the FOT, as well as events used in analyses for both FCW safety and FCW acceptance. The sections of this report that address ACC safety also use scenario-type labeling of driving situations, but those labels are described within the ACC safety sections.

5.3.1 Motivating the Use of Scenarios

A scenario is a *label* that is attached to each of a similar set of driving situations which are distinguished from other sets by certain kinematic relationships between the host vehicle and the potentially threatening target(s), as well as the traffic context within which they occur. Assigning scenarios is most importantly done with respect to imminent alerts. An example is: “host vehicle approaches a lead vehicle that is turning right.”

Assigning scenarios to selected events is valuable in helping to address the major questions of safety and driver acceptance for primarily two reasons. First, previous research has noted that driver management of headway depends on the driving scenario. For example, drivers may regularly generate small values of headway or time to collision (TTC) when they anticipate that the forward conflict will be resolved without braking, perhaps due to a lead vehicle turning and leaving their path, or due to an intended host-vehicle passing maneuver.

Second, the FCW system’s capability to identify scenarios and anticipate the future is necessarily limited relative to the driver. FCW cannot adjust its actions to the developing scenario in the same way that an alert driver would adjust their sense of potential danger. Therefore, there will be situations in which FCW is producing alerts when drivers may not consider them necessary, which is likely to affect drivers’ acceptance responses.

Scenarios are assigned in post-processing, using analysts’ review of data and video of the scene, as described in Section 5.3.3.1. Scenarios are assigned at a moment of interest, although driving often involves a series of maneuvers and events unfolding within the span of several seconds. The moment of interest will be the onset of an imminent alert, except in Section 7.1.4, where the event is the crossing of a defined conflict-level threshold.

The scenarios chosen were developed through experience with previous projects (see LeBlanc et. al, 2002) as well as analyses in the pilot FOT testing and discussions within the FOT team. The list of scenarios is presented in Section 5.3.2, but some dimensions that are addressed are shown in Figure 5.1. These dimensions include:

- Target's relationship to the host's path:
 - ◇ *Out-of-host's path (OHP) scenarios.* The object triggering the conflict or alert was never in the same lane as the host vehicle. OHP events may involve either moving targets (e.g., adjacent-lane traffic), but most often stationary targets. These stationary targets could be parked vehicles, overhead objects, or objects on the roadside.
 - ◇ *In host's path (IHP) scenarios.* IHP scenarios are those during which the target and host vehicles remain in the same shared lane throughout the episode. Examples of IHP scenarios include approaches to stopped vehicles, conflicts with lead vehicles that are decelerating, or approaching a slower moving lead vehicle. Figure 5.2 shows some examples of IHP scenarios.
 - ◇ *Transitioning-host path (THP) scenarios.* These are scenarios in which the host vehicle is approaching the lead vehicle at some point in the event, and the vehicles also share a lane at some point. In THP scenarios, either one or both vehicles maneuvers laterally, for example, changes lanes, turns onto, or off of, the roadway, merges, or exits. Thus there is the possibility that the forward conflict may be resolved entirely by lateral motion of one or both vehicles. Examples of these are shown in Figure 5.3.
- Precipitator of the scenario conflict:
 - ◇ Lead vehicle precipitates conflict (e.g., lead vehicle ahead decelerates).
 - ◇ Host action precipitates conflict (e.g., host approaches to pass a slower lead vehicle)

Regarding the precipitator (or actor) in the scenario, this is usually assigned based on a scenario stereotype, and not on the specifics of a particular event. Therefore the precipitator assignment is a rather approximate one.

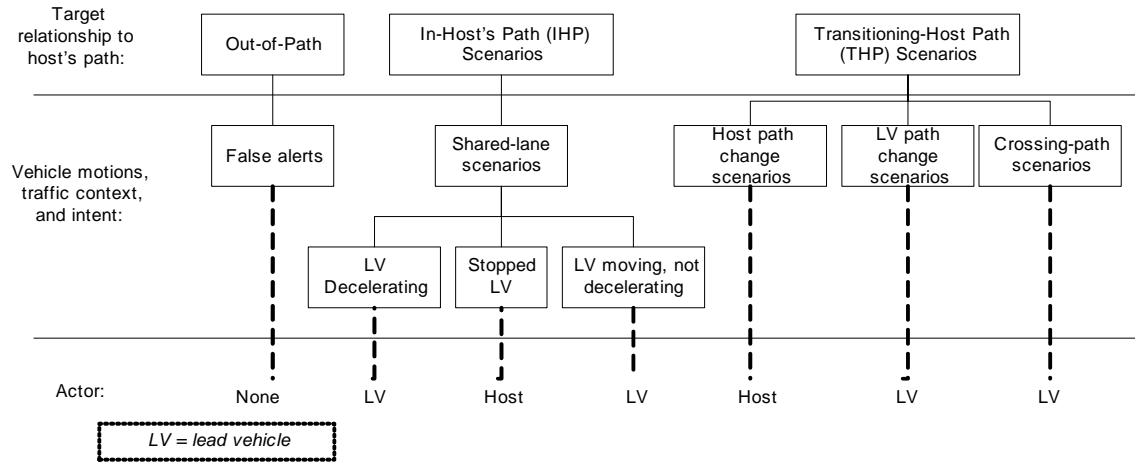

Figure 5.1. Scenario taxonomy

In-Host-Path Scenarios

Both vehicles share a lane throughout the event

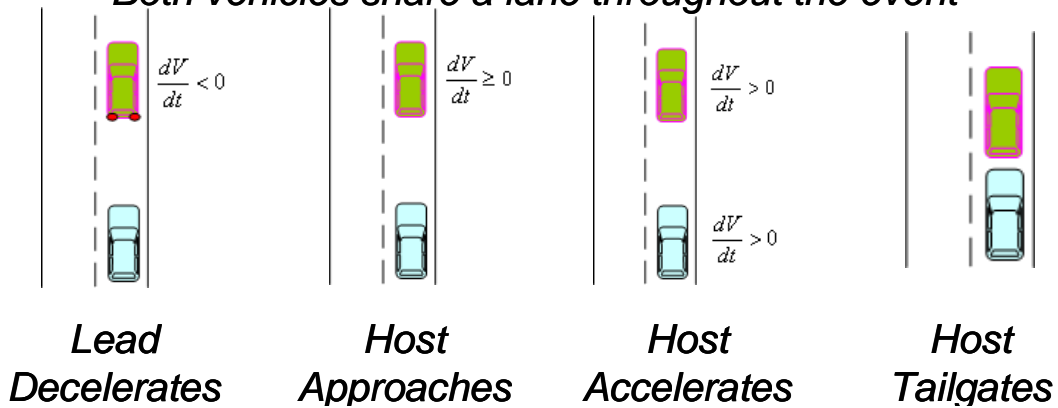

Figure 5.2. Driving scenarios: examples of in-host-path (IHP) scenarios

Transitioning-Host-Path Scenarios

Target or Host Transition from Initial Lane

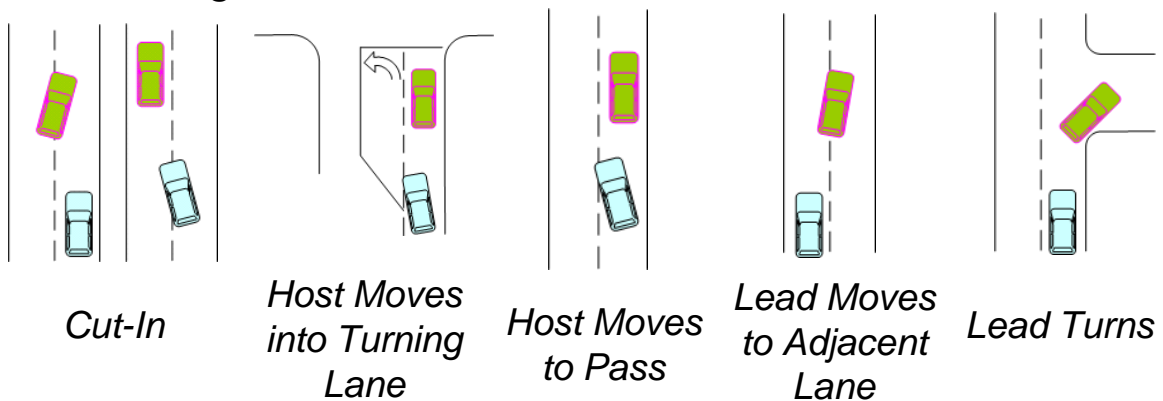

Figure 5.3. Driving scenarios: examples of transitioning-host-path (THP) scenarios

It is important to note that the scenario assignments here go beyond identifying kinematic states before, during, or after the imminent alert event. Scenarios are assigned using the analyst's observations in the video and data that brings forth other information available to the driver that is hard to find in the data or reliably capture from video coding results. An example of this is the labeling of a "lead vehicle turning right" scenario after observing the lead vehicle braking near an intersection, turn signal initiation, and finally the turn. The post hoc analyst can almost always immediately understand the lead vehicle's intent, just as an attentive host driver would, even if the moment of interest is before the lead vehicle has begun to turn. This clearly illustrates how technically challenging it can be to create an algorithm that would take a set of facts about a conflict situation and correctly identify the scenario.

5.3.2 Driving Scenarios Used in the Conflict Analysis

Twenty-eight driving scenarios have been defined for use in FCW analyses. Table 5.4 on the next page lists the scenarios using a shorthand label. The table also groups the scenarios into the three scenario classes introduced in the previous section: out-of-host's-path (OHP), in-host's-path (IHP), and transitioning-host's-path (THP) alerts.

Appendix I includes the coding key for the video-based review of imminent alerts, as well as a more extensive description of the particular scenarios.

5.3.3 Identifying FCW Driving Scenarios from FOT Data

Driving scenarios are identified in two ways to support FCW safety and acceptance analyses. Section 5.3.3.1 describes an extensive manual review of video, audio, and numerical data. This addresses FCW and ACC imminent alerts during algorithm C, as well as random samples of time during non-event periods. Section 5.3.3.2 introduces a smaller activity that led to automatic identification using database querying of in-host-path scenarios. This second method is used to assess changes in driving behavior in a larger set of several thousand conflicts.

5.3.3.1 Using Video to Identify FCW Driving Scenarios

The forward-camera and face-camera video were examined for 634 Algorithm-C alerts in order to identify and classify environmental factors, characteristics of the target, driver behavior, alert classification, and the driving scenario. These alerts included all algorithm-C alerts where there was a target speed estimated on-board to be at least 2 m/sec and all others with a target vehicle in the host's path. Most out-of-host's path (OHP) alerts were not coded.

Table 5.4. Driving scenarios used in FCW analyses

Code	Scenario label	Scenario type	Actor	Scenario class
100	False alert - target always out of path	False alert	None	OHP
200	Host tailgates LV	Shared-lane	Host	IHP
210	Host approaches accelerating LV	Shared-lane	Host	IHP
220	Host approaches const speed LV	Shared-lane	Host	IHP
230	Host approaches stopped LV	Shared-lane	Host	IHP
240	LV brakes to unpredictable stop	Shared-lane	LV	IHP
250	LV brakes to predictable stop	Shared-lane	LV	IHP
260	LV brakes unpredictably, not to stop	Shared-lane	LV	IHP
270	LV brakes predictably, not to stop	Shared-lane	LV	IHP
360	LV cuts in	LV path changes	LV	THP
365	LV forced to merge	LV path changes	LV	THP
370	LV performs 2-lane pass	LV path changes	LV	THP
380	LV inadvertently enters host lane	LV path changes	LV	THP
420	LV enters roadway in same direction; same lane as host	LV path changes	LV	THP
430	LV leaves host lane	LV path changes	LV	THP
440	LV leaves host lane into turn lane	LV path changes	LV	THP
450	LV ahead turns left	LV path changes	LV	THP
460	LV ahead turns right	LV path changes	LV	THP
300	Host cuts behind LV	Host path changes	Host	THP
310	Host performs 2-lane pass	Host path changes	Host	THP
315	Host performs 2-lane pass to exit	Host path changes	Host	THP
320	Host changes lanes to pass	Host path changes	Host	THP
330	Host enters turn lane, LV in orig lane	Host path changes	Host	THP
340	Host enters turn lane; LV in turn lane	Host path changes	Host	THP
350	Host avoids obstacle without lane change	Host path changes	Host	THP
355	Host avoids obstacle with lane change	Host path changes	Host	THP
390	LV crosses path; on intersecting roadway	Crossing path	LV	THP
400	LV turns left across host path	Crossing path	LV	THP
410	LV enters roadway in same direction; different lane	Crossing path	LV	THP

A detailed coding rubric was developed to code each imminent alert on 21 factors (see Appendix I). Two researchers initially viewed and coded 103 alerts independently in order to examine the consistency with which the coding criteria were applied and driving scenarios were interpreted. The coding data were compared and percent agreement (typically 95% or higher) was calculated. The high level of agreement verified that the coding criteria were being employed consistently by the researchers. Each researcher then independently coded all remaining 531 alerts. One additional factor, the time to visual (i.e., eye movement) response, was also included.

Upon completion of the individual coding of the alerts, another analysis was run to determine the percent agreement. While these numbers were quite high, indicating consistency in coding between the researchers, the researchers jointly viewed and

recoded all video for which there were factors that were not independently agreed upon. All of the video coding for the Algorithm-C imminent alerts is contained in an SQL database to allow for comparison with vehicle-based data and subjective data.

5.3.3.2 Automatic Processing To Identify In-Host-Path Driving Scenarios

Section 7.1 includes analyses which use an automatic query-based identification of one important type of driving scenario. IHP scenarios were extracted automatically from the numerical data, so that several thousand episodes are available for understanding the different levels of conflict that are tolerated in these events. These episodes include half of the shared-lane (IHP) imminent alerts, but reject other situations known to be shared-lane events because of the design of the conservative queries that seek to minimize false positives (i.e., the inclusion of all OHP and THP alerts). The set of scenarios provides a basis for characterizing baseline driving behavior in situations that is especially targeted by the FCW system. There is no video-based driver-behavior data associated with these events, only measurements supported by the data collection system. Section 7.1.3 will discuss this automatic-processing procedure in some detail.

5.4 Processing to Identify Road Type

The road-class designations in the ACAS FOT database were based on the combination of two channels from the ACAS map sub-system. These channels were from the *Navteq* map database on-board the vehicle, and were called *Link class* and *Segment rank*. The map table of the database contains these channels in their raw form as they were collected during the FOT. Further processing of these channels, for paved surfaces, was done on-board by the DAS as well as after the test to derive what ultimately was saved and classified in the database as road class. This is outlined in Figure 5.4 on the next page.

The result of this derivation is shown in the final list of eight different road classes plus an unknown designation in Table 5.5. Examples of the road classes include: “Interstates” are federal interstates, “freeways” are other limited-access roadways without at-grade intersections, “arterials” are roads with at-grade intersections that serve to move traffic across metropolitan areas or between population centers, “local roads” are typically roads such as neighborhood streets, industry parks, etc., and “collectors” move traffic from local roads to arterials.

Analysis of the road-class data from the FOT showed an unusually large percentage was classified unknown. To address this, the unknown data were post-processed and saved to a new table for use in the analysis and exposure sections of this report.

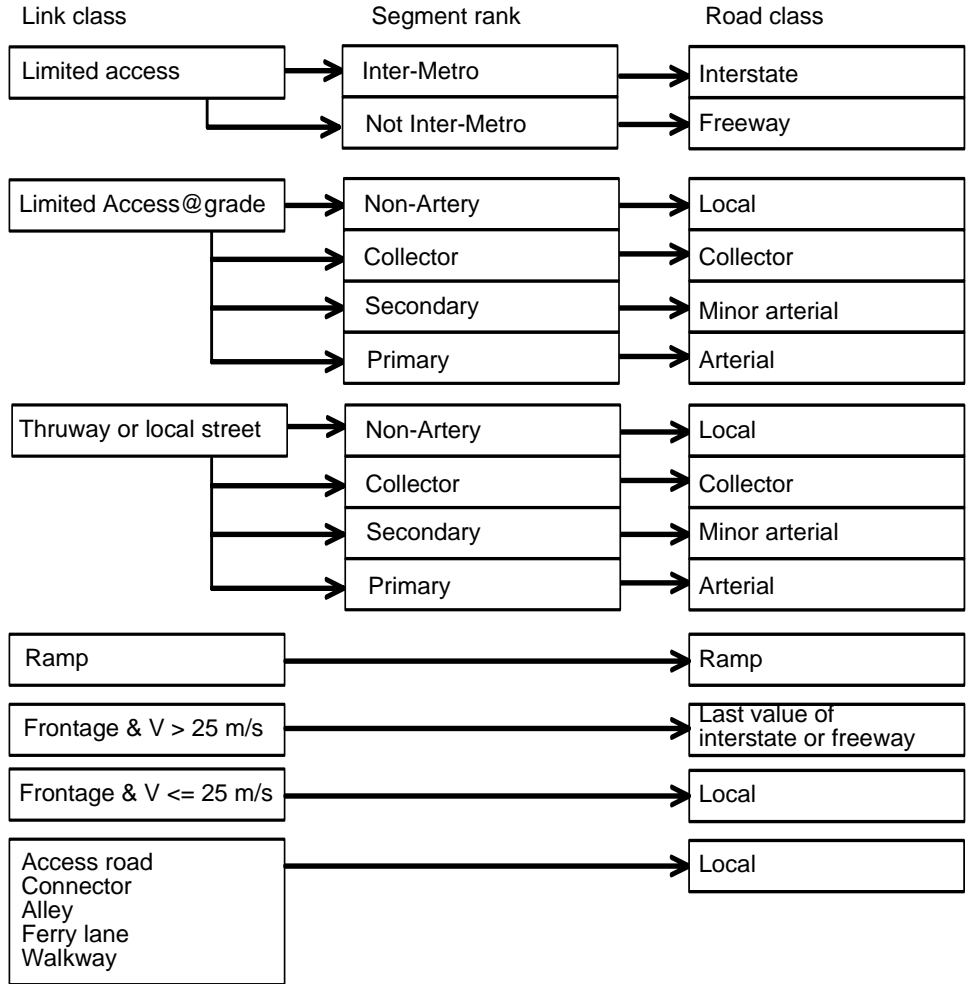

Figure 5.4. Road class derivation for paved surfaces

Table 5.5. Complete road-class designation in the ACAS FOT database

Database key	Name	Description
0	Ramp	Roads that are connections between other roads that are not at grade or connecting limited access roads
1	Interstate	A road that has limited access and crossings not at grade
2	Freeway	A road that has limited access and crossings not at grade
3	Arterial	A primary road with access at grade and few speed changes that allow for high volume, high speed traffic movement
4	Minor Arterial	A secondary road with high volume of traffic movement, but with speeds less than that of Arterials
5	Collector	A road used to distribute traffic between neighborhoods and generally connects with arterials and limited access roadways
6	Local	A road used to distribute traffic in and around neighborhoods
7	Unpaved	A gravel or dirt road
8	Unknown	A parking lot or public/private facility not designated as a public roadway

Two methods were used to re-classify some of the unknown road-class data. These methods are characterized below:

- a) A correction based on surrounding road-class designation: A special routine was developed to find time-segments of unknown road-class data with a duration less than twelve seconds and was bounded by the same road class at start and end of the unknown segment within a given trip. These segments were then re-classified to the bounding value based on the assumption that within the 12-second window the vehicle remained on the same road type.
- b) A speed based correction: This correction is based on the observation that road-class data associated with high speeds is most likely to be Interstate or Freeway classes. To support this assumption a simple analysis of the major road-class types, as shown in Figure 5.5, shows that the vast majority (over 98 percent) of all road-class data associated with speeds of more than 30 m/s (67 mph) can be classified as being either Interstate or Freeway.

For the presentation of results in this report a further simplification of the road-class designation was used. This simplification involved grouping the two types of limited-access road classes together and calling them *Freeway* and grouping the Arterial, Minor Arterial, Collector and Local designations together to form what is commonly labeled *Surface roads* in the presentations of findings.

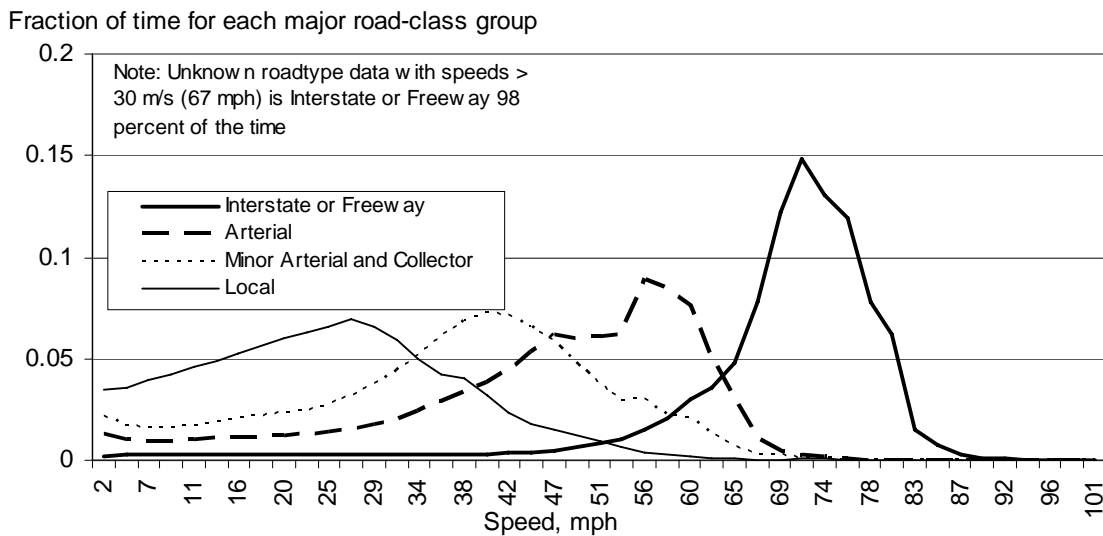

Figure 5.5. Fraction of time spent at different speeds for four major road type classifications

5.5 Combining vs. Segregating Data from Algorithms A, B, C

Section 2.3 described the key differences between the ACAS functionalities associated with algorithms A, B, and C. The vast majority of analysis in this report focuses on algorithm C only. Algorithm A and B data is reported and considered at a high level within some parts of Section 6 and Section 10, but in general the data from drivers with those algorithms is difficult to analyze with a sufficient degree of statistical power because of the small number of drivers. Furthermore, algorithm C is intended to be a state-of-the-art FCW system, and therefore the data is more useful in considering the potential of these countermeasures in the near future in terms of safety and acceptance.

5.6 Processing to Characterize Driving Style

This analysis is aimed at grouping drivers by their measured driving style, or driving behavior. For this purpose, only manual driving data from freeways under moderate traffic conditions were considered. The reason this was done was to maximize commonality of driving conditions across drivers. The statistical method that was used is known as *Clustering Analysis*, in which special procedures are employed on the data to identify distinct groupings, or *clusters*. Several driver-level variables were extracted from the database as performance measures, and the SPSS[©] software package was used to identify clusters in the data. Drivers from across the full 96-person sample of the FOT were employed in the clustering analysis, although two persons were later dropped from this exercise due to no driving data under freeway, moderate traffic conditions.

5.6.1 Methodology and Background

The *TwoStep-Cluster-Analysis* procedure is an exploratory tool designed to reveal natural groupings (or clusters) within a data set that would otherwise not be apparent. As it pertains to this study, the algorithm employed by this procedure has several desirable features that differentiate it from traditional clustering techniques. These include:

- Automatic selection of the number of clusters, and
- The ability to analyze large data files efficiently.

Each continuous variable is assumed to have a normal (Gaussian) distribution. Empirical testing indicates that the procedure is fairly robust to violations of this assumption.

5.6.2 Clustering the ACAS Drivers

The two steps of the TwoStep-Cluster-Analysis procedure's algorithm can be summarized as follows (from the SPSS[©] manual):

Step 1. The procedure begins with the construction of a Cluster Features (CF) Tree. The tree begins by placing the first case at the root of the tree in a leaf node that contains variable information about that case. Each successive case is then added to an existing node or forms a new node, based upon its similarity to existing nodes and using the distance measure as the similarity criterion. A node that contains multiple cases contains a summary of variable information about those cases. Thus, the CF tree provides a capsule summary of the data file.

Step 2. The leaf nodes of the CF tree are then grouped using an agglomerative clustering algorithm. The agglomerative clustering can be used to produce a range of solutions. To determine which number of clusters is “best,” each of these cluster solutions is compared using Schwarz's Bayesian Criterion (BIC) or the Akaike Information Criterion (AIC) as the clustering criterion.

By applying the TwoStep Cluster Analysis to pertinent variables that were extracted from the data, drivers were grouped according to their driving behavior. As indicated earlier, only freeway manual-driving data was considered. In addition, in order to maximize commonality of driving conditions across drivers, only the data from freeway driving under moderate traffic conditions were included in this analysis. Table 5.6 on the next page lists the driver-level variables that were extracted from the database for each driver.

There are two types of variables in the above list: categorical variables and continuous variables. Continuous variables can have any value (within the realm of that particular variable). For example, average speed, average range, etc. Categorical variables have only a finite, prescribed set of possible values (e.g., gender or age group).

The categorical variables are used here as “display” variables. That is, at the conclusion of the clustering process, after the clusters are identified (based on values of continuous variables), they are displayed in the context of the categorical variable. The clusters are broken-down to show association with each of the categorical variables.

Table 5.6. List of all driver-level variables extracted for Cluster Analysis

1	Time fraction in near ²
2	Time fraction in closing ³
3	Time fraction in separating
4	Time fraction passing on the right + on left
5	Time fraction being passed on the right
6	Time fraction being passed on the left
7	Lane changes per 100 miles
8	Time fraction with Th < 0.5 sec
9	Time fraction with TTI < 4 sec
10	Time fraction on a curve
11	Time fraction with a lead car
12	Time fraction with no lead car
13	Brake applications per 100 miles
14	Braking fraction at Vdot < -0.25 g
15	Average speed
16	Average Range at start of braking
17	Average Rdot at start of braking
18	Average Range 2 sec prior to lane change
19	Average Rdot 2 sec prior to lane change
20	Age in years
21	Age group
22	Gender
23	Algorithm
24	Fraction of miles on highway

Several “passes” of clustering analysis were performed, using different sets of continuous variables. As will be explained later, the importance of the continuous variables in the classification process is statistically evaluated during the clustering analysis. This enables removal from the analysis those variables found to be unimportant to the classification. The results presented here are those obtained from the clustering analysis that was judged to offer the most meaningful insight into the data. Table 5.7 lists the continuous variables that were found to be meaningful for clustering.

² Near zone: *at close range that continues to be reduced*, as defined in the ICC FOT report: Rdot<0, and

$$R < 0.5 \cdot V_p + \frac{Rdot^2}{2 \cdot 0.1 \cdot g}$$

³ Closing zone: certain part of *range-is-getting-short* extent, as defined in the ICC FOT report: Rdot<-1.5

$$\text{ft/sec (-1.5 m/sec) and } R > 0.5 \cdot V_p + \frac{Rdot^2}{2 \cdot 0.1 \cdot g}$$

Table 5.7. List of driver-level variables meaningful for clustering

Time fraction in near
Time fraction in closing
Time fraction with $T_h < 0.5$ sec
Time fraction with $TTI < 4$ sec
Braking fraction at $V_{dot} < -0.25$ g
Brake applications per 100 miles
Lane changes per 100 miles
Average range at start of braking
Average range 2 sec prior to lane change
Average R_{dot} 2 sec prior to lane change
Fraction of time passing

Table 5.8 lists the continuous variables that were found not to be meaningful for clustering.

Table 5.8. List of driver-level variables not meaningful for clustering

Time fraction in separating
Time fraction being passed on the right
Time fraction being passed on the left
Time fraction on a curve
Time fraction with a lead car
Time fraction with no lead car
Average speed
Average R_{dot} at start of braking

Table 5.9 below shows the frequency of each cluster. It provides an overview of how drivers are distributed between the clusters. Two clusters were identified, with 72 drivers assigned to the first cluster and 22 to the second. Note that this is a total of only 94 drivers. (Recall two of the 96 participants were excluded from the analysis due to insufficient driving distance under the prescribed conditions – moderate traffic on the highway).

Table 5.9. Distribution of clusters

	N	% of Combined	% of Total
Cluster 1	72	76.6%	76.6%
Cluster 2	22	23.4%	23.4%
Combined	94	100.0%	100.0%
Total	94		100.0%

Later in this discussion we will show a higher-level graphical depiction of how the drivers are grouped. Table 5.10 displays the variables' centroids in terms of mean and standard deviation for each cluster. This table shows that the clusters appear to be well separated by the continuous variables.

Table 5.10. Centroids of clusters

		Cluster		
		1	2	Combined
Time fraction in near	Mean	.0009	.0069	.0023
	Std. Deviation	.00097	.00387	.00327
Time fraction in closing	Mean	.0107	.0315	.0156
	Std. Deviation	.00727	.01465	.01292
Lane changes per 100 miles	Mean	8.5739	16.7259	10.4818
	Std. Deviation	5.18792	8.12149	6.89077
Time frac w. Th < 0.5 sec	Mean	.0017	.0126	.0043
	Std. Deviation	.00194	.00773	.00615
Time frac w. TTI < 4 sec	Mean	.0000	.0002	.0001
	Std. Deviation	.00004	.00020	.00013
Brake applications per 100 miles	Mean	18.9204	49.9252	26.1768
	Std. Deviation	9.96276	34.79390	22.87624
Braking fraction at Vdot < -0.25 g	Mean	.0028	.0076	.0039
	Std. Deviation	.00189	.00507	.00355
Average Range at start of braking	Mean	39.1430	27.8017	36.4887
	Std. Deviation	10.10916	4.27716	10.26923
Average Range 2 sec prior to lane change	Mean	46.3620	35.4772	43.8145
	Std. Deviation	9.58665	4.33683	9.79173
Average Rdot 2 sec prior to lane change	Mean	-.3167	-1.3825	-.5661
	Std. Deviation	1.06908	.48777	1.06401
Pass on RT+LT	Mean	.0336	.1009	.0494
	Std. Deviation	.02805	.04740	.04392

Comparing the first and second clusters, the drivers in cluster 1 spend much less time in the near and closing regions, less time with headways shorter than 0.5 sec. or with time-to-impact values of less than 4 sec. They also brake and start lane changes at higher range, and are more likely to avoid high, negative range rates. The drivers in cluster 2 are 3.3 times more likely to pass other vehicles than the drivers in cluster 1.

The nature of the variables that divide these two clusters is closely associated with what is perceived to roughly define assertive and reserved drivers. For the purpose of this discussion we will label cluster 1 as the *reserved* cluster, and cluster 2 as the *assertive* one. The distinction between the clusters will be further discussed when the importance of the variables is evaluated in a statistical context.

The mean and standard deviation values listed in Table 5.10 represent the variations within the clusters. These variations are depicted in the plots grouped as Figure 5.6. The distinction between the two clusters is strikingly clear.

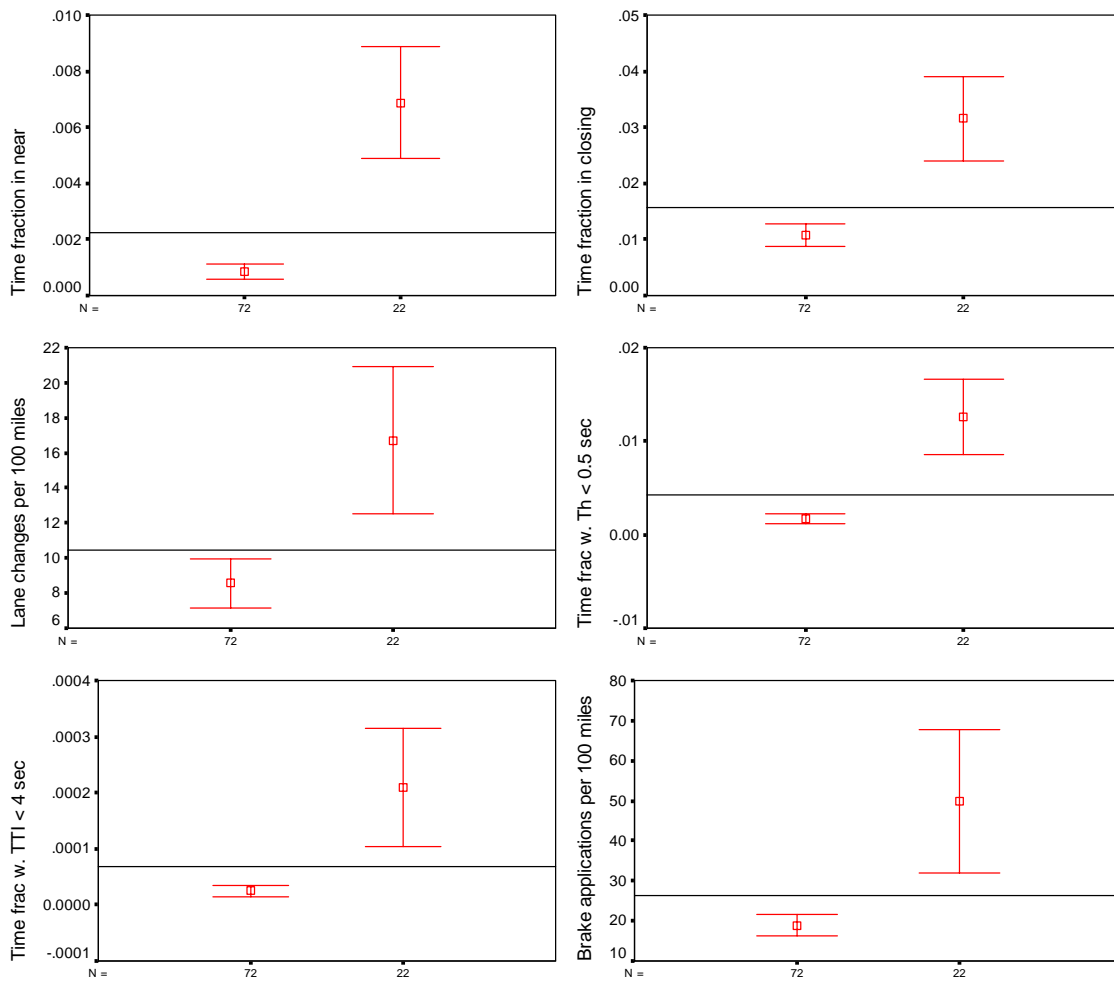

Figure 5.6. Within-cluster variation of variables

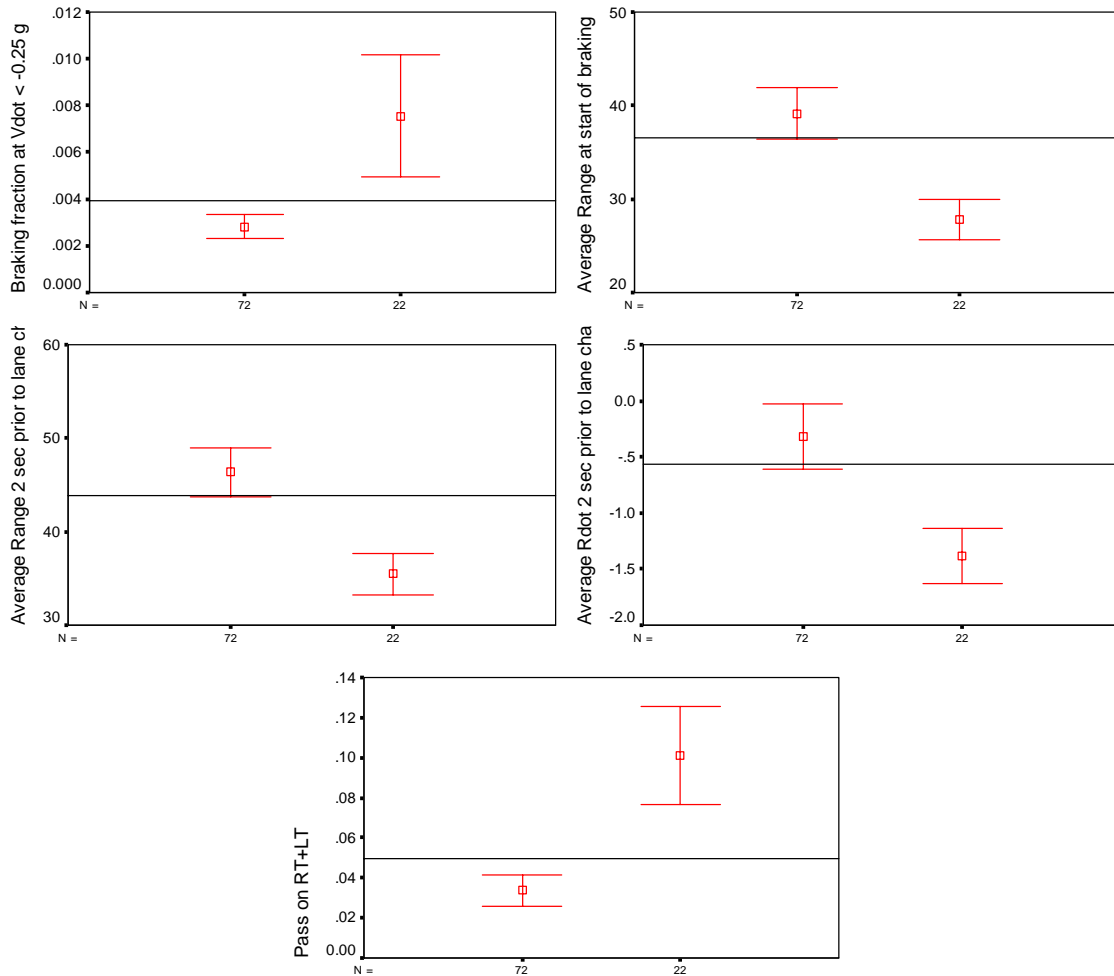

Figure 5.6. (continued) Within-cluster variation of variables

Next, the categorical variable, *age group* was applied to gain an insight into how the two clusters are distributed across the ages and to further clarify the properties of the clusters. Table 5.11 summarizes the cluster frequencies by age group.

Table 5.11. Frequency of clusters by driver age

		Young		Middle-Aged		Older	
		Frequency	Percent	Frequency	Percent	Frequency	Percent
Cluster	1 (<i>reserved</i>)	16	50.0%	25	80.6%	32	100.0%
	2 (<i>assertive</i>)	16	50.0%	6	19.4%	0	0%
Combined		32	100.0%	31	100.0%	32	100.0%

The younger drivers are split exactly half between the reserved and assertive groups (clusters 1 and 2, respectively). The middle-age drivers are split 81% and 19% for reserved and assertive groups, respectively.

The older-driver group is much more consistent in its style. All of these drivers are classified as reserved drivers.

The charts of *importance by variable* are produced separately for each cluster. The variables are lined up on the Y axis, in descending order of importance. Figure 5.7 is the importance chart for the reserved cluster, and Figure 5.8 is the corresponding chart for the assertive cluster.

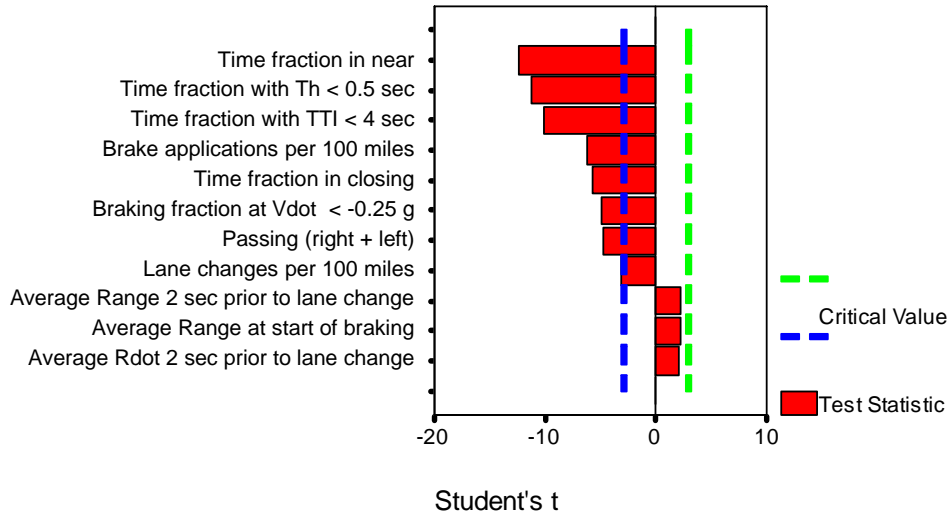

Figure 5.7. Importance by variable for *Reserved* drivers

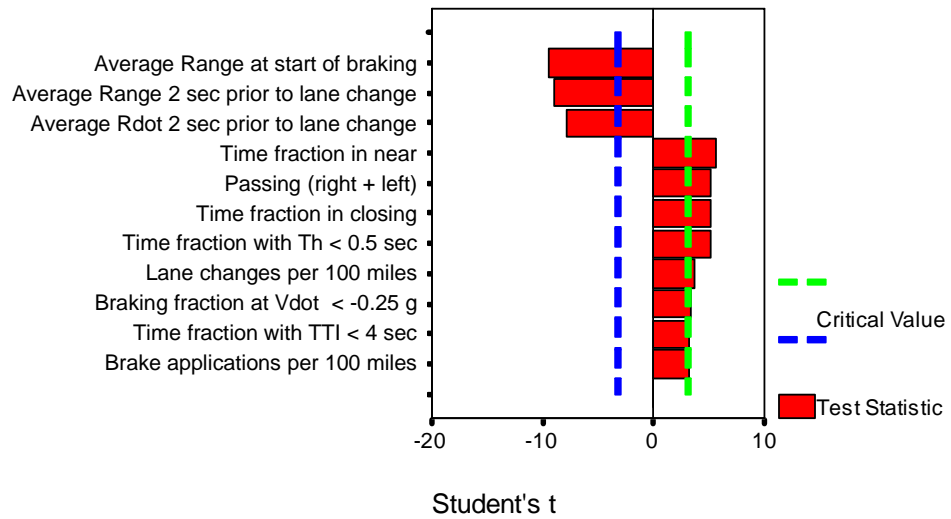

Figure 5.8. Importance by variable for *Assertive* drivers

The dashed vertical lines in these figures mark the critical values for determining the significance of each variable ($p < 0.05$). For a variable to be considered significant, its t statistic must exceed the dashed line in either a positive or negative direction. Since the importance measures for all but the last four variables exceed the critical value in Figure 5.7, we conclude that the first seven continuous variables contribute significantly to the formation of the first cluster. The last three variables approached statistical significance.

A negative t statistic indicates that the variable generally takes smaller than average values within this cluster, while a positive t statistic indicates the variable takes larger than average values. For example, for the *Assertive* cluster, *Time fraction with $T_h < 0.5$ sec* takes higher than average values while *Average range at start of braking* takes lower than average values (see Figure 5.8). Both variables exceed the critical value, so they are meaningful to the formation of the *Assertive* cluster. These results confirm the trends observed in the Centroids Table (5.10).

This depiction of the importance of variables helps enlighten how they contribute to establishing the driving style. For example (refer to Figure 5.7), the reserved driver is not inclined to pass other vehicles ($t < 0$), but this driver is much less inclined to tailgate ($T_h < 0.5$ sec., or time in near), as demonstrated by a higher negative value of t .

As indicated, the most notable characteristic of the drivers in the reserved cluster is the fact that they stay away from short headways. They also avoid the *near* zone and small *time-to-impact* values. When they brake and pass, they do it at a higher range, and they also stay away from the *closing* zone.

The drivers in the assertive cluster are pretty much the opposite of those of the first cluster. The most notable characteristic of the assertive drivers is the fact that when they brake, they start their braking at shorter-than-average range. They pass more often, and when they start a pass it is done more assertively, i.e., with more negative R_{dot} values. They spend more time than average in the closing zone, and they also start to brake at shorter ranges.

One of the key findings of this driver classification process, is the fact that although the main feature of the reserved driving style was the tendency to not tailgate ($T_h < 0.5$ sec), the assertive driving style is not predominantly determined by drivers who do tailgate.

5.7 Identifying Levels of Forward Conflict

Forward conflict metrics are used to study safety and acceptance surrounding both ACC and FCW. Conflict metrics are attempts to quantify the urgency of the forward crash situation. The conflict metrics used in this study are typically computed from the range between vehicles, vehicle speeds, vehicle accelerations, and occasionally other parameters, such as assumed driver response (or brake reaction time) delay. Many metrics have been proposed in the literature based on hypothetical models of driver behavior, driver braking, and/or using mathematical models based on experimental data. Metrics used in this report include the time-based time to collision and enhanced time to

collision metrics, and the acceleration-based metric – the deceleration needed to avoid impacting the lead vehicle. A few results are presented for a variation of the latter metric, namely the deceleration projected to be needed 1.5 seconds into the future to avoid the lead vehicle. These are defined and discussed later in this section.

The metrics used here have the distinct advantage that may be applied across the wide set of situations that were captured in the FOT. The risk of applying a single metric to study crash probabilities, however, is that another plausible metric applied to the same data may give a different result. Thus sometimes two metrics are used, to reduce the chance that a finding is sensitive to the particular metric choice. It should be stressed that each of the metrics below assume collision-course trajectory.

The first metric is simply *time to collision (TTC)*, which is computed as the range to the vehicle ahead divided by the closing speed (Hayward, 1972). For cases where the closing speed is constant – that is, when neither vehicle is accelerating or decelerating – TTC indeed represents the time until the host vehicle will impact the lead vehicle. The literature provides many examples in driving and other collision-related applications where TTC (or $1/TTC$) is useful in modeling human perceptions and actions (van der Horst, 1990, and Kiefer et. al, 2003). This metric, however, does not use vehicle accelerations/decelerations and therefore cannot account for the important role of lead vehicle acceleration/deceleration in determining the urgency of the situation.

The second metric addresses this weakness. The *enhanced TTC (ETTC)* is defined as the time to collision, assuming that the accelerations of each vehicle remains constant until the vehicle comes to rest. Note that the enhanced TTC not only considers lead vehicle braking or accelerations, but it captures the effect of the host vehicle acceleration (Kiefer et. al, 2003). Therefore, if the current level of host braking is sufficient to avoid an impact with the lead vehicle (assuming the lead vehicle's acceleration remains constant until it comes to rest), then the enhanced TTC will be infinite. That is, no crash is anticipated.

The third metric is called *decel-to-avoid*, and is the constant deceleration needed by the host vehicle to avoid impacting the lead vehicle. This assumes that the lead vehicle acceleration will remain constant unless the lead vehicle reaches zero speed, in which case it remains at rest. Notice that host-driver braking is not used to compute decel-to-avoid (this measure is used exclusively at brake onset). Decel-to-avoid is negative if driver braking is required. If no braking is required to avoid an impact, the decel-to-avoid can be zero or even positive, which denotes that the host would have to speed up in order to strike the rear-end of the vehicle ahead.

The fourth metric that is used occasionally is the projected decel-to-avoid. This is the value of decel-to-avoid that is expected to occur at some fixed time in the future – here 1.5 seconds is used. This prediction uses the current range and the speeds and accelerations of both vehicles. This metric is useful for approximating the braking level that would be needed to avoid an impact, if the braking began after some delay. For example, this can approximate the braking that the FCW system assumes from a driver that responds 1.5 seconds after the FCW system issues an alert.

These metrics only capture the longitudinal kinematics and do not address the fact that lateral maneuvers are often the means of resolving approach (or closing) conflicts. Although these lateral maneuvers can be urgent responses, they are more typically the intentional maneuvers of drivers as they navigate through traffic. Therefore, much of the conflict consideration here will highlight and distinguish between driving scenarios (e.g., between *lane-change* versus *stay-in-lane* scenarios) which is believed to be essential for the appropriate understanding of conflict metrics.

The computation of deceleration-to-avoid and enhanced TTC requires the deceleration of the lead vehicle. These computations were done in post-processing, and a smoothed estimate of lead vehicle acceleration was done using the host vehicle speed transducer, the radar range rate, and a 1-second rectangular smoothing filter centered at the moment of interest.

5.8 Characterizing the Traffic Environment

The traffic density and lane position results were derived primarily from information provided by the radar tracking and vision systems. Here, *lane position*, refers to which lane the host vehicle occupies, not its lateral position within that lane. This section of the report describes the process that was followed for computing the traffic density and lane-position variables. The computation is outlined in a step-by-step manner that is intended to: a) lend credibility to the results found here and elsewhere in the report based on these traffic environment characteristics and b) provide a fundamental basis of understanding of the methods used to determine these measures. A summary of the critical steps used to derive these measures are as follows:

1. Select tracks: To be considered in this analysis, the radar tracks had to have the following three characteristics: 1) at least a two-second persistence, 2) are labeled mature by the radar system and 3) be movable and traveling in the same direction as the host vehicle. That is, all stationary tracks and tracks of on-coming vehicles

(tracks where range-rate plus host vehicle speed were less than 2 m/s) were not considered in this analysis.

2. Categorize the lateral position of the tracks: The radar-track position information includes a lateral distance projection that is a function of range, azimuth angle and projected roadway curvature. This lateral distance value was found to be the most accurate measure for determining if the target-radar track is within the lane of the host vehicle even at long-range values. Using this information, a count is made for every time-step in the database of the number of tracks to the left, center and right of the host vehicle.
3. Identify lane changes: A table of lane-change events was based on both the lane-change flag from the vision system and an analysis of speed and heading data surrounding the time of turn-signal usage by the driver. Both sources of lane-change events included information indicating the direction (to the right or left) of each lane change. A total of 76,384 lane changes were found in the entire ACAS database. Of these, 13,796 were identified by processing the turn-signal and associated vehicle kinematic data. The remaining 62,588 had to be identified by the vision system.
4. Quantify the traffic environment and make lane-position assignments: For the time between each of the lane-change events, a count of the amount of time was made in which there was at least one target in each of the three lateral positions. Then using a set of rules, the lane-position of the host vehicle was assigned as being either a 1, 2 or 3 for right-most, inner, and left-most lane positions, respectively. The rules for this designation were primarily based on comparing the amount of time that there were targets in each of the three lateral positions but also considered the lane-change direction when applicable. Figure 5.9 shows the result of the mapping as a fraction of distance for the two primary road-type distinctions. On freeways, 73% of the distance was mapped to a lane position. The remaining 27% was designated either not-mapped (25%) or insufficient-traffic-count (2%). Not-mapped simply means that there was no clear indication of lane-position based on the aggregated time and position information. Insufficient-traffic-count means no or very little target-count data was present between adjacent lane-changes. Figure 5.9 also shows the lane-position assignments for freeway and surface-type roads. Since the rules for determining lane-position were developed for use with freeway data, the results on surface roads are decidedly less impressive. Here, only 37 percent of the surface road data were mapped, as nearly 60% was not mapped to a lane position.

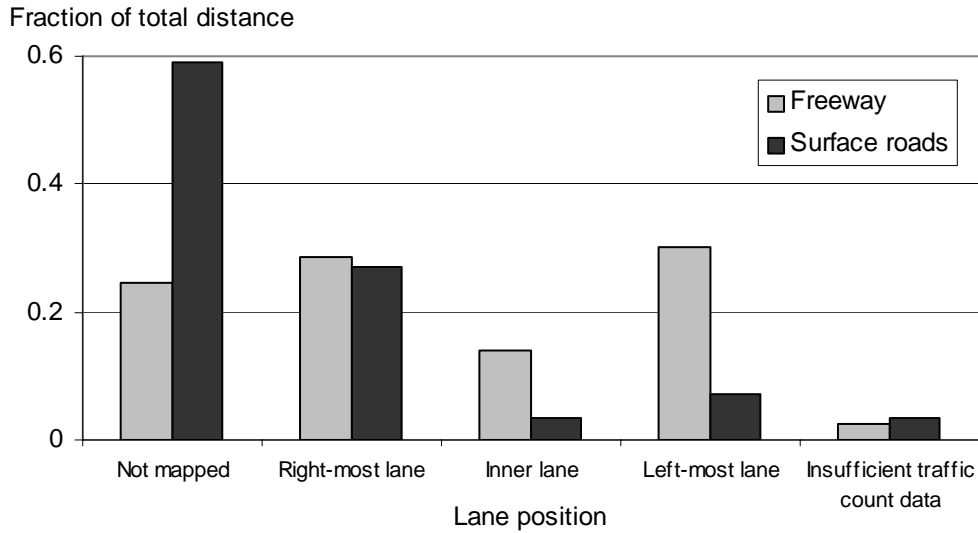

Figure 5.9. Fraction of distance for the different lane-positions, along with the Not-mapped and Insufficient-data categories

5. Validate the three lane-position designations: Validation of the lane-position results was done by randomly selecting five-hundred lane-position events across all drivers and road types. Next, the central forward-looking video frame from each event was manually reviewed and the actual lane-position at that instant was coded. A comparison of the actual results to those found using the rules-based method showed that 91 and 92% of the lane-position assignments were in agreement for freeway and surface roads, respectively.
6. Weight the traffic count: Using the lane-position data, a weighted total traffic count number was derived. For Inner-lane and Insufficient traffic count data, the total traffic count was the sum of the number of radar tracks from the left, center and right fields described in Step 2. For the right- and left-most lane designations the total traffic count was weighted by a factor of 1.5 to reflect the fact that in these lanes the radar can only see the vehicles in two out of three possible lane positions. For times when the lane-position was not mapped, the total traffic count was weighted by a factor 1.25 since it was not known if the factor should be 1.0 or 1.5.
7. Apply a low-pass filter to get traffic density: A 3-minute moving average was applied to the weighted traffic count to derive the final traffic density values.
8. Categorize traffic into three distinct groups: An events table was made that used the smoothed-traffic-count field to classify the traffic environment as being Sparse

(or light), Moderate (or medium) and Dense (or heavy). The criteria used to make these distinctions were:

Sparse = smoothed traffic count < 1.5 targets

Moderate = smoothed traffic count between 1.5 and 4.0 targets

Dense = smoothed traffic count > 4.0 targets

Examples of each of these designations are given in Figure 5.10. Also shown in Figures 5.11 and 5.12 are the average traffic count values as a function of time of day. The time-of-day resolution in these figures is 0.1 hours. A smoothed line of the average traffic count points is also given in each figure.

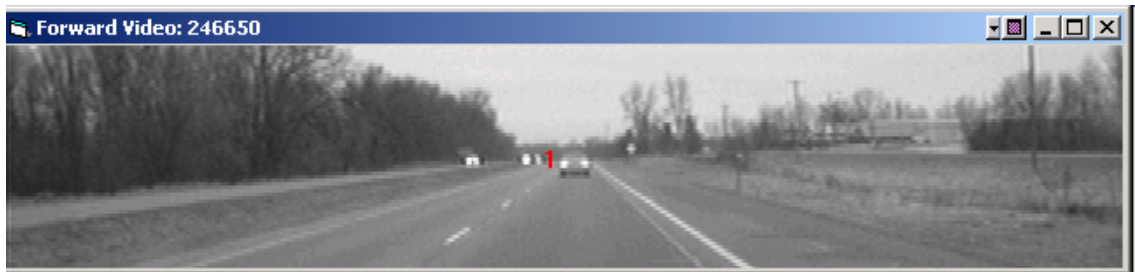

Sparse: Smoothed traffic count < 1.5



Medium: Smoothed traffic count between 1.5 and 4.0

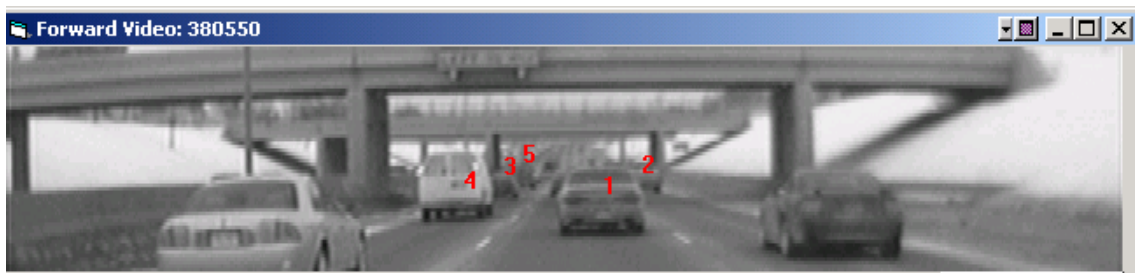

Dense: Smoothed traffic count > 4.0

Figure 5.10. Examples of the three traffic-density designations

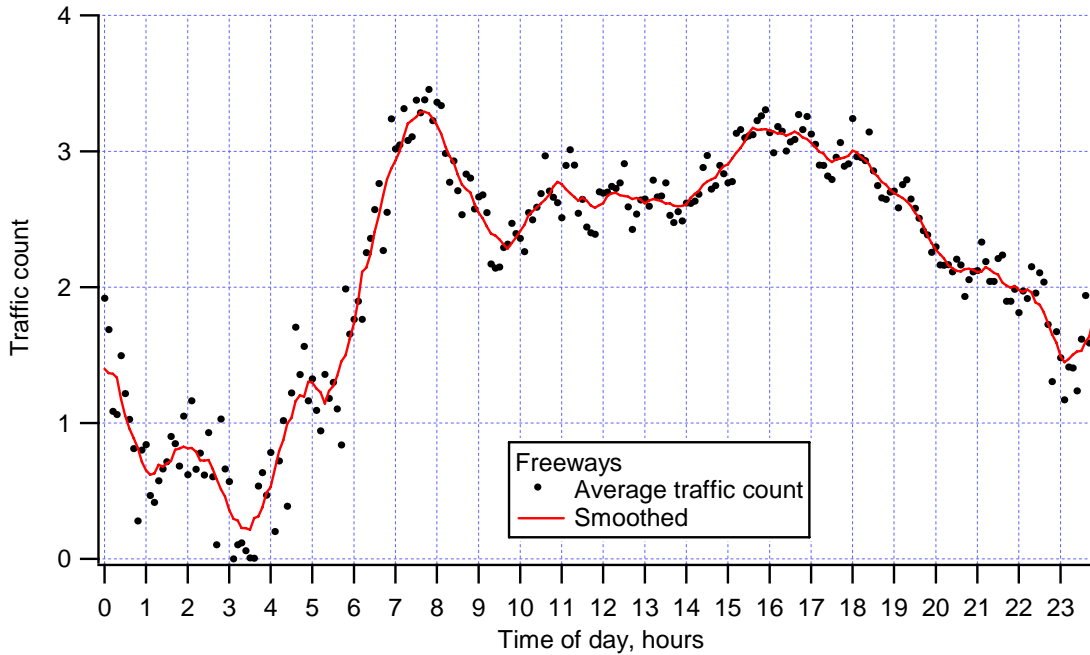

Figure 5.11. Traffic count as a function of time of day for freeways

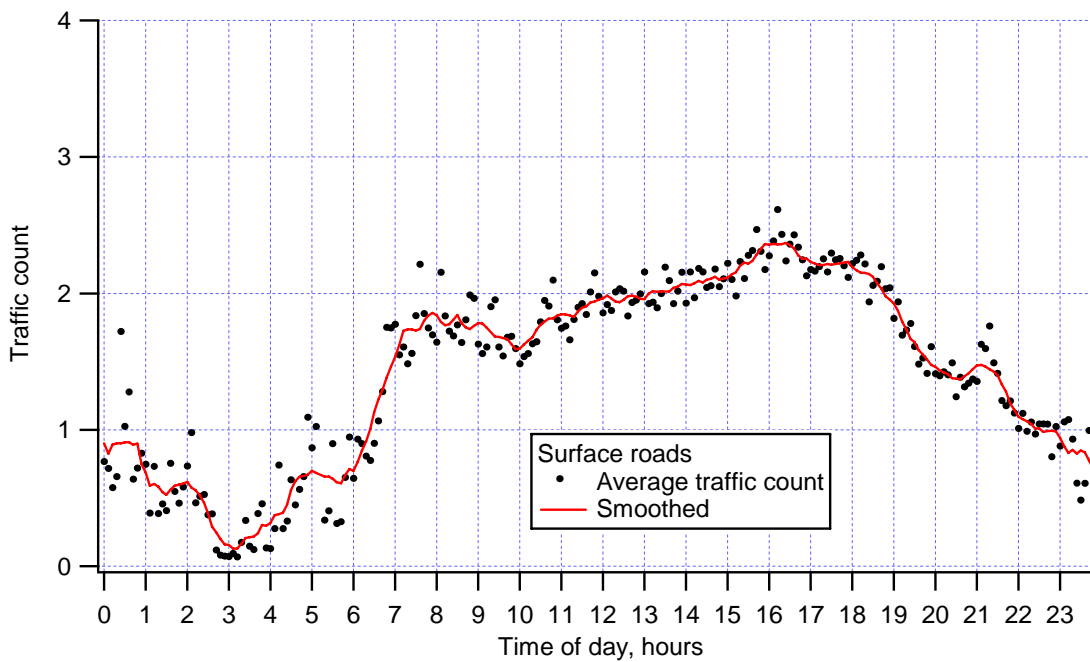

Figure 5.12. Traffic count as a function of time of day for surface roads

Both figures show a steady decline in traffic count from midnight until approximately 3 am. However, they both also show a slight increase between 1 and 2 am. From 3 am onward, the traffic count increases significantly until 8 am. (Interestingly, there is a short span of time between 5 and 6 am when traffic count appears to remain constant or even

decrease.) From 8 am until 10 am traffic decreases significantly on freeways but remains constant on the surface roads. Then, from 10 am until 4 pm there is a steady increase in the count on surface roads and an overall increase on freeways although this increase is not uniform and there is a period from 11 am to 2 pm when the traffic count remains fairly constant on the freeways. From 4 pm until 11 pm there is a steady decrease in traffic count on both road types. There is however, a marked increase in traffic count from 11 pm to midnight on freeways.

6 Presentation of Descriptive Results

This section presents descriptive statistics of the exposure of ACAS to various environmental and driving conditions, descriptive statistics of ACAS-related activity, and a characterization of important aspects of ACAS performance, all of which are intended to be only descriptive of what took place during the FOT. Subsequent sections of the report, particularly Sections 7 and 8, will use these results to address the core questions of the potential safety impacts and driver acceptance findings of the ACAS system.

6.1 Descriptive Statistics on Driving Exposure

This section presents a variety of statistics describing the *exposure* of the ten ACAS FOT vehicles and their drivers. Exposure addresses the conditions experienced by the ACAS system (e.g., miles traveled on surface roads) as well as drivers' experiences with ACAS behavior (vehicle control and warnings). Although a few results address all three ACAS algorithms (A, B and C), most material focuses on the portion of the FOT where 66 drivers used ACAS algorithm C.

6.1.1 Overall Exposure

There were a total of 11,951 *valid* trips during the ACAS FOT. (See Section 4.3 for the definition of *valid* trips.) During these trips, the test vehicles traveled a total distance of 136,792 *valid* miles. All distances traveled in valid trips are considered valid distance.

Figure 6.1 shows the accumulation of valid travel distance over the 12-month period of the field test.

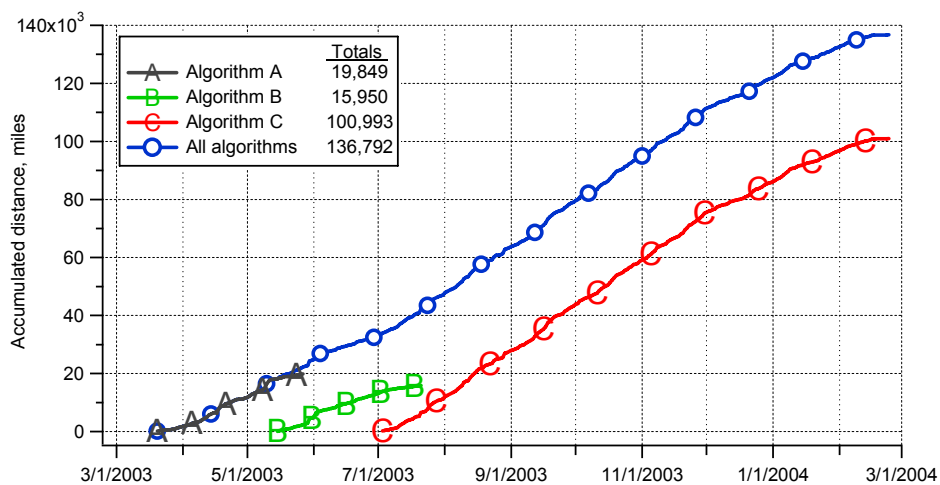

Figure 6.1. Accumulation of all FOT travel distance by calendar time and by algorithm

Figure 6.2 shows the distributions of both distance traveled and number of trips as they were accumulated by vehicles using ACAS algorithms A, B and C, separately and combined.

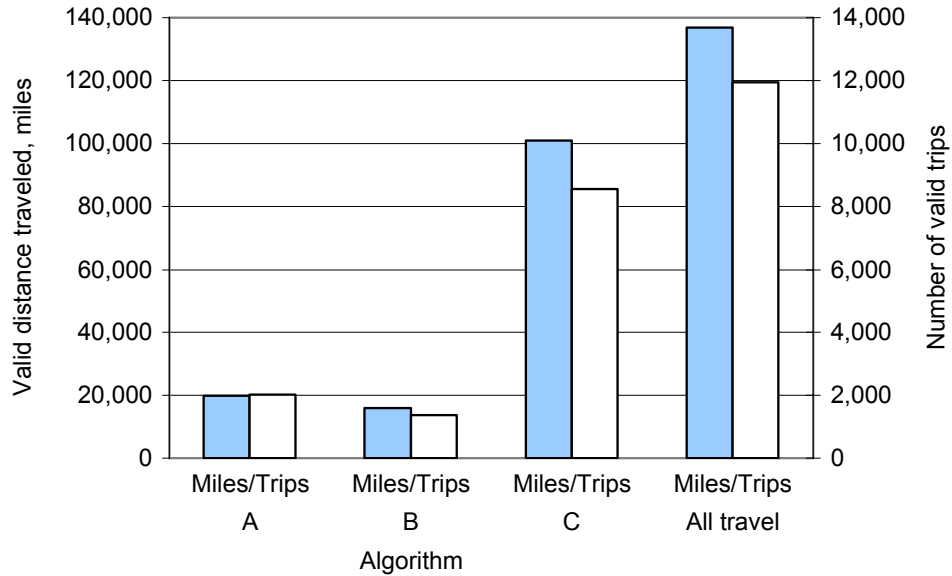

Figure 6.2. Distribution of valid trips and distance travel by algorithm

The subjects of the ACAS FOT each had a test vehicle for nominally four weeks, the first week with ACAS disabled and then three weeks with ACAS enabled. Figure 6.3 shows the relative number of valid trips and distance traveled in the ACAS-disabled and ACAS-enabled states for each of the algorithms and for the entire FOT.

The figure shows that the number of trips and the distances traveled in the disabled state tend to be roughly a quarter (or a bit less) of the respective totals, a result in keeping with the time allotments for driving with ACAS disabled and enabled.

The average length of a valid trip was 11.4 miles. The average length of a valid trip for vehicles using algorithm C was 11.8 miles. This value is indicated on Figure 6.4, which is a histogram showing the distribution of valid algorithm-C trips by distance. The main portion of the graph uses a logarithmic scale on the vertical axis for *number of trips* in order to show that, while there were some 7000 trips of under 10 miles, there were also one trip each in the ranges of 260-to-270 miles, 340 to 350 miles and 440 to 450 miles. The inserted “blow up,” also with a logarithmic scale, shows the distribution of trip length in the range of 20 miles or less. This shows that, while the average may be 11.8 miles, the most likely length of trip is in the range of 0.5 to 1.0 mile.

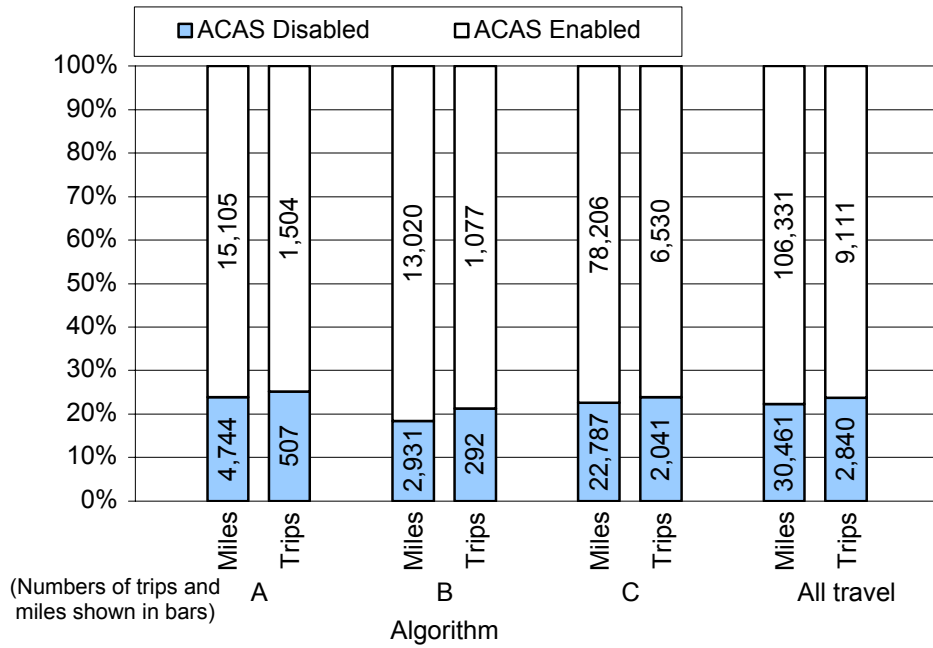

Figure 6.3. Relative number of trips and relative distance traveled with ACAS disabled and enabled, by algorithm

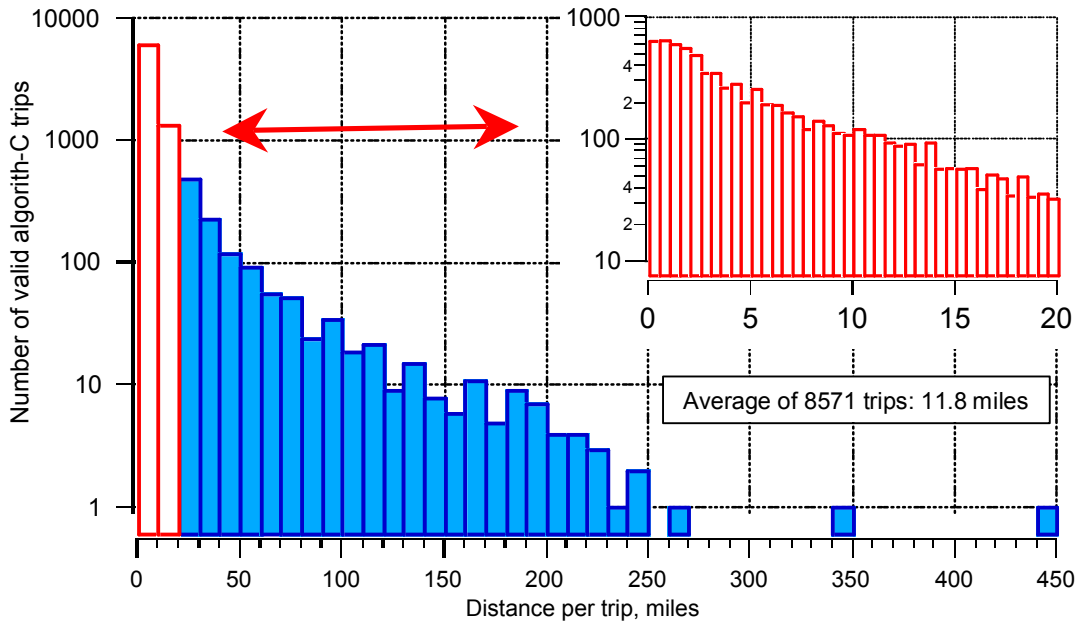

Figure 6.4. Histogram of distances for valid algorithm-C trips

6.1.2 Exposure by Driver

There were 96 drivers in the ACAS FOT, 66 of whom drove vehicles using algorithm C. Valid distance traveled averaged 1425 miles per driver for the 96 drivers and 1558 miles per driver for the 66 algorithm-C drivers. These values are shown on Figure 6.5, along with a histogram showing the distribution of valid distance traveled by individual drivers. Notice that two drivers (one of whom was an algorithm-C driver) drove less than 400 miles while another two drivers (both of whom were algorithm-C drivers) drove more than 3700 miles. Although the distribution in this histogram is asymmetric, the most likely value for distance traveled does fall relatively close to, but a bit below, the average value.

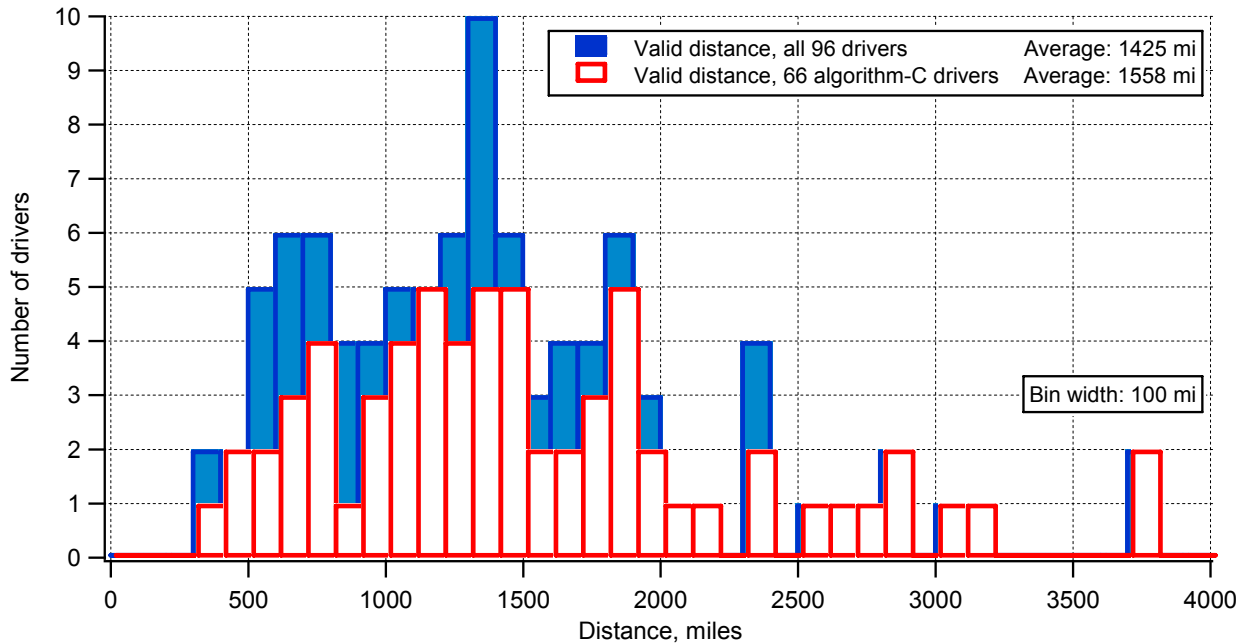

Figure 6.5. Histogram of travel distance during valid trips by all drivers and algorithm-C drivers

The average trip distance varies with driver. Figure 6.6 presents a histogram of the average trip distance of algorithm-C drivers. The figure shows that one of these individuals had an average trip distance of less than 3 miles while another had an average trip distance of more than 35 miles.

The most likely average trip distance (by nine drivers) was in the 8-to-9-mile range. The average of these average trip distances is 12.1 miles or slightly more than the average trip distance (see Figure 6.4).

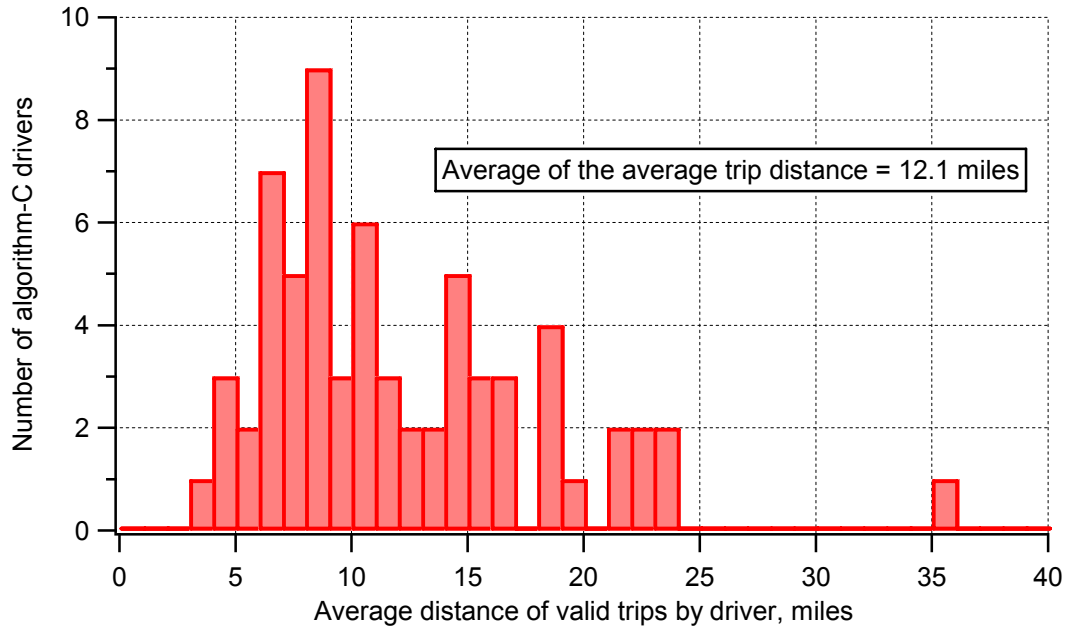

Figure 6.6. Histogram of the average trip distance for algorithm-C drivers

Figure 6.7 presents valid distance traveled by algorithm-C drivers according to gender and age group. The figure shows that total exposure by distance was rather well balanced between males and females and among the three age groups. There was, however, a small increase in distance traveled by older drivers relative to the younger and middle-aged groups and a very slight increase in distance traveled by males relative to females.

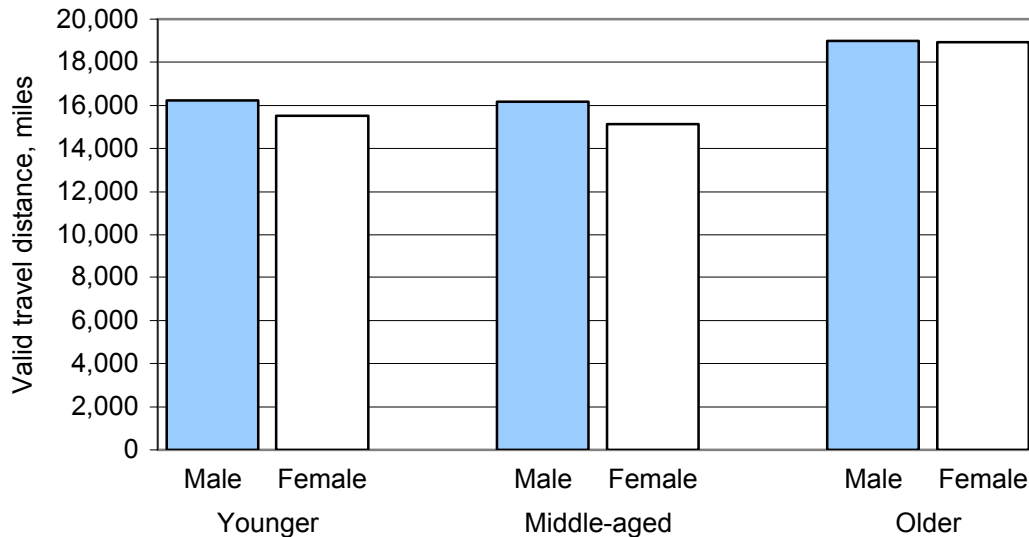

Figure 6.7. Distances traveled in valid, algorithm-C trips by driver gender and age with ACAS enabled and disabled

6.1.3 Exposure by Driving Environment

Figures 6.8 and 6.9 present data describing the exposure of algorithm-C vehicles by road class. Section 5.4 described the computation of road class as based on on-board map-matching, and revised somewhat in post-processing using ad hoc rules. The occasional loss of map-matching confidence on-board the vehicle leads to a significant fraction of travel being associated with unknown road types. In Figure 6.8, the valid distances traveled by these vehicles are displayed according to road class and the disabled/enabled state of the ACAS system. In both disabled and enabled states, the greatest distances are accumulated on freeways (interstates and other limited-access highways).

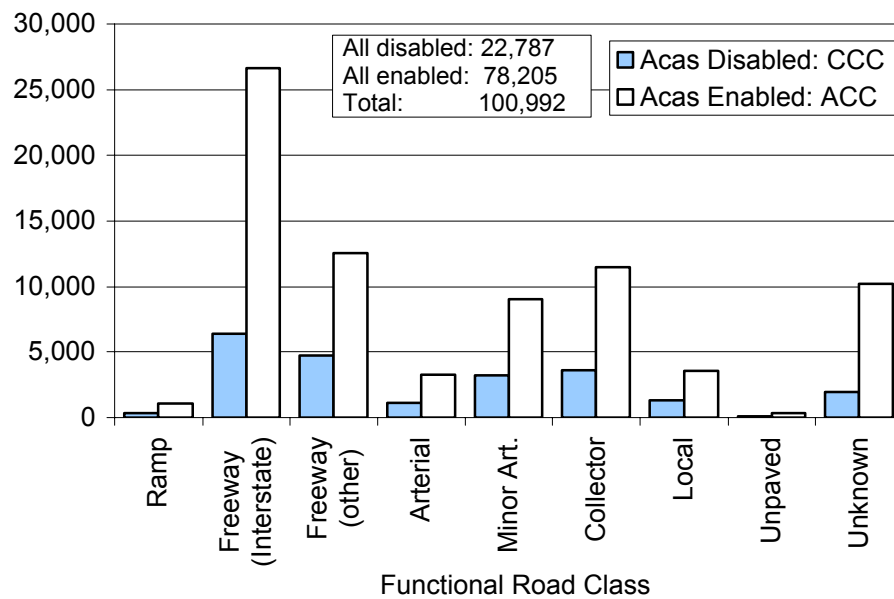

Figure 6.8. Distances traveled in valid, algorithm-C trips by road class with ACAS enabled and disabled

Figure 6.9 presents these same data in a different form that more readily reveals the *relative* distances traveled on the several road classes. This diagram makes it clear that for both the disabled and the enabled operating states, respectively, just about half of all valid distance was accrued on freeways. Moreover, the relative distribution of distance across all road types is rather similar for operations with and without ACAS enabled.

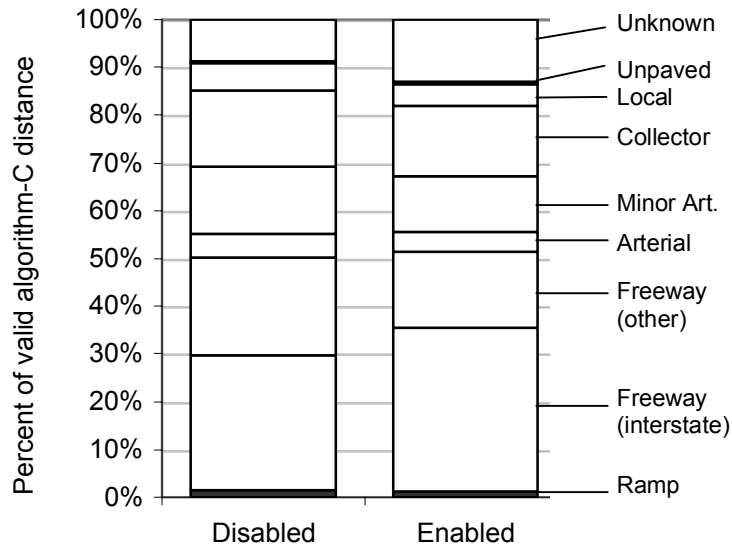

Figure 6.9. Relative distances traveled in valid, algorithm-C trips by road class with ACAS enabled and disabled

Figure 6.10 shows exposure of the algorithm-C vehicles by other qualities of the driving environment, namely: lighting condition, well-lit or darker (per the vehicle’s light sensor); windshield-wiper state, on or off (a surrogate for precipitation); and traffic density, dense, medium, or sparse. (See Section 5.8 for a definition of the traffic density categories.)

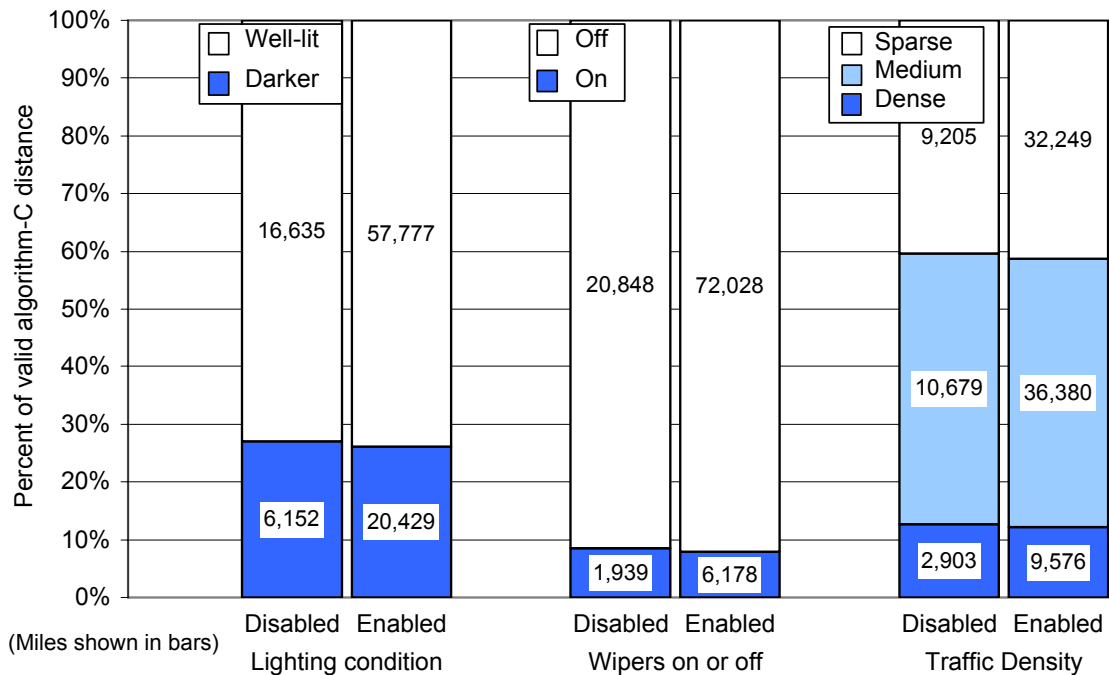

Figure 6.10. Relative distances traveled in valid, algorithm-C trips by driving-environment factors with ACAS disabled and enabled

The graph presents the percent of valid distance traveled (in the ACAS operating state: disabled or enabled) according to these categorizations. (The actual numbers of valid miles traveled are also shown numerically within the bars.) It is apparent that the distribution of these factors was rather even between the disabled and enabled states. In both states (1) a bit more than 25 percent of travel was in darker conditions, (2) less than 10 percent of travel was with wipers on, and (3) about 12 percent of travel was in dense traffic conditions, 40 percent in sparse traffic conditions, and the remainder in medium traffic conditions.

6.1.4 Exposure by Driving Style

Of the 66 algorithm-C drivers, 65 were classified into two driving-style groups: (1) reserved, and (2) assertive drivers. (The one other driver could not be classified into a driving-style type due to the lack of any travel in the conditions used in clustering (freeway driving with moderate values of traffic density, as described in Section 5.6). Figure 6.11 depicts the relative distances traveled by each of the two groups (valid, algorithm-C trips) during the ACAS enabled and disabled periods. The membership count in each driving-style group is also shown.

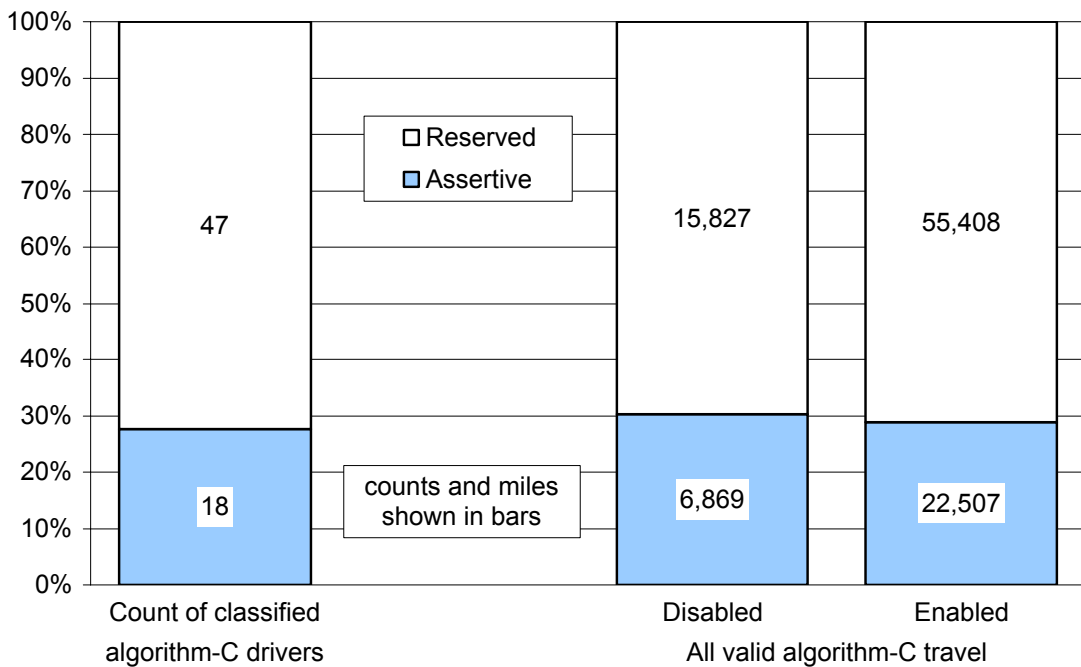

Figure 6.11. Distance exposure by driving-style type with ACAS disabled and enabled

The breakdown of mileage between the two groups reveals that the assertive drivers (27.7% of the overall population) covered mileage that is approximately proportional to

the group's size: 30.3% in the ACAS disabled mode, and 28.9% in the ACAS enabled mode.

The various road types where these miles were accrued by the two groups of drivers are shown in Figure 6.12. This figure may be considered as a representation of road-type choices made by the drivers. It depicts the relative portion of each road class in the overall mileage accumulated by the FOT participants (Algorithm C drivers).

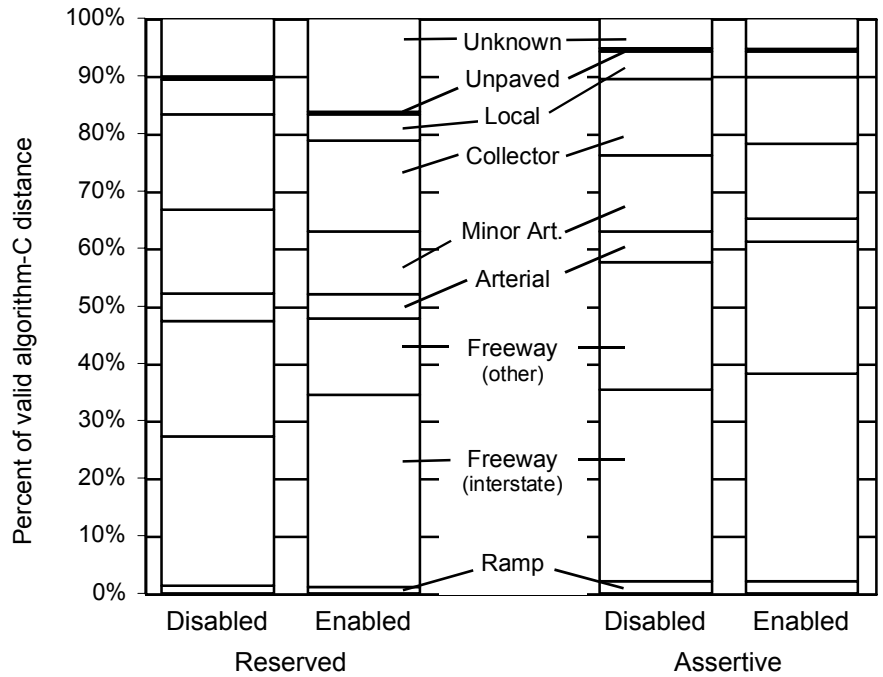

Figure 6.12. Relative distances (algorithm-C) by road class and driving style with ACAS enabled and disabled

Two observations can be readily made from this figure. One, the reserved drivers spent less miles on the highway, and more miles on collector and unclassified (unknown) road types. The assertive drivers were clearly more highway-oriented.

The second observation is that while the driving pattern (by road class) was rather consistent for the assertive drivers during their test period, the reserved drivers shifted more to the Interstate and Unknown roads.

Whereas Figure 6.12 represented the road-type choices made by the drivers, Figure 6.13 represents the drivers' choice to engage CCC/ACC on these roads.

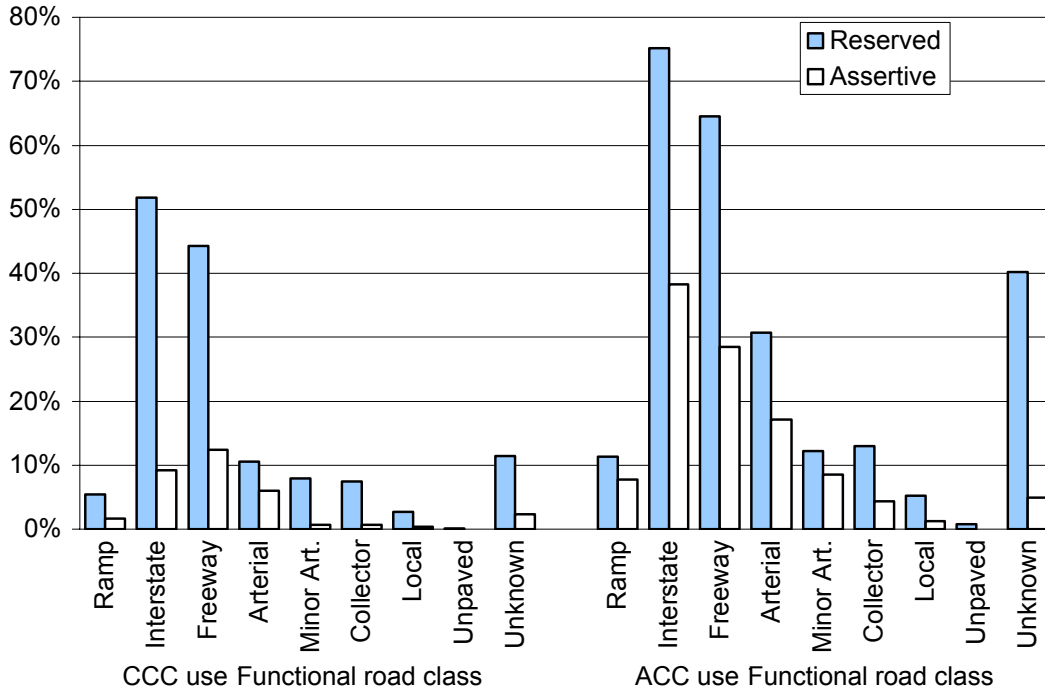

Figure 6.13. Relative engaged distances (algorithm-C) by road class and driving style with ACAS enabled and disabled

Similar to Figure 6.12, the Unknown road class seems to take an exceptionally high growth for the reserved drivers during the ACAS-enabled period. Although no definite accounting can be offered for this phenomenon, one possible explanation may be linked to the fact that reserved drivers spent less time on highway-type roads. As such, on shorter, neighborhood trips, the boot time of the DAS (during which the GPS is initializing and the road class is defaulted to “Unknown”) is more significant. GPS-related artifacts and travel patterns may have played a role in this regard between ACAS-disabled and ACAS-enabled periods. Aside from that observation, the other results show that as a pattern, the reserved drivers engaged CCC/ACC much more than the assertive drivers, and that both types of drivers engaged the cruise mode of control more during the enabled period (ACC) than they did in the ACAS-disabled period (CCC).

Figure 6.14 indicates that driving style, in addition to being a characteristic of the driver, may also be influenced by the driving environment. On highway-type roads, the reserved drivers spent about 16% of their mileage in dense traffic, while the assertive drivers were in dense traffic for about 23% of their mileage. About 20% of the assertive drivers' miles were in sparse traffic, while about 30% of the miles by the reserved drivers were accrued under such conditions.

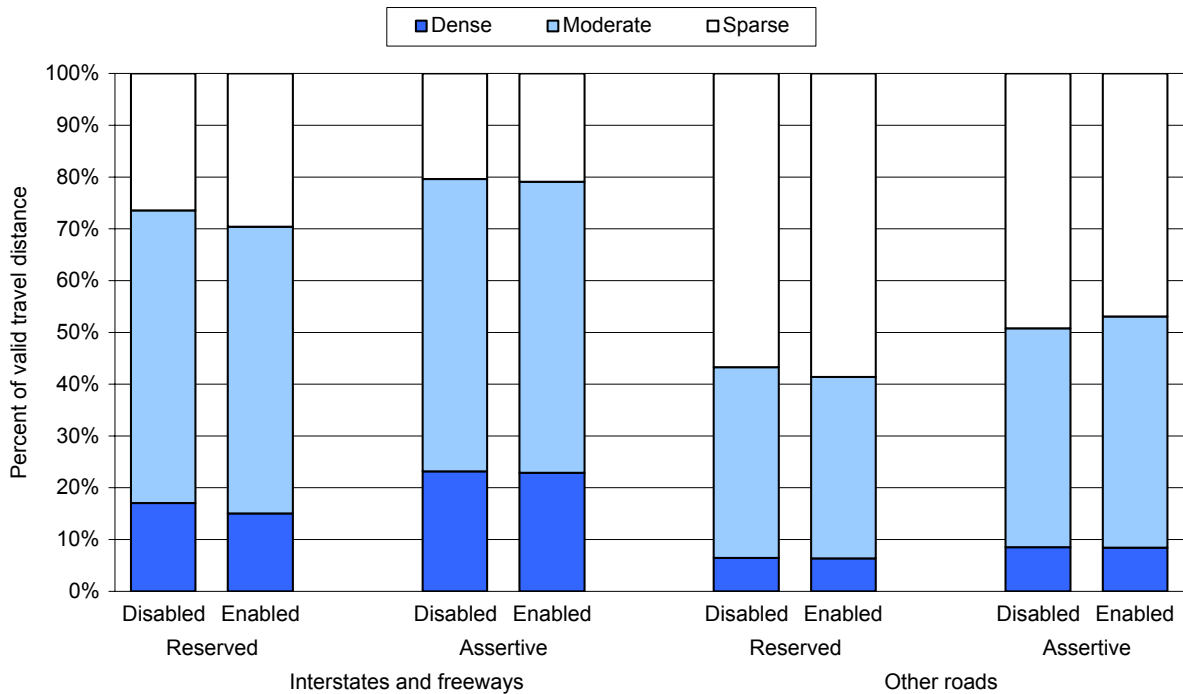

Figure 6.14. Relative exposure to traffic conditions by driver type and road class

Driver style was also studied in conjunction with *commute trips*, which are defined as trips that a driver makes more than once during their ACAS experience. The trips must have the same start and end locations, with a travel distance within 6% of one another. Figure 6.15 shows that about 28% of the mileage driven by the assertive drivers was in these commute trips. The reserved drivers had only about 17% of their miles in commute trips. Relatively speaking, the assertive driver had 65% more miles in commute trips than did the reserved driver, apparently corresponding to both commuter trips and other patterns of repeated travel.

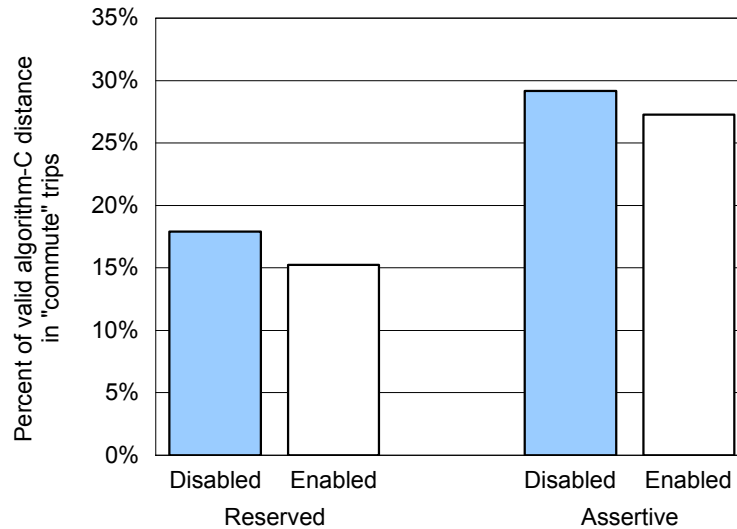

Figure 6.15. Repeated trips portion by driving style with ACAS enabled and disabled

6.1.5 Exposure by Week

To study trends over the 4 weeks of a driver’s exposure to ACAS, each driver’s time with the vehicle was broken up into *weeks*. The term week in this report usually does not refer to 7-day periods, but instead to periods that are roughly that long, but more importantly allow the driver’s time to be split up to study time-dependent trends.

The driver’s exposure to the ACAS vehicle was nominally a 26-day exposure for algorithm-A and C drivers, and 19 days for algorithm-B drivers. Week 1 for all drivers refers to the baseline period (six days for algorithms A and C, and four days for algorithm B). The remaining ACAS-enabled period is then divided equally in time to create three periods (weeks) for algorithm-A and C drivers or two periods for algorithm B drivers. Therefore the latter weeks for algorithm C drivers are nominally 6.6 days long.

6.2 Descriptive Statistics and ACAS Activity

This section characterizes the data volumes obtained from ACAS-enabled driving in terms of factors specific to the ACAS functionality, itself. The material thus pertains to ACAS “activity” in the sense that it addresses the scope of all actions attributable, one way or another, to the ACAS function. In some cases, the scope of the dataset is described by the numbers of FCW alerts or ACC engagements or the rates at which alerts or engagements were seen to be associated with specific condition variables. In other cases, the data describe the scope of the ACAS-adjustment activity of the participants and the relationships between condition variables and the adjustments that were selected. All

data presented in this section pertain only to the algorithm-C portion of the FOT, except where noted.

To study trends over the 4 weeks of a driver's exposure to ACAS, each driver's time with the vehicle was broken up into *weeks*. The term week in this report usually does not refer to 7-day periods, but instead to periods that are roughly that long, but more importantly allow the driver's time to be split up to study time-dependent trends.

The driver's exposure to the ACAS vehicle was nominally a 26-day exposure for algorithm-A and C drivers, and 19 days for algorithm-B drivers. Week 1 for all drivers refers to the baseline period (six days for algorithms A and C, and four days for algorithm B). The remaining ACAS-enabled period is then divided equally in time to create three periods (weeks) for algorithm-A and C drivers and two periods for algorithm B drivers. Therefore the latter weeks for algorithm C drivers are each nominally 6.6 days long.

6.2.1 Activity Involving FCW

This section presents the scope and characteristics of FCW alerts issued during the FOT. More information about the FCW alert circumstances can also be found in Section 6.3.1, which addresses aspects of the system's performance.

6.2.1.1 Availability of FCW

Section 6.1.3 summarized the FOT travel time and distance during which FCW was available. Section 3.1 described the FCW and ACC functionalities, as well as the most important rules determining the availability of cautionary and imminent alerts in both FCW and ACC. The most salient rules for FCW alerts in the manual-driving mode are now repeated in order to set up the presentation of FCW alert data that follows under Section 6.2. First, FCW is always available over 25 mph, except during and shortly after a driver brake application (brake applications always suppress both cautionary and imminent alerts, at any speed). FCW is available down to 20 mph when the vehicle is slowing from a higher speed. Alerts are not available below 20 mph in manual-driving mode. Cautionary alerts for moving targets can also be suppressed by the driver by selecting the latest (least sensitive) FCW sensitivity.

In ACC, imminent-level alerts are available, although moving-target alerts are triggered by ACC's request for maximum 0.3 g braking from the braking system. ACC does not provide any cautionary alerts, other than momentary visual icons before stationary-target imminent alerts. ACC stationary-object alerts use the same alert timing that are used for FCW stationary-target alerts.

6.2.1.2 FCW Imminent Alerts

This section characterizes the volume of FCW imminent alerts and characterizes the conditions in which the alerts occurred. The number of ACC alerts are also reported here. Additional results on ACC alert activity and performance are shown in Sections 6.2.2 and 6.3.3, respectively.

6.2.1.2.1 Alert Terminology and Alert Events Used in Analyses

This section presents the number of crash alerts in the FOT, and defines a number of alert subsets used in analyses in the rest of the report. The terminology in this reporting of the FOT data has one significant difference from prior reports of ACAS results. Here, the alerts that occur during cruise-engaged driving are not referred to as “FCW alerts,” but as *CCC alerts* or *ACC alerts*. The term *FCW alerts* is reserved for only those alerts that occur during manual control of the vehicle. The term *imminent alerts* may refer to either ACC or FCW alerts (or both), and denotes the combined audio and visual alerts.

During the first week of a driver’s use of the ACAS vehicle, visual and/or audio displays were not provided to the driver, but the ACAS system continued its operations silently, with the data collection system recording all data, including when the ACAS system would have issued imminent alerts. These are called *silent alerts*. Note, however, that silent FCW cautionary alerts that are recorded are not meaningful. This is because cautionary alerts depend on the driver-selected FCW sensitivity settings, and during the baseline week, the driver does not have any display of either the sensitivity or the cautionary alerts.

Table 6.1 summarizes the terminology used for the different manifestations of ACAS imminent-level alerts from the data. In general, these terminology definitions are meant to describe alert events, and not the specific audio or visual displays provided to the driver.

Table 6.1. Terminology used to denote ACAS imminent alerts in different control modes

	Cruise-engaged driving	Manual driving	All driving
Baseline period	<i>CCC alerts</i>	<i>Silent FCW alerts</i>	<i>Silent ACAS alerts</i>
ACAS-enabled period	<i>ACC alerts</i>	<i>Heard FCW alerts</i>	<i>Heard ACAS alerts</i>

The set of cautionary alerts does include the special case of the so-called *tailgating alert*, where a visual “crash” icon is presented on the HUD when the driver continues to violate relatively extreme following-distance criteria. However, for the purposes of this FOT report, “cautionary alerts” is not meant to include the momentary presentation of a

visual alert icon before a stationary-target alert while ACC is engaged. While those alerts are important, they are not treated in any analyses.

To ensure consistency in the analyses, a subset of all recorded imminent alerts is defined as *usable alerts*, and only those alerts are used in analyses in all sections of this report. Usable alerts are those for which all data, including video data, is available and readily usable for analysis. The term “usable” does not address whether the alert itself is useful to the driver. Usable alerts constitute 95% of the alerts recorded in the FOT.

Alerts were omitted for a variety of reasons, such as:

- The alert occurs during an invalid trip (see Section 4.3.2),
- The alert occurs within 2 sec of a previous alert, so that it does not constitute a separate event from the previous alert event,
- The alert occurs within a few seconds of the start of data recording (since video surrounding the alert is needed to assign a scenario label),
- Circumstances in the data align with events in the asynchronous data collection so that the data may be misleading unless very carefully handled, (e.g., there are several alerts of very short duration that occur between 10 Hz recording sampling),
- Errors of the on-board ACAS system prevent the system from providing alerts and/or associated data as intended (e.g., some transitions in the brake signal are missed by an on-board component), or
- Video data are not available due to DAS camera issues. (There were two instances in algorithms A and B where camera mount failures led to unusable images. Further, a DAS camera was not well focused for an algorithm C driver.)

Table 6.2 summarizes the number of all alerts as well as usable alerts. There are 942 usable alerts from drivers using algorithm C, and when data from drivers in all three algorithms are considered, there are 2029 usable alerts. Throughout the remaining analyses of this report, only the usable alerts are considered, unless specifically noted.

Table 6.2. ACAS alerts omitted from the analyses

	Alerts (Algs A,B,C)	Alerts (Alg C only)
Usable	2029	942
Not usable	103	61
All alerts	2132	1003

To address the question of whether the alerts omitted from quantitative analyses is significant, consider the ratio of the omitted ACAS alerts to the number of all ACAS

alerts, computed by driver. Fifty-five of the 96 drivers in the FOT experienced an imminent alert that was not considered usable. Thirty-eight of the 66 driver who experienced algorithm C experienced such alerts. However, Figure 6.16 shows that for two thirds of the FOT drivers, the number of alerts considered non-usable were less than 5% of the total number of alerts experienced. Five drivers have ratios of 20% or higher. The maximum ratio is 43% (for driver 34), whose vehicle had a DAS camera that was not properly focused.

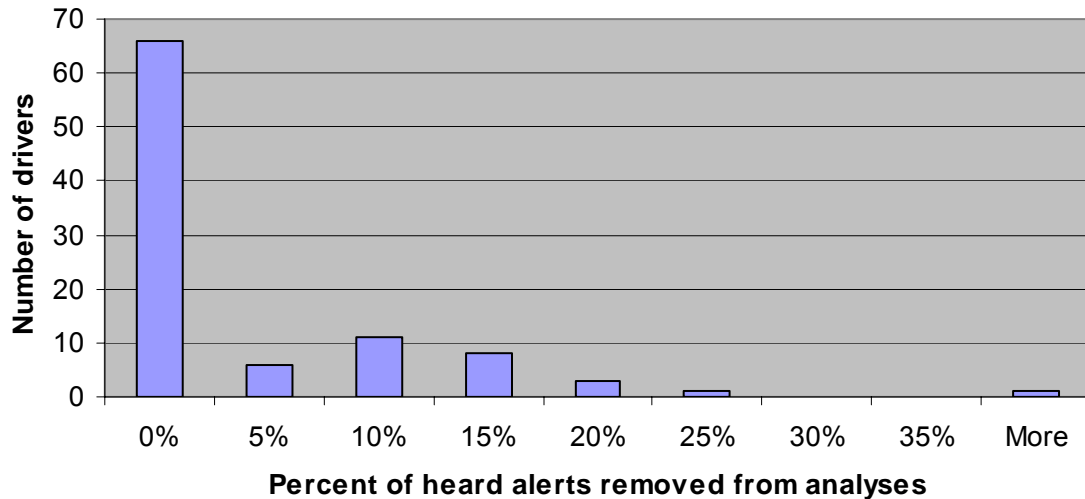

Figure 6.16. Counts of drivers as a function of the ratio of omitted ACAS-enabled alerts to the number of recorded ACAS-enabled alerts (driver 1 – 96)

6.2.1.2.2 Alert Counts and Alert Rates

Of the 942 usable imminent alerts in algorithm C, a total of 706 occurred while ACAS was enabled, of which 287 were triggered by targets that were never in the path of the host, and are considered *false alerts*. This leaves 419 heard, algorithm-C alerts that were *non-false alerts*, in that they are consistent with the general intent of the FCW system design. Table 6.3 shows the total count of usable ACC and FCW alerts that occurred during the FOT.

Table 6.3. Number of usable FCW imminent alerts – broken down by FOT algorithm and whether ACAS displays were enabled (includes cruise-engaged alerts)

	Silent ACAS alerts	Heard ACAS alerts	Total alerts recorded
Algorithm A	220	595	815
Algorithm B	73	199	272
Algorithm C	236	706	942

It is often useful to study the frequency of ACAS alerts, or the alert rate. The frequency is usually expressed in this report as the number of imminent alerts per 100 miles. This alert rate is used to describe ACAS system performance, but is also important in understanding factors that strongly influence the rate at which alerts occur. Building such an understanding is essential to analyzing FOT data, since the recognition of, and accounting for, strong influences of alert rate allows for the real issues of driver behavior to be better isolated and studied.

Alert rates are useful to capture the differences between ACAS algorithms A, B, and C. Figure 6.17 shows the number of ACAS alerts per 100 miles for the three algorithms, with each algorithm's alert rate broken into two components that address the rate at which moving-target and stationary-target alerts were produced.

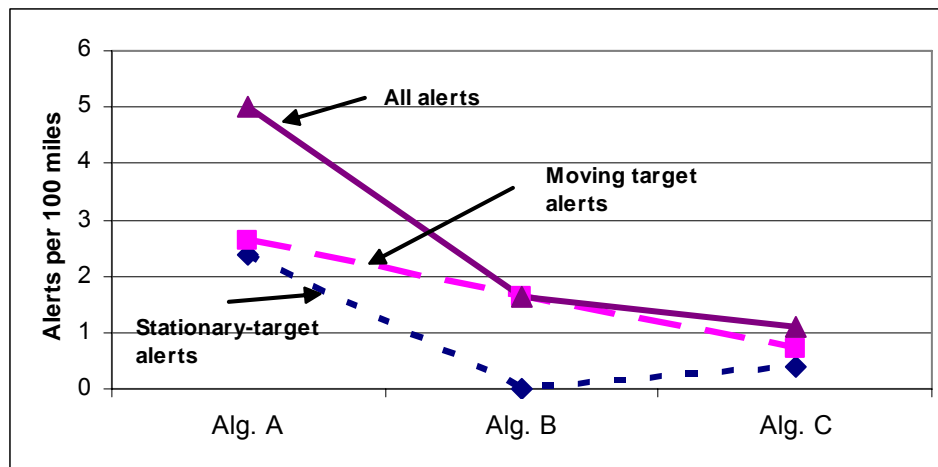

Figure 6.17. ACAS-enabled alert rates for algorithms A, B, and C, expressed as the sum of rates for targets that are stationary and moving

The alerts considered here are the ACAS-enabled alerts that occur during weeks 2, 3, and 4 of a driver's experience, and these composite alert rates are computed by averaging the individual alert rates of the drivers. Moving targets are always vehicles in the FOT, and stationary targets that triggered alerts included stopped vehicles, but were mostly stationary objects on the roadside, with an occasional occurrence of alerts from overhead signs or overpasses.

Figure 6.17 shows that the alert rates for the 15 drivers of algorithm A were 2.4 and 2.6 alerts per 100 miles for stationary and moving target alerts, respectively. The key differences between algorithm B and A is that algorithm B did not provide alerts based on stationary targets. The figure shows that the rate for the 15 drivers in algorithm B to stationary targets is zero, as expected. Algorithm B also included some improvements in

path prediction for moving-target alerts, and this is shown to result in a lower rate for those targets, as well, decreasing by 37% to 1.7 alerts per 100 miles. When algorithm C was introduced for the final 66 drivers, alerts were again provided for stationary targets, but further improvements and changes in the ACAS algorithm resulted in lower alert rates for moving targets, as well as a reduced alert rate, relative to algorithm A, for stationary targets. The alert rates for stationary and moving targets for algorithm C were, respectively 0.7 and 0.4 alerts per 100 miles. Therefore the overall rate for ACAS-enabled alerts (including manual and ACC driving) for algorithm C is 1.09 alerts per 100 miles.

Another option for computing alert rates would have been to normalize by unit travel time. Figure 6.18 shows alert rates for the 66 individuals in algorithm C, expressed in terms of alert rates per hour (abscissa) versus alert rates per 100 miles (ordinate).

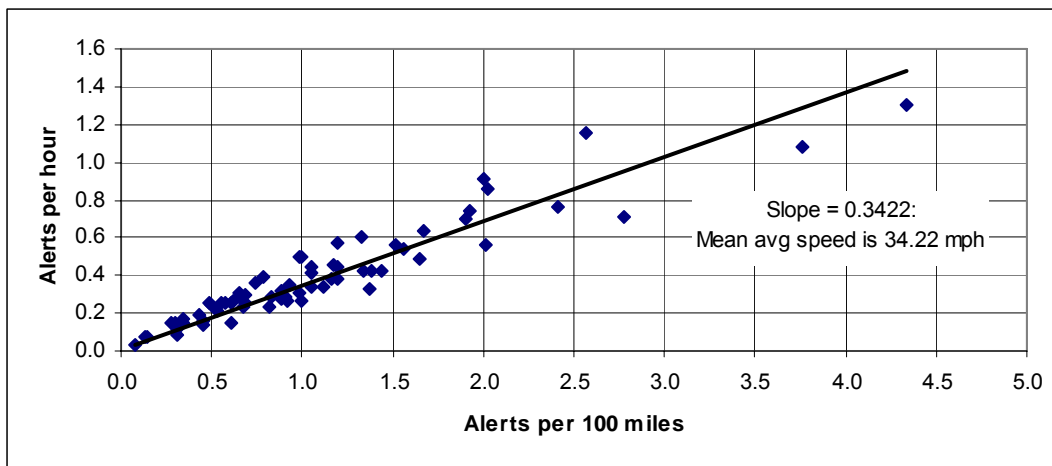

Figure 6.18. Alert rate by unit time, compared to alerts per 100 miles

The ratio of the two rates is simply the driver’s average speed in miles per hour, divided by 100. Thus the vertical spread in the data relative to a straight line drawn through the axis reflects the variation of average speeds of the drivers.

Average speeds vary greatly between drivers, from a minimum within the algorithm-C drivers of 24 mph to a maximum of 55 mph. These speed differences are so large that they are likely to be driven by the road types used by the drivers. The figure shows that the decision to use either distance or time as a basis for normalizing alert rates may have some significance.

6.2.1.2.3 *Characterizing FCW Alert Activity*

The remainder of Section 6.2.1.2 describes the conditions in which FCW imminent alerts occurred, as well as the targets that led to those alerts. There are three points made by this presentation:

- Qualitative and quantitative description of the drivers' experience with the FCW,
- Insight into the successes and challenges of FCW systems such as ACAS's, and
- Difficulties of evaluating driver behaviors when using somewhat infrequent events.

One conclusion that can be drawn from material in this section is that several key factors influence the relative frequency of the ACAS imminent alerts. Although no statistical testing was done, it appears that the most important factors, in approximate order of importance, are:

- Driver (individual vehicle control habits)
- Road type (freeway vs. surface roads)
- Cruise engaged status (engaged vs. manual driving)
- Algorithm (A, B, or C)
- Traffic density (sparse, moderate, high density)

Drivers, of course, belong to age-gender subsets of the FOT testing population, and can also be assigned to driver "style" clusters, as described in Section 5.

In addition, the factors above are inter-related, especially since individual drivers choose the type of roadways to be traveled, select whether to use cruise control, and select their time of travel, which influences traffic density. Therefore, it is important to learn about the relationships between the variables above, and study the alert production as a function of those factors. Alert production outcomes are studied as a function of these variables, and these outcomes include: alert counts; alert rates; alert target types (moving vs. stationary); driving scenarios associated with alert events; and conflicts at the time of alert onsets. The latter two items are discussed in Section 6.3.1.

Finally, a factor of importance will be introduced in Section 7.1, which is whether the ACAS system is enabled to display the alerts to the driver instead of silently generating data that indicate an alert would have occurred, had the displays been enabled. This dimension is very important, since the objectives of the FOT include determining whether the presence of ACAS influences the manner in which drivers control their vehicles.

The approach used to study the infrequent occurrence of imminent alerts, which is influenced by some un-controlled variables (e.g., road type, cruise usage), is to artificially control the variables by selecting data from a targeted set of values of those variables. An example is studying the alert experience on surface roads, while cruise is not engaged. The reader will see that the challenge is that as conditions are “controlled,” the data volume becomes sparse, and oftentimes the events of interest become too few to examine.

6.2.1.2.4 Cruise Usage and Alert Production

The number of cruise-engaged alerts was much smaller than the number of manual-driving alerts. This was true across algorithms, and it held whether ACAS is enabled or disabled. Figure 6.19 shows the fraction of alerts that occurred while cruise was engaged, relative to all alerts occurring for drivers with the three respective algorithms.

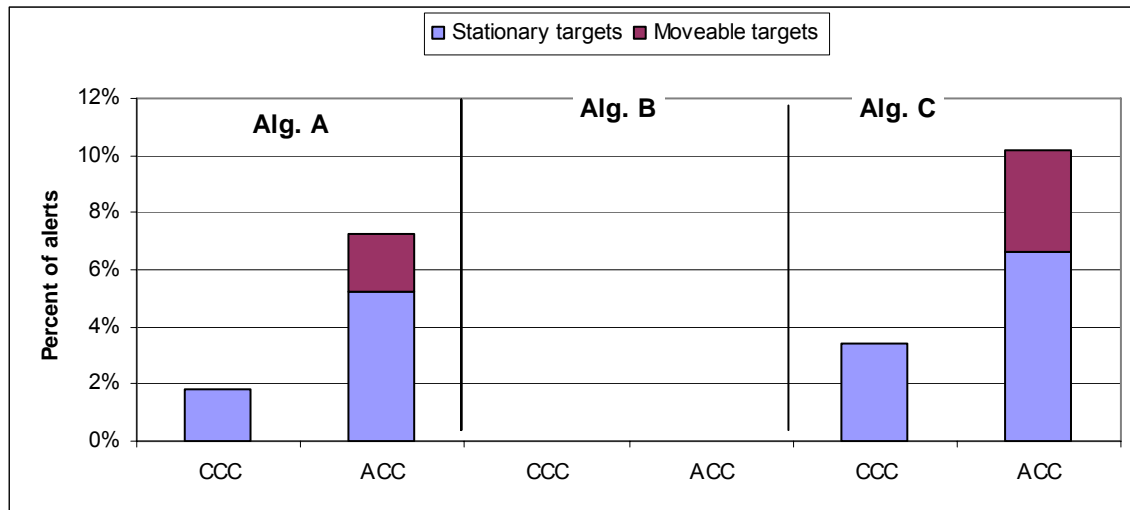

Figure 6.19. Cruise-engaged alerts, as a fraction of all ACAS-enabled alerts (algorithms A, B, and C)

For example, in algorithm A, while ACAS was disabled during the first week, alerts occurring while CCC was engaged accounted for less than 2% of all alerts during the first week. This fraction changed only slightly for algorithm C. In general, ACC driving provided more alerts than CCC driving. For algorithms A and C, respectively, ACC accounted for 7% and 10% of all alerts during the enabled period of the tests with those algorithms. Two reasons are thought to explain why the fraction of alerts in ACC was greater than that in CCC: ACC utilization was higher than CCC utilization, and during CCC, there were no alerts indicated for targets that are moving.

Note that during algorithm B, there were no alerts provided in either CCC or ACC. As described earlier, this was partly intentional, since algorithm B did not include any alerts for targets that were stationary. However, an oversight in the on-board code prevented alerts for moving threats from occurring when cruise was engaged during algorithm B and for roughly half of algorithm C testing. (See Section 6.2.2.3 for more discussion of the code oversight.)

6.2.1.2.5 Variation of Alert Production among Individual Drivers

The driver behind the wheel appears to be the single most powerful factor associated with the number and the rate of ACAS alerts. Alert counts and alert rates vary by almost two orders of magnitude within each of the driver subsets associated with the three ACAS algorithms. A summary of the number of ACAS alerts and the travel distance accumulated by each driver is included in Appendix J. It is hypothesized that the driver may influence the rate of forward crash warning alerts and possibly forward conflict frequency through several mechanisms that include, in approximate order of importance: vehicle control behavior, roadway type, use of ACC, traffic density, as well as perhaps travel speed.

The number of alerts “heard” by drivers in each of the three ACAS algorithms is shown below in Table 6.4, expressed using means and standard deviations. The means for algorithms A, B, and C, respectively, are approximately 40, 13, and 11 alerts per driver. The standard deviations reflect the wide spread in this data. Note again that algorithm B drivers had ACAS enabled for approximately two thirds as long as the other drivers.

Table 6.4. Number of ACAS alerts provided to individual drivers during ACAS-enabled driving by algorithm (includes FCW imminent alerts and ACC alerts)

Algorithm	Weeks of exposure per driver	Number of alerts (mean)	Standard deviation
A	4	39.7	18.9
B	3	13.3	9.2
C	4	10.7	6.7

While alert counts capture the overall accumulation of alerts, it is desirable to employ alert rates to control for the between-drivers variations in weeks of exposure or accumulated travel distance. The mean and standard deviations of the alert rate per 100 miles for ACAS alerts received during ACAS-enabled driving are shown in Table 6.5.

Table 6.5. Alert rate per 100 miles for driver during ACAS-enabled driving. Means and standard deviations (in parentheses) are shown, and rates are normalized by miles driven in the associated control mode.

Algorithm	ACC alerts	FCW imminent alerts	All alerts
	(Collapsed across all drivers)	Mean (std dev)	Mean (std dev)
A	1.88	6.58 (6.53)	5.00 (5.77)
B	n/a	2.59 (1.77)	1.65 (0.98)
C	0.38	1.44 (1.00)	1.09 (0.80)

The rates for ACC alerts in the first column of the table were computed by collapsing the data across drivers, that is, by combining all drivers' alerts and mileage for each algorithm, since fewer than half the drivers received ACC alerts. Rates in the other columns of the table were computed by averaging across the individual drivers' rates, so that standard deviations are available.

The total alert rate is not equal to the sum of the ACC and FCW imminent alert rates because each rate were normalized by the driving distance in that control mode, e.g., the ACC alert rate is normalized by the distance traveled in ACC. There was no ACC alert functionality during algorithm B, as described earlier.

The overall average alert rate for drivers with algorithm C was 1.09 alerts per 100 miles. The histogram in Figure 6.20 shows the number of drivers that produced various values of the combined ACC and FCW alert rate. This data corresponds to the rightmost column of the previous table.

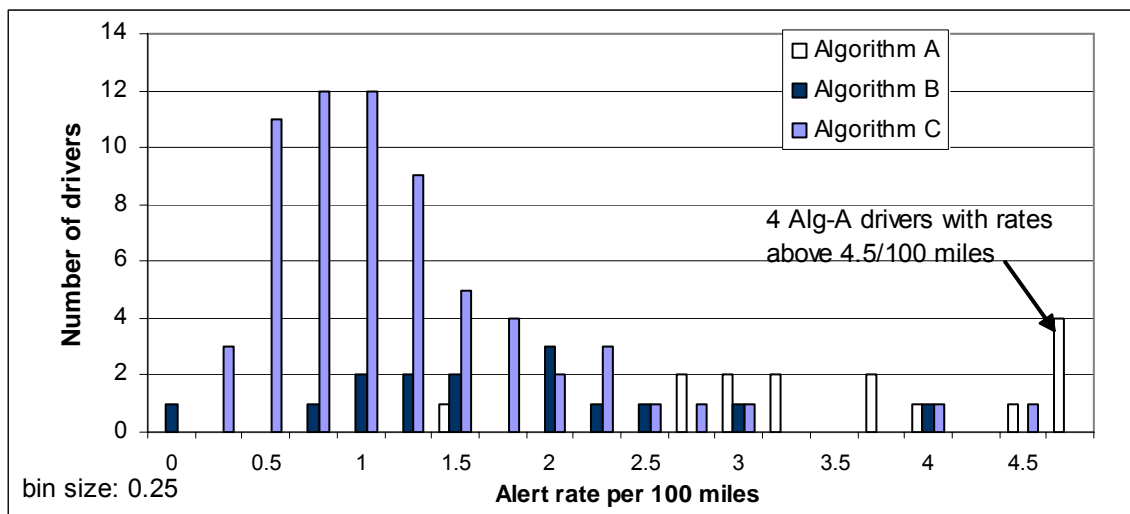

Figure 6.20. Histogram of the number of drivers with various alert rates (includes all ACAS heard alerts, algorithms A, B, and C)

This histogram shows all 96 drivers, identified by the algorithm implemented in their test vehicles. The histogram reflects the general trend of reduced alert rates as the ACAS system progressed from algorithm A to B to C. The histogram also shows the mode of the algorithm C alert rate being around 0.75 to 1.0 alerts per 100 miles.

Figure 6.21 shows that when driving manually (without ACC), the alert rates are higher than the rates for the combined driving modes of manual and ACC driving that was just discussed. This shift is observable in any result that compares manual driving alert experience with combined manual-ACC driving experiences.

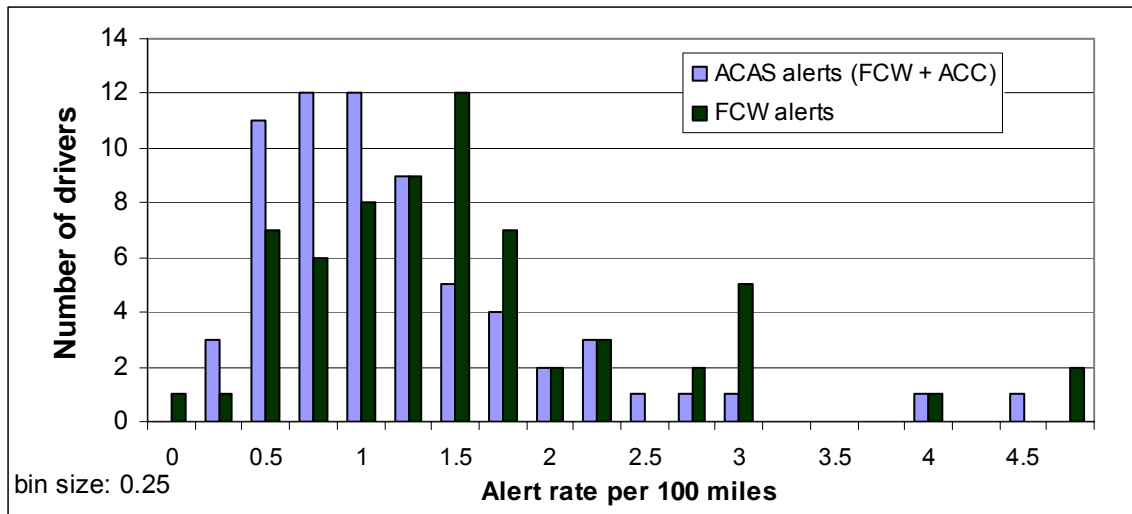

Figure 6.21. Histogram of the number of algorithm C drivers with various alert rates (FCW and all ACAS alerts shown separately)

Because ACC was used for significant part of the travel distance and ACC travel produced very few alerts, a driver’s ACC usage is somewhat of a “dilution agent” for alert rates. Alert rates are likely to be greater in manual driving than for ACC driving for two reasons: (1) drivers are thought to engage ACC more often when conditions are relatively benign in terms of traffic conflicts and roadside clutter, and (2) ACC actively manages the headway, reducing the occurrence of conflicts that lead to alerts. Regarding the large standard deviations in Table 6.5, these are likely caused by both the differences in environments to which the system is exposed and by the differences in drivers and their habits of tolerating or avoiding forward conflicts.

6.2.1.2.6 Variation of Alert Production by Road Type

This subsection looks at the association of alert experience with road type. Most FCW alerts in the FOT occurred on surface roads. Furthermore, the rate of FCW alert occurrence is much higher on surface roads than on freeways.

Figure 6.22 shows the rate of heard FCW alerts per 100 miles. The figure shows the rates expressed as a function of the road type and the ACAS algorithm (A, B, or C). The rates are computed using the mileage accumulated in the appropriate conditions, e.g., miles traveled on freeways in algorithm A.

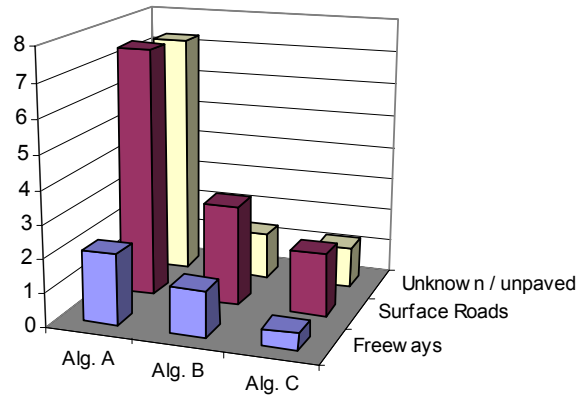

Figure 6.22. FCW alert rate per 100 miles for ACAS-enabled driving: by algorithm and by road type (excluding ramps)

The road types used are: freeways (limited access roads), surface roads (paved, non limited-access roads), and unknown/unpaved roads. (Unknown-class roads are roads where the on-board map-matching did not find a solution, and where the post hoc patching of the road type variable also did not find a solution.) These rates are computed by collapsing across drivers' data. The figure shows that the alert rates on surface roads are roughly three to five times the rates on freeways.

For individual drivers, Figure 6.23 addresses manual driving during the ACAS-enabled weeks, and compares the total number of imminent alerts received with the number received on surface roads. Again, this shows that most manual-driving alerts occurred on surface roads, and the figure also indicates that this holds for all but a few drivers in each algorithm (although these are counts and not rates).

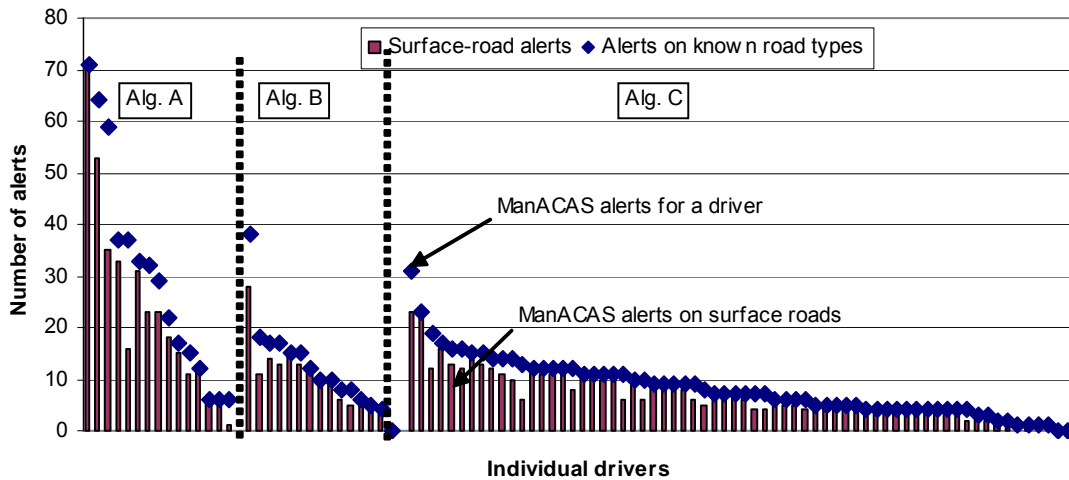

Figure 6.23. Variation among drivers of the number of ACAS-enabled alerts occurring on known road types, with the number of alerts on surface roads also shown.

Alerts are more frequent on surface roads because there is generally more interaction with other vehicles. That is, as speeds fluctuate, vehicles make maneuvers to enter or leave the host vehicle’s roadway, traffic lights bring traffic to a halt, and so on. The surface road environment also has more objects near the roadside to trigger out-of-path alerts. Combined with the sharper curves found on surface roads, especially on rural or suburban roads, this contributes to a higher production of alerts on surface roads. Road signs, mailboxes, telephone poles, vegetation and fences are all seen to produce alerts. Freeway systems, on the other hand, are designed to minimize speed differences between vehicles, and except for congested situations, there are many fewer braking episodes. Very few roadside objects are seen to trigger alerts on freeways (except for within construction zones). This is due in part because of wider shoulders and gentler curves found on freeways. Overpasses and overhead signs do occasionally trigger some alerts in the FOT, but again, overall the production of alerts on freeways is much lower than on surface roads.

Recall from Table 6.5 that the overall alert rate for algorithm C is 1.09 alerts per 100 miles, when all ACAS-enabled (“heard”) alerts and all miles are considered. To study the interaction of road type and cruise-engaged status on alert rates, it is necessary to collapse data across drivers, since many individual drivers did not experience alerts in some of these conditions, e.g., “on ramps, engaged in ACC.” Table 6.6 shows the results after collapsing across drivers in algorithm C. Here the overall rate is computed as a lower rate: 0.90 alerts per 100 miles. The table shows, however, a strong interaction whereby the alert rates depend jointly on the cruise-engaged status and the road type.

Table 6.6. FCW imminent alert rates per 100 miles with the ACAS system enabled, algorithm C, broken down by road type and cruise-engaged status

	Not engaged	Engaged	All alerts
Freeways	0.48	0.13	0.28
Ramps	0.03	0.01	0.02
Surface roads	1.88	1.12	1.79
Unknown /unpaved	1.23	0.15	0.90
All roads	1.27	0.25	0.90

The overall alert rate on surface roads is 1.79 alerts per 100 miles, which is more than six times the alert rate on freeways, which is 0.28 alerts per 100 miles. Freeways, of course, are intended to facilitate low-conflict traffic moving at similar speeds, therefore the relatively low rate of imminent alerts on freeways is expected. Alerts also occur at a lower rate when ACC is engaged – this rate is 0.25 alerts per 100 miles, when all roads are considered. When ACC is not engaged, the rate is five times greater, or 1.27 alerts per 100 miles.

When road type and cruise-engaged status are combined, the rates differ even more. The alert rate for non-engaged driving on surface roads is 1.88 alerts per 100 miles, while the rate for ACC-engaged driving on freeways is a fraction of that, or 0.13 alerts per 100 miles (or about one every 750 miles).

The trends of Table 6.6 -- that the alert level is greater on surface roads than on freeways, and greater in manual driving than in cruise-engaged driving -- are pronounced and were observed in all pilot tests, as well as the FOT. Therefore it appears that increased rates can be expected when driving on surface roads (versus freeways) and driving without cruise control engaged. Thus it is hypothesized that the number of imminent alerts that a driver experiences may be directly influenced by the type of roads they drive, as well as whether they choose to use ACC.

6.2.1.2.7 Alerts Triggered by Stationary and Moving Targets

Stationary targets that trigger alerts are almost entirely out-of-path obstacles such as road signs, lampposts, guardrails, and so on. There are only a handful of stopped vehicles that are in the host’s path that trigger alerts (this is presented in Section 6.3.1). Therefore, comparing alerts that are triggered by stationary or moving targets is a very good surrogate for comparing “false” alerts with “non-false” alerts (which involve moving vehicles that are at one time within the host’s path). Drivers often do not recognize the

cause of stationary target alerts, and sometimes express bewilderment when asked about the source. Therefore, stationary target alerts may have a different quality to some drivers, so that associated alerts become less acceptable and degrade the system credibility more than alerts associated with vehicles that the driver is quite aware of. (Section 7.2.1.4 appears to confirm this hypothesis, based on drivers' post-driving rating of individual alerts' utility.)

Figure 6.24 shows the number of alerts displayed to each of the drivers, as well as the number of those that are associated with stationary targets. The figure shows that the percent of all alerts that are stationary-target alerts varies from 0 to 100% for individual drivers, with a typical ratio of 20% to 50% stationary alerts. This ratio is not highly correlated with the number of alerts received.

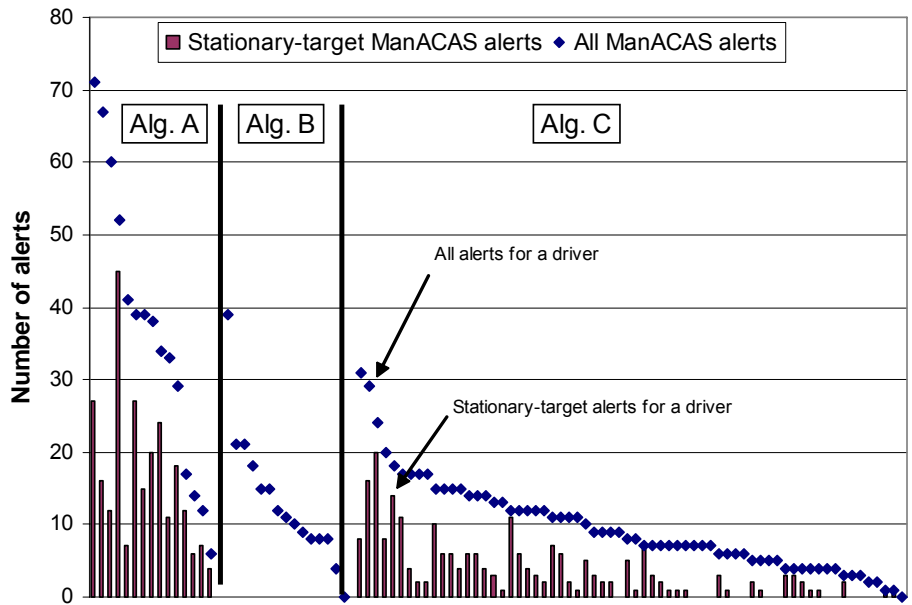

Figure 6.24. Variation among drivers of the number of ACAS-enabled alerts, and the variation in the relative fraction of the alerts that are associated with stationary targets

The fraction of alerts that are associated with stationary targets is higher with cruise engaged, as shown in Figure 6.25. For algorithm C, 65% of all ACC alerts, and 36% of all FCW alerts in manual driving are triggered by stationary targets (collapsed across drivers). ACC manages headway explicitly, and apparently this reduces the frequency of alert-producing conflicts with moving vehicles.

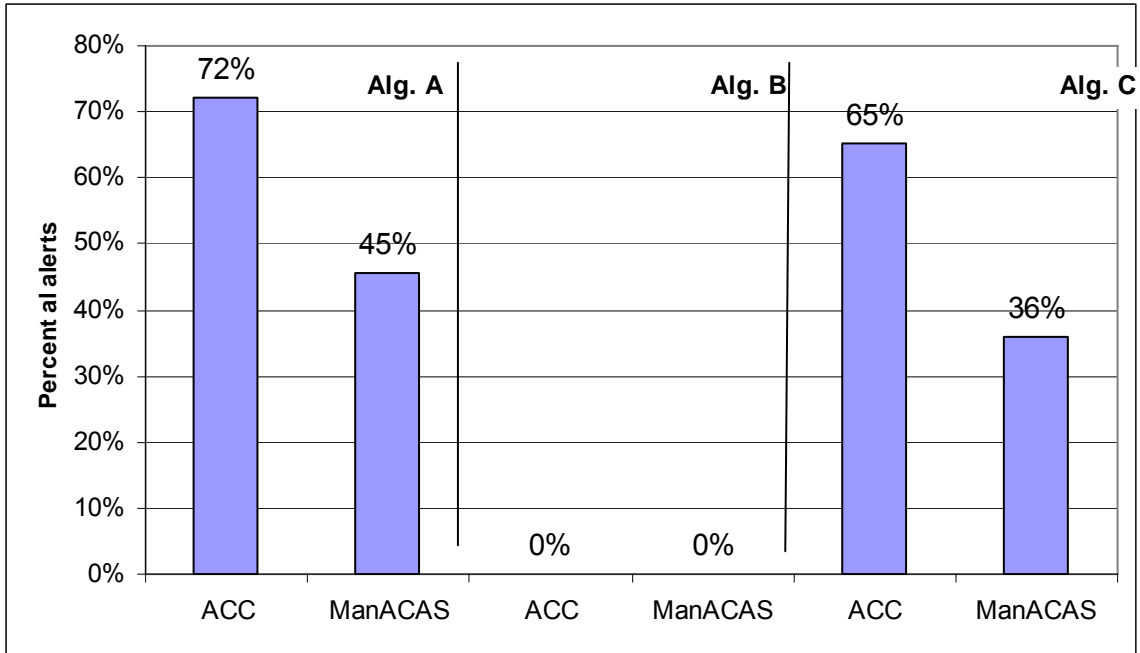

Figure 6.25. Stationary-target alerts, as a fraction of all ACAS-enabled alerts (for algorithm A, B, C)

Figure 6.26 shows the interaction of algorithm C alert rates during the ACAS-enabled phase with the road type and whether the target is stationary or moving. (Figure 6.27 shows the corresponding mileage under these conditions.)

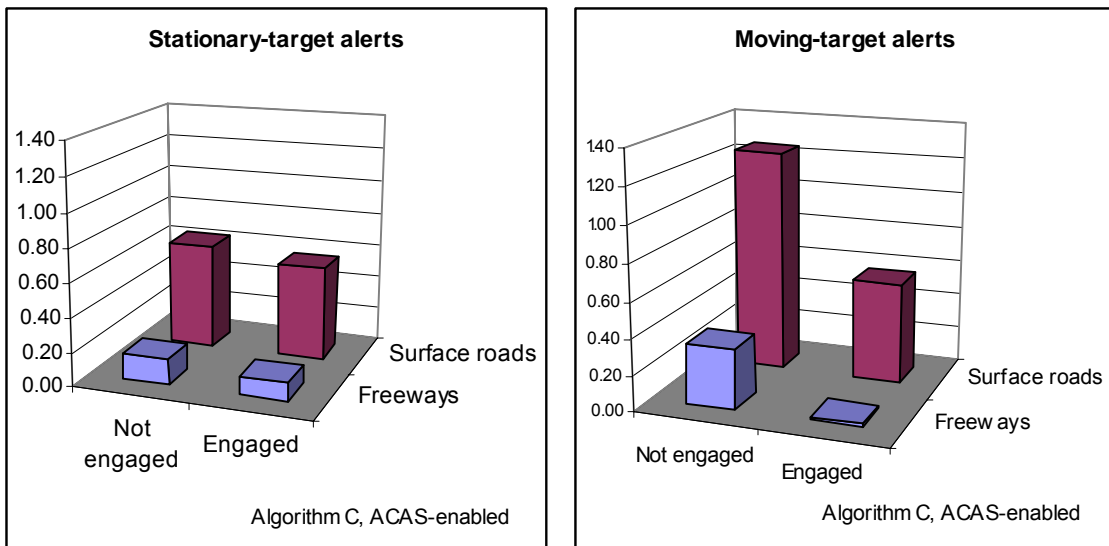

Figure 6.26 Variation of alert rate per 100 miles in ACAS-enabled driving (algorithm C), by road type and cruise-engaged status. Alerts include ACC and manual driving alerts.

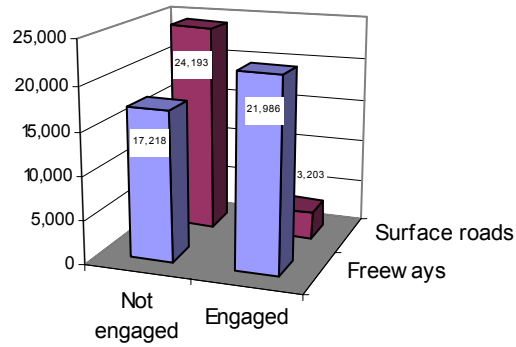

Figure 6.27. Travel distance in miles during algorithm C ACAS-enabled driving, broken down by road type and cruise-engaged status

The following are noted:

- The highest rates are due to moving targets on surface roads, i.e., surrounding traffic.
- When driving manually, moving target alerts are about twice as common as stationary-target alerts. When using ACC, moving target alerts are about as common as alerts triggered by stationary targets, except for a notably small rate of moving target alerts on freeways.
- The rate at which stationary-target alerts occur does not vary much with the cruise-engaged status. In a following section, a detailed characterization of these alerts will be presented, but for now it can be pointed out that the vast majority of these alerts is triggered by non-vehicle objects, such as roadside signs and clutter, guardrails, and to a lesser degree, overhead objects. Whether or not cruise is engaged, the system still senses these objects, so it is not surprising that the rate of alerts due to these objects is not different whether or not ACC is engaged.
- The rate of moving-target alerts, however, is different with and without ACC engaged. With ACC engaged, the rate is about half the rate of non-ACC driving. There are three likely factors behind this: drivers may choose to use ACC in less conflicted conditions; the ACC itself has the effect of maintaining headways, therefore possibly reducing the rates of alerts; and ACC alerts triggered by moving targets are computed using a different algorithm than are alerts in manual driving.

6.2.1.2.8 Host Speed at Onset of Alerts

Host speed is related closely to the type of road traveled, and is not strongly driven by individuals' speed preferences, since the difference in these preferences is often smaller

than the speed differences between general traffic motion on various road types. Nevertheless, it is instructive to view the host speeds at the time of FCW alerts. This is not seeking to investigate speed as a factor in causing alerts, but rather a way to view the output of alert occurrence and learn more about the FCW experience.

The histogram in Figure 6.28 shows the number of alerts that occur within various speed bands. The chart shows moving-target and stationary-target alerts separately, with an overlaid trace of the travel time at the corresponding speeds.

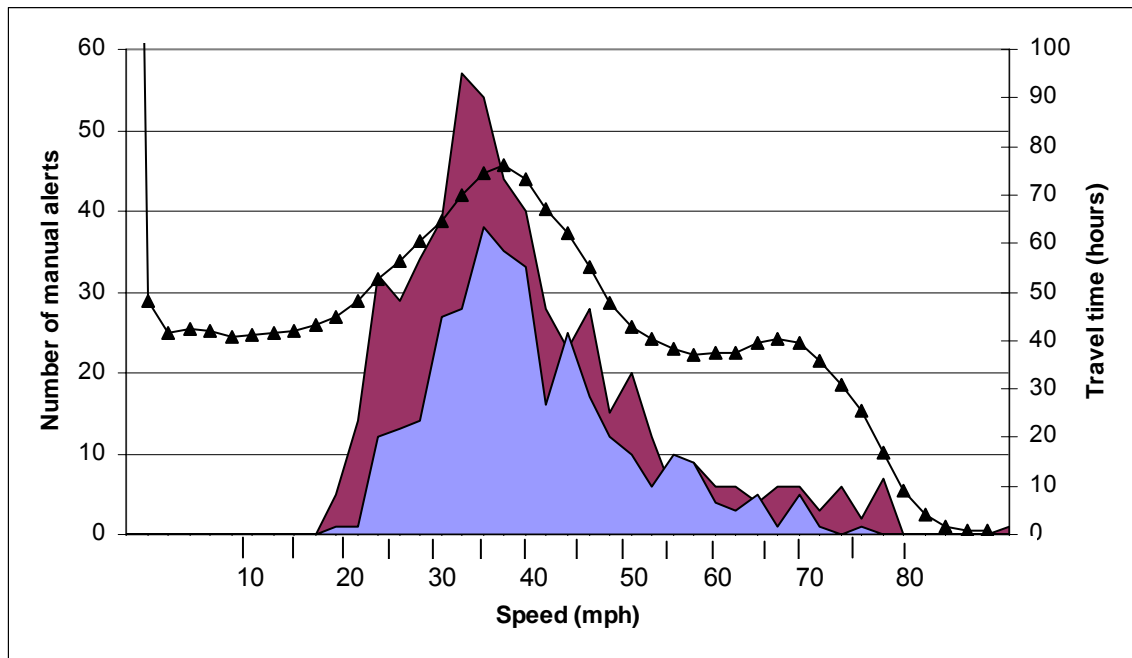

Figure 6.28. Speed at time of FCW imminent alert onset – cruise not engaged, algorithm C

The most common speed for moving and stationary target alerts is approximately 18 m/s (40 mph), which is close to the most likely travel speed. Two observations can be made from this chart: (1) alerts occur disproportionately at lower speeds, which is again consistent with the heightened alert rate seen on surface roads, and (2) there is no major difference between the speeds of stationary and moving target alerts.

6.2.1.2.9 Variation by Traffic Density

Traffic density affects the alert rate, as expected. Figure 6.29 shows that the alert rate per 100 miles is greater during driving in dense traffic than in moderate traffic. In turn, the alert rate is greater in moderate traffic than in sparse traffic.

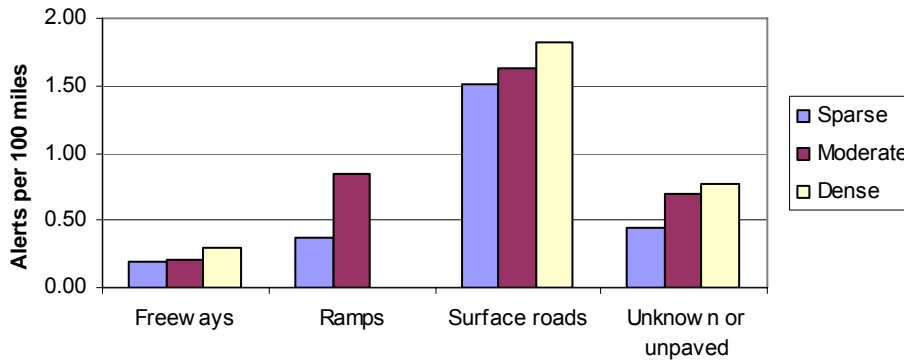

Figure 6.29. Traffic density and road type effect on FCW imminent alert rate (algorithm C, ACAS enabled, includes ACC alerts)

Figure 6.29 shows that the change in alert rate is modest. On surface roads, where most FCW alerts occur, the alerts rates are 1.5, 1.6, and 1.8 alerts per 100 miles on sparse, moderate, and dense traffic roads, respectively. It is noted that the difference here is approximately 20%, and therefore appears to be less important than road type, cruise-engaged status, and the difference between drivers. These alert rates are computed by aggregating alert count and distance traveled across drivers, and taking the appropriate ratio. This is done instead of combining the results for individual subjects because it is common for individuals to have not experienced any alert in some of the 12 cells (there are four road type values and three traffic-density values).

Corresponding to the road types and traffic conditions shown in Figure 6.29, the overall exposure of algorithm-C drivers to these conditions is shown in Figure 6.30.

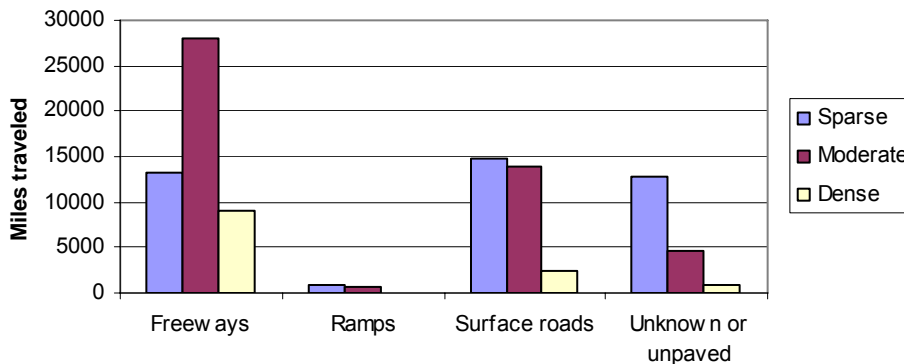

Figure 6.30. Traffic density exposure: miles traveled by road type and traffic density (algorithm C, ACAS enabled, includes ACC mileage)

6.2.1.3 Driver Adjustment of FCW Sensitivity Setting

The only adjustment drivers could make to the operation of the FCW system was to adjust when cautionary icons were presented on the HUD. By examining the frequency with which they adjusted the system sensitivity as well as the settings they selected, it

may be possible to infer both how long it took drivers to gain a sense of the sensitivity setting they were most comfortable with, as well as the degree to which they wanted to receive cautionary level forward collision warnings. It is further important to examine sensitivity selection by driver age and gender, as there are recognized differences in the types of driving environments selected based upon these variables which may strongly influence FCW sensitivity selection.

Adjustment of the FCW sensitivity was done freely by the driver using a toggle switch mounted on the steering wheel. The system had six levels of adjustment with level one being the least sensitive (latest cautionary alerts) and six the most sensitive (earliest cautionary alerts). The driver’s selection of sensitivity was indicated via icons on the HUD when the ACAS system was active, as described in Section 3.1. All the sensitivity results shown in this section are for FCW driving only, that is, when the FCW system was active (i.e., driving weeks 2, 3, and 4, and above the minimum FCW speed threshold with no braking) and the ACC was not engaged. The results are now discussed for algorithm-C drivers only.

Figure 6.31 shows the overall fractions of time and distance for each of the sensitivity settings. The figure shows very little difference between the results for time and distance in terms of exposure for each setting.

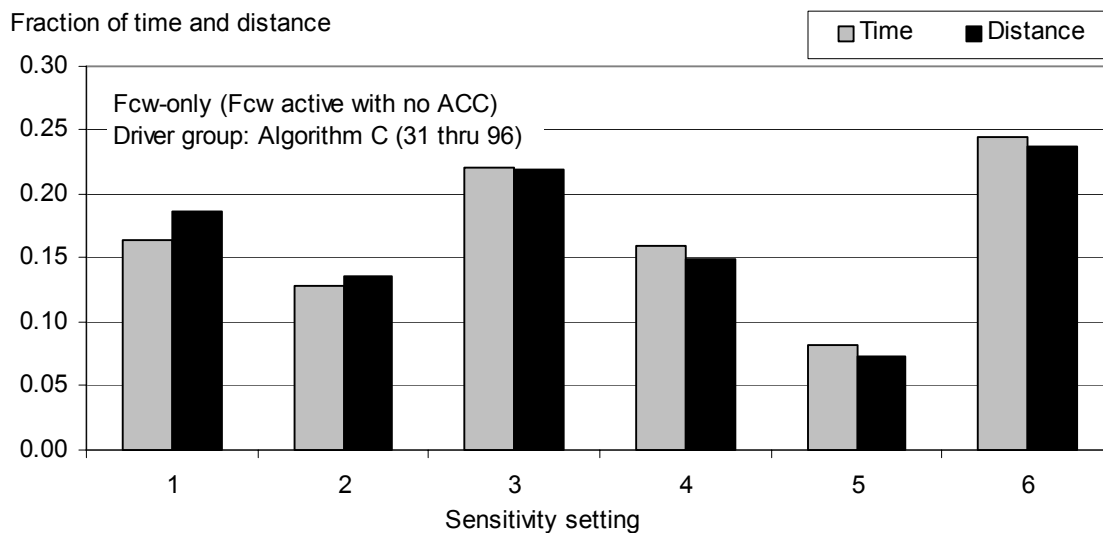

Figure 6.31. Fraction of time and distance by sensitivity setting (FCW-only)

The three most common settings, in order of decreasing usage, across all drivers were 6, 3, and 1, respectively. These three choices represent approximately 63 percent of the FCW-only time and distance. Selection five had the smallest fraction of time and distance with only 8 and 7 percent, respectively. These results show that algorithm-C drivers used all six levels of sensitivity adjustment.

Figure 6.32 shows a more detailed exposure picture of the time spent within different sensitivity values. In this figure the fraction of time for each setting is shown by week, age group and gender.

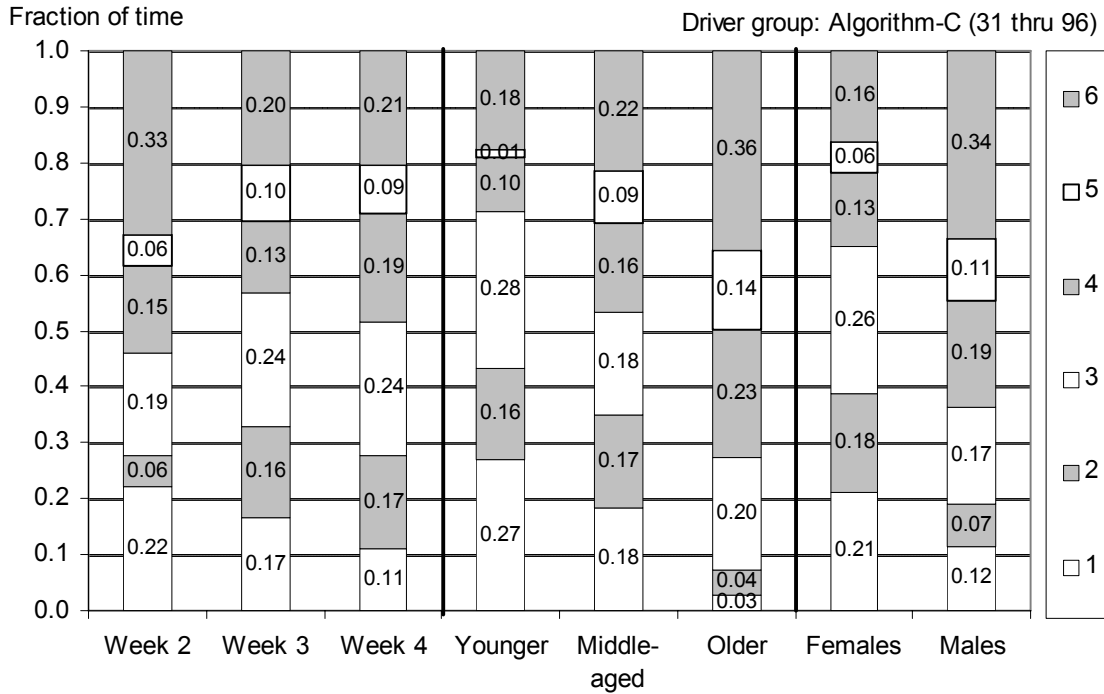

Figure 6.32. Fraction of time by week, age and gender for each sensitivity setting

The leftmost part of the figure shows how sensitivity-setting selection changed as a function of exposure time for weeks 2, 3, and 4. Observations pertinent to this part of the figure are:

- In week 2, setting 6 was used by drivers 33% of the time, but this fraction decreased in subsequent weeks. This setting was the default value when the FCW system first became active for each driver, which probably explains the high usage of this setting.
- There is a decrease in the use of setting 1 over the three week period with the fraction of time decreasing from 22 to 17 to 11 percent in weeks 2, 3, and 4, respectively.
- The amount of change between weeks 3 and 4 is much less than between weeks 2 and 3 suggesting that after week 2 drivers are not changing their sensitivity selection tendencies. The fractions are remarkably consistent in weeks 3 and 4 with the exception of a small decrease in setting 1 in week 4 which is mostly balanced by a small increase in setting 4 in week 4. The other four settings are consistent within 1 percent from weeks 3 to 4. This trend suggests that the overall

exposure results shown in the figure 6.31 are biased by the week 2 results and that a better indication of driver sensitivity selection is shown in weeks 3 and 4.

Sensitivity setting by age is shown in the center of figure 6.32. Notable observations in this part of the figure are:

- Younger drivers favor settings 1 and 3 while older drivers favor setting 6, 4 and 3. Middle-aged drivers used all settings consistently with the exception of setting 5.
- Older drivers rarely use settings 1 and 2.
- Middle-aged drivers agree closely with the overall exposure results for weeks 3 and 4.
- Middle-aged and older drivers used setting 6 most often.

The right-most part of figure 6.32 shows sensitivity-setting usage as a function of gender. Here we see:

- The most common setting for females and males was 3 and 6, respectively.
- Females spent 65 percent of their time using settings 1, 2, and 3 while males spent 70 percent of their time with settings 6, 4, and 3.

To lend statistical credibility to the choice of sensitivity setting by the FOT drivers, a more robust analysis of sensitivity selections is detailed in the following five subsections. The first speaks to the *frequency* of adjustment events by the driver, and describes this activity as function of gender, age and week. This is followed by an analysis of how often drivers actively select particular FCW-sensitivity settings, which will be termed the *sensitivity-setting selection* action. This differs from the results presented above, which addressed the *time* spent within the different sensitivity settings. The purpose of studying the sensitivity-setting selections is again to address the driver-interaction questions, which may illuminate some usability issues. Sensitivity-selection is also examined by gender, age and week. Furthermore, an additional set of analyses were conducted to look at the FCW-sensitivity setting selection as a function of wiper use, ambient light conditions, traffic density, and road class independently. And finally, the last part of this section gives the most likely sensitivity-setting value for all sixty-six, algorithm-C drivers plus other meaningful statistics related to exposure and sensitivity setting.

6.2.1.3.1 Frequency of Adjustment of FCW-Sensitivity Setting by Gender, Age and Week

Sensitivity adjustment events are defined as events in which the driver moves the FCW sensitivity to a new value, and retains the value for at least 3 sec. This value was selected after studying the distribution of times between settings, and represents the duration that seems to be greater than short dwell times that occur while the driver is actively moving between settings. A 2 (gender) X 3 (age group) X 3 (week) repeated-measures ANOVA was conducted to determine the differential rates of adjustments across weeks, age, and gender.

Greenhouse-Geisser adjustments were adopted when $\epsilon < 0.80$ to correct for sphericity violations regarding within-driver variables. A main effect was obtained for gender, $F(1, 60) = 5.406, p = .023$, where males ($M = 6.505$) made a greater number of sensitivity setting adjustments than females ($M = 4.202$) (Figure 6.33). In regards to age group, there was no significant effect obtained; however, middle-aged drivers ($M = 6.515$) made more adjustments than either younger ($M = 4.955$) or older ($M = 4.591$) drivers. In addition, no interaction between age and gender was obtained.

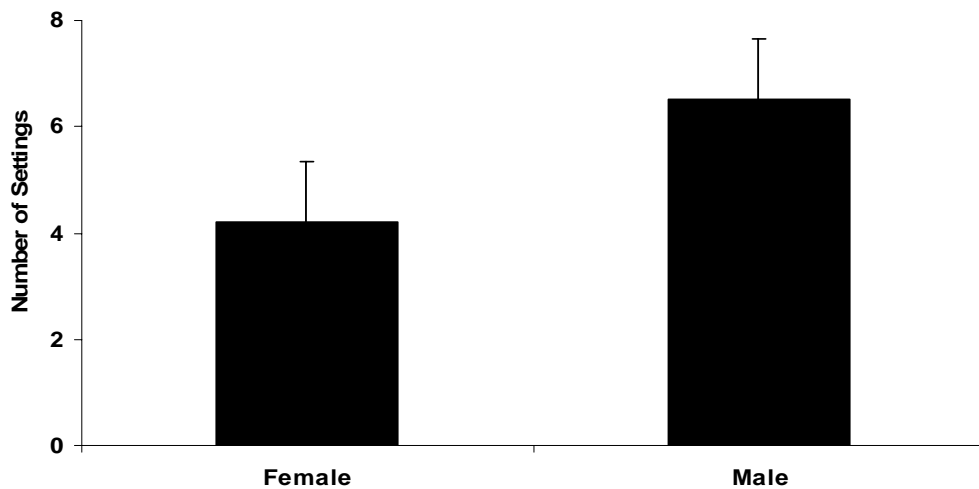

Figure 6.33. Mean number of FCW sensitivity adjustments per week by gender. Error bars represent standard error of the mean (SEM).

In regards to differences associated with week of engagement, a significant main effect of week was obtained, $F(1.395, 83.729) = 30.283, p < .001$, where drivers made more adjustments during the first week FCW was enabled (week 2: $M = 9.121$) than during week 3 ($M = 3.212$) and week 4 ($M = 3.727$) (Figure 6.34).

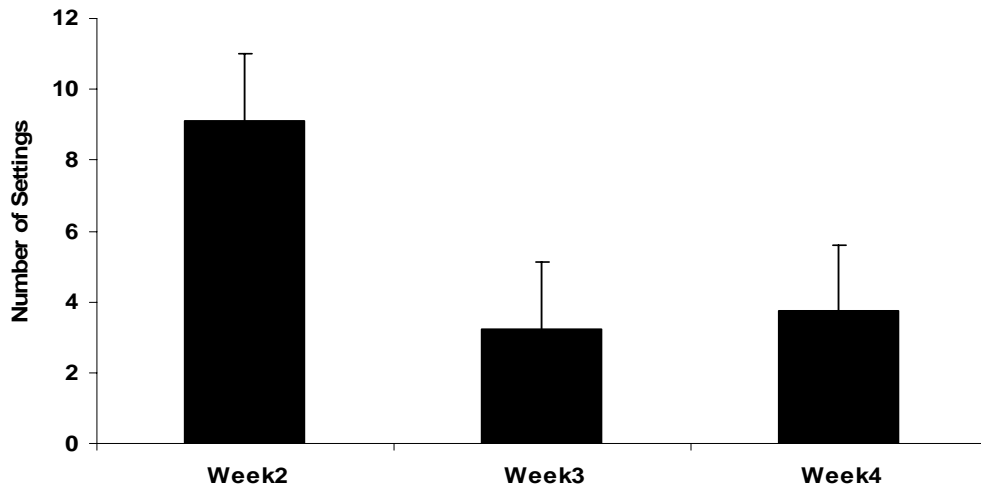

Figure 6.34. Mean number of FCW sensitivity adjustments by week. Error bars represent standard error of the mean (SEM).

Subsequently, a significant interaction between gender and week was obtained, $F(1.395, 83.729) = 3.382, p = .037$. Follow-up comparisons revealed that males ($M = 11.515$) made more sensitivity adjustments per week than females, ($M = 6.727; t(64) = 2.380, p = .020$) during week 2 (Figure 6.35). Males also had numerically greater numbers of adjustments during weeks 3 and 4 than did females; however, the results were not significantly different. No further interactions were obtained.

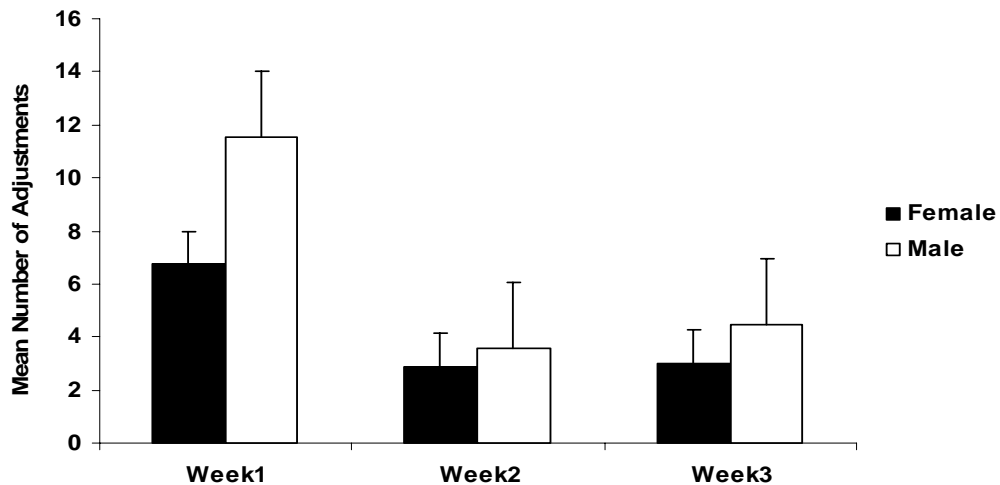

Figure 6.35. Mean number of FCW sensitivity adjustments by the interaction of gender and week. Error bars represent standard error of the mean (SEM).

The total number of adjustments to the sensitivity setting that drivers made over the course of the three-week, ACAS-enabled period was examined as a predictor of the 16

driver-acceptance questions (Section 7.2.1.1.1). The total number of adjustments was predictive of responses to question FCW6. The more frequently a driver changed his or her sensitivity setting, the more stress he or she was likely to experience while driving (FCW6, $p = .02$ ($R^2 = .088$)). Frequent sensitivity-setting changes may be an indicator that the driver is searching for a setting which will provide an acceptable number of cautionary alerts for a given driving situation.

6.2.1.3.2 Selection of FCW-Sensitivity Setting by Gender, Age and Week

A 2 (gender) X 3 (age group) X 3 (week) X 6 (sensitivity selection) repeated-measures ANOVA was conducted to determine differential selection of particular sensitivity settings across weeks, age, and gender. This analysis only examines the process of selecting an alert timing setting, not how often a driver changed the alert timing to a particular setting.

Greenhouse-Geisser adjustments were adopted when $\epsilon < 0.80$ to correct for sphericity violations regarding within-driver variables. A main effect for sensitivity setting selected was obtained, $F(3.386, 203.180) = 10.991, p < .001$ (Figure 6.36). Comparing Figure 6.36 to Figure 6.33 shows that although the frequency with which drivers moved to a sensitivity value of six was noticeably more often than the frequency of moving to other values, the time spent at a sensitivity value of six was only slightly greater than the time spent at a setting value of three.

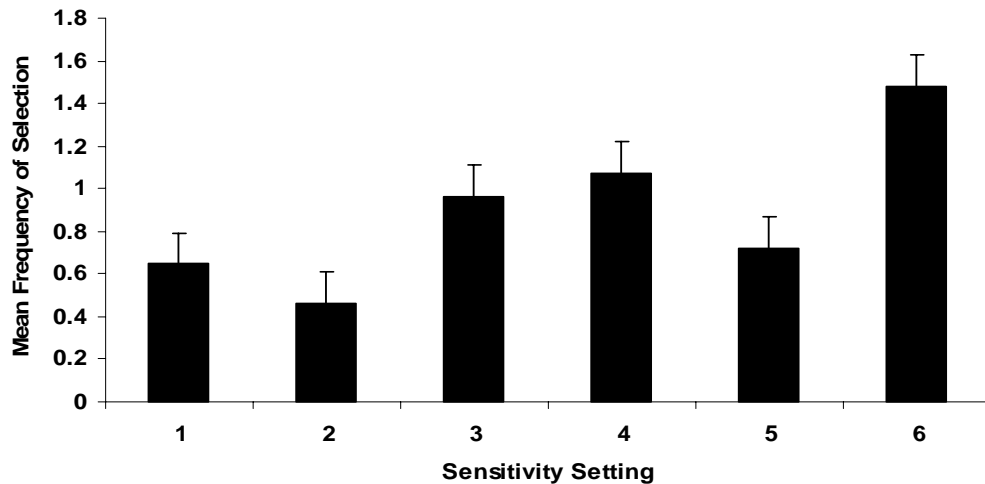

Figure 6.36. Mean frequency of FCW sensitivity-setting selection per week. Error bars represent standard error of the mean (SEM).

Follow-up comparisons are listed in Table 6.7 denoting the mean usage across the enabled period in addition to significant differences amongst settings. Sensitivity

selection was negatively skewed towards the more sensitive settings, with the most-frequently-selected setting being the most sensitive (level 6).

Table 6.7. Paired comparisons: mean frequency per week of sensitivity setting selection events

Setting Sensitivity Mean	1 Least .646	2 .465	3 Intermediate .960	4 1.076	5 Most .722	6 1.480
			<i>t</i> (65)	<i>p</i>		
		1 vs 2	1.594	.116		
		1 vs 3	2.074	.042		
		1 vs 4	2.003	.049		
		1 vs 5	.468	.641		
		1 vs 6	5.433	<.001		
		2 vs 3	4.115	<.001		
		2 vs 4	3.181	.002		
		2 vs 5	1.653	.103		
		2 vs 6	5.751	<.001		
		3 vs 4	.663	.510		
		3 vs 5	1.582	.119		
		3 vs 6	2.919	.005		
		4 vs 5	3.126	.003		
		4 vs 6	2.239	.029		
		5 vs 6	5.403	<.001		

In addition, a two-way interaction between age group and sensitivity selection was obtained, $F(6.773, 203.180) = 2.551, p = .017$ (Figure 6.37). Younger drivers utilized a fairly normalized distribution of setting adjustments with the most frequently selected being the most-sensitive setting ('6'), an intermediate setting ('3'), and the least-sensitive setting ('1'). In contrast, older drivers had a negatively skewed distribution of selected sensitivity level with the majority of the selections occurring for the intermediate- and most-sensitive settings (settings '3'-'6').

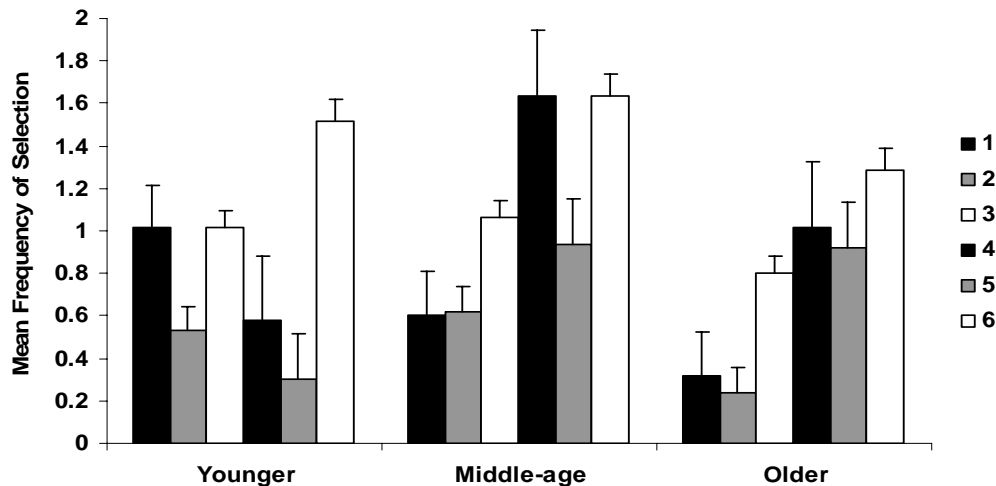

Figure 6.37. Mean frequency of FCW sensitivity-setting selection by driver age group. Error bars represent standard error of the mean (SEM).

Finally, middle-aged drivers tended to select the most-sensitive setting ('6') while also maintaining frequent selection of the intermediate settings ('3' and '4'). A two-way interaction observed between gender and sensitivity selection was also significant, $F(3.386, 203.180) = 2.546, p = .050$ (Figure 6.38). Overall, as aforementioned, males made more adjustments to the sensitivity settings than did females. This trend is consistent across all sensitivity selections with the exception of setting '2' whereby males ($M = .394$) selected the setting less often than females ($M = .535$).

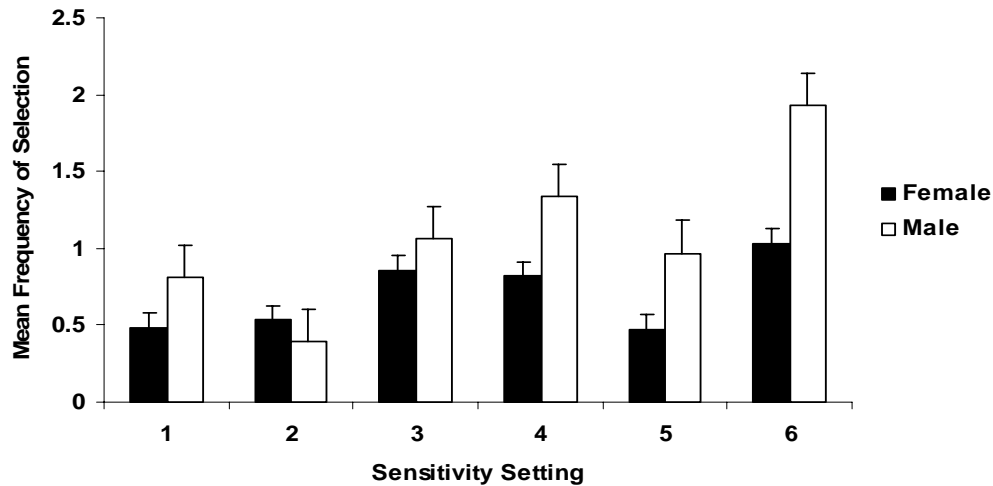

Figure 6.38. Mean frequency of FCW sensitivity-setting selection by driver gender. Error bars represent standard error of the mean (SEM).

Finally, a two-way sensitivity selection by week interaction was obtained, $F(4.272, 256.311) = 8.239, p < .001$ (refer to Figure 6.39). The two least sensitive settings ('1' and '2') were selected slightly more frequently in week 2 as compared to weeks 3 and 4. By contrast, the intermediate and most sensitive settings were selected much more frequently during week 2 than in weeks 3 and 4. Moreover, across sensitivity settings, the frequency of setting selection was similar between weeks 3 and 4 where no significant differences were evidenced.

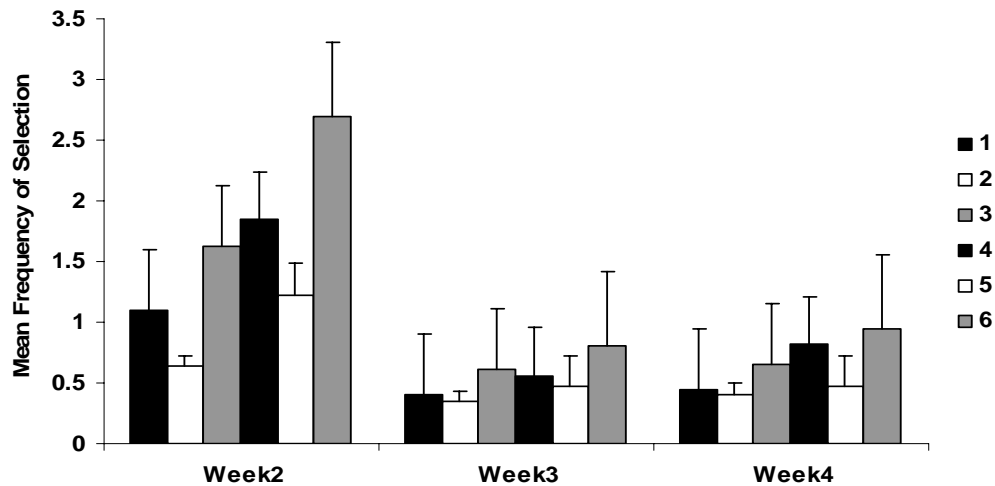

Figure 6.39. Mean frequency of FCW sensitivity selection by setting by week. Error bars represent standard error of the mean (SEM).

6.2.1.3.3 Selection of FCW-Sensitivity Setting and Wiper Use

Overall, a 2 (wiper: on/off) X 6 (sensitivity setting) repeated-measures ANOVA was conducted with the percentage of wiper setting used as the dependent variable. Greenhouse-Geisser corrections were made for repeated-measures variables when $\epsilon < .800$. A significant main effect of sensitivity was observed, $F(3.319, 129.437) = 3.057, p = .026$, denoting differential utilization of sensitivity settings. Follow-up t-tests revealed that sensitivity setting 1, 3, and 6 were used significantly more than settings 4 and 5 (p 's $< .05$; 1 vs. 4, $p = .057$). There was no main effect of wiper state upon setting selection. Finally, there was no two-way wiper X sensitivity setting interaction (see Fig 6.40).

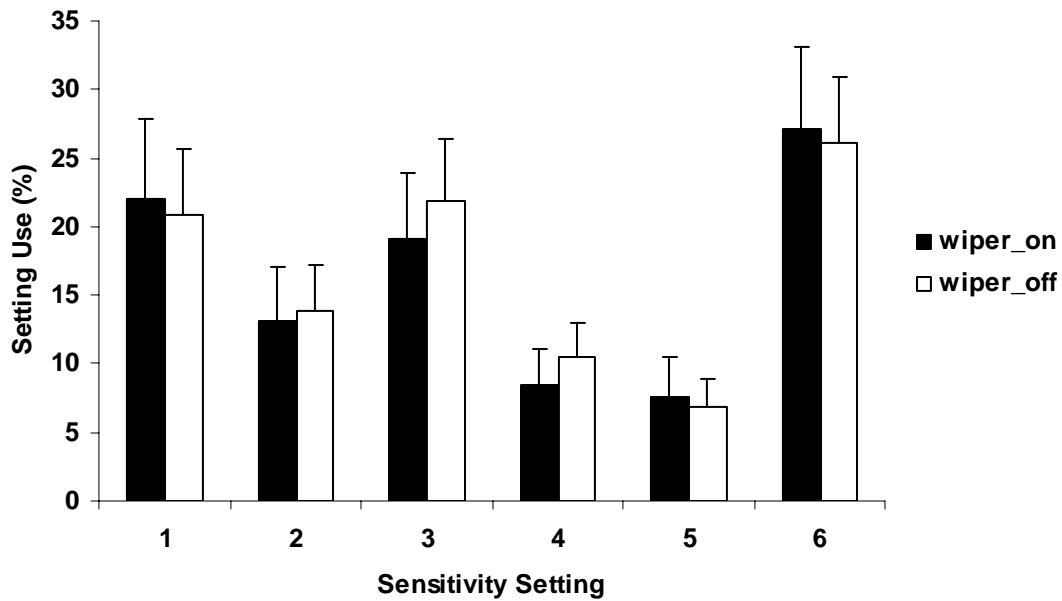

Figure 6.40. Mean frequency of FCW sensitivity-setting selection by wiper use. Error bars represent standard error of the mean (SEM).

6.2.1.3.4 Selection Of FCW-Sensitivity Setting And Ambient Light Conditions

A 2 (dark/light) X 6 (sensitivity setting) repeated-measures ANOVA was conducted using percentage of sensitivity setting use as the dependant measure. Greenhouse-Geisser corrections were made for all variables whose $\epsilon < .80$. Overall, there was no difference in sensitivity setting use across light and dark conditions. Follow-up *t*-tests confirmed the omnibus result, where at each sensitivity setting, there were no significant differences in setting use. Moreover, there was no interaction between dark/light conditions and sensitivity, indicating that change in setting use across sensitivity settings was consistent across ambient light conditions. A main effect of sensitivity, however, was obtained, $F(3.326, 154.108) = 3.316, p = .018$ (see Figure 6.41), where settings 1, 3, and 6 were utilized significantly more than settings 4 and 5 (p 's $< .05$; 1 vs. 4: $p = .078$).

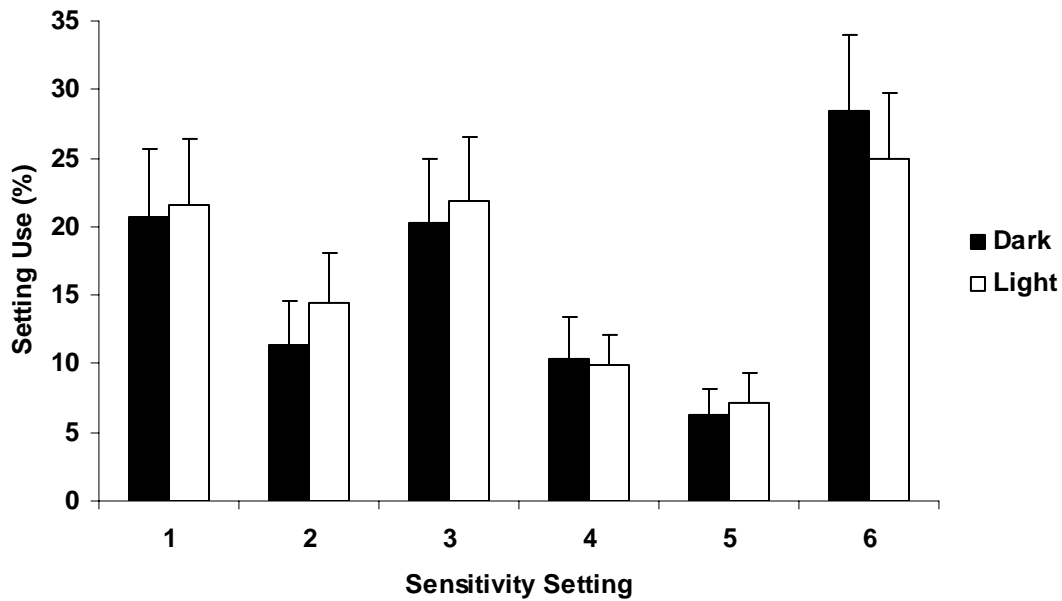

Figure 6.41. Mean frequency of FCW sensitivity-setting selection by ambient light conditions. Error bars represent standard error of the mean (SEM).

6.2.1.3.5 Selection of FCW-Sensitivity Setting and Traffic Density

A 3 (traffic: sparse, medium, dense) X 6 (sensitivity setting) repeated-measures ANOVA was conducted using percentage of setting use as the dependent variable. Greenhouse-Geisser corrections were made for all within-subjects variables whose $\epsilon < .80$. There were no effects of traffic upon sensitivity setting use nor was there an interaction between traffic conditions and setting use, indicating that selection of particular sensitivity settings was stable across sparse, medium, and dense traffic. However, a main effect of sensitivity setting was obtained, $F(3.514, 158.346) = 2.900, p = .030$ (see Figure 6.42). Follow-up t -tests revealed that settings 1, 3, and 6 were used significantly more than settings 4 and 5 (p 's $< .05$; 1 vs. 4, $p = .083$). These findings were repeated when comparing sparse, medium, and dense traffic conditions, respectively, when comparing setting use percent at each sensitivity setting. Across sensitivity settings, there were no differences amongst traffic conditions and setting use except for setting 5, where use was significantly higher during medium traffic ($M = 8.56\%$) than during dense traffic ($M = 7.07\%$; $t(63) = 2.331, p = .023$).

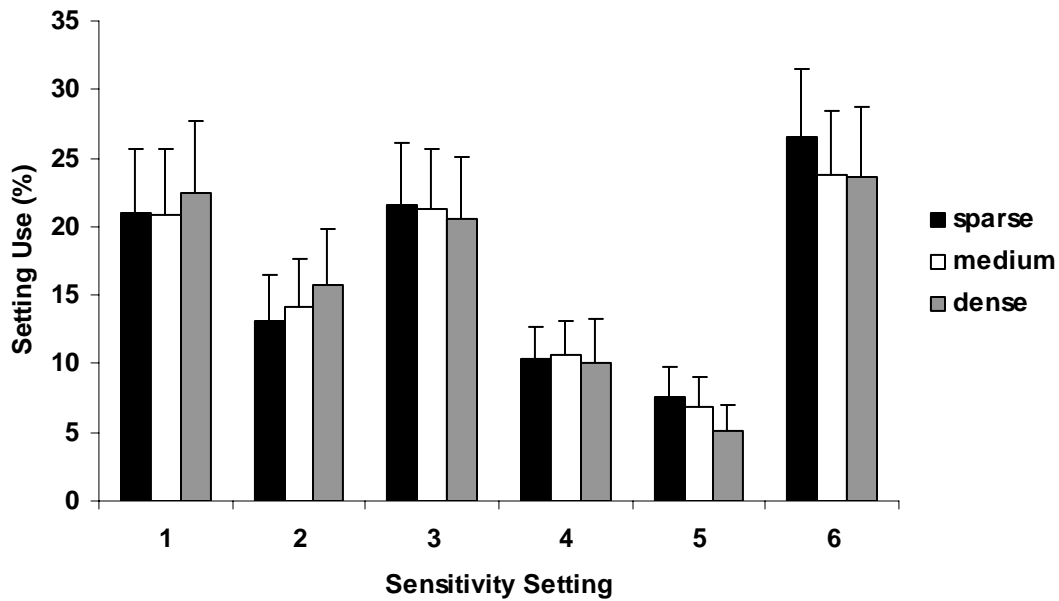

Figure 6.42. Mean frequency of FCW sensitivity-setting selection by traffic density. Error bars represent standard error of the mean (SEM).

6.2.1.3.6 Selection of FCW-Sensitivity Setting and Road Class

To analyze sensitivity setting use across differing road conditions, road class was grouped into one of two categories: highway and surface roads. A 2 (road class: highway/surface roads) X 6 (sensitivity setting) repeated-measures ANOVA was conducted using setting use percent as the dependent measure. Greenhouse-Geisser corrections were made when $\epsilon < .800$. A main effect of sensitivity setting emerged, $F(3.017, 63.348) = 3.665, p = .017$. Follow-up t -tests indicated that settings 1 and 6 were used significantly more than settings 2, 4, and 5 (p 's $< .05$; 1 vs. 5: $p = .057$).

Figure 6.43 represents the relationship between setting use percent across sensitivity settings for highway and surface roads. There was no main effect of road class nor were there any interactions between road class and sensitivity settings indicating that the percentage of use for each setting remained relatively stable across road class.

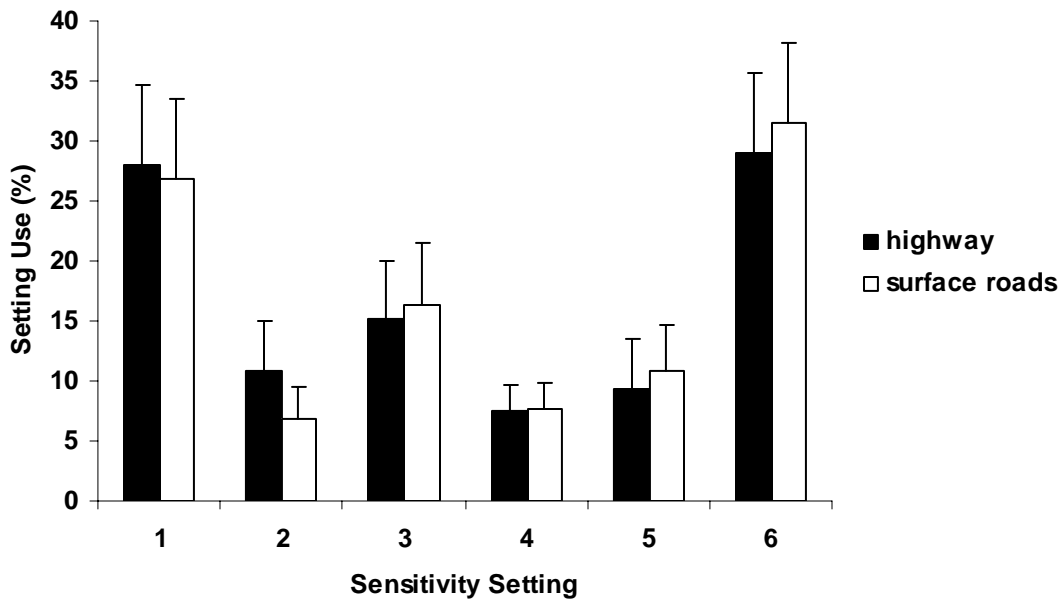

Figure 6.43. Mean frequency of FCW sensitivity-setting selection by road type. Error bars represent standard error of the mean (SEM).

6.2.1.3.7 Most-Used FCW Sensitivity Selections for Individual Drivers

Table 6.8 on the next page is a summary of the sensitivity setting selection for all algorithm-C drivers. It shows the time for each setting, the driver’s most-likely setting (based on the time spent at that setting), how many times they adjusted the setting during their enabled period, total driving time and distances for each of the drivers, and their adjustment rates in terms of time and distance, respectively.

Eight of the 66 drivers with algorithm C spent the most time with a setting of one (least conservative). The number of drivers that spent the most time within other sensitivity values are: five drivers at a sensitivity value of two; 17 drivers at a sensitivity value of three; 12 drivers at a sensitivity value of four; five driver at a sensitivity value of five; and 19 drivers at a sensitivity value of six.

Table 6.8. Driver most-likely-value (MLV) of FCW-sensitivity setting selection

<i>Dr. No</i>	<i>Total setting time, hrs</i>						<i>MLV</i>	<i>Num. Adj.</i>	<i>Time, hrs.</i>	<i>Adj. / hour</i>	<i>Dist., miles</i>	<i>Adj. / 100 miles</i>
	<i>1</i>	<i>2</i>	<i>3</i>	<i>4</i>	<i>5</i>	<i>6</i>						
31	1.3	0.4	14.8	10.8	0.3	4.2	3	17	31.8	0.53	1635	1.04
32	33.2	0.4	0	0	0	6.5	1	10	40.1	0.25	1262	0.79
33	0	0	1.5	0	0	10.9	6	2	12.4	0.16	347	0.58
34	53.5	0	0	0	0	0.2	1	6	53.8	0.11	2923	0.21
35	0	9	17.2	3.3	1.8	0.1	3	28	31.3	0.89	1152	2.43
36	0	0	19	3.9	0	0	3	1	22.8	0.04	880	0.11
37	0	0	53.1	0	0	0.1	3	4	53.2	0.08	2578	0.16
38	0	0	0	0.2	0	47.7	6	7	47.9	0.15	2331	0.30
39	0	0	1.7	5.1	1.8	26.8	6	11	35.5	0.31	1637	0.67
40	0	0	0	0	0.6	19.1	6	7	19.7	0.36	896	0.78
41	0	0	30.2	3.3	0	0	3	15	33.5	0.45	900	1.67
42	9.2	15.4	0.9	0	0	1.4	2	5	26.9	0.19	1000	0.50
43	0	4	0	4.1	0	2.1	4	14	10.2	1.37	292	4.79
44	1.8	48.9	0.9	0	0	0.2	2	5	51.8	0.10	2437	0.21
45	8.1	0	0	0	0	20.5	6	4	28.6	0.14	1282	0.31
46	0	0.2	26.8	0.2	0	0	3	10	27.3	0.37	1270	0.79
47	0	2.5	6.4	18.8	2.2	0	4	22	29.9	0.74	1282	1.72
48	8.7	0	0	2.5	0.3	27	6	30	38.6	0.78	1462	2.05
49	0.5	7	15.8	0	0	0.1	3	24	23.4	1.03	895	2.68
50	0	0	0	0	60.2	11.2	5	1	71.3	0.01	3353	0.03
51	0	10.3	10.5	0	0.1	0.3	3	11	21.2	0.52	920	1.20
52	11.1	0.1	4.3	1.1	0	7.3	1	12	23.9	0.50	1150	1.04
53	0.1	2.4	11.9	0.3	0	0	3	15	14.7	1.02	436	3.44
54	2.5	3.4	0	0	0.6	17.8	6	10	24.2	0.41	1070	0.93
55	9.5	2.4	0.4	0	0.1	0.7	1	15	13.2	1.14	528	2.84
56	21.3	4.3	3.4	3	0	0.2	1	17	32.2	0.53	985	1.73
57	0	0	0	0	0	36.4	6	0	36.4	0.00	1884	0.00
58	0	0	0	5.7	2.4	26.9	6	37	35.1	1.05	1671	2.21
59	0.2	10.8	15.4	2.5	0	0.2	3	11	29	0.38	1128	0.98
60	4.9	0.1	10.8	5.2	3.6	0.1	3	11	24.6	0.45	841	1.31
61	5.3	5.1	5.5	4.2	0	8.3	6	14	28.5	0.49	1104	1.27
62	0	0	1.3	32.7	0	4.6	4	17	38.7	0.44	1744	0.97
63	0	0	10.9	0.2	0.1	0.4	3	14	11.5	1.22	391	3.58
64	0	0	0	11	4.8	29	6	6	44.8	0.13	2671	0.22
65	9.7	9.4	8.1	0.4	0	0.1	1	30	27.8	1.08	1226	2.45
66	0	0.1	14.7	0	2	4.2	3	3	21	0.14	650	0.46
67	0	0	1.9	19.5	4.8	0.4	4	19	26.6	0.71	851	2.23
68	0.1	0.2	0	3	9.1	9.5	6	20	21.8	0.92	606	3.30
69	0	0	0	18.2	0	0.3	4	4	18.5	0.22	565	0.71
70	15.8	24.1	1.1	0	0	7.3	2	7	48.3	0.14	2346	0.30
71	5.3	0	7.2	0.2	11.2	8.9	5	23	32.8	0.70	1700	1.35
72	1	0	10.1	0.4	0.3	4.6	3	22	16.3	1.35	574	3.83
73	0	0	6	7.2	12.6	1.8	5	9	27.5	0.33	1516	0.59
74	27.6	0	0.6	0.6	0.1	1.2	1	24	30.1	0.80	1514	1.59
75	0	0	0	0	0	25.1	6	0	25.1	0.00	786	0.00
76	0	0	26.9	0.8	0	0.4	3	3	28.1	0.11	1297	0.23
77	27.4	2.1	0.2	0.1	0	1.8	1	14	31.7	0.44	1330	1.05
78	0	0	0	0	4.7	10.9	6	8	15.7	0.51	431	1.86
79	0	9.2	1.9	13	0	0.3	4	9	24.5	0.37	727	1.24

Dr. No	Total setting time, hrs						MLV	Num. Adj.	Time, hrs.	Adj. / hour	Dist., miles	Adj. / 100 miles
	1	2	3	4	5	6						
80	0	25.5	0	11.1	0	5.4	2	2	41.9	0.05	1327	0.15
81	4.5	0.4	11.1	0.1	1.2	0	3	28	17.3	1.62	596	4.70
82	0	0	0	0	29.2	16.5	5	1	45.7	0.02	1430	0.07
83	0	0	0	27.1	9.4	0.4	4	7	36.8	0.19	1998	0.35
84	0.5	0	22.2	4.6	3.2	0	3	23	30.6	0.75	903	2.55
85	0	6.5	0	16.6	0	1.9	4	3	25	0.12	981	0.31
86	0	0	0.6	7.2	17.8	10.9	5	46	36.6	1.26	1203	3.82
87	0	0	0	12.1	0	0	4	3	12.1	0.25	321	0.93
88	0	0	2.3	10	0	8.4	4	19	20.7	0.92	493	3.85
89	0	0	0	2.3	2.3	16.9	6	6	21.4	0.28	852	0.70
90	0	0	0.1	1.9	0	10.6	6	5	12.6	0.40	445	1.12
91	0	0	3.5	17.4	12.6	9.5	4	82	43.1	1.90	1419	5.78
92	0	0	0	2	0.8	9.2	6	5	12.1	0.41	291	1.72
93	4.3	0	0.2	0	1.7	5.6	6	36	11.9	3.03	450	8.00
94	0	17.7	8.8	11	1.5	2.1	2	11	41.1	0.27	1770	0.62
95	0	0	0	0	0	25.8	6	19	25.8	0.74	961	1.98
96	0	0	2.1	7.6	0	0	4	5	9.7	0.52	305	1.64

6.2.1.3.8 Summary Comments on FCW Sensitivity Selection

In summary, male drivers were significantly more likely to adjust the FCW sensitivity setting than were their female counterparts. This difference was most evident when FCW was initially enabled (week 2). This may represent a greater tendency to initially explore the range of settings by males given that the difference between genders is considerably less for weeks 3 and 4. In addition, there was a difference in the frequency with which genders chose certain settings. Male drivers were significantly more likely to select more-sensitive settings relative to female drivers. Perhaps this represents more of a desire on the part of male drivers to see the cautionary alerts presented on the HUD.

Adjustments were more frequent during week 2, relative to subsequent weeks, for each combination of age group and gender. This would suggest that drivers tended to explore the sensitivity settings less in weeks 3 and 4 because they found settings that they were comfortable with during week 2.

The finding that older drivers spent significantly more time at the most-sensitive setting (6) was consistent with the apparent value older drivers ascribed to the FCW system when responding to the post-drive questionnaire.

There was no apparent main effect of wiper use, ambient light condition, traffic density and road class on FCW-sensitivity setting selection.

6.2.1.4 FCW Cautionary Alerts

This section describes the presentation of FCW cautionary alerts during the FOT. Cautionary alerts are described in Section 3.1, and consist of visual crash alert icons presented on the HUD device (see Figure 3.4).

The average times that a visual cautionary alert icon was displayed to drivers in algorithms A, B, and C is 8.7%, 8.0%, and 8.8%, respectively, where the percentages are relative to the FCW-active time. Recall that FCW active time is the time that the FCW is available to provide an alert, i.e., the time over the minimum ACAS speed (nominally 25 mph), minus the time that drivers applied the brake. The standard deviations, however, are of the same order as these means, reflecting a wide variation in this quantity among the drivers. Because the headway-based portion of the cautionary alert logic changes only slightly between the algorithms, this consistency in visual cautionary-alert icon times is expected.

Figure 6.44 shows the average time that each of the five visual icons was shown to a driver for each of the three algorithms. The figure below also shows that the amount of time that the visual “crash” icon was displayed is a tiny fraction of the time that other warning icons were shown. (The crash icon is only presented during an imminent alert or during a “tailgating” visual-only warning.)

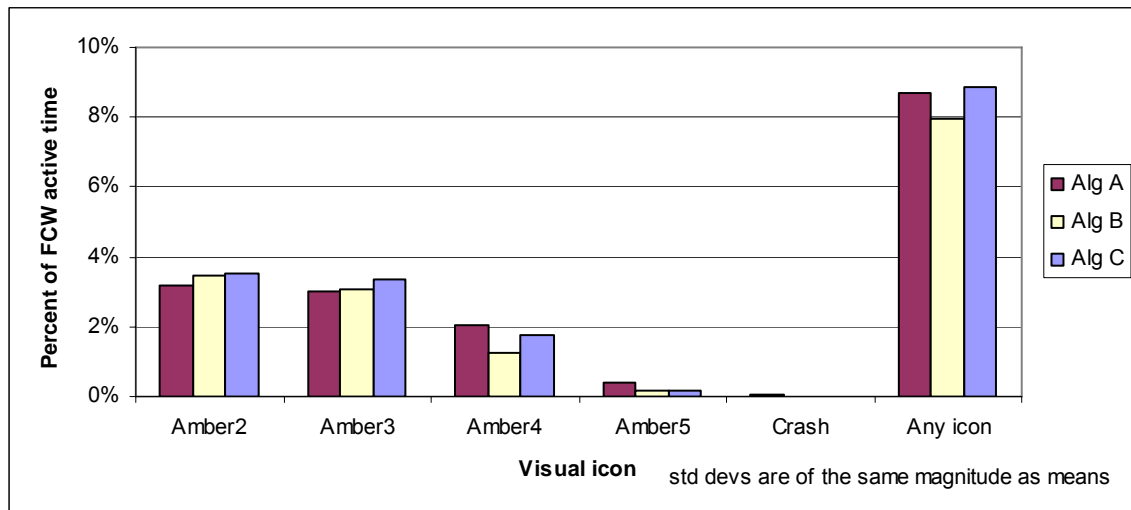

Figure 6.44 Visual alert icons: Time icons are displayed, as a fraction of the FCW-active time (algorithm C drivers)

Among individual drivers, the variation between the fraction of time that cautionary alerts are presented is shown in Figure 6.45.

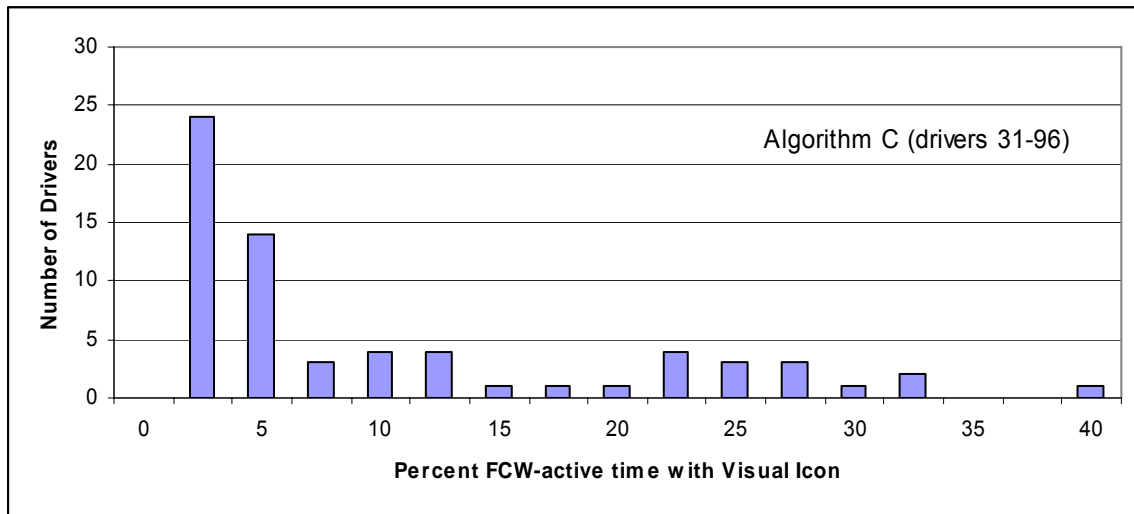

Figure 6.45. Visual alert icons: How often icons were displayed to individual drivers (algorithm C)

While over half of the algorithm C drivers have less than 7.5% time with visual alert icons, there are several drivers with more than 20% of this time with an icon displayed.

Figure 6.46 shows the relationship between the drivers’ sensitivity settings and the amount of time within cautionary alerts. These percentages are computed by collapsing data across the exposures with those sensitivities.

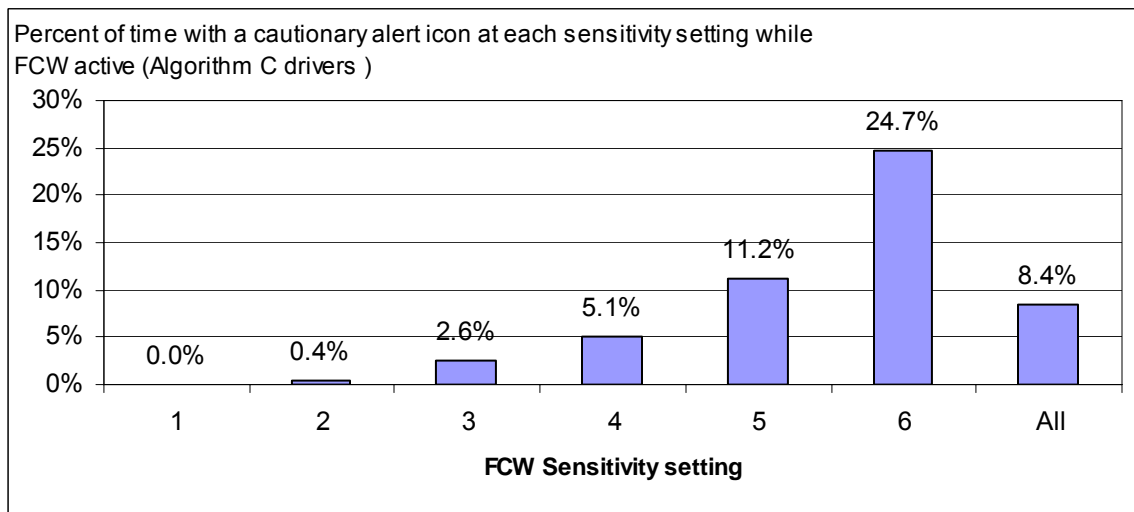

Figure 6.46. Visual alert icons: How often icons were displayed, as function of FCW sensitivity selection by drivers (algorithm C)

Drivers with FCW sensitivity set at the most conservative value of six received cautionary alerts approximately 25% of the time that FCW was active. This percentage far exceeds values associated with the other sensitivity settings, suggesting a cause beyond the sensitivity setting itself. Together, Figures 6.45 and 6.46 suggest a subset of drivers who retained the default setting of “6” and yet drove with headways often within the headway bounds of that setting, perhaps out of disinterest, or perhaps because they valued the cautionary alerts from a safety or “engagement” perspective. These drivers apparently did not avoid the cautionary icons, either through headway management or adjustment of the sensitivity. A hypothesis is that some drivers may have used the sequence of icons as feedback for their headway-keeping, e.g., considering the lowest-level icon not as a signal to move further away from the lead vehicle, but as an indicator that they were, or would soon be, at their desired headway. There is no clear way to examine this hypothesis in the data, however. It is also possible that some or all of these drivers did not notice the alerts, or did not choose to alter their headways despite the frequent alerts. No matter the reasons, the subjective responses to the FCW presented in Section 7.2 did not show any negative acceptance results associated with high rates of visual cautionary alerts, such as these drivers experienced.

Figure 6.47 shows the presentation times for the various visual icons, as a function of the sensitivity setting. These percentages are computed by collapsing data across the exposures with those sensitivities.

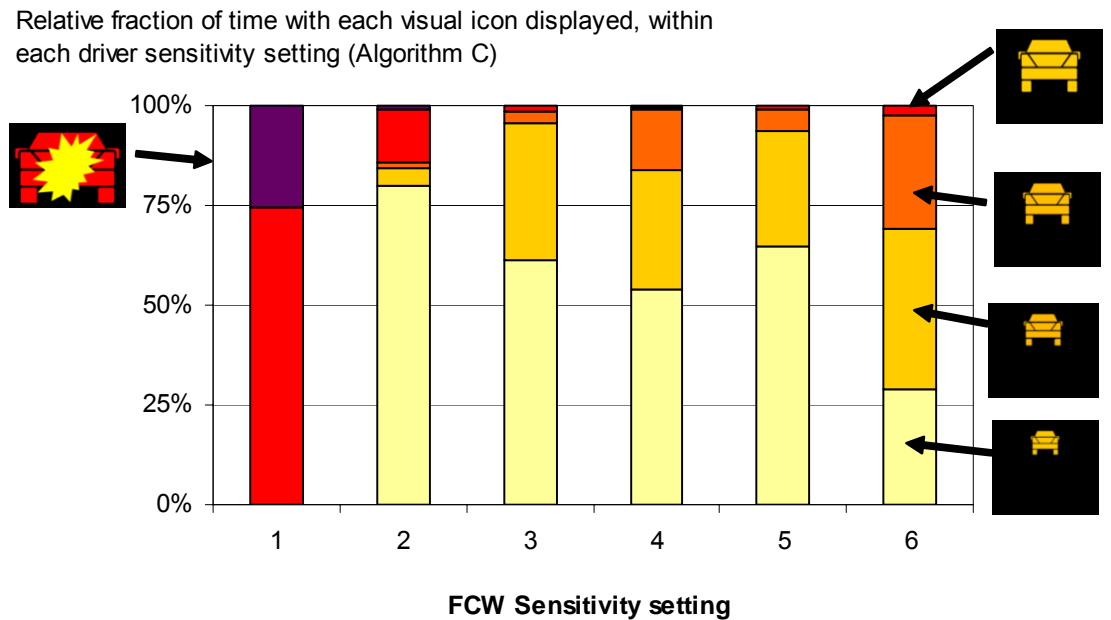

Figure 6.47. Visual alert icons: How often the different icons were displayed, as a function of FCW sensitivity selection (algorithm C)

The set of drivers who accumulated time with the sensitivity set at the most conservative value (six) experienced a variety of alert icons, while those with the second-least conservative setting (two) rarely saw some of the middle icons. Therefore the visual icon experience was different across drivers. When drivers set the sensitivity to its least conservative (one), the only icons seen are the crash icon and the last amber icon, which is shown briefly before imminent alerts triggered by stationary targets, and during tailgating episodes. Recall from the previous figure that drivers with this least-sensitive setting (one) rarely saw visual alerts.

Section 6.2.1.3 showed that drivers adjusted the FCW sensitivity the most during week 2, which was the first week with ACAS available to them. The data from week 2 also showed an apparently unique signature when the amount of visual icon activity is computed per week, and broken down into age groups, as in Figure 6.48. That is, week 2 is the only one in which older drivers had the lowest fraction of FCW active time with a visual warning.

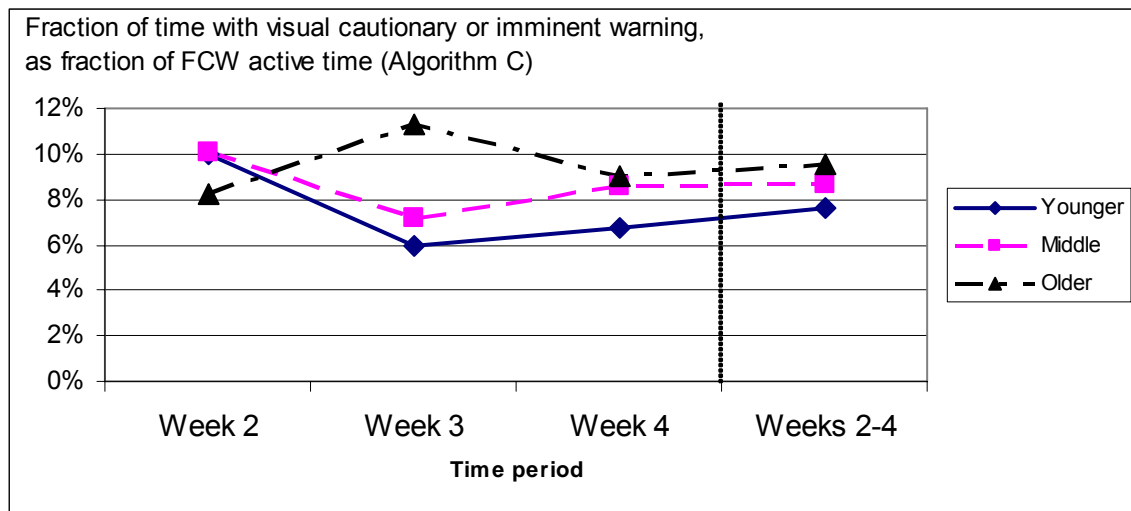

Figure 6.48. Visual alert icons: Effect of age on the fraction of FCW active time that the visual alert icons were displayed (algorithm C)

Figure 6.49 shows results for data collapsed within gender groups. It is clear that males received more cautionary alerts than females.

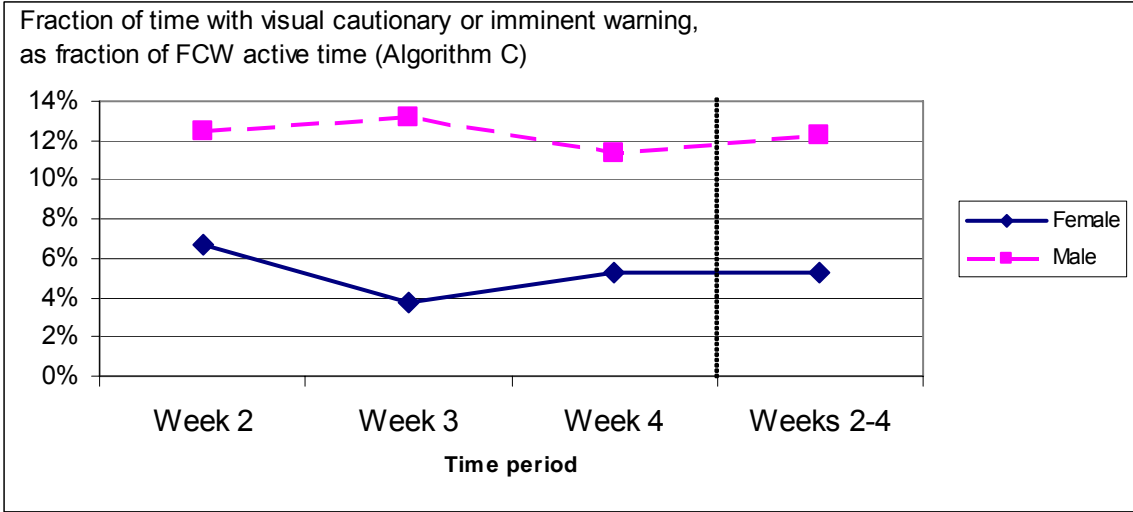

Figure 6.49. Visual alert icons: Effect of gender on the fraction of FCW active time that the visual alert icons are displayed (algorithm C)

When considering the type of target involved in triggering cautionary alerts, it is found that the visual alert icons were almost always triggered by moving targets. For algorithm C drivers, moving targets triggered the icon 99.3% of the time that the visual icon was displayed. If the number of events was considered, however, the fraction would be lower, since moving targets generate much longer events than do stationary targets.

Regarding road type, Figure 6.50 shows the distribution (collapsed across all drivers) of the road types where the cautionary alerts occurred.

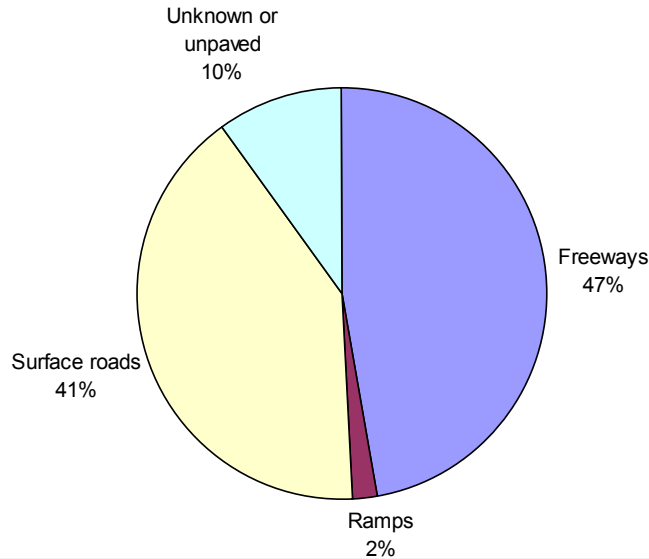

Figure 6.50. Fraction of visual alert icon time on different road types (algorithm C drivers)

The visual alert icons occurred most often on freeways, with 47% of all cautionary alert time accumulated on those roads. Forty-one percent are displayed on surface roads, with 10% of all cautionary alert time accrued on unknown or unpaved roads. Given that the travel time on freeways was much less than on surface roads, this indicates that the accumulation of cautionary alert time accrued more readily on freeways in the FOT. This is consistent with pilot FOT testing, and may be a result of two factors: shorter headways are maintained on freeways than on surface roads (as found in this FOT as well as previous vehicle-following work); and following events can be quite prolonged on freeways, whereas driving on most surface roads does not present as many sustained following situations.

6.2.2 Activity Involving ACC and CCC

This section presents data that characterize FOT driving with CCC or ACC engaged. Section 6.2.2.1 characterizes CCC and ACC utilization rates as a function of several variables including: gender, age group, road type, traffic density, ambient light, and driver style. Utilization is important because it is felt to be a primary measure of acceptance of ACC. In addition, safety analyses in Section 8.1 will use facts presented here regarding the influence of various factors on ACC utilization. There is further examination of ACC utilization in a separate section, Section 8.2, including the change in utilization over exposures weeks and interactions of driver demographics and road type. Section 6.2.2.2 describes drivers' choices of set speeds and ACC gap settings. These choices support insights into drivers' use of ACC. Again, further study of driver adjustments of ACC parameters is presented in Section 8.2, to examine whether this interaction suggests acceptance.

All of the figures presented in this section derive only from data for driving in *valid* trips with ACAS algorithm-C. Figure titles typically include words to this effect, but statements of this kind will not appear repetitively in the text.

6.2.2.1 Utilization of Cruise Control, ACC and CCC

Figure 6.51 shows the utilization of cruise control, in terms of distance traveled, by drivers of the algorithm-C vehicles. These drivers used conventional cruise control (CCC) approximately 20 percent of the distance they travel with ACAS disabled. On the other hand, they use adaptive cruise control (ACC) about 36 percent of the distance they traveled with ACAS enabled. That is, the algorithm-C drivers appeared to choose to utilize ACC some 1.8 times as often as they chose to use CCC.

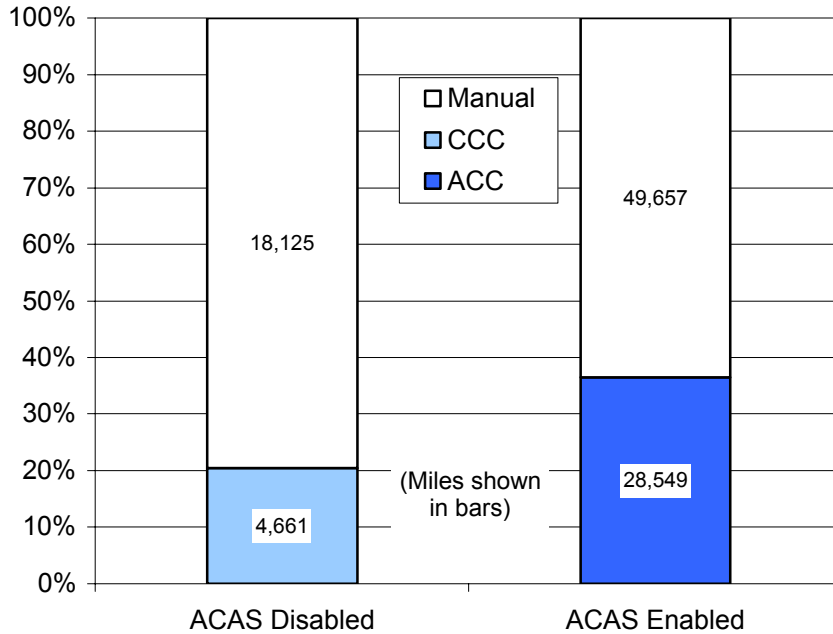

Figure 6.51. Comparison of the use of CCC and ACC by algorithm-C drivers

Figure 6.52 displays utilization of the two types of cruise control by driver gender and age group. (Note that the graphs of Figures 6.52 through 6.55 are of the same form as that of Figure 6.51, except that the “manual” components are not shown in order to expand the vertical scale. That is, for each column of the graph, the difference between the percentage shown and 100 percent is the “manual” percentage for the category.)

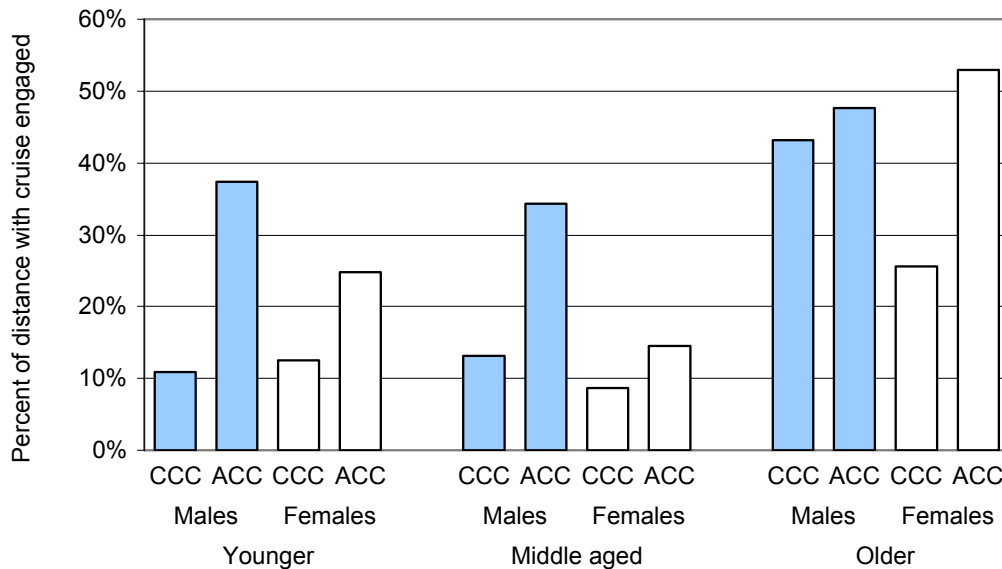

Figure 6.52. Comparison of the use of CCC and ACC by driver gender and age group (algorithm-C drivers)

The figure shows that for all combinations of age and gender, ACC is more heavily utilized than CCC. Younger males had the largest ratio of ACC to CCC use, 3.4; older males had the lowest ratio, 1.1.

Figure 6.53 compares the utilization of CCC and ACC by road class. As one would expect, the greatest use of either type of cruise control takes place on freeways. On these roads, utilization of CCC was about 35 percent, while with ACC, utilization of cruise control increased 1.6 times to 56 percent. Overall on other road types, the utilizations were 6.2 percent for CCC and 16.8 percent for ACC, for an increase of 2.7 times.

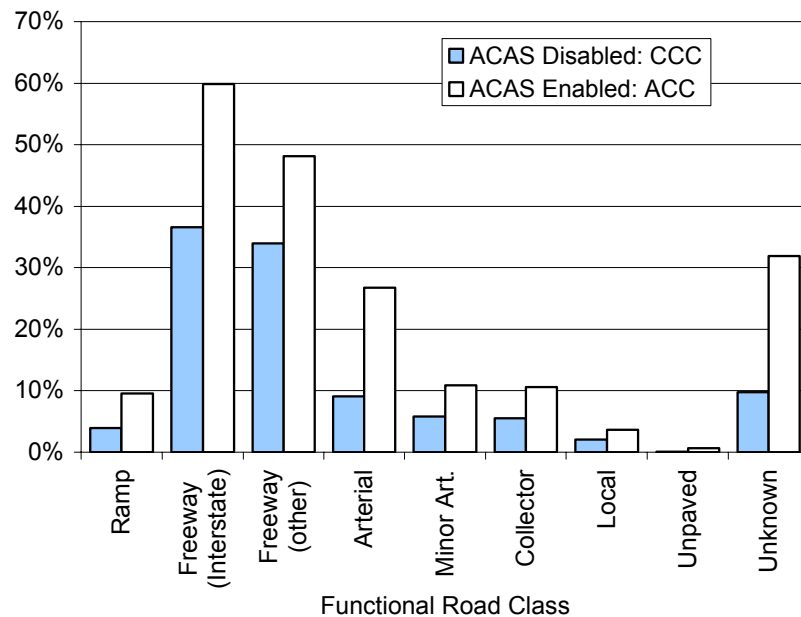

Figure 6.53. Comparison of the use of CCC and ACC by road class (algorithm-C drivers)

Figure 6.54 compares utilization of CCC and ACC as influenced by traffic density. Separate comparisons are made for travel on freeways (on the left) and for all other roads (on the right).

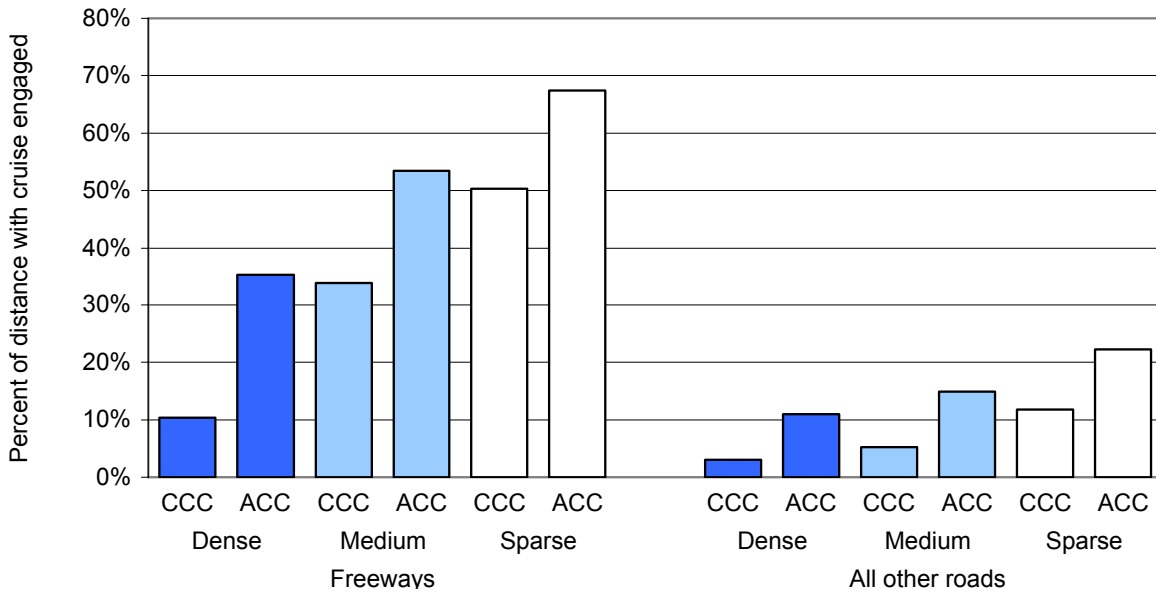

Figure 6.54. Comparison of the use of CCC and ACC by traffic density on freeways and on other road types (algorithm C drivers)

For each type of road and for each type of cruise control, there is a progressive increase in utilization as traffic conditions change from dense to medium to sparse. Also on both types of roads, there is an increase in the tendency for the utilization of ACC to be greater than that of CCC as traffic conditions change in the opposite way, that is from sparse to medium to dense. For example, on freeways, the ratios of ACC utilization to CCC utilization in dense, medium and sparse traffic are 3.5, 1.6, and 1.3 respectively. On other roads these same ratios are 3.7, 2.9, and 1.9, respectively.

The relationships of lighting condition and of windshield-wiper use to CCC and ACC utilization are illustrated in Figure 6.55 on the next page. The data show (1) a rather weak relationship between CCC or ACC utilization and lighting condition, (2) a strong relationship between CCC and ACC utilization and wiper use, and (3) for both factors, an appreciably stronger influence on ACC utilization than on CCC utilization.

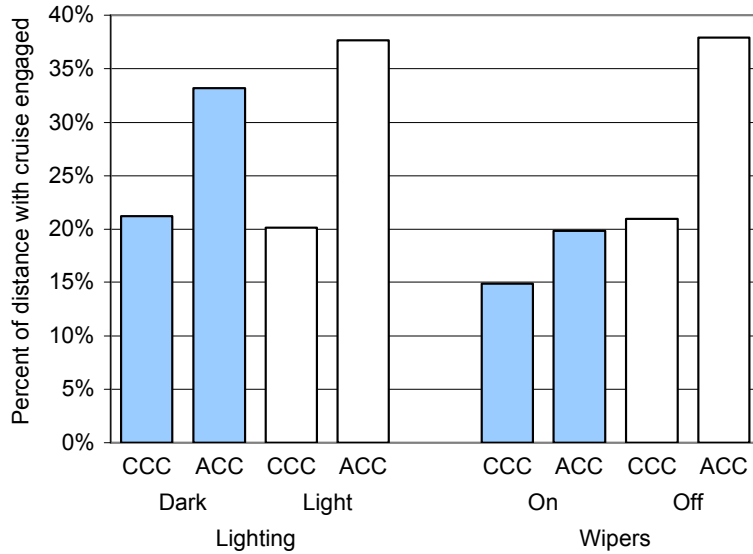

Figure 6.55. Comparison of the use of CCC and ACC by driving-environment factors (algorithm C drivers)

Figure 6.56 compares how drivers of the two types of driving styles utilized the cruise control during the test. Generally speaking, the assertive drivers did not use the cruise-control modes as much as did the reserved drivers. During the ACAS-disabled period, when the cruise mode function took the form of a conventional cruise control, the reserved drivers used it 27% of the miles, while the assertive drivers used it only 6.5% of the miles (a factor of 4 times less utilization).

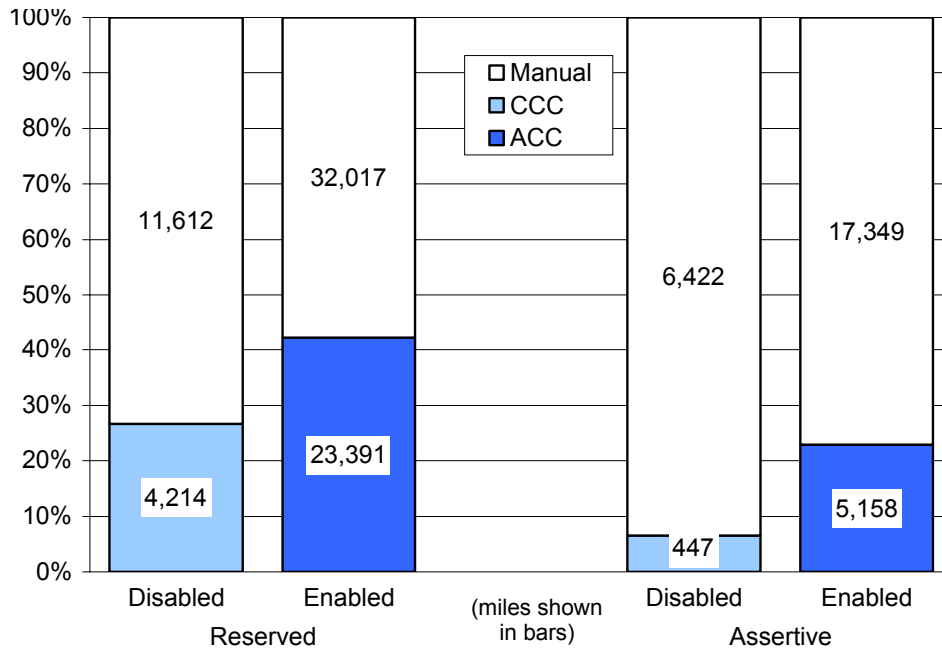

Figure 6.56. Use of cruise control by algorithm-C drivers by driving style

The gap gets smaller when ACC was available: 42% utility by the reserved, and 23% by the assertive drivers (only about 2 times less utilization). This observation may be explained by the “non-compromising” nature of CCC which forces the driver to disengage the system when a slower-moving vehicle is present in the same lane ahead. Given the inherent conflict between the driving characteristics associated with assertive driving and this feature of CCC, the much lower utilization of conventional cruise control by the assertive drivers can be expected. Once ACAS became enabled with the more “compromising” characteristic of ACC which allowed the driver longer engagement periods, the assertive drivers increased the utilization of the system. Overall, when compared to the reserved drivers, the assertive drivers still maintained a lower utilization rate, however, the ratio was not as low as during the ACAS-disabled period.

A closer look at the within-style change of utilization reveals a significant difference between the two groups of drivers. Recalling that the enabled period was 3 times longer than the disabled one, then by extrapolating the 4,214 miles utilized by the reserved drivers during the first week, one would expect about 12,600 utilized miles ($4,214 \times 3$) during the following 3 weeks. However, these drivers utilized the system almost twice as much (23,391 miles). The same extrapolation for the assertive drivers leads to an expected 1,340 utilized miles in the next three weeks. However, the assertive drivers utilized the system almost 4 times more than what one would expect by simply extrapolating the first-week utilization.

Clearly, the assertive drivers utilized ACC less than their counterpart, the reserved drivers. Nevertheless, it is important to point out the fact that when ACC became available, the comfort and convenience features of this system appealed to the assertive drivers to the point that their within-style change of utilization was much higher than that of the reserved drivers.

6.2.2.2 Adjustment of Set Speed and Headway Time

Figure 6.57 presents two histograms showing the distribution of set speed during CCC and ACC use, respectively. The histograms are by distance traveled and only travel with cruise control engaged is considered. Overlaid, on these histograms, using a solid line, is the actual speed distribution for each of the control modes. The data show that the average set speed under ACC is almost the same as that under CCC (70.3 mph versus 69.8 mph) and that the median values and most-likely values are the same (within the 1-mph resolution of the histogram) for the two systems; they are 72 mph and 71 mph, respectively. The graphs do show, however, that the distribution of ACC set speed is

considerably less “smooth” than the distribution for CCC. Perhaps the most striking difference is that the maximum set speed allowed by the system (80 mph) is among the three most likely set speeds for ACC while it is a rather unlikely set speed for CCC. Also note that the actual ACC-speed distribution does not peak at the maximum set speed allowed by the system.

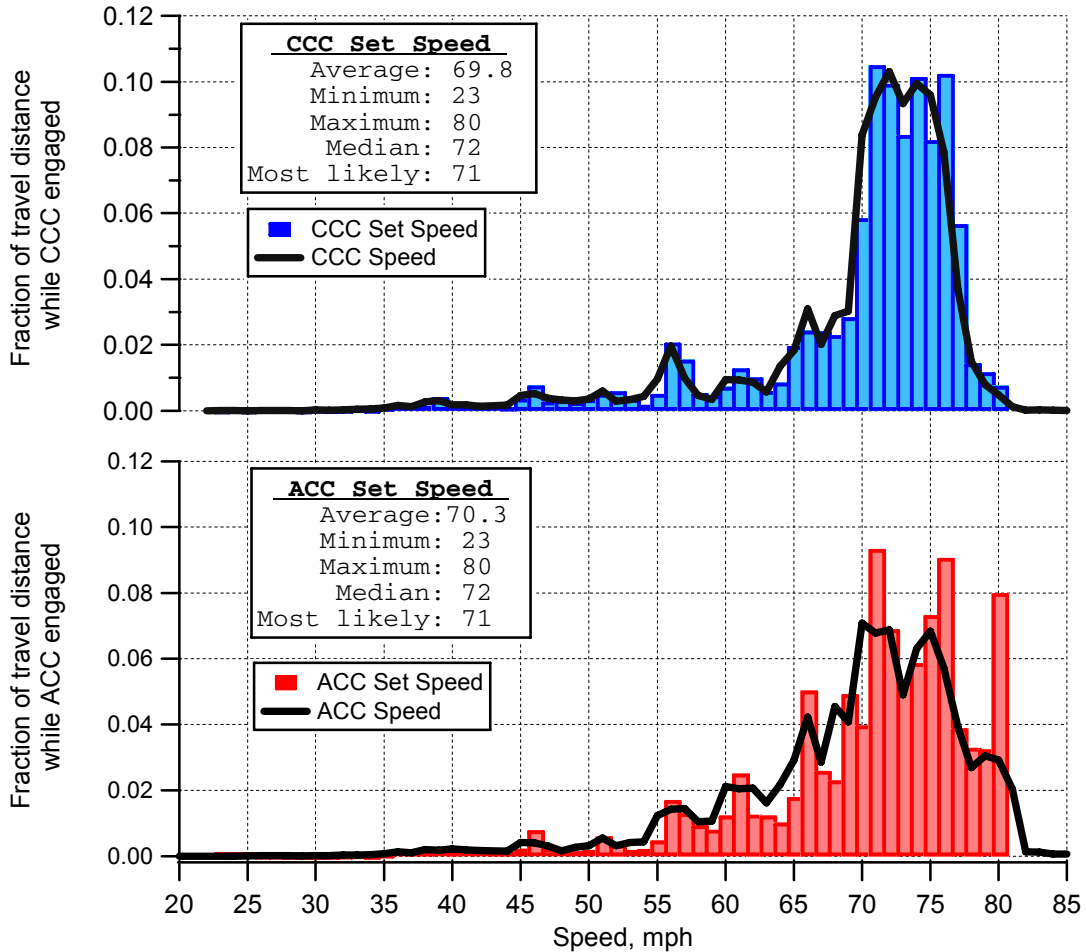

Figure 6.57. Histograms of set speeds with CCC and ACC (algorithm C drivers)

Figure 6.58 presents a histogram of gap setting during travel with ACC engaged. Again, the histogram is by distance traveled. The settings appear similar to those for FCW sensitivity settings (see Figure 6.31).

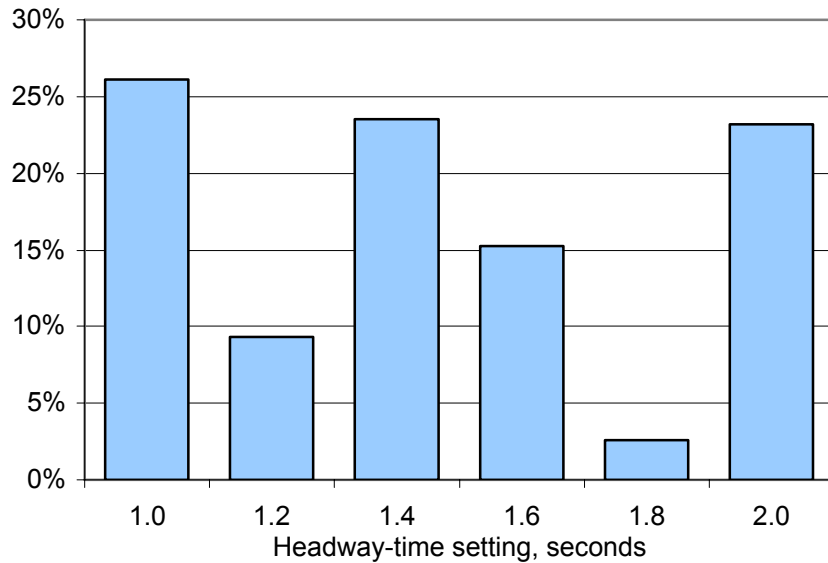

Figure 6.58. Histogram of ACC headway (gap) setting (ACC engaged), algorithm-C driving

Perhaps the most notable quality is that both the maximum (2.0 seconds) and the minimum (1.0 seconds) settings are among the three most likely values (1.4 seconds being the other). This, and the raggedness of the data, might suggest that the 0.2-second resolution of the system is finer than users can (or, at least, do) use effectively. If the full range of this adjustment is restrained to 1 to 2 seconds, it would appear that three settings may be adequate.

Figure 6.59 on the next page presents histograms of the average set speed for individual drivers while CCC and ACC were engaged respectively. First, note that there were 66 algorithm-C drivers whose performance is the basis for this figure. From the numbers of drivers shown in the inserts, it can be seen that 12 drivers never used CCC and one driver never used ACC.

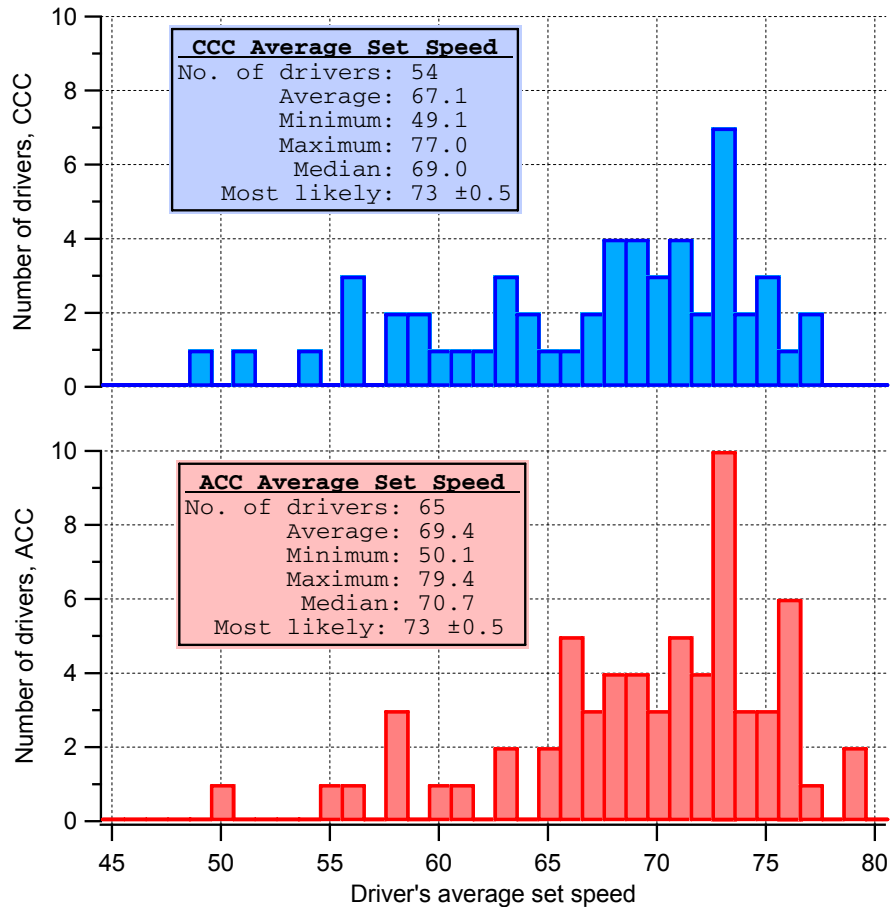

Figure 6.59. Histograms of the drivers’ average set speed with CCC and ACC, algorithm-C driving

For those who did use CCC, one driver had an average set speed as low as 49 mph while two drivers averaged as high as 77 mph (both within the 1-mph resolution of the histograms). Similarly for ACC, one driver averaged a 50-mph set speed while two others averaged 79 mph. For both systems, the most likely average set speed for individual drivers was 73 mph. Because of the shape of the distributions, the medians and averages of driver-average set speed were lower than the most-likely values. ACC had slightly higher median and average values of set speed than CCC.

Figure 6.60 shows a similar histogram of the average gap setting for individual drivers. (Note that the resolution, i.e., the bin width, in this figure is 0.1 second even though the resolution of gap setting is 0.2 seconds. That is because this is a histogram of the drivers *average* gap setting, which, of course, need not be equal to any particular setting.) The pattern of these data is very similar to that of Figure 6.50. That is, the maximum gap setting (2.0 seconds), the minimum (1.0 seconds), and a midway value (1.4 seconds) are the three most likely values (with the caveat that in these data, the

maximum is tied with two other values for third place). The notion that the resolution of gap setting may be finer than necessary again suggests itself.

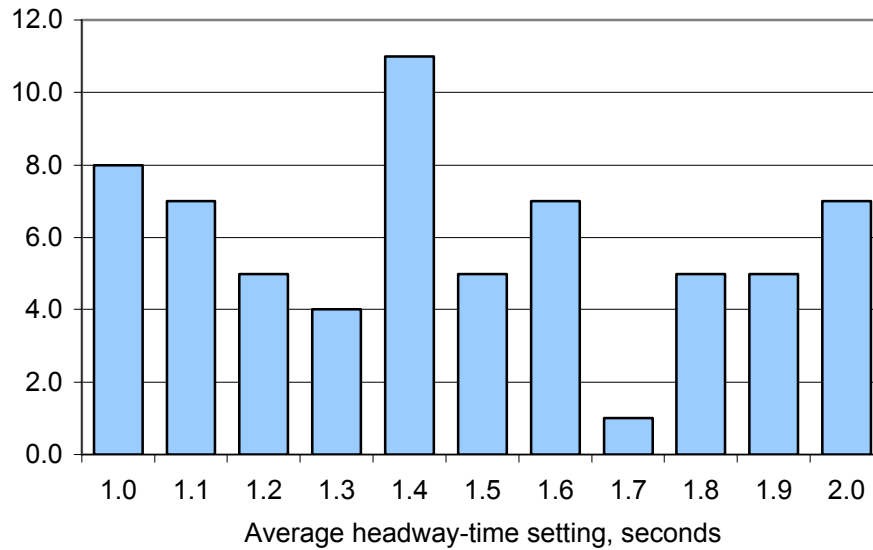

Figure 6.60. Histogram of drivers' average ACC headway time (gap) setting with ACC engaged, algorithm-C driving

Figure 6.61 on the next page presents average set-speed for CCC and ACC according to driver gender and age group. The trends are mixed: Males average higher set speeds than females in the young and older categories, but not in the middle-age group. Younger drivers average higher set speeds than middle-aged and older drivers, but the averages in the middle-age group are generally a bit lower than those for the older group.

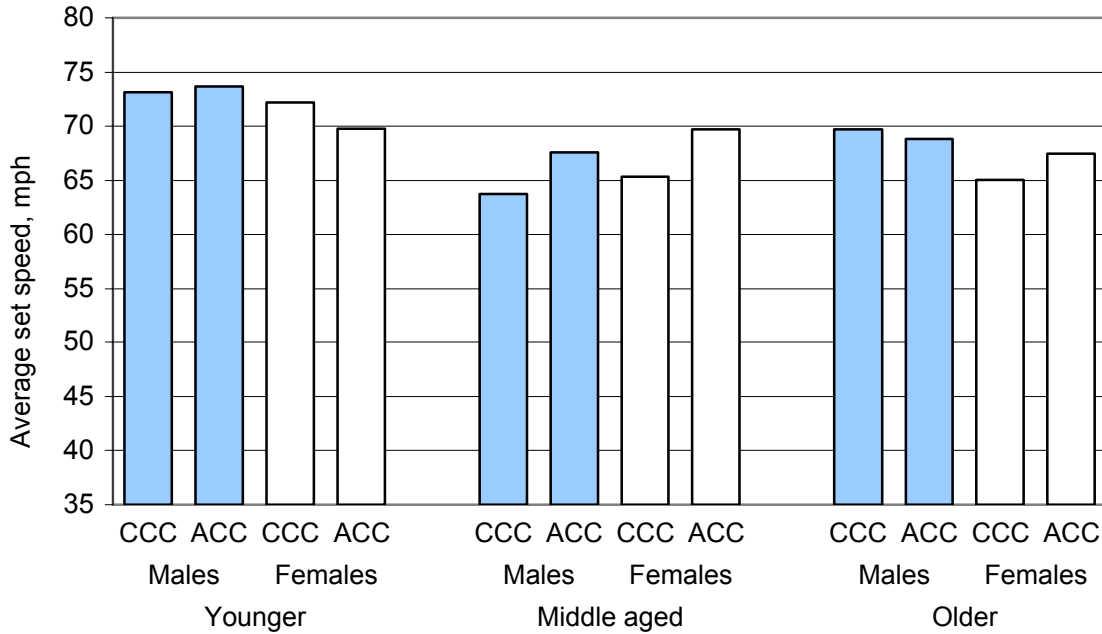

Figure 6.61. Average cruise-control set speed by gender and age group (CCC and ACC, algorithm-C drivers)

Figure 6.62 presents average gap settings by gender and age group. The trends appear to be that males and younger drivers average shorter gap settings than females and older drivers. The average value for middle-age males, however, violates both these generalities.

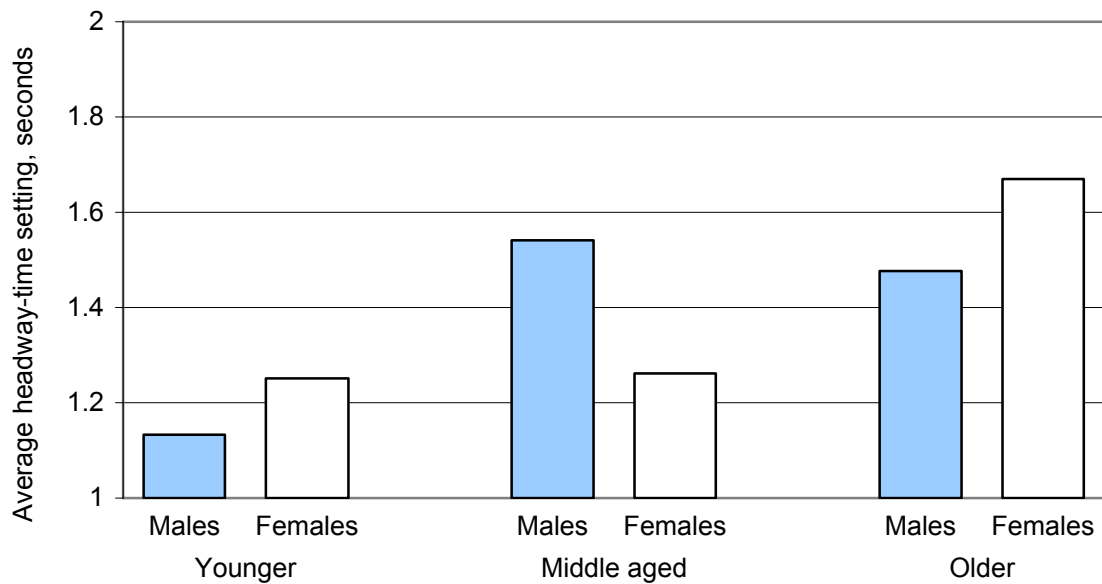

Figure 6.62. Average ACC headway (gap) setting by gender and age group with ACAS enabled (ACC), algorithm-C driving

Figure 6.63 displays average set speed for CCC and ACC driving by road class. As would be the obvious expectation, set speeds are highest for freeways and decline progressively for surface roads ranging from major arterials to minor local roads. Also, the tendency for higher set speeds under ACC than under CCC holds consistently for all road classes with the one exception of unpaved roads.

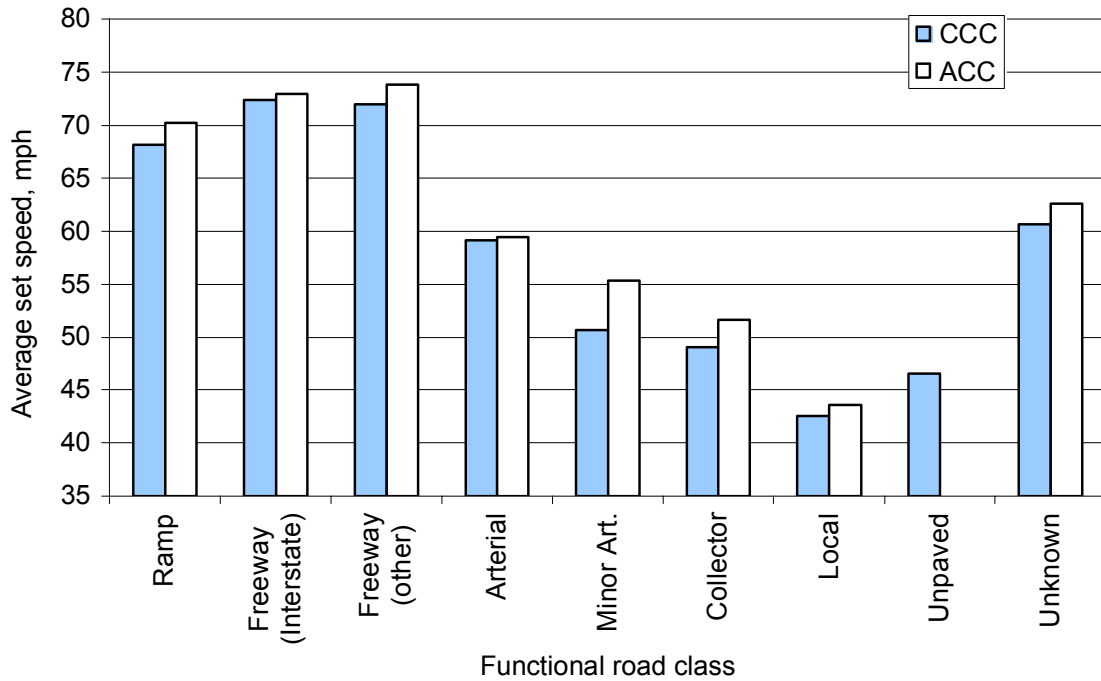

Figure 6.63. Average set speed (mph) by functional road class for CCC and ACC, algorithm-C driving

Figure 6.64 shows average ACC headway or gap settings by road class. There appears to be a modest trend for headway times to be shortest for the high-speed freeway-type roads and to grow longer for surface roads as the classification ranges from major to minor roads and, presumably, average speed declines.

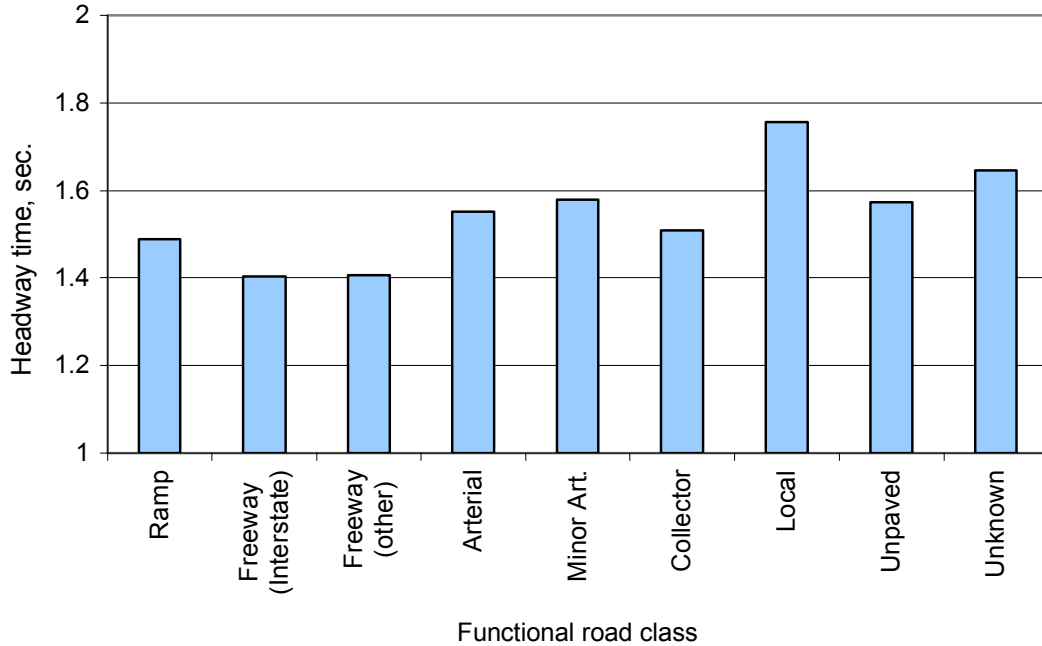

Figure 6.64. Average ACC headway time (gap) setting (seconds) by road class, algorithm-C driving

Average set speeds for CCC and ACC as a function of traffic density are presented in Figure 6.65. The relationships are shown separately for freeways and for all other roads. On freeways the tendency for higher set speeds with ACC than with CCC can once again be seen, but there is only the slightest, if any, tendency for average set speed to increase with decreasing traffic density. On other roads, this latter tendency is stronger, particularly when CCC is in use.

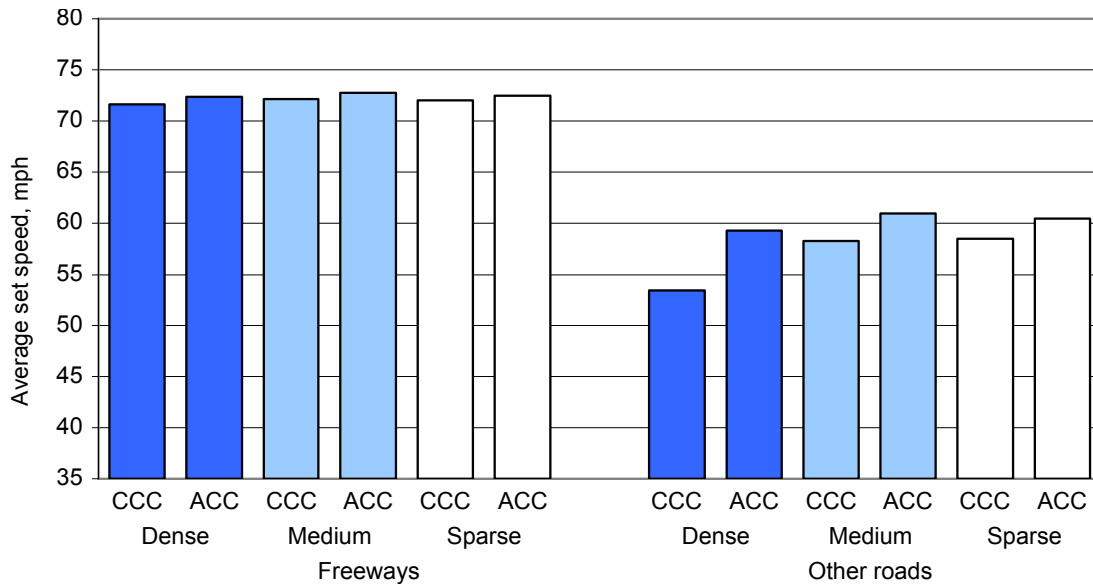

Figure 6.65. Average cruise-control set speeds (mph) for CCC and ACC by road type and traffic density, algorithm-C driving

The apparent influence of lighting condition and windshield-wiper use on average set speed is shown in Figure 6.66. These data show very slightly lower set speeds in darker conditions relative to well-lit conditions. The graph also shows that ACC set speeds are slightly lower than CCC set speeds when wipers are on. This may reflect drivers' caution with using a system with braking capability in wet conditions.

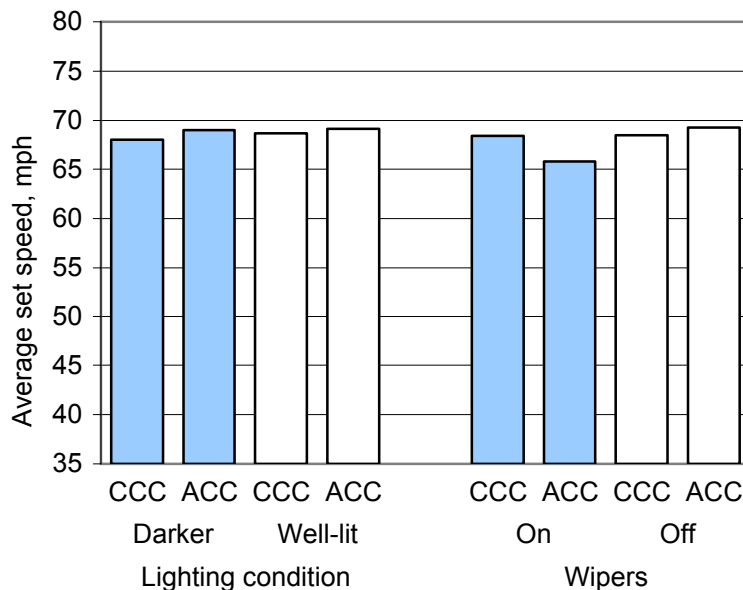

Figure 6.66. Average cruise-control set speeds by driving-environment factors with CCC and ACC, algorithm-C driving

Figure 6.67 shows the relationships between average ACC gap settings and the driving-environment factors of traffic density, wiper use and lighting conditions.

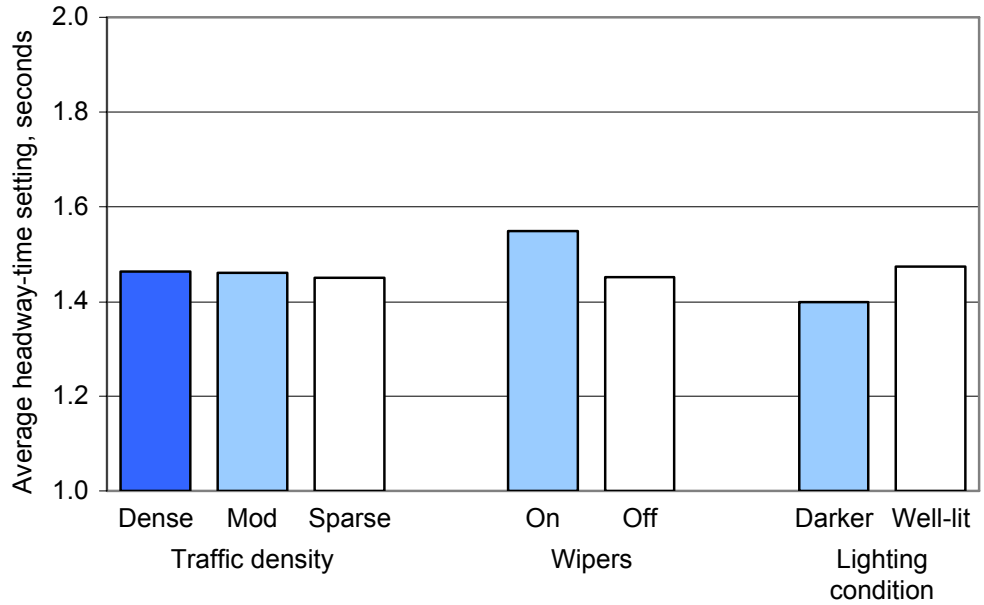

Figure 6.67. Average ACC headway (gap) setting by driving-environment factors, algorithm-C driving

Traffic density is seen to have very little influence on gap setting. Wiper use appears to have an influence in the manner one would expect: slightly longer time settings with wipers on. Lighting condition, on the other hand, may be eliciting slightly longer gap settings in well-lit than in darker conditions.

Figures 6.68 and 6.69 speak to the way the two driver types used the cruise mode of control. The following results might be expected since the behaviors studied are inputs to the driver typing itself, as described in Section 5.6. The average cruising set speed selected by drivers is shown in Figure 6.68.

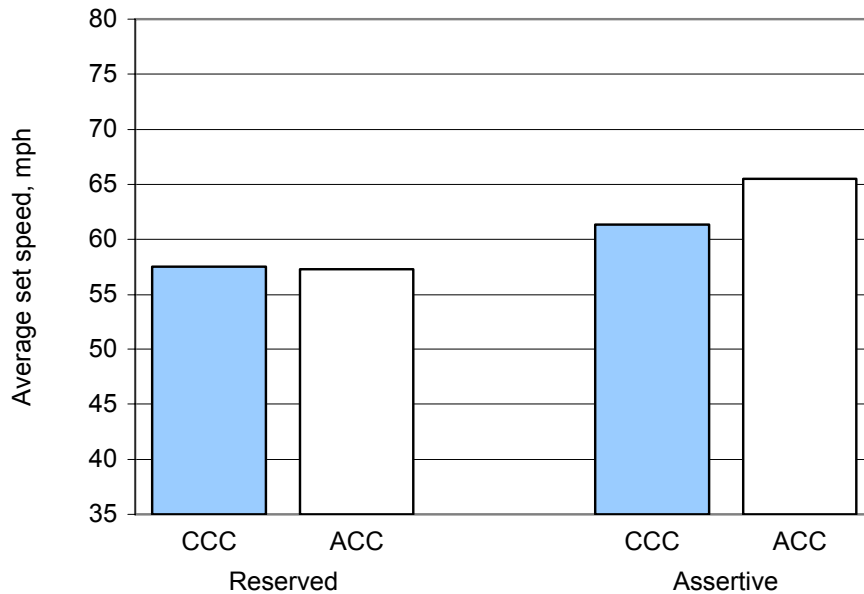

Figure 6.68. Average set speed by driving style, algorithm-C driving

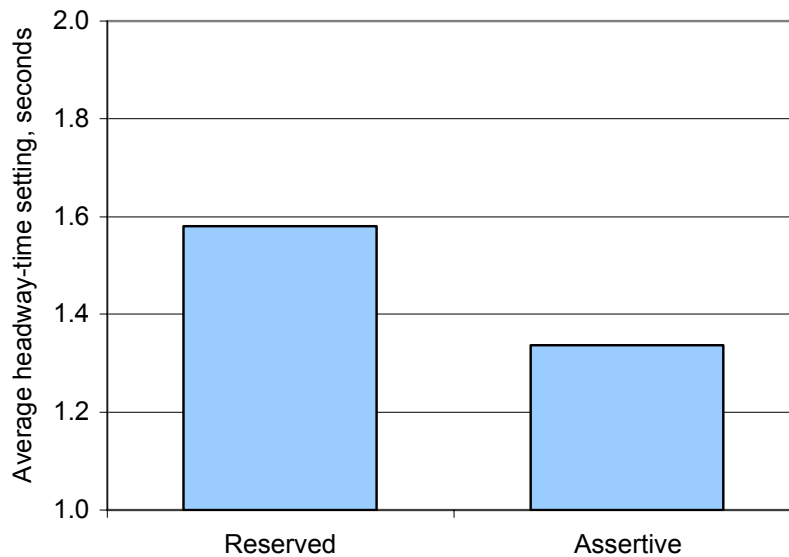

Figure 6.69. Average ACC headway (gap) setting by driving style, algorithm-C

The reserved drivers chose to cruise at a lower speed (both in CCC and in ACC) than the assertive ones. Furthermore, they were rather consistent in selecting the speed throughout their possession of the ACAS car. The assertive drivers, on the other hand, set their speed at a faster level with CCC, and even increased it further when ACC was available. In addition to demonstrating their inclination to drive faster, this behavior may indicate their intent to “latch” on the lead vehicle and drive in unison, as well as possibly their greater understanding of the system such that one may set the ACC speed rather high without rear-ending the lead car while maintaining a sustained “coupling” with it.

The average gap setting selected by the drivers in ACC is shown in Figure 6.69. As expected, the reserved drivers selected a longer-headway setting than the assertive ones. It should be noted that a variation (although somewhat different) on this headway-setting measure was employed in Section 5.6 to classify the drivers.

6.2.2.3 ACC Alerts

This section will present data describing the rates of imminent alerts while driving with ACC as a function of various factors. ACC alerts are important events for safety analyses because of the potential association with conflict and/or driver mismanagement in the role of ACC supervisor. Here alert counts and alert rates are presented, again as a function of several variables. Section 8.1 uses some of these findings. As noted at the outset of Section 6.2.1, all data and their presentations are only for driving in *valid* trips with vehicles using ACAS algorithm C.

Also, in this section, some presentations distinguish between results for software designated as system version 7 (sv-7) and version 8 (sv-8) of algorithm C. Sv-7 software contained a “bug” that unintentionally resulted in the suppression of ACC alerts associated with moving targets. Sv-8 software corrected this error. Twenty-seven of the algorithm-C drivers drove vehicles exclusively using sv-7 software; thirty-five drove vehicles with sv-8 software exclusively; at the changeover, five drivers had sv-7 software initially but their vehicles were converted to sv-8 software while they were using them.

Figure 6.70 summarizes the overall rates of imminent alerts during ACC operation for moving and stationary targets, while distinguishing between sv-7 and sv-8 vehicles. (This figure is based on *all* alerts experienced by algorithm-C drivers. Because of missing data and other problems, three of the ACC alert events represented here are not included as usable alerts in subsequent analyses in this report. See Section 6.2.1.2.1 for details.) ACC Alerts associated with stationary targets occurred at rates of about 0.21 per 100 miles traveled for system version 7 and 0.15 for system version 8. For sv-8 vehicles, the rate for moving-target alerts was 0.16 per 100 miles yielding a total alert rate of approximately 0.30 per 100 miles.

Figure 6.70 shows that the rates of stationary-target alerts were somewhat different for sv-7 and sv-8 travel. Nevertheless, in all of the following, sv-7 and sv-8 data are pooled in determining the rates of stationary-target alerts. On the other hand, only sv-8 travel is used in determining moving-target alert rates.

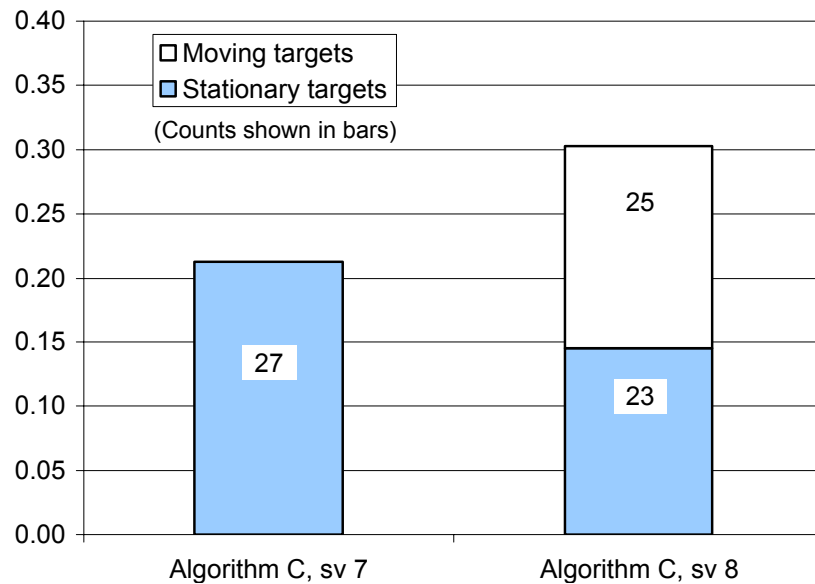

Figure 6.70. ACC alert rates per 100 miles for moving and stationary targets for travel with ACC engaged with moving alerts suppressed (system version 7) and not suppressed (system version 8), algorithm-C driving

Shown in Table 6.9 is a breakdown of all ACC alert activity over the three weeks when ACC was available to the driver. The point of displaying the data by week is to reveal the marked adaptation that was observed to occur over the testing period for participants in terms of ACC alert development.

Table 6.9. Breakdown of ACC alerts by the 3 weeks of ACAS-enabled driving

	<i>Week 2</i>	<i>Week 3</i>	<i>Week 4</i>	<i>All</i>
Number of ACC miles (system 7)	4313	4356	4020	12689
Number of ACC miles (system 8)	3778	4727	7308	15813
Stationary-object ACC Alerts (system 7)	14	6	7	27
Stationary-object ACC Alerts (system 8)	7	10	6	23
Moving-vehicle ACC Alerts (system 8)	11	5	9	25
Total Number of ACC Alerts	32	21	22	75
Stationary-object ACC Alert Rate (Alerts per 100 ACC mi.)	0.26	0.18	0.11	0.18
Moving-vehicle ACC Alert Rate (Alerts per 100 ACC mi., sv 8 only)	0.29	0.11	0.12	0.16
All ACC Alert Rate (Alerts per 100 ACC mi.,sv 8 only)	0.48	0.32	0.21	0.30

While the table is necessarily complicated by the need to breakdown results by the sv 7 and sv 8 software versions, the adaptation issue is portrayed in the large reduction in alert rates that appear along the bottom three rows of the table, going from week 2 to week 4 of ACAS exposure. Later in Section 8.1, it will be shown that the strong decline

in ACC alert rate with time appears to derive from reduced exposure to the more conflict-laden road environments and from a greater readiness by drivers to intervene before a conflict rose to the level that would provoke an alert.

Moreover, the data show that the total number of imminent-alerts during ACC is relatively small. That is, on average, there was less than one of each type of alert per driver: the 65 drivers who could have experienced stationary-target alerts had a total of only 52 alert events; the 39 drivers who could have experienced moving-target alerts had a total of only 23. In the presentations that follow, this relatively sparse data is subdivided into multiple categories such that results in individual categories run a high risk of being random effects. *Consequently, while the presentations that follow show what actually took place in this FOT, the reader should be especially cautious in assuming that the experience of this FOT is representative in all of the implied detail.*

Figure 6.71 presents a histogram describing the distribution of alert rates among drivers. (Note that the bin width for this histogram is 0.25 alerts per 100 miles and that the labels of the horizontal axis give bin centers. Hence, the second bin, labeled 0.5, represents the range from 0.375 to 0.625.)

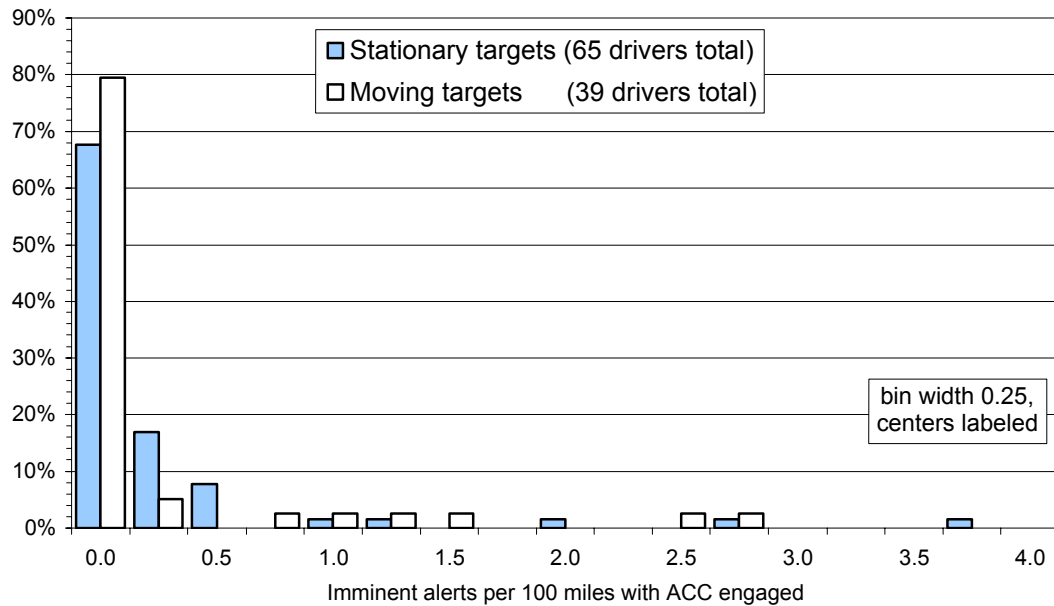

Figure 6.71. Percent of drivers with various ACC alert rates, algorithm-C driving

The figure shows that the great majority of drivers experienced both stationary-target and moving-target alert rates of less than 0.125 alerts per 100 miles. While very few drivers experienced either rate in excess of 0.625 per 100 miles, a small number

experienced moving- or stationary-target alert rates in excess of 2.5 per 100 miles. This figure, then, amplifies the point of the previous paragraph: it indicates that a majority of the alerts were experienced (or generated) by a minority of the drivers and that other results to follow may, in large measure, derive from the driving styles and circumstances of only a few individuals.

Figure 6.72 presents moving-target and stationary-target ACC alert rates as a function of ACC gap setting. There are relatively few ACC alerts and therefore any apparent trends in the figure should be viewed with caution. First, it is noted that stationary target alerts appear to increase with increasing gap setting. Stationary-target alerts may be affected by gap setting due to an increase in visibility of roadside or overhead objects at longer gap settings. There may also be an explanation if drivers prefer longer gap settings on surface roads, where there are more alerts due to roadside objects being closer to the road and curves being tighter than freeways. Regarding the moving targets alerts, there are so few of these alerts (25) that it is not advisable to speculate whether the trend is a real one.

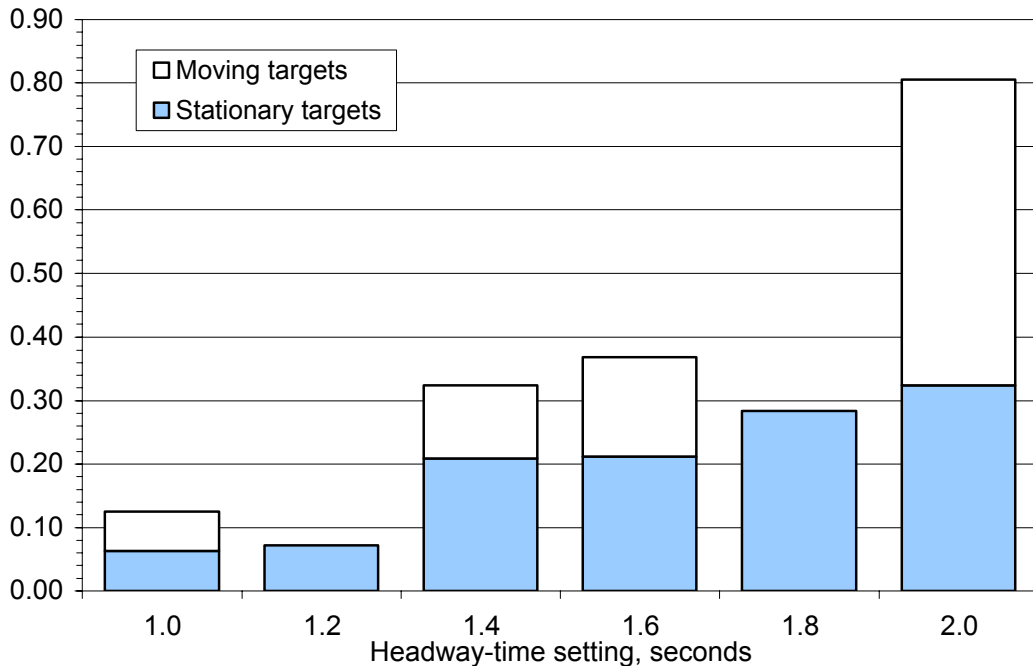

Figure 6.72. ACC alert rates per 100 miles for moving and standing targets by ACC headway (gap) setting for travel with ACC engaged, algorithm-C driving

Figure 6.73 presents alert rates by gender and by age group. Again the alert population is too sparse to support hypotheses regarding the relationship of ACC alert rate and age and gender.

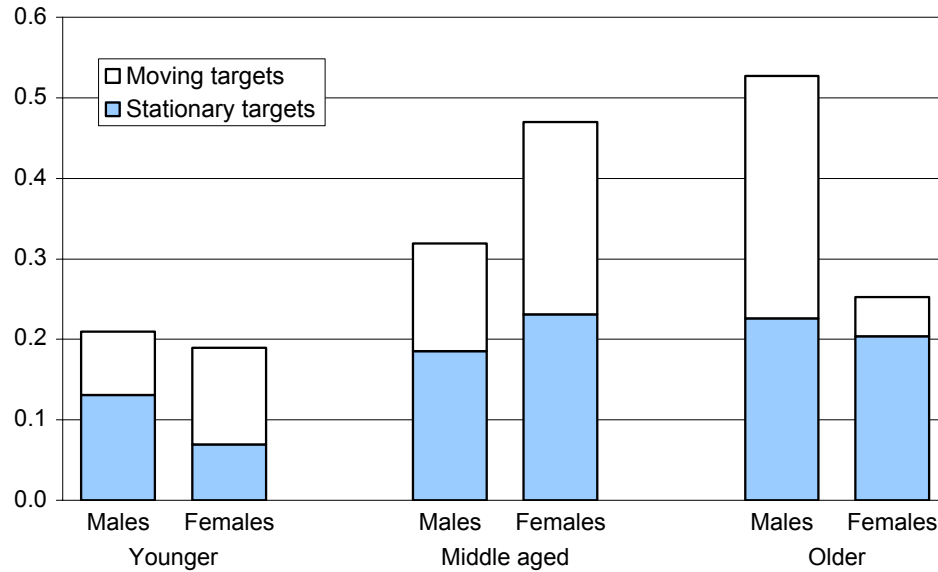

Figure 6.73. ACC alert rates per 100 miles for moving and standing targets by driver gender and age group for travel with ACC engaged, algorithm-C driving

Figure 6.74 presents alert rates as experienced on the various functional road types. This figure does indicate that over-all alert rates, and especially moving-target alert rates, are lower on freeways than on other types of roads.

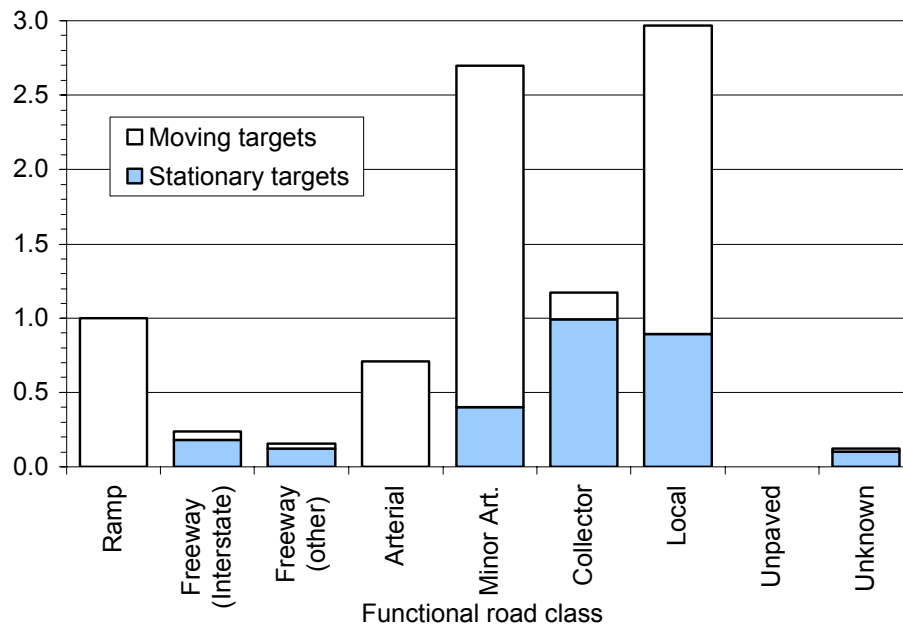

Figure 6.74. ACC alert rates for moving and standing targets by road class for travel with ACC engaged, algorithm-C driving

Figure 6.75 presents alert rates by traffic density while distinguishing between freeways and other road types.

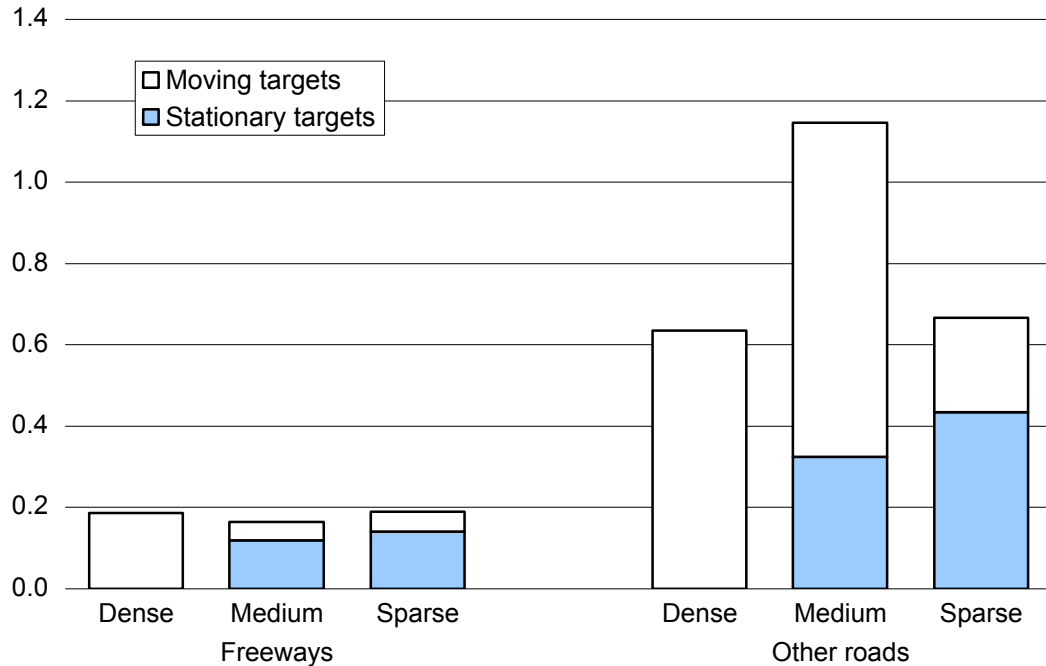

Figure 6.75. ACC alert rates per 100 miles for moving and standing targets by traffic density on freeways and on other roads for travel with ACC engaged, algorithm-C driving

The data suggest that traffic density has little effect on overall alert rate for travel on freeways and interstates, although density does seem to influence the type of alert. On other roads there seems little pattern. It may be noteworthy that, on either type of road, the stationary-target alert rate is zero in dense traffic, perhaps implying that the presence of many vehicles in the radar field masks or occludes whatever might otherwise be interpreted as a stationary target. An alternative possibility is that the traffic aids the radar-based scene tracking function to better estimate road geometry ahead, reducing the number of alerts to roadside signs.

Figure 6.76 presents alert rates as functions of lighting condition and the use of windshield wipers. The figure suggests that rates are slightly lower in those circumstances that would generally elicit reserved driving, i.e., darkness and with wipers on. While it is not apparent from the figure, we note that all alerts experienced with wipers on were with intermittent wiper settings of the longest or second-longest delay (two stationary-target alerts with the longest delay; one moving-target alert with the second-longest delay).

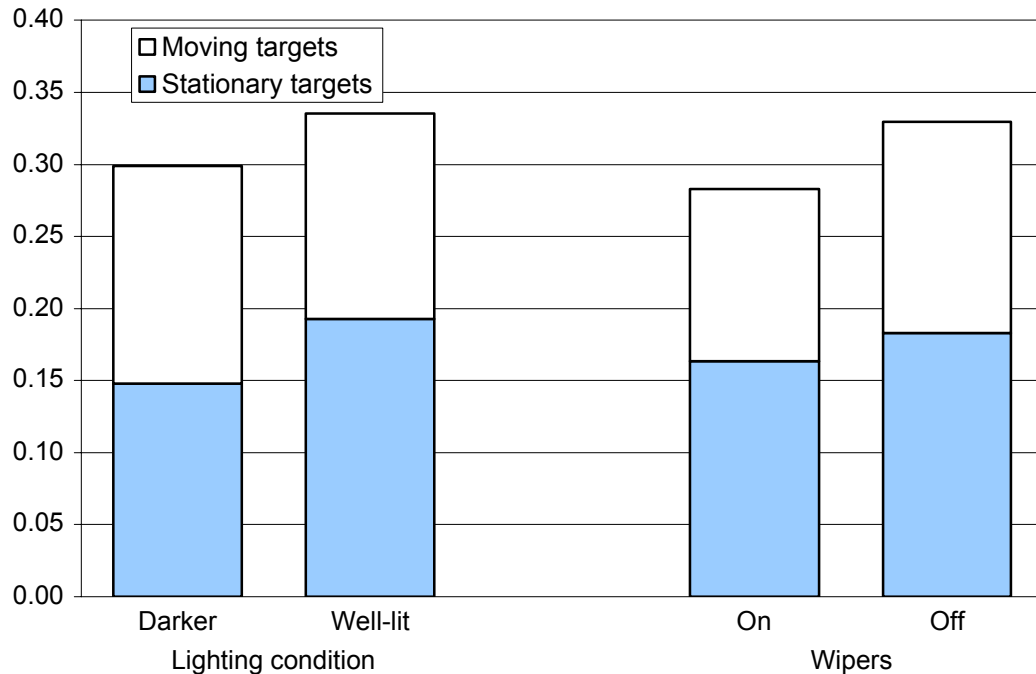

Figure 6.76. ACC alert rates per 100 miles for moving and standing targets by lighting condition and by windshield-wiper use for travel with ACC engaged, algorithm-C driving

6.3 Characterization of ACAS Performance from FOT Data

This section is intended to provide what is the only available form of ‘documentation’ of the performance of the ACAS subsystems. The presentation is drawn entirely from empirical evidence, since formal documentation of the ACAS hardware and software design is considered proprietary. The presentation thus combines a variety of measured responses of the FCW and ACC subsystems with a discussion that seeks to generalize as much as possible on UMTRI’s observations of their performance.

The authors recognize that the performance characterizations that are afforded here give far less than a rigorous definition of the dynamic behavior of these complex systems. One handicap, for example, is that the precise conditions under which the cited responses occurred are not known since the presented data are from the FOT database which, itself, provides only a limited description of the driving environment. More broadly, the actual functioning of ACAS involves extensively-detailed algorithms whose many conditionalities and nonlinearities make it virtually impossible to gain a complete description by means of sampled measurements.

6.3.1 FCW Alert Performance

This section uses FOT data to characterize aspects of the FCW system’s input-output relationships, as a means of describing the FCW system used in the FOT experiment.

6.3.1.1 FCW Imminent Alert Performance

The number of FCW alerts and the conditions associated with those alert events were described in Section 6.2.12. This section addresses the driving scenarios associated with those imminent alert events, as well as the conflict levels at onset of alert. The list of driving scenarios was given in Section 5.2.

Figure 6.77 shows a high-level breakdown of the 634 FCW imminent alerts that occurred during manual driving with ACAS enabled (algorithm C drivers). This depiction is a high-level breakdown of alert scenarios. Note that, in the figure, percentages are slightly different between the right and left side. This is because the numbers in the left figure were computed as means of individual drivers’ experiences, while the numbers in the right figure required collapsing alert counts across all drivers. Collapsing was necessary because not many drivers experienced all types of alerts.

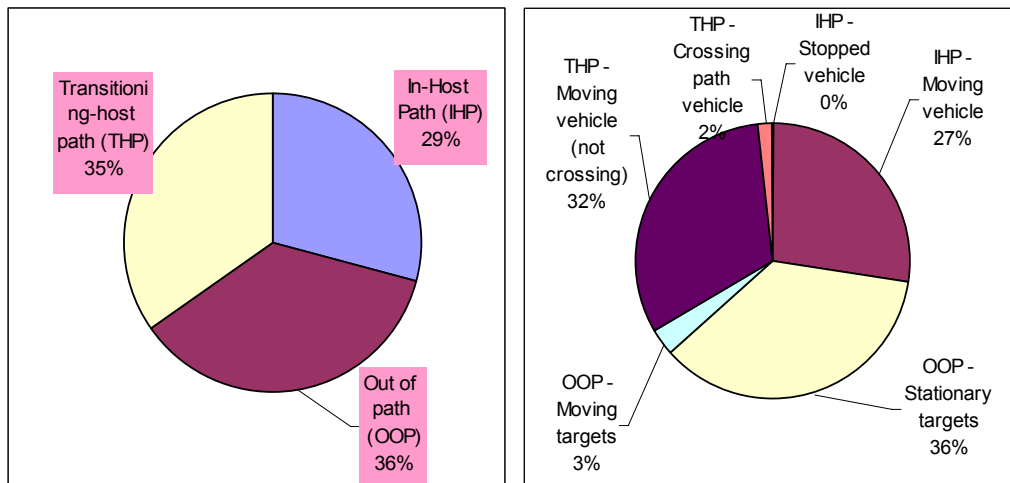

Figure 6.77. FCW imminent alerts during manual driving

The figure shows that thirty nine percent of the alerts were triggered by objects that were obviously out of path. Most of these are due to roadside clutter, but about 8% of these out-of-path alerts (or 3% of all alerts) are caused by moving vehicles, such as vehicles in adjacent lanes. This does not count alerts that are associated with scenarios in which the target vehicle was in the same lane as the host at some period near the alert onset.

Sixty-two percent of the alerts (or 388 of 634 alerts) were triggered by moving vehicles in either same-lane scenarios or in lane-transitioning scenarios; the occurrence of these two types is approximately the same, as Figure 6.77 shows. The twelve remaining alerts include eleven alerts in scenarios in which the “lead” vehicle is actually crossing the path of the host, and a single alert in which the target was a lead vehicle that was stopped well before the alert occurred. (Note that in some decelerating lead vehicle scenarios, the alert onset may occur after the lead vehicle has come to rest.)

Table 6.10 looks at the specific conflict scenarios associated with the in-host-path alerts. Ninety-one percent of these alerts are associated with decelerating lead vehicles. Furthermore only a single alert in manual driving (less than 1% of alerts) is associated with a lead vehicle that has been stopped for several seconds before the alert occurs.

Table 6.10. FCW imminent alert events: breakdown of in-host path (IHP) scenario alerts (algorithm C, ACAS enabled, manual driving)

IHP scenario type	Conflict scenario	Alerts	% of IHP
Lead vehicle decelerating (91%)	LV brakes predictably, not to stop	68	39%
	LV brakes unpredictably, not to stop	60	34%
	LV brakes to predictable stop	29	17%
	LV brakes to unpredictable stop	3	2%
Lead vehicle at constant speed (5%)	Host approaches const speed LV	6	3%
	Host tailgates LV	4	2%
Lead vehicle accelerating (2%)	Host approaches accelerating LV	4	2%
Lead vehicle stopped (1%)	Host approaches stopped LV	1	1%
	Total in-host-path alerts:	175	100%

The difference between the number of alerts due to decelerating lead vehicles and those due to lead vehicles that are stopped well before the alert sounds was not expected. This difference may be due to at least two reasons, the first of which is simply that drivers may be exposed more often to the decelerating-lead-vehicle situation than to the situation where a lead vehicle has been stopped during the entire approach. A second possible reason for these numbers is that the FCW alert timing of this particular system may be relatively “late” for stopped vehicles, but relatively “early” for decelerating lead vehicles. There is reason why this may be true. Tuning alert timing is more difficult for decelerating lead vehicle situations. This is because the lead-vehicle-decelerating situation develops without warning, from the FCW perspective, with driver response generally required within the space of a few seconds or several seconds. Sometimes,

there is little leeway for the FCW to “wait” to allow attentive drivers an opportunity to respond. In addition, while the FCW observes only the vehicle ahead, the attentive driver can observe the entire traffic situation ahead and predict the level of braking that is required. Notice that most of the lead-vehicle-deceleration-related alerts are associated with predictable lead vehicle braking situations, where drivers are likely to be predicting the lead vehicle’s behavior based on other cues, such as the distance to the intersection or the queue ahead. Only 5% of these alerts are associated with a lead vehicle that is moving at approximately steady speed, i.e., within approximately 5 mph.

Table 6.11 shows the distribution of alerts of manual-driving FCW alerts in transitioning-host path (THP) scenarios. Host driver actions are responsible for approximately 19% of THP alerts. The most common scenario is simply that of passing a slower vehicle. Lead vehicle path changes are associated with almost four times the alert frequency of host path changes, or 73% of THP alert events. The bulk of these are triggered by events in which the lead vehicle ahead is turning. This scenario accounts for 100 alerts (78 with the lead vehicle turning right), making it the second-most common alert scenario, following the decelerating-lead-vehicle scenarios. Another group that accounts for 8% of the THP scenarios is crossing-path scenarios, including vehicles turning left across the path of the vehicle, traveling on an intersection roadway, or turning onto the host’s roadway, but into a different lane.

Table 6.11. FCW imminent alert events: breakdown of transitioning-host path (THP) scenario alerts (algorithm C, ACAS enabled, manual driving)

THP scenario type	Scenarios	Alerts	%
Host path change 19%	Host cuts behind LV	6	3%
	Host performs 2-lane pass	1	0%
	Host changes lanes to pass	26	12%
	Host enters turn lane	7	3%
Lead vehicle path changes 73%	Lead vehicle turns right	100	47%
	LV leaves lane, into turn lane	37	17%
	LV leaves lane (other cases)	7	3%
	LV cut in	6	3%
	LV merging into host lane	3	1%
	Other LV maneuvers	3	1%
Lead vehicle crosses hosts path (8%)	(Intersections & left turns)	17	8%
Totals		213	100%

Although the tables above shows the distribution of alerts for all drivers joined into a single data set, it should be cautioned that individual drivers often experience alerts that are distributed quite differently across the scenarios than shown above.

Figure 6.78 shows that a number of drivers have an unusually high fraction of false out-of-path alerts, relative to non-false in-path alerts and others an unusually low fraction of them.

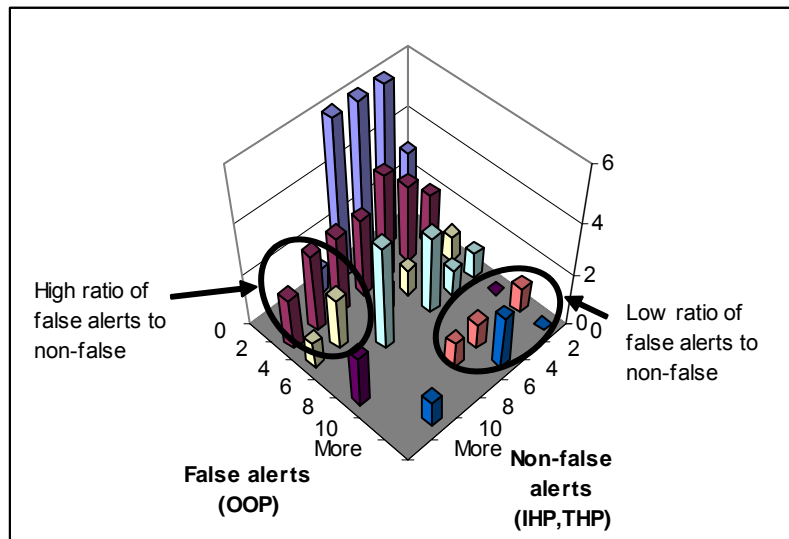

Figure 6.78. Number of false alerts and non-false alerts for individual drivers (algorithm C, manual driving). Number of drivers is indicated on the vertical axis.

In general, the alert experience of drivers has many common themes, but there are sometimes special characteristics of a driver’s exposure to FCW. For example, 36% of the false alerts were experienced by 9% of the drivers, and 36% of the non-false alerts were experienced by 16% of the drivers – and there is only one driver common to those sets.

Conflict metrics are now computed at the moment of alert onset (see Section 5.7 for an introduction to the conflict metrics of this report). Figure 6.79 shows the decel-to-avoid values at alert onset for the sets of THP and IHP alerts.

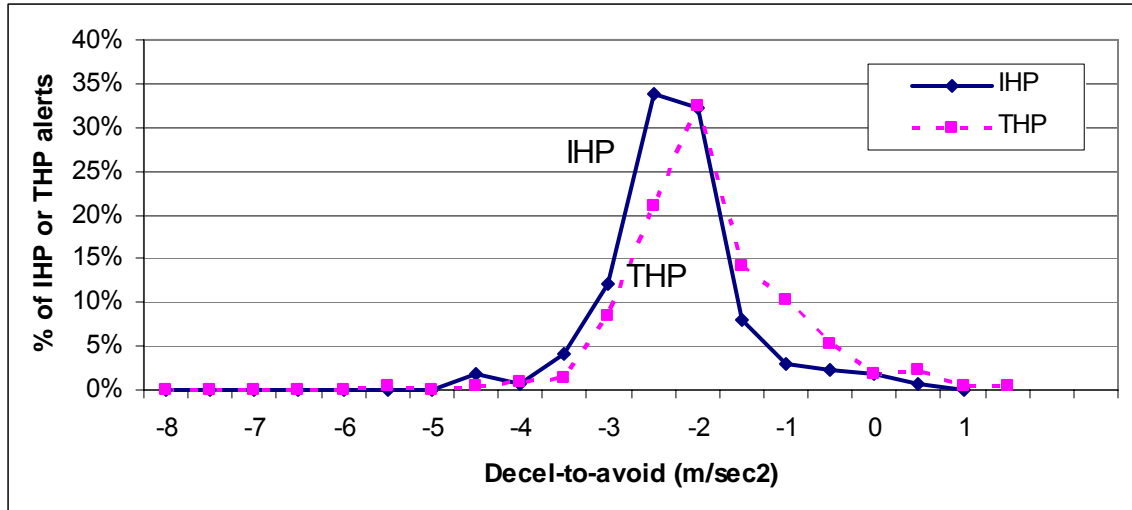

Figure 6.79. Decel-to-avoid at onset of FCW imminent alerts (algorithm C, manual driving)

The values vary from -5 m/sec^2 required to approximately $+1 \text{ m/sec}^2$, with a mode value of approximately -2 and -2.5 m/sec^2 for THP and IHP alert events, respectively. (IHP events tend to require greater braking responses than THP events because the lead vehicle is often braking.) A positive decel-to-avoid value means that the host vehicle would have to accelerate at the computed rate in order to catch up to the lead vehicle. Notice that the values in Figure 6.79 do not capture the fact that often the actual deceleration needed as the event plays out is different (usually less) than that computed at alert onset. This occurs because a lead vehicle may reduce its braking level or even leave the path of the host vehicle, among other reasons.

Figure 6.80 shows these same traces again, but with an overlay of the projected decel-to-avoid numbers for the same alerts. The projected decel-to-avoid values may approximate the driver braking response that the FCW system algorithm would estimate will be needed, if the algorithm assumes a 1.5 sec driver response delay.

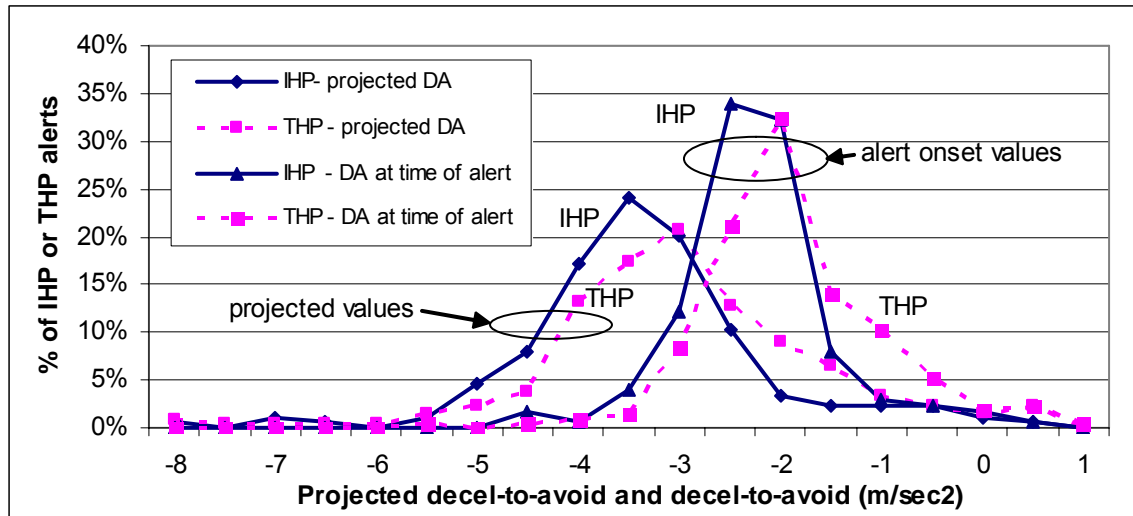

Figure 6.80. Decel-to-avoid and projected decel-to-avoid at onset of FCW imminent alerts (algorithm C, manual driving)

The projected decel-to-avoid numbers vary generally from -6 to 0 m/sec². The most common values of projected decel-to-avoid for IHP and THP situations-are approximately -3.5 and -3 m/sec², respectively. Again, at the time of alert onset, the IHP events are expected to require a bit more braking than the THP events require. The projected values as a set represent higher braking-required values than the decel-to-avoid values. This is true because the projected values assume the host driver does not act for 1.5 seconds, letting the conflict grow.

Figure 6.81 shows the enhanced TTC values at the time of alert onsets. (Section 5 included a discussion of enhanced TTC, among other forward closing-situation conflict metrics.) The values of enhanced TTC range from 2 to 6 seconds, with some outliers of greater values. The THP alert events have smaller enhanced TTC values than the IHP alert events, suggesting the THP events have more conflict at alert onset than the IHP events. This is opposite from the results of decel-to-avoid and projected decel-to-avoid. This illustrates that conflict metrics are not interchangeable, and may not show exactly the same trends, given the same events. Clearly, enhanced TTC and decel-to-avoid represent slightly different characteristics of a conflict. While enhanced TTC describes how much *time* remains until impact occurs, the decel-to-avoid captures how much effort would be needed to avoid the impact. Thus one can hypothesize that while THP alert events may have forward impacts that are computed as more imminent in time than those associated with IHP alert events, the IHP events may require more driver response to avoid the impacts. This could, in turn, be due to the fact that IHPs involve more lead vehicle deceleration than THP events. In general, care is needed in drawing conclusions

from investigating a single forward metric. This is because forward conflicts encompass at least four variables (two vehicle speeds, range, and relative acceleration), so that a single metric will never be able to capture all aspects of the conflict.

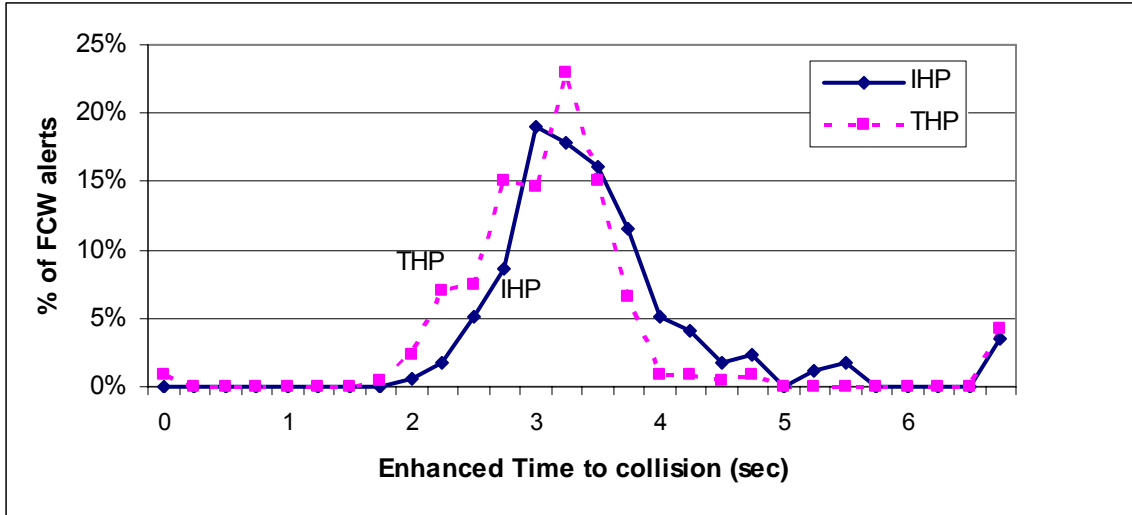

Figure 6.81. Enhanced TTC at FCW imminent alert onset (algorithm C, manual driving)

6.3.1.2 FCW Cautionary Alert Performance

Table 6.12 breaks down the root cause of the cautionary alerts during algorithm C. Almost all of the cautionary alerts (99.9%) are triggered by headway considerations.

Table 6.12. Visual alert icons are almost always triggered by headway considerations

What triggers visual alert	Percent of visual alert icon time
Persistent tailgating (very small headway time margins) triggering the ACAS flashing-visual-icon alert	1.2%
Closing (approaching an imminent alert)	0.1%
Persistent headway (moderate time margins) triggering the ACAS non-flashing cautionary alert	98.5%

6.3.2 ACC Alert Performance

This section provides an overview of the alerts that were produced when operating under either the CCC or ACC mode of vehicle control. The presentation covers a typological classification of the alerts, the distribution of alerts by road type and distributions, and discussion of the conflict kinematics that describe the alert-producing events.

6.3.2.1 Type Classification and Counts of ACC Alerts

The circumstances associated with the occurrence of alerts under cruise-engaged conditions are summarized by the pie chart in Figure 6.82 (alerts by target types) and Table 6.13 (breakdown by maneuvering scenarios). The following observations are noteworthy:

- Only 8 alerts occurred in CCC, and these are due to stopped objects that actually lie outside of the path of the vehicle. Recall that in CCC, the alerts are not displayed to the driver and only stationary-target alerts are registered in the data.
- A total of 72 usable alerts were recorded during ACC driving. Of these, 47 alerts (65%) were in response to stopped objects as shown in the pie chart and the table below. Of these, only 6 alerts were actually triggered by in-path stopped vehicles. The remaining 41 stopped-object alerts were triggered by out-of-path objects including overhead bridges, road signs and other roadside objects, perhaps including stopped vehicles along the roadside or in adjacent lanes. Note that roughly half of the algorithm C portion of the FOT was inadvertently run without enabling the moving-target alert portion of ACC, as described in Section 6.2.2.3. Therefore, had this not occurred, the stopped-object fraction of all ACC alerts would have been roughly 50% (that is, if there had been an approximate doubling of the 25 moving-target alerts, below, a 47/50 proportion between stationary and moving-target ACC alerts, respectively, would have appeared.)
- The 25 moving-target alerts observed under ACC control represent 35% of all ACC alerts (instead of the approximate 50% proportion mentioned above.) The table shows that one alert was triggered by a lead vehicle turning left, and three alerts were triggered when the host approached a slower lead vehicle that was at constant speed. The 21 remaining incidents of moving-target alert, however, involved lead-vehicle deceleration such that the alert essentially coincides with the moment at which the maximum ACC braking level, 0.3 g, was first requested by the system's controller.
- It is notable that only one ACC alert was caused by a scenario in which one or both vehicles were changing lanes. This single event is listed near the bottom of the table, showing that the preceding vehicle turned left. When FCW alerts were observed during manual driving in the FOT, this type of "transitioning-lane" scenario constituted a much greater fraction of all alert episodes.
- In summary, six of the 47 stopped-object alerts and 24 of the 25 moving-object alerts under ACC control appear to have involved a conflict posed by a vehicle

that impeded travel in the host's established path. Adjusting for the roughly-25 additional moving alerts that were not recorded, it would appear that approximately 55% of the ACC alerts match the kinematic profile of actual conflicts for which the system was designed.

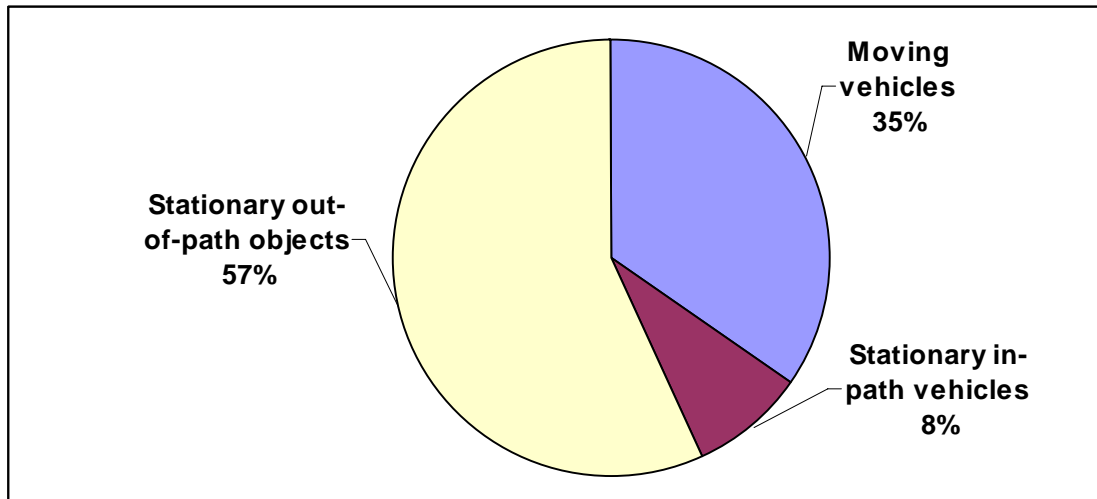

Figure 6.82. Breakdown of ACC alerts by target type

Table 6.13. Forward conflict scenarios associated with CCC and ACC alerts

Driving mode & target	Scenario index	Scenario	Alerts
CCC (stationary targets)	100	Stopped object, out of path	8
ACC (stationary targets)	100	Stopped object, out of path	41
	230	Approaching stopped lead vehicle	6
Subtotal – ACC stationary targets			47
ACC (moving targets)	220	Approaching constant speed lead vehicle	3
	240	Lead vehicle braking to an unpredictable stop	1
	250	Lead vehicle braking to a predictable stop	6
	260	Lead vehicle braking unpredictably, but not to a stop	4
	270	Lead vehicle braking unpredictably to a stop	10
	450	Lead vehicle ahead turns left	1
Subtotal – ACC moving targets:			25
Grand total – all cruise alerts			80

6.3.2.2 Road Types Associated with ACC Alerts

Figure 6.83 shows how ACC alerts are distributed across road types. Note that more ACC alerts occur on surface roads (36) than on freeways (28), despite the far greater ACC-engaged mileage that was traveled on freeways. Considering the respective ACC mileages traveled on these road groups, the ACC alert rate on surface roads is eight times that of the ACC alert rate on freeways.

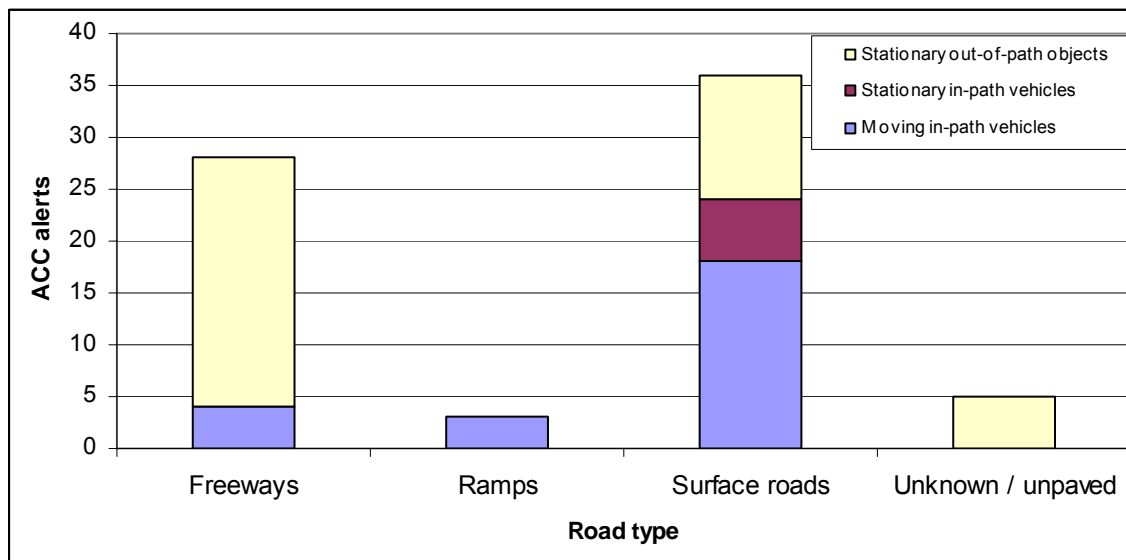

Figure 6.83. ACC alerts on different road types

Also noteworthy is that the freeway alerts are dominated by false triggers due to out-of-path objects such as road signs, overpasses or overhead signs. On the other hand, alerts on surface roads are triggered predominantly by in-path vehicles that are either moving or stationary.

6.3.2.3 Stationary ACC Alerts

Only seven alerts were observed to be triggered by an in-path stationary vehicle during the entire algorithm-C portion of the FOT. Of these, six occurred while ACC was engaged.

Figure 6.84 presents two sets of kinematic measures for the conflicts that provoked these six cases of ACC alert. At the left, the six alerts were triggered at times-to-collision between 2.75 and 3.25 seconds (these are not enhanced TTCs, but ranges divided by closing speeds). All six events were observed in the video record to have occurred on surface roads when the host vehicle was approaching another vehicle that had stopped at a red light or was proceeding to turn from the roadway.

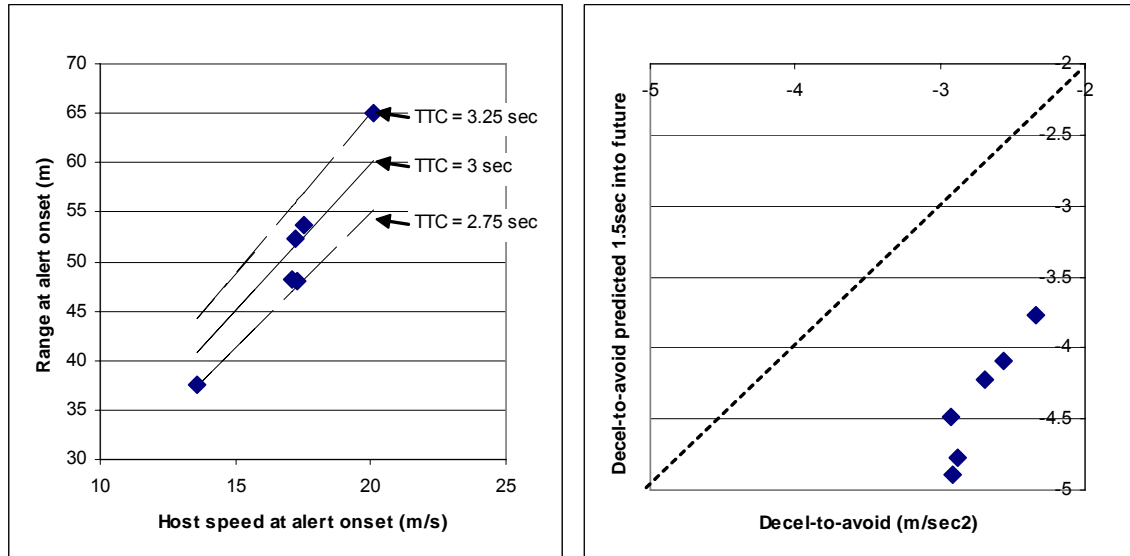

Figure 6.84. Kinematic conditions at the onset of stationary-target ACC alerts experienced by algorithm-C drivers

Note that the speeds at the moment of alert onset are rather high, given that ACC is still engaged within 37 to 65 meters of an in-path vehicle that is essentially stationary. These conditions suggest a rather notable context for ACC engagement on such roads. (Note that the speeds for these alerts involving in-path stationary vehicles are, nevertheless, much lower than those seen with the 41 ACC alerts triggered by out-of-path objects. In the latter case, a high-speed stereotype prevails since many of the out-of-path alerts occur on freeways.) It is noted that the four of the six ACC alerts triggered by in-path stopped-vehicles occur in week 2, suggesting the possibility that drivers may have been experimenting with the system. Another of the alerts was experienced by a driver that had received two such stopped-vehicle-ahead alerts in week 2. (No other drivers received more than one of these alerts.)

Looking at the plot to the right in Figure 6.84, we see that the six stationary, in-path alerts pose levels of decel-to-avoid above 0.35 g. If these alerts were actually to have served as the cue for driver intervention, such that a 1.5-second braking reaction time were yet to elapse following alert onset, then the ‘predicted-decel-to-avoid’ values on the vertical scale would suggest levels of decel-to-avoid of 0.37 to 0.48 g’s.

Inspection of the six individual records, however, shows that the longest delay in brake application following alert onset was 0.5 seconds (while the other five incidents did not exceed a 0.1-second delay.) These results suggest that the drivers had already appraised each of these situations and were moving toward the brake at the time of the

alert. The video records show that all the drivers were looking forward at the time of these alerts and that all of these events were in dry weather.

6.3.2.4 Moving-Target ACC Alerts:

Of the twenty-five moving-target alerts, twelve of the target vehicles were passenger cars, twelve were light trucks, vans, or SUVs, and one was a heavy-duty truck. All of these alerts occurred with the target vehicle in-path at the time of alert. ‘In-path’ is defined as either sharing the same lane as the host vehicle or obviously in the projected transient path of the host vehicle—for example if the host were in the process of changing to the target vehicle’s lane.

Times-to-collision and decel-to-avoid values are plotted for the moving-target ACC alerts in Figure 6.85. The data show that most of these alerts fall in the range of time-to-collision values between 3 and 10 seconds and at decel-to-avoid values between -1 and -2.5 m/s². As a group, they are substantially lower in conflict severity than are the stationary, in-path alert events shown above.

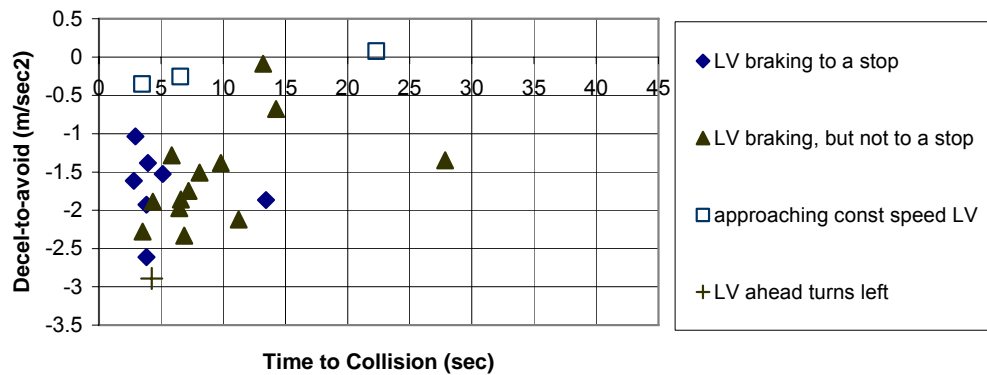

Figure 6.85. Kinematic conditions at onset of ACC moving-target alerts (algorithm C)

6.3.2.5 Speeds Associated with In-Path ACC Alerts

Figure 6.86 shows the distribution of host speeds at the time of alert onset, for those ACC alerts that are triggered by in-path vehicles, either moving or stationary. These speeds are relatively low, given the typical ACC speed-usage regime. Together with the distribution shown earlier for road type, the speed data further portray the stereotype that ACC alerts lie predominantly in the low-speed, surface-street environment.

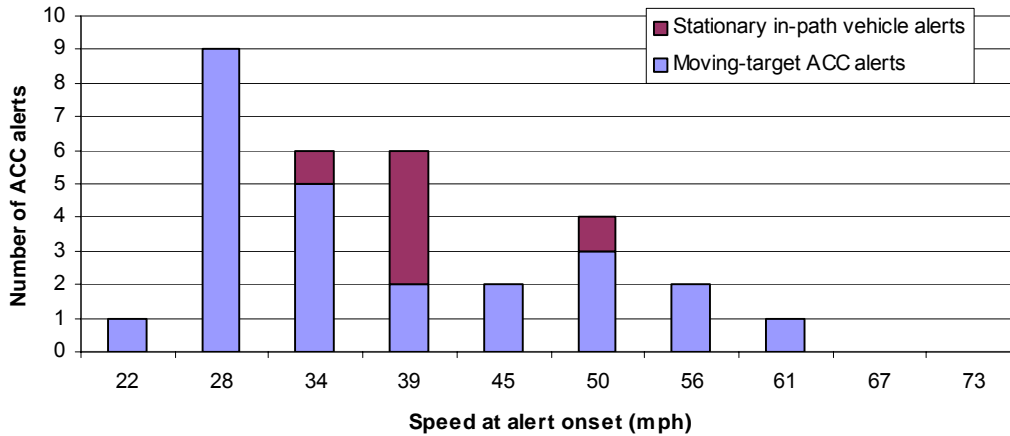

Figure 6.86. Host speed at onset of ACC in-path alerts. Bins have equal sizes, but labels have been rounded

There are not enough data to be confident that there are indeed different speed distributions for the moving and stationary in-path vehicle targets, as the figure might suggest. As will be shown in two different plots, below, the relatively large number of moving-target ACC alerts that occur at speeds of less than 17 m/sec (or 38 mph) is not because drivers have selected a set speed in that region but because the ACC control has already reduced speed to deal with the impediments of traffic before the ACC alert comes on.

For stationary-target ACC alerts, on the other hand, the ACC headway controller does not respond to the target such that the speeds-at-alert in Figure 6.86 tend to match the set-speed values in Figure 6.87. It is worth noting that no CIPV targets existed ahead of any of the six stationary vehicles, so that there were no occurrences during the ACC-driving portion of the FOT in which a moving vehicle ahead changes lanes to “reveal” a stopped vehicle.

6.3.2.6 Set Speeds Associated with In-Path ACC Alerts

Shown in Figure 6.87 is the distribution of set-speed values that complements the previous plot showing actual speeds at the time of the ACC alert onset. We see that while these set-speed values generally suggest the lower-speed travel on surface roads which tends to typify ACC’s in-path alerts, there are nevertheless several moving-target alerts corresponding to high-end set speeds.

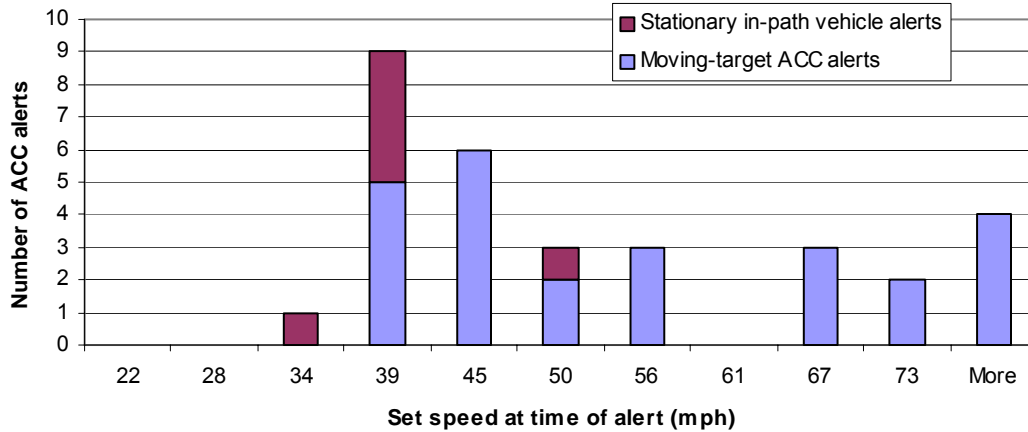

Figure 6.87. Set speed at onset of ACC in-path alerts. Bins have equal sizes, but labels have been rounded.

Figure 6.88 compares set speeds and actual vehicle speeds for the 25 moving-target ACC alerts and the 6 stationary in-path ACC alerts.

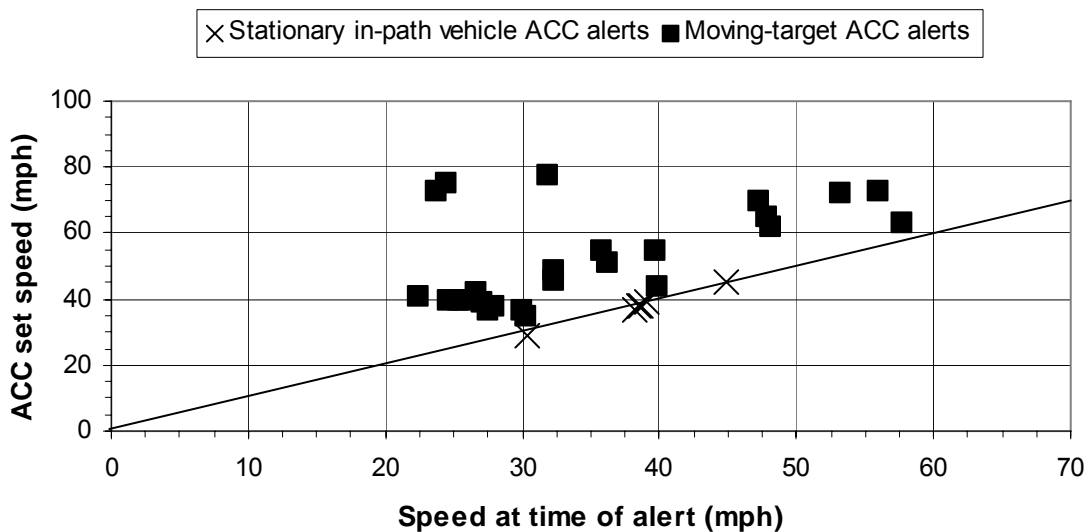

Figure 6.88. Set speed versus host speed at onset of ACC in-path alert

The set and actual speed values are shown relative to the location of a line denoting matched values of both. The figure reveals the following:

- Looking at the stationary-target alerts as a group, the values of set speed and actual vehicle speed are matched, as was discussed above. This is expected since the ACC controller does not apply autobraking for stationary targets, and since the events themselves are rather straightforward, with the ACC system having been tracking the target for some time before the alert occurred. Although not observed here, perhaps the only scenario by which an ACC stationary-target alert

could appear while the actual speed is less than the set speed would require that the ACC vehicle had been behind a slower-than-set-speed CIPV target, following which a lane transition reveals a stationary target just ahead, while the actual speed is still depressed below the set value.

- Looking at the moving-target alerts as a group, we see that the actual speed is always less than the set speed in these data. Cases showing the larger differences in these two speed values certainly reflect situations in which a slower-moving CIPV has caused a reduction in the host vehicle speed substantially in advance of the conflict that gave rise to the ACC alert.

In three of the moving-target alert cases, the ACC set speed was noted to be on the order of 50 mph higher than the actual speed at the time of alert. For illustrative purposes, each of these rather curious cases is briefly described below, based upon video review of the event. These all occur during the first week in which ACC is available to the driver, so there may be a novelty effect that is associated with these events.

- Driver 89/Trip 57/Time 89570, with Set speed=73mph. The vehicle is on a freeway exit ramp approaching a van rapidly. The driver is an older male and is looking ahead, with both hands on the wheel and is not involved in other activities. When ACC begins to decelerate, the closing speed is more than 20 mph. The ACC vehicle slows down to 56 mph while the van is proceeding around a substantial curve in the ramp, at which time the first alert sounds with the range-rate, or closing speed now at 12mph. The driver does not intervene, but lets the ACC engagement continue. The van pulls up to a stop sign at the end of the ramp, whereupon the second alert occurs while the set speed is at 73mph and the actual host speed is 25mph. Subsequently, the host driver applies the brake pedal to terminate engagement.
- Driver 71/Trip 36/Time 116310, with Set speed=75mph. The older-male driver has allowed ACC to slow him down on a ramp, following another car to a stop sign. When the host speed is 22 mph, the alert is presented, following which the driver is heard to chuckle out loud and then applies the brake pedal, terminating engagement.
- Driver 75/Trip 65/Time 51470, with Set speed=78mph. A young female driver has concluded an ACC-engagement episode while on an urban freeway has just exited onto a surface street, disengaging ACC through a brake application. After a traffic-light stop, she begins to accelerate and re-engages ACC at 27mph. At that time the set speed is 78 mph and she does not adjust it. The vehicle speeds

up quickly and within several seconds detects a vehicle almost stopped at a traffic light as it turns from red to green. The ACC then quickly applies brakes and slows to 29mph before issuing the alert. The driver is looking ahead and presumably paying attention at the moment of the alert, having just negotiated a traffic light, an intersection, and a curved roadway in the 15 seconds beforehand. After this alert, the driver re-engages ACC twice more with the same 78-mph value for set speed. These engagements proceed along urban surface streets, presumably with posted speeds around 40 mph. In the next of the engagements in this sequence of episodes, the car gets up to 52mph before the driver applies the brake pedal. In the final engagement in this series, the driver is following a vehicle that keeps her in the speed range approaching 50 mph, with a ACC gap setting of 1, i.e., the closest setting. The driver proceeds to pass this final vehicle and then has to brake for another traffic light, shortly before reaching her destination.

6.3.3 ACC Control Performance

The ACC system is controlled by a highly complex algorithm whose explicit definition is proprietary information. Thus, it is not possible to provide a rigorous description of the ACC controller in this report, although the reader is directed to Section 3.1.4 for available information that summarizes the ACC functional constraints. Nevertheless, a few measured samples of the ACC transient response are presented in this section as illustrations of the time-domain performance of the system. Responses to lead-vehicle-braking and cut-in disturbances have been selected for discussion here.

Response to Lead-Vehicle Braking

Shown in Figure 6.89 is a set of sample time histories from a period of ACC engagement in which the preceding vehicle (the CIPV) undergoes several up and down fluctuations in its speed, including an episode of significant braking that provokes a distinct autobraking response.

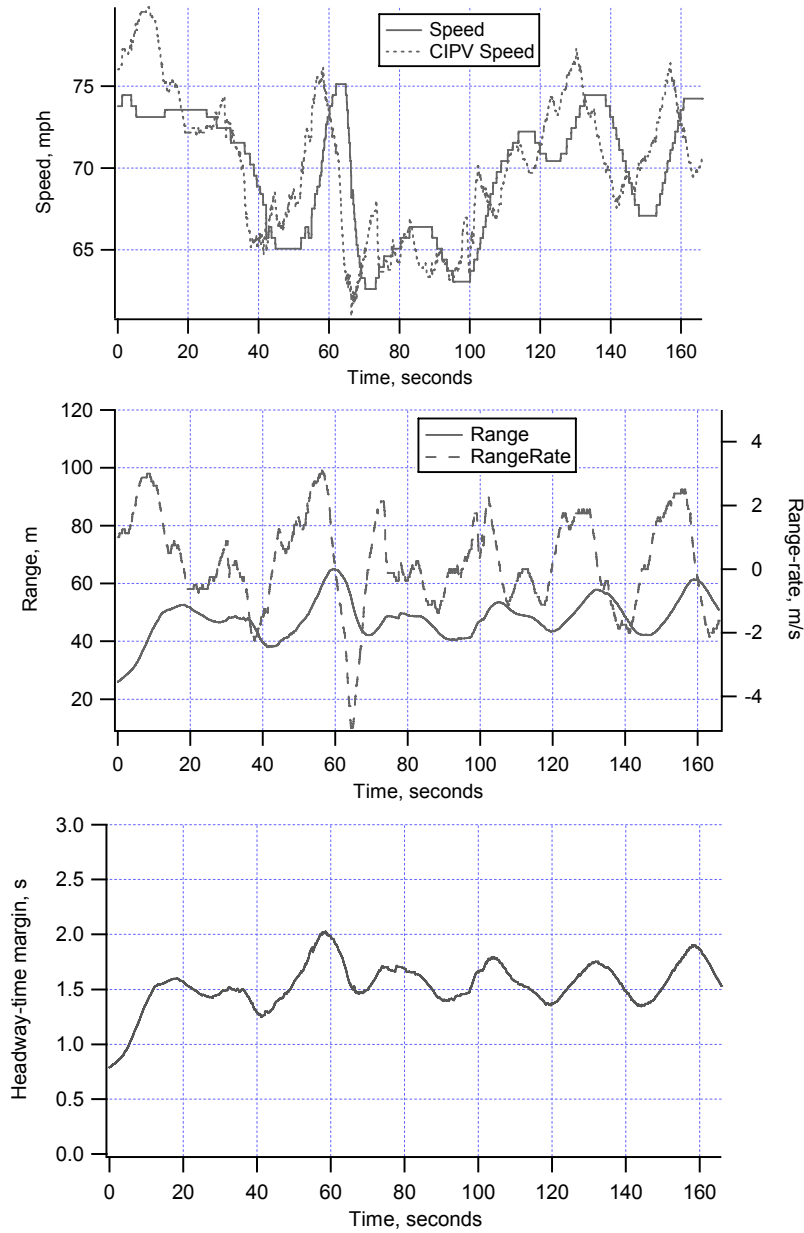

Figure 6.89. Time histories showing the ACC response to lead-vehicle braking

The ACC gap setting throughout this sequence was 1.6 seconds. The data show the following:

- The ACC controller tends to follow fluctuations in CIPV speed with a lag time on the order to 3 to 6 seconds.
- An approximate 0.16-g deceleration by the CIPV prevailed for approximately 2 seconds beginning at $t=63$ seconds on the top plot of the figure.

- The ACC controller responds to the lead-vehicle's deceleration after an approximate, 3-second delay, reaching a peak autobraking deceleration that modestly exceeds that of the CIPV.
- In the middle plot, the ACC autobraking response mitigates the negative-going spike in range rate at 65 seconds that follows the CIPV brake transient.
- The bottom plot shows that the ACC gap margin drops by approximately 0.5 seconds over the course of the braking transient but only undershoots the 1.6-second value of the gap-setting by 0.2 seconds, having briefly overshoot the desired gap setting by approximately 0.4 seconds at the time CIPV braking began.
- Range-rates, as disturbed by a generally-fluctuating speed at the CIPV, vary repeatedly over the range of ± 2 m/s throughout the sequence.
- Moreover, the ACC controller cannot be described as maintaining a "tight" headway loop, since the requirement to ensure driver comfort can only be met by the low-gain and jerk-inhibiting properties of the system.

Response to Cut-In Ahead of the ACC Host

Figure 6.90 presents a set of time histories showing the response of the ACC system to a cut-in event. A CIPV target appears at $t=10$ seconds, when the host speed is 75 mph.

The ACC gap setting throughout this sequence was 1.4 seconds. The plots show the following:

- The CIPV arrives ahead of the host at a speed of approximately 67 mph and settles into the host's lane at a more-or-less steady speed of 68 mph.
- The CIPV thus imposes a headway conflict by virtue of the negative range-rate condition that minimizes at approximately -4m/s , and a headway time of only 0.9 seconds, which is substantially less than the gap-setting value.
- The ACC controller responds by commencing a speed reduction within less than 1 second following the transition in CIPV identification.
- The deceleration response due to ACC autobraking is not severe, peaking in the vicinity of 0.07 g until the range-rate signal becomes positive and then continuing at a somewhat lesser rate for another 5 seconds while speed is further reduced so that the host vehicle gradually falls back toward the ACC gap-setting value for headway time.
- The net headway intrusion was thus allowed to reach a minimum of 0.7 seconds, or half of the ACC gap-setting value, without the ACC controller having invoked more than about 25% of its available deceleration authority to control the headway loop.

- The desired headway time of 1.4 seconds was not restored until more than 15 seconds following the arrival of the cut-in vehicle.
- The subsequent, more or less steady-state, control of headway time shows fluctuations of the order of ± 0.2 seconds or less, depending upon the constancy of the CIPV speed and, presumably, the prevailing grade.

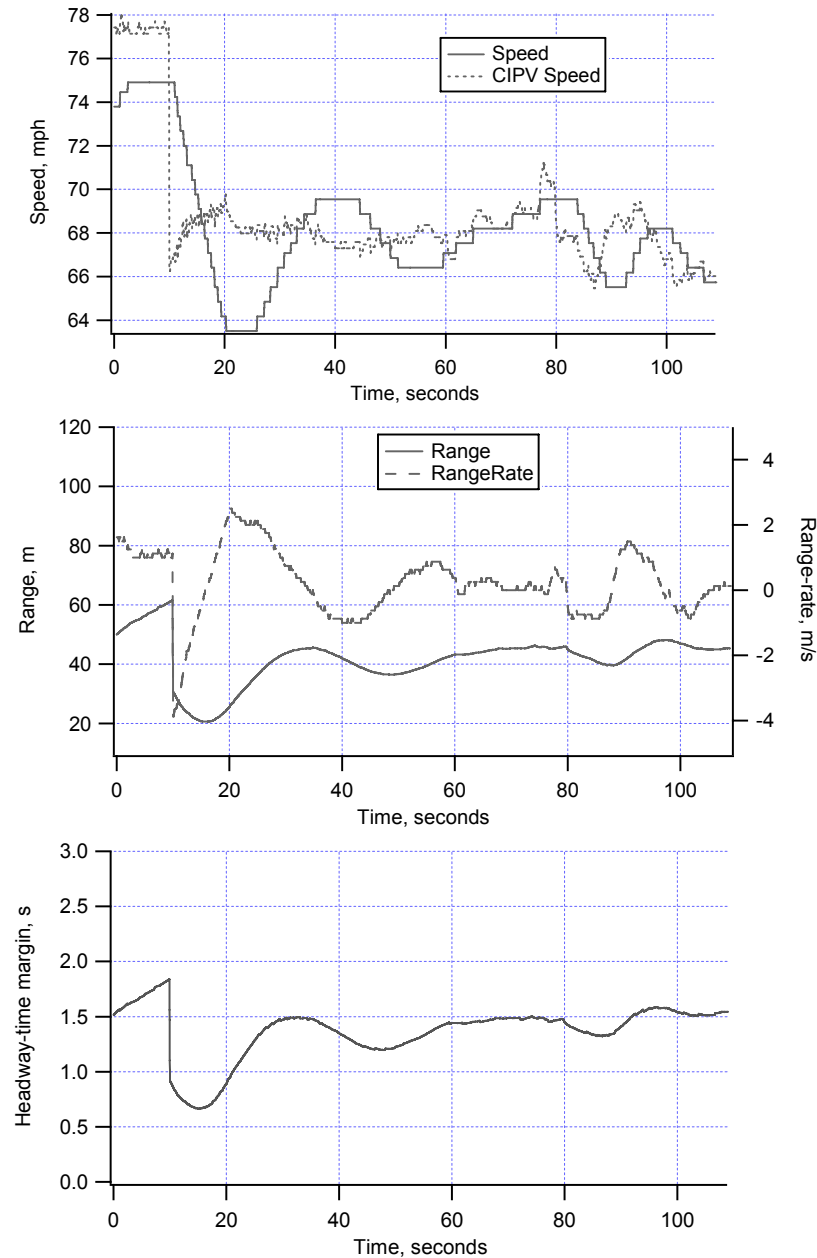

Figure 6.90. Time histories showing the ACC response to a cut-in episode

7 Presentation of Results – FCW Theme

This section presents findings that address the two central issues addressed in this report regarding FCW—potential safety impacts and driver acceptance. Section 7.1 describes the effects of ACAS on driver behavior with potential to impact safety, and Section 7.2 presents data and analyses addressing the driver acceptance of the ACAS system.

7.1 FCW Safety Results

In the U.S., the driver’s expected involvement as the driver of the striking vehicle in a police-reported rear-end crash is approximately once every 105 years. This is based on U.S. crash data for the year 2000, which finds that there were 1.816M police-reported rear-end crashes (Najm, et. al 2003) with 190.6M licensed drivers (USDOT, 2000). Because the FOT encompassed 137,000 miles of driver (on the order of 10 driver-years of data), the probability of a police-reported crash involving the ACAS vehicle striking the rear end of another vehicle was not expected to be high. Therefore the analysis addressing FCW safety was always targeted at surrogate measure of safety.

This section uses data collected on-board the FOT vehicles to look for evidence of changes in drivers’ behavior that may impact safety. This report does not attempt to estimate the potential crash- or harm-reduction benefits of ACAS or a similar countermeasure system. Instead, within this report, a set of safety-related hypotheses and assumptions that are described in Section 7.1.1 are used to analyze the FOT data to address the following potential safety-related effects:

- Impacts on steady-state headway distance behavior (Section 7.1.2),
- Impacts on the number and severity of transient forward conflicts (“closing approaches”) that drivers experience (Section 7.1.4, using the characterizations of baseline behavior in Section 7.1.3),
- Impacts of FCW imminent alerts on braking responses to associated conflicts (Section 7.1.5.1)
- Impacts of FCW cautionary alerts on prolonged episodes of shorter headway-distance behavior (Section 7.1.5.2),
- Examples of FCW alerts that may have had actual safety benefits during the FOT (Section 7.1.6), and,
- Impact of ACAS on drivers’ decisions to engage in secondary activities, e.g., cell phone conversations (Section 7.1.7).

This combination of surrogate measures of safety and driver-behavior observations will allow a fairly broad investigation into the safety issues impacting the suitability of a

countermeasure such as the ACAS system for widespread deployment. Conclusions from the sections within this section are summarized in Section 7.1.8.

Finally, safety benefits of a rear-end crash countermeasure will depend strongly on driver acceptance of the system, i.e., drivers perceiving enough value of FCW so that drivers will purchase the system. The acceptance of the system is treated later, in Section 7.2. Overall conclusions can be found in Section 10.

7.1.1 FCW Safety Hypotheses

The main hypotheses addressed in studying FCW safety are:

1. Safety issues may be addressable through the use of surrogate measures. Since the scope of the FOT is necessarily limited, insofar as no crash data have been collected, the analyses make use of the non-crash data set that has been generated.
2. Effects of ACAS on driving behavior may include the following influences that will be studied individually:
 - ACAS may affect behavior in the control of headway in quasi-steady state following situations (Section 7.1.2 and 7.1.5.2).
 - ACAS may affect the rate or the frequency of forward conflict with a lead vehicle, as measurable using longitudinal kinematics quantities (Section 7.1.4).
 - ACAS alerts may induce appropriate or inappropriate control responses by the driver (Section 7.1.5).
 - Driver responses to ACAS may change over time (Section 7.1.6).
 - ACAS may change drivers' decisions to engage in secondary tasks in the vehicle, thereby possibly reducing or increasing driver attentiveness to the driving task (Section 7.1.7).

Regarding the analyses that explore these hypotheses, important assumptions include:

1. Classic metrics of forward closing-approach conflicts are sufficient to identify any changes in forward conflict severity or frequency.
2. Drivers vary their rules for managing headway times and closing approaches depending on the driving scenarios, and this needs to be considered in the analyses.

7.1.2. *The Influence of ACAS¹ on Headway Keeping during Manual Driving*

The data of the FOT provide substantial evidence that the presence of ACAS¹ influences headway-keeping while following other vehicles in *manual* driving in a manner that results in *less tailgating*. The observed effect of ACAS occurs primarily under those driving conditions where tailgating is seen to be most common: on limited-access roads, as opposed to surface roads, and under well-lit conditions, as opposed to darker conditions. The presentation that follows supports these assertions.

All the analyses presented below concentrate on headway-keeping during what could nominally be called *following situations* under *manual control*. That is, the data selected for analysis are confined to situations during which (1) cruise control, be it CCC or ACC, is *not* engaged, (2) range rate to the vehicle ahead falls in the range of ± 2 m/s (4.5 mph), and (3) headway-time-margin falls in the range of 0.25 seconds to 3.05 seconds.² All analyses are also restricted to times at which the host vehicle's speed exceeds 11 m/s (25 mph). The analyses examine distributions of headway-time-margin while these conditions hold with ACAS disabled and ACAS enabled, respectively, and demonstrates that the observed differences with and without ACAS are statistically significant. Moreover, all the analyses of this section deal only with the driving of vehicles equipped with ACAS algorithm C.

To begin, consider Figure 7.1. This figure displays histograms of headway-time-margin while following (per the above conditions and without additional filters) for two individual FOT drivers during their first weeks when ACAS was disabled.

Note that in this figure and others that follow in this section, the bin width for the histograms is 0.1 seconds of headway time margin. Each data point represents a bin and the points are shown at the center of the bin. These two particular individuals were chosen to illustrate the range of following behavior among the FOT drivers. That is, the data show these two individuals to be the *closest follower* and the *farthest follower*, respectively.³

¹ This section is included within the larger discussion on FCW as it seems likely that the portion of the ACAS system that drives the results discussed here is, indeed, FCW. However, some influence of ACC cannot be ruled out. For example, at least some fraction of the data examined will have been gathered shortly after the drivers disengaged cruise control. In later analyses, other filters will be applied to limit potential for this and other influences.

² All histograms in this section are based on headway-time data that have been organized into bins of 0.1-second width with bin centers ranging from 0.3 seconds to 3.0 seconds. Thus, the lower edge of the lowest bin is 0.25 seconds and the upper edge of the highest bin is 3.05 seconds. In the text, reference will be made only to the center value of these bins.

³ The criterion for this choice was the cumulative percentile of following time at the headway time margin of 1 second.

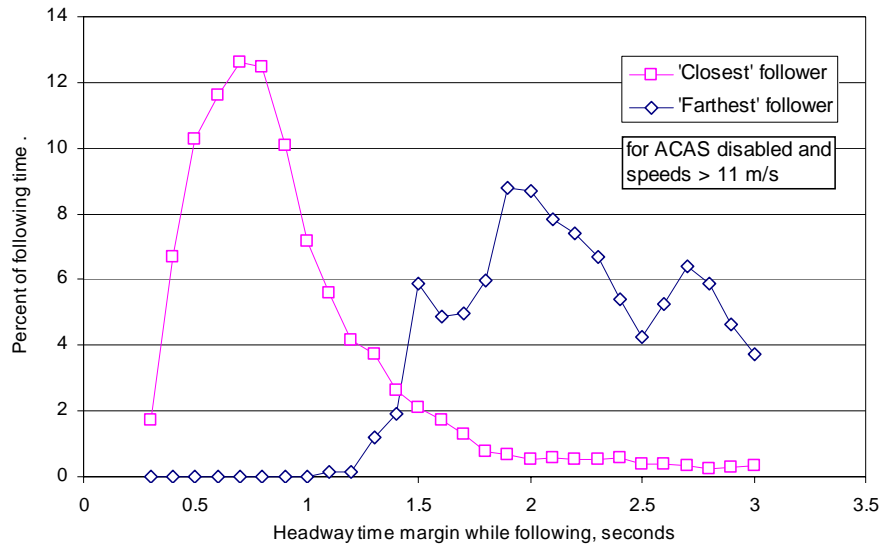

Figure 7.1. Histograms of headway time margin while following for the *closest follower* and the *farthest follower*, respectively, with ACAS disabled

The figure shows that, during the first week of FOT experience, the closest follower did the majority of his/her following with headway time margins of less than 1 second and that his/her most-likely headway time margin was in the range of 0.65 to 0.75 seconds. On the other hand, the farthest follower, also during the first week, did the majority of his/her following with headway time margins in excess of 2 seconds and was most likely to follow with a 1.9 second margin. Moreover, this driver *never* followed with a headway time margin of 1 second or less during this week.

Figure 7.2 adds two more histograms to those in Figure 7.1. The new histograms are for the same two individuals, respectively, but they are for performance during weeks 2 through 4 when ACAS was enabled. The data appear to indicate that in the latter three weeks, the closest follower did not follow quite so close and the farthest follower did not follow quite so far away. Regardless of whether these small changes in performance resulted from the introduction of ACAS (these changes could just as well have resulted from other influences; in this case regression-to-the-mean seems a good candidate), it is clear that the large difference between the performance of the individuals was maintained with or without ACAS.

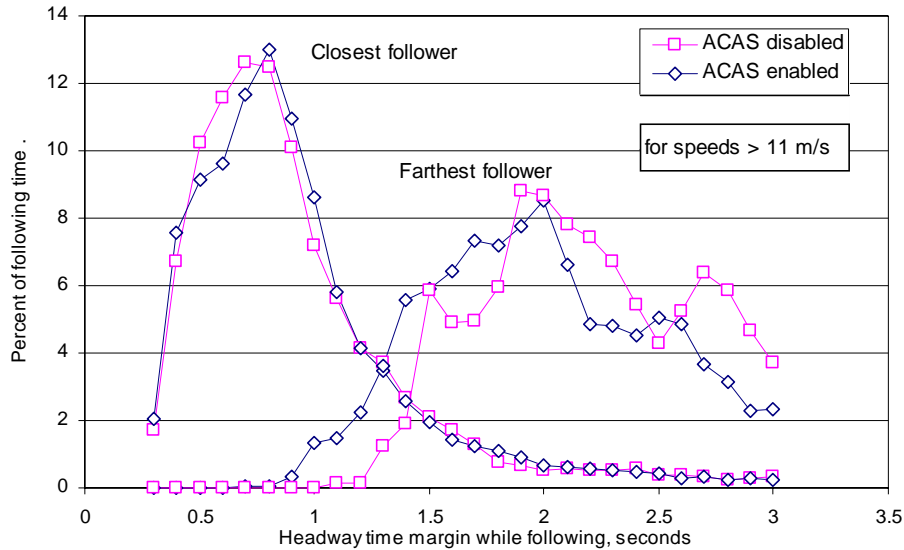

Figure 7.2. Histograms of headway time margin while following for the *closest follower* and the *farthest follower*, respectively, with ACAS disabled and enabled

The important question at hand, however, is not whether ACAS influenced the performance of the two drivers chosen as examples, but whether or not ACAS has a statistically significant influence on the behavior of drivers in general as indicated by the sample of drivers in the FOT. To begin to address this question, two histograms were generated for each of the 66 algorithm-C drivers, one for driving with ACAS disabled and one for driving with ACAS enabled (for a total of 132 histograms). The influence of ACAS on headway time margin while following was then evaluated by examining the differences between these 66 matched pairs of performance distributions. The following steps were taken:

- All of the individual distributions were cumulated.
- For presentation purposes, “average” cumulative histograms for the ACAS-disabled and ACAS-enabled conditions, respectively, were produced by plotting the means of the individual cumulative percentiles (i.e., at each of the values of headway time margin) for each set of 66 samples (i.e., the ACAS-engaged and ACAS-disengaged sets). These average, cumulative histograms are shown in the upper portion of Figure 7.3.
- For analysis purposes, the differences (at each of the values of headway time margin) between each of the 66 matched pairs (the ACAS-engaged and ACAS-disengage for each driver) of cumulative histograms were determined. At each headway time margin, the mean of the differences and the 95 percentile confidence interval on that mean were determined. These are plotted on an expanded scale in the lower portion of Figure 7.3.

Figure 7.3 shows a clear tendency for a reduction in the fraction of following time when headway time margins are less than 1 second and a corresponding increase in the fraction of following time when headway time margins are larger than 1 second.

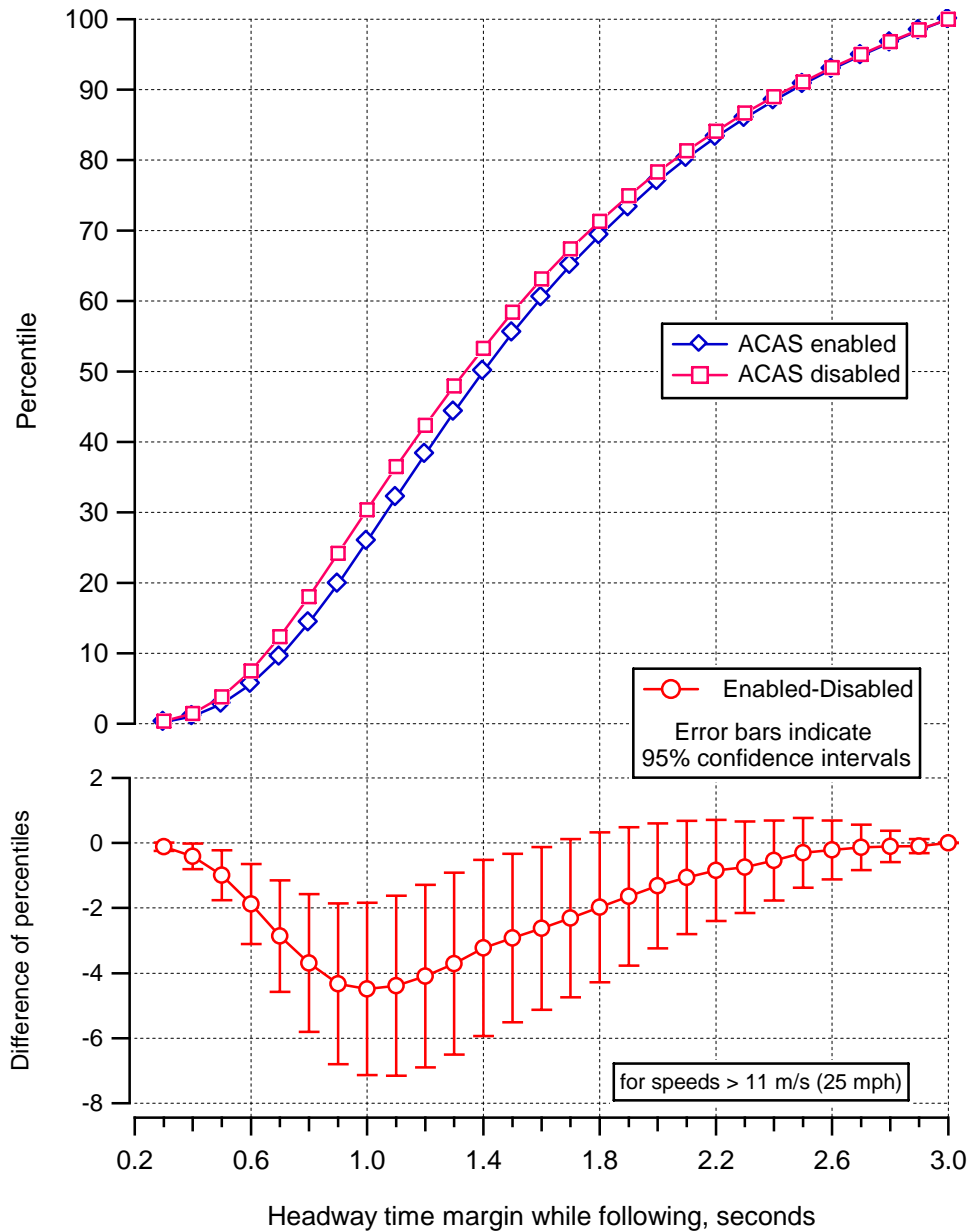

Figure 7.3. Means and differences of the cumulative histograms of headway time margin while following for driving with ACAS disabled and ACAS enabled

That is, in the upper portion of the graph, the mean cumulative distribution with ACAS enabled generally lies to the right of the mean cumulative distribution with ACAS disabled. More specifically, in the lower portion of the graph, the consistently negative slope of the plot over the range of headway time margins from 0 to 1 second, indicates

that in each individual 0.1-second bin in this range, the fraction of following time was less with ACAS enabled than with ACAS disabled.

Conversely, for headway time margins greater than 1 second, the slope of this plot is always positive indicating that for each bin in this range, the percentage of following time was greater with ACAS enabled than with ACAS disabled. Moreover, the error bars showing the confidence intervals of the differences suggest that the differences are statistically significant over the range of headway time margins from 0.4 seconds through 1.6 seconds. (That is, in this range, the 95-percent confidence intervals of the differences do not cross zero.) The observed difference in the means of the cumulative percentiles is largest (most negative) at the headway time margin of 1.0 seconds. At this 1-second margin, the difference of the means is -4.33% and Student's t-test on this set of data (i.e., the 66 matched pairs) yields a probability of 0.0015. In fact, similar tests yield probabilities of less than 0.01 for the observed differences of the means over the range of headway time margins from 0.6 through 1.2 seconds. In the vicinity of 1-second headway time margin, the nominal values of the mean percentiles with and without ACAS are 25.9 and 30.4, respectively, i.e., the nominal value of the reduction of the mean percentile with ACAS is 4.5. Thus, at this point of strongest influence, the observed reduction of the mean is about 15 percent of its initial value.

Consequently, with rather high confidence, it can be said that the presence of ACAS can be expected to influence following behavior of the general population of drivers in manual driving in a manner that would reduce the fraction of following time spent at low headway time margins.

The above considers only the presence or absence of ACAS as the independent variable influencing headway-time-margin. After some initial exploration, four multifactor, repeated-measures analyses of variance (multifactor ANOVA) were conducted to examine the potential for cross influence from other objective factors along with ACAS while also filtering the data to reduce the potential of confounding influences. The other factors that were included in these analyses were:⁴

- driver's age group (younger, middle-aged, or older),
- lighting condition (well-lit or darker, per the vehicles' light sensor)

⁴ Other factors initially considered but dropped from the analyses, having been found to be insignificant, included driver's gender and seasonal influence (binary: July through October 15 and October 16 through February). FCW sensitivity setting was also considered for use as an independent variable, but has been treated separately. This is discussed further at the end of this section.

- road type (limited-access, i.e., classes 1 and 2, or major surface roads, i.e., classes 3, 4, and 5; driving on ramps and minor surfaces roads was excluded), and
- traffic density (sparse, moderate, or dense; see Section 5.8).

Driver's age group was handled as a covariant. Lighting condition, road type, and traffic density were introduced through the use of multiple dependent variables, namely, the cumulative percentiles at the 1-second headway time margin for the full matrix of those conditions. The cumulative percentile at 1 second was chosen as the primary measure because it had been seen in the histogram analysis to be the strongest indicator of the influence of ACAS on headway time margin. (Moreover, these percentiles were calculated directly from the database, not by manipulation of the histogram data as described above.)

Two additional filters were applied to the data for the multifactor ANOVAs. (1) In two of the four analyses, data from week 2 (the first week of ACAS use) were not used in order to reduce the potential for the influences of novelty and learning. (2) In two of the four analyses, data from time periods of 15 seconds immediately following disengagement of cruise control were excluded. The purpose of eliminating these data was to minimize the potential effects of the different influences of ACC and CCC that might linger briefly following disengagement. The four multifactor ANOVAs arise from the four combinations of applying or not applying these two filters, respectively. The four analyses gave rise to largely the same results. The discussion in the text that follows is based on the analysis using both filters. Details of the results of the four approaches appear in Appendix K.

The results of the multifactor ANOVA revealed that road type, age group, lighting condition, and traffic density all have a *main effect* on *the cumulative percentile of headway time margin of 1 second*. The strength, in terms of differences of the means, and the significance of these effects are listed in Table 7.1.

Table 7.1. Main effects on the cumulative percentile of headway time margin of 1 second

Source	Percentile means, %		Difference in the means	
			%	Sig
Road type	limited-access 32.6	major surface 14.7	17.9	.000
Age group	younger 29.1	older 14.9	14.2	.001
	middle-aged 26.9	older 14.9		
Lighting	well-lit 27.1	20.2	7.0	.000
Traffic density	moderate 25.4	22.0	3.4	.019

Given the polarity of the differences, these results indicate that *tailgating* (i.e., the tendency to follow with headway time margin equal to or less than 1 second), is (1) more prevalent on limited-access roads than on major surface roads, (2) more prevalent among younger and middle-aged drivers than among older drivers,⁵ (3) more prevalent in well-lit conditions than in darker conditions, and (4) more prevalent in moderate than in sparse traffic conditions.⁶

While the multifactor ANOVA did not show a main effect of ACAS, it did show ACAS to have two *main effects on the cumulative percentile of headway time margin of 1 second*: This measure was significantly reduced with ACAS enabled (1) for driving in well-lit conditions (but not in darker conditions) and (2) for driving on limited-access roadways (but not on surface roads). The strengths and significance of these two-way influences are shown in Table 7.2.

Table 7.2. Two-way effects of ACAS on the cumulative percentile of headway time margin of 1 second

Source	Percentile means, %		Difference in the means	
	ACAS disabled	ACAS enabled	%	Sig
In well-lit conditions	29.2	25.1	4.1	.019
On limited-access roads	34.5	30.8	3.7	.040

This seems an intuitively pleasing result as it implies that ACAS reduces the tendency for tailgating *under conditions where tailgating is more prevalent*. (Conversely, ACAS could hardly be expected to reduce tailgating where tailgating was not prevalent.) That is,

⁵ The age effect appears to be progressive, but the difference between younger and middle-aged groups is smaller ($p = .022$) and does not approach statistical significance. See appendix K.

⁶ The observed mean for dense traffic lies between the means for sparse and moderate traffic and is not significantly different from either. See appendix ERD2. The difficulty of measuring traffic density may play a role in this apparent inconsistency. See section 5.8.

we have seen that (1) tailgating is more prevalent in well-lit conditions and ACAS reduces tailgating in well-lit conditions, and (2) tailgating is more prevalent on limited-access roads and ACAS reduces tailgating on limited-access roads. However, this same point of view might also raise the question as to why ACAS does not have a significant effect on younger or middle-aged drivers or in moderate traffic conditions. Figure 7.4 addresses this issue. The graph on the left deals with the two-way influence of ACAS and age group.

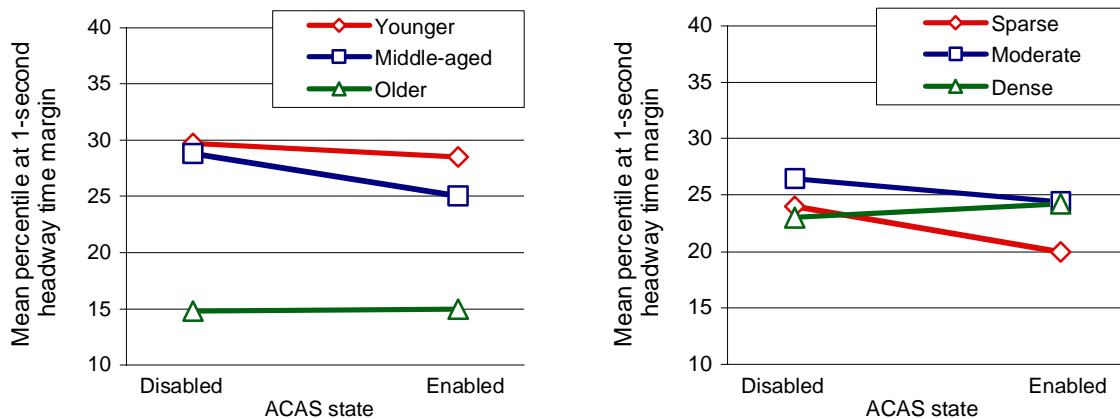
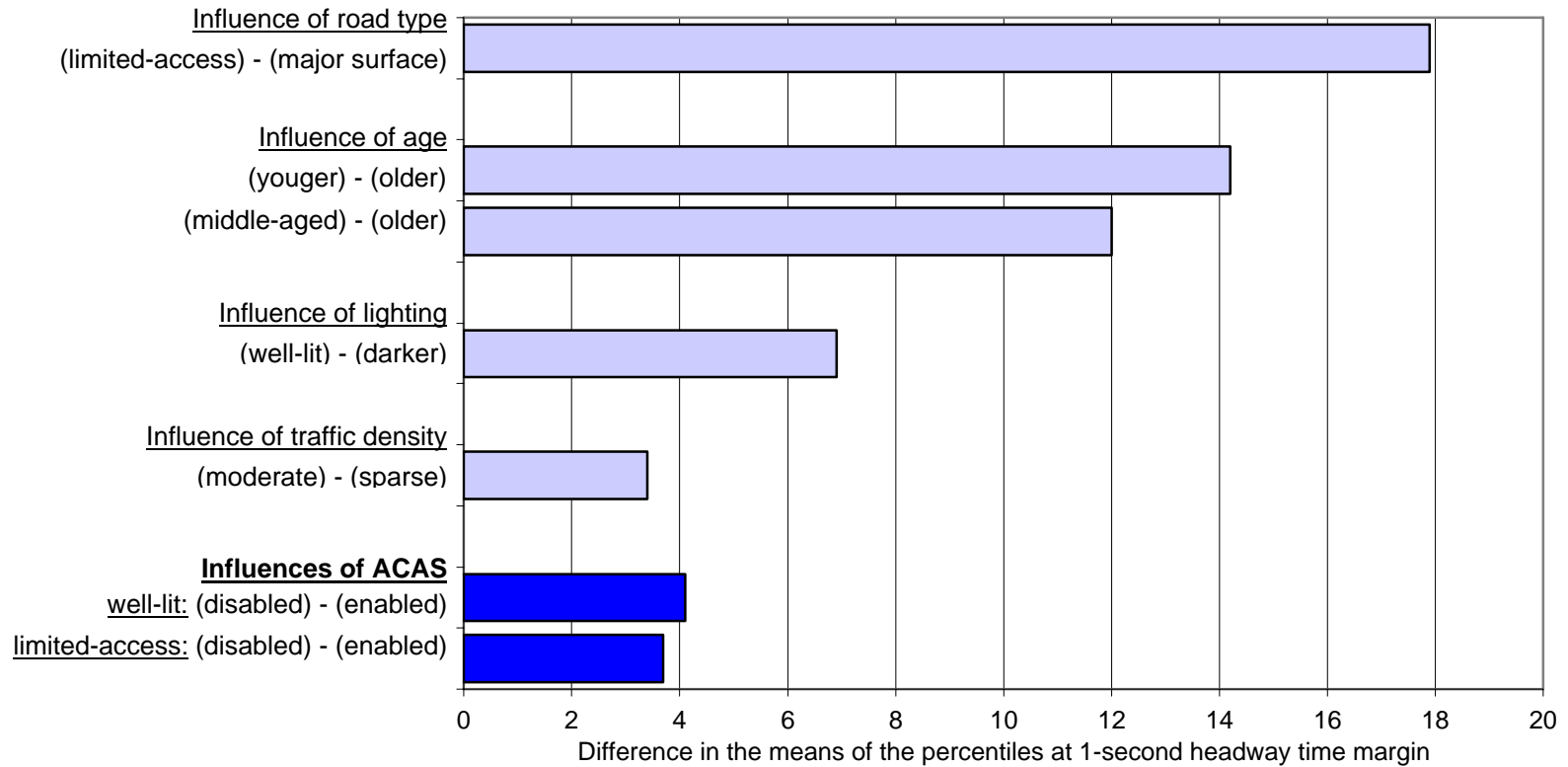

Figure 7.4. Mean percentiles for the two-way effects of ACAS x age group and ACAS x traffic density

While the influence of ACAS may not be statistically significant within any of the age groups, the observed differences in the means shown in the graph on the left at least suggest that ACAS reduces tailgating in the younger and middle-aged groups. In the graph on the right, however, the overall effect of traffic density is shown to be rather weak and inconsistent. Again ignoring the lack of significance, the suggestion would be that ACAS was a bit more effective at reducing tailgating in sparse traffic than in moderate traffic.

Figure 7.5 summarizes and compares the statistically significant differences of the 1-second percentile means derived from the multifactor ANOVA. In addition to this comparison of the relative strengths of the several influences on the tendency for, recall that Figures 7.1 and 7.2 clearly illustrated the strong influence of individual driving style can have on following behavior.



- Notes: 1) A positive value indicates a tendency for more tailgating in the first condition than in the second condition.
 2) Percentile at 1-sec HTM = (time spent following with HTM ≤ 1 sec) / (time spent following) x 100.
 3) Analysis uses only data from vehicles using ACAS algorithm C on limited-access roads (road classes 1 and 2) and major surface roads (road classes 3, 4, and 5) and traveling at speeds > 11 m/s (25 mph).
 4) Analysis excludes data from 15-second periods immediately following disengagement of cruise control (CCC or ACC).
 5) Analysis excludes data from week 2 (i.e., ACAS disabled = week 1; ACAS enabled = weeks 3 and 4).

Figure 7.5. Comparison of the strengths of factors influencing the tendency to tailgate

The difference between the percentiles of following time at 1-second headway time for the *closest* and *farthest* followers, calculated using the same data filters as used in the multifactor ANOVA, is, in fact, 73%. Comparing this difference (73%) to the largest difference shown in Figure 7.5 (18%), it is apparent that the individual has the potential for the greatest influence on this aspect of driving performance. This is in keeping with similar findings in other studies of driving behavior (Winkler et. al, 2002, and Fancher et. al, 2003)

Finally, each driver's favored FCW sensitivity setting was considered for use as a between-subjects factor in formulating the multifactor ANOVAs that have been discussed. Favored setting was *not* used, however, as it was felt that this factor was, in essence, a behavioral choice of the driver that was too closely related to the behavior being examined. (That is, a driver's choices of favored headway-time-margin and of favored sensitivity setting may be seen as two, closely related symptoms of the same behavioral tendency.) Instead, this factor and the percentile at 1-second headway-time-margin were examined for correlation.

Using the same data filters as used in the multifactor analysis discussed above, these two factors were found to have a Pearson correlation factor of -0.208.⁷ The negative polarity of the correlation indicates that those drivers who tailgated more (higher percentile) tended to favor a lower sensitivity setting.

7.1.3 Identifying Levels of Conflict in Forward Closing Situations

This section presents distributions of metrics associated with forward-closing conflicts during baseline driving. This provides basic knowledge to support Section 7.1.4, which directly investigates possible change in driving behavior (as described by these metrics) when the ACAS system is available to the driver. This section also compares conflict levels within data sets representing different types of driving scenarios, specifically a set of events with only *IHP-scenario* events and a set of events with a *mixed-scenario* set of events that includes both IHP and THP events. (See Section 5.3 for the definition of classes of driving scenarios, including IHP, THP, and OHP.)

The metrics used to identify the events include time to collision (TTC) and decel-to-avoid, but the conflict levels are measured with enhanced TTC (ETTC) and decel-to-avoid. (Section 5.7 defined these metrics.)

⁷ This correlation factor ranged from -0.201 to -0.226 with data filters as used in all four analyses. Larger negative correlations were associated with the inclusion of data from week 2.

7.1.3.1 FCW Conflict Study Set

Potential conflict episodes are identified in the data through a series of database queries. These queries have been validated using manual review of video to ensure that the general intent of the automatic capturing of data is satisfied. The events that are identified with the queries comprised what is called the *conflict-study set* that numbers a total of 44,827 distinct events during manual driving with algorithm C, where the host driver encounters another vehicle in the forward direction with a defined amount of potential conflict. The events are identified using the following conditions:

1. The host speed must be at least 11.5 m/s (25 mph).
2. Cruise control must not be engaged anytime during the episode, or within 5 sec of the start and finish of the episode. This focuses the analysis on manual driving.
3. Forward-conflict kinematics satisfy conditions illustrated in Figure 7.6 below. These rules use TTC and decel-to-avoid. The shape of the region in the figure was developed by observing conflicts in the FOT data and video. The region was intended to capture events that appeared to require driver attention and, in some cases, direct action, in order to avoid conflict with a preceding lead vehicle.
4. Episodes satisfying these conflict conditions are then merged together if they are within eight seconds of one another, in order to mitigate the possibility of a single real-world episode being used more than once in the analysis.

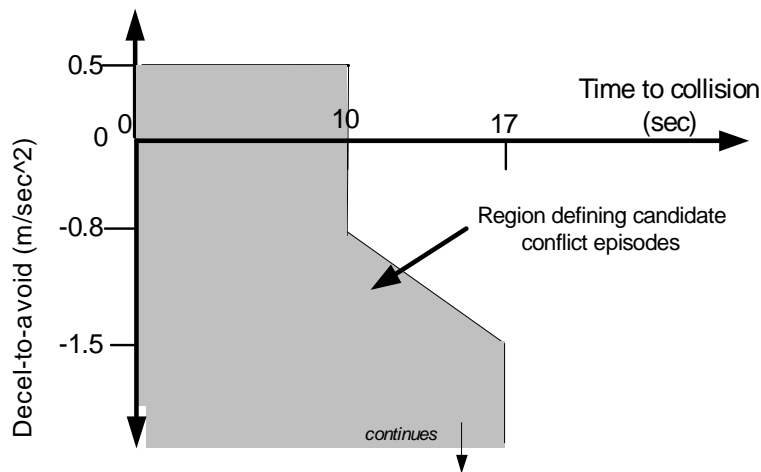

Figure 7.6. Kinematic conditions used to identify potential forward conflicts

The kinematic space represented by the decel-to-avoid and time to collision axes in Figure 7.6 is only a conceptual device. These two variables are not orthogonal, and a single point in this space can represent an infinite combination of ranges, speeds, and accelerations. Forward conflicts require at least four variables for a full description: the range, the speeds of the two vehicles, and the accelerations of both vehicles. Time-to-

collision only depends on the range and the closing speed, but the decel-to-avoid relies on both speeds, the range, and the lead vehicle deceleration.

A subset of the conflict study events are called the IHP-scenario event set, and is identified by applying an additional set of constraints:

1. The same moving target (vehicle) is present during the entire time that the episode is within the conflict domain shown in Figure 7.6 above. Furthermore, that same target vehicle was present four seconds before the kinematics entered the domain, and remained present four seconds after leaving the domain. This conservative constraint seeks to identify only events which are indeed IHP events.
2. There are no lane changes within 5 seconds of the episode's kinematics falling into the conflict zone of Figure 7.6.
3. The event is not within 5 seconds of the start or end of the trip (since the routine for evaluating events requires 5 seconds before and after the conflict thresholds are satisfied).
4. The centroid of the lead vehicle radar return is within 1.3 meters laterally of the host vehicle's center. This constraint is only applied at the moment of entering and exiting the conflict zone.

A total of 16,584 IHP-scenario events are identified in this manner (37% of the conflict study set).

The algorithm that identifies IHP-scenario events was validated by using results from the post hoc video-based assignment of scenarios of the FCW imminent alerts, as described in Section 5.3. That data set serves as a ground truth for the automatic scenario-identification routine. The automatic algorithm for identifying IHP events correctly captures the data containing 107 of the 208 alerts that were coded as IHP alerts in the video-coded set (for a true positive rate of 51% and false negative rate of 49%). On the other hand, for the remaining 734 alerts that the manual scoring of video identifies as non-IHP scenarios, i.e., THP or OHP scenarios, the automatic algorithm identified only one of those as a IHP scenarios (true negative 99.8%; false positive 0.2%). This performance, together with the large number of events, is considered acceptable for evaluating differences in driver management of conflicts between IHP scenarios and other moving-target scenarios.

The high number of false negatives (misses) of the IHP-scenario identification algorithm is due in large part to the conservative requirements disallowing changes in lead vehicles or host lane changes. Consequently, the remaining events (the mixed-scenario set) contain many IHP events. Other mixed-scenario events will be THP events

and a smaller number of moving-target OHP alerts, e.g., false alerts due to adjacent-lane traffic. The approximate partitioning of events, however, is still quite useful and allows a focus on the IHP events, which represent the most important scenarios for studying approach behavior most directly relevant to potential rear-end crashes.

7.1.3.2 Braking Behavior and Maximum Conflict Levels Associated with the Conflict Set

Driver braking behavior associated with the IHP conflicts is quite different from braking behavior associated with the mixed-scenario events. To show this, the set of events that occur during the first week’s baseline period were studied. First, it is found that braking begins earlier in IHP events. One demonstration of this is to determine whether driver braking occurred before the conflict zone was entered; both before and after the conflict zone was entered; only after the zone was entered; or whether braking never occurred during the event. Figure 7.7 shows the corresponding results for the baseline week’s 4,151 IHP events and Figure 7.8 shows the results for the 7,277 non-IHP events. For IHP events, braking occurs in 93% of the situations. For the remaining 7%, braking may not occur because the conflict is resolved by the lead vehicle speeding up, or the host vehicle “throttle-off” state is adequate. The same figure shows that half of all the IHP events involve driver braking before the conflict zone is entered. This supports the assumption that this zone is within the region in which drivers would normally be responding to the situation.

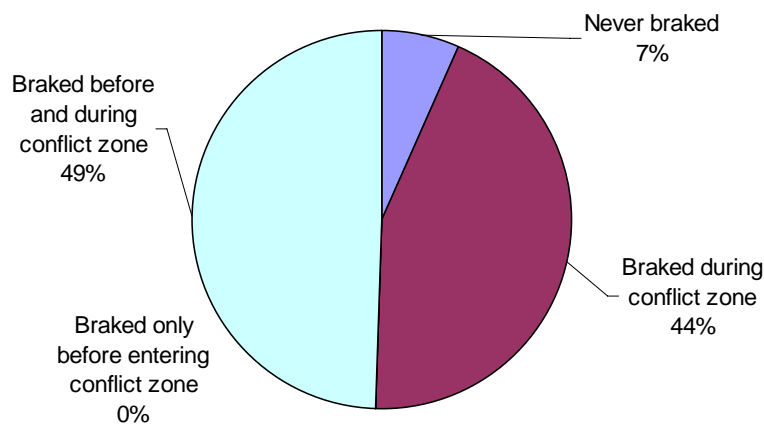

Figure 7.7. Driver braking behavior computed over IHP-scenario event set (baseline, algorithm C)

In comparison, Figure 7.8 on the next page, which addresses the events left over from the IHP identification process, shows that only 76% of these situations involve driver braking of some kind.

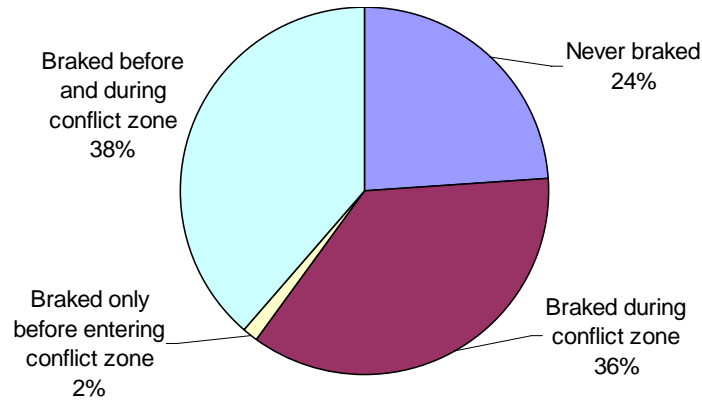

Figure 7.8. Driver braking behavior computed over the set of mixed-scenario events (baseline, algorithm C)

The remaining 26% of events without braking include scenarios in which the host driver does not brake because either (1) the lead vehicle is speeding up (or the host “throttle-off” is adequate), or (2) the conflict is resolved by lateral motion of one or the other vehicles, or (3) both of the above. Note, too, that fewer braking events occur before the conflict zone is entered (38% versus 49% for IHP events).

Brake onsets that occur within the conflict region tend to occur relatively soon after the trajectory of an event has entered the region, as suggested by Figure 7.9, which is a histogram of the time to collision and decel-to-avoid values at the brake onsets for the identified IHP scenarios events.

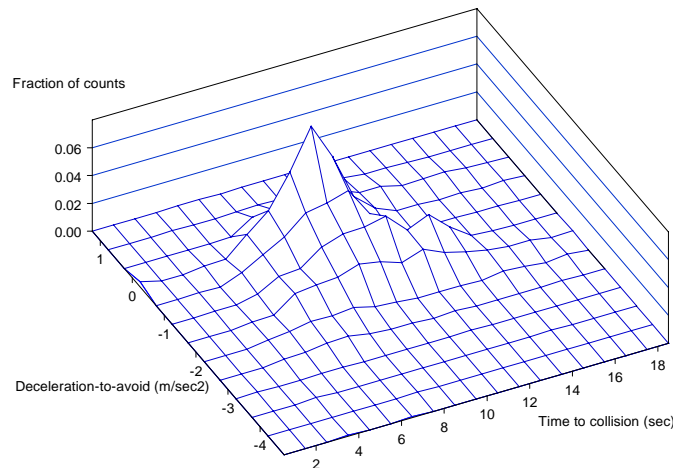

Figure 7.9. Histogram of time-to-collision/decel-to-avoid at brake onsets – IHP cases without recent braking (from algorithm-C drivers)

The figure shows that it is most common for braking to occur near the entry boundaries of the conflict region, near time-to-collision of 9 seconds and decel-to-avoid numbers between 0 and -1.5 m/sec².

Two useful metrics are the minimum value of time-to-collision and the minimum value of decel-to-avoid during the maneuver. (Since decel-to-avoid is negative when braking is required, the minimum decel-to-avoid value describes the highest level of braking required.) These two metrics do not specify whether the driver is braking, but rather they provide a pair of simple comparison metrics that are used later in Section 7.1.4 to examine the possible effects of ACAS on conflict resolution behavior. Figure 7.10 shows a histogram of the minimum values for time to collision and decel-to-avoid for each of the identified IHP-scenario events. Note that the data points in Figure 7.10 are not associated with actual simultaneous values of time-to-collision and decel-to-avoid. Instead, the data points in this figure represent a pairing for each event of the minimum values of the two variables.

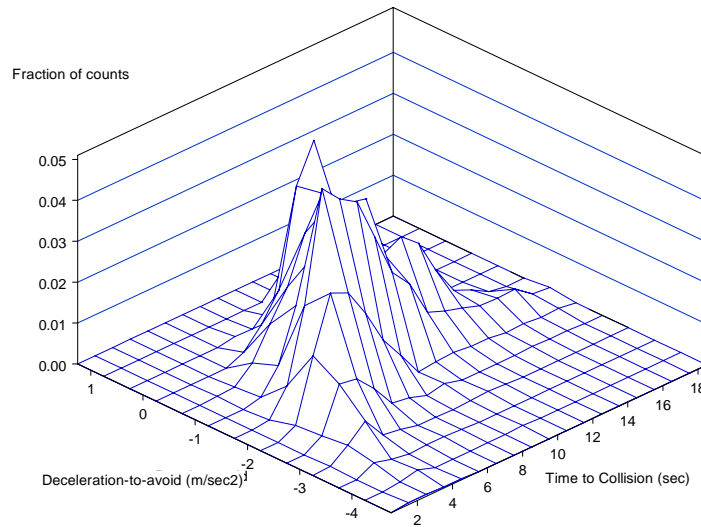

Figure 7.10. Histogram of the minimum time-to-collision / minimum decel-to-avoid in all IHP scenarios (algorithm-C only)

7.1.4 FCW Effect on Conflict Resolution

This section finds that the level of conflict that drivers experience with ACAS is not significantly different than the conflict levels during their baseline driving period. That is, drivers in manual driving neither tolerate nor avoid closing conflicts more often during their ACAS period than during the baseline period. Furthermore, during manual ACAS driving, they engage in braking to resolve conflicts with the same frequency, and at the same conflict levels, as they do during the baseline period.

These findings result from two basic analyses, the first of which uses the conflict-study set of events discussed in Section 7.1.3. The second analysis uses the rate of FCW imminent alerts, as a separate measure of conflict.

7.1.4.1 Rate of Conflict-Zone Events

There are 44,827 events in the conflict-study set. The analysis here will address the 39,343 events that occurred on roads identified as either freeways or surface roads, and will omit those that occurred on ramps, unknown, or unpaved roads. Table 7.3 shows the breakdown of the alerts by road type and by the scenario identification variable. Note that mixed-scenario events occur more often than IHP-scenario events. Also, the event rate is much higher on surface roads than on freeways, especially when considering that the distance traveled on freeways is greater than that on surface roads.

Table 7.3. Number of conflict-study events occurring on freeways and surface roads (algorithm-C drivers)

Road type	IHP-scenario events	Mixed-scenario events
Freeways	3,335	5,312
Surface roads	11,479	19,217

Across algorithm C drivers, the average rate at which events in the conflict study set occur is 25 and 47 times per 100 miles for the IHP-scenario and mixed-scenario events, respectively. (This computation is for manual driving on freeways or surface roads.) These events therefore occur on the average of about once per 1.4 miles, but the average is much higher on surface roads than on freeways. A plot showing the sample cumulative distribution of the number of drivers with various event rates for the IHP-scenario events is shown in Figure 7.11. The rates vary from less than 5 per 100 miles to over 60 events per 100 miles.

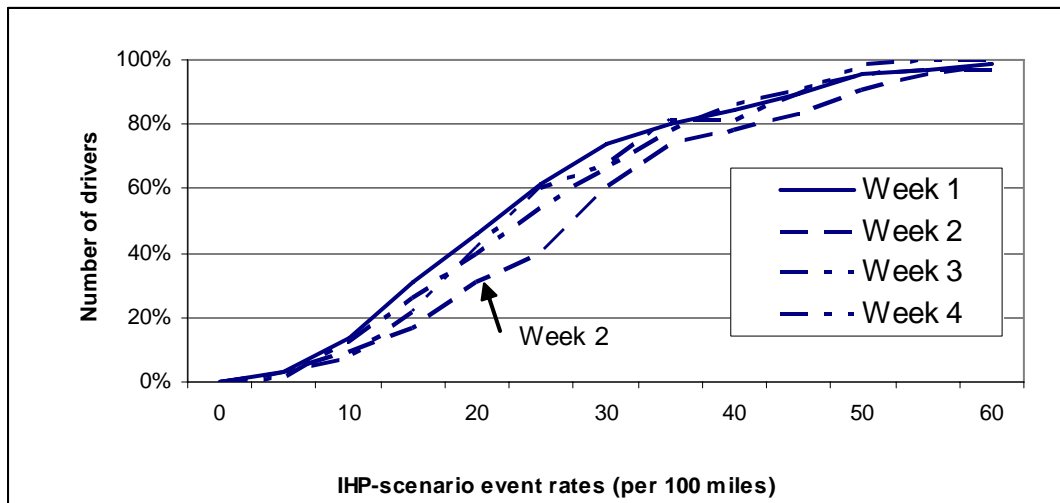

Figure 7.11. Cumulative distribution among drivers of the rate of IHP-scenario events, by week (algorithm C drivers, excluding driver 52)

The rate of IHP-scenario events is higher during week 2 than in week 1, and the rate of events in week 2 is significantly higher than in week 3 and 4 (individually, or as a set). This is also true for mixed-scenario events, which are also shown in Figure 7.12. These results do not include driver 52's data, since that driver did not drive during week 3, and therefore that driver's data cannot be used in this week-by-week analysis.

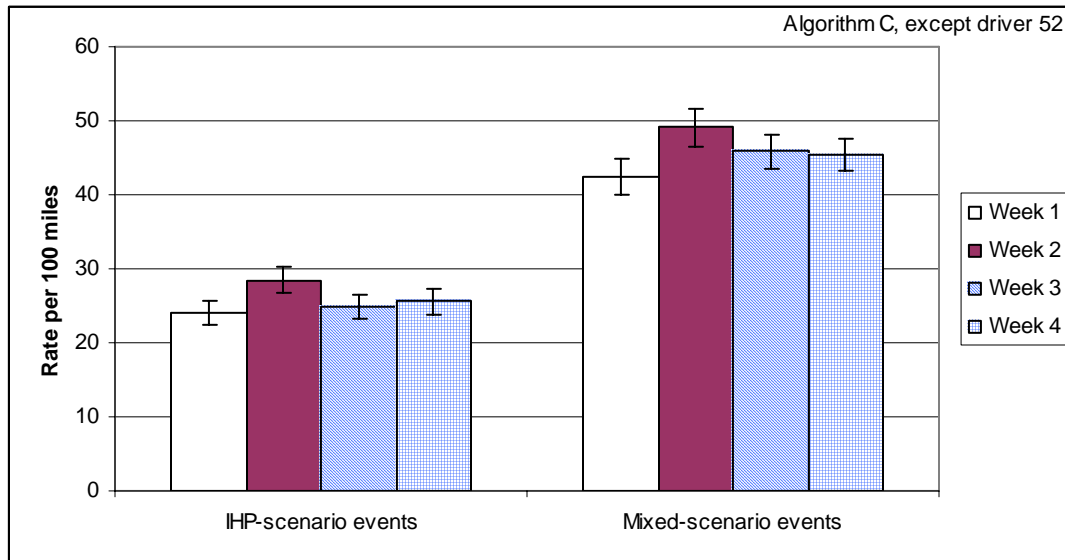

Figure 7.12. Rate of conflict-study events by driver week (algorithm-C drivers): mean of individual driver's rates. Error bars represent the standard error of the mean (SEM).

These differences are statistically significant for both IHP-scenario events and for mixed-scenario events ($p < 0.05$). This difference again suggests that drivers experimented with the FCW system during week 2. In fact, the magnitude of the difference of rates between week 2 and the other weeks is somewhat surprising since the week 2 mean rates are about 7 events per 100 miles higher than in the subsequent weeks, when the event types are combined. If this is indicative of driver experimentation with the ACAS system, then driver experimentation appears to involve more than just a handful of episodes per driver. Recall that the FCW imminent alert rate was greatest in week 2 as well, but the difference in imminent alert rate relative to the other weeks was much less than 1 event per 100 miles. Perhaps drivers are trying to provoke imminent alerts and failing, or perhaps they are attempting to stimulate the cautionary alerts. Therefore, when examining the effect of ACAS on the occurrence or the characteristics of these events, week 2 will be omitted.

When comparing the rate of events during the baseline week to ACAS-enabled weeks 3 and 4, there is no statistically significant difference. This is true for both IHP-scenario events and mixed-scenario events. Therefore ACAS does not appear to affect drivers' involvement in the type of conflicts represented by the conflict-study set.

7.1.4.2 Braking Responses to Conflict Events:

When ACAS is enabled, the occurrence of braking before or during the conflict period is unchanged relative to the baseline period. Figures 7.13 and 7.14 respectively show the breakdown of driver brake applications for IHP-scenario events and mixed-scenario events. When compared to Figures 7.7 and 7.8 in Section 7.1.3, it is seen that the breakdowns of braking onsets are the same, with or without ACAS available. These results are computed by collapsing across all events, and not averaging breakdowns of behavior of individual drivers.

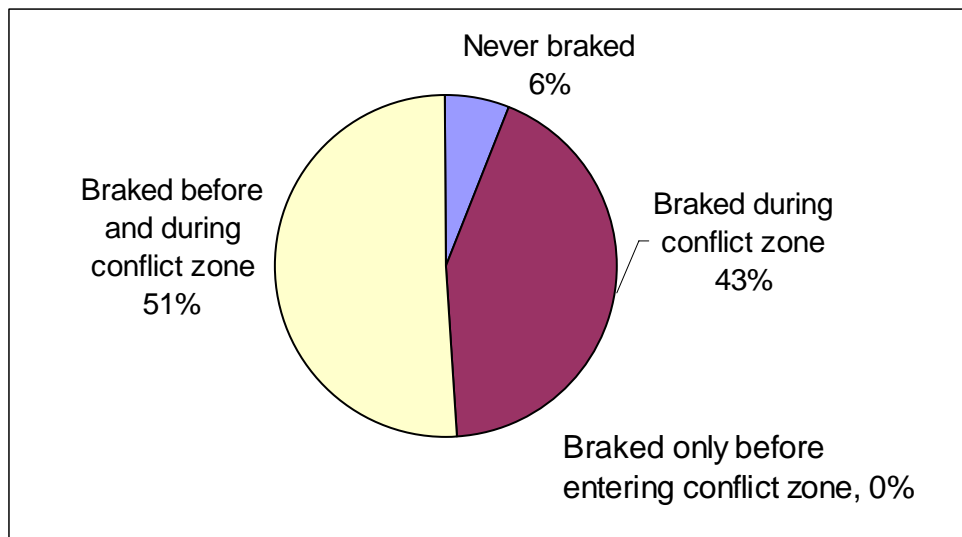

Figure 7.13. Driver braking behavior in IHP-scenario events (ACAS-enabled, algorithm C)

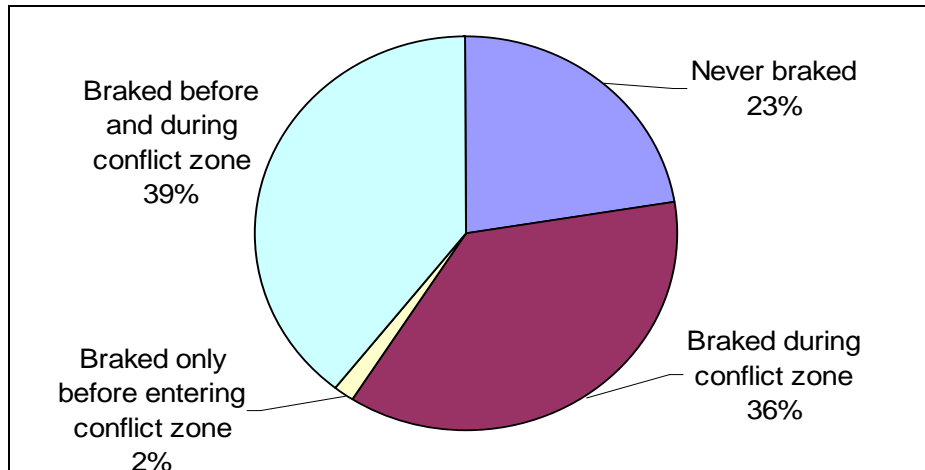

Figure 7.14. Driver braking behavior in mixed-scenario events (ACAS-enabled, algorithm C)

7.1.4.3 Conflict Levels at Braking Onsets – Effect of Enabling ACAS

This subsection shows that the data do not support the hypothesis that ACAS influences the timing of drivers' braking decisions, at least for those situations captured by the conflict study set. The previous section showed that ACAS does not appear to affect whether braking occurs within the conflict study zone, but this section examines the conflict levels at the time of driver braking onset.

A subset of the conflict study set is selected to focus the analysis:

- Week 2 data is not used, thereby removing from the analysis the observed short-lived increase in conflicts that may be due to driver experimentation with ACAS.
- Only IHP-scenario events are studied. Previous results showed that at least 94% of these events involve braking and, by definition, the conflict is resolved primarily through braking. This greatly reduces the possibility that braking is incidental and not related to the conflict at hand.
- Only conflicts that occur on roads identified as either freeway or surface roads are used, since the conflict study-set analysis is done for these road types.
- Driver braking occurs while in the conflict zone, but not during the 3 seconds before entering the zone. This increases the likelihood that the braking onset is truly an “onset” and not part of a series of brake applications, for example, pumping the brakes.
- Driver braking may be necessary to resolve the forward conflict. This is quantified by requiring the following to hold at brake onset: (1) the decel-to-avoid is either negative (braking required), or is less than a positive 1 m/sec^2 ,

and (2) the enhanced TTC is less than 30 seconds. These criteria serve to discards events in which braking is probably unnecessary.

This produces 3599 IHP-scenario events distributed across all 66 drivers and the three weeks being considered. The conflict metrics used to study this are the decel-to-avoid and the enhanced TTC at driver braking onset. For each driver, the average of the conflict metric is computed. Figures 7.15 and 7.16 show the distribution of these means for decel-to-avoid and enhanced TTC, respectively.

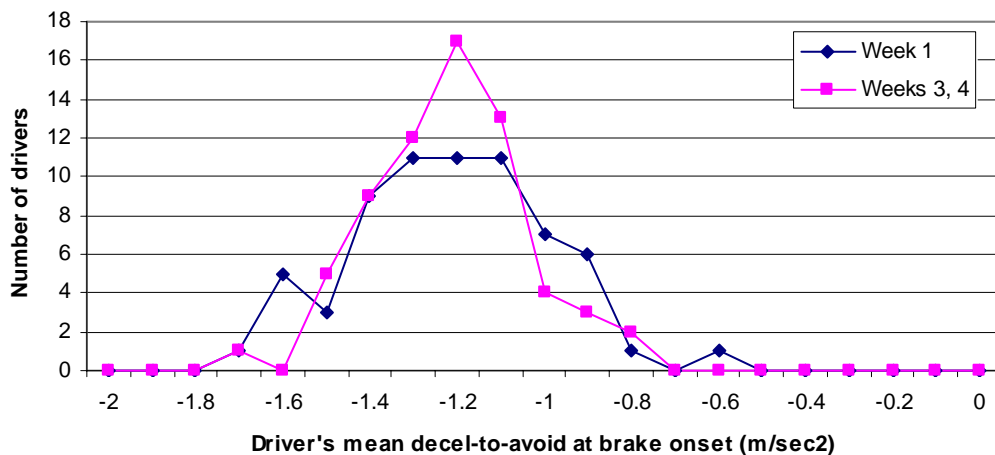

Figure 7.15. Distribution of individual drivers' mean values of decel-to-avoid at brake onset within the conflict zone (algorithm C drivers)

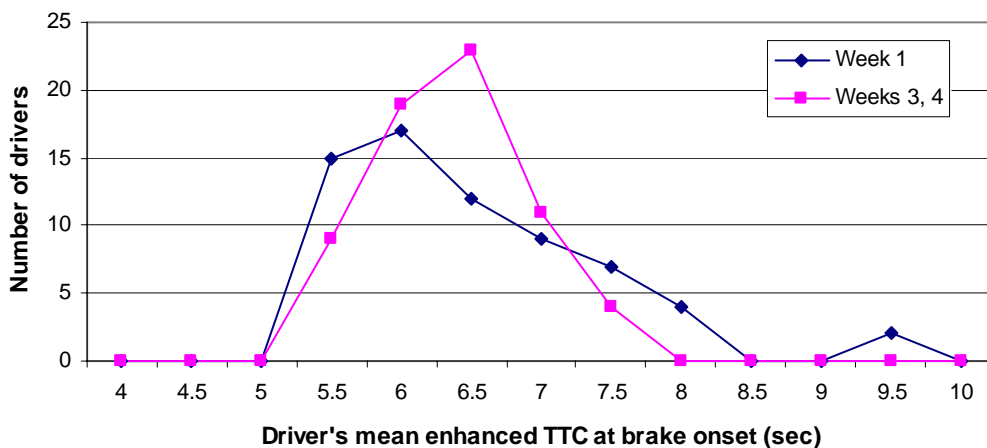

Figure 7.16. Distribution of individual drivers' mean values of enhanced TTC at brake onset within the conflict zone (algorithm C drivers)

A paired t-test is done to determine whether the mean of each metric is statistically different when ACAS is enabled (during weeks 3 and 4). This test finds no significant difference for either metric. Table 7.4 below shows that that average of the drivers' mean values of decel-to-avoid is -1.26 m/sec^2 during week 1, and -1.27 m/sec^2 during weeks 3

and 4. The table also shows that across the drivers, the mean of enhanced TTC at brake onset for these events is 6.23 sec during week 1 and 6.13 sec during weeks 3 and 4.

Table 7.4. Means of conflict metrics at braking onset for selected IHP-scenario events

	Decel-to-avoid, mean	Enhanced TTC, mean
ACAS disabled (week 1)	-1.26 m/sec ²	6.23 sec
ACAS enabled (weeks 3, 4)	-1.27 m/sec ²	6.13 sec
Statistical test	Means not significantly different. t(65) = 1.997, p = 0.377 (2-tail), a=0.05	Means not significantly different. t(65) = 1.997, p = 0.901 (2-tail), a=0.05

7.1.4.4 Highest Conflict Level during Conflict Events – effect of enabling ACAS

The next hypothesis to test is whether ACAS changes the peak conflict levels associated with the conflict-study set of situations. To test this, the peak levels of both decel-to-avoid and enhanced TTC are computed for each of the 39,343 events that occur on freeways or surface roads. The events are divided into four sets: IHP-scenario events on surface roads, IHP-scenario events on freeways, mixed-scenario events on surface roads, and mixed-scenario events on freeways. For each driver, for each of those four sets, the 10th and 20th percentile values of the peak values are computed. This gives a measure of the high-conflict boundary for each driver. (Since both metrics denote lesser conflicts as the metric values get larger, the 10th and 20th percentiles are associated with the higher end of the conflict scales.)

Then for each of the four roadway/scenario groups, and for each of the two metrics, paired t-tests are computed to determine whether ACAS influences the average among drivers of the 10th and 20th percentiles. Data from week 1 is compared to data from weeks 3 and 4 combined. The result is that among the 16 compared sets of data (2 roadways X 2 scenarios X 2 metrics X 2 percentile-values), there are no statistically significant differences between the data from the baseline week and that of the ACAS-enabled weeks 3 and 4. Therefore, there is no evidence that ACAS influences the peak level of conflicts that drivers encounter, whether or not brakes are applied. Table 7.5 below shows the results of the comparisons.

Table 7.5. Testing ACAS effect on means of peak-conflict levels (algorithm C drivers)

Metric & percentile tested	Scenario type	Road type	t-test for difference in means			
			Mean, wk 1	Mean, wks 3&4	Difference?	Test results
Decel-to-avoid 10 th percentile	Mixed-scenario	Fwy	-2.30 m/s ²	-2.31 m/s ²	No	t(60) = 2.000, p = 0.888 (2-tail), a=0.05
		Surf	-2.49 m/s ²	-2.45 m/s ²	No	t(65) = 1.997, p = 0.227 (2-tail), a=0.05
	IHP-scenario	Fwy	-2.31 m/s ²	-2.17 m/s ²	No	t(53) = 2.006, p = 0.308 (2-tail), a=0.05
		Surf	-2.32 m/s ²	-2.30 m/s ²	No	t(65) = 1.997, p = 0.695 (2-tail), a=0.05
Decel-to-avoid 20 th percentile	Mixed-scenario	Fwy	-1.89 m/s ²	-1.77 m/s ²	No	t(60) = 2.000, p = 0.169 (2-tail), a=0.05
		Surf	-2.14 m/s ²	-2.12 m/s ²	No	t(65) = 1.997, p = 0.564 (2-tail), a=0.05
	IHP-scenario	Fwy	-2.05 m/s ²	-1.88 m/s ²	No	t(53) = 2.006, p = 0.159 (2-tail), a=0.05
		Surf	-2.03 m/s ²	-1.99 m/s ²	No	t(65) = 1.997, p = 0.272 (2-tail), a=0.05
Enhanced TTC 10 th percentile	Mixed-scenario	Fwy	3.61 sec	3.67 sec	No	t(59) = 2.001, p = 0.671 (2-tail), a=0.05
		Surf	3.07 sec	3.14 sec	No	t(65) = 1.997, p = 0.137 (2-tail), a=0.05
	IHP-scenario	Fwy	4.19 sec	4.31 sec	No	t(53) = 2.006, p = 0.574 (2-tail), a=0.05
		Surf	3.73 sec	3.64 sec	No	t(65) = 1.997, p = 0.074 (2-tail), a=0.05
Enhanced TTC 20 th percentile	Mixed-scenario	Fwy	4.15 sec	4.18 sec	No	t(59) = 2.001, p = 0.806 (2-tail), a=0.05
		Surf	3.66 sec	3.73 sec	No	t(65) = 1.997, p = 0.173 (2-tail), a=0.05
	IHP-scenario	Fwy	4.54 sec	4.70 sec	No	t(53) = 2.006, p = 0.433 (2-tail), a=0.05
		Surf	4.15 sec	4.12 sec	No	t(65) = 1.997, p = 0.555 (2-tail), a=0.05

There are, however, notable effects of the road type and the scenario type on the level of both conflict measures. The IHP-scenario events are associated with higher conflict levels for both decel-to-avoid and enhanced TTC, when compared with the mixed-scenario events. This was expected, and simply reflects that the mixed-scenario set includes THP events, for which the lane position of the vehicles often plays the primary role in resolving the conflict. Likewise, higher conflict levels occur on surface roads than on freeways, except in one case: the peak conflict levels of decel-to-avoid in IHP-scenario events on freeways are similar to those levels observed on surface roads. Higher conflict levels on surface roads were expected, based on the experience that the FCW alert rates are higher on surface roads, braking levels are higher on surface roads, and the interaction between vehicles involves higher levels of relative speed and accelerations on surface roads.

The observation that the peak decel-to-avoid for this set of conflicts is not sensitive to road type is interesting, although it was stated earlier that the rate of these conflicts is much greater on surface roads. Also, the decel-to-avoid peak conflicts are not far removed from the requirements on the event to belong to the conflict-study set itself. That requirement will tend to compress the peak decel-to-avoid distribution, and overall, may reduce sensitivity to detection of differences in the peak values with and without ACAS.

7.1.4.5 Change in the Rate of FCW Alerts as an Indicator of Changes in Conflict Incidence

Section 6.2 characterized the occurrence of FCW alerts during the ACAS-enabled period. In this section, the change in the rate of alerts from baseline driving to ACAS-enabled driving is presented as a means to support the results reported from the conflict-study set. This exercise shows that the alert rate does not change when ACAS is enabled, suggesting again that ACAS may not affect the rate at which drivers are involved in conflicts.

Figure 7.17 below compares alert rates for the baseline week with rates during ACAS-enabled weeks 2, 3, and 4. This comparison is only for manual driving (FCW imminent alerts), using a within-subjects analysis (average of individual driver's changes in alert rates).

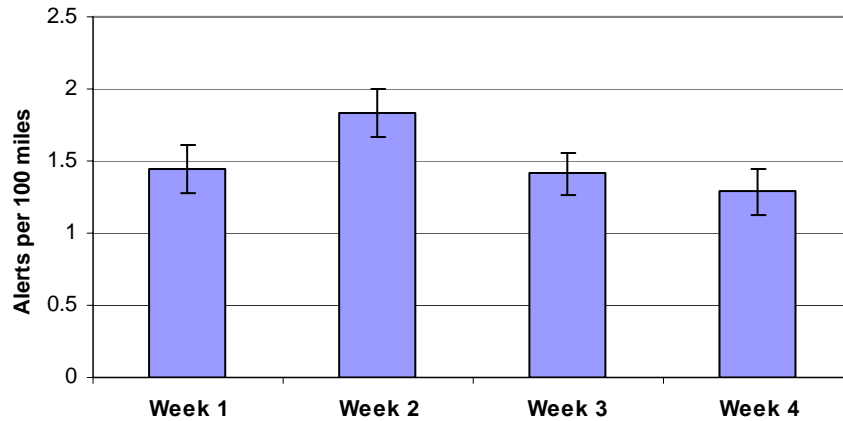

Figure 7.17. FCW imminent alert rates by week for manual driving (algorithm-C drivers, with bars denoting standard errors of the mean)

Paired t-tests confirm that the rate for week 2 is significantly different from the rates of the other weeks. For week 1 vs. week 2, for example, the test result gives $t(65) = 1.997$, $p = 0.038$ (2-tailed). A similar test shows that the rates during weeks 3 and 4 as a set are not statistically different from the rate during the baseline week 1 ($t(65) = 1.997$, $p = 0.413$ (2-tailed)).

A comparison is also done for an alert rate that is less sensitive to the “diluting” effect of freeway driving on the alert rate, and to remove the possible confounding effect of changes in environmental factors that influence the incidence of out-of-path alerts. The alert rate considered is the average rate across drivers for moving-target alerts on surface roads. Figure 7.18 shows the rates by week, and again the temporary jump in alert rate during week 2 is noted for this set of alerts. The paired t-tests confirm that the rate during week 2 is higher than week 1 ($t(65) = 1.997$, $p = 0.013$ (2-tailed)), and that there is no difference between week 1 and the combined rate for weeks 3 and 4 ($t(65) = 1.997$, $p = 0.514$ (2-tailed)). Therefore, as with the conflict rates seen with the conflict-study set of Sections 7.1.3 and 7.1.4, it is found that there is not a sustained influence of ACAS on the rate of conflict events.

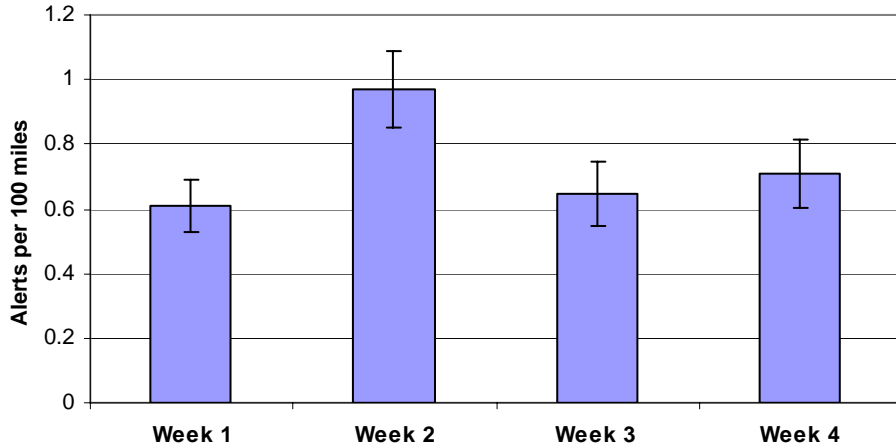

Figure 7.18. FCW imminent alert rates by week for manual driving on surface roads – moving-target alerts only (algorithm-C drivers)

Figure 7.19 compares the distribution of conflict scenarios associated with silent and heard manual-driving imminent alerts. This also supports the finding that the alert experience does not change significantly when ACAS is enabled. The leftmost pie chart is from the baseline week of driving, and the rightmost chart is ACAS-enabled driving, including week 2.

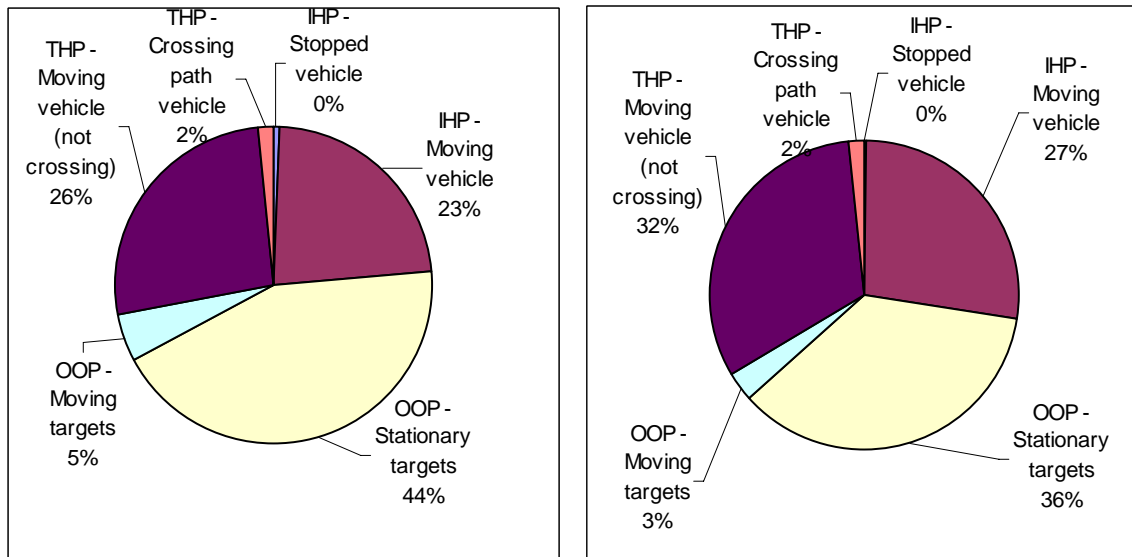

Figure 7.19. Comparing the conflict scenario breakdown for alerts in manual baseline driving (left) with that for manual ACAS-enabled driving (right). Algorithm-C drivers only.

The distributions are quite similar, except that the fraction of out-of-path alerts drops from 49% to 39% of all alerts, and this difference is picked up by the in-host path alerts and the transitioning-host path alerts. There are two reasons this may be happening. The

first and more likely explanation is that drivers spent more time on freeways during the latter weeks, as a group, and the freeway roadway environment is less likely to trigger out of path alerts. The second possible reason may be that drivers with displayed alerts are interested enough in week 2 to experiment with the system, provoking alerts. Only a small number of alerts were obvious in the videos, but several subjects admitted some experimenting activity.

7.1.5 Driver Response to FCW Alerts

Drivers' responses to FCW alerts provide insight into whether ACAS changes behavior in alert-producing events, as well as whether FCW itself is well calibrated to normal driving behavior. Section 7.1.5.1 addresses braking and steering responses associated with both silent and heard imminent alerts. That section also examines some cases of drivers who may have exhibited startled responses following imminent alerts. Section 7.1.5.2 addresses headway-keeping events relevant to the FCW cautionary alert displays. Conclusions from these sections that address FCW safety are also summarized with those from other sections into the summary of FCW safety in Section 7.1.8.

7.1.5.1 Driver Actions Following Imminent Alerts

This section characterizes driver actions following FCW imminent alerts. Driver actions that are studied include braking, steering, and changes in the driver's direction of gaze. In addition to characterizing some of this behavior, this section also studies whether drivers' actions following the imminent alerts differ when ACAS becomes enabled. If that is observed, it might be considered a safety effect of ACAS or FCW.

An overall view of drivers' braking and steering actions following an imminent alert is now introduced. For the purposes of this section, a driver is said to be engaged in a *braking action* following the alert if the brake application begins within 2 seconds of the alert onset and the duration is at least 1 sec. This logic attempts to identify events in which the driver brakes in response to either the alert or the situation triggering the alert. The duration requirement seeks to capture events in which the driver does not simply tap the brakes. (Recall that driver braking suppresses the alert, so that only braking following the alert is treated here.) A *steering action* associated with an alert is assigned by expert reviewers of the video captured of the alert event. Steering is defined as a lateral motion of the host vehicle that is likely taken to avoid the target vehicle, with a motion of at least half a lane-width. Steering action is not assigned for those events in which the conflict itself derives from an intended host vehicle passing event.

The fraction of FCW imminent alert events associated with driver braking or steering is shown in Figure 7.20.

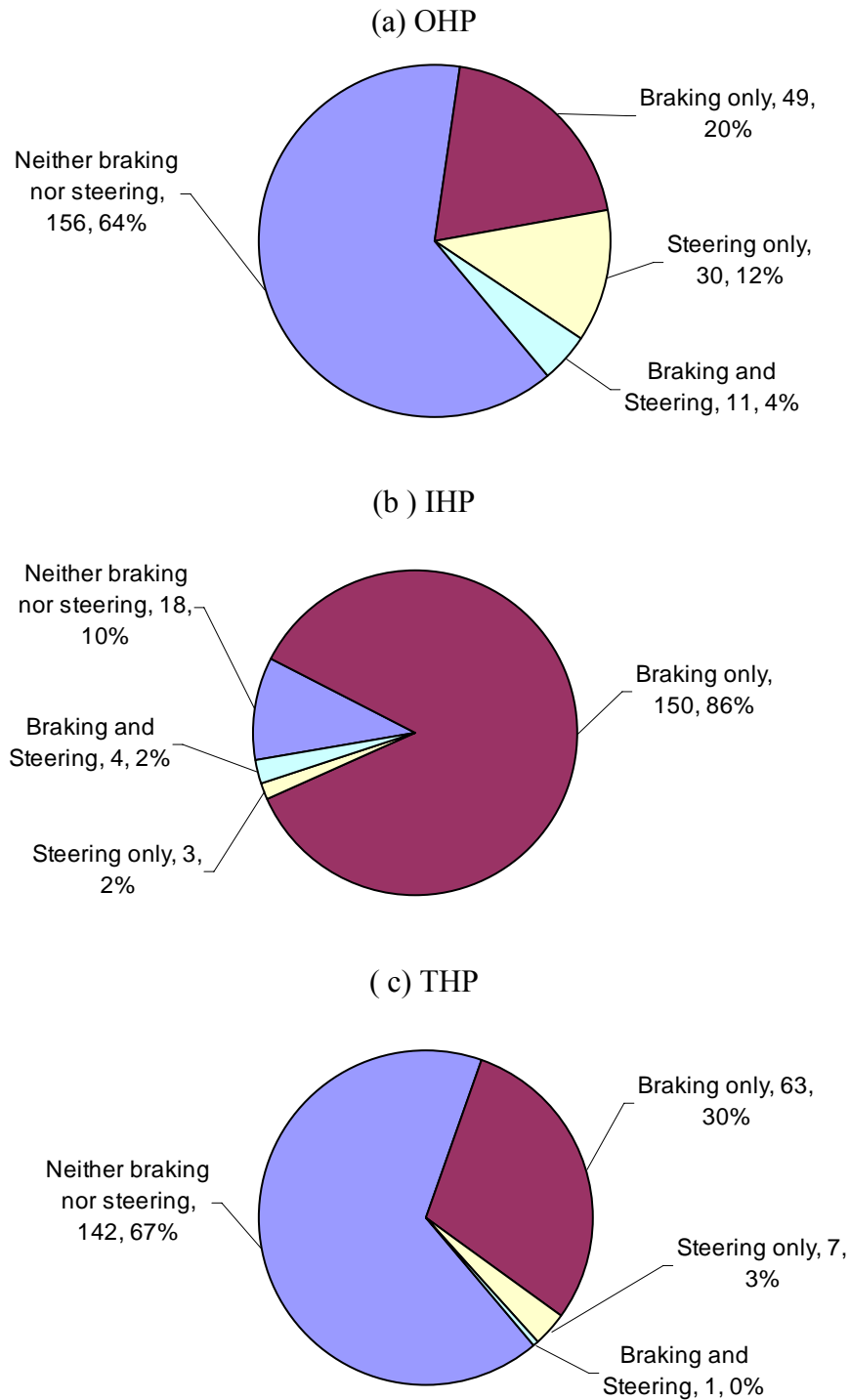

Figure 7.20. Driver actions following FCW imminent alerts during ACAS-enabled weeks 2, 3, and 4 (algorithm-C drivers)

This figure addresses manual driving during the ACAS-enabled weeks, and presents the results for all alerts, collapsed across drivers. The figure shows three pie charts that address, respectively, events associated with OHP, IHP, and THP conflict scenarios. Later there will be comparisons of the rates of braking and steering actions with and without the ACAS system. Overall, for the 862 usable imminent alerts that occurred during the manual driving of algorithm-C drivers, driver braking as defined above occurred after 346 alerts. (Fifty-four other events involved driver braking with durations less than 1 sec.)

Observations from Figure 7.20 now follow. Many of these will be revisited in the following subsections.

- There is a high probability driver braking following an alert in an IHP scenario. The figure shows 88% of the alerts in ACAS-enabled weeks are followed by driver braking. That the driver brakes in these events is a partial validation of the alerts provided, presuming the driver feels that braking is appropriate in the situation. For those events without driver braking action, the conflict is resolved in other ways, including the lead vehicle accelerating or the host driver braking beginning more than 2 sec after the onset of the alert. By definition, IHP conflicts are not resolved by a lane change. The effect of ACAS on drivers' decisions to brake in alert-provoking decisions is studied in the next subsection.
- Driver steering is uncommon in IHP-scenario alert events, occurring in only 4% of the imminent-alert events that occurred during ACAS-enabled driving. Indeed, driver steering as a means to avoid a vehicle ahead is rather rare, no matter the scenario, occurring in only 20 of the 506 FCW alerts involving vehicles in IHP or THP scenarios (including the baseline week). Driver steering will be addressed in a later subsection.
- Driver braking occurs much less frequently in the THP and OHP scenario-type events. For THP scenarios, Figure 7.20 shows that braking follows the imminent alert in only 30% of the events in ACAS-enabled weeks, respectively. For those THP events where braking does not occur, the conflict was resolved primarily by lateral motion of one of the vehicles, e.g., by a lead vehicle that completes a turn onto a different road. The low percentage of braking in THP alerts suggests that alert drivers do not always feel that braking is needed to manage the forward conflict, so that some alerts in these cases may be perceived as nuisances. This is supported by results presented later in Section 7.2.1.4, which reports on driver ratings of the utility of FCW alerts during their post-drive debriefing.

- For OHP scenarios, driver braking occurs in 24% of the events during ACAS-enabled weeks. OHP-scenario alerts can be assumed to be unnecessary alerts since by definition of OHP scenarios, the vehicle or object triggering the alert was never in the host’s path. Therefore any braking that occurs after the alert is not associated with drivers avoiding the object that triggered the alert, although at times drivers brake for a curve that has beside it a roadside object that triggers the alert. Braking may be associated with slowing for a curve, slowing for an intersection, or many other reasons. It is interesting to note that the fraction of driver actions following THP alerts is closer to OHP activity results than to IHP results. This suggests further that THPs are quite different than IHPs, and alerts that drivers receive in THP situations may often be perceived by the driver as nuisance alerts. (Again, the reader is referred to Section 7.2.1.4.)

7.1.5.1.1 Driver Braking Following Imminent Alerts in Manual Driving

The previous section included the introduction of a definition of driver braking associated with imminent alerts. That section also introduced some data regarding the frequency of driver braking during ACAS-enabled weeks.

To study whether drivers apply the brakes more often when ACAS is enabled, within-subjects statistical tests were conducted within each of the three scenario groups (IHP, THP, and OHP). Paired t-tests were computed to determine whether the mean braking percentage was different with ACAS enabled. Figure 7.21 below shows the average percentages across the subset of drivers who experienced alerts in baseline and enabled conditions.

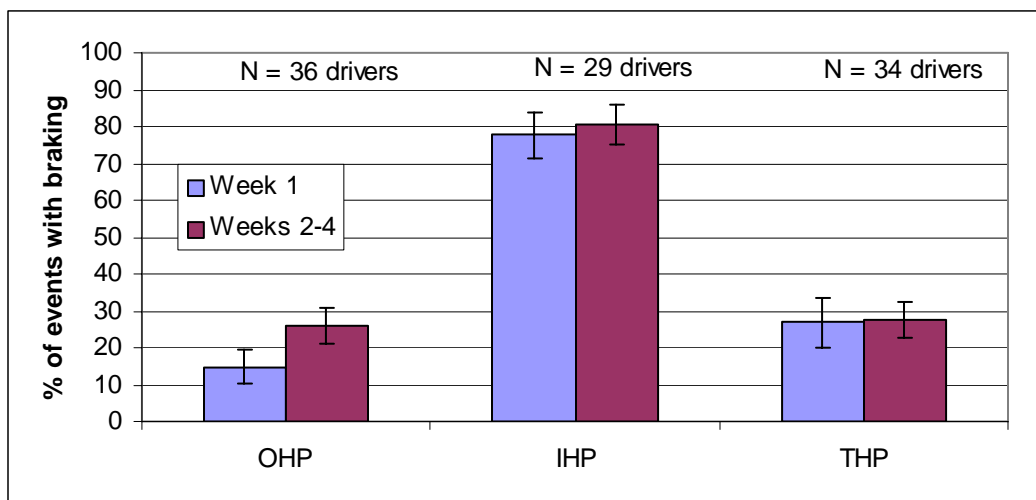

Figure 7.21. Mean fraction of FCW alert events with driver braking. Error bars represent standard error of the means.

When requiring a $p < 0.05$ for statistical significance, none of these means is significantly changed. The figure shows that results for OHP, IHP, and THP were computed using data from 36, 29, and 34 drivers, respectively.

The finding that ACAS does not affect driver braking following imminent alerts agrees with another test in which the effects of ACAS are studied by considering together the effects of scenario type and ACAS-enabled status on the mean fraction of events in which driver braking occurs. Only 9 drivers had alert events in each of the scenario groups, both with and without ACAS enabled, so these results should be treated somewhat cautiously. However, the results were that (a) the use of braking in IHP is significantly higher than the other two scenario types, and that braking usage rates with THP- and OHP-scenario alerts are not significantly different from one another; and (b) enabling ACAS is not associated with a significant change in the fraction of either IHP-, THP-, or OHP-scenario alerts. These results are entirely consistent with those in Figure 7.21.

The data were also examined for age and gender influences on the rate of braking after imminent alerts. The data for all alerts, including CCC and ACC alerts, suggests that there was no significant effect of either variable, or evidence of an interaction.

Regarding whether the braking activity changes by the week during exposure to ACAS, there is not enough data to support a within-subjects test of this hypothesis. Collapsing all alerts across drivers has been performed, and the result does not appear to suggest a sizable change in response over successive weeks, but this data is not presented because collapsing across drivers is thought to be an inadvisable method. The method is not recommended since it was found for a related question – whether ACAS affects braking rates – that results with data collapsed across drivers suggested an effect that was not seen with the within-subjects test presented above (see Figure 7.21). This data suggests again that studying simple metrics of brake onset leaves the results quite vulnerable to the many confounding influences of the actual traffic scenario, and presumably the driver's influence on the occurrence of conflicts and their style in resolving them.

Figure 7.22 shows the cumulative distribution of brake durations following alert events. Note that this includes baseline (silent alerts) and ACAS-enabled data (heard alerts).

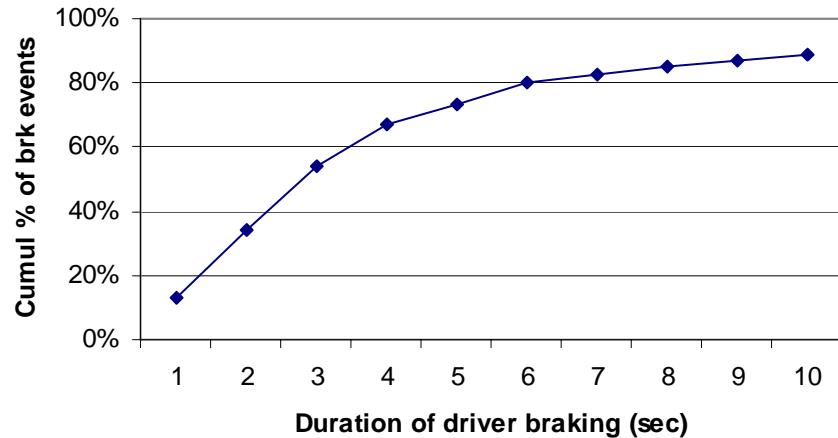

Figure 7.22. Cumulative distribution of brake duration following alerts

7.1.5.1.2 Steering as a Means of Conflict Resolution

This section comments on the number and characteristics of imminent-alert events where the driver initiated a steering response. Steering responses were identified using expert review of the videos associated with all algorithm C imminent alerts. These events included all events that involved an IHP or THP scenario. (Steering responses in OHP scenarios are not considered meaningful, since any steering is judged to be motivated by something other than the object triggering the OHP alert.) The definition of steering response was given earlier, in Section 7.1.5.1, along with a discussion of the fact that a host-initiated lane change that itself precipitates the alert is not considered a steering response.

Steering involvement in avoiding a forward conflict is observed in 20 events during manual driving with algorithm-C. These events are from a pool of 469 alert events in which the target was a vehicle in an IHP- or THP-scenario alert event, and where a host-vehicle lane change was not involved in precipitating the conflict. (Thirty-seven events were not considered because the alerts were coded as one of the four scenarios that are essentially due to a host passing maneuver around the target vehicle, which correspond to indices 310, 315, 320, and 330 in Appendix I.) The occurrence of the 20 events with steering is shown in Table 7.6 with a sorting by the event’s scenario type, the availability of the ACAS system to provide alerts, and whether braking was also involved. It should be noted that in several of these events, the driver was already beginning to move the vehicle laterally, so that here, steering is not necessarily a response to the alert. Also, the 20 events involved 16 different drivers, and no driver had more than two imminent-alert events with steering involved. Braking was involved in 8 of 20 events (using the definition of braking activity from Section 7.1.5.1).

Table 7.6. Steering associated with imminent-alert events (excluding host-initiated steering)

Scenario assoc'd with alert	Baseline (week 1)			ACAS-enabled (weeks 2-4)		
	All alerts*	Steering only	Steering & braking	All alerts*	Steering only	Steering & braking
IHP	54	1	0	175	3	4
THP	64	1	3	213	7	1

* All alerts means usable alerts during manual driving with algorithm-C

Overall, steering occurred in 20 of 469 events (4%), so it is not a common means of avoiding forward conflicts in this FOT. When considering the scenario types, the rates for IHP and THP events are 3.5% and 4.3%, respectively. These rates are not evaluated statistically due to the sparseness of data. The specific scenarios associated with the 20 events are shown in Table 7.7.

Table 7.7. Driving scenarios associated with FCW imminent-alert events with driver steering (manual driving, algorithm-C)

ACAS status	Scenario type	Scenario index*	Scenario*	Braking involved?	
Baseline	IHP	230	Host approaches stopped LV	No	
		THP	450	LV ahead turns left	Yes
			460	LV ahead turns right	Yes
			420	LV enters roadway in same direction; same lane as host	No
			365	LV forced to merge	Yes
Enabled	IHP	270	LV brakes predictably, not to stop	No	
		270	LV brakes predictably, not to stop	No	
		270	LV brakes predictably, not to stop	Yes	
		270	LV brakes predictably, not to stop	Yes	
		250	LV brakes to predictable stop	No	
		260	LV brakes unpredictably, not to stop	Yes	
		260	LV brakes unpredictably, not to stop	Yes	
		THP	450	LV ahead turns left	No
	450		LV ahead turns left	No	
	460		LV ahead turns right	No	
	460		LV ahead turns right	No	
	460		LV ahead turns right	Yes	
	390		LV crosses path; on intersecting roadway	No	
	430		LV leaves host lane	No	
	440	LV leaves host lane into turn lane	No		

* Scenario indices and descriptions are introduced in Section 5.3.2, with more descriptions also in Appendix I.

Recall, however, that host steering, per se, occurs in more than the 20 events presented in the tables above, since the table addresses only steering to avoid the lead vehicle. First, there are the 37 events mentioned already, in which a host lane change around a target vehicle is part of the maneuver precipitating the alert event. Furthermore,

there are 16 additional alert events in two other scenarios where the host-vehicle lane change is not a primary reason for the conflict. These scenarios are the host vehicle cutting behind another vehicle, thereby triggering an alert (6 events), and a host vehicle moving into a turn lane, with the alert being subsequently triggered by a vehicle in the turn lane (10 events). Altogether, then, host-vehicle steering to move laterally with respect to the lane occurs in 73 of the 509 IHP and THP alerts (or 14% of these alerts).

7.1.5.1.3 Brake Reaction Time (BRT)

For those imminent-alert events where driver braking occurs, this section studies the time between the onset of the imminent alert and the onset of driver braking. This is referred to as *brake reaction time* (BRT), even though braking may or may not be in response to the alert. (Earlier sections suggested braking is primarily related to the actual traffic context.)

For the 346 alert events in which driver braking meets the criteria given in Section 7.1.5.1, the means, 85th percentiles, and 95th percentile BRTs are shown in Figure 7.23. The time to braking onset (BRT) is smallest on average for the IHP-scenario alert events, with a mean of just over 0.4 seconds.

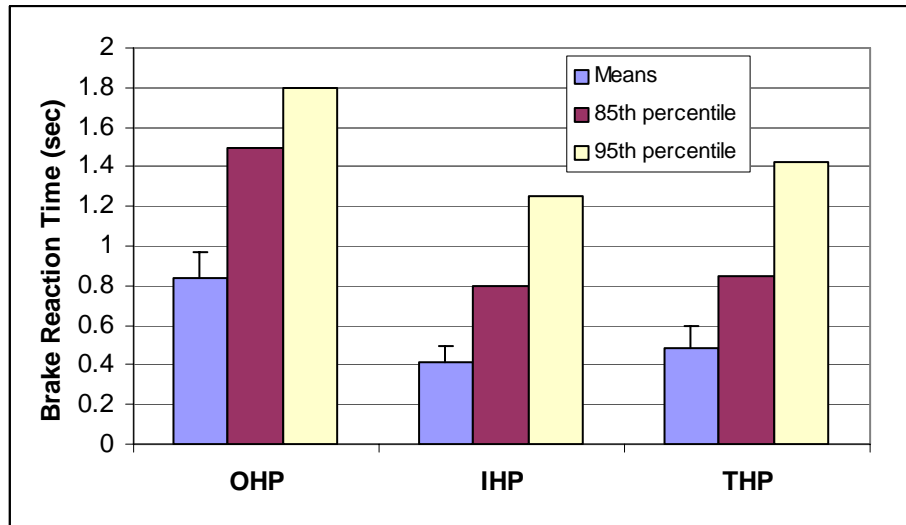

Figure 7.23. Brake reaction time across forward conflict scenarios.

Values for THP events are approximately 0.5 seconds, and the mean of OHP values is 0.8 seconds. Again, the values for OHP events are not considered meaningful, since the stimulus for braking is thought to be unlikely to be caused by the alert itself (see the section on startle-response, later in this section). This is supported by the observation that the mean of the OHP BRTs is not far from 1.0 second, which would be the expected value of time between the alert and the onset of any random event process with a mean

time between occurrences that is much longer than the 2-second window after the alert that these events satisfy. The trends are similar in data of the 85th and 95th percentiles in the figure.

The values of BRT for IHP and THP are relatively similar, even though the incidence of braking is almost three times greater for IHP alert events than for THP alert events. One explanation for this is that perhaps most of the THP events with driver braking were those where the headway conflict would not have been resolved entirely by lane changes by one or both vehicles. In these situations, of course, drivers may use braking to manage the headway distance in a manner similar to IHP situations.

The mean values of BRT are shown in Figure 7.24 by the week of the driver's exposure. There are no clear trends in this data. The available data does not support a proper statistical analysis of this variable, but at least the figure does not suggest any unexpected results.

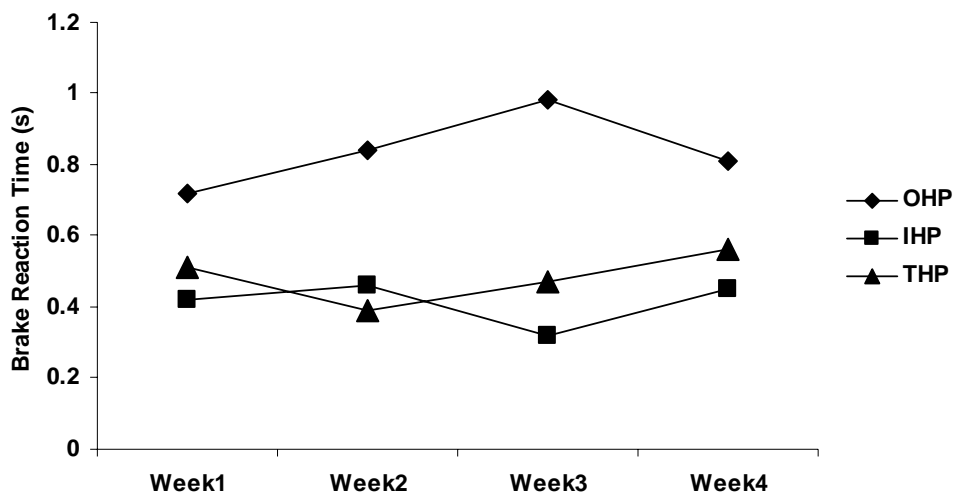

Figure 7.24: Brake reaction time across forward conflict scenarios and system exposure

The values of BRT were also examined for differences in age and gender. The finding here is that males had significantly longer reaction times during THP conflict scenarios than did their female counterparts (refer to Figure 7.25). It is possible that male drivers may tolerate more conflict in THP scenarios.

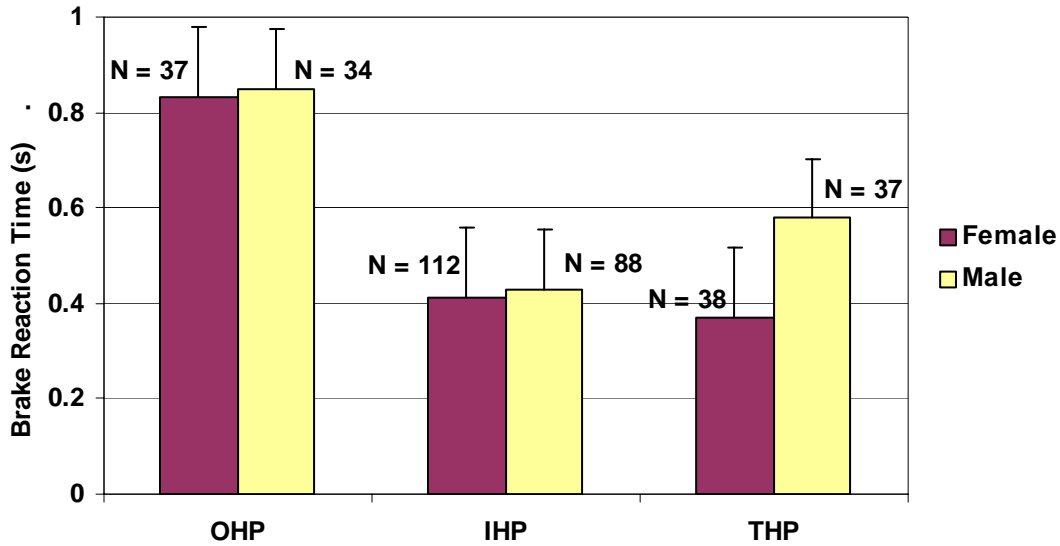

Figure 7.25: Mean brake reaction times as a function of scenario type and gender (bars denote standard errors)

7.1.5.1.4 Change in Speed Following Imminent Alerts

The previous sections have studied the frequency and timing of driver braking after FCW imminent alerts, and found no evidence that ACAS influenced either. This section looks at whether ACAS has an effect on whether the host speed changes after an alert. *Driver speed change* is defined as the change in the host driver’s speed from the time of the alert to two seconds after experiencing the alert. This is studied only during manual driving conditions. The two-second-long window is selected to capture the influence of ACAS on driver’s general timelines of responses. It is considered long enough to include some response to the alert itself and not so long that events involving eventual large speed changes have undue weight.

Robust differences emerge when comparing the net driver speed change across forward conflict scenarios. Namely, as seen in Figure 7.26, drivers reduce their speed upon receiving an imminent conflict warning more when the target in question remains in the host’s path (IHP) as compared to when targets lie outside the host’s path (OHP) or when the target’s presence in the host path is changing (THP).

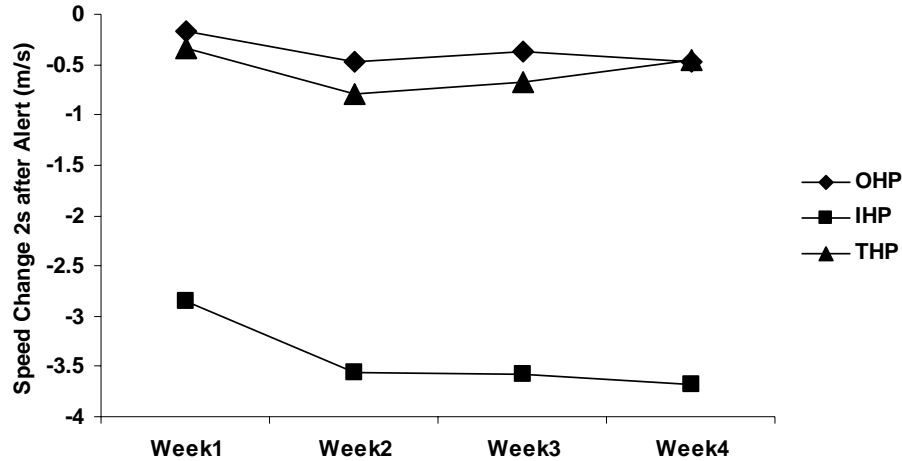

Figure 7.26. Net change in driver speed across forward conflict scenarios 2 s after alert.

There is also a statistically significant effect that the mean driver speed change across the individual weeks is affected by ACAS ($p < 0.05$). That is, the mean speed change in weeks 2, 3, and 4 has a mean value of approximately -3.7 m/sec^2 (8.3 mph) and this is significantly greater than the speed change in week 1, which has a mean value of approximately -2.8 m/sec^2 (6.3 mph). The difference between the mean value of speed change in week 1 is significantly different than the mean values in other weeks, and this is true whether the ACAS-enabled weeks are considered separately, or as a set. It is also seen that driver speed change did not change significantly over the successive weeks for THP or OHP imminent-alert events. For reference, it is noted that for a “throttle-off” event that leaves the vehicle decelerating due to parasitic drag, the deceleration is approximately -0.2 to -0.4 m/sec^2 , which leads to a speed reduction of 0.4 to 0.8 m/sec (0.9 to 1.8 mph).

As another illustration that drivers manage headway and speed differently according to the driving conditions, it is interesting to compare how often the host speed increases or decreases following imminent-alert events. Figure 7.27 shows the three scenario types and whether the fraction of imminent-alert events for each after which host speed increases, decreases, or stays the same within the two-second window after an imminent alert.

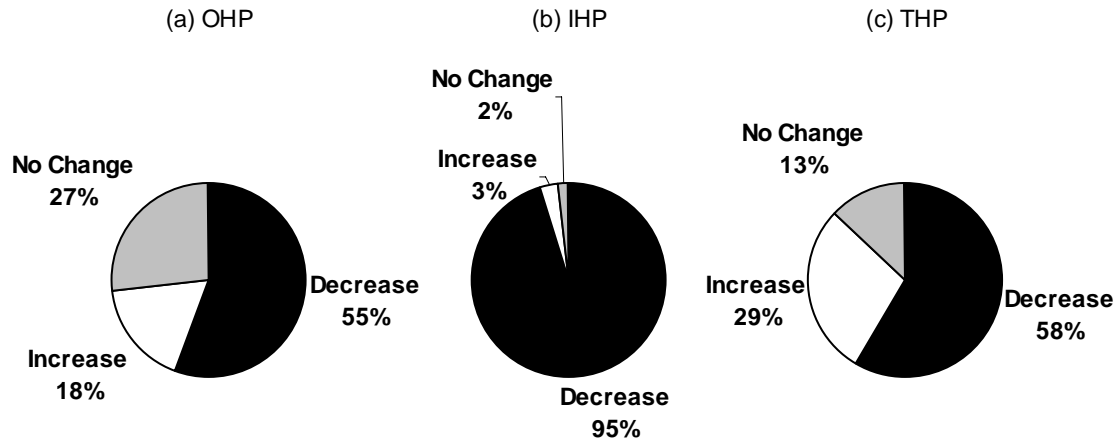

Figure 7.27. Driver changes in speed 2s after alert for (a) OHP, (b) IHP, and (c) THP scenarios

The speed is considered to be unchanged if it remains constant within the 0.1 m/sec (0.2 mph) resolution of the data. All alerts are considered here, including ACC alerts and alerts during all weeks of driving. Figure 7.27 (b) shows that the speed decreases for 95% of the IHP events, the scenarios, clearly denoting that these events are almost always perceived by drivers as requiring some slowing of their vehicle. For THP events shown in Figure 7.27(b), speed decreases 58% of the time, but speed increases 29% of the time. This speed increase sometimes is associated with the driver beginning a passing maneuver (12% of THPs), but speed may increase because the lead vehicle is getting out of the way, and the driver is climbing to their preferred speed. Speed decreases for about half of the OHP events (55%), but only increases 18% of the time, as shown in Figure 7.27(c). Clearly the OHPs are not uniformly distributed in driving time, but are often associated with driving in curves, lane changes, entering turn lanes or ramps, and other maneuvers where speed tends to decrease. This may explain the relatively small fraction of OHP alerts with speed increases.

7.1.5.1.5 Apparent Startle Responses during the Imminent Alert Event

Drivers' apparent startle responses were identified during review of the imminent-alert event videos. Facial expressions or body motions were observed to identify only those alerts in which the driver's expression seemed likely to indicate a startle response. Because identifying these events involves judgment by the analyst, they are referred to as *apparent* startle responses. Startle response were presumably caused by the alert itself and/or or the event that triggered the alert.

Twenty-four alert events with apparent driver startle responses were identified out of 598 that were reviewed for this variable. Twenty-three of these startle responses were associated with heard FCW alerts, and only one occurred during baseline (week 1) manual driving. No startle responses were identified during either CCC driving or ACC driving. The 24 events were distributed across 17 drivers, with twelve drivers having one startle-response event, three drivers with two events each, and two drivers with three events each. Therefore, the startle-response events are not ascribed to just a few drivers.

Table 7.8 below shows information about events associated with apparent startle responses, including whether ACAS was enabled, the type of scenario involved, whether the target was moving, and whether the driver applied the brakes in a significant manner (using the criteria of Section 7.1.5.1).

Table 7.8. FCW imminent alert events with apparently-startled driver response (algorithm C)

ACAS state	Scenario type	Scenario	Moving Target?	Does driver brake?
Baseline (manual)	IHP (1 apparent startle of 54 examined, or 2%)	LV brakes predictably, not to stop	Yes	Yes
FCW	OHP (6 apparent startles out of 41 alerts examined, or 15%)	False alert – target always out of path	No	Yes
		False alert – target always out of path	No	No
		False alert – target always out of path	No	Yes
		False alert – target always out of path	No	No
		False alert – target always out of path	Yes	
		False alert – target always out of path	Yes	Yes
	IHP (6 apparent startles out of 205 alerts examined, or 3%)	LV brakes to predictable stop	Yes	Yes
		LV brakes unpredictably, not to stop	Yes	Yes
		LV brakes unpredictably, not to stop	Yes	Yes
		LV brakes unpredictably, not to stop	Yes	Yes
		LV brakes unpredictably, not to stop	Yes	Yes
		LV brakes predictably, not to stop	Yes	Yes
	THP (11 apparent startles of 215 alerts examined, or 5%)	LV turns left across host path	Yes	No
		LV leaves host lane	Yes	No
		LV leaves host lane into turn lane	Yes	No
		LV leaves host lane into turn lane	Yes	No
		LV ahead turns left	Yes	No
		LV ahead turns right	Yes	No
		LV ahead turns right	Yes	Yes
		LV ahead turns right	Yes	No
LV ahead turns right	Yes	Yes		
LV ahead turns right	Yes	No		
LV ahead turns right	Yes	No		

Four aspects of these results deserve comment. First, the lack of apparent startle responses during the baseline period suggests that the apparent startle responses that occurred during the ACAS-enabled period are related to the alert. That is, the apparent driver startle event is a response to the alert itself or to what is detected in the forward scene when the driver has re-directed his/her attention forward. Apparent startle responses may not necessarily be a negative effect of FCW, since there may be situations in which the driver's attention has been returned to a forward scene that is startling to the driver because of its need for possible braking and/or steering response.

The second notable item is that the ratio of apparent startle-response events within a scenario category to all events examined within that category suggests that drivers may be more likely to be startled when they have less reason to be concerned about forward conflicts. For alerts triggered by OHP events, the apparent startle-response events comprise 15% of all events examined. For THP alerts, the ratio is about 5%, and for IHP alerts – where the driver is approaching a vehicle in the same lane, and can be assumed to be most wary of forward conflicts – the apparent startled-response events make up only 3% of all events examined.

Furthermore, an additional fact is that within the OHP alerts, there are four and two apparent startle-response events associated with stationary and moving out-of-path targets, respectively. There were 21 and 20 alert events examined with stationary and moving out-of-path targets, so the fraction of those events with apparent startle responses is about 20% and 10%, respectively. Again, since moving, out-of-path alerts require a nearby vehicle and stationary-target alerts do not, this comparison seems consistent with the hypothesis that drivers are more likely to be startled when there is no forward conflict, and hence, when they may be less likely to be expecting forward conflicts.

It is important to note that the frequency of driver braking is not out of line with the frequency of braking in all alert events, when the scenario type is considered. Therefore it does not appear that there is a major issue with drivers reflexively reacting to an alert and substantially slowing the vehicle without reason.

Examination of the alerts that occurred while ACC was engaged reveals that there were no apparent startle responses in ACC driving. There were no apparent startle responses during the 25 ACC-alert events in which ACC was responding to a moving vehicle. This may be because the ACC autobraking provides a haptic cue that may be effective in returning the driver's attention to the forward scene. For the remaining 47 ACC alert events associated with stationary targets, however, there are 41 events in which the triggering object is on the roadside or overhead. The driver is assumed to not

expect these alerts, and yet there are no startled responses. On the other hand, during FCW-only driving mode, a startled response occurs in 6 of 41 cases examined.

7.1.5.2 Driver Responses to Cautionary Alerts

The FCW cautionary alerts have two purposes: (1) to assist drivers in avoiding tailgating under steady-state headway conditions, through the presentation of visual icons when headway remains below a driver-adjustable threshold, and (2) to provide additional time for some drivers to respond to a developing forward threat during a closing-type approach, through a sequence of visual icons that grow in size to suggest a looming threat. Earlier in Section 7.1.4, it was found that ACAS does not appear to influence drivers' exposure to forward conflict events, and so no further analysis into the role of cautionary alerts in reducing forward conflicts is performed. Instead, since over 98% of all cautionary alert icon time is related to headways violating a threshold (as described in Section 6.3.2), this section focuses on whether cautionary alerts appear to be influencing driver headways.

Recall that Section 3.1.3 described that cautionary alerts are presented if a driver's headway remains for some time below a headway threshold (whose value is influenced by the driver-adjustable FCW sensitivity setting). Therefore we study whether the enabling of ACAS in the second, third, and fourth weeks of use has an influence on the frequency of events in which a driver violates a headway threshold that corresponds to their most-used sensitivity setting. Section 6.2.1 presented a table that showed individual drivers' most-used FCW sensitivity selections.

In order to investigate the effect of cautionary alerts on headway keeping behavior, maximum headway time margins for the lowest-level ("amber 2") cautionary icon level were examined using the following criteria:

- Host speed greater than 55 mph (since cautionary alerts are most common on highways)
- Maximum headway time margins at each sensitivity setting had to persist for a minimum of ten seconds to be considered in the analysis. This was done to exclude cautionary alerts presented during transitory events
- Since cautionary icons are not presented when a driver selects sensitivity setting "1," the drivers whose most-used setting was "1" were not used in the analysis.

Data were grouped by week and collapsed across drivers within each age group. The results are displayed in Figure 7.28, which shows the rate per hour of events in which the

driver remains within a headway distance corresponding to the “amber 2” icon for more than 10 seconds.

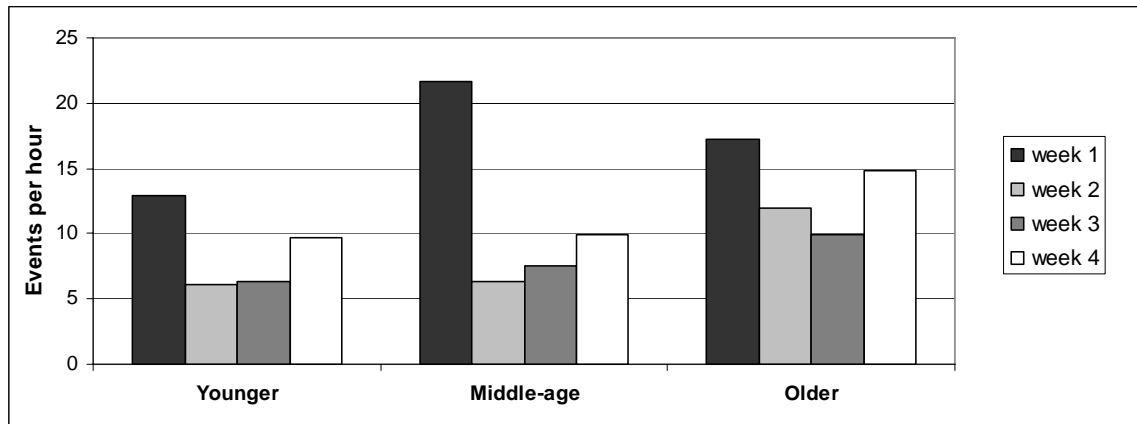

Figure 7.28. Amber 2 cautionary alert icon maximum headway time margin events persisting for 10 seconds or more at speeds greater than 55 mph

For the younger and middle-aged age groups, the figure shows an initial effect whereby the rate of cautionary icon-producing headway behaviors is reduced during week 2. By week 4, however, the rates for the younger and middle-aged groups appear to be regressing back toward the baseline rate of week 1. For older drivers, the rate of these events does not vary much from week to week.

The change in the rate from week 1 to week 4 of these persisting headway violations is only statistically significant for the middle-aged drivers, but the data suggests that this change may erode somewhat over time. Therefore the only conclusion that can be made is that there may well be a possible benefit of cautionary alerts for increasing the quasi-steady state following behavior for drivers in the middle-aged group.

7.1.6 Potentially Useful FCW Alerts

This section refers to two different approaches that investigate how often the FCW alerts may have had real or perceived safety utility for the driver during the alert episode itself. The first approach is reported at length in Section 7.2.1.4, and consists of the drivers themselves reviewing video of up to 12 alerts from their time with the FCW system. Drivers separate the alerts into those that are useful and those that are unnecessary. As they do this, they are asked to relive the moment of the alert and not rate the alert in a different, hypothetical context. This was done for 565 alerts, and the results are shown in Section 7.2.1.4. Note that both of these approaches address only potential utility associated with the conflicts associated with specific alerts. It is possible that FCW alerts have contributed to an increased awareness of headway management that may have led to

the reduction in time that drivers spend in short headways, as discussed in Section 7.1.2. The utility of FCW alerts in contributing to longer-term behavioral changes is not addressed in this section, nor is it addressed in Section 7.2.1.4.

The second approach was for an analyst to search a subset of the alerts to find examples of alerts that appear to have had the potential for real safety value in that circumstance. This approach is different than the driver rating approach, because it seeks to attach more of an objective safety rating that is constant across drivers, rather than addressing perceptions of safety or utility. The disadvantages are that only 65 events were reviewed, and the analyst is asked to make judgment regarding driver awareness and the role of the alert in a response to a real threat. This second disadvantage is mitigated by attempting to assign rather conservative assignments of value.

The second approach results in the identification of 13 alerts that were judged to have contributed directly to an improved driver awareness and/or an improved driver response to real and immediate forward crash threats. Thirteen more events were rated as having possible contributions to improvements in awareness or response. This demonstrates that FCW has the ability to address mechanisms that lead to many rear-end crashes. It must be stated, of course, that since the average involvement of a driver in the U.S. to a police-reported rear-end crash is on the order of one crash per 105 years where the driver may be in the striking vehicle or in the stricken vehicle, (as described in Section 7.1), the probability of 13 rear-end crashes within the enabled period of algorithm C driving is very small. Therefore, one could speculate that without the FCW, most if not all of these could have been expected to be resolved without a crash, or lead to non-police-reported rear-end crashes. Nonetheless, the events are compelling evidence that FCW has, at a minimum, real safety potential. This is because the events show that the mechanisms of inattention, misjudgment, and reaction delays that contribute to the rear-end crash set are addressable with FCW. Issues of driver acceptance are treated separately in Section 7.2.

The remainder of this section presents the second method, and then compares results with those of the second method from Section 7.2.1.4.

7.1.6.1 Analyst Safety Ratings of Selected FCW Alerts

Data and video scoring results were used to identify sixty five alerts events for events with a heightened likelihood that the alert may have provided actual utility at the moment it was displayed. Four categories of alert events were reviewed:

- alert events during which drivers were apparently startled by the alert or the situation (17 events identified in the video scoring of imminent alerts described in Section 5.2),
- alert events during which drivers chose to steer in response to the conflict event or the alert (15 events identified in the video scoring),
- alert events with peak braking deceleration exceeding -4 m/sec^2 within 3 sec after the alert (28 events), and
- alert events where drivers eyes were not on the driving task at the time of the alert (5 events).

There are probably other alerts outside this 65-alert set that also could have had been judged to have real value, but these are not identified or investigated. These 65 alert events constitute 12% of the 537 non-false alerts during algorithm C.

The alerts from this 65-alert set are assigned one of three ratings: valuable, possibly valuable, and not valuable. This judgment is based on three factors:

1. Driver awareness level before the alert: Awareness includes attentiveness to the driving task as well as accurate perception of the forward crash risk. This distinction is useful in instances where the driver is attentive but does not anticipate the manner in which the situation ahead unfolds. Awareness is judged from gaze direction, apparent post-alert startle, inaction when action appears needed, and audio comments. Audio comments are sometimes useful for discriminating inattentive from attentive driver states. (“Whups”, says one driver, and in another event, the passenger comments to the driver who has not responded to a decelerating truck, “I’m like, ‘Didn’t you see that?’” Another driver curses at an alert, another laughs and his passenger curses, and another says to their passenger after an alert where little action was taken, "It scares me every time that happens".)
2. Level of forward crash risk: Alerts are deemed valuable only when there is immediate need for strong action. An alert given to an inattentive driver approaching a slowly developing forward crash risk situation is rated as possibly valuable, because there would have been another second or more for the driver to notice and respond.
3. Driver’s actual response: Hard braking or an intense braking pulse occurs for most of the 26 valuable or possibly valuable alert events. In several cases, the driver’s foot hits the pedal hard enough to hear in the audio recordings.

Table 7.9 has more specific rules, but for some cases the analyst is ultimately making a judgment about the value of the alert in that situation.

Table 7.9. Selected criteria for analyst’s ratings of alert safety value

Rating	General criteria	Comments
Valuable	<ul style="list-style-type: none"> If driver appears surprised by situation, and braked or steered quickly or forcefully. If video or audio strongly suggests that alert was useful in returning driver's attention to an immediate crash risk 	A few situations involve drivers who appear to have made reasonable, but incorrect, assumptions regarding the lead vehicle’s actions (e.g., a lead vehicle brakes late and awkwardly to a stop between a twin set of red lights).
Possibly valuable	If immediate crash risk exists and evidence exists to support the possibility that the driver may be unaware of the real and immediate crash risk.	Even drivers looking forward can misjudge the crash situation, and then need to respond late and forcefully. Alerts sometimes occur at the same time as the response; such alerts are possibly valuable in encouraging firm responses
Not valuable	<ul style="list-style-type: none"> If driver appears aware of the situation, however risky. If driver’s awareness is not known, but crash risk is not yet great. 	These alerts may have been valuable if the driver state had appeared different.

The results of this rating exercise are summarized in Table 7.10. The table breaks down the events by the four categories identified earlier. Since there are four events that fall into multiple categories, the rightmost column in Table 7.10 shows how many events within each category are *not* listed in that category’s row, but rather are counted in a previous category.

Table 7.10. Analyst’s rating of utility of FCW alerts from a sample of 65 algorithm-C alerts

Event category	Number of alerts				Alerts in this category that are counted in a previous category
	Valuable	Possibly valuable	Not valuable	Total	
Driver apparently startled	4	1	12	17	0
Driver steers to avoid target	1	5	9	15	0
Eyes not on task at alert time	1	1	2	4	1
High decel following alert	7	6	16	29	3
Total	13	13	39	65	4

Ranking 13 of 65 alerts as valuable for the specific episode in which the alert occurred, and another 13 as possibly valuable is considered a notable fraction of the candidate set, given the relative rarity of a rear-end crash. Given the earlier mention of

the improbability of 13 rear-end crashes from the algorithm C data set, it can be conjectured that most of these specific alerts were probably helping most of these drivers avoid near crashes or perhaps avoid minor impacts. This of course assumes that without FCW that some of the involved drivers would have looked ahead or realized their situation was more risky than they seemed to understand in the video, and responded accordingly.

Not shown in the table is the fact that IHP (IHP) alerts contribute 46 of 65 of the candidate alerts (71%), but IHP alerts constitute all 13 alerts judged to be valuable (100%) and 8 of 13 (61%) of the alerts considered possibly valuable. Furthermore, all 13 alerts judged to be valuable involved driver braking as a response, and 10 of the 13 considered possibly valuable involved driver braking as well. This suggests that FCW needs to continue focusing on addressing IHP scenarios, with the knowledge that driver braking is the likely response, while still accommodating potential crash risks associated with other scenarios, but perhaps more importantly to avoid excessive nuisance alerts in non-IHP situations.

Table 7.10 shows that the steering-in-response-to-alert category of alerts is the least likely to contribute an event judged to be “valuable,” since only 1 in 15 is rated as valuable. However, 5 of 15 are considered possibly valuable. The steering cases are difficult to assess because the driver’s awareness and intent are more difficult to know since they can often begin a successful steering maneuver at a later time than a braking maneuver. An interesting example of a possibly valuable alert was one event in which the lead vehicle, turning ahead onto a cross street, stops without leaving the roadway because of a bicyclist crossing the cross-street at the intersection. The other three categories each contribute about 1 of 4 of their alerts to the alert set judged to be valuable.

Regarding the high deceleration cases, almost half of those alerts were judged to be possibly valuable, or valuable. However, it is clear from reviewing the 28 cases of post-alert braking with peaks over 4 m/sec^2 that driver braking levels after an alert are not necessarily related to the value of that alert. Hard braking with a target ahead is not always associated with near-crash circumstances.

7.1.6.2 Comparing Alert-Event Ratings: Drivers’ Utility Ratings vs. Analyst’s Safety Rating

Fifty one alert events were addressed in both the drivers’ ratings during their debriefing interviews (Section 7.2.1.4) and the analyst’s ratings (see previous section). Both ratings

sought to address the specific incident, and not generalize the event to other hypothetical situations or driver states. The comparison is shown below in Table 7.11, where three rows indicate the analyst ratings from Section 7.1.6.1 and two columns denote whether the driver rated the alerts as useful or not useful.

Table 7.11. Comparing results of driver’s utility ratings and an analyst’s safety judgments for 51 FCW alert events

Analyst rating for safety value	Number of alerts (with mean driver ratings in parentheses)	
	Alerts rated as useful	Alerts rated as unnecessary
	Number of alerts	Number of alerts
Valuable	8 (3.5)	1 (1.0)
Possibly valuable	5 (4.1)	3 (1.9)
Not valuable	14 (4.4)	20 (1.7)

Each of the six cells includes two numbers. The first is the number of alerts (out of 51) associated with that combination of driver rating and analyst judgment. The second number, in parentheses, shows the mean value of the secondary ratings that drivers made. These second ratings are different for the two columns, as described in Section 7.2.1.4. Alerts rated by drivers as useful, i.e., alerts in the left column of Table 7.11, were rated on a 5-point Likert-type scale with anchors of 1 and 5, respectively, for “not at all useful” and “quite useful.” Alerts that drivers rated as not useful were then rated on a scale where anchor values of 1 and 5 were associated with “completely unnecessary” and “not at all unnecessary.”

Of this subset of 51 alerts, nine were rated by an analyst as valuable for safety. Eight of these nine (89%) were considered useful by the drivers themselves. The remaining alert was considered as “completely unnecessary” by the driver. (The analyst had noted that the driver was looking forward but his driving response to a line of vehicles stopped on a two-lane rural road that were waiting for a semi-truck to back into a driveway included driving onto the shoulder to avoid an almost-stopped vehicle). For the eight alerts in this overlapping set that the analyst deemed possibly valuable, drivers rated five as useful (63%) and three as not useful. For the 34 alerts that the analyst considered not valuable, drivers considered 14 of 34 (41%) as useful. Therefore, there is some correlation of these two views of the alerts, but there are also frequent differences between the judgments of the driver and the analyst.

The numerical ratings provided by the drivers, however, show a trend that is contradictory to the analyst’s rating. The higher the analyst’s safety ratings, the lower the

usefulness rating was from the drivers for those alerts deemed useful by the driver. There may be several reasons for this discrepancy: the analyst may misinterpret driver awareness and risk-acceptance levels; drivers could be resistant to admit fault in a potential near-crash; or the data set may simply be too small to make conclusions. Neither method is likely to be entirely accurate in assessing individual events. Nevertheless, there is clearly a set of FCW alerts that are perceived as useful by drivers, with an independent rating that also assigns the alerts some real safety value.

7.1.7 Evaluation of Secondary Behaviors with FCW

The data acquisition system was programmed to capture a four second long video clip from the driver-face camera every five minutes that the engine was running, with the first exposure coming after the vehicle had been running for five minutes. Recall that images were collected from the forward-scene camera at a rate of once every second. A random sample of five percent of the driver face clips were examined for evidence of secondary, non-driving, behaviors. This five percent was stratified by week. Only clips in which the vehicle was traveling 25 mph (the minimum speed at which FCW is active and ACC can be engaged) or faster were included in the sample. This filter of 5 percent of the clips from each week when the vehicle was going faster than 25 mph, resulted in a total 890 clips. The approach of stratifying the sample by week was utilized in order to better understand how driver behaviors may or may not change with exposure to the FCW and ACC systems without the risk of obtaining a disproportionate sample from one portion of the driving experience. Because the sampling technique was random, there was no attempt made to weight the sample on the basis of individual drivers or the mileage they accrued.

7.1.7.1 Secondary Behaviors with Manual Driving

This section investigates the issue of whether drivers became engaged in fewer or more secondary tasks when ACAS was enabled.

For purposes of evaluating secondary, non-driving, behaviors with FCW, only clips in which neither conventional nor adaptive cruise control were engaged are reviewed in this section of the report. This additional conditionality left 614 of the 890 original clips to be examined. Clips involving conventional or adaptive cruise control usage are discussed in Section 8.1.9 of this report. Table 7.12 shows that, of the 614 clips, overall, slightly more clips from female drivers were examined for secondary behaviors than for males.

Table 7.12 Counts of exposure clips reviewed by gender

Gender	Week 1-CCC Not Engaged	Week 2-ACC Not Engaged	Week 3-ACC Not Engaged	Week 4-ACC Not Engaged	Total Clips
Female	79	79	86	84	328
Male	81	65	62	78	286
Total Clips	160	144	148	162	614

The distribution of clips by age group reveals that overall, an equal number of clips for the younger and middle-aged groups were examined, while slightly fewer clips were viewed for the older group (Table 7.13).

Table 7.13 Counts of exposure clips reviewed by age group

Age Group	Week 1-CCC Not Engaged	Week 2-ACC Not Engaged	Week 3-ACC Not Engaged	Week 4-ACC Not Engaged	Total Clips
Younger	64	48	49	55	216
Middle-aged	50	57	52	57	216
Older	46	39	47	50	182
Total Clips	160	144	148	162	614

Table 7.14 provides the distribution of exposure clips reviewed for evidence of secondary, non-driving, behaviors for the combination of driver gender, age group, week, and cruise control mode (CCC or ACC).

Table 7.14 Counts of exposure clips reviewed by gender and age group

Gender x Age Group	Week 1-CCC Not Engaged	Week 2-ACC Not Engaged	Week 3-ACC Not Engaged	Week 4-ACC Not Engaged	Total Clips
Younger Female	26	25	34	22	107
Middle-aged Female	30	36	35	34	135
Older Female	23	18	17	28	86
Younger Male	38	23	15	33	109
Middle-aged Male	20	21	17	23	81
Older Male	23	21	30	22	96
Total Clips	160	144	148	162	614

Table 7.15 provides the counts with which a variety of secondary, non-driving, behaviors were observed in the sample of exposure videos as a function of driver gender and age group for the first week of manual driving (ACAS disabled, no conventional cruise control in use). A complete list of the keys used to code the exposure videos for evidence of secondary, non-driving, behaviors can be found in Appendix I.

Table 7.15 Counts of clips containing secondary behaviors by driver gender and age group during week 1 (ACAS disabled and no conventional cruise control in use)

Non-driving Behavior	Female Younger	Female Middle-aged	Female Older	Male Younger	Male Middle-aged	Male Older	Total Clips	% of Total Week 1 Clips
Cell phone: conversation, in use	4			5	2		11	7
Cell phone: reaching for							0	0
Cell Phone: dialing							0	0
Conversation		3	1		2	1	7	4
Drinking: high involvement							0	0
Drinking: low involvement					1		1	1
Eating: high involvement							0	0
Eating: low involvement		1					1	1
Grooming: high involvement							0	0
Grooming: low involvement		1		1	1	2	5	3
Headset/hands-free phone: conversation							0	0
Headset/hands-free phone: reaching for headset							0	0
Headset/hands-free phone: unsure if any activity				2			2	1
In-car system use							0	0
None	22	25	22	30	14	19	132	83
Other/multiple behaviors							0	0
Smoking: lighting a cigarette							0	0
Smoking: reaching for cigarettes or lighter							0	0
Smoking						1	1	1
Total Clips	26	30	23	38	20	23	160	
Clips w/ non-driving behaviors (%)	4 (15)	5 (17)	1 (4)	8 (21)	6 (30)	4 (17)	28 (18)	

The total number of clips in which secondary behaviors were observed for each gender-by-age group combination is provided at the bottom of the table, along with the percentage of clips in which secondary behaviors were observed. On average, during the first week under manual control, drivers were engaged in secondary, non-driving, behaviors 18% of the time, based upon the sampling. Older female drivers appear far less likely, on a percentage basis, to engage in secondary behaviors (4%) than any of the remaining five gender-by-age group segments of the population in the manual driving mode, whereas middle-aged males were most likely (30%). The secondary task most frequently recorded, again on a percentage basis, was cell phone use, which was observed taking place in 7% of the exposure clips. This was followed by conversation (4%) and low-involvement grooming (3%).

Table 7.16 provides a count of secondary, non-driving, behaviors observed in the sample of exposure videos as a function of driver gender and age group for weeks 2 through 4 (ACAS enabled, no adaptive cruise control in use). On average, during weeks 2 through 4 drivers were engaged in secondary, non-driving, behaviors 19% of the time, based upon the sampling. However, under these conditions, it was older and middle-aged male drivers who were least likely, on a percentage basis, to engage in secondary behaviors (10%) compared to any of the remaining gender-by-age group segments of the population. Younger females were most likely (30%).

The secondary task most frequently recorded, again on a percentage basis, was conversation (non-cellular telephone) which was observed in approximately 9% of the exposure clips. This was followed by cell phone conversation (3%) and low involvement grooming (3%). It is hypothesized that the increase in observing conversation by the drivers when the FCW system was enabled is quite possibly associated with the novelty of having the ACAS system and drivers' desire or excitement at the opportunity to explain how the ACAS system operated to passengers in the vehicle.

Table 7.16 – Counts of clips containing secondary behaviors by driver gender and age group during weeks 2-4 (ACAS enabled but no adaptive cruise control in use)

Non-driving Behavior	Female Younger	Female Middle-aged	Female Older	Male Younger	Male Middle-aged	Male Older	Total Clips	% of Total Weeks 2-4 Clips
Cell phone: conversation, in use	10			4	1		15	3
Cell phone: reaching for							0	0
Cell Phone: dialing							0	0
Conversation	6	7	14	6	1	5	39	9
Drinking: high involvement							0	0
Drinking: low involvement	1				1		2	0.4
Eating: high involvement		1					1	0.2
Eating: low involvement		1					1	0.2
Grooming: high involvement							0	0
Grooming: low involvement	2	3		3	2	2	12	3
Headset/hands-free phone: conversation	2						2	0.4
Headset/hands-free phone: reaching for headset							0	0
Headset/hands-free phone: unsure if any activity	1			3			4	1
In-car system use							0	0
None	57	87	49	54	55	66	368	81
Other/multiple behaviors		1		1	1		3	1
Smoking: lighting a cigarette							0	0
Smoking: reaching for cigarettes or lighter	1						1	0.2
Smoking	1	5					6	1
Total Clips	81	105	63	71	61	73	454	
Clips w/ non-driving behaviors (%)	24 (30)	18 (17)	14 (22)	17 (24)	6 (10)	7 (10)	86 (19)	

Lastly, Table 7.17 provides a count of exposure clips containing secondary behaviors for all weeks (1 - 4) while no conventional or adaptive cruise control was in use, collapsed across all drivers.

Table 7.17 Counts of exposure clips containing secondary behaviors by week 1-4 (disengaged).

Non-driving Behavior	Week 1 Disengaged	Week 2 Disengaged	Week 3 Disengaged	Week 4 Disengaged	Total Clips
Cell phone: conversation, in use	11 (7%)	4 (3%)	9 (6%)	2 (1%)	26 (4%)
Cell phone: reaching for					
Cell Phone: dialing					
Conversation	7 (4%)	13 (9%)	12 (8%)	14 (9%)	46 (7%)
Drinking: high involvement					
Drinking: low involvement	1 (1%)	1 (1%)	1 (1%)		3 (.5%)
Eating: high involvement			1 (1%)		1 (.2%)
Eating: low involvement	1 (1%)		1 (1%)		2 (.3%)
Grooming: high involvement					
Grooming: low involvement	5 (3%)	7 (5%)	3 (2%)	2 (1%)	17 (3%)
Headset/hands-free phone: conversation			2 (1%)		2 (.3%)
Headset/hands-free phone: reaching for headset					
Headset/hands-free phone: unsure if any activity	2 (1%)		3 (2%)	1 (1%)	6 (1%)
In-car system use					
None	132 (83%)	117 (81%)	112 (76%)	139 (86%)	500 (81%)
Other/multiple behaviors		1 (1%)	1 (1%)	1 (1%)	3 (.5%)
Smoking: light a cigarette					
Smoking: reaching for cigarettes or lighter		1 (1%)			1 (.2%)
Smoking	1 (1%)		3 (2%)	3 (2%)	7 (1%)
Total Clips Reviewed	160	144	148	162	614
Clips w/ non-driving behaviors	28 (18%)	27 (19%)	36 (24%)	23 (14%)	114 (19%)

The bottom row of this table contains the percentages of clips in which drivers were engaged in secondary behaviors. These percentages show the relative frequency of observing drivers taking part in non-driving behaviors has only a slight degree of variation over the four week period, with the difference between week 1 and weeks 2 – 4

being not statistically significant according to a Pearson χ^2 test ($p < .05$). Furthermore, other than the change in driver involvement in conversation (non-cellular), which is hypothesized to be associated with the novelty of having the ACAS system, the pattern and frequency of other common secondary behaviors does not appear to change. In other words, categories such as cell phone conversation and low involvement grooming appear to be equally frequent in both FCW disabled and FCW enabled periods.

Overall, there was no change in the relative frequency with which drivers took part in secondary, non-driving, behaviors when the FCW system was enabled relative to the baseline of manual control. The only substantive change appears to be an increase in relative frequency of conversation taking place inside the vehicle (non-cellular telephone) which, again, is hypothesized to be associated with the novelty of having the FCW system, and the desire of drivers to describe the system or participation in the ACAS study to passengers. However, it is important to note that the available data do not permit distinguishing between a conversation with passenger(s) in the vehicle versus hands-free telephone use which does not require a headset, but this caveat is equally true for all periods of exposure (i.e., both FCW disabled and FCW enabled). The pattern and relative frequency of other common forms of secondary behavior that were observed in the sample of exposure videos did not change in conjunction with the enablement of the FCW system. These results suggest that the presence of the FCW system did not alter the drivers' willingness to take part in secondary, non-driving, behaviors. This is the first naturalistic driving data set with a driver assistance/warning system to address this important issue.

7.1.7.2 FCW Imminent-Alert Scenarios Involving Secondary Behaviors

Video clips from imminent alerts were reviewed for instances of secondary, non-driving, behaviors. As discussed earlier, secondary, i.e. non-driving, behaviors are herein defined as behaviors that are not directly related to the task of driving. For example, brushing one's hair, eating, drinking, conversing, and talking on the cell phone are all examples of secondary behaviors. Table 7.18 provides the frequency with which the coded, secondary behaviors were observed during imminent alerts by week and by whether or not cruise control was engaged. Of the 537 imminent-alert clips reviewed, evidence of secondary behaviors was observed in 168, or approximately 31% of the cases.

Table 7.18. Imminent-alert clips containing secondary behaviors by week and cruise control engagement (Eng. = Engaged, Dis. = Disengaged)

Secondary Behavior	Week 1		Week 2		Week 3		Week 4		Total Clips
	Eng. ⁸	Dis. ⁸	Eng	Dis	Eng	Dis	Eng	Dis	
None	78		110	10	73	4	84	10	369
Cell phone: conversation, in use	6		6		3		2		17
Cell phone: Reaching for									
Cell phone: Dialing									
Headset/hands-free phone: Conversation					2		1		3
Headset/hands-free phone: Reaching for headset									
Headset/hands-free phone: Unsure if any activity	1		1		2		2		6
Eating: high involvement			1						1
Eating: low involvement	1		2						3
Drinking: high involvement									
Drinking: low involvement	1						1		2
Conversation	14		32	4	11		13	1	75
In-car system use	1				2		1		4
Smoking: Lighting a cigarette					1				1
Smoking: Reaching for cigarettes or lighter			1						1
Smoking	3		1			1			5
Grooming: high involvement	1				1				2
Grooming: low involvement	4		4				3		11
Other/multiple behaviors (in notes)	8		12	1	8		8		37
Total Imminent alert clips by week	118		170	15	103	5	115	11	537
Count/percentage of alert clips containing secondary behaviors (week collapsed over engagement)	40 (24%)		65 (39%)		31 (18%)		32 (19%)		168 (31%)

⁸ Eng. = Engaged, Dis. = Disengaged

The percentage of imminent alerts in which secondary behaviors were being performed does not change appreciably across exposure. In fact, a slight decrease in alerts with secondary behaviors is observed in weeks 3 and 4. However, overall, involvement in secondary behaviors is more prevalent during imminent alerts than in baseline exposure conditions (Table 7.17). The increased instance of secondary involvements observed in week 2, when the FCW function became active, is largely associated with conversations taking place between the driver and passengers. This is hypothesized to be associated with the novelty of having the researcher vehicle, and a desire on the part of the participant to convey to passengers the driver’s involvement in the study and the functionalities being evaluated. This may include increased attempts by the participants to demonstrate the FCW functionality when passengers are present. Tables 7.19 through 7.21 provide breakdowns, by driver age group, gender and the interaction of age group by gender, of the frequency with which secondary behaviors were observed during imminent alerts.

Table 7.19. Imminent-alert clips containing secondary behaviors by age group

Age Group	Week 1		Week 2		Week 3		Week 4		Total Clips Containing Secondary Behaviors
	Eng	Dis	Eng	Dis	Eng	Dis	Eng	Dis	
Younger	19		29	3	20		11		82 (49%)
Middle-aged	14		21		4		10		49 (29%)
Older	7		10	2	6	1	10	1	37 (22%)
Total imminent alerts with secondary behaviors	40		60	5	30	1	31	1	168

Table 7.20. Imminent-alert clips containing secondary behaviors by gender

Gender	Week 1		Week 2		Week 3		Week 4		Total Clips Containing Secondary Behaviors
	Eng	Dis	Eng	Dis	Eng	Dis	Eng	Dis	
Male	22		37	1	17		12	1	90 (54%)
Female	18		23	4	13	1	19		78 (46%)
Total imminent alerts with secondary behaviors	40		60	5	30	1	31	1	168

The prevalence of secondary behaviors during imminent alerts is over represented in the younger age group (47%) relative to the middle-aged and older drivers (28% and 25%, respectively). In other words, younger drivers were more likely to be engaged in secondary behaviors during imminent alerts relative to their older cohorts.

Table 7.21. Imminent-alert clips containing secondary behaviors by gender and age group

Age by Gender	Week 1		Week 2		Week 3		Week 4		Total Clips Containing Secondary Behaviors
	Eng	Dis	Eng	Dis	Eng	Dis	Eng	Dis	
Younger Female	11		18	1	14		5		49 (29%)
Middle-aged Female	8		12		1		3		24 (14%)
Older Female	3		7		2		4	1	17 (10%)
Younger Male	8		11	2	6		6		33 (20%)
Middle-aged Male	6		9		3		7		25 (15%)
Older Male	4		3	2	4	1	6		20 (12%)
Total imminent alerts with secondary behaviors	40		60	5	30	1	31	1	168

Table 7.22 provides the frequency of secondary behaviors being observed during imminent alerts by forward-conflict scenario. Secondary behaviors are noticeably more frequent during conflict scenarios 260 and 270 where the lead vehicle brakes but does not stop, especially during those conflicts in which the lead vehicle’s stopping was not likely predictable by the driver.

7.1.7.3 Secondary Behaviors Observed During Commutes

In an attempt to examine driver behaviors during frequently traveled commuting trips and whether behaviors might change associated with these commutes, a review of the time-history data was performed in order to develop criteria to define what was to be considered a commute. For the purpose of the analysis to follow, commutes were defined as those trips which complied with the following conditions: trips were between 5 and 150 miles in length, they shared a point of origin that was within a 0.5 miles radius, they shared a destination that was within a 0.5 miles radius, they were of the same distance (± 6 percent), and they were traversed at least twice during the four week exposure. Then, in order to have more precise matching of trips that met the initial qualifications, some additional constraints were imposed, which allowed for more control of variables such as weather and time of day:

- a. There had to be at least one trip in week one and at least two trips in any of the remaining three weeks.
- b. The duration had to be within 20% of other matched trip(s).

Table 7.22. Imminent-alert clips containing secondary behaviors by conflict scenario

Code	Scenario Label	Younger Female	Middle-aged Female	Older Female	Younger Male	Middle-aged Male	Older Male	Secondary Behaviors Observed	Imminent Alerts Observed
200	Host tailgates LV							0	4
210	Host approaches accelerating LV					1		1	5
220	Host approaches const speed LV							0	12
230	Host approaches stopped LV				1			1	8
240	LV brakes to unpredictable stop	1						1	4
250	LV brakes to predictable stop	4	4		4	1		13	42
260	LV brakes unpredictably, not to stop	7	4	3	2	6	3	25	85
270	LV brakes predictably, not to stop	8	4	5	10	7	7	41	99
300	Host cuts behind LV	1		1				2	6
310	Host performs 2-lane pass	1						1	1
320	Host performs 2-lane pass to exit	7	1		3			11	33
330	Host changes lanes to pass	1						1	3
340	Host enters turn lane, LV in orig lane	1				1		2	10
360	Host enters turn lane; LV in turn lane	1		2				3	7
365	Host avoids obstacle without lane change					1		1	2
370	Host avoids obstacle with lane change							0	1
380	LV cuts in	2						2	3
390	LV forced to merge						1	1	4
400	LV performs 2-lane pass	1	1	1		2	2	7	10
410	LV inadvertently enters host lane							0	7
420	LV enters roadway in same direction; same lane as host			1				1	3
430	LV leaves host lane	1	3	1	1	1	2	9	11
440	LV leaves host lane into turn lane	5	2	1	3	1		12	51
450	LV ahead turns left	2	2		2	2		8	31
460	LV ahead turns right	6	3	2	7	2	5	25	95
Total		49	24	17	33	25	20	168	537

- c. Windshield-wiper status was also important. Therefore, three groups of distance-traveled-with-windshield-wipers-on were established: zero, more than zero but less than 75 meters, or the usage amount was within 20% of another commute to be considered matched.
- d. The headlamp status had to be on the entire trip or off the entire trip.
- e. The time of day in which the commutes took place had to be similar. Four groupings based on clock time were established: morning rush hour (7 am-9 am), evening rush hour (4:30 pm-6:30 pm), the daytime between the two rush hours (9am – 4:30 pm), and the nighttime after the evening rush hour but prior to morning rush (6:30 pm – 7:00 am).

The resulting sample included 23 drivers with a combined total of 169 trips. The pairing of these trips resulted in 32 different commutes (using the above criteria). For the sum of the trips, there were 580 clips of exposure video to be reviewed, each of which was examined for instances of secondary behaviors. An average number of secondary behaviors per week was calculated by dividing the number of secondary behaviors observed by the number of clips reviewed for the matched commuting trips during that week. It was appropriate to determine an average because some weeks had different numbers of clips to be reviewed (Table 7.23).

Table 7.23. Secondary behaviors observed during commutes by week

Secondary Behaviors	Week 1	Week 2	Week 3	Week 4	Total Clips
Cell phone: conversation, in use	8	17		3	28
Cell phone: reaching for					
Cell Phone: dialing					
Conversation		1		1	2
Drinking: high involvement					
Drinking: low involvement	2	1		2	5
Eating: high involvement	1				1
Eating: low involvement		1			1
Grooming: high involvement				2	2
Grooming: low involvement		1	3	1	5
Headset/hands-free phone: conversation					
Headset/hands-free phone: reaching for headset					
Headset/hands-free phone: unsure if any activity		5			5
In-car system use					
None	153	155	85	127	521
Other/multiple behaviors		2	2		4
Smoking: light a cigarette					
Smoking: reaching for cigarettes or lighter					
Smoking	2	2		2	6
Total Clips	166	186	90	138	580
Total Secondary Behaviors	13 (8%)	30 (16%)	5 (6%)	11 (8%)	59 (10%)

The percentage of clips in which secondary behaviors were observed on a per-week basis is as follows: week 1 = 8%, week 2 = 16%, week 3 = 6%, and week 4 = 8%. Week 2 showed the highest percentage of secondary behaviors during commutes, while in weeks one, three, and four a relatively consistent rate of secondary behaviors was observed. A detailed examination of the data determined that the increase in secondary behaviors in week 2 was almost exclusively associated with increased cellular telephone use, either hand-held, and therefore clearly in use, or hands-free, and therefore unclear if actually in use (22 total events). The majority, 16 events, can be attributed to two drivers, one younger male and one younger female. The relative frequency of observing drivers taking part in non-driving behaviors between week 1 and weeks 2 – 4 is not statistically significant according to a Pearson χ^2 test. Hence, these results are consistent with the those presented earlier for which there was no “commute” filter.

7.1.8 Summary of FCW Safety Analyses

Section 7.1 has studied FCW safety by investigating the data collected on-board the vehicle during manual driving (with cruise control not engaged). The main findings now follow, with elaboration of the results further below.

Events in the FOT suggest that FCW is capable of assisting drivers in avoiding near-crashes or crashes by improving the drivers' awareness of an immediate forward-crash risk, and perhaps encouraging decisions to take prompt braking action. Most alerts, however, occur in circumstances in which drivers ultimately never apply the brakes. ACAS does not appear to influence either the frequency or the severity of forward conflicts that drivers experience during manual driving. ACAS does appear, however, to reduce the time that drivers spend with short headway times (less than 1.0 second). During manual driving on freeways, the fraction of time with headways under 1.0 sec is reduced from 34.5% to 30.8%. During daytime driving, the fraction of time with headways under 1.0 sec is reduced from 29.2% to 25.1%. Longer headways allow drivers more time to react to events unfolding in front of them, which is a potential safety payoff. Drivers do not brake more often after FCW alerts that are displayed to them, versus “silent” alerts that occur during the baseline period. They may, however, reduce closing speed a bit more rapidly with FCW enabled. Steering appears to be a very uncommon response to conflicts associated with FCW alerts in those cases where drivers were not already changing lanes. The FCW system did not affect any tendencies surrounding steering behavior. There is an initial novelty effect that may be due to drivers purposefully provoking alerts and forward conflicts in general, during the first week that FCW is available. This may be

exacerbated by the test participants' awareness of the purposes of their experimental participation. A small number of FCW alerts were followed by apparently-startled expressions on the driver's face, but these were not associated with improper vehicle control actions. Overall, no evidence was found of unintended negative consequences of the FCW. No forward crashes occurred during the FOT, as expected, and no significant abuse of the FCW was noted. Drivers engaged in neither more nor less secondary task activity during manual driving when the ACAS was available to them. FCW was judged in cases identified to have the potential to assist drivers in improving responses to forward (closing-type) conflicts.

Because of the scope of the FOT project and the absence of any obvious abuse and negative unintended consequences of the presence of FCW, the safety conclusions reported in this section are reached by examining surrogate measures of safety. These included studying driver behaviors that include steady-state headway distances, the frequency and level of transient forward closing conflict events, driver actions following alerts, driver behavior in specific events judged as notable, adaptation of driver braking responses over time, and secondary task behavior with and without ACAS.

The occurrence of FCW imminent alerts in shared-lane (IHP) situations constitutes 29% of all alerts, and is usually (90%) coincident with driver braking (or rarely steering) responses to the situation, providing validation of the FCW alerts in those situations. Overall, however, driver braking or steering begins after an alert in less than half of the situations that provoke FCW alerts. This includes those alerts (41% of all alerts) that are triggered by out-of-path objects such as roadside objects, overpasses, or much less frequently, adjacent-lane traffic, or alerts occurring in transitioning-host-path (THP) situations in which one or both vehicles is making a lane change. The THP scenarios constitute 30% of all imminent alerts, with driver actions following the alerts in 27% of those events. The lack of braking action in THP scenarios suggests that drivers may be less satisfied with alerts in THP scenarios. However, during post-drive debriefing sessions, the drivers did not rate the alert utilities for IHP scenarios differently than for THP scenarios (see Section 7.2.1.4). On the other hand, the on-board data shows clearly that drivers manage THP conflicts much differently than they do IHP conflicts. Because the lateral motions of the vehicles resolve the conflict, drivers tolerate much smaller time to collisions and use the brakes much less often in THP situations than in IHP situations.

Overall, the frequency of driver braking actions following imminent alerts is unchanged by ACAS. However, when braking occurs, there is a slightly greater reduction in speed during the first two seconds after the alert, which may suggest a

possible increase is safety margins. Steering that begins after an imminent alert is presented is a rather rare occurrence, and FCW does not appear to change this.

There was no evidence that FCW had a significant effect on the frequency of conflict level associated with manual-driving “closing-type” forward conflicts. A set of over 44,000 forward conflict events during manual driving were identified and a subset of over 16,000 were identified as shared-lane (IHP) events. As mentioned earlier, drivers clearly make distinctions in headway management between the IHP set and the remaining events. The effects of FCW on conflict metrics values were studied using both the IHP set and the mixed-scenario set. There was no statistically significant difference in either decel-to-avoid or enhanced TTC at the time of brake onsets, suggesting no observed change in the timing of braking onsets. Furthermore, the peak level of conflict – characterized by the 10th and 20th percentiles of decel-to-avoid and enhanced TTC – was also unchanged. Furthermore, when comparing the rate of FCW alerts per distance traveled with the rate of baseline “silent” alerts, there is no change, even when the data is controlled for road type and target type (moving or stationary). The broad conclusion from this evidence is that FCW does not influence the frequency or severity of conflict events that drivers experience.

The data supports the hypothesis that novelty effects play a role in FCW usage and activity in the first week of use. Week 2 includes a higher alert rate, higher speed changes, more frequent conflicts, and more adjustments of FCW sensitivity than the other weeks (weeks 3 and 4).

Finally, the level of secondary, non-driving task activity in the vehicle (e.g., conversations, eating, cell phone use) does not change when ACAS is made available to the driver. The results are drawn from an examination of 614 randomly-selected video clips drawn from all driving time. There was no change in the relative frequency with which participants took part in secondary behaviors when the FCW system was enabled, relative to the baseline period during the first week. The only substantive change was an increase in relative frequency of conversation taking inside the vehicle (not including cellular telephone activity) which is hypothesized to be associated with the novelty of having the FCW system, and the desire of participants to describe the system or the test to passengers.

7.2 FCW Acceptance

The evaluation of algorithm-C driver’s acceptance of the FCW system is based largely on subjective assessments provided by the FOT drivers through a variety of mechanisms.

Much of what is contained in Section 7.2 on FCW acceptance is based upon responses to questionnaires that each driver completed immediately upon returning the research vehicle: the post-drive questionnaire (Section 7.2.1.1). Furthermore, there was an optional take-home questionnaire (Section 7.2.1.2). Information regarding specific instances in which drivers received imminent warnings was obtained during an optional debriefing session in which drivers reviewed video and vehicle data of select imminent warning events (Sections 7.2.1.3 and 7.2.1.4). Lastly, drivers had additional opportunity to express their opinions about the FCW system by participating in an optional focus group (Section 7.2.1.5). All but two of the algorithm-C drivers completed the take-home questionnaire, 65 of the 66 algorithm-C drivers reviewed data of select imminent warning events, and 26 drivers attended one of the four focus groups that were held.

Analyses were also performed that examined the existence of relationships between the subjective responses and objective data (Sections 7.2.2 and 7.2.3), namely an attempt to predict how the rate and number of imminent alerts a driver received may influence their acceptance of the FCW system. Finally, relationships between driver acceptance of FCW and personal characteristics (e.g., income, education, etc.) are examined (Section 7.2.4).

7.2.1 Drivers' Perceptions and Evaluations of FCW

This section focuses on providing an overview of algorithm-C drivers' subjective perceptions of the FCW system. The results are based almost exclusively on responses to a post-drive questionnaire. The post-drive and take-home questionnaires, with summary statistics, are provided in Appendices E and F of this report. Where appropriate, statistical analyses have been performed and reported.

7.2.1.1 FCW Post-Drive Questionnaire Results

The results from the post-drive questionnaire, which follow, were exclusive to those drivers experiencing algorithm C, all 66 of whom completed the post-drive questionnaire. Appendix E provides the entire questionnaire and descriptive statistics for individual questions by driver age group and gender along with plots of the overall mean responses by algorithm-C drivers. The majority of the questions utilized anchored, 7-point Likert-type scales. The statistical analysis of questions employing Likert-type scales utilized the non-parametric Kruskal-Wallis (K-W) one-way analyses of variance (ANOVA) by ranks test. For each analyzed question, all the responses were combined and ranked in a single series. The smallest scale response was replaced with rank 1, the next smallest response was replaced by rank 2 and the largest response with 66. The K-W test computes a mean

rank for each group (e.g. age group). The K-W tests performed assessed rank differences in ratings based on driver gender, age group, and the interaction of gender and age group. A significant K-W ANOVA as is determined by using the H statistic whose distribution is similar to χ^2 (chi-square) when the size of each group is greater than 5 (Siegel & Castellan, 1988). A significant H for any of the questions indicated that there was a difference amongst driver groups. Alpha was set at 0.05 to determine statistical significance. Group differences were based upon mean ranks. The mean rankings for each group were then analyzed using the K-W statistic to determine if there were differences amongst groups of drivers for any given question.

Follow-up multiple comparisons on all Likert-type questions with significant group differences were performed using Dunn's test to determine how or where the groups differ. The Dunn's test is a conservative post-hoc test; therefore a moderate alpha correction of 0.15 was used to control for experiment-wise error that can occur with multiple comparisons (Daniel, 1990). Nonetheless, because of how conservative the Dunn's test is, it is not possible to report multiple comparisons for all questions where statistically significant main effects were observed using the K-W ANOVA.

Manual Comparison Questions. The first seven questions in the post-drive questionnaire asked drivers to assess the base vehicle, a Buick LeSabre, on several of the same dimensions as those addressed in the FCW and ACC portions of the questionnaire. The purpose for analyzing these questions was to determine if there might be a driver bias associated with the vehicle that was contributing to responses regarding acceptance of either the FCW or ACC systems. Six of the seven manual comparison questions utilized anchored, 7-point Likert-type scales. No significant differences associated with driver age, gender, or the age-by-gender interaction was observed. Means, and the distribution, of driver responses to these questions can be found in Appendix E.

Gender. For gender, a one-way K-W ANOVA was conducted across all Likert questions regarding drivers' interactions and opinions of FCW. For the FCW system, only one statistically significant gender effect emerged. Rankings for ease of remembering how to use the FCW system (FCW32) were higher for males than for females $H(1) = 4.7, p = .03$.

Age. In contrast to the single difference associated with gender, numerous age differences emerged. All FCW-related questions that were significantly different according to a one-way K-W ANOVA are listed in Table 7.24. Follow-up multiple comparisons using Dunn's test for questions with significant age effects were conducted to see how the three driver age groups differed from each other.

Table 7.24. Post-drive questionnaire differences by age for FCW (Algorithm C)

Question Number	Question Description	Age	Mean	Mean Rank	<i>H</i> (2)	<i>p</i>
FCW1	Comfort using FCW	Younger	5.5	33.45	6.767	.034
		Middle	5.0	26.23		
		Older	6.1	40.82		
FCW3	Ease of keeping a safe distance	Younger	6.5	40.30 ¹	10.103	.006
		Middle	5.7	24.05 ¹		
		Older	6.2	36.16		
FCW5	Ease of driving while using FCW	Younger	6.1	34.73	12.309	.002
		Middle	5.5	23.55 ¹		
		Older	6.6	42.23 ¹		
FCW6	Amount of Stress w/ and w/o FCW	Younger	4.2	28.50	7.189	.027
		Middle	4.4	29.73		
		Older	5.5	42.27		
FCW9	Quick Attn/ Annoyance of unneeded alerts	Younger	4.2	27.86 ¹	12.548	.002
		Middle	4.2	27.50 ²		
		Older	5.9	45.14 ^{1,2}		
FCW20	Amount of false alarms	Younger	4.1	27.36 ¹	6.429	.040
		Middle	4.5	31.70		
		Older	5.6	41.43 ¹		
FCW33	Awareness while using FCW	Younger	6.2	25.86 ¹	16.359	< .001
		Middle	6.3	29.41 ²		
		Older	6.9	45.23 ^{1,2}		
FCW34	Responsive while using FCW	Younger	6.2	27.50 ¹	17.114	< .001
		Middle	6.1	27.14 ²		
		Older	6.9	45.86 ^{1,2}		
FCW _{add3}	Use of on/off switch if provided	Younger	4.0	40.29 ¹	10.723	.005
		Middle	3.1	34.02		
		Older	1.8	23.12 ¹		

Mean ranks with matching superscript indicates a statistically significant difference exists between the means ($p < .05$, Dunn's test). Each mean is based upon an N of 22 except for the younger and older drivers' mean responses to FCW_{add3} which had Ns of 21.

Older drivers reported being more comfortable using FCW (FCW1) than either the younger or middle-aged drivers, $H(2) = 6.7$, $p = .034$. Younger drivers rated the ease of keeping a safe distance using FCW (FCW3) higher than middle-aged drivers, but no difference between middle-aged and older drivers was present, $H(2) = 10.1$, $p = .006$. Similarly, middle-aged drivers rated the ease of driving while using FCW (FCW5) lower than older drivers, but no difference existed between the younger and middle-aged drivers for this question, $H(2) = 12.3$, $p = .002$. By and large, however, most age-related differences were obtained when comparing older drivers to both middle-aged and younger drivers. For instance, older drivers reported being less stressed (FCW6) than middle-aged and younger drivers, as compared to driving manually, when using FCW, $H(2) = 7.2$, $p = .027$.

Older drivers also viewed the crash alert as being more quickly attended to and less annoying (FCW9) than their middle-aged and younger driver cohorts, $H(2) = 12.6, p = .002$. Older drivers' perceptions regarding the frequency of false alarms were significantly lower (FCW20) than for younger drivers, $H(2) = 6.4, p = .040$. Older drivers also rated themselves as being both more aware of their environment (FCW33), $H(2) = 16.4, p < .001$ and more responsive (FCW34), $H(2) = 17.1, p < .001$ when using FCW than middle-aged and younger drivers. Finally, older drivers were less likely to want to disable the FCW system (FCW_{add3}) than younger drivers, $H(2) = 10.7, p = .005$.

Due to observed differences among age groups, a one-way K-W ANOVA was also conducted across questions for the interaction of gender and age group. For FCW, there were six questions where the interaction of gender and age resulted in significantly different ratings across groups. The results are listed in Table 7.25. To determine how groups differed, a follow-up Dunn's test was conducted for those questions with significant gender-by-age differences.

Due to the number of comparisons being made amongst groups, alpha was set at 0.15 to control for experiment-wise error. Differences amongst groups were primarily due to the rating disparities between either older males or older females in comparison to their middle-aged and younger cohorts. For FCW-related questions, only one significant difference emerged between middle-aged and younger drivers, where younger males found it easier to maintain safe distances (FCW3) while using FCW than middle-aged females, $H(5) = 12.1, p = .033$.

Older males rated the vehicle as easier to drive using FCW (FCW5) than middle-aged males, $H(5) = 15.1, p = .010$. Older drivers and the other groups emerged in the perception of the effectiveness of the crash alert and its possible annoyance (FCW9), where older females rated the crash alert as being more effective and less annoying than middle-aged female and younger male drivers, $H(5) = 15.8, p = .007$. In addition, older males and older females reported being more aware of their driving environment while using FCW (FCW33) than were younger males, $H(5) = 19.0, p = .002$, and felt more responsive to other vehicles while using FCW (FCW34) as compared to younger females, $H(5) = 18.3, p = .003$. Lastly, older males were less likely to disable the FCW system (FCW_{add3}), had they been given the opportunity to do so, as compared to middle-aged females and younger males, $H(5) = 15.4, p = .009$.

Table 7.25. Post-drive questionnaire differences for FCW of age-by-gender

(Algorithm C)

Question Number	Question Description	Age	Mean	Mean Rank	H(5)	p
FCW3	Ease of keeping a safe distance using FCW	Younger_Male	6.6	41.77 ¹	12.107	.033
		Younger_Female	6.5	38.82		
		Middle_Male	5.9	28.41		
		Middle_Female	5.5	19.68 ¹		
		Older_Male	6.0	33.50		
FCW5	Ease of driving while using FCW	Older_Female	6.5	38.82	15.064	.010
		Younger_Male	6.0	28.77		
		Younger_Female	6.3	40.68		
		Middle_Male	5.1	22.86 ¹		
		Middle_Female	5.9	24.23		
FCW9	Quick attention & annoyance of unneeded alerts using FCW	Older_Male	6.7	44.14 ¹	15.789	.007
		Older_Female	6.5	40.32		
		Younger_Male	3.6	22.00 ¹		
		Younger_Female	4.8	33.73		
		Middle_Male	4.5	30.91		
FCW33	Awareness while using FCW	Middle_Female	4.0	24.09 ²	18.981	.002
		Older_Male	5.6	42.59		
		Older_Female	6.2	47.68 ^{1,2}		
		Younger_Male	5.9	20.36 ^{1,2}		
		Younger_Female	6.5	31.36		
FCW34	Responsiveness while using FCW	Middle_Male	6.5	31.36	18.255	.003
		Middle_Female	6.1	27.45		
		Older_Male	6.9	45.23 ¹		
		Older_Female	6.9	45.23 ²		
		Younger_Male	6.4	31.41		
FCW _{add3}	Use of on/off switch if provided w/ FCW	Younger_Female	6.0	23.59 ^{1,2}	15.427	.009
		Middle_Male	6.1	27.14		
		Middle_Female	6.1	27.14		
		Older_Male	6.9	45.86 ¹		
		Older_Female	6.9	45.86 ²		
FCW _{add3}	Use of on/off switch if provided w/ FCW	Younger_Male	4.6	44.05 ¹	15.427	.009
		Younger_Female	3.5	36.86		
		Middle_Male	2.5	29.73		
		Middle_Female	3.8	38.32 ²		
		Older_Male	1.0	17.00 ^{1,2}		
FCW _{add3}	Use of on/off switch if provided w/ FCW	Older_Female	2.5	28.68	15.427	.009

Mean ranks with matching superscript indicates a statistically significant difference exists between the means ($p < .05$, Dunn's test). Each mean is based upon an N of 11 except for the younger male and older male drivers' mean responses to FCW_{add3} which had Ns of 10.

7.2.1.1.1 Factor Analysis of FCW Post-drive Questionnaire

Factor analysis is a statistical method used in order to reduce data. This process involves taking many variables and attempting to group particular variables together into factors. A principal component factor analysis (the type used in these analyses) works to detect an underlying structure of the data and variables relationships to one another. Principal component analysis attempts to fit a line to a set of variables, in an attempt to

conceptualize the data in a linear relationship. Imagine the data on a scatter plot and then connecting the variables into groups by their locations in regards to one another. Of course, the analysis uses an approach of greater than two dimensions, but this description is a simple mechanism to explain factor analysis. There are several ways to rotate the axis of this scatter plot. By rotating the axis the relative locations of the variables do not change, but their coordinates do. Rotations change how variables load onto factors. The goal of rotation is to find the simplest and clearest picture of the relationships. Such a picture reveals more clearly, and with less obscurity, that a variable loads higher on one factor than another. More over, the variance will be spread more evenly throughout the factors.

A factor analysis of the FCW post-drive questionnaire data for algorithm-C drivers produced 11 factors. These factors were retained based on their Eigenvalues being greater than or equal to 1. The eleven-factor solution accounted for 76.730 percent of the variance (see Table 7.26). The factors were extracted using principal component analysis and were rotated with a varimax rotation. This rotation produced a simpler rotation than an equamax, quattrimax, or an un-rotated solution, meaning the variance was most evenly distributed among the factors using this rotation method.

Table 7.26. Total variance explained by each factor

Factor	Percentage of Variance	Cumulative Percentage	Eigenvalues
1	15.331	15.331	11.687
2	14.716	30.048	3.703
3	8.770	38.818	2.990
4	7.472	46.290	2.654
5	5.701	51.990	2.296
6	5.157	57.147	1.734
7	4.203	61.350	1.566
8	4.046	65.397	1.327
9	3.856	69.253	1.313
10	3.770	73.023	1.153
11	3.708	76.730	1.038

The results are below (items in parentheses are not as clearly placed, and are listed on two factors, the one in bold is where it best fits conceptually):

- Factor 1 (acceptance, worth having): FCW1, FCW6, FCW22, FCW25, FCW35, FCW36*, FCW37, FCW39, FCW43
- Factor 2 (annoyance): FCW16, FCW17, FCW18, FCW30, FCW31A, FCW31B, 31C, FCW31D, FCW31F, **(FCW31G)**, FCW31H,
- Factor 3 (false alarms): FCW5, FCW13, FCW20, FCW27*, FCW28*, (FCW31G)

- Factor 4 (ease in detecting visual alerts): FCW2, FCW7, FCW10, FCW12, FCW32,
- Factor 5 (attentiveness): FCW9, FCW33, FCW34,
- Factor 6 (effectiveness of audio tone): FCW14, FCW15
- Factor 7 (ease of maintaining a safe distance): FCW3
- Factor 8 (annoyance when car cuts in front): FCW31E
- Factor 9 (necessary alerts): FCW26, FCW29*
- Factor 10 (ease in detecting audio alerts): FCW11
- Factor 11 (adverse weather): FCW21

* – Items designated by an asterisk have been reverse coded so that positive values indicate positive attributes about the FCW system. Also, responses of “0” or “never” were not used when calculating factors with question 20. These responses were treated as 7’s (very infrequently) in order to prevent skewing the data.

7.2.1.1.2 Scale Reliability

Cronbach alphas were calculated for subscales that had been determined a priori; comfort and convenience, safety, ease of use, and willingness to purchase. This evaluated the internal consistency of items on a previously constructed scale. A Cronbach’s alpha greater than or equal to .70 is the lenient cut-off in the literature; often .80 is cited. Of the four a priori categories, the ease-of-use category did not quite meet this criterion. In addition, several questions were not included in this analysis. All questions that were not in the form of a Likert scale were not included. Also, question 9 was not included because it could not be categorized theoretically into one of the 4 categories. Though question 24 would have fit into the safety category, it could not be used because of the manner in which its scale was formatted.

Comfort and convenience. Cronbach alpha: 0.9017

FCW1, FCW6, FCW16, FCW17, FCW18, FCW20^, FCW21, fcw27*, fcw28*, FCW30, FCW31a, FCW31b, FCW31c, FCW31d, FCW31e, FCW31f, FCW31g, FCW31h, FCW35

Safety. Cronbach alpha: 0.7609

FCW2, FCW13, FCW14, FCW15, FCW22, FCW25, FCW26, fcw29*, FCW33, FCW34, fcw36*, FCW37 (FCW36* was negatively correlated)

Ease of use. Cronbach alpha: 0.6245

FCW3, FCW5, FCW7, FCW10, FCW11, FCW12, FCW32 (FCW11 was negatively correlated)

Willingness to purchase. Cronbach alpha: .8733

FCW39, FCW43

*Items designated by an asterisk have been reverse coded so that positive values indicate positive attributes about the FCW system. Also, responses of “0” or “never” were not used when calculating factors with question 20. These responses were treated as 7’s (very infrequently) in order to prevent skewing the data.

These results suggest that the predetermined subscales of comfort and convenience, safety, ease of use, and willingness to purchase provided a more robust model for categorizing the questions of the post-drive questionnaire than did the factor analysis. It is possible that the wording of the questions and/or the drivers’ understanding of the ACAS system made it difficult to reduce the questionnaire into a small number of factors by way of a factor analysis.

Summary of Scale-Reliability Results: Post-Drive Questionnaire

Below is a summary of the results from the post-drive questionnaire for the four subscales; comfort and convenience, safety, ease of use, and willingness to purchase. Unless otherwise noted, the scales are 7-point Likert-type scales with higher scores indicating positive attributes about the FCW system.

Comfort and Convenience

Overall, drivers reported that they were generally comfortable using the FCW system (FCW1, Mean = 5.5) and that they found driving with FCW to be slightly less stressful than manual driving (FCW6, Mean = 4.7). Older drivers tended to be more comfortable and less stressed than their middle-aged and younger counterparts. Perhaps as a result of feeling less stressed while driving with FCW as compared to manual driving, drivers stated that they felt more comfortable performing additional tasks (FCW35, Mean = 5.2). Overall, drivers rated the annoyance level of the cautionary alerts, the visual and audio alerts accompanying imminent alerts nearly identically (overall mean scores of 3.8, 3.9, and 3.8 respectively on a 5-point scale) (FCW 16-18). When asked about the frequency of false alarms, older drivers reported receiving them less frequently than did younger drivers (FCW20r, Mean_{Older} = 5.6, Mean_{Younger} = 4.4). On average, drivers reported receiving alerts in inappropriate situations once or twice per week (FCW27). Generally, drivers reported being able to identify the sources of alerts as they reported, on average, being unable to determine the source of an alert only once or twice during the ACAS-enabled period (FCW28). As for their overall annoyance level associated with unnecessary FCW alerts, drivers’ responses resulted in a mean score of 3.4 on a 5-point

scale (FCW30). Using a 5-point scale, drivers were asked to indicate their overall annoyance level associated with numerous types of conflict scenarios. The scenarios listed below are in order of annoyance from more to less annoying (FCW31):

- Passing a sign, light post or guardrail (Mean = 3.1)
- Passing a parked vehicle (Mean = 3.5)
- Lead vehicle turning (Mean = 3.6)
- Passing a moving vehicle and lead vehicle cut-in (tie) (Mean = 3.7)
- Lead vehicle changing lanes (Mean = 3.8)
- Host cut-in behind another vehicle and host changing lanes (tie) (Mean = 4.0)

Safety

Overall, drivers felt safe while driving with FCW (FCW2, Mean = 6.0). The overall mean response to the suggestion that FCW would increase one's driving safety (FCW37) had an overall mean score of 4.6. When asked to evaluate if they drove more safely with FCW as compared to manual driving, the responses resulted in a mean score of 5.1 (FCW22). Additionally, they felt aware of the driving situation (FCW33, Mean = 6.5) and responsive to the actions of other vehicles around them (FCW34, Mean = 6.4) with older drivers rating their awareness and responsiveness levels higher than younger and middle-aged drivers. Drivers found both the visual and the auditory alerts to be effective at quickly getting their attention (FCW13, Mean = 6.2 and FCW15, Mean = 6.5). Additionally, the audio alert was rated as effective in communicating a situation in which a crash may be about to occur (FCW14, Mean = 6.2). On average, drivers felt that the FCW system provided alerts in appropriate situations about one or twice per week (FCW26) while failing to provide an alert when one was deemed to be necessary only one or twice during the three-week enabled period (FCW29). Overall, drivers did not feel that they relied too much on the FCW system (FCW36, Mean = 2.0).

Ease of Use

Overall, drivers found it easy to remember how to use and operate the FCW system (FCW32, Mean = 6.7). Additionally, they found it easy to drive with FCW (FCW5, Mean = 6.1). Older drivers rated the FCW system higher for ease of use than their middle-aged cohorts with older males rating the system more favorably than middle-aged males (Mean_{OM} = 6.7 and Mean_{MM} = 5.1). Younger drivers (Mean = 6.5) found it easier to maintain a safe distance to preceding vehicles when using FCW than did middle-aged ones (Mean = 5.7) with younger males (Mean = 6.6) finding it easier than middle-aged females (Mean = 5.5) (FCW3). On average, it was easy for drivers to recognize alerts

from the FCW system (FCW7, Mean = 6.7). Drivers were equally as able to easily detect the visual crash alerts as they were the audio ones (Mean = 6.7, Mean = 6.8 respectively, FCW10 and FCW11). Overall, drivers were well able to distinguish between the visual alerts for a cautionary situation versus those for an imminent threat (FCW12, Mean = 6.3).

Willingness to Purchase

When drivers were asked how satisfied they were with the FCW system the responses produced a mean score of 4.8. When asked about the likelihood of purchasing FCW if they were purchasing a new vehicle at the time of their completion in the FOT, drivers mean response was a 3.1 on a 5-point scale.

7.2.1.1.3 Van Der Laan Scale of FCW Acceptance

There is no standardized manner for measuring driver acceptance of new technologies. The Van Der Laan scale is a straight-forward, 5-point scale, which has been employed in a multitude of studies investigating driver acceptance of new technologies. The use of this scale allows researchers to compare driver acceptance across studies. At the end of this section, ACAS FCW acceptance is compared to driver acceptance of another collision avoidance system.

The Van Der Laan scale is composed of nine questions. The scale was integrated into the post-drive questionnaire and was the second-to-last question in the FCW section. This scale was developed in the Netherlands and is described in Van Der Laan, Heino, and De Waard (1997). The scale is anchored on each end by an adjective. The left side of the scale typically states the positive adjective, while the right has the corresponding negative adjective. Questions 3, 6, and 8 are mirrored, such that the negative adjective is anchored on the left side. The scale is scored from -2 to +2 with 0 in the center. Negative adjectives are scored with negative values, and marks on the positive side of the scale are scored with positive values. Thus, a mark in the most extreme positive box is scored with a +2. The nine positive adjectives are: useful, pleasant, good, nice, effective, likeable, assisting, desirable, and raising alertness. The nine corresponding negative adjectives are: useless, unpleasant, bad, annoying, superfluous, irritating, worthless, undesirable, and sleep-inducing. The results are later collapsed, and result in two separate scale scores. One score is a composite score that addresses system usefulness, and the second is a composite score representing system satisfaction. The usefulness scale is comprised of 5 questions: 1, 3, 5, 7, and 9. The satisfying scale is a comprised of 4 questions: 2, 4, 6, and 8.

A section at the end of Van Der Laan, et al. (1997), entitled *Guide for scale users*, explains how to use and score the instrument. However, one error appears in the instructions as they indicate that negative numbers indicate positive adjectives, which is contrary to how results are commonly described in the literature (de Waard, Van Der Hulst, Brookhuis, 1999; Van Der Laan, et al., 1997). Per the instructions in this section, scale reliability tests were run in order to confirm the appropriateness of the usefulness and satisfying scales for the study's population. The results indicated that both scales, usefulness and satisfying, are indeed appropriate. The usefulness scale had a Cronbach's Alpha of .9249 while the satisfying scale had a Cronbach's alpha of .9572. Van Der Laan, et al. state that an alpha of .65 or greater is required in order to use these scales for analyses. Given that the data exceeded the criteria, further analyses were conducted.

The two scales were evaluated for each driver. This was done by taking the average response across the scale. This resulted in a range of numbers from -1.40 to +2.00 for the usefulness scale and a range of numbers from -2.00 to +2.00 for the satisfying scale. The scale scores were then averaged across all algorithm-C drivers to arrive at an overall usefulness score and an overall satisfying score. One driver did not complete one question on the usefulness scale, thus a usefulness score could not be calculated directly for this driver. In order to calculate a score for this driver, the responses to the other four questions on the scale were averaged and this score was used as the usefulness scale score. The replaced value was also used in calculating the overall scale score across all drivers.

The usefulness scale resulted in a mean score of 0.90. A value of .90 indicates positive feelings toward the FCW system. In comparing these findings to a study investigating a similar system (a collision warning system referred to as CAS), a slight preference for the FCW system was found. The study by Janssen, Brookhuis, and Kuiken (1993) had an overall usefulness score of .45 according to Van Der Laan et al. (1997). This score also indicates positive feelings about the system, but not with the same strength as with the FCW system. However, the procedure of the Janssen et al. study was very different from the ACAS procedure as the drivers were only on the road for approximately two hours, and one of those hours was a baseline condition without the assistance of the CAS system. The mean satisfying scale score for the FCW system was 0.50, also indicating positive feelings toward the system. However satisfaction was not rated as highly as usefulness. According to Van Der Laan et al., the CAS system had a satisfying score of -.66 indicating negative feelings toward the CAS system. It appears that the FCW was more satisfying than the CAS system. The usefulness and satisfying

scores in this analysis are significantly correlated ($R = .775, p < .001$), indicating that drivers that reported the FCW system to be useful were also likely to report the system to be satisfying—and vice-a-versa.

7.2.1.2 Results of the FCW Take-Home Questionnaire

Again, one-way K-W ANOVAs were conducted on all Likert-type questions concerning the use of FCW in the take-home questionnaire. Males and females tended to have similar reactions to the FCW system, such that no significant differences were obtained for gender. However, a one-way K-W ANOVA conducted for age group as the independent variable resulted in two differences amongst age groups for the FCW system. A main effect of age was found in regards to the distractibility of the cautionary visual alerts (FCWTH6), $H(2) = 9.2, p = .010$, and a driver’s willingness to rent an FCW-equipped vehicle (FCWTH11), $H(2) = 6.4, p = .040$ (Table 7.27). Follow-up Dunn’s multiple comparison tests were conducted to test for differences between age groups. Follow-up comparisons for FCWTH6 revealed no differences in FCW ratings between younger and middle-aged drivers and between middle-aged drivers and older drivers; however a difference emerged when comparing younger to older drivers. Younger drivers rated the cautionary visual alerts as more distracting than their older cohorts. The direction of the difference was similar for FCWTH11, but the Dunn’s statistic did not establish a significant difference among the comparisons.

Table 7.27. Take-home-questionnaire differences across age for FCW

(Algorithm C)

Question Number	Question Description	Age	Mean	Mean Rank	$H(2)$	p
FCWTH6	Distraction w/ visual alerts	Younger	4.6	26.38 ¹	9.215	.010
		Middle	5.3	29.93		
		Older	6.2	42.39 ¹		
FCWTH11	Willingness to rent FCW-equipped car	Younger	5.0	27.19	6.415	.040
		Middle	5.4	31.00		
		Older	6.2	40.55		

Mean ranks with matching superscript indicates a statistically significant difference exists between the means ($p < .05$, Dunn’s test). Each mean is based upon an N of 22 except for the younger drivers’ mean responses which had Ns of 21.

Finally, due to differences that emerged within age groups, age-by-gender groups were analyzed using a one-way K-W ANOVA. For FCW, the only age-by-gender difference obtained was the difference in the distractibility of cautionary visual alerts (FCWTH4), $H(5) = 11.102, p = .049$. A follow-up multiple comparison test using Dunn’s test, revealed that younger male drivers rated the alert as more distracting than

older male drivers. Similar to the post-drive questionnaire, an α of 0.15 was again set to control for experiment-wise error.

7.2.1.2.1 Results from Factor Analysis of Take-Home-Questionnaire

A factor analysis of the take-home questionnaire data for 64 algorithm-C drivers produced 3 factors. The factors were retained based on their Eigenvalues being greater than or equal to 1. A three-factor solution accounted for 63.64 percent of the variance (Table 7.28). The factors were extracted using principal component analysis and were rotated with a varimax rotation. This rotation produced a simpler rotation than an equamax, quatrimax, or an un-rotated solution, meaning the variance was most evenly distributed among the factors using this rotation method.

Table 7.28. Total variance explained by each factor

Factor	Percentage of Variance	Cumulative Percentage	Eigenvalues
1	29.490	29.490	3.736
2	18.257	47.747	1.930
3	15.8998	63.645	1.335

The results are below (items in parentheses are not as clearly placed, and are listed on two factors; the one in bold is where it best fits conceptually).

- Factor 1 (comfort and overall satisfaction): (FCWTH3), FCWTH5, FCWTH6, FCWTH8, FCWTH9, FCWTH10, FCWTH11
- Factor 2 (settings and operations): FCWTH1*, (FCWTH2*), FCWTH13*, FCWTH14* (FCWTH14 was negatively loaded after being reverse coded).
- Factor 3 (Ease of use, understanding operations): (**FCWTH2***), (**FCWTH3**)

*Items designated by an asterisk have been reverse coded so that positive values indicate positive evaluations of the FCW system

Scale Reliability. Cronbach alphas were also determined for the subscales that had been determined a priori. This evaluated the internal consistency of items on a previously constructed scale. Only the ease of use scale met the criterion for a valid scale, a Cronbach alpha value greater than or equal to .70. The low Cronbach alphas indicate that these scales are not that reliable. Several questions were not included in this analysis. All questions that were not in the form of a Likert scale were not included, such as yes/no or fill-in-the-blank. Question 4 was not included even though it was Likert based because it did not have clearly positive and negative anchors. Questions FCWTH7 and FCWTH12 were not on Likert scales and were, thus, not included.

Comfort and convenience Cronbach alpha: 0.5194

FCWTH1*, FCWTH5, FCWTH8

Safety Cronbach alpha: 0.0994

FCWTH6, FCWTH10, FCWTH13*, FCWTH14* (FCW13 and 14 are negatively correlated in the scale after being reverse coded.)

Ease of use Cronbach alpha: 0.8103

FCWTH2*, FCWTH3

Willingness to purchase Cronbach alpha: 0.5653

FCWTH9, FCWTH11

*Items designated by an asterisk have been reverse coded so that positive values indicate positive evaluations of the FCW system.

Summary of Scale-Reliability Results: Take-Home Questionnaire

Below is a summary of the results from the take-home questionnaire for the four subscales: *comfort and convenience*, *safety*, *ease of use*, and *willingness to purchase*. Unless noted, all scores are based on 7 point Likert scales with higher scores denoting positive attributes regarding FCW.

Comfort and Convenience

Overall, drivers did not take long to become comfortable with FCW (FCWTH1*: *Mean* = 3.0 on a 5 point scale), with the majority of drivers reporting feeling comfortable by the second to third day of system exposure. Older females (*Mean* = 2.6), however, reported being the slowest to acclimate to the system where most felt comfortable by the end of the first week of system exposure. Subsequently, males (*Mean* = 3.2) reported feeling comfortable with FCW earlier than females (*Mean* = 2.9).

Moreover, in terms of how startling the FCW alert was (FCWTH5), drivers, on average, reported that the alert was only somewhat startling (*Mean* = 4.7). In addition, males (*Mean* = 4.4) rated the alerts as slightly more startling than females (*Mean* = 4.9). Subsequently, differences amongst age groups also emerged where older drivers (*Mean* = 5.7) reported alerts being less startling than middle-age (*Mean* = 4.5) and younger drivers (*Mean* = 4.1). Finally, in regards to whether drivers would be comfortable recommending FCW to a friend or loved one (FCWTH8), drivers reported being somewhat comfortable (*Mean* = 5.7). Males (*Mean* = 5.8) and females (*Mean* = 5.6) felt similarly in regards to comfort; however, comfort with the system appeared to increase with age. Specifically, younger drivers (*Mean* = 5.1) reported feeling the least comfortable, while older drivers (*Mean* = 6.3) reported feeling the most comfortable. In

contrast, middle-age drivers (*Mean* = 5.7) reported feeling more comfortable than younger drivers but less comfortable than older drivers.

Safety

In terms of how distracting FCW alerts were (FCWTH6), drivers on average reported alerts to be somewhat not distracting (*Mean* = 5.4). Differences in ratings, however, were reported amongst age and gender groups. Specifically, females (*Mean* = 5.5) reported that the alerts were slightly less distracting than males (*Mean* = 5.2). Similarly, for age groups, older drivers (*Mean* = 6.2) reported that the alerts were less distracting than did middle-age (*Mean* = 5.3) and younger drivers (*Mean* = 4.6). In addition middle-age drivers felt the alerts were less distracting than younger drivers.

When drivers were asked to make a safety comparison between FCW and anti-lock brakes, drivers felt that the two systems were comparable (FCWTH10: *Mean* = 4.0). Moreover, no differences emerged between males and females (*Mean*'s = 4.0). With regards to age, however, older drivers (*Mean* = 4.3) gave higher favorability ratings to FCW than did middle-age drivers (*Mean* = 4.0), who subsequently gave higher favorability ratings than did younger drivers (*Mean* = 3.7).

In reference to the whether an addition of a more sensitive FCW setting should be added (FCWTH13*), drivers' responses were widely distributed across the 7 point Likert scale where a bimodal distribution of preferences emerged. Drivers tended to be either highly in favor of an additional setting or highly opposed. A comparison of age and gender cohorts revealed that, on average, males (*Mean* = 2.8) were more in favor of adding a more sensitive setting than females (*Mean* = 3.3). Subsequently, for age groups, middle-age drivers (*Mean* = 2.7) reported being in slightly more favor of an additional setting than older drivers (*Mean* = 2.9). In addition both middle-age and older driver reported being in more favor of an additional setting than younger drivers (*Mean* = 3.5).

In regards to whether there should be an addition sensitivity setting that would provide alerts later than the least sensitive FCW setting (FCWTH14*), drivers, on average, were in fair disagreement with the additional setting (*Mean* = 4.4). In particular, older females (*Mean* = 5.3) felt the strongest opposition to the addition of a less sensitive setting. In comparison of gender and age groups, males and females were equally opposed to the new setting (*Mean* = 4.4); whereas, differences across age groups were evidenced. In particular, younger drivers (*Mean* = 3.9) were more in favor of adding a setting than were both middle-age (*Mean* = 4.5) and older drivers (*Mean* = 4.8). Furthermore, middle-age drivers were more in favor of adding than were older drivers.

Ease of Use

In regards to how long it took to understand the operation of FCW (FCWTH2*), drivers, on average, were able to comprehend its activity with the first 3 days (Mean = 3.5 on a 5 point scale). Males (Mean = 3.4) and females (Mean = 3.6) reported comprehending the system's operation relatively similarly. In addition, middle-age drivers reported the quickest comprehension (Mean = 3.7) as compared to younger (Mean = 3.4) and older drivers (Mean = 3.4), which did not differ. In regards to how easy it was to understand and use the FCW sensitivity settings (FCWTH3), drivers reported the setting adjustment easy to understand and use (Mean = 6.3). Furthermore, ratings did not differ across age groups or gender, where all groups reported the FCW sensitivity setting as easy to operate.

Willingness to Purchase

With concerns about the ease of FCW's marketability, drivers felt that it would be somewhat easy to sell (FCWTH9: Mean = 5.0). On average, males (Mean = 5.1) reported the FCW would be slightly easier to market than females (Mean = 4.8). In addition, older drivers (Mean = 5.1) reported that FCW would be slightly easier to market than both middle-age (Mean = 4.8) and younger drivers (Mean = 4.9).

In regards to ones willingness to rent an FCW-equipped vehicle (FCWTH11), drivers reported being somewhat willing (Mean = 5.5). Across male drivers, older males (Mean = 6.6) reported being more willing than both middle-age (Mean = 5.7) and younger males (Mean = 4.6). Subsequently, middle-age males reported feeling more willing to rent an FCW-equipped vehicle than younger males. For females, older females (Mean = 5.8) were also more willing to rent than were middle-age (Mean = 5.0) and younger females (Mean = 5.3). Moreover, younger females reported feeling slightly more favorable towards renting an FCW-equipped vehicle than middle-age females.

7.2.1.3 FCW Debriefing Questions

As part of the post-drive supplemental questionnaire, drivers were asked whether or not they would have turned off the FCW system if they were able to do so (FCWadd3). Nearly one-third of algorithm-C drivers responded that they would have turned off the FCW system if an On/Off switch had been provided. Older drivers were less likely to want to disable the FCW system than younger drivers ($H(2) = 10.7, p = .005$, Table 7.24). Approximately half of the drivers who said that they would have turned off the FCW system indicated that they would have done so after experiencing the system for one week or less. Four drivers responded that they would have allowed the driving

environment to dictate when they used the FCW system. For example, one driver indicated that he would have turned off the system for highway driving, but turned the system back on for city driving.

Additionally, 29 drivers indicated that they found the FCW alerts to be annoying, were asked which specific characteristics of the alert made it annoying. Of the drivers who responded, more than one-third commented that the audio component of the imminent alert was too loud and/or startling.

All drivers were asked to provide suggestions for modifications to the FCW system. Reducing the incidence of false alarms was the improvement suggested most frequently (8 drivers). Four drivers indicated that they would have liked to have received imminent alerts sooner than they did. Others suggested modifications include changes to the HUD in terms of location and color choices, having the FCW system active at speeds below 25 mph, volume adjustment for the audio tone and providing an On/Off switch.

The debriefing sessions revealed one relatively common misconception regarding the FCW system. As part of the orientation session, drivers were instructed that the timing of the imminent alert would remain the same regardless of the alert-timing setting that they selected. This point was articulated in the training video as well as during the hands-on orientation to the FCW system. During the debriefing session, drivers were asked, “Was it your understanding that the timing of an imminent alert would change based upon the alert-timing setting that you selected, or would the timing of an imminent alert remain the same irrespective of the setting?” A number of drivers believed that the timing of an imminent alert was based upon the alert-timing setting that they had selected. The roots of this misconception may be in a training saturation effect. Within a two-hour period, drivers were presented with details about two new automotive technologies as well as a vehicle that was not familiar to the vast majority of them. It stands to reason that not all of the details would be recalled accurately. Further, since the onset of the cautionary icons was affected by changing the alert-timing setting, it is understandable that some drivers would assume that all timing aspects of the alert would be affected. Given the design and nature of the ACAS FOT, it is not possible to determine if changing the onset of the cautionary AND imminent alerts should occur in tandem. However, these results suggest that such a yoking of cautionary and imminent alerts may be a prevailing assumption by drivers.

7.2.1.4 Review of FCW Key Events for Utility

As part of the debriefing session, drivers viewed forward-camera and face-camera video for several of the alerts that they received during weeks 2 through 4, and they were asked to provide a rating of usefulness for these alerts. If they received more than 12 alerts during weeks 2 through 4, then only 12, randomly-selected, alerts from among the total were shown to them. Whenever possible, drivers were shown an equal number of moving and stationary alerts. The goal of presenting video to drivers was to ascertain a rating of usefulness as it applied to alerts in a variety of forward conflict scenarios, allowing the driver to “re-live” actual events they had previously experienced.

Sixty-five of the 66 algorithm-C drivers reviewed video, and provided usefulness ratings for 566 alerts. Fifty-five of these alerts were excluded from the following analyses because they were not included in the 942 useable algorithm-C alerts, leaving 511 alerts. One driver did not review video as a result of technical problems during the day of his scheduled debriefing session. Subsequent personal circumstances, a serious health issue, made it impossible for him to reschedule his debriefing session.

Drivers were first asked, “Was the warning in this instance useful?” Based upon the answer to this question, drivers rated either “how useful” the alert was on a five-point Likert-type scale (anchored by 1=Not at all useful and 5=Quite useful) or “how unnecessary” the alert was on a different five-point Likert-type scale (anchored by 1=Completely unnecessary and 5=Not at all unnecessary). This unnecessary rating scale was employed as an attempt to ascertain the degree to which drivers distinguished between nuisance alerts and false alarms. For example, a driver may rate receiving an alert in response to a guardrail as “completely unnecessary” while rating an alert elicited by the lead car turning right as “somewhat unnecessary”. Driver responses to the first question of utility and the follow-up ratings are presented and analyzed in the next two subsections. However, it is important to note that, due to unequal numbers and conditionality, the useful and unnecessary ratings should not be interpreted in isolation of one another. Nonetheless, the follow-up ratings are useful as expressions of *how* useful or unnecessary the driver perceived the alerts to be.

While reviewing videos, drivers were asked to recall, as much as possible, their state of mind and attentiveness to the driving task at the time when they received an alert. They were further encouraged not to engage in “hypothetical thinking” such as, “If I had not been paying attention, that alert would have been useful.” They were asked to evaluate the alert based on the driving situation and their behavior at the time of the alert.

Of the 511 useable alerts that were rated by the drivers, 356 of them had also been reviewed in detail by UMTRI analysts and coded for several characteristics (as described in Section 5.2). For this set of rated and coded alerts as well as the stationary alerts that the drivers reviewed and rated, Table 7.29 shows the set of results for both levels of questions, broken down into individual scenarios as well as scenario types. The table shows that drivers considered alerts in IHP scenarios to be the most useful (53% useful), followed by alerts in THP scenarios (32% useful), and finally those in OHP (false-alert) scenarios (14% useful). It is not surprising that OHP alerts are the least valued. Similarly, it is consistent with other findings that the fraction of THP alerts considered useful is not much higher than the same fraction for IHP alerts, since the primary mechanism for conflict resolution is by lateral motion(s) of one or both vehicles.

In Section 6, Figure 6.76 had shown that the breakdown of alerts in algorithm C manual driving was 29% IHP alerts, 35% THP alerts, and 36% OHP alerts. An estimate of the overall fraction of FCW alerts considered useful by drivers can be computed by weighting the ratings by the relative frequency of occurrence, which results in an estimate that 35% of the manual-driving FCW alerts were considered useful. For those alerts where the target was a vehicle that shared a lane with the host vehicle at some point in time, the corresponding estimate of the fraction of alerts considered useful by drivers is 41%, or two of every five alerts.

Table 7.29. Mean ratings of alert utility by scenario type and precipitator⁹

Code	Scenario label	Scenario type	Precipitator	% Useful alerts	Mean Useful	Mean Unnecessary
100	False alert - target always out of path	OHP - False alert	None	14%	3.88 N=27	1.45 N=165
200	Host tailgates LV	IHP - Shared-lane	Host	53%	3.93 N=85	1.72 N=75
210	Host approaches accelerating LV					
220	Host approaches const speed LV					
230	Host approaches stopped LV		LV			
240	LV brakes to unpredictable stop					
250	LV brakes to predictable stop					
260	LV brakes unpredictably, not to stop					
270	LV brakes predictably, not to stop	THP - Host path changes	Host	33%	3.10 N=10	2.00 N=20
300	Host cuts behind LV					
310	Host performs 2-lane pass					
320	Host changes lanes to pass					
330	Host enters turn lane, LV in orig lane					
340	Host enters turn lane; LV in turn lane					
350	Host avoids obstacle without lane change					
355	Host avoids obstacle with lane change	THP - LV path changes	LV	33%	3.69 N=41	1.54 N=80
360	LV cuts in					
365	LV forced to merge					
370	LV performs 2-lane pass					
380	LV inadvertently enters host lane					
420	LV enters roadway in same direction; same lane as host					
430	LV leaves host lane					
440	LV leaves host lane into turn lane					
450	LV ahead turns left					
460	LV ahead turns right					
390	LV crosses path; on intersecting roadway					
400s	LV left turns					

⁹ One of the following scales was used to rate each driver-reviewed alert: 5-point Likert-type scale for “How Useful” anchored by 1=Not at all useful and 5=Quite useful or 5-point Likert-type scale for “How Unnecessary” anchored by 1=Completely unnecessary and 5=Not at all unnecessary

These estimates are only approximations since both the fraction of rated alerts and the breakdown of relative occurrence of alerts in the three scenario groups were computed by collapsing across drivers. It is assumed that the alerts which were rated by the drivers are representative of all of the imminent alerts as drivers either viewed all of the alerts that they received if they received fewer than 12 alerts, or if they received in excess of 12 alerts, the alerts that they reviewed were selected at random.

7.2.1.4.1 Ratings of Relative Alert Utility by Age and Gender

For those FCW alerts events reviewed and identified by participants to be useful, the mean overall usefulness rating was 3.78. FCW alerts events reviewed and identified by participants to be unnecessary had an overall mean rating of 1.56 on the unnecessary scale. When men identified alerts to be useful, they rated these alerts slightly more useful than women (3.95 versus 3.56, respectively). For alerts deemed to be unnecessary, alert ratings were virtually the same for men and women (1.59 versus 1.53, respectively). For alerts deemed to be useful by younger and middle-aged drivers, their ratings of these events was nearly identically (3.67 and 3.68) and only slightly lower than those of older drivers (3.96). For alerts deemed to be unnecessary, middle-aged drivers rated unnecessary alerts higher than younger and older drivers (1.61, 1.53 and 1.54 respectively). These results are displayed in Figures 7.29 - 7.31.

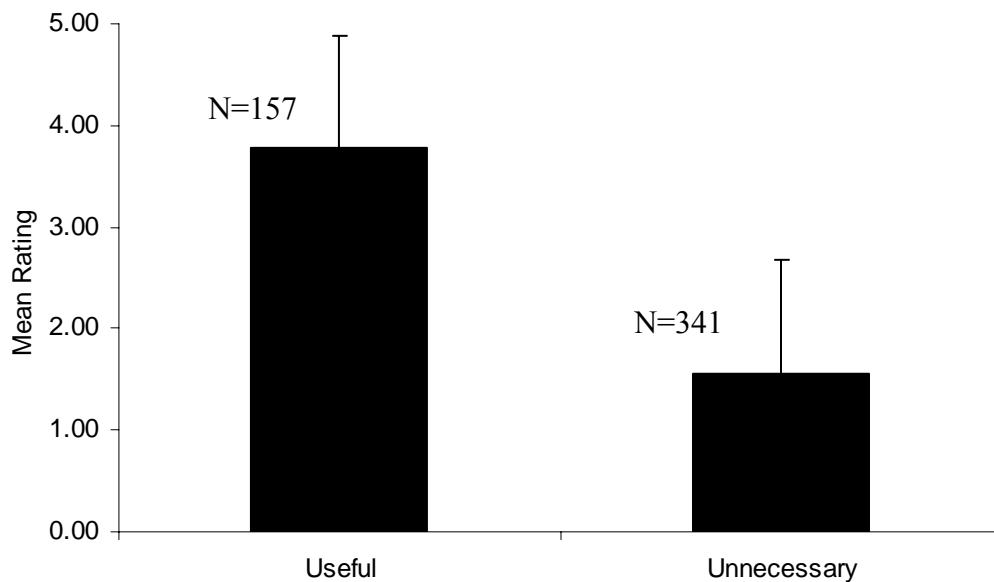

Figure 7.29. Overall mean ratings of alert utility. Error bars represent standard error of the mean (SEM).

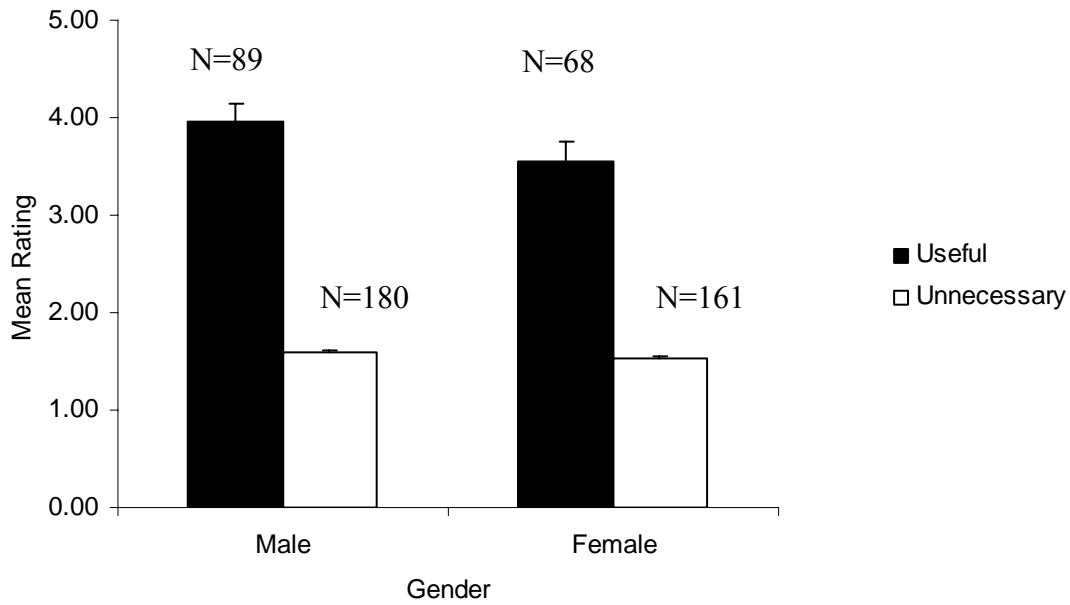

Figure 7.30. Mean ratings of alert utility by gender. Error bars represent standard error of the mean (SEM).

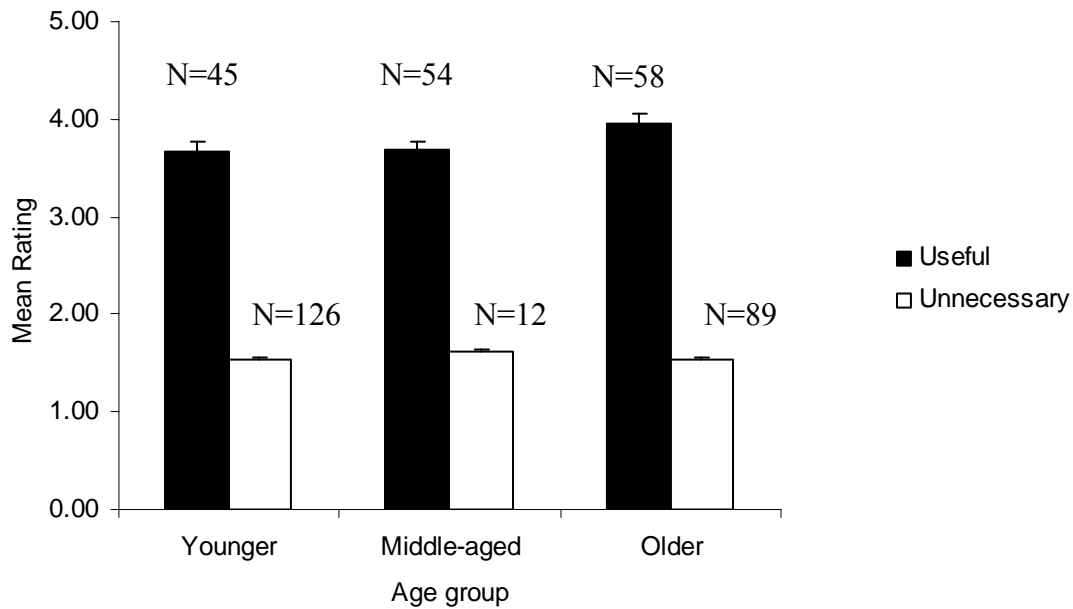

Figure 7.31. Mean ratings of alert utility by age. Error bars represent standard error of the mean (SEM).

7.2.1.4.2 *Ratings of Relative Alert Utility by Alert Type*

Infrequently, drivers reported stationary-target FCW alerts to be useful, but when they did, they rated them as slightly more useful than moving-target alerts (3.88 versus 3.78, Figure 7.32).

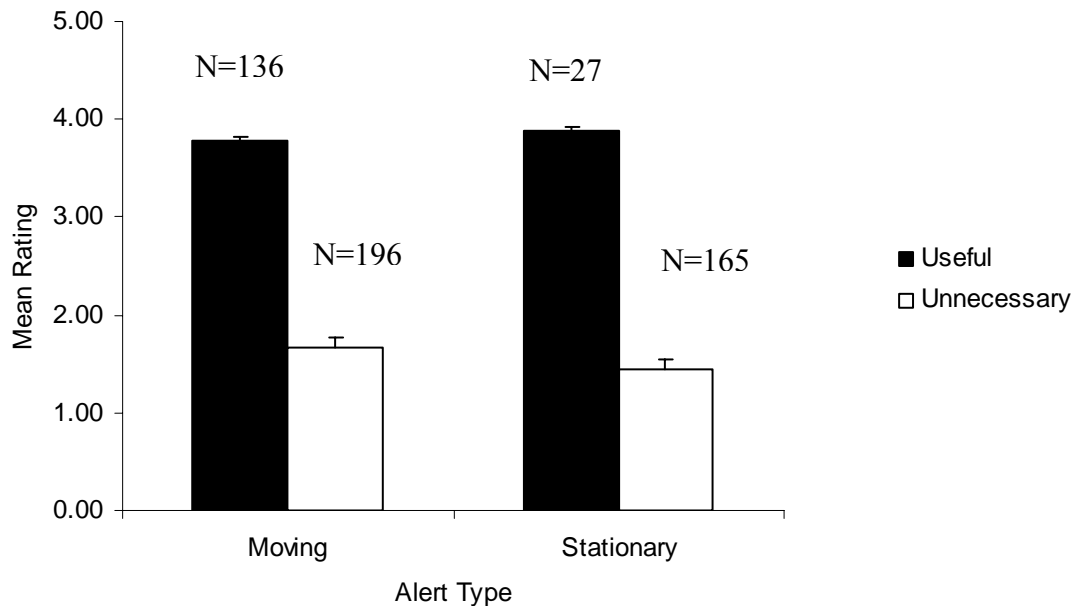

Figure 7.32. Mean ratings alert utility by type. Error bars represent standard error of the mean (SEM).

From comments made in debriefing sessions, it appears as though some drivers used the FCW for additional purposes other than those intended by the system designers. For example, receiving an FCW alert in a curve in which there was a signpost, but no lead vehicle, prompted at least one driver to state that the alert prompted him to slow down in the curve. Several drivers reported that, although they received alerts at times when no other vehicles were present, the alert did draw their attention back to the driving task, and they therefore rated the alert as being useful as opposed to being unnecessary. Additionally, the sample size of the evaluated moving alerts deemed to be useful is five times the sample size of the evaluated stationary alerts (N= 136 versus N=27).

For the alerts that were deemed to be unnecessary, stationary alerts were found to be slightly more unnecessary than moving alerts (1.45 and 1.66 respectively. Figure 7.32). Older drivers found stationary alerts to be significantly more useful than younger and middle-aged drivers.

Older drivers also found moving alerts to be more useful than their middle-aged and younger cohorts (Figure 7.34). For moving alerts that were categorized as unnecessary, older drivers rated them better than either middle-aged or younger drivers (1.77, 1.70 and 1.58 respectively). The results for the gender by age combinations are presented in Figures 7.33 and 7.35.

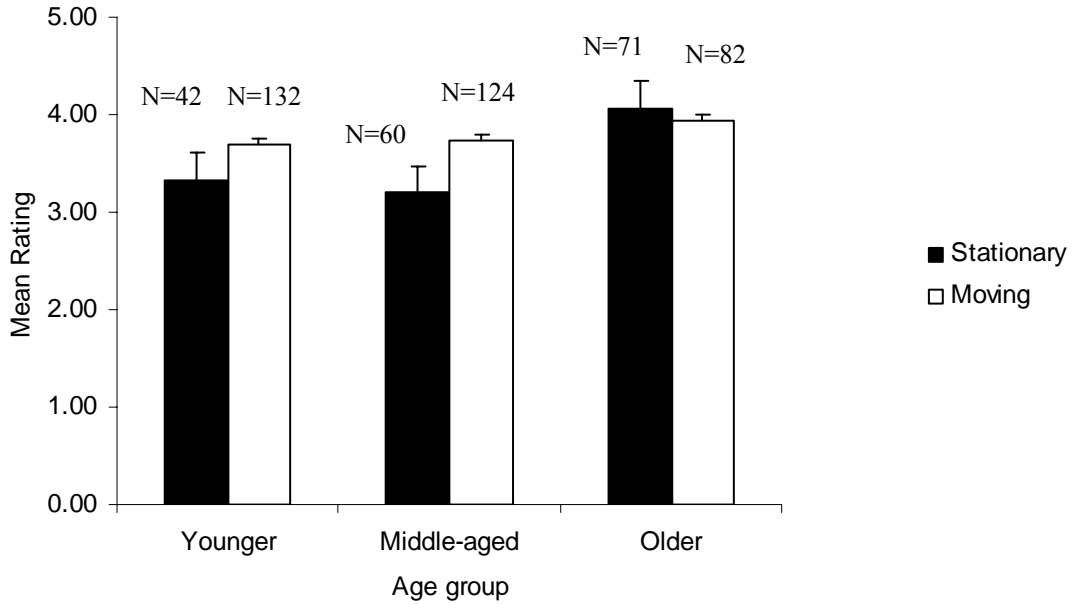

Figure 7.33. Mean ratings of utility for moving and stationary alerts by age group. Error bars represent standard error of the mean (SEM).

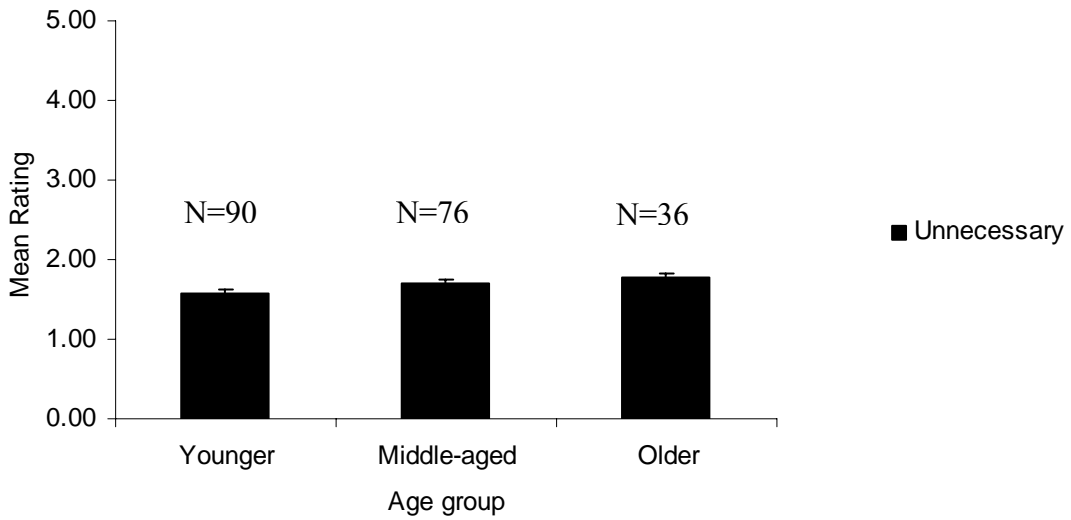

Figure 7.34. Mean ratings of utility for moving alerts judged to be unnecessary. Error bars represent standard error of the mean (SEM).

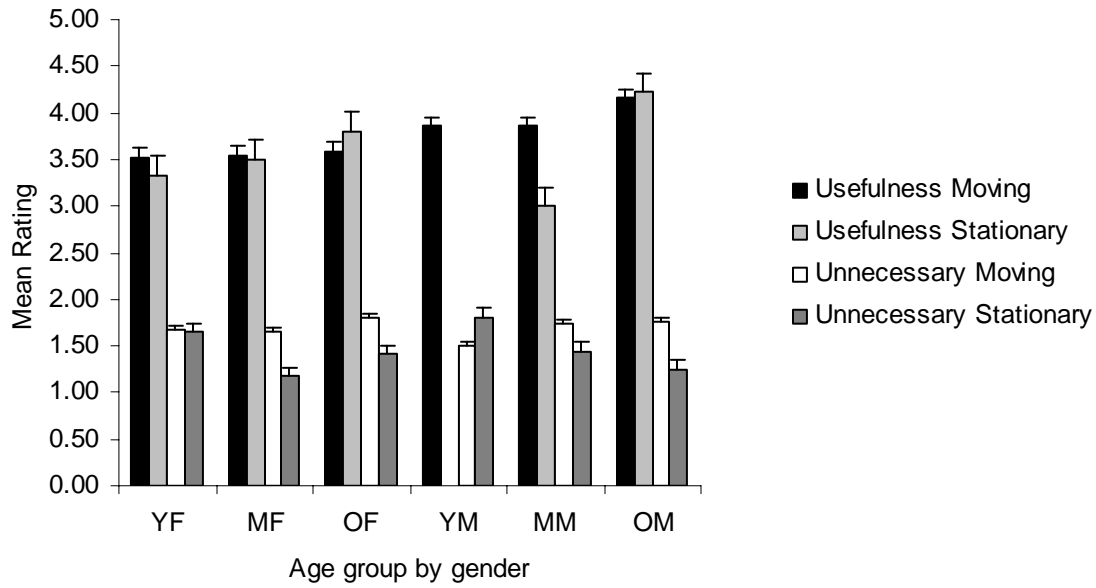

Figure 7.35. Mean ratings of utility by alert type, age group, and gender. Error bars represent standard error of the mean (SEM).

7.2.1.5 Synopsis of the Responses from Focus Groups Regarding FCW

In general, focus groups are capable of generating data through group discussion and interaction that may not emerge from more structured, written questionnaires. They not only provide details about what people think, but often why they think the way they do. Focus group data do not lend themselves to quantitative analyses for a variety of reasons, rather from these data patterns or themes emerge. The range of information gleaned from the ACAS FOT focus groups provides a partial story concerning FCW system acceptance.

There were four focus groups held in the hopes of obtaining a better understanding of drivers' experiences with the ACAS system. Each focus group involved a small number of drivers (5 to 7) and was a structured discussion led by a facilitator. Each of the four groups was asked the same questions in the same order. Discussion was guided by a presentation by which the questions were displayed. In order to provide an overall sense of the drivers' responses, the following summaries to each individual FCW-related question is provided.

How often did you encounter situations where you felt the FCW system was useful?

There tended to be some people who found the system very useful and some that did not find it useful at all. The number of situations where people remembered finding FCW useful ranged from never to 8 or 10 times. Overall, it seemed people found FCW

useful when they were not fully aware of their surroundings or when that environment changed quickly such as coming suddenly upon a traffic backup or a cut-in. For example, one instance of this was when a driver recalled that “somebody had pulled out of the intersection in front of me and the alarm went off and brought my attention to it where I could, you know, really stop.” In another example, one driver remarked that “It would just bring it to my attention that I was coming up on someone kind of fast or, you know, just kind of caught my attention.”

How often do you get into a situation where an FCW system could help prevent a rear-end accident?

Overall, people seemed to think that there were a few instances that a warning system would have been useful. The answers ranged from never to 3 during the course of the study. Again, the fact that the system made them more aware was mentioned. Some people detailed specific instances while others just gave a general estimate.

How often do you come close to having a rear-end accident?

For three of the focus groups the consensus was that near, rear-end collisions occur fairly infrequently. Referring to how often he has situations where he is close to a rear-end accident, one driver commented, “When I had the car there was that one time and in general for me it is very infrequently.” However, in one focus group, people seemed to express that near rear-end accidents happened fairly frequently to them. One driver said, “I come close quite often.” The drivers discussed how they were often distracted or people cut-in, etc. The overall range in response was from one a year to quite often.

Were there situations when you got an alert when you were not paying enough attention?

In general people did not stay on this topic very long. It often spiraled into other topics including general driving habits of the population as a whole. When people did respond the answers seemed to be approximately one situation. One driver said that “there was one situation like that. But it’s definitely—I think this is a great system to keep you focused on driving because there are so many distractions that are out there.”

Were there situations when FCW prevented a rear-end accident?

This question very often received very little discussion. It was very similar to an earlier question and so there were some references to previous answers. Two of the focus groups seemed to feel there may have been one instance or that there was some potential. For instance, one driver recalled, “I was zoning out and if I had been paying attention I would have noticed the car slowing down and change lanes, so it brought me back.” One group had just one reply which was “no”. The fourth group had everyone respond; all

but one said “no.” One person commented that “even though it went off, I don’t think it would have prevented a crash.”

When (if ever) did you find false alarms annoying?

- *Did you tend to not pay much attention to FCW due to false alarms?*
- *What false alarm situations did you find most/least annoying?*

There seemed to be some variation to the response to this question. Some people reported having no false alarms at all, while one driver indicated that he remembered having six a day.

Many drivers seemed to say that they could predict when consistent false alarms would go off. Thus, they were not as annoyed because they expected it. One driver said, “I started to know that it’s going to go off falsely if I’m turning, if I’m coming around the bend on the guard rail.” Though one driver said, “I had pylons on right before the corner where I’m supposed to turn into my street, so I think I had six or seven of them on the videotape, and they were the same place, and they would go off every night when I was coming home from work and that really annoyed me.” Some drivers actually changed how they drove through an area in response to consistent false alarms. One example is the following: “I changed my driving habits a little bit because I picked up the mailbox every morning, so I would make sure I would stay to the right and go slower so I wouldn’t.”

Some drivers said the alerts were never annoying while another driver said that they “bugged the hell out of me”. Drivers indicated that they ignored the alerts they knew would go off, but that this did not cause them to ignore the system in general. One driver mentioned being able to turn the system, off and another mentioned being able to mark certain places to avoid consistently getting the same alert.

Were there situations when you did not get an alert when you felt one was required?

At least some drivers in each group reported an instance where the alert did not go off when they thought it should.

Three of these instances involved motorcycles. One reported event involved both ACC and FCW when a driver explained that “It was a motorcycle was in front of me, and the Adaptive Cruise Control actually started to accelerate me into the motorcycle, and the alert system didn’t go off, and I was really close to hitting that.”

In some instances the driver was trying to provoke and test the system and it did not sound an alert when they thought it should. Sometimes it was simply later than they would have liked.

There seemed to be a trend toward thinking that in some instances the warning was too late to be effective; people feared means other than braking may have had to be employed in order to prevent an accident. One driver expressed a concern that “if you were in a dozing state and slowly coming up to a vehicle that’s in front of you that’s going a little bit slower, I think that is a fault of the system that you could get right on top of it, that there was no way that even if the alarm went off that it would allow you time to react to it.”

Overall, did you think FCW warnings were useful?

– *When (if ever) were the FCW warnings useful?*

Drivers seemed to be fairly split on this question. Some drivers emphatically supported FCW’s usefulness, while others were as equally negative. One driver who did not find it useful commented that he “didn’t think it was useful in any of (his) situations. (He) wouldn’t pay extra for it in a car.” They said that it depended on the driver and the situation. Several older drivers thought it was useful given their deteriorating eyesight. For example, one driver explained that “the one instance I saw it I thought it was useful was at dusk. I have some trouble with when the light was changing with depth perception at my age.” People also mentioned that it might be useful for younger drivers and for drivers that are distracted easily. Generally, the groups were fairly evenly split with a few more indicating they did find it useful.

Would you have turned FCW off if you could have?

– *If so, when and why?*

Opinions on whether or not drivers would have turned off the system varied widely. The overall impression was that people would like to be able to selectively turn off the system. For instance when asked in what situations they would turn it off, one driver said, “Like I said, when I was in my rural area, the mailboxes or the trees, whenever when I came in or went out.” People did not want it on in situations when it was distracting such as construction areas or in bad weather. Other people said they did not care one way or another, they simply had learned to ignore it. Drivers seemed to agree that there were instances when they would want the system on, such as if they were feeling particularly tired. For instance one driver who said she would want to be able to turn it off also said, “I played with it, but I would have turned it off unless I was falling asleep at the wheel, in which case it could stay on.” Others thought that it was most useful for freeway driving. Again, some drivers felt that it was not necessary to be able to turn it off at all. One remarked that “it’s actually not that annoying.”

When you got an imminent FCW alert, what did you typically do?

- *Apply the brakes, check the traffic, or simply ignore the alert?*
- *Did your response change depending on the scenario?*

Drivers indicated very different responses to an imminent alert. Three drivers stated that they went for the brake immediately every time. One woman stated, “If it was imminent and I saw the big icon I hit the brake because that was imminent to me.” Two people mentioned that their first reaction was startle. Overall, most people indicated that they remember their attention focusing on the forward scene and then taking the appropriate action based on the situation. For instance one driver said, “My response was in response to the scenario so depending on the scenario is how I responded.” Several people expressed a desire to not rely too heavily on technology and to still have their own awareness of their surroundings. Many drivers also recalled taking their foot off of the brake and then assessing the situation. The general feeling seemed to be that the system brought the focus back to the forward scene. One driver summed up those feelings with his comment that “the system, it forces you to do something. And I think what it forces you to do is to take a quick sense check of what you are doing.”

Did the way you responded to the alerts change with more FCW experience?

- *If so, how?*

Overall, drivers did not express that they changed their reactions to the alerts that much over the course of the three weeks. One driver stated that he did change his reaction, but his comment seemed to be more in terms of changing his driving in response to the system and the cautionary alerts: “But by the end of it you had a better read of the system, and you knew what to expect because at that point you knew how far you could really be behind somebody. So I think that modified my driving more than, you know, the first week because by then I had also learned the system”.

Several drivers stated that their amount of startle decreased, which may have effected how they responded to the alert. One person mentioned that they had learned how to ignore the cautionary alerts whereas another stated that she “didn’t become comfortable with it and start ignoring it.” Generally it seemed people had become more comfortable with and knowledgeable of the system, but that their reactions had not necessarily changed.

Do you think the FCW cautionary alert (amber icons that changed size) affected how you followed vehicles in normal traffic?

- *If so, how?*

Many drivers said that they did not feel that the cautionary alerts had any effect on their driving. People seemed to think that they were fairly stuck in their ways and that it could maybe help others. For instance one driver thought that driver's-education students could really benefit: "No, I mean I know how to drive. I think this would be a great system on driver's-ed car...But I've been driving for 10 years, I've got a pretty good idea what is safe and what isn't." Others thought that people who tailgated might benefit, and one driver who admitted that she often followed too close to the cars in front of her did say that she gave more space in front of her because of the system. Some drivers mentioned that they adjusted the setting to fit their styles rather than their driving in response to the system. One driver said, "I didn't change my driving habits, you know. I'm 69 years old, I can't change. So the fact is I would change the settings so that it sort of corresponded to what I was comfortable with, and I was happy with it that way, no problem."

What did you think of the timing of the FCW imminent alert?

- *Was it too early, just right, too late?*
- *Describe what led you to this conclusion?*

There seemed to be two main opinions expressed on this topic. Many people felt that the alert was too late and that there would not have been enough time to react given the timing of the warning. One woman commented that it was not enough time, alluding to the fact that you would need to take time to check the scene and see if it was a false warning and that then there would not be enough time to react: "And if you are driving and you look up to check traffic, by the time you actually realize there is a vehicle there and it is not a false warning, then by the time you hit your brake it is going to be over with."

Others felt that the timing was just right. Some drivers justified their feelings that the system was just right because situations change quickly and one would also not want the warning to be constantly going off as that could become annoying. One driver said, "I don't want to be braking all the time because the system if I'm, really using it, if I'm depending on it, I don't want to be slamming on the brake every time it goes off. So I think it is actually right that it doesn't give you a whole lot of time."

Some drivers brought up improvements that they thought might help with the overall timing. One driver indicated that he felt the system was based too much on distance and not enough on speed. It was clear from his comments that he did not grasp that speed was integrated into the algorithm. On the other hand one driver, a self-identified police officer, said he felt that distance needed to be more integrated. He felt that one was able to get right up on a car if the difference in velocity was not enough and that this should be improved. "...we did it with a scout car, and we were right on the trunk-right on the trunk, and it never went off because we just slowly crept up onto the vehicle."

Do you think that FCW will reduce harm caused by rear-end accidents?

The majority of drivers seemed to indicate that they did think FCW would reduce harm. Some felt it would reduce the number of accidents but not change the amount of damage done and others felt just the opposite. Drivers also seemed to be of the opinion that it would reduce accidents for people who were likely to cause them, i.e., people who were highly distracted or performing non-driving behaviors. One concern expressed was that the amount of false alarms would make it less likely to prevent accidents because drivers may be so accustomed to the beeping that they will not respond when there is a genuine situation ahead. "I don't think necessarily it will until they can get those false alarms out of there. You are just, you are going to get so used to hearing it, and it is not even going to register after a while." Overall, people thought there was potential to reduce harm but were not sure if it would really do so.

Do you think FCW made you a safer driver?

– *Did you drive more or less aggressively?*

Drivers indicated changes in driving as well as no changes. The most common changes reported were being more aware or cognizant of their surroundings, being more aggressive because they were testing the system, and being more defensive in order to avoid warnings.

Several people mentioned that they were very aware of their status as a subject and that this may have changed their behaviors because they did not want to be recorded or knew people could be watching them. "Did it make me a safer driver? Only because I was aware that I was in a test group so I was trying to be a safer driver."

Other drivers did indicate that using FCW changed their behaviors. One driver discussed how he used the system in bad weather: "I would lengthen the distance in inclement weather causing a caution just to make myself aware that I'm, getting closer to the vehicle than again more just as a reminder to yourself it's crappy outside, keep more

distance.” Another driver mentioned that she became more aware of how close she got to vehicles as she was passing them “Now I’m a lot more aware of that when I am passing.”

The notion that the system served as reinforcement for safe driving behaviors was also mentioned. Though most drivers expressed at least a small change in awareness there were some drivers who felt that their driving was not changed by use of the system.

Are there other ways you think FCW may have changed the way you drove?

There was fairly limited discussion on this topic. Most drivers simply said, “no.” One person mentioned that they looked at the icons a lot, and two people mentioned driving differently because they were trying to provoke warnings. In one focus group several people mentioned that they felt more aware of the traffic ahead of them. One driver stated that “after driving with it that it made me, sort of realize well, I could pay a little more attention to, you know, what’s right in front of me. Maybe I am coming up a little too close so I think it did change the way I drive, you know, to some degree.” One focus group got into a discussion regarding how the camera affected drivers’ driving. Only two drivers expressed that their behaviors had changed: “So the camera did make me, the camera affected my behavior in the car which ultimately affected the way I drove.” Overall, people did not feel that FCW affected their driving.

Did FCW perform in the way you would expect it to if you bought this feature?

- *If not, how should FCW perform differently?*

In the discussion on this topic, most people made comments for improvement, though some drivers simply answered yes or no. It seemed that most people thought overall, FCW functioned as they expected, but that they had some areas for improvement. “The system performed pretty much the way you predicted it and the way the videotape did.” The number of false warnings was one area for improvement. The most common suggestion was for a system that was more able to be tailored to the driver and/or the situation. For instance, one driver commented that “the warning system is not soon enough for my driving habits. If that were even adjustable or something where you could tailor it to, or if it was, it had its own learning function it learned how you drove aggressive/non-aggressive”. Another driver thought that drivers should be able to tell the system what the environment was like and have that impact the warning system: “People need to know enough to be paying attention to know what conditions they are driving in to set it for bumper-to-bumper traffic, set it for highway traffic, set it for city traffic, set it for bad weather conditions and then have a custom setting.” Other comments included having it function under the speed of 25 MPH so that it could assist in parallel parking

etc. and having an on/off switch. However, the idea of an on/off switch was opposed by some other drivers.

Do you think FCW is ready for production?

The overall sense seemed to be that the system was close to ready but that there needed to be some additional tweaking done. “So at this time today, I don’t think it is production ready. I don’t think they are far off. Some tweaks have to be done, and the boys and girls in the labs probably have the answer.” There were several people, in more than one focus group, who commented that they thought a side-warning system was needed, and perhaps that even this was more important than forward warnings, at least that the area should be broadened. “And as much urban driving as I do, the system has some blind spots, and I think those blind spots are pretty big. When you get into an interstate situation like the Lodge, Northwestern Highway, 696, 94, your side is where there are more cars going to come and hit you into the side than I think you are going to end up plowing somebody in the rear end.”

Other items mentioned for improvement were the excess of false alarms, excess of missed alerts, and the need for more education on what a gap setting really represents in terms of distance. There were a few people who felt FCW was ready. One said it was ready for driver’s-education cars, but not for the general public, and another said that for young drivers it would be useful. One driver was quite impressed with how it seemed to follow his driving path: “It seemed almost to be directional and followed the way I wanted to go in some cases.” Drivers indicated that they system was very close to being ready for production, but simply wanted to see a few things improved.

Would you buy an FCW system?

- *If not, why not*
- *If so, why*

There were a variety of responses to this question. Some drivers firmly felt that they would buy the system while others were adamant that they would not. There was also a large group of people that thought they might, if improvements were made. Those who wanted the system expressed that it was another means of helping them be alert and aware, since they are not constantly aware of what is going on while they are driving. One driver commented, “I think I would because...it is just one more thing that could alert me to a potential problem.” Those who did not think they would buy the system cited that they did not think it was worth the amount of money they assumed it would cost. “No, I would rather not because you are talking it is going to be an extra at least

(\$1,000 on your car and I don't think it had a drastic enough effect on my driving for me to warrant spending that kind of money." Many people seemed to be interested in the system if there were improvements made, such as fewer false alarms. Some people said that they would buy a car with it, but seemed to indicate that they would not seek it out in particular. "I wouldn't delete it if came with the system, but I would not purchase it extra." One driver expressed interest if it was offered with ACC when he said "I wouldn't buy this by itself, that wouldn't be the way I would go. If I could get both I would be ready to buy." There were opinions on every side of the aisle and there was not an overall consensus.

How would you suggest improving the FCW system?

Drivers had a wide variety of suggestions for the system. Some drivers disagreed with other driver's suggestions. For instance many people wanted a wider range of sensitivity settings, but others feared that might contribute to more false alarms. Many drivers were interested in seeing the system being more adjustable. People wanted to be able to adjust many system attributes, including having a variety of warning beeps to choose from, the colors and types of the icons, being able to turn off the cautionary alert system, having an on/off switch, being able to set it for city vs. expressway driving, and being able to set it for a certain type of weather. Some comments on this topic were as follows: "Like your computer icons, you can have a system that you can change the icon that appeals to you." "I thought a bar system going across possibly changing colors, you know, that green/yellow/red kind of effect. I thought that might be better instead of the car."

Drivers also mentioned getting rid of many of the false alarms. "If they find some way to filter out the false alarms I would be happier." One suggestion was made to be able to indicate an alarm as false, especially for commuter routes, etc. One driver suggested that "it would be better if it adapted itself. That it seems that same point, well coordinates or whatever, sees it so many times and then says, "no, cancel, that is not an--- or even prompt you, you know, if it was a false warning or a bad warning." The conditions for which it worked were also mentioned.

People wanted FCW to work in poor weather conditions, as this is when many people thought it could be most helpful since it has radar. Suggestions including having the system functional at speeds below 25mph and having the system pick up targets such as pedestrians or deer. A driver suggested that "maybe it could say detect maybe like deer or people that—because I've seen people in the middle of the dark wearing nothing but black, and when there is a lot of accidents caused by deer running out in front of you."

Other conditions of concern were also that the system gave malfunction messages in raining conditions, that it seemed to overheat during one particular long trip, and that it had to be cleaned quite often. “Maybe you could have a little windshield wiper or something, you, know, but it was such that it wouldn’t have to be cleaned quite so often.”

7.2.2 FCW Acceptance by System Exposure

7.2.2.1 Acceptance by Cautionary-Alert Exposure

The fraction of ACC-disengaged, FCW-active time that each driver spent with any cautionary icon displayed was computed. This measure was used in an ordinal regression to determine whether or not the amount of time spent with any cautionary icon displayed can serve as a predictor of FCW acceptance. Sixteen questions from the post-drive questionnaire which deal with FCW acceptance were examined (FCW1, FCW6, FCW9, FCW18, FCW20, FCW25, FCW26, FCW27, FCW28, FCW29, FCW30, FCW35, FCW37, FCW39, FCW43 and FCWadd3). Where significant predictive qualities are observed the amount of variance accounted for (Nagelkerke pseudo R^2), the level of significance and the nature, or direction (parameter estimate value), of the association is reported. However, while several statistically significant associations were found, the low R^2 values may indicate little practical significance (because they may not allow for accurate modeling).

The fraction of time spent with any cautionary icon was significantly predictive of drivers’ responses to only two of the FCW acceptance questions (FCW25 and FCW29). FCW25 reads, “Overall, please rate the extent to which FCW alerts were useful in providing a warning about a driving situation that might result in a collision.” FCW29 reads, “How often, if ever, did FCW not give you an alert when you felt that one was necessary?” Time spent with any cautionary icon was negatively (-4.824) associated with responses to FCW25, $p = .033$ ($R^2 = .06$). The results of the ordinal regression indicate that as time spent with cautionary icons decreases, there is a greater probability that drivers will find the FCW alerts to be *more* useful in providing warnings in potential rear-end crash situations. Thus, drivers were more likely to report not finding frequent displays of cautionary icons to be useful.

Additionally, time spent with any cautionary icon was positively (9.689) associated with drivers’ responses to FCW29, $p < .001$ ($R^2 = .225$). This result indicates that the more time that drivers spent with a cautionary icon displayed, the greater the probability that they believed that they did not receive an imminent alert when they felt that one was necessary. Perhaps drivers who spent the greatest time with a cautionary icon displayed

expected the FCW system to continue to progress in the warning cycle to an imminent alert more often than it happened.

7.2.2.2 FCW Acceptance by Imminent-Alert Exposure

Using the ordinal regression technique, a series of analyses was performed in order to determine whether certain system-exposure variables (e.g., imminent-alert rate) can serve as predictors of FCW system acceptance. Only select questions from the post-drive questionnaire are examined, in particular those which most clearly address drivers' acceptance of imminent alerts. This included post-drive questions FCW6, FCW9, FCW18, FCW25, FCW26, FCW27, FCW28, FCW30, FCW35, FCW37, FCW38, FCW39, FCW43, FCWadd1, and FCWadd3. At the heart of this analysis is an attempt to understand how exposure to various FCW imminent alerts may influence driver acceptance for algorithm C-drivers.

Imminent alerts utilized in FCW acceptance analyses. The following is a breakdown of the 942 usable, imminent alerts from algorithm C (see Section 6.2.1.2 for further details of this alert set):

- 236 Week 1 imminent alerts which were not heard or seen by drivers. These alerts are silent alerts. They were not included in this analysis of acceptance, as those events had no opportunity to influence drivers' opinions of the FCW system.
- 706 took place during weeks 2, 3 and 4 and were heard or seen by the drivers. These 706 alerts are hereafter referred to as total alerts heard or TAH.
 - 419 of these 706 imminent alerts, were deemed to be valid, moving alerts, or stationary in-path alerts or alerts in responses to movable objects, hereafter referred to as non-false alerts heard or NAH.
 - 287 imminent alerts were associated with stationary, out-of-path objects, false forward conflicts, or stationary objects the FCW system identified as moving, hereafter referred to as false alerts heard or FAH.

Alert rates (alerts/100 miles) are also examined for the total alerts heard (TAHrate), non-false alerts heard (NAHrate) and false alerts heard (FAHrate). In addition, the ratio of FAH to NAH was calculated ($1-(FAH/NAH)$) and utilized as a predictor (hereafter referred to as "RATIO").

7.2.2.2.1 Acceptance by Imminent-Alert Rate

FCW Question 9. “Overall, I think the crash alert got my attention quickly in rear-end crash situations but it was not overly annoying if I felt the alert was unnecessary.” The predictor TAHrate was negatively (-.594) associated with driver responses, $p = .036$ ($R^2 = .08$). In other words, those drivers that experienced higher rates of imminent alerts were less likely to respond favorably to this question.

7.2.2.2.2 Acceptance by Imminent-Alert Count

FCW Question 9. “Overall, I think the crash alert got my attention quickly in rear-end crash situations but it was not overly annoying if I felt the alert was unnecessary.” The predictor TAH was negatively (-.066) associated with driver responses, $p = .046$ ($R^2 = .06$). In other words, the more total alerts heard by a driver, the less likely they were to respond favorably to the question. This pattern was followed by NAH, (-.104), $p = .046$ ($R^2 = .06$), which was also negatively associated with the drivers’ responses. In other words, independent of whether the imminent alert was true or false, the more a driver heard imminent alerts the less likely they were to agree with the positive FCW statement above.

FCW Question add3. “I would have used an on/off switch at some point, had it been provided, to turn off the FCW system for the rest of my experience.” The predictor NAH was positively (.126) associated with driver responses, $p = .028$ ($R^2 = .08$). This translates into an unfavorable response on the part of drivers. In other words, there was an increased probability that drivers would report the desire to turn the FCW system off with an increased number of NAH.

7.2.2.2.3 Acceptance by False-Alert Rate

Using FAHrate as the predictor did not reliably predict drivers’ responses to any of the questions examined.

7.2.2.2.4 Acceptance by False-Alert Count

FCW Question 27. *How often, if ever, did the FCW system give you an alert in a situation that you felt was not appropriate?* The predictor FAH was positively (.118) associated with driver responses, $p = .015$ ($R^2 = .08$). In other words, there was an increased probability of drivers reporting false alarms if they actually heard false imminent alerts—assuming that the phrase, “was not appropriate”, was thought to have been interpreted by drivers as representing false alarms.

In summary, while some statistically significant associations were found to exist between the rates at which drivers heard various FCW alerts and subjective ratings of the

system none of these associations is of much practical significance due to the very low R^2 values observed. Therefore, attempts to model driver acceptance on the basis of FCW alerts heard, using the associations reported above, will result in rather poor predictive quality.

7.2.4 Driver Profiles Corresponding to FCW Acceptance

Analyses were performed using ordinal regression in order to determine whether certain demographic characteristics for the population that comprised algorithm-C drivers can serve as predictors of FCW system acceptance. The driver demographic characteristics that are examined include age, gender, income, education and self-characterization as a driver. Only select questions from the post-drive questionnaire were examined, in particular those which are most likely to reflect drivers' overall acceptance of, or likelihood to purchase, an FCW system. This included the following 16 acceptance questions from the post-drive questionnaire: FCW1, FCW6, FCW9, FCW18, FCW20, FCW25, FCW26, FCW27, FCW28, FCW29, FCW30, FCW35, FCW37, FCW39, FCW43 and FCWadd3.

7.2.4.1 Acceptance of FCW by Age

Driver age in years at the time of participation (as opposed to the independent variable classification of age group) was used in this analysis. Ordinal regression was used to determine whether driver age can serve as a predictor of FCW system acceptance. Of the 16 questions examined, age was found to be a significant predictor for responses to 11 questions (see Table 7.30). Age was positively associated with eight of these questions.

Table 7.30 Predictive values of driver age on FCW acceptance

FCW Question	Estimate	<i>p</i>	R^2
6	.035	.013	.096
9	.044	.002	.147
18	.058	.000	.215
20	.038	.007	.110
25	.034	.015	.088
27	-.031	.027	.073
28	-.042	.005	.124
30	0.80	.000	.353
39	.035	.014	.101
43	.030	.029	.077
add3	-.053	.001	.175

Older drivers were more likely to report that the system was less stressful to use (FCW6), that it got their attention quickly (FCW9), that the auditory alert was not particularly annoying (FCW18), that FCW alerts were useful (FCW25), that they would consider purchasing an FCW system (FCW39), and that they were generally more

satisfied with the system overall (FCW43). Older drivers were also less likely to report having frequent false alarms (FCW20), receiving inappropriate alerts (FCW27) as well as ones they could not identify a source for (FCW28), that unnecessary alerts were annoying (FCW30), and that they would have turned off the FCW system had they been given the opportunity (FCWadd3). Yet older drivers were no more likely to recommend FCW to a loved one (FCW38). By far, the strongest of the age related associations was with the rating of annoyance for false alerts. In summary, some statistically significant associations were found to exist between driver age and subjective ratings of the FCW system. However, other than with the possible exception of the association between question FCW30 and driver age, there is little practical significance due to the very low R^2 values observed.

7.2.4.2 Acceptance of FCW by Gender

Using the 16 previously identified acceptance questions, an examination of potential differences in FCW system acceptance which are associated with driver gender was conducted. A composite (mean) rating across the acceptance questions was calculated for each driver, and an independent samples t-test was performed on the composite ratings by driver gender. This analysis technique was performed, rather than the correlations, because gender could only be treated as a two-level categorical variable. The mean acceptance rating for female drivers was 3.78 with a standard deviation of .70, whereas the mean for male drivers was 3.82 with a standard deviation of .62. The difference in composite scores between genders was not significant nor was gender a significant factor in responses to any one of the individual 16 questions.

7.2.4.3 Acceptance of FCW by Income

Ordinal regression was used to determine whether certain measures associated with driver income can serve as predictors of FCW system acceptance. The 16 questions from the post-drive questionnaire which most clearly address drivers' acceptance of imminent alerts are examined. Income related variables included Median Household Income (MIH), Median Family Income (MIF), and Per Capita Income (PCI). Household income is the sum of money income received in the previous calendar year by all household members 15 years old and over, including household members not related to the householder, people living alone, and others in nonfamily households. The median household income reported here was produced through statistical modeling of census data. Family income is the sum of money received in the previous calendar year by all family members in one household who are 15 years old and over, excluding household

members not related to the householder, but including people living alone. The median family income reported here was also produced through statistical modeling of census data. PCI is the mean income computed for every man, woman, and child in a geographic area. It is derived by dividing the total income of all people 15 years old and over in a geographic area by the total population in that area. Modeling of all income values were based upon the drivers' zip codes and determined using data generated from the 2000 U.S. census. The mean of the MIH for zip codes in which algorithm-C drivers lived is \$53,637 with a standard deviation of \$18,855 (Figure 7.36). The mean of the MIF was \$64,027 with a standard deviation of \$22,043 (Figure 7.37). Lastly, mean PCI for these zip codes was \$26,406 with a standard deviation of \$9838 (Figure 7.38).

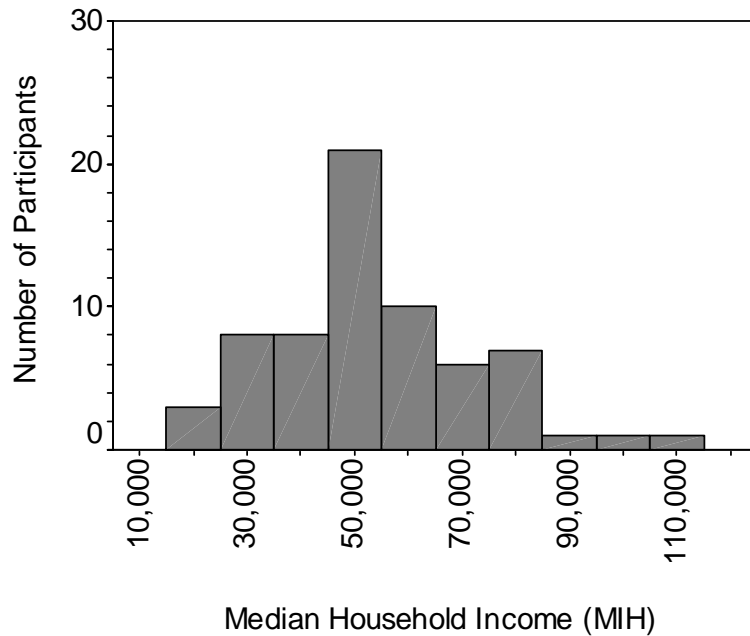

Figure 7.36. Distribution of median household incomes for algorithm-C drivers

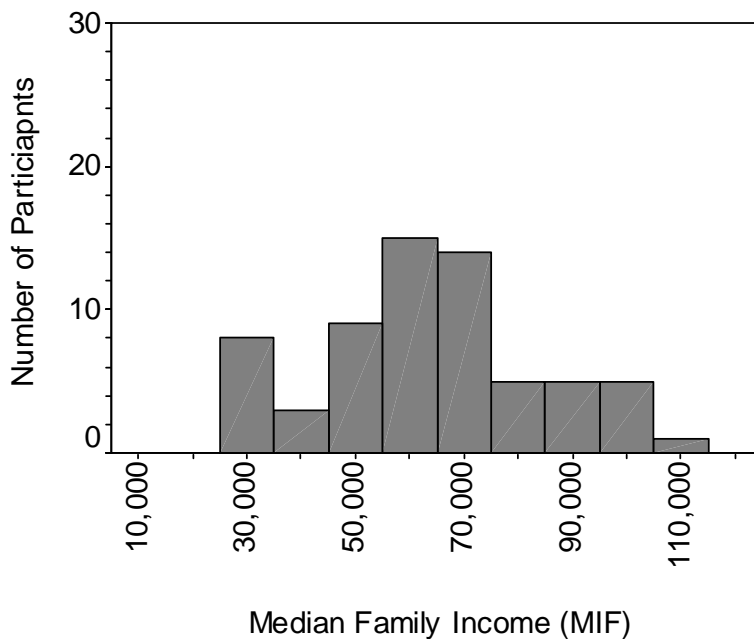

Figure 7.37. Distribution of median family incomes for algorithm-C drivers

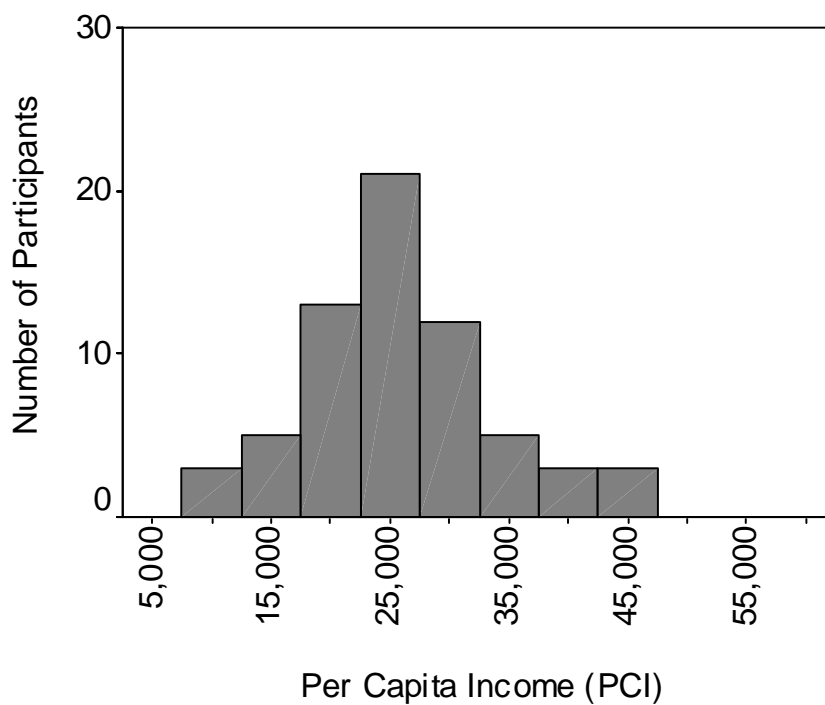

Figure 7.38. Distribution of per capita incomes (PCI) for algorithm-C drivers

Median Household Income was significantly predictive of drivers’ responses to two of the 16 FCW questions, those questions being FCW27 (*How often, if ever, did FCW give you an alert in a situation that you felt was not appropriate?*) and FCW37 (*Overall, I think that FCW is going to increase my driving safety.*). The predictor MIH was

positively (.0002) associated with driver responses to FCW27, $p = .042$ ($R^2 = .07$). In other words, there is an increased probability that a driver would have reported a high frequency of inappropriate alerts if they resided in a zip-code with a higher MIH. Relative to FCW37, the predictor MIH was again positively (.0002) associated with driver responses, $p = .036$ ($R^2 = .06$). In this instance, there is an increased probability that a driver would agree that FCW would increase their driving safety if they resided in a zip-code with a higher MIH.

Median family income was significantly predictive of drivers' responses to three of the 16 FCW questions, those questions being FCW18 (*How annoying was the auditory alert that signaled a situation in which you may be about to crash (an imminent threat)?*), FCW27 (*How often, if ever, did FCW give you an alert in a situation that you felt was not appropriate?*), and FCW37 (*Overall, I think that FCW is going to increase my driving safety.*). MIF was positively (.0002) associated with driver responses to FCW18, $p = .046$ ($R^2 = .07$) in that there is an increased probability that a driver would have reported less annoyance associated with imminent alerts if they resided in a zip-code with a higher MIF. MIF was positively (.0002) associated with driver responses to FCW27, $p = .042$ ($R^2 = .06$). In other words, there is an increased probability that a driver would have reported a high frequency of inappropriate alerts if they resided in a zip-code with a higher MIF. For FCW37, the predictor MIF was again positively (.0002) associated with driver responses, $p = .026$ ($R^2 = .07$). In this instance, there is an increased probability that a driver would agree that FCW would increase their driving safety if they resided in a zip-code with a higher MIF.

Per capita income was significantly predictive of drivers' responses to only one of the 16 FCW questions, that question being FCW37 (*Overall, I think that FCW is going to increase my driving safety.*). PCI was again positively (.0004) associated with driver responses, $p = .041$ ($R^2 = .06$). In other words, there is an increased probability that a driver would agree that FCW would increase their driving safety if they resided in a zip-code with a higher PCI.

In summary, income, at least as measured using surrogate values based upon the drivers home zip code and values provided by census data, did not result in practically significant predictions of FCW system acceptance. This may be a function of the methods used (i.e., the use of surrogate measures of income) or may simply be the result of diverse attitudes towards FCW acceptance.

7.2.4.4 Acceptance of FCW by Education

Analyses were performed using ordinal regression in order to determine whether level of driver education can serve as a predictor of FCW system acceptance. An education variable, expressed as years of schooling, was examined. It was often the case that responses to the driver biographical questionnaire (appendix G) had to be transformed. This transformation was necessary because drivers would state the types of education degree they had achieved (GED, High School, Associates, etc.) as opposed to years of formal schooling. Where necessary, degrees achieved were converted into the following assumed years of schooling: 12 years for completing a GED or high school, 14 for an associate's degree, 16 for a bachelor's degree, 18 for a master's degree, and 20 for a doctorate or medical degree.

Figure 7.39 provides the distribution of educational experience for algorithm-C drivers. Years-of-formal-education was not significantly predictive of driver responses to the selected subset of FCW questions.

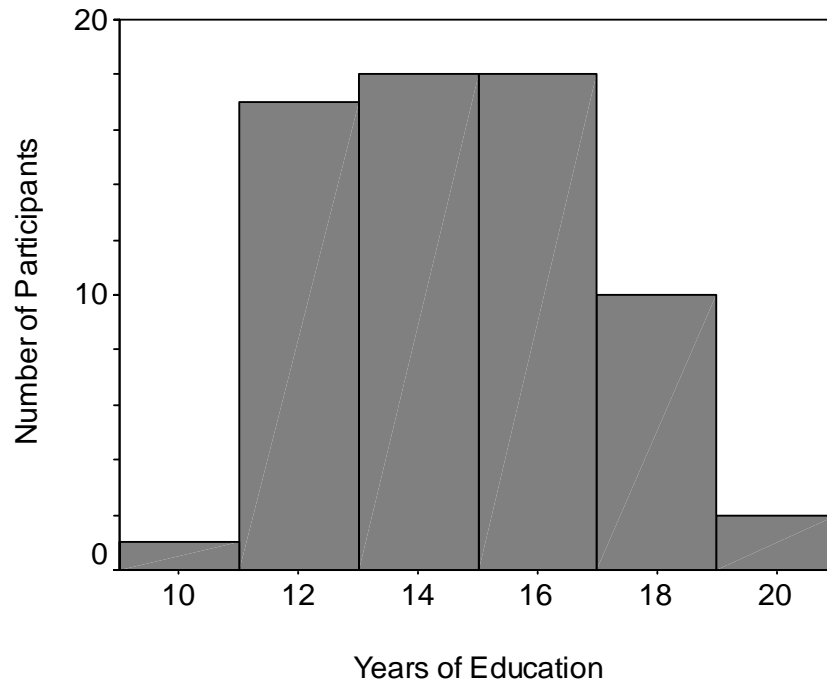

Figure 7.39. Distribution of years of formal education of algorithm-C drivers

7.2.4.5 Acceptance of FCW by Driver Self-Characterization

Ordinal regression was used to determine whether measures of driver self-characterization can serve as predictors of FCW system acceptance. The 16 questions from the post-drive questionnaire that most clearly address drivers' acceptance are

examined. Scale scores from the Driver-Behavior Questionnaire (DBQ) and Driving Style Questionnaire (DSQ) were examined as predictors (see Section 4.4.2 for a complete description of these instruments). Lastly, the driving-style classification was analyzed for its predictive value in assessing FCW system acceptance. However, while a number of statistically significant associations are reported, there is little practical significance, with a few possible exceptions, due to the low R^2 values that were observed.

7.2.4.5.1 Acceptance of FCW by Driver-Behavior Questionnaire

The three subscales (lapses, violations, and errors) resulting from the DBQ were examined as predictors of the 16 acceptance-related questions (see Section 4.4.2.1 for a description of the subscales). The DBQ subscale *lapse* was predictive of questions FCW18, FCW25 and FCW43. Lapse scores were negatively (-1.262) associated with driver responses to FCW18, $p = .015$ ($R^2 = .10$). Therefore, drivers who rated themselves as more prone to inattention or slips in memory were less likely to report the auditory alert to be annoying. The lapse scores were also negatively (-.992) associated with responses to FCW25, $p = .015$ ($R^2 = .10$). This suggests that drivers who rated themselves as more prone to inattention or slips in memory were less likely to report FCW alerts as being useful. Finally, lapse scores were negatively (-1.081) associated with responses to FCW43. In other words, drivers who rated themselves as more prone to inattention or slips in memory were less likely to be satisfied with the FCW system.

The subscale *violation* was predictive of FCW questions 6, 9, 18, 25, 26 30, 35, 37, 39, 43 and add3. The responses were negatively associated with all but question add3 (see Table 7.31). Drivers with high scores for violation rate themselves as more likely to commit deliberate acts which break social norms—such as speeding or running a stop sign, and may therefore be less receptive of the FCW system regarding each of the questions listed above. These drivers were more likely to report that the system is stressful to use (FCW6), that it does not get their attention quickly (FCW9), that the auditory alert is annoying (FCW18), that unnecessary alerts are annoying (FCW30), and disagreement with the statement that FCW will increase their safety (FCW37). They are less likely to report FCW alerts as being useful (FCW25), getting FCW alerts they deemed appropriate (FCW26), feeling comfortable performing additional tasks (FCW35), that they would consider purchasing an FCW system (FCW39), they were generally less satisfied with the system overall (FCW43), and they would more likely have turned off the FCW system had they been given the opportunity (FCWadd3).

Table 7.31 Predictive values of the DBQ violation scores on FCW acceptance

FCW Question	Estimate	<i>p</i>	R ²
6	-1.464	.006	.112
9	-1.585	.003	.120
18	-1.360	.014	.095
25	-1.442	.007	.117
26	-1.203	.027	.077
30	-1.216	.026	.080
35	-1.368	.013	.100
37	-1.702	.002	.142
39	-1.645	.003	.133
43	-1.979	< .001	.193
Add3	1.947	.001	.167

The DBQ subscale *error* was predictive of questions FCW9 and FCWadd3. Error scores were negatively (-1.806) associated with driver responses to FCW18, $p = .024$ ($R^2 = .08$), meaning that drivers who rated themselves as more prone to failures or misjudgments in driving were less likely to report that the FCW system got their attention quickly. On the other hand, error scores were positively (1.726) associated with responses to FCWadd3, such that drivers who rated themselves as more prone to driving failures or misjudgments would have been more likely to have turned the FCW system off during their experience had they been given the opportunity to do so.

7.2.4.5.2 Acceptance of FCW by Driver Style Questionnaire

The six subscales (calmness, social resistance, speed, deviance, planning, and focus) resulting from the DSQ were examined as predictors of the 16 acceptance related questions (see Section 4.4.2.2 for a description of the subscales).

The DSQ *calmness* scores were predictive of three acceptance questions. Calmness scores were positively associated with two questions (1.124 and 1.103) and negatively associated with one additional question (-.992). That is, drivers with high scores in calmness, those drivers who stay calm in dangerous and quick paced situations, were more likely to report receiving imminent alerts that were either not appropriate, FCW27 ($p < .001$, $R^2 = .22$), or ones for which they could not identify the source, FCW28 ($p < .001$, $R^2 = .19$). The negative association (-.992) with responses to FCW25 ($p = .027$, $R^2 = .08$) indicates that drivers with high scores on the calmness scale were also more likely to report receiving frequent false alerts.

Of the sixteen FCW acceptance questions, the DSQ *planning* scores were predictive of twelve; FCW questions 1, 6, 9, 18, 25, 26, 30, 35, 37, 39, 43, and Add3 (Table 7.32). The responses were all positively associated with the exception of question Add3.

Table 7.32. Predictive values of the DSQ planning scores on FCW acceptance

FCW Question	Estimate	p	R^2
1	0.42	0.044	0.065
6	0.597	0.005	0.11
9	0.476	0.022	0.086
18	0.909	<.001	0.221
25	0.612	0.004	0.121
26	0.462	0.031	0.067
30	0.455	0.036	0.077
35	0.659	0.003	0.124
37	1.001	<.001	0.242
39	0.858	<.001	0.119
43	0.736	0.001	0.159
Add3	-0.618	0.011	0.114

Drivers with high planning scores tend to plan ahead before embarking on a trip. They were more likely to report that the system was comfortable to use (FCW1), that the system produced less stressful driving than manual driving (FCW6), that the crash alert got their attention quickly (FCW9), that the auditory alert was not annoying (FCW18), that the FCW alerts were useful (FCW25), that they frequently received appropriate alerts (FCW26), that they were not annoyed by unnecessary FCW alerts (FCW30), that they felt more comfortable performing secondary tasks while driving with FCW (FCW35), that FCW will have a safety benefit (FCW37), that they would consider purchasing FCW (FCW39), that they were satisfied with the FCW system (FCW43), and that they would not have turned off the FCW system if they had had the opportunity to do so (FCWAdd3).

The DSQ *deviance* scores were only predictive of FCW43, and they were negatively associated (-.660). Drivers who score high on the deviance scale rated themselves as more likely to engage in actions that are inconsiderate of other drivers and often dangerous, and they were more likely here to report that they were dissatisfied with the FCW system, FCW43 ($p = .05$, $R^2 = .055$).

The *social resistance* scores were predictive of FCW questions 6, 18, 25, 26, 35, 37, 39, and 43 (Table 7.33). The responses were all positively associated. People with high

social resistance scores rated themselves as more likely to dislike getting advice concerning their driving. Drivers with high social resistance scores were more likely to report that the system produced less stressful driving than manual driving (FCW6), that the auditory alert was not annoying (FCW18), that the FCW alerts were useful (FCW25), that they frequently received appropriate alerts (FCW26), that they felt more comfortable performing secondary tasks while driving with FCW (FCW35), that FCW will have a safety benefit (FCW37), that they would consider purchasing FCW (FCW39), and that overall they were satisfied with the FCW system (FCW43).

Table 7.33. Predictive values of the DSQ social resistance scores on FCW acceptance

FCW Question	Estimate	p	R^2
6	0.493	0.014	0.094
18	0.521	0.015	0.101
25	0.703	0.001	0.169
26	0.551	0.008	0.101
35	0.617	0.003	0.124
37	0.651	0.002	0.159
39	0.563	0.006	0.115
43	0.467	0.019	0.087

The DSQ *focus* scores were predictive of eight of the FCW acceptance questions (Table 7.34). Focus scores were positively associated with questions 6, 9, 18, 26, 30, 37, 39 and 43. People with high focus scores rated themselves as tending to drive cautiously and to ignore distractions. Drivers with high focus scores were more likely to report that the system produced less stressful driving than manual driving (FCW6), that the crash alert got their attention quickly (FCW9), that the auditory alert was not annoying (FCW18), that they frequently received appropriate alerts (FCW26), that they were not annoyed by unnecessary FCW alerts (FCW30), that FCW will have a safety benefit (FCW37), that they would consider purchasing FCW (FCW39), and that they were satisfied with the FCW system (FCW43).

Table 7.34. Predictive values of the DSQ focus scores on FCW acceptance

FCW Question	Estimate	p	R^2
6	0.428	0.025	0.055
9	0.403	0.034	0.075
18	0.501	0.014	0.101
26	0.553	0.006	0.097
30	0.468	0.021	0.093
37	0.566	0.004	0.122
39	0.593	0.003	0.131
43	0.484	0.012	0.089

The final DSQ subscale examined was *speed*. Speed scores were predictive of seven of the FCW acceptance questions (Table 7.35). The responses were negatively associated with questions 6, 18, 27, 30, 35, 39 and 43.

Table 7.35. Predictive values of the DSQ speed scores on FCW acceptance

FCW Question	Estimate	<i>p</i>	R ²
6	-0.793	0.001	0.168
18	-0.601	0.015	0.102
27	0.671	0.006	0.121
30	-0.824	0.002	0.166
35	-0.5	0.038	0.071
39	-0.547	0.022	0.088
43	-0.659	0.006	0.111

High speed scores indicate that drivers rated themselves as more likely to drive over the posted speed limit. Further, they were more likely to report that the FCW system produced more stressful driving than manual driving (FCW6), that they found the auditory alert annoying (FCW18), that they were more likely to receive alerts that were not appropriate (FCW27), that they were annoyed by unnecessary FCW alerts (FCW30), that they felt less comfortable performing secondary tasks while driving with FCW (FCW35), that they would not consider purchasing FCW (FCW39), and that, overall, they were dissatisfied with the FCW system (FCW43).

7.2.4.5.3 Acceptance of FCW by Driver Style

A series of nonparametric tests, Mann-Whitney U, were performed to examine whether the two categories of driver style, reserve and assertive, differed in their responses regarding FCW acceptance. Of the 16 post-drive questions related to system acceptance that were examined, statistically significant differences between the two driver styles were found for three. In response to FCW1, drivers with a reserve style were significantly ($p = .026$) more likely to report being comfortable using the FCW system. Reserved drivers were also significantly ($p = .040$) less annoyed by the auditory component of the imminent alert (FCW18). Lastly, a significant difference ($p < .001$) between the two driver styles was found for FCWadd3. Reserved drivers were less likely than assertive drivers to report that they would have turned the FCW system off had they been given the opportunity.

7.2.5 Summary of FCW Acceptance Analyses

In summary, the overall evaluation of FCW system acceptance is mixed. Acceptance as measured in the post-drive and take-home questionnaires differ amongst drivers due

largely to age rather than gender. The majority of age effects were constituted in the dissociations between older drivers' ratings of FCW and their middle-aged and younger counterparts. Further comparisons dividing the drivers into age-by-gender cohorts tended to support this assertion whereby most differences were again evidenced when comparing older drivers, regardless of gender, with the remaining groups. In general, the obtained age differences resulted in older drivers viewing the FCW system more favorably than either the middle-aged or younger driving groups. This finding was consistent in both the post-drive and take-home questionnaires regardless of gender.

Attempts to determine how exposure to various FCW alerts may influence driver acceptance for the population which experienced algorithm C did not produce any strong, practically significant, predictors of a driver's FCW acceptance. Similarly, there were no real "standout" characteristics of drivers that would seem to serve as practical predictors of driver acceptance of the FCW system.

The focus groups and debriefing sessions, in which drivers reviewed video of imminent alerts they received, generally produced mixed results in terms of FCW acceptance. There are numerous instances where drivers would report that *they* did not need to receive imminent warnings, as they were attentive drivers, but that they could see where the FCW system would be good for *others*. Young and old drivers were frequently mentioned as those that might benefit most, typically by the opposing age group.

In terms of how drivers utilized the FCW system, to the degree to which their interactions with the system can connote acceptance, there were significant differences in the frequency with which male drivers adjusted the FCW sensitivity (that being more often than females), as well as the frequency with which all drivers adjusted sensitivity across their exposure. All groups of drivers made significantly more frequent adjustments in FCW sensitivity in week 2 relative to weeks 3 and 4. This suggests that drivers tended to explore the sensitivity settings less in weeks 3 and 4, perhaps because they found settings that they were comfortable with during week 2. Finally, older drivers spent significantly more time at the most-sensitive setting (6) relative to younger and middle-aged drivers, a result that was somewhat expected based upon the apparent value older drivers ascribed to the FCW system when responding to the post-drive questionnaire. Overall sensitivity selection was negatively skewed towards the high sensitive settings, with the most-frequently-selected setting being the highest sensitivity setting (level 6).

8 Presentation of Results – ACC Theme

Section 8 is devoted to the examination of FOT data in the context of ACC safety and acceptance. Section 8.1 explores ACC safety issues by means of analysis of the objective-data content of the FOT database. Section 8.2 explores ACC acceptance as it is revealed primarily through subjective responses to questionnaires, plus some aspects of the objective data record. All analyses reported in this section are drawn from algorithm C drivers, only, except for a brief summary of appended material that appears as Section 8.1.10.

8.1 ACC Safety Results

The FOT data are examined in various ways here to explore the extent to which safety risks may be affected by ACC driving. In some cases, a rather commonly-recognized risk factor that prevails in conventional driving is examined to see how it changes under the ACC mode of control. A safety assessment is then sought by comparing the prevalence or severity of the factor as it is observed from one control mode to the next. In other categories of safety interest, the examination entails a factor that applies only to ACC, given the specific configuration of the system, such that no reference case from conventional modes of driving can be cited for comparison. In cases such as this, one attempts to characterize the ACC response or the usage-behavior of its drivers using a metric that has at least some kind of crash-conflict connotation so that it can support a safety-related interpretation.

In any analyses of this kind, however, it is recognized that true safety judgments are tenuous because crashes in real life have multi-factor dependencies that are largely unknown. What can be done is to show whether driving with ACC is very much like, or unlike, that which occurs with other modes of control and then to suggest that a) the very-much-like cases imply little impact beyond contemporary safety expectations and, b) the very-much-unlike cases have at least a better-or-worse polarity to their measured differences, even if the magnitude of the implied safety impact is beyond the realm of the analysis.

Several rather complex and, in some cases, maneuver-specific comparisons between ACC and other driving modes are explored in this section of the report. The investigation has been guided according to several safety hypotheses, stated below, that have been formulated to guide the ACC safety assessment. Following upon these hypotheses, the results on ACC safety are covered in Sections 8.1 through 8.10. While the sub-sections address a wide range of ACC operating conditions and performance issues, they all

reflect the point of view that ACC control constitutes a significant innovation in the relationship between the driver and the motor vehicle. The significance, of course, lies simply in the fact that the separation between successive vehicles is being conducted automatically under ACC control.

ACC Safety Hypotheses to be Examined

The ACC safety analyses of Section 8.1 are organized to address ten areas of safety-related hypothesis as follows:

- 1) *Basic headway keeping under ACC control* – one can readily hypothesize that ACC introduces a potential safety advantage relative to the manual mode of driving by the fact that it minimizes the occurrence of very-short headways. By placing the minimum gap-setting value at 1.0 second, one of the implicit design goals of this ACC system is to substantially avoid the sub-1-second headways where a significant amount of manual driving is known to be clustered. The FOT data are easily examined to illustrate the effectiveness by which ACC manages to avoid the short-headway regime.
- 2) *Throttle Override into Headway Conflict* – it was hypothesized that drivers will employ the throttle-override feature while under ACC control and, in the process, cultivate headway conflicts marked by intrusion to shorter than the gap-setting value. It is further hypothesized that some of these episodes may reflect the deliberate cultivation of headway conflict for the sake of eliciting the ACC autobraking response as a means of learning system behavior through direct observation. Since throttle-override vis-à-vis an ensuing headway conflict is of meaning only in the case of ACC control, this issue is not examined relative to other modes of control.
- 3) *Reverse cut-in Maneuver Leading to Headway Conflict* – it was hypothesized that the ACC driver may either deliberately (for the sake of observing system control performance) or inadvertently perform a so-called ‘reverse cut-in’ maneuver that leads to a headway conflict with a preceding vehicle in the new lane. The reverse cut-in sequence involves a lane change with ACC engaged, culminating in a headway relationship with a vehicle in the new lane. Since the ACC controller would be forced to manage the resulting headway transient unless the host driver intervened, any ensuing conflict is seen as pertinent to the evaluation of ACC safety. (Please note that the complementary term, “cut-in,” is applied in this report only for the case in which the host vehicle keeps its original lane but another

- vehicle arrives from an adjacent lane to become the new CIPV. The cut-in case is treated under item (6), below.)
- 4) *Passing Other Vehicles Under ACC Control* – it was hypothesized that the ACC driver will adapt his or her passing behavior to the characteristics of the ACC controller, thereby yielding a differing passing frequency and pattern of conflict arising from the passing transient. The specific maneuver type believed to most discriminate ACC from the other modes of control is the so-called ‘flying pass’ by which the host vehicle approaches the preceding vehicle with a substantially-negative range-rate before pulling out to pass.
 - 5) *Lane Selection Under ACC Control* – it was hypothesized that ACC control presents a special opportunity for conflict if used significantly in the right-most lane of freeways where traffic is merging from the right. Since the ACC controller may not give way to a merging vehicle in the same manner as a courteous, human driver, it was expected that ACC might be differentiated from the alternative modes of control by some pattern of conflict with merging vehicles in the rightmost lane.
 - 6) *Other Vehicles Cutting in Ahead of the ACC Host* – it was hypothesized that the characteristically-longer headways that have been shown to differentiate ACC from manual driving, especially in heavier freeway traffic, would yield a greater rate of cut-in activity under ACC control, all other things being equal. If that were the case, then both the frequency and the severity of conflicts due to cut-ins experienced under ACC control could be higher than those arising under the other modes of control.
 - 7) *Secondary Task Activity in ACC Driving* – it was hypothesized that drivers might give more liberal attention to secondary, non-driving tasks because the ACC system substantially relieves driver workload by continuously managing both speed and headway while also affording deceleration-based cues when headway conflicts do call for attention. The haptic sensation of autobrake deceleration, as well as the audible ACC alert could subtly enable a more frequent diversion of the driver’s attention when ACC is engaged. The investigation of such a behavioral change requires that secondary-task activity be compared under corresponding samples of ACC, CCC, and manual driving.
 - 8) *Intervention by Braking* – it was hypothesized that the desire to prolong ACC engagement (because of the perceived relief of driving stress) might induce drivers to ‘ride out’ transient headway conflicts by postponing brake-intervention as long as possible, thereby giving the ACC controller a greater chance of

sustaining the engagement. If such a pattern of ACC-supervision develops, then the manual-braking levels and associated conflict severities that prevail when brake-intervention finally does take place might be greater than those seen in manual driving and when intervening upon CCC control. This investigation thus focuses around a set of braking events that occur under similar driving conditions for comparing ACC brake intervention with brake applications that emerge from manual and CCC control.

- 9) *Staying Engaged up to the 0.3-g Deceleration Limit of ACC* – it was hypothesized that drivers might begin to unreasonably depend upon ACC for resolving challenging headway conflicts with other vehicles, if the deceleration authority of the ACC controller was too high and too easily invoked. It was further supposed that evidence of an “unreasonable dependency” might be indicated by a high occurrence of cases in which the autobraking response of the ACC system did reach the full, 0.3-g limit of its capability. By implication, if the autobraking limit were reached frequently, it might indicate a habit of “staying engaged” as the preferred tactic for resolving the higher-level conflicts.
- 10) *ACC Driving Corresponding to Owner’s Manual Advisories* – a dozen different issues were identified in the form of driver advisories, or precautions, that were being considered as candidate statements for an ACC owner’s manual. While a few of these precautions are closely related to performance issues cited above, most represented specialized concerns calling for their own brief examination via FOT data. While the hypotheses behind each of these precautions are not explicitly stated here, each of the individual analyses that are summarized in this section of the report are traced to an owner’s manual text where the assumed potential safety risks were stated or implied.

Accordingly, the remainder of Section 8.1 addresses the issues that have been raised in (1) through (10) above. The reader is reminded that the term, “ManBase”, that appears throughout Section 8.1, refers to manual driving during the week-1 baseline period.

8.1.1 Basic Headway-Keeping in ACC Driving

A working assumption in the analysis of FOT data is that the general pattern by which a driver manages the headway relationship to a preceding vehicle represents a basic provision for safety in the driving process. The importance of the headway-time condition, for example, can be stated in the form of a simple kinematic axiom that directly suggests a safety implication. That is, when one vehicle is following another at the same speed and the preceding vehicle suddenly commences to brake toward a stop at

some constant level of deceleration, the following driver can delay by an interval no longer than the initial value of the headway time in applying the same exact, constant deceleration level, if a crash is to be avoided while remaining in the lane. Although this specific kinematic scenario is simplistic, it does characterize the intuitively-obvious fact that the headway time employed when following another vehicle is directly related to the braking response needed during a severe headway conflict to avoid a rear-end crash, assuming collision-course trajectories are maintained. Thus, it is important to compare the general headway-keeping experience of ACC driving with that obtained under the other modes of control.

Shown in Figure 8.1 are two headway-time histograms for all ACC, CCC, and ManBase (i.e., first-week manual) driving in heavy- and sparse-density freeway traffic, respectively, at speeds greater than 50 mph.

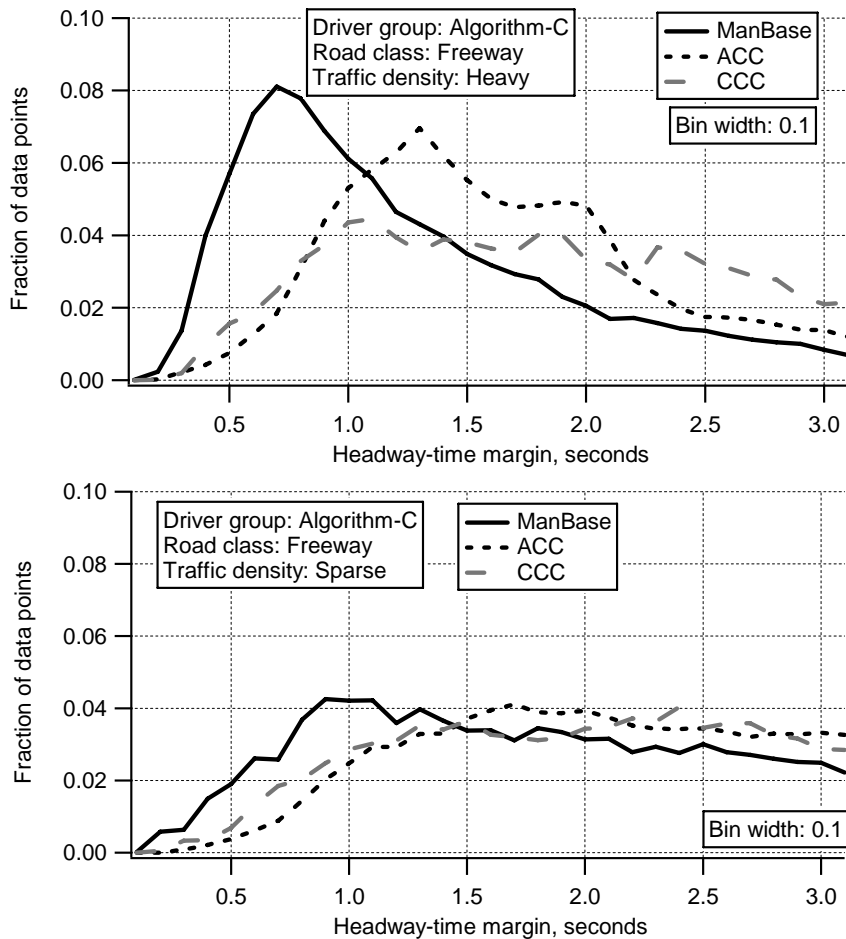

Figure 8.1. Headway-time histograms in heavy and sparse freeway traffic for all driving over 50 mph

The analysis is limited to freeway driving so as to obtain large data sets for quantifying the headway-keeping relationship, over all three modes of control. The data show that headway times shorter than 1.0 second prevail commonly in manual driving, especially in dense traffic, but far less so under ACC and CCC control.

In dense traffic, where other vehicles are in continuous supply for establishing a headway relationship, we see that ACC driving tends to cluster the driver’s total headway experience primarily within the 1.0- to 2.0-second range of adjustment of the ACC gap setting. As traffic becomes sparse, the differences in headway-time distribution tend to disappear because much longer headway values than are shown on the chart become common.

Shown in Figure 8.2 are two headway-time histograms representing only the “steady-following” portion of ACC, CCC, and ManBase driving in heavy and sparse freeway traffic at speeds greater than 50 mph. The steady-following condition is defined to prevail when the range-rate value is within +/- 1 m/sec of zero.

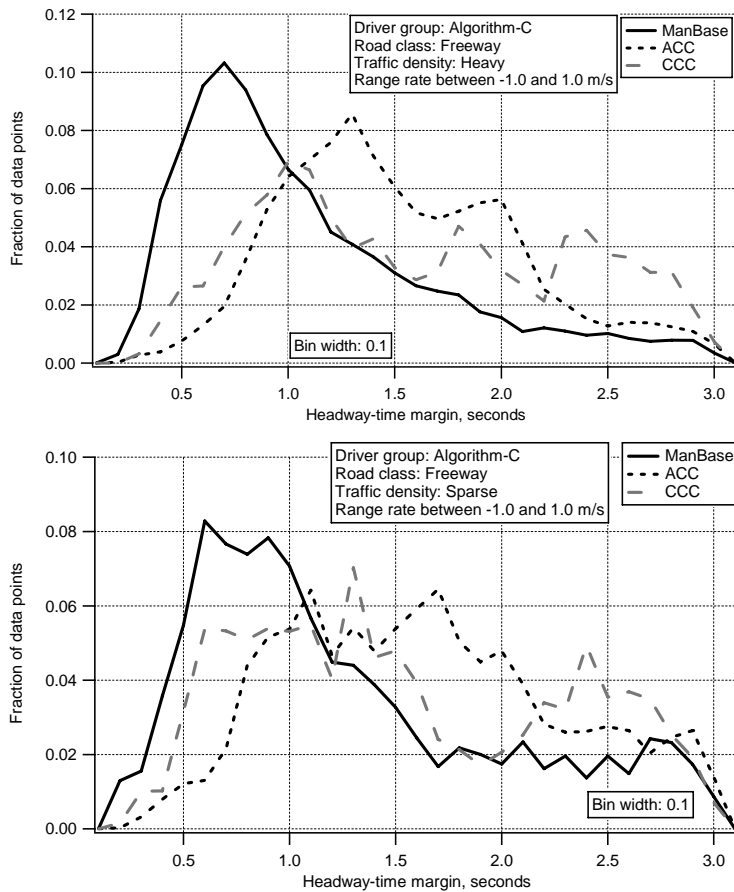

Figure 8.2. Headway-time histograms for heavy and sparse freeway traffic in the following mode of driving ($-1\text{m/s} < \text{Rdot} < +1\text{m/s}$) over 50 mph

The data for the following mode of driving in heavy-traffic condition are very similar to those shown above for all freeway driving at these speeds. In the case of sparse traffic, the data once again show that the ACC distribution is distinctly more toward the right than those of both of the other two modes. The data basically confirm that the ACC controller is doing what it was designed to do, keeping the headway time in the vicinity of 1.0 to 2.0 seconds during following, with upward and downward tails that extend either side of that window due to transient traffic.

To gain a fairly general picture of the transient conflicts that do lie in the low-probability tails of the data for *all* freeway driving above 50 mph, Figure 8.3 presents the decel-to-avoid distributions for the three driving control modes and the two respective traffic-density levels.

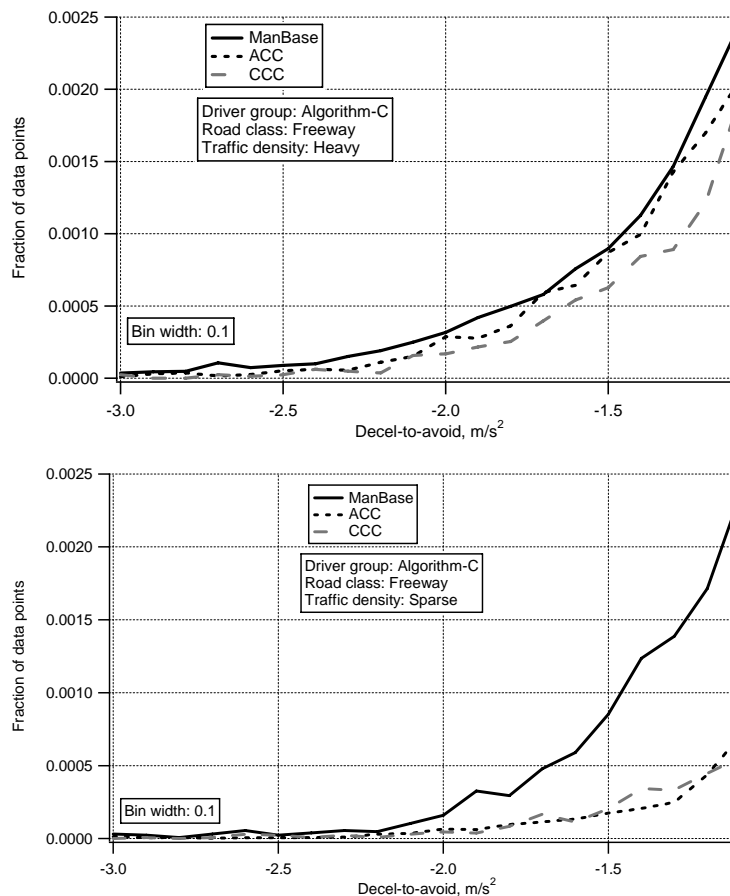

Figure 8.3. Tails of the decel-to-avoid histograms for all driving in heavy and sparse freeway traffic over 50 mph

For the case of heavy traffic, in the upper figure, the ACC mode of control is distributed very nearly the same as that of manual driving but somewhat higher in conflict levels than the data from CCC driving. Under the heavy-traffic conditions, the

disturbances in flow that tend to provoke headway conflicts are being managed by the ACC controller with virtually the same overall performance as the manual driver. In the case of sparse traffic, manual driving stands out as much more likely to incur potential conflict. Presumably, the contrasting data reflect a difference in the way the manual driver manages headway while approaching a slower-moving vehicle—a scenario that is, of course, very common when driving in sparse traffic (whereas driving in heavy traffic tends to provide little opportunity for the approaching scenario.) In any case, the ACC controller manages conflict in sparse traffic with the same nominal degree of caution as appears under CCC control.

Shown in Figure 8.4 are the two-dimensional histograms for headway-time vs. range-rate in manual (ManBase) driving. These plots correspond to the all-driving histograms shown above, but represent all traffic densities combined. The right-side chart shows a close-up of the zone having headway values less than one second, emphasizing that manual driving contains a substantial amount of activity that combines short headway time with negative-polarity range-rates. As a comparative marker on the lower plot, for example, note that there is an observable amount of activity that falls at or below 0.4-second headway and lies along the negative portion of the range-rate axis. The lower-left corner of such a plot is, of course, the domain of short times-to-collision. Later in this section of the report, most of the comparative exploration of kinematic conflict with and without ACC will be focused in this domain.

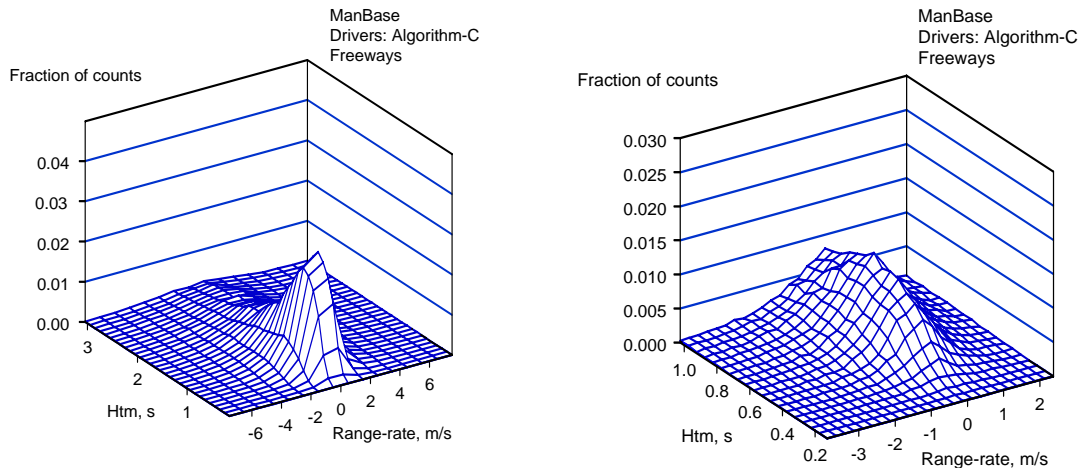

Figure 8.4 Headway-time vs. range-rate histograms, manual driving on freeways

By way of contrast, Figure 8.5 shows the corresponding plots produced under ACC control. In this case, the headway-time variable, Htm, has been normalized by the ACC gap-setting value, T_h , so that all of the ACC data can be consolidated to show how the ACC controller manages the headway and range-rate variables once the gap has been set.

Looking at the plot on the right, note that there are virtually no observable data in the vicinity of $(Htm/Th) = 0.4$ (which corresponds to $Htm = 0.4$ seconds when the gap setting is at its shortest value, 1.0 second.) Further, the accompanying range-rate level in this short-headway domain is also essentially zero.

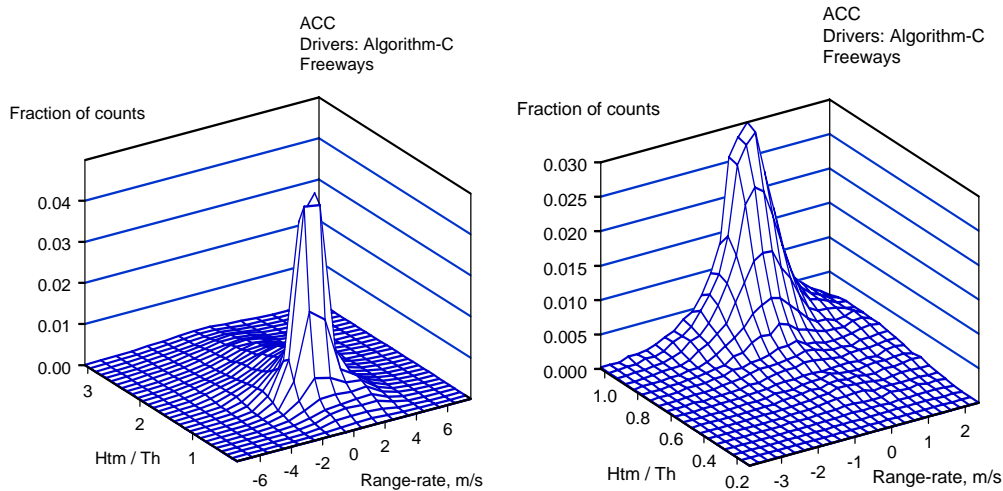

Figure 8.5. Headway-time vs. range-rate histograms, ACC driving on freeways

Summary of Observations

In summary, the ACC controller is distinctive in its ability to modulate headway time around a gap-setting value that can be adjusted by the driver over the range from 1.0 to 2.0 seconds. Considering a wide range of freeway driving conditions, the data show the following:

- Headway times lying in the regime below 1.0 second are much less prevalent in ACC driving than under manual control, especially in dense traffic.
- Conflict levels that occur in general ACC driving tend to be comparable to those seen under CCC control and generally lower than those seen in manual driving.
- When transient disturbances arise, the ACC controller acts to minimize intrusion into the regime where headway time is shorter than the gap-setting and range-rate is negative.

Moreover, the basic headway-keeping performance of the ACC controller as explored here under freeway operating conditions appears to diminish certain potential safety risks relative to those of manual driving.

8.1.2 Cases of ACC Throttle Override into Headway Intrusion

It was hypothesized that some new users of ACC may choose to cultivate or at least tolerate the emergence of certain types of headway intrusions or conflicts in order to observe and learn the ACC system's response and its braking capabilities. Two types of such 'deliberate' activity were identified for study, namely:

- The host driver's intentional use of throttle override to diminish headway space to well within the value that corresponds to the ACC gap setting and,
- The so-called "reverse cut-in" tactic by which the ACC host driver changes lanes to arrive close in behind another vehicle in the adjacent lane.

In this subsection, the first of these two deliberate activities is examined for its possible safety implications. In the following subsection, 8.1.3, the second type of activity is explored. As alluded to in other contexts earlier in this report, examining specific activities of this kind requires that a stereotype of the driving activity be defined within a database query containing constraints that are judged to be appropriate, although perhaps somewhat arbitrary. Initial results often show that actual driving data correspond to a much richer array of apparent driver intentions, maneuvering details and ambient traffic and roadway situations than is apparent when first crafting the query.

Accordingly, what might begin as a focused study of drivers deliberately probing an imagined intrusion scenario often reveals a much broader range of behaviors, some of which fit the imagined probing behavior, and some of which do not.

The data which follow provide a rather broad picture of the deliberate behaviors cited above, showing that the desire to infer driver intent, such as the intention to learn the ACC system response, is a tenuous pursuit. On the other hand, kinematic descriptions of the conflicts arising from such scenarios appear to be quite useful for appraising the potential safety implications of ACC control.

For exploring the scenario of intrusions that are cultivated by means of throttle-override, a query was designed to find the cases in which:

- the ACC system remains engaged throughout the sequence of interest;
- a CIPV target is present throughout the sequence;
- the Throttle Override signal goes high at a time labeled, t_{t-o} , and stays high for at least 3 seconds;
- the headway time, H_{tm} , falls to a value that is less than 0.7 times the gap-setting time, T_h , within 5 seconds following t_{t-o} . (Thus, the "intrusion window" for this query is defined by headway margins in which $H_{tm}/T_h < 0.7$. Please note that the H_{tm}/T_h ratio is also used as a metric for grading

each intrusion case, based upon the view that the driver's own preference (or, perhaps, tolerance) for headway keeping is indicated in their T_h selection for the gap setting. When the extent of the intrusion inside that gap is expressed by the H_{tm}/T_h ratio, the resulting measure is viewed as being normalized to the preference/tolerance sensitivity of the individual for headway space.)

- no lane change occurs within 10-seconds following t_{t-o} .

A total of 263 events were found to satisfy this query, involving a total of 34 drivers, as shown in the right-most column of Table 8.1. The table indicates that the number of related events was the greatest in the final week of ACAS-enabled driving but that the number of drivers involved each week in this behavior and the minimum values of the several response metrics were relatively flat over the three weeks in question.

Table 8.1. Overall summary table for throttle-override intrusions

	Week 2	Week 3	Week 4	All
Number of cases	57	71	135	263
Number of drivers	20	20	16	34
Mean minimum H_{tm}/T_h (10 s window)	0.47	0.49	0.49	0.49
Mean minimum H_{tm} , s (10 s window)	0.73	0.76	0.66	0.70
Mean minimum A_x , m/s^2 (autobraking only)	-1.01	-1.08	-1.28	-1.15

Of the 263 cases, the following breakdown further distinguishes the data:

- 132 of the cases involved a single intrusion during a pairing of the host vehicle with one CIPV target vehicle;
- The other pairings involved multiple cycles of throttle override that proceeded into and then back out of the intrusion window. In one case, the driver went in and out of the window a total of ten times while driving behind the same target vehicle, perhaps trying to coerce the lead driver out of the fast lane so that the host could pass;
- in 61 of the 263 cases, the host driver disengaged ACC while still traveling behind the target with which a throttle-override conflict had occurred; in the remaining 202 cases, the driver stayed engaged throughout the encounter with this particular target;
- an ACC autobraking response lasting at least one second was stimulated upon release of the throttle in 42 of the cases. The peak deceleration values accrued by autobraking in these cases are distributed as shown in Figure 8.6. The fact that only 42 out of the 263 cases (i.e., 16%) of throttle override intrusions caused autobraking to be invoked at all indicates that the controller generally defers from autobrake actuation in cases such as this when range-rate tends to

be near zero. The data in Figure 8.6 also confirm that no case of throttle override caused autobraking to be manifested at the 0.3-g limit of the controller (with ACC autobraking reaching a maximum of only 0.23g.)

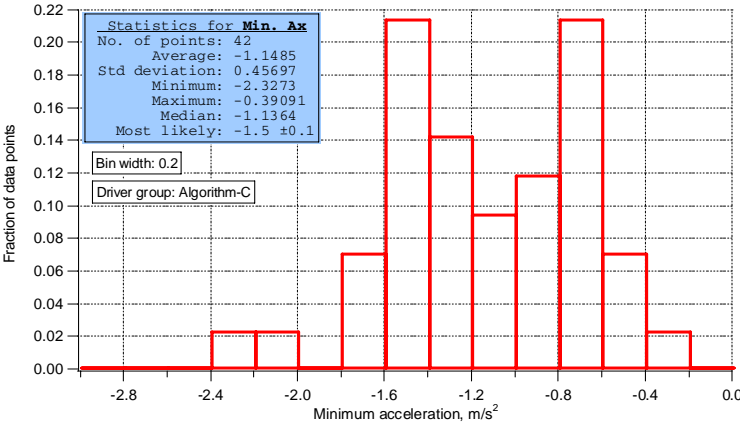

Figure 8.6. Peak decelerations reached in 42 cases of autobraking response following a headway intrusion provoked by throttle-override

Quantitative results drawing upon the full set of 263 events are presented using several different illustrations, below.

Shown in Figure 8.7 is the probability distribution for the minimum values of headway ratio, H_{tm}/Th , that were reached within either 5- or 10-seconds following the time, t_{t-o} , at which throttle-override had commenced.

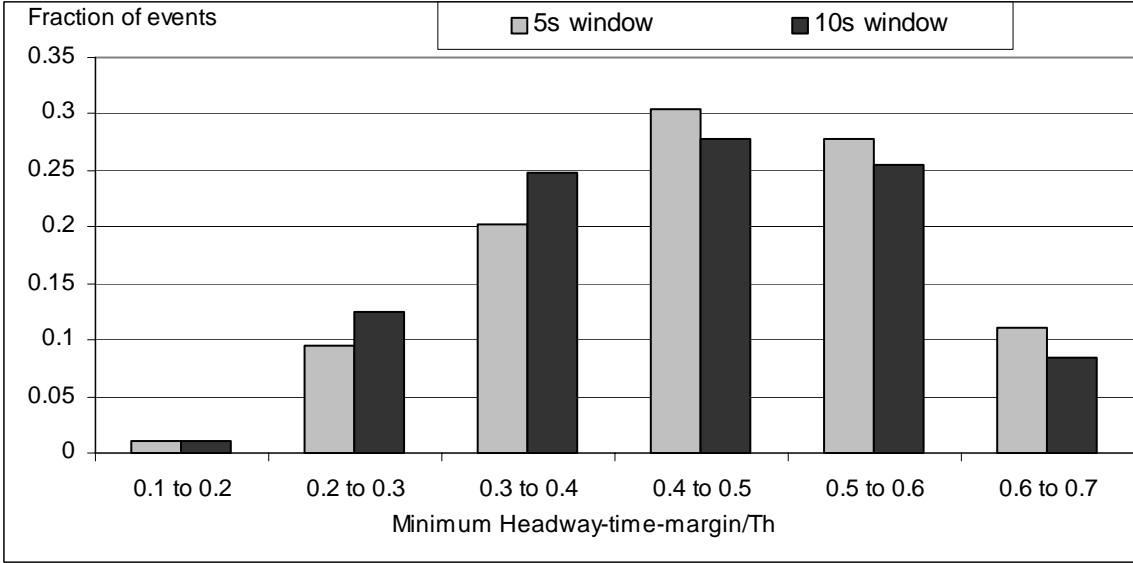

Figure 8.7. Distribution of H_{tm}/Th minima provoked by throttle override.

We see that intrusions reaching H_{tm}/Th values in the range of 0.3 to 0.6 times were more or less characteristic of this group. It also would appear that a substantial portion of

these intrusion events caused Htm/Th to reach its minimum value later than 5 seconds following the throttle onset, since the minima achieved within the 10-second window (see the dark bars in the figure) are distributed more toward the lower values of Htm/Th than those achieved within the 5-second window (i.e., the light bars). It is also instructive to note that, although rare, intrusions that go even into the region of Htm/Th values between 0.1 to 0.2 have been observed (i.e., there were three such events).

Shown in Figure 8.8 are the ACC gap settings (Th) that prevailed during the 263 throttle override events discussed above. The data show that throttle-override-into-conflict is a tactic that was applied from across the full range of gap-setting values. It is important to note that none of these cases included the use of throttle override to achieve a passing maneuver. Thus, the implication is that persons may have sought to cultivate a rather persistent type of conflict and they did it from across a broad range of initial headway conditions.

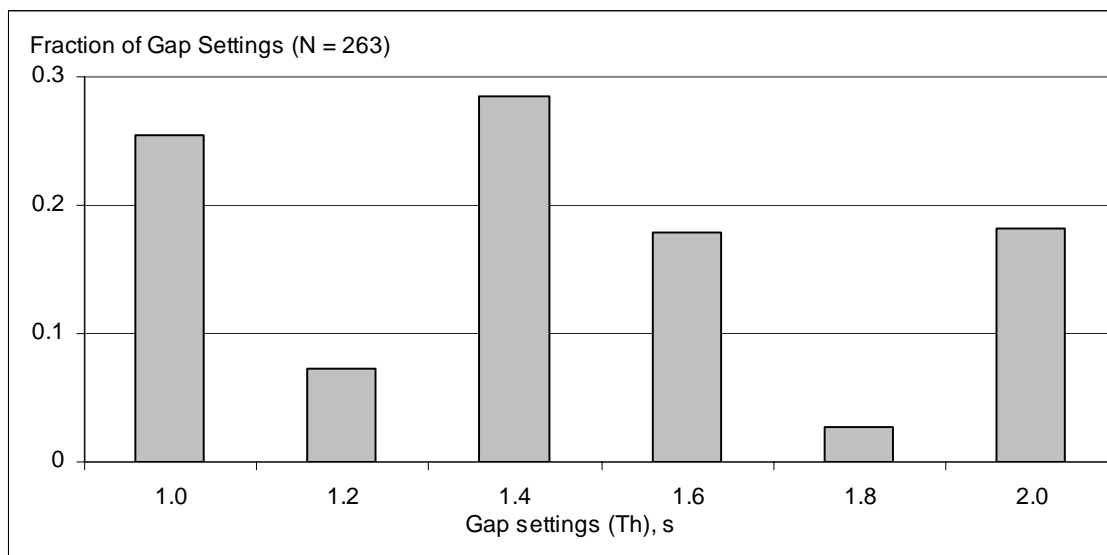

Figure 8.8. Distribution of ACC gap setting during throttle-override-into-conflict

Figure 8.9 shows all of the minimum values of Htm/Th, and the averages thereof, that were seen within a 10-second window following throttle override for each of the 34 individuals who entered the defined conflict window. Thus, we note that approximately half of the 66 persons that drove algorithm-C vehicles chose to cultivate a throttle override conflict of this kind. The data show that a few individuals employed this tactic many times and reached Htm/Th minima values that varied over a wide range.

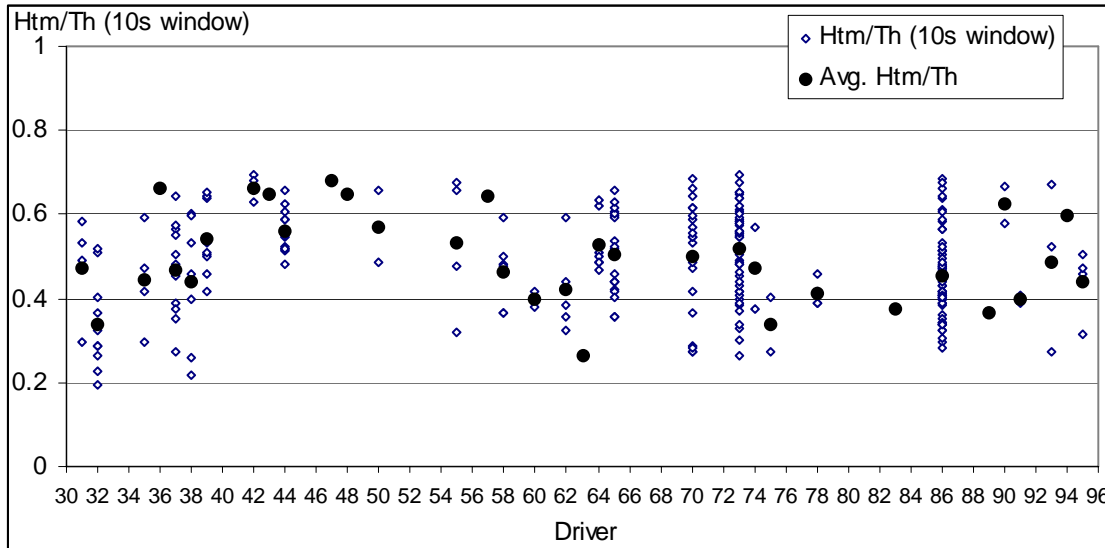

Figure 8.9. Plot of all minimum Htm/Th values, and the averages thereof, attained by individual persons whose driving contained such data

Figures 8.10 through 8.12 provide quantitative metrics that compare the throttle override actions of the 34 drivers who were involved. In Figure 8.10, the group of 34 is ranked from left to right according to the number of times that each individual reached the defined conflict window by means of throttle-override. We see that about half of these drivers stimulated such a response three times or less. Another sixteen persons exhibited this behavior between about 4 and 20 times and two individuals distinguished themselves with tallies of 46 and 59 episodes.

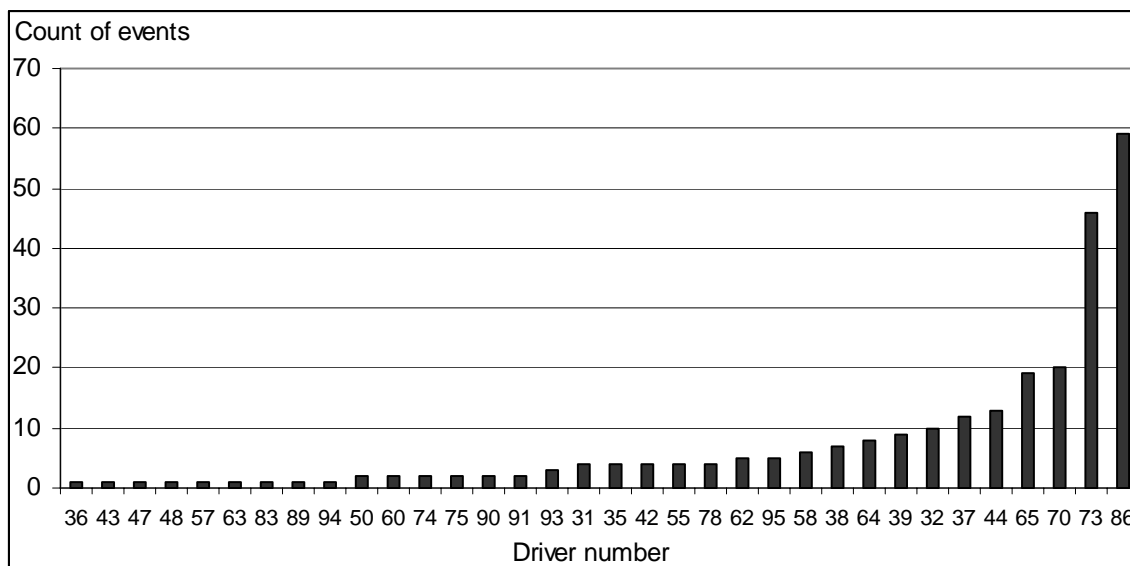

Figure 8.10. Ranking of 34 drivers according to the total number of “throttle-override conflicts” that they cultivated

Figure 8.11 provides a rank-ordering of the 34 drivers according to the average values of Htm/Th minima that each individual reached within 10 seconds of the throttle onset. The data show that more than half of the individuals who chose to cultivate a throttle override of the queried type reached an average intrusion that was as low as 50% of the ACC gap setting.

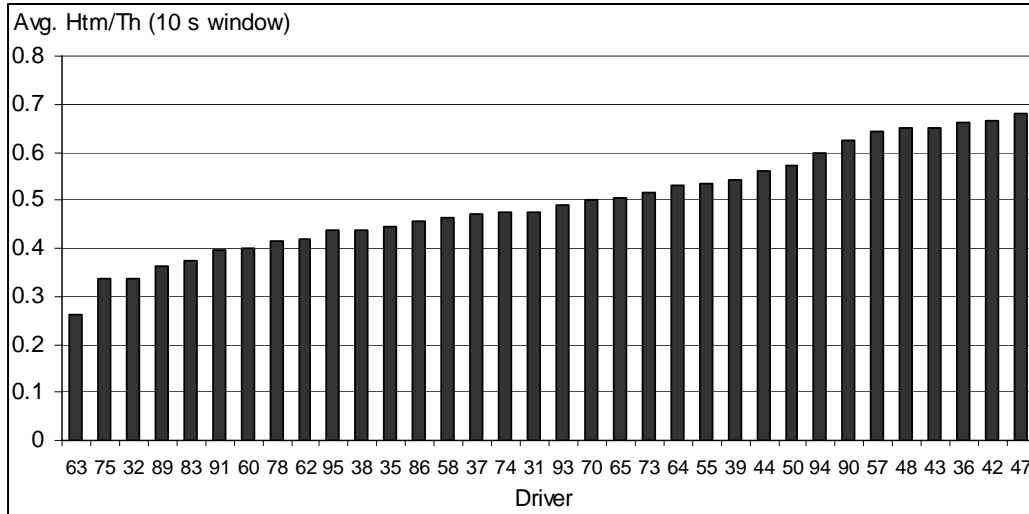

Figure 8.11. Ranking of 34 drivers according to the average value of $(Htm/Th)_{min}$ that they each cultivated by means of throttle override

We also note the four individuals with the highest counts in Figure 8.10, above, happen to show average Htm/Th minima that lie near the center of all averages shown below (suggesting that these high-count contributors to the throttle-override data did not tend to skew the overall distribution of results shown earlier in Figure 8.7.)

Shown in Figure 8.12 is the rank-ordering of the 34 drivers according to the minimum value of Htm that each individual reached within 10 seconds of throttle onset in their deepest-intrusion episode. The data show that almost all of these drivers intruded into headways of less than one second and half of this group (corresponding to a quarter of all algorithm-C drivers) intruded to less than 0.5 seconds of headway time.

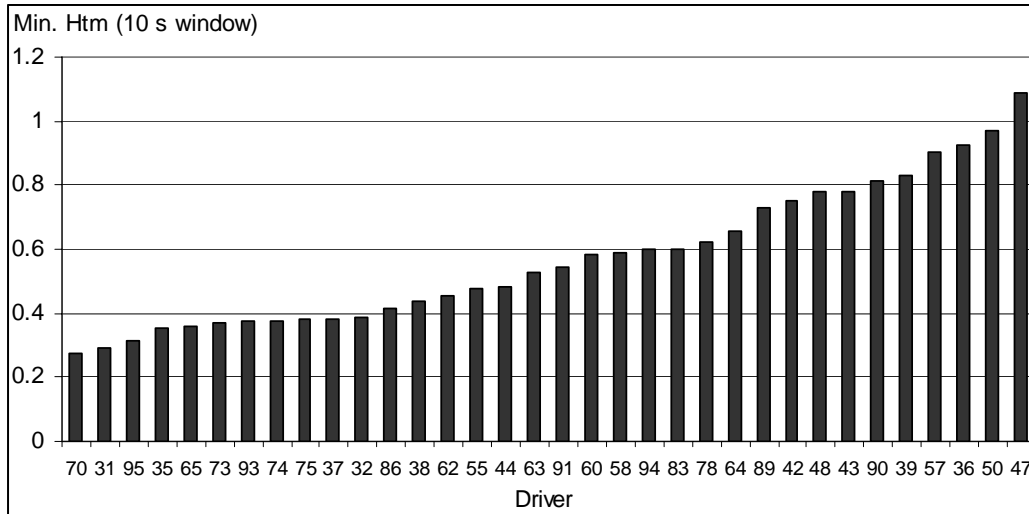

Figure 8.12. Ranking of 34 drivers according to the minimum value of Htm that they each cultivated by means of throttle override

Whether expressed as normalized to the driver’s ACC gap-setting or in terms of absolute headway time, it is clear that a substantial portion of the algorithm-C drivers employed the throttle-override to arrive much closer to the preceding vehicle than the ACC controller seeks to avoid. Such a practice can be looked upon as simply one of the many ways by which individuals will tailor their ACC driving to suit personal preferences and driving style.

Summary of Observations:

In summary, the practice of reducing headway to values that are at 70% or less of the gap setting, by means of throttle override during ACC engagement, was not uncommon in the FOT. The data show the following:

- Approximately half of the sample of 66 drivers of algorithm C undertook a throttle-override tactic that produced a headway conflict within the defined window.
- The throttle-override tactic was employed rather evenly from across the full range of gap settings that the drivers had selected for ACC control.
- Ten percent of the driver sample exercised this tactic more than ten times during the three weeks of ACAS-enabled driving.
- Forty percent of the algorithm-C sample employed throttle override to reach a headway minimum that was half or less of the ACC gap-setting value.
- A quarter of the algorithm-C sample used throttle override to reach an absolute value of headway time that was equal to 0.5 second, or less.
- No driver elicited the 0.3g limit-autobraking response from the ACC system.

Although a practical assessment of the safety impacts of such throttle override behavior is unavailable, none of the results presented here suggest a notable safety risk arising from this feature of the ACC system. Indeed, throttle-override requires such a deliberate behavior on the part of the driver that a substantial degree of attentiveness is believed to accompany its occurrence.

8.1.3 Cases of Reverse Cut-in Leading to Headway Intrusions in ACC Driving

Another way in which the host driver's actions can precipitate a headway intrusion under ACC control involves a reverse cut-in maneuver by which a lane change is performed by the host vehicle to take a gap in the adjacent lane and arrive closely behind a new target vehicle in that lane.

If the combination of new headway and range-rate is sufficiently demanding following a reverse cut-in maneuver, the ACC vehicle may commence its autobraking response in order to manage the forward conflict. It is conceivable that the reverse cut-in scenario would be employed, intentionally, by a new user as a means of probing the ACC response so as to observe the system's deceleration behavior and associated capabilities. The same intrusion scenario could also develop, however, without any deliberate intent on the part of the host driver to provoke headway conflict—simply as the result of encountering an unanticipated headway disturbance upon arriving in the target lane. No attempt at inferring the driver's intent will be provided here. Nevertheless, it was determined that quantitative measures of the conflicts produced under the reverse cut-in scenario could provide a useful complement to the study of ACC safety implications, even if the driver's intention cannot be determined.

The query that was designed for finding cases of ACC reverse cut-in conflicts in the data employed the following constraints:

- The host vehicle is traveling on a high-speed (limited-access) roadway.
- ACC is engaged before the sequence of interest begins.
- The host vehicle changes lanes, with ACC engaged.
- A CIPV is acquired in the new lane, with a sufficient degree of headway conflict that ACC autobraking begins within 6 seconds of the lane-change time (i.e., the time at which the “lane-change flag” goes high, corresponding to the center of the vehicle passing over the lane-edge marking).
- The same target remains the CIPV for at least 3 seconds following commencement of ACC autobraking.

- ACC autobraking reaches at least a deceleration level of 0.01 g's and remains active for at least 0.5 seconds.

A total of 82 episodes of this kind were found in the database involving 30 drivers. Of these, 11 episodes culminated in ACC disengagement (by means of manual braking or through application of the “cancel”, or the “off” buttons) within 6 seconds following the lane change, while the other 71 cases stayed in engagement through that point in time. All 82 cases, however, yielded the required autobraking transient and are reported in the various data presentations, below.

Shown in Table 8.2 is a summary of the 82 cases of reverse cut-in that occurred over the three weeks of ACAS driving. The data do not suggest a strong adaptation by the ACC drivers over this period, either in the number of events produced, the number of individuals that were involved each week, or in any of the measures implying the severity of the events.

Table 8.2. Summary table of acc reverse cut-in events

	<i>Week 2</i>	<i>Week 3</i>	<i>Week 4</i>	<i>All</i>
Number of cases	33	20	29	82
Number of drivers	18	12	18	30
Mean Htm/Th	0.72	0.66	0.69	0.69
Mean Htm	0.89	0.82	0.72	0.81
Mean minimum Ax (autobraking only), m/s ²	-1.07	-0.84	-1.01	-0.99

Shown in Figure 8.13 is a distribution of the time that elapsed between the moment of lane-change crossover (signaled by the transition of the lane-change flag in the data stream) and the onset of autobraking. These data merely serve to characterize the time-development of the conflicts that prevailed over the set of 82 cases of reverse cut-in conflict that were observed, indicating that the onset of autobraking did not tend to come immediately upon crossing into the next lane.

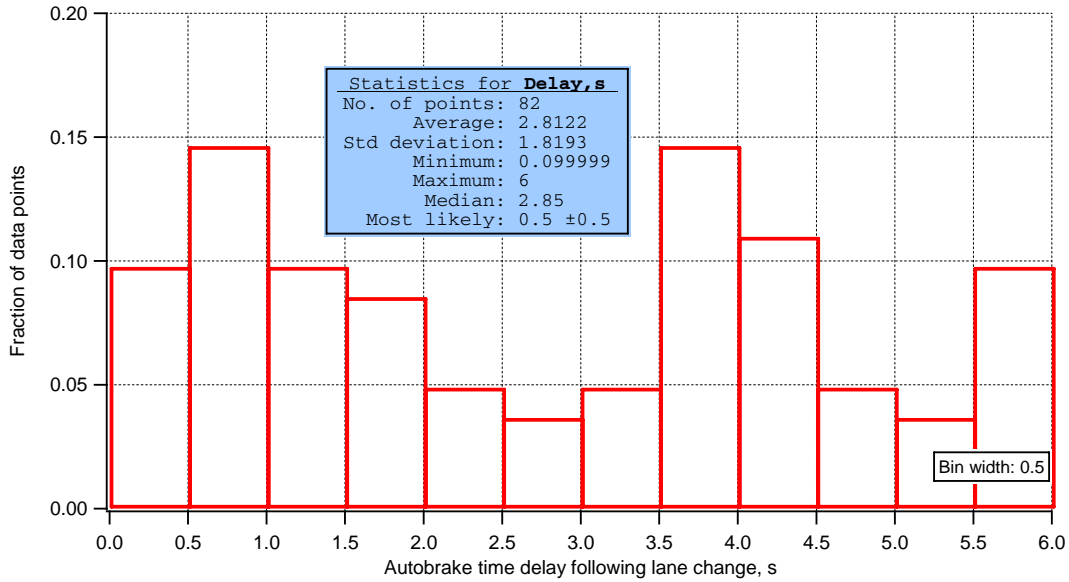

Figure 8.13 Distribution of time that elapsed between the lane-change flag and the commencement of autobraking in response to reverse cut-in conflicts

Shown in Figure 8.14 is a distribution of the minimum values of Htm/Th that were reached during the 82 episodes of reverse cut-in conflict.

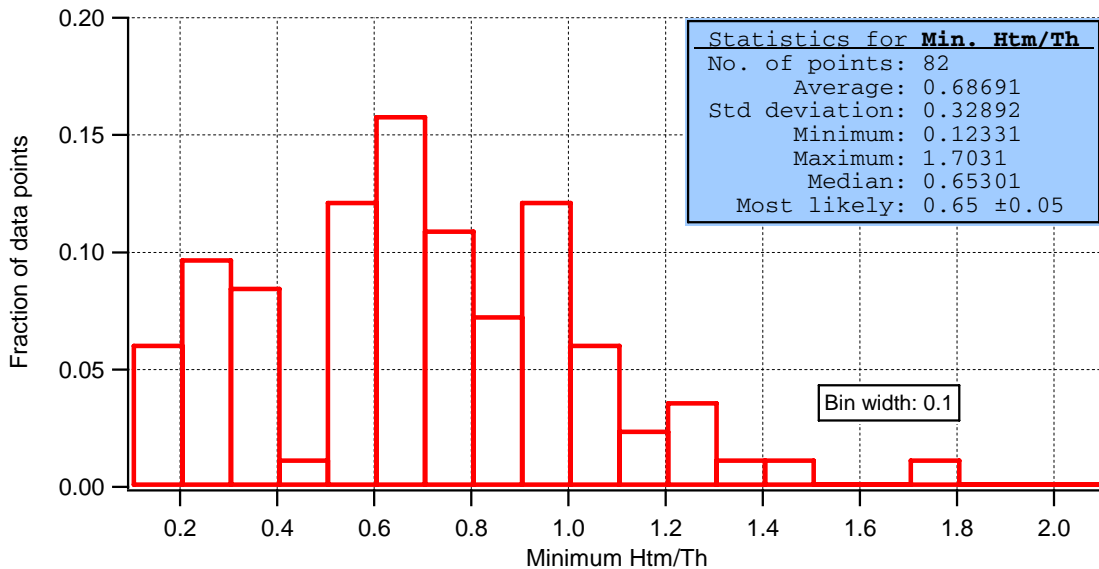

Figure 8.14 Distribution of minimum values of Htm/Th reached in reverse cut-in conflicts

Noting that a value of 1.0 indicates that the minimum headway matched the desired Th value, we note that the conflict often developed in such a way that the autobraking response could prevent the accrual of significant intrusion inside of the set headway. On the other hand, the majority of the responses yielded intrusions into the headway space,

with about 25% of the cases resulting in H_{tm} less than half of the T_h value and a few reaching to less than 0.2 times T_h .

Shown in Figure 8.15 is the distribution of the minimum (i.e., most-negative) values of longitudinal acceleration, during the autobraking response.

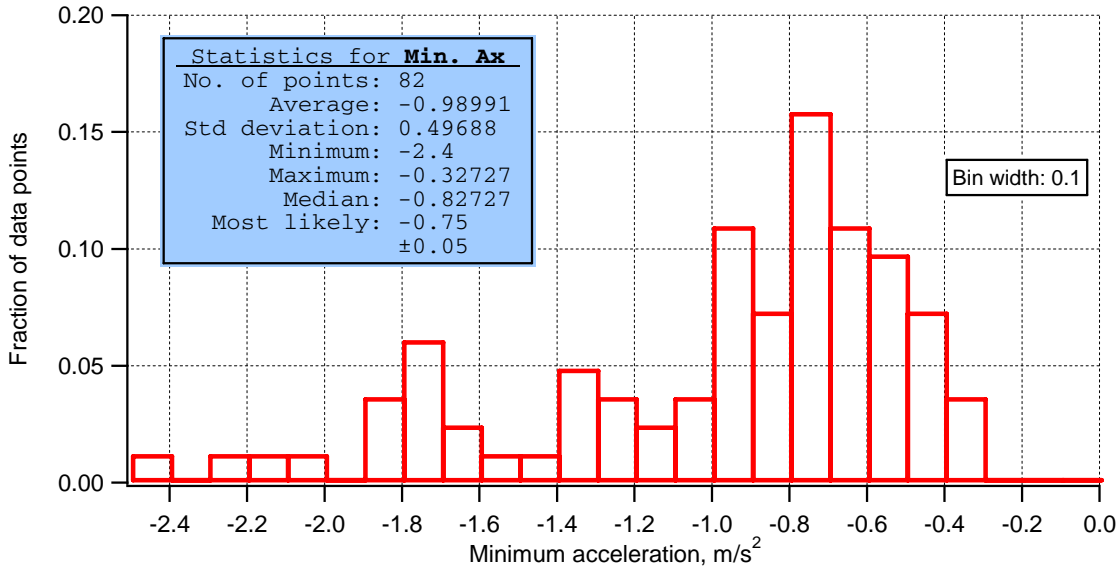

Figure 8.15. Distribution of minimum A_x (maximum deceleration) during the autobraking response to a reverse cut-in conflict

Such results are referred to here as the maximum decelerations that were achieved. Recognizing that the query required only that the autobraking level exceeds a mere 0.01 g, it may not be surprising that 60% of the cases, below, entailed no more than 0.1 g of deceleration. Only four individual cases exceeded 0.2 g, with a maximum response of 0.24g, such that none reached the 0.3 g maximum capability of the autobrake controller. Thus one could say that if, indeed, any drivers used the reverse cut-in driving tactic as a way of exploring or probing the ACC’s braking response, none managed to observe the system’s full deceleration capability by this means.

Shown in Figure 8.16 is a distribution of the duration of the autobraking responses that prevailed during the 82 episodes of reverse cut-in conflict. The data show that the typical sequence entailed about 2 seconds of automatic ACC braking, as needed to manage the headway conflict, given its severity, the T_h setting, and the autobraking control rule. A few cases involved autobrake applications lasting continuously for 7 or 8 seconds, as warranted by the conditions.

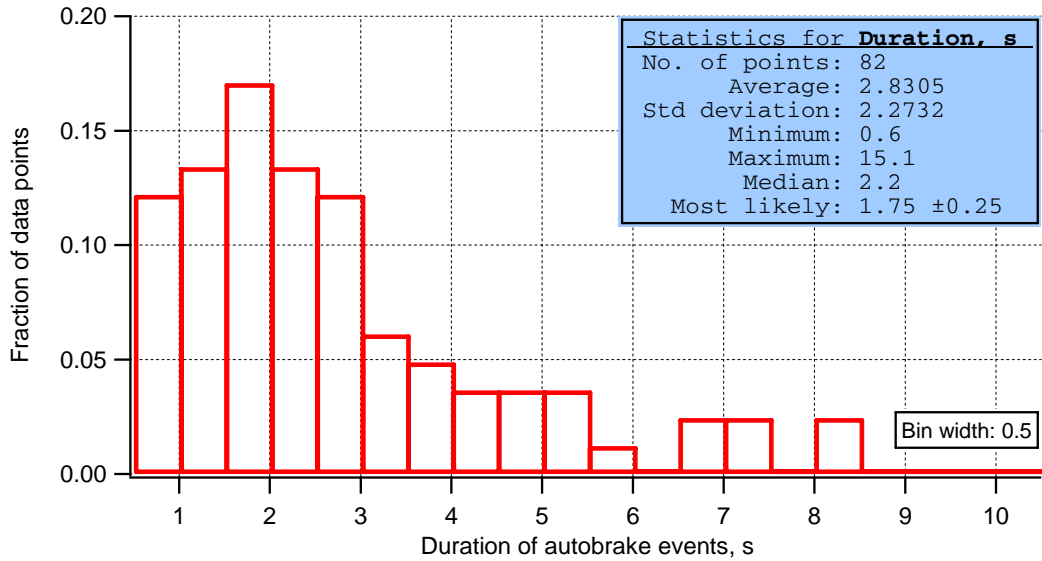

Figure 8.16. Distribution of the duration of autobraking in response to reverse cut-in conflicts

The fact that the cases are distributed so broadly across the 6-second window that the query allowed suggests that a rather wide array of conflict-development sequences were involved. Clearly, the driver is likely to have a rather different perception when a conflict severe enough to provoke autobraking appears immediately upon arrival in the target lane as opposed to one that appears a full six seconds later.

Figure 8.17 identifies the driver numbers for all individuals who encountered one or more reverse cut-in conflicts of the type described.

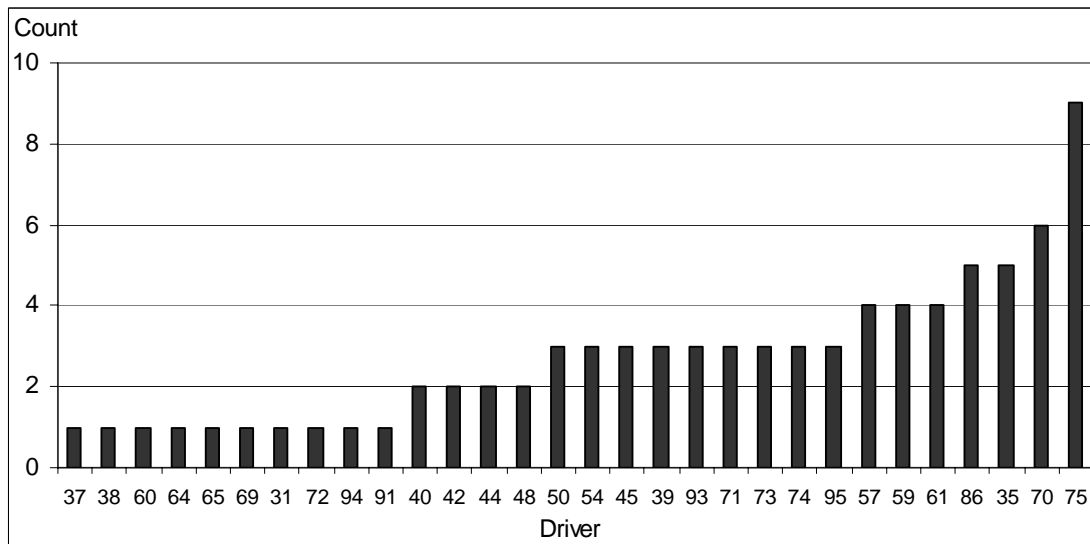

Figure 8.17. Rank order of drivers who encountered reverse cut-in conflict, according to the total number of such episodes experienced

The plot shows these individuals in rank order according to the number of reverse cut-in conflicts experienced by each. We see that:

- Ten persons (15% of the algorithm-C sample) had only one such episode.
- Seven persons (11% of the sample) had more than three episodes.
- One individual had nine such episodes.

In Figure 8.18, the drivers who experienced a reverse cut-in conflict are rank-ordered according to the maximum deceleration level that was experienced due to ACC autobraking.

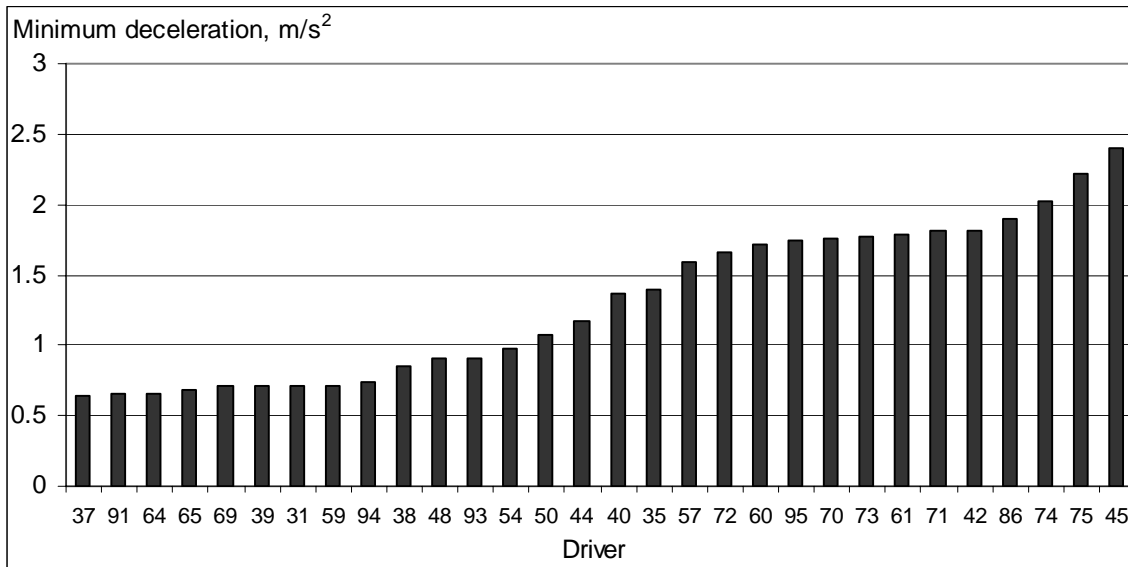

Figure 8.18. Rank order of drivers who encountered reverse cut-in conflict, according to the maximum deceleration level experienced from ACC autobraking

Clearly, the typical individual in this group did not encounter a reverse cut-in conflict that produced much more than half of the 0.3 g deceleration authority that the ACAS ACC system can provide. This result seems to suggest either that a) provocation of a reverse cut-in conflict did not succeed as a deliberate tactic for stimulating the full deceleration limits of the ACC system or, b) drivers were unwilling to tolerate the levels of conflict that were involved and sought braking interventions instead. (Please note that a general consideration of braking intervention behavior is covered under Section 8.1.7 of this report.)

Figure 8.19 shows a rank order of the drivers according to the minimum headway ratio, H_{tm}/Th , that they reached in any reverse cut-in conflict. We see that only 12 individuals, or 18% of the algorithm-C sample, encountered (or tolerated, given their option to intervene) an H_{tm}/Th intrusion that went below the 0.5 value.

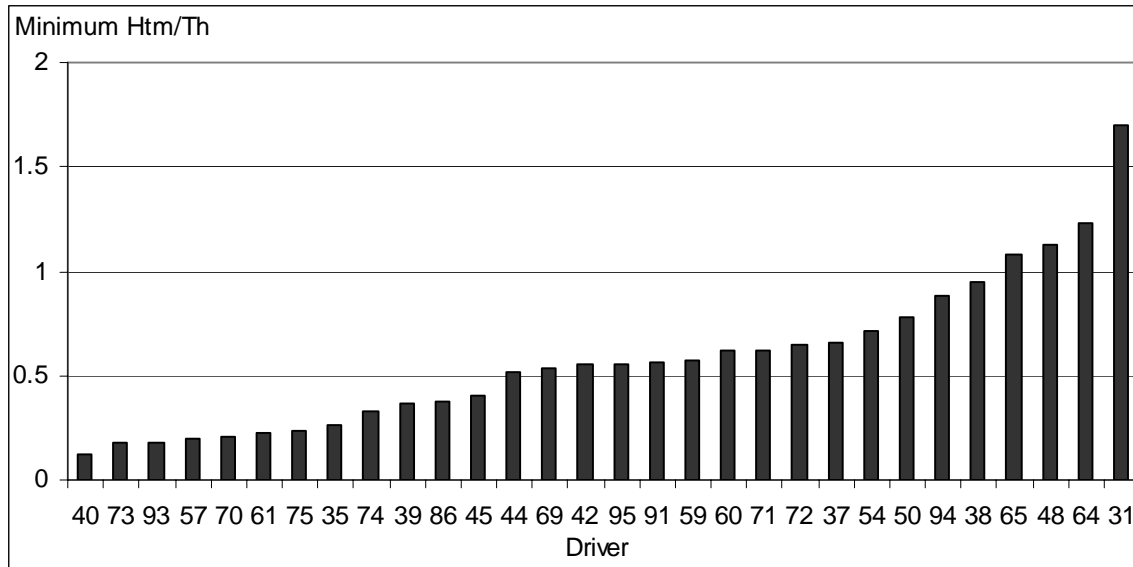

Figure 8.19. Rank order of drivers who encountered reverse cut-in conflict, according to the minimum Htm/Th value experienced in any such episode

In contrast, it was seen in the previous section of the report that some 26 individuals (39% of the sample) deliberately provoked the throttle-override type of conflict to an Htm/Th value that falls below 0.5. One might hypothesize that the throttle-override events—all being confined to a sustained relationship with one preceding vehicle—involve a greater sense of control on the driver’s part than is the case during the reverse cut-in transient that is initiated by a lane-change maneuver. In the case of throttle-override, the driver has the continuous authority of modulating the throttle to a greater or lesser degree as the conflict develops. In the case of reverse cut-in, the driver does not participate in managing the resulting headway conflict, once the reverse cut-in has begun, unless there is an intervention that disengages ACC. Thus, it is suggested that the driver’s acceptance of a certain level of headway conflict during ACC engagement depends, like almost all other perceptions of driving risk, on the context and on the relative predictability of, and direct control over, the future development of the conflict.

Summary of Observations:

In summary, ACC conflicts were observed to arise from reverse cut-in maneuvers, but drivers chose to intervene with braking before any such conflict caused the ACC braking controller to reach its full, 0.3g, deceleration authority.

- Approximately half of the sample of 66 drivers of algorithm C experienced (or provoked) at least one reverse cut-in conflict while under ACC control, eliciting ACC autobraking within a few seconds following a lane-change maneuver.

- Of the total of 82 cases of reverse cut-in conflict observed during ACC engagement, 7 individuals encountered the condition more than three times and one individual encountered the condition as many as 9 times.
- A quarter of these conflicts involved a headway intrusion that penetrated to less than half of the prevailing gap setting of the ACC controller.
- Although it was originally hypothesized that some drivers would employ the reverse cut-in tactic as a means of stimulating (and thus observing) the full range of ACC autobraking responses, no single case of a reverse cut-in conflict ever reached the full (0.3g) braking capacity of the ACC system. Thus, if a portion of the reverse cut-in conflicts were deliberately induced in order to observe and learn about the ACC system's ability to manage a severe headway conflict, no driver was able to actually experience the limits of such control in this way.
- Half of the reverse cut-in responses did encounter ACC autobrake responses that reached beyond 50% of the 0.3g capability of the system.
- Fifteen percent of the reverse cut-in cases were terminated by driver intervention using the brake. In general, it appeared that drivers showed less tolerance for a kinematic conflict that arises in a reverse cut-in scenario than when applying throttle-override to induce conflict.

Moreover, although a practical assessment of the safety impacts of reverse cut-in conflicts is unavailable, it seems fair to observe again that the shorter headway times observed in this scenario occur commonly in manual driving and yet the deliberate steering activity needed to set up a reverse cut-in transition suggests a substantial degree of driver attentiveness for dealing with the conflicts that arise.

8.1.4 Passing Other Vehicles under ACC Control

One passing-type maneuver that tends to pose a degree of inter-vehicular conflict (and thus a possible safety question) under ACC and other modes of longitudinal control is the so-called "flying pass." The flying pass is defined as an overtaking maneuver that is begun by a driver approaching from directly behind the vehicle that is to be passed. Thus, it comprises a lane-change-and-passing sequence, throughout which the speed of the host vehicle substantially exceeds that of the vehicle being passed.

On the one hand, the flying pass may have its own safety merit as a tactic that minimizes the conflict within the gap that is being taken in the adjacent lane. On the other hand, at least some nominal degree of conflict arises in the initial lane by the fact

that the range to the preceding vehicle continually declines with little or no reduction in speed by the host vehicle. The magnitude of this “initial-lane-conflict” can be seen as representing a potential safety risk insofar as the driver’s expectation of resolving it (by changing lanes) can be violated at some point in the sequence due to unanticipated actions by others. If that were to happen when the conflict level is high (such as, for example, with a very short time-to-collision) the lane change may need to be aborted—presenting the host driver with the challenge of resolving the in-lane conflict by means of braking. Accordingly, it is of interest to compare the flying-pass behaviors that are exhibited in each of the alternative modes of control, in order to explore any differences in risk-taking within the initial lane that are being adopted by the ACC-user.

In order to construct a query for finding a significant set of flying passes, it is necessary to define a threshold for the minimum value of negative range rate. It is also necessary to isolate the query to those driving environments that offer a significant opportunity for conducting such passing maneuvers, particularly if the total distance traveled under those conditions is to be used to normalize all of the observed flying-pass events so as to compute a rate of occurrence of such episodes. Because this type of maneuver represents a common behavior on the highway, it is seen as an reasonable context within which to compare the conflicts generated under ACC control with those arising under CCC and manual control.

The query that was designed for finding cases of the flying-pass maneuver in the data employed the following constraints:

- The host vehicle is traveling on a freeway.
- The host is being operated in one of three control modes: ACC or CCC engagement or the ManBase mode corresponding to manual driving during the baseline, or first, week of FOT driving.
- ACC or CCC has become engaged before the sequence of interest begins, in either of those two modes,
- A preceding vehicle has been detected in the lane ahead as the CIPV target.
- The host vehicle is approaching the CIPV with a range rate that is less than or equal to -2 m/s.
- The host vehicle changes lanes to the left.

This query identified the following number of flying pass events in the three respective modes of driving control:

- ManBase Driving — 273 events
- CCC Engagement — 118 events

- ACC Engagement — 458 events

Table 8.3 shows a summary of the development of the 458 cases of flying pass with ACC engaged over the three weeks of ACAS driving. The data suggest minimal adaptation by the ACC drivers over this period, although more individuals are involved in generating these cases in Week 4. The response metrics (which are defined and developed in detail later in this section) indicate no important changes in the way the flying pass maneuver is being executed over the three weeks of measurement.

Table 8.3. Summary table of flying pass with ACC engaged

	<i>Week 2</i>	<i>Week 3</i>	<i>Week 4</i>	<i>All</i>
Number of cases	136	135	187	458
Number of drivers	25	24	39	49
Mean Range, m	62.0	62.5	64.7	63.3
Mean Rdot, m/s	-4.2	-4.0	-4.5	-4.3
Mean TTC, s	16.0	16.6	15.4	15.9
Mean Decel-to-avoid, m/s ²	-0.19	-0.17	-0.22	-0.20

To reflect the different distance exposures that apply to freeway travel under each of the three driving-control modes, the respective rates of occurrence of the defined flying-pass event are shown in Figure 8.20. We see that the ACC mode of driving has the lowest proclivity for generating flying-pass events and that the manual mode of control (i.e., the ManBase data) has the highest. Thus, one observation is that something about ACC driving yields a substantially lower rate of flying-pass maneuvering than in either of the other two indicated modes of control. No analysis was done to investigate whether auto-braking activity occurred immediately after a flying pass.

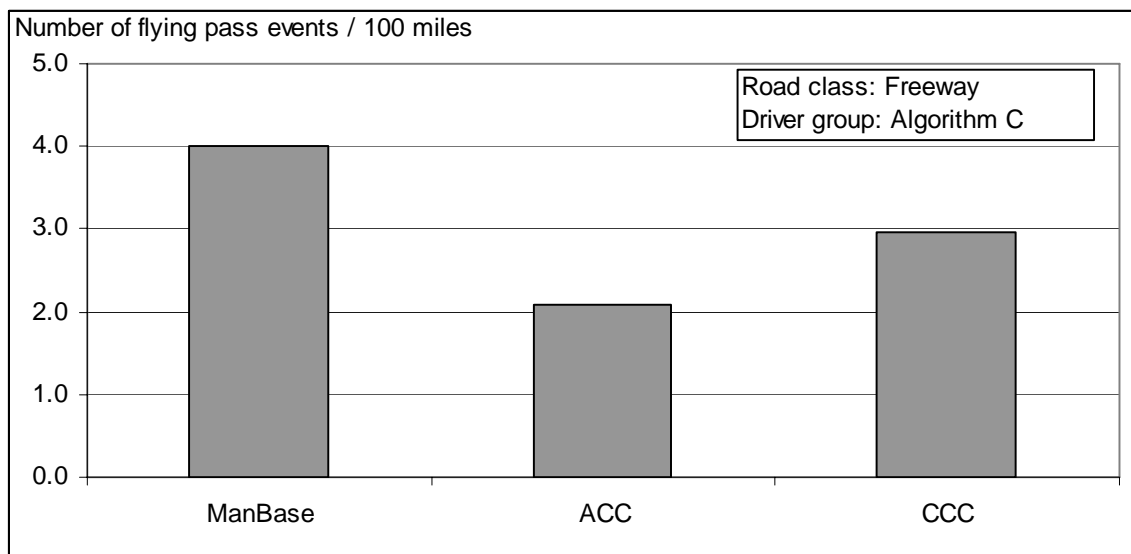

Figures 8.20. Flying pass rate in each of three modes of longitudinal control

Interestingly, it also appears that ACC driving involves less passing, overall, since ACC has been seen to induce following as a more sustained behavior. Figure 8.21, for example, compares the cumulative distributions of the time duration over which individual CIPV targets were followed by the host vehicle under manual, CCC, or ACC control on freeways.

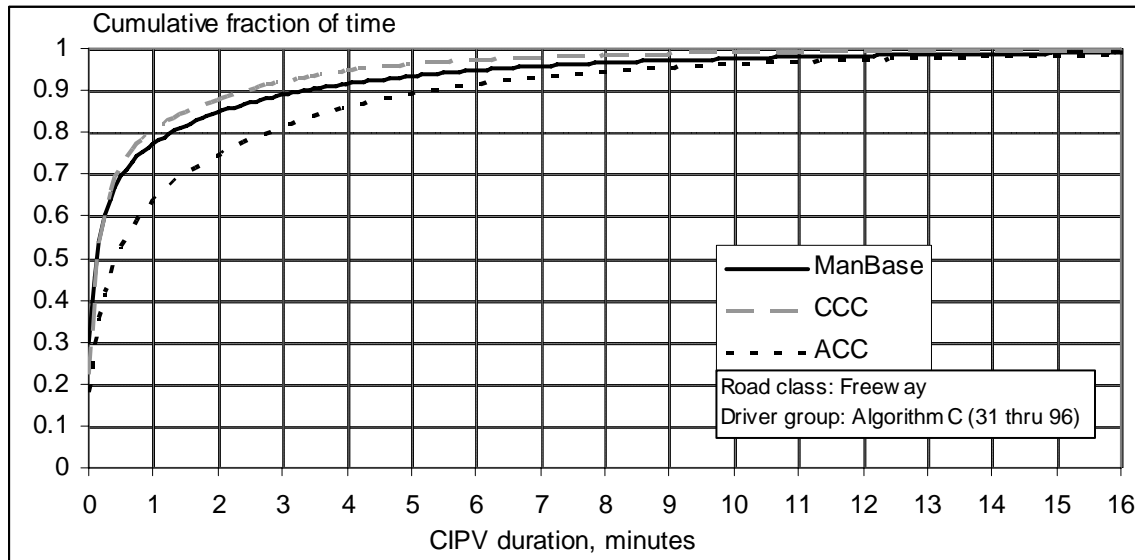

Figure 8.21. Cumulative distribution of the time spent driving behind an individual, preceding vehicle that has been identified by radar as the CIPV target

Average and median values of this metric are also illustrated in Table 8.4, below. At least to first order, the lower rates of flying pass under ACC control, in Figure 8.20 above, appears to correspond to longer periods in which the ACC driver simply dwells behind a preceding vehicle that has been encountered in the same lane. It seems reasonable to hypothesize that this notable characteristic may pose a potential safety benefit simply from the reduced rate of lane-change activity under ACC control.

Table 8.4. High-level summary of CIPV durations when driving on freeways

Control Mode	Average CIPV Duration (minutes)	Median CIPV Duration (minutes)
ManBase	1.31	0.20
CCC	0.91	0.22
ACC	2.02	0.50

Shown in Figure 8.22 are the distributions of host vehicle speed values that prevailed under each of the three modes of control at the moment when the lane-change flag was detected in the course of a flying pass. (Please note that the automatic detection of a lane change is typically flagged in the ACAS data stream at approximately the time in which

the center of the host vehicle is crossing directly over the lane marker.) The speed data are thought to be important in considering the flying-pass scenario because the maneuver inherently requires that the host vehicle travel at a speed that exceeds that of the ambient traffic (or at least that of the individual, preceding vehicle.)

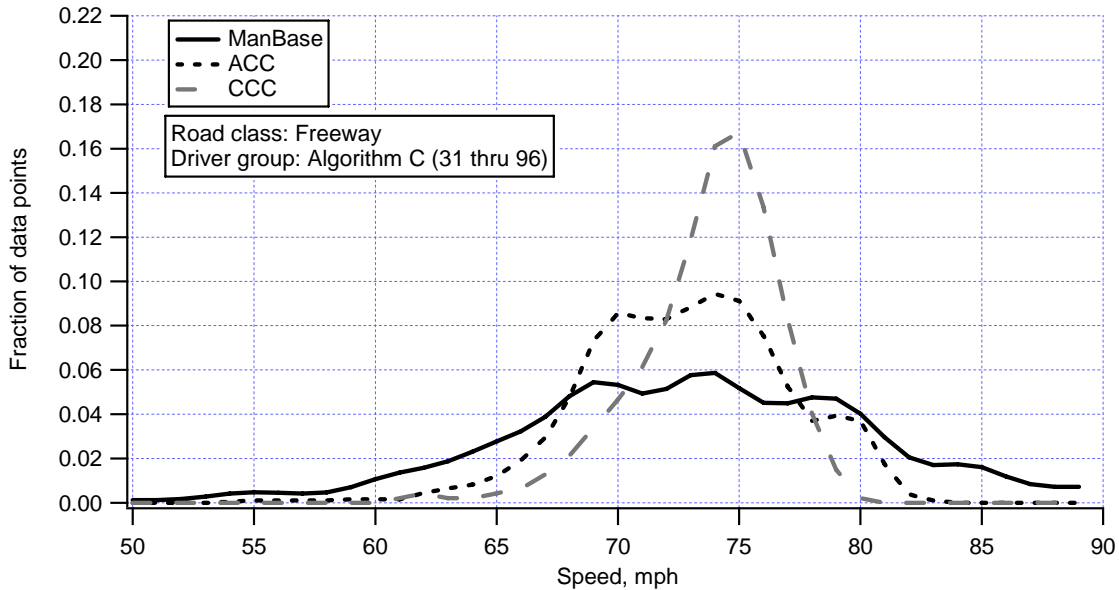

Figure 8.22. Distribution of speed during flying passes in three alternative modes of control

The ManBase speed data in Figure 8.22 are seen to have the broadest distribution among the three modes of control, showing both higher and lower extremes of speed at the moment of a flying-pass maneuver than either of the cruise modes of control. We observe that a larger portion of the ManBase passes were conducted at speeds above 80 mph (i.e., approximately 15% of the ManBase events compared to 6% for ACC and 0% for CCC) perhaps suggesting that ManBase driving involves a greater degree of high-speed travel, overall. On the other hand, the substantial portion of travel at the lower-speed end of the scale in the ManBase distribution is more puzzling. Clearly, the host vehicle can successfully pass another vehicle in the 50- to 65-mph regime on a freeway only if some other vehicles are traveling even slower than those levels, thereby implying a congested traffic condition in which such lower speeds tend to prevail. Thus, it should be recognized that the three driving modes differ from one another not only by the preferential behaviors (such as speed choice) that apply, but also by the ambient traffic environment that, itself, influences the driver’s choice of which mode to utilize.

The next sequence of figures examines the respective elements of the kinematic relationship between the passing and passed vehicles. The rudiments of this relationship

are summarized rather conveniently by the range and range-rate values that prevail at the moment that the lane-change flag goes high. Below, each of these variables is examined in turn and the variables are then combined to obtain time-to-collision and decel-to-avoid metrics that serve to characterize the severity of the conflicts arising during flying-pass events. (The reader should keep in mind the different frequency of flying passes that was manifest across the three control modes, when interpreting these results.)

Shown in Figures 8.23 through 8.26 are three individual distributions and one composite overlay of the range values that were measured upon transitioning the lane in flying passes in each of the three modes of longitudinal control.

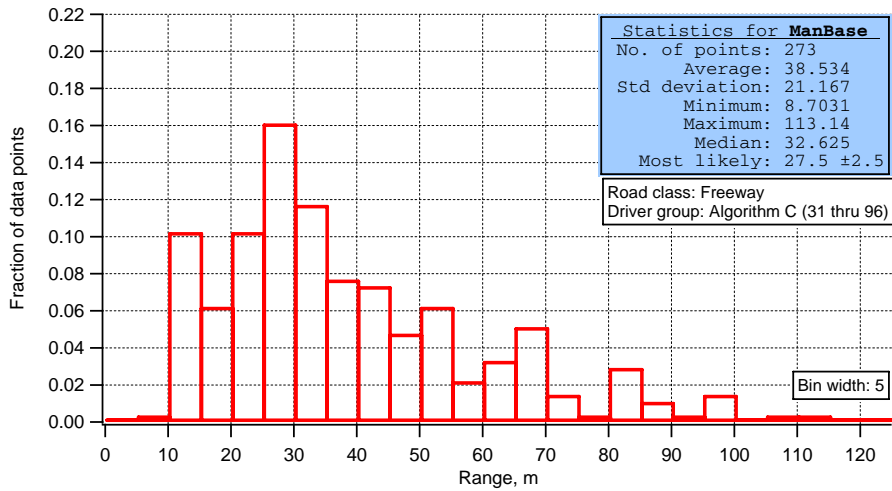

Figure 8.23. Distribution of range values upon transitioning the lane in flying passes during ManBase driving

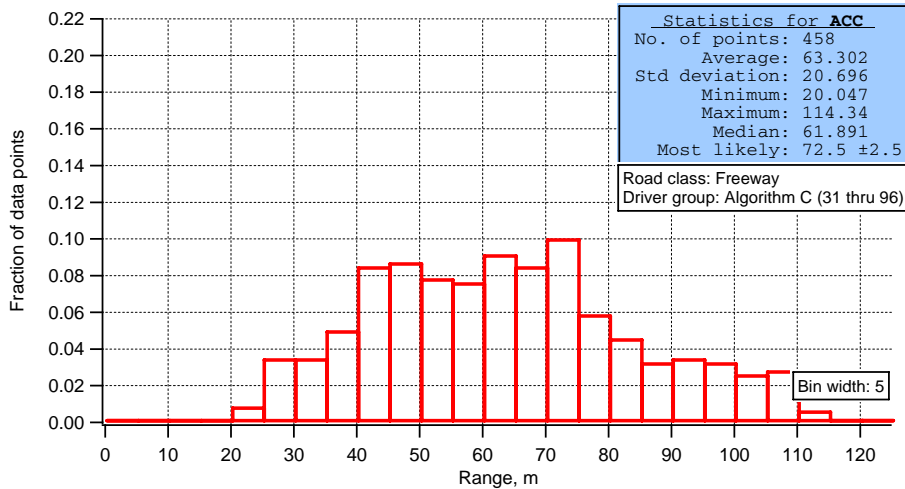

Figure 8.24. Distribution of range values upon transitioning the lane in flying passes during ACC driving

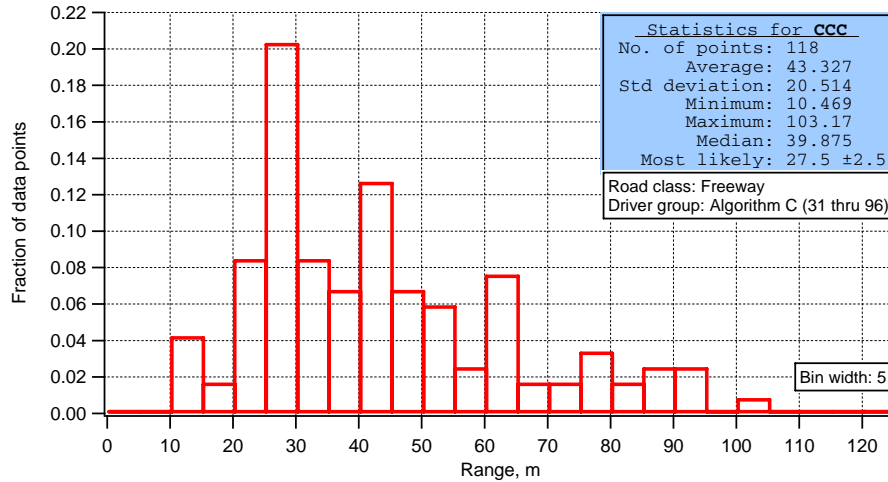

Figure 8.25. Distribution of range values upon transitioning the lane in flying passes during CCC driving

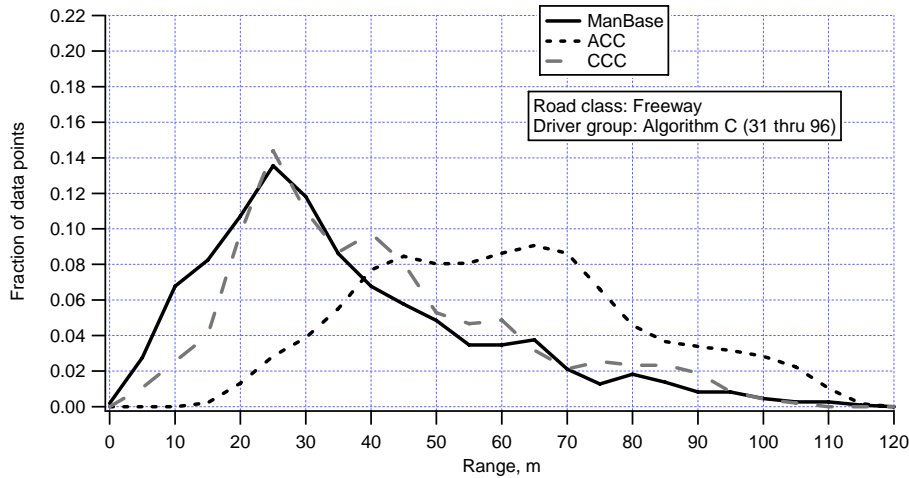

Figure 8.26. Overlaid distribution of range values in flying passes under three differing modes of longitudinal control

We see that the ranges prevailing under ACC control are substantially different than those seen under manual control, and to a lesser but similar extent, under CCC control. For example, the average ranges in a flying-pass maneuver under manual and CCC control are 38.5 and 43.3 meters, respectively, compared to 63.3 meters under ACC control. The minimum values of range observed under manual and CCC control are 8.7 and 10.5 meters, respectively, compared to 20.0 meters under ACC control. Moreover, these results suggest something rather fundamental about the ACC control mode, per se, that tends to promote flying-pass transitions at longer range.

One hypothesis that may offer a partial explanation for these results would build on the proposition that drivers readily learn the relationship between headway range and the

ACC system response. Then, if the nature of a flying-pass maneuver is such that the speed of the host vehicle must be sustained throughout the transition (in order to take an available gap in the adjacent lane), the lane change must take place at a sufficiently-long range under ACC engagement that the headway controller has not yet responded much to the emerging conflict by slowing down. To slow down in the process of a flying pass is to disrupt the cadence of the maneuver. Thus, to prevent disruption under a continuous process of ACC engagement, the maneuver must be consummated at relatively long range, as seen in these data.

Shown in Figures 8.27 through 8.30 are three individual distributions and one composite overlay of the values of range-rate (or overtaking speed) that were measured upon transitioning the lane in flying passes in each of the three modes of longitudinal control. We see that the ranges-rates prevailing under each of the respective control modes are very similarly distributed. Thus, even though the ACC driver tends to execute the flying-pass maneuver at considerably longer range than when driving under manual or CCC control, the distributions of range-rate are virtually indistinguishable from one another across the three modes of control.

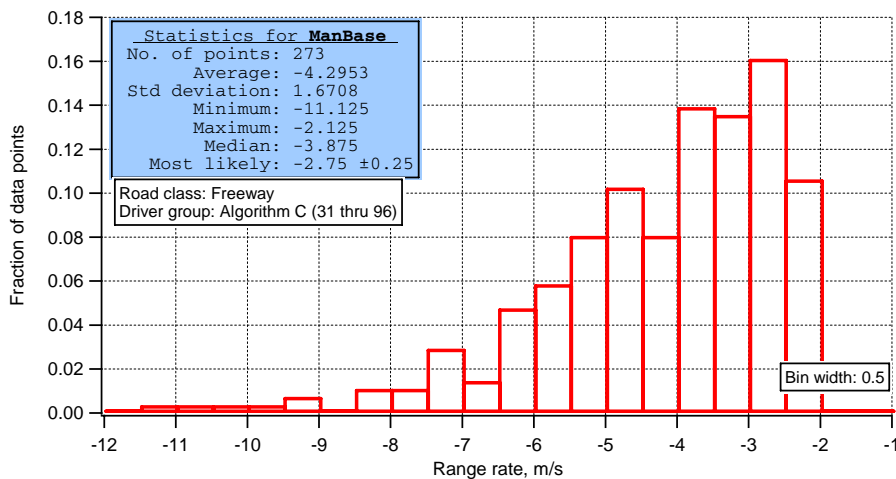

Figure 8.27. Distribution of range-rate values upon transitioning the lane in flying passes manual driving

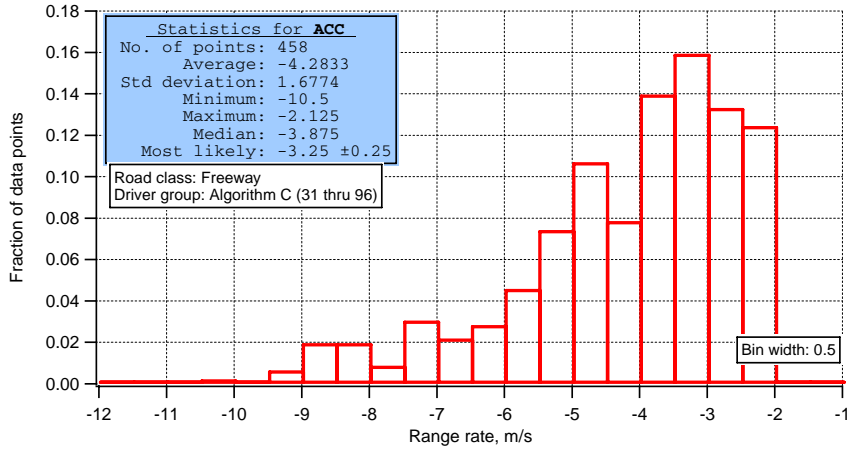

Figure 8.28. Distribution of range-rate values upon transitioning the lane in flying passes during ACC-engaged driving

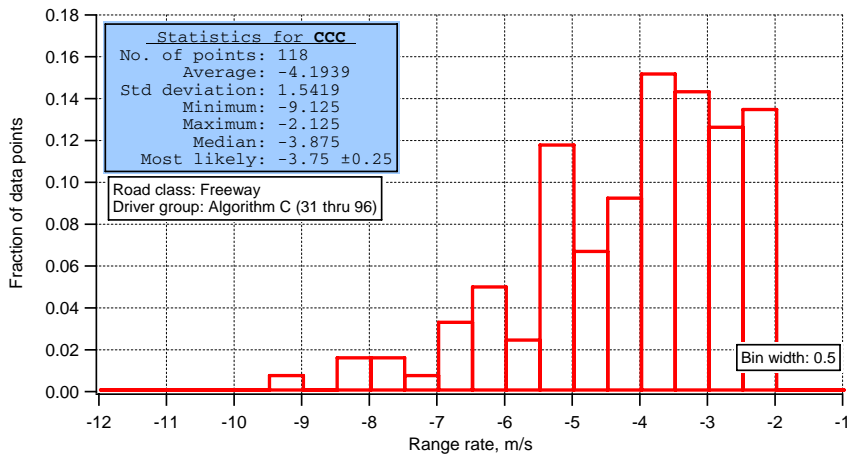

Figure 8.29. Distribution of range-rate values upon transitioning the lane in flying passes during CCC-engaged driving

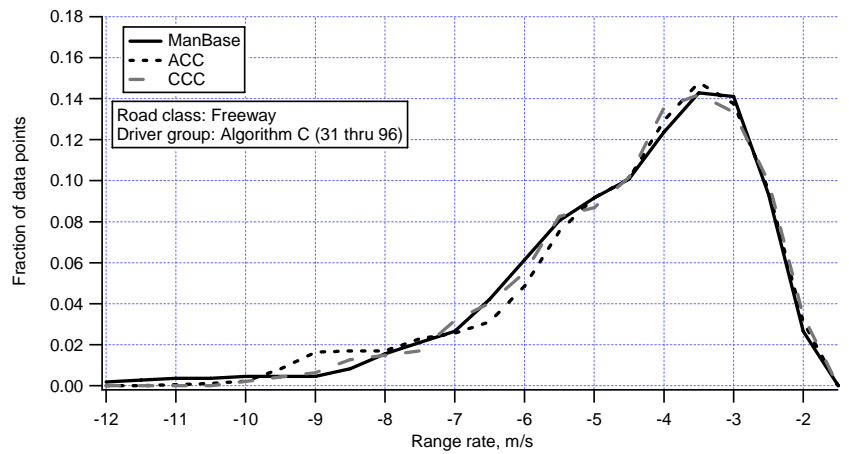

Figure 8.30. Overlay of the range-rate distributions from flying passes

Given that flying passes are conducted at relatively long range when ACC is engaged—although range-rate values are not distinguishable as distributions across the three modes of control—the next step is to examine the composite types of metrics that describe the net conflict severity of a flying-pass maneuver.

Figures 8.31 through 8.34 provide the complete set of data addressing the time-to-collision metric, TTC. The first three plots show the TTC distributions for the three control modes. Following these plots, Figure 8.34 presents an overlay of the three respective TTC distributions.

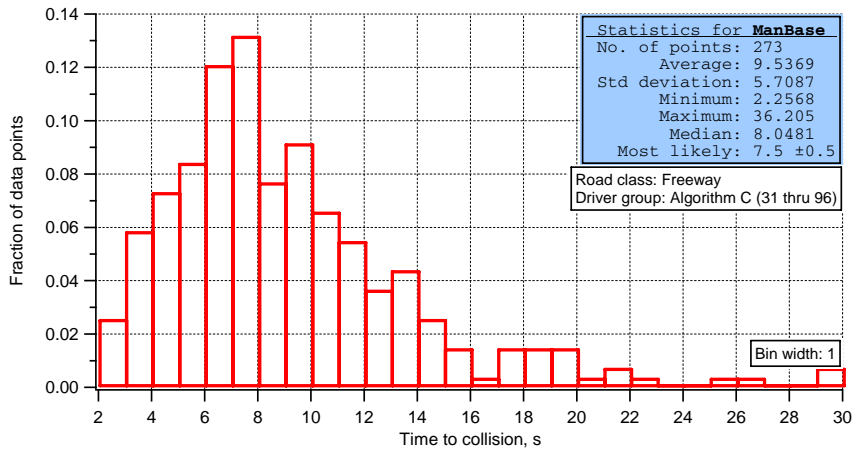

Figure 8.31. Distribution of times-to-collision upon transitioning the lane in-flying pass maneuvers during ManBase driving

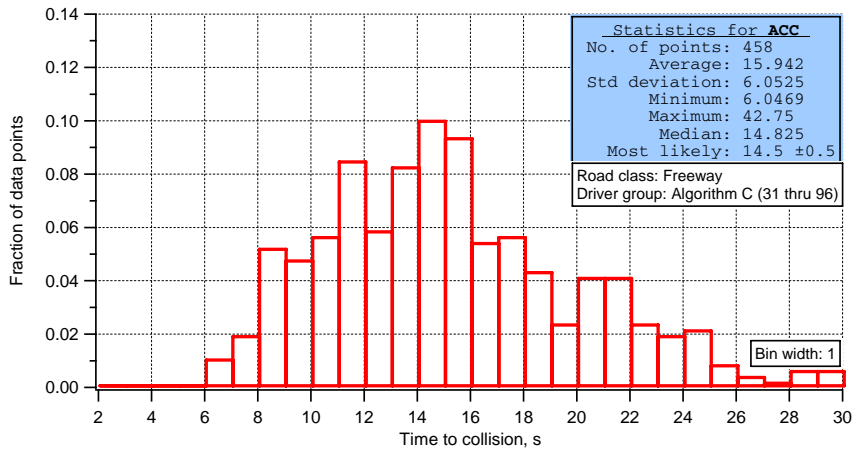

Figure 8.32. Distribution of times-to-collision upon transitioning the lane in flying passes during ACC-engaged driving

Clearly, the TTC results show that when driving with ACC engaged, the TTC values under ACC control tend to be considerably longer than those when passing under the other modes of control. Further, none of the 458 incidents of flying-pass conflict seen

with ACC reached a TTC value of less than 6.0 seconds, although approximately 25% of the manual-control events and 17% of the CCC events reached TTC values that were under 6 seconds.

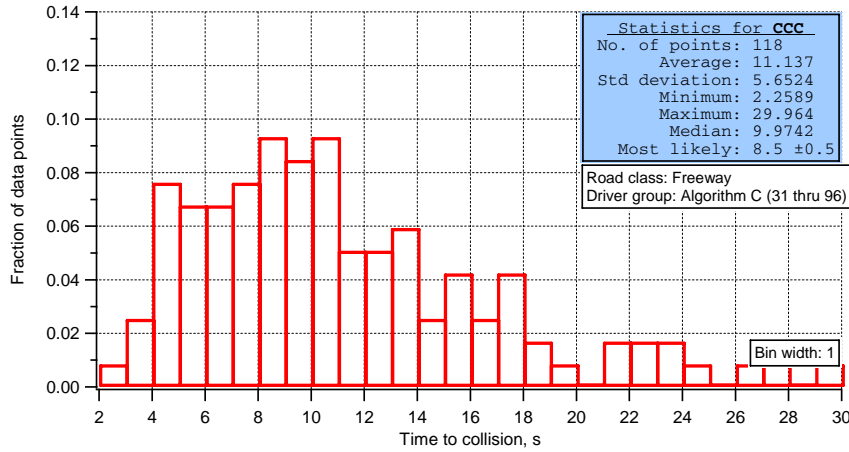

Figure 8.33. Distribution of times-to-collision upon transitioning the lane in flying passes during CCC-engaged driving

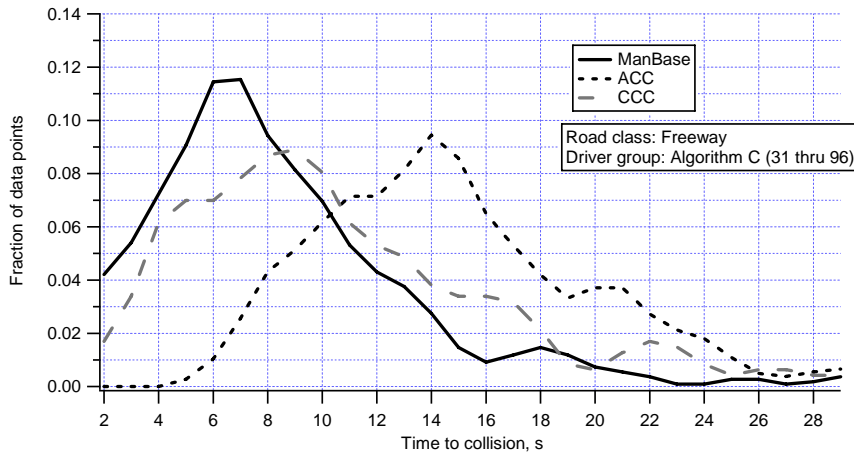

Figure 8.34. Overlay of times-to-collision from flying-passes in each of three modes of longitudinal control

To supplement the distributions for all the TTC data obtained from the query, an ANOVA analysis was then conducted using the average TTC values from only those individual drivers who had experienced at least 3 such flying-pass incidents (where 3 is taken to be the minimum practicable number for obtaining a useful average value). For subsets of individuals constituting the test sample within each control mode, pairwise differences were computed on the three respective samples of averages, as a test for significance. In each of the pairwise analyses that are presented throughout the ACC-safety portion (i.e., all of Section 8.1) of this report, the Newman-Keuls post-hoc test was

employed with an alpha value of 0.05, thereby requiring pairwise differences to be significant at the 5% level of confidence.

In analyzing the averaged-TTC data for individuals in flying pass events, the sample sizes and mean values (in seconds) were as follows:

- ACC: 33 drivers, M=13.72
- CCC: 18 drivers, M=10.66
- ManBase: 31 drivers, M=9.37

Significant differences were seen between both the ACC/CCC pair of distributions and the ACC/Manbase pair, $F(2) = 15.3, p < .001$. While such comparative analyses often point to little difference in means but, perhaps, important differences in the tails of the distributions, the situation here is that the TTC levels encountered under ACC control are simply removed, overall, from the domain of results seen in the other two modes of control.

Figures 8.35 through 8.38 show the corresponding decel-to-avoid data which (unlike TTC) takes into account any deceleration of the preceding vehicle that may have prevailed at the time of transition into the adjacent lane. The first three plots show the decel-to-avoid distributions for the three control modes. Also, Figure 8.38 presents an overlay of the three respective decel-to-avoid distributions.

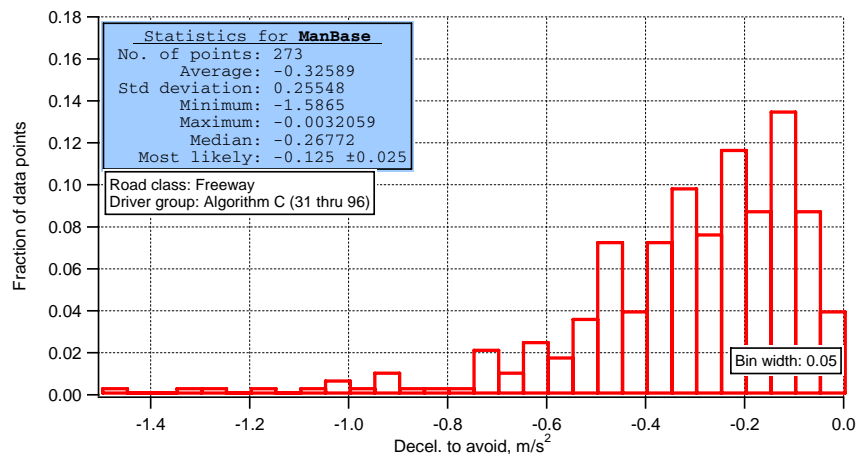

Figure 8.35. Distribution of deceleration-to-avoid values (m/s^2) upon transitioning the lane in flying-passes during ManBase driving

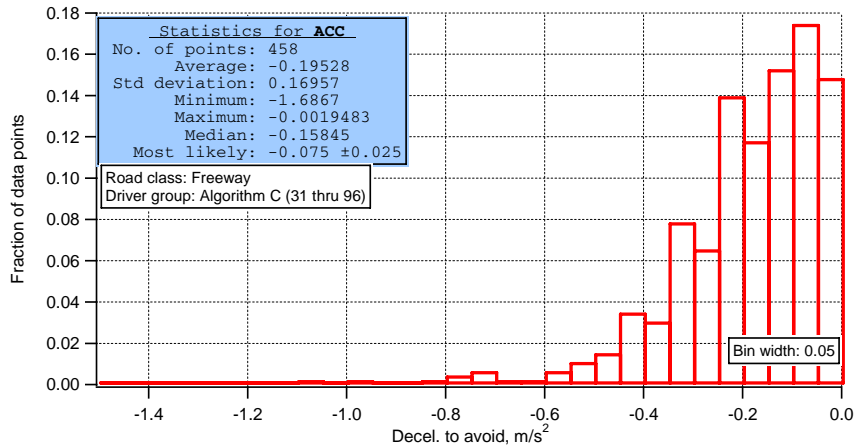

Figure 8.36. Distribution of deceleration-to-avoid values (m/s^2) upon transitioning the lane in flying-passes during ACC driving

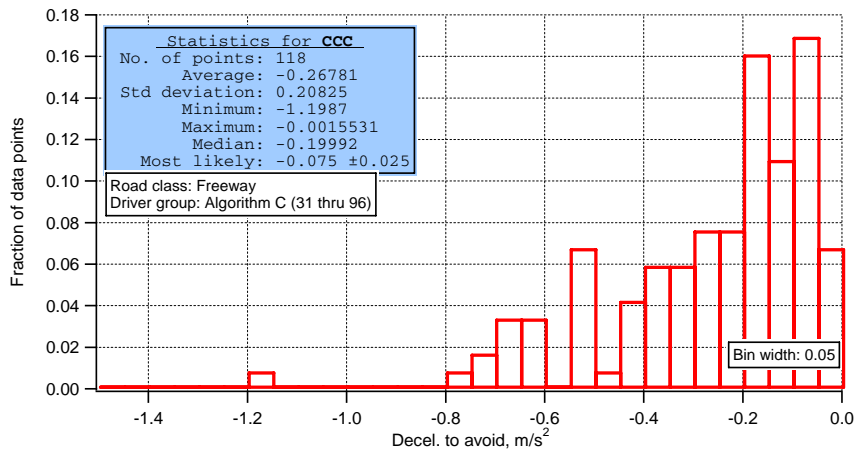

Figure 8.37. Distribution of deceleration-to-avoid values (m/s^2) upon transitioning the lane in flying-passes during CCC driving

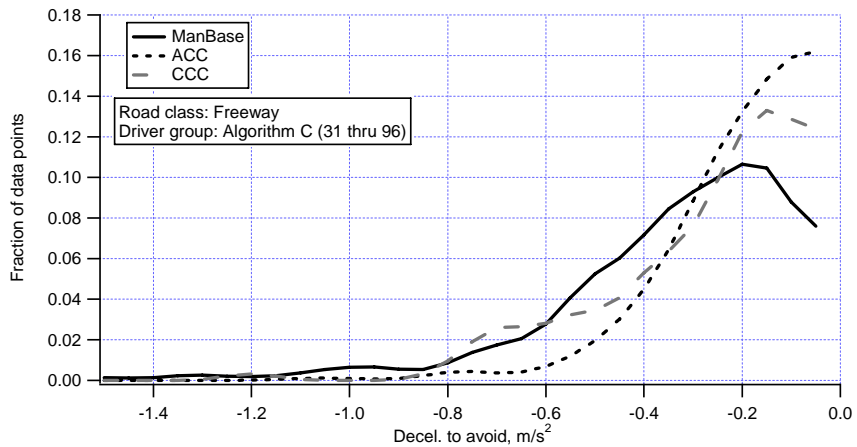

Figure 8.38. An overlay of deceleration-to-avoid distributions from flying-passes in three modes of longitudinal control.

The data show that decel-to-avoid values represent rather modest levels of implied braking demand during flying-pass transitions in each of the three modes of control. These results also show that typical decel-to-avoid levels obtained with ACC engaged tend to be lower than in either of the other two modes. Interestingly, however, the ACC results are not as sharply differentiated from those of the manual and CCC modes of control as had been seen in the case of the TTC data. Presumably, this is due to the fact that deceleration by the preceding vehicles influences the decel-to-avoid, but not the TTC, results.

Although the nature of the flying-pass maneuver is such that these modest decel-to-avoid peaks are reached as only a momentary condition, i.e., while the host is transitioning into the next lane, they do suggest the relative magnitude of braking that would be required if the host driver needed to abort the overtaking process and brake to avoid a crash in the initial lane of travel. In such a case, the actual decelerations required to avoid collision could differ from those shown here depending upon the delay in the host-driver's response and the deceleration profile of the preceding vehicle.

An ANOVA analysis was conducted using the average decel-to-avoid data from only those individual drivers who had experienced at least 3 incidents satisfying the query. The sample sizes and mean values (in m/s^2) of the averaged decel-to-avoid data for individuals in flying pass events were as follows:

- ACC: 33 drivers, $M = -0.231$
- CCC: 18 drivers, $M = -0.280$
- ManBase: 31 drivers, $M = -0.343$

Significant differences were seen only between the ACC/Manbase pair of distributions, $F(2) = 8.3, p < .001$. The importance of this difference is believed to lay not so much in the mean values, however, as in the variances for which the average decel-to-avoid data from ACC control are an order of magnitude smaller than in the ManBase data (thereby implying a thinner tail in the decel-to-avoid extremes for ACC driving.)

Shown in Figure 8.39 is a rank ordering of all the algorithm-C drivers who conducted at least one flying-pass maneuver.

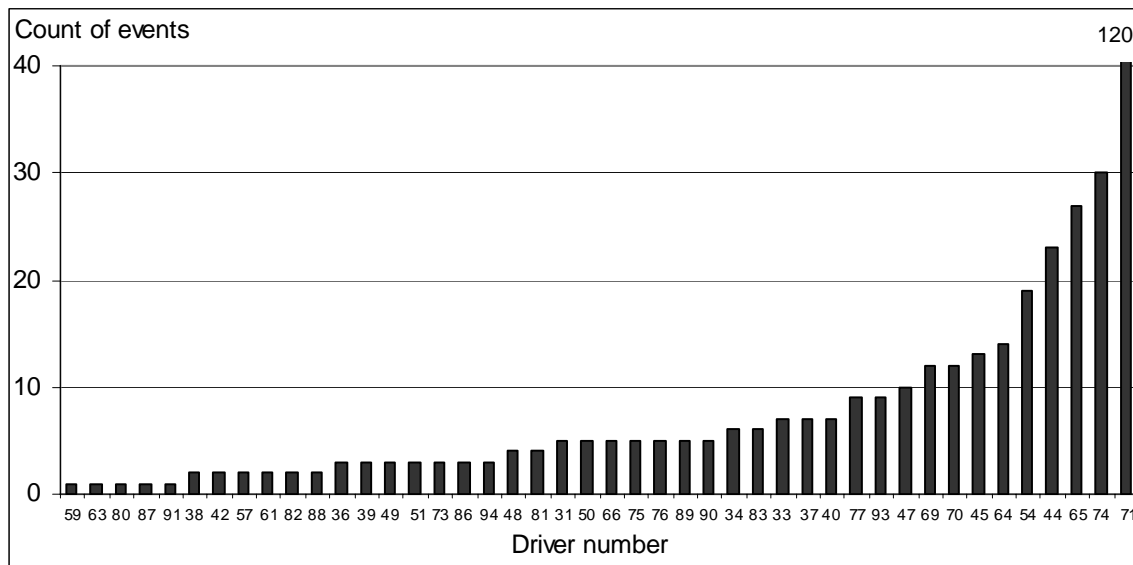

Figure 8.39 A rank ordering of the 44 drivers who conducted at least one flying pass during ACC driving, by the event count of each individual, under algorithm C.

Of the 44 individuals on this chart, 11 of them conducted the maneuver only once or twice. Nine individuals undertook more than 10 flying passes. One individual, driver number 71, accumulated a total of 120 flying pass events, thereby accounting for one quarter of all such maneuvers conducted among the 66 individuals who drove in the algorithm-C portion of the FOT. (The strong influence of individuals has been, of course, removed from influencing the earlier pairwise treatments of ACC against the other two control modes by comparing only the distributions of conflict metrics that have been computed as average values for each individual.)

Summary of Observations:

In summary, the flying pass is conducted less frequently and with lower levels of kinematic conflict under ACC control than when driving under either a manual or CCC mode of control. The data show the following:

- The ACC control mode significantly diminishes the rate of passing, overall, since ACC drivers tend to retain a following position, once it’s established, for 50% longer than when under manual control and 120% longer than when under CCC control.
- The flying pass maneuver, as defined here, represents an overtaking transient that begins in the same initial lane as that of the vehicle passed. This common

driving tactic was conducted approximately once every 30 miles of freeway driving, depending upon the mode of longitudinal control.

- Compared to the alternative modes of control, ACC driving yields a distinctly lower rate of flying-pass activity. The rate of flying pass maneuvers per 100 miles of ACC driving was seen to be half that of manual driving and approximately one third lower than that seen with CCC engaged.
- ACC drivers employ a quite distinctive form of the flying-pass tactic in that they move into the adjacent lane at considerably longer range—but with comparable values of range-rate—than those seen under either of the other two modes of control.
- Combining the range and range-rate aspects of the flying-pass maneuver, the ACC driver encounters time-to-collision values that tend to be 30% to 45% longer (i.e., less conflict) than those seen when conducting the same kind of maneuver under CCC or manual control, respectively.
- Only two-thirds of the algorithm-C drivers conducted even a single-flying pass maneuver, and most of them conducted less than 10 such maneuvers over the three weeks of ACC availability. One individual was responsible for 120 such events, or one quarter of the entire total for 66 persons.

Noting that the overall rate of passing other vehicles is lower with ACC, it is surmised that ACC control makes it more attractive to simply follow behind a vehicle that is encountered ahead. Moreover, the unusually-low conflict severities suggest that this maneuver will pose less of a safety issue under ACC control than may prevail in the other modes of vehicle control.

8.1.5 Lane Selection with ACC Engaged

Another question of ACC usage that has been hypothesized to have potential safety implications is the selection of the freeway lane of travel. One supposed issue involves a possible awkwardness of ACC usage in the right-hand lane, given the gap-acceptance behavior that normally prevails in merging and weaving traffic at on- and off-ramps (which are typically placed as a matter of highway design policy on the right side of the freeway.) If the ACC controller is not programmed to “give way” by yielding suitable gaps to traffic merging in from the right, some degree of elevated conflict may be hypothesized to occur. Lanes that lie inside of the right and left outermost lanes, (termed “inner lanes” throughout this presentation) would, on the other hand, appear to be more shielded from the drama of merging but they do present the opportunity for cut-ins from both sides, possibly elevating the rate at which disturbances are presented for

management by the ACC controller. Left-lane traffic would seem to be shielded from most of the merging activity at ramp entrances as well as the extra cut-in activity that has two paths of access to inner lanes (but one also notes that assertive claims to the left lane by those seeking to travel at higher speeds may imply its own patterns of elevated cut-in activity). Accordingly, examination of the exposure of ACC usage, by lane-position, was seen as another attractive context within which to search for possible ACC safety issues.

In order to construct a query for studying the relationship between the lane selection and control mode, the lane-position descriptor defined in Section 5.8 was employed under the conditions cited below:

- The host vehicle is traveling on a freeway.
- The speed exceeds 50 mph, thereby restricting the examination to those travel conditions in which cruise usage is most prevalent.
- The ambient traffic level is sufficiently high for lane-position data to be imputed from the radar detection of other vehicles nearby.
- The host is being operated in one of three control modes: ACC or CCC engagement, or the ManBase mode of first-week manual driving.

This query identifies blocks of distance traveled in each of the three control modes, comprising segments of freeway driving for which the lane positions were known, as broken down in Table 8.5.

Table 8.5. Mileages supporting analyses that relate lane position to control mode

Control Mode	Freeway Mileages (at V > 50mph) Supported by Lane-Position Data
ManBase	4,923
CCC	2,596
ACC	15,826

As in other analyses presented here, a considerably larger amount of data is available to represent ACC driving over the three weeks of ACAS enablement, than in either of the other two modes of first-week control. The differing levels of coverage should be kept in mind when reviewing the results that follow.

Shown in Figure 8.40 is the distribution of the average travel distances of individuals that were accrued under each control mode, by lane position.

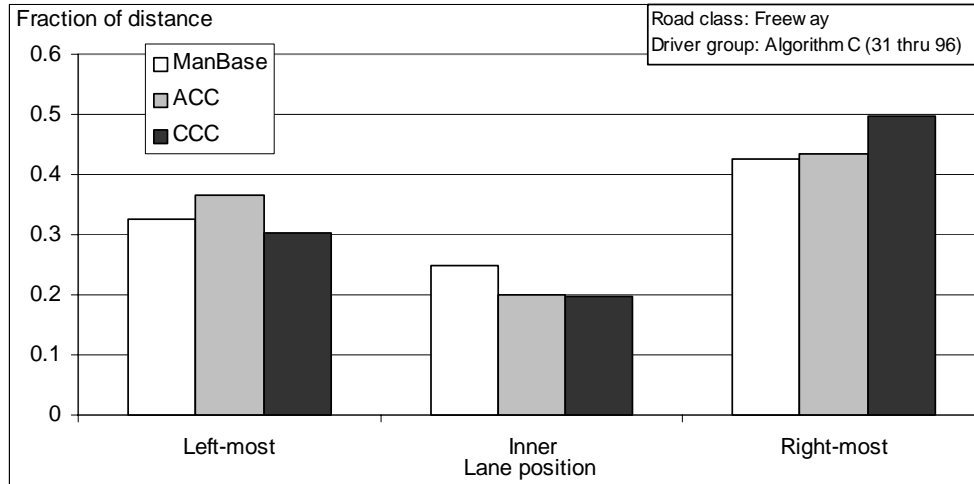

Figure 8.40. The average fraction of individual’s freeway driving distances at speeds above 50 mph, distributed among lane positions and modes of control

Noting that the portion of distance driven in the “inner lane” position is considerably less than that represented in either the “left-most” or “right-most” lanes, it must be recognized that many of the suburban and rural freeways in Southeast Michigan are two-lane facilities that provide no inner lane, and that information on the number of freeway lanes that prevailed was not readily available. Nevertheless, a rather clear pattern of lane-choice distributions is apparent, with all freeway travel above 50 mph being substantially biased toward the right-most lane, depending upon control mode.

ANOVA results were obtained for averaged values of this metric computed on individual drivers. The sample sizes and mean values of the averaged fraction of the distance traveled by individuals in the left-most (L), inner (I), and right-most (R) lanes were as follows:

- ACC: 64 drivers, M= 0.366(L), 0.199(I), 0.435(R)
- CCC: 49 drivers, M= 0.304(L), 0.197(I), 0.499(R)
- ManBase: 64 drivers, M= 0.326(L), 0.249(I), 0.425(R)

The results show that none of the control modes is significantly different from the others in terms of its fraction-of-distance metric in any of the three lane positions, $F(2,176) = 1.0, p = 0.36$ for the left lane position, $F(2,176) = 1.24, p = 0.29$ for the inner lane position, and $F(2,176) = 1.40, p = 0.25$ for the right lane position)

Nevertheless, relative to the concern expressed in the introduction of this section we do see that the ACC mode of control does tend to be engaged for very significant distances in the right lane of travel. But then, a good deal of driving in the cruise mode under the lighter traffic densities that tend to promote cruise utilization would naturally

result in right-lane driving as the proper lane position on a two-lane freeway, except when passing other vehicles.

Figure 8.41 shows that the average traffic counts (implying relative levels of traffic density) on freeways that lie within what has been labeled the “moderate-density” condition—between counts of 1.5 and 4.0.

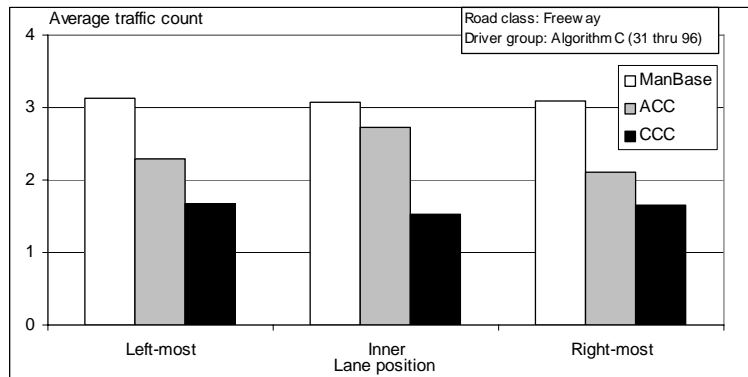

Figure 8.41. Distributions of average traffic counts at speeds above 50 mph, distributed among lane positions and modes of control.

The data constitute averages of all individual-driver averages in the traffic counts that prevailed during their respective blocks of driving at the indicated freeway lane positions. We observe the following:

- The ManBase mode is characteristically associated with the higher traffic counts in all three lane positions. This result is in keeping with the observation shown earlier in Section 6.2. that cruise-utilization (as the alternative to manual driving) declines as traffic count rises.
- ACC tends to be selected at higher traffic counts than is the CCC mode of control (again, as shown earlier in Section 6.2).
- The use of either cruise mode in the right-most lane (in which the peculiar merge-related conflicts are hypothesized) is associated with lower traffic count values. In fact, the two cruise modes show average traffic counts in the right lane that are in the vicinity of 2.0, i.e. a rather sparse level of traffic density in which the provocation of right-lane conflicts by merging traffic may be diminished considerably because the host driver has much wider latitude for changing lanes when a merge conflict appears to be developing.

Looking into the conflict patterns that relate to ACC usage by lane position, Figure 8.42 presents the fraction of all travel distance (per the query) that was covered with decel-to-avoid $< -1 \text{ m/s}^2$. Thus, where the figure shows that 0.003 (or 0.3%) of the travel distance in the right-most lane was traveled with conflict levels more severe than decel-to-avoid = -1 m/s^2 for ManBase driving, it implies that the conditions and/or behaviors associated with manual driving in the right lane tended to yield the highest fractional travel with conflicts which were at or above this admittedly-modest level of conflict.

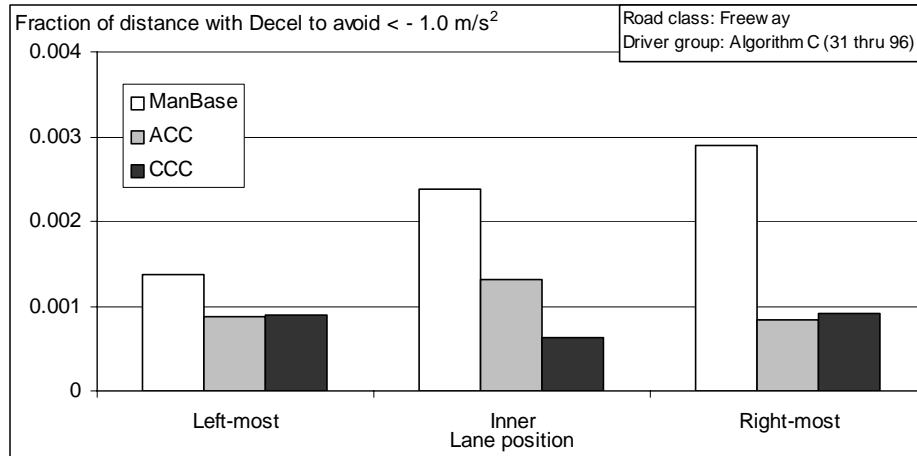

Figure 8.42. Cumulative values of decel-to-avoid $< -1.0 \text{ m/s}^2$ for each of the three control modes in each of the three nominal lane positions

The fractional travel metric with decel-to-avoid values more negative than -1 m/s^2 can thus be considered something of a conflict rate, per this definition. The ANOVA results were obtained for averaged values of this metric computed on individual drivers.

The sample sizes and mean values of the averaged fraction of the distance traveled by individuals in the left-most (L), inner (I), and right-most (R) lanes at more than the indicated decel-to-avoid level were as follows:

- ACC: 64 drivers, M= 0.00087(L), 0.0013(I), 0.00084 (R)
- CCC: 49 drivers, M= 0.00089(L), 0.00063(I), 0.00091 (R)
- ManBase: 64 drivers, M= 0.0014(L), 0.0024(I), 0.0029 (R)

No significant differences were seen in the pairwise comparisons of data for the left-lane results, $F(2) = 1.6, p = 0.205$. For the inner-lane results, significant differences were seen between both the ACC/Manbase and CCC/Manbase pair of distributions, $F(2) = 11.9, p < .001$. Significant differences were also seen in the right-lane results between both the ACC/Manbase and CCC/Manbase pair of distributions, $F(2) = 27.8, p < .001$.

It is interesting that the manual mode of control sees distinctly higher rates of conflict in both the inner and right-most lanes. Also, the conflict rate arising from ACC usage in any of the lane positions is insignificantly different from that of CCC. Considering the right-lane concern that was hypothesized earlier for ACC, then, the data suggest that ACC is not producing anything like an anomalous degree of conflict with the merge/weave traffic that appears in the right-most lane position—at least not as is observable from the current query approach. (Note that the merging motorist could still be suffering frustration with ACC acting to deny gap availability at freeway entrance ramps, but such a scenario does not show up in conflict data that are based upon the prevailing CIPV target vehicle that appears in the ACC data.)

Summary of Observations:

In summary, the driver's choice of lane position, per se, during ACC engagement does not pose significantly-different levels of conflict to the host driver than are incurred by the other modes of control. The data show the following:

- Approximately 80% of the ACC-engaged miles traveled on freeways involved use of either the right-most or left-most lane (this result is significantly influenced by the extent of 2-lane rural freeways serving the southeast Michigan area.)
- ACC, like the other modes of control, is most often employed in the right-most lane on freeways.
- The engagement of ACC (and CCC) in the right-most lane is generally associated with relatively-low levels of traffic density (which is, of course, the expected pattern on two-lane freeways when traffic levels are sparse).
- ACC engagement yielded its lowest rates of longitudinal conflict when traveling in either the left- or right-most lanes, in contrast to the inner lane.
- The higher rate of longitudinal conflict seen with ACC driving in the inner lane is believed due at least in part to higher traffic densities associated with the particular freeways that provided an inner-lane opportunity for measurement.

Any difference in conflict that might arise due to the link between lane selection and the choice of control mode appears to be substantially less than the common tilt toward decreasing cruise utilization as traffic density goes up. Accordingly, no specific safety factors are seen to be degraded by the lane choices that accompany ACC driving.

8.1.6 Other Vehicles Cutting in Ahead of the ACC Host

Part of the occurrence of forward conflict that arises under ACC control derives from the cut-in behavior of other drivers who choose to move into the gap that exists between the ACC host and another preceding vehicle. In this case, the role of the ACC driver is basically passive with regard to generating the conflict but may require some kind of response including, perhaps, an intervention on ACC control.

Since the practice of cut-in maneuvers is generally understood to depend at least in part on the size of the headway gap that prevails in front of any vehicle, the fact that ACC is precisely a gap-control mechanism suggests that examination of the safety implications of cut-in activity on ACC driving is warranted. Further, it has been hypothesized that since ACC gaps tend to be longer than the headway clearances that commonly prevail in manual driving (as was shown in Section 8.1), the opportunity for cut-in ahead of an ACC-engaged vehicle will tend to occur more frequently, all other things being equal. However, several of the important things do not appear to be equal, especially since the driver's choice to utilize the ACC mode of control is, itself, dependent upon the road and traffic environment, among other conditions. Thus, it is of interest to determine how the give-and-take factors play against one another in determining the level of conflicts imposed upon the ACC driving experience due to cut-in.

In order to construct a query for meaningfully comparing a set of cut-in maneuvers, it is necessary to capture a sequence in which the cut-in vehicle arrives at reasonably-close range, such that a conflict of some magnitude is presented. This objective is satisfied by putting parametric limits on the initial gap that precedes the cut-in event, in terms of initial headway and range-rate values. It is also fruitful to isolate the query to the freeway driving environment in which the opportunity for cross-lane movements depends primarily on the state of the gap, itself, rather than on other complexities which can arise on non-limited-access roadways. As in evaluating other scenarios for ACC conflict, the implications of cut-in for the potential safety of ACC driving are compared with the corresponding conflicts that arise under CCC and manual control.

The query that was designed for finding cases of the cut-in maneuver in FOT data employed the following constraints:

- The host vehicle is traveling on a freeway.
- The host vehicle speed exceeds 50 mph.
- The host is being operated in the ACC, CCC, or ManBase mode of control.
- ACC (or CCC) has become engaged before the sequence of interest begins, in either of those two modes.

- The host vehicle does not change lanes during the cut-in sequence.
- The sequence begins with an initial CIPV target that is no more than 3 seconds ahead of the host in the same lane.
- The host vehicle’s range behind the initial CIPV is essentially fixed, such that the range-rate value is at zero +/- 1.5 m/s.
- A new CIPV target appears at a range less than that of the initial CIPV target.

This query identified the following number of cut-in events in the three respective modes of driving control:

- ManBase — 283 events
- CCC — 58 events
- ACC — 639 events

Shown in Table 8.6 is a high-level summary of the 639 ACC events that were found by means of this query, broken down by the test-week in which they occurred. We see that cut-in rates were stable across the four weeks, suggesting that the cut-in experience of FOT drivers did not entail any significant novelty effect.

Table 8.6. Summary table for ACC

	<i>Week 2</i>	<i>Week 3</i>	<i>Week 4</i>	<i>All</i>
Number of cases	176	188	275	639
Number of drivers	37	34	43	54
Mean Th, s	1.51	1.43	1.42	1.45
ACC distance, miles	6221	6435	9286	21942
Cut-in per 100 miles	2.83	2.92	2.96	2.91
Mean Htm at cut-in,s	0.998	0.994	0.963	0.982

Before differentiating the cut-in results according to the three modes of control, it is useful firstly to consider the overall effect of two variables that tend to dominate all of these data and which relate strongly to the control mode. These variables are: 1) the initial headway gap that prevails ahead of the host vehicle just before the cut-in occurs and 2) the nominal traffic density condition in which the cut-in event is observed. Taking into account the different mileage exposures as well as the count of cut-in events that are accrued within bins of the combined conditions, (1) and (2) above, the respective rates of occurrence, per 100 miles of travel, for the defined cut-in type of conflict are shown in Figure 8.43.

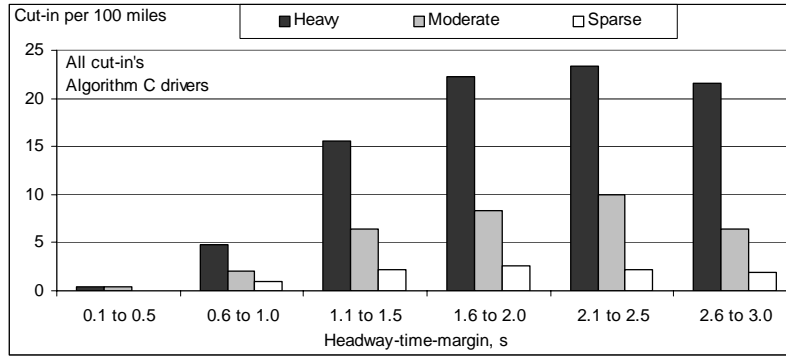

Figure 8.43. Cut-in rates vs. initial headway time margin for each of three levels of traffic density, combining all modes of control

These data represent a pooling of all cut-in events, regardless of the control mode of the host vehicle, over all of the algorithm-C driving that was logged on freeways at speeds above 50 mph. The plot shows that the initial headway time gap (prior to cut-in) and the traffic density both have exceptionally strong influences on determining the resulting rate of cut-in. Looking at the data between headway-time values of 1.6 and 3.0 seconds, for example, we see that the cut-in rate increases a full order of magnitude from the sparse to the heavy traffic condition. Furthermore, the rate of cut-in diminishes sharply in the region of headway times below 1.0 second and is practically non-existent below 0.5 seconds (where a passenger-vehicle’s length begins to exceed about 1/3 of the range dimension that corresponds in this speed regime to a 0.5-second time gap.)

Figure 8.44 simply expands the portion of the scale below 1.5 seconds which is relevant to the issue of selecting minimum gap setting in the design of ACC products (where current SAE J2399 and ISO 15622 standards identify a 1-second minimum).

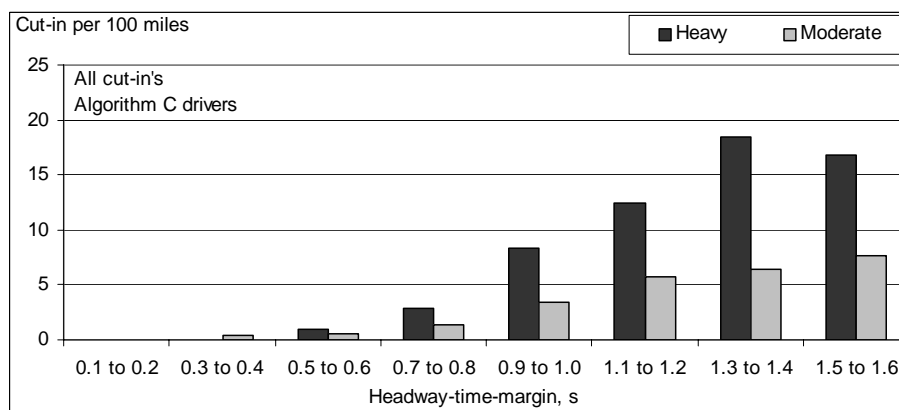

Figure 8.44. Cut-in rates at the low end of the headway-time scale

Speaking generally, it may be observed that the initial headway gap determines what might be called the *supply* of spatial opportunity for cut-in while the ambient traffic condition establishes the *demand* for cut-ins to take place. Interestingly, the supply and demand factors become traded off against each other across the three control-mode options because of the following:

- a) The ACC controller manages the gap within an intermediate—one-to-two-second— band of headway time values compared to the sub-second headways that are often seen in manual driving and the decidedly-longer headways that are common under CCC control.
- b) The driver’s decision to engage either form of cruise control is strongly influenced by the traffic condition, resulting in suppressed utilizations of ACC and especially CCC in heavy traffic.

In light of these general observations, it is not surprising to see in Figure 8.45 that the ACC-engaged mode of driving has an intermediate rate of cut-in experience, overall, when compared with that of either the ManBase or CCC datasets.

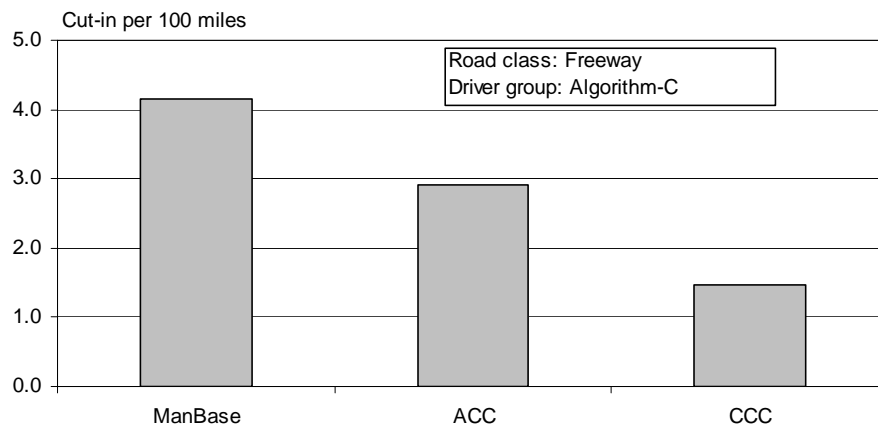

Figure 8.45. Overall cut-in rates experienced in each of three driving control modes

Apparently, the intermediate positioning of ACC both in terms of its characteristic headway times and the traffic density levels at which it is characteristically engaged have helped to determine the intermediate rate of cut-in experienced in ACC driving. This contention is clarified by the data in Figure 8.46.

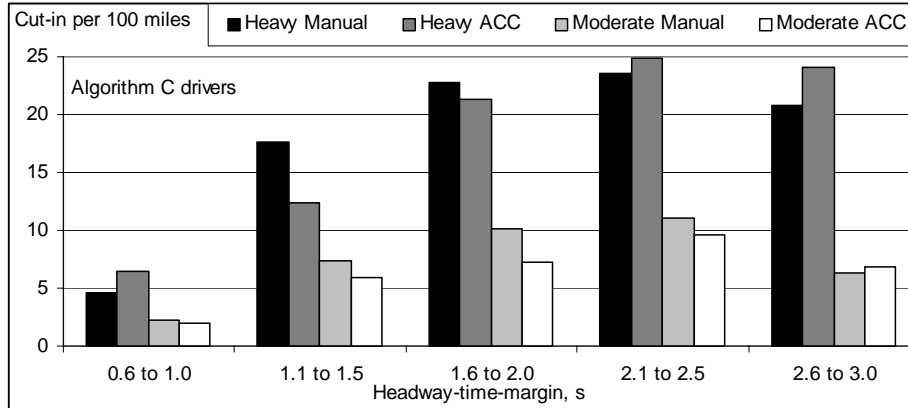

Figure 8.46. Cut-in rates within bins of constant initial headway time and traffic density, for manual and ACC modes of control

Combining the dependent variable, cut-in rate, with the interacting factors of initial headway time, traffic density, and control mode, Figure 8.46 basically shows that when both the headway time and the traffic density are held fixed, the manual and ACC control modes produce similar, but certainly not matching, cut-in rates per 100 miles of travel under any given combination of those conditions. Thus, traffic density and headway time are strong determinants of the cut-in rates in these data, but not the only ones.

Looking into more detail relating to the cut-in rates occurring with ACC engaged, Figure 8.47 shows that a substantial number of cut-in events were observed across all of the six alternative values of ACC gap setting, although the largest numbers occurred at the 1.0, 1.4 and 2.0 settings that are also known to have been the three most popular gap selections, overall (see Section 6.2.)

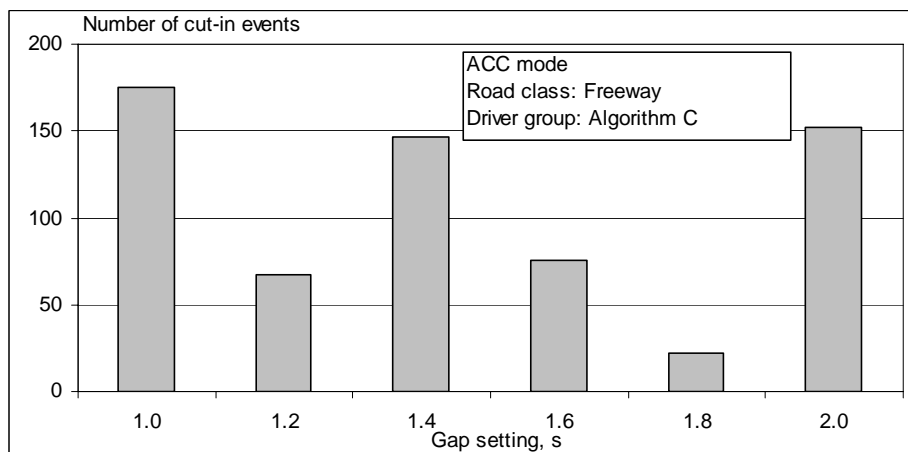

Figure 8.47. Total number of cut-ins observed at each of the ACC gap settings

Figure 8.48 shows cut-in *rates* for each value of gap setting, thereby normalizing the above numbers of cut-in events by the corresponding mileages traveled with ACC engaged at each gap setting. A simple linear fit to these data suggests that the cut-in rate increases by approximately fifty percent as the gap setting doubles from 1 to 2 seconds. The fact that the absolute values of cut-in rate are in the range of 2 to 4 per 100 miles indicates (from Figure 8.44) that ACC was engaged predominantly in relatively sparse traffic conditions.

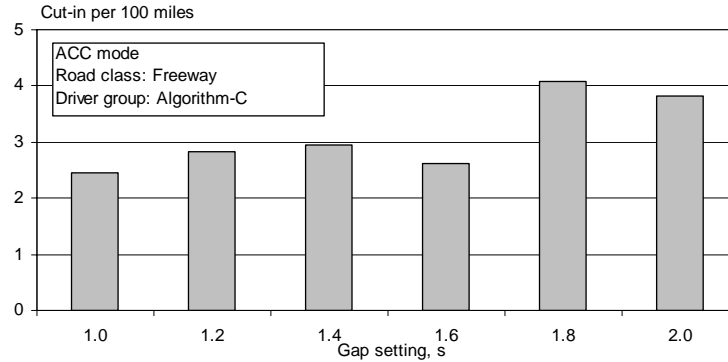

Figure 8.48. Cut-in rates observed at each of the ACC gap settings

Having observed factors influencing the cut-in rate, the remainder of this section explores the conflict characteristics of cut-in incidents under each mode of control. For each of the three alternative control modes, Figure 8.49 shows the distributions of the new headway time values that materialize once the cut-in vehicle has arrived in front of the host.

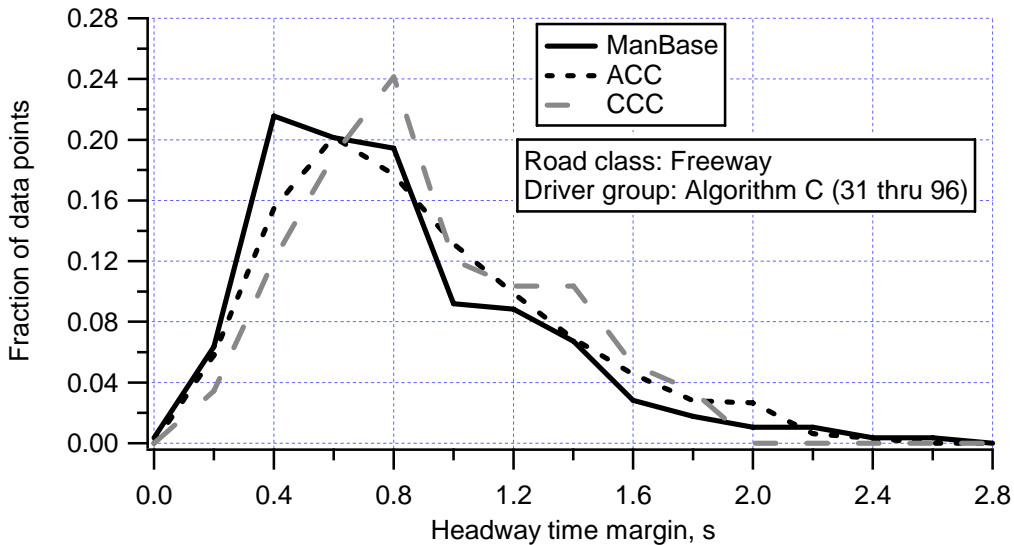

Figure 8.49. Distributions of the headway times posed by arriving cut-in vehicles, for each of the three modes of control

We see that the three distributions are quite similar to one another, although manual driving yields the higher incidence of short-headway cut-in that would follow from the combination of shorter initial headways and denser traffic conditions that attend that mode of control.

To supplement the distributions for all the headway-time data obtained from the cut-in query, an ANOVA analysis was conducted using the average values from only those individual drivers who had experienced at least 3 such incidents. The sample sizes and mean values (in seconds) of these data were as follows:

- ACC: 43 drivers, $M= 1.00$
- CCC: 9 drivers, $M= 0.97$
- ManBase: 34 drivers, $M= 0.89$

Significant differences were seen only between the ACC/Manbase pair of distributions, $F(2) = 3.8, p = 0.027$. Since ACC enjoys the longer of the mean values shown above as averages for individual drivers, ACC cannot be said to pose any peculiar burden on the driver in terms of the headway times imposed by cut-in vehicles.

In addition to the headway times, per se, the range values at cut-in were also examined simply for reporting example minima occurring on freeways above 50 mph. It was noted that the shortest of all range values measured in each of the three modes of control, ManBase, ACC, and CCC were 5.0, 6.6, and 11.7 meters, respectively, at the moment of cut-in. Figure 8.50 shows the range-rate values with which cut-in vehicles arrive ahead of the host.

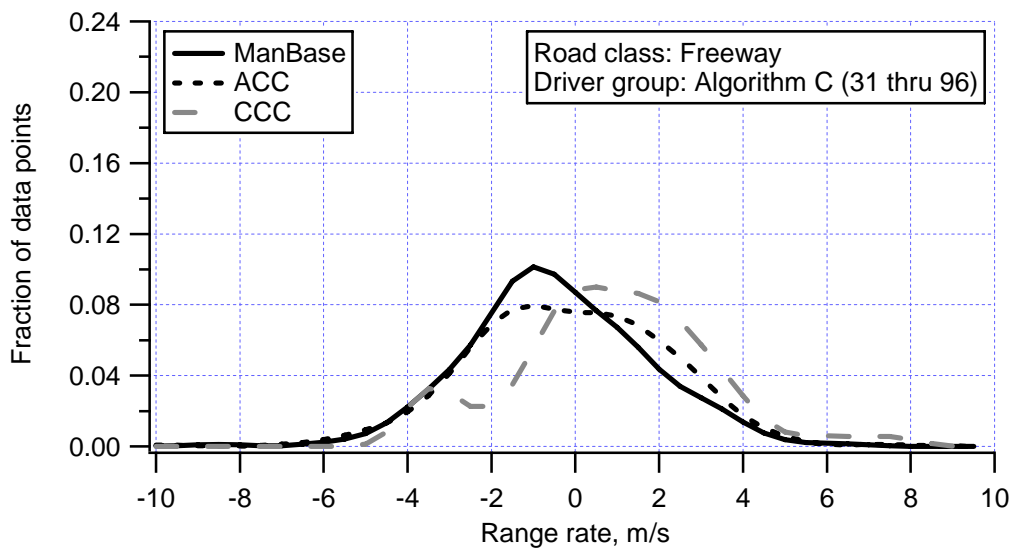

Figure 8.50. Distributions of the range rate values with which cut-in vehicles arrived ahead of the host, for each of the three modes of control

Both the ACC and CCC distributions for this variable are nominally distributed more toward positive, lower-conflict values than the manual data, but the overall comparisons are qualitatively similar. The primary potential safety issue, of course, may be more directly addressed in the negative-going tail of such distributions, but those features are also qualitatively similar across the three modes of control.

For addressing statistical significance in the range-rate data, an ANOVA analysis was conducted using the average result from only those individual drivers who had experienced at least 3 cut-in incidents in these data. The sample sizes and mean values of the averaged range-rate data (in m/s) for individuals were as follows:

- ACC: 43 drivers, $M = +0.012$
- CCC: 9 drivers, $M = +0.735$
- ManBase: 34 drivers, $M = -0.114$

No significant differences were seen between any of the pairs of distributions, $F(2) = 2.7, p = .071$. Accordingly, none of the control modes is distinguished relative to the others by the range-rates imposed during their respective cut-in experiences.

Shown in Figure 8.51 are the distributions of the host vehicle’s speed that prevailed when cut-in occurred, under each of the modes of control.

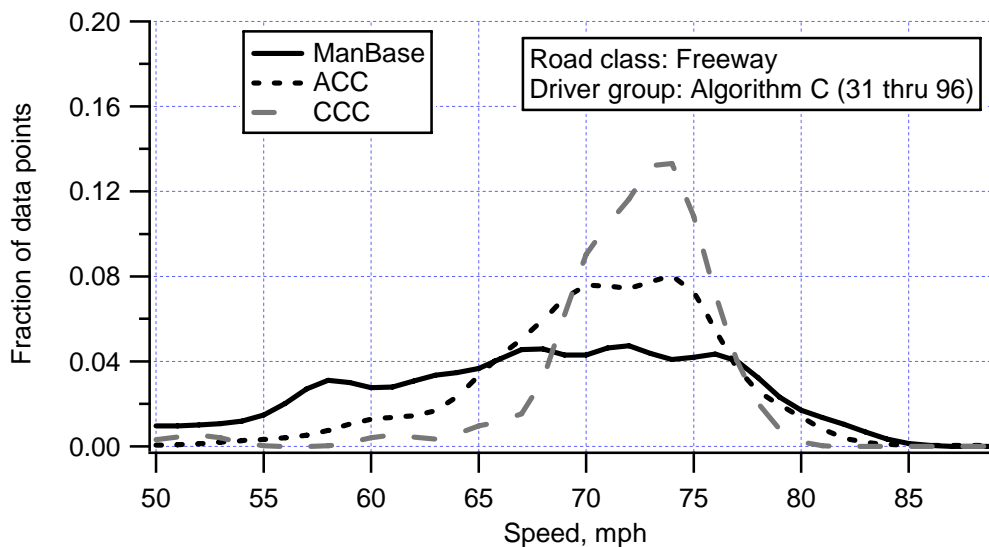

Figure 8.51. Distributions of the host-vehicle speed values at the moment of cut-in, for each of the three modes of control

We see that the substantial differences in speed distributions more or less align with the differences in ambient traffic under which the respective modes are chosen for control. Clearly, the manual mode is selected over a wide range of traffic conditions, including a large proportion of incidents at speeds below 65 mph—normally connoting

some degree of traffic congestion that causes the freeway to operate at less than its free-stream speeds. ACC represents an intermediate distribution of speeds over which cut-in was measured. Cut-ins on CCC driving take place over a more narrow distribution of host speeds that lies almost exclusively in the free-stream domain of traffic operations.

Figure 8.52 presents a plot of range and range-rate values prevailing at the moment of cut-in. For each 0.5 m/s increment of range rate, the average value of the cut-in range has been plotted for the manual and ACC modes of control. Recognizing that the data take on a distinctly bi-linear form—more or less applying to the right and left quadrants of the plot—straight-line fits have been computed to approximate the respective negative- and positive-polarity sets of the data as a way of summarizing the range versus range-rate relationships that are observed.

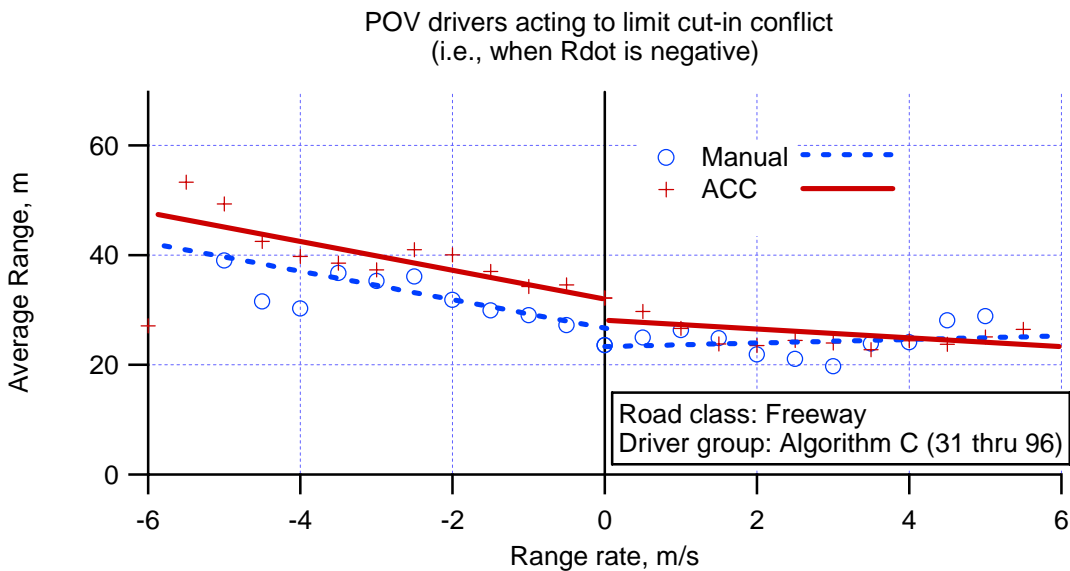

Figure 8.52. Comparison of cut-in events under manual and ACC control, according to the average cut-in range value that was seen in each 0.5 m/s bin of range-rate

We see that while positive-polarity range-rates appear in a rather flat relationship with range, the range value clearly grows as the corresponding range-rate takes on a greater negative value (i.e., on the left side of the plot). Since all such data simply portray “other-driver” behavior, the apparent tendency to afford longer range when the cut-in imposes a more-negative range-rate appears to suggest a courtesy pattern that serves to manage the severity of cut-in conflicts that confront the host vehicle. The nominal lines fitted to the data on the left side of Figure 8.52 have a slope of about 3 meters of additional range for each -1m/s of negative-polarity range-rate. Noting that the typical average cut-in range is approximately 25 meters under these freeway conditions, the

observed relationship between range and negative-polarity range-rates is equivalent, on average, to managing a sort of “time-to-25-meter” metric around a nominal minimum of 3 seconds. Looking toward the left-extreme of this plot, one can also observe that the shortest times-to-collision (as distinct from times-to-25-meters) that emerge from such average data are of the order of 7 seconds.

In any case, the conflicts posed to the ACC driver by cut-in events are seen to be less severe, overall, than those implied in the manual data shown below.

Summary of Observations:

In summary, the ACC driver’s experience of other vehicles cutting into the gap ahead do not appear to pose higher rates of occurrence or levels of conflict severity than those which arise during manual driving. The data show the following:

- The occurrence of cut-in ahead of the ACC driver takes place at rate that is intermediate between those that derive from manual and CCC driving.
- The rates of cut-in are strongly determined by at least the typical headway times and traffic density levels that are characteristic of operation in each mode.
- Cut-in rates vary by at least an order of magnitude as the headway time gap prior to cut-in goes from the vicinity of 0.5 seconds to approximately 2 seconds.
- Cut-in rates also vary by at least an order of magnitude as the nominal traffic density goes from sparse to heavy, as defined here.
- When the initial headway time and traffic density are fixed at any nominal combination of conditions, the cut-in rate is (as expected) largely unrelated to the control mode of the host vehicle.
- From the shortest to the longest of the six gap-adjustment settings afforded by the ACC system, the cut-in rate increases by approximately 50%, given all of the specific traffic conditions in which ACC drivers choose to engage and to adjust the system.
- The severity of cut-in conflicts encountered during ACC driving are not significantly different from those experienced in the other modes of control.
- There appears to be a pattern of cut-in “courtesy”, one might say, by which cut-in vehicles tend to arrive further ahead of the host when a negative range-rate would otherwise pose a greater conflict for the host vehicle (in any host control mode).

Moreover, analysis of cut-in by other vehicles ahead of the host does not show any degradation in safety quality that is unique to ACC driving. The fact that the ACC controller permits gap settings only down to the 1.0-second value, however, does result in considerably higher cut-in rates than are experienced by the driver under manual control at shorter headways, especially in dense traffic.

8.1.7 Secondary Task Activity with ACC Engaged

Since ACC is seen as a control aid that relieves the driver of the task of continuous modulation of the throttle and brake for the control of speed and headway, it has been hypothesized that the driver may a) perceive the “underload” afforded by the ACC control function and b) exploit this underload by executing secondary, or discretionary, tasks unrelated to driving, per se. If it did turn out that drivers heavily indulged in secondary tasking when ACC is engaged, there might then arise a concern for a potential negative safety effect due to the distraction of secondary activities.

As presented earlier in Section 7.2 as part of the analysis of FCW safety issues, non-driving behaviors were examined in FOT data by means of the sampled manual review of video records taken at evenly-spaced exposure clips throughout all driving. An explanation of the video review method is presented in detail in Section 5.3.3, and a detailed presentation of the video review data applying to ACC appears in Appendix L.

For consideration as part of this analysis of safety issues in ACC driving, let it simply be noted that a 5% sample was taken of the video clips that had been recorded every five minutes throughout the FOT, including not only the manual-driving episodes that were reported in Section 7.2 but also a complementary 5% sample of video clips from the respective cruise modes of control, CCC and ACC. Since the exposure frames, themselves, are evenly-spaced in time, a random sampling of these clips thereby yields a data set whose size is proportional to the time spent driving in each mode. Thus, the fraction of time spent in secondary-task activity, by control mode, is obtained by dividing the count of such incidents observed in each mode by the total number of all clips that were sampled under that mode.

Shown in Table 8.7 is the raw tally of secondary task data obtained by sampling video clips from the CCC and ACC modes of driving. For the total of 276 video clips represented in this Table, 43 of the sampled clips were from CCC driving and 233 were from the three weeks of ACC driving. Clearly the behavior that is labeled, ‘conversation’ (where the driver is apparently speaking to a passenger) is the dominant type of secondary task activity, followed by cell-phone conversations.

Table 8.7. Counts of secondary task activity seen during CCC and ACC driving

Non-driving Behavior	Week 1 CCC	Week 2- ACC	Week 3- ACC	Week 4- ACC	Total Clips
Cell phone: conversation, in use		2	2	3	7
Cell phone: reaching for					
Cell Phone: dialing					
Conversation	2	9	9	8	28
Drinking: high involvement					
Drinking: low involvement				1	1
Eating: high involvement					
Eating: low involvement				1	1
Grooming: high involvement					
Grooming: low involvement	1	2	3	1	7
Headset/hands-free phone: conversation					
Headset/hands-free phone: reaching for headset					
Headset/hands-free phone: unsure if any activity				1	1
In-car system use					
None	40	51	58	77	226
Other/multiple behaviors		3	1	1	5
Smoking: light a cigarette					
Smoking: reaching for cigarettes or lighter					
Smoking					
Total Clips	43	67	73	93	276
Total secondary behaviors (and fractions of time)	3 (0.07)	16 (0.24)	15 (0.20)	16 (0.17)	50 (0.18)

Shown in Table 8.8, the itemized data from Table 8.7, above, have been consolidated into just a few categories and combined with the corresponding results from manual driving that were presented earlier in Section 7.2.

Table 8.8. Driver’s secondary task activity in all three alternative control modes

Counts	Manual	CCC	ACC
Conversation by Cell Phone	29	0	7
Conversation w/ Occupants	48	2	26
Other (eating, grooming, smoking, etc.)	42	1	14
Total Secondary Task Counts	119	3	47
Total Clips Sampled for Review	652	43	233
Fraction of Time in Secondary Tasks	0.183	0.070	0.202

The counts are listed by the individual control modes, where the “manual” data represent the sum of all ManBase and ManACAS driving time, taken together. The bottom row presents the fraction of time spent in secondary task activity by drivers in each control mode.

We see that the rate of secondary tasking during ACC driving is much higher than in the sparsely-represented CCC data, but roughly equivalent to that seen in manual driving. Notwithstanding the limited sampling available for the CCC driving condition, the Pearson χ^2 test does show that the difference seen between secondary tasking in ACC and CCC driving is statistically significant. Further, since the difference lies primarily in the surplus of the activities summarized as ‘conversations w/occupants’, it may be hypothesized that the novelty of the ACC system has served to stimulate both the situation of driving with occupants present (in order to demonstrate the novel system) and the desire to discuss ACC operation in the early periods of ACC usage. The modest decline in the rate of secondary tasks seen in Table 8.7 over the period of ACC usage from weeks 2 through 4 nominally supports this view.

Summary of Observations:

In summary, secondary tasking under ACC control occurs at roughly the same rate as it does under manual control but (perhaps due to a limited sample) at a significantly higher rate than under CCC control. The data show the following:

- Secondary task activity is present approximately 20% of the time while driving in either the manual or the ACC mode of control.

- The higher incidence of conversation with occupants is conspicuous as the primary activity differentiating secondary activity under ACC control from that under CCC control. It is suspected that the novelty of ACC may have contributed to the peculiar rise in conversational involvement of the ACC driver.

8.1.8 Intervention by Braking

The driver's role in ACC control is basically that of a control supervisor. As long as the driver judges that ACC control is the suitable mode for the present point on a route and that the ACC controller can suitably manage the speed and headway conditions, given other traffic, the driver actively chooses to continue under this mode of control. When the driver does choose to "take over", an intervention action is required.

Intervention to disengage ACC is achieved by means of either moving the ACC switch to the OFF position, or by applying the brake. If ACC is disengaged in the absence of a current conflict—simply because the cruise mode is no longer desired or if, say, the driver is about to exit the freeway—a light tap on the brake is most-often employed instead of throwing the ON/OFF switch to terminate engagement.

Clearly, however, a more sustained brake application is presumed to constitute the primary means of disengagement, if a headway conflict is to be resolved. It is such substantive brake applications that are of special interest in exploring how drivers supervise the ACC mode of control, in contrast with driver-applied braking to resolve conflict in the alternative control modes of CCC and manual driving. Even though one must invoke a rather broad use of the term "intervention" if driver braking from the manual-control state is to be compared with driver braking from a cruise-mode state, it is nevertheless necessary to use the braking behavior from manual driving in this analysis because of its status as the ubiquitous reference case. Further, it is desirable to distinguish between light-tapping of the brake as a means of disengaging the cruise modes of control and the longer-duration type of brake application that may be required to resolve a prevailing kinematic conflict.

The query that was crafted to address brake intervention as a safety question involved two stages for screening the large number of cases in which a brake-switch transition accounted for the cruise-disengagement (or ordinary manual-braking) events of interest. The query posed the following constraints:

- The host vehicle is operating on a freeway at a speed above 50 mph.
- The host is in a state of ACC or CCC engagement or in the ManBase (i.e., first-week) segment of manual driving.
- A CIPV target exists ahead of the host prior to the onset of the brake application.
- This same CIPV target persists throughout the 5 seconds following brake onset.
- The duration of the brake application falls into either of two cases:
Case-1 braking duration = 0.1 second or longer (i.e., the case by which tap-type brake applications would be included in order to realize the full scope of brake intervention under the defined ambient conditions before focusing upon the more safety-instructive content of the subsequent case)
Case-2 braking duration = 2.0 seconds or longer.

By requiring that there be a CIPV target ahead, the query focuses the entire analysis on those events in which there is at least a possibility of forward conflict, while also affording the associated radar data by which to quantify conflict severity in kinematic terms. Also, the host vehicle must continue to follow the original CIPV for at least 5 seconds after the onset of braking—thereby seeking only the cases in which a potential in-path conflict could have persisted significantly into the future.

Taking, then, case-1 of the query in which any duration of brake application longer than 0.1 seconds was allowed, the following total numbers of braking-intervention events were identified:

- ACC — 441 events
- CCC — 223 events
- ManBase— 3,645 events (where, again, braking during manual driving is included here as a reference case, although the term “intervention” takes on special meaning as a control-mode interruption only in the case of the cruise modes.)

Table 8.9 shows a summary of the development of the 441 cases of ACC braking intervention over the three weeks of ACAS driving. The data do not suggest a strong adaptation by the ACC drivers over this period, although more individuals are involved in each successive week and a considerably larger mileage exposure is apparent in Week 4.

Table 8.9. Summary table of ACC braking intervention, case 1

	Week 2	Week 3	Week 4	All
Number of cases	131	140	170	441
Number of drivers	32	38	44	52
ACC distance, miles	6221	6435	9286	21942
Brake interventions per 100 miles	2.1	2.2	1.8	2.0

Upon normalizing the counts of brake-application events by the respective mileages traveled on freeways above 50 mph in the respective modes of control, Figure 8.53 presents the braking rates that differentiate the three modes. Thus, for example, we see that braking intervention from the ACC state occurs at approximately 4% of the rate at which brakes are applied during manual driving. These results suggest that the ACC controller is being judged acceptable by the driver in its management of the headway condition for rather long stretches of time. We also see, as a function of traffic density, that all of the braking rates vary by approximately an order of magnitude when going from the sparse to the heavy traffic condition. Note that ACC control imposes approximately the same braking-frequency requirement under the heavy-traffic condition as does the manual mode in sparse traffic.

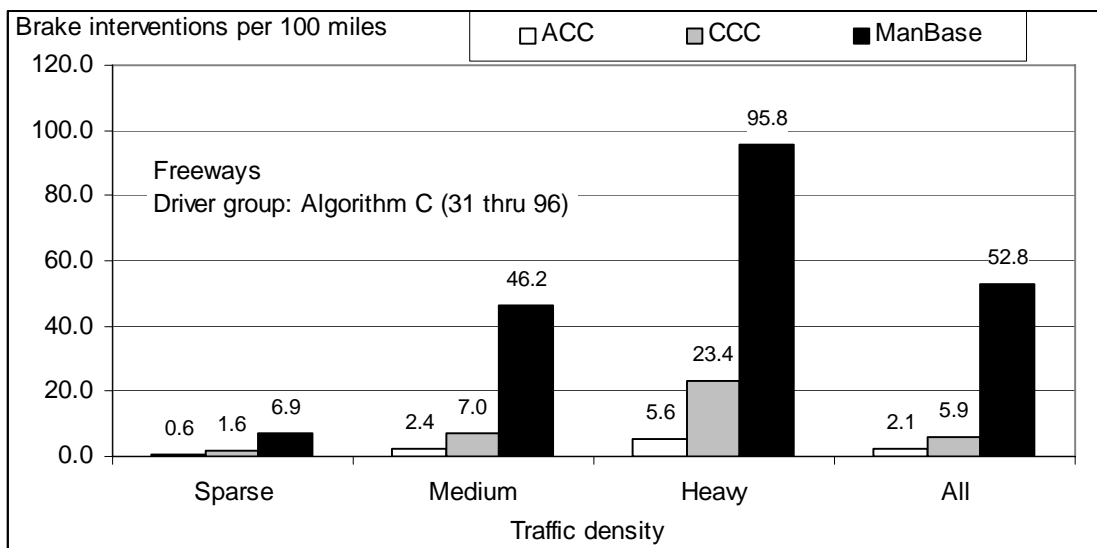

Figure 8.53. Rates of brake apply under the stated query condition, case-1

Taking case-2 of the query in which the brake application must be at least 2 seconds in duration, the following total numbers of braking events were identified:

- ACC — 148 events
- CCC — 75 events
- ManBase— 1,840 events

Normalizing these values by the respective freeway mileages, as above, Figure 8.54 shows that the rate of braking from the ACC state (with a CIPV ahead as defined above) was 0.7 applications per 100 miles of related ACC driving, compared with 2.0 from the CCC state and 26.6 from the ManBase mode. Thus, when the query’s requirement for braking duration is made long enough that the brief “tap” applications are removed, we see that braking intervention from the ACC state occurs at approximately 2.6% of the rate at which brakes are applied during manual driving.

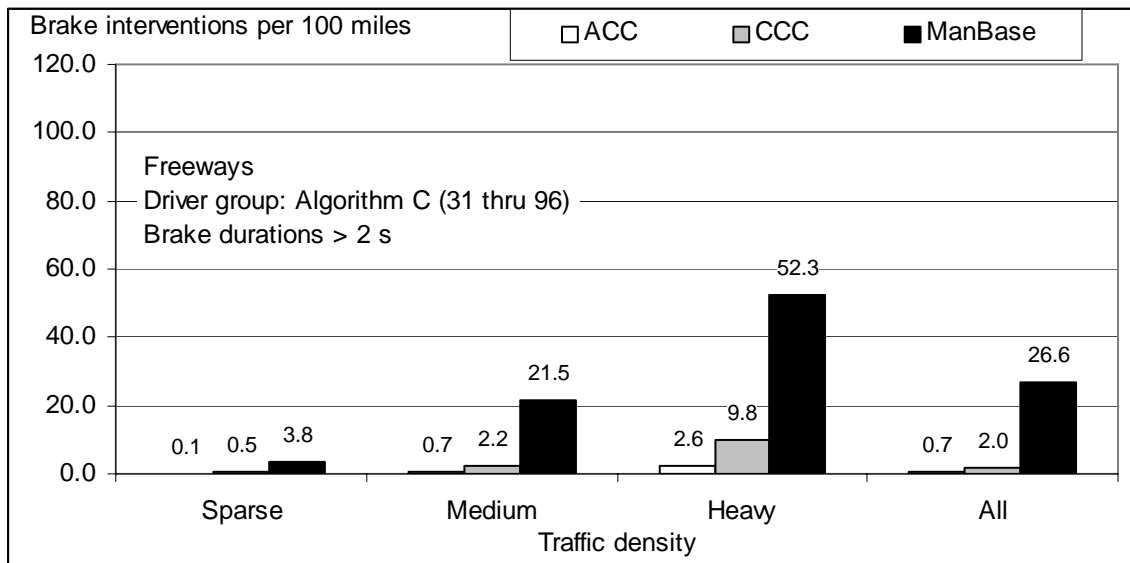

Figure 8.54. Rates of brake apply under the stated query condition, case-2

If the ACC segment of these data can be assumed to include all of the events in which intervention was truly required for addressing a forward conflict, then one can readily see that very long ACC engagements are possible, when one undertakes a long trip. In sparse rural traffic, for example—where an ACC braking intervention is “needed” only once every 1000 miles—it is conceivable to travel cross-country with ACC control being interrupted mostly for the purpose of exiting the freeway.

The remainder of this section addresses the severity of the braking applications that were made under Case-2 of the above query, *for the medium-traffic condition*, only. The following total number of braking events were found for this set of query constraints:

- ACC — 83 events
- CCC — 47 events
- ManBase — 882 events

The rationale for limiting this analysis to the medium-traffic data is to control the range of ambient driving conditions on the recognition that the rate and severity of traffic disturbances are influenced by traffic density. If braking applications are needed largely to resolve such disturbances, then controlling for the influence of traffic density on their production is needed. Otherwise, the strong tendency of drivers toward cruise control in sparse traffic and toward manual control in dense traffic will artificially bias the study of braking activities according to control mode, itself. Medium traffic is chosen as the favored driving condition for this analysis because it constitutes the largest segment of the driving data and occupies a centralized slice of the traffic-disturbance phenomena.

A total of 83 incidents of manual braking intervention under ACC control apply to this reduced set of the Case-2 results. Table 8.10 shows a summary of the development of these cases over the three weeks of ACAS driving. The data do not suggest a strong adaptation by drivers, over the three-week period, in terms of either the intervention rate or the peak braking levels or conflict severities characterizing the intervention events. The individual response measures (i.e., A_x , which is the peak deceleration level; H_{tm} , which is the headway time at the moment of brake onset; and the decel-to-avoid value at the brake onset) are among the various metrics used to explore braking intervention phenomena in the analyses which follow.

Table 8.10. Summary table for ACC brake interventions, case-2 in medium traffic only

	<i>Week 2</i>	<i>Week 3</i>	<i>Week 4</i>	<i>All</i>
Number of cases	24	29	30	83
Number of drivers	15	20	22	34
ACC distance, miles	6221	6435	9286	21942
Brake interventions per 100 miles	0.39	0.45	0.32	0.38
Mean minimum A_x , m/s^2	-1.51	-1.26	-1.23	-1.32
Mean H_{tm} at brake onset, s	1.56	1.37	1.46	1.46
Mean Decel-to-avoid at brake onset, m/s^2	-0.65	-0.45	-0.57	-0.55

Figures 8.55 through 8.58 show that the peak decelerations reached during braking intervention to terminate ACC control are roughly comparable in distribution to those obtained from CCC- and manual-related datasets. Note that this discussion employs the term, “peak deceleration” in referring to the minimum values of negative-going “accelerations”, as plotted in Figures 8.55 through 8.58.

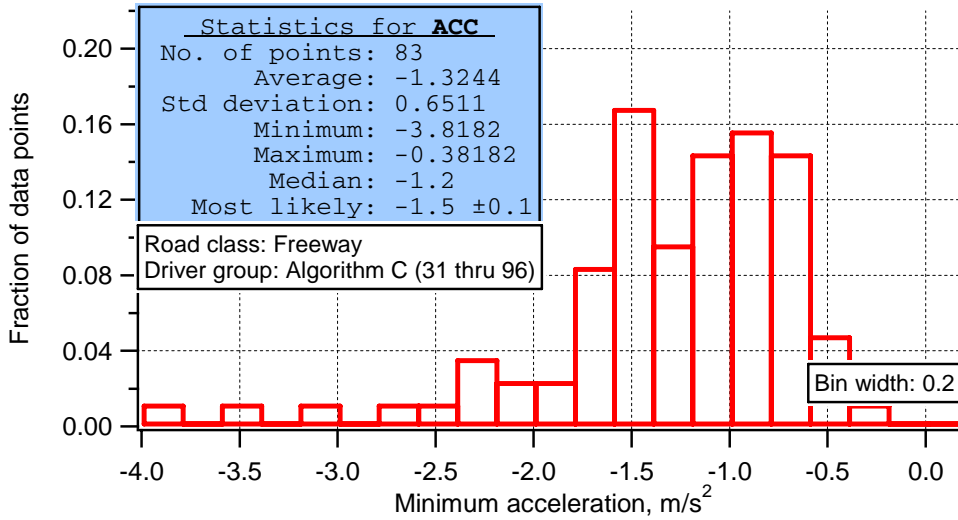

Figure 8.55. Peak decelerations reached during ACC braking intervention under case-2 of the stated query condition in medium traffic

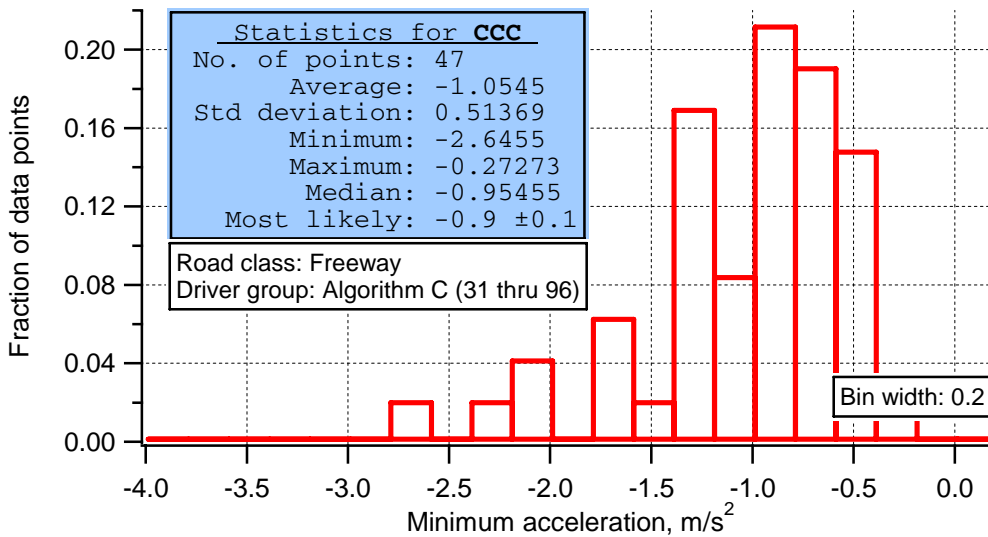

Figure 8.56. Peak decelerations reached during CCC braking intervention under case-2 of the stated query condition in medium traffic

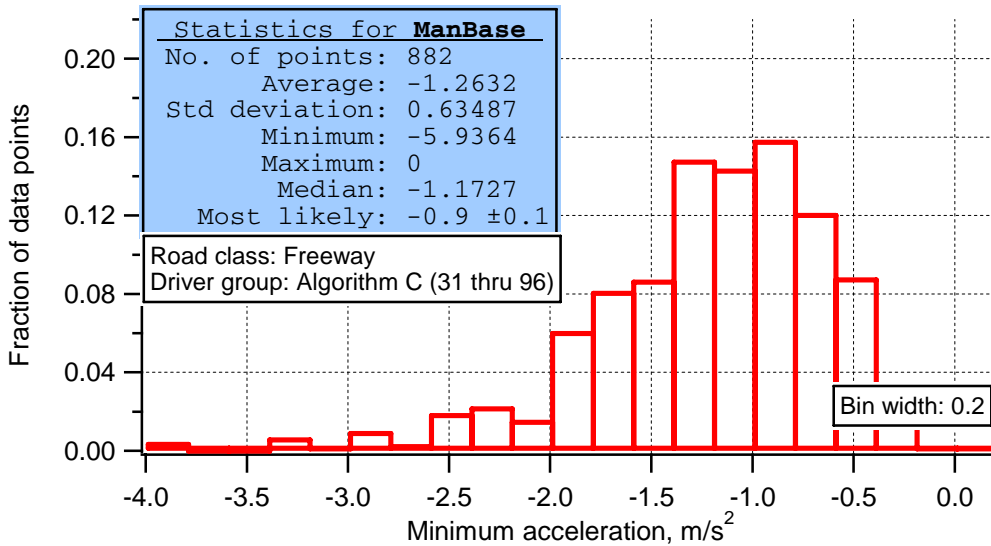

Figure 8.57. Peak decelerations reached in ManBase brake applications under case-2 of the stated query condition in medium traffic

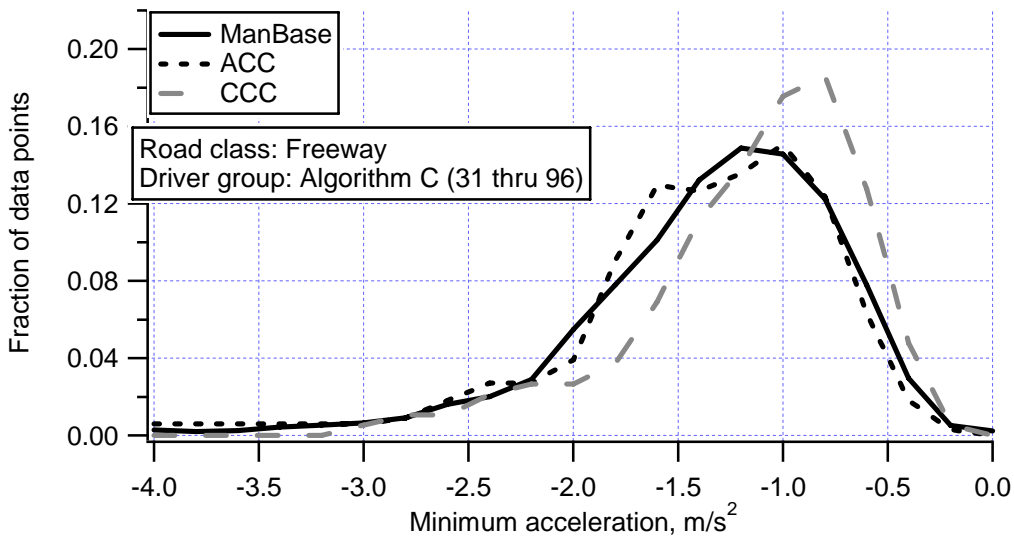

Figure 8.58. Peak decelerations overlaid for all three control modes under case-2 of the stated query condition in medium traffic

Notwithstanding the substantial skew in these distributions, it is instructive to note that the standard deviations as well as the average and median statistics for decelerations across all three modes are rather close to one another. The similarities in standard deviation values, particularly in the ACC and manual modes of control, suggest that the prospects for extreme-value responses (i.e. high deceleration levels) are roughly comparable.

Among the most safety-relevant implications of these results is the issue of conflict that might be posed to the driver who is following an ACC (vs. CCC or manually-controlled) vehicle on the freeway. That is, if the deceleration distributions portray the probability that lead-vehicle braking will pose a sudden challenge to the following driver, we can postulate that other drivers following behind ACC-engaged vehicles in this FOT encountered little difference in the severity of conflicts arising from ACC braking-interventions than are experienced when following either CCC or manually-controlled vehicles. We also note that the highest single peak deceleration value exhibited during an ACC braking intervention under the defined freeway operating conditions was 0.38g's.

Having shown distributions for all the data obtained from the case-2 query, an ANOVA analysis was then conducted using only the average peak-deceleration values from those individual drivers who had experienced at least 3 incidents of such events in medium-density traffic. The sample sizes and mean values (in m/s^2) of the peak-deceleration data for individuals were as follows:

- ACC: 11 drivers, $M = -1.20$
- CCC: 7 drivers, $M = -1.06$
- ManBase: 47 drivers, $M = -1.24$

No significant differences were seen between any of these pairs of distributions, $F(2) = 1.1$, $p = 0.358$, given this limited sample, particularly for ACC and CCC.

Shown in the next four figures are distributions of the total speed change that accrued over the entire duration of the brake application in each control mode, given case-2 brake applications and the medium-traffic condition. The speed-change metric is a useful elaboration on the braking severity data because they roughly estimate the overall speed differences between vehicles that the brake was applied to resolve. Very small speed changes would imply no substantive speed conflict, even though the brake may have been briefly spiked if, for example, the driver was startled.

We see that the largest of the respective average speed changes arose during brake interventions that disengage ACC control. Figure 8.59 shows that the ACC distribution has a lower incidence of speed changes in the regime of 5 mph and below and a modestly-higher incidence in the range of 5 to 25 mph, relative to those for manual and CCC control. Since the data volumes are rather low, however—especially for the cases of ACC and CCC—we cannot speak with much confidence about the tails of these distributions and the likelihood that very large speed reductions will be required, upon disengaging ACC by use of the brake. We also note that the highest single speed-change

value exhibited among the 83 episodes of ACC braking intervention under the defined freeway operating conditions was only 27 mph.

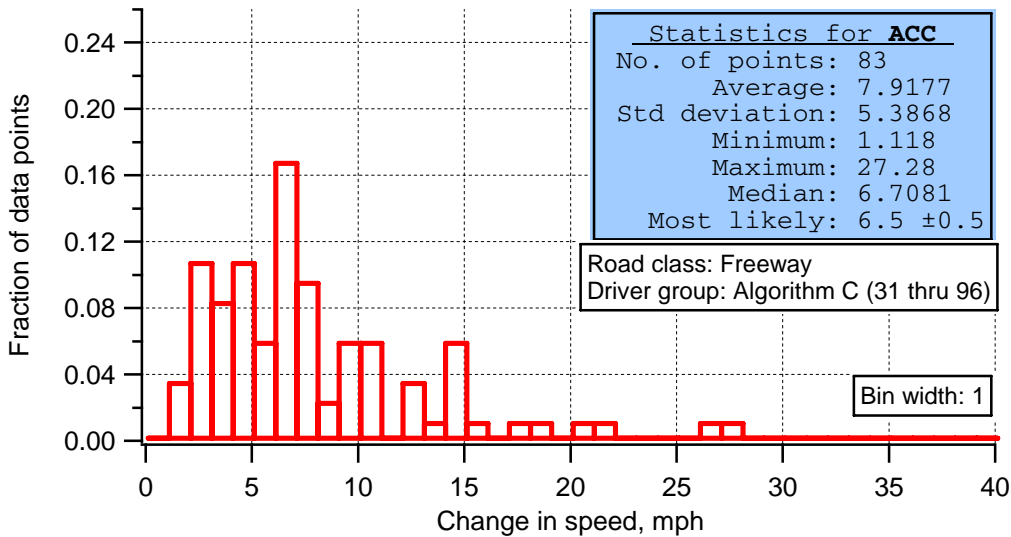

Figure 8.59. Speed changes derived from ACC braking intervention under case-2 of the stated query condition in medium traffic

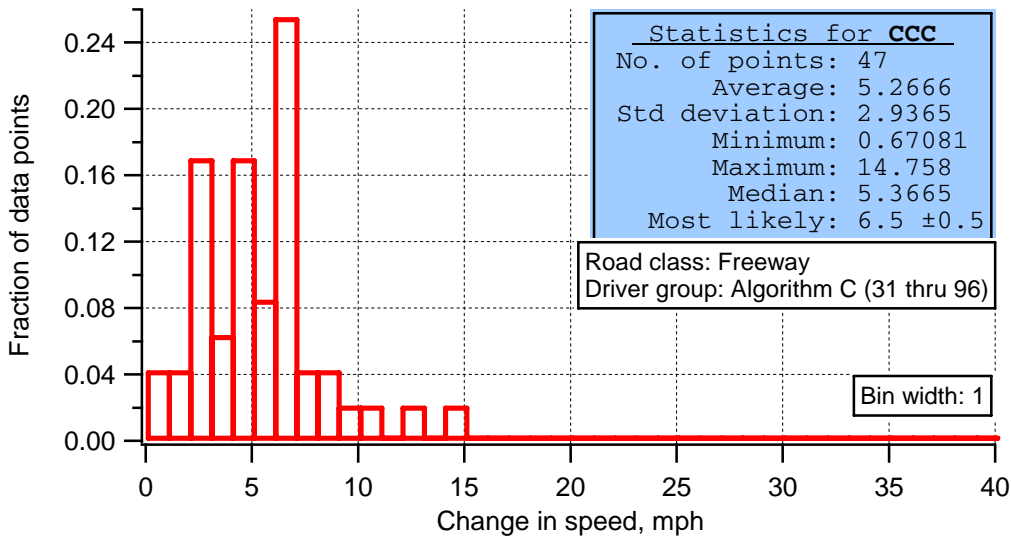

Figure 8.60. Speed changes derived from CCC braking intervention under case-2 of the stated query condition in medium traffic

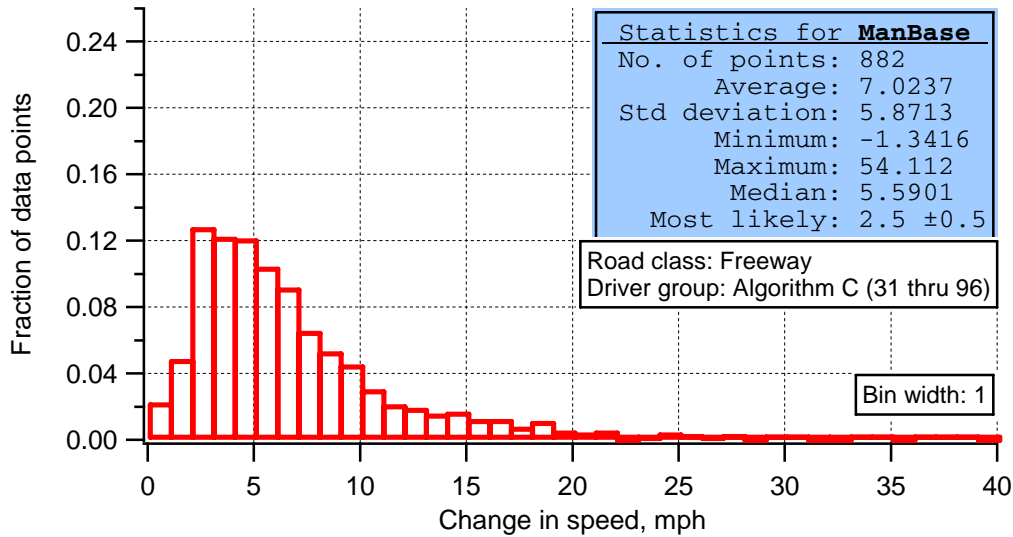

Figure 8.61. Speed changes derived from ManBase brake applications under case-2 of the stated query condition in medium traffic

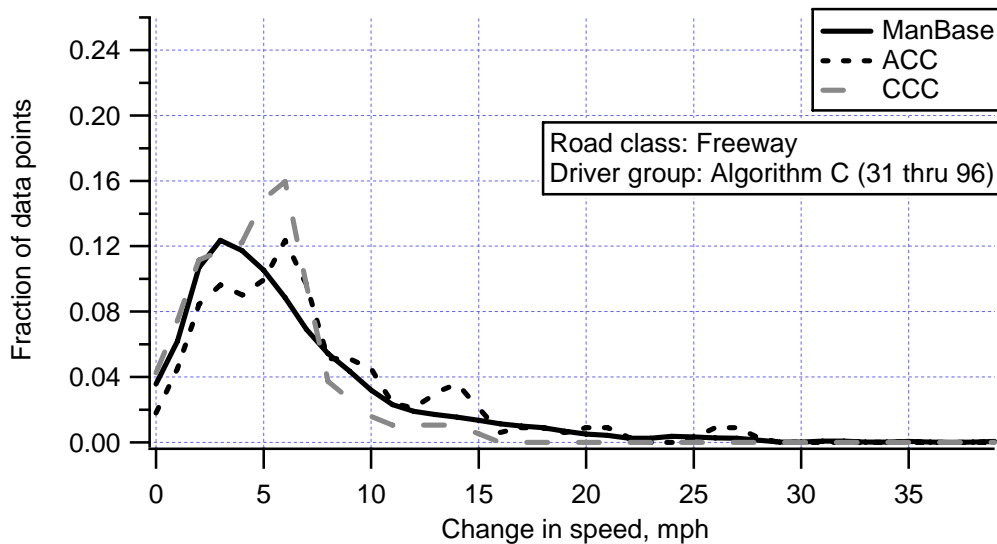

Figure 8.62. Overlaid speed changes under case-2 of the stated query condition in medium traffic

An ANOVA analysis was conducted using only the average speed-change values from those individual drivers who had experienced at least 3 incidents satisfying the case-2 query for medium-density traffic. The sample sizes and mean values (in mph) of the averaged speed-change data for individuals were as follows:

- ACC: 11 drivers, M= 3.28
- CCC: 7 drivers, M= 2.43
- ManBase: 47 drivers, M= 3.24

No significant differences were seen between any of the pairs of distributions, $F(2) = 1.8$, $p = 0.174$, for this admittedly-small sample.

Shown in Figures 8.63 to 8.66 are distributions of the value of headway time margin that prevailed in each control mode at the moment of the brake onset, for brake applications under case-2 and medium traffic.

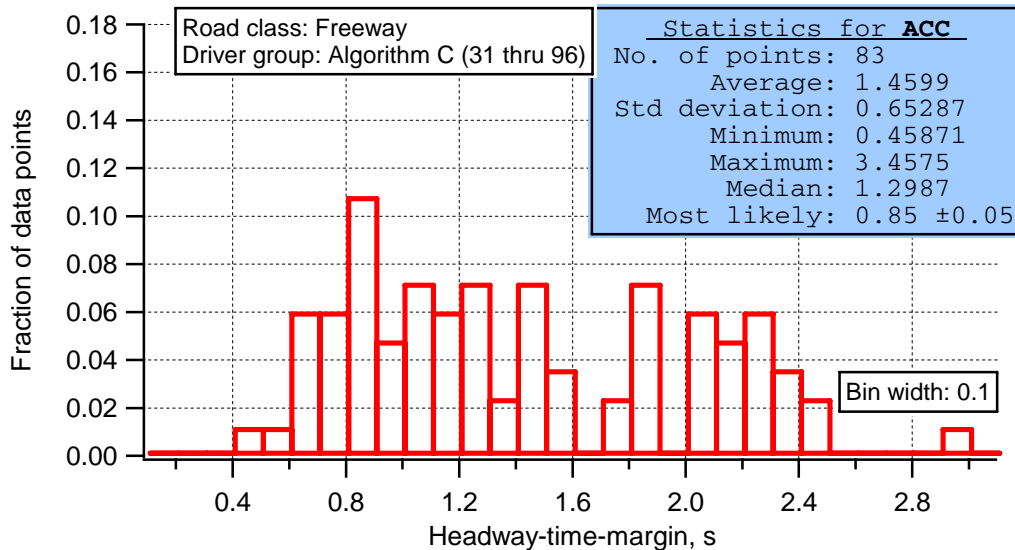

Figure 8.63. Headway time values at onset of ACC braking intervention under case-2 of the stated query condition in medium traffic

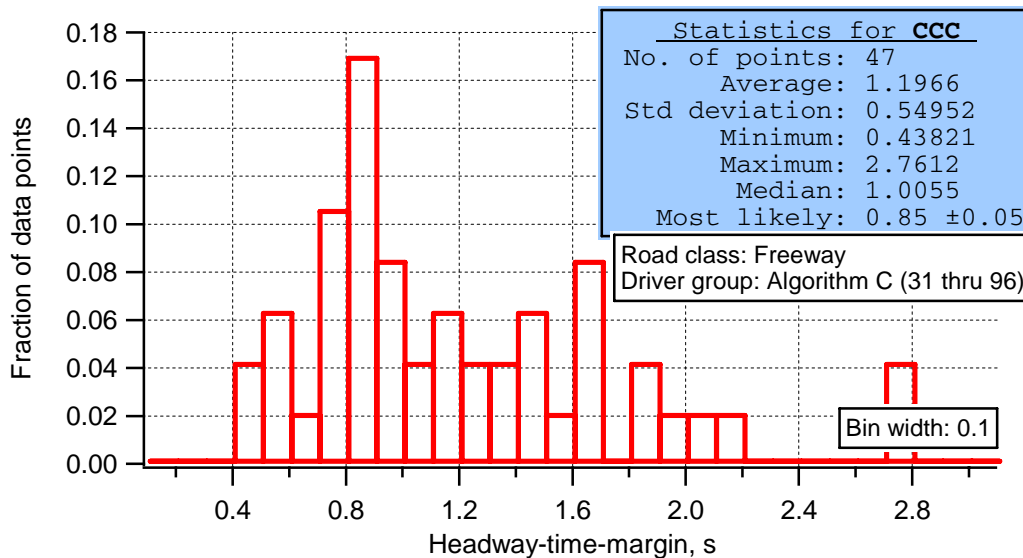

Figure 8.64. Headway time values at onset of CCC braking intervention under case-2 of the stated query condition in medium traffic

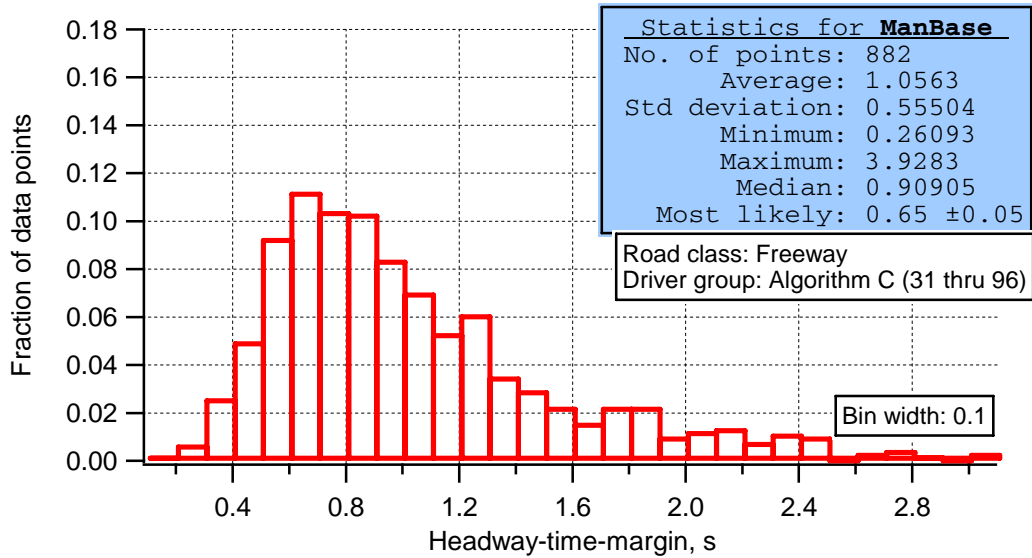

Figure 8.65. Headway time values at onset of ManBase braking application under case-2 of the stated query condition in medium traffic

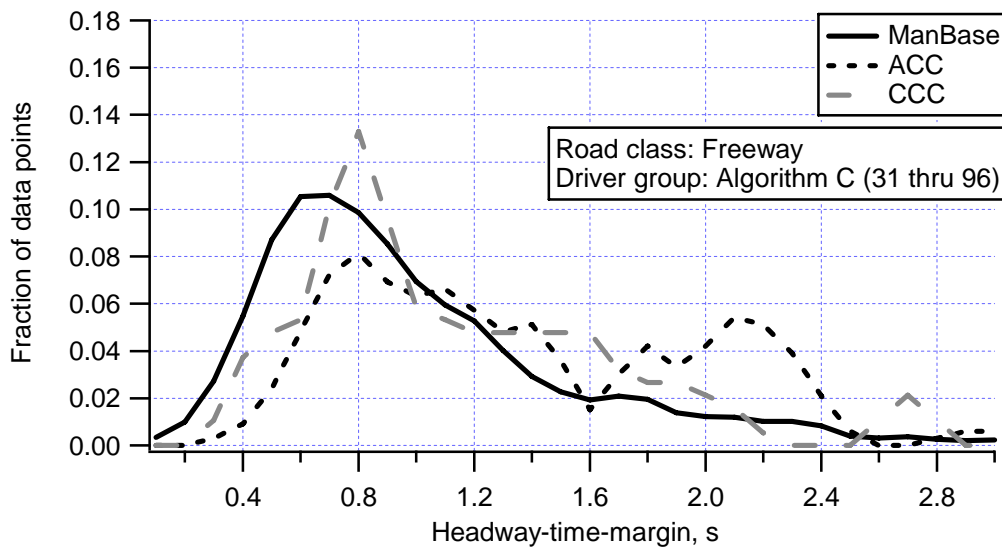

Figure 8.66. Overlay of headway time values at braking onset, under case-2 of the stated query condition in medium traffic

We see that headway times were larger, on average, at the onset of ACC braking intervention than in either of the other two modes of vehicle control. Noting that this ACC system is designed to control headway in the 1.0 to 2.0-second range, we see that the typical ACC braking intervention occurs essentially in the middle (at an average of 1.46 seconds, in Figure 8.63) of that window. Taking a high-level view, the average-headway results presented here suggests that braking interventions that disengage ACC do not typically occur after a deep intrusion beyond the gap-setting value. (Please see an

alternative illustration of this point in Figure 8.67, below, in which the headway intrusion is normalized for the gap-setting value.) Rather, it appears that ACC brake interventions are often pre-emptive and, in any case, involve brake-onset headways that do not intrude as deeply as under manual control. We observe, for example, the minimum headway value at which any of the 83 ACC braking interventions occurred was 0.46 seconds (compared, for example, to a minimum value of 0.26 seconds for the corresponding set of manual-braking data under these same nominal operating conditions.)

An ANOVA analysis was conducted using only the average headway time values (at the moment of braking) from those individual drivers who had experienced at least 3 incidents satisfying the case-2 query for medium-density traffic. The sample sizes and mean values (in seconds) of the averaged headway-time data for individuals were as follows:

- ACC: 11 drivers, M= 1.31
- CCC: 7 drivers, M= 1.20
- ManBase: 47 drivers, M= 1.08

No significant differences were seen between any of the pairs of distributions, $F(2) = 2.0$, $p = 0.141$, given a somewhat limited sample.

Figure 8.67 presents the distribution of the minimum value of the ratio, $(H_{tm}/Th)_{min}$, that was reached within 5 seconds following ACC braking intervention under query case-2 and medium traffic.

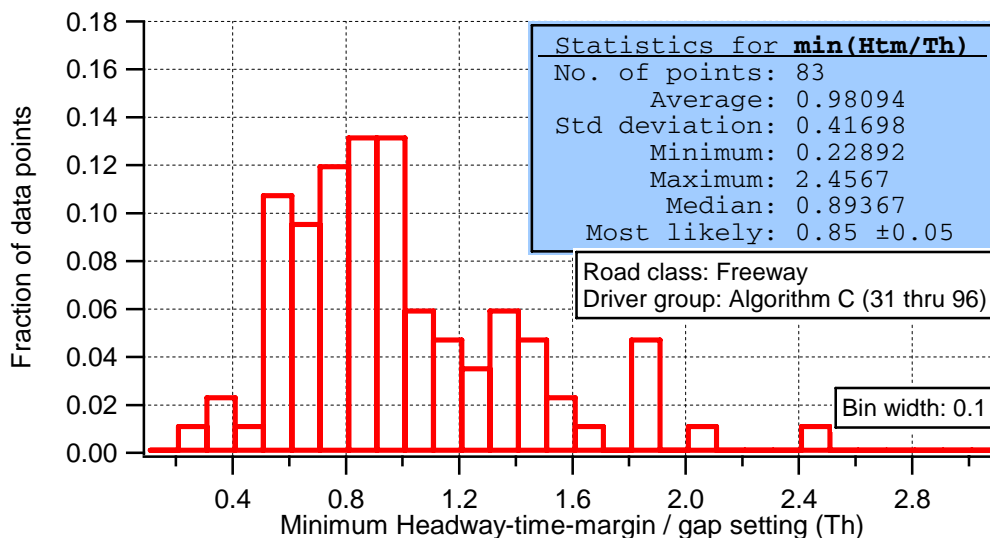

Figure 8.67. Distribution of $(H_{tm}/Th)_{min}$ that was reached within 5 seconds after ACC braking intervention under query case-2 and medium traffic.

The average value of $(H_{tm}/Th)_{min}$ reached through ACC braking intervention is 0.98, indicating that the typical intervention event takes place very nearly at the headway gap that had been selected for ACC control. On the other hand, we see that approximately 60% of the intervention events reached into the regime of $(H_{tm}/Th)_{min} < 1.0$ implying, perhaps, that intervention took place from an initial state of steady headway-keeping near the Th value. The other 40% of events that yielded $(H_{tm}/Th)_{min} > 1.0$ are thought to have taken place while the ACC host was either approaching the target at some overtaking speed or otherwise dwelling at relatively long range (such that the reason for a 2-second brake-apply when terminating engagement is unclear).

Figures 8.68 through 8.71 characterize the conflict levels more directly, at the onset of braking, by means of the decel-to-avoid measure for each of the control modes.

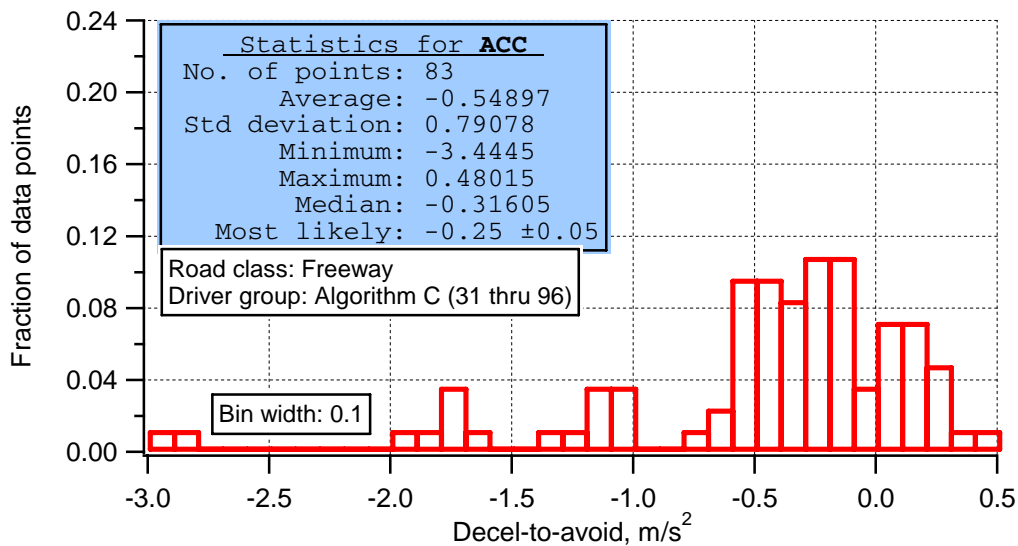

Figure 8.68. Decel-to-avoid values at onset of ACC braking intervention under case-2 of the stated query condition in medium traffic

Here we see that the plots for ACC intervention and manual braking are similar, but they both differ from that applying to CCC intervention. The average decel-to-avoid values for the ACC and manual cases are almost equal to one another and 50% higher than the average value for CCC intervention. Also, the higher standard deviations seen in the ACC and manual plots reflect the more numerous individual cases in which decel-to-avoid reached into the regime beyond (i.e., more negative than) -2 m/s^2 , although the left-going tails of these distributions are sparse. What can be said is that drivers clearly operated ACC (and drove manually) up to more fully-developed levels of forward conflict than they did with CCC, before the brake pedal was applied. The earlier plots would indicate, however, that when braking intervention on ACC did occur, it prevented

very-close-headway intrusions from developing. The typically-longer value of initial headway under ACC control, is presumed to be a primary factor explaining this outcome.

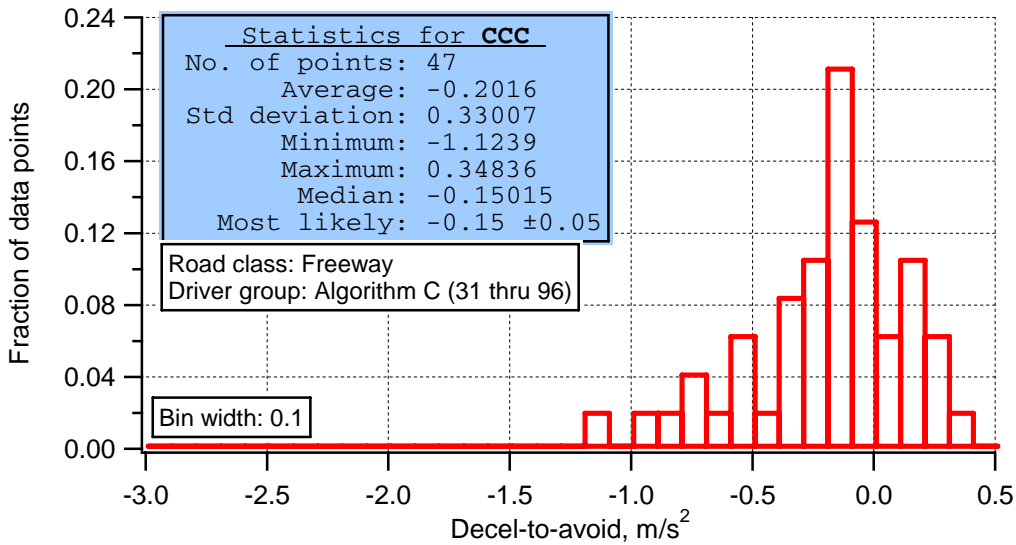

Figure 8.69. Decel-to-avoid values at onset of CCC braking intervention under case-2 of the stated query condition in medium traffic

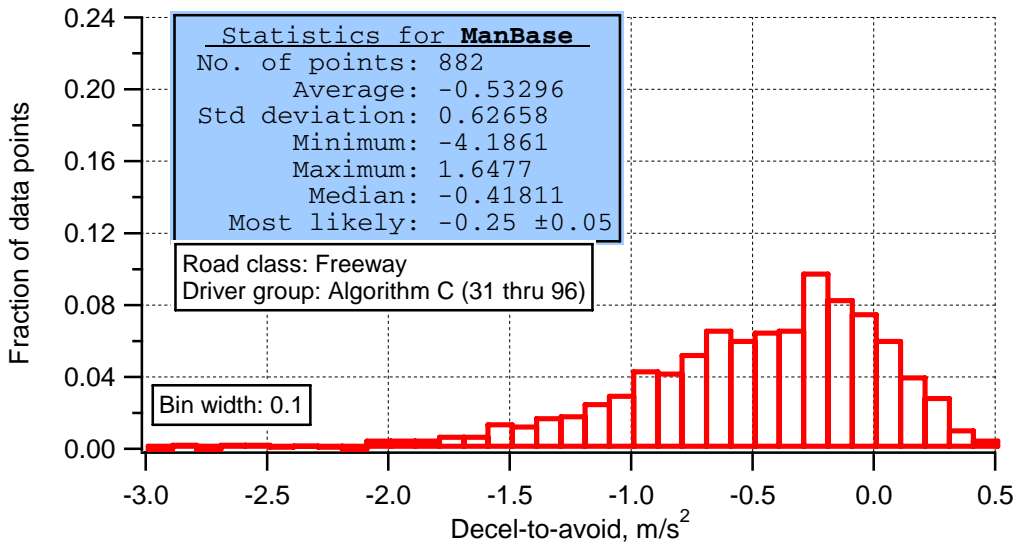

Figure 8.70. Decel-to-avoid values at onset of ManBase brake application under case-2 of the stated query condition in medium traffic

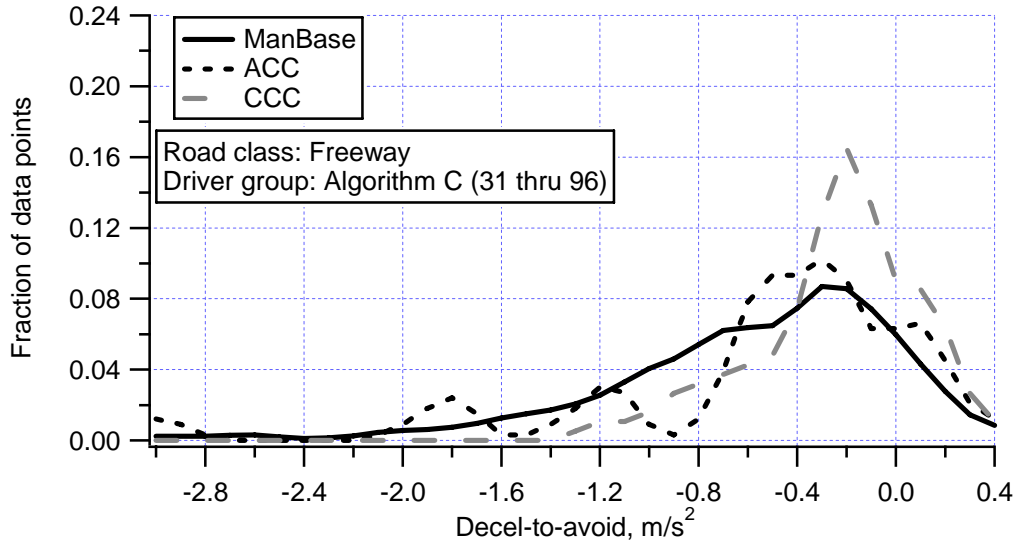

Figure 8.71. Overlay of Decel-to-avoid values at onset of braking under case-2 of the stated query condition in medium traffic.

An ANOVA analysis was conducted using only the average decel-to-avoid values (at the moment of braking) from those individual drivers who had experienced at least 3 incidents satisfying the case-2 query for medium-density traffic. The sample sizes and mean values (in m/s^2) of the averaged decel-to-avoid data for individuals were as follows:

- ACC: 11 drivers, $M = -0.442$
- CCC: 7 drivers, $M = -0.212$
- ManBase: 47 drivers, $M = -0.521$

A significant difference was seen only between the CCC/ManBase pair of distributions, $F(2) = 4.5$, $p = 0.016$, for this limited sample of drivers.

Shown in Figure 8.72 is the distribution of the value of longitudinal acceleration measured under ACC control at the last time step before the driver's application of the brake pedal in an ACC braking intervention. Of the 83 cases included in the overall dataset, 15 of them involved actuation of the ACC autobraking function, basically accounting for the portion of the plot lying to the left of approximately $-0.5 m/s^2$. The figure also indicates that approximately a third of the braking interventions occurred at a moment in time when the longitudinal acceleration under ACC control was within $\pm 0.2 m/s^2$ of zero. This implies that many of the interventions may have been simply discretionary actions unrelated to any current conflict to which the ACC controller was responding.

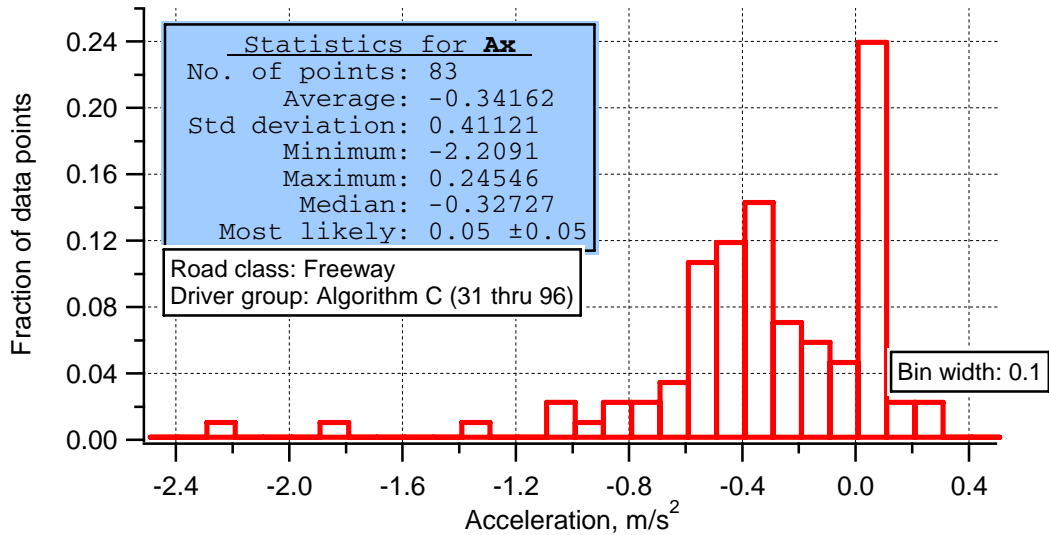

Figure 8.72. Distribution of longitudinal acceleration under ACC control just prior to brake onset under case-2 of the stated query condition in medium traffic.

The figure confirms that not even one of the braking interventions under these ACC driving conditions followed an ACC autobraking response that had reached the 3 m/s^2 limit of the system's authority. Although the data are indeed limited, it is useful to recognize that the extent of the ACC driving exposure supporting this particular result is on the order of 15,000 miles of freeway travel in medium-density traffic with ACC engaged. The next section will show that a total of 60 incidents of full, 3 m/s^2 autobraking did occur during the FOT, but they were distributed in other driving conditions than the medium-traffic-freeway context of this overall analysis.

Summary of Observations:

In summary, braking intervention from the ACC driving state occurs much less frequently and with comparable levels of deceleration as in the other modes of control. Recognizing that the results were drawn only from medium-traffic, freeway travel above 50 mph, the data showed the following:

- The brake is used to intervene upon ACC control approximately one-third as often (per 100 miles of cruise-engaged driving) as under CCC control and one-twentieth as often as the driver applies the brake pedal under normal manual control.
- Brake interventions that disengage ACC control yield deceleration distributions that are not significantly different from those seen in CCC brake intervention and when braking during manual driving. This result tends to imply that other drivers following behind ACC-engaged vehicles under the

stated conditions encountered little difference in the severity of conflicts arising from lead-vehicle braking under the differing modes of control.

- In the course of a single-brake application that disengages ACC control, the speed changes are not found to be significantly different from those obtained during either CCC brake intervention or when braking during the manual driving process.
- Although ACC brake intervention appears to be initiated at modestly longer headway values than are seen in CCC brake intervention or in braking during manual driving, the differences are not found to be significant. On the other hand, the distribution of headway values for ACC brake intervention does include the characteristically-thinner tail in the very-short headway domain than is seen in the data from manual driving.
- Approximately 60% of the observed ACC braking interventions appeared to have been initiated from the so-called “following mode”, i.e., with headway at or near the selected gap-setting value. The remaining 40% of cases were at longer headway than the gap setting.
- The decel-to-avoid conflict levels that prevail at the moment of ACC brake intervention are not significantly different from those seen in either CCC brake intervention or braking during manual driving.

Moreover, no particular safety concerns are supported by the measured ACC brake intervention activity of the FOT drivers, under the studied conditions.

8.1.9 Staying Engaged up to the 0.3-g Deceleration Limit

The nominal, 0.3-g limit of the deceleration authority of the ACC controller is a key aspect of its design. It is recognized that the limit braking authority of such systems has been the subject of extensive debate among the community seeking to write industry standards for ACC. Most of the debate over setting the deceleration limit has included a concern that drivers might become overly-dependent on a system that provided too high a value for the deceleration limit. Over-dependence, in turn, might be reflected in both a relatively high frequency of events in which the ACC controller reaches its limit and a relatively high level of the forward conflict that prevails when it does. The data shown below indicate that a low incidence of these events were seen in the FOT, overall, and the rate at which such events occurred was significantly reduced over the three weeks of ACAS-enabled driving. This latter trend suggests that drivers were adapting their behavior so that ACC would be very rarely operated up to the deceleration limit of the system.

This issue was explored in FOT data simply by retrieving and examining the prevailing conditions and driver responses associated with ACC autobraking events where the delivered deceleration was at the nominal 0.3-g limit. The query for recovering these data included any case of ACC autobraking in which the deceleration response of the vehicle exceeded a 1-second-filtered peak of 2.9 m/s^2 (i.e., 0.296 g). As listed below in Table 8.11, a total of 60 such events were seen to have occurred in the entire FOT. (Subsequent presentations in this section will address the conflict severities of these events and will show the rates of 0.3-g autobraking responses, given distances traveled). It is important to note that the set of 60 events were experienced by only 23 of the 66 drivers in the algorithm-C part of the field test.

Table 8.11. Summary table of cases of the limit-autobraking response by ACC

	<i>Week 2</i>	<i>Week 3</i>	<i>Week 4</i>	<i>All</i>
Number of cases	34	19	7	60
Number of drivers	19	10	6	23
Mean Speed at 0.3 g onset, mph	39.8	36.3	32.4	37.8
Mean Range at 0.3 g onset, m	26.7	28.3	21.8	26.6
Mean Range rate at 0.3 g onset, m/s	-4.7	-3.4	-5.8	-4.4
No of manual brake interventions	14	9	5	28

The table also shows the weekly differences in the occurrence of limit-autobraking events, indicating that the practice of staying engaged up to this limit condition was most prevalent in Week-2 of an individual's participation. Because there has been a strong interest in seeing how drivers adapt to ACC autobraking over time, several aspects of the characteristic measures are taken up later in this presentation. It is also notable that the number of individual drivers encountering the limit-autobraking response declines strongly over the three-week sequence.

Not shown in the table, half of these events were attributable to only 5 individuals. By age group, 16 of the sixty total events were experienced by younger drivers, 8 by middle-aged drivers, and 36 by those in the older-age group.

The full set of limit-autobraking events are shown in Figure 8.73 by the respective counts that occurred on freeways, surface roads, and ramps. We see that 46 events (or 77%) of all limit-autobraking responses of the ACC system took place while driving on surface streets.

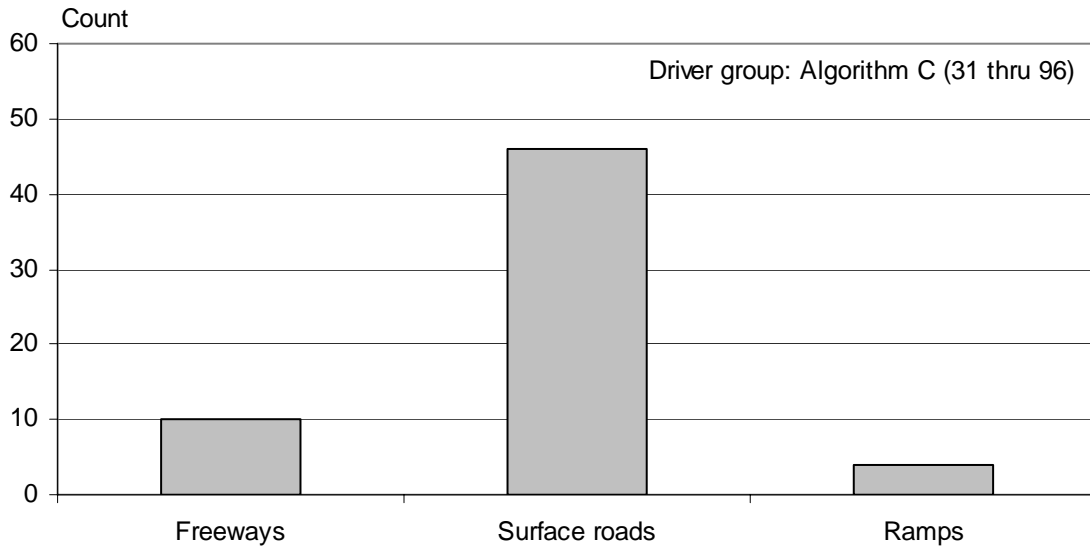

Figure 8.73. Distribution of the sixty total events of 0.3-g autobraking by road type

Shown in Figure 8.74 is the distribution of speed values that prevailed at the onset of 0.3-g autobraking by the ACC controller. The average speed for the sixty events is 38 mph and the maximum speed for any event is 59 mph. Thus, recognizing that the vast majority of all ACC driving takes place at speeds above the range of these values, the incidence of 0.3-g autobraking is largely confined to the lower-speed tail of the ACC speed distribution. Even the ten events of this kind that took place on freeways were at speeds well below the posted-speed values (since no event occurred above 59 mph). It is also noted that about 10% of the events took place at speeds lying near or below the minimum-speed threshold for ACC engagement, including a few cases in which the preceding vehicle was being followed down toward a stop, with “driver-control-required” showing on the HUD.

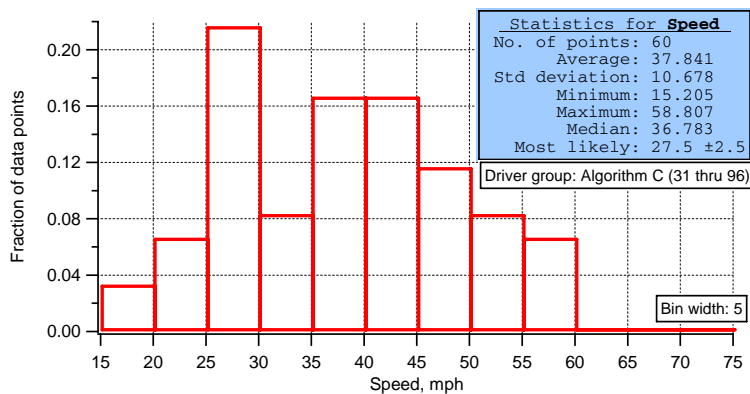

Figure 8.74. Distribution of 0.3-g autobraking events by speed at the time of 0.3-g onset

Regarding the driver's response during events of 0.3-g autobraking, Figure 8.75 shows that braking intervention occurred in approximately half of the cases. Thus, drivers chose to "ride out" the full extent of the autobraking response half the time.

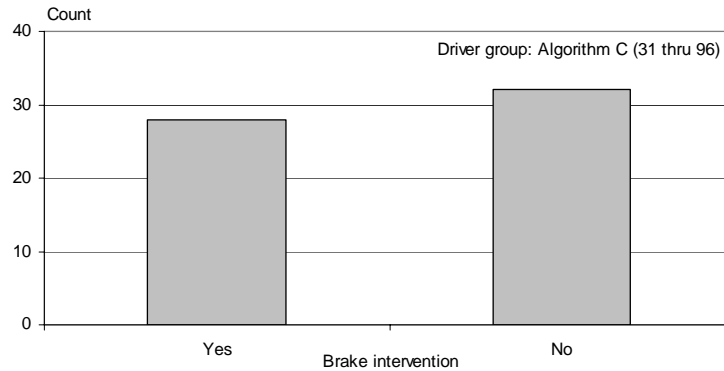

Figure 8.75. Distribution of 0.3-g autobraking events by whether the driver intervened by application of the brake pedal.

Shown in Figure 8.76 is the time that elapsed between the onset of the 0.3-g autobraking response and the driver's application of the brake pedal, for the 28 out of 60 cases of this event in which braking intervention did occur. The fact that several of the interventions took place after delays that exceed typical braking reaction times suggests that the driver was deliberately waiting to allow the autobraking response to proceed.

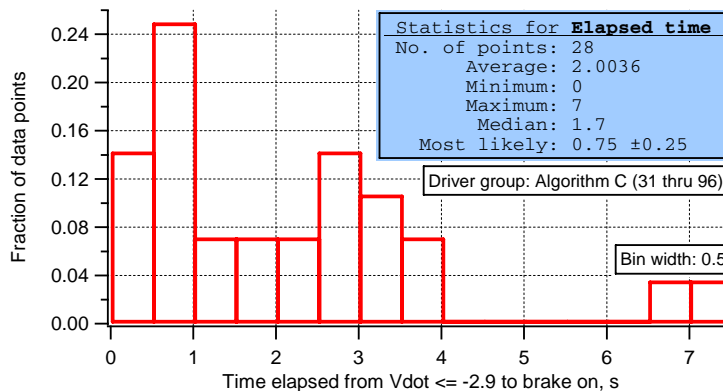

Figure 8.76. Distribution of the elapsed time between onset of the 0.3-g autobraking and driver intervention by application of the brake pedal

Related, of course, to the circumstances of 0.3-g autobraking events is the magnitude of the forward conflict that prevailed at the time that the autobrake limit was reached. Inspection of the enhanced time-to-collision values for all sixty cases shows that only in one incidence was this crash metric less than infinity, indicating no projected conflict. The single exception, with ETTC = 4.7 seconds, was a case in which the preceding vehicle had braked to a high deceleration level by the time that the 0.3-g autobraking

level was reached, but was turning out of the host-vehicle's path such that the host driver had the potential to perceive that the conflict would be short-lived. A value of infinity accrues in the ETTC metric for all of the other events because the 0.3-g autobraking level sufficiently exceeds the deceleration level of the lead vehicle to squelch the projection of a collision. The implication of these results is that the deceleration response of this ACC system was almost always successful in completely zeroing-out the conflict at the time of 0.3-g autobraking, given the conflict severities that FOT participants allowed to develop while still engaged. Also, examination of these data shows that driver brake intervention was not strictly required for resolving any one of the conflicts that had provoked a 0.3-g autobrake response during ACC driving in the FOT.

Turning to the apparent novelty, or experimentation character of events that provoked 0.3-g autobraking, Figure 8.77 gives the charted depiction of data summarized earlier in Table 8.11. The figure shows that the weekly count of such events declined precipitously from week-2 to week-4, with only seven events being logged in the final week of ACAS-enabled driving (representing a travel distance of approximately 25,000 miles).

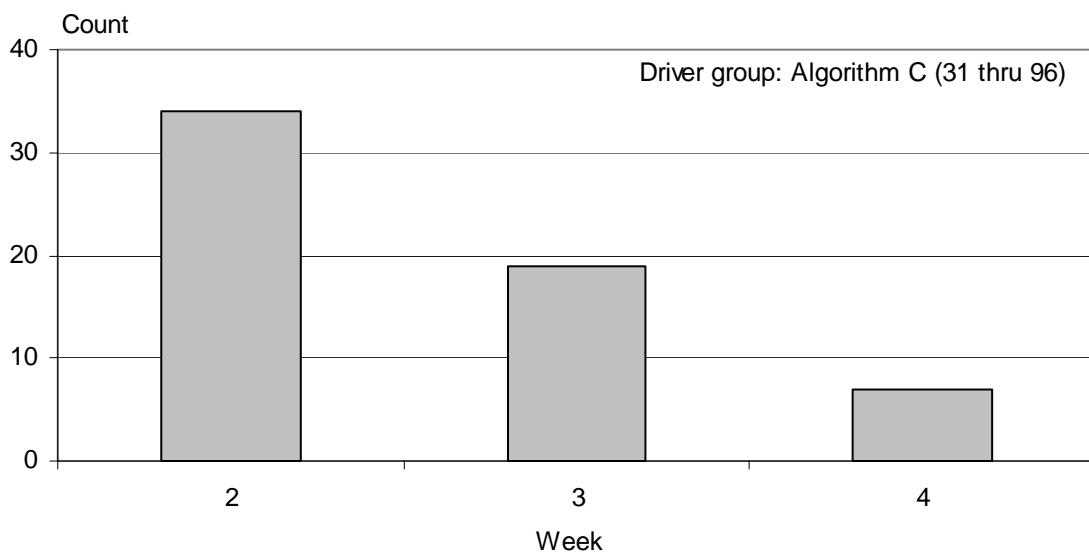

Figure 8.77. Weekly count of 0.3-g autobraking events over the period of ACAS-enabled driving

Since the count of 0.3-g autobraking events are presumed to have a first-order relationship to the exposure that accompanies ACC driving mileage, it is appropriate to

normalize the count data to derive a rate of event production. Such results are shown for freeway- and surface-road-driving, respectively, in Tables 8.12 and 8.13.

Table 8.12. ACC utilization and 0.3-g events on freeways

Measure	Week 2	Week 3	Week 4
Total Mileage	11475	12389	15285
Total ACC Mileage	6221	6434	9286
ACC Utilization (%)	54.2	51.9	60.7
No. of 0.3g events	8	2	0
Rate of 0.3-g events per 100 miles	0.13	0.031	0

The freeway results track the respective total and ACC-engaged mileages by week so as to reveal both the changing ACC driving exposure, shown as the utilization percentage, and the rate of production of 0.3-g autobraking events. We see that the rate of occurrence of 0.3-g autobraking events diminished to zero in the 4th week of exposure, even though ACC mileages and utilization percentages rose substantially. Admittedly, the absolute count of 0.3-g autobraking events is so low that the rate numbers are considered rather tentative.

For surface roads, as shown in Table 8.13, the rate of occurrence of 0.3-g autobraking events dropped by two thirds in going from the 2nd to the 4th week of ACAS-enabled driving. Interestingly, we also see that total ACC miles and the accompanying utilization percentages declined from the 2nd to the 4th week. The results appear to indicate that drivers may be reducing both their readiness to engage ACC in the surface-road environment as well as their tolerance for leaving ACC engaged in the more severe conflict situations that require a 0.3-g autobraking response.

Table 8.13. ACC utilization and 0.3-g events on surface roads

Measure	Week 2	Week 3	Week 4
Total Mileage	9684	8084	9597
Total ACC Mileage	1253	999	940
ACC Utilization (%)	12.9	12.4	9.8
No. of 0.3g events	23	17	6
Rate of 0.3-g events per 100 miles	1.8	1.7	0.6

Finally, Table 8.14 shows that the 0.3-g autobraking events took place across the full spectrum of traffic densities. Thus, even in sparse traffic, incidents of one-on-one conflict can arise to stimulate the ACC braking limit, especially in the surface-street

environment in which intersections pose a ready source of transient blockage of the host's path.

Table 8.14. ACC's 0.3-g autobraking events by traffic density

Event Counts	Sparse Traffic	Medium Traffic	Dense Traffic
Events on Freeways	2	4	4
Events on Surface Streets	19	24	3

Summary of Observations:

In summary, the incidence of the 0.3-g autobraking response by the ACC controller is quite rare and is argued to have been encountered by FOT drivers primarily as part of their learning curve as ACC users. The results show that autobraking at the full 0.3-g authority of the ACC controller was never experienced at all by two-thirds of the algorithm-C drivers. For the total of 60 events in which it did occur during the FOT, the data showed that full-authority autobraking...

- occurred primarily on surface roads, but diminished by two thirds in its rate of occurrence in that environment over the three weeks of ACAS-enabled driving, suggesting a strong adaptation by drivers to avoid the related condition;
- occurred much more rarely on freeways, and then primarily in the first week of ACC driving, again suggesting that drivers learned to avoid the related condition in the ensuing couple of weeks;
- was interrupted through braking intervention by the driver in approximately half of the cases of its occurrence, although in none of these events would the driver's brake application have actually been necessary to avoid a crash;
- was increasingly avoided over the three weeks of the system's availability by, a) using ACC less frequently in the more conflicted driving conditions and b) disengaging ACC earlier in the conflict transient;

Moreover, driver use of the full autobraking capability of the ACC controller is not seen to pose a long-term safety issue in these data. It is believed that the deliberately-retarded delivery of the 0.3-g response is a feature of the ACC controller that effectively discourages drivers from depending upon it.

8.1.10 ACC Driving Corresponding to Owner's Manual Advisories

This section is structured differently from all of the material that has preceded it in Section 8.1. Basically, example evidence has been drawn from FOT data to address each

of a diverse set of possible safety issues that have been under consideration as precautions or advisories for an ACC owner's manual. For each of twelve such advisories that are considered, evidence from the FOT served to indicate the extent to which the tested group of drivers exhibited the pertinent behavior while driving with ACC.

A full reporting of the "owner's manual" analyses appears in Appendix M. In this section, a summary of the appended results is offered in Table 8.15 on the next page, as a supplement to the foregoing analysis of ACC safety issues. Each subject is treated in the table by the topic in question, a paraphrase of the owner's manual precaution on that topic, and a high-level summary of the evidence obtained by analyzing the FOT dataset. Because this analysis involved many queries that yielded sparse results, the choice was made to study these issues using the whole FOT database covering all 96 drivers (thereby not confining this examination to algorithm-C subjects, only).

The combining of all ACC data is appropriate for these analyses since the ACC control algorithm, itself, was unchanged over all 96 subjects, although some details have differentiated the triggering of alerts under ACC control, from one subgroup of drivers to the next (see Section 3.1.3.) None of the differences in alert production are believed to have significantly affected the results of the ACC analyses presented below and in Appendix M.

It is also important to note that the FOT drivers were not advised about the specific precaution statements that are identified here (although the procedure for orientation of test subjects that was presented in Section 3.4.3 did touch on some of the same issues using alternative language.) The fact that certain owner's manual precautions were covered in some fashion during the orientation of FOT subjects while others were not constitutes an uncontrolled portion of the examination and could be a source of unknown effects in the reported results. Nevertheless, the purpose of this examination was simply to ask the question, "do the precautionary issues actually manifest themselves in FOT data?"

Table 8.15. Summary from studying owner’s manual precautions using FOT data

Topic	Precaution Issue	Observations from FOT data
Moderate Traffic Conditions	ACC is intended for engagement in light or moderate traffic conditions	One tenth of ACC usage in the FOT took place under heavy traffic conditions.
Moderate ACC Braking Limit	ACC can apply (only) limited braking levels	The full, 0.3-g autobraking response of ACC is rarely reached, indicating that a) this braking limit is almost always sufficient and/or, b) drivers tend to intervene before reaching it.
Readiness to Intervene	Drivers should be ready to take action and apply the brakes	Drivers showed a high level of readiness to intervene on ACC control, presumably aided by the haptic cue that arises from autobraking.
Winding Roads	Due to less detection range on tight curves, drivers should not use ACC on winding roads	1.5% percent of ACC driving was on curves that constrained detection ranges. These cases tend to be on low-speed roads where the need for full-range detection is reduced.
Slippery Roads	Due to reduced control on low-friction surfaces, drivers should not use ACC on slippery roads	ACC utilization typically fell by three quarters when wipers were on, but 4% of all ACC miles were traveled in the wipers-on condition. (see also the next item)
Low Visibility	Due to reduced vision and ACC performance, drivers should not use ACC when visibility is low	As with slippery roads, above, the wiper on/off state provides the only pertinent data from the FOT. Thus, friction and visibility effects of precipitation are assumed to combine in explaining the ACC utilizations cited above.
Leaving the ACC switch ON	Due to the risk of inadvertent engagement, drivers should switch ACC OFF until using it	A majority of all FOT trips were traveled with the ACC switch continuously ON. No inadvertent engagements are known to have occurred.
Stationary Objects	Since ACC may not detect and react to stationary, in-path objects, drivers should not use ACC when approaching them	FOT drivers did encounter stationary objects that triggered alerts once every 80 miles of ACC travel on surface roads. The short reaction times suggest that drivers were quite attentive to such threats.
Stopped Vehicles that may Suddenly Appear	Since ACC may not detect a stopped vehicle that suddenly appears, drivers should be ready to brake	Thirteen such incidents did occur while under ACC control, leading to ACC disengagement. Disengagement derived from driver braking and other switched transitions of the system.
Resting Foot on Accelerator Pedal	Since accelerator pedal application suppresses autobraking, ACC drivers should not rest their foot on the accelerator pedal	Throttle override is a frequently-occurring state in ACC driving. The portion of such events due to inadvertent resting of one’s foot is not apparent from FOT data.
ACC Use on Freeway Exit Ramps	Since ACC may lose track of targets on ramps, drivers should not use ACC on exit ramps	ACC was used on exit ramps rather frequently—once every 250 miles of ACC driving on freeways.
ACC Response to Cut-ins	Since ACC may not detect a cut-in vehicle until it is fully within the lane, drivers should be ready to intervene	Cut-ins are common under ACC control, with 6% resulting in driver interventions that spanned a wide range of delay times, presumably reflective of the perceived need for action.

8.1.11 Summary of ACC Safety Analyses

Section 8.1 has examined several aspects of driver interaction with ACC from the viewpoint of hypothesized potential safety implications. Each of the individual areas of analysis has concluded with a set of observations that are now summarized as a group, below. The specific contexts in which the ACC system appears to offer the same or better safety qualities than conventional modes of driving are as follows:

- *Longer headway times—ACC driving is transacted at longer headway times than are employed in manual driving under the same conditions.*
- *Reduced tendency to pass—Because ACC drivers tend to follow any given preceding vehicle for approximately twice as long as in manual driving, the ACC driver passes less frequently, presumably thereby lessening exposure to the hazards associated with lane-changing.*
- *Passing conflicts—When the flying pass is executed under ACC control, it is initiated at considerably longer range, resulting in lower levels of forward conflict than in either of the other modes of control.*
- *Reduced rate of manual brake application—The frequency with which the driver applies the service brake is much lower in ACC driving than in either manual or CCC driving under the same conditions.*
- *Comparable levels of deceleration—When the driver does apply the brake to intervene upon ACC control, the peak decelerations achieved and the prevailing conflict levels at the moment of braking onset are not significantly different from those observed when driver braking occurs in manual driving or as a means of intervening upon CCC control. Thus, other drivers following behind the ACC host vehicle should have encountered little difference in the severity of conflicts posed by ACC braking interventions from those commonly experienced when following either CCC- or manually-controlled vehicles.*
- *Low overall rate of imminent alerts—The fact that the overall rate of imminent alerts under ACC control is well below that of manual driving under the same nominal conditions suggests that the ACC controller may serve to moderate conflict severity better than does the driver operating manually.*
- *Relatively credible alerting to moving objects—Almost all of the moving-target alerts that were presented during ACC driving were deemed to be highly credible as a warrant for brake intervention.*
- *Relatively credible alerting to stationary objects—The stationary-target alerts that were presented during ACC driving were much more likely to be credible as*

a warrant for braking than was seen in stationary-target alerts during manual driving. Thus, while stationary targets were the source of a large group of false alerts by the FCW system, overall, they were much more likely to constitute a useful alert for the ACC driver, especially on surface streets

Other observations from the ACC driving data do not suggest safety improvements relative to conventional modes of driving. Listed below, these observations all derive from choices that drivers make about where, when, and how to undertake ACC driving.

- *Higher utilization in heavy traffic—ACC was utilized at several times the rate of CCC under heavy traffic conditions. Since heavy traffic calls for a higher rate of significant braking intervention by the ACC driver, this practice poses a significant requirement upon the driver's skill and readiness to intervene, (although conflict levels encountered during ACC control intervention were not higher than those seen in the manual or CCC modes of control).*
- *Higher utilization on surface roads—ACC was utilized at double the rate of CCC on surface roads. Although local roads pose more intense and more frequent conflict events, the significant decline in ACC usage in this environment over time suggests a novelty effect such that drivers were adapting to avoid the higher threats as they gained more experience with ACC.*
- *High novelty rate of limit autobraking events—The rate of limit autobraking responses by the ACC controller was noted to be markedly higher when drivers chose to utilize ACC on surface streets, although limit autobraking also occurred at intermediate speeds on freeways. A very rapid decline in the rate of limit-autobraking occurrences over the three weeks of ACAS driving showed that individuals were adapting to avoid such events.*
- *Constrained ACC performance on tight curves—A small fraction of ACC use was seen to occur on curves that were sharp enough to reduce the effective range of the radar. Although ACC control performance may be diminished in this circumstance, the lower traffic speeds on roads containing such curves tend to moderate any safety effects.*
- *The review of secondary, non-driving, behaviors showed that drivers did take on significantly more secondary tasks under ACC control than were seen under CCC control. However, the CCC data were notably sparse and the specific kind of additional secondary behaviors appeared to involve conversation with passengers in the vehicle, possibly as a novelty effect of ACC usage.*

8.2 Results of ACC Acceptance

The evaluation of algorithm-C driver acceptance of the ACC system is based largely on subjective assessments provided by the FOT drivers through a variety of mechanisms. Much of what follows in this section on ACC acceptance is based upon responses to a questionnaire which each driver completed immediately upon returning the research vehicle – the post-drive questionnaire (Section 8.2.1.1). In addition, there was an optional take-home questionnaire (Section 8.2.1.2). A review of driver’s responses to video replay of a sample of imminent alerts they experienced while using ACC is also provided (Section 8.2.1.3). Lastly, drivers had an opportunity to express their opinions about the ACC system by participating in an optional focus group session (Section 8.2.1.4). All but 2 of the algorithm-C drivers completed the take-home questionnaire, and 26 of the 66 drivers attended one of four focus groups that were held.

Where appropriate, drivers’ interactions which might connote acceptance of the ACC system are also examined (Section 8.2.2). Participant interactions with the ACC system, such as utilization, headway selection, the frequency of headway adjustment and changes in headway over time, are reported (Sections 8.2.2.1 and 8.2.2.2). Finally, the relationship between driver acceptance of ACC and person characteristics (age group, gender and income) are examined (Section 8.2.3).

8.2.1 Driver’s Perceptions and Evaluations of ACC

This section focuses on providing an overview of algorithm-C drivers’ subjective perceptions of the ACC system. The results are based almost exclusively on responses to post-drive questionnaires. The questionnaires, along with summary statistics, are provided in the Appendix E and F of this report. Where appropriate, statistical analyses have been performed and reported.

8.2.1.1 ACC Post-Drive Questionnaire Results

Appendix E contains summary statistics for each of the ACC post-drive questions examined. Responses to several key ACC acceptance questions indicate that only a few drivers felt that the ACC system they experienced was unacceptable. More often than not, there was a clear consensus that ACC was a desirable system. The overall mean response to the suggestion that ACC would increase one’s driving safety (ACC25) had an overall mean score of 5.5 on a 7-point scale, and a clear majority were willing to recommend the ACC system to a loved one (ACC31). When asked if they would consider purchasing an ACC system if they were buying a new car today (ACC32), approximately three-fourths of the drivers stated that they probably or definitely would

consider the purchase of an ACC system. However, when asked if they would consider purchasing an ACC system at a cost of \$1000, little more than one-third of the drivers stated that they definitely or probably would consider the purchase. However the sample of drivers was random from the licensed driving population, and therefore may not be representative of drivers (i.e., income levels) most likely to purchase initial ACC systems.

As for their overall satisfaction with the ACC system, drivers' responses resulted in a mean score of 6.0 on a 7-point scale (6.6 for older drivers). Differences amongst drivers were largely due to age rather than gender, where the majority of age effects were constituted in the dissociations between older drivers' ratings of the ACC systems to their middle-aged and younger counterparts. In general, the age differences resulted in older drivers viewing the ACC system more favorably than either the middle-aged or younger driving groups.

The results from the post-drive questionnaire, which follow, were exclusive to those drivers experiencing algorithm-C, all 66 of whom completed the post-drive questionnaire. Appendix E provides the entire questionnaire and descriptive statistics for individual questions by driver age group and gender along with plots of the overall mean responses by algorithm-C drivers. The majority of the questions utilized anchored, 7-point Likert-type scales. The statistical analysis of questions employing Likert-type scales utilized the non-parametric Kruskal-Wallis (K-W) one-way analyses of variance (ANOVA) by ranks test. For each analyzed question, all the responses were combined and ranked in a single series. The smallest scale response was replaced with rank 1, the next smallest response was replaced by rank 2 and the largest response with 66. The K-W test computes a mean rank for each group (e.g. age group). The K-W tests performed assessed rank differences in ratings based on driver gender, age group, and the interaction of gender and age group. A significant K-W ANOVA as is determined by using the H statistic whose distribution is similar to χ^2 (chi-square) when the size of each group is greater than 5 (Siegel & Castellan, 1988). A significant H for any of the questions indicated that there was a difference amongst driver groups. Alpha was set at 0.05 to determine statistical significance. Group differences were based upon mean ranks. The mean rankings for each group were then analyzed using the K-W statistic to determine if there were differences amongst groups of drivers for any given question.

Follow-up multiple comparisons on all Likert-type questions with significant group differences were performed using Dunn's test to determine how or where the groups differ. The Dunn's test is a conservative post-hoc test; therefore a moderate alpha correction of 0.15 was used to control for experiment-wise error that can occur with

multiple comparisons (Daniel, 1990). Nonetheless, because of how conservative the Dunn's test is, it is not possible to report multiple comparisons for all questions where statistically significant main effects were observed using the K-W ANOVA.

Manual Comparison Questions The first seven questions in the post-drive questionnaire asked drivers to assess the base vehicle, a Buick LeSabre, on several of the same dimensions as those addressed in the FCW and ACC portions of the questionnaire. The purpose for analyzing these questions was to determine if there might be a driver bias associated with the vehicle that was contributing to responses regarding acceptance of either the FCW or ACC systems. Six of the seven manual comparison questions utilized anchored, 7-point Likert-type scales. No significant differences associated with driver age, gender, or the age-by-gender interaction was observed. Means, and the distribution, of driver responses to these questions can be found in Appendix E.

Gender A one-way K-W ANOVA was conducted on all Likert-type questions regarding drivers' opinions of the adaptive cruise control (ACC) system. Differences between males' and females' subjective assessment of ACC were obtained. One significant difference that was observed was for comfort ratings using ACC in adverse weather (ACC7), where males were more comfortable than females, $H(1) = 5.529, p = .019$. In addition, males also rated higher their willingness to use ACC in adverse weather conditions (ACC35) than females, $H(1) = 5.941, p = .015$.

Age Comparable to age effects with FCW (Section 7.2), the results of driver responses to ACC also evidenced a similar dissociation between older drivers and the remaining age groups. Overall, for ACC, all questions that were rated differently according to a one-way K-W ANOVA are listed in Table 8.16.

To illustrate the differences in subjective assessments using ACC, follow-up multiple comparisons for questions with significant age effects were conducted using Dunn's test. Older drivers rated feeling safer using ACC (ACC2), $H(1) = 7.2, p = .028$, and differed from middle-aged drivers in the belief that it was safer to drive with ACC as compared to without the system (ACC8), $H(1) = 9.0, p = .011$. Older drivers also felt that ACC would improve overall safety (ACC25), $H(1) = 8.1, p = .017$. Older drivers were more satisfied with ACC (ACC10) than both middle-aged and younger drivers, $H(1) = 14.9, p = .001$, and had higher ratings in terms of using ACC to maintain safe distances (ACC3), $H(1) = 7.3, p = .026$, and to make lane changes (ACC22), $H(1) = 9.1, p = .011$, than middle-aged drivers.

In comparison to younger drivers, older drivers rated ACC as being more predictable (ACC9), $H(1) = 12.8, p = .002$, and felt they were more responsive drivers to other

vehicles while using ACC (ACC21), $H(1) = 10.2, p = .006$. There were no differences in ACC assessments between younger and middle-aged drivers.

Table 8.16. Post-drive questionnaire differences across age for ACC

Question Number	Question Description	Age	Mean	Mean Rank	$H(2)$	p
ACC1	Comfort using ACC	Younger	6.1	32.61	7.180	.028
		Middle	5.9	27.11		
		Older	6.6	40.77		
ACC2	How Safe while using ACC	Younger	5.6	29.41 ¹	9.601	.008
		Middle	5.8	27.95 ²		
		Older	6.5	43.14 ^{1,2}		
ACC3	Ease of keeping a safe distance	Younger	6.2	33.52	7.291	.026
		Middle	5.6	26.45 ¹		
		Older	6.6	40.52 ¹		
ACC5	Ease of driving while using ACC	Younger	6.3	31.36	6.107	.047
		Middle	6.0	28.59		
		Older	6.7	40.55		
ACC8	Drive safer w/ or w/o ACC	Younger	5.3	32.23	9.016	.011
		Middle	5.0	25.77 ¹		
		Older	6.1	42.50 ¹		
ACC9	Predictability of ACC	Younger	5.5	24.95 ¹	12.830	.002
		Middle	5.9	31.30		
		Older	6.5	44.25 ¹		
ACC10	Satisfaction with ACC	Younger	5.7	29.18 ¹	14.890	.001
		Middle	5.6	25.82 ²		
		Older	6.6	45.50 ^{1,2}		
ACC20	Aware of environment w/ ACC	Younger	6.3	30.05	8.544	.014
		Middle	6.4	28.80		
		Older	6.8	41.66		
ACC21	Responsiveness w/ ACC	Younger	5.9	27.89 ¹	10.168	.006
		Middle	6.1	29.48		
		Older	6.8	43.14 ¹		
ACC22	Comfort changing lanes w/ ACC	Younger	5.5	32.36	9.058	.011
		Middle	5.0	25.75 ¹		
		Older	6.3	42.39 ¹		
ACC25	Safety increased by ACC	Younger	5.3	30.80	8.117	.017
		Middle	5.0	27.25 ¹		
		Older	6.2	42.45 ¹		
ACC30	Comfort w/ ACC versus Trad. Cruise Control	Younger	5.5	28.23	6.979	.031
		Middle	5.9	30.82		
		Older	6.5	41.45		
ACC32	Likelihood of purchasing ACC	Younger	3.6	28.52	7.752	.021
		Middle	3.6	29.77		
		Older	4.3	42.20		

Mean ranks with matching superscript indicates a statistically significant difference exists between the means ($p < .05$, Dunn's test). Each mean is based upon an N of 22.

Due to age group differences, a one-way K-W ANOVA was also conducted across questions for the 6 possible Age X Gender groups (i.e., younger male, middle-aged female, older male, etc.). For ACC, there were 2 questions where driver assessments differed across groups.

The results are listed in Table 8.17. To determine what groups differed, a follow-up Dunn's test was conducted for those questions with significant Age X Gender differences. Differences amongst age groups for both ACC were primarily due to the rating disparities either older males or older females in comparison to their middle-aged and younger cohorts. For example in regards to ACC, older females viewed the system as being more predictable (ACC10) than younger females, $H(1) = 15.0, p = .010$, and were more satisfied with ACC (ACC9) than were middle-aged females, $H(1) = 13.8, p = .017$.

Table 8.17. Post-drive questionnaire differences across age x gender for ACC

Question Number	Question Description	Age	Mean	Mean Rank	H(5)	p
ACC9	Predictability of ACC	Younger_Male	5.6	28.32	13.846	.017
		Younger_Female	5.3	21.59 ¹		
		Middle_Male	5.9	32.41		
		Middle_Female	5.9	30.18		
		Older_Male	6.5	42.59		
		Older_Female	6.5	45.91 ¹		
ACC10	Satisfaction w/ ACC	Younger_Male	5.7	28.59	15.010	.010
		Younger_Female	5.6	29.77		
		Middle_Male	5.6	26.32		
		Middle_Female	5.6	25.32 ¹		
		Older_Male	6.6	44.41		
		Older_Female	6.5	46.59 ¹		

¹ = Difference between age groups ($p < .05$, Dunn's test); ² = Difference between age groups ($p < .05$, Dunn's test). Each mean is based upon an N of 11.

8.2.1.1.1 Factor Analysis of ACC Post-Drive Questionnaire Results

A factor analysis of the data for all algorithm-C drivers produced 7 factors. The factors were retained based on their Eigenvalues being greater than or equal to 1. A seven factor solution accounted for 74.737 percent of the variance. The factors were extracted using principal component analysis and were rotated with an equamax rotation. This rotation produced a simpler rotation than a varimax, quatrimax, or an un-rotated solution, meaning the variance was most evenly distributed among the factors using this rotation method.

Total Variance Explained

Component	% of Variance	Cumulative %	Eigenvalues
1	13.974	13.974	8.137
2	12.447	26.422	3.195
3	11.551	37.973	2.540
4	11.314	49.287	1.768
5	9.773	59.059	1.522
6	9.613	68.673	1.202
7	6.064	74.737	1.068

The results are below (items in parentheses are not as clearly placed, and are listed on two factors, the one in bold is where it best fits conceptually):

- Factor 1 (comfort and overall satisfaction): Q9, Q10, Q13, Q22, (Q23), (Q25) Q30, Q32
- Factor 2 (overall ease and comfort): Q1, Q2, (Q3), Q5
- Factor 3 (individual comprehension and awareness): Q6, Q19, Q20, Q21, **(Q23)**
- Factor 4 (safe distance from lead): **(Q3)**, Q17*, Q24*, Q28*
- Factor 5 (comparative to without ACC): Q8, **(Q18)**, **(Q25)**, Q26*, Q27
- Factor 6 (Adverse conditions): Q7[^], Q35
- Factor 7 (unsafe braking): (Q18), Q29*

* Items designated by an asterisk have been reverse coded so that positive values indicate positive attributes about the ACC system. Also, responses of "0" "did not experience" was not used when calculating factors with question 7, these responses were treated as null values.

Scale Reliability. Cronbach alphas were also determined for the subscales that had been determined a priori. This evaluated the internal consistency of items on a previously constructed scale. All of these values were near acceptable to acceptable (greater than .70, which is a lenient cut off). However, the *ease of use* category did not quite meet this criterion. Several questions were not included in this analysis. All questions that were not in the form of a Likert scale were not included, such as yes/no or fill in the blank. Questions 14, 15, and 16 could not be used because their scales were formatted differently; the positive evaluation was in the middle of the scale rather than on either end.

Comfort and convenience. Cronbach alpha: .7691

Q1, Q13, Q22, Q27, Q30

or Cronbach alpha: .8273

Q1, Q7^{r^}, Q10, Q13, Q22, Q27, Q30, Q35

(where items 7, 10, and 35 are not as directly related to comfort and convenience)

Safety. Cronbach alpha: .7679

Q2, Q3, Q7^{r^}, Q8, Q9, Q17*, Q18, Q20, Q21, Q24*, Q25, Q26*, (Q29* was negatively correlated.), Q28*, Q29*, Q35

Ease of use. Cronbach alpha: .6609

Q5, Q6, Q19, Q23

Willingness to purchase. Cronbach alpha: .8266

Q10, Q32

^”0” “did not experience” was not used when calculating scales with question 7, these responses were treated as null values

These results suggest that the predetermined subscales of comfort and convenience, safety, ease of use, and willingness to purchase provided a more robust model for categorizing the questions of the post-drive questionnaire than did the factor analysis. It is possible that the wording of the questions and/or the drivers’ understanding of the ACAS system made it difficult to reduce the questionnaire into a small number of factors by way of a factor analysis.

8.2.1.1.2 Van Der Laan Scale of ACC acceptance

The Van Der Laan scale, which allows researchers to compare driver acceptance across studies, was used to evaluate driver acceptance of ACC. See section 7.2.1.1.3 for a complete description of the Van Der Laan scale procedure.

The usefulness scale resulted in a score of +1.49, as compared to the .90 obtained for FCW. A value of +1.49 indicates very positive feelings toward the ACC system. In comparing these findings to a study investigating a similar system, a stronger preference for the ACC system evaluated here was found. The study by Rothengatter and Heino (1995) that analyzed an AICC system had an overall usefulness score of +.34 according to Van Der Laan et al. (1997). This score also indicates positive feelings about the system, but not with the same strength as with the current ACC system. However, the procedure of the Rothengatter and Heino study was very different from the ACAS procedure as the drivers of the AICC study were in a simulator, rather than on the road. Also, the study was over a much shorter time. The satisfying scale score for the ACC system was +1.48, as compared to .50 for the FCW, also indicating positive feelings toward the system. Satisfaction was rated nearly equally with usefulness. According to Van Der Laan et al., the AICC system had a satisfying score of -.18 indicating slightly negative feelings toward the AICC system. It appears that the ACC was much more satisfying than the AICC system.

8.2.1.2 ACC Take-Home Questionnaire Results

Gender. Males and females tended to have similar reactions to the ACC system, and no significant differences were obtained.

Age. Unlike the results obtained for gender, the one-way K-W ANOVA conducted for age as the grouping variable found various differences amongst age groups regarding the ACC system. Table 8.18 lists statistically significant differences in the subjective ratings of ACC between age groups. Follow-up Dunn's multiple comparison tests revealed no differences between younger and middle-aged drivers. However, middle-aged drivers were less comfortable than others using ACC (ACC12), $H(1) = 11.3, p = .004$, and were less willing to use ACC in multiple traffic conditions (ACC17), $H(1) = 8.3, p = .016$, than were older drivers. In regards to younger versus older drivers, younger drivers were significantly more in favor of adding a closer, less conservative, headway setting (ACC4) than were older drivers, $H(1) = 12.3, p = .002$. Furthermore, younger drivers felt ACC was less predictable (ACC9) than did older drivers, $H(1) = 8.8, p = .012$. There were also age related significant differences associated with the ACC slowing the vehicle (ACC16), $H(1) = 6.1, p = .047$, and a willingness to rent a vehicle with ACC (ACC18), $H(1) = 7.2, p = .028$. In both instances, older drivers were more receptive to ACC than their younger and middle-aged counterparts.

Table 8.18. Take-home questionnaire ranking mean differences across age for ACC

Question Number	Question Description	Age	Mean	Mean Rank	$H(2)$	p
ACC4	Addition of a closer gap setting	Younger	3.8	42.31 ¹	12.343	.002
		Middle	2.5	33.59		
		Older	1.5	23.52 ¹		
ACC9	Predictability of ACC	Younger	5.3	26.45 ¹	8.769	.012
		Middle	6.0	30.48		
		Older	6.5	41.77 ¹		
ACC12	Comfort with others using ACC	Younger	6.0	32.21	11.301	.004
		Middle	5.6	24.89 ¹		
		Older	6.7	41.86 ¹		
ACC16	Comfort with ACC slowing car	Younger	5.2	29.21	6.120	.047
		Middle	5.3	28.80		
		Older	6.2	40.82		
ACC17	Willingness to use ACC across cond.	Younger	4.6	30.86	8.330	.016
		Middle	4.2	26.14 ¹		
		Older	5.6	41.91 ¹		
ACC18	Willingness to rent ACC-equipped car	Younger	6.0	31.02	7.152	.028
		Middle	5.3	27.30		
		Older	6.4	40.59		

Mean ranks with matching superscript indicates a statistically significant difference exists between the means ($p < .05$, Dunn's test). Each mean is based upon an N of 22 except for the younger drivers' mean responses which had Ns of 21.

Finally, due to differences that emerged within age groups, Age X Gender groups were analyzed using a one-way K-W ANOVA. For ACC, Age X Group differences were obtained when drivers were queried about adding an additional headway setting (ACC4) allowing for closer following distances, $H(5) = 21.496, p = .001$, and one's comfort level

with allowing a loved one to drive an ACC-equipped vehicle (ACC12), $H(5) = 11.965$, $p = .035$. Follow-up multiple comparisons using Dunn's test for those questions with significant Age X Gender effects revealed that younger females and middle-aged females were more in favor of adding an additional closer headway setting than were older females. Moreover, middle-aged women were more likely than their middle-aged male cohorts to prefer adding an additional headway setting on the ACC. No significant Age X Gender differences were obtained using Dunn's test regarding comfort level with others using ACC-equipped vehicles.

8.2.1.2.1 Factor Analysis of Take-Home Questionnaire Results

A factor analysis of the data for all algorithm-C drivers produced 5 factors. The factors were retained based on their Eigenvalues being greater than or equal to 1. A five factor solution accounted for 65.991 percent of the variance. The factors were extracted using principal component analysis and were rotated with an equamax varimax rotation. This rotation produced a simpler rotation than a varimax, quartimax, or an un-rotated solution, meaning the variance was most evenly distributed among the factors using this rotation method.

Total Variance Explained

Component	% of Variance	Cumulative %	Eigenvalues
1	16.828	16.828	4.602
2	15.480	32.308	1.723
3	13.920	46.228	1.485
4	10.996	57.224	1.069
5	8.767	65.991	1.019

The results are below (items in parentheses are not as clearly placed, and are listed on two factors, the one in bold is where it best fits conceptually):

- Factor 1 (overall comfort and likeability): Q10, Q12, Q13, Q14, Q15, (**Q18**)
- Factor 2 (Ease of use, understanding operations): (**Q1***), Q2*, Q9
- Factor 3 (Overall liking and acceptance): (Q1*), Q8, Q16, (**Q18**)
- Factor 4 (Safety: aggressive?): Q4*, Q11*
- Factor 5 (Safety): Q5*, Q7*

* Items designated by an asterisk have been reverse coded so that positive values indicate positive evaluations of the FCW system.

Scale Reliability. Cronbach alphas were also determined for the subscales that had been determined a priori. This evaluated the internal consistency of items on a

previously constructed scale. Only the *ease of use* scale met the criterion for a valid scale, a Cronbach alpha value greater than or equal to .70. The low values of the scales Cronbach alphas indicate that these scales are not very reliable at predicting the predetermined categories, which may be due in part to the categorization of questions performed a priori. Several questions were not included in this analysis. All questions that were not in the form of a Likert scale were not included, such as yes/no, choose as many options as you'd like, or fill in the blank. Questions 3 and 17 were not included even though it was Likert based because they did not have clearly positive and negative anchors.

Comfort and convenience. Cronbach alpha: .6873

Q1*, Q10, Q11*, Q12, Q16

Safety. Cronbach alpha: .3196

Q4*, Q5*, Q7*, Q8, Q13, Q14 (Q7* is negatively correlated in the scale after being reverse coded.)

Ease of use. Cronbach alpha: .55499

Q2*, Q9

Willingness to purchase. Cronbach alpha: .5653

Q15, Q18

*items designated by an asterisk have been reverse coded so that positive values indicate positive evaluations of the FCW system.

8.2.1.3 Review of ACC Key Events for Utility

As part of the orientation session (in an instructional video and on an accompanied test drive), drivers were instructed that ACC would not respond to stopped vehicles in the path of the ACAS-equipped vehicle or vehicles traveling very slowly relative to the ACAS vehicle's speed. Several drivers believed that ACC would decelerate the ACAS-equipped vehicle as they approached stopped vehicles at traffic lights. There were six imminent alerts resulting from drivers driving with ACC engaged and approaching vehicles which were stopped at lights. In this situation, the comments, which were recorded in the vehicle, made by one driver indicate that he was waiting for the ACC system to brake in response to the stopped lead vehicle. While attempting to demonstrate ACC's automatic braking feature to her spouse, one driver appears to become quite alarmed when the system did not decelerate the test vehicle as she approached slow-moving, expressway traffic.

Overall, drivers were quite satisfied with the performance of the ACC system. During the debriefing session, drivers had the opportunity to make recommendations for changes to the ACC system. The most frequently reported recommendation was to make the onset of braking and acceleration more gradual. Additionally, a number of drivers requested greater acceleration for passing maneuvers. Changing the number of headway settings was mentioned by several drivers. A complete list of the recommendations from the post-drive questionnaire results can be found to question ACC34 in Appendix N.

8.2.1.4 Synopsis of Focus Group Responses Regarding ACC

In general, focus groups generate data through group discussion and interaction. They not only provide details about what people think, but why they think the way they do. Focus group data do not lend themselves to quantitative analyses, rather from these data patterns or themes emerge. The range of information gleaned from the ACAS FOT focus groups provides a partial story concerning ACC system acceptance.

There were four focus groups held in order to obtain a better understanding of drivers' experiences with the ACAS system. Each focus group involved a small number of drivers (5 to 7 drivers) and was a structured discussion led by a facilitator. Each of the four groups was asked the same questions in the relatively the same order. Discussion was guided by a power point presentation on which the questions were displayed. In order to provide an overall sense of the drivers' responses the following summaries to each individual ACC related question is provided.

Overall, did you find ACC useful?

- *In what traffic conditions did you like using ACC?*
- *In what conditions did you prefer not to use ACC?*

The overall sentiment was that drivers liked the ACC system and found it useful. "I loved the ACC. I used the ACC in almost any traffic conditions there was." However, one driver expressed great dislike. "I did not like the system at all. They couldn't give it to me...I disliked it that much that I wouldn't even use it." Participants willing to use ACC in a myriad of situations, though there were some in which some drivers were hesitant to use it, especially in heavy traffic, poor weather, and sometimes on the expressway. "(I)f I had my choice because I err on the cautious side, I would prefer not to use it in heavy traffic". Participants recalled that at some points the brakes were applied by ACC when they should not have been, or that the system did not accelerate as quickly as they desired. "(W)hen I would approach a vehicle and I would pull out into the passing lane it was almost I had to fight the system to accelerate. And I found myself

spending more time looking in the rearview mirror as traffic is coming up to me saying if I didn't hit this accelerator—". The vast majority of drivers expressed comments which reflected their finding the system useful. "I can see my ride going up north being a lot less stressful by just that feature."

Compare your overall driving experience with ACC versus conventional cruise control.

Participants seemed to like the system better than conventional cruise control, though many did express some concerns. Some drivers felt that the system had made them lazier and perhaps even less aware of their surroundings. "I think it lessened my awareness of the situation around me using that...with ACC I would literally find myself in more situations where I was zoned out and didn't even know I had decelerated 10 miles an hour and all of sudden, wait a minute, I'm going 62 and so that concerned me." Other drivers expressed concern that the system braked harder than they would have with conventional cruise control. "(A)t times brought you a little bit too close to the vehicle before it did brake...and then when it did brake it did it hard instead of like a gradual slow down like you would do in normal driving". Participants did really like features unique to adaptive cruise control. For instance that "it didn't take my reaction time to back off on the cruise...so it eliminated that time...makes it much more effective as compared to conventional cruise". Some drivers just really loved the system and found it a very positive experience. One even commented that ACC "Beats it all to pieces, beats conventional to pieces."

Did you make any errors when using ACC?

– *If so, what types?*

The most common errors appeared to be ones of forgetfulness. Several people mentioned forgetting to turn it off, in general and on exit ramps. "All I had to do was tap the brake. It just never entered my mind." Others made mistakes when they forgot that they were not in ACC, one occurred after the driver had returned the car and was then in his own vehicle. One woman recalled thinking "Oh hey I'm not in cruise control I've got to brake." Participants talked about being in control, shadowing the brake, etc. Some drivers felt it was an error when they did not intervene when they felt uncomfortable with the braking of the system. "I made an error in judgment really, letting the car drive me when I should be in control."

Were there situations when ACC prevented a rear-end accident?

There was not much discussion on this topic. Those drivers that did speak on the subject varied in their opinions. When people thought it did it was mainly for instances

where they were zoned out or distracted, though one driver thought that ACC had gotten her to that state in the first place. One driver thought that the relaxed state in and of its self may have prevented accidents. “I think in like a, very, very proactive sense it does because it made me able to just pretty much sit back, relax and let the thing drive so I’m more relaxed...so road rage disappeared.” Some drivers felt that it did not and some even thought there was a potential for it to create more, given their increased apprehension regarding the traffic behind them.

Were there situations when you were uncomfortable with the ACC behavior?

There were two main things that made drivers uncomfortable: slow acceleration and incorrect braking. Many drivers recalled being worried about traffic behind them and frustrated with the hesitation in the acceleration. “I would pull into a lane and I would be waiting for it to take off and it would take forever and there would be cars flying up behind me and it took a long time to kick in.” One driver reported pressing on the gas himself to increase the acceleration. Several people described times when there seemed to be an error in braking, either it missed something or it braked and the driver could not tell why. “When it was braking that car there when there was absolutely nothing in front of me”. Some drivers felt that the braking was too harsh, others felt that it was too late. One person felt that it accelerated too fast.

Were there situations when ACC behaved such that it could have led to a rear-end accident?

Participants talked about two main ways they thought ACC might contribute to a rear-end accident. The first was when they reported that the system missed the target ahead, for instance motorcycles, car haulers, or in one instance during rush hour. The other main situation was when it was reported that a driver pulled out into the lane to pass and there was no acceleration or it was slower than they would have liked. One driver described a time the acceleration seemed to not kick in at all: “When I pulled out it just failed to accelerate...So I had to take over and accelerate and then it was okay again.” People also reported being concerned with the traffic behind them when they were decelerating behind a slower vehicle. Some people mentioned that ACC braked too hard and one man mentioned that the people behind might brake too strongly in response to the brake lights, not knowing that you have ACC, and then they might cause a collision behind you.

How do you think the ACC responded to stopped vehicles?

Overall it seemed that most drivers did not recall encountering any situations with stopped vehicles. A few people talked about their experiences with it. They commented

that they found it would slow down with the vehicle, but that they had to do they actually stopping, even that the system seemed to drop the target once the lead vehicle stopped completely. “(O)nce that vehicle came to a complete stop it is like your system shutdown and you kept going. I had to override it.” One driver reported approaching stopped vehicles the ACC never picked up, “It just kept going, the Forward Collision system, the warning went off, but the ACC was still accelerating”. Most people reported no experience with the situation.

How about slow-moving vehicles?

The drivers that answered this question seemed to be very pleased with ACC’s response to slow moving vehicles. “I think it really did a good job at least with slow-moving people coming out of the ramp...It would back itself all the way down and slowly bring itself back up again”. One woman felt that it was too jerky in terms of braking but another driver really appreciated the hard braking and others agreed. “I noticed that it actually did respond to slower moving vehicles and it braked really nice and hard. I let it go and it did exactly what it needed to.”

How often did you override the ACC braking?

- *You applied the brakes harder than ACC would.*

Many drivers did not recall ever overriding the braking; in one focus group no one did. Those who did stated that it occurred fairly infrequently, one or two times. In one focus group a driver talked about overriding the brake more at the beginning. “At the very beginning I overrode it a couple of times. Then I started letting it do its thing, but then I had my foot hovering over the brake.” In response to that comment another driver talked about how “I think the more comfortable that you get with it the better the system will work. You are not always second-guessing it.” Several people agreed with him. Though most people did not recall many instances, one woman said that she overrode the system often while on the expressway as she did not feel comfortable with the braking and so she wanted to be in control.

What do you think about the maximum level of ACC braking?

- *Did you get a good sense of the maximum braking level?*
- *Did you experiment to find this level of braking?*
- *Too high, just right, too low?*
- *Were you comfortable with this level of braking?*

Overall drivers seemed to be comfortable with the level of braking and thought it was just right. “My feeling it was just right. I don’t want that thing to slam the brakes on for

me, I want that to slow me down.” People stated that they were impressed with its braking. However, if people were leaning one way it was toward thinking that the braking was a bit too harsh. Some people felt it was too harsh and did not like it while two people directly commented that it was more severe than they would like, but it did not really bother them. “I thought it was a little harsh, but when I consider how close the car was coming I guess it was just right.” People appear to have mainly experimented by changing headway settings and approach situations to see what ACC would do.

What did you think of the range of settings for adjusting the distance to the vehicle ahead?

- *Were there enough settings?*
- *What about the closest distance setting, was it too close, just right, too far?*
- *What about the farthest distance setting, was it too close, just right, too far?*

Participants seemed very satisfied with the range of headway settings. “I was comfortable with the setting the way it was 1 through 6. I thought it was a good range.” Most drivers expressed having a favorite setting; some had different settings for different situations and road class. One person expressed interest in a setting closer than 1 while two people wanted a setting one car further than 6. Some drivers described one problem with the 6 setting, and why they did not use it. People found that it left too large of a headway which “allowed cars to cut in front of you which caused you to brake where you were attempting to keep a particular distance.”

Do you think that ACC will reduce harm caused by rear-end accidents?

There were a variety of responses for this question and one focus group did not get to this question, due to running out of time. One group thought yes and one reason was because “everybody takes their eyes off the road for a second, but with Adaptive Cruise Control that at least will back you off if the vehicle in front of you slows.” Many people felt that there simply were not enough opportunities for ACC to reduce rear-end collisions because “Most people won’t use it in the type of traffic situations that rear-end accidents are caused”. The possibility that ACC could cause some rear-end collisions was also raised. One driver discussed an issue he had with the acceleration and its potential to create a situation where the person behind would run into you: “there is definitely something wrong in an algorithm or how it is programmed that when you pull

out to pass that that system doesn't, it fights you...the guy in front of you or the gal in front of you is going to be fine. You are the one that is going to be hit."

Do you think this ACC made you a safer driver?

– *Did you drive more or less aggressively?*

Overall drivers expressed that they felt the ACC system made them a less aggressive driver and more relaxed. A few drivers even commented that they felt there had been some lasting change: "Yeah, I think it actually led me to be a less aggressive driver now. I was kind of a lead foot before...now I just keep my foot at one steady pace...it actually has had a lasting effect on me which I think is great." People said that they maintained a longer following distance, did the speed limit more often, and felt more relaxed and less aggressive. "it just slowed you down and made you a little bit less aggressive I think."

Are there other ways you think ACC may have changed the way you drove?

This question resulted in very little discussion. In two of the four groups there was no answer. The overall sense was that it made drivers more relaxed and a little more content to be behind slower moving traffic. One driver commented that it "Just made me more relaxed, more comfortable." People found that it reduced their stress, though one driver reported that it had no effect.

Did ACC perform in the way you would expect it to if you bought this feature?

– *If not, how should ACC perform differently?*

Overall drivers thought that the system performed the way that it should, though some drivers did have some suggestions. Braking seemed to be the largest issue. One driver, picking up on the differences in driver's opinions, suggested that "We all drive so different...it should be customizable...it could be a 1 to 6 braking speed or something like that...because some people say, well, it made it brake too fast. Some people say it doesn't brake fast enough." One woman who received a *dirty radar* message said that she would change it by adding a switch to where (she) could shut the adaptive cruise off and used (her) normal cruise". No one mentioned that they felt that it performed differently than they had thought it would given their instructions.

Do you think ACC is ready for production?

The response to this question varied heavily by focus group. Two of the group's drivers who answered all said yes or I don't know whereas the other two had some people who thought that some improvements needed to be made first. Many people were fairly general with their comments, suggesting that it needed to be "tweaked". Other drivers had specific suggestions. For example, that "you might be able to reduce the amount of

information in terms of quantity of information that's on that screen. I think it might be a little bit less distracting." Braking too hard and a delayed acceleration were still topics of conversation.

Would you buy an ACC system?

The overall response of the drivers was yes. One group did not answer this question and in one group all of the people who responded said yes. People in the other two focus groups put more qualifications on their response such as "If the price was right". Other people said that they probably would buy ACC because \$1000 dollars likely would not effect their monthly payments that much. Some drivers also thought that it would depend on why they were buying the car, what type of driving they planned to do with it. One driver expressed well what the sentiment seemed to be in at least two of the groups: "I would be hard pressed to pay \$1,000 for that. But I really like the idea of this."

How would you improve the ACC system?

Most of the comments had to do with issues that were brought up before and people seemed to be fairly happy with the overall system. "I was happy with it the way it was. I mean other than the little quirky thing the aggressive braking and lack of acceleration on lane change." A few individual had some specific other suggestions. People generally remarked that they like the HUD. One person found it somewhat distracting, though she liked it, and another had problems with it showing ghost shadow images of the black box at night. "At night I would drop it down so I wouldn't see it so much because it kind of had a glare in your eye." One driver wanted either pedal, brake or gas, to disengage the system. Another driver did not and wanted to keep it as is.

8.2.2 ACC Interactions Connoting Acceptance

The following analyses examine the degree to which drivers utilized the ACC system, the headways (i.e., headway time margins) selected by drivers while ACC was engaged, and the frequency with which drivers changed headway settings. These analyses are aimed at understanding differences in driver comfort using ACC and preferences for specific headway settings.

Because drivers had the choice of whether or not to engage the ACC system during the enabled period, the degree to which individual drivers choose to use ACC (utilization) is also examined. Percent ACC utilization was defined as $= ((\text{time engaged}/\text{time available}) * 100)$. Therefore, in order to be included in the analyses for ACC utilization the state of the vehicle during the enabled period had to meet the following condition: vehicle speed was greater than 25 mph and maintained for at least 3 s.

In order for data to be included in the headway selection and change analyses, the state of the vehicle during the enabled period had to meet the following conditions: 1) ACC had to be engaged, 2) the vehicle speed had to be greater than 25 mph, and 3) the dwell time on any particular setting was greater than 3 s.

8.2.2.1 Acceptance of ACC by Utilization

Utilization for All Road Classes. The overall availability for the use of both conventional and adaptive cruise control systems is defined as driver speeds greater than 25 mph. Subsequently, the percentage of time drivers who were engaged in conventional cruise control while the system was available is used a metric to gauge driver acceptance of both conventional (CCC) and adaptive cruise control systems.

A 2 (gender) X 3 (age group) X 4 (week) repeated-measures ANOVA was used to analyze if 1) there was difference in utilization between CCC (week 1) and ACC (weeks 2-4), and if 2) there was a change in ACC utilization across weeks 2 thru 4. In addition, age and gender were added as between-subject factors to determine if cruise utilization differed across demographic groups. Greenhouse-Geisser corrections were not applied due to a sufficient established sphericity coefficient ($\epsilon = .936$).

A significant main effect of week was obtained, $F(3, 180) = 7.712, p < .001$. Follow-up planned simple contrasts revealed that cruise utilization was significantly less for CCC during week 1 ($M = 14.74\%$) than for ACC during week 2 ($M = 22.28\%$; $F(1, 60) = 10.921, p = .002$), week 3 ($M = 23.35\%$; $F(1, 60) = 11.514, p = .001$), and week 4 ($M = 26.44\%$; $F(1, 60) = 24.273, p < .001$). Furthermore, there was no change in ACC utilization across weeks 2 thru 4. Figure 8.78 illustrates the relationship of cruise utilization across weeks.

In addition to effects of week, a main effect was also obtained for gender, $F(1, 60) = 4.252, p = .044$, where males ($M = 24.96\%$) utilized both forms of cruise control more than females ($M = 18.45\%$; Figure 8.79).

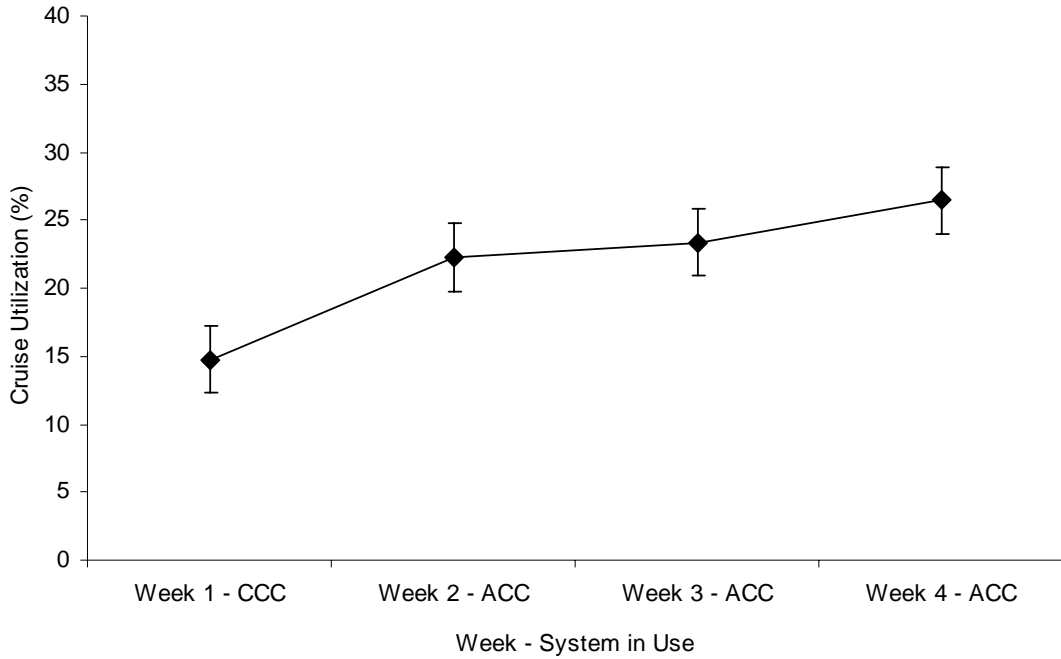

Figure 8.78. Percent of cruise utilization by ACAS enablement and week. Error bars represent standard error of the mean (SEM).

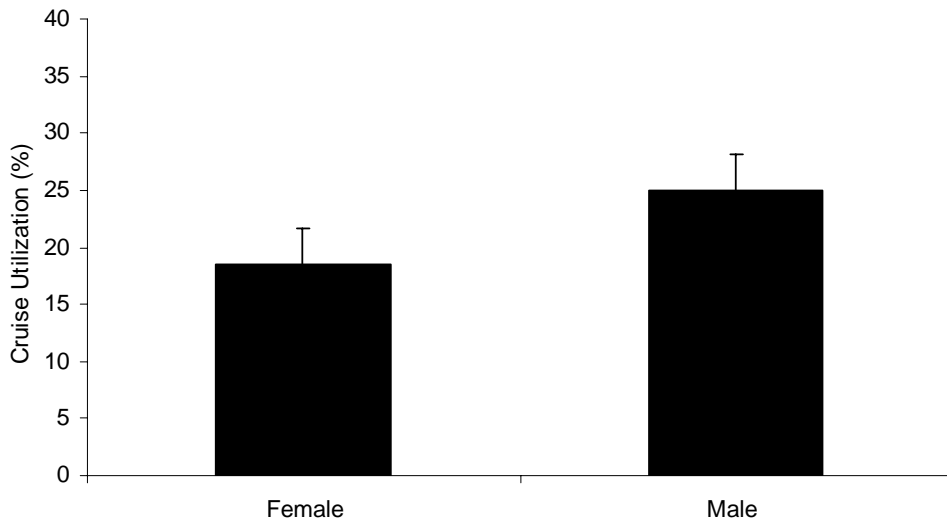

Figure 8.79. Overall mean cruise utilization by gender. Error bars represent standard error of the mean (SEM).

A main effect of driver age group was also observed, $F(2, 60) = 9.717, p < .001$. Follow-up paired comparisons revealed that younger ($M = 18.15\%$) and middle-aged drivers ($M = 15.53\%$) did not differ in their utilization of cruise control across weeks; however, older drivers ($M = 31.42\%$) utilized cruise at approximately twice the rate of

middle-aged drivers, $t(42) = 4.832, p < .001$, and significantly more than younger drivers, $t(42) = 3.123, p = .003$ (Figure 8.80).

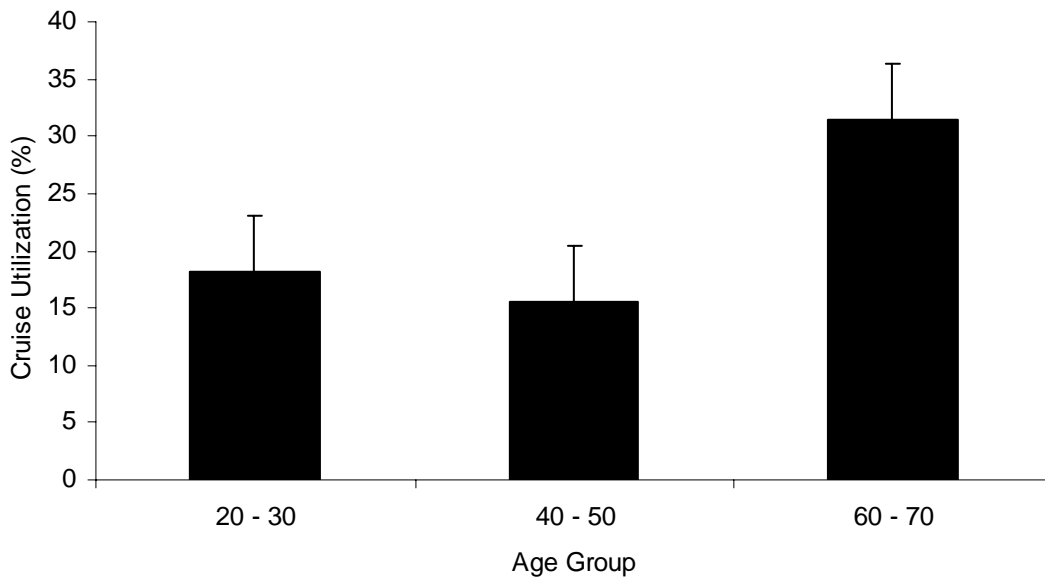

Figure 8.80. Overall mean cruise utilization by age group. Error bars represent standard error of the mean (SEM).

Overall, these results indicated that ACC was utilized more than CCC. This may be that drivers preferred ACC in addition to finding that it could be utilized in a wider range of conditions relative to CCC. Another factor that may contribute to the differences observed between the two cruise control systems is the notion of novelty. ACC may have been used more often than it would have been otherwise due to a desire to experiment and explore the system. However, because ACC rates were sustained across the three week enabled period, it is thought to be unlikely that a novelty alone could offer an explanation. One additional factor to be considered is the demand characteristic of the experiment. Drivers understood that usage of ACC was being examined, so they may have utilized the system above and beyond the rates they would typically employ cruise control. However, ACC could have been utilized more because drivers simply preferred this system relative to CCC which can be corroborated by subjective data (see Section 8.2.1.1).

Utilization for Freeway Driving. The percent of time drivers utilized either cruise control option in freeway settings was analyzed. Availability for using cruise control was established based on three parameters: 1) drivers must be on multi-lane freeways; 2) driver speeds must exceed 45 mph; and 3) speeds above 45 mph must be maintained for

at least 3 s. Likewise, to calculate when drivers were engaged in either form of cruise control use, the same parameters as above needed to be met with the cruise control system engaged. Therefore, cruise utilization percent was derived from the time drivers were using cruise control on freeways divided by their total time on those roads.

A 2 (gender) X 3 (age group) X 4 (week) repeated-measures ANOVA was conducted to determine if 1) utilization differed from week 1 when only CCC was available as compared to weeks 2 thru 4 when ACC became enabled and 2) utilization of ACC changed as exposure to the system increased across weeks 2, 3, and 4. In addition, gender and age groups were also included in the analysis to determine if utilization differed by driver demographics. The sphericity assumption was sufficiently met ($\epsilon = .905$); therefore, no Greenhouse-Geisser correction was applied to any within-driver factors.

A significant main effect of week was obtained, $F(3, 180) = 11.350, p < .001$. Follow-up simple contrasts revealed that drivers utilized ACC more than CCC on freeways during each week (p 's $< .03$). Moreover, in regards to ACC utilization during weeks 2 thru 4, weeks 2 and 3 did not statistically differ, with a slight drop in utilization percent occurring in week 3 (Figure 8.81). However, during week 4, ACC utilization percent on freeways was higher than all other weeks (p 's $< .03$) suggesting that not only was ACC used more than CCC, but that its utilization did not likely suffer from a “novelty effect” but rather was a robust system that drivers may opt to further utilize.

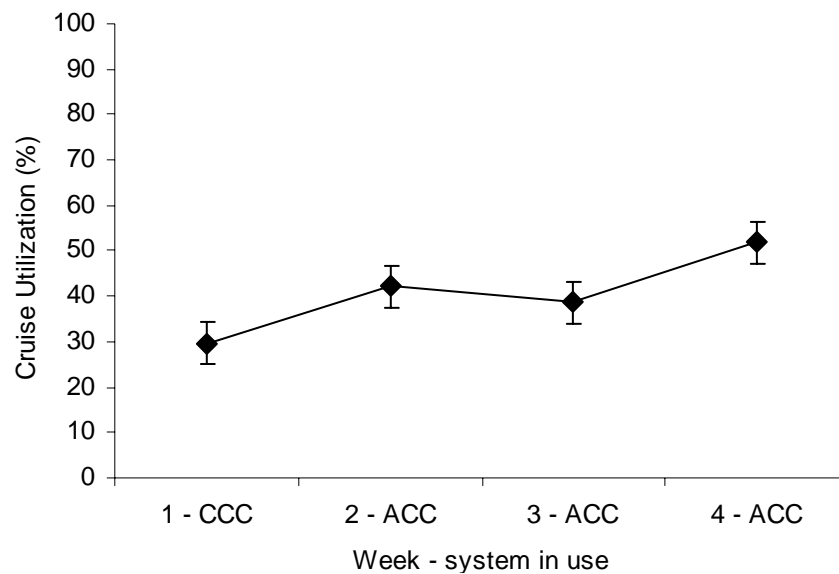

Figure 8.81. Percent Cruise Utilization on Freeways by Week. Error bars represent standard error of the mean (SEM).

In addition to week, a main effect was also observed for driver gender, $F(1, 60) = 12.427, p = .001$, where over all weeks males used cruise control ($M = 48.40\%$) more than females ($M = 32.64\%$) when in freeway settings. There was no gender by week interactions obtained; however as illustrated in Figure 8.82, males had numerically higher percentages of freeway cruise utilization across weeks.

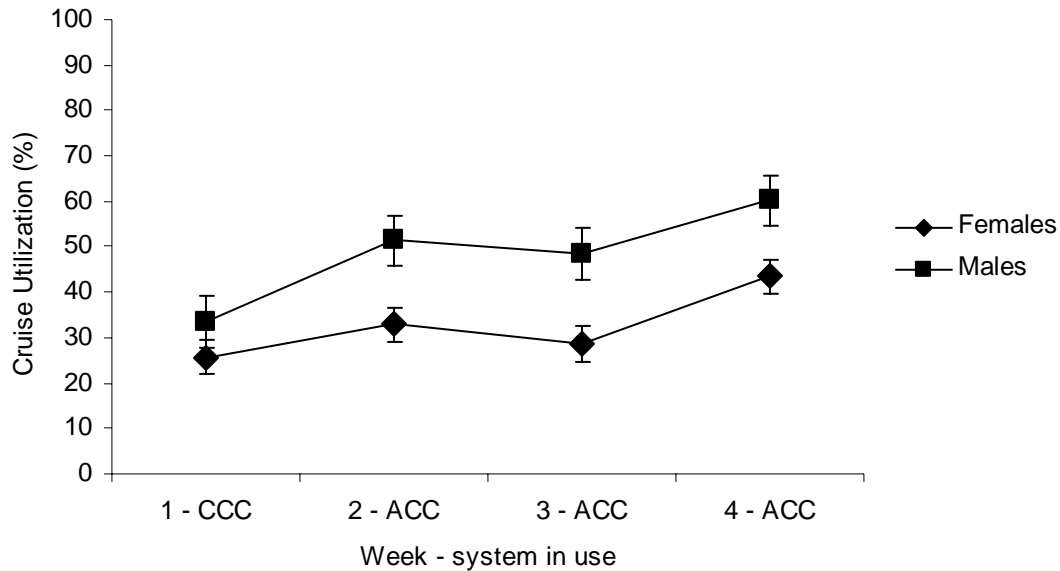

Figure 8.82. Effect of gender on cruise utilization percent by week. Error bars represent standard error of the mean (SEM).

Follow-up independent samples t -tests confirmed these findings in all weeks except week 1, where the differences were not significant. Table 8.19 reports the means and significance of percent cruise utilization on freeways for week by gender.

Table 8.19. Effect of gender on cruise usage by week

	Gender	M	$t(64)$	p
Week 1 - CCC	Female	25.69%	1.222	.226
	Male	33.44%		
Week 2 - ACC	Female	32.84%	2.460	.017
	Male	51.47%		
Week 3 - ACC	Female	28.64%	2.745	.008
	Male	48.48%		
Week 4 - ACC	Female	43.40%	2.531	.014
	Male	60.21%		

Similar to gender, a main effect of age group was also obtained, $F(2, 60) = 9.053, p < .001$. Planned-comparisons revealed that older drivers utilized cruise more across weeks ($M = 53.90\%$) than middle-aged drivers ($M = 35.01\%$; $t(42) = 3.205, p = .003$) and younger drivers ($M = 32.65\%$; $t(42) = 3.569, p = .001$). There was no age group by

week interaction obtained; however, as depicted below (Figure 8.83), older drivers had numerically the highest percent utilization on freeways across weeks as compared to middle-aged and younger drivers.

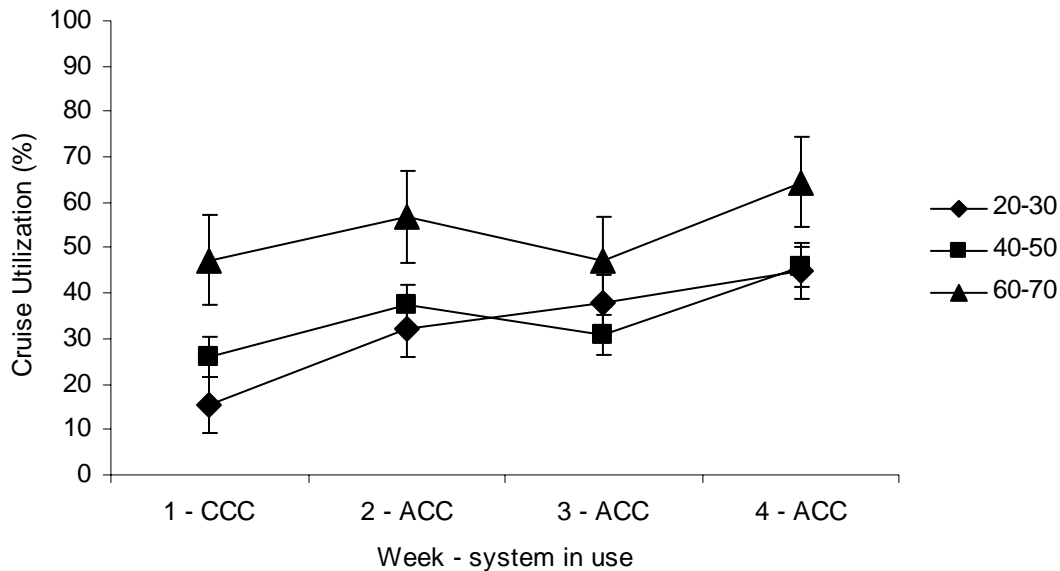

Figure 8.83. Effect of age group on cruise utilization percent across week. Error bars represent standard error of the mean (SEM).

Follow-up independent samples *t*-tests revealed that younger and middle-aged drivers did not differ in utilization percent on freeways during any week. In a comparison of older to younger drivers, older drivers significantly utilized cruise more than younger drivers for all weeks (p 's < .02) except week 3 where the results were not significant, $t(42) = .945, p = .350$. Likewise, in a comparison of older to middle-aged drivers, older drivers had significantly greater utilization on freeways during week 1, $t(42) = 3.045, p = .004$, and week 4, $t(42) = 2.440, p = .019$ and had marginally higher percentages during week 2, $t(42) = 2.012, p = .051$, and week 3, $t(42) = 1.758, p = .086$. Finally, there was no two-way interaction between gender and age group ultimately suggesting that older males and females together utilize cruise control, albeit CCC or ACC, more than middle-aged and younger males and females.

In summary, by week, ACC was utilized more often than CCC during freeway driving, suggesting the possibility that drivers preferred ACC above and beyond traditional cruise control. However, the possibility exists that the differences across week 1 with CCC versus the ACC-enabled weeks may be due to the demand characteristics of the FOT, where drivers utilized the ACC at an artificially higher rate due to the fact that

one of the primary purposes of the study was to examine and evaluate the ACC system. In regards to ACC use by week, the increase in overall usage during week 4 as compared to the weeks prior potentially indicate that the system is well accepted by drivers; otherwise, the significant increase that occurred during week 4 would not likely have been obtained. In regards to gender, it seems apparent that males utilize ACC in freeway driving more than females. However, concerning CCC, only a tentative conclusion may be drawn. While males numerically utilized CCC more than females, the results were not significant. Therefore, it appears that males may utilize CCC more than females due to the fact that they did have a higher utilization percent and that they were more apt to employ ACC in freeway driving once it was enabled. Finally, in reference to age groups, younger and middle-aged drivers appear to utilize both ACC and CCC systems rather equally in freeway driving; however, utilization percentages dissociate once comparisons are made between older drivers and the other groups. Specifically, it appears that regardless of cruise control system available, older drivers tend to rely on its utilization during freeway driving more than middle-aged and younger drivers.

8.2.2.2 Acceptance of ACC by Headway Selection

The following analyses examine the headway settings selected by drivers and the frequency with which drivers made changes to the headway setting. For purposes of the analyses that follow, use of the headway setting was counted provided that three conditions were met: 1) cruise was engaged; 2) speed was greater than 25 mph; and 3) dwell time on any particular headway setting was greater than 3 seconds. Counts of headway adjustments were used in lieu of changes in setting.

8.2.2.2.1 Frequency of Headway Adjustment - Overall

The frequency with which headway was adjusted was calculated across all drivers experiencing algorithm-C. During weeks 2 through 4 when ACC was enabled, drivers could choose a preferred headway between their vehicle and a lead vehicle while ACC was engaged. Six settings, ranging from '1' (shortest headway or 1s of headway time margin) to '6' (longest headway or 2s headway time margin), were available for the driver to choose. Throughout each week that included exposure to the ACC system, driver's adjustments between headway settings were calculated. At the onset of week 2, the default setting was at the longest headway ('6').

A 2 (gender) X 3 (age group) X 3 (week) X 6 (headway setting) repeated-measures ANOVA was conducted on the number of times drivers selected each setting to determine both what headway settings were most frequently selected across each week

and if the rate of headway adjustments changed with exposure to ACAS. Demographic factors of gender and age group were also incorporated to determine if settings selected and the frequency of adjustment differed by age and gender. For all within-subjects variables a Greenhouse-Geisser correction was used due to the sphericity assumption being insufficiently met (ϵ 's < .9). To begin, a main effect of gender was obtained, $F(1, 60) = 10.205, p = .002$, where the average number of adjustments per week was twice the number for males ($M = 1.052$) as it was for females ($M = .502$). Subsequently, there was no main effect of age group obtained nor was there any gender-by-age group interaction, indicating that the differences in gender were substantiated at across age levels (see Figure 8.84).

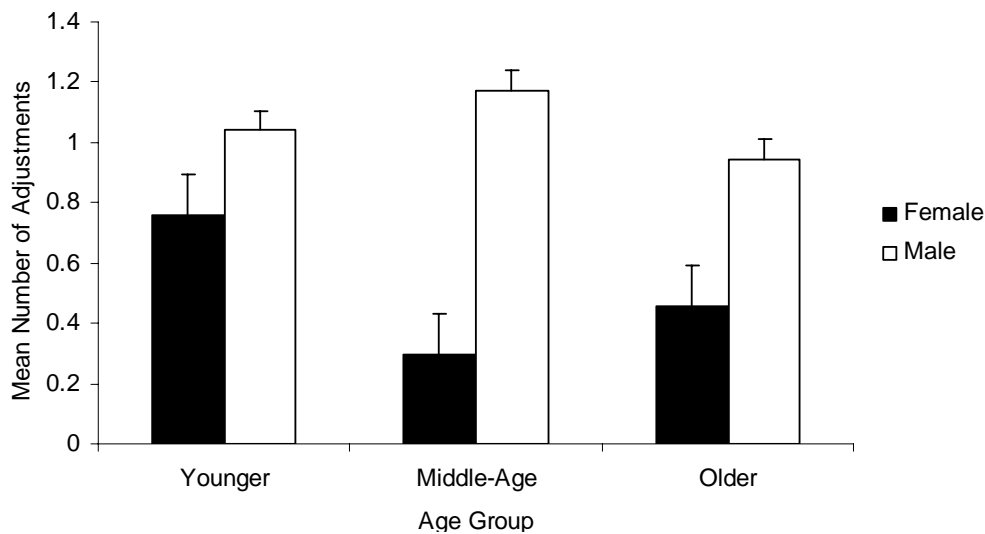

Figure 8.84. Mean number of headway adjustments by gender and age group. Error bars represent standard error of the mean (SEM).

In regards to week, a significant main effect was obtained, $F(1.297, 77.802) = 4.359, p = .030$. Follow-up paired t -tests revealed that the number of headway adjustments was significantly fewer during week 3 ($M = .556$) as compared to week 2 ($M = 1.008; t(65) = 3.522, p = .001$) and week 4 ($M = .768; t(65) = 1.776, p = .080$). Adjustment rates did not significantly differ between week 2 and week 4. Figure 8.85 illustrates headway adjustments across weeks. Finally, there were no effects of gender or age group interacting week.

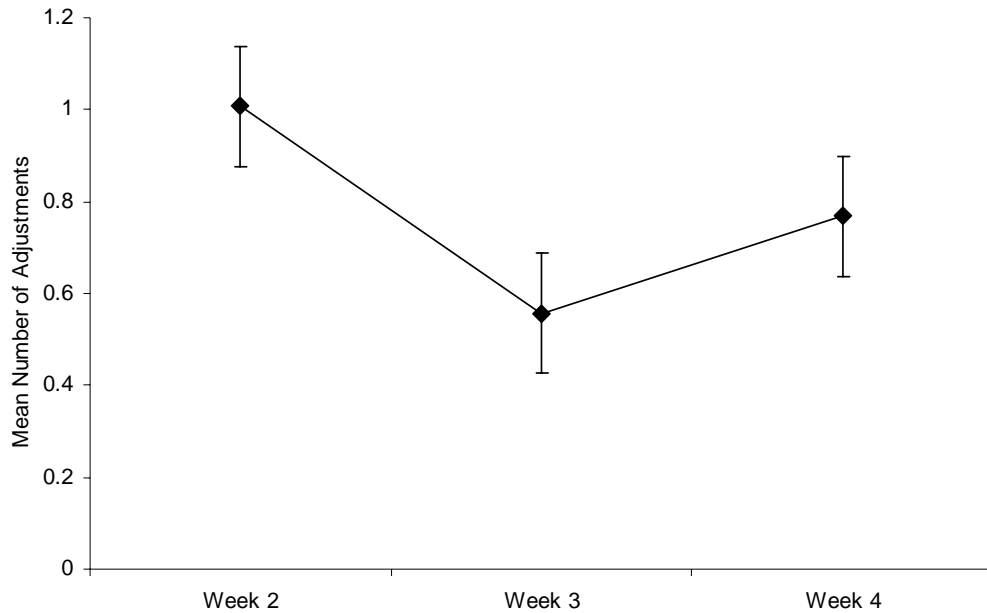

Figure 8.85. Mean number of adjustments of headway by week. Error bars represent standard error of the mean (SEM).

With regards to headway setting, a significant main effect was obtained, $F(3.425, 205.515) = 9.231, p < .001$ (refer to Figure 8.86). Table 8.20 lists the average number of adjustments per week for each headway setting and contains the paired t -tests results for differences across settings. Setting 5 ($M = 328$) was the least frequently selected headway setting. With the exception of setting 6, headway setting adjustments were positively skewed with drivers more often making adjustments to the less conservative (shorter) headway time margins.

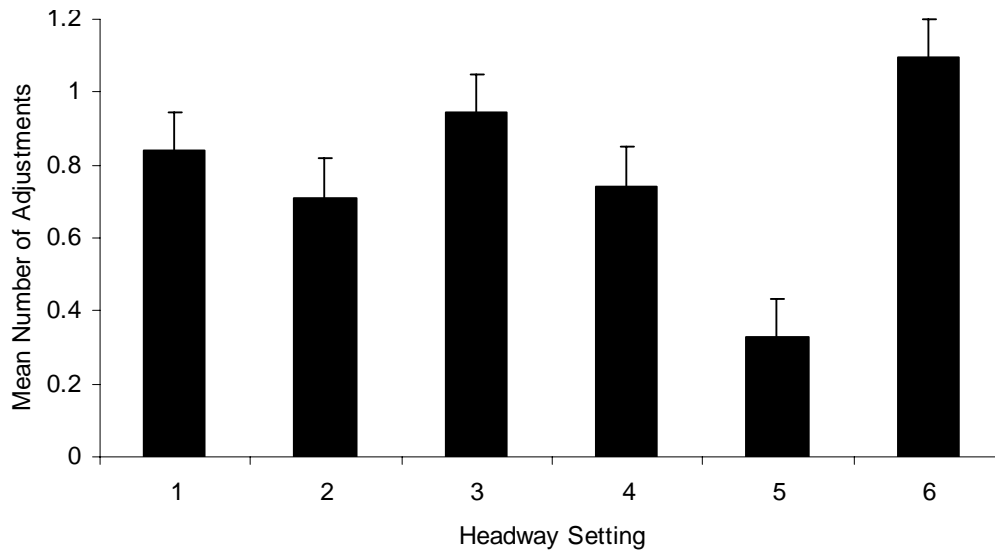

Figure 8.86. Mean number of adjustments to a particular headway setting by week. Error bars represent standard error of the mean (SEM).

Table 8.20. Mean number of adjustments to a particular headway setting by week

	1	2	3	4	5	6
Mean	.838	.712	.944	.742	.328	1.096
2	$p = .313$					
3	$p = .479$	$p = .018$				df = 65
4	$p = .543$	$p = .778$	$p = .076$			
5	$p = .001$	$p = .001$	$p < .001$	$p < .001$		
6	$p = .071$	$p = .009$	$p = .306$	$p = .003$	$p < .001$	

In regards to headway adjustments across both gender and age group, various findings emerged. There was no interaction between gender and adjustments, whereby, males made predominately more adjustments to each headway setting with the exception of setting 3 ($p = .122$) and headway 5 ($p = .206$) where males only slightly outnumbered females in the number of adjustments (see Figure 8.87).

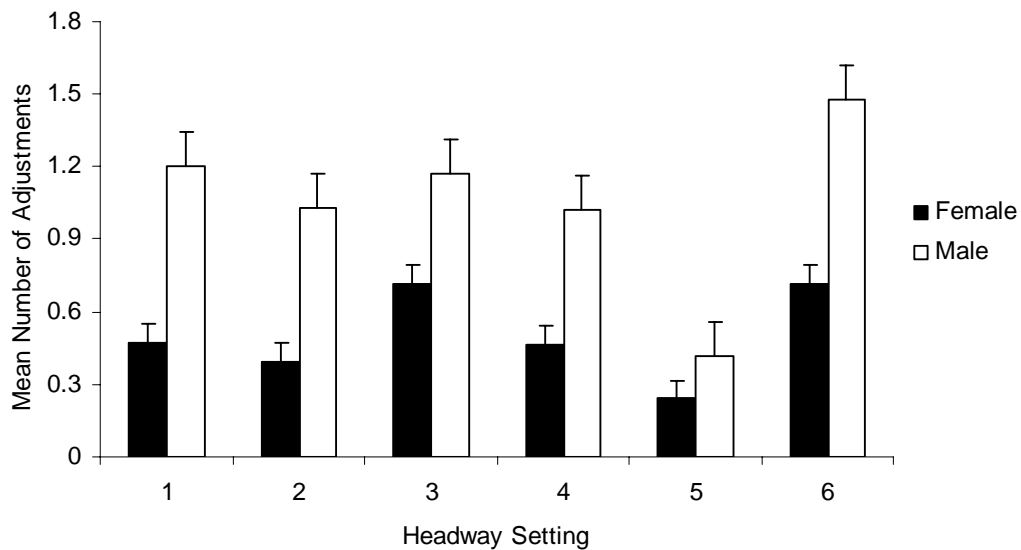

Figure 8.87. Mean number of adjustments to a particular headway setting by week and gender. Error bars represent standard error of the mean (SEM).

In contrast, a significant two-way interaction between age group and adjustments emerged, $F(6.851, 205.514) = 3.166, p = .004$, (Figure 8.88).

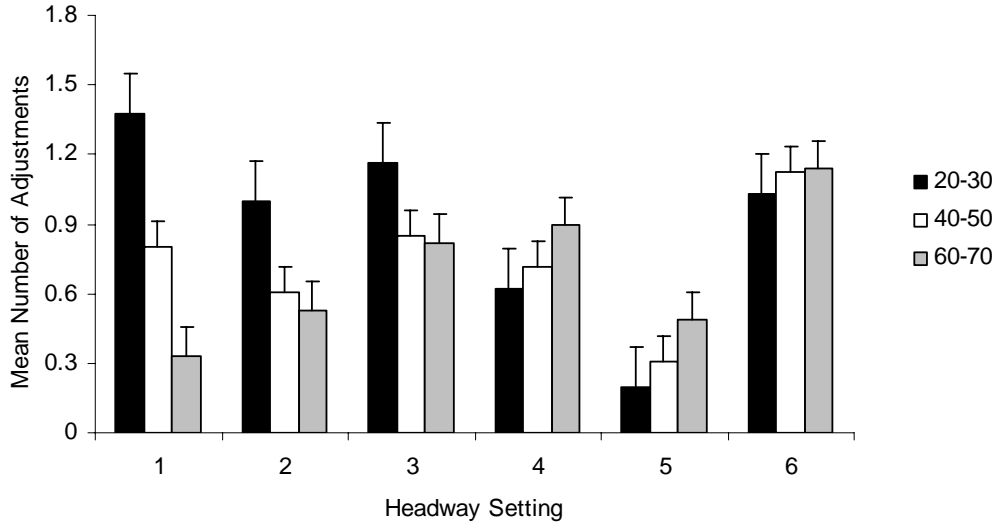

Figure 8.88. Mean number of adjustments to a particular headway setting by week and age group. Error bars represent standard error of the mean (SEM).

Independent samples *t*-tests revealed no significant differences in adjustments to any sensitivity setting for middle-aged drivers and either younger or older drivers. However, differences emerged between younger and older drivers. Specifically, older drivers tended to adjust more frequently to setting 5 ($M = .485$) than younger drivers ($M = .197$; $t(42) = 1.927, p = .061$) while younger drivers more often adjusted the headway to setting 1 ($M = 1.379$) more than did older drivers ($M = .333$; $t(42) = 3.335, p = .002$).

Finally, a headway adjustment by week interaction was obtained, $F(5.685, 341.073) = 3.591, p = .002$. Figure 8.89 depicts the mean number of adjustments to each headway setting by week.

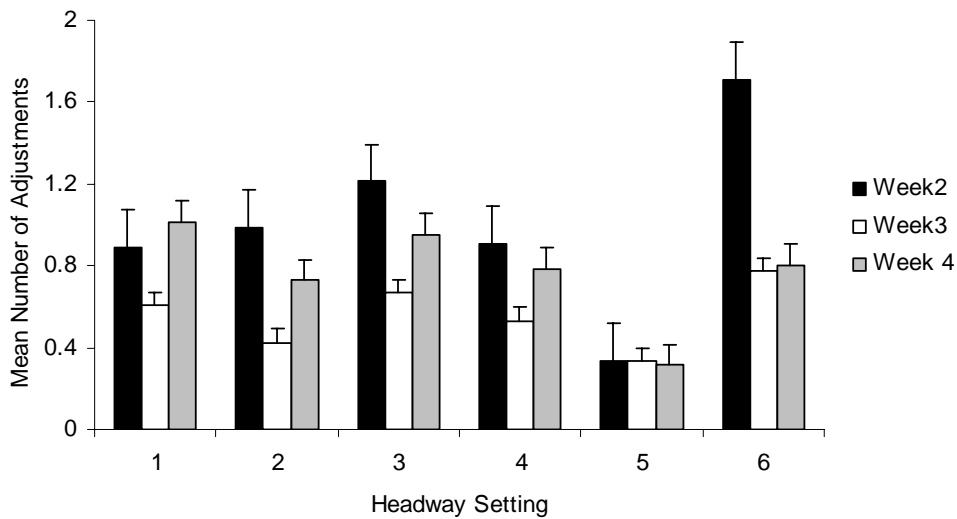

Figure 8.89. Mean number of adjustments to a particular headway setting by week. Error bars represent standard error of the mean (SEM).

The largest difference occurs at setting 6 where the frequency of it being selected during week 2 greatly exceeds the remaining weeks (p 's < .001). This is most likely due to the fact that the default headway setting was 6 at the onset of week 2 (when ACAS was first enabled). Of note, unlike the other headway settings, setting 5 remained relatively unselected across weeks. For settings 1 through 4, adjustments to these settings in week 2 were statistically greater than during week 3 (p 's < .05) for settings 2, 3, and 4 and marginally greater for setting 1, $t(65) = 1.818, p = .074$. The mean number of adjustments between week 2 and week 4 did not differ, while an adjustment comparison between week 3 and week 4 revealed marginally more adjustments to headways 2 and 4 for week 4.

Overall, drivers tended to make more frequent adjusts toward the shorter headway settings. This effect was exaggerated by age where younger drivers appear to have adopted less conservative strategies than older drivers. In regards to the use of setting 6, the results must be tempered with the fact that setting 6 was the default setting. It was also discovered that regardless of age or exposure to ACC across weeks, males made more adjustments to headway setting than did females. In summary, drivers were more likely to adjust headway settings toward a more liberal headway criterion and they made, on average, fewer than 1.5 headway setting adjustments per week.

8.2.2.2.2 Frequency of Headway Adjustment – Limited Access Roads

Drivers' use of ACC on freeways and other limited access roads was analyzed based on the frequency of headway adjustment.

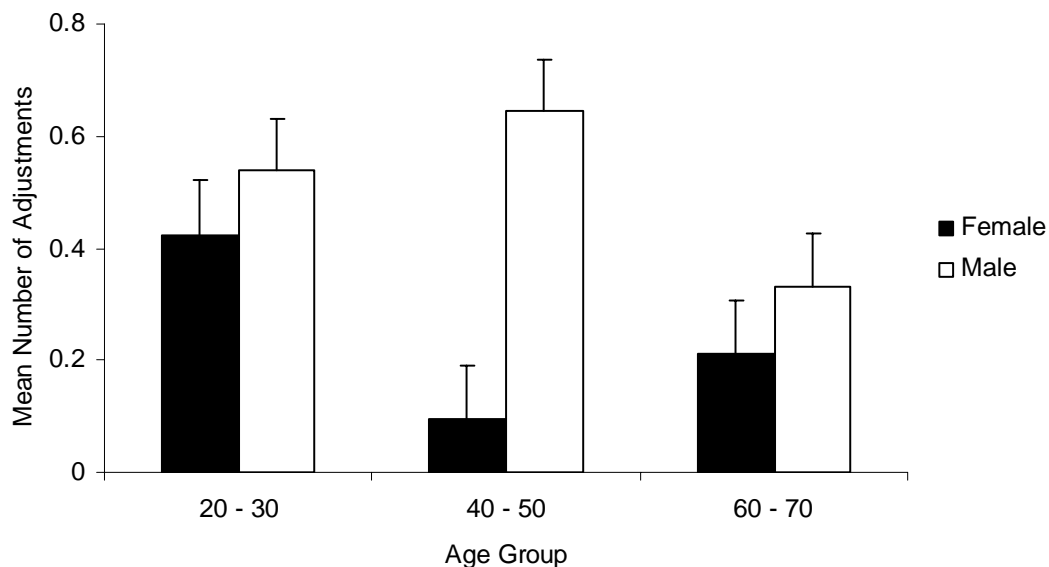

Figure 8.90. Mean number of headway adjustments on limited access roads per week by age and gender. Error bars represent standard error of the mean (SEM).

Frequency of adjustment on limited access roads was defined as the number of times a driver selected a particular setting with the ACC engaged while 1) speed was greater than 45 mph, 2) dwell time on a setting was at least 3 s, and 3) the driver was on a limited access road.

A 2 (gender) X 3 (age group) X 3 (week) X 6 (headway setting) repeated-measures ANOVA was used to determine the number of adjustment made to each headway setting. The purpose of the analysis will serve to determine what headway settings drivers selected and if the frequency of adjustment changes with extended exposure to the ACC system. In addition, gender and age group will also be included to determine if driver demographics shapes ACC headway adjustment behavior. Finally, a Greenhouse-Geisser correction was applied to all within-participant factors due to a violation of sphericity ($\epsilon < .90$).

A main effect was observed for gender, $F(1, 60) = 4.641, p = .035$, where males made more headway adjustments per week on freeways ($M = .507$) than females ($M = .244$). No main effect was obtained for age group nor was there a significant interaction between gender and age group, which suggests that males had a consistently higher rate of adjusting headway than females. However, upon closer inspection, it appears that for middle-aged males there is a much greater number of headway adjustments than with middle-aged females. Therefore, independent sample t-tests were conducted at each age level. At each age level, males and females did not statistically differ except for middle-aged males who made marginally more adjustment to the headway setting ($M = .647$) than did females ($M = .096; t(20) = 1.993, p = .060$). The lack of significant effects can primarily be attributed to the sizeable variances found within each age group.

Across weeks, no significant main effect was obtained. Likewise, interactions between week and gender and/or age groups failed to reach significance. Nevertheless, further comparisons were made to determine if differences in headway setting use was sustained across weeks. Figure 8.91 depicts the mean number of adjustments to headway by gender across weeks.

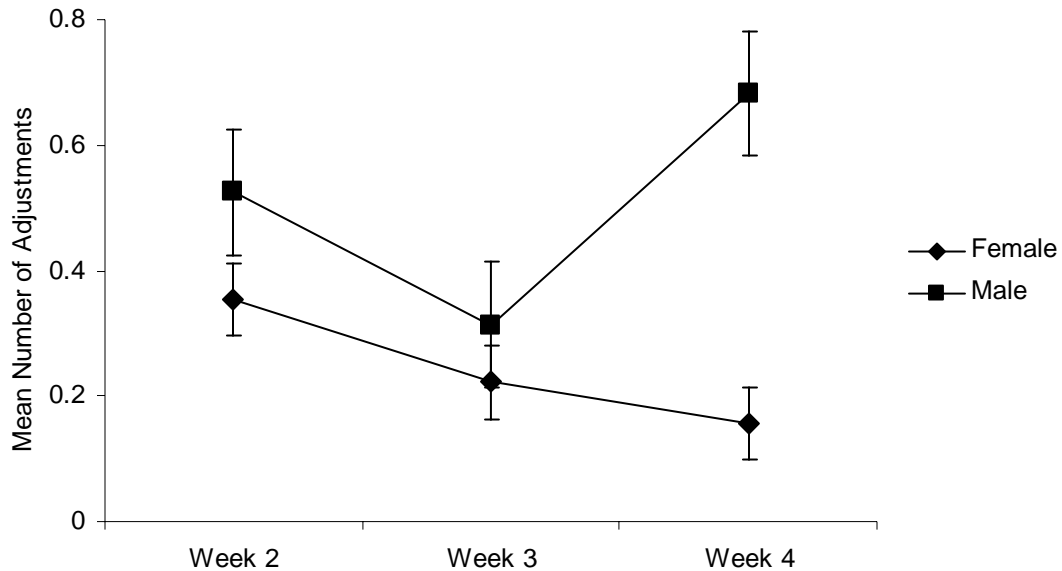

Figure 8.91. Mean number of headway adjustments on limited access roads per week by gender. Error bars represent standard error of the mean (SEM).

Although males made more adjustments throughout the three weeks of exposure to ACC, differences in the frequency of adjustment were only significant during week 4 where males ($M = .682$) made more adjustments than females ($M = .157$; $t(64) = 2.201$, $p = .031$). Interestingly, female headway adjustment appears to taper with increased exposure to ACC, while male headway setting use shows the opposite trend. This difference might represent a greater propensity on the part of male drivers to explore the range of headway settings relative to females. Whereas female drivers appear to explore the range of settings early in the exposure to ACC, only later to decide upon a few headway settings they are most comfortable using in a limited access roadway environment.

A similar follow-up analysis was conducted to compare potential age group differences in headway adjustment across weeks (Figure 8.92). Independent sample t -tests were used to compare the number of adjustments to headway made each week. Due to the individual variability amongst drivers, no statistically significant differences emerged. However, *prima facie*, it appears as if younger drivers consistently adjusted headway settings across weeks more so than older drivers. Moreover, younger drivers also adjusted headways settings more frequently than middle-aged drivers during weeks 2 and 3 until week 4 when middle-aged drivers made slightly more adjustments. Finally, weeks 2 and 3, middle-aged drivers had similar adjustment rates as older drivers.

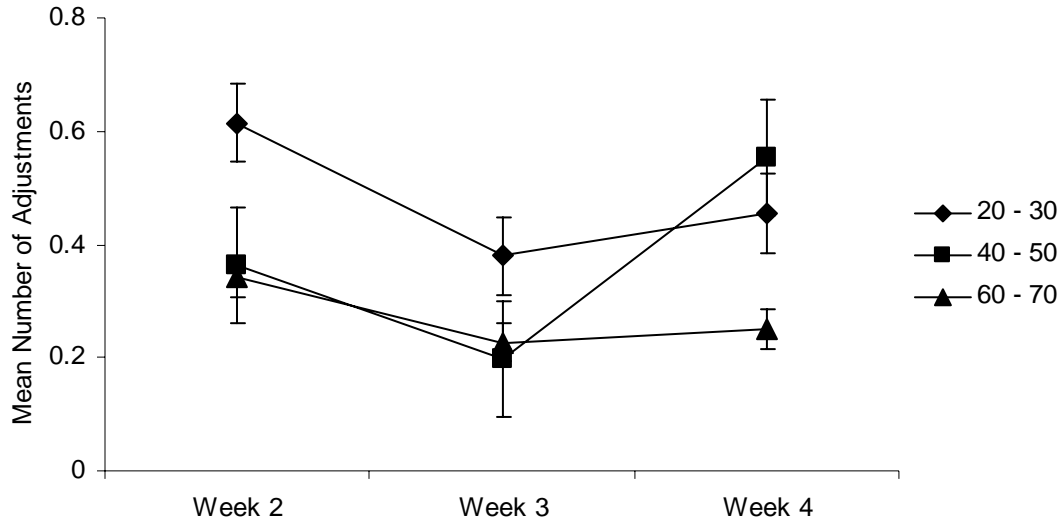

Figure 8.92. Mean number of headway adjustments on limited access roads per week by age group. Error bars represent standard error of the mean (SEM).

Finally, a main effect was obtained for the frequency of adjustment to particular headway settings, $F(3.145, 188.682) = 4.306, p = .005$. Table 8.21 lists the mean number of adjustments per week for each headway setting. There were no differences across headway settings except for setting 5, which was selected on a significantly less frequency than all other headway settings (p 's < .01).

Table 8.21. Mean number of adjustments to a particular setting across weeks on limited access roads.

Setting	1	2	3	4	5	6
Mean =	.460	.429	.449	.379	.187*	.348

Note: * indicates that setting 5 is used significantly less than all other settings ($p < .01$).

In addition to the main effect of the frequency of adjustment to particular headway settings, a headway setting by gender interaction approached significance, $F(3.145, 188.682) = 2.389, p = .067$ (Figure 8.93). Follow-up independent sample t -tests revealed that males and females did not differ in the number headway adjustments per week to setting 3 and setting 5. However, males did significantly differ from females in adjustments made to settings 4, $t(64) = 2.419, p = .018$, and 6, $t(64) = 3.326, p = .001$. In addition, males drivers made more adjustments to settings 1 and 2 than females, both of which approached significance ($p = .081$ and $p = .093$, respectively).

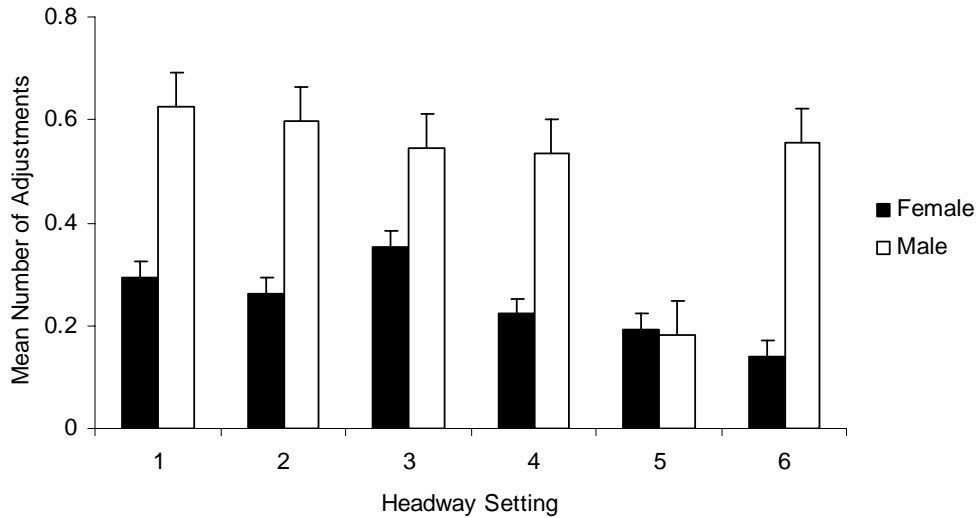

Figure 8.93. Mean number of headway adjustments on limited access roads per week to particular settings by gender. Error bars represent standard error of the mean (SEM).

In addition, a significant two-way interaction was observed between headway setting and age group, $F(6.289, 188.682) = 3.017, p = .007$ (Figure 8.94).

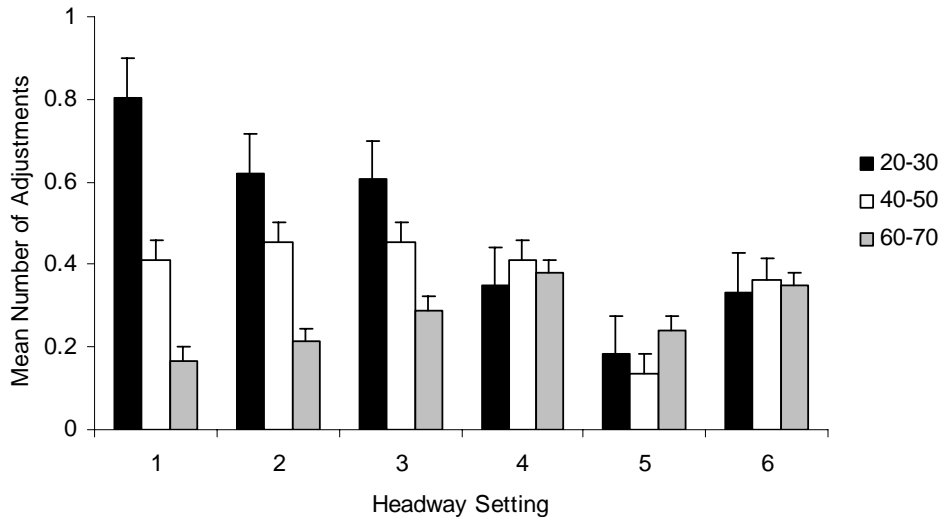

Figure 8.94. Mean number of headway adjustments on limited access roads per week to particular settings by driver age group. Error bars represent standard error of the mean (SEM).

Follow-up independent sample comparisons between age groups revealed no significant differences in the frequency of adjustment between younger and middle-aged drivers and between middle-aged and older drivers. However, when comparing younger versus older drivers differences emerged. Younger drivers adjusted headway to the shortest setting, (setting 1; $M = .803$) more frequently than older drivers ($M = .167$; $t(42)$

= 2.986, $p = .005$). Furthermore, a trend towards significance was obtained for setting 2, $t(42) = 1.764$, $p = .85$, and setting 3, $t(42) = 1.874$, where younger drivers again more often adjusted the headway setting to less conservative settings relative to older drivers. A supplemental analysis was therefore conducted dividing headway settings into two categories, shorter headway settings (1-3) and longer headway settings (4-6), to better understand the relationship between adjustment to headway settings and age group. Independent sample t -tests were used to compare differences in adjustments to shorter and longer headway settings by driver age. No differences were obtained between age groups regarding the frequency of adjustment to the longer headway settings. However, in regards to shorter headway settings, younger drivers ($M = 2.030$) adjusted headway setting more frequently than older drivers ($M = .667$; $t(42) = 2.466$, $p = .018$) to the shorter settings. Subsequently, middle-aged drivers ($M = 1.318$), numerically fell in between older and younger drivers in terms of shorter headway setting adjustments, but the differences were not statistically significant.

Finally, there was no interaction obtained between the adjustment to particular headway settings and weeks exposed to ACC for limited access roads. This finding suggests that drivers collectively were fairly consistent in their pattern of headway setting adjustments across weeks. Figure 8.95 represents the adjustment by week and headway setting.

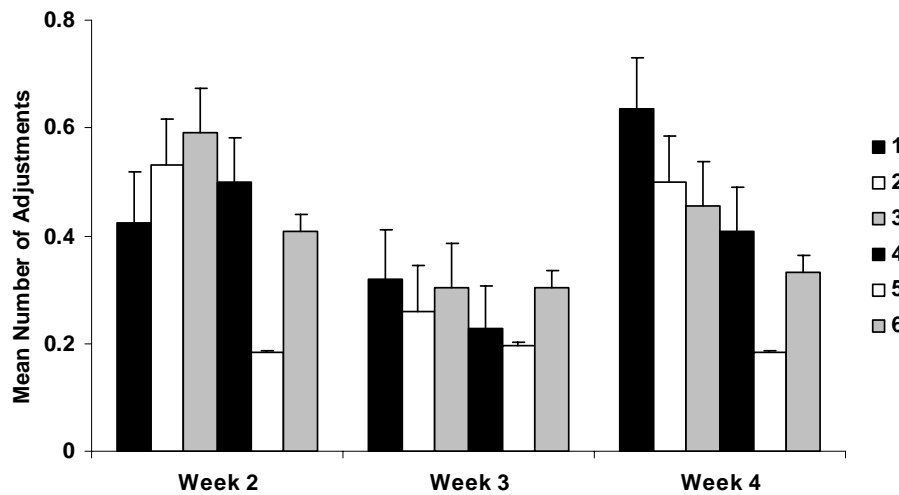

Figure 8.95. Mean number of headway adjustments on limited access roads per week to particular settings by week. Error bars represent standard error of the mean (SEM).

However, it appears that while there is a relatively normal distribution of settings selected in weeks 2 and 3, there is a clear positively skewed distribution present in week

4 indicating a trend towards drivers at least exploring the less conservative, shorter headway settings later in the exposure period.

Overall, during freeway driving, there is a considerable amount of individual difference in the frequency of adjusting ACC headway that obscures many differences in gender and age groups. However, what is relatively clear is the robust finding that males, regardless of age, make more adjustments to the headway settings than females in their same cohort. In addition, there appears to be differences amongst age groups in the frequency with which they adjust headway settings and the settings they select. As driver age increases, a trend emerges where shorter headway settings become eschewed towards more conservative settings. Figure 8.94 represents this phenomenon. As age increases, the willingness to adjust the setting to shorter headways decreases. It is interesting to note that for longer headway settings, the frequency of selection becomes indistinguishable across driver age groups.

8.2.3 Driver Profiles Corresponding to ACC Acceptance

Ordinal regression was used to determine if driver age, gender, income, education, and self-characterization can serve as predictors of ACC acceptance. Only select questions from the post-drive questionnaire were examined, in particular those which are most likely to reflect drivers' overall acceptance of, or likelihood to purchase, an ACC system. The 14 questions examined were: ACC1, ACC8, ACC10, ACC13, ACC14, ACC17, ACC24, ACC25, ACC26, ACC27, ACC28, ACC29, ACC30, and ACC32. Where significant predictive qualities are observed the amount of variance accounted for (Nagelkerke pseudo R^2), the level of significance and the nature, or direction (parameter estimate value), of the association is reported. However, while several statistically significant associations were found, the low R^2 values may indicate little practical significance (because they may not allow for accurate modeling).

8.2.3.1 Acceptance of ACC by Age

Actual age in years at the time of participation, as opposed to independent variable classification of age group, was used in this analysis. Driver age was predictive of questions ACC8, ACC10, ACC25, ACC30, and ACC32. Age was positively associated with each of the questions (Table 8.22) and as such, older drivers were more likely to report that they drove more safely with ACC as compared to manual driving (ACC8), that overall they were very satisfied with the ACC system (ACC10), that they felt that ACC was going to increase their driving safety (ACC25), that they would be comfortable

if ACC completely replaced conventional cruise control (ACC30), and that they would be likely to purchase ACC (ACC32).

Table 8.22. Predictive values of driver age on ACC acceptance

ACC Question	Estimate	<i>p</i>	R ²
8	0.029	0.042	0.061
10	0.048	0.002	0.156
25	0.033	0.022	0.082
30	0.043	0.006	0.121
32	0.039	0.01	0.112

8.2.3.2 Acceptance of ACC by Gender

Using the 14 previously defined acceptance questions, an examination of potential differences in ACC system acceptance which are associated with driver gender was conducted. A composite (mean) rating across the acceptance questions was calculated for each driver, and an independent samples t-test was performed on the composite ratings by driver gender. The mean acceptance rating for female drivers was 3.94, with a standard deviation of .62, whereas the mean for male drivers was 4.17, with a standard deviation of .53. The difference in composite scores between genders was not significant. However, gender was a significant factor in responses to the individual questions ACC17 ($t(64) = -2.306, p = .024$) and ACC27 ($t(64) = -2.185, p = .033$). In both instances males' ratings were higher. Males reported experiencing unsafe following distances more frequently (ACC17) and being more comfortable performing secondary tasks while driving with ACC engaged (ACC27).

8.2.3.3 Acceptance of ACC by Income

The 14 questions from the post-drive questionnaire which most clearly address drivers' acceptance of ACC were examined. Income related variables included median household income (MHI), median family income (MFI), and per capita income (PCI). See Section 7.2.5.3 for additional information on how these variables were determined. The three surrogate measures of income were examined as predictors of responses to the 14 driver acceptance questions. The results indicate that none of the surrogate income measures are able to serve as predictors of ACC acceptance.

8.2.3.4 Acceptance of ACC by Education

Drivers' highest level of education was examined for its predictive value of ACC acceptance. Education level, measured in number of years of formal education, was predictive of driver's responses to questions ACC14, ACC24, and ACC32. Education level was negatively (-.203) associated with responses to ACC14, $p = .049$ ($R^2 = .059$).

Therefore, the higher the education level, the more likely drivers were to report that the deceleration provided by the ACC system was too great. Additionally, education level was negatively (-.266) associated with responses to ACC32, $p = .01$ ($R^2 = .114$) indicating that drivers with higher levels of education were less likely to consider purchasing ACC. Finally, education level was positively (.253) associated with responses from ACC24, $p = .02$ ($R^2 = .099$) suggesting that drivers with higher education levels were more likely to inadvertently experience unsafe following distances when driving with ACC engaged. These results, when taken together, suggest that as a result of a deceleration level that is perceived to be too great and the reported incidence of unsafe following distances, drivers with higher levels of education are less likely to consider purchasing ACC.

8.2.3.5 Acceptance of ACC by Driver Self-Characterization

Scale scores from the Driver Behavior Questionnaire (DBQ) and Driving Style Questionnaire (DSQ) were examined as predictors of ACC acceptance. A complete description of the DBQ and DSQ self-characterization questionnaires may be found in Section 4.4.11).

8.2.3.5.1 Driver Style Questionnaire

The six scale scores (calmness, social resistance, speed, deviance, planning and focus) resulting from the DSQ were examined as predictors of the 14 ACC driver acceptance related questions. The DSQ calmness scale scores were predictive of responses to ACC28. Calmness was positively (3.320) associated with ACC28, $p = .001$ ($R^2 = .194$). Drivers with high calmness scores were more likely to report that the ACC system failed to indicate the presence of a vehicle when one existed.

The DSQ planning scale scores were predictive of responses to eight of the ACC acceptance questions; ACC questions 1, 8, 10, 13, 14, 25, 30, and 32. The planning scale scores were positively associated with each of the questions (Table 8.23).

Table 8.23. Predictive values of DSQ planning scale scores on ACC acceptance

ACC Question	Estimate	p	R^2
1	0.942	0.001	0.175
8	1.086	<0.001	0.226
10	1.248	<0.001	0.291
13	1.407	<0.001	0.36
14	0.685	0.009	0.092
25	1.42	<0.001	0.359
30	3.53	<0.001	0.725
32	1.464	<0.001	0.356

Drivers with high planning scores are more likely to report that they are comfortable using ACC (ACC1), that they drove more safely using ACC as compared to manual driving (ACC8), overall they are more satisfied with the ACC system as compared to manual driving (ACC10), they report less stress when driving with ACC engaged (ACC13), that the level of deceleration when following other vehicles is too slow (ACC14), they think that ACC is going to increase their driving safety (ACC25), they are comfortable with ACC completely replacing conventional cruise control (ACC30), and they are more likely to consider purchasing ACC (ACC32).

The DSQ social resistance scale score was also predictive of responses to eight of the ACC acceptance questions; ACC questions 1, 8, 10, 13, 25, 27, 30, and 32. The social resistance scale scores were positively associated with each of the questions (Table 8.24). Drivers with high social resistance scores are more likely to report that are comfortable using ACC (ACC1), that they drove more safely using ACC as compared to manual driving (ACC8), overall they are more satisfied with the ACC system (ACC10) as compared to manual driving, they report less stress when driving with ACC engaged (ACC13), they think that ACC is going to increase their driving safety (ACC25), they were more comfortable performing secondary tasks while driving with ACC engaged (ACC27), they are comfortable with ACC completely replacing conventional cruise control (ACC30), and they are more likely to consider purchasing ACC (ACC32).

Table 8.24. Predictive values of DSQ social resistance scale scores on ACC acceptance

ACC Question	Estimate	<i>p</i>	R ²
1	1.014	<0.001	0.249
8	1.296	<0.001	0.341
10	1.968	<0.001	0.555
13	1.617	<0.001	0.486
25	1.471	<0.001	0.426
27	0.608	0.008	0.118
30	1.260	<0.001	0.335
32	2.010	<0.001	0.550

The DSQ speed scale scores were predictive of responses to the same eight ACC questions that the social resistance scale scores were, namely, ACC questions 1, 8, 10, 13, 25, 27, 30, and 32. The speed scale scores were positively associated with each of the questions (Table 8.25). Therefore, drivers with high speed scores are more likely to report that are comfortable using ACC (ACC1), that they drove more safely using ACC as compared to manual driving (ACC8), overall they are more satisfied with the ACC system as compared to manual driving (ACC10), they report less stress when driving with ACC engaged (ACC13), they think that ACC is going to increase their driving safety (ACC25), they were more comfortable performing secondary tasks while driving

with ACC engaged (ACC27), they are comfortable with ACC completely replacing conventional cruise control (ACC30), and they are more likely to consider purchasing ACC (ACC32).

Table 8.25. Predictive values of DSQ speed scale scores on ACC acceptance

ACC Question	Estimate	<i>p</i>	R ²
1	1.359	<0.001	0.364
8	1.190	<0.001	0.325
10	1.758	<0.001	0.493
13	1.775	<0.001	0.515
25	2.141	<0.001	0.604
27	0.783	0.001	0.183
30	1.224	<0.001	0.338
32	0.988	<0.001	0.248

The deviance scale scores were predictive of the responses to ACC questions 1, 8, 17, 24, and 28. The deviance scale scores were negatively associated with ACC questions 1 and 8 (-1.110 and -1.009 respectively) and were positively associated with ACC17 (3.803), ACC24 (10.286), and ACC28 (2.404) (Table 8.26). These results suggest that drivers with high deviance scores are more uncomfortable using ACC (ACC1, *p* = .008, R² = .094), feel that they drove less safely as compared to how they drive manually (ACC8, *p* = .011, R² = .087), experienced unsafe following distances more frequently (ACC17, *p* < .001, R² = .539), inadvertently experienced unsafe following distances more frequently (ACC24, *p* < .001, R² = .874) and more frequently indicated that the ACC system failed to indicate the presence of a vehicle when one existed (ACC28, *p* < .001, R² = .320).

Table 8.26. Predictive values of DSQ deviance scale scores on ACC acceptance

ACC Question	Estimate	<i>p</i>	R ²
1	-1.110	0.008	0.094
8	-1.009	0.011	0.087
17	3.803	0.001	0.539
24	10.286	0.001	0.874
28	2.404	0.001	0.320

The DSQ focus scale score was not predictive of responses for any of the ACC acceptance questions.

8.2.3.6.2 Driver Behavior Questionnaire

The three scale scores (lapses, errors, and violations) resulting from the DBQ were examined for serving as predictors of the 14 ACC driver acceptance related questions. The DBQ lapse scale scores were predictive of responses to questions ACC8, ACC10, and ACC13. The lapse scale scores were negatively associated with each of the questions (-1.238, -1.188, and -1.129 respectively). These results indicate that drivers

with higher lapse scores are more likely to feel that they drove less safely with ACC engaged than driving manually (ACC8, $p = .014$, $R^2 = .098$), are more dissatisfied with the ACC system (ACC10, $p = .022$, $R^2 = .082$), and are more likely to experience additional stress when driving with ACC engaged (ACC13, $p = .025$, $R^2 = .077$).

The error scale scores were predictive of ACC questions 1, 10, 13, 30 and 32. The responses were all negatively associated (Table 8.27). Drivers with high violation scale scores were more likely to report that they were uncomfortable with the ACC system (ACC1), were dissatisfied with the ACC system (ACC10), were more likely to experience more stress driving with ACC engaged as compared to driving manually (ACC13), would be uncomfortable if ACC completely replaced conventional cruise control (ACC 30), and would not likely purchase ACC (ACC32).

Table 8.27. Predictive values of DBQ error scale scores on ACC acceptance

ACC Question	Estimate	p	R^2
1	-1.994	0.022	0.093
10	-2.194	0.009	0.116
13	-2.392	0.004	0.119
30	-2.669	0.002	0.161
32	-2.244	0.008	0.121

The violation scale scores were predictive of the responses for the same ACC questions that the error scale scores were (ACC1, ACC10, ACC13, ACC30, and ACC32). The responses were again all negatively associated (Table 8.28).

Table 8.28. Predictive values of DBQ violation scale scores on ACC acceptance

ACC Question	Estimate	p	R^2
1	-1.168	0.043	0.072
10	-1.672	0.003	0.150
13	-1.557	0.005	0.128
30	-1.251	0.026	0.084
32	-1.403	0.012	0.107

Just as for drivers with high error scores, drivers with high violation scale scores were more likely to report that they were uncomfortable with the ACC system (ACC1), were dissatisfied with the ACC system (ACC10), were more likely to experience more stress driving with ACC engaged as compared to driving manually (ACC13), would be uncomfortable if ACC completely replaced conventional cruise control (ACC 30), and would not likely purchase ACC (ACC32).

8.2.3.7 Acceptance of ACC by Driving Style

A series of nonparametric tests, Mann-Whitney U, were performed to examine whether the two categories of driver style, reserved and assertive, differed in their responses

regarding ACC acceptance. Of the 14 post-drive questions related to system acceptance examined, statistically significant differences between the two driver styles were found for two of these questions. In response to ACC10, drivers with a reserved style were significantly ($p = .018$) more satisfied with the ACC system in comparison to assertive drivers. Reserved drivers were also significantly ($p = .019$) more likely to report that ACC was going to increase their driving safety (ACC25). Overall, reserved drivers responded more favorably to ACC acceptance questions than did the assertive drivers.

Summary of ACC Acceptance

In summary, most drivers found ACC to be both acceptable and desirable. Responses to several key ACC acceptance questions indicate that only a few drivers felt that the ACC system they experienced was unacceptable. More often than not, there was a clear consensus that ACC was a desirable system. The overall mean response to the suggestion that ACC would increase one's driving safety (ACC25) had an overall mean score of 5.5 on a 7-point scale, and nine out of ten drivers were willing to recommend the ACC system to a loved one (ACC31). When asked if they would consider purchasing an ACC system if they were buying a new car today (ACC32), approximately three-fourths of the drivers stated that they probably or definitely would consider the purchase of an ACC system. When asked if they would consider purchasing an ACC system at a cost of \$1000, little more than one-third of the drivers stated that they definitely or probably would consider the purchase. However, it should be noted that the population of drivers that took part in the study is probably not be representative economically of the population of new car buyers thought likely to be early purchasers of ACC systems. As for their overall satisfaction with the ACC system, drivers' responses resulted in a mean score of 6.0 on a 7-point scale (6.6 for older drivers).

In summary, between the post-drive and take-home questionnaires, differences amongst drivers were largely due to age rather than gender. The majority of age effects were constituted in the dissociations between older drivers' ratings of the ACC systems to their middle-aged and younger counterparts. Further comparisons dividing groups into their age-by-gender cohorts tended to support this assertion whereby most differences were again evidenced when comparing either older males or females with the remaining groups. In general, the age differences resulted in older drivers viewing the ACC system more favorably than either the middle-aged or younger driving groups. This finding was consistent in both the post-drive and take-home questionnaires and was obtained regardless of gender.

Attempts to determine how characteristics of individual drivers would seem to serve as practical predictors of driver acceptance of ACC were modestly successful. Driver age, in particular, was more likely to predict ACC system acceptance than was driver gender, education or income. But to a much greater degree, drivers' self-report of driving style (DSQ) was a highly statistically significant predictor of ACC acceptance. Specifically, responses by drivers to several questions in the post-drive questionnaire were strongly associated with driver scores on the planning, social resistance, speed and deviance scales of the DSQ. Drivers that tend to plan ahead before embarking on a trip, are more likely to drive over the posted speed limit, dislike getting advice concerning their driving, and who are more likely to engage in actions that are inconsiderate of other drivers responded very favorably to the ACC system. Perhaps because ACC would not allow drivers to behave as they otherwise would (i.e., drive over 80 mph, tailgate, perform flying passes at close ranges, etc.), and these drivers recognized the inherent benefits and reduced stress associated with the more contentious forms of behavior.

In terms of how drivers utilized the ACC system, to the degree to which their interactions with the system can connote acceptance, there were significant differences in the frequency with which male drivers utilized ACC (that being more often than females), a trend which was consistent across the three-week exposure. Most all groups of drivers showed a significant trend toward increased use of ACC, on all road types, with increased exposure. However, male drivers explored the range of headway settings significantly more often than female drivers, perhaps because the female drivers found settings that they were comfortable with early in their experience with ACC. Older drivers also seemed to have settled on a limited number of headway settings early in their experience, but this was least true of middle-aged males.

9 Analyses Examining Differences in Acceptance between Algorithms A, B and C

The following section examines questionnaire responses across algorithms A, B and C in an attempt to distinguish whether changes in the FCW algorithm resulted in significant changes in drivers' responses to the FCW system. In addition, comparisons are made between the self-characterization of drivers in order to assess whether the three groups of drivers associated with the respective algorithms were inherently different to begin with. If little or no difference in the self-characterization exists, then the ability to make comparisons between subjective responses to the FCW across algorithms is strengthened (i.e., suggesting that it is only the FCW system that is changing across algorithms and not the people experiencing the system). Similarly, if the populations of drivers do not differ, then the possibility of collapsing ACC data from all drivers (algorithms A, B and C) is increased, assuming that there is no interaction between a driver's experience with FCW and ACC that is associated with the FCW algorithm a driver experienced.

There were 15 drivers in both algorithm A and B, and 66 drivers took part in the algorithm C portion of the study. Algorithm A and C drivers had the research vehicles for a total of 26 days, with the first 6 days serving as a baseline period. Drivers in algorithm B had the vehicles for only 19 days, with the first 5 days serving as the baseline period. Drivers in Algorithms A and B were approximately balanced for gender, while gender was balanced for drivers in algorithm C. For each of the three algorithms, the three different age groups (20-30, 40-50 and 60-70) were balanced. One notable difference between drivers taking part in the three different algorithms was income. Drivers who experienced algorithms A had a mean MIH of \$48,551, while drivers experiencing algorithms B and C had mean MIHs of \$58,987 and \$53,637, respectively.

9.1 Differences in Driver Characteristics

Both the Driving Behavior Questionnaire (DBQ) and the Driving Style Questionnaire (DSQ) were evaluated for differences in subscale scores between algorithms using a between groups ANOVA. The DBQ and DSQ were given to drivers prior to their participation in the study. These analyses were run in order to determine if there were pre-existing differences in the driving behaviors or styles of drivers experiencing the three different ACAS algorithms.

A Levene's test of homogeneity of variance was run for each subscale. The test of homogeneity determines whether equal variances can be assumed (this means that the groups being compared have approximately equal variance on the dependent variable

being evaluated). If the test of homogeneity returned a significance level of less than or equal to .05, equal variances could not be assumed. The significance values derived from assuming equal variances were used except where the test of homogeneity indicated that the variances were not equal. In which case significance values derived assuming unequal variances were used.

Three contrasts were run in order to compare the mean scores of each algorithm for each subscale. The three contrasts compared subscale scores for drivers in algorithm A to those of algorithm B, algorithm A to algorithm C, and algorithm B to algorithm C.

9.1.1 Differences in DBQ Scores between Algorithms A, B and C

The ANOVA revealed no significant differences in the mean scores of the DBQ subscales by algorithm experienced (Table 9.1). Therefore, analyses across algorithms can assume that each algorithm was composed of drivers with similar driving behaviors to the drivers in other algorithms.

Table 9.1. Differences between DBQ subscale scores by algorithm

Subscale	Algorithm	Mean	Relationships of difference	Significance level
Lapse	A	0.55		0.241
	B	0.74		0.433
	C	0.65		0.474
Error	A	0.30		0.261
	B	0.43		0.689
	C	0.34		0.301
Violation	A	0.48		0.594
	B	0.57		0.383
	C	0.59		0.847

*Items denoted with an asterisk indicate that equal variances could not be assumed for the question. *Significance levels in italics denote significant values at the <.05 level.* Non-italicized significance levels do not meet the criteria established for significance, nor do they approach significance.

9.1.2 Differences in DSQ Scores between Algorithms A, B and C

Only one of the DSQ subscale means varied significantly by algorithm (Table 9.2). The mean response of drivers in algorithm A varied significantly from the means of both algorithm-B and algorithm-C drivers. Drivers in algorithm A indicated significantly lower overall scores on the questions that comprised the *Social Resistance* subscale. Lower scores indicate less of that particular characteristic. Thus, based on the self-report data of the DSQ, drivers in algorithm A are significantly less socially resistant. None of

the other subscales had significantly different mean scores by algorithm. The predisposition of algorithm-A drivers to be slightly less socially resistant should be considered when interpreting results that compare algorithms.

Table 9.2. Differences between DSQ subscale scores by algorithm

Subscale	Algorithm	Mean	Relationships of difference	Significance level
Calmness	A*	4.20		0.797
	B*	4.16		0.583
	C*	4.11		0.675
Planning	A	3.23		0.539
	B	3.47		0.154
	C	3.66		0.518
Social Resistance	A	1.57	A vs. B	<i>0.004</i>
	B	2.90	A vs. C	<i>0.020</i>
	C	2.41		0.171
Speed	A	1.73		0.402
	B	2.07		0.723
	C	1.84		0.473
Deviance	A	0.87		1.000
	B	0.87		0.982
	C	0.87		0.982
Focus	A	3.12		0.399
	B	3.02		0.263
	C	3.02		0.962

* Items denoted with an asterisk indicate that equal variances could not be assumed for the question. *Significance levels in italics denote significant values at the <.05 level.* Non-italicized significance levels do not meet the criteria established for significance, nor do they approach significance.

9.2 Differences in Acceptance of ACAS

The post-drive and take-home questionnaires were evaluated for differences in driver acceptance of the ACAS system between algorithms A, B and C using between groups ANOVAs. The results of the analyses are reported separately for the FCW and ACC systems. A Levene’s test of homogeneity of variance was run for each question. The test of homogeneity determines whether equal variances can be assumed (this means that the groups being compared have approximately equal variance on the dependent variable being evaluated). When the test of homogeneity returned a significance level of less than or equal to .05 then equal variances could not be assumed.

Three contrasts were run in order to compare the mean scores of each algorithm for each FCW and ACC post-drive and take-home question. The three contrasts compared responses from drivers in algorithm A to those of algorithm B, algorithm A to those of

algorithm C, and algorithm B to those of algorithm C. The significance values derived from assuming equal variances were used except where the test of homogeneity indicated that the variances were not equal. In this latter case, significance values were derived assuming unequal variances were used.

9.2.1 Drivers’ Perceptions and Evaluations of FCW in the Post-Drive Questionnaire

Responses to eight of 51 questions in the FCW section of the post-drive questionnaire were significantly different, or showed a trend toward significance (i.e., $p < .10$), between at least two algorithms. Three of these questions were significantly different in two of the contrasts, one was significantly different in all three contrasts, and responses to the remaining four questions only showed differences in one contrast.

The means for FCW20 differed significantly between algorithms A and B and algorithms B and C (Table 9.3). The mean of the responses for algorithm A and algorithm C approached a significant difference.

Table 9.3. Differences between algorithms for specific post-drive FCW questions

Question	Algorithm	Mean	Relationships of difference	Significance level
Q20r	A	3.80	A vs. B*	<i>0.000</i>
	B	6.60	A vs. C*	0.073
	C	4.94	B vs. C*	<i>0.000</i>
Q24	A	4.07	A vs. C	0.068
	B	3.85		
	C	4.71	B vs. C	<i>0.022</i>
Q28	A	2.14	A vs. B	<i>0.018</i>
	B	1.40	B vs. C	<i>0.013</i>
	C	2.00		
Q31A	A	3.53	B vs. C	<i>0.030</i>
	B	2.71		
	C	3.58		
Q31C	A	3.40	B vs. C	<i>0.034</i>
	B	3.00		
	C	3.83		
Q31D	A	3.47	B vs. C	<i>0.022</i>
	B	3.14		
	C	4.03		
Q34	A	6.67	A vs. C*	0.095
	B	6.73	B vs. C*	0.072
	C	6.39		
Q40	A	1163.82	B vs. C*	<i>0.000</i>
	B	296.43		
	C	914.15		

* Items denoted with an asterisk indicate that equal variances could not be assumed for the question. Significance levels in italics denote significant values at the $<.05$ level.

Non-italicized significance levels indicate comparisons that show a trend toward significance ($p < .10$), but do not meet the $<.05$ cut off.

The question asked, “How often, if ever, did FCW give you a warning that was false (i.e. there were no other vehicles to warn about)?” Drivers from algorithm B indicated that they perceived the fewest number of false alerts, while algorithm-A drivers indicated receiving the most false alerts. Algorithm B was the algorithm which was significantly different from both algorithms A and C in that stationary objects did not produce alerts.

Mean responses to question FCW24 varied significantly between algorithms B and C. The means of algorithms A and C approached being significantly different. Question FCW24 asks, “Overall, evaluate the timing of the auditory alert when FCW was responding to a vehicle ahead. Please check the option that best applies.” A response of 4 indicated that the timing was “just right” whereas greater values indicated the alert was later than desired and smaller values indicated that the alert was earlier than desired. Mean responses from drivers in all three algorithms were near 4; however, the mean response from algorithm C was significantly different from that of algorithm B.

The mean response from drivers in algorithm B varied significantly from those of algorithms A and C for question FCW28. Question FCW28 inquires, “How often, if ever did FCW give you an alert where you could not identify the source of the alert? Please check the one option that best applies.” Algorithm-B drivers responded with the lowest mean response, indicating that they remembered receiving significantly fewer of these unidentifiable alerts than drivers that experienced the other two algorithms.

Three related questions showed significant differences in the mean responses between algorithms B and C. These three questions are all sub-questions of FCW31. Question FCW31 presented a scale and then stated, “Indicate the annoyance level associated with the event listed below which could result in unnecessary FCW alerts (In the space provided, please write the number corresponding to the annoyance level of each condition)”. Lower numbers indicated greater annoyance. The mean responses for drivers experiencing algorithm C were significantly higher for each of the three sub-questions, thus indicating less annoyance than reported by their algorithm B counterparts. The three specific sub-questions were, a = “when a vehicle ahead of me turned”, c = “when a vehicle ahead changed lanes”, and d = “when my vehicle changed lanes”.

The mean response to question FCW34 from drivers experiencing algorithm C approached being significantly different from the mean responses from algorithm-A and algorithm-B drivers. Question FCW34 asked drivers “When using FCW, how responsive were you to the actions of vehicles around you?” Algorithm-C drivers indicated the

lowest mean response. This implies that algorithm-C drivers showed a trend toward rating themselves as significantly less responsive than either algorithm-A or -B drivers.

Question FCW40 asked drivers “At what price level might you begin to feel this feature is too expensive to consider purchasing?” The mean dollar amount indicated by drivers experiencing algorithm C was significantly higher than the mean dollar amount indicated by drivers experiencing algorithm B. Even though algorithm A had a higher mean response than algorithm C the difference between algorithm A and algorithm B was not statistically significant. This may be partially because the test of homogeneity indicated that equal variances could not be assumed, thus the significance values used were those for contrasts than did not assume equal variances. The responses, however, are not consistent with what might otherwise be expected based upon the mean MIH values for the drivers in the respective algorithms. Drivers in algorithm B had the highest mean MIH, but were willing to pay significantly less than those with lower household incomes.

9.2.2 Drivers’ Perceptions and Evaluations of FCW in the Take-Home Questionnaire

Seven of 38 questions in the FCW section of the take-home questionnaire showed significant differences, or showed trends toward significant differences ($p < .10$), between the mean responses of at least two algorithms. Three of these questions showed differences in two of the contrasts while the remaining four questions only showed differences in one contrast.

The means for question FCW3 differed significantly between drivers experiencing algorithms B and C (Table 9.4).

The question asked: “How easy or difficult was it to understand and use the alert timing adjustment for FCW?”. Higher scores indicated a greater ease perceived by the drivers. Drivers who used algorithm B reported finding the alert timing adjustment significantly easier than the drivers who experienced algorithm C.

The mean scores of drivers who experienced algorithms B and C showed a trend towards being significantly different on question FCW5. Question FCW5 inquired “How startling did you find the auditory alert when it occurred?”. Drivers who used algorithm C had a higher mean response than drivers who experienced algorithm B. Higher scores indicate less startle. Thus, drivers using algorithm C showed a trend toward finding the auditory alerts less startling than did their counterparts who used algorithm B.

Table 9.4. Differences between algorithms for specific take-home FCW questions

Question	Algorithm	Mean	Relationships of difference	Significance level
Q3	A	6.58	B vs. C*	<i>0.010</i>
	B	6.86		
	C	6.33		
Q5	A	4.25	B vs. C	0.073
	B	3.54		
	C	4.66		
Q6	A	6.42	A vs. C	<i>0.045</i>
	B	5.86		
	C	5.38		
Q7e	A	1.55	A vs. C	0.098
	B	2.14		
	C	2.15		
Q7g	A	3.27	A vs. B *	<i>0.001</i>
	B	1.14	B vs. C*	<i>0.000</i>
	C	2.85		
Q7h	A	2.00	A vs. B *	<i>0.020</i>
	B	1.08	B vs. C*	<i>0.000</i>
	C	1.85		
Q13	A	4.36	A vs. B	0.071
	B	2.71	B vs. C	0.061
	C	3.97		

* Items denoted with an asterisk indicate that equal variances could not be assumed for the question. Significance levels in italics denote significant values at the <.05 level. Non-italicized significance levels indicate comparisons that show a trend toward significance, but do not meet the <.05 cut off.

Question FCW6 asks drivers “How distracting were the visual alerts that signaled a cautionary situation (a moderate threat)?”. The means of drivers using algorithm A and those using algorithm C varied significantly from each other. Drivers who experienced algorithm A had significantly higher scores, indicating that they found the visual alerts less distracting than drivers who experienced algorithm C.

Three similar questions revealed differences between the mean responses of particular algorithms. Question FCW7 provided a scale and then asked drivers to rate the frequency of alerts they perceived as unnecessary for given situations. Situation FCW7e referred to “when a vehicle cut in front of me (the driver)”. The mean frequency reported by drivers who experienced algorithm A approached being significantly less frequent than the drivers who experienced algorithm C. Situation FCW7g referred to “when I (the driver) passed a sign, light post or guardrail”. Drivers who used algorithm B reported unnecessary FCW alerts for this situation significantly less frequently than drivers using either algorithm A or algorithm C. The third situation revealing differences between algorithms was FCW7h: “When I passed a parked vehicle”. Drivers who experienced

algorithm B reported experiencing unnecessary alerts in this situation significantly less frequently than drivers who experienced either algorithm A or algorithm C.

The mean response to question FCW13 from drivers who used algorithm B showed a trend towards varying significantly from the mean response of drivers who experienced either algorithm A or algorithm C. Question FCW13 stated “If I was designing an FCW system, I would add an alert timing setting that allowed me to receive alerts sooner than the most sensitive alert timing setting that I experienced with this FCW system”. A score of 4 indicated neutrality towards this statement while higher scores indicated greater driver agreement with this statement. Drivers who used algorithm B reported scores that approached being significantly lower than drivers using either algorithm A or algorithm C, indicating less agreement with this statement.

9.2.3 Drivers’ Perceptions and Evaluations of ACC in the Post-Drive Questionnaire

Responses to seven of 20 possible questions in the ACC section were significantly different between at least two algorithms. Two of these questions were different in two of the contrasts and the remaining five questions only showed differences in one contrast. In theory, since only negligible changes were made to the ACC system across the three FCW algorithms, one might expect that subjective assessments of the ACC system should remain relatively consistent, unless the driver’s experience with the FCW system affects the drivers perception of ACAS as a whole—including ACC.

The mean response of drivers experiencing algorithm A and algorithm C differed significantly for question ACC7 (Table 9.5). Question ACC7 asked, “How comfortable did you feel using ACC in adverse weather conditions?” The mean response for algorithm C was significantly lower than that for algorithm A, indicating that algorithm-C drivers felt less comfortable using ACC in adverse weather conditions.

Question ACC9 stated, “Overall, I felt the operation of the ACC system was predictable”. Lower mean values indicated disagreement with this statement, whereas higher numbers indicated agreement with this statement. The middle value of 4 indicates ambivalence. Drivers experiencing algorithm B indicated the lowest value, implying that these drivers found the system less predictable, while drivers experiencing algorithm C indicated the highest value. The differences between these mean scores approached significance.

The mean response of drivers experiencing algorithm A and algorithm B differed significantly on question ACC13. Question ACC13 inquired of the drivers, “Did you experience more of less stress when driving with ACC as compared to manual driving?”

The mean response from algorithm A was significantly higher than that from algorithm B. A higher score indicated feelings of reduced stress compared to manual driving, thus drivers experiencing algorithm A felt a greater relief compared to manual driving than did those experiencing algorithm B.

Table 9.5. Differences between algorithms for specific post-drive ACC questions

Question	Algorithm	Mean	Relationships of difference	Significance level
Q7r	A	6.00	A vs. C*	<i>0.004</i>
	B	4.88		
	C	4.62		
Q9	A	5.93	B vs. C	0.094
	B	5.33		
	C	5.94		
Q13	A	5.93	A vs. B	<i>0.042</i>
	B	4.73		
	C	5.33		
Q20	A	6.47	B vs. C*	0.098
	B	5.80		
	C	6.52		
Q21	A	6.27	B vs. C	0.088
	B	5.73		
	C	6.27		
Q33min	A	1345.45	A vs. B	0.058
	B	342.86	B vs. C	0.053
	C	1099.98		
Q33max	A	1345.45	A vs. B	0.058
	B	342.86	B vs. C	<i>0.050</i>
	C	1109.63		

* Items denoted with an asterisk indicate that equal variances could not be assumed for the question. *Significance levels in italics denote significant values at the <.05 level.* Non-italicized significance levels indicate comparisons that show a trend toward significance, but do not meet the <.05 cut off.

The mean response to question ACC20 showed a trend towards being significantly different for algorithm B than for algorithm C. Question ACC20 asked, “When using ACC, how aware were you of the driving situation (surrounding traffic, posted speed, traffic signals, etc)?” Larger values indicated greater awareness. Drivers experiencing algorithm C responded with higher responses than drivers in algorithm B. However, this difference only approaches significance.

Question ACC21 asked drivers, “When using ACC, how responsive were you to the actions of vehicles around you?” Higher values represented a greater sense of responsiveness. Drivers experiencing algorithm C had a higher mean response than did

drivers experiencing algorithm B. This difference in the value of the mean responses approached statistical significance.

Question ACC33 was recorded as two separate questions, as some drivers entered a range rather than a single monetary value. Both the minimum value in the range and the maximum value in the range showed some variation between algorithms. Mean responses from drivers experiencing algorithms-A and -B approached being significantly different, as did the mean responses of drivers experiencing algorithms-B and -C. Drivers experiencing algorithm B indicated lower monetary values than the drivers in either algorithm A or C. The differences in the mean responses of drivers in algorithms A and B to the maximum value in the range also showed a trend towards varying significantly from each other. Again, the responses are not consistent with what might otherwise be expected based upon the mean MIH values for the drivers in the respective algorithms. Drivers in algorithm B had the highest mean MIH, but were willing to pay significantly less than those with lower household incomes.

9.2.4 Drivers’ Perceptions and Evaluations of ACC in the Take-Home Questionnaire

Only two of 18 possible questions in the ACC section of the take-home questionnaire showed significant differences, or trends toward significant differences, between the mean responses of at least two algorithms. One showed differences in two of the contrasts and the other showed differences in one contrast. Question ACC6 was not evaluated as it was categorical in nature and not suited to an ANOVA.

The means for question ACC2 differed significantly between drivers experiencing algorithms B and C (Table 9.6). The question asked: “How long did it take before you understood the operations of ACC? (check one)”. Lower scores indicated a shorter time to comprehension, while higher values indicated a longer time to comprehension. Drivers who used algorithm B reported needing a significantly shorter time to understand the operations of the ACC system than the drivers who experienced algorithm C.

Table 9.6. Differences between algorithms for specific take-home ACC questions

Question	Algorithm	Mean	Relationships of difference	Significance level
Q2	A	1.42	B vs. C*	0.049
	B	1.14		
	C	1.41		
Q16	A	6.55	A vs. B*	0.053
	B	5.36	A vs. C*	0.001
	C	5.55		

* Items denoted with an asterisk indicate that equal variances could not be assumed for the question. *Significance levels in italics denote significant values at the <.05 level.* Non-italicized significance levels indicate comparisons that show a trend toward significance, but do not meet the <.05 cut off.

Question ACC16 asks drivers “How comfortable did you feel having ACC slow your vehicle without feeling the need to depress the brake yourself?”. The mean response of drivers who experienced algorithm A varied significantly from the mean response of drivers who experienced algorithm C. The mean response of drivers who used algorithm A showed a trend towards being significantly higher than the mean response of drivers who used algorithm B. Drivers who used algorithm A had higher scores than either of the two groups. Higher scores indicated greater comfort with ACC slowing the vehicle.

9.3 Summary of Acceptance Differences by Algorithm

In comparisons of DBQ and DSQ, only 1 difference emerged where drivers in algorithm A reported having a less socially resistant driving style than either drivers in algorithms B and C. Otherwise, drivers evinced similar driving behaviors and styles, thereby increasing the strength of comparison of FCW and ACC across algorithms.

In regards to FCW, differences amongst groups were primarily amongst drivers in algorithm B versus drivers in algorithm A and algorithm C. For instance, drivers in algorithm B reported experiencing the least false alerts (FCW20r), the least numbers of unidentifiable alerts (FCW28), the least numbers of stationary alerts (FCWTH7g and FCWTH7h), and being least willing to incorporate a more sensitive FCW setting (FCWTH13). Consequently, drivers in algorithm B were willing to spend the least amount of money to purchase FCW as compared to drivers in algorithm A and algorithm C (FCW40). In addition, drivers in algorithm B reported being more annoyed than drivers in algorithm C in various alert-eliciting situations such as lead vehicle turning or changing lanes (FCW31a and FCW31c, respectively) or when their vehicle changed lanes (FCW31d). There were also some differences that existed between drivers in algorithm A and algorithm C. For example, drivers in algorithm A reported more false alerts (FCW20r), reported the visual alerts as being less distracting (FCWTH6), and reported less instances of alerts elicited with lead vehicle cut-ins (FCWTH7a) than drivers in algorithm C. Finally, drivers in algorithm C reported being the least responsive to vehicles around them (FCW34).

Because ACC underwent only moderate modifications across algorithms, few differences in drivers’ subjective evaluations of ACC across algorithms were expected.

Most differences in ACC were between drivers in algorithm B and algorithm C. Specifically, marginally significant trends indicated that drivers in algorithm B reported ACC as being more predictable (ACC9) and easier to use (ACCTH2) and that drivers in algorithm B were slight less aware and responsive to their driving environments while using ACC (ACC20 and ACC21, respectively). In addition, differences also existed between algorithm B and algorithm A, where drivers in algorithm B reported that using ACC was more stressful than manual driving (ACC13) as compared to drivers in algorithm A. Differences also emerged amongst algorithm A and algorithm C, where drivers in algorithm A reported being more comfortable using ACC in adverse weather conditions (ACC7r). Moreover, drivers in algorithm A were also the most comfortable allowing ACC to slow their vehicle (ACCTH16). Finally, in regards to amount of money drivers were willing to spend on ACC, drivers in algorithm B reported the lowest amount of money to purchase the ACC system (ACC33_{min} and ACC33_{max}), similar to the results regarding FCW.

10 Conclusions

The FOT has succeeded in testing the ACAS package of FCW and ACC functions under naturalistic conditions. An almost-complete capture of data from more than 250 data channels plus forward- and face-oriented video cameras has resulted in a massive, permanent database that archives approximately 137,000 miles of driving by laypersons. Thus, the first conclusion from this project is that a very valuable resource has just been added to the state of available information on the naturalistic driving process. Further, the ACAS system, in its final algorithm-C version as well as two earlier configurations, functioned very closely to the design intent throughout the respective segments of testing. This is not to say that improvements in system performance might not be made to arrive at product-ready versions of the ACAS elements, but that the test system was a successful artifice for studying ACAS-type functionalities in naturalistic driving. The suitability of FOT data for supporting conclusions on the safety and acceptance of the ACAS system is based, generally, on the extent and nature of the test exposure, as follows:

- Almost all of the conclusions are drawn from the 101,000-mile portion of the FOT involving algorithm C.
- Sixty-six individuals drove an ACAS vehicle in the algorithm-C configuration.
- These persons were evenly distributed across both genders and younger (20-30 yrs.), middle-aged (40-50 yrs.), and older (60-70 yrs) age groups.
- The typical subject drove 1,500 miles, covering some 1,100 miles with ACAS enabled.
- The FOT driving conditions varied significantly, thereby exercising the ACAS system and its drivers across a broad range of common driving environments. Mileages were generally distributed as follows:
 - half on freeways, half on surface roads;
 - three quarters in the light, one quarter in dark;
 - 10% with wipers on, 90% off;
 - 40% in sparse traffic, 45% in medium traffic and 15% in dense traffic.
- Distributions of the above factors were approximately the same for the first-week, baseline segments of the FOT and the subsequent three-week ACAS segment of testing.
- Exposure to cruise control (i.e., when the individual chose to engage it) is summarized as follows:
 - 20% of the ACAS-disabled distance was traveled with CCC engaged.
 - 37% of the ACAS-enabled distance was traveled with ACC engaged.

- The strongest of all exposure variations afforded by the field test lies in the differences between individual drivers in terms of their driving styles and travel patterns. These variations are so profound in many cases as to be the primary factor determining the pattern of results.

The principal conclusions of the FOT are stated in boxes, below, followed by a few selected observations that either elaborate on the underlying results or state a caveat to the generalization. The conclusions are based almost entirely on data collected from driving with Algorithm C. The sequence of presentation covers FCW safety and acceptance followed by ACC safety and acceptance.

10.1 Conclusions Pertaining to FCW Safety

Unintended Consequences of FCW Deployment

There was no evidence of unintended, negative consequences of FCW during the FOT.

- No forward crashes occurred during the FOT, as expected.
- No obvious abuse of the FCW system by drivers was noted.
- Secondary, non-driving task activity during manual driving was largely unchanged when ACAS was made available, although an increase was seen in conversations with passengers during the first week of ACAS exposure, probably due to its novelty.
- Drivers experimented with FCW when it was first available to them, but there were no observations of unsafe experimentation.

FCW Safety Contributions When Vehicles Share a Lane

FCW may be capable of assisting drivers in avoiding crashes within their own lane by improving awareness of a developing conflict and prompting its recognition.

- Scenarios in which the host conflicts with a vehicle that remains in the same lane throughout the event appear to be the most addressable for safety gains from FCW. These events are called in-host-path (IHP) events.
- At least thirteen events occurred in which FCW appeared to have improved drivers' awareness of an immediate forward-crash risk and/or encouraged an appropriate response. The thirteen events were found from a select set of events examined. All thirteen were IHP events.

- In 90% of the cases in which an FCW alert occurred during an IHP event, the driver applied the brake within two seconds of the alert, providing partial validation of the function, especially in terms of FCW timing, in these situations.
- Only 29% of all FCW alerts occurred in IHP events.
- Scenarios with a decelerating-lead-vehicle were by far the most common type of IHP events in which an FCW alert occurred.
- IHP events were rated as useful by drivers more so than other scenarios.

FCW Alerts Triggered by Stationary and Out-of-path Objects

Forty-one percent of FCW imminent alerts involved objects that were never in the vehicle's lane or path. Almost all were stationary roadside objects.

- Only 5% of out-of-path alerts were triggered by moving vehicles in adjacent lanes. The remainder were stationary objects along the roadside or overhead.
- Only one FCW alert was triggered by a stopped, in-path vehicle that had not been observed to move by the ACAS system. Six ACC alerts were triggered by a stopped, in-path vehicle.
- It is much more common for FCW alerts to be triggered by a very-slow-moving vehicle ahead than by a vehicle that is stopped, some of which come to rest shortly after the alert.
- Clearly there is a tradeoff involved in FCW considering vehicles never observed to have moved – this resulted in over 300 nuisance alerts in the FOT.

FCW Alerts Triggered during Transitioning-host-path Events

In thirty percent of the FCW alerts, triggering occurred in scenarios in which at least one vehicle changed lanes or entered or exited the roadway.

- A large, fairly-complex group of FCW alerts arose from moving vehicles whose conflict relationship with the host was called transitioning-host-path (THP).
- The most common THP event involves a lead vehicle turning off the roadway.
- Drivers applied the brakes within 2 sec of the alert in only 27% of the THP events, indicating that braking is often not the preferred means to resolve these types of forward conflict.
- Time-to-collision values in THP events are much lower than those tolerated by drivers in IHP events.

- Lateral movement of the host vehicle rarely begins after an imminent alert has occurred, however it is difficult to discriminate movements that may have been underway in advance of the alert.
- When drivers rated the utility of more than 500 imminent alerts through post-drive video-review sessions, 53% of the IHP alerts were rated as useful. Also, 33% of the THP and 14% of the out-of-path (OHP) alerts were rates as useful.

FCW Effect on Driver Behavior: Closing Conflict Exposures

Exposure to ACAS did not change the involvement of drivers in forward closing-type approaches, nor did it affect their braking reaction times, but a slight change was seen in speed reductions obtained through braking.

- Times-to-collision (TTC) and Decel-to-avoid (DA) were unchanged from the baseline week to the three subsequent weeks with ACAS enabled, in 16,000 in-host-path events and 28,000 other events examined.
- The alert rates in manual driving did not change when ACAS became enabled, even when isolating alerts onto surface streets and moving targets. (Alerts were “silent” during the baseline period.)
- Braking-reaction-times were unchanged, before and after ACAS.
- Braking was used to achieve greater speed reductions during the first 2 seconds after an alert during ACAS-assisted driving, with the average speed reduction increasing from 2.8 to 3.6 m/sec (6.3 to 8.0 mph).

FCW Effect on Driver Behavior: Headway Distance during Vehicle-following

Exposure to ACAS reduced the time spent in short headways when traveling behind other vehicles in quasi-steady-state following.

- Fourteen percent less daytime-driving time was spent at headways times under one second when FCW was available compared to the first-week baseline period. (The average percentage of daytime driving time that drivers spent with headway under one second decreased from 29.5% to 25.1% when ACAS became enabled.)
- Eleven percent less freeway-driving time was spent at headways under one second when FCW was available, compared to the first-week baseline period.
- Cautionary alerts may have led to fewer sustained periods of close- or moderate-headway following for middle-aged drivers, but this behavior appeared to erode as ACAS exposure grew.

Driver Experimentation with FCW

Drivers experimented with FCW during the first week of its availability.

- The rate of imminent alerts peaked during the week in which FCW was first available.
- Conflict rates and severities were significantly higher during the first week in which the FCW system was available.
- The rate of sensitivity adjustment by drivers was highest during the week in which FCW was first available.
- The frequency of sustained periods of following at short or moderate headways was lowest during the week in which FCW was first available.
- Drivers often reported testing the FCW by tailgating another vehicle, although this steady-state maneuver is not well-suited to provoking alerts. Their reported surprise at the absence of an alert in this situation appears to partially explain a stated general belief by drivers that FCW alerts come too late.

Patterns of Secondary-task behaviors

Drivers did not generally increase their frequency of secondary, non-driving, tasks when driving with FCW as compared to the baseline condition.

- The same lack of increase in secondary tasks was seen when frequently traveled commuting trips were examined as a specific subset of all travel.
- A small temporary increase in secondary behaviors was seen in the first week of engagement, mostly conversations with passengers, after which the behaviors returned to the baseline level.

10.2 Conclusions Pertaining to FCW Acceptance

Overall Acceptance of FCW

FCW system acceptance is mixed: Some drivers find FCW acceptable; others clearly do not.

- When rating whether FCW would increase one's driving safety, the mean score was 4.6 on a 7-point scale, where 1 = strongly disagree and 7 = strongly agree.
- Approximately 2/3 of the drivers were willing to recommend FCW to a loved one.

- If buying a new car today 45% of the drivers would consider purchasing FCW.
- At a cost of \$1000, 32% of the drivers indicated that they “probably or definitely” would purchase FCW with a new vehicle (although the \$1000 figure, per se, seems to have so affected the response to this question for appraising willingness to buy either FCW or, in the next section, ACC that the results are seen as questionably useful.)
- Overall satisfaction with FCW had a mean score of 4.8 on a 7-point scale where 1 = very unsatisfied and 7 = very satisfied.
- Approximately 1/3 of the drivers indicated they would have turned FCW off if given the opportunity.

Factors Predictive of the FCW Acceptance Result

In general, older drivers viewed the FCW more favorably than did either middle-aged or younger drivers, but no other strong biographical indicators of acceptance were found.

- Gender was not a significant predictor of acceptance, as a main effect or in combination with age.
- The frequency of FCW alerts was not a significant predictor of a driver’s FCW acceptance.
- Education and income were not practically significant predictors of a driver’s FCW acceptance.

Perceptions on the Utility of FCW Alerts

Drivers gave mixed judgments on the utility of individual alerts when reviewing them after their driving period, through video-replay.

- Most drivers report that they, *themselves*, do not need FCW, given their attentive behavior, but they can see where *others* need it.
- Younger drivers frequently mentioned the old, and older drivers frequently mentioned the young as those that might benefit most from FCW.
- Drivers were judged to be startled in 4% of the 634 alert events examined, and this apparent startle was most often associated with out-of-path alerts.

Patterns of FCW Sensitivity Adjustment

Patterns were observed in the adjustment of FCW sensitivity level, differentiating driver groups by adjustment frequency and preferred settings, once adaptation had occurred.

Recognizing that FCW adjustment affects only the cautionary, visual display...

- Male drivers adjusted the FCW sensitivity more than females.
- Older drivers spent significantly more time at the most-sensitive setting (for which the FCW cautionary alerts appeared earliest).
- Overall, sensitivity selection varied widely, and the two sensitivity values that prevailed over the greatest amount of FCW active time were the most sensitive and a mid-range sensitivity value.
- All groups of drivers made significantly more adjustments when ACAS was first enabled than in the subsequent weeks of its use.

10.3 Conclusions Pertaining to ACC Safety

Regarding ACC Alerts

ACC alerts were experienced rarely but tended to reflect meaningful conflicts when the target was a moving vehicle or a stationary vehicle in the surface-street environment.

- An ACC alert was experienced only about once per driver in the FOT.
- Approximately half of the ACC alerts involved stationary objects that did not pose a threat to the host.
- Six ACC alerts, however, did involve a stationary vehicle posing a potential threat to the host—all were on surface streets.
- When substantial brake intervention did follow an ACC alert, the observed delay times were so short as to suggest that driver reaction to the conflict had been underway in advance of the alert.
- None of the cases in which drivers exhibited a startle response were associated with alerts in ACC.

Basic Headway-Keeping in ACC Driving

The ACC controller affords an effective means of managing headway and thus minimizing headway conflict with the immediately-preceding vehicle.

- Headway times lying in the regime below 1.0 second are much less prevalent in ACC driving than under manual control.
- Conflict levels seen in overall ACC driving are comparable to those seen under CCC control and lower than conflicts cultivated in manual driving.
- The continuous action of the ACC controller to manage headway is believed to explain much of the reduction in FCW imminent alert rate under ACC control as compared to that arising from the FCW function during manual driving.

Use of ACC on Surface Streets

The utilization rate and frequency of conflicts encountered with ACC on surface streets is notable as a potential safety issue, at least in the initial usage of ACC.

- ACC utilization on surface streets was more than twice that of CCC but fell by a quarter over the three weeks of ACAS availability, suggesting driver adaptation toward a more cautious match of the ACC-utilization choice to the conflict environment.
- The ACC alert rate was eight times higher on surface streets than on freeways.
- The rate at which incidents of 0.3-g limit autobraking by the ACC controller occur was thirty times higher on surface streets than on freeways, although the rate of occurrence of such events on any type of roadway fell precipitously over the three weeks of ACAS availability and autobraking was seen to effectively resolve all the headway conflicts that were encountered while ACC remained engaged.
- Counterbalancing the risk, but suggesting more dependence by the driver on the technology, the ACC alert function is more often a credible warning for prompting intervention when driving on surface streets, as judged by the circumstances of the alerts.

Cultivation of Conflicts Using ACC Throttle-Override

Overall, throttle-override is practiced frequently under ACC control and is used occasionally to intrude well inside of the ACC gap-setting value.

- Approximately half of the FOT drivers used throttle-override at least once to reach a headway time that is approximately 2/3 or less of the gap-setting value.
- A quarter of the drivers used throttle-override to reach an absolute value of headway time equal to 0.5 seconds, or less.
- One possible motivation for this behavior may be the desire to intimidate a preceding driver that appears to be impeding one's progress in the fast lane of a freeway.

Conflicts Encountered During a Reverse Cut-in Maneuver with ACC Engaged

Reverse cut-in conflicts were not uncommon but their severity levels were relatively benign and drivers appeared very attentive to their occurrence.

(A reverse cut-in maneuver involves a lane change by the ACC host, whereupon a headway conflict almost immediately arises with a vehicle in the new lane.)

- Approximately half of the drivers had one or more reverse cut-in conflicts of sufficient severity to provoke ACC autobraking.
- One in four of these cases resulted in the minimum headway time reaching half or less of the gap-setting value. Only one in six culminated in a manual brake intervention.
- No single case of reverse cut-in ever caused the ACC braking controller to deliver its 0.3-g braking capacity (thus, no such event managed to exhibit the ACC limit-autobraking response to the driver).

Passing with ACC Engaged

ACC driving tends to involve longer intervals in which the driver is continually following a preceding vehicle and less-frequent and less-conflicted passing than in manual or CCC control.

- The passing rate with ACC engaged is lower, generally, since targets are followed for 50% longer than in manual control and 120% longer than in CCC control

- The rate of flying passes with ACC engaged is 1/2 that seen in manual driving and 1/3 that seen under CCC control.
- ACC drivers execute the flying-pass maneuver at longer range but at similar values of range rate.
- Times-to-collision in the initial, forward-conflict phase of the flying pass are 30% to 45% longer in ACC driving than in CCC or manual driving, respectively.

Lane Selection with ACC

Right-lane travel on freeways with ACC is common but yields no greater severity in the values of conventional conflict metrics.

- ACC, like manual and CCC, is used most often in the rightmost freeway lane, thereby being exposed to the merge/weave traffic that transitions on and off the freeway at right-side ramps.
- When driving in the center lane, ACC conflicts are much less frequent than those under manual control in any lane position but greater than those with CCC.
- When driving near entrance ramps, no specific problem was observed relating to the inability of the ACC controller to give way like a courteous, human driver to merging vehicles.

Cut-Ins That Occur Just Ahead of the ACC Vehicle

While the rate of cut-in by other vehicles may have a certain nuisance character with ACC engaged, the associated conflicts appear to pose no peculiar safety risk.

- The rate of cut-in by other vehicles that pull in front of the host vehicle during ACC driving is intermediate between those of manual and CCC driving.
- The inability to set the ACC gap shorter than one second does yield considerably higher rates of cut-in than are achieved at headways less than one second under manual control, particularly when traffic is dense.
- Cut-in conflicts with ACC driving are not greater in severity than those seen under manual and CCC control.

Driver-applied, Braking-Intervention on ACC

Overall, no particular safety issues were observed in ACC brake intervention.

- The driver brakes to disengage ACC at 1/3rd the rate (per 100 mi) of braking to disengage CCC and 1/20th of the rate of braking in manual driving.
- Deceleration levels from manually-applied braking are comparable among ACC and CCC interventions, as well as the manual modes of control. (Thus, it is surmised that driving behind a single ACC vehicle would cause one to encounter approximately the same peak braking disturbances as when following conventional passenger vehicles.)
- The levels of kinematic conflict facing the ACC driver at the moment of brake-intervention are not significantly different from those that coincide with braking from CCC or manual control when driving on freeways.
- ACC autobraking had already begun in only 20% of ACC brake interventions.

ACC Use under Heavy Traffic Conditions

The attractiveness of ACC control appears to be encouraging its use even in heavy traffic conditions that pose higher rates and severities of conflict.

- ACC was utilized at more than three times the rate of CCC under heavy traffic conditions.
- ACC was utilized for driving 12% of all distance traveled on surface streets when heavy traffic prevailed.
- ACC was utilized for driving 35% of all distance traveled on freeways in heavy traffic.

ACC Use on Winding Roads

While relatively rare, delayed detection of the ACC target vehicle due to road curvature can occur on surface roads but the lower speeds on such roads tend to offset the effect of a reduction in ACC's detection range.

- 1.5% of all ACC driving is on road segments too tightly-curved for full-range detection.

ACC Use under Conditions of Precipitation

Drivers are markedly more hesitant to use ACC during periods of precipitation.

- ACC utilization dropped by 45% when the wipers were on.
- Approximately 4% of all ACC miles were traveled with wipers on.
- Instrumentation could not assess the roadway conditions as being slippery or snow covered during ACC utilization.
- ACC set speeds were 5% lower when wipers were turned on rather than off.

ACC Use at Night

Drivers were slightly more hesitant to use ACC in the dark.

- ACC-utilization levels dropped approximately 10% in the dark.
- Approximately 18% of all ACC miles were driven in the dark.
- ACC set speed was unaffected by the light/dark condition.

Leaving the ACC Switch ON

The ACC switch (which does not self-deactivate at the end of the trip) was left continually ON for the majority of all driving with ACAS enabled.

- The ACC switch was left continuously in the ON position in 58% of all ACAS-enabled trips.
- Although a potential concern with the 'switch-ON' state is that ACC might become inadvertently engaged if the right steering-wheel button is accidentally pressed by the driver, no such incidents were reported.

Stopped Vehicles that May Appear Suddenly

Although suddenly-appearing objects could pose a conceivable challenge for the driver under ACC control, no cases of unusual conflict severity were observed.

- Suddenly-appearing, stopped vehicles were encountered under ACC control, but rarely.
- Thirteen incidents were observed to occur, where the ACC host emerged from behind a prior CIPV target thereupon encountering a stopped, in-path vehicle.

The incidents occurred on surface-streets and at the end of exit ramps and were all successfully resolved through braking intervention by the driver.

ACC Driver Inadvertently Resting Foot on the Accelerator Pedal

Very light throttle-override applications are regularly observed during ACC driving but no safety threats were seen to accompany them.

- The case of light, inadvertent application of the throttle was part of the safety analysis because such an action suspends the headway-keeping function of ACC, thereby posing a peculiar need for driver supervision of headway developments.
- About 100 candidate cases of sustained, low-level throttle-override were observed under conditions that might have been problematical, but the associated approach conflicts were minimal.
- Since one can only speculate about the driver intentions that lie behind throttle override, it is not possible to state that the observed throttle applications are inadvertent.

ACC Use on Freeway Ramps

ACC usage on ramps is common but no distinctive conflicts were observed.

- ACC was engaged for at least part of the traversal of 19% of all ramps traveled during the ACC-available portions of the FOT.
- ACC usage on an EXIT ramp occurred once every 250 miles of ACC engagement on freeways.
- One distinctive scenario of ACC use observed on exit ramps involved the practice of following a preceding, decelerating vehicle down to a virtual halt under ACC control until, finally, the 'PCM Inhibit' function automatically terminated engagement and prompted the 'driver control required' message.

ACC Gap-Setting Adjustment

Drivers commonly adjusted the ACC headway gap to its shortest or longest settings or to a mid-range selection

- Relatively high rates of usage at the extreme settings, i.e., the 1st and 6th levels of adjustment, might suggest that drivers prefer a wider range of adjustment

- (although subjective responses did not explicitly reveal a strong preference along these lines.)
- Male drivers explored the range of gap settings more than females.
 - Older drivers spent significantly more time at the longest gap setting and settled on it earlier in their experience relative to younger and middle-age drivers.

ACC Set-Speed Adjustment

ACC set-speed values were comparable to those in CCC driving, although more biased toward the maximum-possible value of 80 mph.

- Most ACC and CCC driving on freeways was done at similar speeds, predominantly in the range of 68 to 77 mph.
- The set speed was situated at 80 mph for 8% of all ACC travel distance but less than 1% of the travel distance with CCC.

Patterns of Secondary-task Behavior in ACC Driving

The frequency of secondary-task behaviors in ACC driving was comparable to that of manual driving but more than twice that of CCC.

- Although this result is statistically significant, the data for CCC driving are quite sparse.
- The secondary-task rates seen with ACC may be inflated by a novelty effect, since ACC driving shows much more conversation taking place with occupants.

10.4 Conclusions Pertaining to ACC Acceptance

Overall Acceptance of ACC

Most drivers found ACC to be both acceptable and desirable.

- Overall satisfaction with ACC had a mean score of 6.0 on a 7-point scale (6.6 for older drivers), where 1 = very dissatisfied and 7 = very satisfied.
- The judgment that ACC would increase one's driving safety had a mean score of 5.5 on a 7-point scale.
- Approximately 90% of drivers indicated willingness to recommend the ACC system to a loved one.
- If buying a new car today 73% of the drivers would consider purchasing ACC.

- At a cost of \$1000, 36% of the drivers indicated that they “probably or definitely” would purchase ACC with a new vehicle (although the \$1000 figure, per se, seems to have so affected the response to this question for appraising willingness to buy either FCW or, in the prior section, ACC that the results are seen as questionably useful.)

Factors that Tend to Predict ACC Acceptance Results

Although older drivers favored ACC more than either middle-aged or younger drivers, no other strong biographical indicators of acceptance were found.

- Gender was not a significant predictor of acceptance, as a main effect or in combination with age.
- Education and income were not practically significant predictors of a driver’s ACC acceptance.
- Drivers’ self-report of driving style (DSQ) was a significant predictor of ACC acceptance.

ACC Utilization

Significant differences in the ACC-utilization rate were seen between groups of drivers and as a function of increased exposure.

- Because utilization is an implicit form of acceptance, the high rates of ACC utilization (i.e., 36% overall and 60% of all freeway miles) are taken as confirmation of generally high acceptance.
- The highest rate of ACC utilization was among older drivers.
- Male drivers used ACC more than females.
- Almost all groups of drivers increased their overall rates of ACC utilization with increased exposure.

10.5 Overall Conclusions from the ACAS FOT

The following simple statements encapsulate the central findings of the ACAS FOT:

Regarding FCW:

Driver response to the ACAS FCW system was mixed. Older drivers were more likely to view the system favorably, and middle-age drivers the least likely. Most drivers saw some limited benefit associated with the FCW system, but typically reported that the

benefit would be greater for drivers other than themselves. After experiencing the FCW feature for three weeks, most of the FOT subjects were not willing to purchase such a system.

There was substantial variation in the frequency of, and conditions in which, individual drivers experienced alerts from the FCW system. The most important factor influencing this experience appears to be the individual driver, with the type of road (and therefore, traffic dynamic and roadside environment) being the second most important factor. Drivers frequently commented that they received more FCW alerts than they believed were truly necessary, with the additional alerts being deemed as nuisances or false alarms. This seemed to contribute significantly to what were generally negative perceptions of the FCW system. The two statements most frequently associated with FCW system attributes that needed improvement were first, to reduce the frequency of nuisance and false alarms, and second, to provide a means for turning off the FCW system in certain types of traffic conditions.

Overall there was no change in the rate or the severity of approach conflicts when driving with FCW versus driving without it. There was also no consistent set of results suggesting that driver braking responses to conflicts were either positively or negatively affected. The visual cautionary alerts appear to have introduced a short-lived change in headway following, but this effect is limited to middle-aged drivers. The headway distances during periods of vehicle-following in manual driving were also seen to increase on limited-access highways, as well as during daytime driving on all road types. The source of these effects remains somewhat unclear, given the lack of a sustained effect due to cautionary alerts, but it may be that ACAS creates a general increase in drivers' awareness of headway.

There were suggestions of safety potential of the FCW system. At least 13 situations were identified in which FCW appeared to contribute to the driver's proper awareness of a potential rear-end crash, and/or an encouragement of appropriate firm braking response to the situation.

Regarding the state of maturity of the FCW system, a majority of FCW imminent alerts were either false alerts triggered by objects not on the roadway or alerts in which the driver anticipates the benign resolution of the conflict via lateral motions of one or both vehicles, with no braking required. These implied deficiencies of the system trace to the current state of sensors and sensory processing that leaves FCW operating with much less information than drivers have at their disposal, and therefore a lesser ability to identify relevant in-path objects and to predict the likely motions of the vehicles. This

aspect of system performance appears to have negatively influenced driver acceptance of FCW, and provides a primary area for system improvement.

Regarding ACC:

The ACAS ACC system was widely used and favorably regarded by most participants. After experiencing the ACC feature for three weeks, most of the FOT subjects seemed genuinely willing to purchase such a system. The ability of this ACC controller to provide smooth, effective management of speed and headway over a very broad range of driving conditions is believed to account for its wide utilization by FOT drivers. A broadly distinctive feature that differentiates ACC control from any other driving mode is the reduced time spent at headway values below one second.

ACC was found to be basically benign in all of its safety implications for freeway driving. In particular, ACC driving produced fewer and lower-magnitude conflicts with other traffic on freeways, generally, as a result of either the system's control performance or differences in the way the ACC driver tends to follow and pass other vehicles. The rather popular usage of ACC in dense, but flowing, freeway traffic does result in more cut-in activity ahead of the ACC vehicle due to the somewhat longer headway times that are managed by the system. Also, the very long distances that can be driven with ACC continuously engaged makes it quite possible to travel for hours without a braking intervention.

ACC driving on surface streets, at least during the first week or so of many driver's exposure to the system, appears as an issue of some concern since the data showed that strong conflicts with other vehicles arise frequently in that environment. On the other hand, drivers adapted quickly to the task of supervising ACC such that the rate of full-autobraking incidents dropped precipitously within the short, three-week span of system testing.

Finally, although the tested ACC system was capable of automatically decelerating at up to 0.3g, the deliberately-retarded delivery of this response by the ACC controller is believed to have been an effective characteristic in discouraging drivers from depending upon it. Further, it appears that drivers were not generally able to experience the full 0.3-g braking response of ACC by means of experimentation.

References

- Daniel, W.W. (1990). *Applied Nonparametric Statistics (2nd Ed.)*. Boston: PWS-Kent Publishing Co.
- de Waard, D., van der Hulst, M., Brookhuis, K. A. (1999). Elderly and young drivers' reaction to an in-car enforcement and tutoring system. *Applied Ergonomics*, 30, 147-157.
- Fancher, P.; Bareket, Z.; Peng, H.; Ervin, R. *Research on desirable adaptive cruise control behavior in traffic streams*. Michigan University, Ann Arbor, Transportation Research Institute, Engineering Research Division. 62 p. Report No. UMTRI-2003-14. 2003.
- Hayward, J.Ch. (1972). *Near misses as a measure of safety at urban intersections*. Thesis, Dept. of Civil Engineering, The Pennsylvania State University, Pennsylvania.
- Horst, A.R.A. van der, (1990). *A time-based analysis of road user behaviour in normal and critical encounters*. TNO Institute for Perception, Soesterberg, the Netherlands.
- Janssen, W. H., Brookhuis, K. A., Kuiken, M. (1993). *Simulator and field evaluation of in-vehicle collision avoidance systems: Report of first year of research for Nissan (IZF 1993 C-46)*. Soesterberg, The Netherlands: TNO Institute for Perception.
- Kiefer, R.J., M.T Cassar, C.A. Flannagan, D.J LeBlanc, M.D.Palmer, R.K.Deering and M.A Shulman (2003). *Forward Collision Warning Requirements Project Task 1 – Final Report*. U.S. Department of Transportation report DOT HS 809 574. Washington, D.C.
- LeBlanc, D., Bareket, Z., Ervin, R., and Fancher, P. (2002). *Scenario-based analysis of forward crash warning systems in naturalistic driving*. Proc. 9th World Congress on Intelligent Transport Systems, Chicago, IL, October 2002.
- Najm, W. G., Sen, B., Smith, J., and Campbell, B. (2003). *Analysis of light vehicle crashes and pre-crash scenarios based on the 2000 General Estimates Systems*. U.S. Department of Transportation report DOT HS 809 573. Washington, D.C.
- Siegel, S., & Castellan, N.J. (1988). *Nonparametric Statistics for the Behavioral Sciences (2nd Ed.)*. New York: McGraw-Hill.

U.S. Department of Transportation National Highway Transportation Safety Administration (2000). *Traffic Safety Facts 2000*. Washington, D.C.

Van Der Laan, J. D., Heino, A., De Waard, D. (1997). A simple procedure for the assessment of acceptance of advanced transport telematics. *Transportation Research*, 5(1), 1-10.

West, R., Elander, J., & French, D. (1992). *Decision making, personality and driving style as correlates of individual accident risk* (Contractor Report 309). Crowthorne, England: Transport Research Laboratory.

Winkler, C.; Sullivan, J.; Bogard, S.; Goodsell, R.; Hagan, M. (2002). *Field operational test of the Freightliner/Meritor WABCO Roll Stability Advisor & Control at Praxair*. Michigan University, Ann Arbor, Transportation Research Institute, Report No. UMTRI-2002-24. 348.

Acknowledgments

The work reported here was executed under a subcontract from General Motors Corporation, as part of a cooperative agreement with the U. S. Department of Transportation (No. DTNH22-99-H-07109). This work was made possible by the dedicated efforts of many UMTRI professionals, including Bob Goodsell, Yi Liu, Dan Huddleson, Mike Campbell, John Koch, Ben Powell, Joel Devonshire, Kezia Shirkey, Jake Wetzel, Dillon Funkhouser, and Jessica Lantz.

The authors wish to acknowledge the substantial benefits of close collaboration with GM and Delphi staff, including Ray Kiefer, Jeremy Salinger, and Ron Colgin (GM), as well as the entire ACAS staff at GM and Delphi Corporation. Acknowledgment is also due to key U.S. DOT personnel including Jack Ference and August Burgett (NHTSA), Ray Resendes (FHWA), and the Volpe Center team led by Wassim Najm (RSPA).

Glossary

ACAS	Automotive Collision Avoidance System
ACAS-A	Automotive Collision Avoidance System with FCW Algorithm A
ACAS-B	Automotive Collision Avoidance System with FCW Algorithm B
ACAS-C	Automotive Collision Avoidance System with FCW Algorithm C
ACAS-disabled	A six day period in which ACC/FCW functionality was not available to the driver
ACAS-enabled	Approx. a 20 day period in which the vehicle operated with the ACAS functionality
ACC	Adaptive Cruise Control
ACC-engaged	ACC is controlling headway and longitudinal speed of the vehicle
Algorithm-A	Initial FCW algorithm with alerts for both moving and stationary objects
Algorithm-B	Same as Algorithm-A only with stationary object alerts suppressed
Algorithm-C	Final FCW algorithm with alerts for both moving and stationary objects
ANOVA	Analysis of variance
Autobraking	Modulation of the service brakes by the ACC controller
BRT	Brake reaction time
Baseline	A six day period in which ACC/FCW functionality was not available to the driver
CCC	Conventional cruise control
CCC-engaged	CCC is controlling longitudinal speed of the vehicle
CDPD	Cellular Digital Packet Data
CIPS	Closest in-path stationary target
CIPV	Closest in-path moving vehicle (could be stopped was previously moving)
Control-mode	Longitudinal control mode either manual, ACC or CCC
Cronbach	A test for a model or survey's internal consistency.
CSC	Circuit switched cellular
Cut-in	A maneuver in which a driver moves into the gap between the host and CIPV
Cut-Out	a lane change by the ACC host, whereupon a headway conflict almost immediately arises with a vehicle in the new lane
DA	Deceleration-to-avoid. A measure of forward conflict between the host and target
DAS	Data acquisition system
DB	Database
DBQ	Driver behavior questionnaire
Decel-to-avoid	Deceleration-to-avoid. A measure of forward conflict between the host and target

Deceleration-to-avoid	A measure of forward conflict between the host and target
Disabled	A six day period in which ACC/FCW functionality was not available to the driver
DSQ	Driving style questionnaire
DVI	Driver vehicle interface
EBX	Embedded board expandable
Enabled	Approx. a 20 day period in which the vehicle operated with the ACAS functionality
Engaged	The ACC or CCC controller is commanding longitudinal speed
FAH	False alerts heard
FAHrate	False alerts heard rate in alerts per 100 miles
FCW	Forward collision warning
FCW-active	FCW is available to provide an alert (nominally above 25 mph with no braking)
FCW-only	Manual longitudinal-speed control with FCW-active true
FFOV	Forward field of view
First-week	The baseline period of exposure when the ACAS system is disabled
Flying-pass	A maneuver where the host driver passes a slower moving vehicle on the left.
FOT	Field Operational Test
Freeways	The combination of Interstate and highway road types
FTP	File Transfer Protocol
Fusion	A subsystem of ACAS responsible for assimilating other subsystem information
Gap	The headway time between the host vehicle and the CIPV with ACC-engaged
Gap-setting	A driver selected headway time used by the ACC controller
GM	General Motors Corporation
Headway-time	a.k.a. headway time margin (Range/Speed) in seconds
Histogram	A graphical display of tabulated frequencies
Host	The ACAS vehicle
Htm	Headway time margin
Htm/Th	Headway time margin normalized by gap setting
Htm/Thmin	minimum headway time margin normalized by gap setting
HUD	Head-up display
HURP	Human Use Review Panel
Hz	The unit of frequency
IHP	In host's path
Imminent-alert	The highest level of FCW alert
IRB	Internal Review Board

K-W	Kruskal-Wallis one-way analyses of variance
LV	Lead vehicle
M	Mean
ManACAS	ACAS enabled with the ACC system not engaged
ManBase	ACAS disabled with the CCC system not engaged
Manual	The driver is controlling longitudinal headway and speed
Manual-braking	The driver is controlling the service brakes
Manual-control	The driver is controlling longitudinal headway and speed
Manual-driving	The driver is controlling longitudinal headway and speed
Map	A subsystem of ACAS
MFI	Median family income
MHI	Median household income
Mi	miles
Middle-age	40 to 50 year olds
Mode	Longitudinal control mode either manual, ACC or CCC
NAH	Non-false alerts heard
NAHrate	Non-false alert rate
NHTSA	National Highway Traffic Safety Administration
NPTS	National Personal Transportation Survey
OEM	Original equipment manufacturer
OHP	Out-of-host's path
Older	60 to 70 year olds
PC104-plus	a standard for pc-compatible modules used to create an embedded computer system
PCI	Per capita income
Prndl	Acronym for park, reverse, neutral, drive and low
PT2	Pilot test 2
R	Range
Rca	Crash avoidance range
Rdot	Range rate
road-class	Road type designation
S	seconds
SEM	Standard error of the mean
Sensitivity	FCW sensitivity setting; a value from 1 to 6
Sensor	A subsystem of ACAS
Set-speed	The driver's desired speed when engaged in CCC or ACC
SPSS©	Statistical Package for the Social Sciences
SQL	Structured Query Language

Stationary	A non-moving object
Std	Standard deviation
STVRc	A database table with the scene, target, vision, and radar control data
SUVs	Sport utility vehicles
Sv-7	Sensor system version 7
Sv-8	Sensor system version 8
TAH	Total alerts heard
TAHrate	Total alerts heard rate
Target	Current in-path stationary, moving, or movable object
Th	Driver selected gap (headway) setting; a value from 1.0 to 2.0 seconds
THP	Transitioning-host path
Tr	Driver reaction time
TRC	Transportation research center
TTC	Time to collision
TTI	Time to impact
UFOV	Useful field of view
UMTRI	University of Michigan Transportation Institute
USDOT	U.S. Department of Transportation
VCR	Video cassette recorder
Vdot	Host vehicle acceleration
Veh	Vehicle
VGA	Video Graphics Array
Vp	Target vehicle speed
Vpdot	Target vehicle acceleration
Vset	The driver's desired speed when engaged in CCC or ACC
Week1	Days 1 to 6
Week2	Days 7 to 12
Week3	Days 13 to 18
Week4	Days 19 to 24
Week1 (Alg. B only)	Days 1 to 4
Week2 (Alg. B only)	Days 5 to 11
Week3 (Alg. B only)	Days 12 to 18
Young	20 to 30 years old

DOT HS 809 900
August 2005



U.S. Department
of Transportation
**National Highway
Traffic Safety
Administration**

www.nhtsa.dot.gov
nhtsa 
people saving people