

DEPLOYABLE HEAD RESTRAINTS

Final Report

Joseph F. Hilyard
John W. Melvin
James H. McElhaney

January 31, 1973

1. Report No. UM-HSRI-BE-73-1		2. Government Accession No.		3. Recipient's Catalog No.	
4. Title and Subtitle Deployable Head Restraints				5. Report Date 31 January 1973	
				6. Performing Organization Code	
7. Author(s) J. F. Hilyard, J. W. Melvin and J. H. McElhanev				8. Performing Organization Report No.	
9. Performing Organization Name and Address Highway Safety Research Institute The University of Michigan Huron Parkway and Baxter Road Ann Arbor, Michigan 48105				10. Work Unit No.	
				11. Contract or Grant No. HS-031-2-281	
				13. Type of Report and Period Covered Final Report 15 January 1972-1 Feb. 1973	
12. Sponsoring Agency Name and Address National Highway Traffic Safety Administration U.S. Department of Transportation Massif Building, 7th and E. Streets, S.W. Washington, D.C. 20590				14. Sponsoring Agency Code	
15. Supplementary Notes					
16. Abstract <p>This research program was a continuation of NHTSA Contract FH-11-7612 (1 July 1970-30 June 1971). The object of this program has been to extend and further develop the concept of the inflating head restraint system, with special emphasis on:</p> <ol style="list-style-type: none"> development of totally inflating systems with self-contained fore-and-aft stiffness, and development of optimum head restraint shapes for oblique as well as direct rear end impacts. <p>The tasks carried out in this program were:</p> <ol style="list-style-type: none"> Definition of the dimensional constraints and performance requirements of head-restraint structures and inflator devices. Evaluation of proposed head-restraint/inflator concepts and selection of "candidate systems" for study. Design and construction of an integral seat/head-restraint/inflator system, for use in an impact-sled test program at HSRI and in a series of real-vehicle barrier and car-to-car crash tests at Dynamic Science in Phoenix, Arizona. Performance of comparative prototype testing on the "candidate systems" then final performance testing of the systems judged best at the conclusion of the development tests. 					
17. Key Words			18. Distribution Statement		
19. Security Classif.(of this report)		20. Security Classif.(of this page)		21. No. of Pages	
				22. Price	

TABLE OF CONTENTS

	Page
Table of Contents	i
Figures	ii
Tables	v
Acknowledgements	vi
1. Introduction	1
2. Conclusions and Recommendations	5
3. Definition of System Requirements	10
3.1 Deployable Head-Restraint	10
3.2 Inflator Device	10
4. Evaluation of Proposed Concepts	14
4.1 B.F. Goodrich Prototype	14
4.2 Goodyear Prototype	17
4.3 HSRI/UniRoyal Prototype	21
4.4 Head-Restraint Modifications	23
4.4.1 B.F. Goodrich Prototype	23
4.4.2 Goodyear Prototype	28
4.4.3 HSRI/UniRoyal Prototype	30
5. Seat/Head-Restraint Design	32
6. Development and Testing of Head-Restraint Prototypes	40
6.1 Sled-Test Equipment and Instrumentation	43
6.2 Sled-Test Data Handling and Analysis	46
6.3 Sled-Test Results	48
6.4 Vehicle Crash-Test Equipment and Instrumentation	70
6.5 Vehicle Crash-Test Results	73
7. Discussion of Test Results	96
7.1 B.F. Goodrich Prototype	100
7.2 Goodyear Prototype	106
7.3 HSRI/UniRoyal Prototype	115
7.3.1 Initial Sled-Tests	115
7.3.2 Vehicle Crash-Tests	119
7.3.3 Oblique Impact Tests	129
7.3.4 Final Performance Sled-Tests	129
References	147
Appendix A - Preliminary Specifications for Head-Restraints and Inflator Devices	148
Appendix B - Sled-Test Equipment Specifications and Calibration Procedures	153

FIGURES

	Page
1. Inflatable Head-Restraint per Contract FH-11-7612 (June 1971)	3
2. Head-Restraint Inflator (Olin Corporation)	12
3. B.F. Goodrich Prototype/Basic Configuration	15
4. Typical Dropweave Fabric	18
5. Goodyear Prototype/Basic Configuration	19
6. HSRI/UniRoyal Prototype/Basic Configuration	22
7. B.F. Goodrich Prototype/Mod 1 Configuration	24
8. B.F. Goodrich Prototype/Mod 2 Configuration	26
9. B.F. Goodrich Prototype/Mod 3 Configuration	27
10. Goodyear Prototype/Mod 1 Configuration	29
11. HSRI/UniRoyal Prototype/Mod 1 Configuration	31
12. Sled-Test Seat Structure (Front)	33
13. Sled-Test Seat Structure (Rear)	34
14. Vehicle Crash-Test Seat Structure (Front)	35
15. Vehicle Crash-Test Seat Structure (Rear)	36
16. Final-Design Seat Structure (Front)	38
17. Final-Design Seat Structure (Rear)	39
18. HSRI Impact Sled Facility	41
19. Sled- and Crash-Test Deceleration Pulses	42
20. HSRI Dummy Neck	44
21. Dummy Head Accelerometer Locations	45
22. Dynamic Science Crash-Test Matrix	71
23. Dynamic Science Vehicle Accelerometer Locations	72
24. Vehicle 261-4: Pre-Impact	74
25. Vehicle 261-4: Post-Impact	75
26. Dummy 261-4: Pre-Impact	76
27. Dummy 261-4: Post-Impact	77
28. Dummy 261-4: Pre-Impact	78
29. Vehicle 261-5: Pre-Impact	80
30. Vehicle 261-5: Post-Impact	80
31. Dummy 261-5: Pre-Impact	81
32. Dummy 261-5: Post-Impact	81
33. Vehicle 261-8: Pre-Impact	84
34. Vehicle 261-8: Post-Impact	85

FIGURES (Continued)

	Page
35. Vehicle 261-8: Post-Impact	86
36. Dummy 261-8: Pre-Impact	87
37. Dummy 261-8: Post-Impact	88
38. Dummy 261-8: Post-Impact	89
39. Vehicle/Bogey 261-9: Pre-Impact	91
40. Vehicle 261-9: Post-Impact	92
41. Dummy 261-9: Pre-Impact	94
42. Dummy 261-9: Post-Impact	95
43. Test A-627: Graph-Chek Sequence	97
44. Test A-627: Visicorder Traces	98
45. Test 261-5: Dummy and Vehicle Accelerations	99
46. Test Z-143: Graph-Chek Sequence	101
47. Test Z-143: Visicorder Traces	102
48. Test A-618: Graph-Chek Sequence	103
49. Test A-618: Visicorder Traces	104
50. Test Z-143: Graph-Chek Sequence	107
51. Test Z-143: Visicorder Traces	108
52. Test A-615: Graph-Chek Sequence	109
53. Test A-615: Visicorder Traces	110
54. Test A-616: Graph-Chek Sequence	111
55. Test A-616: Visicorder Traces	112
56. Test Z-126: Test Set-Up	116
57. Test Z-141: Graph-Chek Sequence	117
58. Test Z-141: Visicorder Traces	118
59. Test Z-145: Graph-Chek Sequence	120
60. Test Z-146: Visicorder Traces	121
61. Test 261-4: Dummy and Vehicle Accelerations	123
62. Test 261-8: Dummy and Vehicle Accelerations	124
63. Test 261-9: Dummy and Vehicle Accelerations	126
64. Test 261-9: Rotation of Seat and Head-Restraint	127
65. Test 261-9: Measurement of Relative Rotation	128
66. Test A-622: Graph-Chek Sequence	130
67. Test A-622: Visicorder Traces	131

FIGURES (Continued)

	Page
68. Test A-623: Graph-Check Sequence	133
69. Test A-623: Visicorder Traces	134
70. Test A-624: Graph-Check Sequence	136
71. Test A-624: Visicorder Traces	137
72. Test A-625: Graph-Check Sequence	139
73. Test A-625: Visicorder Traces	140
74. Test A-626: Graph-Check Sequence	141
75. Test A-626: Visicorder Traces	142
76. Test A-628: Visicorder Traces	143
77. Test A-629: Visicorder Traces	144
78. Test A-630: Graph-Check Sequence	145
79. Test A-630: Visicorder Traces	146

TABLES

	Page
1. Test Program Summary	49
2. Typical Head Angular Accelerations	52

ACKNOWLEDGMENTS

This research program was carried out by the staff members of the Biosciences Division of the Highway Safety Research Institute, The University of Michigan, under the direction of Drs. J. W. Melvin and J. H. McElhaney. The assistance of the following personnel is appreciated: N. Alem, J. Brindamour, R. Crombez, M. Dunlap, C. Dunn, S. Fisher, J. Hilyard, K. Saucier and A. Schweitzer. The cooperation of R. Anderson and B. Enserink of Dynamic Science is gratefully acknowledged also.

1. INTRODUCTION

On all new automobiles manufactured for sale in the United States since January 1, 1969, head restraint protection for occupants at each outboard front seating position has been required by law. FMVSS 202 directs that during a half-sine acceleration pulse of 8 to 9.6 G amplitude and 80 to 96 msec duration, the rearward rotation of the head relative to the torso shall be limited to 45 degrees by the action of the head restraint.

Current head-restraint systems to meet this requirement are generally of two types: fixed extensions of the seat-back, or a separate head cushion, adjustable for height, attached to the seat back. Such systems, however, can restrict rearward visibility for some drivers, and, if not adjusted properly (referring to the height-adjustable type), will not provide effective protection. For these reasons, the concept of a deploying head-restraint is attractive; such a system would remain out of sight in the seat-back until required then deploy rapidly to the proper position in the event of rear-end impact.

Under NHTSA Contract FH-11-7612 (1 July 1970 - 30 June 1971), the Highway Safety Research Institute at the University of Michigan developed and tested two automatically deploying head restraint systems -- one an inflating-bag system, the other a rigid sliding panel system -- and concluded that deployable head restraints are technically feasible and that they can provide a general level of performance better than conventional fixed head restraints.

Of the two types tested, the inflating system exhibited several advantages over the rigid system:

1. more compact packaging,
2. lower inertia during deployment,
3. greater potential for contact-surface shaping,
4. ability to expand fore and aft while deploying vertically.

These advantages were somewhat offset, however, by two related structural problems: provision for adequate fore and aft stiffness, and for oblique-impact protection. Regarding the first problem, the final report on this earlier study indicated that "...bag type inflatable head restraints were found to require a rigid rotating flap...

to provide necessary stiffness." As can be seen in Figure 1, such a rotating flap or comparable external mechanical support could pose a serious threat of injury to a vehicle occupant who was out of position (i. e., close to, or on top of, the support) at the instant of deployment. The oblique-impact situation -- which is, again, a "stiffness" or support problem -- was recognized but not investigated in depth in this earlier study.

The final report on Contract FH-11-7612, recommended several areas for further study, including:

- a) development of totally inflating systems with self-contained fore-and-aft stiffness, and
- b) development of optimum head restraint shapes for oblique as well as direct rear end impacts.

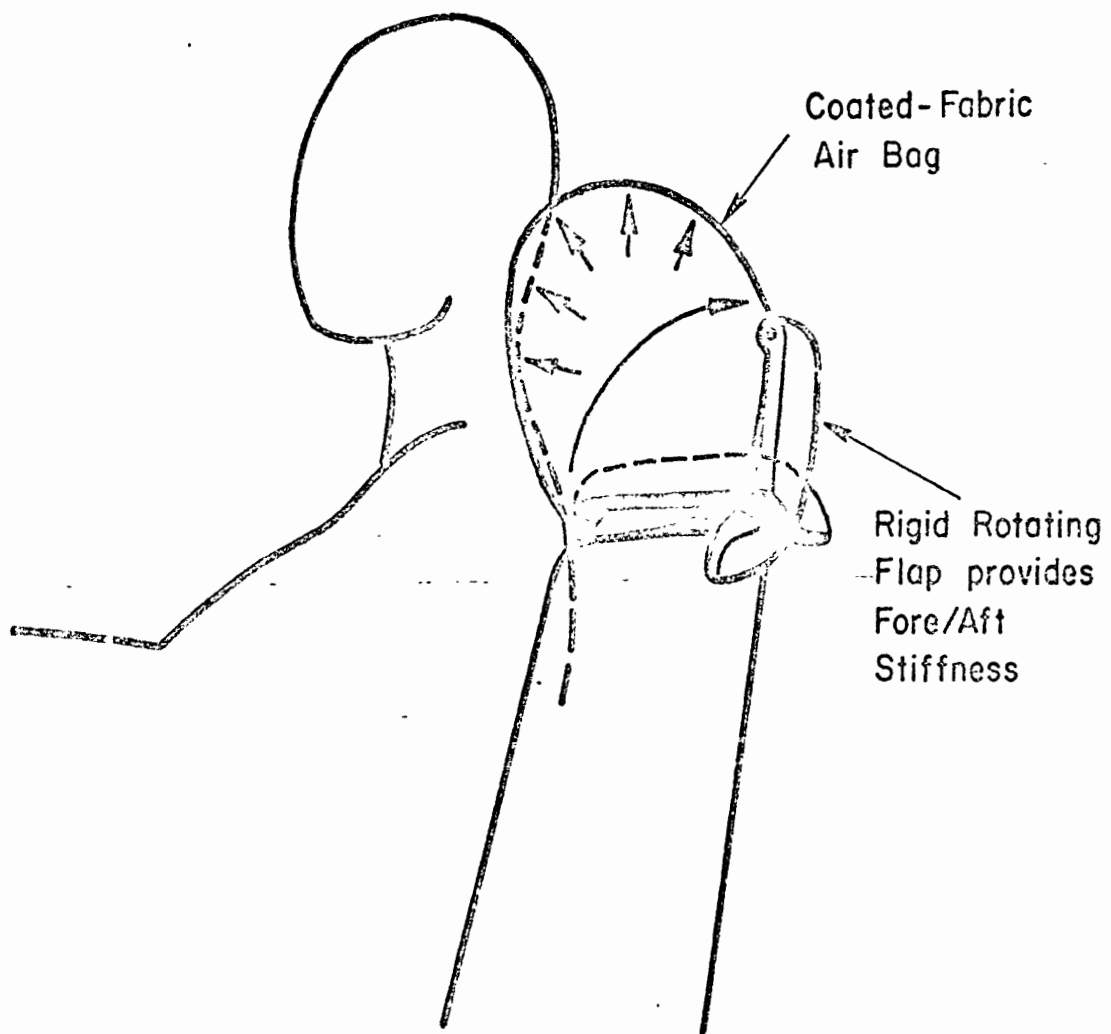

INFLATABLE HEAD RESTRAINT CONFIGURATION
PER CONTRACT FH-II-7612 (June 1971)

FIGURE I. 3

Contract HS-031-2-281 has been a program to extend and further develop the concept of the inflating head restraint system, with special emphasis on the two technical problems described above. In a series of related tasks, HSRI undertook:

1. Definition of the dimensional constraints and performance requirements of head-restraint structures and inflator devices.
2. Evaluation of proposed head-restraint/inflator concepts and selection of "candidate systems" for study.
3. Design and construction of an integral seat/head-restraint/inflator system, for use in an impact-sled test program at HSRI and in a series of real-vehicle barrier and car-to-car crash tests at Dynamic Science in Phoenix, Arizona.
4. Performance of comparative prototype testing on the "candidate systems," then final performance testing of the system judged best at the conclusion of such development tests.

Following sections of the report describe in detail the way each of these tasks were carried out.

2. CONCLUSIONS AND RECOMMENDATIONS

This study has demonstrated the technical feasibility of a deployable inflating head restraint that requires no external support for fore-and-aft stiffness. Of three "candidate systems" studied, the HSRI/UniRoyal prototype described in Section 4.3 best met the following criteria:

- minimization of head displacement and acceleration (both linear and angular)
- minimization of relative head/torso motion
- compact storage in a realistic seat structure
- rapid inflation, but with minimum hazard to occupants in atypical as well as normal position, both during a crash and during inadvertant actuation.
- simplicity of construction

The system was subjected to 16 impact-sled tests and to 4 vehicle crash tests, in simulations equivalent to car-to-car rear end impacts of 40, 60 and 80 mph. The performance of the head restraint in one such sled test, A-626, indicates how effectively it reduces the head/neck hyperextension ("whiplash") that characterizes rear-impact kinematics:

- 95th percentile male dummy, lap belted
- 40 mph/32 G direct rear impact
- deployment time 32 msec
- maximum head/neck extension 10 1/4°
- peak head A-P acceleration 71 G

- ramping and rebound moderate
- stowage volume 20" x 4" x 1".

Head-restraint effectiveness must be evaluated in combination with the seat structure to which it mounts, since dynamic performance depends upon the degree to which the load/deflection characteristics of the two are matched. Elastic deformation or energy storage in the seat, or relative motion between seat-back and head-restraint, will amplify the problems of extension, ramping and rebound. For this reason, a very strong and rigid seat was designed and built in parallel with head-restraint development. The approach taken in this study of rear-impact kinematics was that the occupant "ride down" the crash pulse; no attempt was made to absorb kinetic energy by allowing plastic deformation of seat/head-restraint components. This latter approach might be worth study, but caution is recommended.

Energy absorption must involve both the seat and the head restraint; otherwise, undesirable differential motion between head and torso can result, as test Z-140 made clear. The head-restraint mounting platform deformed 39° (plastically) while the seat remained rigid. Ramping was moderate and rebound severe, and extension was close to 30°. A more acceptable approach to energy absorption might involve crushable foam behind the seat-back and possibly within the head-restraint mounting structure, "matched" to maintain torso/head geometry during deformation.

Alternatively, the seat-back could incorporate a "plastic hinge" at the point where it joins the seat-pan. This would absorb occupant kinetic energy, but would also create problems of occupant ramping and rear-passenger-compartment intrusion.

Finally, seat-to-floor mounting is important in the "crash energy management" scheme also, as seen in the vehicle crash tests in Phoenix. Despite a rigid seat structure and head-restraint mount, rebound was a definite problem, primarily due to elastic deformation of the vehicle floor below and behind the test seat.

Protection against oblique rear impact was a design objective in this study, and both the Goodrich and Goodyear prototypes incorporated side-panels or projections for this purpose in their original designs. Both units, however, failed under dynamic test, due not to head loading but to material failure caused by the stress of rapid inflation. Neither could be evaluated in an oblique impact situation.

The HSRI/UniRoyal was tested twice in 30° oblique 40 mph impact simulations -- once in the basic configuration (no side panels) in a car, once in the Mod 1 configuration (with side panels) on the impact sled. Performance was good in both cases (5° maximum extension, 49 G peak head A-P acceleration), but further tests are recommended before conclusions about oblique crash performance can be made with real confidence. Bag shaping was attempted in fabricating the Mod 1 unit, but this concept could be explored further. Also, the side load straps might be modified to share more of the load generated by oblique impact.

Other refinements in design could reduce the phenomenon of "bag slap" encountered in several deploying tests. Contact between the head and bag, after impact but before complete bag deployment, gives the back of the head a "slap" that shows up as a sharp spike on the head accelerometer trace. Two possible solutions are:

- modification of the inflator to "soften" or "flatten" the initial portion of the pressure-time profile;
- modification of the air-bag -- built-in leakage, or "blow-out" patches -- to reduce the stiffness caused by initial high pressure.

Both types of modification were attempted -- use of a "choke plate" on the inflator to reduce flow, and deliberate "controlled leakage" assembly of the air-bag -- and both helped reduce bag slap. Further study of the problem, and exploration of other possible solutions would be helpful.

Another parameter that caused some initial concern was angular head acceleration, which, in test A-626, for example, reached 4190 rad/sec² at the time of maximum head extension (57 msec after impact). Closer analysis revealed, however, that a similar high angular head acceleration also occurred early in the crash pulse (5520 rad/sec² at 33 msec for A-626) due to the onset of dummy head deceleration. Thus, the head restraint did not generate the high angular acceleration, but "returned" the input it received as the head moved into the bag. Values of peak angular head acceleration are noted in Table 2 for a number of other tests; some discussion of these results is warranted.

First, these angular accelerations were computed directly from Visicorder traces of the two head S-I accelerometers, not from photometric film analysis as is more typical. (The latter technique usually employs smoothing of any peaks in angular acceleration.) In recent work

by T. D. Clarke, et. al. (1971) with human volunteers, and by Clemens and Burow (1972) with cadaver preparations, the same accelerometer-trace analysis method was used; similar values for peak head angular acceleration were obtained.

Second, the HSRI neck (see Section 6.1) used for these tests is much less stiff than a conventional rubber dummy neck, and offers less resistance to motion at the start of the crash pulse and at the time of maximum head extension. This more human like characteristic of the neck coupled with the severe "square wave" nature of the crash pulse used in the sled test program (see Figure 51 for example) would explain, at least in part, the rather high angular head accelerations noted.

Since this was primarily a feasibility study, "product development" problems -- packaging, protection from the elements, crash sensor integration and the like -- were recognized but not explored in any detail. Effort was concentrated on designing a compact functional prototype system, integrated into a seat structure for repeatable test purposes.

It should be noted that the failure of the other two prototypes was due essentially to materials problems; investigation of improved bladder materials and fabrication methods might be worth consideration. More complete dynamic testing of the two systems -- which did incorporate some sound design approaches to the head-restraint problem -- could then be conducted.

3. DEFINITION OF HEAD RESTRAINT SYSTEM REQUIREMENTS

The goal in this phase of the program was to define the dimensional constraints and performance requirements of head restraint structures and inflator devices. (Definition of a seat structure into which the head restraint and inflator could be integrated was the subject of a separate task, described in Section 5.)

3.1 HEAD RESTRAINT GEOMETRY AND PERFORMANCE

Based on a careful review of the work carried out under Contract FH-11-7612 -- computer simulations of occupant motion and head restraint effectiveness (using the HSRI two dimensional crash victim computer model), plus extensive sled tests of inflating head restraints -- requirements for head-restraint geometry and performance were defined. (Appendix A).

This specification sheet was discussed with the B. F. Goodrich Research Center (Brecksville, Ohio), Goodyear Aerospace Corp. (Akron, Ohio), and UniRoyal, Inc. (Mishawaka, Indiana); all three organizations had previously expressed interest in working with HSRI to investigate the concept of the deployable head restraint. (The prototype test units proposed and built by each firm are described in Section 4 of this report.)

3.2 INFLATOR DEVICE PERFORMANCE

In conjunction with the decision to limit the scope of this program to inflating head-restraint, a specification sheet defining inflator geometry and performance (Appendix A) was drawn up. Two inflator systems were considered for possible use.

The first was the "Safe-T-Flate" unit from Olin Corp. (Marion, Illinois), developed for use with a steering-wheel air-bag system. The rechargeable 13 cubic-inch cylinder (see Figure 2) operates on the augmented air principle:

- prior to testing, the bottle is charged to about 2000 psi with compressed air.
- upon actuation, an electric squib ignites the pyrotechnic portion of the inflator.
- pyrotechnic pressure builds up until a rupture disc fails, allowing the hot gas to enter the chamber containing the compressed air.
- the compressed air heats up and pressure rises until a second rupture disc fails, allowing the air/gas mixture to enter the restraint bag.

Also considered was a gas generator system developed by Rocket Research Corp. (Redmond, Washington). The unit is basically a small modified solid-fuel rocket motor whose exhaust gas, cooled by the evaporation of Freon, could be ducted into the restraint bag to achieve inflation.

For several reasons, HSRI chose to use the Olin system for use throughout the program:

- successful use in the test programs of Contract FH-11-7612,
- well established procedures for shipment, recharge and return,
- uncertain cost and availability of the RRC system,
- little information available on automotive application of the RRC system,

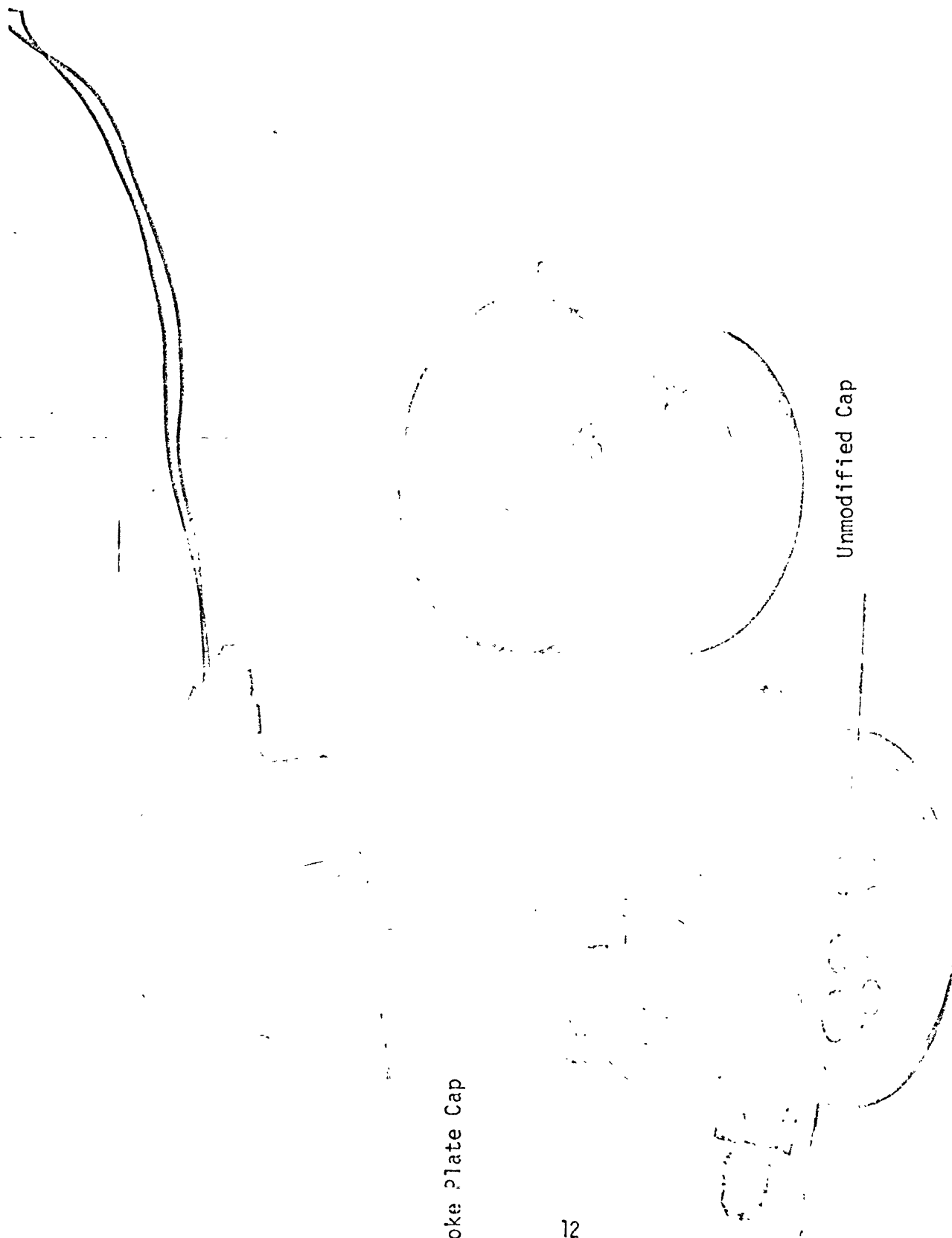

Choke Plate Cap

Unmodified Cap

Figure 2. Head Restraint Inflator (Olin Corp.)

- questionable acceptability of possible toxic gas generation with the RRC system.

4. EVALUATION OF PROPOSED HEAD-RESTRAINT/INFLATOR CONCEPTS AND SELECTION OF CANDIDATE HEAD RESTRAINT SYSTEMS

This task involved preliminary evaluation of three head-restraint concepts proposed in response to the specifications described earlier, and indicated that all three of the prototype units deserved more thorough development testing at HSRI.

Each of the systems underwent modifications in the course of development, and these are described in Section 4.4. In this section, however, only the original prototypes are described, to indicate the starting points for subsequent development work.

The "design goal" in each case, to repeat, was a self-supporting inflating head restraint that satisfied the requirements spelled out in Appendix A.

4.1 THE B. F. GOODRICH PROTOTYPE

Goodrich devised a "curved-tube" structure similar in construction to a segment of fire hose; i.e., a tube of rubber bladder material enclosed within a tubular sheath of coarse-woven abrasion-resistant fabric (the deflated bladder and the fabric sheath having the same nominal diameter and length).

To achieve shaping, the fabric tube incorporated adjustable cables to control the curve and shape of the sheath as the rubber bladder within expanded upon inflation. Figure 3 illustrates the final shape taken by the curved tube with the bladder inflated to 10 - 15 psi.

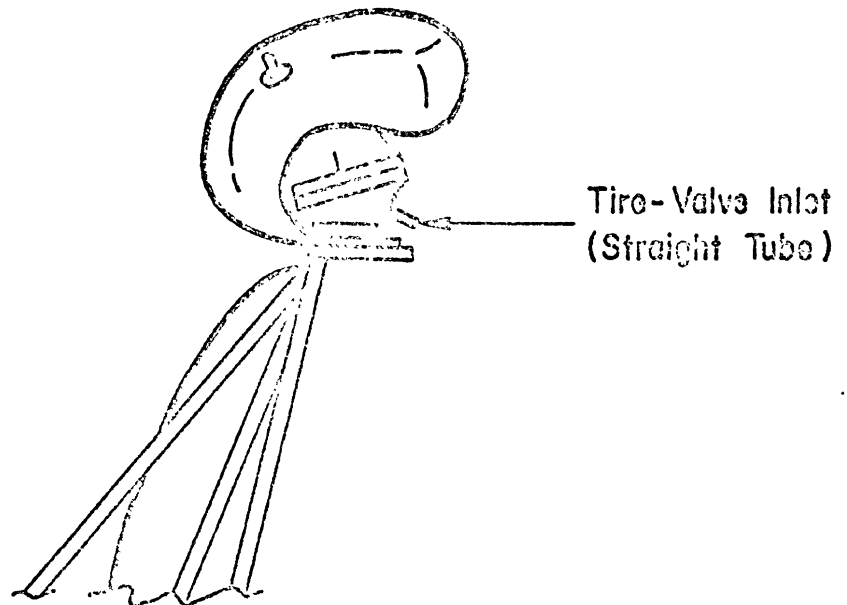
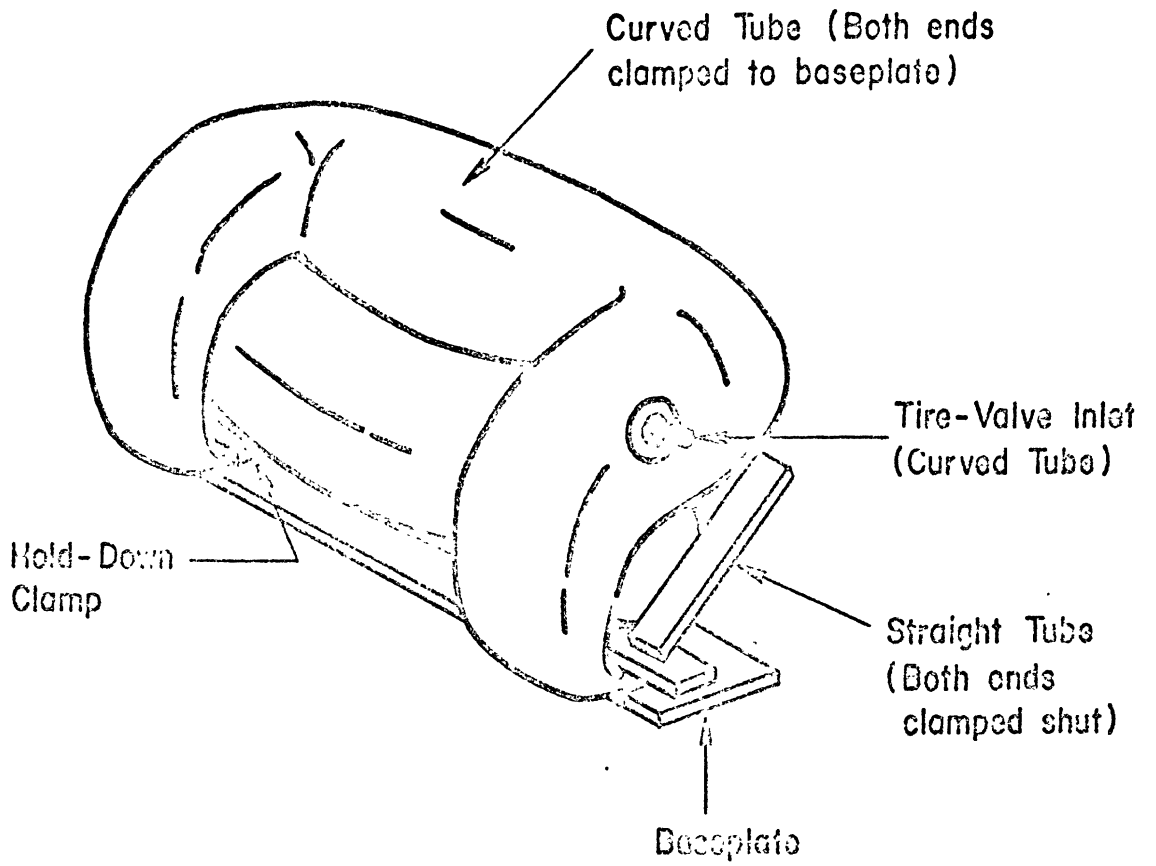

B.F. GOODRICH PROTOTYPE BASIC CONFIGURATION
(Two Separate Tubes)

FIGURE 3.

Note also the straight tubular segment that forms the head contact surface. Although Goodrich first suggested that a conventional small air-cushion could be used as the head-contact surface, it proved to be very difficult to position and restrain an elliptical or cylindrical bag between the vertical "legs" of the curved tube.

This basic prototype was not designed for use with an inflator. The ends of both the curved and the straight segments were clamped shut; tire valves in each segment allowed preinflation to any desired level for sled testing. While the ends of the curved segment were bolted to a mounting plate on the top of the seat-back, the clamped ends of the straight segment were unrestrained. Sections of rope (replaced later by seat-belt webbing) were used, however, to hold the straight tube in place behind the curved segment.

As may be seen in Figure 3, the unit was designed to provide resistance to direct-rearward and oblique-rearward loading in two ways. Under direct loading, the curved segment "works against" the straight segment to resist rearward motion; note also that the forward projection of the curved-tube's vertical legs helps "pocket" the shoulders to prevent excursion over the head-restraint. In the case of oblique loading, the same forward projections would help to catch the head and prevent excessive sideways twisting of the head and neck.

The results of tests on this system -- and on modified versions of it -- are described in Section 6.

4.2 THE GOODYEAR AIRMAT PROTOTYPE

In the late stages of Contract FH-11-7612, Goodyear Aerospace suggested the possible application of their unusual drop-weave structure called "Airmat" to the inflating head restraint investigation. Time limitations made it impossible to develop the Airmat structure to any degree under that earlier contract, but the concept was examined closely in the course of this program.

Figure 4 shows such a drop-weave material in unfinished form. The basis for its unusual mechanical properties is the three-dimensional manner in which it is woven. The tightly woven upper and lower surfaces form fabric faces, while the drop-woven threads tie the two surfaces together. When the fabric faces are then sealed or coated to provide an air-tight system, the resulting inflatable structure is much stiffer in bending than a simple bag-like inflatable, due to the three-dimensional nature of the drop-weave. A head restraint of such material would provide its own fore-and-aft stiffness, making external mechanical support unnecessary.

Airmat was most easily fabricated and readily available in flat planar form, and so the basic Goodyear prototype was constructed from three such panels (see Figure 5). A vertical rear panel 18 inches wide, 11 inches high, and 4 inches thick was joined with two perpendicular side panels 5 1/2 inches wide, 11 inches high and 4 inches thick to form a U-shaped structure with the "open side" forward. (All three sections were connected internally to form an integral pressure-tight structure.)

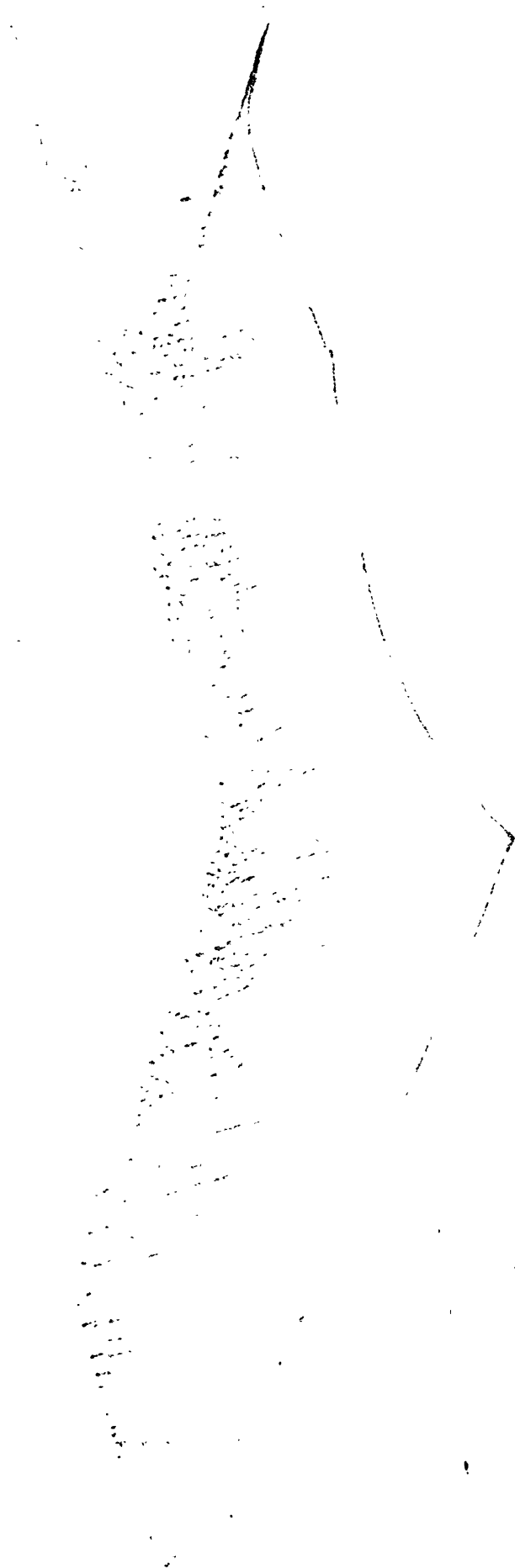
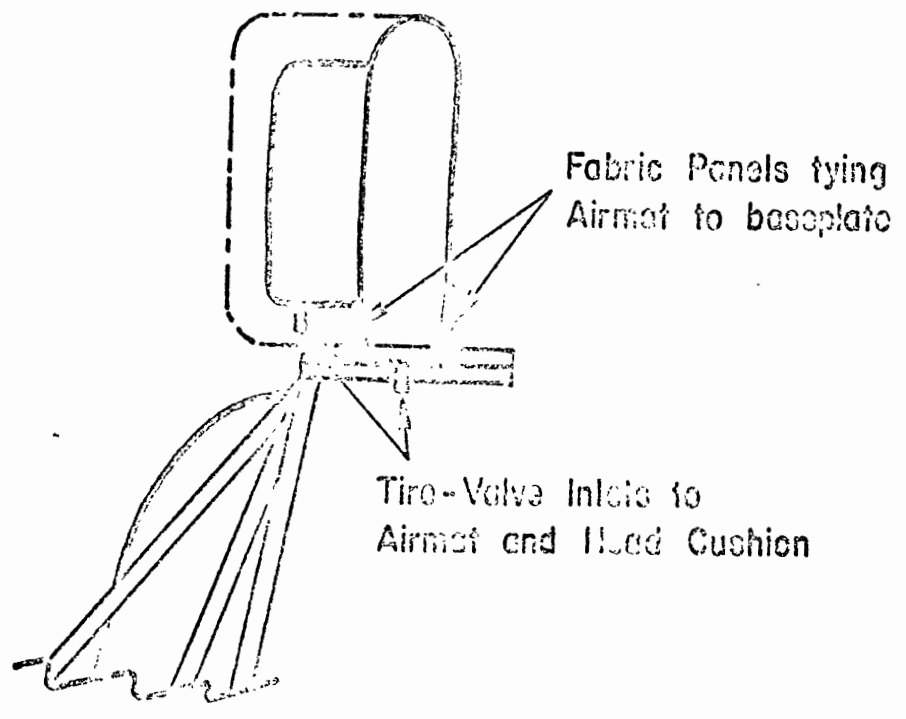
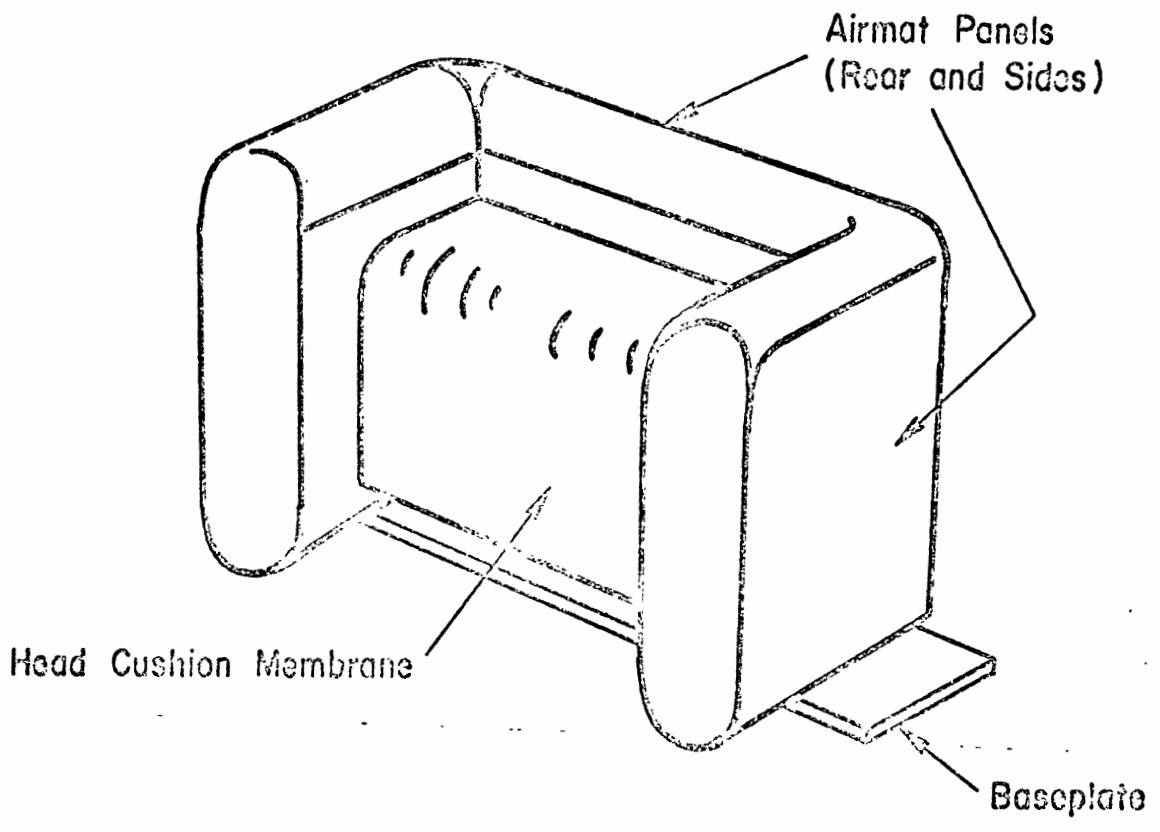

Figure 4. Typical Dropweave Fabric.



GOODYEAR PROTOTYPE BASIC CONFIGURATION
FIGURE 5.

As delivered for initial tests, the rear Airmat panel included a tire-valve inlet for pre-inflated tests; in addition, the panel incorporated a flanged fabric inlet tube -- sealed internally, to be opened when ready for dynamic inflation tests -- by which an inflator could be interfaced to the unit. A membrane of coated fabric was bonded across the side panels and the rear panel to create a recessed head-contact cushion with its own pre-inflation inlet valve.

The Airmat structure was mounted to a baseplate in such a way that the inflator flange and inlet valve on the bottom surface of the rear panel passed through the baseplate; 10-inch-wide fabric panels bonded to the front and back faces of the rear Airmat panel tied the structure to the baseplate.

The test program run on the Goodyear Airmat system is described in Section 6.

4.3 THE HSRI/UNIROYAL PROTOTYPE

The deployable head-restraint studied in most detail under Contract FH-11-7612 was a neoprene-coated nylon bag supplied by UniRoyal, Inc., inflated by an Olin "Safe-T-Flate" inflator. The same basic system was developed further under this program, in an effort to do away with the external mechanical support found to be necessary in that earlier investigation.

HSRI constructed the basic prototype (Figure 6) using a coated fabric bag of elliptical cross-section (10 inches high, 8 inches deep), 18 inches wide. Identical hole patterns in the bottom of the bag and in a rectangular metal baseplate provided an inlet port for the Olin inflator that mounted beneath the baseplate and discharged upward through the baseplate and into the bag.

To provide resistance to rearward loading, a fiberglass-reinforced vinyl hood 18 inches wide was fastened to the front and rear of the baseplate; the length of the hood was adjustable, so that when the bag within was inflated, the hood was pulled taut. Rearward loads applied to the hood/bag were transmitted, in part, to the baseplate and seat structure by the hood.

Additional "load sharing" was provided by a load-strap (seat-belt webbing 2 inches wide, about 10 feet long) sewn across the top rear of the hood, then attached at its ends to the edges of the seat pan. The belt segments running parallel to the sides of the seat also help to keep the occupant in the seat during an oblique impact situation.

Tests run on the HSRI/UniRoyal prototype are described in, Section 6.

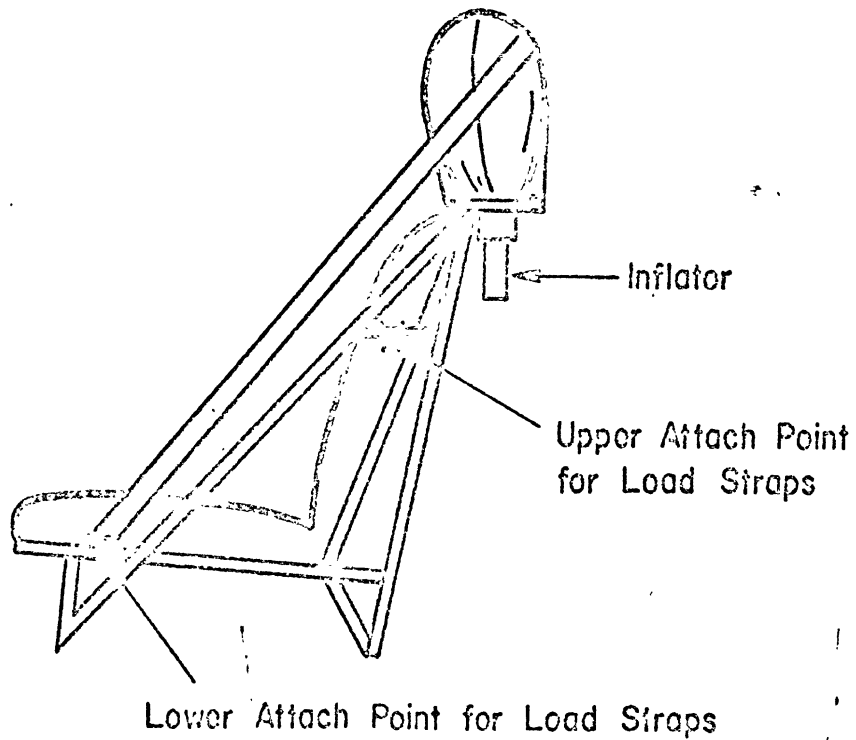
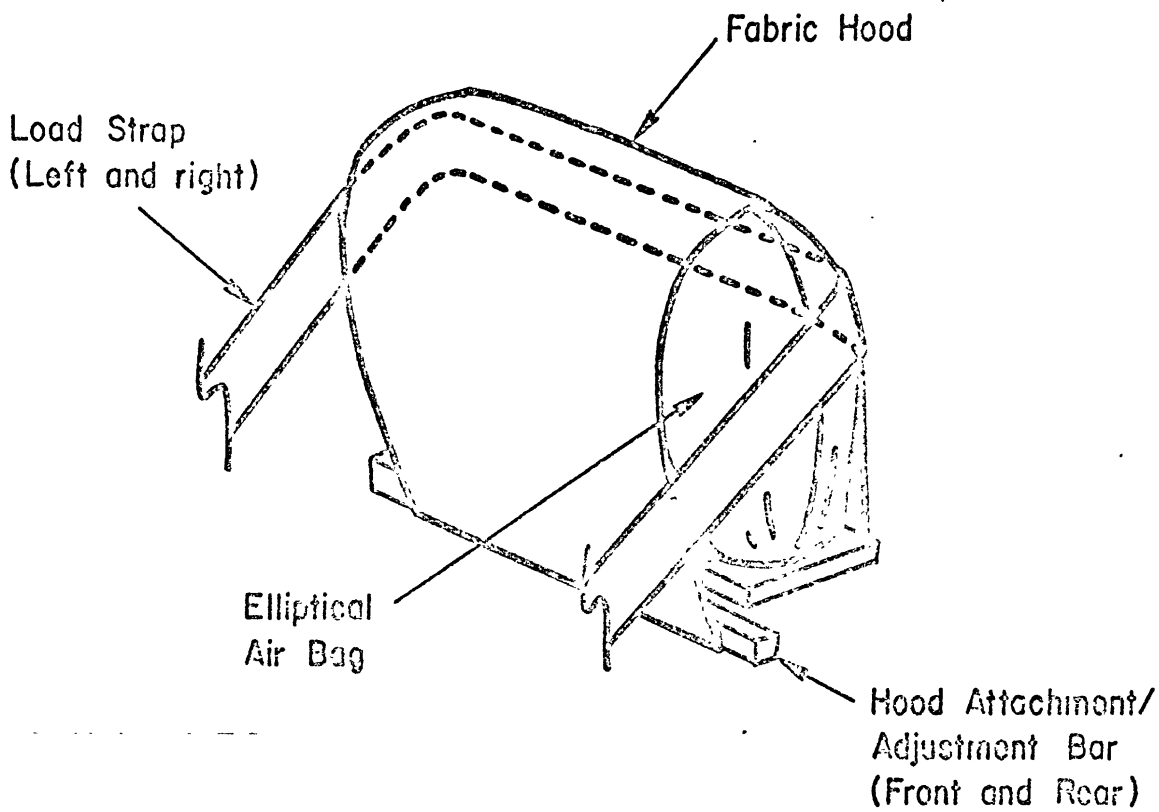

HSRI/UNIROYAL PROTOTYPE BASIC CONFIGURATION
 FIGURE 6.

4.4 HEAD RESTRAINT MODIFICATIONS

In the course of the development test program, changes were made to all three basic head-restraint prototypes to improve performance. This section of the report describes the "Mod 1," "Mod 2" and "Mod 3" configurations of each prototype, corresponding to the notation used in the narrative test summaries of Section 6.3 and in Table 1.

4.4.1 Goodrich Prototype

A) Mod 1 Configuration (Figure 7)

- A single 5-foot segment of sheath-enclosed bladder --- various types of rubber were tried as bladder material --- replaced the two separate segments in the basic prototype.
- At one end of the baseplate, both ends of the tube/sheath were clamped in place; at the other end, a pass-through clamp held the tube/sheath in position but allowed air to pass from the front (curved) to the rear (straight) section.
- A large (1" ID) inlet port replaced the tire-valve inlet on the curved (forward) section of the tube/sheath; a 3-foot length of 1" ID tubing connected the head-restraint inlet to the outlet of the Olin inflator (which was mounted low on the side of the test seat structure). An inlet-port adapter valve was used for pre-inflation tests.
- A short segment of seat-belt webbing held the rear (straight) section of tube/sheath in place behind the front (curved) section to form a head-contact surface.

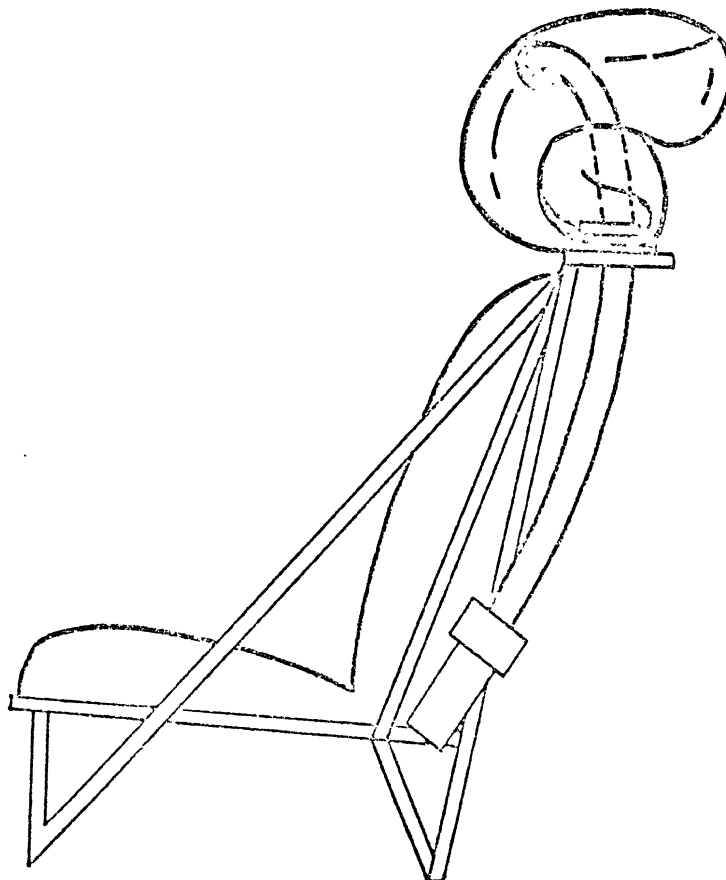
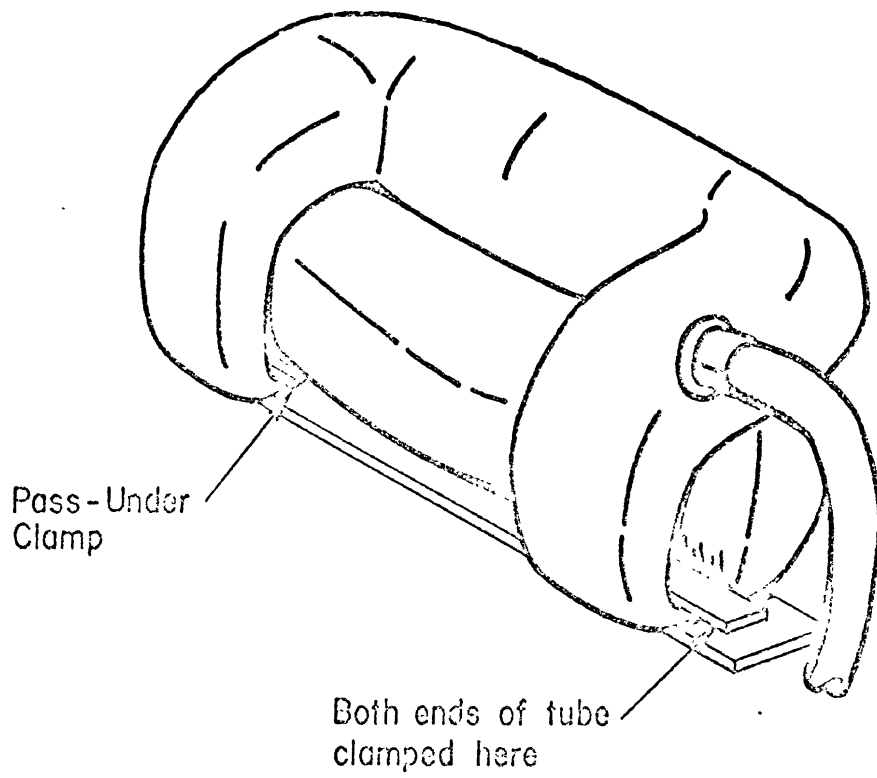

B.F. GOODRICH PROTOTYPE MOD I CONFIGURATION
(Single tube)

FIGURE 7.

B) Mod 2 Configuration (Figure 8)

- The 1" ID inlet port was moved so that inflowing gas entered not through the sidewall (perpendicular to the centerline) of the tube/sheath, but through one of the clamped-down ends of the tube/sheath (coaxial with the tube centerline). A segment of inner tube was used as a bladder.
- This unit underwent only one test -- a vehicle/barrier crash test at Dynamic Science -- which proved unsuccessful due to bladder failure and inflator misfire.

C) Mod 3 Configuration (Figure 9)

- The large 1" ID inlet port on the Mod 1 and Mod 2 units was eliminated.
- The center of the rear (straight) tube/sheath segment was clamped to the baseplate, and a pattern of inlet holes was cut through the sidewall of the tube/sheath in the clamp area.
- The Olin inflator was again mounted below the baseplate, to discharge upward through the baseplate, through the sidewall hole pattern, and directly into the head restraint.

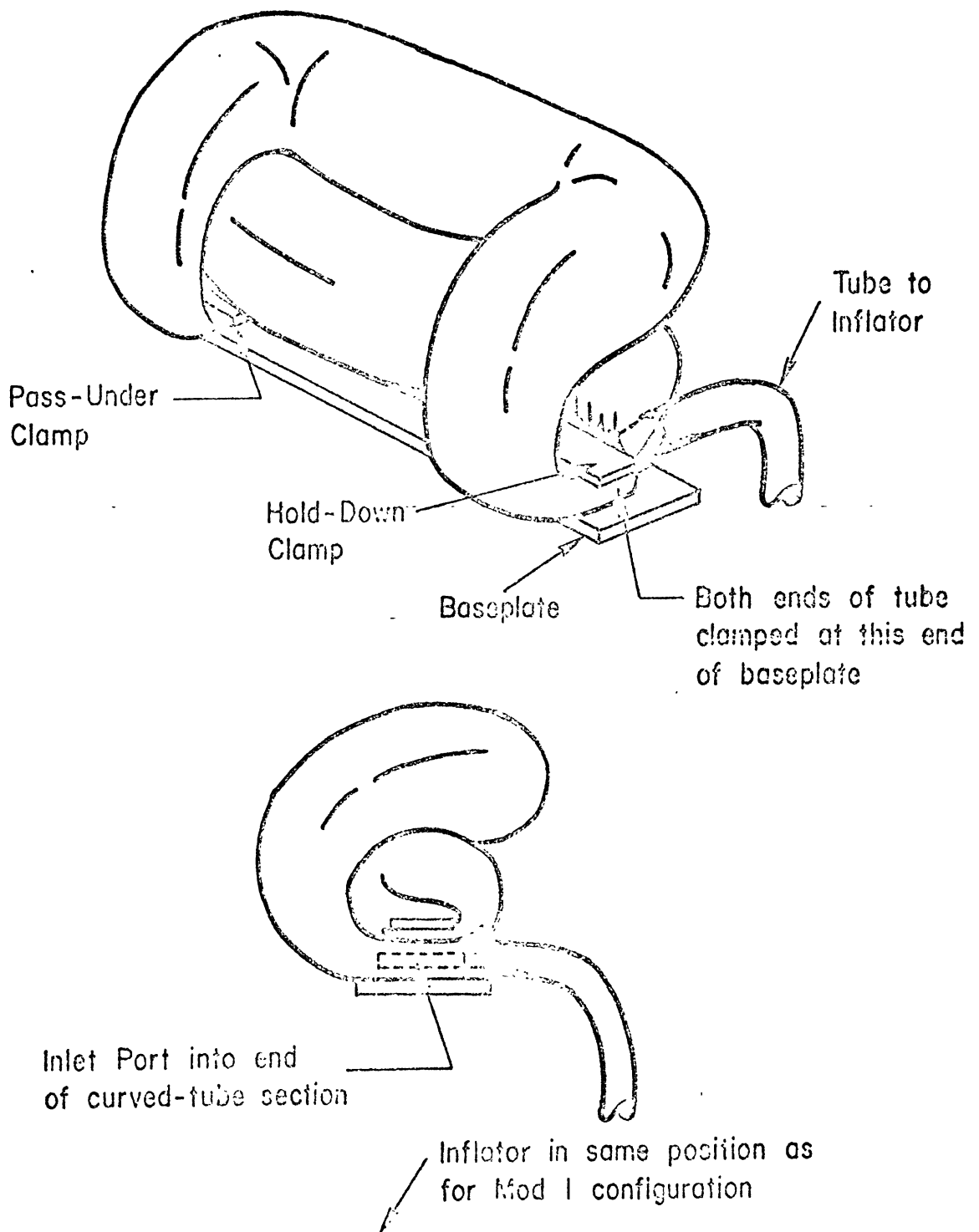

B.F. GOODRICH PROTOTYPE MOD 2 CONFIGURATION
(Single Tube)

FIGURE 8.

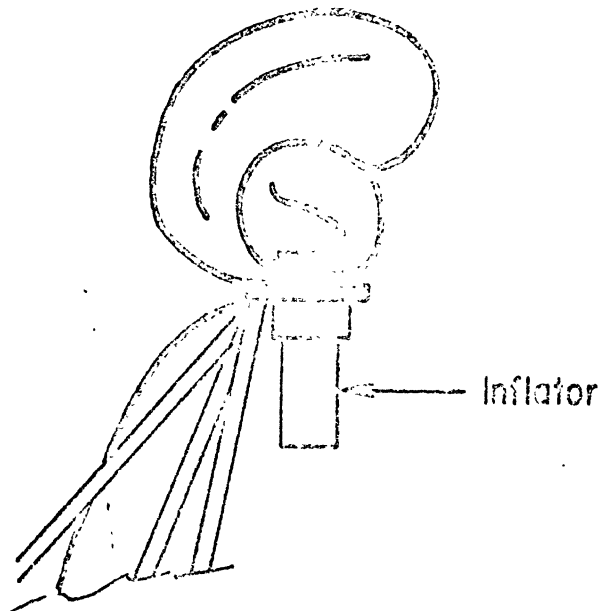
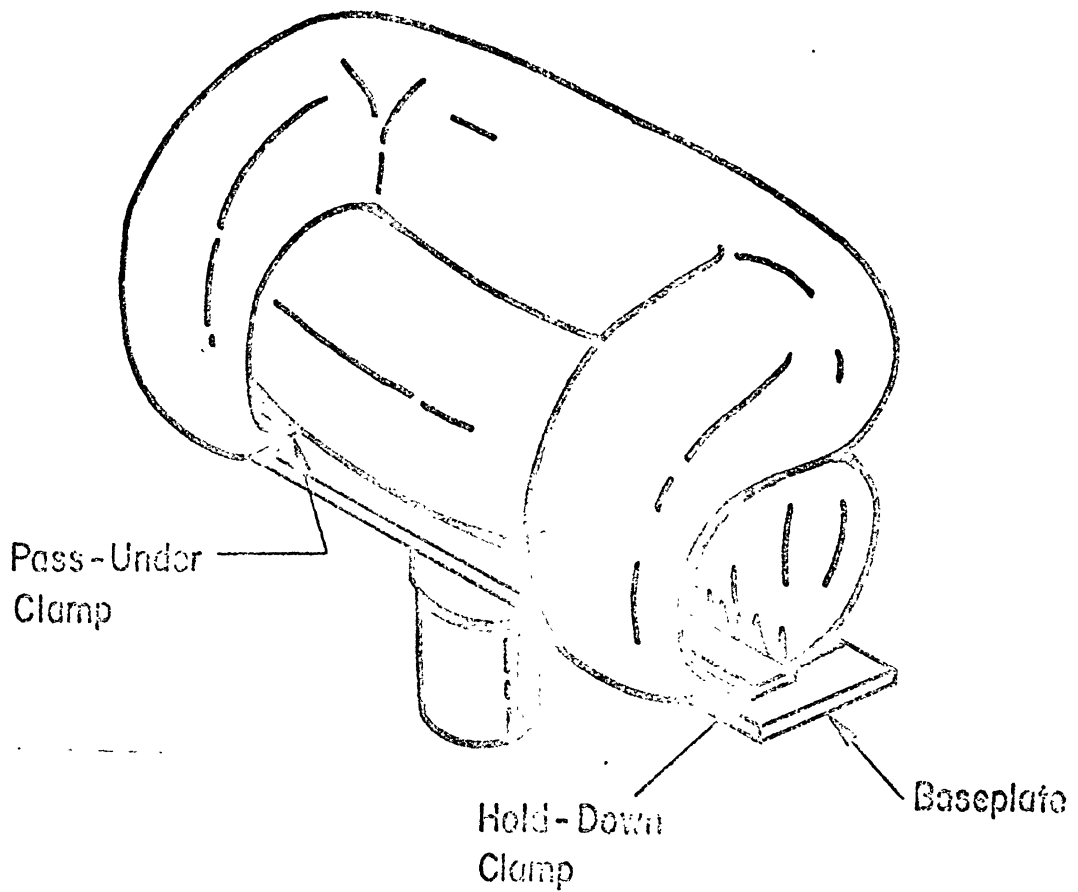

B.F. GOODRICH PROTOTYPE MOD 3 CONFIGURATION
(Single Tube)
FIGURE 9.

4.4.2 Goodyear Prototype

A) Mod 1 Configuration (Figure 10)

- The head-cushion membrane was removed, and the two separate hold-down panels on the rear Airmat segment were replaced with a single hold-down panel of fiberglass-reinforced vinyl -- bonded to the back face of the Airmat, passing over its top and down its front face -- to provide better mounting to the baseplate.
- A separate head-cushion bag of coated fabric (10 inches wide, 12 inches high, 3 inches thick) was attached to the front hold-down panel to provide a more compliant head-contact surface.
- Two three-inch-wide straps of the same reinforced vinyl were added to the front faces of the side panels and tied into the seat to increase resistance to rearward loading.
- For test A-620 only, the unit was adapted for use with the Olin inflator; this involved closing the pre-inflation inlet valves and opening the fabric-flange inlet at the base of the rear Airmat panel (see the end of Section 4.2).

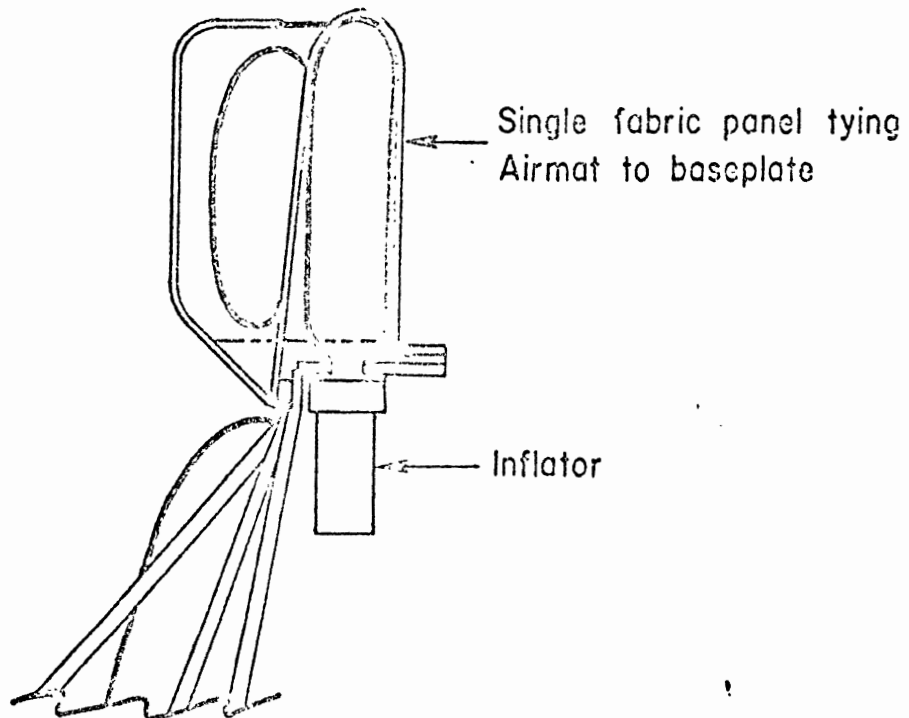
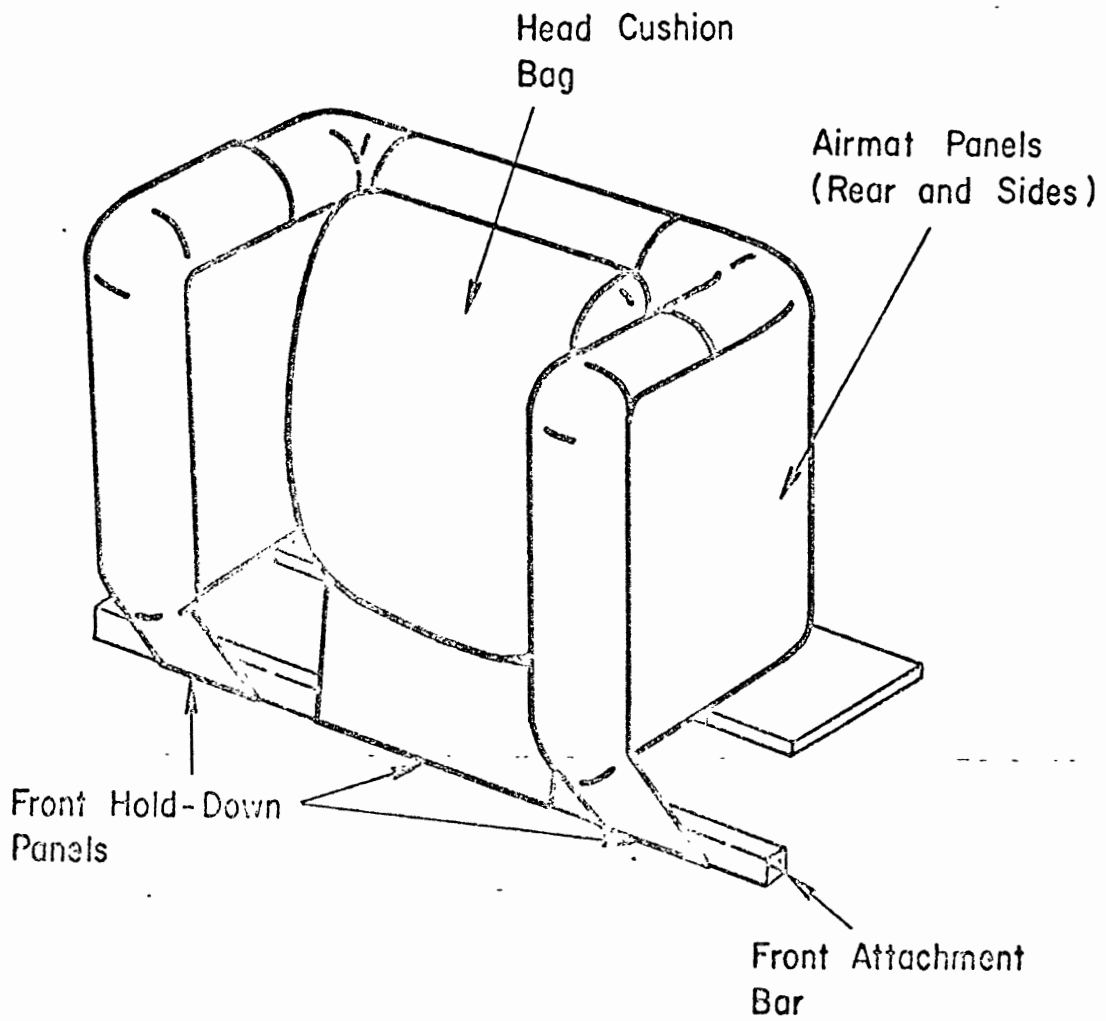

GOODYEAR PROTOTYPE MOD I CONFIGURATION
FIGURE 10.

4.4.3 HSRI/UniRoyal Prototype

A) Mod 1 Configuration (Figure 11)

- Side-panels (approximately 5 inches long, 10 inches high and 4 inches thick) of the same coated-nylon fabric were bonded to each end of a simple elliptical bag to form an integral inflatable structure. The panels were added to provide oblique-impact protection.
- The configuration of the vinyl hood, the load straps and the inflator inlet were identical to the "basic" prototype. The load straps were adjusted to hold the side-panels in position when inflated (extending forward and slightly downward).

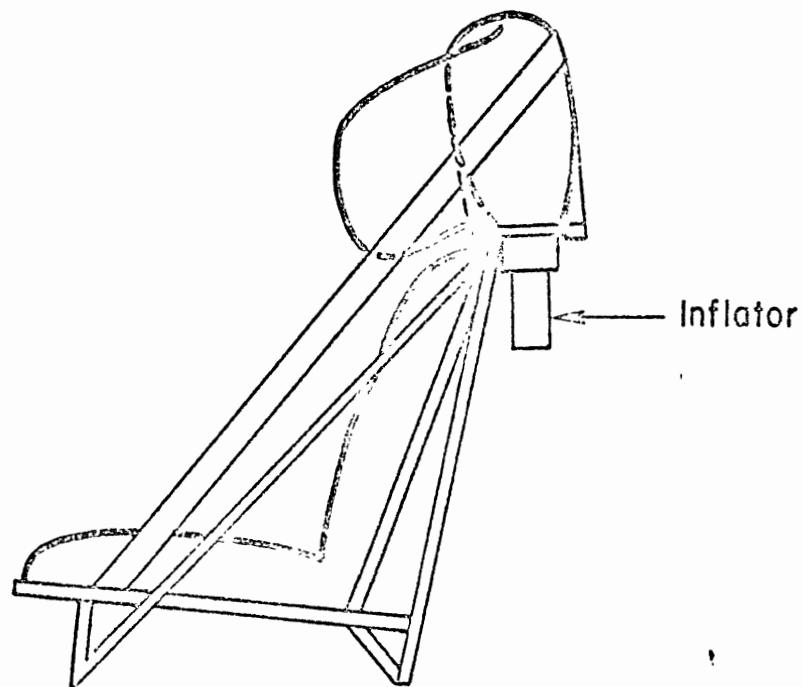
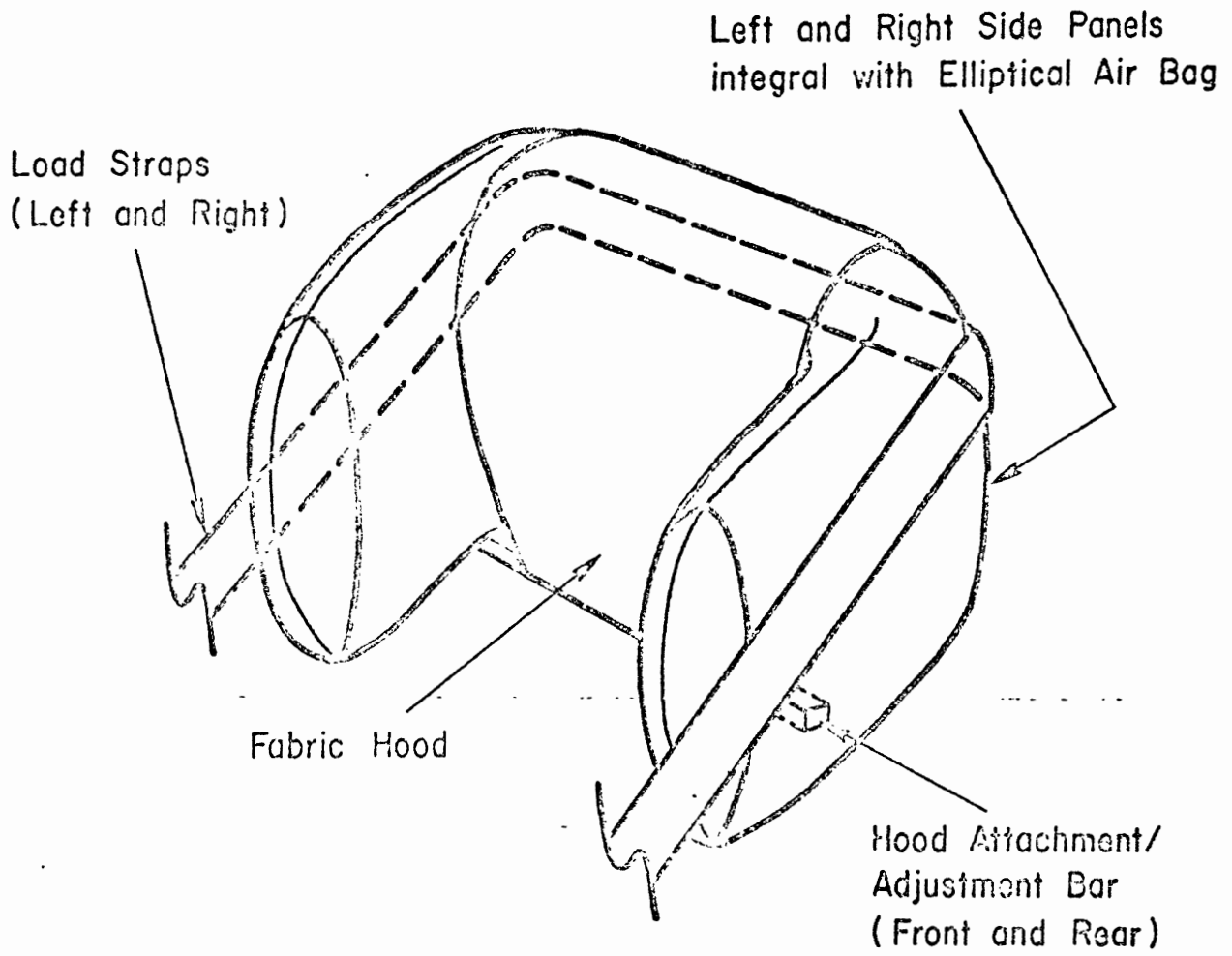

HSRI/UNIROYAL PROTOTYPE MOD I CONFIGURATION.

FIGURE II.

5. SEAT/HEAD RESTRAINT DESIGN

Head-restraint design requires that certain assumptions be made about the geometrical relationship between occupant head/neck, seat-back, and head-restraint. And in a test program to evaluate head restraints, this geometrical relationship must be incorporated into a strong test platform that can provide repeatable, reliable information about dynamic system performance. For this reason, HSRI undertook the design and construction of a seat structure in parallel with its study of head-restraint concepts.

The seat structures used in this program (for sled tests and for vehicle crash tests) were based on seat designs developed at HSRI during an earlier DOT-sponsored program on integrated restraint systems. One-inch-square steel tubing welded into the configurations shown in Figures 12-17 provided a seat structure much stronger and more rigid than a conventional automobile seat. Thin sheet metal, then a panel of 0.75 inch plywood was attached to the seat pan and seat back, to provide a mounting surface for seat cushions. The cushions were composites of quarter-inch plywood, one-inch Ensolite AH energy-absorbing foam (made by UniRoyal), and 1.5 inch polyfoam sponge rubber for comfort; the cushions were upholstered with naugahyde vinyl.

The method used to mount the head-restraint to the seat varied on each of the three seats. On the two seats used for sled testing and vehicle crash testing (see Figures 12-15), a removable metal plate was bolted to the top of the seat-back; the head-restraint system attached to

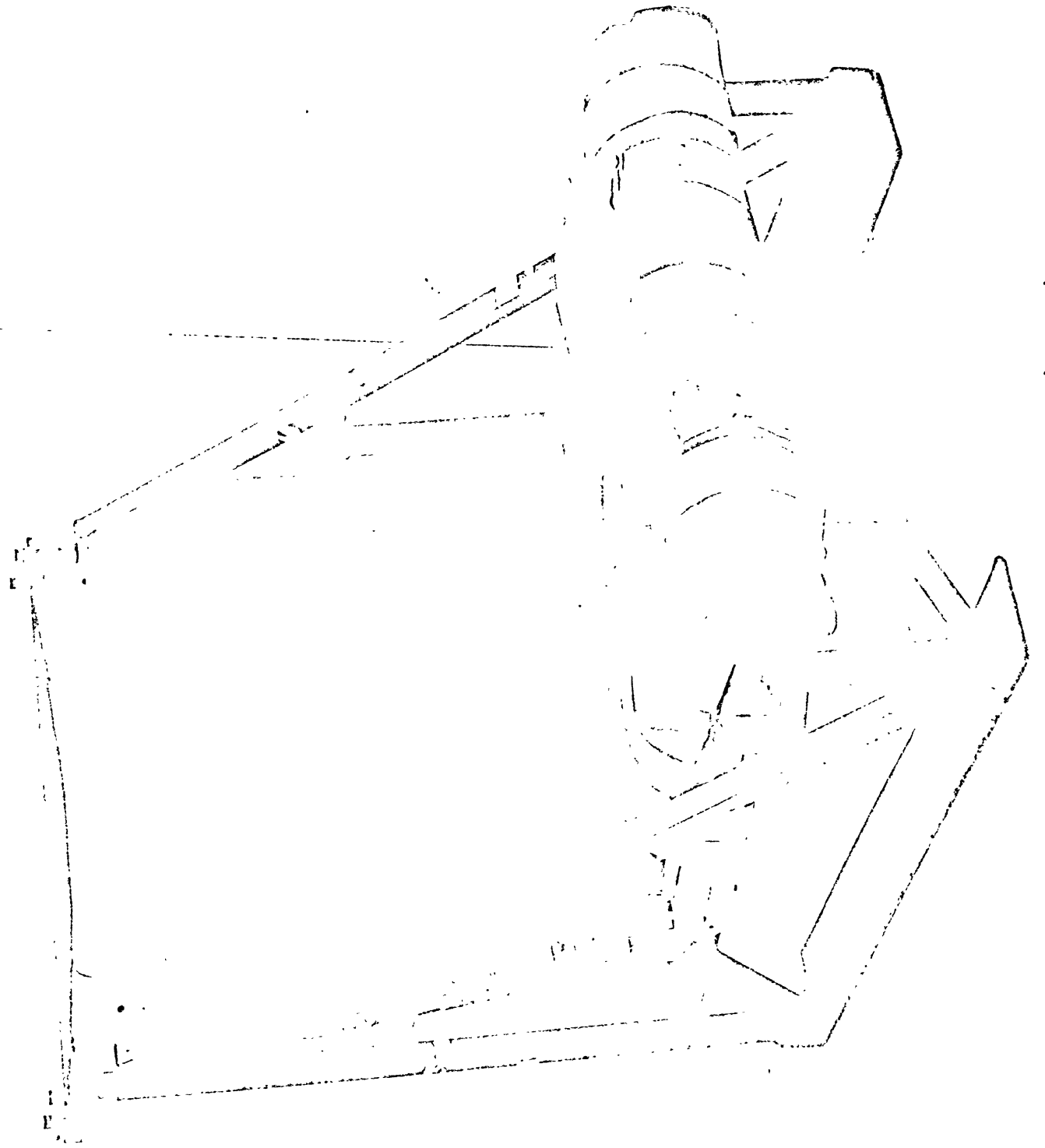

Figure 12. Sled Test Seat Structure (Front.)

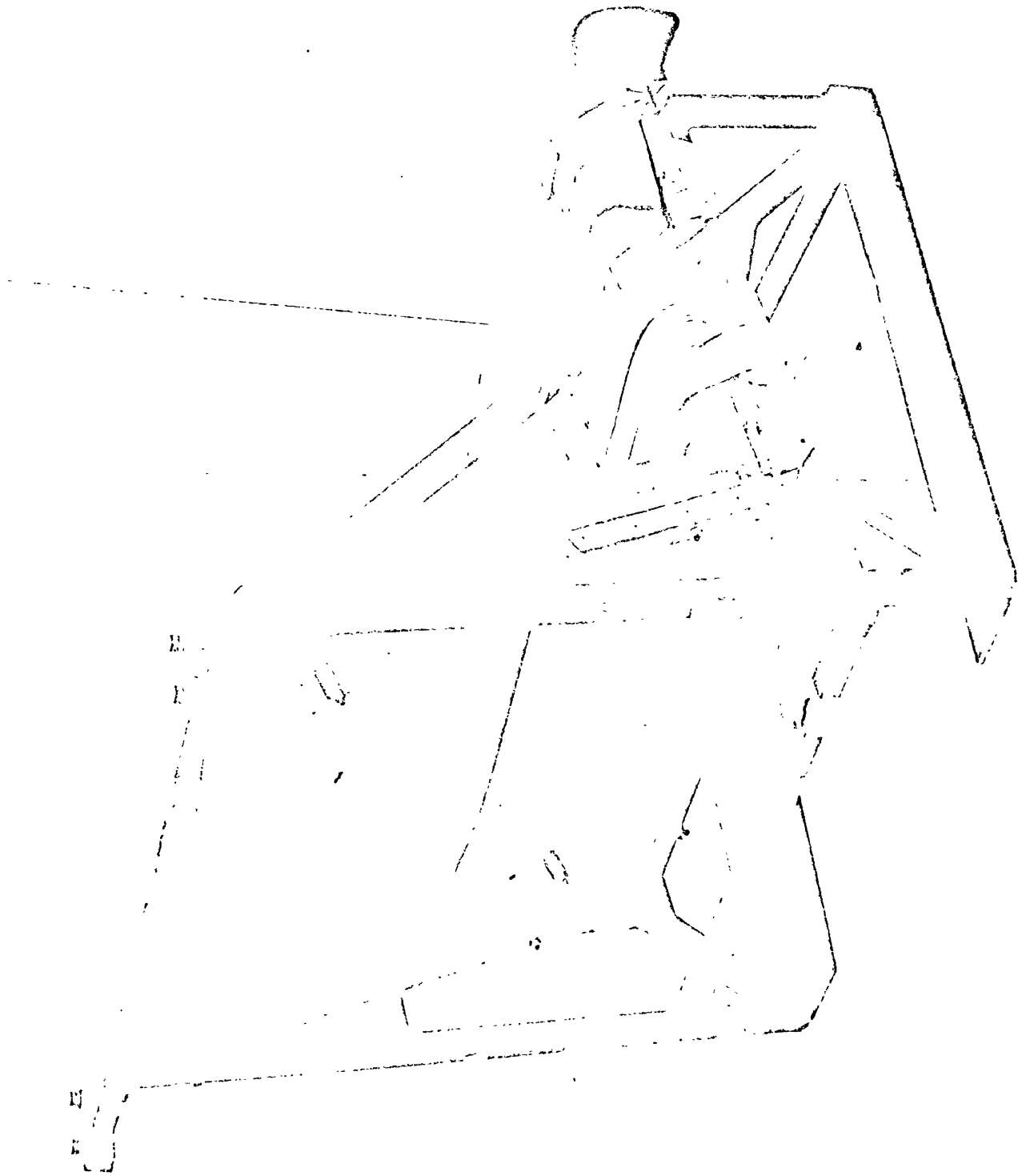

Figure 13. Sled Test Seat Structure (Rear.)

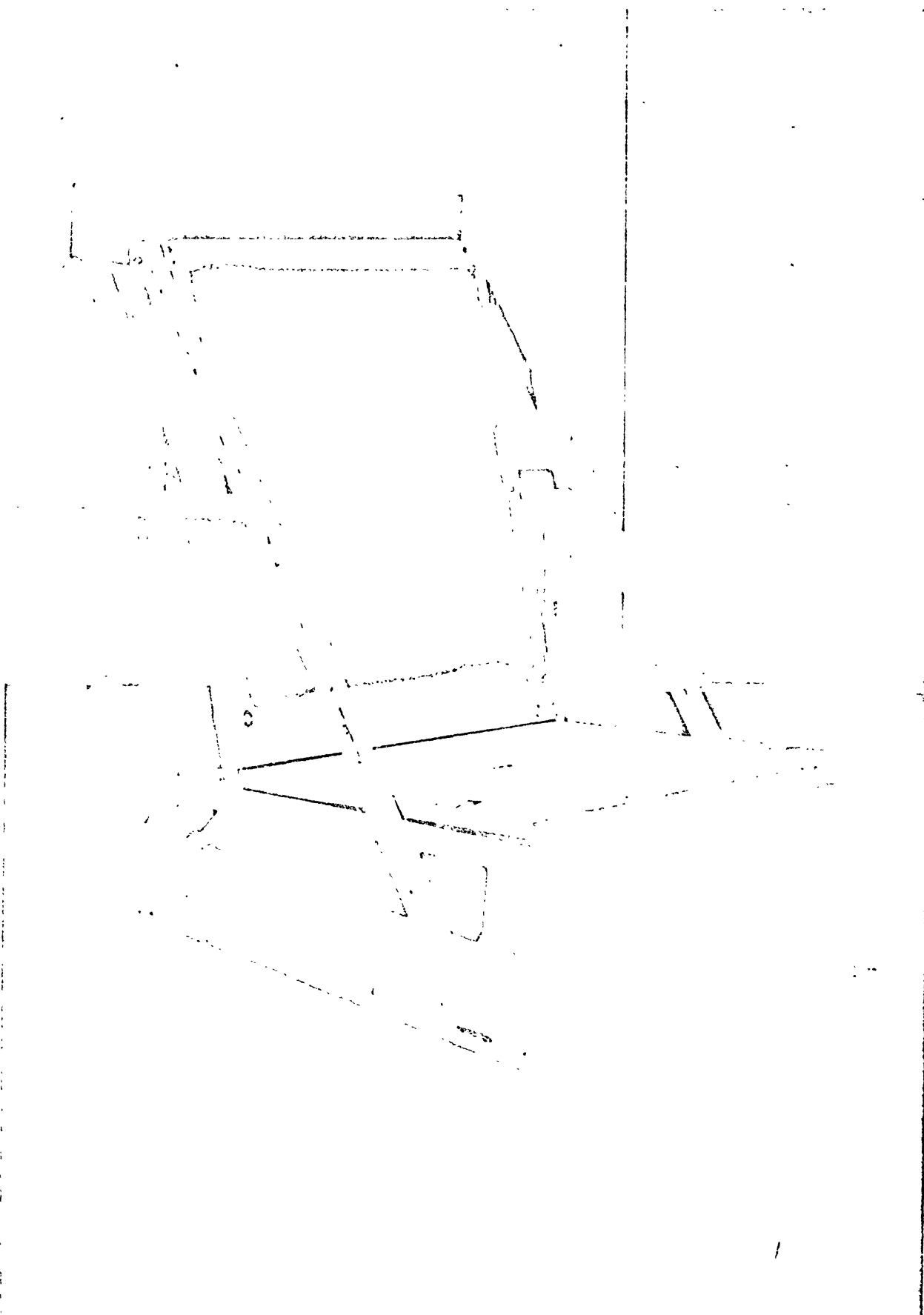

Figure 14. Vehicle Crash Test Seat Structure (Front.)

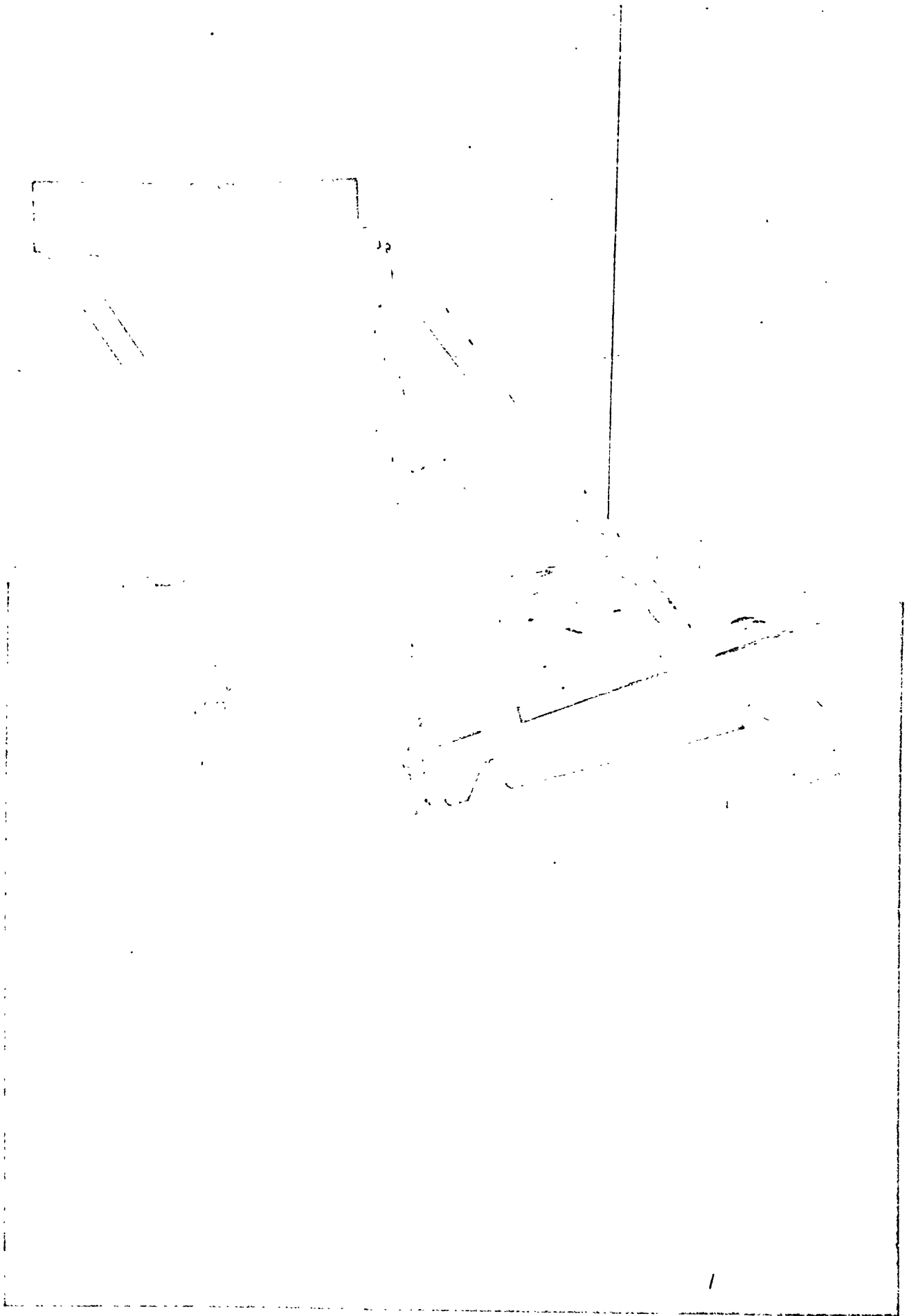

Figure 15. Vehicle Crash Test Seat Structure (Rear.)

the top, the inflator to the bottom of the plate. (For tests on the Goodrich Mod 1 and Mod 2 units, the inflator mounted on the side of the seat; see Figure 7.) On the final or finished seat (Figures 16-17), the head restraint mounting platform was a permanent integral part of the seat back structure.

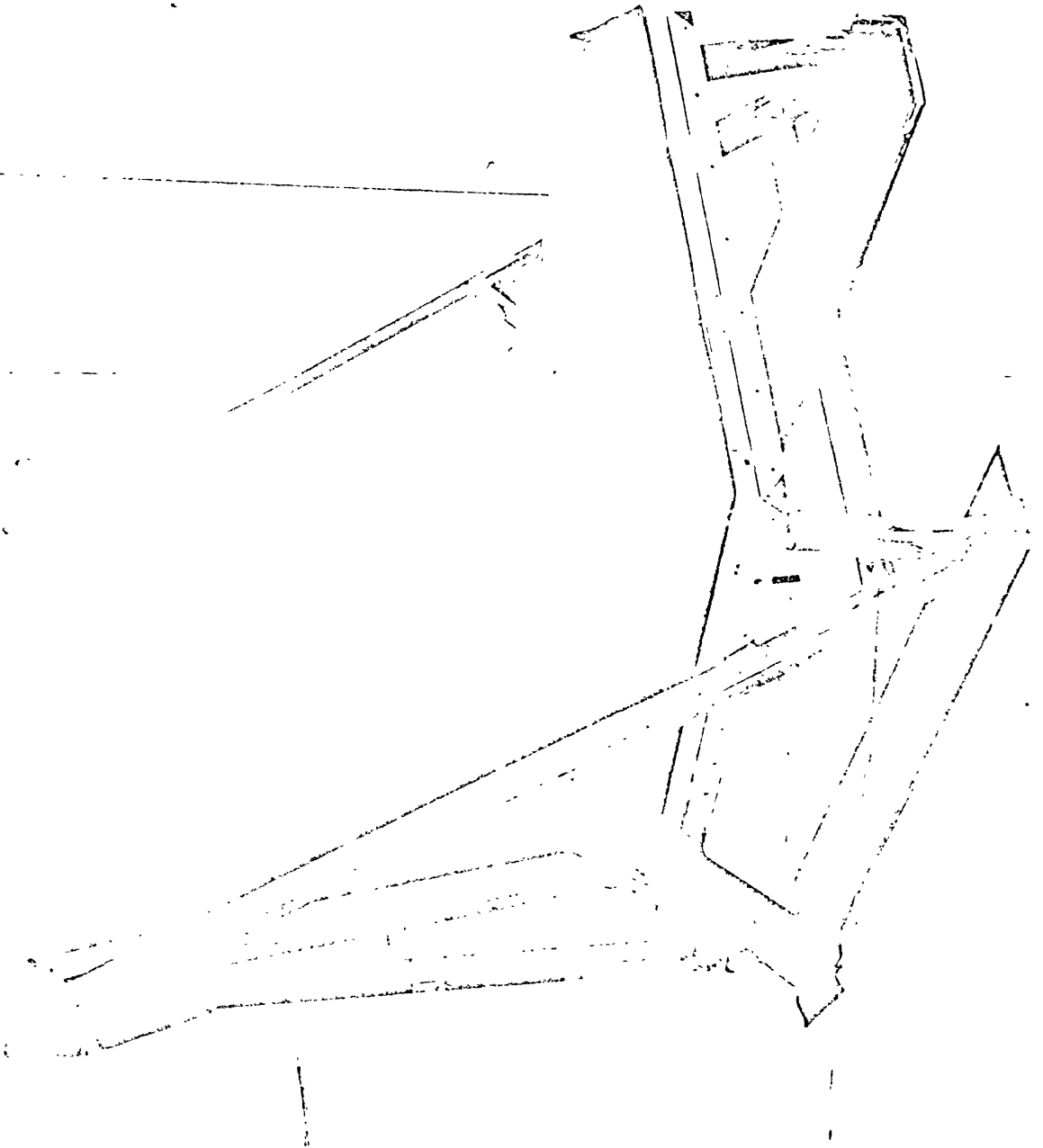

Figure 16. Final Design Seat Structure (Front.)

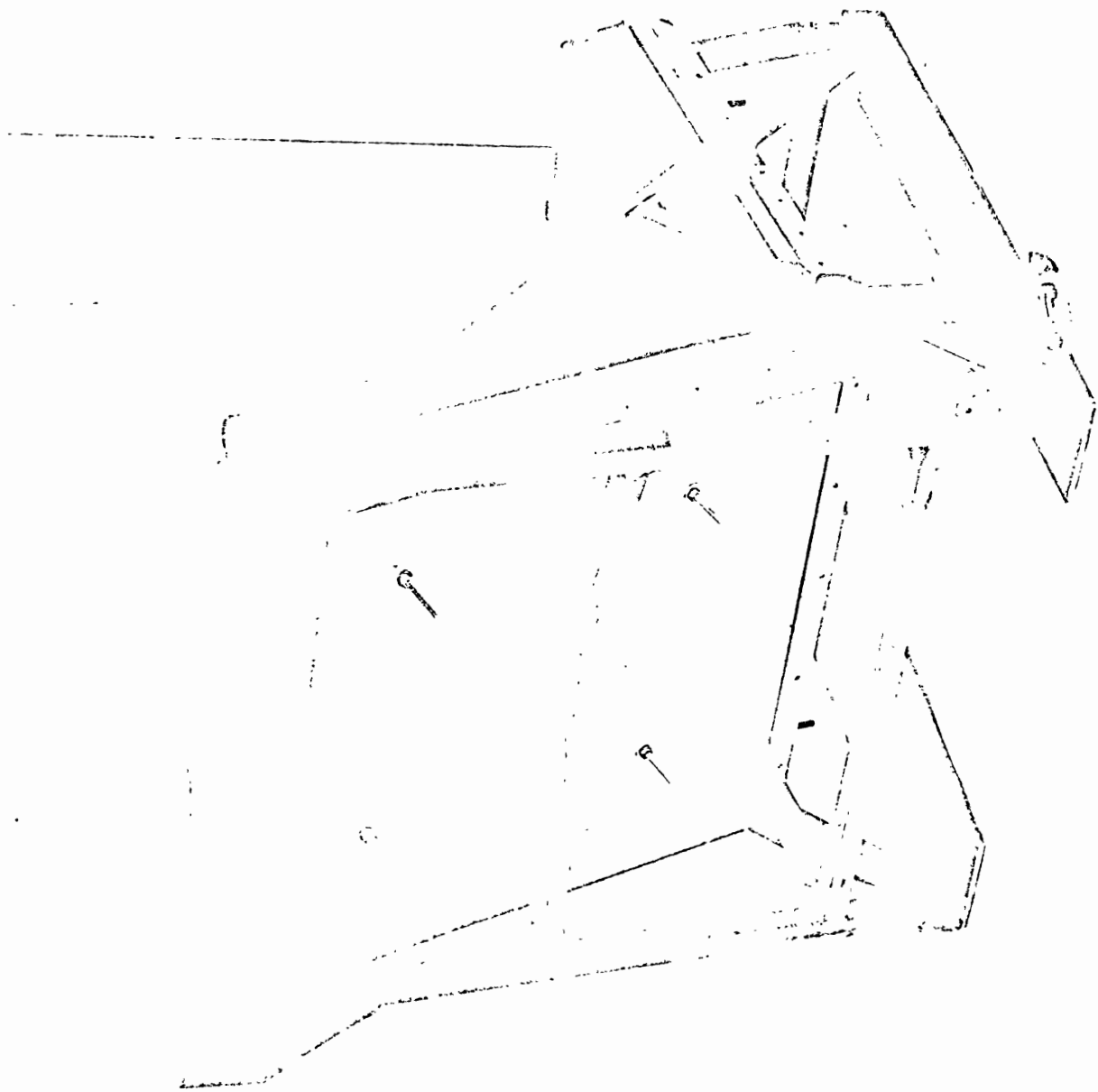

Figure 17. Final Design Seat Structure (Rear.)

6. DEVELOPMENT AND TESTING OF HEAD RESTRAINT PROTOTYPES

The purpose of the development, testing and demonstration program was to evaluate and compare the performance and characteristics of the three prototype units described in Section 4. The majority of this work was carried out at the HSRI Impact Sled Facility (Figure 18), although important real-vehicle crash testing was done also, at Dynamic Science in Phoenix, Arizona.

The nominal square-wave sled pulses used to simulate impact were 30 mph/20 G and 40 mph/40 G, although 20 mph/20 G, and 40 mph/30 G pulses were also used in the final performance sled test series. Typical acceleration/time profiles for these pulses are shown in Figure 19. Also shown is the deceleration pulse from a 60-mph car-to-car crash test (261-9) conducted at Dynamic Science as part of this program.

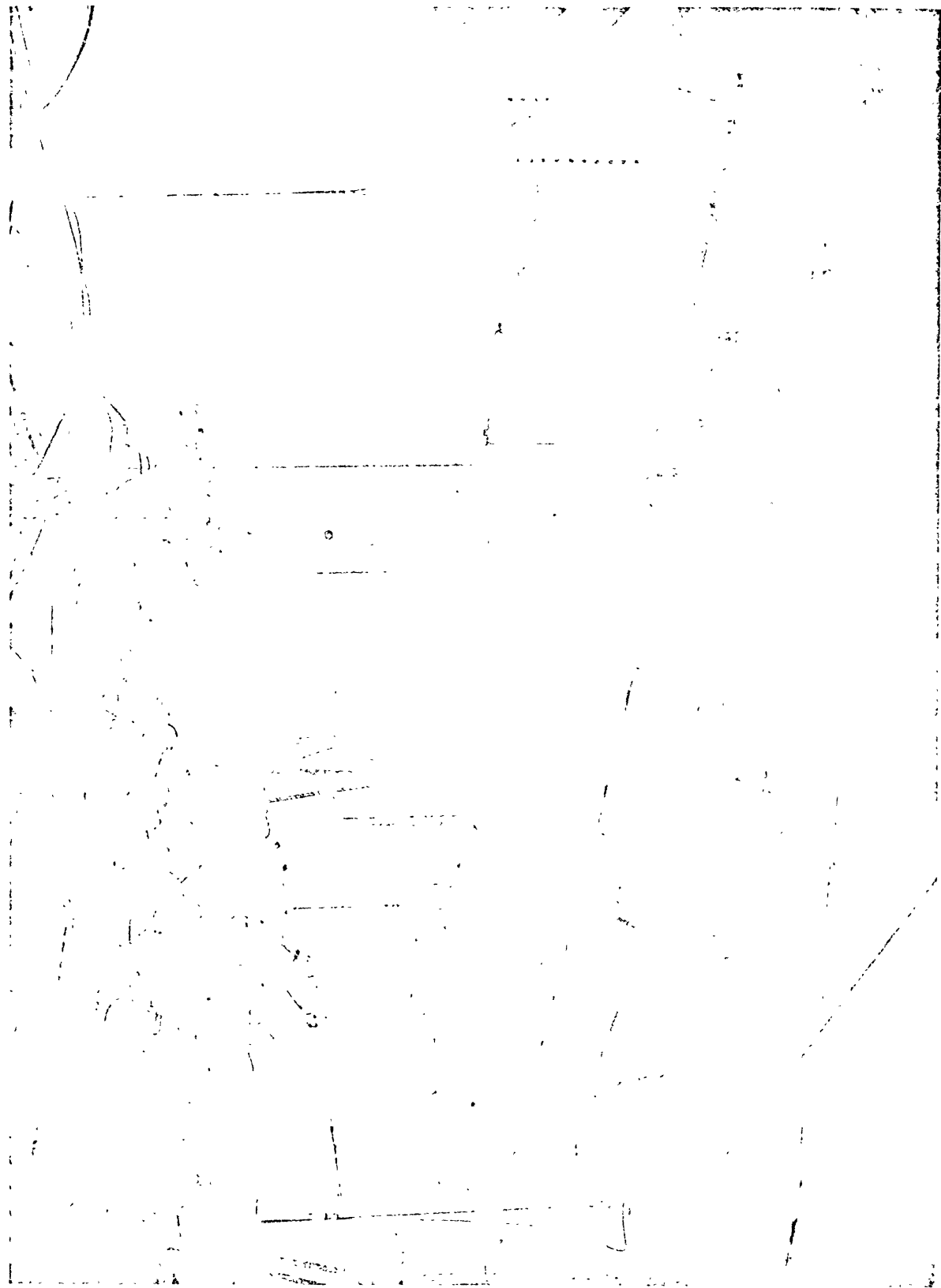
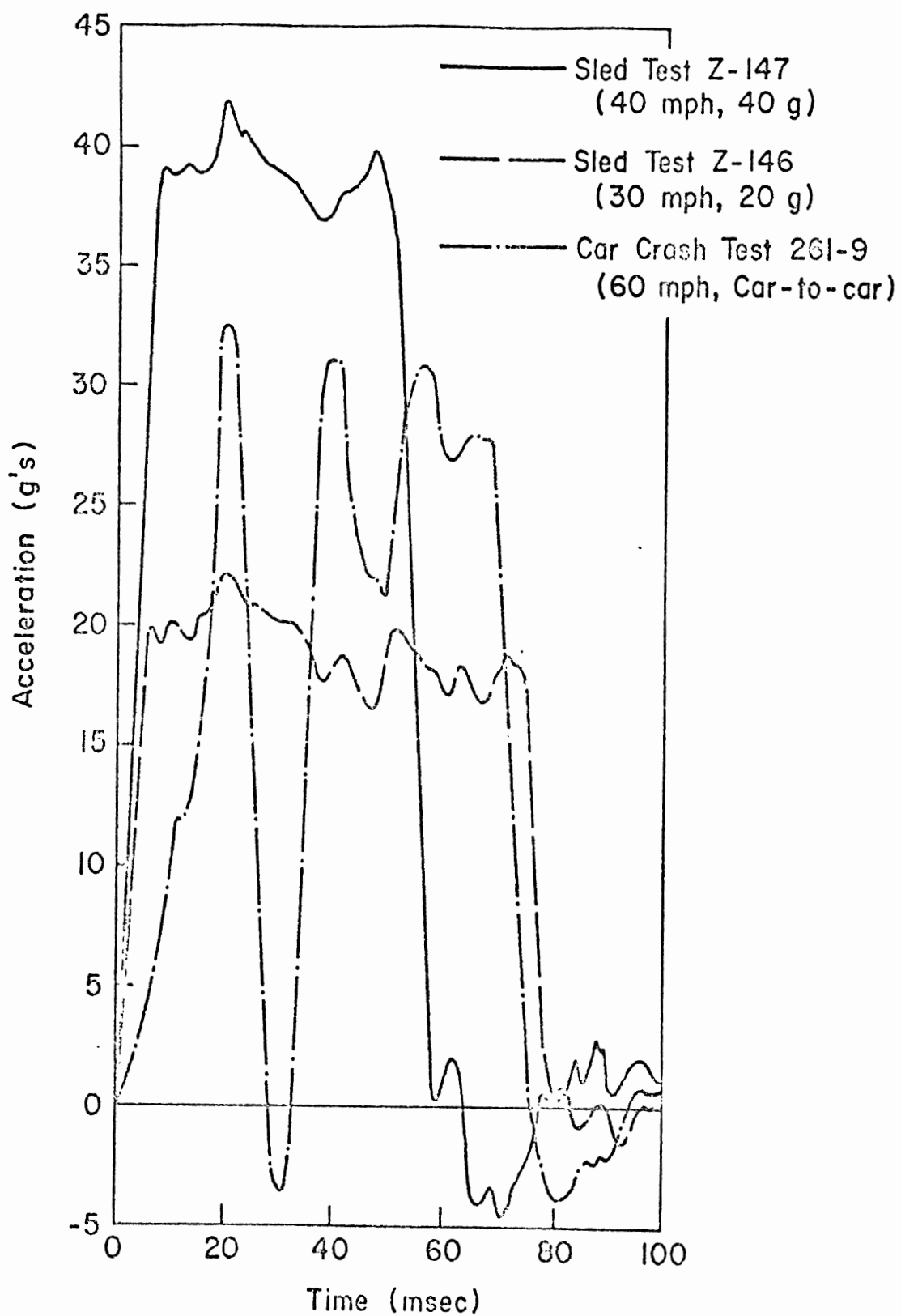

Figure 18. HSRI Impact Sled Facility.



SLED AND CRASH TEST ACCELERATION PULSES.

FIGURE 19.

6.1 SLED TEST EQUIPMENT AND INSTRUMENTATION

Three sizes of anthropometric dummies were used in the sled test program: Sierra No. 292-895 95th percentile male, weight 217 lbs., standing height 73.3 inches, erect sitting height 37.75 inches; Sierra No. 292-850 50th percentile male, weight 166 lbs., standing height 68.5 inches, sitting height 35.75 inches; and Sierra No. 592-805 5th percentile female, weight 106 lbs., standing height 59.8 inches, sitting height 30.75 inches. A dummy neck (see Figure 20) developed by HSRI (Melvin, 1972) and described in detail at the 16th Stapp Conference was used for all sled tests except A-623 through A-625 and A-630. In these tests (with the 5th percentile female dummy) a standard Sierra rubber neck was used.

In all sled tests with the male dummies, two biaxial accelerometer packs were mounted in the head to sense A-P and S-I acceleration -- one pack forward of the head CG, the other to the rear (see Figure 21). The female dummy head was fitted with a single triaxial accelerometer pack located to the rear of the CG (see Figure 21). Setra Model 111 accelerometers were used for all sled tests.

The specifications and calibration procedures for the Setra accelerometers, the sled accelerometer and the signal conditioning/recording equipment are given in Appendix B.

The photographic coverage of each test consisted of high speed 16 mm movies (side view), a Graph-check sequence camera (side view) for immediate photographic evaluation, and before and after-test still photographs of the test set up. The high speed movies were made with

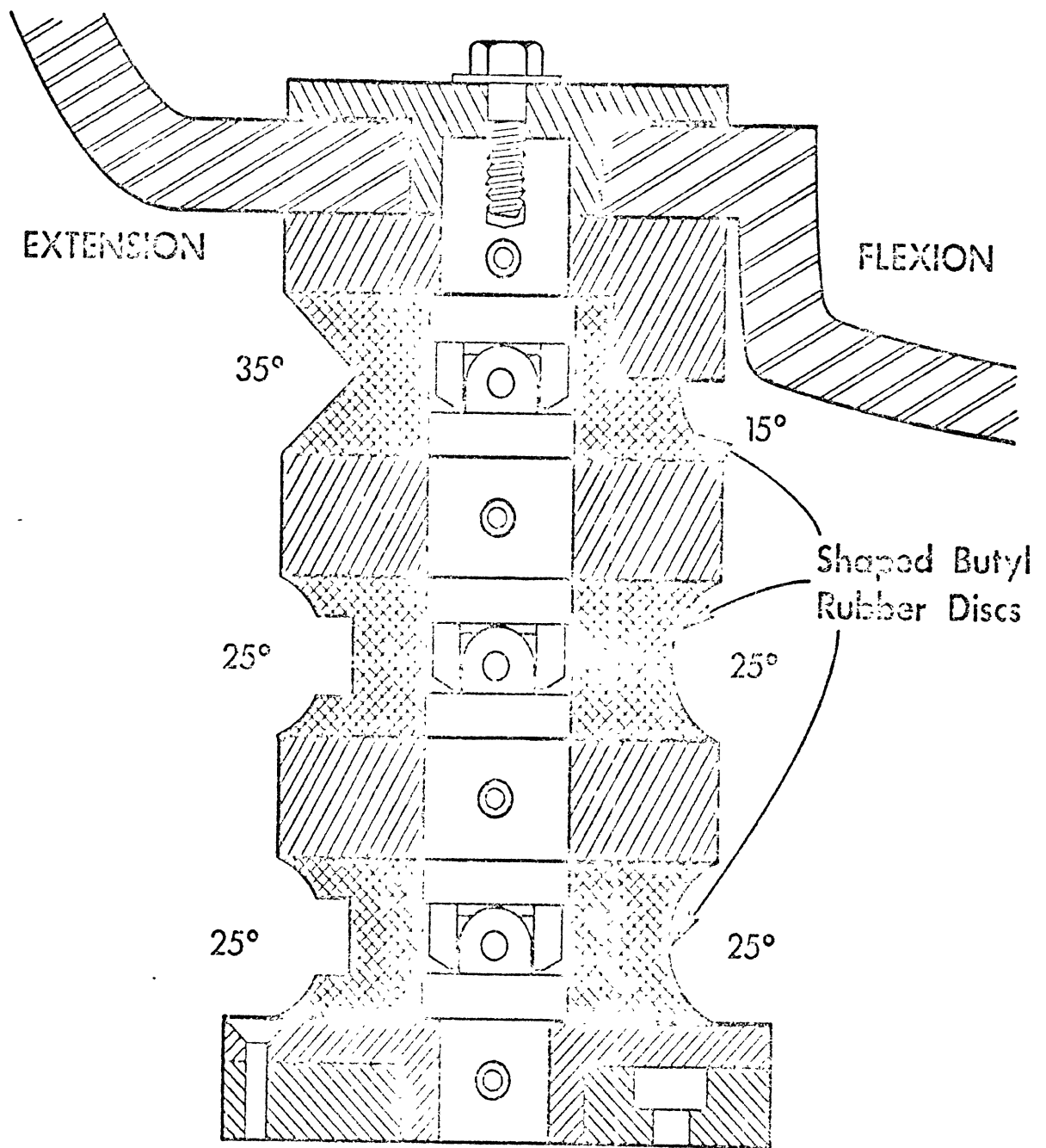

HSRI DUMMY NECK.

FIGURE 20.

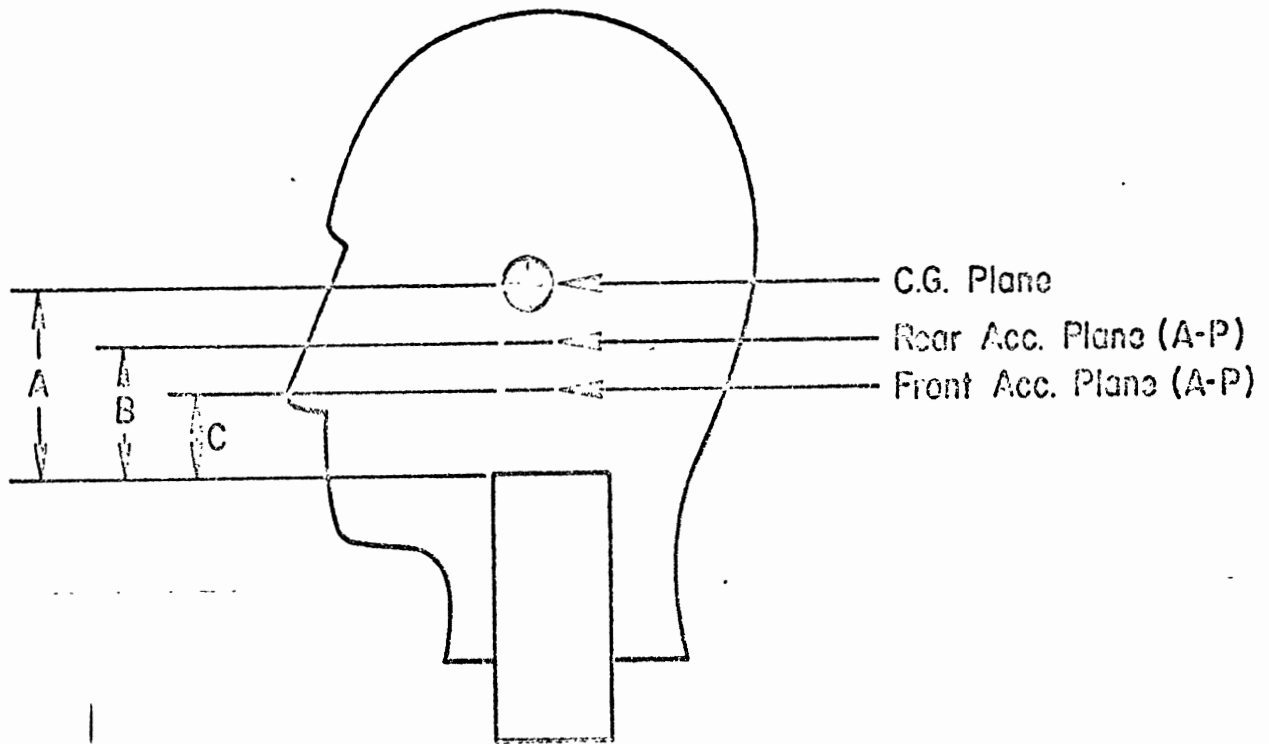

Dummy	A	B	C	Head Weight
5% Female*	1.99in.	1.15in.	N/A	6.8lb.
50% Male**	2.97	2.53	2.33in.	10.4
95% Male**	2.97	2.53	2.33	13.6

*Single Triaxial Accelerometer (Rear)

**Two Biaxial Accelerometers (Front and Rear)

ACCELEROMETER LOCATIONS IN DUMMY HEADS.

FIGURE 21.

Photosonics cameras and in some cases a Hi-Cam camera with nominal frame rates of 1000 fps.

In those tests which required dynamic deployment, detonation of the inflator was accomplished by a set of electrical contacts that were actuated as the sled passed by them. The placement of the contacts was adjustable so that the timing of the detonation could be selected at any point during the sled pulse. The bag pressure readout in these tests was accomplished using a strain-gaged diaphragm type pressure transducer designed by Eaton and built in-house at HSRI. In all tests the dummy was held in place by a lap restraint belt or rope.

6.2 SLED-TEST DATA HANDLING AND ANALYSIS

The data from the dummy accelerometers was recorded directly on magnetic tape (Honeywell Model 7600 tape recorder) and a filtered version (Burr-Brown filters, SAE J211 channel class 180) was recorded on a Honeywell Model 1612 Visicorder light beam oscillograph. The Visicorder traces were used for determination of peak acceleration; linear head and chest accelerations were measured directly, while angular head acceleration was computed for certain tests from the difference between the two S-I head accelerometer traces. (Angular acceleration was proportional to this difference, since the two S-I accelerometers were parallel and were a known fixed distance apart.)

Maximum extension angle was determined photometrically, using two targets on the dummy -- one on the side of the head, the other on an angle plate bolted to the upper torso at the base of the neck. (In some tests, the torso target was affixed to the dummy shoulder.) Calculation of maximum extension angle was carried out in the following way.

1. Before impact, head and torso target angles were measured relative to the horizontal. If the head target angle was less than the torso target angle, the difference between the two ("offset") was noted for use in step 3 below. If the head angle was greater than the torso angle, the difference in angle was disregarded and step 2 yielded the maximum extension angle.

2. At the point of maximum rearward head rotation, the difference between head target angle and torso target angle was measured.

3. If applicable, the head/torso "offset" computed in step 1 was subtracted from the step 2 calculation to yield maximum offset angle. (Without this adjustment, any initial rearward offset of the head relative to the torso would be attributed incorrectly to the deflection of the head restraint.)

For tests A-626 through A-629, an attempt was made to make dummy posture more lifelike; by inserting a wedge between the top of the torso and the base of the neck to tilt the head forward 15° from its normal position. (This "slouch" would be due to combined curvature of the lumbar and cervical spine in a human; since the dummy lumbar

spine could not be "adjusted," however, all the offset was introduced at the base of the dummy neck.)

This change increased head offset -- distance between head and bag surface -- and thereby increased the force exerted on the head restraint; the further the head from the bag before impact, the greater its kinetic energy when it contacts the bag. Tests A-626, -628 and -629 were "worst case" tests for the head restraint in this regard.

6.3 SLED TEST RESULTS

The results of the sled crash simulations are presented in this report in three forms: a descriptive summary of each test, a numerical summary table of pertinent data, and, in the case of particularly important tests, Graphchek sequence photographs and accelerometer traces.

The summary of the numerical data for each test is found in Table 1. The descriptive summaries of each test follow below. Detailed analysis of particularly pertinent tests results is found in Section 7 of the report.

TABLE 1 : DEPLOYABLE HEAD RESTRAINT TEST PROGRAM SUMMARY (Page 1)
 CONTRACT HS-031-2-281

TEST NUMBER	DUMMY SIZE	HEAD RESTRAINT TYPE	AVERAGE INFLATION PRESSURE (PSI)	PEAK. DECEL. PULSE G @ MSEC	PEAK HEAD AP ACCEL. G @ MSEC	PEAK HEAD SI ACCEL. G @ MSEC	PEAK CHEST AP ACCEL. G @ MSEC	PEAK CHEST SI ACCEL. G @ MSEC	MAXIMUM EXTENSION ANGLE DEG. @ MSEC	COMMENTS
Z 126	50% M	HSRI/URIROYAL BAG ONLY	DEPLOYED	N/A	89 @ 5	48 @ 4	9 @ 27	10 @ 13	N/A	Out-of-position occupant test
Z 128	50% M	HSRI/URIROYAL BASIC	PREINFLATED 5.5	22 @ 13	36 @ 60	18 @ 34	46 @ 39	12 @ 42	2 @ 64	30 mph
Z 129	50% M	HSRI/URIROYAL BASIC	PREINFLATED 5.5	22 @ 13	46 @ 65	27 @ 46	47 @ 37	13 @ 63	20 @ 65	30 mph
Z 139	50% M	HSRI/URIROYAL BASIC	PREINFLATED 7.0	46 @ 22	N/A	N/A	N/A	N/A	N/A	40 mph Dummy not seated correctly
Z 140	50% M	HSRI/URIROYAL BASIC	PREINFLATED 5.0	45 @ 22	91.5 @ 52	60 @ 47	85 @ 25	27 @ 28	43.5 @ 57	40 mph Mounting platform bent 39° by impact
Z 141	50% M	HSRI/URIROYAL BASIC	PREINFLATED 7.0	44 @ 21	92.5 @ 46	45 @ 50	80 @ 37	30 @ 30	25.5 @ 54	40 mph
Z 142	50% M	GOODRICH BASIC	PREINFLATED 10/8	22.4 @ 23	42.5 @ 53	45 @ 53	46 @ 40	16 @ 36	52 @ 66	30 mph
Z 143	50% M	GOODRICH BASIC	PREINFLATED 15/15	21.6 @ 20	40 @ 53	26 @ 42	46.5 @ 40	16 @ 44	30.5 @ 60	30 mph Mounting platform raised 1 3/8 in.
Z 146	50% M	HSRI/URIROYAL BASIC	DEPLOYED	21.2 @ 20	28.5 @ 34	42 @ 44	37.5 @ 33	19.5 @ 40	NONE	30 mph
Z 147	50% M	HSRI/URIROYAL BASIC	DEPLOYED	42 @ 19	26 @ 38	45 @ 42	84.5 @ 23	30.2 @ 36	NONE	40 mph
Z 148	50% M	GOODYEAR BASIC	PREINFLATED 15/8	43.2 @ 20	N/A	N/A	N/A	N/A	N/A	40 mph Head restraint mount failed

TABLE 1 : DEPLOYABLE HEAD RESTRAINT TEST PROGRAM SUMMARY (PAGE 2)

TEST NUMBER	DUMMY SIZE	HEAD RESTRAINT TYPE	AVERAGE INFLATION PRESSURE (PSI)	PEAK DECEL. PULSE G @ MSEC	PEAK HEAD AP ACCEL. G @ MSEC	PEAK HEAD SI ACCEL. G @ MSEC	PEAK CHEST AP ACCEL. G @ MSEC	PEAK CHEST SI ACCEL. G @ MSEC	MAXIMUM EXTENSION ANGLE DEG. @ MSEC	COMMENTS
261-4	50% M	HSRI/UNIROVAL BASIC	DEPLOYED	58 @ 87	47 @ 77	34 @ 53	42 @ 105	14 @ 58	Not Measurable	40.4 mph
A 614	50% M	GOODYEAR MOD 1	PREINFLATED 15/3	Not recorded	50 @ 40	20 @ 47	15 @ 39	44 @ 37	10.25 @ 59	30 mph nominal Sled pulse and speed not recorded
A 615	50% M	GOODYEAR MOD 1	PREINFLATED 15/3	23.2 @ 17	41 @ 47	18 @ 53	15 @ 36	44 @ 36	8.5 @ 66	30 mph Repeat of A 614
A 616	50% M	GOODYEAR MOD 1	PREINFLATED 15/3	44 @ 20	90 @ 43	50 @ 38	25 @ 32	75.5 @ 23	25 @ 49	40 mph
A 617	50% M	GOODRICH MOD 1	PREINFLATED 15	22.4	62.5	37.5	17	38	17.75 @ 57	30 mph Time base not recorded
A 618	50% M	GOODRICH MOD 1	PREINFLATED 20	44 @ 18	110 @ 50	78 @ 40	35 @ 52	68.5 @ 39	43.5 @ 50	40 mph
A 619	50% M	GOODRICH MOD 1	DEPLOYED	40.8 @ 18	N/A	N/A	N/A	N/A	N/A	40 mph Head-restraint bladder failed
261-5	50% M	NONE	N/A	42 @ 24	77 @ 99	63 @ 67	50 @ 59	15 @ 84	106 @ 98	40 mph Baseline test after inflator misfired
A 620	50% M	GOODYEAR MOD 1	DEPLOYED	21 @ 27	N/A	N/A	N/A	N/A	N/A	30 mph Airmat failed
A 621	50% M	GOODRICH MOD 3	DEPLOYED	20.5 @ 17	N/A	N/A	N/A	N/A	N/A	30 mph Bladder failed
261-6	50% M	HSRI/UNIROVAL BASIC	DEPLOYED	N/A	N/A	N/A	N/A	N/A	N/A	39.6 mph Inflator did not fire and seat tore loose

TABLE 1 : DEPLOYABLE HEAD RESTRAINT TEST PROGRAM SUMMARY (Page 3)
 CONTRACT HS-031-2-281

TEST NUMBER	DUMMY SIZE	HEAD RESTRAINT TYPE	AVERAGE INFLATION PRESSURE (PSI)	PEAK DECEL. PULSE G @ MSEC	PEAK HEAD AP ACCEL. G @ MSEC	PEAK L1AD SI ACCEL. G @ MSEC	PEAK CHEST AP ACCEL. G @ MSEC	PEAK CHEST SI ACCEL. G @ MSEC	MAXIMUM EXTENSION ANGLE DEG. @ MSEC	COMMENTS
251-8	50% M	HSRI/UNIROYAL BASIC	DEPLOYED	19 @ 49	49 @ 28	23 @ 45	29 @ 82	19 @ 58	NONE	39.3 mph 30° oblique impact
A 622	50% M	HSRI/UNIROYAL MOD 1	DEPLOYED	33 @ 16	16.5 @ 57	9.5 @ 57	51 @ 28	7.5 @ 50	5° estimated	40 mph 30° oblique impact
261-9	50% M	HSRI/UNIROYAL BASIC	DEPLOYED	35 @ 22	76 @ 87	35 @ 205	40 @ 72	16 @ 50	12 @ 70	60 mph car-to-car
A 623	5% F	HSRI/UNIROYAL BASIC	DEPLOYED	30 @ 23	50 @ 49	62 @ 21	54 @ 25	15 @ 22	NONE	40 mph
A 624	5% F	HSRI/UNIROYAL BASIC	DEPLOYED	22 @ 16	18 @ 45	28.5 @ 55	42 @ 34	21 @ 33	NONE	30 mph
A 625	5% F	HSRI/UNIROYAL BASIC	DEPLOYED	21.5 @ 17	24.5 @ 48	14.5 @ 53	42 @ 37	15 @ 32	NONE	20 mph
A 626	95% M	HSRI/UNIROYAL BASIC	DEPLOYED	32 @ 6	71 @ 53	40 @ 59	48.5 @ 42	33 @ 29	33 @ 59	40 mph Modified inflator to slow inflation
A 627	95% M	NONE	N/A	24 @ 6	150 @ 83	122 @ 84	35 @ 40	15 @ 39	92 @ 81	30 mph Baseline test with final test seat
A 628	95% M	HSRI/UNIROYAL BASIC	DEPLOYED	23 @ 7	77 @ 71	50 @ 60	32 @ 43	14 @ 39	32.5 @ 67	30 mph Modified Inflator Final test seat
A 629	95% M	HSRI/UNIROYAL BASIC	DEPLOYED	22.5 @ 7	52 @ 72	51 @ 59	32 @ 42	14 @ 38	43 @ 66	20 mph
A 630	5% F	HSRI/UNIROYAL BASIC	DEPLOYED	23.5 @ 5	36.5 @ 46	26.5 @ 59	34 @ 27	22 @ 30	NONE	30 mph Repeat of A 624

TABLE 2
TYPICAL ANGULAR HEAD ACCELERATIONS

TEST	REARWARD ACCELERATION AT INITIATION OF HEAD MOTION (rad/sec ² @ msec)	FORWARD ACCELERATION AT MAXIMUM HEAD EXTENSION (rad/sec ² @ msec)
Z141	- 3230 @ 36.3	+ 4540 @ 48
Z143	- 1390 @ 36.3	+ 3110 @ 56.9
Z146	- 5270 @ 40.7	+ 1190 @ 59
A615	- 2010 @ 37.5	+ 1340 @ 55
A616	- 2920 @ 25	+ 5030 @ 43.8
A618	- 3240 @ 25.6	+ 4780 @ 55.7
A626	- 5520 @ 33.1	+ 4190 @ 57
A627	- 3590 @ 43.8	+ 9570 @ 76.9
A628	- 3710 @ 36.9	+ 4190 @ 61.9
A629	- 2630 @ 35	+ 4210 @ 63.2

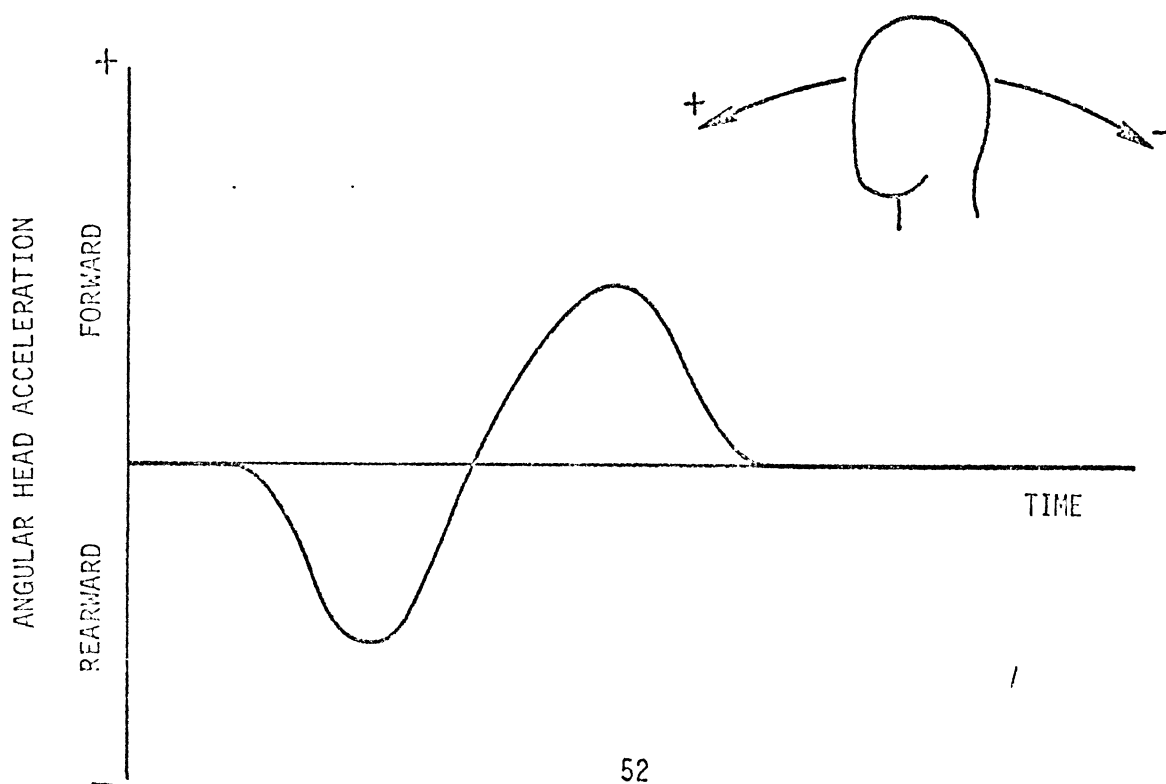

TEST Z-126 Out-of-position occupant test, 50th percentile male dummy

A simple UniRoyal bag (no hood or straps) was mounted and folded in place on the head-restraint platform, and the dummy was seated and lap-belted with his head back, resting on the folded bag. The inflator was charged to 2000 psi. Bag deployment threw the dummy forward and slightly upward, imparting a 99.5 G resultant head acceleration for 10 msec (HIC 907.1).

SLED TEST Z-128 30 mph, 22 G peak pulse, rear impact, 50th percentile male dummy, lap-belt restraint

The basic HSRI/UniRoyal prototype (see Section 4.3 and Figure 6) was preinflated to 5.5 psi. Head/neck extension was almost negligible (2°); ramping and rebound were only minor to moderate. Comparison of this test with Z-129 indicates how much the load-straps contribute to the fore-and-aft stiffness of the HSRI/UniRoyal system.

SLED TEST Z-129 30 mph, 22 G peak pulse, rear impact, 50th percentile male dummy, lap-belt restraint.

The same HSRI/UniRoyal head restraint was set up as in Z-128, with only one change: the nylon load straps were disconnected from the seat-pan and taped out of the way, to evaluate how much of the head-load they carried in test Z-128. Head/neck extension increased to about 20°; both ramping and rebound were moderate to severe. The inflated bag acted like a spring, rotating backward under load, then returning all its stored energy to the head during rebound.

SLED TEST Z-139 40 mph, 46 G peak pulse, rear impact, 50th percentile male dummy, rope lap restraint

The basic HSRI/UniRoyal system -- with load straps attached to the upper sides of the seat frame (see Figure 6) -- was preinflated to 7.0 psi. Due to inadequate installation of cables that hold the dummy in the seat during sled acceleration, the dummy was badly out of position at impact. The results of the test are invalid; test Z-140 is a repeat of Z-139.

SLED TEST Z-140 40 mph, 45 G peak pulse, rear impact, 50th percentile male dummy, lap-belt restraint

Repeat of Z-139, but with preinflation pressure of 5.0 instead of 7.0 psi. (Note that the load-straps were again attached to the upper seat frame.) On impact, the dummy underwent moderate ramping, moving backward and upward into the bag. Rebound was severe, as the inflated bag acted like a spring, absorbing energy as it rotated then returning it during dummy rebound.

Although Table 1 shows maximum head/neck extension of $43\ 1/2^\circ$, a major part of this rotation was traced to plastic deformation of the head-restraint mounting platform, which rotated downward about 39° during impact. The platform was repaired and strengthened, for use in later tests.

Attaching the load straps high on the seat increased the stiffness of the simple bag/hood system, but it was obvious that the straps could be more effective if their attachment points were lower down and further forward on the seat frame. Test Z-141 demonstrated the results of such a change in attachment points.

SLED TEST Z-141 40 mph, 44 G peak pulse, rear impact, 50th percentile
male dummy, lap belt restraint

The basic HSRI/UniRoyal system -- with load straps bolted to the sides of the seat-pan (see Figure 6) -- was preinflated to 7.0 psi for comparison with test Z-140. The change in belt attachment point was a definite improvement, as dummy ramping was very minor and rebound only minor to moderate. The increased bag pressure also contributed to system stiffness. Maximum head extension was 25.5° @ 57 msec.

SLED TEST Z-142 30 mph, 22.4 G peak pulse, rear impact, 50th percentile
male dummy, lap-belt restraint

In this first test of the basic Goodrich prototype (see the description in Section 4.1, and Figure 5), the curved-tube section was preinflated to 10 psi and the straight tube section to 8 psi. Both had natural-rubber bladders.

The position of the dummy's head with respect to the head restraint was less than optimal, in this and in several other tests. The neck was not stiff enough to prevent the head from tipping backward in what was judged an abnormal posture; the head was against the head restraint even before impact.

Ramping was minor and rebound moderate, but the 52° extension angle was considered excessive. The head restraint was mounted too low, and inflation pressure was not high enough to resist rearward loading effectively. Both problems were corrected for test Z-143.

SLED TEST Z-143 30 mph, 21.6 G peak pulse, rear impact, 50th percentile
male dummy, lap-belt restraint

For this re-run of Z-142, the basic Goodrich prototype was raised 1 3/8 inches to improve head/head-restraint contact geometry, and both tube sections (natural rubber bladders) were inflated to 15 psi to increase stiffness.

Dummy position was again slightly unusual, with head tipped back and in contact with the head-restraint at impact. Nevertheless, the maximum extension angle was only 30 1/2° (compared to 52° in Z-142); ramping was well controlled, and rebound minor to moderate.

SLED TEST Z-146 30 mph, 21.2 G peak pulse, rear impact, 50th percentile
male dummy, lap-belt restraint

The basic HSRI/UniRoyal system -- with load straps bolted low on the seat-pan (Figure 6) -- was deployed using the Olin inflator, charged to 2000 psi (compressed air). The inflator fired 5 msec after impact, and the bag was fully inflated 29 msec after impact. The dummy head/neck underwent no measurable extension; upon moving backward into the head restraint, the head went immediately into moderate flexion. Ramping and rebound were very well controlled. Bag slap generated a 46 G head A-P acceleration @ 7 msec after impact.

SLED TEST Z-147 40 mph, 42 G peak pulse, rear impact, 50th percentile
male dummy, lap-belt restraint

The same HSRI/UniRoyal basic prototype was tested in this 40 mph test as was run in test Z-146 (30 mph). Head-restraint geometry and inflator pressure were the same as Z-146; the inflator fired 6 msec after impact, and the bag was fully inflated 28 msec after impact. As in Z-146, there was no measurable head/neck extension, the head immediately going into flexion; this was because the bag was slightly further forward than usual, and because the bag was still in the final stages of inflation when contacted by the head (bag "slap"). The shoulders were well pocketed, which minimized ramping; rebound was minor. Bag slap spike: 95 G @ 22 msec.

SLED TEST Z-148 40 mph, 43.2 G peak pulse, rear impact, 50th percentile
male dummy, lap-belt restraint

The first sled test of the Goodyear Airmat structure (basic configuration, as described in Section 4.2 and in Figure 5) was a preinflated test. Airmat pressure was 15 psi, head-cushion pressure 8 psi. The mounting platform was raised 1 3/8 inches to improve head/head-restraint contact geometry. Head loading, however, caused failure of the front hold-down clamp on the Airmat structure; this allowed the head-restraint to rotate rearward, which in turn permitted the dummy neck to contact the front edge of the head-restraint mounting platform. Although head/neck extension was limited to about 28°, the results of this test were inconclusive.

SLED TEST A-614 30 mph (nominal), 20 G peak pulse (nominal), rear
 impact, 50th percentile male dummy, lap-belt
 . restraint

This preinflated test of the Mod 1 Goodyear Airmat system (see Section 4.4.2 and Figure 10) was made to evaluate the performance of a stronger mounting structure. Instrumentation failure, however, caused the loss of both the sled deceleration and sled velocity pulses, making accurate analysis difficult. Films showed head-restraint performance to be quite acceptable, however, limiting head/neck extension to 10 1/4° at 59 msec. The head-restraint stored (then returned) some energy as it deflected under load, but did not cause a rebound problem. - Rebound was minor, with some very mild flexion as the dummy moved away from the seat back and head restraint. Ramping was very well controlled; the forward-projecting side-panels of the head restraint quickly caught the dummy shoulders as he began to move upward.

SLED TEST A-615 30 mph, 23.2 G peak pulse, rear impact, 50th percentile
male dummy, lap-belt restraint

This was a repeat of A-614 with the preinflated Mod 1 Goodyear head restraint (three front tie-down panels and a separate head-cushion bag). The Airmat structure was pressurized to 15 psi, the head-cushion to 2 psi. The changes made to the mounting structure (see test Z-148 and Figure 10) strengthened the unit considerably; maximum head/neck extension was only 8 1/2°. Ramping was very slight, as the side-panels pocketed the shoulders; rebound was moderate.

SLED TEST A-616 40 mph, 44 G peak pulse, rear impact, 50th percentile
male dummy, lap-belt restraint

The Mod 1 Goodyear system was evaluated in a "worst case" 40mph/40 G test in the preinflated condition (15 psi in the Airmat, 3 psi in the head-cushion bag). Maximum extension of 25° occurred 49 msec after impact. The entire Airmat structure did rotate slightly rearward, then returned its stored energy to the head during rebound. Ramping was minor to moderate, rebound moderate.

SLED TEST A-617 30 mph, 22.4 G peak pulse, rear impact, 50th percentile male dummy, lap-belt restraint

The Mod 1 Goodrich unit with a natural rubber bladder (see Section 4.4.1 and Figure 7) was tested in the preinflated mode at 15 psi, with the mounting platform raised 1 3/8 inches for better head-contact. The time base was not recorded, but acceleration data and film analysis was still useful. Maximum extension was limited to 17 3/4°, and ramping was minor as the shoulders were well-pocketed by the curved-tube section of the head-restraint. Rebound was moderate; the head restraint deflected elastically under load, storing energy as it rotated rearward, then returning the energy to the head as the load decreased. This was even more of a problem in test A-618.

SLED TEST A-618 40 mph, 44 G peak pulse, rear impact, 50th percentile male dummy, lap-belt restraint.

This was another preinflated test (15 psi) of the Mod 1 Goodrich unit, set up and mounted as it was for test A-617. Bladder material was natural rubber. Maximum head/neck extension of 43 1/2° occurred at 50 msec, and while ramping was relatively minor, rebound was moderate to severe. As in test A-617, the head-restraint did not provide sufficient rearward stiffness to be effective. It acted as something of an "air spring," storing energy as it deflected under load, then throwing the head forward as it returned to its original position.

SLED TEST A-619 40 mph, 40 G peak pulse, rear impact, 50th percentile
male dummy, lap-belt restraint

The Mod 1 Goodrich system was set up for a deploying test with the Olin inflator (charged to 1850 psi). The bladder (natural rubber) failed at and near the inlet port when the inflator fired; the nature of the failure -- a "shattering" of the rubber -- suggests that the rapid gas inflow created extremely high local stresses in the bladder.

SLED TEST A-620 30 mph, 21 G peak pulse, rear impact, 50th percentile
male dummy, lap-belt restraint

This was the only deploying test run with the Goodyear Airmat head-restraint. Section 4.4.2 describes the Mod 1 unit, which, for this test incorporated changes to permit use of the system with the Olin inflator. The head-restraint deployed and began to take shape following inflator firing, but as internal pressure increased, one or more of the drop-weave fibers ruptured, triggering the failure of the other drop-weave threads as they tried to pick up the load. This progressive failure then allowed the front fabric panel of the Airmat to bulge and stretch to the point where it tore, causing massive failure of the head-restraint.

SLED TEST A-621 30 mph, 20.5 G peak pulse, rear impact, 50th percentile
male dummy, lap-belt restraint

The Mod 3 Goodrich prototype (with the inflator inlet changes described in Section 4.4.1 and Figure 9) was evaluated in a dynamic deployment test using the Olin inflator charged to 1750 psi. A special tubular bladder was used in this unit, made by UniRoyal from the same neoprene-coated nylon material they used to make the elliptical bags used in the HSRI/UniRoyal head-restraint.

Inflator discharge again caused bladder failure around the inlet port making the test inconclusive.

SLED TEST A-622 40 mph, 33 G peak pulse, 30° oblique rear impact,
50th percentile male dummy, lap-belt restraint

The Mod 1 HSRI/UniRoyal prototype -- same as the basic unit except for the addition of side panels for oblique-impact protection -- was tested dynamically with the Olin inflator (charged to 1900 psi).

The dummy was tipped slightly to one side before impact, but not to such a degree as to compromise the test. The inflator fired 5 msec after impact, and the bag was fully deployed 19 msec after impact; the load straps did keep the side panels in good position to arrest sideways motion.

At impact, the dummy did rotate about a vertical axis as he translated backward into the seat, so that the side as well as the back of his head and neck contacted the head restraint. Neck twist, however, was not serious. There was no head contact with side panels or load straps; the dummy stayed in the center of the seat, although he did tip to one side during rebound. The left leg flailed outward during rebound, and the left hip did contact the left load strap; the right shoulder also contacted the right load strap late in the rebound phase. Ramping was very well controlled, and rebound was only moderate. Maximum extension was estimated at 5°.

FINAL PERFORMANCE SLED TESTS

Sled test A-623 through A-630 were conducted as final performance tests of the basic HSRI/UniRoyal system (with load straps fastened to the sides of the seat pan). For this test series, three atypical square-wave sled pulses were used, at the suggestion of DOT and as described in DOT report HS-810-197.

Performance of a 4000 lb. car with a modified "fixed force" rear end (one that collapses controllably when subjected to 120,000 lb. of force) striking a fixed flat barrier was simulated by sled pulses of 20 mph/20 G and 40 mph /30 G.

Performance of a full-size current production car striking a fixed flat barrier (rear impact) was simulated by a sled pulse of 30 mph/20 G.

SLED TEST A-623 40 mph 30 G peak pulse, rear impact, 5th percentile female dummy, lap-belt restraint

The basic HSRI/UniRoyal system was set up (load straps bolted to the sides of the seat-pan); the inflator was charged to 2000 psi (air). The standard Sierra rubber neck was used with the female dummy, not the HSRI-developed neck described earlier (see Figure 20). Also, only one tri-axial accelerometer pack was used in the dummy head instead of the usual four accelerometers (two packs, AP and SI accelerometers in each pack).

Bag "slap" generated a peak head acceleration spike of 88 G @ 22 msec. There was no extension as the head went immediately into flexion upon contact with the still deploying bag. The inflator fired 15 msec after impact; the bag was fully deployed 24 msec after impact. Ramping was very well controlled and rebound was minor.

SLED TEST A-624 30 mph, 22 G peak pulse, rear impact, 5th percentile
female dummy, lap-belt restraint

This was the second final performance test of the basic HSRI/Uni-Royal system. Dummy configuration and inflator pressure were the same as A-623. Although head-restraint set-up was nominally the same also, it was observed in test films that the inflated bag was slightly further forward in this test than in A-623. This aggravated the bag slap phenomenon, which generated a 102 G head A-F acceleration spike 28 msec after impact.

The inflator fired 15 msec after impact; the bag was fully deployed 29 msec after impact. As in A-623, there was no measurable head/neck extension; the dummy moved backward into the seat, and as the head and neck contacted the bag, the head went into moderate flexion. Rebound and ramping were minor. The HIC value calculated for this test was 560.3.

SLED TEST A-625 20 mph, 21.5 G peak pulse, rear impact, 5th percentile female dummy, lap belt restraint.

The third final performance test of the HSRI/UniRoyal system was run with the same dummy configuration and inflator pressure as in A-623. The inflator fired 14 msec after impact; the bag was fully deployed 30 msec after impact.

There was no measurable head/neck extension as the dummy translated backward into the head-restraint and seat-back, only very minor flexion. Ramping was negligible, but rebound was judged moderate, as the dummy bent forward about 45° at the waist with both legs pointing straight outward (parallel to the sled track).

The front panel of the vinyl hood pulled loose from its attachment bar as the dummy moved into the head-restraint; the hood did not tear, but pulled out from under its clamping bar due to incorrect installation. This allowed the load strap to slip downward on the back of the inflated bag. The female dummy head contacts the bag low on the front face, however, so the load strap still worked well in resisting rearward motion.

/

SLED TEST A-626 40 mph, 32 G peak pulse, 95th percentile male
dummy, lap belt restraint

For the fourth final performance test of the HSRI/UniRoyal system, several changes were made to the inflator, the bag, and the dummy neck.

A choke plate was installed on the inflator cap to reduce the outlet flow area and thereby slow down the bag inflation (see Figure 2). Also, the bag itself was installed without using any sealant material at the bag/mounting plate/inflator interface; the goal in allowing the system to be slightly "leaky" was, again, to reduce air bag pressure and thereby reduce, if possible, the bag "slap" encountered in tests A-623, 624 and 625.

In an attempt to improve the seated posture of the test dummy, a metal wedge was installed at the base of the neck, tilting the head and neck forward about 15°. The resulting "slouch" was a much more realistic approximation of human seated posture, although it did increase head/head-restraint offset distance.

The inflator fired 13 msec after impact, and the bag was fully deployed 32 msec after impact. The modifications described earlier did allow 33° maximum head/neck extension (at 59 msec), and did reduce the bag slap severity. However, the dummy did ramp upward moderately as his head contacted the bag high on its front surface. Rebound was moderate; the dummy bent forward at the waist as his knees came upward, causing head/knee contact.

SLED TEST A-627 30 mph, 24 G peak pulse, 95th percentile male
dummy, lap belt restraint

This was a baseline test to determine dummy kinematics during a rear impact with no head restraint. The final design seat was used for the first time, with a one-inch-thick slab of polystyrene foam installed behind the seat-back cushion to refine head/head-restraint geometry. The HSRI/UniRoyal head restraint was mounted but not deployed during the test. The "neck wedge" described for test A-626 was also used in this test.

Ramping was moderate to severe, and head/neck extension reached 92° at 81 msec as the back of the dummy head contacted the surface of the head-restraint mounting platform. Rebound was moderate to severe.

SLED TEST A-628 30 mph, 23 G peak pulse, 95th percentile male
dummy, lap belt restraint

This test was run under the same conditions as A-627, except that the HSRI/UniRoyal head restraint was deployed. The inflator fired at 11 msec after impact, and the bag was fully inflated at 29 msec.

Although the tall 95th male dummy does load the bag high on its front surface, the bag "fitted" well behind head and neck and did pocket the shoulders. The side load-straps also helped keep ramping moderate. Maximum head/neck extension of 32 1/2° occurred at 67 msec after impact. Rebound was moderate.

The increased head/head-restraint offset caused by the installation of the wedge at the base of the neck, contributed to the higher than expected extension and to the subsequent moderate rebound.

SLED TEST A-629 20 mph, 22.5 G peak pulse, rear impact, 95th percentile male dummy, lap-belt restraint

The basic HSRI/UniRoyal system was set up as it was for test A-627, incorporating the same modifications to bag, inflator and dummy neck as described in the summary of that test. The final-design seat with a one-inch-thick polystyrene foam panel behind the seat-back cushion was used for this test and for A-630.

The inflator fired 11 msec after impact; the bag was fully deployed 27 msec after impact. Although the bag "fit" well in the "hollow" of the neck just above the shoulders, the tall 95th percentile male dummy did load the bag higher on its front surface than either the 50th or 5th percentile dummy. Ramping was very well controlled; maximum extension (43°) occurred at 66 msec after impact.

Rebound was minor to moderate; the dummy bent forward at the waist and the head underwent moderate flexion, chin almost striking chest. The knees came upward, but there was no contact with the head until very late in the rebound as the dummy bent far forward. Maximum left side belt load of 890 lb. occurred about 54 msec after impact.

SLED TEST A-630 30 mph, 23.5 G peak pulse, rear impact, 5th percentile female dummy, lap-belt restraint

This was a rerun of A-624, to evaluate changes made to the bag and inflator (see A-626) to reduce bag "slap" encountered in A-624, 625 and 626. The standard Sierra rubber neck was used, as well as the final-design seat with the extra polystyrene seat-back panel.

Inflator actuation occurred 16 msec after impact; the bag was fully deployed 29 msec after impact. Dummy kinematics were virtually ideal. There was no noticeable ramping and no measurable extension as the dummy translated into the seat-back and head restraint with only very minor flexion of the head. Maximum side belt load of 1040 lbs. was indicated at 37 msec after impact. Rebound was very minor as the dummy slid forward on the seat-pan cushion in almost perfect translation. The dummy did bend forward very slightly at the waist, late in the pulse as she reached the limit of travel allowed by the lap-belt.

6.4 VEHICLE CRASH TEST EQUIPMENT AND INSTRUMENTATION

To evaluate head-restraint performance in a crash environment more realistic than could be simulated on the impact sled, HSRI collaborated with Dynamic Science (Phoenix, Arizona) on a series of five real-vehicle crash tests being run as part of their study of vehicle crashworthiness. Figure 22 describes the nature of each test.

In each test, a seat/head-restraint system and an unrestrained Alderson VIP 50th percentile male dummy were installed in the right-front seating position of the impact vehicle. The dummy had an inverted General Motors rubber neck, and was instrumented with one triaxial accelerometer in the head (at the CG) and a second in the thorax. Vehicle instruments (Figure 23) included accelerometers on the floor of the car (triaxial) and on the bottom of the seat-pan (biaxial: AP and SI). High-speed film coverage was provided by on-board, track-side hand-held, overhead and under-vehicle movie cameras. A bumper-mounted contact switch triggered the head-restraint inflator at impact.

In tests 261-4, -5 and -6, the impact vehicle was brought up to speed (on its own wheels) by an engine-driven cable system. In test 261-8, however, the car was mounted 30° off center on a set of dolly wheels. For the final test, 261-9, the stationary impact vehicle was struck from behind by a specially-designed striker vehicle with a modified front-end structure.

The impact vehicle in each test incorporated a modified rear-end structure (see Figure 24), stiffer than that found in conventional cars. Without describing the modifications in detail, it can be said that the controlled-collapse structure generated occupant-compartment accelerations somewhat greater in magnitude than would occur in an equivalent speed crash of a conventional car and somewhat lower than would be generated in an equivalent sled test.





TEST NUMBER	IMPACT CONFIGURATION	IMPACT VEHICLE	STRIKING VEHICLE	IMPACT SPEED	HEAD RESTRAINT
261-4		Modified 1968 Plymouth	Barrier	40 mph	HSRI/Uniroyal
261-5		Modified 1968 Plymouth	Barrier	40 mph	Goodrich
261-6		Modified 1968 Plymouth	Barrier	40 mph	HSRI/Uniroyal
261-8		Modified 1963 Plymouth	Barrier	40 mph	HSRI/Uniroyal
261-9		Modified 1963 Plymouth	Fixed-Force Front Modified Vehicle	60 mph	HSRI/Uniroyal

Figure 22. Dynamic Science Crash Test Matrix.

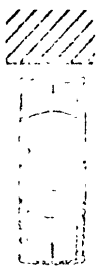

View looking down from top of vehicle.

LEGEND

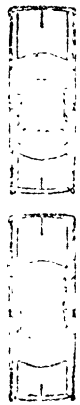
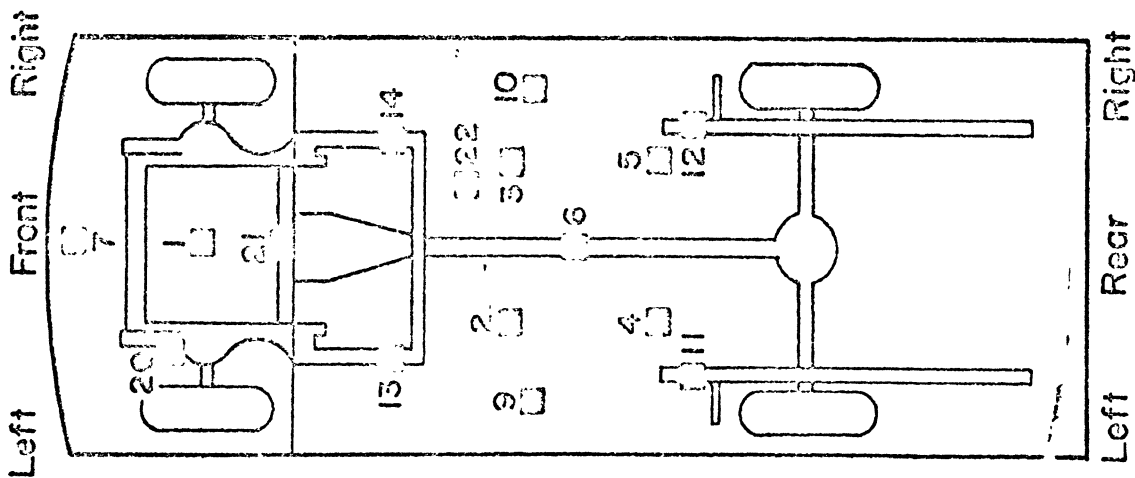
1. On engine (triaxial mount)
2. Under driver's position on floor (triaxial)
3. Same as 2 except on right side
4. Under left rear passenger position on floor
5. Under right rear passenger position on floor
6. On tunnel approximately at vehicle CG (triaxial)
7. On front cross member under radiator (triaxial)
9. On rocker panel under "B" post on left side (triaxial)
10. Same as 9 except on right side (triaxial)
11. On rear frame near wheel well on left side
12. Same as 11 except on right
13. On left front stub frame near end
14. Same as 13 except on right
20. On left front stub frame near shock mount
21. In engine compartment on firewall
22. On seat pan

Note: Readings from locations 2 through 6 were averaged to obtain "occupant compartment acceleration" traces for each test.

ACCELEROMETER LOCATIONS ON DYNAMIC SCIENCE CRASH TEST VEHICLES
(1968 PLYMOUTH).

FIGURE 23.

6.5 VEHICLE CRASH TEST RESULTS

The results of each vehicle crash test are described in the narrative summaries that follow, and in the numerical summary of Table In addition, the more significant of the tests are described in detail in Section 7.3.2, Discussion of Test Results.

PHOENIX TEST 261-4 (28 July 1972)

40.4 mph, direct rear impact, 58 G peak occupant compartment pulse, 50th percentile male dummy, no restraint belts, basic HSRI/UniRoyal head restraint.

Although it was possible to determine via film analysis that bag deployment took 18 msec, crash debris obscured the camera field to such a degree that measurement of head/neck extension was impossible.

At impact, the floor of the car deformed in such a way that the rear legs of the test seat moved downward, tilting the seat backward an estimated 15°. As this occurred, the dummy loaded the seat-back and head-restraint, disappearing from camera view as debris filled the car. The head-restraint deployed fully and apparently functioned well to limit extension; it is probable, however, that the backward tilt of the seat allowed the dummy to ramp upward more than he normally would.

After impact, the dummy remained in the seat, but tilted to his left at the waist, then slid forward sufficiently to contact the dashboard with his knees and possibly with his head. He then moved back into the seat and came to rest twisted to the left and bent slightly at the waist.

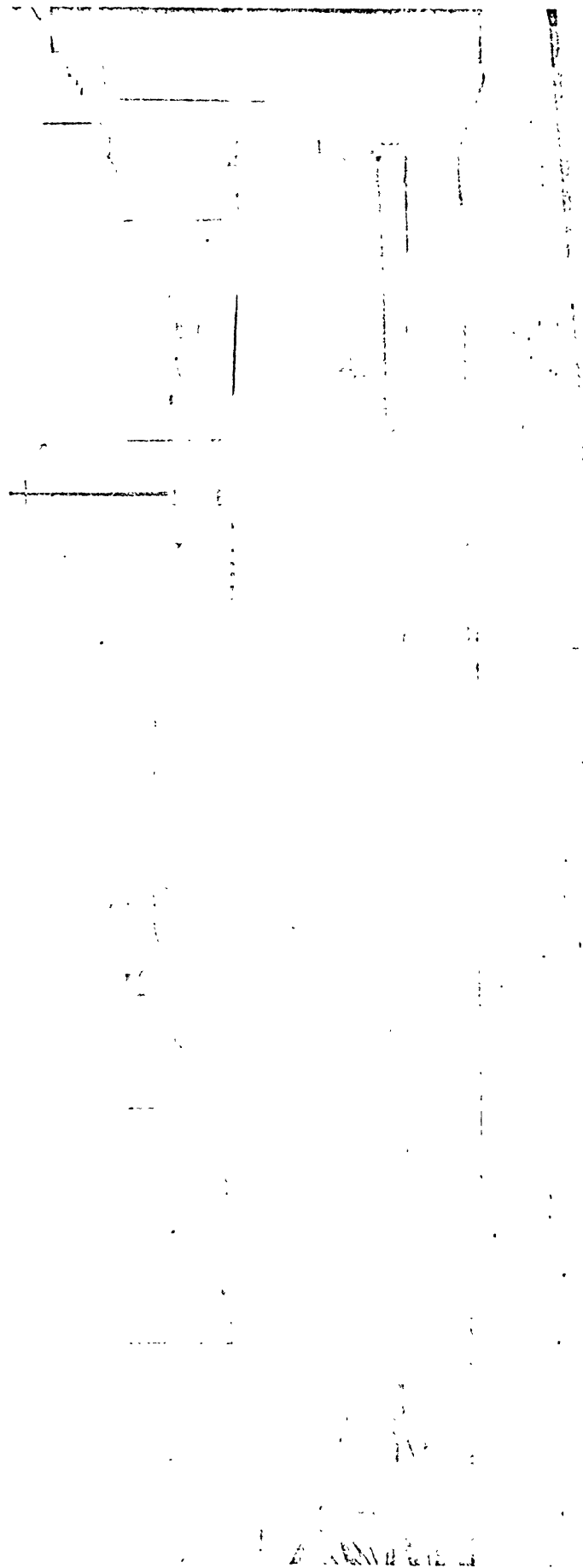

Figure 24. Vehicle 267-4: Pre-Impact.

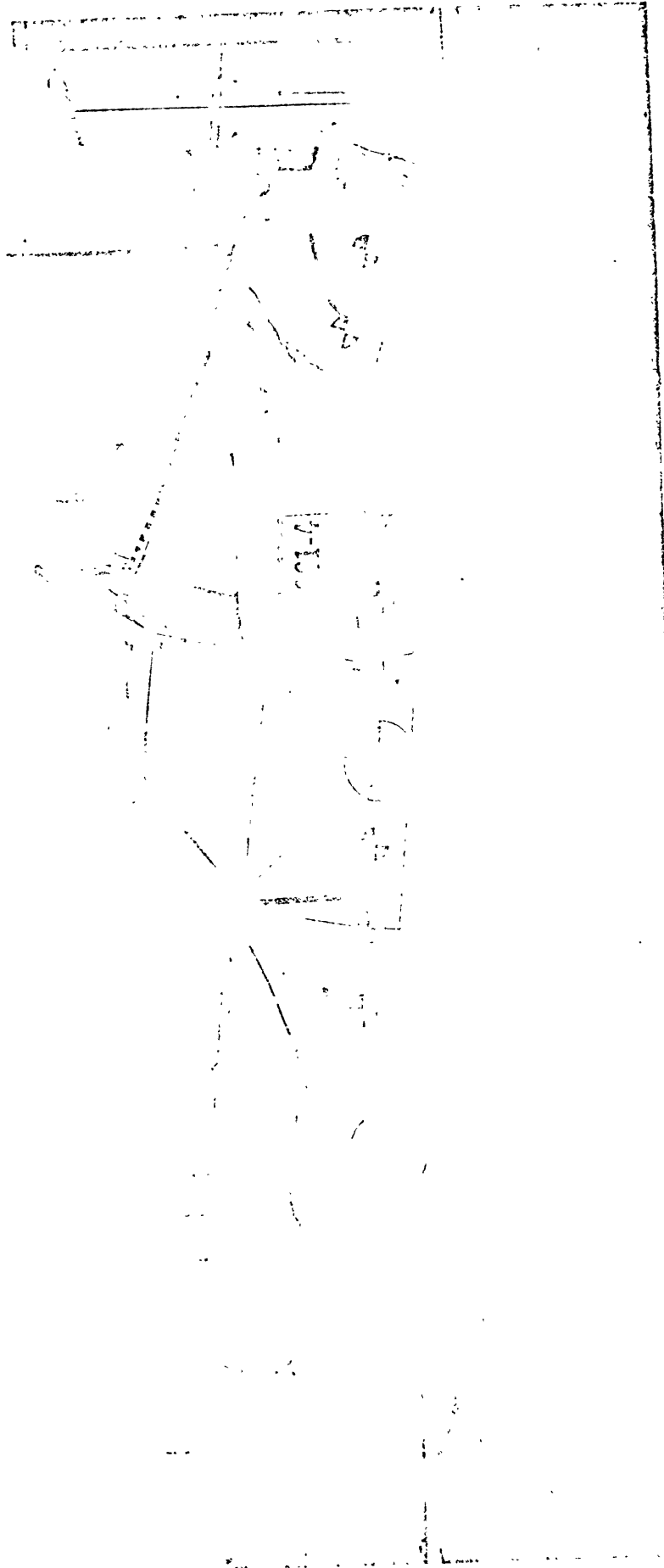

Figure 25. Vehicle 261-4: Post-Impact.

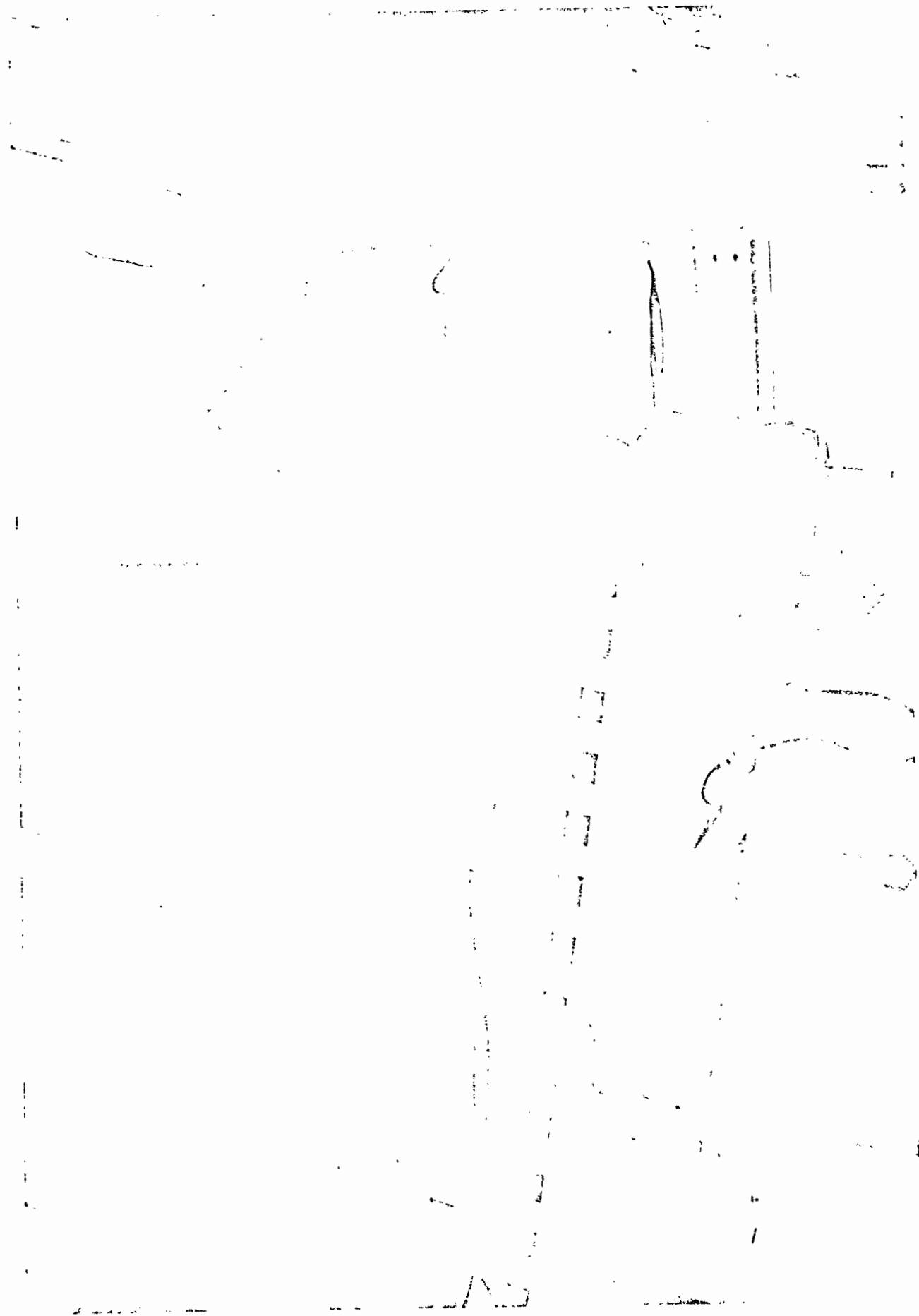

Figure 26. Dummy 261-4: Pre-Impact.



Figure 27. Dummy 261-4: Pre-Impact.



Figure 28. Dummy 261-4: Post-Impact.

PHOENIX TEST 261-5 (5 September 1972)

39.7 mph, direct rear impact, 42 G peak occupant compartment pulse, 50th percentile male dummy, no head restraint.

The Goodrich Mod 2 prototype was to be evaluated in this test, however, the first test-run was aborted before impact. Immediately after the abort, the inflator fired accidentally and tore the head-restraint bladder (a segment of auto tire inner-tube). Since neither a preinflated or deploying test could be run, a "baseline" test was then conducted. Seat and dummy remained in the car, and the head restraint was left in its stowed position.

The dummy underwent severe whiplash, as head/neck extension reached 106° at about 98 msec after impact. As in all the vehicle crash tests, the seat itself tilted rearward (approximately 13° in this case) under the stress of dummy loading and vehicle floor deformation. In this test, the seat did not return to its original orientation; it was still tilted backward 5° after the impact. This partially-elastic seat deformation contributed to the severe rebound problem (see below).

Following the whiplash sequence, the dummy rebounded upward and slightly forward out of the seat, his motion aggravated by the severe vertical oscillations of the vehicle as it moved away from the barrier. He underwent minor flexion just before contacting the roof with the top part of the forehead.

Dropping back down into the seat, he sat almost upright for a moment, tipped slightly forward; then began to fall backward and to the left bending at the waist.

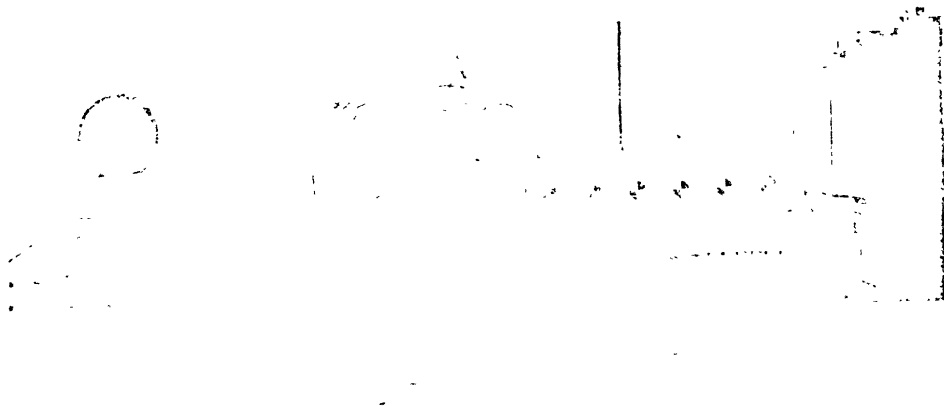

Figure 29. Vehicle 261-5: Pre-Impact.



Figure 30. Vehicle 261-5: Post-Impact.

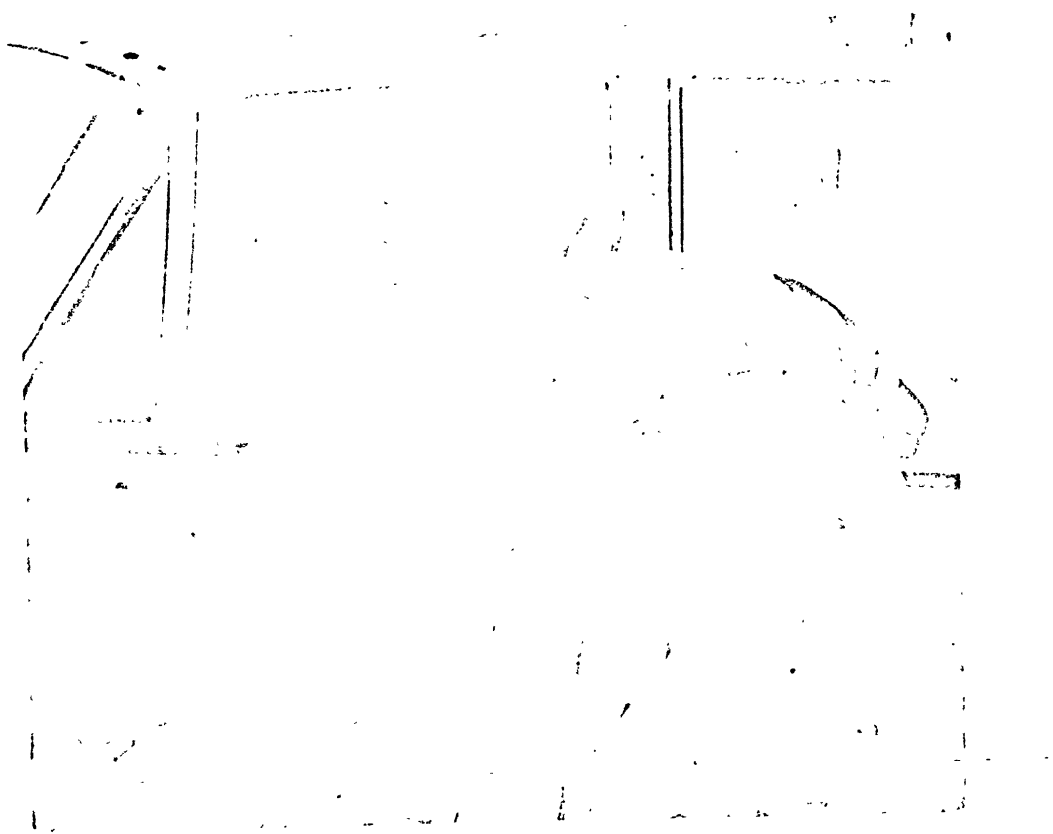

Figure 31. Dummy 261-5: Pre-Impact.

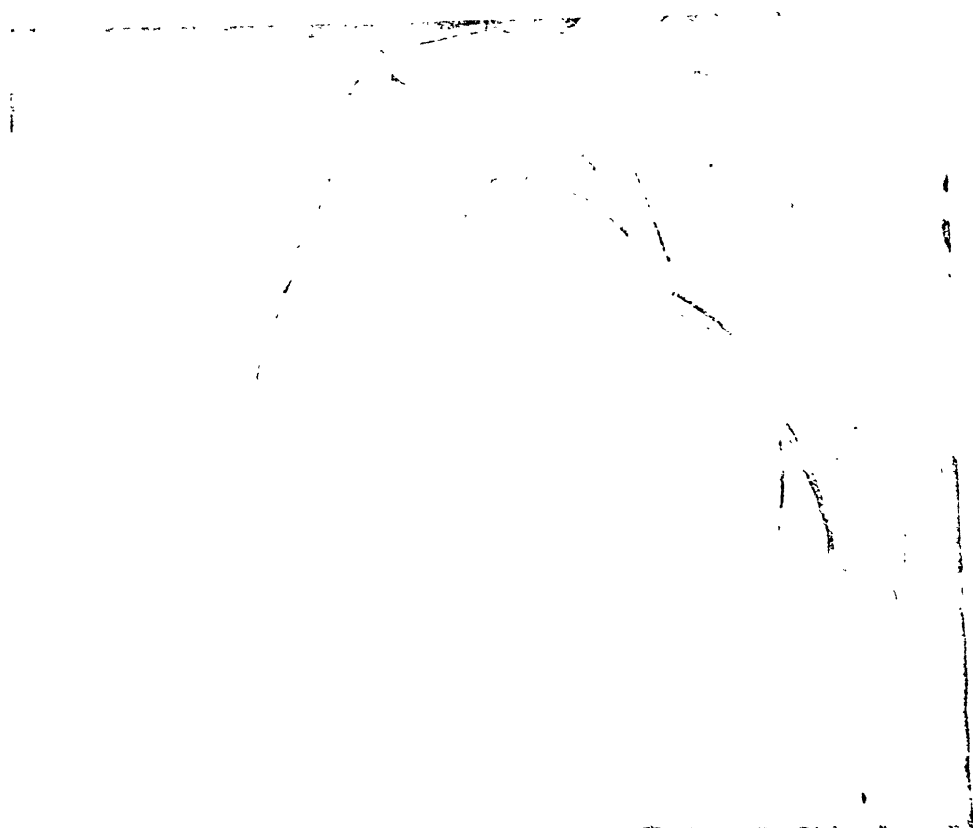

Figure 32. Dummy 261-5: Post-Impact.

The torso then twisted to the left, and, pivoting in the seat on his left hip, the dummy fell into a horizontal position, his head approximately where the driver's seat-pan would be. He rolled onto his face, and came to rest in this position.

PHOENIX TEST 261-6 (17 October 1972)

39.6 mph, direct rear impact, 30 G peak occupant compartment pulse, 50th percentile male dummy, HSRI/UniRoyal head restraint.

This test was a failure for two reasons. The inflator failed to fire due to incorrect squib installation, and the seat tore loose from the floor during impact due to inadequate mounting. No useful data was obtained.

PHOENIX TEST 261-8 (18 November 1972)

39.3 mph, 30° oblique rear impact, 19 G peak occupant compartment pulse, 50th percentile male dummy, HSRI/UniRoyal head restraint.

This test was run to evaluate the performance of the basic HSRI/UniRoyal system in oblique impact; set-up was the same as for test 261-4. The inflator fired 10 msec after impact, and the bag was fully deployed 24 msec after impact. As the dummy moved into the bag, there was no measurable extension, but there was slight flexion. Immediately, however, the head turned to the left and rolled backward slightly, with the left side of the head in contact with the bag.

As the torso turned to the left, the left arm and shoulder went under the left load strap, allowing the side of the face to contact the upper part of the strap. At the same time the knees came up, and the left thigh swung into contact with the left load strap (lower part). In a ramping motion that was aggravated by the vertical oscillations of the car as it left the barrier, the dummy rose about 6 inches off the seat, knees moving upward; the position of the left shoulder -- under the load strap -- prevented excessive upward excursion.

As in test 261-4, deformation of the vehicle floor caused the rear of the seat to drop downward at impact, resulting in a rearward seat rotation of about 10° that also aggravated ramping and rebound.

The dummy slid back down into the seat, bending forward and leaning to the left at the waist. He came to rest sitting on the left-front corner of the seat-pan, tilted backward and to the left, with left shoulder and left side of head against seat-back and head-restraint respectively.

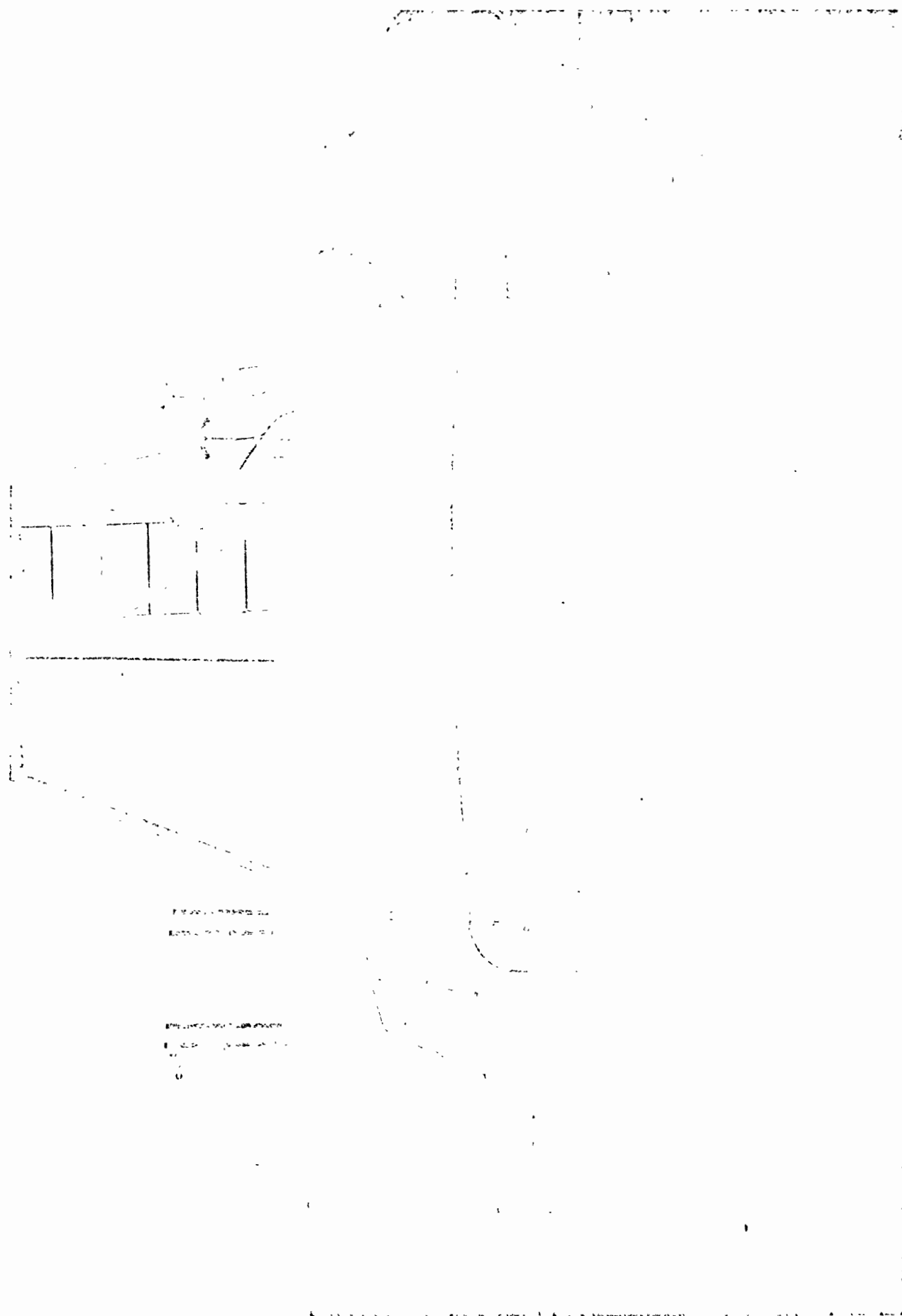

Figure 33. Vehicle 261-8: Pre-Impact.

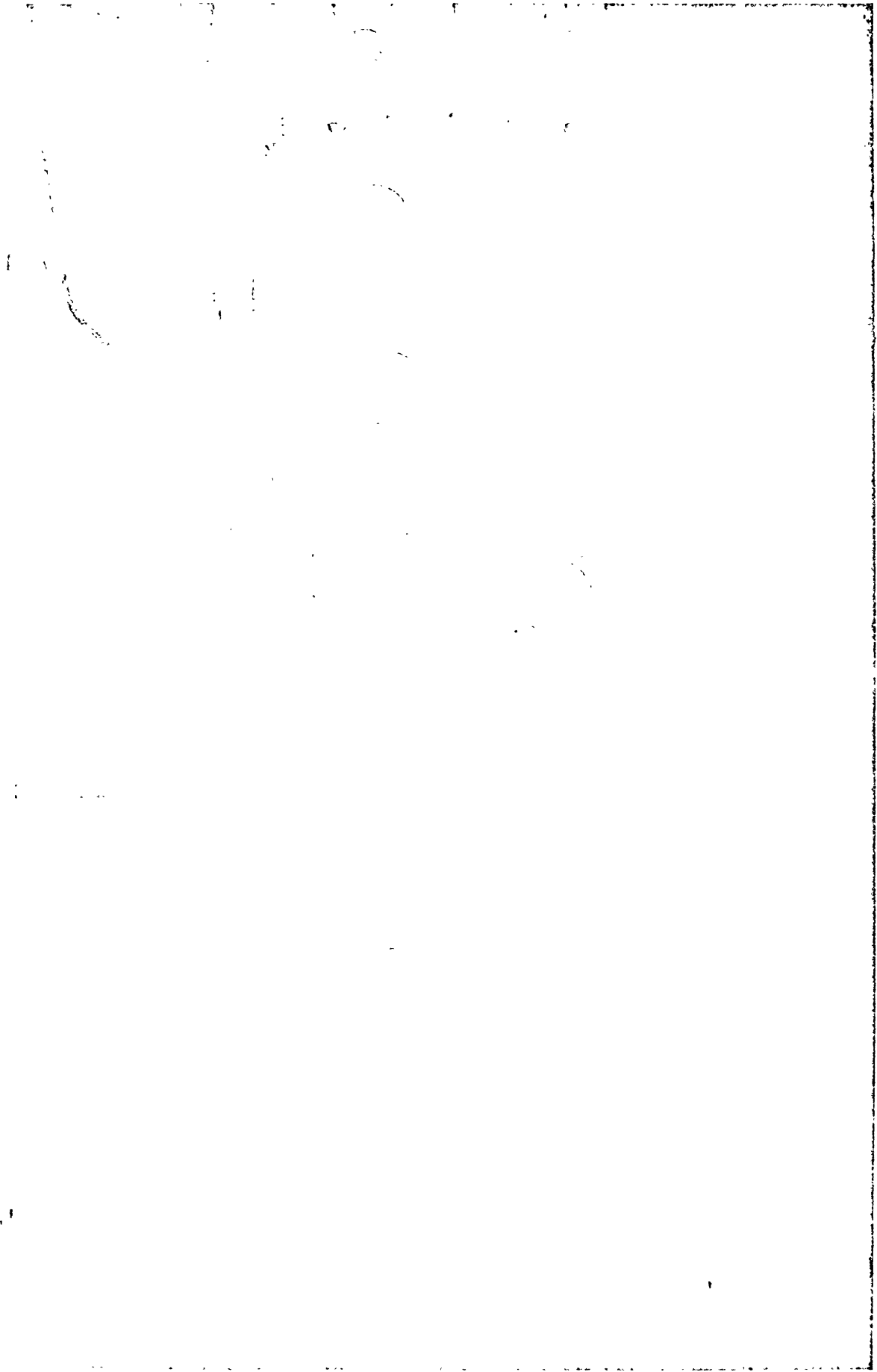

Figure 34. Vehicle 261-8: Pre-Impact.

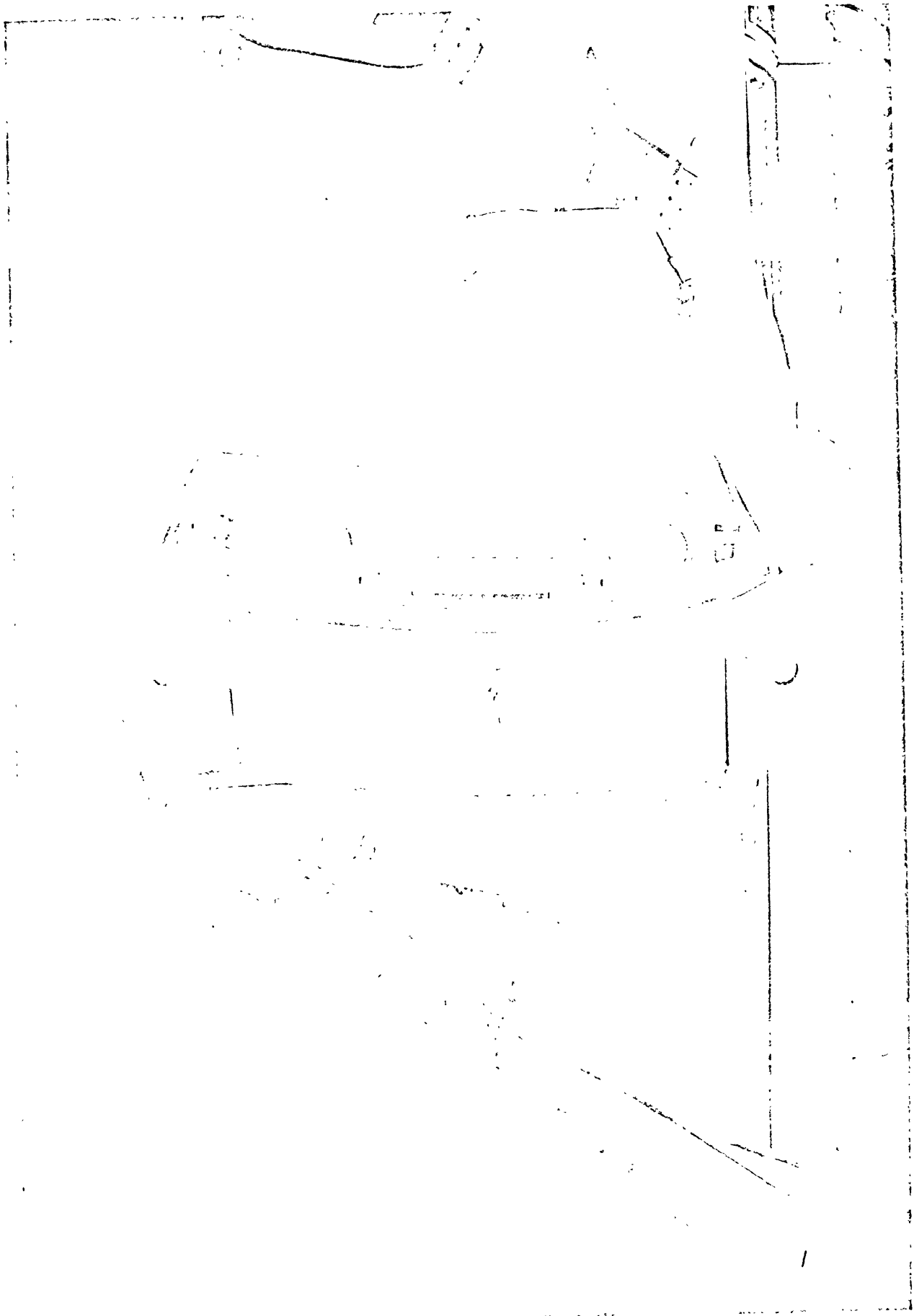

Figure 35. Vehicle 261-8: Post-Impact.

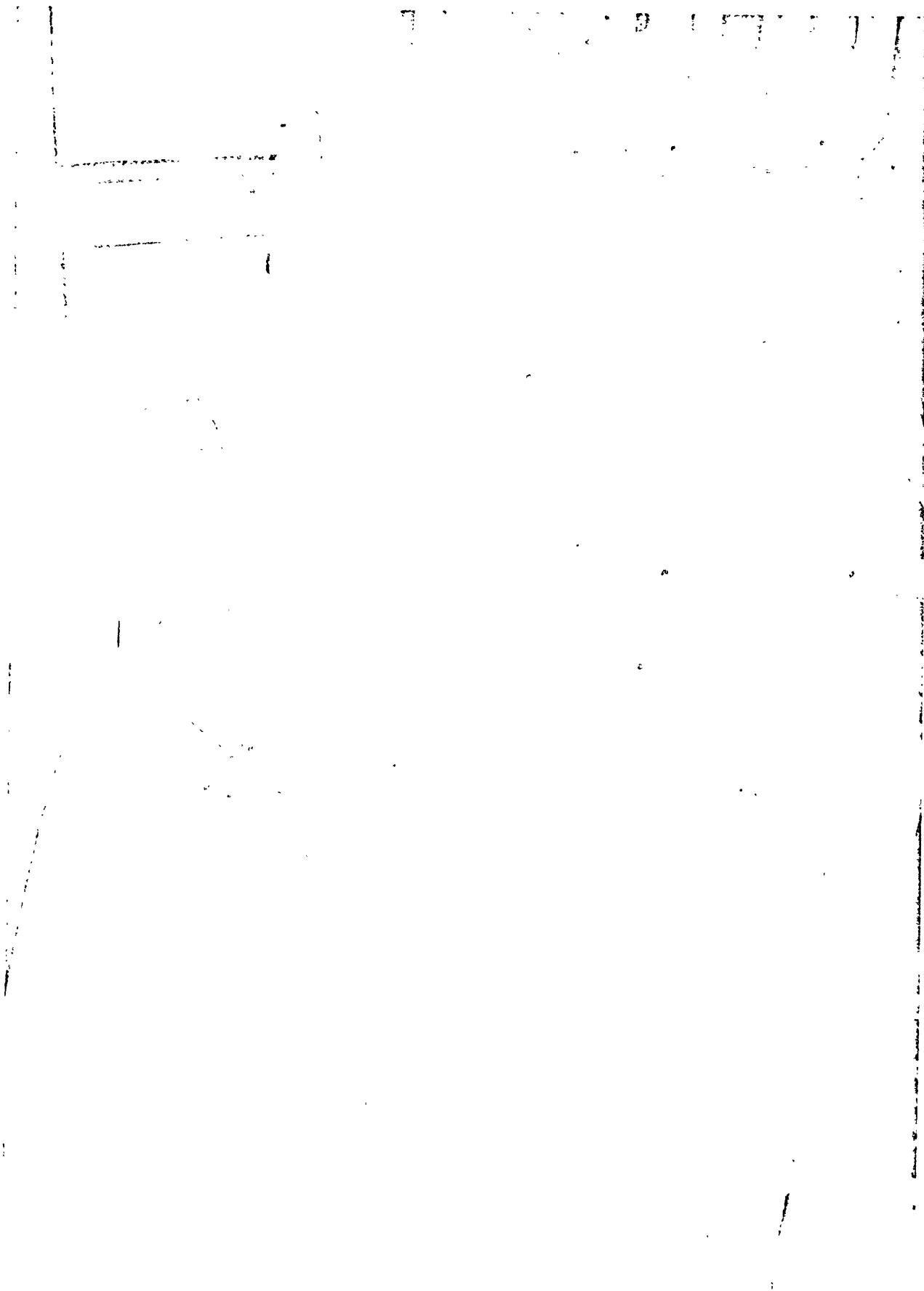

Figure 36. Dummy 261-8: Pre-Impact.

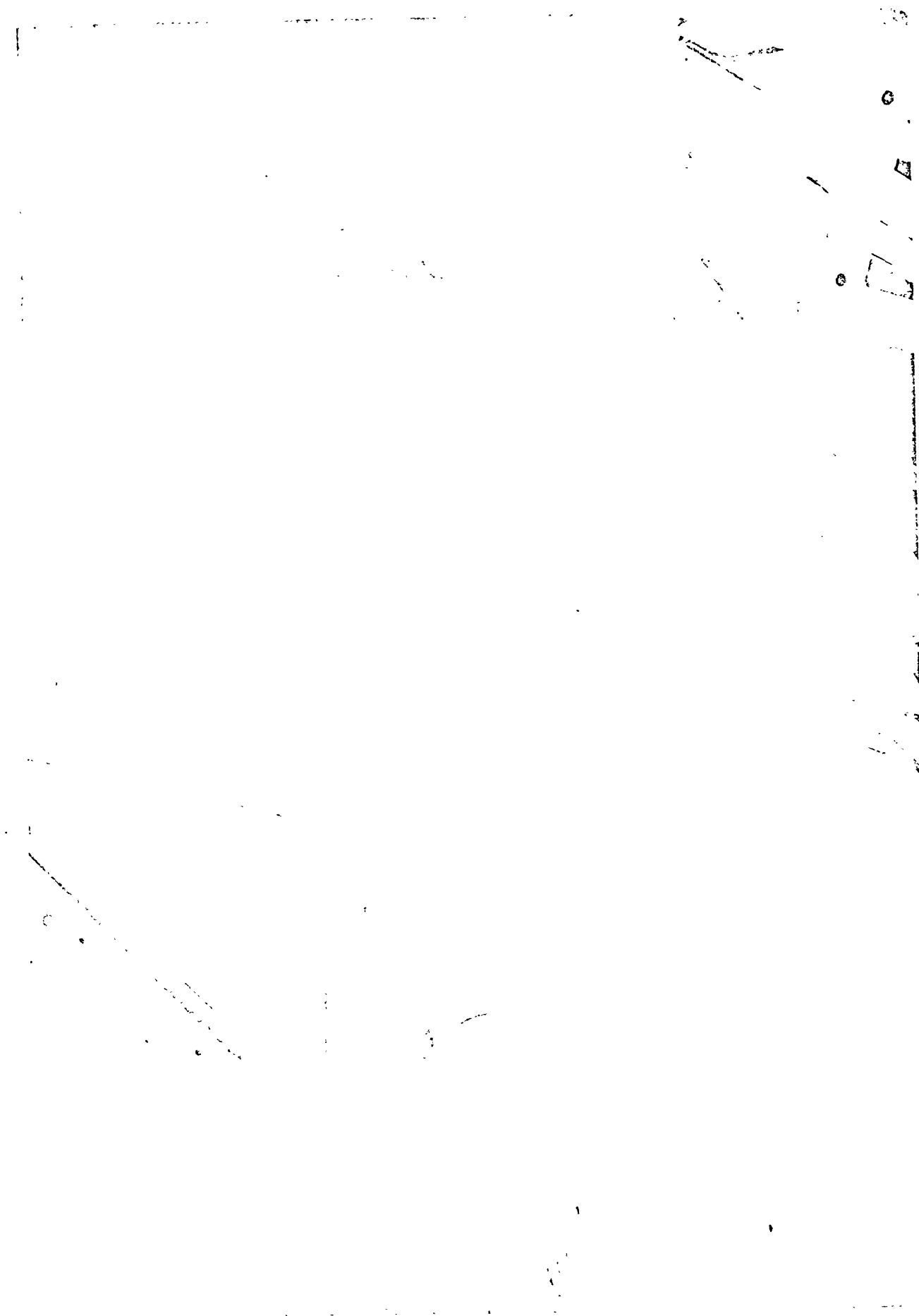

Figure 37. Dummy 261-8: Post-Impact.

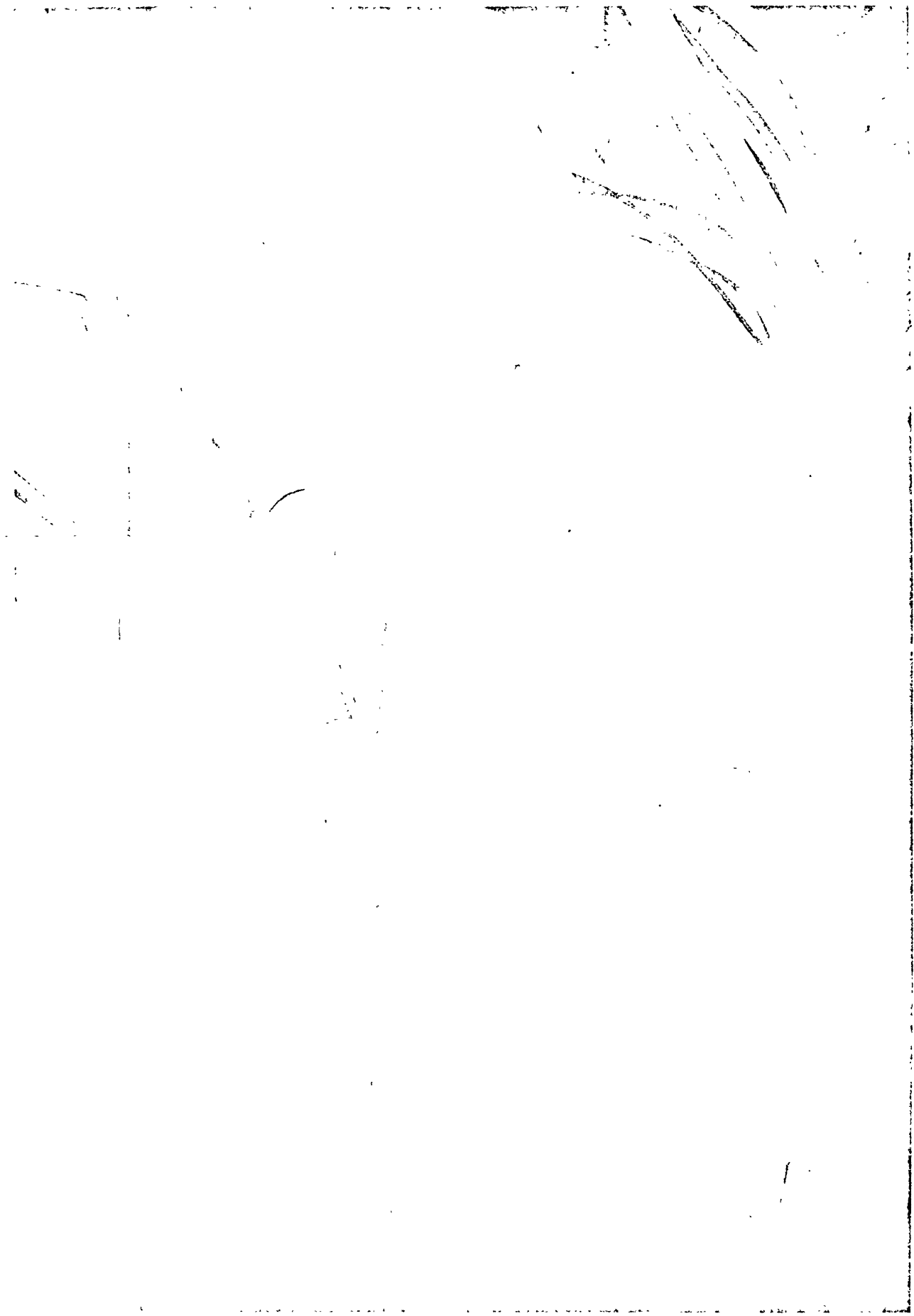

Figure 38. Dummy 261-8: Post-Impact.

PHOENIX TEST 261-9 (11 December 1972)

60.9 mph, car-to-car direct rear impact 40 G peak occupant compartment pulse, 50th percentile male dummy, basic HSRI/UniRoyal head restraint.

Vehicle set-up and head-restraint installation was the same as for test 261-4. The test vehicle was not crashed into the barrier, but was struck from behind (while at rest) by a bogey vehicle with a specially designed energy absorbing front end.

The inflator fired approximately 8 msec after impact; the bag was fully deployed 23 msec after impact. The seat rotated about 10° rearward, but ramping was very well controlled as the load straps and bag pocketed the shoulders. There was some initial minor flexion as the head first contacted the bag, but extension became apparent as the head and shoulders loaded the bag. Maximum extension (approximately 12°) occurred at about 70 msec after impact. Debris made it difficult to determine the exact time and magnitude of extension.

Test films showed the deployed bag to be tilted slightly forward of its optimum position, and this may have contributed to the severe rebound that occurred. A second factor, however, was also important. The test seat deformed elastically (10° rearward rotation) during impact, storing then "feeding back" into the dummy some of the dummy's kinetic energy. The nature of this seat/head-restraint contribution to rebound is discussed in Section 7.3.2.

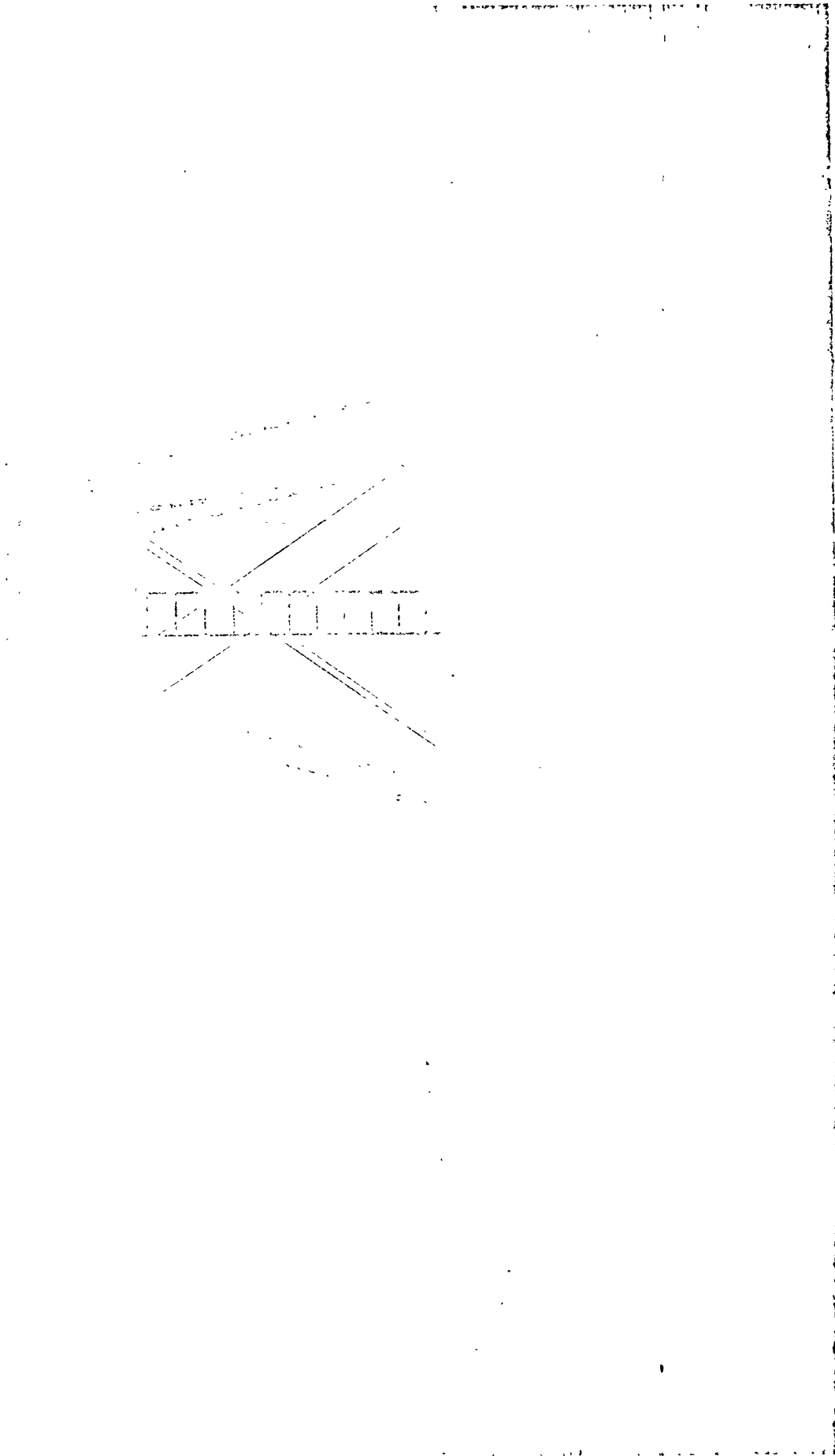

Figure 39. Vehicle/Bogey 261-9: Pre-Impact.

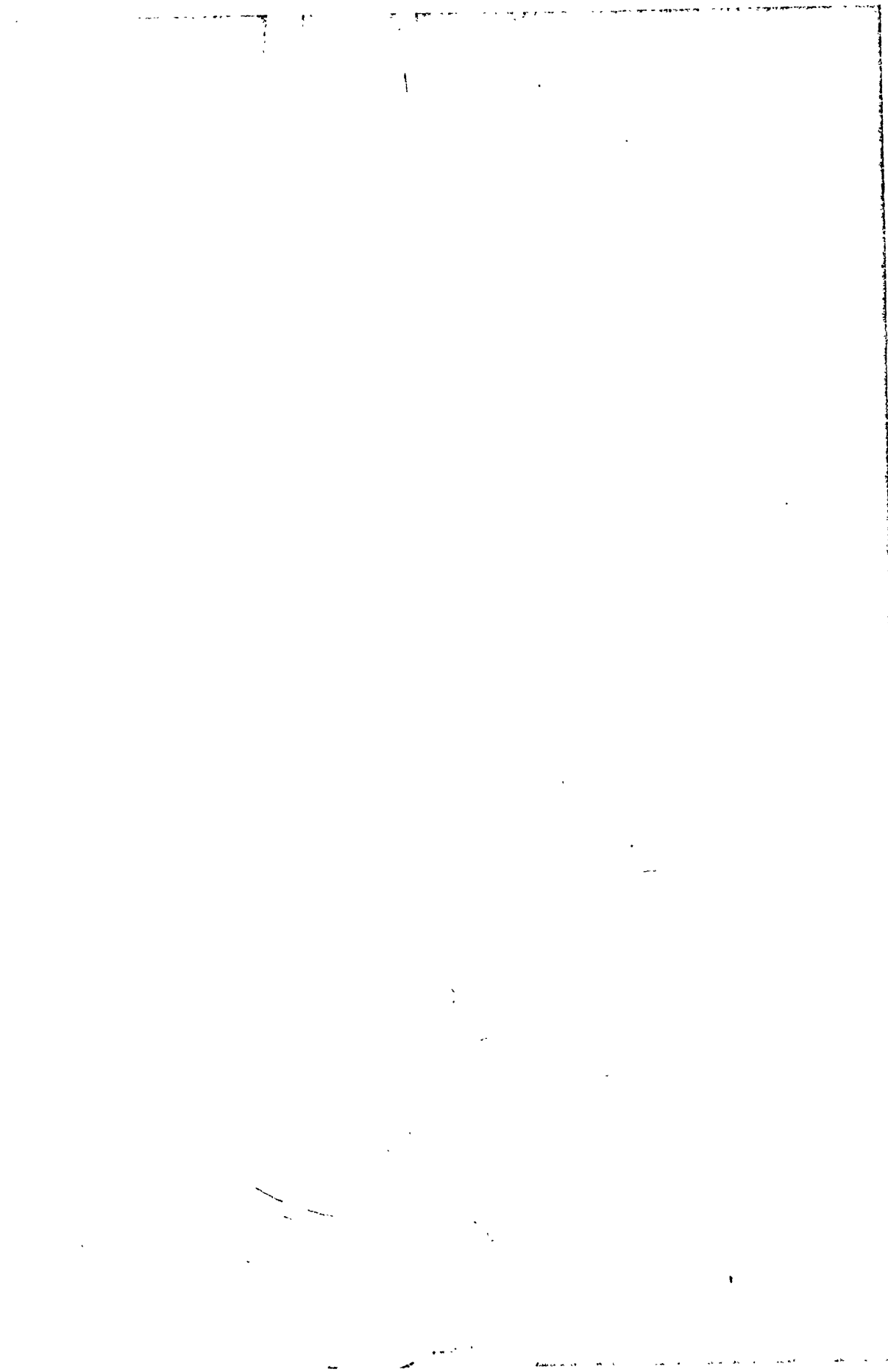

Figure 40. Vehicle 261-9: Post-Impact.

The dummy did rebound severely, bending forward slightly at the waist, sliding forward to the front edge of the seat, striking and cracking the windshield with his forehead. His chest appeared to strike the dash. Moving backward into the seat, the dummy assumed a nearly upright position, then tipped to the left, striking the steering wheel rim with the left side of his head.

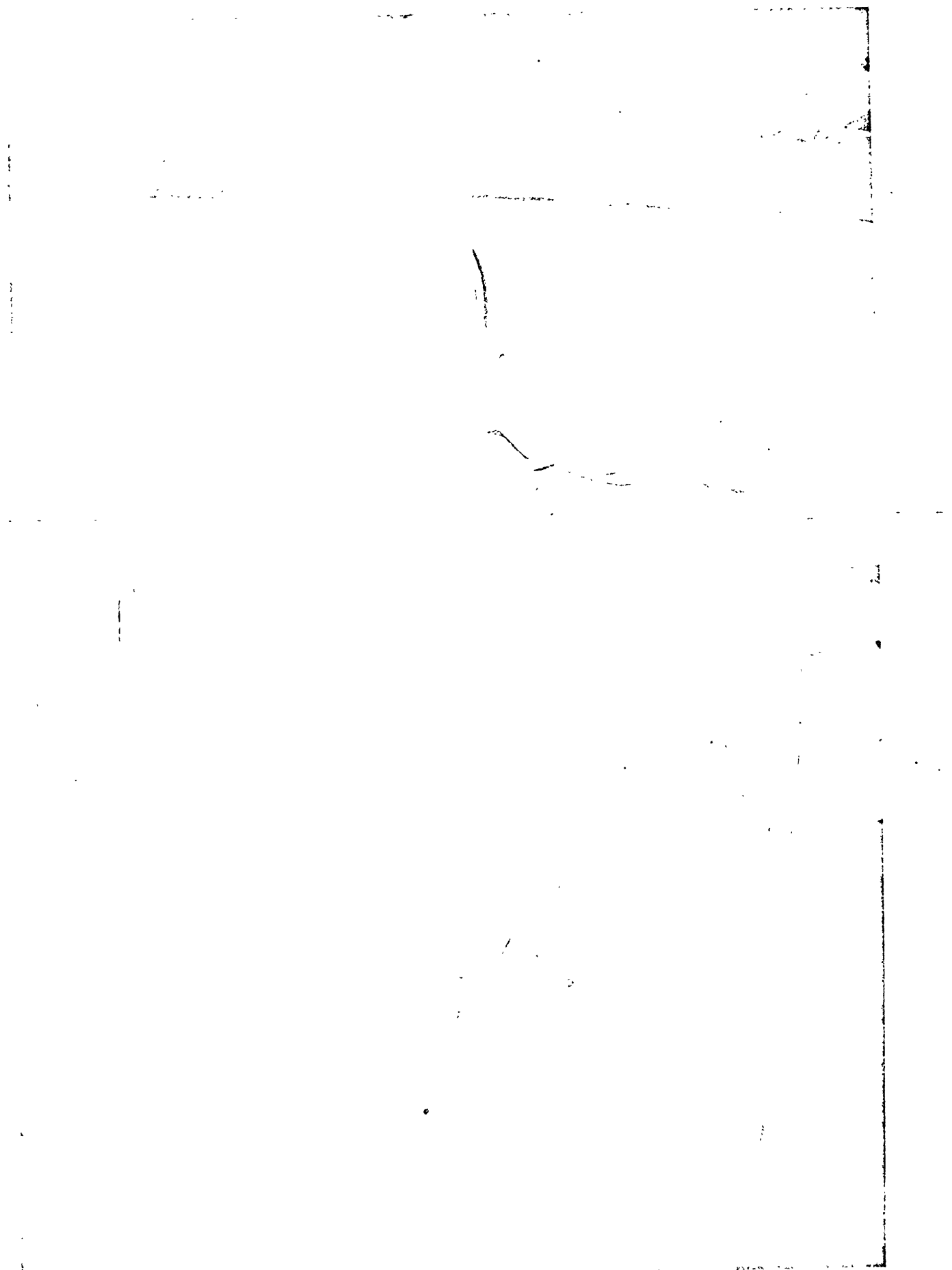

Figure 41. Dummy 261-9: Pre-Impact.

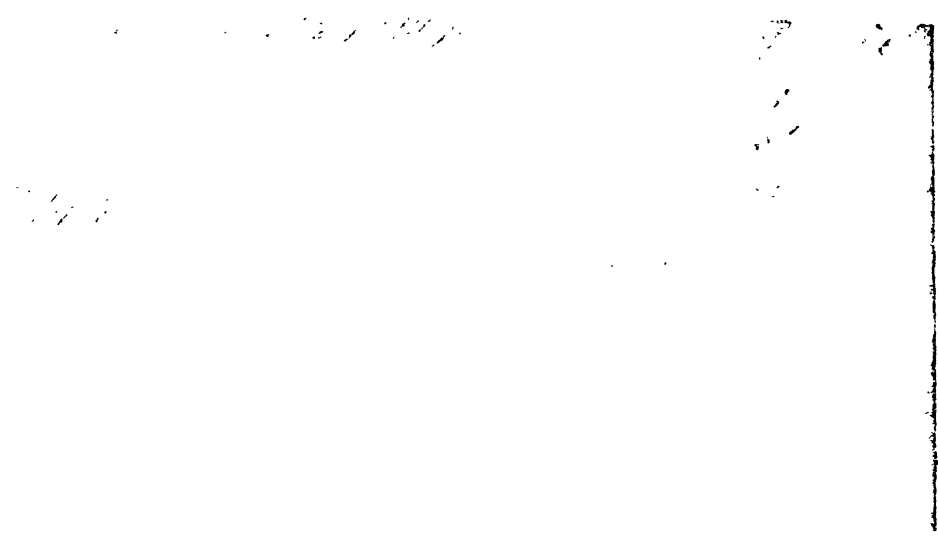

Figure 42. Dummy 261-9: Post-Impact.

7. DISCUSSION OF TEST RESULTS

This section discusses and analyzes in detail those parts of the development and testing program that were of special significance in the evaluation of deployable head restraint concepts and in the selection of the best of the systems studied.

To illustrate the injury hazard posed by rear-end impact without head-restraint, to quantify the parameters involved, data from sled test A-627 and from vehicle crash-test 261-5 is useful. As the sequence photographs of Figure 43 show, head/neck extension in test A-627 (30 mph/24 G) was severe (92° at 81 msec), accompanied by a peak head angular acceleration of 9570 rad/sec^2 . It should be noted, too, that extension was limited in this case by head contact with the stowed head-restraint and its mounting plate, which also caused the very high angular acceleration (Table 2).

In vehicle crash test 261-5 (40 mph/42 G), extension reached 106° as the unrestrained dummy also underwent considerable ramping. (It was not possible to determine head angular acceleration.) As noted in the narrative summary for this test (Section 6.5), rebound was also severe; the dummy struck both the roof of the car and the dash.

Dummy kinematics, degree of head/neck extension, and rebound for these two tests can be compared to those observed in sled tests at comparable speeds and decelerations.

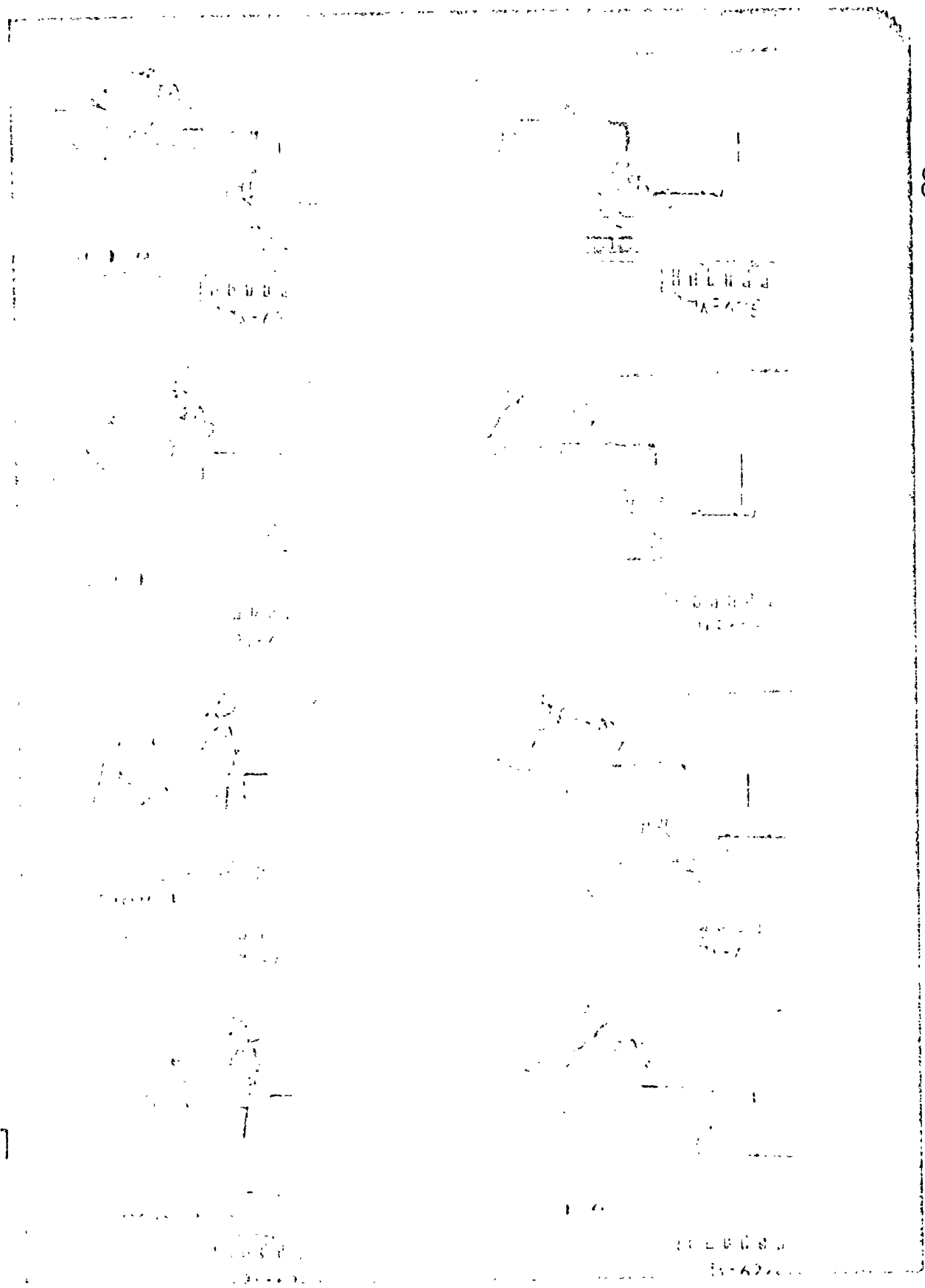
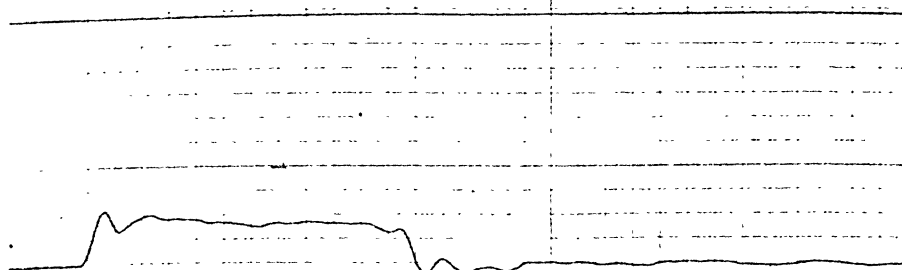
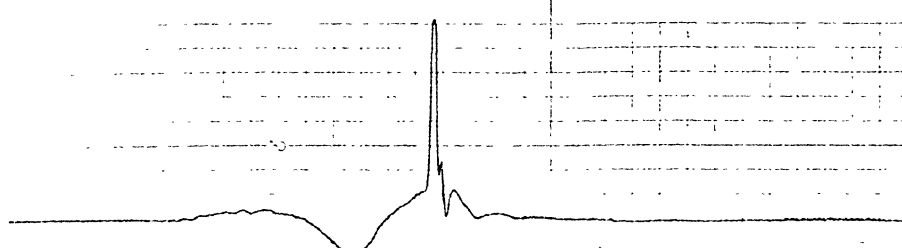

Figure 43. Test A-627: Graph-Chek Sequence.

SLED PULSE
(10 G/DIVISION)



HEAD ACCEL., A-P (1)
(25 G/DIVISION)



HEAD ACCEL., A-P (2)
(25 G/DIVISION)

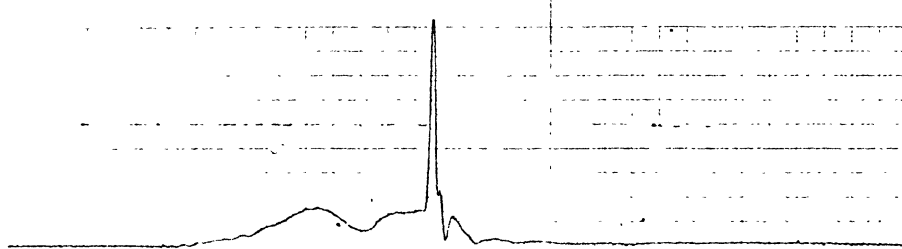

HEAD ACCEL., S-I (1)
(25 G/DIVISION)

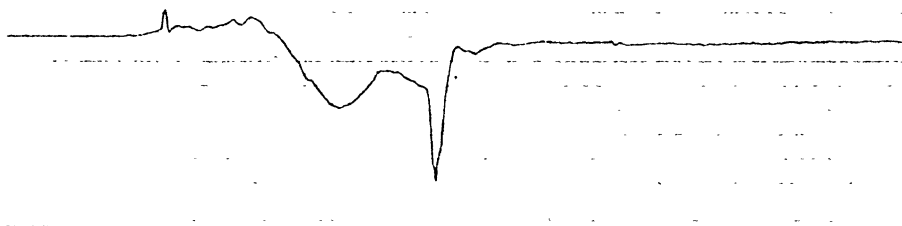

HEAD ACCEL., S-I (2)
(25 G/DIVISION)

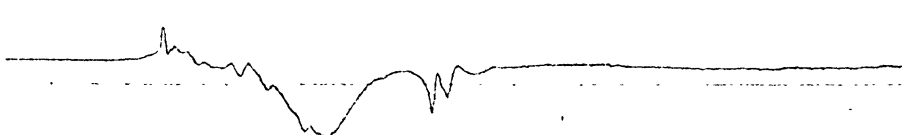

TIME BASE 6.25 MSEC/DIVISION

VISICORDER TRACES FOR SLED TEST A-627
(29.2 MPH REAR IMPACT, NO HEAD RESTRAINT)

FIGURE 44.

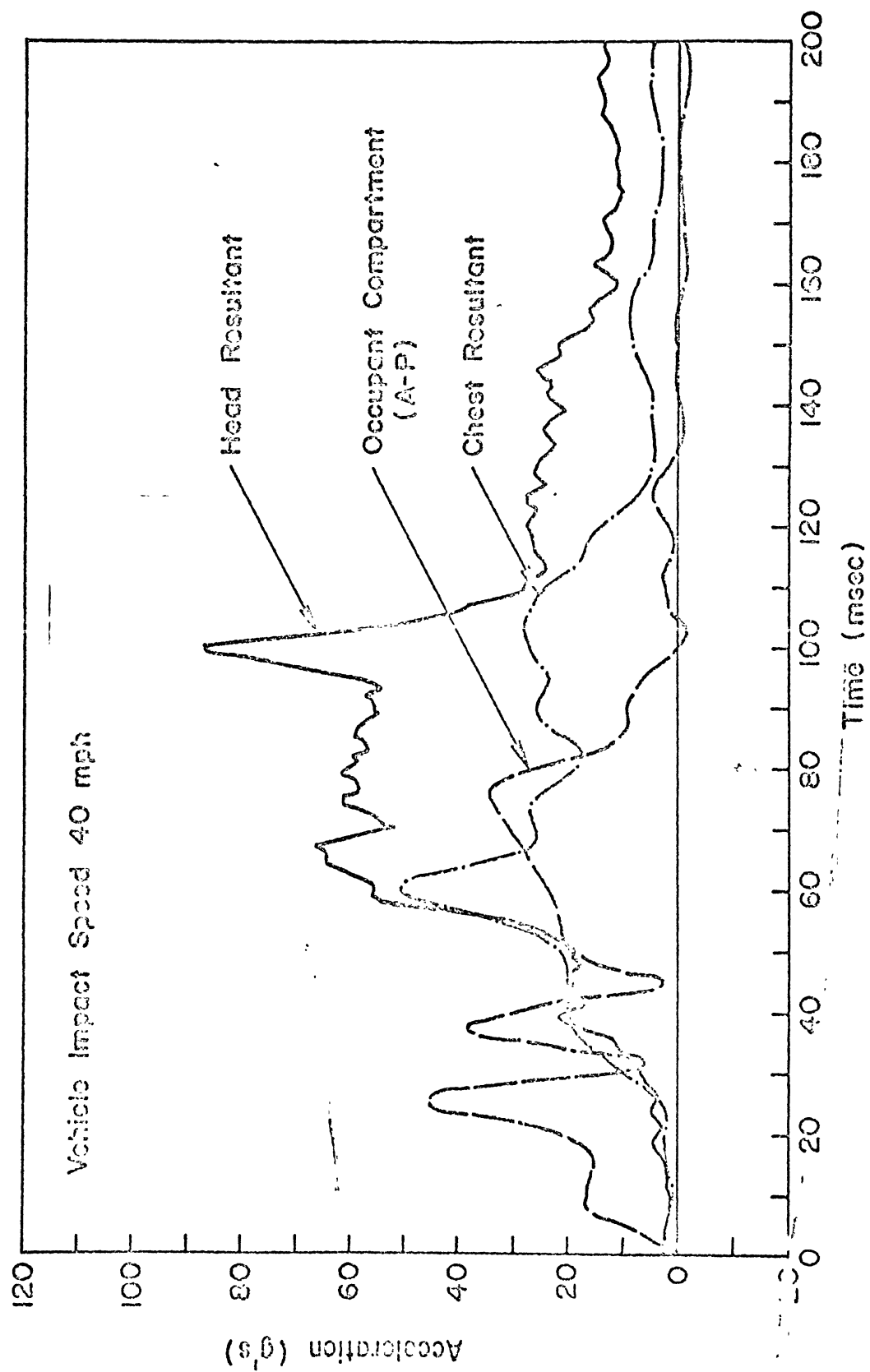

VEHICLE CRASH TEST 261-5 WITH NO HEAD RESTRAINT
 FIGURE 45.

7.1 B.F. GOODRICH HEAD RESTRAINT

The Goodrich system underwent six sled-tests (four pre-inflated, two deploying) and one vehicle crash-test (deploying). Pre-inflated tests (Z-142, -143) of the basic unit determined the mounting geometry and inflation pressure required for adequate fore-and-aft stiffness. The results of Z-143 (30 mph/21.6 G) are presented in Figures 46 and 47 ; ramping and rebound were well controlled, and rearward extension was limited to 30.5°. It was apparent, however, that the system tended to deform elastically under load, storing energy as it rotated rearward, then feeding it back into the head and thereby causing a rebound problem. This was verified in later tests at higher speeds.

In a series of three sled-tests, the Mod 1 configuration was evaluated. A-617 and A-618 were preinflated tests; the results of A-618 (40 mph/44 G) are representative of system performance, and are described in Figures 48 and 49 . Although the head-restraint was pressurized to 20 psi and was raised to improve head-contact geometry, extension still reached 43.5° as the head-restraint deflected rearward under load. Also, the head saw a peak A-P acceleration of 110 G at the same time that maximum extension occurred. These events, coupled with the severe rebound that followed indicated again the seriousness of the energy-storing "air-spring" characteristics of the Goodrich system.

For comparison, two deploying tests of the Mod 2 system were attempted: sled-test A-619 and vehicle crash-tests 261-5. Although the inlet-port configurations and bladder materials were different for the two tests -- Mod 1/natural rubber, and Mod 2/ inner-tube rubber,

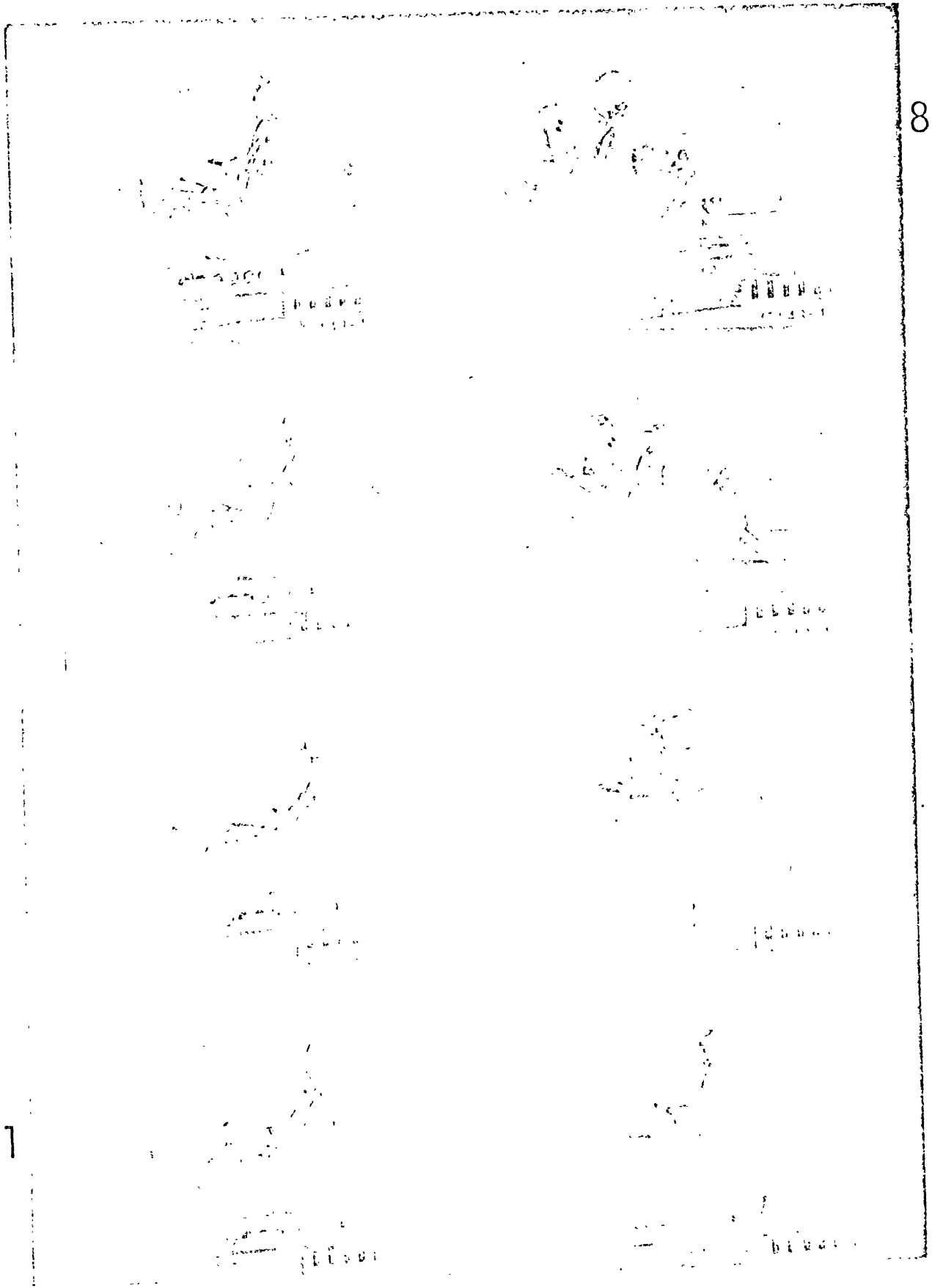

Figure 46. Test Z-143: Graph-Chek Sequence.

SLED PULSE
(10 G/DIVISION)

HEAD ACCEL., A-P (1)
(5 G/DIVISION)

HEAD ACCEL., A-P (2)
(5 G/DIVISION)

HEAD ACCEL., S-I (1)
(5 G/DIVISION)

HEAD ACCEL., S-I (2)
(5 G/DIVISION)

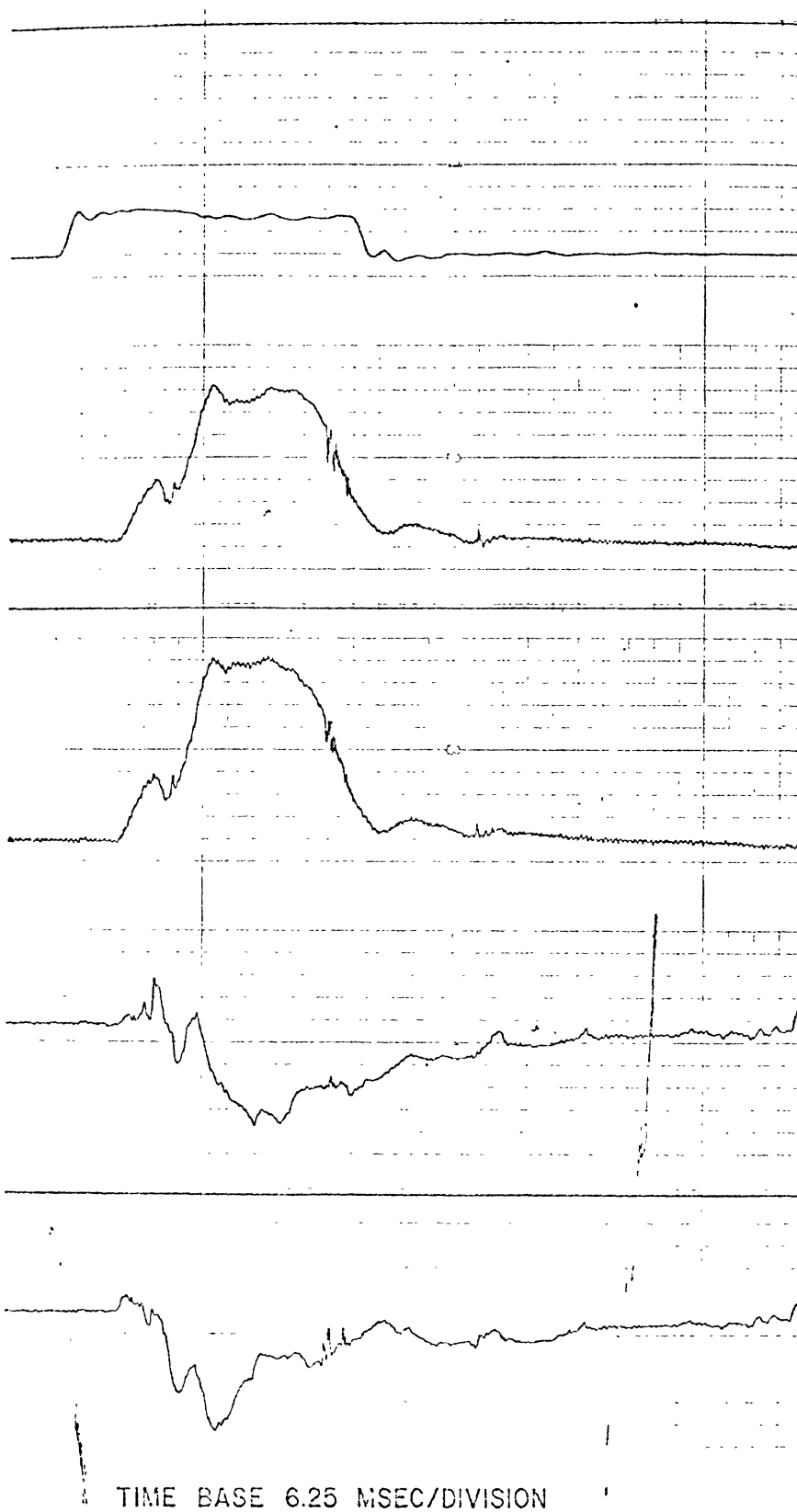

VISICORDER TRACES FOR SLED TEST Z-143
(31.1 MPH REAR IMPACT, B.F. GOODRICH HEAD RESTRAINT)

FIGURE 47.

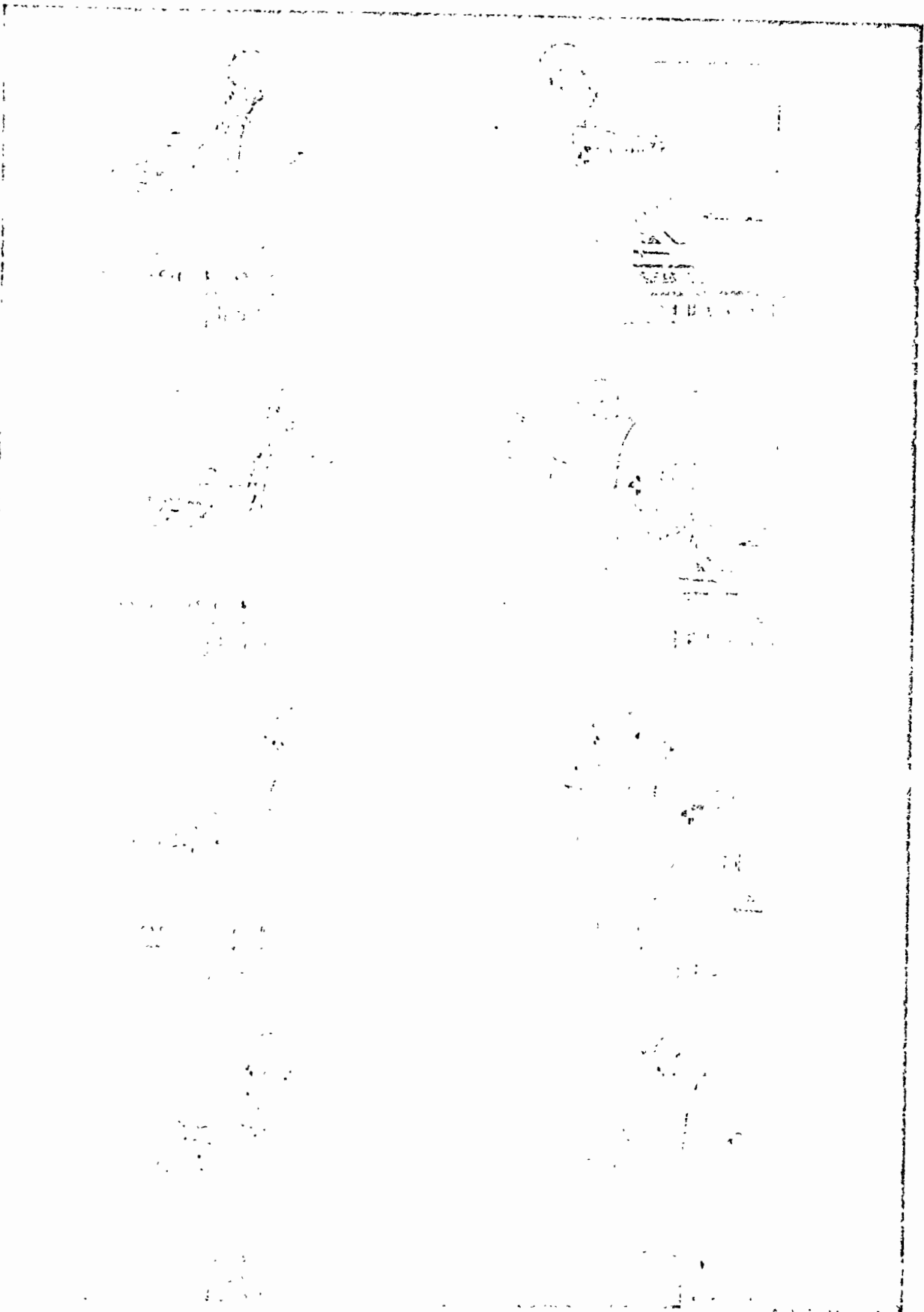

8

Figure 48. Test A-613: Graph-Chek Sequence.

SLED PULSE
(10 G/DIVISION)

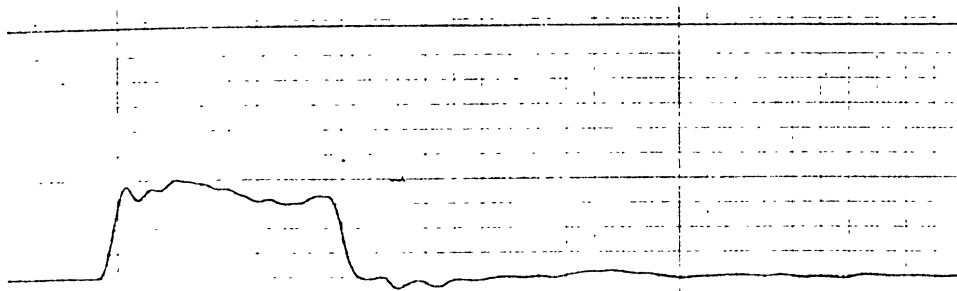

HEAD ACCEL., A-P (1)
(12.5 G/DIVISION)

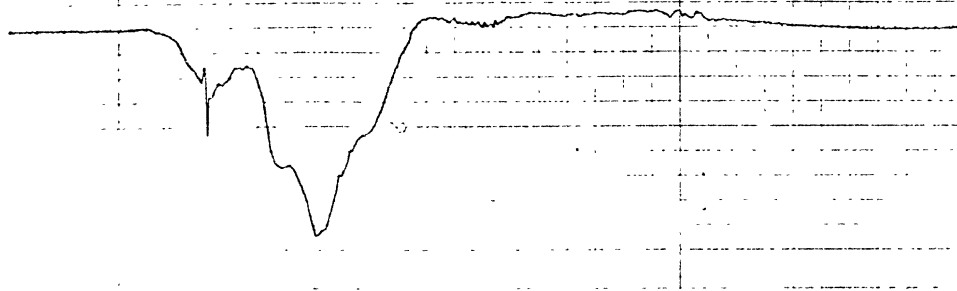

HEAD ACCEL., A-P (2)
(12.5 G/DIVISION)

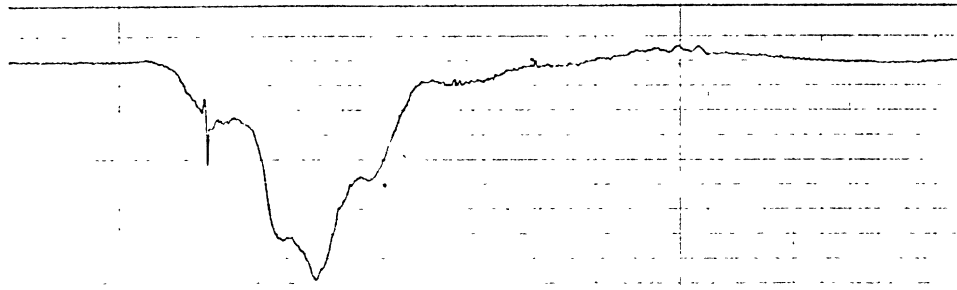

HEAD ACCEL., S-I (1)
(12.5 G/DIVISION)

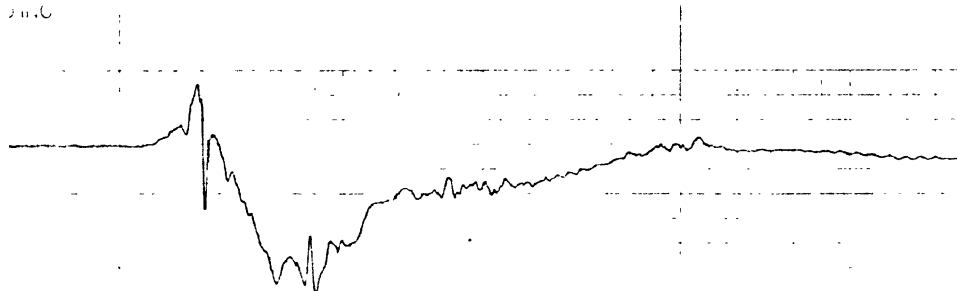

HEAD ACCEL., S-I (2)
(12.5 G/DIVISION)

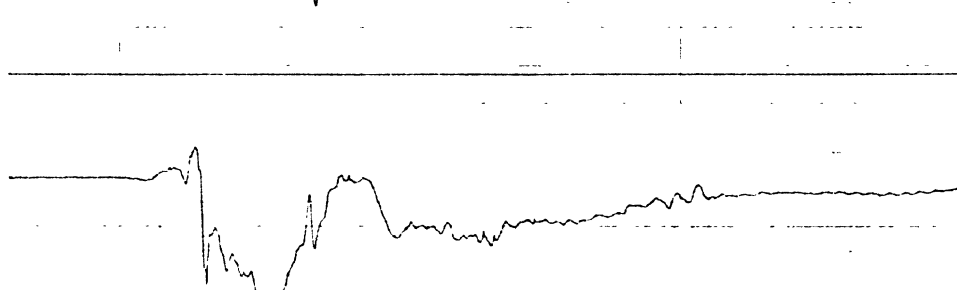

TIME BASE 6.25 MSEC/DIVISION

VISICORDER TRACES FOR SLED TEST A-618
(39.6 MPH REAR IMPACT, B.F. GOODRICH HEAD RESTRAINT)

FIGURE 49.

respectively -- the stress of dynamic inflation caused bladder failure in both cases.

The Mod 3 unit with a neoprene-coated nylon bladder was tested in deploying sled-run A-621, and again, bladder failure at and near the inlet made the test unsuccessful. (Bladder material for this test was identical to that used to construct the HSRI/UniRoyal air-bag, described in Section 4.3; geometry was, of course, different.)

The major insufficiencies of the Goodrich unit were its elastic load-deflection characteristics and its bladder material problem. It was not possible to pursue solutions to these problems and at the same time to develop the HSRI/UniRoyal prototype, which appeared to offer substantially better performance at lower "cost" in time and development effort. The problems do not appear to be insoluble, and might be worth further study, as the Goodrich unit offered a relatively simple, low cost approach to obtaining inflatable structures with complex shapes.

7.2 GOODYEAR AIRMAT HEAD RESTRAINT

The Goodyear prototype was subjected to five sled tests: four preinflated, one deploying. In test Z-148, the first preinflated evaluation, mounting design on the basic system was found to be inadequate; this problem proved to be one of the major deficiencies of the system. Figures 50 and 51 illustrate the results of Z-148 (40 mph/ 43.2 G), in which the front tie-down clamp failed under load, allowing the head restraint to rotate rearward. Although extension was limited to 28°, the dummy neck did contact the front edge of the mounting platform, rendering the test inconclusive.

The Mod 1 prototype incorporated a stronger front hold-down mechanism (see Figure 10) that improved head-restraint performance in the next sequence of preinflated tests: A-614, -615 and -616. In a 30 mph/ 23.2 G test (A-615), extension was limited to 8.5°, and ramping was well-controlled by the forward-projecting Airmat side-panels; Figures 52 and 53 describe the test results.

A-616 was a more severe 40 mph/44 G test of the system, and again extension (25° maximum) and ramping were well-controlled (see Figure 54); it appeared, however, that the system was almost too stiff. As Figure 55 shows, a 90 G head A-P acceleration spike occurred 43 msec after impact, despite the separate 3 psi head-cushion bag installed specifically to "soften" head contact with the 15 psi Airmat.

In preparation for possible dynamic testing in Phoenix in September 1972, the Mod 1 unit was adapted for use with the Olin inflator, and a deploying test, A-620, was run at 30 mph/21 G. The stress of rapid inflation ruptured the rear Airmat panel, in a

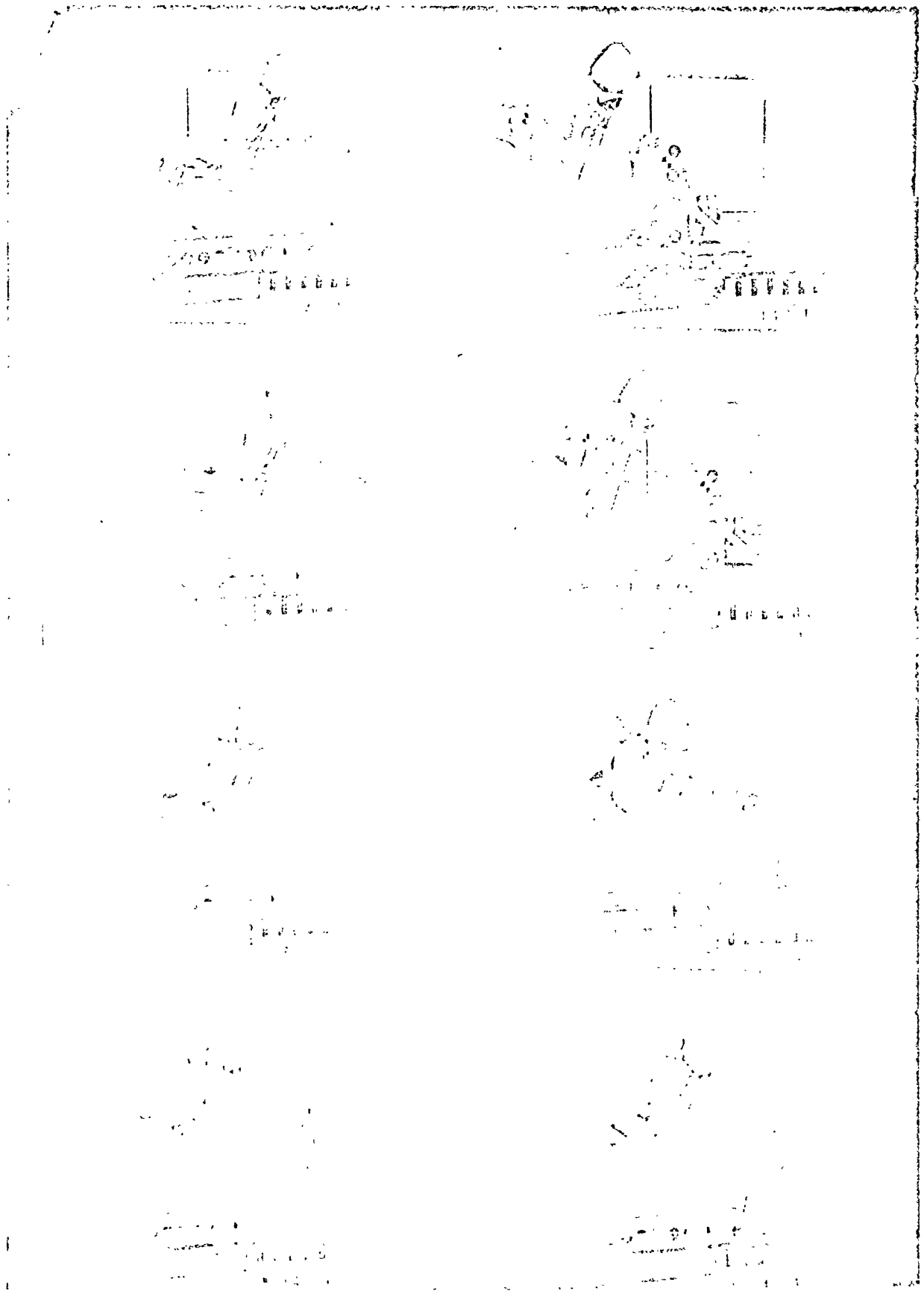
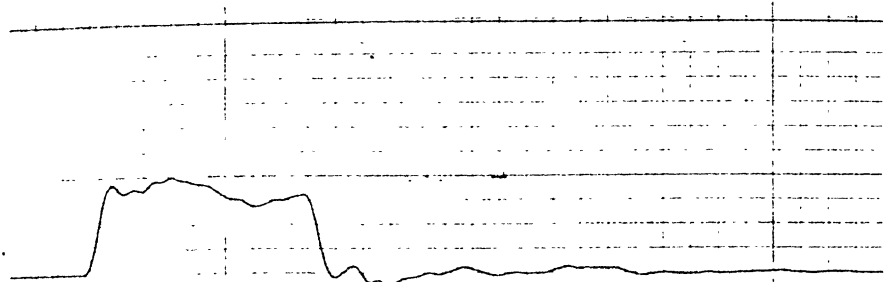
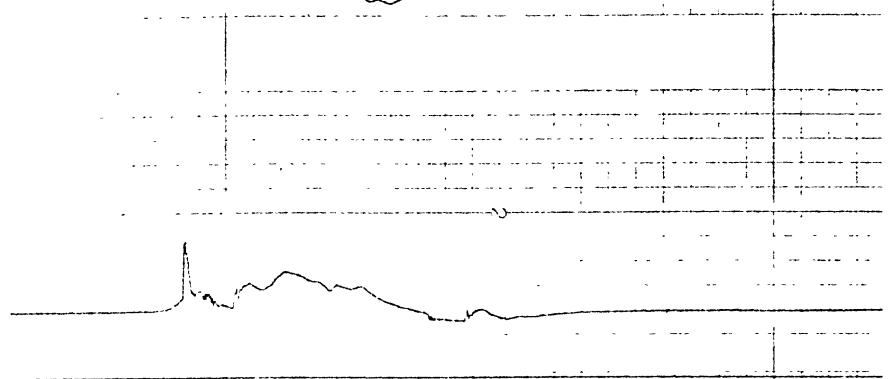

Figure 50. Test Z-148: Graph-Chek Sequence.

SLED PULSE
(10 G/DIVISION)



HEAD ACCEL., A-P (1)
(50 G/DIVISION)



HEAD ACCEL., A-P (2)
(50 G/DIVISION)

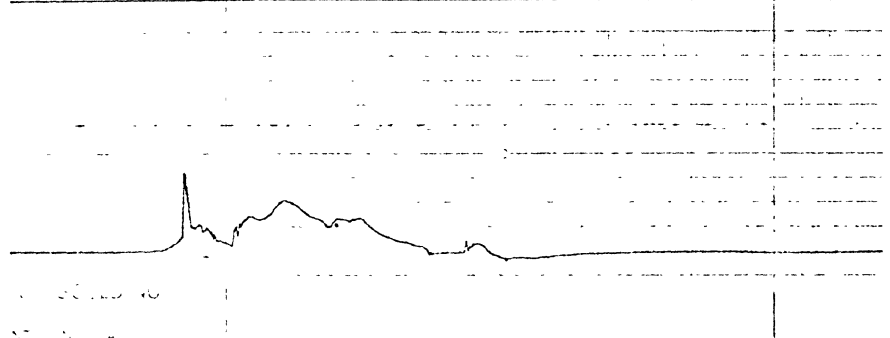

HEAD ACCEL., S-I (1)
(50 G/DIVISION)

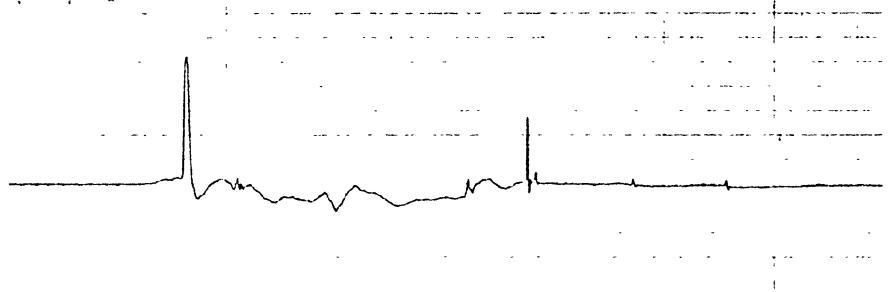

HEAD ACCEL., S-I (2)
(50 G/DIVISION)

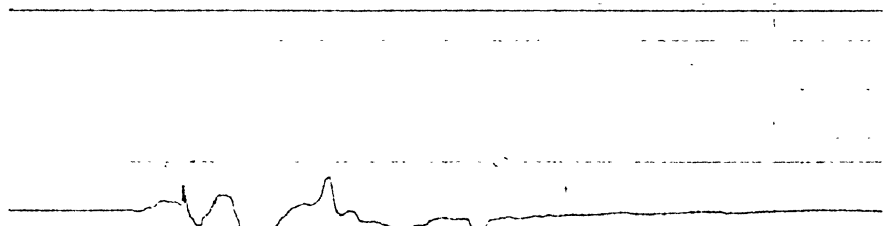

TIME BASE 6.25 MSEC/DIVISION

VISICORDER TRACES FOR SLED TEST Z-148
(40.3 MPH REAR IMPACT, GOODYEAR HEAD RESTRAINT)

FIGURE 51.

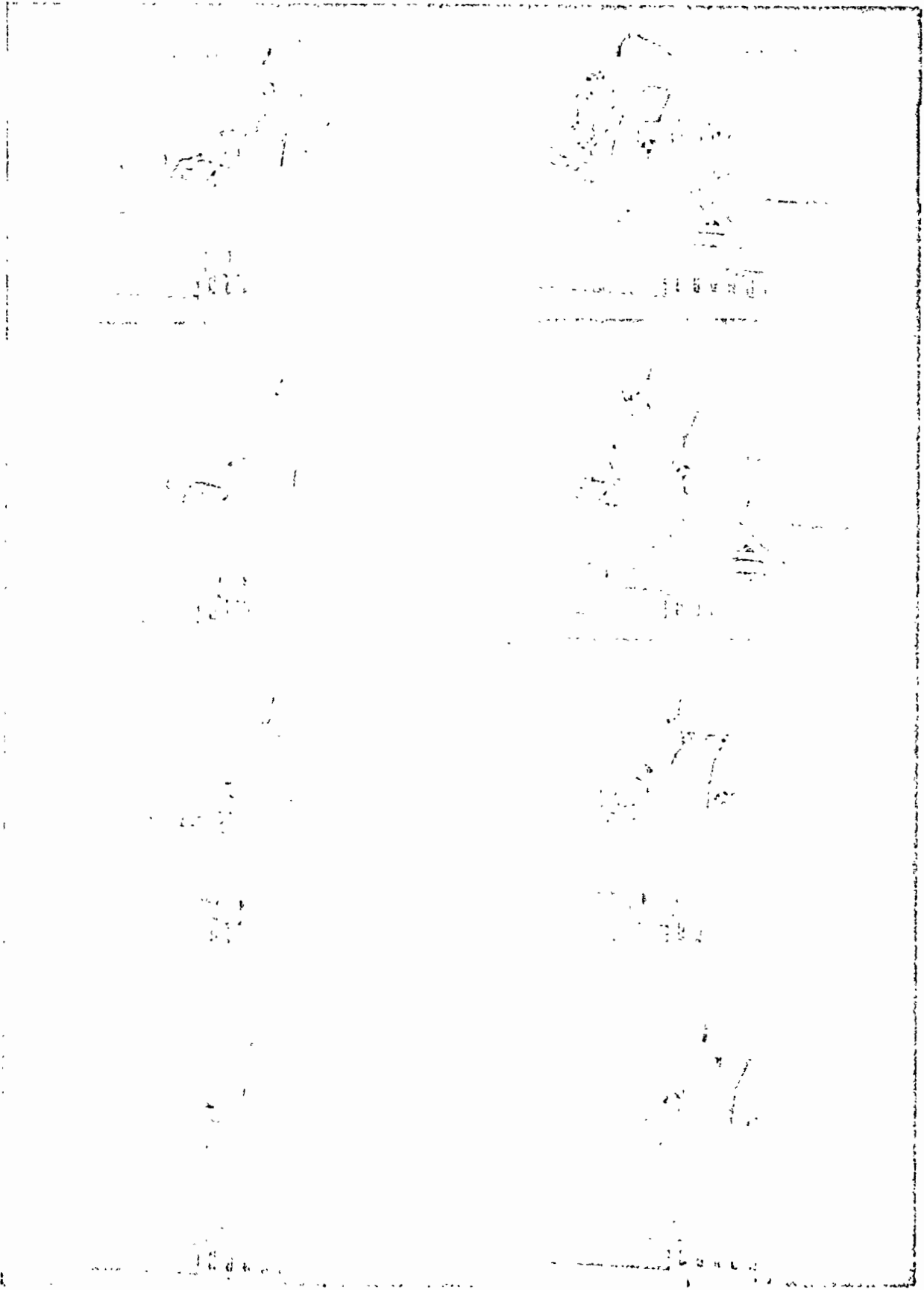

8

7

Figure 52. Test A-615: Graph--Chek Sequence.

SLED PULSE
(10 G/DIVISION)

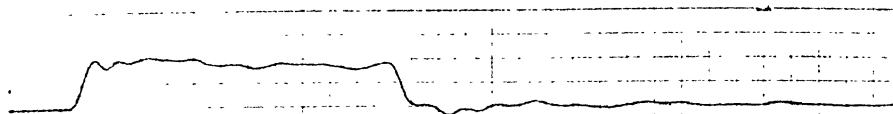

HEAD ACCEL., A-P (1)
(5 G/DIVISION)

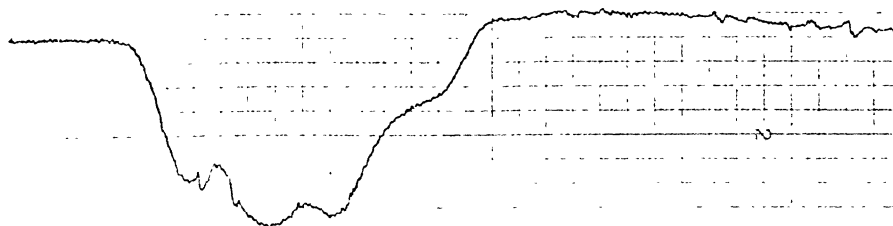

HEAD ACCEL., A-P (2)
(5 G/DIVISION)

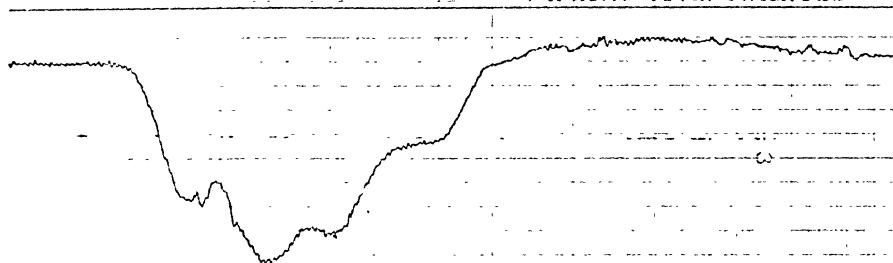

HEAD ACCEL., S-I (1)
(5 G/DIVISION)

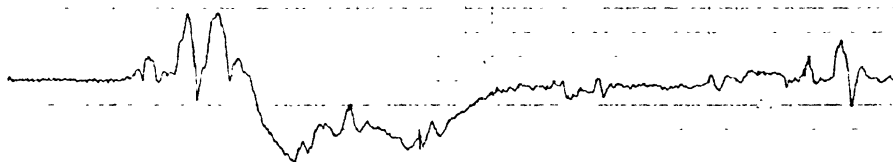

HEAD ACCEL., S-I (2)
(5 G/DIVISION)



TIME BASE 6.25 MSEC/DIVISION

VISICORDER TRACES FOR SLED TEST A-615
(29.8 MPH REAR IMPACT, GOODYEAR HEAD RESTRAINT)

FIGURE 53.

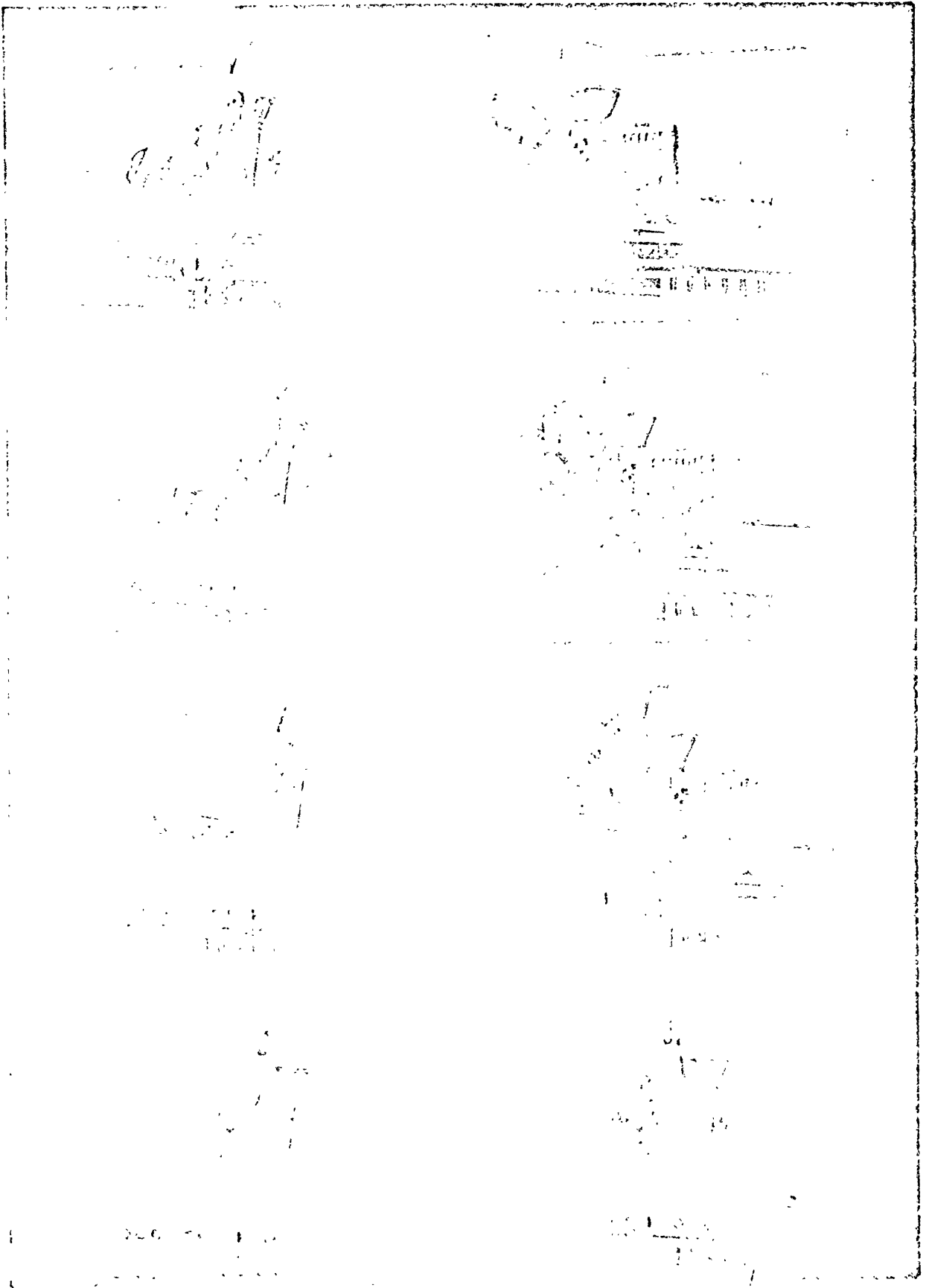

Figure 54. Test A-616: Graph-Check Sequence.

SLED PULSE
(10 G/DIVISION)

HEAD ACCEL., A-P (1)
(12.5 G/DIVISION)

HEAD ACCEL., A-P (2)
(12.5 G/DIVISION)

HEAD ACCEL., S-I (1)
(12.5 G/DIVISION)

HEAD ACCEL., S-I (2)
(12.5 G/DIVISION)

TIME BASE 6.25 MSEC/DIVISION

VISICORDER TRACES FOR SLED TEST A-616
(39.8 MPH REAR IMPACT, GOODYEAR HEAD R. STRAINT)

FIGURE 55.

progressive failure that Goodyear described this way (following post-test analysis):

- one or more of the dropweave threads failed in tension during the initial pressure spike, due most likely to an error made during fabrication -- incomplete bonding, or perhaps excessive use of bonding material in laying up the dropweave;
- other drop threads tried to take up the load from the failed fibers, and were overstressed to the point where they began to fail or pull out from the fabric panels to which they were attached;
- the fabric panels began to bulge as pressure increased and more drop threads failed, finally, overexpanding until the front panel tore across its front face; the rip also extended into the inboard walls of both Airmat side-panels.

The inherent stiffness of the Airmat head-restraint -- a result of the dropweave construction plus the very thick coating of sealant applied to the fabric panels -- appeared to be the cause of several problems encountered in development testing. Stowing the unit even in its deflated state was difficult. In addition, the inflated system (see the narrative summary of A-616 and the discussion above) was almost board-like in its stiffness and non-compliance under head loading. And finally, the inability of the system to "give" or stretch under the pressure surge of dynamic inflation contributed to its failure in test A-620.

Although HSRI contemplated redesign of the Airmat system in collaboration with Goodyear after test A-620, the time and cost involved in such an effort proved to be beyond the scope of contract HS-031-2-281.

7.3 HSRI/UNIROYAL HEAD RESTRAINT

The HSRI/UniRoyal system was the most extensively tested of the head-restraint prototypes, undergoing a total of sixteen sled tests (five preinflated, eleven deploying) and four vehicle crash tests (all deploying).

7.3.1. Initial Sled Tests

The first test, Z-126, was an investigation of inflation dynamics and of the effect of rapid bag deployment on an out-of-position occupant. Seated as shown in Figure 56, the 50th percentile male dummy received a 99.5 G head acceleration spike as the bag inflated, corresponding to a HIC of 907.1. Although close to the injury tolerance limit, this index was considered acceptable.

A sequence of five preinflated tests on the basic prototype (see Section 4.3 and Figure 6) established mounting geometry and demonstrated the ability of the system to carry head loads in 30 mph/20 G and 40 mph/30 G rear impacts. A comparison of tests Z-128 and Z-129 indicates the significant contribution to fore-and-aft stiffness made by the side load straps; head/neck extension was reduced from 20° to about 2° by adding load straps and attaching them low on the seat-frame to the sides of the seat pan (see Table 1 and Figure 6).

Figures 57 and 58 show the results of Z-141, a 40 mph/44 G "worst case" test with load-straps in place and bag preinflated to 7 psi. Extension was limited to 25.5°, and both ramping and rebound were well controlled. The only cause for concern was the rather high head A-P acceleration peak of 92.5 G that occurred about 2 msec before maximum extension. This peak was attributed not to bag/head contact but to

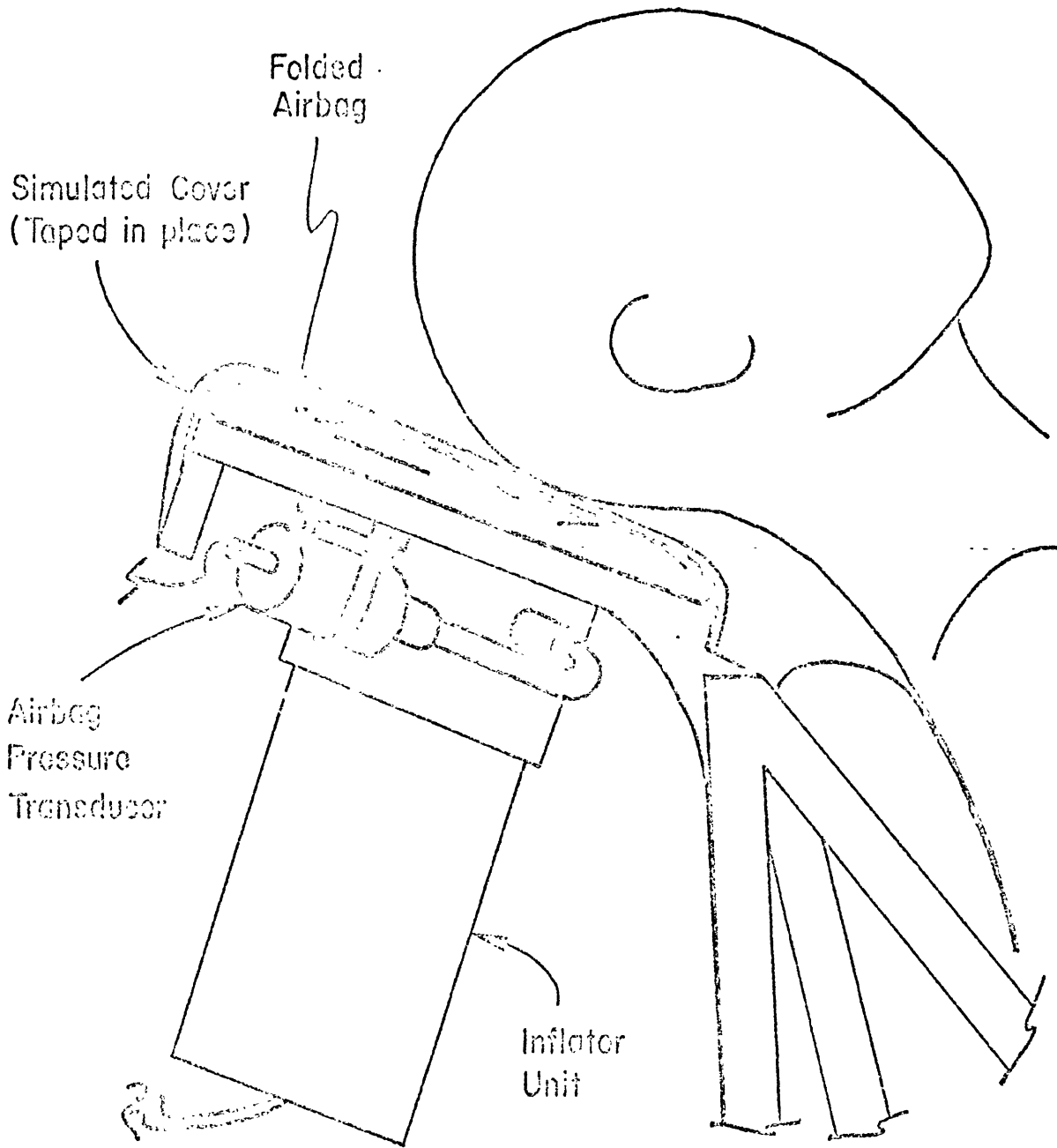

SET-UP FOR "OUT-OF-POSITION OCCUPANT TEST," Z-126.

FIGURE 53.

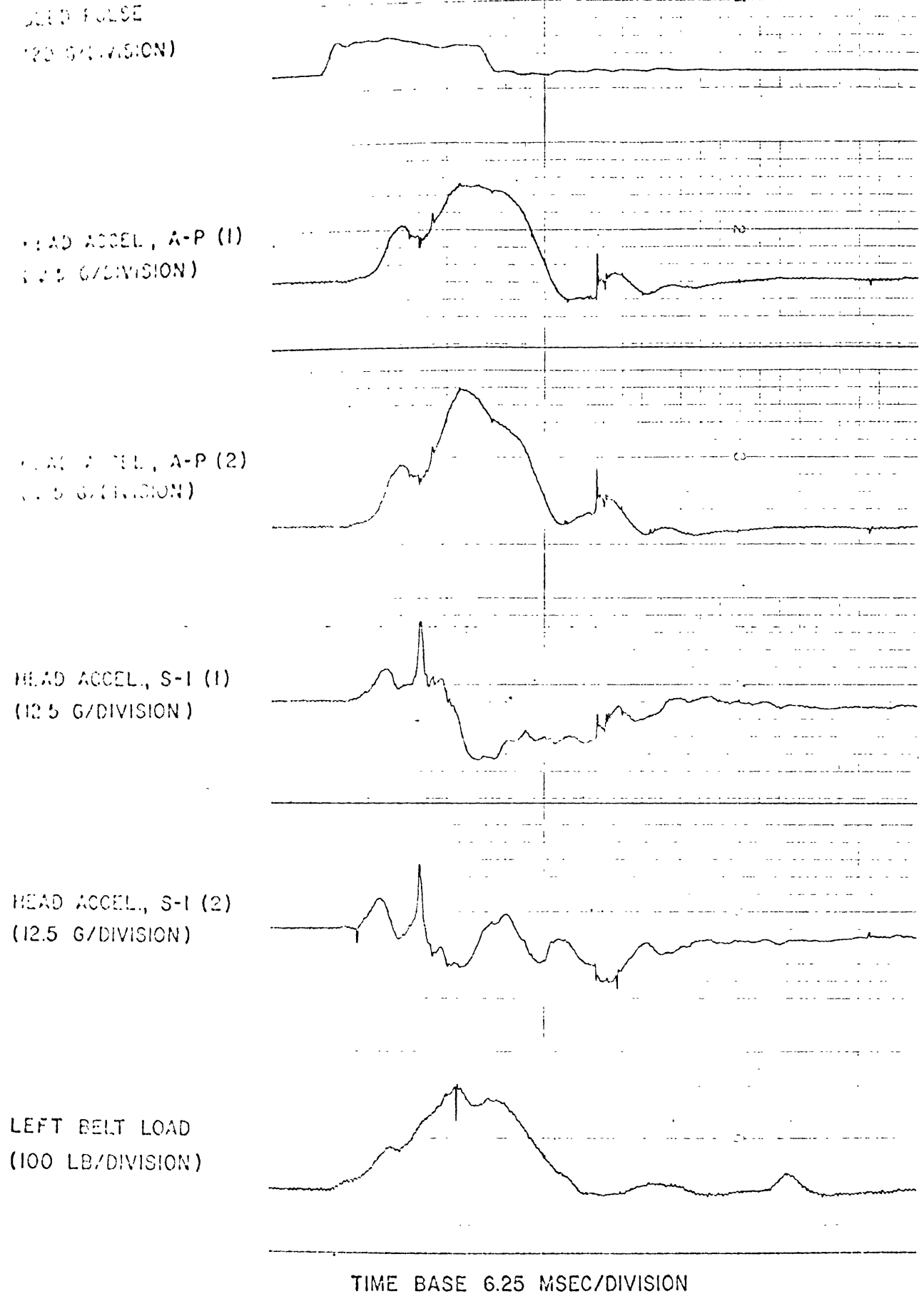

VISICORDER TRACES FOR SLED TEST Z-141
 (40.0 MPH REAR IMPACT, HSRI/UNIROYAL HEAD RESTRAINT)

FIGURE 58.

angular head acceleration, which reached a maximum of 4540 rad/sec² also at about 6 msec before maximum extension (48 msec after impact). The nature of this head angular acceleration is discussed in more detail in Section 2, and is presented in both schematic and tabular form in Table 2.

Two deploying sled tests, Z-146 and Z-147 were then run with the HSRI/UniRoyal system and the Olin inflator in preparation for vehicle crash testing in Phoenix. The results of Z-146 (30 mph/21.2 G) are shown in Figures 59 and 60; although there was no measurable head/neck extension in Z-146, the head did go into flexion as it made contact with the deploying bag, generating a peak head A-P acceleration of about 50 G. Ramping and rebound were well controlled.

[This phenomenon of bag "slap" -- contact between the rearward-moving head and the deploying bag that causes sharp head-acceleration spikes -- was the only significant problem in later deploying sled-tests of the HSRI/UniRoyal system, including the final development test series (A-623 through A-630). Results of these later tests, the severity of the bag slap in each test, and the changes made to reduce the severity are all described later in this section.]

7.3.2 Vehicle Crash Tests

In conjunction with Dynamic Science, in Phoenix, Arizona, the HSRI/UniRoyal system was evaluated in four vehicle crash tests. (Vehicle preparation is described in Section 6.4.) Test 261-6 yielded no useful data, not because of head-restraint failure but because of inflator malfunction and inadequate seat installation. However, tests 261-4, -8 and -9 provided valuable comparative data on head-restraint performance in real vehicle versus sled-test impacts, and on the differences between the types of deceleration pulses generated in each case.

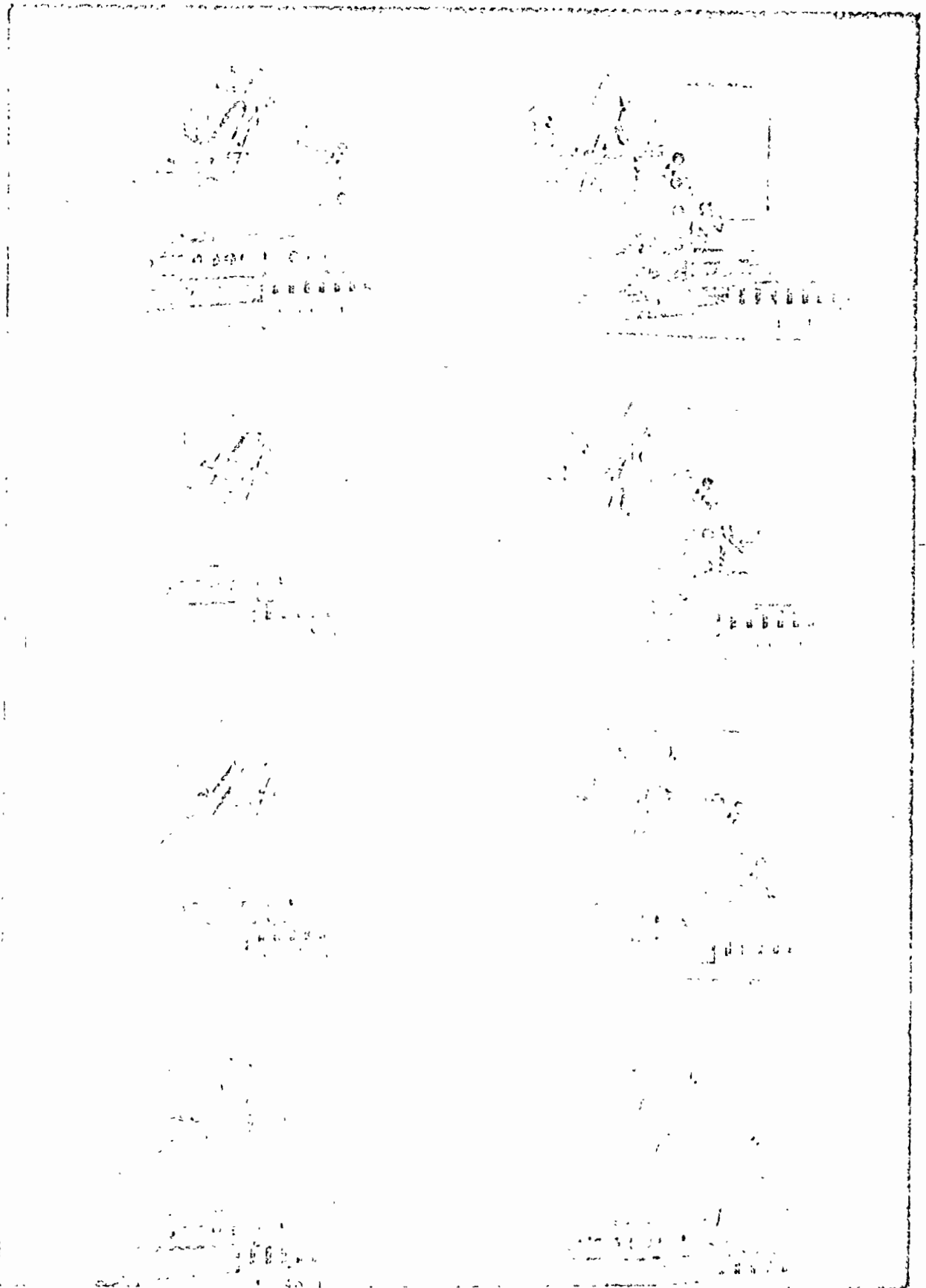

8

Figure 59. Test Z-146: Graph-Chek Sequence.

SLED PULSE
(10 G/DIVISION)

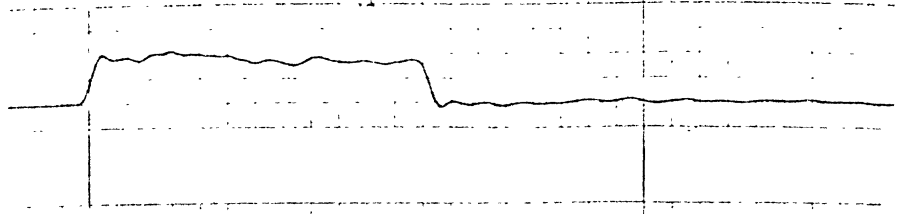

HEAD ACCEL., A-P (1)
(12.5 G/DIVISION)

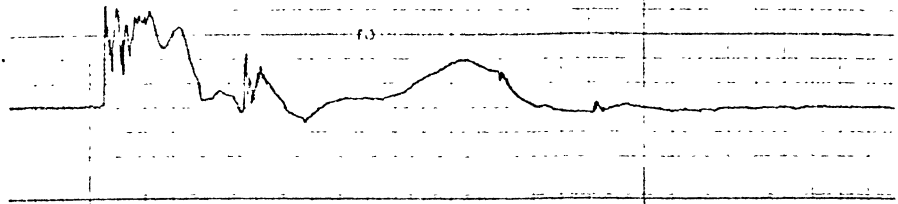

HEAD ACCEL., A-P (2)
(12.5 G/DIVISION)

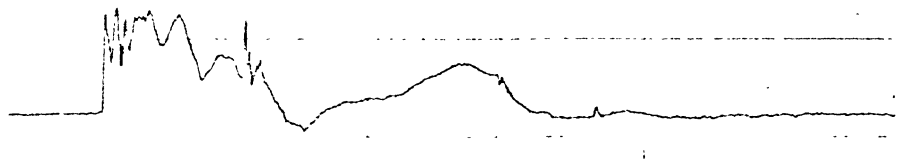

HEAD ACCEL., S-I (1)
(12.5 G/DIVISION)

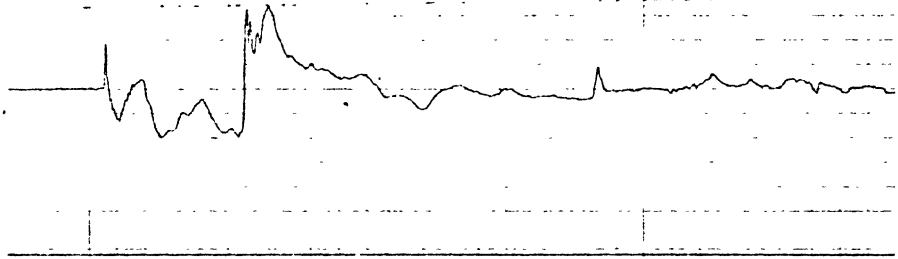

HEAD ACCEL., S-I (2)
(12.5 G/DIVISION)

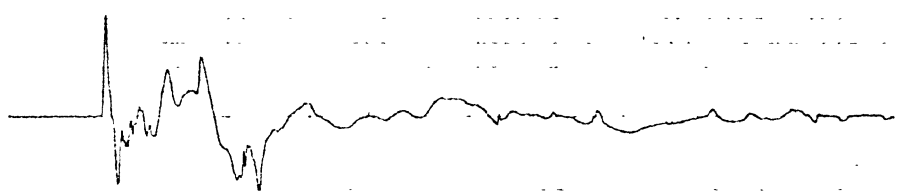

BAG PRESSURE
(5 PSI/DIVISION)

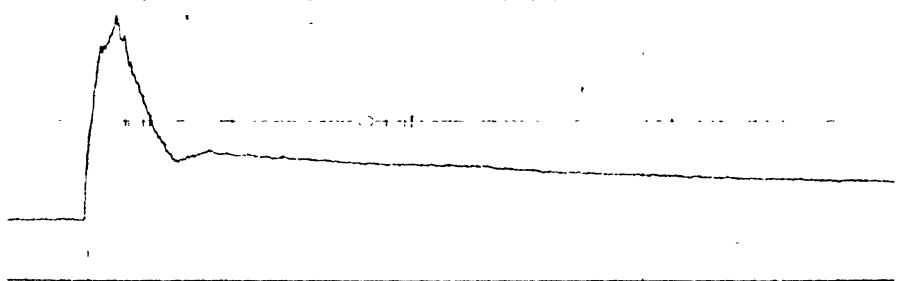

BRUSH INSTRUMENT
CLEVELAND OHIO

TIME BASE 6.25 MSEC/DIVISION

VISICORDER TRACES FOR SLED TEST Z-146
(31.6 MPH REAR IMPACT, HSRI/UNIROYAL HEAD RESTRAINT)

FIGURE 60.

- In all three tests, the inflator was triggered by a rear-bumper contact switch, and the bag was fully deployed within 15 to 24 msec. In a typical sled test, bag deployment was not complete until 28 or 30 msec after impact.

- Occupant-compartment deceleration pulses were less severe (lower average magnitude, with "ramp-type" onset) than sled deceleration pulses for equivalent-speed impacts. For example, compare the occupant compartment trace of Figure 61 (261-4/40 mph barrier impact/58 G peak) with the sled pulse of Figure 75 (A-626/40 mph/30 G) or of Figure 58 (Z-141/40 mph/40 G).

- In every vehicle crash test, the test seat underwent significant rearward rotation (10-15°) as the floor of the car deformed at impact. This deformation and seat rotation was elastic in nature, and did contribute to the head-acceleration and rebound problems noted in tests 261-5 and 261-9.

- It should be noted that the dummies in the crash-test vehicles were unrestrained (no lap or torso belts), while sled-test dummies were lap-belted in every case.

In both 261-4 (direct rear impact) and 261-8 (30° oblique rear impact), the head restraint effectively limited extension and ramping. Resultant head acceleration was about 45 G for 261-4 and about 60 G for 261-8. Rebound was more severe than expected, due primarily to the elastic seat deformation and to the non-use of restraint belts on the test dummies, as noted above.

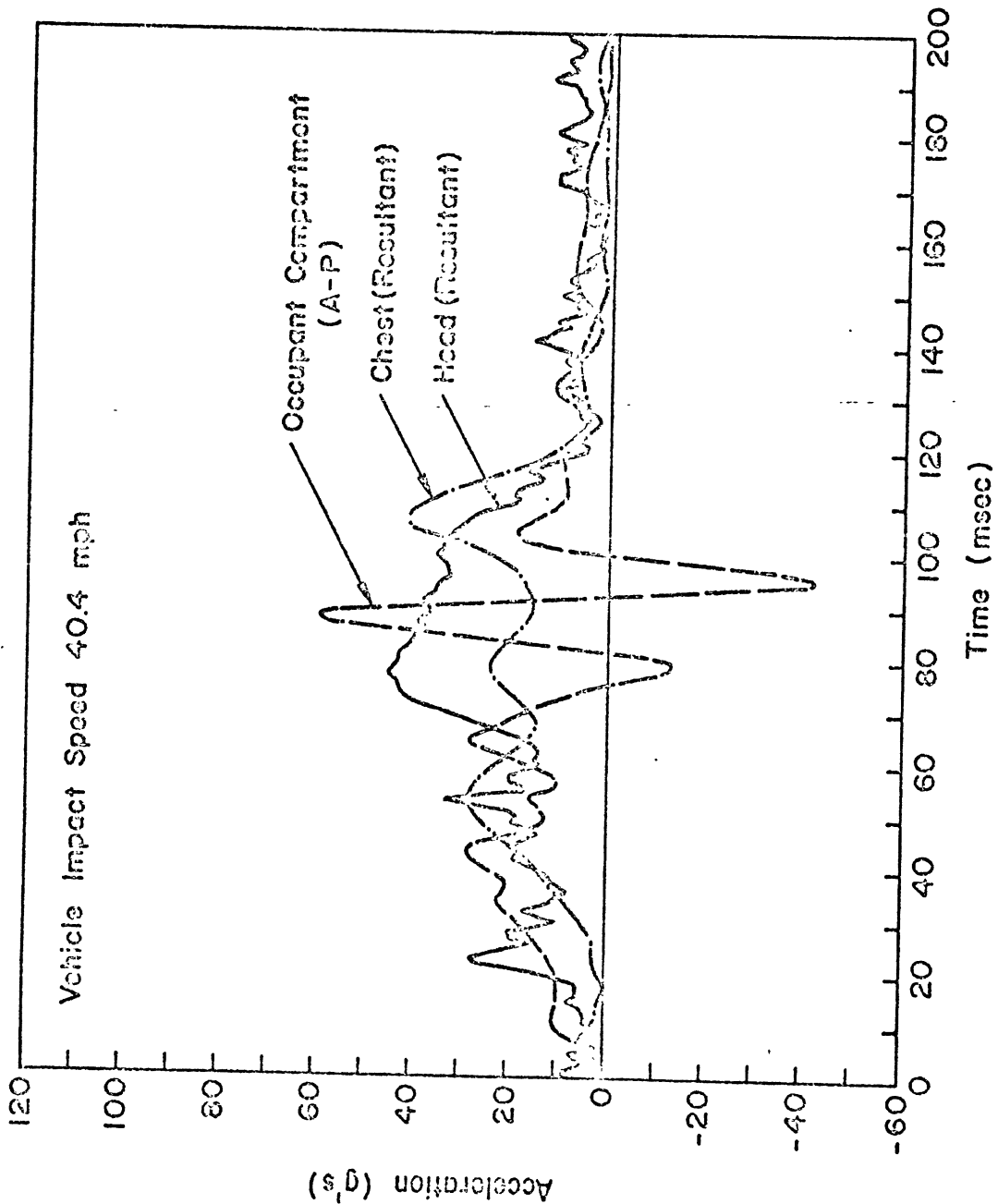

VEHICLE CRASH TEST 26I-4 WITH HSRI/UNIROYAL HEAD RESTRAINT
 FIGURE 61.

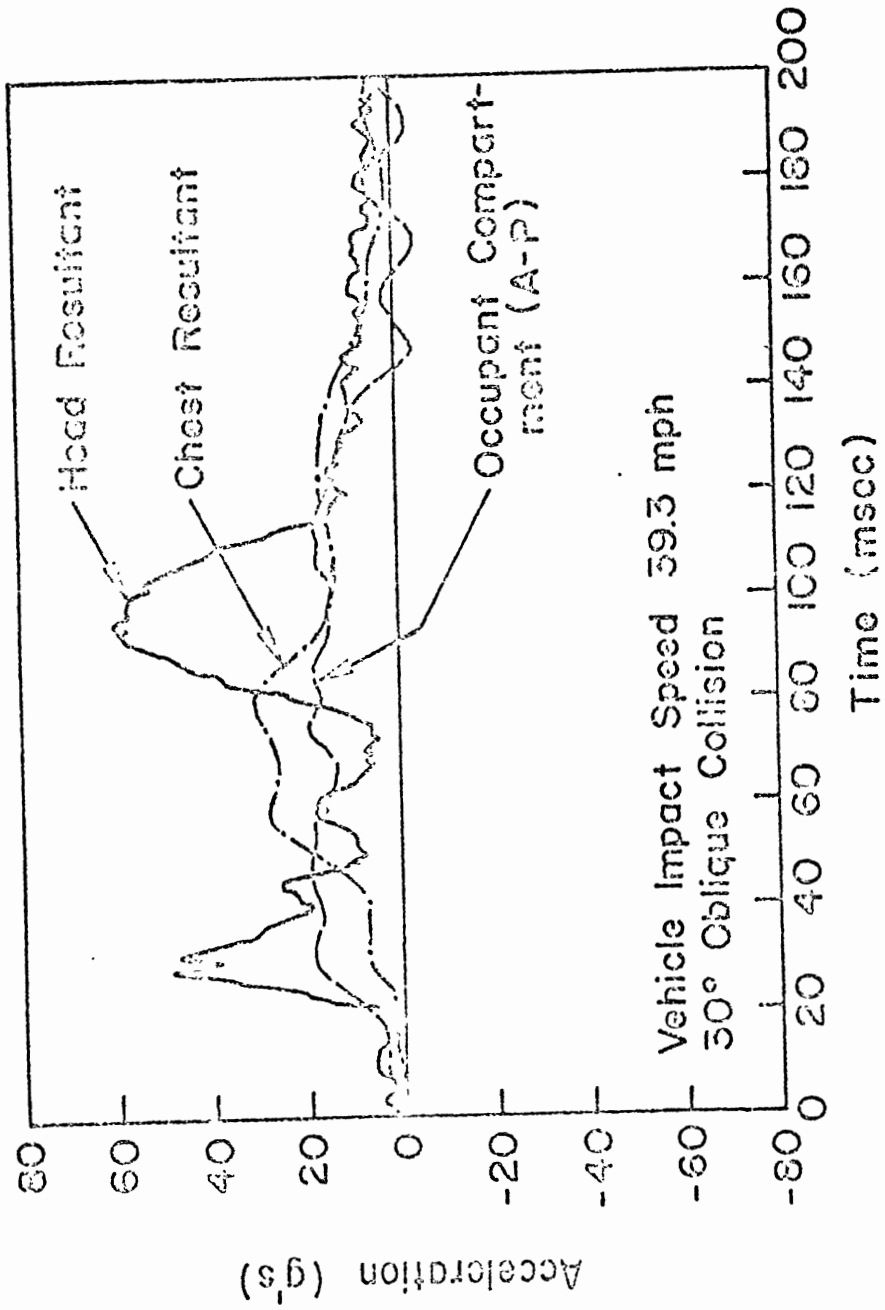

VEHICLE CRASH TEST 261-8 WITH HSRI/
UNIROYAL HEAD RESTRAINT

FIGURE 62.

In test 261-9, extension was more severe (12°), but still well below the 45° limit considered dangerous; ramping was well-controlled by the bag and the side load straps. Rebound was quite severe, however, and was accompanied by an 80 G resultant head acceleration spike just as the dummy head left the bag and went into flexion at about 100 msec after bogey impact. Both problems were the result of the head being thrown forward rather sharply after the extension phase, and it is felt that two factors combined to cause this sharp forward motion. These factors -- seat rotation with respect to vehicle interior, and head-restraint rotation with respect to the test seat -- are shown graphically in Figures 64 and 65.

First, the seat deformation problem described earlier was quite apparent in this test, and is shown as a plot of seat-back angle versus time from impact. Seat back angle was defined as the angle between the seat back and a non-moving reference plane on the interior passenger-side door, measured photometrically from a Dynamic Science test film.

Second, the angle between the deployed head-restraint bag and the seat-back frame was measured from the same film and plotted on the same time base. A vertical line indicates the time at which the dummy's head left the bag and entered the rebound phase (approximately 100 msec).

It would appear that both seat and head-restraint bag fed energy back into the head of the dummy after deforming (elastically) rearward at impact. The head acceleration spike is clearly not the result of contact between head and bag, head and seat or head and vehicle interior, but rather the result of high head angular acceleration as the head (and seat and head restraint) stopped rotating

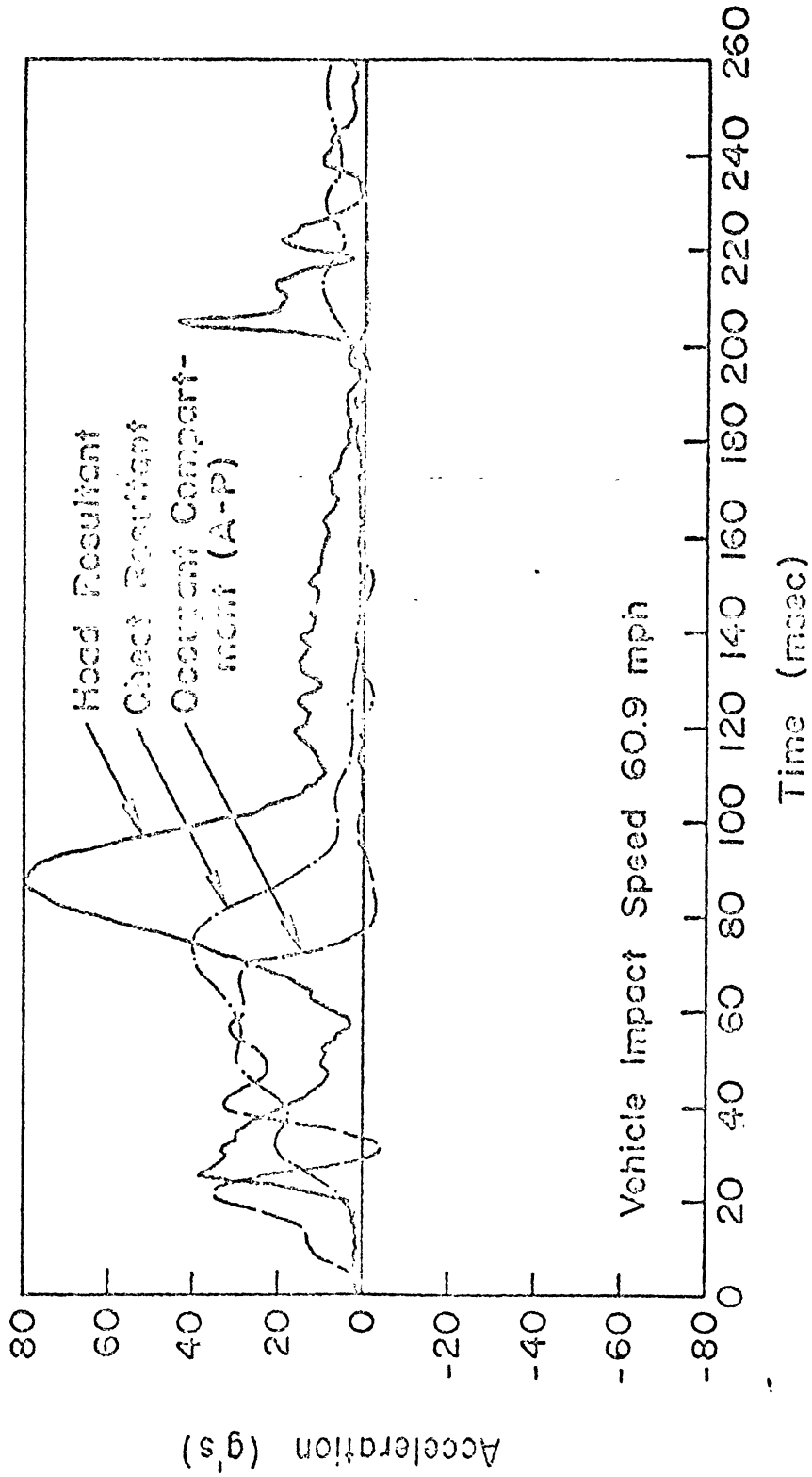

VEHICLE CRASH TEST 261-9 WITH HSRI/UNIROYAL HEAD RESTRAINT

FIGURE 63.

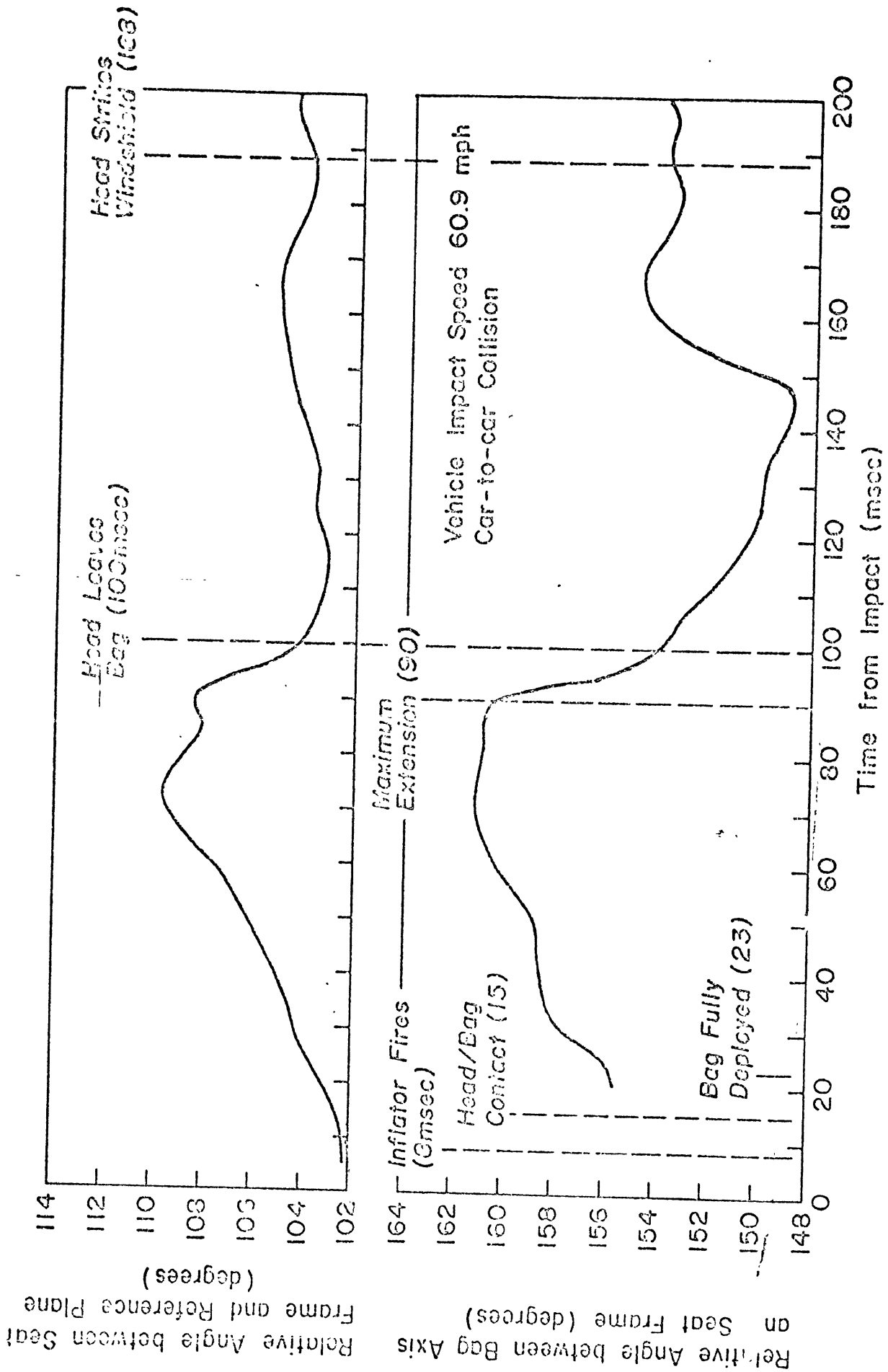

ROTATION OF SEAT AND HEAD RESTRAINT DURING CRASH TEST 261-9.

FIGURE 64.

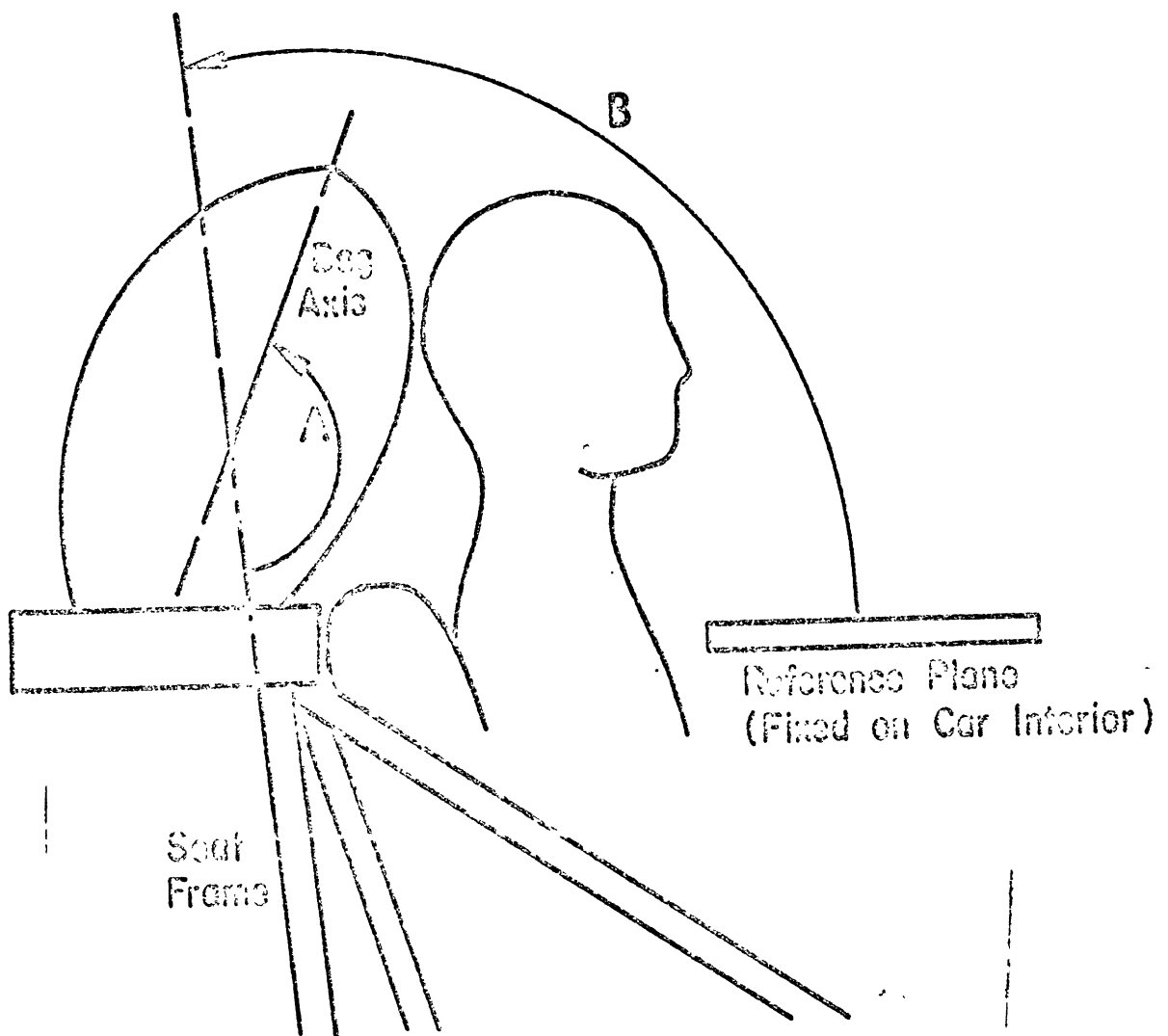

A = Relative angle between Beg Axis and Seat Frame.

B = Relative angle between Seat Frame and Reference Plane.

PHOTOMETRIC MEASUREMENT OF RELATIVE
ROTATIONS PLOTTED IN FIGURE 64

FIGURE 65.

backward and started rotating forward. The fact that the head underwent moderate flexion as it left the bag would tend to confirm this hypothesis.

7.3.3 Oblique Impact Tests

An attempt was made to modify the HSRI/UniRoyal system to improve oblique-impact performance, by adding integral side-panels to the simple elliptical bag and using the side load-straps to hold the panels in position during inflation. Test A-622 was a 40 mph/33 G deploying sled-run, 30° oblique rear impact with this modified system; results are shown in Figures 66 and 67. This test was run after 261-8, in which the unmodified HSRI/UniRoyal system performed very well in a 30° oblique barrier crash (see the test summary in Section 6.3). Although performance of the modified system was very good also (5° extension, well-controlled ramping, moderate rebound, 50 G maximum resultant head acceleration), the added side panels were difficult to stow compactly and tended to slip out from under the side load straps.

7.3.4 Final Performance Sled Tests

The last sequence of tests in the program (A-623 through A-630) consisted of four deploying sled tests with the 5th percentile female and three with the 95th percentile male. (A-627 was a baseline test with no head restraint, described at the beginning of Section 7.) As noted in Section 6.3 just before the summary of test A-623, three slightly different sled pulses were used for these final performance tests, at the suggestion of DOT.

8

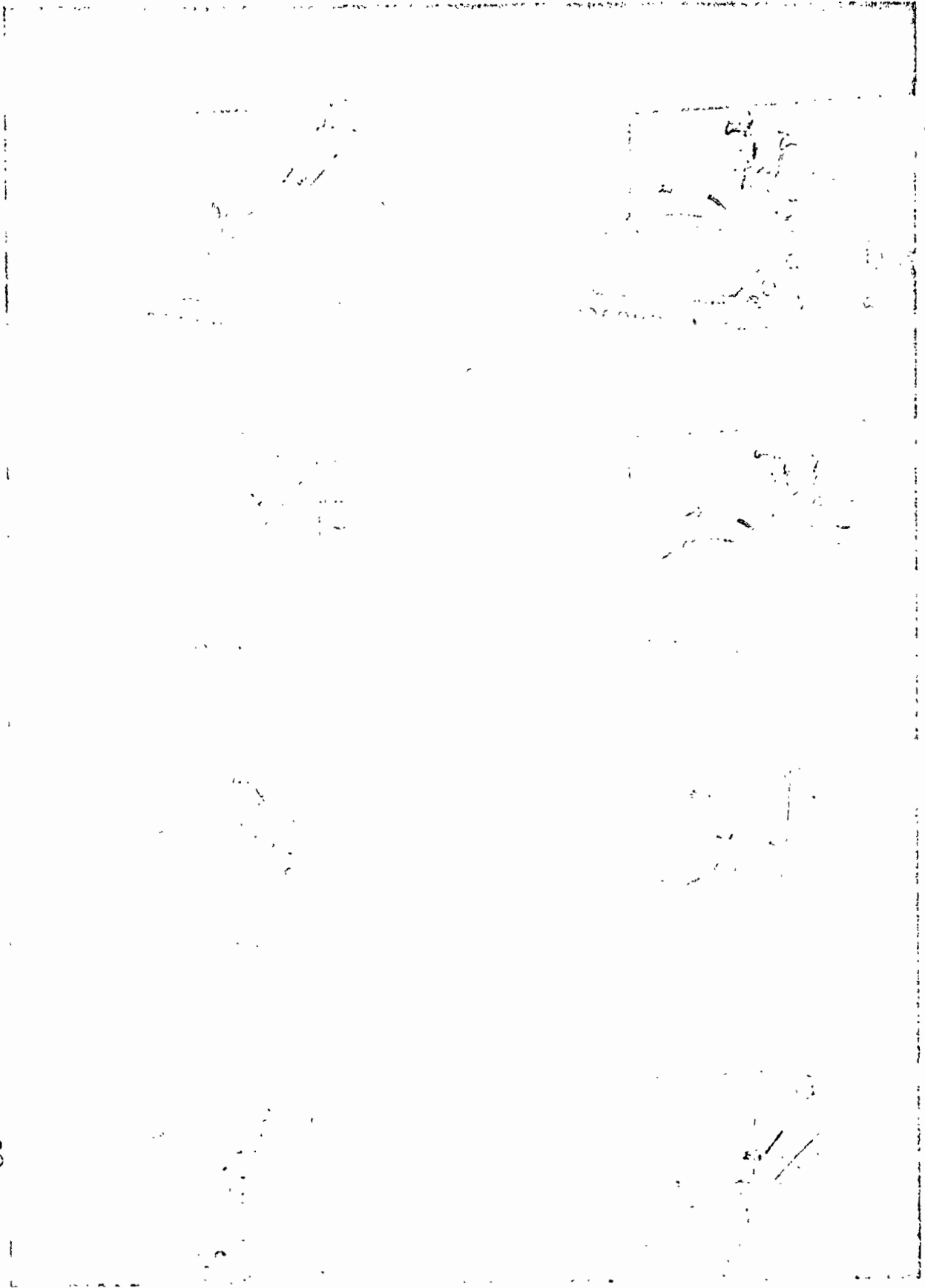

Figure 66. Test A-622: Graph-Chek Sequence.

SLED PULSE
(10 G/DIVISION)

HEAD ACCEL., A-P (1)
(12.5 G/DIVISION)

HEAD ACCEL., A-P (2)
(12.5 G/DIVISION)

HEAD ACCEL., S-I (1)
(12.5 G/DIVISION)

HEAD ACCEL., S-I (2)
(12.5 G/DIVISION)

BAG PRESSURE
(2.5 PSI/DIVISION)

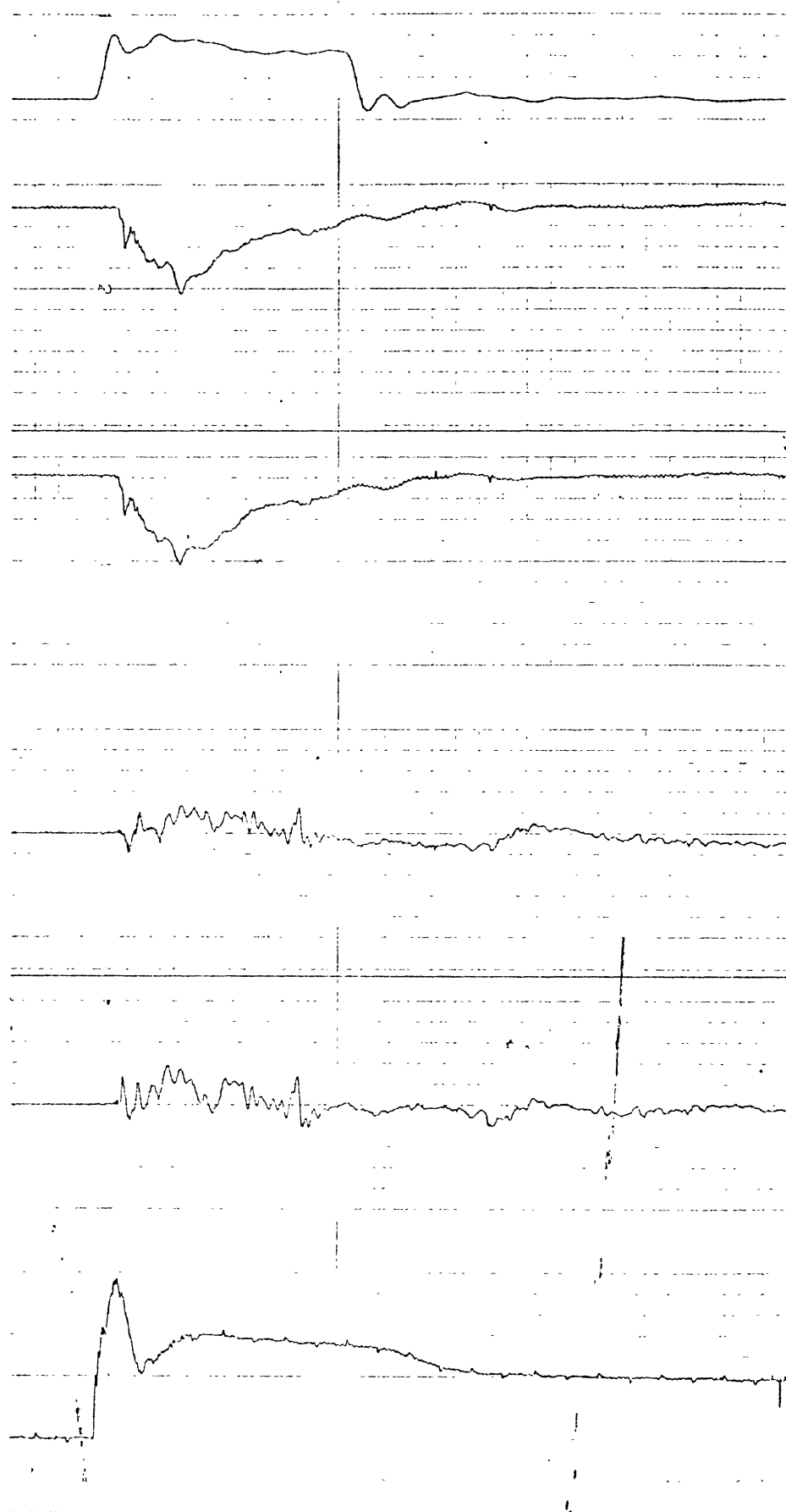

TIME BASE 6.25 MSEC/DIVISION

VISICORDER TRACES FOR SLED TEST A-622
(399 MPH REAR IMPACT, HSRI/UNIROYAL HEAD RESTRAINT)

FIGURE 67.

In terms of limitation of head/neck extension and control of ramping and rebound, head-restraint performance throughout the series was very good (see Figures 68-79). There was, for example, no measurable extension in any of the four tests with the 5th percentile female (see Table 1). Extension for the 95th male did reach 50° in test A-629, but the comparatively large maximum extension angles noted for test A-626, -628 and -629 can be attributed mainly to dummy geometry. First, the 95th male is the tallest of the three dummies used in the program (see Section 6.1), and his more massive head contacts the head-restraint higher than do the heads of the 5th female or 50th male. Therefore, a greater rearward loading moment is applied to the head restraint for, say, a 30 G/95th male test than for a 30 G/5th female test or a 30 G/50th male test.

Secondly, noticeable "slouch" or forward tilting of the head was introduced for tests A-626, -628 and -629 (as noted in the summary for A-626, Section 6.3). This increased initial offset allowed the head to achieve a higher velocity, and therefore higher kinetic energy, before contacting the head restraint; in attempting to dissipate or manage this extra kinetic energy, the head restraint would undergo more rearward rotation than it would if pre-impact head offset were smaller.

The most important comparison to be made in the final performance test series is between tests A-624 and A-630, both 30 mph/20 G impacts with the 5th percentile female. Such a comparison illustrates the effectiveness of the modifications to bag and inflator to reduce bag slap, since A-624 evaluated a "tight" HSRI/UniRoyal system (well-sealed bag, unmodified inflator) and A-630 evaluated a "controlled leakage"

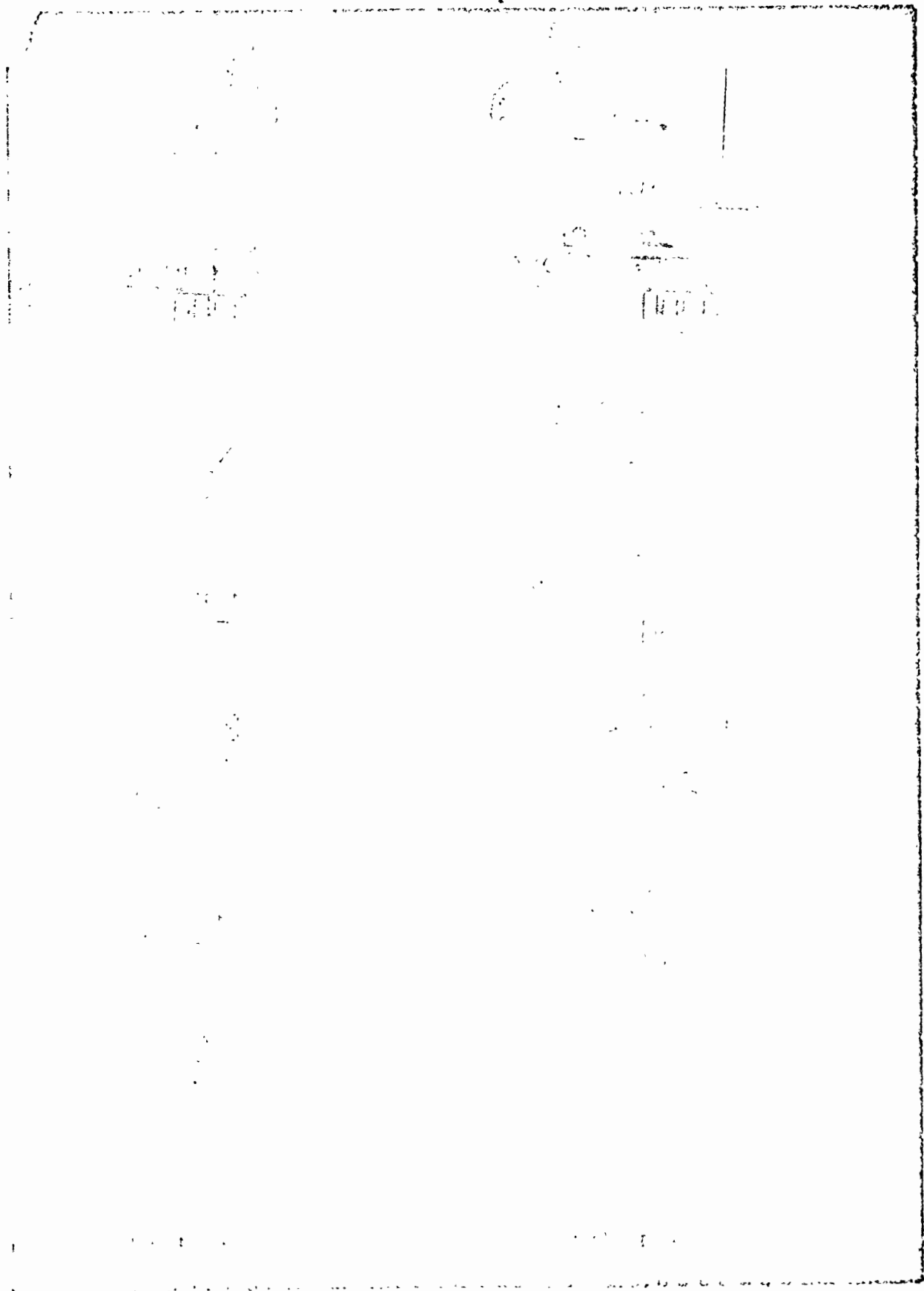
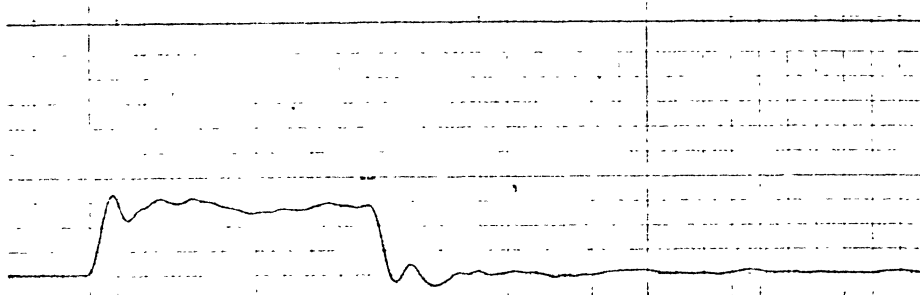
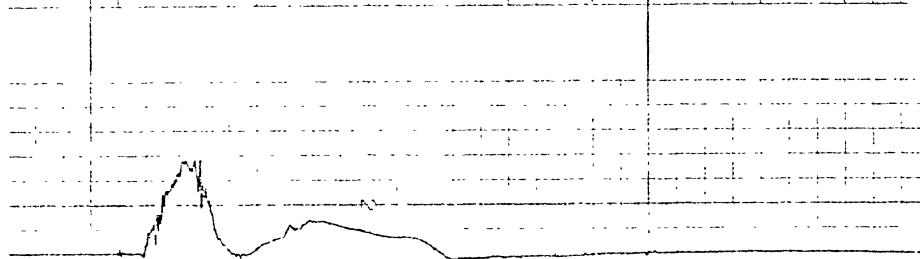

Figure 68. Test A-623: Graph-Chek Sequence.

SLED PULSE
(10 G/DIVISION)



HEAD ACCEL., A-P
(25 G/DIVISION)



HEAD ACCEL., S-I
(25 G/DIVISION)

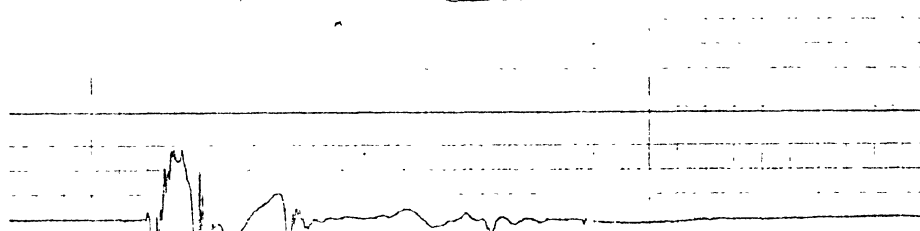

HEAD ACCEL., L-R
(25 G/DIVISION)

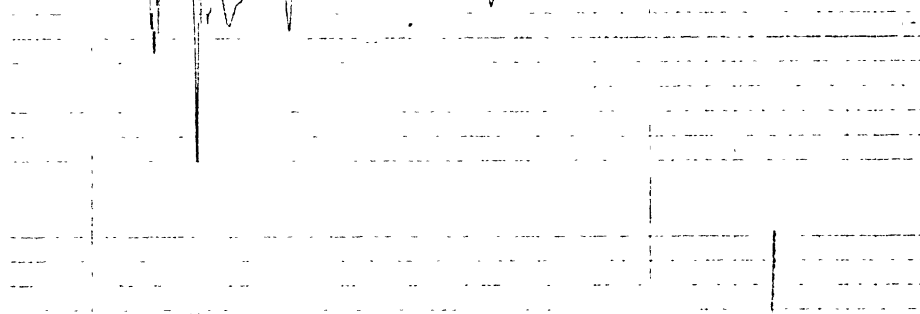

BAG PRESSURE
(2.5 PSI/DIVISION)

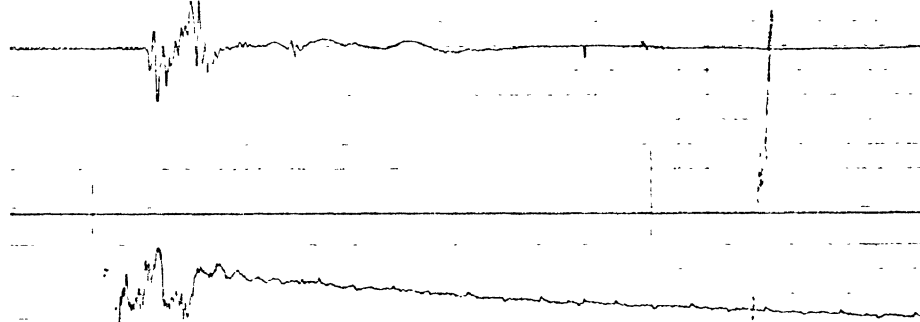

TIME BASE 6.25 MSEC/DIVISION

VISICORDER TRACES FOR SLED TEST A-623
(38.8 MPH REAR IMPACT, HSRI/UNIROYAL HEAD R. STRAINT)

FIGURE 69.

HSRI/UniRoyal system (less well-sealed bag and choked-flow inflator, as noted in test summary A-626, Section 6.3).

For test A-624 (Figures 70, 71), bag contact caused a bag-slap spike of 102 G, moderate flexion, and minor but noticeable rebound; a HIC value of 560.3 was calculated. In A-630 (Figures 78, 79), dummy motion was almost purely translational, with no ramping or upward rebound. There was a bag-slap spike of 90.5 G, but barely noticeable flexion. More important, the HIC for A-630 was only 380.9. It is felt that performance of the HSRI/UniRoyal head restraint in test A-630 would have been even better if it had been possible to position the 5th female dummy head more realistically (slouched or tipped forward slightly) as was done for tests A-626, -628 and -629 with the 95th male dummy.

This final test series reconfirmed the consistent performance of the HSRI Uni/Royal head restraint in earlier test -- rapid inflation, repeatable deployment geometry, compact stowage and excellent load/deflection characteristics. It also made clear, however, the compromises and tradeoffs involved in designing a head-restraint system to adequately protect a large male and a small female vehicle occupant. A system that is large and stiff enough, and that deploys fast enough, to protect the former can conceivably create bag slap for the latter. (Note, however, that this bag slap phenomenon is directly related to the pre-impact orientation of the head; if the head is tipped or slouched slightly -- a human-like posture not easily achieved with test dummies -- bag slap does not occur.)

The solution would seem to require simultaneous "optimization" of head acceleration and head/neck extension -- that is, reduce the stiffness

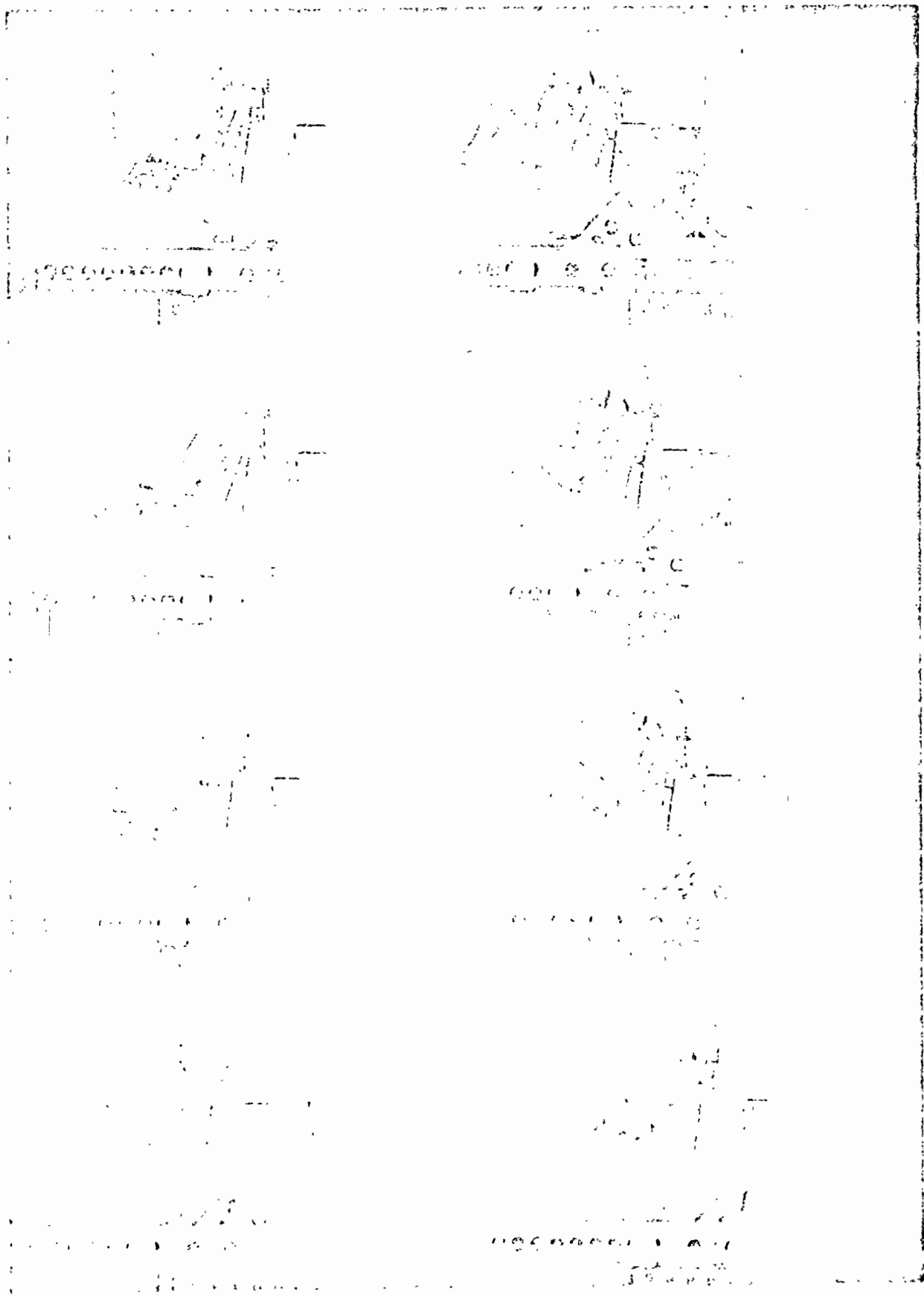

8

Figure 70. Test A-624: Graph-Chek Sequence.

SLED PULSE
(10 G/DIVISION)

HEAD ACCEL., A-P
(25 G/DIVISION)

HEAD ACCEL., S-I
(25 G/DIVISION)

HEAD ACCEL., L-R
(25 G/DIVISION)

BAG PRESSURE
(5 PSI/DIVISION)

HEAD ACCELERATION
RESULTANT
(20 G/DIVISION)

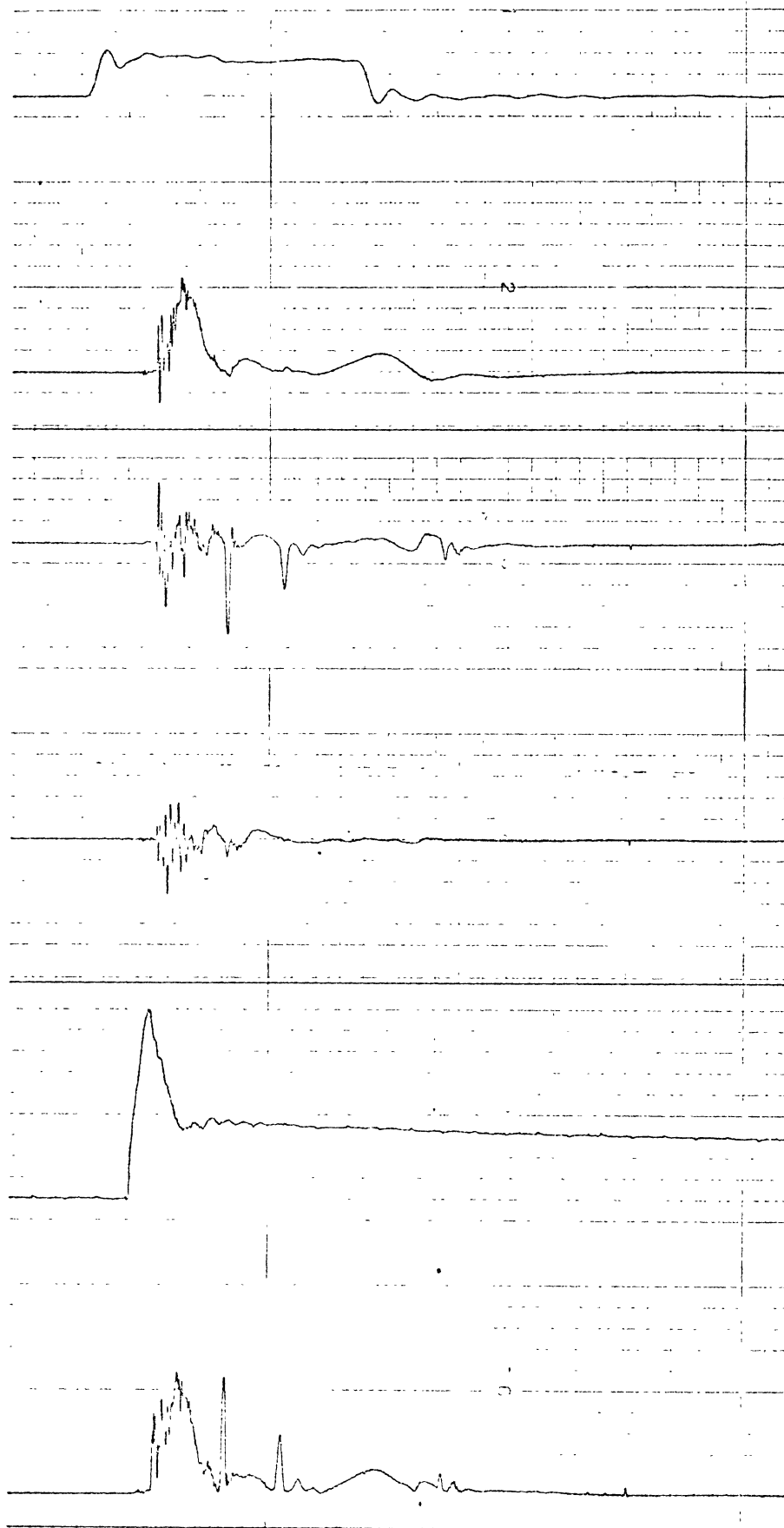

TIME BASE 6.25 MSEC/DIVISION

VISICORDER TRACES FOR SLED TEST A-624
(29.2 MPH REAR IMPACT, HSRI/UNIROYAL HEAD RESTRAINT)

FIGURE 71.

of the system and thereby reduce head-acceleration spikes at contact, at the "cost" of allowing some controlled head/neck extension. Such optimization of the HSRI/UniRoyal head restraint could probably be accomplished by incorporating blow-out ports in the air-bag, and by modifying the inflator system to produce a "ramp-type" bag pressure versus time profile instead of the triangular profile now produced (see Figure 60). More realistic simulation of occupant slouch would also yield a more realistic indication of head restraint performance.

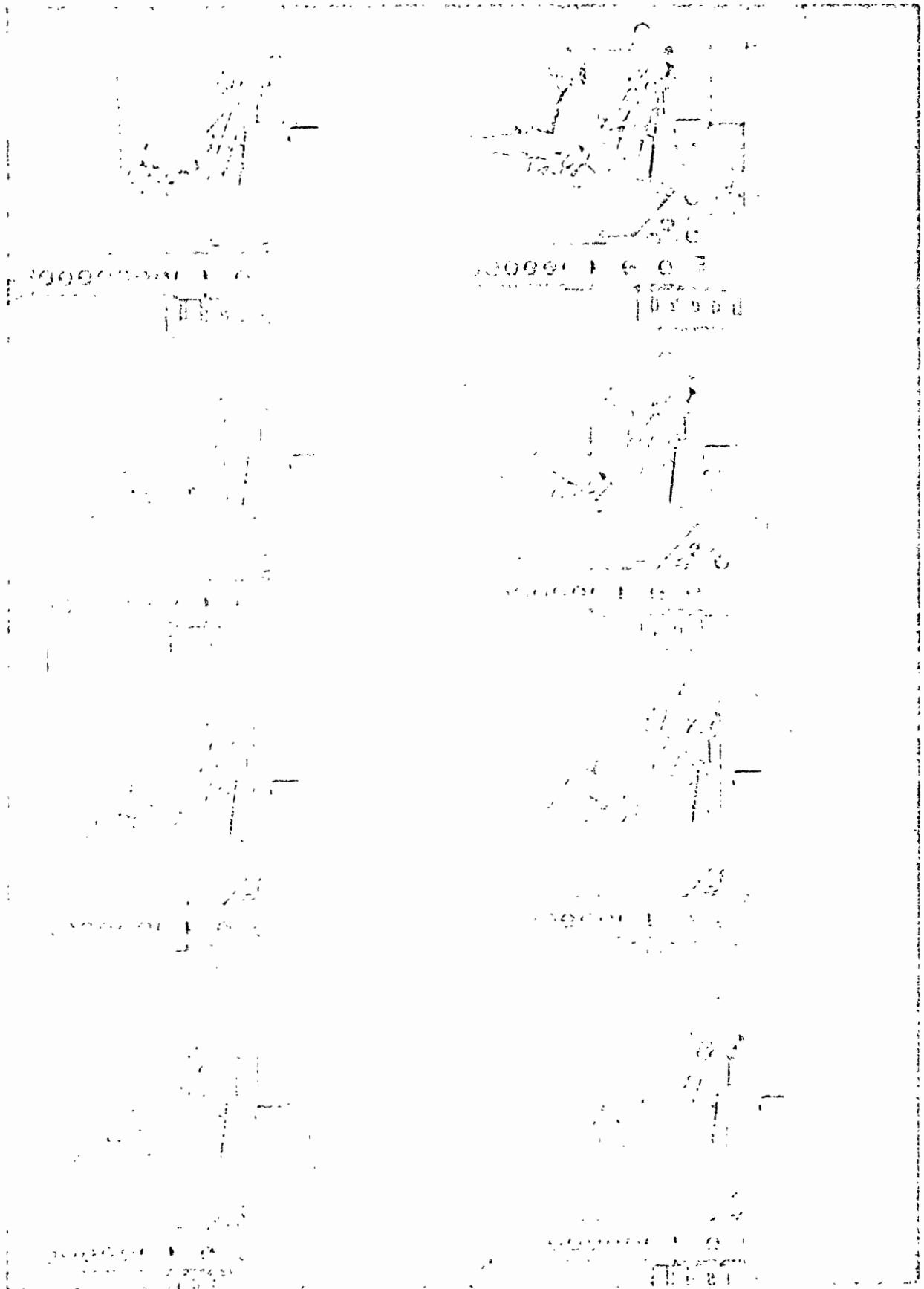

Figure 72. Test A-625: Graph-Chek Sequence.

SLED PULSE
(10 G/DIVISION)

HEAD ACCEL., A-P
(12.5 G/DIVISION)

HEAD ACCEL., S-I
(12.5 G/DIVISION)

HEAD ACCEL., L-R
(12.5 G/DIVISION)

BAG PRESSURE
(5 PSI/DIVISION)

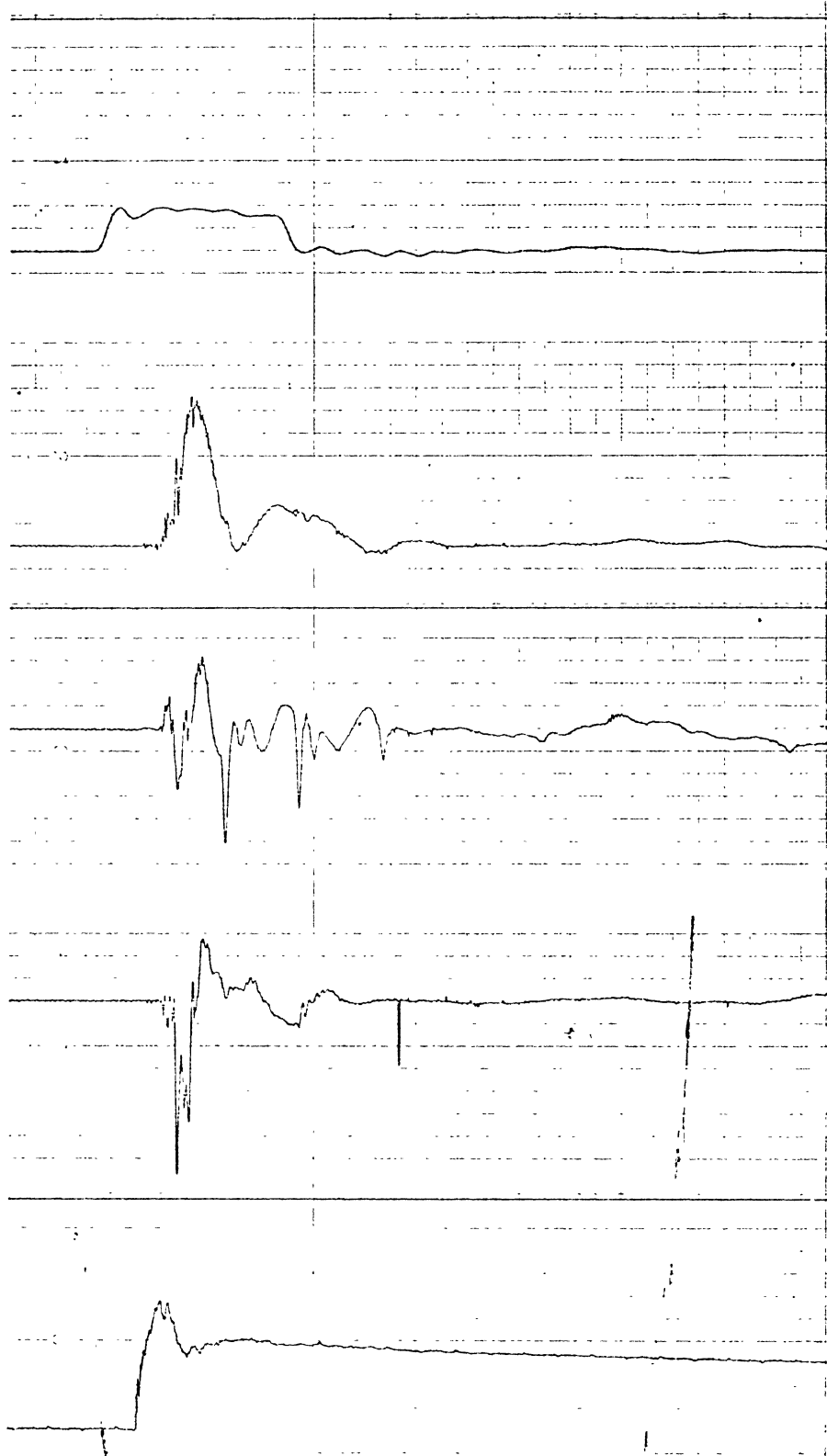

TIME BASE 6.25 MSEC/DIVISION

VISICORDER TRACES FOR SLED TEST A-625
(18.1 MPH REAR IMPACT, HSRI/UNIROYAL HEAD RESTRAINT)

FIGURE 73.

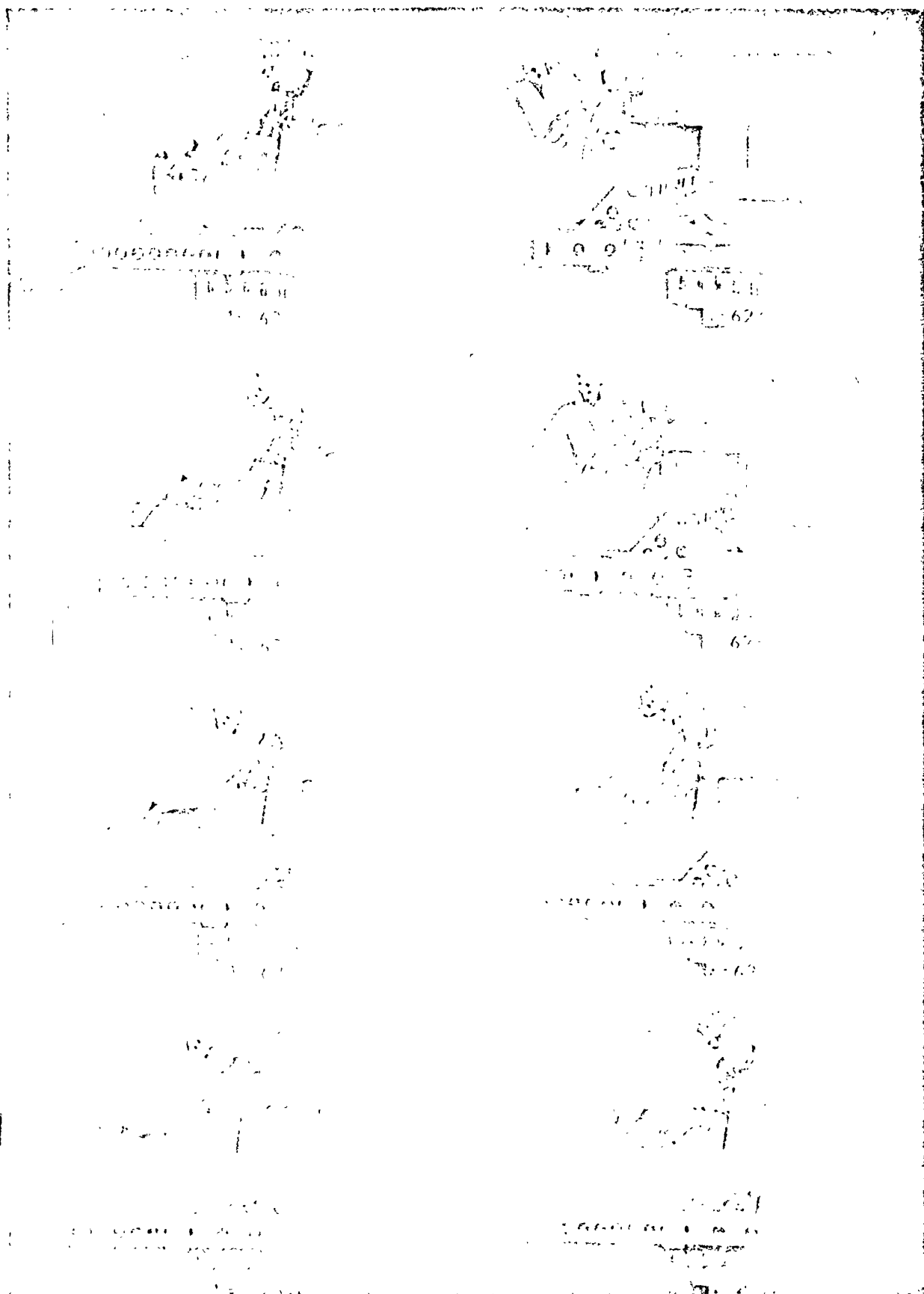

Figure 74. Test A-626: Graph-Chek Sequence.

SLED PULSE
(10 G/DIVISION)

HEAD ACCEL., A-P (1)
(12.5 G/DIVISION)

HEAD ACCEL., A-P (2)
(12.5 G/DIVISION)

HEAD ACCEL., S-I (1)
(12.5 G/DIVISION)

HEAD ACCEL., S-I (2)
(12.5 G/DIVISION)

BAG PRESSURE
(10 PSI/DIVISION)

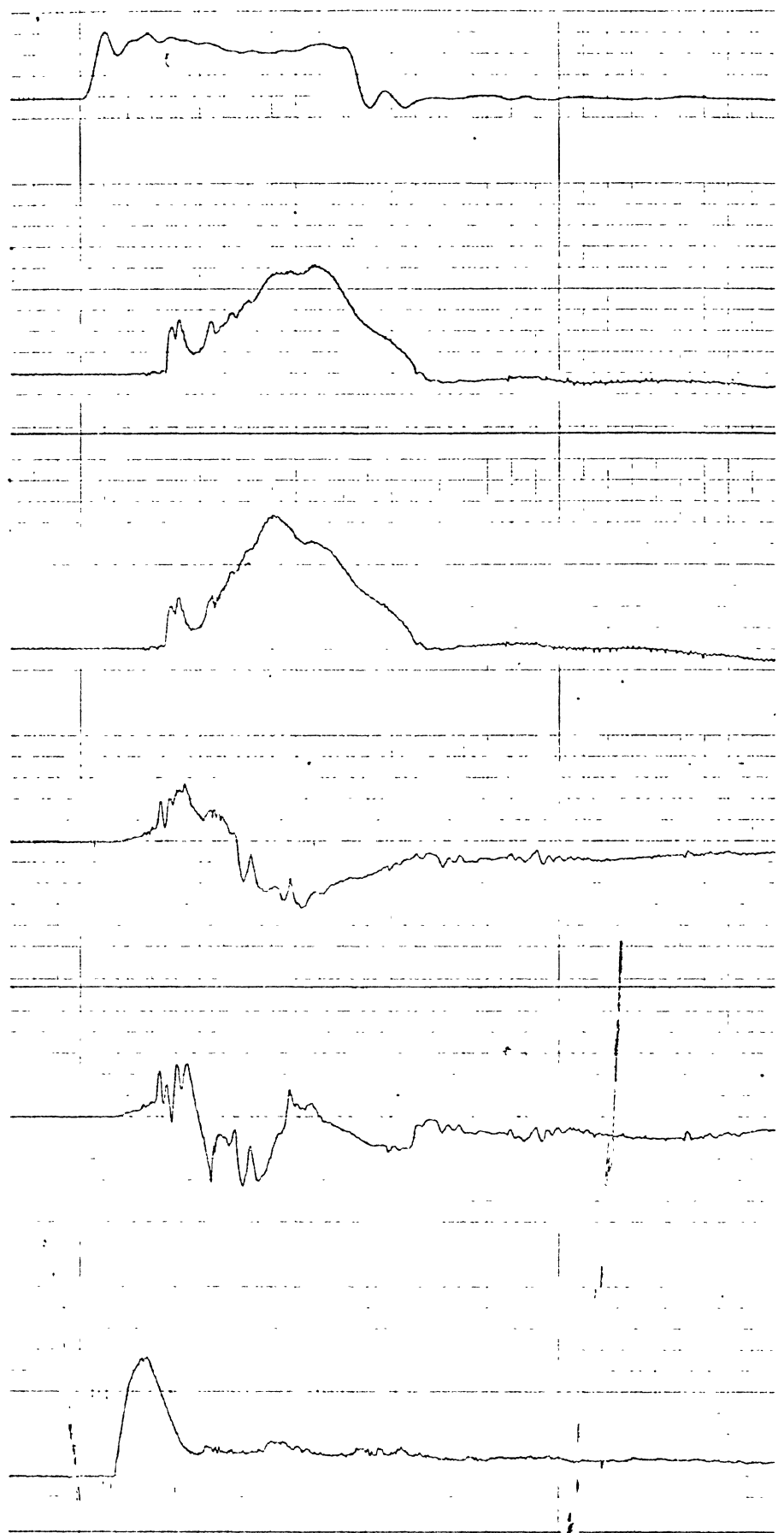

TIME BASE 6.25 MSEC/DIVISION

VISICORDER TRACES FOR SLED TEST A-626
(39.3 MPH REAR IMPACT, HSRI/UNIROYAL HEAD RESTRAINT)

FIGURE 75.

SLED PULSE
(10 G/DIVISION)

HEAD ACCEL., A-P (1)
(12.5 G/DIVISION)

HEAD ACCEL., A-P (2)
(12.5 G/DIVISION)

HEAD ACCEL., S-I (1)
(12.5 G/DIVISION)

HEAD ACCEL., S-I (2)
(12.5 G/DIVISION)

LEFT BELT LOAD
(250 LB/DIVISION)

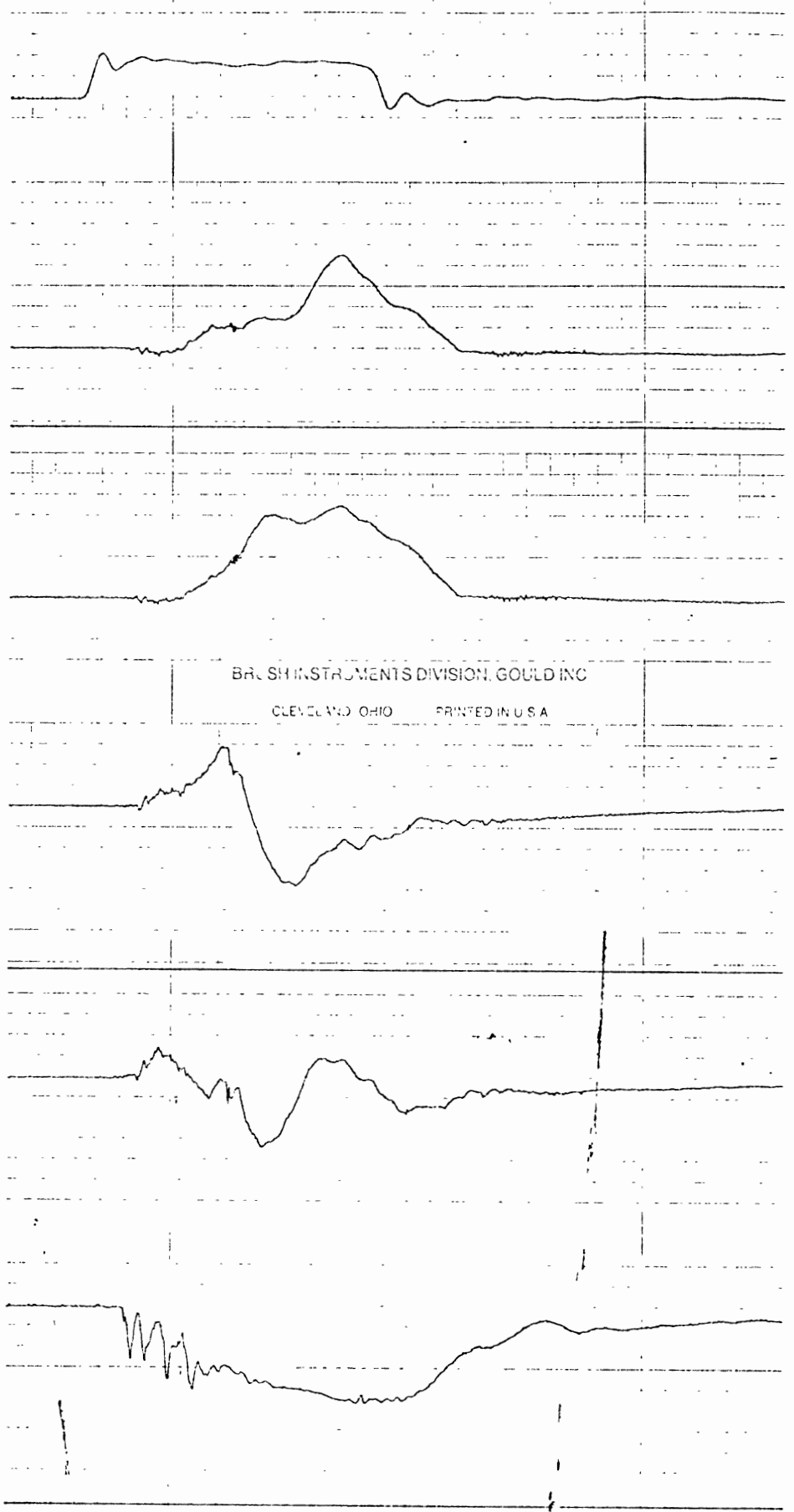

TIME BASE 6.25 MSEC/DIVISION

VISICORDER TRACES FOR SLED TEST A-628
(29.1 MPH REAR IMPACT, HSRI/UNIROYAL HEAD RESTRAINT)

FIGURE 76.

SLED PULSE
(10 G/DIVISION)

HEAD ACCEL., A-P (1)
(12.5 G/DIVISION)

HEAD ACCEL., A-P (2)
(12.5 G/DIVISION)

HEAD ACCEL., S-I (1)
(12.5 G/DIVISION)

HEAD ACCEL., S-I (2)
(12.5 G/DIVISION)

LEFT BELT LOAD
(250 LB/DIVISION)

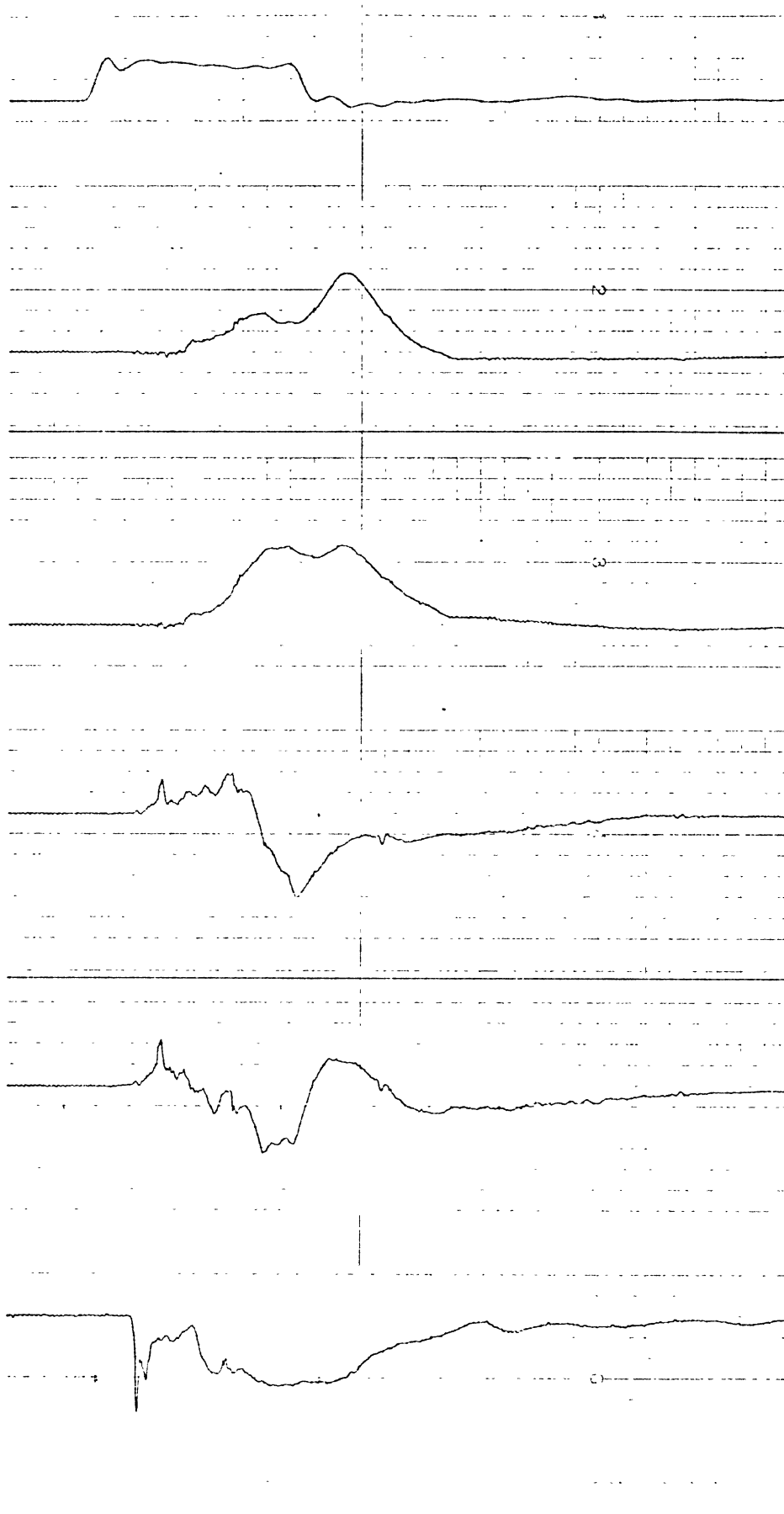

TIME BASE 6.25 MSEC/DIVISION

VISICORDER TRACES FOR SLED TEST A-629
(20.7 MPH REAR IMPACT, HSRI/UNIROYAL HEAD RESTRAINT)

FIGURE 77.

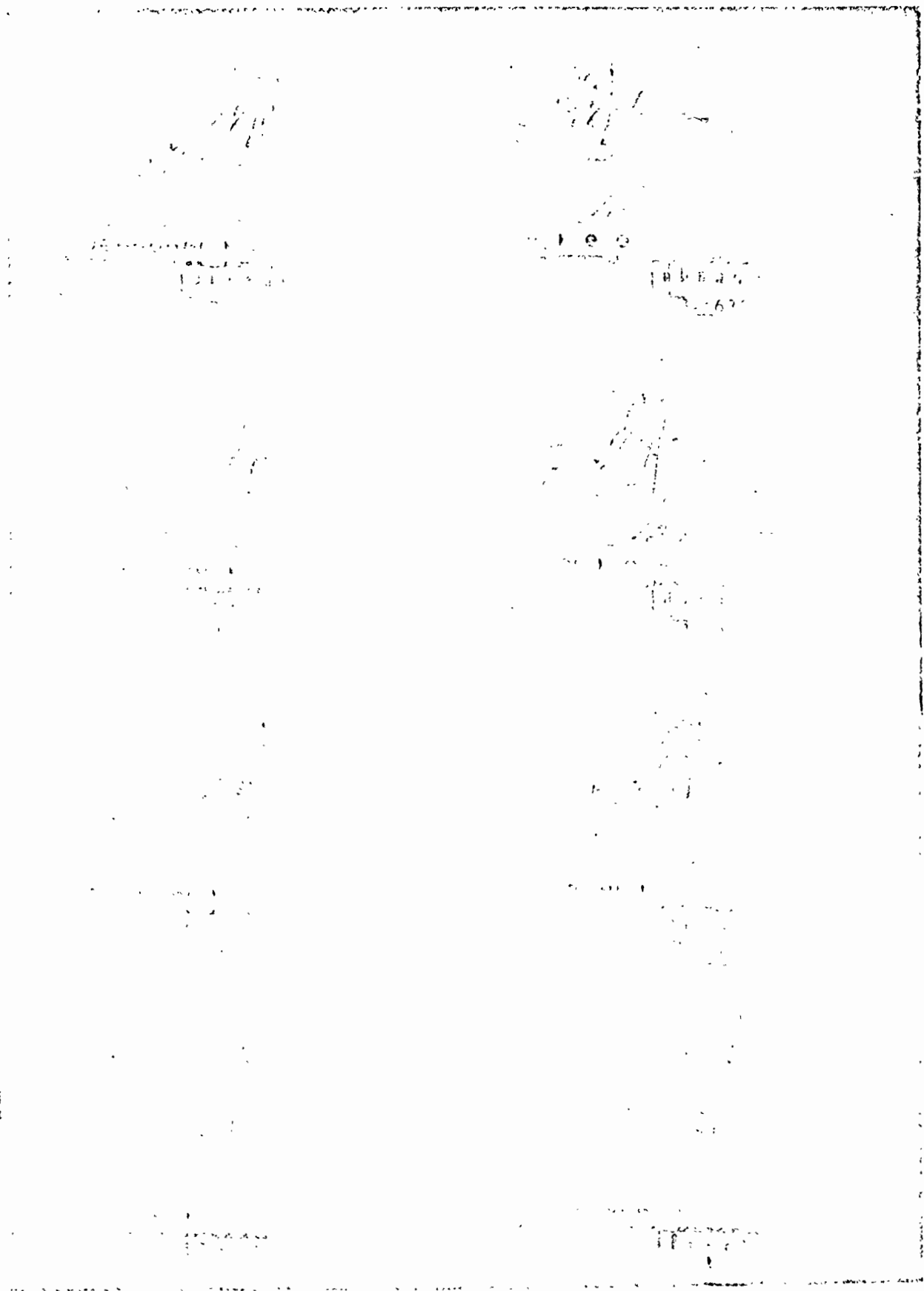

8

Figure 78. Test A-630: Graph-Chek Sequence.

SLED PULSE
(10 G/DIVISION)

HEAD ACCEL., A-P
(12.5 G/DIVISION)

HEAD ACCEL., S-I
(12.5 G/DIVISION)

HEAD ACCEL., L-R
(12.5 G/DIVISION)

LEFT BELT LOAD
(250 LB/DIVISION)

HEAD ACCELERATION
RESULTANT
(20 G/DIVISION)

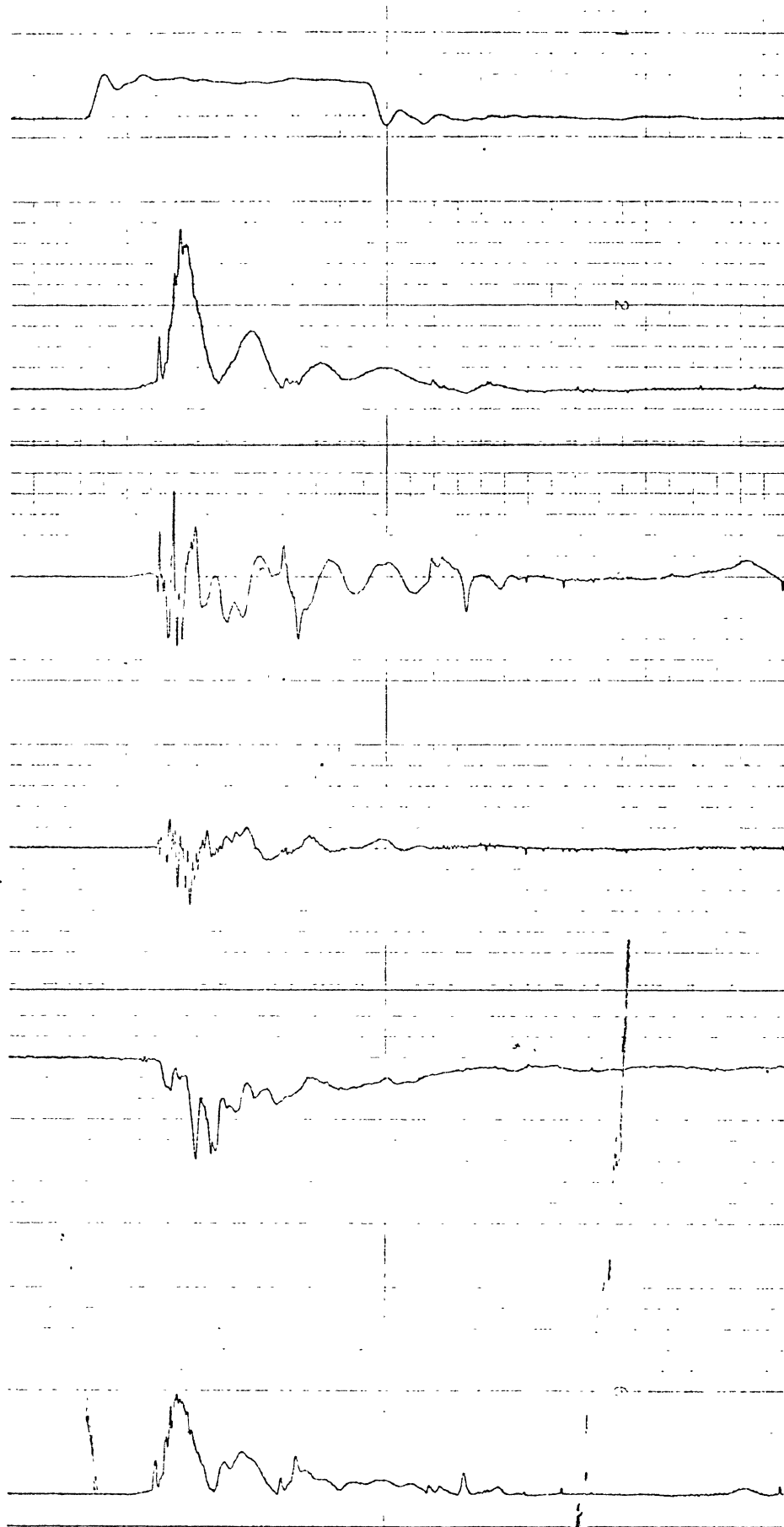

TIME BASE 6.25 MSEC/DIVISION

VISICORDER TRACES FOR SLED TEST A-630
(30.1 MPH REAR IMPACT, HSRI/UNIROYAL HEAD RESTRAINT)

FIGURE 79.

REFERENCES

- Clarke, T. D., et. al.: Human Head Linear and Angular Accelerations During Impact. Proceedings, 15th Stapp Car Crash Conference. pp. 269-286, 1971.
- Clemens, H. J. and Burow, K.: Experimental Investigation on Injury Mechanisms of Cervical Spine at Frontal and Rear-Front Vehicle Impacts. Proceedings 16th Stapp Car Crash Conference. pp. 76-104, 1972.
- Melvin, J. W. and McElhanev, J. H.: Deployable Head Restraints. U.S. Department of Transportation Report DOT HS-800 515, 1971.
- Melvin, J. W., et. al.: An Improved Neck Simulation for Anthropometric Dummies. Proceedings 16th Stapp Car Crash Conference. pp. 45-60, 1972.

APPENDIX A
PRELIMINARY SPECIFICATIONS FOR
INFLATABLE HEAD RESTRAINTS
AND INFLATOR DEVICES

INFLATING HEAD RESTRAINT SYSTEM
SPECIFICATIONS FOR INFLATABLE STRUCTURE

1. Envelope (Maximum Dimensions)

- Stored 18" wide x 8" deep x 1" high
- Inflated 18" wide x 12" deep x 11" high

2. Volume

- Inflated 2376 in³ (1.375 ft³) max

3. Pressure/Time Profile

- Dynamic Inflation 0-10 psig in 20 msec
- Static Leakage hold 10 $\begin{matrix} +0 \\ -0.1 \end{matrix}$ psig for 30 minutes

4. Static Load/Deflection

When loaded as shown in Figure 1, maximum angular rotation of the major axis of the inflating structure shall not exceed 20° from vertical.

5. Inflator Interface

Inflating structure shall interface with the gas-discharge baseplate of the Olin Inflator bottle as shown in Figure 2.

6. Inflated Shape

In designing the shape of the forward (head-contact) surface of the inflating structure, consideration shall be given to minimizing:

- a. Hyperextension (excessive rearward rotation relative to the torso) of the head and neck;
- b. "Ramping," or upward motion of the torso parallel to the seat back;
- c. Side-to-side rotation and translation of the head; and,
- d. Forward rebound after impact.

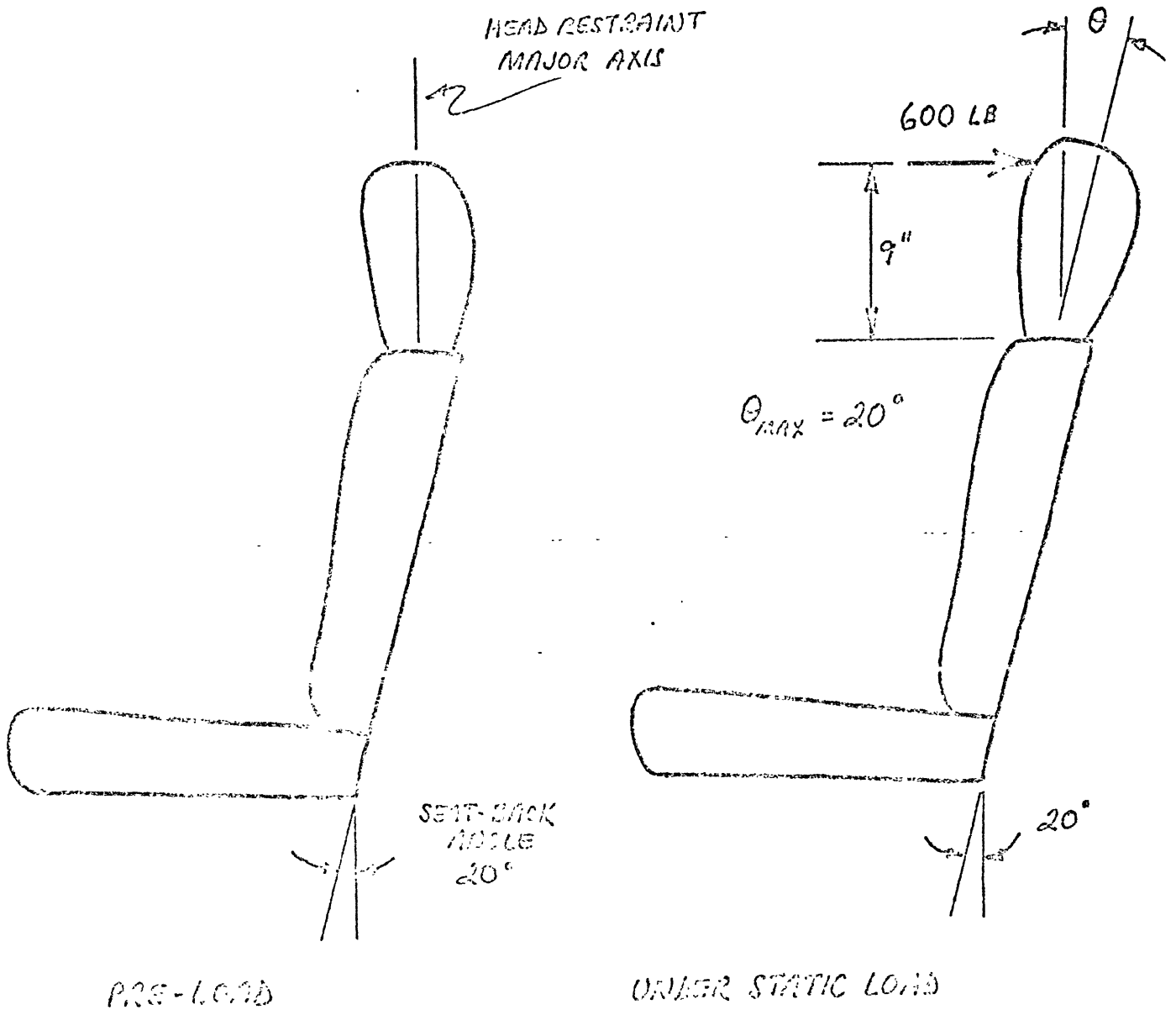
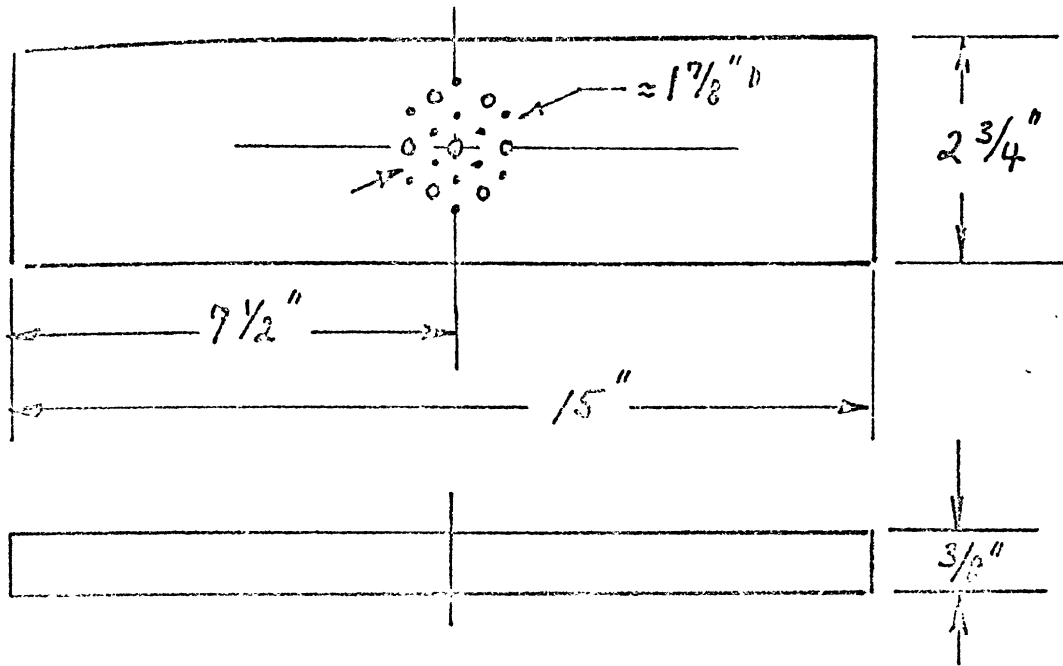
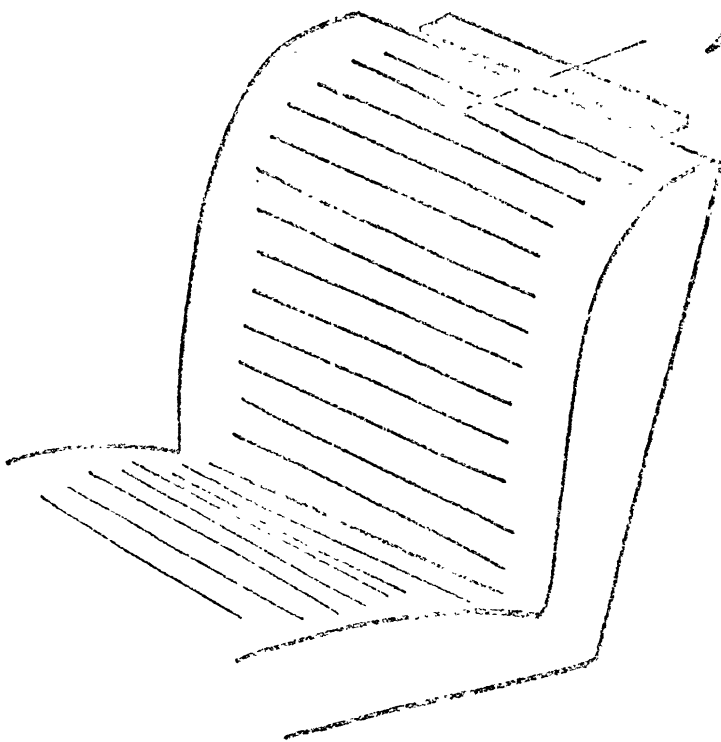

FIGURE 1
 STATIC LOAD / DEFLECTION
 PERFORMANCE

JH



GAS DISCHARGE BASEPLATE
IN RELATION TO
TEST SEAT



(OLIN GAS CYLINDER
MOUNTS BELOW
DISCHARGE PLATE)

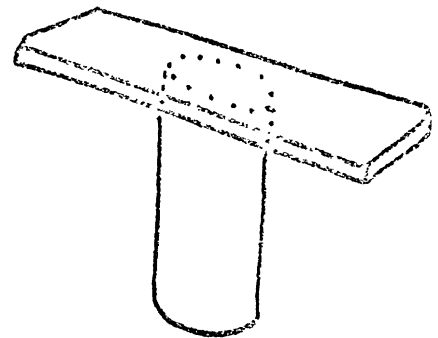

FIGURE 2
OLIN
GAS - DISCHARGE
BASEPLATE

INFLATING HEAD RESTRAINT SYSTEM
SPECIFICATIONS FOR INFLATOR DEVICE

1. Dimensions

- Unit size and weight shall be minimized, consistent with safety and reliability considerations. (Guideline: unit should mount to the seat back structure of an automobile seat.)

2. Inflation Performance

- Unit shall inflate a structure of 1.375 ft³ (max) to 10 psig $\pm \frac{1}{0}$ psig in 20 msec.

3. Noise

- Inflation noise shall not exceed 150 dB in amplitude, 20 msec duration during inflation.

4. General

- Unit shall be a "one-shot" device, requiring replacement or re-charge after each use.

- Unit should be designed to minimize accidental actuation and to discourage tampering.

APPENDIX B

SLED TEST EQUIPMENT SPECIFICATIONS AND
CALIBRATION PROCEDURES

A. Equipment Specifications

Transducers

1. Setra Model III Accelerometer (Dummy)
Type: Variable capacitance sensor with pulse width modulation.
Range: ± 250 G, ± 500 G
Sensitivity: 6 mV/G, 3 mV/G
Frequency Response: 0 to 1800 hz, 0 to 2500 hz
Natural Frequency: 2600 hz, 3600 hz

2. Statham Model A69TC-100-350 Accelerometer (Sled)
Type: Temperature compensated, unbounded strain gauge
Range: ± 100 G
Natural Frequency: 1800 Hz
Damping: 0.7 (± 0.1) of critical room temperature

3. Lebow Model 3371 Belt Load Cell
Type: Strain gauge
Range: 3500 pounds, with 50% overload capacity
Sensitivity: 2.2906 mV/V/3500 pounds

4. HSRJ Pressure Transducer
Type: Strain gauged diaphragm using Micromasurements
EA-06-455-08-350 Strain Gauge
Range: 0-30 psi

Signal Conditioners

1. Setra SCM-1 Signal Conditioner
Type: Solid state, direct coupled, differential input and output, operational amplifier and regulated transducer excitation.
Gain: .01 to 2.5
D.C. Gain Linearity: Better than $\pm 0.1\%$ of full scale
Frequency Response: 0 to 20 KHz

2. Honeywell Model 120 D.C. Amplifier
 Type: Solid state, direct coupled, wideband differential
 Gain: 10 - 1000
 D.C. Gain linearity: better than $\pm 0.2\%$ of full scale
 D.C. Gain accuracy, calibrated gain ranges: better than $\pm 0.5\%$
 Frequency Response: $\pm 2\%$ D.C. to 10 KHz

3. Honeywell Model 105 Bridge Balance (Gauge Control) Unit
 Frequency Response: $\pm DC$ to 10 KHz within $\pm 0.5\%$

Recorders

1. Honeywell Model 1612 Visicorder Light-Beam Oscillograph
 Galvanometer response:
 - M-3300 (15 channels): $\pm 5\%$, 0 to 2000 Hz
 - M-1650 (4 channels): $\pm 5\%$, 0 to 1000 Hz
 - M-1000 (1 channel): $\pm 5\%$, 0 to 600 Hz

2. Honeywell Model 7600 F.M. Tape Recorder/Reproducer
 Tape speeds: 1 7/8 to 120 ips
 Frequency response: ± 1.0 db 0 - 10000 Hz (at recording speed
 used - 30 ips)
 Harmonic distortion: 1.2%

3. CEC Model VR-3300 F.M. Tape Recorder
 Tape speeds: 1 7/8 to 60 ips
 Frequency response: ± 0.5 db 0 - 10000 Hz (at recording speed
 used - 30 ips)
 Harmonic distortion: 1.5%

B. Calibration Procedures

Transducers: The calibration sensitivities of the transducers are checked to insure that there has been no appreciable deviation from manufacturer's specified sensitivity.

1. Setra Model 111 Accelerometer

The sensitivity of the Setra 111 Accelerometer is checked by mounting the accelerometer on a centrifuge and measuring the output at various steps of centrifuge speed. A synchronous drive in the centrifuge gives a known rotational speed which, combined with the arm length, gives a known acceleration. Measuring the output voltage from the accelerometer at various known accelerations gives a determination of the accelerometer sensitivity.

2. Statham Model A59TC Accelerometer

This strain-gauge accelerometer, used to monitor sled deceleration, is calibrated by comparing its output with that of an NBS-traceable standard accelerometer. The two accelerometers are mounted piggy-back on a common carrier block and impacted. Their outputs are displayed, via the sled umbilical and the signal conditioning system, on the oscillograph. The excitation voltage of the Statham is adjusted until its output agrees with the standard accelerometer. This excitation voltage becomes the standard for subsequent use of the accelerometer.

3. Lebow Seat-Belt Load Cells

Calibration sensitivity of these load cells is checked by applying a known load to a length of seat-belt material on which the cell is mounted. The output signal is compared with that obtained when a shunt resistor is paralleled with one leg of the transducer's bridge. The resistor value is that which has been specified by the manufacturer to produce a transducer output equal to the output produced by a known load.

Calibration - Signal Conditioning/Recording Systems

1. Setra Accelerometer Channels

Application of the 6 VDC accelerometer excitation voltage to the calibration terminal of the Model 111 accelerometer internally switches a shunt resistance into the accelerometer circuit and produces a known calibration signal (DC) on the transducer output terminals. Knowing the transducer sensitivity, an equivalent acceleration (nominally 20% of F.S.) required to produce this same output voltage under dynamic conditions can be determined. The calibration signal is applied to the input of the signal conditioner and the gain is adjusted to produce an output signal with the desired scale factor (1 volt = 50 G's).

2. Strain-Gauge Transducer Channels

Calibration of strain-gauge channels is accomplished by introducing shunt resistors across one leg of the bridge of the transducers in question, and checking the excitation required to produce the galvanometer deflection desired. A significant change in the required excitation for any transducer would indicate the need to check the calibration sensitivity of the transducer, or otherwise determine the cause of the change.

For the Statham accelerometer channel, the calibration resistors are the internal "Cal I" and "Cal II" calibration resistors of the Honeywell 105 gauge unit, and their corresponding G-value and galvanometer deflection were determined at the time of calibration of the transducer itself.

In the case of the Lebow belt load cells, a 60 K-ohm resistor is introduced in the transducer cable parallel to one leg of the transducer bridge, and whose corresponding belt load value was specified by the manufacturer.

The pressure transducer channel is calibrated directly by applying a known pressure (10 psi) to the transducer and adjusting the transducer excitation voltage from the Honeywell 105 gauge unit to produce an output voltage from the Honeywell 120 amplifier with the desired scale factor. (1v = 10 psi).

3. Tape Recorder

Calibration of the tape recorder is accomplished by adjusting its input attenuators to obtain a 40% carrier frequency deviation when a calibrated 3 volt source is applied to the tape inputs.

NOTE: Calibration of the signal conditioning equipment, oscillograph, and top units is done routinely for each sled test.

C. Data Display and Processing Equipment

Data is recorded on tape during a sled test at 30 ips tape speed. To obtain the proper frequency response from the strip chart recorder the tape speed is reduced to 1 7/8 ips for data output. The data channels desired for display are filtered according to the SAE J211 specification.

1. Gould Brush 200 Recorder

Type: 6 channel strip chart recorder

Function: Plots data channels pre-recorded on tape.

2. Burr-Brown Filter 5703-LP4L-2000/16

Type: Fixed filter with 200 Hz cut-off

Function: Filter raw data from tape for input to strip chart recorder.

3. Krohn-Hite 3750 Filter
Type: Variable filter with cut-off 0 - 20 KHz and roll-off rate 6 - 24 dB/octave.
Function: Filter raw data from tape for input to strip chart recorder.

4. Thomas 1710 Impact Computer
Type: Analog computer
Function: Computed resultant and Severity Index of biaxial or triaxial acceleration data for input to strip chart recorder or digitizer.

5. Thomas 1720 Recording Analog Digitizer
Type: A/D converter with memory unit to store data and encoder for output to standard teletype.
Function: Digitize analog data from tape or Impact Computer for input to teletype.

/