

ENGINEERING RESEARCH INSTITUTE  
UNIVERSITY OF MICHIGAN  
ANN ARBOR

THE PASSAGE OF SHOCK WAVES OVER OBLIQUE OBSTACLES

REPORT 51-4

ROBERT N. HOLLYER, JR.

ALFRED C. HUNTING

Supervised by

OTTO LAPORTE

Project M-720-4

U.S. NAVY DEPARTMENT, OFFICE OF NAVAL RESEARCH  
CONTRACT NO. N6-onr-232 T.O. IV

27 August 1951

**THIS REPORT PUBLISHED**

**FOR**

*Armed Forces  
Special Weapons Project*

*for*

*dissemination to  
authorized agencies*

## THE PASSAGE OF SHOCK WAVES OVER OBLIQUE OBSTACLES

The series of shadowgraphs presented in this report were prepared at the request of the ARMED FORCES SPECIAL WEAPONS PROJECT and THE SANDIA CORPORATION. They are being distributed with the hope that they will be of interest to other investigators. In three previous reports<sup>1,2,3</sup> the passage of shock waves over vertical walls and over rectangular obstacles, all of which were aligned with and at right angles to the flow, were studied. In the present report rectangular walls are placed at certain definite angles to the flow. Due to the complexity of the obstacle no real theoretical interpretation has been attempted, although many details can be understood using standard textbook procedures.

Fig. 46 shows the method of mounting a typical block for this study. The tape along the edge of the false wall and along the edge of the model served primarily to prevent gas leakage between these surfaces and the test section windows. Blocks two inches in width(\*) were mounted at an angle of inclination ( $\theta$ ) of 30°, 45°, 60°, and 90° (Figs. 1-20, 30-45). In addition, a model one inch wide was mounted at an angle of inclination of 45° (Figs. 21-29).

Photographs have been taken at three values of primary shock-wave Mach number, 1.1, 1.2, and 1.3 and at several positions of the primary shock wave. Complete data for each photograph are contained in

1. Uhlenbeck, G., Diffraction of Shock Waves Around Various Obstacles, E.R.I., University of Michigan, Report No. 50-1, 21 March 1950.
2. Hollyer, R. N., and Duff, R. E., Effect of Wall Boundary Layer in the Diffraction of Shock Waves Around Cylindrical and Rectangular Obstacles. E.R.I., University of Michigan, Report No. 50-3, 7 Nov. 1950.
3. Hollyer, R. N., and Duff, R. E., Growth of the Turbulent Region at the Leading Edge of Rectangular Obstacles in Shock Waves Diffraction, E.R.I., University of Michigan, Report 51-2, 18 Jan. 1951.

\* Width refers to the dimension across the shock tube, parallel to the direction of observation.

Table I. In all cases the pressure ( $P_0$ ) ahead of the primary shock wave is one atmosphere. The time ( $t$ ) for each photograph is the time elapsed after the primary shock wave had reached the leading edge of the model and was computed from the measured position of the primary shock wave. In all cases, the upper edge of the photograph coincides with the plate to which the model has been attached (see Fig. 46). The photographs have been reduced slightly to facilitate publication. The proper scale factor may be determined by noting that the actual thickness of the models was 0.50 inch.

It may be possible to correlate the size of the turbulent region at the tip of the block with the flow speed in a manner similar to that previously reported<sup>3</sup>; however, no such correlation has been attempted at present.

TABLE I

For All Pictures,  $P_0 = 1$  Atmosphere

Figure No.	*t [ $\mu$ sec.]	Shock Velocity [mm./ $\mu$ sec.]	Shock Mach No.	Flow Velocity [mm./ $\mu$ sec.]	Flow Mach No.	$\theta$ [Degrees]
1	59	0.380	1.08	0.056	0.152	30
2	162	.379	1.08	.054	.148	30
3	292	.383	1.09	.062	.165	30
4	85	.416	1.19	.108	.293	30
5	126	.413	1.18	.104	.283	30
6	175	.417	1.19	.109	.297	30
7	267	.416	1.19	.108	.293	30
8	285	.418	1.20	.1105	.300	30
9	28	.456	1.31	.162	.425	30
10	134	.454	1.30	.160	.420	30
11	189	.443	1.27	.145	.385	30
12	72	.379	1.09	.054	.148	45
13	178	.379	1.09	.054	.148	45
14	237	.380	1.09	.056	.152	45
15	86	.417	1.20	.109	.297	45
16	173	.417	1.20	.109	.297	45
17	213	.415	1.19	.106	.290	45
18	39	.449	1.29	.153	.405	45
19	82	.435	1.25	.134	.335	45
20	184	.450	1.29	.154	.406	45
21	18	.378	1.08	.053	.145	45
22	199	.379	1.09	.054	.148	45
23	305	.380	1.09	.056	.152	45

\* t = time in  $\mu$ sec. after passage of shock wave past leading edge of model.

TABLE I (cont'd)

For All Pictures,  $P_0 = 1$  Atmosphere

Figure No.	*t [ $\mu$ sec.]	Shock Velocity [mm./ $\mu$ sec.]	Shock Mach No.	Flow Velocity [mm./ $\mu$ sec.]	Flow Mach No.	$\theta$ [Degrees]
24	30	.416	1.19	.108	.293	45
25	158	.420	1.20	.113	.308	45
26	244	.420	1.20	.113	.308	45
27	49	.445	1.28	.148	.391	45
28	155	.445	1.28	.148	.391	45
29	184	.445	1.28	.148	.391	45
30	35	.380	1.09	.056	.152	60
31	126	.381	1.09	.057	.157	60
32	240	.380	1.09	.056	.153	60
33	39	.416	1.20	.108	.293	60
34	104	.415	1.19	.106	.290	60
35	221	.416	1.20	.108	.293	60
36	51	.450	1.29	.154	.406	60
37	110	.450	1.29	.154	.406	60
38	229	.454	1.30	.160	.420	60
39	49	.380	1.09	.056	.152	90
40	159	.378	1.09	.053	.145	90
41	19	.415	1.19	.106	.290	90
42	121	.415	1.19	.106	.290	90
43	37	.458	1.32	.165	.432	90
44	89	.460	1.32	.167	.438	90
45	106	.461	1.33	.168	.441	90

\* t = time in  $\mu$ sec. after passage of shock wave past leading edge of model.

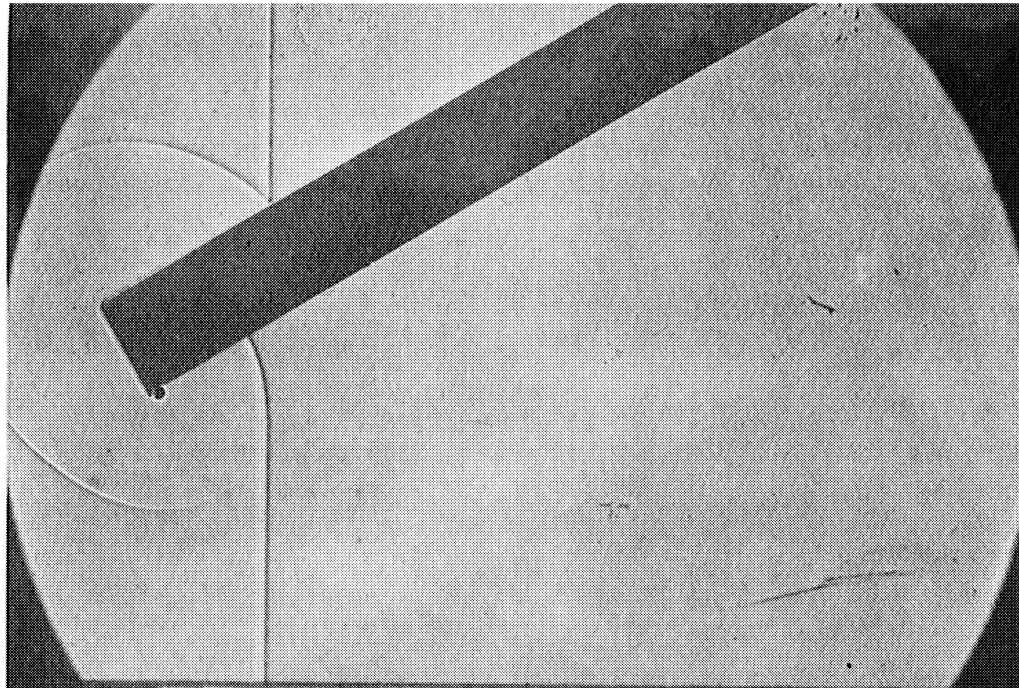

Fig. 1

$M = 1.1$   
 $t = 59$

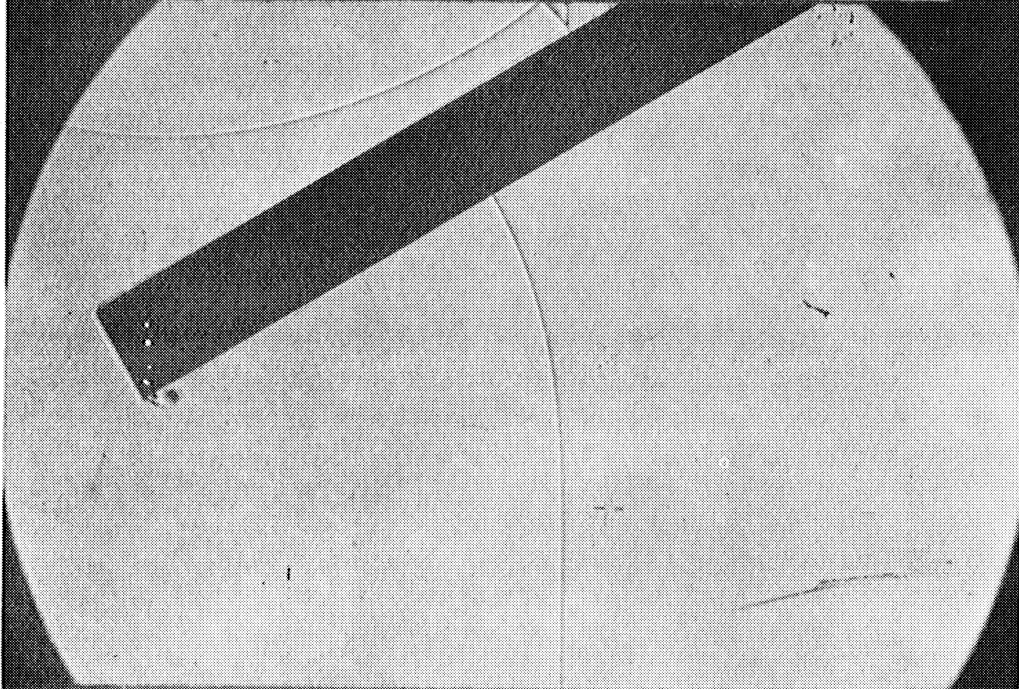

Fig. 2

$M = 1.1$   
 $t = 162$

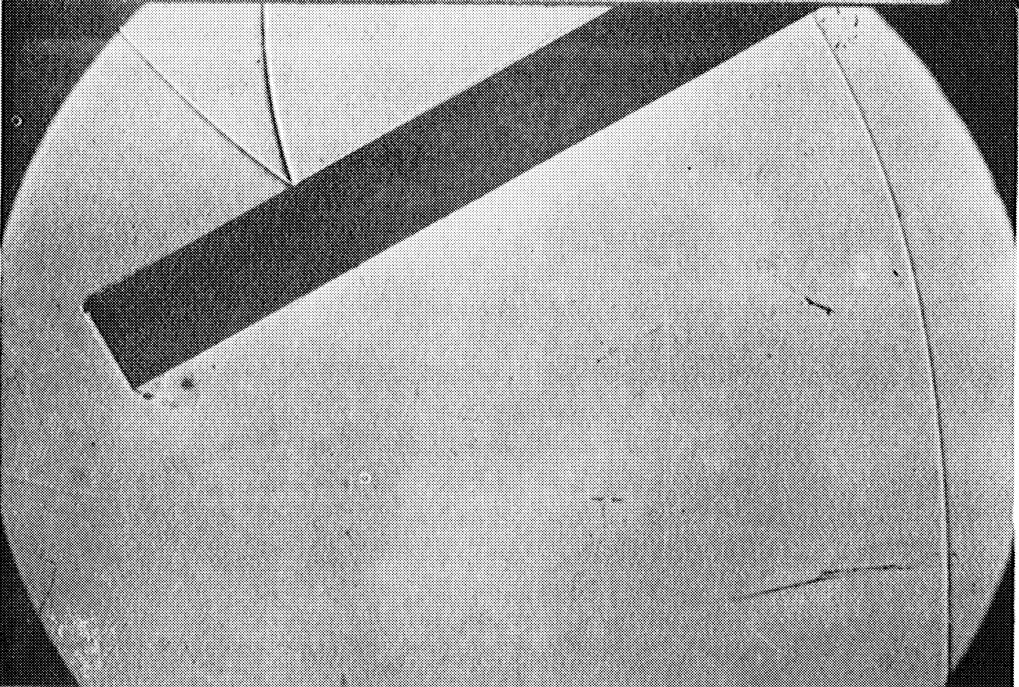

Fig. 3

$M = 1.1$   
 $t = 292$

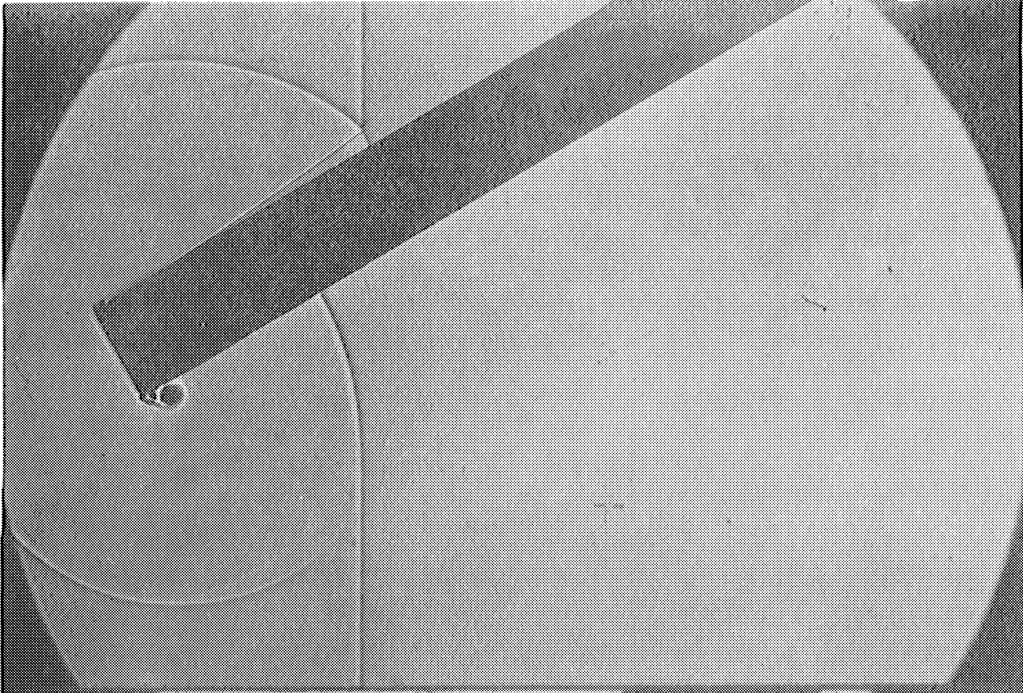

Fig. 4

$M = 1.2$   
 $t = 85$

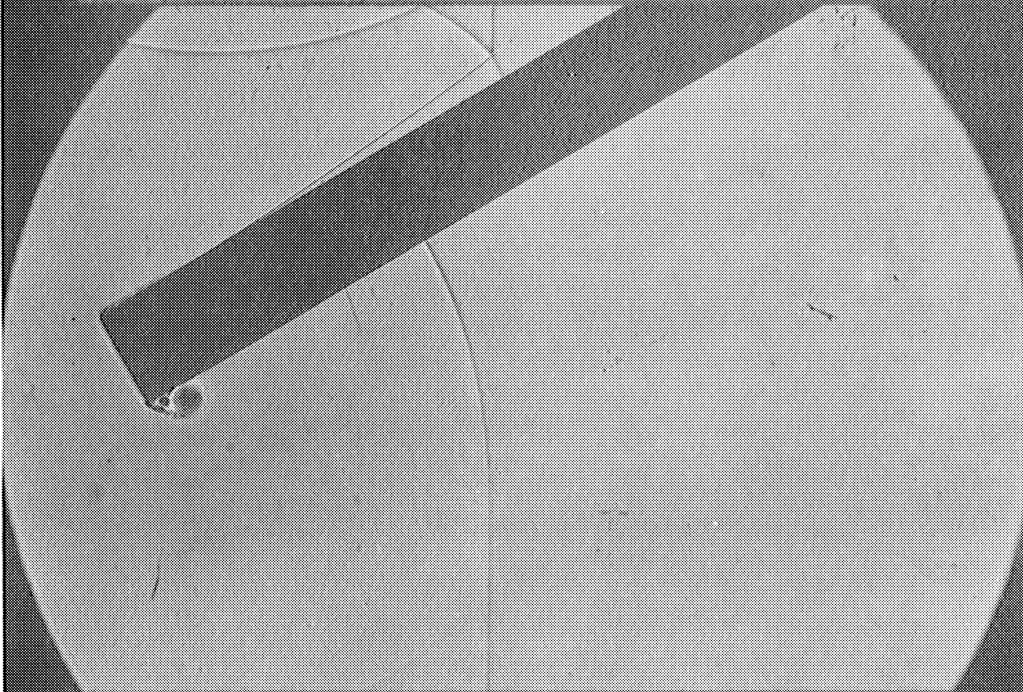

Fig. 5

$M = 1.2$   
 $t = 126$

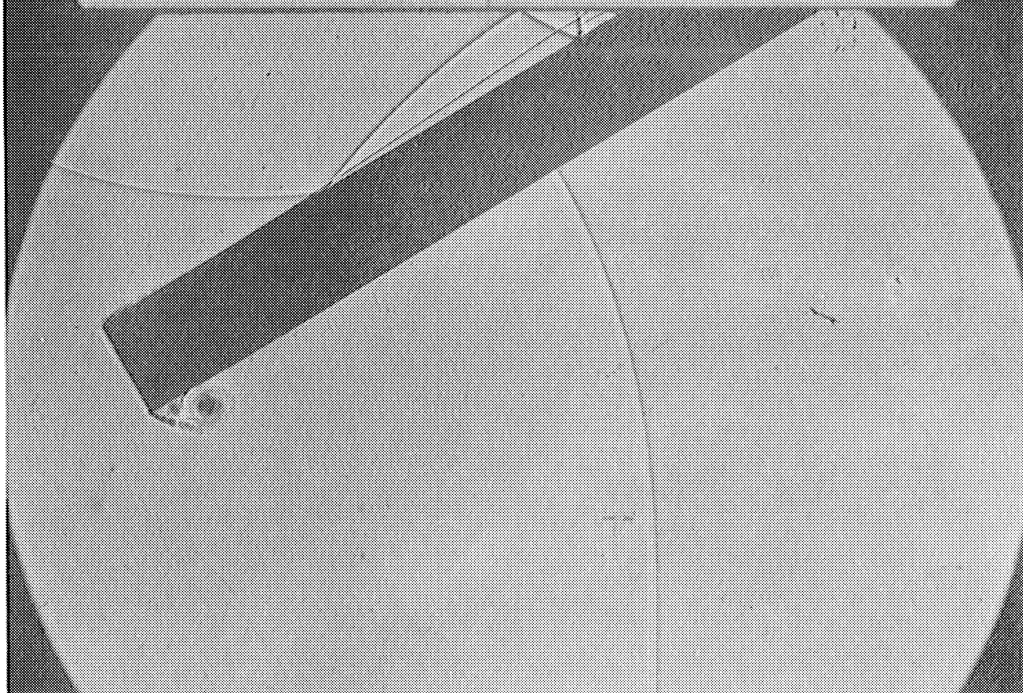

Fig. 6

$M = 1.2$   
 $t = 175$



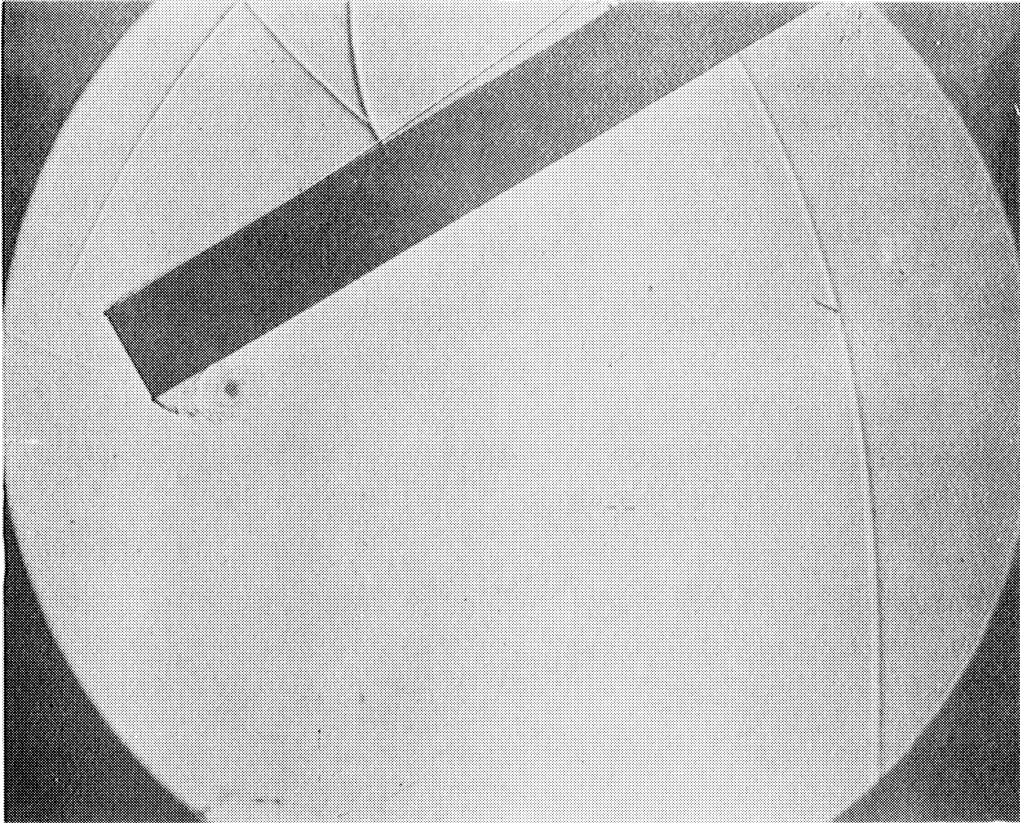

Fig. 7

$M = 1.2$   
 $t = 267$

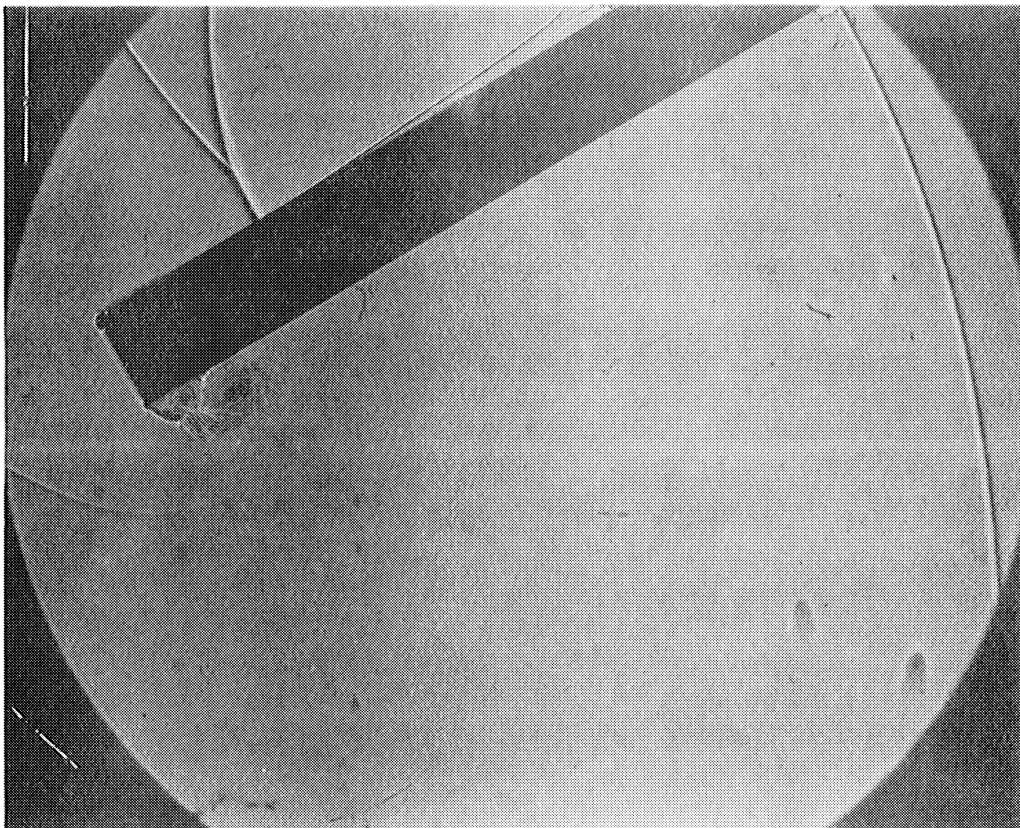

Fig. 8

$M = 1.2$   
 $t = 285$

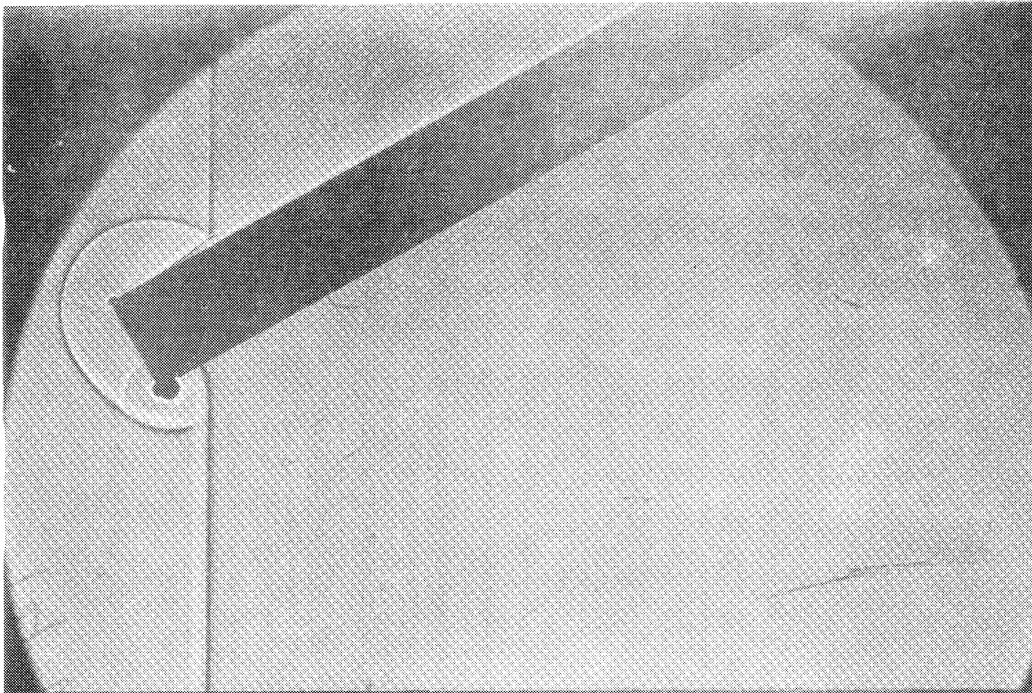

Fig. 9

$M = 1.3$   
 $t = 28$

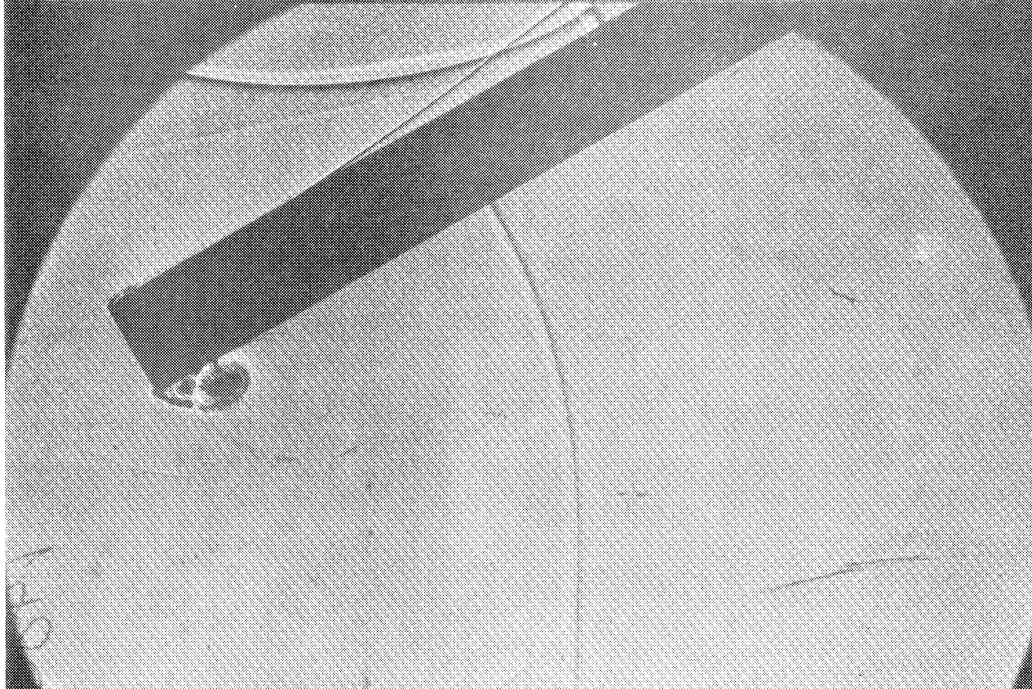

Fig. 10

$M = 1.3$   
 $t = 134$

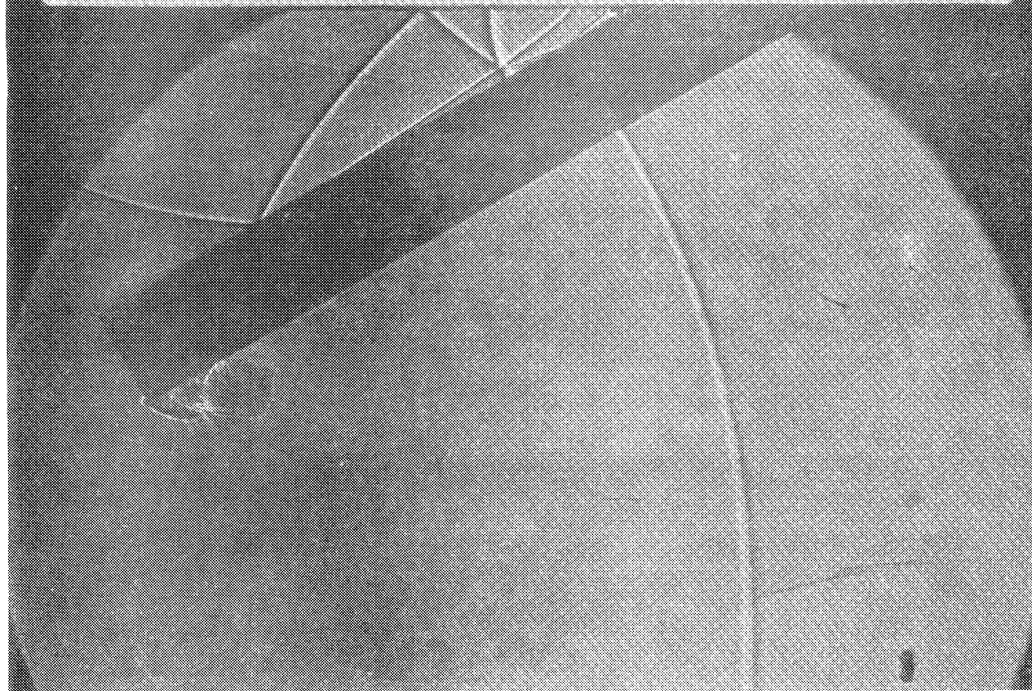

Fig. 11

$M = 1.3$   
 $t = 189$

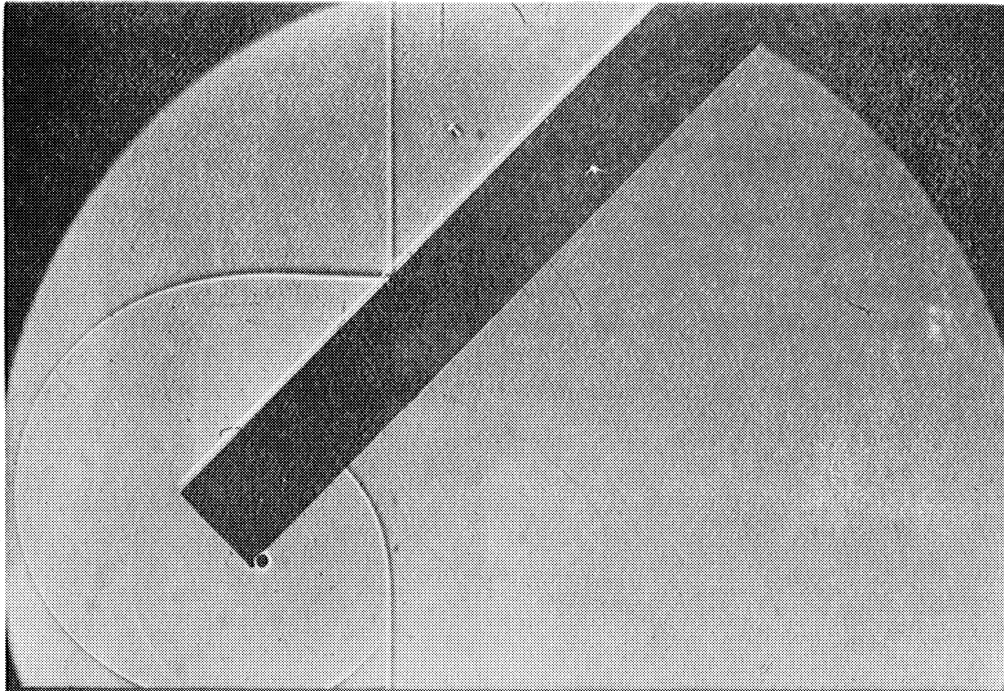

Fig. 12

$M = 1.1$   
 $t = 72$

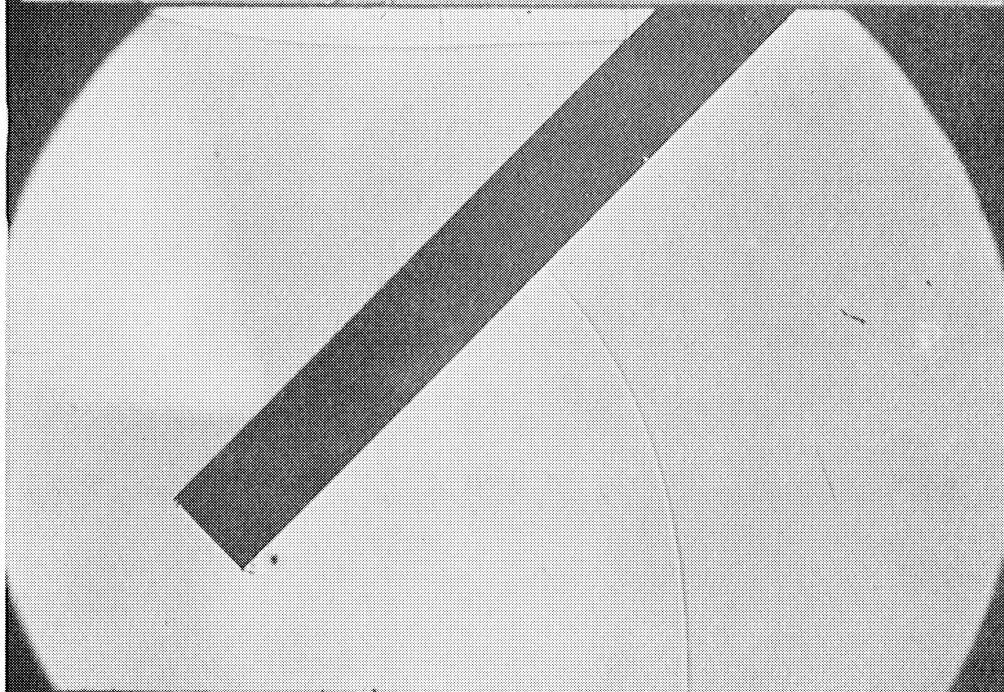

Fig. 13

$M = 1.1$   
 $t = 178$

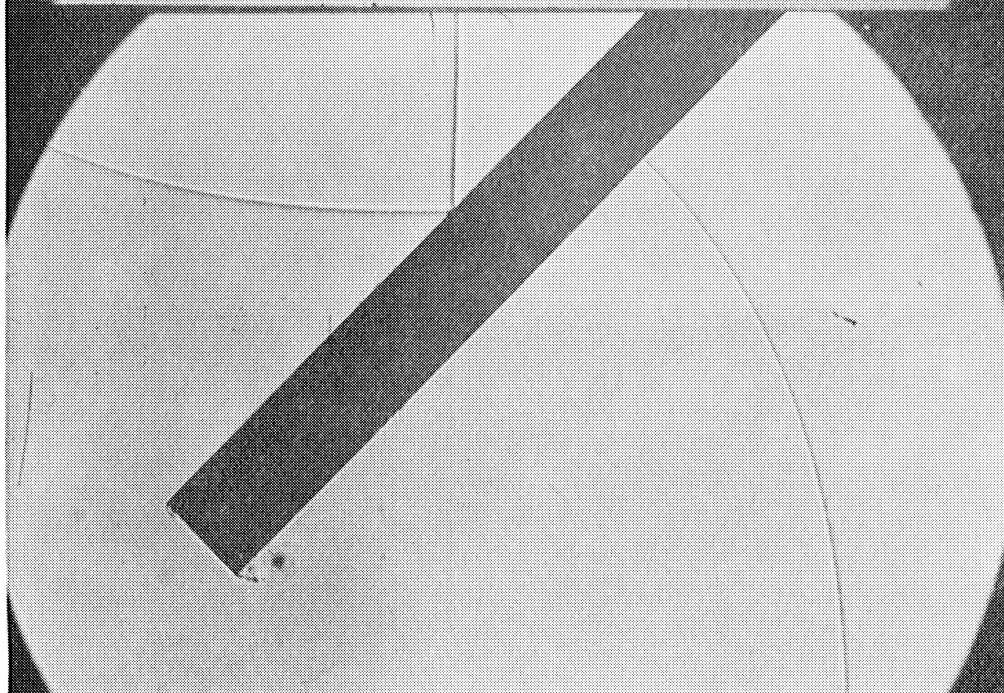

Fig. 14

$M = 1.1$   
 $t = 237$

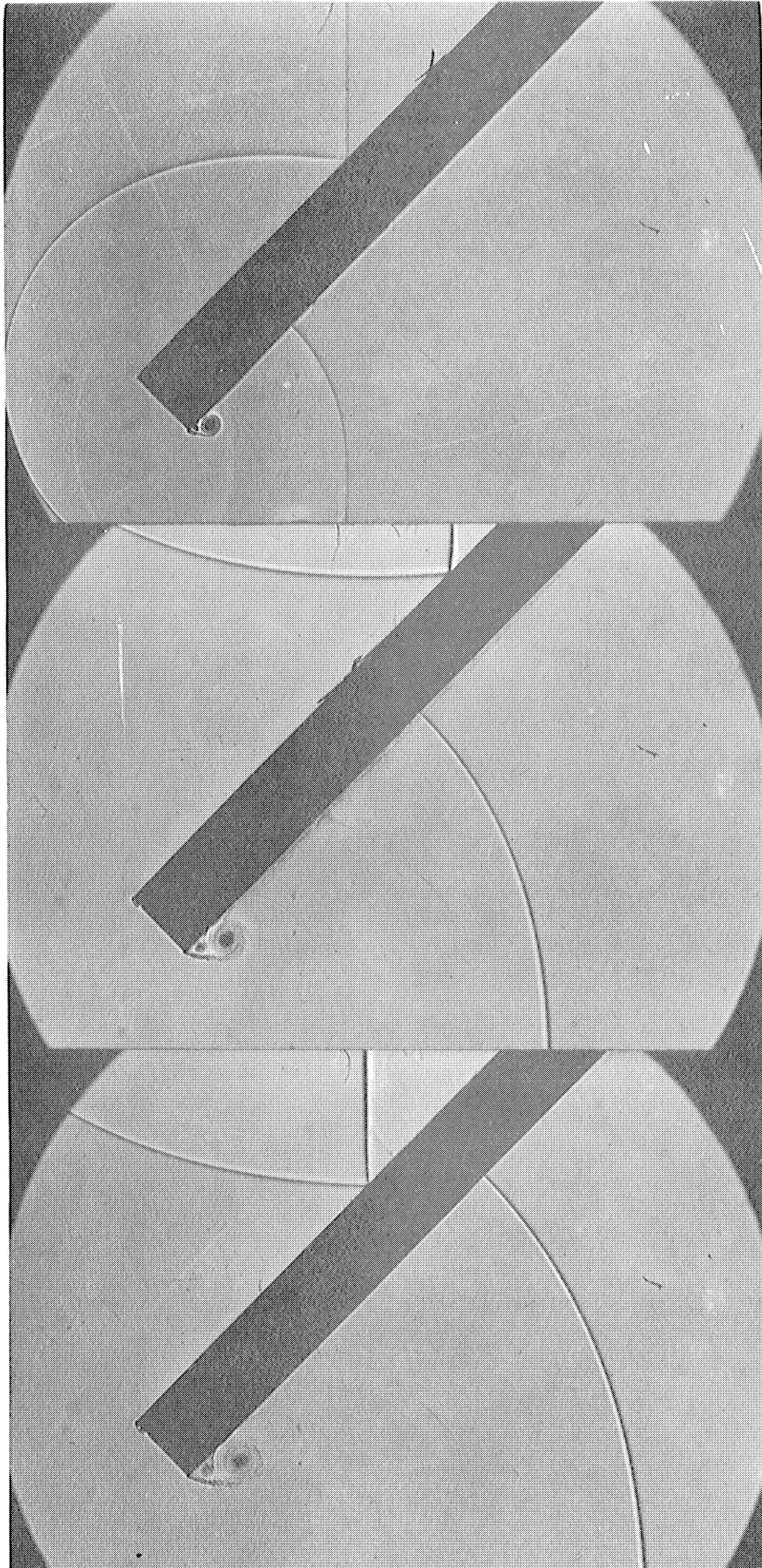

Fig. 15

$M = 1.2$   
 $t = 86$

Fig. 16

$M = 1.2$   
 $t = 173$

Fig. 17

$M = 1.2$   
 $t = 213$

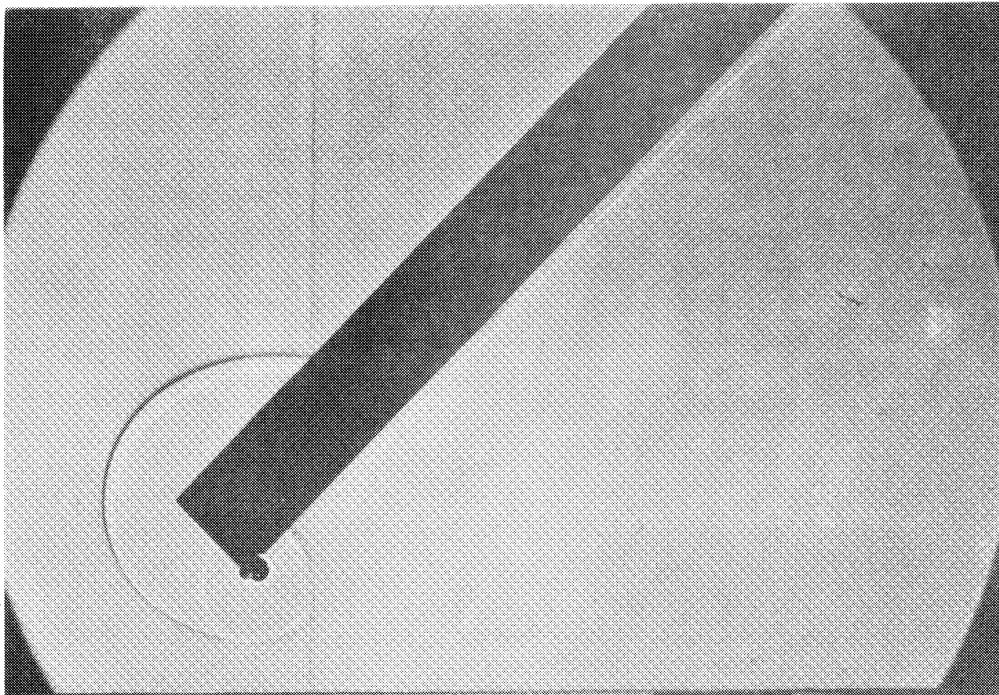

Fig. 18

$M = 1.3$   
 $t = 39$

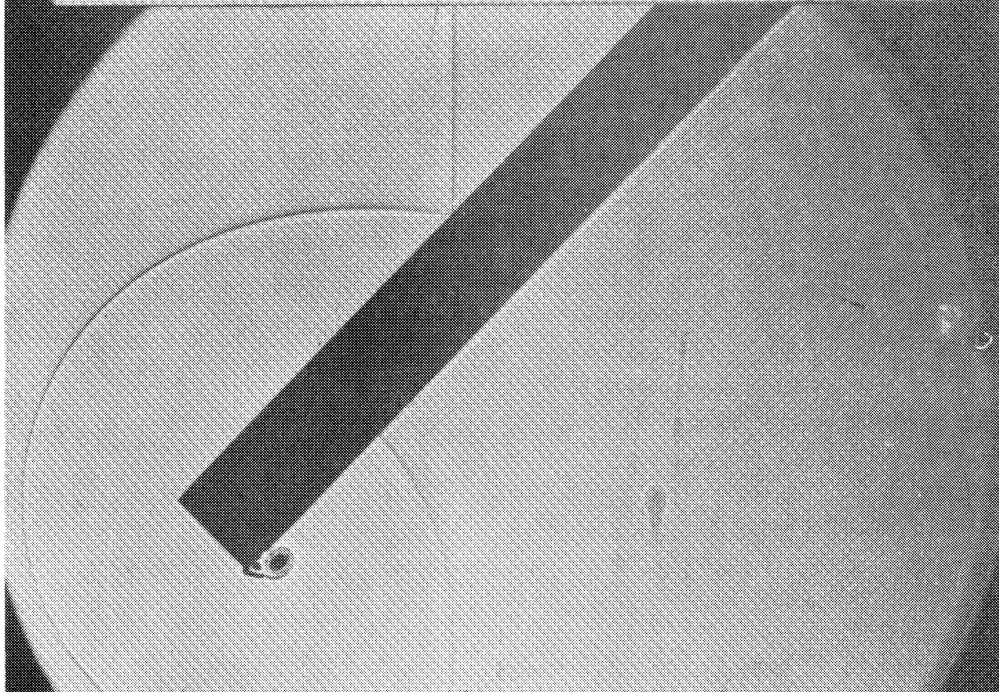

Fig. 19

$M = 1.3$   
 $t = 82$

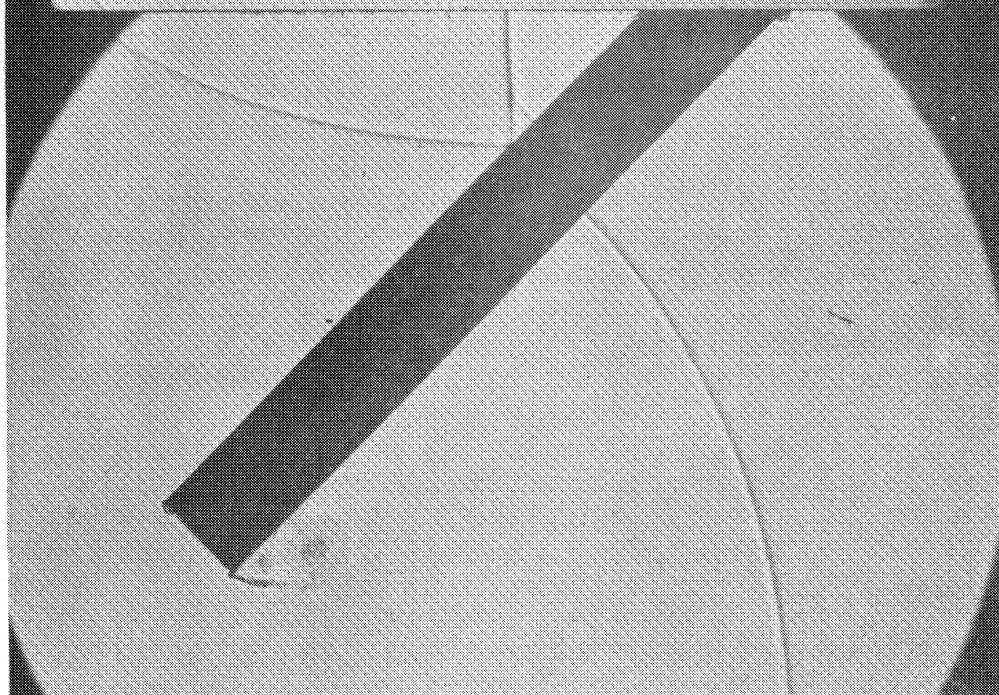

Fig. 20

$M = 1.29$   
 $t = 184$

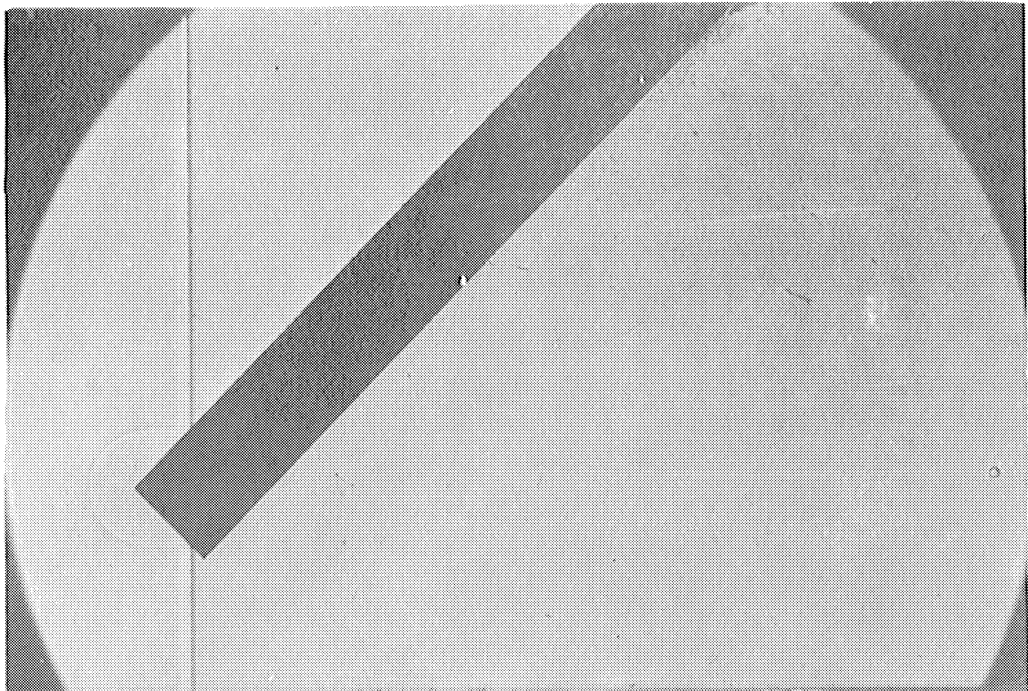

Fig. 21

$M = 1.1$   
 $t = 18$

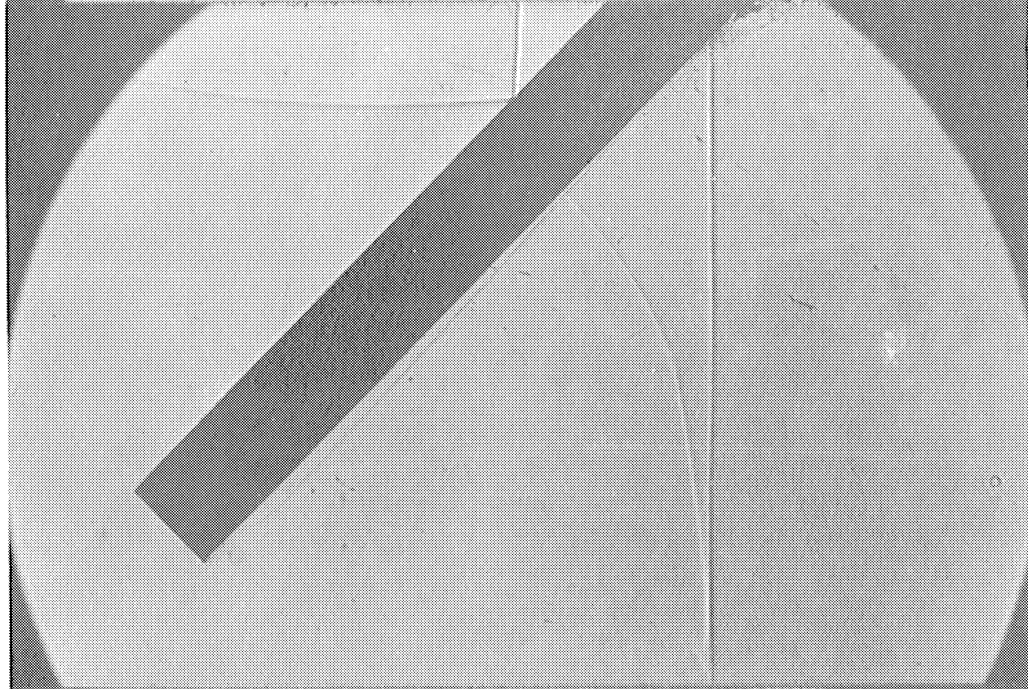

Fig. 22

$M = 1.1$   
 $t = 199$

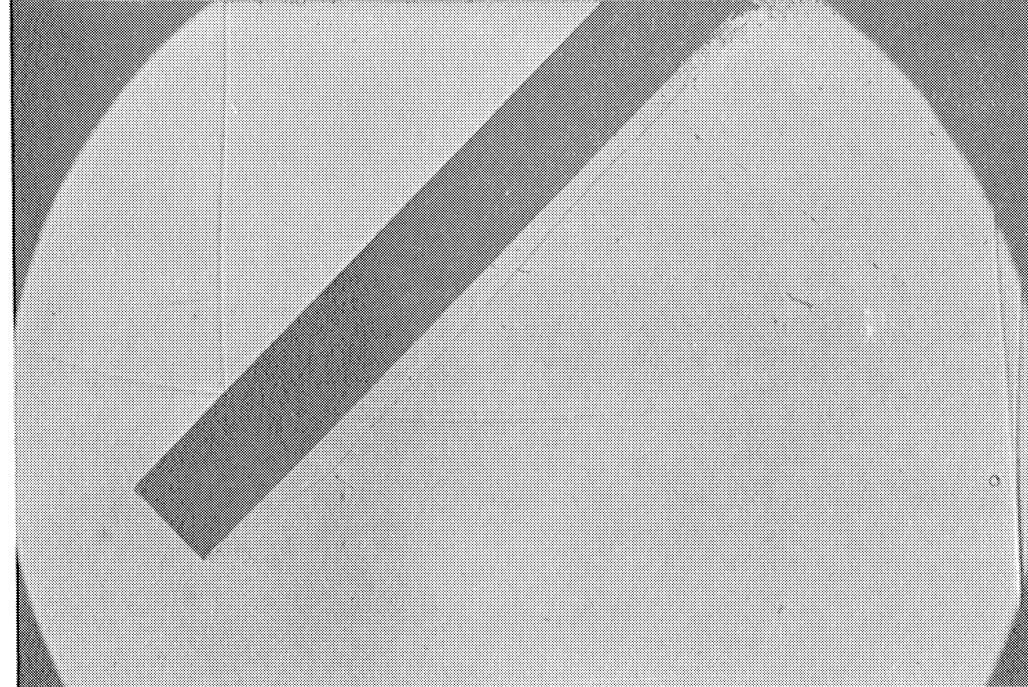

Fig. 23

$M = 1.1$   
 $t = 305$

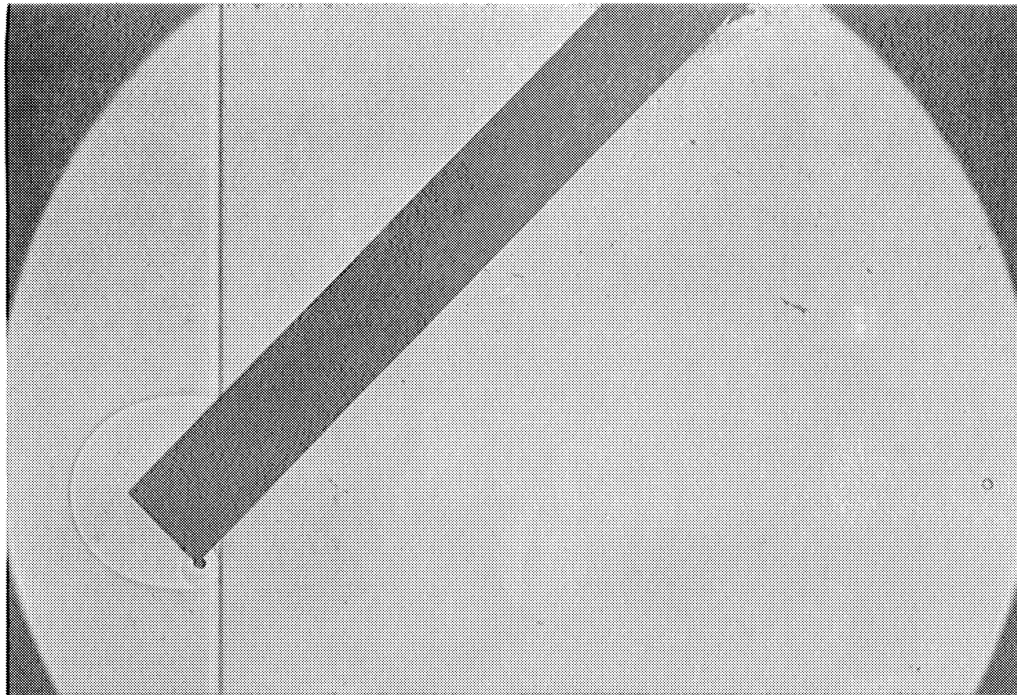

Fig. 24

$M = 1.2$   
 $t = 30$

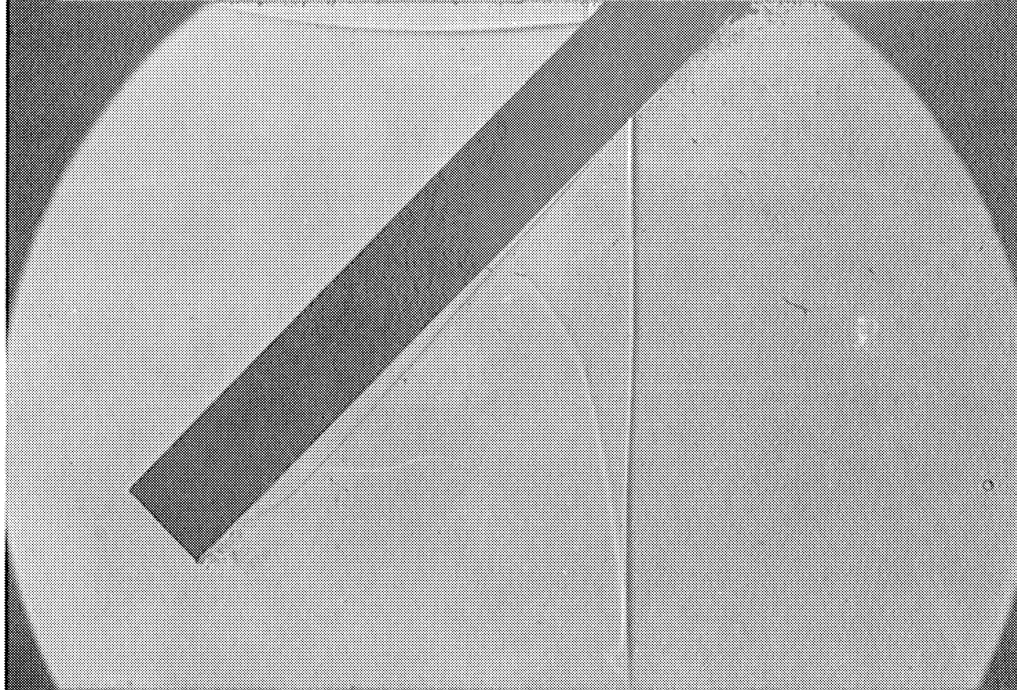

Fig. 25

$M = 1.2$   
 $t = 158$

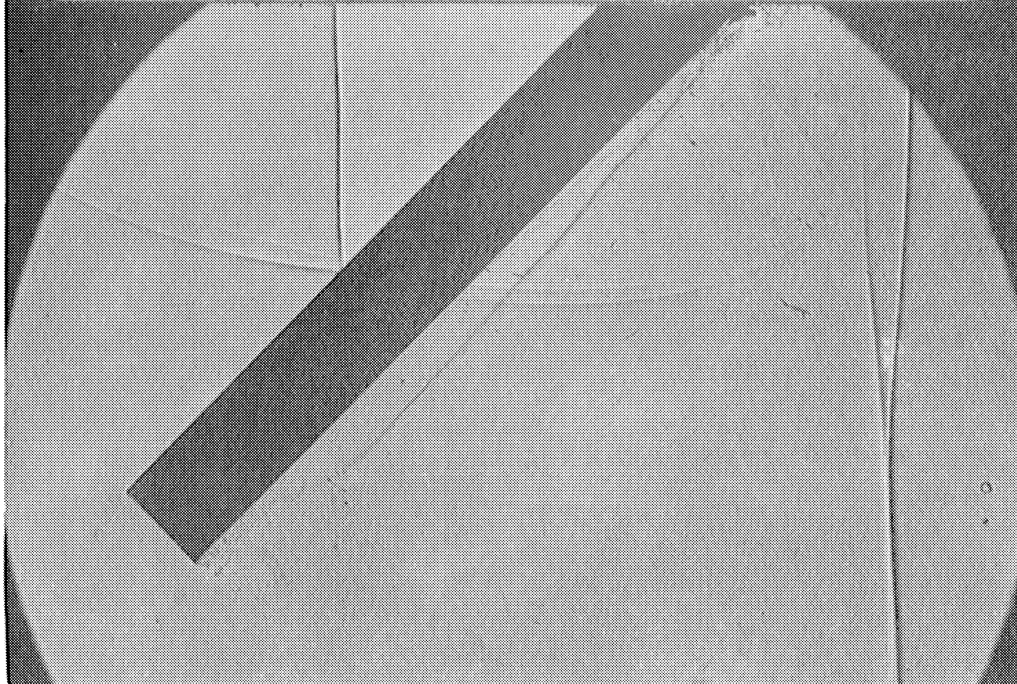

Fig. 26

$M = 1.2$   
 $t = 244$

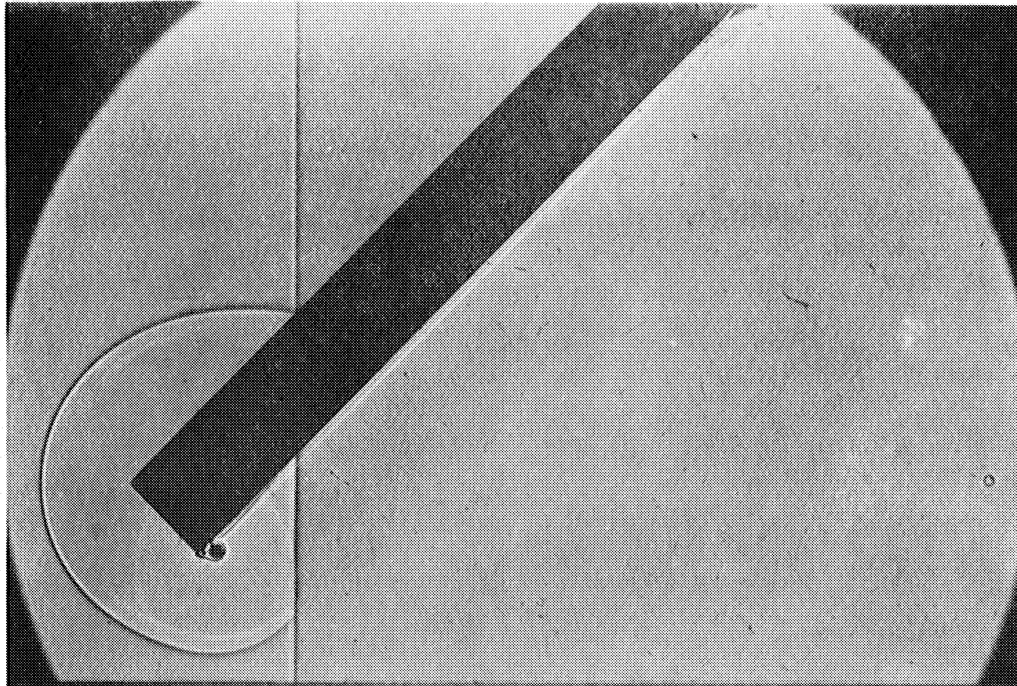

Fig. 27

$M = 1.3$   
 $t = 49$

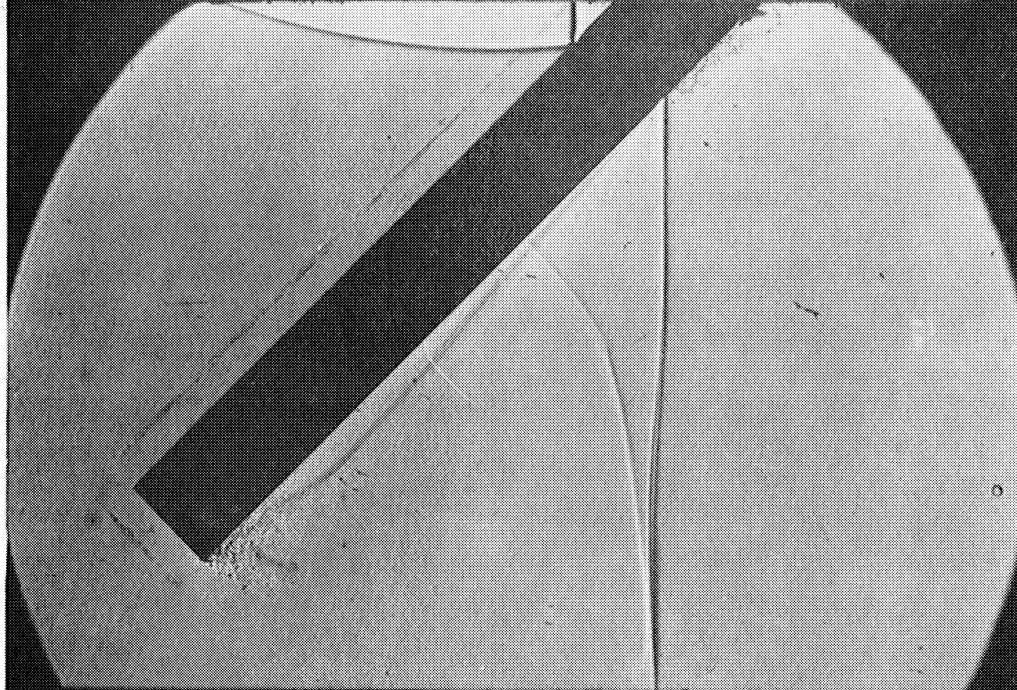

Fig. 28

$M = 1.3$   
 $t = 155$

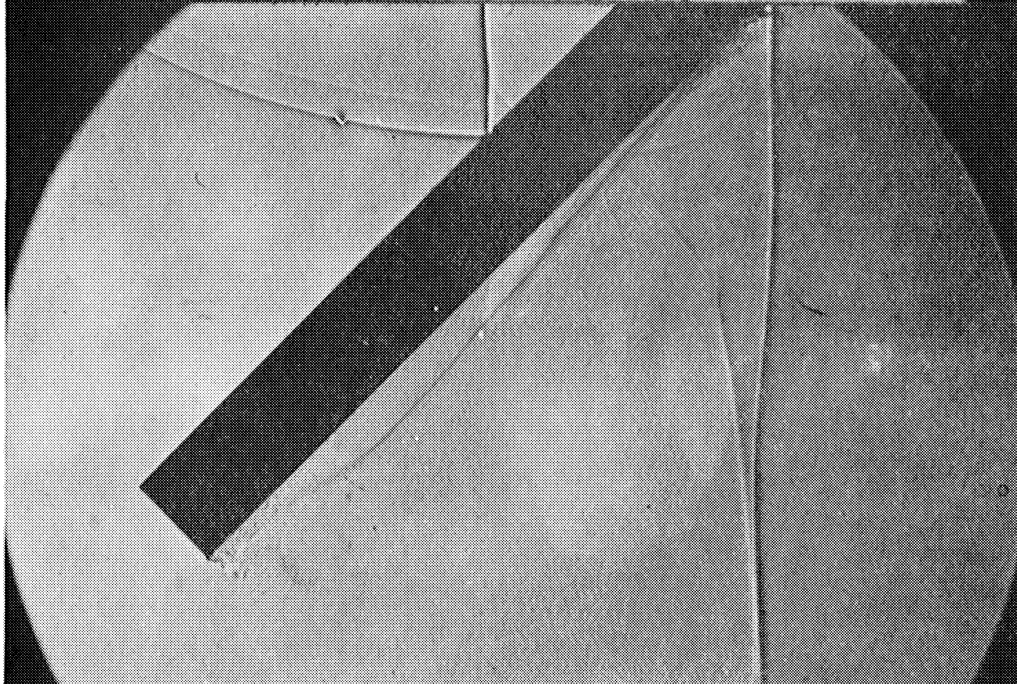

Fig. 29

$M = 1.3$   
 $t = 184$



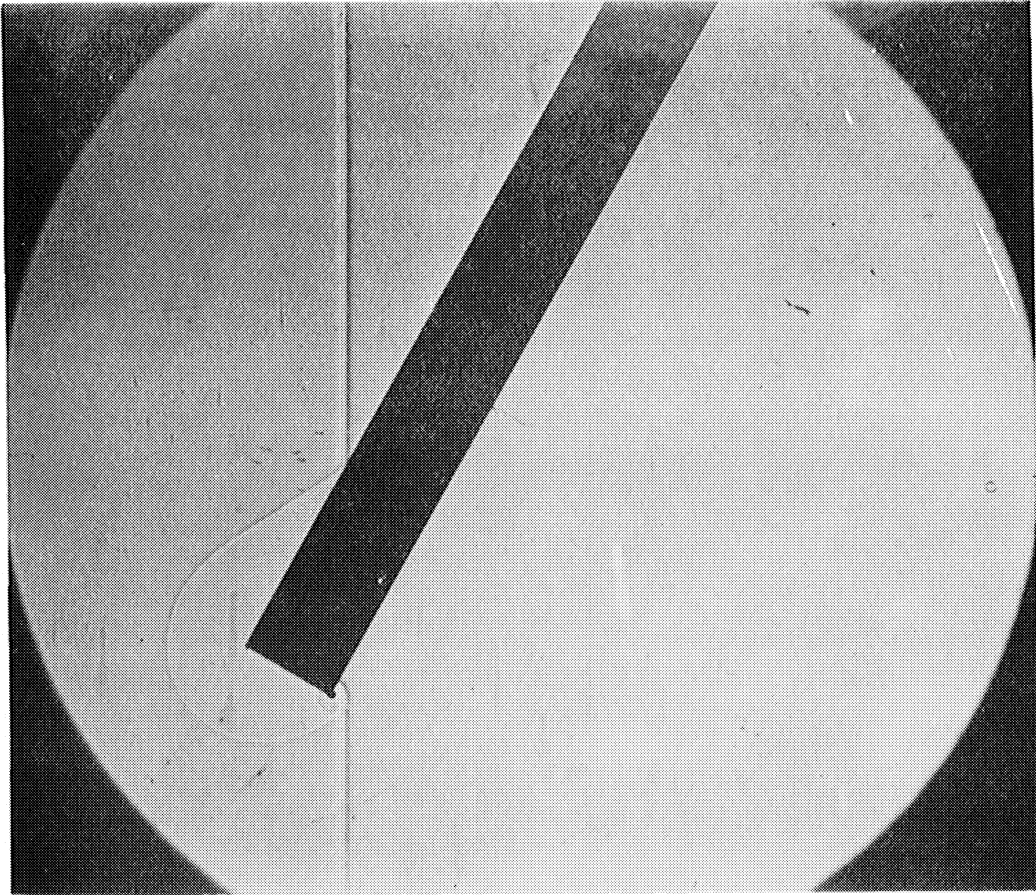

Fig. 30

M = 1.1  
t = 35

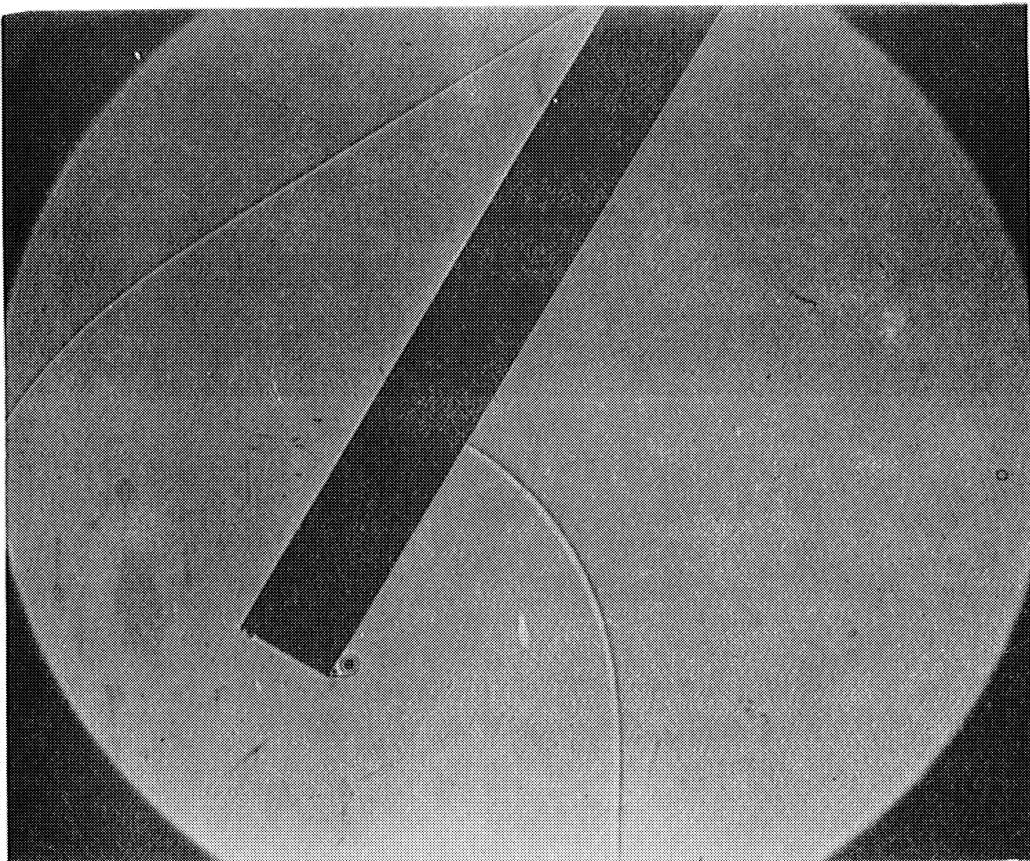

Fig. 31

M = 1.1  
t = 126

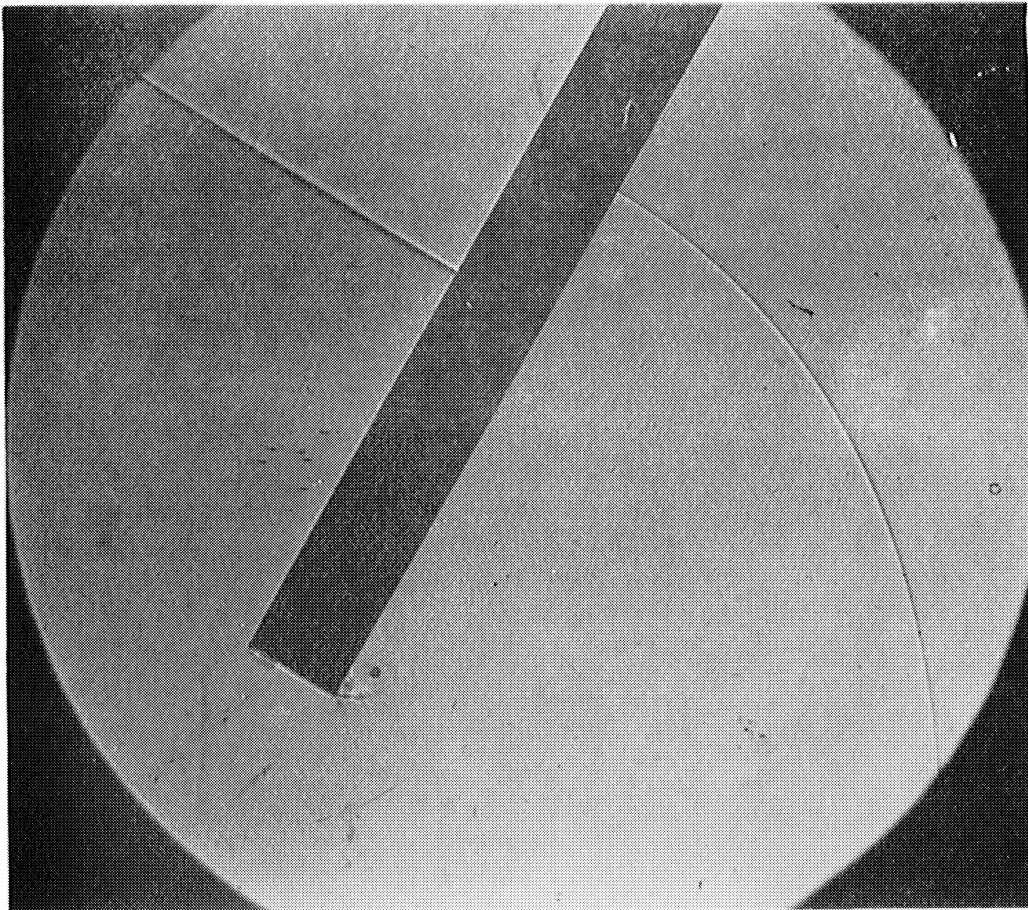

Fig. 32

$M = 1.1$   
 $t = 240$

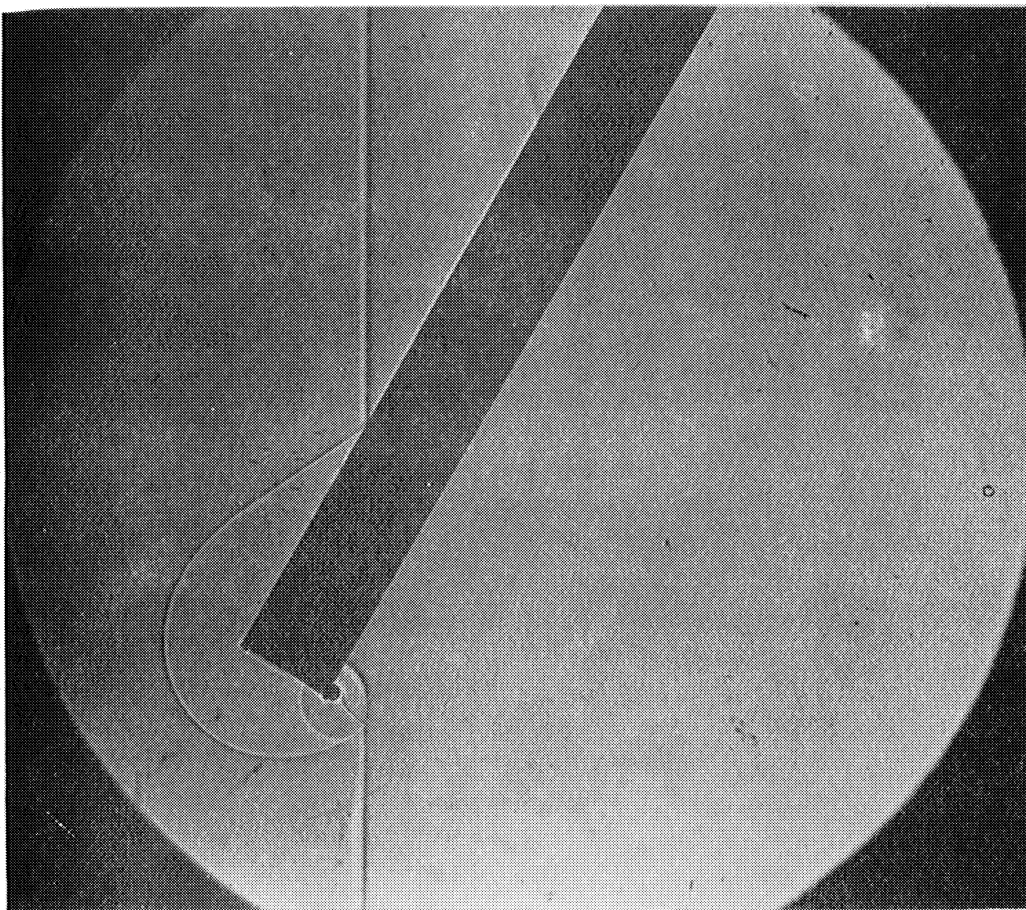

Fig. 33

$M = 1.2$   
 $t = 39$

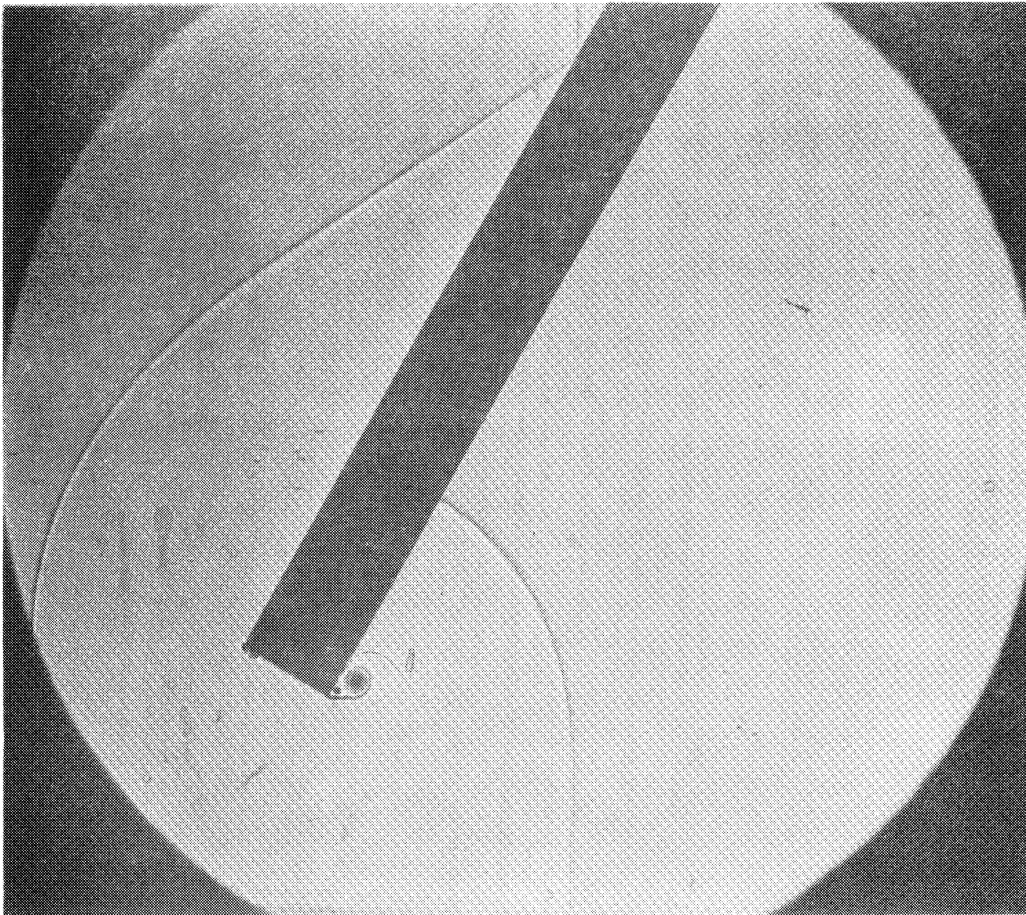

Fig. 34

$M = 1.2$   
 $t = 104$

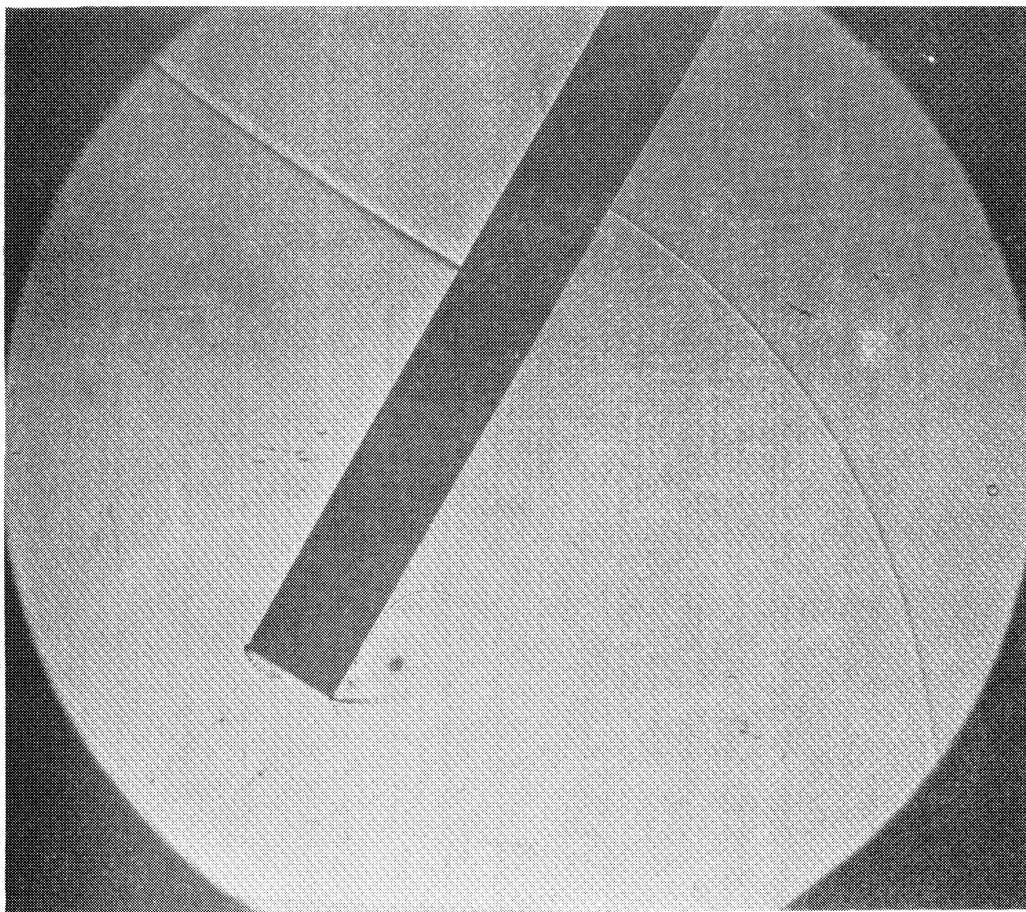

Fig. 35

$M = 1.2$   
 $t = 221$

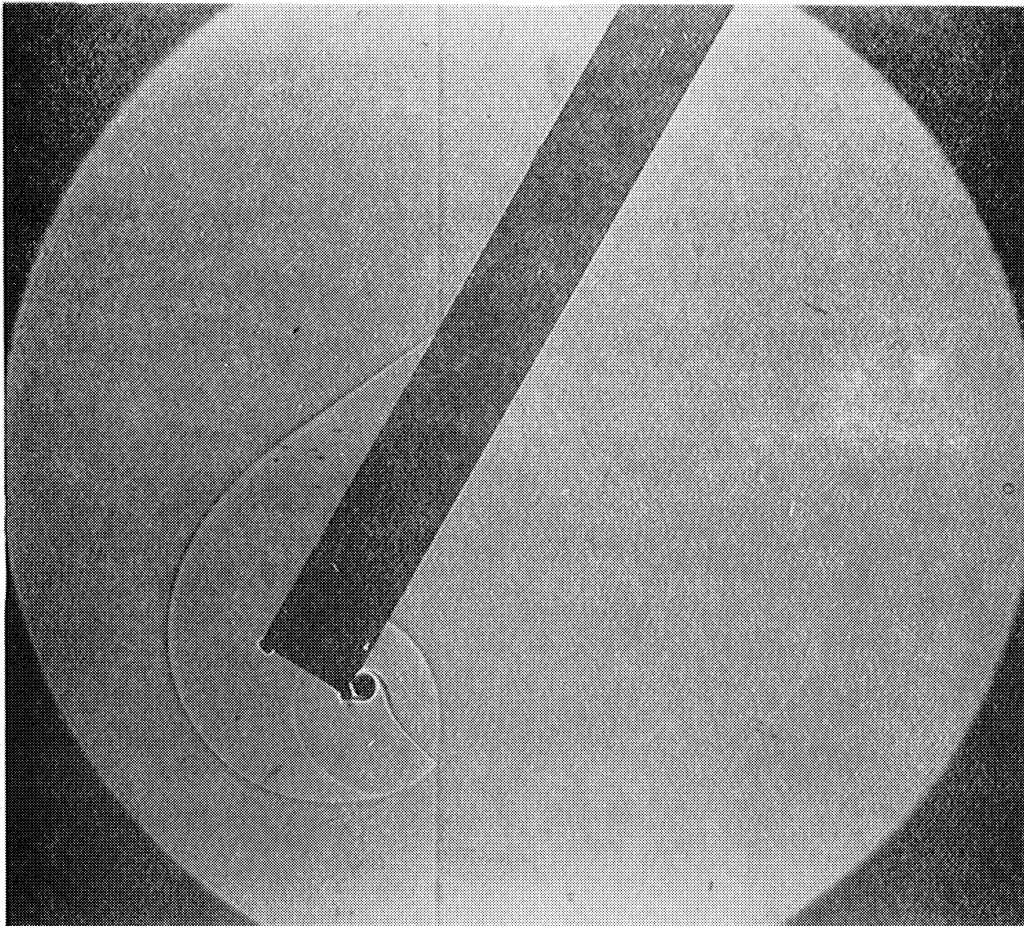

Fig. 36

$M = 1.3$   
 $t = 51$

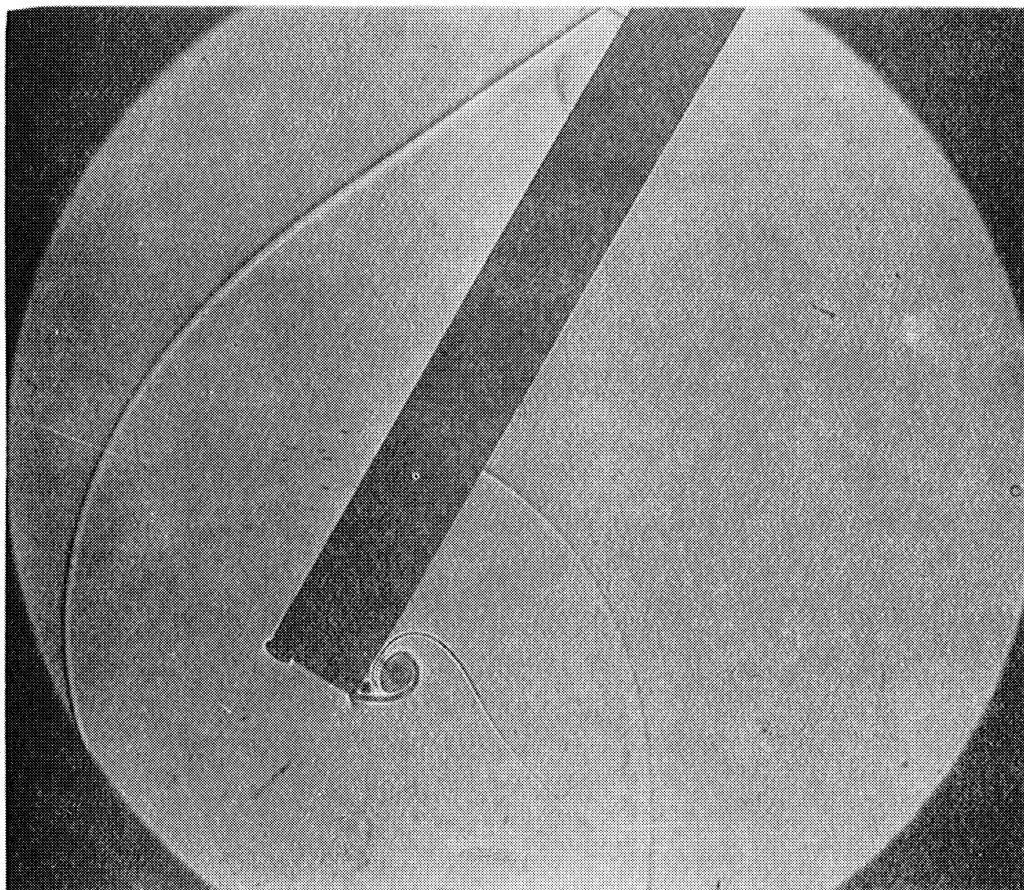

Fig. 37

$M = 1.3$   
 $t = 110$

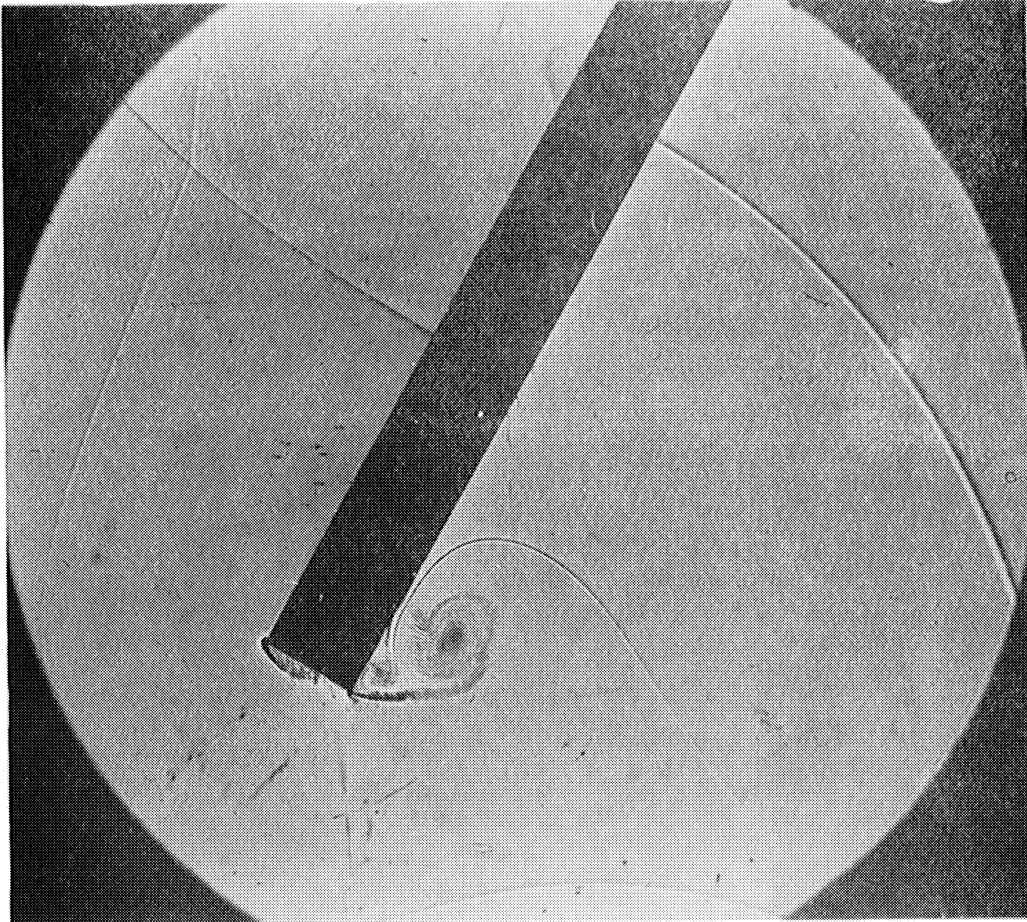

Fig. 38

$M = 1.3$   
 $t = 229$

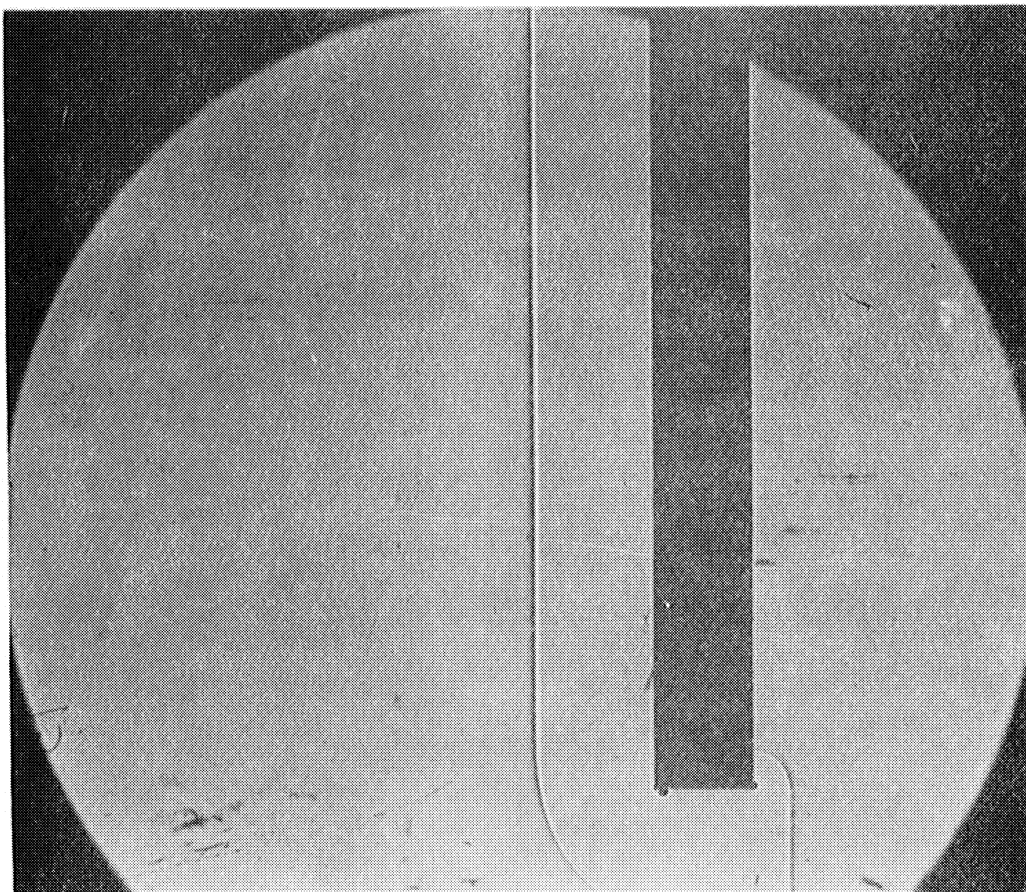

Fig. 39

$M = 1.1$   
 $t = 49$

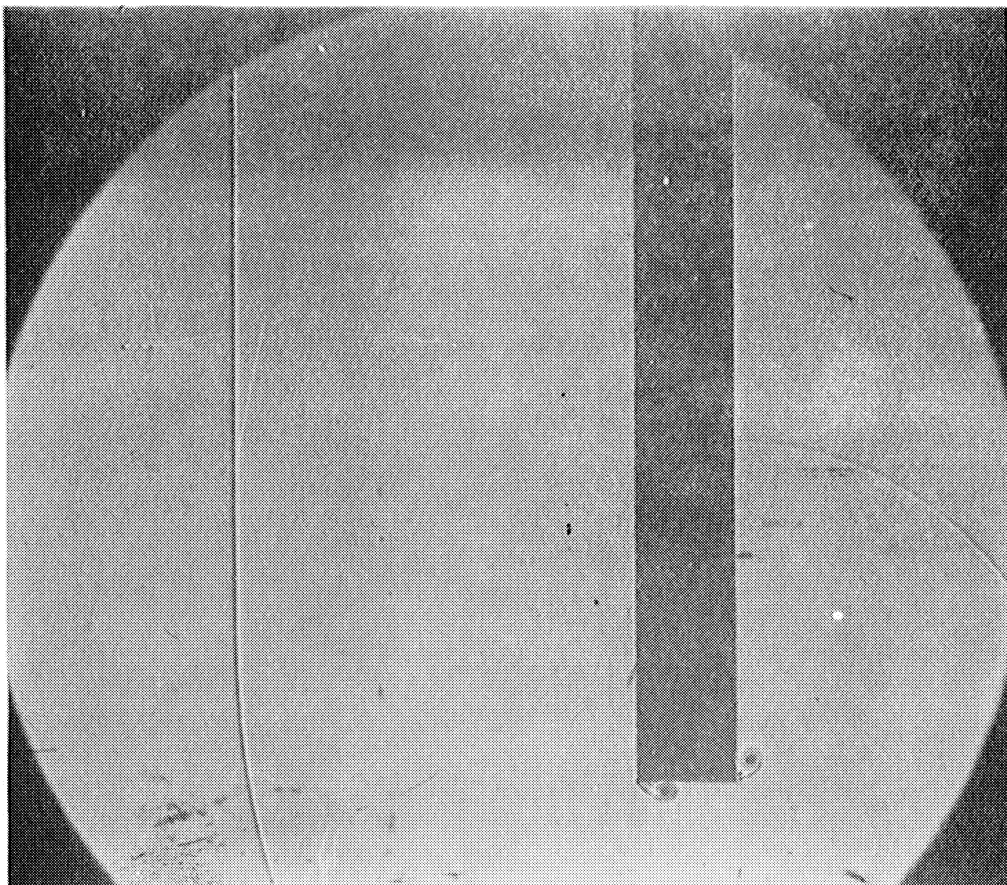

Fig. 40

$M = 1.1$   
 $t = 159$

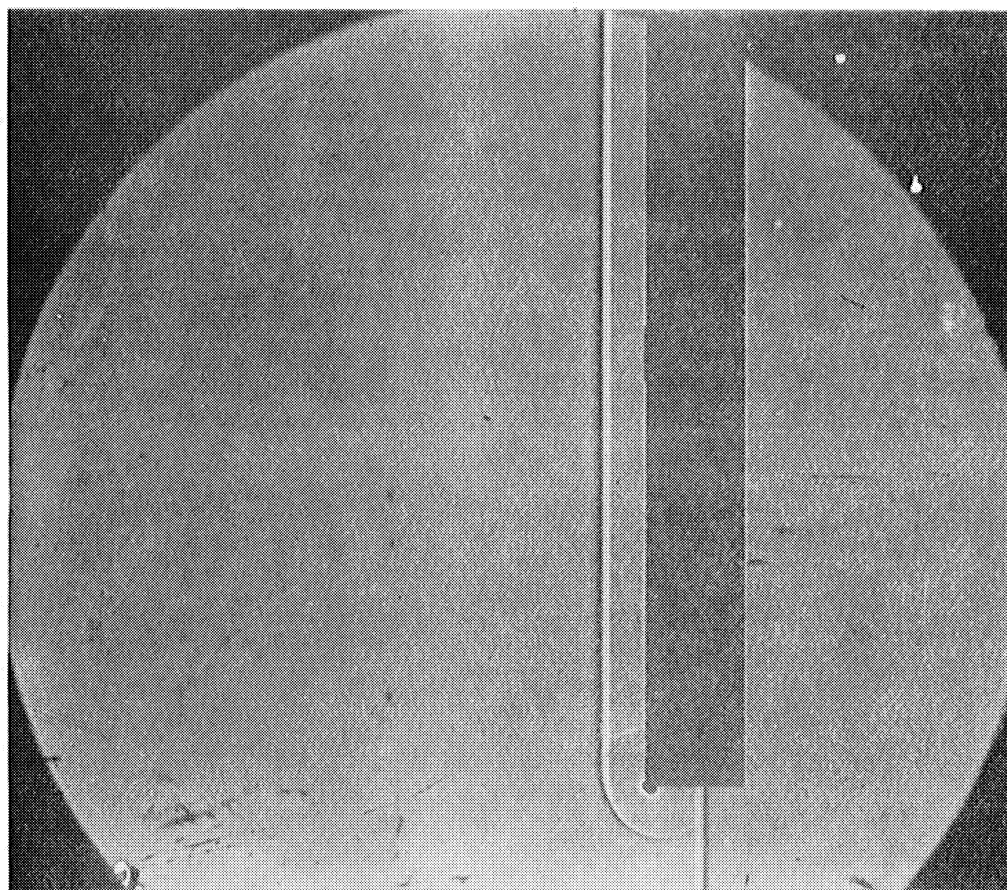

Fig. 41

$M = 1.2$   
 $t = 19$

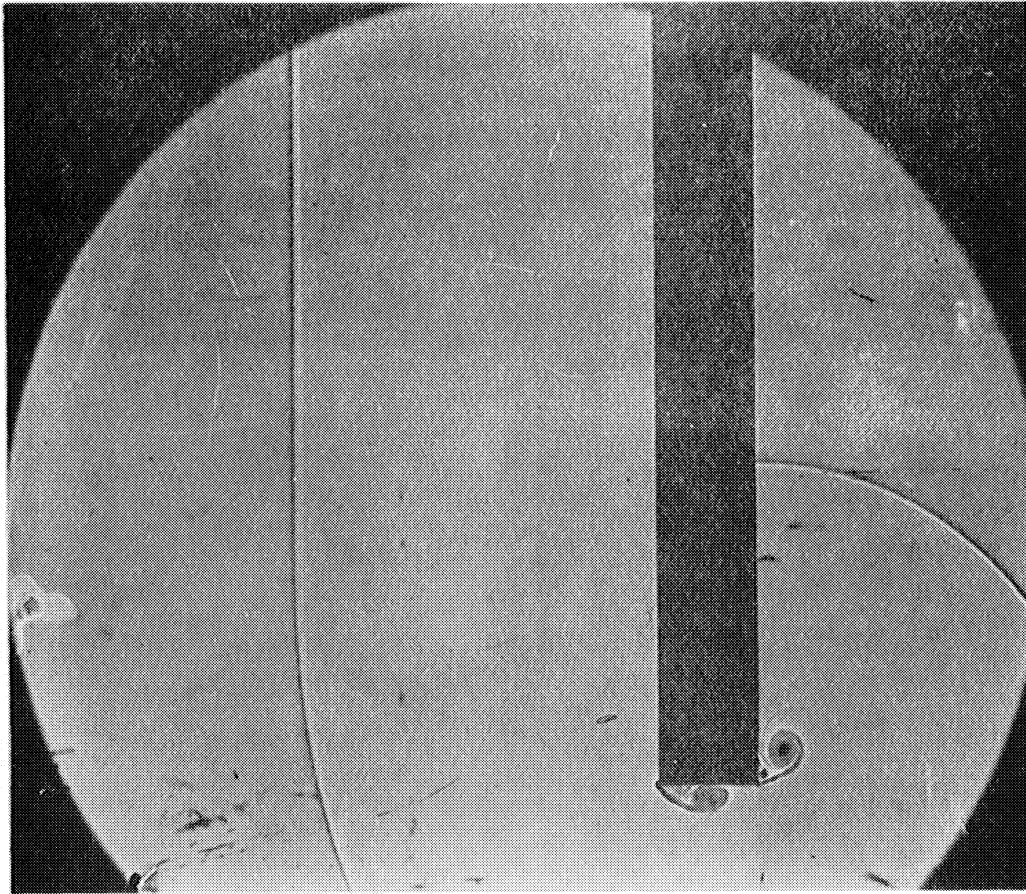

Fig. 42

$M = 1.2$   
 $t = 121$

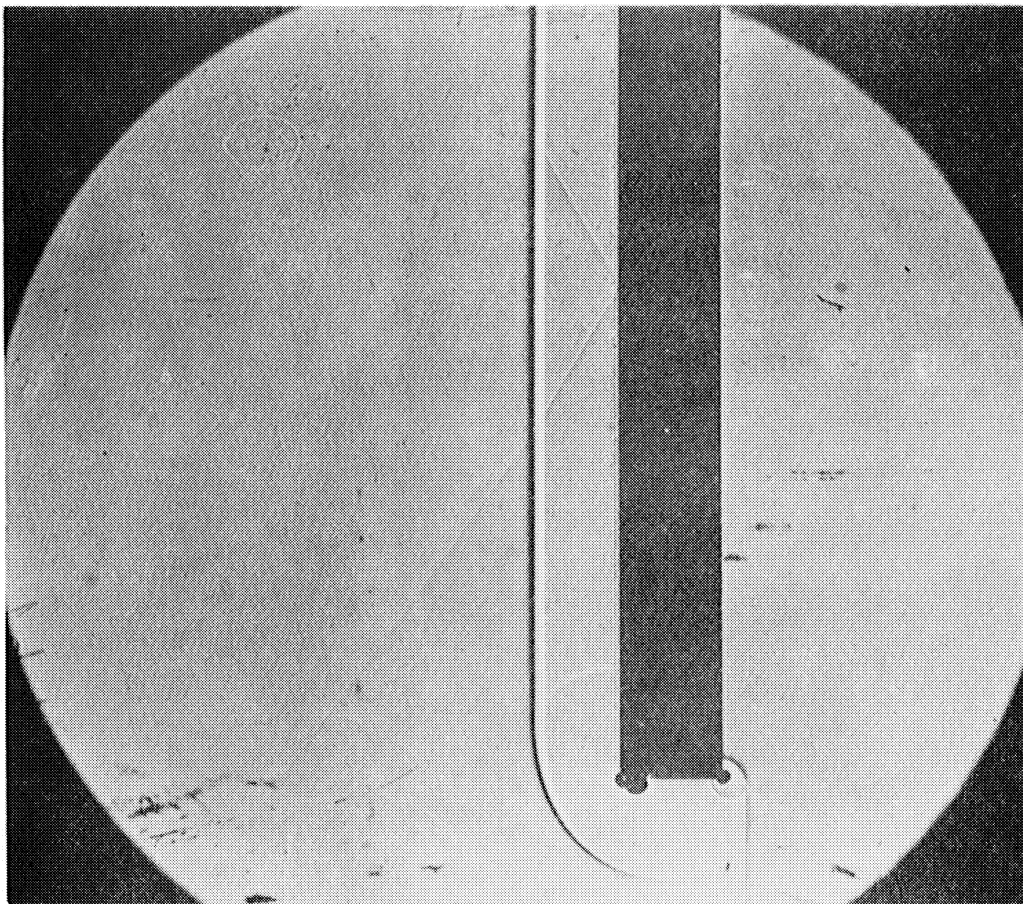

Fig. 43

$M = 1.3$   
 $t = 37$

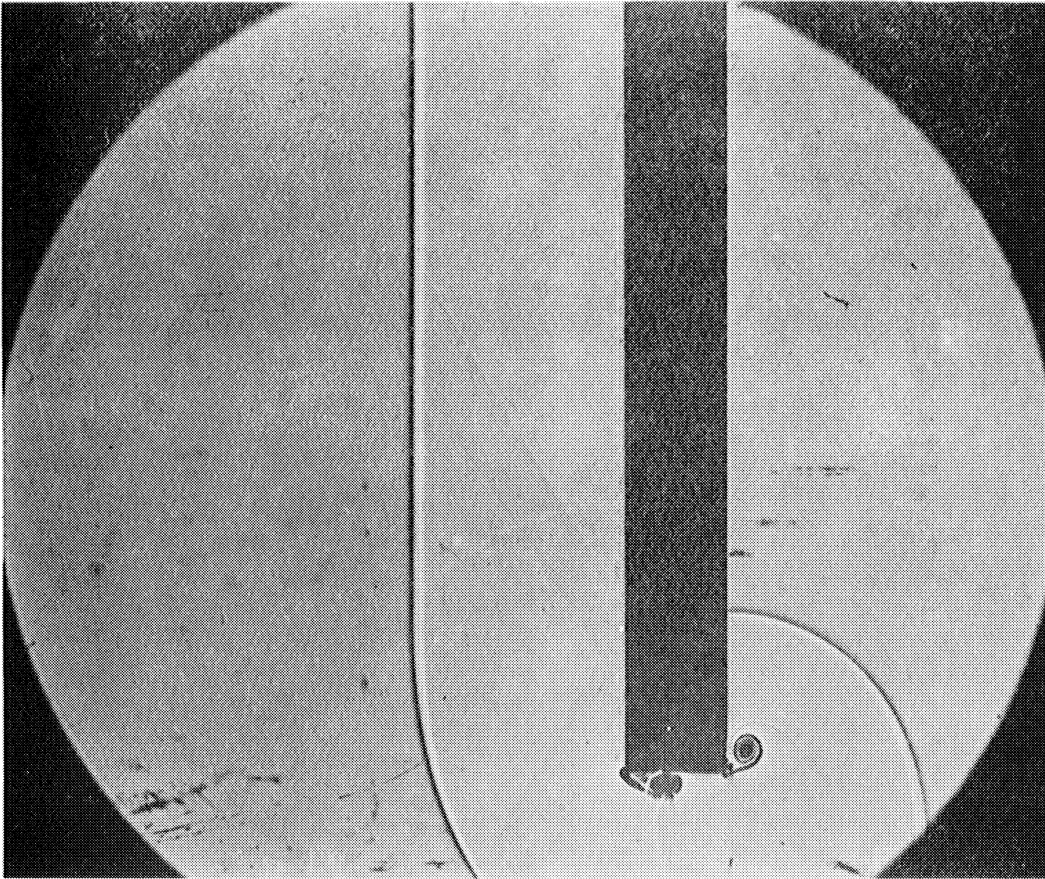

Fig. 44

$M = 1.3$   
 $t = 89$

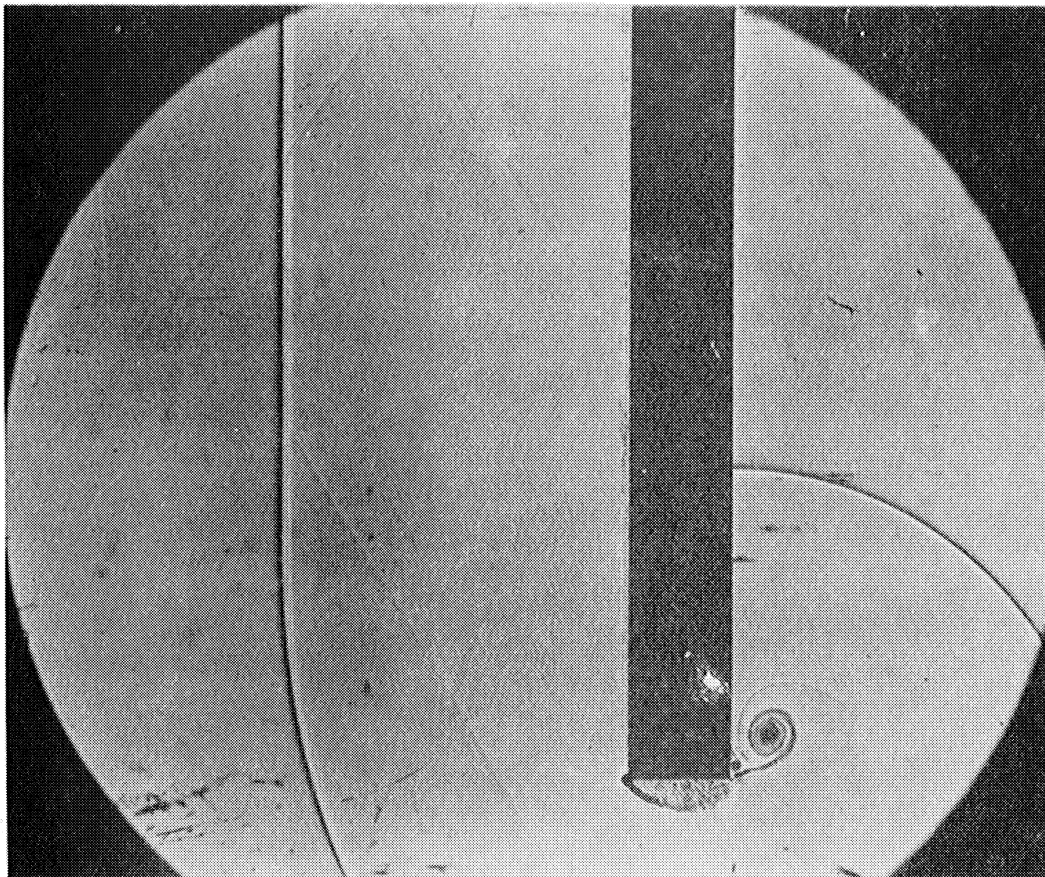
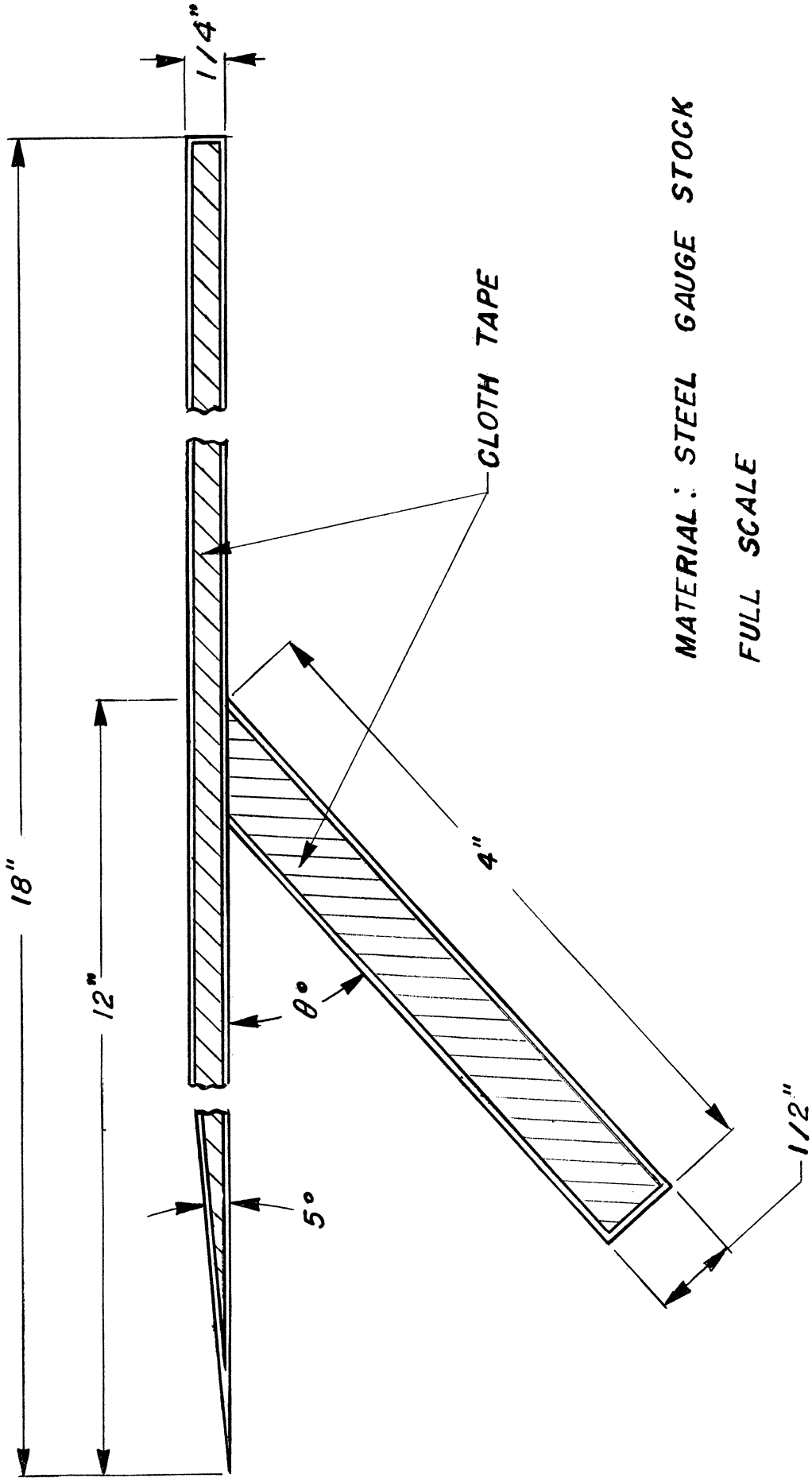

Fig. 45

$M = 1.3$   
 $t = 106$





MATERIAL: STEEL GAUGE STOCK  
 FULL SCALE

FIGURE 46  
 METHOD OF MOUNTING MODEL

DISTRIBUTION LIST

ARMY:	COPIES
Commanding Officer Ballistic Research Laboratory Aberdeen Proving Ground Aberdeen, Maryland ATTN: Dr. C. W. Lampson	1
Commanding Officer Watertown Arsenal Watertown, Massachusetts ATTN: Laboratory Division	2
Commanding Officer Frankford Arsenal Philadelphia, Pa. ATTN: Laboratory Division	2
Commanding General Army Chemical Center Technical Command Edgewood, Maryland ATTN: Col. J. A. MacLaughlin	1
NAVY:	
Commanding Officer Naval Ordnance Laboratory White Oak, Maryland ATTN: Dr. G. K. Hartmann Library Room 1-333	2
Chief, Bureau of Yards and Docks Department of the Navy Washington 25, D. C. ATTN: Plans and Research	2
Officer in Charge Naval Civil Engineering Research and Evaluation Laboratory Naval Station Port Hueneme, California	1

## AIR FORCE:

COPIES

Air Force Cambridge Research Laboratory  
230 Albany Street  
Cambridge, Massachusetts  
ATTN: ERHS-1, Geophysical Research Library

1

Director of Intelligence  
Headquarters, U. S. Air Force  
Washington 25, D. C.  
ATTN: Air Targets Division  
Physical Vulnerability Branch

2

Chief  
Research Division  
Research and Development Directorate  
Office DCS, Development  
Headquarters, U. S. Air Force  
Washington 25, D. C.

1

Director of Intelligence  
Headquarters, U. S. Air Force  
Washington 25, D. C.  
ATTN: Mr. D. H. Gagon  
Air Targets Division

1

## ATOMIC ENERGY COMMISSION:

Chairman  
Military Liaison Committee to the  
Atomic Energy Commission  
1901 Constitution Avenue, N.W.  
Washington 25, D. C.

1

J-1 Division  
Los Alamos Scientific Laboratory  
P.O. Box 1663  
Los Alamos, New Mexico  
ATTN: Dr. A. C. Graves

3

U. S. Atomic Energy Commission  
Division of Research  
Washington 25, D. C.

1

## OTHERS:

Commanding General, Field Command  
Armed Forces Special Weapons Project  
P.O. Box 5100  
Albuquerque, New Mexico

1

OTHERS (Cont'd)	COPIES
Dr. E. B. Doll Stanford Research Institute Palo Alto, California	1
Dr. R. P. Peterson Director, Applied Physics Division Sandia Corporation Albuquerque, New Mexico	2
RAND Corporation 1500 4th Street Santa Monica, California ATTN: Dr. E. H. Plesset	2
Dr. S. Raynor Armour Research Foundation Illinois Institute of Technology Chicago, Illinois	1
Professor R. L. Bisplinghoff Massachusetts Institute of Technology Cambridge 39, Massachusetts	1
Dr. R. J. Hansen Massachusetts Institute of Technology Cambridge 39, Massachusetts	1
Dr. N. M. Newmark 111 Talbot Laboratory University of Illinois Urbana, Illinois	1
Dr. Walker Bleakney Department of Physics Princeton University Princeton, New Jersey	1
Office of Naval Research Department of the Navy Washington 25, D. C. ATTN: Code 438	5
Chief, AFSWP P.O. Box 2610 Washington 25, D. C. ATTN: Blast Branch	10

