

TUNABLE ELECTRICALLY SMALL ANTENNAS  
FOR 30 - 100 MHZ OPERATION

John A.M. Lyon, Alan G-T Cha and Mohamed A. Hidayet

Distribution limited to U. S. Government agencies only; test and evaluation results reported; June 1971. Other requests for this document must be referred to the Air Force Avionics Laboratory (AFAL/TEM), Wright-Patterson AFB, OH 45433

## FOREWORD

This report, 1770-6-T, was prepared by the Radiation Laboratory of The University of Michigan, Department of Electrical Engineering, 2455 Hayward Street, Ann Arbor, Michigan 48105, under the direction of Professor Ralph E. Hiatt and Professor John A. M. Lyon on Air Force Contract F33615-68-C-1381, Task 627801 of Project 6278, "Study and Investigation of UHF-VHF Antennas". The work was administered under the direction of the Air Force Avionics Laboratory, Wright-Patterson Air Force Base, Ohio 45433. The Task Engineer was Mr. Olin E. Horton and the Project Engineer, Mr. Edwin M. Turner, AFAL/TEM. This report was submitted by the author in April 1971.

Publication of this report does not constitute Air Force approval of the report's findings or conclusions. It is published only for the exchange and stimulation of ideas.



WILLIAM J. EDWARDS  
Chief, Radar & Microwave Technology Br.  
Electronic Technology Division  
Air Force Avionics Laboratory

## ABSTRACT

The possibilities for tunable electrically small antennas are explored and analyzed. Although experimental determinations were made of impedance characteristics from 30 to 220 MHz, the objective was to study the possibility of tuning and bandwidth control for antennas in the range 30 to 100 MHz. A considerable part of the discussion is devoted to acceptable circuit representations or models for the antennas. Both the electric monopole and the folded monopole, each over a conducting ground plane, are considered in detail. The first of these tends to become capacitive as it is operated at progressively lower frequencies whereas the second tends to become inductive as the frequency is decreased.

The practicality of having tunable small antennas is directly associated with the possibilities of remote tuning and remote bandwidth control. Both of these topics were investigated. It appears entirely possible to have such remote control units operable at 30 MHz and above. The present state of the art of transistors would make this more difficult for frequencies approaching 100 MHz. Transistors, however, are currently being produced which show great promise for control units even at this frequency. Fortunately, some phase shift in a transistor is tolerable for the tuning reactance units and the bandwidth control units.

The range required for the tuning unit was thoroughly explored and two examples are given of antennas which are properly tuned by an external tuning unit. The electric monopole studied was electrically small, being less than  $1/4$  of its usual height, when operated at the lower end of the frequency range. Data are presented on the tuning of a folded monopole and show the possibility of operation of this type of antenna with a similar reduction in size. It is apparent that greater reduction factors could be obtained with both of these antennas.



## TABLE OF CONTENTS

I	INTRODUCTION	1
	1.1 Noise	2
	1.2 Tuning and Bandwidth Control	5
	1.3 Physical Circuit Model	8
	1.4 Other Small Antennas	8
II	CIRCUIT REPRESENTATIONS	9
	2.1 Input Impedance of a Short Monopole	9
	2.2 Equivalent Circuits for a Short Monopole	9
III	TECHNIQUES OF TUNING AND MATCHING SMALL ANTENNAS	22
	3.1 Tuning and Matching of a Short Monopole	22
	3.2 Tuning and Matching of a Short Folded Monopole	28
	3.3 Considerations in Broadband Applications	35
	3.4 Experimental Results	37
	3.5 Other Possible Tuning and Matching Techniques	44
IV	CONCLUSIONS	46
	REFERENCES	48

## LIST OF ILLUSTRATIONS

1-1	Average Atmosphere Noise Level in Microvolts/Meter, as a Function of Frequency.	3
1-2	Atmospheric Noise to Antenna Thermal Noise Ratio.	4
1-3	Noise Figure for 2N1405 Transistor.	6
1-4	Block Diagram for Voltage Tunable Antenna.	7
2-1	Calculated Resistance of a Short Monopole: length = 75 cm, diameter = 0.1 cm.	10
2-2	Calculated Reactance of a Short Monopole : length = 75 cm, diameter = 0.1 cm.	11
2-3	Two Equivalent Circuits for a Short Monopole.	12
2-4	Measured Impedance of a 75 cm Monopole: diameter = 0.2 cm. Frequencies are in MHz.	19
2-5	Calculated Input Impedance for a 75 cm Monopole using the Equivalent Circuit of Fig. 2-3(b). Frequencies are in MHz.	20
3-1	Measured Impedance of a 36 cm Monopole over a Large Ground Plane. Frequencies are in MHz.	23
3-2	Tuning and Matching a Monopole Using Two Inductors.	25
3-3	The Tuning and Matching Processes of a Monopole as Explained on the Smith Chart.	27
3-4	Tuning and Matching of a Monopole Using One Inductor and One Capacitor.	29
3-5	Measured Impedance of a 36 cm Folded Monopole over a Large Ground Plane. Frequencies are in MHz.	30
3-6	The Tuning and Matching Processes of a Folded Monopole as Explained on the Smith Chart.	31
3-7	Tuning and Matching a Short Folded Monopole Using Two Capacitors.	33
3-8	Tuning and Matching a Short Folded Monopole Using One Capacitor and One Inductor.	34
3-9	Two Suggested Methods for Tuning and Matching Small Antennas with Highly Capacitive Input Impedance.	36

LIST OF ILLUSTRATIONS  
(continued)

3-10	Inductors $L_1$ , $L_2$ and a Ferrite Core Used with $L_2$ .	38
3-11	Measured Reactance of the Coil $L_1$ With and Without a Ferrite Core.	39
3-12	The 75 cm Monopole With the Inductor $L_1$ Connected in Series.	40
3-13	Measured Impedance of a 75 cm Folded Monopole When Tuned and Matched at 46 MHz Using the C-L Tuning Technique.	42
3-14	Measured Impedance of a 75 cm Folded Monopole When Tuned and Matched at 58 MHz Using the C-L Tuning Technique.	43
3-15	A Tuning and Matching Arrangement Using a Transformer and an Inductor.	45





# I

## INTRODUCTION

This report is concerned with tuning and bandwidth control of electrically small antennas by means of semiconductor elements. It has been recognized that the loss of "space filtering action" inherent in small antennas is a disadvantage due to their lack of directivity. Furthermore, highly tuned electrically small antennas inherently have a narrow frequency band of operation. It is possible in some cases to partially compensate for these difficulties by making the antenna tunable using voltage controlled semiconductor elements. One such means of tuning can be accomplished by the use of varactors. In some cases, other circuits using active elements can be used for tuning. A voltage tunable narrow band antenna may actually cover the frequency range of a broadband antenna. Thus, the tunable feature when applied to an electrically small antenna will in many instances provide an adequate substitute for a broadband antenna. Control of the bandwidth at any given center frequency can also be achieved by remote voltage tuning of a negative conductance converter. The frequency filtering of a narrow band, but tunable, antenna can reduce the noise problem and in this way frequency filtering can be made to compensate for the loss of space filtering.

The studies described in this report consider in detail the impedance characteristics offered by electric monopoles or dipoles and folded monopoles or dipoles through a wide range of frequency. At the lowest part of the frequency range these antennas are indeed electrically small. This impedance information is then used to synthesize an adequate circuit model of the antenna in question. The circuit model is then used in conjunction with a voltage controlled tuning unit and a voltage controlled bandwidth unit in order to meet a prescribed frequency bandwidth and to provide an acceptable low noise input to a receiver. Throughout

these studies emphasis has been placed on antennas to be used for receiving. It will be apparent from time to time, however, that certain of the ideas could be used for transmitting antennas. Actually in the transmitting case deliberate tuning procedures are often used for particular antenna types.

The use of active circuit elements presents the possibility of additional contributions of noise. Some discussion of noise at various points in the frequency spectrum is now given.

### 1.1 Noise

The objective of this work was the development of small antennas using active elements with the antennas usable down to 30 MHz. Such small antennas will be of use primarily in the range 30 to 100 MHz. In this range of frequency, atmospheric noise is of great importance. Much of the atmospheric noise is due to lightning flashes. Thunderstorms occur more over land than over sea; they are more frequent at low altitudes than at high altitudes. However, even in relatively storm-free areas there is considerable atmospheric noise due to thunderstorms since such noise is readily propagated from storm susceptible areas. The noise power attributable to an individual lightning flash varies inversely with the square of the frequency above 20 KHz. Noise level varies with location, time of day, and season. Noise levels vary over a dynamic range of 68 dB in polar regions and over an 80 dB range in equatorial regions. Noise level as a function of frequency taken at mid-day and averaged over a year, are shown for polar regions, equatorial regions and the United States in Fig. 1-1 (NBS data). Atmospheric noise is compared to antenna thermal noise for a small dipole receiving antenna in Fig. 1-2. In addition to atmospheric noise there is local noise associated with rain, snow or dust storms. Often there is considerable man-made noise in the frequency range considered; the value of this at 30 MHz has been given in one reference as 10 microvolts/meter. Because of the high atmospheric noise in the frequency band of interest there appears to be a good

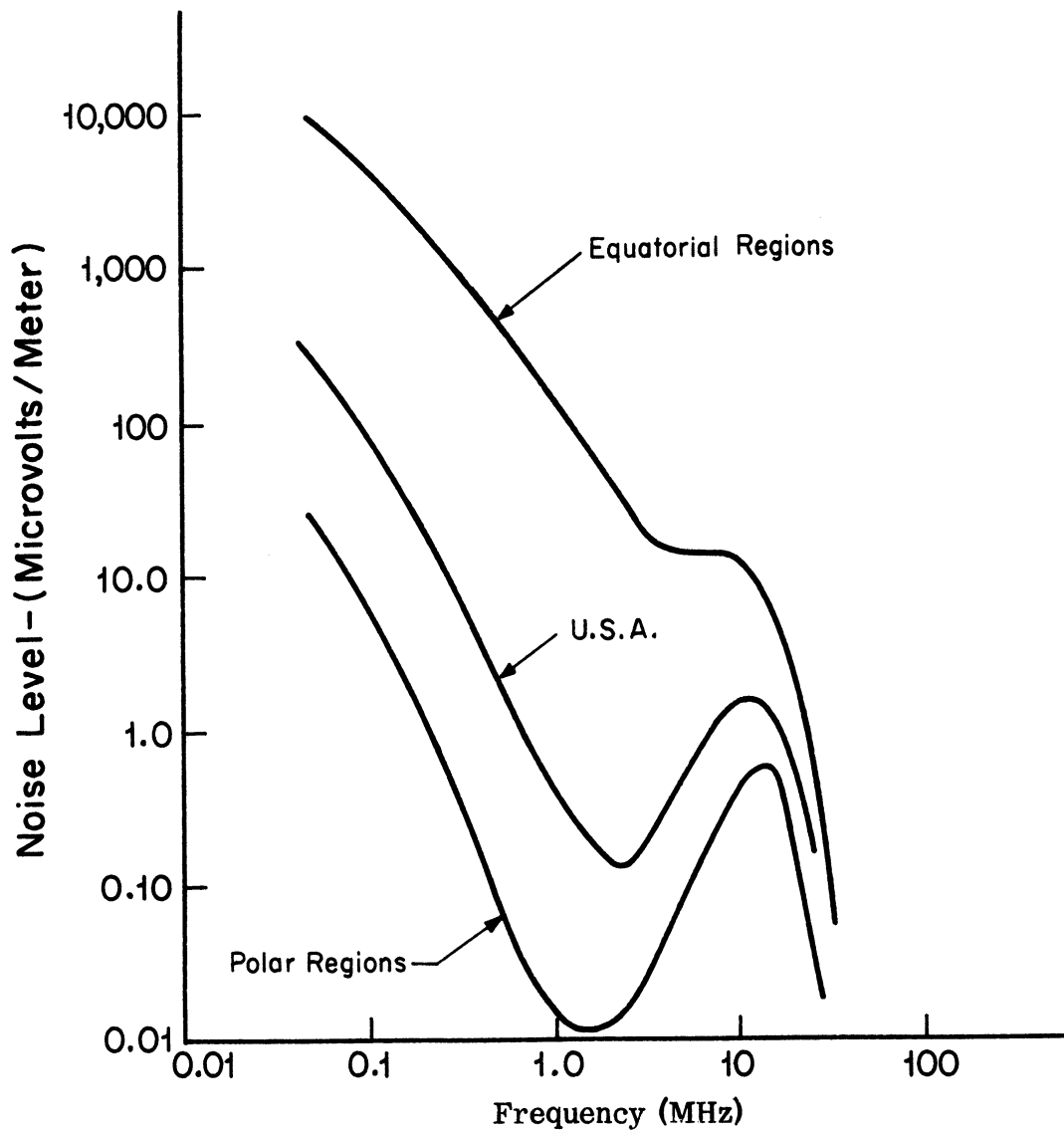

FIG. 1-1: Average Atmosphere Noise Level in Microvolts/Meter, as a Function of Frequency.

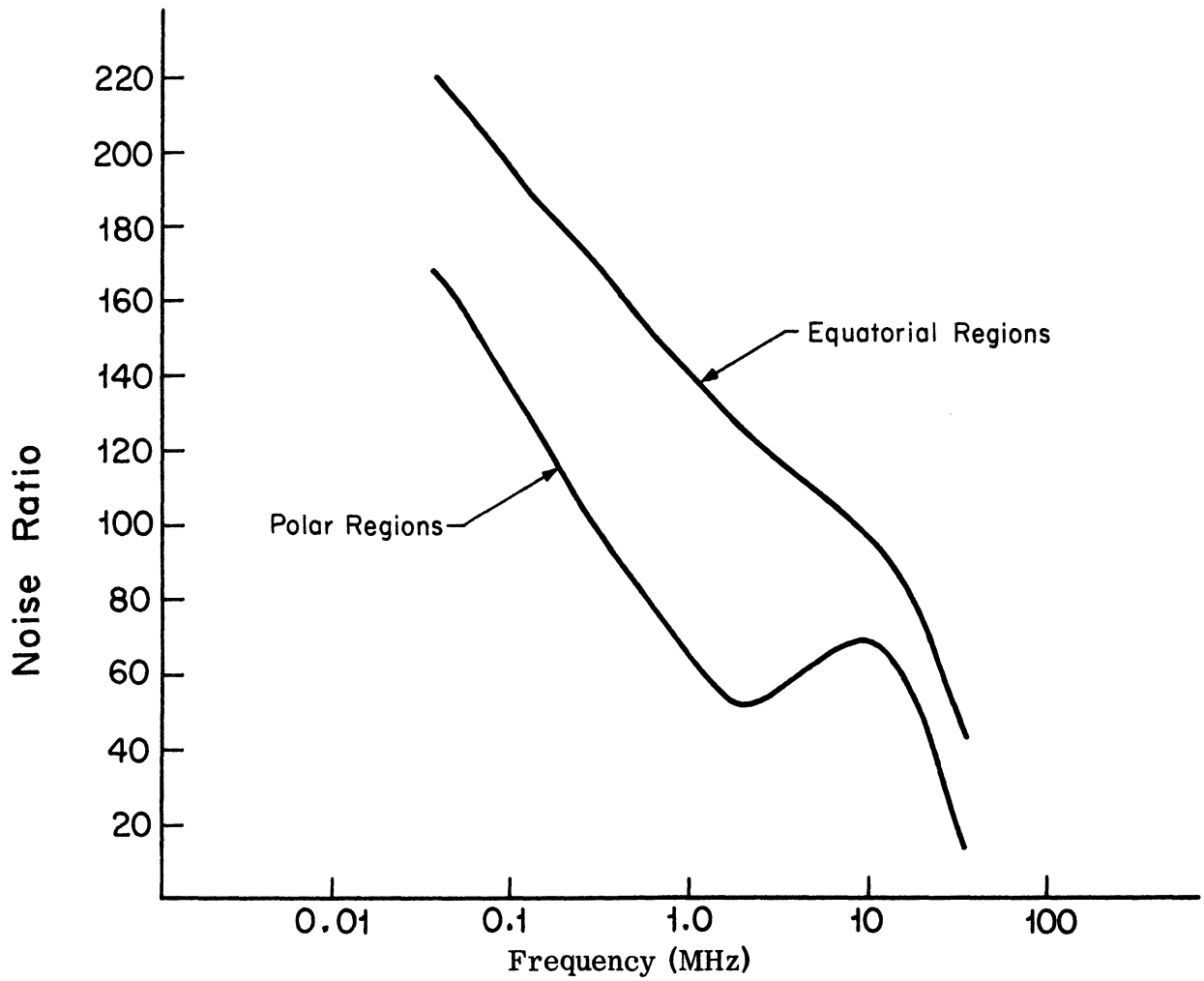

FIG. 1-2: Atmospheric Noise to Antenna Thermal Noise Ratio.

prospect that a voltage tunable small antenna can be designed without degradation of the signal-to-noise ratio. Figure 1-3 shows noise figure data for a 2N1405 MESA type transistor. It is to be noted that between 30 and 100 MHz the noise figure is close to 4 dB. Devices using this transistor would not greatly change the overall noise figure. In fact if the bandwidth is controlled by the introduction of a negative conductance using a positive feedback circuit there is the possibility of reducing the noise level by reducing the bandwidth.

## 1.2 Tuning and Bandwidth Control

The voltage controlled antenna of the present study is one that is electrically small at the low end of the operating frequency band. The operating frequency band is largely determined by a voltage tunable circuit containing active elements. The bandwidth is controllable by a positive feedback circuit simulating a negative conductance. In addition, the output of the antenna equivalent tank circuit augmented by the negative conductance and tuning element is connected to the receiver by an amplifier transformer combination giving gain as well as the desired impedance transformation. Some of the elements to be utilized have previously been studied in some depth in University of Michigan laboratories and elsewhere. The negative conductance often called a  $Q$  multiplier has been studied over a period of several years. It still presents some difficulties for frequencies near 100 MHz. One tuning reactance element studied consists of an operational amplifier circuit employing feedback. Several other possibilities also exist. The amplifier may be conventional integrated circuitry including a transformation to low impedance output using a collector follower to feed a cable to the receiver. Figure 1-4 shows a block diagram of a voltage tunable small antenna.

The small antenna first studied was an electric monopole less than one-quarter wavelength long over much of the frequency range selected. Short monopoles are good illustrative examples of antennas to use in the detailed study of the impedance variations with frequency. Impedance measurements of monopoles

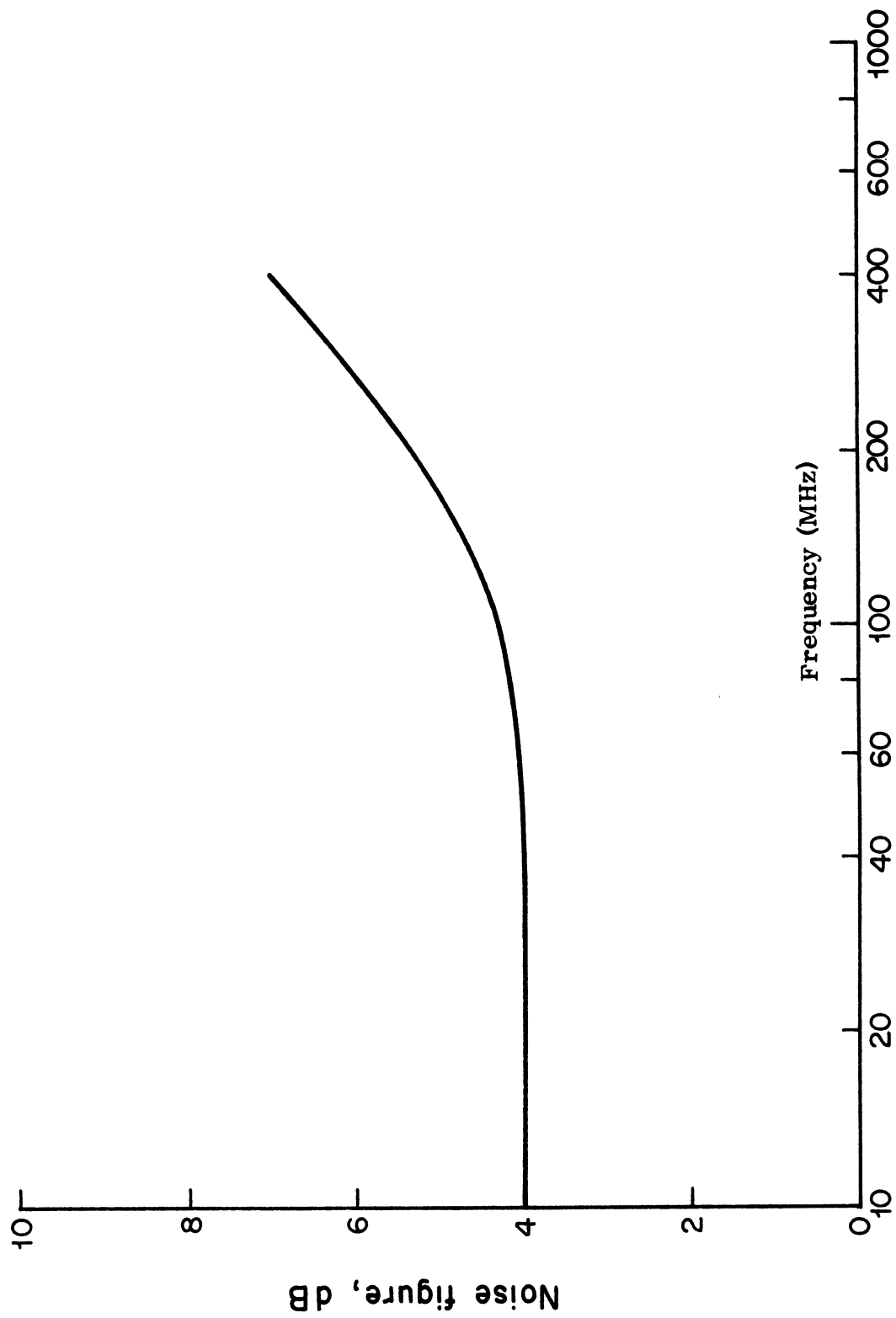

FIG. 1-3: Noise Figure for 2N1405 Transistor.

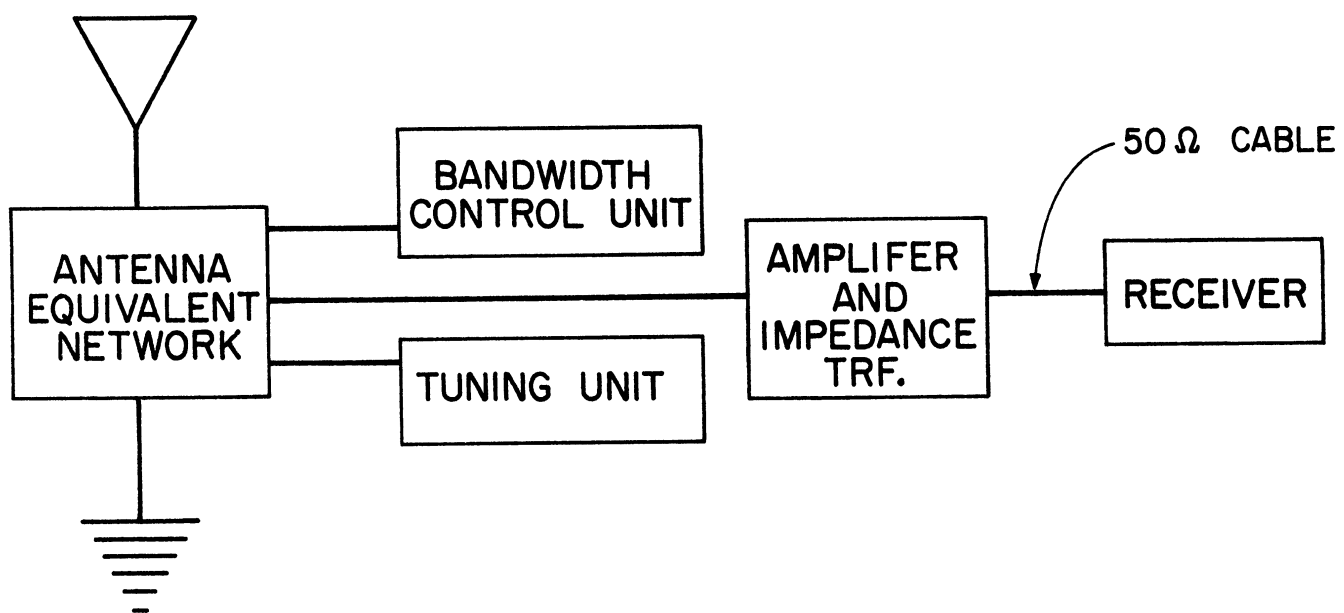

FIG. 1-4: Block Diagram for Voltage Tunable Antenna.

arranged over ground planes of various sizes including 91 x 91 cm, 215 x 215 cm and 500 x 300 cm were made. The results achieved with the largest ground plane were in substantial agreement with anticipated values. However, with the two smaller ground planes, noticeable discrepancies were observed in the measured data compared with expected theoretical results with an infinite ground plane.

### 1.3 Physical Circuit Model

In making the studies of voltage tuning and voltage control of  $Q$  or bandwidth it is important to know the detailed behavior of an antenna as a circuit element. With this knowledge a suitable circuit model can be synthesized for the antenna. Once the general arrangement of the equivalent circuit model was decided upon, then the proper parameters for the various circuit elements in the model were determined. The first objective was to get an adequate physical circuit model to apply to a monopole mounted over an infinite ground plane. However, the antenna methods applied are such that a similar appropriate circuit model could be obtained for any antenna. A logical first step in modeling an antenna impedance characteristic would be to try to fit a simple resonant series circuit so that its characteristics coincided with the impedance characteristics of the antenna. However such a simple series circuit does not have a sufficient number of parameters to adequately portray the characteristics of the antenna. A simple series circuit was tried and found to be quite deficient. This work is discussed in more detail in Chapter II.

### 1.4 Other Small Antennas

A folded dipole was examined for impedance characteristics so that an adequate circuit model could be obtained. Appropriate control units could then be designed for this circuit model. Impedance data were taken on other electrically small antennas. Some of the antennas involved capacitive loading; others involved various kinds of folding. Still others involved multiple feeding through transformers. These data are not included in this report since the corresponding radiation patterns are yet to be taken.



## II

### CIRCUIT REPRESENTATIONS

#### 2.1 Input Impedance of a Short Monopole

The input impedance of a short monopole on an infinite ground plane for frequencies well below resonance is

$$Z_{in} = 20 (k\ell)^2 -j \frac{120}{k\ell} (\log_e \frac{2\ell}{a} - 1) , \quad (2.1)$$

where

$\ell$  = antenna length (meters),

$a$  = antenna diameter (meters),

$k = \frac{2\pi}{\lambda}$  = free space wave number (radians/meter).

Figures 2-1 and 2-2 show the calculated input impedance of a 75 cm monopole based on Eq. (2.1). The theoretical resonant frequency of this antenna is 100 MHz. Note the impedance of the antenna is predominantly capacitive when the frequency is below resonance.

#### 2.2 Equivalent Circuits for a Short Monopole

Equivalent circuits for a short monopole may at times be useful in considering techniques that may improve the performance of small antennas. At any one frequency, the equivalent circuit for a short monopole can be represented by a resistance in series with a capacitance, as shown in Fig. 2-3(a). If one wishes to use this simple equivalent circuit over a band of frequencies, both the resistor and the capacitor would have to be properly frequency dependent. It is possible to devise an equivalent circuit using only frequency independent circuit elements if more elements are used.

In pursuing a more adequate model it was realized that the problem would be greatly simplified if the requirement for accurate performance was primarily

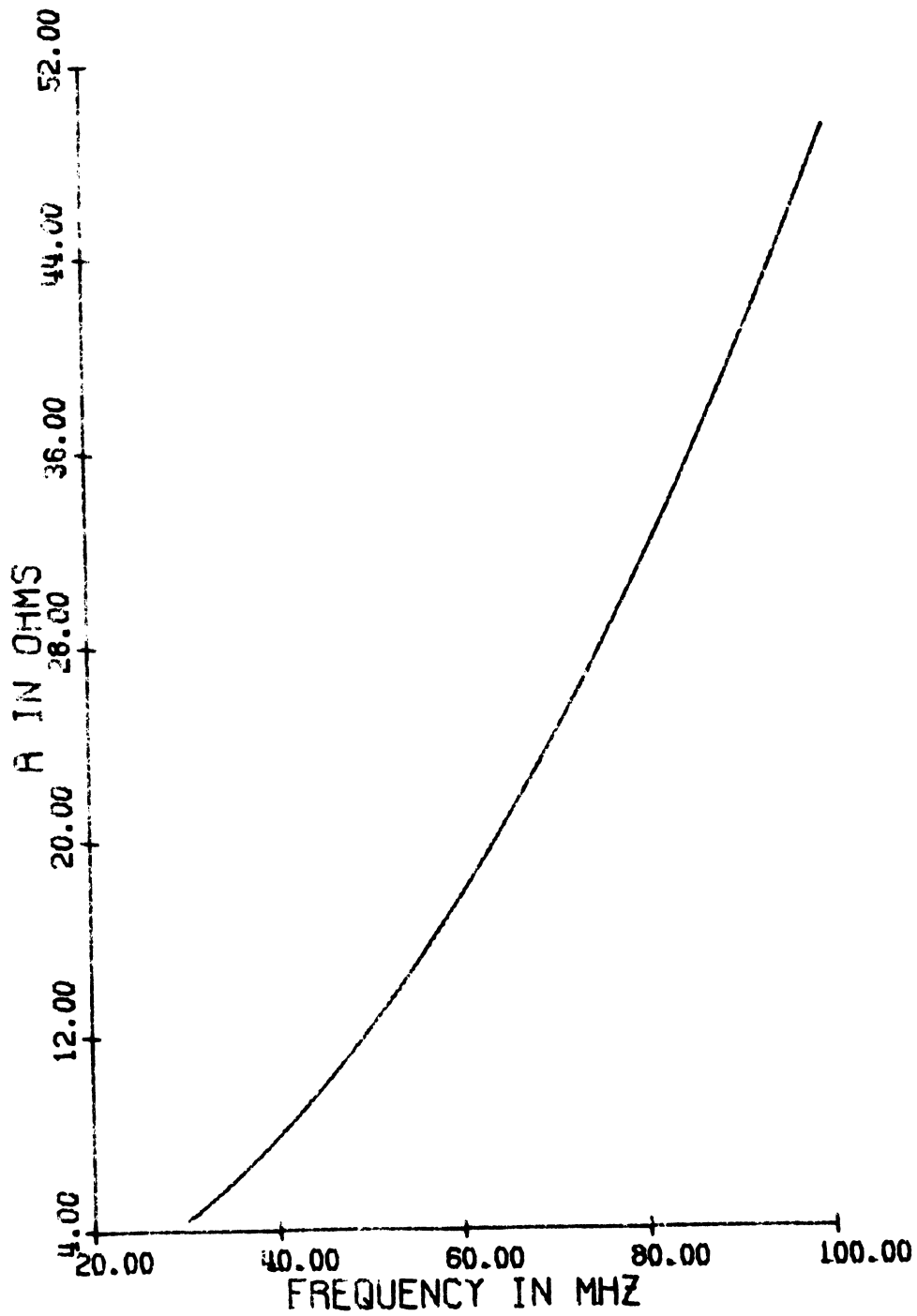

FIG. 2-1: Calculated Resistance of a Short Monopole: length = 75 cm, diameter = 0.1 cm.

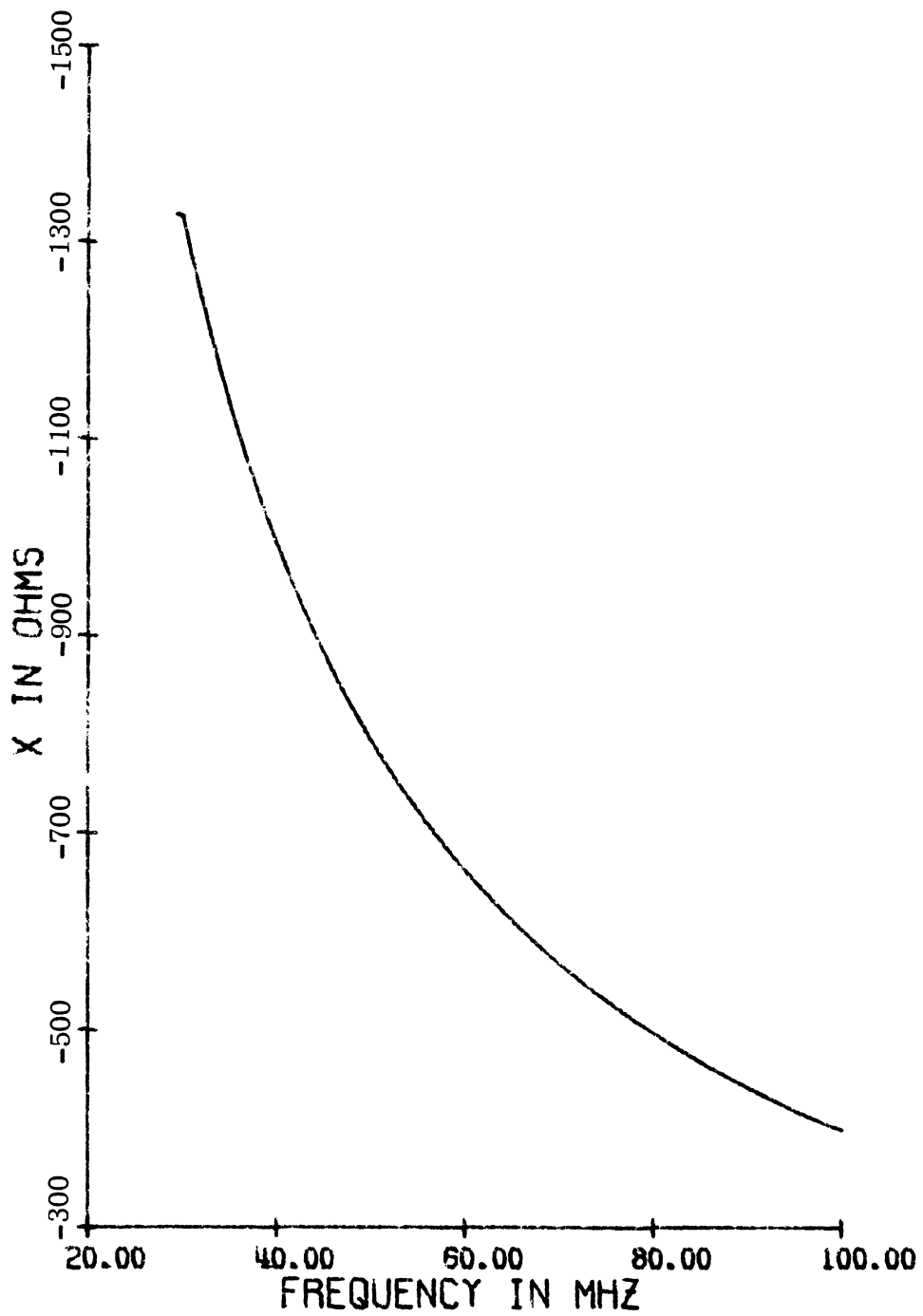

FIG. 2-2: Calculated Reactance of a Short Monopole: length = 75 cm, diameter = 0.1 cm.

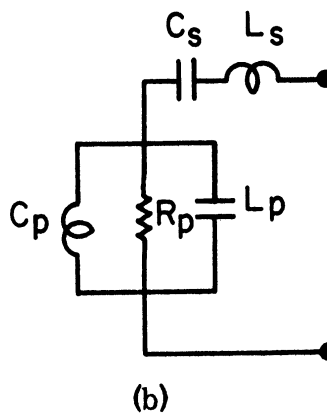
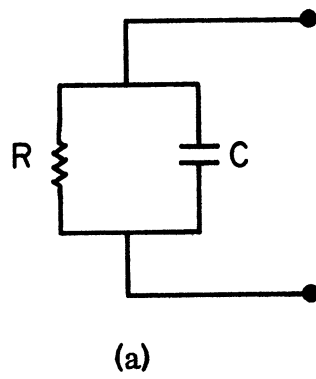

FIG. 2-3: Two Equivalent Circuits for a Short Monopole.

in the region of very low frequencies. In studies leading to antennas of reduced size the problem is of course at the low frequency range for the antenna. It was also realized that the model might very well depart from the actual antenna impedance when it is used at frequencies higher than the frequencies usually intended for the simple antenna.

The next model which was synthesized was a series resonant circuit in series with a parallel resonant circuit. Each of these circuits included the three parameters R, L and C. For a model such as this a fairly simple analysis yields the following equation for the impedance looking into the two terminals of the network:

$$Z_{in} = R_s + \frac{R_p}{1 + Q_p^2 \left( \frac{f}{f_p} - \frac{f_p}{f} \right)^2} + j \left[ R_s Q_s \left( \frac{f}{f_s} - \frac{f_s}{f} \right) - \frac{R_p Q_p \left( \frac{f}{f_p} - \frac{f_p}{f} \right)}{1 + Q_p^2 \left( \frac{f}{f_p} - \frac{f_p}{f} \right)^2} \right] \quad (2.2)$$

where

$$\begin{aligned} \omega_s &= \frac{1}{\sqrt{L_p C_p}} ; & Q_s &= \frac{\omega_s L_s}{R_s} \\ \omega_p &= \frac{1}{\sqrt{L_s C_s}} ; & Q_p &= \frac{R_p}{\omega_p L_p} \end{aligned}$$

$$Z_{in} = R_s + \frac{R_p}{Q_p^2 \frac{f^2}{f_p^2}} f^2 - j R_s Q_s \frac{f_s}{f} = R_s + \frac{R_p f^2}{Q_p^2 \frac{f^2}{f_p^2}} - j X_s \frac{f_s}{f} \quad (2.3)$$

The equations have symbols which pertain to the elements shown in Fig. 2-3(b). In Eq. (2.2) it is helpful to consider what happens to the expression when the frequency is below the indicated resonant frequency. For instance, if  $f$  is

much lower than  $f_p$  and is also much lower than the series resonant frequency designated as  $f_s$ , then it is possible to see that the impedance represented in Eq. (2.2) degenerates to that which is shown in (2.3). Equation (2.3) should now be compared to (2.1) which represents the impedance of a simple electric monopole at low frequencies. Comparing these two equations shows that in (2.3)  $R_s$  is an unwanted term and should be minimized. There are certain limitations, of course, as  $R_s$  includes the loss in the circuit conductors. However, it is true that  $R_s$  could be made to represent the loss in the antenna circuit including the conductive loss but not the radiation resistance. In both expressions the radiation loss represented by radiation resistance is expressed in the term having  $f^2$ . It is also to be observed that both of the reactive terms are inversely proportional to frequency. This favorable comparison between Eqs. (2.3) and (2.1) accounts for the decision to consider this model as a final circuit model for a short monopole.

In Eq. (2.3) it is necessary to determine the six parameters indicated. However, if the conductive loss of the conductors of the antenna is to be neglected then  $R_s$  will not be utilized in the circuit model. There will then be five parameters remaining which must be determined. A choice must be made of the experimental data points to be utilized in determining these five parameters. It would be possible to impose the restraints either at very low frequency, or at some other region of frequency. In this way it would be possible to make the response of such a circuit model to be a good fit for any limited range of frequency for the antenna. For example, it would be possible to make the circuit model represented by Eq. (2.3) to fit the case of a monopole of finite radius located over an infinite ground plane. The impedance characteristic of such a monopole is, of course, represented by (2.1). Since (2.1) represents the idealized case of a monopole over an infinite ground plane at very low frequency then the circuit model is an adequate representation at low frequency of a monopole over an infinite

ground plane. It means that the parameters of Eq.(2.3) have been so chosen as to make it correspond to (2.1). Both equations are asymptotic representations.

In going into the details of the determination of the parameters of the circuit model, the first step is to use information for the low frequency asymptote. This consists of two steps. First, equate the coefficients of the  $f^2$  term in Eq.(2.3) to the coefficient of the  $f^2$  term in (2.1). This is shown below:

$$\frac{R_p}{2 Q_p^2 f_p^2} = 80 \pi^2 \left( \frac{\ell}{c} \right)^2 , \quad (2.4)$$

where  $c$  is the free space velocity of light. The second step in utilizing the characteristics in the asymptotic region is to equate the imaginary term of Eq.(2.3) to the imaginary term of (2.1). This is done as follows:

$$X_s f_s = \frac{120 c}{2 \pi \ell} \left( \log \frac{2\ell}{a} - 1 \right) . \quad (2.5)$$

In order to completely determine the unknown parameters of the model, it is necessary to make use of additional conditions. One of these conditions is to consider the resonant frequency  $f_o$  of the antenna;  $f_o = c/4\ell$  since  $\ell = \lambda/4$ . At resonance it is known that the impedance of the monopole will be a pure resistance of approximately 37 ohms. We equate this value to the real term in Eq.(2.2) is shown below.

$$37 = \frac{R_p}{1 + Q_p^2 \left( \frac{f_o}{f_p} - \frac{f_p}{f_o} \right)^2} . \quad (2.6)$$

Also at the resonant frequency of the antenna ,  $f_o$  , the imaginary part of Eq. (2.2) should be equal to zero. Bear in mind that  $R_s Q_s = X_s$  even though  $R_s$  is negligibly small. The two parts of the imaginary term on the right-hand side of Eq. (2.2) are involved in Eq. (2.7):

$$X_s \left( \frac{f_o}{f_s} - \frac{f_s}{f_o} \right) = \frac{R_p Q_p \left( \frac{f_o}{f_p} - \frac{f_p}{f_o} \right)}{1 + Q_p^2 \left( \frac{f_o}{f_p} - \frac{f_p}{f_o} \right)^2} . \quad (2.7)$$

The remaining restraint to be utilized in the determination of the model parameters is to use a frequency point of the antenna corresponding to  $X=R$  for convenience. This is an arbitrary choice and some other frequency point could be utilized. This permits simple formulation in (2.2); it is possible thereby to set the second term on the right which is a resistive term equal to the negative of the third term on the right. The negative of the third or reactive term has been taken because it is this frequency point which corresponds to the antenna having capacitive reactance. This last step is represented below.

$$\frac{R_p}{1 + Q_p^2 \left( \frac{f_1}{f_p} - \frac{f_p}{f_1} \right)^2} = -X_s \left( \frac{f_1}{f_s} - \frac{f_s}{f_1} \right) + \frac{R_p Q_p \left( \frac{f_1}{f_p} - \frac{f_p}{f_1} \right)}{1 + Q_p^2 \left( \frac{f_1}{f_p} - \frac{f_p}{f_1} \right)^2} . \quad (2.8)$$

It is interesting to consider the value of  $f_1$  corresponding to the  $X=R$  point. This could be obtained by a theoretical determination. This was not the choice made in this study. It is recognized that for a simple monopole over an infinite ground plane, the 3 dB bandwidth is well established at 10 percent. Therefore, in the expression in (2.8), it is possible to readily substitute for  $f_1$  the value of  $0.95 f_o$  . It is believed that this is adequate for all modeling purposes.



Using Eqs. (2.4) through (2.8) solutions for five unknowns were obtained using the IBM 360 computer:

$$X_S = 477.27, \quad R_p = 36.71, \quad Q_p = 0.84717, \quad f_s/f_o = 1.00052, \text{ and} \\ f_p/f_o = 1.00796.$$

From these the following parameters were ascertained:

$$C_S = 3.18 \text{ pF}, \quad L_S = 722 \text{ nH}, \quad R_p = 36.71 \text{ ohms}, \quad L_p = 67.8 \text{ nH}, \text{ and} \\ C_p = 46.1 \text{ pF}.$$

The above solutions were calculated based on a theoretical monopole with an assumed input impedance equal to 37 ohms at resonance. For a physical monopole whose input impedance at resonance differs from 37 ohms, the circuit elements can be obtained through modification of the results just given without resorting to further use of the computer. From the above, some interesting observations can be made. First, the ratios  $f_s/f_o$  and  $f_p/f_o$  are very close to one. This means that the series circuit is at resonance at  $f_o$  and therefore the series inductance and series capacitance nullify each other and form a short circuit or zero impedance circuit. The parallel circuit is also at resonance at  $f_o$  and offers an impedance equal to  $R_p$ . Therefore, looking into the total equivalent circuit corresponds to seeing a resistance of  $R_p$ . With this in mind, it is possible to make a simplification in the use of the equations. By plotting the input impedance of a monopole antenna on a Smith chart, the intersection of this plot with the real axis can be used as the value of  $R_p$ . This intersection on the Smith chart axis also indicates the resonant frequency  $f_o$ . Also, it can be observed that using the impedance plot of experimental values for  $Z_{in}$  at very low frequencies, results in essentially a perfect circle close to the outer bounding circle of the chart. Thus at appropriately low frequencies (as designated on this plot), calculations can be made at any specific frequency for values of  $C_S$  and  $L_S$  knowing  $f_s = f_o$ , and that  $f_o$  can be read off the impedance plot. Since

$L_s \gg L_p$ , the impedance at very low frequencies is given by

$$Z_{in} \approx j X_s = j \left( \omega L_s - \frac{1}{\omega C_s} \right). \quad (2.9)$$

Also

$$f_s = f_o = \frac{1}{2\pi} \sqrt{\frac{1}{L_s C_s}}. \quad (2.10)$$

Equations (2.9) and (2.10) together determine  $L_s$  and  $C_s$ . For a point near resonance on the Smith chart, the impedance is given to a close approximation by the parallel circuit alone:

$$Z_{in} \approx Z_p = \frac{1}{\frac{1}{R_p} + j \left( \omega C_p - \frac{1}{\omega L_p} \right)}, \quad (2.11)$$

$$f_p = f_o = \frac{1}{2\pi} \sqrt{\frac{1}{L_p C_p}}. \quad (2.12)$$

Equations (2.11) and (2.12) can be used to obtain  $L_p$  and  $C_p$ .

Figure 2-4 shows a Smith chart plot for experimentally determined values of input impedance for a 75 cm monopole antenna. The parallel resistance  $R_p$  is read off the chart as  $R_p = 27.5$  ohms. Utilizing the discussion just given, the equivalent circuit would then have elements with the following numerical values for each parameter:

$$C_s = 9.6 \text{ pF}, L_s = 240 \text{ nF}, R_p = 27.5 \text{ ohms}, L_p = 68 \text{ nH} \text{ and } C_p = 36.1 \text{ pF}.$$

For comparison, certain calculated points based on the use of the equivalent circuit model are shown in Fig. 2-5.

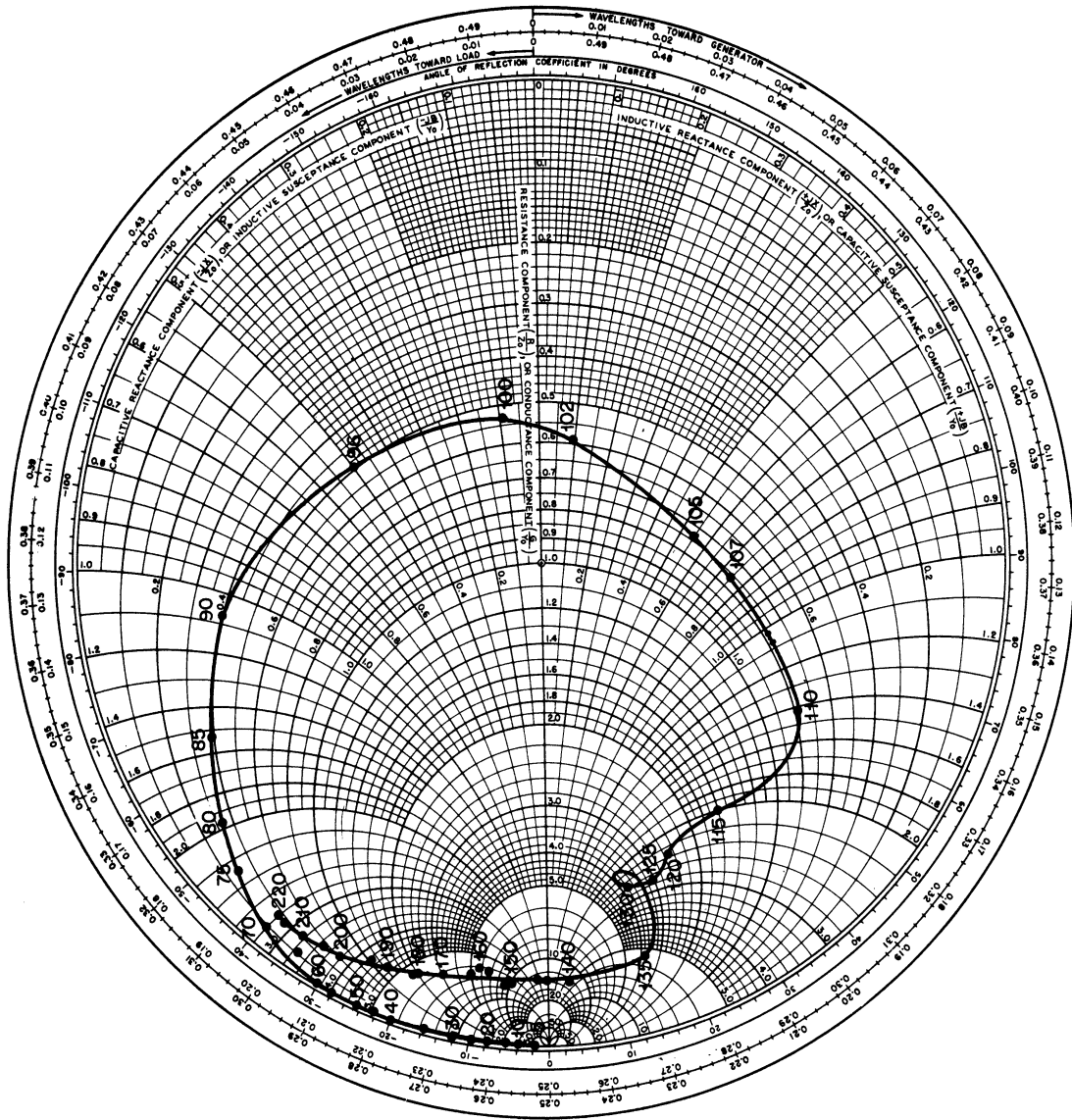

FIG. 2-4: Measured Impedance of a 75 cm Monopole:  
 diameter = 0.2 cm. Frequencies are in MHz.

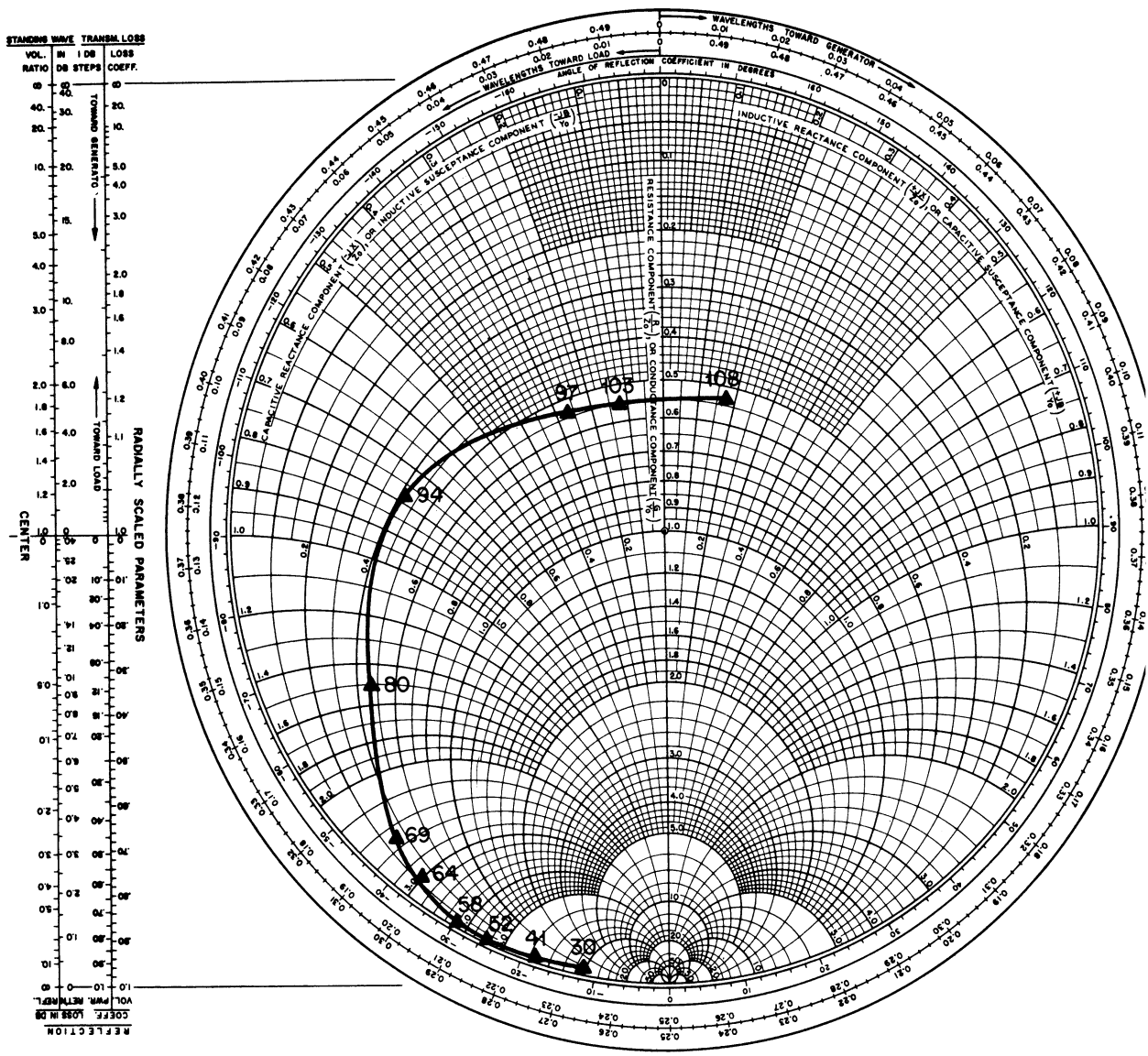

FIG. 2-5; Calculated Input Impedance for a 75 cm Monopole using the Equivalent Circuit of Fig. 2-3(b). Frequencies are in MHz.

It is to be observed that the calculated points in Fig. 2-5 show good agreement with the points in Fig. 2-4 drawn through the experimentally determined impedance points for the antenna. This means that within the limitations of calculation, the equivalent circuit offers very nearly the same impedance as the antenna itself. However, it is to be noticed that above resonance the 108 MHz point is somewhat removed from the measured impedance value for the antenna. This is not unexpected since the equivalent circuit was developed using certain approximations appropriate for frequencies at and below resonance.

### III

#### TECHNIQUES OF TUNING AND MATCHING SMALL ANTENNAS

Tuning and matching techniques will be discussed in this chapter. The tuning and matching of a short monopole, whose input impedance is highly capacitive, is discussed in Section 3.1. The tuning and matching of a short folded monopole whose input impedance is highly inductive, is discussed in Section 3.2. It is obvious that the same techniques may be applied to other types of small antennas.

##### 3.1 Tuning and Matching of a Short Monopole

Figure 3-1 shows the measured input impedance of a 36 cm monopole mounted over a large ground plane. The resonant frequency of the antenna is seen to be near 200 MHz. As the frequency falls below resonance, the input impedance rapidly becomes highly capacitive.

Two adjustments are generally needed to match the impedance of an antenna to the transmission line impedance. This is because the antenna impedance has a resistive part and a reactive part which vary independently of each other as the frequency changes. The ineffectiveness of a single adjustment for matching an antenna impedance to the transmission line can be seen using Fig. 3-1 as an example. The input impedance at 130 MHz is  $0.2 - j 3.6$  (normalized with respect to 50 ohms). This corresponds to a voltage reflection coefficient of  $\rho$ ;

$$\rho = \left| \frac{(0.2 - j 3.6) - 1}{(0.2 - j 3.6) + 1} \right| = 0.94 \quad .$$

A variable inductor can be connected in series with the antenna and adjusted to obtain a better match between the antenna and the transmission line. In this case the minimum reflection coefficient is achieved when the negative reactance of the antenna is balanced out by the positive reactance of the inductor.

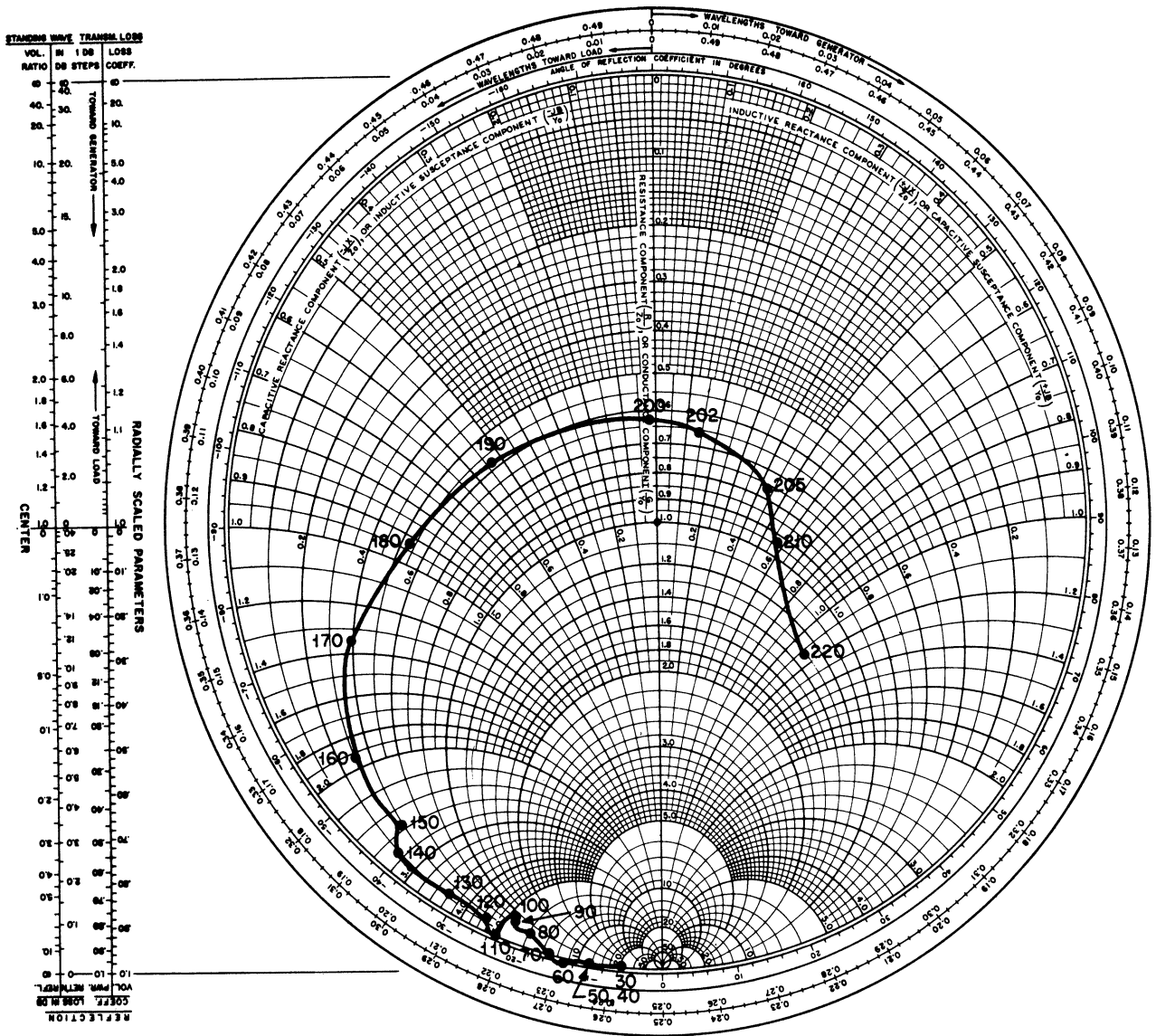

FIG. 3-1: Measured Impedance of a 36 cm Monopole Over a Large Ground Plane. Frequencies are in MHz.

This minimum reflection coefficient represents the best match that may be obtained using only one variable inductor. With this adjustment, the normalized input impedance,  $z_a$ , is equal to  $0.2 + j0$  and

$$\rho = \left| \frac{0.2-1}{0.2+1} \right| = 0.67 .$$

It is seen that this modified antenna is still far from a good match for the transmission line.

As noted above, tuning and matching the antenna requires two adjustments. Since the input impedance is capacitive, one of the adjusting elements must be inductive. The other adjusting element can be either inductive or capacitive. A tuning technique utilizing two inductors is shown in Fig. 3-2. Figure 3-2(a) shows the physical structure of a monopole antenna and its tuning elements, two adjustable inductors  $L_s$  and  $L_p$ . Figure 3-2(b) shows the equivalent circuit of the arrangement in Fig. 3-2(a). As an example to illustrate how the arrangement performs, it is assumed that the monopole antenna of Fig. 3-1 is to be tuned at 130 MHz and matched to a 50 ohm transmission line. The (normalized) input impedance  $z_a$  of the antenna at 130 MHz, as already stated, is

$$z_a = 0.2 - j 3.6 . \quad (3.1)$$

If the series inductor  $L_s$  is adjusted to provide an impedance,  $z_s = j 3.2$ , the combined admittance of the antenna and the series inductor is

$$\begin{aligned} \frac{1}{z_a + z_s} &= \frac{1}{(0.2 - j 3.6) + (j 3.2)} \\ &= \frac{1}{0.2 - j 0.4} \\ &= 1 + j2 . \end{aligned}$$

The input admittance found from the parallel combination of the series circuit ( $z_a + z_s$ ) and the parallel circuit consisting of the parallel inductor  $L_p$  with impedance  $z_p = j 0.5$  is



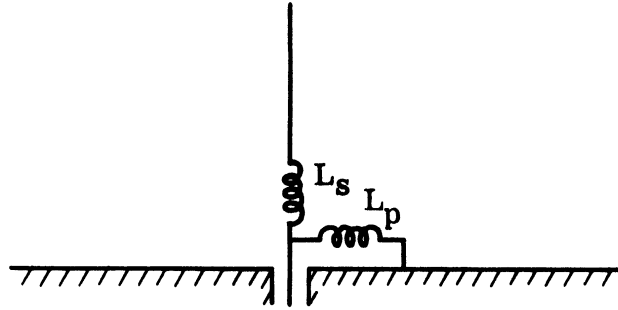

(a)

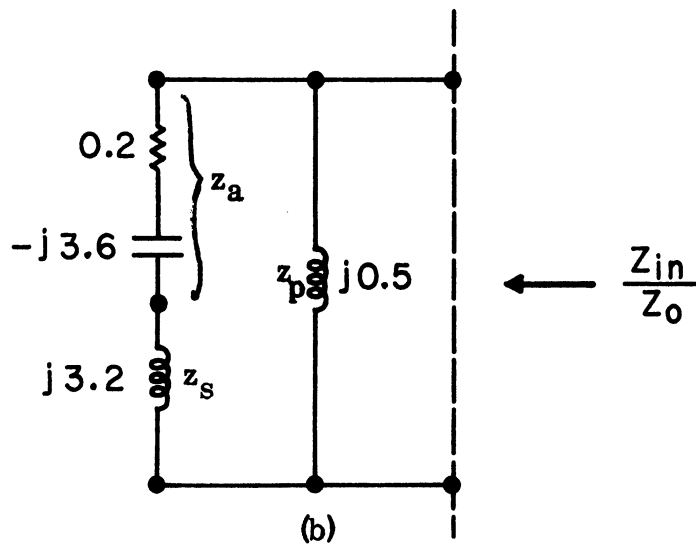

(b)

FIG.3-2: Tuning and Matching a Monopole Using Two Inductors.

$$\begin{aligned}
y_{in} &= \frac{1}{z_a + z_s} + \frac{1}{z_p} \\
&= (1 + j2) + (-j2) \\
&= 1 .
\end{aligned}$$

Therefore

$$z_{in} = \frac{1}{y_{in}} = 1 .$$

The input impedance is thus matched to the normalized transmission line impedance  $z_o = 1$  at  $f = 130$  MHz.

The impedance values of the two inductors required for the tuning and matching process described above are found most easily from the Smith chart in Fig. 3-3. The circle C-1 in the figure is the unit resistance circle with  $r=1$ . The circle C-2 is the inverse circle of C-1. For example, if the point B on C-2 gives certain impedance value, the point C on C-1 then gives the corresponding admittance value.

The point A in Fig. 3-3 gives the input impedance  $z_a$  of the antenna at 130 MHz. The impedance  $z_s$  for the series inductor  $L_s$  should be such that the total impedance of the antenna and  $L_s$  in series is  $z_B$ , the impedance at point B. Therefore,

$$z_s = z_B - z_a = (0.2 - j0.4) - (0.2 - j3.6) = j3.2 . \quad (3.2)$$

The corresponding admittance is given by the value at point C on circle C-1 :

$$y_c = \frac{1}{z_B} = \frac{1}{0.2 - j0.4} = 1 + j2 . \quad (3.3)$$

To change  $y_c$  to the required input admittance 1, a second inductor may now be connected in parallel with  $y_c$ . The admittance value  $y_p$  of the inductor  $L_p$  should therefore be:

$$y_p = y_{in} - y_c = 1 - (1 + j2) = -j2 . \quad (3.4)$$

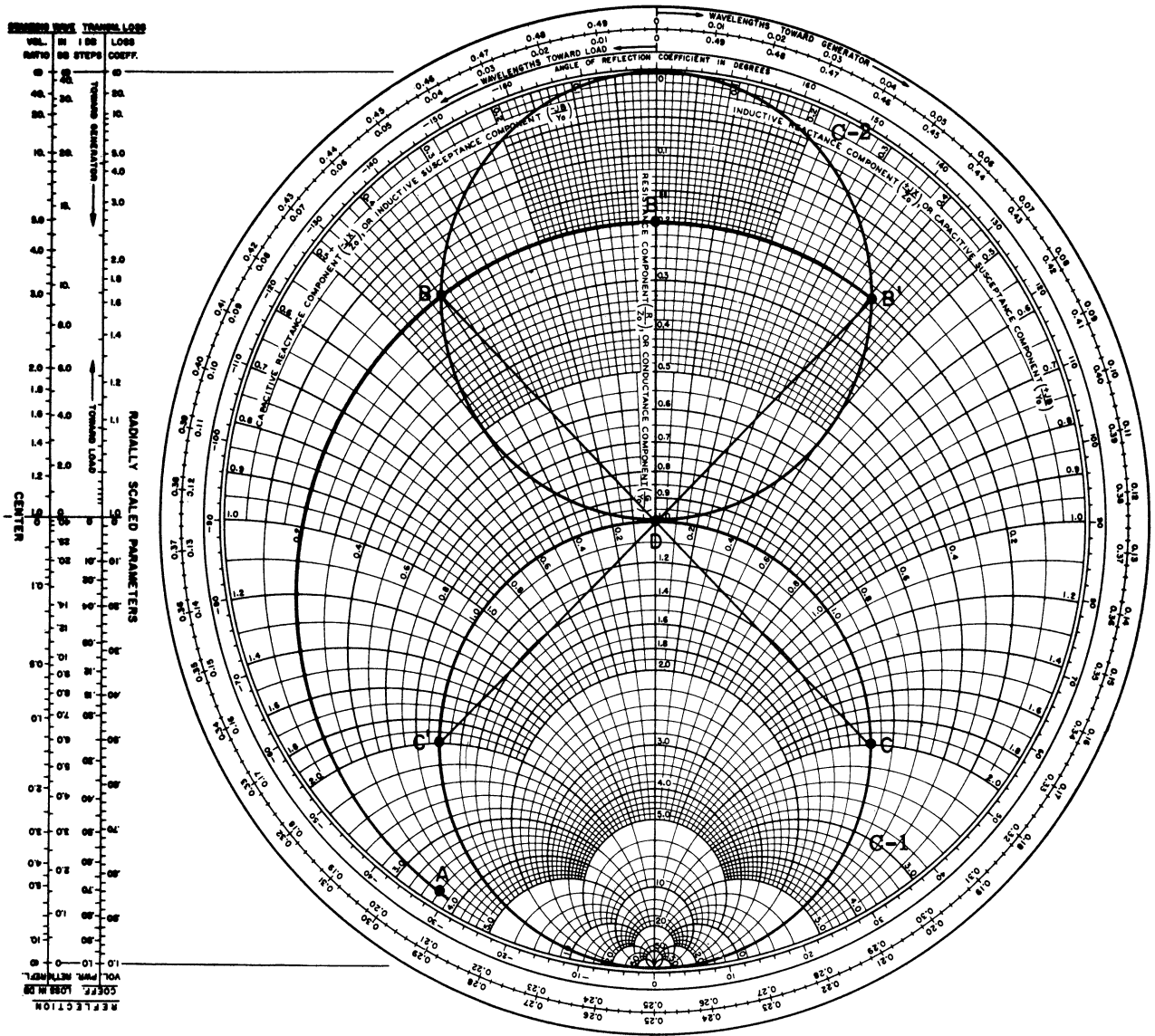

FIG. 3-3: The Tuning and Matching Processes of a Monopole as Explained on the Smith Chart.

The required impedance  $z_p$  of the inductor  $L_p$  is, therefore,

$$z_p = \frac{1}{y_p} = j 0.5 . \quad (3.5)$$

A second tuning and matching arrangement utilizes a capacitor  $C_p$  in parallel connection with the series connection of the antenna and an inductor  $L_s$ . This is shown in Fig. 3-4(a) where the whole structure is tuned and matched following the path A B' C' D on the Smith chart in Fig. 3-3. The point B' is also an intersection of the constant resistance circle  $r=0.2$  and the circle C-2 which is the inverse to the unit resistance circle C-1. The impedance  $z_s$  required to bring the antenna impedance  $z_a$  to the point B' is

$$z_s = z_{B'} - z_a . \quad (3.6)$$

The admittance  $y_p$  that must be provided by the capacitor  $C_p$  is

$$y_p = \frac{1}{z_p} = 1 - y_c . \quad (3.7)$$

The values for  $z_s$  and  $z_p$  as calculated from (3.6) and (3.7) to tune the monopole antenna at 130 MHz to a 50 ohm transmission line are shown in Fig. 3-4(b).

### 3.2 Tuning and Matching of a Short Folded Monopole

Figure 3-5 shows the measured impedance of a folded monopole over a large ground plane. The distance from the top of the antenna to the ground plane is 36 cm. Below 100 MHz, it is seen that the impedance is largely inductive.

To tune and match a short antenna with highly inductive input impedance, either of two schemes may be employed. These are explained on the Smith chart in Fig. 3-6. In the following discussion, it will be assumed that the antenna is to be tuned at 60 MHz to a 50 ohm transmission line. At  $f = 60$  MHz, the antenna input impedance is

$$z_a = 0.2 + j 4.7 \quad (3.8)$$

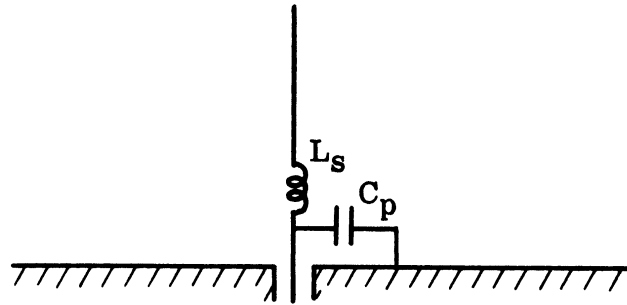

(a)

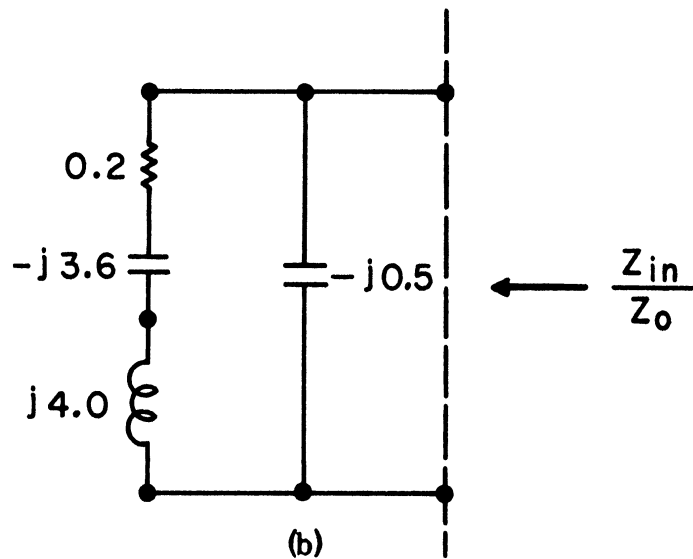

(b)

FIG. 3-4: Tuning and Matching of a Monopole Using One Inductor and One Capacitor.

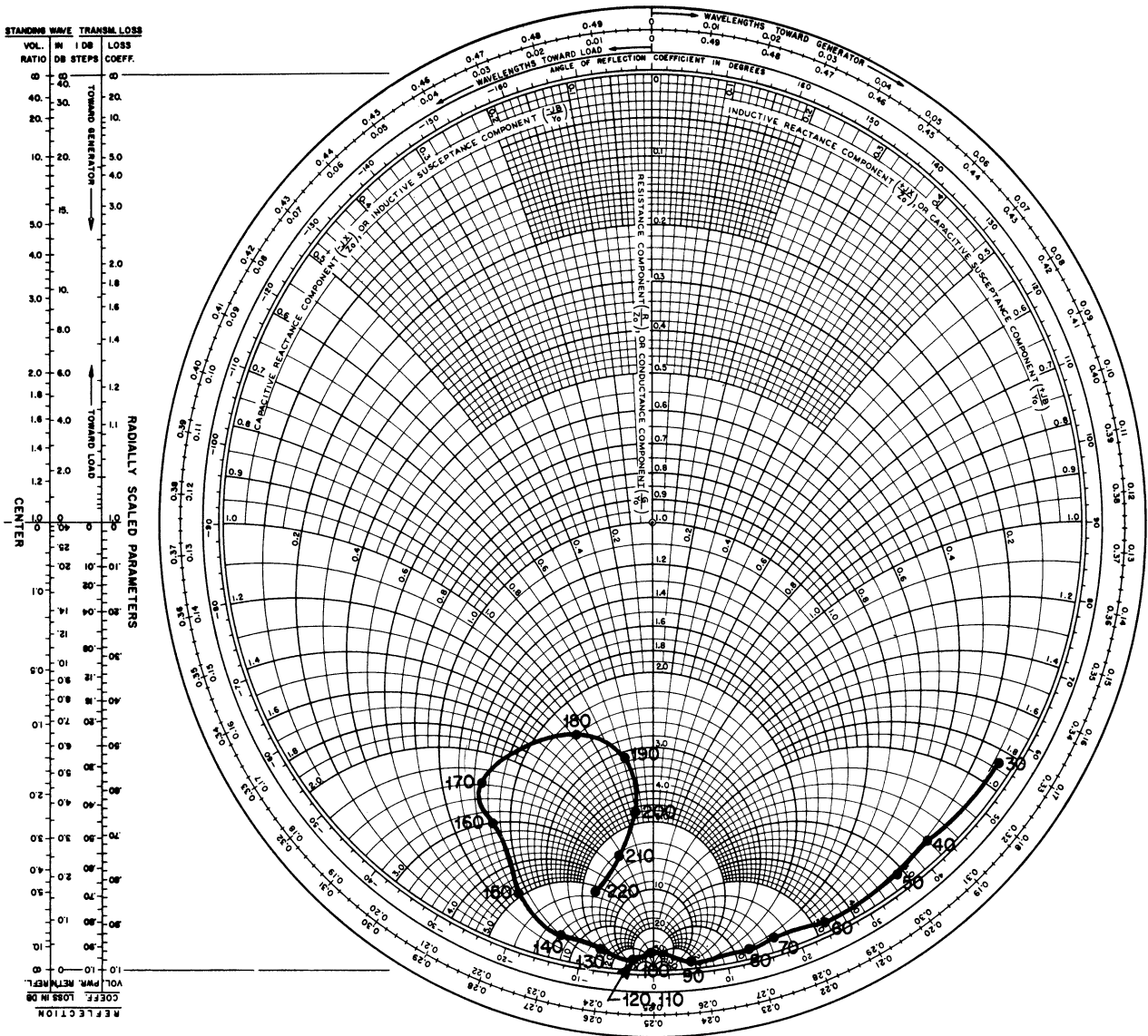

FIG. 3-5: Measured Impedance of a 36 cm Folded Monopole Over a Large Ground Plane. Frequencies are in MHz.

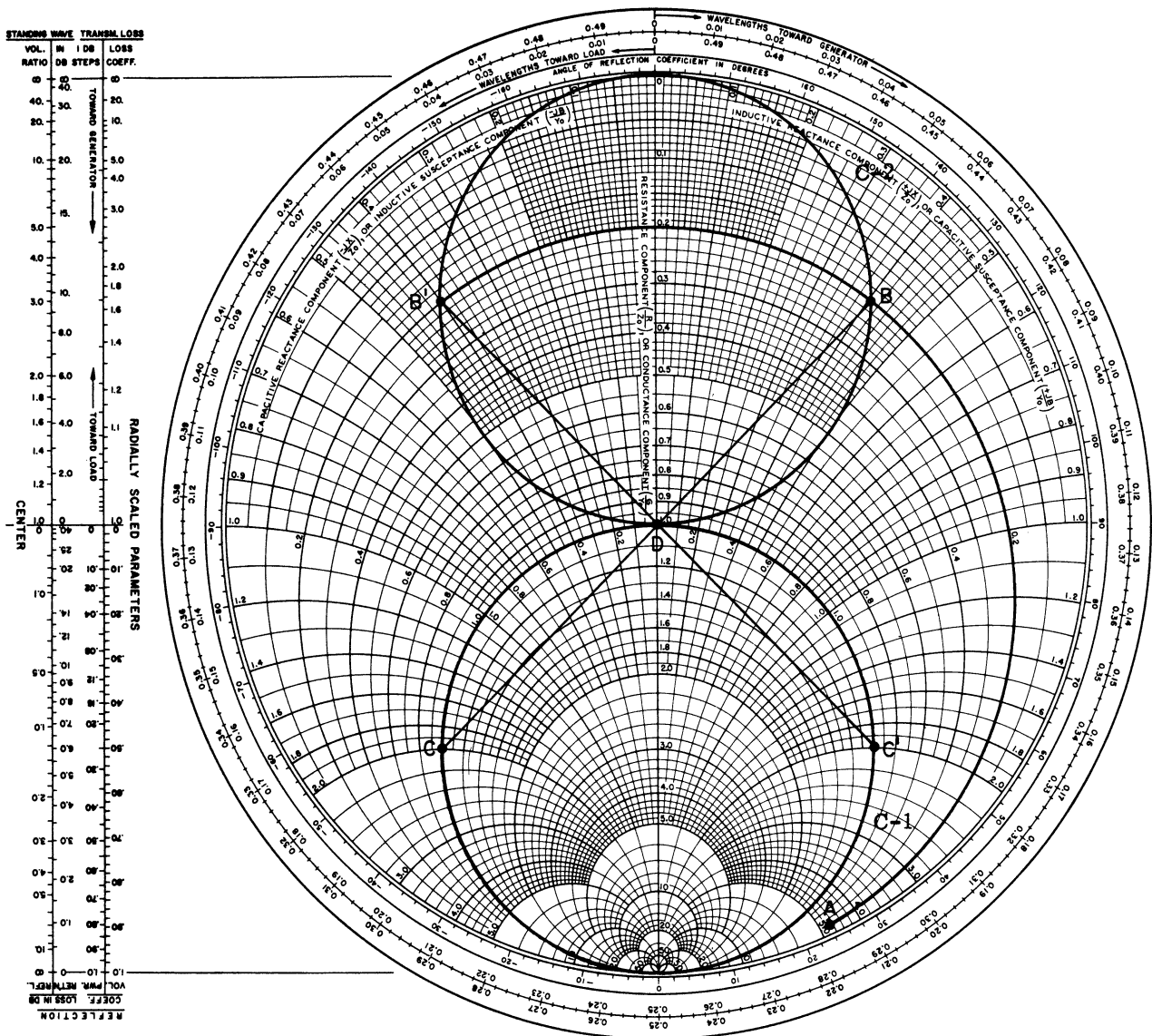

FIG. 3-6: The Tuning and Matching Processes of a Folded Monopole as Explained on the Smith Chart.

from Fig. 3-5. This is shown as point A in Fig. 3-6. The two points B and B' are again the two intersections of the circle with  $r = 0.2$  and the circle C-2 inverse to the unit resistance circle C-1. The points C and C' give the admittances corresponding to the impedances at B and B' respectively, or,

$$y_c = \frac{1}{z_B} \quad , \quad (3.9)$$

$$y_{c'} = \frac{1}{z_{B'}} \quad . \quad (3.10)$$

The first tuning and matching scheme utilizes two capacitors. The physical structure of the antenna with tuning and matching elements is shown in Fig. 3-7(a). The impedance of the antenna and the capacitor  $C_s$  in series should be  $z_B$ , the value at the point B in Fig. 3-6. Therefore,

$$z_s = z_B - z_a \quad . \quad (3.11)$$

The admittance  $y_p$  of the capacitor  $C_p$  should add to  $y_c$  to bring the total admittance to unity. Therefore,

$$y_p = 1 - y_c \quad . \quad (3.12)$$

The impedance of  $C_p$  is therefore

$$z_p = \frac{1}{y_p} \quad . \quad (3.13)$$

Figure 3-7(b) shows the equivalent circuit of this tuning and matching arrangement as calculated for tuning the folded monopole of Fig. 3-5 at  $f = 60$  MHz.

A second tuning and matching scheme for small antennas with predominantly inductive input impedance is shown in Fig. 3-8(a). This corresponds to the path A B' C' D on the Smith chart of Fig. 3-6. The impedances of the capacitor  $C_s$  and the inductor  $L_p$  required to tune and match the antenna are found from

$$z_s = z_{B'} - z_a \quad . \quad (3.14)$$

$$y_p = \frac{1}{z_p} = 1 - y_{C'} \quad . \quad (3.15)$$



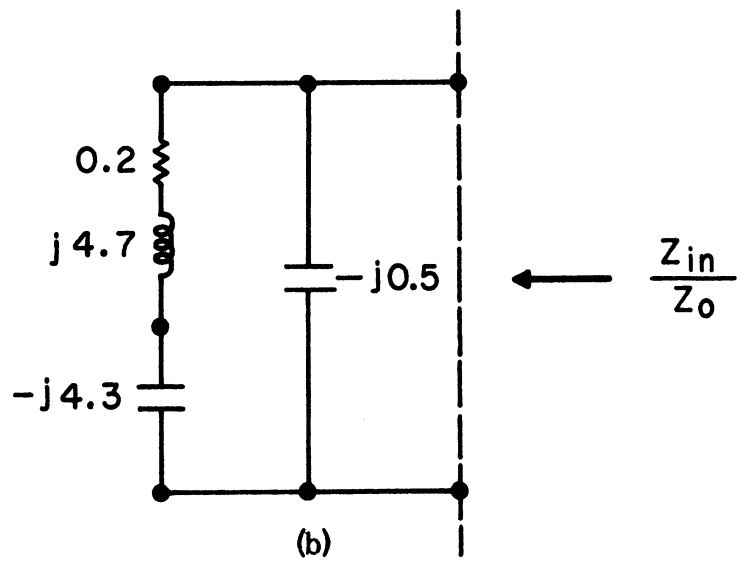
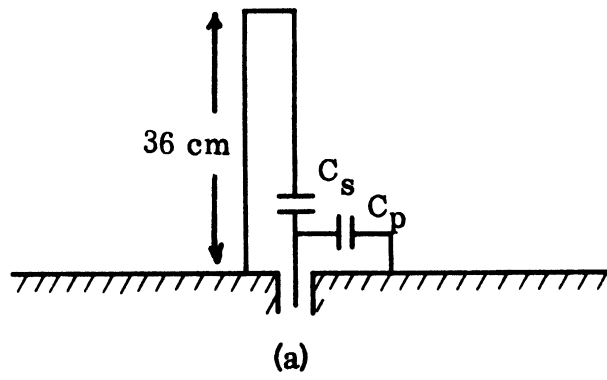

FIG. 3-7: Tuning and Matching a Short Folded Monopole Using Two Capacitors.

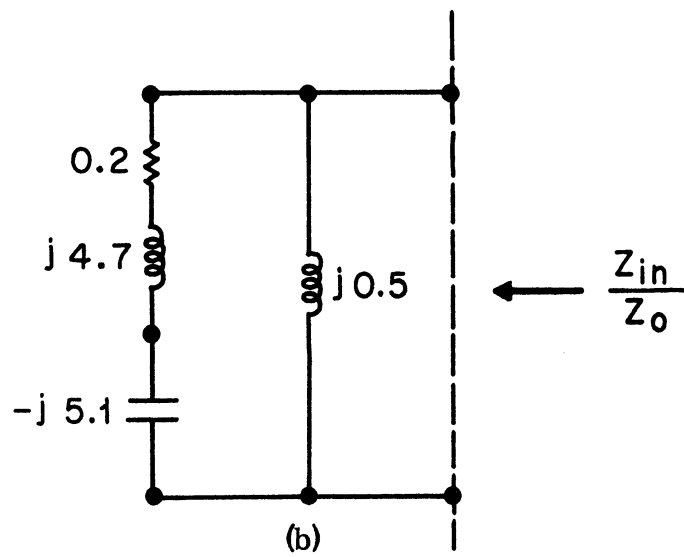
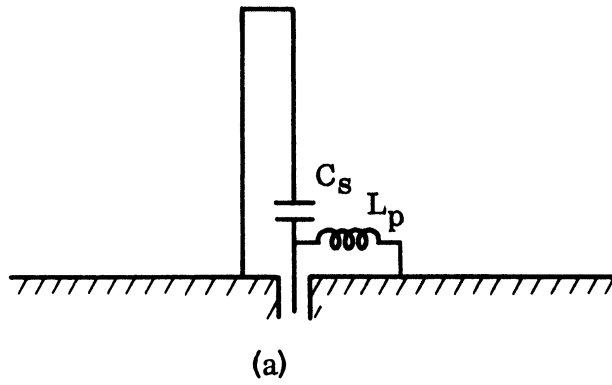

FIG. 3-8: Tuning and Matching a Short Folded Monopole Using One Capacitor and One Inductor.

The equivalent circuit for tuning the folded monopole at  $f=60$  MHz and matching it to a 50 ohm transmission line is calculated using Eqs. (3.14) and (3.15); the computed values are shown in Fig. 3-8(b).

### 3.3 Considerations in Broadband Applications

The most severe limitation to the tuning and matching techniques discussed above seems to be the difficulty in obtaining tuning elements,  $L$  and  $C$ , of proper value. Small antennas with predominantly reactive input impedances would have to be tuned and matched using series elements with large values of reactance; this means capacitors with very small values of capacitance and inductors with very large values of inductance are needed. Furthermore, continuous tuning and matching of small antennas with respect to frequency is possible only if continuously adjustable elements are available. Although variable capacitors controlled by either mechanical or electrical means may be obtained quite easily, variable inductors of proper range are generally not available. For this reason, tuning arrangements that utilize variable capacitors appear to have an advantage over arrangements that require variable inductors at the present time.

For a small antenna with a highly inductive impedance, it is therefore recommended that a capacitor-capacitor tuning arrangement be used for tuning and matching the antenna over a wide range of frequencies. For a small antenna with a highly capacitive impedance, either of the two arrangements shown in Fig. 3-9 may be used for broadband applications. A small antenna with predominantly capacitive impedance may be made into a small antenna with predominantly inductive impedance by connecting a very large inductance in series with the antenna. The modified antenna can then be tuned and matched using the capacitor-capacitor tuning technique. This method, shown in Fig. 3-9(a), however, has the drawback that the circuit  $Q$  for the overall structure increases rapidly as the frequency increases. The bandwidth about any tuned resonant

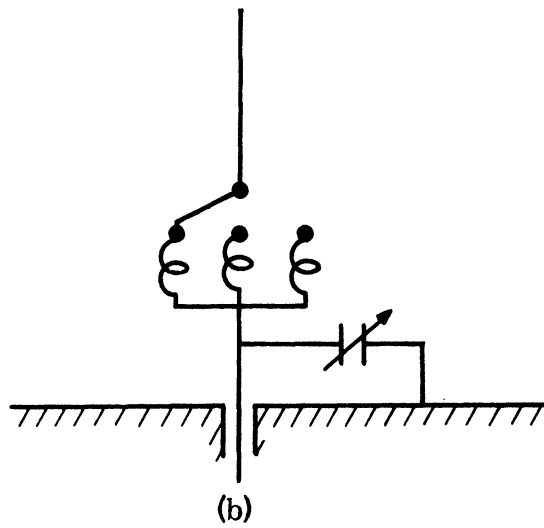
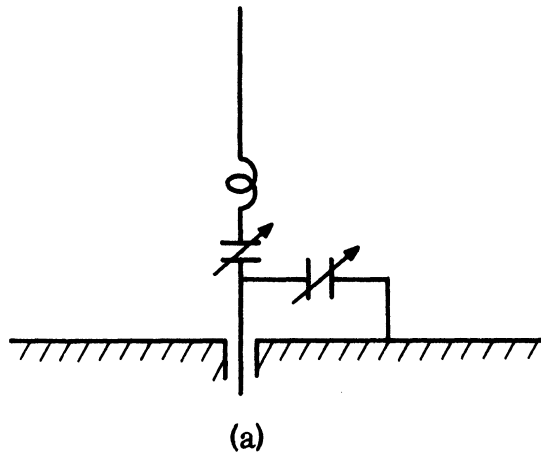

FIG. 3-9: Two Suggested Methods for Tuning and Matching Small Antennas with Highly Capacitive Input Impedance.

frequency would be inherently very narrow. To avoid this difficulty, the arrangement in Fig. 3-9(b) may be employed. This alternative arrangement differs from the ideal L-C tuning scheme only in that the continuously variable inductor required in the ideal case is replaced by a set of inductors that may be switched into the circuit one at a time.

### 3.4 Experimental Results

The L-C tuning technique (Fig. 3-4) was tried on the 75 cm monopole of Fig. 2-4. The inductor used in this measurement is a coil of 17 turns with a length of 6 cm and a diameter of 1.25 cm. This is converted into an adjustable inductor by inserting a piece of ferrite tube part way or all of the way into the coil. Figure 3-10 shows this coil,  $L_1$  and another coil  $L_2$ . A piece of ferrite tube used with  $L_2$  is also shown in Fig. 3-10. The ferrite tube core for  $L_1$  is similar to the ferrite core for  $L_2$  but is of the same length as the coil  $L_1$ . Figure 3-11 shows the measured (inductive) reactance of coil  $L_1$  with and without the ferrite tube core. When the ferrite core is partially in the coil, the reactance of the coil assumes values between the air core reactance  $X_a$  and the ferrite core reactance  $X_f$ . Figure 3-12 shows the 75 cm monopole antenna with the inductor  $L_1$  attached to it. All the variable capacitors used for measurements are the ordinary air-filled parallel plate capacitors.

The tuning and matching process is accomplished by measuring the reflection coefficient of the L-C tuned monopole antenna. The minimum reflection coefficients obtained through adjusting the series inductor and the parallel capacitor are tabulated in Table III-1. The near zero reflection coefficients at different frequencies indicate that the antenna is almost perfectly matched to the 50 ohm transmission line. It should be remembered that the reflection coefficient of the untuned antenna at and below 50 MHz is always nearly unity (see Fig. 2-4).

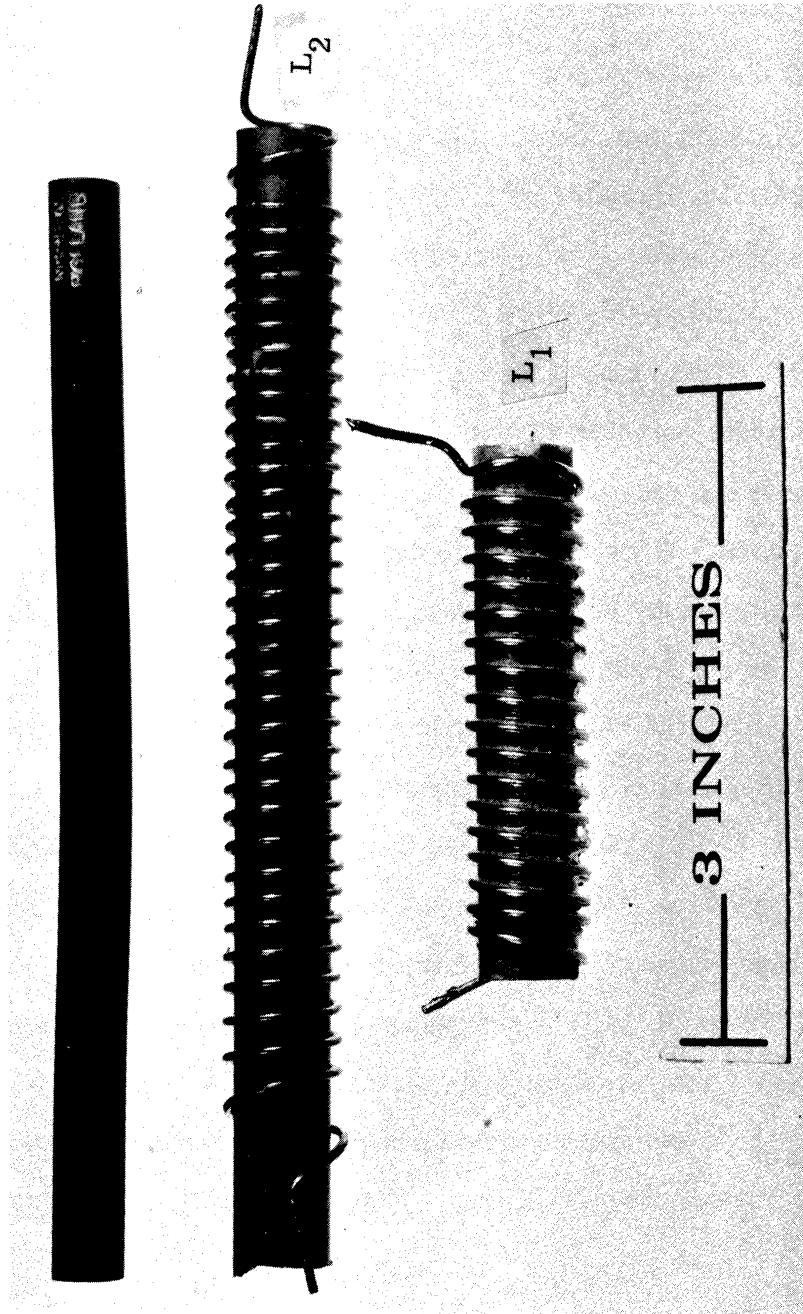

FIG. 3-10: Inductors  $L_1$ ,  $L_2$  and a Ferrite Core Used With  $L_2$  .

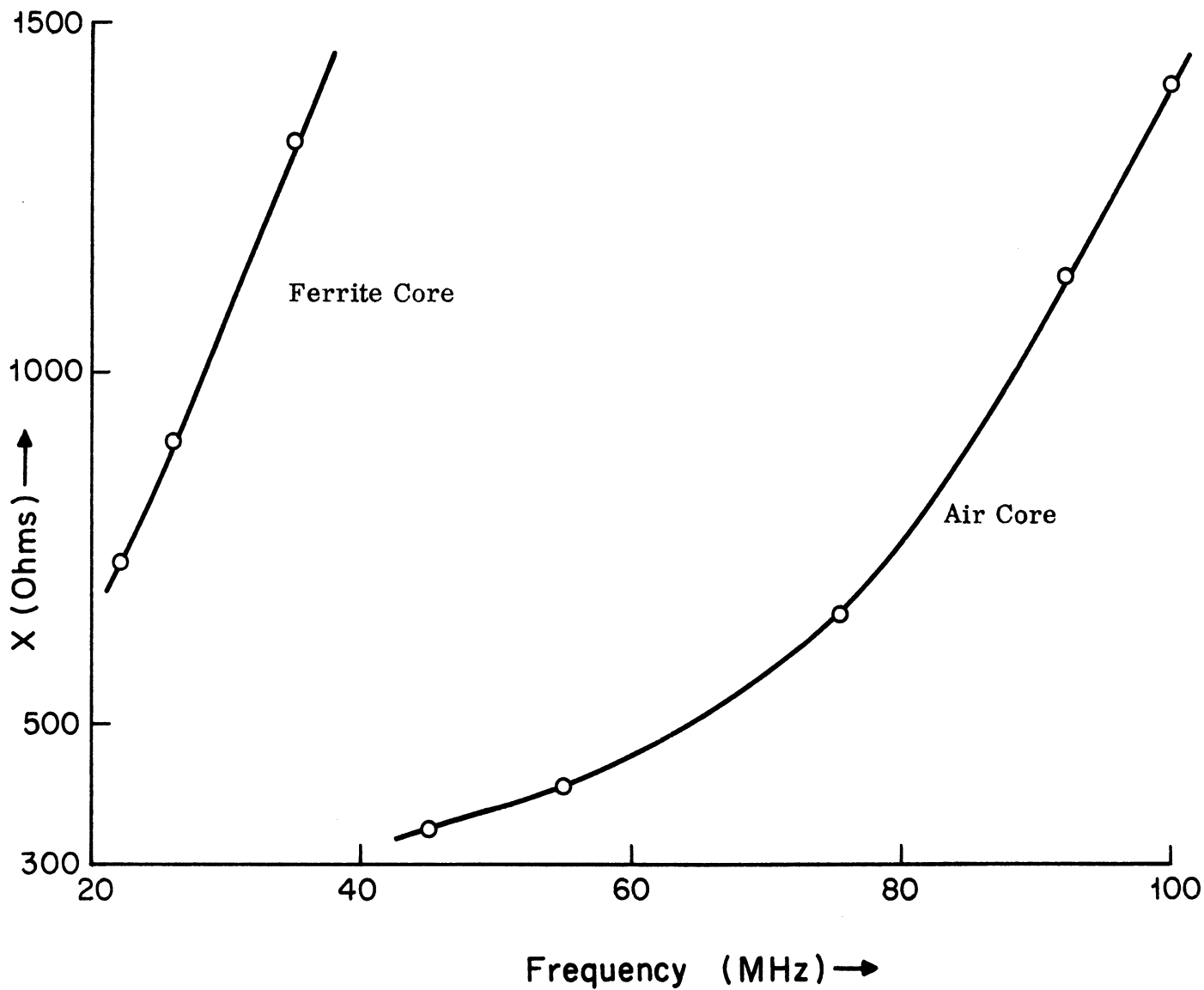
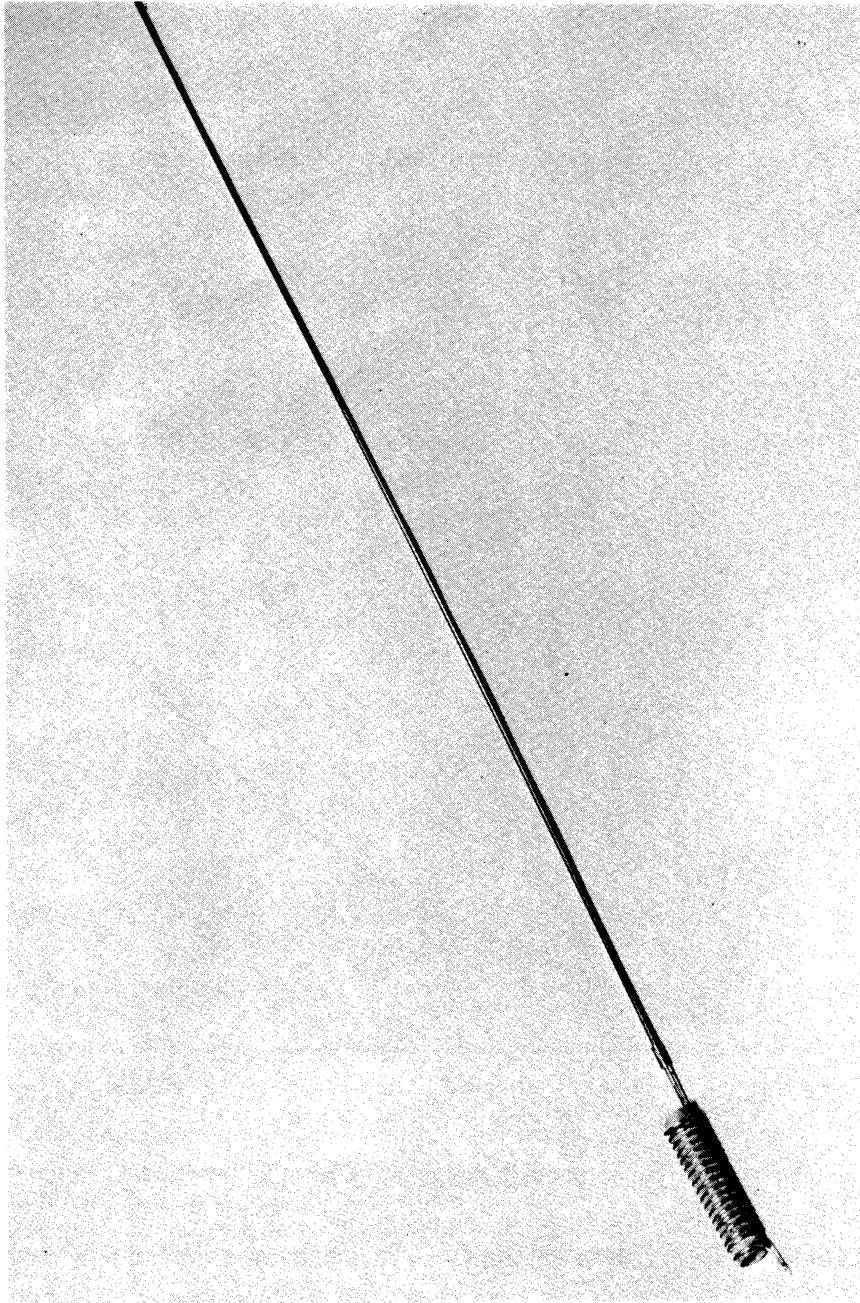

FIG.3-11: Measured Reactance of the Coil  $L_1$  With and Without a Ferrite Core.



**FIG. 3-12: The 75 cm Monopole With the Inductor  $L_1$  Connected in Series.**



TABLE III-1: Measured Reflection Coefficients of the L-C Tuned Monopole

<u>Frequency (MHz)</u>	<u>Reflection Coefficient</u>
50	0.01
45	0.02
38.7	0.01
34	0.08
29	0.03

The C-L tuning technique as shown in Fig. 3-8 was tried on a 75 cm folded monopole. In order to obtain some information on the bandwidth of the tuned antenna, the antenna was tuned and matched at 46 and 58 MHz. Then impedance measurements about these two frequencies were taken. These are shown in Figures 3-13 and 3-14. Again, the antenna is almost perfectly matched to the transmission line at both tuned frequencies.

It should be pointed out that the actual tuning and matching process normally requires repeated adjustments of the two tuning elements. Again using the monopole of Fig. 3-1 as an example, the tuning and matching is observed by measuring the voltage reflection coefficient of the antenna. Let us refer to Fig. 3-3: Assuming the antenna is to be tuned using the L-C tuning technique, this corresponds to the path A B' C' D in Fig. 3-3. When the series inductor  $L_s$  is increased from zero inductance and the parallel capacitor  $C_p$  not in use, the minimum reflection coefficient observed corresponds to the point B'', not B' which was required in the L-C tuning scheme. In the practical tuning process, it is found that tuning the series inductor  $L_s$  and the parallel capacitor  $C_p$  alternatively a few times after the minimum reflection coefficient point B'' is reached, permits the reflection coefficient to be reduced to near zero.

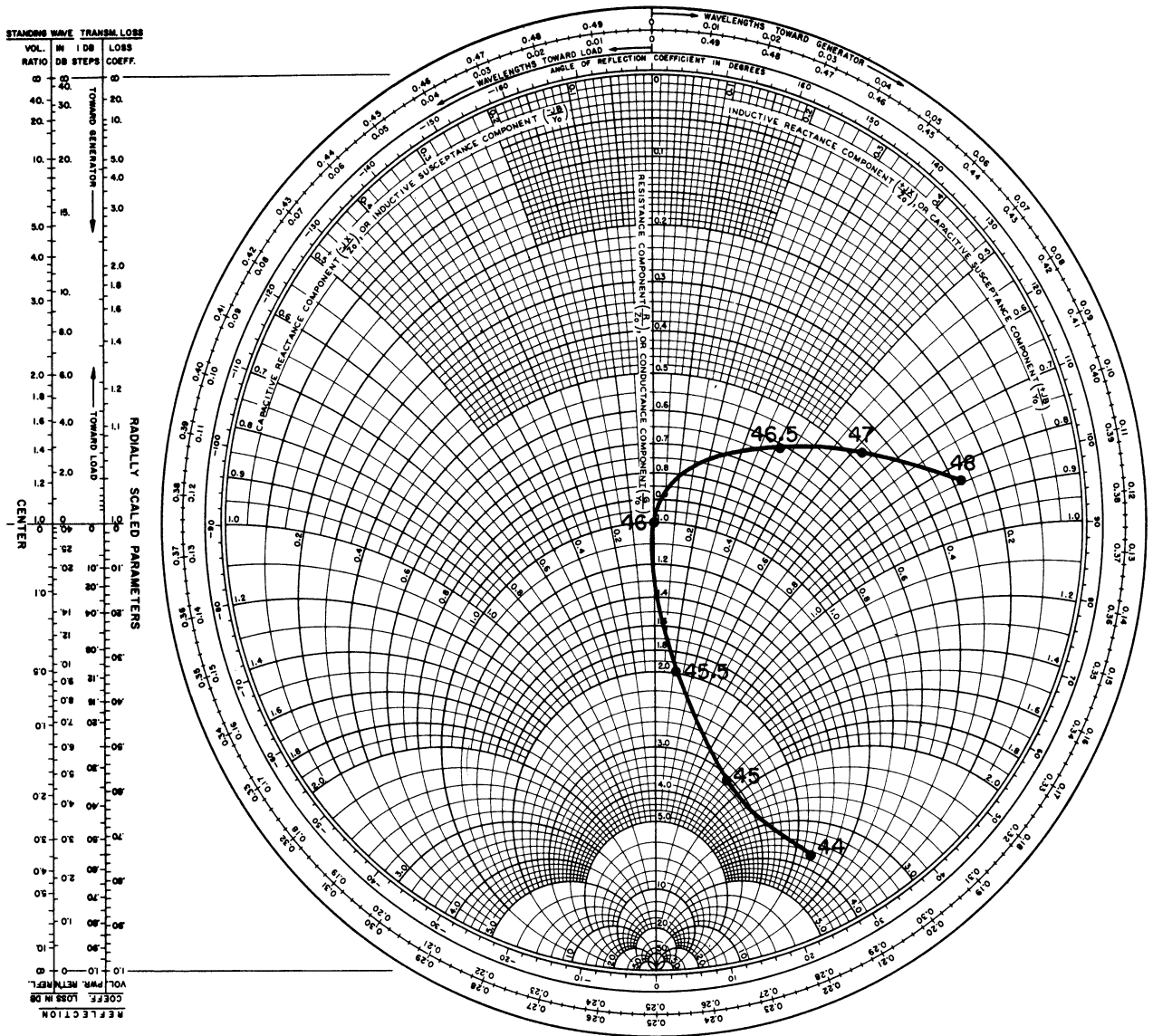

FIG. 3-13: Measured Impedance of a 75 cm Folded Monopole When Tuned and Matched at 46 MHz Using the C-L Tuning Technique .

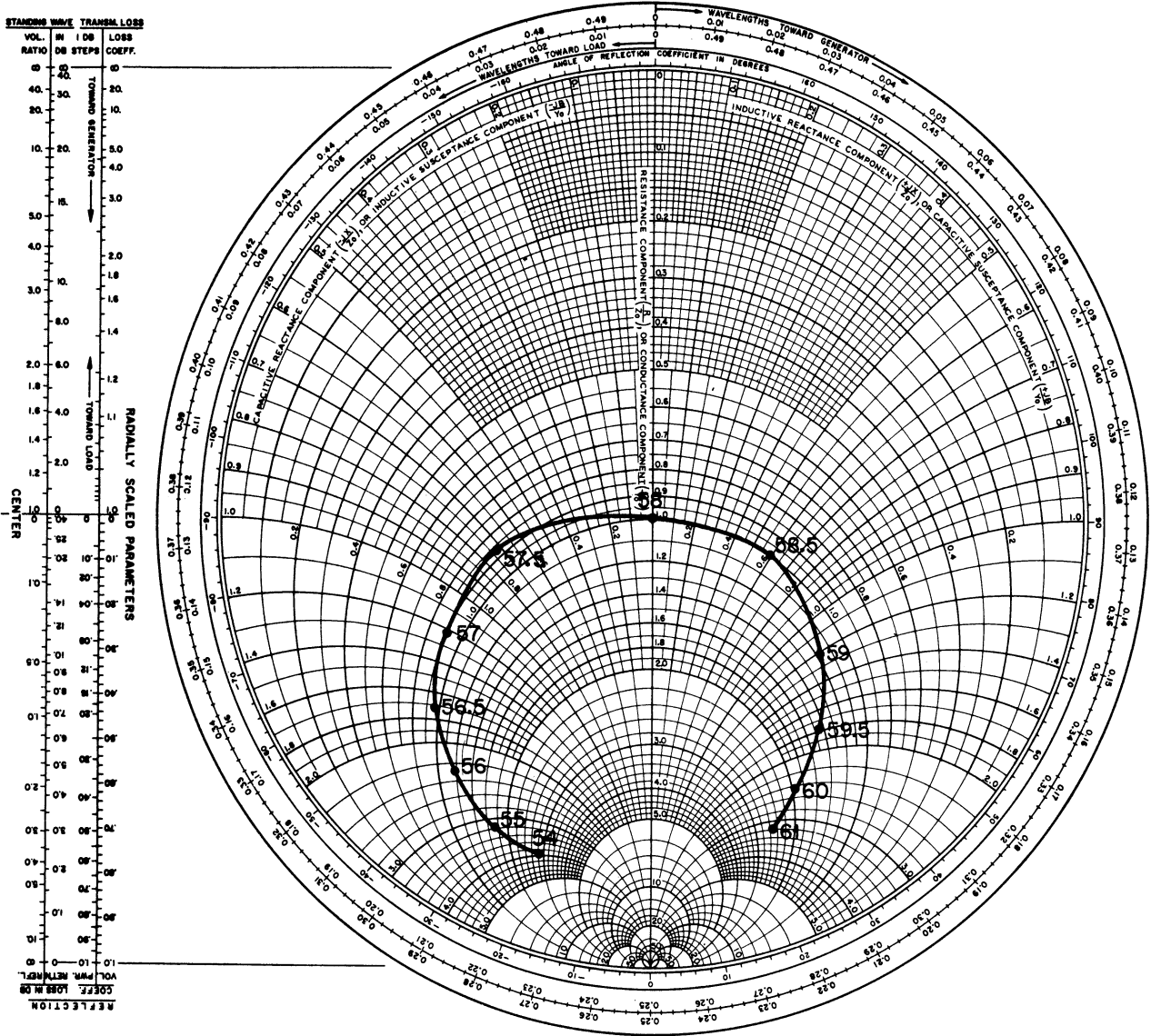
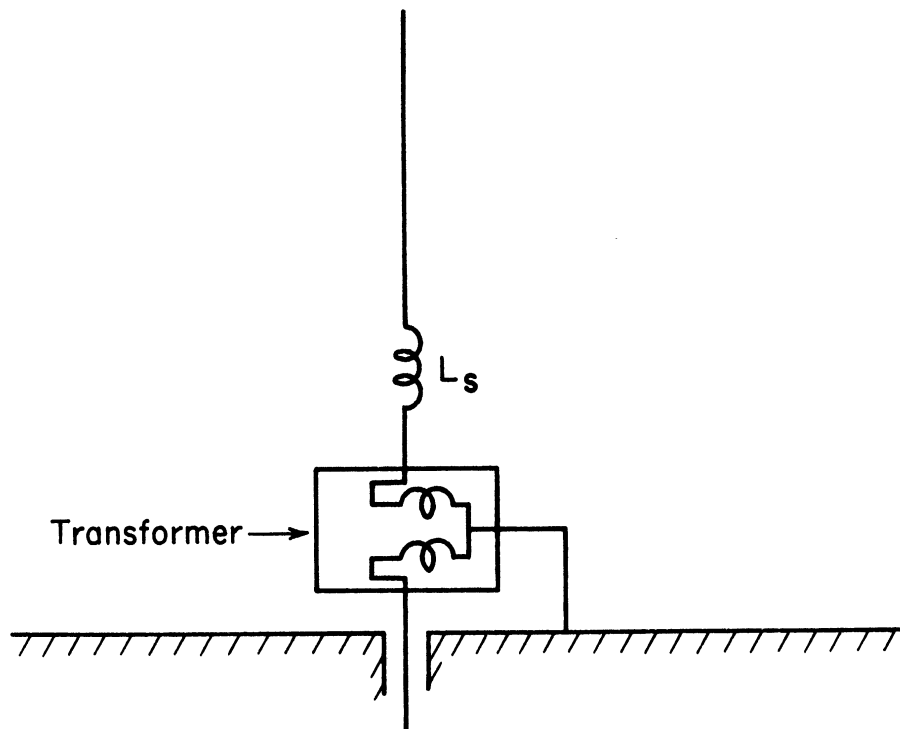

FIG. 3-14: Measured Impedance of a 75 cm Folded Monopole When Tuned and Matched at 58 MHz Using the C-L Tuning Technique.

### 3.5 Other Possible Tuning and Matching Techniques

It is clear that other tuning and matching techniques may be devised. One obvious arrangement is shown in Fig. 3-15. Using the short monopole as an example, the tuning arrangement in Fig. 3-15 corresponds to the path A B'' D on the Smith chart in Fig. 3-3. The series inductor  $L_s$  is first adjusted to cancel out the reactive part of the monopole impedance. The resistive part of the monopole impedance is then matched to the transmission line using an ideal transformer. Note that in this particular arrangement, the tuning and matching steps are clearly isolated. Practical utilization of this tuning and matching arrangement seems to be very limited at present, especially if a fairly wide tuning range is desired. This is because a transformer with adjustable transformation ratio would be required to match the real part of the antenna impedance to the transmission line as the frequency is varied.



**FIG. 3-15: A Tuning and Matching Arrangement Using a Transformer and an Inductor.**

## IV

### CONCLUSIONS

Methods have been developed for obtaining satisfactory circuit models for a simple monopole and for a folded monopole antenna over a ground plane. The methods can easily be extended to other types of antennas. Circuit models of the types described are useful in the study of remotely controlled antennas. Such control can be made to provide for changing the tuning and bandwidth characteristics of the antennas. The inductance and capacitance necessary to provide for the control of an electrically small antenna is shown.

Various experimental tuning arrangements can be used. In the case of a simple monopole, one of a length 75 cm was tuned using an inductor  $L_1$  connected in series. In addition a capacitor was connected from the side of the inductor nearest the ground plane to the ground plane. The experimental results are in satisfactory agreement with the expected behavior. Data is presented showing that, from the impedance standpoint, such an antenna can operate satisfactorily with the length reduced by a factor of 4 over the usual length of such a monopole. Experimental data was also presented on a C-L tuning arrangement for a folded monopole. Operation was satisfactory for a length reduction of a factor of 2. It was apparent that greater reduction would also permit satisfactory performance.

In the experiments for both the simple monopole and folded monopole where the actual tuning changes were made, it was found that repeated adjustments were necessary. This very fact points to the significance of having appropriate arrangements where the controls can be remote. These control units can be made properly responsive to a change of operating frequency so that the desired pure resistance value can be offered as the composite impedance of the antenna system including the circuit parameters introduced by the

control units. While these control units were not actually fabricated, certain designs were studied and there is no question concerning the feasibility of such units, particularly for frequencies in the vicinity of 30 MHz. For frequencies approaching 100 MHz a certain amount of further research and development would be necessary.

It is entirely possible in the consideration of physically small antennas that it would be desirable for the bandwidth control to provide increased rather than decreased bandwidth. This means that such a "Q multiplier" circuit should be able to change the  $Q$  in either direction (upward or downward).

Based on the success of the analysis and experiments recorded in this report, it appears very possible that in the future, the tuning of electrically small antennas will be accomplished as part of a receiver circuit. The tuning and control requirements of the antenna can then be made compatible with the tuning and bandwidth requirements of the receiver proper.

## REFERENCES

- Harris, H. E. (May 1951), "Simplified Q-Multiplier," Electronics , pp. 120-124.
- Huelsman, L. P. (1968), Theory and Design of Active RC Circuits, McGraw-Hill Book Company, New York,
- Khan, P. J., et al (May 1968), "Improved Performance Techniques for Small Antennas," The University of Michigan Cooley Electronics Final Report on DA-043-AMC-02246(E).
- Lyon, J. A. M. , P. J. Khan and M. A. Hidayet (October 1970), "Equivalent Circuits for Tuning Small Antennas with Active Elements," Twentieth Annual Symposium on USAF Antenna Research and Development. 17 pgs.
- Lyon, J. A. M. , et al (June 1968), " Study and Investigation of a UHF-VHF Antenna Final Report" The University of Michigan Radiation Laboratory Report 7848-1-F, AFAL-TR-68-114. 304 pgs.
- Mitra, S. K. (1969), Analysis and Synthesis of Linear Active Circuits, John Wiley and Sons.
- National Bureau of Standards (1948), Ionospheric Radio Propagation , NBS Circular 462, U. S. Government Printing Office.
- Texas Instruments (1963), Transistor Circuit Design, McGraw-Hill Book Company, New York, p. 300.



## DOCUMENT CONTROL DATA - R &amp; D

(Security classification of title, body of abstract and indexing annotation must be entered when the overall report is classified)

1. ORIGINATING ACTIVITY (Corporate author) The University of Michigan Radiation Laboratory 2216 Space Research Bldg., North Campus Ann Arbor, Michigan 48105		2a. REPORT SECURITY CLASSIFICATION <b>UNCLASSIFIED</b>	
		2b. GROUP NA	
3. REPORT TITLE  Tunable Electrically Small Antennas for 30 - 100 MHz Operation.			
4. DESCRIPTIVE NOTES (Type of report and inclusive dates) Technical Report, Scientific			
5. AUTHOR(S) (First name, middle initial, last name) John A. M. Lyon, Alan G-T Cha and Mohamed A. Hidayet			
6. REPORT DATE June 1971		7a. TOTAL NO. OF PAGES 48	7b. NO. OF REFS 8
8a. CONTRACT OR GRANT NO. F33615-68-C-1381		9a. ORIGINATOR'S REPORT NUMBER(S) 1770-6-T	
b. PROJECT NO. Proj. 6278, Task 627801		9b. OTHER REPORT NO(S) (Any other numbers that may be assigned this report) AFAL-TR-71-184	
10. DISTRIBUTION STATEMENT Distribution limited to U. S. Government agencies only; test and evaluation results reported; June 1971. Other requests for this document must be referred to Air Force Avionics Laboratory (AFAL/TEM) Wright-Patterson AFB, OH 45433.			
11. SUPPLEMENTARY NOTES		12. SPONSORING MILITARY ACTIVITY Air Force Avionics Laboratory Air Force Systems Command Wright-Patterson AFB, Ohio 45433	
13. ABSTRACT The possibilities for tunable electrically small antennas are explored and analyzed. Although experimental determinations were made of impedance characteristics from 30 to 220 MHz, the objective was to study the possibility of tuning and bandwidth control for antennas in the range 30 to 100 MHz. A considerable part of the discussion is devoted to acceptable circuit representations or models for the antennas. Both the electric monopole and the folded monopole, each over a conducting ground plane, are considered in detail. The first of these tends to become capacitive as it is operated at progressively lower frequencies whereas the second tends to become inductive as the frequency is decreased. The practicality of having tunable small antennas is directly associated with the possibilities of remote tuning and remote bandwidth control. Both of these topics were investigated. It appears entirely possible to have such remote control units operable at 30 MHz and above. The present state of the art of transistors would make this more difficult for frequencies approaching 100 MHz. Transistors, however, are currently being produced which show great promise for control units even at this frequency. Fortunately some phase shift in a transistor is tolerable for the tuning reactance units and the bandwidth control units. The range required for the tuning unit was thoroughly explored and two examples are given of antennas which are properly tuned by an external tuning unit. The electric monopole studied was electrically small, being less than 1/4 of its usual height, when operated at the lower end of the frequency range. Data are presented on the tuning of a folded monopole and show the possibility of operation of this type of antenna with a similar reduction in size. It is apparent that greater reduction factors could be obtained with both of these antennas.			

14. KEY WORDS	LINK A		LINK B		LINK C	
	ROLE	WT	ROLE	WT	ROLE	WT
Electrically Small Antennas Tunable Small Antennas Antenna Impedance Control Tuning and Bandwidth Control Electrical Tuning of Antennas						



UNIVERSITY OF MICHIGAN



3 9015 03483 1530