

Unless otherwise noted, the content of this course material is licensed under a Creative Commons Creative Commons Attribution - Non-Commercial - Share Alike 3.0 License.

<http://creativecommons.org/licenses/by-nc-sa/3.0/>

Copyright © 2009, Paul Conway.

You assume all responsibility for use and potential liability associated with any use of the material. Material contains copyrighted content, used in accordance with U.S. law. Copyright holders of content included in this material should contact open.michigan@umich.edu with any questions, corrections, or clarifications regarding the use of content. The Regents of the University of Michigan do not license the use of third party content posted to this site unless such a license is specifically granted in connection with particular content. Users of content are responsible for their compliance with applicable law. Mention of specific products in this material solely represents the opinion of the speaker and does not represent an endorsement by the University of Michigan. For more information about how to cite these materials visit <http://michigan.educommons.net/about/terms-of-use>.

Any medical information in this material is intended to inform and educate and is not a tool for self-diagnosis or a replacement for medical evaluation, advice, diagnosis or treatment by a healthcare professional. You should speak to your physician or make an appointment to be seen if you have questions or concerns about this information or your medical condition. Viewer discretion is advised: Material may contain medical images that may be disturbing to some viewers.

SI 640 Digital Libraries and Archives

Week 5 – Interface and Infrastructure

Themes of the Week

- Underlying technical infrastructure is a critical DL component
- Multiple infrastructure models
- Interface is representation of infrastructure
- Two – way communication between user and system
- Metadata schemas are increasingly complex and standardized

Harvard Library Digital Initiative Model

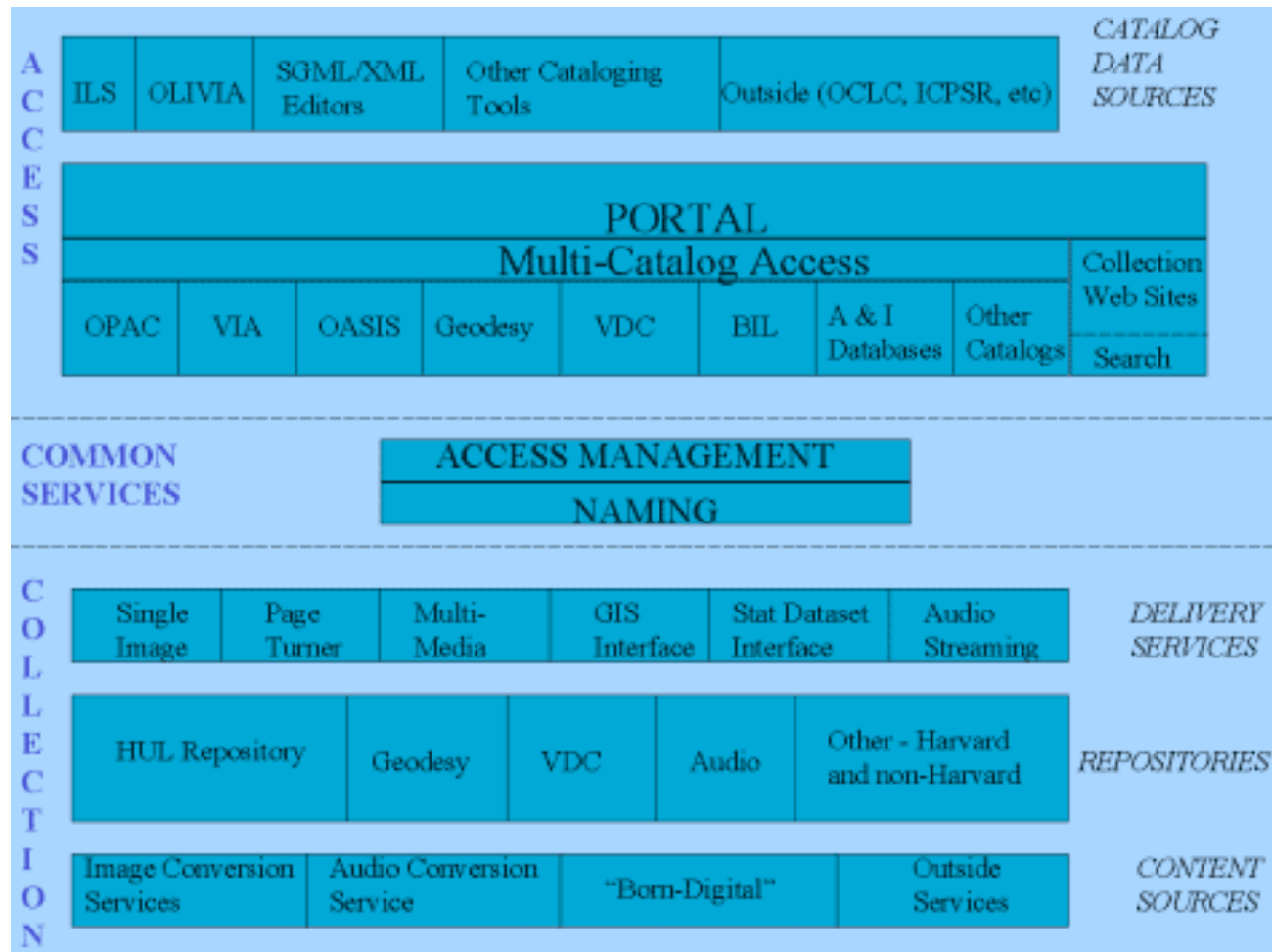

Systems Integration

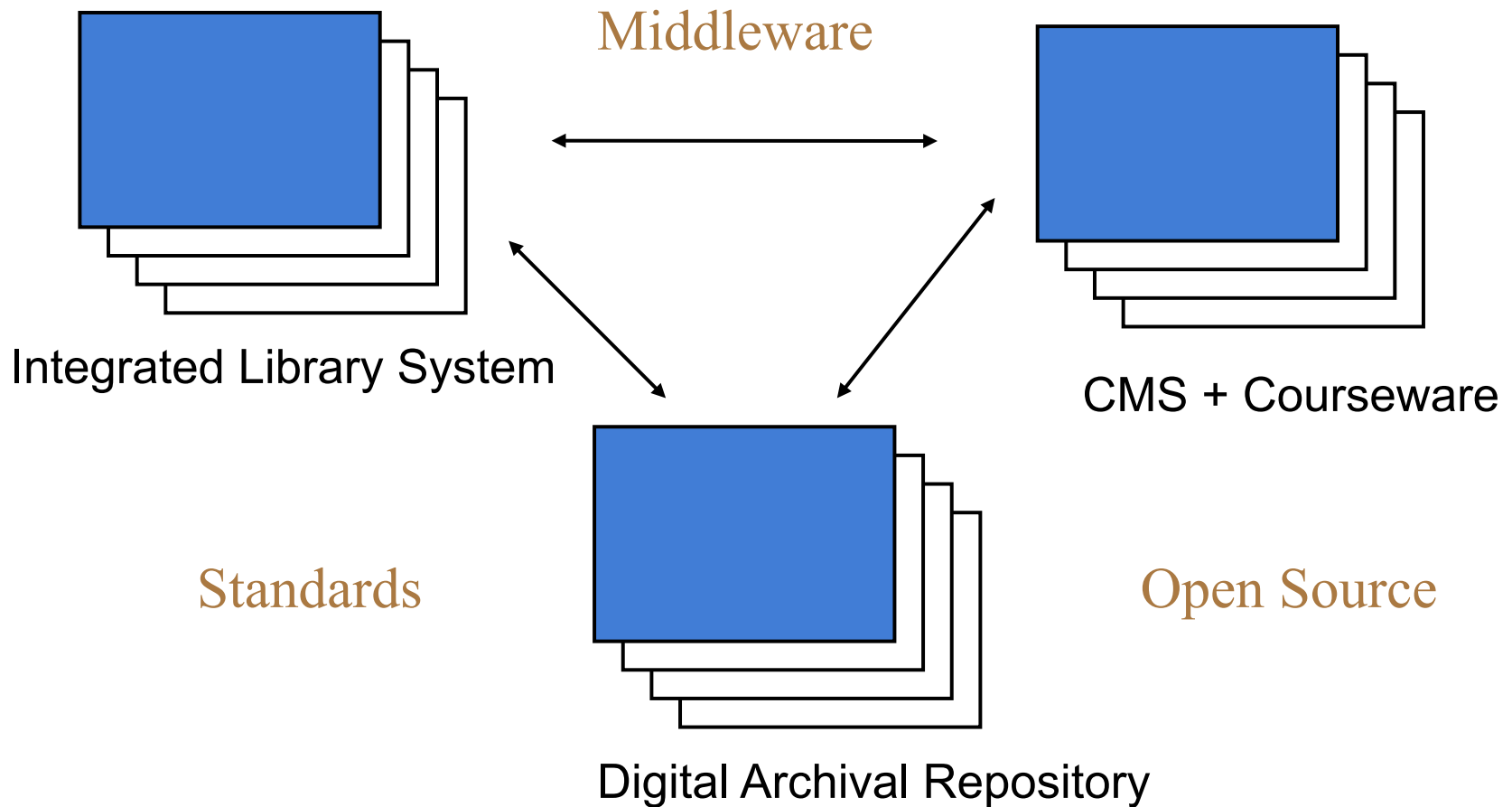

Open Archival Information System

◆ Open

- Reference Model standard(s) are developed using a public process and are freely available

◆ Information

- Any type of knowledge that can be exchanged
- Independent of the forms (i.e., physical or digital) used to represent the information
- Data are the representation forms of information

◆ Archival Information System

- Hardware, software, and people who are responsible for the acquisition, preservation and dissemination of the information
- Additional OAIS responsibilities are identified later and are more fully defined in the Reference Model document

OAIS Information Definition

- Information is defined as any type of knowledge that can be exchanged, and this information is always expressed (i.e., represented) by some type of data
- In general, it can be said that “Data interpreted using its Representation Information yields Information”
- In order for this Information Object to be successfully preserved, it is critical for an archive to clearly identify and understand the Data Object and its associated Representation Information

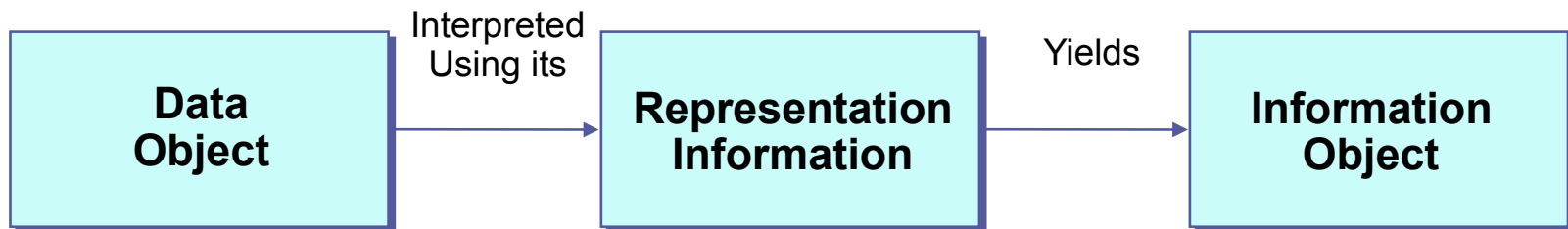

On a abstract level a PLM roughly identifies 4 abstraction levels

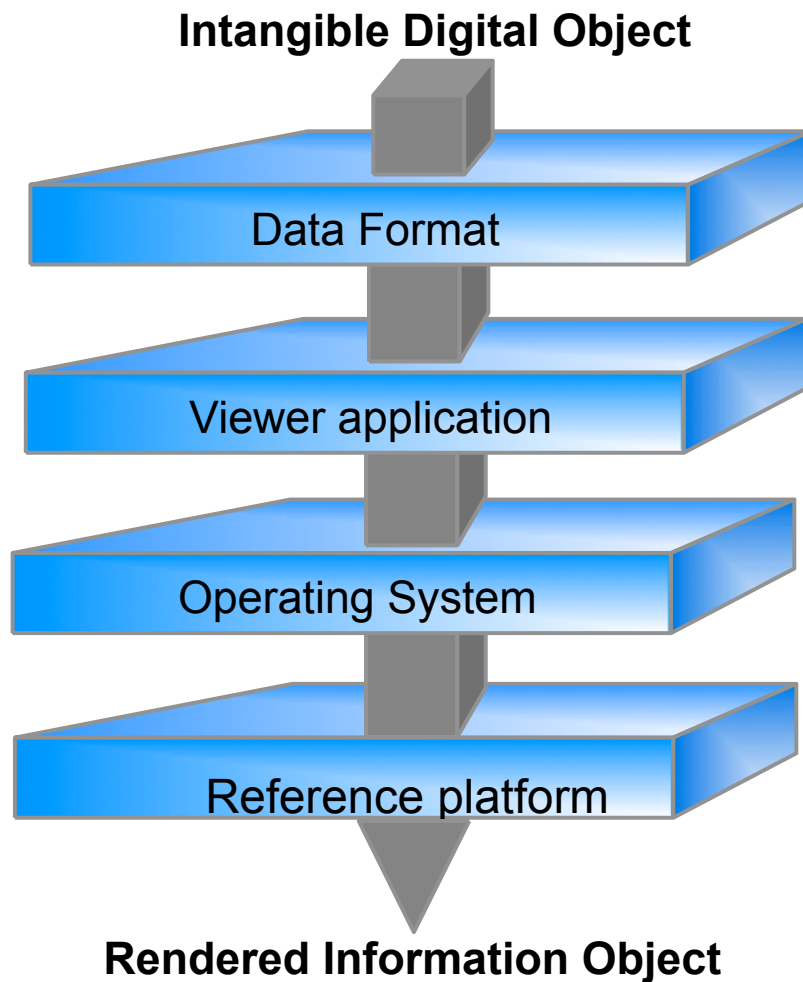

- **Data format** identifies the structuring and meaning of raw bit stream, i.e. the intangible digital object.
- The structuring and meaning of the the raw bit stream are defined within the application logic of specific **viewer applications**. These applications are used to create, modify, and present the information in its intended format.
- The **operating system** provides the shared functionality needed by all viewer applications like peripheral access and basic file management
- The **reference platform** represents the hardware on which the intangible digital objects are rendered into real world physical objects, like for instance a print out or the screen representation.

External Data Flow Diagram

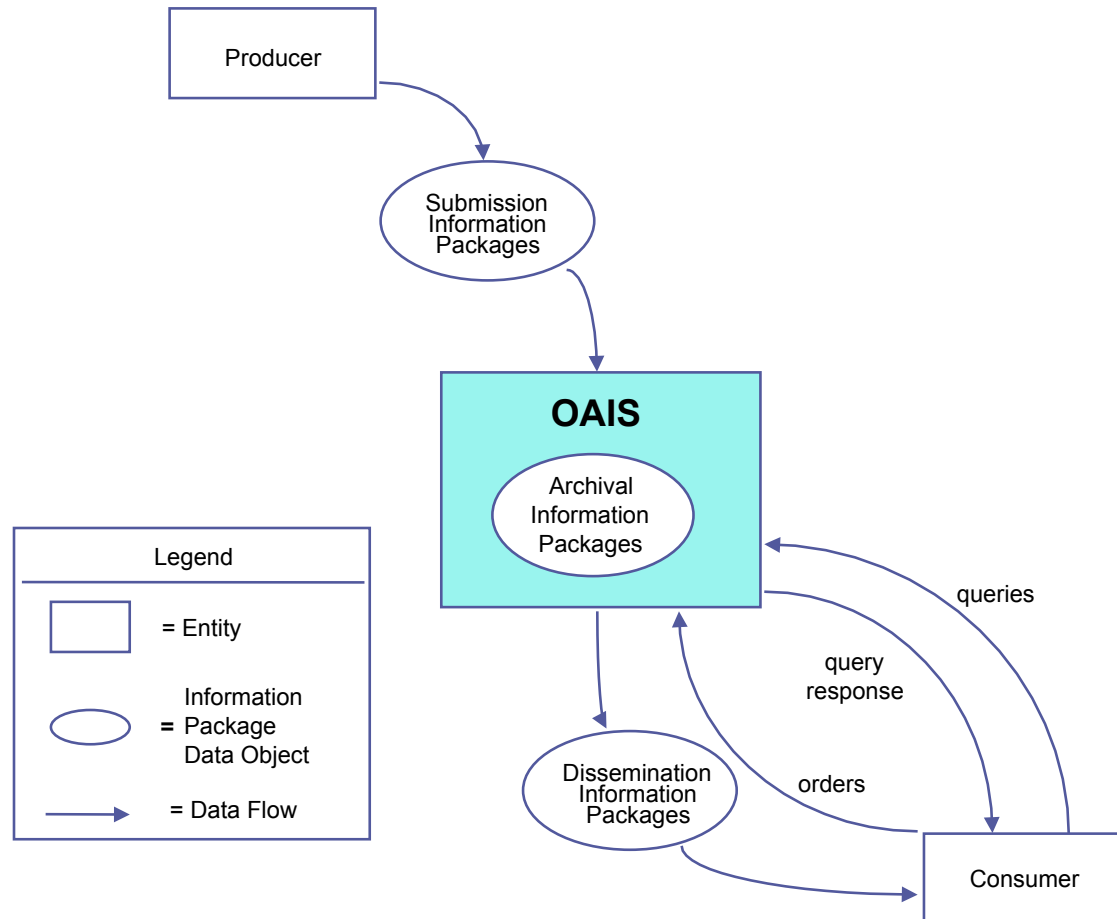

Base Processes Within the OAIS Model

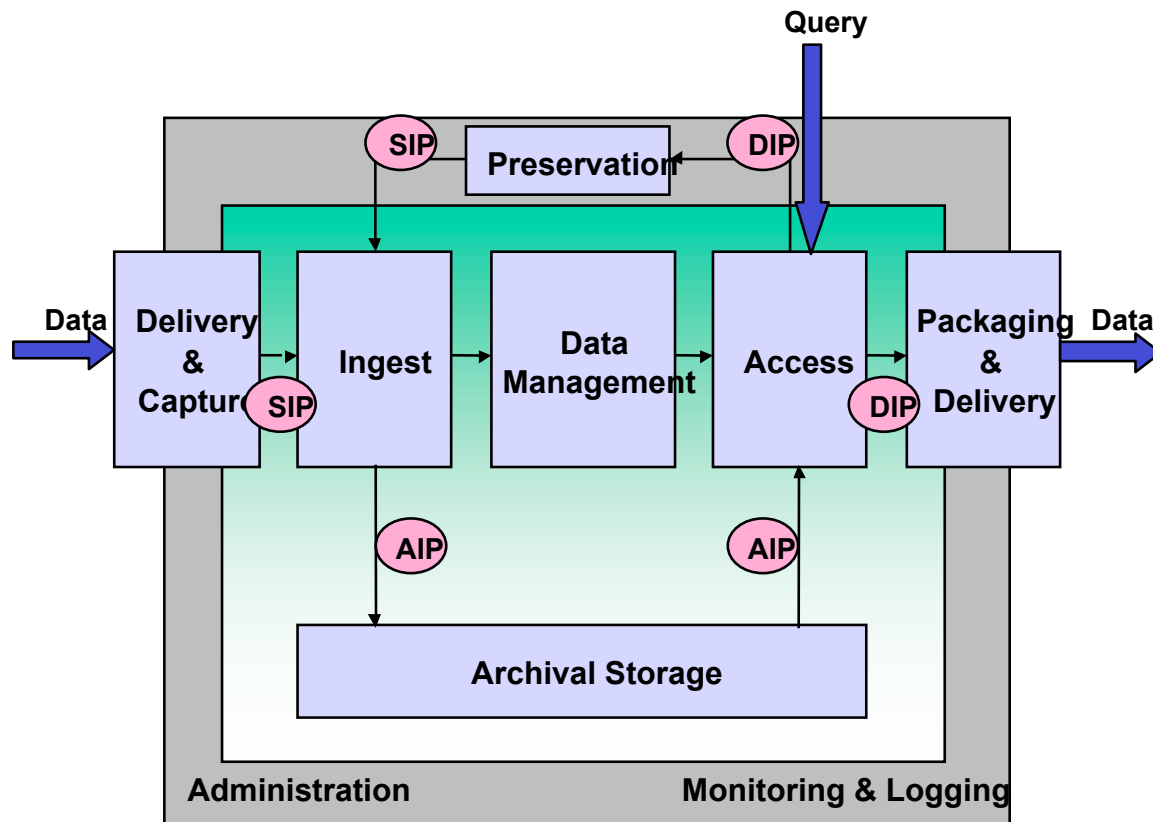

Types of Information Used in OAIS

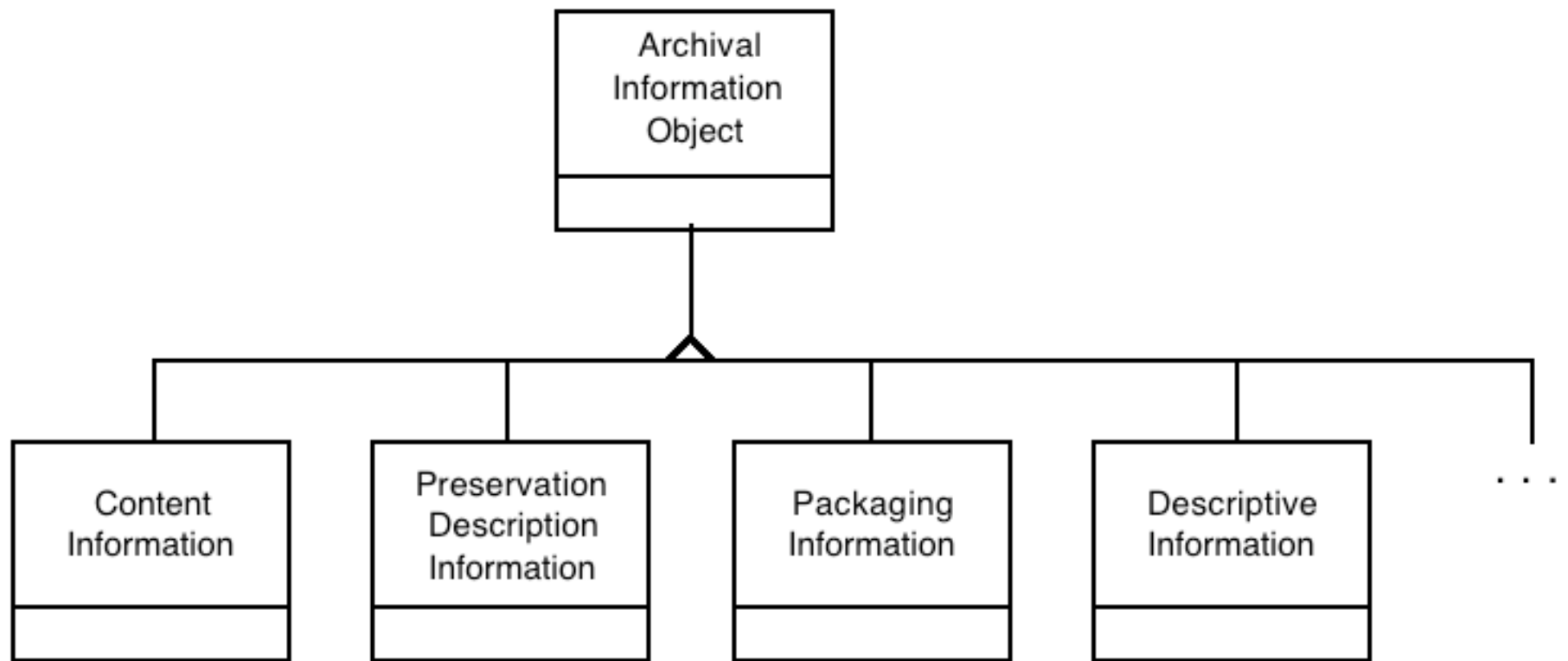

10041267-10

Preservation Description Information

◆ Provenance Information

- Describes the source of Content Information, who has had custody of it, what is its history

◆ Context Information

- Describes how the Content Information relates to other information outside the Information Package

◆ Reference Information

- Provides one or more identifiers, or systems of identifiers, by which the Content Information may be uniquely identified

◆ Fixity Information

- Protects the Content Information from undocumented alteration

Example of Preservation Description Information

Content Information Type	Reference	Provenance	Context	Fixity
Space Science Data	<ul style="list-style-type: none"> ■ Object Identifier ■ Journal Reference ■ Mission, instrument, and title attribute set 	<ul style="list-style-type: none"> ■ Instrument Description ■ Processing History ■ Sensor Description ■ Instrument ■ Instrument mode ■ Processing history ■ Decommunication map ■ Software Interface Specifications ■ Printing history 	<ul style="list-style-type: none"> ■ Calibration history ■ Related data sets ■ Mission ■ Funding history 	<ul style="list-style-type: none"> ■ CRC ■ Checksum ■ Reed-Solomon coding
Bibliographic Information	<ul style="list-style-type: none"> ■ ISBN ■ Title ■ Author 	<ul style="list-style-type: none"> ■ Copyright ■ Position in series ■ Manuscripts ■ References 	<ul style="list-style-type: none"> ■ Related References ■ Dewy Decimal System ■ Publishing Data ■ Publisher 	<ul style="list-style-type: none"> ■ Author Digital signature ■ Cover
Software Package	<ul style="list-style-type: none"> ■ Name ■ Author ■ Version number ■ Serial Number 	<ul style="list-style-type: none"> ■ Revision Histroy ■ License holder ■ Registration ■ Copyright 	<ul style="list-style-type: none"> ■ Help file ■ User Guide ■ Related Software ■ Language 	<ul style="list-style-type: none"> ■ Certificate ■ Checksum ■ Encryption ■ CRC

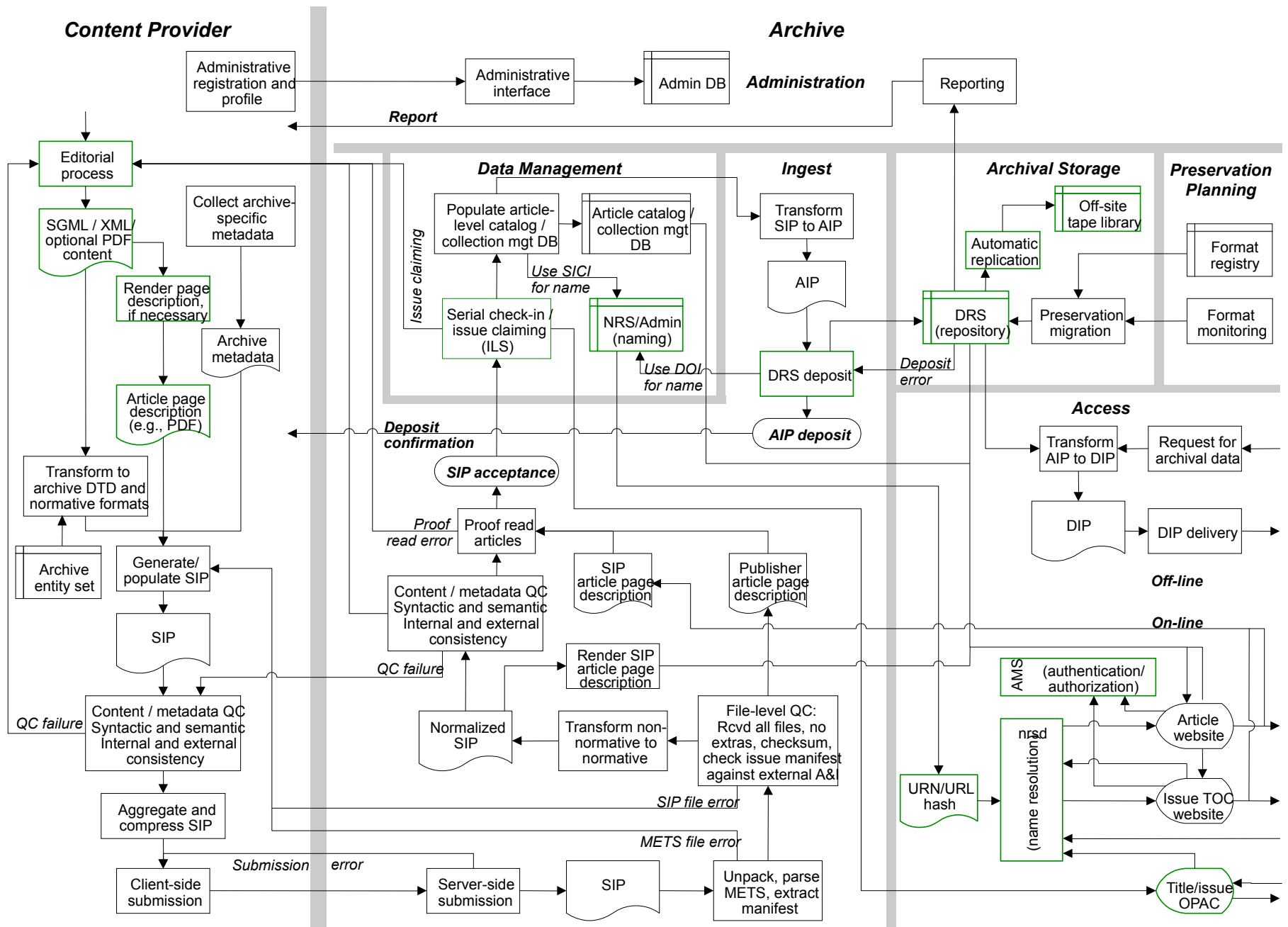

Proposed OAIS-based E-Journal Archive Mapped to Harvard's LDI Infrastructure

Categories of Archive Interactions

- **Independent:** no knowledge by one OAIS of Standards implemented at another
- **Cooperating:** Potentially common submission standards, and common dissemination standards, but no common access. One archive may make subscription requests for key data at the cooperating archive
- **Federated:** Access to all federated OAIS is provided through a common set of access aids that provide visibility into all participating OAISs. Global dissemination and Ingest are options
- **Shared resources:** An OAIS in which Management has entered into agreements with other OAISs is to share resources to reduce cost. This requires various standards internal to the archive (such as ingest-storage and access-storage interface standards), but does not alter the community's view of the archive

Cooperating Archives

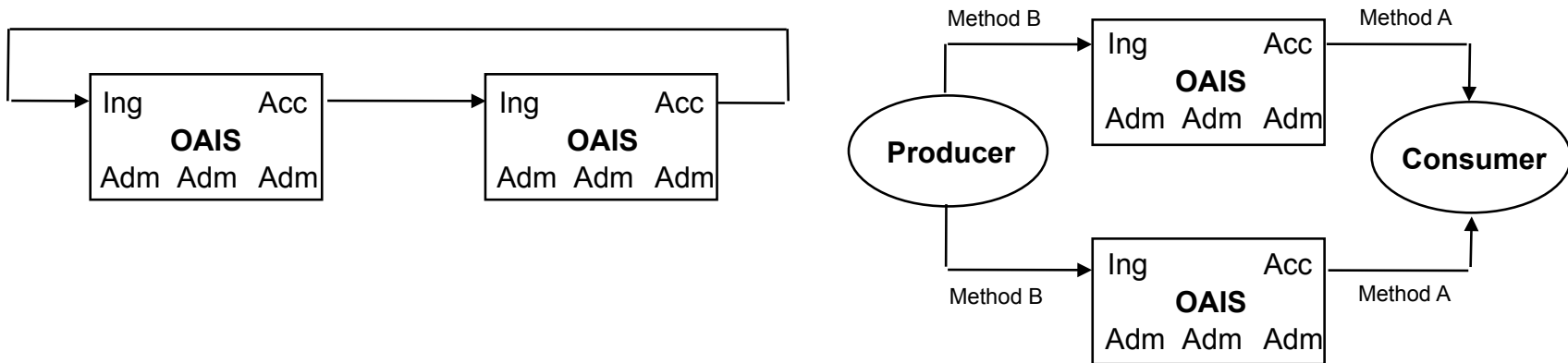

- The first set of cooperating OASIS merely have an agreement to share at least on common SIP and DIP format to enable the transfer of holdings
- The second set of cooperating OASIS have standardized their DIP and SIP formats for use by producers and consumers

Federated Archives

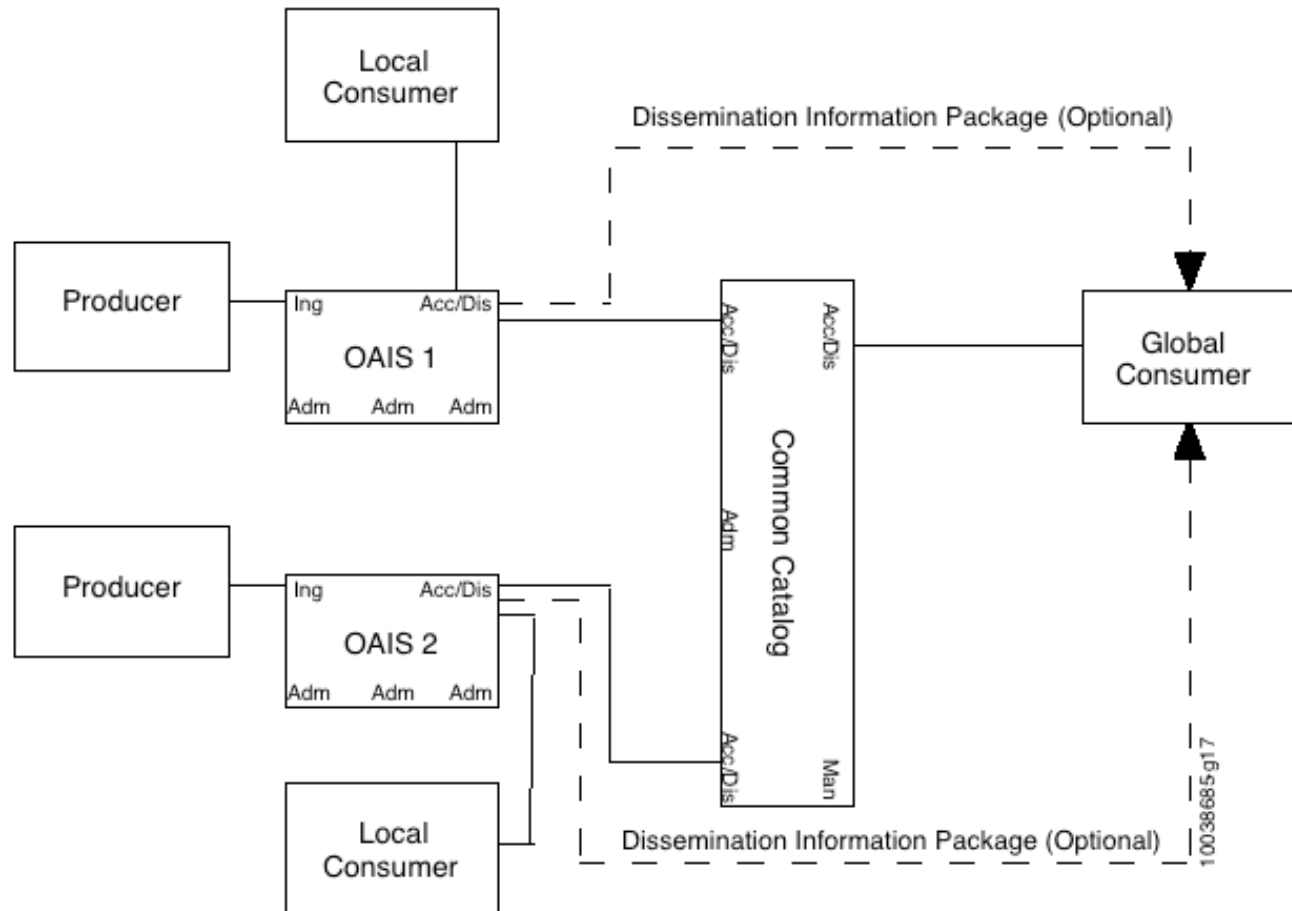

Establishing a User Context

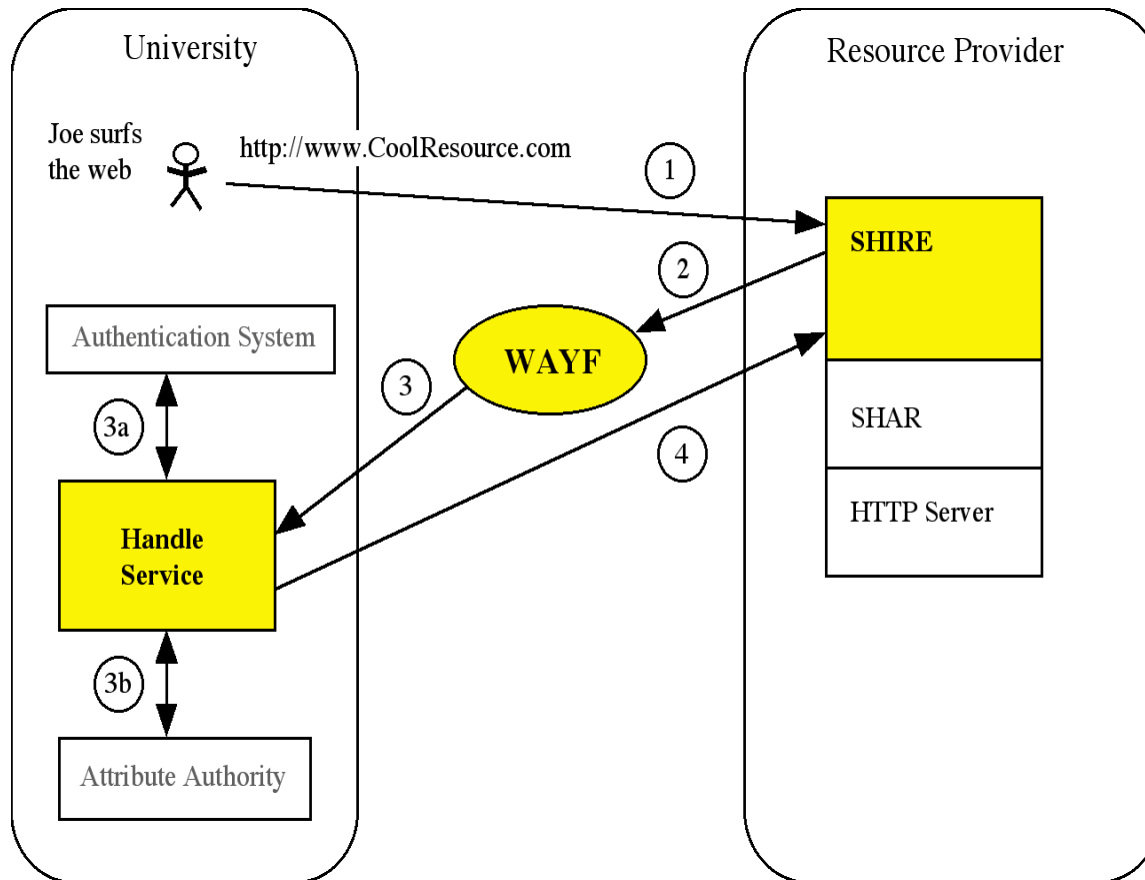

From: Internet2 (<http://www.internet2.edu/>)

Getting Attributes and Determining Access

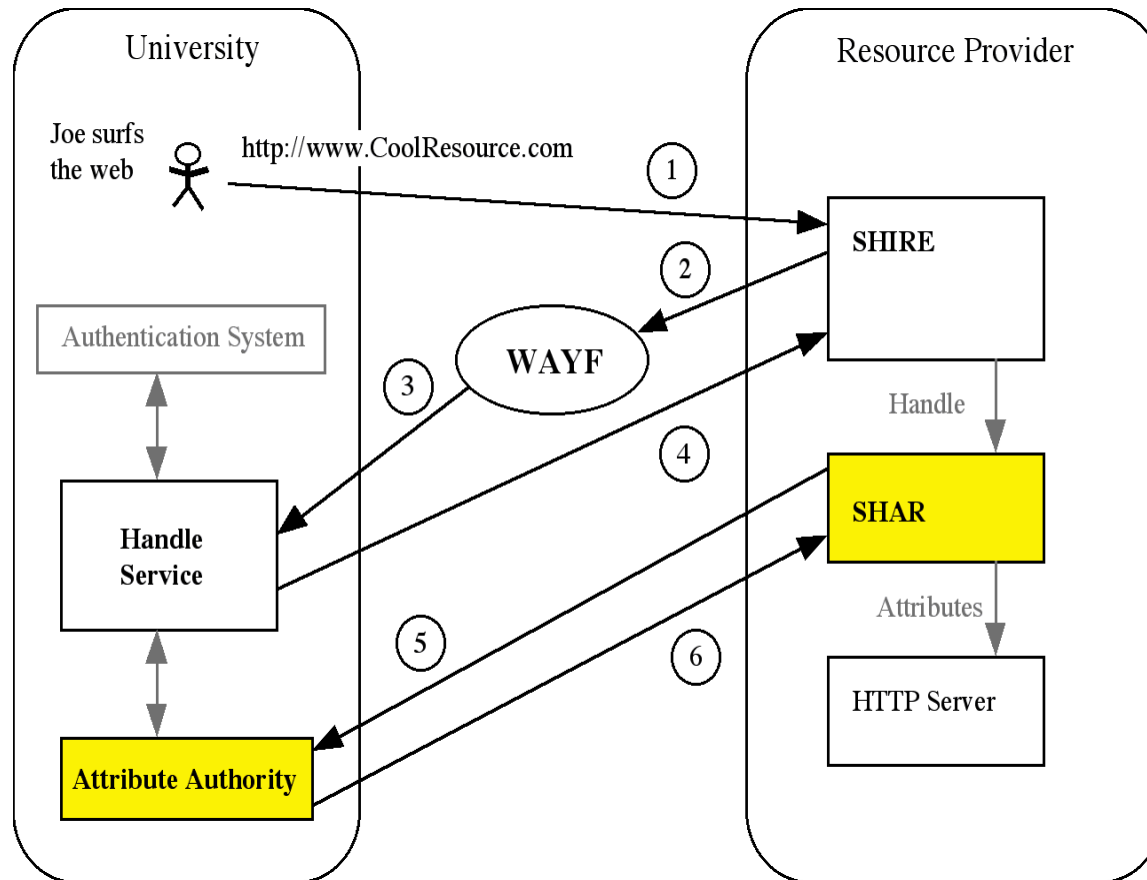

From: Internet2 (<http://www.internet2.edu/>)



Attribute Authority -- Management of Attribute Release Policies

The AA provides ARP management tools/interfaces.

Different ARPs for different targets

Each ARP Specifies which attributes and which values to release

Institutional ARPs (default)

- *administrative default policies and default attributes*
- *Site can force include and exclude*

User ARPs managed via "MyAA" web interface

Release set

determin

e

d by "combining" Default and User ARP for the specified resource



Authorization Attributes

Typical Attributes in the Higher Ed Community

Affiliation	“active member of the	Member@washington.edu
EPPN	community”	gettes@georgetown.edu
Entitlement	identity	Urn:mace:infovendor:contract1234
OrganizationalUnit	An agreed upon opaque string	Economics Department
EnrolledCourse	Department	Physics 201
	Opaque course identifier	

From: Internet2 (<http://www.internet2.edu/>)

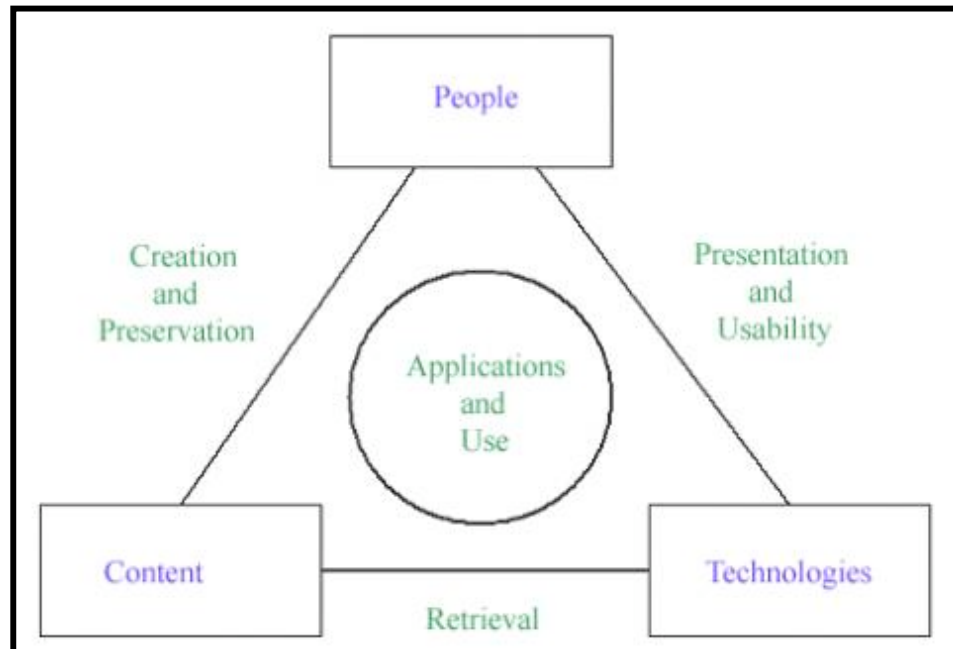

NSF/DELOS. (2003) Working Group on Digital Imagery for Significant Cultural and Historical Materials.

http://www.dli2.nsf.gov/internationalprojects/working_group_reports/digital_imagery.html

From: Internet2 (<http://www.internet2.edu/>)

Thank you!

Paul Conway

Associate Professor

School of Information

University of Michigan

www.si.umich.edu

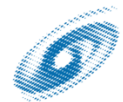

SCHOOL OF INFORMATION
UNIVERSITY OF MICHIGAN