

---

# **Comparison of Child Body Dimensions with Rear Seat Geometry**

**Stephanie Huang and Matthew P. Reed**  
University of Michigan Transportation Research Institute

Reprinted From: **Air Bags and Occupant Restraints  
(SP-1994)**

ISBN 0-7680-1722-X

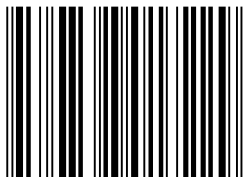

9 780768 017229

**SAE** *International*<sup>™</sup>

2006 SAE World Congress  
Detroit, Michigan  
April 3-6, 2006

The Engineering Meetings Board has approved this paper for publication. It has successfully completed SAE's peer review process under the supervision of the session organizer. This process requires a minimum of three (3) reviews by industry experts.

All rights reserved. No part of this publication may be reproduced, stored in a retrieval system, or transmitted, in any form or by any means, electronic, mechanical, photocopying, recording, or otherwise, without the prior written permission of SAE.

For permission and licensing requests contact:

SAE Permissions  
400 Commonwealth Drive  
Warrendale, PA 15096-0001-USA  
Email: [permissions@sae.org](mailto:permissions@sae.org)  
Tel: 724-772-4028  
Fax: 724-776-3036



For multiple print copies contact:

SAE Customer Service  
Tel: 877-606-7323 (inside USA and Canada)  
Tel: 724-776-4970 (outside USA)  
Fax: 724-776-0790  
Email: [CustomerService@sae.org](mailto:CustomerService@sae.org)

**ISSN 0148-7191**

**Copyright © 2006 SAE International**

Positions and opinions advanced in this paper are those of the author(s) and not necessarily those of SAE. The author is solely responsible for the content of the paper. A process is available by which discussions will be printed with the paper if it is published in SAE Transactions.

Persons wishing to submit papers to be considered for presentation or publication by SAE should send the manuscript or a 300 word abstract to Secretary, Engineering Meetings Board, SAE.

**Printed in USA**

# Comparison of Child Body Dimensions with Rear Seat Geometry

Stephanie Huang and Matthew P. Reed

University of Michigan Transportation Research Institute

Copyright © 2006 SAE International

## ABSTRACT

Children who are too large for harness restraints but too small to obtain good restraint from a vehicle seatbelt alone should be seated in a belt-positioning booster. Boosters have been shown to significantly reduce abdominal injuries caused by seatbelts. This effectiveness may be due in part to the fact that boosters reduce the effective seat cushion length, allowing children to sit more comfortably without slouching. NHTSA recommends that children who do not use harness restraints use boosters until they are at least 145 cm tall. In this paper, data from several sources were combined to assess how well children fit on rear seat cushions. Data from NASS-GES were analyzed to determine the age distribution of rear-seat occupants. Anthropometric data from several sources were analyzed to determine the distribution of buttock-popliteal length, a measure of thigh length that is a key determinant of seat fit, as a function of age and gender. Second- and third-row cushion lengths were measured on a convenience sample of 56 late-model vehicles. Comparing the distribution of body size for rear-seat occupants with the seat cushion lengths showed that most cushions are too long for most rear-seat occupants, using commonly applied standards of seat fit. Given that most rear-seat occupants in the U.S. are children, rear-seat design standards should consider the smaller body dimensions and different restraint needs of this population.

## INTRODUCTION

The U.S. National Highway Traffic Safety Administration has recommended that children who are too large for harness restraints but less than 145 cm tall use a belt-positioning booster (NHTSA 2004). Boosters raise the child on the seat and improve the fit of lap and shoulder belts. Studies have proposed that one of the advantages of boosters is that they effectively shorten the seat cushion length (Klinich et al. 1994). Children seated on vehicle seats that are too long for them often

slouch, as shown in Figure 1 (Reed et al. 2005). Children may slouch so that they can rest their feet on the floor, or to achieve more comfortable knee angles even when their feet cannot reach the floor (Klinich et al. 1994).

Seat length recommendations for adults are based on the lower percentiles of the distribution of buttock-popliteal length (BPL). BPL is measured horizontally from a vertical plane tangent to the buttocks to the popliteal fossa behind the knee with the subject in a standardized erect sitting posture as shown in Figure 2 (Gordon et al. 1989; Roebuck 1995). Typical practice is to recommend that seats and chairs made for adults be constructed such that the seat length, measured from the front of the seat back to the front of the seat cushion, is less than the 5th percentile of female buttock-popliteal length (e.g., Pheasant 1996). Using this criterion, the maximum cushion lengths for seats and chairs is recommended to be 440 mm or less (Keegan 1964; Pheasant 1996; Reed et al. 1994). None of these recommendations includes consideration of child body dimensions.



Figure 1. Child in a seat with a long seat cushion. Note the slouched posture and lap belt fit on the lower abdomen.

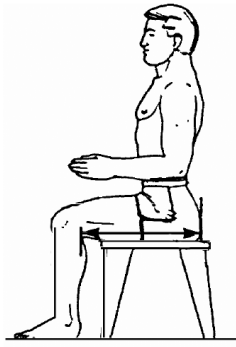

Figure 2. Buttock-popliteal length dimension. Modified from Gordon et al. (1989).

The objectives of the current study were (1) to quantify several dimensions of second- and third-row seats that are important for occupant fit; (2) to determine the age distribution of occupants in rear seats; (3) to calculate the distribution of thigh length (BPL) for several age- and stature-based cohorts of rear-seat occupants, and (4) to compare the distribution of BPL with the distribution of seat cushion length. The analysis supports conclusions about appropriate design practices for rear seats.

## METHODS

### Overview

Seat cushions in 56 late-model vehicles were measured using a protocol developed for the current study. Data on the distribution of rear-seat occupant age were obtained from NASS-GES, a nationally representative sample of U.S. crashes. Age distributions were converted to distributions of buttock-popliteal length by reference to anthropometric data from three sources. Data from a large-scale study of U.S. child anthropometry from the 1970s were adjusted and weighted using data from (1) a detailed study of military (adult) body dimensions, and (2) more recent data on overall child body size (stature and weight).

### Measurement of Seat Cushion Length

The objective in developing the seat cushion length measurement procedure was to approximate the dimension that would be obtained by measuring along the thigh line of the SAE J826-1995 H-point manikin when installed according to the measurement procedure for seat cushion angle (SAE 2005). This is also approximately equivalent to a measurement along the thigh line of the HPM-II manikin described in SAE J4002.

Figure 3 shows the definition schematically. Cushion length was measured using a specially designed fixture and measuring square, shown in Figure 4. The dimensions of the metal plate were determined from H-point manikin dimensions using the following criteria and assumptions:

- The H-point of the J826 manikin is located approximately 135 mm from the seat back along the thigh line and 100 mm above the compressed cushion surface, measured perpendicular to the thigh line.
- At a point 250 mm forward of the H-point along the thigh line, the profile of the H-point manikin bottom surface is 80 mm from the thigh line.
- The seat cushion compresses approximately 25 mm under the H-point and 10 mm under the thigh point (250 mm forward of the H-point) during loading by the H-point manikin.
- The weight of the measuring devices used in the current study does not significantly compress the seat cushion.

Using these criteria and assumptions, a measurement fixture was constructed such that its orientation approximated the H-point manikin thigh line. When the back of the metal plate is positioned on a seat cushion flush with the seat back and the centerline of the metal plate is aligned with the centerline of the seat, the surface of the metal plate approximates the manikin thigh line.

Using these procedures, the seat cushion length (SCL) of second- and third-row seats was measured on 56 late-model vehicles (27 passenger cars, 21 SUVs, and 8 minivans). Showroom vehicles were measured at nine automotive dealerships in the metro-Detroit area.

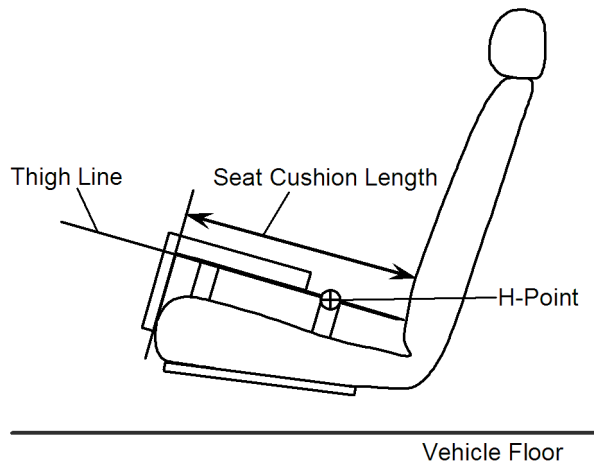

Figure 3. Schematic definition of seat cushion length (SCL).

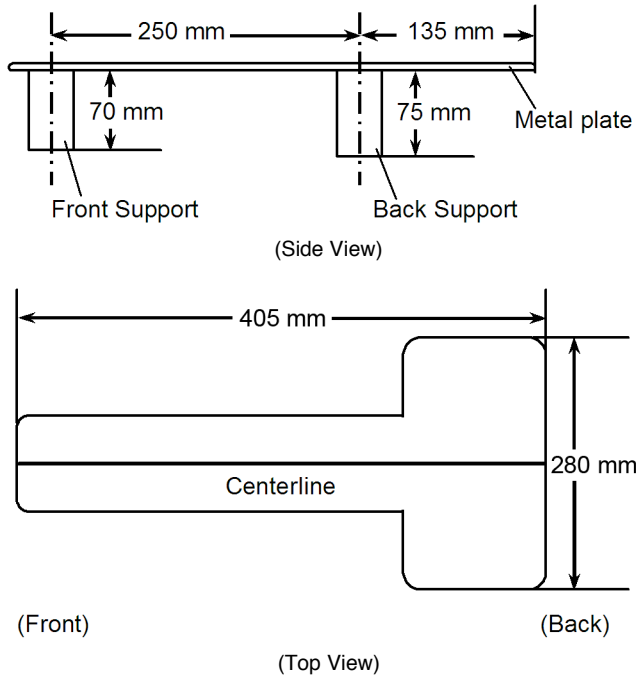

Figure 4. Fixtures for measuring seat cushion length.

For each seat measured, the year, make, and model of the vehicle was recorded along with vehicle type (passenger car, SUV, minivan), seat row (2nd, 3rd), seat type (bench, captain). The measurement procedure is shown in Figure 5. The following steps were followed to measure seat cushion length:

1. The lateral centerline of the seat was found using seat inserts, seams, and other seat styling.
2. The metal plate (with supports) was positioned on the seat cushion such that the centerline of the metal plate was aligned with the lateral centerline of the seat. The back edge of the metal plate was flush with the seat back.
3. The measuring square was positioned along the centerline of the metal plate so that the circular weight was flush to the surface of the metal plate.

4. The distance from the inner corner of the measuring square to the front of the metal plate was read directly from the measuring scale on the measuring square. This distance was added to the length of the metal plate (405 mm) to give seat cushion length.

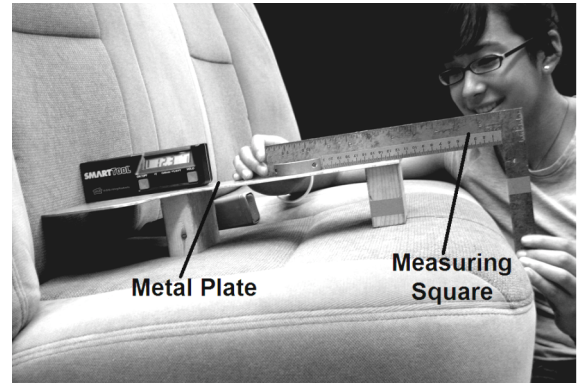

Figure 5. Seat cushion length (SCL) measurement procedure.

## ANALYTICAL APPROACH

A series of statistical analyses was conducted to compare buttock-popliteal lengths of rear seat occupants to rear seat cushion lengths, shown in Figure 6.

### Age Distributions of Rear Seat Occupants

Age distributions of rear seat occupants by age and gender, stratified by vehicle type, were determined from vehicle crash data obtained from NASS-GES (National Automotive Sampling System General Estimates System). GES data are derived from a nationally representative probability sample of police-reported crashes (NHTSA 2005). The subpopulation of occupants in rear seats of passenger cars, SUVs, and minivans was extracted from the NASS-GES sample for the years 1999-2002. Full-size vans, cargo vans and extended-cab pickup trucks were excluded. The years 1999-2002 were selected to balance the desire to have a sufficient sample size while also using the most recent data. Because the fraction of children sitting in the front seat has decreased rapidly in recent years, due to concern about airbags-induced injuries, the most-recent available data were used.

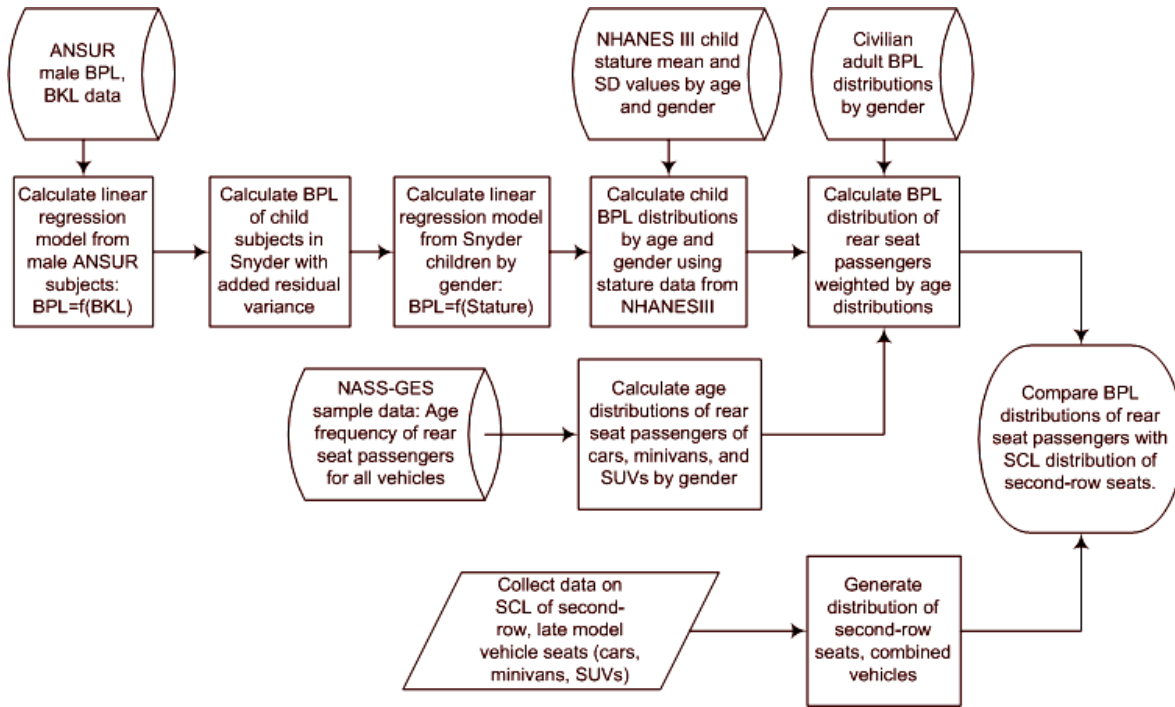

Figure 6. Schematic of analytical process.

### BPL Distributions as a Function of Age

Figure 6 outlines the process used to calculate child BPL distributions by age and gender. The best available child anthropometric data for U.S. children are from Snyder et al. (1977). No large-scale, detailed studies of child anthropometry in the U.S. have been conducted since the 1970s. Snyder and coworkers completed a series of anthropometric surveys on more than 8,000 infants and children as a reference for consumer product safety design. The Snyder data do not include BPL but do include buttock-knee length (BKL), a closely related dimension measured from the back of the buttocks to the front of the knee. The relationship between these two dimensions was estimated using adult data from a study of more than 9,000 U.S. Army personnel known as ANSUR (Gordon et al. 1988). The ANSUR data from adult men were used to establish the relationship between BKL and BPL, because the male buttock and thigh data were believed to be more representative of the body proportions of prepubescent children.

A BPL value was estimated from BKL for each child using a linear regression model from ANSUR:

$$BPL = 0.862 BKL - 31.0, R^2 = 0.94, RMSE = 6.40 \quad [1]$$

for BPL and BKL in mm.  $R^2$  for the regression is 0.94, and the root-mean-square error (RMSE), interpreted as the standard deviation of the normally distributed residual error, was 6.4 mm, indicating that BPL and BKL are very closely related.

The residual variance (root-mean-square error) was included in the BPL estimates for each child in the Snyder database by adding a random sample from a normal distribution with zero mean and the standard deviation given by the RMSE of 6.40 mm to each value estimated from BKL.

Because the average size of U.S. children in each age cohort has changed since the 1970s, more recent data were used to adjust the BPL distributions. First, a linear regression was performed in the Snyder data to obtain BPL as a function of stature. The regression was performed separately for males and females ages 4 to 17, yielding:

$$\text{Males: } BPL = 0.328 \text{ Stature} - 93.8, R^2 = 0.97, RMSE = 14.07 \quad [2]$$

$$\text{Females: } BPL = 0.336 \text{ Stature} - 97.3, R^2 = 0.97, RMSE = 14.44 \quad [3]$$

Examination of the residuals showed that the linear function was an excellent fit to the data across the age range. Based on analysis of BPL distributions in Snyder et al. (1977) and Gordon et al. (1989), BPL within gender was assumed to be normally distributed for each age cohort defined by a one-year-age span (e.g., six-year-olds).

Means and standard deviations of child stature as a function of age were obtained from NHANES III, a large-

scale survey of U.S. civilians conducted from 1988 to 1994 (NCHS 2005). The NHANES III summary results used for the present analysis are weighted to represent the U.S. civilian population as of 1990. To compute BPL distributions for each child age category, normal distributions based on the NHANES III means and standard deviations of stature were convolved with the linear regression equations 2 and 3 from the Snyder data. The mean and standard deviation for the age-specific BPL are calculated from the mean and standard deviation of stature for each age group by

$$\begin{aligned} \text{Males: } \overline{BPL} &= 0.328 \cdot \overline{Stature} - 93.8, \\ \sigma_{BPL}^2 &= 0.328^2 \cdot \sigma_{Stature}^2 + 14.07^2 \end{aligned} \quad [4]$$

$$\begin{aligned} \text{Females: } \overline{BPL} &= 0.336 \cdot \overline{Stature} - 97.3, \\ \sigma_{BPL}^2 &= 0.336^2 \cdot \sigma_{Stature}^2 + 14.44^2 \end{aligned} \quad [5]$$

BPL distributions of the adult population were estimated using the mean and standard deviation BPL values from ANSUR for each gender. The current focus on child-occupant accommodation did not necessitate adjustments to ANSUR to make it more representative of adult civilians.

### Determining BPL Distributions for Populations of Rear Seat Occupants

Age distributions of rear seat occupants from NASS-GES were used to weight the BPL distributions of children and adults by age group to generate BPL distributions of male and female rear seat occupants ages 4-80+ years. Children under 4 years were not included in the occupant population because most of these children would be seated in harness restraints if restrained appropriately. The child population (ages 4-17 years) was divided into subpopulations by gender and age and the adult population (ages 18+ years) was divided into subpopulations by gender.

The calculation of the BPL distributions for all occupants proceeded as follows:

1. The BPL distribution for each age group (one-year cohorts for ages 4 to 17, plus all adults) was divided into 5-mm bins from 100 to 700 mm. Each bin was assigned the integral of the probability density for that bin within the age cohort, so the bins summed to unity within each cohort (neglecting the extreme tails accounting for less than 0.1% of the total).
2. This discrete BPL probability density function for each subpopulation was multiplied by the frequency of rear seat occupants in the age group, extracted from NASS-GES. This gave a

different “weight” to the buttock-popliteal distributions of each age cohort.

3. The BPL probabilities were summed across all subpopulations, which resulted in the total probability across age groups.
4. The total probability was adjusted to unity.

The calculation of the distribution of BPL for populations defined by stature limits (e.g., children with stature  $\geq 145$  cm) involved an additional process prior to the steps outlined above. Each age cohort’s normal stature distribution, truncated at 145 cm, was convolved with the gender-specific linear relationship between stature and BPL from Snyder (equations 2 and 3). This process is depicted in Figure 7 and summarized in the steps below.

1. BPL mean values were calculated for the entire stature range (900mm to 2100 mm) using a linear regression model predicting BPL from stature. In this step, stature was treated as a discrete variable in 10-mm increments to obtain the corresponding BPL means and standard deviations.
2. Normal BPL distributions were calculated for the entire range of discrete stature values, using appropriate mean BPL and standard deviation as distribution parameters. Standard deviation was taken as the RMSE of the regression (equations 2 and 3).
3. For a given age cohort (e.g., 5-year-olds), within gender, the normal distribution of stature was estimated using mean and standard deviation values from NHANES III for that age. The probability of each stature value above the stature threshold was multiplied by the corresponding BPL distributions calculated in step 2. This resulted in a weighted BPL distribution for each stature value.
4. The BPL probabilities for each stature value were summed across the entire stature range. The BPL total probability was normalized to unity to adjust for truncating the stature distribution. This resulted in a BPL distribution for the entire stature range for an age group.

The resulting BPL distributions, by age and gender, were weighted by the age distributions from NASS-GES as described previously.

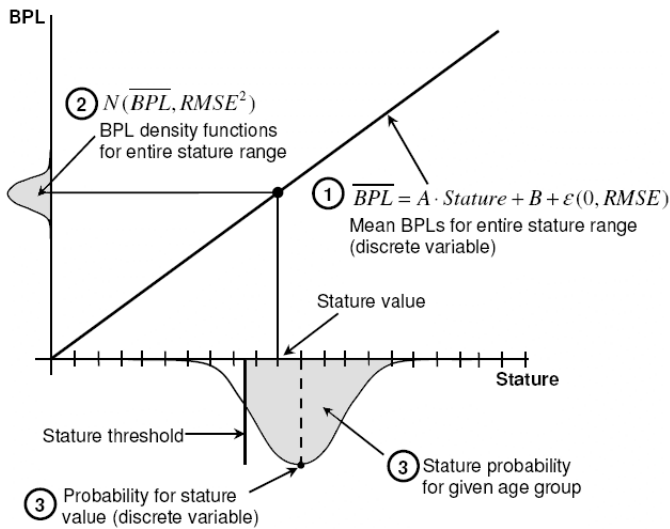

Figure 7. Diagram of convolution process for calculating age-weighted BPL distributions. Individual steps (circled numbers) are described in the text.

## RESULTS

### Rear Seat Occupant Age Distributions

Chi-square analysis on the age distributions of occupants in passenger cars, SUVs, and minivans NASS-GES showed no significant difference between the passenger age distributions of different vehicle types ( $p=1.00$ ). Therefore, the age distributions from all three vehicle types were combined for subsequent analyses.

Frequency and cumulative probability of the age of rear-seat occupants, by gender, are shown in Figures 8 and 9. According to NASS-GES data, approximately 70% of rear-seat occupants of passenger cars, SUVs, and minivans are children (<18 years old). Approximately half are less than 12 years old.

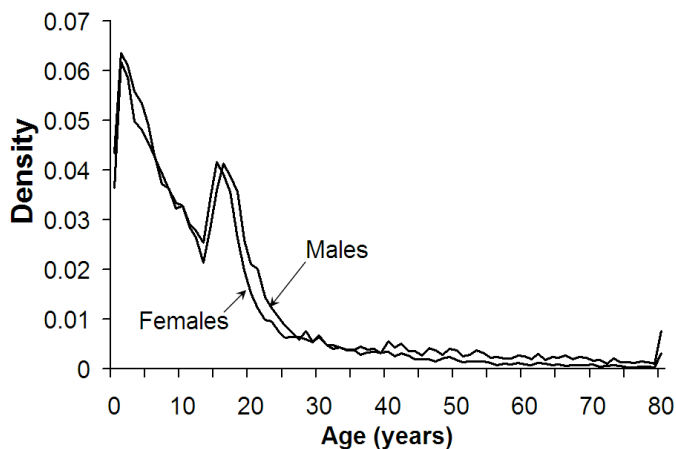

Figure 8. Frequency of rear seat occupant age in passenger cars, SUVs, and minivans from NASS-GES.

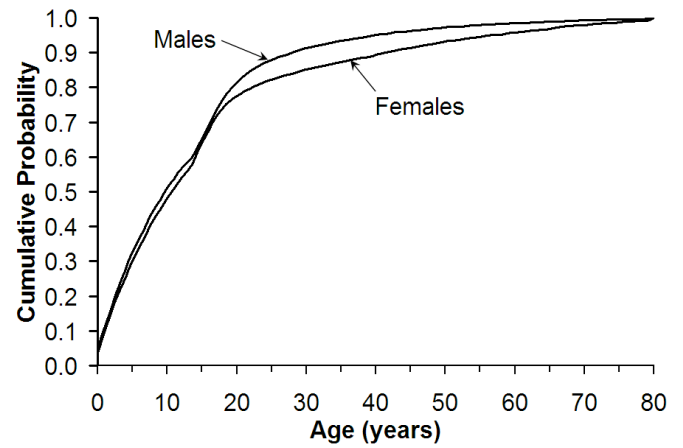

Figure 9. Cumulative probability of rear seat occupant age in passenger cars, SUVs, and minivans from NASS-GES.

### BPL Distributions by Age

Mean and standard deviation BPL by age group are shown in Table 1. These values were calculated by the process outlined above.

Table 1  
BPL (mm) by Gender and Age

Age (years)	Males		Females	
	Mean	SD	Mean	SD
2	207.1	20.0	202.9	20.5
3	233.1	20.2	231.5	20.9
4	254.2	21.3	254.2	21.3
5	277.7	22.8	277.7	22.6
6	299.6	25.9	296.2	23.8
7	323.1	25.4	318.1	27.8
8	340.8	23.6	339.9	26.5
9	361.8	26.3	358.4	26.3
10	376.1	27.3	378.6	26.5
11	393.7	27.8	403.0	27.8
12	420.6	29.3	420.6	27.6
13	440.8	32.7	435.8	28.0
14	465.2	29.1	440.0	27.1
15	477.8	29.8	445.0	24.6
16	485.4	29.3	445.9	24.4
17	490.4	29.8	446.7	25.6
18+	500.3	25.2	481.0	26.9

### Seat Cushion Lengths of Rear Vehicle Seats

Summary statistics for seat cushion lengths are shown in Table 2. Second-row vehicle seat cushion lengths are significantly longer than third row vehicle seat cushion lengths ( $p=0.003$ ). Five outlying seat cushion lengths, whose values were above the upper quartile plus 3 times the interquartile range (IQ) or below the lower quartile minus  $3 \cdot IQ$ , were removed from the sample of second-



and third-row seats before conducting ANOVA. With extreme values removed, the sample of second- and third-row seats did not differ significantly from a normal distribution ( $W=0.968$ ,  $p=0.075$ ) using a Shapiro-Wilk test.

Mean seat cushion lengths by vehicle type and row are shown in Table 2. Third-row seat cushion lengths are more variable than second-row seat cushion lengths. In SUVs in the sample, third-row seats are significantly shorter than second-row seats ( $p<0.001$ ). However, in minivans, second- and third-row seat lengths were not significantly different ( $p=0.535$ ).

Table 2  
Mean (sd) Seat Cushion Length by Vehicle Type

Vehicle Type	Second Row	Third Row
Cars (n=27)	470.9 (19.6)	--
SUVs (n=21)	465.4 (17.2)*	422.8 (31.8)*
Minivans (n=8)	460.1 (18.0)	452.5 (28.8)

\*Second- and third-row seat cushion lengths are significantly different in SUVs but not in minivans.

Among second-row seats, vehicle type (passenger car, SUV, minivan) does not significantly affect cushion length ( $p=0.960$ ). Seat type (bench seat, captain chair) also does not significantly affect cushion length of second-row seats ( $p=0.586$ ). Subsequent analyses focused exclusively on second-row seats (56 vehicles). The cumulative distribution of second-row seat cushion lengths is shown in Figure 10.

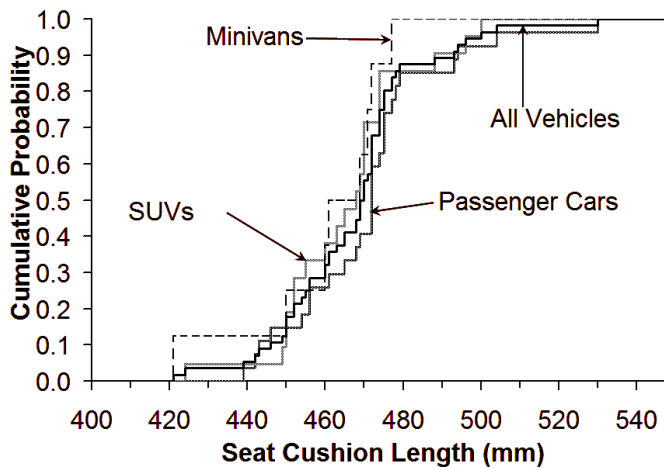

Figure 10. Cumulative distribution of second-row seat cushion lengths.

**Comparison of BPL and SCL Distributions in the Second Row of Vehicles**

BPL and SCL distributions were compared for five subpopulations:

- a. children age 4-17 years with stature < 145 cm,
- b. children age 4-17 years with stature ≥ 145 cm,

- c. children age 4-17 years,
- d. adults age 18-80+ years, and
- e. all passengers 4-80+ years.

The age ranges within each subpopulation were weighted according to the rear-seat occupant age distribution from NASS-GES.

The BPL distributions of the five subpopulations are compared to the second-row SCL distribution in the density plots shown in Figure 11.

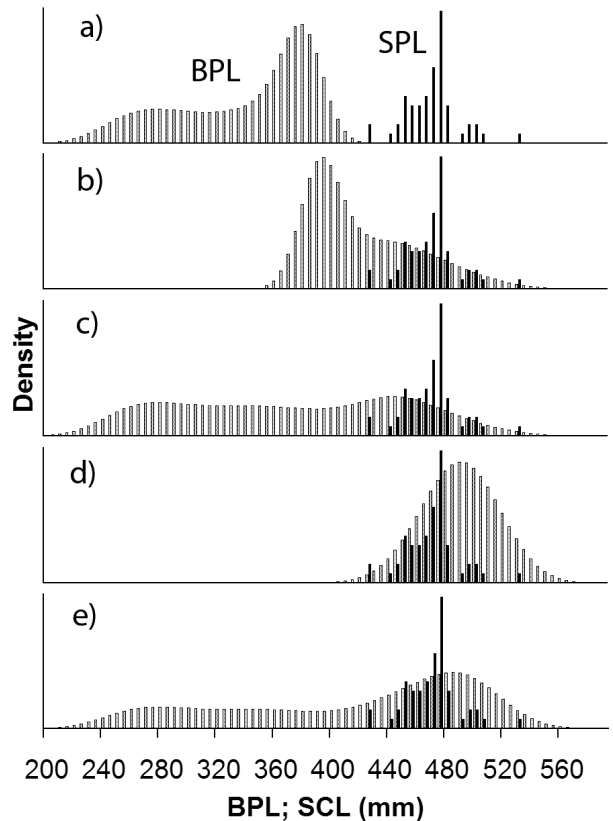

Figure 11. BPL distributions, weighted by NASS-GES, for (a) children shorter than 145 cm, (b) children 145 cm and taller, (c) all children, (d) adults, and (e) all children and adults compared to second-row SCL distribution.

Figure 12 shows the cumulative distributions of BPL populations for children shorter than 145 cm, children 145 cm and taller, and all children regardless of stature. The cumulative probabilities BPL distributions for all children, adults, and both children and adults are shown in Figure 13. BPL percentiles for the five subpopulations are compiled in Table 3. Second-row seat cushion length percentiles are compared to corresponding BPL percentiles for the five subpopulations in Table 4.

The median second-row SCL of 455 mm was longer than the BPL of 24 percent of adult rear-seat occupants and 83 percent of children. Overall, considering that approximately half of rear-seat occupants are children, the median SCL exceeds the BPL of approximately 65 percent of rear-seat occupants. The median SCL

exceeds BPL for 87 percent of rear seat child occupants  $\geq 145$  cm tall, i.e., those children who are taller than NHTSA's recommended minimum stature for sitting without a booster. Thus, most individuals greater than this stature do not have BPL greater than typical cushion lengths. Among children less than 145 cm tall, essentially none have BPL exceeding the length of even the shortest seats.

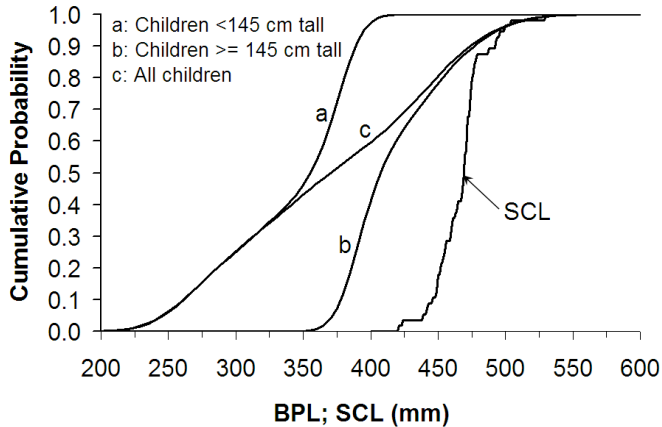

Figure 12. Cumulative probabilities of child BPL distributions compared to second-row SCL distribution.

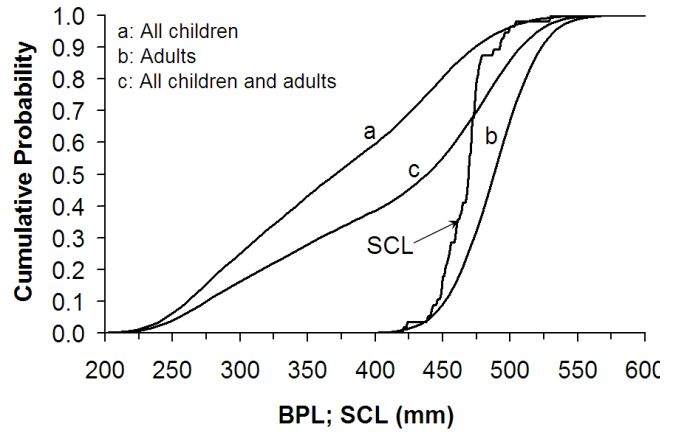

Figure 13. Cumulative probabilities of child and adult BPL distributions compared to second-row SCL distribution.

### DISCUSSION

The preceding analysis suggests that there is a substantial mismatch between the high dimensions of rear-seat occupants and rear seat cushion lengths. Only about five percent of second-row vehicle seats meet the consensus recommendation for cushion length of about 440 mm (approximately fifth-percentile adult female BPL). As the analysis has documented, most rear-seat occupants are children, so a large percentage of rear-seat occupants are disaccommodated on cushion length.

Table 3  
BPL and SCL Percentiles\*

Percentile	Children <1450	Children $\geq 1450$	All Children	Adults	All Children and Adults	2 <sup>nd</sup> Row SCL
1	224	361	223	422	228	421
2.5	236	367	234	432	241	424
5	246	372	246	441	255	439
10	261	378	261	452	275	446
20	286	386	287	464	316	452
25	299	389	300	469	338	455
50	355	407	370	488	438	468
75	377	444	438	507	483	474
80	381	453	449	511	490	475
90	389	477	474	523	508	491
95	395	495	493	533	520	498
97.5	400	509	508	541	531	503
99	406	524	524	551	542	503

\* Weighted within cohort according to NASS-GES.

Table 4  
SCL Percentiles and BPL Percentiles for the SCL Length\*

Percentile	2 <sup>nd</sup> Row SCL	BPL Percentile				
		Children <1450	Children >=1450	All Children	Adults	All Children and Adults
1	421	>99	61	67	1	44
2.5	424	>99	63	69	1	45
5	439	>99	72	75	4	50
10	446	>99	76	79	7	53
20	452	>99	79	81	10	57
25	455	>99	81	83	12	58
50	468	>99	87	88	24	65
75	474	>99	89	90	31	69
80	475	>99	89	90	32	70
90	491	>99	94	95	54	80
95	498	>99	96	96	64	85
97.5	503	>99	97	97	71	88
99	527	>99	99	99	92	97

\* Weighted within cohort according to NASS-GES.

One might reasonably ask why rear seats are so long, apparently exceeding ergonomics guidelines. One possibility is that open knee angles exceeding 90 degrees (say, 120 or 130 degrees) allow for a longer seat without disaccommodation. However, this is not the case, because the calf protrudes rearward of the popliteal landmark to which BPL is measured for knee angles up to about 130 degrees. Thus, the functional thigh length is even shorter than BPL. Moreover, constrained foot room in rear seats often causes even small adult women to sit with knee angles of 90 degrees or less (Reed et al. 2005a). Long seat cushions in rear seats also cause small women as well as taller adults to sit with their hips further forward on the seat, i.e., to slouch (Reed et al. 2005a).

Another possibility is that manufacturers believe that people with long thighs are more likely to complain that the seat cushion is too short than that smaller people are to complain that the cushion is too long, and hence the optimal length is one that disaccommodates a significant fraction of smaller occupants, predominantly women and children. More likely, though, is that manufacturers have not systematically optimized rear seat cushion lengths, but rather have relied on stylists to determine their dimension. Evidence for this comes from an examination of the seat profiles, which often feature a large-radius “waterfall” at the front end of the cushion. This styling feature has creates a large difference between the cushion lengths experienced by sitters with long and short thighs. Sitters with long thighs experience a relatively *short* cushion length, because their most-

forward contact with the cushion is often 100 mm or more rearward of the front of the cushion. But the sitters with short thighs experience a *long* cushion, because their calves are contacted by the front edge of the cushion, pulling them forward and causing slumping.

From a crash safety perspective, a slumped occupant, whether a child or an adult, is difficult to restrain properly with a safety belt. The lap portion of the belt tends to ride up on the abdomen, so that submarining (sliding below the belt during a crash, causing injurious abdominal loading) becomes inevitable.

Solutions to the coupled problems of rear-seat occupant comfort and safety will be found by focusing on proper accommodation of the occupants who actually sit in rear seats, i.e., predominantly children. Many rear seats, particularly in minivans, are now highly adjustable, with reclining seat backs, fore-aft tracks, and features for folding and stowing. These seats should also be adjustable to accommodate the children who are the majority of their users. The data in this paper indicate that the seat should be able to accommodate sitters whose buttock-popliteal length is as little as 255 mm (the 5th percentile of BPL for the weighted population of rear-seat occupants age 4 and up). Because the range of rear-seat occupant dimensions is so large, the seat cushion length should be adjustable. The integrated booster seat is one approach that provides two cushion lengths. The center portion of the seat cushion can be raised and moved rearward, shortening the seat and

improving both lap and torso belt fit for an appropriate-size child.

Even if manufacturers rely on their customers supplying add-on boosters to accommodate some children, seat cushions should still be shortened to improve comfort and belt fit for larger children and adults. The analysis in this paper shows that slumping due to excessive cushion length can be expected for a large percentage of children >1450 mm tall with the prevalent cushion lengths. Shortening rear seat lengths can also improve ingress/egress for all passengers, particularly benefiting elderly passengers who have difficulty with egress from long seats.

This study used NASS-GES data to estimate the age distribution of rear-seat occupants. Because GES uses a statistical sample of crashes, and rear-seat occupancy rates overall are low, the age-distribution estimates used in this paper are based on a much smaller number of raw data than would be the case for estimating driver age distributions, for example. However, the aggregation of vehicles into broad categories (passenger car, SUV, minivan) reduces the importance of this issue. More generally, using NASS-GES to quantify occupant age distributions has a substantial limitation, namely that the vehicle must have been in a crash to be sampled. Because certain types of drivers and vehicles are more likely to be in crashes, the types of passengers likely to be in those crashes are overrepresented. For example, the prominent spike in the distribution of passengers by age in the mid-teen years probably results in part from the relatively high crash rates of teen drivers (who also are more likely to have teen passengers). Similarly, adults driving minivans with child passengers are among the safest combinations of driver and vehicle, so child minivan passengers may be underrepresented. However, the net effect of this bias is likely to be conservative with respect to the current analysis, because this crash-derived dataset probably understates the true percentage of rear-seat occupants who are children.

## ACKNOWLEDGEMENTS

The authors thank Charles Compton of UMTRI for assistance with the NASS-GES data analysis. The authors also thank Kristy Arbogast of the Children's Hospital of Philadelphia for comparative data on rear-seat occupancy that were used to confirm the NASS analysis.

## REFERENCES

Gordon, C. C., Churchill, T., Clauser, C. E., Bradtmiller, B., McConville, J. T., Tebbetts, I., & Walker, R. A. (1989). 1988 Anthropometric Survey of U.S. Army Personnel: Methods and Summary Statistics. Final

Report. (NATICK/TR-89/027). Natick, Massachusetts: U.S. Army Natick Research, Development and Engineering Center.

Keegan, J.J. (1964). The medical problem of lumbar spine flattening in auto seats. Technical Paper 838A. Society of Automotive Engineers, Warrendale, PA.

Klinich, K.D., Pritz, H.B., Beebe, M.S., and Welty, K.E. (1994). Survey of older children in automotive child restraints. *Proceedings of the 38th Stapp Car Crash Conference*, pg. 245-264. Society of Automotive Engineers, Warrendale, PA.

National Highway Traffic Safety Administration (2004). <http://www.nhtsa.dot.gov/people/injury/childps/>.

National Highway Traffic Safety Administration (2005). National Center for Statistics and Analysis. (<http://www-nrd.nhtsa.dot.gov/departments/nrd-30/ncsa/NASS.html>).

National Center for Health Statistics (2005). <http://www.cdc.gov/nchs/>

Pheasant, S. (1996). *Bodyspace: Anthropometry, Ergonomics and the Design of Work*. CRC Press, London.

Reed, M.P., Schneider, L.W., and Ricci, L.L. (1994). Survey of Auto Seat Design Recommendations for Improved Comfort. Technical Report UMTRI-94-6. University of Michigan Transportation Research Institute, Ann Arbor, MI.

Reed, M.P., Ebert-Hamilton, S.M., Manary, M.A., Klinich, K.D., and Schneider, L.W. (2005). A new database of child anthropometry and seated posture for automotive safety applications. Technical Paper 2005-01-1837. SAE International, Warrendale, PA.

Reed, M.P., Ebert-Hamilton, S.M., and Schneider, L.W. (2005a). Development of ATD installation procedures based on rear-seat occupant postures. *Stapp Car Crash Journal*, Vol. 49, pp. 201-222.

Roebuck, J.A. (1995). *Anthropometric Methods*. Human Factors and Ergonomics Society, Santa Monica, CA.

Snyder, R.G., Schneider, L.W., Owings, C.L., Reynolds, H.M., Golomb, D.H., and Schork, M.A. (1977). Anthropometry of Infants, Children, and Youths to Age 18 for Product Safety Design. Final Report UM-HSRI-77-17. University of Michigan Transportation Research Institute, Ann Arbor, MI.