

## Crosswind Sensitivity of Passenger Cars and the Influence of Chassis and Aerodynamic Properties on Driver Preferences

C. C. MACADAM,\* M. W. SAYERS,\* J.D. POINTER,\*\*  
and M. GLEASON\*\*

### SUMMARY

Results of vehicle crosswind research involving both full-scale driver-vehicle tests and associated analyses are presented. The paper focuses on experimental crosswind testing of several different vehicle configurations and a group of seven drivers. A test procedure, which utilized wind-generating fans arranged in alternating directions to provide a crosswind "gauntlet", is introduced and described. Driver preferences for certain basic chassis and aerodynamic properties are demonstrated and linked to elementary system responses measured during the crosswind gauntlet tests. Based on these experimental findings and confirming analytical results, a two-stage vehicle design process is then recommended for predicting and analyzing the crosswind sensitivity of a particular vehicle or new design.

### 1. INTRODUCTION

This paper is based on recent findings from a vehicle aerodynamics research project [1] sponsored by the Chrysler Motors Corporation at the University of Michigan Transportation Research Institute. The general thrust of that research was directed at the crosswind sensitivity of passenger cars, and specifically, the influence and interaction of chassis characteristics and aerodynamic properties on driver preferences. The key elements considered in that study are outlined in Figure 1 and included: (A) vehicle dynamics considerations (e.g., weight distribution, tire, and suspension characteristics), (B) vehicle aerodynamic properties, (C) steering system characteristics (most notably steering system compliance, friction and torque assists), and (D) driver closed-loop steering behavior and preferences obtained from experimental crosswind tests. This paper focuses on the experimental crosswind testing conducted during the project using several different vehicle configurations and a group of seven drivers. It reports on driver preferences for certain basic chassis and aerodynamic properties and demonstrates a linkage to elementary system responses measured during those crosswind tests.

The paper begins with an examination of previous research findings related to crosswind sensitivity of passenger cars. A computer model, developed under this

\* The University of Michigan. Transportation Research Institute and

\*\* The Chrysler Motors Corporation Aerodynamics Department

research program, is then briefly described. The use of that model at different stages of the research helped to identify and probe certain vehicle-related mechanisms identified as possibly significant contributors to the issue of crosswind sensitivity. As will be seen, the ability of the model to predict basic dynamic behavior patterns, observed in experimental measurements of driver-vehicle systems operating in crosswinds, is an important factor for recommending it as a tool within the vehicle design process. The basis of the conclusions of this paper, however, rest upon experimental measurements and evaluations of a group of seven test drivers operating seven distinctly different vehicle configurations during nearly identical crosswind conditions. The crosswind tests were conducted using a set of eight fans (arranged in an alternating direction over a length of several hundred feet) to approximate a random-like crosswind "gauntlet" driven repeatedly by each driver. On-board measurements of the driver-vehicle responses, combined with the subjective evaluations of the test drivers during these tests, form the basis of the paper's conclusions.

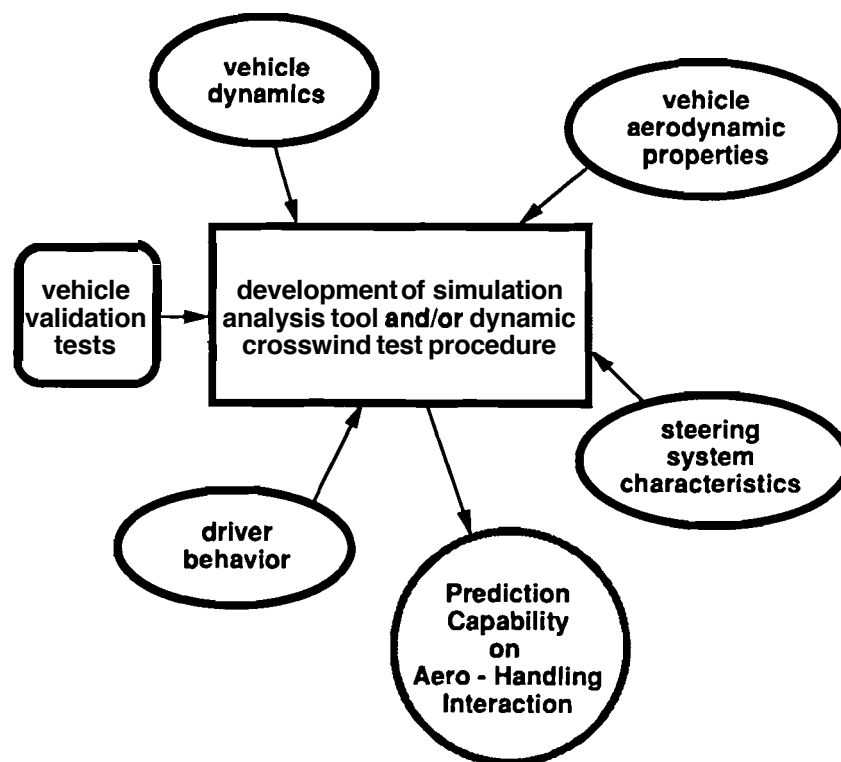

Fig. 1. Key Elements in Vehicle Crosswind Stability.

## 2. PREVIOUS RESEARCH

The trends during the last decade or so to lighter, more fuel efficient cars in response to changing energy policies, combined with more recent trends toward higher performance passenger cars, have led to increased interest in aerodynamic styling as a means for providing low drag configurations and for mitigating any high-speed crosswind sensitivities. In many cases, attempts at streamlining passenger cars for minimizing drag have led to unwanted increases in crosswind sensitivity. As noted in such comprehensive texts such as Hucho [2] and Scibor-Rylski [3], this **tradeoff** was observed as early as 1933 by Kamm [4] out of which arose the well-known truncated rear-end design ("Kamm-back") which helped to offset much of the the crosswind susceptibility introduced from streamlining. More recent observations, such as Kohri and Kataoka [5] or Hucho [2], have contributed to improved understandings on the subtle influences relating to A- and C-pillar styling designs and their importance in affecting crosswind sensitivity of passenger cars. Studies such as Noguchi [6] have also noted the importance of certain suspension properties (e.g., roll steer and lateral force compliances) as elements not to be discounted when considering a vehicle's crosswind sensitivity. Other studies relating to crosswind sensitivity of passenger cars have been compiled in such documents as Kobayashi and Kitoh [7], which was primarily concerned with literature related to the crosswind sensitivity of light weight cars.

### Analytical Work

Numerous formulations aimed at simplified identifications of the crosswind sensitivity of passenger cars have been offered in the technical literature. In 1974 at the FISITA Congress, Watari et al [8] offered a crosswind sensitivity formulation based upon the steady-state lateral acceleration response of a vehicle to a constant aerodynamic side force. This paper is an example of many studies that have noted the importance of the neutral steer point and its relationship to the mass center and aerodynamic center of pressure in the question of crosswind sensitivity. (Very often in the literature, researchers have puzzlingly identified the mass center as the key point of reference in crosswind sensitivity considerations, suggesting that aerodynamic side forces acting at the mass center, instead of the neutral steer point, would produce zero steady-state turning responses.) In 1985, Bucheim et al [9], proposed a formula for predicting the crosswind sensitivity based upon the initial transient response of a vehicle to a step input of crosswind and its subsequent steady-state turning response. However, that formulation is largely dominated by the steady-state response of the vehicle and, in effect, is similar in many applications to what others have proposed based upon steady turning analyses. The static turning analysis method offered by MacAdam [10] also identified the importance of the relative locations of the neutral steer point, the mass center, and the aerodynamic center of pressure in addressing the crosswind sensitivity problem. (That method is further extended in this paper to

explicitly include vehicle aerodynamic properties within a formulation that relates a vehicle's static turning response to a constant crosswind input.)

More comprehensive analyses of vehicle crosswind sensitivity have also been undertaken which utilized computer simulation to analyze the time history responses of driver-vehicle systems operating under natural, or random-like, crosswind conditions. For example, in 1985 Uffelmann [11] argued for the need to include driver steering behavior under natural crosswind conditions to more accurately evaluate the "active" crosswind sensitivity of the combined driver-vehicle system. Uffelmann outlined an example of how chassis-related and aerodynamic-related properties might be traded off to help maintain a similar level of crosswind sensitivity for the total driver-vehicle system. In 1989, MacAdam [12] conducted a simulation-based study involving systematic parameter variations of a validated computer model by Sayers et al [13] that included detailed representations of the vehicle dynamics, aerodynamic properties, steering system characteristics, and driver steering behavior. That study utilized step-wind inputs to characterize the "passive" wind sensitivity of the vehicle alone, and then, contrasted those results with "active" crosswind sensitivities obtained from driver-regulated maneuvers during simulated random crosswind conditions. A crosswind handling index, involving root mean square values of vehicle yaw rate and driver steering power, was proposed as a candidate method for more precisely identifying crosswind sensitivities of driver-vehicle systems during dynamic side wind conditions.

#### Full-Scale Testing

Numerous full-scale test programs have also been conducted which attempted to identify and illustrate influences of chassis and aerodynamic properties on vehicle crosswind sensitivity. Many of these full-scale studies have employed crosswind fan generator facilities, most of which are located in Europe and Japan. An example of a simple test track survey of eleven European passenger cars appeared in *Auto Motor and Sport* in 1985. Each vehicle was driven past a German fan facility (with a fixed steering wheel) while lateral path and yaw rate responses deriving from the side wind were recorded to illustrate the degree of variation in the selected sample of cars. In 1975, Barter [14] conducted crosswind tests with fans at the MIRA facility in England as part of a doctoral thesis, primarily to obtain disturbance inputs to support the system identification work that was the main thrust of his thesis. While Barter noted that the short duration and quality of the crosswind tests were largely insufficient for his system identification purposes, it was observed that closed-loop regulation tests did result in a "rather more violent" system response than the more conventional fixed steering wheel drive-bys also conducted. Such amplifications for the closed-loop driver-vehicle system were presumably associated with driver steering behavior and driver lags.

Bundorf et al [15] in 1963 reported on a small hydrogen peroxide rocket engine system used to study the passive response of a station wagon to lateral force inputs at various fore-aft locations. The lateral disturbance input from the rocket engine was intended to approximate an aerodynamic disturbance force.

Different vehicle responses were observed with the the rocket motor located at several different longitudinal positions. The authors noted that minimal **steady-state** yaw disturbance was imparted to the vehicle when the disturbance was applied at the vehicle's neutral steer point, and, that minimal lateral displacement (immediately following the force application) was imparted to the vehicle when the disturbance force was applied slightly aft of the neutral steer point.

In 1980, Klein and Hogue [16] reported on findings of a full-scale test program involving five distinctly different U.S. vehicles. Crosswind tests were conducted with a newly-developed crosswind fan facility [17]. (These same fans, and the only ones available in the **U.S.**, were also utilized in the test work appearing in this paper.) During that study, open-loop (fixed steering wheel) and closed-loop (driver regulated) tests of each vehicle were conducted at forward speeds of 50 mph. Crosswind fan speeds were nominally 35 mph. Based upon these test conditions, Klein and Hogue concluded that "Passenger cars, pickup trucks, and most vans do not have a directional control crosswind sensitivity problem." However, as part of that test program, a strong correlation was observed between increased yaw rate levels and driver steering wheel angles and poorer subjective ratings by the test drivers during the crosswind tests. Since many of these tests were conducted at fairly large aerodynamic sideslip angles, the authors also noted the importance of accounting for the nonlinear aerodynamic influences under such sideslip conditions that usually result in a rearward shifting of the center of pressure, and an in turn, an eventual reduction in the crosswind yaw disturbance.

In 1987 van den Hemel et al [18] conducted similar tests with a group of 15 drivers at vehicle speeds of 100 km/h. A European crosswind fan facility was utilized which provided aerodynamic slip angles of 20 degrees at such test speeds. The authors noted difficulty in discriminating between vehicle configurations because of the short crosswind duration provided by the fans, the magnitude of crosswinds, and the relatively modest level of differences in aerodynamic properties of the vehicles tested. However, van den Hemel et al did note that yaw rate and lateral acceleration appeared to be the most useful measurements as discriminators of different vehicle configurations during these tests.

Lastly, Willumeit et al [19], also in 1987, reported on a sequence of crosswind driver-vehicle tests conducted under natural crosswind conditions along a North Sea coast **motorway** in 1985. Five drivers and five test vehicles were used. (Initial closed-loop tests were also conducted at a European crosswind fan facility, but later proved to be unsatisfactory because of the short duration of crosswind input and driver anticipatory behavior to the fan disturbance.) Willumeit's study indicated that the passive (non-driver, fixed steering wheel) vehicle response to crosswinds does not "fully correlate with driver's impressions of side wind sensitivity." The study carefully analyzed a number of driver-vehicle responses recorded during normal driving under random crosswind conditions and observed that yaw velocity, lateral acceleration, and driver steering wheel angular displacement were **vehicle/driver** responses most perceived and utilized by drivers

in evaluating the crosswind sensitivity of vehicles. Also observed as important were vehicle yaw angle, steering wheel velocity, vehicle roll angle, and driver steering wheel input power. Smaller levels of all of these responses correlated with better subjective ratings. Vehicle lateral velocity and displacement were observed to be of secondary importance. Opposite and less significant correlations were identified for vehicle yaw acceleration.

#### Wind Measurement Technology

In addition to the studies cited above, a number of technological advancements in on-board wind measurement capabilities have also occurred in the last two decades which have helped to promote further understanding of the nature of crosswinds acting on vehicles in open areas, as well as in the vicinity of fixed roadway objects and other moving vehicles. Smith in 1972 [20] described a MIRA wind measurement device (utilizing anemometers) and its use in measuring a number of different crosswind profiles. More recently, Tran [21] presented a pressure transducer system for measuring the wind forces and moments acting on a vehicle by recording the pressures at approximately 10 points along the circumference of a vehicle and then combining this information with a uniform flow model. A wind transducer developed by the the **Chrysler** Corporation aerodynamics department utilizing a strain-gauged sphere in combination with an inertial mass compensating accelerometer, is described by Pointer in [22]. This latter device was also used during the crosswind testing described subsequently in this paper.

#### A Driving Simulator Study

Lastly, a study conducted by Alexandridis et al [23], utilizing a moving-base simulator, is noteworthy because of the inherent ability of such devices to carefully control test conditions and systematically vary vehicle parameters without the normal accompaniment of test track background noise. Using both step gusts and random crosswind inputs to the simulator (for 12 test subjects and 12 vehicle configurations), the authors observed that driver subjective ratings favoring rearward aerodynamic center-of-pressure locations were statistically significant. At a simulator vehicle speed of 60 mph, lane deviations decreased as the aerodynamic center of pressure was moved rearward, or, as steering control sensitivity was increased. For one very forward center-of-pressure location (at the front axle), lane deviations were observed to decrease with an increased level of understeer. Similar results were not observed for more rearward center-of-pressure locations and increased understeer. Steering wheel activity was seen to be reduced for increased understeer and control sensitivity and also for rearward center-of-pressure locations. In general, Alexandridis et al noted that the aerodynamic center-of-pressure location (ranging from the front axle to as much as 37% behind the front axle) was the most dominant factor when compared with the level of variations in understeer (3 and 5 **deg/g**) and control sensitivity (0.8 and 1.2 **g/100 deg**) examined.

### 3. A DRIVER-VEHICLE CROSSWIND MODEL

A computer model for predicting the interaction between vehicle and driver during crosswind conditions is introduced and outlined briefly in this section. Its use as an advanced tool, that can be used in place of, or in conjunction with, certain types of dynamic random crosswind test procedures, is subsequently being recommended as part of a total crosswind sensitivity design process. The model was developed during this research and was used to help identify and separate different mechanisms of the driver-vehicle system contributing significantly to the crosswind sensitivity of the system. An example of its use in understanding and interpreting the experimental findings from this study will be demonstrated subsequently during the discussion of findings in Section 5.

Figure 2 shows a block diagram outlining the principal components of the crosswind **driver/vehicle** model. The technical details of the computer model can be found in Sayers et al [13]. The four primary components of the model are described briefly in the following.

#### Vehicle Model

The vehicle model is characterized by five degrees of freedom for the sprung mass, constant forward speed, and massless **suspension/wheel** assemblies. Tire and suspension compliances are also included. Tire lateral force is treated as largely linear except for cornering stiffness dependency on vertical load. The basic dynamics of the vehicle are very similar to that developed by Segel [24]. High speed test data, collected during the course of the aerodynamic crosswind stability research program at UMTRI [1], were used to validate the baseline model behavior through direct comparisons with model predictions. Test track handling measurements and aerodynamic wind tunnel measurements of a baseline passenger car, in several different aerodynamic configurations, were conducted at nominal speeds of 50 and 100 mph to validate the model. As part of the model validation process, a stable platform and a variety of transducers were used to measure all body motions. Steering wheel displacement and torque measurements, front wheel rotations, and other steering system functions (power boost pressures, **pitman** arm motion, and tie rod forces) were also recorded and utilized in the model validation.

#### Aerodynamics

A linear-regime aerodynamics model is employed and includes the three conventional forces (drag, side force, and lift) and the three corresponding moments acting about each body axis. Each force and moment is characterized by a constant coefficient and a linear or quadratic variation with respect to aerodynamic yaw angle. The aerodynamics used in the computer model for examining different vehicle configurations were based upon aerodynamic measurements performed by **Chrysler** at the **Lockheed** wind tunnel in Atlanta, Georgia. The nature of wind

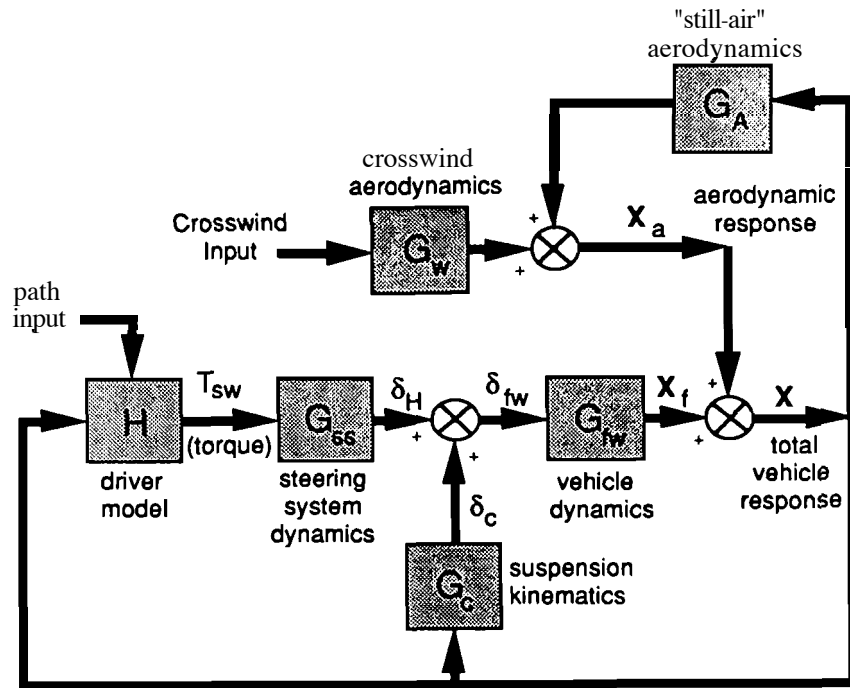

- $\delta_H$  front wheel angle contribution from steering command and compliance
- $\delta_C$  front wheel angle contribution from suspension kinematics
- $\delta_{fw}$  total front wheel steer angle
- $X_f$  non-aerodynamic vehicle response

Fig. 2. Chrysler/UMTRI Crosswind Vehicle Model.

tunnel data collected under this work is analogous to traditional, previously published passenger car aerodynamic data, such as seen in Hogue [25].

### Driver Characteristics

An existing driver steering control model by MacAdam [26, 27] was extended within this study to provide for generation of steering wheel torque,  $T_{sw}$ , seen in Figure 2 as the output from the driver model block. Steering wheel torque produced by the driver model served as the primary control input to the dynamic steering system model during most of the simulated closed-loop driving scenarios



studied. It also (in combination with steering wheel angular displacement) provided a means for **calculating** energy expenditures for simulated drivers during either discrete steering maneuvers or simple path regulation tasks as demonstrated in [12].

**Steering System**

A simplified second order dynamic steering system model, as seen in Figure 3, augments the aforementioned sprung mass dynamics and relates steering wheel torque and displacement to front wheel motion. Properties of the steering system include: compliance, friction, steering wheel inertia, lash, and power steering boost characteristics. The basic steering system model is patterned after that originally proposed by Segel [24, 28]. However, the high frequency dynamics of the front wheels included by Segel were replaced here by a quasi-static treatment that included rotational motion of the front wheels through a lash element. A power steering boost torque approximation was also added. The power steering boost was treated as a driver-assisting torque, linearly proportional to the sum of the front tire aligning torques.

Figure 4, from [12], shows an example comparison for the steering system model and test data collected at 100 mph during which low frequency **sinusoidal**-like steering torque inputs were applied by a test driver for purposes of validating the baseline vehicle model and its steering system properties. This type of steering input is similar to that proposed by Norman [29] as part of an on-center handling test procedure (normally conducted at 100 kmh) for evaluating basic properties of the steering system and associated vehicle responses. Other example uses of the model for predicting total system responses during dynamic

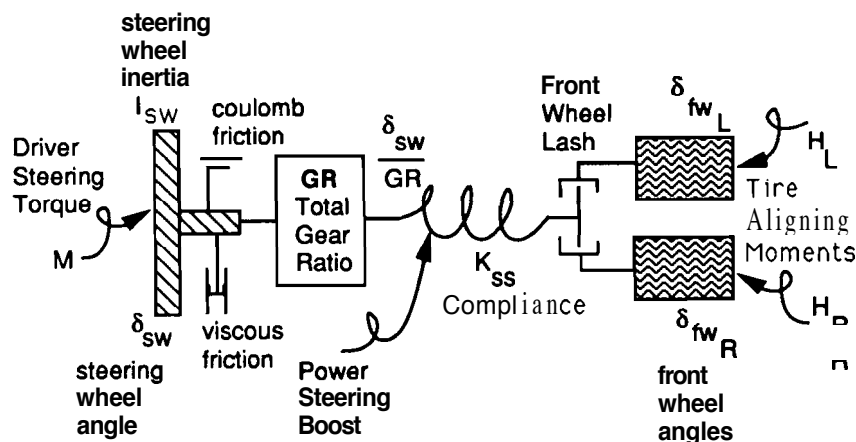

Fig. 3. **Steering System Model.**

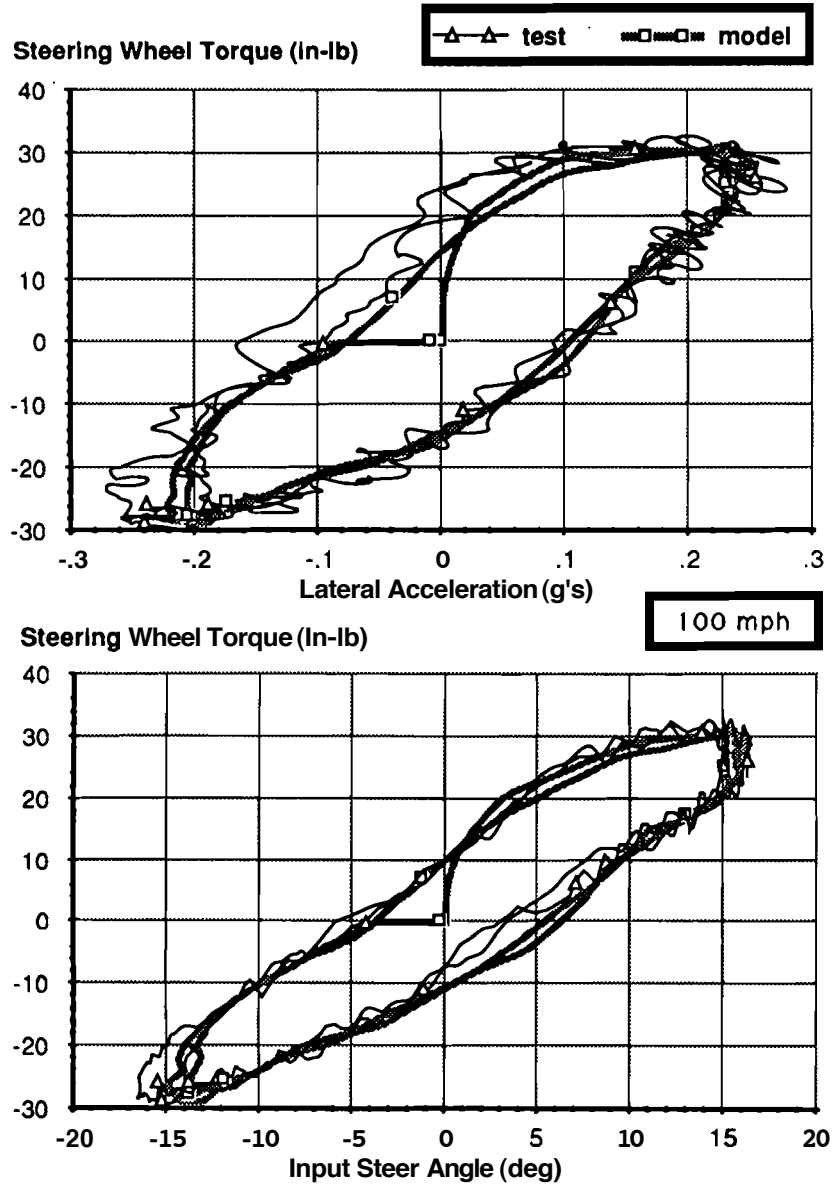

Fig. 4. Steering System Measurements and Model Predictions.

crosswind conditions appear in [12]. Its use as a tool in explaining certain findings from the crosswind tests is also illustrated by the example calculation appearing in Section 5.

#### 4. EXPERIMENTAL CROSSWIND MEASUREMENTS

The results of experimental crosswind tests of driver-vehicle systems conducted during the research program are presented in this section. All full-scale testing was performed on the vehicle dynamics facility at the Chrysler Proving Grounds in Chelsea, Michigan. The vehicle crosswind testing results were obtained with the use of eight U.S. Government-owned wind generating fans described in detail by Klein and Jex in [17].

The use of fan-generated crosswinds in this research program was based upon several needs. One need was to obtain crosswinds of sufficient magnitude that the test drivers would be given a definite subjective impression of the different vehicle configurations being driven, and, that would also produce a system response that could be readily measured by on-board instrumentation. Test speeds of 90-100 mph were selected so that the aerodynamic inputs provided by sizeable crosswinds (25 mph or so) would still permit a linear-regime characterization of the vehicle aerodynamics. A second need was to have available a generally repeatable set of crosswind conditions so that different drivers could be exposed to more or less the same crosswind experiences at widely varying times during the test program. And finally, there was the practical need to be able to schedule test drivers on a regular basis and be guaranteed that sufficient crosswind test conditions would be available.

Against this back-drop of perceived needs was the clear observation, well reported in the literature, that fan-generated crosswinds were generally insufficient for obtaining reliable subjective evaluations from test drivers. Since nearly all of the previous uses of fans for subjective evaluations were for short duration drive-by scenarios, in which drivers attempted to regulate the lateral path in response to a short-term pulse of crosswind, a different approach was considered for this research program. It was decided that the traditional, closely-grouped fan arrangement, which provides a short-duration pulse of crosswind, would be used only to evaluate the passive (non-driver) vehicle response. A new arrangement of the fans, in the form of a crosswind "gauntlet" course, would be used, instead, to expose the test drivers to the fan-generated crosswinds over a longer period of time for collecting their subjective evaluations.

##### **Vehicle Configurations**

A total of seven different vehicle configurations were used. Of the seven configurations, one served as the nominal baseline vehicle configuration. Two additional configurations provided variations of aerodynamic properties, and two other configurations were used to vary certain chassis properties. The last two configurations consisted of simultaneous combinations of aerodynamic and chassis variations. Table 1 lists the particular vehicle configurations studied.

As noted in Table 1, Configuration #1 corresponds to the baseline vehicle. Configurations #2 and #3 represent significant fore-aft modifications of the vehicle aerodynamic center of pressure, CP. Configuration #2 moves the CP forward

Table 1. Vehicle Configurations Examined in Test Program.

Configuration	Description
1	Baseline Vehicle (see Figure 5 for specific information)
2	Aerodynamic CP Moved Forward 10 inches from Baseline
3	Aerodynamic CP Moved Rearward 30 inches from Baseline
4	320 lb Ballast Load Added to Rear Trunk of Baseline Vehicle
5	Baseline Vehicle with Roll Stiffness Reduced 35%
6	Configuration #2 with Roll Stiffness Reduced 35%
7	Configuration #2, with 320 lb Ballast, and Reduced Roll Stiffness

10 inches from the baseline position, while Configuration #3 moves the CP rearward approximately 30 inches from the baseline configuration. Configuration #4 corresponds to the baseline vehicle with 320 lb of ballast weight added to the vehicle trunk resulting in a 10 inch rearward shift of the vehicle's mass center. It also produced an estimated 22% increase in the vehicle's yaw and pitch moments of inertia and 11% increase in weight. Configuration #5, due to disconnection of the front suspension roll bar, corresponds to a roll stiffness reduction from the baseline vehicle of approximately 35%. The last two configurations involved simultaneous aerodynamic and chassis modifications. Configuration #6 represents the combined effects of the forward CP location (configuration #2) and the reduced roll stiffness variation (configuration #5). Lastly, configuration #7 corresponds to a worst case scenario, combining the forward CP location (#2), with a rearward mass center (#4), and a reduced roll stiffness (#5). Numerical values for several of the key parameters are seen in Figure 5 which further describes the baseline vehicle and each of the alternate configurations.

All of the aerodynamic modifications were accomplished through the use of small vertical fins designed by the Chrysler aerodynamics department and mounted on the vehicle with light-weight tubular framing at distances of approximately 5 feet fore or aft of the vehicle ends. Full-scale wind tunnel measurements of the fin-equipped vehicle configurations were also performed in the Lockheed wind tunnel to identify their exact aerodynamic properties. The primary intent of the fins was to move the aerodynamic CP of the baseline vehicle (no fins) forward and rearward by significant distances by altering the aerodynamic yaw moment, without also significantly affecting the remaining aerodynamic properties (such as lateral force) of the baseline vehicle. The subsequent wind tunnel measurements verified the intended effects. Table 2 list the aerodynamic force and moment coefficients obtained from the Lockheed wind tunnel measurements. The data shown here apply for yaw angles as large as 20 degrees. The reference area for these measurements was 21 ft<sup>2</sup>. All measurements are with respect to a point located on the vehicle center-line, at the mid-wheelbase position, and in the ground-plane. (It should be noted that the data seen here correspond to a research test vehicle and are not necessarily indicative of production vehicles manufactured by the Chrysler Corporation or other automotive manufacturers.)

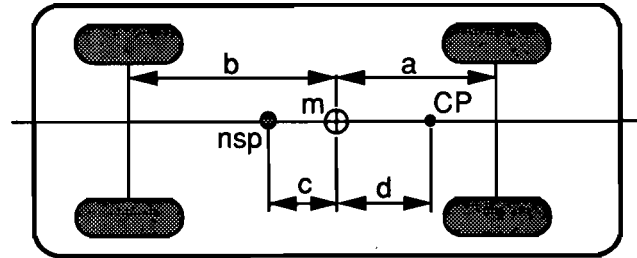

- a distance from mass center to front axle
- b distance from mass center to rear axle
- nsp neutral steer point ("center of tire forces")
- m mass center
- CP aerodynamic center of pressure
- c distance from nsp forward to mass center
- d distance from mass center forward to CP

Config #	a	b	c	d	Weight	Roll Stiffness
	(in)	(in)	(in)	(in)	(lb)	
1	37.4	59.6	18.7	19.8	3160	baseline value
2	37.4	59.6	18.7	29.8	3160	baseline value
3	37.4	59.6	18.7	-9.7	3160	baseline value
4	47.4	49.6	14.0	29.8	3480	baseline value
5	37.4	59.6	22.2	19.8	3160	65% baseline
6	37.4	59.6	22.2	29.8	3160	65% baseline
7	47.4	49.6	18.2	39.8	3480	65% baseline

Fig. 5. Description of Test Vehicle Configurations.

At speeds of 100 mph, the aerodynamic lift force and pitch moment data seen in Table 2 indicate a relatively small lifting force (e.g., 135 lb at zero yaw) as a percentage of vertical load that acts almost entirely at the front axle. Consequently, most of the aerodynamic inputs affecting the test vehicle with regard to crosswind sensitivity issues, are being generated by yaw-plane forces and moments.

Table 2. Aerodynamic Wind Tunnel Data.

Aerodynamic Coefficients	Config #1	Config #2	Config #3
(variations are per degree or degree <sup>2</sup> )			
Linear side force variation with yaw	0.0326	0.0353	0.0408
Linear yaw moment variation with yaw	0.0104	0.0149	0.0006
Linear roll moment variation with yaw	0.0087	0.0092	0.0117
Constant drag force coefficient at zero yaw	0.359	0.359	0.362
Quadratic drag force variation with yaw	0.000302	0.000309	0.000295
Constant lift coefficient at zero yaw	0.253	0.249	0.252
Quadratic lift force variation with yaw	0.000655	0.000670	0.000687
Constant pitch moment coefficient at 0 yaw	0.0939	0.102	0.106
Quadratic pitch moment variation with yaw	0.000106	0.000092	0.000096

Steady turning tests at 50 mph were conducted for both the baseline vehicle and the rear ballast configuration to measure their respective understeer gradients. Interestingly, even though configuration #4 represents a significant 10 inch rearward shift of the mass center, the understeer gradient of the loaded test vehicle did not change significantly from the baseline condition. This was a result of the test vehicle's tires having a significant sensitivity of cornering stiffness to vertical load. These tests indicated approximate understeer gradients of 3.2 **deg/g** for the baseline vehicle and 2.7 **deg/g** for the loaded configuration. The net effect of the rear loading, therefore, was to produce a rearward shift of not only the vehicle's mass center, but its neutral steer point as well. The amount of rearward shift for the neutral steer point varied, depending upon the loading and roll stiffness (as noted previously in Figure 5).

### Test Procedures

Two basic test maneuvers were used to evaluate the response of the various driver-vehicle configurations. The first maneuver was a fixed steering wheel drive-by of a constant pulse of fan-generated crosswind. It was used to primarily characterize and verify differences in the passive crosswind behavior of the different vehicle configurations. The second maneuver, serving to evaluate the active (driver and vehicle) crosswind system behavior, employed the same fans spread out over a longer distance but arranged in alternating directions. Active steering for path regulation by each driver was required during this latter test. All tests were conducted for vehicle speeds of 90-100 mph. Further descriptions of the these two test procedures follow.

- **Crosswind Pulse.** This maneuver was conducted with the eight fan units grouped together and facing perpendicular to the test track as seen in Figure 6. Fixed steering wheel drive-by tests were then performed for each vehicle configuration to evaluate their respective passive (no regulatory driver steering) wind **behav-**

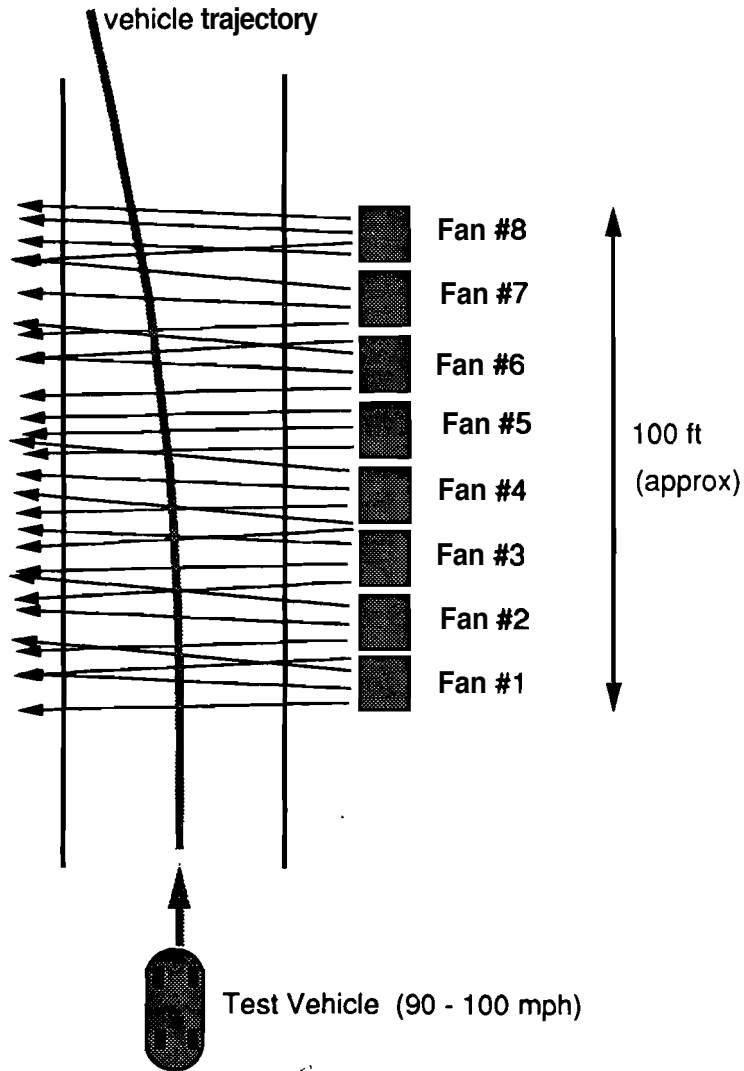

Fig. 6. Crosswind Pulse, Fixed Steering Wheel Test.

ior. Each test vehicle was driven in a straight line at 100 mph from the ambient environment past the fans whereupon it encountered an approximately constant 25 mph crosswind for a period of nearly 0.7 seconds. A pulse-like vehicle response due to entering and then exiting the crosswind stream was recorded by on-board instrumentation. The resulting peak yaw rate and lateral acceleration responses observed for each vehicle configuration were then used to confirm that

significant and distinctly measurable differences in the vehicle aerodynamic and chassis configurations were present in the passive crosswind behavior of each vehicle. (The short duration of the crosswind pulse at these speeds did not permit the vehicle to fully establish itself in a steady-state turning condition.)

• **Crosswind "Gauntlet" Maneuver.** For this set of tests, the eight fan units were located, in an alternating manner, along opposite sides of a straight-line test course (single lane width) and distributed over a longitudinal travel distance of approximately 350 feet. See Figure 7. This arrangement presented the driver-vehicle system with a series of fluctuating pulses of crosswind from one side and then the other in a repeating sequence. The spacing between the fans was approximately 52 feet. Wind output from each fan was set at an approximate level of 25 mph and the test course was driven at speeds of 90 to 100 mph. An inner lane width of approximately 8 to 9 feet was defined by a series of traffic cones along the center of the course in order to require each driver to regulate the vehicle path (without undue demand) within those bounds during traversal of the crosswind course. All of the subjective evaluations collected during the test program were obtained from this crosswind test procedure.

Impressions of several drivers who drove past the fans in both arrangements (Crosswind Pulse versus the Crosswind Gauntlet) noted significant differences. The closely grouped pulse arrangement had a very small effect on a driver's subjective and objective response as the crosswind pulse was encountered. The primary inputs to the drivers were reported to be sound (from wind noise) and a mild change in direction as the fans were passed. Drivers also commented that the experience was too brief. In contrast, the driving experience through the crosswind gauntlet generally made a much stronger impression on the test drivers. This was most likely due to the longer length of time of crosswind exposure provided by the gauntlet course and significantly increased driver-vehicle system responses during this test. For the same levels of fan wind output, the gauntlet course produced noticeably amplified system responses compared to those obtained from simple drive-bys of the closely-spaced pulse arrangement. The alternating pulses and their input frequency during the gauntlet test produced a more resonating dynamic response that further contributed to subjective driver impressions. The on-board measurements, as well as simple visual observation of the different vehicle configurations traversing the gauntlet, confirmed the amplifying qualities of the gauntlet test procedure. As an example, in a few of the worst-case vehicle configurations, peak lateral accelerations greater than 0.6 g were recorded at the driver head position and more than 0.45 g's on the stabilized platform. Levels approximately half these would have been recorded in the crosswind pulse test for the same fan output.

#### Drivers

Seven different drivers were utilized in the test program to provide subjective evaluations of each of the vehicle configurations during the crosswind gauntlet



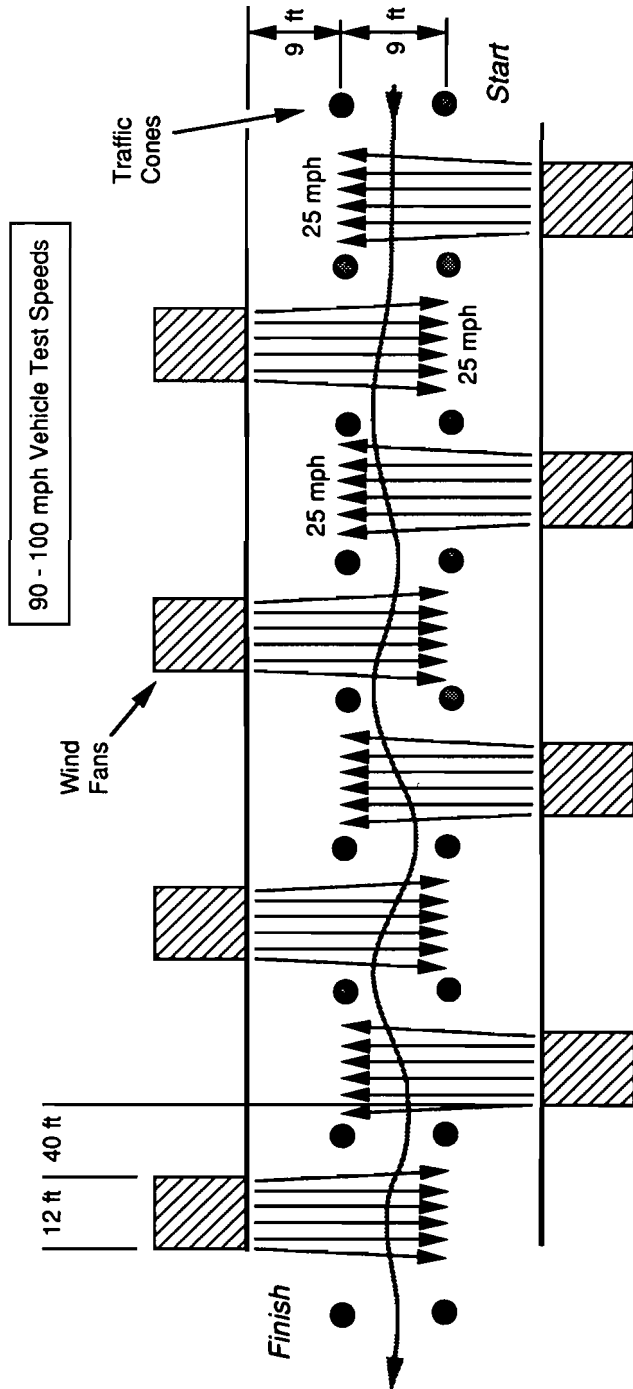

Fig. 7. Crosswind Gauntlet Test Course Used in Study.

tests. Objective measurements of the total driver-vehicle system responses were also collected for four of these test drivers to obtain representative system responses during the gauntlet tests. All of the drivers were males with backgrounds as engineers or technicians ranging in age from 25 to 55. All drivers, but one, were associated to varying degree with the crosswind research program. (Other drivers also participated intermittently during the testing but were not included in these results because of not having driven each of the different vehicle configurations, or, because their chosen speeds fell significantly outside the nominal 90-100 mph range.)

### Instrumentation

A stable platform and a variety of transducers were used to measure primary driver-vehicle responses during the gauntlet tests and included: lateral and longitudinal acceleration, yaw rate, roll rate, forward speed, steering wheel displacement and torque. In addition, an accelerometer was mounted laterally in the driver's head-rest to measure accelerations, deriving primarily from lateral vehicle motion and body roll, in the vicinity of the driver's head position. A Chrysler-developed wind transducer [22], utilizing a strain-gauged sphere in combination with an inertial mass compensating accelerometer, was also employed on top of the test vehicle to record the crosswind profiles experienced during the tests. Figure 8 shows example wind profile measurements of aerodynamic sideslip [30] from both test maneuvers at 80 mph using this transducer. The zero offsets seen for each of these examples reflect ambient wind conditions prevailing at the time of these tests.

### Crosswind Pulse Measurements

An example test result (fixed steering wheel) illustrating the baseline vehicle response (configuration #1) and the degree of variation provided by the two fore/aft CP variations (configurations #2 and #3) are seen in Figure 9. Peak lateral accelerations, ranging from about 0.11 g's to 0.24 g's, are seen for each of these aerodynamic configurations. Figure 10 shows a similar comparison between the baseline vehicle, the rear ballast configuration (#4), and the worst case configuration (#7, rear ballast and forward CP). The peak lateral accelerations seen here range from about 0.15 g's to 0.25 g's. (The data seen in Figures 9 and 10 were collected on two different days, with different ambient wind conditions.)

In general, the results from the crosswind pulse tests indicated that distinct and measurable degradations to the baseline vehicle (as reflected by peak lateral acceleration and yaw rate responses) were associated with forward movement of the CP and for rearward shifts in the mass center/neutral steer point due to the rear ballast. In contrast, rearward movement of the CP produced a noted improvement in the vehicle's passive crosswind sensitivity. The effects of reduced roll stiffness were not evaluated with the crosswind pulse test procedure. However, the reduced roll stiffness was estimated to produce a small increase in the vehicle's understeer gradient, and correspondingly, a small decrement in its pas-

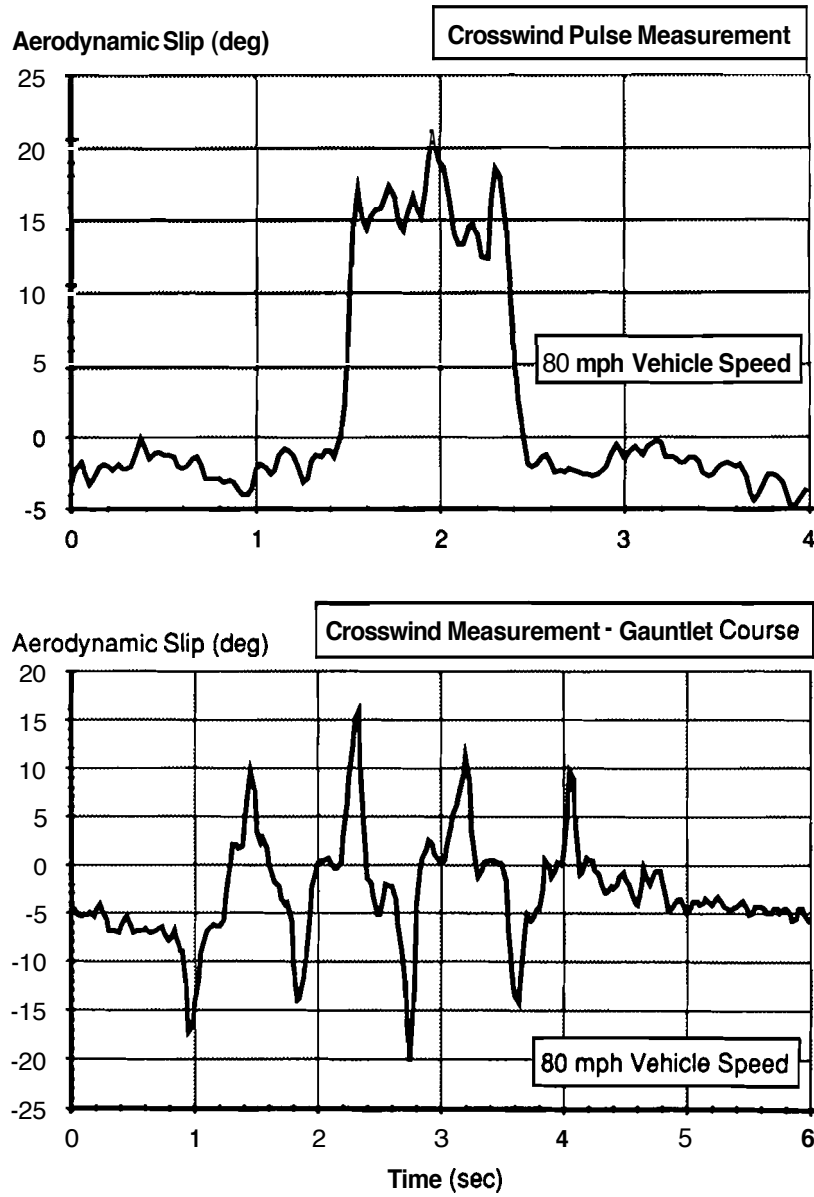

Fig. 8. Example On-Board Measurements of Crosswind Profiles Using the Chrysler Wind Transducer (22).

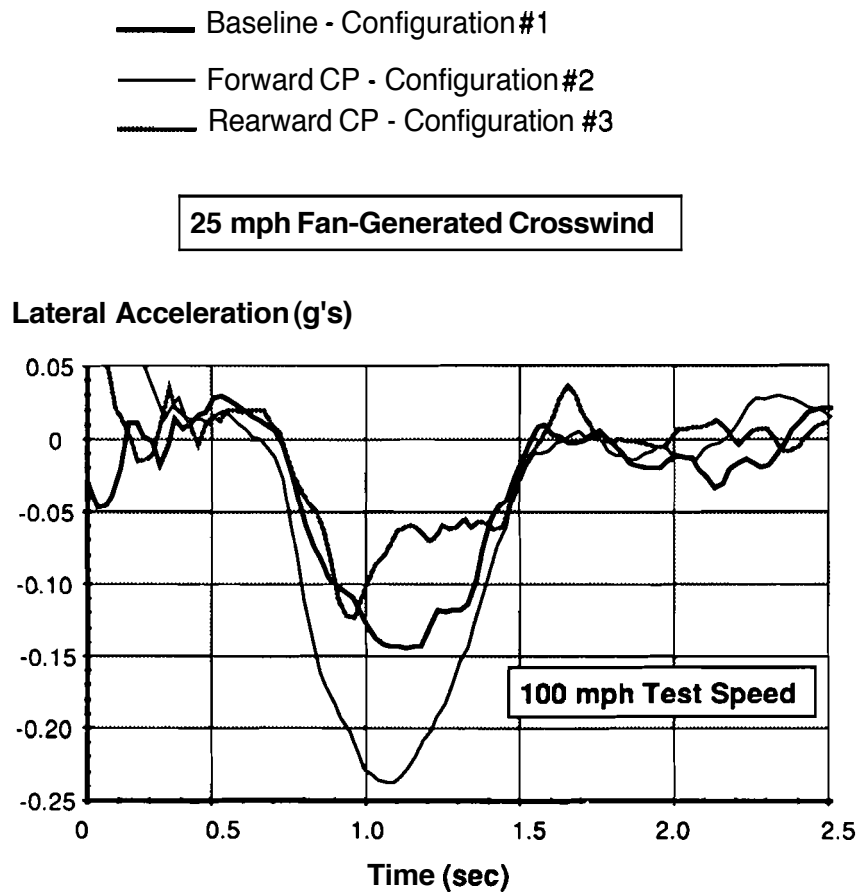

Fig. 9. Example Measurements of Vehicle Response Due to Pulse of Fan-Generated Crosswind. CP Influence.

sive crosswind sensitivity. This particular variation was primarily introduced for the subsequent closed-loop crosswind gauntlet tests in order to obtain driver subjective reactions to increased levels of roll compliance.

Having confirmed that known and measurable differences in passive crosswind sensitivity were being introduced by these vehicle modifications (aerodynamic and loading), the primary test procedure, the crosswind gauntlet, was then undertaken utilizing a variety of drivers.

#### Crosswind Gauntlet Measurements

To reiterate, the primary purpose of the crosswind gauntlet was to collect driver reactions (in the form of subjective evaluations and representative system response measurements) to these same vehicle modifications during a closed-loop

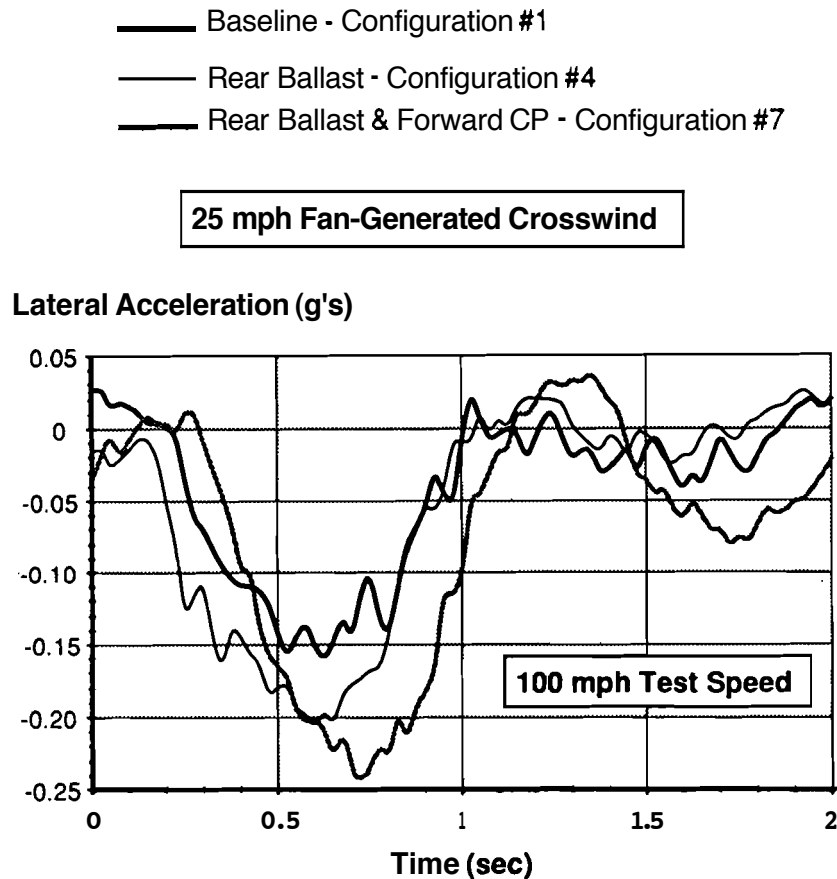

Fig. 10. Example Measurements of Vehicle Response Due to Pulse of Fan-Generated Crosswind. Load Influence.

regulation task in the presence of dynamic, and presumably more realistic, crosswind conditions. Figure 11 shows a representative set of **time** histories corresponding to the baseline vehicle traversing the gauntlet test course at a nominal speed of 100 mph. Seen here are driver steering wheel displacement, yaw rate, and lateral acceleration time histories from the same test. The sinusoidal-like, qualitative nature of these time histories were similar for each of the drivers. The magnitudes, however, would vary depending upon the degree of steering control elected by each driver in regulating the vehicle's lateral and yaw motion through the gauntlet course.

The primary difference in driver behavior seemed to derive from how tightly a driver elected to control the vehicle. While some steering regulation was re-

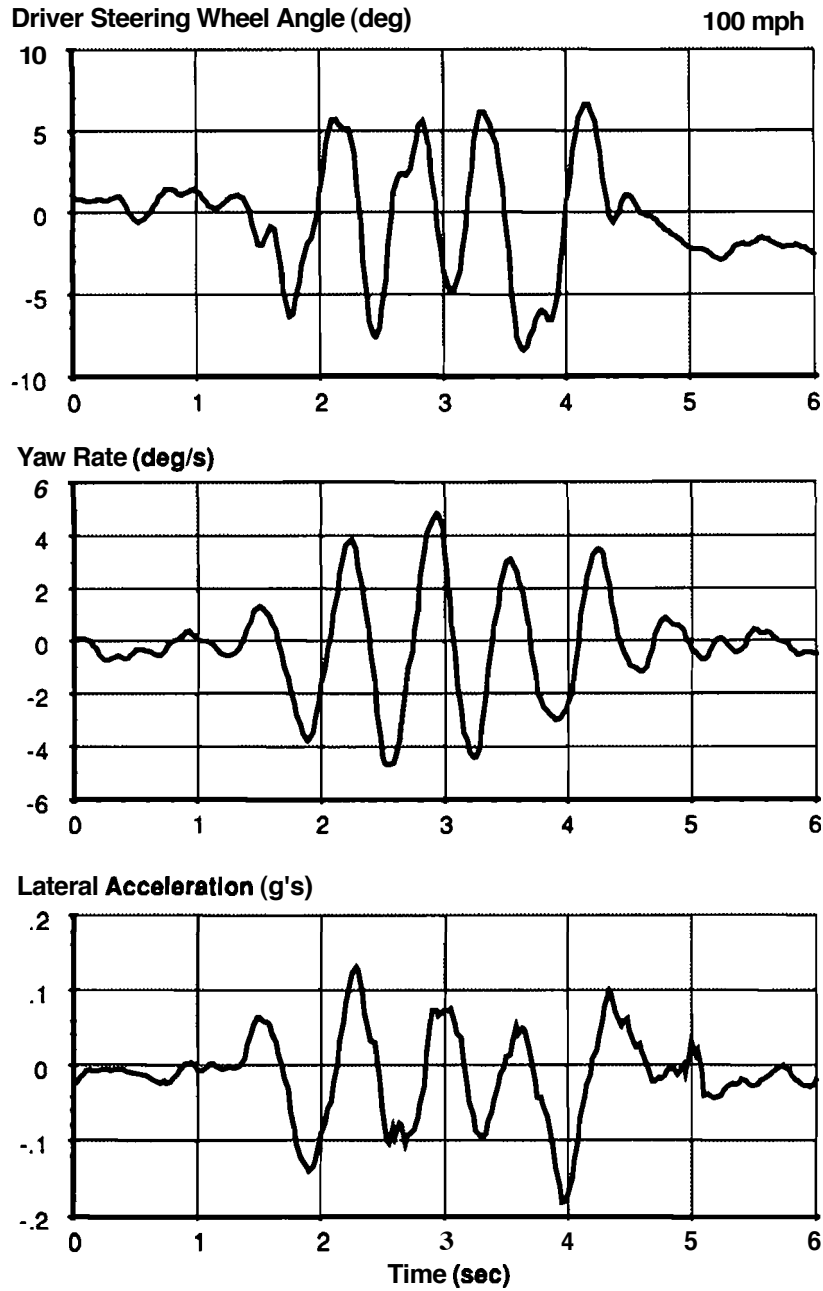

Fig. 11. Example Driver-Vehicle Response Measurement from the Crosswind Gauntlet Course/Baseline Vehicle.

quired to maintain the gauntlet course and avoid cones strikes, driver behavior seemed to separate into two basic types: a) those who chose to provide minimal steering through the course, and b) those who tried to closely regulate the lateral path deviations caused by the crosswind. It was observed that poorer lateral performance and amplified system responses were exhibited by drivers who attempted to closely regulate the vehicle during the crosswind course. This is likely explained by the inherent time lags of most drivers while attempting to respond to relatively high frequency disturbance inputs (as provided here by the crosswind pulses). Those drivers who more or less "went along for the ride" provided smaller corrective steering inputs and focused more on controlling any significant path deviations. Despite such differences in observed driver steering behavior patterns during the crosswind gauntlet, the subjective evaluations of most drivers still generally agreed with one another regarding preferences for different vehicle configurations.

In Figure 12, an overlay of three yaw rate responses (not synchronized in time) are seen to illustrate the degree of variation routinely observed from the

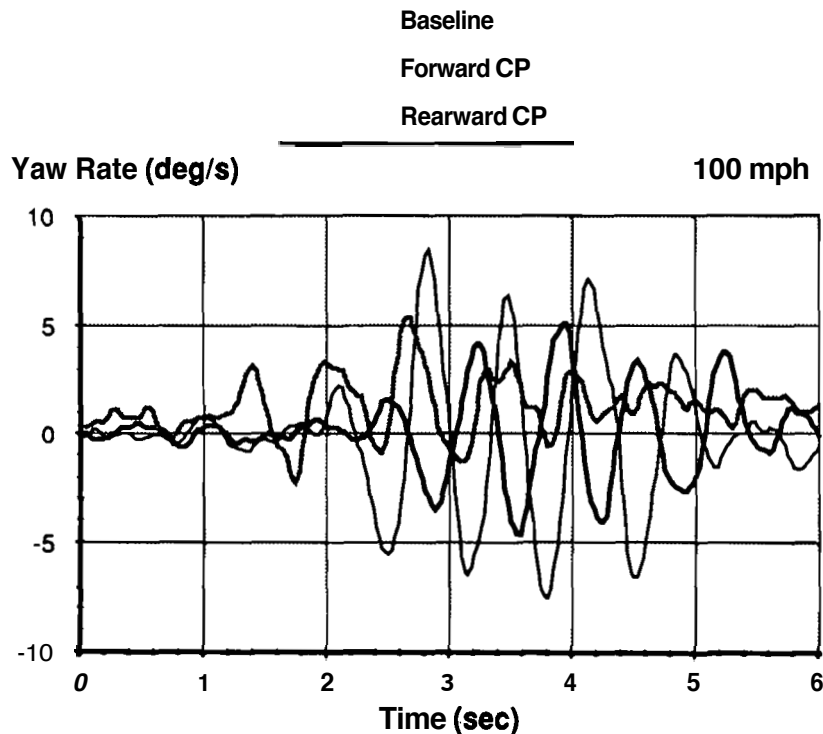

Fig. 12. Example Yaw Rate Measurements from the Crosswind Gauntlet Course.

three different aerodynamic configurations. The three runs seen in Figure 12 are for the same test driver. Again, the absolute magnitudes of system responses such as these may have varied from driver to driver, but the relative scaling from vehicle configuration to configuration tended to remain about the same. For example, if driver A utilized 25% more steering activity than driver B through the gauntlet course to control vehicle configuration #1, it was likely that driver A would also use about 25% more steering control than driver B in controlling vehicle configuration #2.

Testing was conducted for seven drivers, across all seven vehicle configurations, and for three repeats each **driver/vehicle** configuration. Subjective ratings were obtained from each driver regarding general impressions of controllability and preferences. A 10-point rating scale was used to rank each vehicle configuration with the extremes of the scale implying such descriptions as "uncontrollable" for a value of 10, to "ideal - no noticeable crosswind effect" corresponding to a value of 1. All ratings fell in the range from 3 to 8.5, with 4.8 being the average rating for the baseline configuration in these tests. Figure 13 shows a plot of the driver subjective ratings for the gauntlet tests versus vehicle **configuration** averaged over all seven drivers. The degree of scatter about each average value is also indicated by the small vertical bars seen in Figure 13.

Objective measurements of driver-vehicle responses noted above were also collected for four of these same tests drivers with an on-board data acquisition system. RMS values of each of these responses were calculated over a time period starting approximately 1 second prior to commencement of the crosswind gauntlet and ending 1 second after the gauntlet traversal. These RMS values were then normalized by the baseline configuration values so that a value of 1 repre-

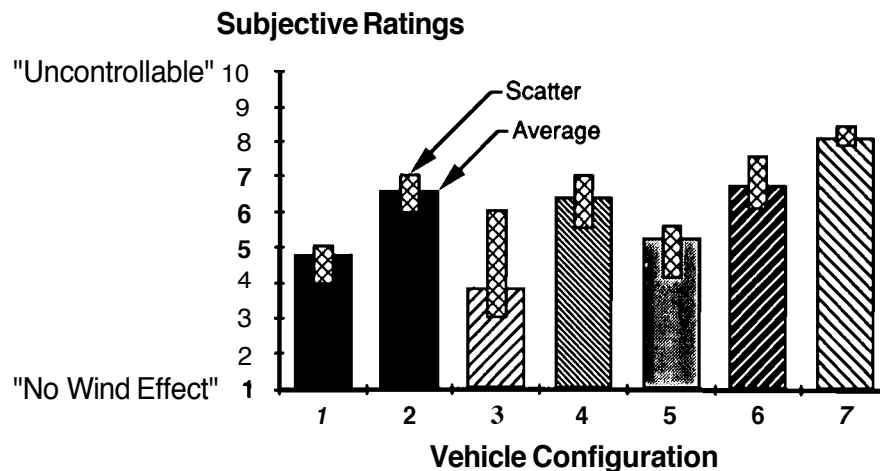

Fig. 13. Subjective Ratings from 7 Drivers - Crosswind Gauntlet Course.



Table 3. Normalized RMS Responses from the Crosswind Gauntlet Tests.

<i>RMS Driver/Vehicle Response</i>	<i>Vehicle Configuration</i>						
	1	2	3	4	5	6	7
Yaw Rate (2.29 deg/s)	1.0	1.56	0.63	1.52	1.13	1.63	2.41
Lateral Acceleration (0.069 g)	1.0	1.52	0.99	1.28	1.07	1.51	2.03
Driver Steering Angle (2.9 deg)	1.0	1.39	0.85	1.28	1.07	1.69	1.76
Driver Steering Torque (6.7 in-lb)	1.0	1.31	1.07	1.15	1.0	1.03	1.81
Head-Rest Acceleration (0.113 g)	1.0	1.57	0.90	1.38	1.11	1.59	2.27

sents the baseline response, values larger than 1 correspond to amplified responses relative to the baseline response, and values less than 1 correspond to responses less than the baseline. Table 3 lists the average **RMS** values (across 4 drivers and 3 repeats each) of several different driver-vehicle responses and all seven vehicle configurations.

The average, non-normalized baseline responses are also listed in parentheses in Table 3 to gauge the absolute response levels being experienced. In general, peak values of these responses are approximately twice the RMS values listed here. For example, an estimate of the average peak value of head-rest acceleration for configuration #7 would be approximately: **0.113 g** (Baseline value) x **2.27** (Configuration #7 normalized ratio) x **2** (peak/RMS approximate ratio) = **0.51 g's**.

## 5. FINDINGS

Direct observation of the test results of Section 4 indicate certain driver preferences regarding vehicle aerodynamic properties, weight distribution, and roll compliance as represented by the different vehicle configurations tested. Further analysis of those preferences will be shown to be related to certain basic driver-vehicle responses, which in turn, can be predicted (to first order) by simple static analyses, and more completely, by use of dynamic simulation.

The results of Figure 13 indicate clear driver preferences for more rearward locations of the aerodynamic center-of-pressure (Configurations #1, #2, and #3). Similarly, a clear preference is seen for the more forward mass center location (Configuration #1 versus #4). A less pronounced, but definite preference is also indicated for less roll compliance in Figure 13 (Configurations #1 and #2, versus #5 and 6). Finally, Configuration #7, which combined the detrimental qualities of a forward center-of-pressure, rearward mass center, and increased roll compliance, is given the lowest subjective rating of all vehicle configurations tested.

If a linear regression analysis is performed between the subjective evaluations appearing in Figure 13 and each of the driver-vehicle normalized responses

appearing in Table 3, some interesting results are observed. For example, Figure 14 shows the linear regression between subjective ratings and normalized RMS vehicle yaw rate measurements. (The  $y(x)$  regression equation and its  $r^2$  correlation is seen in the inset box appearing in Figure 14.) The high degree of correlation between subjective ratings and the measured yaw rate responses is surprisingly strong, suggesting that nearly all of the variation in subjective ratings can be accounted for by the RMS levels of yaw rate alone.

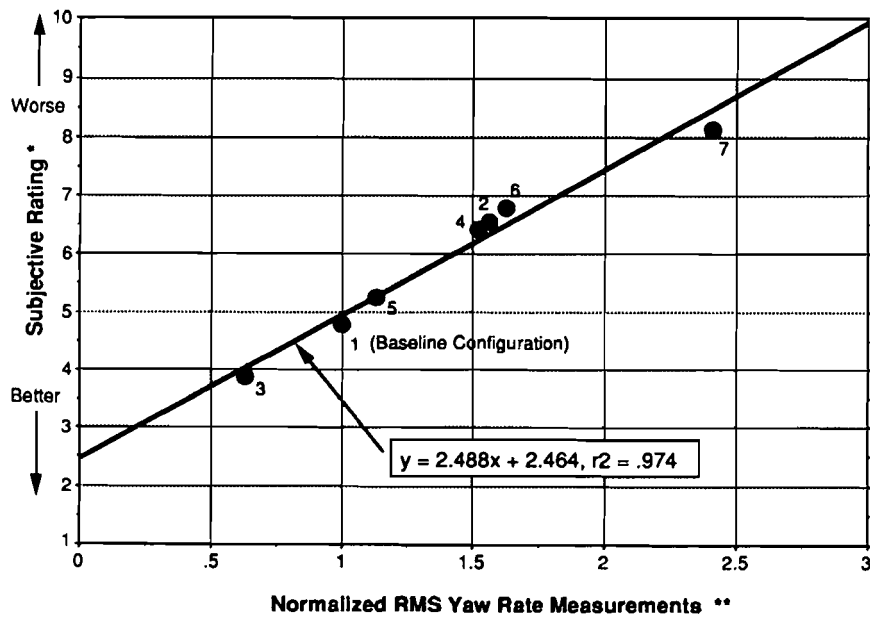

Vehicle Configurations:	
1	Baseline
2	Forward CP
3	Rearward CP
4	320 lb Rear Ballast
5	Baseline & Reduced Roll Stiffness
6	Forward CP & Reduced Roll Stiffness
7	Forward CP, Rear Ballast, & Reduced Roll Stiffness

•• Average of All 7 Drivers  
 Average of 4 Instrumented Drivers

Fig. 14. Correlation between Subjective Ratings and Normalized RMS Yaw Rate Responses during Crosswind Fan Test.

If similar regression analyses are performed, one at a time, on each of the remaining response variables appearing in Table 3, the  $r^2$  correlation coefficients rank the responses in the order listed in Table 4. Also included in Table 4 is a numeric, *S*, defined as the ratio of the ensemble average for the configuration with the highest RMS level to that configuration with the lowest RMS level. This numeric provides an approximate description of the "spread in the data and identifies those system responses having greater discriminatory ability or sensitivity to changes in vehicle configuration. It also happens that the numeric, *S*, ranks the response variables here in the same order as the  $r^2$  correlation coefficient.

The results appearing in Table 4 rank vehicle yaw rate first, with head-rest acceleration (which includes body roll motion effects), driver steering wheel displacement, and vehicle lateral acceleration (stable platform measurement; no direct body roll influence) also as strong correlating responses. Driver steering wheel torque showed relatively poor correlation with the subjective ratings. Since a strong correlation normally exists between most of these same responses in typical steering maneuvers, further interpretation of these results without additional test data and statistical analysis is probably not warranted here. However, it is clear from these results (yaw rate, in particular, and the other measurements representing various types of driver-vehicle responses) that *increased* levels of these motion responses during crosswind conditions, are clearly associated with *poorer* subjective ratings by the test drivers. On the basis of the results seen in Table 4, the indicated **rankings** would suggest which response variables best predict the subjective ratings of drivers during these specific crosswind gauntlet tests.

Whether, these test results and analyses can be extended to more natural crosswind conditions and other vehicles is a legitimate question. Evidence supporting the generalization of these findings is found in several studies appearing in the technical literature [7, 16, 18, 19] – all of which are in basic agreement on the importance of the indicated responses as key variables related to driver subjective evaluations of crosswind sensitivity. Furthermore, the one study conducted during purely natural crosswind conditions [19] also supports the same basic observation noted here regarding the special significance of yaw rate, lateral acceleration, and driver steering wheel displacement as responses significantly correlated with driver subjective ratings.

Table 4. **Rankings** of the Response Variables by Degree of Correlation with Driver Subjective Ratings.

Response Variable	Ranking	$r^2$ Correlation	<i>S</i>
Yaw Rate	<b>1</b>	<b>0.974</b>	<b>3.83</b>
Head-Rest Acceleration	<b>2</b>	<b>0.925</b>	<b>2.52</b>
Driver Steering Wheel Displacement	<b>3</b>	<b>0.909</b>	<b>2.07</b>
Lateral Acceleration	<b>4</b>	<b>0.890</b>	<b>2.05</b>
Driver Steering Wheel Torque	<b>5</b>	<b>0.561</b>	<b>1.81</b>

Since the RMS yaw rate measurements from the gauntlet tests correlate so well with the driver subjective evaluations of crosswind sensitivity, a pertinent question is to ask how well the steady-state yaw rate responses (due to a constant crosswind and fixed steering wheel) might correlate with the same subjective ratings. Using the dynamic crosswind model [13], steady turning responses, induced by a constant crosswind with a fixed steering wheel, were calculated for each of the test vehicle configurations. A regression analysis, similar to above, was then performed to obtain the relationship between the subjective ratings from the gauntlet tests, and the calculated steady-state yaw rate responses (normalized by the baseline vehicle response), for each of the test vehicle configurations. Figure 15 shows the result of this regression. (The yaw rate response of the baseline vehicle has a gain of 0.122 **deg/sec** per degree of crosswind). As seen, the calculated steady-state yaw rate responses provide a reasonably good correlation. This would suggest, that even in the absence of test measurements, a **first-order** prediction of a vehicle's subjective rating may be provided by its passive (**non-driver, fixed steering**) turning response to a constant crosswind (also referred to as a vehicle's "passive crosswind sensitivity").

### Static Analysis

Further insight regarding a vehicle's passive wind sensitivity and the basic vehicle parameters that affect it can be seen in the diagram and equation of Figure 16. The contents of this figure are based upon reference [10]. The equation seen in Figure 16, is shown here as Equation (1),

$$r / Fa = [1 / m U] (c + d) / (c + \zeta) \quad (1)$$

and relates a vehicle's yaw rate response,  $r$ , to an applied aerodynamic side force,  $Fa$ , in terms of certain fundamental vehicle properties. These fundamental properties are simply the relative locations of a vehicle's mass center, its neutral steer point, the aerodynamic center of pressure, and the tire yaw damping moment arm — all defined by the parameters  $c$ ,  $d$ , and  $\zeta$  in Figure 16. If the aerodynamic side force,  $Fa$ , is expressed in terms of the conventional aerodynamic properties,

$$Fa = q C_s A \alpha \quad (2)$$

where,

$q$  is the dynamic pressure =  $0.5 \times \text{air density} \times V^2$

$V$  is the magnitude of the relative wind vector

$C_s$  is the aerodynamic side force coefficient

$A$  is the cross-sectional reference area

and,

$\alpha$  is the aerodynamic slip angle (corresponding to a constant crosswind,  $\alpha V$ , and forward vehicle speed,  $U$ )

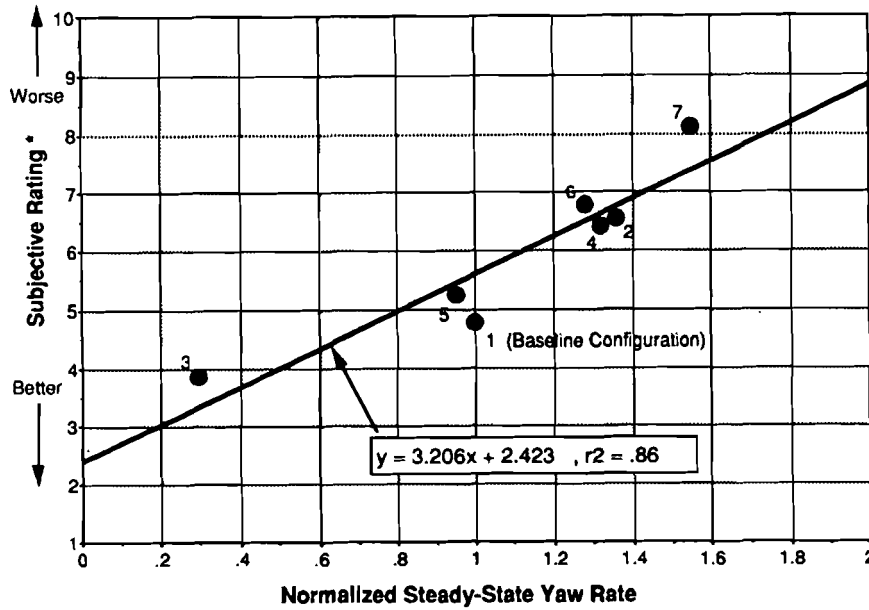

Vehicle Configurations:	
1	Baseline
2	Forward CP
3	Rearward CP
4	320 lb Rear Ballast
5	Baseline & Reduced Roll Stiffness
6	Forward CP & Reduced Roll Stiffness
7	Forward CP, Rear Ballast, & Reduced Roll Stiffness

• From Fan-Generated Crosswind "Gauntlet" Tests (Average of 7 Drivers)

Fig. 15. Correlation Between Subjective Ratings and the Steady-State Yaw Rate Response due to a Constant Crosswind.

Equation (1) can be re-arranged to express the passive wind sensitivity of a vehicle in terms of its yaw rate response *per angle of aerodynamic sideslip*, as given by Equation (3):

$$r / \alpha = [q C_s A / m U] (c + d) / (c + \zeta) \tag{3}$$

Equation (3) predicts a vehicle's static yaw rate response per angle of aerodynamic sideslip (as produced by a constant crosswind of magnitude  $\alpha V$ ), when travelling at a speed, U. By noting that d is given by  $(a - L / 2 + L C_{mz} / C_s)$ ,

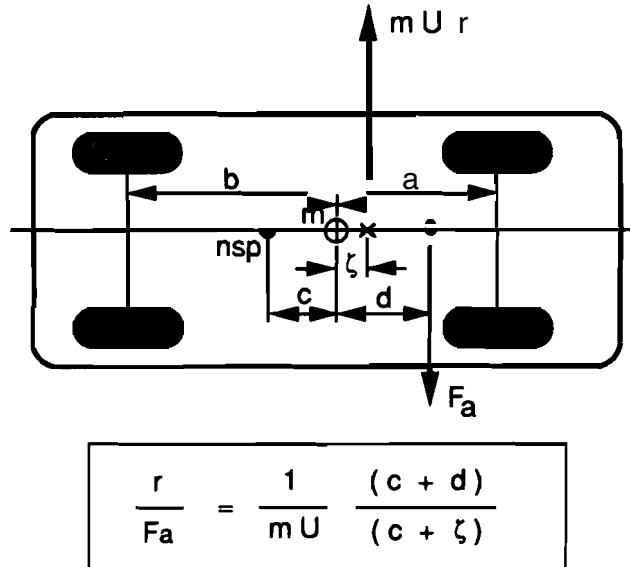

where,

- a** distance from mass center to front axle
- b** distance from mass center to rear axle
- nsp** neutral steer point ("center of tire forces")
- m** vehicle mass
- CP** aerodynamic center of pressure
- c** distance from nsp forward to mass center  
 $= (b C_r - a C_f) / (C_f + C_r)$
- d** distance from mass center forward to CP
- U** vehicle speed
- r** vehicle steady turning yaw rate response
- F<sub>a</sub>** constant, aerodynamic side force
- ζ** moment arm proportional to the tire force yaw damping moment about the nsp

$$= (a + b)^2 C_f C_r / [(C_f + C_r) m U^2] \quad *$$

- C<sub>f</sub>** effective total tire cornering stiffness of front axle
- C<sub>r</sub>** effective total tire cornering stiffness of rear axle

- \* e.g., at 100 mph,  $\zeta = 3.5$  inches for baseline vehicle configuration with  $C_f = 300$  lb/deg and  $C_r = 400$  lb/deg

Fig. 16. Static Turning Response of a Vehicle Subject to a Constant Aerodynamic Crosswind Force.

where,

$L = a + b$  is the vehicle wheelbase

and

$C_{mz}$  is the aerodynamic yaw moment coefficient

Equation (3) may be further expanded to express a vehicle's passive crosswind sensitivity completely in terms of its aerodynamic properties,

$$r / \alpha = [q C_S A / m U] [c + (a - L / 2 + L C_{mz} / C_S)] / (c + \zeta) \quad (4)$$

For either Equation (1), (3), or (4), a principal factor determining the yaw rate response to a crosswind is the ratio of moment arms,  $(c + d) / (c + \zeta)$ . The distance  $c$  locates the neutral steer point and is affected by a vehicle's tire force properties, steering system compliance, suspension kinematics, and mass distribution. The distance,  $d$ , between the aerodynamic CP and mass center, is clearly determined by the vehicle aerodynamics and weight distribution. And finally,  $\zeta$ , the tire yaw damping moment arm, is influenced by tire and weight properties, but primarily by forward speed. Consequently, the opportunity to alter a vehicle's passive crosswind sensitivity can be affected by any number of vehicle and aerodynamic modifications as well as forward speed. Fortunately, the relatively simple formulation provided by Equations (1) or (4) permits one to anticipate and predict, rather easily, how proposed chassis or aerodynamic modifications are likely to influence the passive crosswind sensitivity of a vehicle. For example, Equation (3) or (4) can be used with the numerical values contained in Table 2 and Figures 5 and 16, to calculate the normalized steady turning yaw rate responses appearing in Figure 15. (It should be noted that such analytical calculations normally need to represent the effects of steering system compliance and suspension properties, bounce-camber and bounce-steer, by means of *equivalent* tire cornering stiffnesses which, in turn, are reflected in the moment arms  $c$  and  $\zeta$ .)

### Dynamic Analysis

While the static turning analyses noted above are useful for understanding and estimating a vehicle's passive wind sensitivity, the reliance upon such properties *alone* for predicting driver subjective evaluations can be misleading in certain cases. For example, configurations #5 and #6, corresponding to increased levels of front suspension roll compliance relative to those seen in configurations #1 and #2, will normally introduce more understeer, and thereby produce a decreased crosswind turning response under these *static* conditions. This would then result in a prediction of improved subjective ratings under this scheme. However, under *dynamic* wind conditions, increased roll compliance was seen in the test data to produce a poorer driver subjective rating due to amplified motions caused by the increased roll compliance. Consequently, the use of the static turning analysis for predicting driver crosswind subjective ratings on the basis of *steady-state* yaw rate responses is viewed here only as a first-stage screening method.

More careful analyses should subsequently be conducted with dynamic simulation models, or vehicle crosswind testing, to further refine any static analysis. That is, simulations or vehicle tests can be conducted, under dynamic crosswind conditions, to examine effects of other vehicle properties (*e.g.*, steering system characteristics and suspension properties) that are related to crosswind sensitivity in a more subtle manner.

To illustrate this latter point, computer simulations of the baseline vehicle and its more roll-compliant counterpart (with no front suspension roll bar) were conducted for a gauntlet-like crosswind input seen in Figure 17. The crosswind model described in Section 3 and reference [13] was utilized for these calculations. The closed-loop driver model [26] is activated to steer and regulate the vehicle along a straight-line course in response to the dynamic crosswind buffeting. Time histories of driver steering wheel angle, vehicle yaw rate, and lateral acceleration are seen in Figure 18 for both vehicle configurations. Simple examination of these results show that, if these time histories were processed to obtain RMS values, the vehicle configuration with the increased roll compliance would exhibit higher RMS levels. The increased RMS value of yaw rate for the more roll compliant vehicle would imply a poorer subjective rating, as was previously observed for the crosswind gauntlet test data. Thus, the use of a more comprehensive dynamic analysis (through simulation or testing) is seen as a recommended means for fine-tuning and extending the basic crosswind sensitivity predictions provided by the simplified static turning analysis, to more realistic dynamic crosswind conditions. Similar examples of subtle conflicts that can arise between predictions of crosswind sensitivity obtained from static turning analyses, versus crosswind sensitivity predictions obtained from RMS system responses and dynamic analyses, are also provided in reference [12] using this same approach.

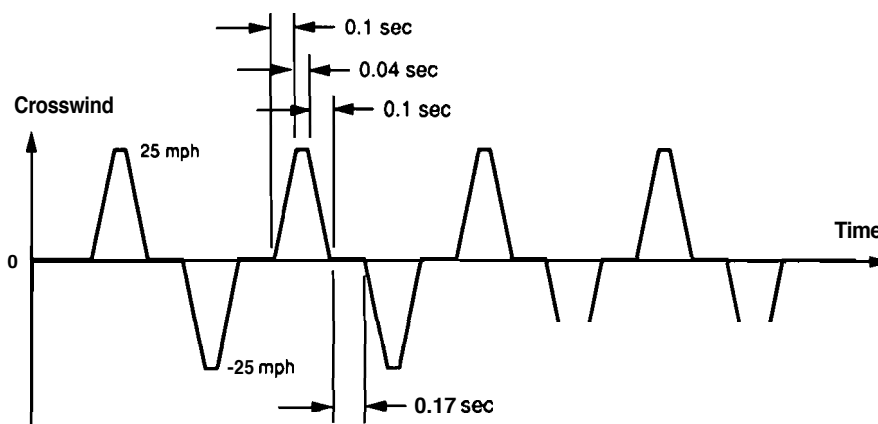

Fig. 17. Crosswind Profile Used in Example Calculations of Figure 18.



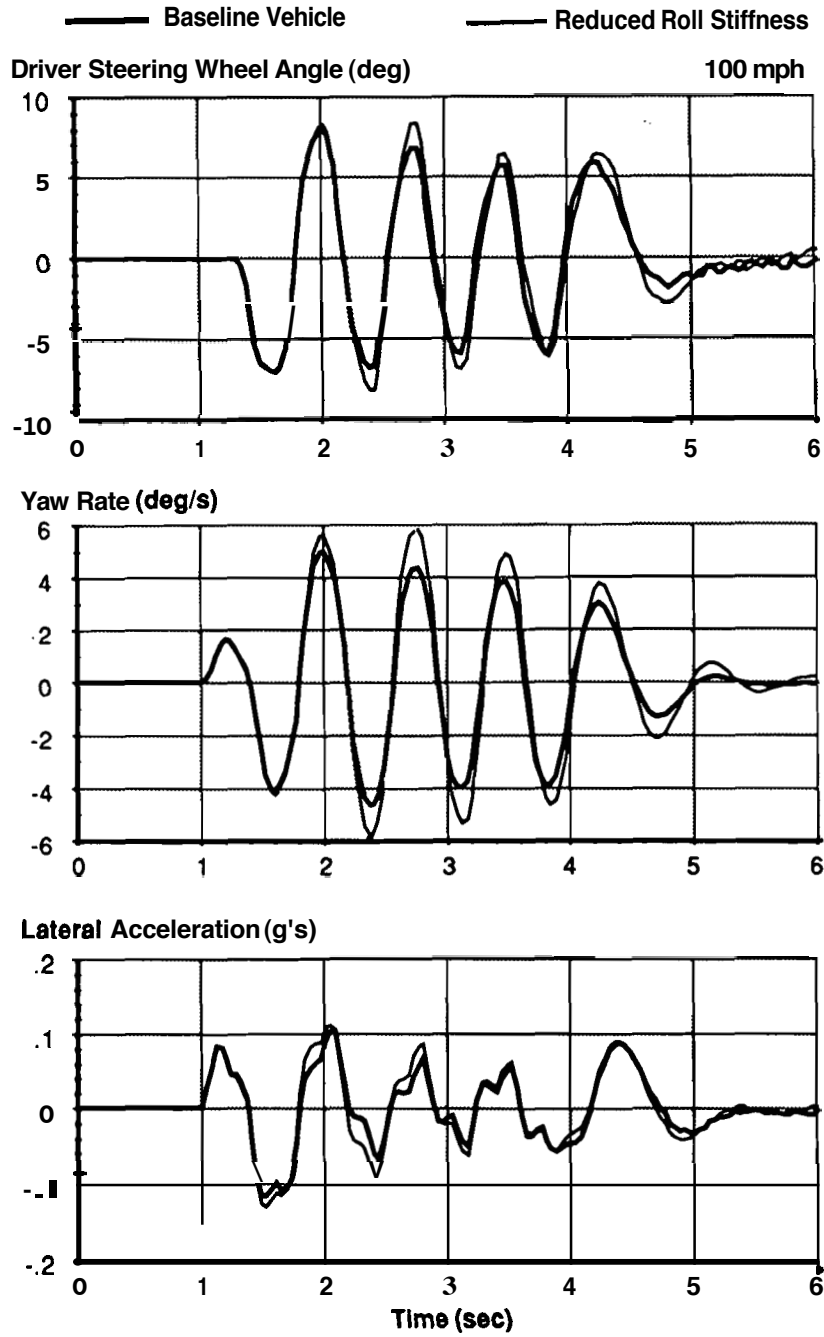

Fig. 18. Simulated Driver-Vehicle Response Using the Dynamic Crosswind Model - Gauntlet Course Example.

Downloaded by: [University of Michigan] at 21:57 22 February 2015

## 6. CONCLUSIONS

The results of the full-scale driver-vehicle crosswind tests presented above, in combination with static turning analyses of vehicles in constant crosswinds and more complete dynamic crosswind simulations, suggest the following conclusions:

- A vehicle's static turning response due to a constant crosswind input and fixed steering wheel angle is a useful, first-stage predictor of driver's likely subjective evaluation of a vehicle's crosswind sensitivity.
- That same static turning measure will also frequently predict a vehicle's likely ranking of RMS responses obtained during dynamic crosswind maneuvers.
- A more reliable and accurate method for predicting subjective evaluations of vehicle crosswind sensitivity is with RMS yaw rate values obtained from full-scale testing or comprehensive dynamic simulation of driver-vehicle systems during dynamic, random-like or natural crosswind conditions.
- Increased roll motion due to decreased suspension roll stiffness was associated with lower driver subjective evaluations of vehicle crosswind sensitivity.
- At vehicle speeds of 90-100 mph, variations in fore-aft weight distribution played as important a role as comparable variations in aerodynamic center-of-pressure location in influencing both subjective and objective evaluations of vehicle crosswind sensitivity.
- A two-stage vehicle design process is recommended for analyzing the crosswind sensitivity of a potential vehicle or new design: (1) A preliminary screening of candidate vehicle designs for crosswind sensitivity, based upon the simplified statics analysis of Equations (3) or (4), should first be conducted to screen out ineligible candidate designs having unsuitable vehicle properties (e.g., relative locations of mass center, neutral steer point, and aerodynamic CP that promote high passive crosswind sensitivity). (2) Conduct a more in-depth and comprehensive analysis of the "final round" candidate designs using dynamic analysis (such as the crosswind model described above). The dynamic model should employ random-like, natural crosswind inputs to examine likely driver-vehicle responses to systematic variations of vehicle chassis properties (suspension, steering system, and weight distributions particularly) and different aerodynamic designs. RMS values of system responses (e.g., yaw rate) can be used to evaluate the influence of alternate designs.
- The dynamic crosswind model developed under this work can be used to further explain and analyze the crosswind sensitivity of driver-vehicle systems in a dynamic context, particularly for driving scenarios involving active driver steering control during representative random crosswind conditions. Its use as a tool to systematically examine the influences of vehicle sub-components on crosswind stability is especially useful.
- Further man-machine research into likely driver preferences regarding body roll motion and driver-centered motion experiences deriving from aerodynamic crosswind forces and moments is recommended.

- Re-examination by other parties of the crosswind gauntlet test procedure (or similar procedures) utilizing wind-generating fans is also recommended. Based on the experiences reported here, this type of crosswind test procedure appears to offer significant promise for collecting driver-based subjective data of vehicle crosswind sensitivities. Whether such procedures can effectively replace natural crosswind testing as a reliable method for collecting driver subjective information, remains to be seen.

### REFERENCES

1. Vehicle Crosswind Stability. Chrysler Challenge Fund Project - #2000533, UMTRI, Sponsored by the Chrysler Motors Corporation, 1987-1990.
2. W. Hucho, *Aerodynamics of Road Vehicles*. Butterworths, 1987.
3. A. J. Scibor-Rylski, *Road Vehicle Aerodynamics*. Revised by D.M. Sykes ed. Wiley, New York, 1984.
4. W. Kamm, Anforderungen an Kraftwagen bei Dauerfahrten. ZVDI. vol 77, 1933.
5. I. Kohri and T. Kataoka, Research on Improvement of Cross-Wind Properties of Passenger Cars. *JSAE Review*, Vol. 10, No. 3, 1989. pp. 46-51.
6. H. Noguchi, Crosswind Stability and Suspension Properties. MIRA Translation by G. Wood, Rept No. Translation 2/87. 1987.
7. T. Kobayashi and K. Kitoh, Cross-Wind Effects and the Dynamics of Light Cars. *Int.J. of Vehicle Design*. Vol. No. Special Publication SP3, 1983. pp. 142-157.
8. A. Watari, S. Tsuchiya and H. Iwase, On the Cross-Wind Sensitivity of the Automobile. *Proceedings of the 15th FISITA Congress*, Paris, 1974.
9. R. Buchheim, J. Maretzke and R. Piatek, The Control of Aerodynamic Parameters Influencing Vehicle Dynamics. SAE Paper no. 850279. 1985.
10. C. C. MacAdam, Static Turning Analysis of Vehicles Subject to Externally Applied Forces - A Moment Arm Ratio Formulation. *Vehicle System Dynamics*, Vol. 18, No. 6, 1989. pp. 345-357.
11. F. Uffelmann, Influence of Aerodynamics and Suspension on the Cross-Wind Behaviour of Passenger Cars - Theoretical Investigation under Consideration of the Driver's Response. *Proceedings of the 9th IAVSD Symposium of the Dynamics of Vehicles on Roads and Tracks*. Ed. Nordstrom. Linkoping, Sweden, Swets & Zeitlinger B.V. - Lisse. 1985.
12. C. C. MacAdam, The Interaction of Aerodynamic Properties and Steering System Characteristics on Passenger Car Handling. *Proceedings of the 11th IAVSD Symposium of the Dynamics of Vehicles on Roads and Tracks*. Ed. Anderson. Kingston, Canada, Swets & Zeitlinger B.V. - Lisse. 1989.
13. M. Sayers, C. C. MacAdam and Y. Guy, Chrysler/UMTRI Wind-Steer Vehicle Simulation. User's Manual, Version 1.0, vols I and II, Report No. UMTRI-89-8/1-2, 1989.
14. N. F. Barter, *The Transient Response of Automobiles to Steering and Wind Gust Inputs*. Doctoral Thesis, The Loughborough University of Technology, 1975.
15. R. T. Bundorf, D. E. Pollack and M. C. Hardin, Vehicle Handling Response to Aerodynamic Inputs. SAE, 1963.
16. R. H. Klein and J. R. Hogue, Effects of Crosswinds on Vehicle Response - Full-Scale Tests and Analytical Predictions. SAE Paper no. 800848, 1980.
17. R. H. Klein and H. R. Jex, Development and Calibration of an Aerodynamic Disturbance Test Facility. SAE Paper No. 800143, 1980.
18. H. van den Hemel et al., The Cross-Wind Stability of Passenger Cars: Development of an Objective Measuring Method. Fourth IAVD Congress, 1987.
19. H. P. Willumeit et al., Method to Correlate Vehicular Behaviour and Driver's Judgement Under Side Wind Disturbances. *Proceedings of the 10th IAVSD Symposium of the Dynamics of Vehicles on Roads and Tracks*, Prague, Cz, 1987.
20. J. P. Smith. Wind Gusts Measured on High-Speed Roads. The Motor Industry Research Association. Rept No. 1972/7, May, 1972.

21. V. T. **Tran**, Determining the Wind Forces and Moments Acting on Vehicles by Means of Pressure Transducers. **SAE** Paper No. 900313, 1990.
22. J. D. Pointer, On-Road Calibration of the Dynamic Pressure Vector System. **10/17/88** Memorandum to G. Romberg. **Chrysler** Motors Corporation. 1988.
23. A. Alexandridis, B. **Repa** and W. Wierwille, The Influence of Vehicle Aerodynamic and Control Response Characteristics on Driver-Vehicle Performance. **SAE** Paper no. 790385.1979.
24. L. Segel, On the Lateral Stability and Control of the Automobile as Influenced by the Dynamics of the Steering System. *Journal of Engineering for Industry*, Vol. **66**, No. 8, 1966. pp.
25. J. R. Hogue, Aerodynamics of Six Passenger Vehicles Obtained from Full Scale Wind Tunnel Tests. SAE Paper no. 800142. 1980.
26. C. C. MacAdam. Application of an Optimal Preview Control for Simulation of Closed-Loop Automobile Driving. *IEEE Transactions on Systems, Man, and Cybernetics*, Vol. **SMC-11**, No. 6, 1981. pp. 393-399.
27. C. C. MacAdam, Development of **Driver/Vehicle** Steering Interaction Models for Dynamic Analysis. Final Technical Report. UMTRI-88-53. TACOM Contract **DAAE07-85-C-R069**, 1988.
28. L. Segel and C. C. MacAdam, The Influence of the Steering **System** on the Directional Response to Steering. *Proceedings of the 10th IAVSD Symposium of the Dynamics of Vehicles on Roads and Tracks*. Prague. **Cz**, 1987.
29. K. D. Norman. Objective Evaluation of On-Center Handling Performance. SAE Automotive Engineering Congress. Paper no. 840069. 1984.
30. Society of Automotive Engineers, **SAE** Recommended Practice. Vehicle Dynamics Terminology, **SAE J670e**. 1978.