

Technical Report

Coastwise Currents in the Vicinity of Chicago, and  
Currents elsewhere in Southern Lake Michigan

by

Edward C. Monahan,  
Department of Atmospheric and Oceanic Science

and

Philip C. Pilgrim  
Department of Computer and Communication Sciences

The University of Michigan  
Ann Arbor, Michigan 48104

Research Sponsored by:

1) City of Chicago, Department of Development  
and Planning

and

2) N.O.A.A. Office of Sea Grant, U.S. Department  
of Commerce, Grant #04-5-158-16



## Introduction

by

Edward C. Monahan

The study, the results of which are presented in this technical report, was undertaken to obtain background information about the coastwise currents in the immediate vicinity of the city of Chicago, Illinois, and to a lesser degree to characterize the circulation in the southern basin of Lake Michigan. The motivation for conducting this research arises from the city of Chicago's active consideration of the construction of recreational islands offshore of that city.

Knowledge of the "typical currents" in the immediate area under consideration, as well as an awareness of the occasional exceptional currents, and of the oscillatory seiches that can be encountered in the lake, is a necessary input to the engineering studies being undertaken prior to the construction of the aforementioned offshore structures.

Numerous studies, observational and theoretical, have been conducted to determine the current patterns in Lake Michigan. Many of these will be referred to explicitly later in this report, but immediate mention of Harrington's (1895) pioneering work of the 1890's and the extensive survey conducted a decade ago by the Federal Water Pollution Control Administration (1967) is appropriate. Unfortunately, none of the previous studies provide adequate information on the currents in the immediate area of concern.

The current measurement techniques used in this study are four in number. The two Eulerian techniques of current measurement used in this study are: 1) vertical current profiling using a current meter lowered from an anchored research vessel with the data on speed and direction recorded on a deck readout unit; and 2) subsurface current meter moorings. The latter technique is described in detail in a U-M Sea Grant Technical Report (#18) by Johnson and Monahan (1971). The vertical profile results are described in Chapter 1 of this report, while Chapter 2 treats the results from the subsurface moorings. Two complementary Lagrangian techniques of current measurement were also employed in this study. They are: 1) drogue tracking; and 2) the release of lake surface drifters. The technique of determining circulation patterns from drogues is described in a U-M Sea Grant Technical Report (#35) by Monahan, Kaye, and Michelena (1973). The application of surface current drifters to the determination of surface current patterns, with specific reference to the study of coastwise currents in the vicinity of Chicago, is discussed in a Michigan Sea Grant report by Monahan, Hawkins, and Monahan (1974). The drogue results of this study are discussed in Chapter 3 of this report, and in Chapter 4 the returns from the lake surface current drifters are described.

To assist in the interpretation of the current measurements, a series of vertical temperature profiles were obtained using a mechanical bathythermograph (BT). Lake surface

temperatures were measured using a thermometer bucket of a type described in Geo-Marine Technology (1966) and illustrated in Monahan and Zietlow (1968). Likewise, to aid in the interpretation of the current measurements, wind speed and direction were measured aboard ship whenever feasible. Hourly wind data from the airports at Chicago, Illinois; Milwaukee, Wisconsin; and Muskegon, Michigan; were obtained via the National Climatic Center, Environmental Data Service, N.O.A.A., Ashville, North Carolina.

All of the observations discussed in this report were made from the University of Michigan's Research Vessel LAURENTIAN (Figure 1), or were obtained from sub-surface current meter moorings set and retrieved by her or from the return of surface current drifters set out from her. The assistance of her master, Captain Richard L. Thibault, and of her crew is gratefully acknowledged. Support for the operation of the R/V LAURENTIAN came from a supplementary grant to the University of Michigan from N.O.A.A.

The details of the research cruises during which observations for this study were made are included in appendices to this report: Appendix A, Log of R/V LAURENTIAN Cruise 18-20 July 1974; Appendix B, Log of R/V LAURENTIAN Cruise 5-10 August 1974; and Appendix C, Log of R/V LAURENTIAN Cruise 15-24 October 1974. Charts of Lake Michigan showing the various station locations, drifter release points, sub-surface mooring locations, and drogue positions accompany this introduction (Figures 2-6).

The University of Michigan scientific staff aboard for all or part of one or more of these cruises, and those who participated in the laboratory preparation and/or data reduction and/or report preparation are as follows:

Dr. Edward C. Monahan, Principal Investigator and Chief Scientist

Mr. Philip C. Pilgrim, Grad. Res. Asst. and Asst. Chief Scientist

Mr. H. Chuen-hwei, Grad. Res. Asst.

Mr. Douglas Huizenga, Grad. Res. Asst.

Mr. Cary L. Mrozowski, Grad. Res. Asst.

Mr. William Snell, Grad. Res. Asst.

Mr. James G. Fausone, Res. Asst.

Mr. John Hinch, Res. Asst.

Mr. Roy Monier, Res. Asst.

Mr. David R. Nelson, Res. Asst.

Mr. Terrance G. Oas, Res. Asst.

Mr. James Scherr, Res. Asst.

Mr. Thomas Spoering, Res. Asst.

Mrs. Judi Tucker, Secretary

Mr. Stephen S. Wright, Res. Asst.

The cooperation of Dr. David L. Gross of the Illinois State Geological Survey, Urbana, and of his field crew, during several intervals of shared ship-time is acknowledged with thanks.

The work described in this report has been sponsored by two agencies: 1) the City of Chicago, Department of Development and Planning; and 2) the N.O.A.A. Office of Sea Grant, U.S.

Department of Commerce, via the University of Michigan Sea Grant Program Office. The aid of Mr. David N. Larson, Deputy Commissioner, City of Chicago, and of Prof. S. Ross Tocher and Prof. John M. Armstrong of the U-M Sea Grant Program, in establishing this research program is gratefully acknowledged.

As this report proceeds now to a discussion of the observations, and ultimately to the conclusions in Chapter 5, it must be stated that while the work was focused on the region of interest, the limited duration of the observations makes the conclusions preliminary. Observations should be extended in this region for a period of perhaps several additional years to confirm the findings set forth herein.

Woods Hole, Massachusetts  
May, 1975







Figure 1: University of Michigan's R/V LAURENTIAN in Chicago Harbor (City of Chicago photograph)

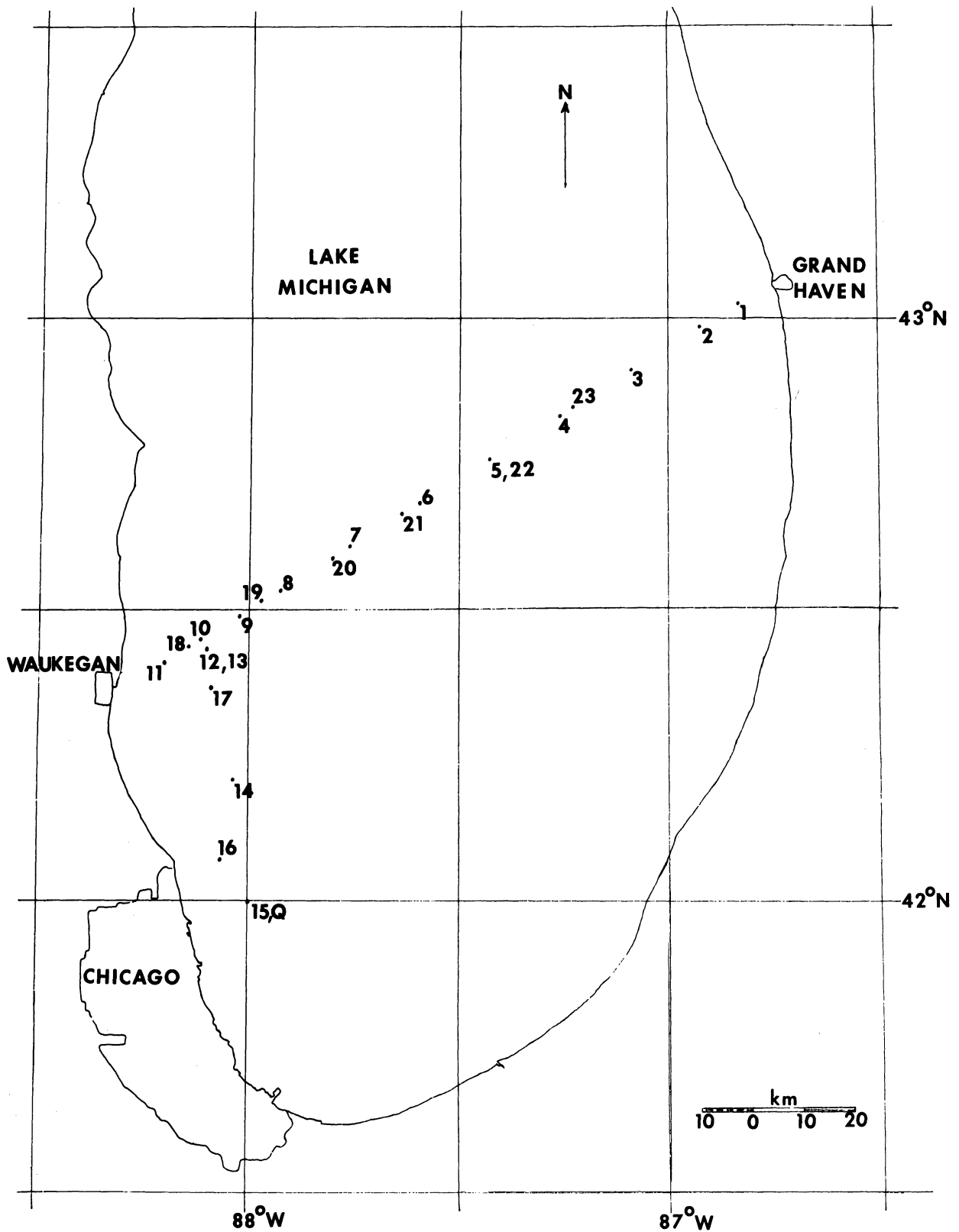

Figure 2: Cruise chart: 18-20 July, 1974 (Note: Longitude mislabeled. Meridian marked 88°W is 87°30'W. Meridian marked 87°W is 86°30'W)

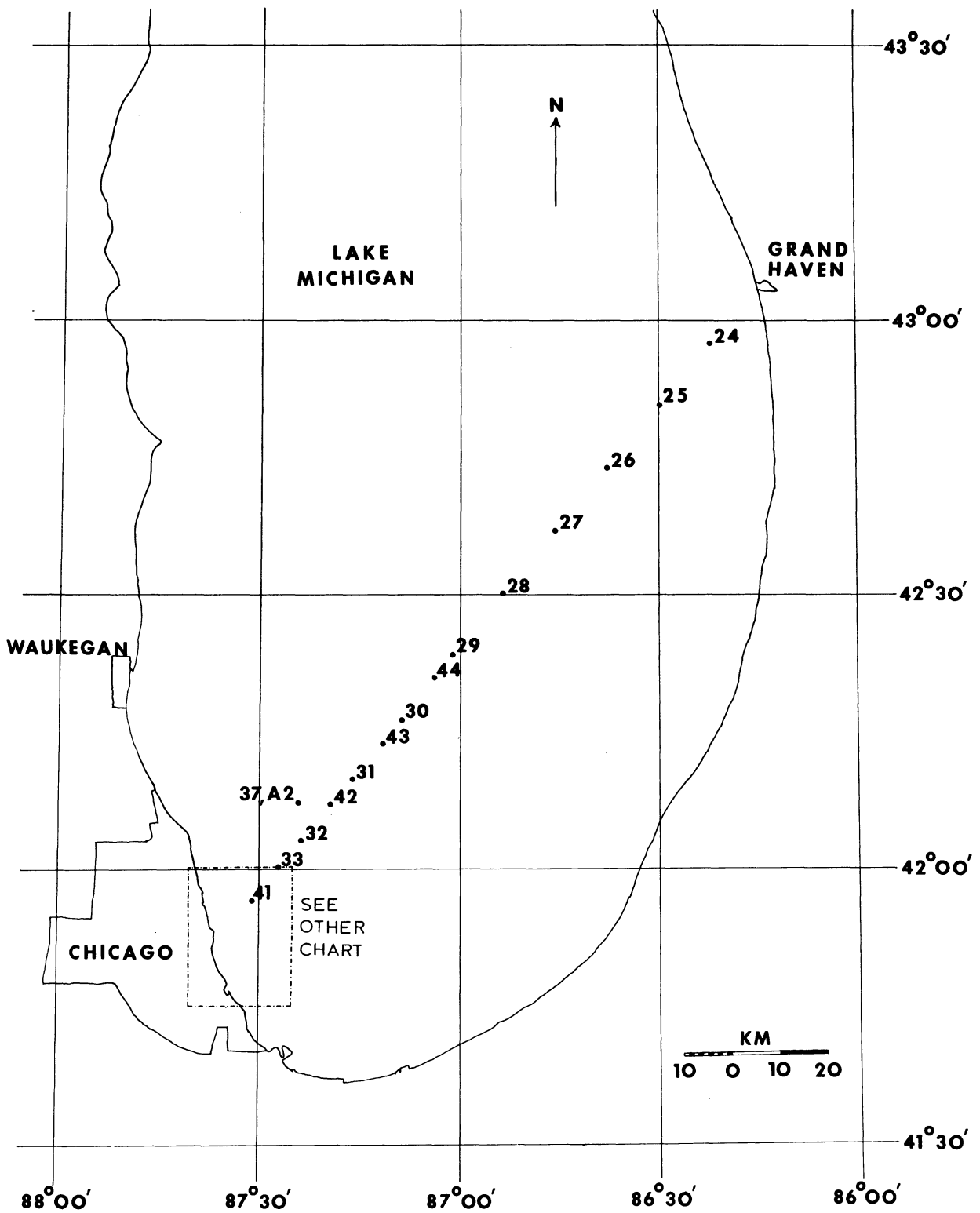

Figure 3: Small scale cruise chart: 5-10 August 1974.

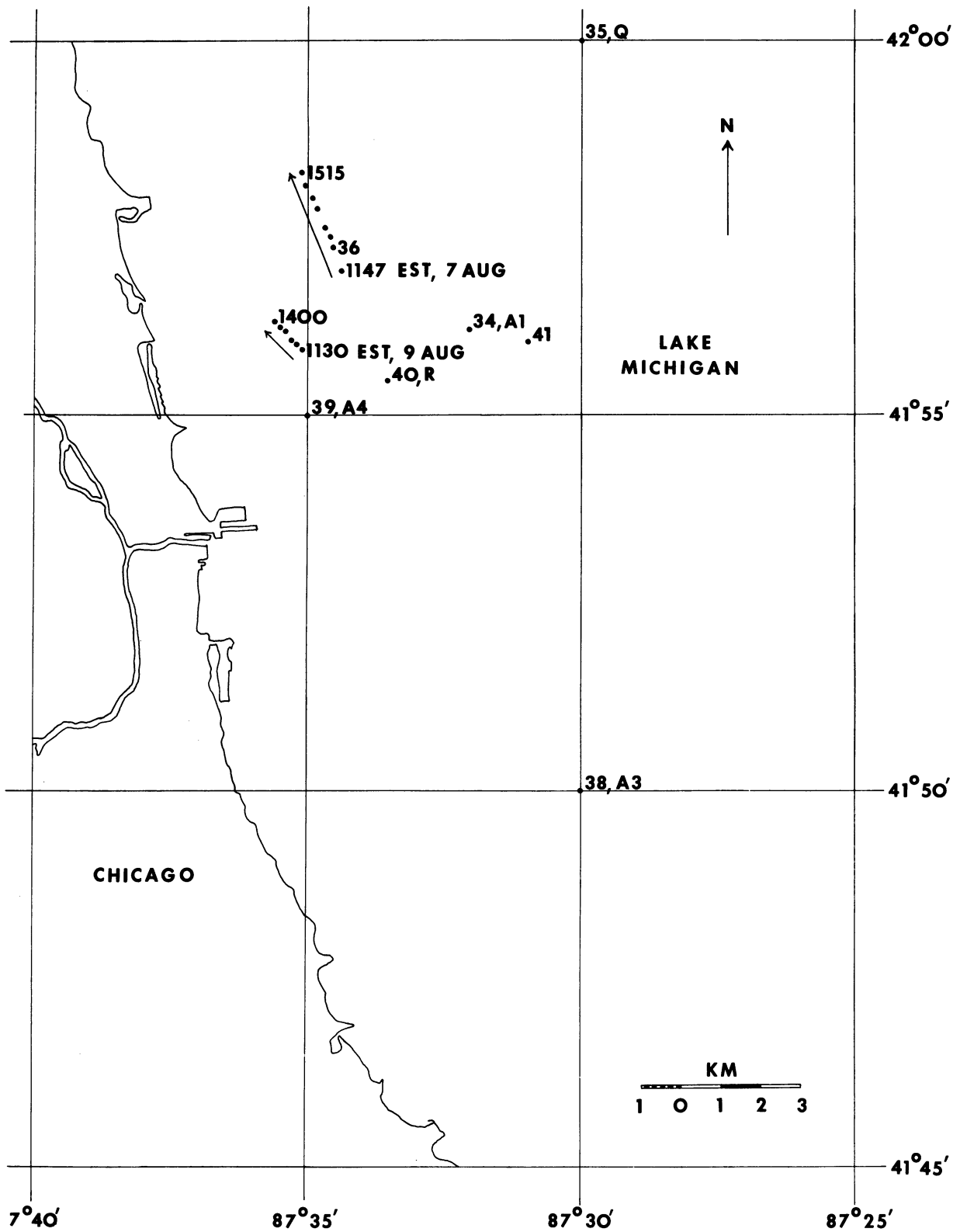

Figure 4: Detailed cruise and drogue chart: 5-10 August 1974.

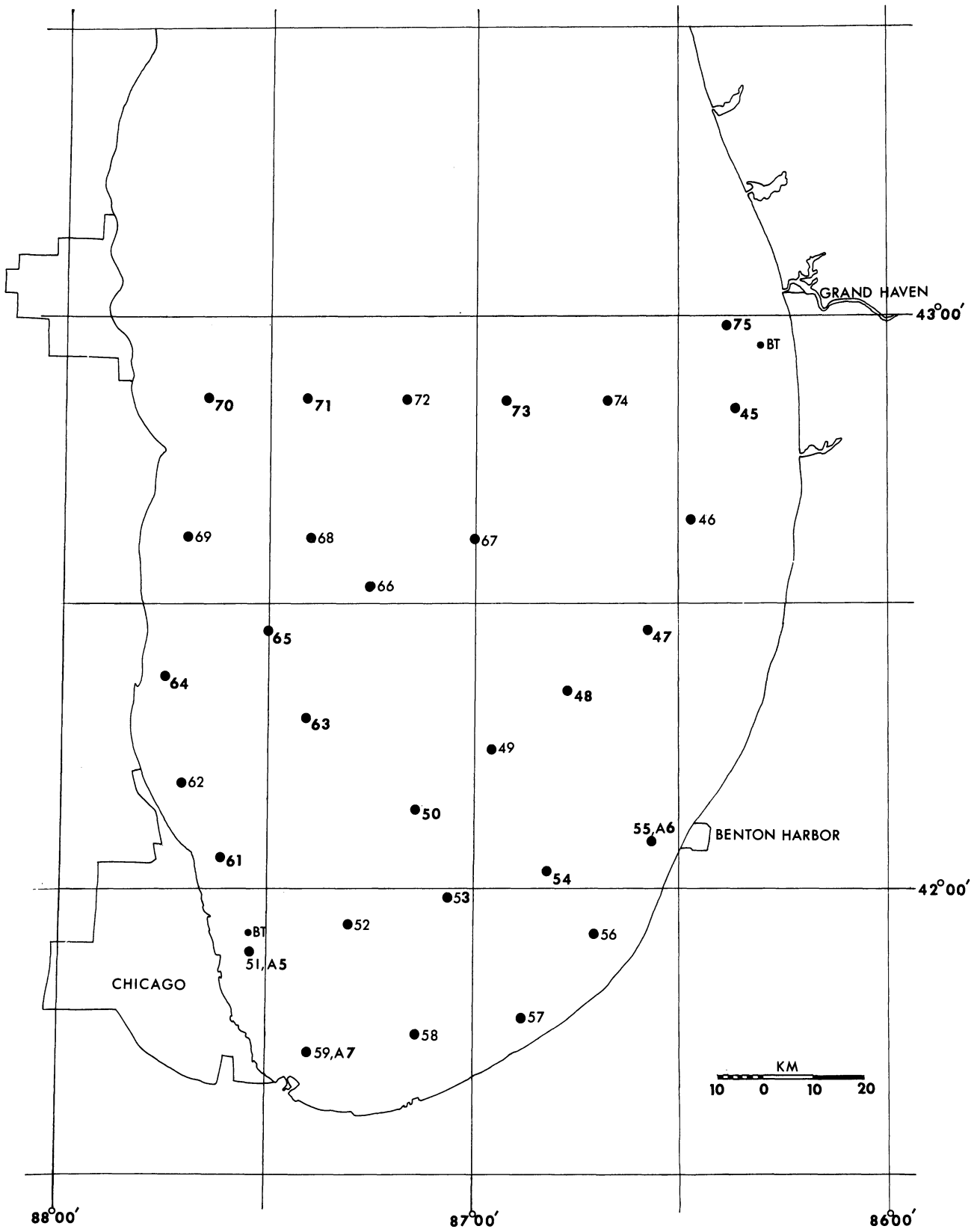

Figure 5: Small scale cruise chart: 15-24 October 1974.

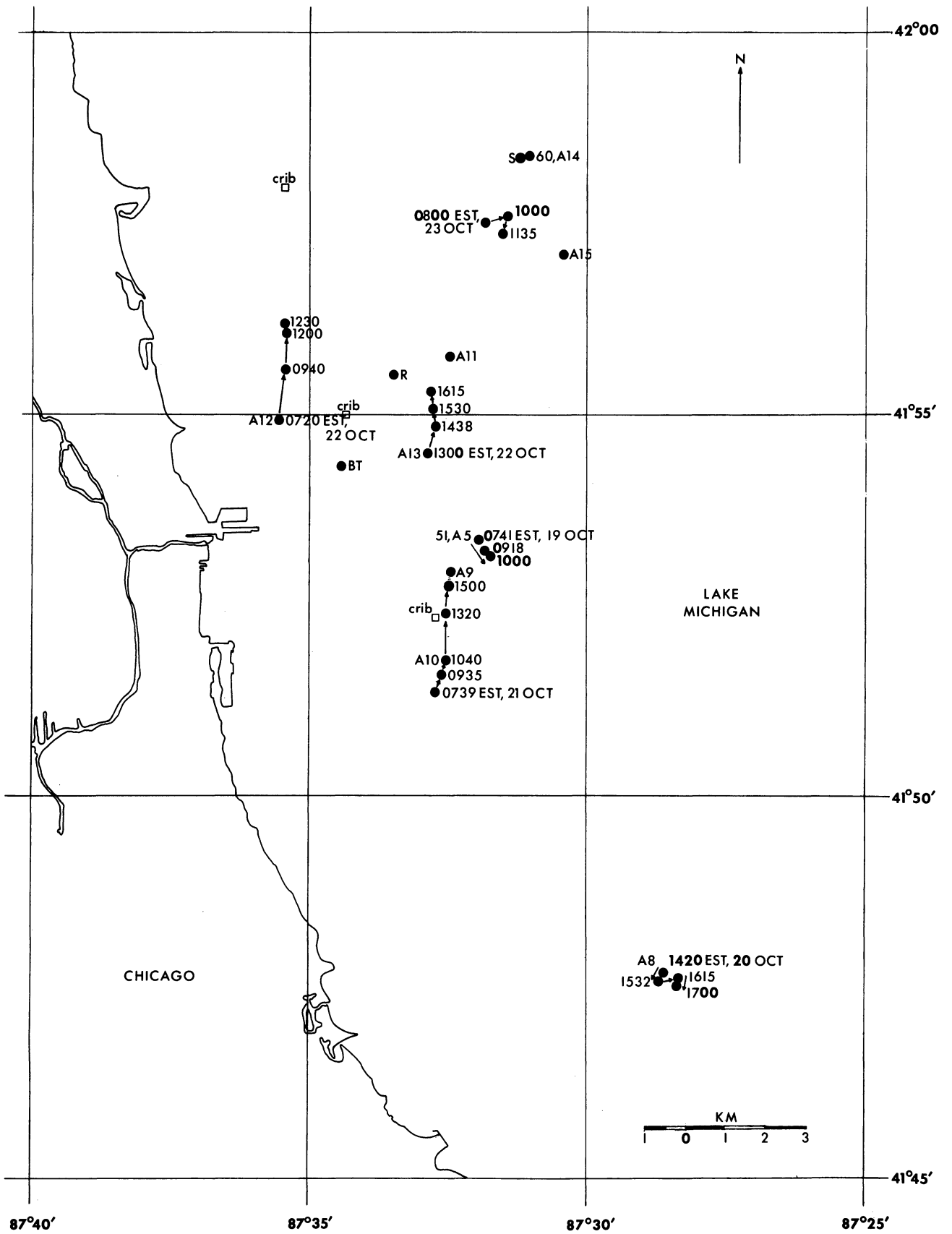

Figure 6: Detailed cruise and drogue chart: 15-24 October 1974.

## Chapter 1: Vertical Current Profiles

At numerous locations, primarily in the immediate vicinity of Chicago, Illinois, anchor stations were made with the R/V LAURENTIAN. While the ship was at anchor, a Bendix Marine Advisors savonius rotor current meter was lowered over the side, and the current speed and direction were recorded on the deck read-out unit, while the meter was held for five or more minutes at each of a series of selected depths extending from just below the keel depth of the ship to just above the bottom of the lake. At each such anchor station a mechanical bathythermograph (BT) was lowered from the surface to just above the bottom and retrieved. The BT slide thus obtained provided a vertical temperature profile to accompany the current profile. During the October cruise a thermometer bucket was used at each station to obtain an independent reading of the lake surface temperature. At each station occupied on the October cruise a Casella sensitive anemometer was used to obtain the wind speed. Details of the current profile anchor stations are to be found in appendices B and C of this report. Table 1 lists the anchor station designations, their times and dates, the numbers of the figures which illustrate each station's current and temperature data, and the numbers of the figures that present the appropriate wind histories based on data from Chicago's O'Hare Airport. The last column gives the Figure number of the chart showing the location of the anchor station.

Table 1

<u>Time Station Designation</u>	<u>Time Interval on Station</u>	<u>Date</u>	<u>Current and Temperature Profile Figure No.</u>	<u>Appropriate Wind History Figure No.</u>	<u>Figure No. of Location Chart</u>
A1	0647-0833	EST 7 Aug '74	7	12	4
Q	0957-1100	EST 7 Aug '74	7	12	4
A2	0820-1208	EST 8 Aug '74	8	12	3
A3	1420-1500	EST 8 Aug '74	11	12	4
A4	0920-1054	EST 9 Aug '74	11	12	4
A5	0759-0855	EST 19 Oct '74	13	18	5,6
A6	1538-1623	EST 19 Oct '74	13	18	5
A7	1245-1315	EST 20 Oct '74	13	18	5
A8	1430-1508	EST 20 Oct '74	13	18	6
A9	0800-0853	EST 21 Oct '74	14	18	6
A10	1003-1040	EST 21 Oct '74	14	18	6
A11	1135-1234	EST 21 Oct '74	14	18	6
A12	0740-0845	EST 22 Oct '74	14	18	6
A13	1315-1400	EST 22 Oct '74	15	18	6
A14	0903-0935	EST 23 Oct '74	15	18	6
A15	1016-1059	EST 23 Oct '74	15	18	6



The initial, and the prevailing, impression gotten from a study of these current profiles is that the currents in the immediate vicinity of Chicago are characteristically of quite low speed. The low current speeds encountered during the August cruise may be explained, at least in part, by the low wind speeds that prevailed during most of the cruise (Figure 12). The low current speeds measured in October are relatable to the fact that when the wind speed was high, the wind was usually from the south or south-west (Figure 18) and hence the fetch was extremely limited. A comparison of the current profiles with the appropriate wind histories shows a not unexpected correlation of current direction with wind direction. When the wind is out of the south-east, the current is usually toward the northwest, and so forth.

Figure 8 shows the uncharacteristically complex current profile measured at anchor station A2. As can be seen from the plan view representations of the current vectors from A2 shown in Figures 9 and 10, the data from anchor station A2 describe a nearly classical Ekman spiral, with the most rapid change of current direction with increase in depth occurring at about the thermocline depth.

Figures 16 and 17 show some additional temperature profiles (see Appendix C for further information).



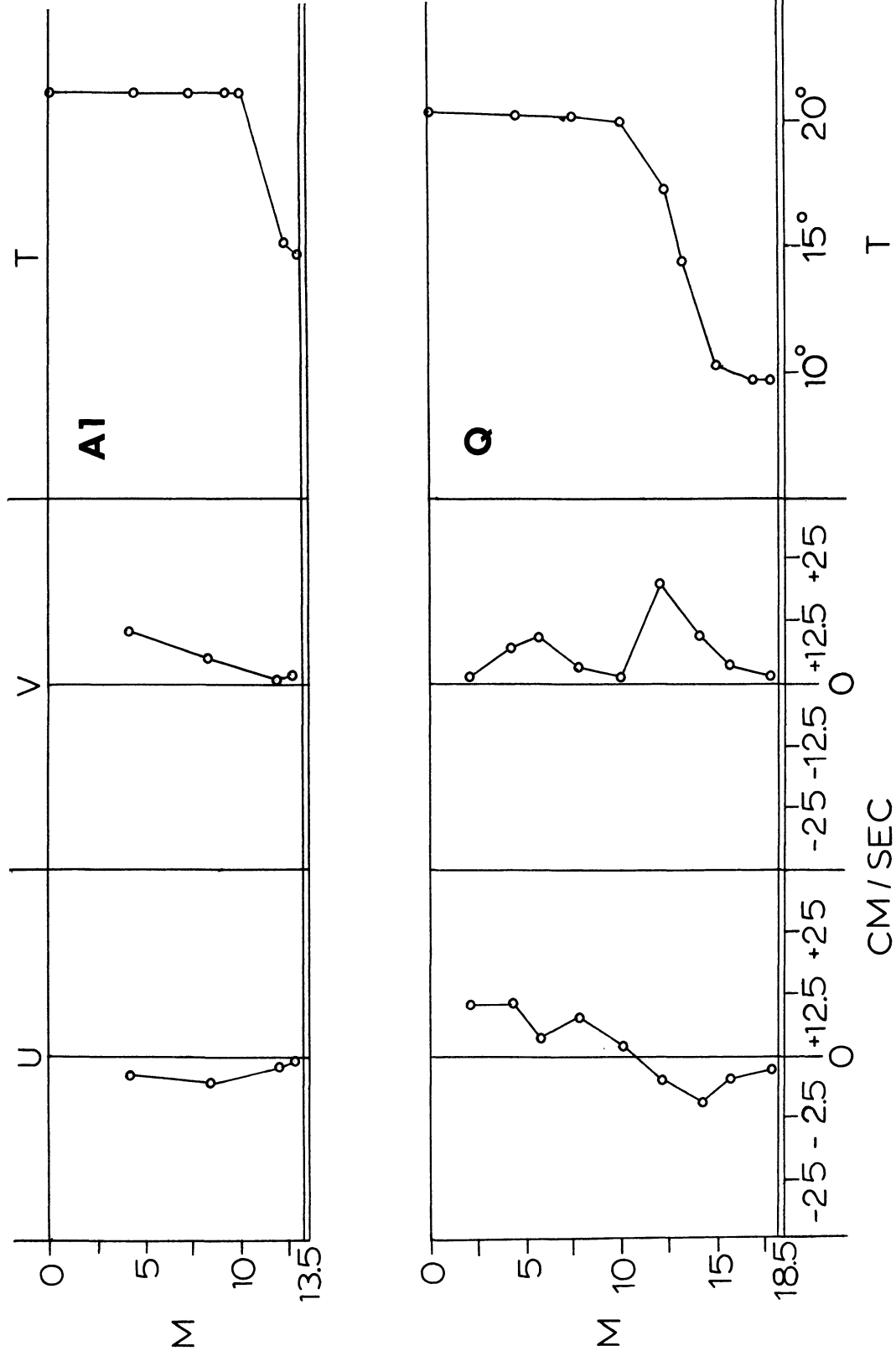

Figure 7: Current and temperature profiles from anchor stations A1 and Q. U; eastward velocity component. V; northward velocity component. Temperature given in degrees Centigrade, depth in meters.

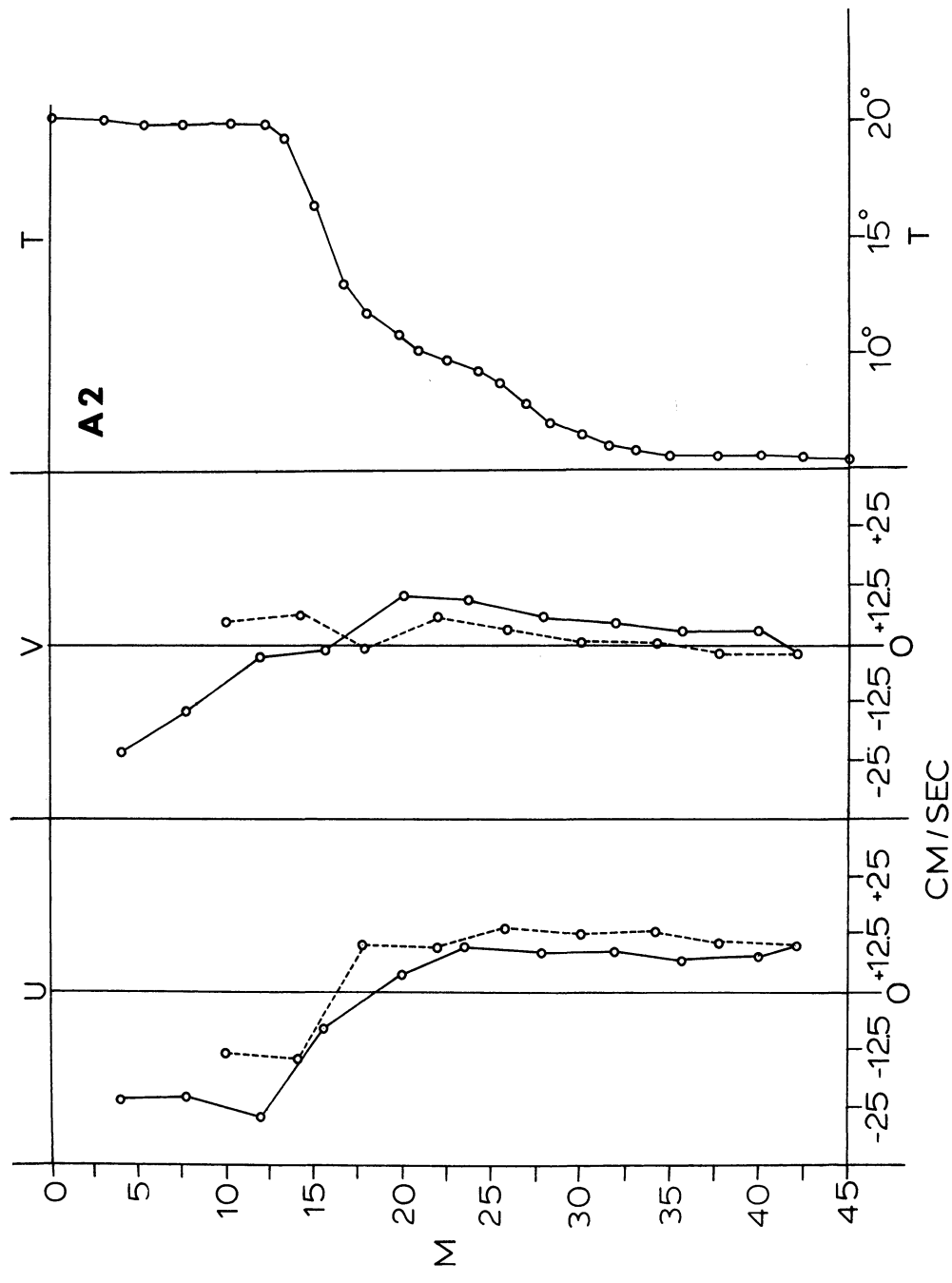

Figure 8: Current and temperature profiles from anchor station A2. U; eastward velocity component. V; northward velocity component. Temperature given in degrees Centigrade, depth in meters.

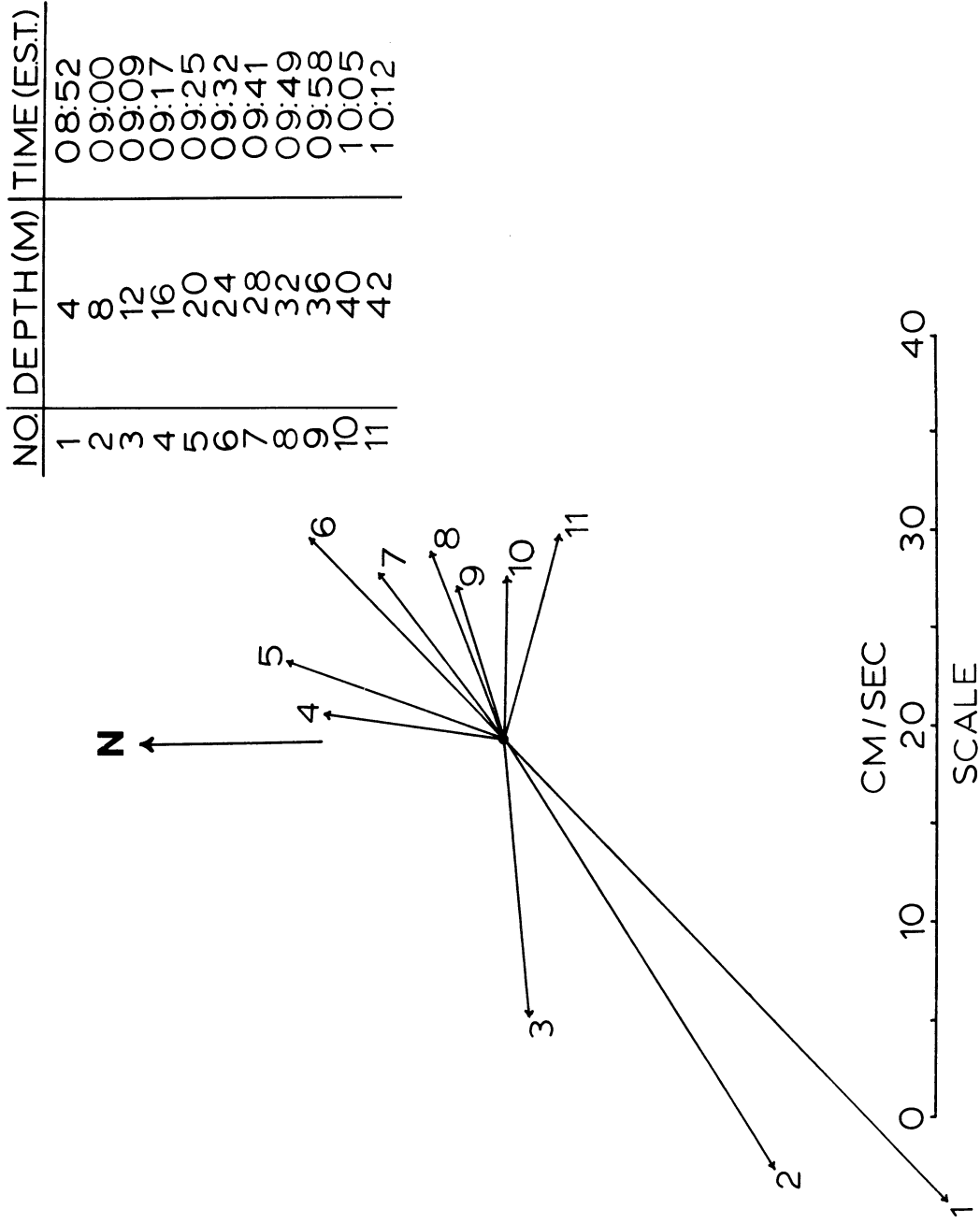

Figure 9: Plan view of current spiral observed during meter lowering phase of anchor station A2 current measurements.

NO	DEPTH (M)	TIME (EST.)
11	42	10:12
12	38	10:20
13	34	10:32
14	30	10:40
15	26	10:47
16	22	10:54
17	18	11:03
18	14	11:13
19	10	11:50

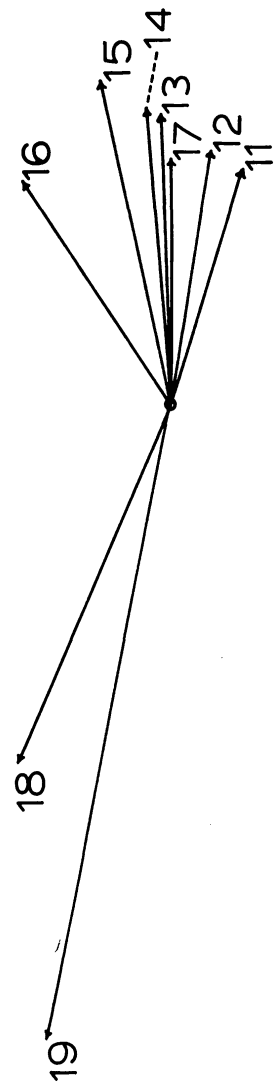
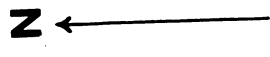

Figure 10: Plan view of current spiral observed during meter raising phase of anchor station A2 current measurements.

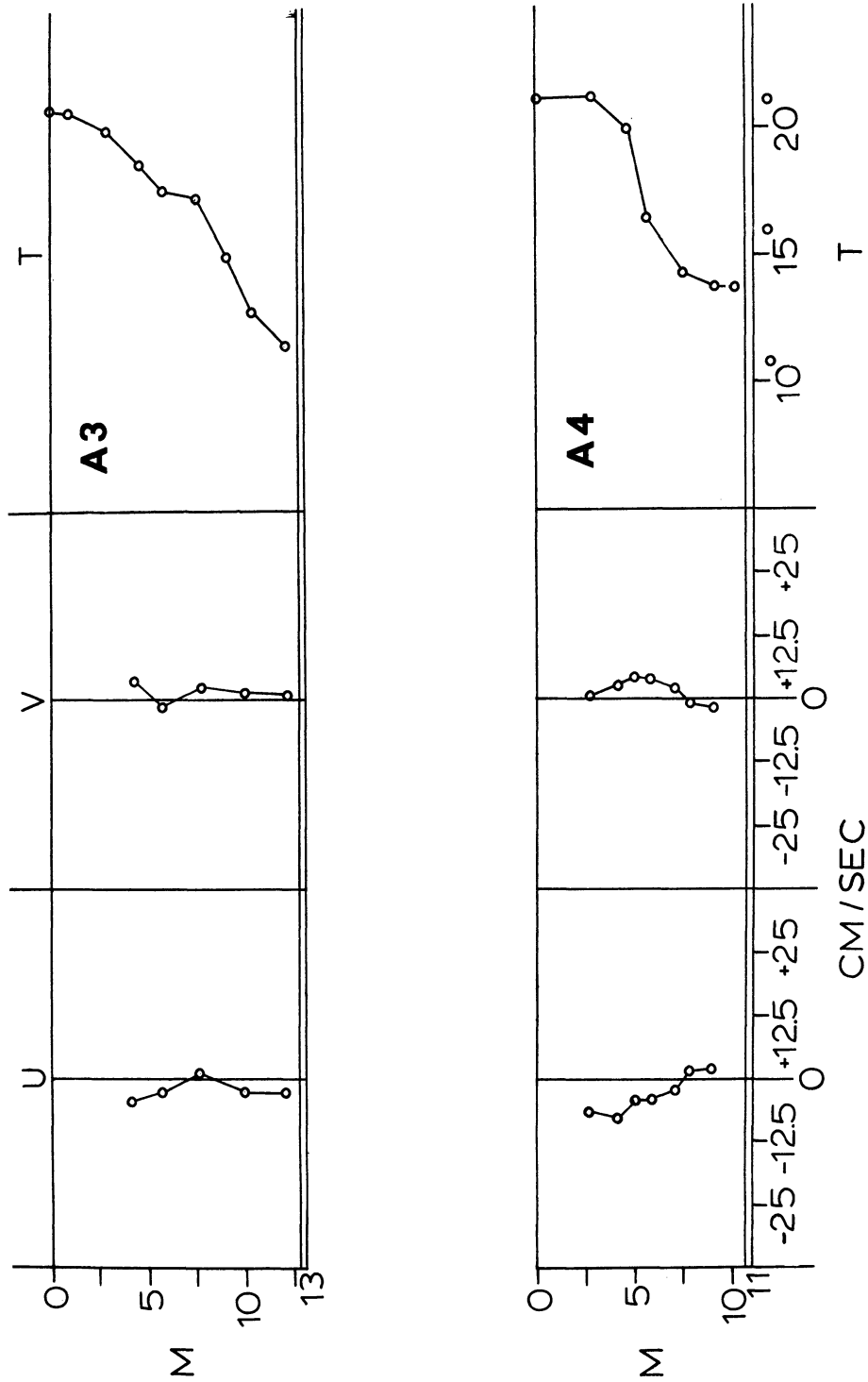

Figure 11: Current and temperature profiles from anchor stations A3 and A4. Temperature given in degrees Centigrade, depth in meters.

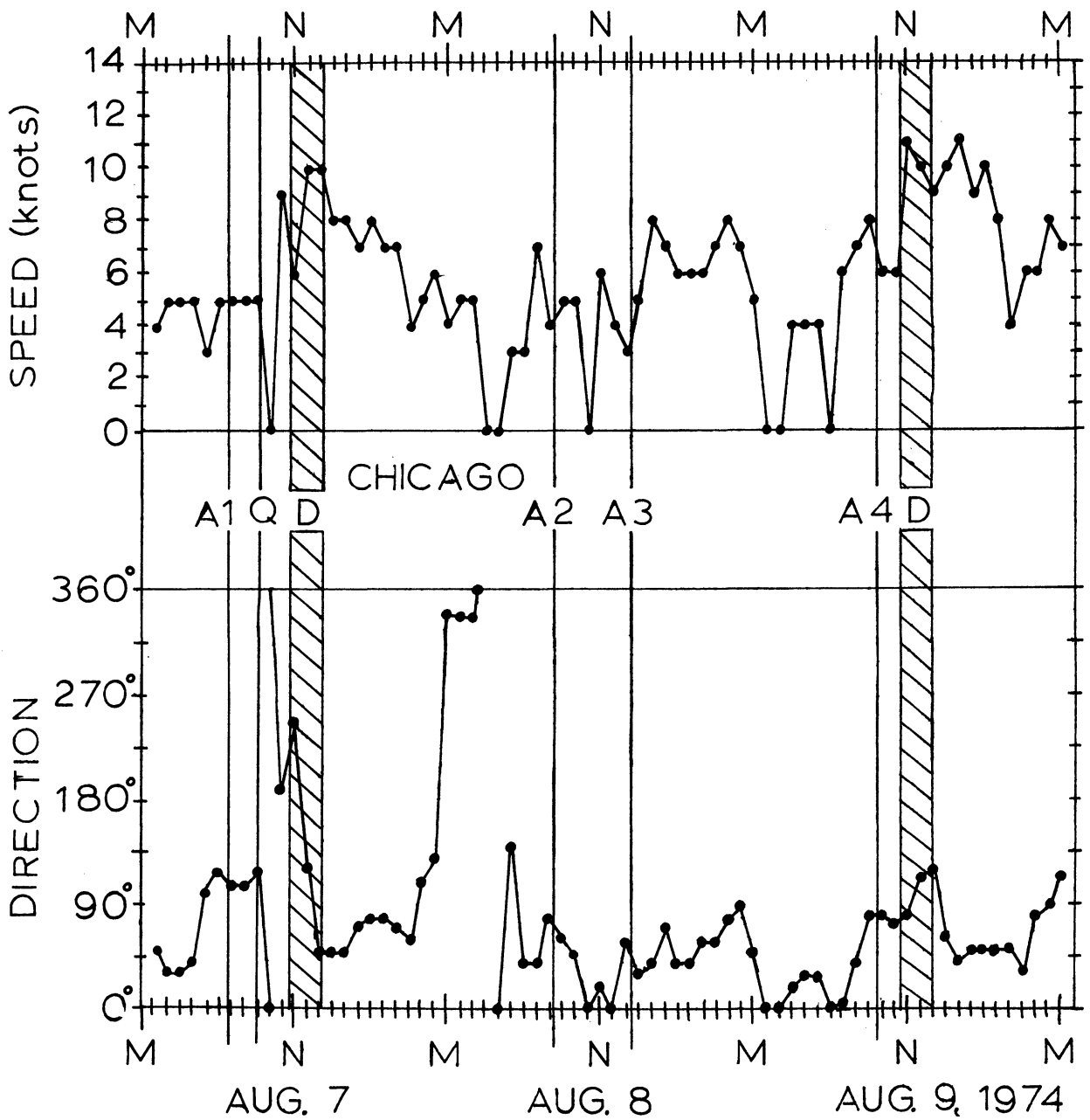

Figure 12: Chicago wind history (speed and direction versus time) for interval 7-9 August 1974. In accord with meteorological convention, wind direction is that from which wind is blowing. Vertical lines indicate time at which various stations were occupied. Hatched columns indicate intervals when drogues were adrift.



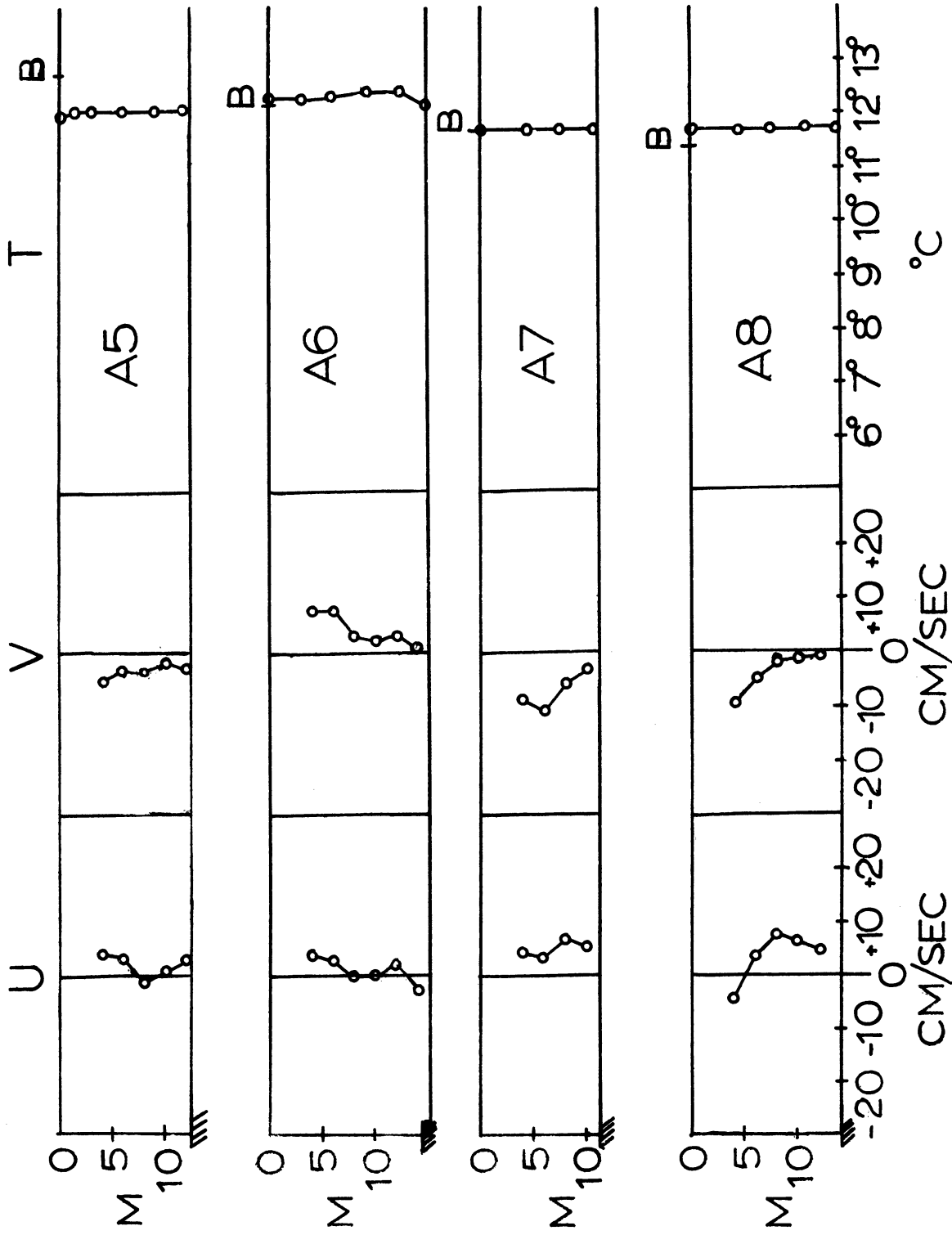

Figure 13: Current and temperature profiles from anchor stations A5, A6, A7, and A8. U; eastward velocity component. V; northward velocity component. Vertical bar marked B shows surface bucket temperature. Depth given in meters. Hatched step shows depth determined by sounding wire.

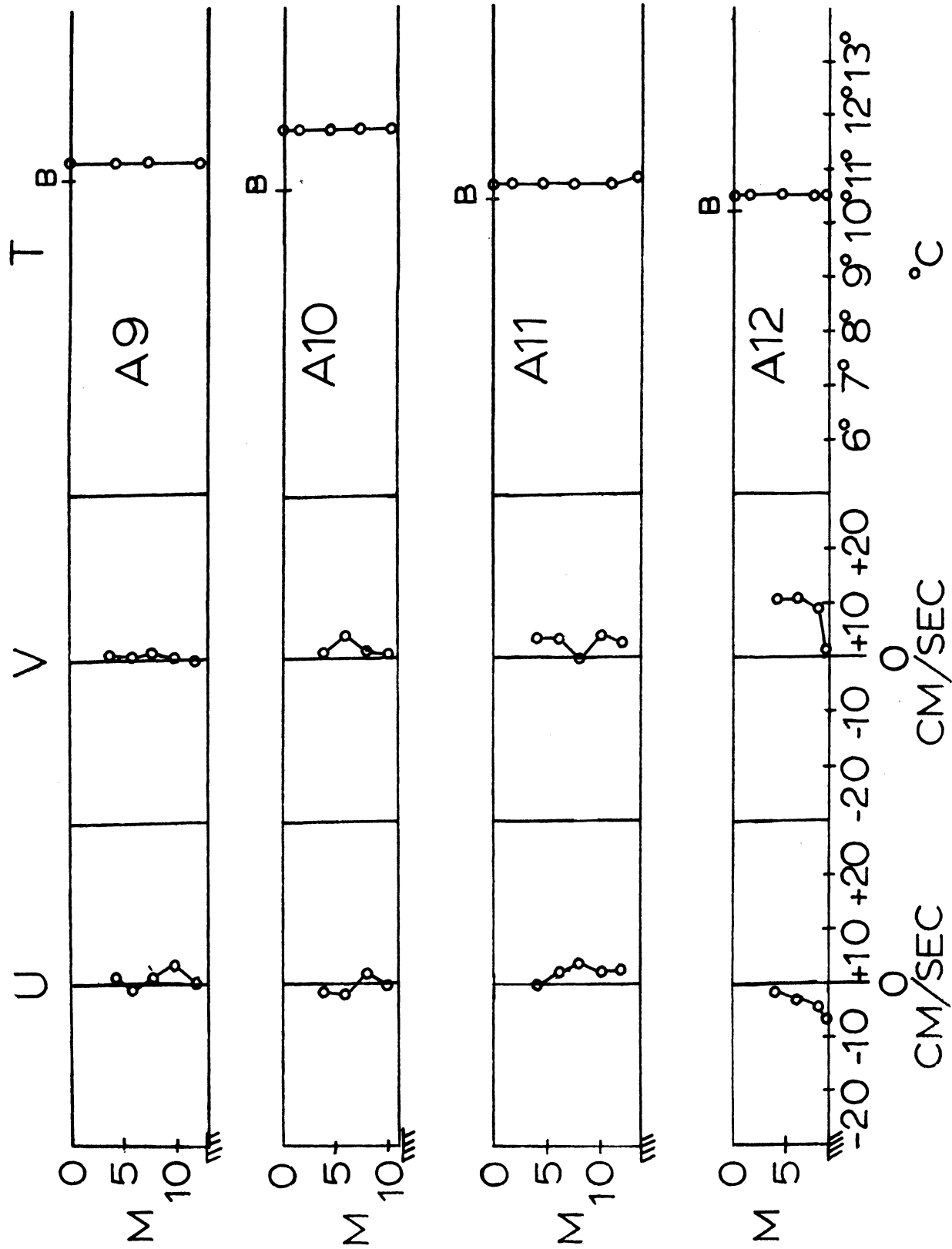

Figure 14: Current and temperature profiles from anchor stations A9, A10, A11, and A12. See caption to Figure 13 for meaning of various symbols.

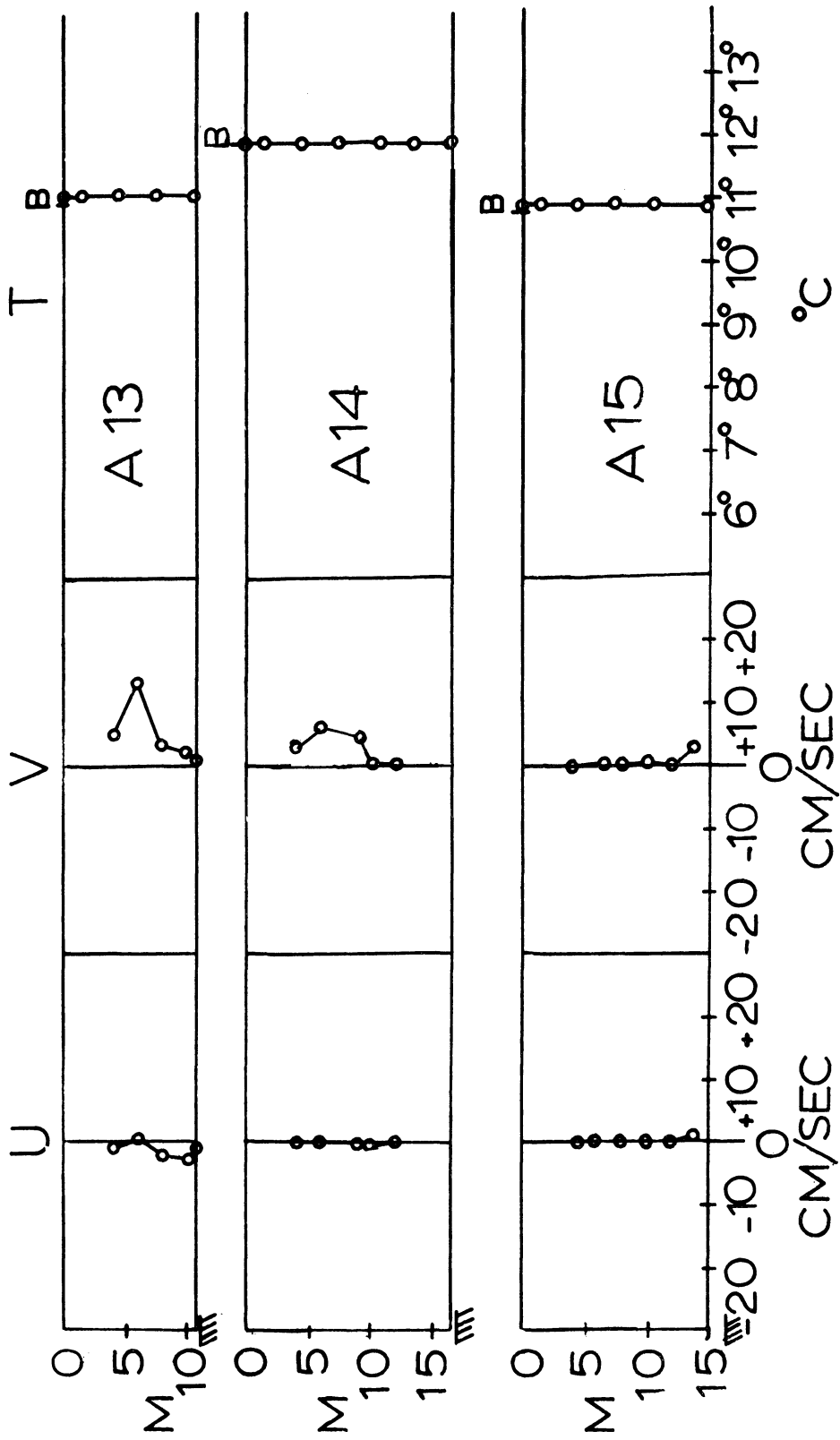

Figure 15: Current and temperature profiles from anchor stations A13, A14, and A15. See caption to Figure 13 for meaning of various symbols.

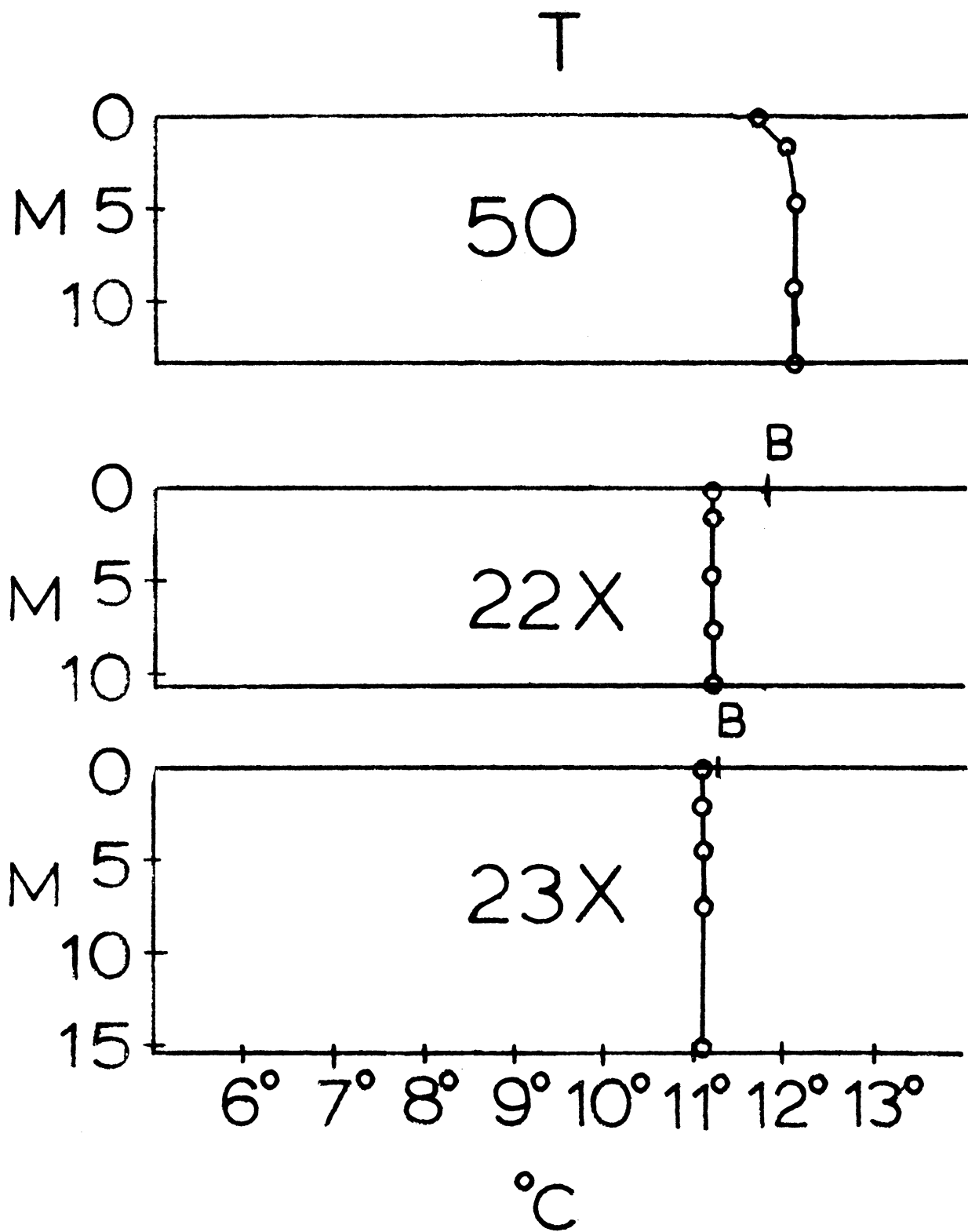

Figure 16: Additional temperature profiles. Vertical bars marked B; surface bucket temperature. Depth in meters.

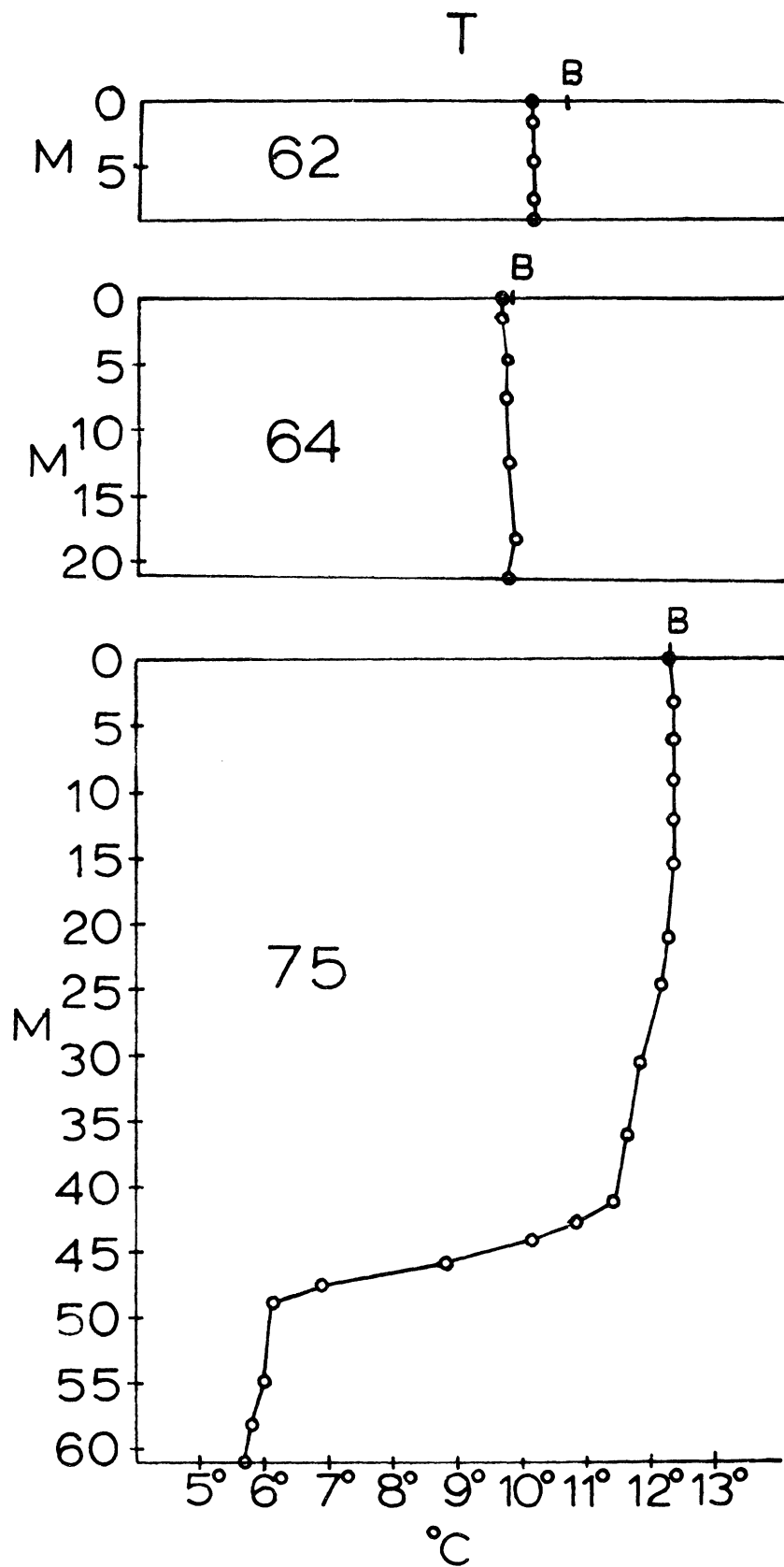

Figure 17: Additional temperature profiles. Vertical bars marked B; surface bucket temperatures. Depth in meters.

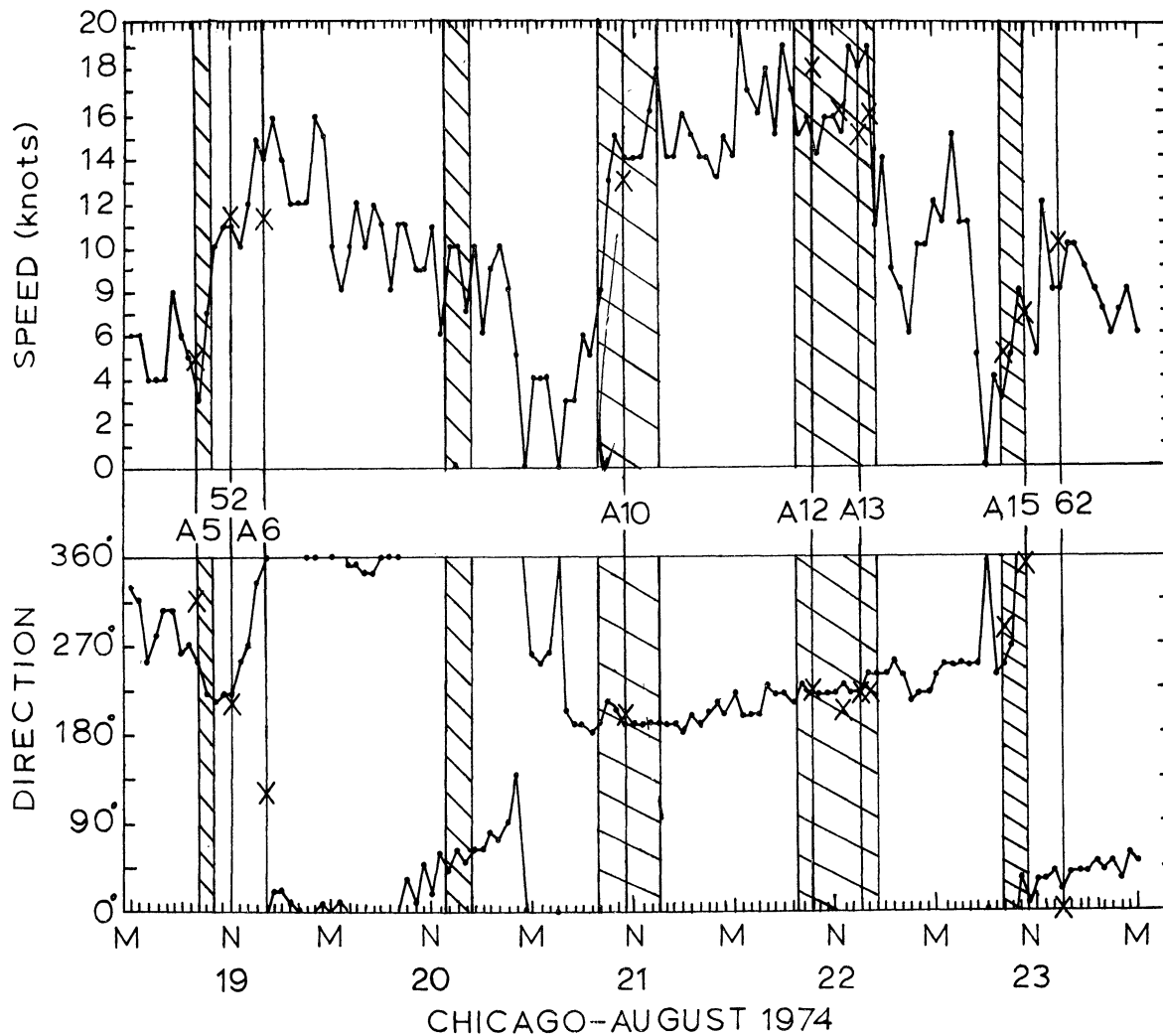

Figure 18: Chicago wind history (speed and direction versus time) for interval 19-23 October 1974 (NOTE: LEGEND INDICATING AUGUST IS INCORRECT). Vertical lines indicate time at which various anchor stations were occupied. Hatched columns indicate intervals when drogues were adrift. X's represent wind data measured aboard the R/V LAURENTIAN.

## Chapter 2: Sub-surface Current Meter Mooring Results

In the course of this study three sub-surface current meter moorings were installed in the portion of Lake Michigan close to the Chicago lakefront. These moorings, designated "Q", "R", and "S", in the University of Michigan current meter mooring sequence, were located as shown on Figures 2, 4, and 6 of this report. A detailed discussion of this type of mooring can be found in U-M Sea Grant Technical Report No. 18, by Johnson and Monahan (1971). The configuration of Mooring "Q" was similar to that shown in Figure 19, but mooring "Q" included a Timed Release Mechanism (and a cannister with a slack tether) just above the primary anchor. Moorings "R" and "S" were like mooring "Q", except for the absence of any surface marker buoys in these later moorings. Figure 20 shows mooring "R" in the process of being set from the R/V LAURENTIAN. Details of moorings "Q" and "R", the two moorings from which current meter results were available during the preparation of this report, are given in the following Moored Current Meter Data Records, and in Appendices A, B, and C.

### Moored Current Meter Data Record

Mooring <u>Q</u>	Record Begins <u>1625 E.S.T. 19-VII-74</u>
DATA ID# <u>405090</u>	Record Duration _____
C.M. S/N <u>378</u>	Sampling Interval <u>5 min</u>
C.M. Depth <u>10.6m</u>	Magnetic Variation _____
Water Depth <u>21.2m</u>	Set <u>1710 E.S.T. 19-VII-74</u>
Latitude <u>42°00.0'N</u>	Longitude <u>87°30.0'W</u>
Raw Data Form <u>Film</u>	

Comments: 12 lobe cam, 100 ft film, ~34 recording days set to release 10:00 E.S.T. 7 Aug, '74

MOORED CURRENT METER DATA RECORD

Mooring <u>"R"</u>	Record Begins <u>1100 E.S.T. 9-VIII-74</u>
DATA ID# <u>405091</u>	Record Duration _____
C.M. S/N <u>427</u>	Sampling Interval <u>10 min.</u>
C.M. Depth <u>8.5m</u>	Magnetic Variation _____
Water Depth <u>12m</u>	Set <u>1108 E.S.T. 9-VIII-74</u>
Latitude <u>41°55.5'N</u>	Longitude <u>87°33.5'W</u>
Raw Data Form <u>Film</u>	

Comments: 6 lobe cam, 100 ft film ~67 recording days set to release 1000 E.S.T. 22-X-74

The analyses of the current meter record from mooring "Q" are summarized in Figures 21 through 24. From Figure 21 we learn that during late July and early August 1974 the current ran primarily to the northwest. This tends to confirm the direction of flow deduced by extrapolating the circulation pattern presented for the summer, under S-SW winds, in the FWPCA (1967) report. (We note from Figure 25 that during this interval the winds at Chicago were often from the W or SW.) Our results definitely contradict the results presented by Harrington (1895). The currents measured during mooring "Q" were rarely in excess of 0.4 knots (nautical miles per hour; one nautical mile equals 6080 feet), as is seen from Figure 22. Indeed, the number of measurements with speed above 0.6 knots was negligible. Figure 23 shows that the highest speed currents were those to the NNW. A progressive vector diagram, plotting the flow past the current meter in mooring "Q" (Figure 24), indicates that the general flow of the NW was for several brief intervals interrupted by rotary clock-wise, flows.

The analyses of the record from current meter mooring "R" are contained in Figures 26 through 29. Figure 26 shows



that while again the preferred direction of the current is toward the NW, that flow to the SE was not uncommon. Figure 27 shows that during the interval of mooring "R" the current speed was rarely in excess of 0.5 knots, and from Figure 28 it is apparent that the highest speeds were associated with flow to the NW and NNW, and also with flow to the SSE. Figure 29 indicates that the net water motion past mooring "R" during the interval of 9 August to 21 October 1974 was to the north. Superimposed on the net northward drift in this interval were numerous rotary and oscillatory motions. Referring to Figure 25, it would appear that the wind being out of the north rather steadily from 28 August until 5 September was responsible for the south-south-eastward current observed from 3 to 6 September. Likewise, the SSE current of 28 September to 1 October correlates with the essentially NW wind that blew from 28 September until 2 October. The southward current observed between 9 and 15 October does not have associated with it a similar interval of N or NW winds. (The FWPCA (1967) report did report SE currents in the general vicinity of Chicago during the summer under the influence of N or NE winds.)



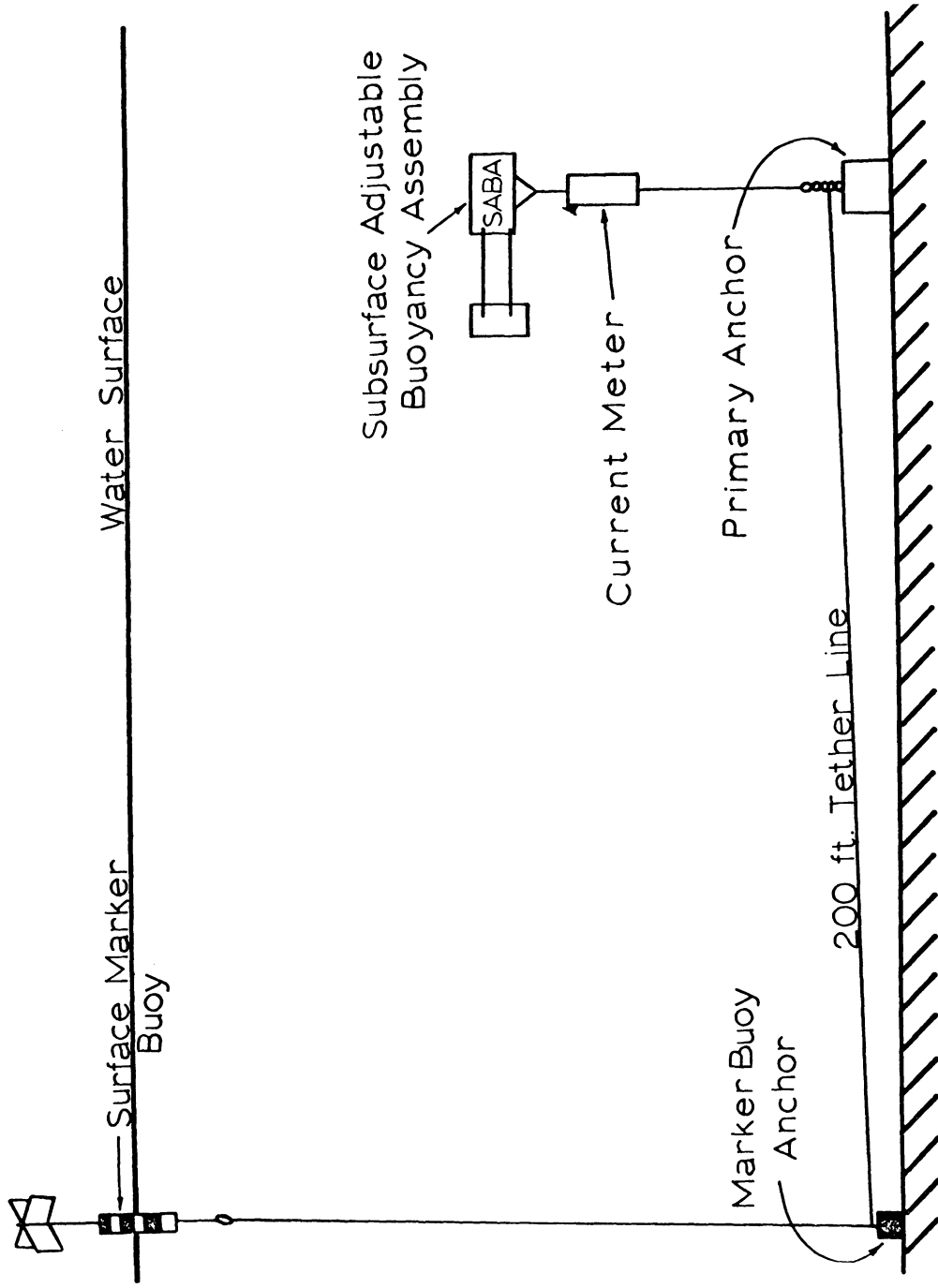

Figure 19: Sub-surface current meter mooring configuration. For details, see Johnson and Monahan (1971). Moorings "Q", "R", and "S", included Timed Release Mechanism (and cannister with slack tether) just above primary anchor.



Figure 20: Sub-surface current meter mooring "R" being set from the starboard rail of the R/V LAURENTIAN on 9 August 1974, in the vicinity of Chicago, Illinois. In the foreground is the sub-surface (S.A.B.A.) buoy. Suspended above the lake surface is the barrel of concrete that acts as the anchor. Just visible beneath the surface is the E.G.&G. Model A102 current meter. (City of Chicago photograph).

UNIV OF MICHIGAN MOORING Q 405050 0.0  
POLAR COORDINATE HISTOGRAM PLOT OF DIRECTION  
A SERVICE OF EG-6

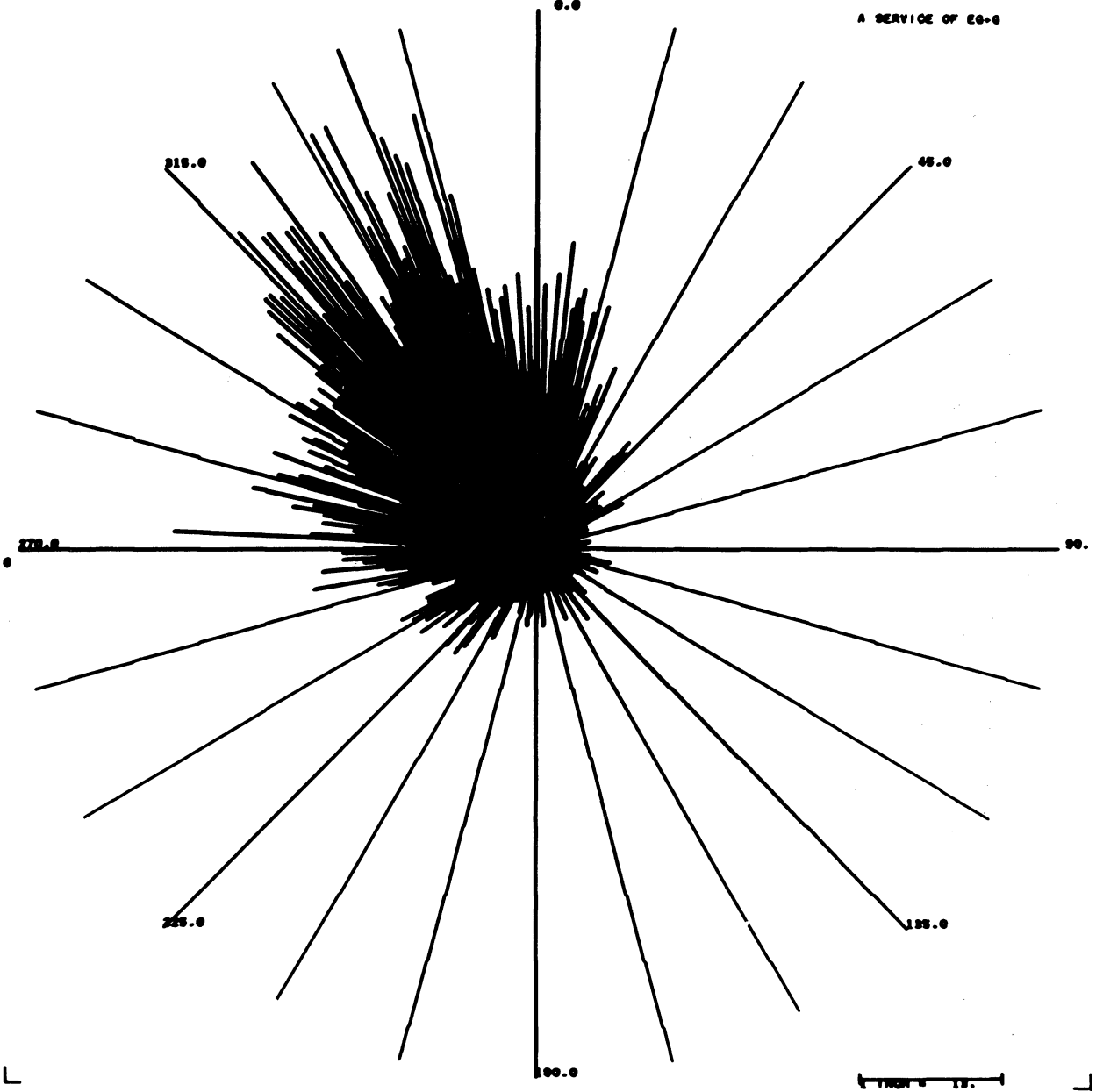

Figure 21: Mooring "Q" polar coordinate histogram plot of current direction.

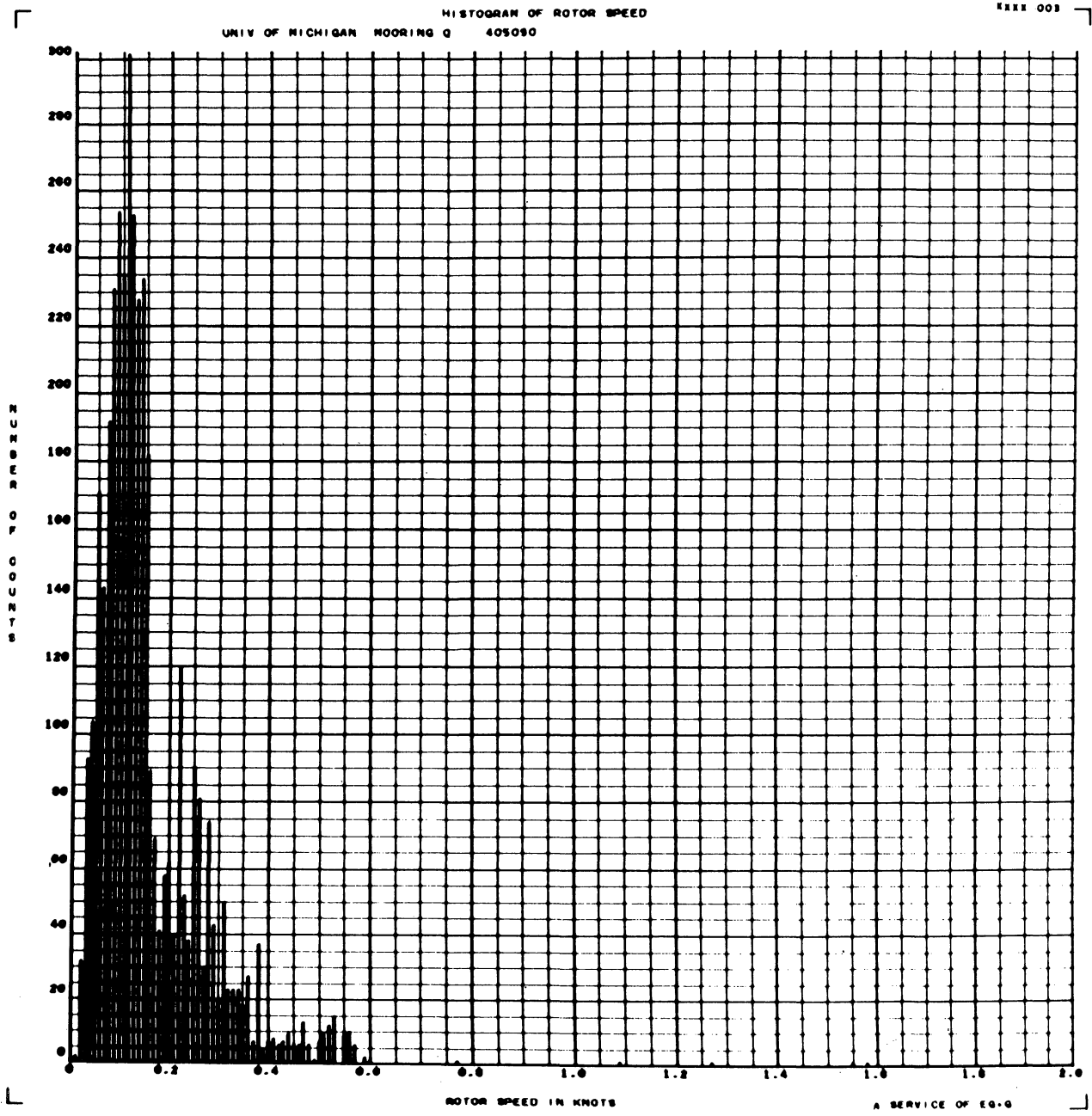

Figure 22: Mooring "Q" histogram plot of current speed.

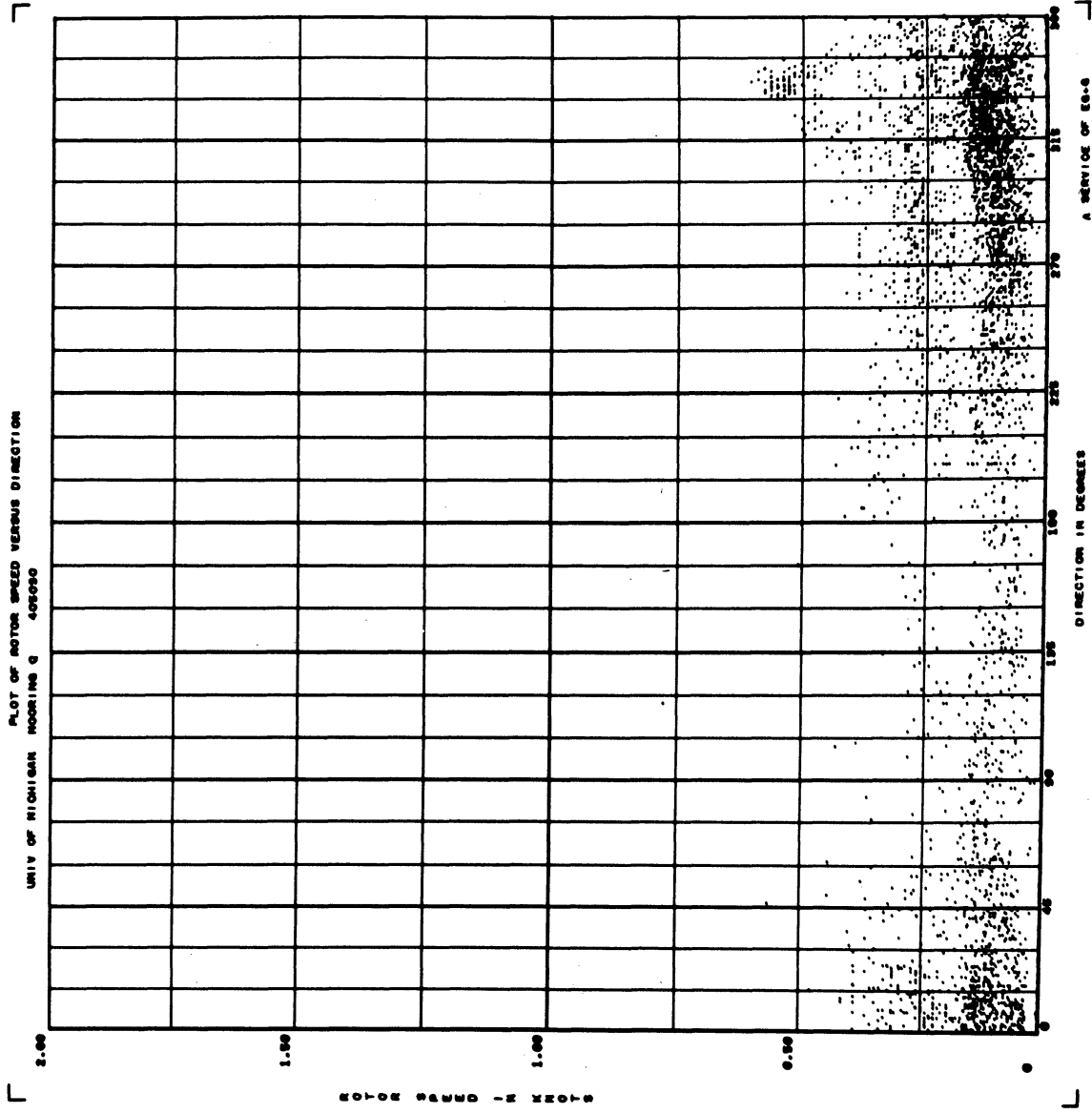

Figure 23: Mooring "Q"; plot of current speed versus direction.

405090

7/13/74 TO 8/ 3/74

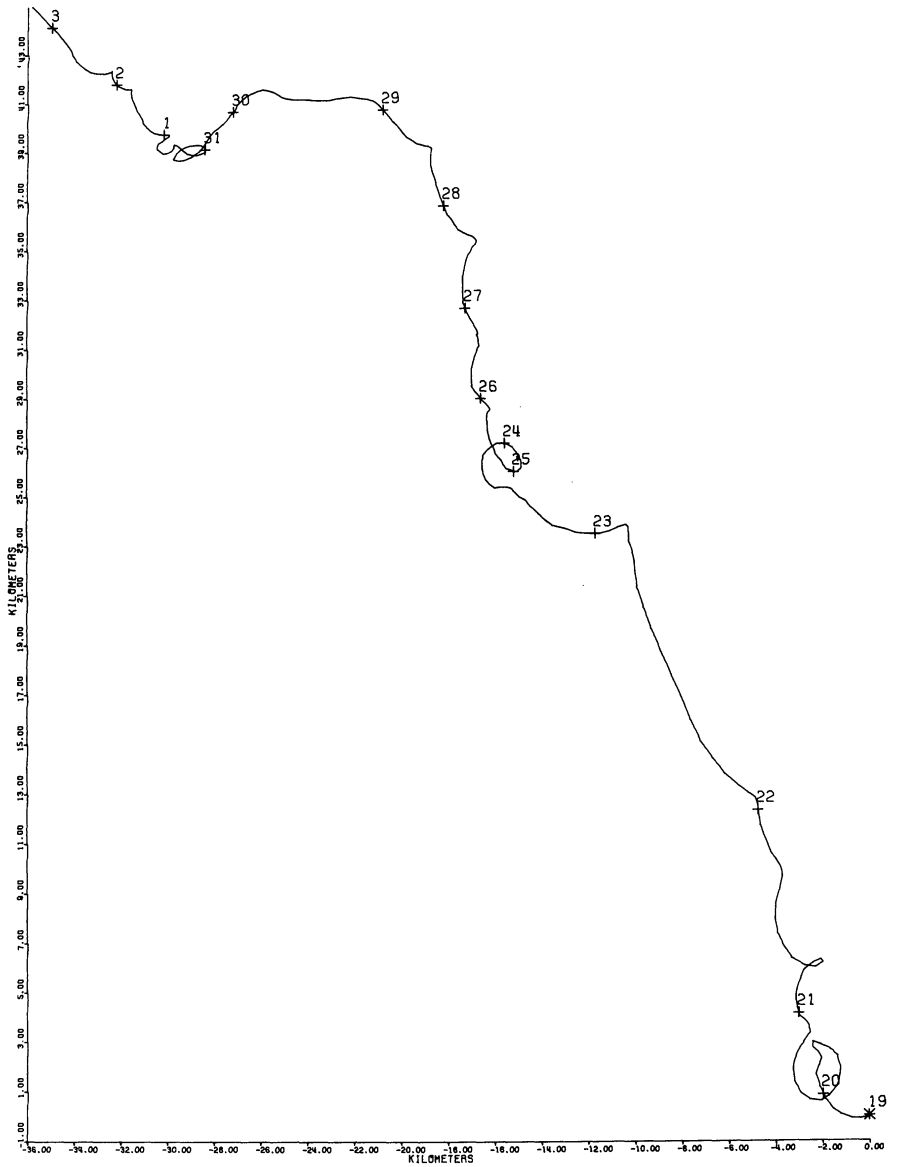

Figure 24: Mooring "Q" progressive vector diagram.



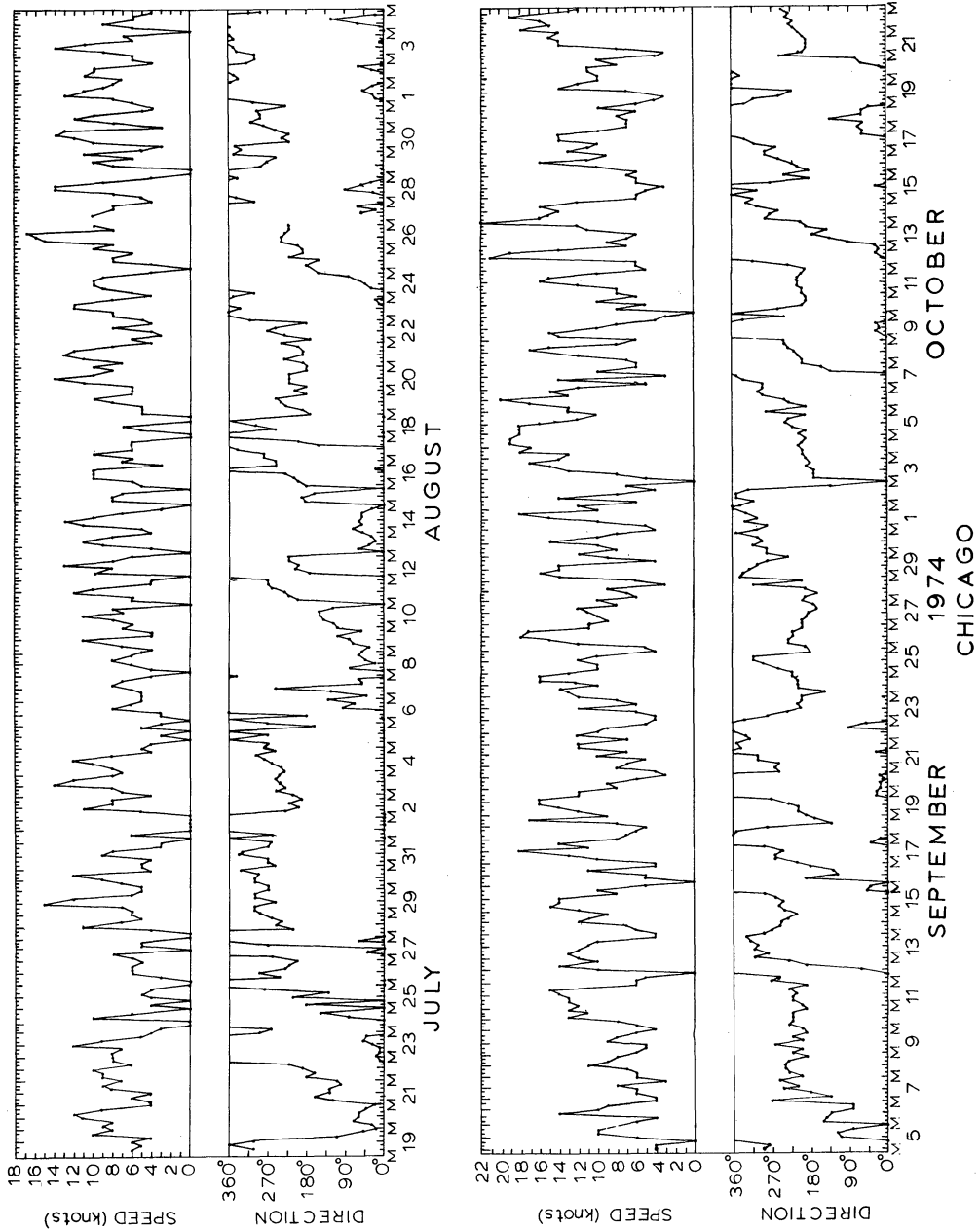

Figure 25: Wind history (speed and direction versus time) from Chicago's O'Hare Airport for interval 19 July - 22 October 1974.

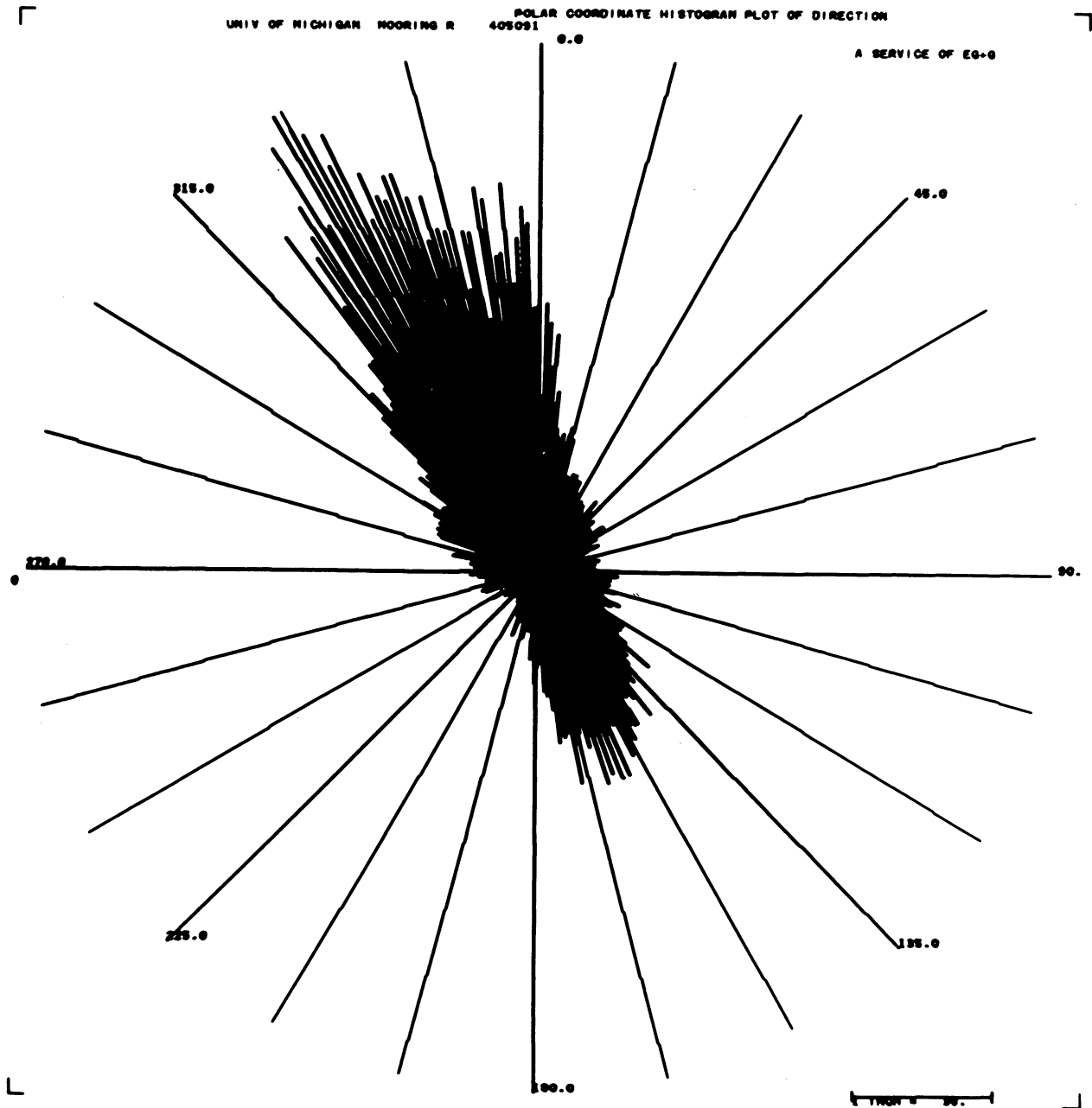

Figure 26: Mooring "R" polar coordinate histogram plot of current direction.

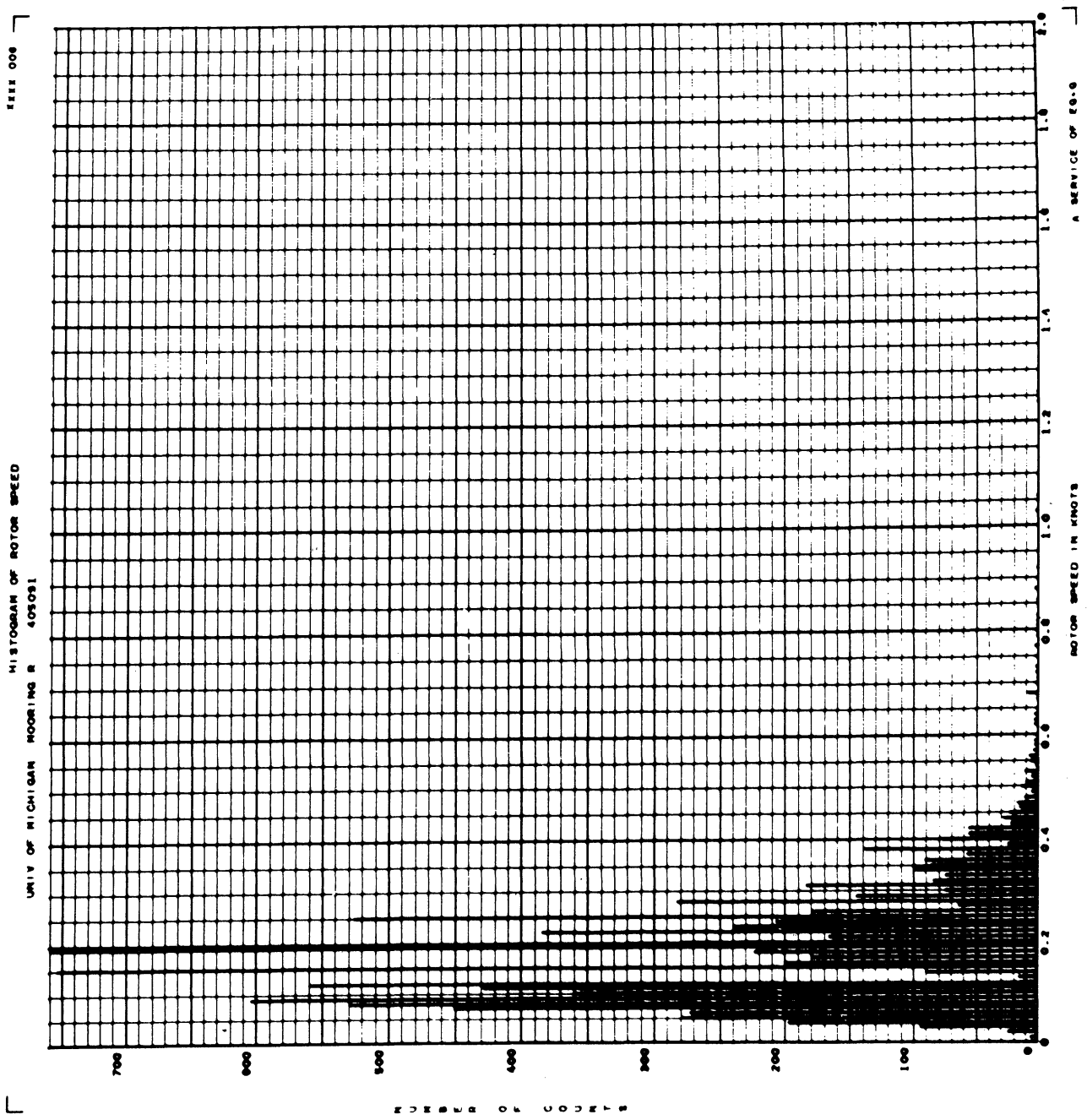

Figure 27: Mooring "R" histogram plot of current speed.

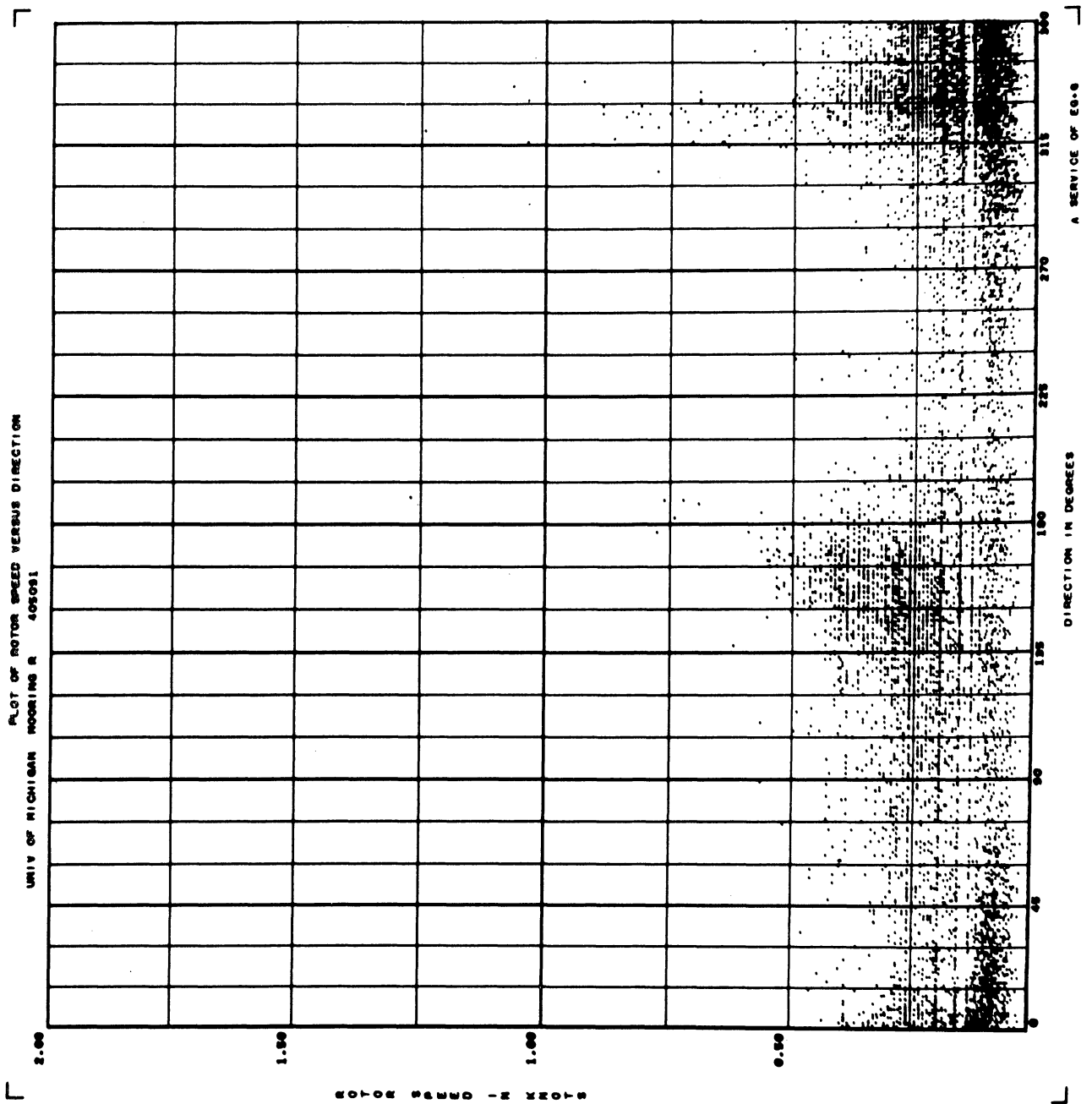

Figure 28: Mooring "R"; plot of current speed versus direction.

405091

8/ 9/74 TO 10/21/74

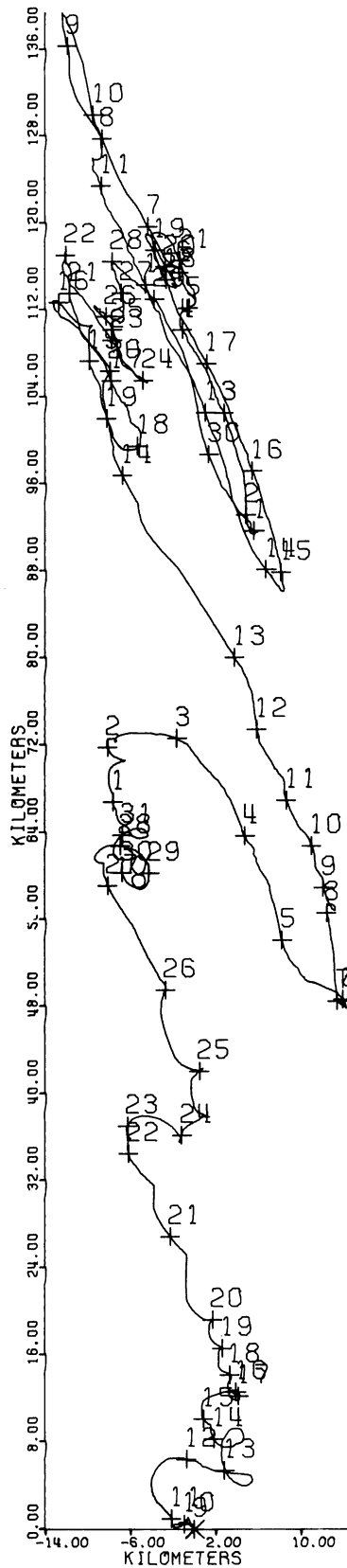

Figure 29: Mooring "R" progressive vector diagram.



### Chapter 3: Drogue Results

The drogue trajectories obtained on the August and October 1974 cruises of the R/V LAURENTIAN indicate very weak currents were present on those occasions in the region of Lake Michigan studied. Figures 4 and 6 show the trajectories of the clusters of drogue-buoy pairs. (For details of these drogue measurements see Appendices B and C.) The drogues tracked on 7 and 9 August (Figure 4) moved to the northwest. We note from Figure 12 that just before the drogues were released on 7 August, and for most of the time they were adrift, the wind had a southerly component. Before and during the drogue tracking interval on 9 August the wind was from the east.

On 19 and 20 October the drogues released hardly moved (Figure 6). The appropriate wind history (Figure 18) shows that on 19 October the wind was light and from the W and SW while the drogues were adrift. But on 20 October the wind was stronger (approximately 10 knots) and from the NE while the drogues were out in the lake. The progressive vector diagram from current meter mooring "R" (Figure 29) confirms that the currents near Chicago were negligible on 19 and 20 October 1974.

The drogues tracked on 21 and 22 October 1974 were seen to drift northward (Figure 6). The Chicago winds (Figure 18) were from the SW, and relatively strong (15 knots and higher), on these days during most of the time the drogues were afloat.

On 23 October the set of drogues released in Lake Michigan moved initially to the ENE and then later in the morning headed off to the SSW (Figure 6). Figure 18 indicates that for a while before the drogues were released, and even after they were set out, the Chicago winds were from the WSW. Before the drogues were retrieved, the wind, which was increasing in strength, had shifted around to the NNE. Thus on 23 October 1974 the water parcel in which the drogues were imbedded seemed to respond directly to the local wind field.

A discussion of the technique of determining circulation patterns making use of drogue-buoy pairs can be found in U-M Sea Grant Technical Report #35 (1973), by Monahan, Kaye, and Michelena. Information about various drogue designs, including the "windowshade" or "sail" drogue design used in this study is presented in "Drogues, Drags, and Sea Anchors" (U-M Sea Grant Technical Report #36) by Monahan and Monahan (1973a) and in "Trends in drogue design" by Monahan and Monahan (1973b). A technique for correcting drogue trajectories to account for the influence of surface currents on the surface buoy is described in Appendix D of this report. Because of the very slow drogue-buoy motions observed in the present study the trajectories presented on Figures 4 and 6 have in fact not been corrected.



## Chapter 4: Lake Surface Current Drifter Returns

During the July, August, and October cruises, large numbers of surface current drifters were released at various points in the lower basin of Lake Michigan for the purpose of studying the large-scale advective characteristics of this region. The release points are numbered from 1 to 75, with their locations summarized in Figures 2, 3, and 5, and with the time of release, number and type of drifters described in the cruise logs (Appendices A, B, and C). Each drifter bore a unique serial number, so that on its return it could be ascertained which release site it was from. Given this as well as the time and location of recovery, the goal is to infer something about its trajectory and, hence, something about the currents transporting it. The returns are summarized in graphical form in Figure 30 (several pages).

The number on each chart is the release number and is located at the point of release. The diamonds represent recovery sites, the area of each diamond being proportional to the number of days adrift, as outlined on the first page of Figure 30. Only those releases from which there is at least one recovery are depicted here.

In order to use these data effectively, it is necessary to clarify several assumptions regarding the transport and recovery of surface drifters. These are: 1) The drifters are transported primarily by the advective motion of the surface water, and are carried at the same velocity as the advected water

parcels. 2) Due to turbulence in the medium, the drifters are subjected to a dispersive "force", so that drifters initially occupying a given small region are seen to become gradually separated as they move along. (For a thorough treatment of turbulent diffusion, see Csanady (1973)). 3) The direct effect of the wind on drifter motion is negligible. (The role of the prevailing winds in determining the surface motion of the water is considered to be an indirect effect.) 4) The pattern of advection is essentially stable throughout the period of a drifter study. 5) Drifters which are washed ashore may lie there several days before being discovered. This results in uncertainty in the time adrift for a given drifter. Hence, preference for recoveries in a given area for a given release is given to the earlier arrivals. Isolated recoveries with long drift times are considered only in the context of obvious trends in the drift patterns. Naturally, none of these assumptions holds strictly, but they are included simply as a point of reference for the subsequent discussion.

The analysis of the data has a twofold nature. First, by comparing returns from various release sites, it should be possible to make hypotheses about various aspects of the advective currents. Second, these same data and some preliminary conclusions drawn therefrom may be used to judge the "compatibility" of various hypotheses in the literature with the current structure implied by the drifter returns. For this study, several hypotheses available for consideration - some theoretical, some empirical - are reproduced in graphical form in Figures 33 to 41.

The data obtained from releases made during separate cruises are considered separately at first and then compared. This is done because any prior assumption of stability in the advective pattern over several months is unjustified; if seasonal trends can be detected, so much the better. In terms of release numbers, this means that releases 1 through 23 (July), 24 through 44 (August), and 45 through 75 (October) are discussed initially only within the context of their group.

For the July releases, the global pattern of advection seems to be a clockwise circulation. This is supported principally by data from releases 1, 4, 5, 10, 11, 14, and 17-23 (Figure 30). That is, the bulk of early returns from releases near the western shore around  $42^{\circ}30'N$  are from north of the release point, with returns from the eastern shore coming much later. Returns from releases near the eastern shore tend to group into clusters to the north and to the south of the release point. Those from the south show some tendency to have greater time adrift the further south they are returned from.

Aside from these general observations, the data demonstrate remarkable local anomalies in the current pattern, if one is to believe the prior assumptions. Comparing releases 9-13 and 18, considerable evidence is present to indicate a small southerly swing in the current off the shore which turns west and then north along the western shore at  $42^{\circ}20'N$ . Moreover, there seems to be a splitting of the current near here which develops into a southerly coastal current south of  $42^{\circ}20'N$ . This conjecture is further supported by releases near Chicago (15 and 16) whose recoveries indicate a definite southward trend. Recoveries from

release 14, however, hint at a northerly flow as one moves away from the shore in this region, but it is not possible to tell just how far in towards shore this flow extends. The details of this hypothesis are summarized graphically in Figure 31.

The recoveries from the eastern shore are much more difficult to analyze, since significant trends in location along the shore vs. time adrift are not present. While the general motion away from shore is probably southerly south of  $43^{\circ}\text{N}$ , recoveries from releases considerably offshore (5-7, 20-23) show considerable spreading and relatively little change in time adrift as one goes one way or the other along the shore. This could be explained in several ways. First, drifters released from these points may be subjected to a very slow eastward drift followed by a very strong southerly coastal current. This would tend to obliterate all but the finest distinctions in recovery time, since the drifters involved all spent the same high percentage of drift time moving east. An alternative explanation would involve a northerly coastal countercurrent along this shore, resulting in a shear which would tend to disperse the drifters more evenly than would otherwise be expected. North of  $43^{\circ}\text{N}$  the current is definitely northerly with a splitting occurring near that latitude. Again, see Figure 31. As far as the southernmost portion of the Lake Michigan basin is concerned, nothing can be induced from the data except that there is probably a general westward trend, in keeping with the overall clockwise circulation.

In comparing the data with results expected under the various published hypotheses, it is necessary to consider the direction of the prevailing wind, since several of the theoretical results use this as a parameter. As can be seen from Figures 25 and E8, the steadiest wind was from the south and west toward the latter part of July, although considerable shifting is in evidence during the release period. This allows us to consider the hypotheses of Figures 33, 35, 38, 40 and 41.

Harrington's conjecture (Figure 33) is definitely incompatible with the data obtained, since the global pattern of advection is counter-clockwise. The same applies to the FWPCA results (Figure 35). As for Ayers' observations (Figure 38), it is difficult to make a comparison due to the complicated nature of his results. Nonetheless, it is of interest to note the coastal countercurrent along the eastern shore, as well as the fact that certain small gyres on the western shore tend to correlate well with the conjectures made above. The latter is probably an insignificant coincidence since the overall pattern in Figure 38 is nothing like the simple one proposed. Figure 40, on the other hand, shows the general trends indicated by the data, except for a distinctive northerly flow on the east coast extending further south than the drifter results imply. In addition, none of the local anomalies induced along the western shore are shown. By contrast, neither pattern in Figure 41 explains the data well at all. On the whole, then, Figure 40 is the "best" hypothesis of the group, but even then not an extremely viable one.

Returns from the August releases (24-44) again indicate a general clockwise circulation. This is primarily supported by returns from 25, 32-37, 39, and 41 (Figure 30), where releases along the western shore tend to move north, with later returns from the eastern shore, and some trend toward the south on the lower part of the eastern shore. The local patterns are rather different from those of July, however. Although no effort was concentrated near the area around  $42^{\circ}20'N$ ,  $87^{\circ}40'W$ , releases from further south (34-36) moving north seem to hint at the absence of the small gyre there noted from the July data. In fact, the current along the entire western shore up to  $42^{\circ}45'N$  seems to be flowing north. Since no returns came from this side of the lake north of that latitude, it seems reasonable to conclude that the current begins to veer eastward near there. The situation along the eastern shore is not so well defined. While some southward current is apparent south of  $42^{\circ}30'N$ , the current north of that appears to be northward flowing. As in July, no definite pattern of times adrift for recoveries along this shore is manifest. Moreover, there is neither enough data nor a wide enough spread in the data at hand to suggest a coastal countercurrent south of  $42^{\circ}30'N$ , so not much can be said of this region at all. Again, no conclusions can be made about currents in the very southern part of the basin due to lack of releases or returns in the area. The conjecturing made above is summarized graphically in Figure 32.

As in July, the steadiest winds during August tend to be from the south and west (see Figure 25), although considerable shifting took place in the critical, early part of the month. Nonetheless, it seems reasonable to consider those same hypotheses as were considered for July. Most of the same comments apply to the comparability of the August returns with these hypotheses as to the July data, with the following exceptions. Ayers' observations (Figure 38) are much less an explanation than before, since much less support is in evidence for his local irregularities. On the other hand, Figure 40 shows considerable agreement with the conjecture arrived at from the data. In addition to the general sense of the circulation, the strong northward current along the western shore as well as the extent of the northward current along the eastern shore compare favorably to the conclusions drawn from the data. The only significant problem is that under this hypothesis, one would expect more returns along the northern reaches of the western shore, since the current follows it for quite a distance. Nevertheless, this hypothesis is certainly the best among those considered, and perhaps even a good one standing on its own.

During the October cruise much more attention was paid to getting an even coverage in the release pattern over the entire southern basin. Unfortunately, the summer crowds had left the shores, and for that reason or others, the returns were scant. Consequently, little can be inferred from them except to say that the flow along the eastern shore is predominantly northward. But in view of the apparent southern migration of such a northward current from July to August, it is possible that

a seasonal change has been found. It would be extremely far-fetched to assert this without significant further study carried out over several years, though.

In conclusion, the three drifter studies have shown the following: 1) The general circulation pattern for July and August, 1974, for the lower basin of Lake Michigan was clockwise. 2) In July, certain irregularities in the current along the western shore occurred, including a southerly coastal current near Chicago. 3) The coastal current along northern reaches of the western shore of the lower basin was northward during the months of investigation, and the domain of this northward current underwent a migration southward from July to August and perhaps into October. 4) The Kizlauskas model (Figure 40) is rather consistently compatible with the August returns and is still better than the others, though much less so, for the July data. Finally, 5) in terms of cost-effectiveness the data obtained from a drifter study such as this one seem well worth the effort, especially since releases can be made with virtually no interference with other experiments aboard ship or with the ship's headway while in motion between stations.



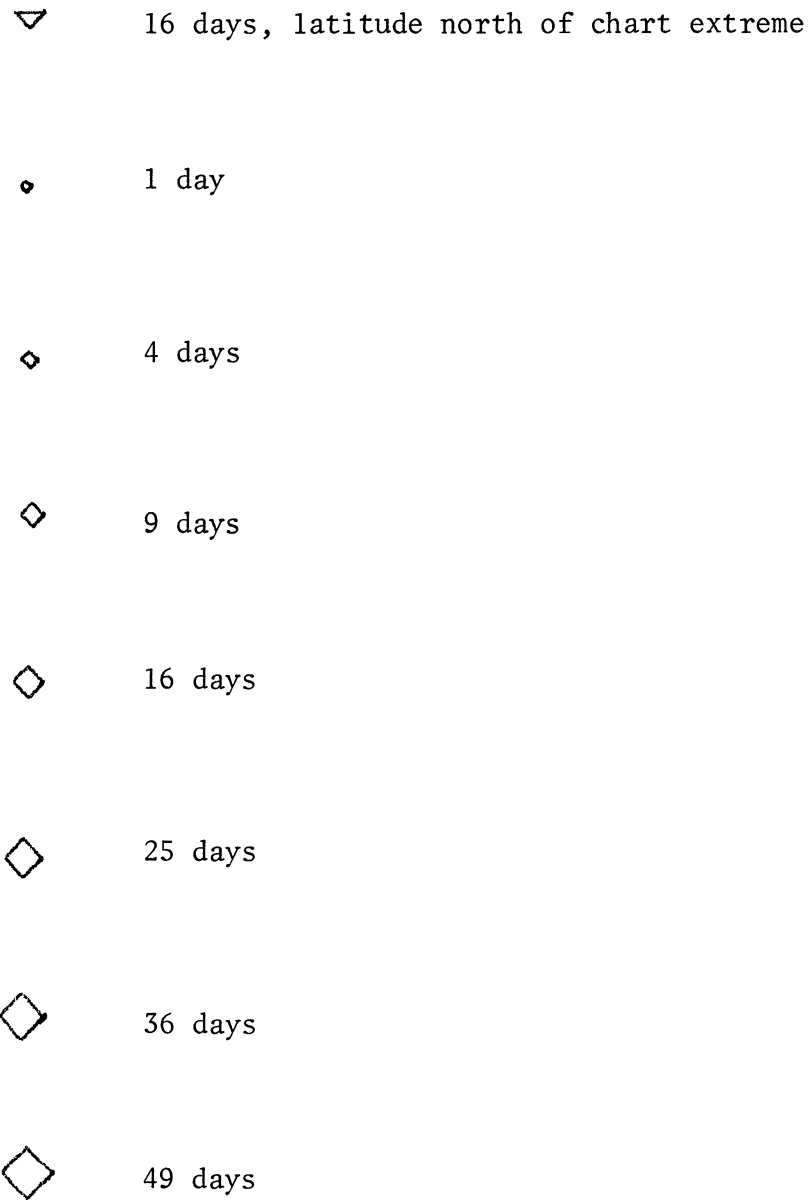

Number of days adrift as a function of recovery symbol size.

Figure 30: Graphical summary of recoveries from releases 1 through 55. Release number is located at point of release; recoveries are represented as diamonds indicating time adrift as shown.

LAKE MICHIGAN

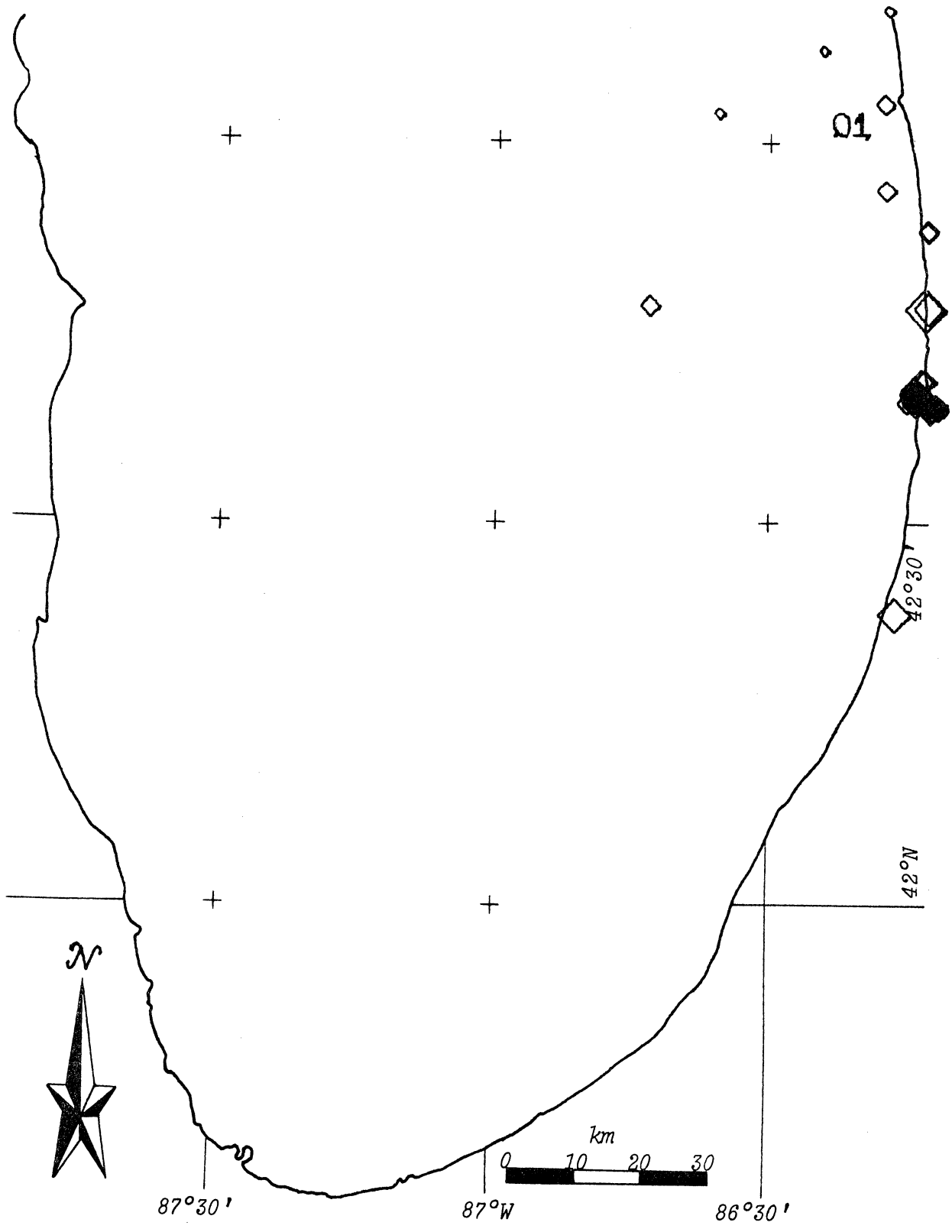

LAKE MICHIGAN

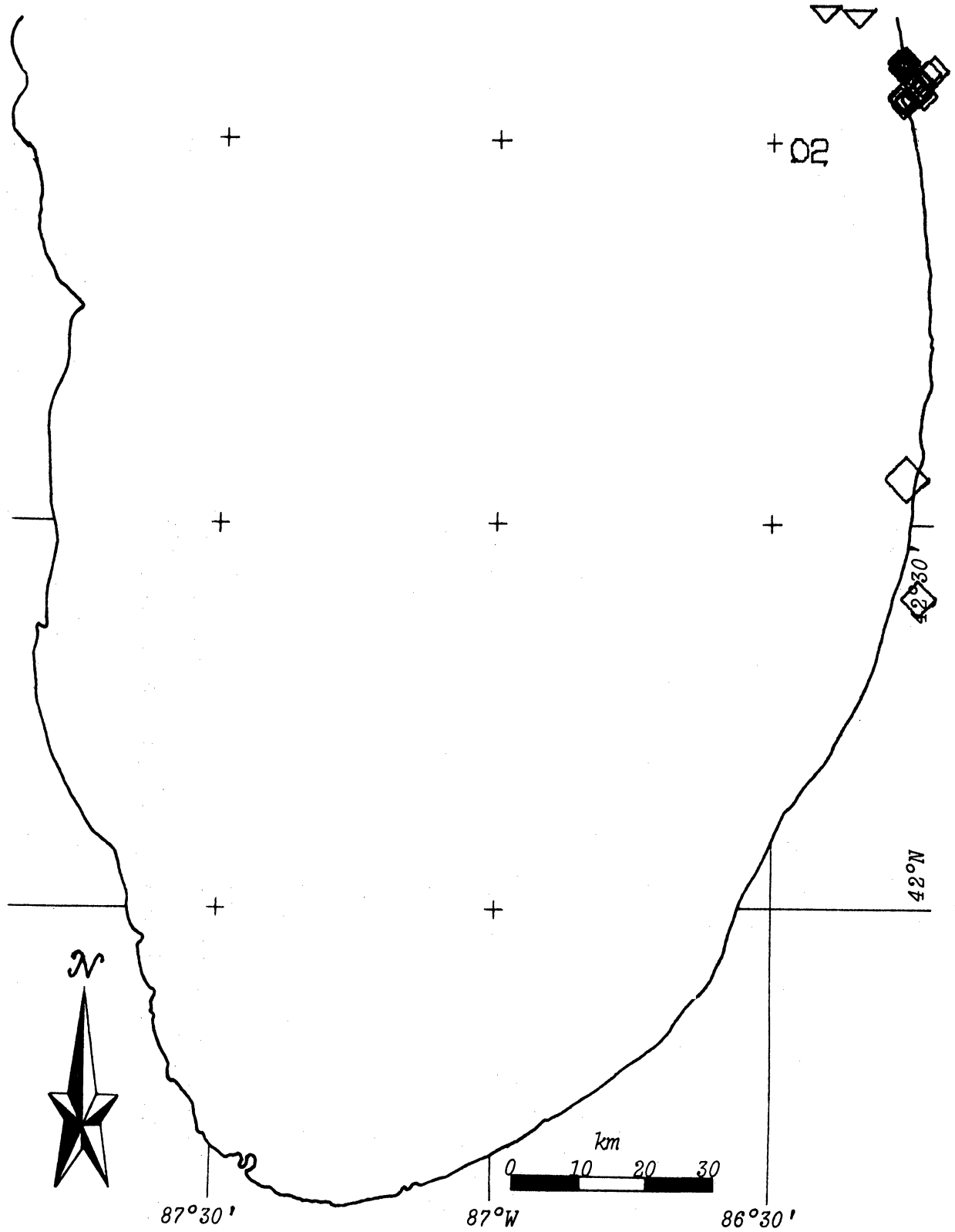

LAKE MICHIGAN

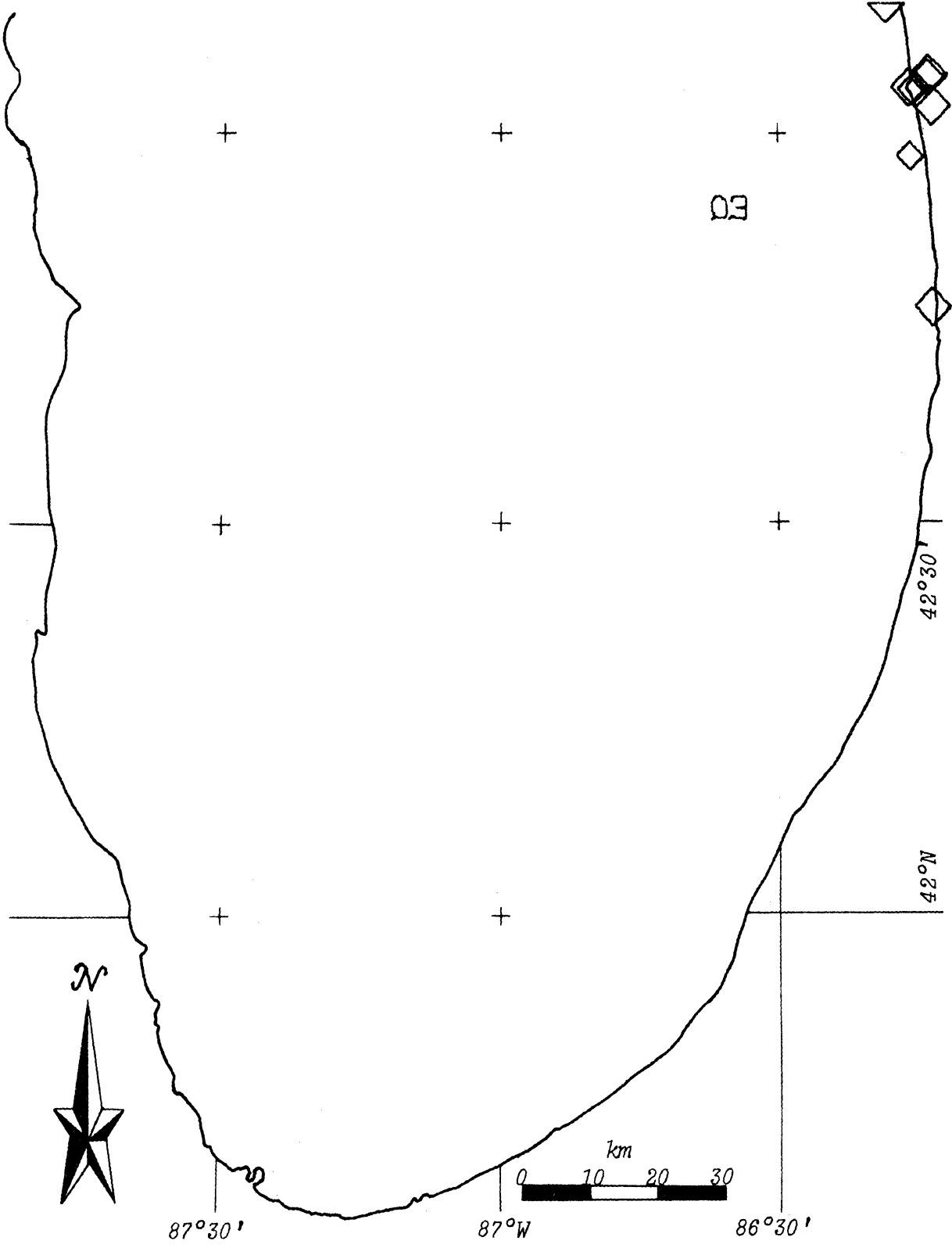

LAKE MICHIGAN

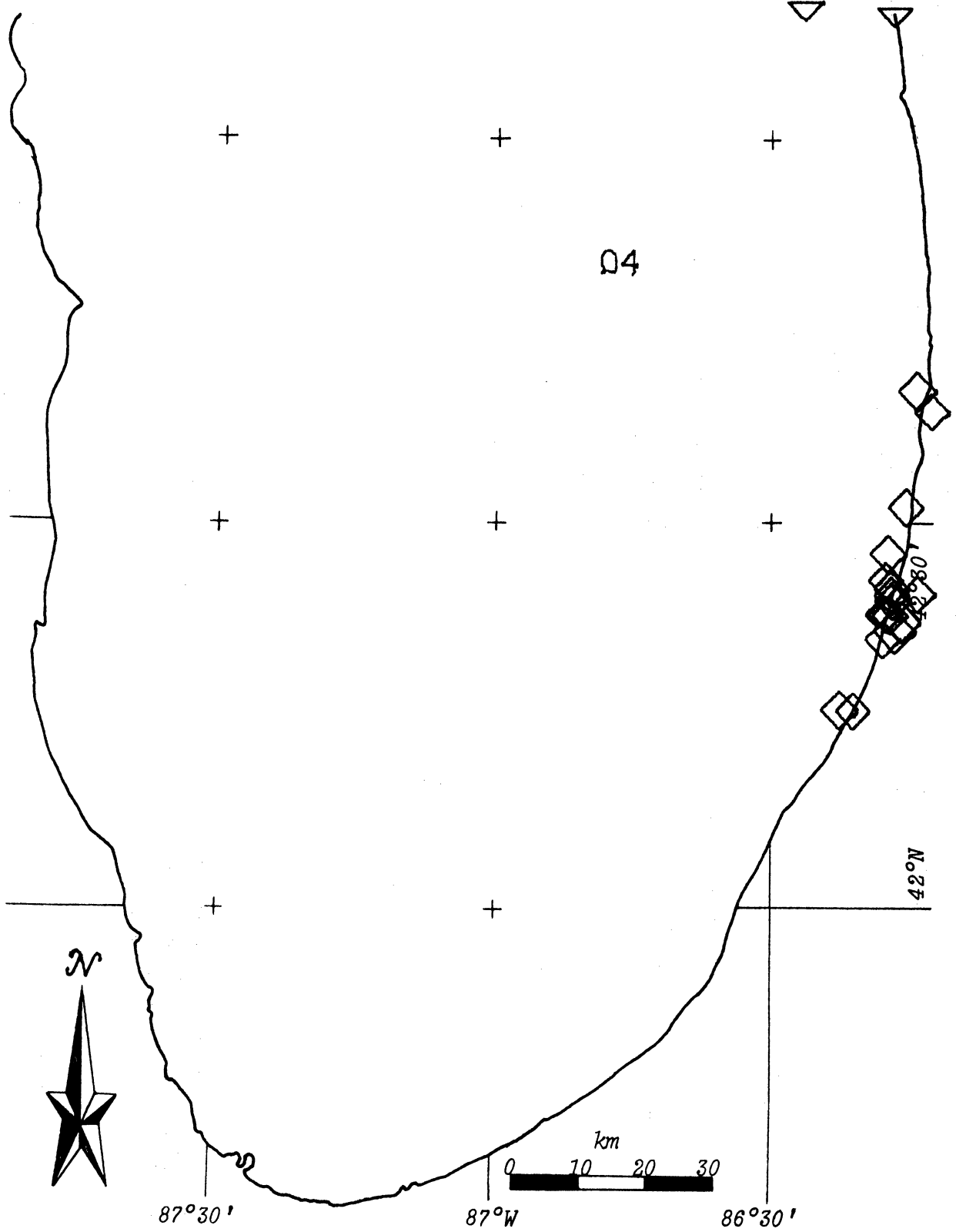

LAKE MICHIGAN

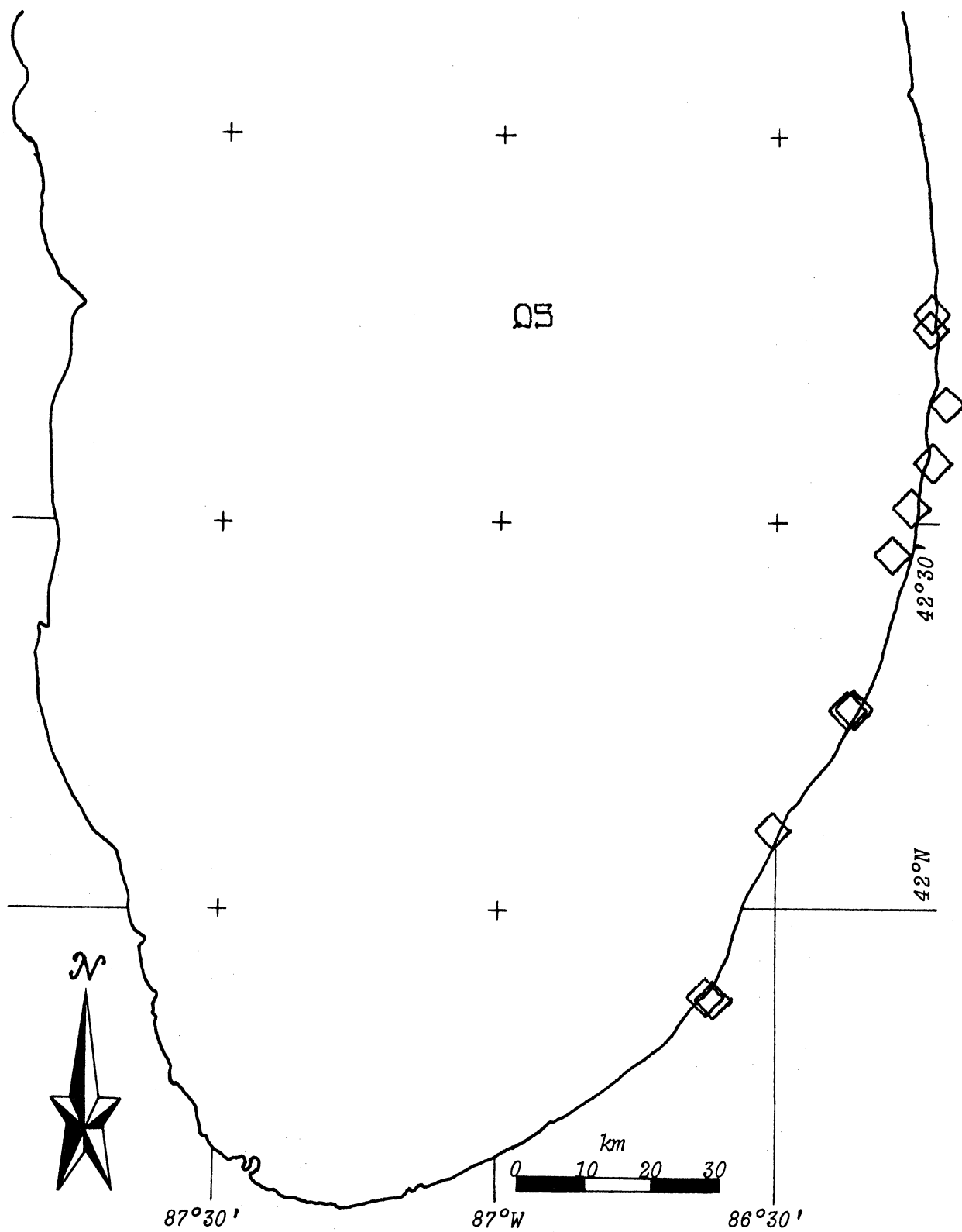

LAKE MICHIGAN

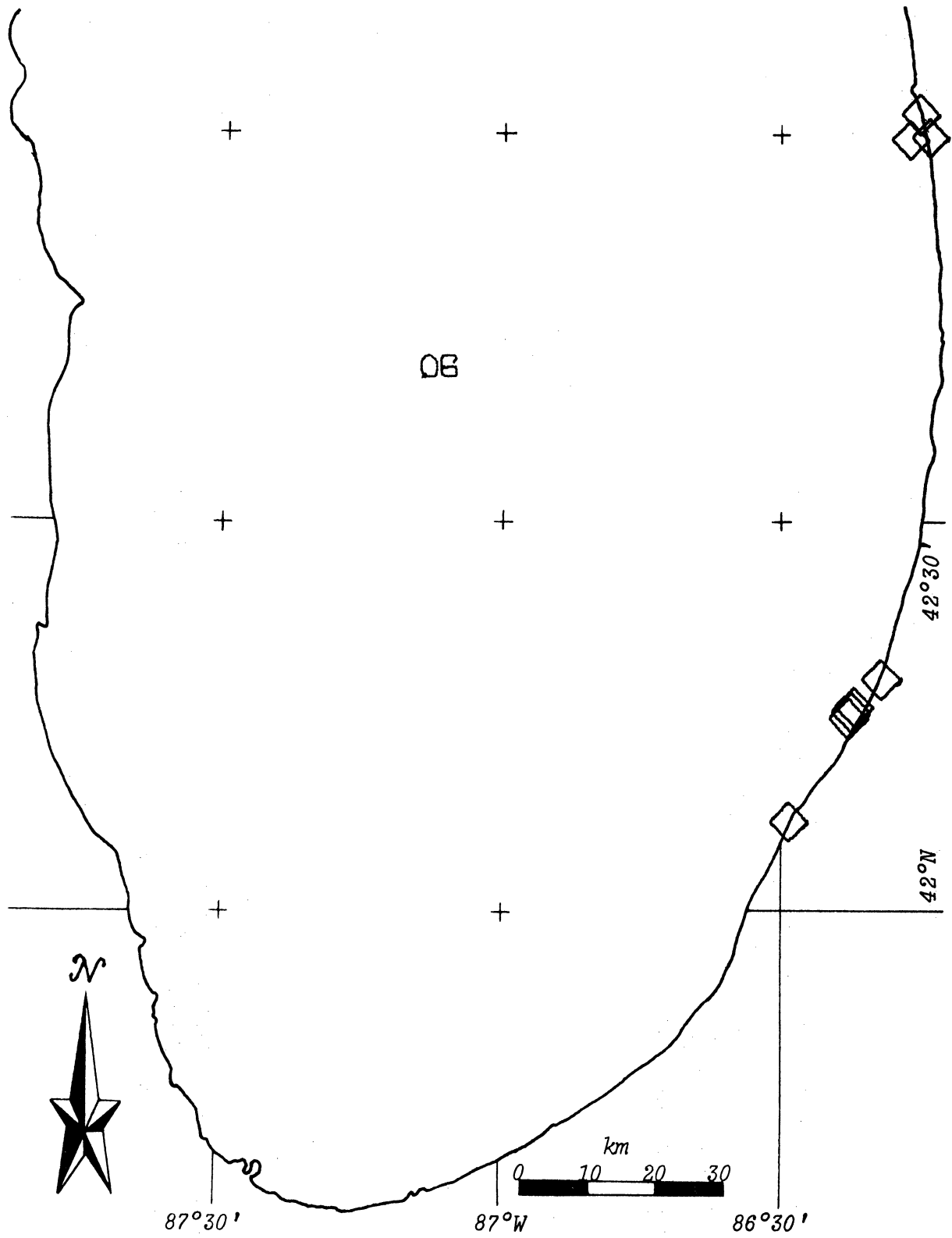

LAKE MICHIGAN

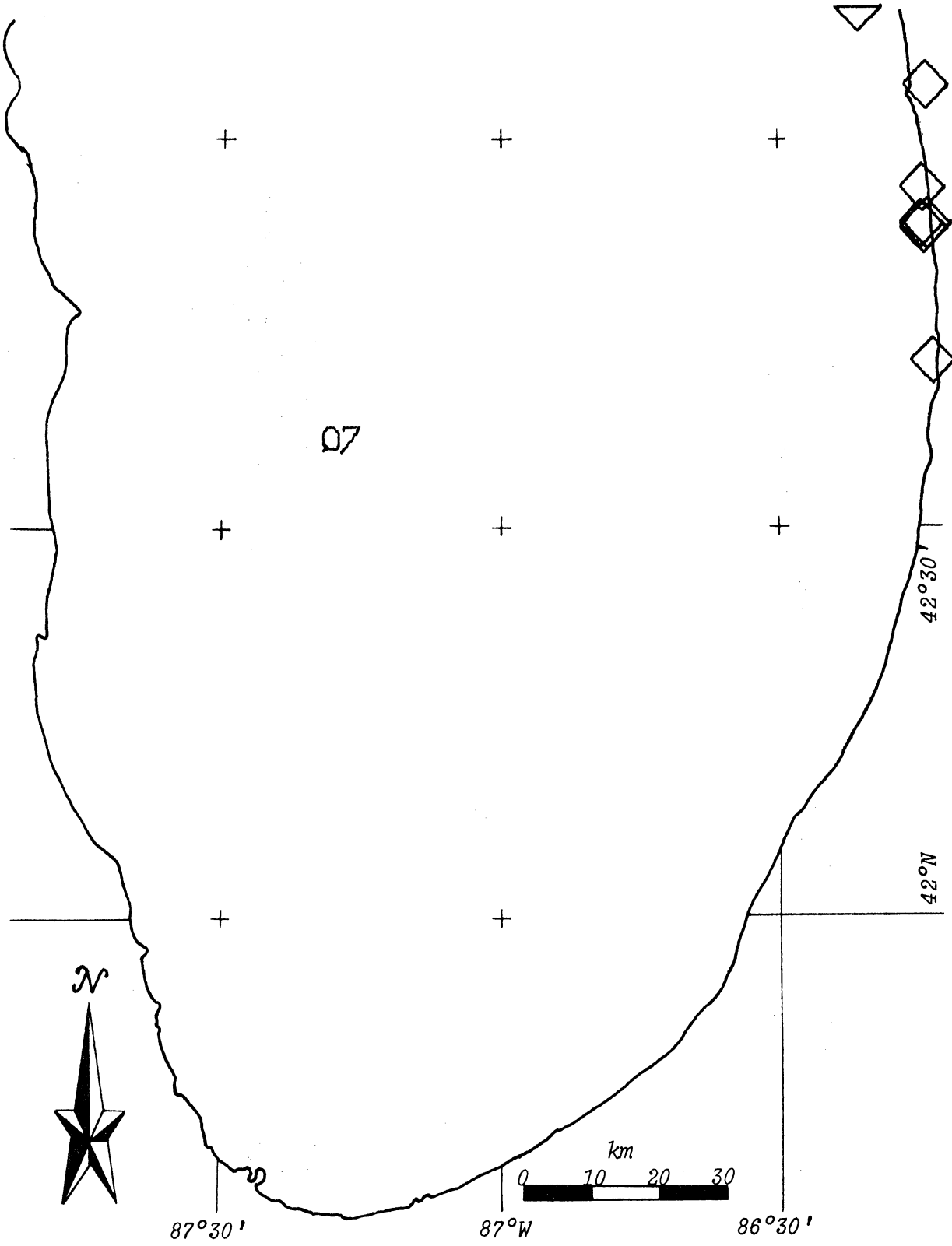



LAKE MICHIGAN

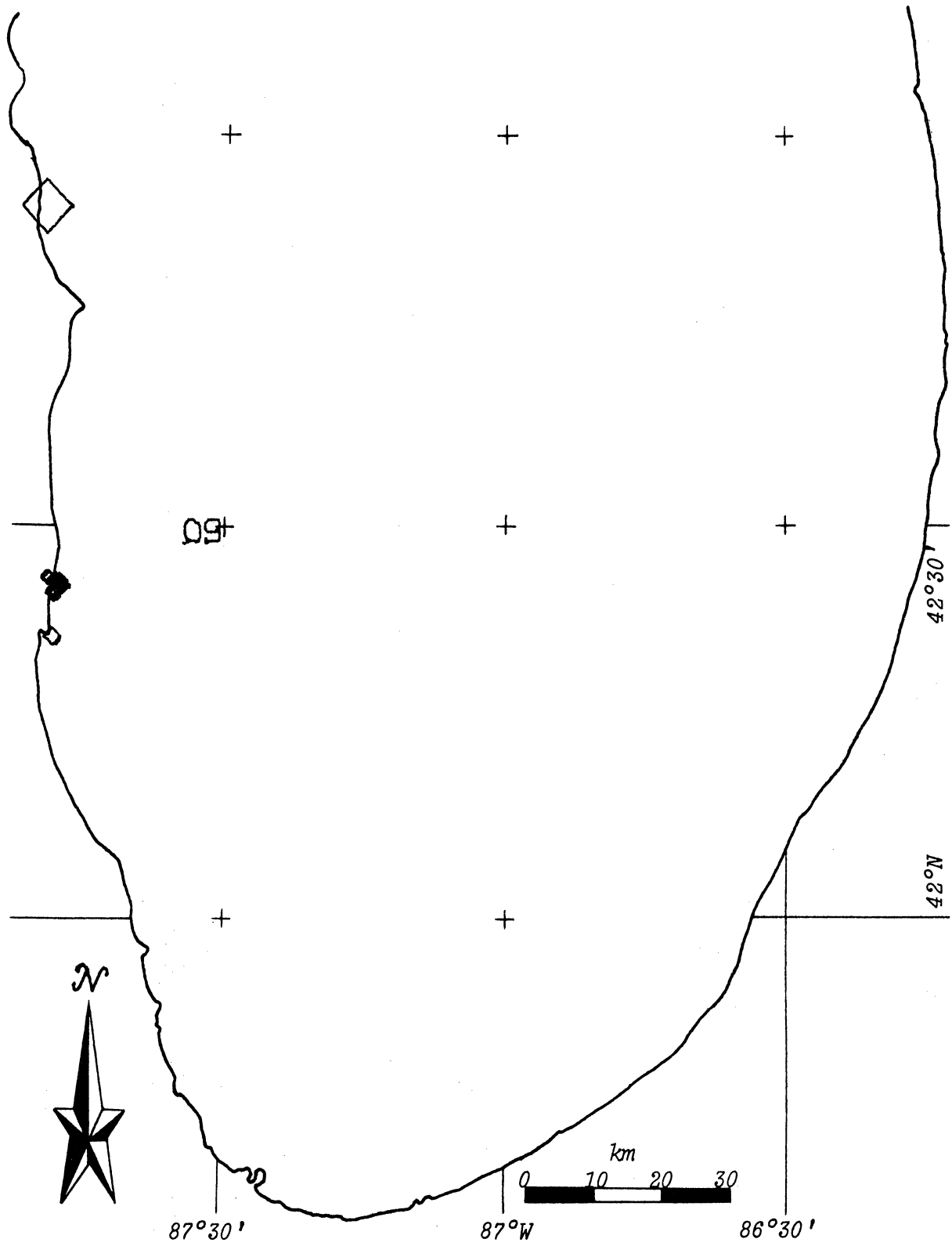

LAKE MICHIGAN

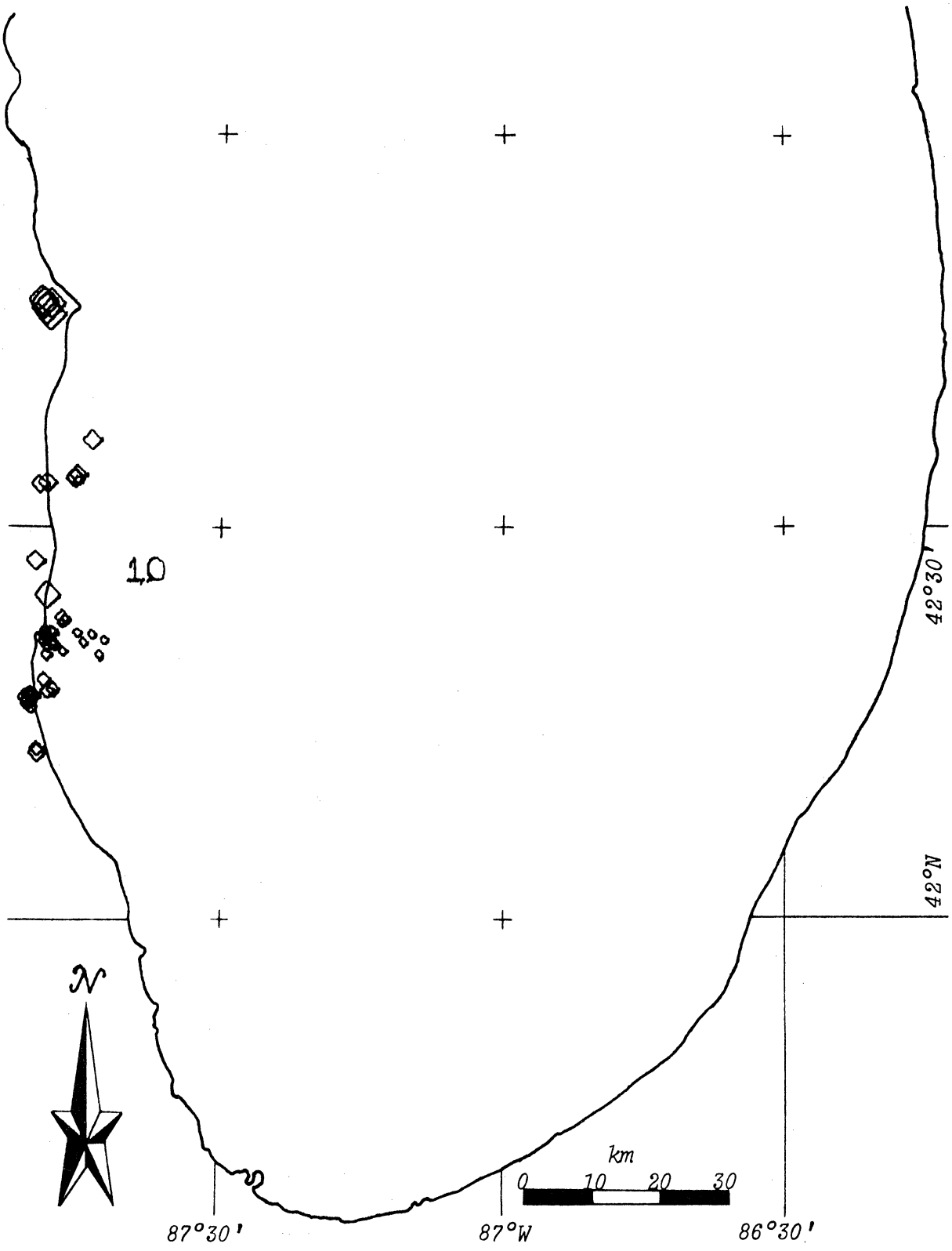

LAKE MICHIGAN

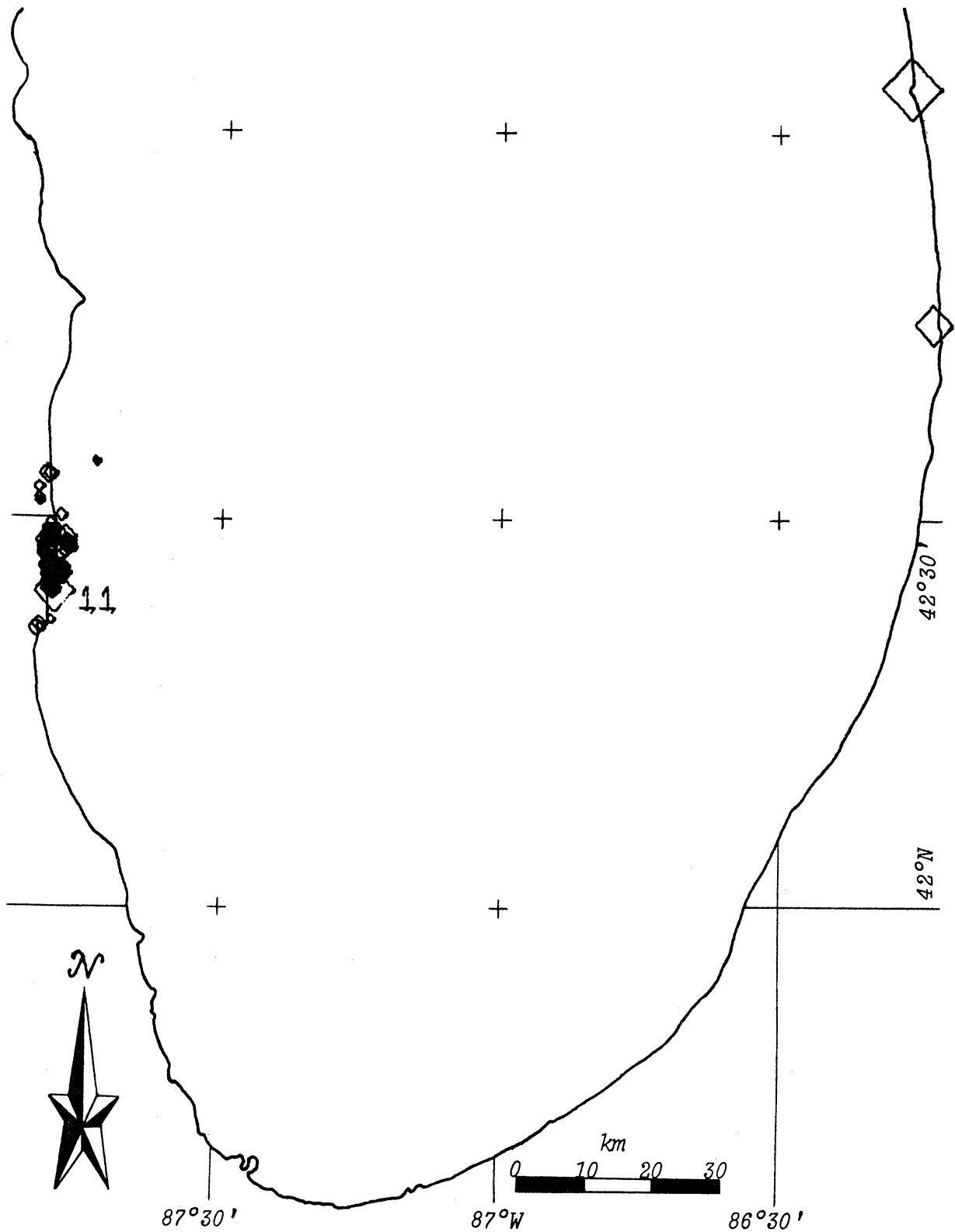

LAKE MICHIGAN

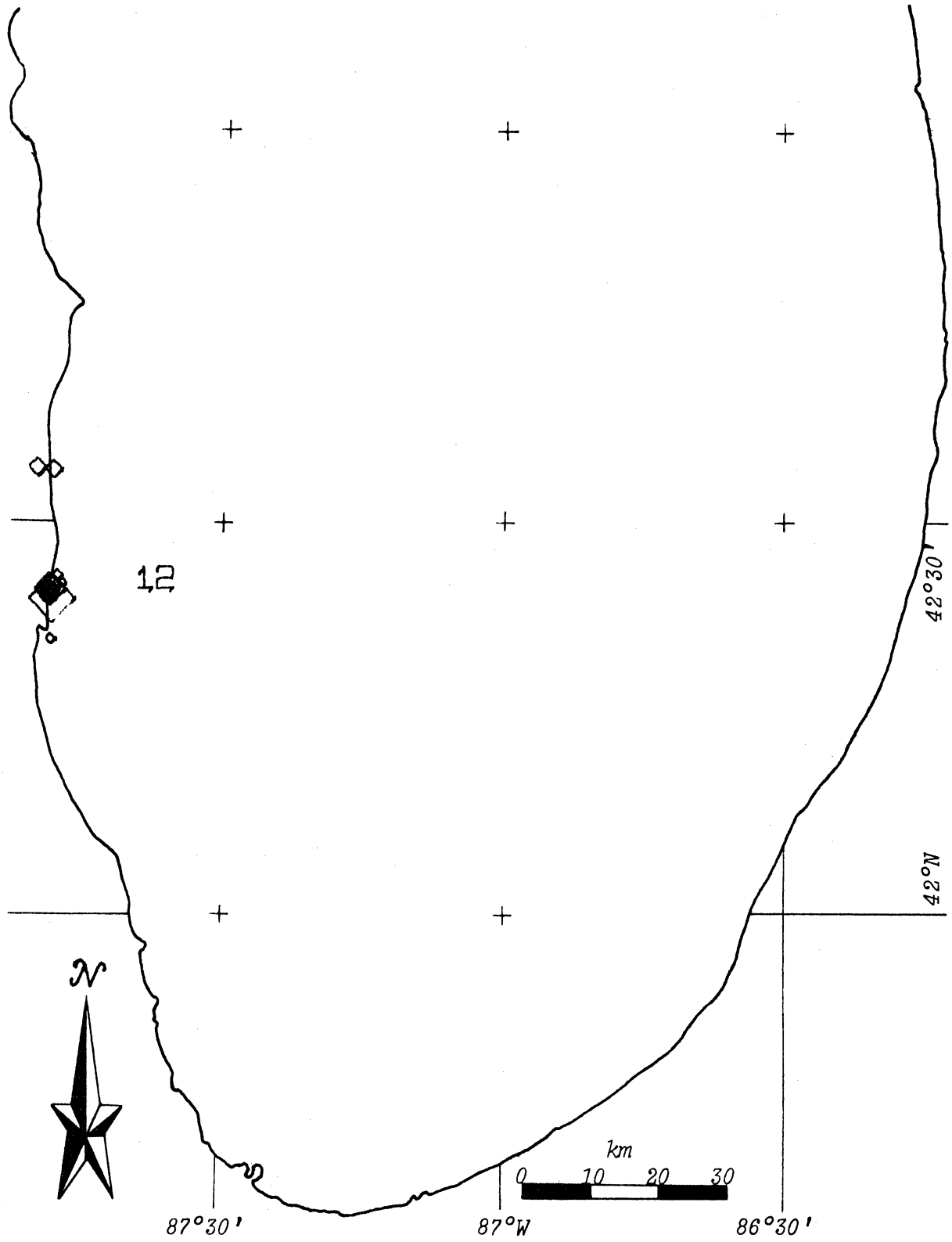

LAKE MICHIGAN

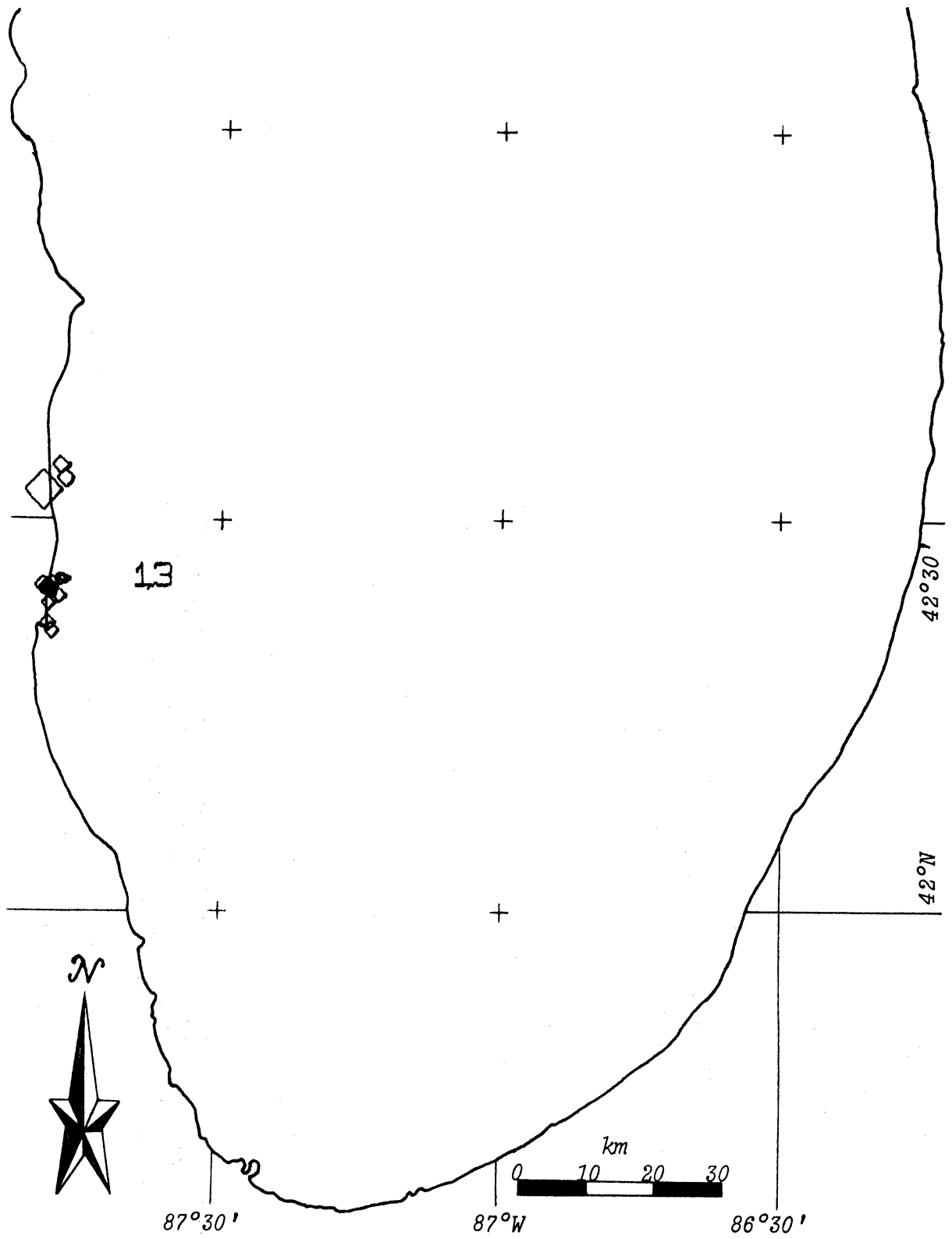

LAKE MICHIGAN

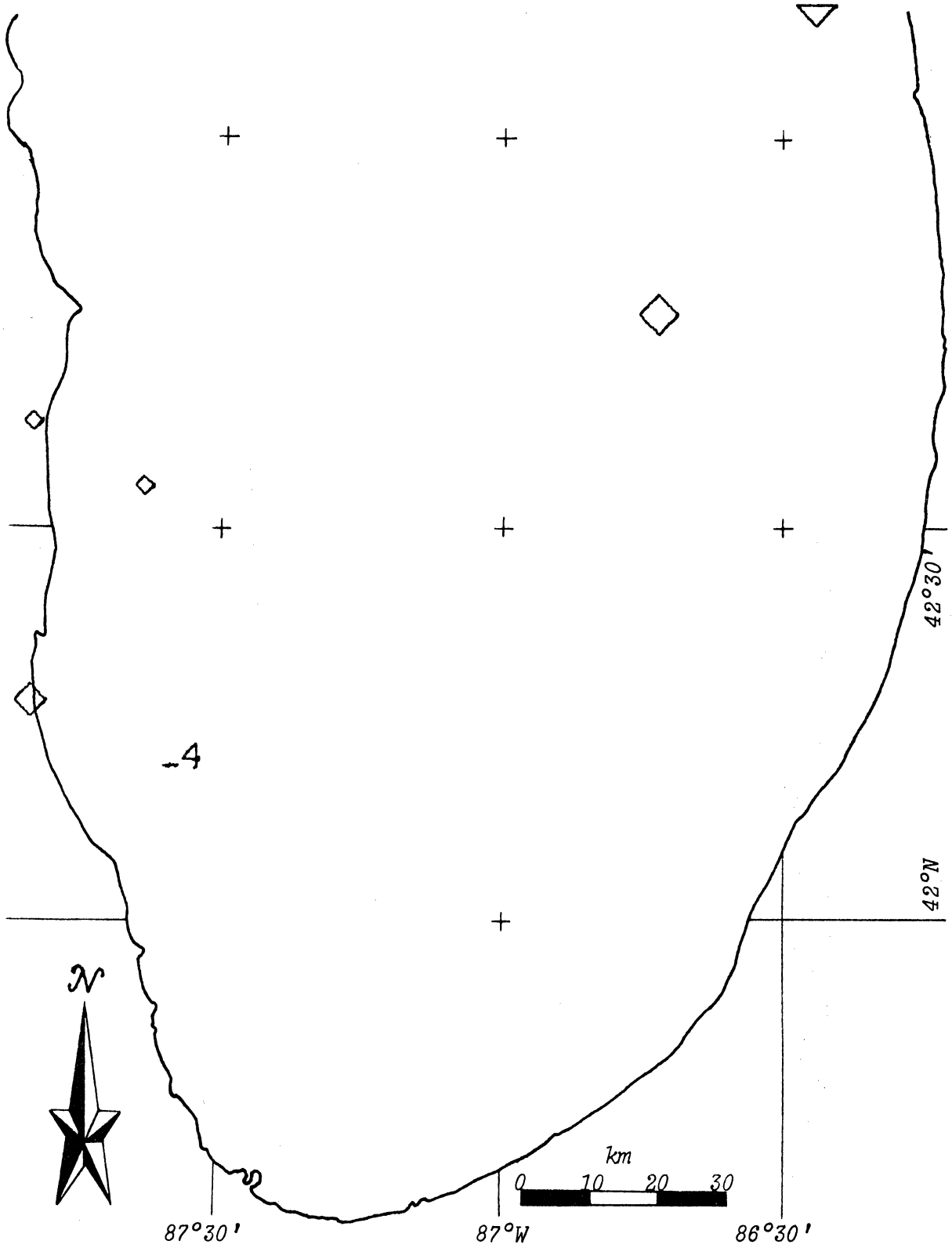

LAKE MICHIGAN

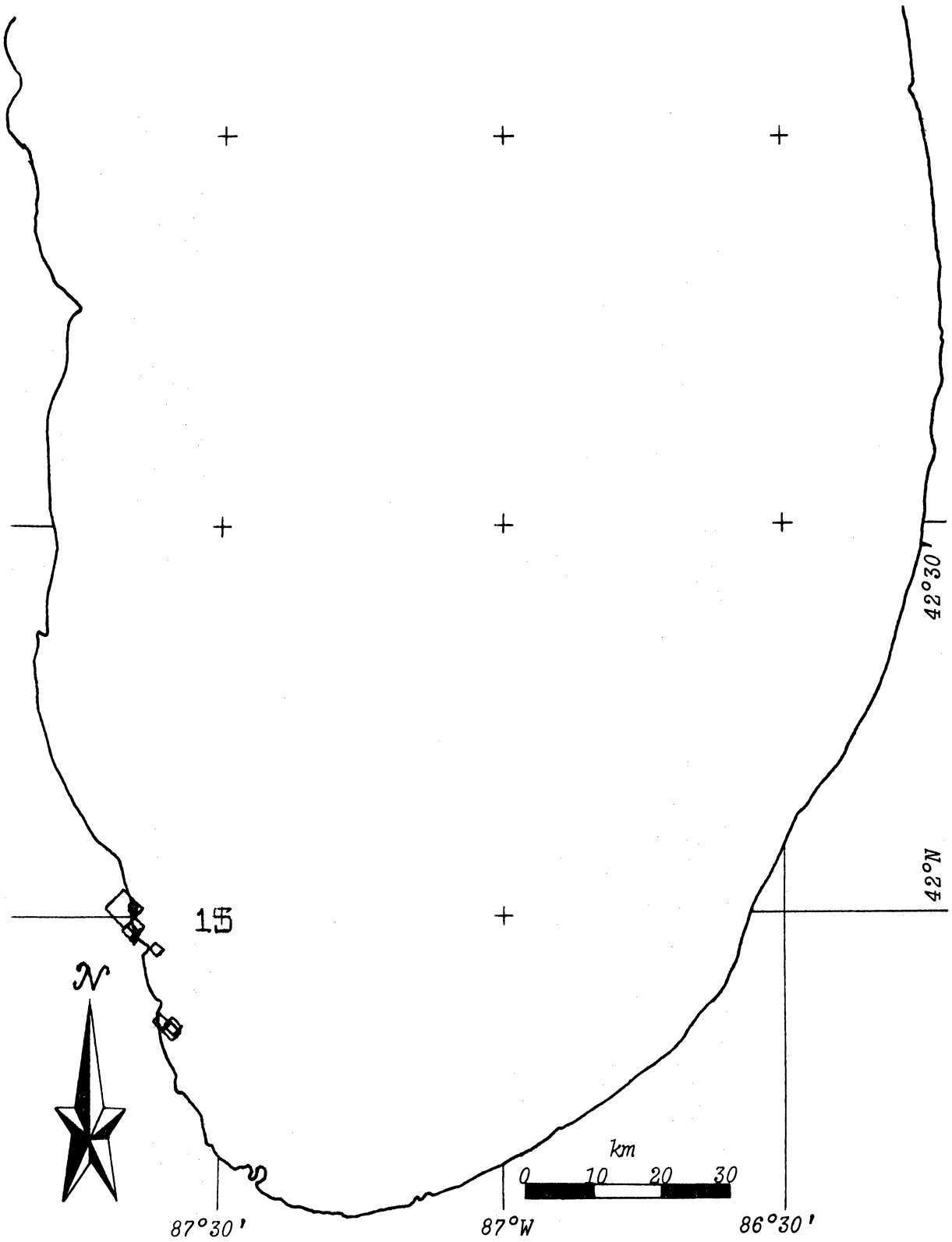

LAKE MICHIGAN

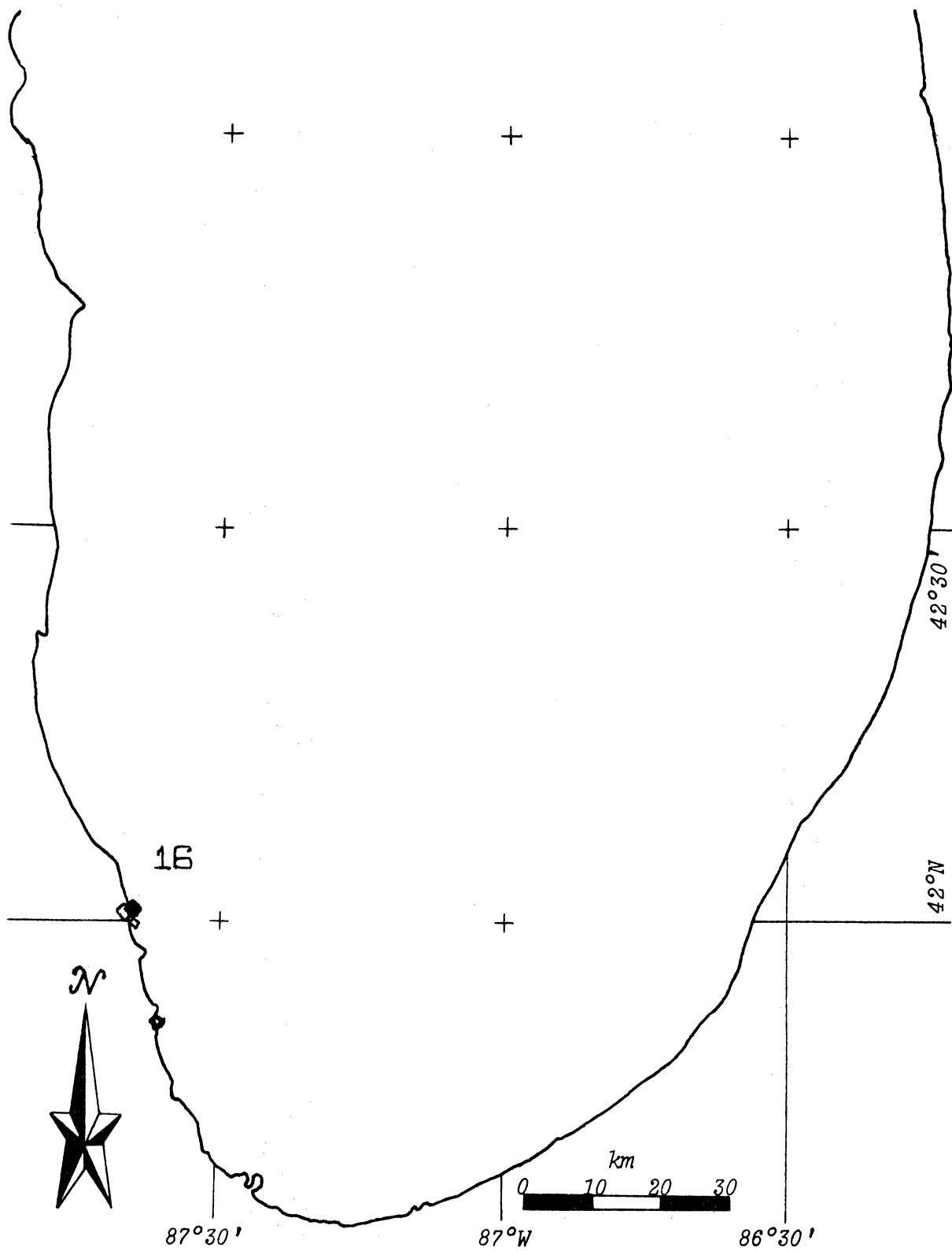



LAKE MICHIGAN

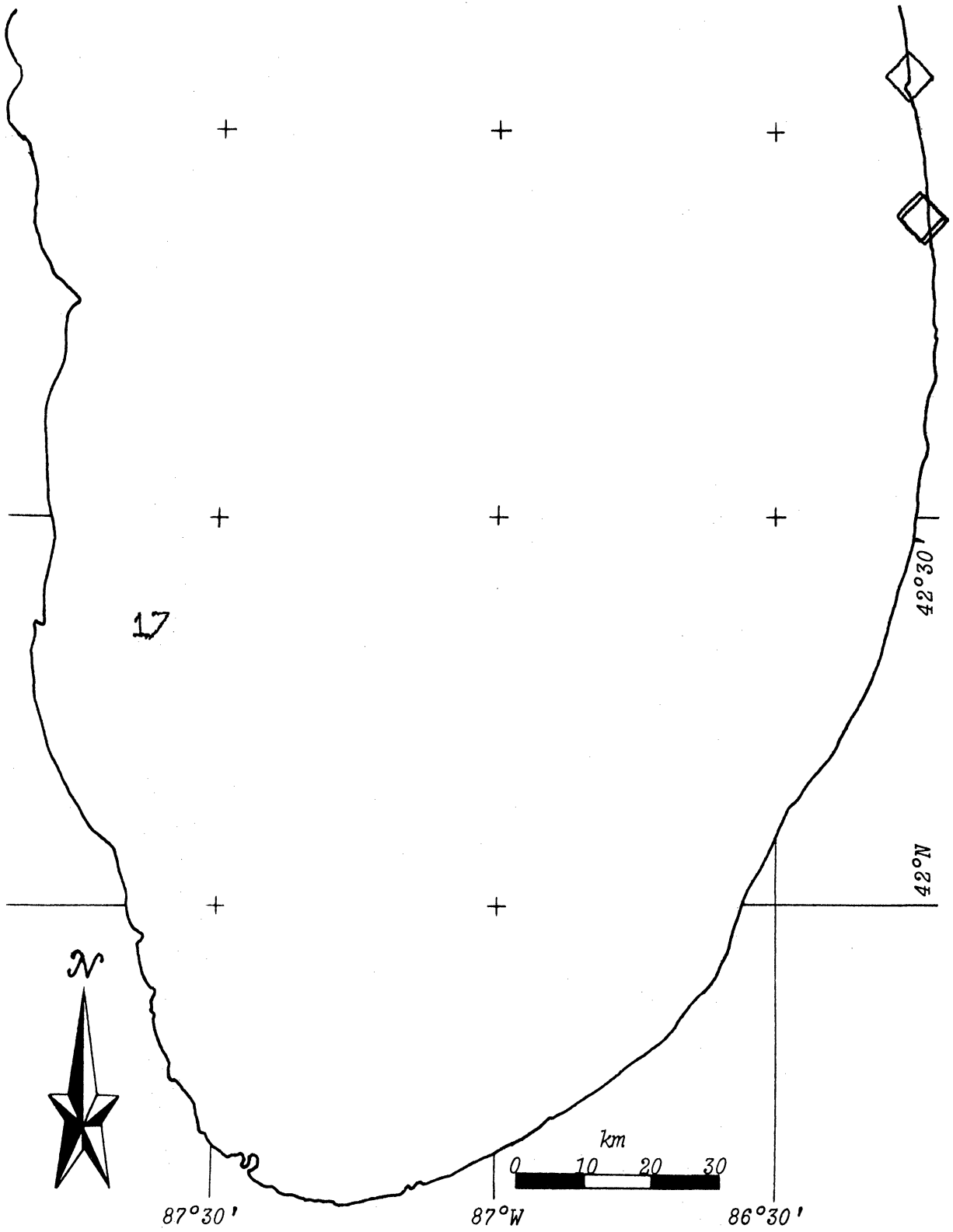

LAKE MICHIGAN

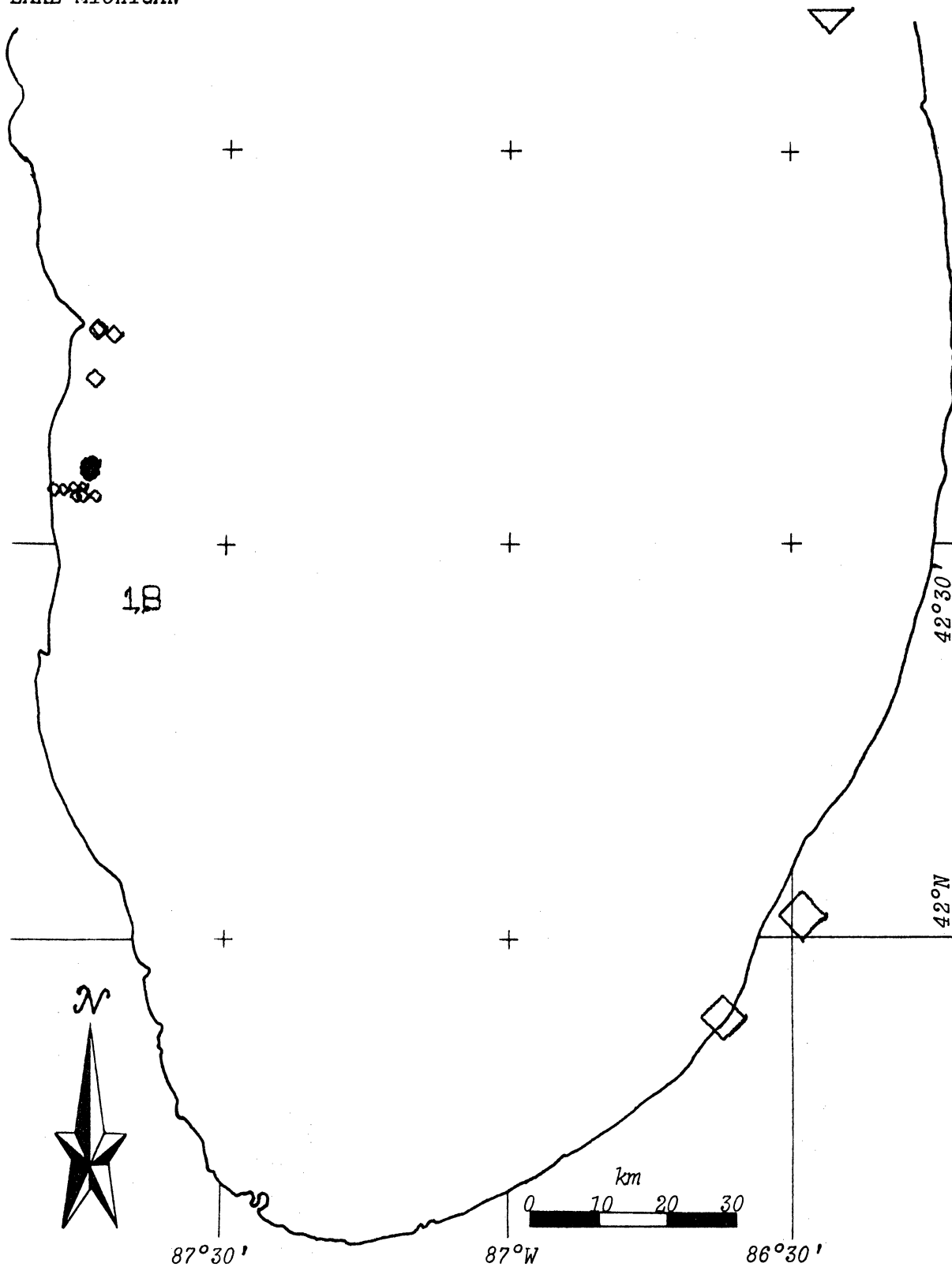

LAKE MICHIGAN

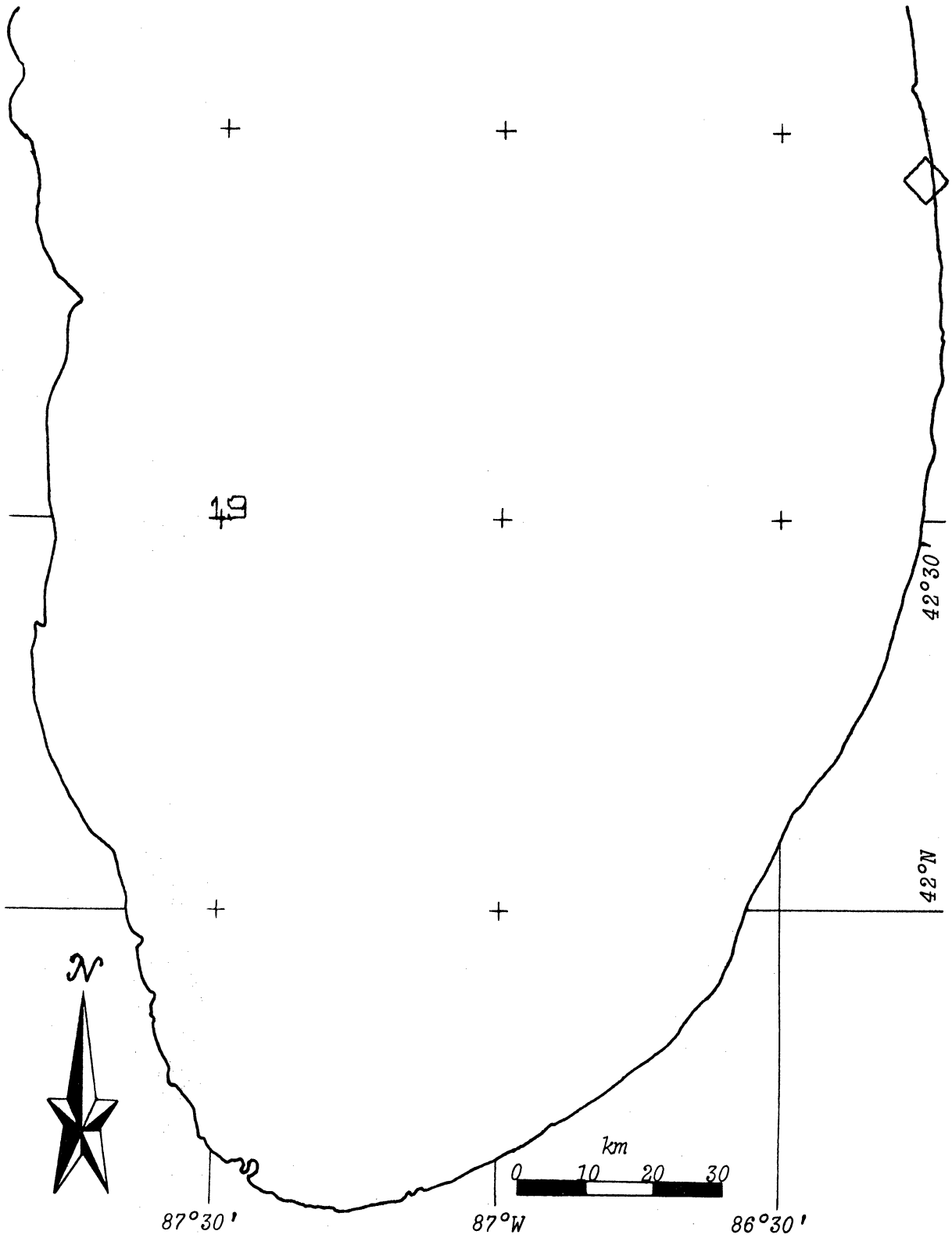

LAKE MICHIGAN

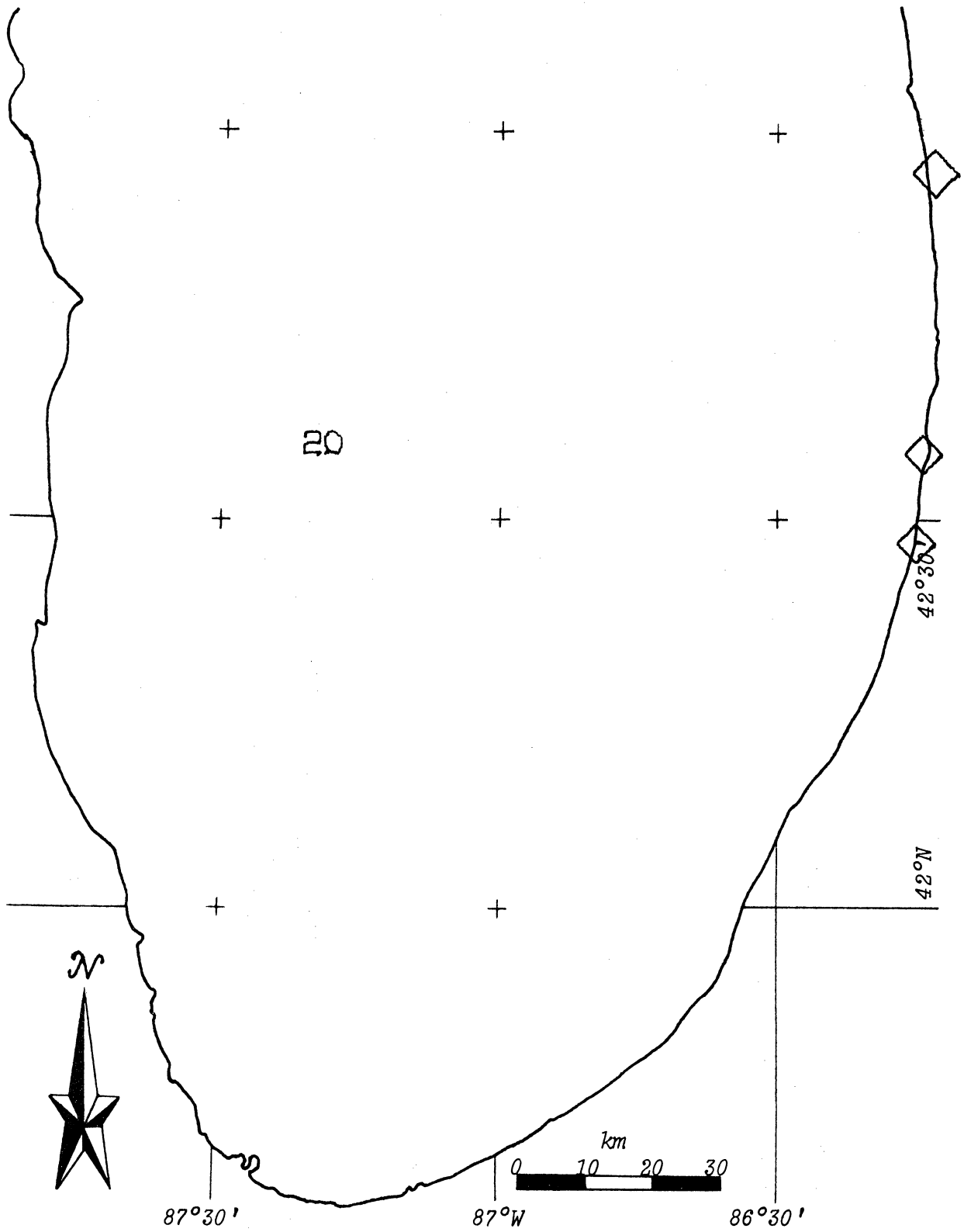

LAKE MICHIGAN

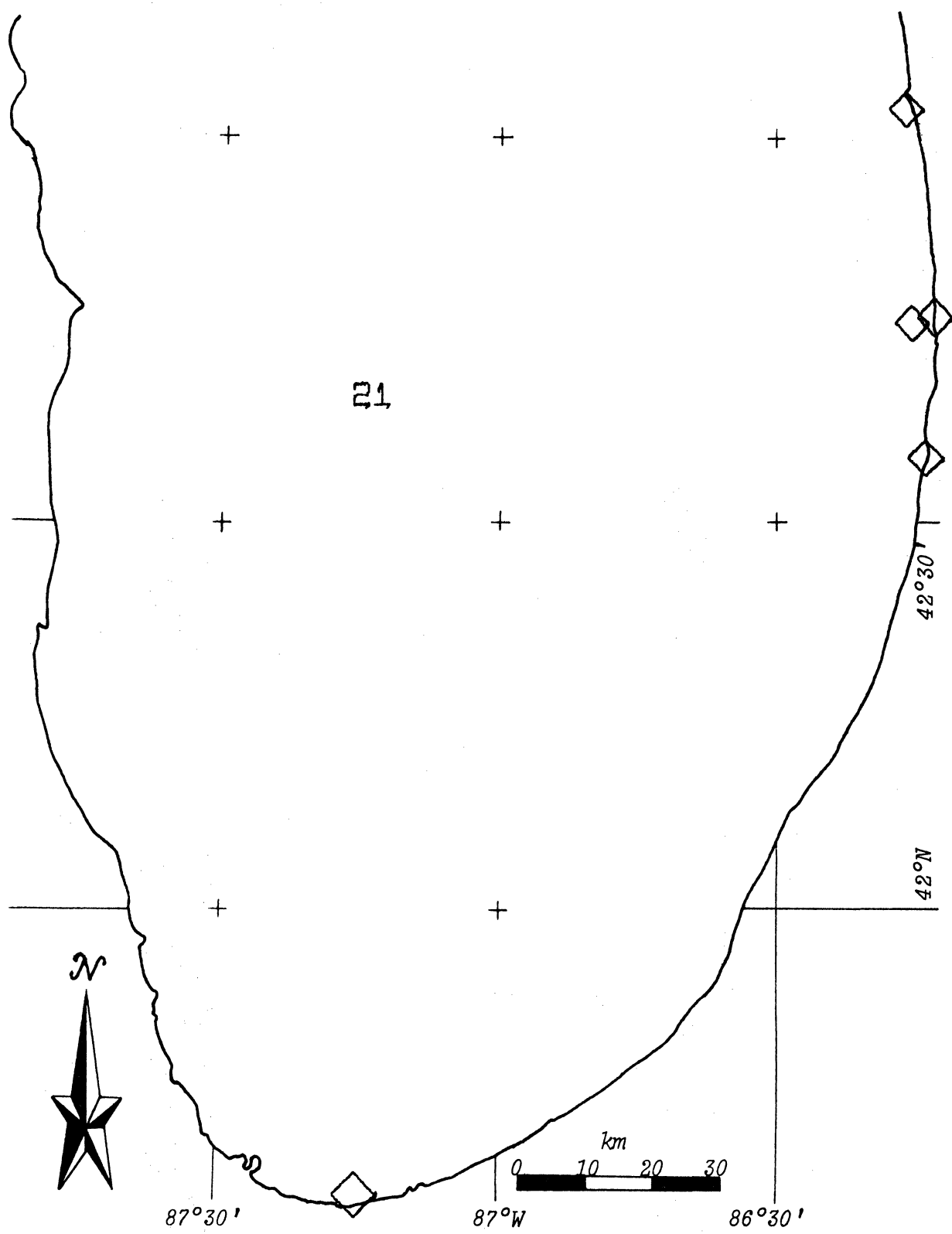

LAKE MICHIGAN

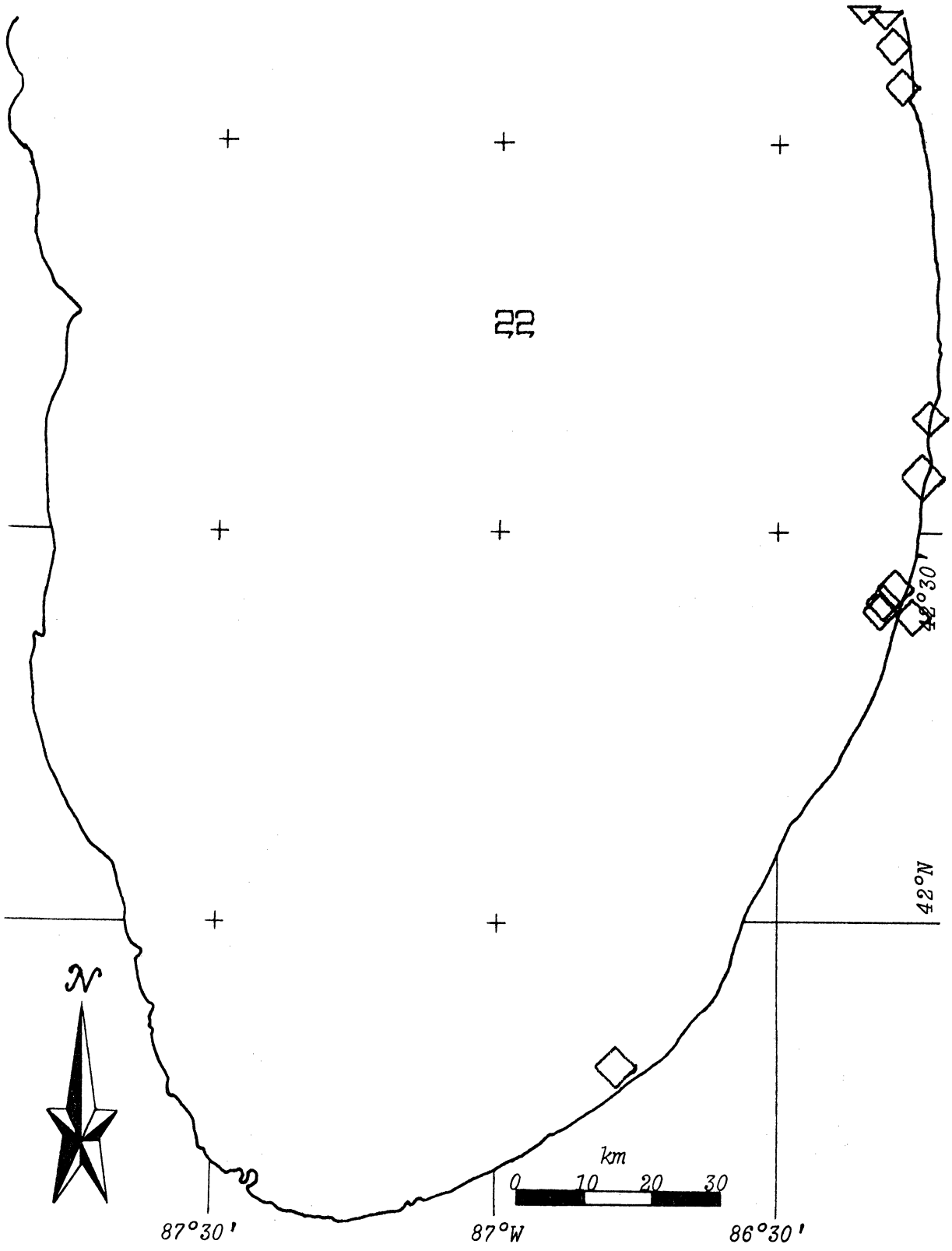

LAKE MICHIGAN

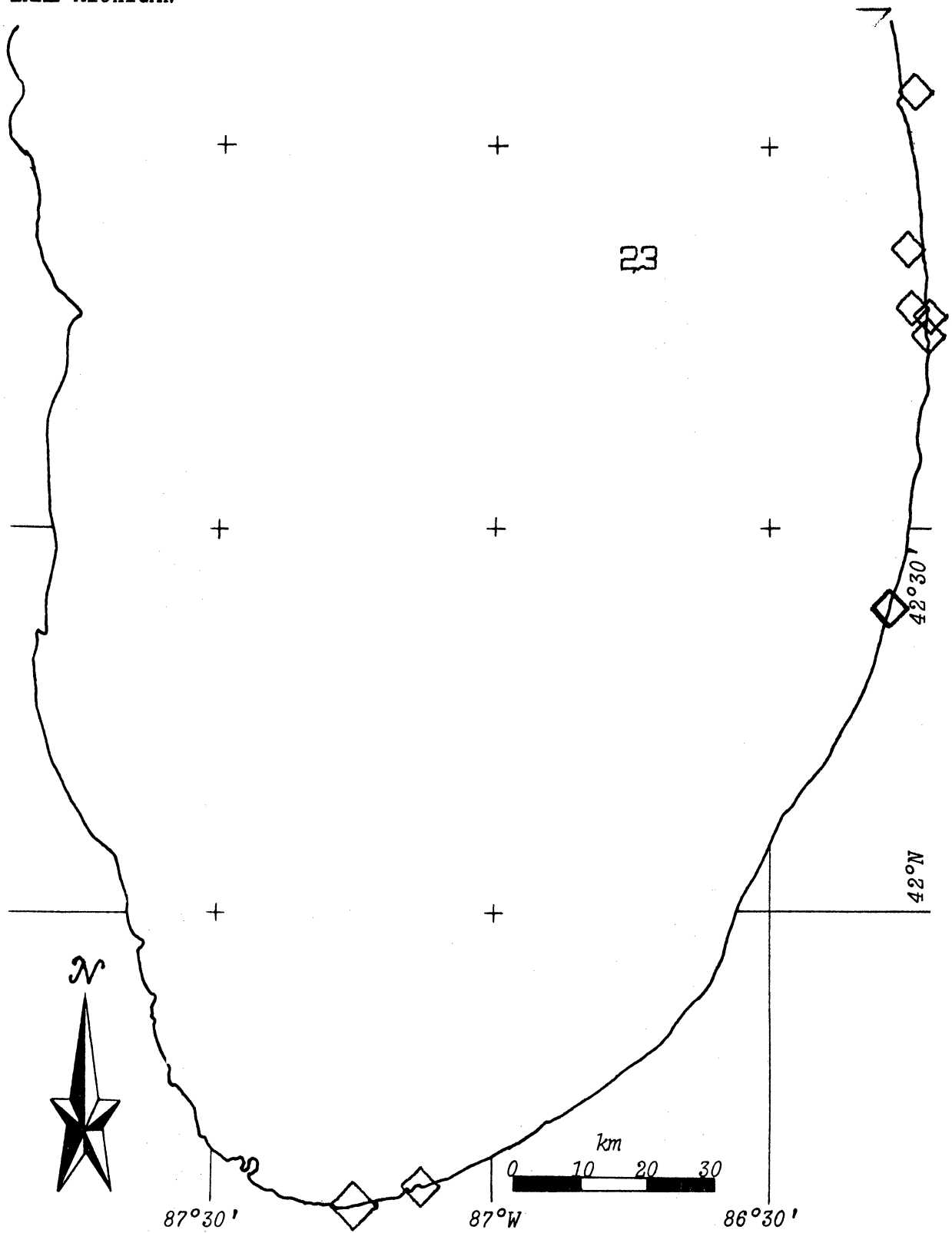

LAKE MICHIGAN

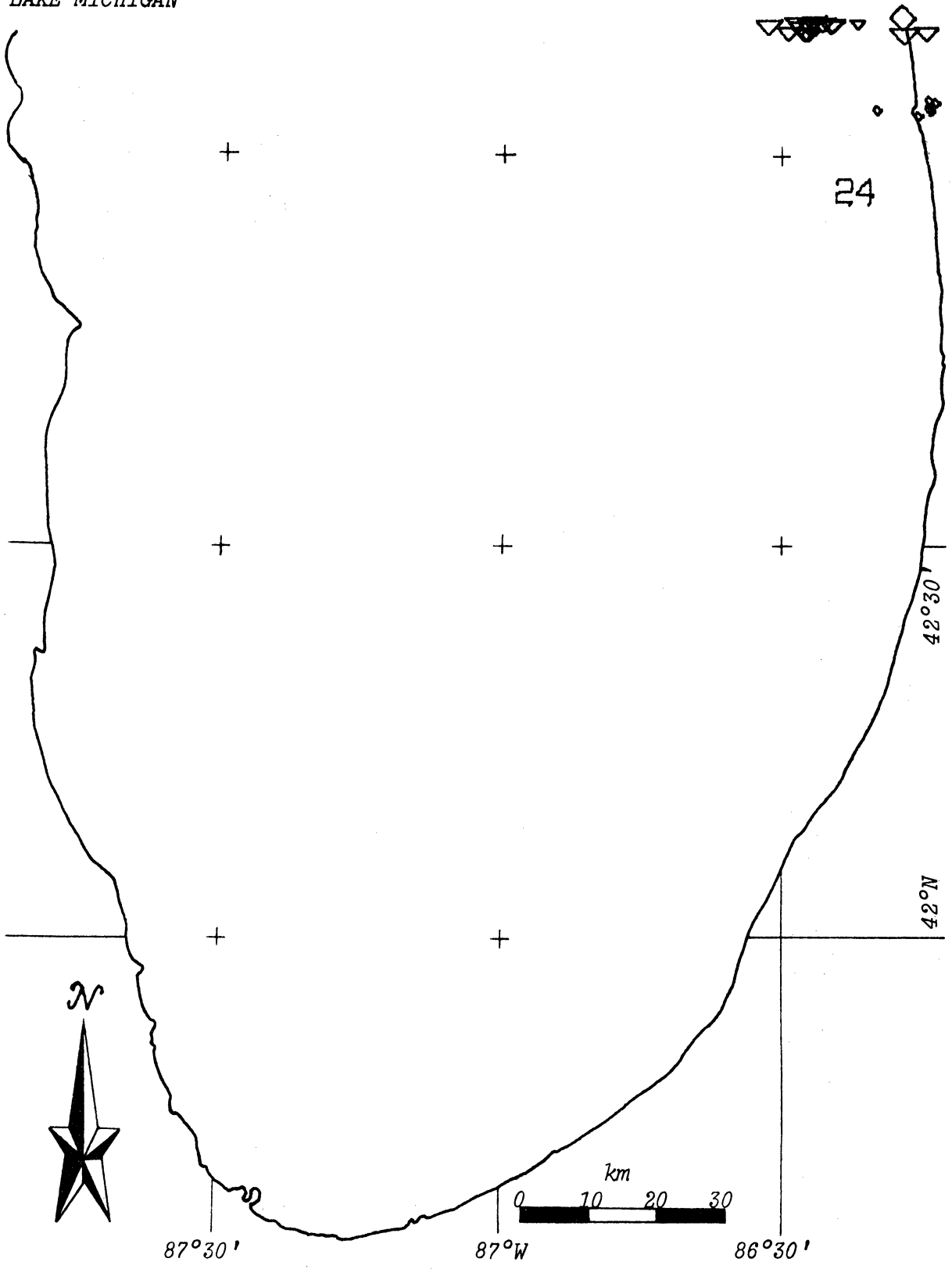



LAKE MICHIGAN

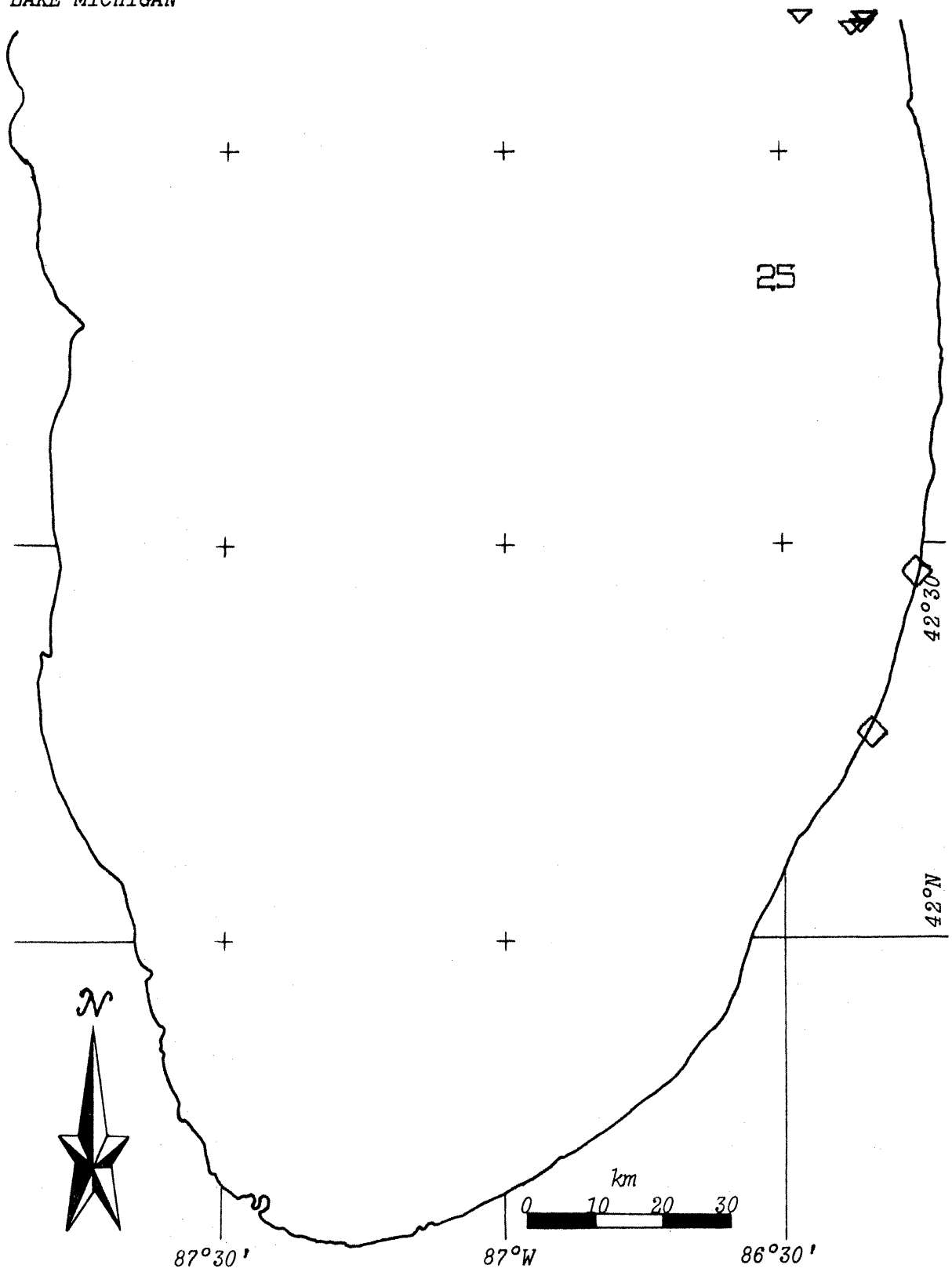

LAKE MICHIGAN

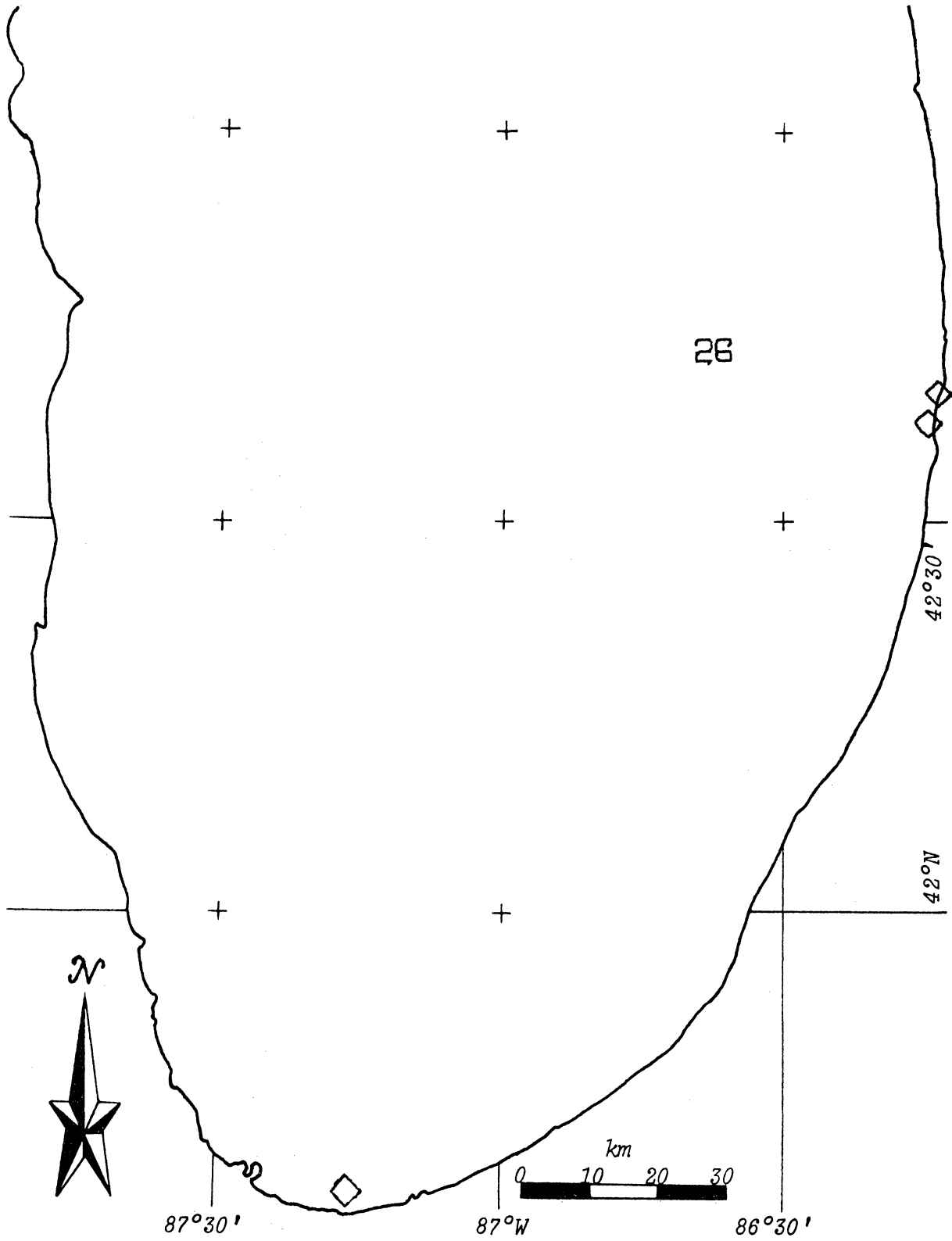

LAKE MICHIGAN

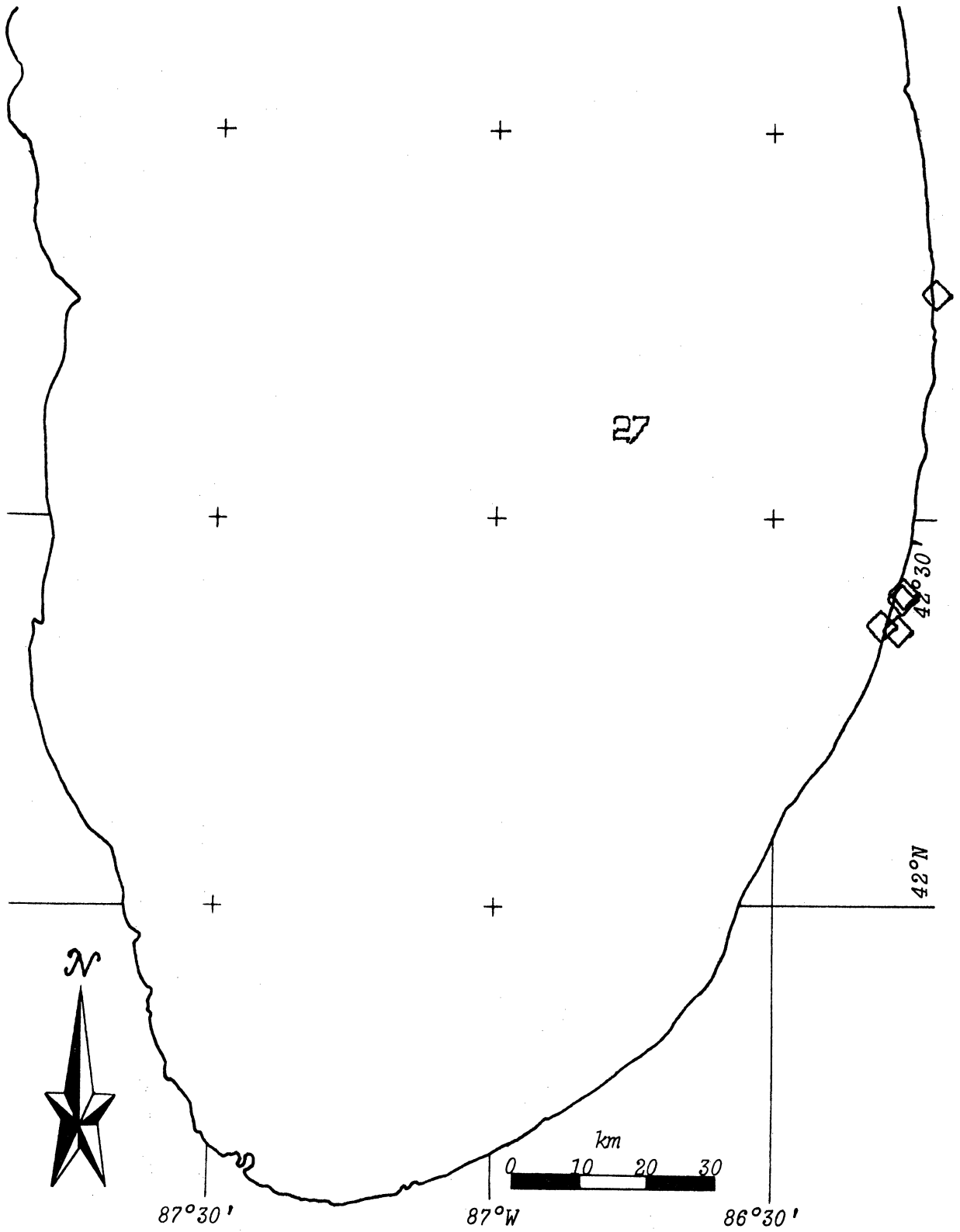

LAKE MICHIGAN

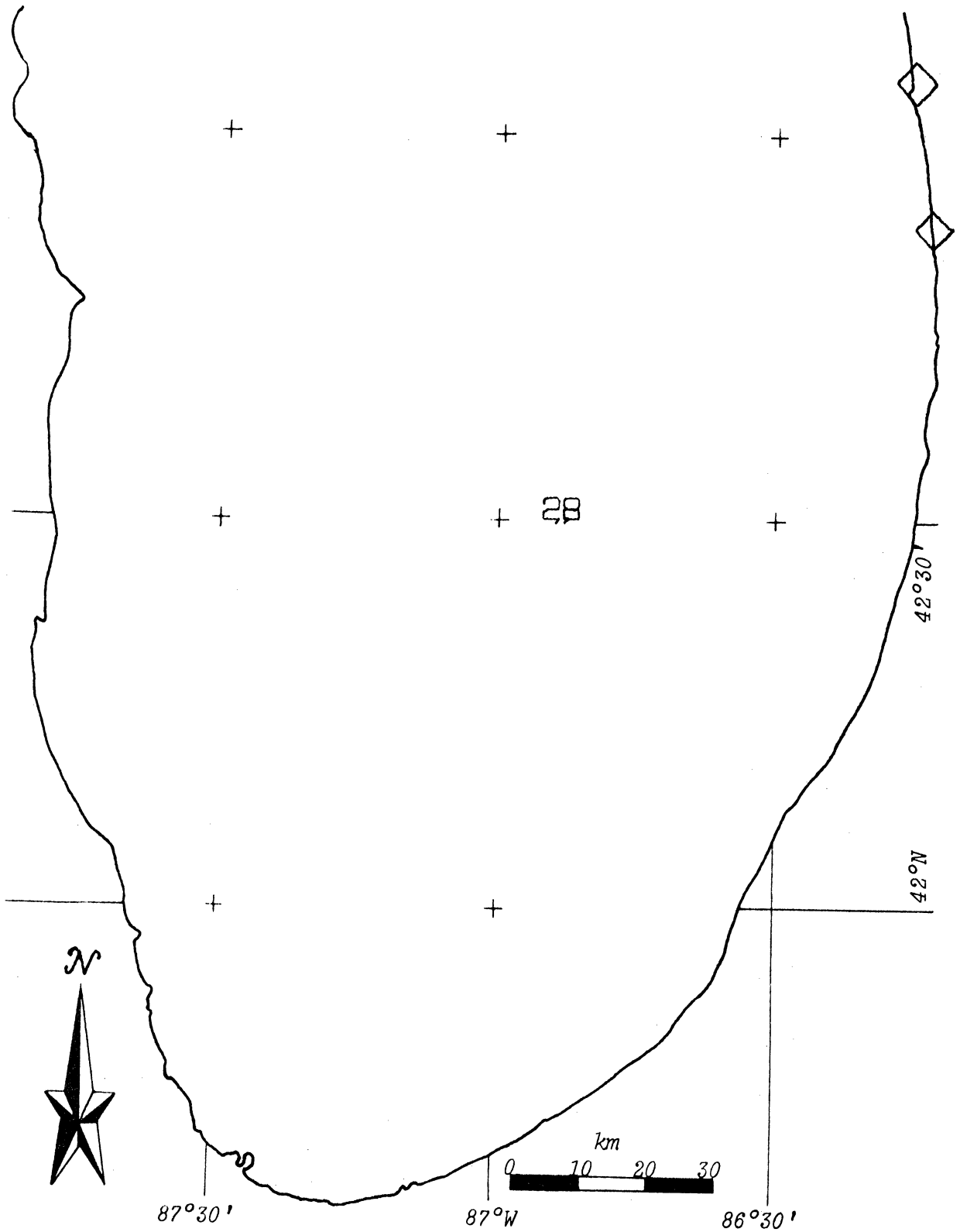

LAKE MICHIGAN

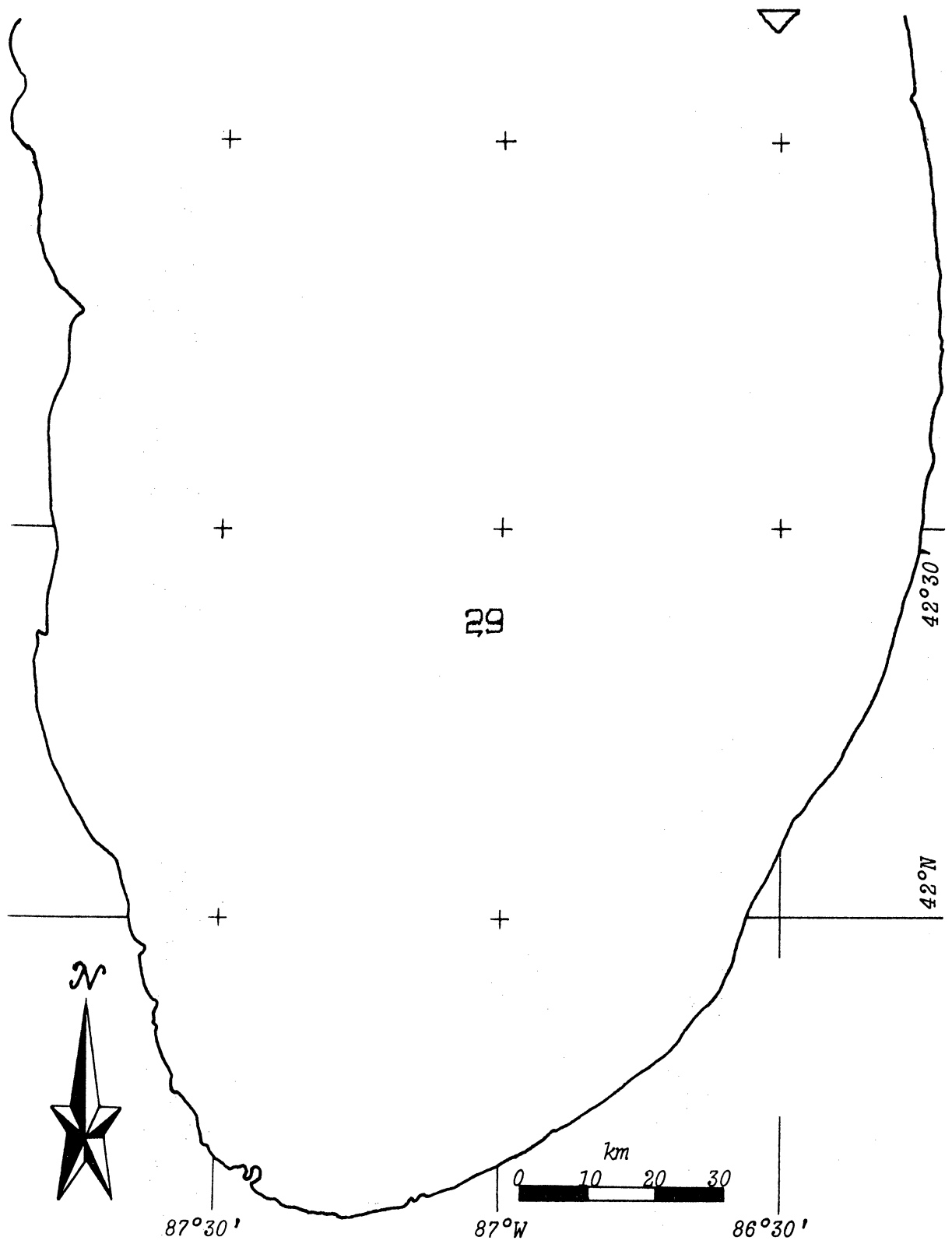

LAKE MICHIGAN

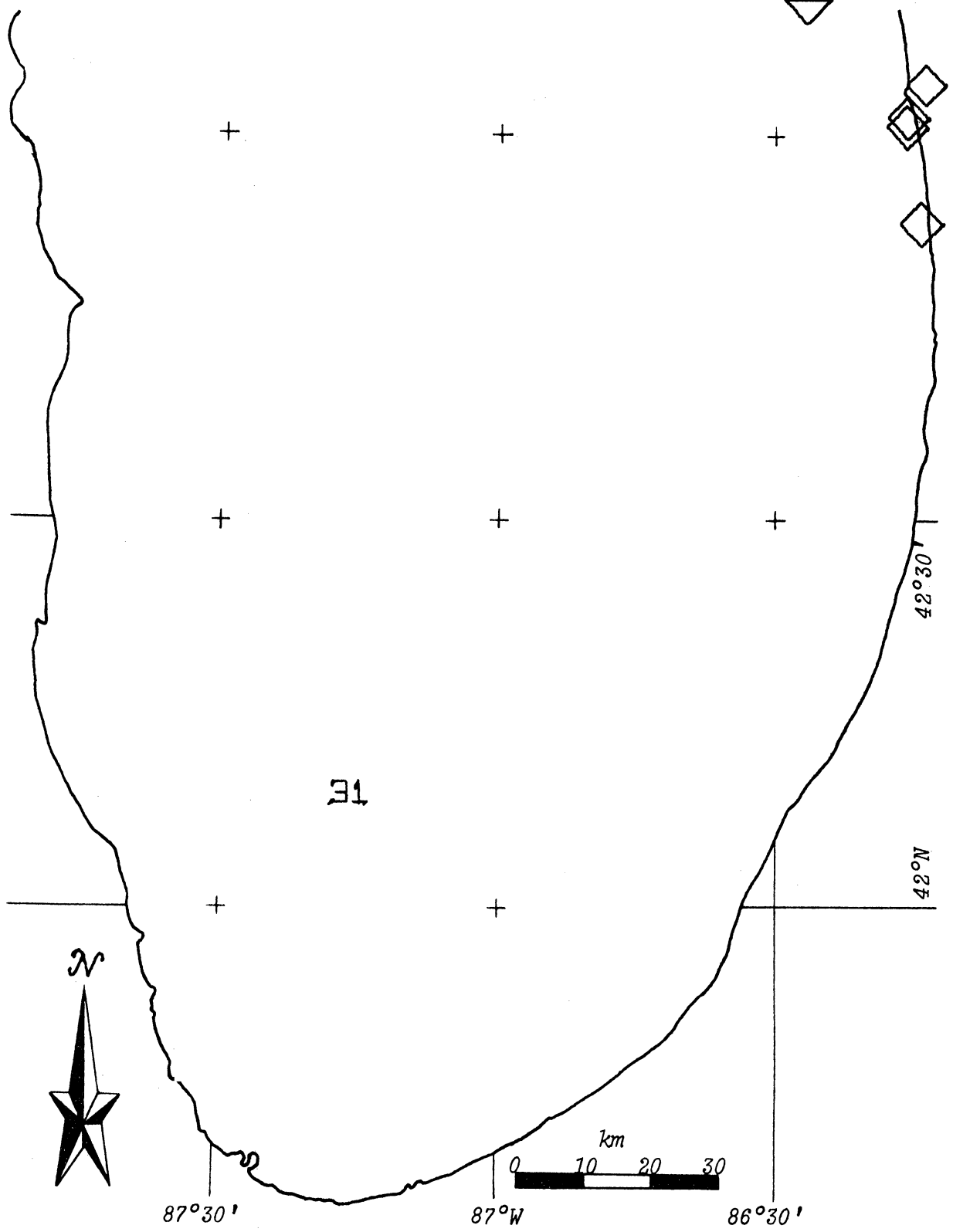

LAKE MICHIGAN

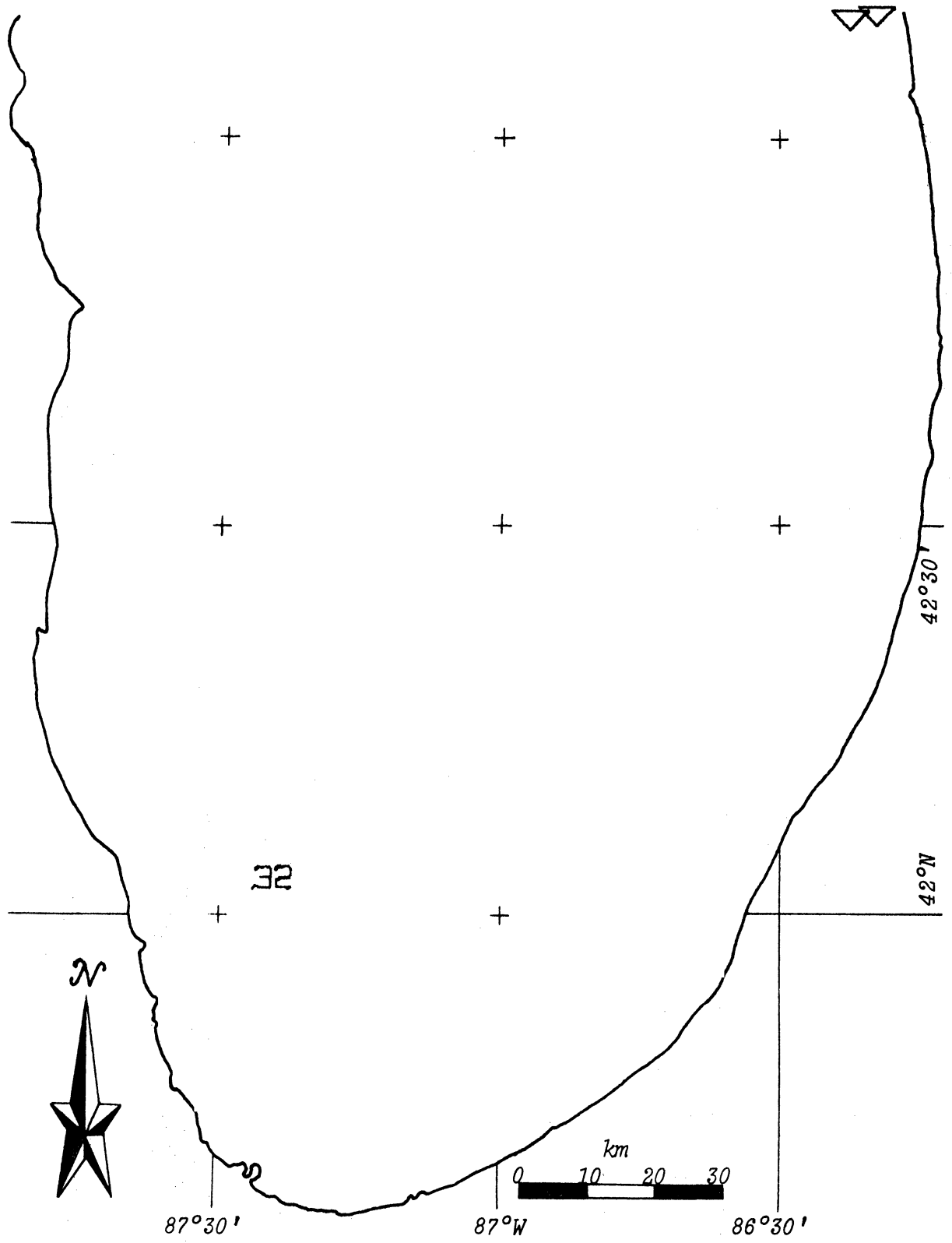

LAKE MICHIGAN

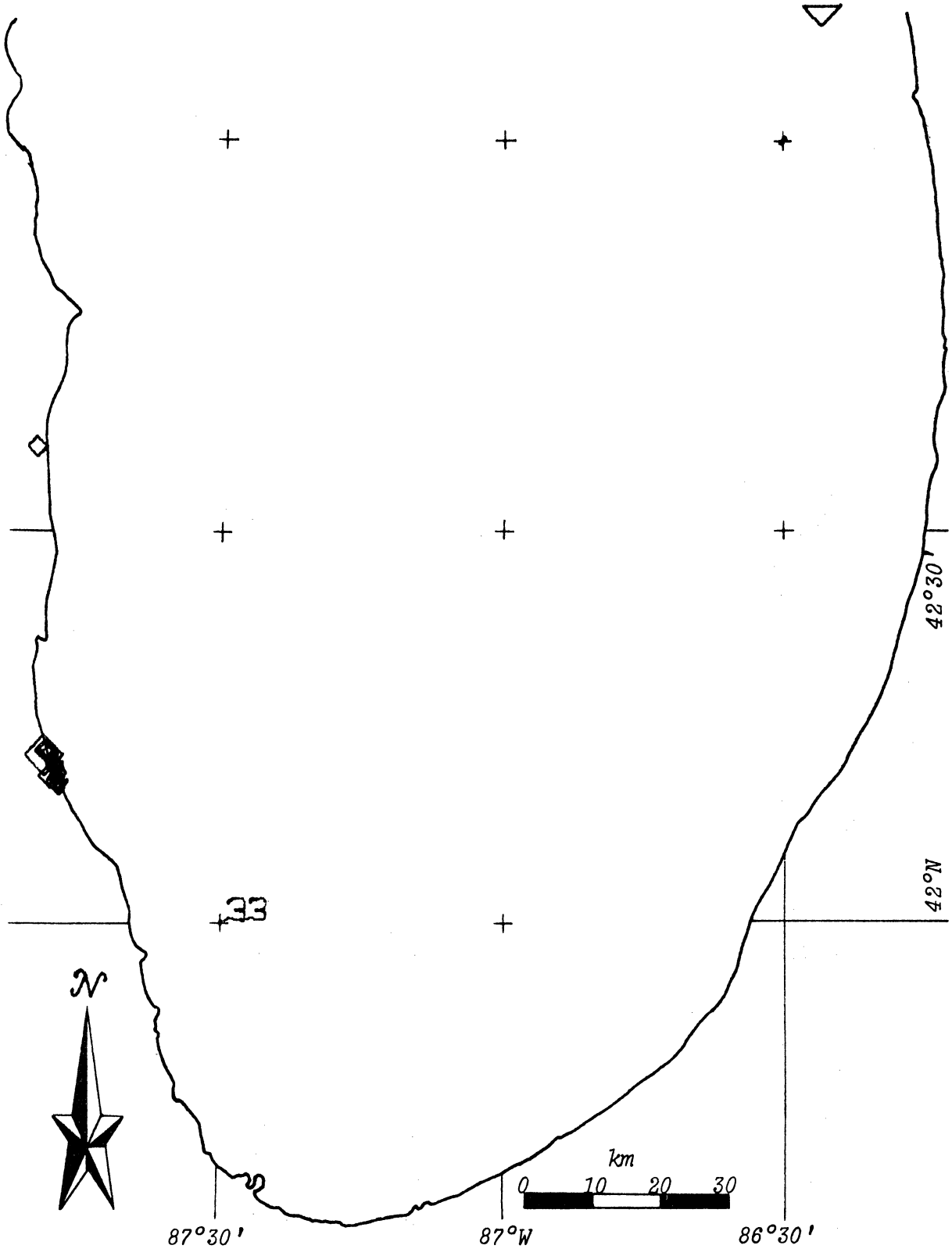



LAKE MICHIGAN

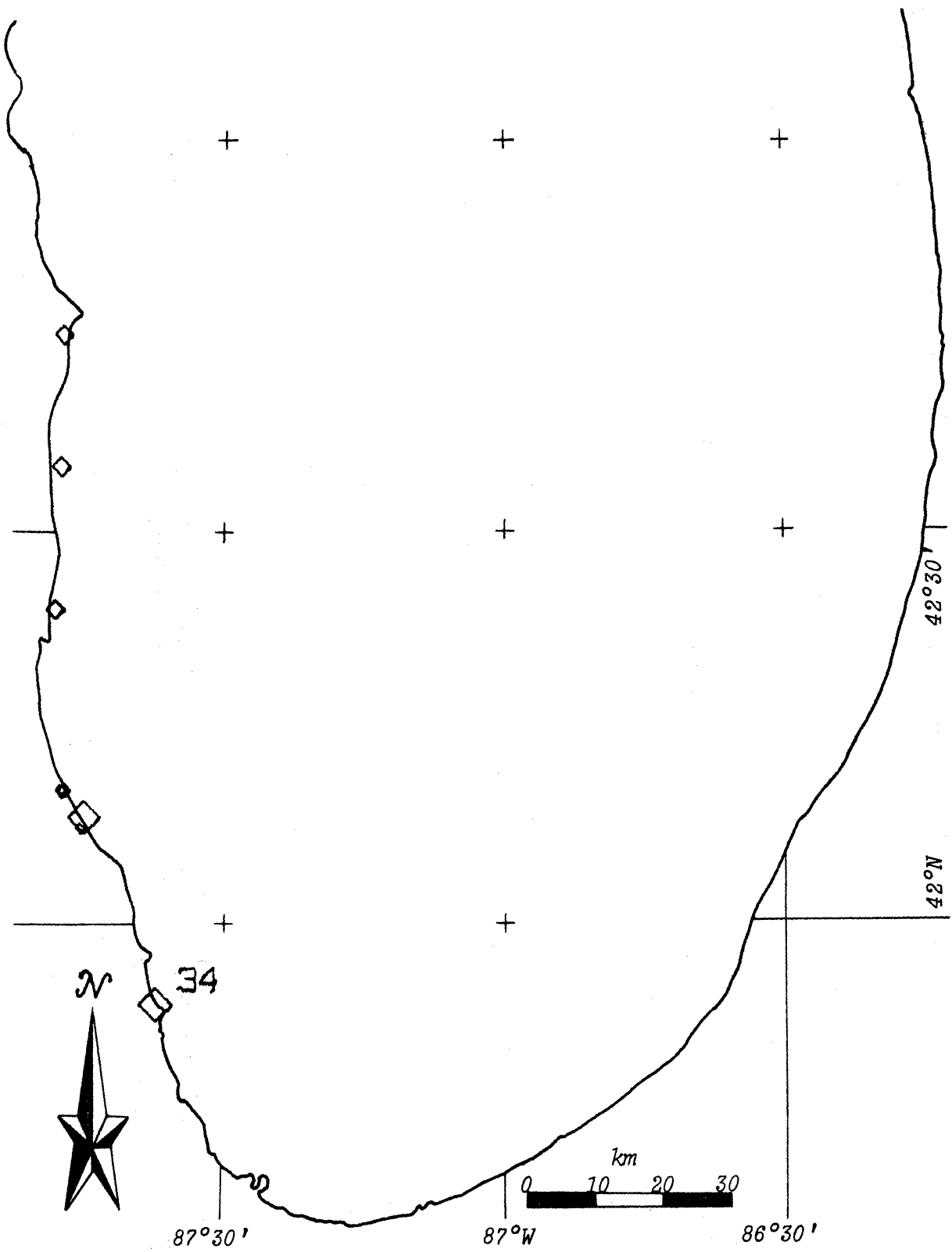

LAKE MICHIGAN

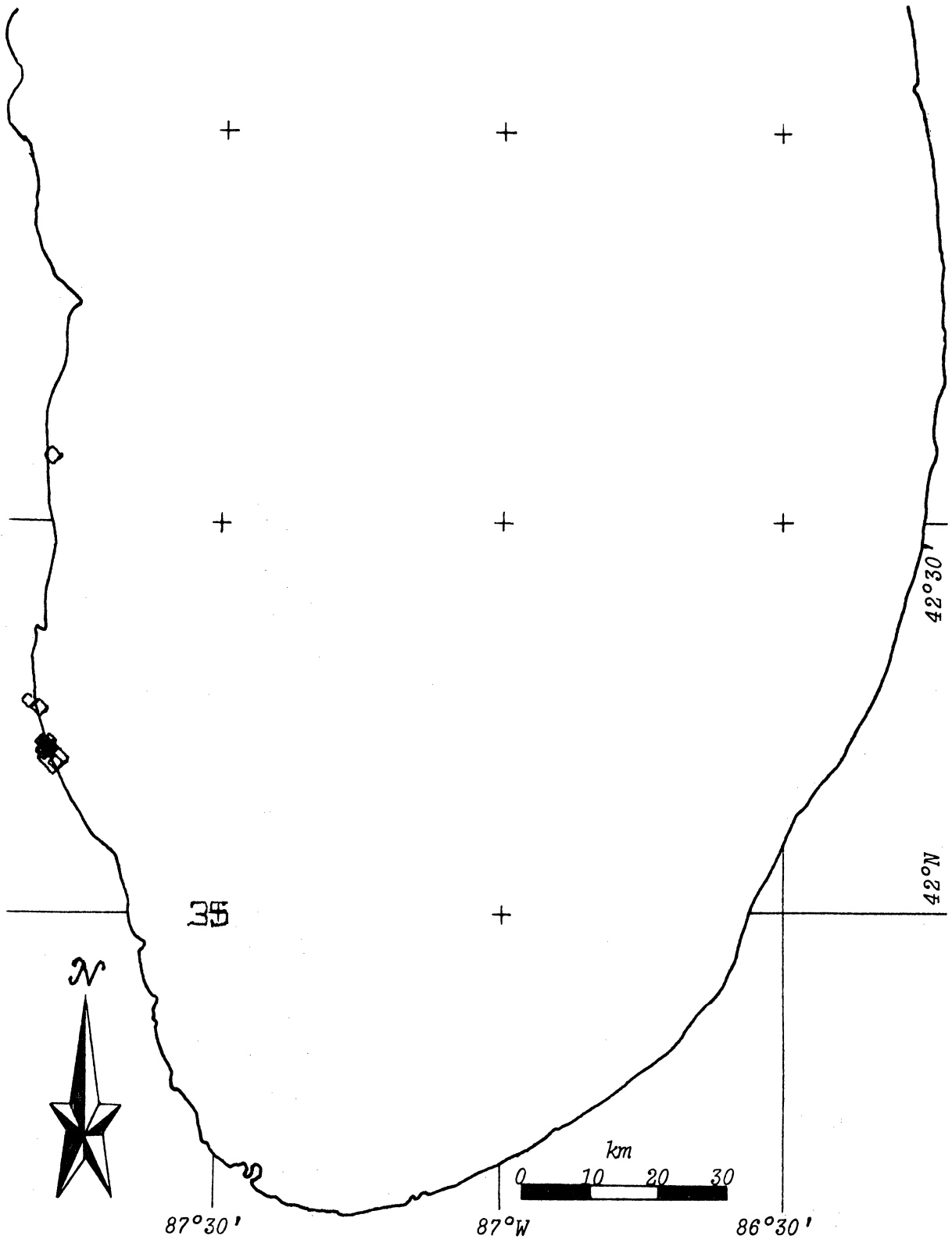

LAKE MICHIGAN

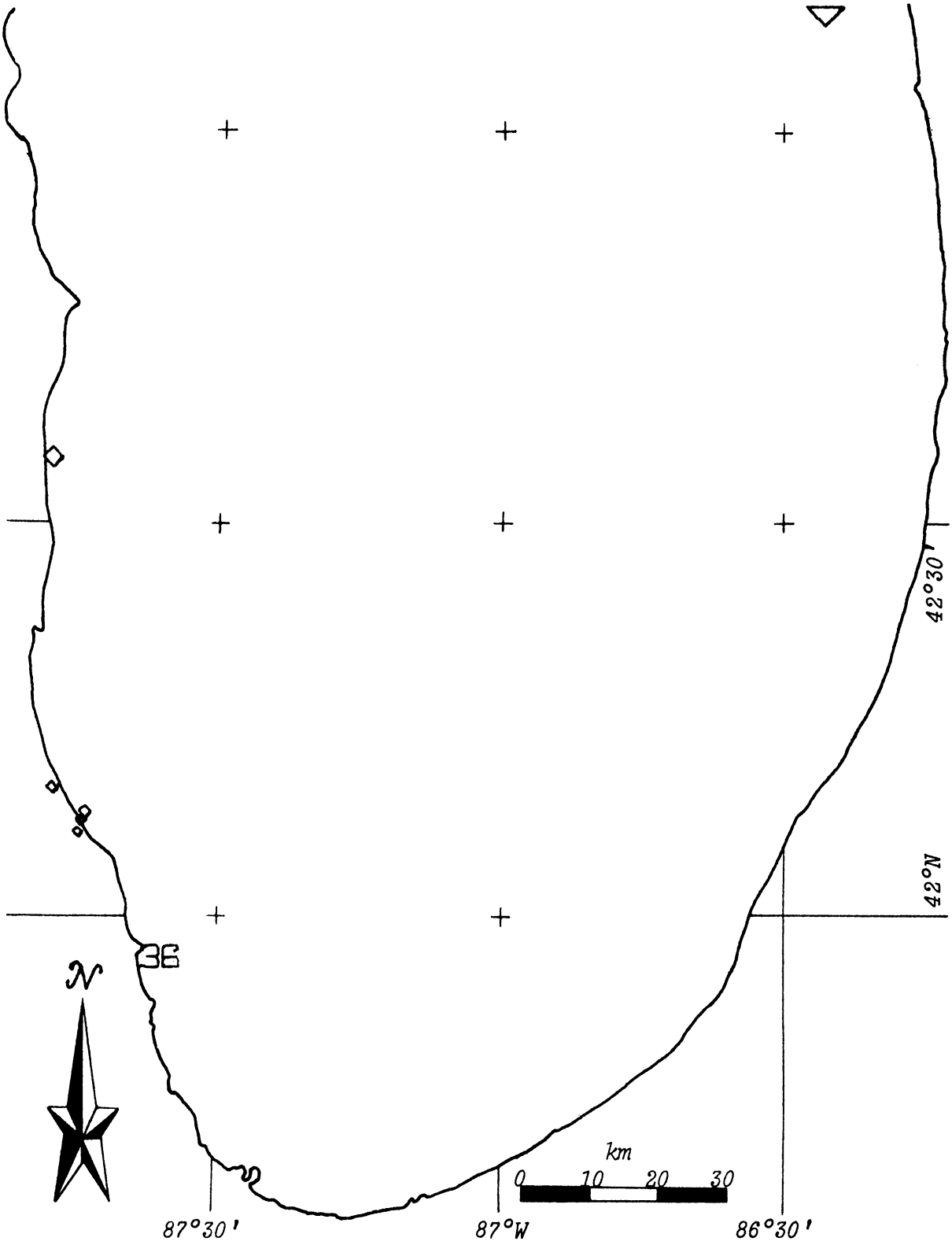

LAKE MICHIGAN

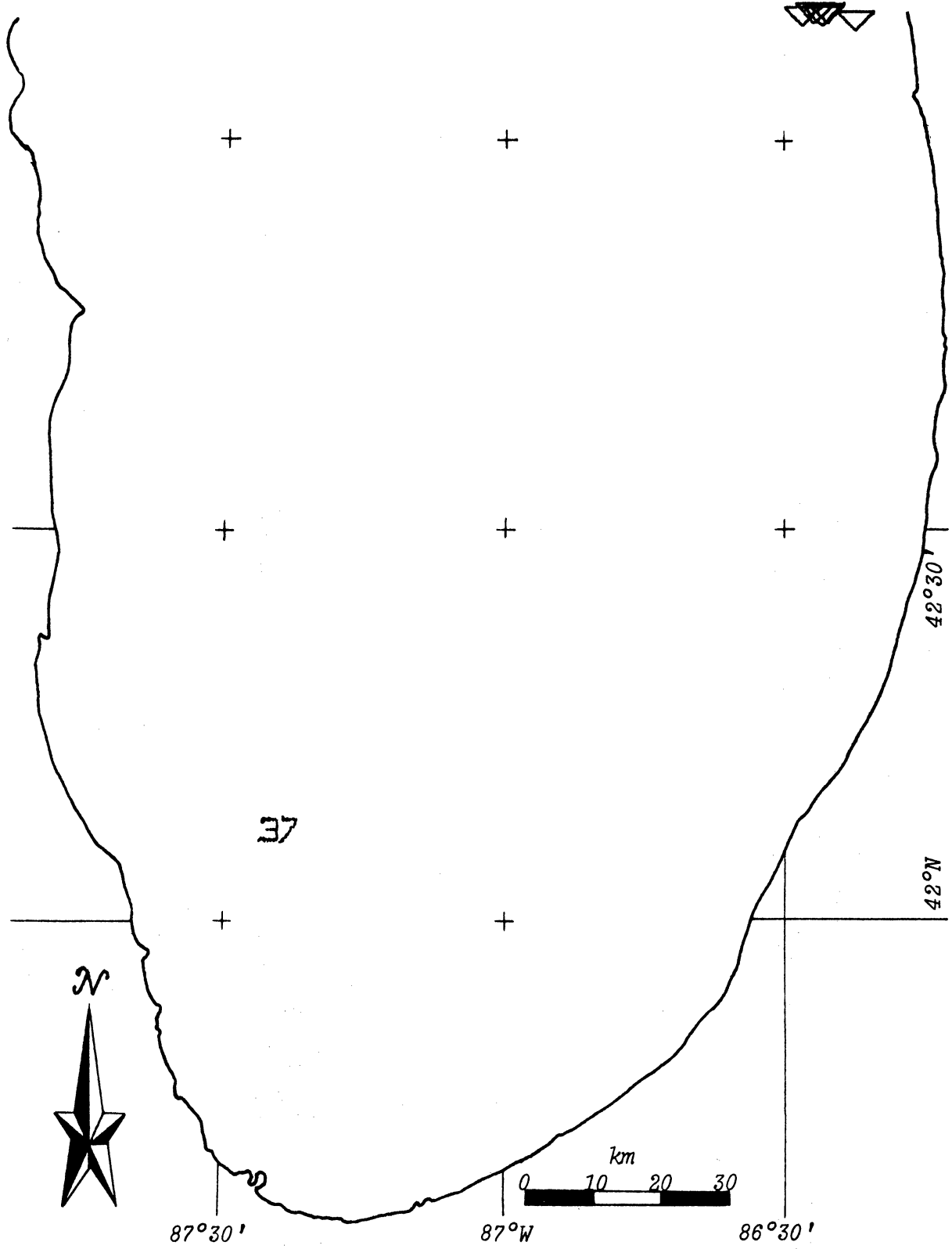

LAKE MICHIGAN

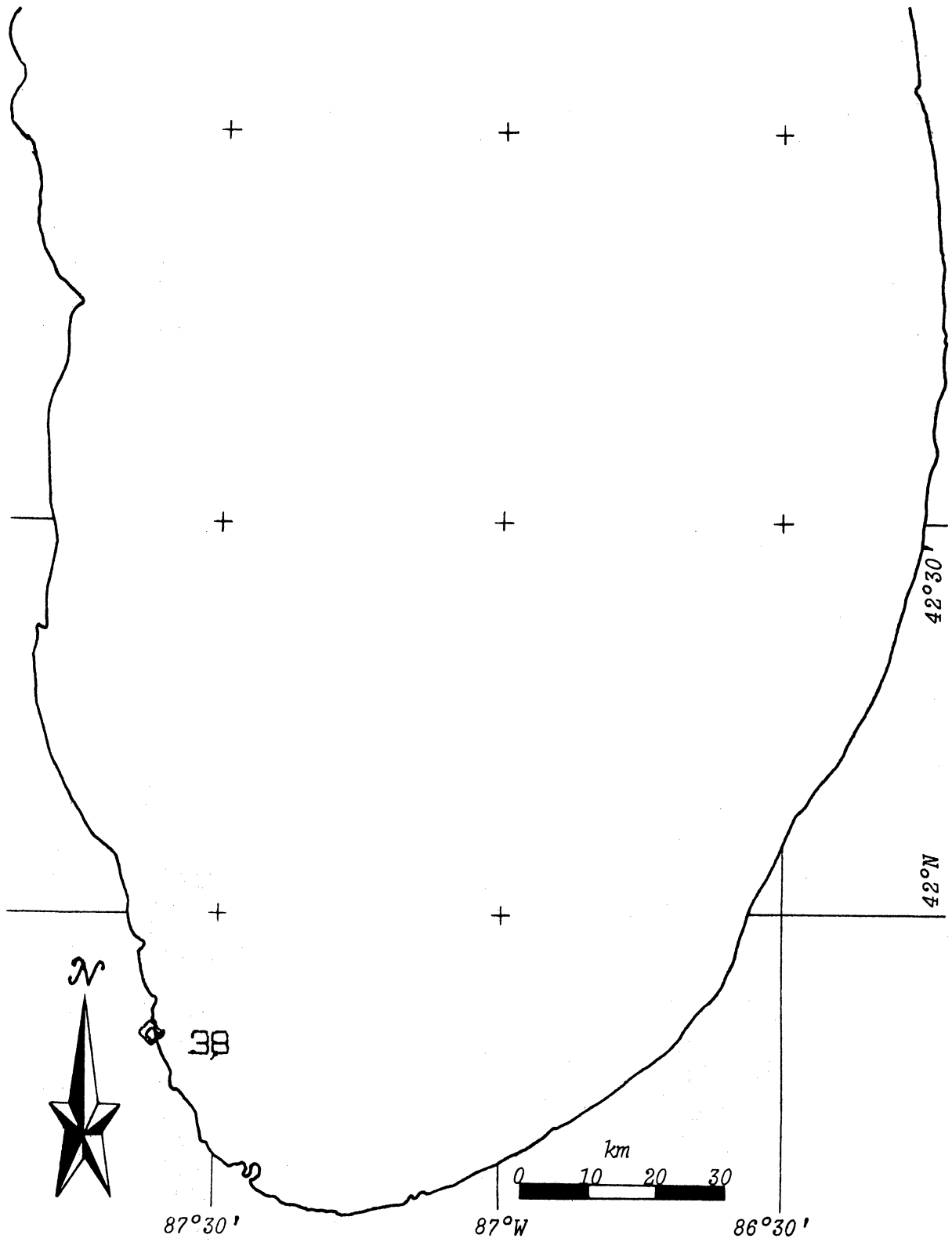

LAKE MICHIGAN

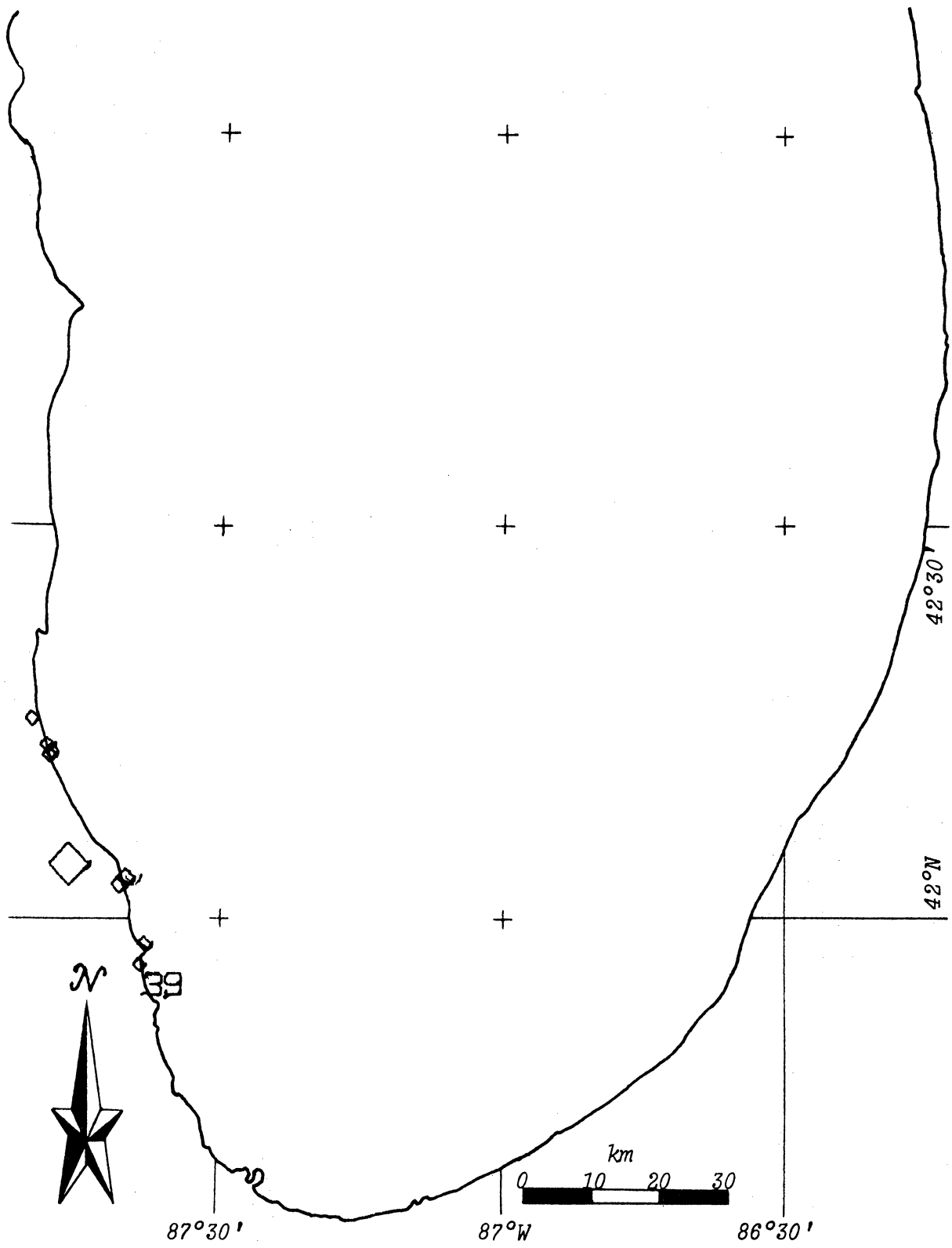

LAKE MICHIGAN

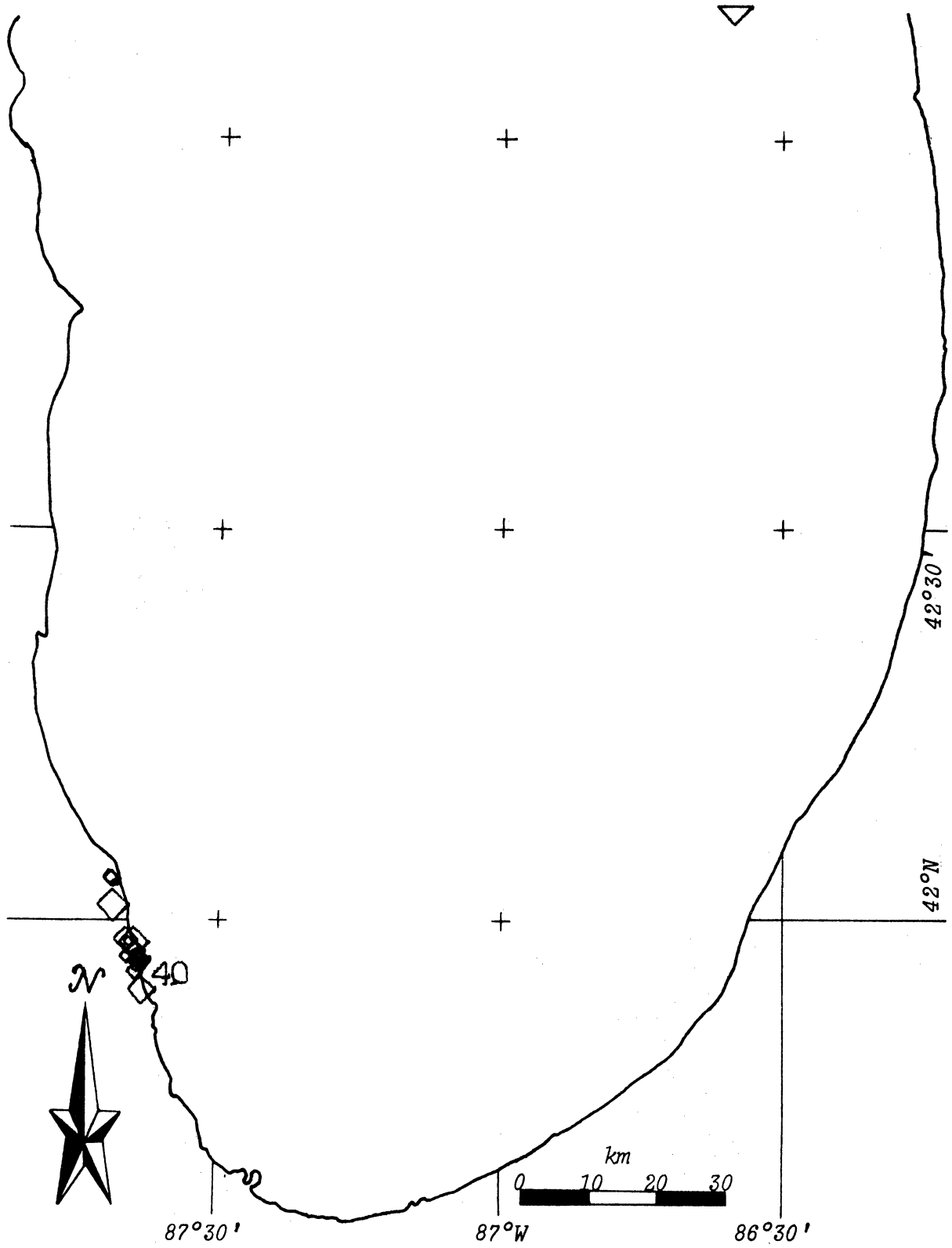

LAKE MICHIGAN

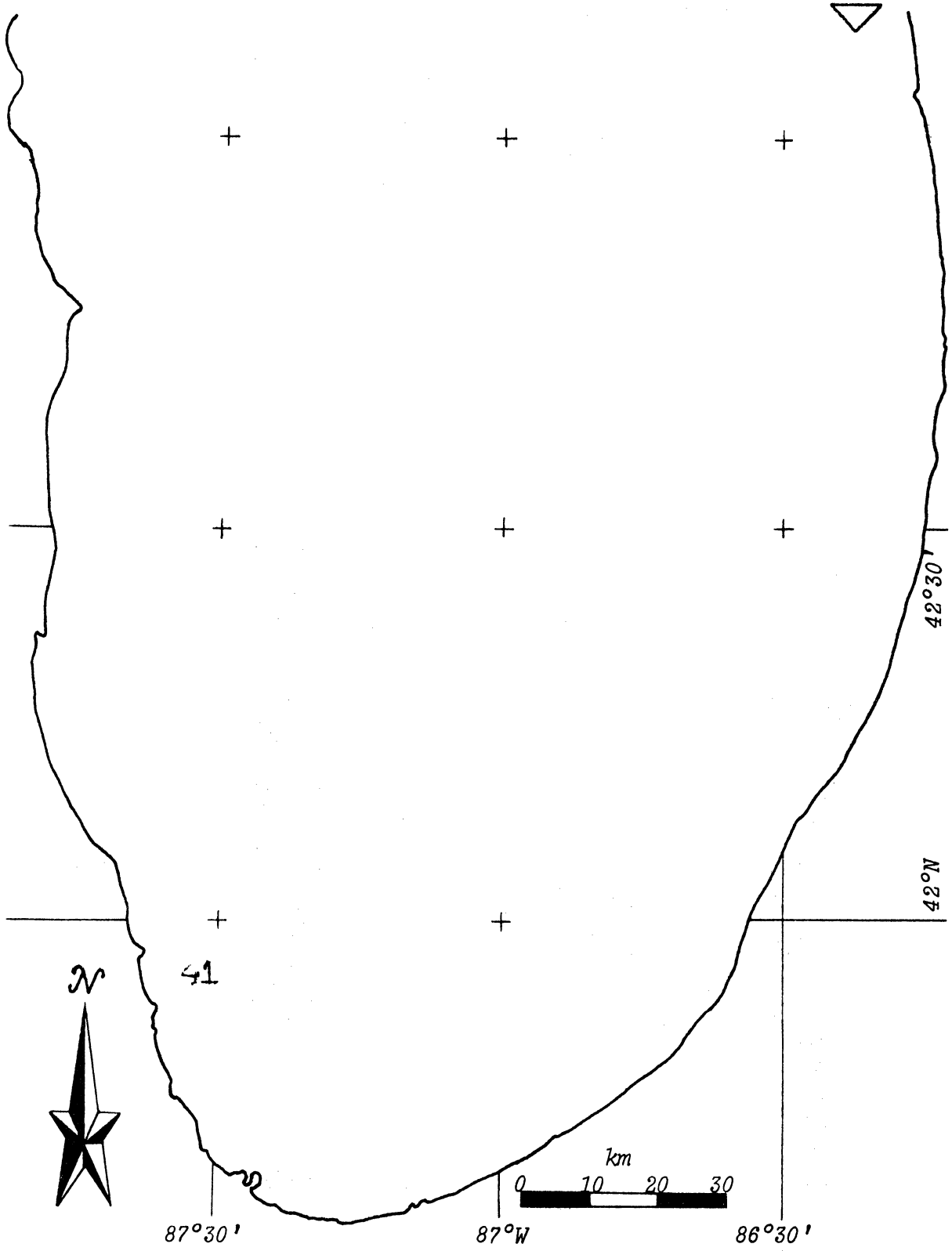



LAKE MICHIGAN

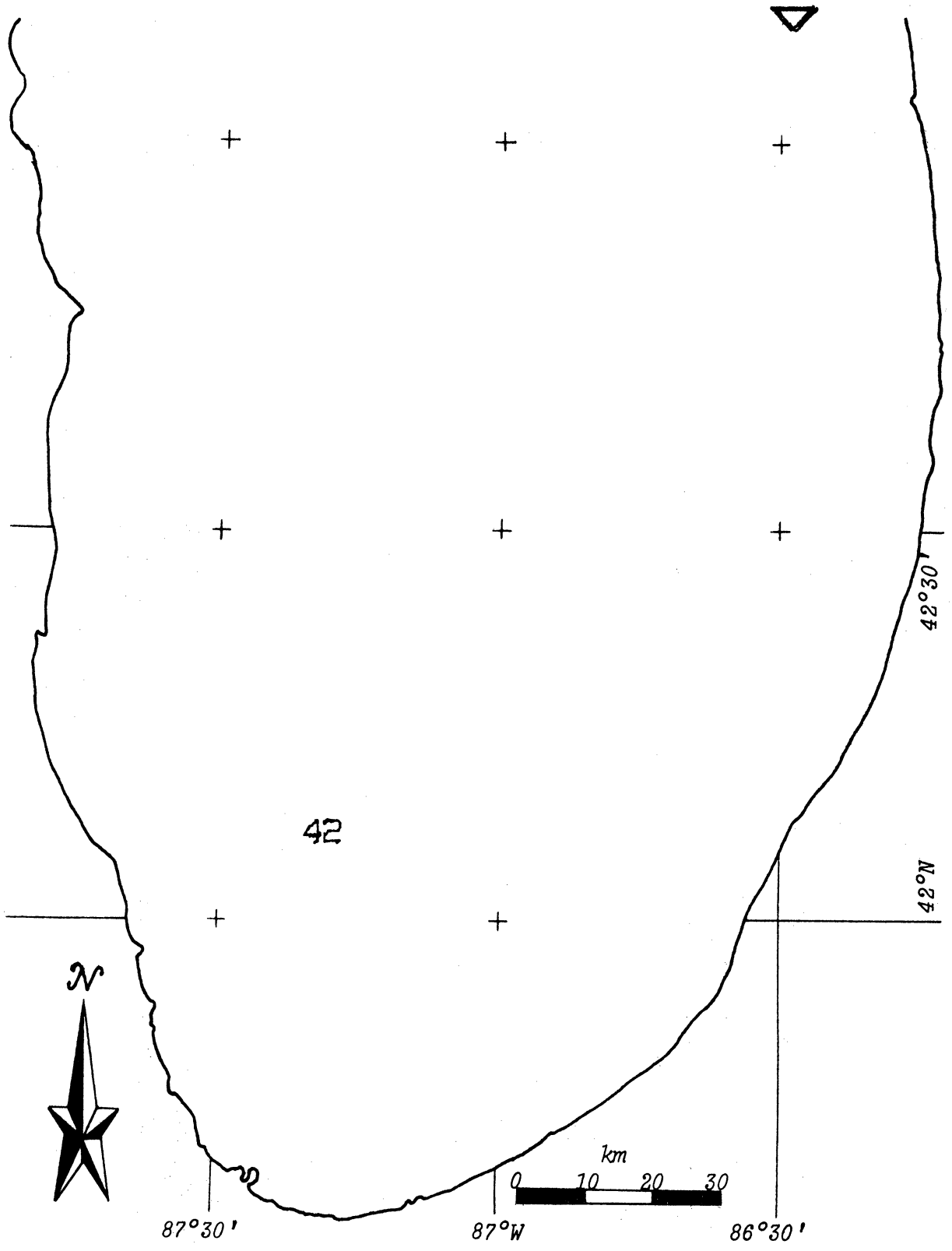

LAKE MICHIGAN

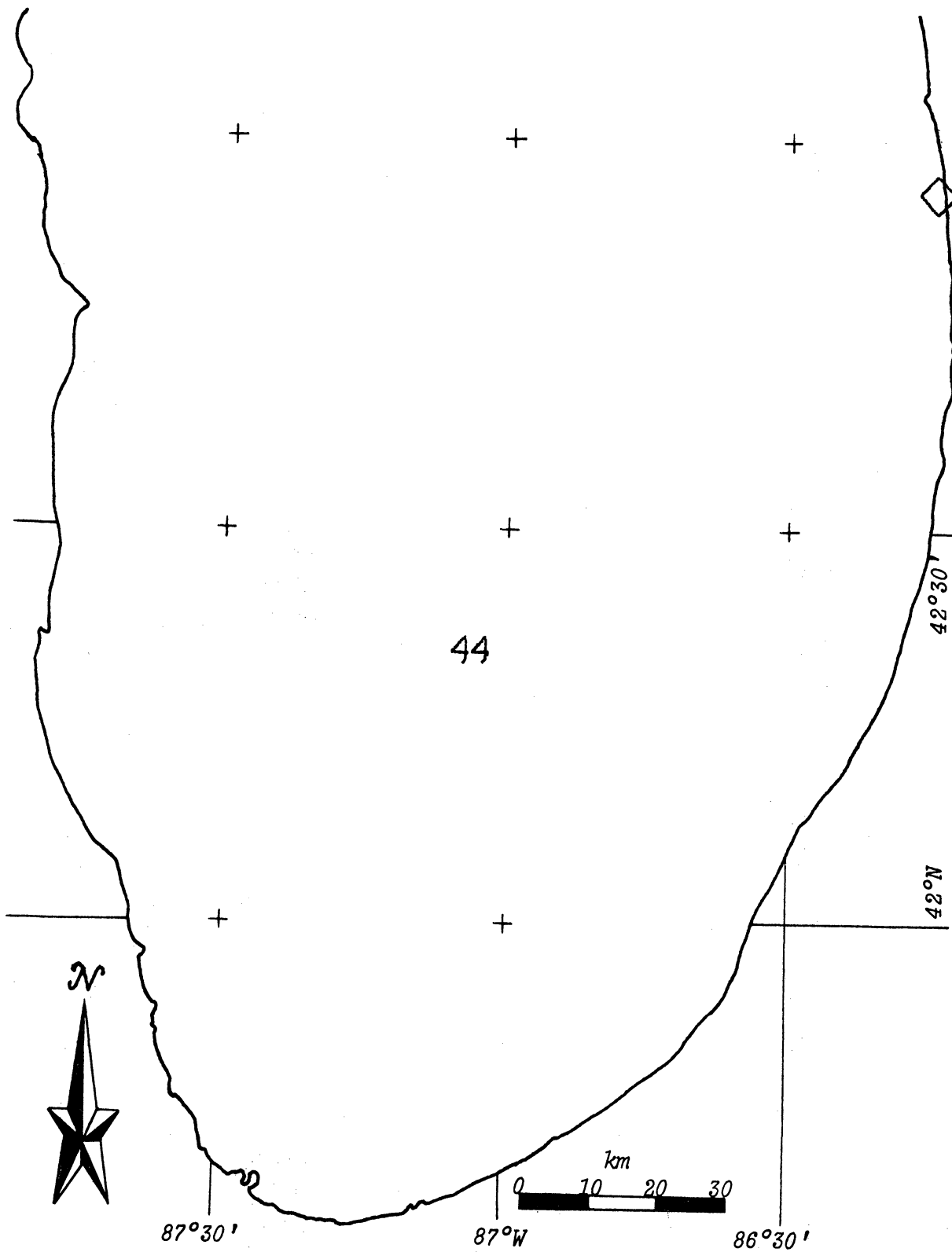

LAKE MICHIGAN

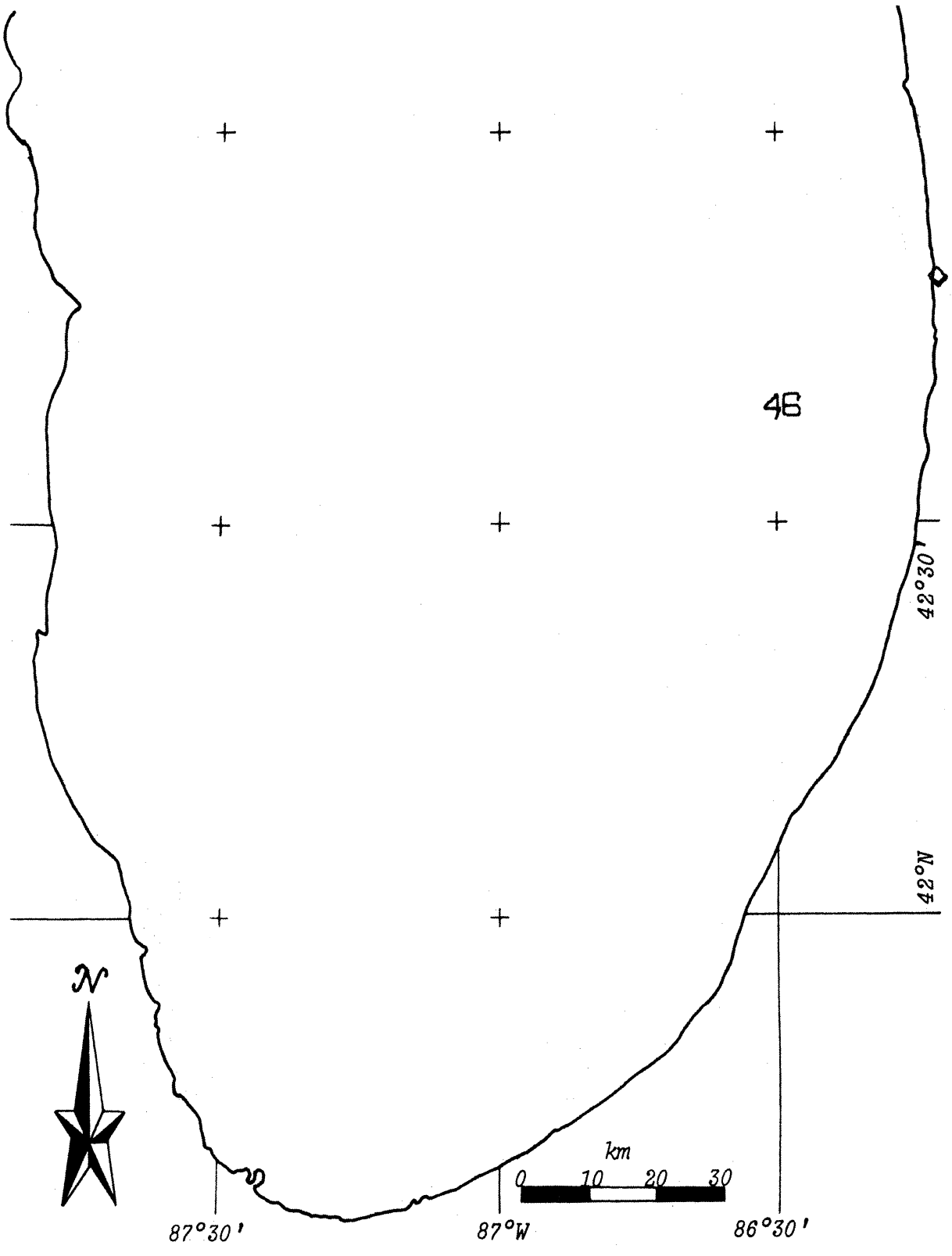

LAKE MICHIGAN

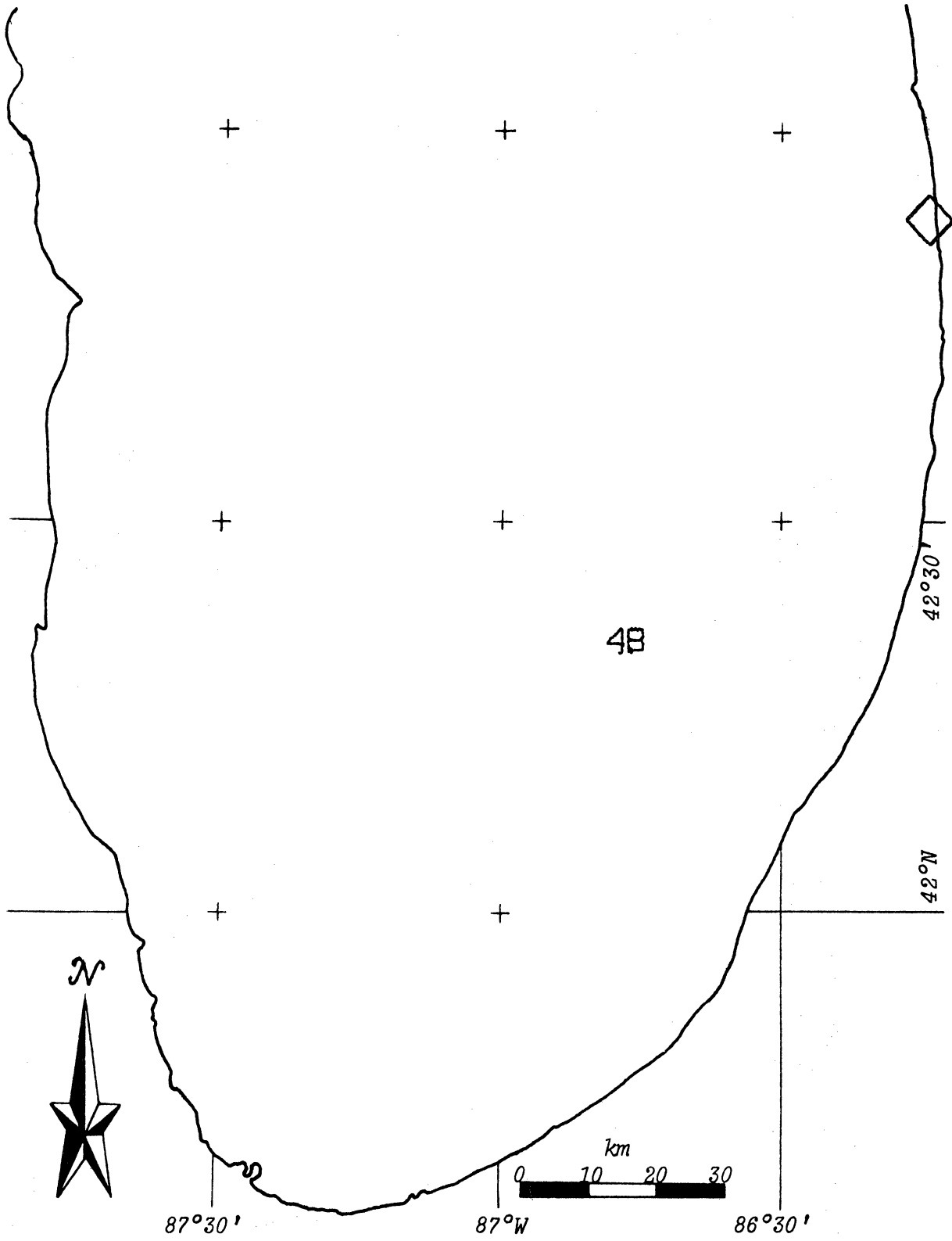

LAKE MICHIGAN

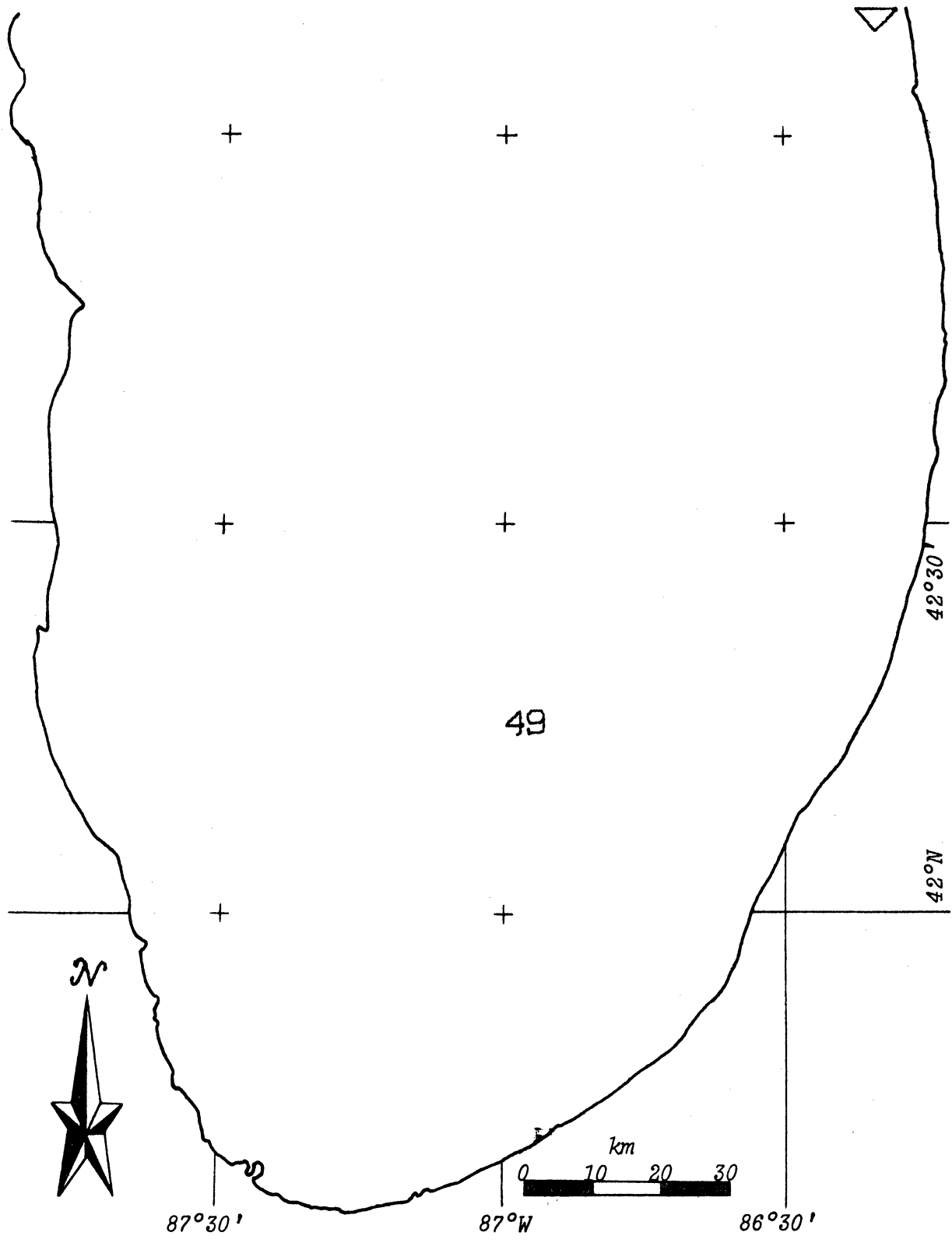

LAKE MICHIGAN

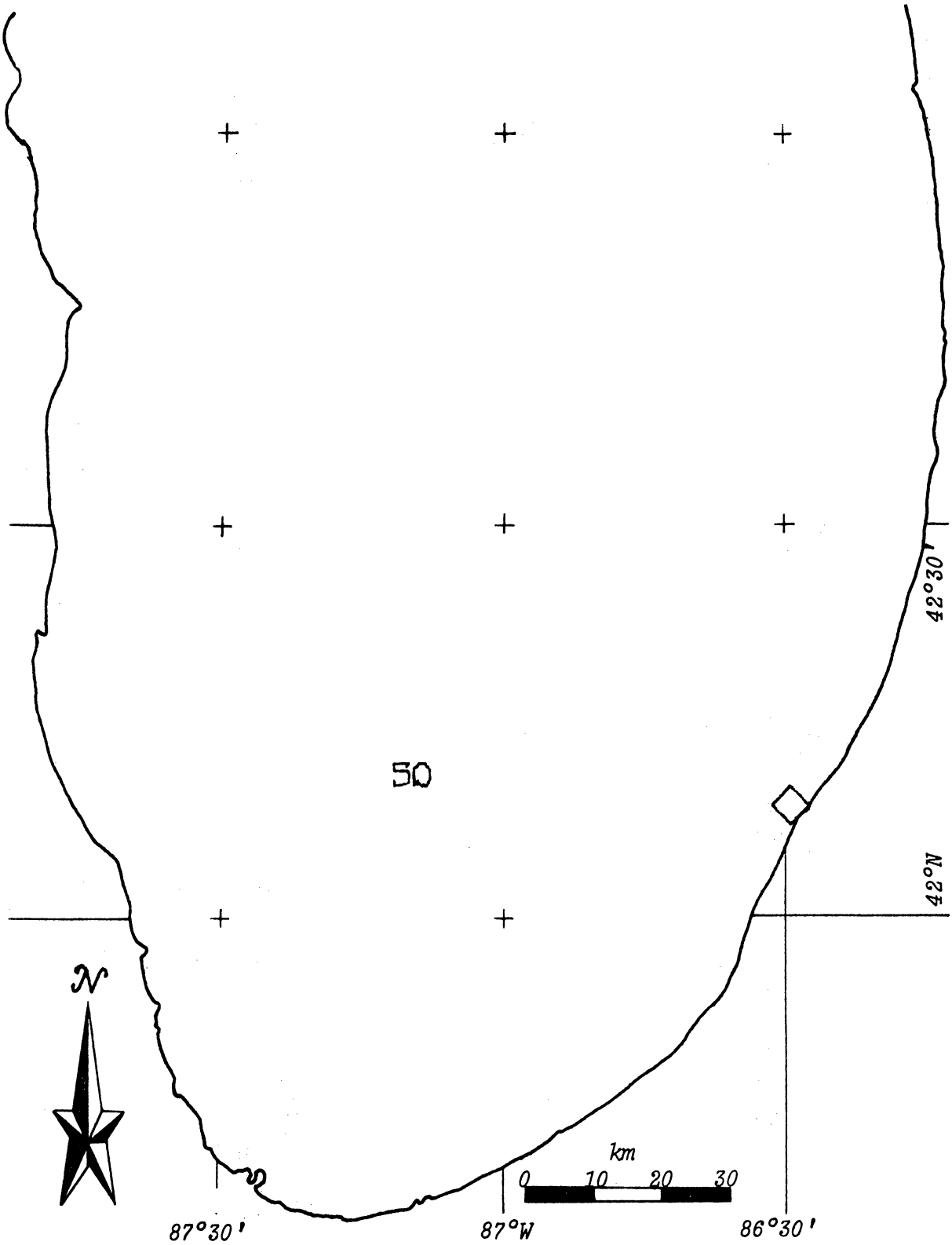

LAKE MICHIGAN

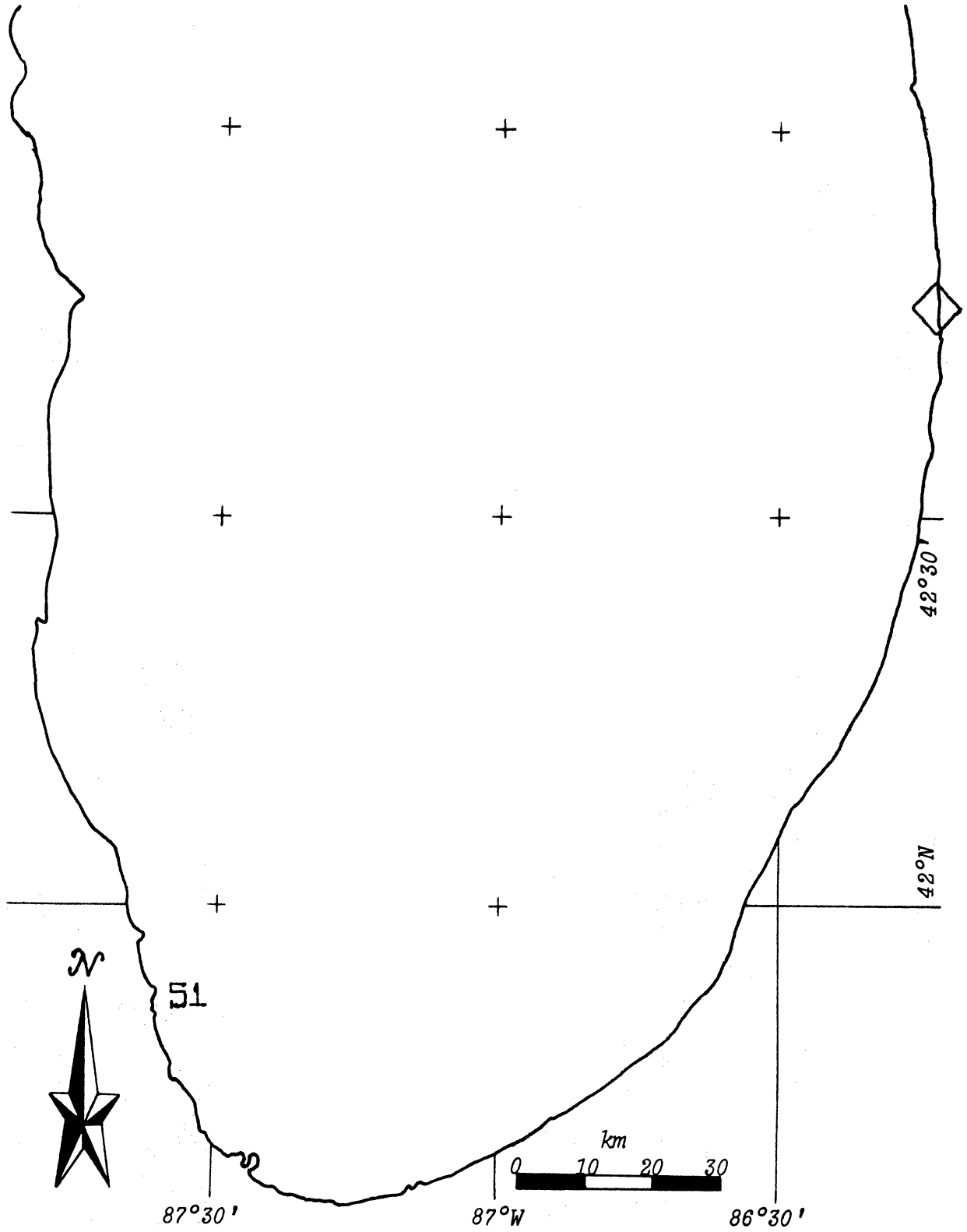

LAKE MICHIGAN

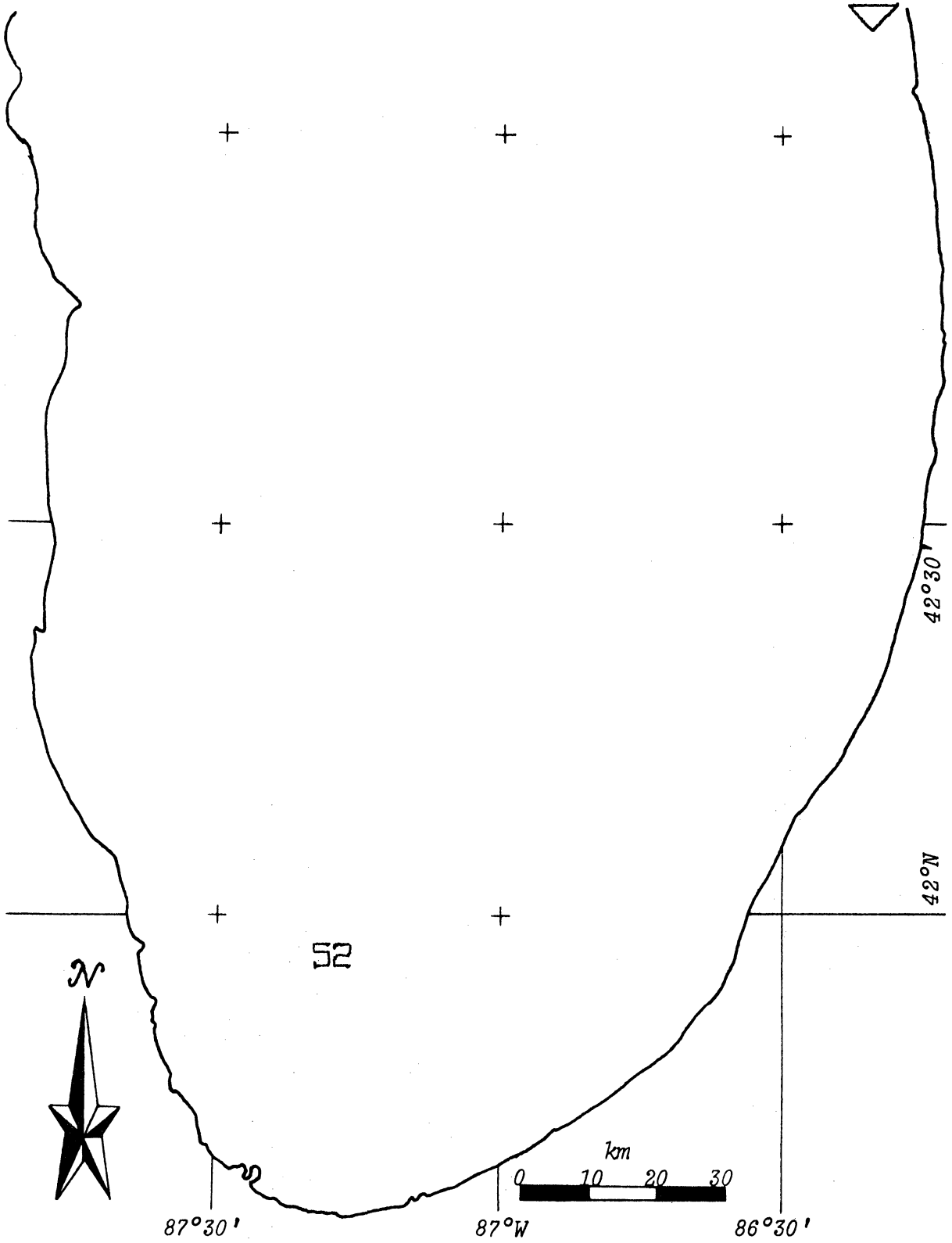



LAKE MICHIGAN

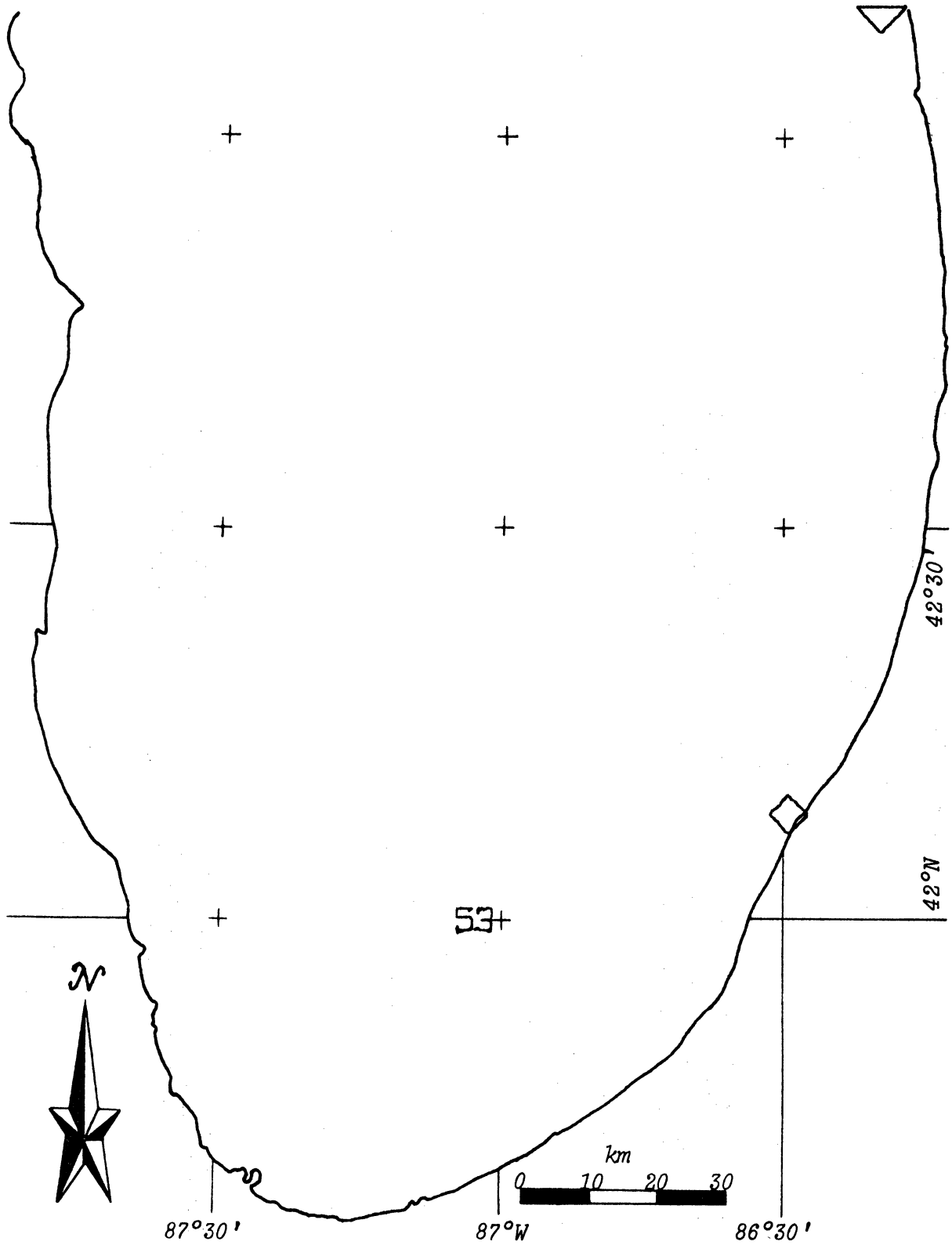

LAKE MICHIGAN

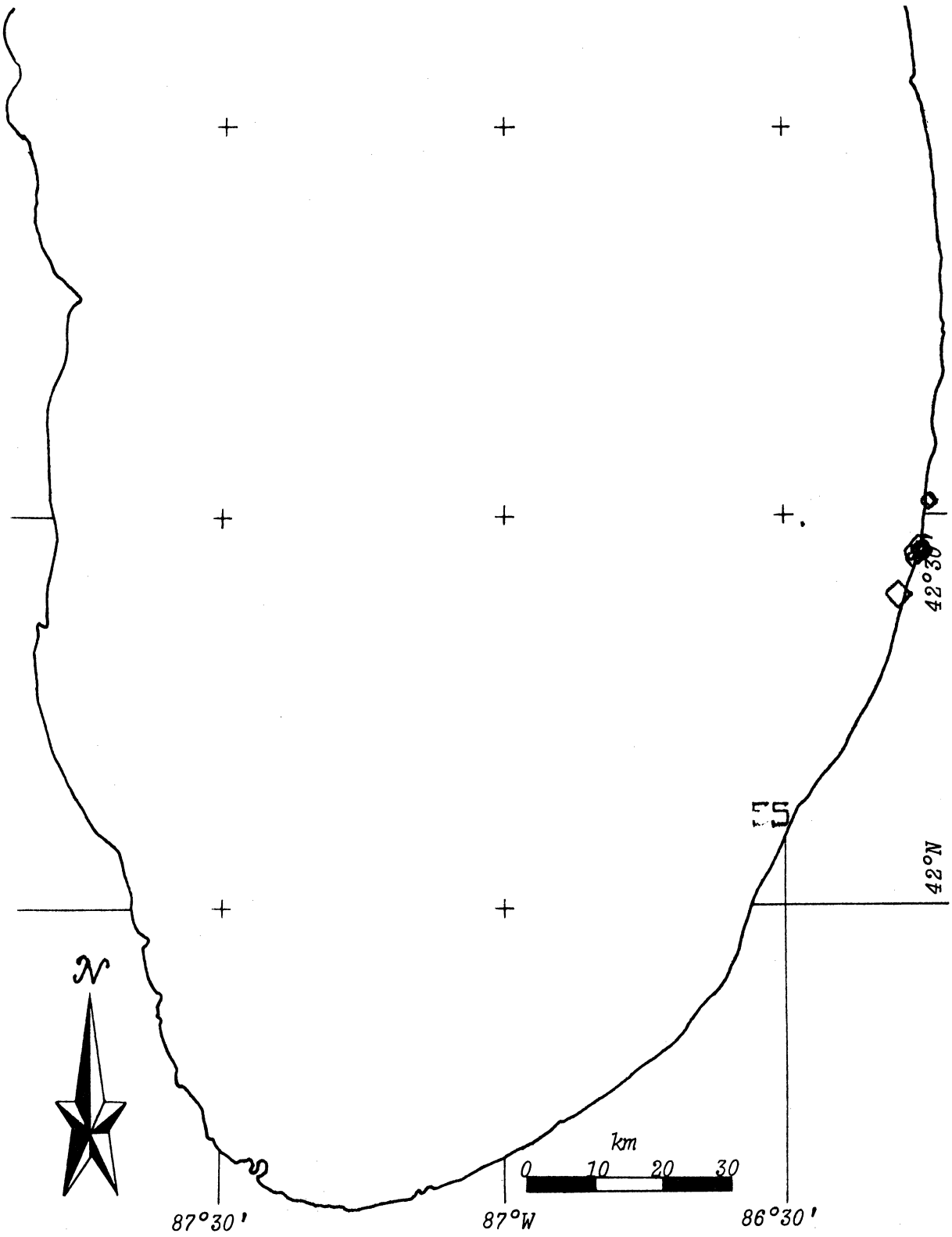

LAKE MICHIGAN

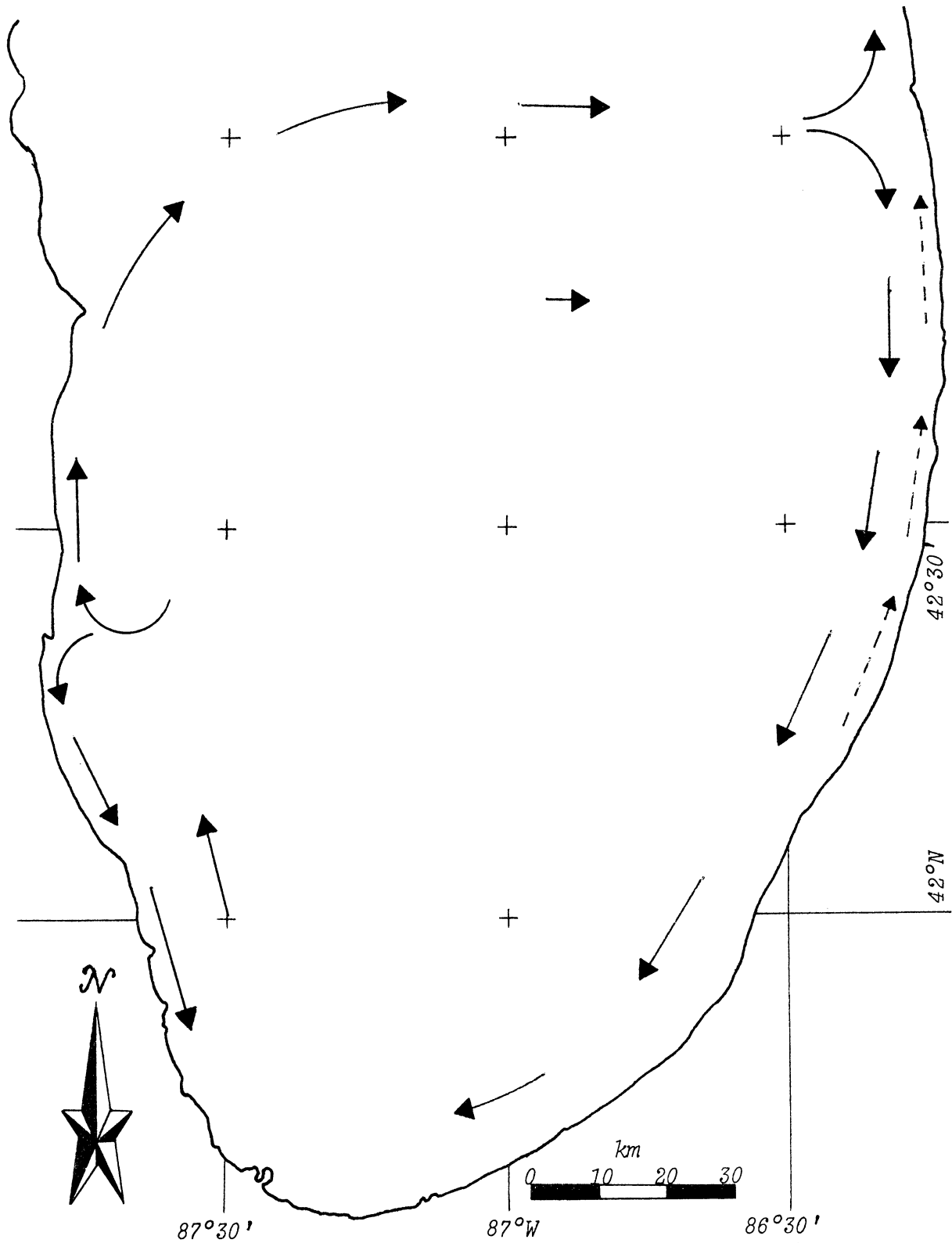

Figure 31: Summary of conjecture for July surface currents inferred from drifter returns.

LAKE MICHIGAN

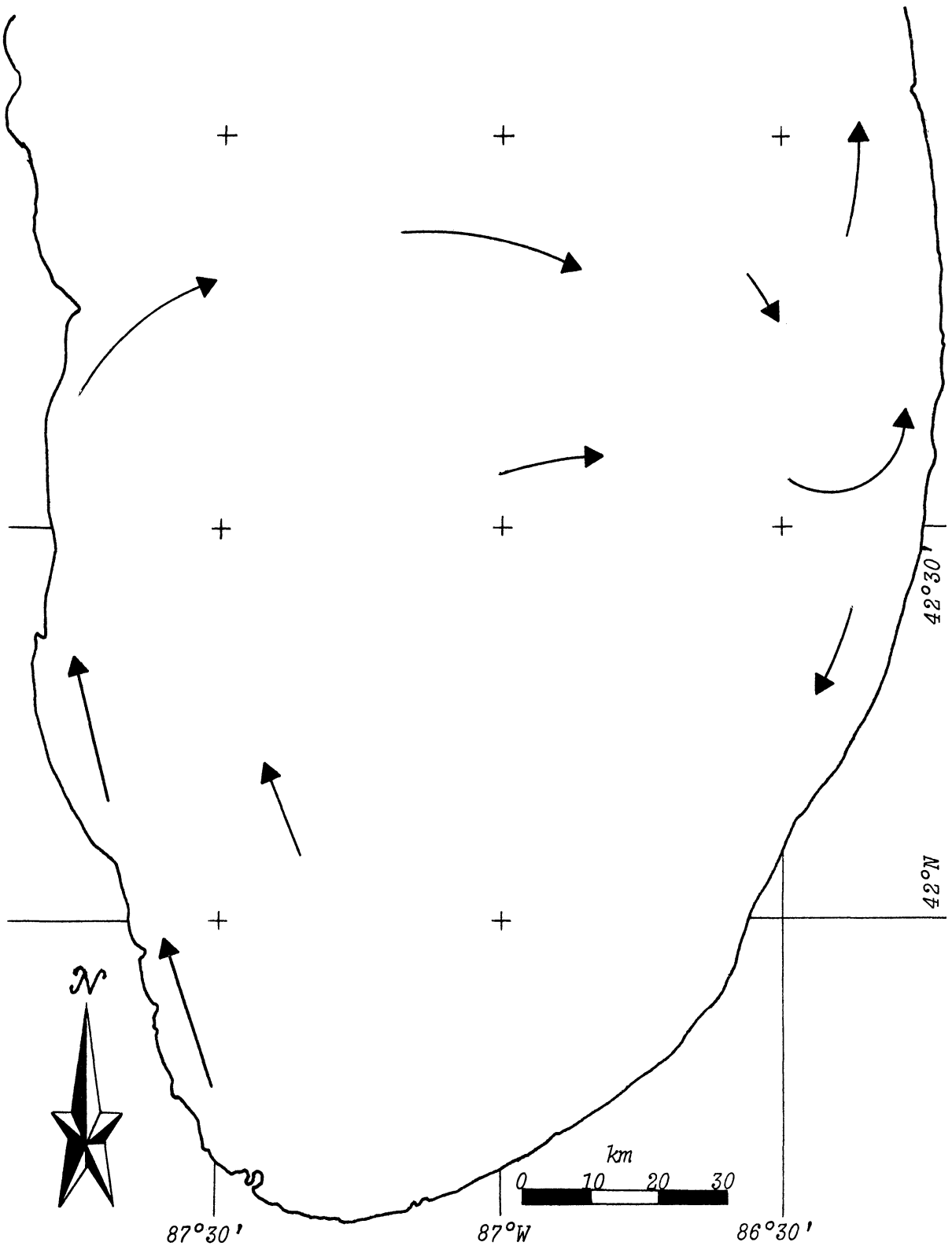

Figure 32: Summary of conjecture for August surface currents inferred from drifter returns.

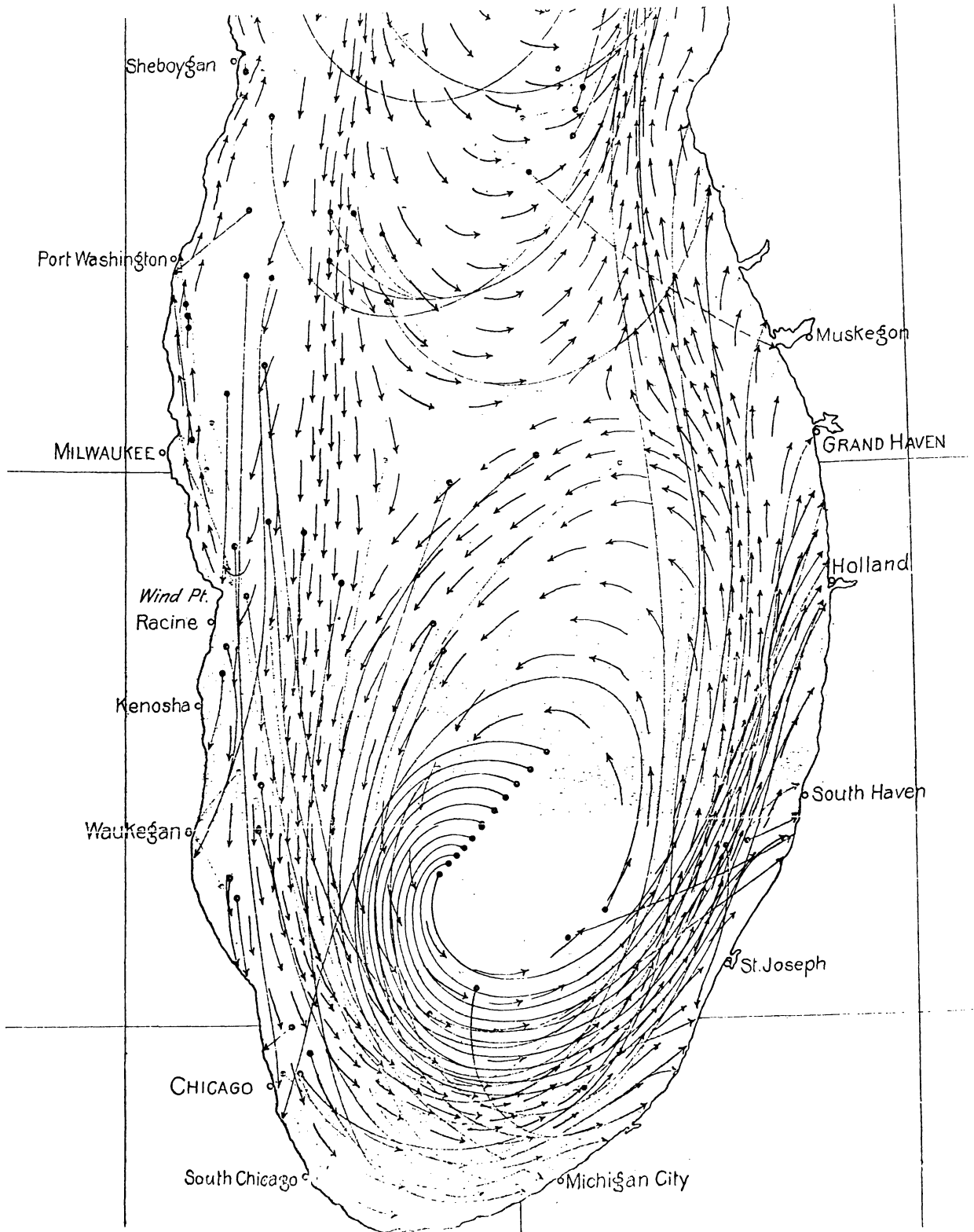

Figure 33: Currents inferred by Harrington (1895) from drift bottle returns.

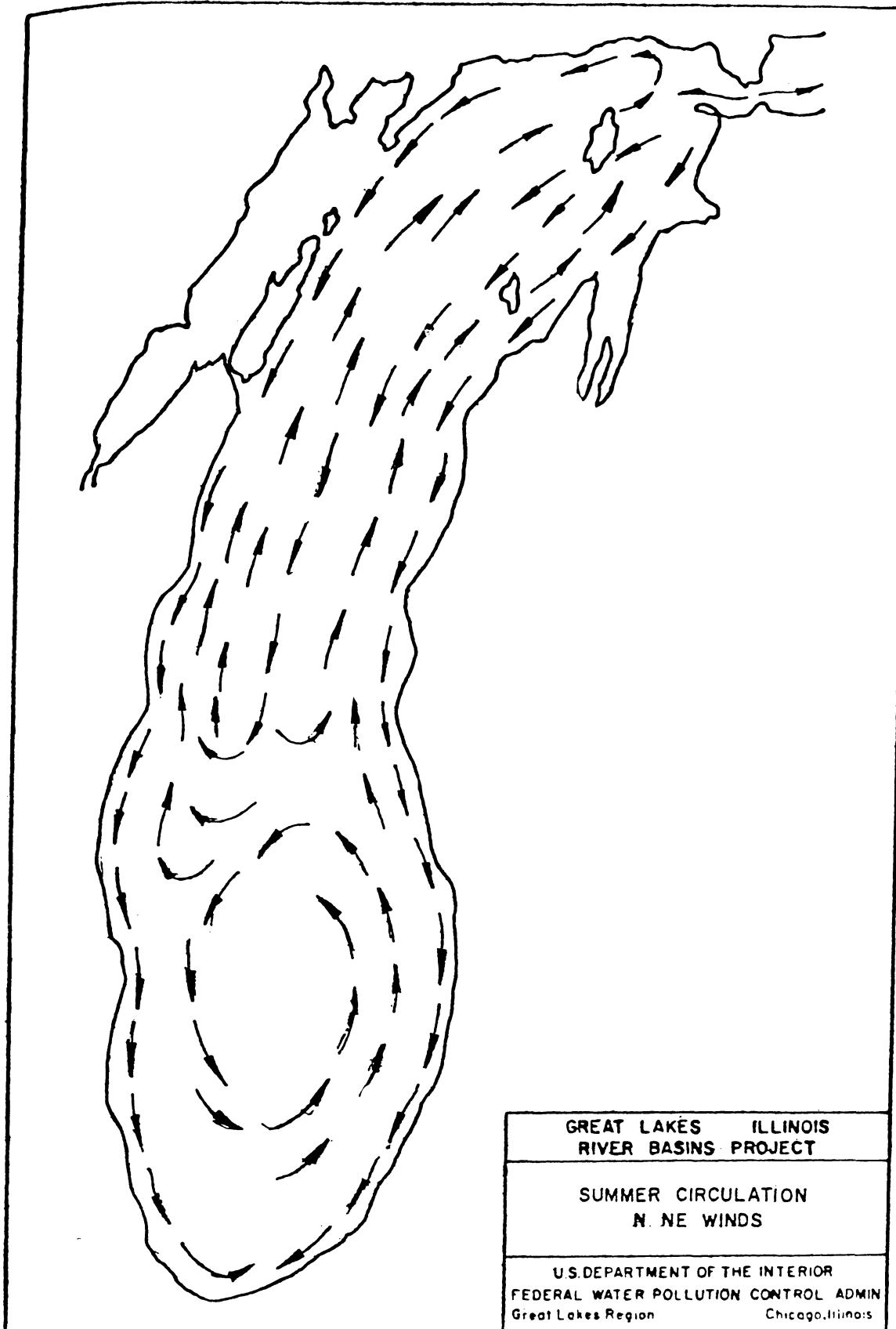

Figure 34 Measurements made by FWPCA (1967).

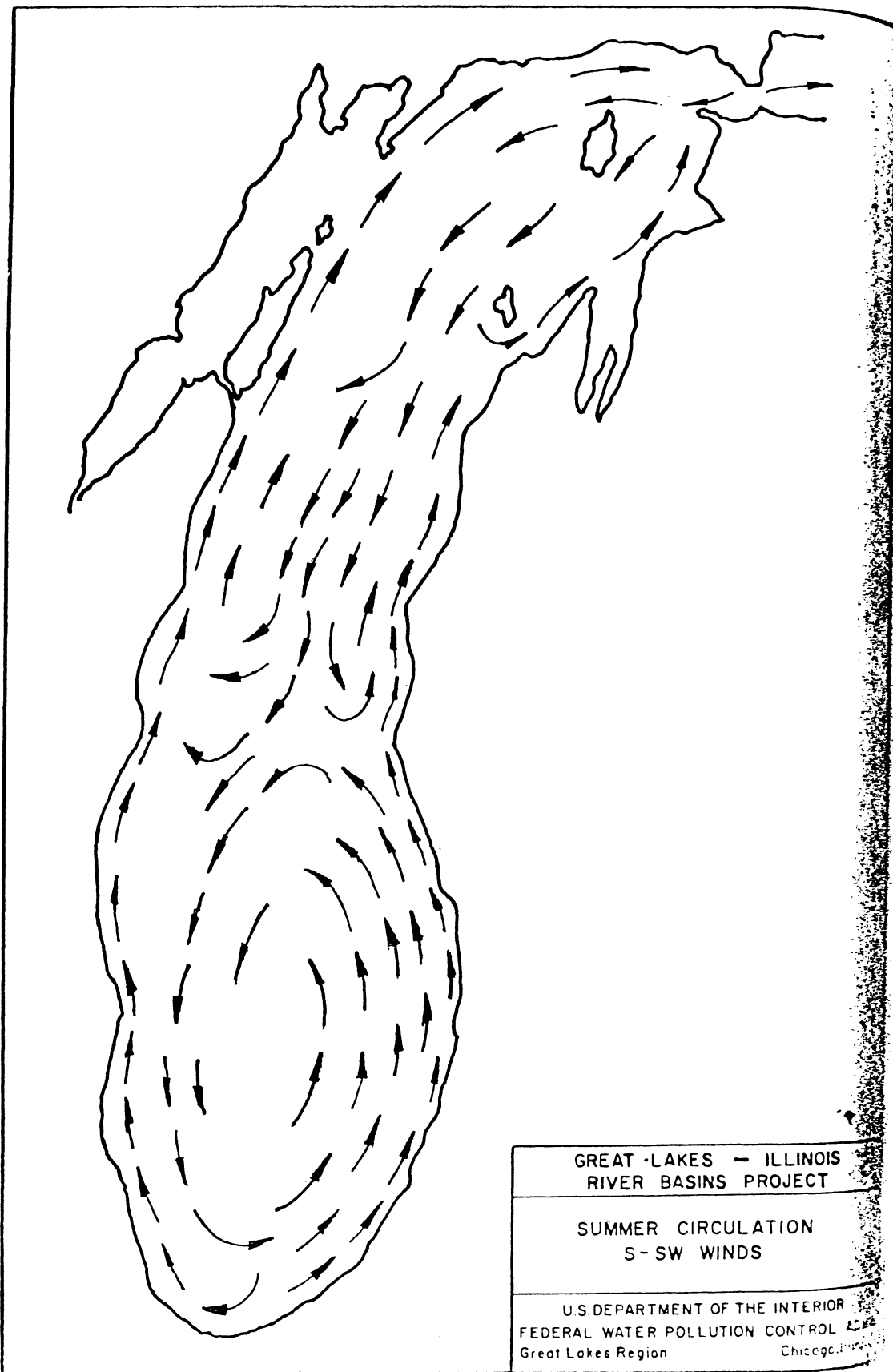

Figure 35 Measurements made by FWPCA (1967)

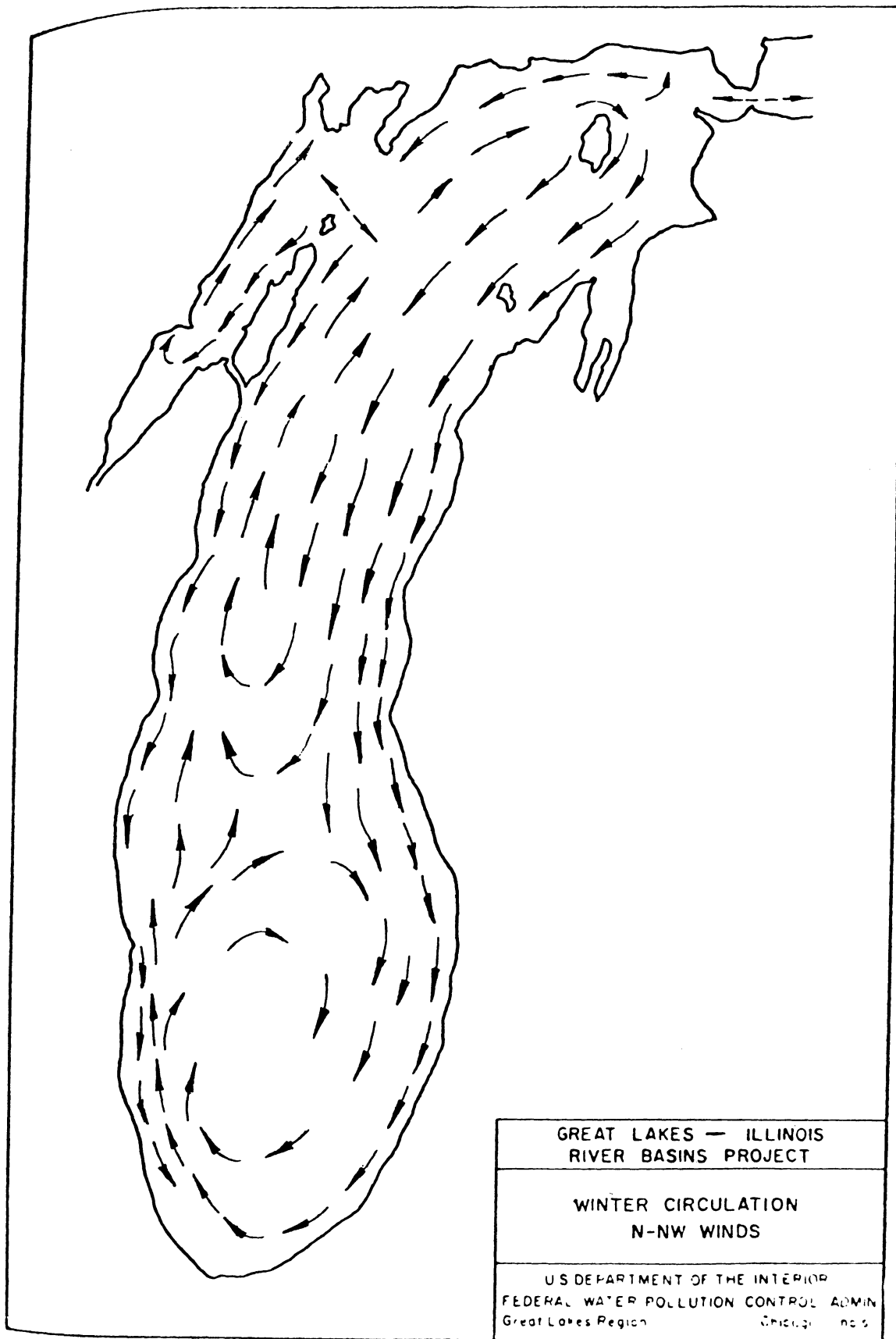

Figure 36 Measurements made by FWPCA (1967).



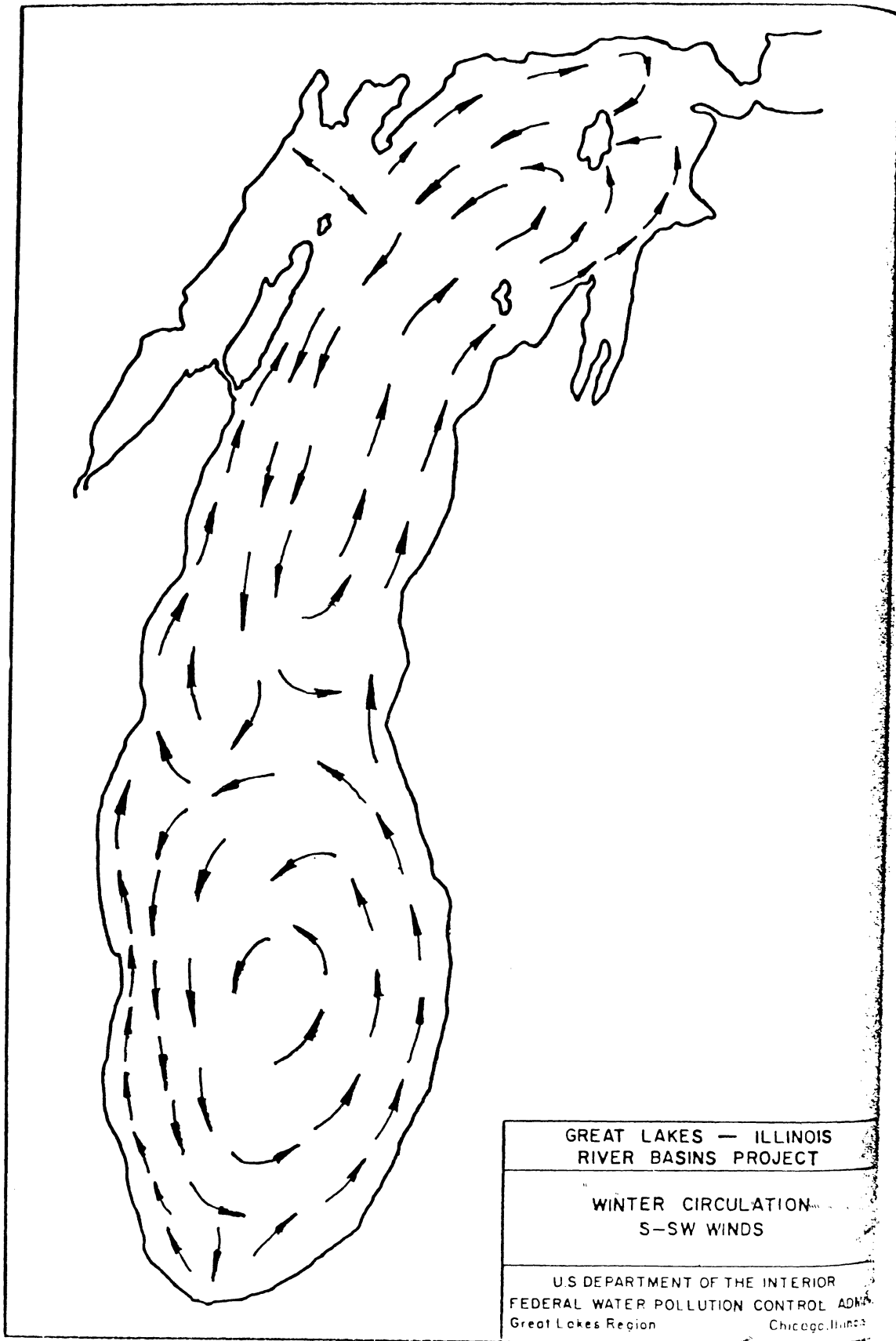

Figure 37 Measurements made by FWPCA (1967).

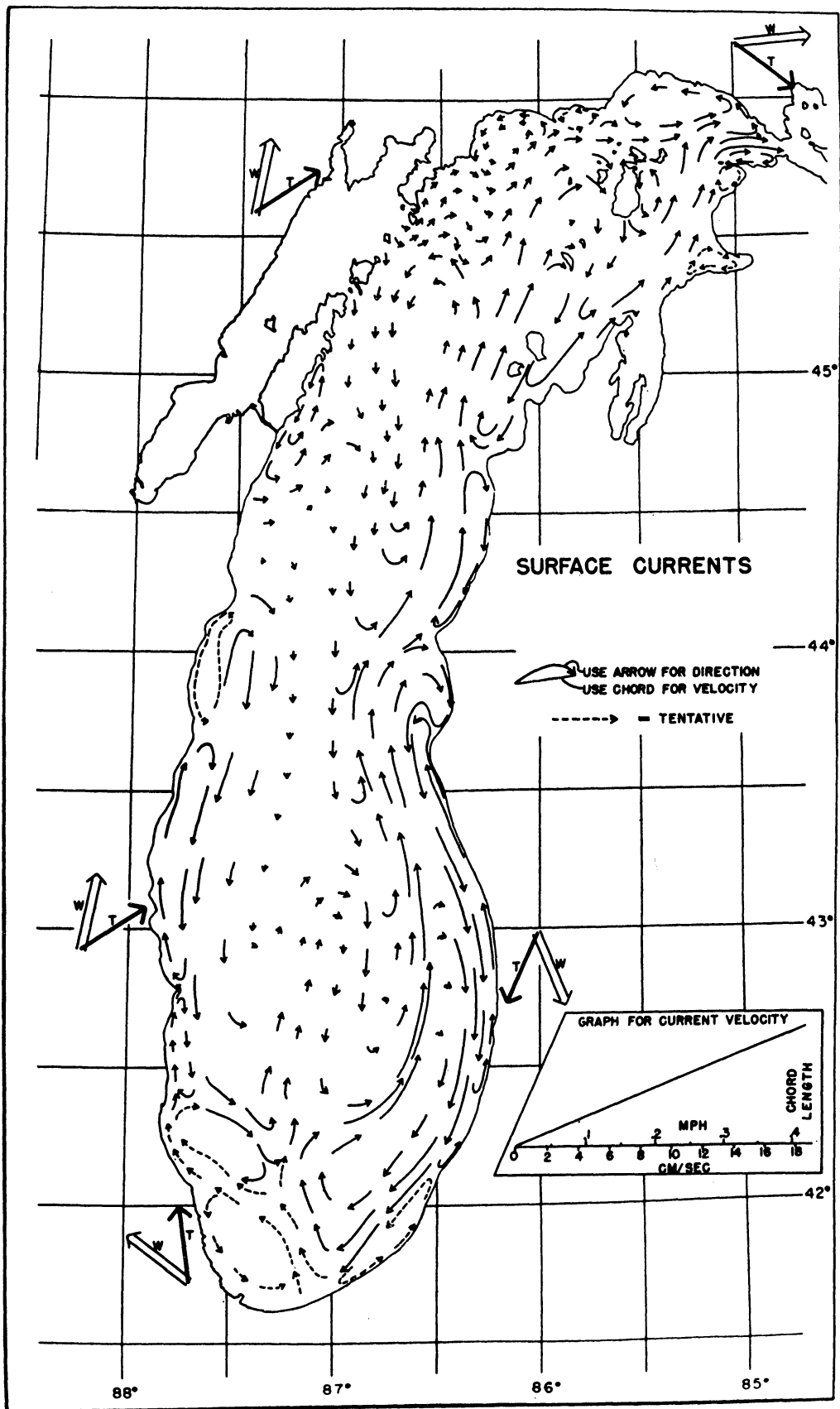

Figure 38: Current observations made by Ayers, et al. (1958).

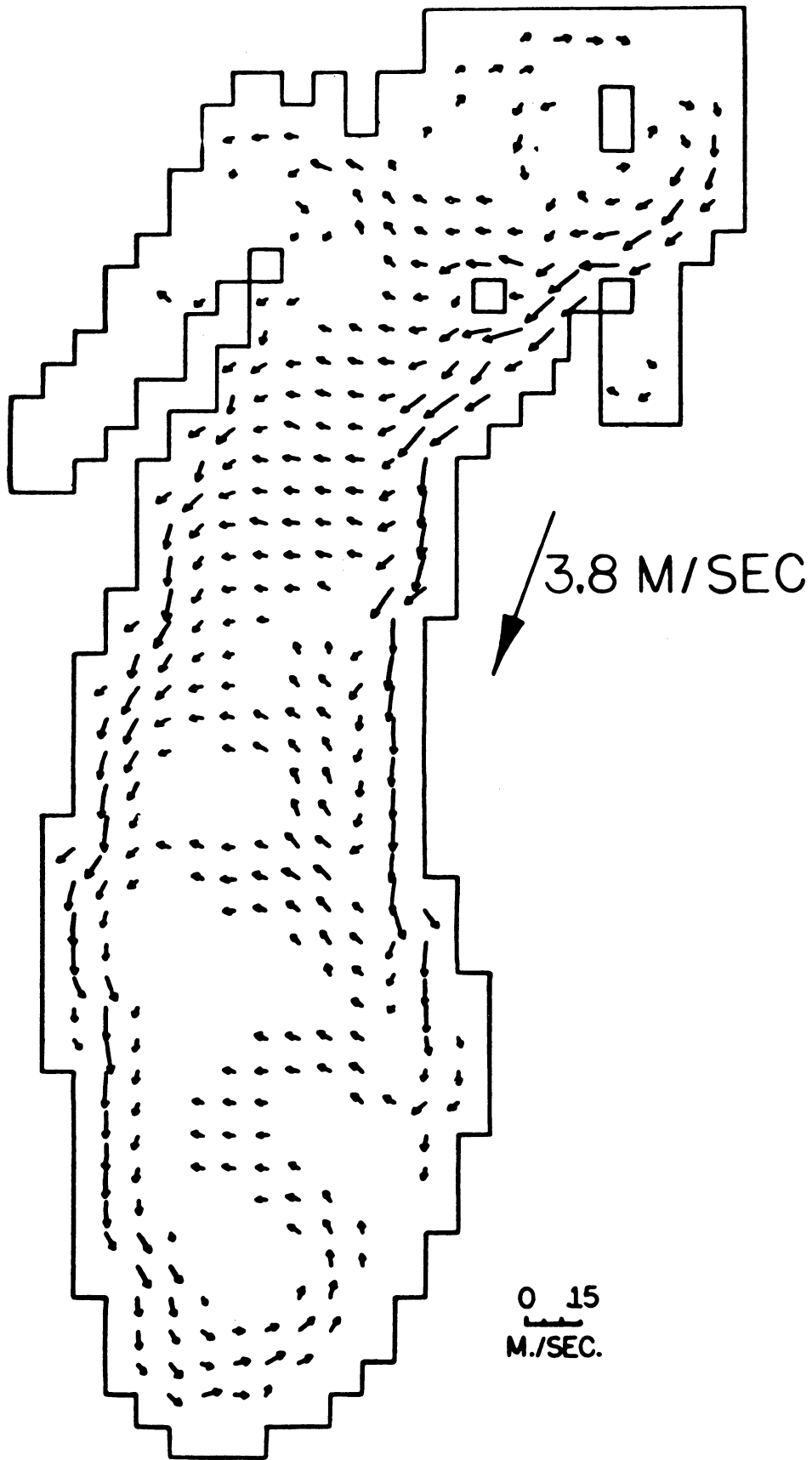

Figure 39 Current predictions from a computer model by Kizlauskas and Katz (1973).

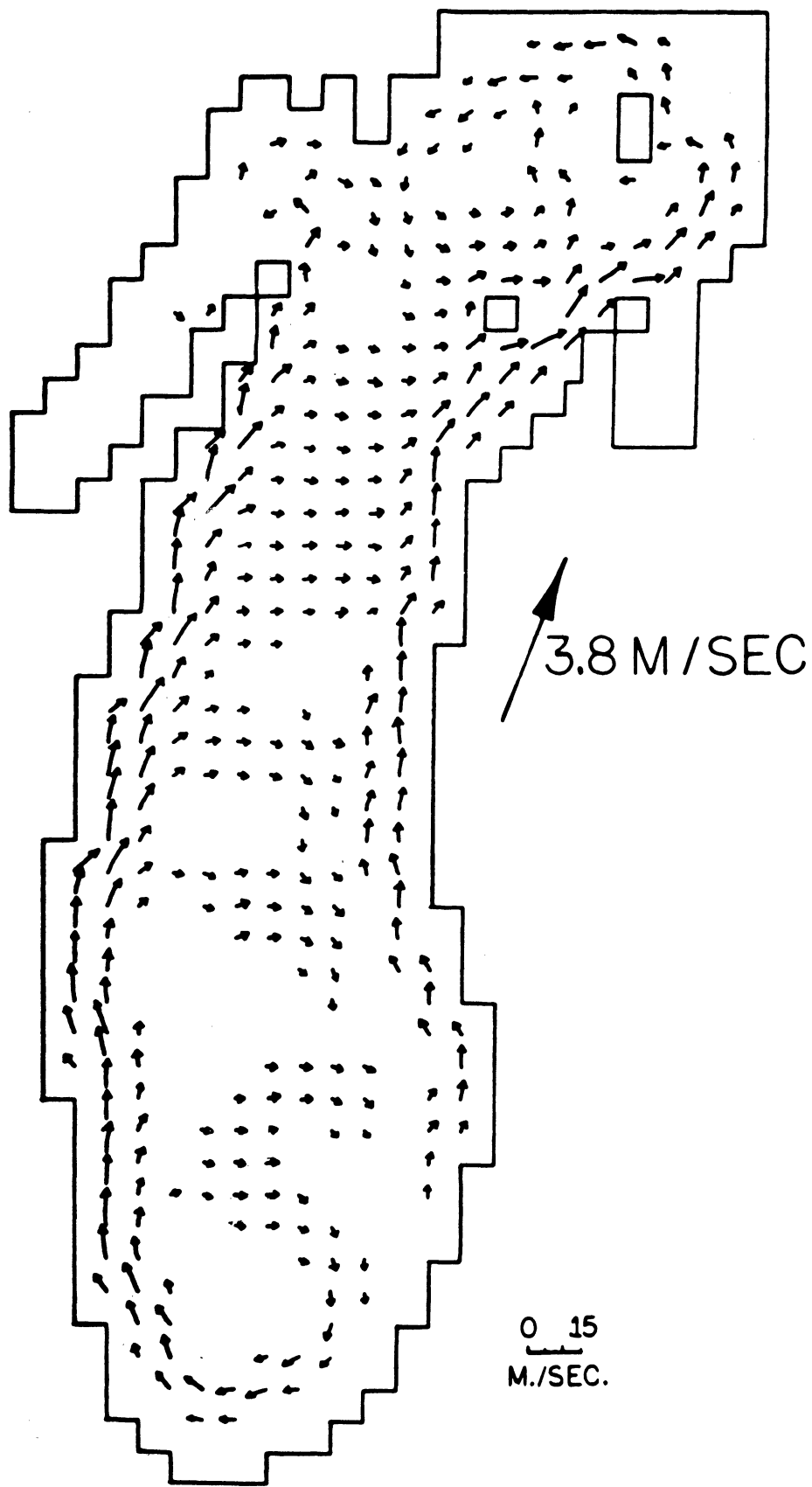

Figure 40 Current predictions from a computer model by Kizlauskas and Katz (1973).

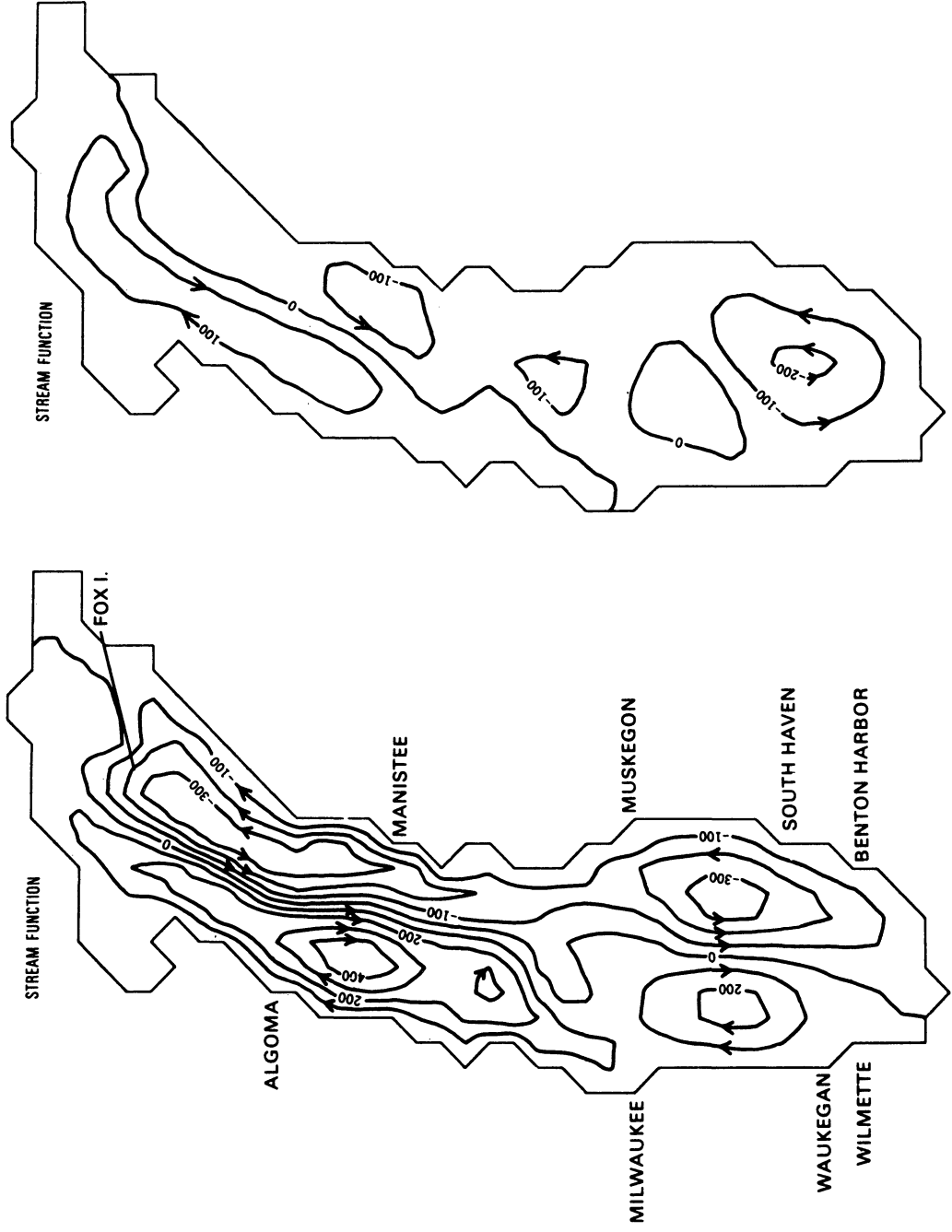

Figure 41: Current predictions from a mathematical model by Murty and Rao (1970). "... applicable to late fall and early spring situations only."



## Chapter 5: Conclusions

Listed below are the several major\* and a number of minor conclusions drawn from this study. These conclusions apply only for the season in which the observations were taken, and must be considered tentative until reinforced by observations taken during additional years.

- \*1. The currents encountered in this region are typically weak (less than 0.6 knots). (See Chapters 1, 2, and 3).
2. A degree of correlation between current and wind directions is often evidenced. (See Chapters 1, 2, and 3).
3. Some observations show a marked change in current at the depth of thermocline. (See Chapter 1).
- \*4. Offshore currents near Chicago (at sub-surface mooring locations) during summer run primarily to NW or N, in accord with earlier FWPCA (1967) findings. (See Chapter 2).
- \*5. A clockwise circulation in the southern basin of Lake Michigan exists during the summer months. (See Chapter 4).
6. This general circulation pattern in the southern basin of Lake Michigan is not compatible with the FWPCA (1967) results. (See Chapter 4).
7. The results of Harrington's (1895) classical study are also not in accord with the present findings (See Chapters 2 and 4).

- \*8. A northward coastal current exists during the summer along the east coast of southern Lake Michigan north of 43°N. (See Chapter 4).
- \*9. A northward coastal current exists during the summer along the west coast of southern Lake Michigan, the southward extent of which changes with time (See Chapter 4).
10. Appreciable agreement exists between the results of this study and the theoretical picture of Kizlauskas and Katz (1973). Less agreement exists between the present results and those presented by Ayers, et al (1958). (See Chapter 4).
11. Occasional rotary and oscillatory flows occur during the summer months in southern Lake Michigan. (See Chapter 2).
12. The need for simultaneous wind (and water temperature) data in the interpretation of Great Lake's current measurements has been again demonstrated.
13. The advisability of using a "mix" of current measurement techniques some of short time scale (vertical profiling, drogues) and some of long time scale (surface drifters and moored current meters) is apparent from this study.
14. The benefits of combining Eulerian measurement techniques (vertical profiling from anchored ship, sub-surface current meter moorings) with Lagrangian techniques (drogues, surface drifters) are hopefully also apparent.



APPENDIX A:

Log of R/V LAURENTIAN Cruise 18-20 July 1974

by R. Monier

Wednesday, July 17

The R/V Laurentian arrived at the Government Pier in Grand Haven, Michigan at 2220 EST and was met by Dr. Edward C. Monahan, chief scientist, and assistants Doug Huizenga and Roy Monier, all from the University of Michigan. Equipment brought from the University was then loaded on the vessel. When loading was completed at 2340 the scientific personnel came aboard for the night.

Thursday, July 18

The morning of the 18th was devoted to squaring away storage areas of the vessel and taking on provisions. The vessel left the pier at 1230 EST on a direct course for Waukegan, Ill. Scientific work consisted of the release of surface drifters at selected points along the transect. The schedule was as follows:

<u>Time EST</u>	<u>No</u>	<u>Type</u>
1310	50	vertical envelope
1310	50	small ring
1310	50	mobius loop
1338	50	small ring
1338	50	mobius loop
1440	50	small ring
1540	50	small ring
1640	50	small ring
1740	50	small ring

<u>Time EST</u>	<u>No</u>	<u>Type</u>
1840	50	small ring
1940	50	small ring
2040	50	small ring
2040	200	mobius loop
2110	200	mobius loop

The vessel arrived and docked in Waukegan, Ill. at 2130. A group of scientists from the Illinois Geological Survey came aboard and loaded equipment after the vessel was docked.

Friday, July 19

The vessel left Waukegan at 0615 EST and headed northeast. The first station was made at 0715. 50 small ring surface drifters were released upon arrival at the station. Current measurements were taken with two Bendix current meters one at 4 meters depth and one at 12 meters depth from 0820 to 0935. At 1240 an additional 50 small ring surface drifters were released. The vessel left the first station at 1400, having been delayed by an inoperative anchor winch, and headed for Chicago. 50 small ring surface drifters were released at 1533. At 1710 mooring "Q" was set off Chicago and 50 mobius loop surface drifters were released at the mooring site. The vessel then headed back to Waukegan 50 small ring surface drifters were released at 1750. The vessel arrived and docked in Waukegan at 1950.

Saturday, July 20

Doug Huizenga left the cruise before the vessel left port in the morning. The vessel left Waukegan at 0545 EST

and arrived at the first station at 0710. 50 small ring surface drifters were released at that time. The vessel left the first station at 0725 and arrived back in Waukegan at 0907. The scientists from the Illinois Geological Survey, and one scientist from the University of Illinois-Chicago Circle, unloaded their equipment and left the vessel. At 0950 the vessel left Waukegan and headed for Grand Haven, Michigan. Surface drifters were released along the way on the following schedule:

<u>Time EST</u>	<u>No.</u>	<u>Type</u>
1108	65	mobius loop and large ring
1200	50	small ring
1300	50	small ring
1400	50	small ring
1500	50	small ring
1600	50	mobius loop

The vessel docked in Grand Haven at 1920, equipment was removed from the vessel and loaded on a truck and driven back to Ann Arbor that night by Dr. Monahan and Roy Monier.

APPENDIX B:

Log of R/V LAURENTIAN Cruise 5-10 August 1974

by R. Monier

Monday, August 5

Dr. Edward C. Monahan, Associate Professor of oceanography at the University of Michigan, graduate assistant William Snell and undergraduate assistant Roy Monier left Ann Arbor with a truck load of equipment and drove to Grand Haven where the equipment was loaded aboard the R/V LAURENTIAN. Loading was completed and the scientific staff aboard by 1730 EST.

Tuesday, August 6

The vessel left Grand Haven at 0600 EST and set course for Chicago. The cruise was devoted to the release of surface current drifters at selected points along the way in accordance with the following table.

<u>Time</u>	<u>Drifters Released</u>
0700	50 ring sfc drifters
0800	50 " " "
0900	25 " " "
1000	25 " " "
1100	25 " " "
1200	25 " " "
1300	25 " " "
1400	24 " " "
1500	50 " " "
1600	50 " " "

The vessel docked in Chicago at 1655.

Wednesday, August 7

The vessel left port at 0600 and arrived at the first station (A1) at 0647. A wire sounding determined the water depth to be 13m. A BT was lowered and a Bendix current meter was used to measure current speed and direction at 4, 6, 8, 12 and 13.5 meters depth. 11 readings were taken at one minute intervals at each depth. 50 ring surface drifters were released on station. The vessel left station A1 at 0833 and arrived at the second station ("Q") at 0908. A wire sounding determined the water depth to be 18 m. A BT was lowered and current speed and direction measurements taken with the Bendix current meter from 2 m to 18 m depth in 2 m increments. 5 readings were taken at 1 minute intervals at each depth. 50 ring surface drifters were released on station.

At 0957 subsurface mooring "Q" was observed on the surface and was retrieved at 1100 after completion of the work at station Q. The subsurface buoyancy assembly and current meter appeared in good condition. The auxiliary anchor for the surface marker float was fouled with the release mechanism and was recovered along with the line that had connected it to the surface float. (Note - surface marker float was found ashore near Chicago on 25 July). The line was severely abraded in three areas roughly 15 cm long and 30 cm apart and 8 m above the anchor. A portion of the wire cable by which the surface marker float had been attached to the mooring line was found still attached to the surface end of the line and had been severed cleanly 16 cm inside the length of the conduit through which it ran.

At 1150 two sail drogue-buoy pairs were released for tracking at station Q. 25 ring sfc drifters were released at the drogues position at 1215. The drogues positions were taken with the ship's navigation system every 30 minutes from 1215 until 1515 when they were retrieved. At that time the drogues were side-by-side. The vessel headed for Chicago and docked at 1625. Shortly before docking two scientists from the Illinois State Geological Survey came aboard with some equipment.

Thursday, August 8

The vessel left port at 0600 after two more scientists from the I.S.G.S. had come aboard with an experimental ground water probe and reached the first station (A2) at 0820. Activities of the U of M personnel at A2 were as at Q with the exception that a wire sounding determined the depth to be 59 meters and current speed and directions were measured and recorded at depths from 4 m to 40 m depth in 4 m increments and then from 42 to 10 m in 4 m increments. Members of the I.S.G.S. took cores and measurements with the ground water probe. At 1208 the vessel left station A2 and arrived at the second station A3 at 1420. Activities of the University of Michigan and I.S.G.S. personnel were as at station A2 with the exception that wire sounding determined the water depth to be 13 m, current measurements were taken from 4 m to 12 m depth in 2 m increments, and 25 ring sfc drifters were released. The vessel left station at 1500 and docked in Chicago at 1635. The members of the I.S.G.S. left the vessel after docking.

Friday, August 9

Two deputy commissioners of the city of Chicago visited the Laurentian, one commissioner and a photographer came aboard

at 0820 to observe a portion of the days work. The vessel left port at 0845 and arrived at the first station (A4) at 0920. Shortly after anchoring a malfunction of the Bendix current meter was discovered and traced to a broken wire in the cable jack for the on-deck readout box. After resoldering the wire the meter resumed functioning normally. Activities of the U of M personnel at station A4 were as at station "Q" with the exception that a wire sounding determined the depth to be 11 m, current measurements were taken from 3 m to 9 m depth in 1 m increments, and 25 ring surface drifters were released. The vessel left station A4 at 1054 and arrived at the second station ("R") at 1108 at which time subsurface mooring "R" was set in 12 m of water and 50 ring surface drifters were released. At 1130 two sail drogue-buoy pairs were released for tracking. Positions were taken using the ship's navigation system every 30 minutes from 1130 until 1400 when the drogues were recovered and the ship returned to Chicago. In Chicago, Dr. Edward C. Monahan, the one deputy commissioner and the photographer left the vessel. The Laurentian left Chicago at 1445 and set a course for Grand Haven. Surface drifters were released along the way, 50 ring drifters being released at 1600 and 1700 EST and 25 being released at 1800 and 1900. The vessel arrived in Grand Haven at 0130 August 10.

#### Saturday, August 10

Assistants William Snell and Roy Monier removed the U of M equipment from the vessel and returned it to Ann Arbor by truck, leaving Grand Haven at 0900 EST.

APPENDIX C:

Log of R/V LAURENTIAN Cruise 15-24 October 1974

by Philip C. Pilgrim

Tuesday, 15 October

Research assistants Roy Monier and John Hinch and graduate assistant Philip Pilgrim departed Ann Arbor with a truckload of equipment. 2030 EST: The scientific party arrived in Grand Haven, loaded the equipment aboard the LAURENTIAN, and boarded the vessel themselves.

Wednesday, 16 October

The vessel did not depart Grand Haven due to a continued radar malfunction. Roy Monier returned to Ann Arbor with the truck.

Thursday, 17 October

The vessel remained in port due to bad weather and the expected arrival of a diesel mechanic.

Friday, 18 October

0740 EST: The vessel departed Grand Haven on a jagged course for Chicago. 0800: A bathythermogram (BT) was taken in 42m of water about four miles from shore. Twenty-five ring surface drifters were released at each of the following times and release points.

<u>Time</u>	<u>Release Point</u>
0903	45
1027	46
1148	47
1253	48
1404	49
1517	50



1740: A BT was taken in 14.2m of water about five miles offshore from Chicago. Wind speed and direction measurements were taken at all numbered locations on this and all subsequent days of the cruise. 1810: The vessel arrived and docked in Chicago. After assembling drogue buoys on deck, John Hinch departed for Ann Arbor. Graduate assistants Cary Mrozowski and Chuen-hwei Ho and research assistant James Fausone boarded the LAURENTIAN.

Saturday, 19 October

0700 EST: The vessel departed Chicago on a course for Benton Harbor. 0730: It arrived on station A5, and 0741: five sail drogue-buoy pairs were released for tracking. 0759: A current profile was begun using the Bendix current meter in 12.5m of water at depths of 4, 6, 8, 10, and 12m, with 5 readings at one-minute intervals being taken at each depth. The bow anchor had to be set due to sway detected during the 8m reading, and this reading was repeated. 0800: Two BT's were taken - one with U of M's instrument and one with one of the ship's to compare results and to correlate with previously uncertain thermometer bucket readings. The results compared favorably. 0855: The current profile was completed and the current meter hauled aboard. 0918: A fix was taken on the drogues, and by 1000 the drogues were on board. 1015: The vessel got underway and 25 ring surface drifters were released immediately (release point 51) and at each of the following times and release points:

<u>Time</u>	<u>Release Point</u>
1129	52
1250	53
1407	54

1538: A current profile (A6) was begun after having anchored in 14.2m of water. The procedure was identical to that at A5 except that a malfunctioning bow anchor motor prevented its deployment at this time and subsequently. A BT was taken, and by 1623 the profile was completed. 1640: The vessel got underway, and 25 drifters (point 55) were immediately released. 1715: The LAURENTIAN arrived and docked in St. Joseph.

Sunday, 20 October

0650 EST: The vessel departed St. Joseph to follow a southerly-curved trajectory to Chicago. Considerably rough seas were experienced en route. 0836: 18 drifters (point 56) were released, and 25 drifters each were loosed at 0957 (57) and 1114 (58). 1230: The ship arrived at station A7, and 1245: a current profile was begun in 11m of water with 7 readings each at 4, 6, 8, and 10m. 1250: A BT was taken and by 1315 the current profile was completed and 25 drifters released (59). 1400: The LAURENTIAN arrived at station A8, and a BT was taken in 14m of water. 1420: Five drogues were released for tracking, but they barely moved. 1430: A current profile was begun with readings taken at 4, 6, 8, 10, and 12m, with 5 one-minute-spaced readings at each depth and 7 extra readings at 12 meters. 1508: The current profile was completed, and the meter was

hailed aboard, during which time one wire of the anchor cable snapped. Fixes were taken on the drogue positions at 1532, 1615, and 1700, the drogues being retrieved after the last fix. 1830: The ship arrived and docked in Chicago.

Monday, 21 October

0700 EST: The LAURENTIAN departed Chicago for stations just offshore. 0739: Five drogues were released about one mile south of Four-mile Crib. The flags were furled on all but one to test the differential influence of the considerable wind on the motions of the two configurations. 0800: The ship had set anchor at A9, and a current profile was begun in 13m of water. Because of excessive sway, readings were taken for 10 minutes at each of 4, 6, 8, and 10 meter depths. During this time, it was noticed that the chart recorder was malfunctioning, so the frequency of readings was increased to once every 30 seconds. 0815: A BT was taken, and by 0853 the current profile was completed. 0935: A fix was taken on the drogues, and the drogue with the unfurled flag was already well alee of the others. 1003: Current profile A10 was begun in 12m of water with ten 30-second interval readings at each of 4, 6, 8, and 10 meters. The profile was finished at 1026 and a BT taken at 1040. 1041: Another fix was taken on the drogues, and the vessel departed the area for anchor station A11. Between 1135 and 1234, twenty 30-second interval readings were taken at each of 4, 6, 8, 10, and 12 meters, and a BT was lowered to the 14.2 meter bottom. 1320 and 1500: Fixes were

taken on the drogues, hauling them aboard after the last fix.

1610: The vessel docked in Chicago. Ho departed for Ann Arbor, and research assistants Terry Oas and James Scherr joined the scientific staff, bringing a replacement chart recorder for the Bendix current meter.

Tuesday, 22 October

0700 EST: The R/V LAURENTIAN departed Chicago for another day of offshore stations. 0720: The vessel arrived at the first drogue-release site about one mile west of Carter-Harrison Crib. Due to the high winds, only three drogues were released - one with its flag unfurled, which unfortunately became fouled in one of the others and remained so until it was retrieved. From 0740 to 0845 station A12 was manned, performing a BT in 9m of water and a current profile with 10 one-minute interval readings at each of 4, 6, 8, and 9 meter depths. 0940: A fix was taken on the drogues, and the ship departed for subsurface current meter mooring "R", arriving at 0950. This mooring was set on 9 Aug., 1974 and scheduled to surface at 1000. The float surfaced at 1122 and was retrieved along with the current meter and release mechanism. Everything appeared to be in good shape after washing, and the meter was deactivated and crated. Several of the trawl floats on the buoyancy assembly had become waterlogged and were subsequently replaced. 1200: Another fix was made on the drogues and a BT performed in 12m of water. 1230: A final drogue fix was gotten and the drogues retrieved. 1300: Three drogues were

again released in the same configuration as before about one mile ESE of Carter-Harrison Crib. From 1315 to 1400 anchor station A13 was manned and included at BT in 11m of water and 8 current profile readings at each of 4, 6, 8, 10, and 11 meters. At 1438, 1530, and 1615, fixes were gotten on the drogues, followed by their retrieval. No significant difference was observed in the behavior of the drogue with the unfurled flag this time. 1640: A BT was taken in 10m of water about 3/4 mi south of Carter-Harrison, and the vessel docked in Chicago at 1700. Dr. Edward C. Monahan, Associate Professor of Oceanography at the University of Michigan, boarded at 1900 and assisted in the rearming of the mooring release mechanism for subsurface mooring "S". The release was set to trigger at 1000 EST, 28 April, 1975. Fausone and Morzowski departed for Ann Arbor.

Wednesday, 23 October

0700 EST: The vessel departed Chicago for a last day of offshore stations. 0800: Four drogues were released for tracking - two with sails an additional five meters below the standard three-meter depth. A BT was taken in 15.5m of water, and the ship steamed for mooring site "S". 0845: After being assembled on deck, subsurface current meter mooring "S" was set without fouling in 17m of water, being established 5m above the bottom. A current profile was taken nearby (A14) from 0903 to 0935 at 4, 6, 8, 10 and 12m during which time a BT was also taken and 25 ring surface drifters released (point 60). 1000: A fix was gotten on the drogues, and the

vessel headed for station A15. From 1016 to 1059, a current profile was taken at A15 in 16.5m of water at depths of 4, 6, 8, 10, 12, and 14m. Only at 14m was any current whatsoever detected. A BT was also taken at this station. 1135: The last fix was taken on the drogues and they were recovered. No difference in behavior was noted for the deep-running drogues as compared to the other two. 1215: Dr. Monahan disembarked at Chicago to return to Ann Arbor, and the vessel set a zig-zag course to Waukegan to release drifters in areas missed due to initial delays. The following drifter releases were made, with 25 drifters in each release.

<u>Time</u>	<u>Release</u>
1404	61
1504	62 + Bt in 11m of water
1649	63

The ship arrived and docked in Waukegan at 1855.

Thursday, 24 October

0600 EST: The research vessel departed Waukegan for the last leg of the cruise. A zig-zag course was established to Grand Haven in order to complete the drifter-release coverage of lower Lake Michigan. Except where noted, 25 drifters were released at each of the following release points.

<u>Time</u>	<u>Release</u>
0625	64 + BT in 22m of water
0745	65
0900	66
1025	67 (20 drifters)
1220	68 (24 drifters)

again released in the same configuration as before about one mile ESE of Carter-Harrison Crib. From 1315 to 1400 anchor station A13 was manned and included at BT in 11m of water and 8 current profile readings at each of 4, 6, 8, 10, and 11 meters. At 1438, 1530, and 1615, fixes were gotten on the drogues, followed by their retrieval. No significant difference was observed in the behavior of the drogue with the unfurled flag this time. 1640: A BT was taken in 10m of water about 3/4 mi south of Carter-Harrison, and the vessel docked in Chicago at 1700. Dr. Edward C. Monahan, Associate Professor of Oceanography at the University of Michigan, boarded at 1900 and assisted in the rearming of the mooring release mechanism for subsurface mooring "S". The release was set to trigger at 1000 EST, 28 April, 1975. Fausone and Morzowski departed for Ann Arbor.

Wednesday, 23 October

0700 EST: The vessel departed Chicago for a last day of offshore stations. 0800: Four drogues were released for tracking - two with sails an additional five meters below the standard three-meter depth. A BT was taken in 15.5m of water, and the ship steamed for mooring site "S". 0845: After being assembled on deck, subsurface current meter mooring "S" was set without fouling in 17m of water, being established 5m above the bottom. A current profile was taken nearby (A14) from 0903 to 0935 at 4, 6, 8, 10 and 12m during which time a BT was also taken and 25 ring surface drifters released (point 60). 1000: A fix was gotten on the drogues, and the

<u>Time</u>	<u>Release</u>
1343	69
1510	70
1619	71
1727	72
1830	73
1940	74
2110	75 (26 drifters) + BT in 7lm of water

The boat docked in Grand Haven at 2200

Friday, 25 October

John Hinch arrived at 1230 with a truck, and all equipment was loaded into it. 1300: The scientific staff departed in the truck for Ann Arbor.



## Appendix D: Technique of Correcting Drogue Trajectories

by

Edward C. Monahan

Due to the very modest drogue motions encountered during the field work for this study, it was felt that it was unwarranted to attempt to correct the trajectories observed for the drogue-buoy pairs for the influence of the surface currents upon the surface buoys, and to thereby determine the precise currents at the depths of the drogues. Nevertheless, since we have evolved a specific procedure for such corrections, and prepared a series of previously unpublished figures to aid in the description of this procedure, this appendix will set forth this correction procedure in the hope that it will be useful to co-workers in this area.

For the restricted case where it can be assumed that currents at all depths are flowing in the same direction at different speeds, and where tow tank calibration studies have yielded Drag Force vs Relative Velocity plots for drogues and buoys separately, then a graphical procedure for obtaining the necessary velocity correction has already been set forth by our group (Monahan, Kaye, and Michelena; 1973). For this same restricted case, but in the instance where "square-law" drag can be assumed and drag coefficients for the drogues and buoys used have been obtained, Figure D1 summarizes the velocity correction procedure. Table DI defines the symbols that appear on Figure D1.

Table DI

<u>Symbol</u>	<u>Meaning</u>
$A_B$	Cross-sectional area presented by buoy to relative surface current.
$A_D$	Cross-sectional area presented by drogue to relative current at drogue depth.
$C_B$	Drag Coefficient for buoy design.
$C_D$	Drag Coefficient for drogue design.
$F_B$	Drag force on buoy.
$F_D$	Drag force on drogue
$\rho_s$	Density of surface water.
$\rho_u$	Density of water at drogue depth.
$S$	Absolute surface current velocity.
$U$	Absolute current velocity at depth or drogue.
$V$	Absolute velocity of drogue-buoy pair.

On Figure D1 are equations for the drag forces on the buoy and drogue separately. If we assume that the direct wind drag on the buoy and the current drag on the wire suspending the drogue beneath the buoy can both be ignored, and if we recognize that the acceleration of the drogue-buoy pair is extremely small (practically zero), then we recognize that by Newton's First Law of Motion there must be no net force on the buoy-drogue pair and hence the two horizontal forces ( $F_B$  and  $F_D$ ) must be oppositely directed and of equal magnitude (next to last line of Figure D1). Since we can determine  $V$  directly from the drogue-buoy trajectories, and can measure  $S$  by any one of a number of means (such as tracking a surface buoy which is not connected to a drogue), we are now in a position to determine

U, the actual current velocity at drogue depth (see last line on Figure D1).

While Figure D1 is the mechanical free body diagram for the drogue-buoy pair, Figure D2 is the free body diagram for the drogue alone. Symbols not previously defined in Table DI are listed in Table DII. The derivation presented on

Table DII

<u>Symbol</u>	<u>Meaning</u>
R	Radius (Of spherical drogue).
$\rho_D$	Mean density of drogue.
T	Tension in suspension wire.
$\theta$	Angle suspension wire makes with vertical.
g	Acceleration due to gravity.

Figure D2 is based on the sound assumption that the drogue is accelerating in neither the horizontal or vertical direction, and hence there must be no net force on it in either the horizontal or vertical direction (Newton's First Law again). This Figure is included to demonstrate (via the last line which shows that  $\theta$  increases as R decreases) that a large drogue is better than a small drogue of the same design, a contention set forth (without this illustration) by Monahan and Monahan (1973b). While the derivation presented on Figure D2 is specifically for a drogue of spherical geometry, it applies to any of the multitude of drogue designs in use (see various drogue designs in Monahan and Monahan (1973b), but more particularly the 110 designs presented in U-M Sea Grant Technical Report (#36) by Monahan and Monahan (1973a).)

The extension of the drogue velocity correction technique from the case where the currents at all depths are assumed to flow in the same direction to the realistic case where not only current speed but current direction vary with depth can be accomplished by the construction of a planar (horizontal) velocity (and force) diagram such as is shown in Figure D3. The thin arrows are current vectors while the thick arrows are force vectors. All of the symbols have already been defined in Tabel DI. Having obtained the drogue-buoy pair's velocity ( $\vec{V}$ ) from a trajectory plot, and the surface current velocity ( $\vec{S}$ ) by some other means, the surface current velocity relative to the buoy ( $\vec{S}-\vec{V}$ ) is obtained via vector subtraction (the parallelogram construction). Since any suitable buoy design leads to a buoy that is symmetric with respect to the relative current (indeed, is ideally radially symmetric with respect to the vertical axis), we can conclude (ignoring any net wave force) that the drag force on the buoy ( $\vec{F}_B$ ) is in the same direction as the flow relative to the buoy ( $\vec{S}-\vec{V}$ ). For the reason previously stated, we know that the drag force on the drogue ( $\vec{F}_D$ ) is oppositely directed to  $\vec{F}_B$  (and of equal magnitude). Using the final equation listed on Figure D1 we can compute the magnitude of the flow relative to the drogue ( $\vec{U}-\vec{V}$ ). Since all good drogue designs include the feature that the drogue is symmetric with respect to the relative flow at its depth, we know that ( $\vec{U}-\vec{V}$ ) is colinear with  $\vec{F}_D$ . To obtain the corrected velocity, i.e.,  $\vec{U}$ , the true current at the depth of the drogue, we need only carry out the vector addition of ( $\vec{U}-\vec{V}$ ) and  $\vec{V}$ , as shown on Figure D3 (the parallelogram method again).

Discussion of the error introduced by assuming that the velocity obtained from the trajectory of a drogue-buoy pair is the same as the current at drogue depth, and equations for obtaining the necessary corrections, have also been set forth by others (Terhune, 1968; and Vachon, 1973).

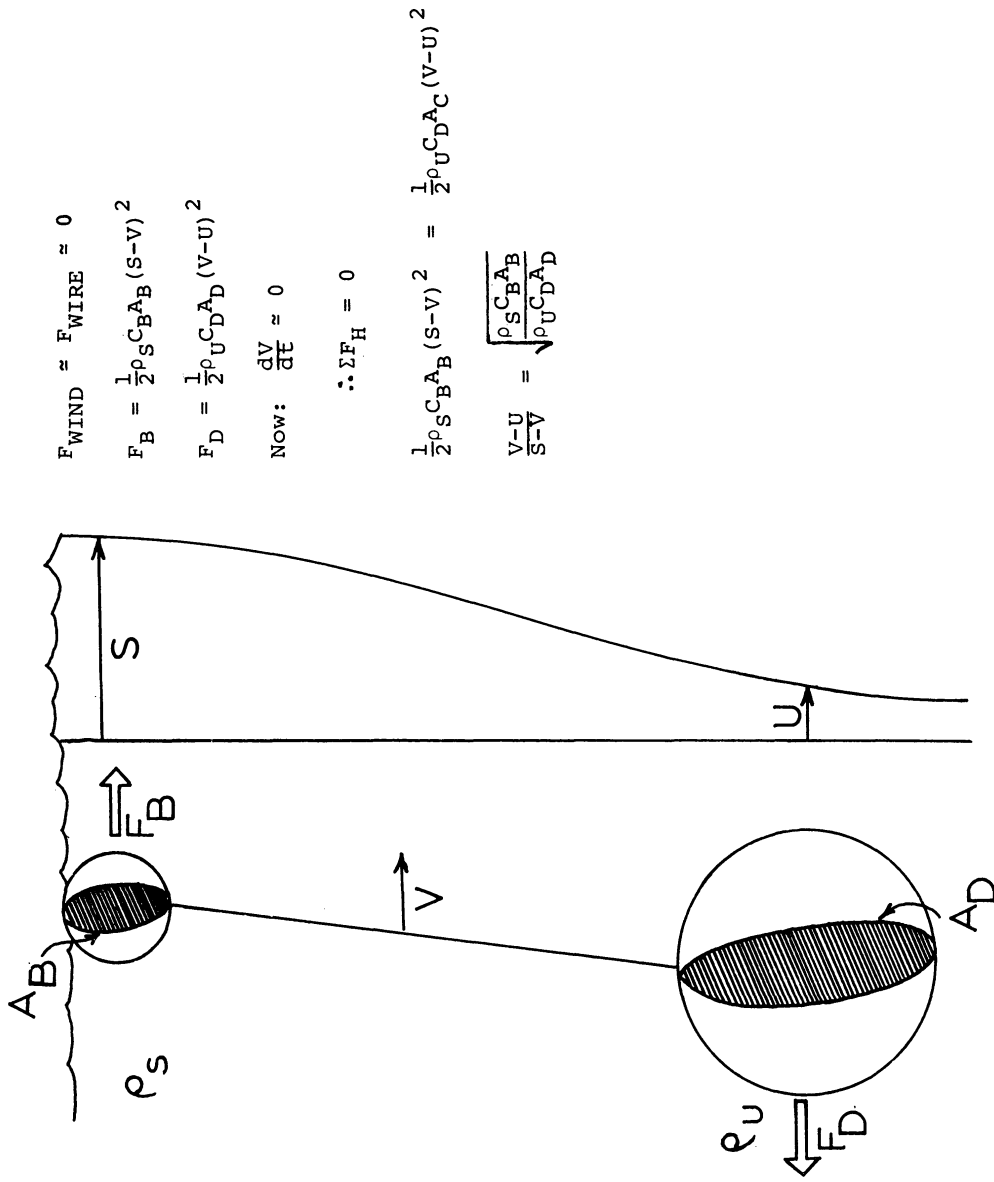
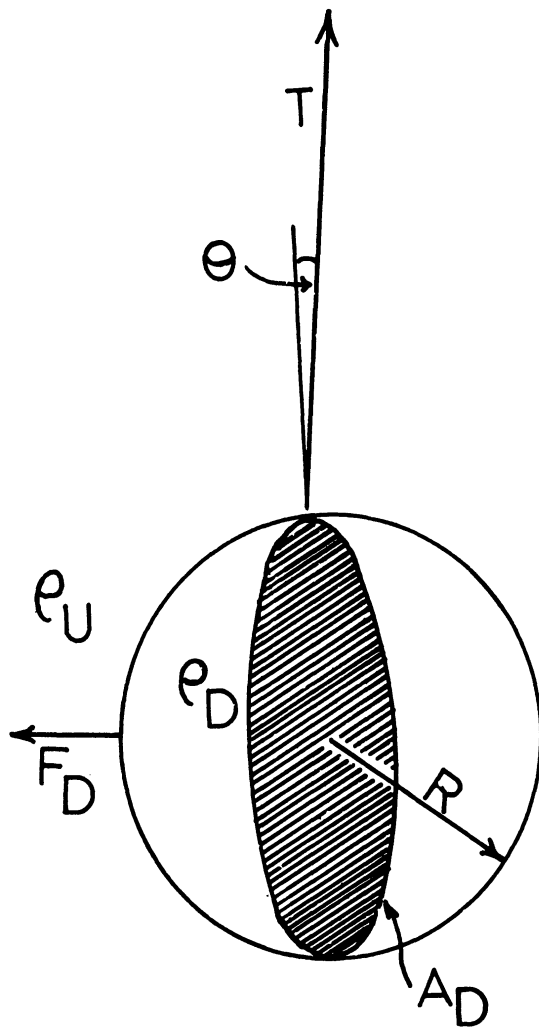

Figure D1: Free body diagram for idealized drogue and buoy pair. Symbols defined in table D1. See text for further explanation.



$$\Sigma F_V = 0$$

$$T \cos \theta - (\rho_D - \rho_U) g \frac{4}{3} \pi R^3 = 0$$

$$\Sigma F_H = 0$$

$$T \sin \theta - \frac{1}{2} \rho_U C_D \pi R^2 (V-U)^2 = 0$$

$$\tan \theta = \frac{3 \rho_U C_D (V-U)^2}{8 (\rho_D - \rho_U) g} \cdot \frac{1}{R}$$

Figure D2: Free body diagram for drogue alone. Symbols not previously defined can be found in Table DII.

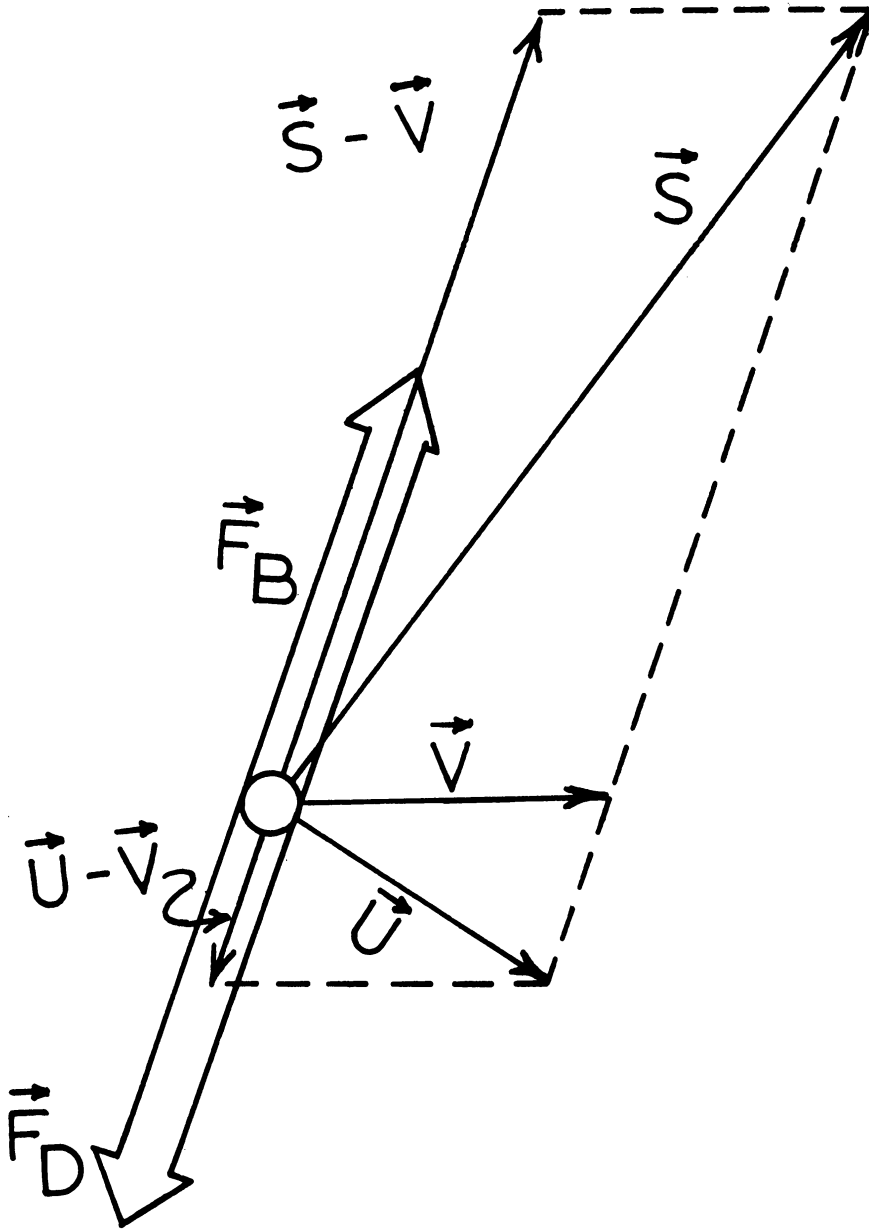

Figure D3: Drogue Mechanics in Planar View. Thin arrows are current vectors. Thick arrows are force vectors. Symbols defined in Table DI.



APPENDIX E:

Intercomparison of Behavior of Several Drifter Types  
Based on Returns from Release Point  
No. 1

by E. C. Monahan

That surface current drifters of different design respond differently to the same current and wind conditions has already been demonstrated (Monahan, Higgins, and Kaye, 1975). The differences in response can often be detected by plotting separately cumulative return numbers versus time adrift for each drifter design used, or from plots of drifter landfalls where the location of each drifter recovery is indicated by a distinctive symbol marking the design of that drifter.

When the information used to construct Figure E1, the cumulative return number versus time adrift for all the Mobius (M) and Ring (O) drifters released during the July cruise, is broken down and two separate plots are constructed, one for the Mobius drifters (Figure E2) and one for the Ring drifters (Figure E3) some distinctions are apparent. The time adrift for the typical Ring drifter appears to be longer than for the typical Mobius drifter. Unfortunately, since the distribution of Mobius releases over the lake surface during the July cruise was markedly different from the distribution of Ring releases during the same cruise, no firm conclusion can be drawn by the intercomparison of these two figures. The information contained in Figure E4 (cumulative return number versus time adrift for the Ring drifters released during the August Cruise) can not aid in the intercomparison since the meteorological (and in all probability current) conditions were not the same as for the earlier cruise.

The best basis for an intercomparison is to consider the cumulative return number versus time adrift, and the drifter landfall pattern, for a single release station, at which equal numbers of the several kinds of drifters were released. Drifter release point (Station) Number 1 suits the requirements in this regard. Indeed, not only were 50 Mobius drifters (M) and 50 Ring drifters (O) released at this location, but 50 vertical envelopes (E) were also released there at that time (1310 EST, 18 July 1974). Figure E5 depicts one of each of these three drifter types as they would appear adrift, and a conventional drift bottle (S) as well. Figure E6 shows, for each design separately, the cumulative return number versus time adrift from release point No. 1. The most striking information conveyed by this figure is the low return total for the vertical envelopes. It is to be noted that no Ring drifters were found until 28 July, 10 days after the drifters were set out at Station No. 1. Figure E7, a chart of Eastern Lake Michigan, shows the recovery locations of the drifters released at Station No. 1. It shows that all of the Ring drifter recovery locations were well south of the release point, while one of the few envelopes recovered, and three of the many Mobius drifters recovered, were found north of the release point. A glance at Figure E8, which presents the wind history for the appropriate interval from nearby Muskegon, Michigan, shows that during the first several days the winds were mostly from the west and south, which suggests that early returns from north

(and east) of the release station were the result of direct wind influence on certain of the drifters. Subsequent to these first few days the wind veered about in direction so much that a straight forward explanation of later returns in terms of possible direct wind influence is not feasible.

Clearly the bulk of the returns are from south of the release location, as would be expected if these drifters (the Ring drifters in particular) moved with the prevailing currents (as opposed to directly with the winds), and if the coastal current were to the south in this region, as has been reported in the summer for the case of north and northwest winds (F.W.P.C.A, 1967). Certainly, during the interval 29-30 July, when the greatest number of drifters were being found, the winds were from the northwest and west.

The general conclusion from this limited intercomparison study is that the Mobius drifters and the Ring drifters behave in a quite similar manner, but the vertical envelopes do not. The envelopes either are not as readily detectable on the beach as the other two types of drifter (perhaps because the transparent plastic envelopes contained pink postcards while the other drifters were made of fluorescent orange Underwater Ascot) or that the plastic envelopes were often torn (and the paper postcards destroyed) when they encountered the surf, while the other drifters (made of Ascot, a coated plastic fabric) were not often made illegible as they made their way through the breaking waves to the beach.

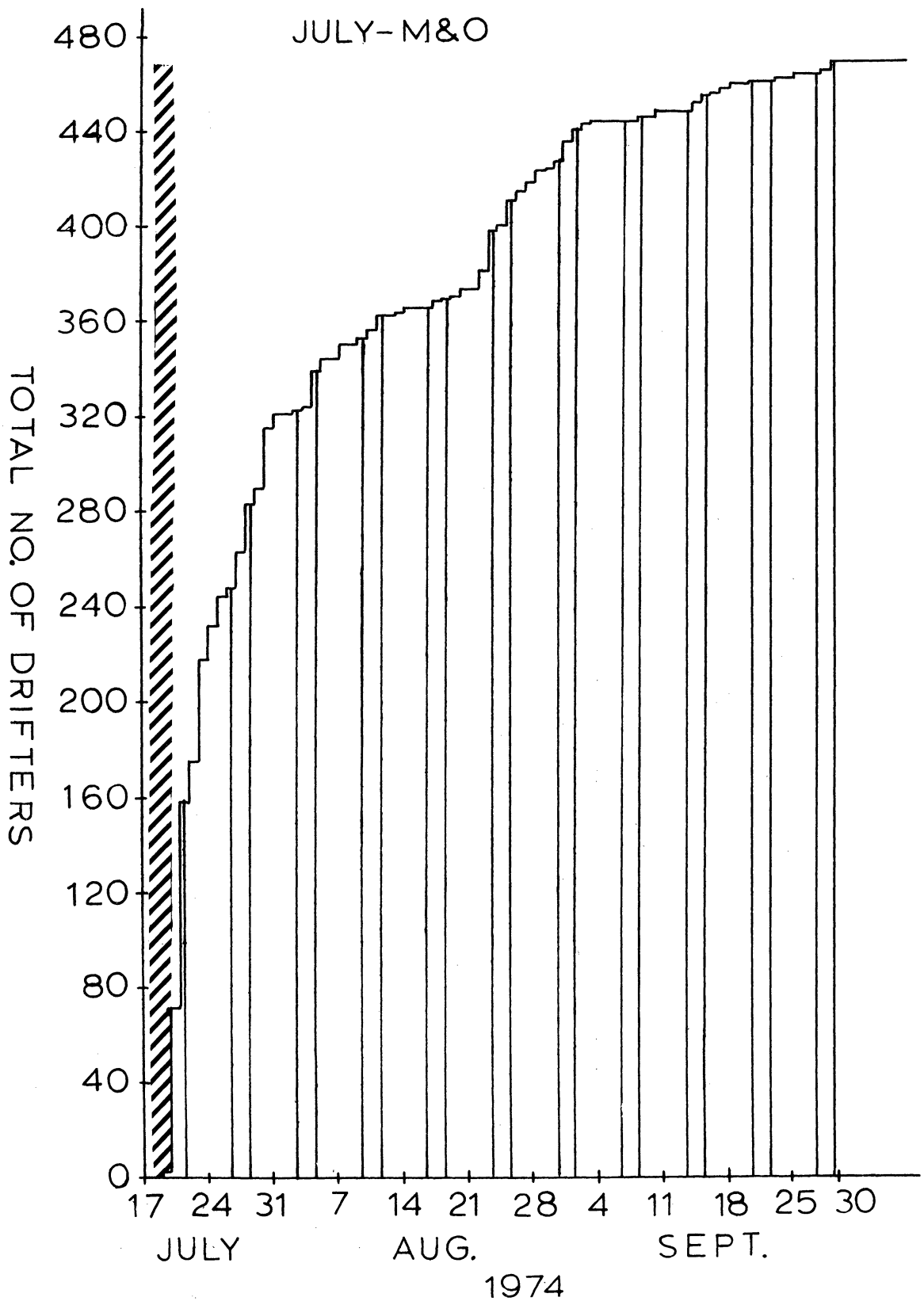

Figure E1: Cumulative drifter return number for all Mobius and Ring Drifters released during 18-20 July 1974 cruise versus time adrift. Hatching indicates dates of release. Narrow vertical columns delineate weekends.

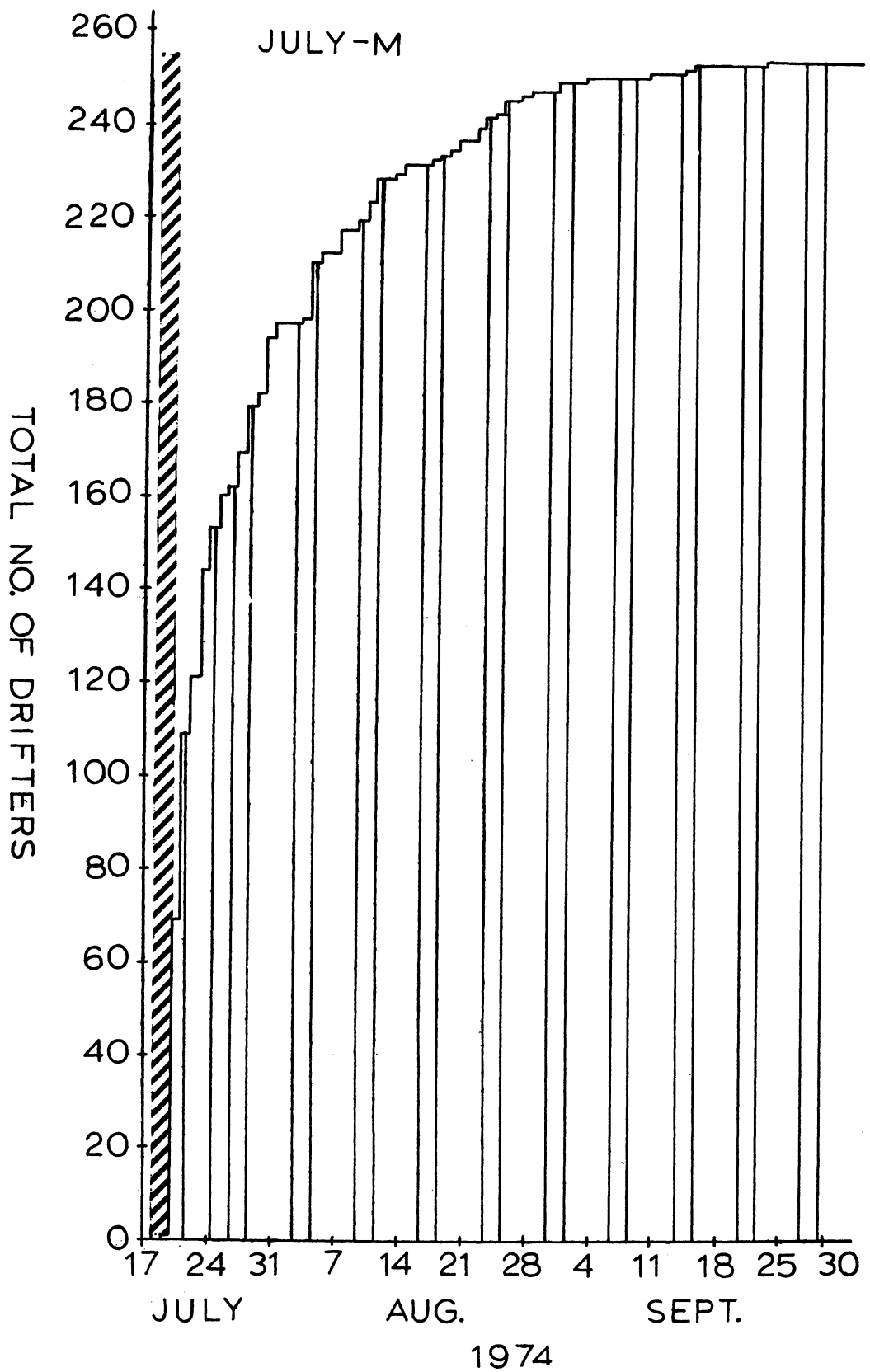

Figure E2: Cumulative drifter return number for Mobius Drifters released during 18-20 July Cruise versus time adrift. Hatching indicates dates of release. Narrow vertical columns delineate weekends.

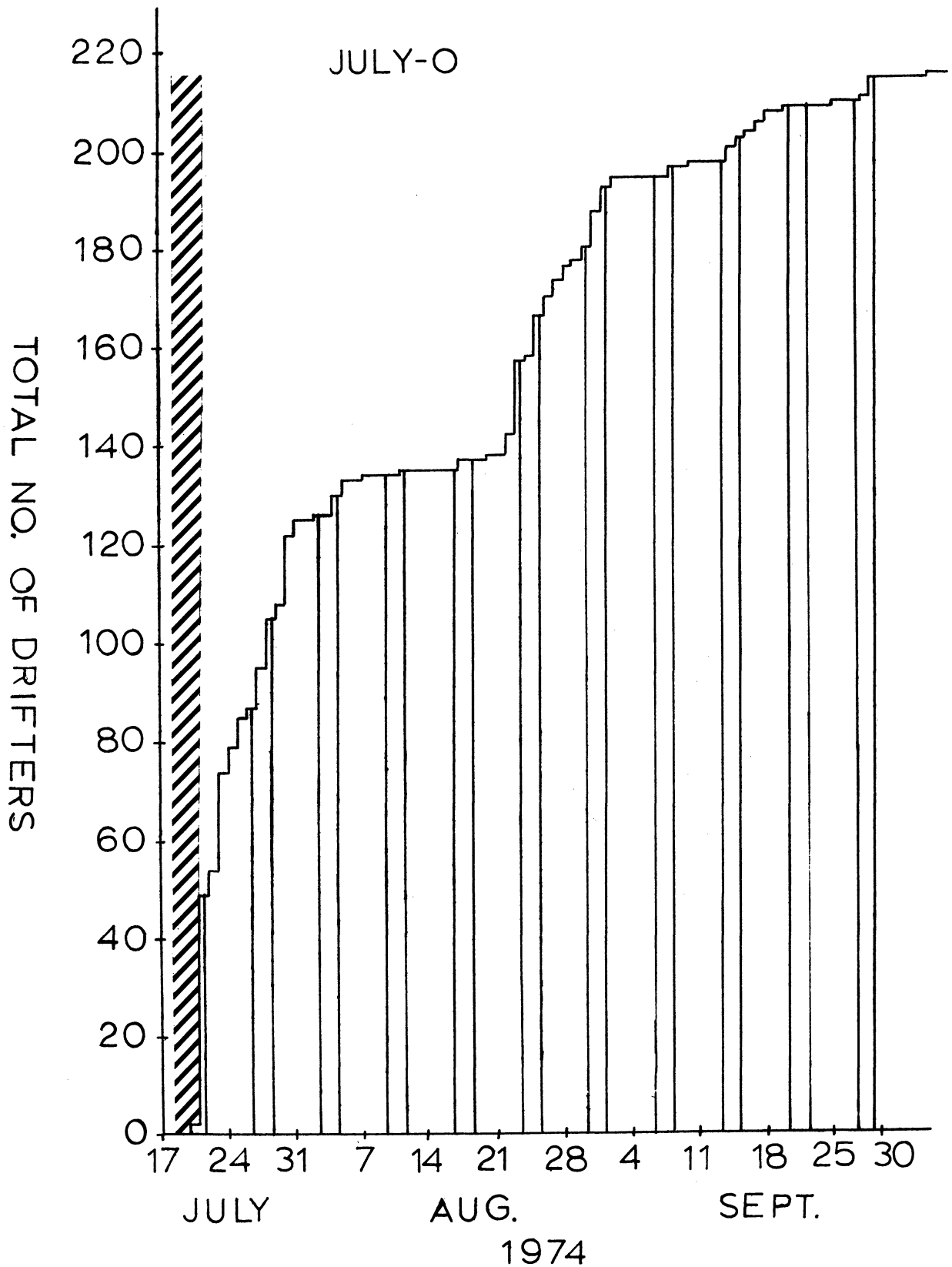

Figure E3: Cumulative drifter return number for Ring Drifters released during 18-20 July Cruise versus time adrift. Hatching indicates dates of release. Narrow vertical columns delineate weekends.

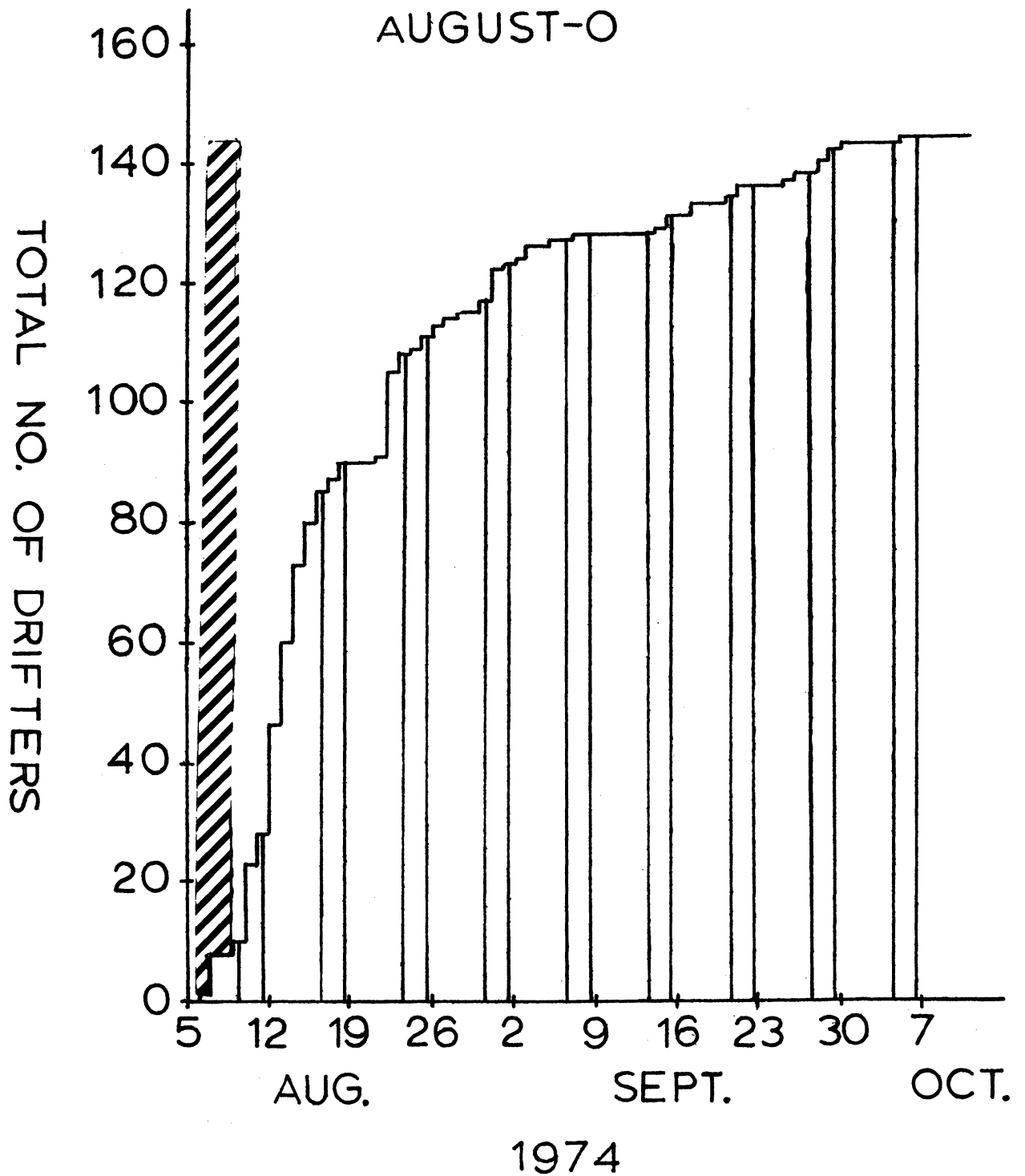
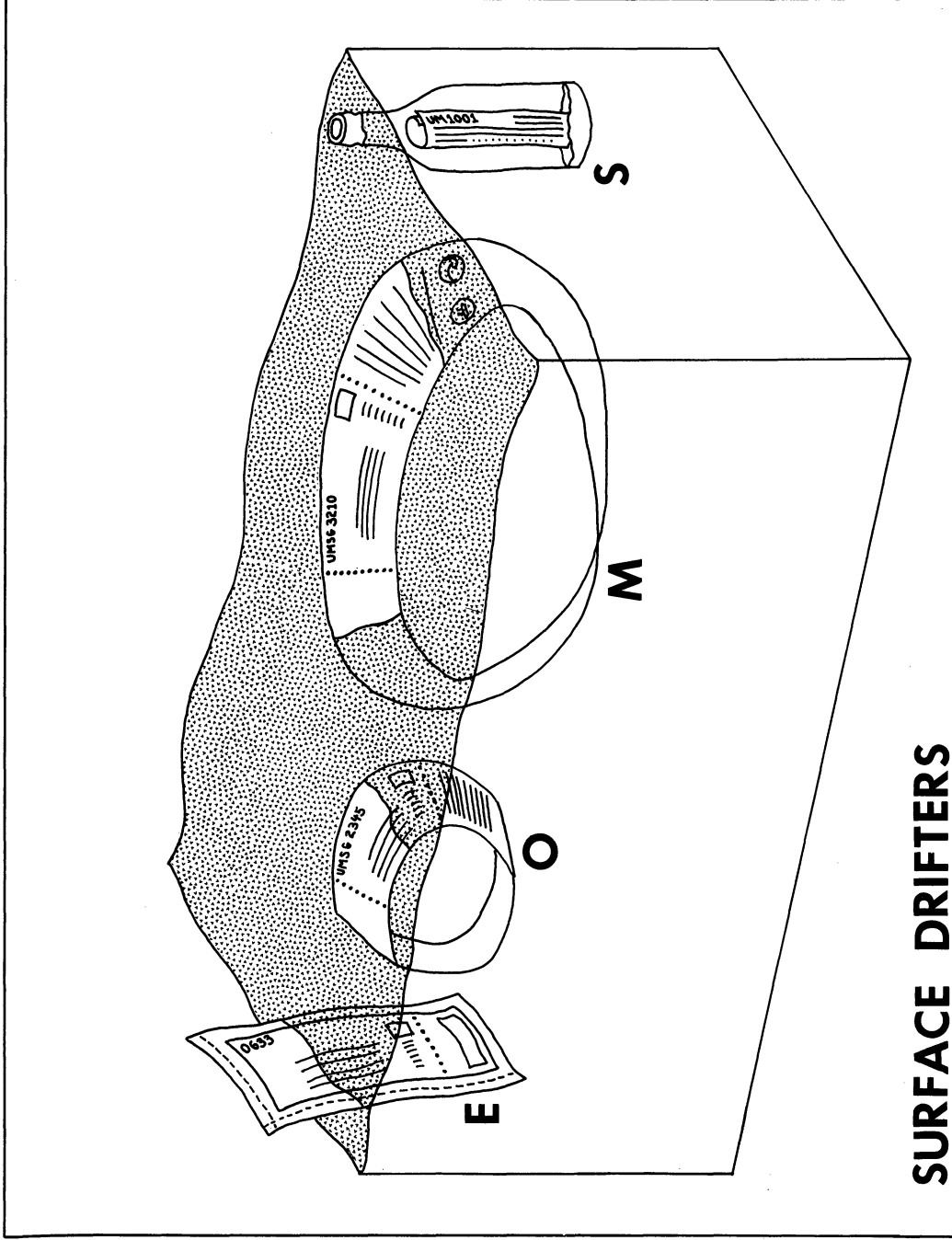

Figure E4: Cummulative drifter return number for Ring Drifters released during 5-10 August Cruise versus time adrift. Hatching indicates dates of release. Narrow vertical columns delineate weekends.



## SURFACE DRIFTERS

Figure E5: Sketch of four drifter types as they would appear afloat. The vertical envelope (E), the ring drifter (O), and the Mobius drifter (M), are all types that were released in quantity at drifter release point No. 1. The ballasted drift bottle (S) is shown to provide scale - none were used in the present study.



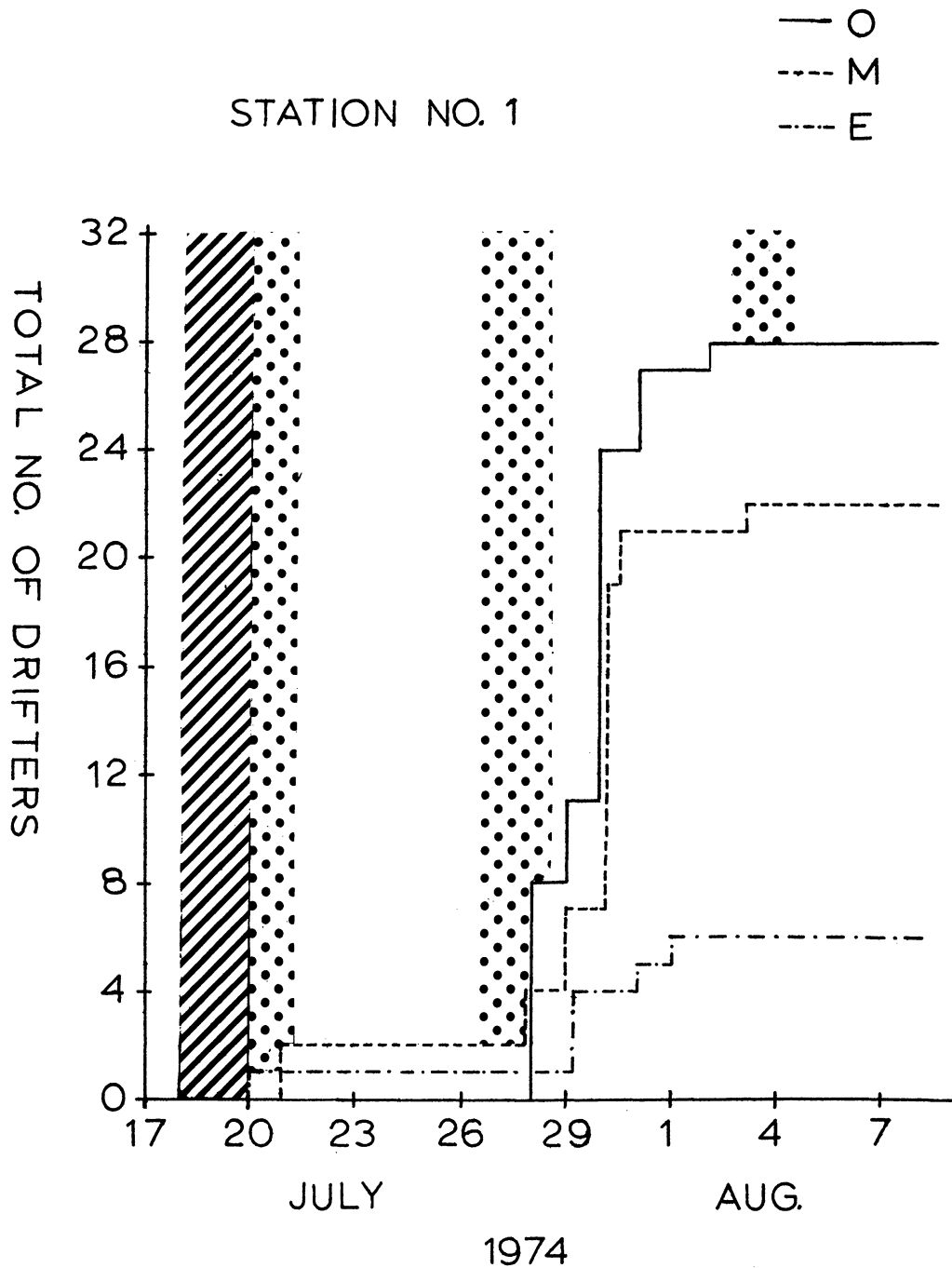

Figure E6: Cumulative drifter return numbers for each of three drifter types released at point No. 1 plotted separately versus time adrift. O-ring drifters. M-Mobius drifters. E-vertical envelopes. Hatching indicates dates of release for July cruise. Dot filled columns delineate weekends.

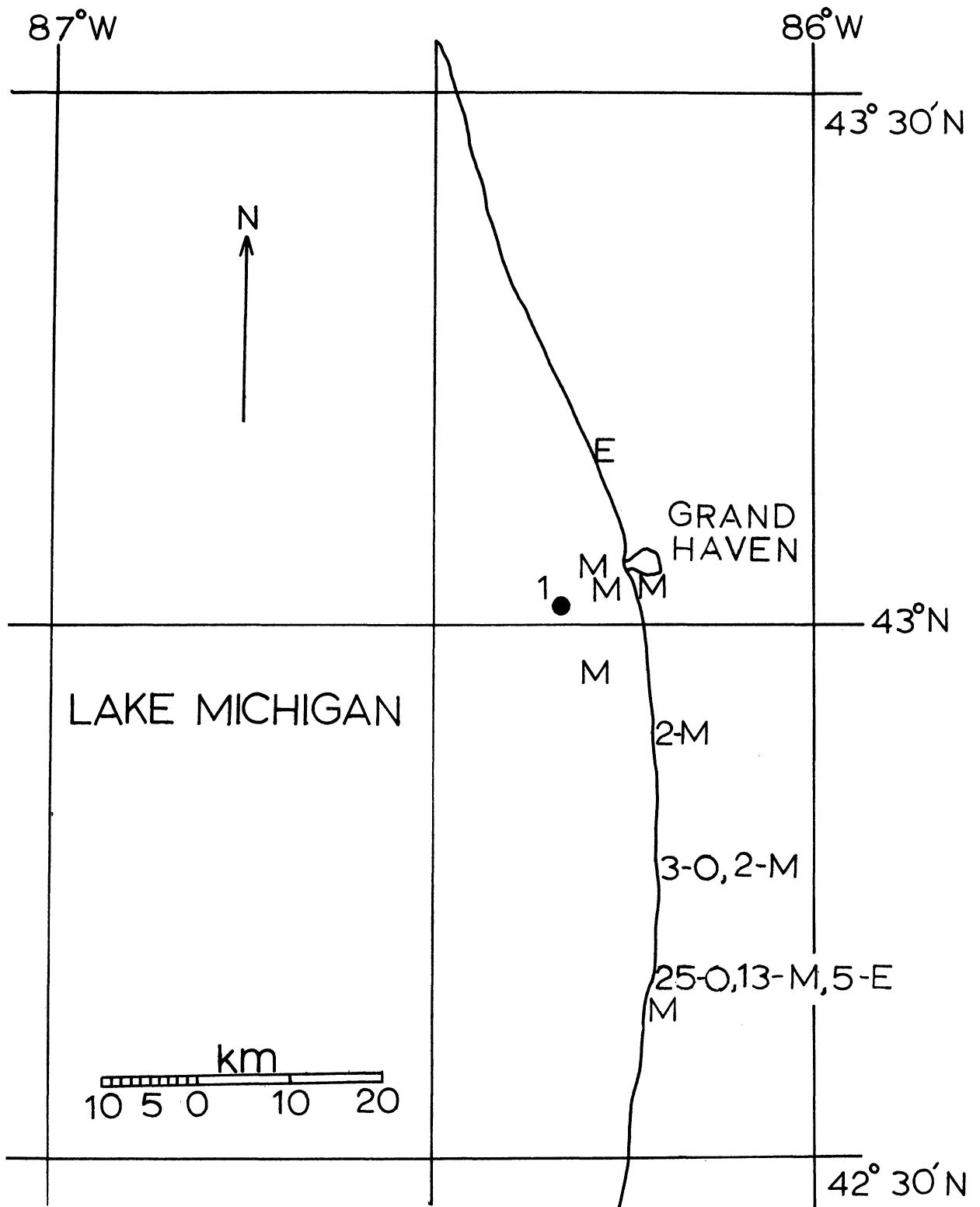

Figure E7: Chart of a portion of Eastern Lake Michigan. Dot indicates location of drifter release point No. 1. Each letter E marks location of recovery of envelope released from point No. 1. Each letter M marks location of recovery of Mobius drifter released from point No. 1. Each letter O marks location of recovery of ring drifter released from point No. 1.

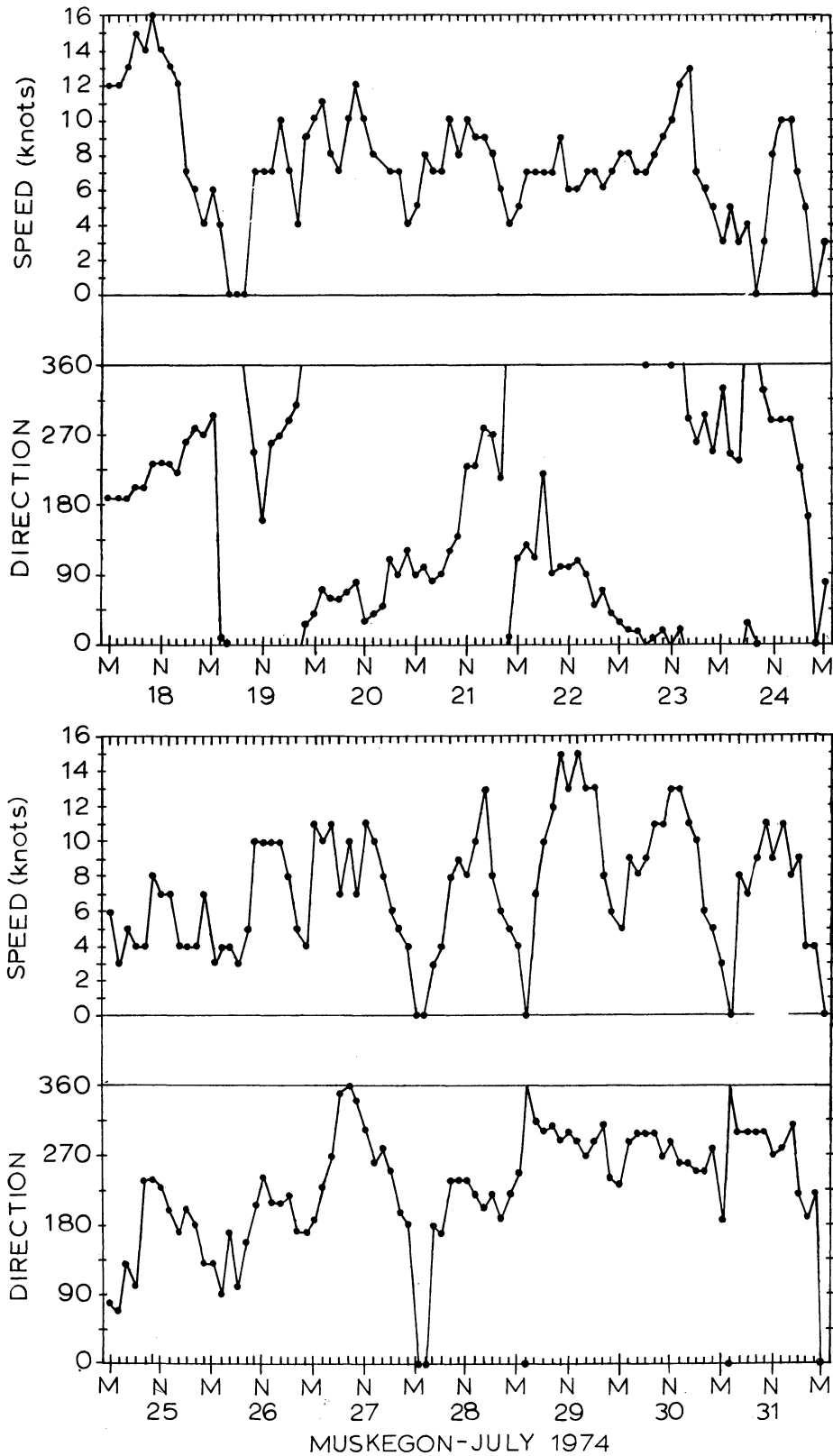

Figure E8: Wind history (direction and speed versus time) from Muskegon, Michigan, airport. Wind direction, in accord with meteorological convention, indicates direction from which wind was blowing.

## Bibliography

- Ayers, J. C., D. C. Chandler, G. H. Lauff, and C. F. Powers, 1958. Currents and Water Masses of Lake Michigan. University of Michigan Great Lakes Research Division Publication No. 3, Ann Arbor. Pp 169.
- Crawford, A. B., 1966. A replacement at last for "The Old Oaken Bucket" Geo-Marine Technology, 2, pp. 25-27.
- Csanady, G. T., 1973. Turbulent Diffusion in the Environment. D. Reidel, Dordrecht, Holland.
- Federal Water Pollution Control Administration, 1967. Lake Currents. Water Quality Investigations: Lake Michigan Basin. FWPCA Great Lakes Region, Chicago, Illinois, Pp 364.
- Harrington, M. W., 1895. Currents of the Great Lakes as deduced from the movements of bottle papers during the seasons of 1892, 1893, and 1894. U.S. Dept. of Agriculture, Weather Bureau, Bulletin B, Pp 6.
- Johnson, R. G. and E. C. Monahan, 1971: Current Meter Observations of the Circulation in Grand Traverse Bay of Lake Michigan: Mooring Methods and Initial Results. University of Michigan Sea Grant Technical Report No. 18, Ann Arbor, Michigan, Pp 58.
- Kizlauskas, A. G. and P. L. Katz, 1973. A Two-Layer Finite-Difference Model for Flows in Thermally Stratified Lake Michigan. Proceedings of the 16th Conference on Great Lakes Research, International Association for Great Lakes Research, Pp 743-753.

- Monahan, E. C., P. C. Hawkins, and E. A. Monahan, 1974. Surface Current Drifters: Evolution and Application, University of Michigan Sea Grant Report, Ann Arbor, Michigan, Pp 46.
- Monahan, E. C., B. J. Higgins, and G. T. Kaye, 1975. A comparison of vertical drift-envelopes to conventional drift-bottles. Limnology and Oceanography, 20, Pp 141-147.
- Monahan, E. C., G. T. Kaye, and E. D. Michelena, 1973. Drogue Measurements of the Circulation in Grand Traverse Bay, Lake Michigan. University of Michigan Sea Grant Technical Report, No. 35, Ann Arbor, Michigan, Pp 35.
- Monahan, E. C. and E. A. Monahan, 1973a. Drogues, Drags, and Sea Anchors. University of Michigan Sea Grant Technical Report No. 36, Ann Arbor, Michigan, Pp 21.
- Monahan, E. C. and E. A. Monahan, 1973b. Trends in Drogue Design. Limnology and Oceanography, 18, Pp 981-985.
- Monahan, E. C. and C. R. Zeitlow, 1968. Lake Superior Studies, Report No. 2, Northern Michigan University, Marquette, Michigan, Pp 74.
- Murty, R. S. and D. B. Rao, 1970. Wind-generated Circulations in Lakes Erie, Huron, Michigan, and Superior. Proceedings of the 13th Conference on Great Lakes Research, International Association for Great Lakes Research, Pp 927-941.
- Terhune, L. D. B., 1968. Free-floating current followers. Fisheries Research Board of Canada, Technical Report No. 85, Pp 33.
- Vachon, W. A., 1973. Scale Model Testing of Drogues for Free Drifting Buoys, Charles Stark Draper Laboratory Report R-769. Cambridge, Massachusetts, Pp 143.



UNIVERSITY OF MICHIGAN



3 9015 03483 7453