



AIAA 94-3297

**Non-Intrusive Plasma Diagnostics for Electric
Propulsion Research**

S. Ohler and B. Gilchrist

Department of Electrical Engineering & Computer Science

A. Gallimore

Department of Aerospace Engineering

The University of Michigan

Ann Arbor, MI

**30th AIAA/ASME/SAE/ASEE Joint
Propulsion Conference**

June 27-29, 1994 / Indianapolis, IN

NON-INTRUSIVE ELECTRON NUMBER DENSITY MEASUREMENTS IN THE PLUME OF A 1 KW ARCJET USING A MODERN MICROWAVE INTERFEROMETER

Shawn G. Ohler,* Brian E. Gilchrist,† and Alec D. Gallimore‡
University of Michigan
Ann Arbor, Michigan

Abstract

Reported here is the use of a microwave interferometric technique for making non-intrusive measurements of electron number density. Electron number density profiles were obtained throughout the plume of a 1 kW hydrogen arcjet by using a modern microwave network analyzer to obtain highly accurate differential phase measurements. Spatially resolved integrated phase shifts for a 17.5 GHz signal radiated through the plume at various radial positions were Abel inverted to calculate radial electron density profiles. For these tests, a probe positioning system was used to radially sweep the antenna assembly across the plume at various axial positions. All measurements were taken in the University of Michigan's Large Chamber Plasma Facility, a 6 m by 9 m vacuum chamber, at pressures of 2×10^{-4} Torr or less. The interferometer was shown to measure electron densities as low as $1 \times 10^{15} \text{ m}^{-3}$ and is predicted to be capable of measuring peak densities as high as $3 \times 10^{18} \text{ m}^{-3}$. The accuracy of this technique is estimated to be on the order of $\pm 10\%$. Comparison with Langmuir probe electron number density measurements demonstrate general agreement to within the accuracy of the two measurement techniques. However, a tendency for the Langmuir probe to under predict electron number density was observed for all experiments. It is postulated that this under prediction may be due to small Langmuir probe perturbations in the local plasma of the far-field plume, an observation shared by others.

Nomenclature

f	=	Interferometer operating frequency (Hz)
kT_e	=	Electron Temperature (eV)
n_c	=	$(f/8.98)^2$, Critical or cutoff density (m^{-3})
n_e	=	Electron density given (m^{-3})
r	=	Radial distance from center of plume (m)
r_p	=	Radius of Langmuir probe (m)
R	=	Maximum plume radius (m)
x	=	Dimension normal to thruster and antenna axis (m)
ϵ_r	=	Relative permittivity
ϕ	=	Phase of a wave (degrees)
λ	=	Wavelength of a wave (m)
λ_D	=	Debye Length (m)

1 • Introduction

Microwave interferometry using modern microwave technology to measure electron number density is demonstrated for the application of electric propulsion. The nonintrusive measurement system presented here provides high measurement sensitivity, accuracy, and allows for high spatial resolution. The technique generates density mappings radially and axially.

The microwave interferometric technique has many desirable attributes. This includes being nonintrusive, which avoids any local perturbations of the flow [1-4]. It also does not rely on complicated models that make a priori assumptions about the plasma (e.g., local thermal equilibrium, LTE). In fact, many non-intrusive techniques are ineffective for non-hydrogenic propellants for which Einstein coefficients, oscillator strengths, etc., are not well known (e.g., xenon). In addition, this technique is capable of measuring electron number density over a range of several orders of magnitude with high accuracy. Because of these reasons, microwave interferometers have long been used as the standard measure of electron number density to which other diagnostics are calibrated against.

The basis for both the theory and experimentation involved in microwave diagnostics of plasmas has a long history [5]. It is well known that an electromagnetic signal propagating through a plasma interacts directly with the ionized constituents and therefore can be a direct measure of plasma density. Further, the technique is in common practice for diagnostics of fusion plasmas [6-8]. The work

* Graduate Student Research Assistant, Electrical Engineering and Computer Science

† Assistant Professor, Electrical Engineering and Computer Science, member AIAA

‡ Assistant Professor, Aerospace Engineering, member AIAA

by Kelly [9] is the only other report of using microwave interferometry for electric propulsion of which we are aware. In Kelly's work, a 24 GHz antenna pair was swept through the thruster plume. However, this implementation of the technique cannot be considered nonintrusive. Further, it was limited by the technology of that time to detecting densities between 10^{18} and $7 \times 10^{18} \text{ m}^{-3}$.

Since this early effort, advances in high frequency technology have made microwave interferometry a highly reliable, accurate, and relatively inexpensive measurement technique. Further, recent work with laboratory plasmas has shown that the microwave interferometry technique compares well with Langmuir probe measurements over a wide range of pressure and electron density with differences occurring only where the Langmuir probe models begin to break down [3, 4].

This paper is intended to serve as a demonstration of the method of non-intrusive microwave interferometry as applied to electric propulsion. Although not intended to be exhaustive at this time, we report on initial comparisons between our microwave measurements and Langmuir probe derived density estimates. The following section reviews the theory of microwave interferometry and the Abel inversion technique as applied to our situation. The third section describes the experimental apparatus including the arcjet, vacuum chamber, and positioning system in addition to a description of the microwave measurement system. In section 4, experimental results are described which include a comparison of microwave interferometer and Langmuir probe electron density measurements as well as a plume density map. In section 5, the measurement accuracy of our experimental system is assessed and finally a summary is given of our results and accomplishments.

2 • Theory of Microwave Interferometry

Microwave interferometry uses the integrated phase shift of a wave passing through a plasma to find the line integrated plasma electron density (see Figure 1). The basic principle behind microwave interferometry is that electromagnetic waves propagating through different materials have different phase velocities. In this experiment the phase of a wave traveling through the plasma is compared to a reference wave in a vacuum. The measured phase shift is related to the line integrated electron density of the plasma. By making multiple measurements along a plane of the plasma that is radially symmetric, the local electron density can be found using the Abel inversion technique [10-12].

Microwave interferometry is based on the relationship between the electron density and the propagation of electromagnetic waves through the plasma. In a nonmagnetic plasma, where the collision frequency is expected to be less than 1 MHz (*i.e.*, is much less than the

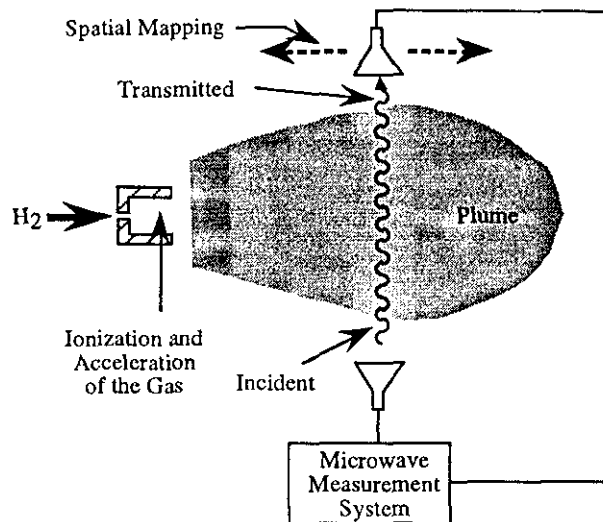

Figure 1: General components of the microwave interferometer.

propagation frequency), the relationship between the relative dielectric constant and the electron density is given simply by equation 1.

$$\epsilon_r = 1 - \frac{n_e}{n_c} \quad (1)$$

Given that the phase of a propagating wave is related directly to the square root of the dielectric constant, the integrated electron density of the plasma can be found by transmitting a wave through a plasma and tracking the phase difference relative to a known reference.

Microwave interferometry uses the phase to find integrated line density of the plasma. In order to find the local density throughout the plasma, several chordal measurements are needed. One method, Abel inversion, uses chordal measurements from a cross section across a radially symmetric plane of the plasma. By using the gradient of the phase along the measurement axis the local electron density is found throughout the plane. In order to use microwave interferometry and Abel inversion, the local density must be below the critical density, n_c , of the propagating wave. In other words, the wave must propagate at a frequency above the plasma frequency. For the 17.5 GHz interferometer used here, the plasma density should be at some value below $3.7 \times 10^{18} \text{ m}^{-3}$. Higher densities can be measured by simply using a higher frequency interferometer. The following Abel inversion equation was used to find electron density in this work [10]:

$$n(r) = -\frac{\lambda n_c}{\pi^2} \int_r^R \left(\frac{\partial \phi / \partial x}{\sqrt{x^2 - r^2}} \right) dx \quad (2)$$

For the case where the electron density of the plasma is spatially varying, the measured phase is still related to the integrated density. For microwave interferometry to be a valid technique the plasma must conform to the following condition for the wavelength, density, and density gradient in order to make the geometrical optics approximation to a wave [13]:

$$\lambda \ll \frac{n_e}{\partial n_e / \partial r} \quad (3)$$

In addition, the plasma must be stable over the dwell time at each axial location (~4 minutes). Plasma in the far-field arcjet plume generally conforms to both of these conditions [14].

3 • Experimental System

Figure 2 shows a cross sectional view of the 1 kW-class arcjet that was supplied by the NASA Lewis Research Center for this study. The engine features a 2%-thoriated tungsten cathode and nozzle that serves as the anode. The arcjet has a 0.51-mm-diameter by 0.25-mm-long constrictor, a 30 degree half-angle converging nozzle section upstream of the constrictor, and a 20 degree half-angle diverging section. The exit diameter of the nozzle is 9.52 mm, giving the expansion section an area ratio of 350. The electrode gap spacing is 0.51 mm and the outer housing of the device is constructed of titanated zirconiated molybdenum (TZM).

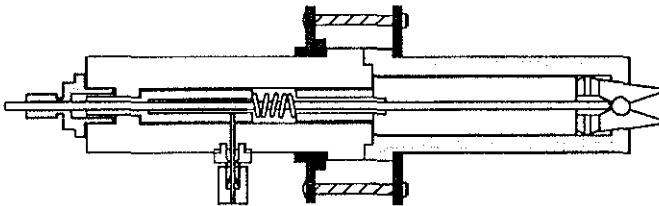

Figure 2: Cross section of the 1 kW arcjet.

All experiments reported were performed at the Plasma Electric Propulsion Laboratory (PEPL) at the University of Michigan in a 9-m-long by 6-m-diameter stainless-steel vacuum chamber (Figure 3). The facility is supported by six 81-cm-diameter diffusion pumps each rated at 32,000 L/s (with water-cooled cold traps), backed by two 2,000 cfm blowers, and four 400 cfm mechanical pumps. These pumps give the facility an overall pumping speed of over 100,000 L/s at 10^{-5} Torr. In addition, a Polycold PFC-1100 closed-loop cold trap system has been installed above two of the diffusion pumps to increase the water pumping speed of the facility, thus greatly reducing the pump-down time. A more complete description of the experimental facilities can be found in Gallimore [15].

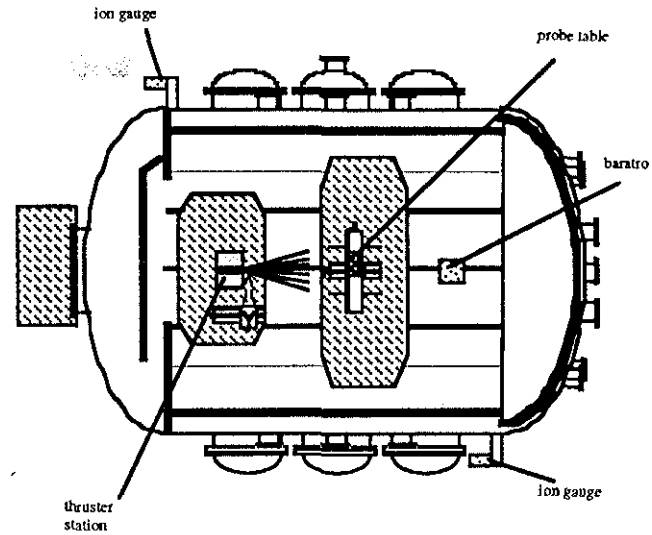

Figure 3: Schematic of the 9 by 6 m vacuum chamber.

Plume diagnostics are performed through the use of a state-of-the-art probe positioning system developed by New England Affiliated Technologies (NEAT). The table contains two rotary platforms on a linear stage with 1.5 m of travel in the radial direction on a 0.9 m travel axial stage. With the microwave system present, one of the rotaries is removed. The rotary actuators not only allow Langmuir probes to be rotated to minimize measurement errors due to probe misalignment with the flow [16], but also for the purpose of characterizing the local flow field. The system allows for sweeps at radial speeds in excess of 60 cm/s with an absolute position accuracy of 0.15 mm with time (or radial position) varying probe angles. The system is driven with a Macintosh computer running National Instruments LabView software. Like the thruster station, the entire probe positioning system is mounted on a movable platform to allow for measurements to be made throughout the chamber.

A cylindrical single Langmuir probe was used to measure n_e and kT_e in the plume of the arcjet. The probe is composed of a rhenium electrode, 0.42 cm in diameter and 5.1 cm long, attached to a triaxial boom that is constructed of titanium with Teflon insulation. The boom is approximately 4 mm in diameter and 18 cm long.

The collector electrode of the probe was biased with respect to the chamber. A function generator was used to provide the 12.7 Hz triangular source wave form that was amplified by a bi-polar power supply.

Probe current, measured through a 10 Ohm shunt, and probe voltage, measured with respect to tank ground, are collected by LabView through an interface circuit. Since r_p/λ_d is expected to be 20 or greater [14], the standard Bohm thin-sheath ion saturation current model was used to interpret Langmuir probe data.

Microwave Measurement System

The microwave interferometer (Figure 4), that was developed for these demonstration measurements, was designed to work throughout the Ku band (12-18 GHz). However, the density measurements presented here were taken with a 17.5 GHz beam transmitted at less than 0.1 mW through the plume. Resolution was limited by the wavelength of the beam (1.7 cm). The measurement system consisted of a computer controlled network analyzer connected to a frequency conversion circuit by 15 meters of flexible microwave coaxial cable. The circuit was attached, along with the antennas, to a support structure that was mounted vertically on the probe positioning table. The Langmuir probe was offset from the microwave system but was in the same axial plane with respect to the thruster. The positioning table moved the microwave system and the Langmuir probe throughout the plume.

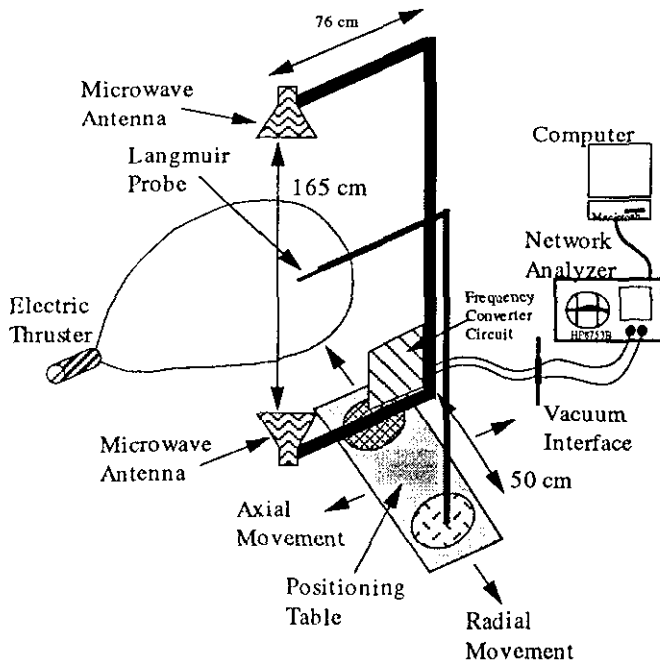

Figure 4: Sketch of the 17.5 GHz interferometer, Langmuir probe, and arcjet thruster. Included for the microwave system are two lens corrected horn antennas, a frequency converter circuit (2.5 GHz to 17.5 GHz), network analyzer, and computer controller.

This measurement system utilized the capabilities of the Hewlett Packard 8753B network analyzer as a stable microwave source and highly sensitive receiver. By frequency sweeping from 16 to 18 GHz the measurement took advantage of standard time gating[§] features of modern network analyzers to isolate the test signal. The instrument

was controlled by a Macintosh IIcx computer using LabView through a GPIB interface.

Due to the long distance between the network analyzer outside of the chamber and the antenna system inside the chamber, a frequency up-down converter was utilized in order to transmit a lower frequency over that distance with corresponding lower losses and lower phase inaccuracies. The up-down converter, placed near to the antennas, frequency shifted the 2.5 GHz signal from the network analyzer to 17.5 GHz using a 15 GHz local oscillator.

Both the network analyzer and the local oscillator were independently phase locked. The total phase noise of the system is $\pm 0.5^\circ$ which was due primarily to the 40 dB difference[§] in the transmitted and received signal at the network analyzer. Given this high phase stability, the system allowed measurement of electron density distributions in plumes with peak densities up to $3 \times 10^{18} \text{ m}^{-3}$ while still being sensitive to local density of order 10^{14} m^{-3} (peak density greater than 10^{15} m^{-3}).

The lens corrected horn antennas used to transmit the signal through the plasma had with full angle half power beam widths between 7° and 8° for both the *E*-plane and the *H*-plane and approximately 25 dB gain. The lens was designed so that the focal point of it was aligned with the phase center of the horn and placed experimentally to optimize the power transmitted between the horns. The horns were designed to minimize size while maintaining high gain. The antennas were placed 165 cm apart standing vertically on the probe position system in the chamber. It was experimentally determined that the antenna system exhibited no detectable phase sensitivity to nonhomogeneous dielectric distributions or metallic objects surrounding the antenna beam (*i.e.* not directly between the antennas). This indicates that the transmitted signal was essentially limited to a collimated beam 13 cm in diameter (dimension of antenna).

Two special issues of note pertain to the antenna system when assessing possible error sources: finite horn aperture and horn separation distance. The measured phase is the weighted average of the electromagnetic signal phase transmitted and received over the horn aperture which is 13 cm in diameter. It is estimated that the finite horn aperture dimension can reduce our plasma density measurements by 2% at the center of the plume. Away from plume center this error would tend to be less for monotonic variations. The finite horn separation has an effect only when significant plasma exists beyond the propagation path of the antennas. In this instance, the wave does not propagate through the entire plasma; hence, the phase shift is reduced. For plume profiles presented in this paper, the peak electron densities are suppressed no more than 4% for the closest axial distance due to these effect. This phase error decreases for lower perimeter electron densities.

[§] See Hewlett Packard Reference Manual for the IIP8753 network analyzer

4 • Experimental Results

All of the data were measured in the far field of a 1 kW arcjet with hydrogen propellant, operating at 10 Amperes and a flow rate of 10 SLPM (15 mg/s). Tank pressure was maintained to 2×10^{-4} Torr or less during arcjet operation. The arcjet was given 20 minutes to reach thermal equilibrium before data were collected.

The positioning system moved across the plume at a rate of 0.635 cm/sec from 106 cm to -46 cm measured radially from the center of the plume. The phase measurements were recorded every 0.5 cm radially. The Langmuir probe was offset from the center of the antennas by approximately 50 cm, but still swept across a comparable portion of the arcjet plume.

The phase measured by the network analyzer was referenced to the phase at the perimeter of the plume where the electron density was below the detectability of the system. In addition, a small phase drift of 0.16° per sweep due to temperature change and outgassing was accounted for. The phase noise of the complete system was approximately $\pm 1^\circ$ and primarily resulted from the vibration caused by the positioning system and phase noise inherent in the microwave system.

The phase shift measurement, Gaussian curve fit, and derived electron density are shown for a single radial sweep at 38.7 cm from the arcjet in Figure 5. As seen, the Gaussian curve fit closely follows the phase measurements from the arcjet which is also true at other axial positions.

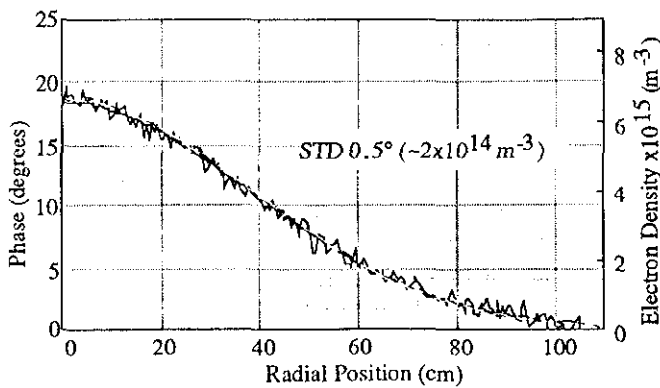

Figure 5: Comparison of the measured phase shift with the best fit Gaussian curve and the electron density calculated from the Abel inverted Gaussian curve. The measurement is 39 cm from the exit plane of a 1 kW hydrogen arcjet.

Multiple sweeps across a path 30 cm from the thruster indicate the repeatability of the measurement to be $\pm 5\%$ for same day measurements and $\pm 10\%$ for measurements on separate days. This variation could, in part, be due to variation in the arcjet plume. A peak density of approximately 10^{15} m^{-3} corresponds a peak phase shift of under 3° . Given that the phase noise is $\pm 1^\circ$, density

distributions with less than 10^{15} m^{-3} are below the limit of detectability for the current system operating at 17.5 GHz.

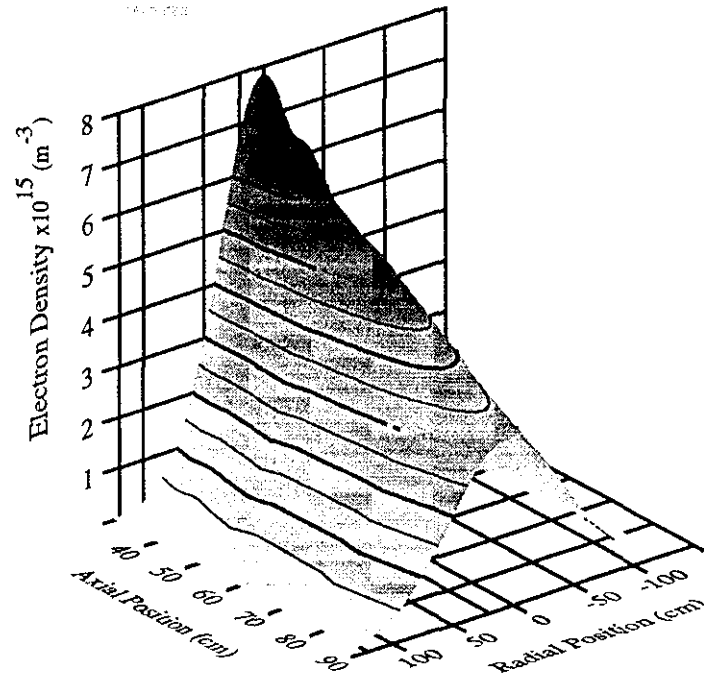

Figure 6: The electron density contour mapping developed from a 1 kW hydrogen arcjet. Measurements were taken at various axial distances from the exit plane of the arcjet. Phase measurements were taken every 0.5 cm radially.

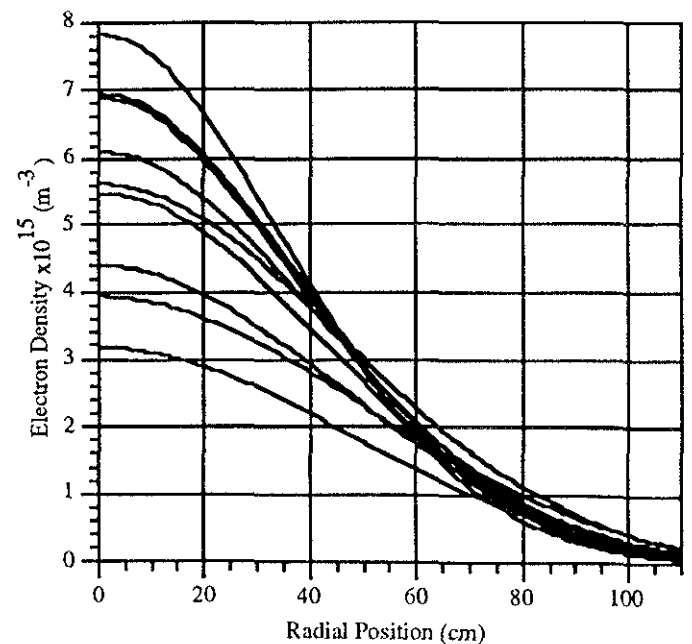

Figure 7: Electron density profiles at various axial positions: 30, 34, 39, 43, 50, 55, 71, 75, and 88 cm from the thruster.

A mapping of the electron density was developed by sweeping across the plume at many axial positions. Figure 6

shows the resulting electron density contours. This figure highlights the Gaussian nature across the radial direction and the approximate linear decrease of density along the axis. Figure 7 shows several density profiles for the measured axial positions. This representation shows a general spreading of the plume in the radial direction for the distances progressively farther from the thruster.

In Figure 8A and Figure 8B, Langmuir probe data is shown calculated using the Bohm thin-sheath ion saturation current model. The data is fit to a Gaussian to highlight the trends in the probe measurements in order to more readily compare to the microwave interferometry data. As with the interferometry data, the Langmuir probe data follows the Gaussian well (except at the lowest densities) even though greater scatter exists with the probe data.

While the shape of the two data sets matches well, as with past comparisons [3, 4], the Langmuir probe predicts a lower density than microwave interferometry. In this case, Langmuir probe results are up to 50% lower which is within the expected experimental uncertainty of the Langmuir probe.

Although no papers were found reporting on a 1 kW arcjet using hydrogen, Carney [14] reported on a 1 kW arcjet with simulated hydrazine which should have a lower electron density than hydrogen. The peak density for hydrazine was measured to be $2 \times 10^{15} \text{ m}^{-3}$ at a distance of 30 cm which agrees with our own measurements using hydrazine, i.e. just at the limit of detectability of our present system.

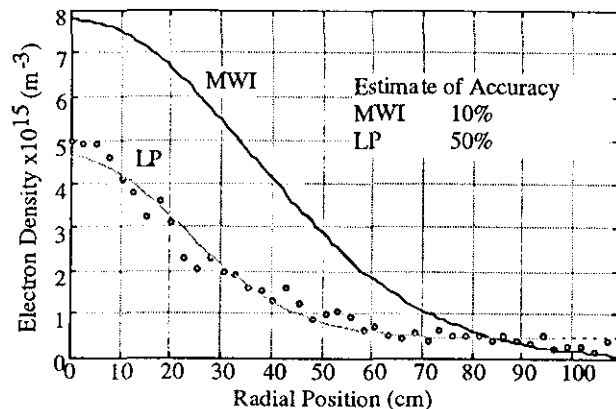

Figure 8A: Comparison of electron density measured by a microwave interferometer with that of a Langmuir probe at 30 cm axially from the exit plane of the arcjet.

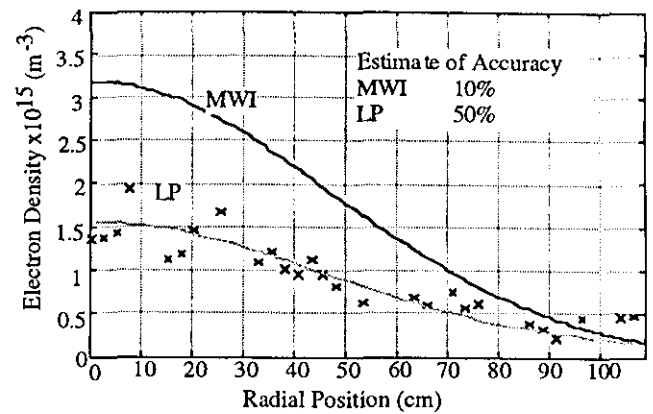

Figure 8B: Comparison of electron density measured by a microwave interferometer with that of a Langmuir probe at 88 cm axially from the exit plane of the arcjet.

5 • Concluding Remarks

This paper presented a highly successful demonstration of microwave interferometry for electric propulsion applications. The technique is nonintrusive with the antennas out of the plume and uses very low transmitted power. The method is straightforward, uses well understood electromagnetic theory and results in direct, plasma induced, phase measurements from a network analyzer to find local density via Abel analysis. The system achieves high stability and high accuracy utilizing modern microwave technology.

The microwave interferometer described here can map the electron density of an electric thruster plume in the far field. Langmuir probe measurements of the same arcjet plume compared well with the interferometry results assuming recognized limitations of the Langmuir probe. With the complexities of Abel inversion, an exact statement of accuracy is difficult. Our analysis of phase accuracy, measurement repeatability, and antenna effects lead to an estimate of system accuracy on the order of $\pm 10\%$. The system can map distributions with peak densities from 10^{15} m^{-3} up to an estimated value near $3.7 \times 10^{18} \text{ m}^{-3}$. In addition, it should be possible to measure electron number densities within a few centimeters of the arcjet exit plane.

Several possibilities for system improvement exist. Additional circuit components as well as computer optimization could produce faster data rates, thus loosening the time stability restriction and/or allowing for data averaging. Modified antenna and support structure design could reduce the effects of finite antenna size and spacing. Higher transmission frequency would allow measurement of higher density plasmas at better resolutions. By using an Abel analysis that uses a frequency domain transform [17] of the raw data, problems inherent with curve fitting could be avoided.

The same microwave system provides significant flexibility. With slight modification, other diagnostics could be implemented. General effects on communication through a thruster plume could be experimentally studied to supplement theoretical work such as Carney [18]. Reflectometry could be done to find higher electron density. Furthermore, by examining the Doppler spreading of the incident signal, information on the ion distribution function and temperature can be obtained. Lastly, drift velocity could be measured by examining the Doppler shift of a signal.

Acknowledgments

One of the authors (S.G.O.) would like to thank all of his fellow students at the Plasma Electric Propulsion Laboratory especially M. Richenbacher who worked with the positioning system and S-W. Kim who worked with the Langmuir probes. Thanks also goes T. Budka of the Radiation Laboratory at the University of Michigan for help with the microwave filters and Prof. V. Liepa also of the Radiation Laboratory for his endless advice and generous use of equipment. We wish to thank Dr. Frank Curran of NASA Lewis Research Center for the loan of the 1 kW arcjet and PPU. Finally, we thank Dr. Larry Brace of the UM's Space Physics Research Laboratory for the use of his Langmuir probe. This work was sponsored by University of Michigan start-up research funding from the office of the Vice-President for Research and the College of Engineering.

References

1. Hopkins, M.B. and W.G. Graham, *Langmuir probe techniques for plasma parameter measurements in a medium density discharge*. Rev. Sci. Instrum., 1986. 57(9): p. 2210-2217.
2. Tilley, D.L., A.J. Kelly, and R.G. Jahn. *The Application of the Triple Probe Method to MPD Thruster Plumes*. in *21th International Electric Propulsion Conference*. 1990. Orlando, FL:
3. Overzet, L. and M. Hopkins, *Comparison of electron-density measurements made using a Langmuir probe and microwave interferometry in the Gaseous Electronics Conference reference reactor*. J. Appl. Phys., 1993. 74(7): p. 4323-4330.
4. Neumann, G., et al., *Plasma-density measurements by microwave interferometry and Langmuir probes in an rf discharge*. Rev. Sci. Instrum., 1993. 64(1): p. 19-25.
5. Heald, C.B. and M.A. Wharton, *Plasma Diagnostics With Microwaves*. 1965, New York: John Wiley and Sons, Inc.

6. Efthimion, P.C., et al., Rev. Sci. Instr., 1985. 56: p. 908.
7. Fessey, J.A., et al., Journal of Phys. E, 1987. 20: p. 169.
8. Pearson, D.A., et al. in *Mater. REs. Soc. Symp. Proc.* 1988.
9. Kelly, A.J., *A Microwave Probe for Plasma Plumes*. AIAA Journal, 1965. .
10. Sips, A.C.C., *Doctoral Thesis: Reflectometry and Transport in Thermonuclear Plasmas in the Joint European Torus* 1991, College van Dekanen:
11. Wu, H.P. and R.L. McCreery, *Observation of Concentration Profiles at Cylindrical Microelectrodes by a Combination of Spatially Resolved Absorption Spectroscopy and the Abel Inversion*. Anal. Chem., 1989. 61: p. 2347-2352.
12. Okada, S., et al., *Reduction of the Density Profile of a Field-reversed configuration From Detailed Interferometric Measurements*. J. Appl. Phys., 1989. 16(12): p. 4625-3631.
13. Ginzburg, V.L., *The Propagation of Electromagnetic Waves in Plasmas*. 1970, Pergamon Press.
14. Carney, L.M. and J.M. Sankovic. *The Effects of Arcjet Thruster Operating Condition and Constrictor Geometry on the Plasma Plume*. in *25th Joint Propulsion Conference*. 1989. Monterey, CA:
15. Gallimore, A., M. Reichenbacher, and F. Guiczinski. *Near and Far-Field Plume Studies of a 1kW Arcjet*. in *30th Joint Propulsion Conference*. 1994. Indianapolis, IN:
16. Tilley, D.L., et al., *The Adverse Effect of Ion Drift Velocity Perpendicular to a Cylindrical Triple Probe*. Rev. Sci. Instr., 1994. 65(3).
17. Smith, L.M., D. Keefer, and S.I. Sudharsnan, *Abel Inversion Using Transform Techniques*. J. Quant. Spectrosc. Radiat. Transfer, 1988. 39(5): p. 367-373.
18. Carney, L. *Evaluation of the Communications Impact of a Low Power Arcjet Thruster*. in *24th Joint Propulsion Conference*. 1988. Boston, Massachusetts: