

REPORT DOCUMENTATION PAGE		READ INSTRUCTIONS BEFORE COMPLETING FORM
1. REPORT NUMBER AFML-TR-77-82	2. GOVT ACCESSION NO.	3. RECIPIENT'S CATALOG NUMBER
4. TITLE (and Subtitle) EFFECTS OF MOISTURE AND TEMPERATURE ON THE TENSILE STRENGTH OF COMPOSITE MATERIALS		5. TYPE OF REPORT & PERIOD COVERED Technical-Annual March 1976-March 1977
		6. PERFORMING ORG. REPORT NUMBER
7. AUTHOR(s) George S. Springer Chi-Hung Shen		8. CONTRACT OR GRANT NUMBER(s) F33615-75-C-5165
9. PERFORMING ORGANIZATION NAME AND ADDRESS The University of Michigan Department of Mechanical Engineering Ann Arbor, Michigan 48109		10. PROGRAM ELEMENT, PROJECT, TASK AREA & WORK UNIT NUMBERS 734003A5
11. CONTROLLING OFFICE NAME AND ADDRESS Air Force Materials Laboratory (AFML/MBM) Air Force Wright Aeronautical Laboratories Wright-Patterson Air Force Base, Ohio 45433		12. REPORT DATE May 1977
		13. NUMBER OF PAGES 45
14. MONITORING AGENCY NAME & ADDRESS (if different from Controlling Office)		15. SECURITY CLASS. (of this report) UNCLASSIFIED
		15a. DECLASSIFICATION/DOWNGRADING SCHEDULE
16. DISTRIBUTION STATEMENT (of this Report)  Approved for public release; distribution unlimited		
17. DISTRIBUTION STATEMENT (of the abstract entered in Block 20, if different from Report)		
18. SUPPLEMENTARY NOTES		
19. KEY WORDS (Continue on reverse side if necessary and identify by block number) Moisture Absorption and Desorption Tensile Strength Graphite Epoxy Composites		
20. ABSTRACT (Continue on reverse side if necessary and identify by block number)  The ultimate tensile strengths of Thornel 300/Fiberite 1034 graphite epoxy composites were measured with material temperatures ranging from 200 K to 422 K and moisture contents from 0% (dry) to 1.5% (fully saturated). All measurements were performed using 0°, 90° and $\pi/4$ laminates. A survey was also made of the existing data showing the effects of temperature and moisture content on the tensile strength of different composites.		



## FOREWORD

This annual report was submitted by Dr. George S. Springer and Dr. Chi-Hung Shen of The University of Michigan, Mechanical Engineering Department, Ann Arbor, Michigan, under contract F33615-75-C-5165, Project 7340, Task 734003, with the Air Force Materials Laboratory, Wright-Patterson Air Force Base, Ohio. Stephen W. Tsai, AFML-MBM was the laboratory project monitor.



## TABLE OF CONTENTS

Section	Page
I INTRODUCTION .....	1
II CONCLUSIONS .....	1
III EXPERIMENTAL .....	3
IV RESULTS.....	11
REFERENCES .....	36

## LIST OF ILLUSTRATIONS

Figure		Page
1	Geometry of the test specimen a) $0^\circ$ and $\pi/4$ laminates, b) $90^\circ$ laminates .....	6
2	Moisture distribution inside the specimen after immersion in 50, 75 and 100 percent relative humidity air. Moisture distributions for a) specimen fully saturated (top curves), b) specimen moisture content 66 percent of full saturation (middle curves), and c) specimen moisture content 33 percent of full saturation (bottom curves) .....	7
3	Thickness of the layer affected by three minutes of drying at different temperatures. Within "penetration depth" effect of drying is greater than 1%. $M_m$ denotes moisture content at full saturation .....	9
4	Moisture loss of specimen during three minutes of drying at different temperatures. $M_i$ and $M_f$ are the moisture contents before and after drying. $M_m$ denotes moisture content at full saturation .....	10
5	Ultimate tensile strength of Thornel 300/Fiberite 1034 as a function of temperature and moisture content. Present data. Fiber volume fraction $\sim 0.68$ .....	12
6	Ultimate tensile strength of Hercules AS-5/3501 as a function of temperature and moisture content. Data of Browning et al, 1976 [3] .....	17
7	Ultimate tensile strength of Hercules AS-5/3501 as a function of temperature and moisture content. Data of Verette, 1975 [4] .....	18
8	Dry ultimate tensile strength of Hercules AS-5/3501 as a function of temperature. Data of Kerr et al, 1975 [5] .....	19
9	Quasi-isotropic ultimate tensile strength of Hercules AS-5/3501 as a function of temperature and moisture content. Data of Kim and Whitney, 1976 [6] .....	20
10	Ultimate tensile strength of Thornel 300/Narmco 5208 as a function of temperature and moisture content. Data of Hofer et al, 1975 [7] .....	21
11	Transverse ultimate tensile strength of Thornel 300/Narmco 5208 as a function of temperature and moisture. Data of Husman, 1976 [8] .....	22
12	Ultimate tensile strength of Modmor II/Narmco 5206 as a function of temperature and moisture content. Data of Hofer et al, 1974 [9] .....	23

Figure		Page
13	Ultimate tensile strength of Courtaulds HMS/Hercules 3002 M as a function of temperature and moisture content. Data of Hofer et al. 1974 [9] .....	24
14	Quasi-isotropic ultimate tensile strength of HT-S/ERLA-4617 as a function of temperature and moisture content. Data of Browning, 1972 [10] .....	25
15	Quasi-isotropic ultimate tensile strength of HT-S/Fiberite X-911 as a function of temperature and moisture content. Data of Browning, 1972 [10] .....	26
16	Quasi-isotropic ultimate tensile strength of HT-S/UCC X-2546 as a function of temperature and moisture content. Data of Browning, 1972 [10] .....	27
17	Dry longitudinal ultimate tensile strength of PRD 49/ERLB-4617 as a function of temperature. Data of Hanson, 1972 [11] .....	28
18	Transverse ultimate tensile strength of HT-S/(8183/137-NDA-BF <sub>3</sub> :MEA) as a function of temperature and moisture content. Data of Hertz, 1973 [12] .....	29
19	Quasi-isotropic ultimate tensile strength of HT-S/Hysol ADX-516 as a function of temperature and moisture content. Data of Browning, 1972 [10] .....	30
20	Dry ultimate tensile strength of Hercules HT-S/710 Polyimide as a function of temperature. Data of Kerr et al. 1975 [5] .....	31
21	Dry quasi-isotropic ultimate tensile strength of HT-S/P13N Polyimide as a function of temperature. Data of Browning, 1972 [10] .....	32
22	Ultimate tensile strength of Boron/AVCO 5505 as a function of temperature and moisture content. Data of Hofer et al. 1974 [9] .....	33
23	Dry longitudinal and transverse ultimate tensile strengths of Boron/Narmco 5505 as a function of temperature. Data of Kaminski, 1973 [13] .....	34
24	Quasi-isotropic ultimate tensile strength of Boron/Narmco 5505 as a function of temperature and moisture content. Data of Browning, 1972 [10]. ○ △: post-cured specimens; ● ▲: not post-cured specimen.....	35

## LIST OF TABLES

Table		Page
I	Autoclave Cure Cycle for T300/1034 .....	4
II	Conditions Used in Preparing the $0^\circ$ and $\pi/4$ Specimens .....	5
III	Summary of Experimental Data on the Effects of Moisture and Temperature on the Ultimate Tensile Strength of Composites....	14



## I. INTRODUCTION

The mechanical properties of composite materials may suffer when the material is exposed to high temperature, high humidity environments. Therefore, in order to utilize the full potential of composite materials, their performance at elevated temperatures and at high moisture contents must be known. The objective of this investigation was to evaluate the changes in the ultimate tensile strengths of composite materials exposed to air in which the relative humidity varied from 0 to 100 percent and the temperature ranged from 200 K to 450 K. The changes in the ultimate tensile strengths were assessed a) by performing tensile tests on Thornel300/Fiberite 1034 graphite epoxy composites using  $0^\circ$ ,  $\pi/4$ , and  $90^\circ$  lay-ups and b) by summarizing the existing data and comparing them to the present results.

## II. CONCLUSIONS

On the basis of both the present data and the available existing data (see Table III) the following general conclusions may be drawn.

### (1) Temperature Effects

a) For  $0^\circ$  and  $\pi/4$  laminates changes in temperature in the range 200 K to 380 K appear to have negligible effects on the ultimate tensile strength, regardless of the moisture content of the material. There may be a slight decrease in strength ( $<20\%$ ) as the temperature increases from 380 K to 450 K.

b) For  $90^\circ$  laminates the increase in temperature from 200 K to 450 K causes a significant decrease in the ultimate tensile strength. The decrease depends both upon the temperature and the moisture content and may be as high as 60 to 90 percent.

(2) Moisture Effects

a) For  $0^\circ$  and  $\pi/4$  laminates the moisture content of the composite material has only a small effect on the ultimate tensile strength. At moisture contents (weight gain) below 1 percent, the effects of moisture seem to be negligible. At moisture contents above 1 percent the tensile strength appears to decrease with increasing moisture content. The maximum decrease in the ultimate tensile strength is about 20 percent. This reduction in strength seems to be insensitive to the temperature of the material.

b) For  $90^\circ$  laminates the moisture content affects significantly the ultimate tensile strength. The reduction in strength depends both on the moisture content and on the temperature. The reduction in strength may be as high as 60 to 90 percent.

c) In all the tests reported here the moisture distribution was not uniform inside the specimens. For  $0^\circ$  and  $\pi/4$  specimens differences in moisture distribution did not seem to affect the results. For  $90^\circ$  specimens the moisture distribution may influence the absolute value of the ultimate tensile strength, but is unlikely to affect the trend in the data.

(3) A 20 to 60 percent scatter in the data is quite common in the tests. For this reason, and because for some materials the reported data are quite scarce, the above overall conclusions must be regarded only as generalizations. For specific conclusions regarding each particular composite material the relevant tensile test data must be examined.

(4) The above conclusions are based on data obtained in tests where the loading rate was "fast", such that the ultimate tensile strength was reached in matters of minutes. The interactions between loading rate, temperature, and moisture content have not yet been investigated.

### III. EXPERIMENTAL

The tensile test data reported in this paper were obtained using 8 ply T300/1034 specimens with fiberglass tabs attached to the ends of the specimens. The dimensions of the specimens are given in Fig. 1. The specimens were obtained from 0.66 m x 0.66 m autoclave cured panels. The panels were fabricated from 30.5 cm (12 in.) prepreg (Fiberite Corp.) using standard lay-up and vacuum bagging procedures. The cure cycle used in manufacturing the panels is given in the Table I.

Prior to the tensile tests all the specimens were completely dried at 366 K in a desiccator. The specimens were then placed in environmental chambers (see ref. 1) in which the temperature and the relative humidity were controlled and kept constant. The  $0^\circ$  and  $\pi/4$  specimens were "conditioned" by placing them in 50, 75, and 100% relative humidity environments and also by immersing them in water. The temperatures of the environmental chambers ranged from 300 K to 422 K. A summary of conditions used in preparing these specimens are listed in Table II. The  $90^\circ$  specimens were all conditioned at 366 K and 100% relative humidity.

The specimens were kept in the environmental chambers until the moisture content (weight gain) reached the required value. Specimens were tested with the material fully saturated and also at moisture contents corresponding to  $1/3$  and  $2/3$  of the fully saturated value. In the latter two cases the moisture distribution was not uniform inside the specimen at the end of the conditioning period. The moisture distributions in each specimen at the end of different conditioning periods were calculated from the theory presented by Shen and Springer [2]. The results of these calculations are shown in Fig. 2. Some drying of the outer layer occurred once the specimen was removed from the environmental chamber. This effect will be discussed subsequently.

Table I

Autoclave Cure Cycle for T300/1034

1. Vacuum bag - insert layup into autoclave at room temperature.
2. Apply full vacuum and contact pressure.
3. Raise temperature to 250°F at 3°F per minute.
4. Hold at 250°F for 15 minutes. Apply 100 psi.
5. Hold at 250°F and 100 psi for 45 minutes.
6. Raise temperature to 350°F.
7. Hold at 350°F for 2 hours.
8. Cool under pressure to below 175°F.

Table II Conditions Used in Preparing the 0° and  $\pi/4$  Specimens

AMBIENT MOISTURE CONTENT	TEMPERATURE, K					
	300	322	344	366	394	422
Dry	x	x	x	x	x	x
50% rel. humidity*	x	x	x	-	-	-
75% rel. humidity*	x	x	x	x	-	-
100% rel. humidity*	x	x	x	x	ss	ss
Immersed in water*	x	x	x	x	x	x

\* Three different saturation levels were reached at each temperature:  
a) specimen fully saturated, b) specimen's moisture content 66% of  
full saturation, c) specimen's moisture content 33% of full saturation.

ss denotes saturated steam

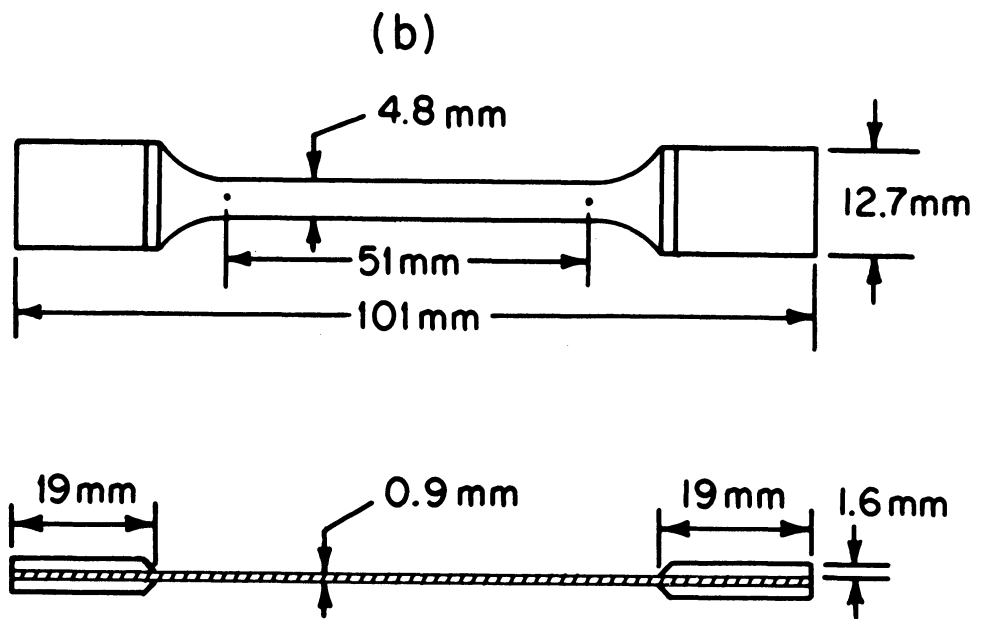
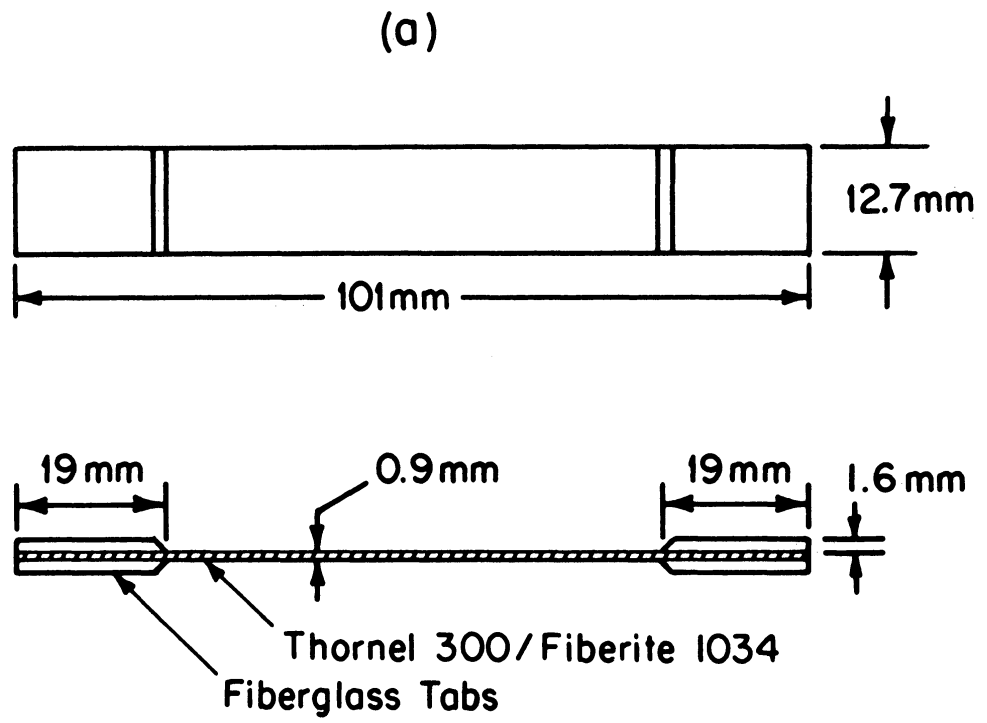

Geometry of the Test Specimen a)  $0^\circ$  and  $\pi/4$  Laminates, b)  $90^\circ$  Laminates.

Figure 1

RELATIVE HUMIDITY OF ENVIRONMENT:

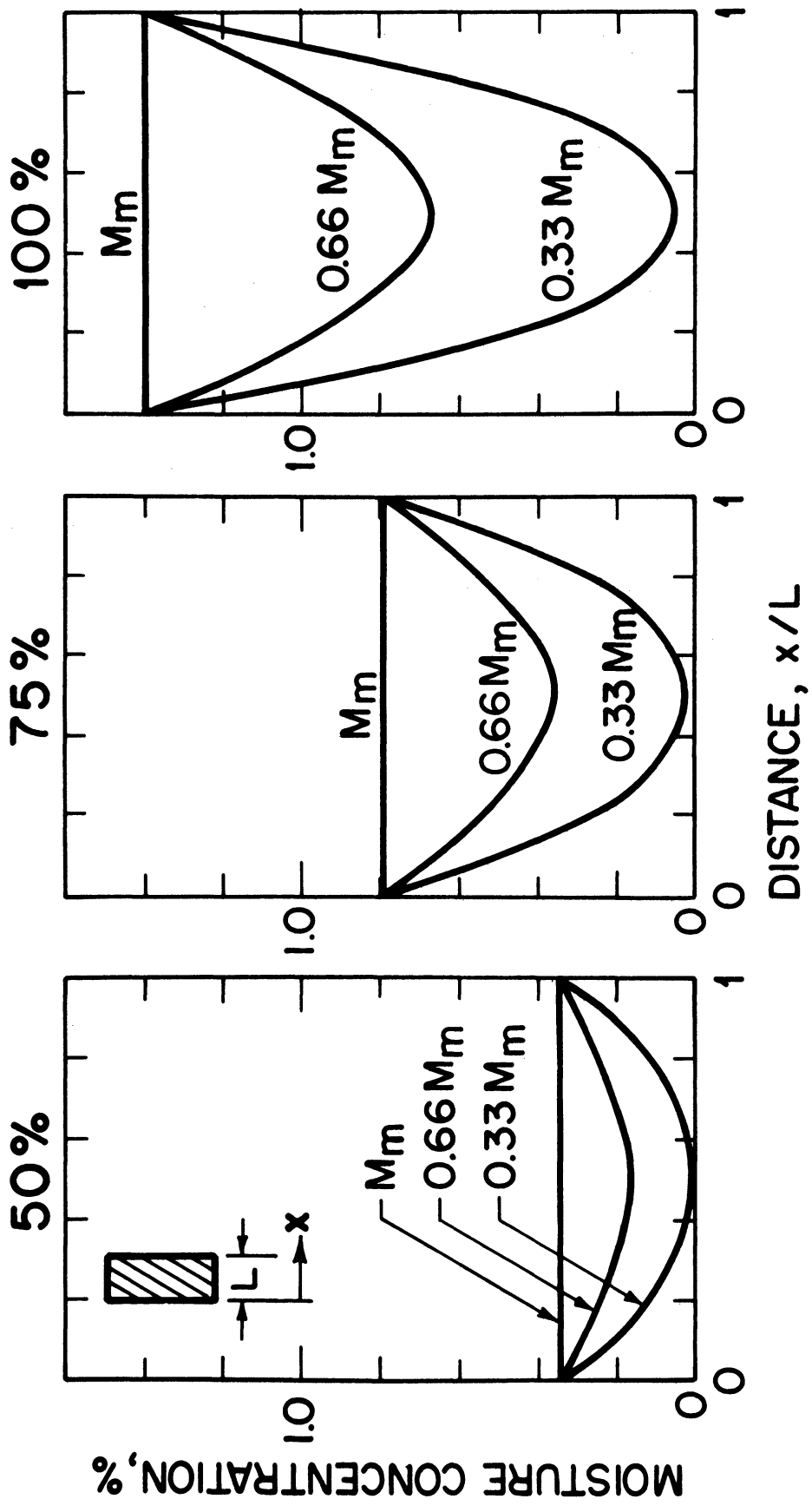

Moisture distribution inside the specimen after immersion in 50, 75 and 100 percent relative humidity air. Moisture distributions for a) specimen fully saturated (top curves), b) specimen moisture content 66 percent of full saturation (middle curves), and c) specimen moisture content 33 percent of full saturation (bottom curves)

Figure 2

When the specimens reached the required moisture content (weight gain) their ultimate tensile strengths were determined using a 10,000 lb capacity Instron machine (Model TTCLM 1-4). For the  $0^\circ$  and  $\pi/4$  specimens a cross-head speed of  $1.27 \text{ mm min}^{-1}$  (0.05 in/min) was used, while for the  $90^\circ$  specimens a cross-head speed of  $12.7 \text{ mm min}^{-1}$  (0.5 in/min) was used. During each test the specimen was maintained at the desired temperature by a specially constructed electric oven. For  $0^\circ$  and  $\pi/4$  specimens the oven temperature was the same as the temperature at which the specimen was conditioned. As noted above, the  $90^\circ$  specimens were all conditioned at 366 K. The oven was about 0.38 m high and 0.23 m in diameter and enclosed completely the specimen and the grips. The temperature of the specimen was measured by a copper-constantan thermocouple attached to the surface of the specimen.

The moisture content inside the oven was not controlled and hence some drying of the outer layer of the specimen occurred during the test. The duration of each test was about 3 minutes. During this time the specimen dries. The thickness of the layer affected by the drying ("penetration depth") and the amount of moisture lost during this drying was calculated by a numerical solution of Fick's equation [2]. The results of these calculations are presented in Figs. 3 and 4. Both the penetration depth and the moisture loss depend on the moisture distribution inside the material (i.e. on the level of saturation) at the beginning of the drying and on the drying temperature.



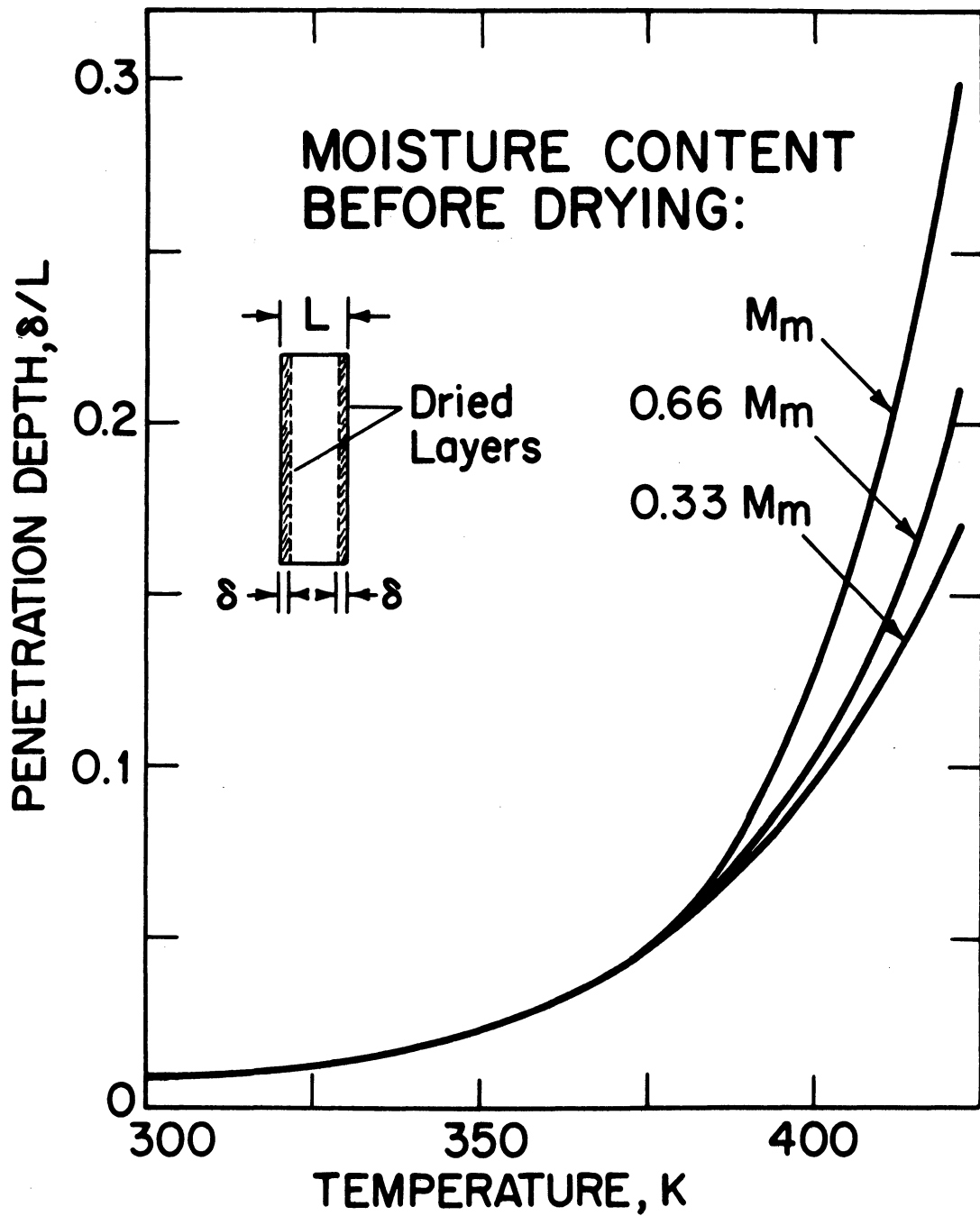

Thickness of the layer affected by three minutes of drying at different temperatures. Within "penetration depth" effect of drying is greater than 1%.  $M_m$  denotes moisture content at full saturation.

Figure 3

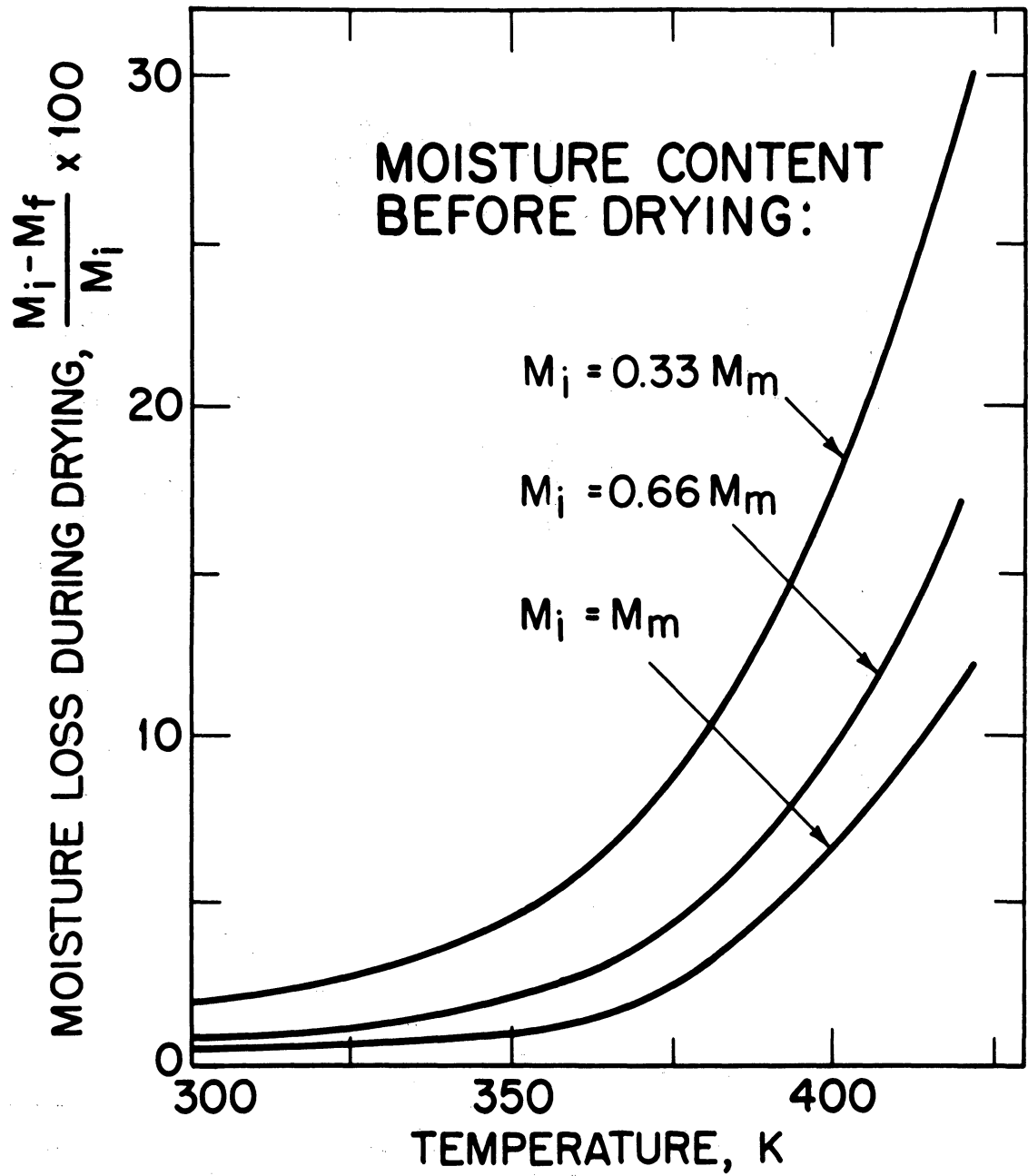

Moisture loss of specimen during three minutes of drying at different temperatures.  $M_i$  and  $M_f$  are the moisture contents before and after drying.  $M_m$  denotes moisture content at full saturation.

Figure 4

#### IV. RESULTS

The data obtained with T300/1034 are presented in Fig. 5. In this figure each data point represents the average of two tests for the  $0^\circ$  and  $\pi/4$  specimens and four to ten tests for the  $90^\circ$  specimens. The results show that for  $0^\circ$  and  $\pi/4$  laminates the ultimate tensile strength is insensitive to temperatures ranging from 300 K to 380 K regardless of the moisture content of the material. There appears to be only a slight decrease in strength at temperatures higher than 380 K. This decrease is, however, within the scatter of the data. For  $0^\circ$  and  $\pi/4$  laminates the decrease in ultimate tensile strength due to increase in moisture content is negligible below 1 percent moisture content. Above 1 percent moisture content the ultimate tensile strength may decrease as much as 20 percent with increasing moisture content. For  $90^\circ$  laminates both the temperature and the moisture affect significantly the ultimate tensile strength.

It is also noted that for dry  $90^\circ$  specimens a slight increase (10%) in strength was observed when the temperature increased from 300 K to 322 K. However, this small increase was well within the scatter of the data. Hence, a definite conclusion regarding such an increase in strength cannot be drawn from these results. This uncertainty is reflected by the dashed lines in Fig. 5.

Some tests were also made at 200 K. The results of these tests are not included in Fig. 5. The data indicate that the ultimate tensile strength does not change appreciably between 200 K (dry ice temperature) and 300 K (room temperature). This conclusion seems to be valid for all three fiber orientations ( $0^\circ$ ,  $\pi/4$ , and  $90^\circ$ ), and for all moisture contents.

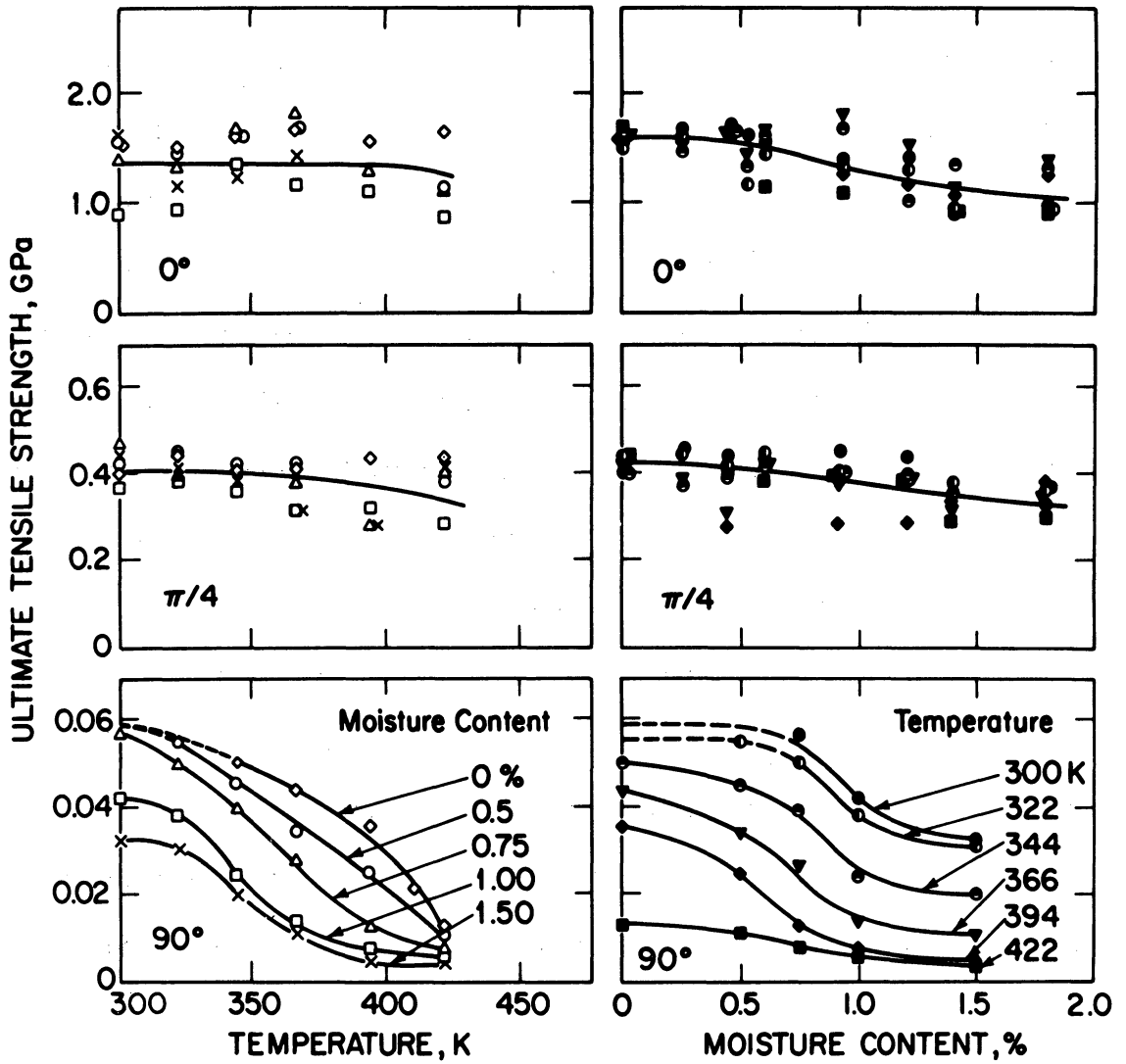

Ultimate Tensile Strength of Thornel 300/Fiberite 1034 as a Function of Temperature and Moisture Content. Present Data.

Figure 5

A survey of all existing data showing the effects of moisture and temperature on the ultimate tensile strength of various composites are presented in Figs. 6-24. In addition to Figs. 6-24, a brief summary is given in Table III of all the data including the type of material tested, the parameters varied, the general trends in the results and the appropriate references. The survey given in Figs. 6-24 and Table III includes all the data known to the authors in which the test conditions were either reported explicitly or could be assessed from the data. Those test results where the test conditions were not properly specified (e.g. "specimen boiled for 24 hours") were not included in this survey.

As evidenced from Figs. 6-24, in some cases only a few (2 or 3) data points were obtained in the tests. In view of the large possible scatter of the data, caution must be exercised in reaching conclusions on the basis of such limited data. Nevertheless, with few exceptions, all existing data seem to follow the trends shown by the present tests on T300/1034.

Figures 5-24 may be used to estimate the reduction in the ultimate tensile strength of various composite materials exposed to humid, high temperature air. These figures also provide guidelines for future tests. For  $0^\circ$  and  $\pi/4$  laminates few data points appear to be sufficient to establish the trend in the reduction of ultimate tensile strengths due to changes in temperature and moisture content. On the other hand, for  $90^\circ$  laminates tests must be performed at many different conditions to determine the effects of temperature and moisture content on the ultimate tensile strength. Figures 5-24 also indicate the conditions where data are lacking, and where further tests are needed.

Table III. Summary of Experimental Data on the Effects of Moisture and Temperature on the Ultimate Tensile Strength of Composites.

Composite	Reference	Laminate Lay-Up Orientation						Remarks
		0°		$\pi/4$		90°		
		Moist	Temp	Moist	Temp	Moist	Temp	
Thornel 300/Fiberite 1034	Shen & Springer 1976	L	N	L	N	S	S	
Hercules AS-5/3501	Browning et al 1976 [3]	N	N	N	N	S	S	
	Verette 1975 [4]	N	N	N	-	S	S	Limited data (2-3 points)
	Kerr, et al 1975 [5]	-	N	-	N	-	S	Two data points for 90° laminates
	Kim & Whitney 1976 [6]	-	-	N	N	-	-	
	Hofer et al 1975 [7]	L	L	N	L	S	S	
Thornel 300/Narmco 5208	Husman 1976 [8]	-	-	-	-	S	L	
	Hofer et al 1974 [9]	N	L	N	L	S	S	
Modmor II/Narmco 5206	Hofer et al 1974 [9]	N	N	N	N	S	S	
Courtaulds HMS/Hercules 3002M	Hofer et al 1974 [9]	N	N	N	N	S	S	Very scattered data for 90° laminates
HT-S/ERLA-4617	Browning 1972 [10]	-	-	L	S	-	-	Only two data points for tem- perature

Table III (continued)

Composite	Reference	Laminate Lay-Up Orientation			Remark
		0°	$\pi/4$	90°	
		Moist Temp	Moist Temp	Moist Temp	
HT-S/Fiberite X-911	Browning 1972 [10]	-	N	-	
HT-S/U.C.C.X-2546	Browning 1972 [10]	-	L	-	
PRD 49/ERLB-4617	Hanson 1972 [11]	-	-	-	
HT-S/(8183/137-NDA-BF <sub>3</sub> :MEA)	Hertz 1973 [12]	-	-	S	
HT-S/Hysol ADX-516	Browning 1972 [10]	-	N	-	Only two data points for tem- perature
Hercules HT-S/710 Polyimide	Kerr, et al 1975 [5]	-	N	N	Only two data points for 90° laminates
HT-S/P13N Polyimide	Browning 1972 [10]	-	-	L	
Boron/AVCO 5505	Hofer, et al 1974 [9]	L	N	L	S
Boron/Narmco 5505	Kaminski 1973 [13] Browning 1972 [10]	-	L	-	S

(a) N = Negligible effect

(b) L = Little effect (&lt; 30%)

(c) S = Strong effect (&gt; 30%)

It is emphasized again that the results presented in this paper only illustrate the trend in the ultimate tensile strength of composite materials exposed to humid, high temperature environments. The actual value of the ultimate tensile strength may also depend upon the past history of the material, and may be influenced by parameters such as cure cycle, temperature history (thermal spikes), and loading history.



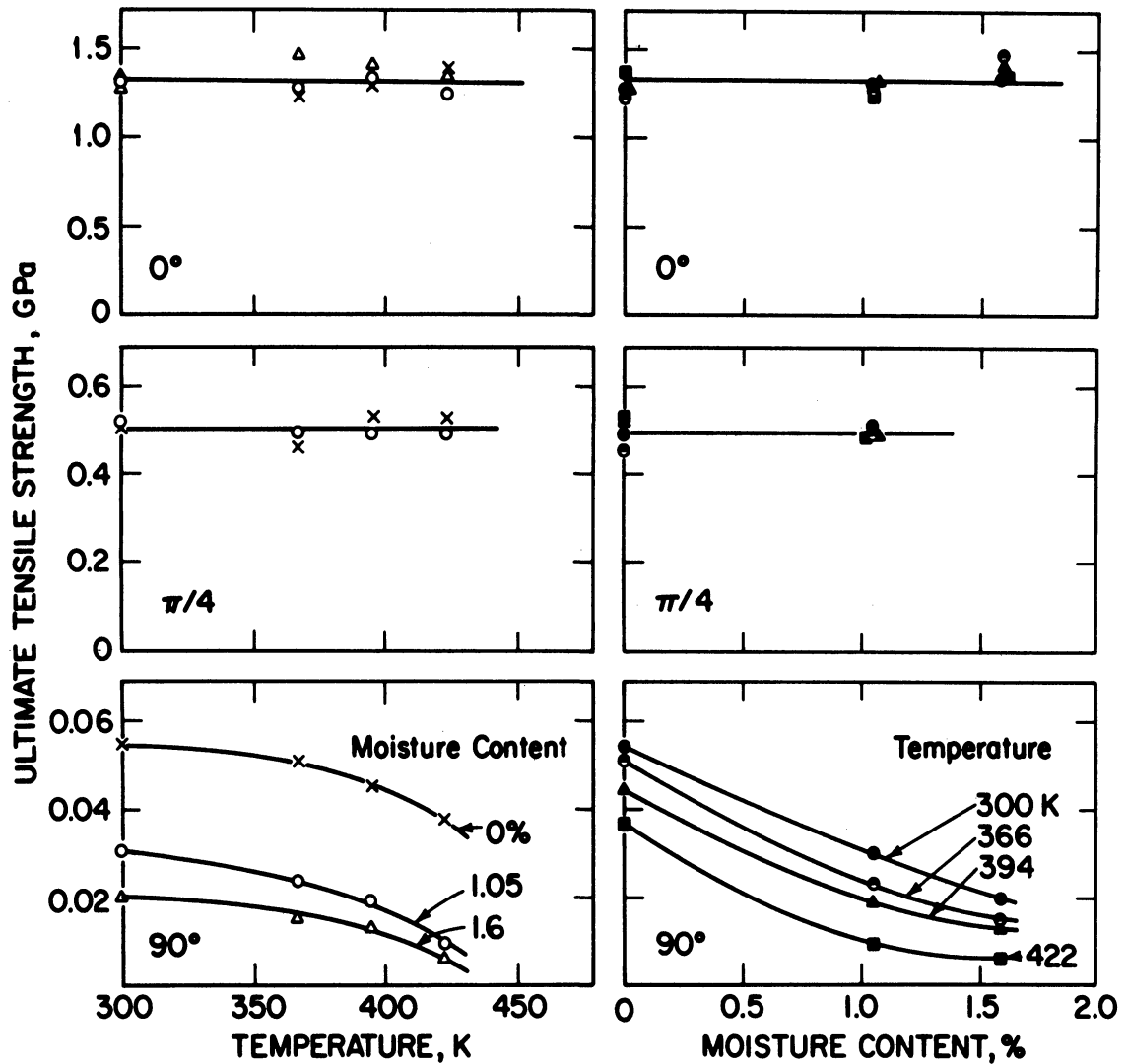

Ultimate Tensile Strength of Hercules AS-5/3501 as a Function of Temperature and Moisture Content. Data of Browning et al, 1976 [3].

Figure 6

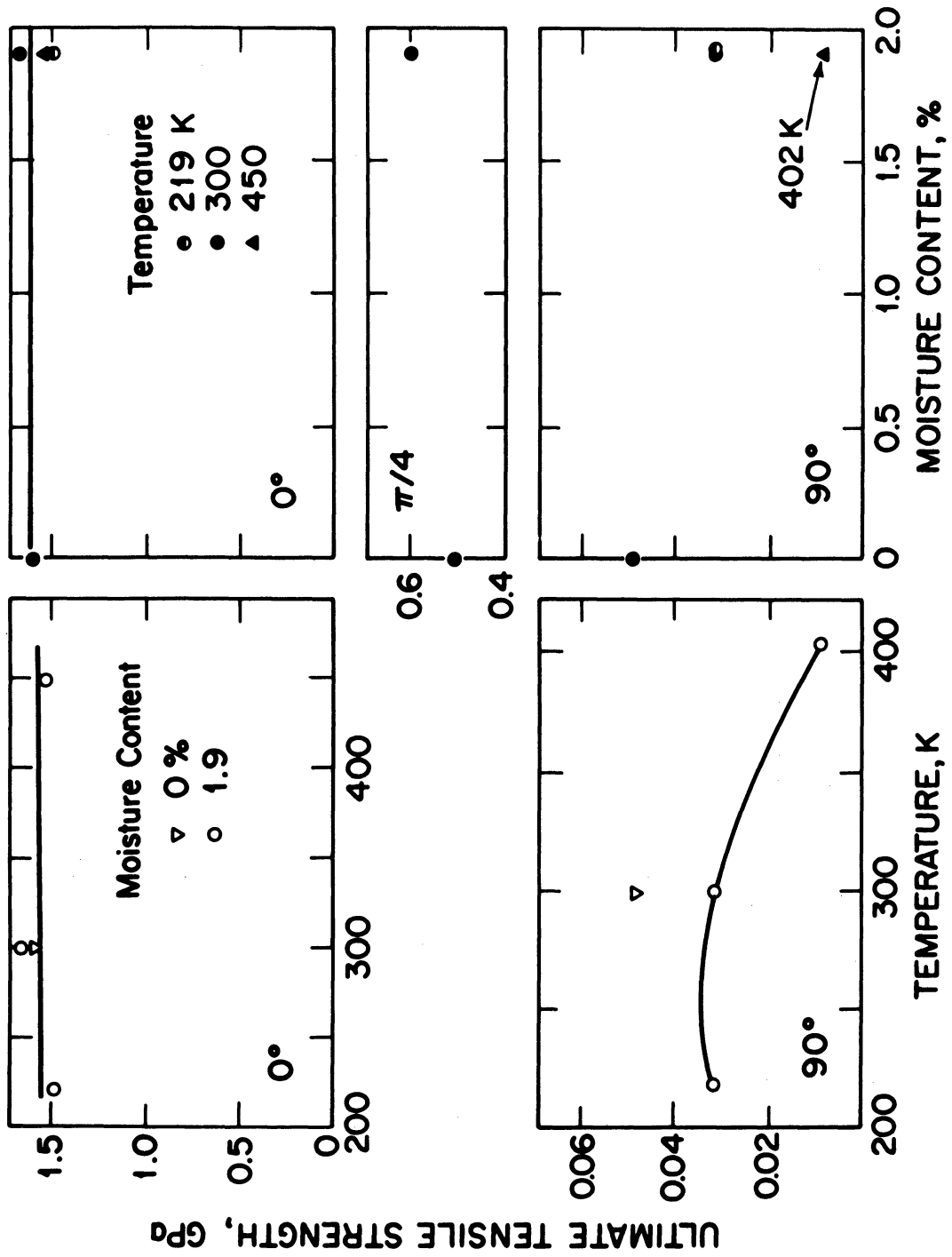

Ultimate Tensile Strength of Hercules AS-5/3501 as a Function of Temperature and Moisture Content.  
 Data of Verette, 1975 [4].

Figure 7

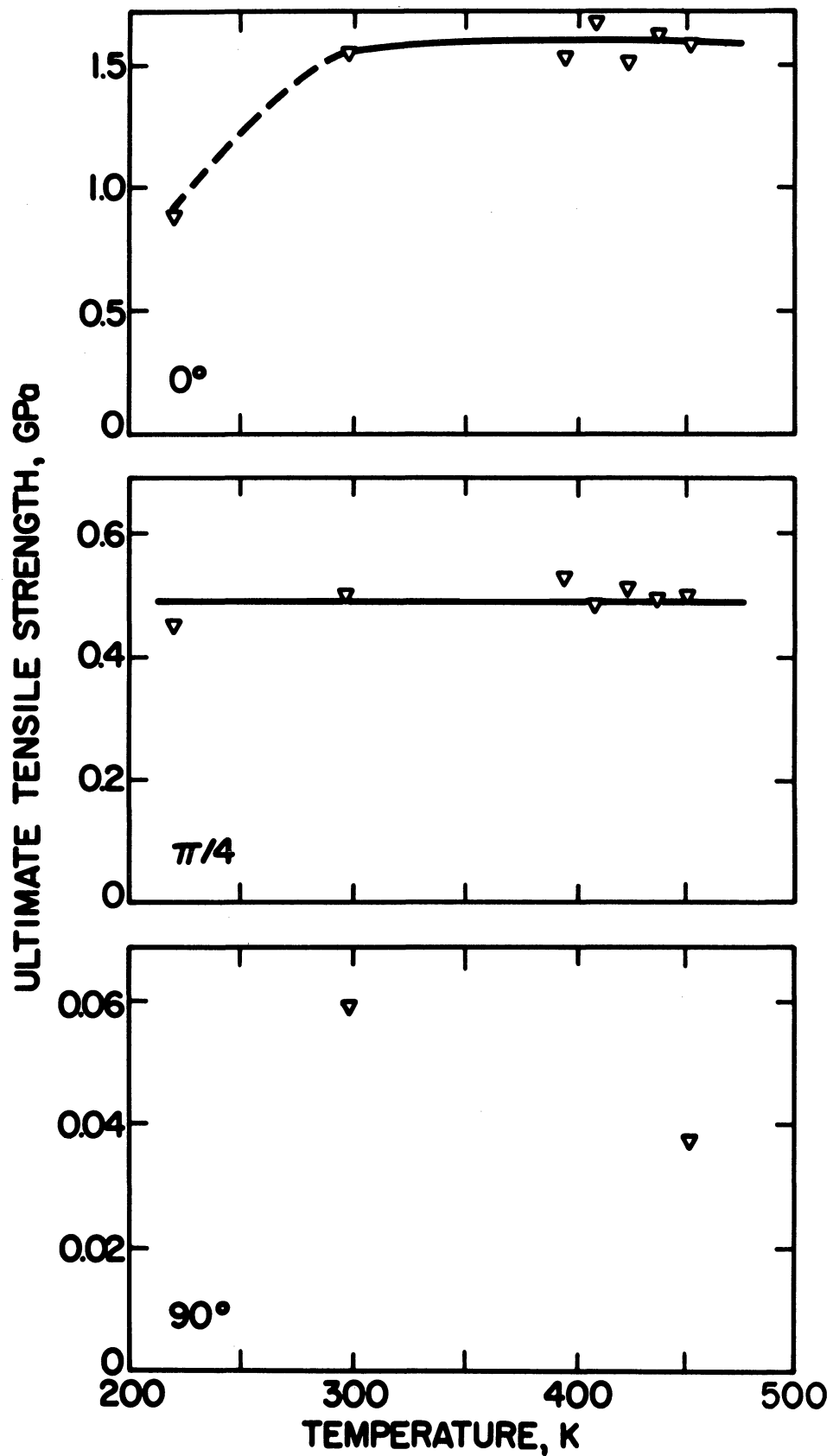

Dry Ultimate Tensile Strength of Hercules AS-5/3501 as a Function of Temperature. Data of Kerr et al. 1975 [5].

Figure 8

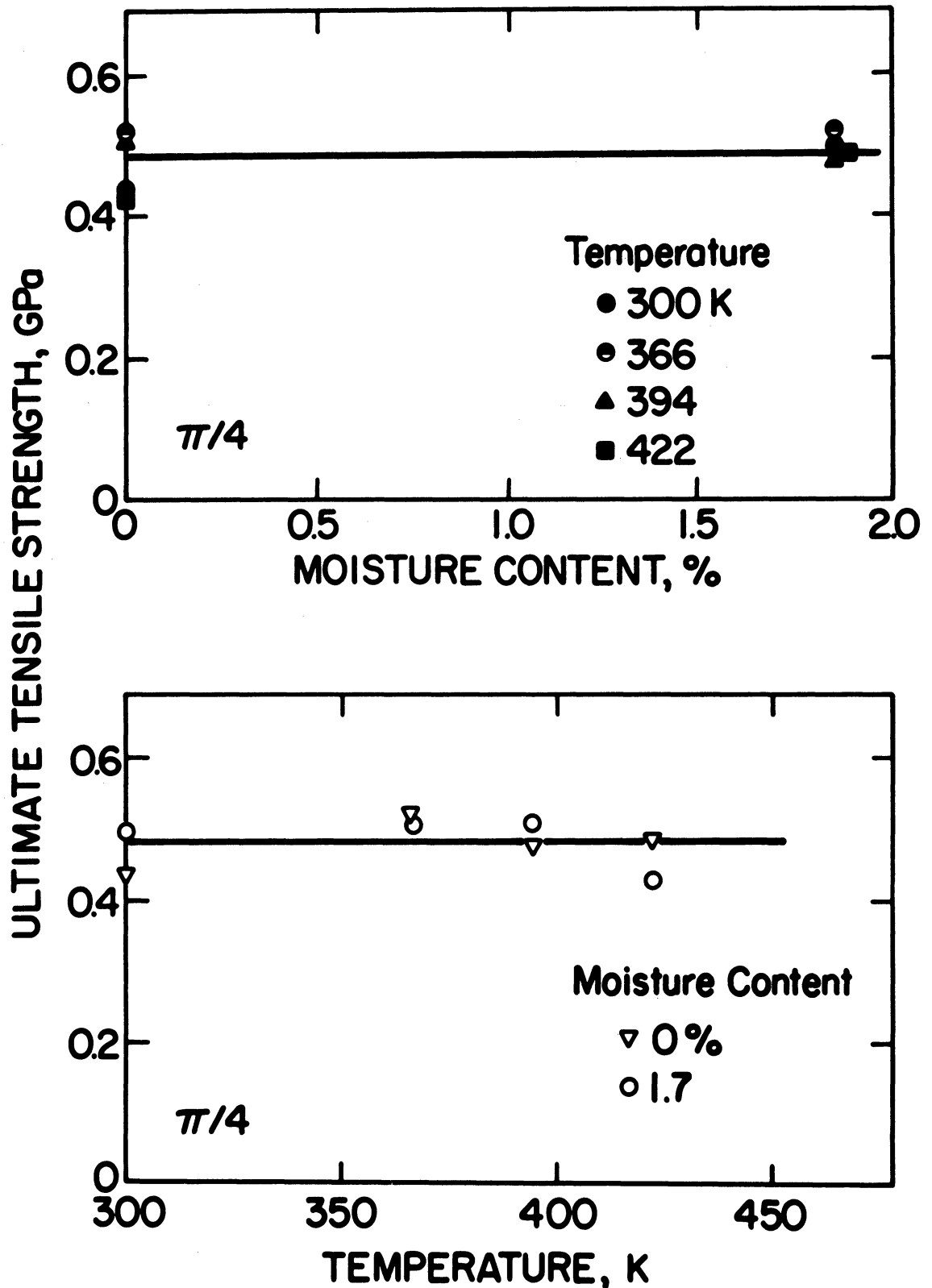

Quasi-Isotropic Ultimate Tensile Strength of Hercules AS-5/3501 as a Function of Temperature and Moisture Content. Data of Kim and Whitney, 1976 [6].

Figure 9

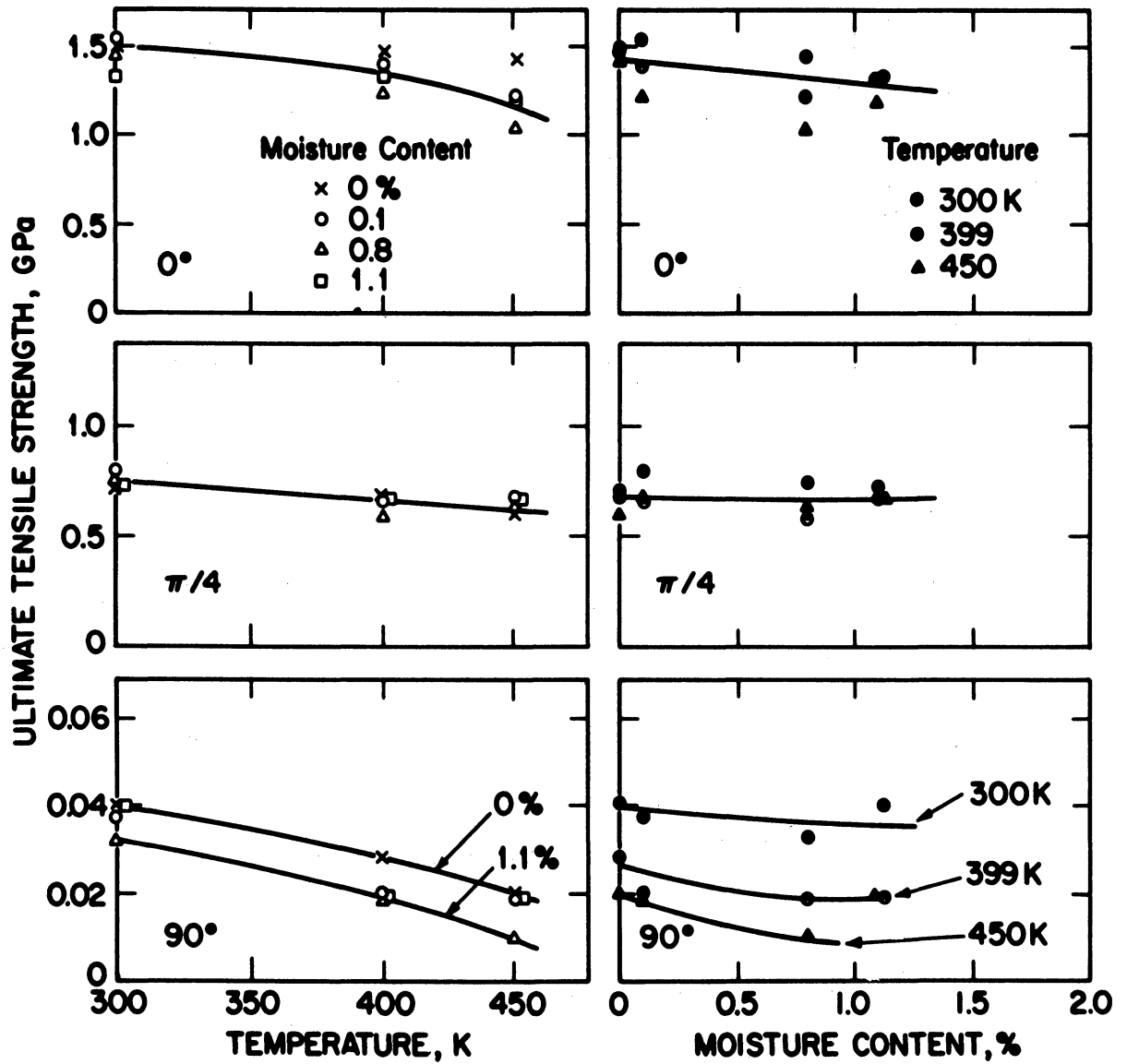

Ultimate Tensile Strength of Thornel 300/Narmco 5208 as a Function of Temperature and Moisture Content. Data of Hofer et al, 1975 [7].

Figure 10

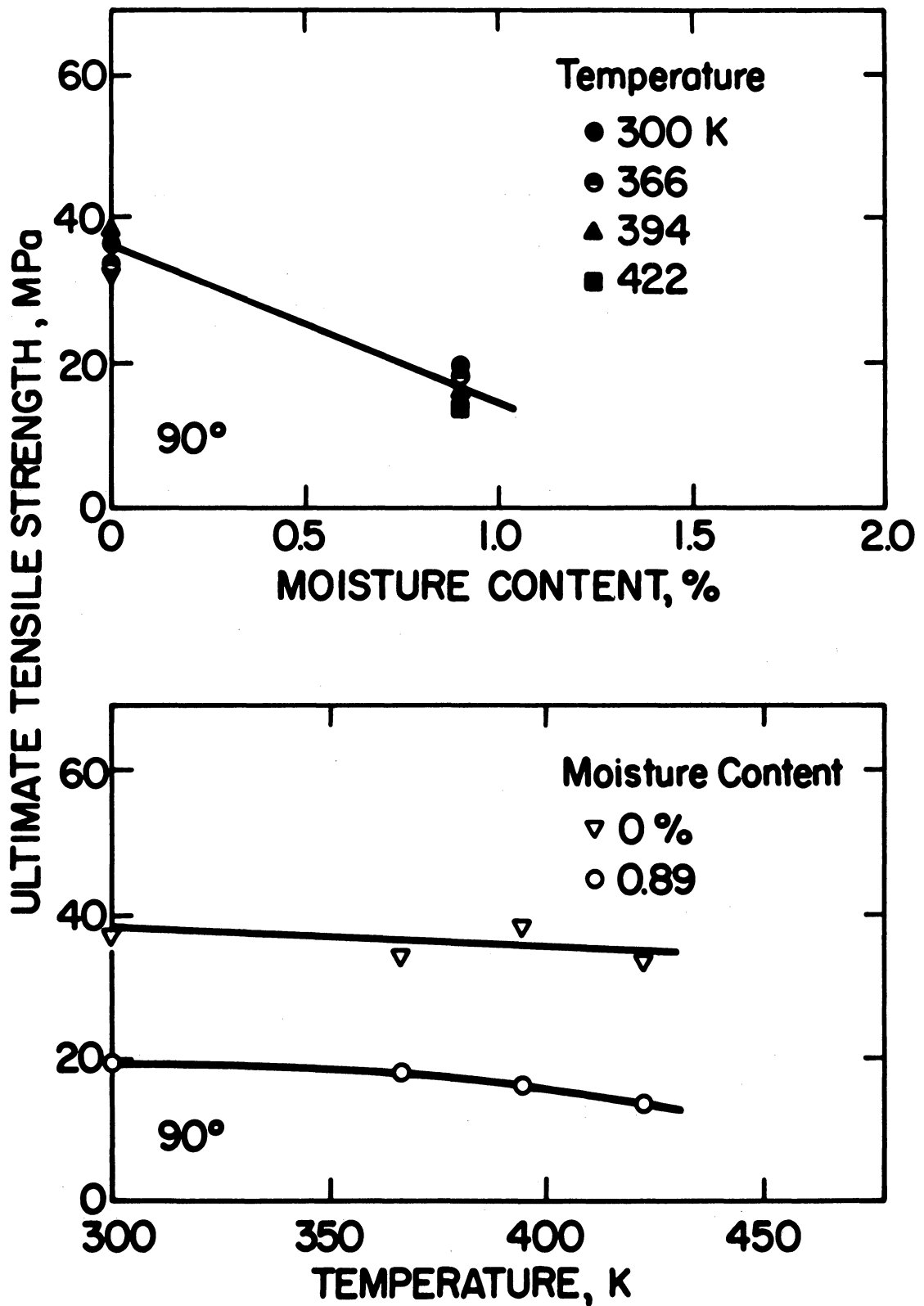

Transverse Ultimate Tensile Strength of Thorne1 300/Narmco 5208 as a Function of Temperature and Moisture. Data of Husman, 1976 [8].

Figure 11

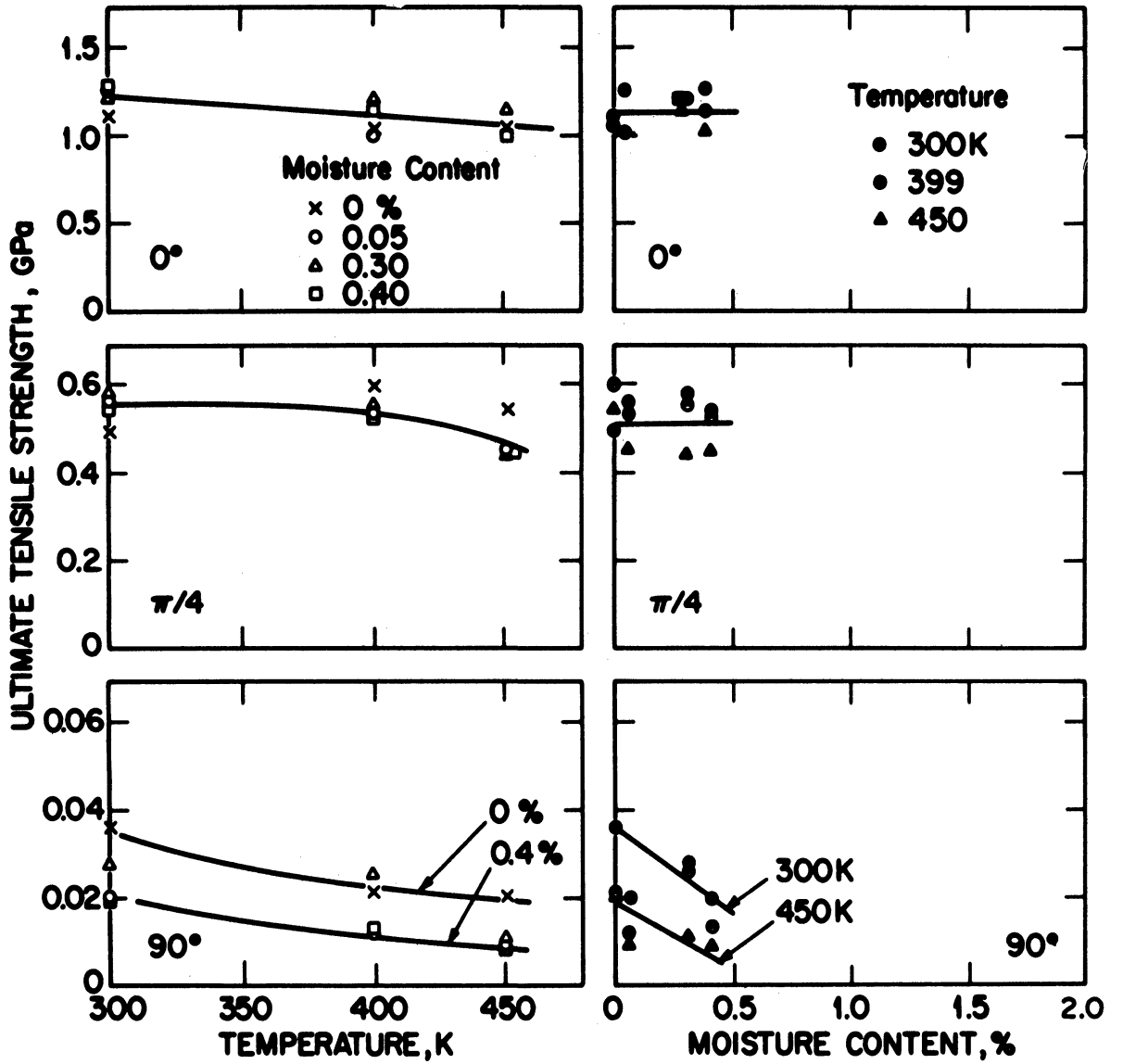

Ultimate Tensile Strength of Modmor II/Narmco 5206 as a Function of Temperature and Moisture Content. Data of Hofer et al, 1974 [9].

Figure 12

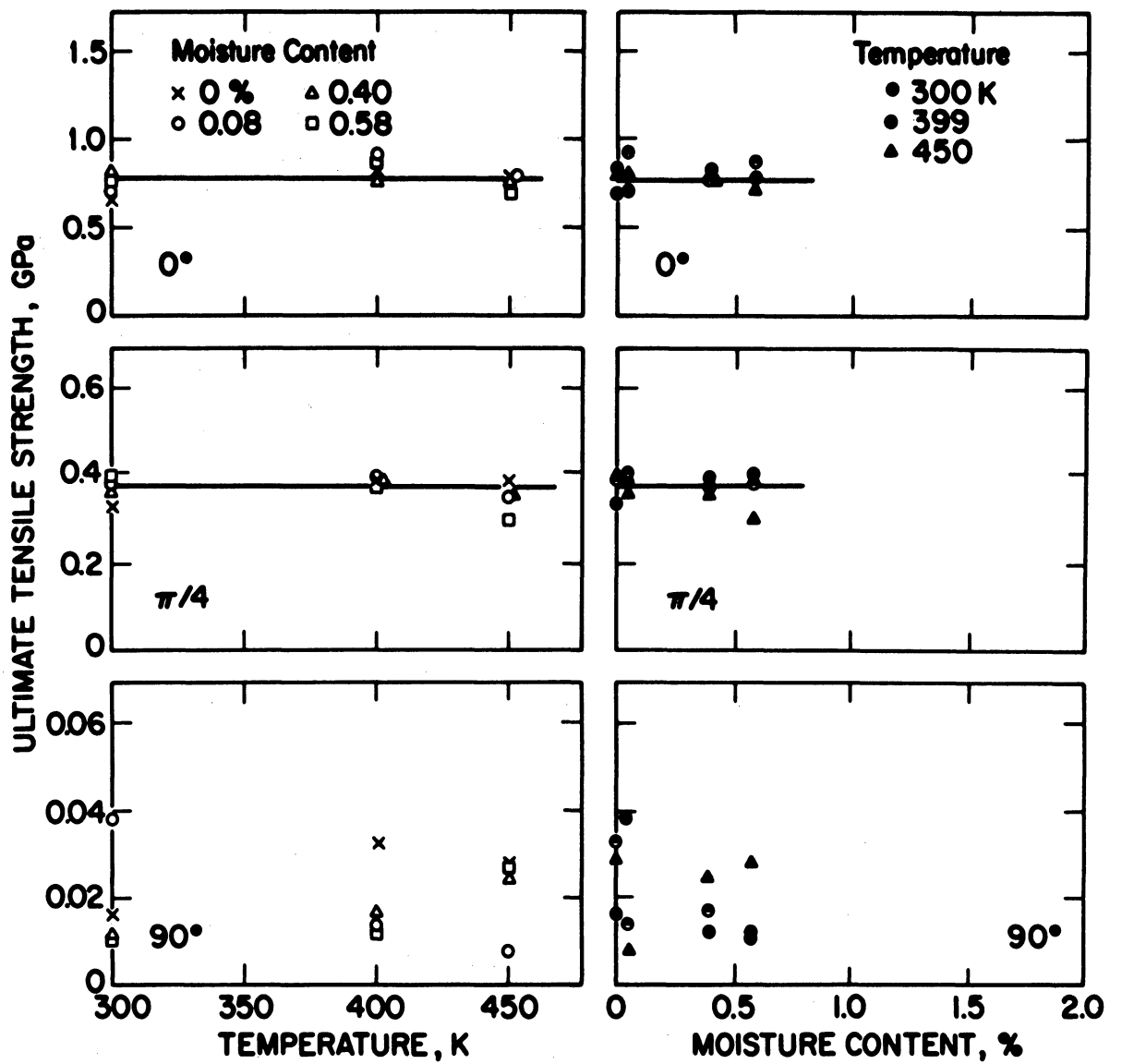

Ultimate Tensile Strength of Courtaulds HMS/Hercules 3002M as a Function of Temperature and Moisture Content. Data of Hofer et al. 1974 [9].

Figure 13



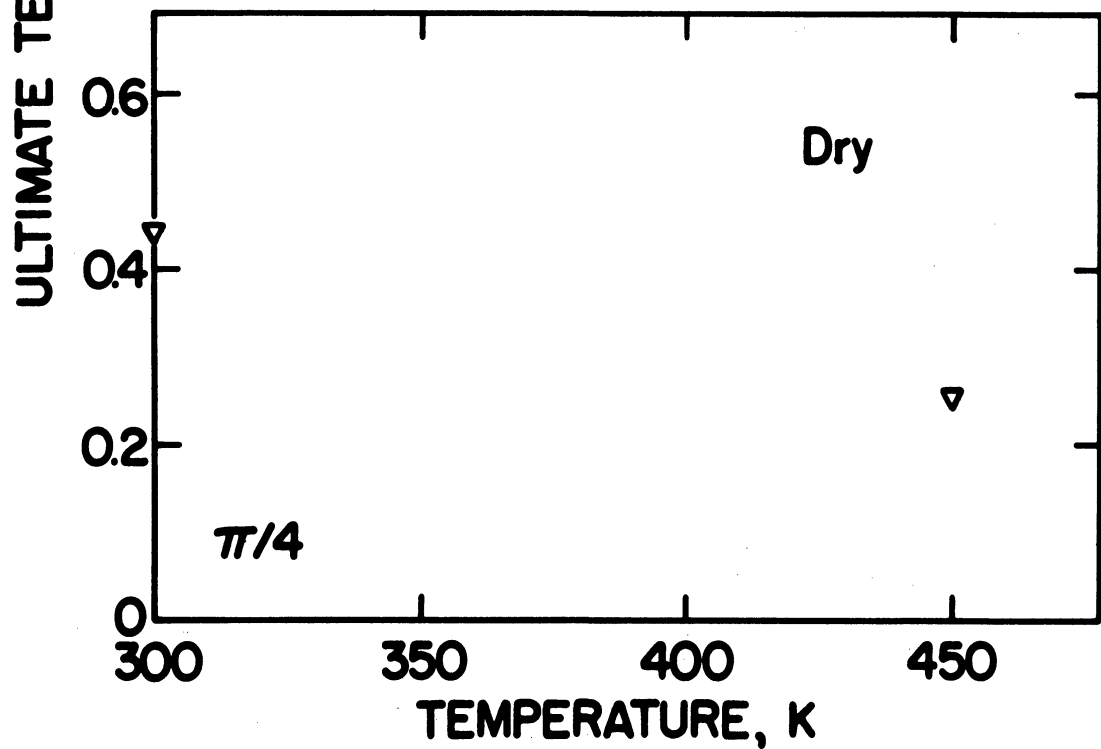
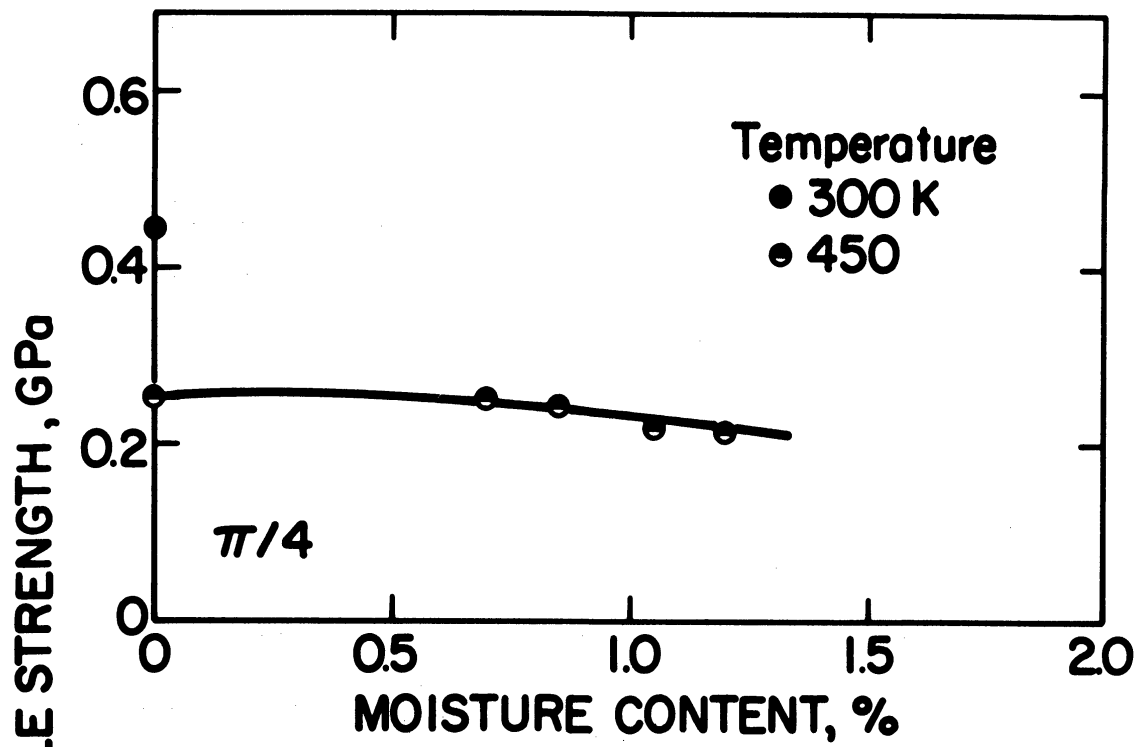

Quasi-Isotropic Ultimate Tensile Strength of HT-S/ERLA-4617 as a Function of Temperature and Moisture Content. Data of Browning, 1972 [10].

Figure 14

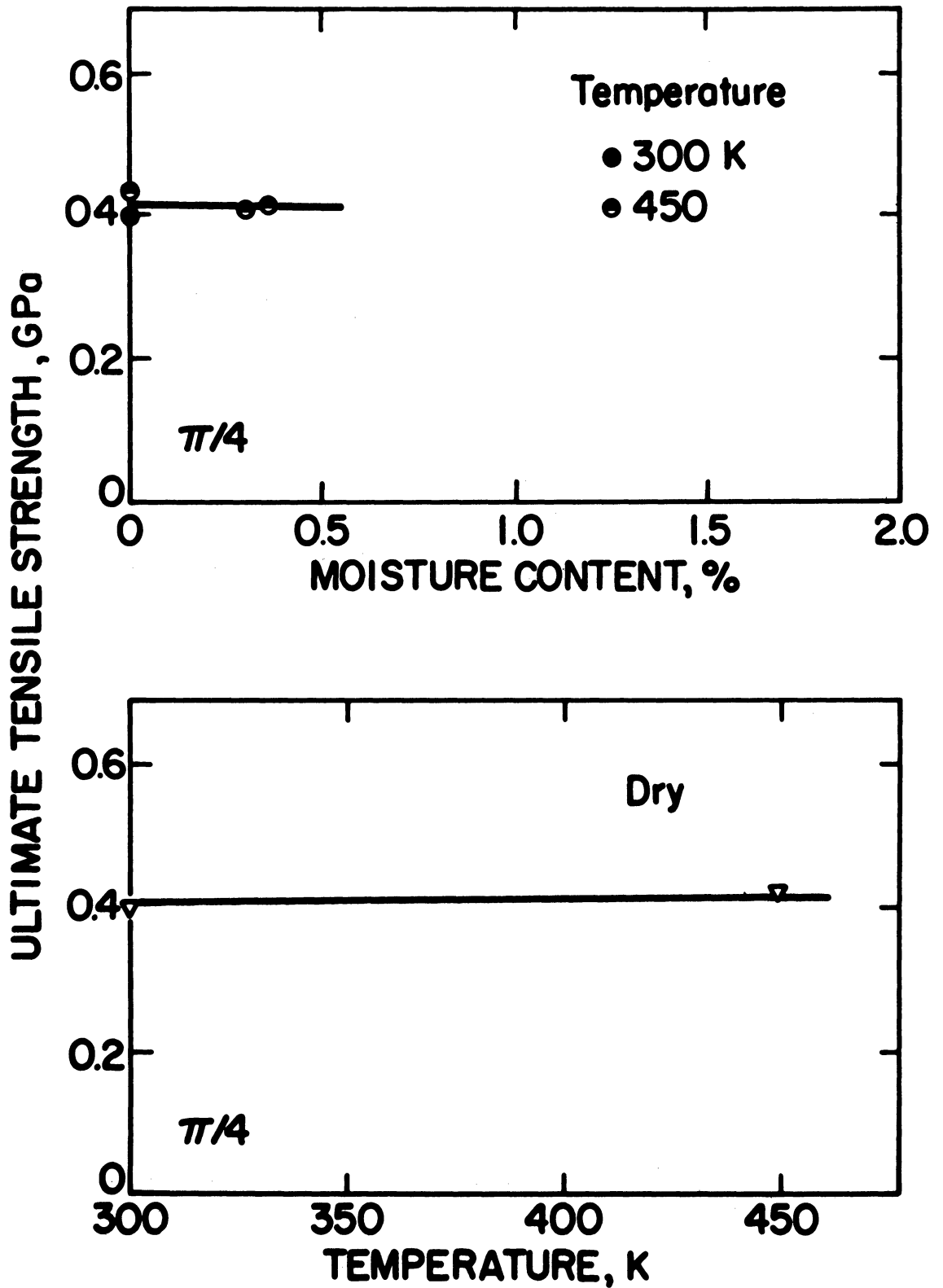

Quasi-Isotropic Ultimate Tensile Strength of HT-S/Fiberite X-911 as a Function of Temperature and Moisture Content. Data of Browning, 1972 [10].

Figure 15

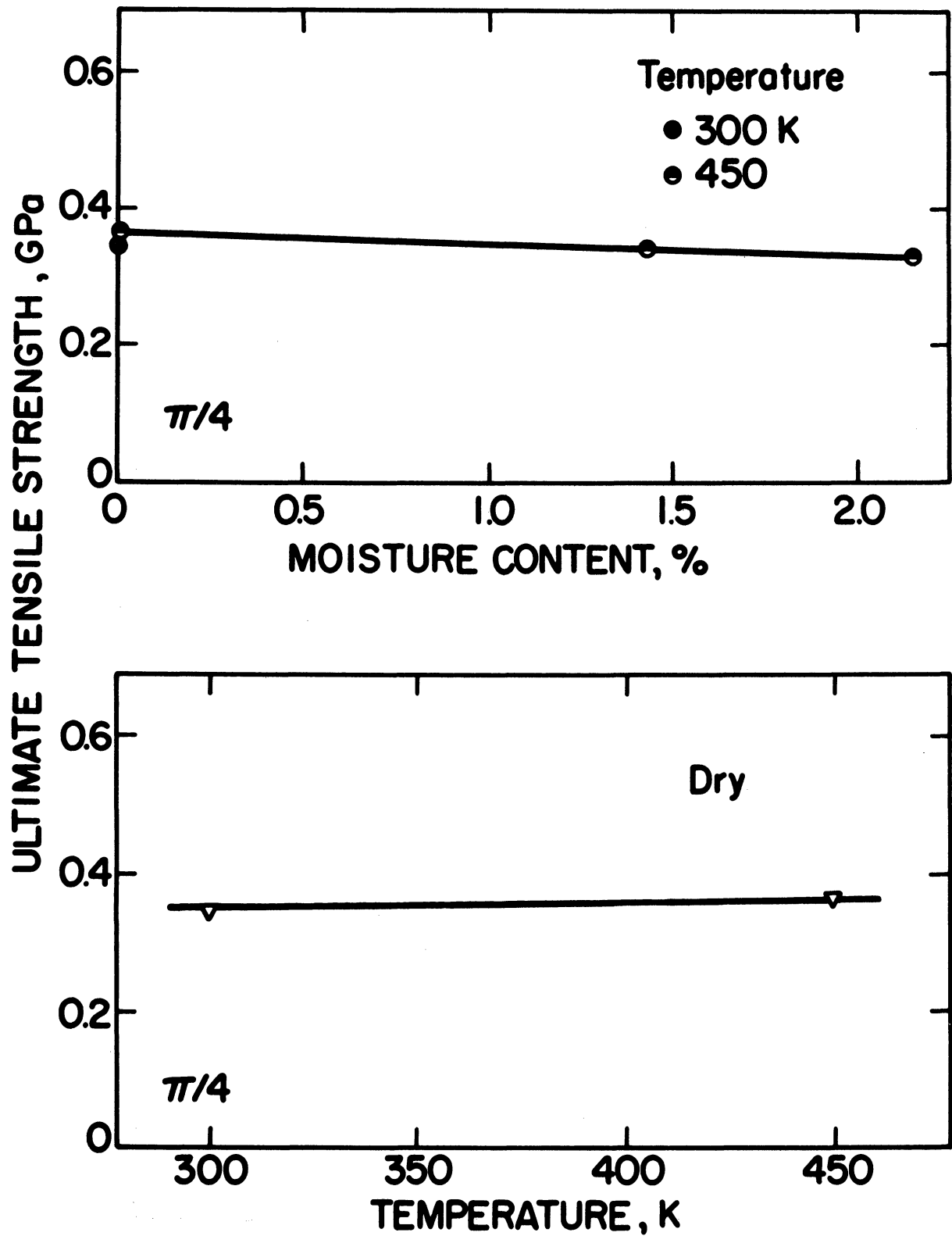

Quasi-Isotropic Ultimate Tensile Strength of HT-S/UCC X-2546 as a Function of Temperature and Moisture Content. Data of Browning, 1972 [10].

Figure 16

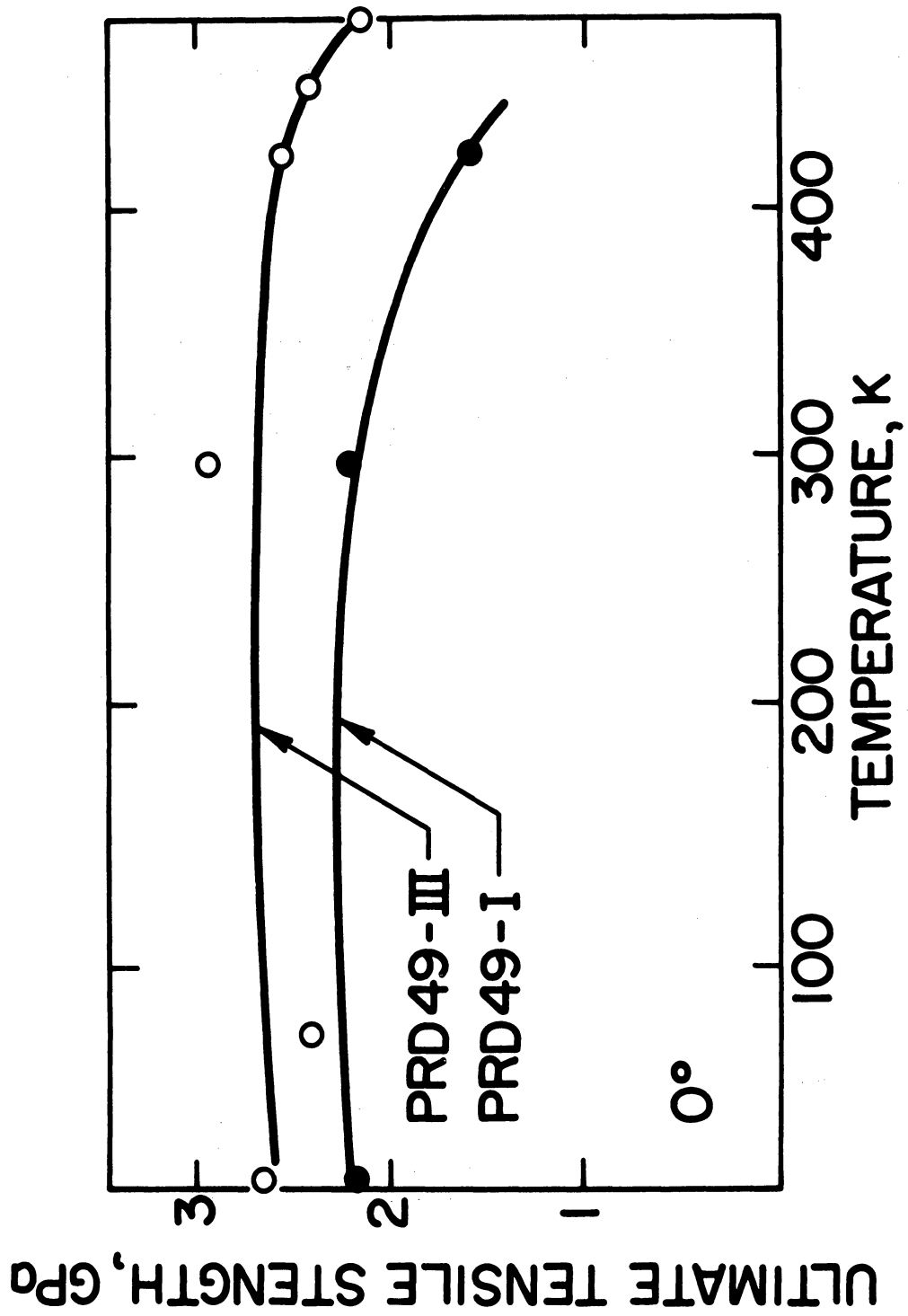

Dry Longitudinal Ultimate Tensile Strength of PRD 49/ERLB-4617 as a Function of Temperature.  
 Data of Hanson, 1972 [11].

Figure 17

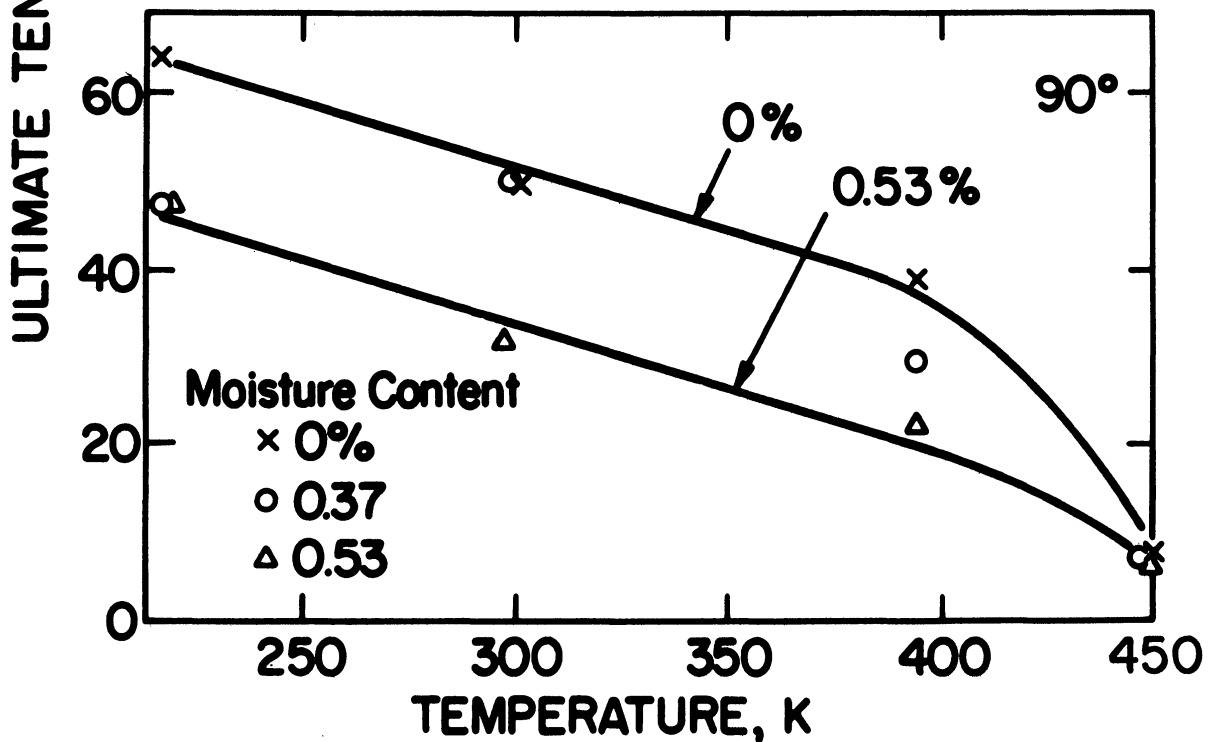
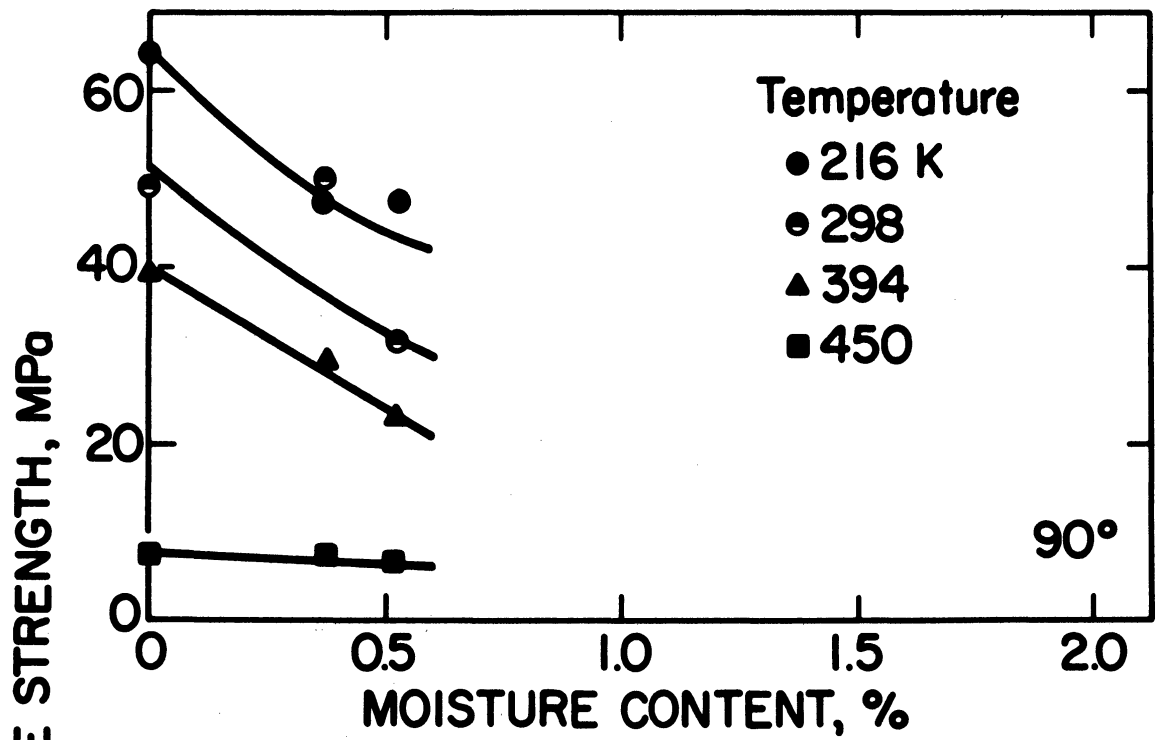

Transverse Ultimate Tensile Strength of HT-S/(8183/137-NDA-BF<sub>3</sub>: MEA) as a Function of Temperature and Moisture Content. Data of Hertz, 1973 [12].

Figure 18

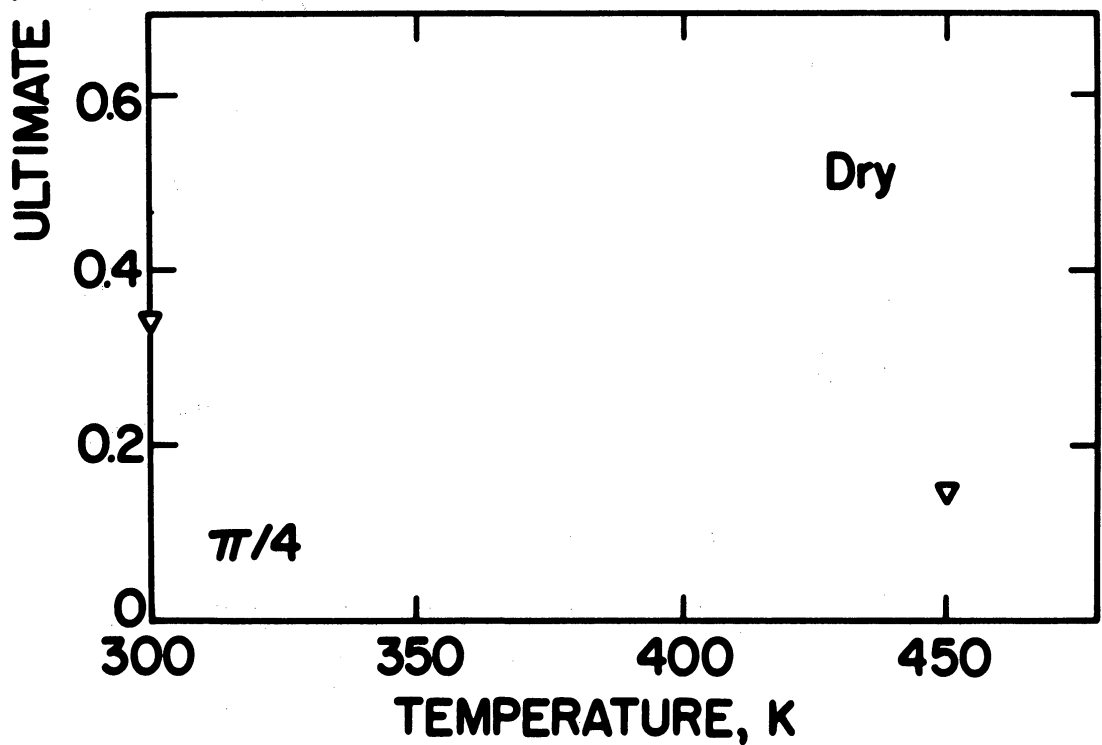
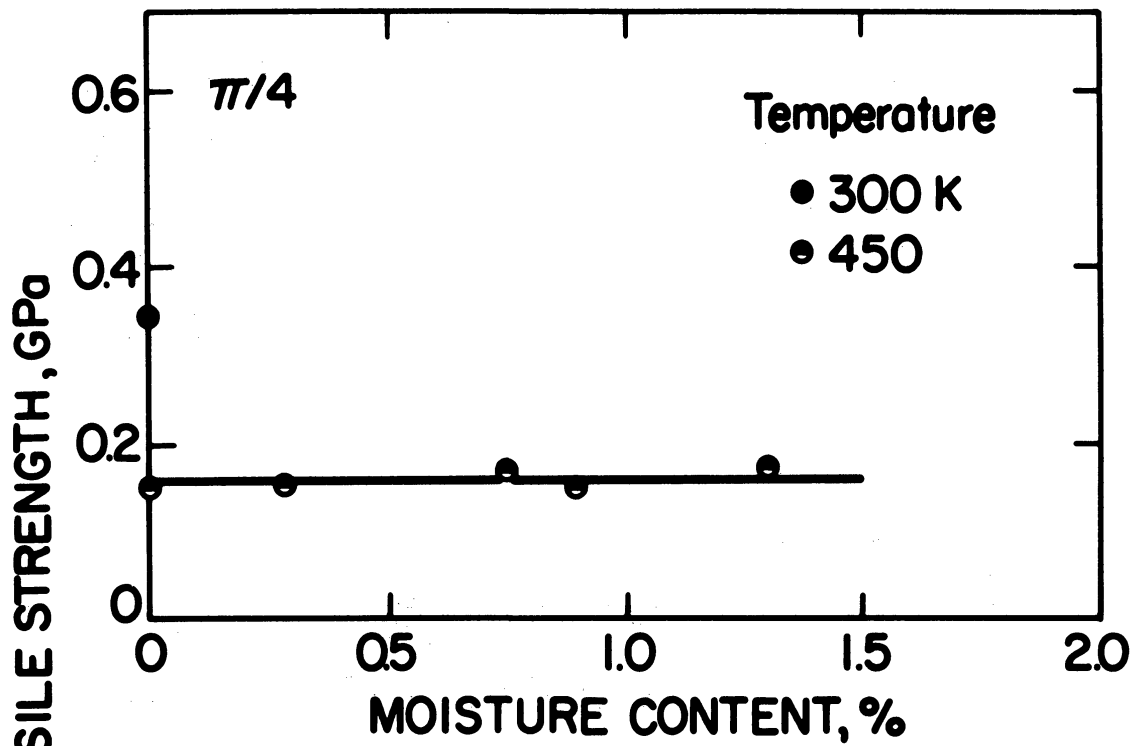

Quasi-Isotropic Ultimate Tensile Strength of HT-S/Hysol ADX-516 as a Function of Temperature and Moisture Content. Data of Browning, 1972 [10].

Figure 19

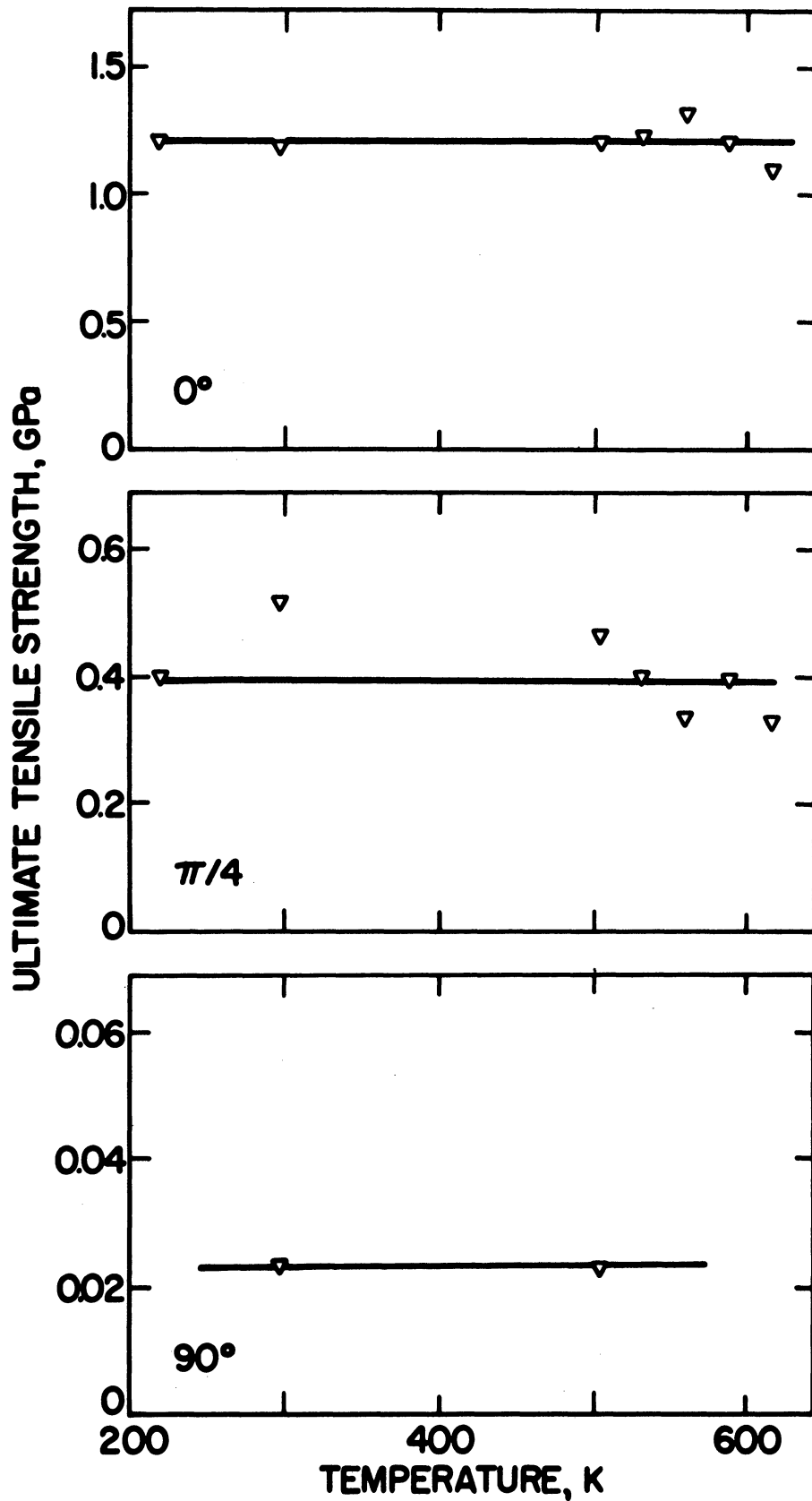

Dry Ultimate Tensile Strength of Hercules HT-S/710 Polyimide as a Function of Temperature. Data of Kerr et al. 1975 [5].

Figure 20

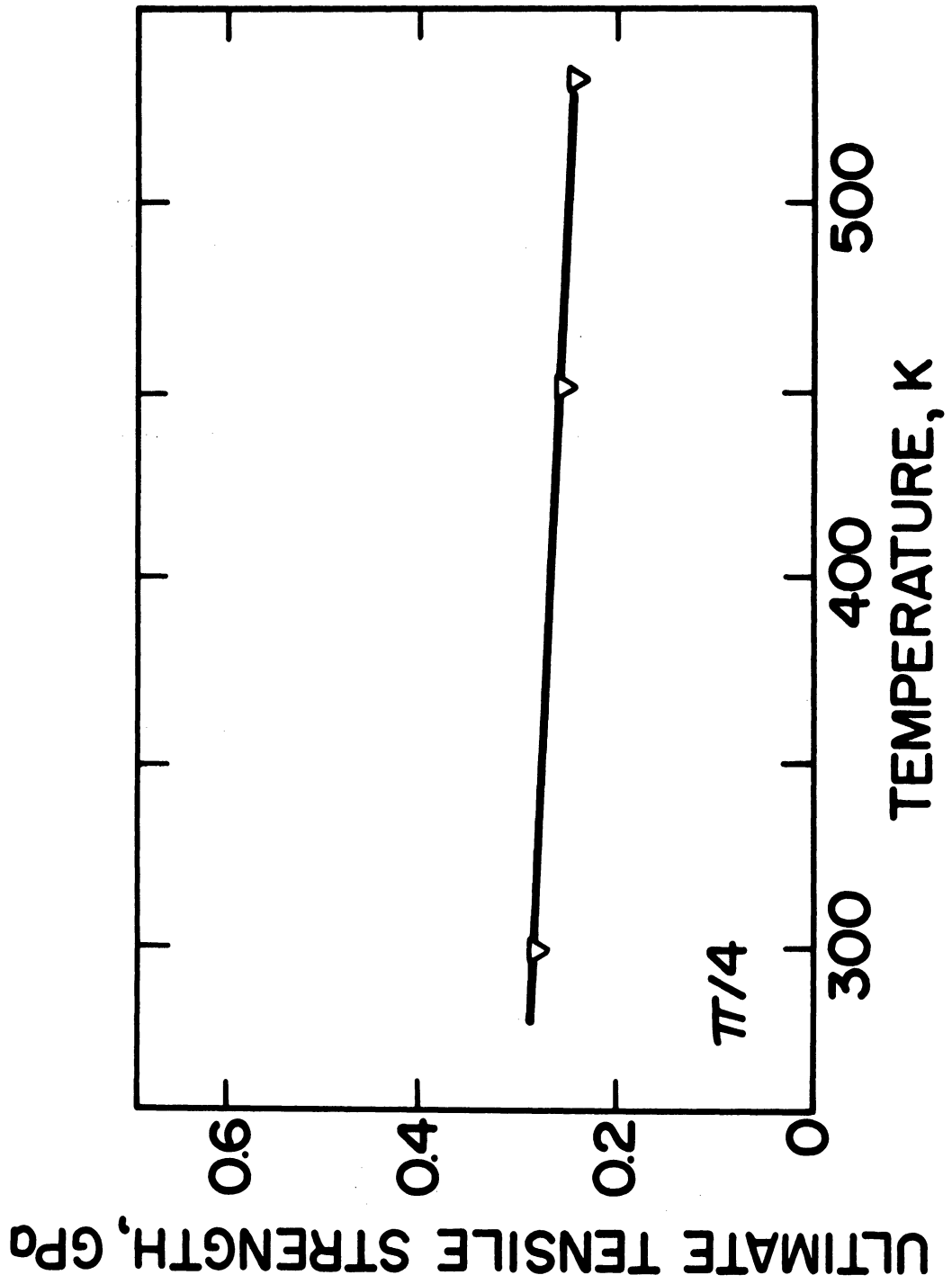

Dry Quasi-Isotropic Ultimate Tensile Strength of HT-S/PI3N Polyimide as a Function of Temperature. Data of Browning, 1972 [10].

Figure 21



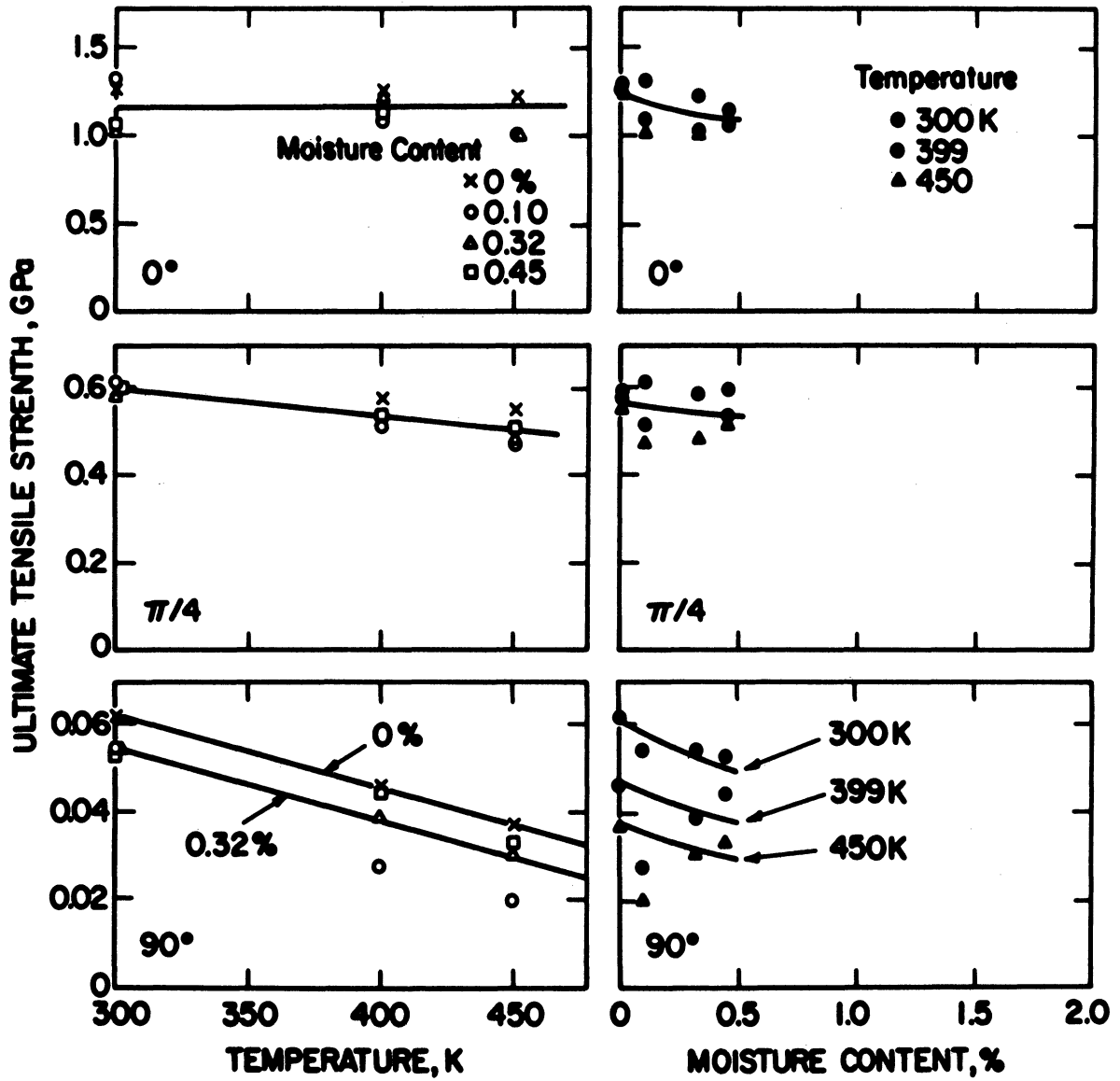

Ultimate Tensile Strength of Boron/AVCO 5505 as a Function of Temperature and Moisture Content. Data of Hofer et al. 1974 [9].

Figure 22

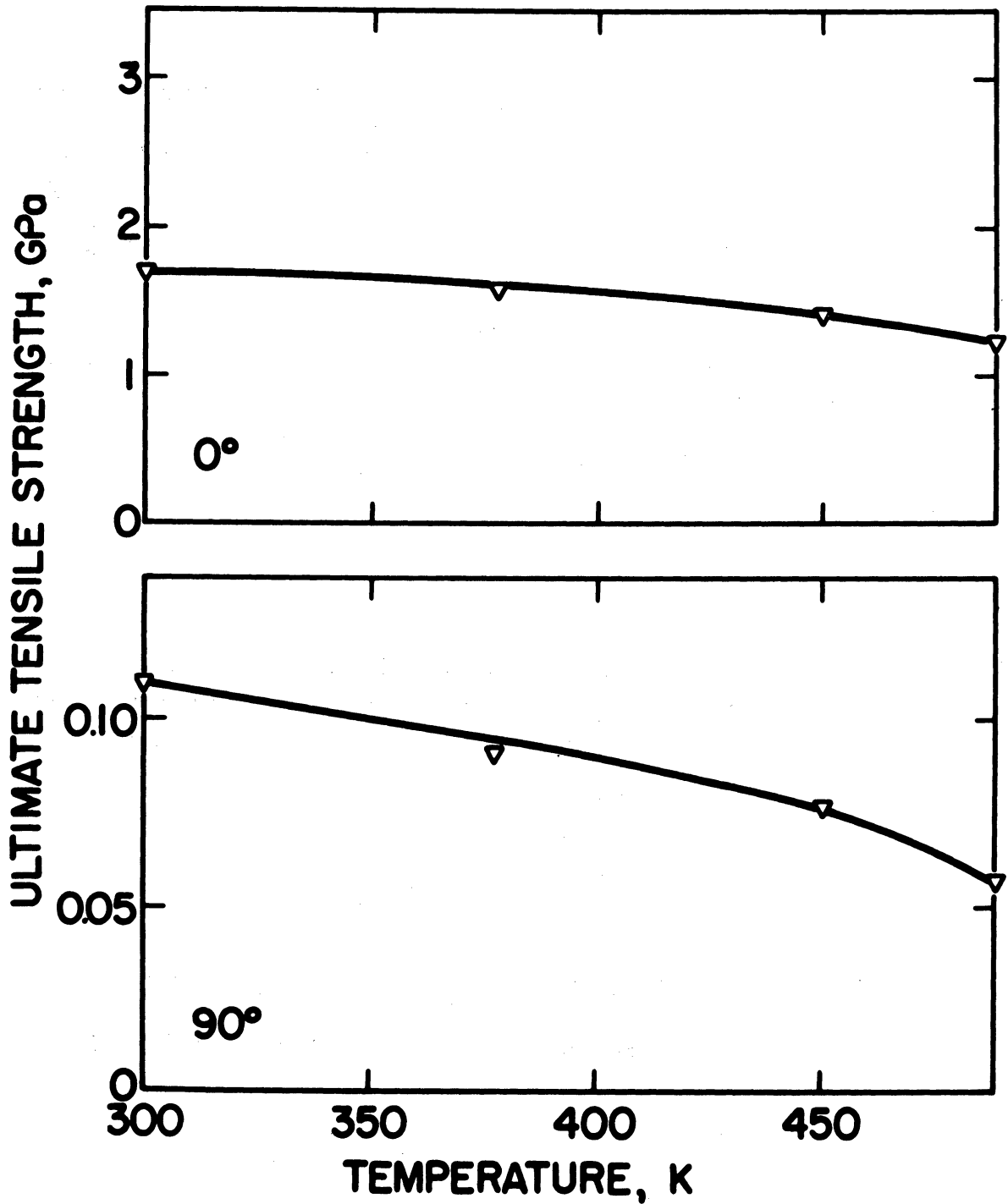

Dry Longitudinal and Transverse Ultimate Tensile Strengths of Boron/Narmco 5505 as a Function of Temperature. Data of Kaminski, 1973 [13].

Figure 23

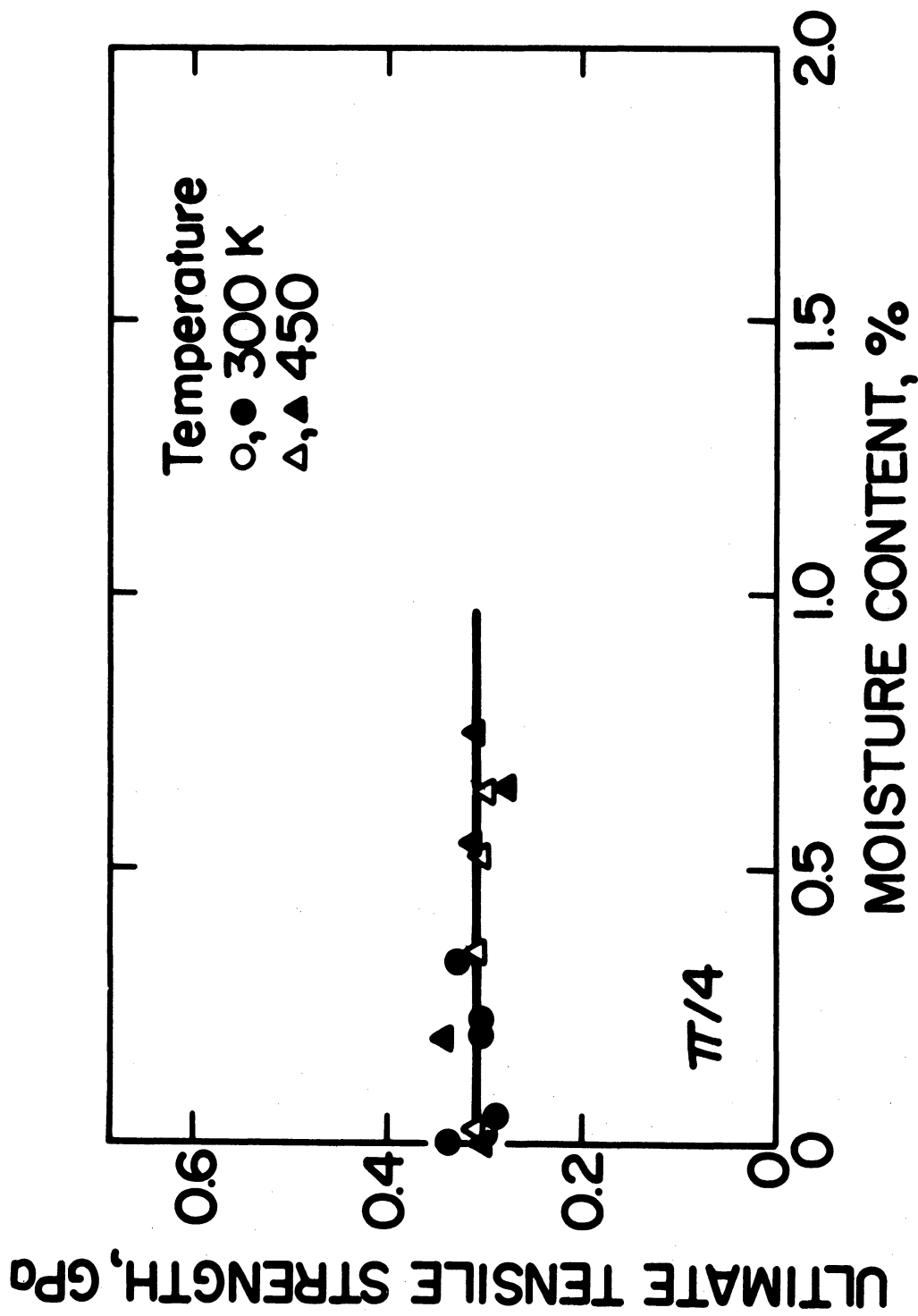

Quasi-Isotropic Ultimate Tensile Strength of Boron/Narmco 5505 as a Function of Temperature and Moisture Content. Data of Browning, 1972 [10].  
 ○ △ : post-cured specimens; ● ▲ : not post-cured specimen.

Figure 24

## REFERENCES

1. G.S. Springer and C.H. Shen, "Moisture Absorption and Desorption of Composite Materials," Technical Report AFML-TR-76-102, June 1976, Air Force Materials Laboratory, Air Force Systems Command, Wright-Patterson Air Force Base, Dayton, Ohio.
2. C.H. Shen and G.S. Springer, "Moisture Absorption and Desorption of Composite Materials," J. Composite Materials, Vol. 10 (1976), p. 2.
3. C.E. Browning, G.E. Husman, and J.M. Whitney, "Moisture Effects in Epoxy Matrix Composites," Composite Materials: Testing and Design, ASTM, STP 617 (1976).
4. R.M. Verette, "Temperature/Humidity Effects on the Strength of Graphite/Epoxy Laminates," AIAA Paper No. 75-1011, AIAA 1975 Aircraft Systems and Technology Meeting, Los Angeles, California, August 4-7, 1975.
5. J.R. Kerr, J.F. Haskins and B.A. Stein, "Program Definition and Preliminary Results of a Long-Term Evaluation Program of Advanced Composites for Supersonic Cruise Aircraft Applications," Environmental Effects on Advanced Composite Materials, ASTM, STP 602 (1975), p. 3.
6. R.Y. Kim and J.M. Whitney, "Effect of Environment on the Notch Strength of Laminated Composites," Presented at the Mechanics of Composites Review, Bergamo Center, Dayton, Ohio, January 28-29, 1976.
7. K.E. Hofer, Jr., D. Larsen and V.E. Humphreys, "Development of Engineering Data on the Mechanical and Physical Properties of Advanced Composites Materials," Technical Report AFML-TR-74-266, February 1975, Air Force Materials Laboratory, Air Force Systems Command, Wright-Patterson Air Force Base, Dayton, Ohio.
8. G.E. Husman, "Characterization of Wet Composite Materials," Presented at the Mechanics of Composites Review, Bergamo Center, Dayton, Ohio, January 28-29, 1976.
9. K.E. Hofer, Jr., N. Rao and D. Larsen, "Development of Engineering Data on the Mechanical and Physical Properties of Advanced Composites Materials," Technical Report AFML-TR-72-205, Part II, February 1974, Air Force Materials Laboratory, Air Force Systems Command, Wright-Patterson Air Force Base, Dayton, Ohio.
10. C.E. Browning, "The Effects of Moisture on the Properties of High Performance Structural Resins and Composites," Technical Report AFML-TR-72-94, September 1972, Air Force Materials Laboratory, Air Force Systems Command, Wright-Patterson Air Force Base, Dayton, Ohio.
11. M.P. Hanson, "Effect of Temperature on the Tensile and Creep Characteristics of PRD 49 Fiber/Epoxy Composites," Composite Materials in Engineering Design, B.R. Norton, ed., Proceedings of 6th St. Louis Symposium, May 11-12, 1972, p. 717. Published by The American Society for Metals.

12. J. Hertz, "Investigation into the High-Temperature Strength Degradation of Fiber-Reinforced Resin Composite During Ambient Aging," Convair Aerospace Division, General Dynamics Corporation, Report No. GDCA-DBG73-005, Contract NAS8-27435, June 1973.
13. B.E. Kaminski, "Effects of Specimen Geometry on the Strength of Composite Materials," Analysis of the Test Methods for High Modulus Fibers and Composites, ASTM STP521 (1973), p. 181.





UNIVERSITY OF MICHIGAN



**3 9015 03526 7528**