

THE UNIVERSITY OF MICHIGAN  
ENGINEERING RESEARCH INSTITUTE  
ANN ARBOR

DEFINITIONS OF  $d'$  AND  $\eta$  AS PSYCHOPHYSICAL MEASURES

Technical Report No. 80

Electronic Defense Group  
Department of Electrical Engineering

By: W. P. Tanner, Jr.  
T. G. Birdsall

Approved by:

  
A. B. Macnee

AFCRC-TR-57-57  
ASTIA Document  
No. AD 146 758

Contract No. AF19(604)-2277

Operational Applications Laboratory  
Air Force Cambridge Research Center  
Air Research and Development Command

February 1958

## TABLE OF CONTENTS

LIST OF ILLUSTRATIONS	iii
ABSTRACT	iv
I. INTRODUCTION	1
II. BASIC DEFINITIONS OF $d'$ and $\eta$	8
III. A THEOREM FOR EXPERIMENTAL INTERPRETATION	13
IV. GENERALIZED DEFINITION OF $d'$	15
V. CONCLUSION	21
REFERENCES	22
DISTRIBUTION LIST	24

## LIST OF ILLUSTRATIONS

		Page
Figure 1	Basic Psychophysical Experiment in Block Diagram Form	3
Figure 2	Probability Densities for $\log_e l(x)$ Conditional on Noise Alone, and On Signal Plus Noise	4
Figure 3a	Receiver Operating Characteristic (ROC) for the Ideal Receiver When $2E/N_0 = 1.00$	7
Figure 3b	Transformation to Double Probability Paper for the ROC Curve of Figure 3a	7
Figure 4	Composite Block Diagram of Channels for Psychophysical Experiments	9
Figure 5	Individual Block Diagram of Channels for Psychophysical Experiments	10
Figure 6	Distributions of the Difference of Two Variables for the the Two Alternative Forced Choice Experiment	16
Figure 7	Difference Signal for the Two Alternative Forced Choice Experiment	16
Figure 8	Illustration of Recognition Space for Definition of $\theta$	18
Figure 9	Recognition Space for Large Signals	20

## ABSTRACT

Since studies employing  $d'$  and  $\eta$  are based on the theory of signal detectability, the theory is reviewed in sufficient detail for the purposes of definition. The efficiency,  $\eta$ , is defined as the ratio of the energy required by an ideal receiver to the energy required by a receiver under study when the performance of the two is the same. The measure  $d'$  is that value of  $(2E/N_0)^{1/2}$  necessary for the ideal receiver to match the performance of the receiver under study, where  $E$  is the energy of the signal, and  $N_0$  is the noise power per unit bandwidth. The measure is extended to include the recognizability of two signals. Every set of signals is described by an Euclidean space in which distances are the square roots of the energy of the difference signal,  $(E_\Delta)^{1/2}$ . The unit of measure is the square root of one-half of the noise power per unit bandwidth  $(N_0/2)^{1/2}$ .

DEFINITIONS OF  $d'$  AND  $\eta$  AS PSYCHOPHYSICAL MEASURES1. INTRODUCTION

The theory of signal detectability (References 1 and 2) has provided a model useful to the study of psychophysical phenomena. Smith and Wilson (Reference 3) and Karlin and Munson (Reference 4) report data suggestive of this application in psychoacoustics. Tanner and Swets (Reference 5) present a more formal treatment of the application of the model to visual experiments, and this formal application is extended to psychoacoustics for both detection and recognition studies (References 6, 7, 8, 9, and 10). Morill (Reference 11) and Fitzhugh (Reference 12) used the model in studies of the physiology of vision employing microelectrode techniques. Egan and his associates find the model useful in the study of voice communication channels (References 13, 14, and 15).

The purpose of this report is to clarify the definitions of  $d'$  and  $\eta$  as used in the studies of the author and his co-workers, and to clarify the reasons for employing these variables in psychoacoustical experiments. The only change in definition is that  $\eta$ , as defined in this paper, is the square of  $\eta$  as defined in a previous paper (Reference 7).

Both of these variables are defined within the framework of the theory of signal detectability (References 1 and 2). The word "detectability" is used, rather than the word "detection", because the theory is one describing the limits placed on the performance of a receiver by the signal energy and noise energy of

## ENGINEERING RESEARCH INSTITUTE • UNIVERSITY OF MICHIGAN

the channel. It is like the limitations on measurement imposed by nature, in this case the channel.

The fundamental problem considered in the theory of signal detectability is illustrated in the block diagram of Figure 1. A signal from an ensemble of signals is transmitted with a fixed probability over a channel in which noise is added. The receiver is permitted to observe during a fixed observation interval in time, at the end of which it must state whether the observation was one of noise alone or signal plus noise.

The particular case upon which this discussion is based is that of an ensemble containing only one signal. That one is a signal known exactly: its voltage point-for-point in time during the observation interval is known. It is not known that the signal exists during the interval. The signal is transmitted over a channel in which band-limited white Gaussian noise is added. By employing a sampling theorem (Reference 1), it is shown that the detectability of this signal in this channel can be described by the ratio  $(2E/N_0)^{1/2}$ , in which  $E$  is the signal energy and  $N_0$  is the noise power per unit bandwidth.

The meaning of this ratio, or detectability index, can be illustrated by the diagram in Figure 2. The information contained in any observation in a signal detection task can be expressed in full by a likelihood ratio: the ratio of the likelihood that the observation would occur if the signal plus noise existed to the likelihood that the observation would occur if noise alone existed. Any variable which is a monotonic transformation of likelihood ratio is equally useful in the signal detection task. In this case the natural logarithm of likelihood ratio leads to convenient statistics. Therefore, it is used as the variable and is plotted on the abscissa in Figure 2. This is called the decision axis. The ordinate of Figure 2 is the probability density of the natural logarithm of likelihood ratio.

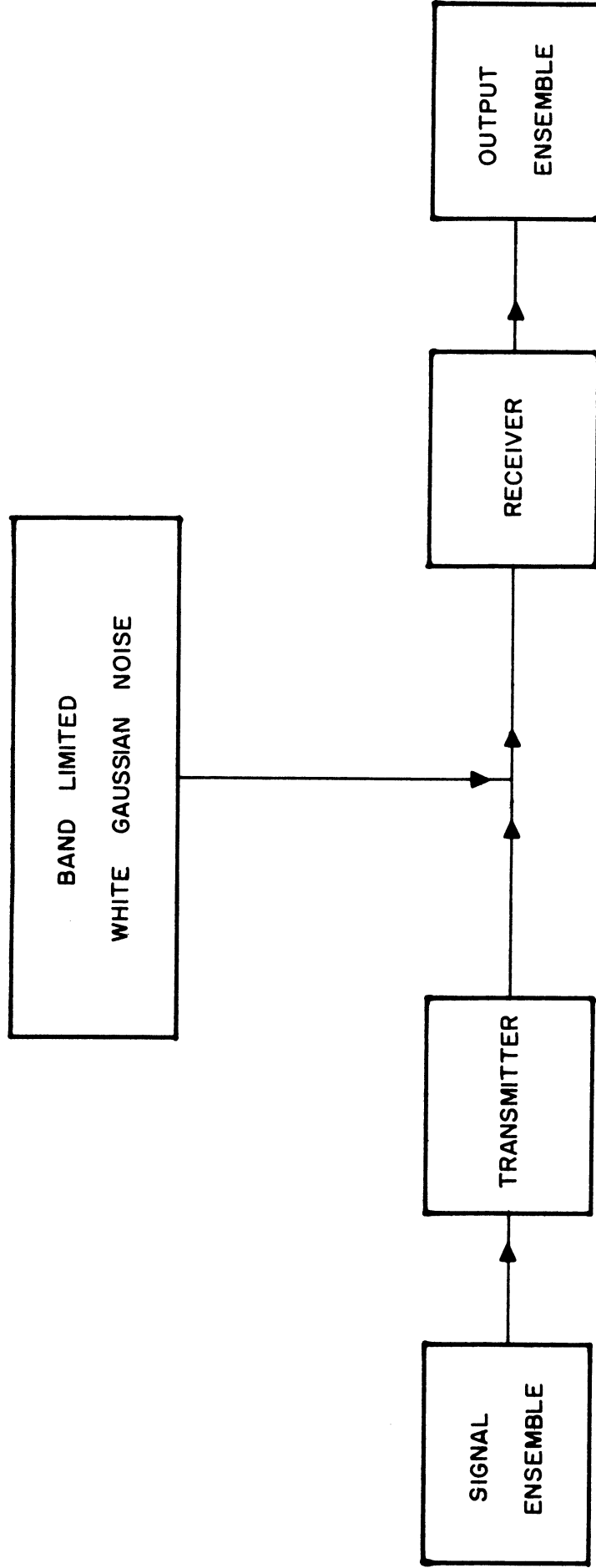

FIG. 1. BASIC PSYCHOPHYSICAL EXPERIMENT IN BLOCK DIAGRAM FORM.

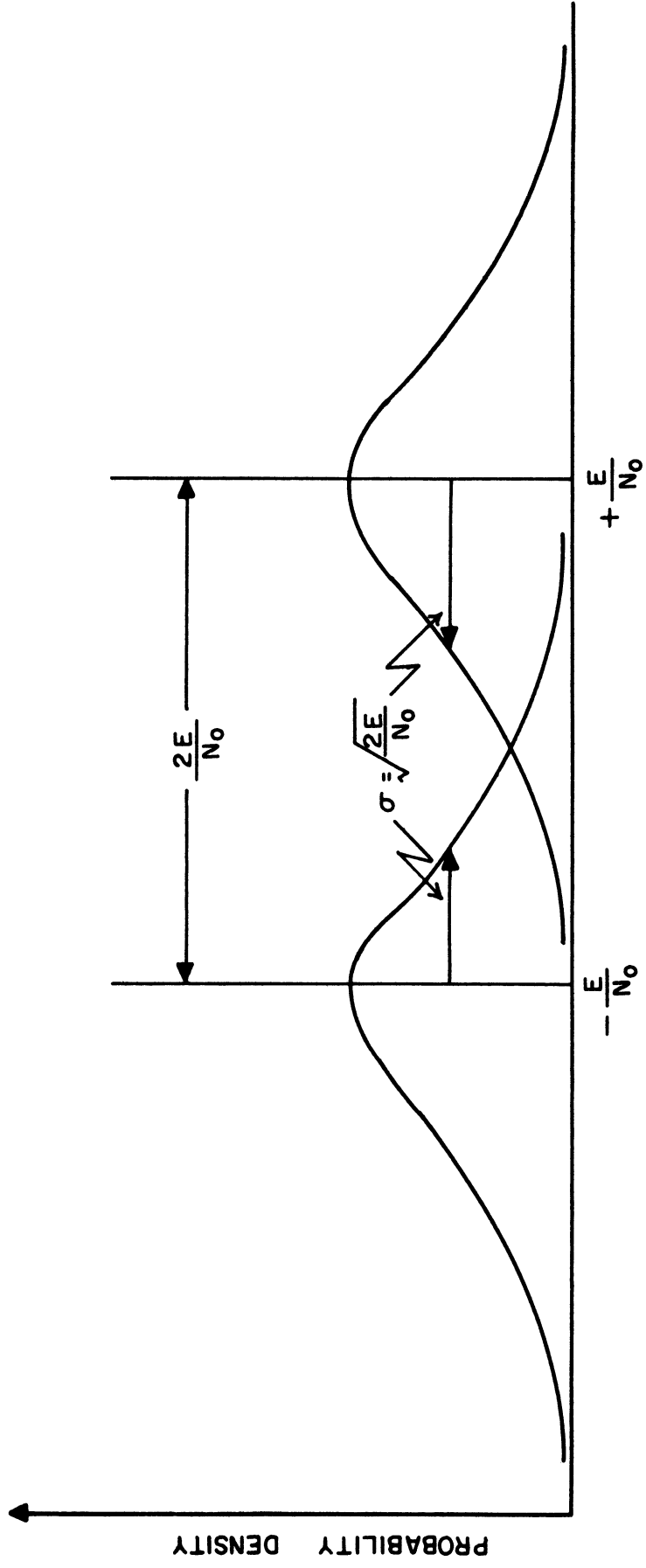

FIG. 2. PROBABILITY DENSITIES FOR  $\log_e \lambda(x)$  CONDITIONAL ON NOISE ALONE, AND ON SIGNAL PLUS NOISE.



## ENGINEERING RESEARCH INSTITUTE • UNIVERSITY OF MICHIGAN

There are two distributions shown in Figure 2. One is conditional upon the existence of noise alone, the other conditional upon the existence of signal plus noise. Peterson, Birdsall, and Fox (Reference 1) show that, for the case under discussion, these distributions are both normal and have equal variance. The mean of the distribution for noise alone is  $-E/N_0$  and for signal plus noise is  $+E/N_0$ . The difference of the means is  $2E/N_0$ . The standard deviation of each of the distributions is  $(2E/N_0)^{1/2}$ . Thus, the difference in the means divided by the standard deviation is the detectability index  $(2E/N_0)^{1/2}$ .

The way in which a measure such as that illustrated in Figure 2 is a statement of capacity is illustrated in Figures 3a and 3b. Figure 3a is an ROC (receiver operating characteristic) curve as defined by Peterson, Birdsall, and Fox. Plotted on the abscissa is the probability that if noise alone exists, the receiver says that the signal exists. On the ordinate is plotted the probability that if signal plus noise exists, the receiver will accept the observation as arising from signal plus noise. An ROC curve thus shows the detection probability as a function of the false alarm probability.

An ROC curve is constructed from the probability distribution of Figure 2. In an experiment involving a choice between two alternatives there is a critical number. Whenever the likelihood ratio is greater than this number one alternative is chosen. The natural logarithm of the critical number is a point on the abscissa of Figure 2. The area under the curve for noise alone to the right of the point is the probability that if signal plus noise exists the receiver will say that signal plus noise exists. These two areas define the location of a point on an ROC curve. The first of the areas defines the location of the point on the abscissa while the second defines the location on the ordinate. The procedure can then be repeated for other values which the critical number can assume, each

## ENGINEERING RESEARCH INSTITUTE • UNIVERSITY OF MICHIGAN

value defining a point on a ROC curve. The ROC curve is the collection of all such points, each arising from a critical number.

The exact location of the points of an ROC curve depends on the separation of the two probability density curves of Figure 2. For the ideal receiver, there is an ROC curve for each value of the  $(2E/N_0)^{1/2}$ . This curve represents the set of all performances utilizing all of the information. The ROC curve is thus an upper bound on performance.

The mirror image of the ROC curve contains the set of points illustrating the worst possible behaviors; i.e., the highest possible miss probability as a function of false alarm probability. The shaded area between the curves contains all achievable operating points, while the bounds of this area are behaviors using the capacities of the signals to be detected. The exact location of the curves and the amount of shaded area depend on the value of  $(2E/N_0)^{1/2}$ , the separation between the statistical hypotheses.

The same ROC curve is plotted in Figure 3b with a transformation of the axis from linear to probability scales. Since the transformation of the axis in this type of graph paper scales standard deviations linearly, and since the distribution of noise alone and signal plus noise of Figure 2 have equal standard deviations for the signal-known-exactly, the ROC curve for the ideal case is a straight line with slope 1 on this paper. The vertical and horizontal scales to the right and above the graph show this linear scaling.

In an experiment the false alarm rate and detection rate can be used as estimates of the probabilities necessary to define a point on an ROC curve. If in Figure 3b one reads the coordinate of this point on the scales to the right and above, the distance of the critical value from the mean in standard units is obtained. The difference of these distances is the minimum value of  $(2E/N_0)^{1/2}$

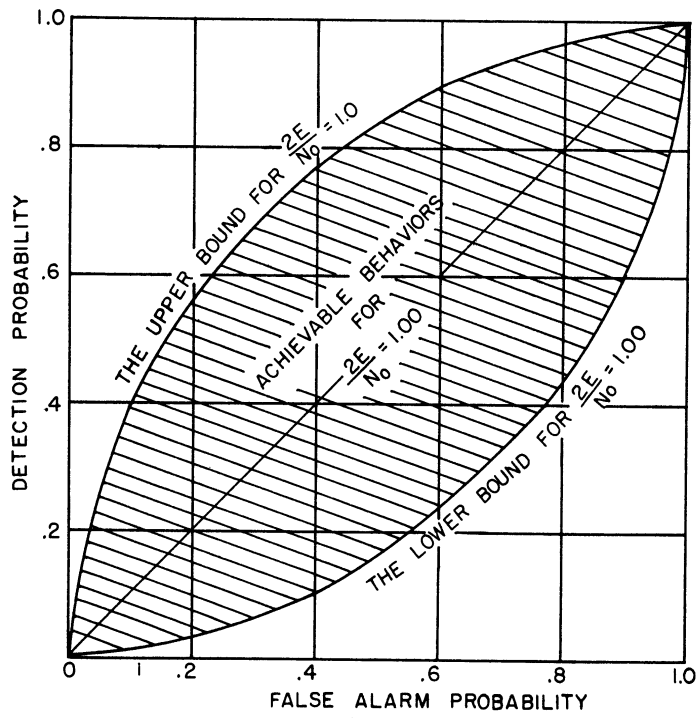

FIG. 3(a). RECEIVER OPERATING CHARACTERISTIC (ROC) FOR THE IDEAL RECEIVER WHEN  $\frac{2E}{N_0} = 1.00$ .

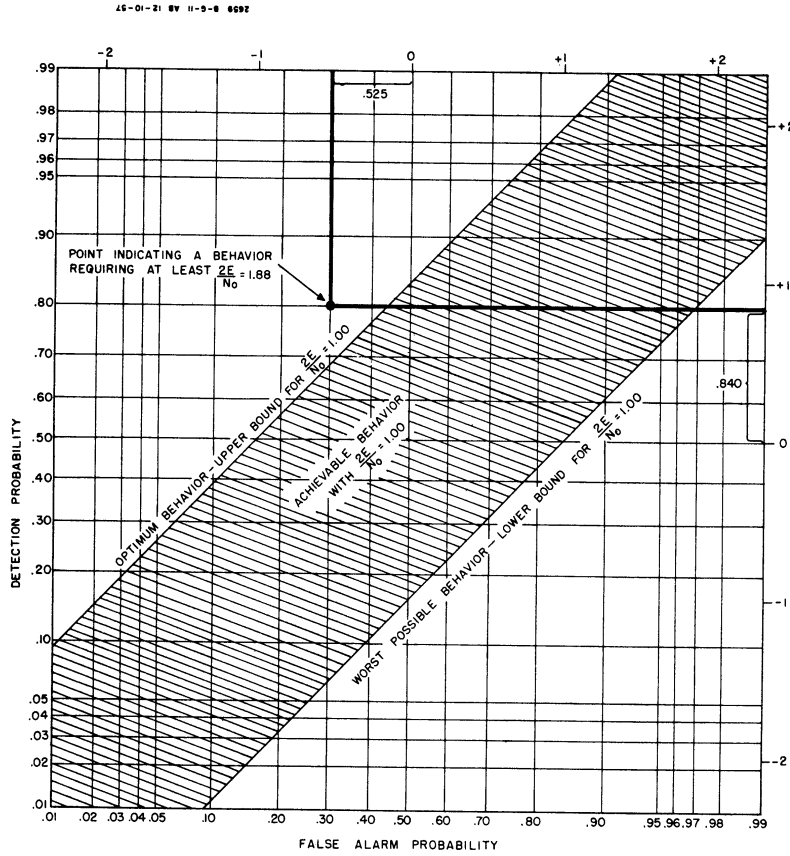

FIG. 3(b). TRANSFORMATION TO DOUBLE PROBABILITY PAPER FOR THE ROC CURVE OF FIG. 3(a).

necessary to lead to this performance; i.e., the particular detection probability when the particular false alarm probability exists.

## II. BASIC DEFINITIONS OF $d'$ AND $\eta$

Consider now the experimental arrangement illustrated in Figure 4. The particular experiment being performed is defined by the positions of switches 1 and 2.

A channel includes the transmitter and the receiver. The block diagrams of Figures 4 and 5 illustrate this use. In Figure 4 there are two possible types of transmitters and two possible types of receivers. The positions of the two switches determine those which are actually in the channel. The switch positions are used as subscripts to specify the channel.

$C_{11}$  is the channel in which the signal transmitted is one known exactly and the receiver is an ideal receiver designed to operate on the particular signal specified (Figure 5a).

$C_{12}$  is the channel in which the signal transmitted is one known exactly and the receiver is the one under study (Figure 5b).

$C_{21}$  is the channel in which the signal transmitted is one known statistically and the receiver is an ideal receiver designed to operate on a particular statistical ensemble of signals. The receiver is designed only with reference to a particular statistical ensemble (Figure 5c).

$C_{22}$  is the channel in which the signal transmitted is one known statistically and the receiver is one under study (Figure 5d).

In each of these channels Fourier series, band-limited white Gaussian noise is added.

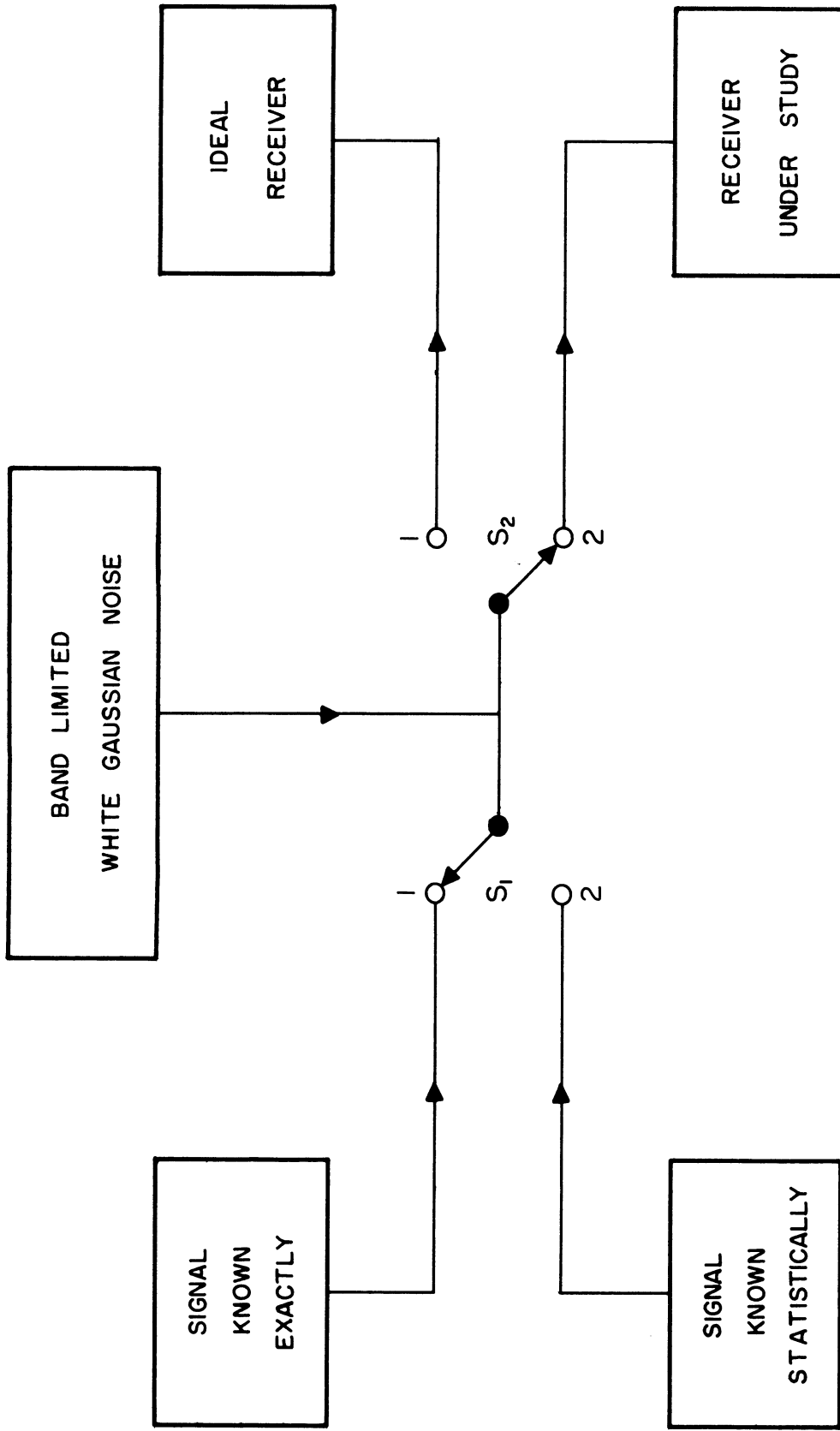

FIG. 4. COMPOSITE BLOCK DIAGRAM OF CHANNELS FOR PSYCHOPHYSICAL EXPERIMENT.

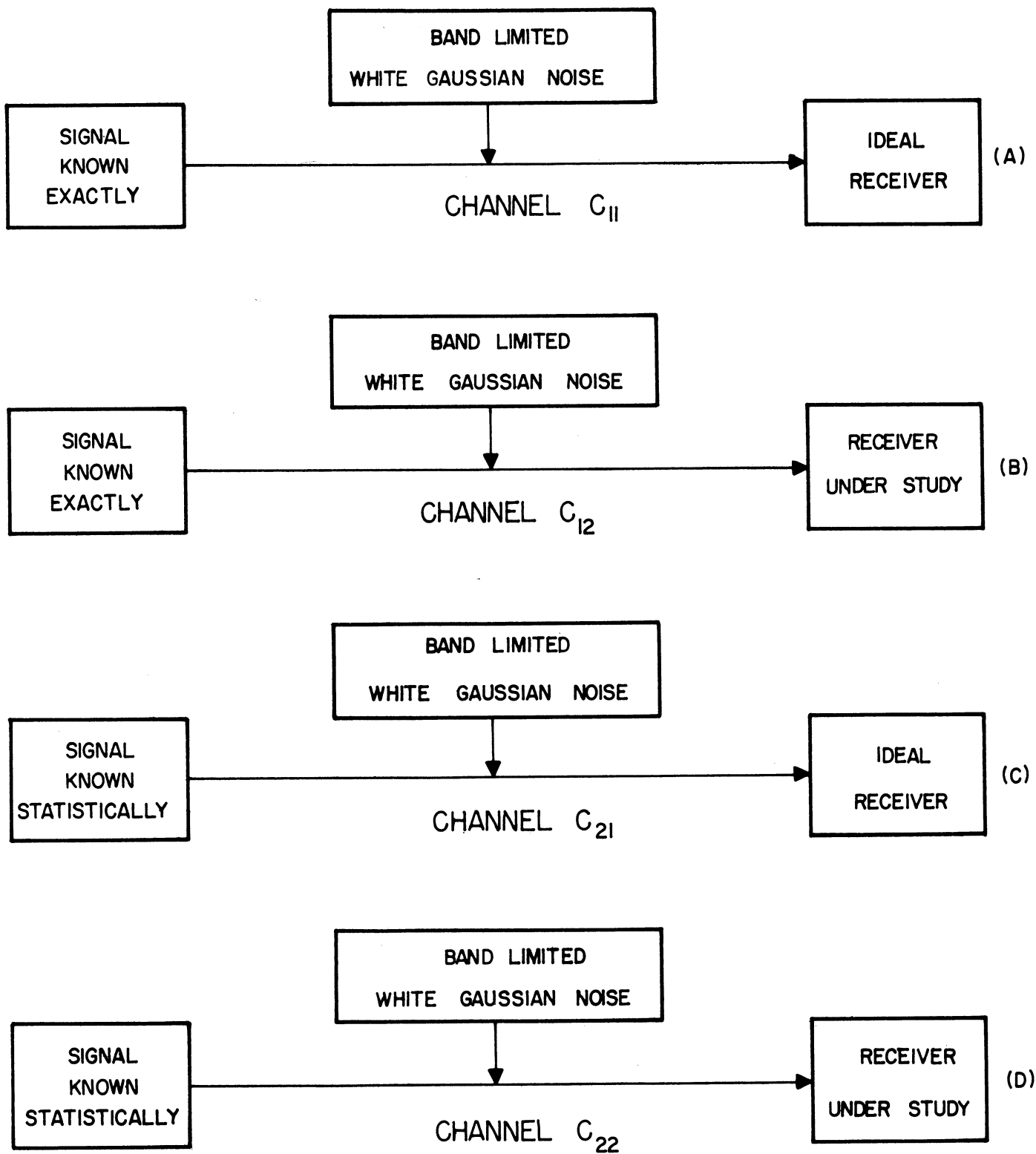

FIG. 5. INDIVIDUAL BLOCK DIAGRAM OF CHANNELS FOR PSYCHOPHYSICAL EXPERIMENT.

## ENGINEERING RESEARCH INSTITUTE • UNIVERSITY OF MICHIGAN

The following symbols are also defined:

$\eta_r$  is the efficiency of the receiver in the channel  $C_{12}$ . Since all of the other components in that channel are ideal, the difference between the performances of channels  $C_{12}$  and  $C_{11}$  is attributable entirely to the receiver.

$\eta_t$  is the efficiency of the transmitter in channel  $C_{21}$ , since all of the other components in that channel are ideal.

$\eta_{tr}$  is the efficiency of channel  $C_{22}$ .

$E_{ij}$  is the energy required of channel  $C_{ij}$  to achieve a given level of performance. The subscript  $i$  refers to the position of the first switch and the subscript  $j$  to the position of the second switch.

First, an experiment is performed in which a signal-known-exactly of energy  $E_{12}$  is transmitted over the channel  $C_{12}$  with band-limited white Gaussian noise of noise power per cycle  $N_0$  is added. The output is presented to the receiver under study, either a human observer or "black box". The task of the receiver is to observe specified waveforms and to determine whether or not that waveform contains a signal. If the question is asked a large number of times, both when the signal is present and when the signal is not present, the data necessary for estimating the false alarm probability  $P_N(A)$  and the detection probability  $P_{SN}(A)$  is obtained.

The next experiment (a mathematical calculation) performed is the same, except that the ideal receiver is substituted for the receiver under study. In this experiment the energy of the signal is "attenuated" at the transmitter ( $N_0$  is the same as in the previous experiment) until the performance obtained in the previous experiment is matched. The energy ( $E_{11}$ ) leading to the matched performance is then determined. The efficiency of the receiver is defined as

$$\eta = \frac{E_{11}}{E_{12}} \quad (1)$$

and the measure  $d'$  is defined by the equation

$$(d')^2 = \eta_r \frac{2E_{12}}{N_0} = \frac{2E_{11}}{N_0} \quad (2)$$

Thus  $(d')^2$  is that the value of  $2E/N_0$  required to lead to the receiver's performance if an ideal receiver were employed in its place.

This second experiment is not performed in the laboratory, since the problem has a mathematical solution (Reference 1). The procedure outlined at the close of Section 1 is followed. One takes the performance of the receiver under study and plots the point on the graph paper of Figure 3b. The coordinates of this point are read on the axis to the right and the axis above. The sum of the standard values is  $(2E_{11}/N_0)^{1/2}$ . The value  $2E_{12}/N_0$  is measured physically. Since  $N_0$  is assumed constant:

$$\eta_r = \frac{2E_{11}/N_0}{2E_{12}/N_0} = \frac{E_{11}}{E_{12}} \quad (3)$$

Both the measure of  $d'$  and  $\eta$  are specific to a particular performance in terms of false alarm rate and detection rate. If a different experiment were performed employing the same signal and noise conditions and permitting a different false alarm rate and consequently a different detection rate, both  $d'$  and  $\eta$  may assume different values. This would be the case if something happened in the receiver to upset the equal-variance condition for noise alone and signal plus noise. However, an examination of the specific cases studied in the theory of signal detectability (Reference 1) suggests that there are a large number of cases in which this departure, while it exists, is not important. That is, the departure over the range likely to be investigated experimentally is not sufficient to lead to significant changes in  $d'$  and  $\eta$ .



Next, consider a mathematical experiment in which a signal known statistically (SKS) is transmitted over the channel to an ideal receiver for that statistical ensemble. Again, the energy  $E_{21}$  is employed and performance is measured. Furthermore, a second mathematical experiment is performed transmitting a signal known exactly (SKE) to the ideal receiver, attenuating  $E_{21}$  until the performance is matched at  $E_{11}$ . This permits calculation of  $\eta_t$ , the efficiency of a transmitter with that statistical ensemble. Both of these experiments are mathematical calculations.

### III. A THEOREM FOR EXPERIMENTAL INTERPRETATION

When  $\eta_t = \eta_r$ , each being referred to the case of the signal-known-exactly, it can be said that the amount of uncertainty represented by the statistical parameters of the transmitter ensemble SKS is reflected to the receiver when SKE is transmitted. This is the same thing as saying that knowledge which the receiver cannot use might as well not be available. If the receiver under study has no provisions built into it for the use of phase information, but all other knowledge can be utilized optimally, then the channel  $C_{12}$  is expected to lead to the same performance as the channel  $C_{21}$  when the signal is known except for phase.

Actually, it is not the specific uncertainty, but rather the degree of uncertainty which is matched when  $\eta_t = \eta_r$ . A signal known except for phase is one in which all phases are equally likely. Measurement is required in two orthogonal dimensions (Reference 1). If the uncertainty were one of frequency such that any frequency within a band were equally likely, and this band is such that again measurement in two orthogonal dimensions is sufficient, then this leads to the same change in performance as does the uncertainty of phase. The parameter,

$m$ , is defined as the number of orthogonal dimensions over which the statistical uncertainty exists. It is now possible to state a theorem leading to inference about the receiver based on the measurement of  $\eta$ .

If  $\eta_r = \eta_t$ , then the receiver, through its inability to use knowledge contained in SKE, introduces an equal statistical uncertainty,  $m$ , to that of the transmitter, SKS. If the channel SKS to the receiver under study is then established and the condition  $\eta_{tr} = \eta_r = \eta_t$ , then the receiver with SKE has introduced exactly that uncertainty existing in SKS.

The first part of the theorem states that, if

$$\eta_r = \frac{E_{11}}{E_{12}} = \eta_t = \frac{E_{11}}{E_{21}},$$

then the receiver has introduced the same amount of uncertainty in the channel  $C_{12}$  as the transmitter in the channel  $C_{21}$  for that statistical ensemble. Essentially, this means that if the efficiency is less than one, there is uncertainty due to something other than white Gaussian noise which was added in the channel. Since in one case the transmitter is ideal, this uncertainty must be introduced by the receiver. In the other case, the receiver is ideal, and the uncertainty must be introduced by the transmitter. The usefulness of the theorem arises from the fact that the amount of uncertainty introduced by SKS can be stated quantitatively.

The second part of the theorem states that, if

$$\eta_{tr} = \frac{E_{11}}{E_{22}} = \eta_t = \frac{E_{11}}{E_{21}} = \eta_r = \frac{E_{11}}{E_{12}},$$

then the exact uncertainties are introduced in the receiver in one case, and in the transmitter in the other case. If particular information, such as that of phase of the signal, is not used by the receiver then no further decrement is introduced by making phase uncertain at the transmitter.

If the theory of signal detectability is applicable, then  $\eta$  is the variable which contains the information necessary to modify the ideal receiver to match the receiver under study.

#### IV. GENERALIZED DEFINITION OF $d'$

So far the discussion of  $d'$  has been entirely in reference to the detectability of signals. The measure can also be applied to the ability of two signals to lead to recognition.

First consider the two-alternative forced-choice experiments in which a signal known exactly is presented in one of two positions in time. The receiver is asked to state in which of the two positions in time the signal did in fact occur. This is essentially a recognition experiment. The question asked the receiver is whether the signal is an 01 or a 10.

An ideal receiver can test each position for the existence of the 1. The position most likely to contain the signal is the one which he chooses. The information upon which he bases his decision is the difference between the two measures. The distribution of the differences is illustrated in Figure 6, a normal distribution with mean  $d'$  and standard deviation  $\sqrt{2}$ . If the two signals are equally likely, then the shaded error represents the probability of a correct choice.

Another way of looking at this type of experiment is to treat the task as one of recognition as illustrated in Figure 7. In this case, the signal shown in line 1 can be subtracted from the observed input which contains either the signal of line 1 plus additive noise, or the signal of line 2 plus additive noise. The subtraction leaves noise alone if the signal of line 1 was present, or the signal of line 3 plus noise if the signal of line 2 was present. Now the receiver

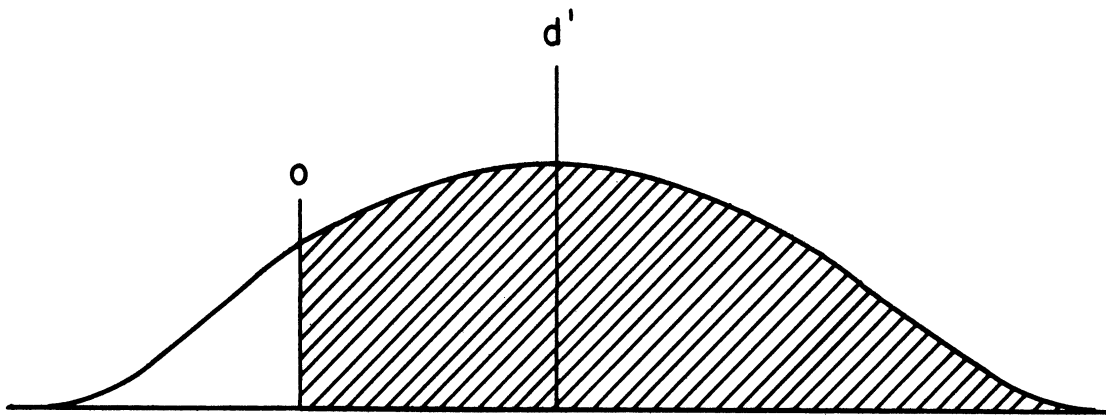

FIG. 6. DISTRIBUTION OF THE DIFFERENCE OF TWO VARIABLES FOR THE TWO ALTERNATIVE FORCED CHOICE EXPERIMENT.

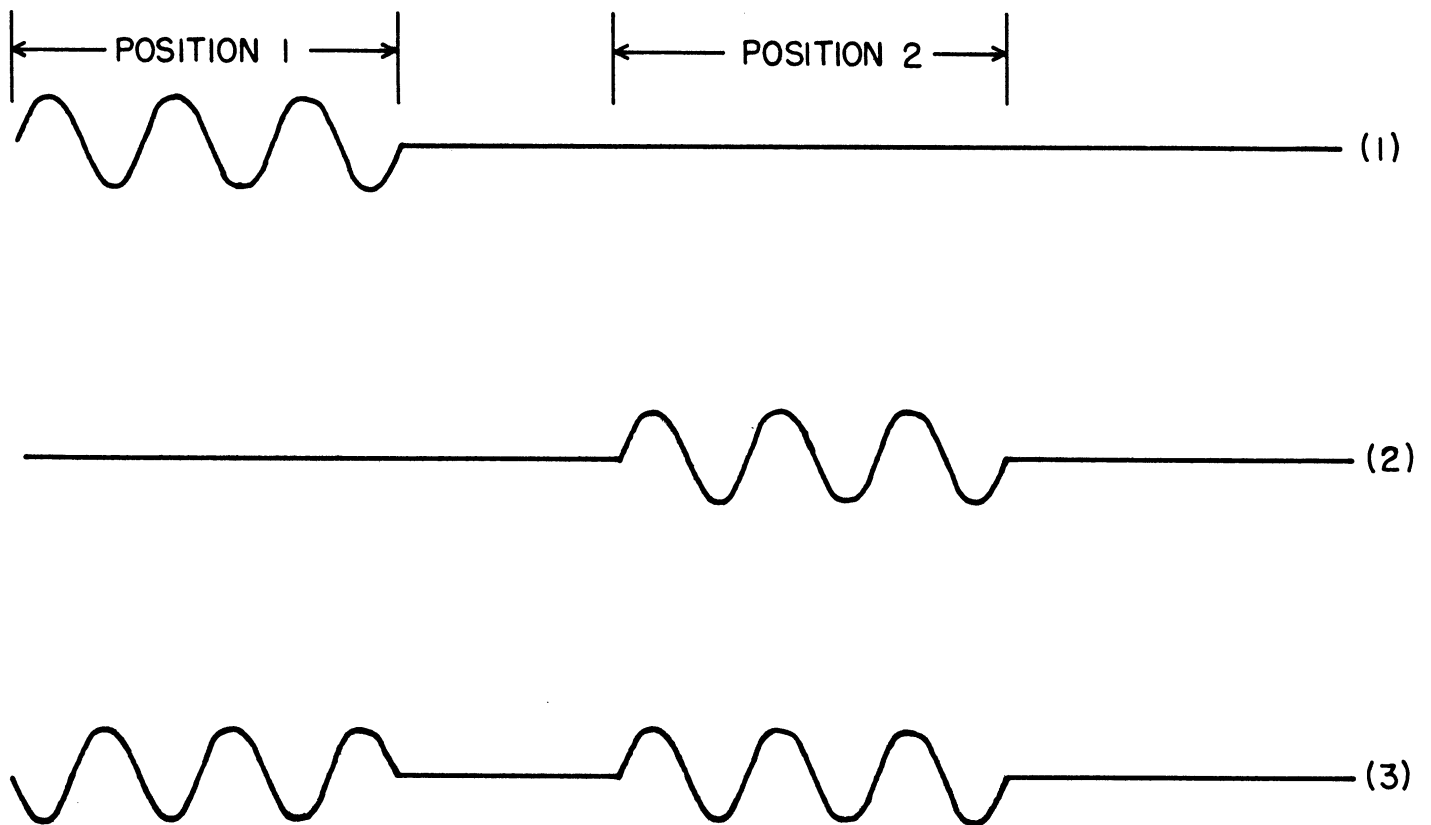

FIG. 7. DIFFERENCE SIGNAL FOR THE TWO-ALTERNATIVE FORCED-CHOICE EXPERIMENT.

can test for the presence of the signal in line 3 in the noise. If the measure is sufficient to state that the signal of line 3 was present, he chooses the signal of line 2. Otherwise, he chooses the signal of line 1. This experiment is like a detection experiment with twice the energy.

A third way of looking at this experiment is illustrated in Figure 8, taken from an earlier paper (Reference 9). The two signals are orthogonal; that is, the angle  $\theta$  is  $90^\circ$ . If  $(2E_1/N_0)^{1/2}$  and  $(2E_2/N_0)^{1/2}$  are equal, then the recognition decision axis is  $(4E/N_0)^{1/2}$ , consistent with the result of the previous two views.

Now, in the two-alternative forced-choice experiments in which the alternatives have equal energy, one could measure either (1) the distance  $(\eta \ 4E/N_0)^{1/2}$ , (2) the recognition  $d'_{1,2}$ , or (3) the distance  $(\eta \ 2E/N_0)^{1/2}$  (the detection  $d'$  for the signal which is presented in one of the two positions in time), since in forced-choice experiments involving more than two alternatives, with each containing equal energy, a single number permitting analysis is the detection  $d'$ . The author and his colleagues have been using this measure. Thus, when a  $d'$  is presented without a subscript, or with a single subscript, it is a measure of the difference between two hypotheses, one of which is noise alone. Whenever the  $d'$  is intended to indicate the difference between two signals, each is indicated by a subscript. In Figure 8,  $d'_1$  refers to the distance 0 to 1,  $d'_2$  to the distance 0 to 2, and  $d'_{1,2}$  to the distance 1 to 2.

If a two-alternative forced-choice experiment is found to lead to a percentage of correct choices, this can be used as an estimate of the probability of a correct choice. This estimate is the data necessary to enter the graph in Figure 3b. The point to be plotted projects on the ordinate at  $P(c)$  and on the abscissa at  $1-P(c)$ . The sum of the standard units is  $d'_{1,2}$  and  $\sqrt{2} \ d'_1$ , if  $d'_1 = d'_2$ .

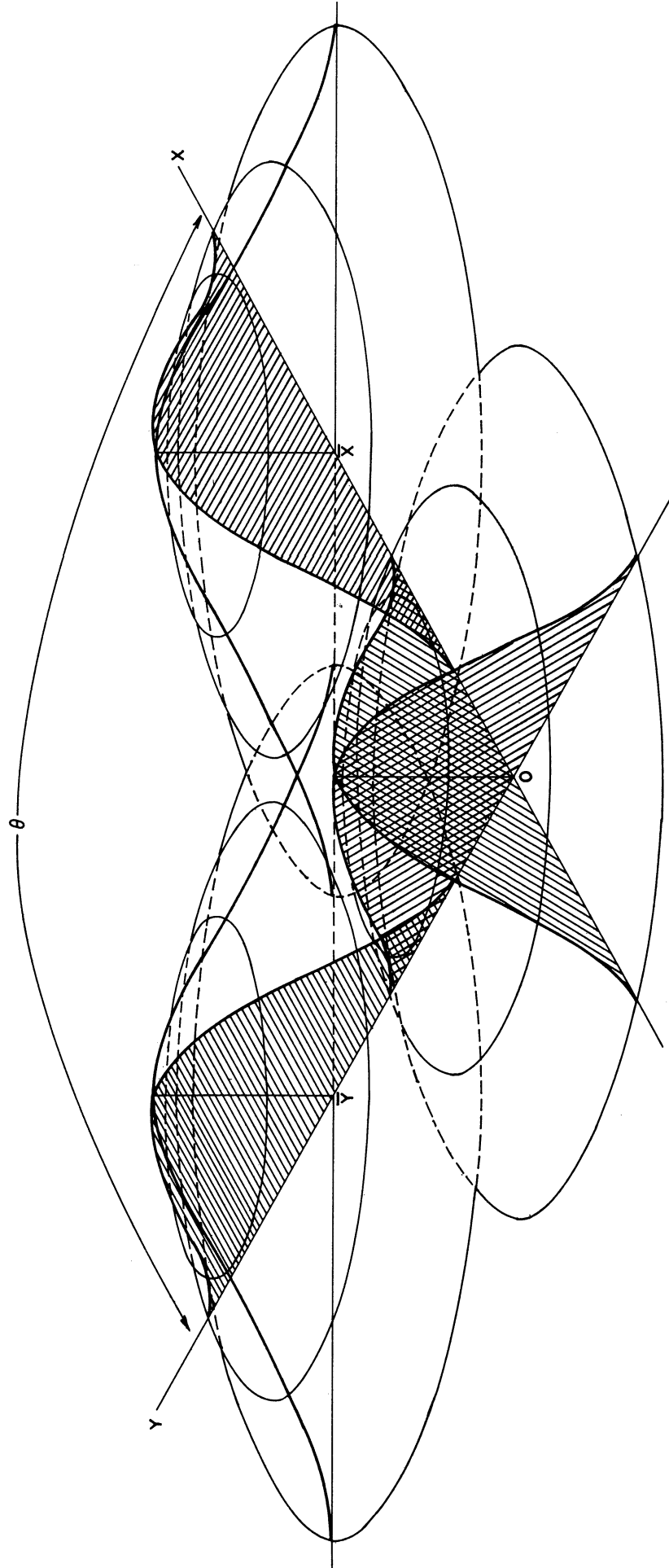

FIG. 8. ILLUSTRATION OF RECOGNITION SPACE FOR DEFINITION OF  $\theta$ .

Now, let us consider a more general case illustrated in Figure 9. In this case the angle  $\theta$  can assume any value and the energies of the two signals,  $S_1$  and  $S_2$ , are not necessarily equal. If an experiment is now performed in which one or the other of the two signals is presented at a fixed position in time, and the receiver is asked to state which one, again the data are furnished for entering the graph of Figure 3b. The estimated probabilities required are  $P_{S_1}(A_1)$ , the probability that if  $S_1$  is presented the receiver is correct, and  $1 - P_{S_2}(A_2)$ , the probability that if  $S_2$  is presented the receiver is incorrect. The  $d'$  so estimated is  $d'_{S_1, S_2} = (\eta \frac{2E_{\Delta}}{N_0})^{1/2}$  where  $\Delta$  is the energy of the difference signal. This can be referred to a shifted point of origin  $O'$  with reference to which these signals are orthogonal. The distance from  $O'$  to each of the signals is  $(\eta \frac{E_{\Delta}}{N_0})^{1/2}$ . The energy required to shift the point of origin from  $O$  to  $O'$  is redundant energy. It may be useful in phasing the receiver or bringing it on frequency. It does not, however, contribute to the capacity of the signals to lead to a decision.

If  $S_1$  and  $S_2$  are now presented in randomized order and the receiver is asked to state the order, again the data necessary to enter the graph of Figure 3b is available. In this case, the pairs can be considered orthogonal to each other. Thus, the measure is now  $d'_{S_1, A} = \sqrt{2} d'_{S_1 S_2}$ .

The theory of signal detectability deals only with signals for which space for any set of signals in a given noise background is Euclidean. Distances in this space are linearly related to the square root of the energy of the difference signal represented by two points. The unit of measure is the square root of the noise power per unit bandwidth  $(N_0/2)^{1/2}$ .

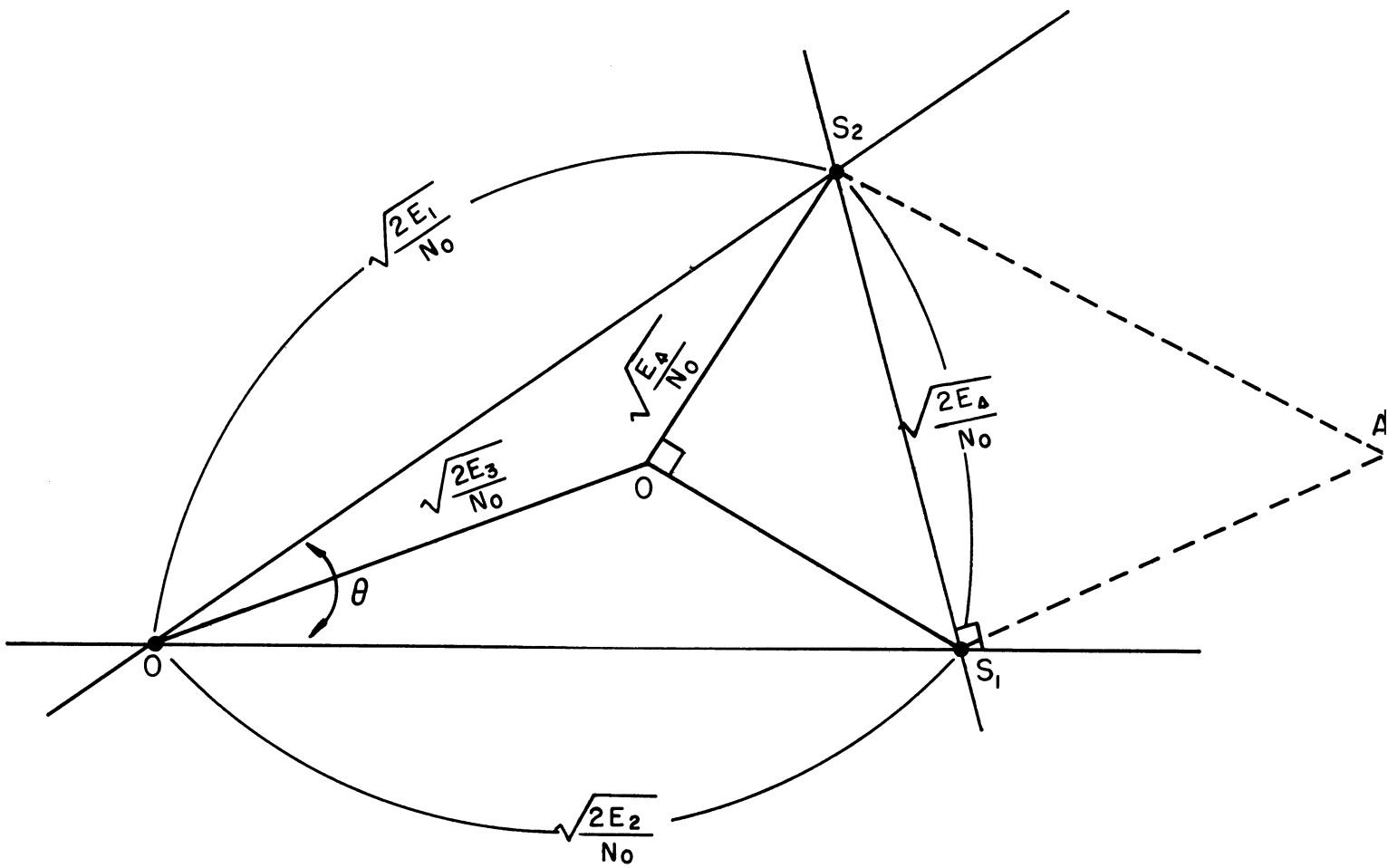

FIG. 9. RECOGNITION SPACE FOR LARGE SIGNALS.



V. CONCLUSION

From the above discussion it is obvious that, in psychoacoustics at least,  $d'$  is a voltage-type variable. Ideally,  $d'$  is linearly related to the square root of the energy of the information carrying component of the signal, not to its power. In studies in which a receiver's response to an incremental stimulus is investigated, the incremental stimulus should be stated in terms of added voltage, not added energy. If one's measure is that quantity leading to a constant  $d'$ , as would be the case if one measured a "difference limen", then this constant  $d'$  would be expected to result when there is a constant voltage difference between the two signals, rather than a constant energy difference. This should be the case whenever there is enough redundant energy to remove the statistical uncertainty of the signal.

In some cases where there is an uncertainty which cannot be removed, as in the case of the signal a sample of white Gaussian noise, the energy of the signal is the basis for a good approximation of the detectability.

On the other hand,  $\eta$  is an energy ratio, since efficiency is commonly measured in terms of energy. This term is useful in inferring the properties of the receiver under study.

## REFERENCES

1. Peterson, W.W., Birdsall, T.G. and Fox, W.C., "The Theory of Signal Detectability," Transactions of the IRE Professional Group on Information Theory, PGIT-4 1954, pp. 171-212.
2. Van Meter, D., and Middleton, D., "Modern Statistical Approaches to Reception in Communication Theory," Transactions of the IRE Professional Group on Information Theory, PGIT-4, 1954, pp. 119-145.
3. Smith, M. and Wilson, Edna A., "A Model of the Auditory Threshold and Its Application to the Problem of the Multiple Observer," Psychol. Monog. Vol. 67, No. 9, 1953.
4. Munson, W. A., and Karlin, J. E., "The Measurement of the Human Channel Transmission Characteristics," JASA Vol. 26, pp. 542-553, July 1956.
5. Tanner, W.P., Jr., and Swets, J. A., "The Human Use of Information: I Signal Detection for the Case of the Signal Known Exactly," Transactions of the IRE Professional Group on Information Theory PGIT-4, pp. 213-221.
6. Tanner, W. P., Jr. and Norman, R. Z., "The Human Use of Information: II Signal Detection for the Case of an Unknown Signal Parameter," Transactions of the IRE Professional Group on Information Theory PGIT-4, 1954, pp. 222-227.
7. Tanner, W. P., Jr., Swets, J. A., and Green D.M., "Some General Properties of the Hearing Mechanism," Technical Report No. 30, Electronic Defense Group, University of Michigan, 1956.
8. Green, D. M., Birdsall, T. G., and Tanner, W. P., Jr., "Signal Detection as a Function of Signal Intensity and Signal Duration," JASA, 1957, Vol. 29 pp. 523-531.
9. Tanner, W. P., Jr., "Theory of Recognition," JASA, 1956, Vol. 28, pp. 882-888.
10. Swets, J. A., and Birdsall, T. G., "The Human Use of Information: III Decision Making in Signal Detection and Recognition Situations Involving Multiple Alternatives," Transactions of the IRE Professional Group on Information Theory, PGIT-2, 1956, pp. 138-165.

11. Marill, T., "Detection Theory and Psychophysics," Research Laboratory of Electronics, Technical Report No. 319, 1956.
12. Fitzhugh, R., "The Statistical Detection of Threshold Signals in the Retina," J. of Gen. Pysiol. 1957, Vol. 40, pp. 925-948.
13. Egan, J. P., "Message Repetition," Operating Characteristics and Confusion Matrices in Speech Communication AFCRC-TR-57-50, Indiana University, 1957.
14. Egan, J. R., Clark, F. R., and Carterette, E. C., "On the Transmission and Confirmation of Messages in Noise," JASA, 1956, 28, 536-550.
15. Egan, J. P., and Clark, F. R., "Source and Receiver Behavior in the Use of a Criterion," JASA, 1956, 28, 1267-1269.



DISTRIBUTION LIST

1 Copy	Document Room Willow Run Laboratories University of Michigan Willow Run, Michigan
12 Copies	Electronic Defense Group Project File University of Michigan Ann Arbor, Michigan
1 Copy	Engineering Research Institute Project File University of Michigan Ann Arbor, Michigan
250 Copies	Operational Applications Laboratory Air Force Cambridge Research Center Air Research and Development Command Bolling Air Force Base 25, D. C. Contract No. AF19(604)-2277
1 Copy	H. H. Goode Engineering Research Institute University of Michigan Ann Arbor, Michigan