



U.S. Department
Of Transportation



Effect of Realistic Vehicle Seats, Cushion Length, and Lap Belt Geometry on Child ATD Kinematics

Kathleen D. Klinich
Matthew P. Reed
Sheila M. Ebert
Jonathan D. Rupp
University of Michigan Transportation Research Institute

December 2011

Technical Report Documentation Page

1. Report No. UMTRI-2011-20		2. Government Accession No.		3. Recipient's Catalog No.	
4. Title and Subtitle Effect of Realistic Vehicle Seats, Cushion Length, and Lap Belt Geometry on Child ATD Kinematics				5. Report Date December 2011	
				6. Performing Organization Code	
7. Author(s) Klinich, Kathleen D., Reed, Matthew P., Ebert, S.M., Rupp, Jonathan. D.				8. Performing Organization Report No.	
9. Performing Organization Name and Address University of Michigan Transportation Research Institute 2901 Baxter Rd. Ann Arbor MI 48109				10. Work Unit No. (TRAIS)	
				11. Contract or Grant No.	
12. Sponsoring Agency Name and Address National Highway Traffic Safety Administration				13. Type of Report and Period Covered	
				14. Sponsoring Agency Code	
15. Supplementary Notes					
<p>16. Abstract</p> <p>This series of sled tests examined the effect of using real vehicle seats on child ATD performance. Cushion length was varied from production length of 450 mm to a shorter length of 350 mm. Lap belt geometry was set to rear, mid, and forward anchorage locations that span the range of allowable lap belt angles found in real vehicles. Six tests each were performed with the standard Hybrid III 6YO and 10YO ATDs. One additional test was performed using a booster seat with the 6YO. An updated version of the UMTRI seating procedure was used to position the ATDs that positions the ATD hips further forward with longer seat cushions to reflect the effect of cushion length on posture that has been measured with child volunteers. ATD kinematics were evaluated using peak head excursion, peak knee excursion, the difference between peak head and peak knee excursion, and the minimum torso angle.</p> <p>Shortening the seat cushion improved kinematic outcomes, particularly for the 10YO. Lap belt geometry had a greater effect on kinematics with the longer cushion length, with mid and forward belt geometries producing better kinematics than the rearward belt geometry. The worst kinematics for both ATDs occurred with the long cushion length and rearward lap belt geometry. The improvements in kinematics from shorter cushion length or more forward belt geometry are smaller than those provided by a booster seat. The results show potential benefits in occupant protection from shortening cushion length, particularly for children the size of the 10YO ATD.</p>					
17. Key Word Older children, belt fit, booster seat				18. Distribution Statement	
19. Security Classif. (of this report)		20. Security Classif. (of this page)		21. No. of Pages	22. Price

Metric Conversion Chart

APPROXIMATE CONVERSIONS TO SI UNITS

SYMBOL	WHEN YOU KNOW		MULTIPLY BY	TO FIND		SYMBOL
LENGTH						
In	Inches		25.4	millimeters		mm
Ft	Feet		0.305	meters		m
Yd	Yards		0.914	meters		m
Mi	Miles		1.61	kilometers		km
AREA						
in²	squareinches	645.2	square millimeters		mm ²	
ft²	squarefeet	0.093	square meters		m ²	
yd²	square yard	0.836	square meters		m ²	
Ac	Acres	0.405	hectares		ha	
mi²	square miles	2.59	square kilometers		km ²	
VOLUME						
fl oz	fluid ounces	29.57	milliliters		mL	
Gal	gallons	3.785	liters		L	
ft³	cubic feet	0.028	cubic meters		m ³	
yd³	cubic yards	0.765	cubic meters		m ³	
NOTE: volumes greater than 1000 L shall be shown in m ³						
MASS						
Oz	ounces	28.35	grams		g	
Lb	pounds	0.454	kilograms		kg	
T	short tons (2000 lb)	0.907	megagrams (or "metric ton")		Mg (or "t")	
TEMPERATURE (exact degrees)						
°F	Fahrenheit	5 (F-32)/9 or (F-32)/1.8	Celsius		°C	
FORCE and PRESSURE or STRESS						
Lbf	poundforce	4.45	newtons		N	

lbf/in²	poundforce per square inch	6.89	kilopascals	kPa
LENGTH				
mm	millimeters	0.039	inches	in
m	meters	3.28	feet	ft
m	meters	1.09	yards	yd
km	kilometers	0.621	miles	mi
AREA				
mm²	square millimeters	0.0016	square inches	in ²
m²	square meters	10.764	square feet	ft ²
m²	square meters	1.195	square yards	yd ²
ha	hectares	2.47	acres	ac
km²	square kilometers	0.386	square miles	mi ²
VOLUME				
mL	milliliters	0.034	fluid ounces	fl oz
L	Liters	0.264	gallons	gal
m³	cubic meters	35.314	cubic feet	ft ³
m³	cubic meters	1.307	cubic yards	yd ³
MASS				
g	grams	0.035	ounces	oz
kg	kilograms	2.202	pounds	lb
Mg (or "t")	megagrams (or "metric ton")	1.103	short tons (2000 lb)	T
TEMPERATURE (exact degrees)				
°C	Celsius	1.8C+32	Fahrenheit	°F
FORCE and PRESSURE or STRESS				
N	Newtons	0.225	poundforce	lbf
kPa	Kilopascals	0.145	poundforce per square inch	lbf/in ²

*SI is the symbol for the International System of Units. Appropriate rounding should be made to comply with Section 4 of ASTM E380.

(Revised March 2003)

Acknowledgments

This work was funded by the National Highway Traffic Safety Administration under cooperative agreement DTNH22-05-01020 with the University of Michigan. The authors acknowledge the efforts of Brian Eby, Carl Miller, and Gillian Hencker on this project.

Table of Contents

Metric Conversion Chart.....	ii
Acknowledgments.....	iv
List of Figures.....	vi
List of Tables.....	vii
Introduction.....	1
Methods.....	3
Belt Geometry.....	3
Seating Procedure.....	6
Test Matrix.....	8
Kinematic Assessments.....	9
Results.....	10
Discussion.....	19
Summary of Key Points.....	22
References.....	23
Appendix 1.....	24

List of Figures

Figure 1.	Side view of vehicle seat configured to cushion lengths of 350 (left) and 450 mm (right).	3
Figure 2.	Side view of lap belt anchorage locations from vehicle rear seats and anchorages selected for testing.	4
Figure 3.	Close-up of outboard anchorage hardware that provides lap belt angles of 23°, 50°, and 75°. (Stars indicate anchorage bolt locations.).....	5
Figure 4.	Close-up of inboard anchorage hardware that provides lap belt angles of 23°, 50°, and 75°. (Stars indicate anchorage bolt locations.).....	5
Figure 5.	Using a heavy-duty locking clip to simulate a buckle stalk and latchplate.	6
Figure 6.	Fixture used to measure distance from hips to front of seat cushion. A foam wedge is used to prevent contact between the head and seat. (See Appendix 1).	7
Figure 7.	Initial positions of 6YO and 10YO ATDs in vehicle seats with cushion lengths of 350 and 450 mm.....	8
Figure 8.	Illustration of kinematics at the time of peak head excursion for 10YO [TA=torso angle, K-H=knee-head excursion].	11
Figure 9.	Illustration of kinematics at the time of peak head excursion for 6YO [TA=torso angle, K-H=knee-head excursion].	12
Figure 10.	Illustration of 6YO kinematics at the time of peak head excursion with and without a booster seat [TA=torso angle, K-H=knee-head excursion].	13
Figure 11.	Typical head resultant accelerations for 10YO and 6YO	15
Figure 12.	Peak torso angle for 10YO ATD for each combination of cushion length (350 vs. 450) and lap belt anchorage location (F, M, R).	16
Figure 13.	Peak torso angle for 6YO ATD for each combination of cushion length (350 vs. 450) and lap belt anchorage location (F, M, R).....	16
Figure 14.	Knee-head excursion for 10YO ATD for each combination of cushion length (350 vs. 450) and lap belt anchorage location (F, M, R).....	17
Figure 15.	Knee-head excursion for 6YO ATD for each combination of cushion length (350 vs. 450) and lap belt anchorage location (F, M, R).	17
Figure 16.	Peak torso angle vs. knee-head excursion for all tests. [Tests with clear submarining circled.]	18
Figure 17.	Kinematic results of the 10YO ATD from current study compared to prior testing on the FMVSS No. 213 bench with booster seats.	20
Figure 18.	Kinematic results of the 6YO ATD from current study compared to prior testing on the 213 bench with and without booster seats.....	21

List of Tables

Table 1.	Test matrix	9
Table 2.	Summary of test conditions, peak resultant accelerations, and kinematic measures	14

Introduction

The number of U.S. children using belt-positioning booster seats in vehicles continues to grow as 47 states now mandate their use for older children. However, compliance with these laws remains incomplete, and a substantial number of children aged 4-9 still travel without a booster or harness restraint. The latest recommendations from NHTSA (March 2011) and the American Academy of Pediatrics (March 2011) recommend booster use once a child outgrows their harness restraint (typically between ages 4-7) and booster use until the seat belt fits properly (typically between ages 8-12). However, caregivers relying on age-based guidelines in legislation are likely to transition their children out of boosters at or around age 8. These use patterns indicate a need for rear seating environments to provide crash protection for children aged 12 years and under age with and without booster seats.

The rear seats of current vehicles are not sized to accommodate children well. Huang and Reed (2006) surveyed the second-row seats of vehicles and found that the median rear seat cushion length of 455 mm is longer than the thigh length of most rear-seat occupants, about half of whom are aged 12 years and under. Long seat cushions cause occupants to slouch, leading to poor lap belt fit (Klinich et al. 1994). Shortening the cushion length of rear seats may improve accommodation and belt fit for children.

Reed et al. (2008) studied the seated posture and belt fit of children aged 5 to 12 with statures ranging from 1100 to 1500 mm (43 to 61 inches). Without a booster, the average lap belt fit achieved by the largest children was poor; more than half of the lap belt width was positioned above the top of the pelvis. In addition, there was minimal improvement in belt fit between the smallest and largest children, particularly when compared to the improvement in belt fit obtained by all children in range of boosters. The same study documented a wide range of shoulder belt fit when using realistic shoulder belt anchorage locations.

Prior studies for NHTSA demonstrated the dynamics effects of belt geometry on the kinematics of the Hybrid III 10YO and 6YO ATDs (Klinich et al. 2008, Klinich et al. 2010, Klinich et al. 2011). Poor belt fit, with or without a booster, can lead to submarining or rollout, increasing the risk of abdomen or head injuries.

These previous studies of the effects of belt geometry on ATD outcomes were conducted using the FMVSS No. 213 test bench. Reed et al. (2011) compared the contour and stiffness of the FMVSS No. 213 seat to the contours of the rear seats of 54 late-model vehicles. The FMVSS No. 213 bench is longer than the average undeflected rear seat contour, and the FMVSS No. 213 bench profile is flatter than all of the vehicle seats. The FMVSS No. 213 bench was softer than 93% of vehicle seats, using the depth of penetration of the SAE J826 H-point machine as an indication of seat stiffness.

This report describes a series of 13 sled tests performed to evaluate the effects of seat cushion length and lap belt angle on child dummy kinematics using a real vehicle seat. Testing was conducted using the Hybrid-III 6YO and 10YO ATDs.

Methods

Vehicle seats

Six second-row captain's chairs from 2008 and later Dodge Caravans (all with the same design) were obtained from junkyards and adapted for mounting on the FMVSS No. 213 buck in place of the test bench. None of the test seats showed any unusual damage or wear on visual inspection. The vehicle seats were positioned on the FMVSS No. 213 buck such that the fore-aft location of the H-point of the vehicle seat matched the fore-aft H-point of the regular FMVSS No. 213 bench to facilitate visual comparison between these tests and comparable tests run on the FMVSS No. 213 bench.

The cushion length of the production vehicle seat is 450 mm, 5 mm less than the median second-row, outboard seat cushion length (Huang and Reed, 2006). The seats were disassembled and mounted such that the seatback and seat cushion were attached separately. Each seat was used in two tests. Half the tests were performed with a cushion length of 450 mm, while the other half used a cushion length of 350 mm, achieved by shifting the seat pan rearward relative to the seat back. Figure 1 shows the seat configured for the two cushion lengths.



Figure 1. Side view of vehicle seat configured to cushion lengths of 350 (left) and 450 mm (right).

Belt Geometry

FMVSS 210 specifies that the lap belt angle should range from 30 to 75 degrees with respect to horizontal when measured from the vehicle seat H-point to the lap belt anchorage location. Figure 2 illustrates the range of lap belt geometries measured in 55 vehicles, together with the FMVSS 210 corridors. On the UMTRI FMVSS No. 213 bench, the location of the anchorages specified in FMVSS NO. 213 fall just outside the legal range of the FMVSS 210 specifications. (The FMVSS NO. 213 bench specification does not include the H-point location. We hypothesize that the FMVSS No. 213 anchorage falls outside current FMVSS No. 210 specifications of 30-70° because it was designed when the allowable FMVSS No. 210 lap belt angle range was 20-70°.) To allow direct comparison to the lap belt anchorages used on the

FMVSS No. 213 buck, the FMVSS No. 213 lap belt anchorage location was used in the current testing to represent a rearward, shallow lap belt condition. Two other anchorage locations were used that provided lap belt angles of 50 and 75 degrees. Because the length of belt from the anchorage to H-point can affect kinematics, these two anchorages were located so the side-view distance between anchorage and H-point was similar (approximately 160 mm), creating an “arc” of belt anchorages providing different angles but similar lengths of belt around the occupant. Lap belt angles tested were 23°, 50°, and 75°, and are referred to as the rear, mid, and forward lap belt geometries, respectively. Figure 3 shows a close-up of the outboard anchorage hardware that provides these lap belt geometries.

Although vehicle seat belts do not necessarily provide the same lap belt angle with the inboard hardware as is provided with the outboard hardware, an effort was made to align the inboard and outboard anchorages. Figure 4 shows the fixture used to mount the inboard belt hardware, with red stars on the diagrams showing the locations of the mounting holes.

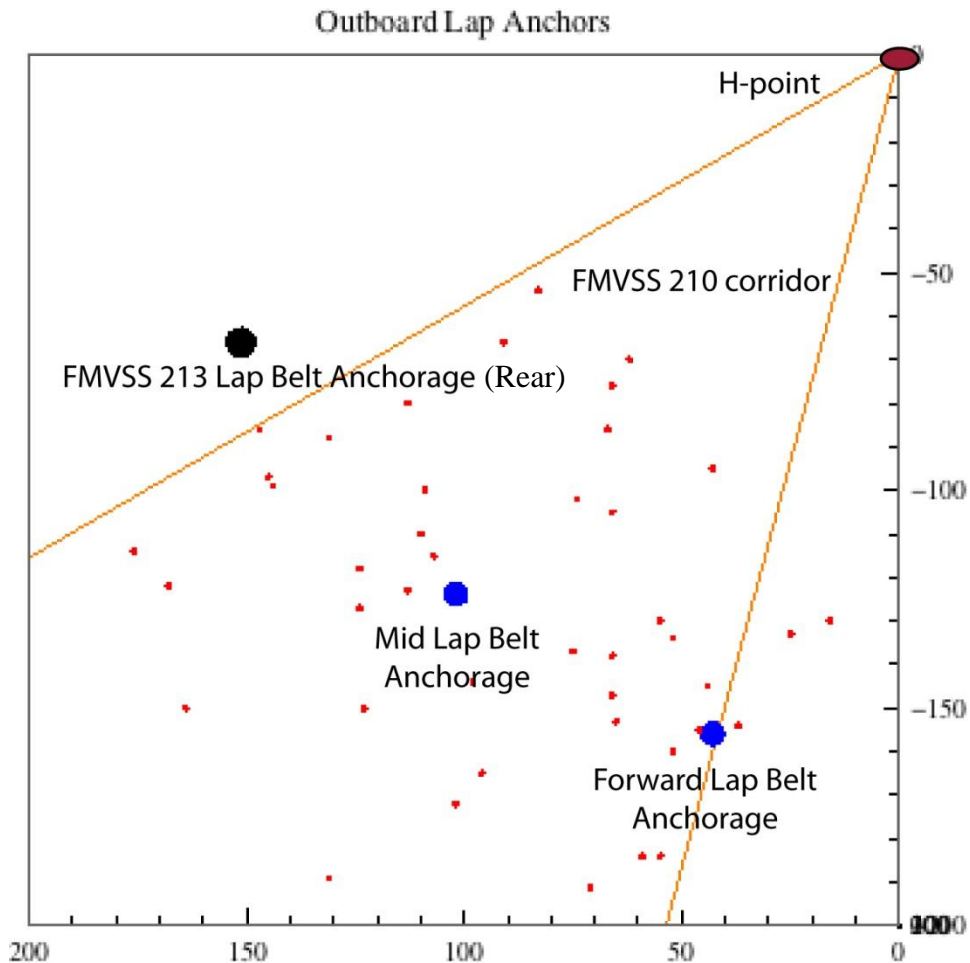

Figure 2. Side view of lap belt anchorage locations from vehicle rear seats and anchorages selected for testing.

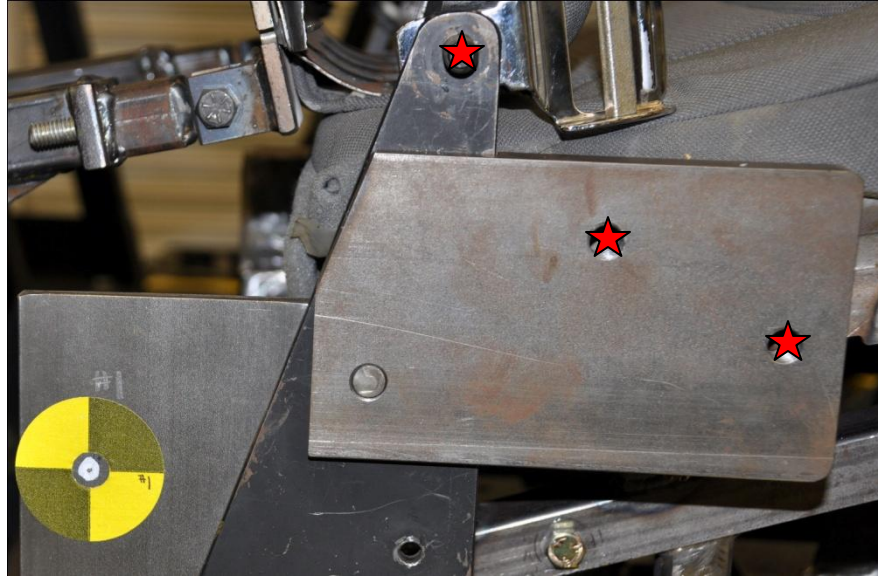

Figure 3. Close-up of outboard anchorage hardware that provides lap belt angles of 23°, 50°, and 75°. (Stars indicate anchorage bolt locations.)

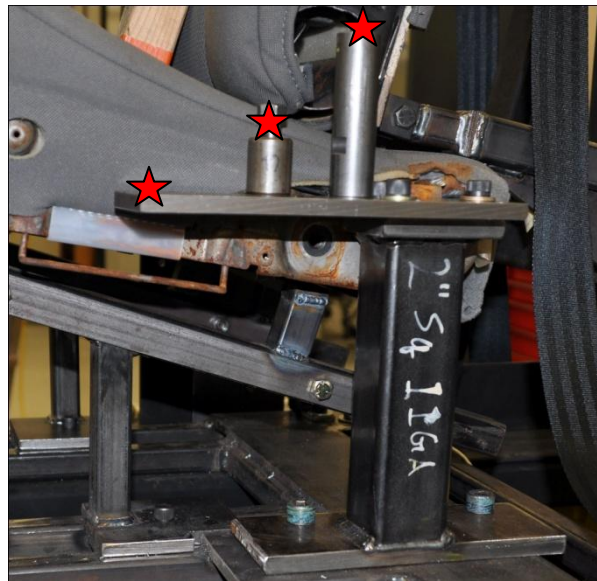

Figure 4. Close-up of inboard anchorage hardware that provides lap belt angles of 23°, 50°, and 75°. (Stars indicate anchorage bolt locations.)

Because a goal of this test series was to test with realistic belt geometry, an effort was made to simulate a buckle stalk. Using data from 24 vehicles in which it was possible to measure the end of the buckle stalk and the attachment bolt, the median buckle stalk length was 150 mm. To simulate a buckle stalk, a heavy-duty locking clip was used to join the lap belt and shoulder belt webbing at a length 150 mm from the inboard mounting belt, as shown in Figure 5. The locking clip worked well to simulate the buckle stalk and was not damaged during testing.

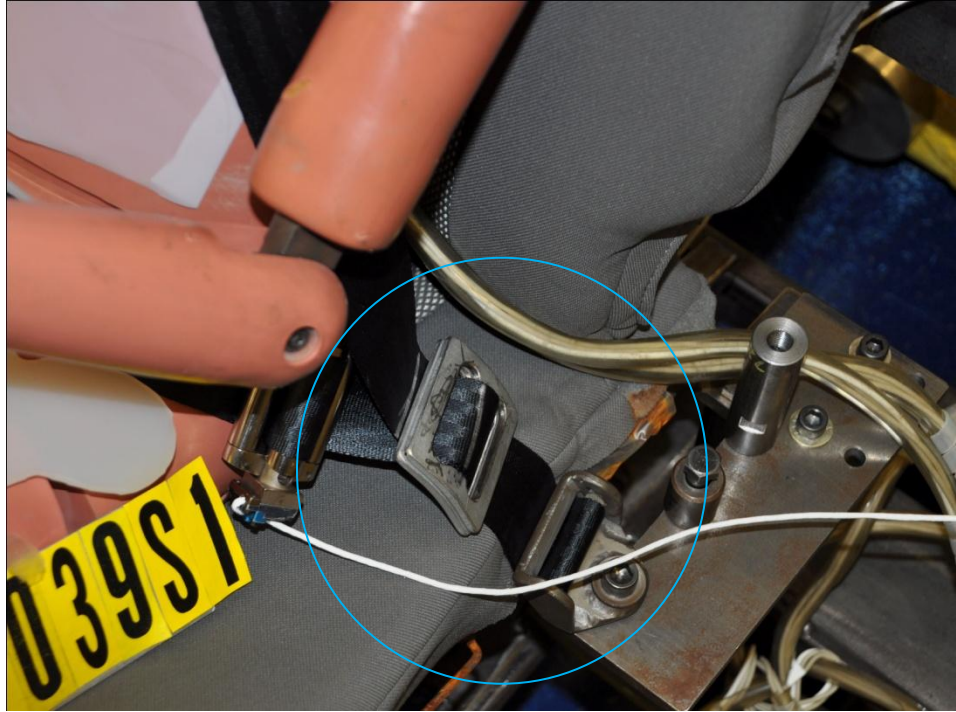

Figure 5. Using a heavy-duty locking clip to simulate a buckle stalk and latchplate.

Seating Procedure

Testing was performed using the standard Hybrid III 6YO and 10YO ATDs. The dummies were seated using a new version of the UMTRI ATD seating procedure. This procedure was developed to produce realistic postures of 6YO and 10YO ATDs on vehicle seats, where long cushion lengths lead to slouched postures in real children. The procedure is described in detail in Appendix 1. The procedure begins using the original UMTRI seating procedure (Reed et al. 2006), which uses a pad attached to the back of the ATD to shift the hips forward. Then the distance from the front edge of the seat cushion to the hips is measured. If this distance is larger than the mean expected value given by an empirical statistical model based on child posture data, the hips are shifted forward to a more realistic position (See Appendix 1). Figure 6 shows the fixture used to document the hip-to-front-of-cushion distance. If the head rests on the seatback without thorax contact (an unrealistic riding posture) a foam wedge is used to shift the ATD forward until the head no longer contacts the seatback, as is also shown in Figure 6.



Figure 6. Fixture used to measure distance from hips to front of seat cushion. A foam wedge is used to prevent contact between the head and seat. (See Appendix 1).

The initial positions of each dummy seated in seats with long and short cushion lengths are shown in Figure 7. The head of the 6YO contacted the seatback, and the head restraint in its lowest position affected the angle of the torso, so the head restraint was raised to eliminate the contact. For the 10YO, the head restraint was adjusted so that the center of its vertical extent was approximately lined up with the head CG. With the shorter cushion length, both ATDs are seated more upright, with their lower legs hanging straight down from the front edge of the seats. With the longer cushion lengths, there are gaps between the seatback and buttocks, and the lower legs are resting at an angle on the fronts of the seats. Belt fit was quantified using shoulder and lap belt scores measured as described in Appendix 1.



Figure 7. Initial positions of 6YO and 10YO ATDs in vehicle seats with cushion lengths of 350 and 450 mm

Test Matrix

The matrix of tests performed in this series is shown in Table 1. Three lap belt angles were tested at each cushion length (350 and 450 mm) with each ATD. After completion of the 12 tests using each dummy with each cushion length and belt geometry, an extra test was run using the 6YO ATD in a backless TurboBooster using the long cushion length and rear belt geometry. This test was intended to provide an example of ATD kinematics in a booster using the geometry from the FMVSS No. 213 buck but on a vehicle seat.

Table 1. Test matrix

Test ID	ATD	Belt Geometry	Cushion Length	Booster
NT1030	6YO	mid	Long	None
NT1031	6YO	forward	Long	None
NT1032	6YO	rear	Long	None
NT1033	6YO	rear	Short	None
NT1034	6YO	mid	Short	None
NT1035	6YO	forward	Short	None
NT1036	10YO	forward	Short	None
NT1037	10YO	mid	Short	none
NT1038	10YO	rear	Short	none
NT1039	10YO	forward	Long	none
NT1040	10YO	mid	Long	none
NT1041	10YO	rear	Long	none
<i>NT1042</i>	<i>6YO</i>	<i>rear</i>	Long	<i>TB no back</i>

Kinematic Assessments

Each dummy was instrumented with triaxial accelerometers in the head, thorax, and pelvis. Six-axis load cells were installed in the upper neck and lumbar spine. ASIS load cells were also mounted in each dummy pelvis. Angular rate sensors were mounted in the spine box and pelvis.

In previous work, we identified two useful measures of ATD kinematics to supplement those commonly used (Klinich et al. 2010, Klinich et al. 2011). We calculate the peak torso angle by adding the peak integrated angular rate to the initial angle of the vector from ATD hip joint to head CG with respect to vertical measured prior to the test. Because of spine flexion, this value will generally be different from the angle that would be obtained if it were feasible to directly measure the hip and head CG locations during the test, but it provides a good indication of the kinematics of thorax during the test. FMVSS No. 213 regulates knee and head excursions independently, but the relationship between the two seems to be at characterizing the performance of a belt restraint, with or without a booster. “Knee minus head” or “knee-head” excursion is calculated by subtracting the peak head excursion measured at the leading edge of the head from the peak forward excursion of the knee joint. Using the differences in excursion, rather than the absolute excursion, accounts for differences in initial position. Larger values of knee-head excursion indicate poorer control of the lower part of the body, potentially leading to submarining. Results from previous testing (Klinich et al. 2010) indicate that knee-head excursions of 200 mm and greater are associated with submarining kinematics. Since values approaching 200 mm may have submarining tendencies, values less than 150 mm would be considered to be associated with desirable kinematics.

Results

Figure 8 and Figure 9 show sideview images from the high-speed video at the point of maximum head excursion. Clear evidence of submarining, with the lap belt visibly entering the abdomen area, was observed with the 6YO and the 10YO with the rear belt geometry and the long cushion length. As indicated by the included data on peak torso angle and knee-head excursion, the kinematics are similar in all conditions for the 10YO except for the 450-mm, rear lap belt geometry condition. For the 6YO, the kinematics for the three tests with the shorter cushion are similar. For the longer cushion, the mid and forward belt conditions have similar peak torso angles, but a greater knee-head excursion value with the forward belt anchorage condition.





Condition	Cushion length 350 mm	Cushion length 450 mm
10YO, rear	 <p>TA: 1.4, K-H:168</p>	 <p>TA: 4.2, K-H:197</p>
10YO, mid	 <p>TA: -0.6, K-H:160</p>	 <p>TA: 2.2, K-H:187</p>
10YO, forward	 <p>TA:0.4, K-H: 156</p>	 <p>TA: 14.2, K-H:262</p>

Figure 8. Illustration of kinematics at the time of peak head excursion for 10YO [TA=torso angle, K-H=knee-head excursion].



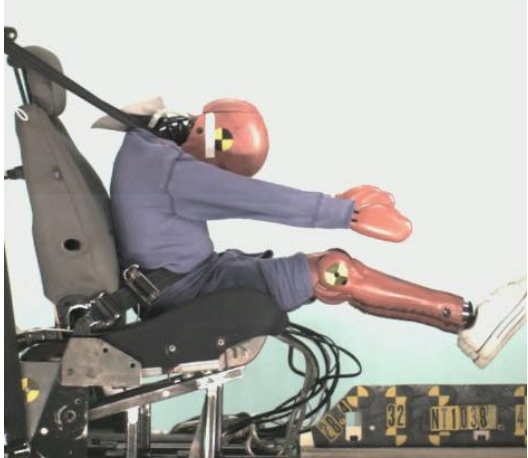

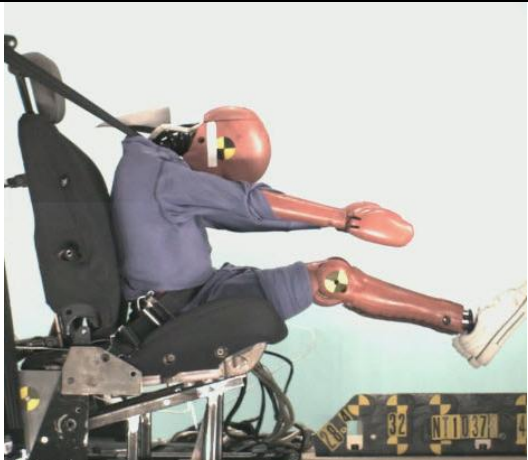
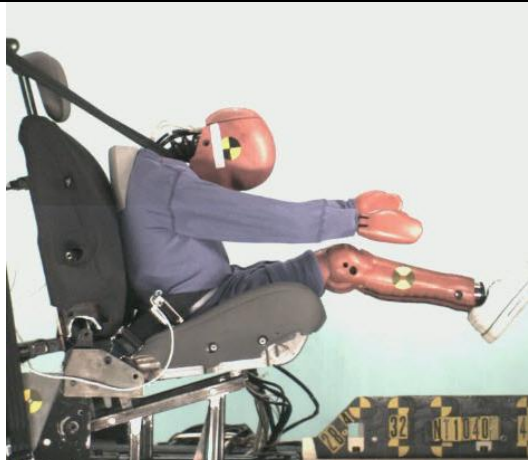

Condition	Cushion length 350 mm	Cushion length 450 mm
6YO, rear	 <p>TA: 10.5, K-H:162</p>	 <p>TA: 24.8, K-H:278</p>
6YO, mid	 <p>TA: 12.8, K-H:138</p>	 <p>TA: 13.8, K-H:179</p>
6YO, forward	 <p>TA: 11.5, K-H:159</p>	 <p>TA: 12.5, K-H:210</p>

Figure 9. Illustration of kinematics at the time of peak head excursion for 6YO [TA=torso angle, K-H=knee-head excursion].

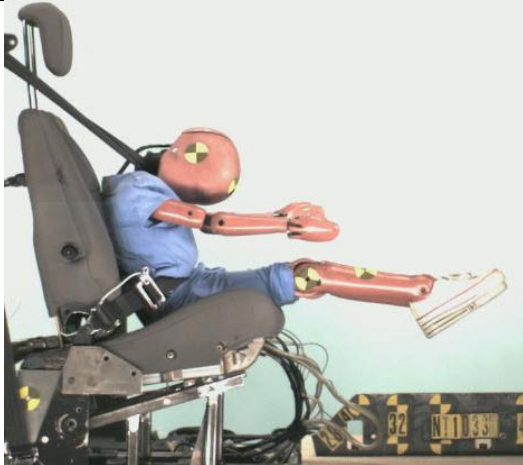
The kinematics of the 6YO with and without a booster seat at the time of peak head excursion are shown in Figure 10. These test conditions use the long cushion length and the rearward lap belt geometry, which is the same as the FMVSS No. 213 belt geometry. The ATD submarines without the booster and has good kinematics with the booster.

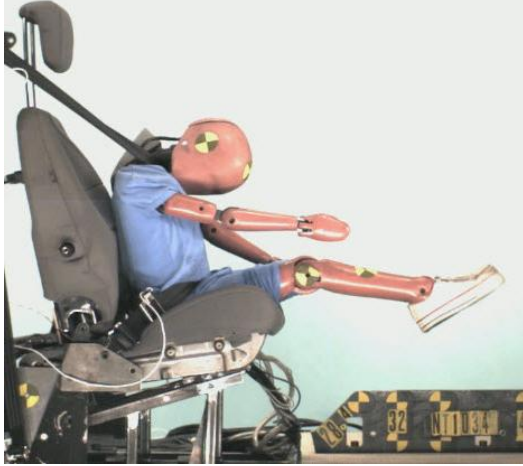

Vehicle seat, cushion length 450 mm	
6YO, rear	 <p>TA: 24.8, K-H:278</p>
6YO, rear, Turbo booster	 <p>TA -19.1, K-H: 99</p>

Figure 10. Illustration of 6YO kinematics at the time of peak head excursion with and without a booster seat [TA=torso angle, K-H=knee-head excursion].

Table 2 summarizes the test results. In each pair of tests using the same belt geometry but different cushion lengths, the peak head resultant acceleration, 36-ms HIC, and 3-ms-clip chest acceleration were usually similar. However, the tests with the shorter cushion length and the mid or forward lap belt geometry had higher peak pelvis resultant accelerations.

Table 2. Summary of test conditions, peak resultant accelerations, and kinematic measures

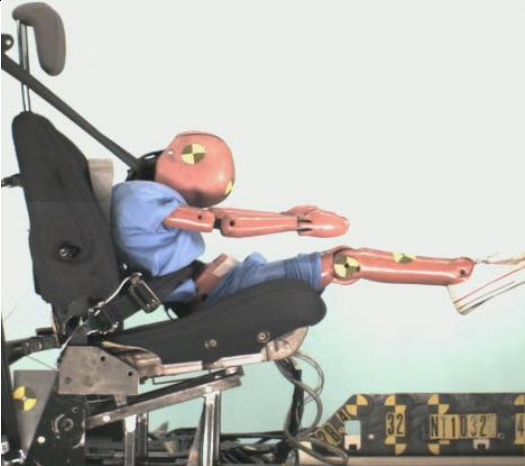
TestID	ATD	Cushion Length	Lap belt	HeadR (g)	HIC (36 ms)	3ms Chest	PelvisR (g)	head ex	knee ex	knee-head	peak torso	SBS	LBS
NT1036	10YO	350	Forward	79	1166*	56	89	524	692	168	1.4	16	24
NT1039	10YO	450	Forward	89	1299*	55	54	540	737	197	4.2	39	14
NT1037	10YO	350	Mid	84	1191*	54	65	511	671	160	-0.6	26	12
NT1040	10YO	450	Mid	85	1152*	48	44	517	704	187	2.2	52	0
NT1038	10YO	350	Rear	87	1154*	45	59	518	674	156	0.4	27	-2
NT1041	10YO	450	Rear	90	951*	44	54	488	750	262	14.2	64	-28
NT1035	6YO	350	Forward	67	672	62	92	482	641	159	11.5	31	-8
NT1031	6YO	450	Forward	59	586	51	80	480	690	210	12.5	38	-7
NT1034	6YO	350	Mid	62	645	56	64	472	610	138	12.8	41	0
NT1030	6YO	450	Mid	58	622	55	51	475	654	179	13.8	57	-7
NT1033	6YO	350	Rear	64	548	53	56	445	607	162	10.5	52	-24
NT1032	6YO	450	Rear	57	492	59	62	435	713	278	24.8	68	-34
<i>NT1042</i>	<i>6YO</i>	<i>450+TB</i>	<i>Rear</i>	<i>76</i>	<i>945</i>	<i>53</i>	<i>71</i>	<i>526</i>	<i>625</i>	<i>99</i>	<i>-19.1</i>	<i>2</i>	<i>17</i>

Belt geometry: Green:=forward, blue= mid, purple=rear

Seat cushion length: normal=350 mm, bold=450 mm

Italic=booster seat

*Chin-to-chest contact occurred and was included in HIC calculation

Figure 11 shows examples of head resultant accelerations for the 6YO and 10YO under conditions with the mid belt geometry and short cushion length. The head accelerations with the 6YO did not exhibit chin-to-chest contact, although there is often a large head acceleration late in the event during rebound that is not typically present during testing with the FMVSS No. 213 buck. This late acceleration is not included in the HIC calculation (because it was not selected for the 36 ms calculation window by the HIC program). The 10YO did experience chin-to-chest contact that is included in the HIC calculation, as well as a large head acceleration during rebound that is not included in the HIC calculation.

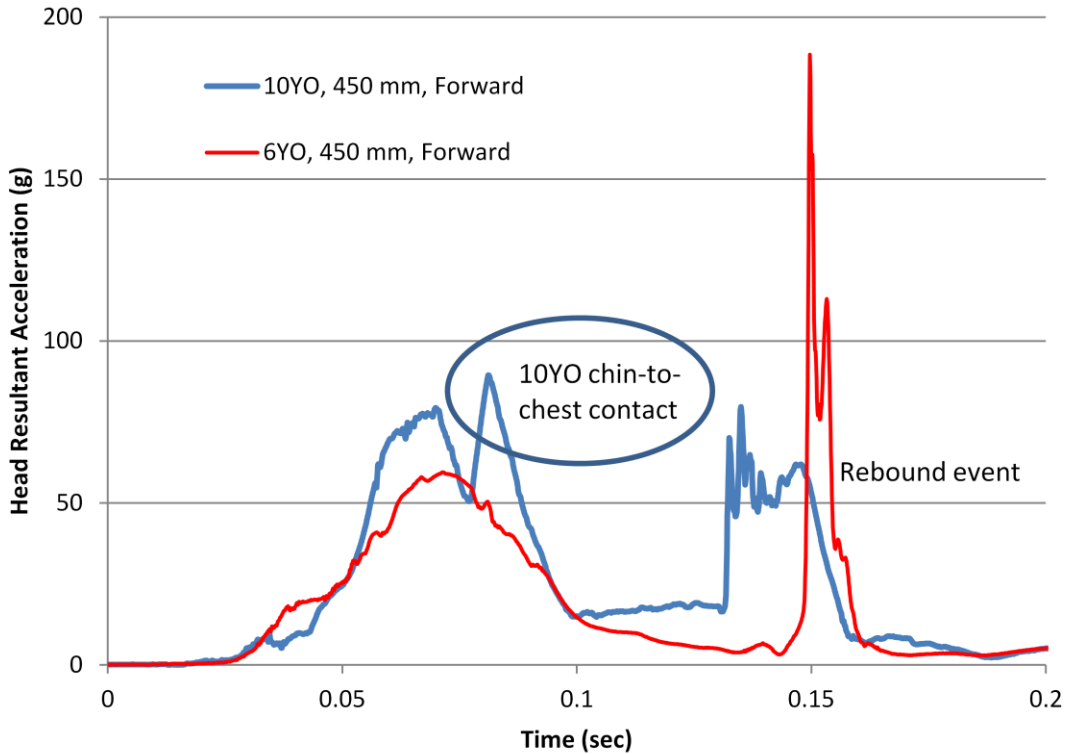

Figure 11. Typical head resultant accelerations for 10YO and 6YO

The shoulder belt score (SBS) varies by 10-19 mm for the 6YO and 23-37 mm for the 10YO, even though the shoulder belt geometry is the same in all tests, because of the change in posture caused between the shorter and longer cushion lengths. In all cases, the longer cushion length leads to more outboard shoulder belt placement, because the shoulder is higher when the ATD is less reclined. For the lap belt score with the 10YO (positive score indicates top of lap belt below ASIS), shorter cushion length always improved the score, and score improved from rearward to forward lap belt geometries.

Lap belt score was less consistent with cushion length for the 6YO, and the mid and forward lap belt scores were similar to each other and better than the rearward lap belt score. The lap belt score achieved with the 6YO on the booster seat was comparable to that obtained with the 10YO with the forward belt geometries.

The peak torso angle from each test condition is shown in Figure 12 for the 10YO and Figure 13 for the 6YO. Past research has shown that the target kinematics indicating good restraint should result in a peak torso angle that goes past vertical (i.e., -10 to -20 degrees). Angles less than this range indicate submarining tendencies, while angles past this range suggest rollout. Overall, reducing cushion length improved peak torso angle, but not as much as is desirable. For the 450 mm cushion length, shifting the belt geometry from rearward to the mid or forward positions also improved peak torso angle, but again not to the target range. For the shorter cushion length,

there were minimal differences in peak torso angle at each belt geometry. Across all conditions, the peak torso angle of the 6YO was on average about 11 degrees more rearward than that of the 10YO.

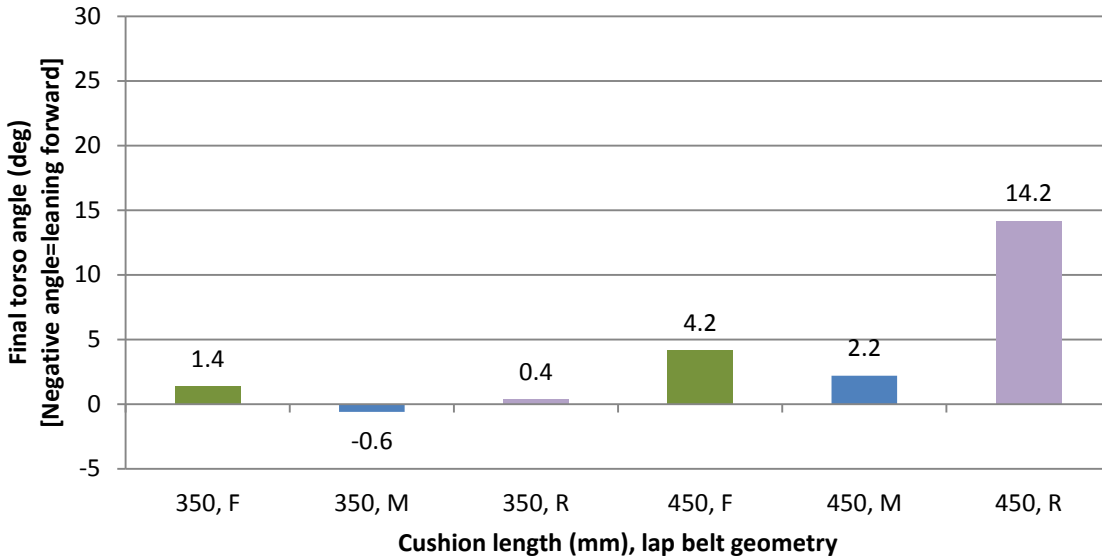

Figure 12. Peak torso angle for 10YO ATD for each combination of cushion length (350 vs. 450) and lap belt anchorage location (F, M, R).

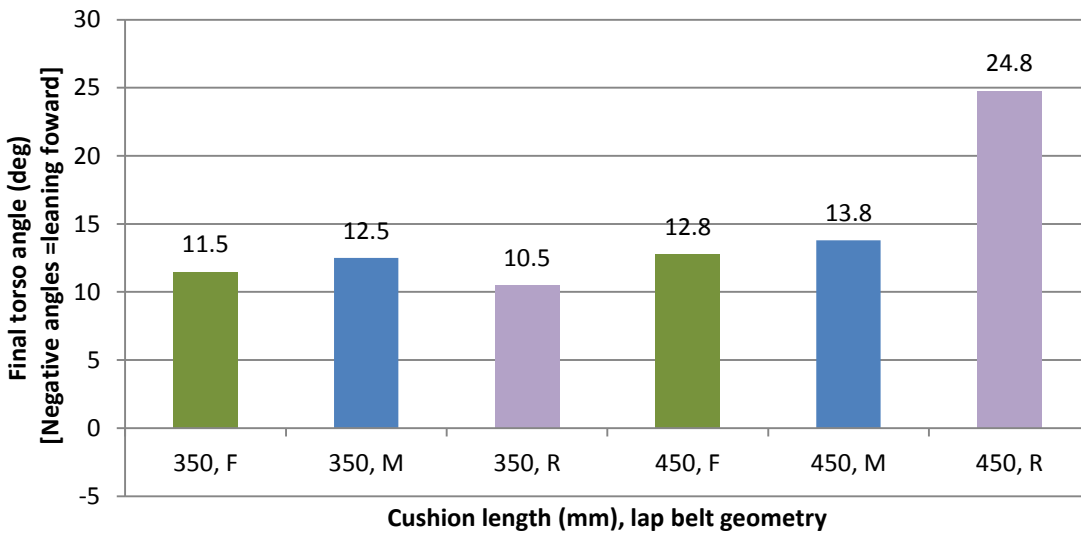

Figure 13. Peak torso angle for 6YO ATD for each combination of cushion length (350 vs. 450) and lap belt anchorage location (F, M, R).

The difference between peak knee excursion and peak head excursion is shown in Figure 14 for the 10YO and Figure 15 for the 6YO. Shortening cushion length reduced knee-head excursion for each belt condition tested with the 10YO, but only in the rear belt geometry condition for the

6YO. For the 10YO, results were similar among the three belt geometries with the short seat cushion, but had a substantially higher value with the rear belt geometry and long cushion length. The 6YO had the largest value of knee-head excursion with the long cushion length and rearward belt geometry, but results did not show any trends with cushion length or belt geometry for the other conditions.

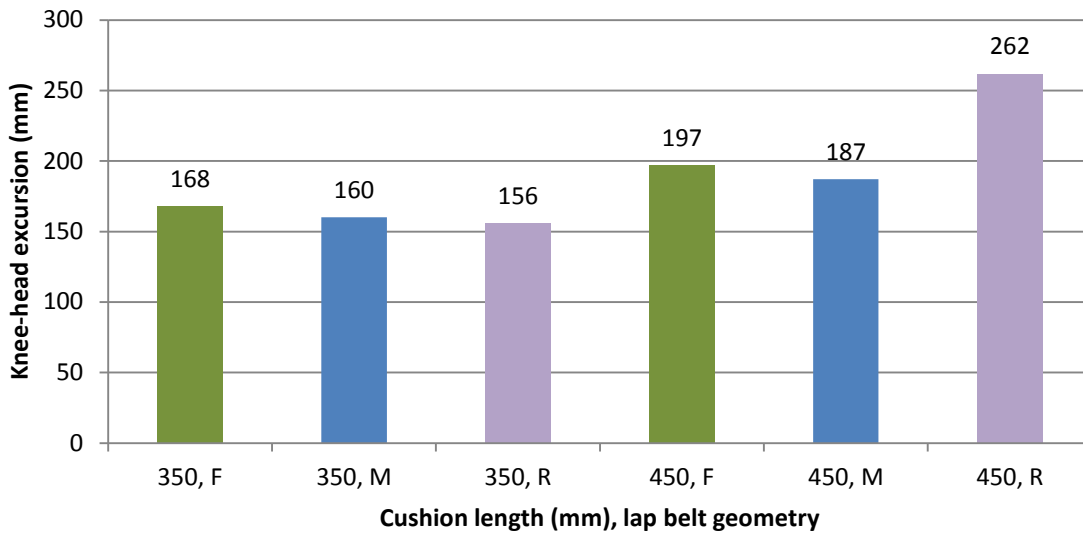

Figure 14. Knee-head excursion for 10YO ATD for each combination of cushion length (350 vs. 450) and lap belt anchorage location (F, M, R).

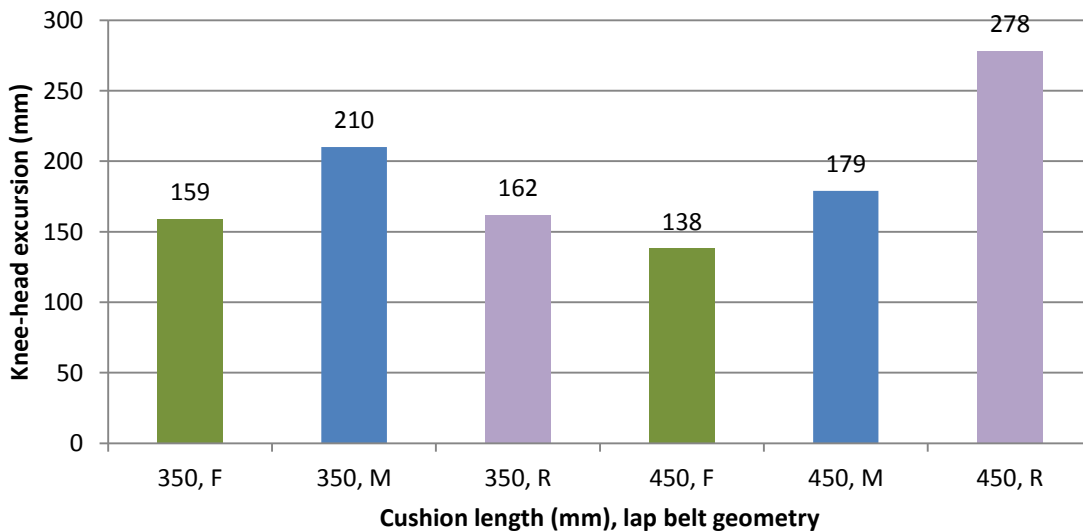

Figure 15. Knee-head excursion for 6YO ATD for each combination of cushion length (350 vs. 450) and lap belt anchorage location (F, M, R).

Figure 16 shows the peak torso angle vs. knee-head excursion for the tests performed in this study. For the 10YO (diamonds), results were similar for the short cushion length (open) at all three lap belt angles (rear, mid, forward). Results were also similar, though with an average of 30 mm more knee-head excursion, for the mid and forward lap belt conditions at the longer seat cushion length (filled). However, the 10YO submarined with the rear lap belt condition and long cushion length. For the 10YO, lap belt angle became less important when the cushion length was shorter.

For the 6YO (squares), the rear lap belt, long cushion condition also produced the worst kinematics. The level of forward torso rotation with the 6YO on the real vehicle seat was similar for all test conditions. The 6YO showed less variation in kinematics between the long and short cushion tests, likely because the short cushion length is still too long to completely accommodate the 6YO thigh length. The forward belt conditions produced less knee-head excursion than the mid condition, while the rear lap belt position fell in between the other two conditions.

One additional test was performed using the 6YO in a backless Graco Turbo booster with the rear lap belt position (same as FMVSS No. 213) and long cushion length to identify how testing with a real vehicle seat affected kinematics. Use of a booster has a much greater effect for the 6YO than shortening the vehicle seat.

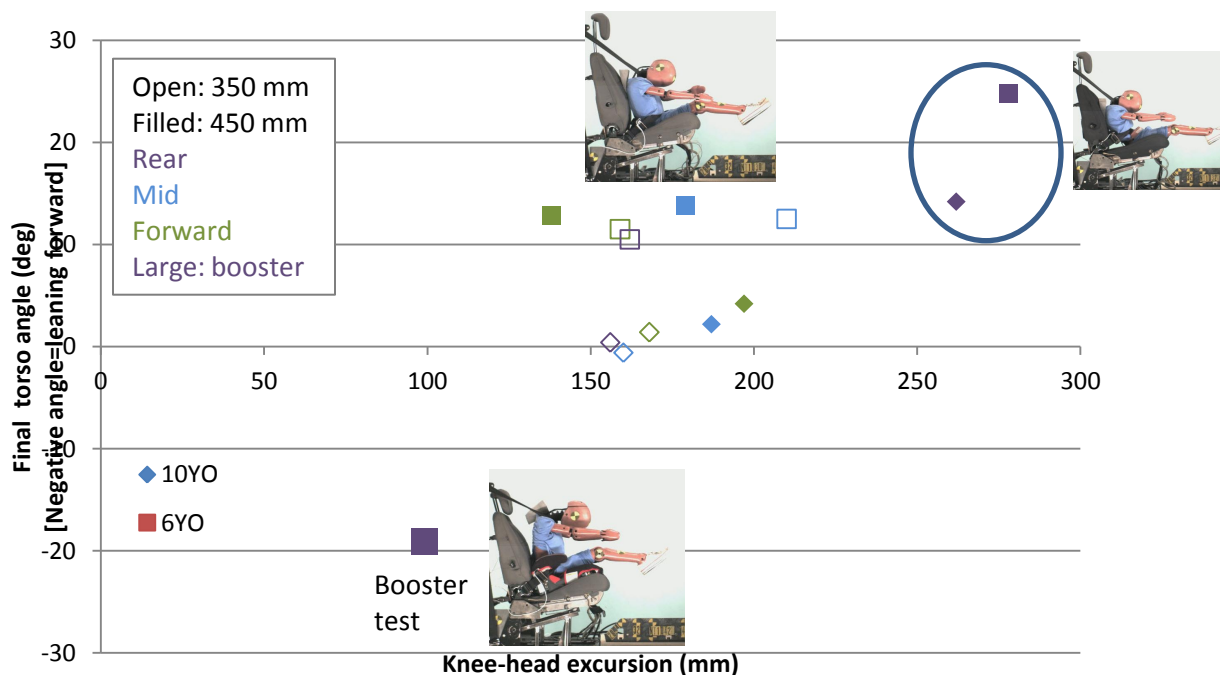

Figure 16. Peak torso angle vs. knee-head excursion for all tests. [Tests with clear submarining circled.]

Discussion

This test series examined the kinematics of the 10YO and 6YO ATDs using real vehicle seat components and a wide range of lap belt angles. The method of securing the vehicle seats to the buck allowed simulation of a shorter cushion length than is typical in rear seats. None of the seats were visibly damaged or deformed during testing.

Using a shorter cushion length improved kinematics consistently for the 10YO across all belt conditions, particularly when using the rearward lap belt geometry. The improvement is believed to be due primarily to the improved belt fit caused by the more-rearward and more-upright seated posture obtained when using the shorter seat cushion length with the UMTRI seating procedure, which is based on measured child postures. Belt geometry had less effect on kinematics with the shorter cushion length.

Results from variation in cushion length were not as consistent for the 6YO, probably because the short cushion length, chosen to provide good accommodation for the 10YO, is still too long to provide ideal accommodation for the 6YO. The rearward belt anchorage locations, which match those used on the FMVSS No. 213 buck, produced the worst kinematics.

An updated version of the UMTRI seating procedure was used to adjust the ATD posture relative to the cushion length of the seat. The ATDs have a more upright posture with the shorter cushion length. Although the same shoulder belt anchorage was used in all tests, the change in posture resulting from different cushion lengths and a realistic seating procedure shifted belt position by 10-37 mm, with the longer cushion length producing more inboard shoulder belt placement. With the 10YO, shorter cushion length and more forward lap belt geometries resulted in better lap belt scores, which is consistent with the kinematic findings. For the 6YO, the effect of cushion length was not as strong, but the lap belt fit at the forward and mid anchorage locations were better than the rearward belt fit. The kinematic effects of these changes in static belt fit confirm the need to use realistic seating procedures for ATD testing.

The 6YO ATD is known to have unrealistic pelvis geometry (Chamouard et al. 1996, Reed et al. 2009). Testing with a prototype pelvis with more realistic geometry showed increased sensitivity to lap belt geometry, with submarining occurring in situations in which the standard Hybrid III 6YO (used in the current testing) did not submarine (Klinich et al. 2010). However, more recent testing with a production version of the new pelvis with a gel-filled abdomen did not show increased sensitivity to submarining compared with the standard ATD (Klinich et al. 2011). Given the ambiguity of previous research concerning the biofidelity of the Hybrid-III child ATDs, particularly the 6YO, the current findings should be interpreted with caution. In particular, similar-size children may be at greater risk of submarining-type kinematics in these test conditions than the results (only two clear submarining cases) suggest.

These test results show potential improvements in occupant kinematics from shortening the cushion length of vehicle rear seats, particularly for children the size of the 10YO ATD who are less likely to use booster seats. The improved kinematics results from more upright posture that leads to improved belt fit. The results of the current testing are compared to results from prior studies (Klinich et al. 2008, Klinich et al. 2011) in Figure 17 for the 10YO and Figure 18 for the 6YO. The results from the prior studies position the dummies using the UMTRI seating procedures using a range of booster seats and belt geometries on the FMVSS No. 213 buck. In most cases with both dummies (but especially the 6YO), the kinematics in tests with the shorter cushion length are worse than tests with booster seats (although some particular booster seat/belt geometries also produce poor kinematics.) Of particular concern is that the torso angle did not come past vertical (-10 to -20 degrees is ideal) in any of the vehicle-seat tests. More research is needed to identify the belt and seat conditions that can produce kinematics as good as those obtained with the belt-positioning booster. The current results suggest that, even with shorter seats and favorable belt anchorage locations, children will experience poorer restraint performance when they transition out of belt-positioning boosters.

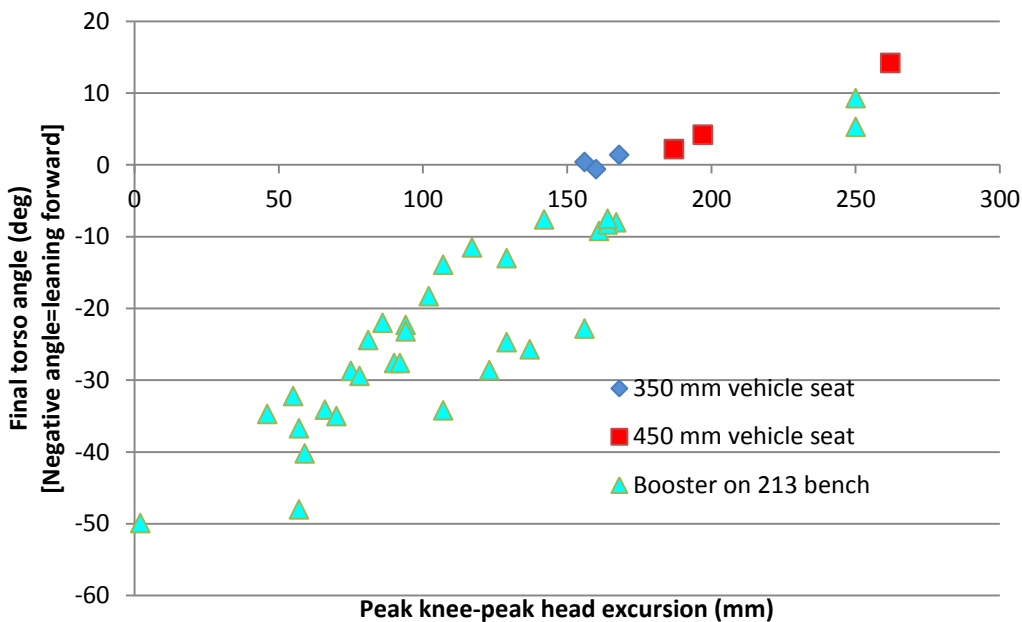

Figure 17. Kinematic results of the 10YO ATD from current study compared to prior testing on the FMVSS No. 213 bench with booster seats.

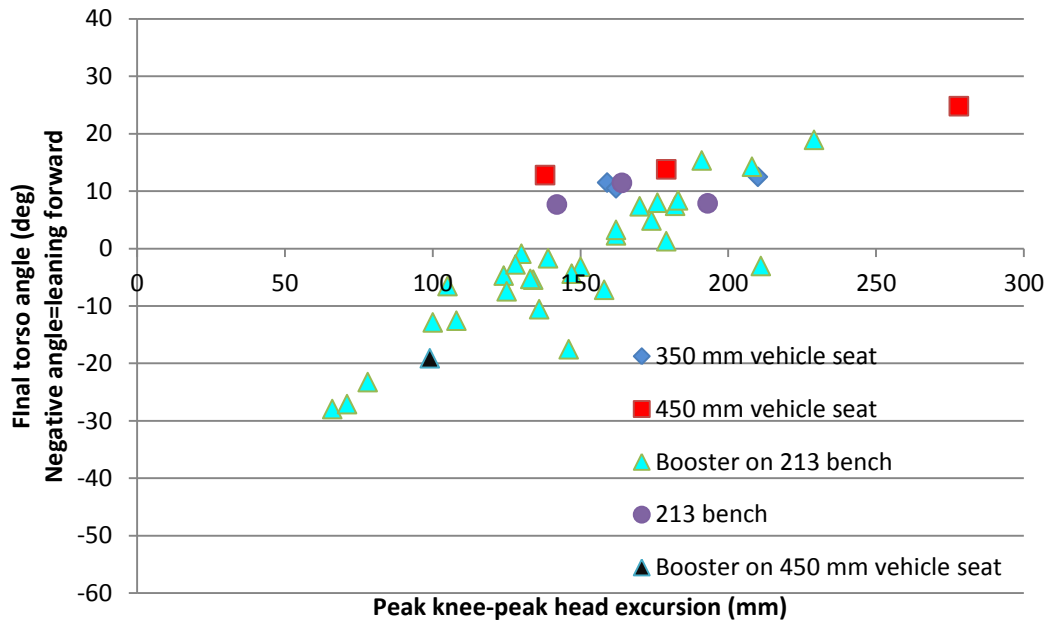

Figure 18. Kinematic results of the 6YO ATD from current study compared to prior testing on the 213 bench with and without booster seats.

Summary of Key Points

- Both the 6YO and 10YO ATDs submarined with the long (typical) seat cushion length and flat (worst-case) lap belt angle.
- None of the tests on the vehicle seat produced good ATD kinematics, considered to be a peak torso angle of -10 to -20 degrees and knee-head excursion of less than 150 mm (well below the submarining level of 0 degrees or more and near 200 mm). In all cases the peak torso angle was positive, indicating that the torso did not rotate far enough forward during the test for the restraint performance to be considered good.
- Shortening cushion length by 100 mm improved kinematics, particularly for the 10YO ATD, when the effect of cushion length is reflected in ATD position.
- Lap belt angle had a greater effect on kinematics with the long cushion length due to a more-forward ATD position.
- The worst kinematics for both ATDs occurred with the long cushion length and rearward lap belt geometry, both of which contribute to flat lap belt angles and poor (high) lap belt fit.
- Use of a booster with the 6YO ATD improved kinematics more than shortening cushion length or using a steeper lap belt angle.
- An updated version of the UMTRI seating procedure that produces realistic postures that account for vehicle cushion length was used successfully.
- The method of simulating shorter cushion length using real vehicle seats was successful and the seats did not sustain damage or deformation during testing.

References

- American Academy of Pediatrics (March 2011) www.aap.org/healthtopics/carseatsafety.cfm
- Huang, S. and Reed, M.P. (2006). Comparison of child body dimensions with rear seat geometry. Technical Paper 2006-01-1142. SAE International, Warrendale, PA.
- Klinich, K. D., Pritz, H. B., Beebe, M. S., and Welty, K. A. (1994). Survey of Older Children in Automotive Restraints and Booster Seats. Technical Paper 94222. *SAE Transactions: Journal of Passenger Cars-Mechanical Systems, Vol. 103*.
- Klinich, K. D., Reed, M. P., Orton, N. R., Manary, M. A., Rupp, J. D. (2011 in review). Optimizing protection for rear seat occupants: assessing booster performance with realistic belt geometry using the Hybrid III 6YO ATD. UMTRI Technical report.
- Klinich, K. D., Reed, M. P., Ritchie, N. L., Manary, M. A., Schneider, L. W., Rupp, J. D. (2008) Assessing Child Belt Fit, Volume II: Effect of Restraint Configuration, Booster Seat Designs, Seating Procedure, and Belt Fit on the Dynamic Response of the Hybrid III 10YO ATD in Sled Tests, UM-2008-49-2
- Klinich, K. D., Ritchie, N., Manary, M. A., Reed, M. P. (2010). Development of a more realistic pelvis for the Hybrid III 6YO ATD, *Traffic Injury Prevention* 11(6):606-12.
- National Highway Traffic Safety Administration (March 2011) www.nhtsa.gov/safety/CPS
- Reed, M.P. (2011) Measurement of contour and deflection of vehicle seats for comparison with the FMVSS NO. 213 dynamic test bench. SAE Technical Paper 2001-01-0265. SAE International, Warrendale, PA.
- Reed, M. P., Ebert, S. M., Klinich, K. D., Manary, M. A. Assessing Child Belt Fit, Volume I: Effects of vehicle seat and belt geometry on belt fit for children with and without belt-positioning booster seats, UM 2008-49-1
- Reed, M. P., Ebert, S. M., Sherwood, C. P., Klinich, K. D., Manary, M. A. (2009). Evaluation of the static belt fit provided by belt-positioning booster seats. *Accident Analysis and Prevention*, 41:598-607.
- Reed, M. P., Ebert-Hamilton, S.M., Manary, M.A., Klinich, K.D., and Schneider, L.W. (2006). Improved positioning procedures for 6YO and 10YO ATDs based on child occupant postures. Technical Paper 2006-22-0014. *Stapp Car Crash Journal* 50:337-388.
- Reed, M.P., Ebert-Hamilton, S.M., Manary, M.A., Klinich, K.D., and Schneider, L.W. (2005). A new database of child anthropometry and seated posture for automotive safety applications. Technical Paper 2005-01-1837. *SAE Transactions: Journal of Passenger Cars - Mechanical Systems, Vol. 114*.

Appendix 1

Child ATD Belt Fit Measurement procedure

April 2011

Editorial Revisions 2011-11

Foreword

Child passengers who have outgrown harness restraints but are too small to be properly restrained by vehicle belts alone should be seated in belt-positioning booster seats (hereafter referred to as boosters). Boosters are designed to improve the position of the child relative to the vehicle belt restraint system and to alter the routing of the belt with respect to the child's body. The intent of the procedure is to compare belt fit across different boosters, vehicle seats, and belt configurations.

This procedure measures belt fit provided by boosters using a six-year-old and ten-year-old Hybrid-III ATDs. Points along the belt relative to the ATD are digitized in a coordinate measurement system, which requires a FARO Arm or similar coordinate measurement device.

1. OBJECTIVE

Describe a method for measuring the static belt fit using a six-year-old and ten-year-old Hybrid-III ATDs.

2. SCOPE

The procedure described in this document provides a method to reliably measure the belt fit produced by booster seats. Instructions are provided for positioning and adjusting the booster, installing and posturing the dummy, applying the belt and recording the belt fit using a FARO Arm coordinate measurement machine. The procedure is designed to produce repeatable and reproducible results using ATD positions that match the expected locations for similar-size children. Belt routing and belt tensions are intended to be typical of those produced by children who don the belt themselves. This procedure is intended for use on a seating buck (mockup), but can also be used in a vehicle.

3. TABLE OF CONTENTS

4. Definitions and Equipment
5. Prepare the seat
6. Prepare the ATD
7. Prepare the booster
8. Position the booster
9. Position the ATD
10. Apply the belt
11. Record booster, ATD, and belt locations

4. DEFINITIONS AND EQUIPMENT

ATD – Anthropomorphic Test Device. In this document, ATD refers to six-year-old or ten-year-old Hybrid-III.

Pelvis Positioning Pad- 125 x 95 x 20 mm piece of foam or rubber centered on the posterior of ATD pelvis with the top edge of the foam aligned with the superior edge of the ATD pelvis skin and adhered to the ATD with double sided tape. The material must have a compression resistance between 13 to 17 pounds per square inch (psi) in a compression deflection test specified in ASTM D-1056-07, a maximum compression set of 25 percent after a 24 hour recovery time in a compression set test for a Type 2—Grade 4 material specified in ASTM D-1056-07, and with a density of 9.5 to 12.5 lb/ft³. Example material: Ensolite IE4 (Armaccell Inc.)

Lap Form – A piece of translucent silicone rubber 1/8 in thick (50A Durometer) cut to the pattern in Appendix A attached to the ATD during the procedure. The purpose of the lap form is to keep the lap belt from becoming caught in the pelvis-thigh gap of the ATD.

Hip-offsets - Hip-offsets are tools used to track the pelvis location and are inserted into the H-point gauging holes of the ATD. Appendix B gives specifications and illustrations.

Teflon Chest Bib- Teflon Film (0.003 inches thick), cut to the pattern in Appendix C and applied to ATD jacket.

ATD Jacket Pads- Spacers used to adjust the position of the jacket on the ATD. Made of the same material as the pelvis pad. Shoulder spacer dimension 2 x 1-3/4 in with varying thickness.

ATD Anatomical Terms of Location - The standardized terms of anatomical location are used when describing the ATD.

Vehicle Seat - Refers to the seat in a vehicle or the seat acting as the vehicle seat in the test buck.

Latch plate – Must be a sliding latchplate.

Retractor – As per FMVSS 209, the retractor shall exert a retractive force of not less than 1 N (0.23 lb) and not more than 7 N (1.6 lb) under zero acceleration when attached to a strap or webbing that restrains both the upper torso and the pelvis.

Vehicle Terms of Location – Terms used within follow those in SAE standards.

Centerplane - A plane that passes through the centerline of an object such as a vehicle seat or booster that bisects the object into two symmetrical halves.

Seat Centerline - A line coplanar with the vehicle's longitudinal center plane (unless specified by the manufacturer) that bisects the head restraint of the seat. If there is no head restraint, it is the geometric centerline as indicated by the contouring of the seat surface.

Booster Centerline – A line coplanar with the booster's longitudinal center plane that bisects the booster.

Inclinometer - An instrument for measuring angles of slope with respect to gravity.

Force gauge – The force gauge must be able to read forces of 133 N (30 lb) and 178 N (40 lb) and have a flat square surface with an area of 2580 square millimeters (4 square inches) with which to apply the force.

Test Buck – The buck consists of a configurable vehicle seat and seatbelt system. The vehicle seat has an adjustable seat back angle (BA), cushion angle (CA), and seat pan length. The seatbelt system allows for motion in three dimensions of the upper (D-ring) and lower (outboard and inboard) belt anchorages. Figure 1 shows an example of a test buck. Configuring the buck requires a J826 H-point manikin for setting the BA, CA and measuring the H-point. The locations of the belt anchorage are measured relative to the H-point of the vehicle seat at each combination of BA and CA.



Figure 1. Example of a test buck at UMTRI

Metal Seat Back Plate - 400 mm (15.75") x 125 mm (4.9") plate of 1/8", 6061-T6 Aluminum

Cushion Length Tool – A tool used to measure seat cushion length and position the ATD pelvis.

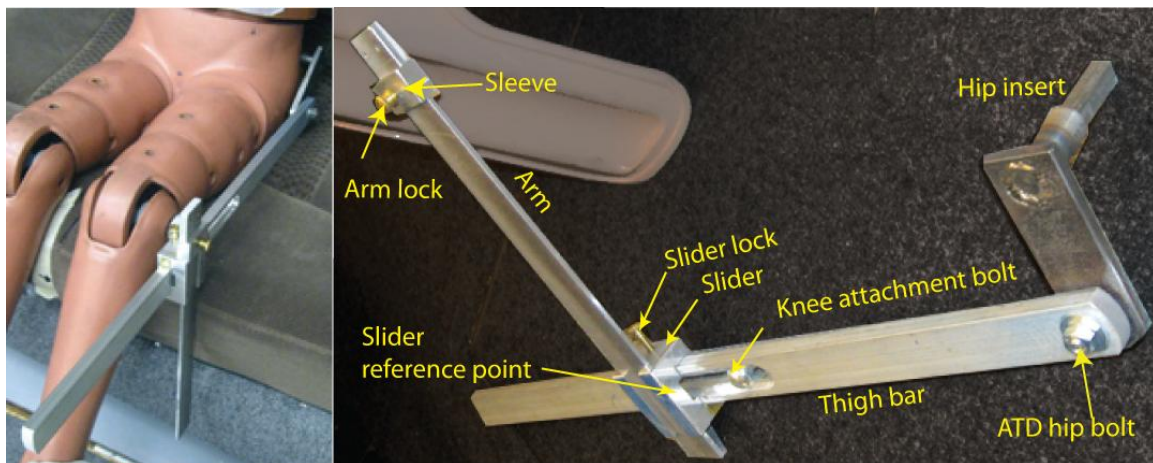

Figure 2. Example of a cushion length tool for six year-old ATD.

5. PREPARE THE VEHICLE SEAT

- 5.1. Adjust the vehicle seat to the required back and cushion angle. Adjust the seatbelt anchorages to the required position.
- 5.2. Prior to the installation of the booster the vehicle seat should remain unloaded for 30 minutes. This is to allow the seat and seat materials (e.g., foam) to recover from compression.
- 5.3. The vehicle seat should be located such that the centerplane of the vehicle seat is parallel to the X-Z plane of a right-handed coordinate system.
- 5.4. Mark the centerline of the vehicle seat with one piece of tape on the top of the head restraint or the highest point on the seat back and one piece of tape on the front edge of the seat cushion.
- 5.5. Record the coordinates of the vehicle seat centerline at two points on the back and cushion. Take the average Y coordinate; this will be the “vehicle seat centerline Y”.
- 5.6. For installations of the ATD directly onto the vehicle seat (i.e. no booster), place the metal seat back plate against seat back and rest bottom on seat cushion. Ensure that the top edge of the plate remains in contact with the seat back; slide the bottom of the plate as far rearward as possible as shown in Figure 3.



Figure 3. Examples of good (left) and bad (right) seat back plate position

6. PREPARE THE ATD

- 6.1. Head. Draw a line on the side of the ATD head that is a projection of the plane of the accelerometer-mounting surface. This line will be used as the ATD's Frankfort plane. The line should extend between the front centerline of the head to the side of the head where the skull skin ends before the skull cap as shown in Figure 4

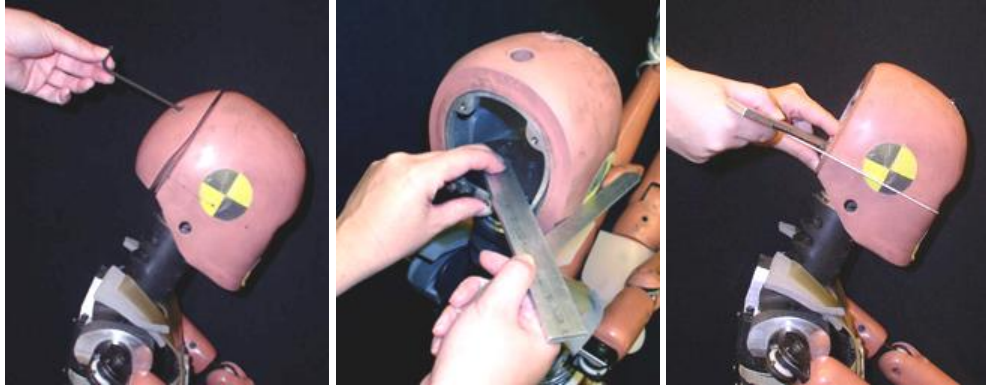

Figure 4. Marking Frankfort Plane of ATD head.

- 6.2. Ten-year-old ATD neck and spine. Set the adjustable neck and lumbar spine to their nominal positions.
- 6.3. Pelvis coordinate system, angle, PS and ASIS locations. Remove the ATD abdomen insert and set the ATD on a hard level surface such that neither the pelvis nor the torso of the ATD will move. Insert the hip-offsets in pelvis H-point gauging holes.
 - 6.3.1. Construct the pelvis coordinate system- Orient the ATD such that the front and side of the lumbar load cell are parallel to the Y and X axes respectively as shown in Figure 5. The pelvis plane (the top surface of the pelvis) is parallel to the X-Y plane. To find the centerline of the ATD digitize the corners of the lumbar load cell as shown in Figure 5. The X and Z values should have the same values, and the centerline should be the average of the Y values. To ensure the pelvis plane is parallel to the X-Y plane, take an additional point on this surface. All three points should have the same Z value.

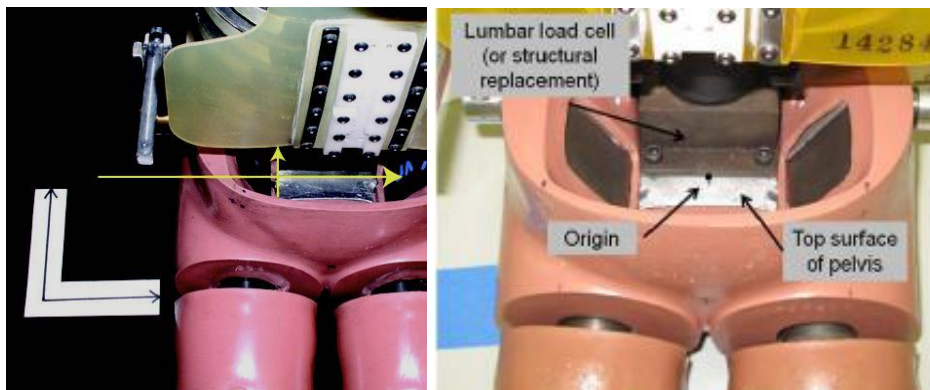

Figure 5. Creating the ATD pelvis coordinate system and landmarks by first aligning the pelvis with an external coordinate system.

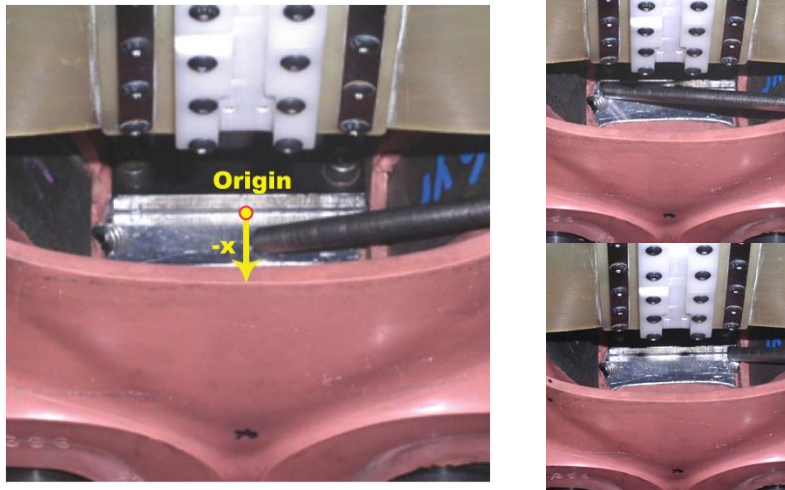

Figure 6. Aligning the lateral axis of the pelvis with the Y-axis and the pelvis plane to the X-Y plane.

6.3.2. Pubic symphysis (PS). Mark the point on the front surface of the ATD's pelvis skin with a Z value of the pelvis plane and the Y value of the centerline.

6.3.3. Anterior superior iliac spines (ASIS). Start with the right side of the pelvis. Digitize three points along the superior/medial margin of the right ASIS load cell or blank. Because the ATD is aligned to the external coordinate system, the Y and Z values of these points should be very similar; take the average Y and Z values, and find the point on the exterior flesh of the ATD with the average Y and Z and mark it. This is the external right ASIS landmark. Repeat this process for the left side.

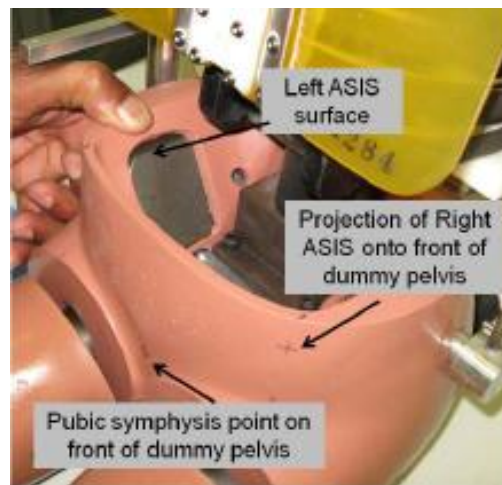

Figure 7. Anterior superior iliac spines and pubic symphysis marks on pelvis flesh

6.3.4. Mark the lateral locations of the ASIS on the superior edge of the pelvis skin (just anterior to the location of the abdomen when inserted) and the anterior edge of the pelvis just before the pelvis-thigh gap. These marks will assist in digitizing the belt location.

6.3.5. Digitize the location of the two reference points on each hip-offset tool with the upright attachment in place. Take the upright attachments off and digitize the location of the two reference points on the part that is inserted into the ATD (Figure 8).

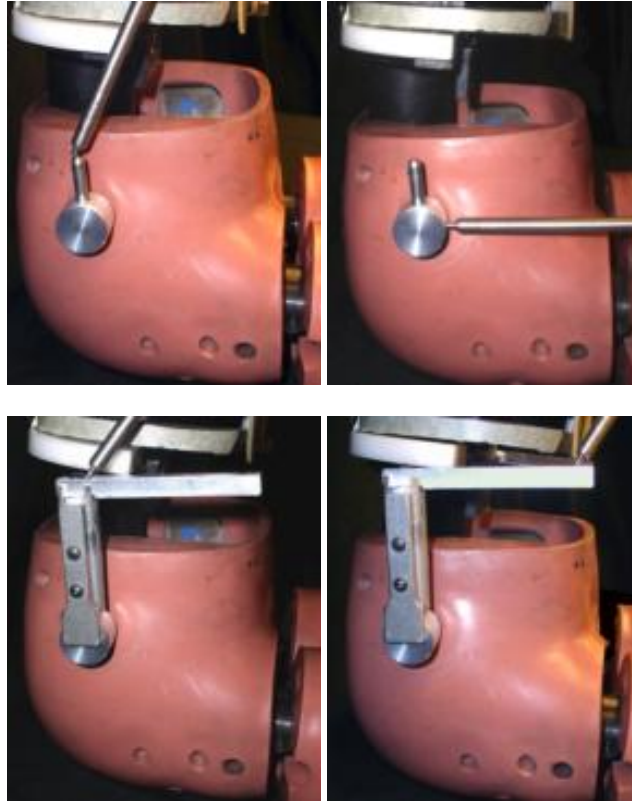

Figure 8. Digitizing the reference marks on the hip offset tools with the upright attachment on and off.

6.4. Limbs. Limb joints are set at between 1 and 2 g's.

6.5. Clothing. The ATD will be used without clothing for belt fit measurement.

6.6. Cover pelvis-thigh gap. Set the ATD on a flat surface with the legs straight forward from the pelvis and the torso upright. Apply double sided tape to the surface of the lap form that will be in contact with the pelvis as shown in Figure 9. Place the lap form on the ATD as shown in Figure 10. The top of the lap form is aligned with the superior anterior edge of the ATD pelvis skin.

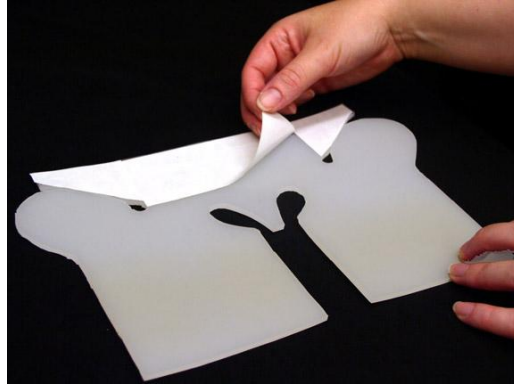

Figure 9. Applying double sided tape to the upper portion of the lap form

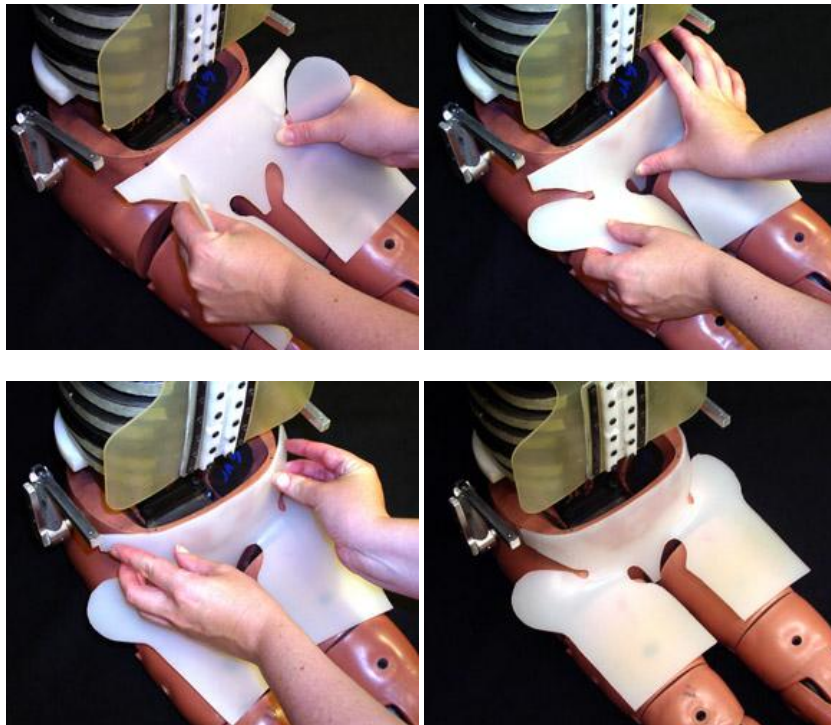

Figure 10. Attaching the lap form to the ATD

- 6.7. Attach pelvis-positioning pad. Cover one side of the pad with double sided tape, and center the long axis of the pad on the posterior of the ATD pelvis with the top edge of the foam aligned with the superior edge of the ATD pelvis skin as shown in Figure 11.

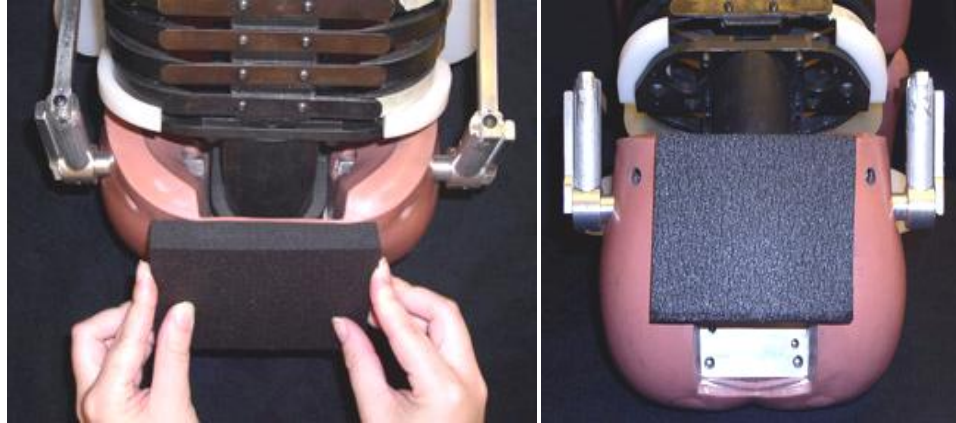

Figure 11. Attaching the pelvis-positioning pad.

- 6.8. Identify landmarks for digitizing. The tables in section 11 illustrate and describe the location of the landmarks and reference points that will be digitized with the FARO Arm.
- 6.9. Apply Teflon Bib. To reduce friction between the shoulder belt and the ATD chest jacket during the procedure, a thin Teflon sheet (see Appendix C) is taped to the front of the ATD chest jacket as shown in Figure 12. Double-sided tape should be placed in the approximate location of the chest reference point to adhere the bib to the jacket.

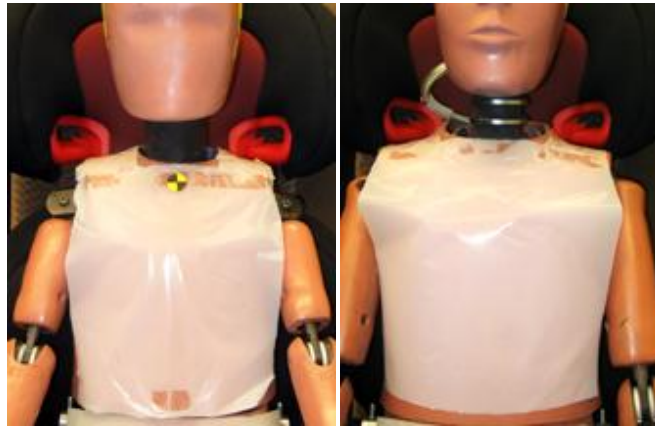

Figure 12. Teflon bibs for six-year-old (left) and ten-year-old ATDs.

- 6.10. For the six-year-old ATD: Check the location of the jacket relative to ATD at reference points on the chest and shoulder. The position of these points is based on the location of the ATD spine box. Place the ATD torso in an upright position, defined as the superior face of the lower neck load cell (or structural replacement) being horizontal as shown in Figure 13.
 - 6.10.1. The orientation of the reference frame is identical to that for the test buck (X-Y plane parallel to the superior face of the load cell), and the origin is the posterior superior edge of the load cell, at the midline of the ATD (Figure 11). (Note that when using a CMM, the torso position does not need to be exactly vertical because the reference frame is determined by the orientation of the lower neck load cell. If a CMM is not used, the ATD spine may need to be more precisely positioned to

accurately position the chest reference point).

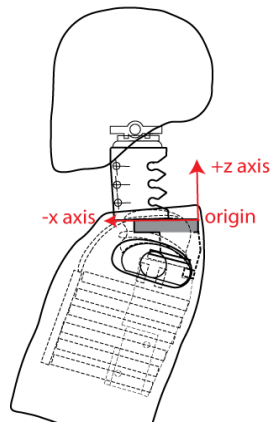

Figure 13. Coordinate system for locating jacket reference points

6.10.2. Preposition ATD shoulders and jacket as shown in Figure 14. First position clavicle link full down (push down firmly on shoulder/arm joint) and clavicle full rear (push rearward firmly on shoulder/arm joint). Then pull the jacket downward as much as possible.

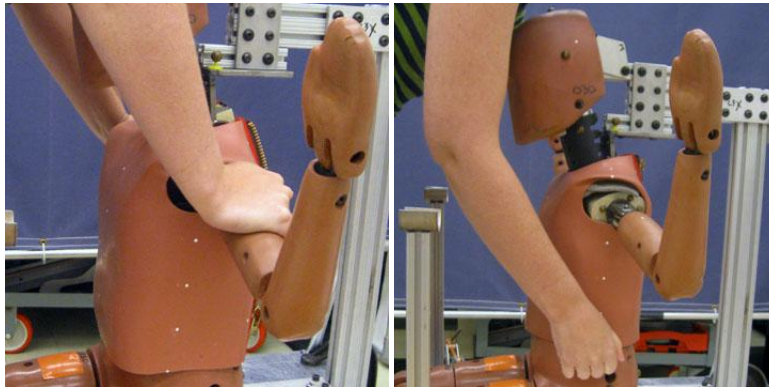

Figure 14. Positioning the shoulders and jacket on the six-year-old ATD

6.10.3. The chest reference point is defined as the location on the anterior surface of the chest jacket, at the ATD centerline, which has a Z coordinate of 0 (same plane as the load cell surface). The coordinate of this point should be $(-110 \pm 5, 0, 0 \text{ mm})$.

6.10.4. The shoulder reference point is defined as the location on the superior surface of the jacket at the midline of the ATD neck (approximate X value of 53 mm), 40 mm out from the edge of the neck. The coordinate of this point should be $(-53, 72, 10 \pm 5 \text{ mm})$. The reference points are illustrated in Figure 15.

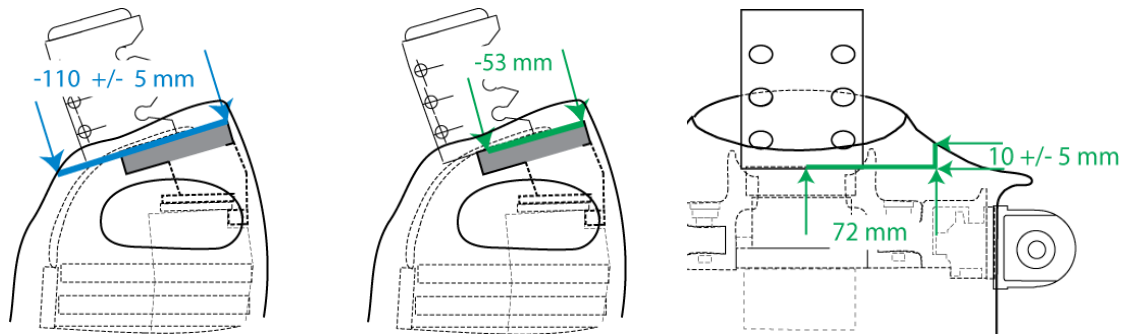

Figure 15. Chest reference point (left) and shoulder (middle and right) reference points on ATD jacket

6.10.5. If the ATD chest jacket does not meet these requirements, spacers must be placed on top of the clavicle (below the chest jacket). The spacers should be the same material as that designated for the pelvis-positioning pad but in the necessary thickness required to properly position the jacket. A first attempt at spacers should include the two shoulder spacers with a thickness of 1/2 inch, and the front chest spacer with a thickness of 3/8 inch. An example is shown in Figure 16.



Figure 16. Example of 1/2 inch thick shoulder spacer

6.11. If using the cushion length tool, remove hip offset tool and replace with hip insert part of cushion length tool and attach the thigh bar to the knee joint of the ATD. Leave the slider off until after the ATD is placed on the vehicle seat.

7. PREPARE THE BOOSTER

IMPORTANT: Find and read the manual for the booster being installed. If installation is being done in a vehicle, find and read the vehicle manual sections on child restraints.

- 7.1. Mark the centerline of the booster on the front edge of the booster seat pan. If the booster has a back, mark the centerline on the top edge of the booster back. Also place two bilaterally symmetrical points on the either side of the booster as shown in Figure 17. These lines and points will be used in aligning the booster with the vehicle seat.



Figure 17. Example bilaterally symmetrical points on booster seat

- 7.2. Check booster settings:
 - 7.2.1. Install the booster on the vehicle seat using the instructions in Section 8.
 - 7.2.2. Place the ATD in the booster and adjust the booster components such as belt guide heights, headrest heights, and cushion dimensions as instructed by the **booster manual** for a child the size of the ATD. Remove the ATD and booster from the vehicle seat.

8. POSITION THE BOOSTER

- 8.1. Place the booster on the vehicle seat so that the centerplane of the booster is aligned with the centerplane of the vehicle seat and the bottom of the booster is flat on the vehicle seat. Move the booster seat rearward into the vehicle seat until some part of the booster touches the vehicle seat back as shown in Figure 18.



Figure 18. Placing the booster on the vehicle seat and applying force

- 8.2. Apply 133 N (30 lb) of force to the front of the booster seat cushion, in a direction parallel to the vehicle seat cushion, moving the booster rearward into the vehicle seat (Figure 18). If there is any additional information in the booster seat manual about how the booster should sit in the vehicle seat, such as points of contact, follow the manufacturer's instructions. See Appendix D for information on dealing with different booster – vehicle seat interactions.
- 8.3. Keep the booster and vehicle seat centerplanes aligned as much as possible. Check the seat centerline against the vehicle seat centerline Y value, and check the X and Z values of two bilaterally symmetrical points against each other (Figure 19 and Figure 20).



Figure 19. Aligning center planes of booster and vehicle seat

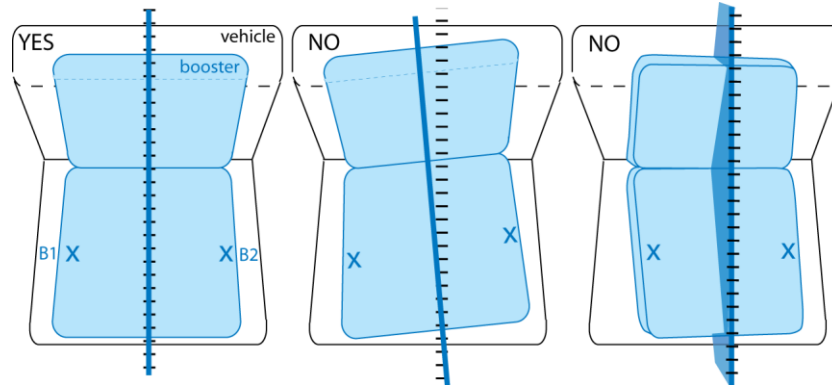

Figure 20. Proper alignment of the centerplanes of the booster and vehicle seat (left) and two examples of unaligned centerplanes (middle and right), in which the bilaterally symmetrical points (B1 and B3) are not aligned.

8.4. If the booster covers the location where the buckle comes through the seat

AND the buckle is mounted so that it cannot be tilted away from the booster to be routed around the booster, move the booster away from the buckle until the buckle can be used. (Figure 21)

AND the buckle is mounted on a flexible piece of webbing move the booster outboard until the buckle is out from under the booster, though the webbing may still be under the booster.

AND the buckle is mounted on a somewhat flexible piece of plastic so that it can be tilted away from the booster, move the booster away from the buckle until the buckle can be bent enough to be used.

8.5. If after installing the booster, the latchplate cannot be inserted into the buckle due to the interaction of the booster and the buckle, move the booster laterally away from the buckle until the latchplate can be inserted. Keep the centerplanes of the booster and vehicle seat parallel.

8.6. If 8.4 the booster is moved laterally, start Section 8 over with the booster centerplane parallel to the vehicle seat centerplane, but moved laterally the required amount.

Important: Keep the centerplanes of the booster and vehicle seat parallel to each other as much as possible while positioning the seat relative to the buckle.

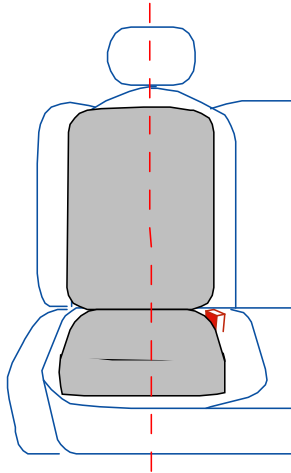

Figure 21. If the buckle is inaccessible due to the location of inboard anchor or the width of the booster, move the booster outboard the minimum distance needed to access the buckle.

9. POSITION THE ATD

- 9.1. *Six-year-old ATD.* As shown in Figure 22, place the ATD on the booster seat cushion such that the plane of the posterior pelvis is parallel to the plane of the booster seat back or metal plate, but not touching. Pick up and move the ATD rearward maintaining the parallel planes until the pelvis-positioning pad and booster seat back (or vehicle seat backrest, for a backless booster) are in minimal contact as illustrated in Figure 23. At the conclusion of this step, the pelvis-positioning pad should not be pressed firmly against the seat back, but rather should only touch the seat back. One should be able to remove a 125 x 95 mm piece of copy paper from between the pad and seatback. The friction produced between the pad and seatback should be the similar at the top and the bottom of the pad. Set the ATD down in the seat.



Figure 22. Moving the ATD rearward in the seat

- 9.2. *Ten-year-old ATD.* Place the ATD on the booster seat cushion such that the inferior surface of the pelvis is parallel to the seat cushion. Pick up and move the ATD rearward maintaining the parallel planes until pelvis-positioning pad and booster seat back (or vehicle seat backrest, for a backless booster) or metal plate are in minimal contact as illustrated in Figure 24. Due to the angle of the pelvis flesh on the ten-year-old ATD, the bottom of the pelvis-positioning pad might not be in contact with the seat back.

However, the pelvis-positioning pad should not be pressed firmly against the seat back, but rather should only touch the seat back. One should be able to remove a 125 x 95 mm piece of copy paper from between the pad and seatback.



Figure 23. Six-year-old ATD pelvis-positioning pad parallel and in minimal contact

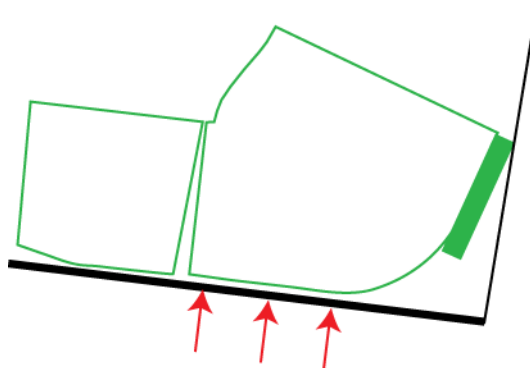

Figure 24. Ten-year-old ATD with bottom of pelvis parallel to the seat cushion

9.3. If during this process with the six-year-old ATD, some part of the seat back moves the pelvis from parallel to the seat back (e.g. the structure of the seat back forces the torso forward before the pelvis touches the seat back, thereby tilting the pelvis relative to the seat back), move the ATD rearward keeping the pelvis as parallel as possible to the seat back until some part of the pelvis pad is in light contact with the seat back. Digitize the location of midsagittal plane of the ATD at the neck-bib assembly point and at the middle of the pelvis, both should be within 5 mm of the centerplanes of the booster and vehicle seat.

9.3.1. Check that the booster seat is still aligned with vehicle seat. If it is not and the booster can be adjusted slightly, stabilize the ATD and make the adjustment. If the booster position cannot be corrected, remove the ATD and repeat the installation of the booster.

9.3.2. Check that the pelvis vertical and centered. The Y and Z values of two bilaterally symmetrical points on the pelvis should be within 5 mm of each other in each direction (Figure 25 and Figure 26).

9.4. Check that the clavicle is down and rearward, and that the jacket is pulled downward.

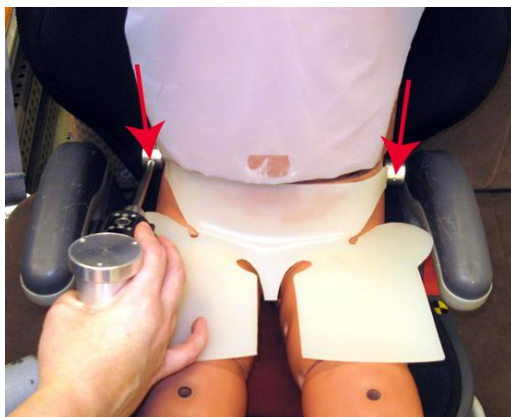

Figure 25 Checking that the X and Z values of the symmetrical points

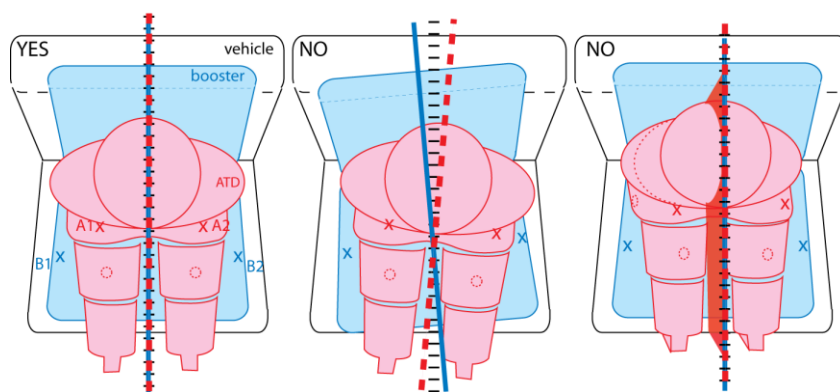

Figure 26. Proper alignment of the centerplanes of the ATD, booster and vehicle seat (left) and two examples of unaligned centerplanes (middle and right).



Figure 27. Pushing clavicles down and rearward at shoulder with arms out and then pulling jacket down

9.5. Straighten and align the arm segments so that the forearms and hands are in the neutral position. Without moving the clavicle, rotate the arms of the test dummy upward at the shoulder as far as possible without contacting the booster seat. Straighten and align the

legs of the ATD and extend the lower legs as far as possible in the forward horizontal direction, with the ATD feet perpendicular to the centerline of the lower legs.

- 9.6. Using the flat square surface of the force gauge apply a force of 177 N (40 lbs), perpendicular to the back of the booster (or seat back if it is a backless booster) first against the ATD lower pelvis and then at the ATD thorax in the midsagittal plane of the ATD.

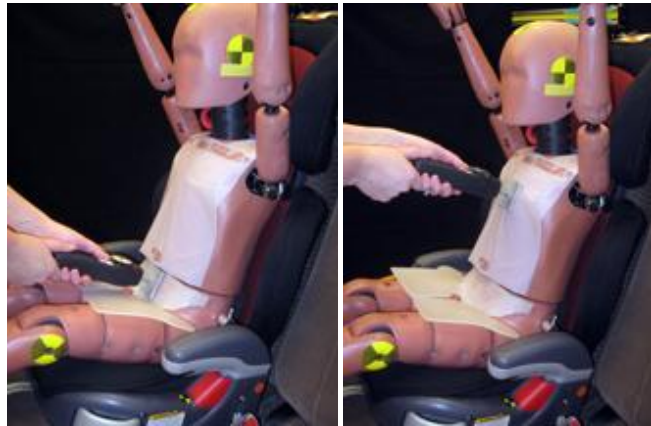

Figure 28. Applying 177 N of force to the pelvis and thorax of the ATD.

- 9.7. Measuring cushion length and adjusting ATD pelvis location [This step is performed only when a booster is not used.]
 - 9.7.1. Rotate the ATD lower legs up to keep them from compressing the front edge of the seat cushion and lock in place with the knee bolt. Check that the thighs are in contact with the seat cushion and that the thigh bar is parallel to the centerline of the seat. Attach the slider to the thigh bar and move rearward to mid thigh. Insert slider arm into sleeve and and slider. Leave slider arm unlocked.
 - 9.7.2. Slowly move slider forward (toward the knees) until the arm drops down at the front of the cushion as shown in Figure 29. Lock slider and slider arm.



Figure 29. Moving the slider forward until the arm drops.

9.7.3. Measure the distance between the hip point bolt center and slider reference point. This is “M,” the measured length of the cushion forward of the ATD hip. Calculate “Hp” using the formulas in Figure 30. If $M > H_p$, move the slider rearward until the distance between the hip bolt and the slider reference point is equal to H_p . Lock slider and loosen arm lock.

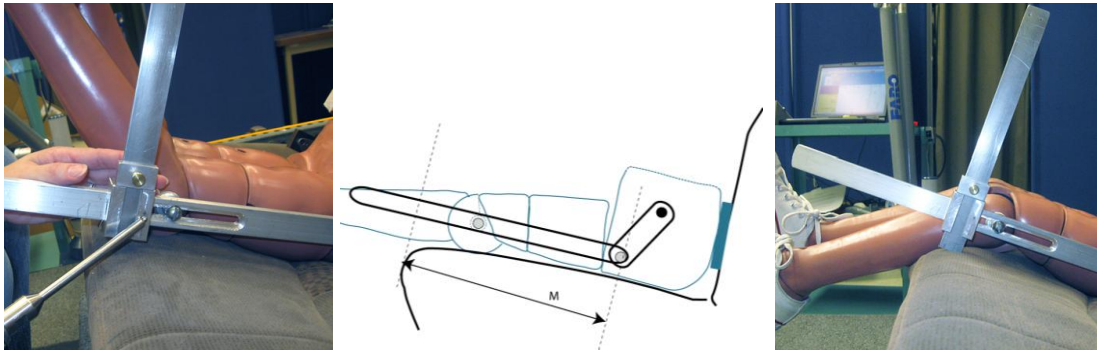

$$\text{Six year-old ATD } H_p = 75 + 0.643 M$$

$$\text{Ten year-old ATD } H_p = 107 + 0.643 M$$

Figure 30. Measuring M, calculating H_p , and moving horizontal slider until $M=H_p$.

9.7.4. Measure the pelvis XZ angle (eg. inclinometer on H-point tool). Pick up and move the pelvis forward maintaining the initial pelvis angle (Figure 31) until the vertical arm drops over the front edge of the seat, then set the pelvis down. While moving the pelvis keep the ATD aligned with the centerplane of the seat.



Figure 31. Moving the pelvis forward

9.7.5. Pull the vertical arm up again and let drop. If the arm does not clear the front of the seat, pick up the pelvis (keeping original pelvis angle) and move it forward. Check arm again. Repeat until the ATD is seated with the backs of the thighs contacting the seat surface and the vertical arm just clears the front of the seat. Once the pelvis is resting on the seat let the torso rest on the seat back; do not try to control the pelvis XZ angle. Lock vertical arm adjustment.

9.7.6. Digitize ASIS, PS and neck. Adjust to meet co-planar criteria explained in previous sections.

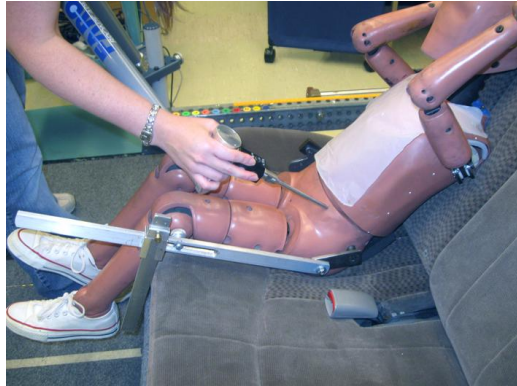

Figure 32. Checking ATD pelvis position

9.7.7. Remove the seat back plate, being careful not to move the ATD.

9.7.8. Unlock knees and loosen until the legs move freely. Let legs drop to seat.

If the head of the ATD is resting on the seat back, insert a foam wedge behind the back of the ATD and prop the ATD until the head is just off the seat back as shown in

9.7.9. Figure 33.

9.7.10. Remove the positioning tool.

9.7.11. Rotate the arms of the ATD down so that they are perpendicular to the torso (i.e., upper extremities horizontal, elbows and wrists straight). Check that the clavicle is down and back, and that the jacket is pulled down as far as possible. Bend the knees until the back of the lower legs are in minimal contact with the booster or vehicle seat. Position the legs such that the outer edges of the knees are 180 mm apart for the six-year-old and 220 mm apart for the ten-year-old. Position the feet such that the soles are perpendicular to the centerline of the lower legs.

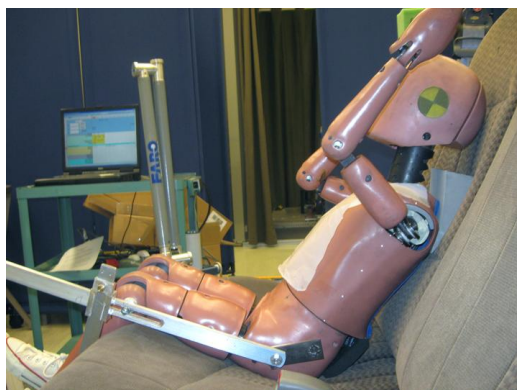

Figure 33. Propping ATD head off the seat back



Figure 34. Keeping clavicles down and back while rotating arm downward.



Figure 35. Setting the distance between the outer edges of the knees to 180 mm for the six-year-old and 220 mm for the ten-year-old.

- 9.8. In the case of high back boosters, adjust the ATD so that the shoulders are parallel to a line connecting the shoulder guides. This can be accomplished by leaning the torso such that the ATD head and neck are centered on the backrest components of the booster.
- 9.9. In the case of backless boosters or on vehicle seats, adjust the ATD torso so that the head is laterally level, or as close to level as possible.
- 9.10. Locate the intersection of the neck and the torso bib assembly in the midsagittal plane and project it out onto the ATD jacket. Place a piece of tape on the jacket extending from this point towards the shoulder that is on the D-ring side of the vehicle seat. The top edge of the tape should be at the same height as the point with the length of the tape parallel to the floor. The process of applying the tape is illustrated in Figure 36. Use a level or a measurement arm. **Do not estimate the position of this line by eye.** As shown in Figure 37, the curvature of the jackets may make a level line appear angled.

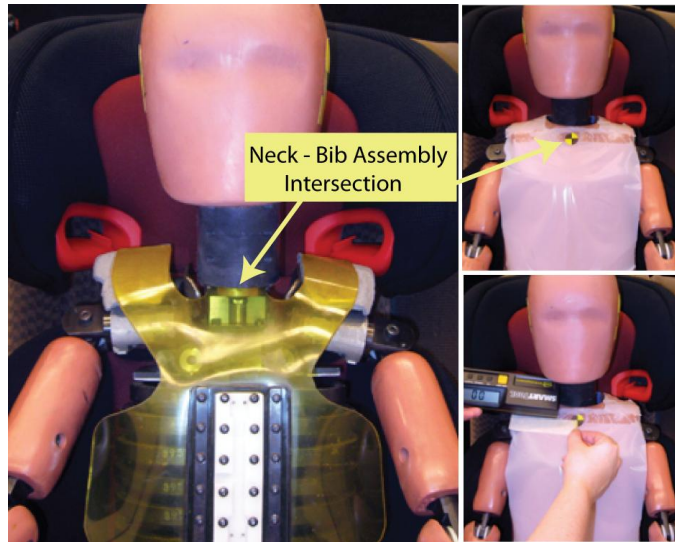

Figure 36. Applying tape used to measure the fit of the shoulder belt

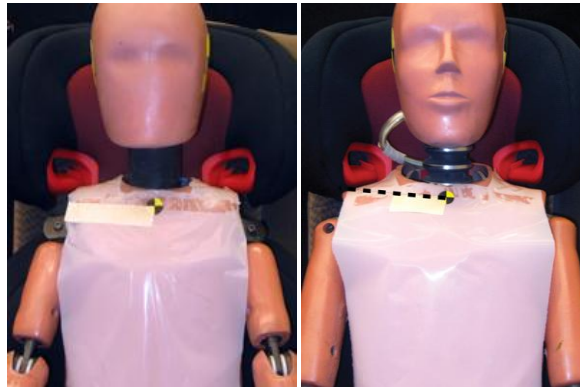

Figure 37. Tape on six-year-old and ten-year-old ATDs. The dashed line drawn past the tape on the ten-year-old ATD is not on the jacket surface.

10. APPLY THE BELT

IMPORTANT: The purpose of this section is to allow the geometry of the booster and vehicle seat to position the lap and shoulder belt on the ATD. Do not try to guide the belt to be in contact with any particular point on the ATD.

- 10.1. Initial Deployment. Pull the belt out of the retractor in a motion across the front of the ATD and booster so that the latch plate ends up above the foot of the ATD located on the buckle side of the booster as shown in Figure 38.
- 10.2. Shoulder Belt *Part 1*. If the booster has a back with belt positioning guides, first route the shoulder belt through the guide as instructed in the booster manual. If there is a belt positioning attachment to a backless booster, route the shoulder belt through the attachment. If there is no guide or attachment go to the next step.

- 10.3. Lap Belt *Part 1*. If using a booster, position the lap belt as indicated by the booster manual on the side away from the buckle. Leave enough slack in the belt between the inboard and outboard lower belt guides to hold the lap belt eight inches out from the midsagittal line of the ATD pelvis. Position the lap belt as indicated by the booster manual on the *buckle side* of the booster and buckle the belt.



Figure 38. Initial deployment of the belt, routing the shoulder belt through the guide and buckling the belt

- 10.4. Shoulder Belt *Part 2*. If there is a lower guide for the shoulder belt on the buckle side of the booster, make sure that it is routed properly. If there is an attached guide on a backless booster, make use it is set to the proper height, as specified by the booster manufacturer.
- 10.5. Lap Belt *Part 2*. With one hand, pull the slack portion of the lap belt that was created between the lower belt guides forward along the midsagittal plane of the pelvis so that the belt is approximately 20 mm above the top surface of the thighs. This can be accomplished by grasping the belt with the palm up, as shown in such that the back of the hand is resting lightly on the tops of the ATD thighs. With the other hand, grasp the torso portion of the belt 150 mm above the latch plate and slowly pull upward in the direction of the shoulder belt path. Allow the hand holding the lap belt to be pulled toward the pelvis, taking the slack out of the lap belt while keeping the lap belt just clear of the thighs (Figure 39). When the leading edge of the lap portion of the belt reaches the thigh area covered by the lap form, release the lap belt and continue pulling slowly but firmly on the shoulder belt until the lap belt has no slack. Do not guide the belt (Figure 40), but do not let it become twisted.



Figure 39. Holding the lap belt off the thighs while removing slack.



Figure 40. Point at which the lap belt is released (left) while pulling on the shoulder belt in the direction of the belt path until slack is removed from lap belt.

10.6. Routing Check. Rotate the ATD arm located nearest the D-ring down to the seat surface until the 5th metacarpal side contacts the booster surface and the palm contacts the outside of the thigh. Check the shoulder belt guide and determine if it is in the setting specified by the booster instruction manual or in the desired location for the test. If not and adjustments can be made without moving the pelvis or torso of the ATD, rotate the arm back up, make the adjustments and start Section 10 over. If not and adjustments cannot be made without moving the pelvis or torso of the ATD, start the installation procedure over. Otherwise, continue to the next step.

10.7. Lap Belt *Part 3* - Tightening. Grasp the torso portion of the belt 150 mm above the latch plate and slowly pull upward in the direction of the shoulder belt path. Stop pulling on the belt when visually apparent movement of the lap portion of the belt stops. If the ATD is observed to move during this step, return to Section 9 (reposition the ATD). Feed the excess belt into the D-ring retractor. Do not let the belt become twisted.

10.8. Shoulder Belt *Part 3*- Position the section of the shoulder belt between the buckle/lower guide and the upper guide or the D-ring (if no upper guide) so that the belt

routes through the shortest path between the two locations. Feed any excess belt into the retractor as shown in Figure 41. The goal is to find the position of the belt across the ATD chest that involves the minimal amount of webbing length. The belt tension applied during this process should not cause visible movement of the ATD.



Figure 41. Feeding the shoulder belt into the retractor

10.9. If during the process changes must be made to the configuration of the booster seat and this disturbs the installation, start over, returning to Section 8.

10.10. ATD Final Positioning

10.10.1. Legs. Check leg and feet position and make adjustments to achieve the described positions in section 9.6.

10.10.2. Arm on the side nearest the buckle. Keep the arm straightened at the elbows and rotate arms at shoulder down towards seat surface until the 5th metacarpal (pinky) side contacts the booster surface and the palms are in contact with the outsides of the thighs. If the shoulder belt interferes with this motion, stop the rotation 1 cm short of contacting the belt.

10.10.3. Thorax and head. Same as 9.8 - 9.9.

10.10.4. Recheck shoulder belt path 10.8



Figure 42. Examples of final positioning

11. RECORD BOOSTER, ATD AND BELT LOCATIONS

1. Record belt tensions
2. Digitize:
 - Booster reference points on each movable part such as
 - Seat pan
 - Seat back and headrest
 - Adjustable belt guides
 - ATD landmarks
 - Belt contact with
 - Vehicle seat, booster and booster belt guides
 - ATD at shoulder, centerline, and lap
 - Lower belt anchorages and Dring
3. Photograph installation from front and inboard side.

Table 1

Points Digitized to Measure Shoulder Belt Fit

Digitized Point	Description
	<p><i>Torso Belt – ATD Shoulder</i> Inboard and outboard points on the torso belt where it crosses the ATD shoulder height (vertical height determined by the location of the Bib Assembly Centerline, marked on the chest jacket with tape). The belt might not be in contact with the ATD at this point – always digitize the point on the belt.</p> <p>It is a good idea to digitize and check the bib-neck assembly point lateral position and height just before digitizing the belt point.</p>
	<p><i>ATD Centerline</i> Upper and lower points of the torso belt where it crosses the ATD centerline.</p>

Table 2
Points Digitized to Measure Lap Belt Fit

Digitized Point	Description
	<p>ASIS (inboard) Fore, mid, and aft points of the lap belt where it crosses the ATD ASIS on the inboard side. Digitized the lateral position of the ASIS first and the belt point to the Y-values. If the belt covers the ASIS marks, use the reference lines on the superior edge of the pelvis flesh.</p>
	<p>ASIS (outboard) Fore, mid, and aft points of the lap belt where it crosses the ATD ASIS on the outboard side. Digitized the lateral position of the ASIS first and the belt point to the Y-values. If the belt covers the ASIS marks, use the reference lines on the superior edge of the pelvis flesh.</p>

Table 3
Points Digitized to Measure the Position of ATD Head and Thorax

Digitized Point	Description
	<p>Top of Head Reference point located at the top of the ATD head.</p>
	<p>Frankfort Plane Two points on a line projected from the plane of the accelerometer mounting surface inside the ATD head.</p>
	<p>Center of Mass Two points on forming a line whose midpoint represents the center of mass of the ATD head.</p>
	<p>Neck Bracket Inboard point on the rear corner of the ATD neck bracket.</p>
	<p>Centerline Bib Assembly - A point on the centerline of the ATD at the top edge of the bib assembly where it meets the molded neck. Lower Torso-Reference point on the chest deflection assembly beneath the chest jacket.</p>

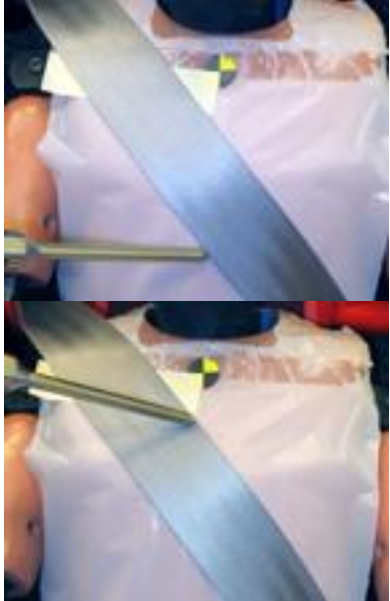
Table 4

Points Digitized to Measure the Position of the ATD Pelvis

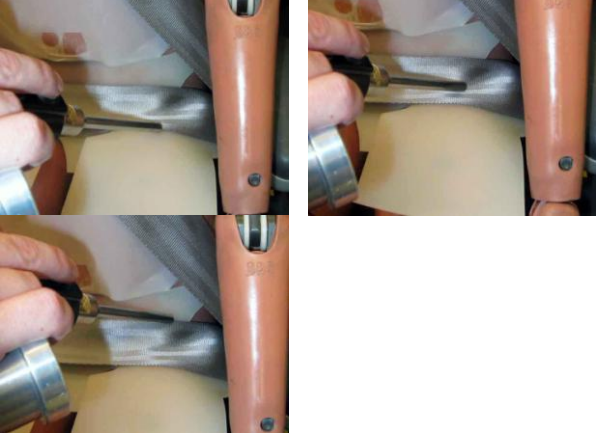
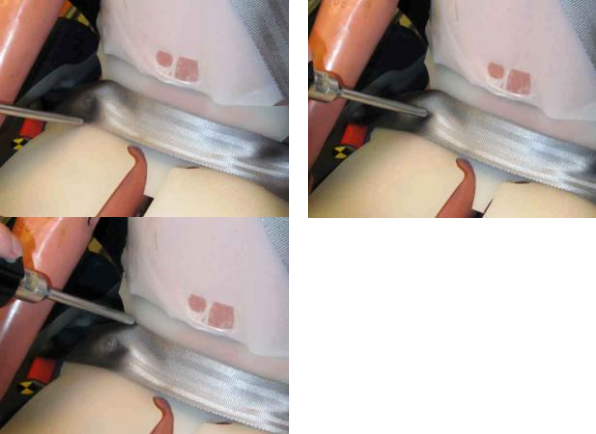



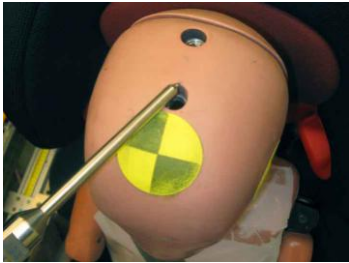
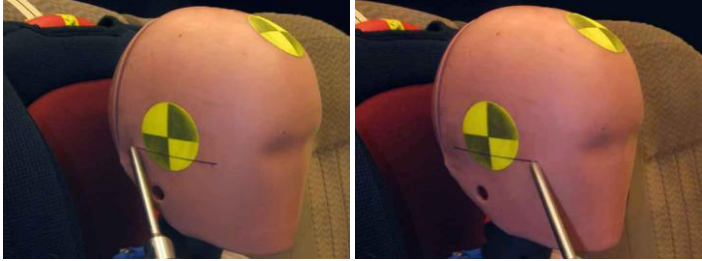
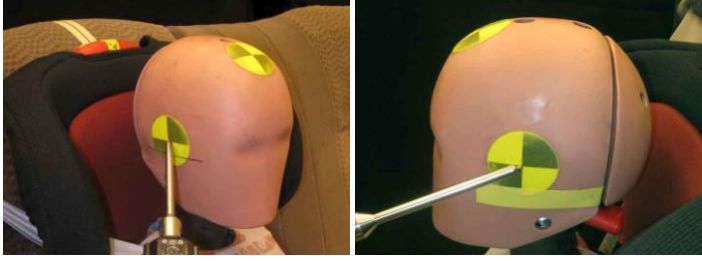
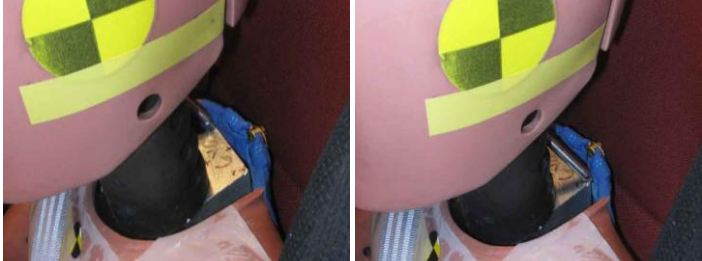
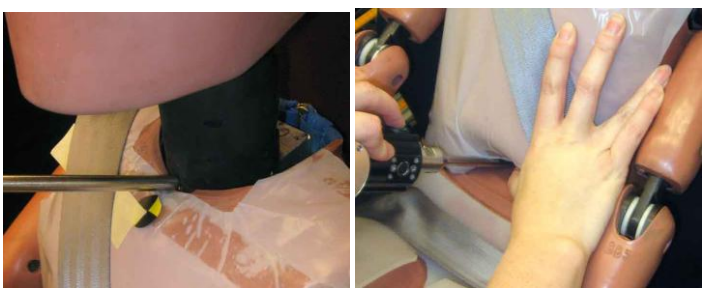

Digitized Point	Description
	<p>Outboard Hip Offset</p> <p>Fore and aft reference points on the hip offset tool. (The tool consists of two pieces; the upright piece can be removed if it interferes with the belt path.)</p>
	<p>Inboard Hip Offset</p> <p>Upper and lower reference points on hip offset tool. (The tool consists of two pieces; the upright piece can be removed if it interferes with the belt path.)</p>
	<p>Pelvis References</p> <p>ASIS -Reference point representing the location of the ASIS on the flesh and on the lap form.</p> <p>PS- Reference point representing the location of the PS on the flesh.</p>

Table 5

Points Digitized to Measure the Position of the ATD Limbs

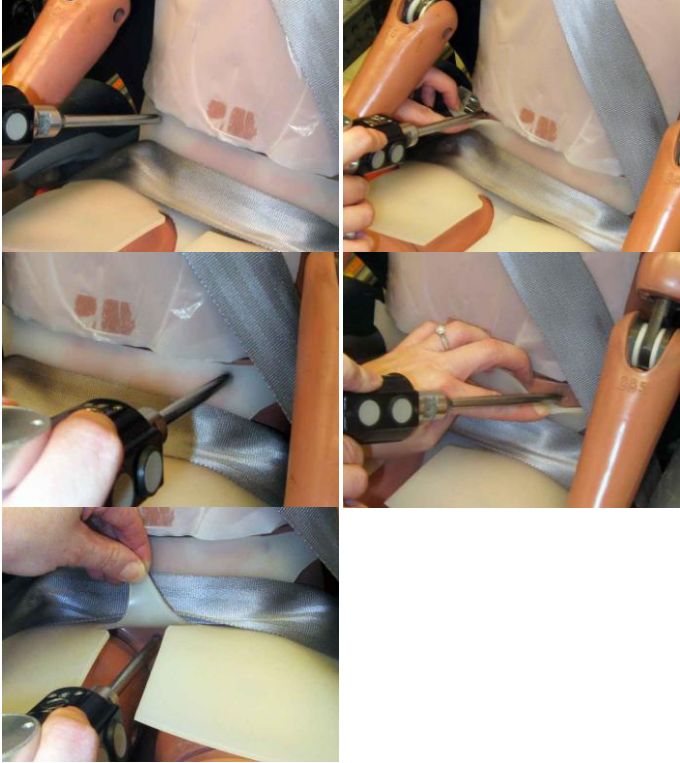
Digitized Point	Description
	<p><i>Shoulder Joint</i> - located on the shoulder pivot bolt.</p> <p><i>Elbow Joint</i> - located on the elbow pivot bolt.</p> <p><i>Wrist Joint</i> - located on the wrist pivot bolt.</p>
	<p><i>Suprapatella</i> - located on the bolt positioned above the knee.</p> <p><i>Knee Joint</i> - located on the knee pivot bolt.</p>
	<p><i>Ankle Joint</i> - located on the ankle ball joint set screw.</p> <p><i>Ball of Foot</i> - located on the shoe where the ball of the foot is.</p>

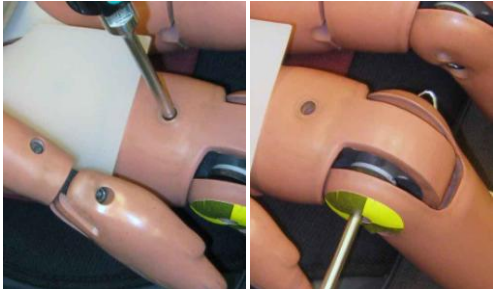
Appendix A. Lap Form

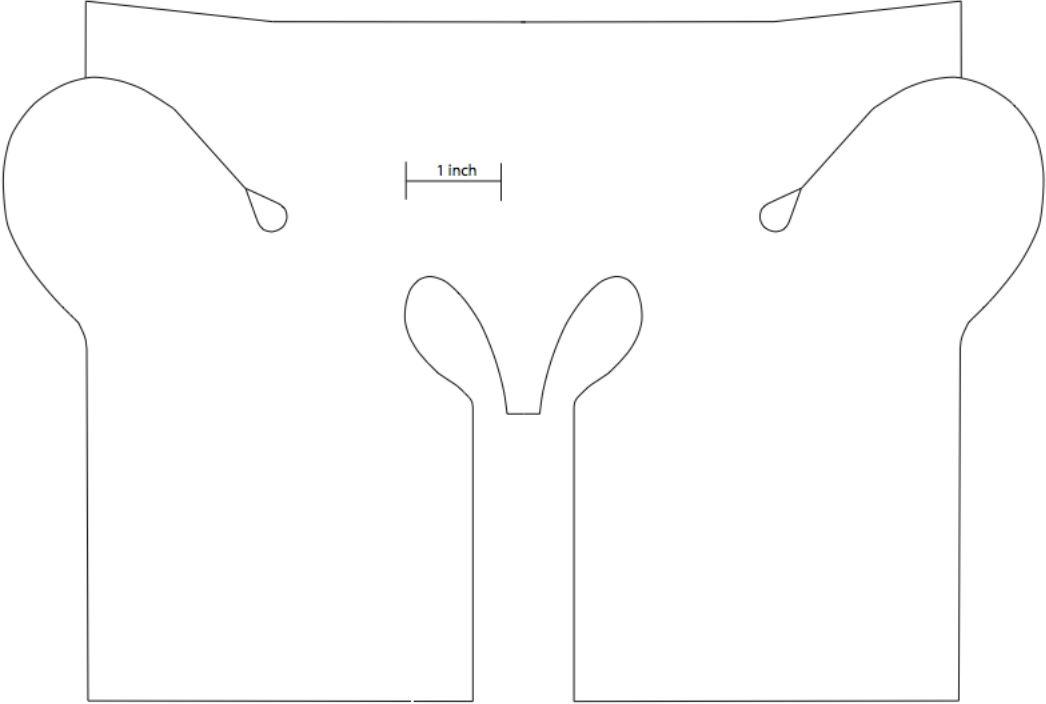

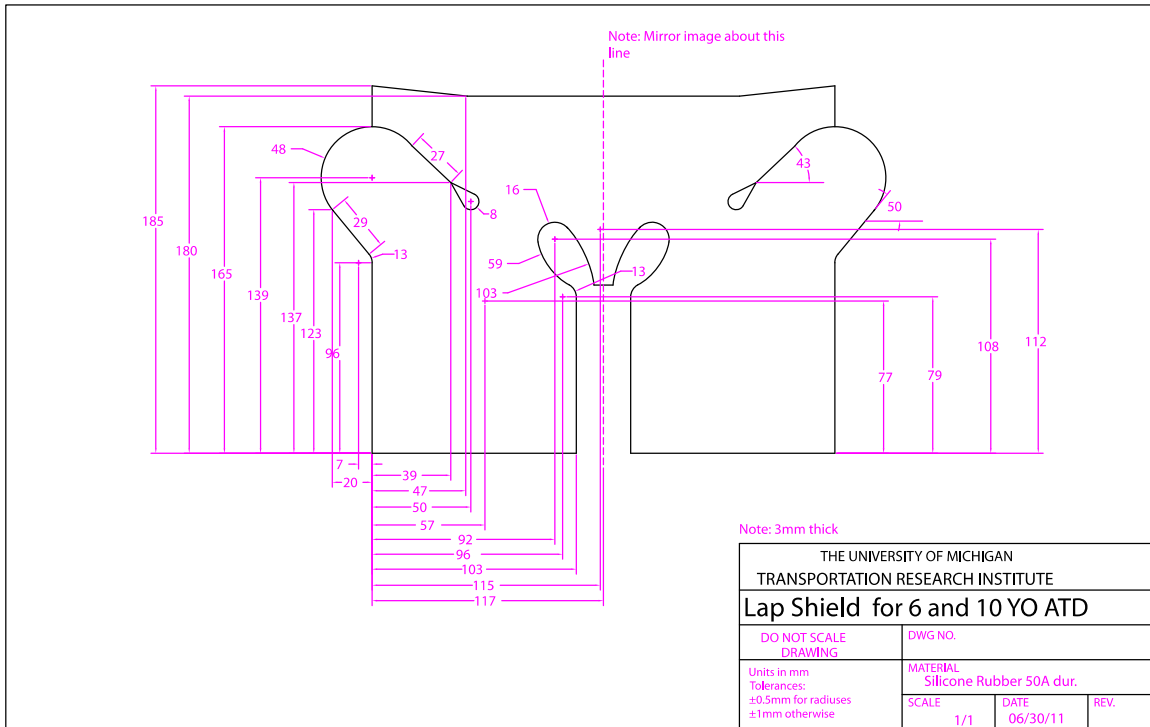

Appendix B. Hip Offset

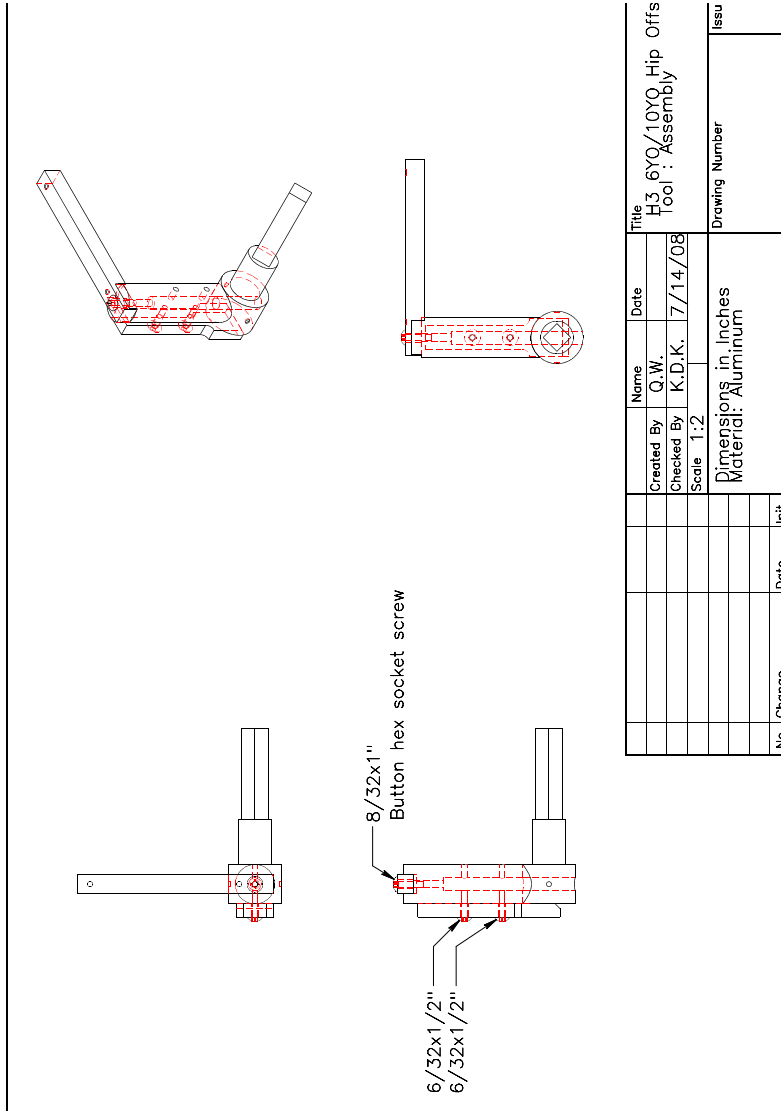

Appendix C. Teflon Bibs for 6YO (above) and 10 YO(below) ATDs

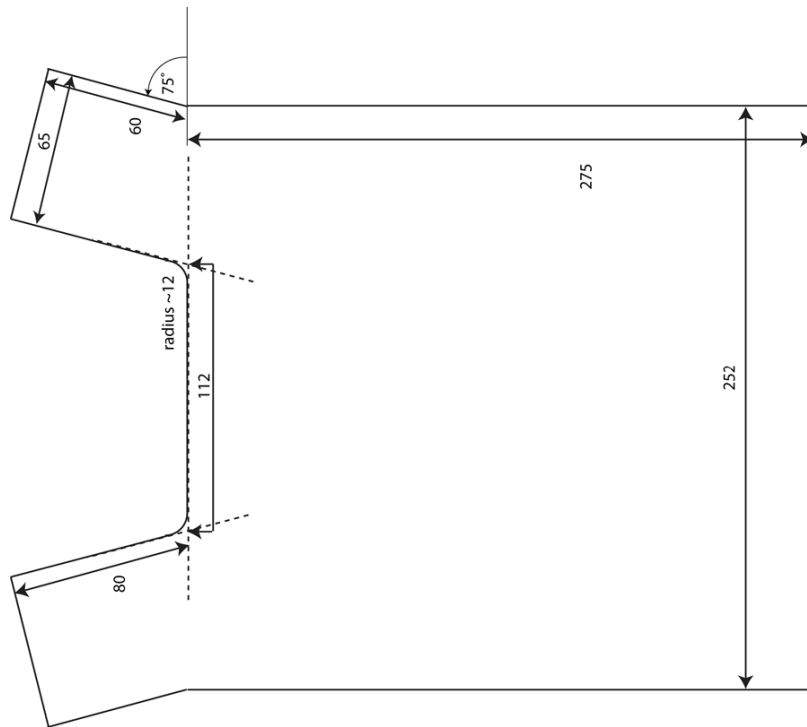
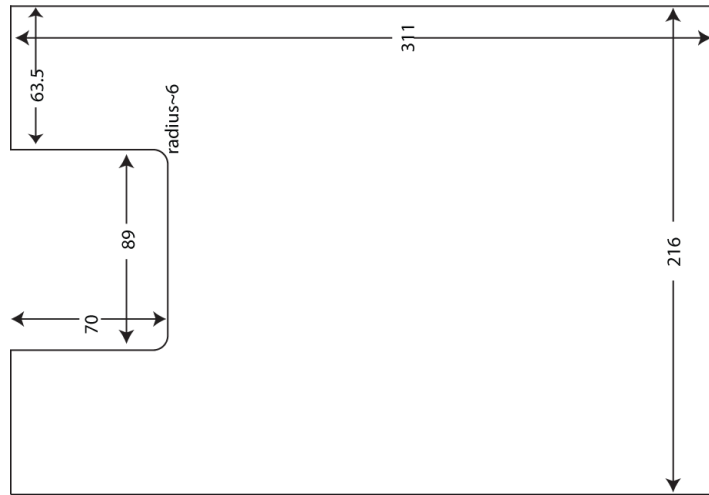

Appendix D. Dealing with Booster – Vehicle Seat Interactions

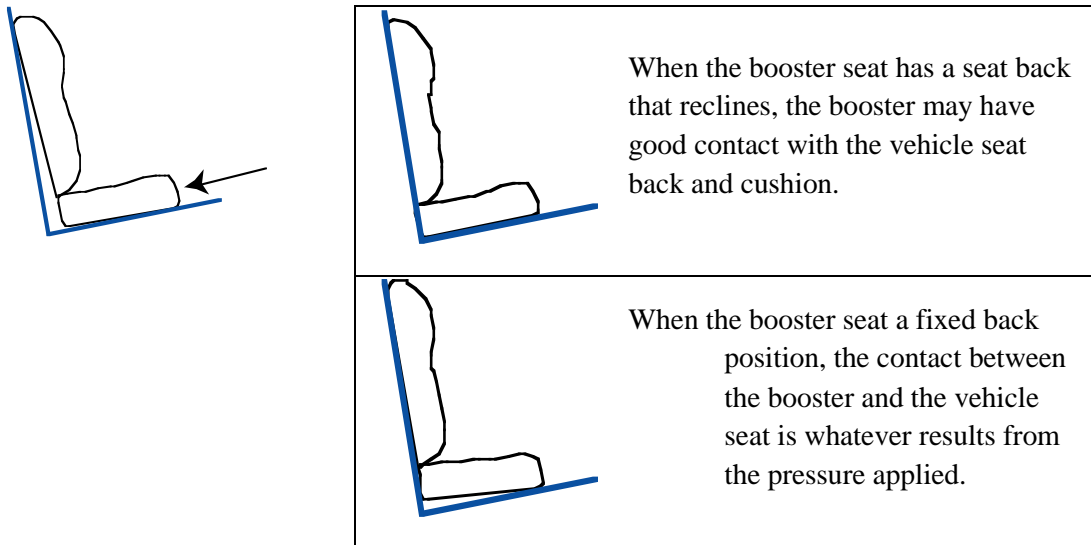

Figure D1. Apply 30 lb force to the front of the booster seat cushion. When the vehicle seat back is very upright and/or the vehicle cushion very angled, boosters with a fixed back angle may not conform to the vehicle seat as much as boosters with seat backs that recline.

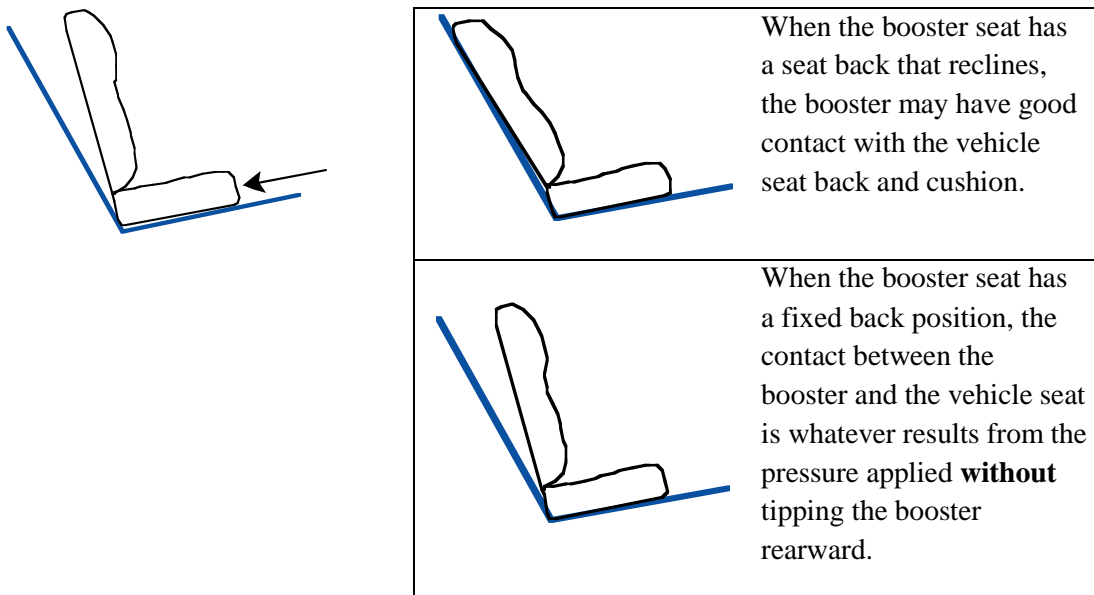

Figure D2. Apply 30 lb force to the front of the booster seat cushion. When the vehicle seat back is very reclined and/or the vehicle cushion very flat, boosters with a fixed back angle may not conform to the vehicle seat as much as boosters with seat backs that recline.