

AAEL

QE
535.2
.T4
N69
1982

MAY 1982

UMEE 82R2

EARTHQUAKE HAZARD ANALYSIS FOR COMMERCIAL BUILDINGS IN MEMPHIS

A. S. Nowak

E. L. R. Morrison

The University of Michigan

Department of Civil Engineering

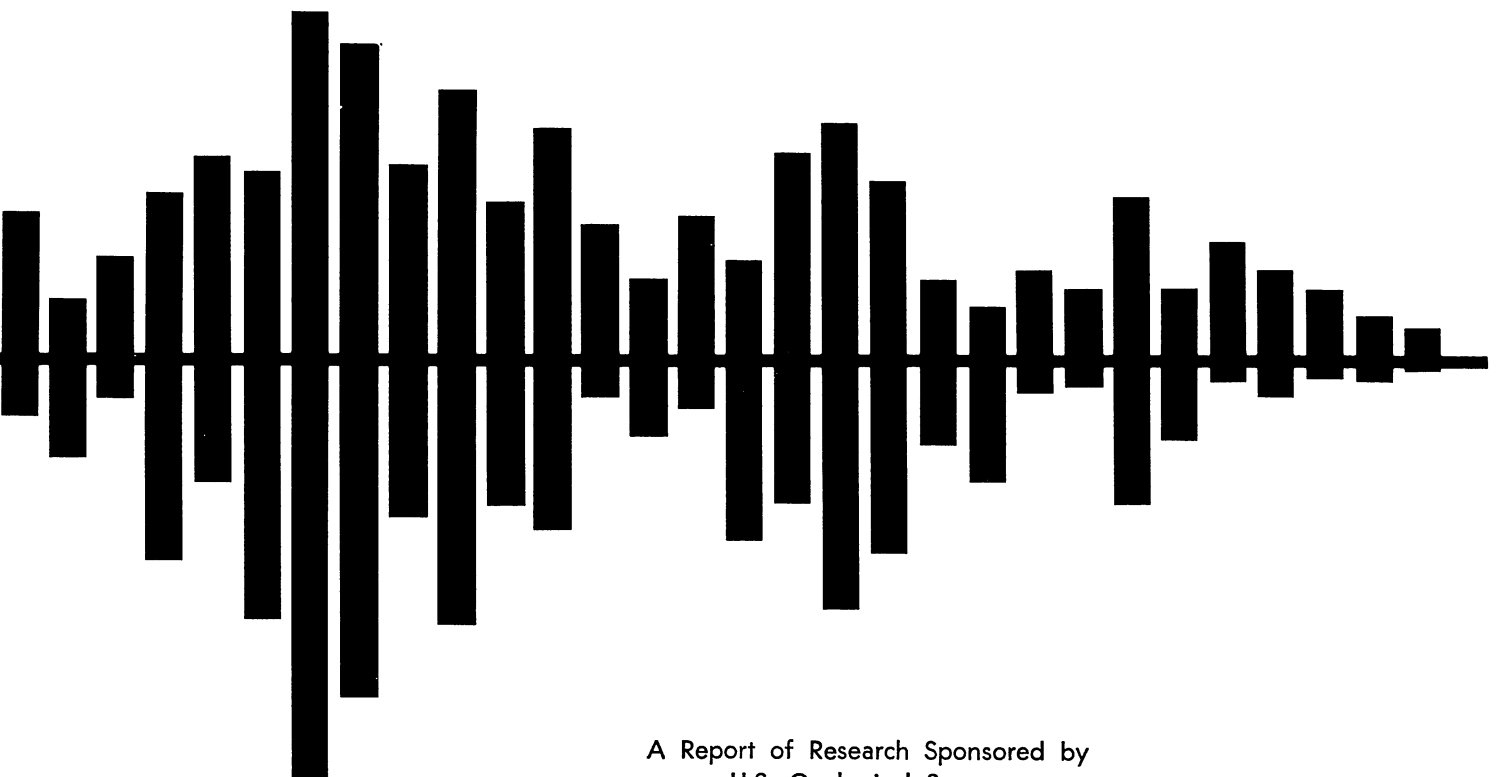

A Report of Research Sponsored by
U.S. Geological Survey
Contract No. 14-08-0001-19829

EARTHQUAKE HAZARD ANALYSIS FOR COMMERCIAL BUILDINGS IN MEMPHIS

Research Report

by

Andrzej S. Nowak and Elizabeth L. Rose Morrison

Submitted to

The US Geological Survey
345 Middlefield Rd., MS-83
Menlo Park, California 94025

Contract No. 14-08-0001-19829

May 1982
Department of Civil Engineering
University of Michigan
Ann Arbor, MI. 48109

EARTHQUAKE HAZARD ANALYSIS FOR COMMERCIAL BUILDINGS
IN MEMPHIS

SUMMARY

The report deals with the evaluation of seismic risk for commercial buildings in Memphis, Tennessee.

The city is situated close to the New Madrid fault, the source of very strong earthquakes in 1811-12. The geology and seismicity of the region are discussed on the basis of the available references.

Memphis, in the building style, materials, and quality of workmanship of its buildings, can be considered as a typical representative of cities in the central United States. Commercial buildings are divided into categories with regard to number of stories, year of construction, assessed value, total floor area and structural type.

Over 15 buildings were selected for site examination by the project team. The quality of design, materials, and construction was found to be surprisingly good, especially in those structures built since 1900. Typical cross sections of structural members and connections are shown in figures.

Seismic resistance has been evaluated for five buildings: a four-story reinforced concrete frame, a four-story steel structure with vertical trusses, a 13-story steel frame, and two multistory reinforced concrete frames. Four reference ground motions were considered: El Centro earthquake, Taft earthquake, UBC design earthquake and BOCA design earthquake. Ratios of load effect to capacity were calculated and are presented in the report.

ACKNOWLEDGMENTS

This project has been sponsored by the US Geological Survey under contract no. 14-08-0001-19829; the support of the USGS is gratefully acknowledged.

The reported research is the result of the joint efforts of a research team which included Glen V. Berg and Robert D. Hanson of the University of Michigan and Ted V. Galambos of the University of Minnesota, in addition to the authors.

Special thanks are due to Warner Howe of Gardner and Howe in Memphis, for his assistance and comments during the various phases of this project. The cooperation of Frank M. Bosak, Memphis Building Official, and his associates Ronald Johnson and Charles M. Caudle, and of William C. Boyd, Shelby County Assessor, is also acknowledged with gratitude.

Throughout the course of the research, the project team was fortunate to be able to garner information from the experience of many people. The authors acknowledge the fruitful discussions with Arch Johnson of the Tennessee Earthquake Information Center, Chris Sanidas, Shelby County Building Official, and O. Clark Mann. Thanks are also due to the owners of the commercial buildings in Memphis who permitted the project team to examine their buildings.

A number of students and staff members at the University of Michigan were involved with the computations, drawings, and typing during the project. The efforts of M. Boutros, D. Daniels, R. C. Ireland, T. S. Lin, K. Polak, D. Shier, G. Singleton, and W. S. Wu are particularly acknowledged.

TABLE OF CONTENTS

Summary	II
AcknowledgementsIII
Table of Contents	IV
List of Tables	V
List of Figures	VIII
1. Introduction	1
2. Geology of the Region	6
3. Urban Development of the Region	36
4. Commercial Buildings in Memphis	52
5. Selected Buildings	65
6. Site Examinations	68
7. Selection of Reference Ground Motion	87
8. Seismic Strength Evaluation	93
9. Prediction of Damage	142
10. Conclusions	146
References	148

LIST OF TABLES

Table 2.1	Soil Deposits in Memphis Area	27
Table 3.1	Population Changes in Memphis/Shelby County	40
Table 3.2	Commercial Building Permit Activity, 1978 . . .	43
Table 3.3	Commercial Building Permit Activity, 1979 . . .	44
Table 3.4	Commercial Building Permit Activity, 1980 . . .	45
Table 3.5	Commercial Subdivision Activity in 1978-80 . . .	49
Table 3.6	Commercial Rezoning Activity in 1978-80 . . .	51
Table 4.1	Height of Commercial Buildings in Memphis . . .	54
Table 4.2	Square Footage of Commercial Buildings in Memphis	55
Table 4.3	Assessed Value of Commercial Buildings in Memphis	55
Table 5.1	Selected Commercial Buildings	67
Table 8.1	Typical Dimensions of Structural Members in Building I	97
Table 8.2	Column Moment Capacities for Building 1	97
Table 8.3	Beam End Moment Capacities for Building 1 . . .	97
Table 8.4	Mass Calculations for Building 1	98
Table 8.5	Earthquake Equivalent Lateral Forces for Building 1	98
Table 8.6	Ratio of M_{D+L+E} to M_n for Column A in Building 1	101
Table 8.7	Ratio of M_{D+L+E} to M_n for Column B in Building 1	101
Table 8.8	Ratio of M_{D+L+E} to M_n for Column E in Building 1	101
Table 8.9	Ratio of $.75M_{D+L+E}$ to M_n for Beam A-B in Building 1	102
Table 8.10	Ratio of $.75M_{D+L+E}$ to M_n for Beam C-D in Building 1	102

LIST OF TABLES (Continued)

Table 8.11	Ratio of $.75M_{D+L+E}$ to M_n for Beam E-D in Building 1	102
Table 8.12	Typical Dimensions of Structural Members in Building 2	106
Table 8.13	Column Moment Capacities for Building 2	107
Table 8.14	Mass Calculations for Building 2	108
Table 8.15	Earthquake Equivalent Lateral Forces for Building 2	110
Table 8.16	Ratio of M_{D+L+E} to M_n for Column A in Building 2	111
Table 8.17	Ratio of M_{D+L+E} to M_n for Column B in Building 2	112
Table 8.18	Ratio of $.75M_{D+L+E}$ to M_n for Beam A-B in Building 2	113
Table 8.19	Typical Dimensions of Structural Members in Building 3	117
Table 8.20	Column Moment Capacities for Building 3	118
Table 8.21	Beam End Moment Capacities for Building 3	119
Table 8.22	Mass Calculations for Building 3	120
Table 8.23	Earthquake Equivalent Lateral Forces for Building 3	122
Table 8.24	Ratio of M_{D+L+E} to M_n for Column C in Building 3	123
Table 8.25	Ratio of M_{D+L+E} to M_n for Column D in Building 3	124
Table 8.26	Ratio of $.75M_{D+L+E}$ to M_n for Beam D-C in Building 3	125
Table 8.27	Typical Dimensions of Structural Members in Building 4	129
Table 8.28	Column Moment Capacities for Building 4	130
Table 8.29	Beam End Moment Capacities for Building 4	131
Table 8.30	Mass Calculations for Building 4	132
Table 8.31	Earthquake Equivalent Lateral Forces for Building 4	134

LIST OF TABLES (Continued)

Table 8.32	Ratio of M_{D+L+E} to M_n for Column A in Building 4	135
Table 8.33	Ratio of M_{D+L+E} to M_n for Column B in Building 4	135
Table 8.34	Ratio of $.75M_{D+L+E}$ to M_n for Beam A-B in Building 4	136
Table 8.35	Ratio of $.75M_{D+L+E}$ to M_n for Beam B-C in Building 4	136
Table 8.36	Ratio of Member Force to Member Capacity in Truss A	141
Table 8.37	Ratio of Member Force to Member Capacity in Truss B	141
Table 8.38	Ratio of Member Force to Member Capacity in Truss C	141
Table 9.1	Expected Percentage of Structural Failure for Analyzed Buildings	145
Table 9.2	Expected Percentage of Structural Failure for All Masonry Commercial Buildings	145
Table 9.3	Expected Percentage of Structural Failure for All Steel and Reinforced Concrete Commercial Buildings	145

LIST OF FIGURES

Fig. 2.1	Seismic Map of the World	7
Fig. 2.2	Damaging Earthquakes in the United States	8
Fig. 2.3	Major Geologic Provinces in the Central United States	9
Fig. 2.4	Mississippi Aluvial Valley Margins	11
Fig. 2.5	Section A-A through Mississippi Aluvial Valley	12
Fig. 2.6	Section B-B through Mississippi Aluvial Valley	12
Fig. 2.7	Active Faults in the Vicinity of Memphis	13
Fig. 2.8	Histogram of Earthquakes in Western Tennessee	16
Fig. 2.9	Annual Frequency of Earthquakes vs. M_b	16
Fig. 2.10	Isoseisms For December 16, 1811 Earthquake	18
Fig. 2.11	Isoseisms For a Major Earthquake in the Southwestern End of the New Madrid Fault	19
Fig. 2.12	Isoseisms For a Major Earthquake in the Central Part of the New Madrid Fault	20
Fig. 2.13	Isoseisms For a Major Earthquake in the Northeastern End of the New Madrid Fault	21
Fig. 2.14	Ground Acceleration vs. Distance from Fault Rupture for California and the Central US, 5-Hz Wave	23
Fig. 2.15	Ground Acceleration vs. Distance from Fault Rupture for California and the Central US, 1-Hz Wave	24
Fig. 2.16	Size of Disaster Area in the West and Central US	25
Fig. 2.17	Cross-Section of the Mississippi Embayment	25
Fig. 2.18	Response Spectra for Design Earthquake I	29

LIST OF FIGURES (Continued)

Fig. 2.19	Response Spectra for Design Earthquake II	30
Fig. 2.20	Response Spectra for Design Earthquake III	31
Fig. 2.21	Ground Acceleration Amplifications due to Earthquake I	32
Fig. 2.22	Ground Acceleration Amplifications due to Earthquake II	33
Fig. 2.23	Ground Acceleration Amplifications due to Earthquake III	34
Fig. 2.24	Liquefaction Potential Microzonation Map	35
Fig. 3.1	Historical Development of Memphis	37
Fig. 3.2	Planning Districts and Rings in City of Memphis and Shelby County	38
Fig. 3.3	Summary of Population Changes	41
Fig. 3.4	Annual Commercial Subdivision Activity	50
Fig. 3.5	Annual Commercial Rezoning Activity	50
Fig. 4.1	Location of Commercial Buildings in Memphis	53
Fig. 4.2	Histogram of the Age of Construction for Commercial Buildings in Memphis	54
Fig. 4.3	Assessed Value vs. Number of Stories for Masonry Buildings	57
Fig. 4.4	Assessed Value vs. Number of Stories for Steel Frame Buildings	57
Fig. 4.5	Assessed Value vs. Number of Stories for Reinforced Concrete Buildings	58
Fig. 4.6	Assessed Value vs. Number of Stories for All Types of Commercial Buildings	58
Fig. 4.7	Assessed Value vs. Year of Construction for Masonry Buildings	59
Fig. 4.8	Assessed Value vs. Year of Construction for Steel Frame Buildings	59
Fig. 4.9	Assessed Value vs. Year of Construction for Reinforced Concrete Buildings	60

LIST OF FIGURES (Continued)

Fig. 4.10	Assessed Value vs. Year of Construction for All Types of Commercial Buildings . . .	60
Fig. 4.11	Assessed Value vs. Square Footage for Masonry Buildings	61
Fig. 4.12	Assessed Value vs. Square Footage for Steel Frame Buildings	61
Fig. 4.13	Assessed Value vs. Square Footage for Reinforced Concrete Buildings	62
Fig. 4.14	Assessed Value vs. Square Footage for All Types of Commercial Buildings	62
Fig. 4.15	Number of Stories vs. Year of Construction for Masonry Buildings	63
Fig. 4.16	Number of Stories vs. Year of Construction for Steel Frame Buildings	63
Fig. 4.17	Number of Stories vs. Year of Construction for Reinforced Concrete Buildings	64
Fig. 4.18	Number of Stories vs. Year of Construction All for Types of Commercial Buildings . . .	64
Fig. 6.1	Building A	69
Fig. 6.2	Building B	69
Fig. 6.3	Propped Walls of Buildings at Beale Street During Reconstruction	71
Fig. 6.4	Front Wall Ornamentations at Mid-America Mall	71
Fig. 6.5	Building C	72
Fig. 6.6	Typical Cross Sections of Beams and Columns in Building C	72
Fig. 6.7	Building D During Demolition	74
Fig. 6.8	Column Detail in Building D (during demolition)	74
Fig. 6.9	Building E	74
Fig. 6.10	Building F	75
Fig. 6.11	Cast Iron Column in the Oldest Part of Building F	75

LIST OF FIGURES (Continued)

Fig. 6.12	Building G	76
Fig. 6.13	Details of Steel Frame in Building G	76
Fig. 6.14	Building H	78
Fig. 6.15	Typical Floor in Building H	78
Fig. 6.16	Typical Beam and Column Section in Building H	78
Fig. 6.17	Building I	79
Fig. 6.18	Typical Cross Sections of Beams and Columns in Building I	79
Fig. 6.19	Typical Cross Sections of Floor Slabs and Columns in Building J	80
Fig. 6.20	Parapet in Building J	80
Fig. 6.21	Building K	82
Fig. 6.22	Building L	83
Fig. 6.23	Building M	83
Fig. 6.24	Building N	85
Fig. 6.25	Back Side of Building N	85
Fig. 6.26	Building O	86
Fig. 6.27	Building O During Construction	86
Fig. 7.1	Response Spectrum for El Centro Earthquake . . .	88
Fig. 7.2	Response Spectrum for Taft Earthquake	89
Fig. 7.3	Response Spectra for the Design Earthquakes	92
Fig. 8.1	Typical Floor Plan in Building 1	95
Fig. 8.2	Selected Frame in Building 1 with Moments of Inertia for Beams and Columns	95
Fig. 8.3	Typical Floor Plan in Building 2	104
Fig. 8.4	Selected Frame in Building 2 with Moments of Inertia for Beams and Columns	105

LIST OF FIGURES (Continued)

Fig. 8.5	Typical Floor Plan in Building 3	115
Fig. 8.6	Selected Frame in Building 3 with Moments of Inertia for Beams and Columns	116
Fig. 8.7	Typical Floor in Building 4	127
Fig. 8.8	Selected Frame in Building 4 with Moments of Inertia for Beams and Columns	128
Fig. 8.9	Typical Floor in Building 5	138
Fig. 8.10	Vertical Trusses in Building 5	138

1. INTRODUCTION

Estimation of potential loss due to earthquakes is essential to establish the optimum safety level for earthquake-resistant design. The risk is defined as degree of probability of such loss. Two random variables are involved: load, in particular ground motion, and structural response.

The major objective of this project is to develop a methodology for the evaluation of potential loss from earthquakes. The approach is demonstrated through evaluation of commercial buildings in Memphis, Tennessee. Emphasis is placed on local characteristics of the commercial structures in the region.

Seismic activity has been a subject of extensive study for years. As a result, seismicity, with regard to ground acceleration and probability of occurrence, is well established for many areas in the US, particularly the West Coast.

Structural response to a ground motion includes deflections, displacements, vibrations, cracking, etc., and may lead to nonstructural damage such as displacement of equipment and furniture, electric short circuits, and fires. The loss includes the cost of repair or replacement of both structural and nonstructural damage.

The recorded history of earthquake activity for different regions of the country varies drastically. Moreover, structural response to a given ground motion is related to local conditions because of the differences in types of construction, materials, ages of structures, code requirements, etc. The damage due to seismic activity has been analyzed for earthquakes occurring in different parts of the world (1-10).

The potential economic damage to large American cities has been studied using the ground motion recorded in several major earthquakes which have occurred on the West Coast during the last 50 years. Systematic survey methods have been developed, such as those presented in the National Bureau of Standards publication "Natural Hazards Evaluation of Existing Buildings" (11) or in the publication of the General Services Administration, "Earthquake Resistance of Buildings" (12). Approximate analytical methods are given in the principal building codes, such as the Uniform Building Code (13). The U.S. Veterans Administration issued "Earthquake Resistant Design Requirements for VA Hospital Facilities" (14).

The Applied Technology Council, the National Bureau of Standards, and the National Science Foundation issued a document entitled "Tentative Provisions for the Development of Seismic Regulations for Buildings" (15), which includes guidelines for the evaluation of damage after an earthquake. Detailed calculations have been done on the cost of upgrading Veterans Administration Hospitals across the country and all public schools in California to meet earthquake code requirements (16).

A study by Pinkham and Hart (17) describes a method of structural analysis, design, and analysis of costs for strengthening multi-story buildings to conform to the 1973 Uniform Building Code earthquake requirements. In a study by Wiggins et al (18), a methodology for estimating the potential damage to buildings by earthquakes is presented. The damage predictions are based on estimates of the deflections required to produce failure of various components. Safety of existing structures located in a

seismic zone was also analyzed by Chen and Yao (19). They tried to relate the damage to the natural frequency of the building. The approach is illustrated by examples of several structures in the San Fernando Valley area.

These studies on the cost necessary to upgrade existing buildings to meet the requirements of current earthquake codes have been done for urban areas and expected earthquakes on the West Coast. The recommendations for needed research on repair, strengthening, and rehabilitation of buildings are listed in (20).

A methodology for determining the risk of seismic activity in Boston and the probable dollar loss has been developed by Whitman et al (21). In this study, dollar losses from different levels of earthquake have been established by comparison with observed damage produced by major earthquakes on the West Coast.

Evaluation of the expected damage due to earthquake for a large area including Memphis was attempted in (22). Seismicity and earthquake engineering problems of the area were the subject of a speciality conference in Knoxville in September, 1981 (23).

The study for this report concerns the Central United States, in particular the New Madrid fault region. The geology and seismic history of the region are summarized in Chapter 2.

The building style of a city is determined by its climate, its population, and the occupations of its inhabitants. The city of Memphis was established in the middle of the last century. The existing buildings vary in age from well over 100 years to newly constructed. Historical development of the city and current trends are discussed in Chapter 3.

Commercial structures can be put into categories with regard to type of structure, number of stories, age, type of occupancy, market value, location in the city, etc. A statistical analysis of the commercial buildings in Memphis has been performed and the results are presented in Chapter 4.

From the whole population of commercial buildings in Memphis, a sample of structures was selected for a more detailed examination. The criteria used in selection included age, number of stories, and type of structure. It has been found that older buildings were designed without special seismic code provisions. Therefore, representative high and medium-high structures were selected and their capacities to resist lateral loads were checked. The selection criteria are discussed in Chapter 5.

The selected representative structures were examined by a project team. Most of these buildings were unoccupied at the time of examination, some due to reconstruction. This simplified the effort of the team. The results of the site examinations are presented in Chapter 6, in the form of team members' comments.

Evaluation of seismic strength for commercial buildings in Memphis is performed for four predetermined design earthquake ground motions. Their characteristic parameters are discussed in Chapter 7.

The analytical evaluation of resistance to ground motion has been performed for several structures. The major difficulty was to obtain engineering and architectural drawings with structural details. Data was obtained for several typical medium-high and low

buildings. Seismic analysis was performed using computer programs developed at The University of Michigan. The procedure and results are described in Chapter 8.

In Chapter 9, the results of site examination, seismic strength evaluation and statistical analysis of commercial buildings in Memphis are combined to predict structural and non-structural damage to the whole building population considered in the project.

Chapter 10 contains conclusions and a list of topics for future research.

2. Geology of the Region

A seismic map of the world is shown in Fig. 2.1 (24). The locations of damaging earthquakes in the United States are shown in Fig. 2.2 (25). The city of Memphis is located in the southern central United States, close to the New Madrid fault.

This chapter is divided into four sections; one is devoted to the geology and seismicity of the central United States, another deals with the seismic history of western Tennessee, the third concentrates on local surficial geology, and the fourth summarizes the available data on microzonation of the Memphis area. Discussion of the geology of the region is based on references (22) and (26) to (35).

2.1 Geology of the Central United States.

Memphis is located within the geologic division known as the Mississippi Embayment Syncline (Fig. 2.3). The Mississippi Embayment is a portion of the Gulf Coastal Plain that extends southward from Illinois and includes parts of Alabama, Arkansas, Illinois, Kentucky, Mississippi, Missouri and Tennessee. It is a syncline in a southerly direction, and its axis is generally parallel to the Mississippi River. The syncline is filled with sedimentary rocks ranging in age from Jurassic to Quaternary; the maximum thickness is approximately 18,000 feet in the southern part of the region. The Embayment is separated into two general areas, the low land of the Mississippi Alluvial Plain and the Coastal Plain uplands.

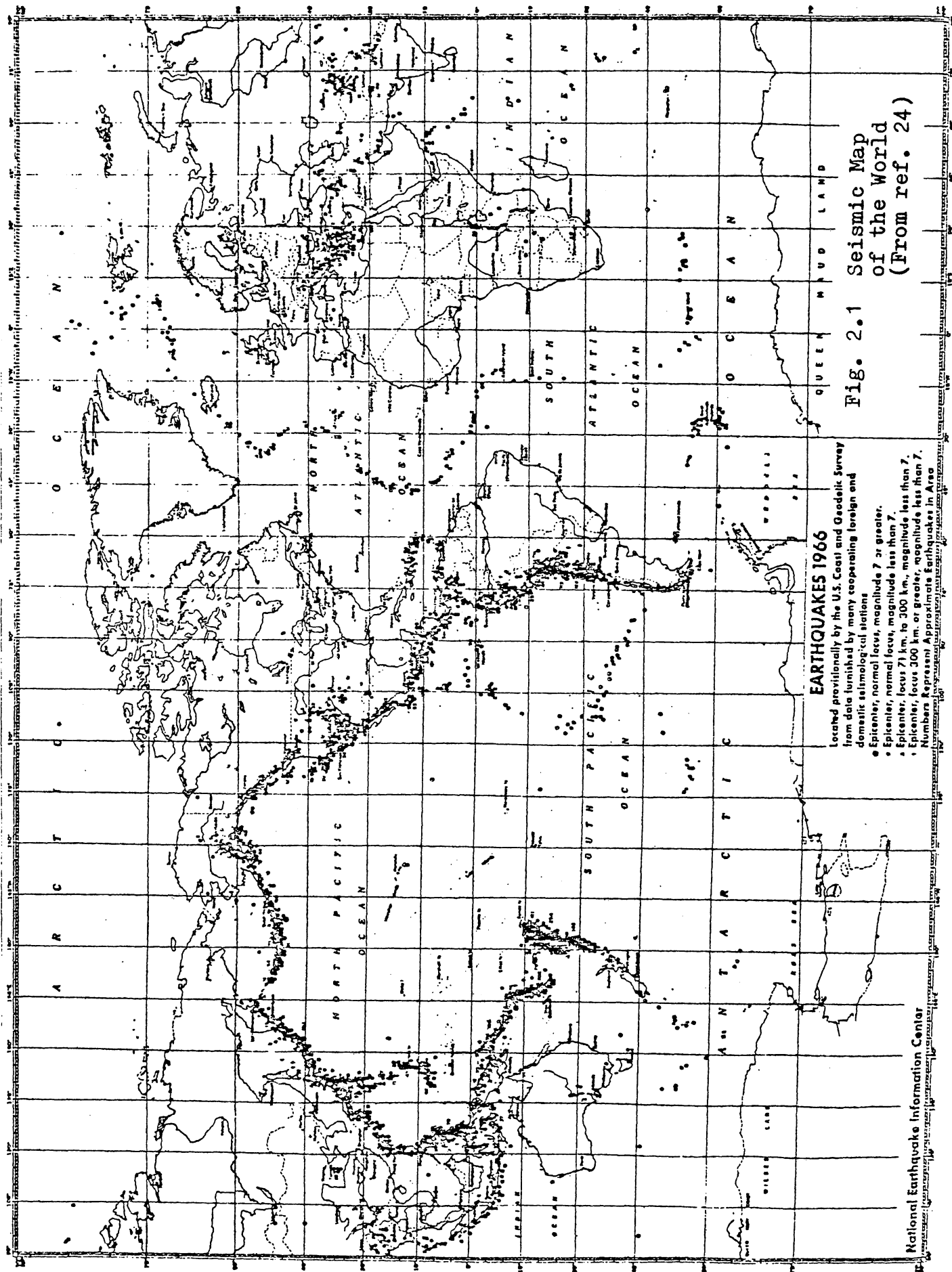

Fig. 2.1 Seismic Map of the World (From ref. 24)

EARTHQUAKES 1966

Located provisionally by the U.S. Coast and Geodetic Survey from data furnished by many cooperating foreign and domestic seismological stations

- Epicenter, normal focus, magnitude 7 or greater.
 - Epicenter, normal focus, magnitude less than 7.
 - Epicenter, focus 71 km. to 300 km., magnitude less than 7.
 - Epicenter, focus 300 km. or greater, magnitude less than 7.
- Numbers Represent Approximate Earthquake in Area

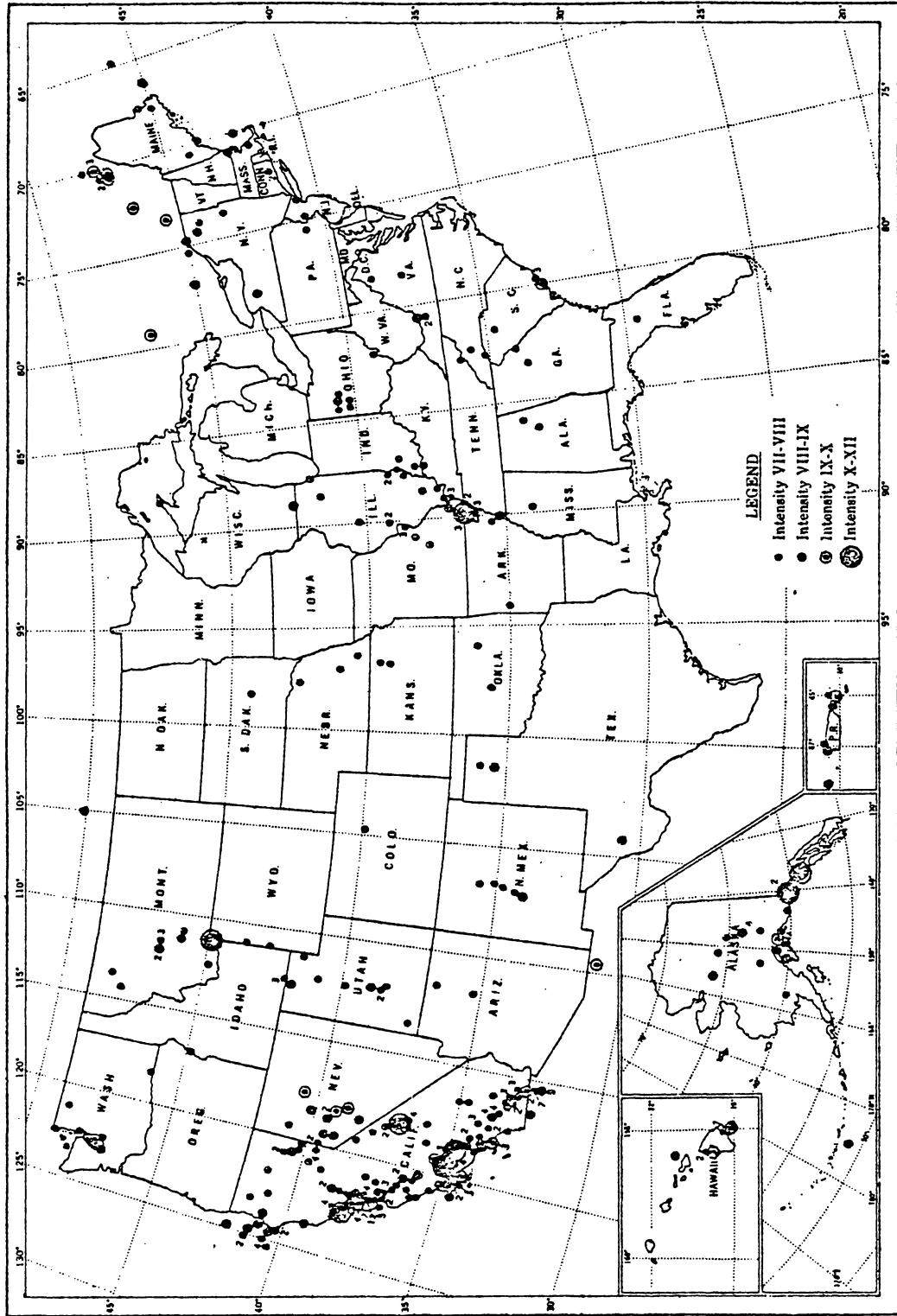

Fig. 2.2 Damaging Earthquakes in the United States (From ref. 25)

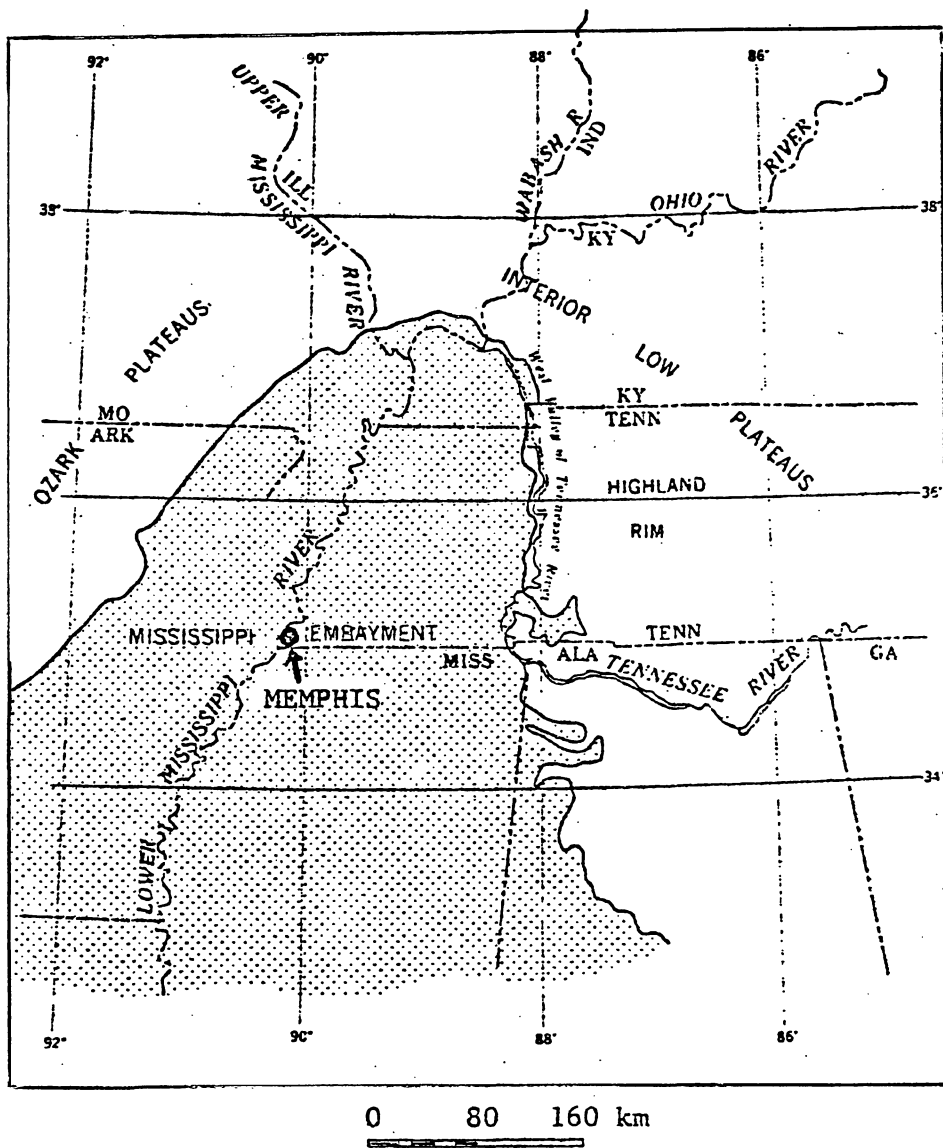

Fig. 2.3 Major Geological Provinces in the Central United States (From ref. 27)

The Mississippi Alluvial Valley consists of a sequence of sediments. The lower layers are generally coarse graveliferous sands, while the upper levels become progressively finer deposits of sands, silts, and clays. Some coarse materials also occur within the upper layers; these sediments are poorly consolidated deposits. Many of them are water-bearing sands and silts, which could be subject to liquefaction in the event of seismic activity. The average thickness of the sediments is 125 feet, except in the entrenched valleys. Geological cross sections of the Mississippi Alluvial Valley, denoted by A-A and B-B in Fig. 2.4, are presented in Fig. 2.5 and 2.6.

The major active faults or fault zones that could affect the Memphis area are shown in Fig. 2.7.

2.2 Earthquake History of the Region

The seismic history of western Tennessee is not well documented. While Indian legends refer to earthquakes, little quantitative evidence is available.

The New Madrid fault has generated earthquakes of extremely large magnitudes. The most recent severe earthquakes in this region occurred during the winter of 1811-12; they are described by Fuller (29). In less than two months, there were three earthquakes believed to be of magnitude 8 or greater. The corresponding maximum intensities would be from X to XII on the Modified Mercalli scale (MM). In addition, there were five earthquakes of magnitude between 7 and 8, and ten of magnitude

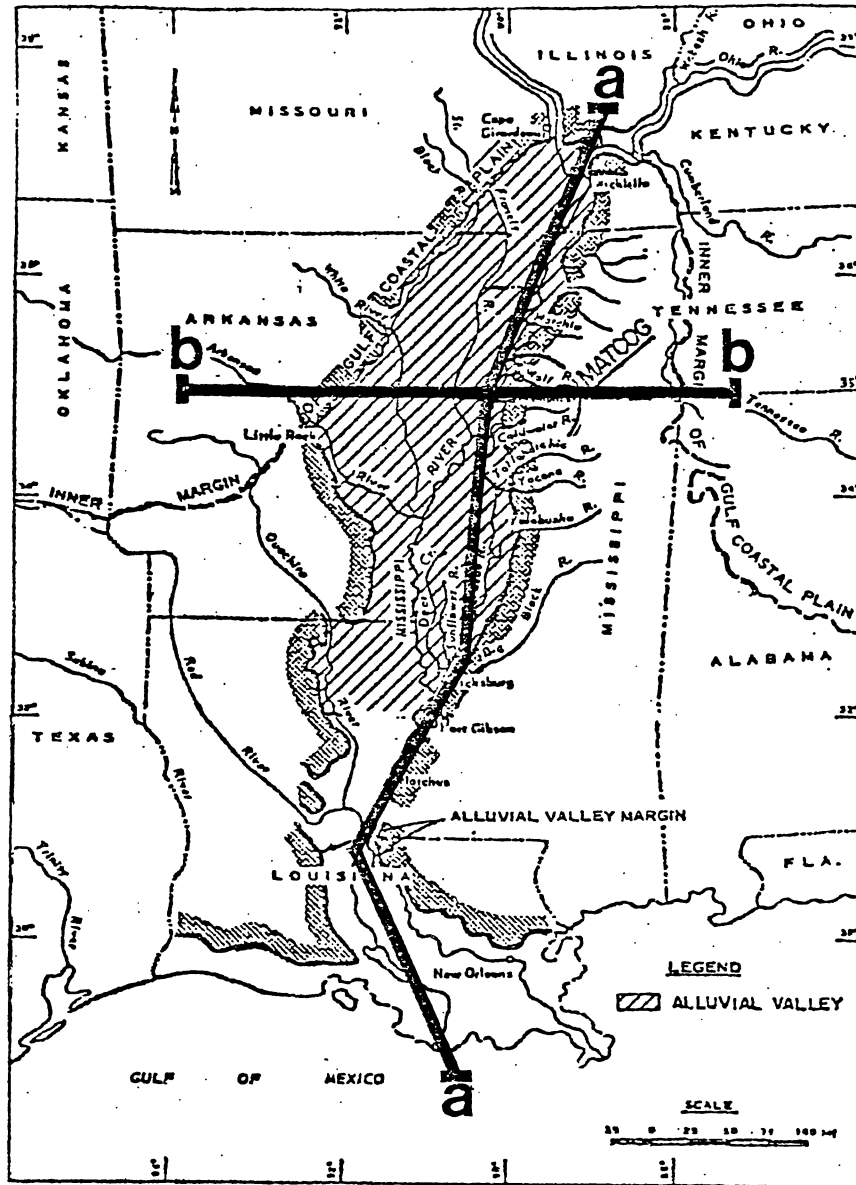

Map of the Lower Mississippi Alluvial Valley and Mississippi Embayment of the Gulf Coastal Plain

Fig. 2.4 Mississippi Aluvial Valley Margins (From ref. 27)

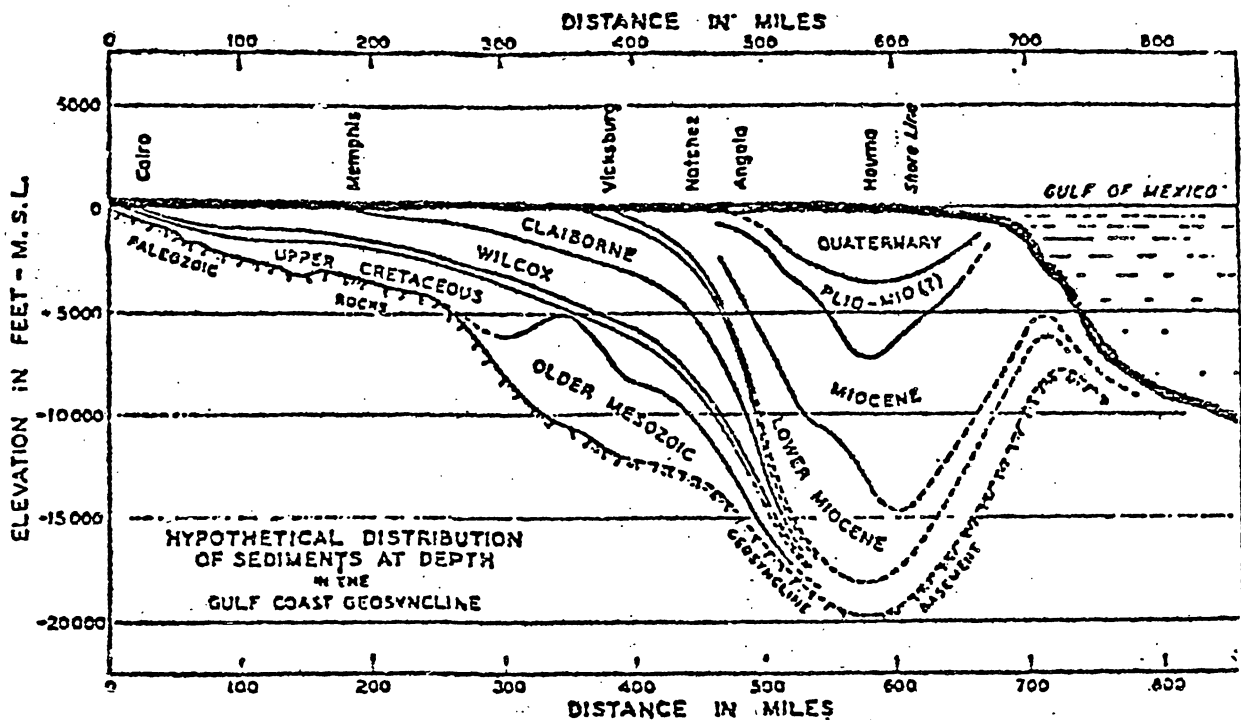

Fig. 2.5 Section A-A through Mississippi Aluvial Valley (From ref. 28)

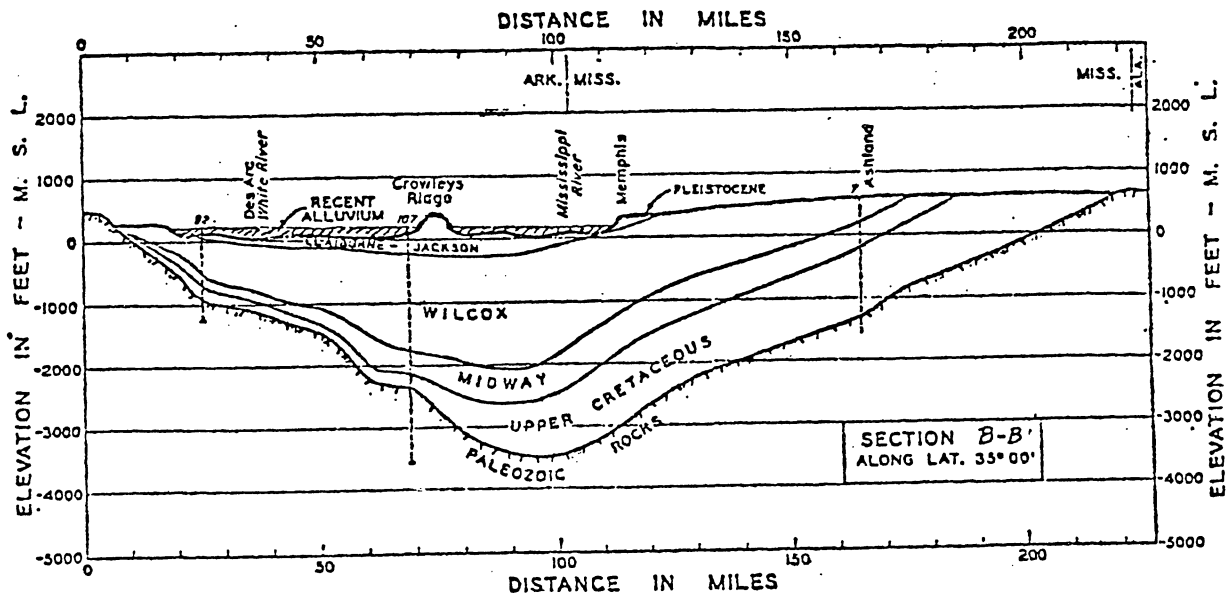

Fig. 2.6 Section B-B through Mississippi Aluvial Valley (From ref. 28)

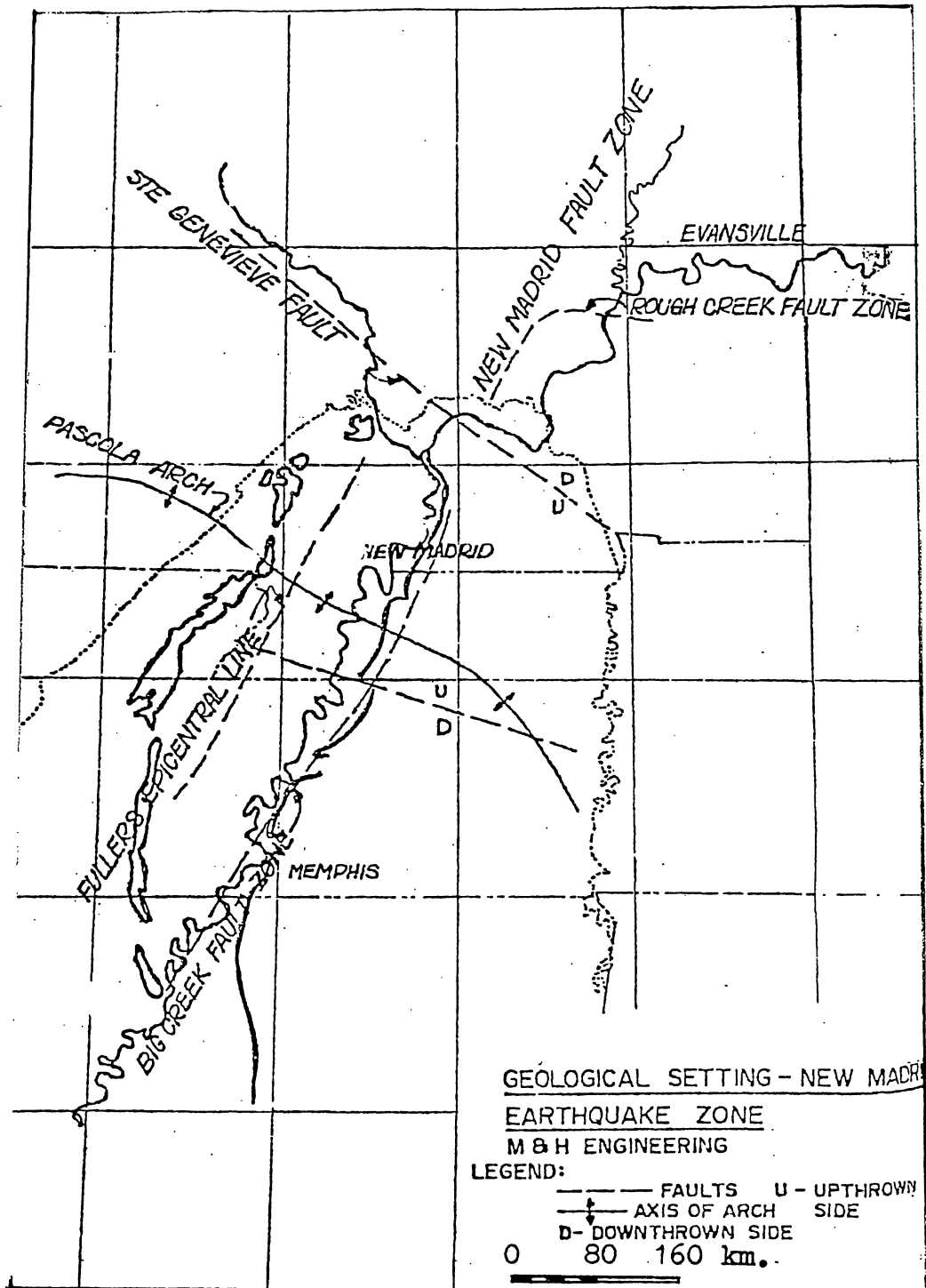

Fig. 2.7 Active Faults in the Vicinity of Memphis (From ref. 27)

between 6 and 7. All 18 earthquakes were strong enough to be felt in Washington, D.C. There were 2000 earthquakes during that winter that were strong enough to be felt in Louisville, Kentucky, approximately 200 miles away from the epicenters. The earthquakes were noticeable over large areas and they effected virtual devastation in an area of 7500 square miles. Significant geologic changes occurred in the Lower Mississippi River Valley as a result of this seismic activity (29), such as uplift and subsidence of the surficial soil layers, opening of fissures, eruptions of water and sand, and landslides. Fortunately, the area that was most severely affected was sparsely populated at that time. The two existing towns in the epicentral area, New Madrid and Little Prairie, were both destroyed. Damage was reported to structures including masonry houses and chimneys in St. Louis, Mo.

For the magnitude estimates of the 1811-12 earthquakes, Richter (30) concluded that each of the three major earthquakes of the 1811-12 sequence had a magnitude of the surface-wave, M_s , exceeding 8. This evaluation was based upon the effects of the seismic activity on the landscape and on the large damage area. Nuttli (31) attempted to give more precise estimates of magnitude, using isoseismal maps and scaling up from the 1968 Illinois earthquake, for which both an isoseismal map and ground-motion data were available. He obtained the following magnitudes of the body wave, M_b : 7.2 for the December 16, 1811 earthquake; 7.1 for the January 23, 1812 earthquake; and 7.4 for the February 7, 1812. The value for the February 7 earthquake was later revised to 7.3,

the value that is believed to be the largest M_b for earthquakes anywhere in the world. Nuttli (31) used an empirical relation between M_b and M_s , suggested by Gutenberg-Richter (32), to estimate M_s values for the 1811-12 earthquakes. In this way the magnitudes of the surface waves for the three major earthquakes were estimated to be 7.5, 7.2, and 7.6 respectively. However, further study by Nuttli, referred to in (22), showed that the empirical Gutenberg-Richter relation did not apply when M_b values were obtained from 1 Hz P-wave amplitude values. In a new work dealing with the relation between M_b and M_s and the scaling of seismic spectra (1981), Nuttli estimated the surface wave magnitudes of the three 1811-1812 earthquakes to be 8.6, 8.4, and 8.7 (33). The last value is the greatest surface-wave magnitude for earthquakes anywhere in the world.

A list of earthquakes in Tennessee and the surrounding areas was compiled by Templeton and Spencer (34). A histogram of recorded earthquakes per year is shown in Fig. 2.8. The apparently increasing frequency of occurrence in the recent years is due to the use of more advanced recording methods. It is logical to assume that, prior to these machines being available, weak or moderate seismic activity would have been undetected and unreported. By trenching in soil layers in Western Tennessee, David Russ of the U.S. Geological Survey in Denver has shown that three major earthquakes occurred prior to 1811 (33).

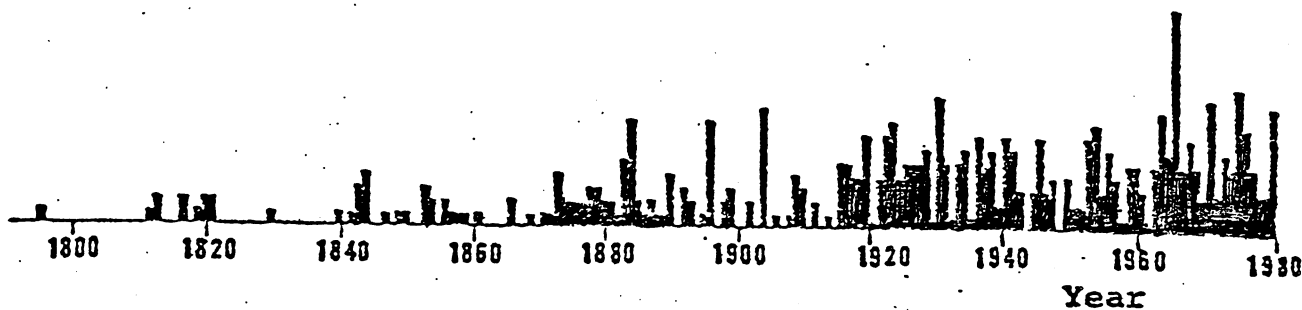

Fig. 2.8 Histogram of Earthquakes in Western Tennessee (From ref. 34)

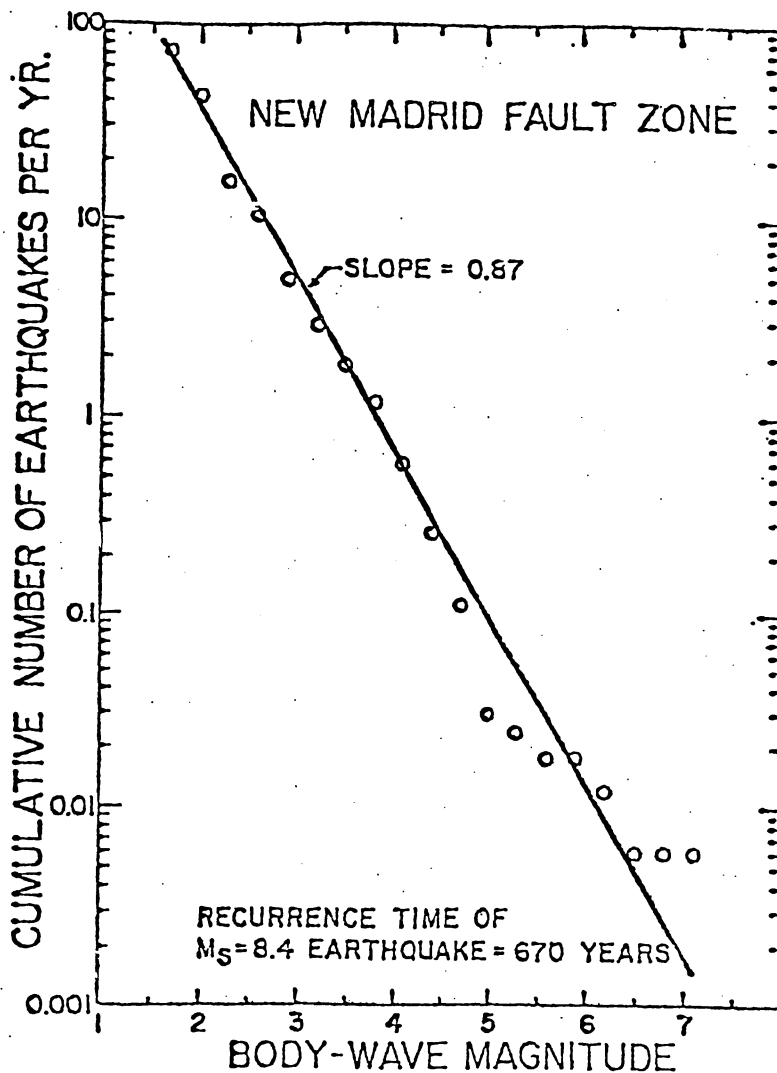

Fig. 2.9 Annual Frequency of Earthquake vs M_b (From ref. 33)

On the basis of the available information Nuttli, (33), attempted to model the frequency of occurrence of various magnitude earthquakes; see Fig. 2.9. He evaluated the probabilities as follows: 25% for recurrence of the 1811/12 earthquakes before year 2000 and 63% for an earthquake with magnitude 6.5. Earthquakes that were less severe than this, but which were damaging, occurred at the southern end of the New Madrid fault in 1843, and at the northern end of the fault in 1895.

The distribution of intensity for earthquakes originating in the New Madrid area was also studied by Nuttli (33). Figure 2.10 shows the MM intensity distribution for the December 16, 1811 earthquake, epicentral intensity XI. Figures 2.11, 2.12, and 2.13 show the distributions of VII to X MM isoseisms for major earthquakes at the southwestern end, the central region, and the northeastern end of the New Madrid fault, respectively. Within the zone of intensity X, most buildings would be destroyed. In the area of intensity VIII and IX, one would expect many collapsed or badly damaged buildings, particularly those of unreinforced masonry. In the broad area of intensity VII, chimney damage and cracked walls could be anticipated. The city of Memphis is located in the zone corresponding to intensity VIII or IX.

Earthquakes in the central United States differ from those on the West Coast in three main aspects: occurrence rate, attenuation of the ground acceleration, and extent of the damage zones.

The frequency of occurrence is lower for the Eastern US. The earthquakes also differ in the manner in which the seismic energy

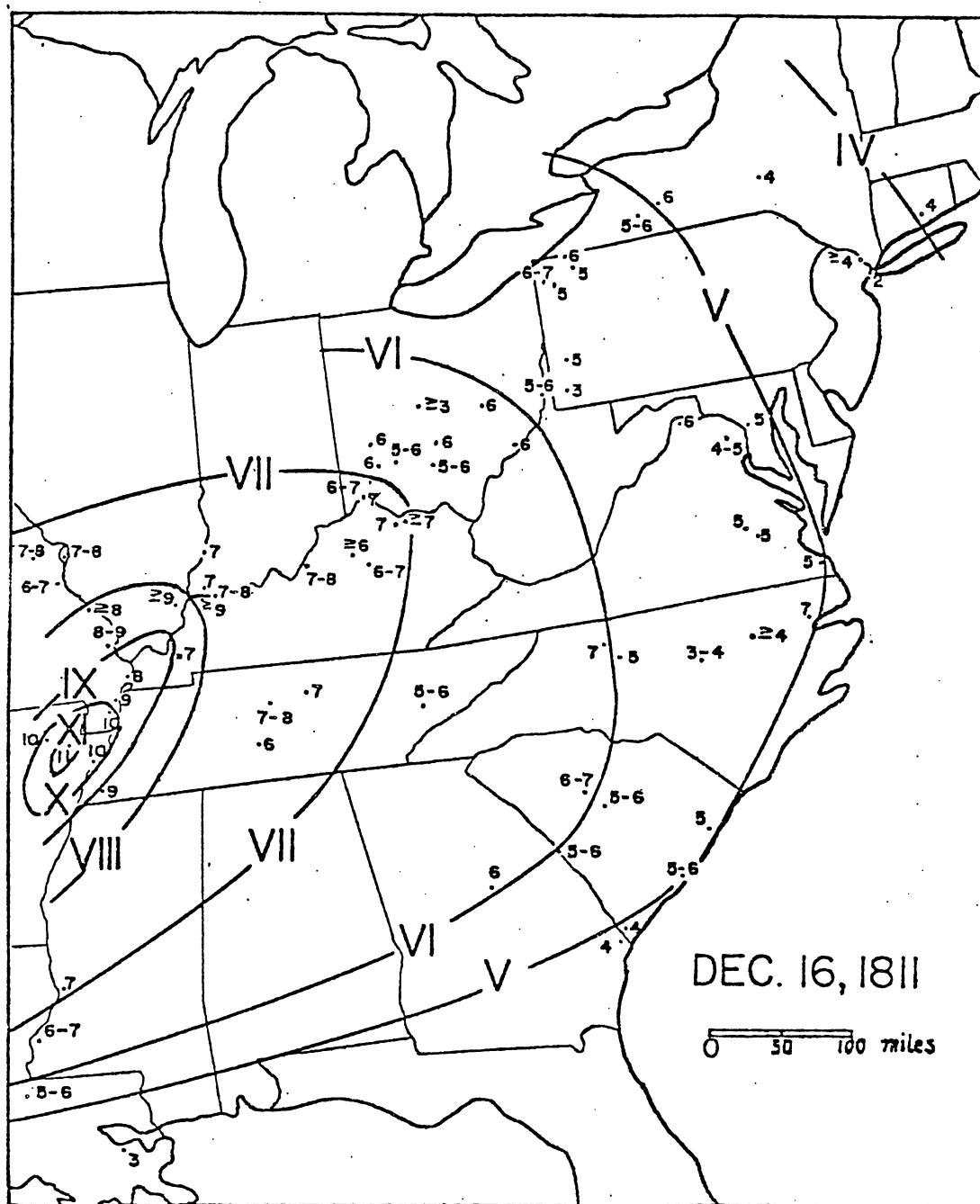

Fig. 2.10 Isoseisms For December 16, 1811 Earthquake
(From ref. 33)

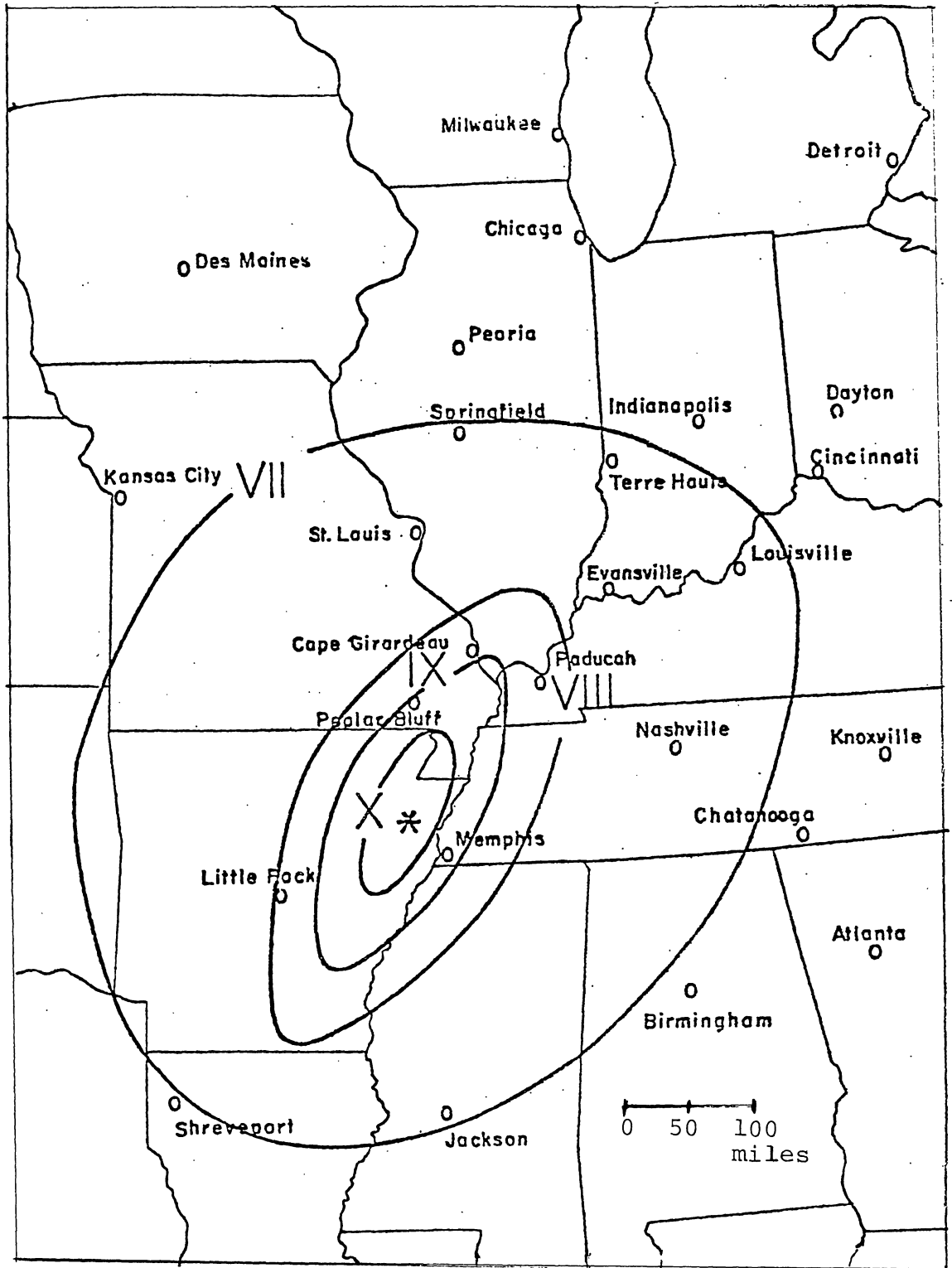

Fig. 2.11 Isoseisms for a Major Earthquake in the Southwestern End of the New Madrid Fault (From ref. 33)

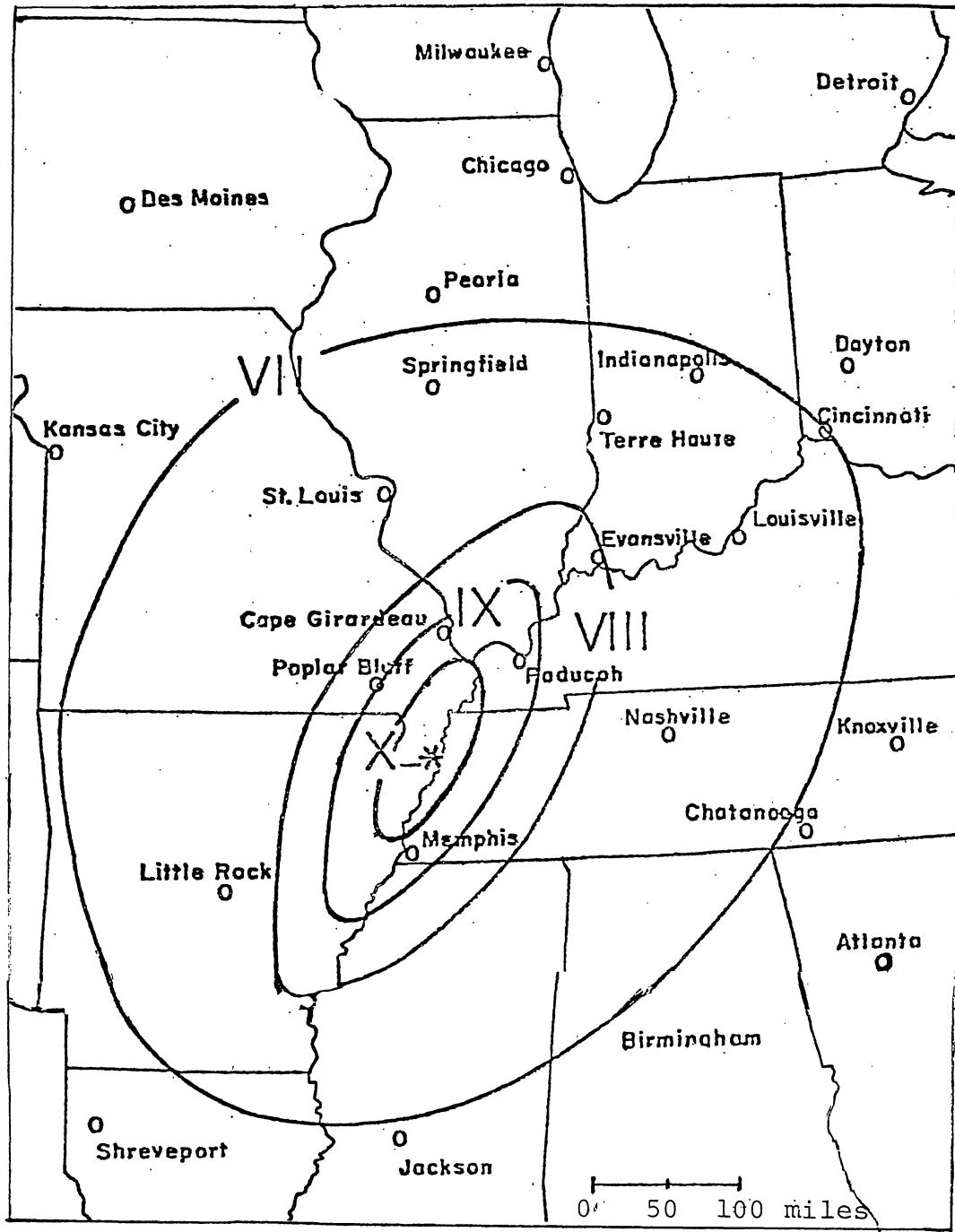

Fig. 2.12 Isoseisms for a Major Earthquake in the Central part of the New Madrid Fault (From ref. 33)

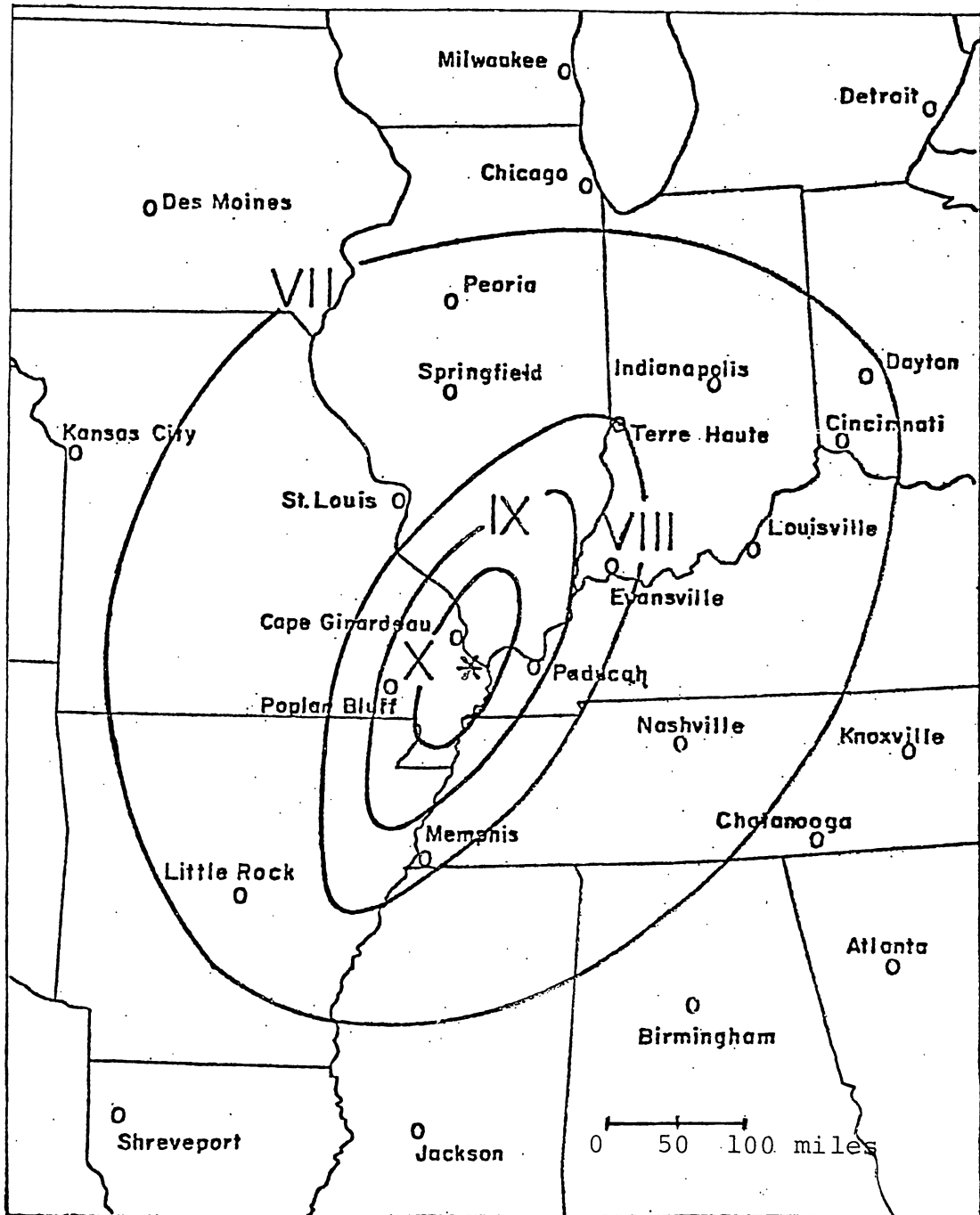

Fig. 2.13 Isoseisms for a Major Earthquake in the Northeastern End of the New Madrid Fault (From ref. 33)

attenuates. Figure 2.14 compares the attenuation of the ground acceleration for 5-Hz waves in California and in the central United States. At approximately 125 miles (200 km) from the epicenter, the central U.S. attenuation of acceleration is about 1/10th as great as for California. At 220 miles (350 km), there is a difference of two orders of magnitude. Similar curves for 1-Hz waves are shown in Figure 2.15. Waves of this frequency tend to be most damaging to very long or high-rise structures (ten stories or more).

The potential extent of the damage is larger for the East. Figure 2.16 shows quite clearly differences in the sizes of disaster areas. The area of structural damage for the New Madrid earthquake of 1811 is approximately five times larger than that for the San Francisco earthquake of 1906. For architectural damage, which can be expensive to repair and can result in injury or loss of life, the difference in areas is approximately 25 times.

Clearly, the New Madrid fault zone is an earthquake source region that is capable of producing major earthquakes, which could cause extensive damage throughout much of the central United States. The next such earthquake could be a major disaster. Fortunately, the return period for an earthquake of that severity is relatively long. The probability of its occurrence in the lifetime of a building, however, is not negligible.

2.3 Local Surficial Geology

Because of the location of possible future earthquake epicenters near Memphis, the nature of the surficial soils up to

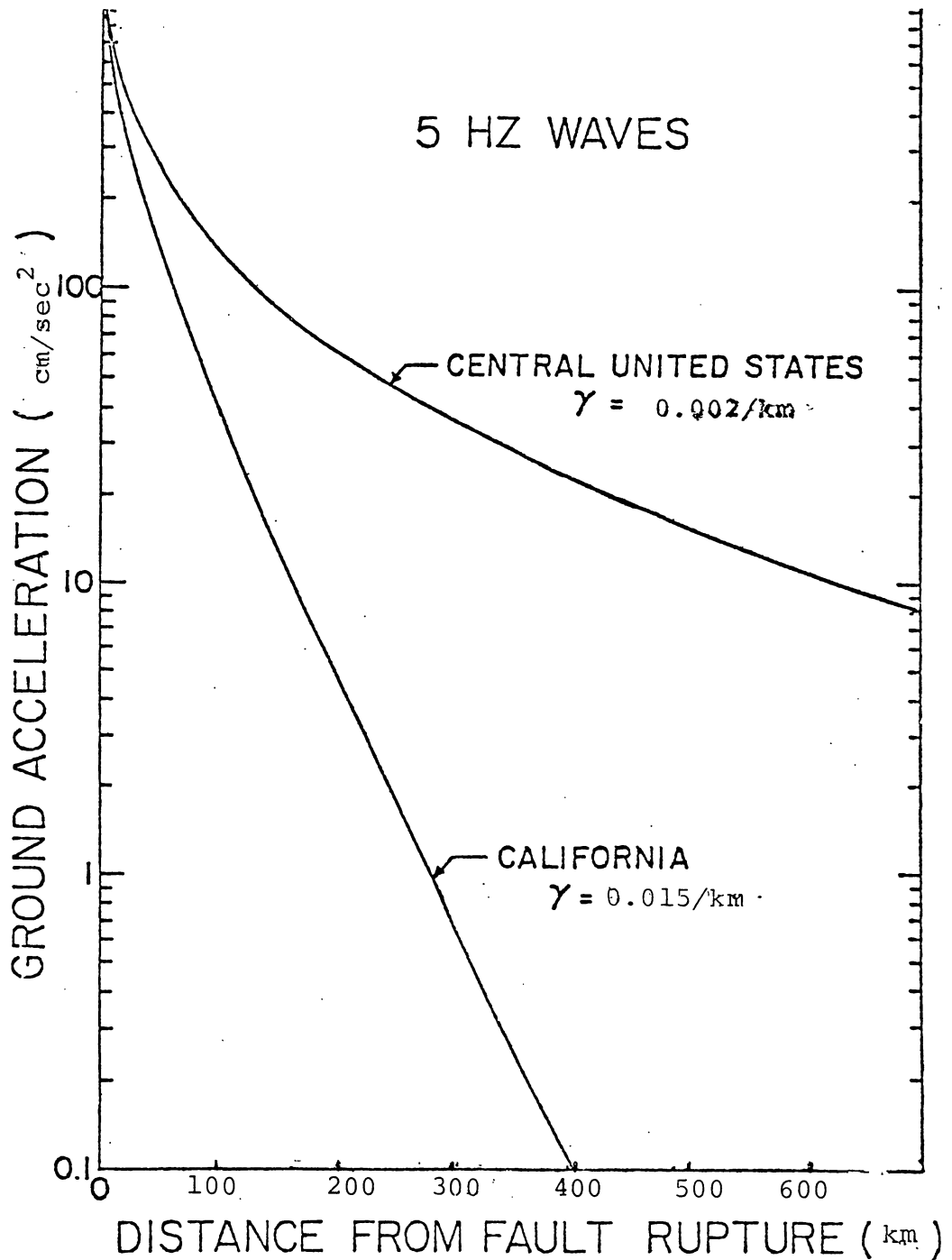

Fig. 2.14 Ground Acceleration vs Distance from Fault Rupture for California and the Central US, 5-Hz Wave (From ref. 33)

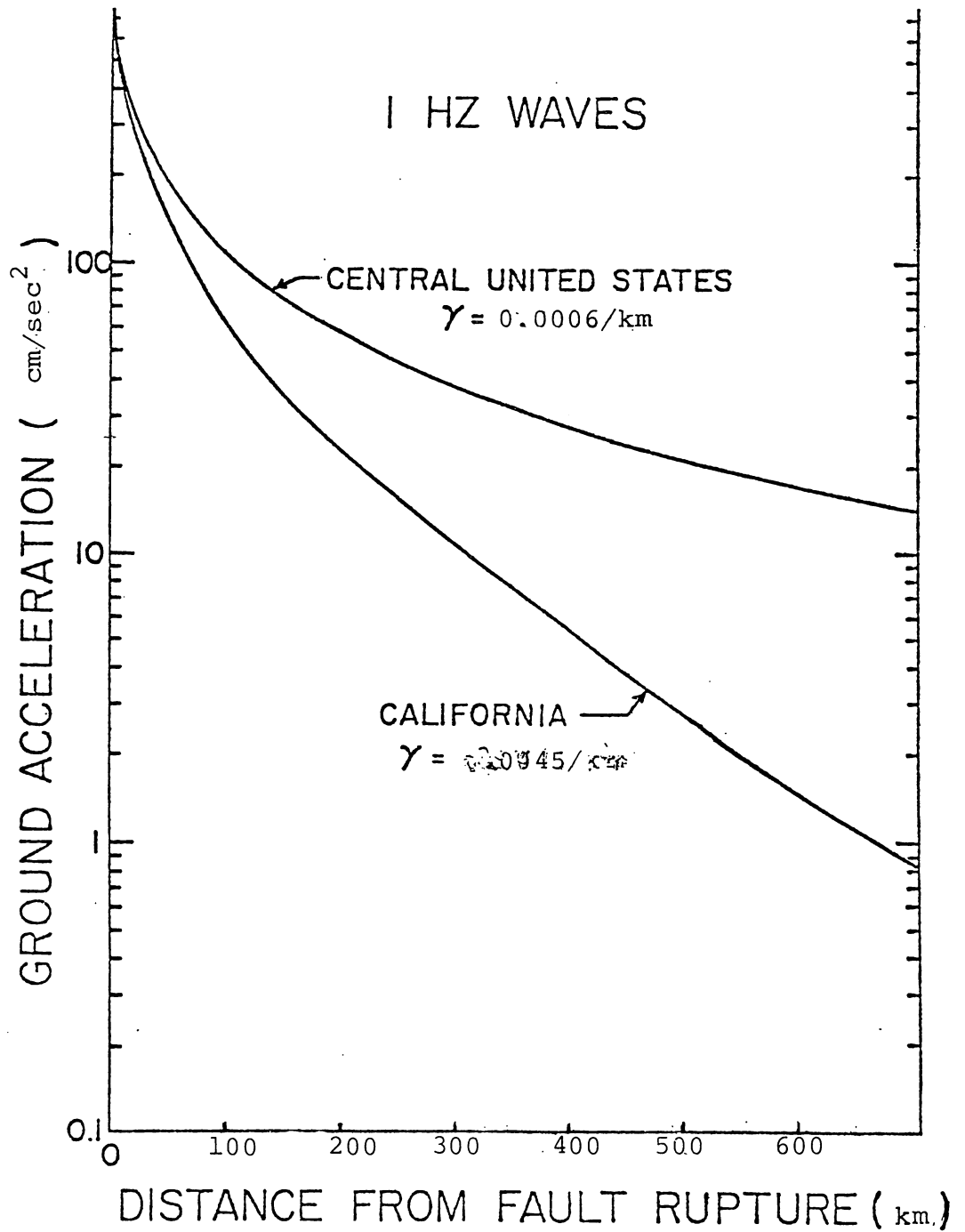

Fig. 2.15 Ground Acceleration vs. Distance from Fault Rupture for California and the Central US, 1-Hz Wave (From ref. 33)

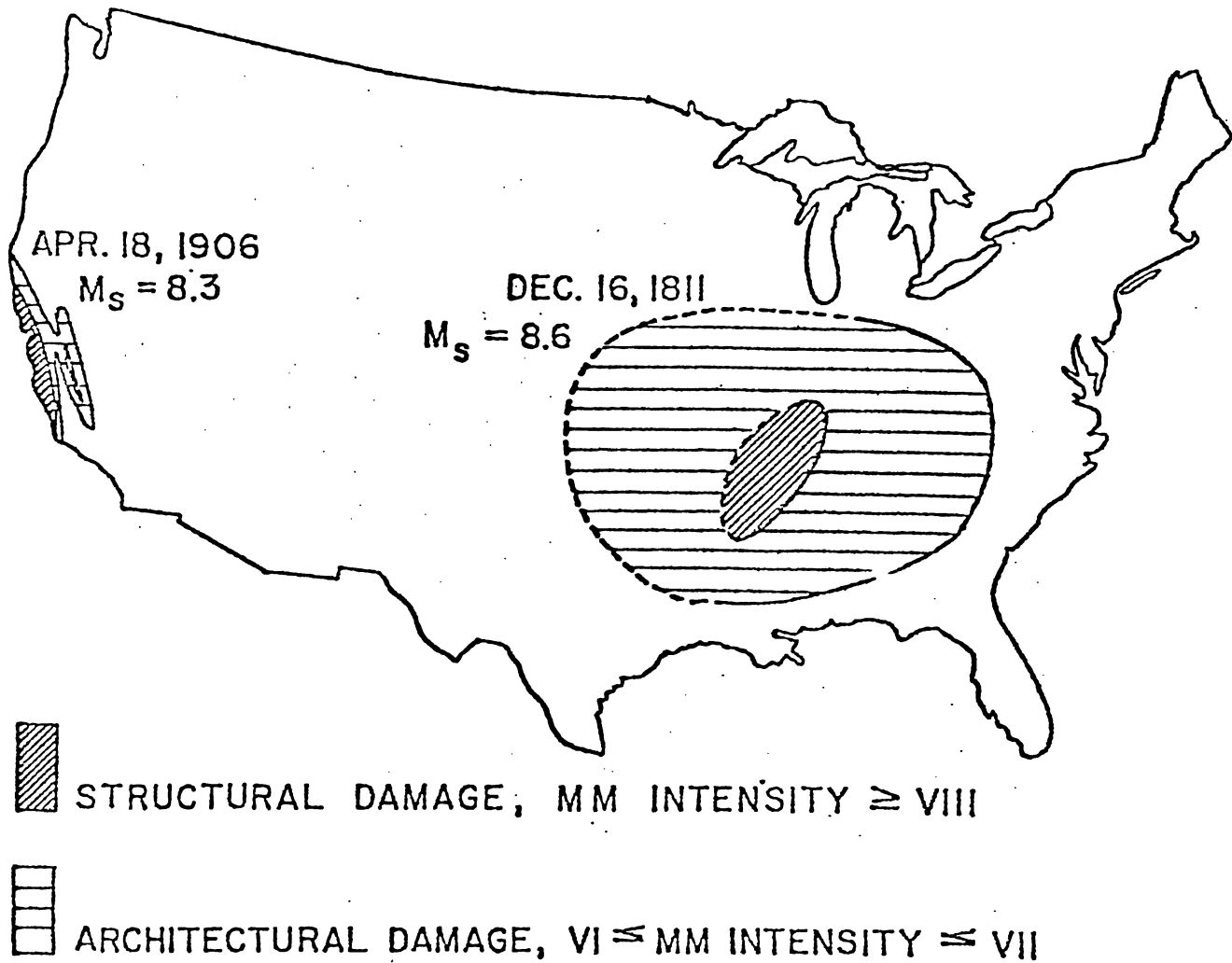

Fig. 2.16 Size of Disaster Area in the West and Central US, (From ref. 33)

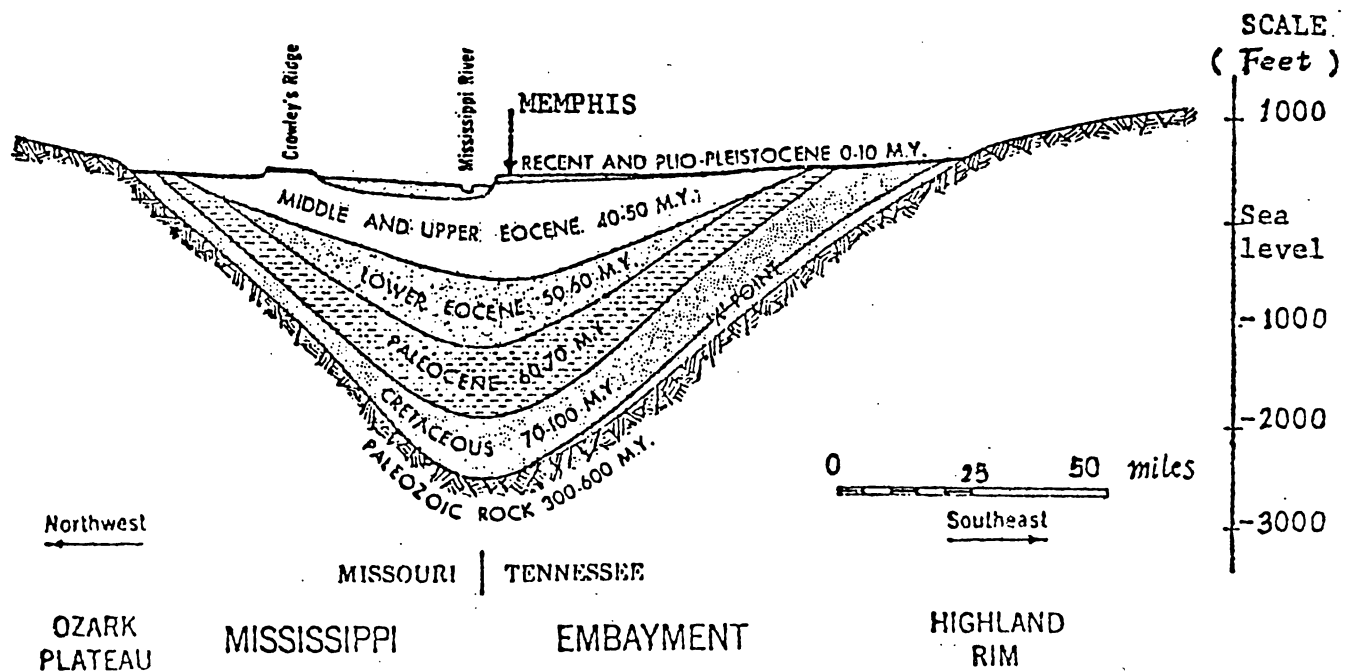

Fig. 2.17 Cross - Section of the Mississippi Embayment (From ref. 26)

160 ft (50 m) depth, is of concern. Fig. 2.17 shows a general description of the strata in the Mississippi Embayment Syncline. Since the nature of surficial soils has a direct effect on the results of any type of response analysis, it is desirable to gain more specific information regarding the soils in the area.

The uppermost layer of soil in the Memphis area generally consists of clayey silt. This stratum is usually 20 ft (6 m) to 35 ft (10 m) thick. It is anticipated that the redeposited, saturated silt would be susceptible to liquefaction under prolonged vibration, such as that caused by seismic activity. The material is therefore undesirable for foundations. Under the clayey silt level are strata of sand and gravel and hard clay.

Fill material may be encountered in the Memphis area. In general, the older fills close to the river are uncontrolled random rubble fills; newer ones are more controlled. It is likely that the majority of fills have been placed on relatively soft alluvial soils. As a result, if the lower sand is not fully confined, liquefaction may occur as a result of moderate seismic activity.

Table 2.1, from (22), lists the various soils which may be found in the Memphis area.

2.4 Microzonation of Memphis Area

Microzonation of the city of Memphis has been attempted by Sharma and Kovacs (35). The study was based on available information; no new field tests were carried out. Three design earthquakes were considered with response spectra shown in

Table 2.1 Soil Deposits in Memphis Area
(From ref. 22)

Series	Subdivision	Range in Thickness - Feet	Description
Recent	Redeposited Loess	0 - 35	Generally water-logged silts or silty clays with a 2-5 ft. crust in dry weather.
	Alluvial sands and gravels	0 - 20	Gray, fine to medium sands with occasional gravel, low to medium relative density.
Pleistocene	Loess	0 - 50	Wind-deposited clayey silts and silty clays.
	Sandy clay	0 - 10	Very stiff silty clay, possibly old erosional surface.
	Terrace sand and gravels	0 - 200*	Fluviatile medium grained sands and gravels, very dense, generally brown or red, frequently iron-oxide-cemented.
Eocene	Jackson (?)	0 - 500	Hard, fat clays interbedded toward east and south with fine, very dense white sands.

*Pockets 100 to 200 feet deep have been found in 4 or 5 places. Generally, thicknesses are 0 - 40 feet.

Fig. 2.18 to 2.20. The maximum intensities are IX, VIII-IX and VII-VIII.

The anticipated ground motion amplifications for the three design accelerograms are shown in Fig. 2.21 to 2.23.

Some of the higher amplifications were determined for the zones close to the Mississippi and Wolf rivers. These regions include the "softer" soil profiles consisting of deposited materials which are of a loose nature. The amplification appears to diminish in the southeastern direction. This is to be anticipated, since the water table is lower and the soils denser away from the rivers.

Structural damage may be expected due to soil liquefaction. A map of potential liquefaction zones is shown in Fig. 2.24 (35).

The microzonation of Memphis suggested in ref. 35 involves a considerable degree of uncertainty. This is caused by the very limited nature of the data that is available regarding the soil conditions in the area, in addition to the fact that no strong motion earthquake records exist for this region.

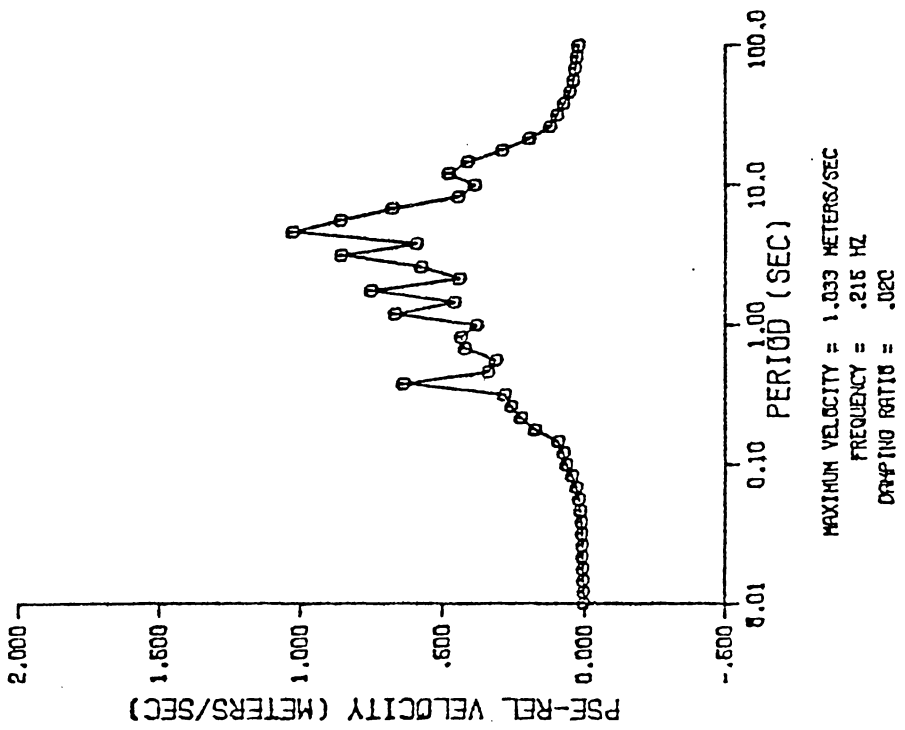
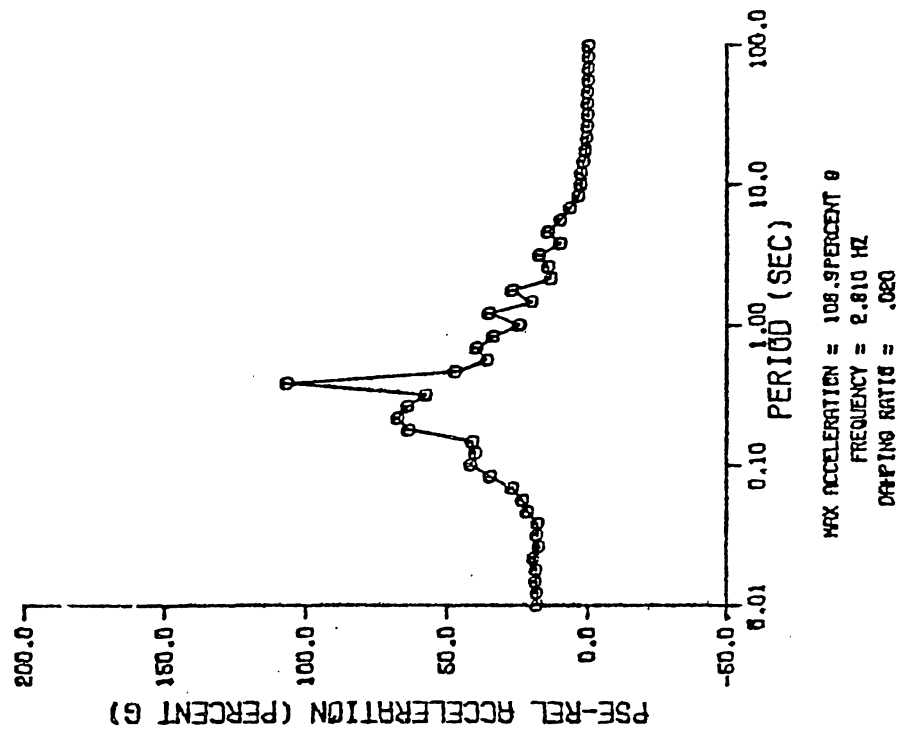

Fig. 2.1.8 Response Spectra for Design Earthquake I,
(From ref. 35)

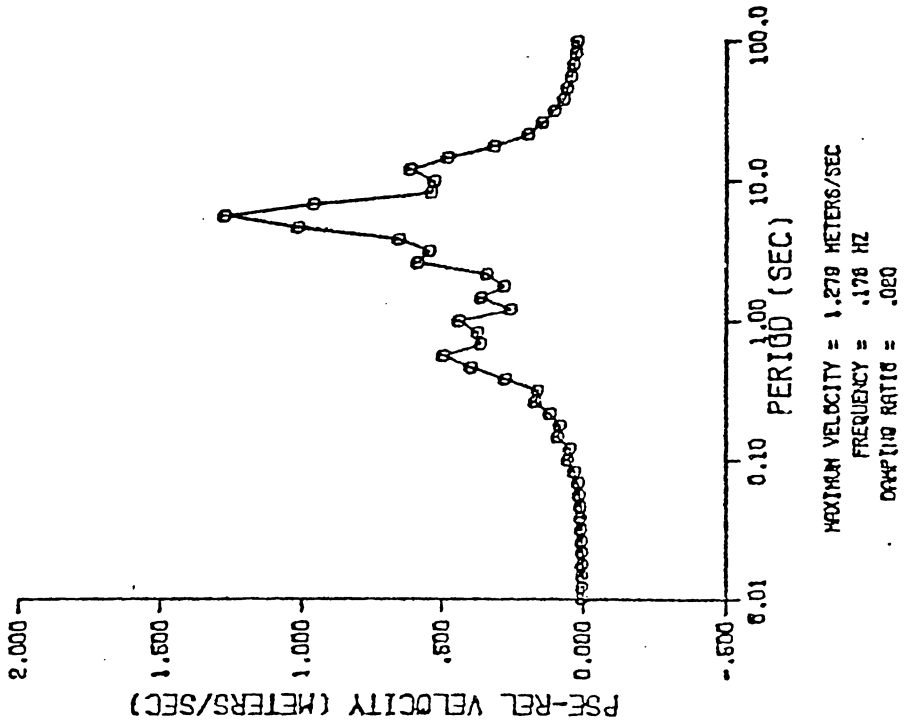
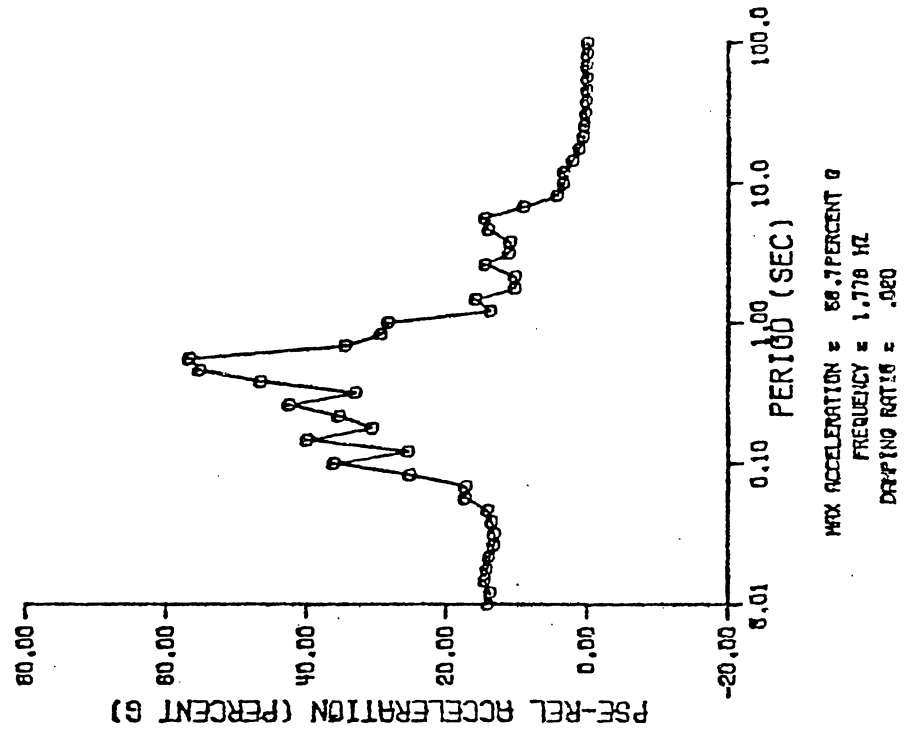

Fig 2.19 Response Spectra for Design Earthquake II,
(From ref. 35)

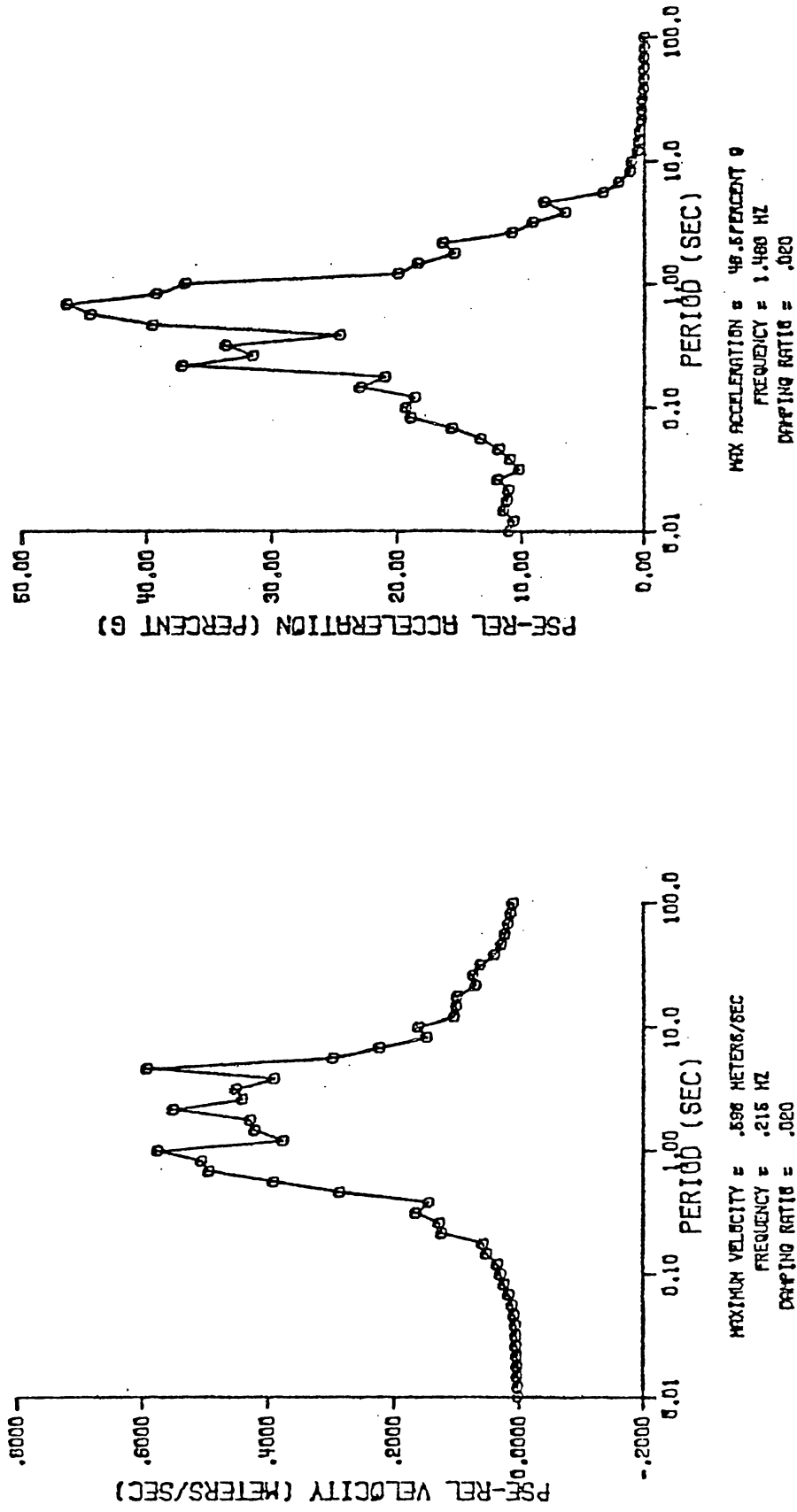
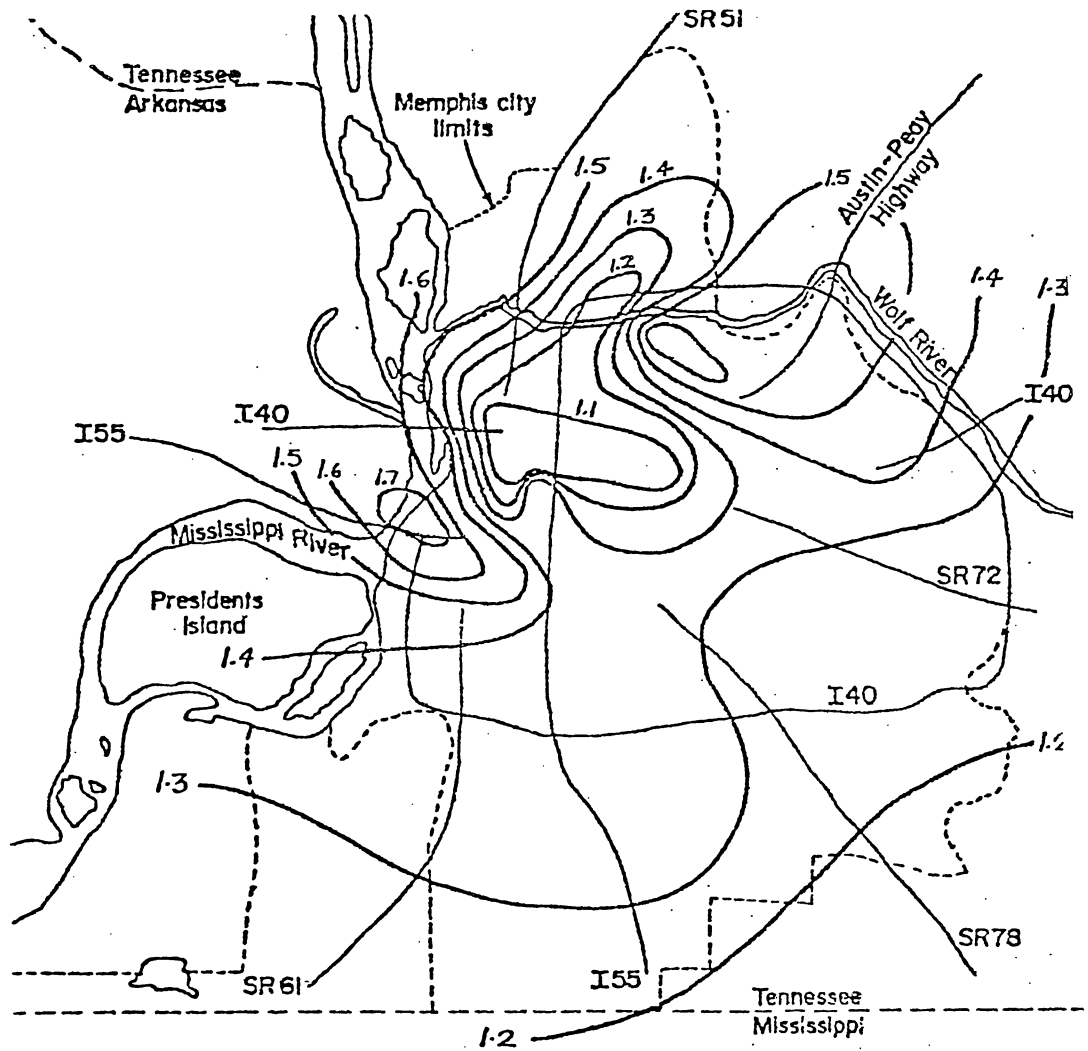
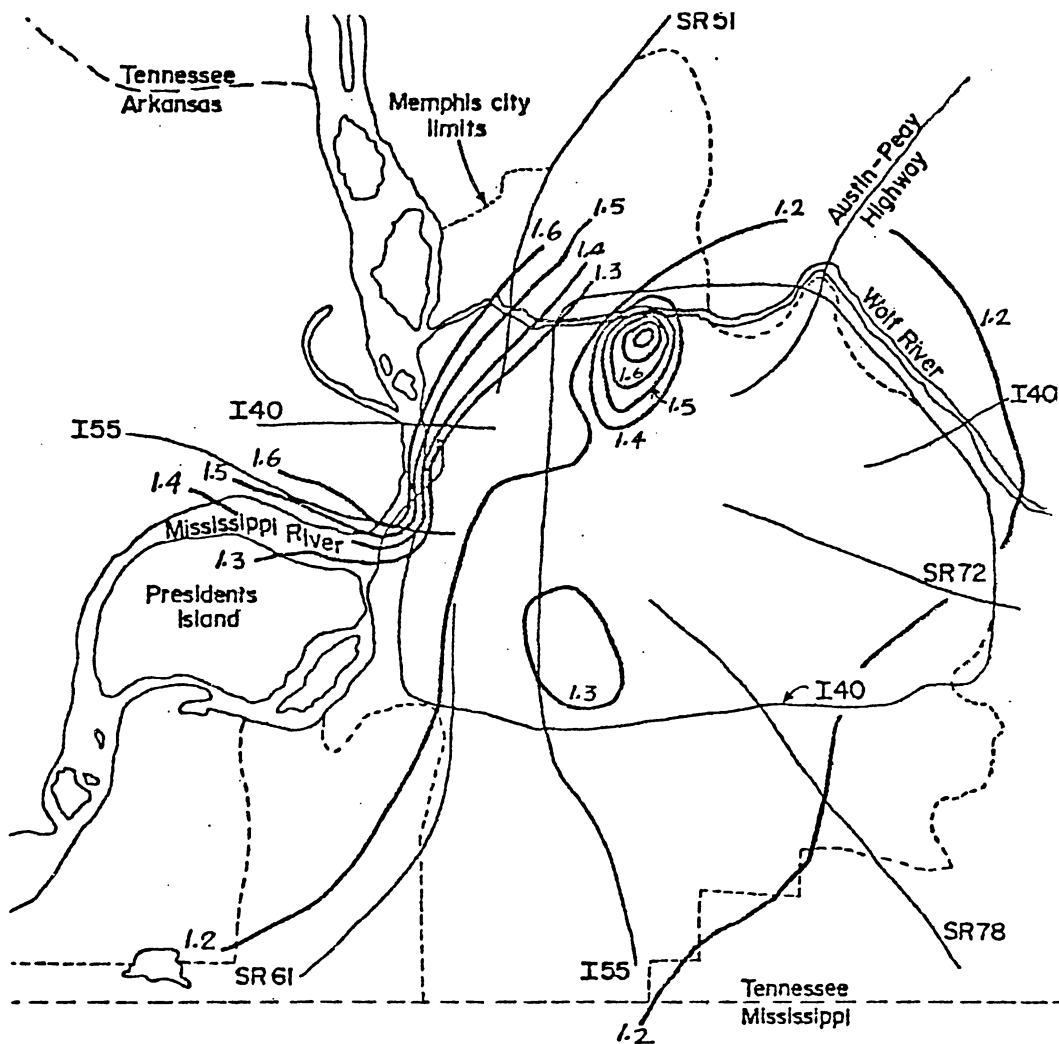

Fig. 2.20 Response Spectra for Design Earthquake III,
(From ref. 35)



Contours indicate amplification factors for the assigned "bedrock" motion of 18% g.

Fig. 2.21 Ground Acceleration Amplifications due to Earthquake I, (From ref. 35)



Contours indicate amplification factors for the assigned "bedrock" motion of 14% g.

Fig. 2.22 Ground Acceleration Amplifications due to Earthquake II,
(From ref. 35)

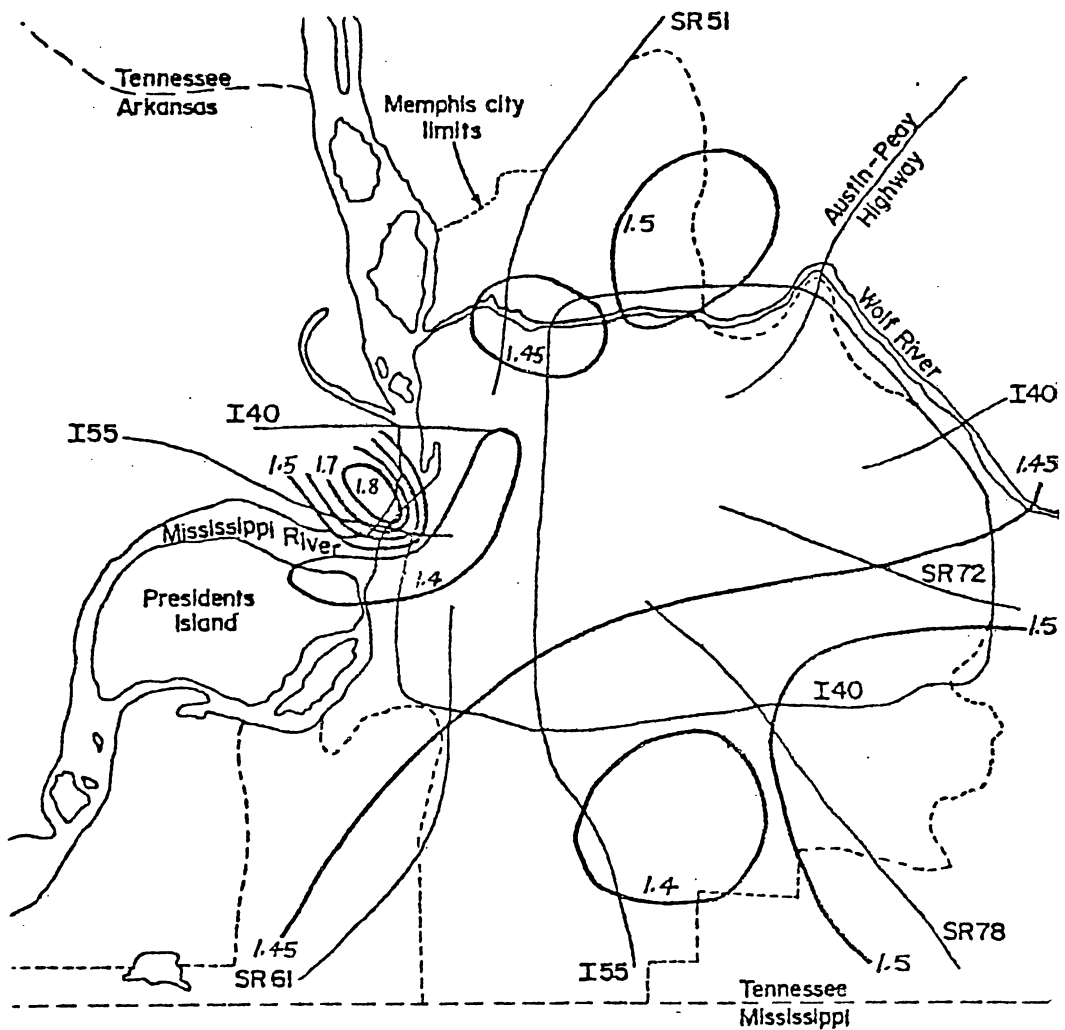

Contours indicate amplification factors for the assigned "bedrock" motion of 11% g.

Fig. 2.23 Ground Acceleration Amplifications due to Earthquake III, (From ref. 35)

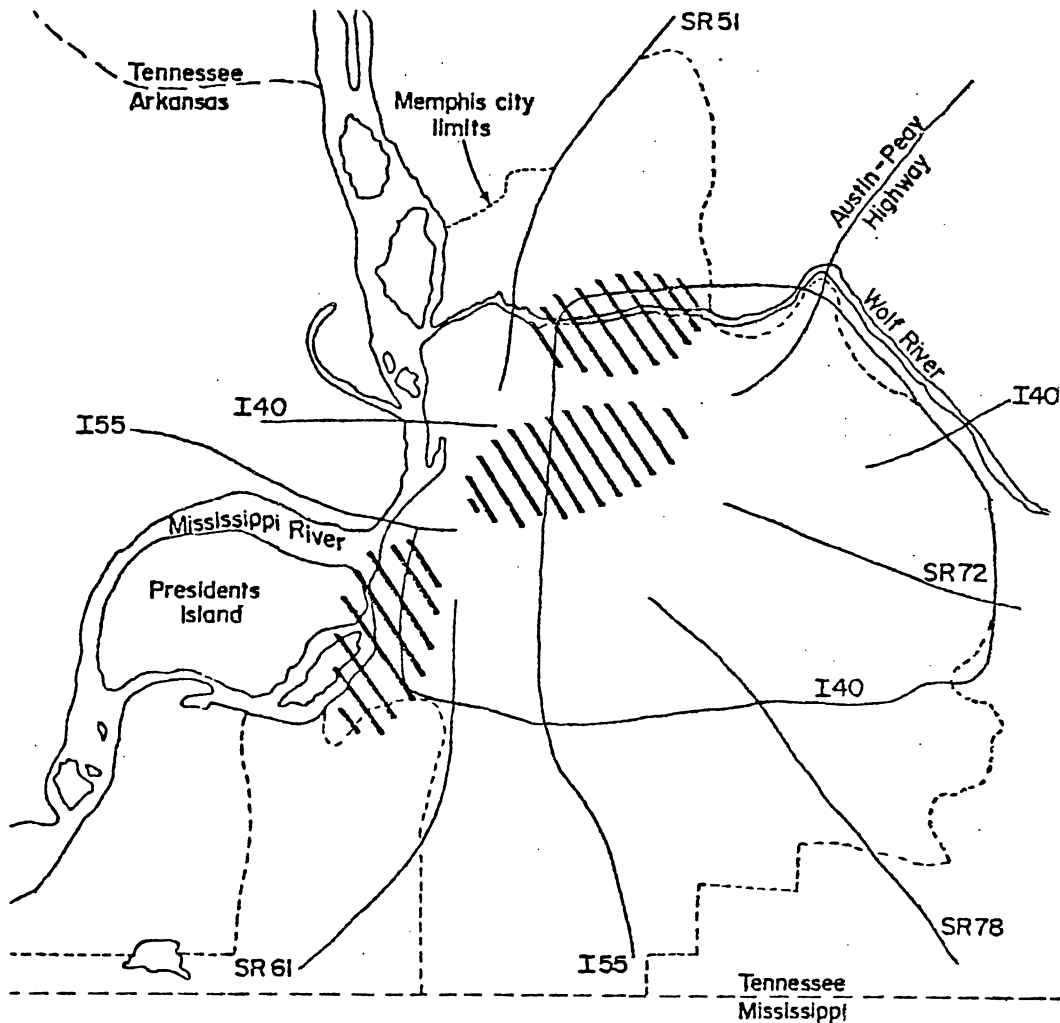

Shaded areas indicate zones where soils may be susceptible to liquefaction for earthquakes with Modified Mercalli Intensity greater than VII.

Fig. 2.24 Liquefaction Potential Microzonation Map
(From ref. 35)

3. URBAN DEVELOPMENT OF THE REGION

Memphis was established in 1819, about 8 years after the earthquakes of 1811/12. From its earliest days, the city was a trading center (river town) and a stopping point for westward travellers. The city grew from about 600 persons in 1830 to 23,000 in 1860. Its location on the Mississippi helped to make Memphis an important agricultural center and a focal point for the cotton industry. The city is also the hardwood lumber capital of the world. The present population is about 700,000.

The oldest settlements were located on the high Chickasaw bluff of the Mississippi River. The present shape and size of the city is influenced by natural limits. On the West, there is the Mississippi River, on the North are the Wolf and Loosahatchie Rivers, and on the South is the state line. Therefore, the city expands mostly in the Easterly direction. The historical and present city limits are shown in Fig. 3.1.

Three aspects of urban development are considered: population, building activity, and commercial subdivision and rezoning. The data is based on information available at the Memphis and Shelby County Office of Planning and Development. The City and County are divided into 20 planning districts, which are grouped into the core area and three concentric rings that reflect three different stages in the development of the urban area, as shown in Fig. 3.2.

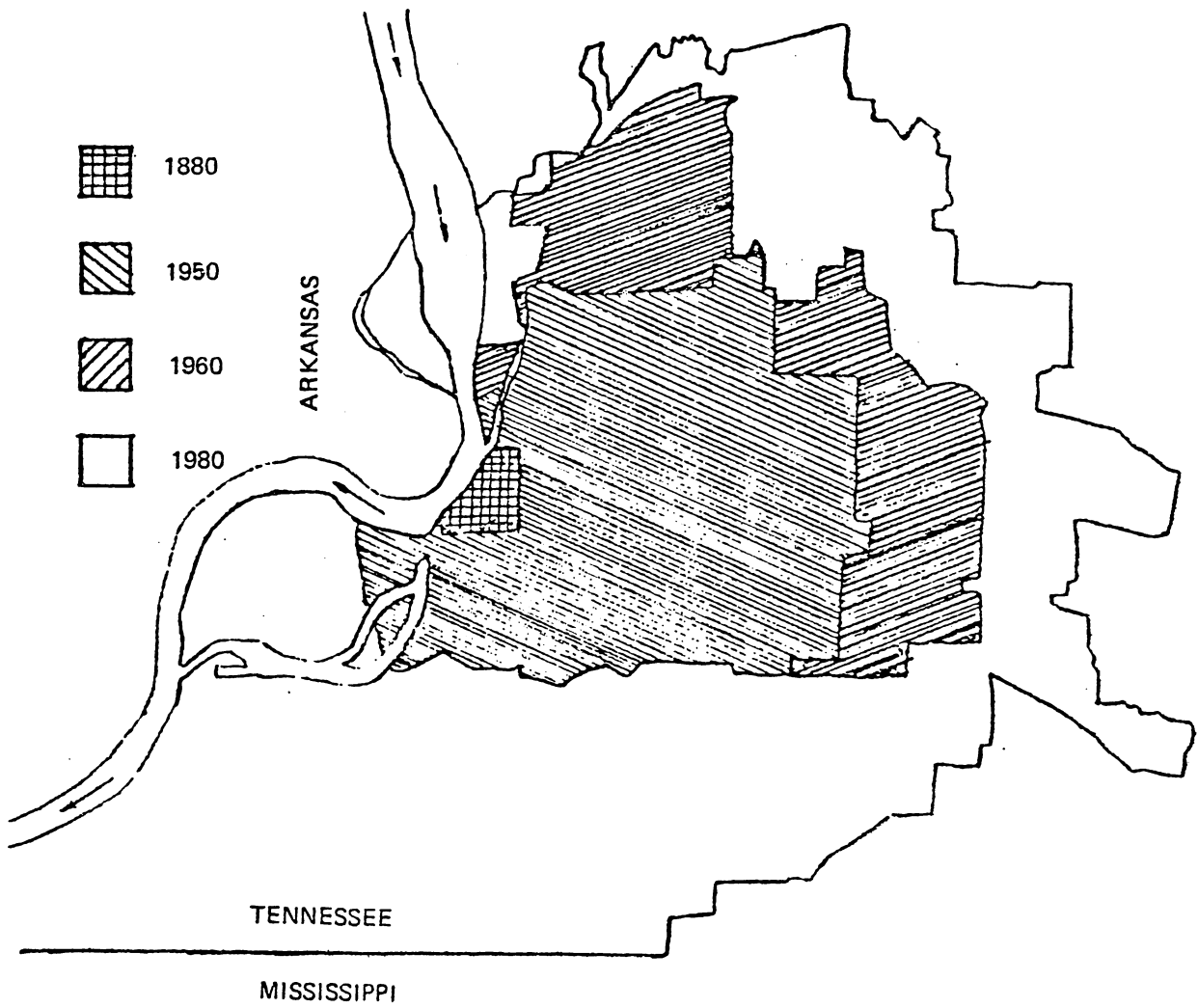

Fig. 3.1 Historical Development of Memphis

- ////// Memphis city
- Core area
- Inner ring
- .-.-.- Middle ring
- Outer ring

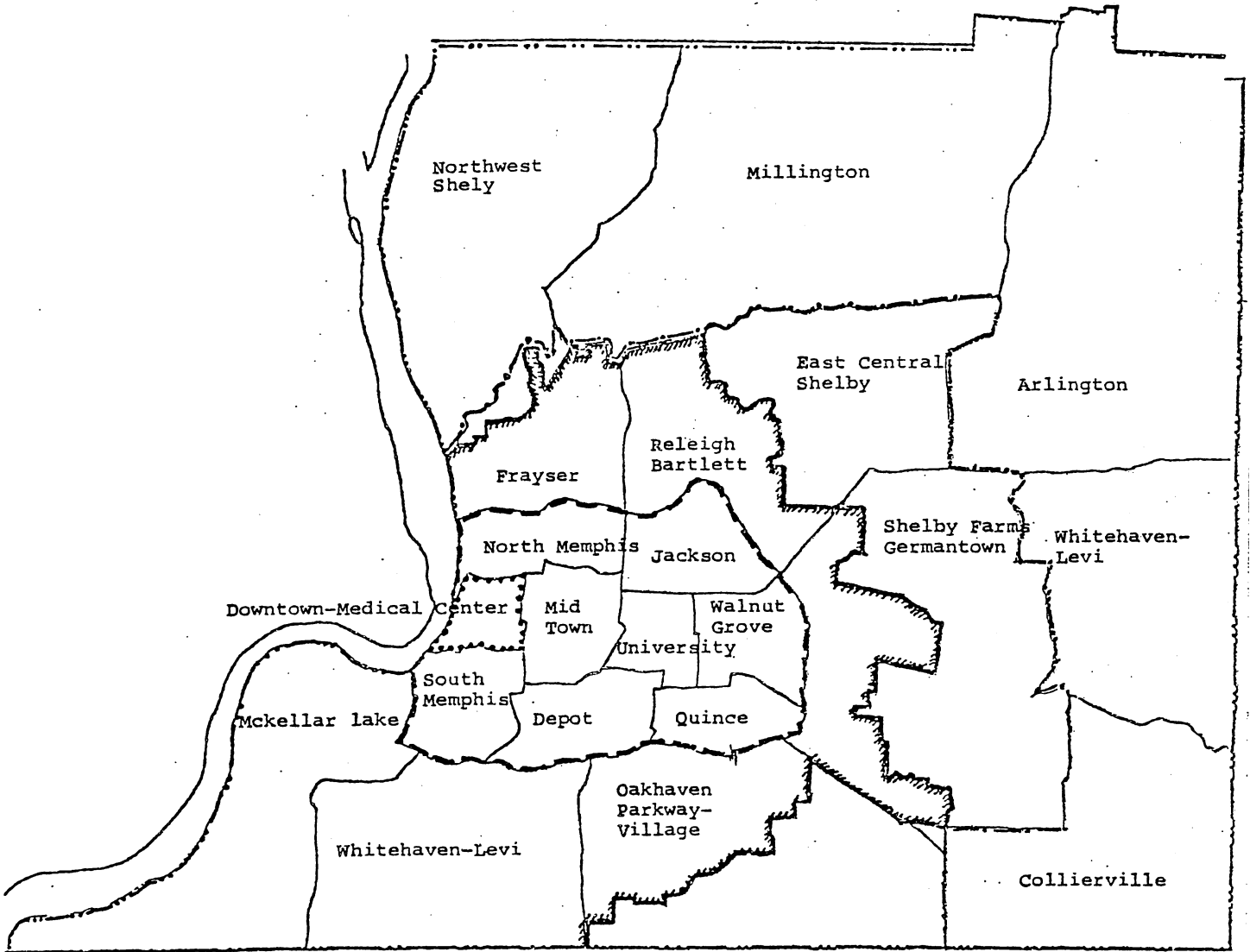

Fig. 3.2 Planning Districts and Rings in the City of Memphis and Shelby County

3.1 Population

Recent changes in population are shown in Table 3.1. Numbers are given for all districts (Fig. 3.2), major areas (core, inner ring, middle ring and outer ring), whole city and county.

Population size in 1990 is also predicted, based on the analysis of three parameters: births, deaths, and migration. The important factors affecting the analysis are the growth rate of the national economy and the growth rate of the city and county economy. The growth of the nation will be determined by national policy, technological development, and cultural norms. The share of the nation's growth captured by the Memphis/Shelby County area will be affected by the region's economic growth and its ability to create new job opportunities.

The density and distribution of the population within Memphis/Shelby County depends upon the following variables:

- 1) Construction trends and changes in construction technology and market preference;
- 2) Land capacity to handle different types of development;
- 3) Public policy with respect to zoning, road and utility extension, provision of community facilities and open space;
- 4) The rate at which existing households break up and former members remain in the Memphis/Shelby County area.

The projections for areas within Memphis/Shelby County are also shown in Table 3.1 (39). The population changes are summarized in Fig. 3.3.

Table 3.1 Population Changes in Memphis/Shelby County

Year	1950	1960	1970	1980	1990
Shelby County total	396,000	626,969	722,094	780,134	991,030
Memphis Area	396,000	497,524	623,530	664,838	x
Core Area Subtotal		48,749	33,674	30,527	23,000
Downtown-Medical Center		48,749	33,674	30,527	23,000
Inner Ring Subtotal		419,910	417,751	360,561	393,500
Depot		62,567	68,218	61,937	70,000
Jackson		51,564	50,534	41,822	48,500
Midtown		64,309	58,132	53,489	48,500
North Memphis		63,296	61,418	51,544	55,500
Quincy		41,532	53,100	39,238	42,000
South Memphis		79,102	77,721	59,594	70,000
University		33,484	30,962	27,832	29,000
Walnut Grove		24,056	27,666	25,105	30,000
Middle Ring Subtotal		115,218	223,990	328,888	452,030
Frayser		28,826	45,359	45,994	57,000
Mckeller Lake		39	33	30	30
Oakhaven-Parkway Village		15,944	42,447	75,237	100,000
Raleigh-Barlette		15,383	31,063	64,096	95,000
Shelby Farms-Germantown		9,292	17,939	53,543	80,000
White Haven - Levi		45,734	87,149	89,988	120,000
Outer Ring Subtotal		43,092	46,679	60,158	122,500
Arlington		5,811	5,730	8,065	12,500
Collierville		4,671	5,605	9,610	20,000
East Central Shelby		2,857	2,517	2,843	7,000
Millington		26,347	30,000	32,077	43,000
Northwest Shelby		3,406	2,827	7,563	40,000

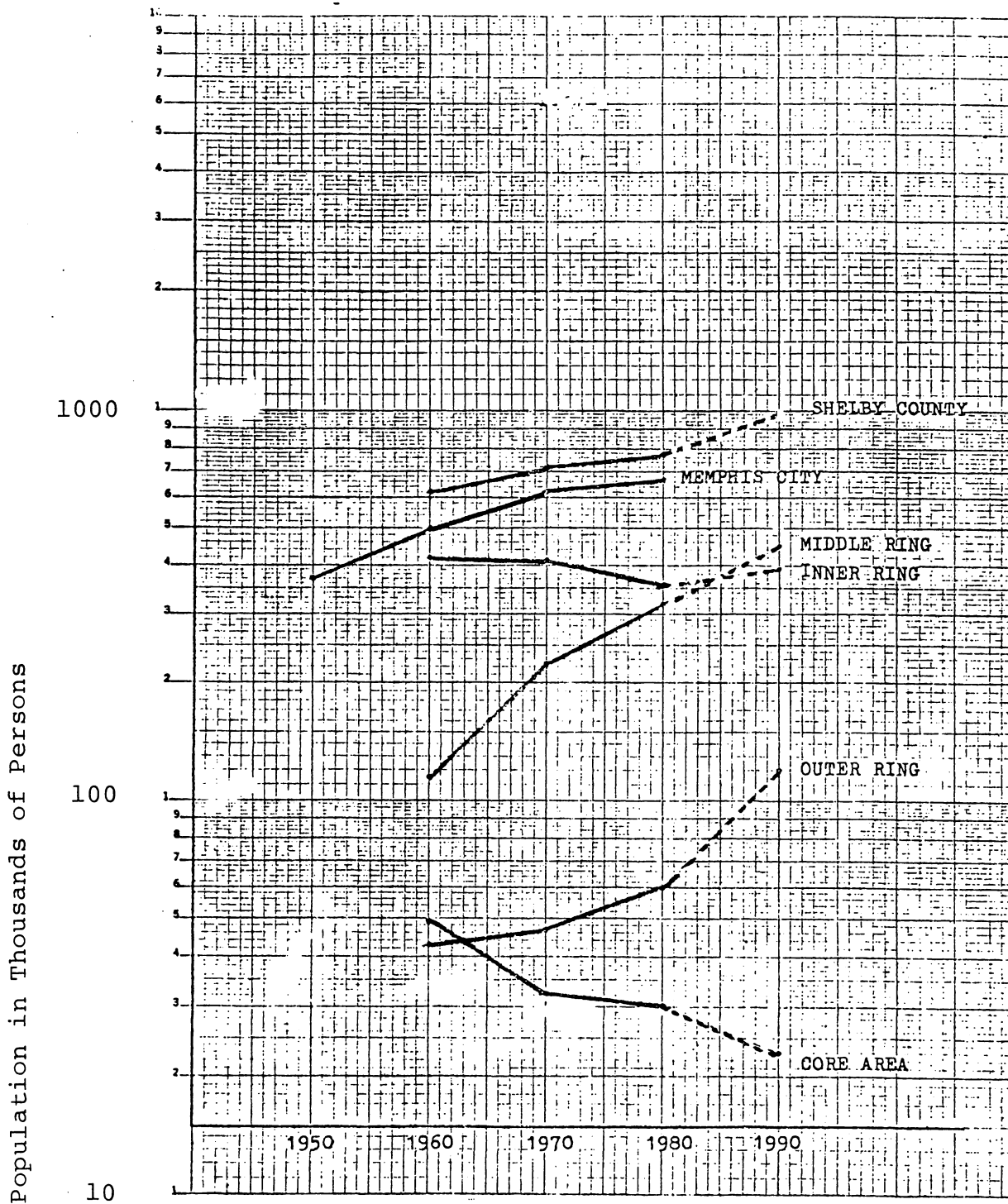

Fig. 3.3 Summary of the Population Changes

In the last 20 years, the population has decreased in the core areas and inner rings while it has increased in the middle and outer rings. The major portions of the growth occurred in Oakhaven-Parkway Village, Shelby Farms-Germantown, and Raleigh-Bartlett.

The accuracy of the prediction for 1990 cannot be evaluated within the scope of this report. Recent trends showing a decline in birth rates nationally might indicate that this figure is too high. Another factor affecting this prediction is migration. The prediction, which was done in 1970, appears to consider a continuation of the past migration pattern, from rural to urban areas. It may be argued that the pattern has reversed, but this cannot be substantiated at the present time.

3.2 Commercial Building Activity

Commercial building activities in 1978, 1979, and 1980 are summarized in Tables 3.2, 3.3, and 3.4, respectively (40). In 1978, the construction of commercial buildings in Memphis/Shelby County was valued at \$32.3 million. This represents 13% of the total value (\$247.7 million) for all new construction. If the conversions of commercial buildings are included, the total commercial floor area added in 1978 was 1,814,200 square feet. The leading planning district was Parkway Village with 38 percent of the net increase in commercial space. The bulk of the commercial building permit activity was concentrated in the middle ring of planning districts with 88% (1.6 million square feet) of the commercial area. The outer ring claimed 11% (538 units) of all new housing units, but experienced little commercial construc-

Table 3.2 Commercial Building Permit Activity 1978

ACTIVITY LOCATION	Conversion		New Construction				All Activity
	added ft ²	deleted ft ²	offices		others		Net Change in ft ²
			Footage ft ²	VALUE \$ (million)	Footage ft ²	VALUE \$ (million)	
Shelby County total	136,494	303,231	609,742	10.1	1,371,191	22.3	1,814,196
Core Area subtotal	-	138,639	80,500	1.53	111,400	0.89	53,261
Downtown-medical center	-	138,639	80,500	1.53	111,400	0.89	53,261
Inner Ring subtotal	62,000	119,730	55,900	1.00	151,130	2.40	149,300
Depot	-	-	-	-	28,283	0.11	28,283
Jackson	23,200	6,450	15,500	0.25	37,403	0.63	69,653
Midtown	17,300	33,824	-	-	34,683	0.86	18,159
North Memphis	-	19,260	-	-	9,833	0.10	-9,429
Quince	3,400	34,579	-	-	14,200	0.21	-16,979
South Memphis	-	23,865	-	-	10,400	0.25	-13,465
University	3,300	1,592	-	-	-	-	1,708
Walnut Grove	14,800	160	40,400	0.75	16,328	0.24	71,368
Middle Ring subtotal	69,552	44,862	468,400	7.22	1,104,091	18.96	1,597,181
Fravser	800	2,500	-	-	155,317	1.64	153,317
Mckellar Lake	-	-	-	-	2,600	0.06	2,600
Oakhaven-Parkway Village	38,452	4,350	52,400	0.55	427,516	8.44	514,018
Rayleigh-Bartlett	7,700	4,224	35,500	0.42	254,733	5.02	293,709
Shelby Farm - Germantown	4,800	-	277,200	4.7	170,959	2.69	452,959
Whitehaven-Levi	17,800	33,488	103,300	1.55	92,956	1.11	180,568
Outer Ring subtotal	4,942	-	4,942	0.29	4,570	0.06	14,454
Arlington	-	-	-	-	-	-	-
Collierville	-	-	-	-	-	-	-
East Central Shelby	-	-	-	-	-	-	-
Millington	4,942	-	4,942	0.29	4,570	0.06	14,454
Northeast Shelby	-	-	-	-	-	-	-

Table 3.3 Commercial Building Permit Activity, 1979

ACTIVITY LOCATION	Conversion		New Construction				All Activity Net change in ft ²
	Added ft ²	deleted ft ²	Office		Other		
			Footage ft ²	VALUE \$ million	Footage ft ²	VALUE \$ million	
Shelby County total	208,987	127,257	708,549	17.4	1,075,074	22.8	1,865,353
Core Area subtotal	38,300	30,775	2,377	0.1	-	-	9,902
Downtown-Medical Center	38,300	30,775	2,377	0.1	-	-	9,902
Inner Ring Subtotal	52,249	83,062	244,197	0.8	207,663	5.1	421,047
Depot	11,042	14,644	13,323	0.3	4,354	0.2	14,075
Jackson	600	1,500	16,094	0.1	17,069	0.3	32,263
Midtown	9,700	7,350	1,208	*	52,119	0.9	55,679
North Memphis	2,018	24,000	-	-	3,508	*	-18,474
Quince	2,580	1,496	99,760	4.5	10,560	0.2	111,404
South Memphis	2,200	17,672	49,485	0.4	5,856	0.1	39,849
University	5,419	13,100	2,400	*	4,951	*	-330
Walnut Grove	18,690	3,300	61,927	1.5	109,266	3.4	186,583
Middle Ring subtotal	118,438	13,420	458,199	10.2	636,839	16.0	1,200,056
Fravser	36,220	5,310	10,765	0.5	21,196	0.4	62,871
Mckellar Lake	2,354	-	58	*	-	-	2,412
Oakhaven-Parkway Village	39,596	2,016	154,344	2.6	186,972	4.9	378,896
Raleigh-Bartlett	13,800	3,400	10,905	0.4	198,449	6.0	219,754
Shelly Farm-Germantown	3,536	-	337,651	6.0	70,043	1.7	311,230
Whitehaven-Levi	22,932	2,694	44,476	0.6	160,179	3.0	224,893
Outer Ring subtotal	-	-	3,776	0.3	230,572	1.7	234,348
Arlington	-	-	-	-	207,512	1.5	207,512
Collierville	-	-	-	-	1,920	*	1,920
East Central Shelby	-	-	-	-	-	-	-
Millington	-	-	3,776	0.3	21,140	0.2	24,916
Northwest Shelby	-	-	-	-	-	-	-

* value is less than \$50,000

Table 3.4 Commercial Building Permit Activity, 1980

ACTIVITY LOCATION	Conversion		New Construction				All activity Net change in ft ²
	added ft ²	deleted ft ²	Office		Other		
			ft ² Footage	VALUE \$ million	ft ² Footage	VALUE \$ million	
Shelby County total	510,316	259,645	435,106	10.8	2,141,310	49.9	2,827,087
Core area subtotal	45,126	154,377	-	-	17,385	0.7	-91,866
Downtown-Medical Center	45,126	154,377	-	-	17,385	0.7	-91,866
Inner Ring subtotal	85,611	86,954	260,910	4.6	103,404	3.0	362,971
Depot	15,062	10,464	2,079	0.3	10,086	0.4	16,763
Jackson	4,408	5,400	552	*	6,080	0.1	5,640
Midtown	30,033	50,080	-	-	10,478	0.5	-9,569
North Memphis	1,203	5,580	9,092	0.1	3,251	0.1	7,966
Quince	4,242	-	199,520	2.9	61,571	1.5	265,333
South Memphis	5,855	6,280	936	*	6,113	0.3	6,624
University	7,294	6,682	-	-	50	*	662
Walnut Grove	17,514	2,468	48,731	1.3	5,775	0.1	69,552
Middle Ring subtotal	205,689	18,312	159,776	6.2	2,015,677	46.1	2,362,828
Frayser	2,009	-	-	-	7,978	0.5	9,987
Mckellar Lake	1,500	-	-	-	108	*	1,608
Oakhaven-Parkway Village	146,112	14,054	23,640	0.9	1,647,782	37.4	1,803,480
Raleigh-Bartlett	5,431	660	2,661	0.2	89,416	1.7	96,848
Shelby Farm-Germantown	15,569	-	112,013	4.4	246,507	5.9	374,089
Whitehaven-Levi	35,068	3,600	21,462	0.8	23,886	0.6	76,816
Outer Ring subtotal	173,890	-	14,420	*	4,844	0.1	193,154
Arlington	170,804	-	10,820	*	1,244	*	182,868
Collierville	-	-	-	-	2,160	*	2,160
East Central Shelby	-	-	-	-	480	*	480
Millington	3,086	-	3,600	*	-	-	6,686
Northeast Shelby	-	-	-	-	960	0.1	960

* value is less than \$50,000

tion. The inner ring received only 8% (150,000 square feet) of the net increase in commercial space in Memphis/Shelby County.

In 1979, new construction of commercial buildings in Memphis/Shelby County was valued at \$40.2 million. This represents 18.4% of the total value (\$218.8 million) of all new construction. If the conversions of commercial buildings are included, the total commercial floor area added in 1979 was 1,900,000 square feet, which is a 3% increase over 1978. The downtown Medical Center planning district continued to show a net loss of commercial buildings in 1979. However, the inner ring showed an increase of commercial permit activity (23% of all commercial growth reported by Memphis and Shelby County Building Department), while there was a net loss of industrial square footage. For many years, the ring of planning districts just outside the beltway formed by the interstate highways I-240 and I-55 has been the area where urban development has advanced most rapidly. The middle ring had 64% of the net increase in commercial space. Oakhaven-Parkway Village, as in 1978, led all planning districts in commercial construction.

In 1980, generally, construction activity in the area reflected the nationwide downward trend, with the commercial sector as the only exception. The growth in commercial square footage was over 50 percent higher than the 1979 figure. New construction of commercial buildings in Memphis/Shelby County was valued at \$60.7 million, which represents 26.5% of the total value (\$228.7 million) for all construction.

In 1980, for the first time in several years, the number of housing units in the core area showed a net gain. This was largely due to the conversion of office space in the Shrine Building to 84 residential units. This conversion accounted for most of a net loss of commercial square footage. The inner ring led all others in office construction (261,000 square feet). Quince, the leading planning district, is the location of the new Audubon Business Campus just east of Audubon Park. In 1980, the middle ring continued to lead the county in all major categories of building activities, with approximately 84% of all commercial construction.

3.3 Commercial Subdivision and Rezoning

In 1978, commercial subdivision activity represented 5% of the total acreage platted. The middle ring of planning districts accounted for 90% of the platted acreage. Platting in the outer ring amounted to 6.4 percent, and the remaining 3.6 percent occurred in the inner ring.

In 1979, commercial subdivision activity increased to 12.6 percent of the total acreage platted. Activity was focused in Oakhaven-Parkway Village (54.4% of the total) and Whitehaven-Levi (21.4%) with 98.3% of the platted acreage located in the middle ring of planning districts. The remaining 1.7% occurred in the inner ring.

In 1980, 4.6% of the total acreage platted was for commercial subdivision activity. The middle ring of planning districts was the site of 78.4% of the platted acreage, while platting in the

inner and outer rings amounted to 16.9 and 4.7% of the total, respectively. The subdivision activities in planning districts in 1978, 1979 and 1980 are shown in Table 3.5. The annual commercial subdivision activity of Memphis/Shelby County from 1974 to 1980 is shown in Fig. 3.4. In 1978, rezonings for commercial land uses amounted to 230 acres, comprising 22.7% of all rezoning activity. Most of this activity occurred in the Oakhaven-Parkway Village planning district; this area contained 60% of the total acreage rezoned for commercial land use. The middle ring of planning districts had the greatest volume of overall rezoning activity. Rezoning for commercial land use in the middle ring involved 220 acres, constituting 95% of the total.

In 1979, rezonings for commercial land uses amounted to 252 acres, or 17.5% of all rezoning activity. Of all the acreage rezoned for commercial land use, 75% was in the middle ring, 15.3% in the inner ring, and 9.7% in the outer ring.

In 1980, the total acreage rezoned for commercial land uses was 104 acres, 58.9% below the 1979 level. Again, most of this activity (over 80% of the total) was concentrated in the middle ring.

The rezoning activities in the planning districts for 1978, 1979, and 1980 are shown in Table 3.6 (40). The annual commercial rezoning activity of Memphis/Shelby County from 1971 to 1980 is shown in Fig. 3.5.

Table 3.5 Commercial Subdivision Activity in 1978-80

(Acres)

LOCATION \ YEAR	1978	1979	1980
Shelby County total	62.35	126.98	73.01
Core Area Subtotal	-	-	-
Downtown-Medical Center	-	-	-
Inner Ring Subtotal	1.10	2.16	12.32
Depot	-	-	10.30
Jackson	-	-	1.87
Midtown	1.10	1.46	0.01
North Memphis	-	-	-
Quince	-	-	-
South Memphis	-	-	-
University	-	-	-
Walnut Grove	-	0.70	0.14
Middle Ring Subtotal	57.26	124.82	57.25
Frayser	3.24	-	0.92
Mckellar Lake	-	-	-
Oakhaven-Parkway Village	19.26	69.04	14.60
Rayleigh-Bartlett	12.45	12.41	18.70
Shelby-Farm-Germantown	10.16	16.18	20.09
Whitehaven-Levi	12.15	27.19	2.94
Outer Ring Subtotal	3.99	-	3.44
Arlington	3.99	-	-
Collierville	-	-	-
East Central Shelby	-	-	-
Millington	-	-	-
Northwest Shelby	-	-	3.44

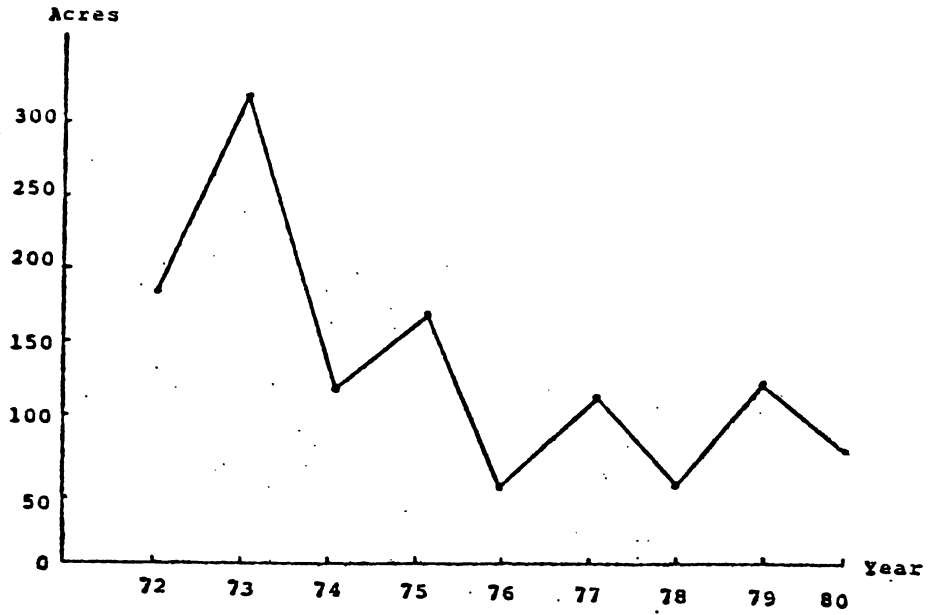

Fig. 3.4 Annual Commercial Subdivision Activity

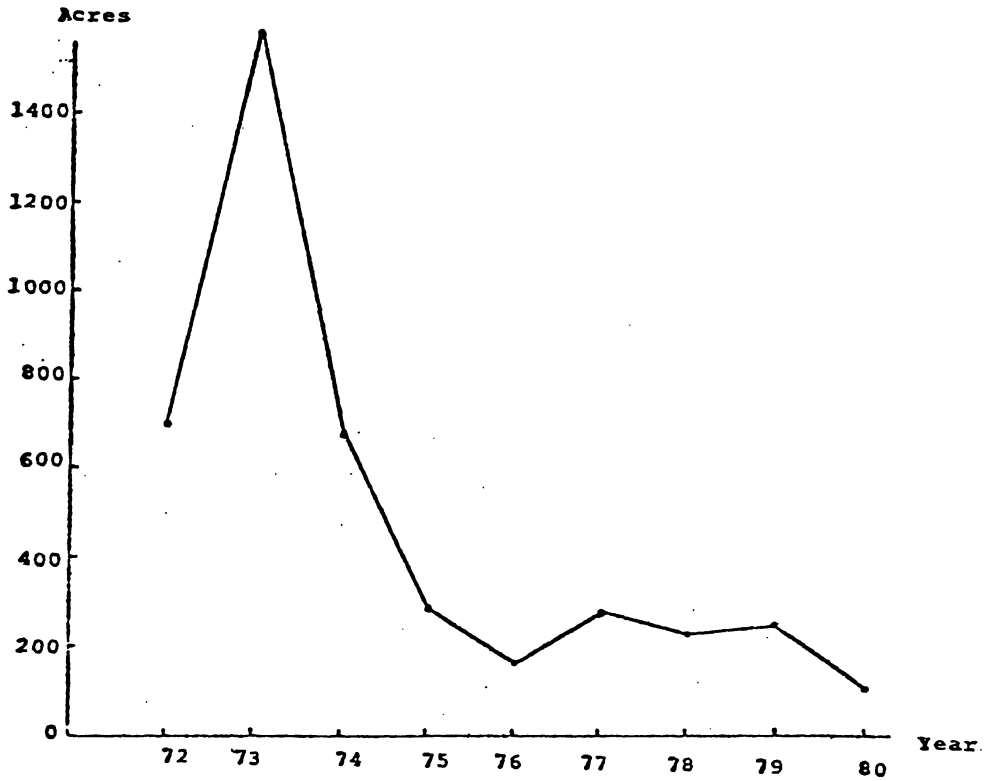

Fig. 3.5 Annual Commercial Rezoning Activity

Table 3.6 Commercial Rezoning Activity in 1978-80

(Acres)

	1978	1979	1980
Shelby County total	231.08	252.03	103.71
Core Area Subtotal	1.23	-	2.00
Downtown-Medical Center	1.23	-	2.00
Inner Ring Subtotal	5.2	38.58	16.84
Depot	1.10	0.92	0.30
Jackson	-	12.57	10.00
Midtown	1.6	1.29	2.18
North Memphis	-	-	-
Quince	-	17.70	-
South Memphis	-	-	-
University	2.5	-	1.00
Walnut Grove	-	6.10	3.36
Middle Ring Subtotal	219.52	188.94	84.07
Frayser	12.20	1.23	7.50
Mckellar Lake	-	-	-
Oakhaven-Parkway Village	138.00	48.61	23.57
Rayleigh-Bartlette	40.15	58.24	49.50
Shelly-Farms-Germantown	14.81	77.77	2.50
Whitehaven Levi	14.36	3.09	1.00
Outer Ring Subtotal	5.13	24.51	1.00
Arlington	1.38	-	-
Collierville	-	-	-
East Central Shelby	-	-	-
Millington	3.75	24.51	-
Northwest Shelby	-	-	1.00

4. COMMERCIAL BUILDINGS IN MEMPHIS

The present commercial buildings in Memphis can be divided into categories with regard to age, number of stories, square footage, type of structure, market value, type of occupancy, and location. The basic data about the buildings was obtained from the files of the Shelby County Assessor's Office.

Commercial buildings are located all over the city. However, most of them are in the downtown area, some along the major thoroughfares, Union Road and Poplar Avenue, and some close to the airport; others are scattered. The tallest structures are located in a small area covering 8 x 3 city blocks. The number of medium-high and high-rise structures outside of this area does not exceed ten. Clusters of commercial buildings are shown on the city map in Fig. 4.1.

There are three major types of structures involved: masonry with timber frame (over 80%), reinforced concrete frame (about 8%) and steel frame (about 9%). The first type includes mostly the low-rise buildings. Precast concrete elements were used in some new structures.

The heights of commercial buildings (in terms of number of stories) are given in Table 4.1 for the three types of structures. One and two story structures are predominant. The square footage is given in Table 4.2. The histogram of the age of commercial structures in Memphis is shown in Fig. 4.2. Most of the downtown area buildings were constructed in the "boom" period between 1920 and 1930. The great depression of 1930's and war years in the 1940's caused a drastic drop in construction activity. Business

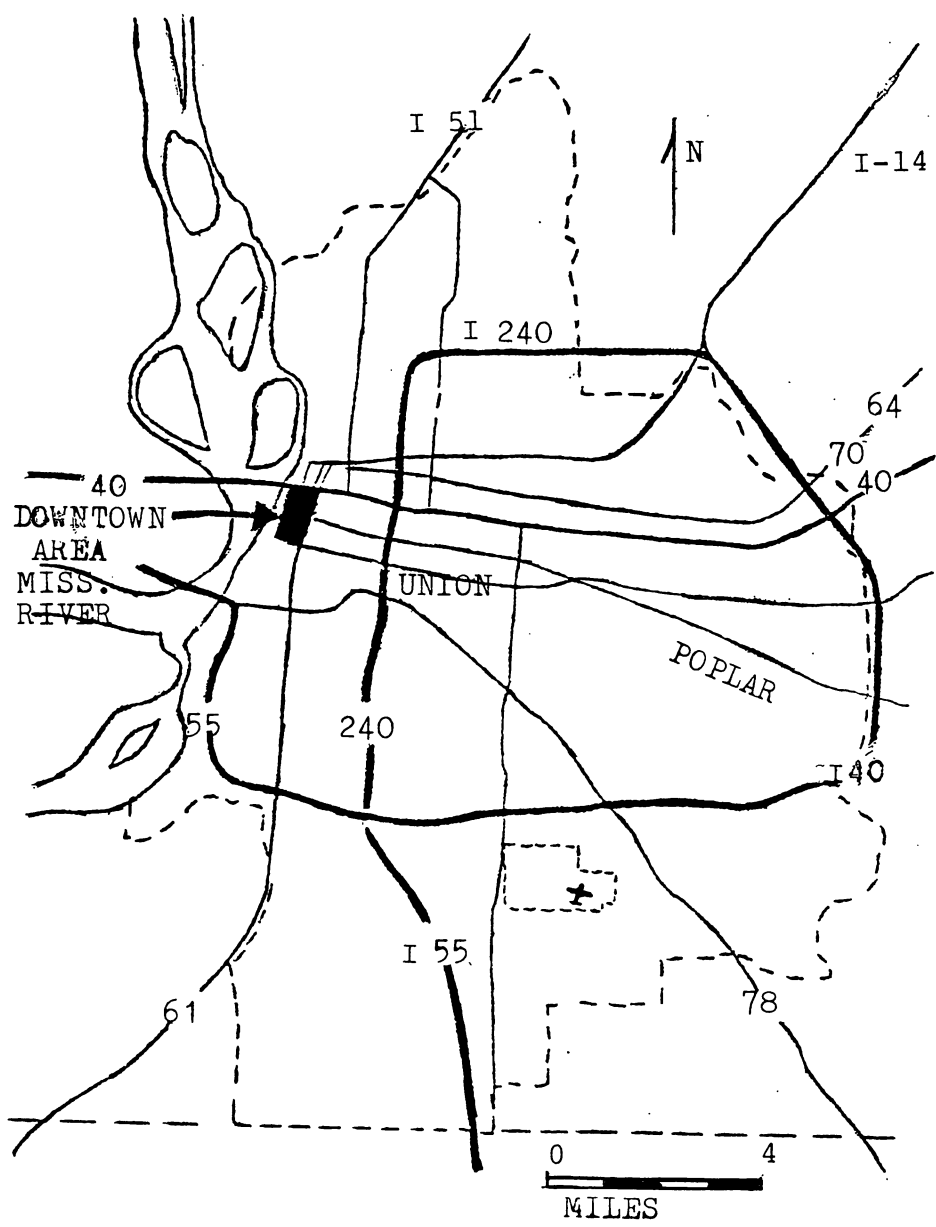

Fig. 4.1 Location of Commercial Buildings in Memphis

Table 4.1 Building Heights

Number of Stories	Masonry and Frame	Steel Frame	Reinforced Concrete Frame	Total
1	576	61	37	674
2	427	26	25	479
3	68	8	14	91
4	37	6	2	45
5	12		4	16
6	8	3	3	14
7	2	4	3	9
8		1	1	2
9		2	4	7
10	1	2	4	7
11	1	4	5	10
12	1	1	2	4
14			1	1
15		1		1
16		2		2
17			1	
18		1		1
20			1	1
21			1	1
22		1	1	2
29		1		1
31			1	1

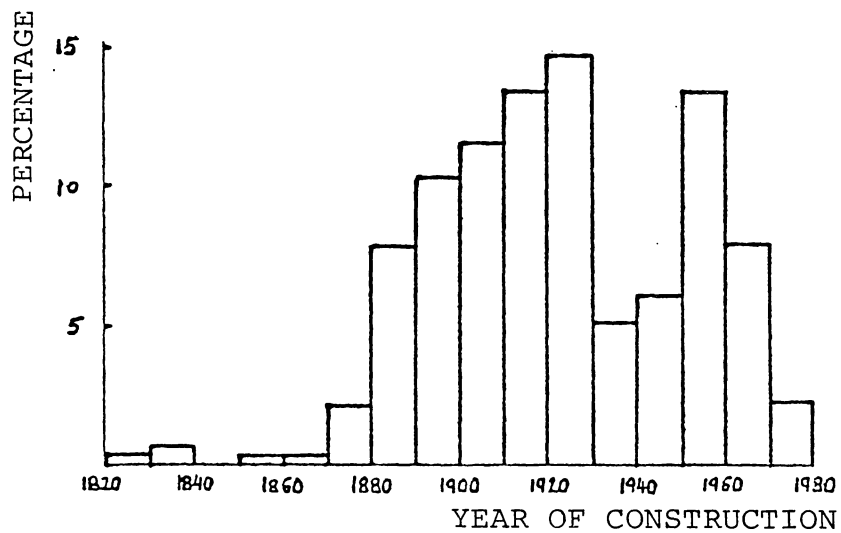

Fig. 4.2 Histogram of the Age of Construction for Commercial Buildings in Memphis

Table 4.2: Square Footage of Commercial Buildings in Memphis

Area (ft ²)	Masonry	Steel	Reinforced Concrete	Total
Below 5,000	835	32	43	910
5,000 to 50,000	277	55	49	381
50,000 to 100,000	11	13	7	31
100,000 to 1,000,000	5	7	10	22
over 1,000,000	1	1	2	4

Table 4.3: Assessed Value of Commercial Buildings in Memphis

Assessed Value (\$)	Masonry	Steel	Reinforced Concrete	Total
below 5,000	282	14	12	308
5,000 to 50,000	602	32	34	668
50,000 to 500,000	221	49	43	313
over 500,000	23	19	24	66

picked up in the 1950's, but has been in a downward mode since that era.

Market value is an important parameter. In this report, assessed values from Assessor's Office are used. Buildings in Memphis are assessed at 40% of their value. The assessed values are given in Table 4.3. Numerous tall buildings in the downtown area have not been occupied for many years. Many are now in the process of rehabilitation, involving structural changes and architectural remodelling. Some of those buildings are currently assessed at close to zero value; however, after the reconstruction, their values will reach normal levels.

The interrelation among various parameters has been studied. The results, in the form of scatter plots, are shown in the following figures.

The assessed value is plotted vs. number of stories for masonry, steel and reinforced concrete buildings in Fig. 4.3 to 4.5 and for all types of structures in Fig. 4.6. Similarly, in Fig. 4.7 to 4.10, the assessed value is plotted vs. year of construction. In Fig. 4.11 to 4.14, the assessed value is plotted vs. square footage. Finally, in Fig. 4.15 to 4.18, the number of stories is plotted vs. year of construction for masonry, steel, reinforced concrete, and for all types jointly. The symbols in scatter plots indicate number of readings in the interval: * stands for one reading, 2 to 9 for 2 to 9 readings and X for over 9 readings.

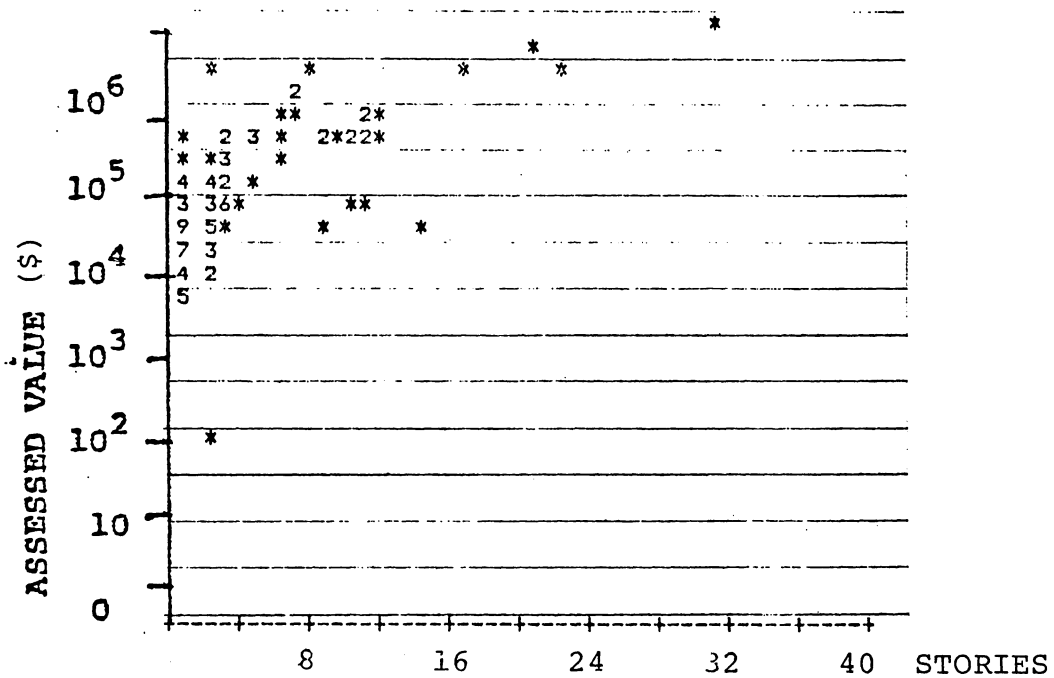

Fig. 4.5 Assessed Value vs. Number of Stories for Reinforced Concrete Buildings

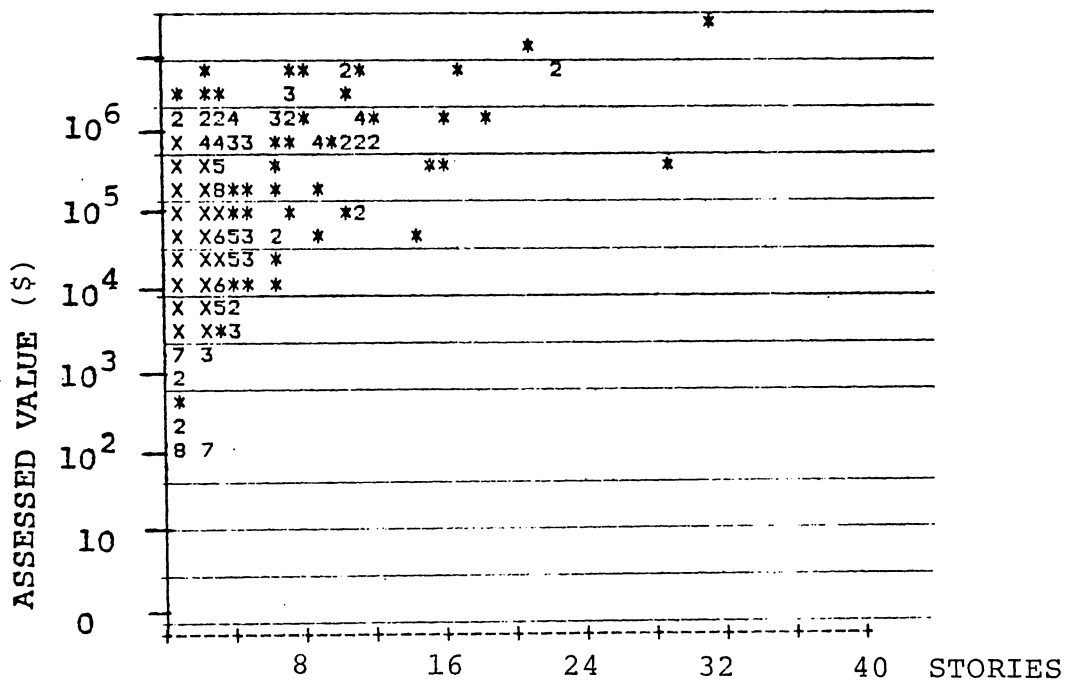

Fig. 4.6 Assessed Value vs. Number of Stories for All Types of Commercial Buildings

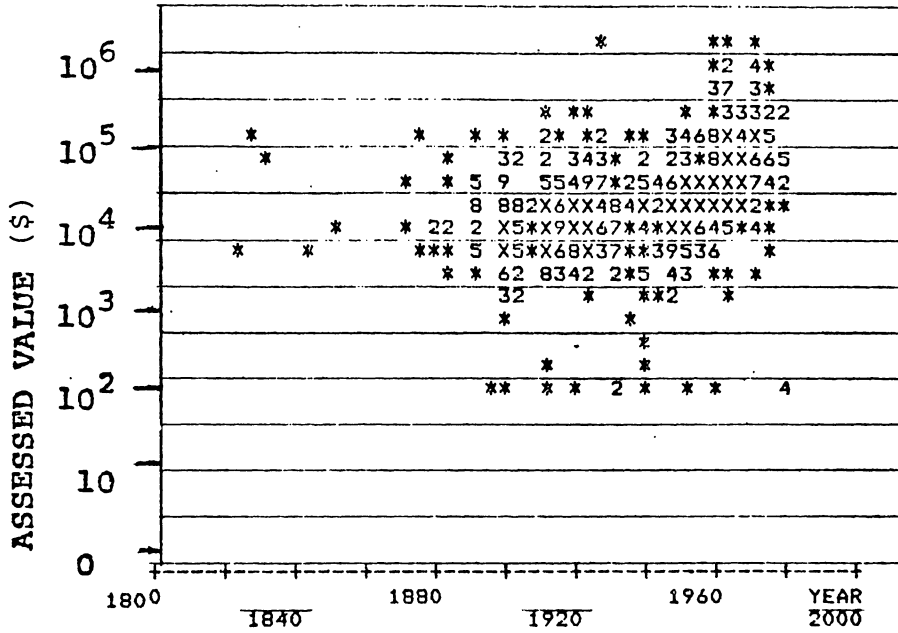

Fig. 4.7 Assessed Value vs. Year of Construction for Masonry Buildings

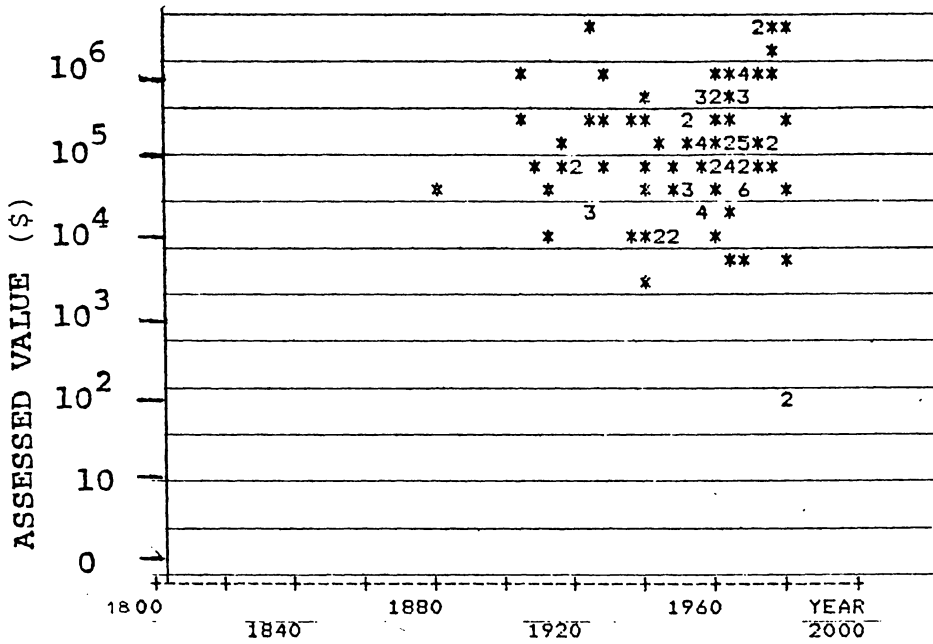

Fig. 4.8 Assessed Value vs. Year of Construction for Steel Frame Buildings

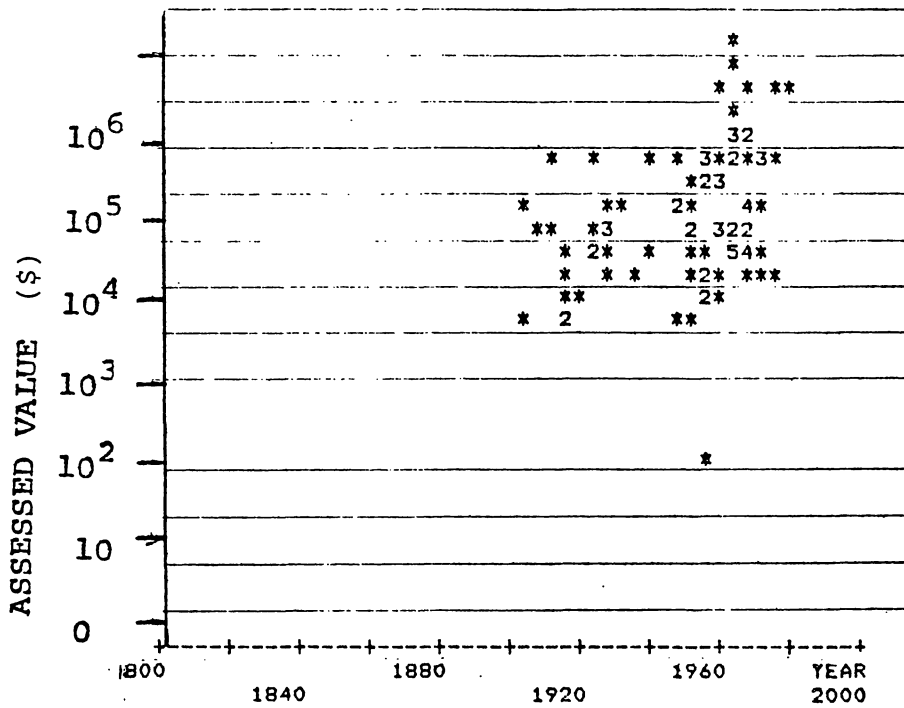

Fig. 4.9 Assessed Value vs. Year of Construction for Reinforced Concrete Buildings

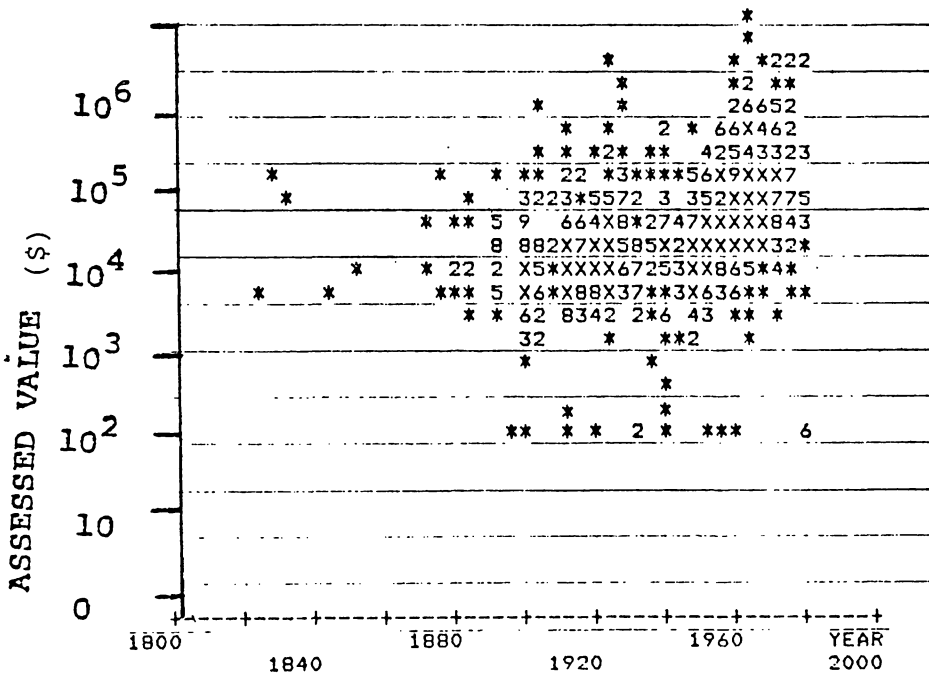

Fig. 4.10 Assessed Value vs. Year of Construction for All Types of Commercial Buildings

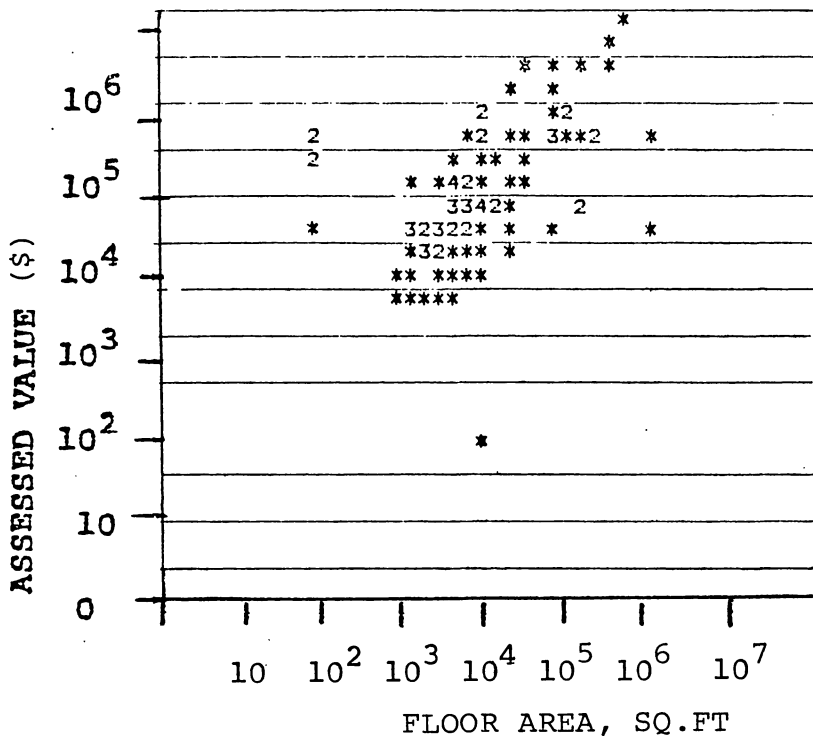

Fig. 4.13 Assessed Value vs. Square Footage for Reinforced Concrete Buildings

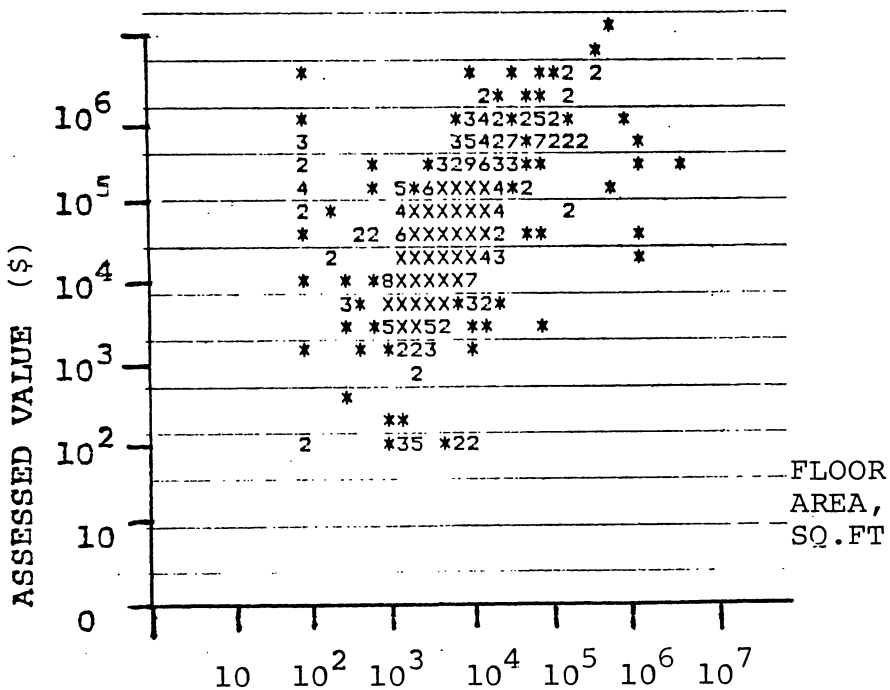

Fig. 4.14 Assessed Value vs. Square Footage for All Types of Commercial Buildings

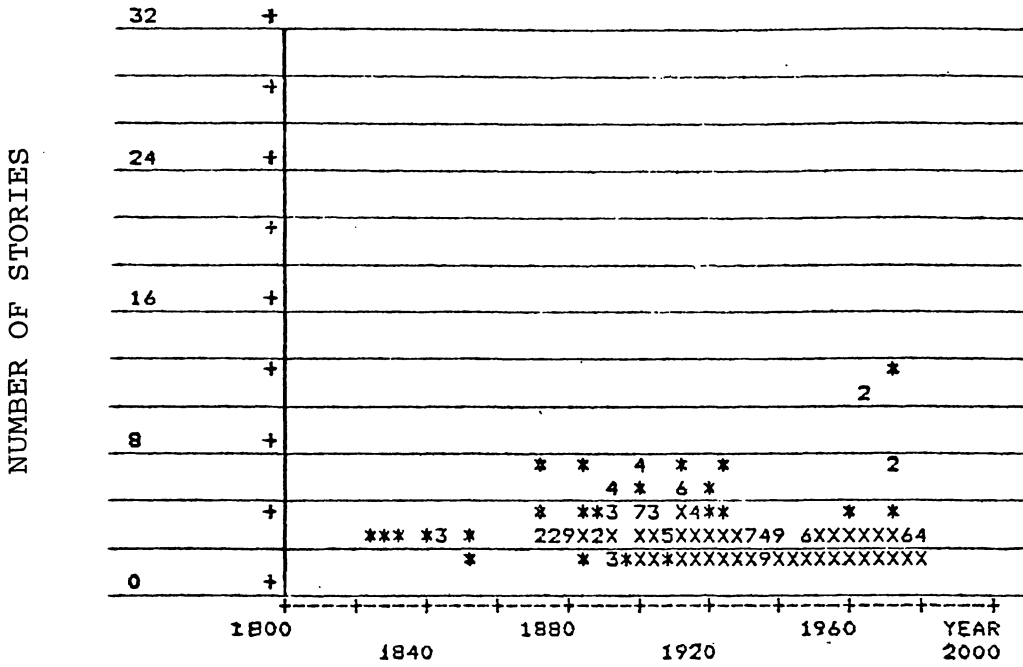

Fig. 4.15 Number of Stories vs. Year of Construction for Masonry Buildings

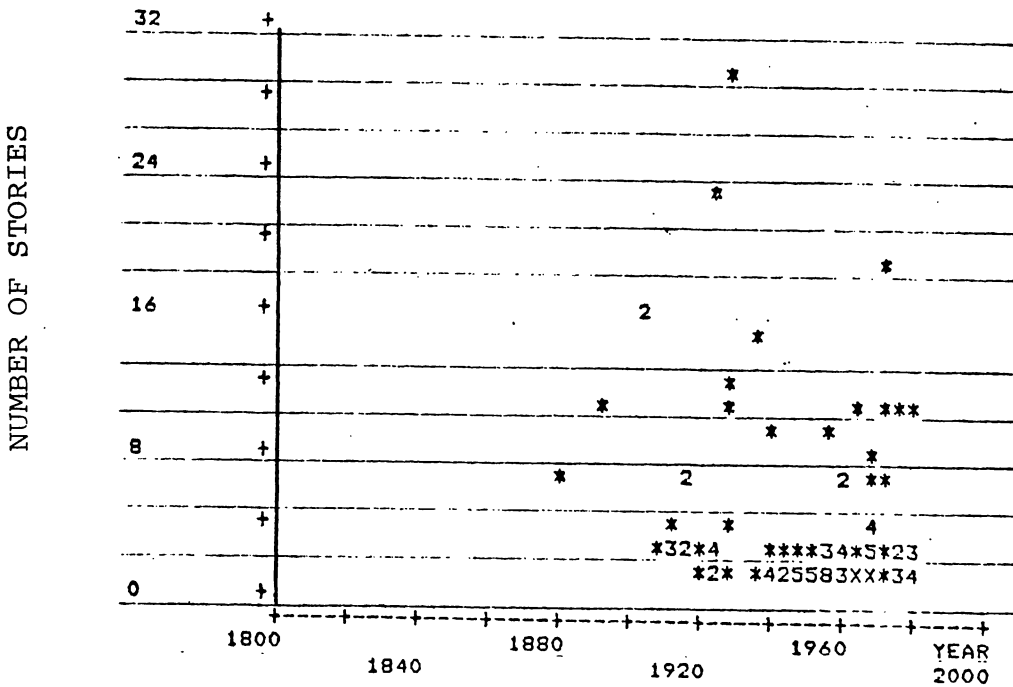
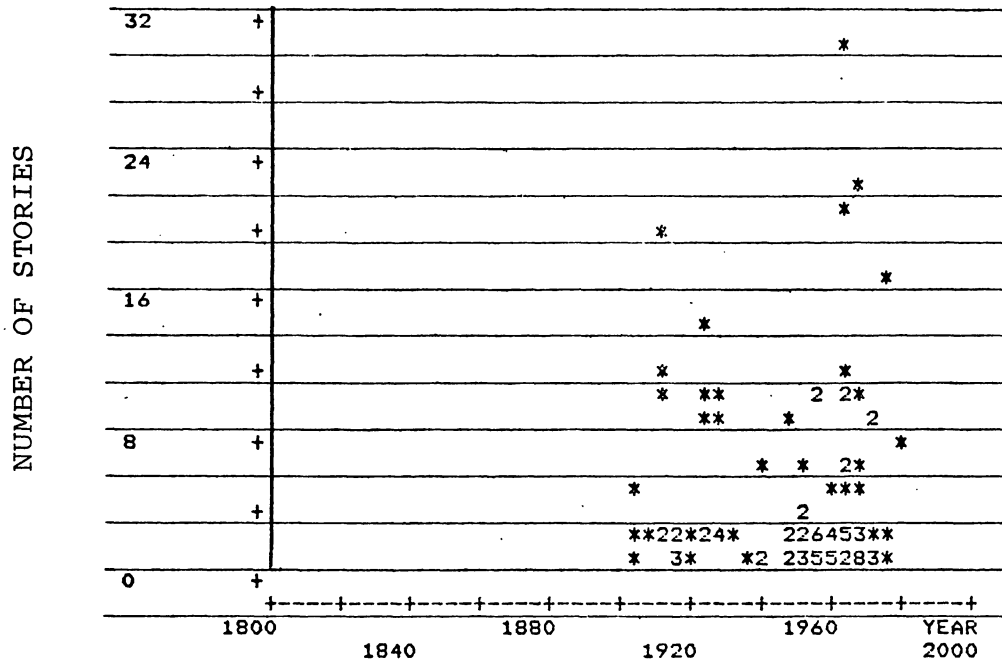

Fig. 4.16 Number of Stories vs. Year of Construction for Steel Frame Buildings



5. SELECTED BUILDINGS

Evaluation of seismic strength was carried out in three steps. First, a number of buildings were selected for site examination by the project team. Then, a more detailed analysis was performed for several buildings to determine the ratios of load effects to building capacities. Finally, the results were used to evaluate the projected damage for commercial buildings in the whole city.

Structures selected for site examination included five low-rise buildings, six medium-high ones and five taller ones (over 16 stories). The selection criteria included: value of the building (in case of presently unoccupied buildings, potential value), degree of uncertainty about seismic strength, number of similar buildings in Memphis, and accessibility to the project team. Low-rise buildings constitute an overwhelming majority in the population of all commercial structures. The examination of statistical data and observation indicate a rather uniform style. Older, one and two story buildings generally have masonry bearing walls supporting a timber floor structure. Newer ones usually have a reinforced concrete frame. Therefore, several older buildings were selected, including all the buildings on the South side of the historical Beale Street between McCalls and Fourth Street, some shops on Main Street, and some others located in the downtown area. Two structures with reinforced concrete frames from the 1920's and 30's were also included, along with a recently completed office building with vertical steel trusses.

Seismic resistance is especially questionable in the case of older, multistory buildings for most of them were built to comply with codes that did not include seismic provisions. Therefore, lateral strength may be critical. The selected medium high buildings included 8- to 13-story structures, with reinforced concrete or steel frames, constructed before 1941.

Five high-rise buildings (over 16 stories) were selected for site examination. All were offices with steel frames and moment-resisting beam-to-column connections. The basic data about commercial buildings selected for site examination are given in Table 5.1.

Table 5.1: Selected Commercial Buildings

Identifi- cation	Number of Stories	Year of Construction	Type of Structure	Remarks
A	3	before 1897	masonry walls, timber joists.	originally 2 stories
B	4	before 1900	masonry	cast iron front
C	3	1930's	reinforced concrete frame	
D	4	1926	reinforced concrete frame	
E	4	1976	steel braced frame, concrete slabs	precast concrete exterior walls
F	8 & 6	about 1881	mixed; steel frame, cast iron columns, timber frame	numerous addi- tions
G	9	1906	steel frame masonry walls	numerous changes
H	12	1906	reinforced concrete frame	
I	13	1923	steel frame	
J	9	1920's	reinforced concrete columns and slabs (no beams)	
K	11	1921	reinforced concrete frame	U shaped
L	18	1901	steel frame masonry walls	Annex added 1937
M	19	1909	steel frame	
N	29	1929	steel frame	U shaped
O	31	1969	steel frame	

6. SITE EXAMINATION

The spectrum of selected buildings included representatives of various categories: taller, medium-high, lower, and two-story ones; older and newer; offices, hotels, warehouses, and stores. The project team examined the structures to estimate their seismic resistances. The following summarizes the team members' conclusions.

Memphis has experienced the flight to the suburbs that has appeared in many American cities. The urban core has many buildings that have stood vacant for years, with the deterioration that accompanies a total lack of maintenance. The city is now engaged in a major urban renewal effort, in which vacated buildings are being rehabilitated and, where feasible, brought up to current building code requirements.

Long periods of vacancy without maintenance have led to severe damage to architectural and mechanical components; however, with few exceptions, there were no signs of structural deterioration. Some of the older structures were in the process of reconstruction, and had structural details exposed. This permitted an evaluation of the quality of the workmanship, the types of materials, sections, and connections which are related to the year of construction.

Building A is a typical representative of low-rise masonry bearing wall structures, Fig. 6.1. It was built around 1867 and has 3 stories, unreinforced brick walls, wood joists, and wood floors and roof. Its weakest feature is the lack of shear walls in the narrow direction. Heavy damage can be expected despite the lightweight floors and roof.



Fig. 6.1 Building A



Fig. 6.2 Building B

Buildings B, also with masonry bearing walls, have four stories and were built before 1900. The fronts are supported by cast iron frames, Fig. 6.2.

Buildings in Beale Street are typical examples of low-rise commercial structures in Memphis. Recently, a decision was made to establish an historical site there. The deteriorating structures of the existing buildings are being replaced by new walls and floors. Only the front walls are being saved. Examination of these propped walls, Fig. 6.3, indicates similarities to building A with regard to lateral strength.

Mid-America Mall (Main Street), in downtown Memphis, is claimed to be the longest shopping street in the United States. On the street level, most of the buildings are occupied by stores. Upper floors of older structures are either used as offices or are vacant. The low-rise (up to 6 stories) buildings usually have masonry bearing walls. The front walls are featured with heavy ornamentation, Fig. 6.4.

Building C is a 3-story reinforced concrete frame building with concrete floors and roof, built in the 1930's, Fig. 6.5. It is a doubly symmetric, rectangular building with few partitions. Typical cross sections of beams and columns are shown in Fig. 6.6. There is little potential for architectural damage, except for some plaster repair and glass replacement that might be required. Judging from a comparison of this structure to others of comparable size that have survived or failed in destructive earthquakes, one would expect structural damage to be minimal.

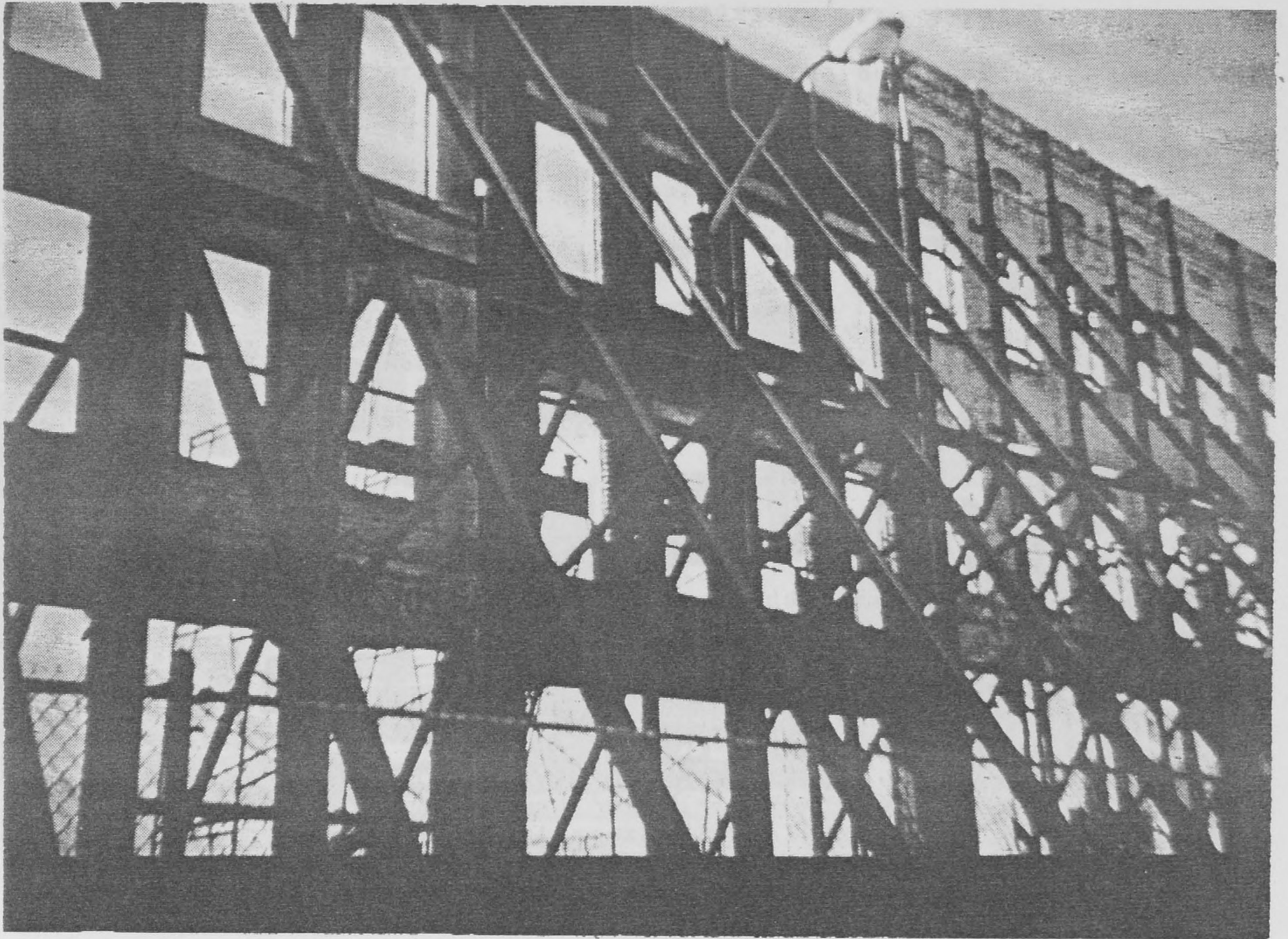

Fig. 6.3 Propped Walls of Building at Beale Street During Reconstructions

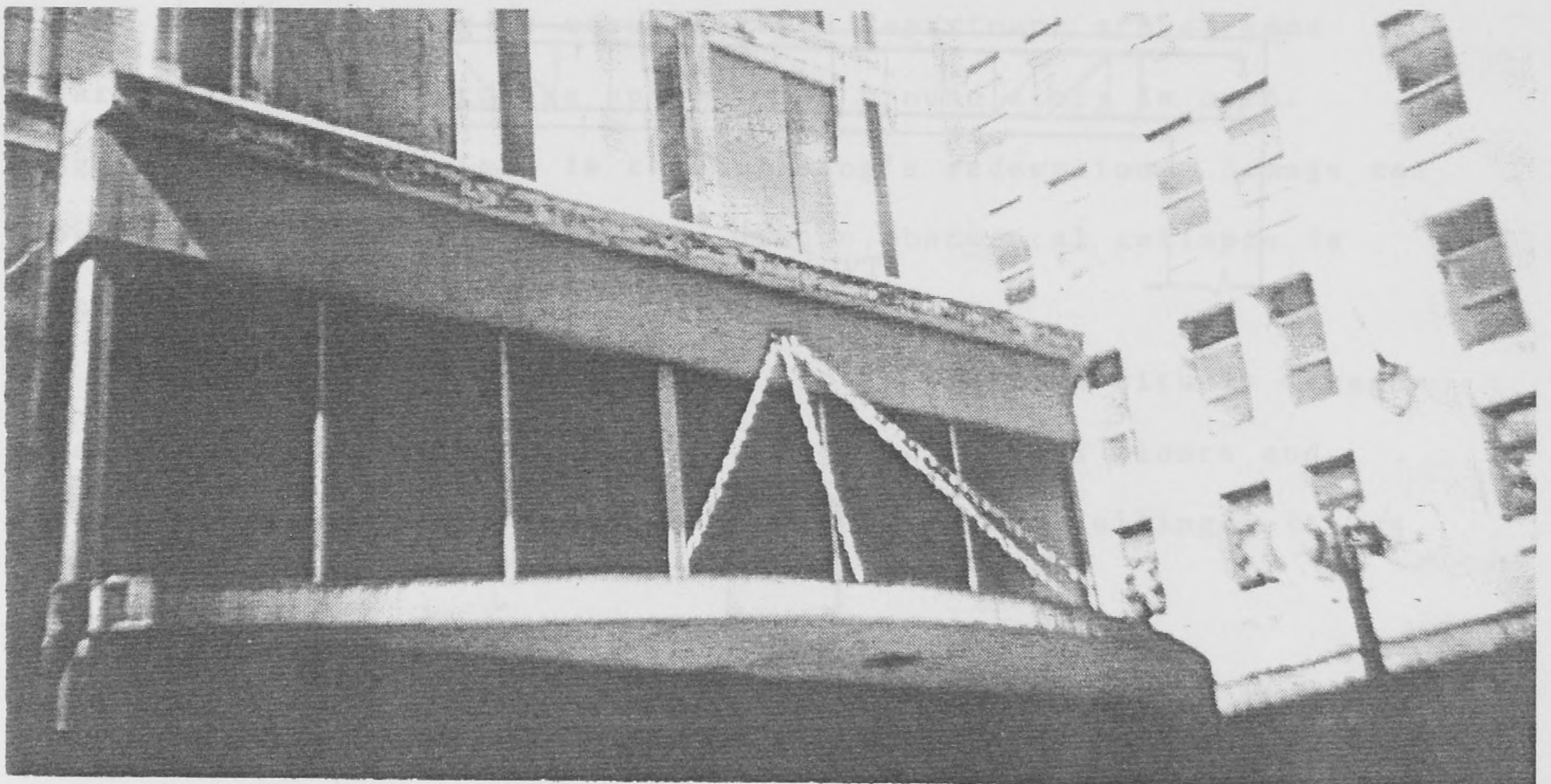

Fig. 6.4 Front Wall Ornamentations at Mid-America Mall



Fig. 6.5 Building C

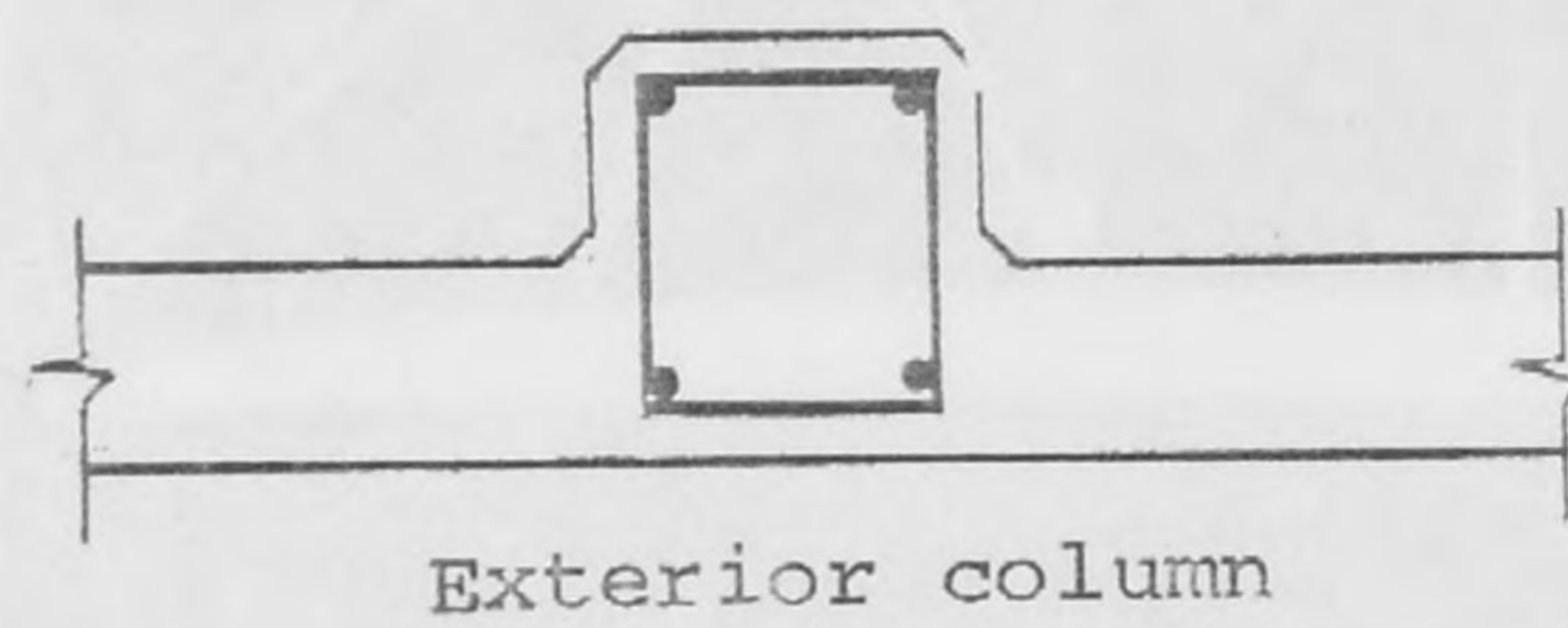
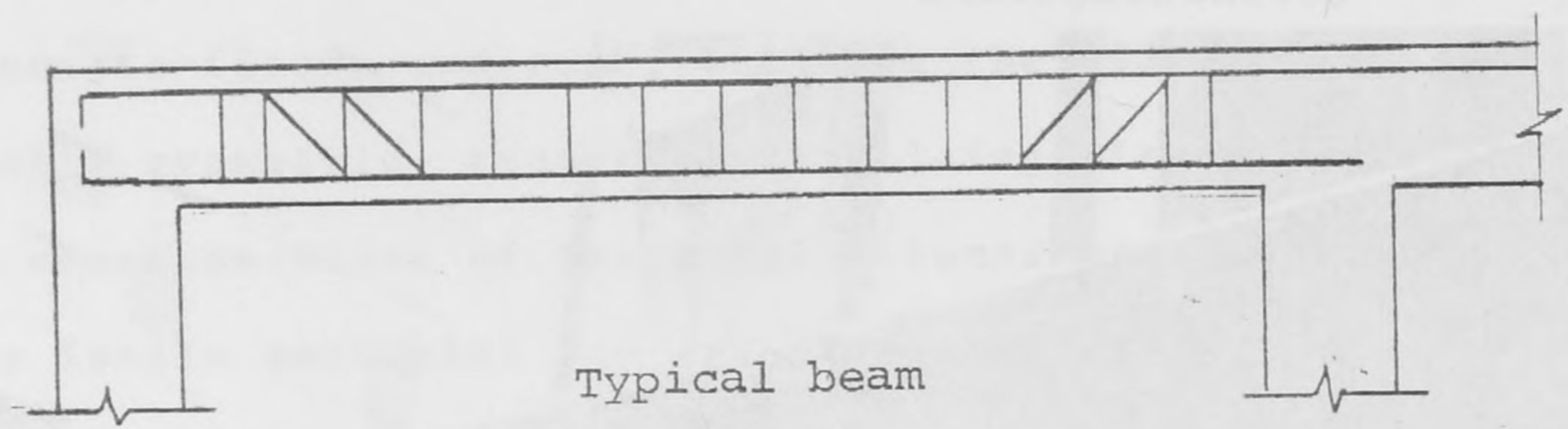

Fig. 6.6 Typical Cross Section of Beams and Columns in Building C

Building D is a 4-story office building, with a reinforced concrete frame and brick exterior walls. The building has a regular, rectangular layout, with 3 bays in the narrow direction and 6 in the long direction. The building was being demolished to make room for a new structure. Exposed parts of the structure do not show any sign of deterioration, and point to a surprisingly good quality of workmanship. A general view of the partially demolished building is shown in Fig. 6.7, with a column detail in Fig. 6.8.

Building E is a 4-story office, constructed in 1976 Fig. 6.9. The structure consists of steel columns and beams and concrete floor slabs. Lateral stiffness is provided by four vertical trusses, two in each direction. Outside walls are precast concrete panels attached to exterior columns and beams.

Building F, six and eight stories high (Fig. 6.10) and of unknown age (originally built in the 1880's), is a mixture of wood frame, steel frame, cast iron post (see Fig. 6.11), and steel lintel, with wood floors and a roof deck on wood joists. Most of the building is occupied by a department store; some parts are used as storage space. The ground story is open. Again, the light weight is the building's redemption. Damage can be expected, possibly extensive damage, but total collapse is unlikely.

Building G is 9 stories high. It is featured with an irregular steel frame with brick walls, Fig. 6.12, wood floors and roof, and is presently undergoing extensive remodelling. It was

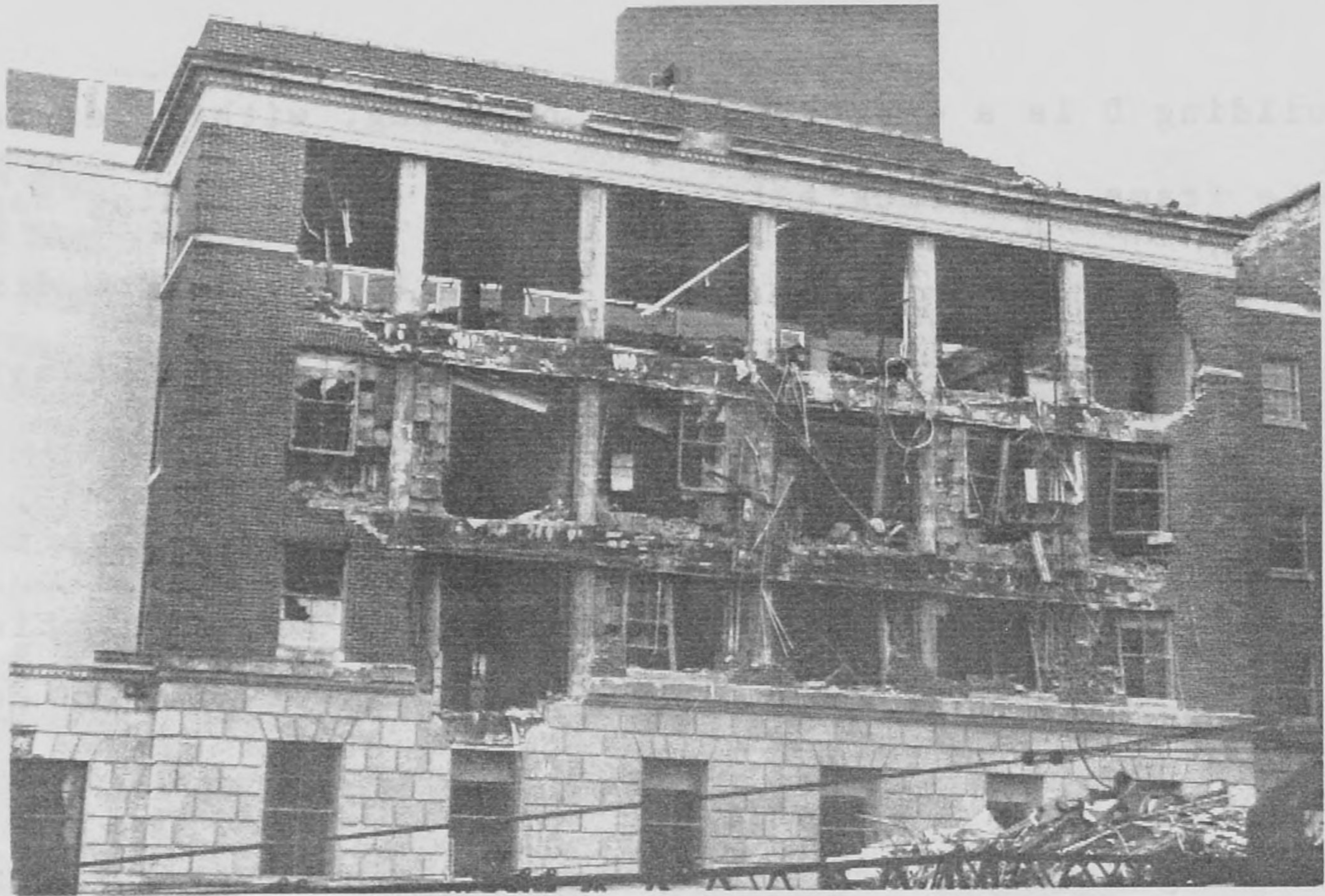

Fig. 6.7 Building D During Demolition

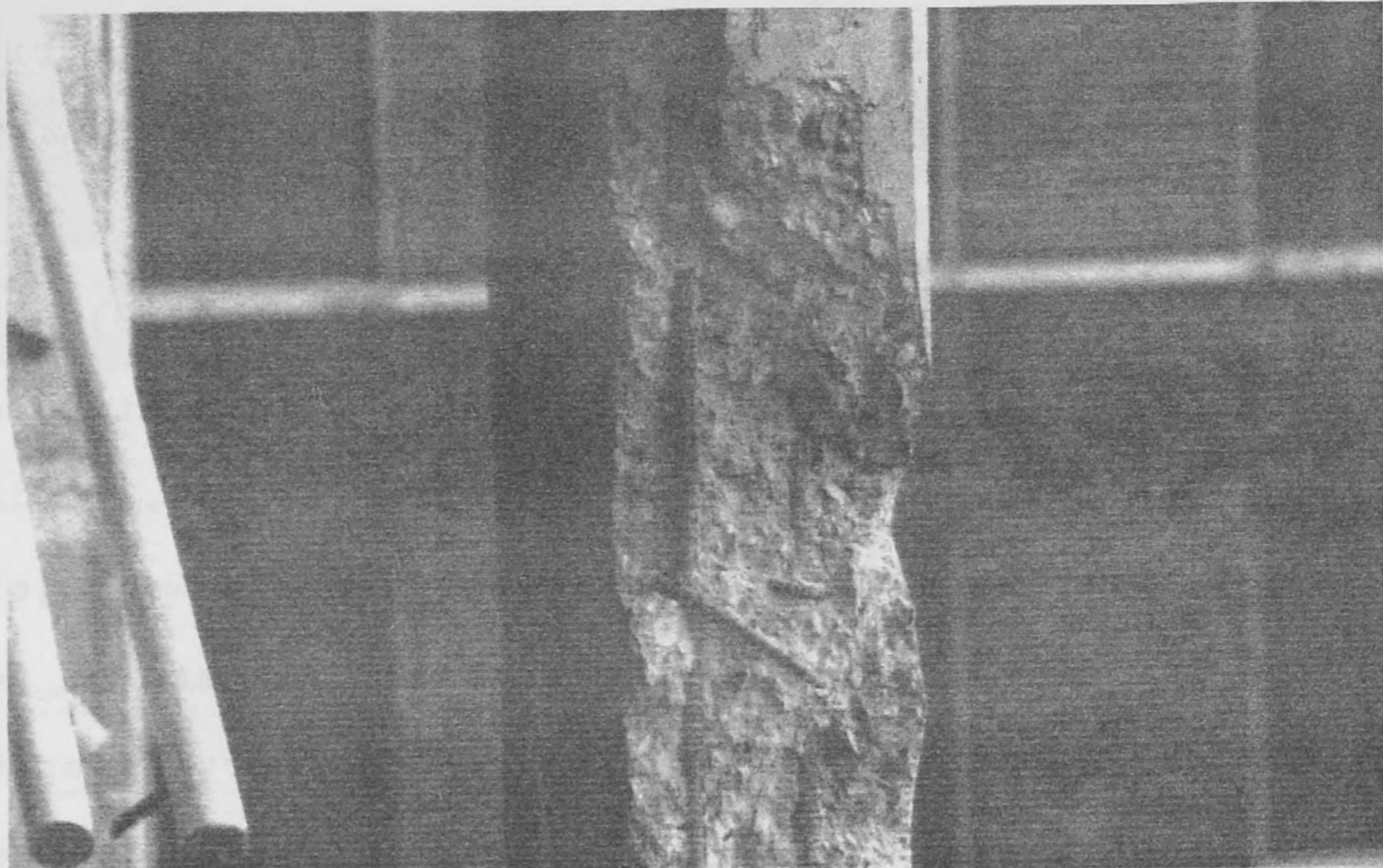

Fig. 6.8 Column Detail in Building D (during demolition)

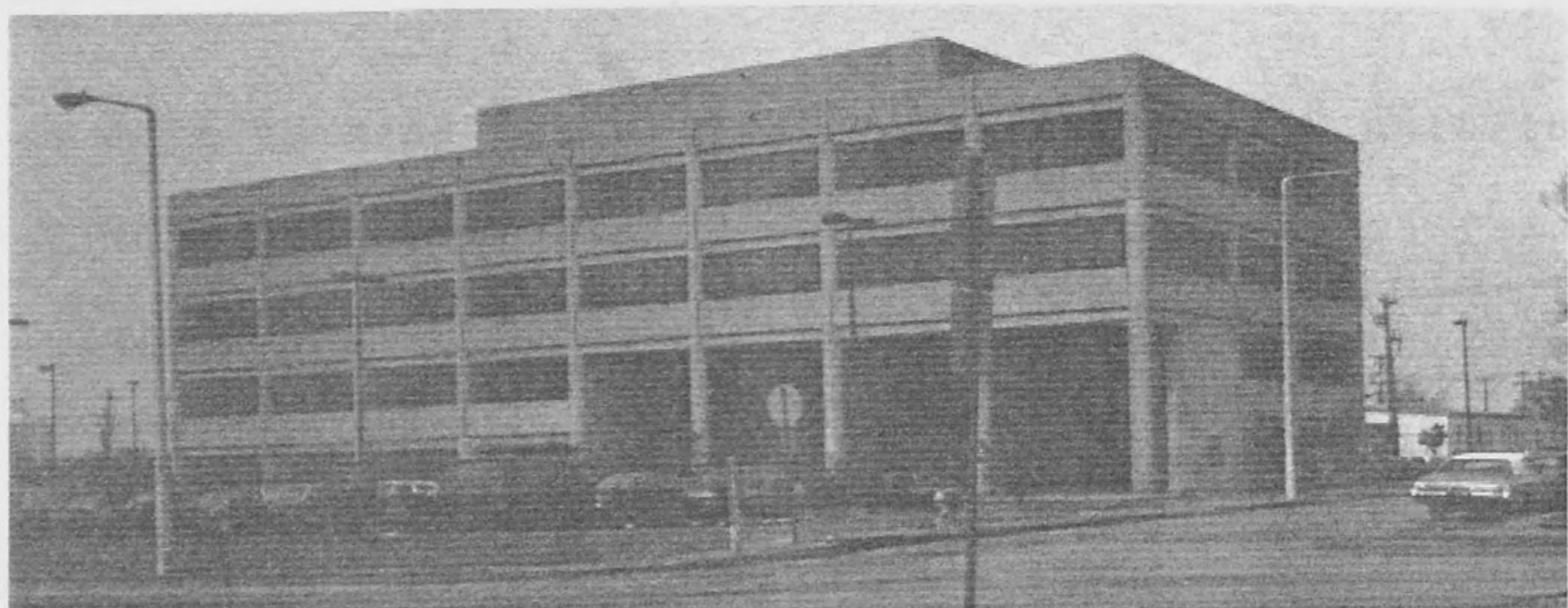

Fig. 6.9 Building E

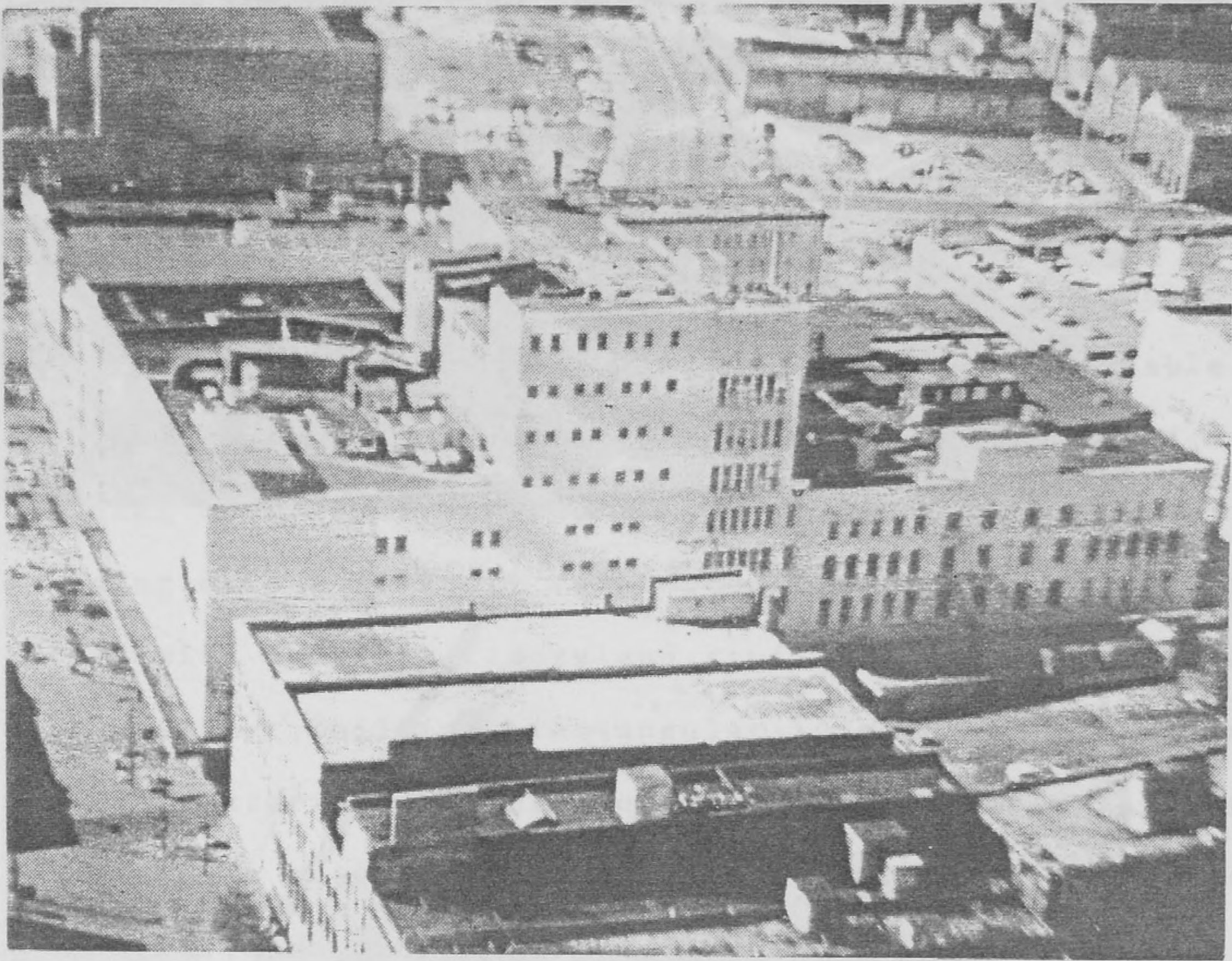

Fig. 6.10 Building F

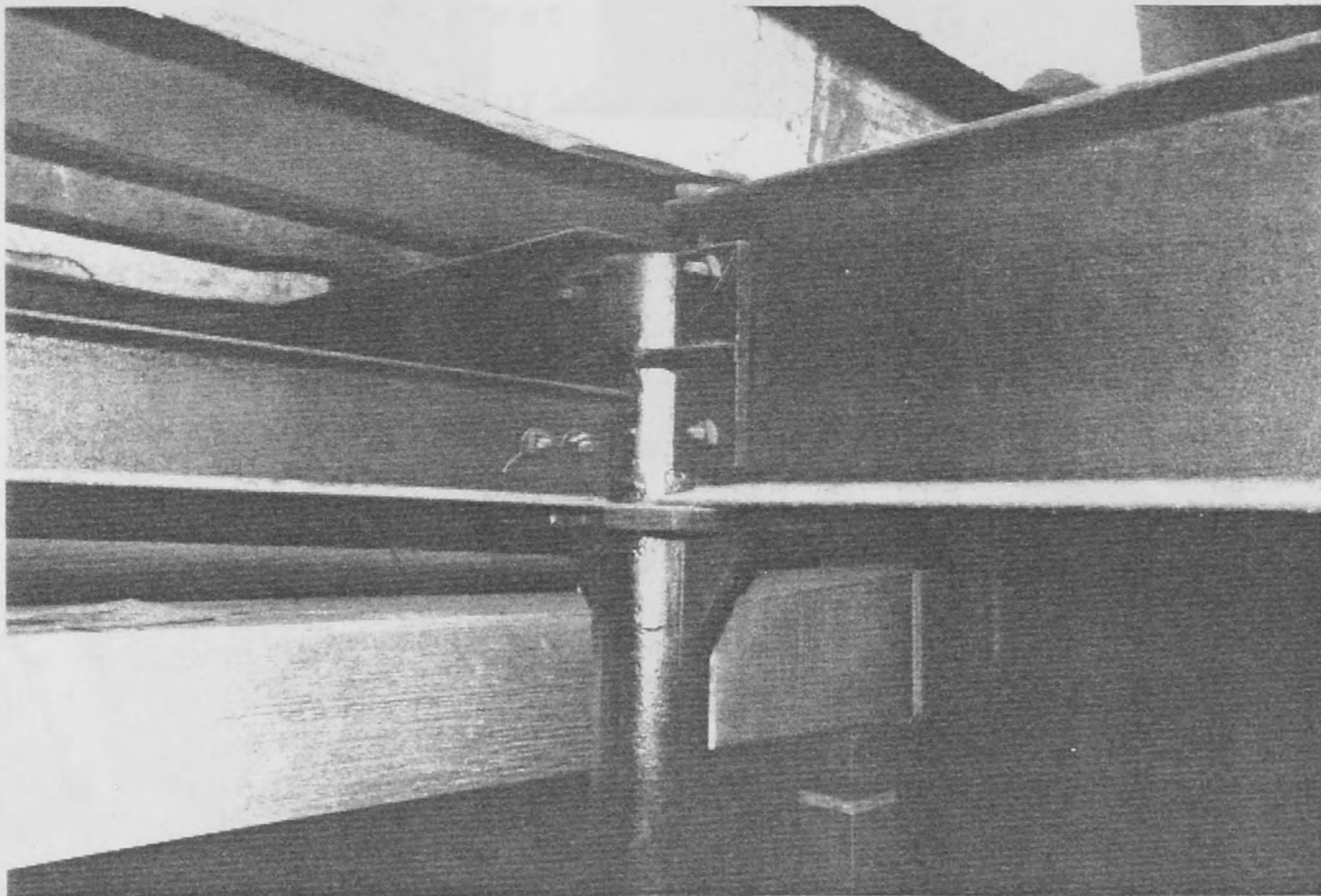

Fig. 6.11 Cast Iron Column in the Oldest Part of Building F



Fig. 6.12 Building G



Fig. 6.13 Details of Steel Frame in Building G

built in 1906 and remodelled several times since then. Some parts of the building have been flooded in the past, causing a deterioration of wood floors and rusting of steel beams.

Structural details are shown in Fig. 6.13. The light weight floors and roof are the redeeming features of this structure. One would expect some shattered brick walls and considerable glass breakage, but no collapse. However, the damage could make the building more costly to repair than to replace.

Building H is a 12-story reinforced concrete frame building, Fig. 6.14, with concrete floors and roof, built in the 1930's. This is a regular building, rectangular in plan, with numerous shear walls: exterior and interior, longitudinal and transverse. A typical floor is shown in Fig. 6.15, and typical cross sections of columns, beams, and floor slabs are shown in Fig. 6.16. Again, comparing this building with similar buildings subjected to previous earthquakes, one would expect no structural damage of any significance, and not a great deal of architectural damage.

Building I, with 13 stories, Fig. 6.17, was built in 1923. It has a steel frame, brick walls, and concrete floors and roof. Typical sections of beams and their connections are shown in Fig. 6.18. Numerous exterior and interior walls (partitions) may contribute significantly to the lateral strength of the building. No serious damage can be expected.

Building J, 9 stories high, was built in the 1920's. Its reinforced concrete structure consists of columns and slabs (no beams except spandrels). Typical sections of columns and slabs are shown in Fig. 6.19. There is a large water tank on the roof



Fig. 6.14 Building H

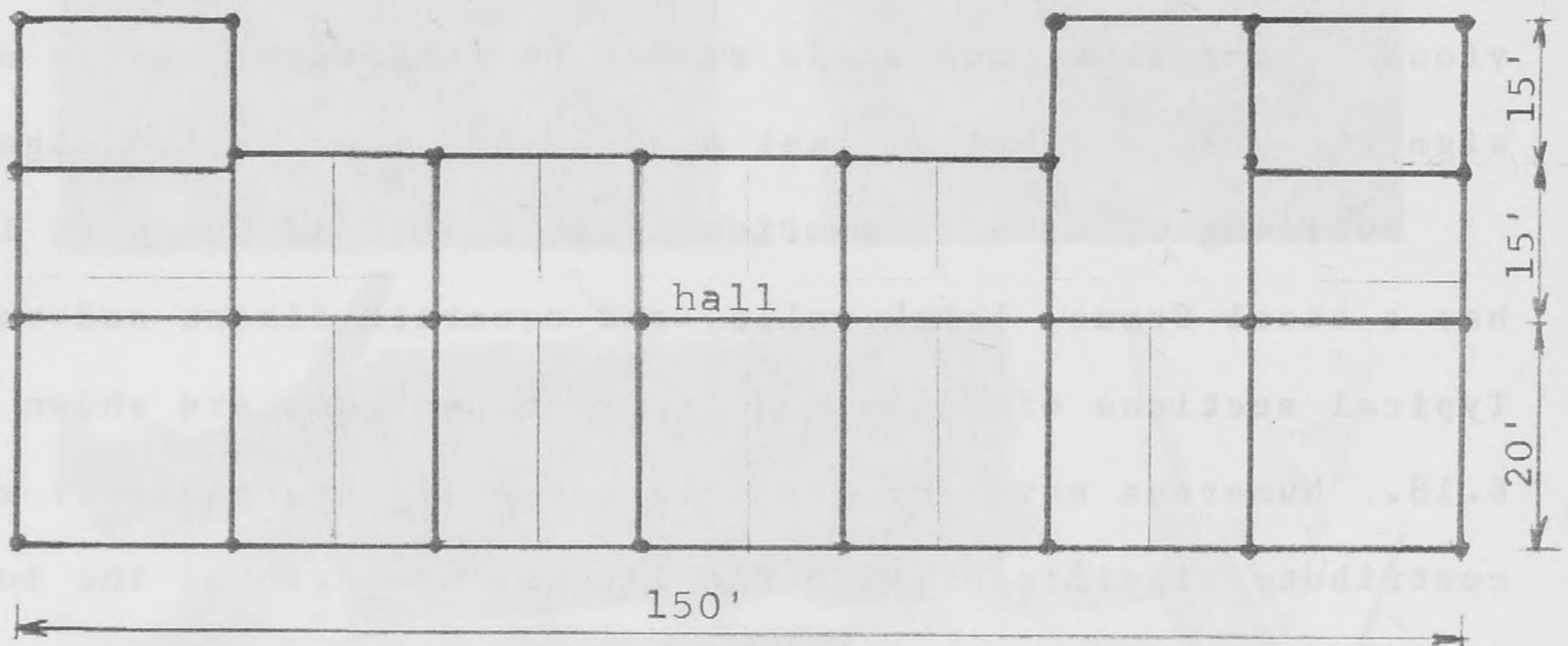

Fig. 6.15 Typical Floor in Building H

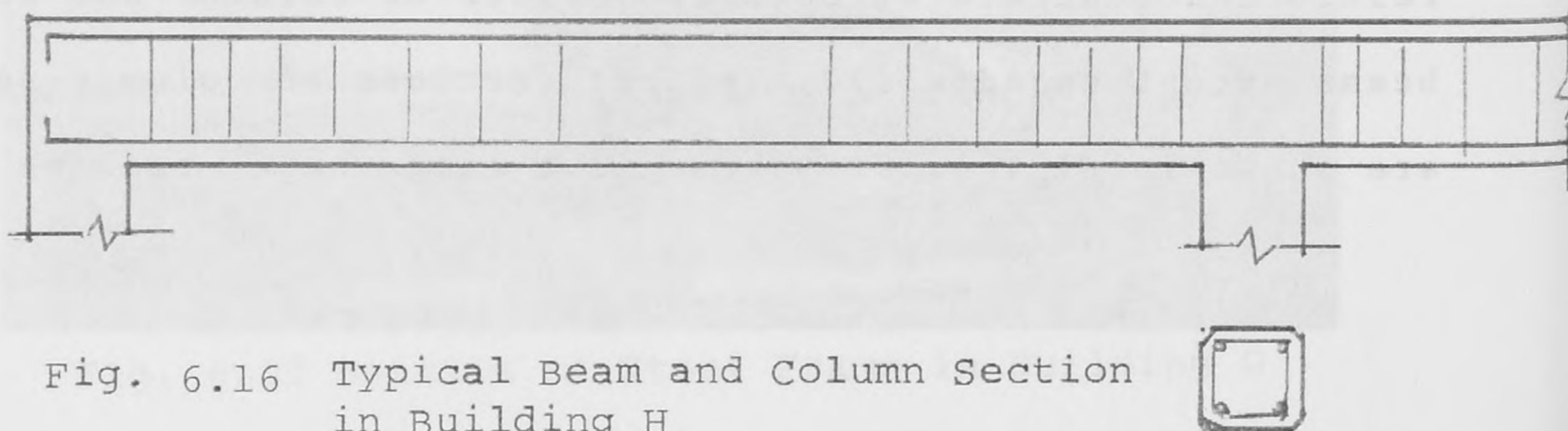

Fig. 6.16 Typical Beam and Column Section in Building H



Fig. 6.17 Building I

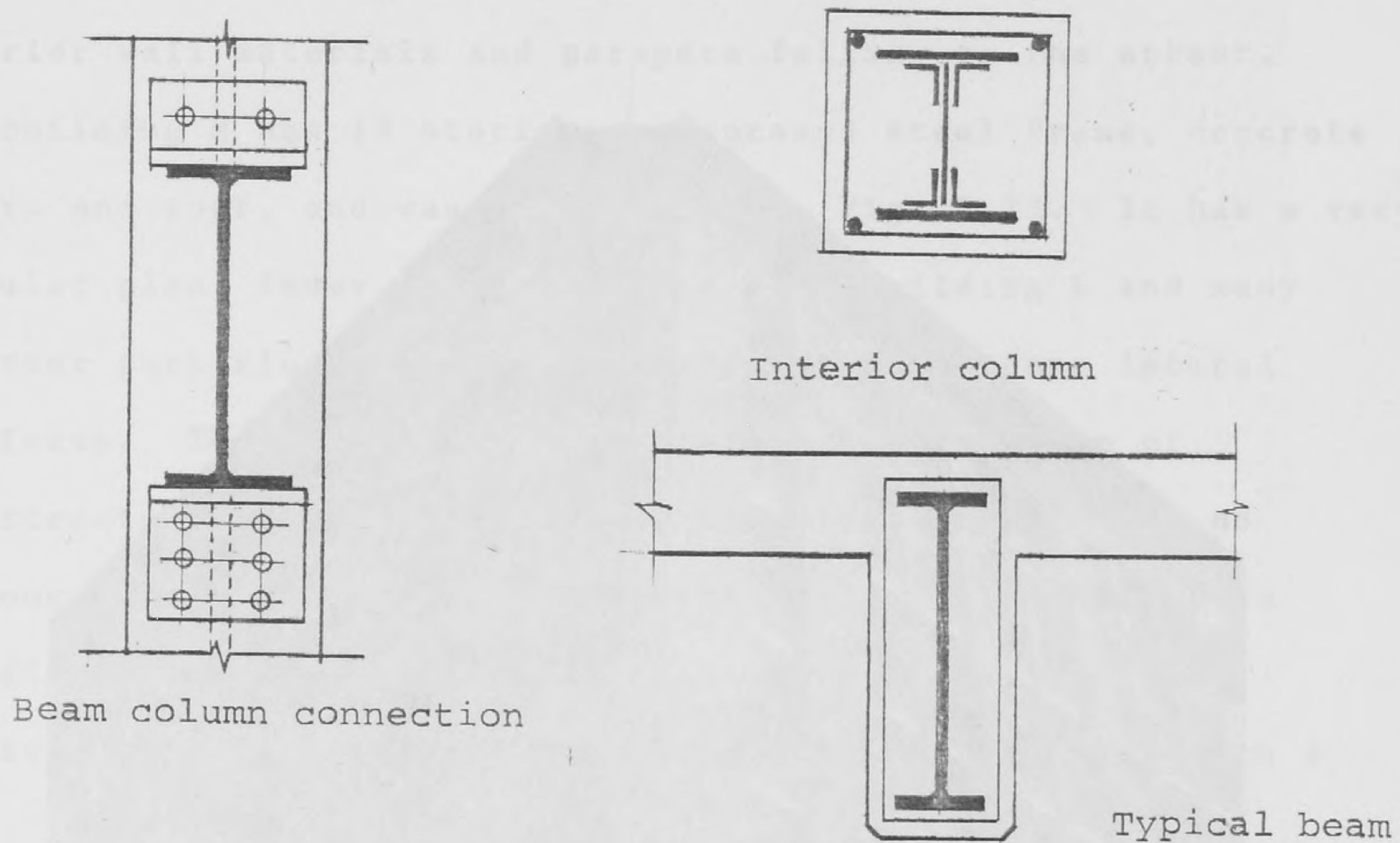

Fig. 6.18 Typical Cross Sections of Beams and Columns in Building I

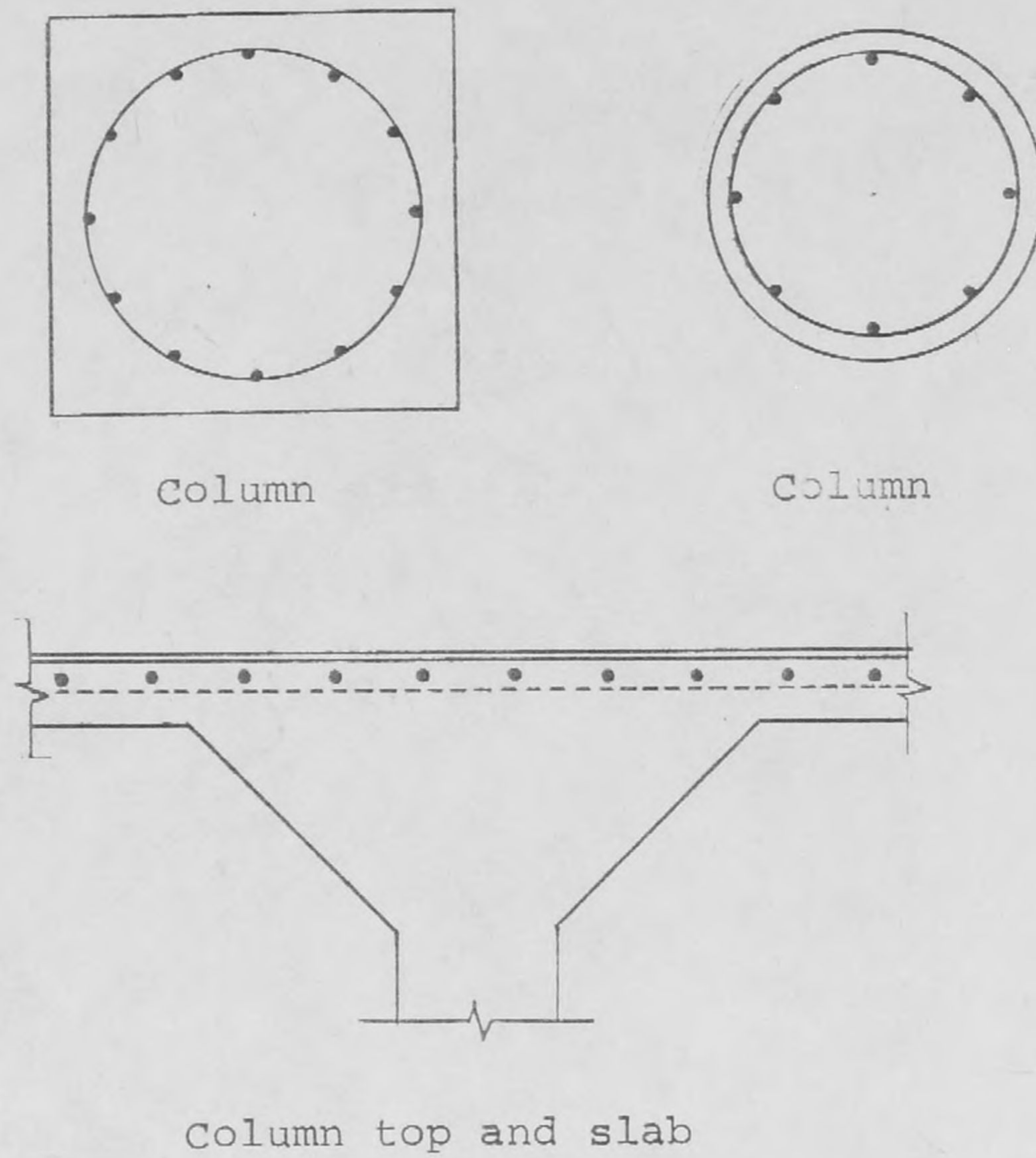

Fig. 6.19 Typical Cross Sections of Floor Slabs and Columns in Building J



Fig. 6.20 Parapet of Building J

and the building is heavily ornamented (Fig. 6.20). A rather good seismic resistance can be expected.

Building K is an 11-story hotel, newly remodelled, which was originally constructed in 1921, Fig. 6.21. Its structure consists of a reinforced concrete frame with ribbed floor slabs and brick outside walls. Numerous exterior and interior walls contribute significantly to the seismic resistance of the building. In case of an earthquake, a relatively good performance can be expected.

Building L, an 18-story steel frame structure with concrete floors and roof, was built in 1901 and extended in 1937, Fig. 6.22. Windows make up a large fraction of the exterior wall length. In case of an earthquake, one can expect the brick piers between the windows to be X-cracked and perhaps badly shattered. One can also foresee potentially severe architectural damage, repairable structural damage, but no collapse. The soft ground story might be a detriment. There would be some hazard due to exterior wall materials and parapets falling to the street.

Building M has 19 stories, an encased steel frame, concrete floors and roof, and was built in 1909, Fig. 6.23. It has a rectangular plan, fewer irregularities than Building L and many interior partitions that can significantly increase lateral stiffness. There are some heavy parapets at the top of the structure. One can expect architectural damage but no serious structural damage, and certainly no collapse. Both buildings L and M are office buildings that are now vacant.

Building N is an office building, 29 stories high, with a



Structural details of floor



Fig. 6.21 Building K



Fig. 6.22 Building L



Fig. 6.23 Building M

steel frame encased in concrete, built in 1929, Fig. 6.24. The floors and roof are concrete. This appears to be a well-designed and well-built structure. The setbacks in the longitudinal direction might enhance the distribution of lateral forces, but they would also generate a reentrant corner problem. The two effects might be offsetting. The lower part of the building is U-shaped, Fig. 6.25, and one could expect structural difficulty at those corners. An earthquake may be expected to cause architectural damage, but only moderate structural damage.

Building O is a 32-story office building, constructed in 1969, Fig. 6.26. Its structure is a regular rectangular steel frame with concrete floor slabs. The framework during construction is shown in Fig. 6.27. In the case of an earthquake, no serious structural damage is expected.

All of the foregoing estimates of damage are based entirely on qualitative judgments, obtained by comparing apparent structural qualities of these buildings with those of other buildings of like kind that have survived or failed in destructive earthquakes in the United States and elsewhere. Such judgments are subjective.



Fig. 6.24 Building N



Fig. 6.25 Back Side of Building N



Fig. 6.26 Building O

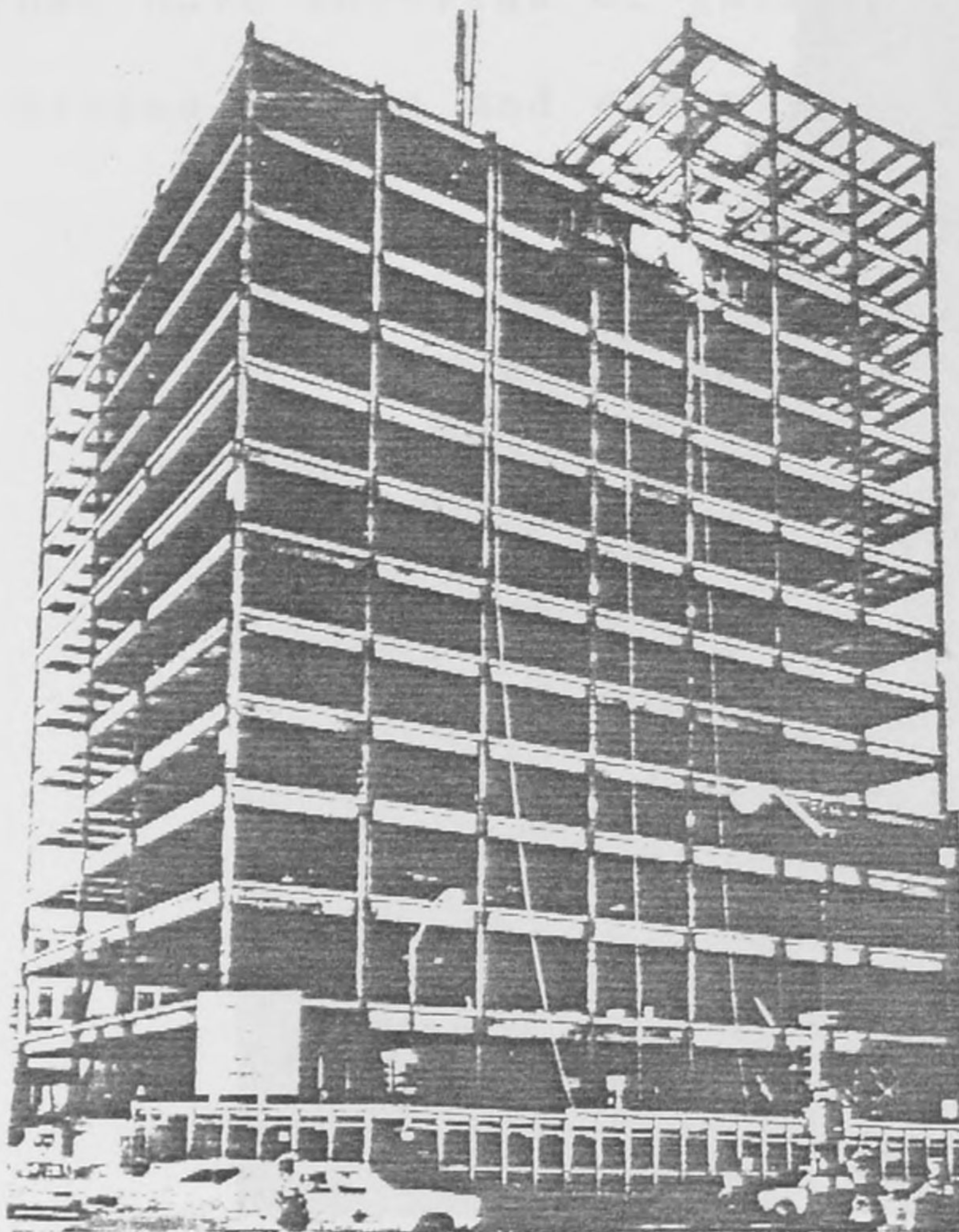

Fig. 6.27 Building O During Construction

7. SELECTION OF REFERENCE GROUND MOTION

Evaluation of seismic strength for commercial buildings in Memphis was carried out using four design earthquakes.

Seismic history of the area is discussed in Chapter 2. Nuttli considers the intensity amplification for major earthquakes originating at the New Madrid fault zone, Fig. 2.11 to 2.13. The city of Memphis falls within the intensity VIII or IX zone. In the analysis, therefore, earthquakes with such intensities are considered. Because no strong motion accelerogram records for the Central United States are available, two California earthquakes are used: El Centro (Imperial Valley Earthquake of May 18, 1940) and Taft (Lincoln School Tunnel, Kern County Earthquake of July 21, 1952). They are widely publicized and may be used for comparison. The maximum Modified Mercalli intensities are estimated at VIII to X for El Centro, and at IX to XI for Taft. These are maximum intensities, not the intensities at the instrument locations. The response spectra are given in Fig. 7.1 and 7.2 (36).

For comparison, the seismic evaluation was also performed using the seismic code provisions from the 1979 UBC (37) and 1981 BOCA (38) codes. The Uniform Building Code specifies the minimum lateral earthquake design force, V , as

$$V = ZIKCSW \quad (7-1)$$

where Z = numerical coefficient dependent upon the zone;
Memphis is in Zone 3, for which $Z = .75$,
 I = occupancy importance factor; it is equal to 1.0
for the considered buildings,

RESPONSE SPECTRUM

IMPERIAL VALLEY EARTHQUAKE MAY 18, 1940 - 2037 PST

IIIA001 40.001.0 EL CENTRO SITE IMPERIAL VALLEY IRRIGATION DISTRICT COMP 500E

DAMPING VALUES ARE 0. 2. 5. 10 AND 20 PERCENT OF CRITICAL

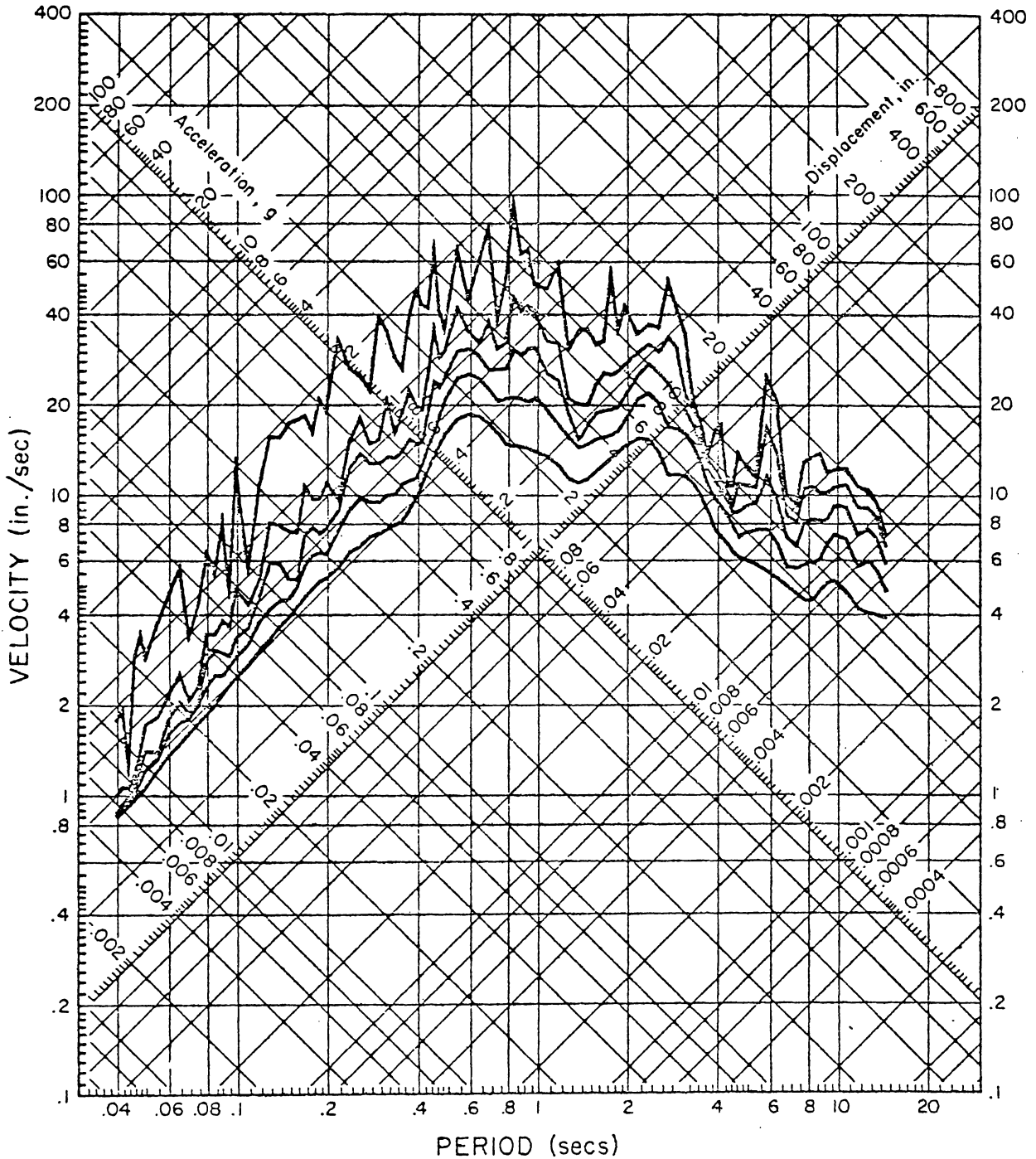

Fig. 7.1 Response Spectrum for El Centro Earthquake (From ref. 36)

RESPONSE SPECTRUM

KERN COUNTY, CALIFORNIA EARTHQUAKE JULY 21, 1952 - 0453 PDT

IIIA004 52.002.0 TAFT LINCOLN SCHOOL TUNNEL COMP S69E

DAMPING VALUES ARE 0, 2, 5, 10 AND 20 PERCENT OF CRITICAL

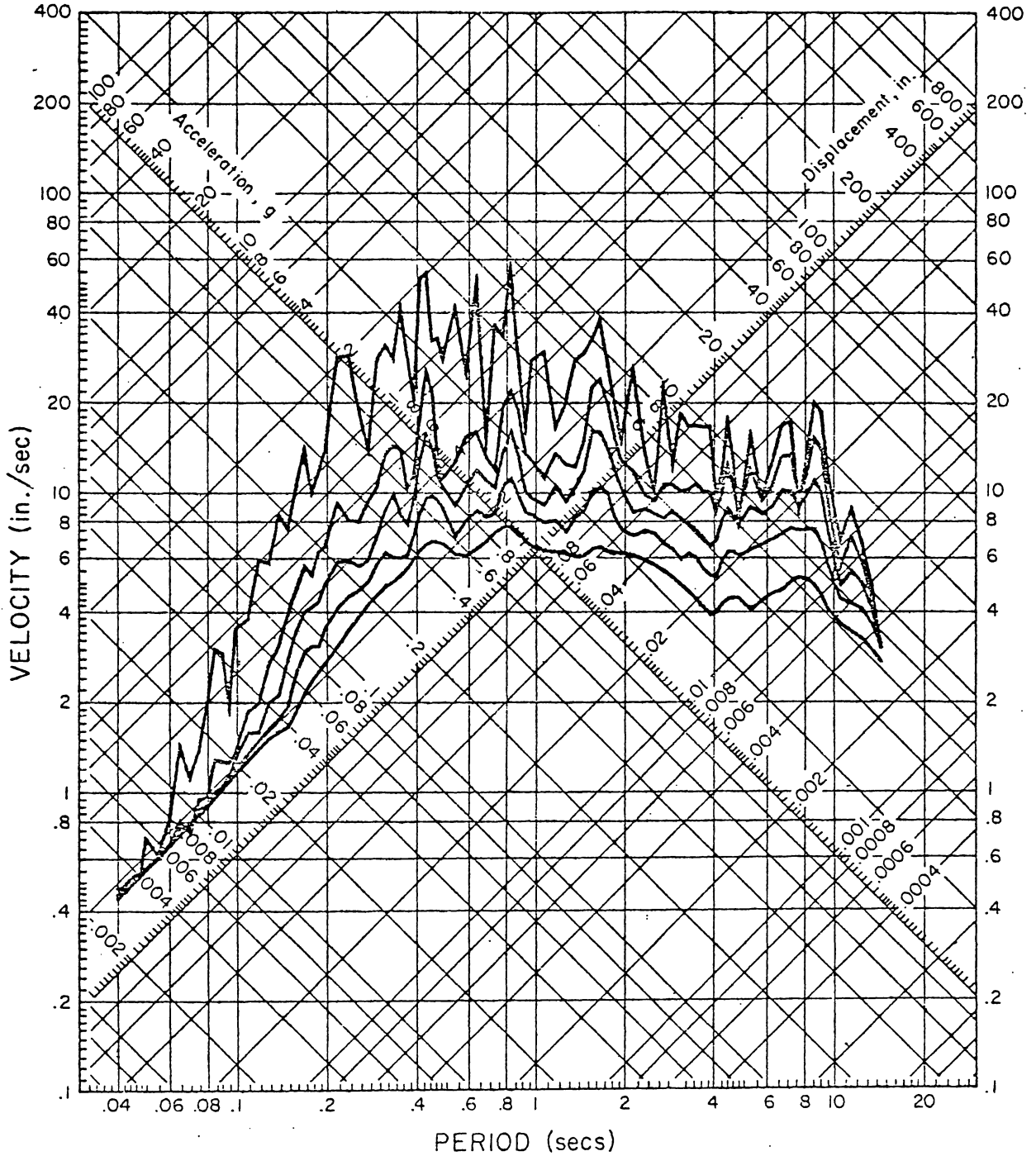

Fig. 7.2 Response Spectrum for Taft Earthquake.
(From ref. 36)

K = numerical coefficient related to the type of structure; it is equal to 1.0 for the considered buildings,

$$C = \frac{1}{15\sqrt{T}}, \text{ but } C \leq .12$$

T = fundamental elastic period of vibration of the building in the direction under consideration,

S = numerical coefficient for site-structure resonance; it is equal to 1.5 in the analysis of the considered buildings; $CS \leq .14$,

W = total dead load.

Replacing the coefficients with the above listed values, eq. 7-1 becomes,

$$V = \frac{.075}{\sqrt{T}} W, \text{ but } V \leq .105W. \quad (7-2)$$

The BOCA Basic Building Code specifies the design minimum lateral seismic force as

$$V = ZKCW \quad (7-3)$$

where Z = numerical coefficient dependent upon the zone; Memphis is in Zone 2, for which Z = .50,

K = numerical coefficient; it is equal to 1.0 for the considered buildings,

$$C = \frac{.05}{\sqrt[3]{T}}, \text{ but } C \leq .10,$$

T = (0.1)n,

n = number of stories,

W = dead load.

Replacing the coefficients with the above listed values,
eq. 7-3 becomes,

$$V = \frac{.025}{\sqrt[3]{T}} W , \text{ but } V \leq .05W \quad (7-4)$$

For comparison, spectra for the two selected earthquakes,
plotted as spectral acceleration vs. period, are shown in Fig. 7.3,
along with the corresponding code provisions.

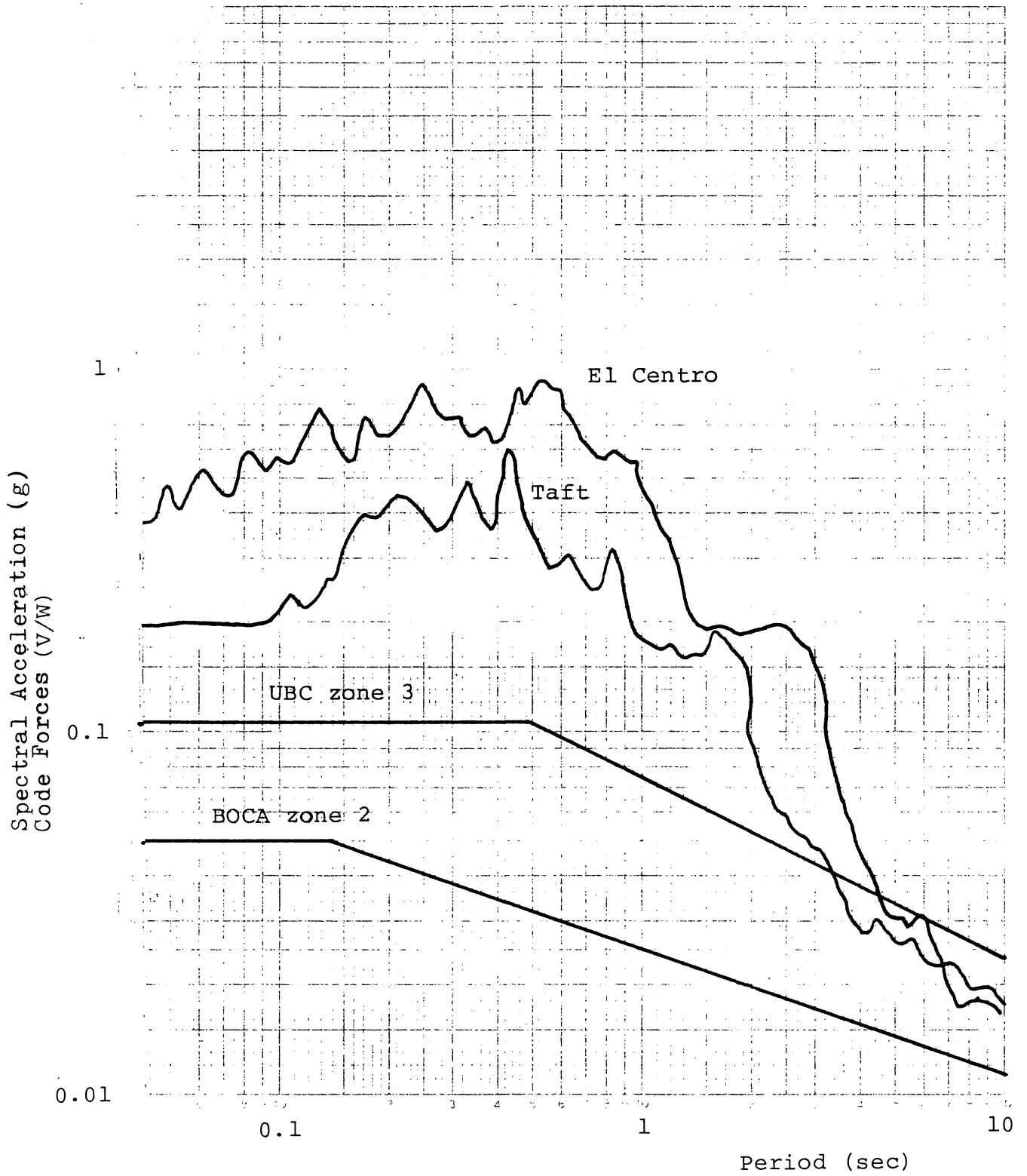

Fig. 7.3 Acceleration Spectra and Code Seismic Forces

8. SEISMIC STRENGTH EVALUTATION

Some of the buildings have been appraised for seismic resistance quantitatively. Two low-rise structures and three medium-high were selected. The analysis is based on available building drawings and follows the procedure outlined below.

- 1) For each building considered, a representative bent was selected.
- 2) Moments of inertia and moment capacities were calculated for all members in the frame.
- 3) Inertia masses were calculated and apportioned, using the building plans along with photographs and observations. The bents were analyzed as weightless frames with the masses lumped at each floor; the tributary mass was considered to be from mid-height of adjacent stories.
- 4) Mode shapes ($\{ \phi_i \}$), frequencies (ω_n), periods (T), and base shear equivalent masses (m_e) were calculated using a Stodola iteration procedure.
- 5) The equivalent lateral forces were calculated for the four design earthquakes described in Chapter 7:
 - UBC (1979) - Zone 3,
 - BOCA (1981) - Zone 2,
 - El Centro, Imperial Valley, California (1940),
 - Taft, Lincoln School Tunnel, Kern County, California (1952).

For the earthquakes defined by UBC and BOCA, the lateral forces were calculated in accordance with the

code provisions. The forces for the two California earthquakes were calculated using response spectrum techniques, with damping assumed to be 5% of critical.

- 6) The effects of these lateral forces were calculated for each bent using rigid frame analysis considering flexural deformations only. The results of this analysis included lateral displacements, joint rotations, end moments and shears, and column axial forces.
- 7) Dead and live load were considered as uniformly distributed. In accordance with the codes, a load combination factor of .75 was applied to the joint effect of the earthquake, dead, and live loads. The moment capacity was compared with the total load effect for each of the four lateral force conditions.

Building 1:

The structure is a low-rise building (three stories and a basement), consisting of a reinforced concrete frame system with slab flooring. A floor plan is shown in Fig. 8.1 and typical dimensions are given in Table 8.1.

The interior bent selected for analysis is shown in Fig. 8.2. Moments of inertia were calculated for columns and beams based on the gross concrete sections; these values are also shown in Fig. 8.2. The ACI code (41) provisions were used in the analysis of beam and slab members.

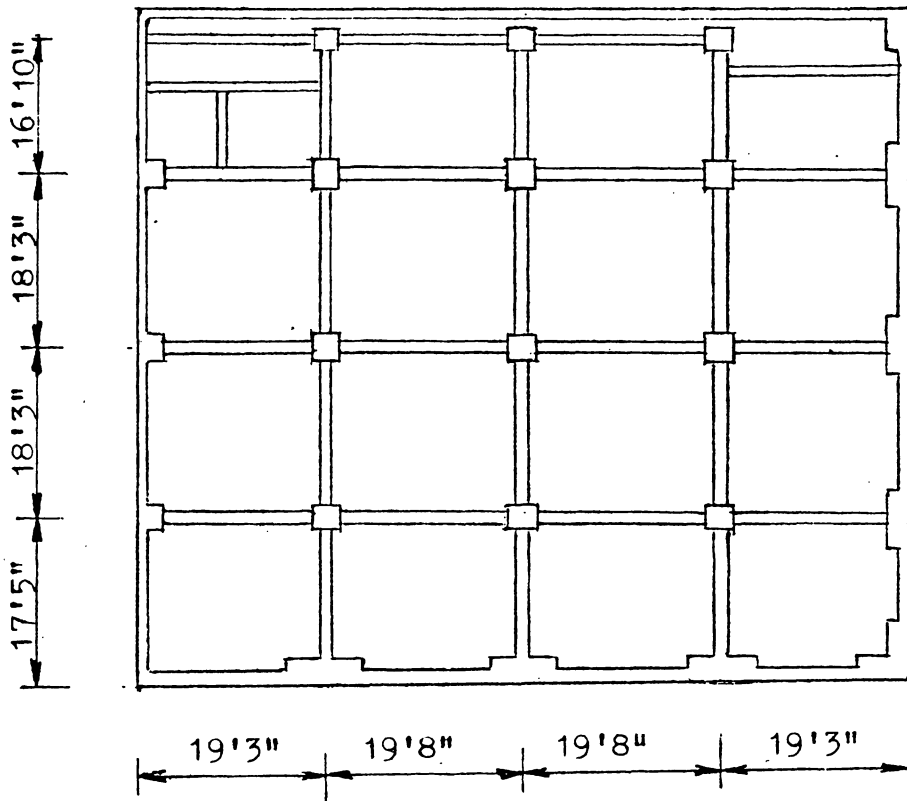

Fig. 8.1 Typical Floor Plan in Building 1

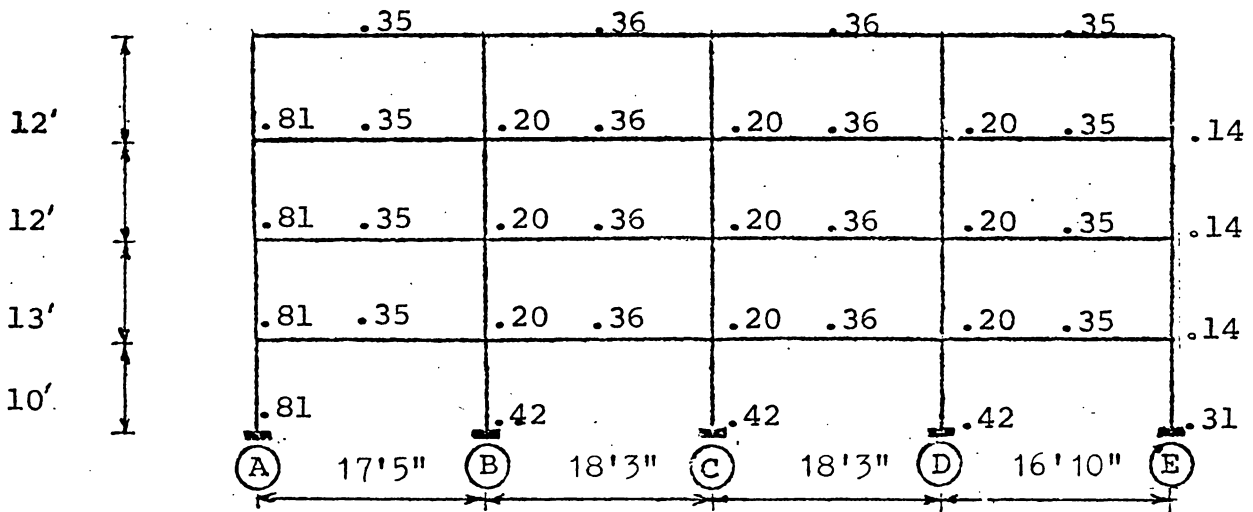

Fig. 8.2 Selected Frame in Building 1 with Moments of Inertia for Beams and Columns, (ft⁴)

Ultimate moment capacity was determined as

$$M_n = A_s f_y d \left(1 - 0.59 \frac{f_y}{f'_c} \rho \right) \quad (8-1)$$

where A_s = cross-sectional area of tensile steel;
 f_y = yield stress of steel, 40 ksi;
 d = depth to centroid of steel;
 f'_c = compressive strength of concrete, 3000 psi;
 ρ = reinforcement ratio.

The moment capacities for the columns and the beams (end moments) are shown in Tables 8.2 and 8.3.

The mass of the structure was determined and apportioned to each floor, Table 8.4. The weight from partitions, flooring, ceilings, ductwork, plumbing, and similar items is taken as 22 psf for the roof and 38 psf for all other levels. The roof load also includes the weight of a parapet that extends above the roof around the perimeter of the building. Exterior wall weights were taken as 80 psf (8" brick walls) and windows as 8 psf.

The first mode properties were determined using a Stodola iteration procedure. For the bent considered, the frequency was 6.93 rad/sec and the period was 0.91 seconds. The base shear equivalent mass was calculated as 567 kips and the first mode shape, $\{\phi\}$, was:

$$\begin{Bmatrix} \phi_1 \\ \phi_2 \\ \phi_3 \\ \phi_4 \end{Bmatrix} = \begin{Bmatrix} .130 \\ .538 \\ .836 \\ 1.000 \end{Bmatrix} \quad (8-2)$$

where ϕ_i represents the lateral displacement at floor i .

Using this information, the equivalent lateral forces were

Table 8.1: Typical Dimensions of Structural Members in Building 1 (inches)

Story	Columns (tied)		Beams		Slab
	Interior	Exterior	Interior	Exterior	
4	15x15	11½x15, 16x49	11½x18	11½x16	4½
3	15x15	11½x15, 16x49	11½x18	11½x16	5
2	15x15	11½x15, 16x49	11½x18	11½x16	5
1	18x18	15x15, 16x49	11½x18	11½x16	5

Table 8.2: Column Moment Capacities for Building 1 (ft-kips)

Story	Column				
	A	B	C	D	E
4	96	36	36	36	26
3	96	36	36	36	26
2	96	36	36	36	26
1	96	78	78	78	36

Table 8.3: Beam End Moment Capacities for Building 1 (ft-kips)

Story	Beams		
	A-B, B-A, B-C	C-B, C-D	D-E, E-D
4	62	73	61
3	128	153	159
2	128	153	159
1	154	182	166

Table 8.4: Mass Calculations for Building 1 (kips)

Floor	Structure	Partitions ductwork, etc.	Exterior walls, windows	Total
4	99.7	45.5*	5.5	150.7
3	115.8	52.9	11.1	179.8
2	117.0	52.9	10.6	180.5
1	117.4	52.9	13.0	183.3
Total				<u>694.3</u>

* roof load includes parapet

Table 8.5: Earthquake Equivalent Lateral Forces for Building 1 (kips)

Floor	El Centro	Taft	UBC	BOCA
4	54.6	23.7	23.2	9.0
3	55.7	27.9	17.8	8.2
2	36.0	18.0	11.7	5.4
1	8.9	4.4	5.2	2.4
Base Shear	155.2	77.6	58.9	124.9

calculated for the two earthquakes and two building codes of Chapter 7. The results are summarized in Table 8.5. For the code earthquakes, the force at each floor was calculated as:

$$F_i = (V - F_t) \frac{m_i h_i}{N \sum_{j=1}^N m_j h_j} \quad (8-3)$$

where m_i = mass of floor i ,

h_i = height of floor i above base of building,

N = number of stories,

V = shear force at the base,

F_t = portion of V considered as concentrated at the top of the structure;

UBC: $F_t = 0.07TV$,

T is calculated first mode period;

BOCA: $F_t = 0.004V(h_N/D_S)^2 \leq 0.15V$,

D_S is plan dimension (feet) of force-resisting system in direction of load; if $(h_N/D_S) \leq 3$, then F_t is zero.

For the two California earthquakes:

$$F_i = V \frac{m_i \phi_i}{N \sum_{j=1}^N m_j \phi_j} \quad (8-4)$$

It should be noted that, for the applications of the building codes, the code coefficients are multiplied by the total mass of the structure. In the response spectrum analysis used for the two California earthquakes, the base shear is the product of the spectral acceleration and the effective mass of the structure. For the buildings considered in this study, the effective mass is on the order of 80% of the total mass of the structure.

End moments resulting from the application of the lateral forces were calculated for each of the four sets of forces. Dead load (other than the weight of the structure) and live load were calculated according to the UBC and BOCA codes in the appropriate cases. For the two California earthquakes, they were taken as $w = 180$ psf, uniformly distributed on the beam/slab element and the resulting end moments were calculated as:

$$M_{D+L} = \frac{wsL^2}{11} \quad (8-5)$$

where $L =$ span length
 $s =$ beam spacing.

The dead and live load effects were superposed on those of the earthquake lateral forces for the beams. This sum was multiplied by the load factor of .75 and divided by the moment capacity for the member. In the case of the columns, the end moments due to earthquake input were divided by the moment capacities to effect the comparison. These results are shown in Tables 8-6 through 8-11 for selected members.

Table 8.6: Ratio of M_{D+L+E} to M_n for Column A in Building 1

Story	El Centro	Taft	UBC	BOCA
4	.92	.63	.38	.15
3	2.03	1.39	.72	.31
2	3.22	2.20	1.15	.49
1	3.07	2.09	1.14	.49

Table 8.7: Ratio of M_{D+L+E} to M_n for Column B in Building 1

Story	El Centro	Taft	UBC	BOCA
4	2.74	1.87	1.12	.44
3	4.65	3.17	1.72	.72
2	5.10	3.79	2.01	.86
1	3.13	2.14	1.16	.50

Table 8.8: Ratio of M_{D+L+E} to M_n for Column E in Building 1

Story	El Centro	Taft	UBC	BOCA
4	2.04	1.39	.84	.33
3	3.54	2.41	1.30	.55
2	4.33	2.96	1.56	.67
1	4.43	3.02	1.64	.70

Table 8.9: Ratio of $.75M_{D+L+E}$ to M_n for Beam A-B in Building 1

Story	El Centro	Taft	UBC	BOCA
4	1.24	.85	.81	.55
3	1.09	.76	.57	.33
2	1.69	1.16	.77	.43
1	1.18	.82	.56	.34

Table 8.10: Ratio of $.75M_{D+L+E}$ to M_n for Beam C-D in Building 1

Story	El Centro	Taft	UBC	BOCA
4	.55	.42	.53	.42
3	.59	.42	.37	.25
2	.83	.59	.45	.28
1	.67	.48	.36	.24

Table 8.11: Ratio of $.75M_{D+L+E}$ to M_n for Beam E-D in Building 1

Story	El Centro	Taft	UBC	BOCA
4	.77	.56	.62	.45
3	.65	.46	.37	.23
2	.94	.65	.46	.27
1	1.54	.59	.42	.25

Building 2:

Building 2 is a 13-story steel frame structure with a typical floor plan as shown in Fig. 8.3. The beams are standard I sections and the columns typically consist of four angles, two flange plates, and a web plate. All beams and columns are encased in concrete and typical member dimensions are given in Table 8.12.

The interior bent depicted in Fig. 8.4 was selected for analysis. Column and beam moments of inertia, given in Fig. 8.4, were calculated using transformed area principles. The moment capacities were determined according to eq. 8-1; the column capacities are given in Table 8.13. For the first floor beams, the ultimate moment capacity is 413 ft-kips, while the capacity is 228 ft-kips for all other beams in the frame.

The building mass calculations are summarized in Table 8.14. The weights for items such as partitions, exterior walls, and windows were calculated using the same unit weights as those described for Building 1. In calculating the roof load, allowances were made for several structures that are located atop the building. These include: roof garden, machine penthouse, decorative tower, and parapet.

For the first mode of vibration, the calculated mode shape,
, was:

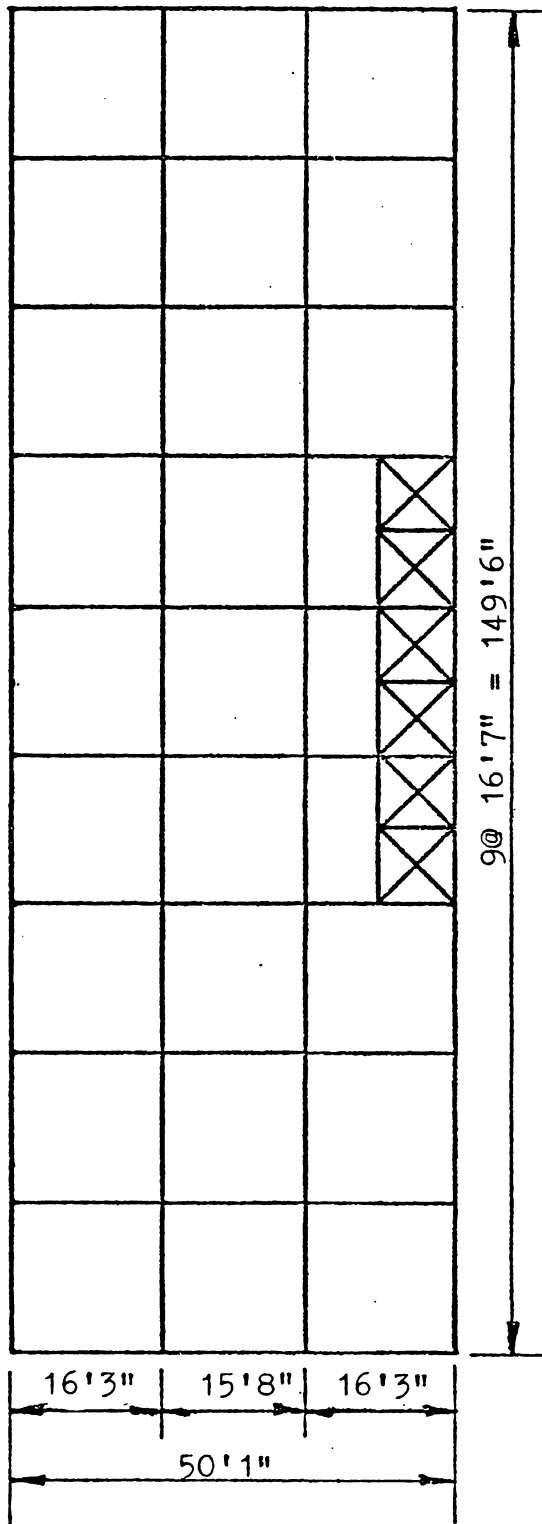

Fig. 8.3 Typical Floor Plan in Building 2

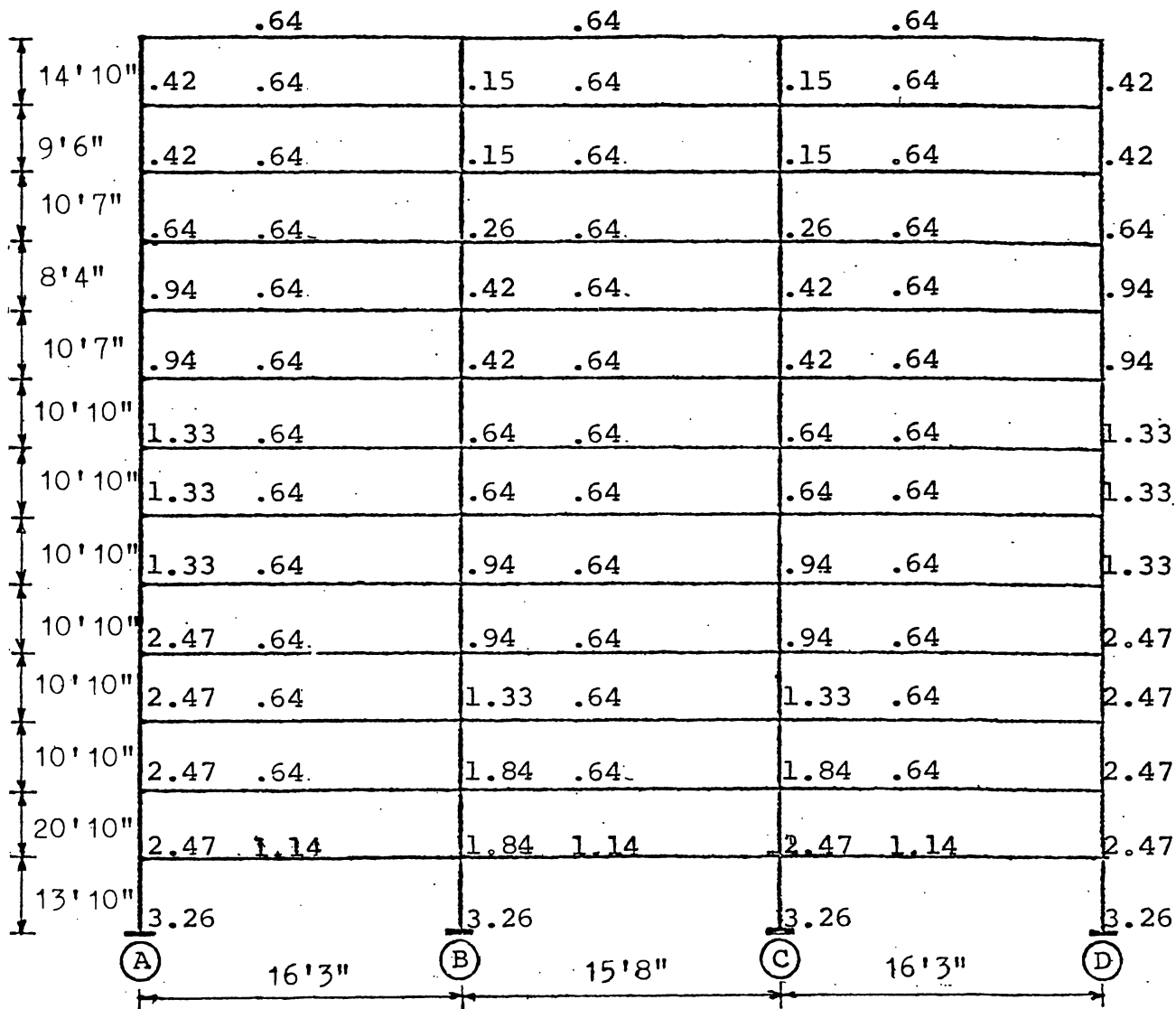

Fig. 8.4 Selected Frame in Building 2. with Moments of Inertia for Beams and Columns, (ft⁴)

Table 8.12: Typical Dimensions of Structural Members in Building 2

Floor	Columns(steel area,concrete) (in. ² , in.)		Beams(steel section, concrete) (in.)		Slab (in.)
	Interior	Exterior	Interior	Exterior	
13	60.0, 14x14	80.0, 18x18	15I42.9, 12x18	12I31.8, 8x17.5	5
12	49.5, 14x14	50.0, 18x18	15I42.9, 12x18	12I31.8, 8x17.5	5
11	49.5, 16x16	37.5, 20x20	15I42.9, 12x18	12I31.8, 8x17.5	5
10	49.5, 18x18	37.5, 22x22	15I42.9, 12x18	12I31.8, 8x17.5	5
9	23.1, 18x18	34.0, 22x22	15I42.9, 12x18	12I31.8, 8x17.5	5
8	23.1, 20x20	34.0, 24x24	15I42.9, 12x18	12I31.8, 8x17.5	5
7	23.1, 20x20	34.0, 24x24	15I42.9, 12x18	12I31.8, 8x17.5	5
6	18.6, 22x22	21.9, 24x24	15I42.9, 12x18	12I31.8, 8x17.5	5
5	18.6, 22x22	21.9, 28x28	15I42.9, 12x18	12I31.8, 8x17.5	5
4	18.6, 24x24	21.9, 28x28	15I42.9, 12x18	12I31.8, 8x25.5	5
3	10.0, 26x26	18.8, 28x28	15I42.9, 12x18	12I31.8, 8x25.5	5
2	10.0, 26x26	18.8, 28x28	15I42.9, 12x18	15I42.9, 8x25.5	5
1	10.0, 30x30	18.8, 30x30	15I42.9, 12x18	18I70.0, 8x25.5	5

Table 8.13: Column Moment Capacities for Building 2 (ft-kips)

Story	Column			
	A	B	C	D
13	226	112	112	226
12	226	112	112	226
11	268	134	134	268
10	343	231	231	343
9	343	231	231	343
8	390	274	274	390
7	479	306	306	479
6	479	361	361	479
5	615	361	361	615
4	680	512	512	680
3	680	597	597	680
2	579	799	797	797
1	1037	1040	890	1025

Table 8.14: Mass Calculations for Building 2 (kips)

Floor	Structure	Partitions, ductwork, etc.	Exterior walls, windows	Total
13	66.4	139.4*	18.0	223.7
12	71.1	29.8	28.4	129.1
11	70.4	29.8	22.8	123.0
10	72.4	29.8	22.6	124.8
9	74.0	29.8	22.6	126.4
8	77.9	29.8	25.2	132.8
7	79.9	29.8	25.4	135.0
6	80.8	29.8	25.4	135.9
5	83.9	29.8	25.4	139.1
4	87.0	29.8	25.4	142.2
3	89.2	29.8	25.4	144.4
2	105.8	29.8	33.2	152.2
1	121.0	29.8	38.4	181.2
Total				<u>1897.8</u>

*Includes roof loading

$$\begin{Bmatrix} \phi_1 \\ \phi_2 \\ \phi_3 \\ \phi_4 \\ \phi_5 \\ \phi_6 \\ \phi_7 \\ \phi_8 \\ \phi_9 \\ \phi_{10} \\ \phi_{11} \\ \phi_{12} \\ \phi_{13} \end{Bmatrix} = \begin{Bmatrix} .049 \\ .256 \\ .378 \\ .432 \\ .513 \\ .591 \\ .668 \\ .737 \\ .799 \\ .836 \\ .887 \\ .927 \\ 1.000 \end{Bmatrix} \quad (8-7)$$

where ϕ_i is the lateral displacement of floor i . The calculated first mode frequency was 3.33 rad/sec, with a corresponding period of 1.89 seconds. The base shear equivalent mass was 1539 kips, which is 81% of the total mass.

The equivalent lateral forces on the frame were calculated for the four ground motion models according to eq. 8-3 and 8-4. Table 8.15 summarizes these calculations. The end moments created by the imposition of these forces were combined with the dead and live load effects where appropriate (beams). Tables 8.16 through 8.18 show the comparisons between the applied moment and the moment capacities for selected members.

Table 8.15: Earthquake Equivalent Lateral Forces for Building 2 (kips)

Story	El Centro	Taft	UBC	BOCA
13	55.5	29.0	32.4	10.4
12	29.7	15.5	9.8	4.5
11	27.0	14.2	8.7	4.0
10	25.9	13.5	8.1	3.3
9	25.0	13.1	7.6	3.5
8	25.2	12.7	7.2	3.4
7	22.3	11.7	6.6	3.0
6	19.9	10.4	5.8	2.7
5	17.7	9.2	5.1	2.4
4	15.2	8.0	4.4	2.0
3	12.4	6.5	3.6	1.7
2	9.7	5.0	2.9	1.3
1	2.3	1.2	1.4	0.7
Base Shear	286.9	150.1	103.6	43.5

Table 8.16: Ratio of M_{D+L+E} to M_n for Column A in Building 2

Story	El Centro	Taft	UBC	BOCA
13	.56	.29	.66	.21
12	.39	.20	.38	.13
11	.53	.28	.49	.18
10	.30	.16	.18	.07
9	.66	.34	.40	.16
8	.51	.27	.28	.11
7	.52	.27	.30	.12
6	.44	.23	.22	.09
5	.49	.25	.30	.12
4	.39	.20	.18	.08
3	.45	.24	.18	.08
2	1.00	.53	.35	.15
1	.74	.39	.31	.13

Table 8.17: Ratio of M_{D+L+E} to M_n for Column B in Building 2

Story	El Centro	Taft	UBC	BOCA
13	.82	.43	.23	.08
12	1.01	.53	.25	.09
11	1.20	.62	.27	.10
10	.92	.48	.26	.10
9	1.07	.56	.29	.12
8	1.24	.65	.34	.14
7	1.12	.59	.27	.11
6	1.22	.64	.34	.14
5	1.14	.59	.24	.10
4	.97	.51	.27	.11
3	1.02	.53	.32	.14
2	1.44	.76	.38	.25
1	.96	.50	.35	.15

Table 8.18: Ratio of $.75M_{D+L+E}$ to M_n for Beam A-B in Building 2

Story	El Centro	Taft	UBC	BOCA
13	.44	.24	.32	.16
12	.66	.36	.42	.18
11	.74	.40	.42	.20
10	.82	.44	.42	.20
9	.96	.52	.46	.22
8	1.20	.64	.54	.26
7	1.34	.72	.58	.28
6	1.46	.78	.62	.30
5	1.58	.84	.64	.32
4	1.68	.88	.68	.32
3	1.80	.96	.72	.34
2	2.08	1.10	.82	.38
1	1.27	.67	.49	.23

Building 3:

This rectangular, 13-story structure has a reinforced concrete frame system with ribbed floor slabs. A floor plan is shown in Fig. 8.5, and typical cross-sectional concrete areas for the members are given in Table 8.19.

Fig. 8.6 shows the exterior frame that was analyzed, with the member moments of inertia. For the beam and slab members, the ACI code provisions were used to determine the width of the slab considered to act integrally with the beam. The moments of inertia for all members were calculated based upon the gross areas of the concrete sections. Eq. 8-1 was used to calculate the member moment capacities, shown in Tables 8.20 and 8.21.

The apportionment of the building mass to each floor is given in Table 8.22. The masses were calculated using the same unit weights for non-structural items as those used in the two previously described buildings; the weight of a machine penthouse was added to the roof load.

A Stodola iteration procedure yielded the parameters of the first mode of vibration for the bent. The frequency was calculated to be 4.62 rad/sec. and the period 1.36 seconds. The base shear equivalent mass was 1836 kips; this is 75% of the total mass of the structure. The shape of the first mode is given by eq. 8-8.

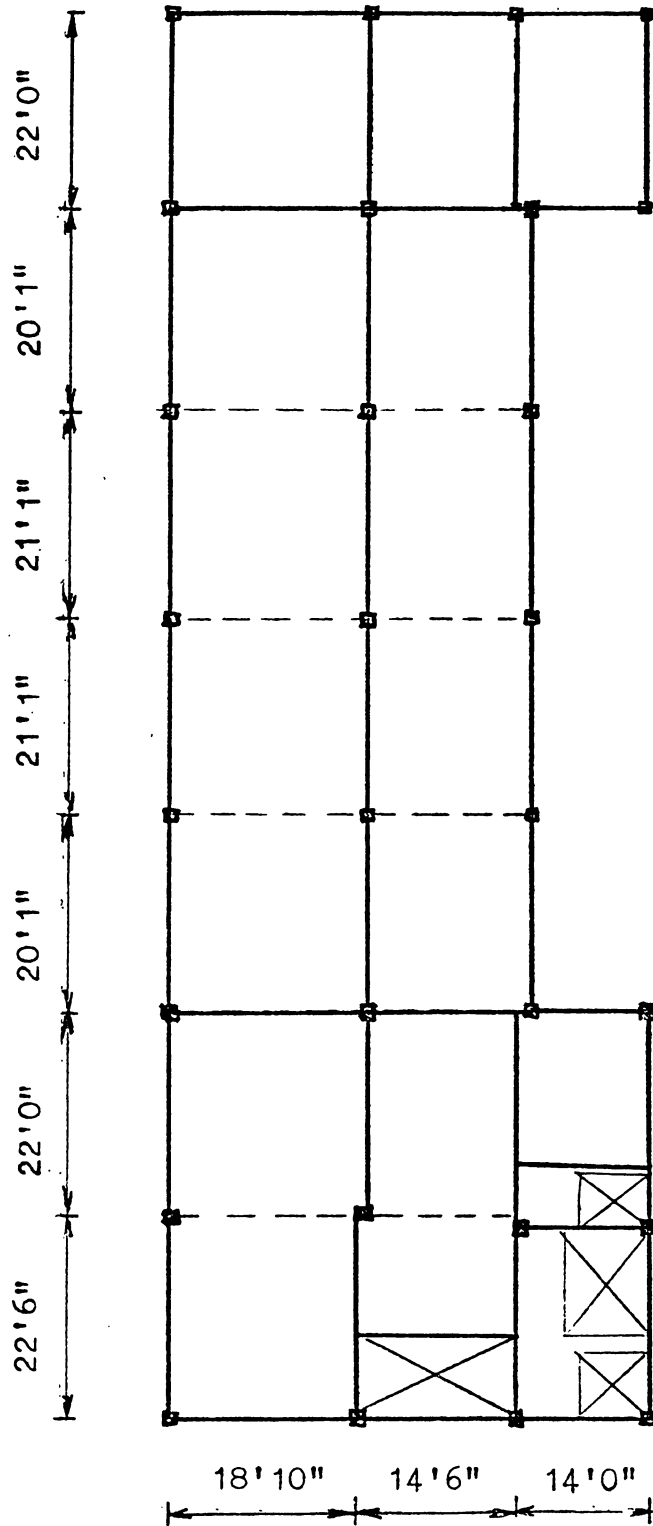

Fig. 8.5 Typical Floor in Building 3

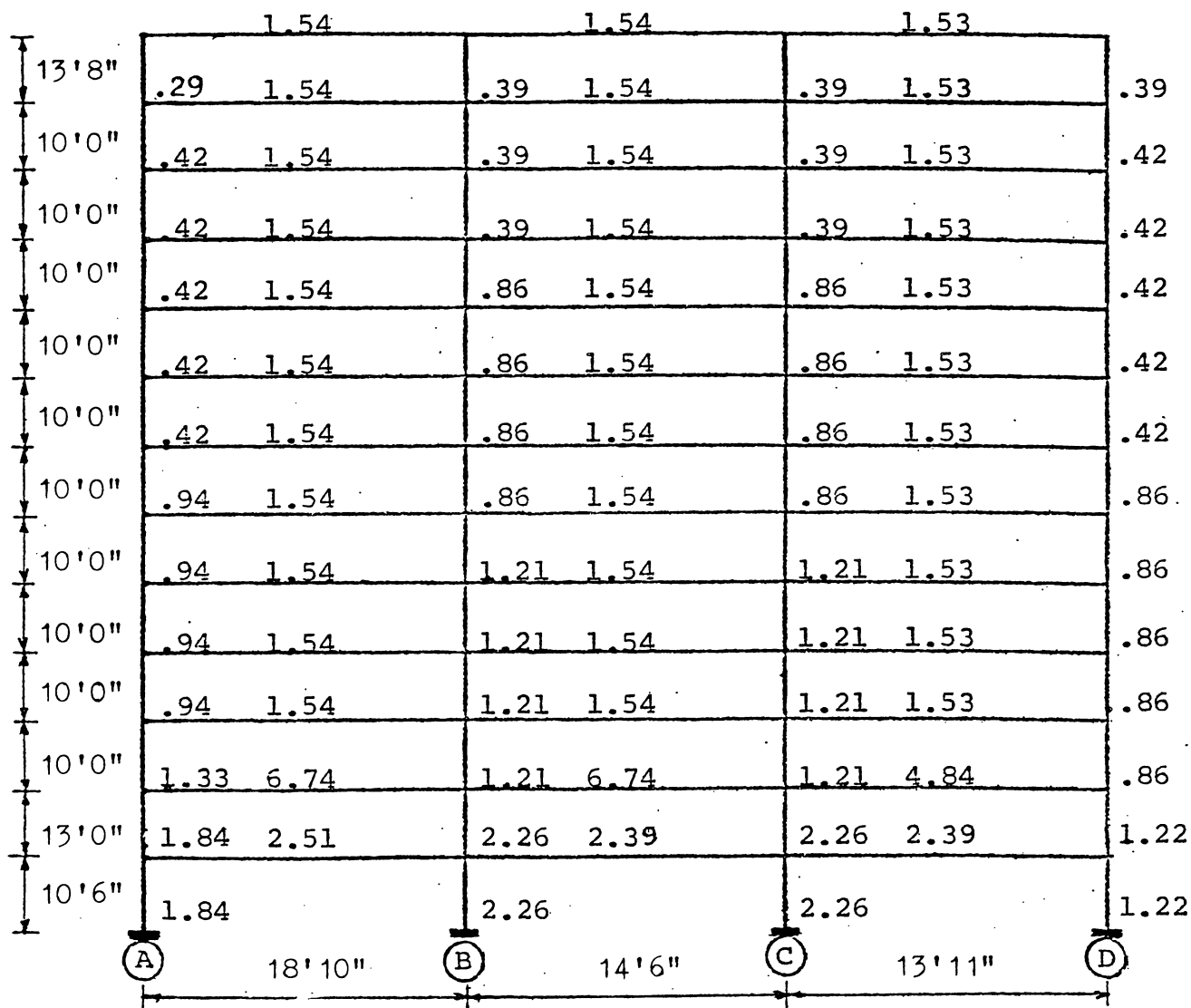

Fig. 8.6 Selected Frame in Building 3 with Moments of Inertia for Beams and Columns, (ft⁴)

Table 8.19: Typical Dimensions of Structural Members in Building 3
(areas in sq. inches)

Floor	Columns		Beams	
	Interior	Exterior	Interior	Exterior
13	280	280	338	288
12	290	318	258	288
11	368	318	258	288
10	387	394	258	288
9	387	394	258	288
8	387	394	258	288
7	545	474	258	288
6	576	474	258	288
5	576	474	258	288
4	646	474	258	288
3	646	474	258	288
2	716	652	410	384
1	716	652	410	336

Table 8.20: Column Moment Capacities for Building 3 (ft-kips)

Story	Column			
	A	B	C	D
13	35	111	111	55
12	55	204	204	55
11	55	204	204	55
10	111	270	270	167
9	184	270	270	184
8	224	357	357	224
7	299	420	420	299
6	323	477	477	323
5	389	513	513	357
4	389	547	547	389
3	513	580	580	420
2	653	892	892	547
1	653	892	892	547

Table 8.21: Beam End Moment Capacities for Building 3 (ft-kips)

Story	Beams		
	A-B, B-A, B-C	C-B, C-D	D-C
13	207	107	207
12	312	312	312
11	312	312	312
10	257	257	257
9	257	257	257
8	257	257	257
7	312	312	312
6	312	312	312
5	312	312	312
4	312	312	312
3	312	312	312
2	437	437	437
1	374	630	308

Table 8.22: Mass Calculations for Building 3 (kips)

Floor	Structure	Partitions, ductwork, etc.	Exterior walls, windows	Total
13	128.5	52.3*	139.4	320.2
12	65.6	40.3	62.8	168.7
11	66.0	39.9	62.8	168.7
10	66.9	40.3	62.8	170.0
9	68.5	40.3	62.8	171.6
8	68.5	40.3	62.8	171.6
7	70.4	40.3	62.8	173.6
6	73.2	40.3	62.8	176.3
5	74.1	40.3	62.8	177.2
4	74.1	40.3	62.8	177.2
3	74.6	40.3	62.8	177.7
2	82.6	42.7	72.1	197.4
1	68.4	44.5	73.6	186.5
Total				<u>2436.7</u>

*Includes roof loading

$$\begin{bmatrix} \phi_1 \\ \phi_2 \\ \phi_3 \\ \phi_4 \\ \phi_5 \\ \phi_6 \\ \phi_7 \\ \phi_8 \\ \phi_9 \\ \phi_{10} \\ \phi_{11} \\ \phi_{12} \\ \phi_{13} \end{bmatrix} = \begin{bmatrix} .044 \\ .127 \\ .198 \\ .286 \\ .373 \\ .456 \\ .541 \\ .629 \\ .706 \\ .774 \\ .849 \\ .909 \\ 1.000 \end{bmatrix} \quad (8-8)$$

Table 8.23 summarizes the equivalent lateral loads on the frame that were calculated for each of the four earthquakes considered for this study. These loads were distributed according to eq. 8-3 and 8-4. Tables 8.24 through 8.26 give the comparisons between the resulting load effects and the member capacities for several members in the frame.

Table 8.23: Earthquake Equivalent Lateral Forces for Building 3 (kips)

Story	El Centro	Taft	UBC	BOCA
13	93.5	55.9	48.5	14.6
12	44.8	26.8	15.9	6.1
11	41.8	25.0	14.6	5.6
10	38.4	23.0	13.5	5.1
9	35.4	21.2	12.3	4.7
8	31.5	18.8	11.0	4.2
7	27.4	16.4	9.8	3.7
6	23.5	14.0	8.6	3.3
5	19.3	11.5	7.2	2.8
4	14.8	8.9	5.9	2.2
3	10.3	6.1	4.6	1.7
2	7.3	4.4	3.6	1.4
1	2.4	1.4	1.5	0.6
Base Shear	390.5	233.3	156.8	35.8

Table 8.24: Ratio of M_{D+L+E} to M_n for Column C in Building 3

Story	El Centro	Taft	UBC	BOCA
13	1.76	1.05	.91	.27
12	1.06	.63	.49	.16
11	1.30	.78	.57	.19
10	1.52	.91	.64	.22
9	1.66	1.00	.68	.24
8	1.45	.87	.59	.20
7	1.15	.69	.46	.16
6	1.26	.76	.50	.18
5	1.18	.71	.47	.17
4	1.17	.70	.47	.16
3	1.14	.68	.46	.16
2	.99	.59	.40	.14
1	.89	.53	.36	.13

Table 8.25: Ratio of M_{D+L+E} to M_n for Column D in Building 3

Story	El Centro	Taft	UBC	BOCA
13	2.87	1.71	1.49	.45
12	2.78	1.66	1.28	.41
11	3.88	2.32	1.71	.56
10	1.07	.64	.46	.15
9	1.24	.74	.51	.18
8	1.08	.64	.44	.15
7	1.19	.71	.48	.17
6	.94	.56	.38	.13
5	.96	.57	.38	.13
4	.92	.55	.36	.13
3	.93	.56	.37	.13
2	.78	.46	.31	.11
1	.78	.46	.31	.11

Table 8.26: Ratio of $.75M_{D+L+E}$ to M_n for Beam D-C in Building 3

Story	El Centro	Taft	UBC	BOCA
13	.60	.36	.35	.14
12	.73	.44	.39	.15
11	.87	.53	.42	.16
10	1.15	.70	.53	.21
9	1.21	.73	.54	.21
8	1.37	.83	.59	.23
7	1.40	.84	.59	.23
6	1.54	.93	.65	.25
5	1.57	.94	.65	.25
4	1.65	.99	.69	.27
3	1.57	.94	.65	.25
2	1.41	.85	.58	.22
1	1.63	.98	.68	.27

Building 4:

Building 4 is 10 stories high and has a reinforced concrete flat slab framing system with recessed central slab panels, column capitals, and deep beams around the building periphery. Typical member sizes and a floor plan are given in Table 8.27 and Fig. 8.7.

The interior frame shown in Fig. 8.8 was analyzed. For the slabs, the moments of inertia were calculated using the method proposed in (42). Gross concrete sections were considered, and the effective slab widths were calculated as functions of column sizes and slab length-to-width ratios. For the spiral-reinforced columns, the moments of inertia were calculated based on gross concrete sections. The member moment capacities were calculated using eq. 8-1. In the case of the slabs, the equivalent dimensions used for this formulation were determined using the procedure referenced above. The moment capacities are summarized in Tables 8.28 and 8.29.

The mass calculations were completed with the unit weights used in the calculations for the other buildings discussed in this section, and are given in Table 8.30. The roof loading for Building 4 includes the effects of a water tank and several mechanical structures.

Dynamic properties for the first mode of vibration of the frame were calculated. The mode shape was:

Table 8.27: Typical Dimensions of Structural Members in Building 4 (inches)

Floor	Columns		Slab Thickness		Exterior Beams
	Interior (circ.)	Exterior (rectang.)	Slabs	Recessed Panels	
10	24	24x24	9	5	19x22
9	24	24x24	10	5.5	12x24
8	24	28x28	10	5.5	12x24
7	26	28x28	10	5.5	12x24
6	26	30x30	10	5.5	12x24
5	28	30x30	10	5.5	12x24
4	28	33.5x33.5	10	5.5	28.5x31
3	30	33.5x33.5	10	5.5	12x33
2	30	36x38	10	5.5	19x44
1	32	38x43	10.5	5.5	24x24

Table 8.28: Column Moment Capacities for Building 4
(ft-kips)

Story	Columns		
	A,H	B,C,F,G	D,E
10	111	89	89
9	138	115	191
8	201	195	239
7	314	288	312
6	425	386	414
5	560	512	512
4	744	549	586
3	888	682	642
2	1123	721	759
1	1318	828	870

Table 8.29: Beam End Moment Capacities for Building 4 (ft-kips)

Story	Beams		
	A-B, H-G	B-A, B-C, C-B, C-D, F-E, F-G, G-F, G-H	D-C, D-E, E-D, E-F
10	122	119	178
9	138	136	204
8	138	136	204
7	138	135	203
6	138	135	203
5	138	135	202
4	138	135	202
3	138	135	202
2	138	135	202
1	145	143	214

Table 8.30: Mass Calculations for Building 4 (kips)

Floor	Structure	Partitions, ductwork, etc.	Exterior walls, windows	Total
10	384.4	286.7*	15.6	686.7
9	452.7	133.1	35.2	621.0
8	459.9	133.1	39.3	632.3
7	465.9	133.1	39.3	638.3
6	470.6	133.1	39.3	643.0
5	478.4	133.1	41.2	652.8
4	509.3	133.1	45.1	687.5
3	500.6	133.1	47.0	680.7
2	551.0	133.1	50.1	734.3
1	563.2	133.1	55.9	752.2
Total				<u>6728.8</u>

*Includes roof loading.

$$\begin{Bmatrix} \phi_1 \\ \phi_2 \\ \phi_3 \\ \phi_4 \\ \phi_5 \\ \phi_6 \\ \phi_7 \\ \phi_8 \\ \phi_9 \\ \phi_{10} \end{Bmatrix} = \begin{Bmatrix} .048 \\ .235 \\ .378 \\ .520 \\ .650 \\ .758 \\ .848 \\ .922 \\ .974 \\ 1.000 \end{Bmatrix} \quad (8-9)$$

The corresponding frequency was calculated as 1.92 rad/sec, the period as 3.27 seconds, and the base shear equivalent mass as 5314 kips (79% of the structure mass).

Equivalent lateral loads were calculated for the four example ground motion inputs; the loads are summarized in Table 8.31. Tables 8.32 through 8.35 show the comparisons between the resulting moment effects and selected member capacities.

Table 8.31: Earthquake Equivalent Lateral Forces for Building 4 (kips)

Story	El Centro	Taft	UBC	BOCA
10	106.4	33.5	102.6	30.2
9	93.8	29.5	32.2	25.2
8	90.4	28.5	29.4	23.0
7	83.9	26.4	26.4	20.6
6	75.5	23.8	23.2	18.1
5	65.8	20.7	20.1	15.7
4	55.4	17.4	17.3	13.5
3	39.9	12.6	13.3	10.4
2	26.8	8.4	10.2	8.0
1	5.6	1.8	4.3	3.3
Base Shear	643.6	202.7	278.9	168.2

Table 8.32: Ratio of M_{D+L+E} to M_n for Column A in Building 4

Story	El Centro	Taft	UBC	BOCA
10	.65	.15	.53	.18
7	.92	.24	.37	.23
2	1.98	.62	.86	.51
1	2.91	.92	1.26	.76

Table 8.33: Ratio of M_{D+L+E} to M_n for Column B in Building 4

Story	El Centro	Taft	UBC	BOCA
10	.77	.37	.94	.33
7	1.18	.37	.62	.33
2	1.22	.38	.52	.31
1	1.15	.36	.50	.30

Table 8.34: Ratio of $.75M_{D+L+E}$ to M_n for Beam A-B in Building 4

Story	El Centro	Taft	UBC	BOCA
10	.60	.29	.79	.55
7	1.99	.72	1.36	.86
2	3.50	1.19	1.83	1.24
1	2.36	.83	1.32	.92

Table 8.35: Ratio of $.75M_{D+L+E}$ to M_n for Beam B-C in Building 4

Story	El Centro	Taft	UBC	BOCA
4	.55	.25	.60	.36
3	1.99	.69	1.21	.72
2	3.55	1.18	1.71	1.11
1	2.38	.82	1.20	.80

Building 5:

The structure is a four story steel frame whose lateral resistance is provided by vertical trusses. A typical floor plan and the locations of the trusses are shown in Fig. 8.9. The trusses are shown in Fig. 8.10.

Seismic loads were determined for two perpendicular directions (torsional vibrations were not considered). The mass of the structure was determined and apportioned to each floor. The floor slab weight was taken as 80 psf and partitions and ductwork were considered to be 25 psf per floor. Additional loads on each floor were: 12 psf for equipment, 50 kips for columns, and 125 kips for beams. The capacities of the steel truss members were calculated using the AISC specification (43).

There are three types of vertical trusses used in the building: truss A in the longitudinal direction and trusses B and C in the transverse direction (see Fig. 8.10).

In truss A, only tension diagonals are considered, which reduces the system to a statically determinate one. The overall stiffness matrix (four degrees of freedom) is

$$[S] = 4 \times 10^{-6} E_s \begin{bmatrix} 426.9 & -459.6 & 15.1 & 9.1 \\ -459.6 & 937.2 & -478.4 & 0.4 \\ 15.1 & -478.4 & 941.0 & -478.5 \\ 9.1 & 0.4 & -478.5 & 1162.6 \end{bmatrix}$$

The units for the stiffness matrix are kips and feet.

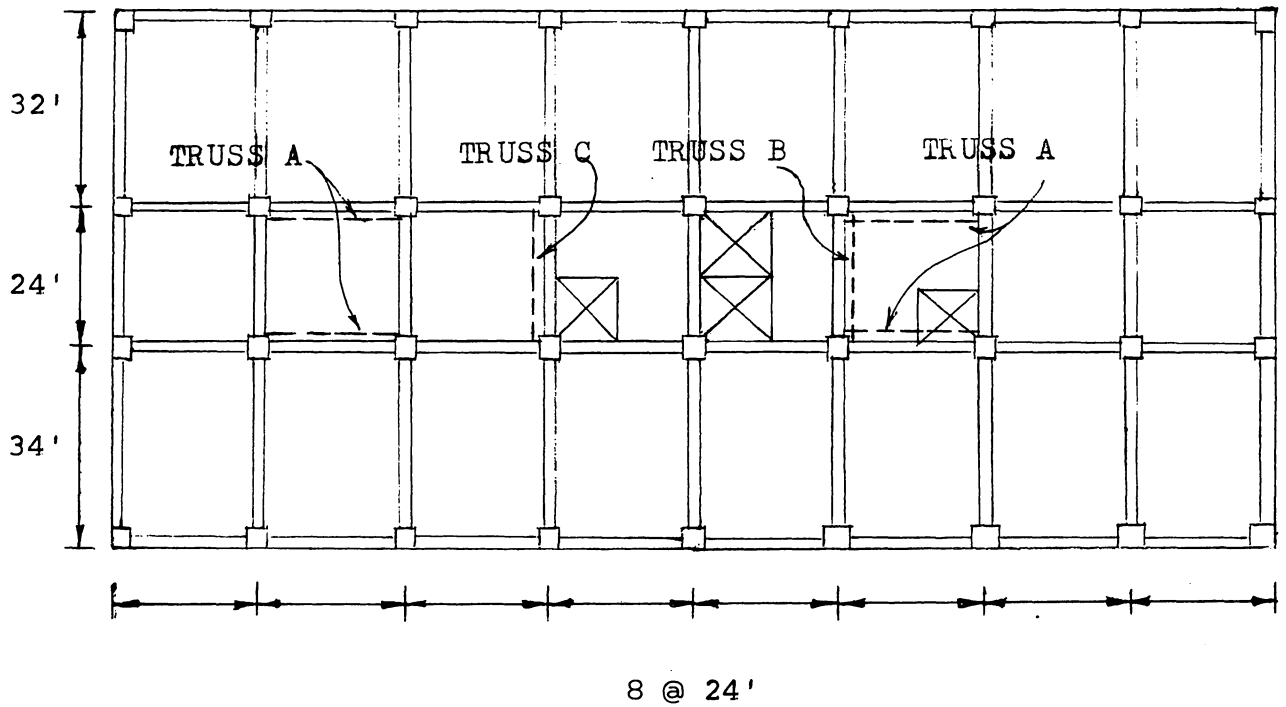

Fig. 8.9 Typical Floor in Building 5

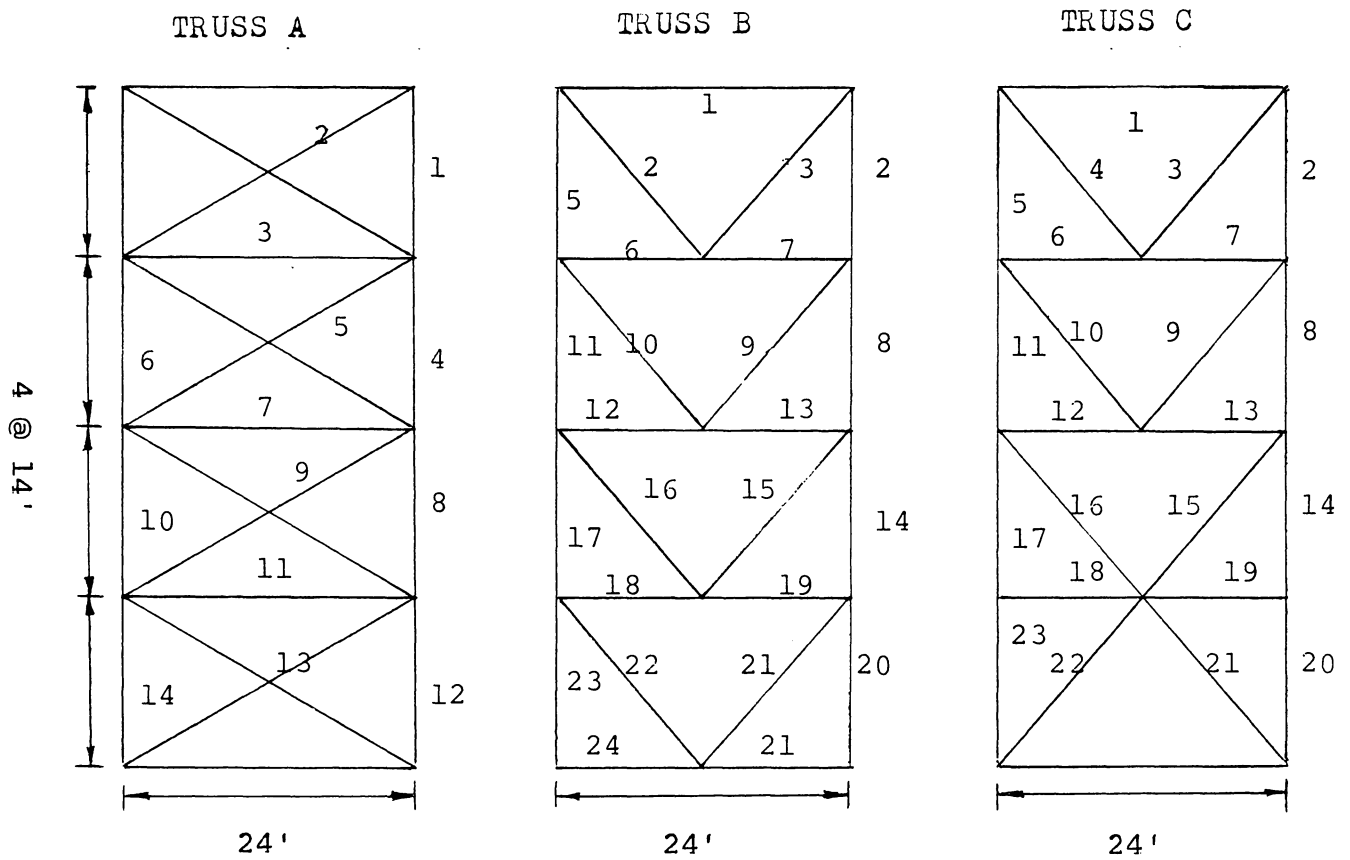

Fig. 8.10 Vertical Braced Frames in Building 5

The stiffness matrix for truss B is

$$[S] = 10^{-6} \times E_s \begin{bmatrix} 782.3 & -942.0 & 124.3 & -78.1 \\ -942.0 & 2865.3 & -2342.0 & 267.1 \\ 124.3 & -2342.0 & 4761.2 & -2211.4 \\ 78.1 & 247.1 & -2211.4 & 5092.6 \end{bmatrix}$$

For truss C, the stiffness matrix is

$$[S] = 10^{-6} \times E_s \begin{bmatrix} 1284.5 & -1535.4 & -29.4 & 201.4 \\ 1535.4 & 3250.8 & -1534.7 & -130.2 \\ -29.4 & -1534.7 & 3702.7 & -1541.7 \\ 201.4 & -130.2 & -1541.7 & 3160.0 \end{bmatrix}$$

Two first modes of vibration were considered. For the longitudinal direction, the first mode period is 2.02 seconds, and

$$\begin{Bmatrix} \phi_1 \\ \phi_2 \\ \phi_3 \\ \phi_4 \end{Bmatrix} = \begin{Bmatrix} .232 \\ .556 \\ .825 \\ 1.000 \end{Bmatrix} \quad (8-10)$$

where ϕ_i is the lateral displacement at floor i . The second mode period is .69 seconds, and

$$\begin{Bmatrix} \phi_1 \\ \phi_2 \\ \phi_3 \\ \phi_4 \end{Bmatrix} = \begin{Bmatrix} .728 \\ 1.000 \\ .176 \\ -.870 \end{Bmatrix} \quad (8-11)$$

For the transverse direction, the first mode period is

1.57 seconds, and

$$\begin{Bmatrix} \phi_1 \\ \phi_2 \\ \phi_3 \\ \phi_4 \end{Bmatrix} = \begin{Bmatrix} .171 \\ .409 \\ .706 \\ 1.000 \end{Bmatrix} \quad (8-12)$$

The second mode period is .53 seconds, and

$$\begin{Bmatrix} \phi_1 \\ \phi_2 \\ \phi_3 \\ \phi_4 \end{Bmatrix} = \begin{Bmatrix} .903 \\ 1.000 \\ .438 \\ -.872 \end{Bmatrix} \quad (8-13)$$

Equivalent lateral loads and resulting member forces were calculated for the four ground motions. Tables 8.36 to 8.38 summarize the ratios of load effect to capacity for selected members in trusses A, B, and C, respectively.

Table 8.36: Ratio of Member Force to Member Capacity in Truss A

Member (Fig. 8.10)	El Centro	Taft	UBC	BOCA
1	.65	.59	.50	.43
2	2.98	2.24	1.15	.57
3	1.05	.92	.73	.63
4&6	1.32	1.23	1.02	.84
5	3.97	3.65	1.79	1.00
7	1.22	1.17	.84	.70
8&10	1.39	1.36	1.10	.88
9	4.66	4.60	2.22	1.29
11	1.34	1.33	.92	.75
12&14	1.89	1.89	1.5	1.19
13	4.07	3.92	1.86	1.09

Table 8.37: Ratio of Member Force to Member Capacity in Truss B

Member (Fig. 8.10)	El Centro	Taft	UBC	BOCA
2&5	.88	.81	.57	.47
3&4	2.41	1.60	.63	.25
6&7	1.18	.90	.69	.58
8&11	2.28	1.77	1.25	.99
9&10	3.36	2.08	1.09	.53
12&13	1.27	1.10	.71	.60
14&17	2.35	1.60	1.22	.89
15&16	2.75	1.53	.90	.46
18&19	1.60	1.26	.75	.62
20&23	3.38	2.24	1.70	1.29
21&22	3.65	2.52	.91	.49
24&25	3.14	2.42	1.43	1.13

Table 8.38: Ratio of Member Force to Member Capacity in Truss C

Member (Fig. 8.10)	El Centro	Taft	UBC	BOCA
2&5	1.18	.94	.65	.51
3&4	3.66	2.50	.97	.41
6&7	1.43	1.27	.87	.73
8&11	2.65	1.90	1.35	1.04
9&10	3.48	1.91	1.12	.56
12&13	1.80	1.28	.98	.80
14&17	2.71	1.78	1.35	1.01
15&16	3.79	2.17	1.23	.67
18&19	1.20	1.11	.61	.60
20&23	2.90	1.96	1.54	1.20
21&22	4.77	3.01	1.50	.86

9. PREDICTION OF DAMAGE

Evaluation of the damage for commercial buildings in Memphis has been performed on the basis of statistical data as described in Chapter 4, site examination of selected buildings (Chapter 6) and seismic analysis (Chapter 8). The conclusions are a result of engineering judgment and involve a high degree of subjectivity.

The damage is a random variable. The elements of uncertainty include loading, structural resistance, type of occupancy, and, in particular, sensitivity of the building to structural damage. In this evaluation, four reference earthquakes are considered as discussed in Chapter 7.

Structural response to the reference earthquakes can be predicted on the basis of the analysis in Chapter 8. In general, the accelerations specified by the BOCA code will not cause excessive deformation of the considered structures. The calculated ratios of nominal load effect to nominal resistance are less than 1.0 (with few exceptions). Failures of columns and beams may be expected in case of El Centro earthquake, for which the ratios of load to resistance exceed 3 and even 4 in some cases.

Structural failure may be expected due to all four reference earthquakes in the case of low-rise masonry buildings. However, local differences in soil accelerations (microzones) will probably determine extent of the damage. The seismic performance may be significantly improved due to the light-weight components of structures (wooden floors), and partitions and other nonstructural elements.

The four story reinforced concrete frame (Building 1) seems to have sufficient strength to resist the seismic loads specified by both of the codes. The ratios of nominal load to resistance for beams do not exceed 1.8 for El Centro and 1.2 for Taft. However, the ratios for columns are higher, reaching 5.1 for El Centro and 3.8 for Taft. Peak values of load effect were found at the second floor level; the lowest values were observed at the top story.

The four story steel braced frame structure (Building 5) has ratios of load to nominal resistance of up to 4.8 for El Centro, but not exceeding 1.3 for BOCA code forces. The largest ratios were calculated for diagonals at the basement level.

Building 4 is a 10-story reinforced concrete structure with columns and slabs. The largest ratios of load to nominal resistance were calculated for slabs at the second floor level (3.6 for El Centro). Ratios were lower for columns.

Buildings 2 and 3 are 13-story structures; Building 2 has a steel frame and Building 3 a reinforced concrete frame. Both seem to be quite strong to resist seismic forces. For El Centro, the load to resistance ratios do not exceed 2.1 (beam at second floor level) in Building 2, and 3.9 (columns at the upper floors) in Building 3. BOCA code specified forces cause loads below 50% of nominal resistance.

The effects of partitions, in-fill walls, and other nonstructural members are also important in the evaluation of the seismic strength of medium-high and high-rise buildings. In addition, design safety factors (ratio of nominal resistance to nominal load) usually exceed 1.6. This, together with the effect

of nonstructural members, allows the expectation that the ratio of load to mean resistance will be well below 1.0 for most of the cases considered in Chapter 8.

The expected degrees of structural failure, given in Table 9.1, are based upon the nominal load to resistance ratios presented in Chapter 8 and standard design safety factors. They are expressed as the percentage of structural members in the building that would need major repair or replacement to restore the load carrying capacity of the structure.

Evaluation of structural damage has been extended to all commercial buildings in Memphis. The results are shown in Table 9.2 for masonry structures and in Table 9.3 for steel reinforced concrete. Total percentages of structural damage are: 2% for the BOCA code design earthquake, 5% for the UBC, 15% for Taft and 35% for El Centro. Nonstructural damage can be predicted from the extent of structural failure, type of building, and occupancy. An accurate evaluation of nonstructural damage requires a thorough knowledge of the costs of equipment and other valuable items in the building, and their distribution on different floors. This information has not been available. An important aspect of the damage evaluation is the expected number of casualties; neither has this information been available. Four of the analyzed buildings were not in service at the time of evaluation.

Dollar damage estimates (including replacement cost) have been derived from the assessed values of commercial buildings. They are \$35 million for the BOCA code design earthquake, \$95 million for the UBC, \$280 million for Taft, and \$650 million for El Centro. Loss of human life has not been included in these calculations.

Table 9.1: Expected Percentage of Structural Failure for Analyzed Buildings

Building	El Centro	Taft	UBC	BOCA
1	60%	20%	0-5%	0%
2	10%	0%	0%	0%
3	15%	10%	0-5%	0%
4	25%	0%	0-5%	0%
5	30%	20%	0-5%	0%

Table 9.2: Expected Percentage of Structural Failure for All Masonry Commercial Buildings

Number of Stories	El Centro	Taft	UBC	BOCA
1 to 3	20%	15%	5%	0-2%
4 to 5	40%	25%	15%	5%
6 to 10	70%	40%	25%	10%

Table 9.3: Expected Percentage of Structural Failure for All Steel and Reinforced Concrete Commercial Buildings

Number of Stories	El Centro	Taft	UBC	BOCA
1 to 3	10-15%	10%	2-5%	0%
4 to 5	20-30%	15%	5%	0-2%
6 to 10	30-40%	20-25%	5-10%	2-5%
over 10	40-60%	25-40%	0-15%	5-10%

10. CONCLUSIONS

Seismic strength of commercial buildings in Memphis has been studied. The buildings were put into categories with regard to type of construction, number of stories, age, square footage, and value. Over 15 buildings were examined by the project team.

The quality of material and workmanship was found to be surprisingly good. With few exceptions, no visible signs of deterioration were observed.

The unreinforced masonry, low-rise buildings are the most vulnerable to earthquakes. They constitute the majority of the commercial structures in Memphis. However, the extent of the potential destruction seems to be related to geological micro-zones and the effects of nonstructural members and equipment, rather than structural performance.

Four reference earthquakes were considered: El Centro, Taft, and two code-specified seismic loadings, BOCA and UBC. For the analyzed buildings, the ratios of nominal load effect to nominal resistance were calculated. All of the considered structures seem to have sufficient strength to resist the BOCA code earthquake forces. UBC code-specified forces exceed the capacities by approximately 50% in several cases. The El Centro earthquake would cause substantial structural damage. The calculated ratios of load to resistance exceed 3 or even 4 in some cases. The ratios for the Taft earthquake are approximately 60% of those for El Centro.

The extent of the damage will be limited by geological microzones, the effects of nonstructural members, and building sensitivity to damage.

Further work is required to include data on other buildings, their configurations, and soil properties. Also, the relationship between structural and nonstructural damage requires further development.

REFERENCES

1. Berg, G. V., "The Skopje, Yugoslavia Earthquake of 1963" Report, American Iron and Steel Institute, New York, 1964.
2. Berg, G. V. and Husid, R. L., "Structural Behavior in the 1970 Peru Earthquake" Proc. 5WCEE, Rome, 1973.
3. Berg, G. V. and Degenkolb, H. J., "Engineering Lessons from the Managua Earthquake" EERI Conference Proceedings, San Francisco, 1973.
4. Berg, G. V., "Response of Buildings in Anchorage" The Great Alaska Earthquake of 1964: Engineering, National Academy of Science, Washington, 1974.
5. Berg, G. V., "Historical Review of Earthquakes, Damage, and Building Codes," Proceedings, National Structural Engineering Conference, ASCE, Madison, August 1976.
6. Berg, G. V. and Bolt, B., "Earthquake in Romania", Preliminary Report, Earthquake Engineering Research Institute, Oakland, 1977.
7. Hanson, R. D. and Aktan, H. M., "Dynamic Behavior of Hotel Managua Intercontinental In the Managua Earthquake of December 23, 1972, Proceedings of the Managua, Nicaragua Earthquake Conference, Volume II, p. 586-603, EERI, San Francisco, November, 1973.
8. Hanson, R. D. and Degenkolb, H. J., The Venezuela Earthquake of July 29, 1967, American Iron and Steel Institute, 1969, 176 p.
9. American Iron and Steel Institute, "Earthquakes", AISI Publication, 1975.
10. Sozen, M. A., Roesset, J., "Structural Damage Caused by the 1976 Guatemala Earthquake", Report for the NSF, University of Illinois, Urbana-Champaign, March, 1976.
11. Culver, C. V., Lew, H. S. Hart, G. C. and Pinkham, C. W., "Natural Hazards Evaluation of Existing Buildings," NBS BSS-61, Washington, D. C. 20234, January 1975.
12. Earthquake Resistance of Buildings: "Volume I, Design Guidelines, PBS (PCD): DG. 1; Volume II, Evaluation of Existing Structures, PBS (PCD): DG. 2; Volume III, Commentary on Design Guidelines, PBS (PCD): DG. 3, General Services Administration, Public Buildings Service, 1976.
13. Uniform Building Code, International Conference of Buildings Officials, 1973 Edition and 1976 Edition.

14. "Earthquake Resistant Design Requirements for VA Hospital Facilities", Handbook H-08-8, Office of Construction, Veterans Administration, Washington, D. C. 20420, March, 1974.
15. "Tentative Provisions for the Development of Seismic Regulations for Buildings", National Bureau of Standards, Special Publication - 510, 1978.
16. Larrabee, Richard D., and Whitman, Robert V., Cost of Reinforcing Existing Buildings and Constructing New Buildings to Meet Earthquake Codes, MIT-CE R76-25, May, 1976.
17. Pinkham, Clarkson W., and Hart, Gary C., A Methodology for Seismic Evaluation of Existing Multistory Residential Buildings, Vol. 1, Department of Housing and Urban Development, June, 1977.
18. Wiggins, John H. et al, Methodology for Hazard Risk Evaluation of Buildings, Vol. I, Technical Report No. 73-36773, Dec., 1973
19. Chen, Shwu-Jen H. and Yao, James T. P., "Data Analysis for Safety Evaluation of Existing Structures", Technical Report No. CE-STR-80-18, Purdue University, Dec., 1980.
20. Hanson, Robert D., "Repair, Strengthening and Rehabilitation of Buildings - Recommendations for Needed Research", Workshop Report. UMEE 77R4, Department of Civil Engineering, University of Michigan, 50pp.
21. Whitman, Robert V., Biggs, John M., et al, Seismic Design Decision Analysis, Structures Publication No. 381, M.I.T., 1974.
22. M & H Engineering and Memphis State University, "Regional Earthquake Risk Study, MATCOG/MCDD, Memphis, 1974
23. Beavers, James E., ed., "Earthquakes and Earthquake Engineering: the Eastern United States", Conference Proceedings, Vol. 1 and 2, Knoxville, Sept., 1981.
24. Fintel, Mark, ed., "Handbook of Concrete Engineering", Van Nostrand Reinhold Co., New York, 1974, p. 358.
25. von Hake, Carl A. and Cloud, William K., "United States Earthquakes 1969, US Department of Commerce Publication, July 1971.
26. Stearns, R. G. and Wilson, C. W., "Relationship of Earthquakes and Geology in West Tennessee and Adjacent Areas", Tennessee Valley Authority, 1972.
27. Krinitzsky, E. L., "Geological Investigation of Faulting in Lower Mississippi Valley", Tech. Report No. 3-658, Tech. Memo No. 3-311, 1950.

28. Fisk, H. N., "Geological Investigation of the Alluvial Valley of Lower Mississippi River", US Corps of Engineers, Mississippi River Com., Vicksburg, 1944.
29. Fuller, Myron L., "The New Madrid Earthquake", Bulletin 494, US Geological Survey, 1912.
30. Richter, C. F., "Elementary Seismology", W. H. Freeman and Company, San Francisco, 1958.
31. Nuttli, O. W., "State-of-the-Art for Assessing Earthquake Hazards in the United States, Report I, Design Earthquakes for the Central United States", US Army Engineer Waterways Experiment Station, Paper S-73-1, Vicksburg, 1973.
32. Gutenberg, B. and Richter, C. F., "Seismicity of the Earth", Geological Society of America, Paper No. 34, 1941.
33. Nuttli, O. W., "Evaluation of Past Studies and Identification of Needed Studies of the Effects of Major Earthquakes Occurring in the New Madrid Fault Zone", Report Sub. to Federal Emergency Management Agency, Region VII, Department of Earth and Atmospheric Sciences, St. Louis University, January, 1981.
34. Templeton, T. R. and Spencer, B. C., "Earthquake Data for Tennessee and Surrounding Areas (1699-1979)", Tennessee Division of Geology, Environmental Geology Series No. 8, 1980.
35. Sharma, S. and Kovacs, W. D., "Microzonation of the Memphis, Tennessee Area", Report for USGS, Purdue University, May 1980.
36. "Analysis of Strong Motion Earthquake Accelerograms", California Institute of Technology, Earthquake Engineering Research Laboratory, Report, Vol. III - Response Spectra, Pasadena, August 1972.
37. Uniform Building Code, International Conference of Building Officials, Whittier, California, 1979 ed.
38. BOCA Basic Building Code, Building Officials Code Administrators International, Inc., Homewood, Illinois, 1981 ed.
39. Urban Growth Indicators, Memphis and Shelby County, Office of Planning and Development, 1977.
40. Urban Development Report, Memphis and Shelby County, Office of Planning and Development, 1978, 1979, 1980.

41. American Concrete Institute, "Building Code Requirements for Reinforced Concrete", ACI Standard 318-77.
42. Cotran, F. S. and Hall, W. J., "Effective Width of Floor Systems for Application in Seismic Analysis", Report, University of Illinois, Urbana-Champaign, November 1980.
43. AISC, "Specification for the Design, Fabrication and Erection of Structural Steel for Buildings", American Institute of Steel Construction, New York, 1979.
44. Byerly, "Seismicity of Western United States", World Conference on Earthquake Engineering, 1956.

UNIVERSITY OF MICHIGAN



3 9015 09400 8086

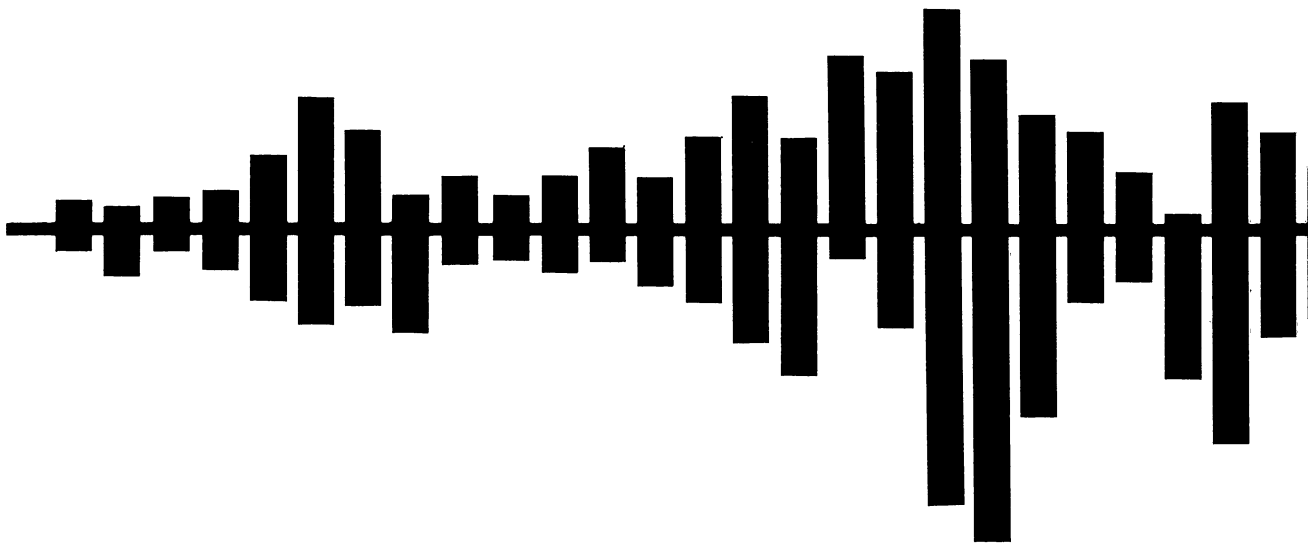

AIIM SCANNER TEST CHART # 2

Spectra

4 PT ABCDEFGHIJKLMNOPQRSTUVWXYZabcdefghijklmnopqrstuvwxyz;"/?0123456789
 6 PT ABCDEFGHIJKLMNOPQRSTUVWXYZabcdefghijklmnopqrstuvwxyz;"/?0123456789
 8 PT ABCDEFGHIJKLMNOPQRSTUVWXYZabcdefghijklmnopqrstuvwxyz;"/?0123456789
 10 PT ABCDEFGHIJKLMNOPQRSTUVWXYZabcdefghijklmnopqrstuvwxyz;"/?0123456789

Times Roman

4 PT ABCDEFGHIJKLMNOPQRSTUVWXYZabcdefghijklmnopqrstuvwxyz;"/?0123456789
 6 PT ABCDEFGHIJKLMNOPQRSTUVWXYZabcdefghijklmnopqrstuvwxyz;"/?0123456789
 8 PT ABCDEFGHIJKLMNOPQRSTUVWXYZabcdefghijklmnopqrstuvwxyz;"/?0123456789
 10 PT ABCDEFGHIJKLMNOPQRSTUVWXYZabcdefghijklmnopqrstuvwxyz;"/?0123456789

Century Schoolbook Bold

4 PT ABCDEFGHIJKLMNOPQRSTUVWXYZabcdefghijklmnopqrstuvwxyz;"/?0123456789
 6 PT ABCDEFGHIJKLMNOPQRSTUVWXYZabcdefghijklmnopqrstuvwxyz;"/?0123456789
 8 PT ABCDEFGHIJKLMNOPQRSTUVWXYZabcdefghijklmnopqrstuvwxyz;"/?0123456789
 10 PT ABCDEFGHIJKLMNOPQRSTUVWXYZabcdefghijklmnopqrstuvwxyz;"/?0123456789

News Gothic Bold Reversed

4 PT ABCDEFGHIJKLMNOPQRSTUVWXYZabcdefghijklmnopqrstuvwxyz;"/?0123456789
 6 PT ABCDEFGHIJKLMNOPQRSTUVWXYZabcdefghijklmnopqrstuvwxyz;"/?0123456789
 8 PT ABCDEFGHIJKLMNOPQRSTUVWXYZabcdefghijklmnopqrstuvwxyz;"/?0123456789
 10 PT ABCDEFGHIJKLMNOPQRSTUVWXYZabcdefghijklmnopqrstuvwxyz;"/?0123456789

Bodoni Italic

4 PT ABCDEFGHIJKLMNOPQRSTUVWXYZabcdefghijklmnopqrstuvwxyz;"/?0123456789
 6 PT ABCDEFGHIJKLMNOPQRSTUVWXYZabcdefghijklmnopqrstuvwxyz;"/?0123456789
 8 PT ABCDEFGHIJKLMNOPQRSTUVWXYZabcdefghijklmnopqrstuvwxyz;"/?0123456789
 10 PT ABCDEFGHIJKLMNOPQRSTUVWXYZabcdefghijklmnopqrstuvwxyz;"/?0123456789

Greek and Math Symbols

4 PT ΑΒΓΔΕΕΘΗΙΚΑΜΝΟΠΦΡΣΤΥΩΧΨΖαβγδεξθηικλμνοπφρστνωχψζ≥≠",./≤±=≠' > < > < > < ≡
 6 PT ΑΒΓΔΕΕΘΗΙΚΑΜΝΟΠΦΡΣΤΥΩΧΨΖαβγδεξθηικλμνοπφρστνωχψζ≥≠",./≤±=≠' > < > < > < ≡
 8 PT ΑΒΓΔΕΕΘΗΙΚΑΜΝΟΠΦΡΣΤΥΩΧΨΖαβγδεξθηικλμνοπφρστνωχψζ≥≠",./≤±=≠' > < > < > < ≡
 10 PT ΑΒΓΔΕΕΘΗΙΚΑΜΝΟΠΦΡΣΤΥΩΧΨΖαβγδεξθηικλμνοπφρστνωχψζ≥≠",./≤±=≠' > < > < > < ≡

White



Black



Isolated Characters

e	m	1	2	3	a
4	5	6	7	o	-
8	9	0	h	l	B

MESH HALFTONE WEDGES

65

85

100

110

133

150

