

033346

88430

Adm

Parameter Measurements of a Highway Tractor and Semitrailer

Final Technical Report

UMTRI-95-47

Submitted to:

Vehicle Research and Test Center
National Highway Traffic Safety Administration
U.S. Department of Transportation

December 1995

UMTRI The University of Michigan
Transportation Research Institute



Technical Report Documentation Page

1. Report No.		2. Government Accession No.		3. Recipient's Catalog No.	
4. Title and Subtitle Parameter Measurements of a Highway Tractor and Semitrailer				5. Report Date December 1995	
				6. Performing Organization Code	
7. Author(s) Winkler, C.B.; Bogard, S.E.; Karamihas, S.M.				8. Performing Organization Report No. UMTRI-95-47	
9. Performing Organization Name and Address The University of Michigan Transportation Research Institute 2901 Baxter Road, Ann Arbor, Michigan 48109				10. Work Unit No. (TRAIS)	
				11. Contract or Grant No. DTNH22-95-C-08125	
12. Sponsoring Agency Name and Address Vehicle Research and Test Center National Highway Traffic Safety Administration East Liberty, Ohio 43319				13. Type of Report and Period Covered Final technical report	
				14. Sponsoring Agency Code	
15. Supplementary Notes COTR: Mr. J. Chrstos					
16. Abstract A series of parameter measurements was conducted on a 1991 White GMC tractor model WIA64T (manufactured by Volvo GM Heavy Truck) and a 1992 Fruehauf trailer model FB-91.5NF2-53. Geometric and inertial parameters were determined for the whole vehicle and/or the sprung mass, and for components of the steering system, suspensions, and unsprung masses. The performance properties of the three suspensions and the torsional stiffness of the vehicle frames and fifth wheel coupling were also measured.					
17. Key Words mass, inertia, geometry, suspension, stiffness, compliance, kinematic, friction, steering system			18. Distribution Statement No restrictions. Available through the National Technical Information Service, Springfield, VA 22161		
19. Security Classif. (of this report)		20. Security Classif. (of this page)		21. No. of Pages 159	22. Price

CONTENTS

INTRODUCTION.....	1
GEOMETRY	2
Geometry of the tractor	2
Geometry of the trailer.....	5
INERTIAL PROPERTIES	8
Inertial properties of the tractor	8
Mass and inertias of the whole tractor.....	8
Masses and inertias of the components of the front suspension and steering system.....	8
Masses and inertias of the components of the rear suspension.....	11
Inertial properties of the trailer.....	14
Masses and inertias of the components of the trailer sprung mass.....	14
Masses and inertias of the components of the trailer suspension.....	14
CHASSIS AND FIFTH-WHEEL STIFFNESSES	19
SUSPENSION PARAMETERS.....	19
Test definitions	19
Results.....	22
Vertical motion	22
Steer and wrap-up.....	23
Roll motion	23
Total roll stiffness	23
Auxiliary roll stiffness	24
Roll center height.....	24
Roll steer coefficient	24
Lateral force	24
Aligning moment.....	25
Longitudinal force	26
Steering ratio	26
APPENDIX—Data Plots from the Suspension Measurement Program.....	A-1

INTRODUCTION

The University of Michigan Transportation Research Institute (UMTRI), under the sponsorship of the Vehicle Research and Test Center (VRTC), has measured the parameters of a tractor and semitrailer combination vehicle. The vehicles measured were a 1991 White GMC tractor model WIA64T (manufactured by Volvo GM Heavy Truck) and a 1992 Fruehauf trailer model FB-91.5NF2-53.

Geometric and inertial parameters were determined for the whole vehicle and/or the sprung mass and for components of the steering system, suspensions, and unsprung masses. The performance properties of the several suspensions and the torsional stiffness of the vehicle frames and fifth wheel coupling were also measured.

Geometric measurements were made to determine the positions of all suspension and steering system joints and the fifth-wheel coupling joint in three dimensions.

The inertial parameters determined were weight, center-of-gravity position in three dimensions, and three moments of inertia of the vehicle and/or its components. For the tractor, these measurements were made for the whole vehicle plus the individual components of the steering system, the front and rear suspensions, and the unsprung masses. Similar measurements were made on the trailer. However, the trailer sprung masses were measured separately instead of the entire vehicle. (Sprung-mass measurements were made on the trailer body and on the moveable suspension subframe, respectively.) The center-of-gravity positions and the mass moments of inertia of the suspension components were determined by measurement, calculation, or estimation as deemed appropriate for the individual measurement by mutual agreement of UMTRI and VRTC personnel. Where a suspension includes multiples of an individual component, only one was measured.

UMTRI's heavy-vehicle-suspension-measurement facility was used to measure the performance properties of the three suspensions of the test vehicles. Test types were:

- vertical motion (without tire shear loads)
- roll motion (without tire shear loads))
- lateral force (without bounce or roll)
- longitudinal force (without bounce or roll)
- aligning moment (without bounce or roll)

The latter four tests were conducted at three levels of vertical load. For the steer axle, all of the listed measurements were conducted at a nominal straight-ahead steer condition with the hand wheel locked in place. An additional test was conducted to establish road-wheel angle as a function of hand wheel angle in the absence of torsional load on the steering system.

Torsional stiffness about a longitudinal axis was measured for the tractor, the trailer, and the fifth-wheel connection. Measurements were made of:

- effective chassis stiffness of the tractor between the front suspension and rear suspension and between the front suspension and fifth wheel
- effective chassis stiffness of the trailer between the fifth wheel and the suspension
- local torsional stiffness of the fifth-wheel coupling between tractor and trailer

GEOMETRY

Geometry of the Tractor

Figure 1 and table 1 describe the geometry of the test tractor. The table lists the locations of the joints between the major components of the tractor steering system, suspension, axles, and fifth wheel. The location of the points in figure 1 are drawn to scale according to the values listed in table 1. The origin of the coordinate system for the figure and the table is the *tractor reference point*. This point is fixed in the sprung mass at the intersection of the x-z plane of symmetry and the plane of the lower face of the frame rails and is directly below the center of gravity of the whole vehicle (tractor).

The vertical position of the reference point, shown in figure 1, is for the unloaded bobtail tractor as tested. Note that the height of the reference above ground is dependent on the specific tires installed, their inflation pressure (recommended cold), and wear state at the time of measurement. Also, note that the vertical position of the lightly loaded rear suspension (relative to the reference point as well as to the ground) may vary as much as an inch depending on the state of suspension friction and the resulting positions of the load leveler and leaf springs. An effort was made to determine these measures at a neutral state (which appears to be low in the range). (Addition of the empty trailer load appears to lower the chassis about 0.2 inches at the longitudinal position of the rear suspension .)

Table 1 presents the actual measurements made on left and right side components, and also provides the averages of left and right side values. Comparison of left and right side values should be generally indicative of the accuracy of the measurements. Note, however, that the left and right front springs were *not* identical components. Also in this regard, note that the x and the z dimensions of the contact points between the ends of the rear suspension springs and the cam surfaces of either the slippers or load equalizer are very difficult to identify on the actual part. The user may wish to adjust the x dimensions particularly in order to obtain static load equalization of the two drive axles.

Top view of joints 0-42

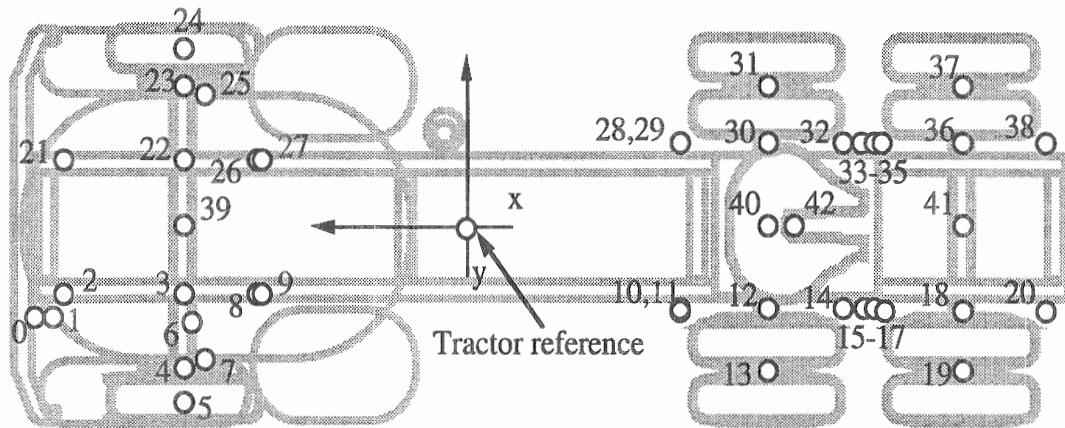

Side view of joints 0-20

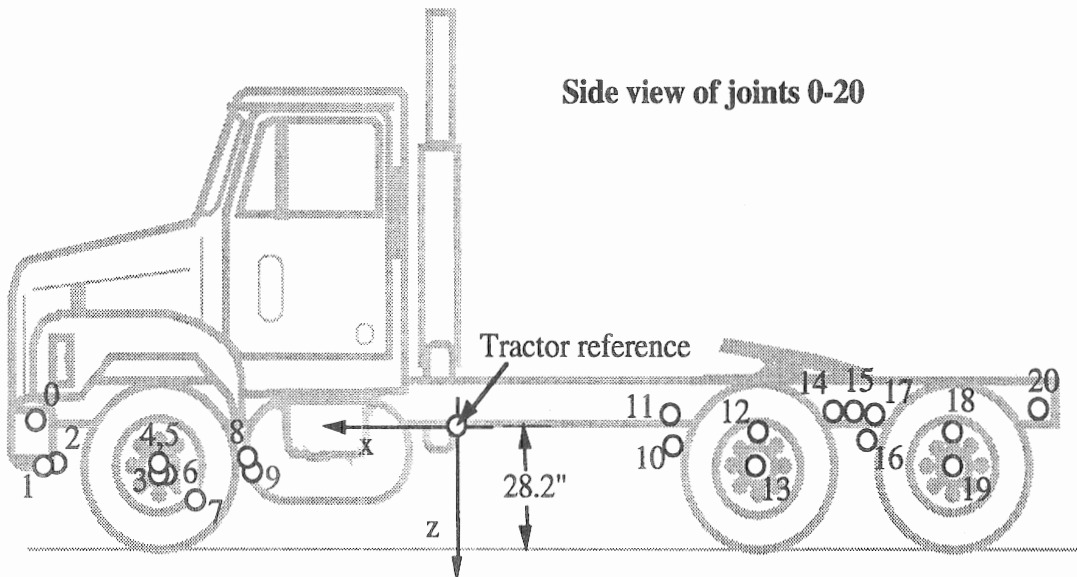

Side view of joints 21-42

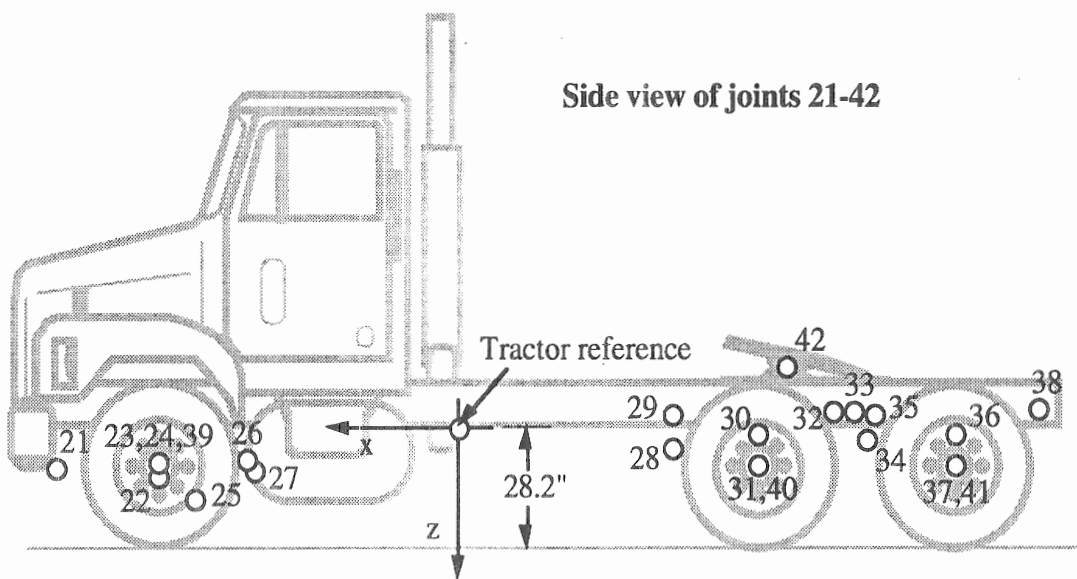

Figure 1. Locations of the joints of the tractor components

Table 1. Geometry of the tractor relative to the tractor reference point

Components	Axlet	Left side			Right Side			Average				
		ID	X (in)	Y (in)	Z (in)	ID	X (in)	Y (in)	Z (in)	X (in)	Y (in)	Z (in)
steering gear out shaft to pitman arm	S	0	112.7	(-21.9)	-1.5							
pitman arm to drag link	S	1	110.6	-21.9	8.1							
front spring hanger pint	S	2	107.4	-16.2	7.8	21	107.5	16.1	8.4	107.45	16.15	8.10
axle to spring	S	3	81.1	-16.3	10.4	22	81.4	16.3	11.1	81.25	16.30	10.75
axle to spindle (kingpin)	S	4	81.1	-34.7	9.2	23	81.4	34.7	9.4	81.25	34.70	9.30
brake drum to wheel	S	5	81.1	-46.0	9.2	24	81.4	46.0	9.4	81.25	46.00	9.30
drag link to steering arm	S	6	79.0	-23.5	10.6				28.2			
tie rod to steering arm	S	7	72.4	-32.6	16.3	25	72.6	32.3	16.4	72.50	32.45	16.35
rear shackie to rear hanger bracket	S	8	56.5	-16.4	6.0	26	56.5	16.3	6.4	56.50	16.35	6.20
spring to rear shacklet	S	9	55.0	-16.4	9.4	27	54.7	16.3	9.7	54.85	16.35	9.55
torque arm to frame pin	LD	10	-57.9	-20.1	5.2	28	-57.6	20.2	5.4	-57.75	20.15	5.30
front of spring to slipper	LD	11	-57.8	-20.3	-3.8	29	-57.6	20.3	-3.6	-57.70	20.30	-3.70
axle to spring	LD	12	-81.1	-20.2	-0.1	30	-81.3	20.3	0.1	-81.20	20.25	0.00
brake drum to wheel	LD	13	-81.1	-35.6	8.3	31	-81.3	35.6	8.4	-81.20	35.60	8.35
rear of spring to equalizer	LD	14	-101.4	-20.1	-4.5	32	-101.3	20.4	-4.3	-101.35	20.25	-4.40
load equalizer pivot	D	15	-106.8	-20.1	-4.3	33	-106.6	20.4	-4.2	-106.70	20.25	-4.25
torque arm to frame pin	TD	16	-110.0	-20.1	3.2	34	-109.7	20.3	3.2	-109.85	20.20	3.20
front of spring to equalizer	TD	17	-112.3	-20.3	-3.8	35	-112.1	20.4	-3.5	-112.20	20.35	-3.65
axle to spring	TD	18	-133.4	-20.3	-0.2	36	-133.4	20.3	0.1	-133.40	20.30	-0.05
brake drum to wheel	TD	19	-133.4	-35.6	8.1	37	-133.4	35.6	8.3	-133.40	35.60	8.20
rear of spring to slipper	TD	20	-155.9	-20.3	-4.8	38	-155.6	20.3	-4.8	-155.75	20.30	-4.80
<i>Symmetric components</i>												
steer axle	S	39	81.25	0.00	9.30							Steer axle track: 79.6 in
leading drive axle	LD	40	-81.20	0.00	8.35							Drive axle track: 72.0 in (center of dual to center of dual)
trailing drive axle	TD	41	-133.40	0.00	8.20							Dual tire spacing: 13.25 in
5th wheel (insecion of pitch and yaw pivots)		42	-88.60	0.13	-15.40							

† S - Steer LD - Leading Drive TD - Trailing Drive D - Drive

†† Right side front spring stack contains one spacer not present on left side.

††† X and Z (relative to sprung mass as well as absolute) values change with suspension load.

Geometry of the Trailer

The sprung mass of the trailer is composed of two elements: (1) the van body including fifth wheel and suspension slider frame, and (2) the moveable suspension subframe. The suspension subframe slides fore and aft and may be fixed at any of twenty positions at 6-inch spacings. The geometry and inertial properties of these two bodies were determined separately so that the properties of the complete sprung mass can be determined for any of the twenty suspension positions.

Figure 2 presents a side view of the test trailer and identifies the longitudinal locations of the kingpin axis and two reference points. These reference points are:

- *Van body reference.* A point at the intersection of the x-z plane of symmetry and the plane of the lower edge of the van body side that is directly below the center of gravity of the van body (275.4 inches aft of the kingpin).
- *Suspension subframe reference.* A point in the van body at the intersection of the x-z plane of symmetry and the lateral axis defined by the center of the rear-most left and right side slider-pin locking holes (493.6 inches aft of the kingpin); and/or, a point in the suspension subframe at the intersection of the x-z plane of symmetry and a lateral line through the centers of the slider locking pins.

These definitions, along with the heights of the reference points define the geometry of the van body. The heights of the reference points above ground are for the empty van in place on the test tractor in the condition tested, including the tires installed, and their inflation (recommended cold) and wear states at the time of measurement.

Figure 3 and table 2 describe the geometry of the suspension subframe, suspension, and unsprung masses. The points are located to scale in the figure. Note that, as with the tractor, the vertical position of the lightly loaded trailer suspension is subject to variation due to the influence of coulomb friction.

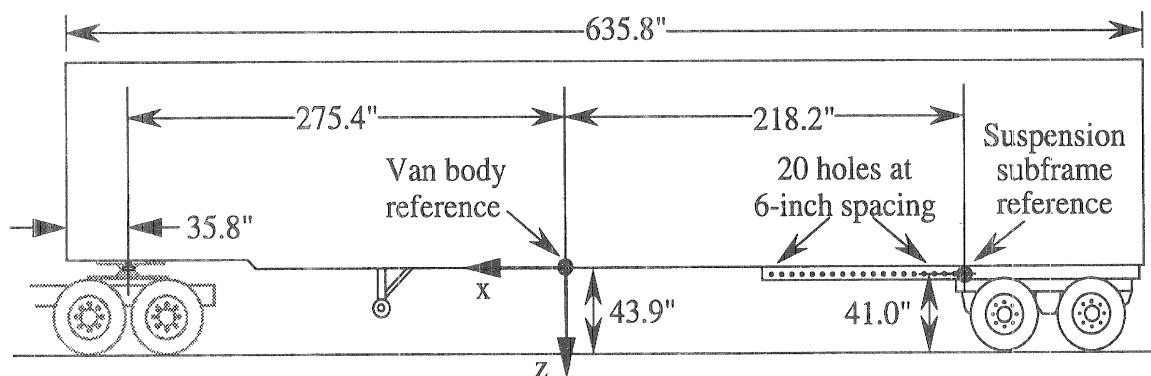
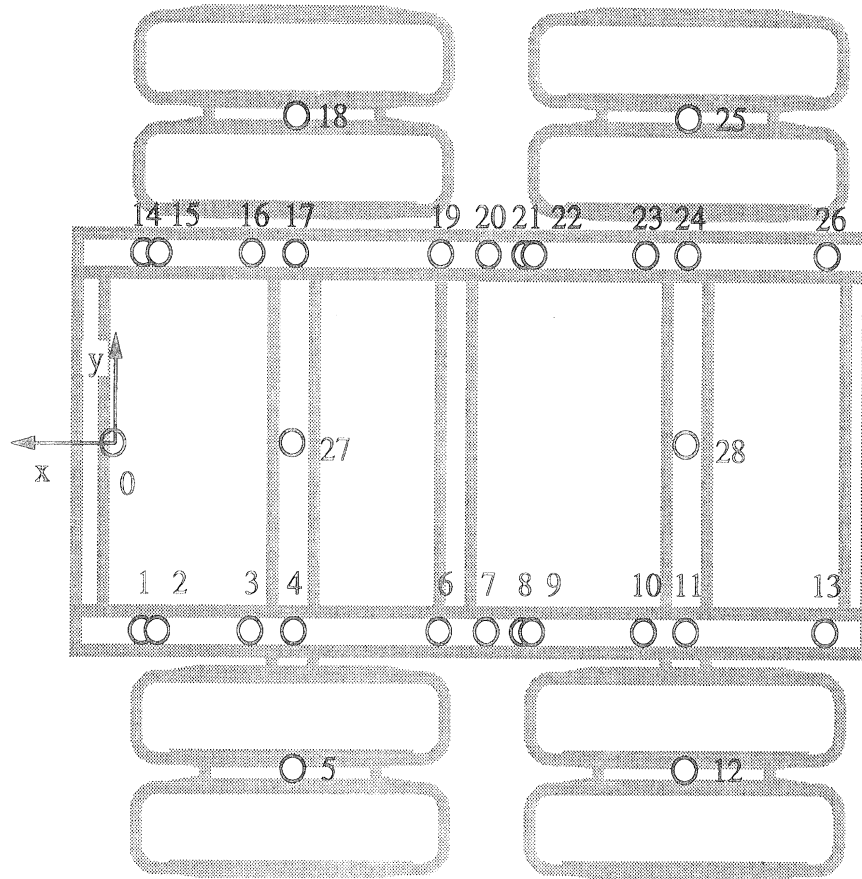

Figure 2. Locations of the sprung mass reference points

Top view of joints 0-28



Side view of joints 0-28

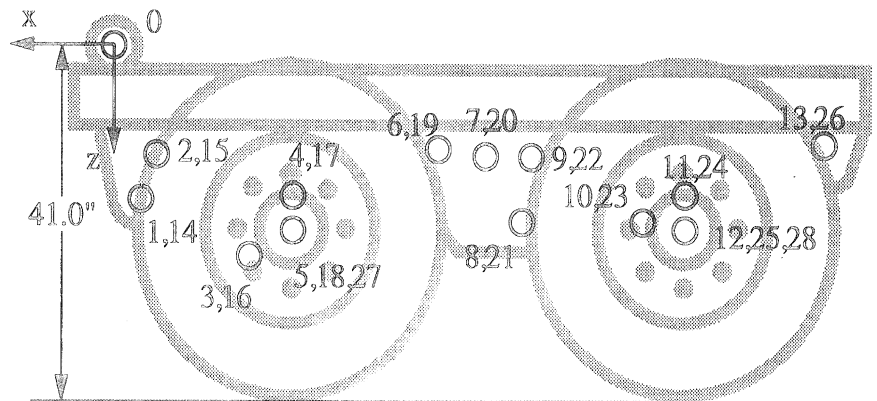

Figure 3. Locations of the joints of the trailer components

Table 2. Geometry of the trailer subframe and suspension relative to the subframe reference point

Components	Axlet†	Left side			Right Side			Average				
		ID	X (in)	Y (in)	Z (in)	ID	X (in)	Y (in)	Z (in)	X (in)	Y (in)	Z (in)
center of locking pins		0	0.0	0.0	0.0							
front control arm pin	LA	1	-3.7	-22.0	17.9	14	-3.9	22.0	17.8	-3.80	22.00	17.85
front of spring to slipper††	LA	2	-5.9	-22.0	12.7	15	-5.9	22.0	12.7	-5.90	22.00	12.70
rear control arm pin	LA	3	-17.8	-22.0	24.6	16	-17.4	22.0	24.7	-17.60	22.00	24.65
axle to spring	LA	4	-23.4	-22.0	17.5	17	-22.9	22.0	17.4	-23.15	22.00	17.45
brake drum to wheel	LA	5	-23.4	-38.1	21.6	18	-22.9	38.1	21.5	-23.15	38.10	21.55
rear of spring to equalizer††	LA	6	-42.1	-22.0	12.1	19	-42.4	22.0	12.1	-42.25	22.00	12.10
load equalizer pivot		7	-48.2	-22.0	12.9	20	-48.2	22.0	12.8	-48.20	22.00	12.85
front control arm pin	TA	8	-52.9	-22.0	20.6	21	-52.9	22.0	20.4	-52.90	22.00	20.50
front of spring to equalizer††	TA	9	-54.1	-22.0	13.0	22	-55.1	22.0	13.2	-54.60	22.00	13.10
rear control arm pin	TA	10	-68.5	-22.0	20.6	23	-68.5	22.0	20.7	-68.50	22.00	20.65
axle to spring	TA	11	-73.9	-22.0	17.4	24	-73.7	22.0	17.2	-73.80	22.00	17.30
brake drum to wheel	TA	12	-73.9	-38.4	21.5	25	-73.7	38.4	21.5	-73.80	38.40	21.50
rear of spring to slipper††	TA	13	-91.7	-22.0	11.5	26	-91.5	22.0	11.5	-91.60	22.00	11.50
Leading axle	LA	27	-23.1	0.00	21.5	Track: 77.6 in (center of dual to center of dual)						
Trailing axle	TA	28	-73.8	0.00	21.5	Dual tire spacing: 13.25 in						

† LA - Leading axle TA - Trailing axle

†† X and Z (relative to sprung mass as well as absolute) values change with suspension load.

INERTIAL PROPERTIES

Inertial properties of the Tractor

The tractor mass and inertial measurements were made on (1) the whole vehicle and (2) on a variety of components of the steering system, suspensions, and unsprung masses.

Mass and inertias of the whole tractor

Mass and inertia properties of the complete tractor are given in figure 4.

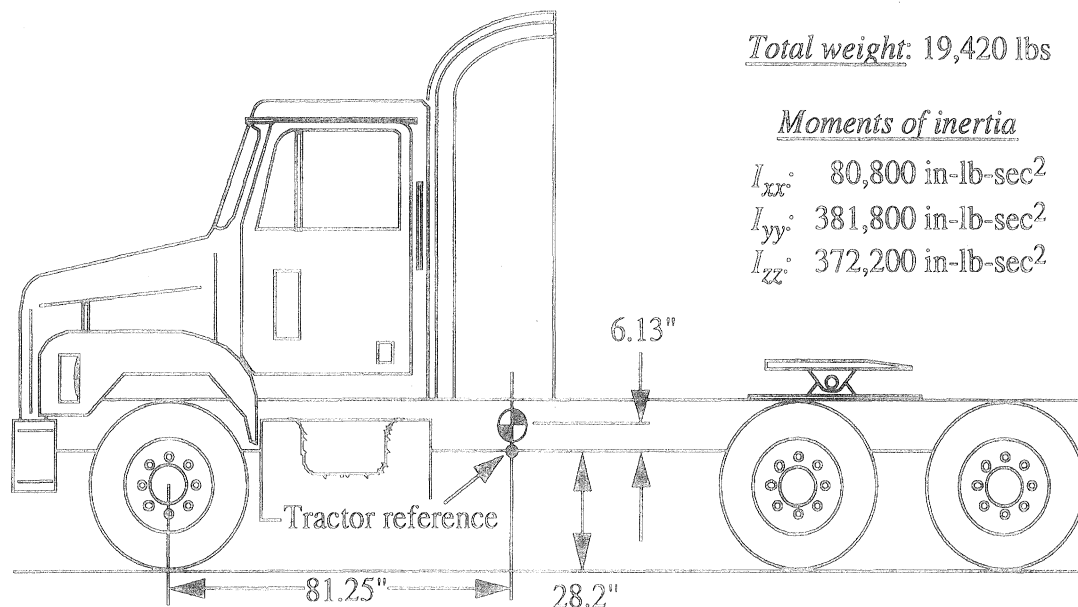

Figure 4. Location of the center of gravity of the White GMC tractor

Masses and inertias of the components of the front suspension and steering system

Figures 5, 6, and 7 show the locations of the centers of gravity of the various components of the front suspension and steering system relative to the points identified in table 1. (For dimensions not shown, assume the center of gravity is on the plane of symmetry.) table 3 shows the weight and moments of inertia of these components. The components are:

- front axle and kingpins (nonspinning)
- spindle/brake (nonspinning)
- brake drum and hub (spinning components)
- tire and wheel (spinning component)
- suspension spring (unloaded)
- pitman arm
- drag link
- tie rod

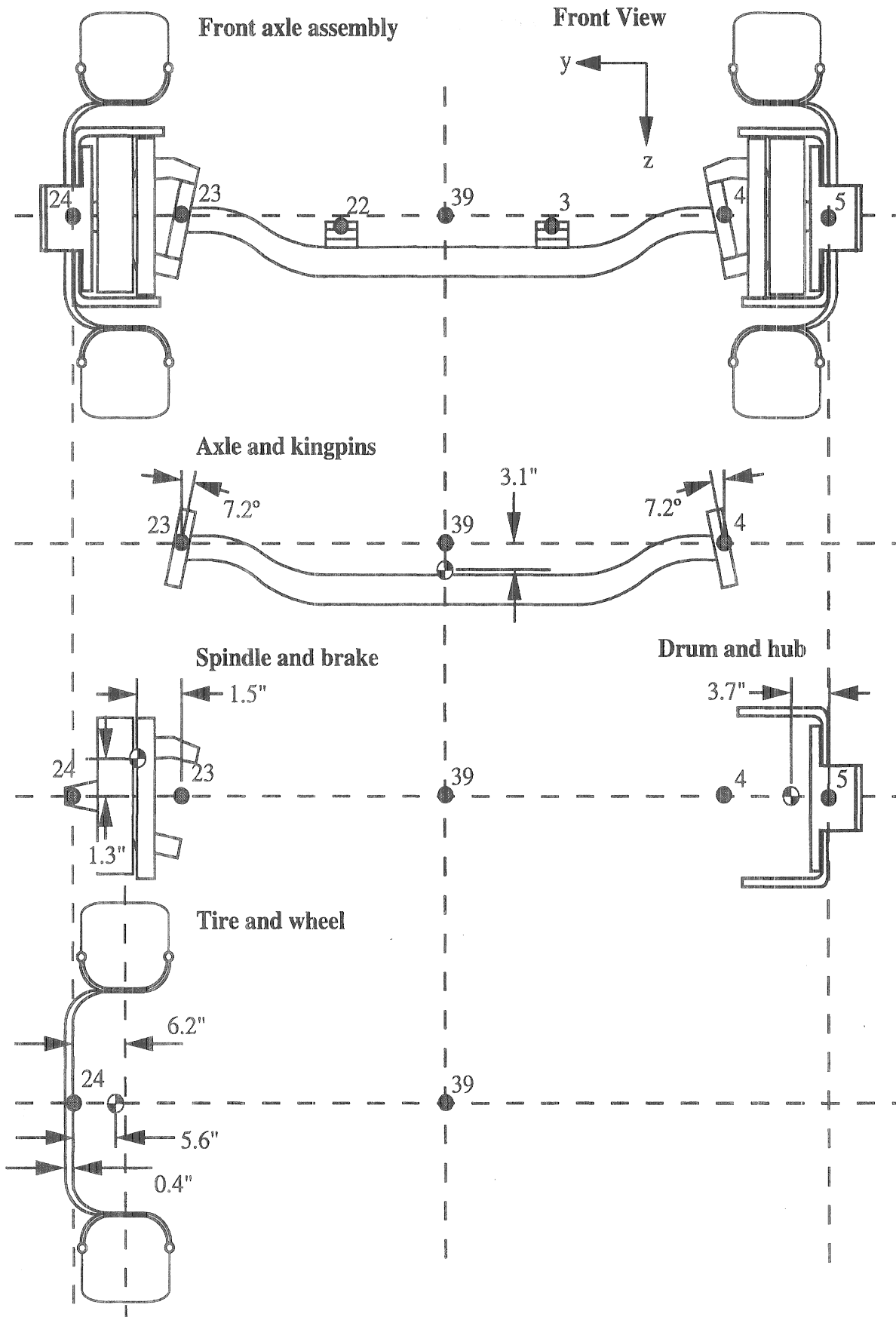

Figure 5. Locations of the centers of gravity of components of the front suspension (front view)

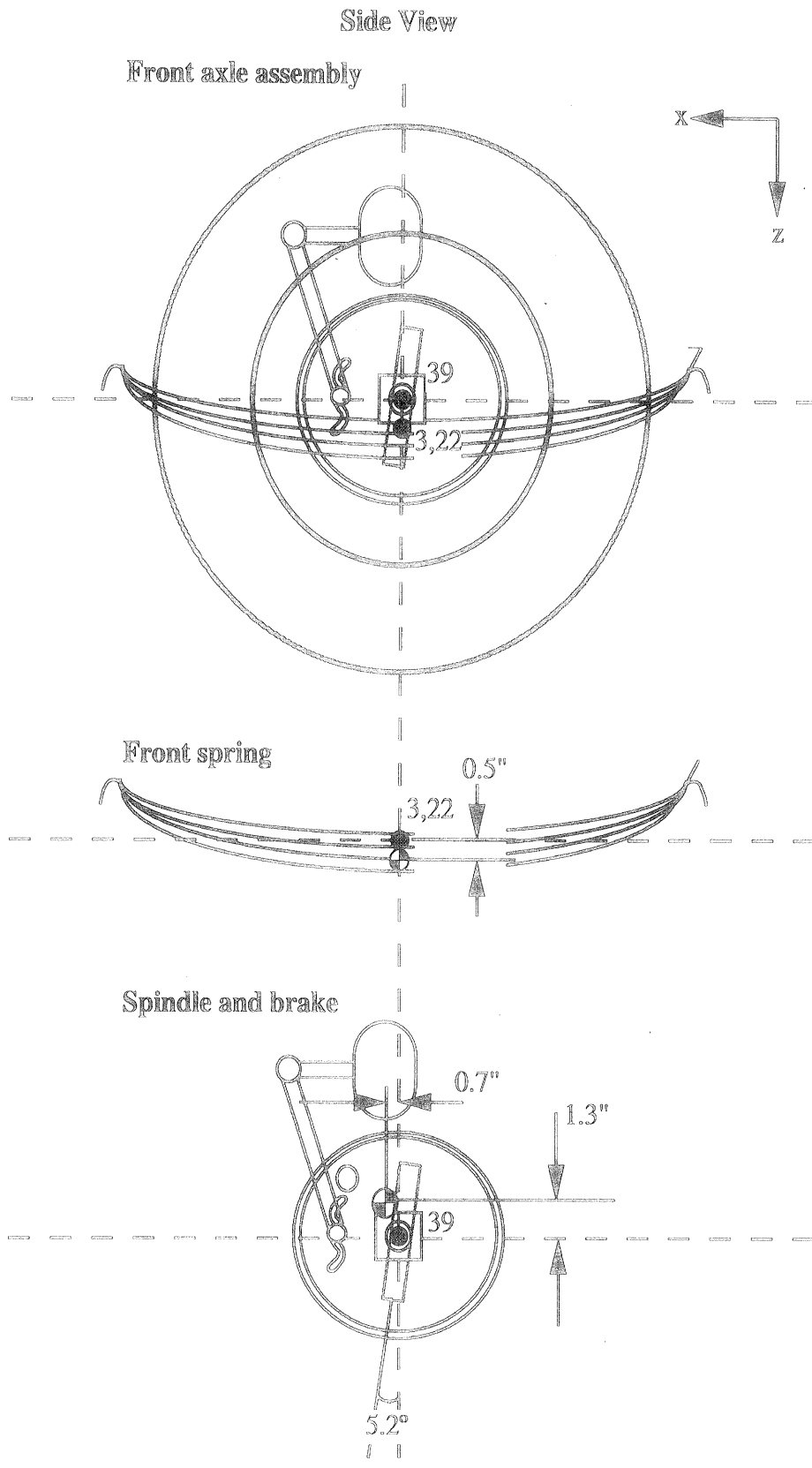

Figure 6. Locations of the centers of gravity of components of the front suspension (side view)

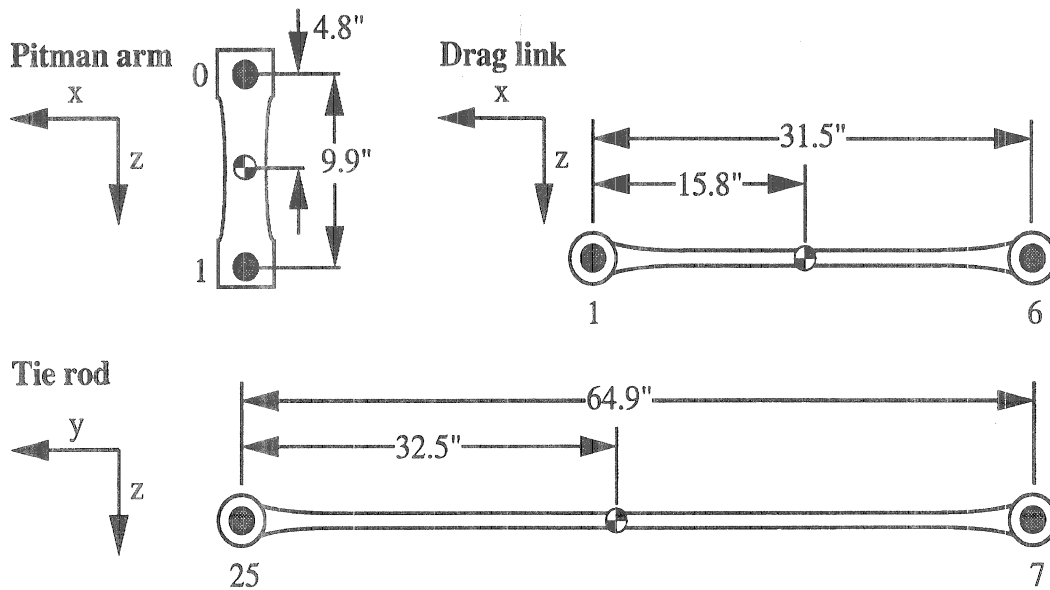

Figure 7. Locations of the centers of gravity of components of the steering system

Table 3. Weights and moments of inertia of the components of the steering system and front suspension and unsprung mass

	Weight, lbs.	I_{xx} , in-lbs-sec ²	I_{yy} , in-lbs-sec ²	I_{zz} , in-lbs-sec ²
<i>Front axle and steering system</i>				
<i>front axle and kingpins</i>	210	292.5	5.96	292.5
<i>spindle and brake (one side)</i>	109	7.22	13.3	7.22
<i>brake drum and hub (one side)</i>	138	9.7	14.0	9.7
<i>tire and wheel (one side)</i>	201	60.6	107.0	60.6
<i>suspension spring (one side)</i>	114	0.78	95.5	95.5
<i>pitman arm</i>	10	0.32	0.32	0.01
<i>drag link</i>	16	0.01	3.99	3.99
<i>tie rod</i>	24	23.6	0.02	23.6

Masses and inertias of the components of the rear suspension

Figures 8, 9, and 10 show the locations of the centers of gravity of the various components of the rear suspension relative to the points identified in table 1. (For dimensions not shown, assume the center of gravity to be on the plane of symmetry of the part.) Table 4 shows the weight and moments of inertia of these components:

- leading axle and brakes (nonspinning)
- trailing axle and brakes (nonspinning)
- brake drum, hub, and half-shaft (spinning components)
- tires and wheels (spinning component)
- suspension spring (unloaded, includes torque-rod leaf)
- load equalizer

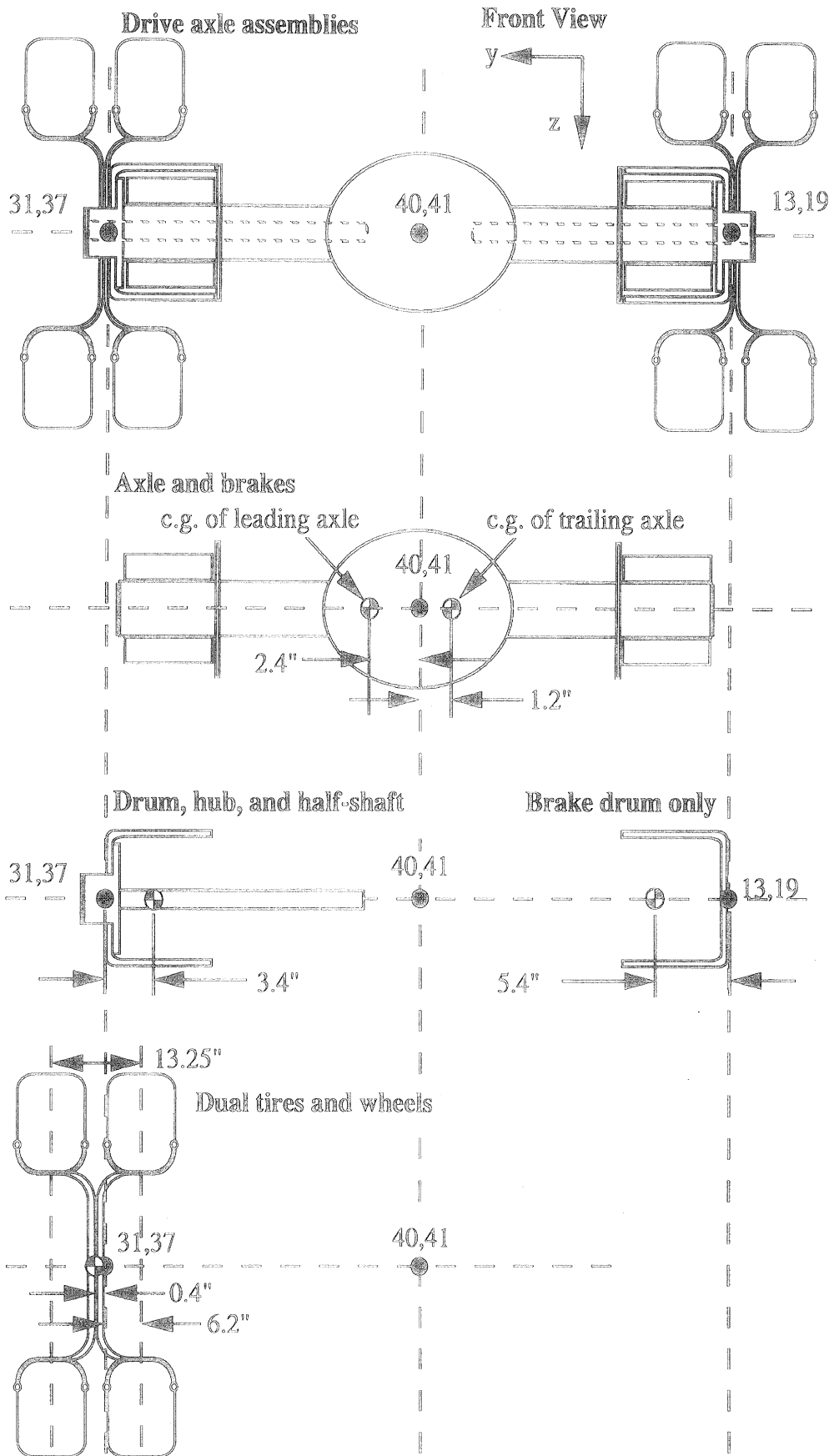

Figure 8. Locations of the centers of gravity of the drive axles components (front view)

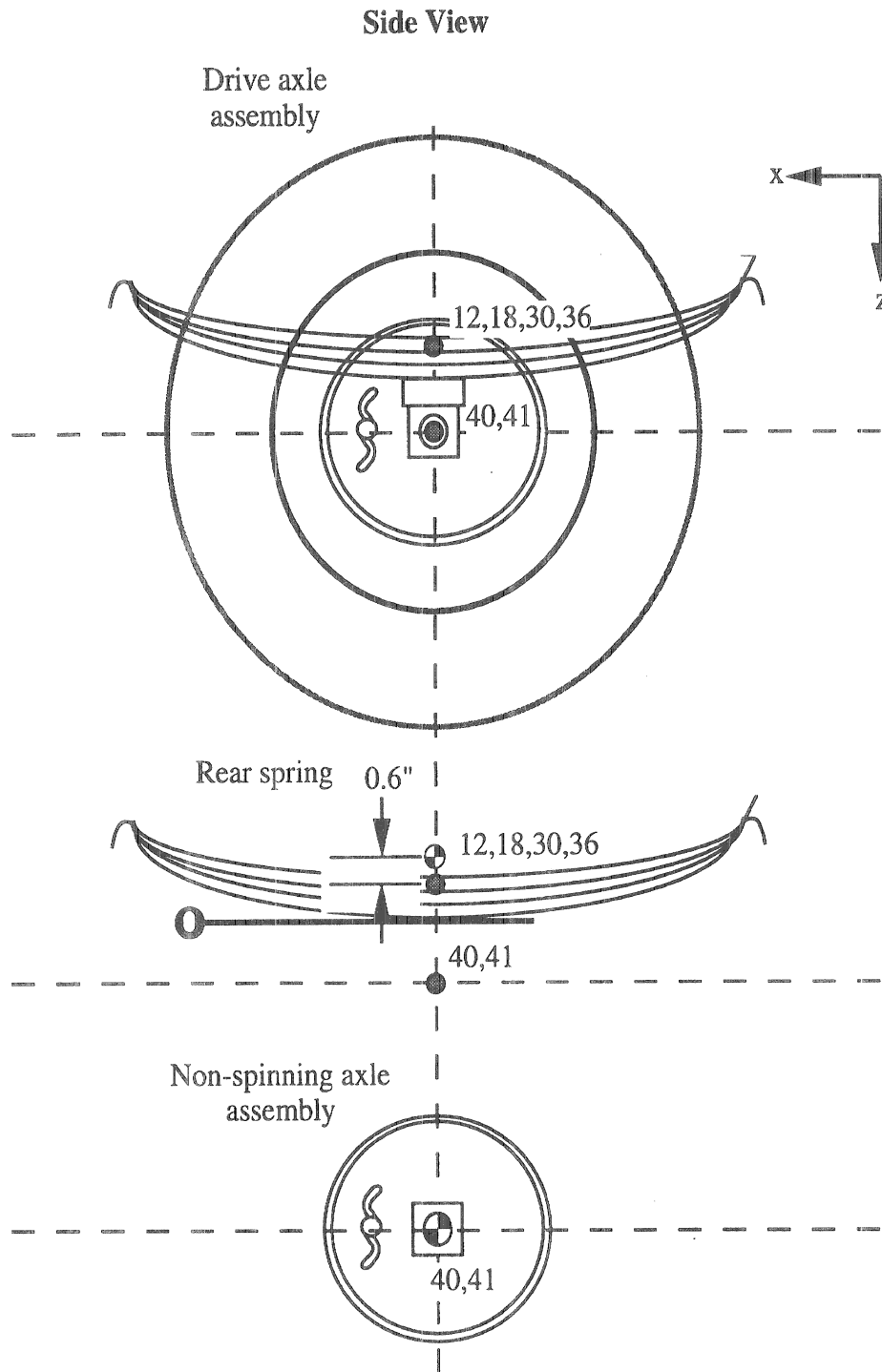

Figure 9. Locations of the centers of gravity of the drive axles components (side view)

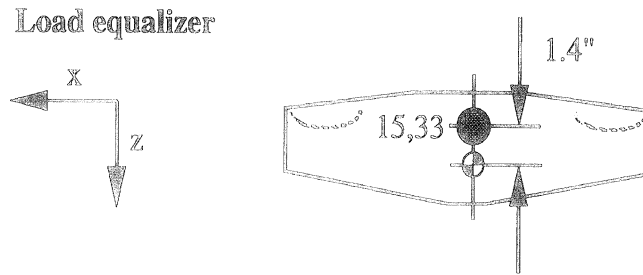

Figure 10. Location of the center of gravity of the load equalizer

Table 4. Weights and moments of inertia of the components of the drive suspension and unsprung masses

<i>Drive axle assemblies</i>	<i>Weight, lbs</i>	<i>I_{xx}, in-lbs-sec²</i>	<i>I_{yy}, in-lbs-sec²</i>	<i>I_{zz}, in-lbs-sec²</i>
<i>dual tires and wheels</i>	402	158.1	225.1	158.1
<i>drum/wheel hub/half-shaft</i>	225	38.2	21.1	38.2
<i>rear brake drum</i>	112	12.6	18.1	12.6
<i>front drive axle</i>	843	636.5	197.2	636.5
<i>rear drive axle</i>	775	690.9	79.1	690.9
<i>suspension spring</i>	93	.62	31.0	36.9
<i>load equalizer</i>	23	0.2	1.2	1.2

Inertial properties of the trailer

Mass and inertial measurements were made on the sprung masses and unsprung masses of the trailer, individually.

Masses and inertias of the components of the trailer sprung mass

The sprung mass of the trailer consists of two parts, namely, the van body and the suspension subframe. Mass and inertial measurements were made on each of these components individually. Results of these measurements are presented in figure 11.

Masses and inertias of the components of the trailer suspension

Figures 12, 13, and 14 show the locations of the centers of gravity of the various joints between components of the suspension and unsprung masses of the trailer. Joint ID numbers are from table 2. (For dimensions not shown, assume the center of gravity to be on plane of symmetry.) Table 5 shows the weight and moments of inertia of these components. The components are:

- axle and brakes (nonspinning)
- brake drum and hub (spinning components)

Sprung mass

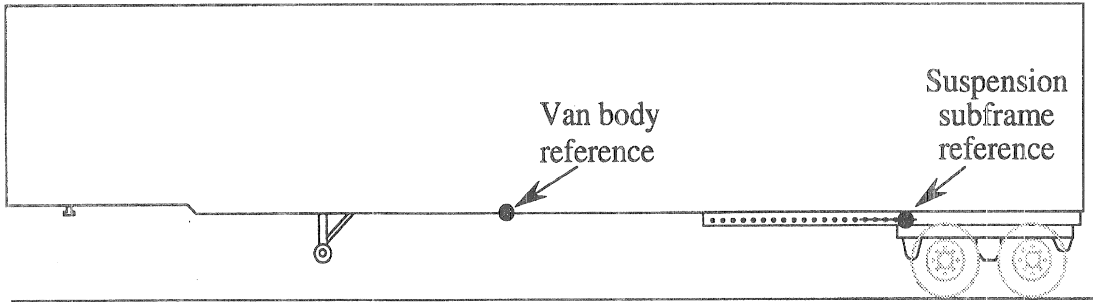

Van body

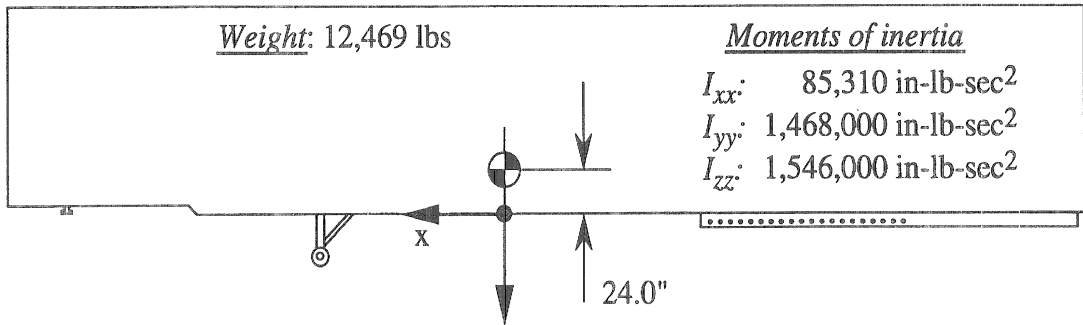

Suspension sub-frame

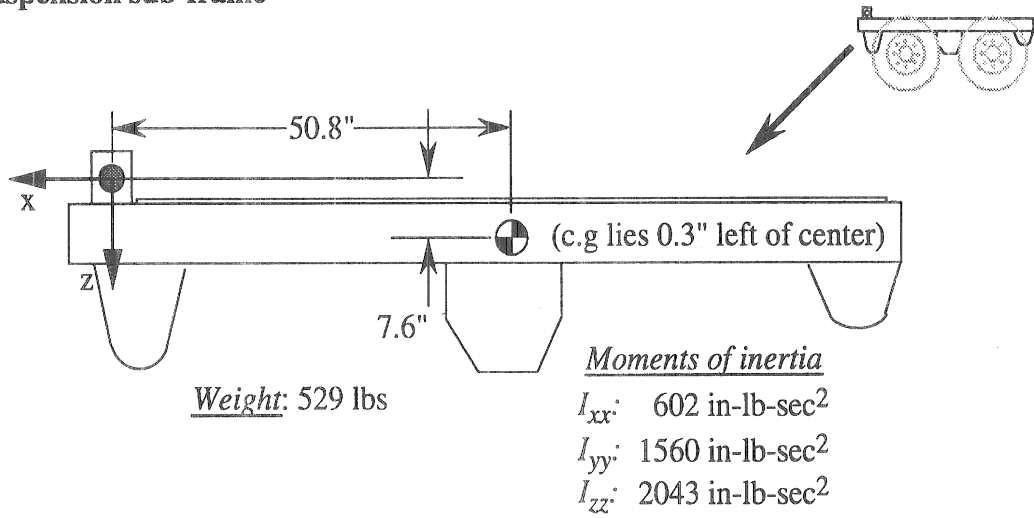

Figure 11. Masses and moments of inertia of the sprung mass components

Front View

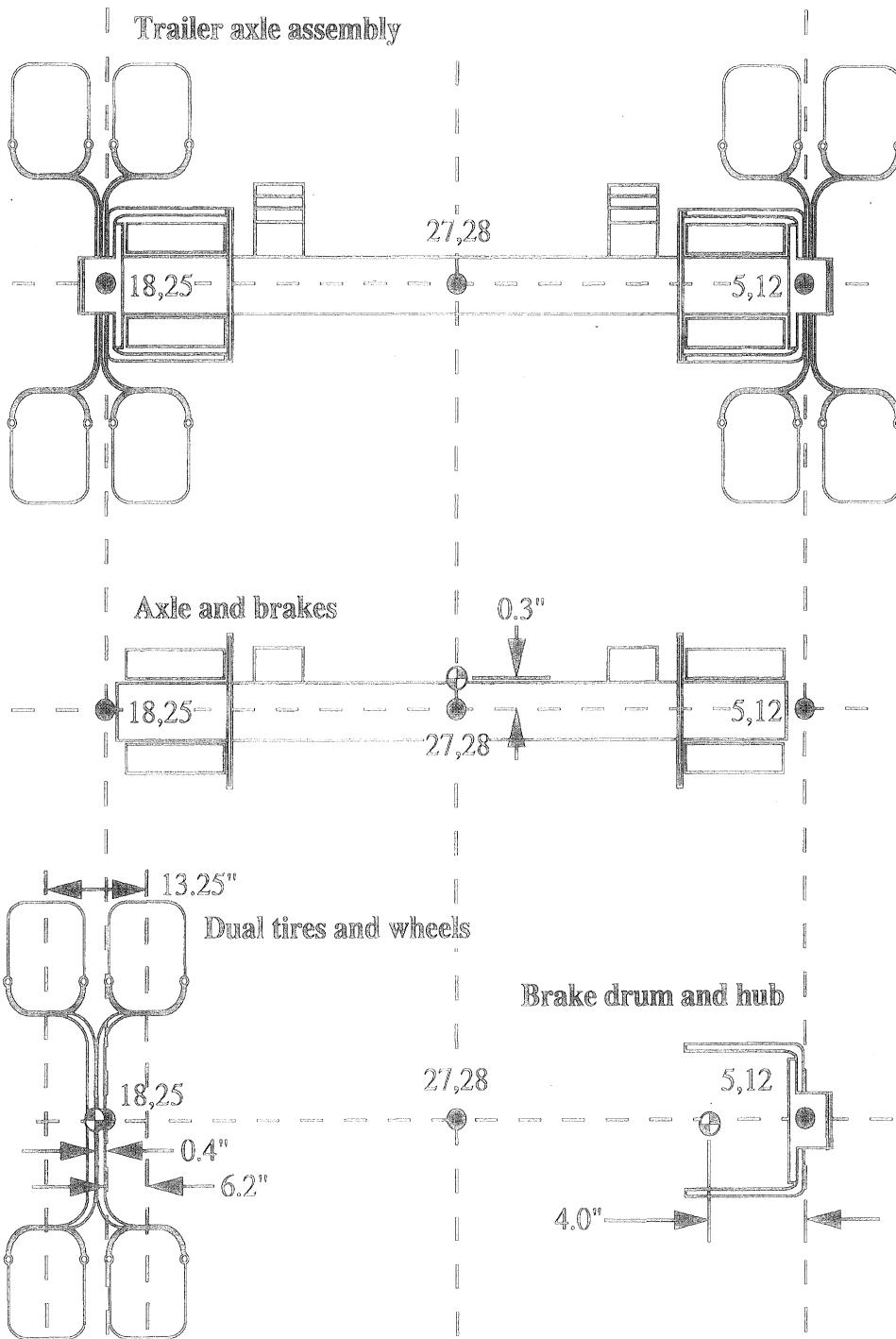

Figure 12. Locations of the centers of gravity of the components of the trailer axles (front view)

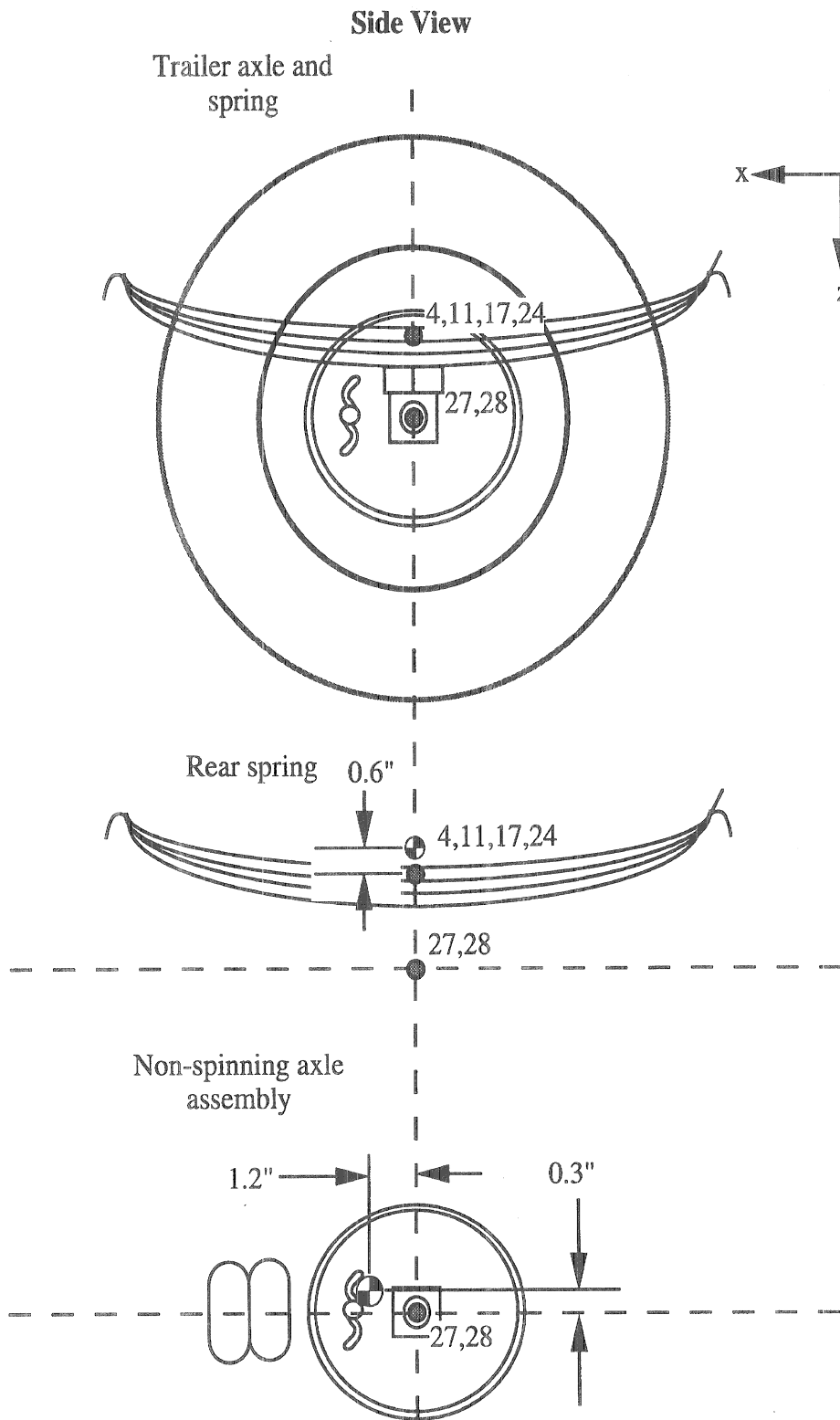
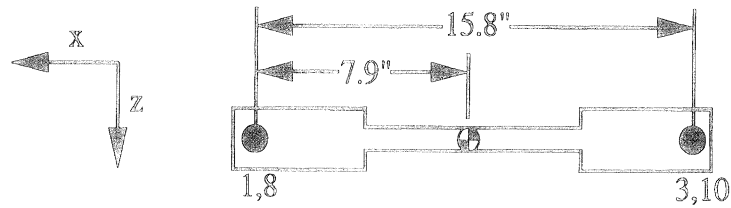
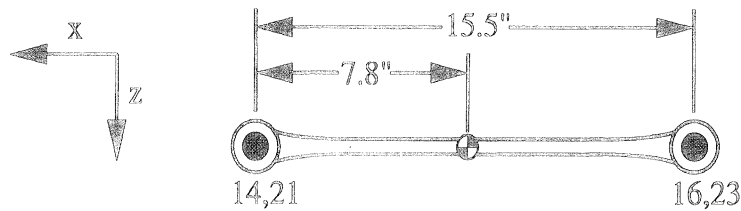

Figure 13. Locations of the centers of gravity of the components of the trailer axles (side view)

Adjustable control arm (left)



Fixed control arm (right)



Load equalizer

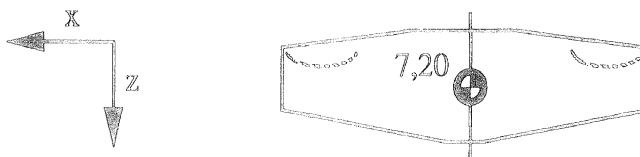

Figure 14. Locations of the centers of gravity of the links of the trailer suspension

- tires and wheels (spinning component)
- suspension spring (unloaded)
- load equalizer
- adjustable control arm
- fixed control arm

Table 5. Weights and moments of inertia of the components of the suspension and unsprung masses

<i>Axle assemblies</i>	<i>Weight,</i> <i>lbs</i>	<i>I_{xx},</i> <i>in-lbs-sec²</i>	<i>I_{yy},</i> <i>in-lbs-sec²</i>	<i>I_{zz},</i> <i>in-lbs-sec²</i>
<i>axle and brakes</i>	437	762.9	29.3	763.1
<i>hub and brake drum</i>	178	26.1	22.9	26.1
<i>dual tires and wheels</i>	378	136.6	186.2	136.6
<i>suspension spring</i>	34	0.54	9.8	9.2
<i>load equalizer</i>	21	0.2	1.6	1.5
<i>adjustable control arm</i>	11	0.02	0.8	0.8
<i>fixed control arm</i>	5.5	0.01	0.4	0.4

CHASSIS AND FIFTH-WHEEL STIFFNESSES

The effective torsional stiffness about a longitudinal axis of the tractor and trailer chassis and of the fifth-wheel coupler were measured. The stiffness of the tractor frame between the front suspension and the rear suspension was found to be 10,700 in-lb/deg. The local torsional stiffness of the fifth-wheel coupling between the fifth-wheel plate and the tractor frame (effectively between the tractor and trailer frames) was 240,000 in-lb/deg. The effective torsional stiffness of the trailer from the fifth-wheel coupling to the rear suspension was 5,750,000 in-lb/deg.

SUSPENSION PARAMETERS

Testing of the functional performance of the tractor and trailer suspensions was done to measure the vertical spring rate, suspension roll stiffness (including auxiliary stiffness), the roll center height, the roll steer performance, the lateral compliance, the aligning moment steer, interaxle load distribution and interaxle load transfer during braking (for the drive and trailer axles), and the steering system performance (for the steer axle). Table 6 describes the measurement program for the steer axle. For the steer axle the roll motion, lateral force, and longitudinal force tests were performed at suspension loads of 14,000, 12,000, and 10,000 pounds. The steering ratio and aligning moment tests were performed at a suspension load of 12,000 pounds. Table 7 describes the measurement program for the trailer and drive axles. The roll motion, lateral force, aligning moment, and longitudinal force tests were performed at suspension loads of 40,000, 25,000, and 10,000 pounds for the trailer axle and 40,000, 28,000, and 16,000 pounds for the drive axle.

The test results corresponding to each entry in the tables are reported in reduced and graphical form. The graphical data, presented in the appendix to this report, provide the functional relationships between the independent and dependent variables of interest. The reduced parameters, presented in this section, represent idealized (usually linear) compliance, kinematic and other properties derived from the graphical data.

Test Definitions

All suspension measurements were conducted using the UMTRI heavy-vehicle-suspension-measurement facility. The facility is described in detail in SAE Technical Paper 800906. In all tests, the frame of the vehicle is held fixed and the suspension is exercised by moving the facility table (simulated ground) vertically and in roll, or by applying tire shear forces using the facility wheel pads.

Force measurements are made with load cell systems located in each of the wheel pads. Thus, in general and *except where noted, the reported forces in the data are absolute values measured at the tire/road interface*. Resulting motions of the suspension and wheels are measured with several potentiometric devices. *Generally, these motion measurements are relative (not absolute) and are referenced to the fixed frame of the vehicle.*

Table 6. Steer Axle Suspension Measurement Program.

<i>Test</i>	<i>Measurement</i>	<i>Reduced Numerics</i>	<i>Data Plots</i>
vertical	vertical rate jounce/rebound steer jounce/rebound wrap-up	boundary tables, beta second-order curve fit linear coefficient	F _Z vs Z Steer vs Z θ vs Z
roll	roll rate roll center roll steer	total roll stiffness, auxiliary roll stiffness roll center height roll steer coefficient	M _X vs Roll Y _{REF} vs Roll Steer vs Roll
aligning moment	aligning moment steer	linear coefficient, freeplay, model parameters	Steer vs M _Z
longitudinal	brake force steer spring wrap-up	linear coefficient linear coefficient	Steer vs F _X
steering ratio	steering ratio	linear coefficient	Wheel Steer vs Road Steer

Table 7. Trailer and Drive Axle Suspension Measurement Program.

<i>Test</i>	<i>Measurement</i>	<i>Reduced Numerics</i>	<i>Data Plots</i>
vertical	vertical rate load distribution	boundary tables, beta linear coefficient	F _Z vs Z F _{ZLD} vs F _{ZLD}
roll	roll rate roll center roll steer	total roll stiffness, auxiliary roll stiffness roll center height roll steer coefficient	M _X vs Roll Y _{REF} vs Roll Steer vs Roll
lateral	lateral compliance lateral force steer	linear coefficient linear coefficient	Y vs F _Y Steer vs F _Y
aligning moment	aligning moment steer	linear coefficient	Steer vs M _Z
longitudinal	inter-axle load transfer	linear coefficient	F _Z vs F _X

The following paragraphs outline the test procedure for the six physical test types listed in tables 6 and 7.

Vertical motion: The suspension is exercised by vertical motion of the table. Table motion is controlled by a force and moment feedback servo-system so that roll moment applied to the suspension is held constant at zero while vertical load on the suspension is varied over the range of interest. Force and moment control servo-systems are also used to maintain zero levels of tire shear force and moment.

Roll motion: The suspension is exercised by roll motion of the table. Table motion is controlled by a force and moment feedback servo-system so that the total vertical

load applied to the suspension is held constant at the desired value while total roll moment on the suspension is varied over the range of interest. Force and moment control servo-systems are also used to maintain zero levels of tire shear force and moment. This force and moment control mode allows the motion of the suspension to be determined by the suspension geometry, rather than by facility geometry.

Lateral force: The suspension is exercised by the application of lateral tire shear force. Prior to the test, the suspension is loaded vertically to the desired level (with zero roll moment). During the test, the table is controlled by feedback of the vertical position of the right and left axle spindles so that the *vertical and roll position of the axle is held fixed*. (As a result, vertical and roll motions, and especially their influence on steer, are not allowed to influence the test, but vertical load on individual tires will change some during the test. Total vertical load may also change slightly.) The force and moment control servo-systems of the wheel pads are used to vary the lateral force at each tire while longitudinal force and aligning moment are held fixed at zero. Lateral force loading is equal at each wheel throughout the test.

Aligning moment: The suspension is exercised by the application of aligning moments at each tire pair. Prior to the test, the suspension is loaded vertically to the desired level (with zero roll moment). During the test, the table is controlled by feedback of the vertical position of the right and left axle spindles so that the *vertical and roll position of the axle is held fixed*. (As a result, vertical and roll motions, and especially their influence on steer, are not allowed to influence the test, but vertical load on individual tires will change some during the test. Total vertical load may also change slightly.) The force and moment control servo-systems of the wheel pads are used to vary the aligning moment at each tire while longitudinal and lateral force are held fixed at zero. Aligning moment is equal at each wheel throughout the test.

Longitudinal force: The suspension is exercised by the application of a longitudinal force under the tires. Prior to the test, the suspension is loaded vertically to the desired level (with zero roll moment). During the test, the table is controlled by feedback of the vertical position of the right and left axle spindles so that the *vertical and roll position of the axle is held fixed*. (As a result, vertical and roll motions are not allowed to influence the test, but vertical load on individual tires will change some during the test. Total vertical load may also change slightly.) The force and moment control servo-systems of the wheel pads are used to vary the longitudinal force at each tire while lateral force and aligning moment are held fixed at zero. Longitudinal force is equal at each wheel throughout the test.

Steering ratio: The suspension is loaded vertically to the desired level (with zero roll moment). The steering system is exercised by moving the steering wheel through its stroke in both directions. During the test, the table is controlled by feedback of the vertical position of the right and left axle spindles so that the vertical and roll position of the axle is held fixed. The forces and moments under the tires are held fixed at zero, and are not allowed to influence the test.

Results

The graphical data collected for the suspensions are provided in an appendix to this report. At least one graph is produced from each test. Each graph identifies the data file, test type, vertical load (if applicable), and other pertinent information. The graphs also provide definitions of the dependent and independent variables, including the units and sign convention. Any explanation needed for interpretation of the graphs is provided in this section.

Reduced data appear in tables 8 through 16, and are discussed in this section. Many of the reduced numerics are simply linear coefficients indicating the nominal slope of the related graphical data. The slopes presented are taken from the data at the nominal suspension operating point for the test, often at the origin of the data graph. Note that, due to nonlinearity of the graphical data, other values may be appropriate for off-center conditions.

For comparison to other common suspensions, see SAE Technical Paper 922426, which presents the range of roll stiffness, lateral compliance, and roll center height of suspensions previously measured at UMTRI. The paper also provides details about the procedures used to measure these properties and estimate their values from the data.

Vertical Motion

The vertical force-deflection behavior is characterized during the vertical motion test. The functional relationship that results from the test is a plot of vertical load versus suspension deflection. The plots provide the suspension spring rate *as measured at the wheel spindle*; that is, they do not include compliance of the tire. In all plots, the vertical load is measured at the ground, not at the spring, so it includes the unsprung weight of the suspension.

The numerics derived from the vertical motion test are linear spring rate and coulomb friction level at a specified operating point, tables describing the compression and extension boundaries of the force-deflection data, and the compression and extension "betas." The load distribution is also derived for the trailer and drive suspensions. The linear spring rate is simply the slope of the vertical force-deflection plot at the operating point. The beta parameter is an exponential coefficient used to model the behavior of the suspension between the compression and extension boundaries. This is described in detail in SAE Technical Paper 800905. The load distribution is derived for the drive and trailer suspensions from the interaxle load distribution plots. It represents the share of the total suspension load that is picked up by the leading axle:

$$\frac{F_{ZL}}{F_{ZL} + F_{ZT}}$$

and the trailing axle:

$$\frac{F_{ZT}}{F_{ZL}+F_{ZT}}$$

where F_{ZL} is the load on the leading axle and F_{ZT} is the load on the trailing axle. If the vertical load is evenly distributed, both expressions will yield a value of .5. Note that the results are very sensitive to the fore-aft leveling of the frame, and are reported for the level condition.

Steer and wrap-up

The jounce/rebound steer and wrap-up rates are derived from the vertical motion test of the steer axle. For the jounce/rebound steer, a second-order curve is fit to the jounce/rebound steer plot, which characterizes the steer as a function of vertical suspension position. The equation for the curve is:

$$\text{average steer angle} = 2.436 - .8917 \cdot Z + .0604 \cdot Z^2$$

The slope of this curve at a given operating point is its jounce/rebound steer coefficient. The Z values that correspond to the three test loads for the steer axle and the jounce/rebound steer coefficients are given in table 9. To derive the jounce/rebound steer coefficient for other loads, use the spring tables provided in table 14 and the above equation. (Absolute values of Z are important in evaluating this quantity. The above equation is appropriate only for the zero reference of Z implied by table 14.)

The jounce/rebound wrap-up rate is the slope of the jounce/rebound wrap-up rate plot at a given operating point. The coefficient indicates the change in steer axle wrap-up for a change in suspension vertical position.

Roll Motion

The suspension total roll stiffness, auxiliary roll stiffness, roll center height, and roll steer coefficient are all reduced from the results of the roll motion test.

Total roll stiffness

The plots entitled "Axle Roll Rate" present roll moment about the suspension roll center versus the roll angle of the axle. The slope of this plot is the total roll stiffness of an axle.

The total roll stiffness of the drive axle increased with nominal suspension load. This is because the stiffness of the springs increased with load. In addition, the roll stiffness of the drive axle decreased at large roll angles. Thus, a separate rate was reported for small and large roll angles.

For the trailer axle, at a suspension load of 10,000 pounds the roll rate decreases significantly for roll angles greater than 0.5 degrees. This is because the low-side spring is extended through its stroke at greater roll angles, and does not contribute to roll stiffness. The same is true at a suspension load of 25,000 pounds for roll angles greater than 1.2 degrees.

Auxiliary roll stiffness

The roll stiffness of most suspensions is higher than the stiffness dictated by the vertical spring rate of the suspension and the spring spacing. Some portion of the overall roll stiffness of a suspension can usually be attributed to auxiliary mechanisms, such as lateral links or antiroll bars. Roll-motion test data and vertical-motion test data are applied to a simple suspension model (based on the UMTRI exponential spring model) to determine what portion of the total roll stiffness is accounted for by the vertical spring rate and what portion derives from auxiliary stiffness.

Roll-center height

The roll center is defined as the *instant center of the rigid axle roll motion with respect to the fixed frame of the vehicle*. The roll center is assumed to be *on the centerline* of the vehicle and its height is relative to the simulated ground plane. Roll-center height is determined from the slope of the Roll Center Height plot (lateral vs. roll motion of the axle). The slope of the plot at a zero roll angle is determined and used in the following formula to calculate h_{rc} , the height of the suspension roll center above the simulated ground plane.

$$h_{rc} = h_a + 57.3 \circ \left. \frac{\partial y_a}{\partial \phi_a} \right|_{\phi_a = 0}$$

where ϕ_a is the roll motion of the axle, y_a is the lateral motion of the axle at an arbitrary height, h_a , above the simulated ground plane. As expected, the roll center height of the suspension lowered with increasing load. The change is due largely to the compression of the suspension springs and tires (making the fixed frame closer to ground).

Roll-steer coefficient

The roll-steer coefficient is the slope of the roll-steer plots at zero roll angle. This coefficient indicates the steer response of the suspension that results from roll motion.

Lateral Force

The lateral compliance coefficient given is the slope of the linear portion of the Lateral Force Compliance plot. That is, the coefficient indicates the lateral motion response of the axle as results from the sum of the two tire lateral forces.

Although the lateral-force-compliance coefficient is given as a linear coefficient, the lateral-force-compliance behavior is often nonlinear. In such cases, a portion of the lateral motion of the suspension in response to lateral force is due to lash (restricted by coulomb friction). For the steer axle, this value was estimated, rather than tested.

The lateral-force-steer coefficient is the slope of the lateral-force-compliance-steer plot at the zero lateral-force condition. The coefficient indicates the steer response of the

suspension that results from the from the sum of the two tire lateral forces. In some cases, the lateral-force steer was either very low or negligible. Therefore, a value of zero was reported.

Aligning Moment

The aligning-moment-steer coefficient for the trailer and drive axles is the slope of the aligning-moment-compliance-steer plots. Note that the aligning moment used is the *total* applied to the two wheel sets. The coefficient indicates the steer response of the suspension that results from the sum of tire aligning moments. Although the aligning-moment-compliance steer is given as a linear coefficient, the aligning moment behavior is sometimes nonlinear. In such cases, a portion of the steer of the suspension in response to aligning moment is due to lash.

The aligning-moment-compliance steer of the steer axle was measured at a suspension load of 12,000 pounds. The steering gear and tie-rod stiffness values are derived from the slopes of the linear portions of the aligning-moment-compliance-steer plots. The calculated spring values were deduced from the model shown in figure15 and the following:

$$K_s = 2 \cdot \left(\frac{\partial \text{SAL}}{\partial \text{MZAV}} \right)^{-1}$$

$$K_T = \left[\left(\frac{\partial \text{SAR}}{\partial \text{MZAV}} \right) - \left(\frac{\partial \text{SAL}}{\partial \text{MZAV}} \right) \right]^{-1}$$

Table 8 provides the results.

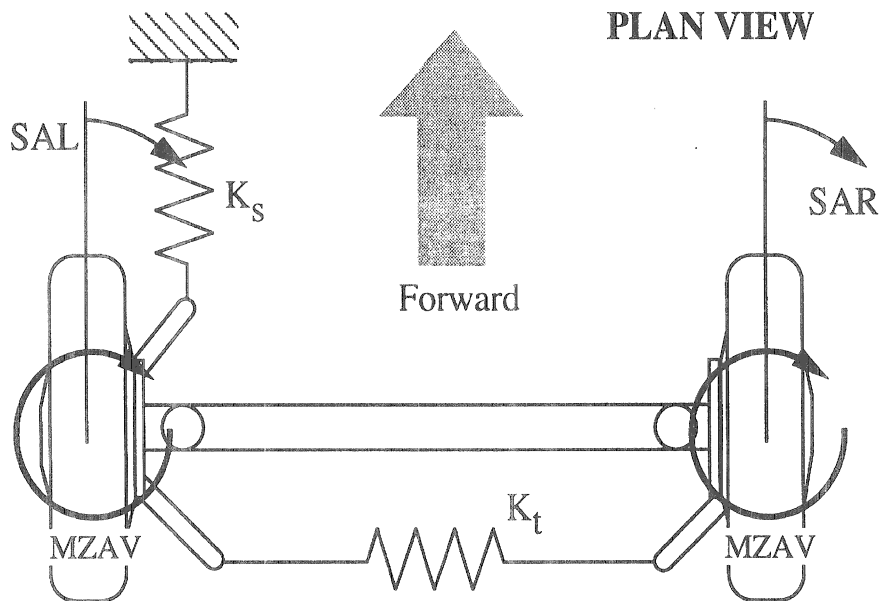

Figure 15. Aligning moment compliance steer model.

Table 8. Steering System Model Parameters.

Test	Freeplay (deg)	Measured Compliance (deg/in-lb)		Calculated Spring Values (in-lb/deg)	
		$\frac{\partial SAR}{\partial MZAV}$	$\frac{\partial SAL}{\partial MZAV}$	K _S	K _T
repeat 1	.50	.172 x 10 ⁻³	.191 x 10 ⁻³	3,970	21,740
repeat 2	.54	.174 x 10 ⁻³	.192 x 10 ⁻³	4,000	20,410
average	.52	—	—	3,985	21,075

Longitudinal Force

The interaxle load transfer coefficient for the trailer and drive axles is the slope of the plots entitled “Interaxle Load Transfer Due to Braking”. Note that the longitudinal force used is the *total* brake force applied to the suspension (lead and trail). The coefficient indicates the shift in vertical load from the leading axle to the trailing axle that results from the application of a brake force.

The brake-force steer and spring wrap-up coefficients for the steer axle are the slopes of the wrap-up-steer and wrap-up-rate plots, respectively. They indicate the steer response and wrap-up of the suspension that results from the application of tire brake forces.

Steering Ratio

Individual response of the left and right road wheel to the steering wheel rotation were measured for the full range of steering. The measurements was made at a steer axle load of 12,000 pounds, and under a condition of zero tire-shear force and moment loading. The plots of left steering ratio, right steering ratio, road wheel steer, and road wheel difference characterize the results of this test. At a nominal steer angle of zero degrees, the ratio of steering wheel angle to road wheel angle is 12.8.

Table 9. Reduced Data, Steer Axle

<i>At a Nominal Suspension Load of:</i>	<i>10,000 lbs</i>	<i>12,000 lbs</i>	<i>14,000 lbs</i>
vertical stiffness (lb/in)	1,230	1,340	1,390
compression β (in)	.06	.07	.08
extension β (in)	.06	.07	.08
coulomb friction (lbs)	315	330	330
vertical reference position (in)	3.82	4.63	5.33
jounce/rebound steer (deg/in)	-.430	-.332	-.247
jounce/rebound wrap-up (deg/in)	.159	.159	.159
total roll stiffness (in-lb/deg)	21,900	21,300	22,200
auxiliary roll stiffness (in-lb/deg)	10,500	9,250	9,000
roll center height, above ground (in)	17.2	16.8	16.3
roll steer coefficient (deg/deg)	.277	.225	.139
lateral compliance coefficient (in/lb)	$.701 \times 10^{-5}$	$.706 \times 10^{-5}$	$.789 \times 10^{-5}$
brake force steer (deg/deg)	-.140	-.140	—
wrap-up rate (lb/deg)	-1140	-1210	—

Table 10. Reduced Data, Leading Drive Axle

<i>At a Nominal Suspension Load of:</i>	<i>16,000 lbs</i>	<i>28,000 lbs</i>	<i>40,000 lbs</i>
vertical stiffness (lb/in)	3,120	4,510	6,110
compression β (in)	.03	.06	.06
extension β (in)	.03	.06	.06
coulomb friction (lbs)	720	940	1,120
total roll stiffness (in-lb/deg) [†]	56,000	76,200	96,400
total roll stiffness (in-lb/deg) ^{††}	56,000	68,200	79,700
auxiliary roll stiffness (in-lb/deg)	14,000	13,000	12,000
roll center height, above ground (in)	28.3	27.8	27.2
roll steer coefficient (deg/deg)	-.069	-.117	-.143
lateral compliance coefficient (in/lb)	$.198 \times 10^{-4}$	$.152 \times 10^{-4}$	$.109 \times 10^{-4}$
lateral force steer (in/lb)	$-.123 \times 10^{-4}$	$-.530 \times 10^{-5}$	$-.673 \times 10^{-5}$
aligning moment steer (deg/in-lb)	$.248 \times 10^{-5}$	$.258 \times 10^{-5}$	$.228 \times 10^{-5}$
inter-axle load distribution (lb/lb)	.528	.500	.489
inter-axle load transfer (lb/lb)	.161	.126	.140

† For roll angles less than 1 degree.

†† For roll angles greater than 2 degrees.

Table 11. Reduced Data, Trailing Drive Axle.

<i>At a Nominal Suspension Load of:</i>	<i>16,000 lbs</i>	<i>28,000 lbs</i>	<i>40,000 lbs</i>
vertical stiffness (lb/in)	3,740	5,550	6,800
compression β (in)	.03	.07	.08
extension β (in)	.03	.07	.08
coulomb friction (lbs)	855	1,480	1,950
total roll stiffness (in-lb/deg) [†]	57,900	87,400	95,700
total roll stiffness (in-lb/deg) ^{††}	57,900	67,500	64,900
auxiliary roll stiffness (in-lb/deg)	10,000	10,000	7,000
roll center height, above ground (in)	29.3	28.7	27.5
roll steer coefficient (deg/deg)	.028	-.002	-.026
lateral compliance coefficient (in/lb)	.189x10 ⁻⁴	.866x10 ⁻⁵	.648x10 ⁻⁵
lateral force steer (in/lb)	-.241x10 ⁻⁵	-.473x10 ⁻⁵	-.657x10 ⁻⁵
aligning moment steer (deg/in-lb)	.189x10 ⁻⁵	.227x10 ⁻⁵	.209x10 ⁻⁵

† For roll angles less than 1 degree.

†† For roll angles greater than 2 degree.

Table 12. Reduced Data, Leading Trailer Axle

<i>At a Nominal Suspension Load of:</i>	<i>10,000 lbs</i>	<i>25,000 lbs</i>	<i>40,000 lbs</i>
vertical stiffness (lb/in)	7,720	10,100	11,500
compression β (in)	- 0 -	.03	.15
extension β (in)	- 0 -	.03	.15
coulomb friction (lbs)	380	1075	---
total roll stiffness (in-lb/deg) [†]	143,500	175,000	245,000
auxiliary roll stiffness (in-lb/deg)	2,000	22,000	27,000
roll center height, above ground (in)	31.1	28.9	26.9
roll steer coefficient (deg/deg)	.096	.035	- 0 -
lateral compliance coefficient (in/lb)	.103x10 ⁻³	.824x10 ⁻⁴	.725x10 ⁻⁴
lateral force steer (in/lb)	.211x10 ⁻⁴	- 0 -	- 0 -
aligning moment steer (deg/in-lb)	.513x10 ⁻⁵	.426x10 ⁻⁵	.382x10 ⁻⁵
inter-axle load distribution (lb/lb)	.527	.524	.507
inter-axle load transfer (lb/lb)	.109	.141	.147

† For roll angles of ± 0.4 degree, ± 1.0 degree, and ± 1.0 degree, respectively.

Table 13. Reduced Data, Trailing Trailer Axle

<i>At a Nominal Suspension Load of:</i>	<i>10,000 lbs</i>	<i>25,000 lbs</i>	<i>40,000 lbs</i>
vertical stiffness (lb/in)	6,520	8,990	16,000
compression β (in)	.007	.004	.02
extension β (in)	.007	.006	.02
coulomb friction (lbs)	260	808	—
total roll stiffness (in-lb/deg) [†]	126,000	178,000	245,000
auxiliary roll stiffness (in-lb/deg)	13,000	19,000	13,000
roll center height, above ground (in)	28.7	27.4	26.1
roll steer coefficient (deg/deg)	.174	.169	.162
lateral compliance coefficient (in/lb)	.568x10 ⁻⁴	.523x10 ⁻⁴	.432x10 ⁻⁴
lateral force steer (in/lb)	.934x10 ⁻⁵	.181x10 ⁻⁴	- 0 -
aligning moment steer (deg/in-lb)	.453x10 ⁻⁵	.386x10 ⁻⁵	.373x10 ⁻⁵

† For roll angles of ± 0.4 degree, ± 1.0 degree, and ± 1.0 degree, respectively.

Table 14. Steer Axle Spring Boundary Tables

<i>Compression Envelope</i>		<i>Extension Envelope</i>	
<i>Deflec (in)</i>	<i>Force (lbs)</i>	<i>Deflec (in)</i>	<i>Force (lbs)</i>
.86	1,668	.90	854
1.76	2,929	1.56	1,831
3.23	4,597	3.77	4,597
4.65	6,386	5.25	6,549
5.89	8,095	6.45	8,461
6.84	9,681	6.94	9,641
7.06	10,983	7.20	10,983

Table 15. Drive Axle Spring Boundary Tables

<i>Leading Axle</i>				<i>Trailing Axle</i>			
<i>Compression Envelope</i>		<i>Extension Envelope</i>		<i>Compression Envelope</i>		<i>Extension Envelope</i>	
<i>Deflec (in)</i>	<i>Force (lbs)</i>	<i>Deflec (in)</i>	<i>Force (lbs)</i>	<i>Deflec (in)</i>	<i>Force (lbs)</i>	<i>Deflec (in)</i>	<i>Force (lbs)</i>
1.18	1220	1.23	746	-.05	881	-.04	610
1.90	3254	1.90	2,169	.19	1,356	.07	881
2.44	5153	2.53	3,797	.39	1,559	.34	1,017
2.98	7051	2.97	5,153	.90	3,390	.82	2,102
3.15	7797	3.42	7,322	1.44	5,627	1.34	3,458
3.62	10712	3.90	10,034	1.85	8,000	1.77	5,017
4.17	14169	4.23	12,203	2.42	12,000	2.20	6,915
4.73	18644	4.78	15,797	2.99	16,271	2.65	9,424
				3.47	19,525	3.12	13,084
						3.63	17,220

Table 16 Trailer Axle Spring Boundary Tables

<i>Leading Axle</i>				<i>Trailing Axle</i>			
<i>Compression Envelope</i>		<i>Extension Envelope</i>		<i>Compression Envelope</i>		<i>Extension Envelope</i>	
<i>Deflec (in)</i>	<i>Force (lbs)</i>	<i>Deflec (in)</i>	<i>Force (lbs)</i>	<i>Deflec (in)</i>	<i>Force (lbs)</i>	<i>Deflec (in)</i>	<i>Force (lbs)</i>
0.55	881	0.51	746	0.44	949	0.45	746
1.21	1017	1.25	949	1.16	1,017	1.21	949
1.32	1627	1.39	1,627	1.34	1,966	1.38	1,627
1.72	5288	1.70	3,797	1.72	4,949	1.67	3,390
2.20	10712	2.27	9,424	2.00	7,525	2.00	5,695
2.51	13898	2.53	12,881	2.24	11,593	2.42	10,102
2.87	18102	2.87	16,746	2.53	16,203	2.90	17,492
				2.73	19,186		

APPENDIX

DATA PLOTS FROM THE SUSPENSION MEASUREMENT PROGRAM

Steer Axle.....	A-2
Vertical Motion	A-2
Roll Motion at 14000 lbs.....	A-4
Roll Motion at 12000 lbs.....	A-7
Roll Motion at 10000 lbs.....	A-10
Vertical Motion	A-13
Longitudinal Force at 12000 lbs.....	A-15
Longitudinal Force at 10000 lbs.....	A-17
Roll Motion at 14000 lbs.....	A-19
Roll Motion at 12000 lbs.....	A-20
Roll Motion at 10000 lbs.....	A-21
Aligning Moment at 12000 lbs.....	A-22
Aligning moment at 12000 lbs (repeat).....	A-25
Steering Ratio at 12000 lbs.....	A-28
Drive Axles	A-32
Vertical Motion	A-32
Roll Motion at 40000 lbs.....	A-36
Lateral Force at 40000 lbs.....	A-42
Aligning Moment at 40000 lbs.....	A-46
Longitudinal Force at 40000 lbs.....	A-48
Roll Motion at 28000 lbs.....	A-49
Lateral Force at 28000 lbs.....	A-55
Aligning Moment at 28000 lbs.....	A-59
Longitudinal Force at 28000 lbs.....	A-61
Roll Motion at 16000 lbs.....	A-62
Lateral Force at 16000 lbs.....	A-68
Aligning Moment at 16000 lbs.....	A-72
Longitudinal Force at 16000 lbs.....	A-74
Trailer Axles.....	A-75
Vertical Motion	A-75
Roll Motion at 40000 lbs.....	A-79
Lateral Force at 40000 lbs.....	A-85
Aligning Moment at 40000 lbs.....	A-87
Longitudinal Force at 40000 lbs.....	A-89
Roll Motion at 25000 lbs (large motion).....	A-90
Lateral Force at 25000 lbs.....	A-96
Aligning Moment at 25000 lbs.....	A-100
Longitudinal Force at 25000 lbs.....	A-102
Roll Motion at 25000 lbs (small motion).....	A-103
Roll Motion at 10000 lbs (small motion).....	A-109
Lateral Force at 10000 lbs.....	A-113
Aligning Moment at 10000 lbs.....	A-117
Longitudinal Force at 10000 lbs.....	A-119

Measured by **UMTRI** for NHTSA
Volvo Tractor Model WIA64T

10 Oct 95
Suspension: Taper-Leaf (3)

Single Steer Axle Suspension
Average Vertical Spring Rate

Data file: NHTSAS00.ERD

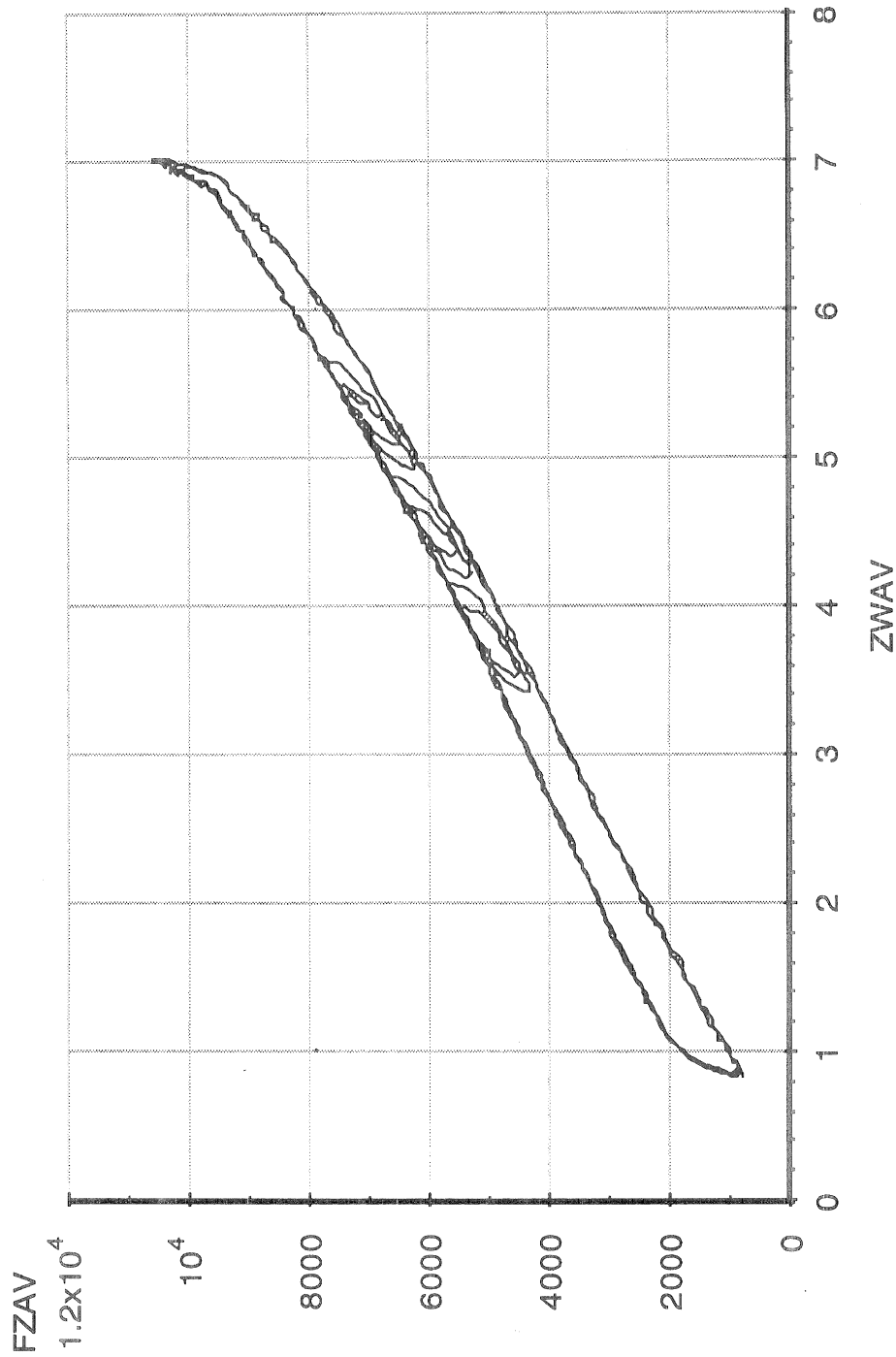

Abscissa (X): Average vertical wheel displacement (ZWAV); inches; spring compression, positive.

Ordinate (Y): Average vertical wheel load (FZAV); pounds; spring compression, positive.

*Note: Brakes on. Position control. Pitman arm blocked.

Measured by UMTRI for NHTSA
Volvo Tractor Model WIA64T

10 Oct 95
Suspension: Taper-Leaf (3)

Single Steer Axle Suspension
Jounce/Rebound Steer

Data file: NHTSAS00.ERD

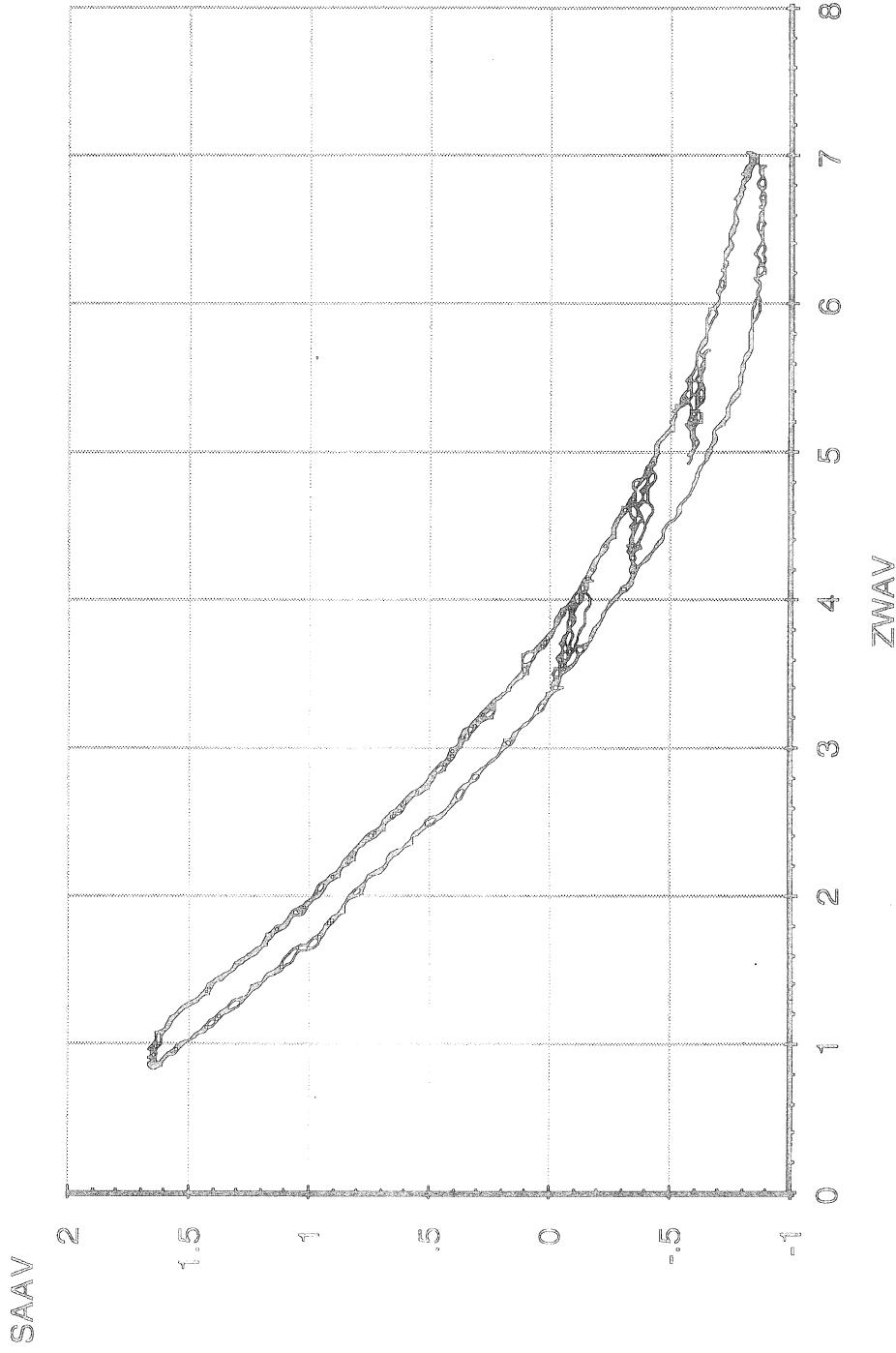

Abscissa (X): Average vertical wheel displacement (ZWAV); inches; spring compression, positive.
Ordinate (Y): Average steer angle (SAAV); degrees; steer toward right, positive.

*Note: Brakes on. Position control. Pitman arm blocked.

Measured by **UMTRI** for NHTSA
Volvo Tractor Model WIA64T

10 Oct 95
Suspension: Taper-Leaf (3)

Single Steer Axle Suspension

Axle Roll Rate

Data file: NHTSAS01.ERD

Suspension Load: 14000 lb.

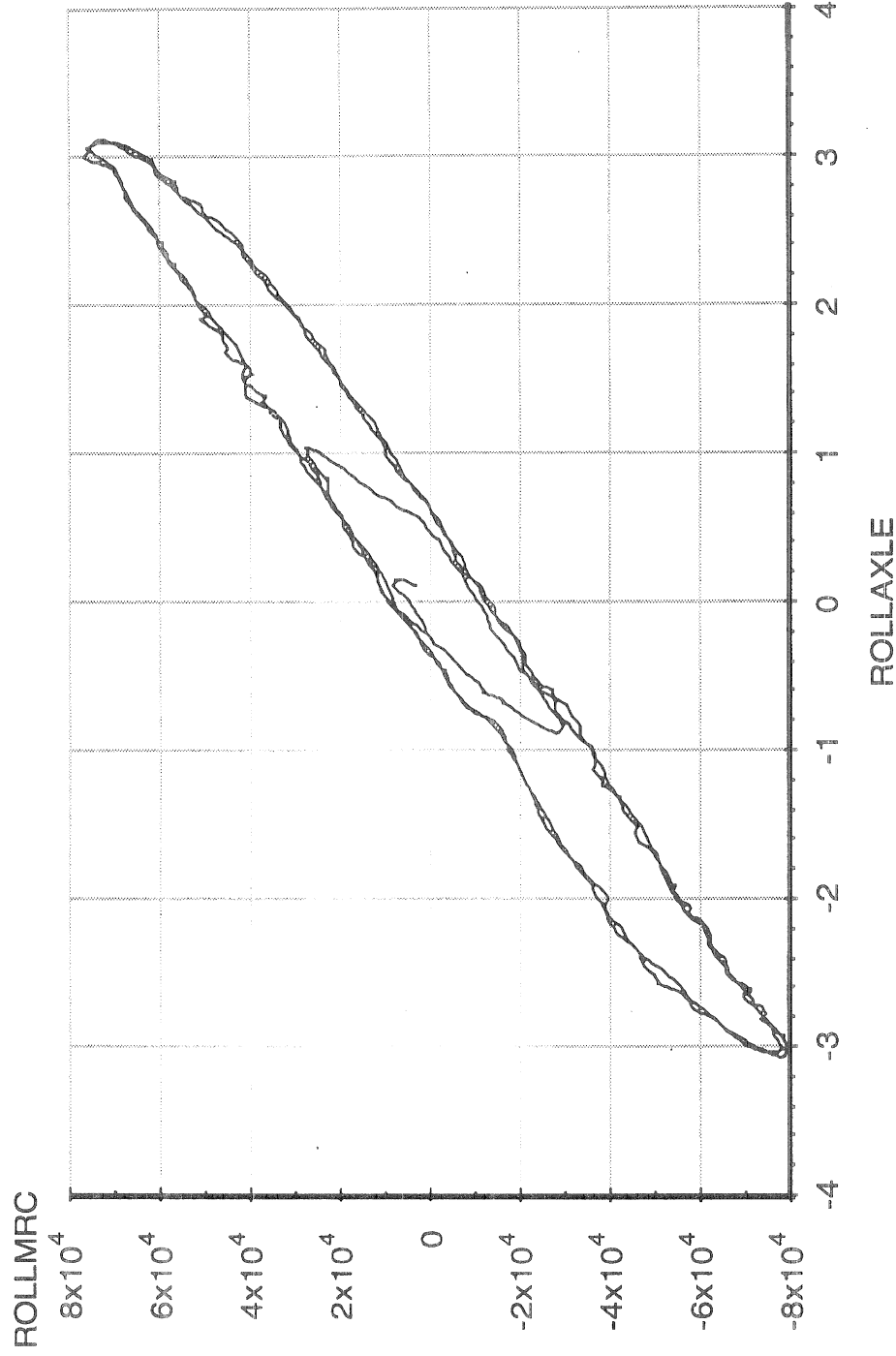

Abscissa (X): Axle roll angle (ROLLAXLE); degrees; right side compressed, positive.

Ordinate (Y): Axle roll moment about the roll center (ROLLMRC); in-lb; right side compressed, positive.

*Note: Brakes on. Force control. Pitman arm blocked. Reference height of 6.38 inches.

Measured by UMTRI for NHTSA
Volvo Tractor Model WIA64T

10 Oct 95
Suspension: Taper-Leaf (3)
Suspension Load: 14000 lb.

Single Steer Axle Suspension
Roll Center Height

Data file: NHTSAS01.ERD

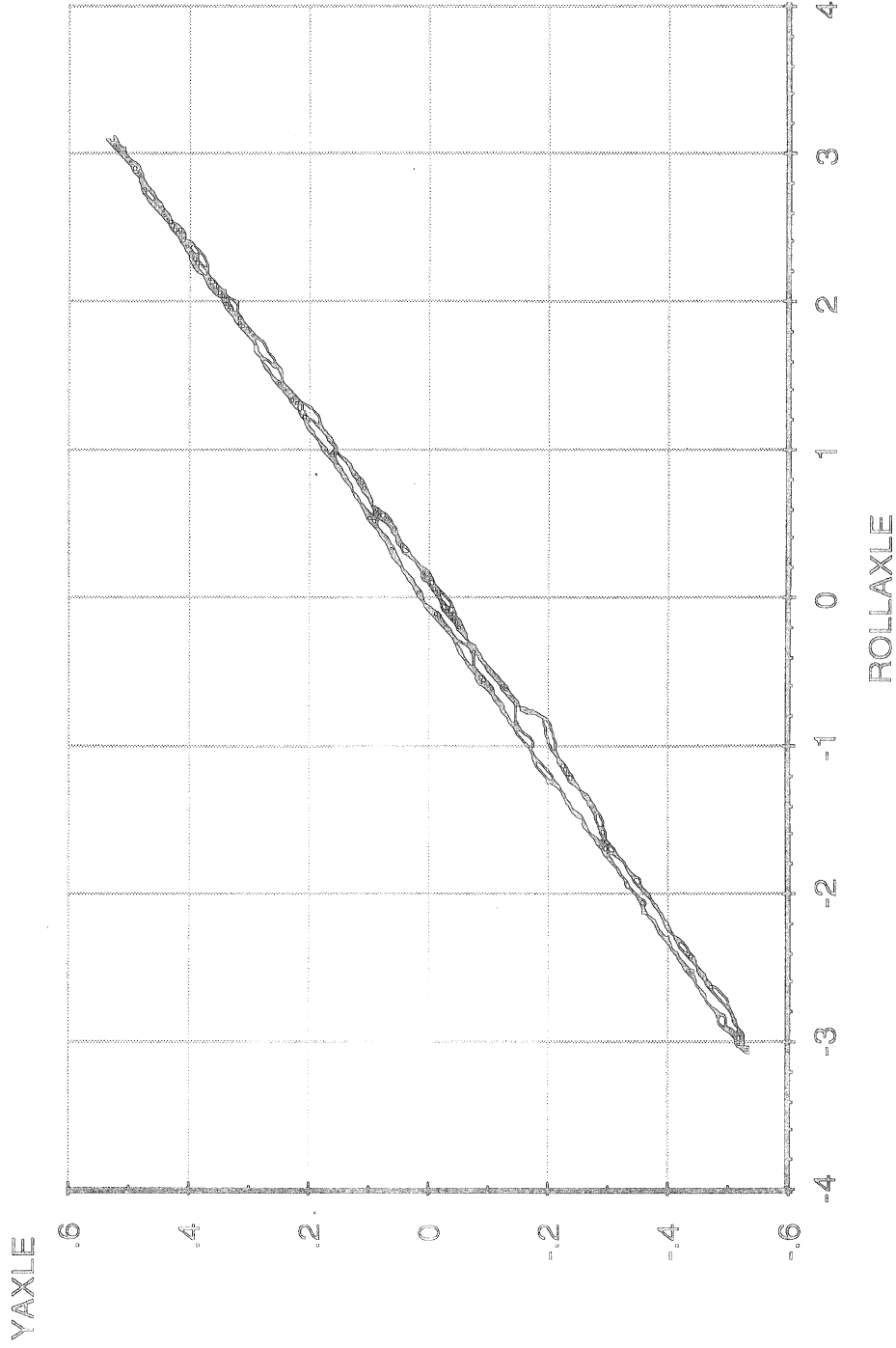

Abscissa (X): Axle roll angle (ROLLAXLE); degrees; right side compressed, positive.
Ordinate (Y): Axle reference point lateral translation (YAXLE); inches; motion toward right, positive.
*Note: Brakes on. Force control. Pitman arm blocked. Reference height of 6.38 inches.

Measured by **UMTRI** for NHTSA
Volvo Tractor Model WIA64T

10 Oct 95
Suspension: Taper-Leaf (3)

Data file: NHTSAS01.ERD

Roll Steer

Suspension Load: 14000 lb.

Single Steer Axle Suspension

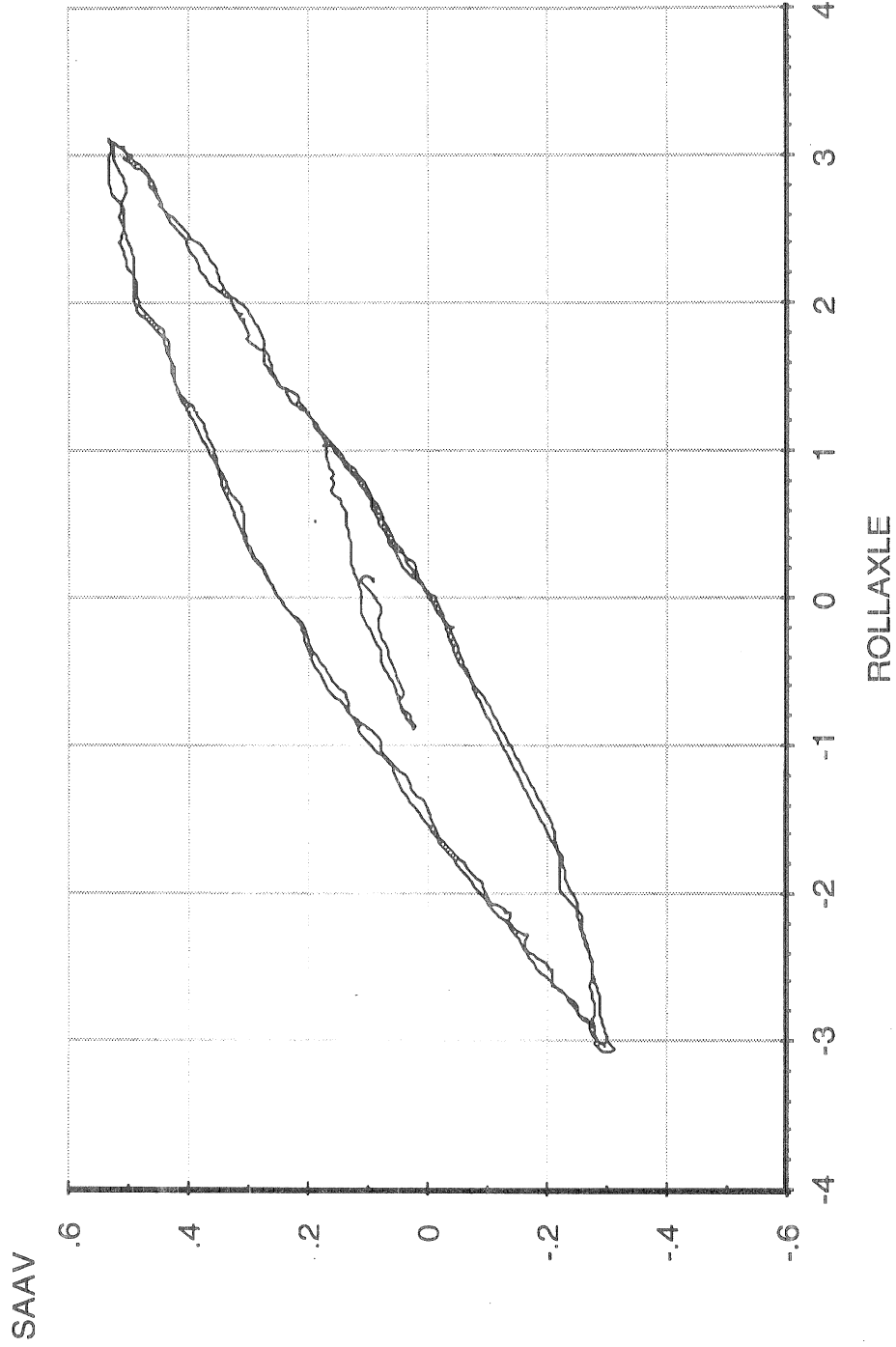

Abscissa (X): Axle roll angle (ROLLAXLE); degrees; right side compressed, positive.

Ordinate (Y): Average steer angle (SAAV); degrees; steer toward right, positive.

*Note: Brakes on. Force control. Pitman arm blocked. Reference height of 6.38 inches.

Measured by UMTRI for NHTSA
Volvo Tractor Model WIA64T

Single Steer Axle Suspension
Axle Roll Rate

10 Oct 95
Suspension: Taper-Leaf (3)
Suspension Load: 12000 lb.

Data file: NHTSAS02.ERD

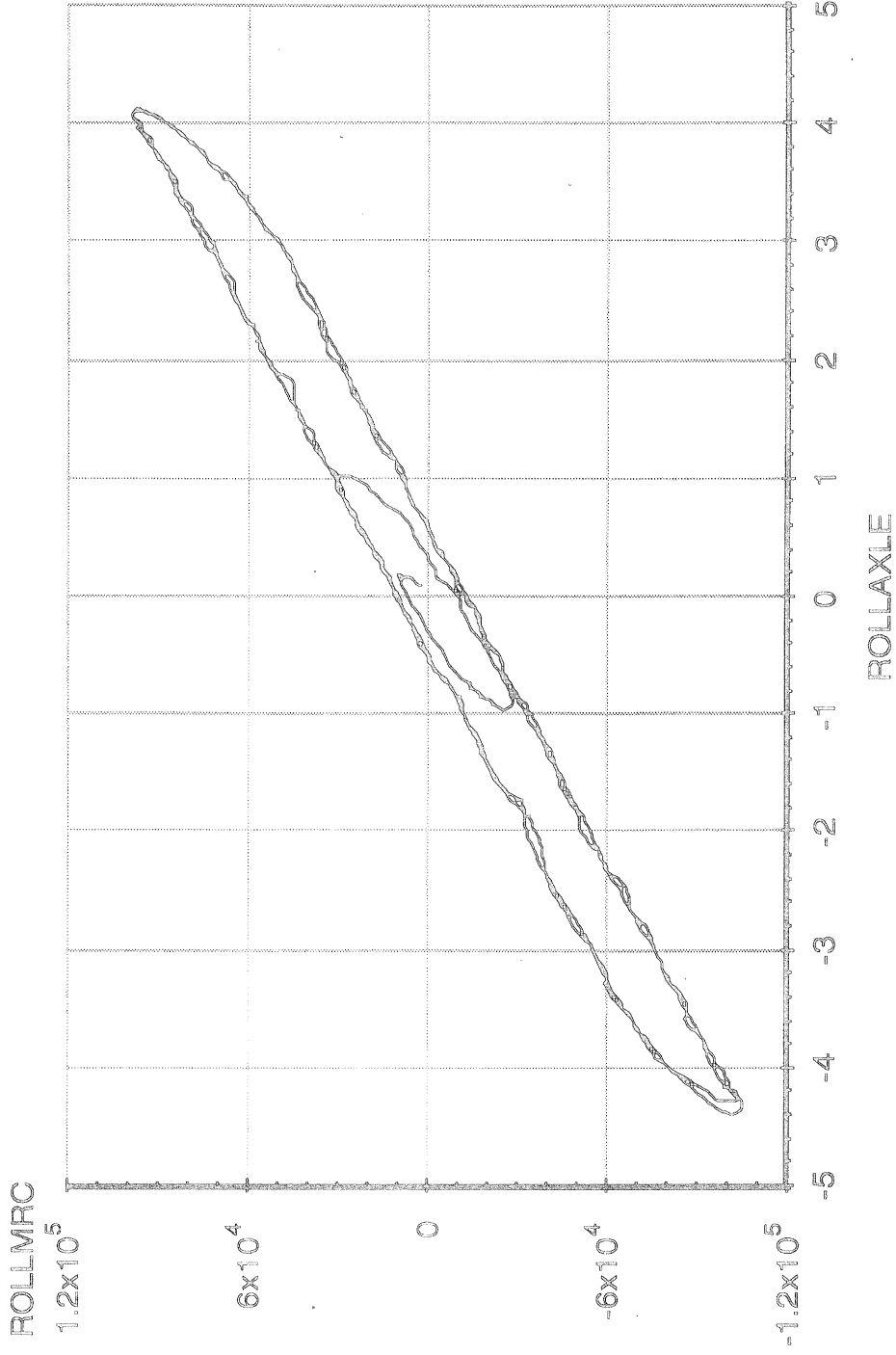

Abscissa (X): Axle roll angle (ROLLAXLE); degrees; right side compressed, positive.
Ordinate (Y): Axle roll moment about the roll center (ROLLMRC); in-lb; right side compressed, positive.
*Note: Brakes on. Force control. Pitman arm blocked. Reference height of 6.56 inches.

Measured by **UMTRI** for NHTSA
Volvo Tractor Model WIA64T

Single Steer Axle Suspension
Roll Center Height

10 Oct 95
Suspension: Taper-Leaf (3)
Suspension Load: 12000 lb.

Data file: NHTSAS02.ERD

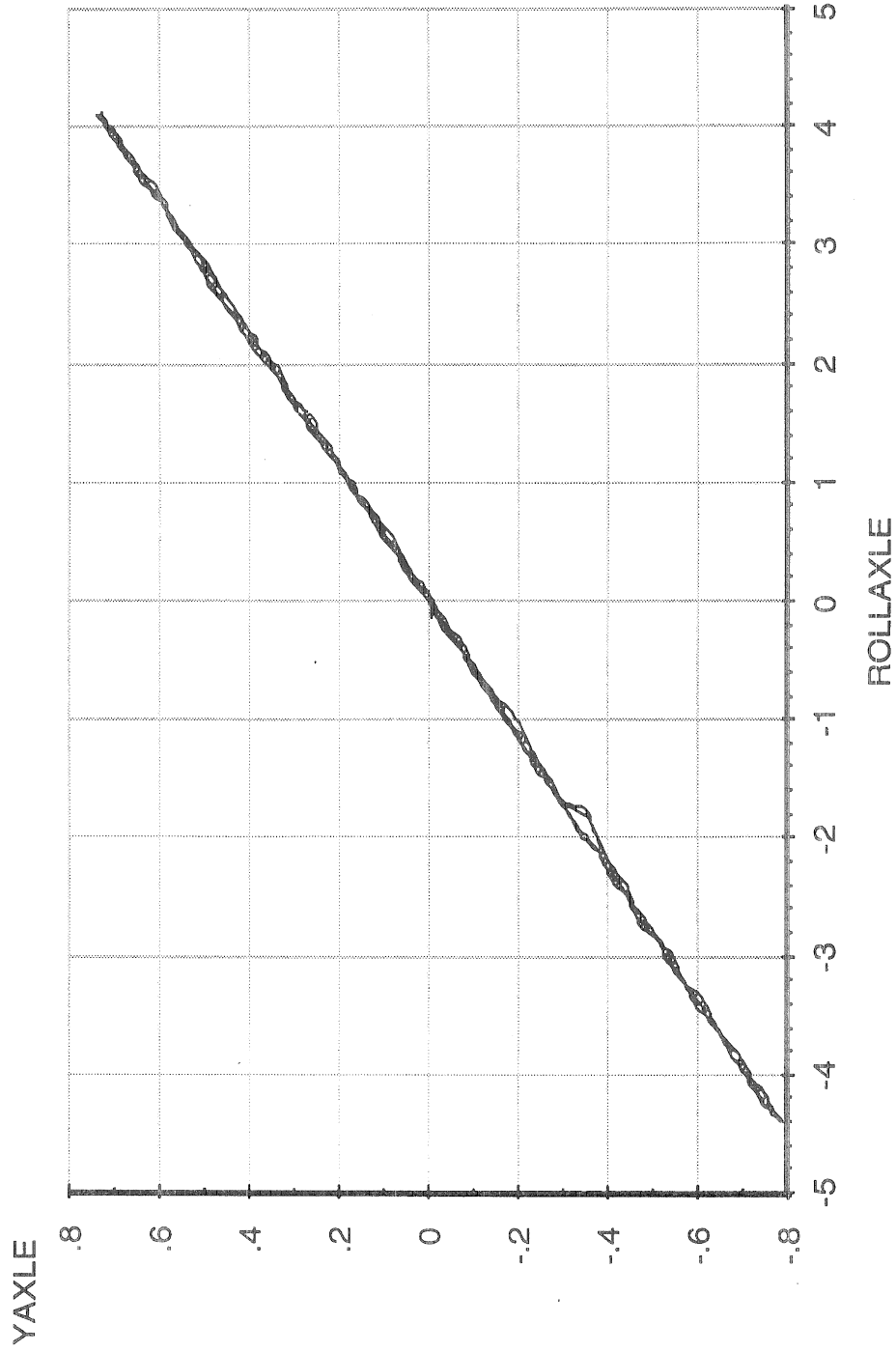

Abscissa (X): Axle roll angle (ROLLAXLE); degrees; right side compressed, positive.

Ordinate (Y): Axle reference point lateral translation (YAXLE); inches; motion toward right, positive.

*Note: Brakes on. Force control. Pitman arm blocked. Reference height of 6.56 inches.

Measured by UMTRI for NHTSA
Volvo Tractor Model WIA64T

Single Steer Axle Suspension
Roll Steer

10 Oct 95
Suspension: Taper-Leaf (3)
Suspension Load: 12000 lb.

Data file: NHTSAS02.ERD

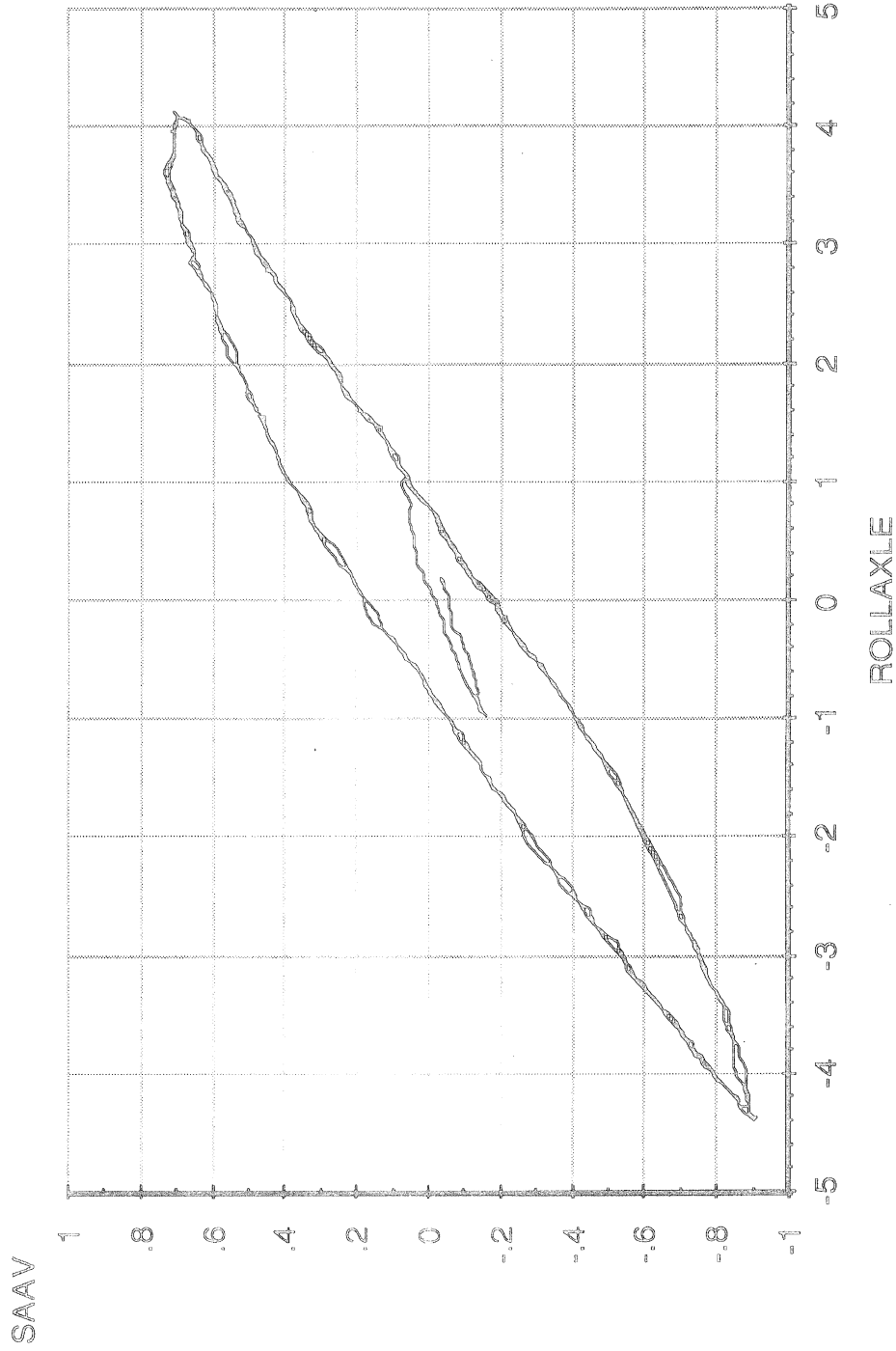

Abscissa (X): Axle roll angle (ROLLAXLE); degrees; right side compressed, positive.
Ordinate (Y): Average steer angle (SAAV); degrees; steer toward right, positive.

*Note: Brakes on. Force control. Pitman arm blocked. Reference height of 6.56 inches.

Measured by **UMTRI** for NHTSA
Volvo Tractor Model WIA64T

Single Steer Axle Suspension
Axle Roll Rate

10 Oct 95
Suspension: Taper-Leaf (3)
Suspension Load: 10000 lb.

Data file: NHTSAS03.ERD

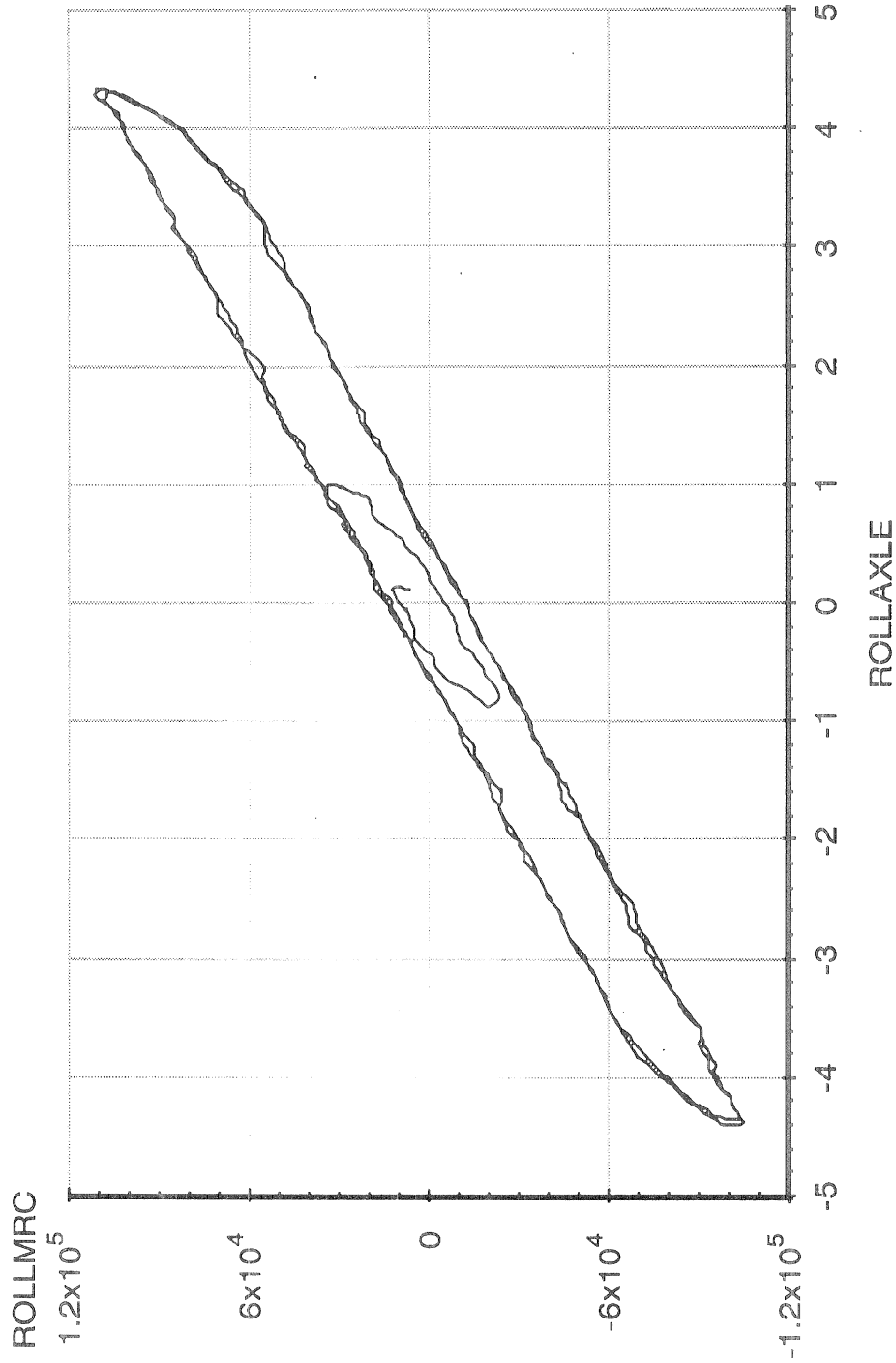

Abscissa (X): Axle roll angle (ROLLAXLE); degrees; right side compressed, positive.

Ordinate (Y): Axle roll moment about the roll center (ROLLMRC); in-lb; right side compressed, positive.

*Note: Brakes on. Force control. Pitman arm blocked. Reference height of 6.75 inches.

Measured by UMTRI for NHTSA
Volvo Tractor Model WIA64T

Single Steer Axle Suspension
Roll Center Height

10 Oct 95
Suspension: Taper-Leaf (3)
Suspension Load: 10000 lb.

Data file: NHTSAS03.ERD

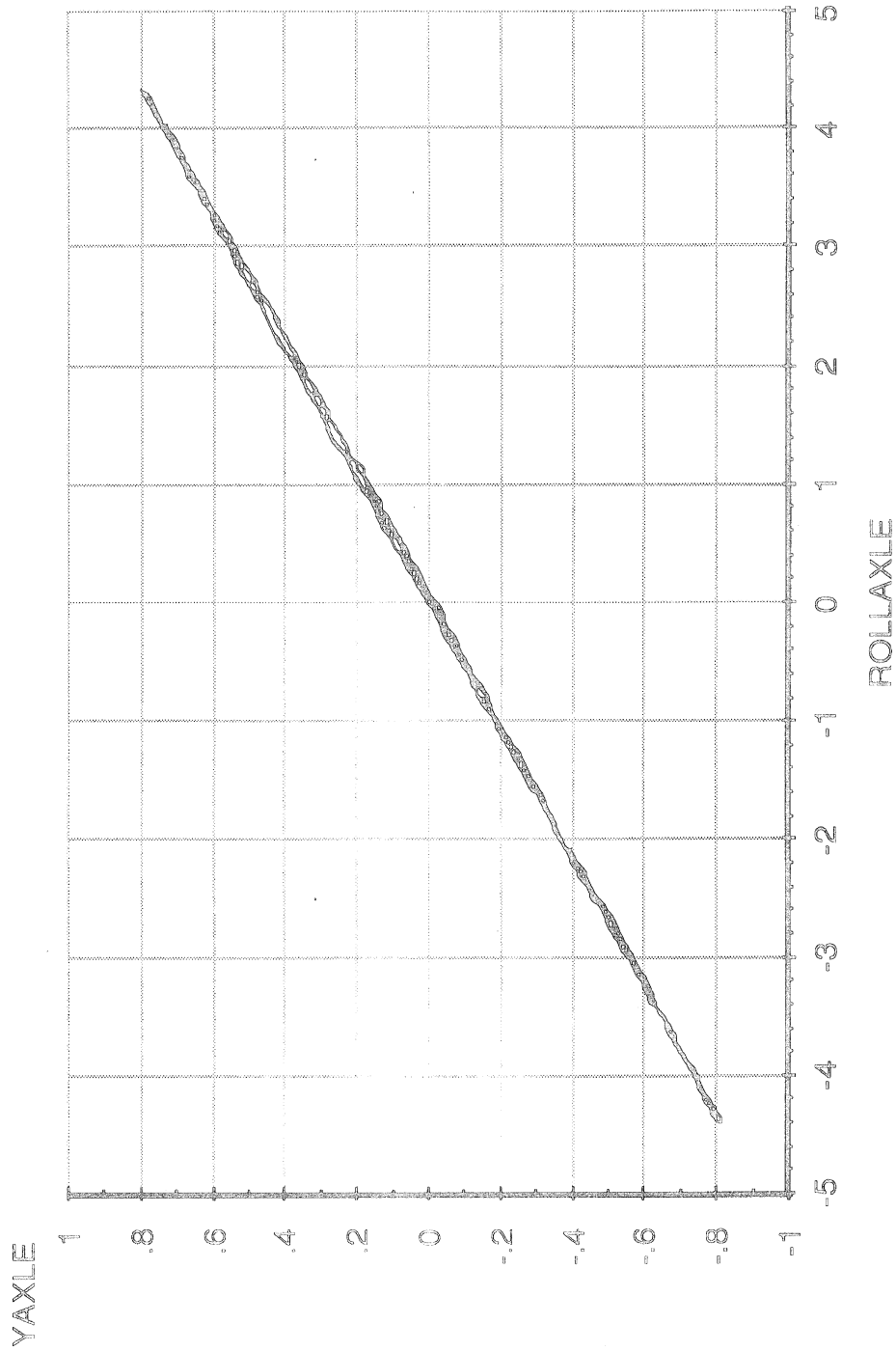

Abscissa (X): Axle roll angle (ROLLAXLE); degrees; right side compressed, positive.

Ordinate (Y): Axle reference point lateral translation (YAXLE); inches; motion toward right, positive.

*Note: Brakes on. Force control. Pitman arm blocked. Reference height of 6.75 inches.

Measured by **UMTRI** for NHTSA
Volvo Tractor Model WIA64T

Single Steer Axle Suspension
Roll Steer

10 Oct 95
Suspension: Taper-Leaf (3)
Suspension Load: 10000 lb.

Data file: NHTSAS03.ERD

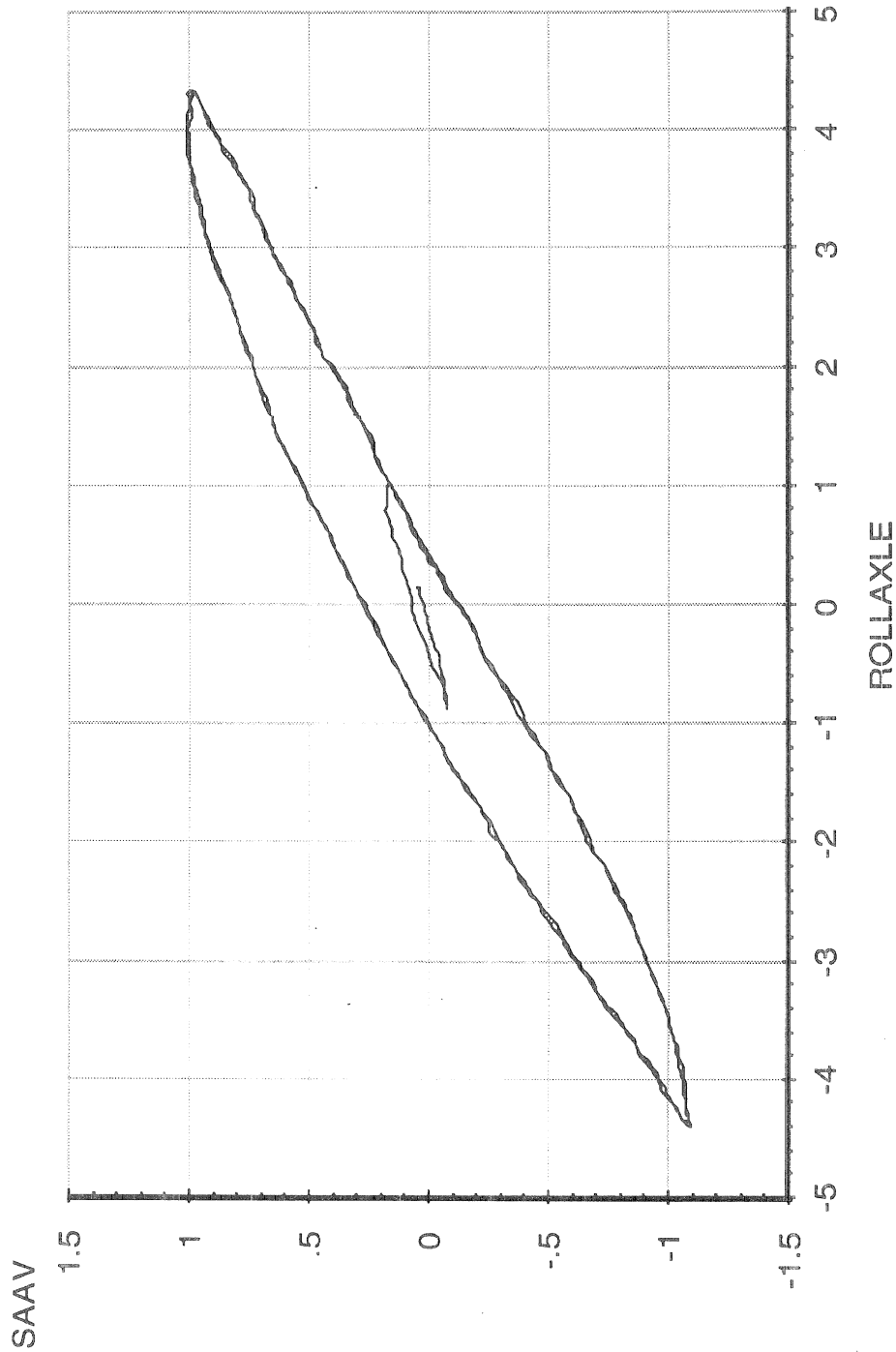

Abscissa (X): Axle roll angle (ROLLAXLE); degrees; right side compressed, positive.

Ordinate (Y): Average steer angle (SAAV); degrees; steer toward right, positive.

*Note: Brakes on. Force control. Pitman arm blocked. Reference height of 6.75 inches.

Measured by UMTRI for NHTSA
Volvo Tractor Model WIA64T

10 Oct 95
Suspension: Taper-Leaf (3)

Single Steer Axle Suspension
Average Vertical Spring Rate

Data file: NHTSAS10.ERD

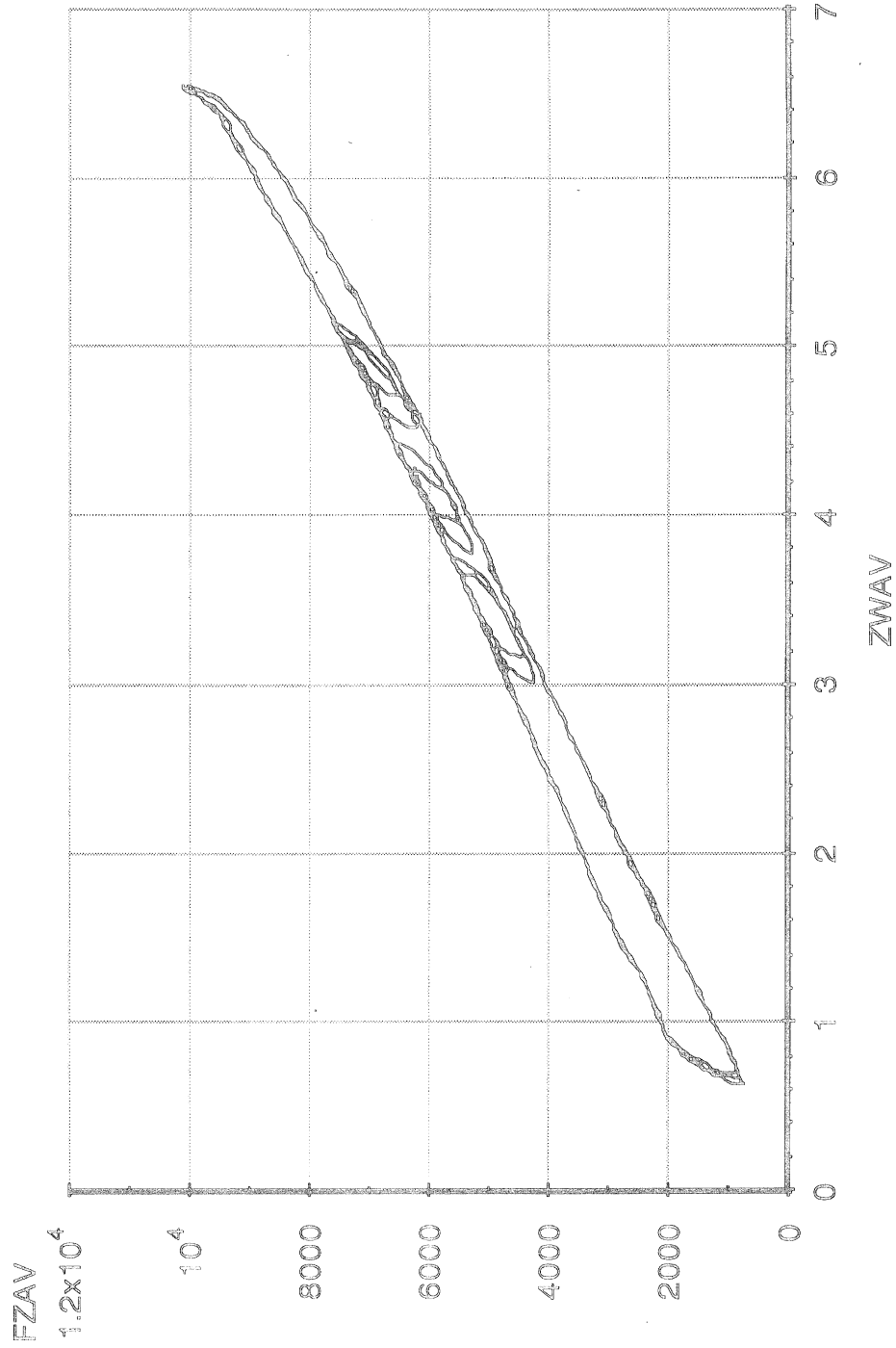

Abscissa (X): Average vertical wheel displacement (ZWAV); inches; spring compression, positive.
Ordinate (Y): Average vertical wheel load (FZAV); pounds; spring compression, positive.

*Note: Brakes on. Position control. Pitman arm blocked.

Measured by **UMTRI** for NHTSA
Volvo Tractor Model WIA64T

10 Oct 95
Suspension: Taper-Leaf (3)

Single Steer Axle Suspension
Jounce/Rebound Wrap-up Rate

Data file: NHTSAS10.ERD

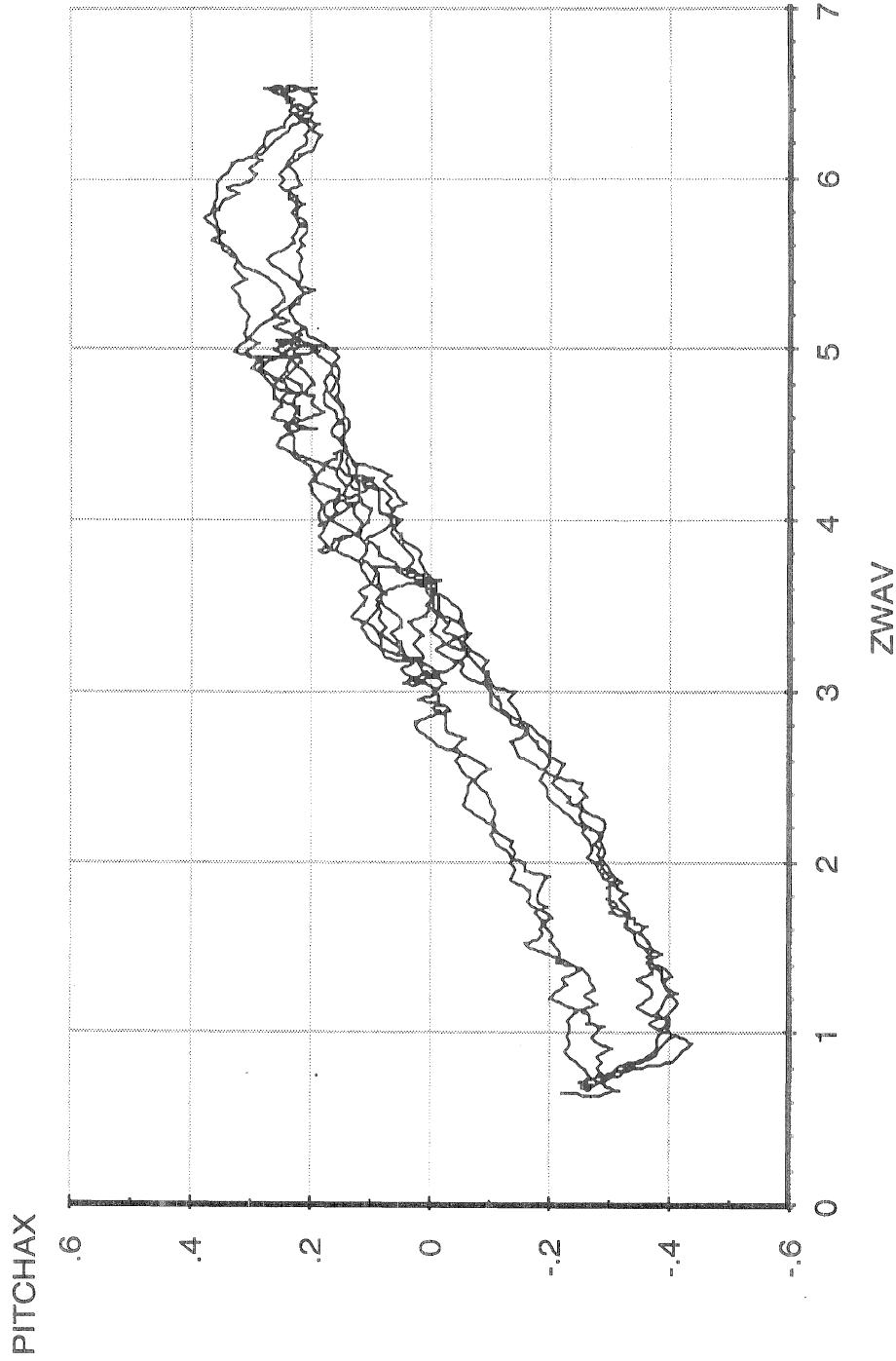

Abscissa (X): Average vertical wheel displacement (ZWAV); inches; spring compression, positive.
Ordinate (Y): Spring wrapup angle (PITCHAX); degrees; wrapup due to brake force, positive.

*Note: Brakes on. Position control. Pitman arm blocked.

Measured by JMTFR1 for NHTSA
Volvo Tractor Model WIA64T

10 Oct 95
Suspension: Taper-Leaf (3)
Suspension Load: 12000 lb.

Single Steer Axle Suspension
Wrapup Steer (vs. Wrapup Angle)

Data file: NHTSAS12.ERD

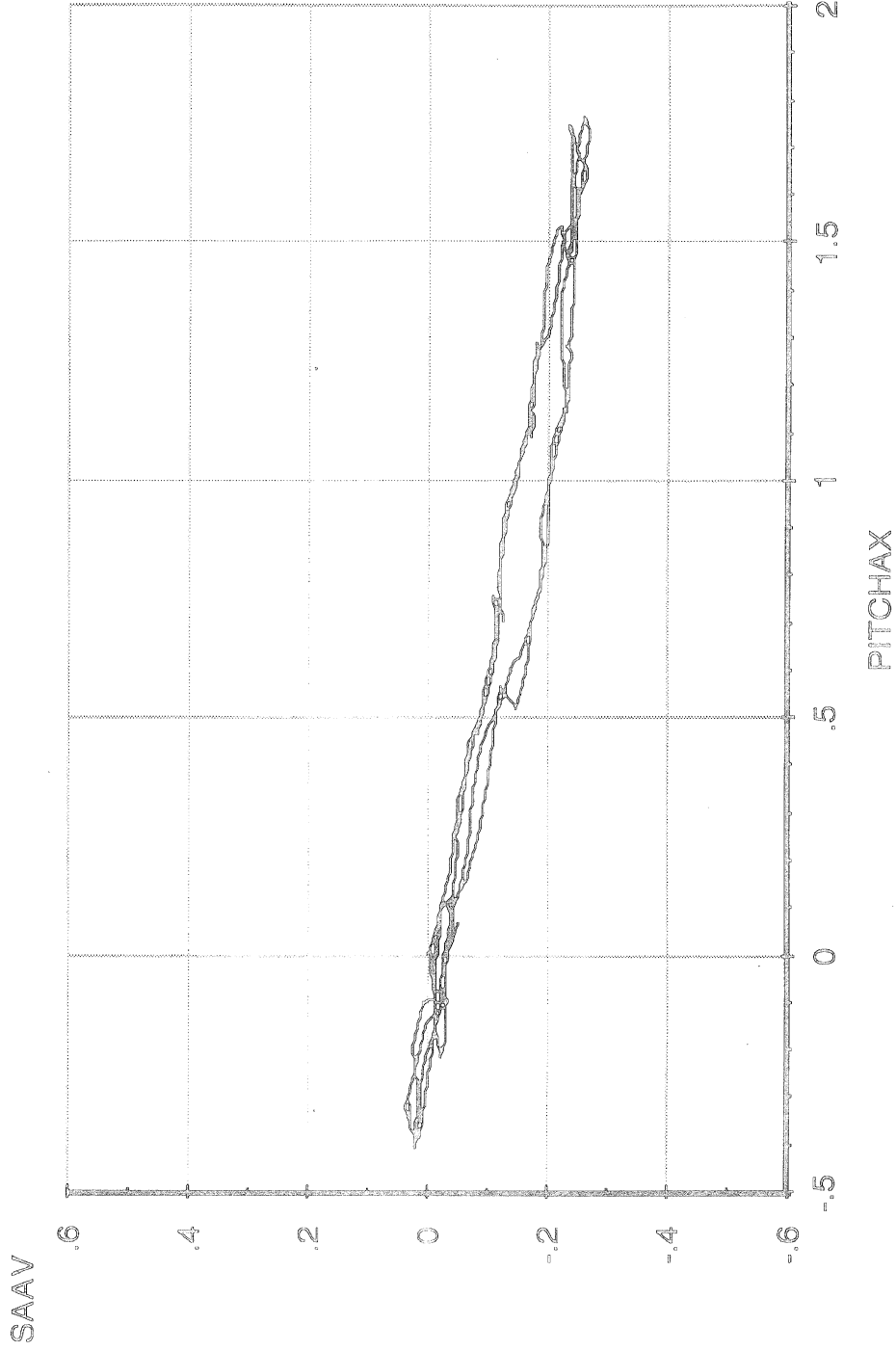

Abscissa (X): Spring wrapup angle (PITCHAX); degrees; wrapup due to brake force, positive.

Ordinate (Y): Average steer angle (SAAV); degrees; steer toward right, positive.

*Note: Brakes on. Position control. Pitman arm blocked.

Measured by **UMTRI** for NHTSA
Volvo Tractor Model WIA64T

Single Steer Axle Suspension

10 Oct 95
Suspension: Taper-Leaf (3)

Data file: NHTSAS12.ERD

Wrapup Rate

Suspension Load: 12000 lb.

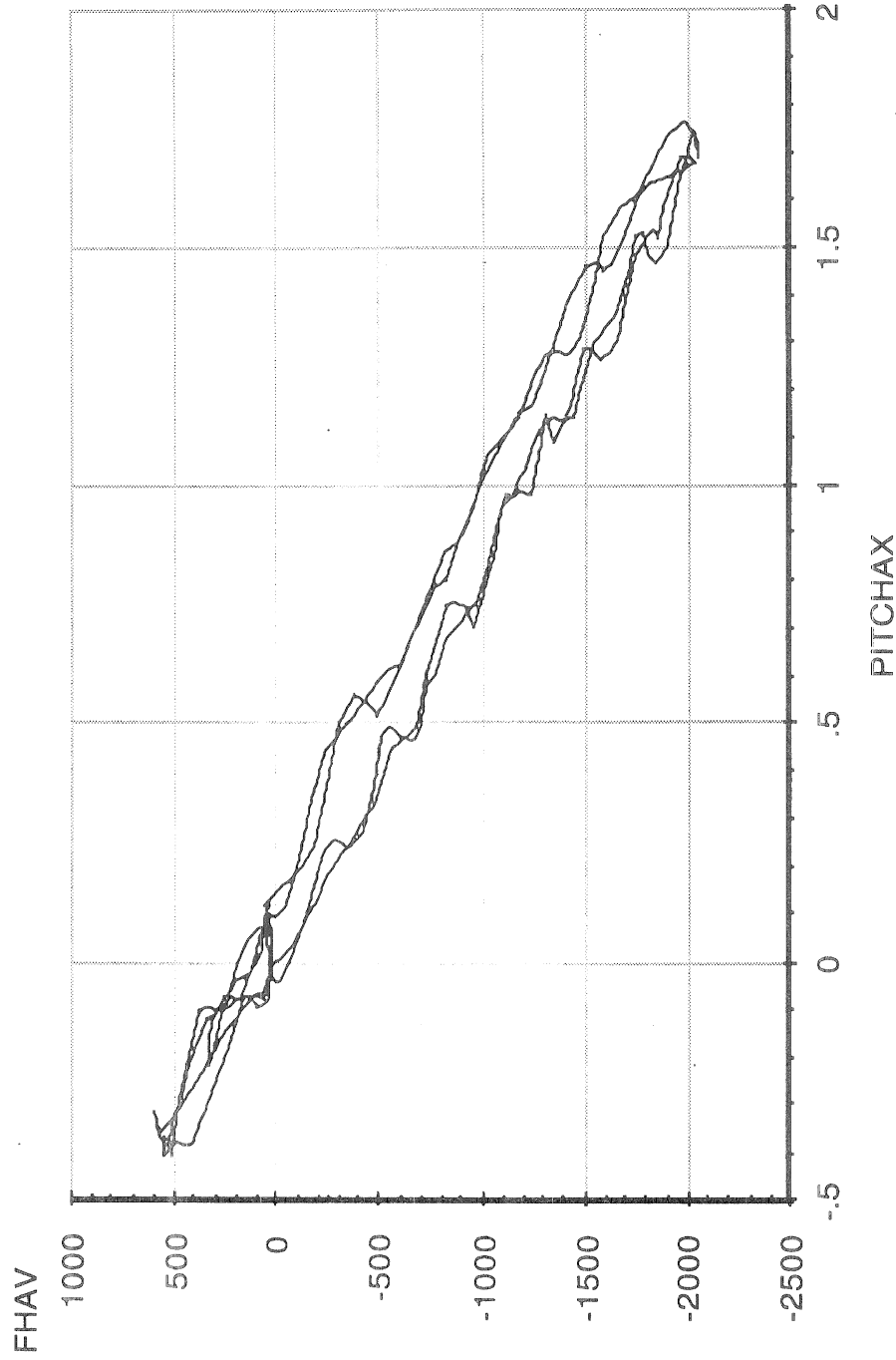

Abscissa (X): Spring wrapup angle (PITCHAX); degrees; wrapup due to brake force, positive.

Ordinate (Y): Average longitudinal force (FHAV); pounds per wheel; applied to left and right wheel sets simultaneously; force applied toward rear, negative.

*Note: Brakes on. Position control. Pitman arm blocked.

Measured by UMTRI for NHTSA
Volvo Tractor Model WIA64T

10 Oct 95
Suspension: Taper-Leaf (3)

Single Steer Axle Suspension

Wrapup Steer (vs. Wrapup Angle)

Suspension Load: 10000 lb.

Data file: NHTSAS13.ERD

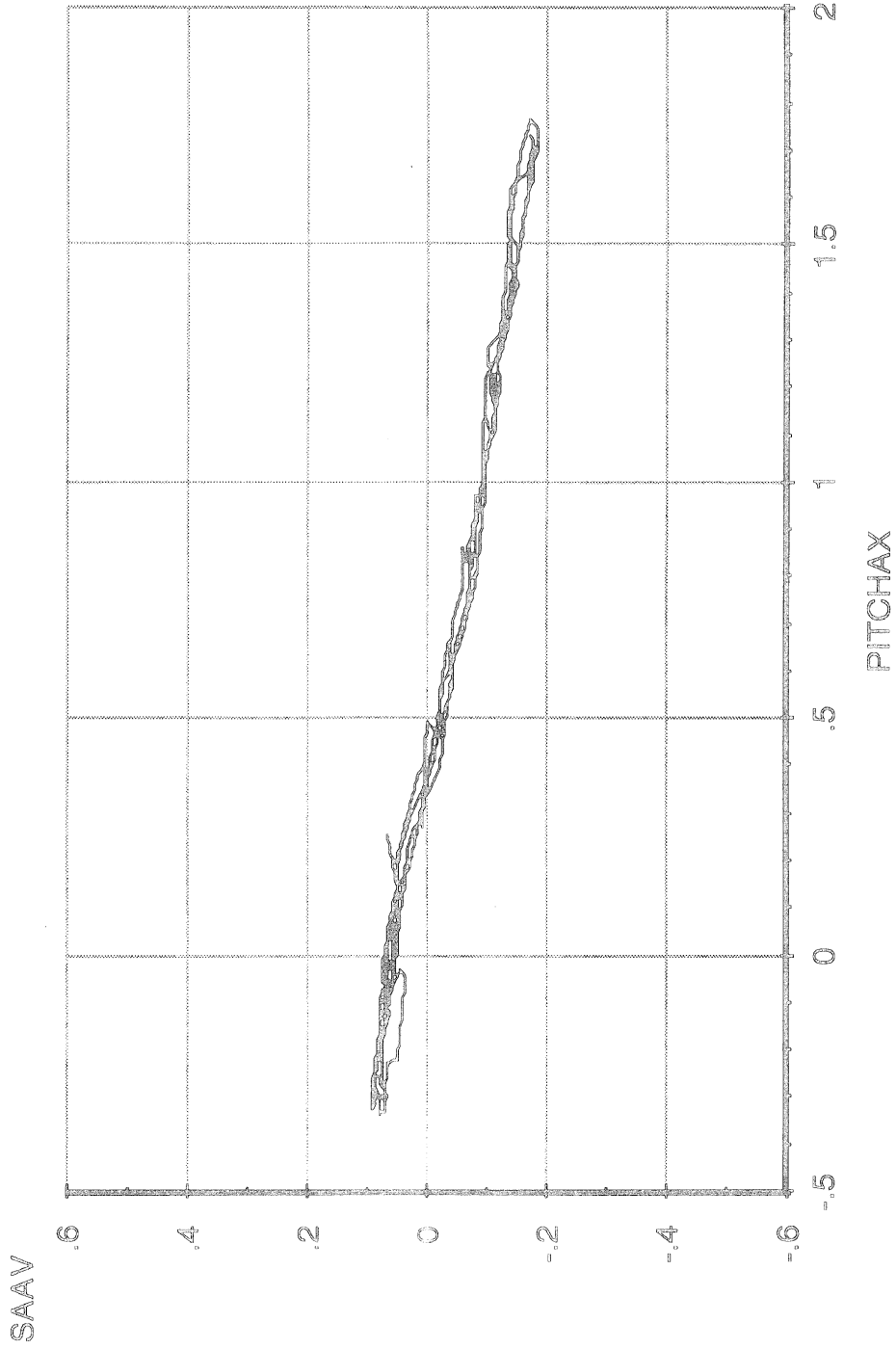

Abscissa (X): Spring wrapup angle (PITCHAX); degrees; wrapup due to brake force, positive.
Ordinate (Y): Average steer angle (SAAV); degrees; steer toward right, positive.

*Note: Brakes on. Position control. Pitman arm blocked.

Measured by **UMTRI** for NHTSA
Volvo Tractor Model WIA64T

10 Oct 95
Suspension: Taper-Leaf (3)

Single Steer Axle Suspension

Data file: NHTSAS13.ERD

Wrapup Rate

Suspension Load: 10000 lb.

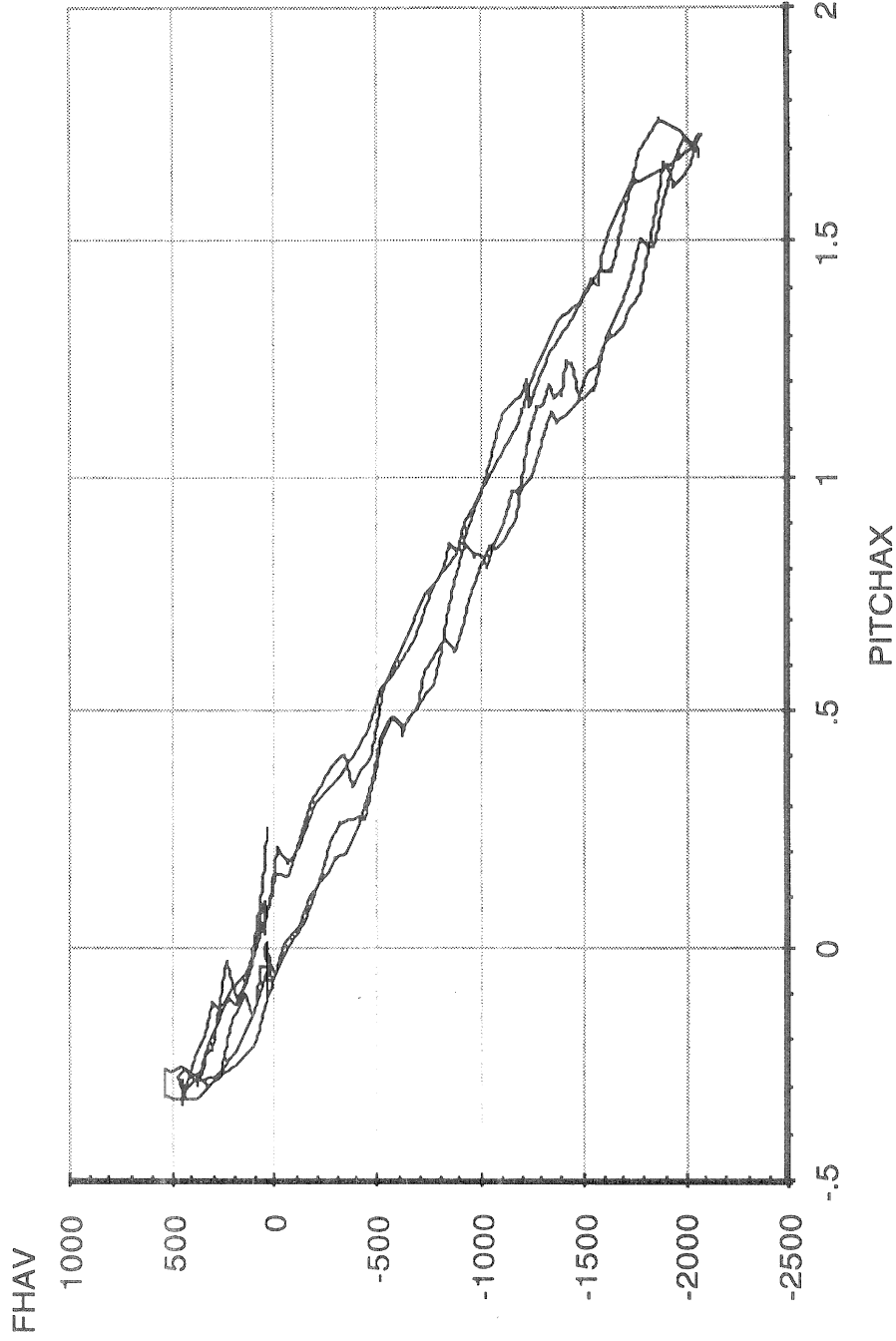

Abscissa (X): Spring wrapup angle (PITCHAX); degrees; wrapup due to brake force, positive.

Ordinate (Y): Average longitudinal force (FHAV); pounds per wheel; applied to left and right wheel sets simultaneously; force applied toward rear, negative.

*Note: Brakes on. Pitman arm blocked.

Measured by UMTRI for NHTSA
Volvo Tractor Model WIA64T

Single Steer Axle Suspension
Roll Steer

10 Oct 95
Suspension: Taper-Leaf (3)
Suspension Load: 14000 lb.

Data file: NHTSAS14.ERD

SAAV

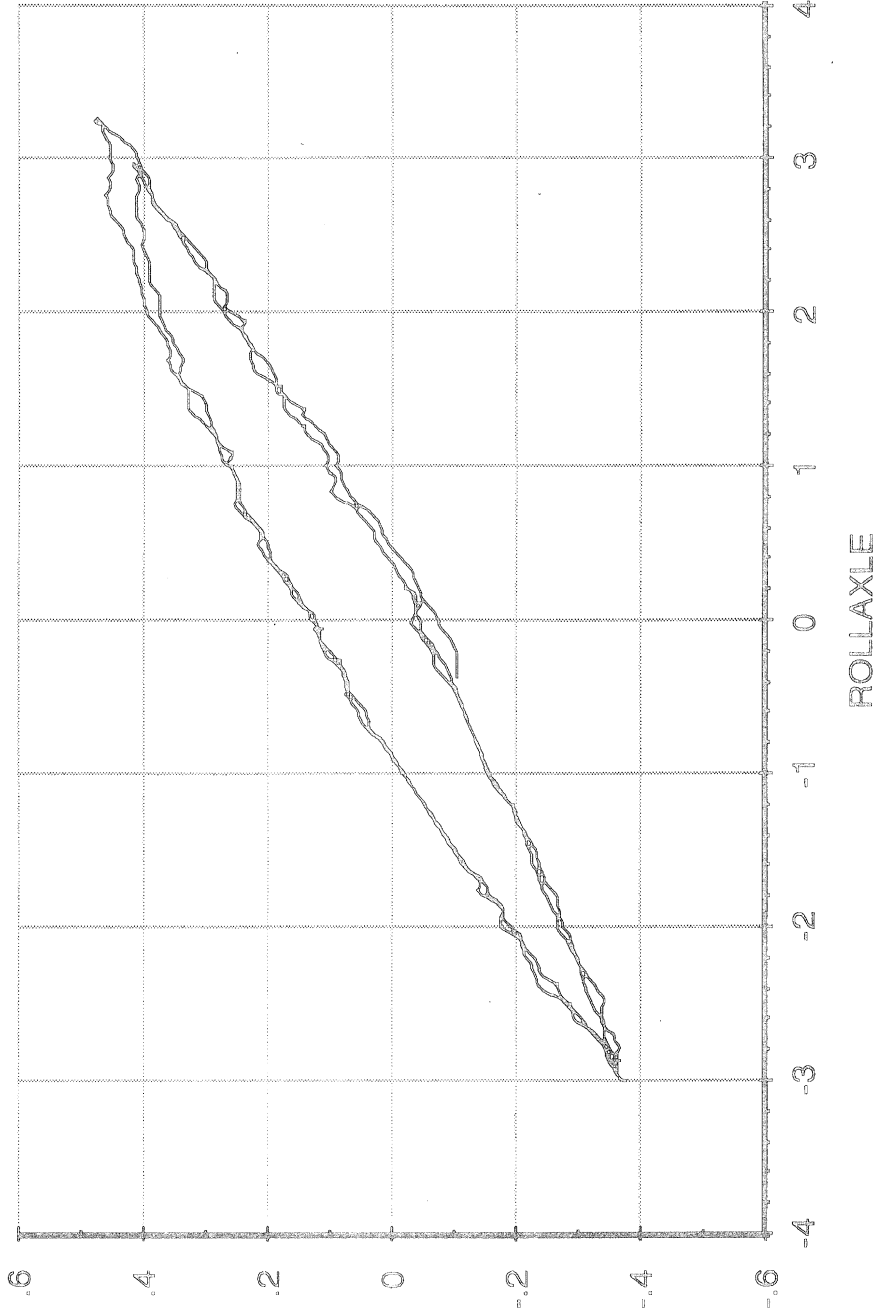

Abscissa (X): Axle roll angle (ROLLAXLE); degrees; right side compressed, positive.
Ordinate (Y): Average steer angle (SAAV); degrees; steer toward right, positive.

*Note: Brakes on. Force control. Pitman arm blocked.

Measured by **UMTRI** for NHTSA
Volvo Tractor Model WIA64T

10 Oct 95
Suspension: Taper-Leaf (3)
Suspension Load: 12000 lb.

Single Steer Axle Suspension

Roll Steer

Data file: NHTSAS15.ERD

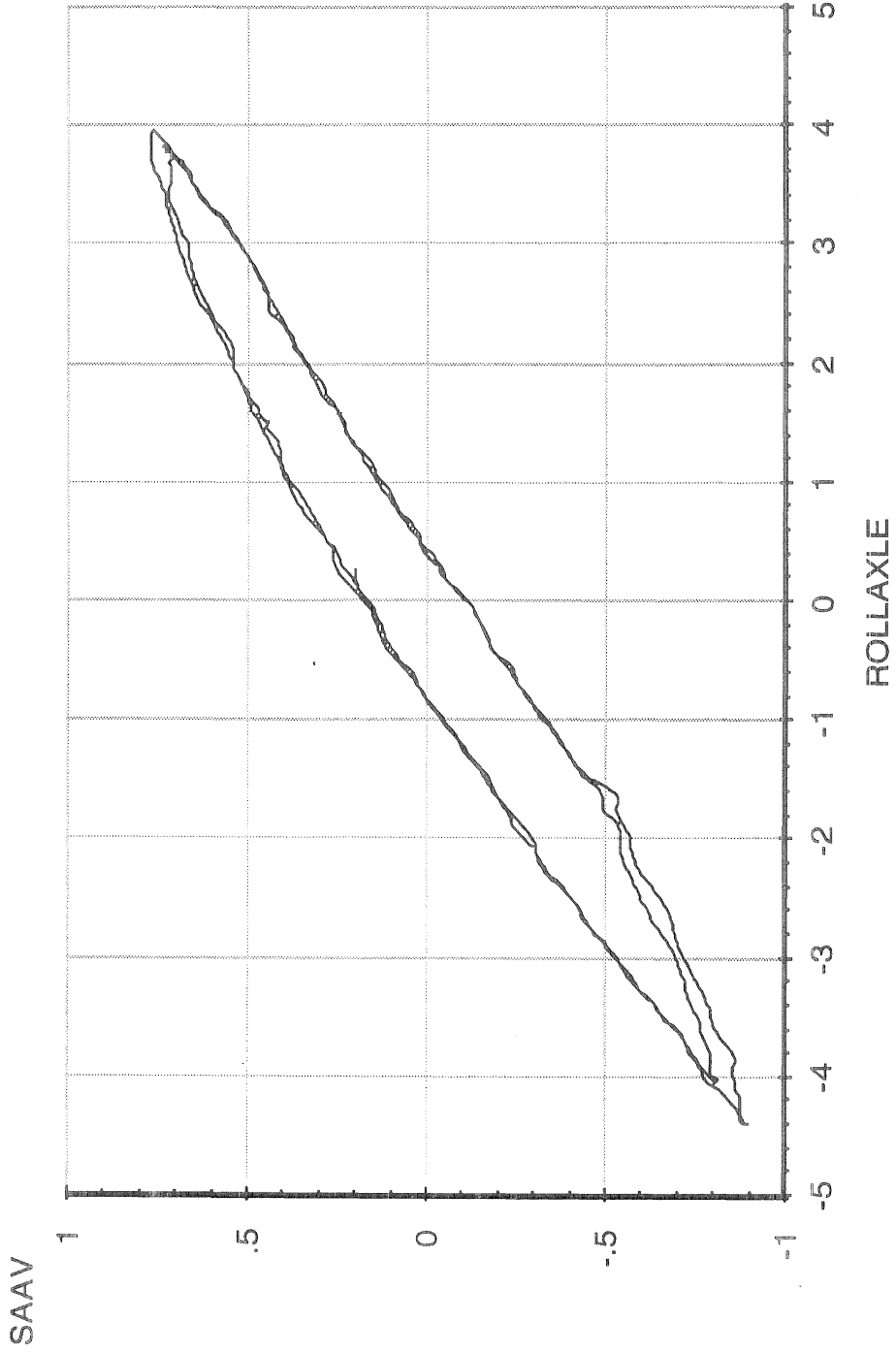

Abscissa (X): Axle roll angle (ROLLAXLE); degrees; right side compressed, positive.

Ordinate (Y): Average steer angle (SAAV); degrees; steer toward right, positive.

*Note: Brakes on. Force control. Pitman arm blocked.

Measured by UMTRI for NHTSA
Volvo Tractor Model WIA64T

10 Oct 95
Suspension: Taper-Leaf (3)

Single Steer Axle Suspension

Data file: NHTSAS16.ERD

Roll Steer

Suspension Load: 10000 lb.

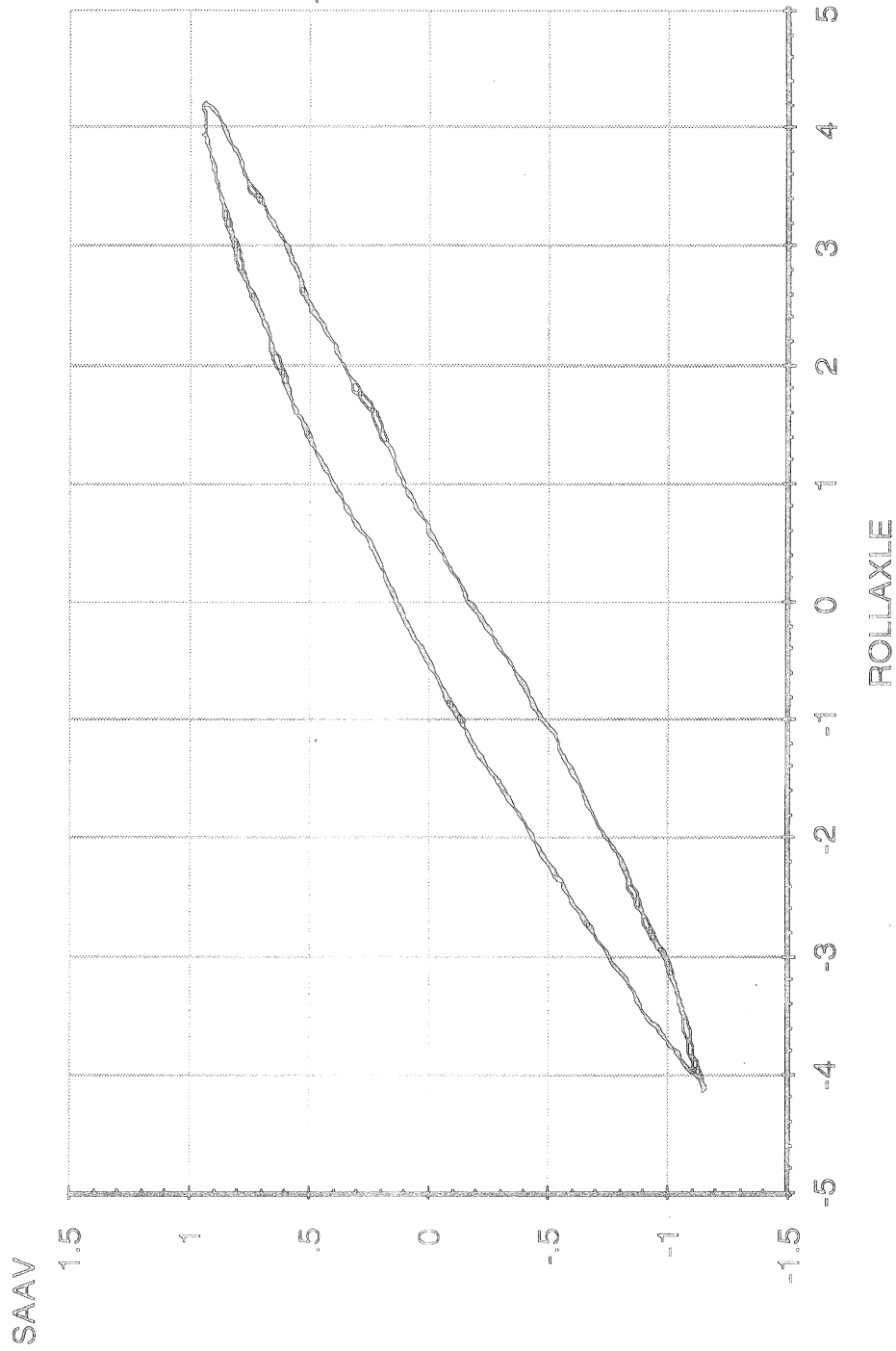

Abscissa (X): Axle roll angle (ROLLAXLE); degrees; right side compressed, positive.

Ordinate (Y): Average steer angle (SAAV); degrees; steer toward right, positive.

*Note: Brakes on. Force control. Pitman arm blocked.

Measured by **UMTRI** for NHTSA
Volvo Tractor Model WIA64T

10 Oct 95
Suspension: Taper-Leaf (3)

Data file: NHTSAS20.ERD

Aligning Moment Compliance Steer

Suspension Load: 12000 lb.

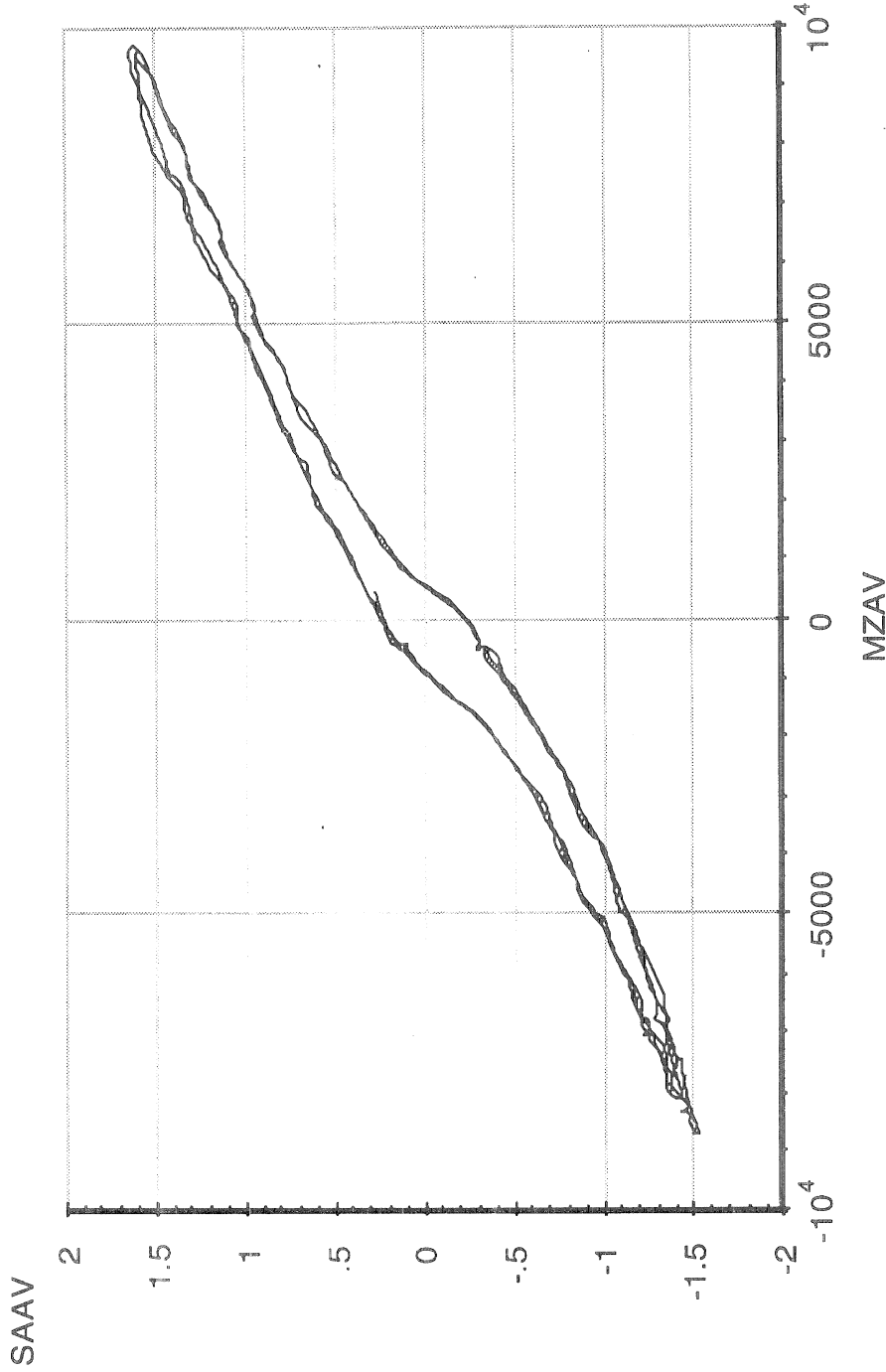

Abscissa (X): Average axle aligning moment (MZAV); in-lb per wheel; applied to both wheels simultaneously; downward (right hand rule) moment vector, positive.

Ordinate (Y): Average steer angle (SAAV); degrees; steer toward right, positive.

*Note: Brakes on. Engine on. Position Control.

Measured by **UMTRI** for NHTSA
Volvo Tractor Model WIA64T

10 Oct 95
Suspension: Taper-Leaf (3)

Single Steer Axle Suspension

Data file: NHTSAS20.ERD Left Wheel Aligning Moment Compliance Steer

Suspension Load: 12000 lb.

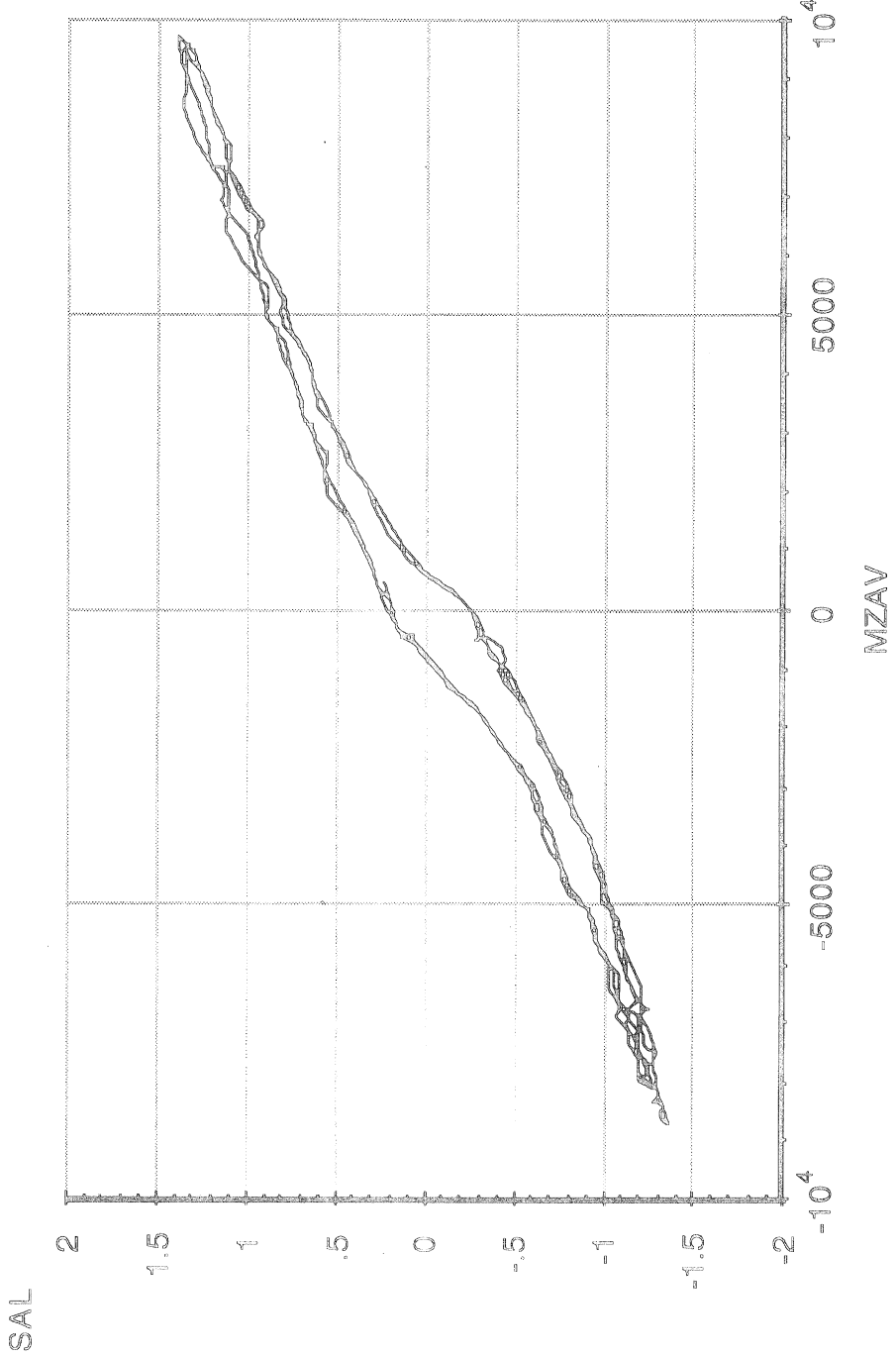

Abscissa (X): Average axle aligning moment (MZAV); in-lb per wheel; applied to both wheels simultaneously; downward (right hand rule) moment vector, positive.

Ordinate (Y): Left wheel steer angle (SAL); degrees; steer toward right, positive.

*Note: Brakes on, Engine on, Position Control.

Measured by **UMTRI** for NHTSA
Volvo Tractor Model WIA64T

10 Oct 95
Suspension: Taper-Leaf (3)

Single Steer Axle Suspension

Data file: NHTSAS20.ERD **Right Wheel Aligning Moment Compliance Steer** Suspension Load: 12000 lb.

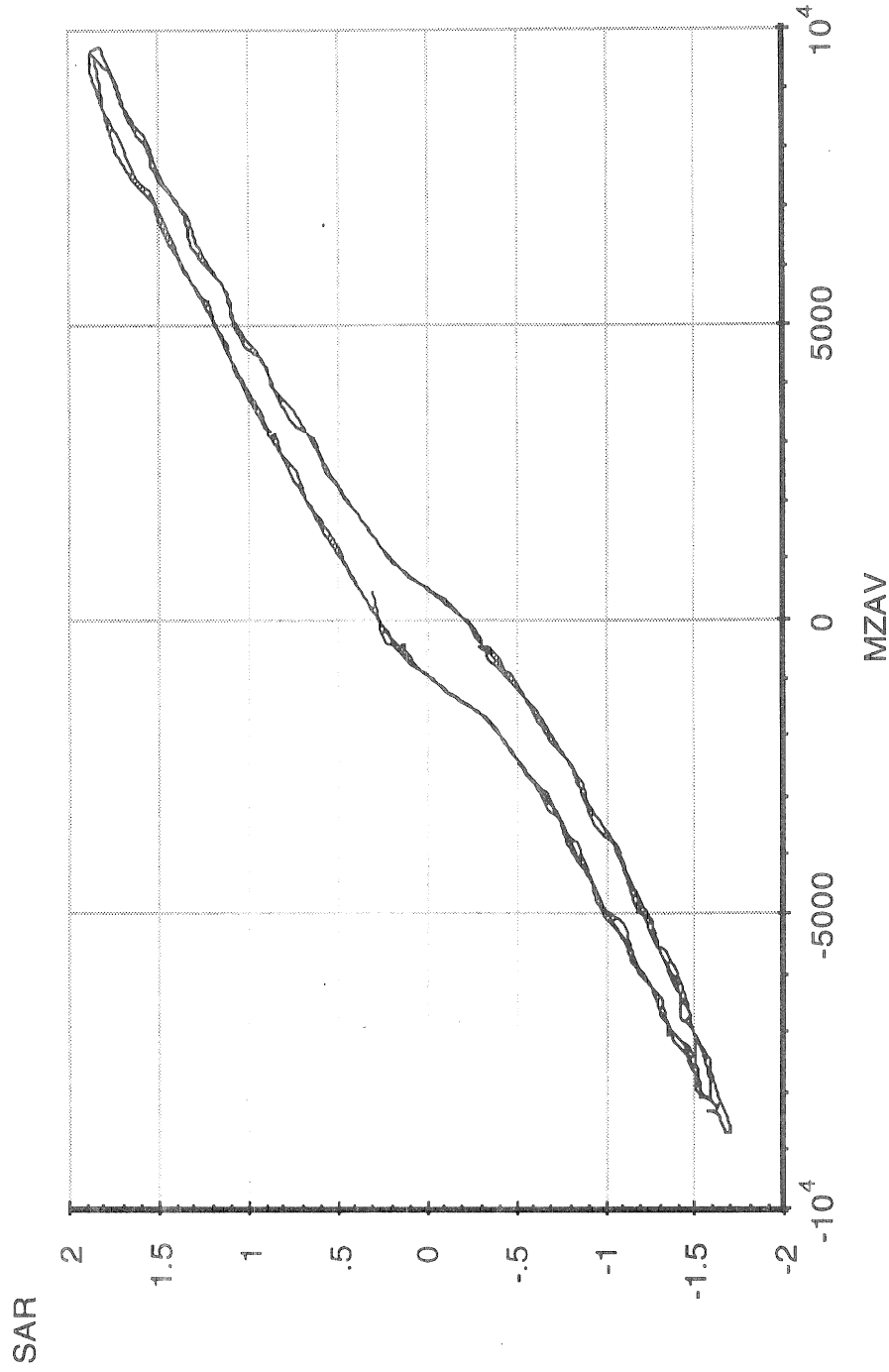

Abscissa (X): Average axle aligning moment (MZAV); in-lb per wheel; applied to both wheels simultaneously; downward (right hand rule) moment vector, positive.

Ordinate (Y): Right wheel steer angle (SAR); degrees; steer toward right, positive.

*Note: Brakes on. Engine on. Position Control.

Measured by UMTRI for NHTSA
Volvo Tractor Model WIA64T

10 Oct 95
Suspension: Taper-Leaf (3)
Suspension Load: 12000 lb.

Single Steer Axle Suspension
Aligning Moment Compliance Steer

Data file: NHTSAS21.ERD

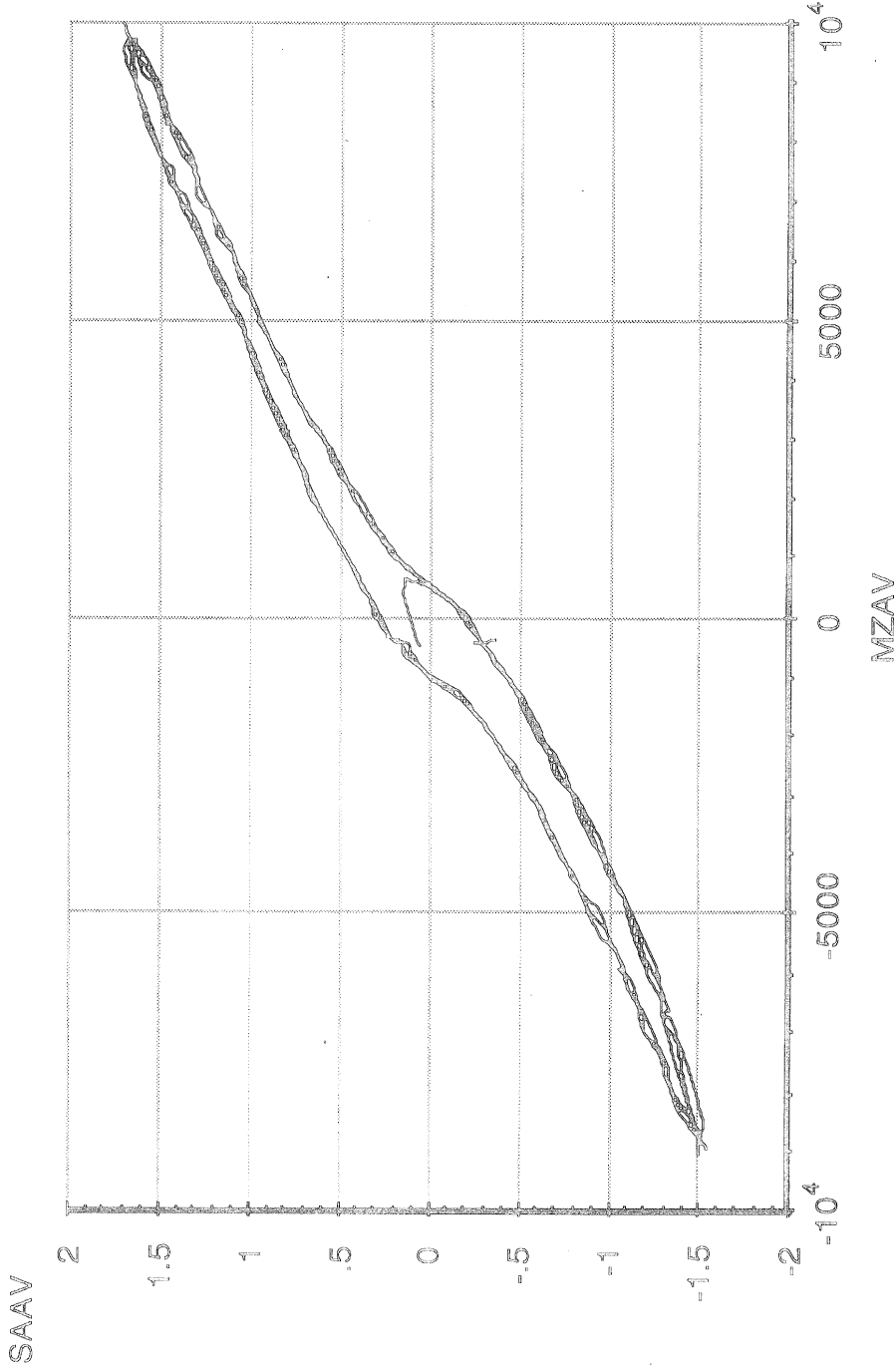

Abscissa (X): Average axle aligning moment (MZAV); in-lb per wheel; applied to both wheels simultaneously; downward (right hand rule) moment vector, positive.

Ordinate (Y): Average steer angle (SAAV); degrees; steer toward right, positive.

*Note: Brakes on. Engine on. Position Control.

Measured by **UMTRI** for NHTSA
Volvo Tractor Model WIA64T

Single Steer Axle Suspension

10 Oct 95
Suspension: Taper-Leaf (3)

Data file: NHTSAS21.ERD

Left Wheel Aligning Moment Compliance Steer

Suspension Load: 12000 lb.

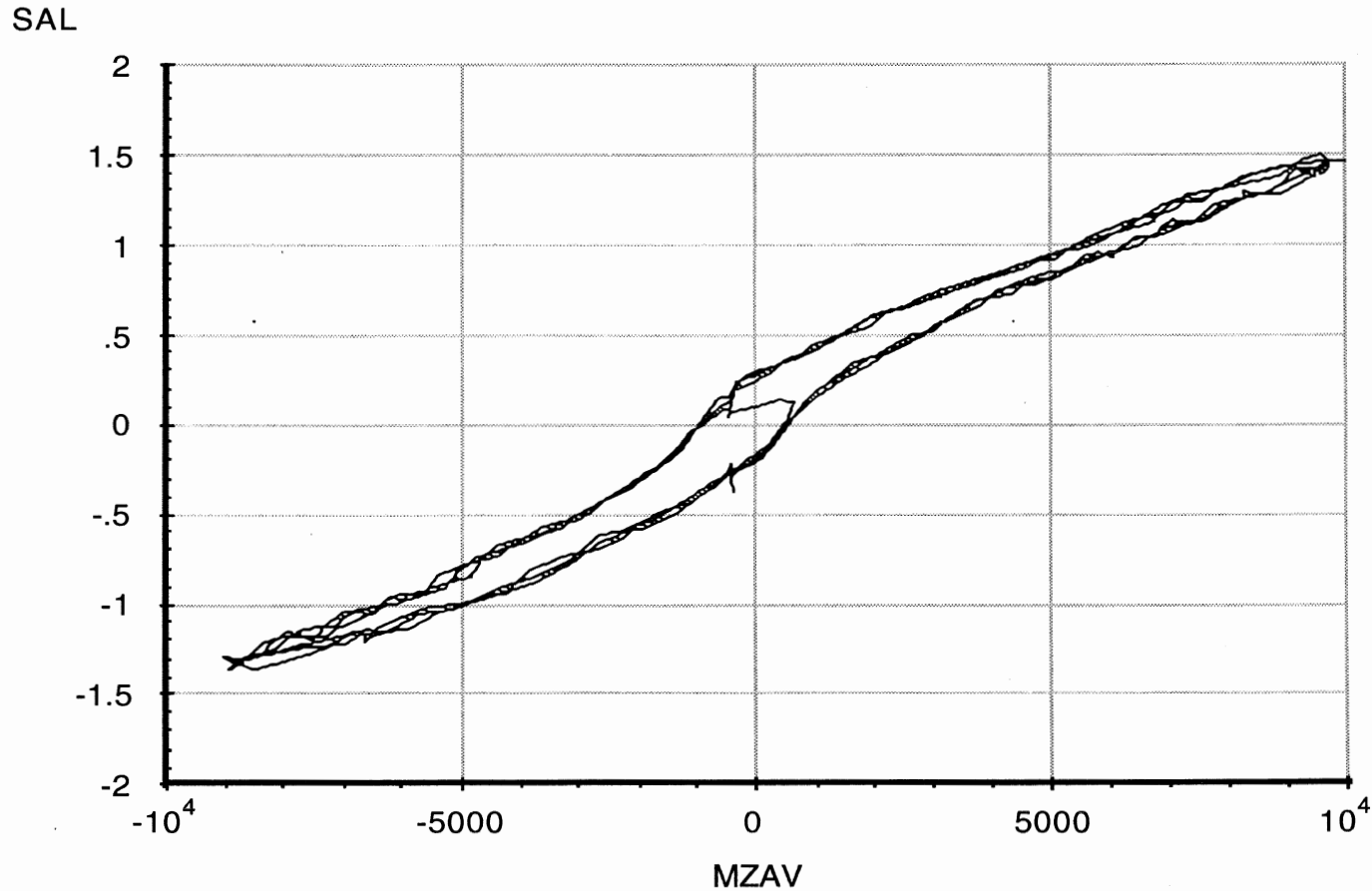

A-26

Abscissa (X): Average axle aligning moment (MZAV); in-lb per wheel; applied to both wheels simultaneously; downward (right hand rule) moment vector, positive.

Ordinate (Y): Left wheel steer angle (SAL); degrees; steer toward right, positive.

*Note: Brakes on. Engine on. Position Control.

Measured by **UMTRI** for NHTSA
Volvo Tractor Model WIA64T

Single Steer Axle Suspension

10 Oct 95
Suspension: Taper-Leaf (3)

Data file: NHTSAS21.ERD **Right Wheel Aligning Moment Compliance Steer**

Suspension Load: 12000 lb.

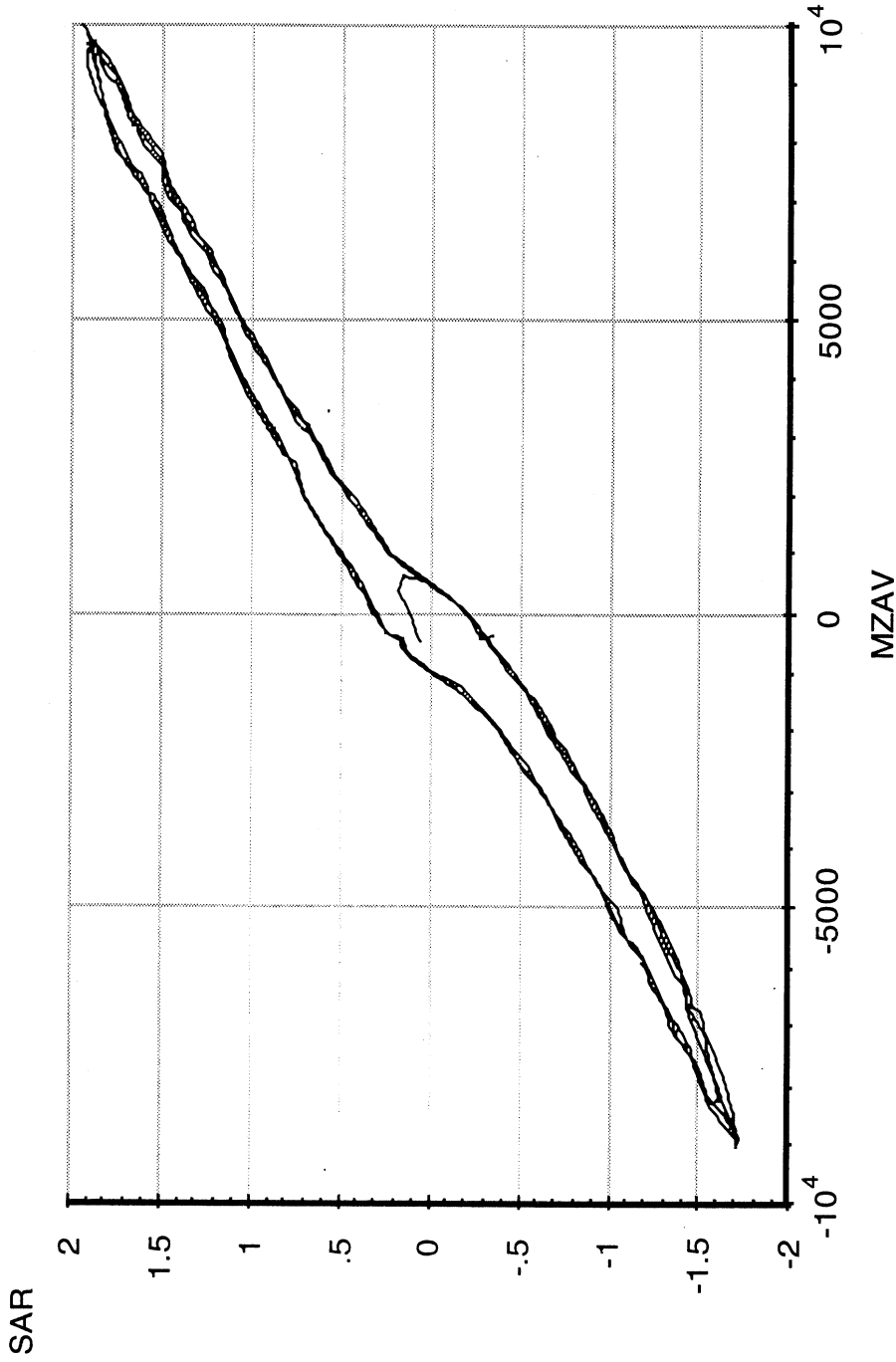

Abscissa (X): Average axle aligning moment (MZAV); in-lb per wheel; applied to both wheels simultaneously; downward (right hand rule) moment vector, positive.

Ordinate (Y): Right wheel steer angle (SAR); degrees; steer toward right, positive.

*Note: Brakes on. Engine on. Position Control.

Measured by **UMTRI** for NHTSA
Volvo Tractor Model WIA64T

Data file: NHTSAS41.ERD

Single Steer Axle Suspension
Left Wheel Steering Ratio

10 Oct 95
Suspension: Taper-Leaf (3)
Suspension Load: 12000 lb.

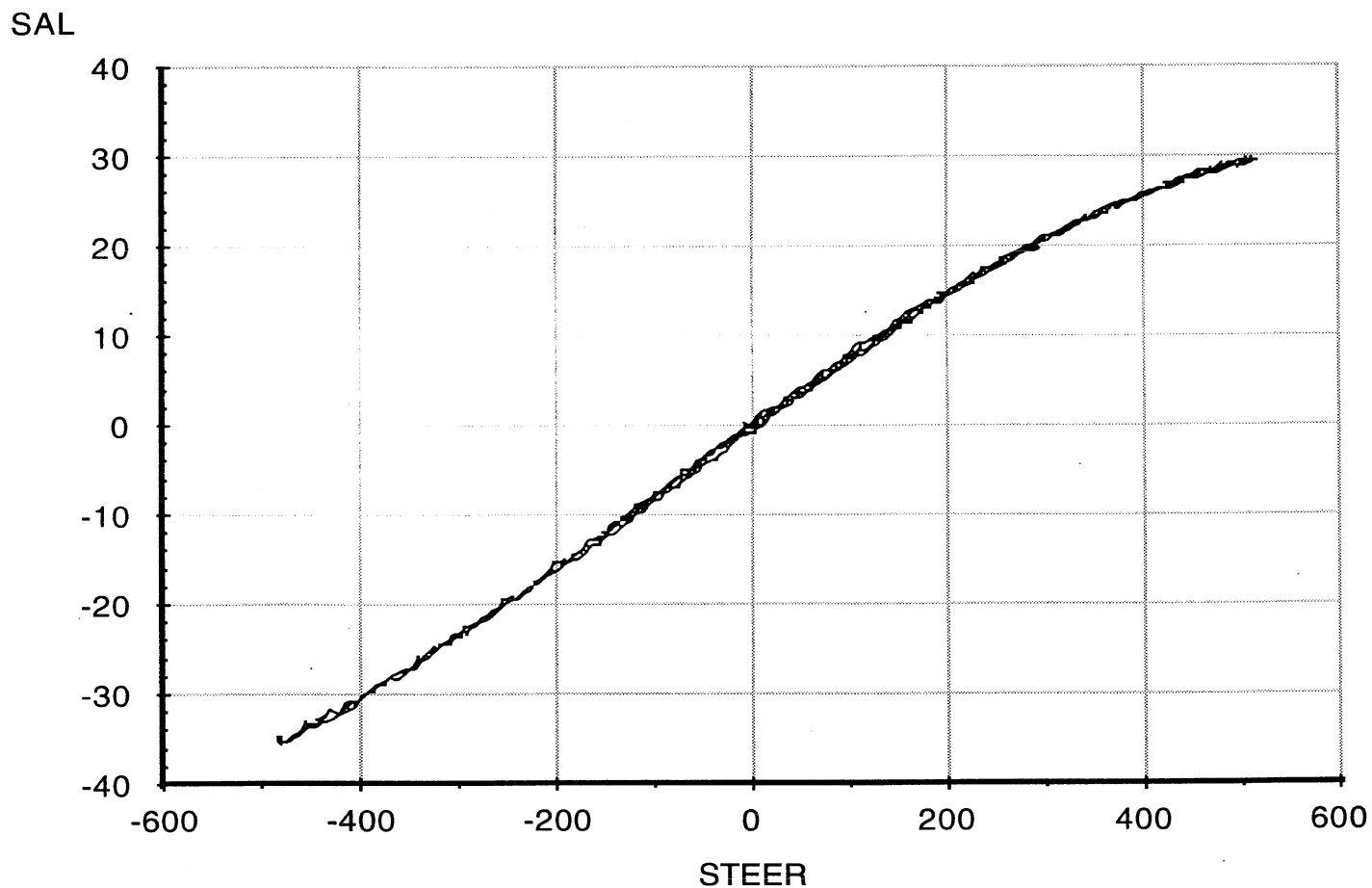

A-28

Abscissa (X): Steering wheel angle (STEER); degrees; steer toward right, positive.

Ordinate (Y): Left wheel steer angle (SAL); degrees; steer toward right, positive.

*Note: Brakes on. Position control. No applied tire shear forces.

Measured by **UMTRI** for NHTSA
Volvo Tractor Model WIA64T

Data file: NHTSAS41.ERD

Single Steer Axle Suspension
Right Wheel Steering Ratio

10 Oct 95
Suspension: Taper-Leaf (3)
Suspension Load: 12000 lb.

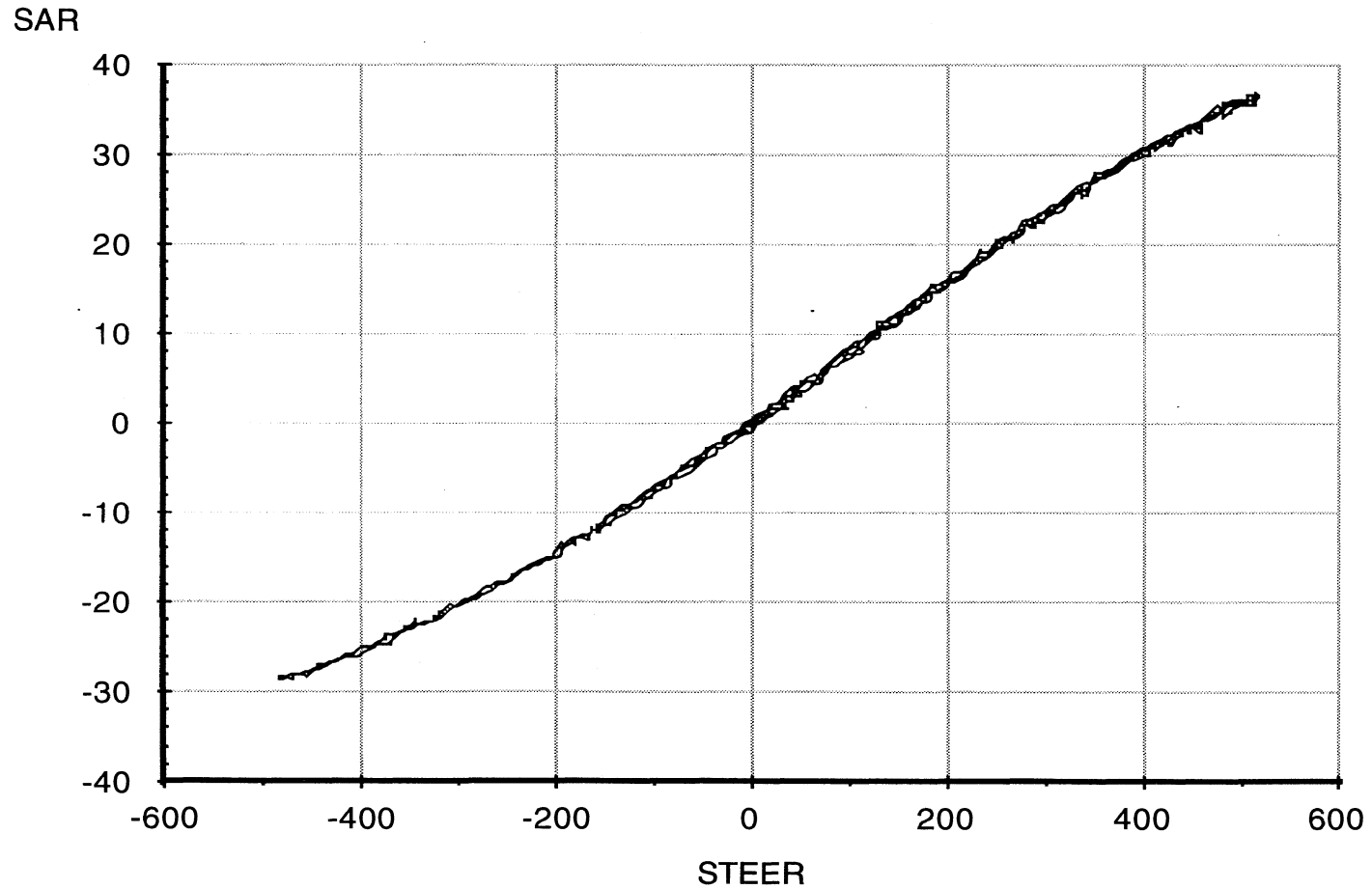

A-29

Abcissa (X): Steering wheel angle (STEER); degrees; steer toward right, positive.

Ordinate (Y): Right wheel steer angle (SAR); degrees; steer toward right, positive.

*Note: Brakes on. Position control. No applied tire shear forces.

Measured by **UMTRI** for NHTSA
Volvo Tractor Model WIA64T

Single Steer Axle Suspension
Road Wheel Steer

10 Oct 95
Suspension: Taper-Leaf (3)
Suspension Load: 12000 lb.

Data file: NHTSAS41.ERD

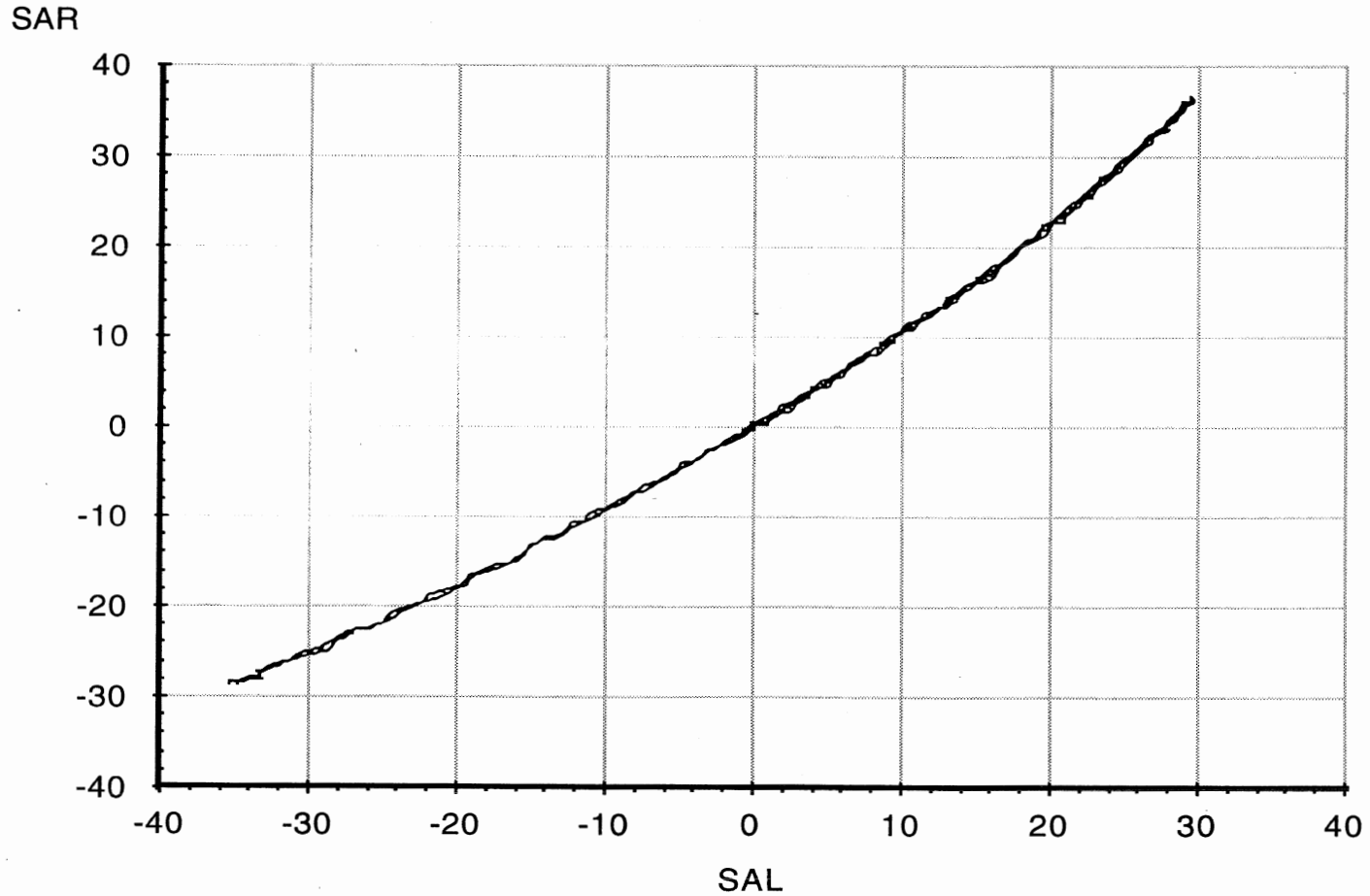

A-30

Abscissa (X): Left wheel steer angle (SAL); degrees; steer toward right, positive.

Ordinate (Y): Right wheel steer angle (SAR); degrees; steer toward right, positive.

*Note: Brakes on. Position control. No applied tire shear forces.

Measured by **UMTRI** for NHTSA
Volvo Tractor Model WIA64T

10 Oct 95
Suspension: Taper-Leaf (3)
Suspension Load: 12000 lb.

Single Steer Axle Suspension
Road Wheel Difference

Data file: NHTSAS41.ERD

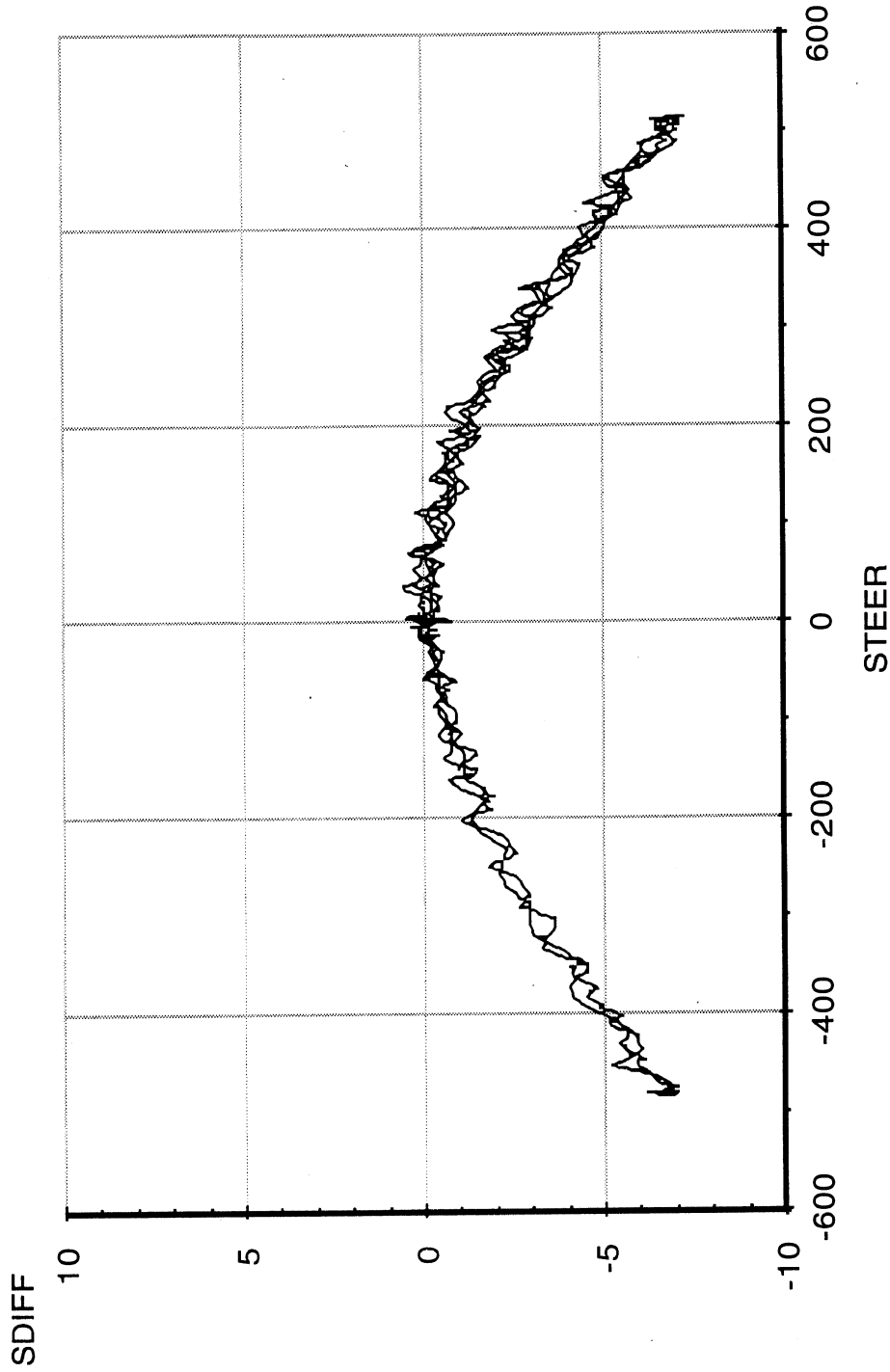

Abscissa (X): Steering wheel angle (STEER); degrees; steer toward right, positive.

Ordinate (Y): Difference between left wheel steer angle and right wheel steer angle (SDIFF); degrees; left - right.

*Note: Brakes on. Position control. No applied tire shear forces.

Measured by **UMTRI** for NHTSA
Volvo Tractor Model WIA64T

Data file: NHTSAD01.ERD

Tandem Drive Axle Suspension
Average Vertical Spring Rate

20 Nov 95
Suspension: 4-Spring/Taper(3)

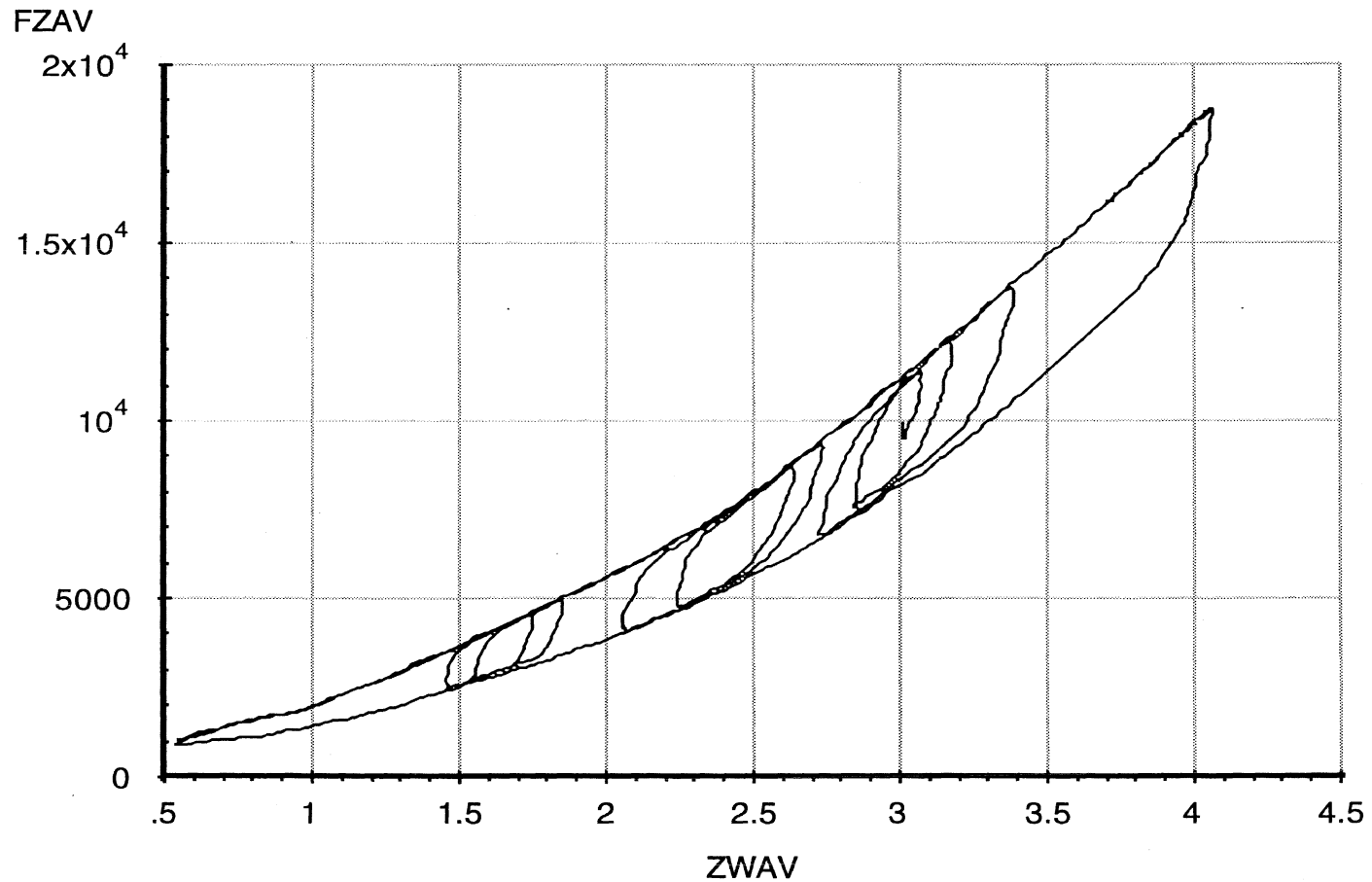

A-32

Abscissa (X): Average vertical wheel displacement (ZWAV); inches; spring compression, positive.

Ordinate (Y): Average vertical wheel load (FZAV); pounds; spring compression, positive.

*Note: Brakes on. Force control.

Measured by **UMTRI** for NHTSA
Volvo Tractor Model WIA64T

20 Nov 95
Suspension: 4-Spring/Taper(3)

Tandem Drive Axle Suspension

Leading Axle Vertical Spring Rate

Data file: NHTSAD01.ERD

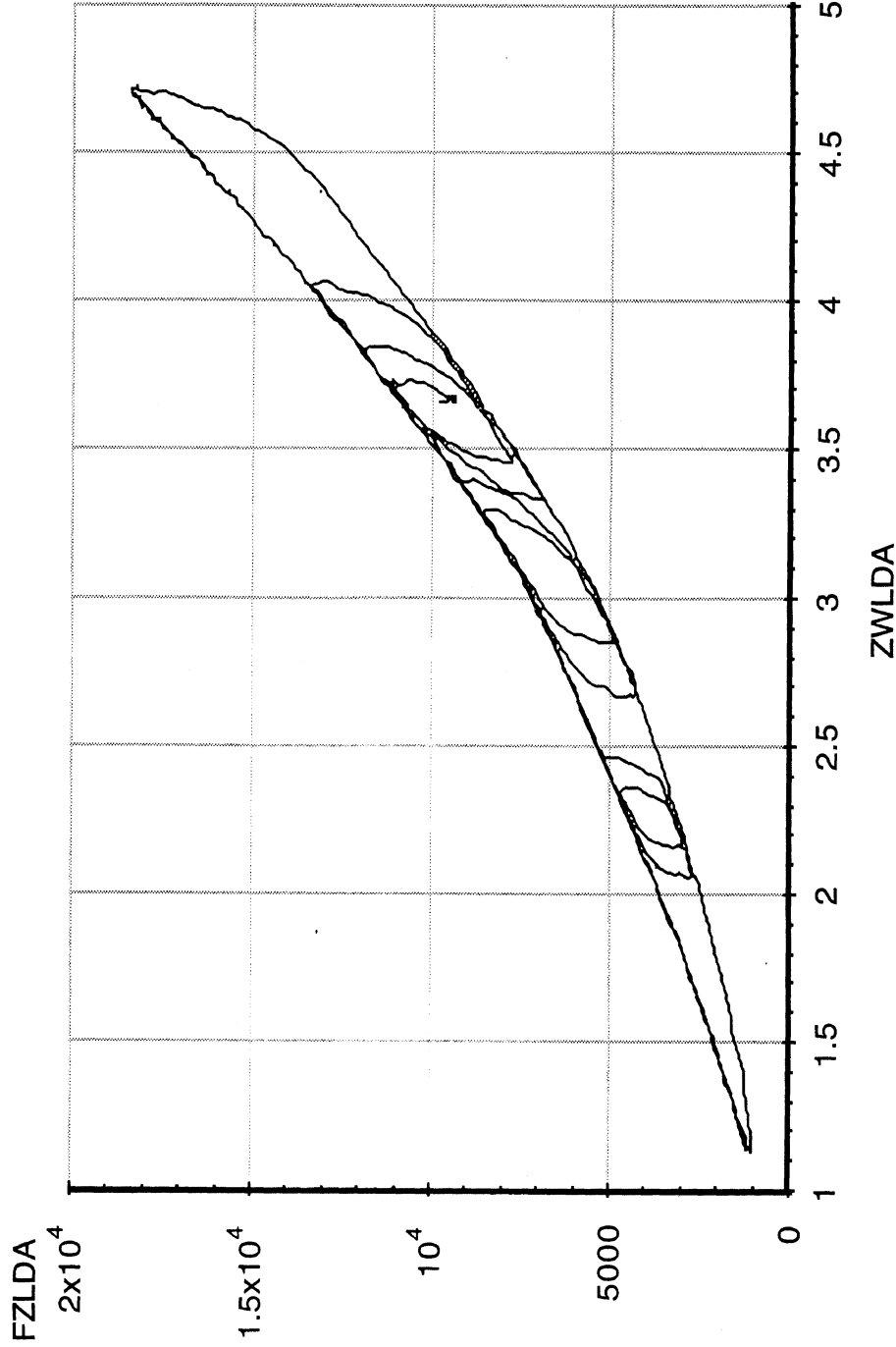

Abscissa (X): Average leading axle vertical wheel displacement (ZWLDA); inches; spring compression, positive.
Ordinate (Y): Average leading axle vertical wheel load (FZLDA); pounds; spring compression, positive.

*Note: Brakes on. Force control.

Measured by **UMTRI** for NHTSA
Volvo Tractor Model WIA64T

Tandem Drive Axle Suspension

20 Nov 95
Suspension: 4-Spring/Taper(3)

Data file: NHTSAD01.ERD

Trailing Axle Vertical Spring Rate

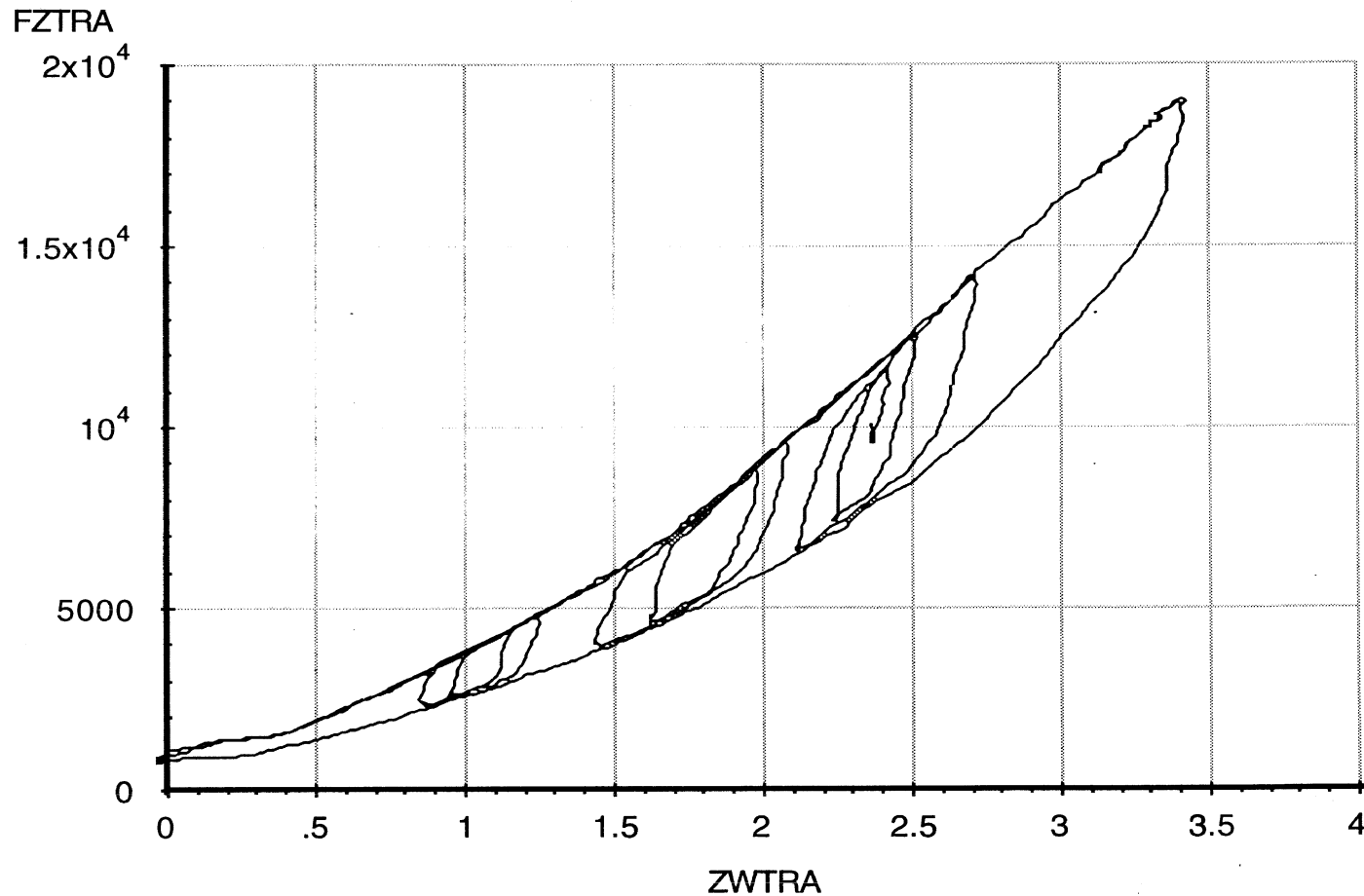

Abscissa (X): Average trailing axle vertical wheel displacement (ZWTRA); inches; spring compression, positive.

Ordinate (Y): Average trailing axle vertical wheel load (FZTRA); pounds; spring compression, positive.

*Note: Brakes on. Force control.

Measured by **UMTRI** for NHTSA
Volvo Tractor Model WIA64T

Data file: NHTSAD01.ERD

Tandem Drive Axle Suspension
Inter-Axle Load Distribution

20 Nov 95
Suspension: 4-Spring/Taper(3)

A-35

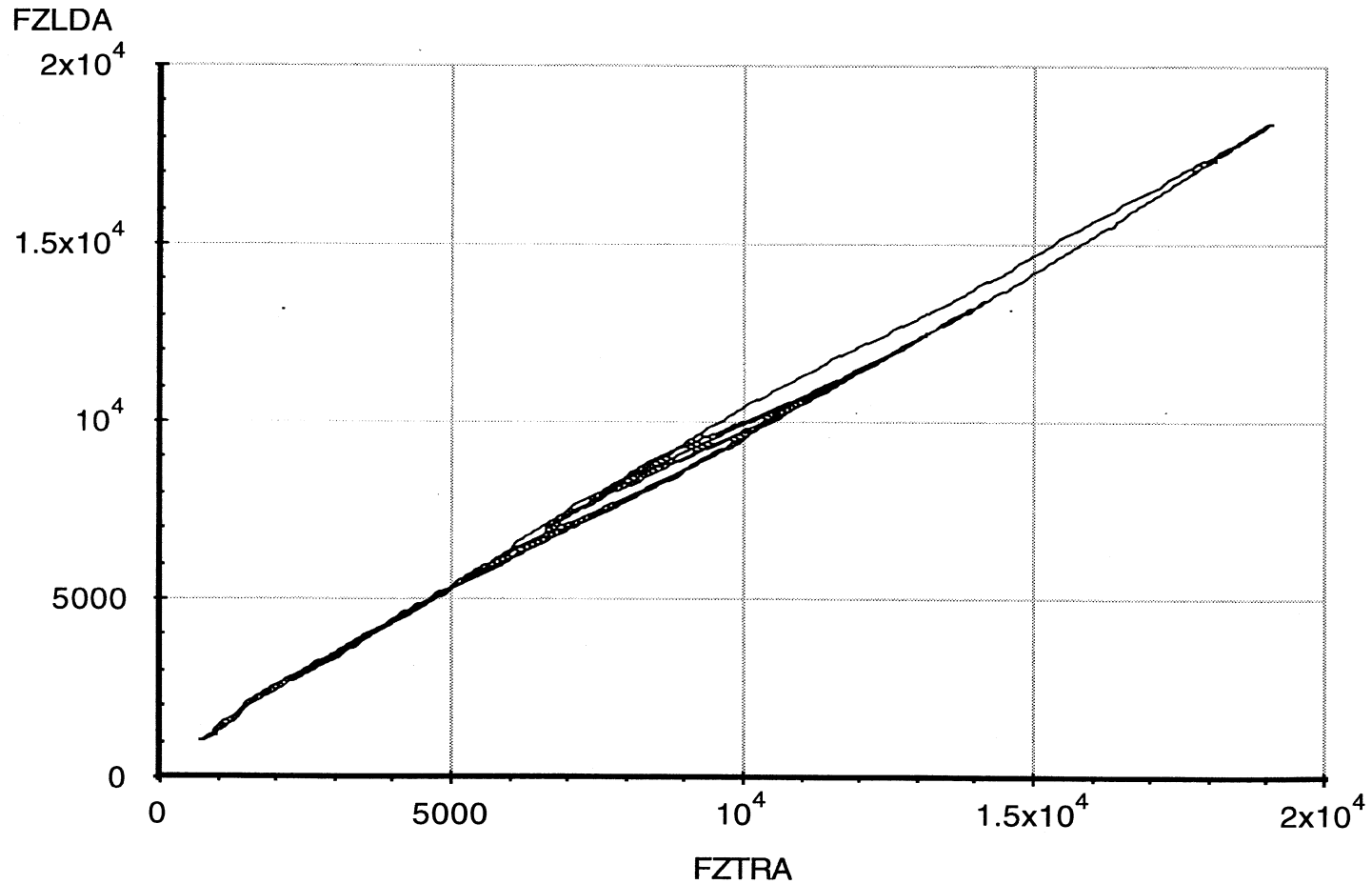

Abscissa (X): Average trailing axle vertical wheel load (FZTRA); pounds; spring compression, positive.

Ordinate (Y): Average leading axle vertical wheel load (FZLDA); pounds; spring compression, positive.

*Note: Brakes on. Force control.

Measured by **UMTRI** for NHTSA
Volvo Tractor Model WIA64T

Tandem Drive Axle Suspension

20 Nov 95
Suspension: 4-Spring/Taper(3)

Data file: NHTSAD10.ERD

Leading Axle Roll Rate

Suspension Load: 40000 lb.

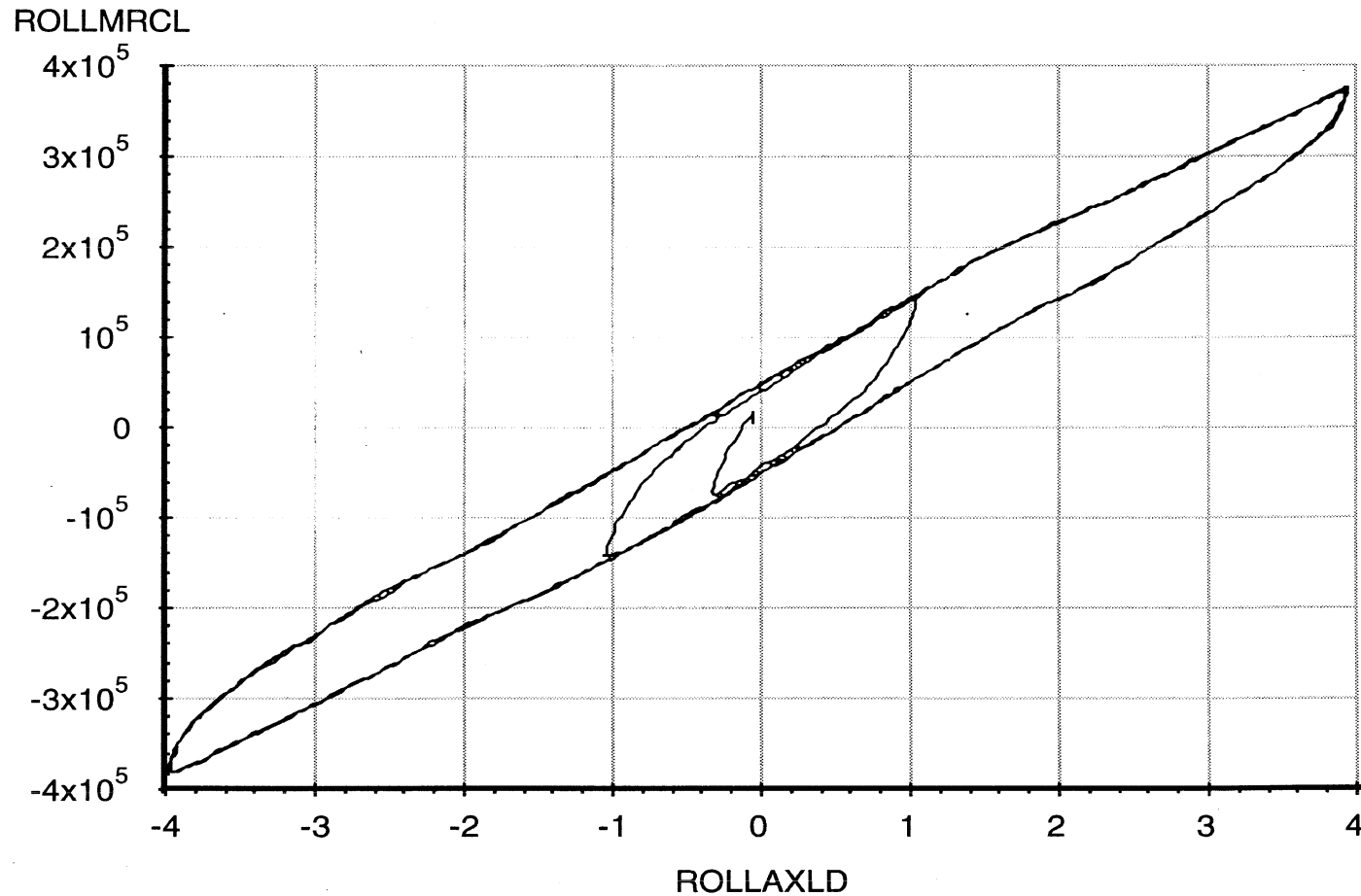

A-36

Abscissa (X): Leading axle roll angle (ROLLAXLD); degrees; right side compressed, positive.

Ordinate (Y): Leading axle roll moment about the roll center (ROLLMRCL); in-lb; right side compressed, positive.

*Note: Brakes on. Force control.

Measured by **UMTRI** for NHTSA
Volvo Tractor Model WIA64T

Tandem Drive Axle Suspension

20 Nov 95
Suspension: 4-Spring/Taper(3)

Data file: NHTSAD10.ERD

Trailing Axle Roll Rate

Suspension Load: 40000 lb.

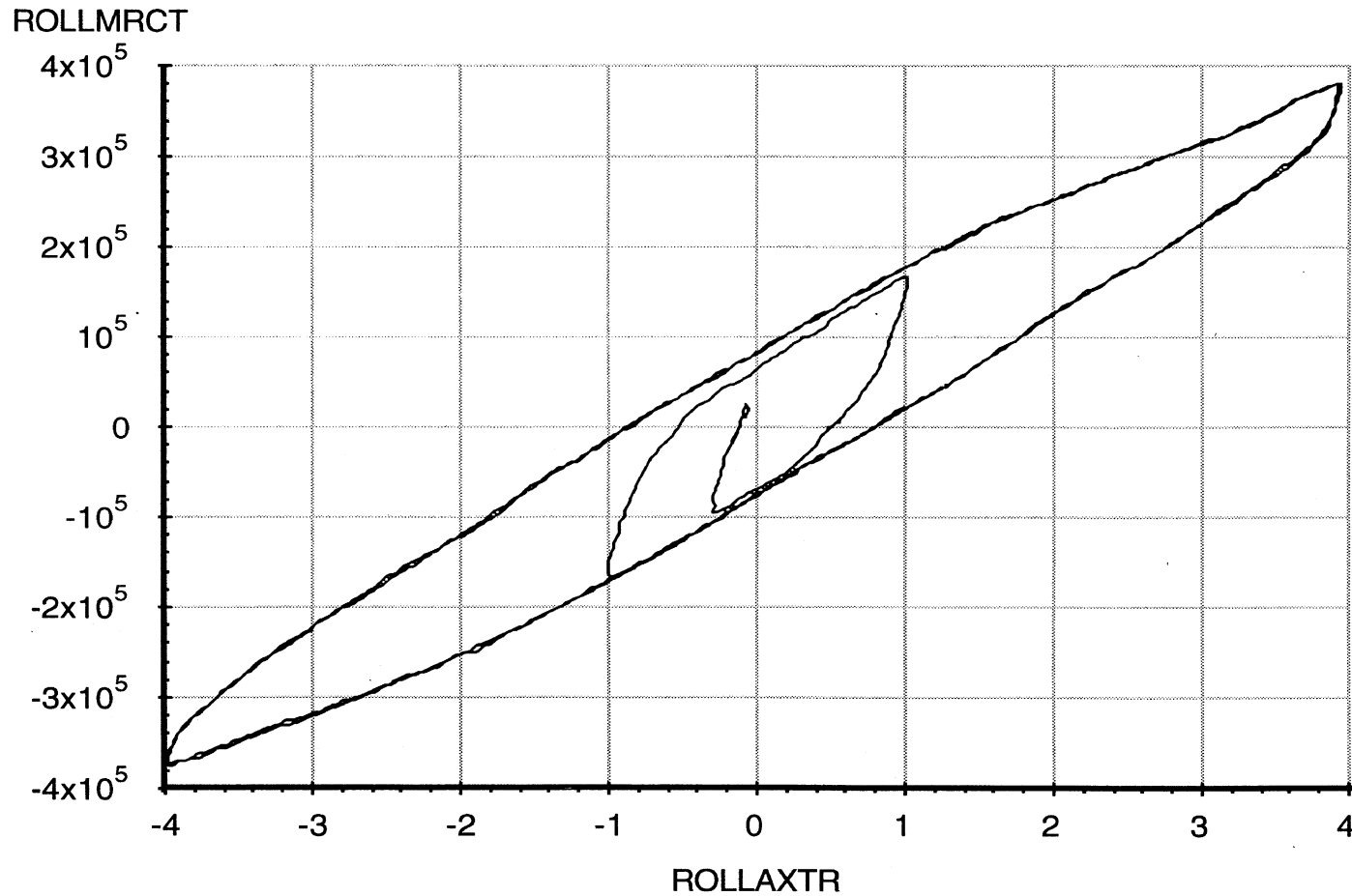

Abscissa (X): Trailing axle roll angle (ROLLAXTR); degrees; right side compressed, positive.

Ordinate (Y): Trailing axle roll moment about the roll center (ROLLMRCT); in-lb; right side compressed, positive.

*Note: Brakes on. Force control.

Measured by **UMTRI** for NHTSA
Volvo Tractor Model WIA64T

Data file: NHTSAD10.ERD

Tandem Drive Axle Suspension
Leading Axle Roll Center Height

20 Nov 95
Suspension: 4-Spring/Taper(3)

Suspension Load: 40000 lb.

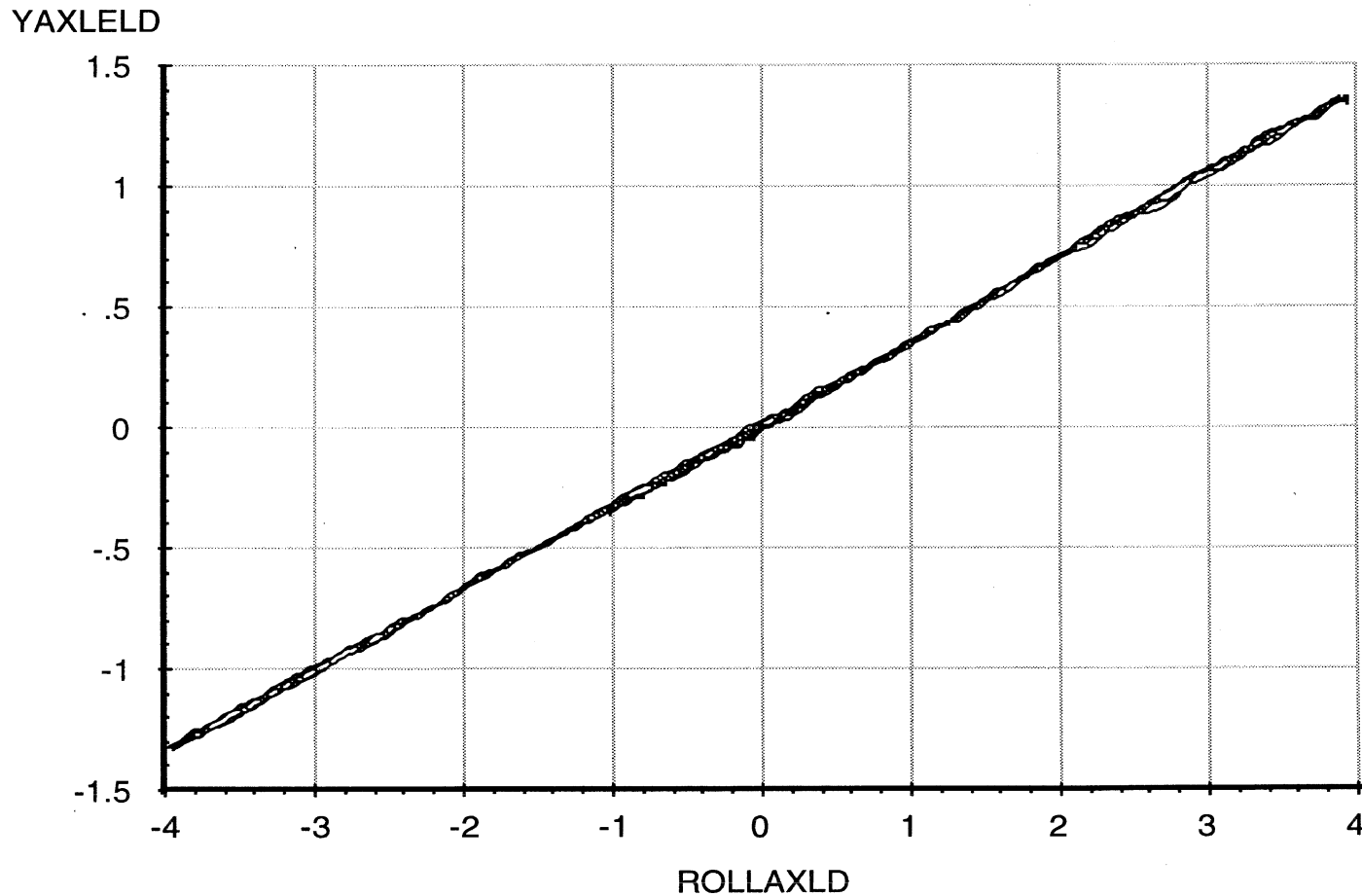

A-38

Abscissa (X): Leading axle roll angle (ROLLAXLD); degrees; right side compressed, positive.

Ordinate (Y): Leading axle reference point lateral translation (YAXLELD); inches; motion toward right, positive.

*Note: Brakes on. Force control. Reference height of 7.56 inches.

Measured by **UMTRI** for NHTSA
Volvo Tractor Model WIA64T

Data file: NHTSAD10.ERD

Tandem Drive Axle Suspension
Trailing Axle Roll Center Height

20 Nov 95
Suspension: 4-Spring/Taper(3)

Suspension Load: 40000 lb.

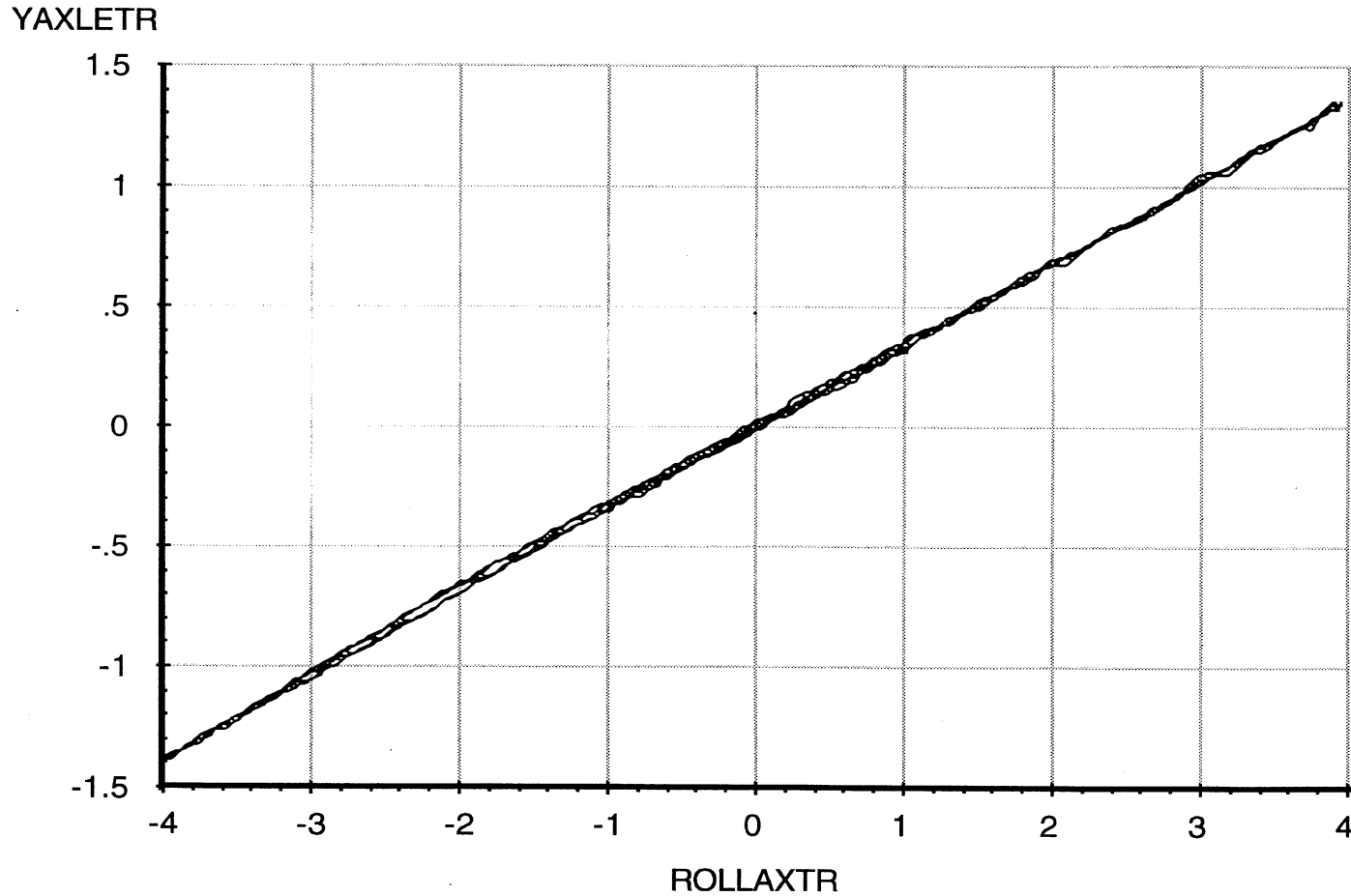

A-39

Abcissa (X): Trailing axle roll angle (ROLLAXTR); degrees; right side compressed, positive.

Ordinate (Y): Trailing axle reference point lateral translation (YAXLETR); inches; motion toward right, positive.

*Note: Brakes on. Force control. Reference height of 7.69 inches.

Measured by **UMTRI** for NHTSA
Volvo Tractor Model WIA64T

Tandem Drive Axle Suspension

20 Nov 95
Suspension: 4-Spring/Taper(3)

Data file: NHTSAD10.ERD

Leading Axle Roll Steer

Suspension Load: 40000 lb.

SALDA

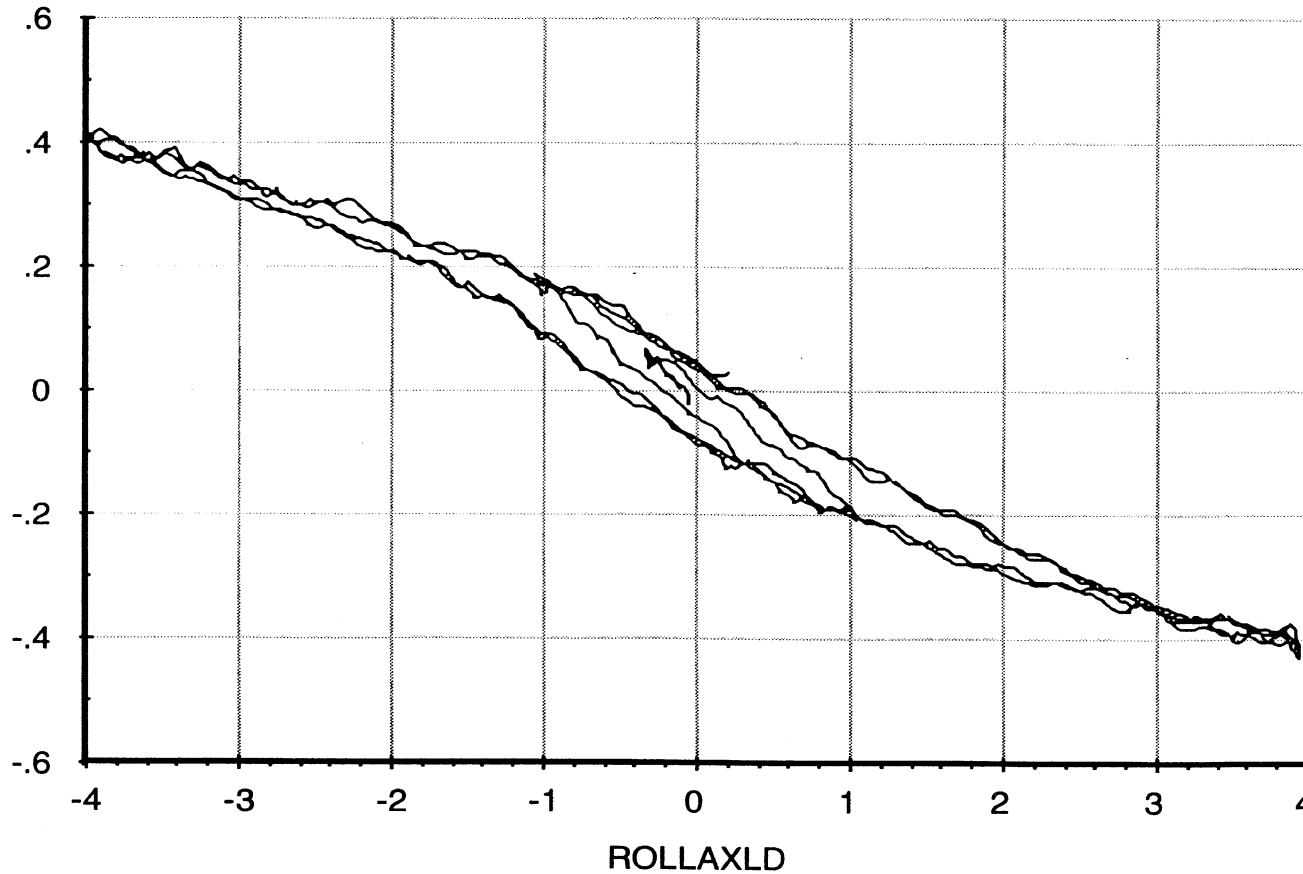

A-40

Abcissa (X): Leading axle roll angle (ROLLAXLD); degrees; right side compressed, positive.

Ordinate (Y): Average leading axle steer angle (SALDA); degrees; steer toward right, positive.

*Note: Brakes on. Force control. Reference height of 7.56 inches.

Measured by **UMTRI** for NHTSA
Volvo Tractor Model WIA64T

Tandem Drive Axle Suspension

20 Nov 95
Suspension: 4-Spring/Taper(3)

Data file: NHTSAD10.ERD

Trailing Axle Roll Steer

Suspension Load: 40000 lb.

SATRA

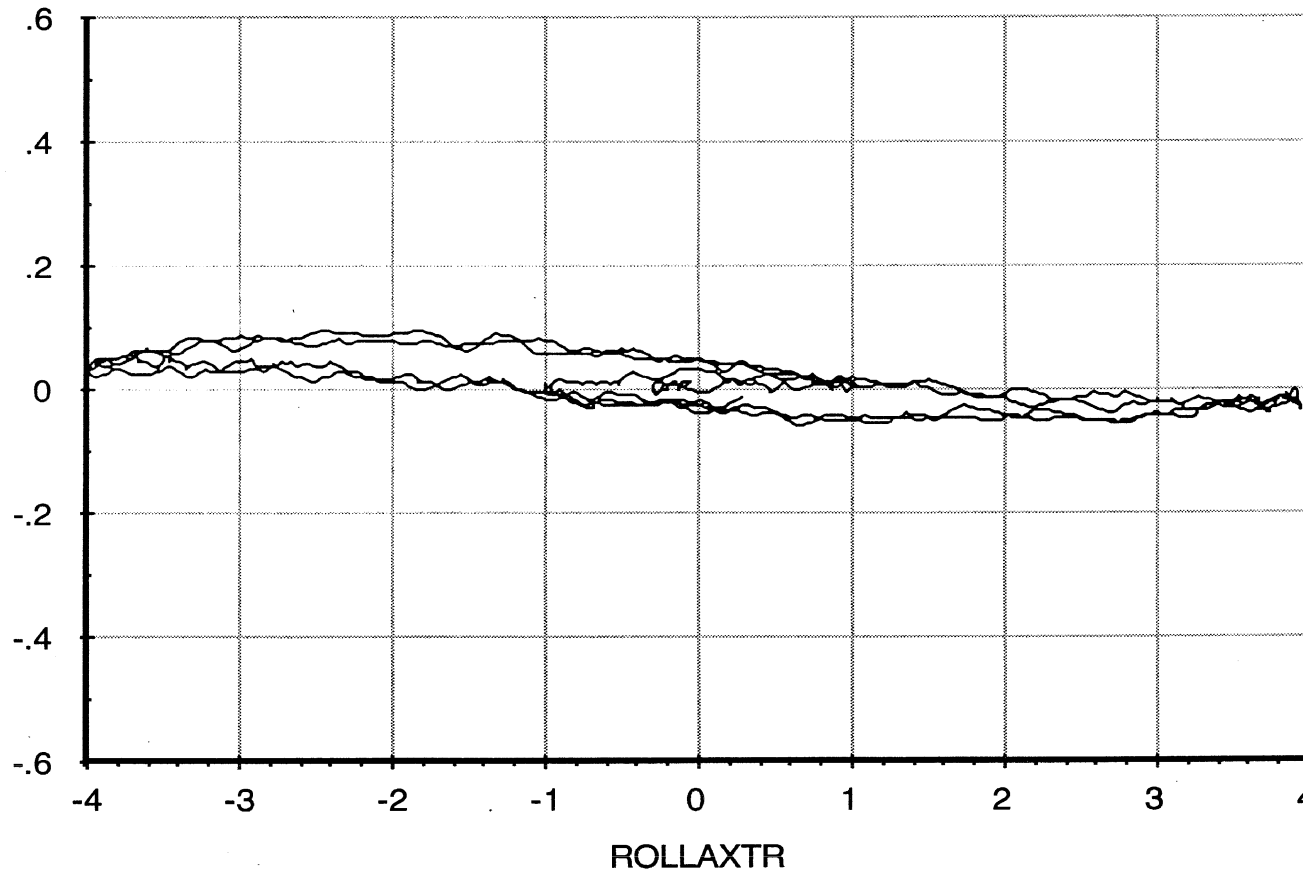

A-41

Abcissa (X): Trailing axle roll angle (ROLLAXTR); degrees; right side compressed, positive.

Ordinate (Y): Average trailing axle steer angle (SATRA); degrees; steer toward right, positive.

*Note: Brakes on. Force control.

Measured by **UMTRI** for NHTSA
Volvo Tractor Model WIA64T

20 Nov 95
Suspension: 4-Spring/Taper(3)

Tandem Drive Axle Suspension

Data file: NHTSAD11.ERD

Leading Axle Lateral Force Compliance

Suspension Load: 40000 lb.

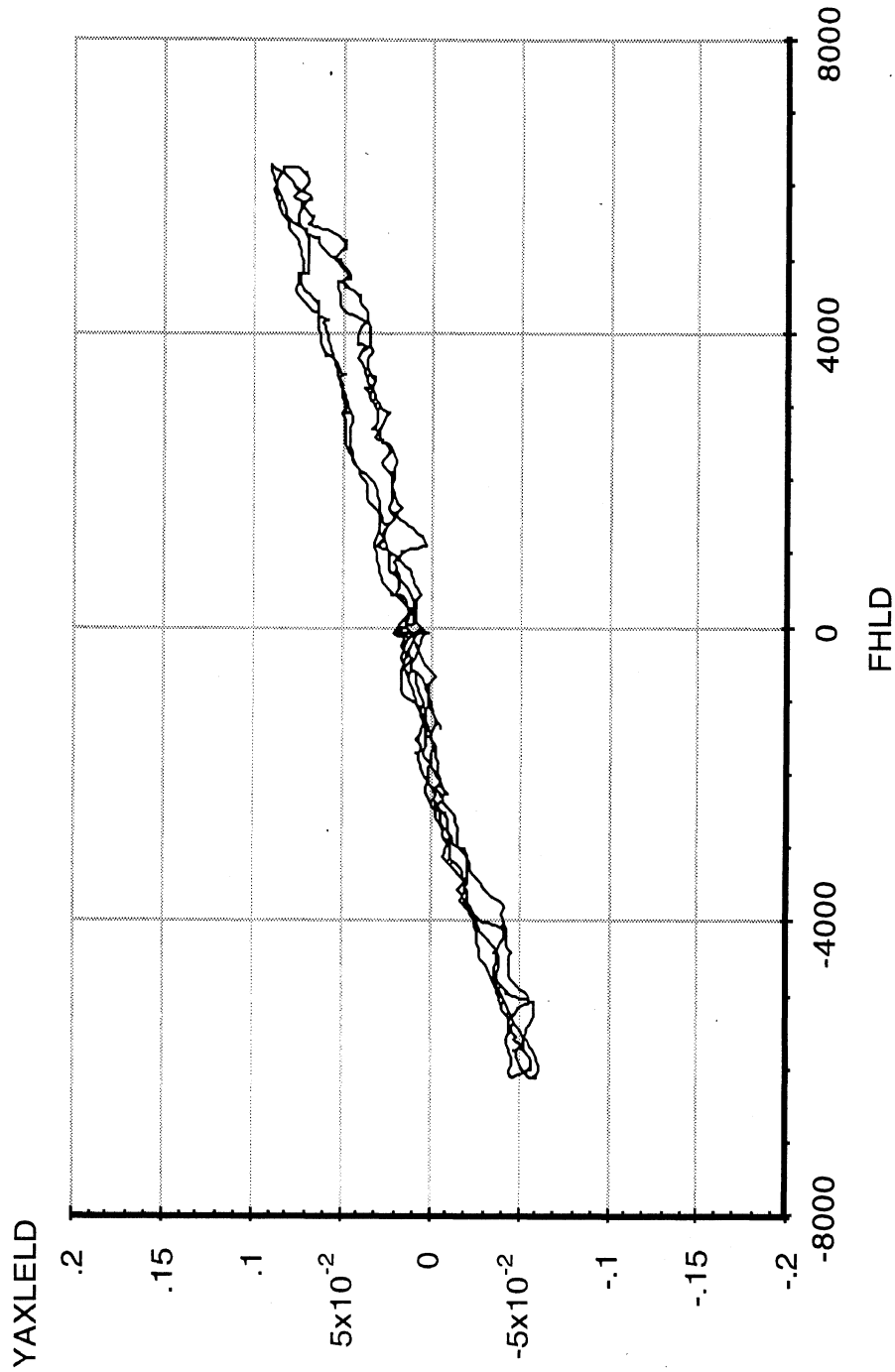

Abscissa (X): Total leading axle lateral force (FHL D); pounds per axle; applied to both axles simultaneously; force applied toward right, positive.

Ordinate (Y): Leading axle lateral translation (YAXLELD); inches; motion toward right, positive.

*Note: Brakes on. Position control.

Measured by **UMTRI** for NHTSA
Volvo Tractor Model WIA64T

Tandem Drive Axle Suspension

20 Nov 95
Suspension: 4-Spring/Taper(3)

Data file: NHTSAD11.ERD

Trailing Axle Lateral Force Compliance

Suspension Load: 40000 lb.

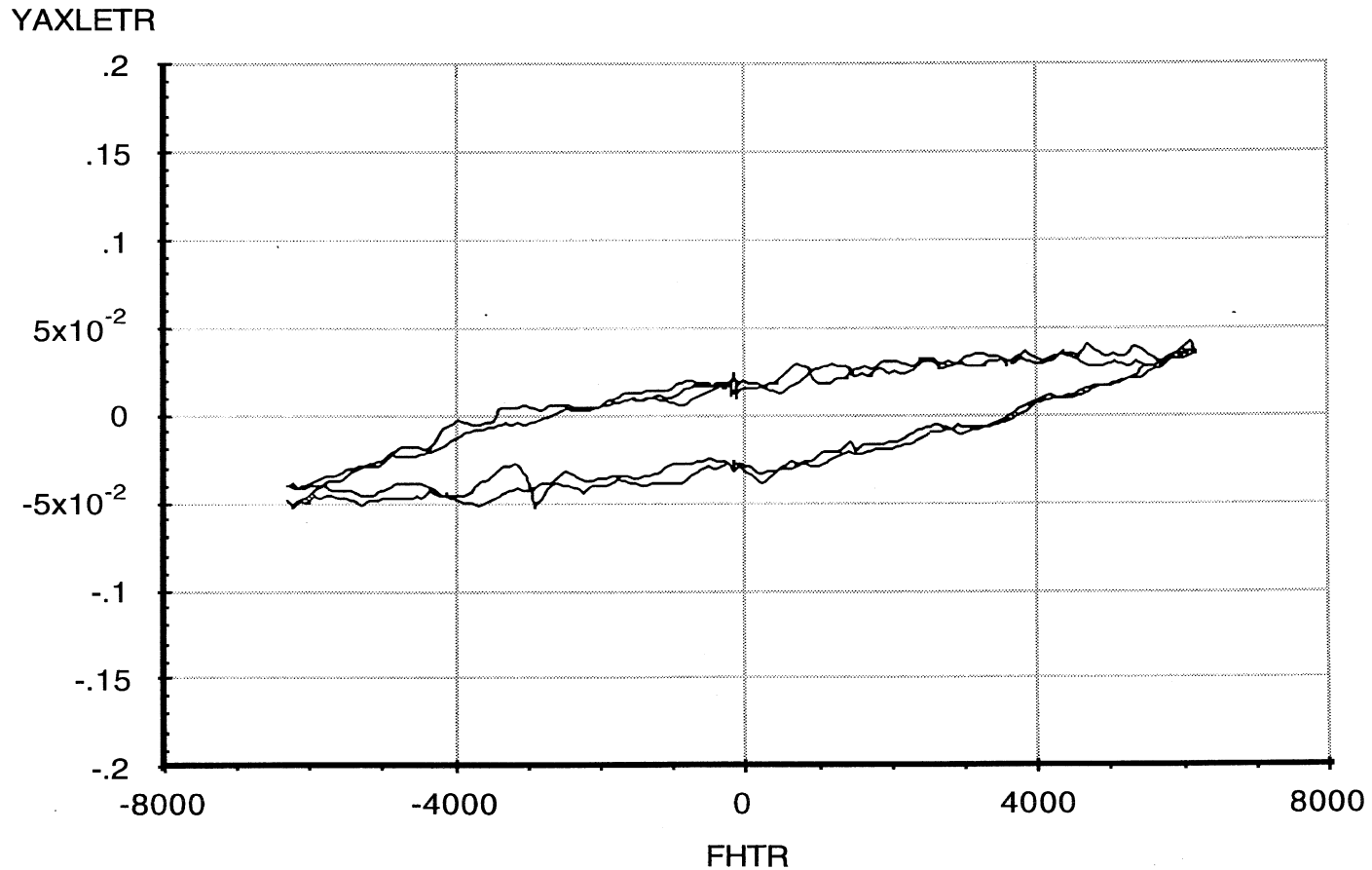

A-43

Abscissa (X): Total trailing axle lateral force (FHTR); pounds per axle; applied to both axles simultaneously; force applied toward right, positive.

Ordinate (Y): Trailing axle lateral translation (YAXLETR); inches; motion toward right, positive.

*Note: Brakes on. Position control.

Measured by **UMTRI** for NHTSA
Volvo Tractor Model WIA64T

Data file: NHTSAD11.ERD

Tandem Drive Axle Suspension
Leading Axle Lateral Force Steer

20 Nov 95
Suspension: 4-Spring/Taper(3)

Suspension Load: 40000 lb.

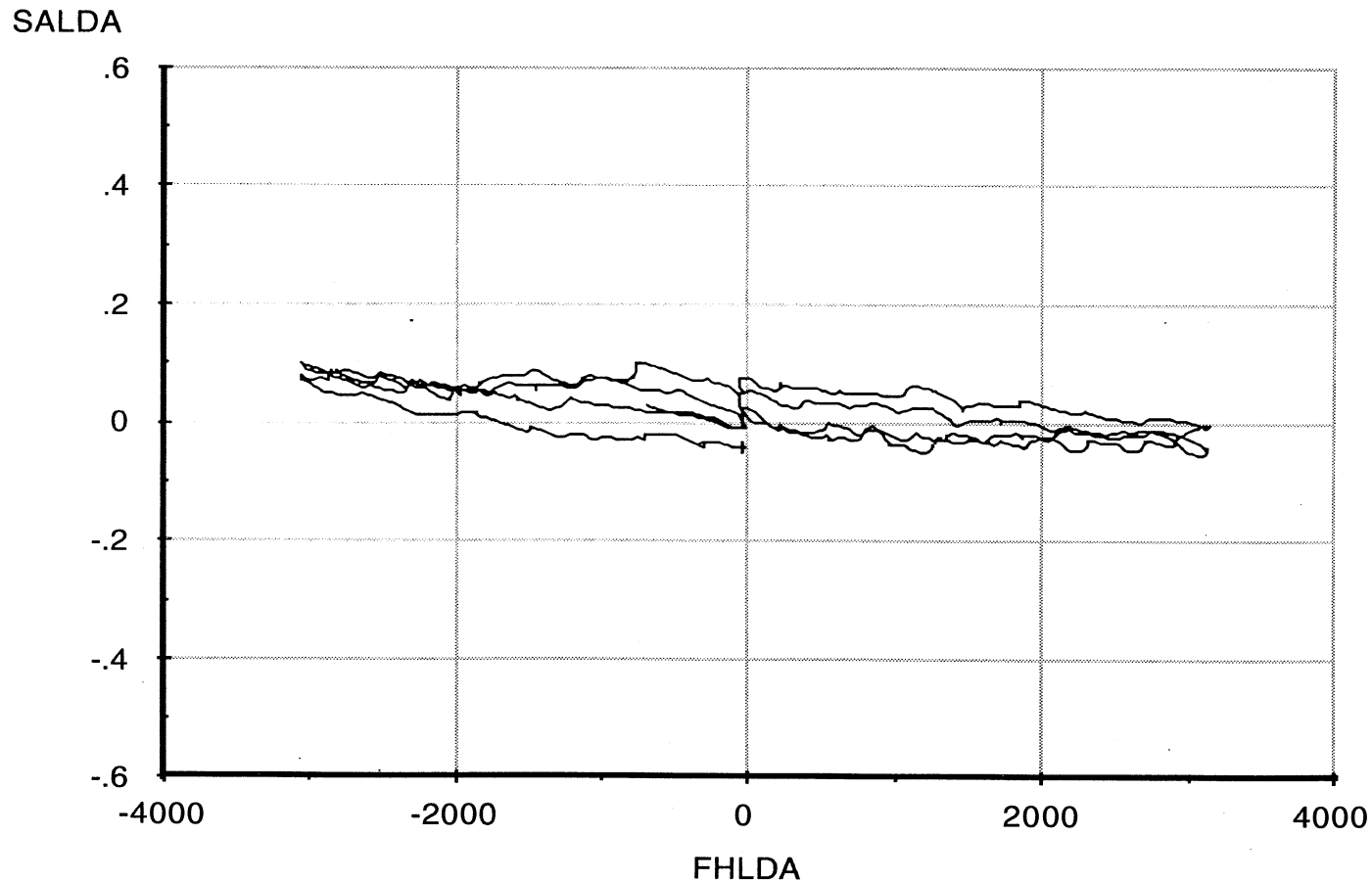

A-44

Abscissa (X): Total leading axle lateral force (FHLDA); pounds per axle; applied to both axles simultaneously; force applied toward right, positive.

Ordinate (Y): Average leading axle steer angle (SALDA); degrees; steer toward right, positive.

*Note: Brakes on. Position control.

Measured by **UMTRI** for NHTSA
Volvo Tractor Model WIA64T

Data file: NHTSAD11.ERD

Tandem Drive Axle Suspension
Trailing Axle Lateral Force Steer

20 Nov 95
Suspension: 4-Spring/Taper(3)

Suspension Load: 40000 lb.

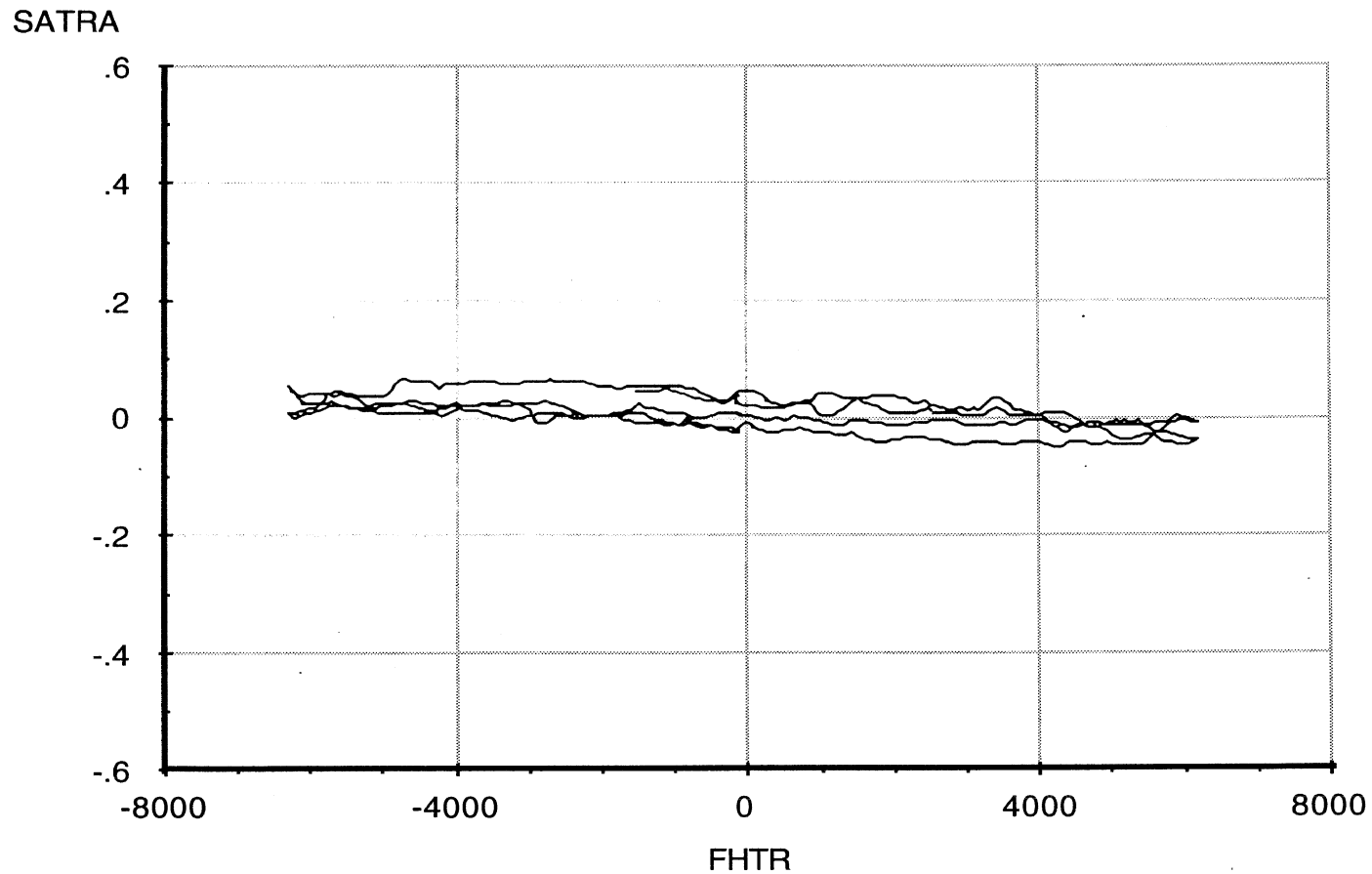

A-45

Abscissa (X): Total trailing axle lateral force (FHTR); pounds per axle; applied to both axles simultaneously; force applied toward right, positive.

Ordinate (Y): Average trailing axle steer angle (SATRA); degrees; steer toward right, positive.

*Note: Brakes on. Position control.

Measured by **UMTRI** for NHTSA
Volvo Tractor Model WIA64T

Tandem Drive Axle Suspension

20 Nov 95
Suspension: 4-Spring/Taper(3)

Data file: NHTSAD12.ERD **Leading Axle Aligning Moment Compliance Steer** Suspension Load: 40000 lb.

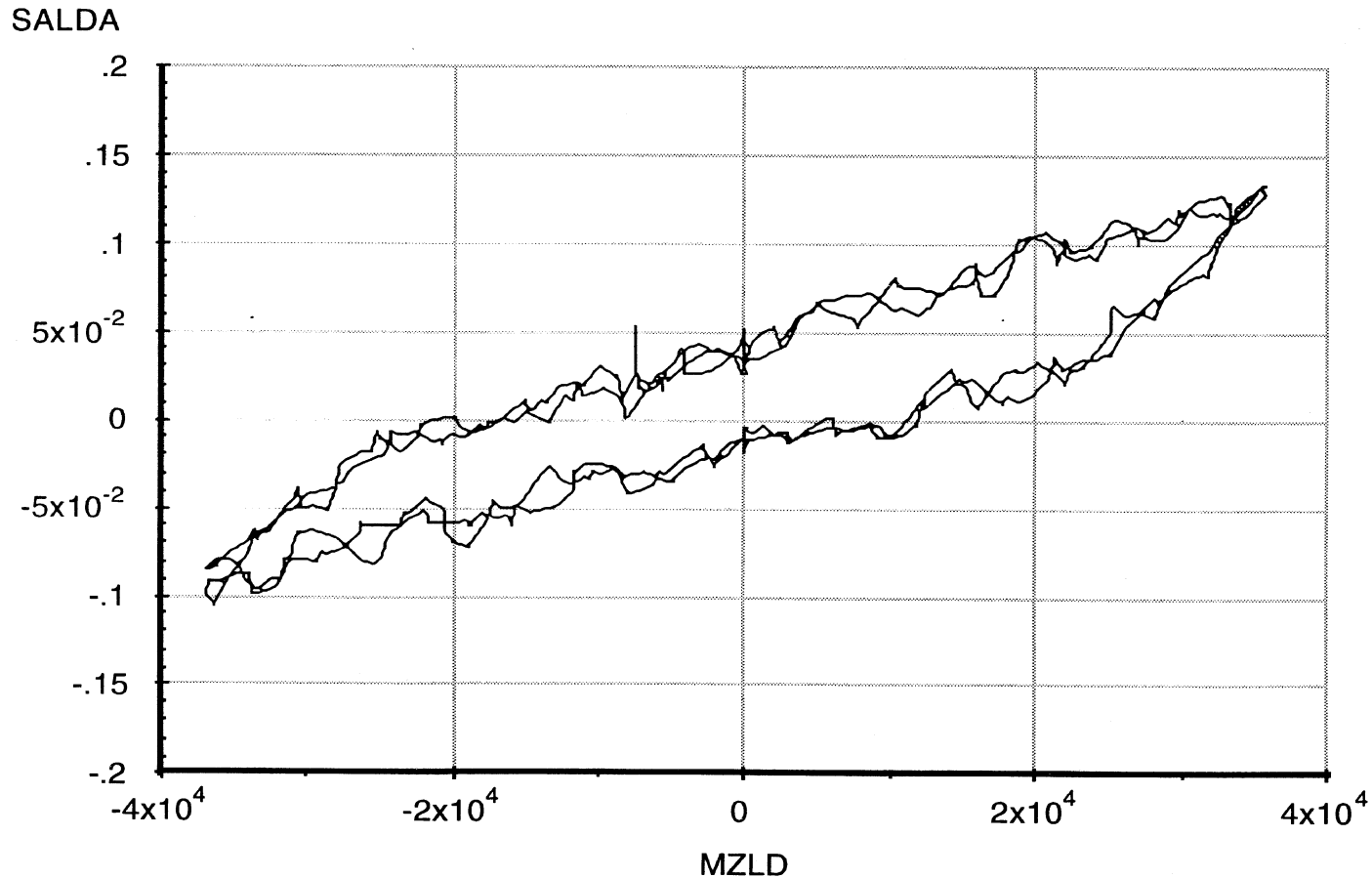

A-46

Abscissa (X): Total leading axle aligning moment (MZLD); in-lb per axle; applied to both axles simultaneously; downward (right hand rule) moment vector, positive.

Ordinate (Y): Average leading axle steer angle (SALDA); degrees; steer toward right, positive.

*Note: Brakes on. Position control.

Measured by **UMTRI** for NHTSA
Volvo Tractor Model WIA64T

Tandem Drive Axle Suspension

20 Nov 95
Suspension: 4-Spring/Taper(3)

Data file: NHTSAD12.ERD **Trailing Axle Aligning Moment Compliance Steer**

Suspension Load: 40000 lb.

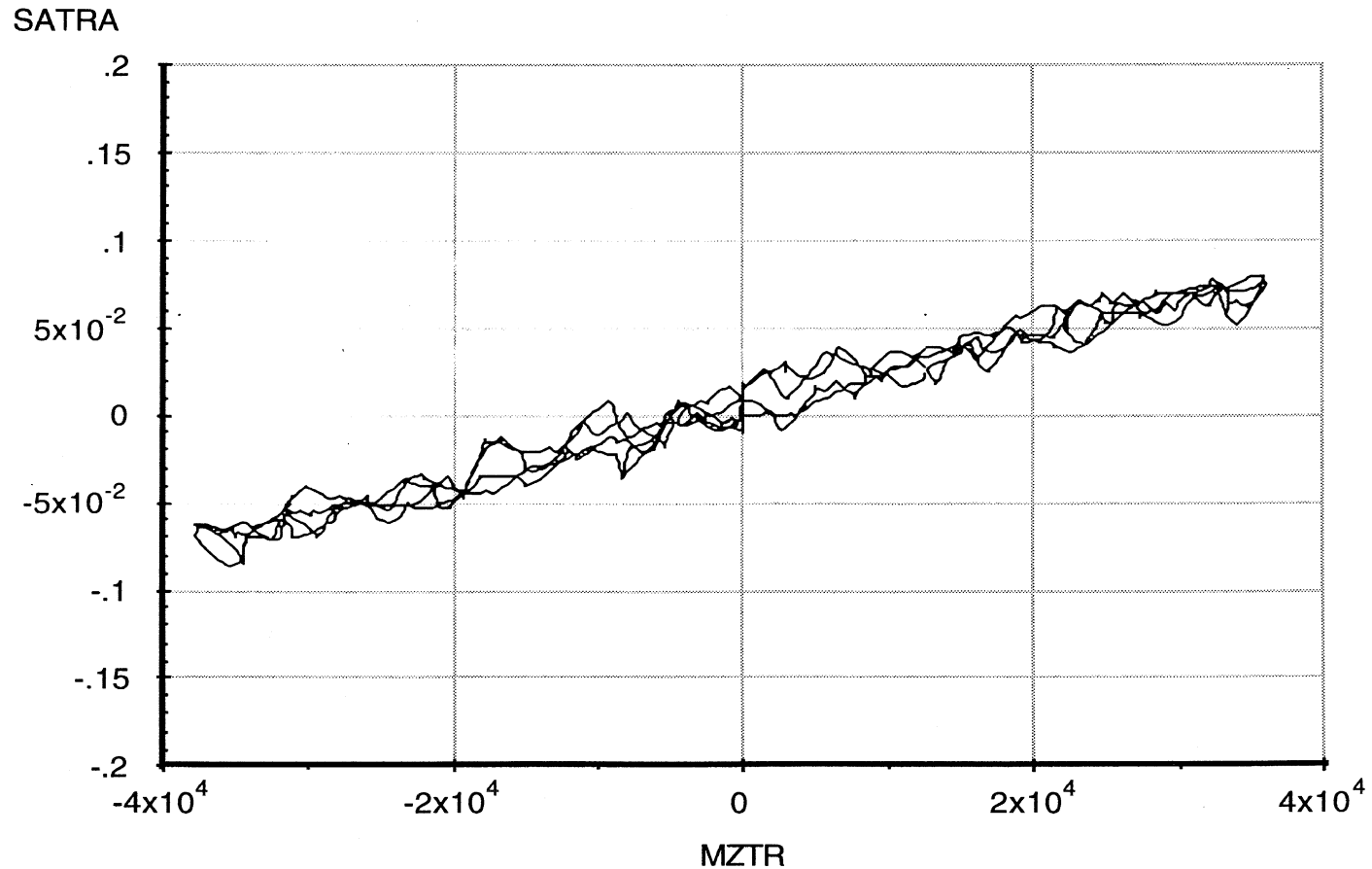

Abscissa (X): Total trailing axle aligning moment (MZTR); in-lb per axle; applied to both axles simultaneously; downward (right hand rule) moment vector, positive.

Ordinate (Y): Average trailing axle steer angle (SATRA); degrees; steer toward right, positive.

*Note: Brakes on. Position control.

Measured by **UMTRI** for NHTSA
Volvo Tractor Model WIA64T

Tandem Drive Axle Suspension

20 Nov 95
Suspension: 4-Spring/Taper(3)

Data file: NHTSAD13.ERD
FZ

Inter-Axle Load Transfer Due to Braking

Suspension Load: 40000 lb.

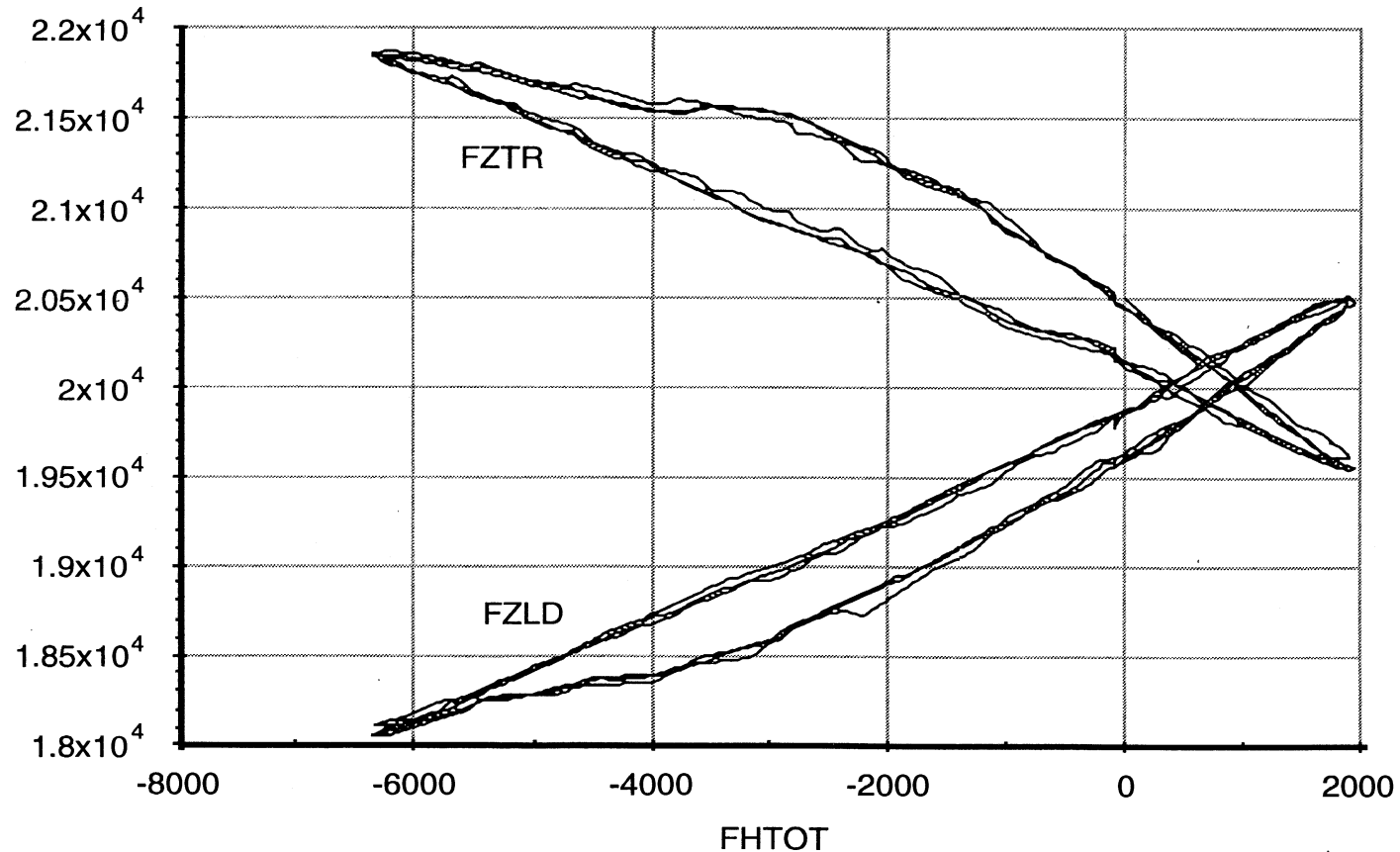

A-48

Abscissa (X): Total longitudinal force (FHTOT); pounds; applied to all wheels simultaneously; force toward front, positive.

Ordinate (Y): Total leading axle vertical wheel load (FZLD); pounds; spring compression, positive.
Total trailing axle vertical wheel load (FZTR); pounds; spring compression, positive.

*Note: Brakes on. Force control.

Measured by **UMTRI** for NHTSA
Volvo Tractor Model WIA64T

Tandem Drive Axle Suspension

20 Nov 95
Suspension: 4-Spring/Taper(3)

Data file: NHTSAD20.ERD

Leading Axle Roll Rate

Suspension Load: 28000 lb.

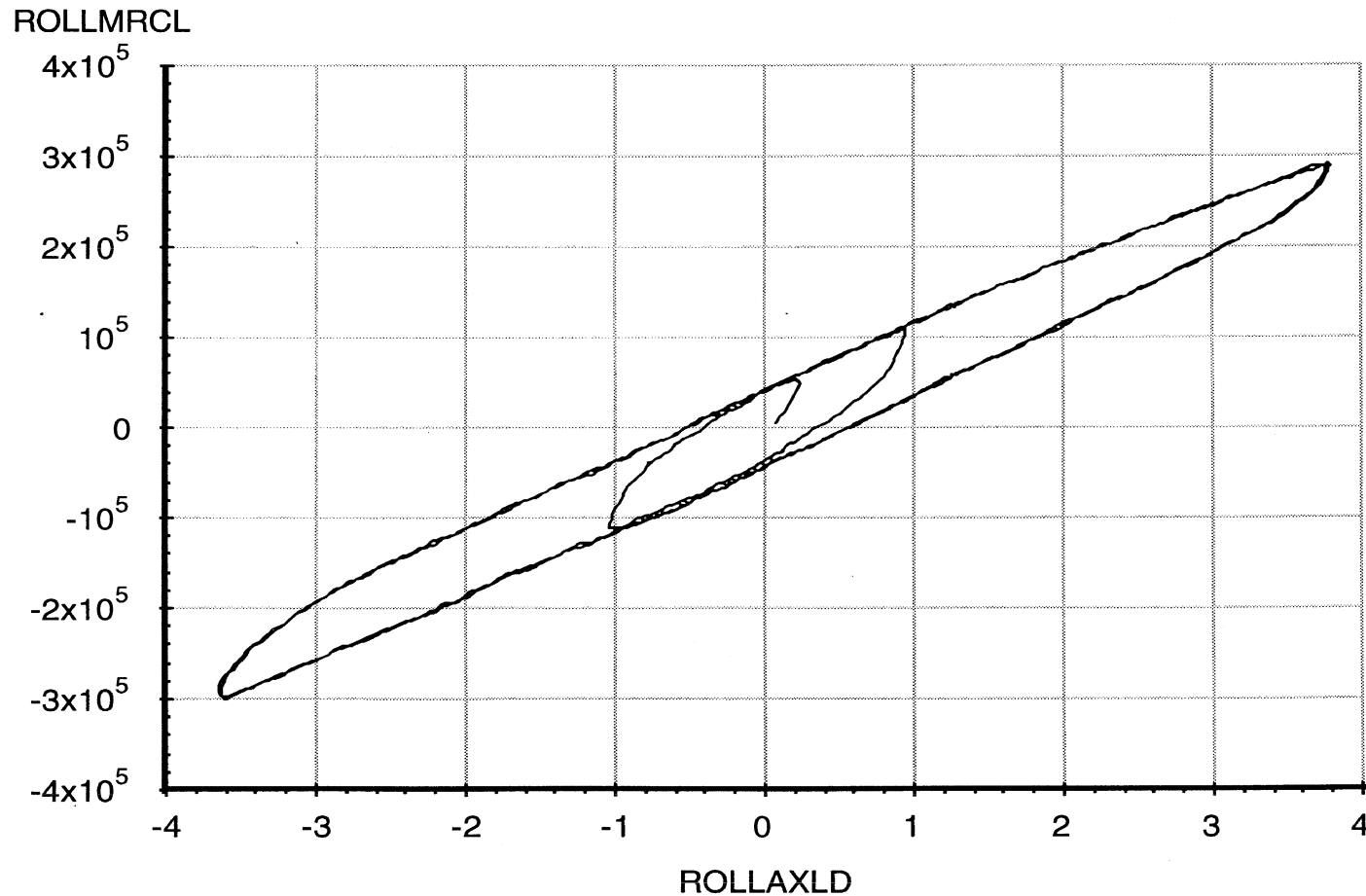

Abscissa (X): Leading axle roll angle (ROLLAXLD); degrees; right side compressed, positive.

Ordinate (Y): Leading axle roll moment about the roll center (ROLLMRCL); in-lb; right side compressed, positive.

*Note: Brakes on. Force control.

Measured by **UMTRI** for NHTSA
Volvo Tractor Model WIA64T

Tandem Drive Axle Suspension

20 Nov 95
Suspension: 4-Spring/Taper(3)

Data file: NHTSAD20.ERD

Trailing Axle Roll Rate

Suspension Load: 28000 lb.

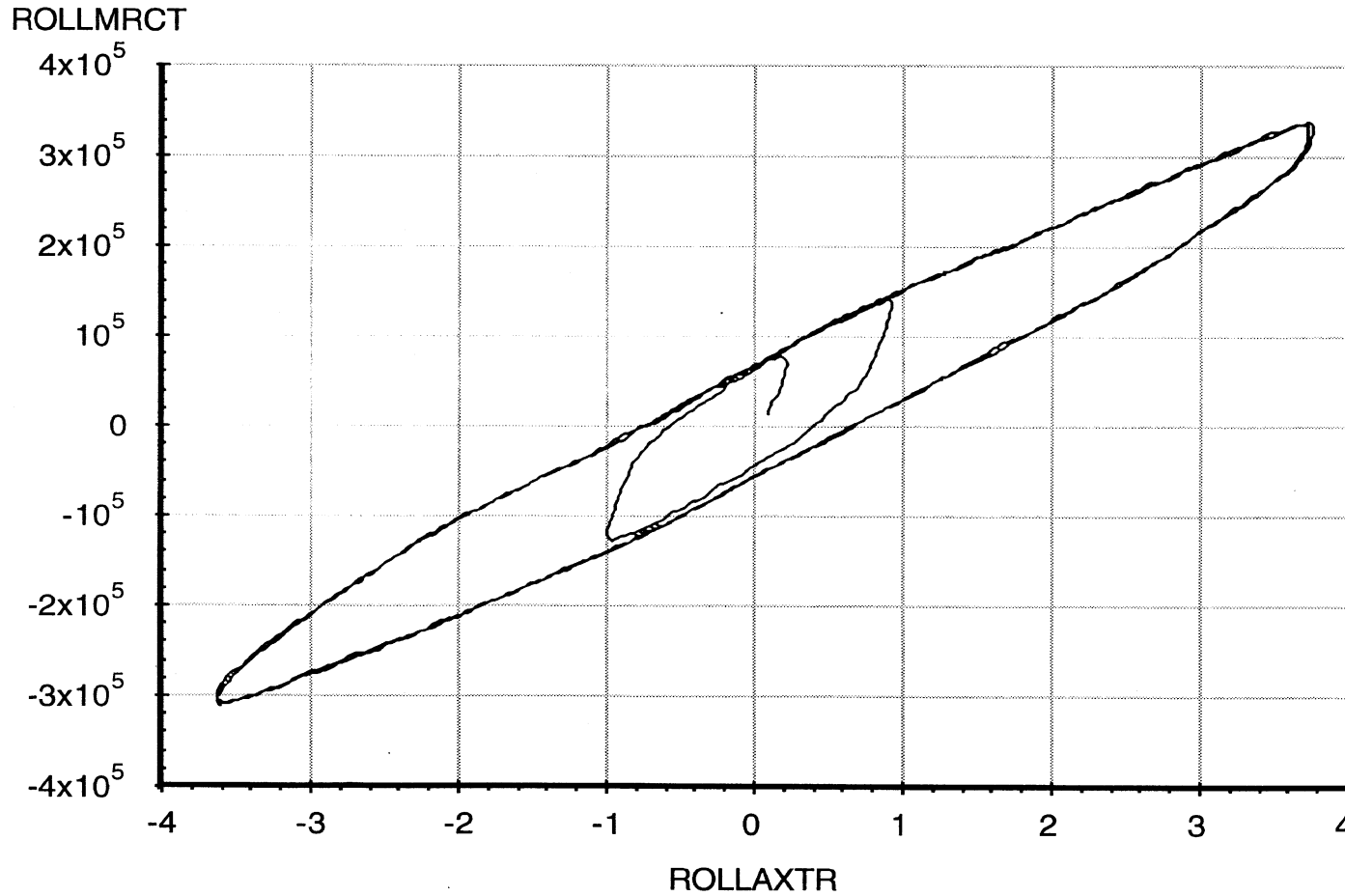

A-50

Abscissa (X): Trailing axle roll angle (ROLLAXTR); degrees; right side compressed, positive.

Ordinate (Y): Trailing axle roll moment about the roll center (ROLLMRCT); in-lb; right side compressed, positive.

*Note: Brakes on. Force control.

Measured by **UMTRI** for NHTSA
Volvo Tractor Model WIA64T

Data file: NHTSAD20.ERD

Tandem Drive Axle Suspension
Leading Axle Roll Center Height

20 Nov 95
Suspension: 4-Spring/Taper(3)

Suspension Load: 28000 lb.

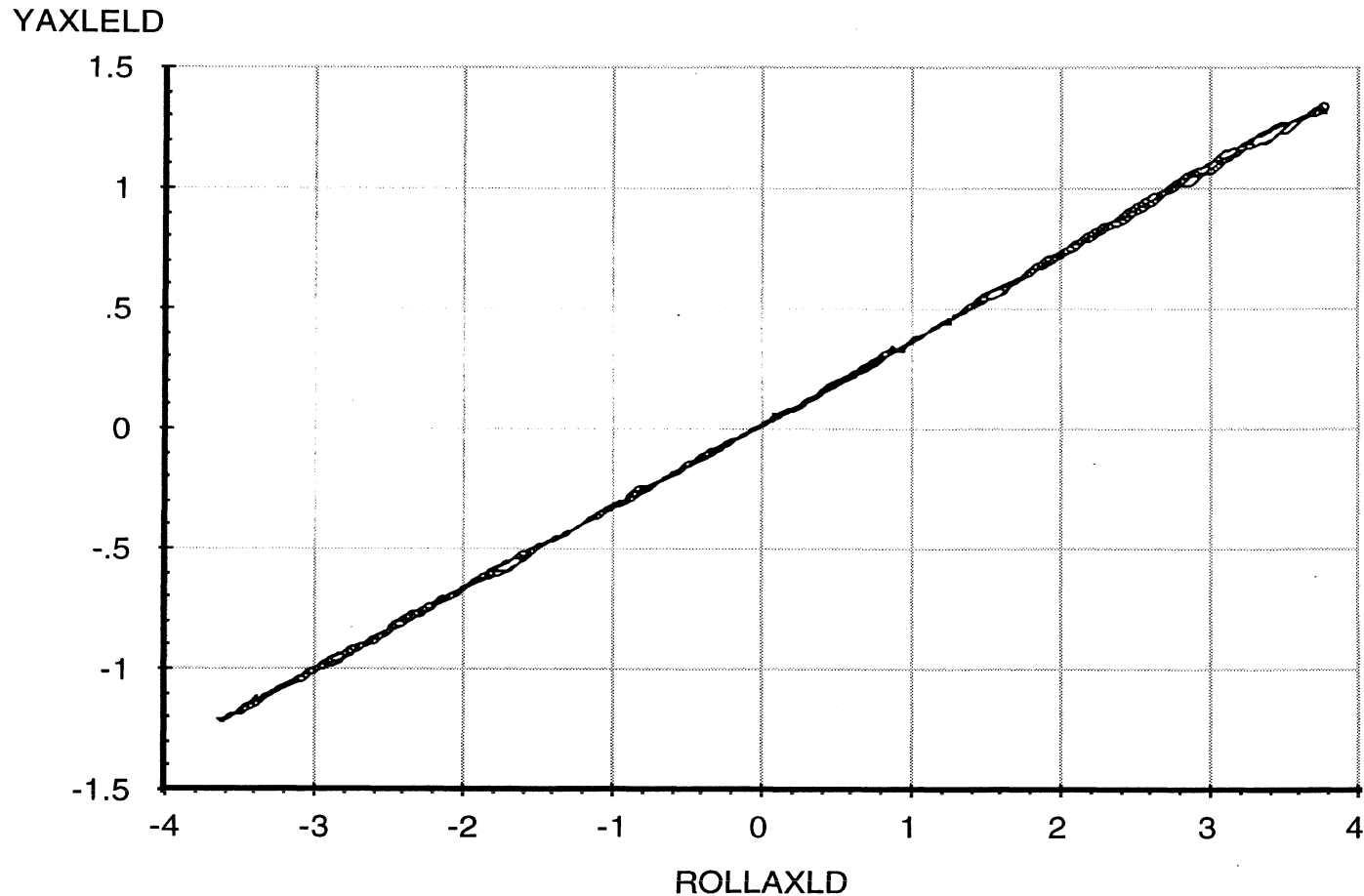

A-51

Abscissa (X): Leading axle roll angle (ROLLAXLD); degrees; right side compressed, positive.

Ordinate (Y): Leading axle reference point lateral translation (YAXLELD); inches; motion toward right, positive.

*Note: Brakes on. Force control. Reference height of 7.81 inches.

Measured by **UMTRI** for NHTSA
Volvo Tractor Model WIA64T

Data file: NHTSAD20.ERD

Tandem Drive Axle Suspension
Trailing Axle Roll Center Height

20 Nov 95
Suspension: 4-Spring/Taper(3)

Suspension Load: 28000 lb.

YAXLETR

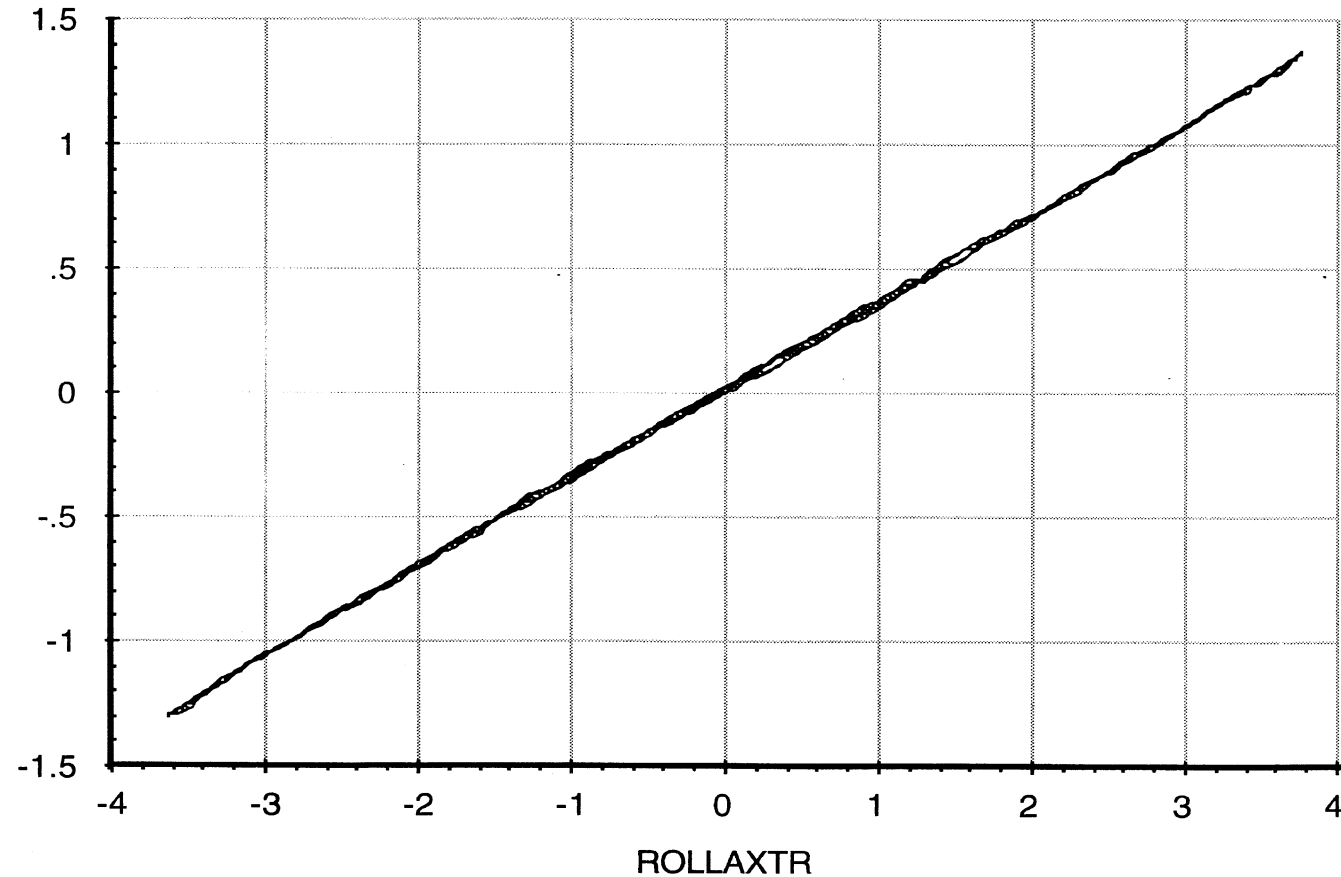

A-52

Abcissa (X): Trailing axle roll angle (ROLLAXTR); degrees; right side compressed, positive.

Ordinate (Y): Trailing axle reference point lateral translation (YAXLETR); inches; motion toward right, positive.

*Note: Brakes on. Force control. Reference height of 8.00 inches.

Measured by **UMTRI** for NHTSA
Volvo Tractor Model WIA64T

Tandem Drive Axle Suspension

20 Nov 95
Suspension: 4-Spring/Taper(3)

Data file: NHTSAD20.ERD

Leading Axle Roll Steer

Suspension Load: 28000 lb.

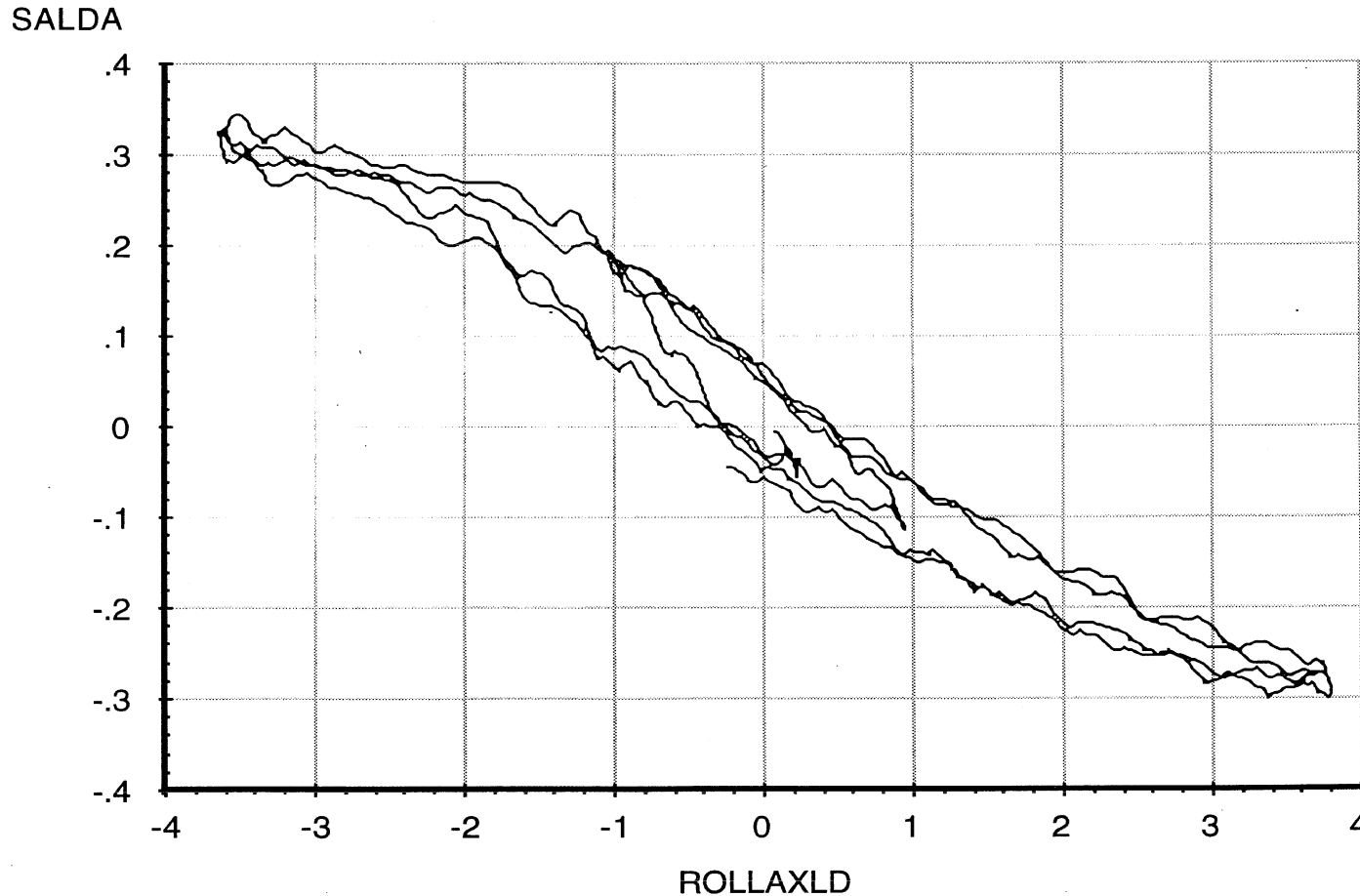

A-53

Abscissa (X): Leading axle roll angle (ROLLAXLD); degrees; right side compressed, positive.

Ordinate (Y): Average leading axle average steer angle (SALDA); degrees; steer toward right, positive.

*Note: Brakes on. Force control.

Measured by **UMTRI** for NHTSA
Volvo Tractor Model WIA64T

Tandem Drive Axle Suspension

20 Nov 95
Suspension: 4-Spring/Taper(3)

Data file: NHTSAD20.ERD

Trailing Axle Roll Steer

Suspension Load: 28000 lb.

SATRA

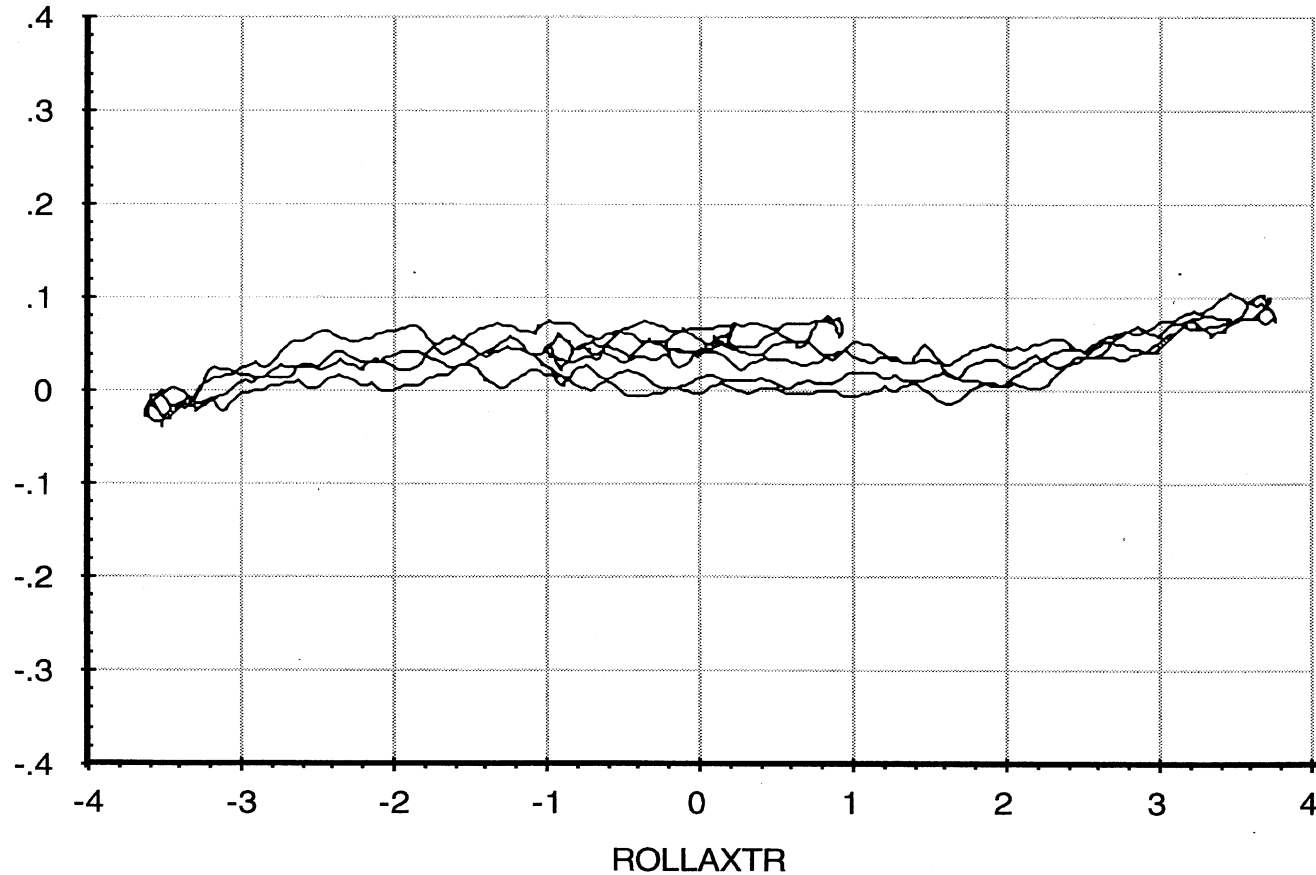

A-54

Abcissa (X): Trailing axle roll angle (ROLLAXTR); degrees; right side compressed, positive.

Ordinate (Y): Average trailing axle average steer angle (SATRA); degrees; steer toward right, positive.

*Note: Brakes on. Force control.

Measured by **UMTRI** for NHTSA
Volvo Tractor Model WIA64T

Tandem Drive Axle Suspension

20 Nov 95
Suspension: 4-Spring/Taper(3)

Data file: NHTSAD21.ERD

Leading Axle Lateral Force Compliance

Suspension Load: 28000 lb.

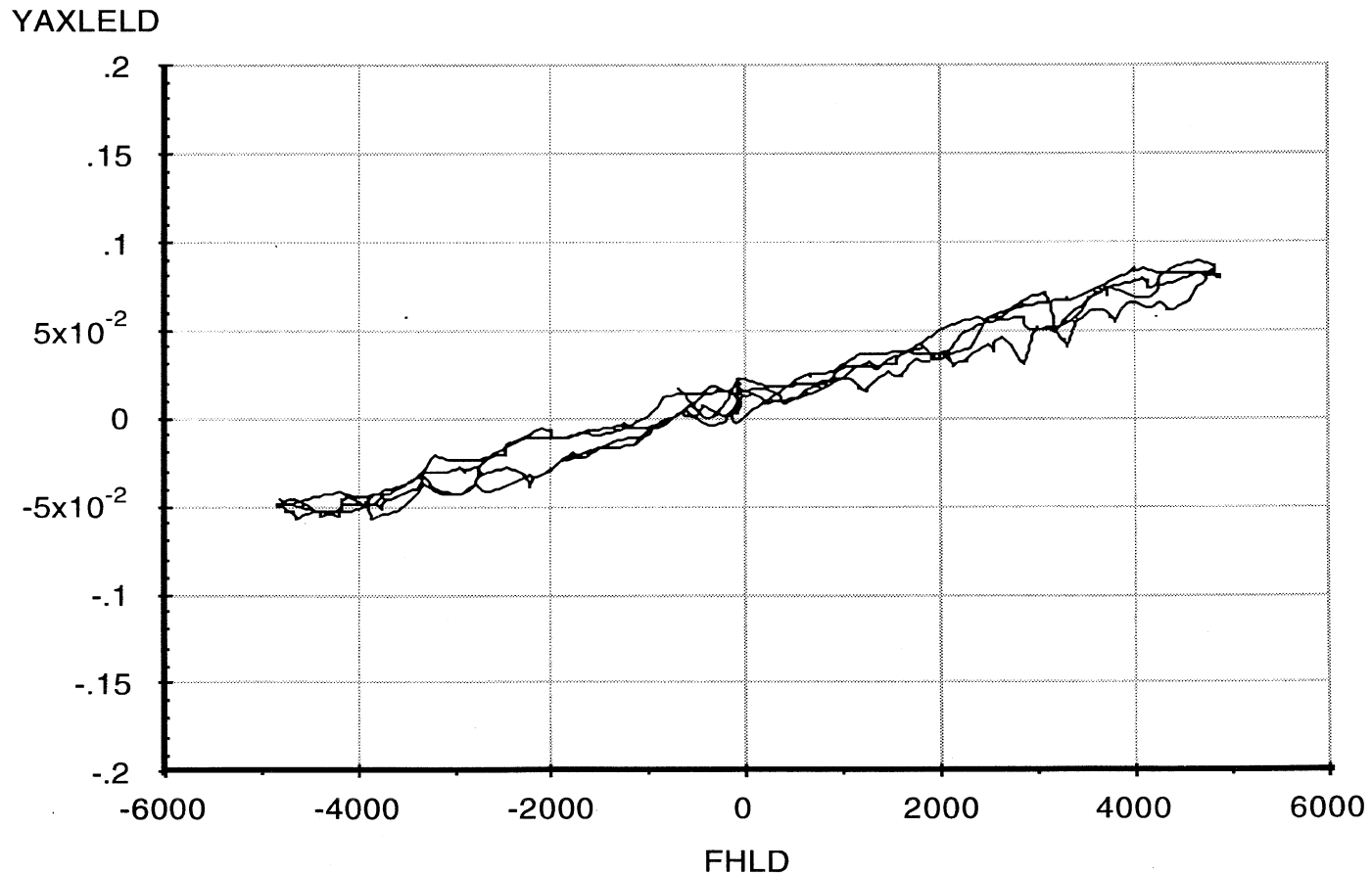

A-55

Abscissa (X): Total leading axle lateral force (FHL D); pounds per wheel; applied to all four wheel sets simultaneously; force applied toward right, positive.

Ordinate (Y): Leading axle lateral translation (YAXLELD); inches; motion toward right, positive.

*Note: Brakes on. Position control.

Measured by **UMTRI** for NHTSA
Volvo Tractor Model WIA64T

Tandem Drive Axle Suspension

20 Nov 95
Suspension: 4-Spring/Taper(3)

Data file: NHTSAD21.ERD

Trailing Axle Lateral Force Compliance

Suspension Load: 28000 lb.

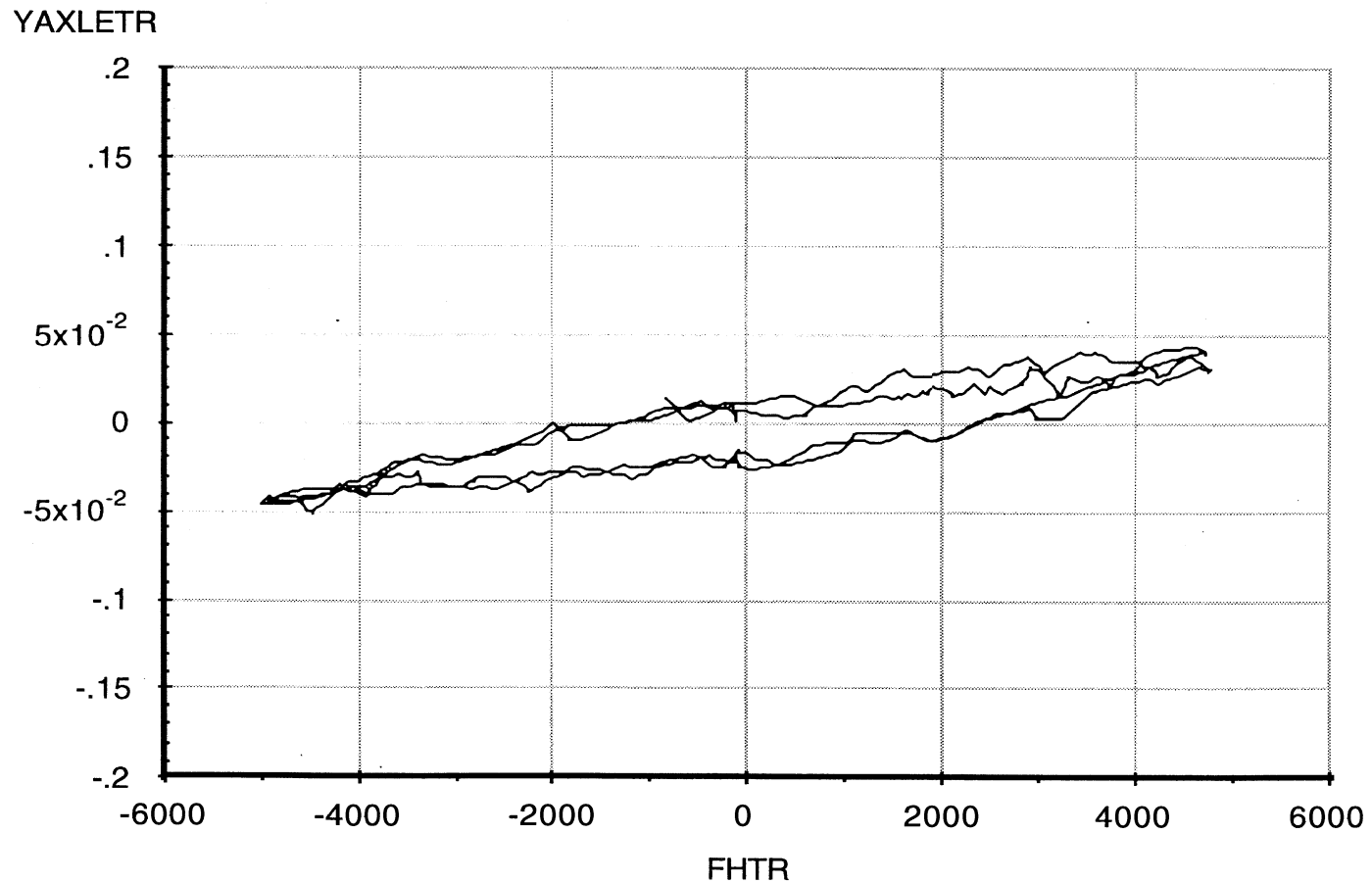

A-56

Abscissa (X): Total trailing axle lateral force (FHTR); pounds per wheel; applied to all four wheel sets simultaneously; force applied toward right, positive.

Ordinate (Y): Trailing axle lateral translation (YAXLETR); inches; motion toward right, positive.

*Note: Brakes on. Position control.

Measured by **UMTRI** for NHTSA
Volvo Tractor Model WIA64T

Data file: NHTSAD21.ERD

Tandem Drive Axle Suspension
Leading Axle Lateral Force Steer

20 Nov 95
Suspension: 4-Spring/Taper(3)

Suspension Load: 28000 lb.

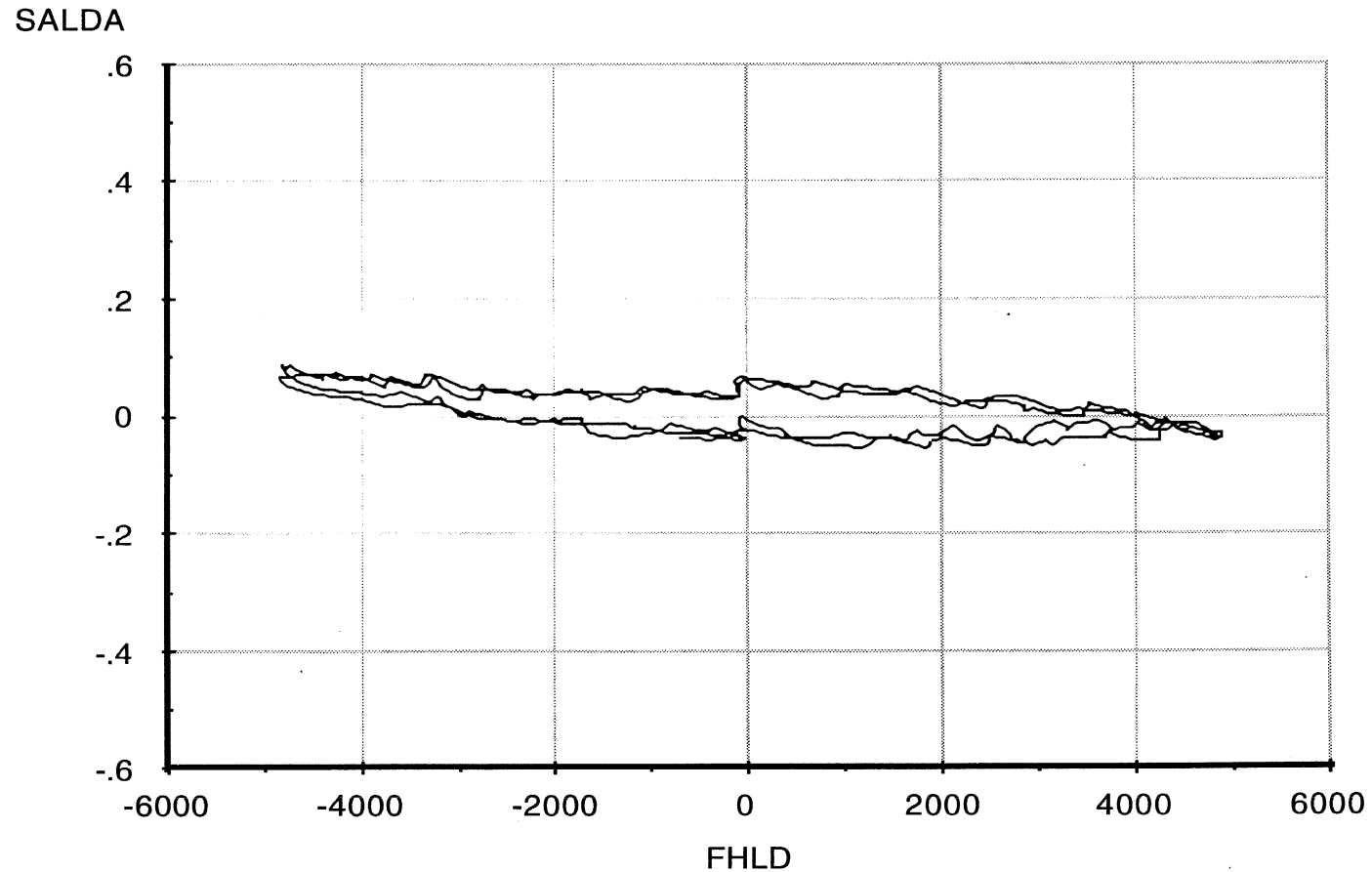

A-57

Abscissa (X): Total leading axle lateral force (FHLD); pounds per wheel; applied to all four wheel sets simultaneously; force applied toward right, positive.

Ordinate (Y): Average leading axle steer angle (SALDA); degrees; steer toward right, positive.

*Note: Brakes on. Position control.

Measured by **UMTRI** for NHTSA
Volvo Tractor Model WIA64T

Data file: NHTSAD21.ERD

Tandem Drive Axle Suspension
Trailing Axle Lateral Force Steer

20 Nov 95
Suspension: 4-Spring/Taper(3)

Suspension Load: 28000 lb.

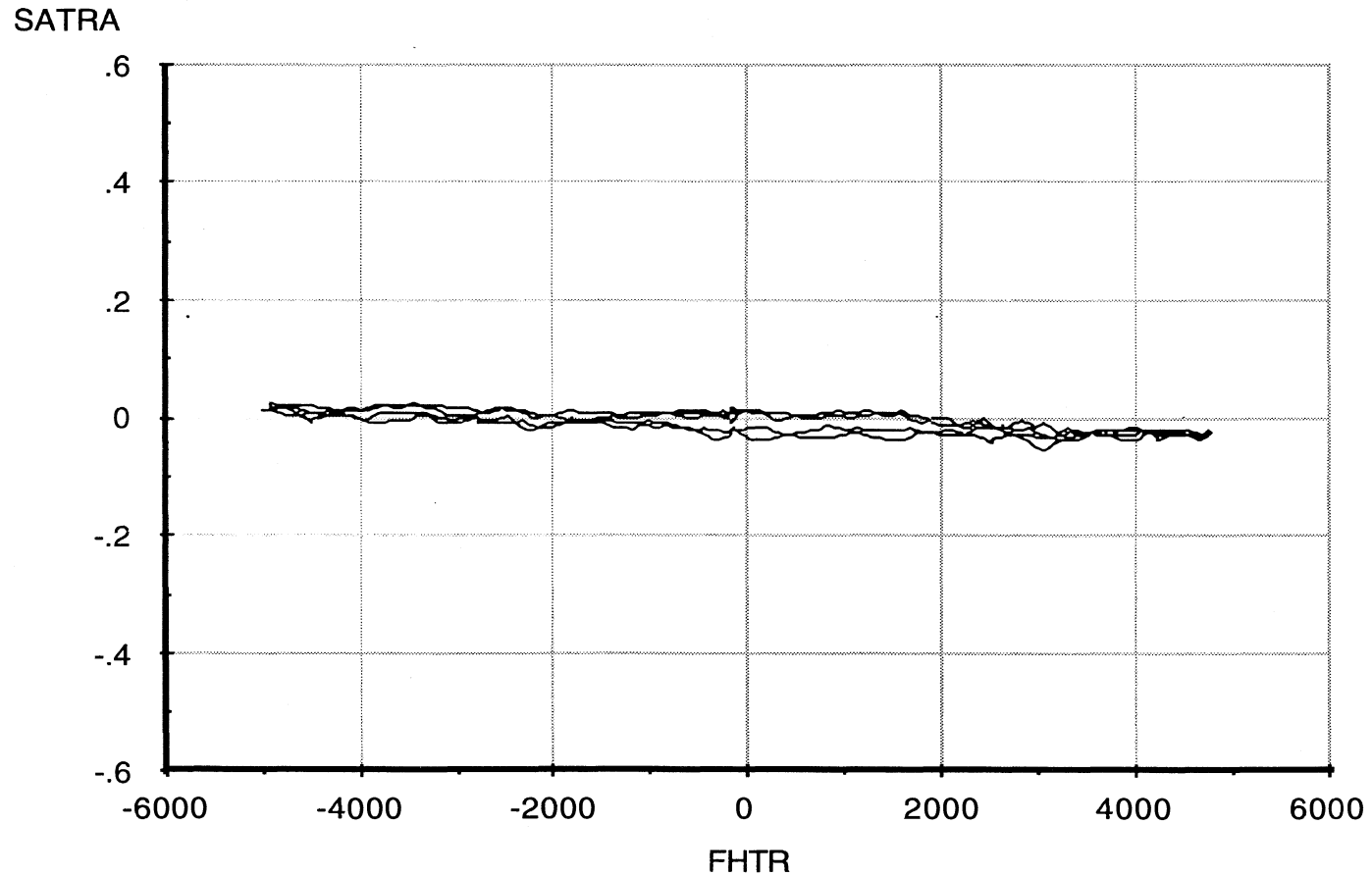

A-58

Abcissa (X): Total trailing axle lateral force (FHTR); pounds per wheel; applied to all four wheel sets simultaneously; force applied toward right, positive.

Ordinate (Y): Average trailing axle steer angle (SATRA); degrees; steer toward right, positive.

*Note: Brakes on. Position control.

Measured by **UMTRI** for NHTSA
Volvo Tractor Model WIA64T

Tandem Drive Axle Suspension

20 Nov 95
Suspension: 4-Spring/Taper(3)

Data file: NHTSAD22.ERD **Leading Axle Aligning Moment Compliance Steer**

Suspension Load: 28000 lb.

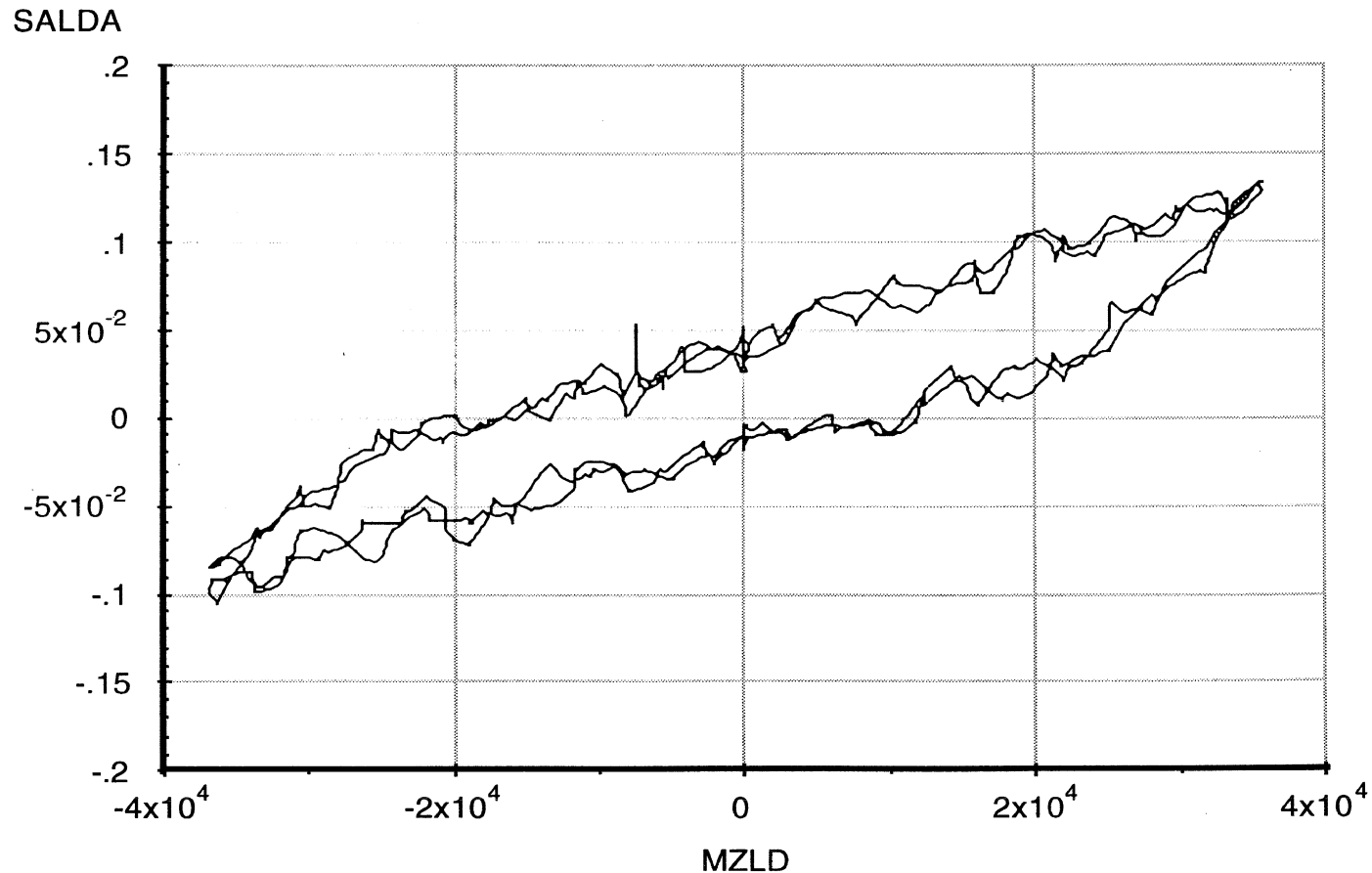

A-59

Abscissa (X): Total leading axle aligning moment (MZLD); in-lb per axle; applied to both axles simultaneously; downward (right hand rule) moment vector, positive.

Ordinate (Y): Average leading axle steer angle (SALDA); degrees; steer toward right, positive.

*Note: Brakes on. Position control.

Measured by **UMTRI** for NHTSA
Volvo Tractor Model WIA64T

Tandem Drive Axle Suspension

20 Nov 95

Suspension: 4-Spring/Taper(3)

Data file: NHTSAD22.ERD

Trailing Axle Aligning Moment Compliance Steer

Suspension Load: 28000 lb.

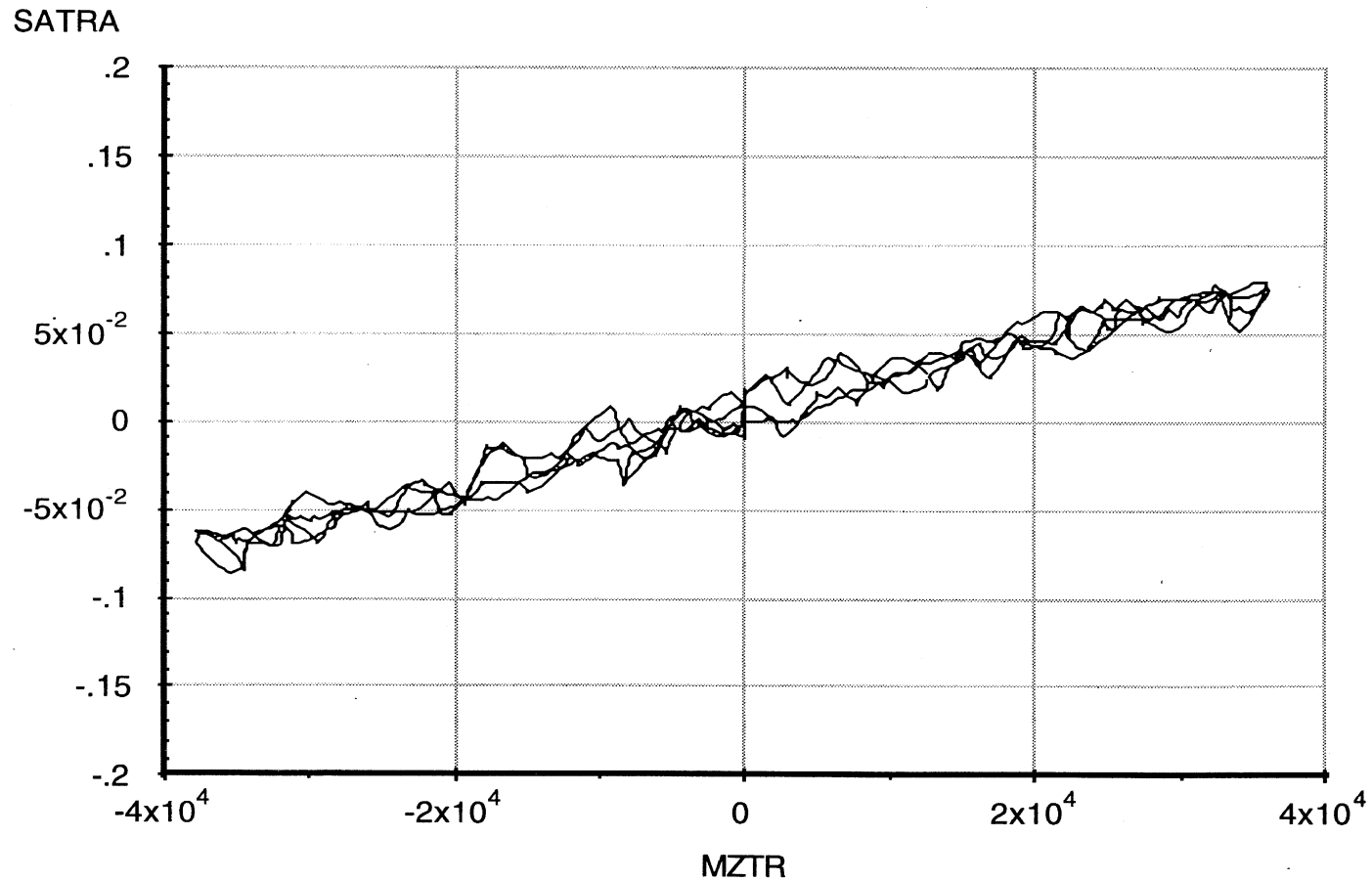

A-60

Abscissa (X): Total trailing axle aligning moment (MZTR); in-lb per axle; applied to both axles simultaneously; downward (right hand rule) moment vector, positive.

Ordinate (Y): Average trailing axle steer angle (SATRA); degrees; steer toward right, positive.

*Note: Brakes on. Position control.

Measured by **UMTRI** for NHTSA
Volvo Tractor Model WIA64T

Tandem Drive Axle Suspension

20 Nov 95
Suspension: 4-Spring/Taper(3)

Data file: NHTSAD23.ERD

Inter-Axle Load Transfer Due to Braking

Suspension Load: 28000 lb.

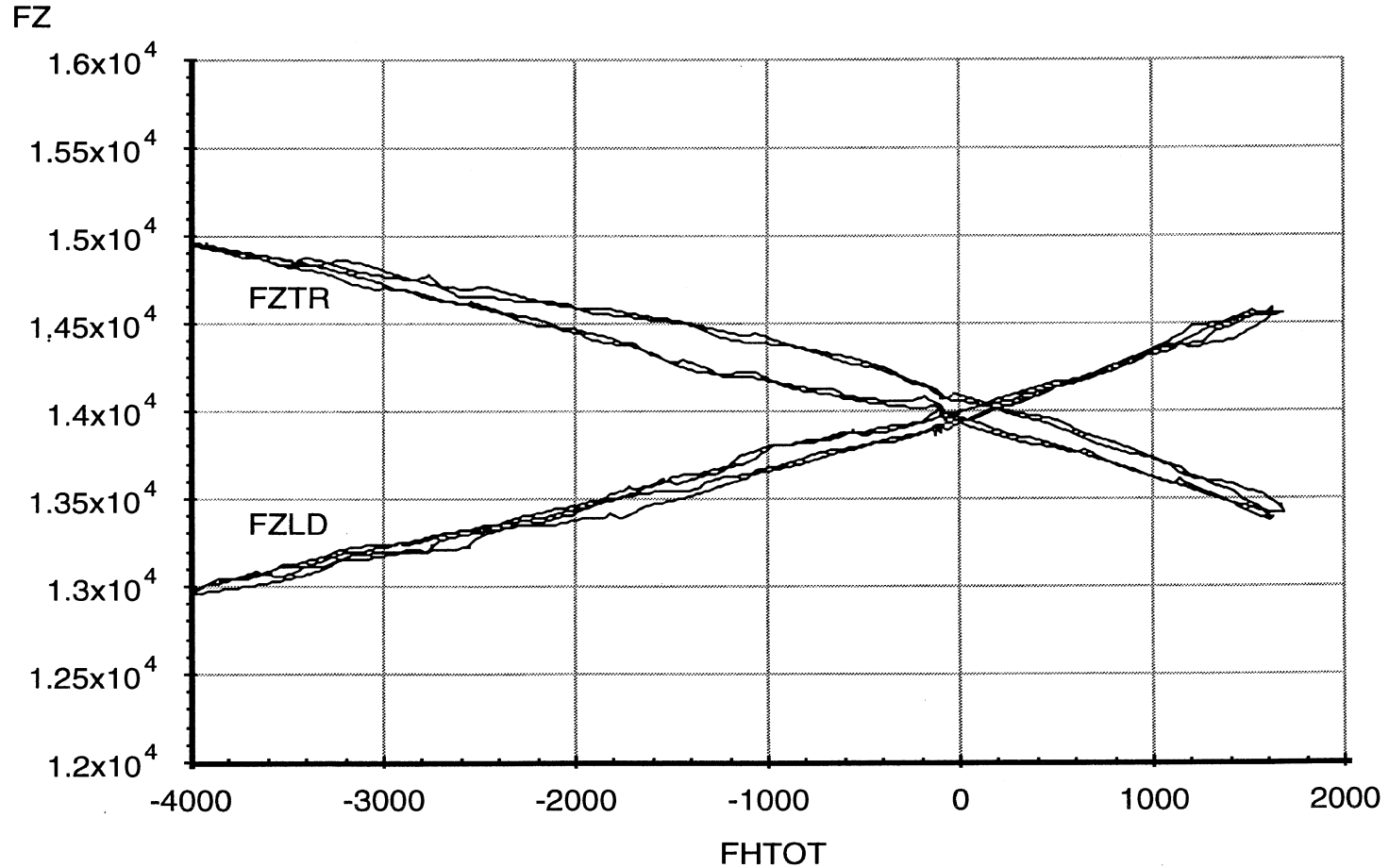

A-61

Abscissa (X): Total longitudinal force (FHTOT); pounds; applied to all wheels simultaneously; force toward front, positive.

Ordinate (Y): Total leading axle vertical wheel load (FZLD); pounds; spring compression, positive.

Total trailing axle vertical wheel load (FZTR); pounds; spring compression, positive.

*Note: Brakes on. Force control.

Measured by **UMTRI** for NHTSA
Volvo Tractor Model WIA64T

Tandem Drive Axle Suspension

20 Nov 95
Suspension: 4-Spring/Taper(3)

Data file: NHTSAD30.ERD

Leading Axle Roll Rate

Suspension Load: 16000 lb.

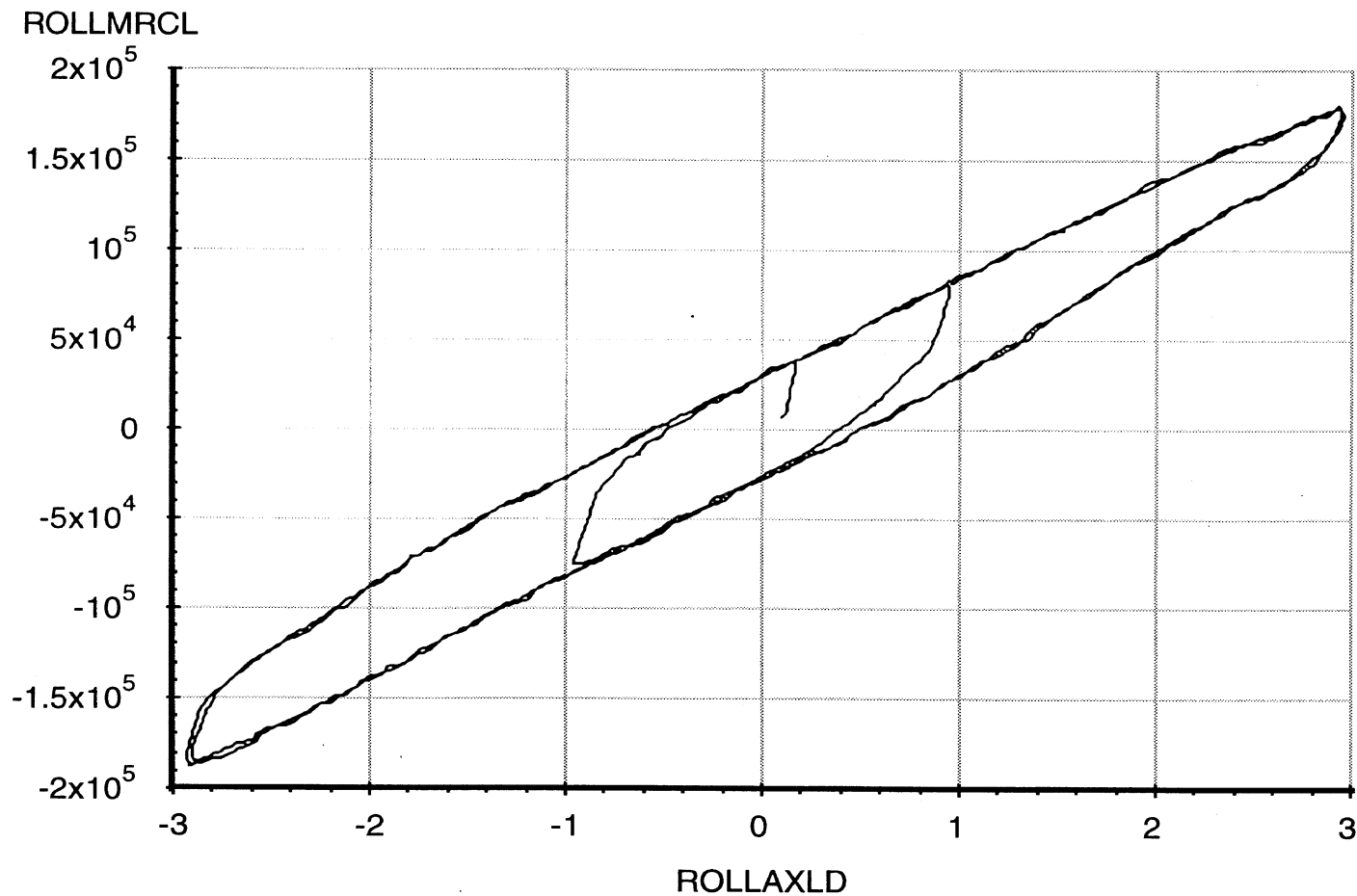

A-62

Abcissa (X): Leading axle roll angle (ROLLAXLD); degrees; right side compressed, positive.

Ordinate (Y): Leading axle roll moment about the roll center (ROLLMRCL); in-lb; right side compressed, positive.

*Note: Brakes on. Force control.

Measured by **UMTRI** for NHTSA
Volvo Tractor Model WIA64T

Tandem Drive Axle Suspension

20 Nov 95
Suspension: 4-Spring/Taper(3)

Data file: NHTSAD30.ERD

Trailing Axle Roll Rate

Suspension Load: 16000 lb.

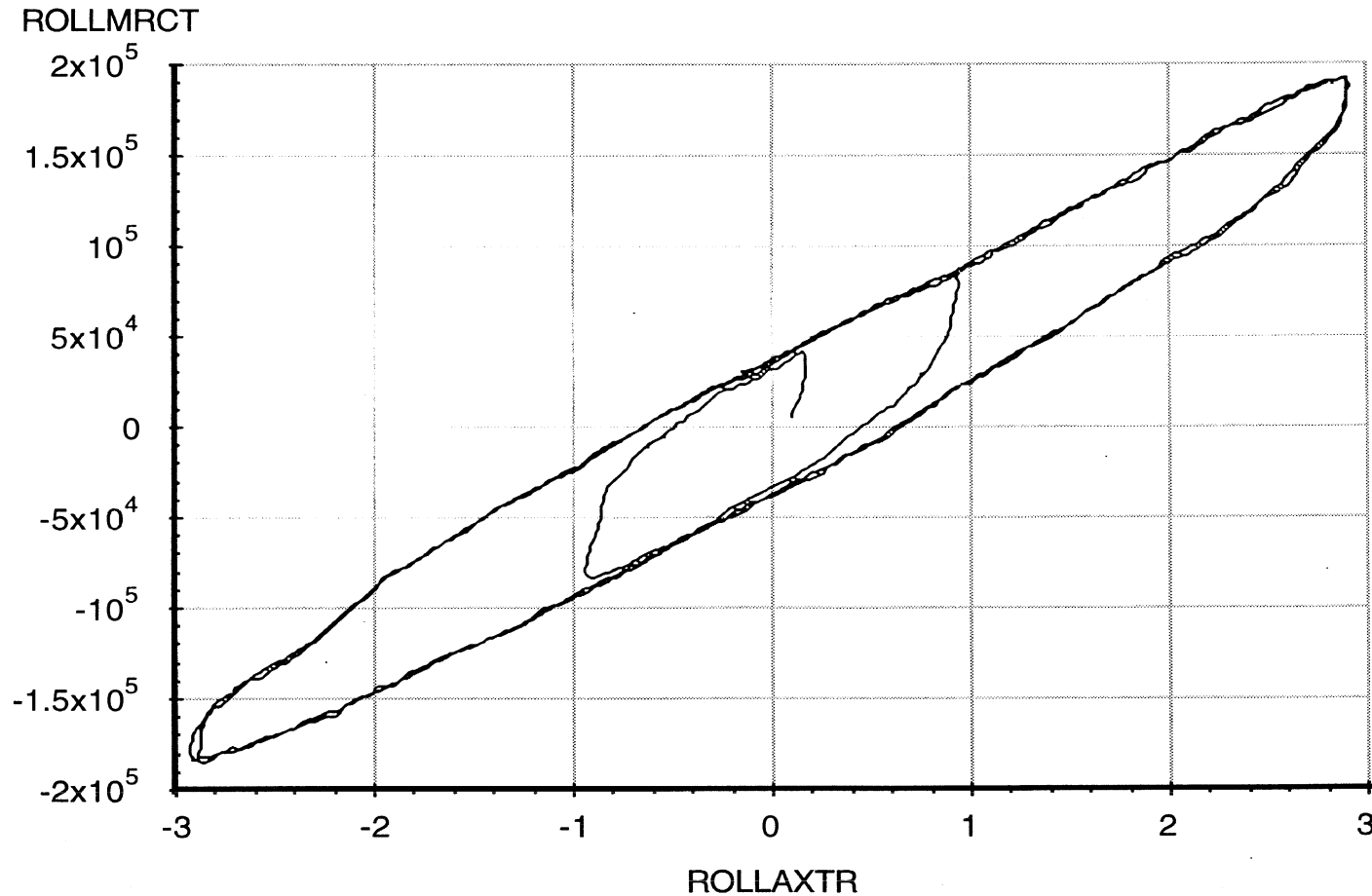

A-63

Abscissa (X): Trailing axle roll angle (ROLLAXTR); degrees; right side compressed, positive.

Ordinate (Y): Trailing axle roll moment about the roll center (ROLLMRCT); in-lb; right side compressed, positive.

*Note: Brakes on. Force control.

Measured by **UMTRI** for NHTSA
Volvo Tractor Model WIA64T

20 Nov 95
Suspension: 4-Spring/Taper(3)

Tandem Drive Axle Suspension

Data file: NHTSAD30.ERD

Leading Axle Roll Center Height

Suspension Load: 16000 lb.

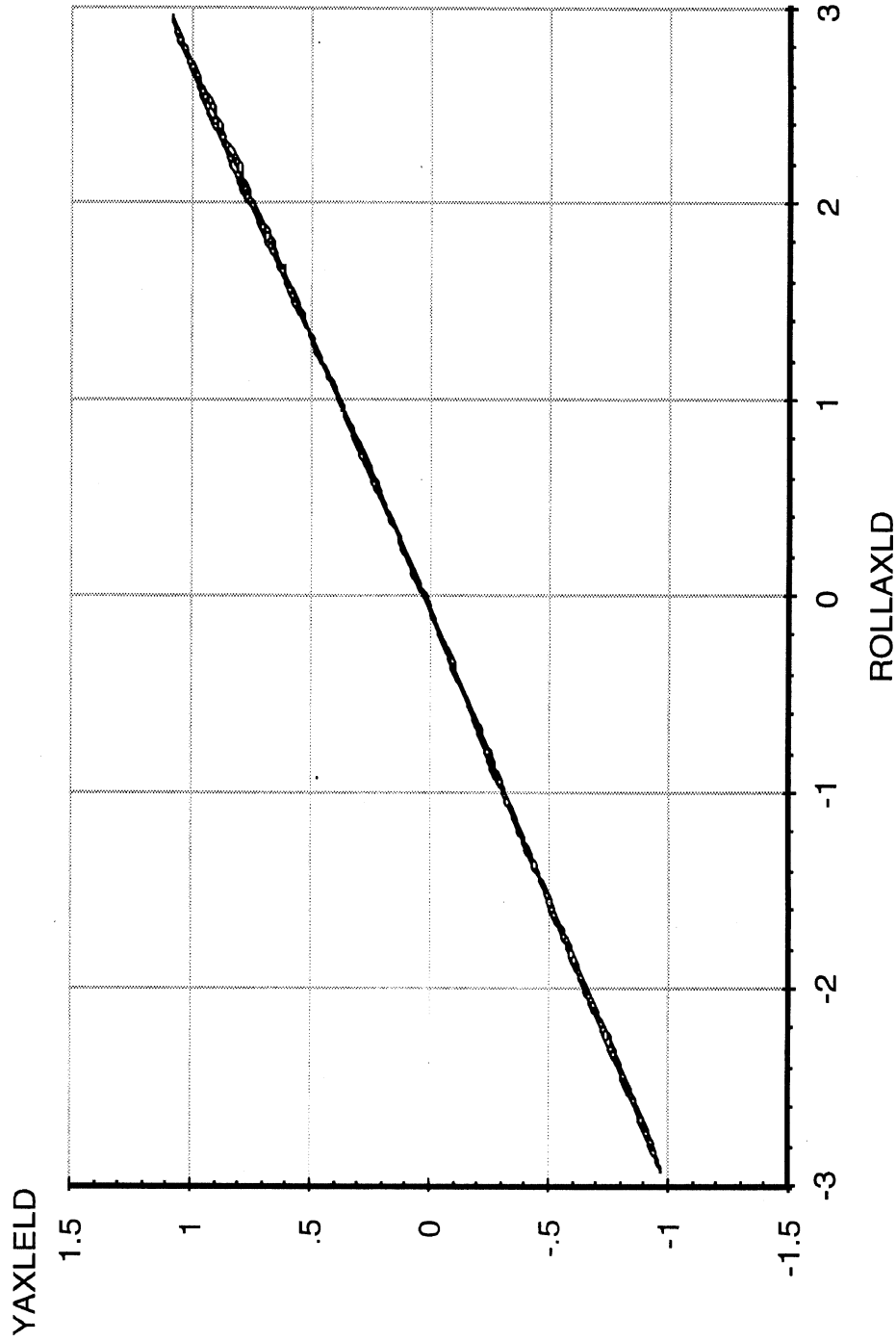

Abscissa (X): Leading axle roll angle (ROLLAXLD); degrees; right side compressed, positive.

Ordinate (Y): Leading axle reference point lateral translation (YAXLELD); inches; motion toward right, positive.

*Note: Brakes on. Force control. Reference height of 8.19 inches.

Measured by **UMTRI** for NHTSA
Volvo Tractor Model WIA64T

Data file: NHTSAD30.ERD

Tandem Drive Axle Suspension
Trailing Axle Roll Center Height

20 Nov 95
Suspension: 4-Spring/Taper(3)

Suspension Load: 16000 lb.

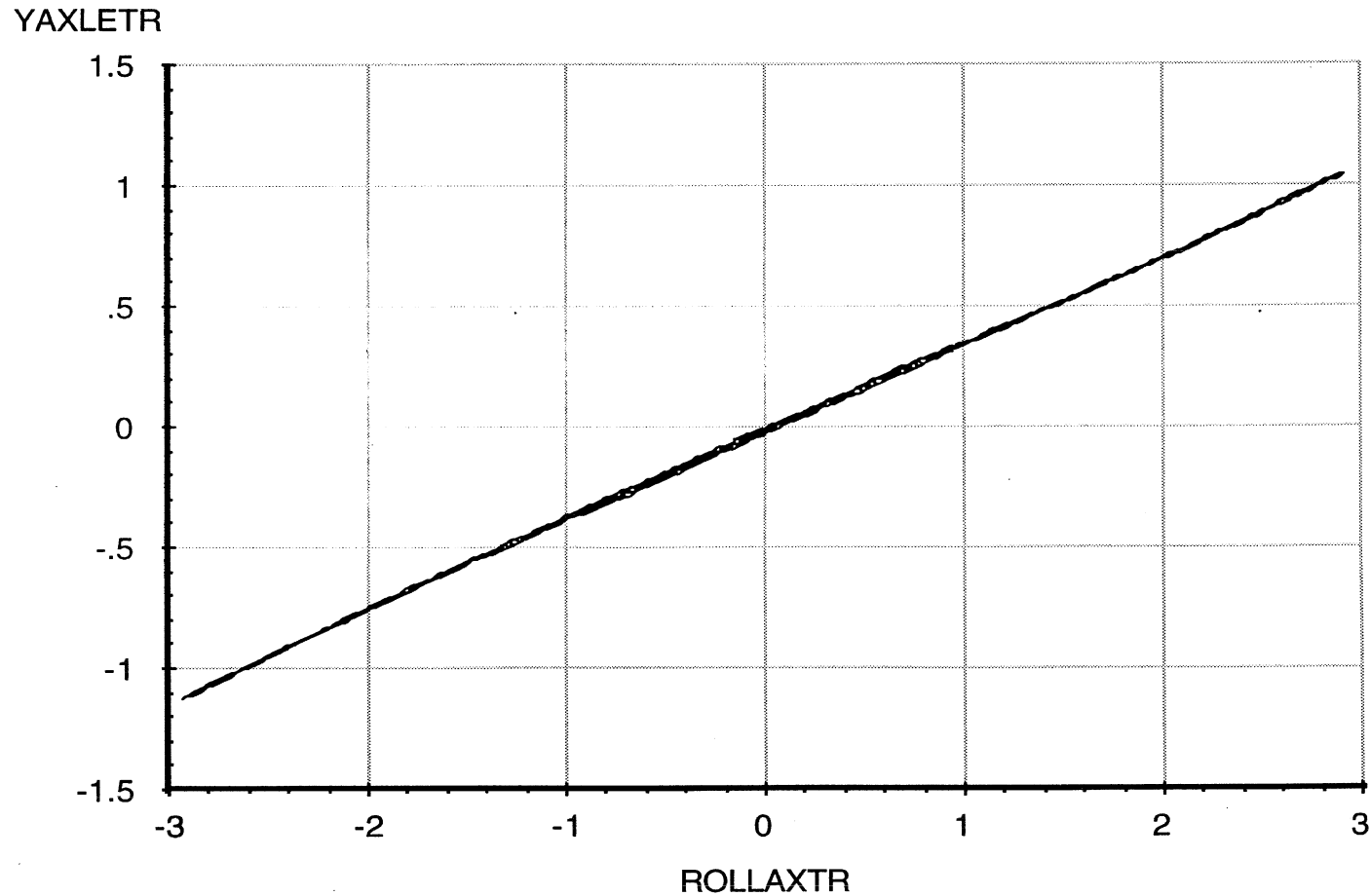

A-65

Abscissa (X): Trailing axle roll angle (ROLLAXTR); degrees; right side compressed, positive.

Ordinate (Y): Trailing axle reference point lateral translation (YAXLETR); inches; motion toward right, positive.

*Note: Brakes on. Force control. Reference height of 8.31 inches.

Measured by **UMTRI** for NHTSA
Volvo Tractor Model WIA64T

Tandem Drive Axle Suspension

20 Nov 95

Suspension: 4-Spring/Taper(3)

Data file: NHTSAD30.ERD

Leading Axle Roll Steer

Suspension Load: 16000 lb.

SALDA

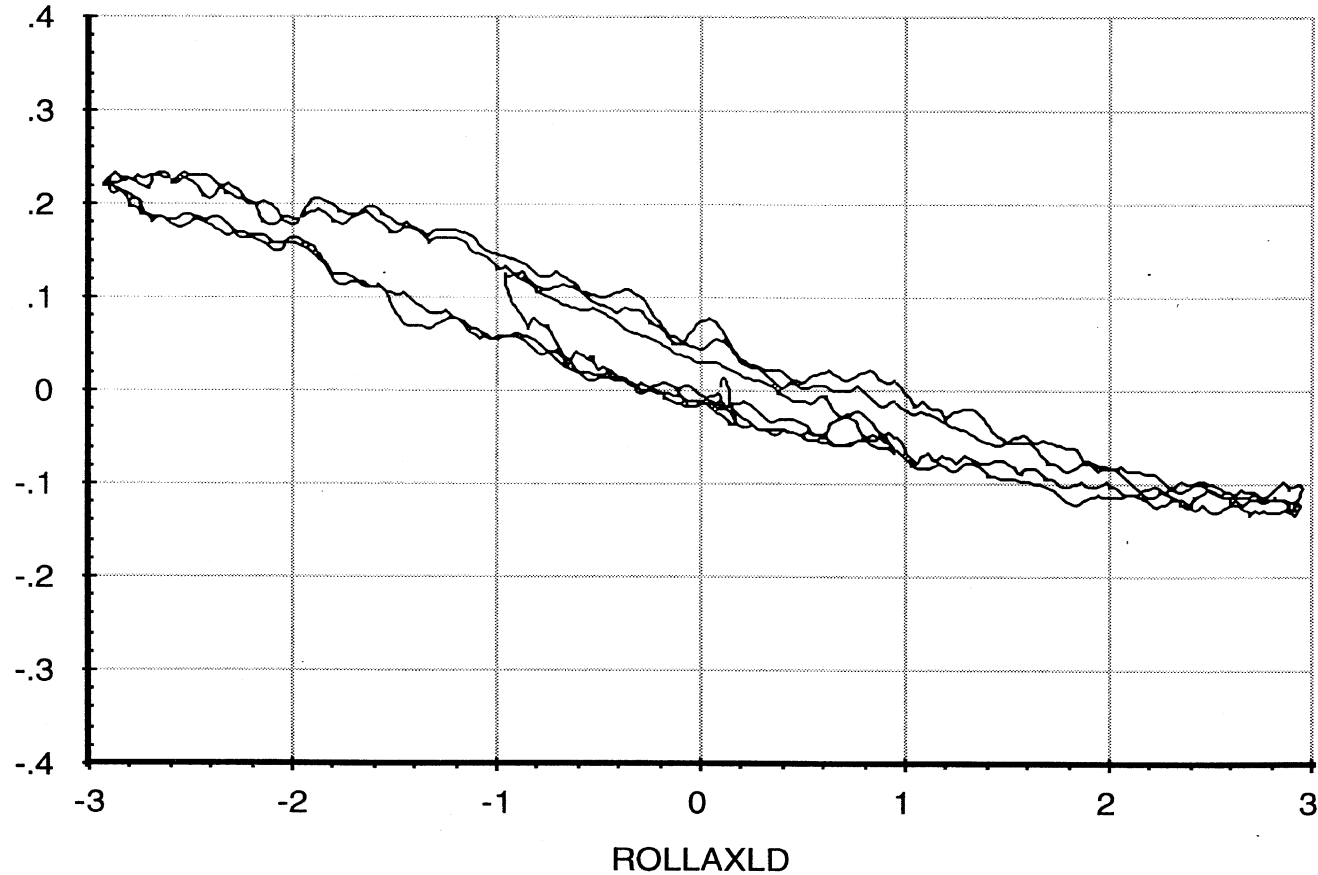

A-66

Abcissa (X): Leading axle roll angle (ROLLAXLD); degrees; right side compressed, positive.

Ordinate (Y): Average leading axle average steer angle (SALDA); degrees; steer toward right, positive.

*Note: Brakes on. Force control.

Measured by **UMTRI** for NHTSA
Volvo Tractor Model WIA64T

20 Nov 95
Suspension: 4-Spring/Taper(3)

Tandem Drive Axle Suspension

Data file: NHTSAD30.ERD

Trailing Axle Roll Steer

Suspension Load: 16000 lb.

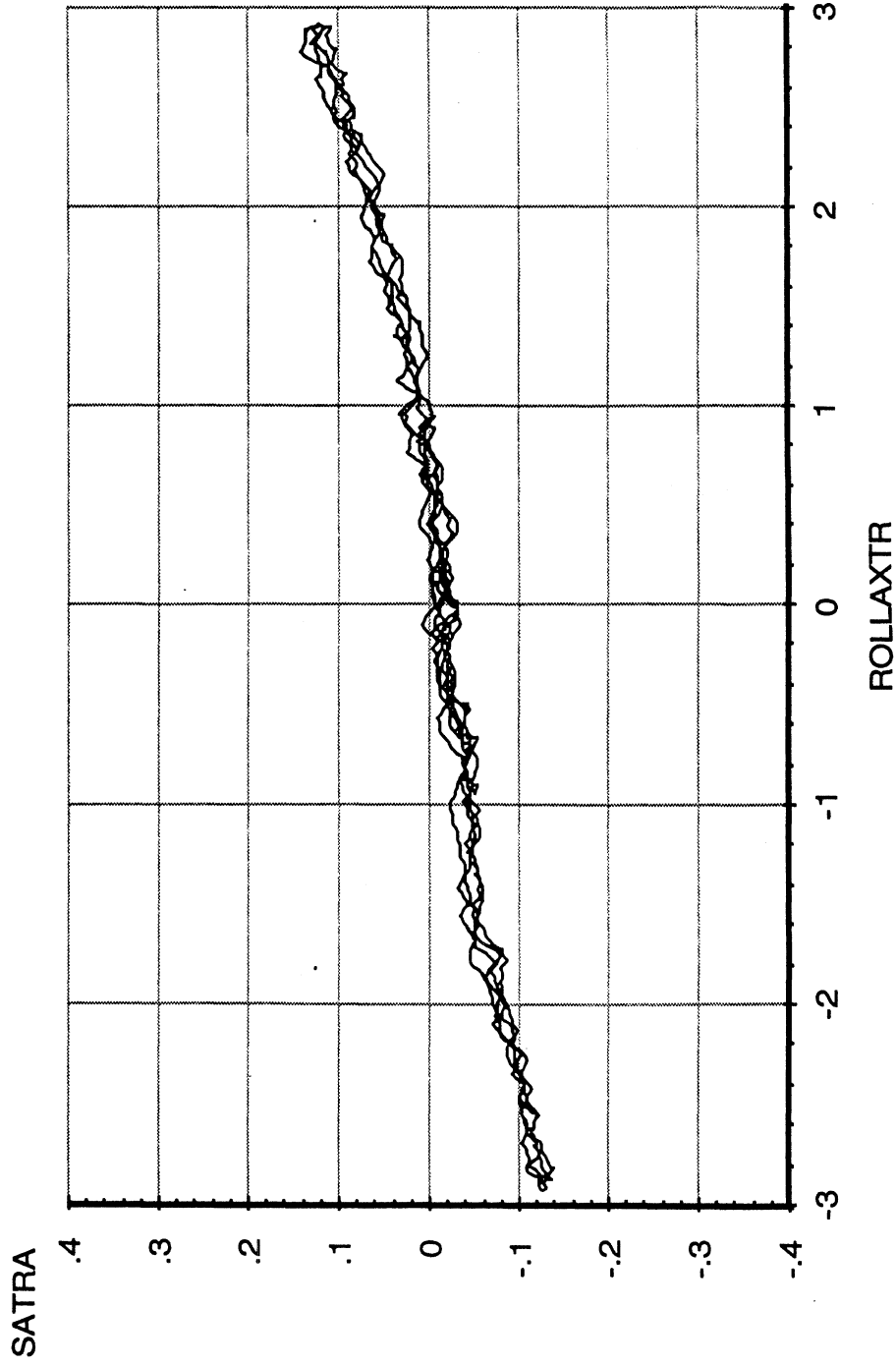

Abscissa (X): Trailing axle roll angle (ROLLAXTR); degrees; right side compressed, positive.
Ordinate (Y): Average trailing axle average steer angle (SATRA); degrees; steer toward right, positive.

*Note: Brakes on. Force control.

Measured by **UMTRI** for NHTSA
Volvo Tractor Model WIA64T

Tandem Drive Axle Suspension

20 Nov 95
Suspension: 4-Spring/Taper(3)

Data file: NHTSAD31.ERD

Leading Axle Lateral Force Compliance

Suspension Load: 16000 lb.

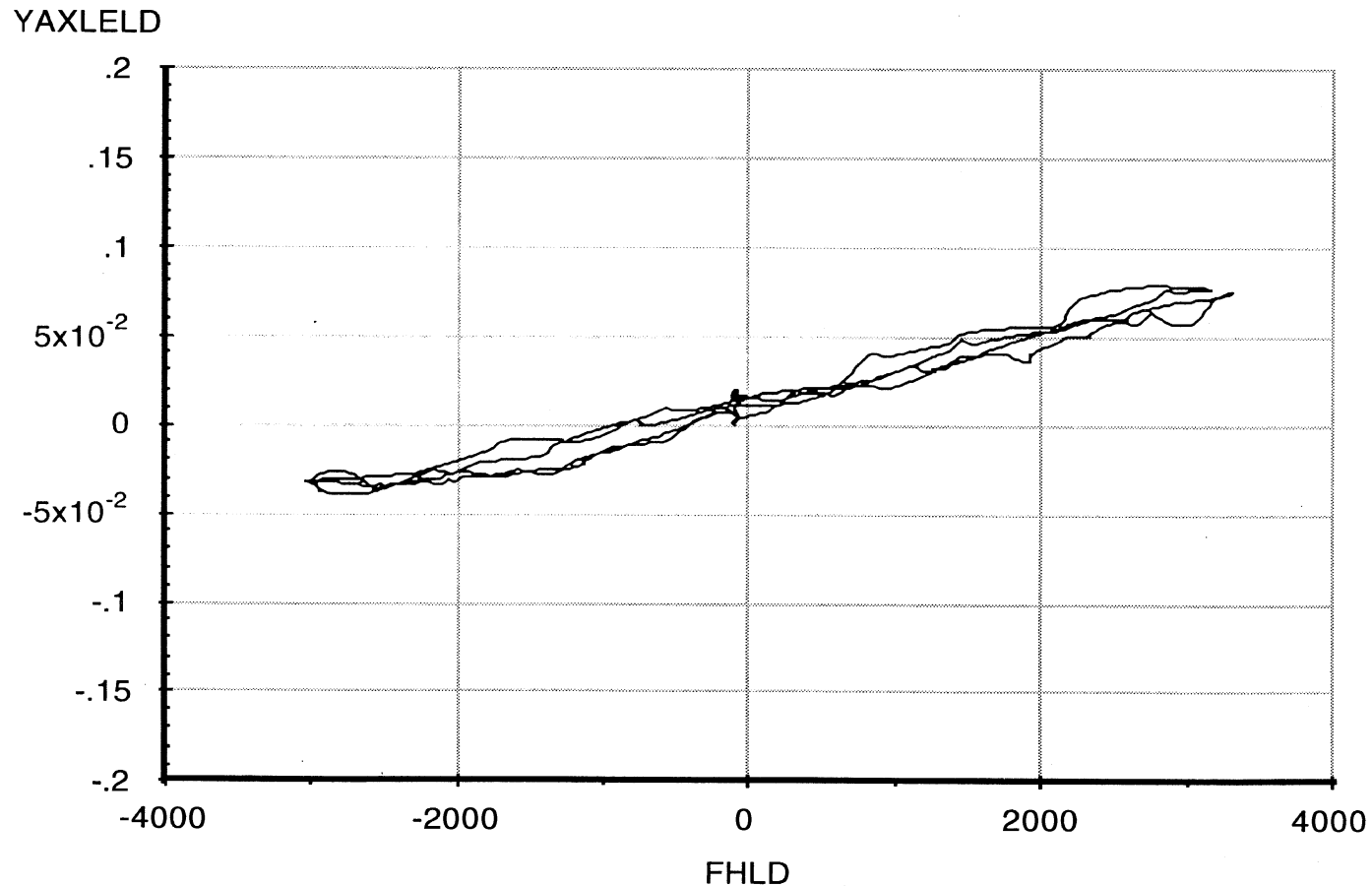

A-68

Abscissa (X): Total leading axle lateral force (FHLD); pounds per wheel; applied to all four wheel sets simultaneously; force applied toward right, positive.

Ordinate (Y): Leading axle lateral translation (YAXLELD); inches; motion toward right, positive.

*Note: Brakes on. Position control.

Measured by **UMTRI** for NHTSA
Volvo Tractor Model WIA64T

Tandem Drive Axle Suspension

20 Nov 95
Suspension: 4-Spring/Taper(3)

Data file: NHTSAD31.ERD

Trailing Axle Lateral Force Compliance

Suspension Load: 16000 lb.

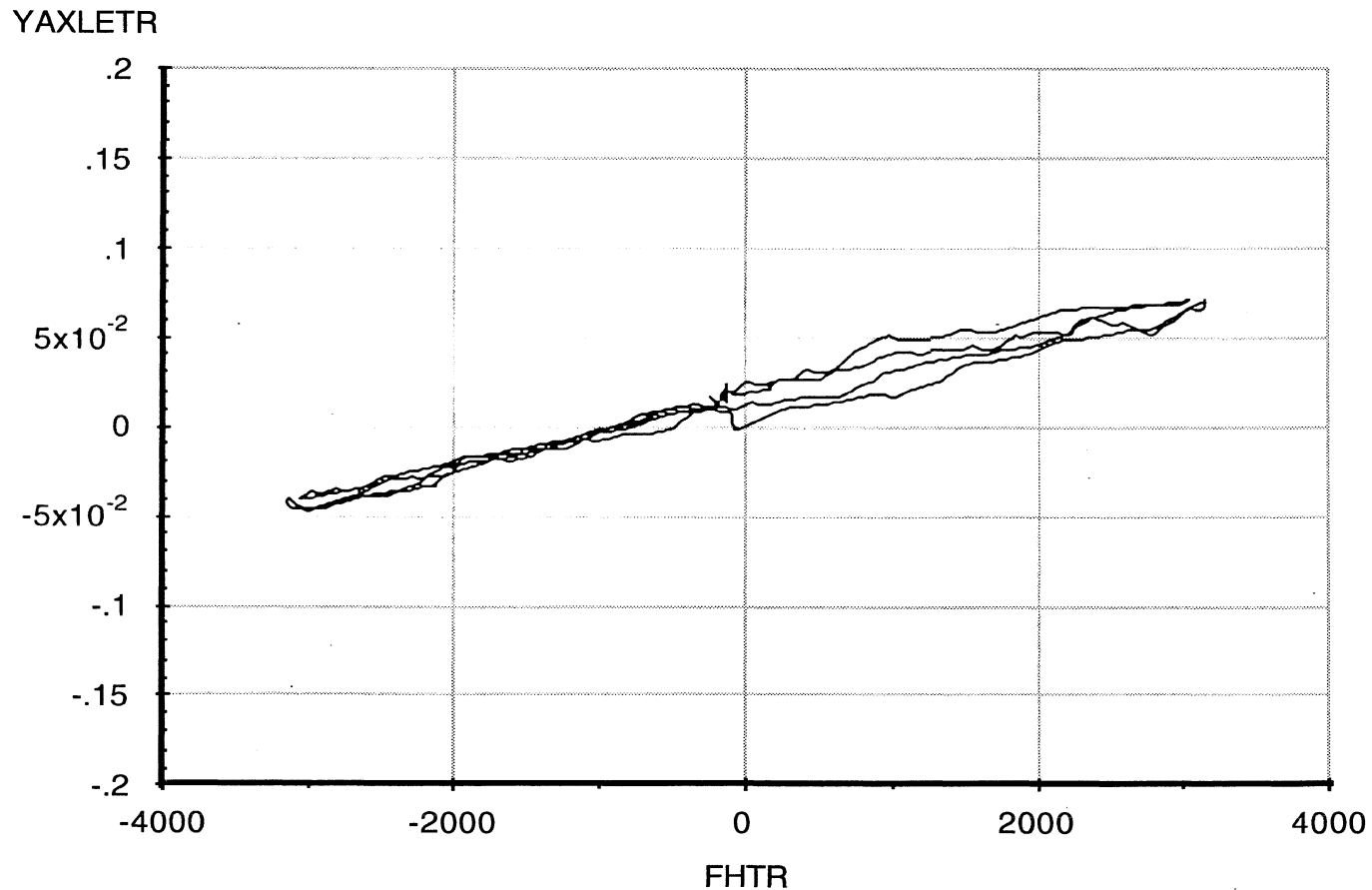

A-69

Abscissa (X): Total trailing axle lateral force (FHTR); pounds per wheel; applied to all four wheel sets simultaneously; force applied toward right, positive.

Ordinate (Y): Trailing axle lateral translation (YAXLETR); inches; motion toward right, positive.

*Note: Brakes on. Position control.

Measured by **UMTRI** for NHTSA
Volvo Tractor Model WIA64T

Data file: NHTSAD31.ERD

Tandem Drive Axle Suspension
Leading Axle Lateral Force Steer

20 Nov 95
Suspension: 4-Spring/Taper(3)

Suspension Load: 16000 lb.

A-70

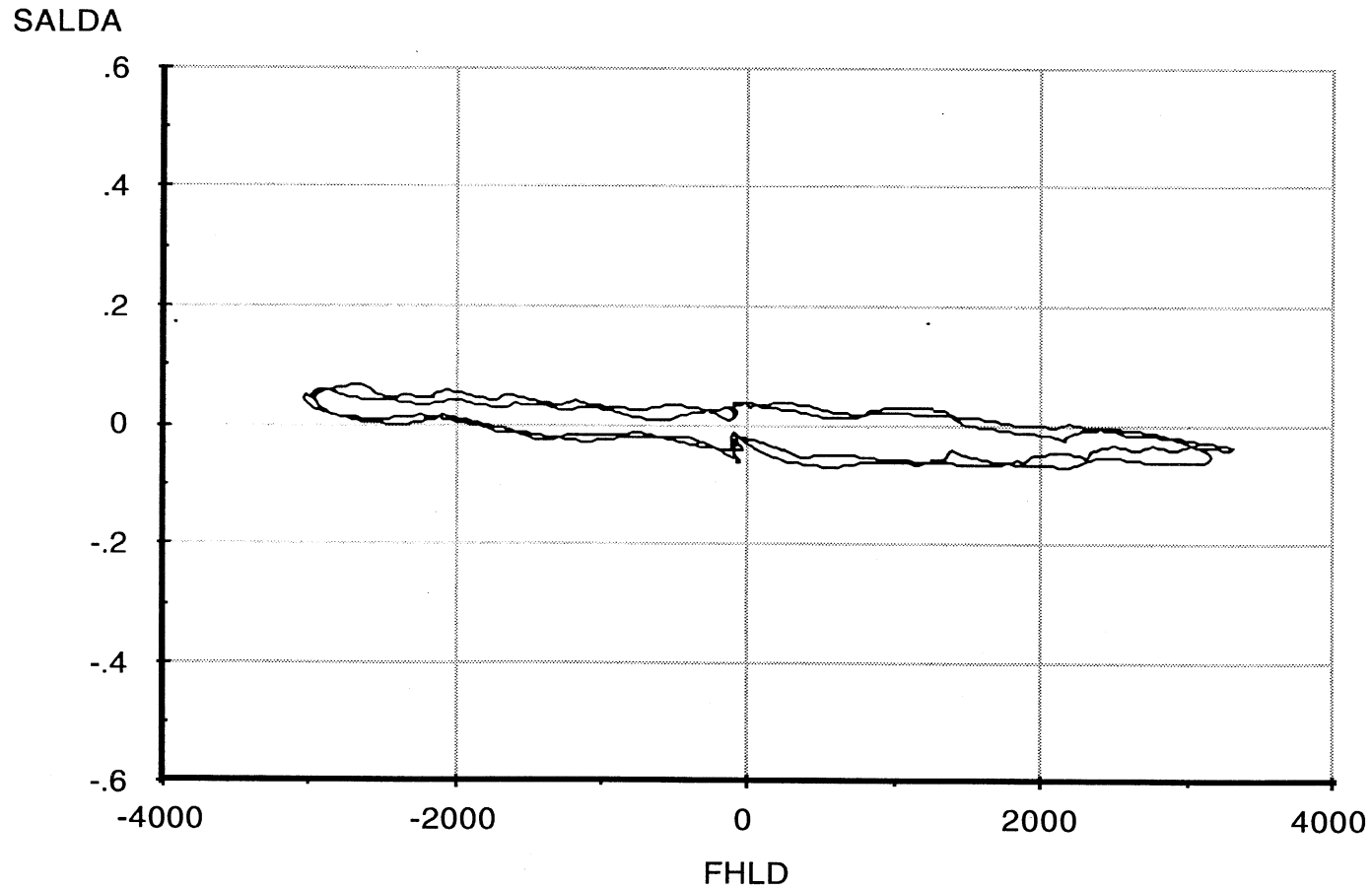

Abcissa (X): Total leading axle lateral force (FHLD); pounds per wheel; applied to all four wheel sets simultaneously; force applied toward right, positive.

Ordinate (Y): Average leading axle steer angle (SALDA); degrees; steer toward right, positive.

*Note: Brakes on. Position control.

Measured by **UMTRI** for NHTSA
Volvo Tractor Model WIA64T

Data file: NHTSAD31.ERD

Tandem Drive Axle Suspension
Trailing Axle Lateral Force Steer

20 Nov 95
Suspension: 4-Spring/Taper(3)

Suspension Load: 16000 lb.

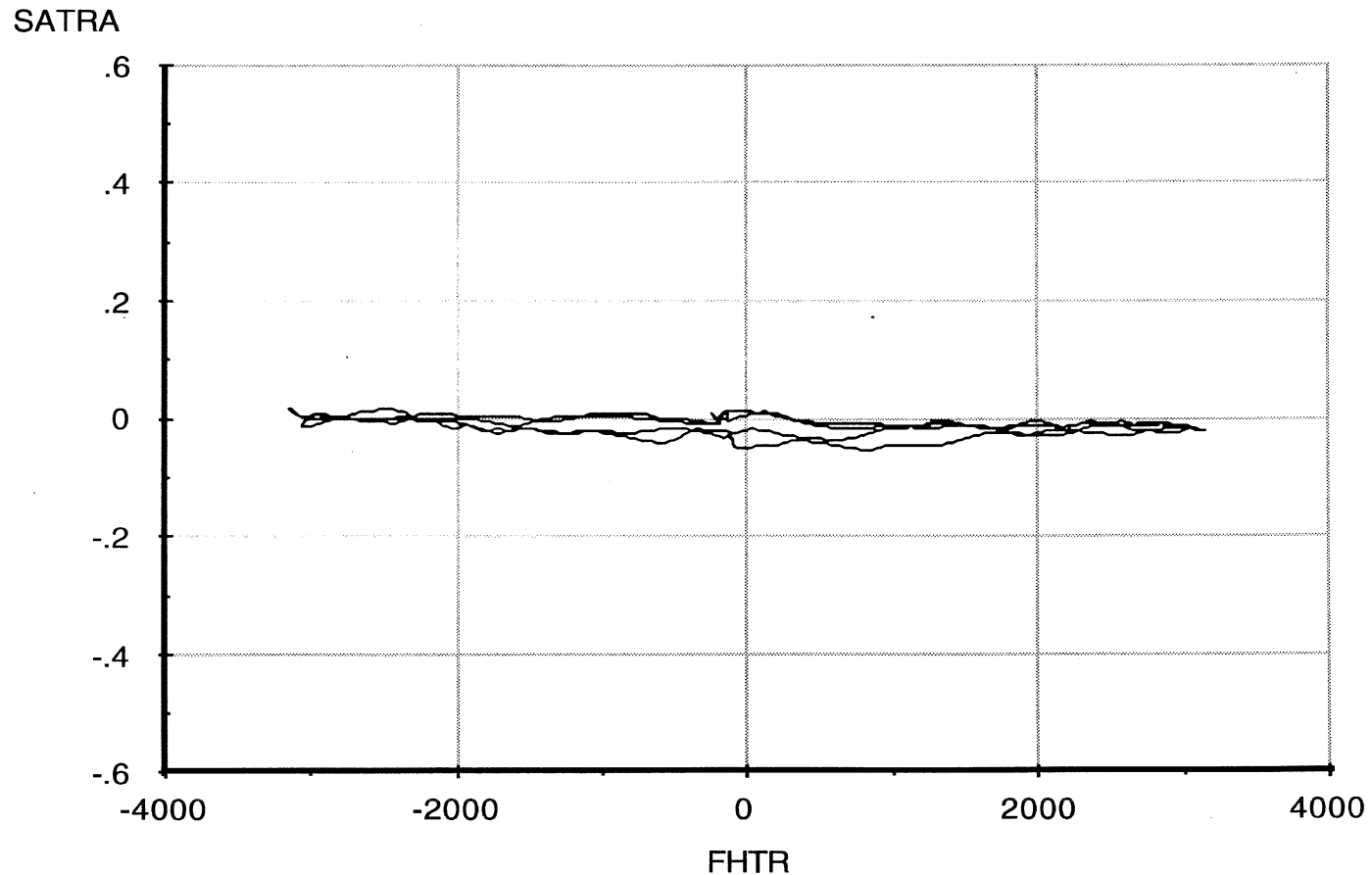

A-71

Abscissa (X): Total trailing axle lateral force (FHTR); pounds per wheel; applied to all four wheel sets simultaneously; force applied toward right, positive.

Ordinate (Y): Average trailing axle steer angle (SATRA); degrees; steer toward right, positive.

*Note: Brakes on. Position control.

Measured by **UMTRI** for NHTSA
Volvo Tractor Model WIA64T

Tandem Drive Axle Suspension

20 Nov 95
Suspension: 4-Spring/Taper(3)

Data file: NHTSAD32.ERD **Leading Axle Aligning Moment Compliance Steer**

Suspension Load: 16000 lb.

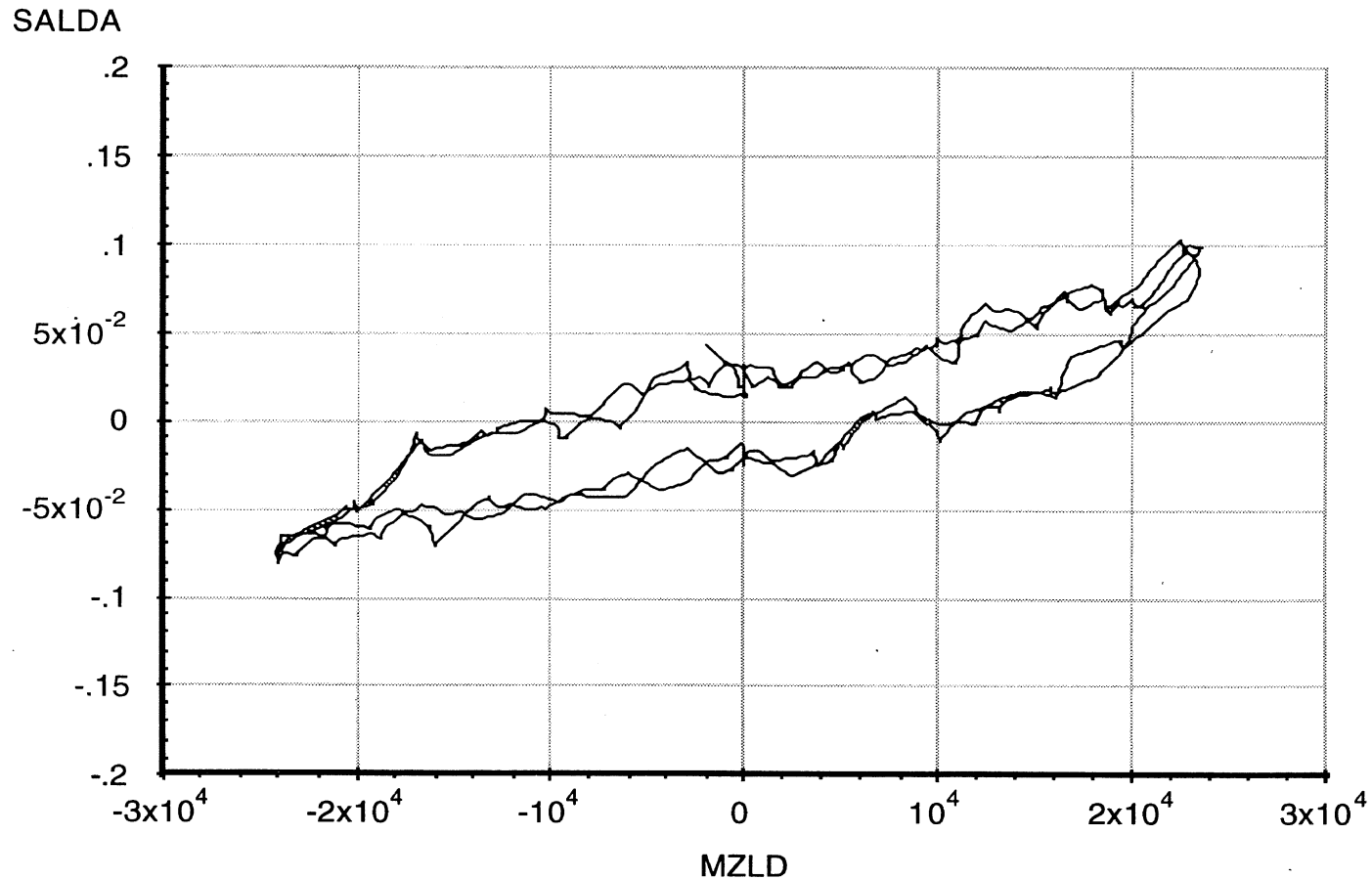

A-72

Abcissa (X): Total leading axle aligning moment (MZLD); in-lb per axle; applied to both axles simultaneously; downward (right hand rule) moment vector, positive.

Ordinate (Y): Average leading axle steer angle (SALDA); degrees; steer toward right, positive.

*Note: Brakes on. Position control.

Measured by **UMTRI** for NHTSA
Volvo Tractor Model WIA64T

Tandem Drive Axle Suspension

20 Nov 95
Suspension: 4-Spring/Taper(3)

Data file: NHTSAD32.ERD **Trailing Axle Aligning Moment Compliance Steer**

Suspension Load: 16000 lb.

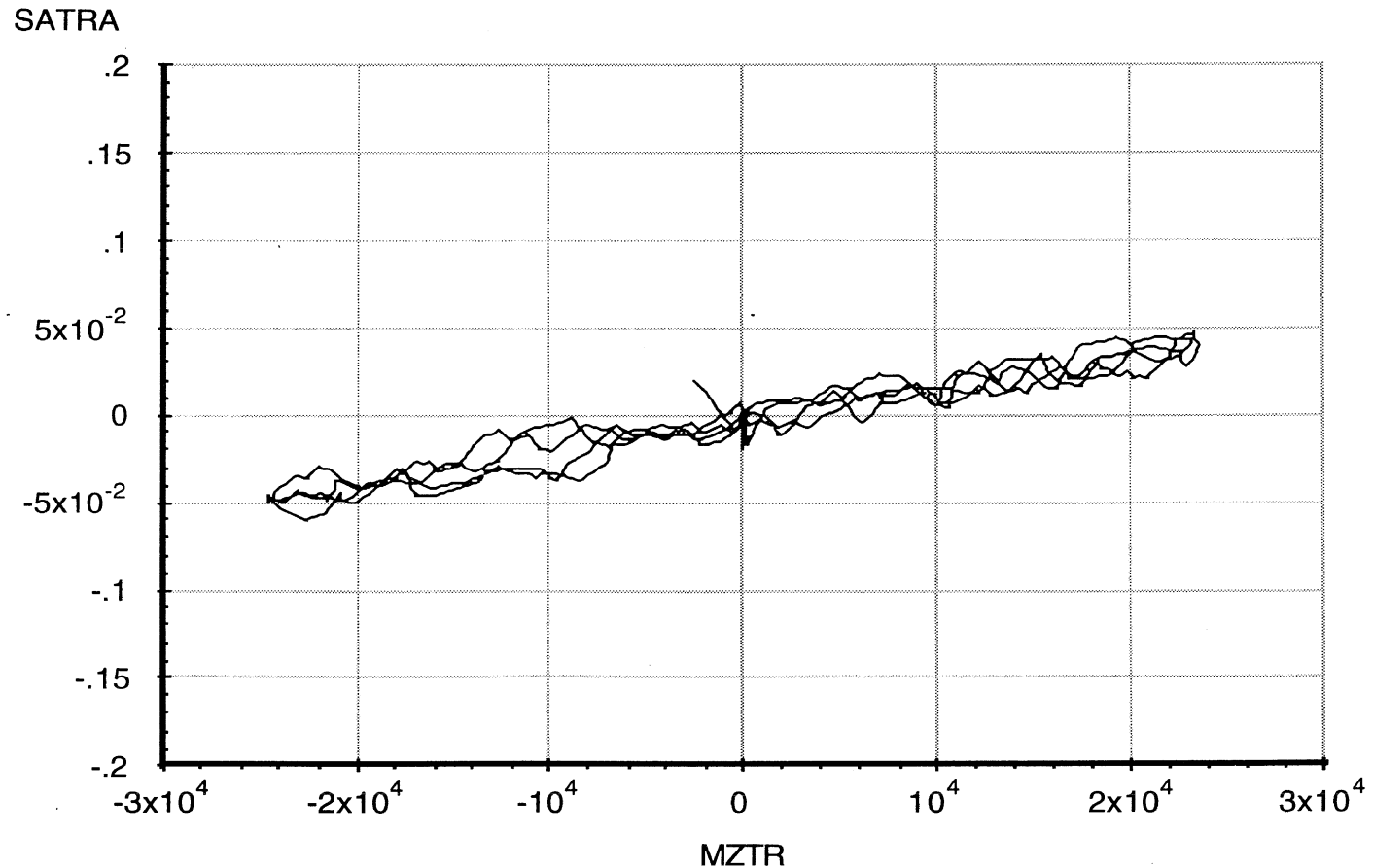

A-73

Abcissa (X): Total trailing axle aligning moment (MZTR); in-lb per axle; applied to both axles simultaneously; downward (right hand rule) moment vector, positive.

Ordinate (Y): Average trailing axle steer angle (SATRA); degrees; steer toward right, positive.

*Note: Brakes on. Position control.

Measured by **UMTRI** for NHTSA
Volvo Tractor Model WIA64T

20 Nov 95
Suspension: 4-Spring/Taper(3)

Tandem Drive Axle Suspension

Suspension Load: 16000 lb.

Inter-Axle Load Transfer Due to Braking

Data file: NHTSAD33.ERD
FZ

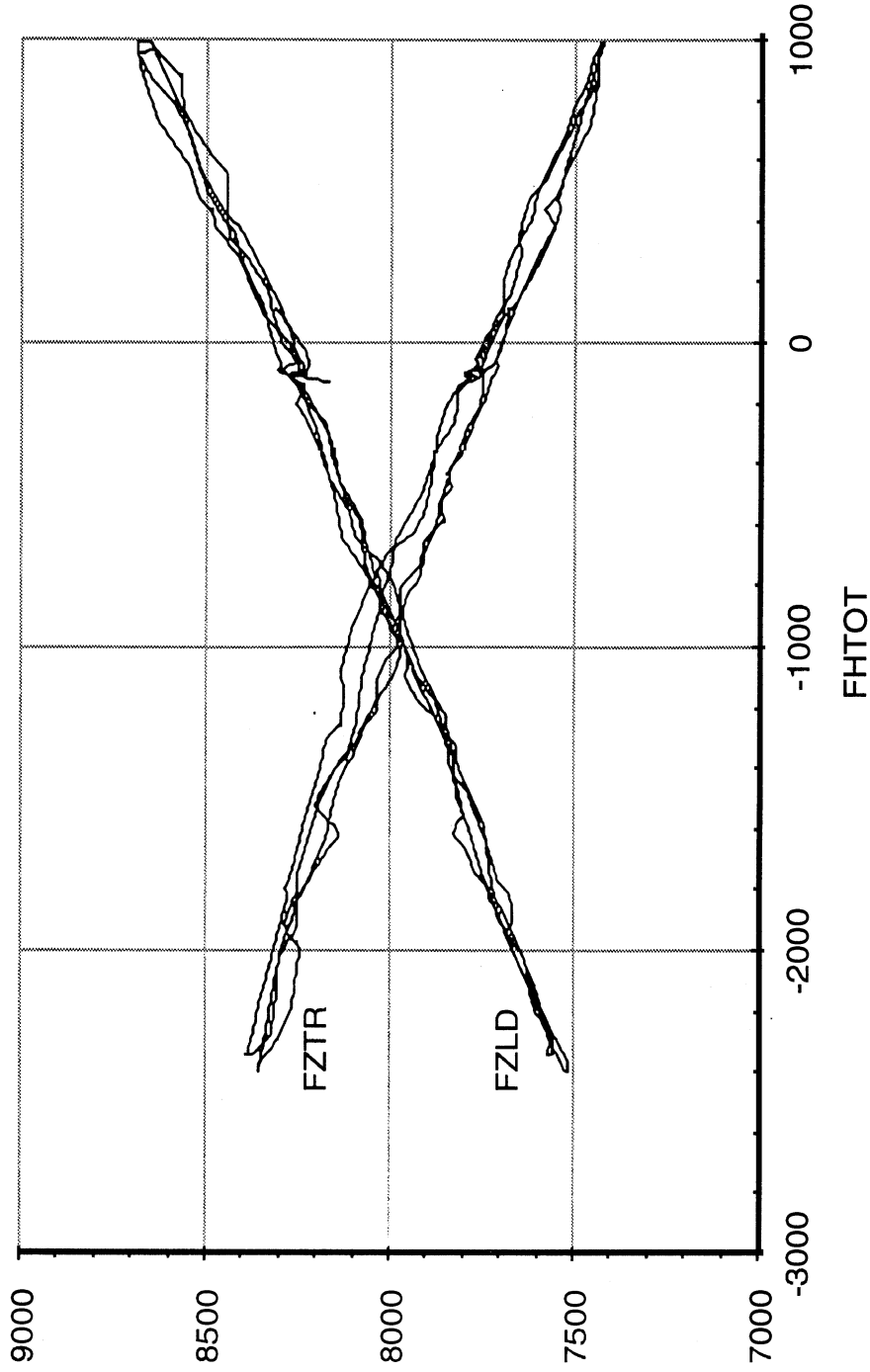

Abscissa (X): Total longitudinal force (FHTOT); pounds; applied to all wheels simultaneously; force toward front, positive.
Ordinate (Y): Total leading axle vertical wheel load (FZLD); pounds; spring compression, positive.
Total trailing axle vertical wheel load (FZTR); pounds; spring compression, positive.

*Note: Brakes on. Force control.

Measured by **UMTRI** for NHTSA
Mounted on a bare frame

Data file: NHTSAT01.ERD

Tandem Trailer Axle Suspension
Average Vertical Spring Rate

7 Aug 95
Suspension: 4-Spring/Taper(1)

A-75

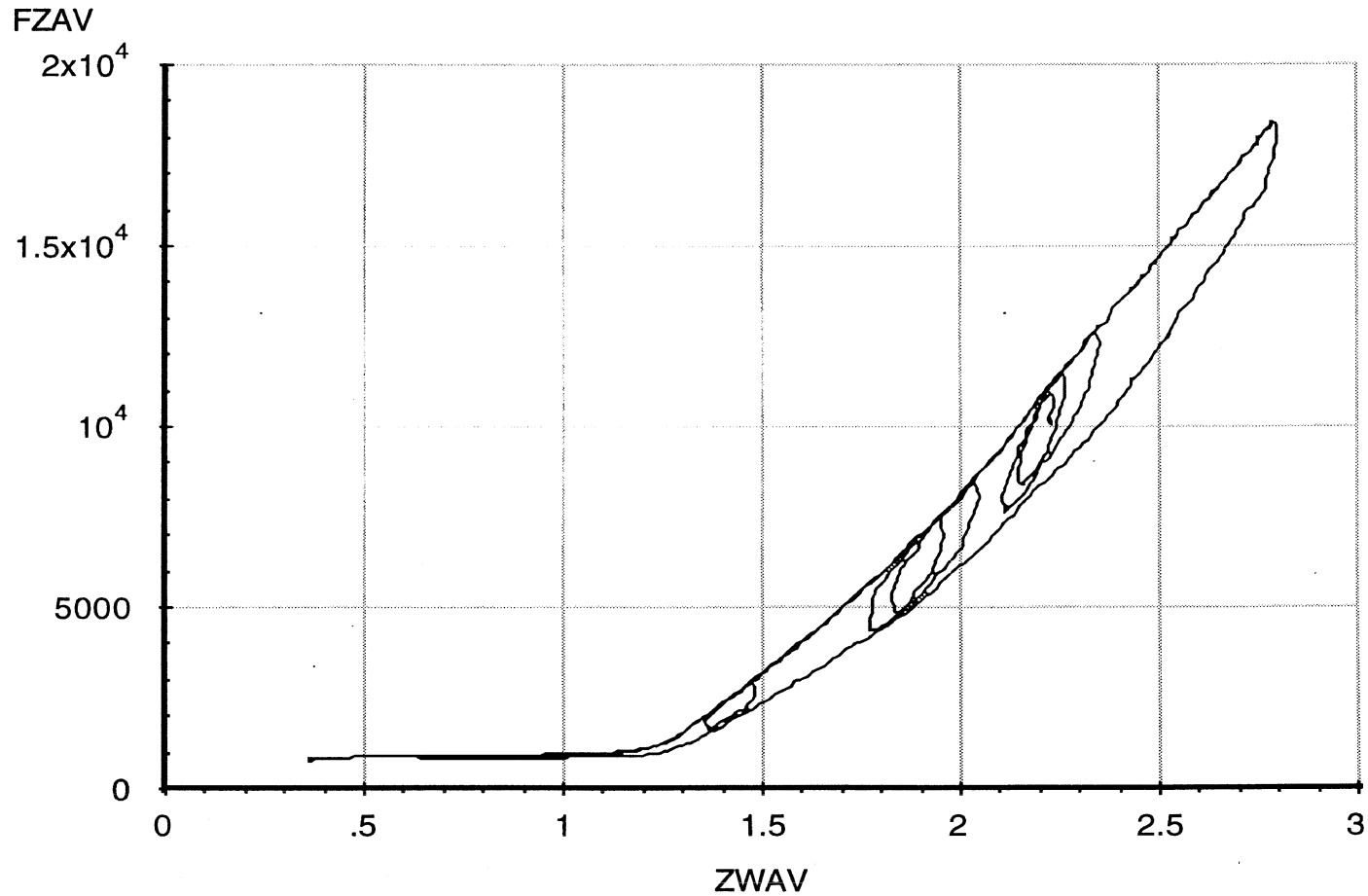

Abscissa (X): Average vertical wheel displacement (ZWAV); inches; spring compression, positive.

Ordinate (Y): Average vertical wheel load (FZAV); pounds; spring compression, positive.

*Note: Brakes on. Force control.

Measured by **UMTRI** for NHTSA
Mounted on a bare frame

Data file: NHTSAT01.ERD

Tandem Trailer Axle Suspension
Leading Axle Vertical Spring Rate

7 Aug 95
Suspension: 4-Spring/Taper(1)

A-76

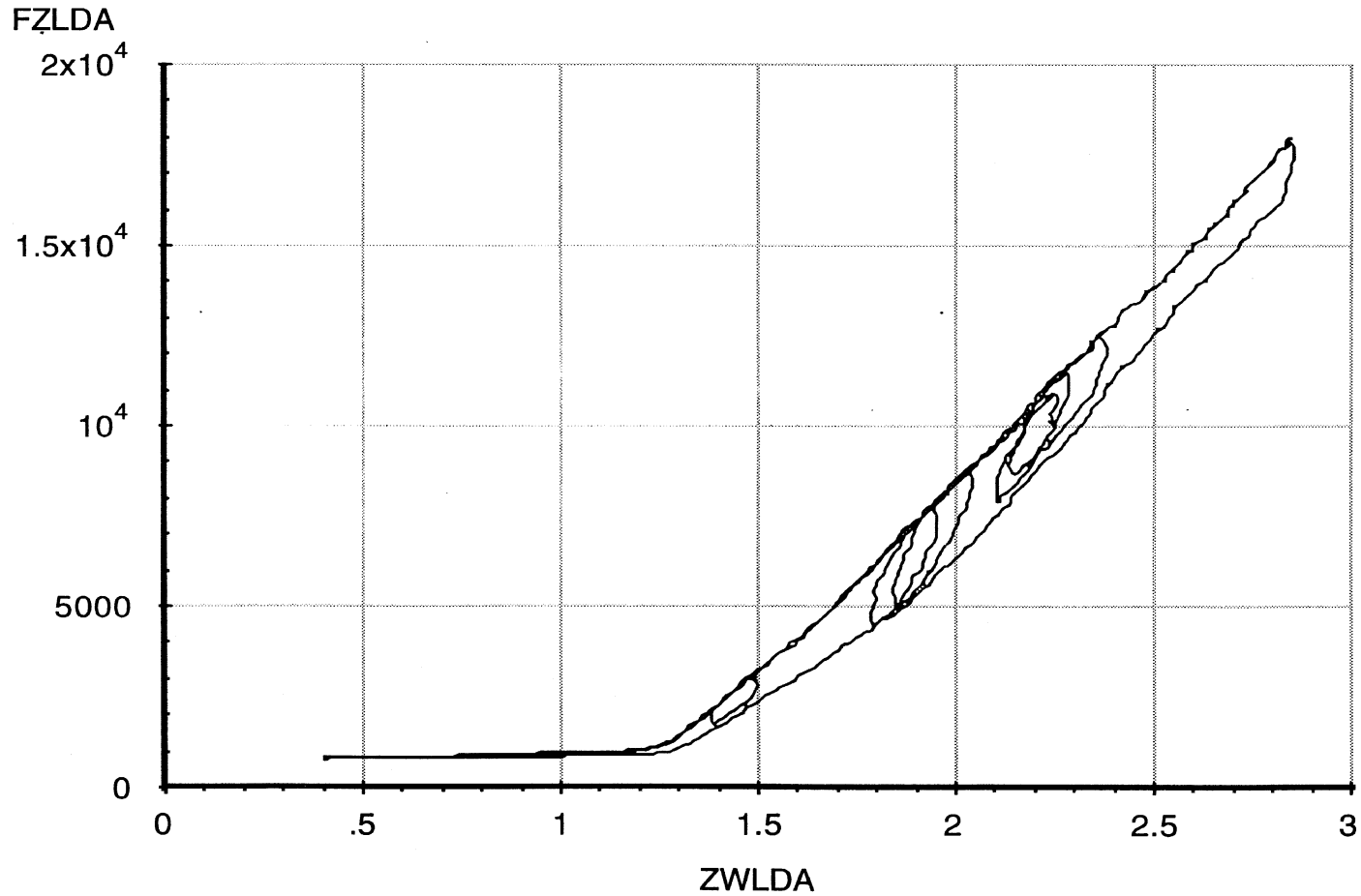

Abscissa (X): Average leading axle vertical wheel displacement (ZWLDA); inches; spring compression, positive.

Ordinate (Y): Average leading axle vertical wheel load (FZLDA); pounds; spring compression, positive.

*Note: Brakes on. Force control.

Measured by **UMTRI** for NHTSA
Mounted on a bare frame

Data file: NHTSAT01.ERD

Tandem Trailer Axle Suspension
Trailing Axle Vertical Spring Rate

7 Aug 95
Suspension: 4-Spring/Taper(1)

A-77

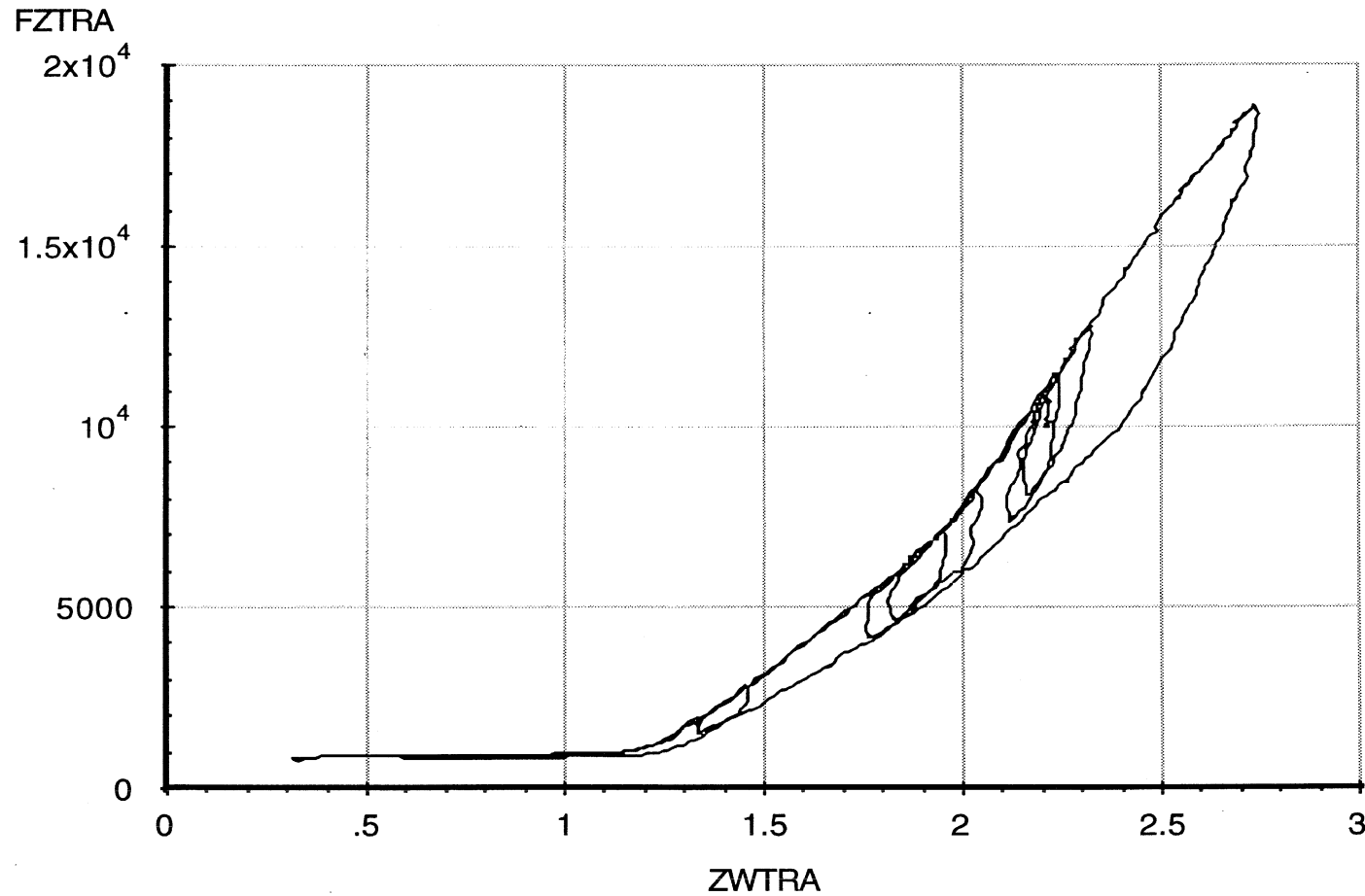

Abscissa (X): Average trailing axle vertical wheel displacement (ZWTRA); inches; spring compression, positive.

Ordinate (Y): Average trailing axle vertical wheel load (FZTRA); pounds; spring compression, positive.

*Note: Brakes on. Force control.

Measured by **UMTRI** for NHTSA
Mounted on a bare frame

Data file: NHTSAT01.ERD

Tandem Trailer Axle Suspension
Inter-Axle Load Distribution

7 Aug 95
Suspension: 4-Spring/Taper(1)

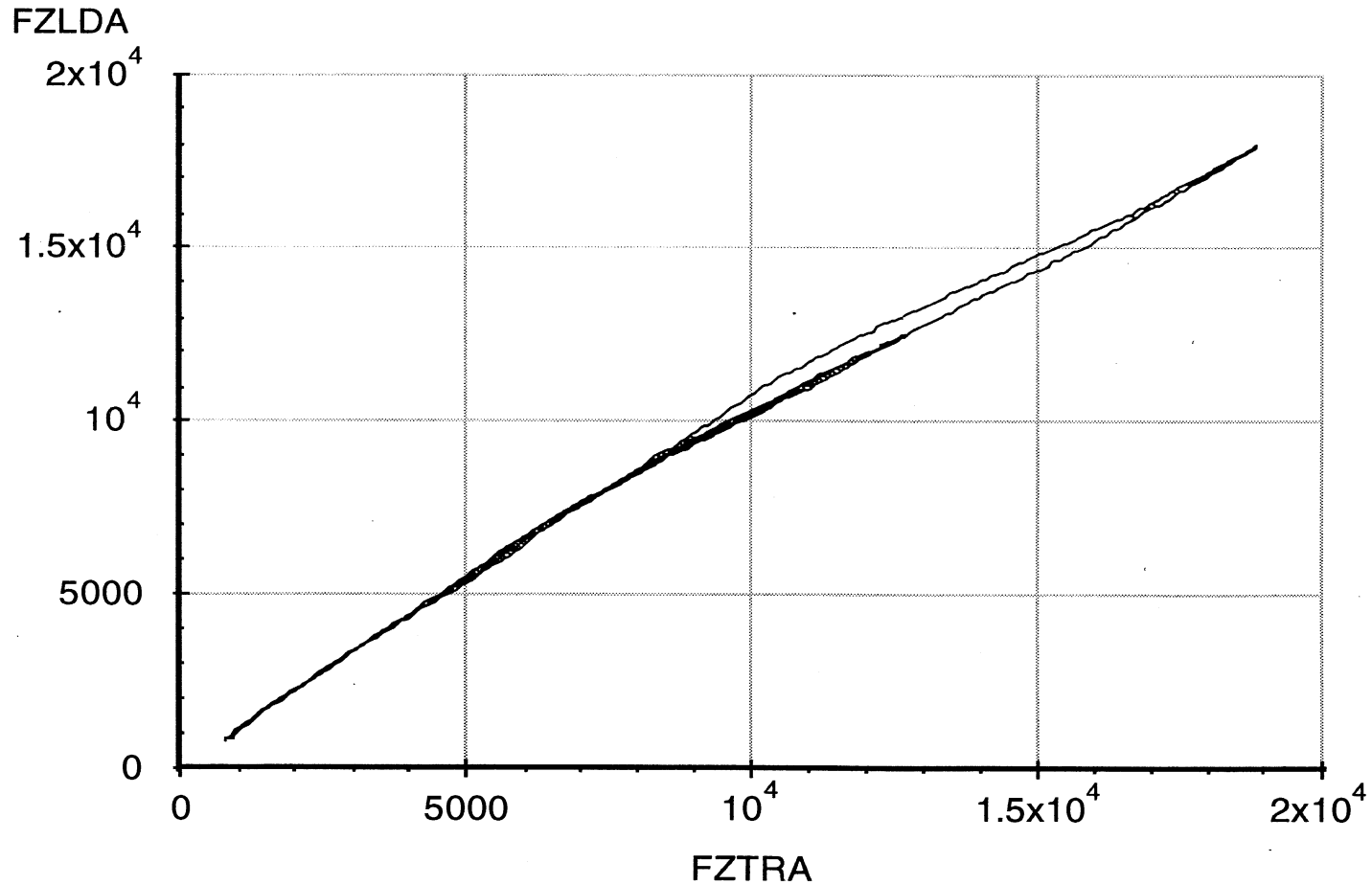

A-78

Abcissa (X): Average trailing axle vertical wheel load (FZTRA); pounds; spring compression, positive.

Ordinate (Y): Average leading axle vertical wheel load (FZLDA); pounds; spring compression, positive.

*Note: Brakes on. Force control.

Measured by **UMTRI** for NHTSA
Mounted on a bare frame

Tandem Trailer Axle Suspension

7 Aug 95
Suspension: 4-Spring/Taper(1)

Data file: NHTSAT30.ERD

Leading Axle Roll Rate

Suspension Load: 40000 lb.

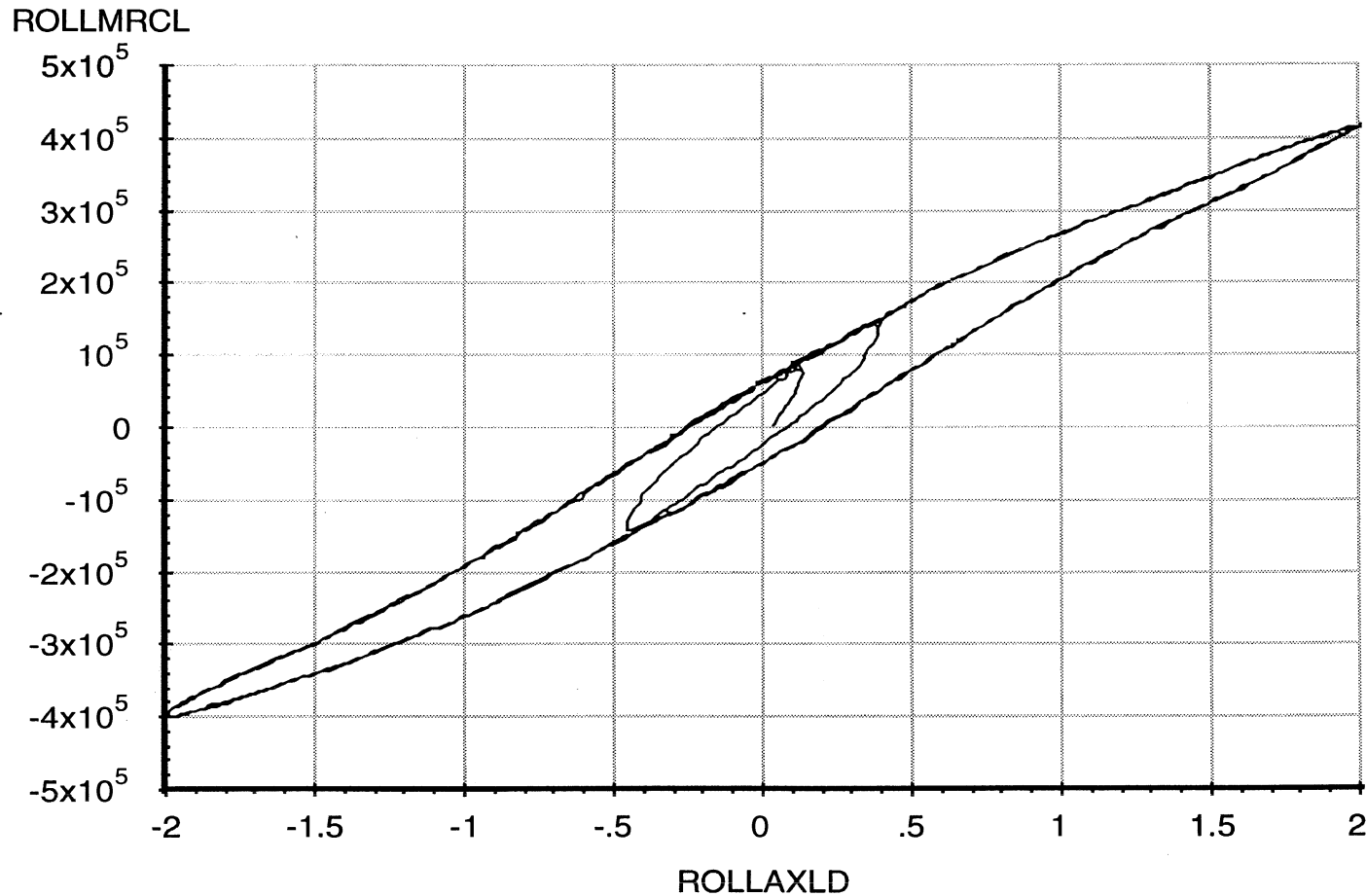

A-79

Abscissa (X): Leading axle roll angle (ROLLAXLD); degrees; right side compressed, positive.

Ordinate (Y): Leading axle roll moment about the roll center (ROLLMRCL); in-lb; right side compressed, positive.

*Note: Brakes on. Force control.

Measured by **UMTRI** for NHTSA
Mounted on a bare frame

Data file: NHTSAT30.ERD

Tandem Trailer Axle Suspension

Trailing Axle Roll Rate

7 Aug 95

Suspension: 4-Spring/Taper(1)

Suspension Load: 40000 lb.

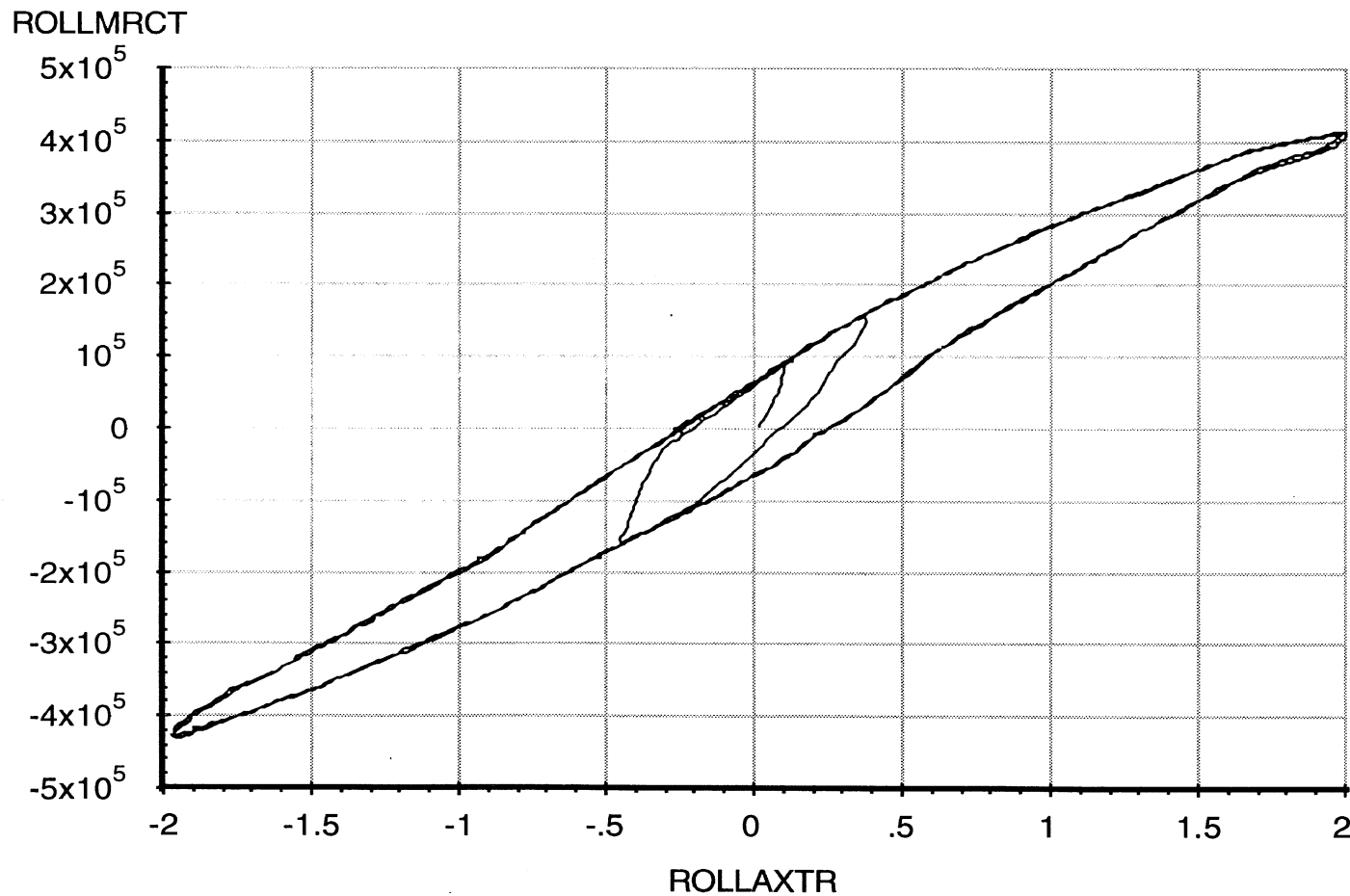

A-80

Abscissa (X): Trailing axle roll angle (ROLLAXTR); degrees; right side compressed, positive.

Ordinate (Y): Trailing axle roll moment about the roll center (ROLLMRCT); in-lb; right side compressed, positive.

*Note: Brakes on. Force control.

Measured by **UMTRI** for NHTSA
Mounted on a bare frame

Data file: NHTSAT30.ERD

Tandem Trailer Axle Suspension
Leading Axle Roll Center Height

7 Aug 95
Suspension: 4-Spring/Taper(1)

Suspension Load: 40000 lb.

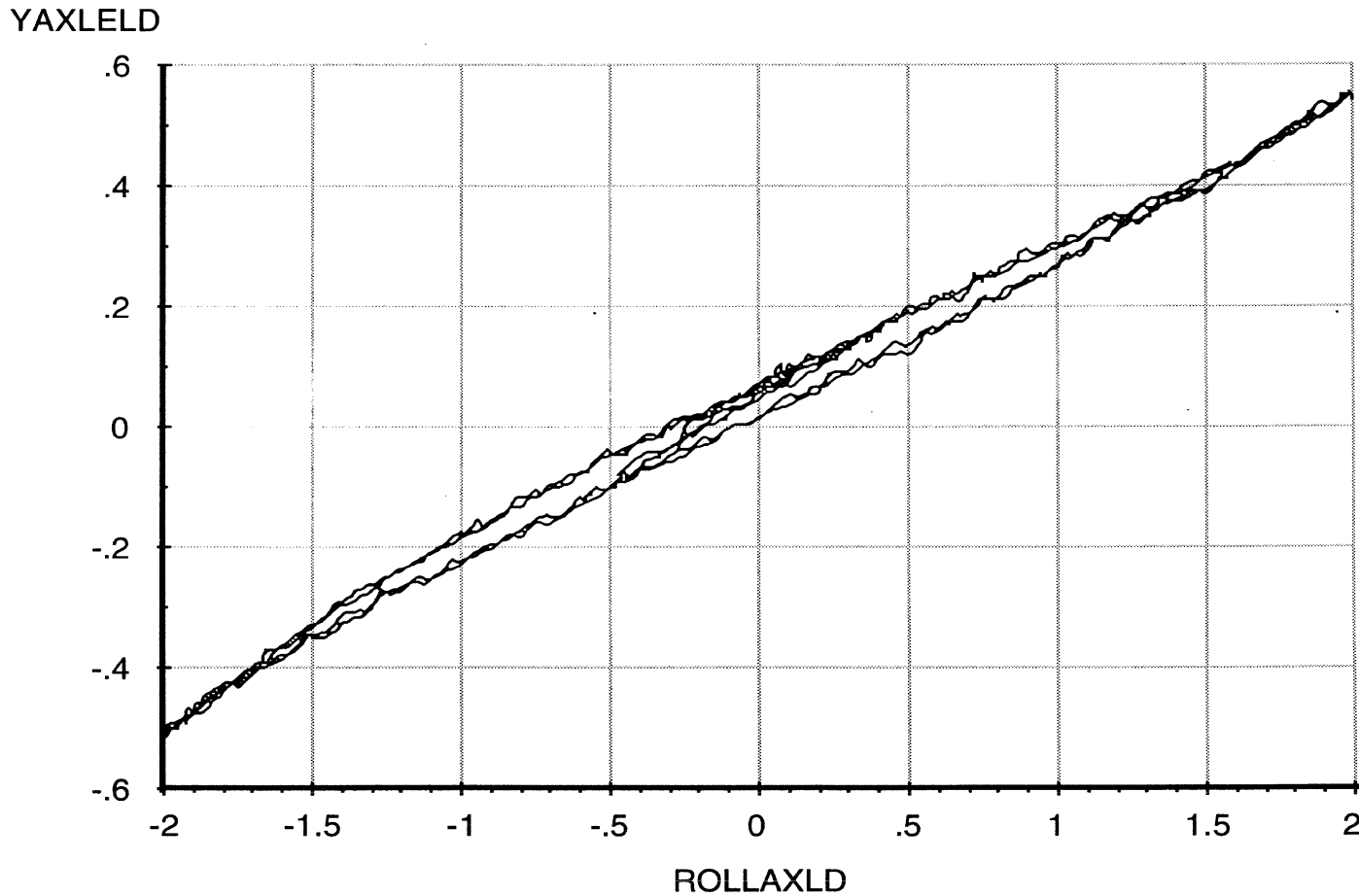

A-81

Abscissa (X): Leading axle roll angle (ROLLAXLD); degrees; right side compressed, positive.

Ordinate (Y): Leading axle reference point lateral translation (YAXLELD); inches; motion toward right, positive.

*Note: Brakes on. Force control. Reference height of 12.75 inches.

Measured by **UMTRI** for NHTSA
Mounted on a bare frame

Data file: NHTSAT30.ERD

Tandem Trailer Axle Suspension
Trailing Axle Roll Center Height

7 Aug 95
Suspension: 4-Spring/Taper(1)

Suspension Load: 40000 lb.

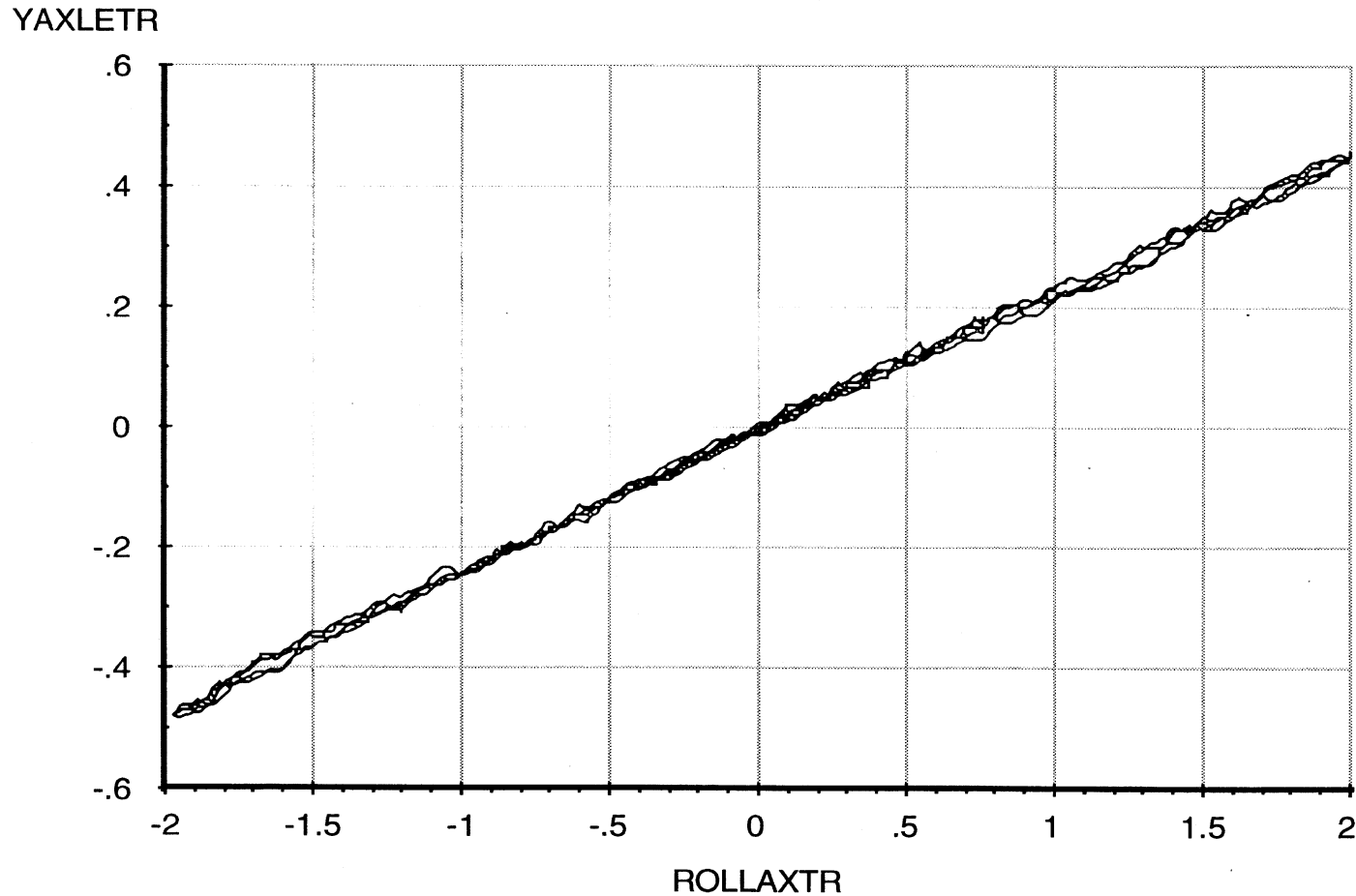

A-82

Abcissa (X): Trailing axle roll angle (ROLLAXTR); degrees; right side compressed, positive.

Ordinate (Y): Trailing axle reference point lateral translation (YAXLETR); inches; motion toward right, positive.

*Note: Brakes on. Force control. Reference height of 12.69 inches.

Measured by **UMTRI** for NHTSA
Mounted on a bare frame

Tandem Trailer Axle Suspension

7 Aug 95
Suspension: 4-Spring/Taper(1)

Data file: NHTSAT30.ERD

Leading Axle Roll Steer

Suspension Load: 40000 lb.

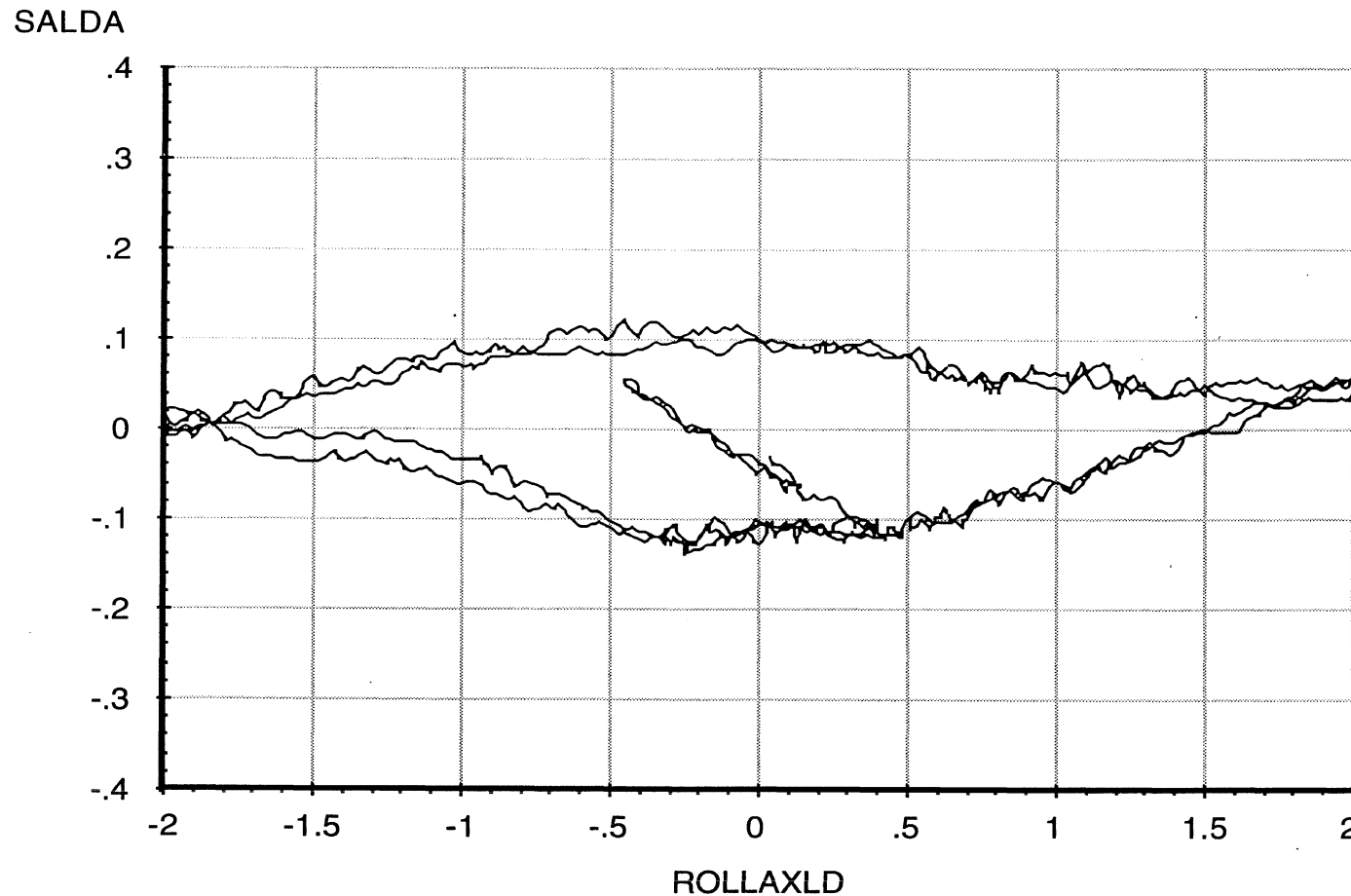

A-83

Abscissa (X): Leading axle roll angle (ROLLAXLD); degrees; right side compressed, positive.

Ordinate (Y): Average leading axle average steer angle (SALDA); degrees; steer toward right, positive.

*Note: Brakes on. Force control.

Measured by **UMTRI** for NHTSA
Mounted on a bare frame

Data file: NHTSAT30.ERD

Tandem Trailer Axle Suspension

Trailing Axle Roll Steer

7 Aug 95

Suspension: 4-Spring/Taper(1)

Suspension Load: 40000 lb.

SATRA

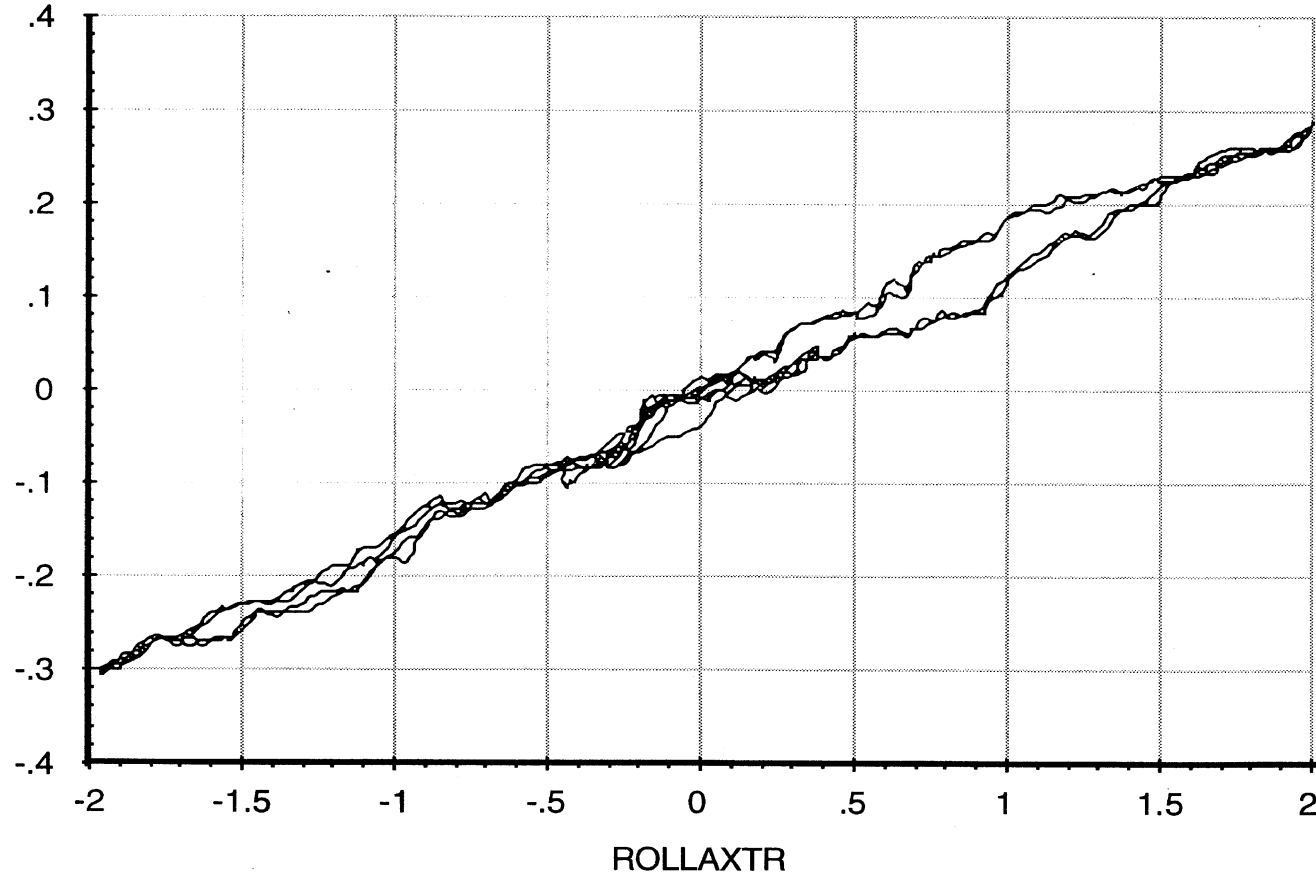

Abcissa (X): Trailing axle roll angle (ROLLAXTR); degrees; right side compressed, positive.

Ordinate (Y): Average trailing axle average steer angle (SATRA); degrees; steer toward right, positive.

*Note: Brakes on. Force control.

Measured by **UMTRI** for NHTSA
Mounted on a bare frame

Tandem Trailer Axle Suspension

7 Aug 95
Suspension: 4-Spring/Taper(1)

Data file: NHTSAT31.ERD

Leading Axle Lateral Force Compliance

Suspension Load: 40000 lb.

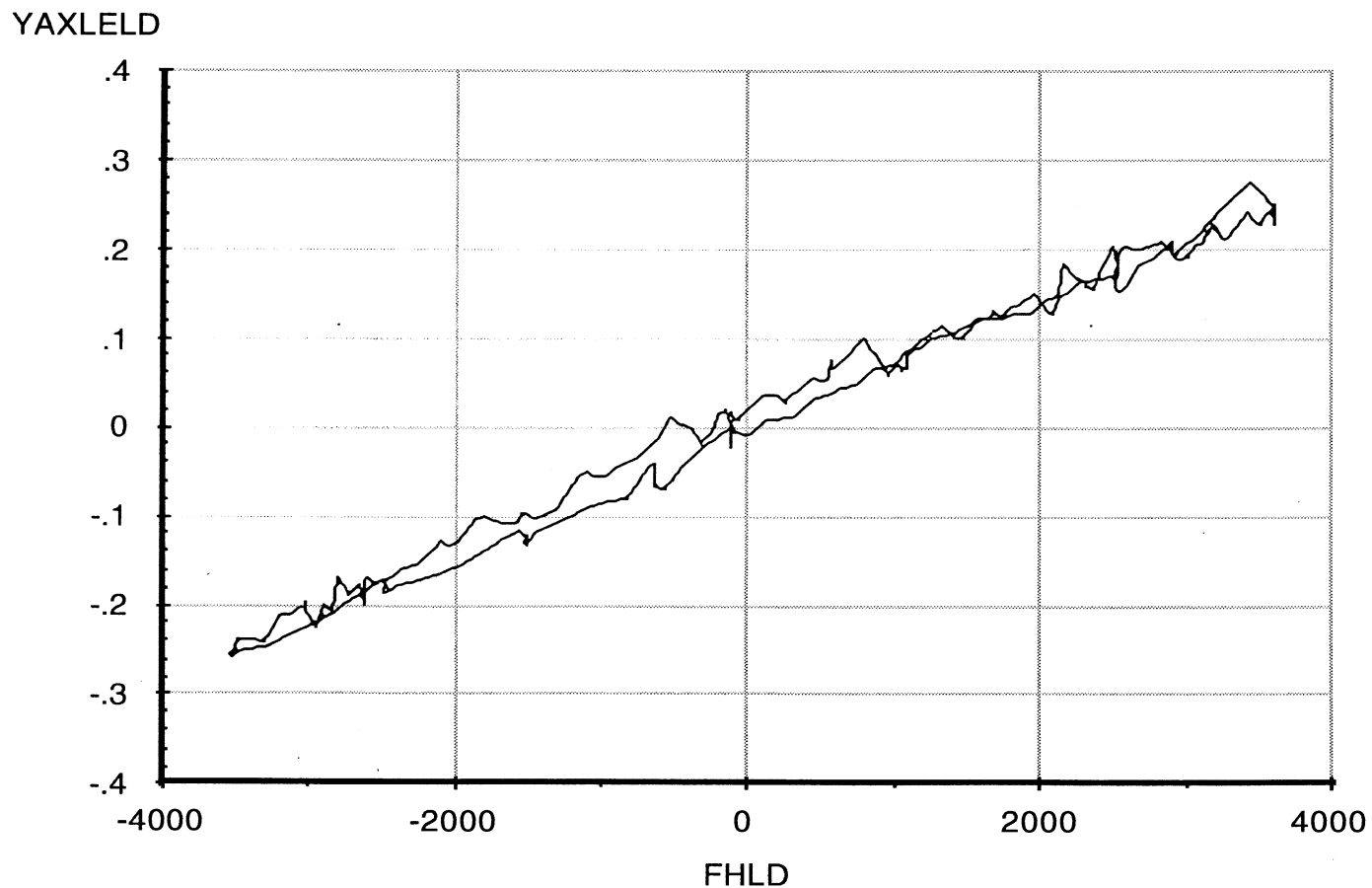

A-85

Abscissa (X): Total leading axle lateral force (FHLD); pounds per axle; applied to both axles simultaneously; force applied toward right, positive.

Ordinate (Y): Leading axle lateral translation (YAXLELD); inches; motion toward right, positive.

*Note: Brakes on. Position control.

Measured by **UMTRI** for NHTSA
Mounted on a bare frame

Tandem Trailer Axle Suspension

7 Aug 95
Suspension: 4-Spring/Taper(1)

Data file: NHTSAT31.ERD

Trailing Axle Lateral Force Compliance

Suspension Load: 40000 lb.

YAXLETR

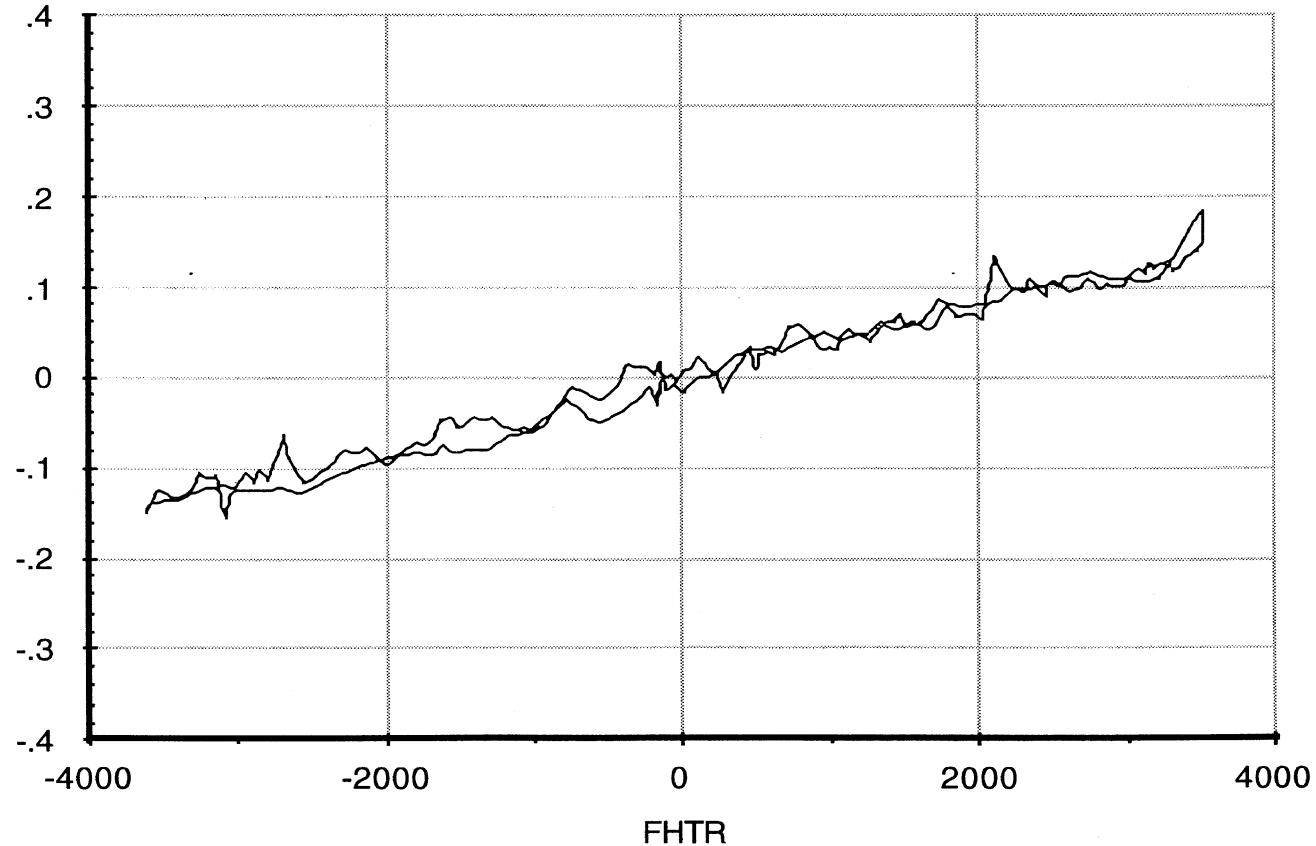

Abscissa (X): Total trailing axle lateral force (FHTR); pounds per axle; applied to both axles simultaneously; force applied toward right, positive.

Ordinate (Y): Trailing axle lateral translation (YAXLETR); inches; motion toward right, positive.

*Note: Brakes on. Position control.

Measured by **UMTRI** for NHTSA
Mounted on a bare frame

Tandem Trailer Axle Suspension

7 Aug 95
Suspension: 4-Spring/Taper(1)

Data file: NHTSAT32.ERD

Leading Axle Aligning Moment Compliance Steer

Suspension Load: 40000 lb.

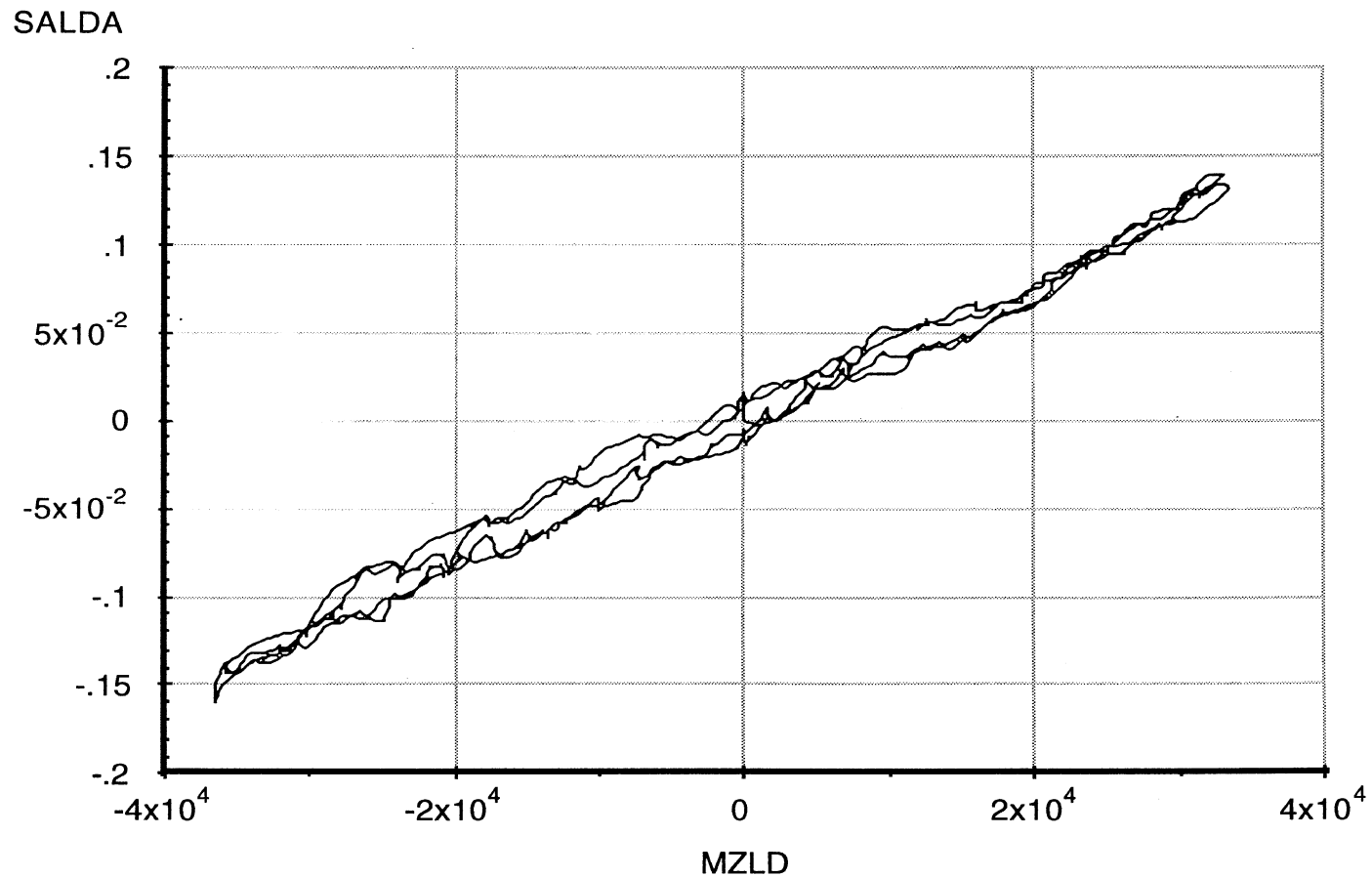

A-87

Abscissa (X): Total leading axle aligning moment (MZLD); in-lb per axle; applied to both axles simultaneously; downward (right hand rule) moment vector, positive.

Ordinate (Y): Average leading axle steer angle (SALDA); degrees; steer toward right, positive.

*Note: Brakes on. Position control.

Measured by **UMTRI** for NHTSA
Mounted on a bare frame

Tandem Trailer Axle Suspension

7 Aug 95
Suspension: 4-Spring/Taper(1)

Data file: NHTSAT32.ERD

Trailing Axle Aligning Moment Compliance Steer

Suspension Load: 40000 lb.

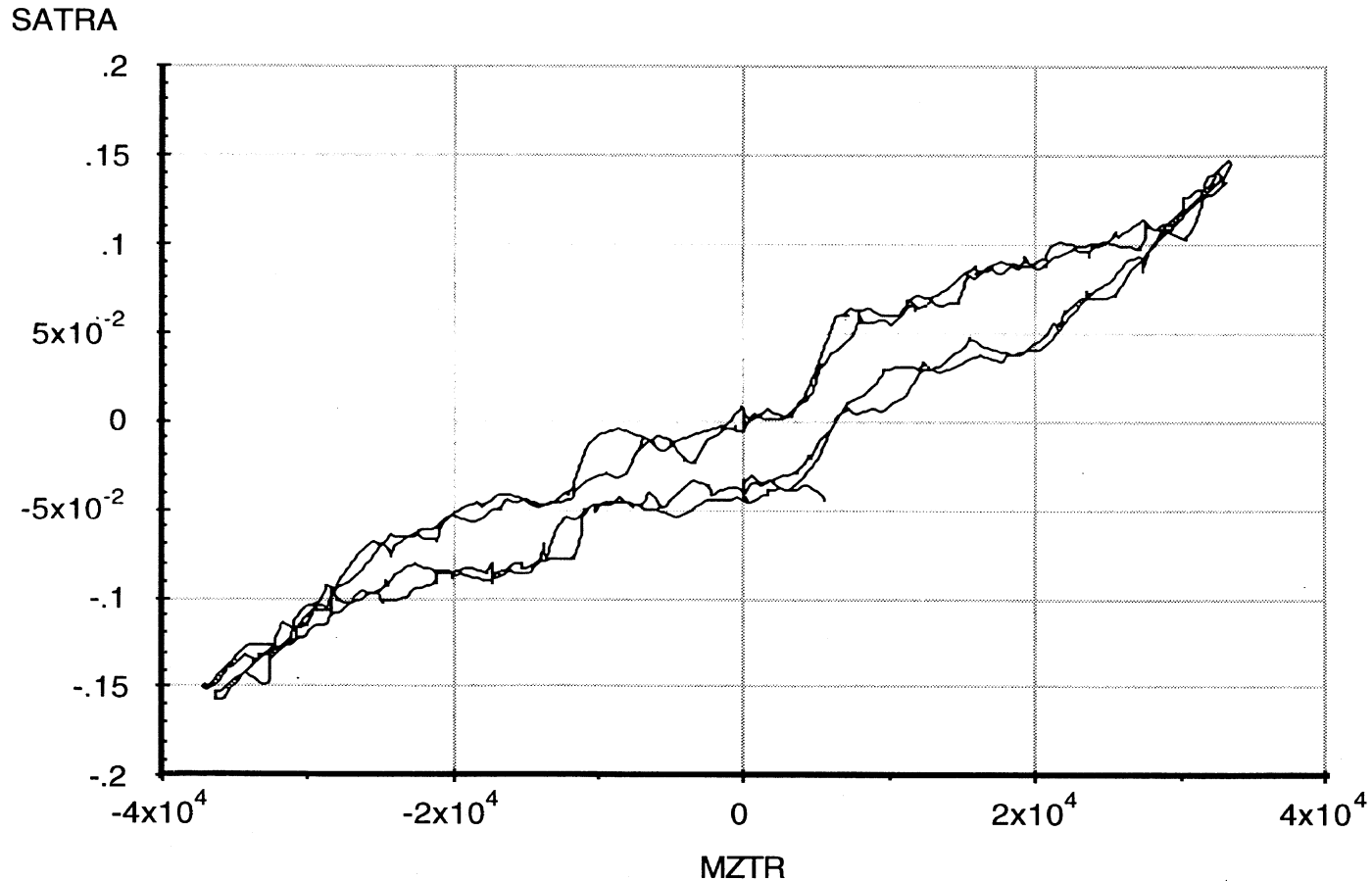

A-88

Abscissa (X): Total trailing axle aligning moment (MZTR); in-lb per axle; applied to both axles simultaneously; downward (right hand rule) moment vector, positive.

Ordinate (Y): Average trailing axle steer angle (SATRA); degrees; steer toward right, positive.

*Note: Brakes on. Position control.

Measured by **UMTRI** for NHTSA
Mounted on a bare frame

7 Aug 95
Suspension: 4-Spring/Taper(1)

Tandem Trailer Axle Suspension

Data file: NHTSAT33.ERD
FZ

Suspension Load: 40000 lb.

Inter-Axle Load Transfer Due to Braking

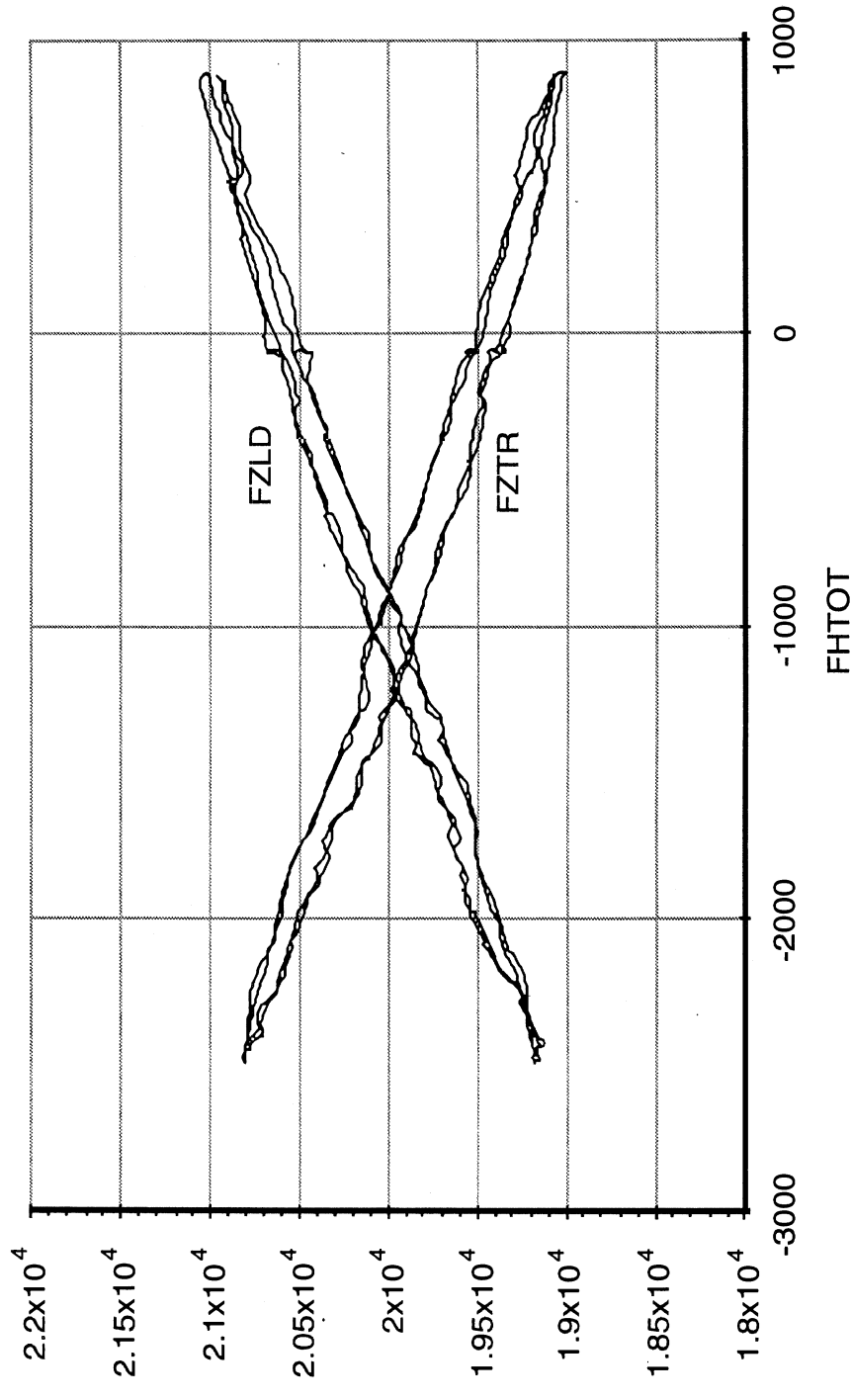

Abscissa (X): Total longitudinal force (FHTOT); pounds; applied to all four wheel sets simultaneously; force applied toward front, positive.

Ordinate (Y): Total leading axle vertical wheel load (FZLD); pounds; spring compression, positive.

Total trailing axle vertical wheel load (FZTR); pounds; spring compression, positive.

*Note: Brakes on. Force control.

Measured by **UMTRI** for NHTSA
Mounted on a bare frame

Tandem Trailer Axle Suspension

7 Aug 95
Suspension: 4-Spring/Taper(1)

Data file: NHTSAT20.ERD

Leading Axle Roll Rate

Suspension Load: 25000 lb.

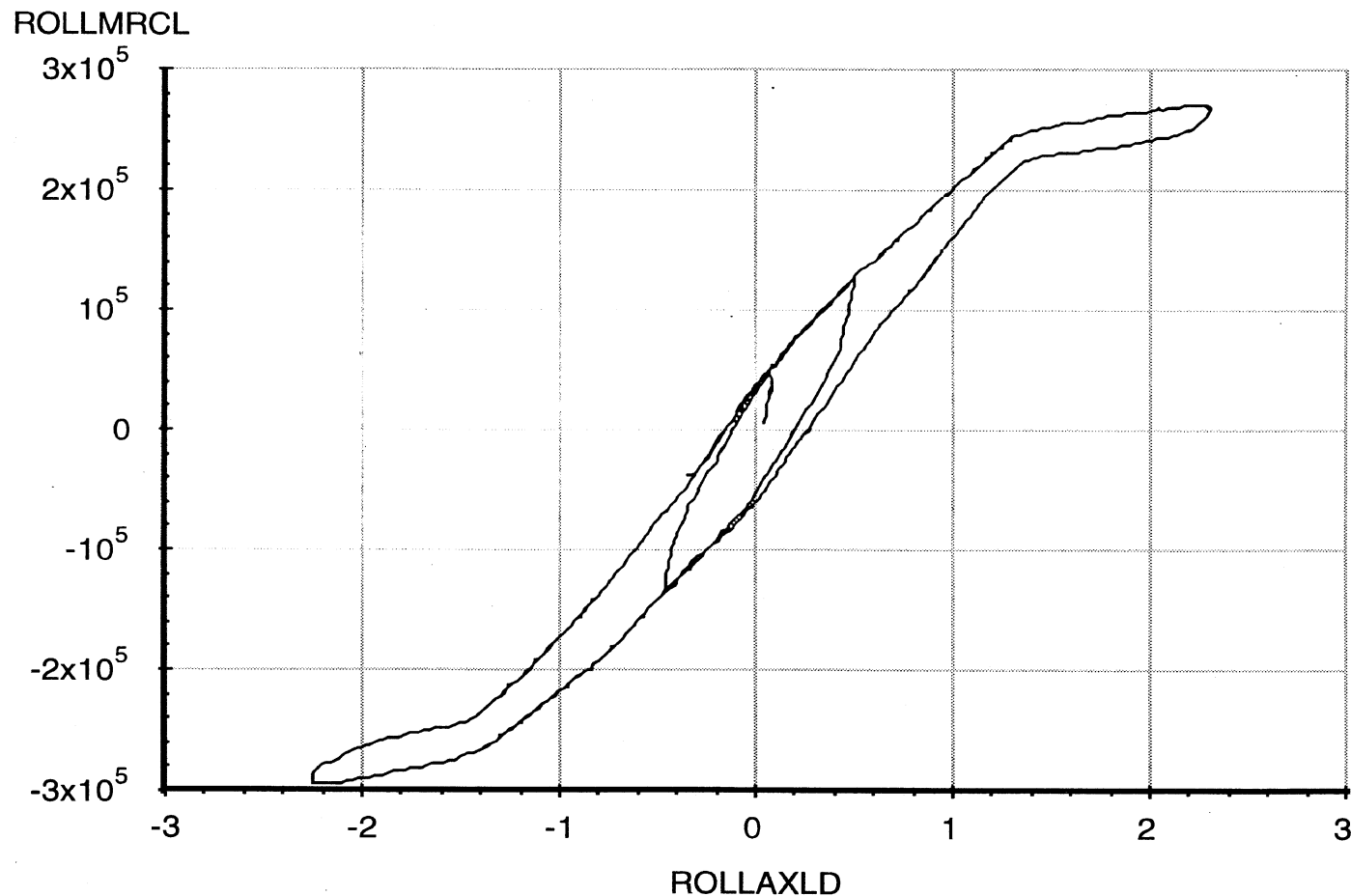

A-90

Abcissa (X): Leading axle roll angle (ROLLAXLD); degrees; right side compressed, positive.

Ordinate (Y): Leading axle roll moment about the roll center (ROLLMRCL); in-lb; right side compressed, positive.

*Note: Brakes on. Force control.

Measured by **UMTRI** for NHTSA
Mounted on a bare frame

Data file: NHTSAT20.ERD

Tandem Trailer Axle Suspension

Trailing Axle Roll Rate

7 Aug 95

Suspension: 4-Spring/Taper(1)

Suspension Load: 25000 lb.

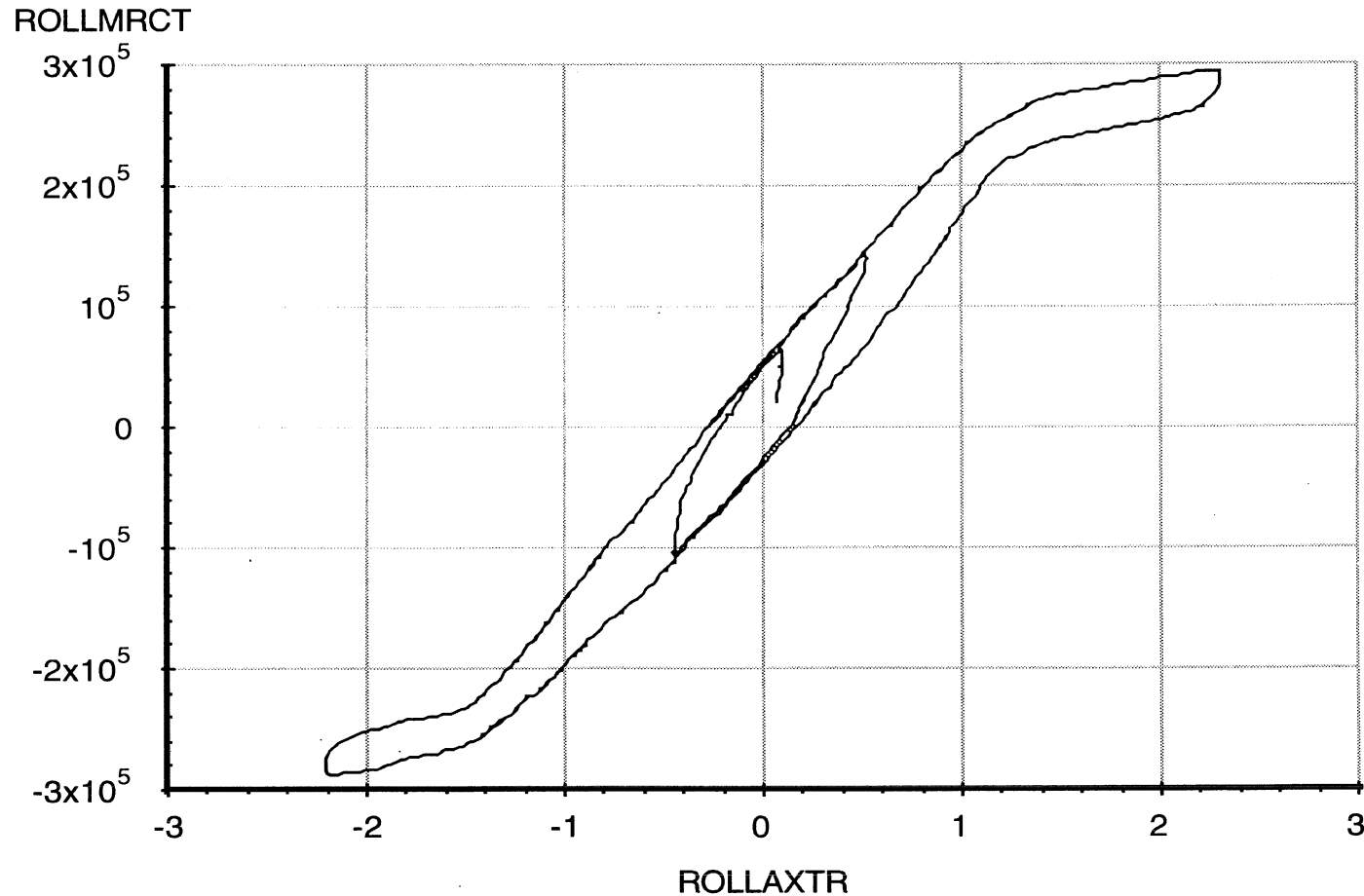

Abscissa (X): Trailing axle roll angle (ROLLAXTR); degrees; right side compressed, positive.

Ordinate (Y): Trailing axle roll moment about the roll center (ROLLMRCT); in-lb; right side compressed, positive.

*Note: Brakes on. Force control.

Measured by **UMTRI** for NHTSA
Mounted on a bare frame

Tandem Trailer Axle Suspension
Leading Axle Roll Center Height

7 Aug 95
Suspension: 4-Spring/Taper(1)
Suspension Load: 25000 lb.

Data file: NHTSAT20.ERD

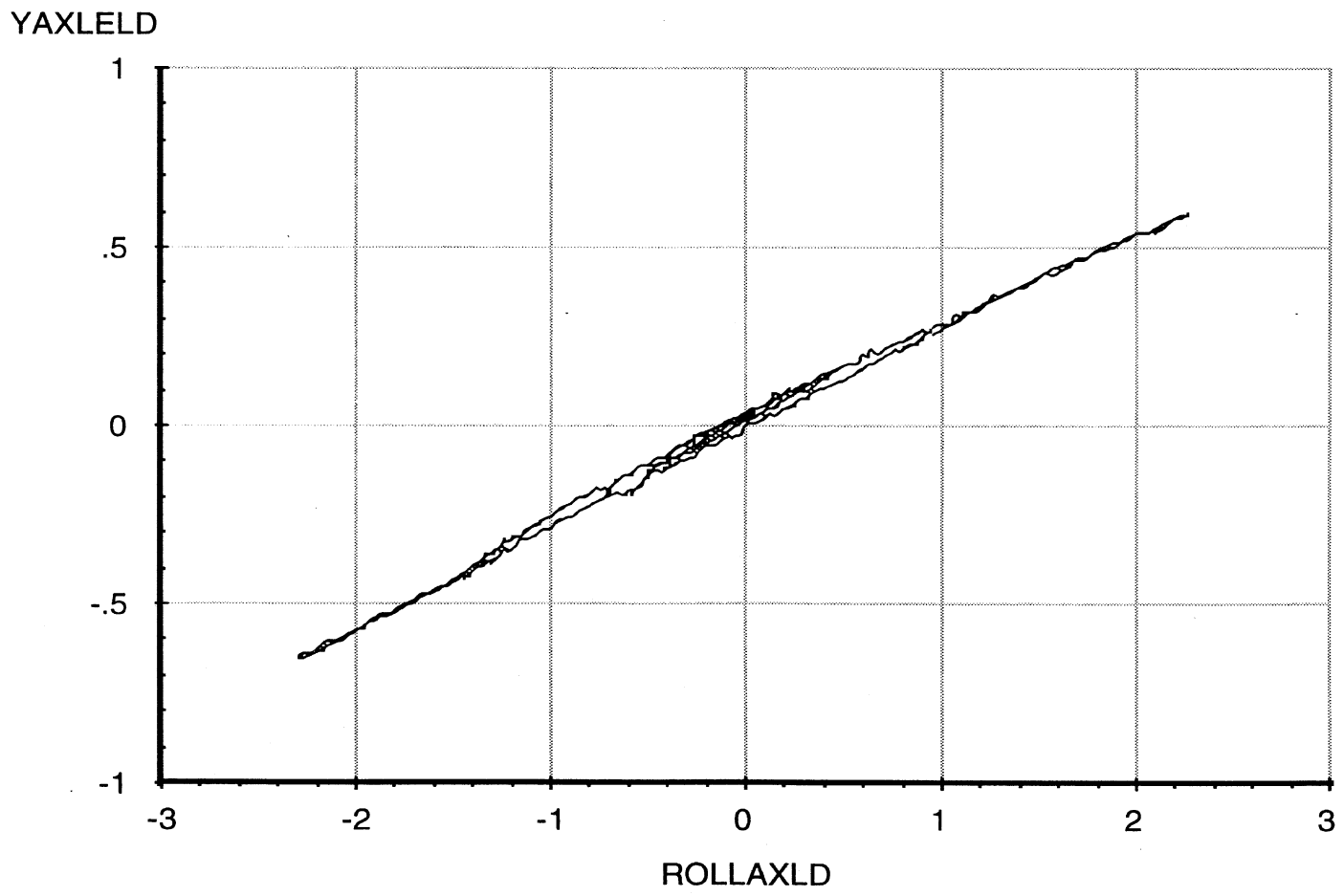

A-92

Abscissa (X): Leading axle roll angle (ROLLAXLD); degrees; right side compressed, positive.
Ordinate (Y): Leading axle reference point lateral translation (YAXLELD); inches; motion toward right, positive.
*Note: Brakes on. Force control. Reference height of 13.13 inches.

Measured by **UMTRI** for NHTSA
Mounted on a bare frame

Data file: NHTSAT20.ERD

Tandem Trailer Axle Suspension
Trailing Axle Roll Center Height

7 Aug 95
Suspension: 4-Spring/Taper(1)

Suspension Load: 25000 lb.

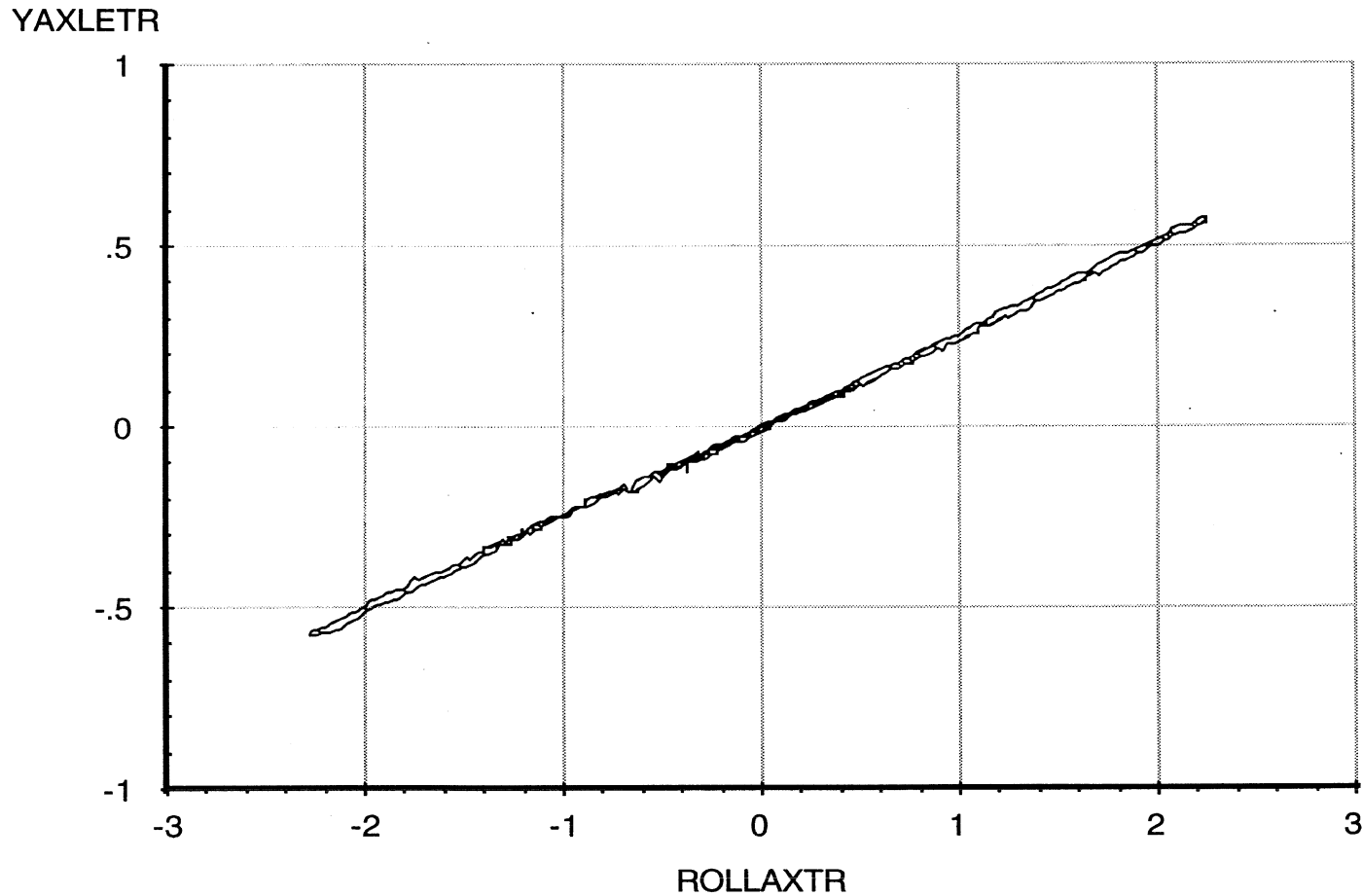

A-93

Abscissa (X): Trailing axle roll angle (ROLLAXTR); degrees; right side compressed, positive.

Ordinate (Y): Trailing axle reference point lateral translation (YAXLETR); inches; motion toward right, positive.

*Note: Brakes on. Force control. Reference height of 13.13 inches.

Measured by **UMTRI** for NHTSA
Mounted on a bare frame

Data file: NHTSAT20.ERD

Tandem Trailer Axle Suspension

Leading Axle Roll Steer

7 Aug 95

Suspension: 4-Spring/Taper(1)

Suspension Load: 25000 lb.

SALDA

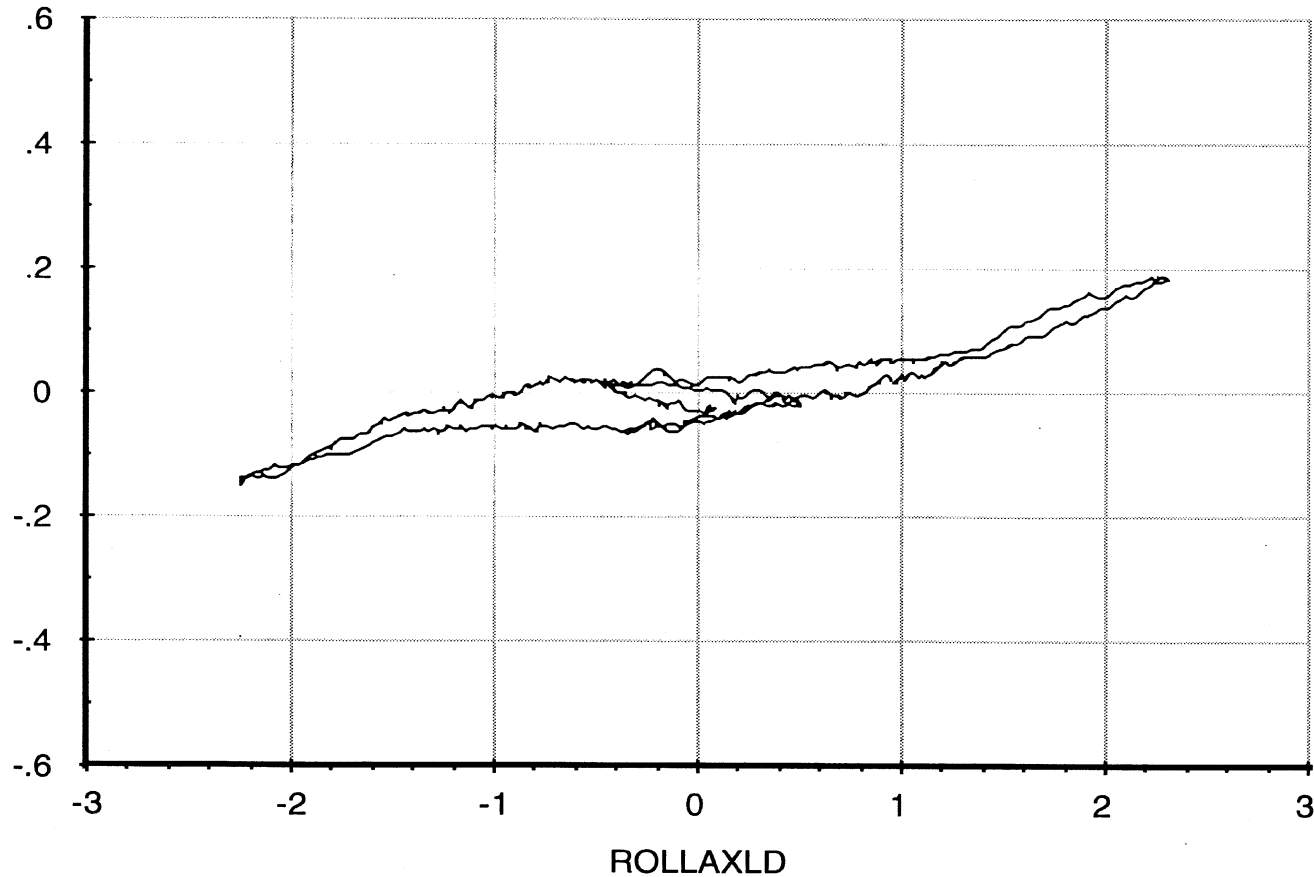

A-94

Abcissa (X): Leading axle roll angle (ROLLAXLD); degrees; right side compressed, positive.

Ordinate (Y): Average leading axle average steer angle (SALDA); degrees; steer toward right, positive.

*Note: Brakes on. Force control.

Measured by **UMTRI** for NHTSA
Mounted on a bare frame

Data file: NHTSAT20.ERD

Tandem Trailer Axle Suspension

Trailing Axle Roll Steer

7 Aug 95

Suspension: 4-Spring/Taper(1)

Suspension Load: 25000 lb.

SATRA

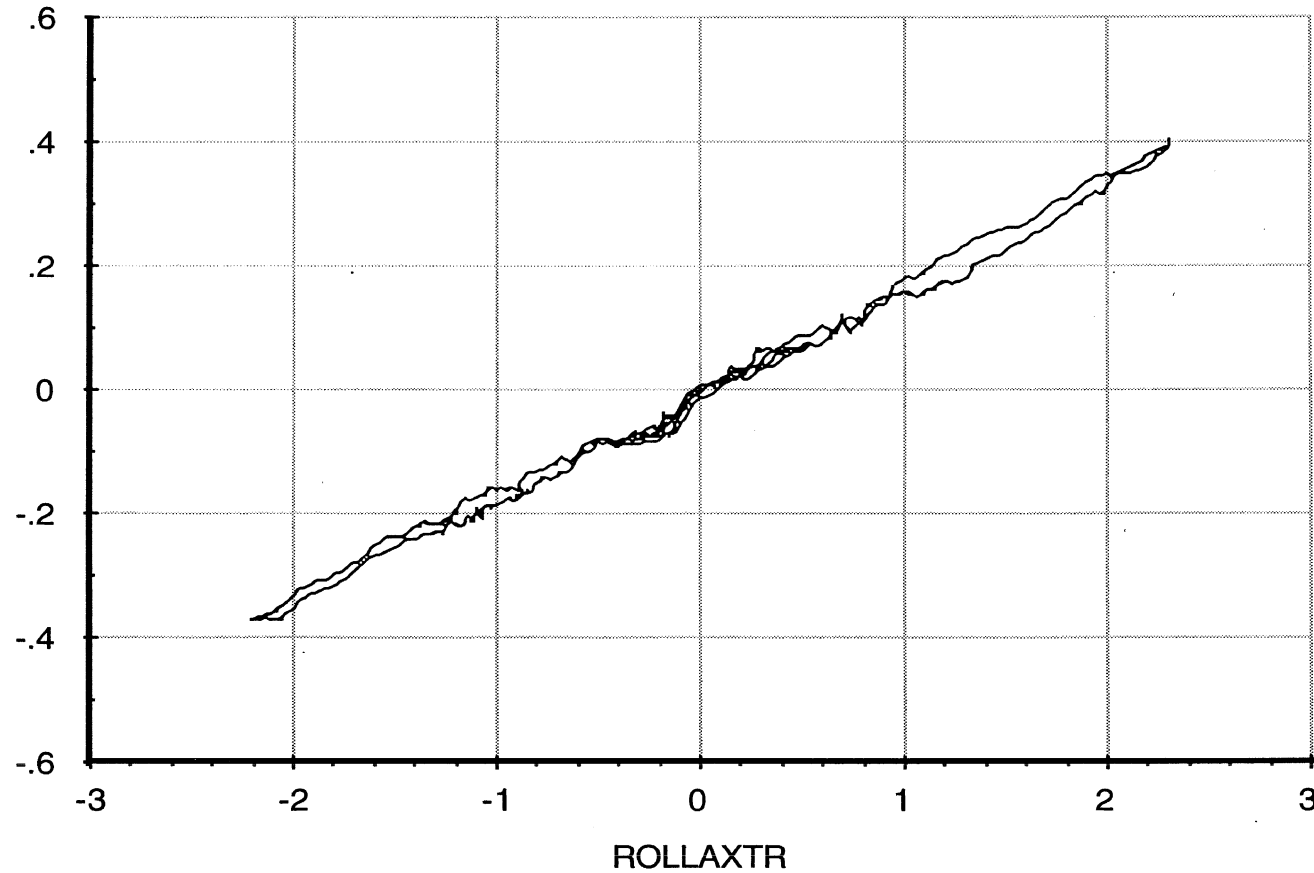

Abscissa (X): Trailing axle roll angle (ROLLAXTR); degrees; right side compressed, positive.

Ordinate (Y): Average trailing axle average steer angle (SATRA); degrees; steer toward right, positive.

*Note: Brakes on. Force control.

A-95

Measured by **UMTRI** for NHTSA
Mounted on a bare frame

Tandem Trailer Axle Suspension

7 Aug 95
Suspension: 4-Spring/Taper(1)

Data file: NHTSAT21.ERD

Leading Axle Lateral Force Compliance

Suspension Load: 25000 lb.

YAXLELD

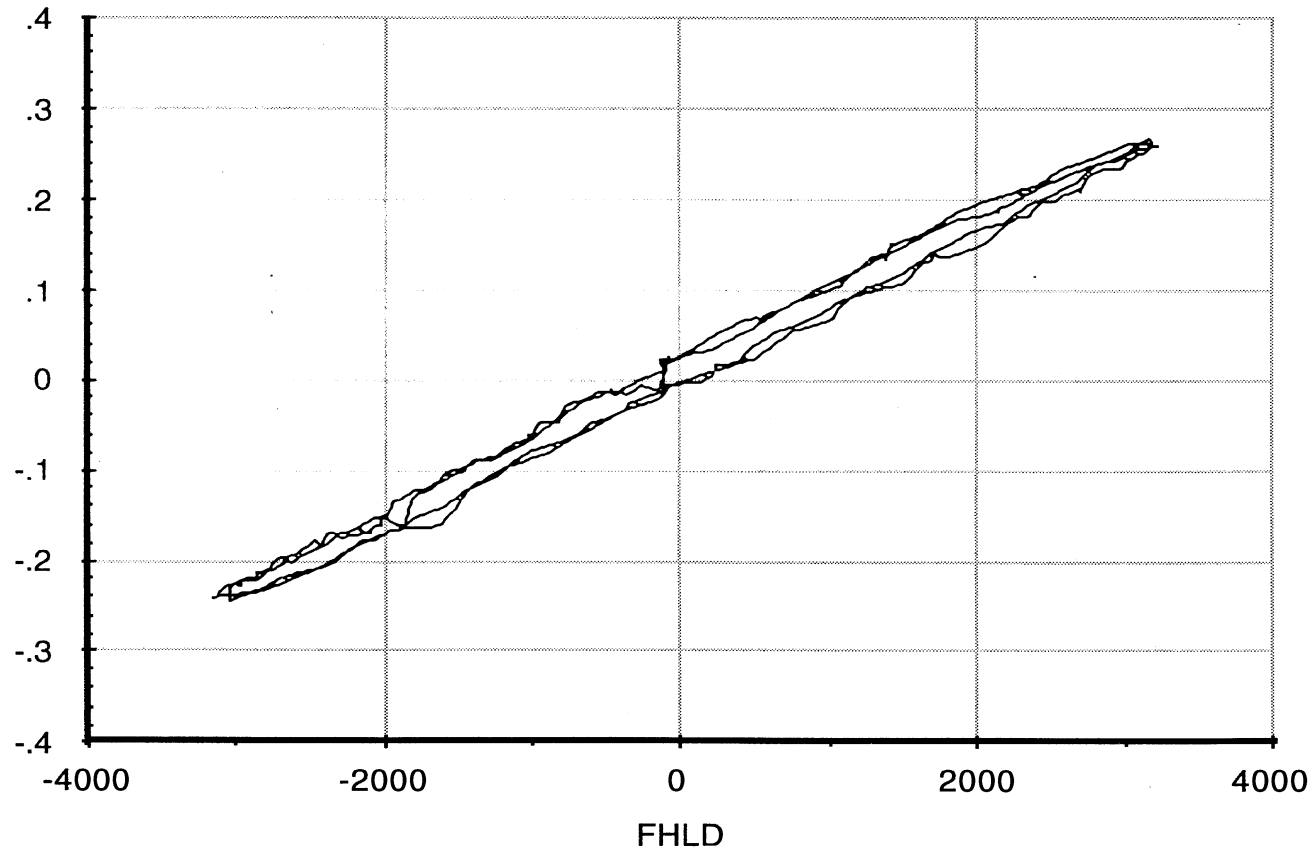

A-96

Abscissa (X): Total leading axle lateral force (FHLD); pounds per axle; applied to both axles simultaneously; force applied toward right, positive.

Ordinate (Y): Leading axle lateral translation (YAXLELD); inches; motion toward right, positive.

*Note: Brakes on. Position control.

Measured by **UMTRI** for NHTSA
Mounted on a bare frame

Tandem Trailer Axle Suspension

7 Aug 95
Suspension: 4-Spring/Taper(1)

Data file: NHTSAT21.ERD

Trailing Axle Lateral Force Compliance

Suspension Load: 25000 lb.

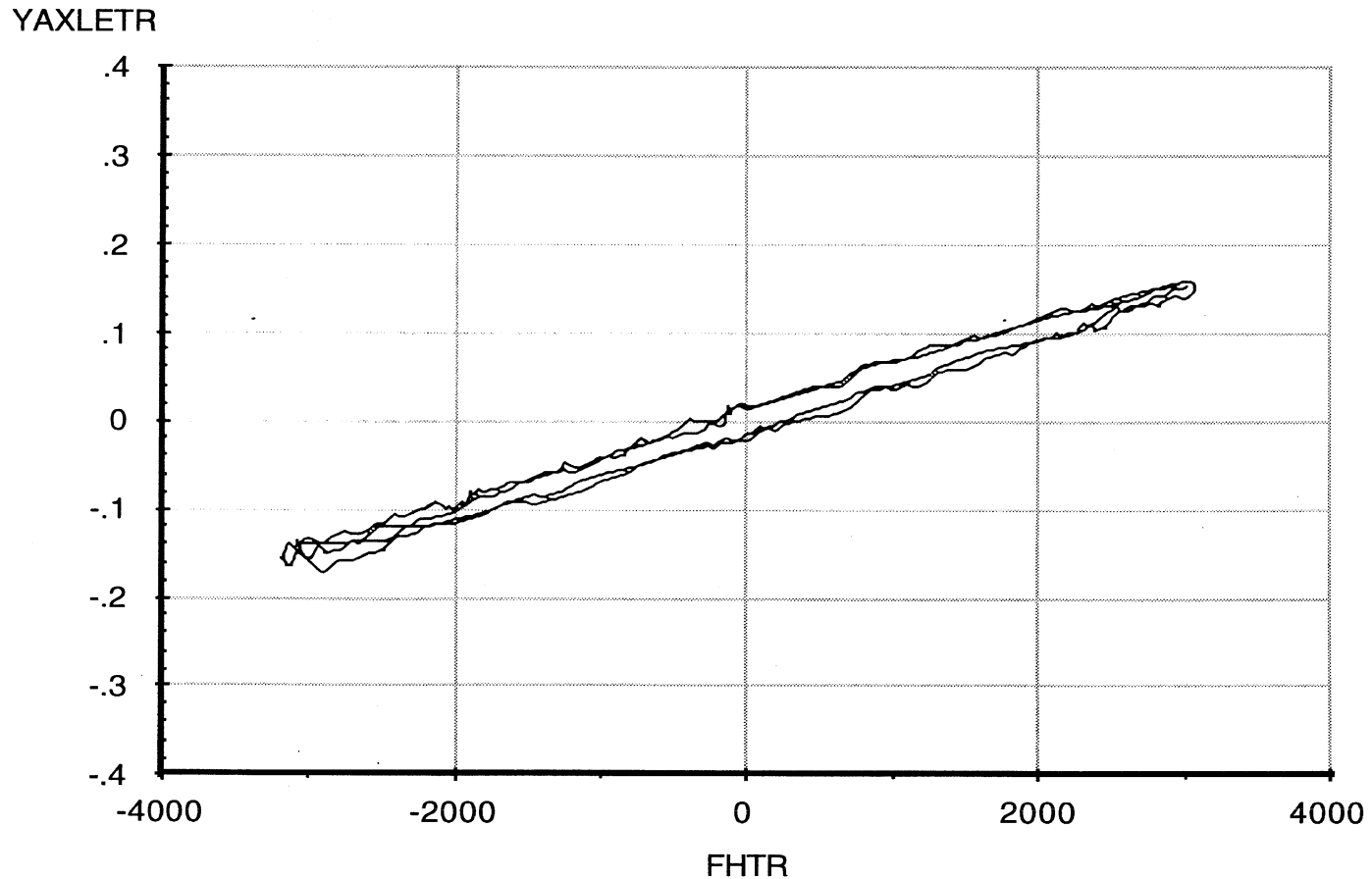

A-97

Abscissa (X): Total trailing axle lateral force (FHTR); pounds per axle; applied to both axles simultaneously; force applied toward right, positive.

Ordinate (Y): Trailing axle lateral translation (YAXLETR); inches; motion toward right, positive.

*Note: Brakes on. Position control.

Measured by **UMTRI** for NHTSA
Mounted on a bare frame

Data file: NHTSAT21.ERD

Tandem Trailer Axle Suspension
Leading Axle Lateral Force Steer

7 Aug 95
Suspension: 4-Spring/Taper(1)

Suspension Load: 25000 lb.

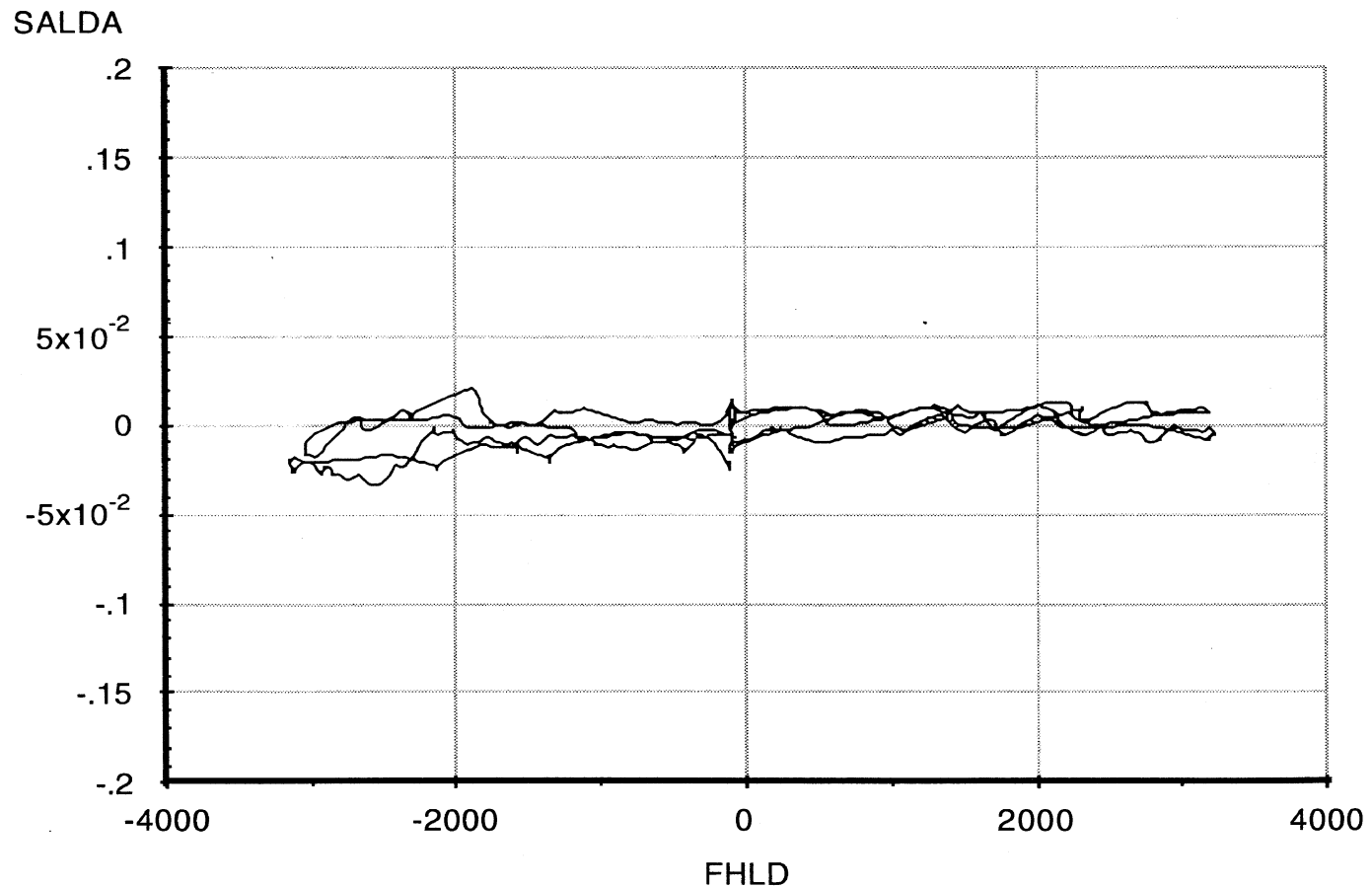

A-98

Abcissa (X): Total leading axle lateral force (FHLD); pounds per axle; applied to both axles simultaneously; force applied toward right, positive.

Ordinate (Y): Average leading axle steer angle (SALDA); degrees; steer toward right, positive.

*Note: Brakes on. Position control.

Measured by **UMTRI** for NHTSA
Mounted on a bare frame

Data file: NHTSAT21.ERD

Tandem Trailer Axle Suspension
Trailing Axle Lateral Force Steer

7 Aug 95
Suspension: 4-Spring/Taper(1)

Suspension Load: 25000 lb.

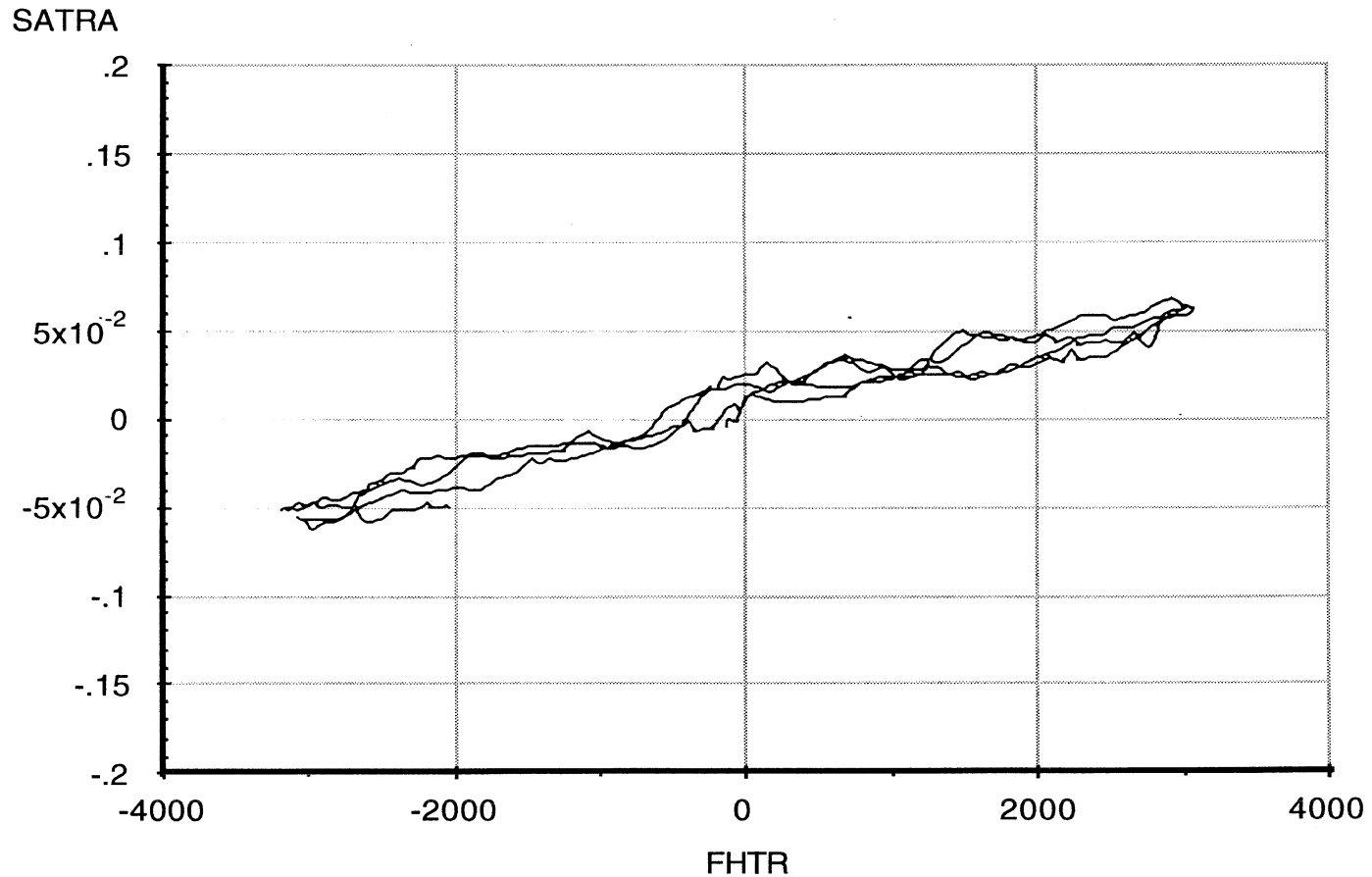

Abscissa (X): Total trailing axle lateral force (FHTR); pounds per axle; applied to both axles simultaneously; force applied toward right, positive.

Ordinate (Y): Average trailing axle steer angle (SATRA); degrees; steer toward right, positive.

*Note: Brakes on. Position control.

Measured by **UMTRI** for NHTSA
Mounted on a bare frame

Tandem Trailer Axle Suspension

7 Aug 95
Suspension: 4-Spring/Taper(1)

Data file: NHTSAT22.ERD

Leading Axle Aligning Moment Compliance Steer

Suspension Load: 25000 lb.

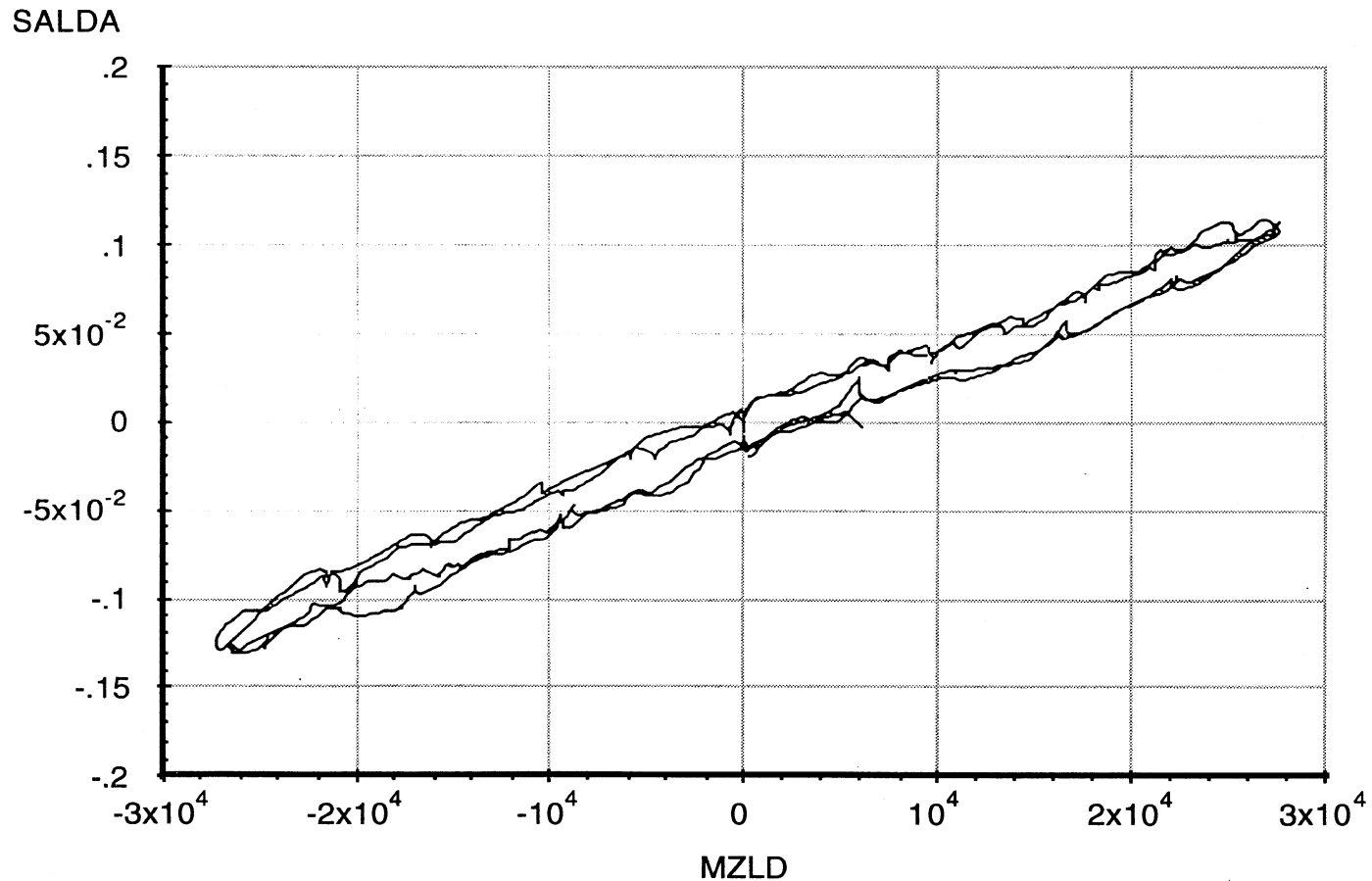

Abscissa (X): Total leading axle aligning moment (MZLD); in-lb per axle; applied to both axles simultaneously; downward (right hand rule) moment vector, positive.

Ordinate (Y): Average leading axle steer angle (SALDA); degrees; steer toward right, positive.

*Note: Brakes on. Position control.

Measured by **UMTRI** for NHTSA
Mounted on a bare frame

Tandem Trailer Axle Suspension

7 Aug 95
Suspension: 4-Spring/Taper(1)

Data file: NHTSAT22.ERD

Trailing Axle Aligning Moment Compliance Steer

Suspension Load: 25000 lb.

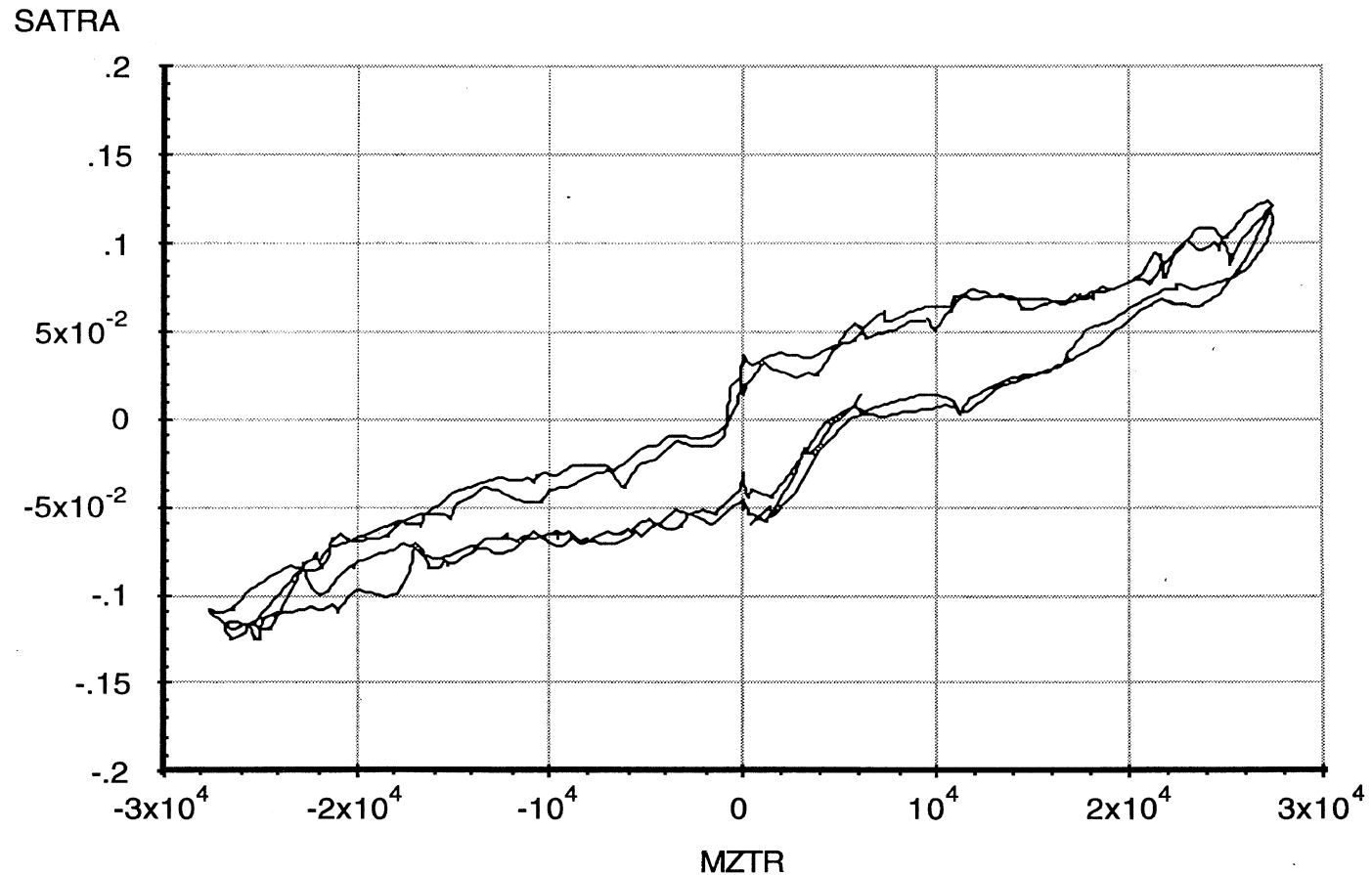

A-101

Abscissa (X): Total trailing axle aligning moment (MZTR); in-lb per axle; applied to both axles simultaneously; downward (right hand rule) moment vector, positive.

Ordinate (Y): Average trailing axle steer angle (SATRA); degrees; steer toward right, positive.

*Note: Brakes on. Position control.

Measured by **UMTRI** for NHTSA
Mounted on a bare frame

Tandem Trailer Axle Suspension

7 Aug 95
Suspension: 4-Spring/Taper(1)

Data file: NHTSAT23.ERD
FZ

Inter-Axle Load Transfer Due to Braking

Suspension Load: 25000 lb.

A-102

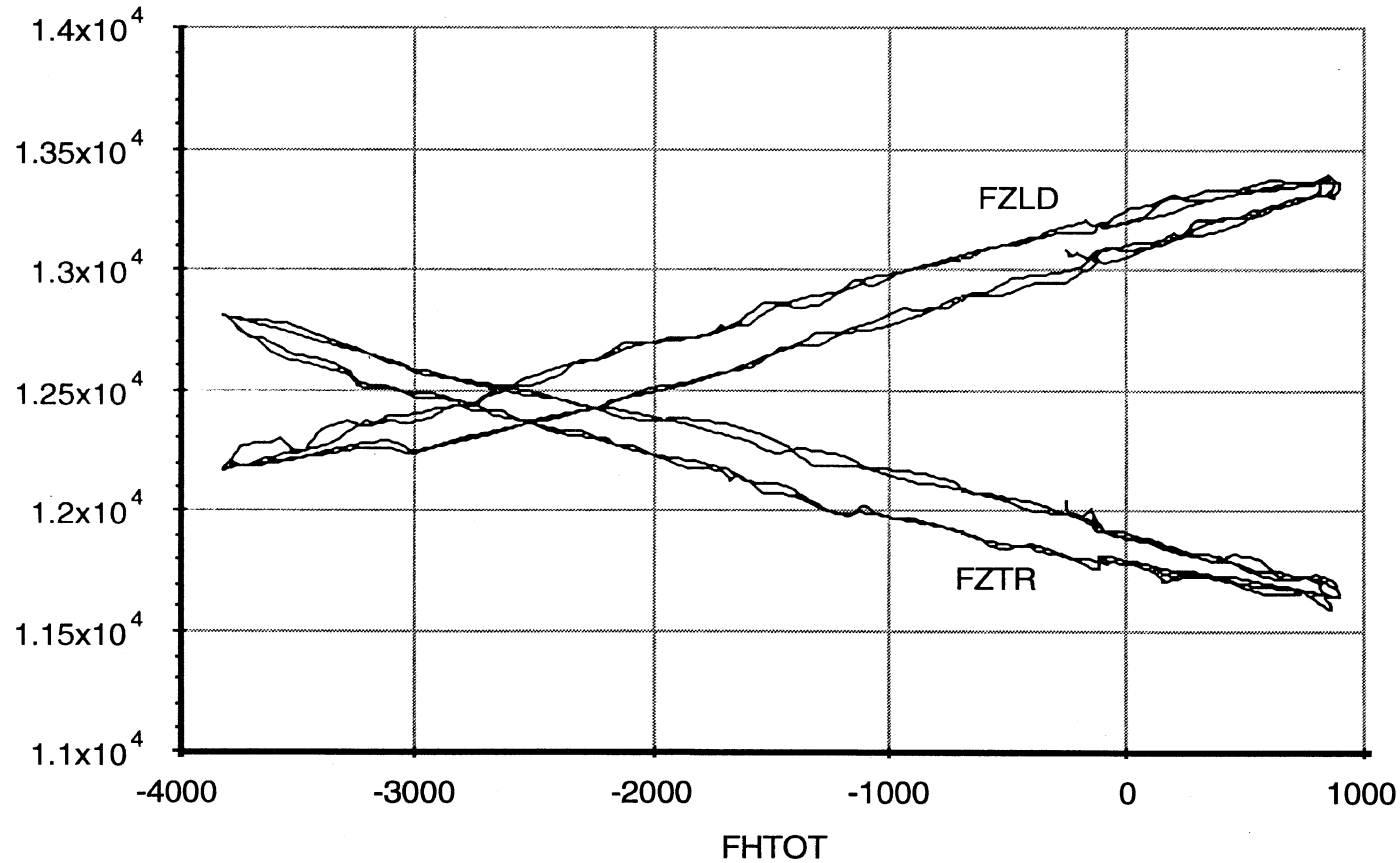

Abscissa (X): Total longitudinal force (FHTOT); pounds; applied to all four wheel sets simultaneously; force applied toward front, positive.

Ordinate (Y): Total leading axle vertical wheel load (FZLD); pounds; spring compression, positive.
Total trailing axle vertical wheel load (FZTR); pounds; spring compression, positive.

*Note: Brakes on. Force control.

Measured by **UMTRI** for NHTSA
Mounted on a bare frame

Tandem Trailer Axle Suspension

7 Aug 95
Suspension: 4-Spring/Taper(1)

Data file: NHTSAT24.ERD

Leading Axle Roll Rate

Suspension Load: 25000 lb.

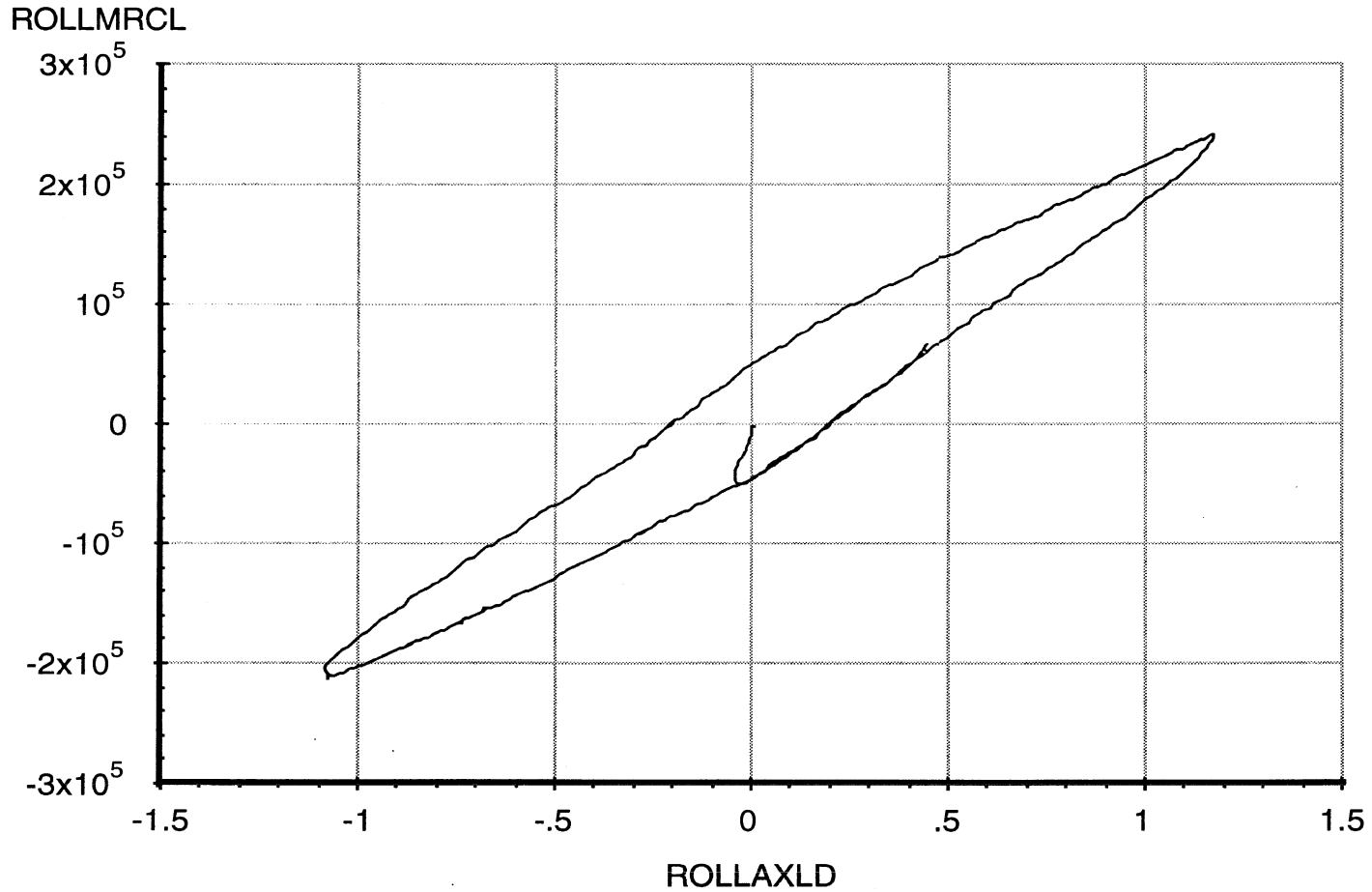

A-103

Abscissa (X): Leading axle roll angle (ROLLAXLD); degrees; right side compressed, positive.

Ordinate (Y): Leading axle roll moment about the roll center (ROLLMRCL); in-lb; right side compressed, positive.

*Note: Brakes on. Force control.

Measured by **UMTRI** for NHTSA
Mounted on a bare frame

Data file: NHTSAT24.ERD

Tandem Trailer Axle Suspension

Trailing Axle Roll Rate

7 Aug 95

Suspension: 4-Spring/Taper(1)

Suspension Load: 25000 lb.

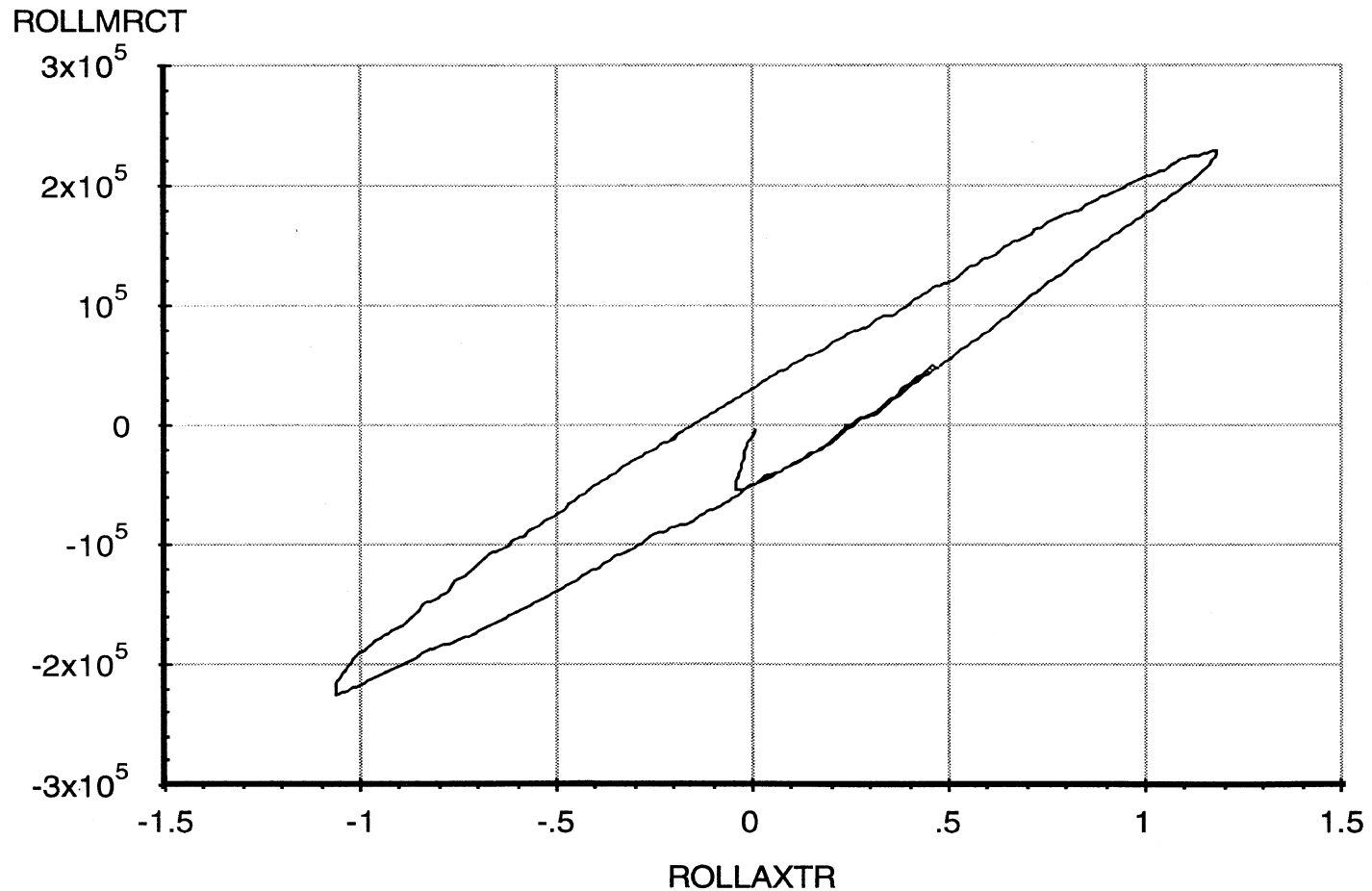

A-104

Abscissa (X): Trailing axle roll angle (ROLLAXTR); degrees; right side compressed, positive.

Ordinate (Y): Trailing axle roll moment about the roll center (ROLLMRCT); in-lb; right side compressed, positive.

*Note: Brakes on. Force control.

Measured by **UMTRI** for NHTSA
Mounted on a bare frame

Data file: NHTSAT24.ERD

Tandem Trailer Axle Suspension
Leading Axle Roll Center Height

7 Aug 95
Suspension: 4-Spring/Taper(1)

Suspension Load: 25000 lb.

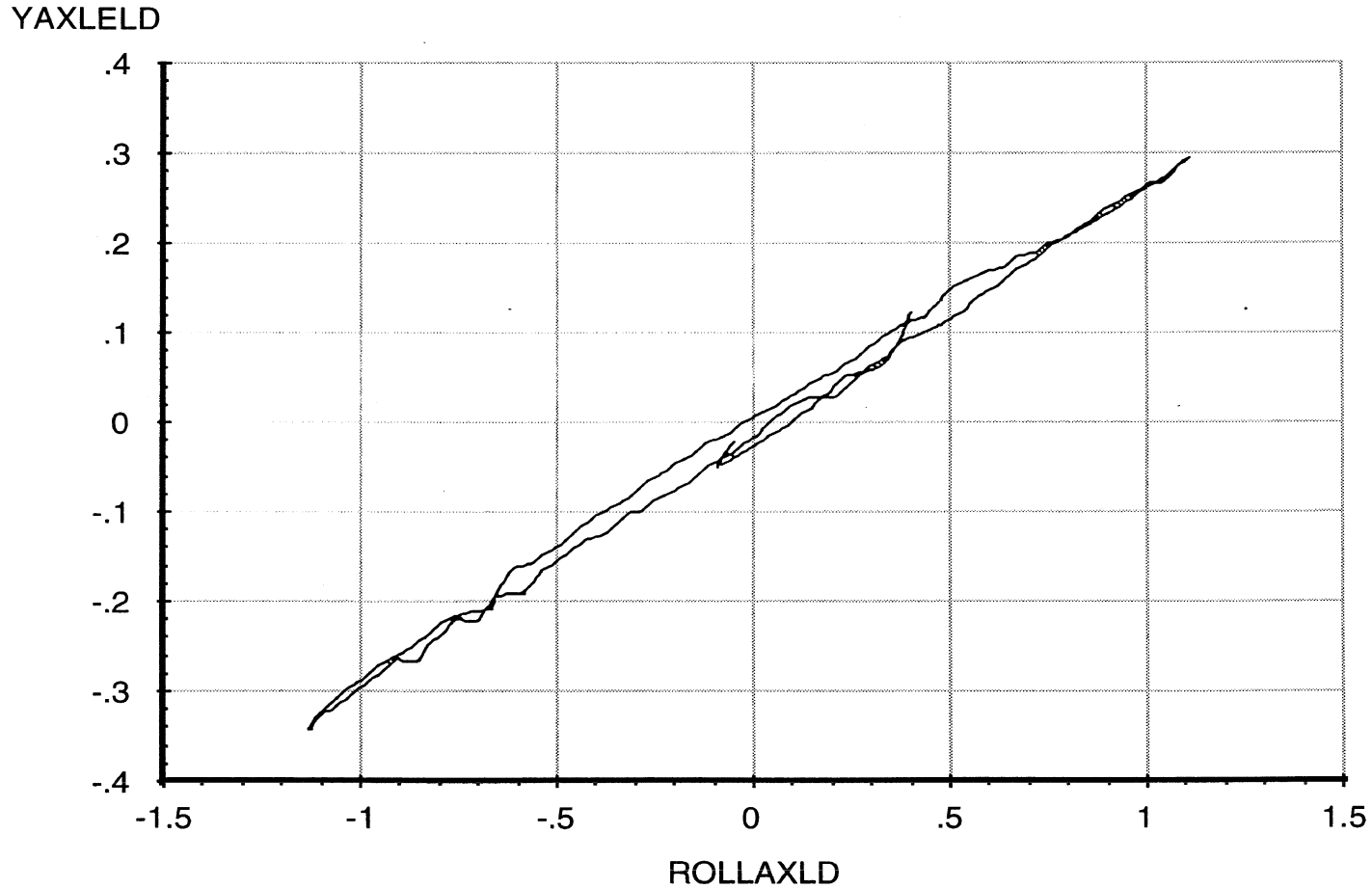

A-105

Abscissa (X): Leading axle roll angle (ROLLAXLD); degrees; right side compressed, positive.

Ordinate (Y): Leading axle reference point lateral translation (YAXLELD); inches; motion toward right, positive.

*Note: Brakes on. Force control. Reference height of 13.13 inches.

Measured by **UMTRI** for NHTSA
Mounted on a bare frame

Data file: NHTSAT24.ERD

Tandem Trailer Axle Suspension
Trailing Axle Roll Center Height

7 Aug 95
Suspension: 4-Spring/Taper(1)

Suspension Load: 25000 lb.

YAXLETR

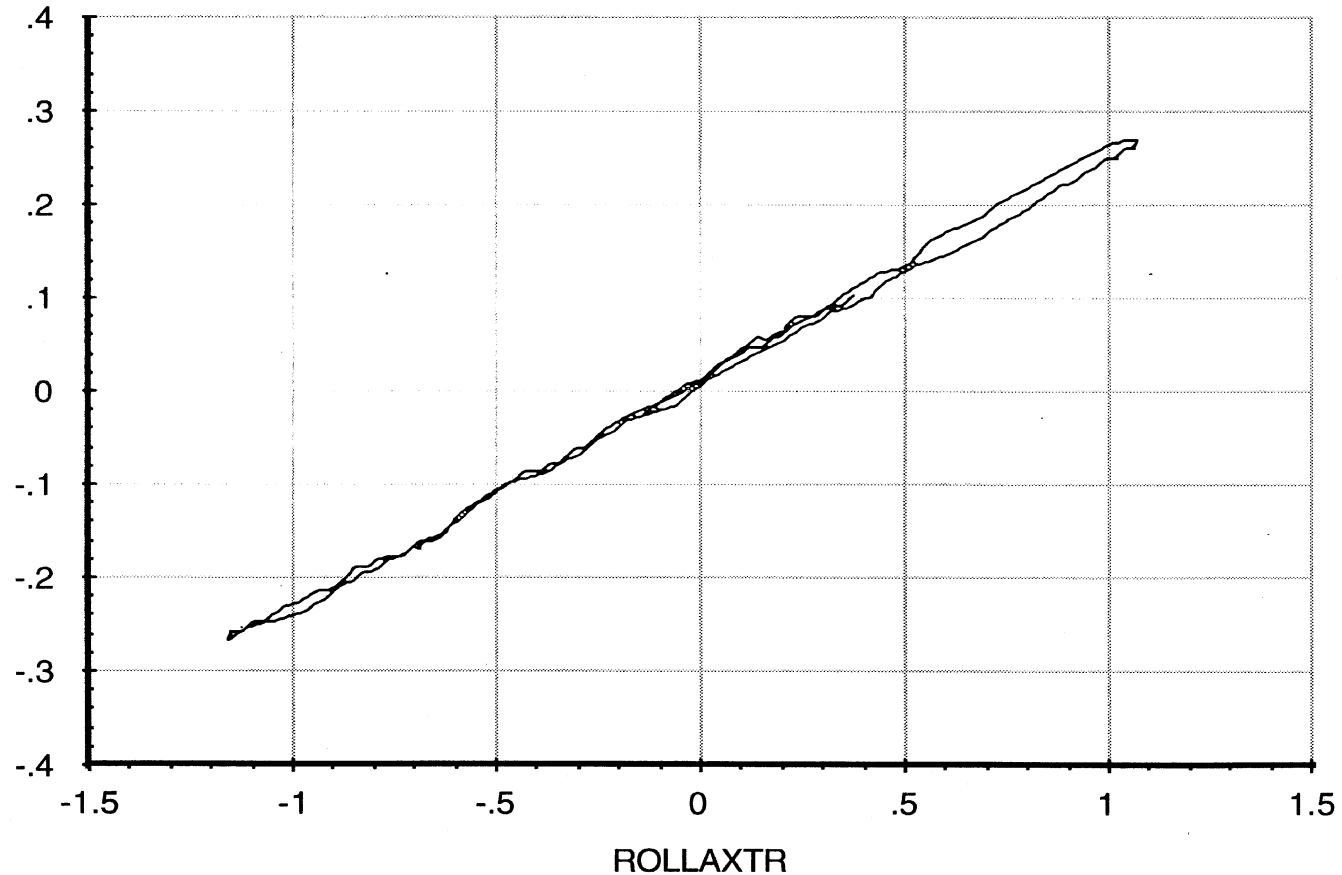

Abscissa (X): Trailing axle roll angle (ROLLAXTR); degrees; right side compressed, positive.

Ordinate (Y): Trailing axle reference point lateral translation (YAXLETR); inches; motion toward right, positive.

*Note: Brakes on. Force control. Reference height of 13.13 inches.

Measured by **UMTRI** for NHTSA
Mounted on a bare frame

Tandem Trailer Axle Suspension

7 Aug 95
Suspension: 4-Spring/Taper(1)

Data file: NHTSAT24.ERD

Leading Axle Roll Steer

Suspension Load: 25000 lb.

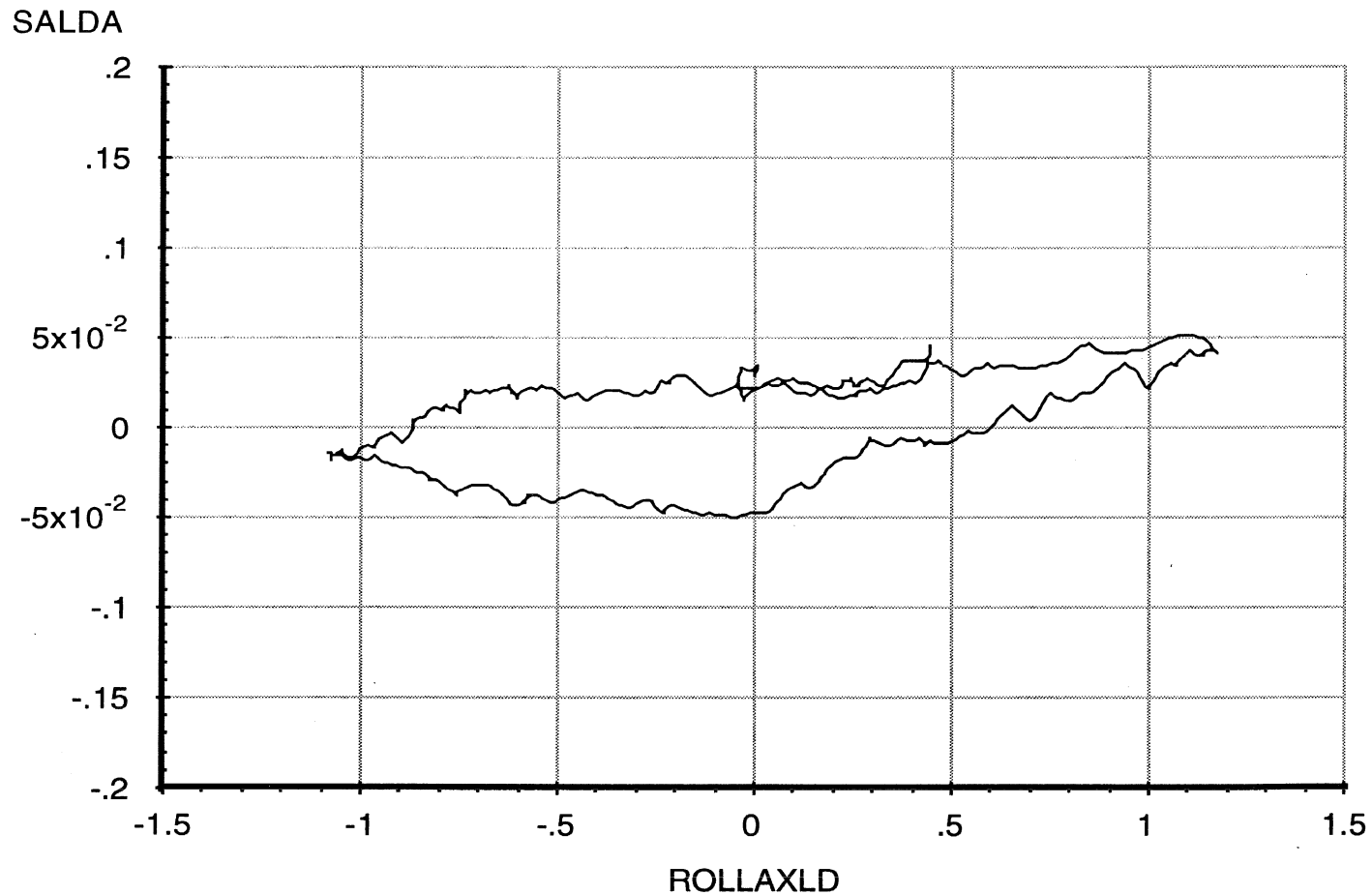

A-107

Abscissa (X): Leading axle roll angle (ROLLAXLD); degrees; right side compressed, positive.

Ordinate (Y): Average leading axle average steer angle (SALDA); degrees; steer toward right, positive.

*Note: Brakes on. Force control.

Measured by **UMTRI** for NHTSA
Mounted on a bare frame

Tandem Trailer Axle Suspension

7 Aug 95
Suspension: 4-Spring/Taper(1)

Data file: NHTSAT24.ERD

Trailing Axle Roll Steer

Suspension Load: 25000 lb.

SATRA

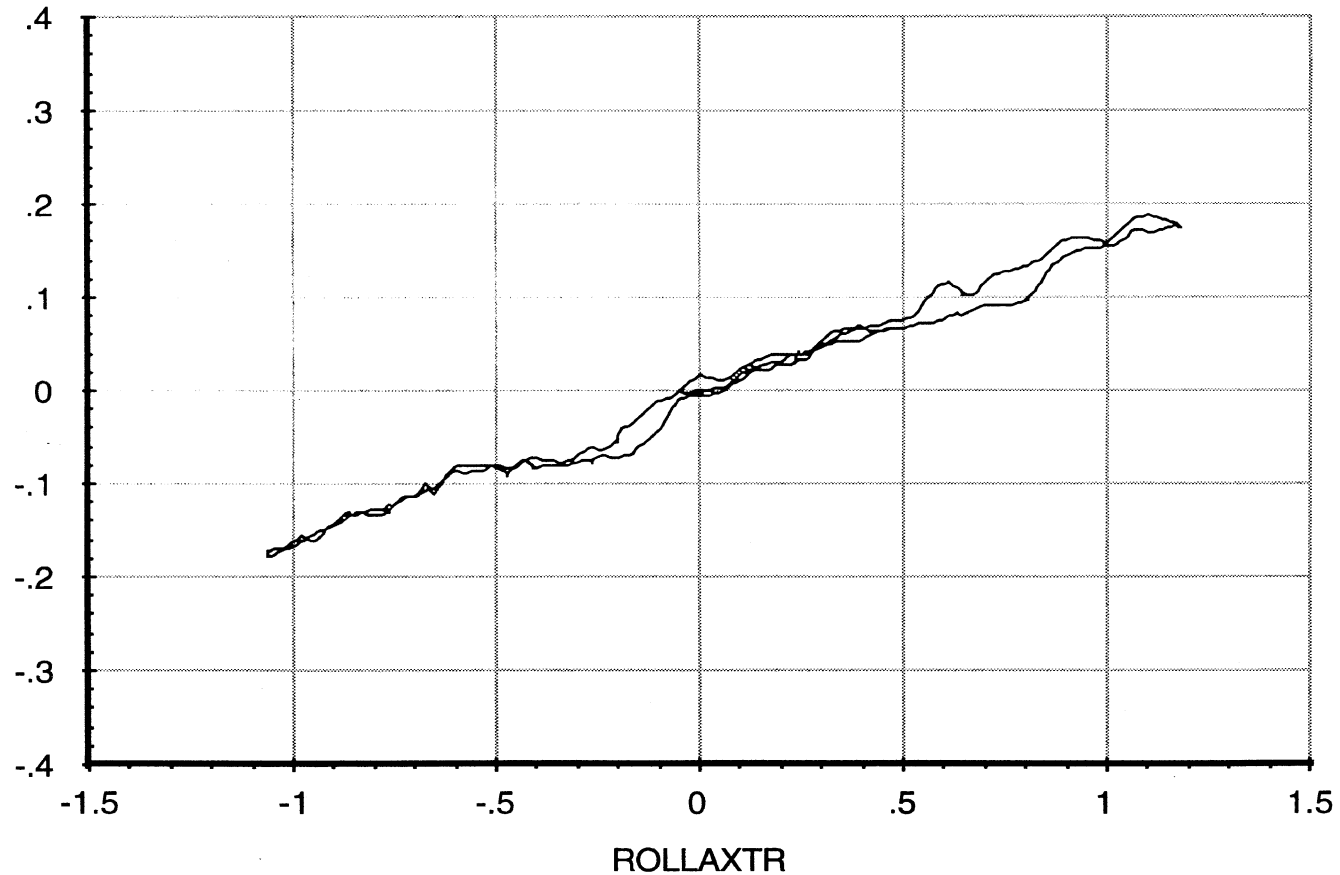

Abscissa (X): Trailing axle roll angle (ROLLAXTR); degrees; right side compressed, positive.

Ordinate (Y): Average trailing axle average steer angle (SATRA); degrees; steer toward right, positive.

*Note: Brakes on. Force control.

Measured by **UMTRI** for NHTSA
Mounted on a bare frame

Tandem Trailer Axle Suspension

7 Aug 95
Suspension: 4-Spring/Taper(1)

Data file: NHTSAT10.ERD

Leading Axle Roll Rate

Suspension Load: 10000 lb.

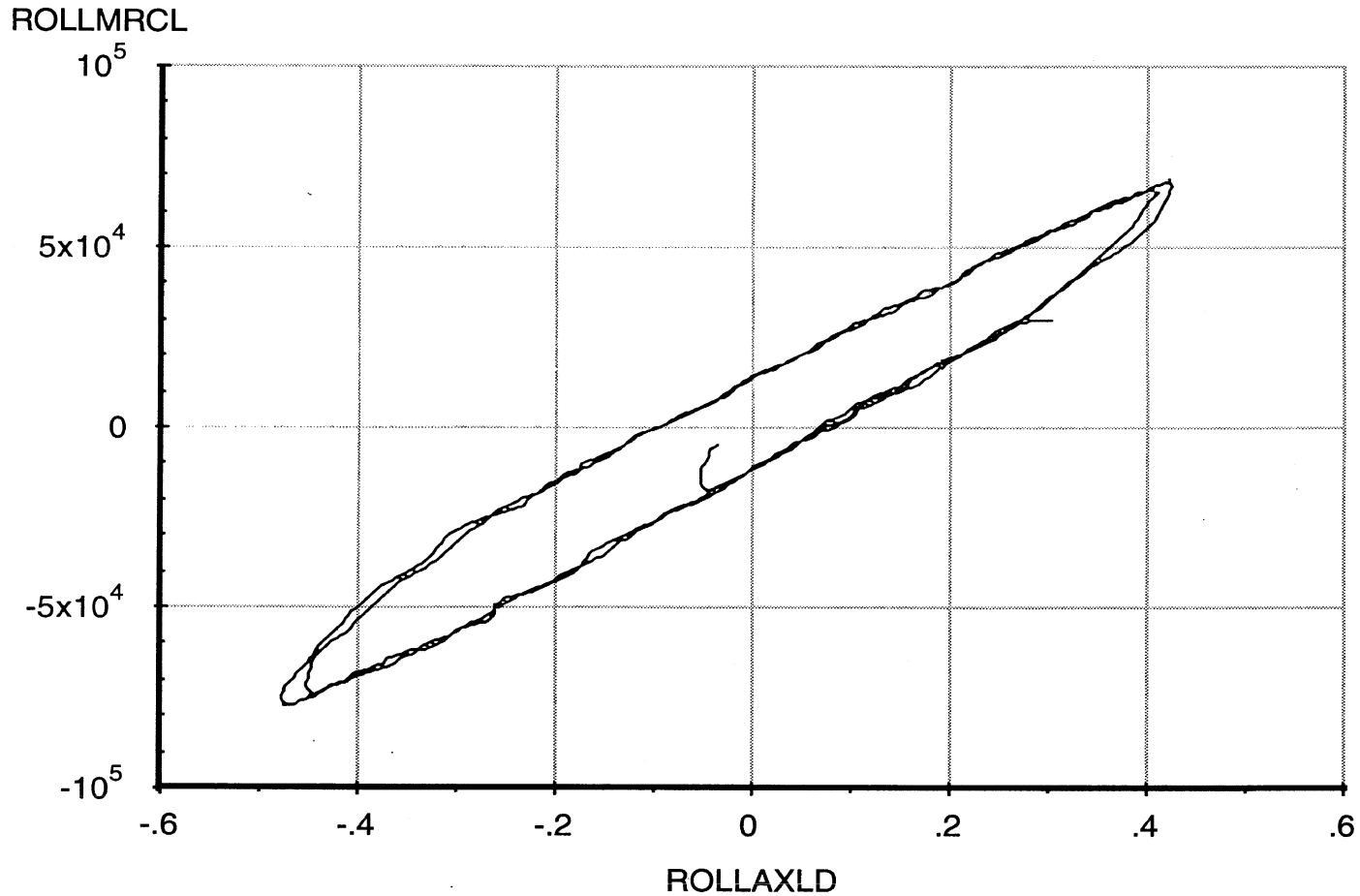

A-109

Abcissa (X): Leading axle roll angle (ROLLAXLD); degrees; right side compressed, positive.

Ordinate (Y): Leading axle roll moment about the roll center (ROLLMRCL); in-lb; right side compressed, positive.

*Note: Brakes on. Force control.

Measured by **UMTRI** for NHTSA
Mounted on a bare frame

7 Aug 95
Suspension: 4-Spring/Taper(1)

Tandem Trailer Axle Suspension

Data file: NHTSAT10.ERD

Trailing Axle Roll Rate

Suspension Load: 10000 lb.

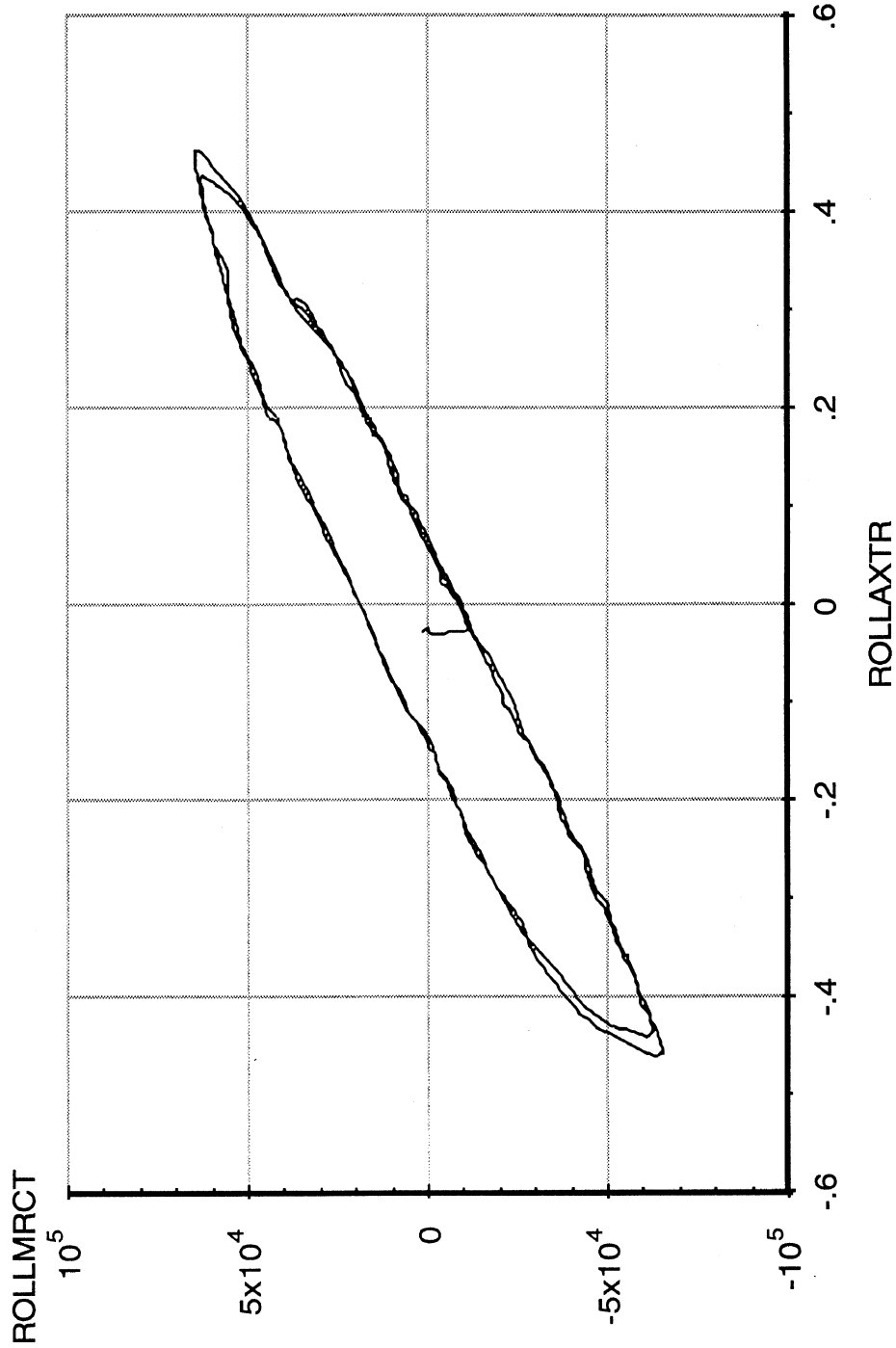

Abscissa (X): Trailing axle roll angle (ROLLAXTR); degrees; right side compressed, positive.

Ordinate (Y): Trailing axle roll moment about the roll center (ROLLMRCT); in-lb; right side compressed, positive.

*Note: Brakes on. Force control.

Measured by **UMTRI** for NHTSA
Mounted on a bare frame

Data file: NHTSAT10.ERD

Tandem Trailer Axle Suspension
Leading Axle Roll Center Height

7 Aug 95
Suspension: 4-Spring/Taper(1)

Suspension Load: 10000 lb.

A-1111

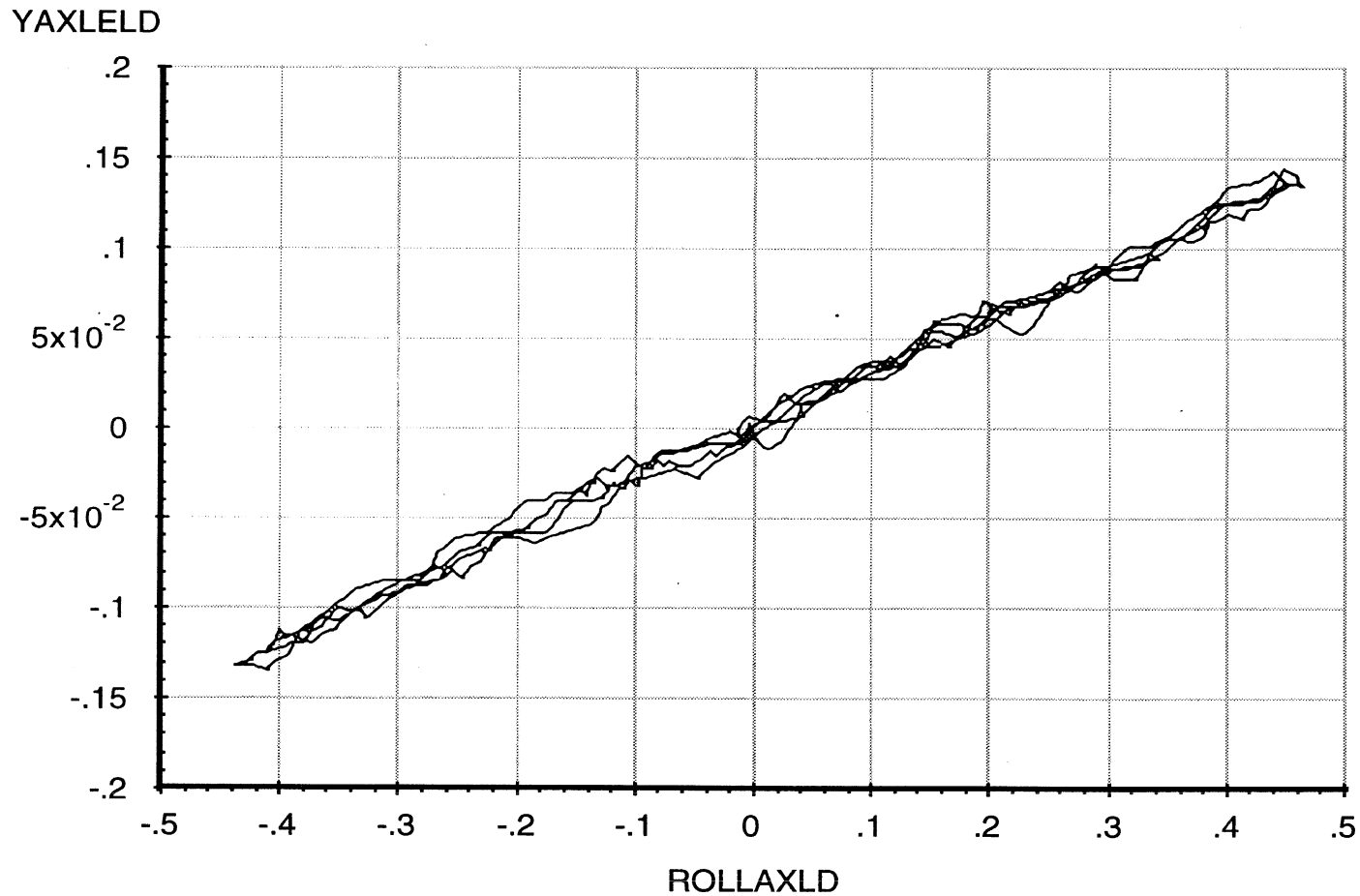

Abscissa (X): Leading axle roll angle (ROLLAXLD); degrees; right side compressed, positive.

Ordinate (Y): Leading axle reference point lateral translation (YAXLELD); inches; motion toward right, positive.

*Note: Brakes on. Force control. Reference height of 13.56 inches.

Measured by **UMTRI** for NHTSA
Mounted on a bare frame

Data file: NHTSAT10.ERD

Tandem Trailer Axle Suspension
Trailing Axle Roll Center Height

7 Aug 95
Suspension: 4-Spring/Taper(1)

Suspension Load: 10000 lb.

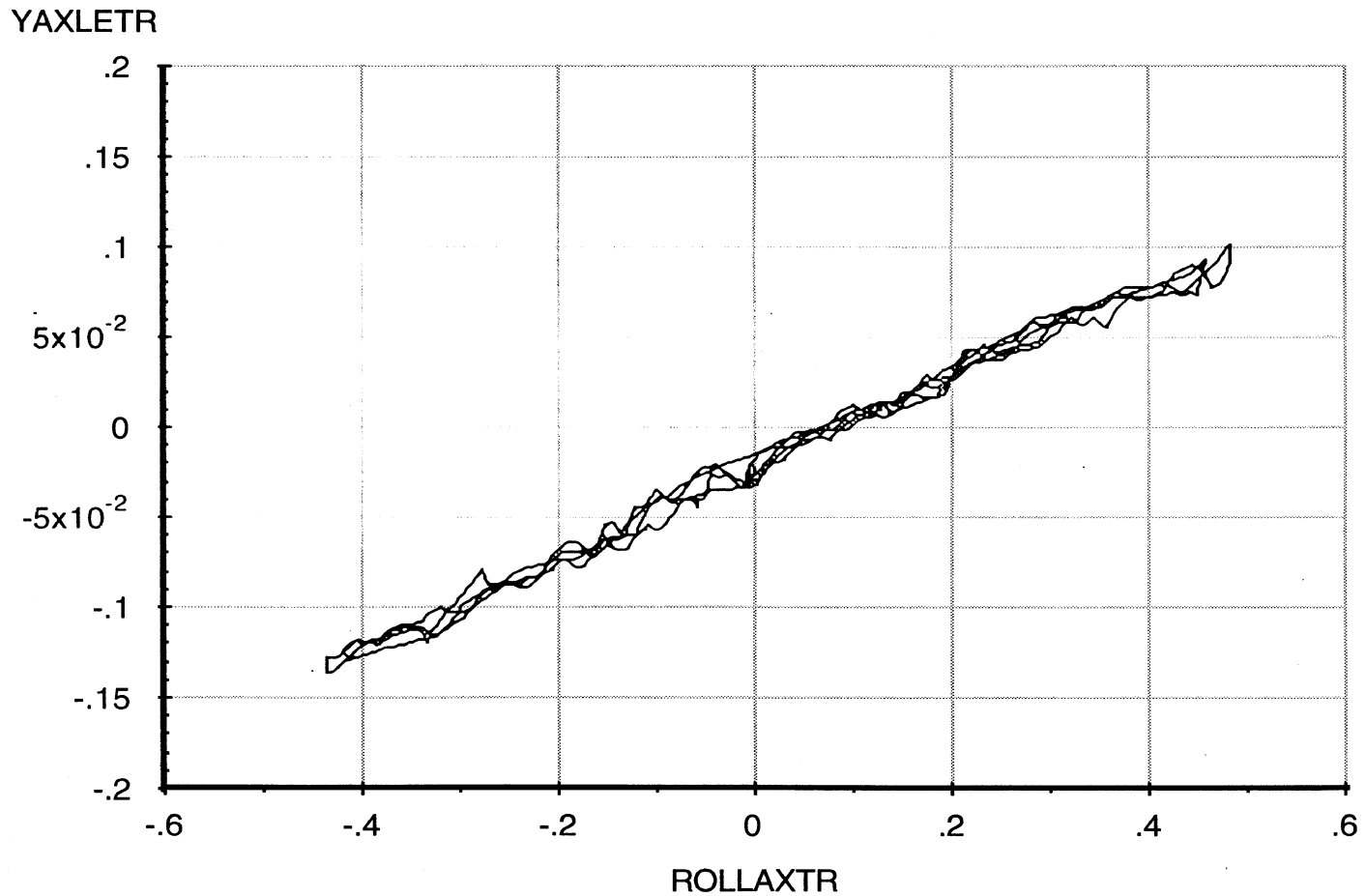

A-112

Abcissa (X): Trailing axle roll angle (ROLLAXTR); degrees; right side compressed, positive.

Ordinate (Y): Trailing axle reference point lateral translation (YAXLETR); inches; motion toward right, positive.

*Note: Brakes on. Force control. Reference height of 13.50 inches.

Measured by **UMTRI** for NHTSA
Mounted on a bare frame

Tandem Trailer Axle Suspension

7 Aug 95
Suspension: 4-Spring/Taper(1)

Data file: NHTSAT11.ERD

Leading Axle Lateral Force Compliance

Suspension Load: 10000 lb.

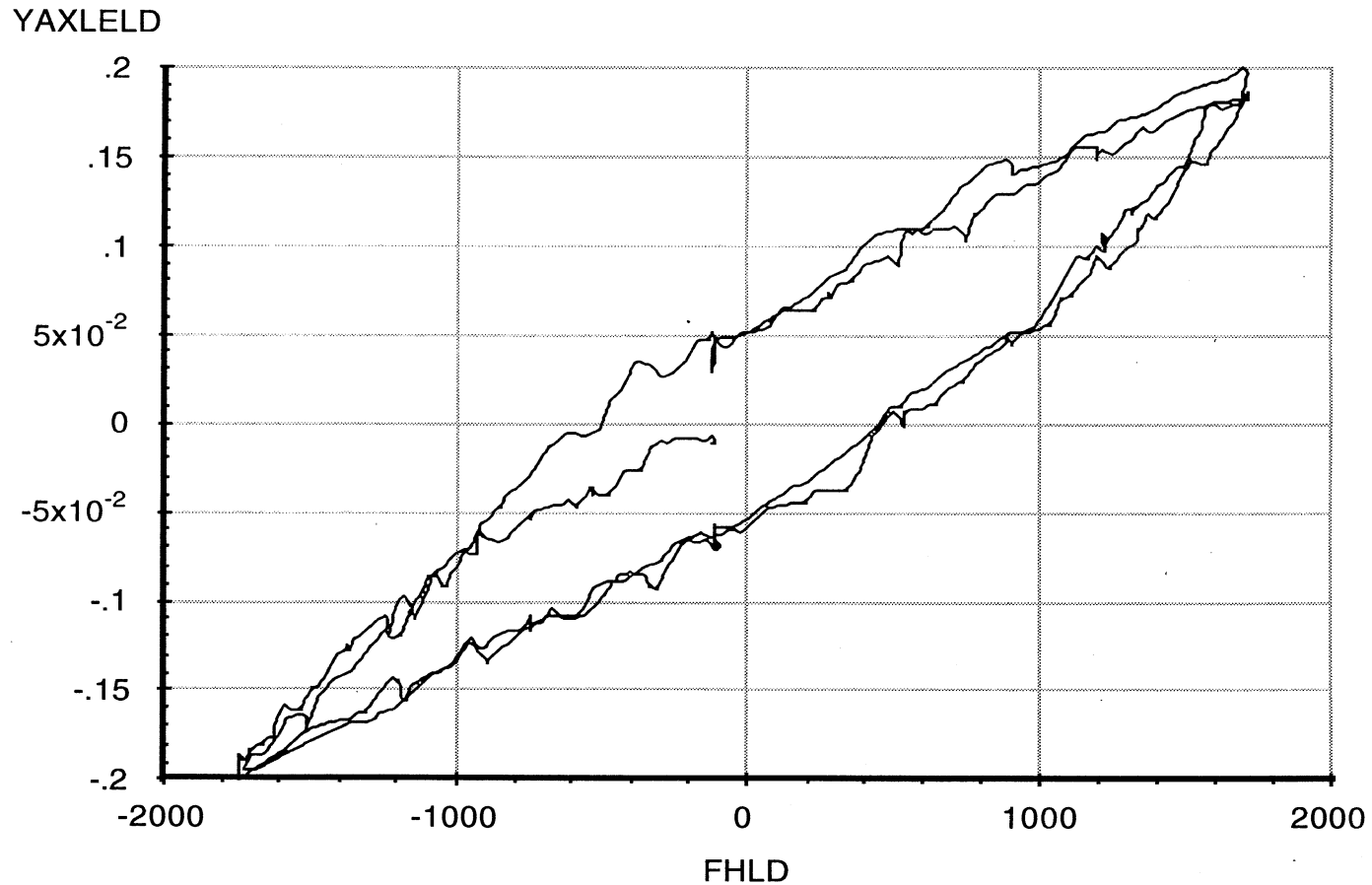

A-113

Abscissa (X): Total leading axle lateral force (FHLD); pounds per axle; applied to both axles simultaneously; force applied toward right, positive.

Ordinate (Y): Leading axle lateral translation (YAXLELD); inches; motion toward right, positive.

*Note: Brakes on. Position control.

Measured by **UMTRI** for NHTSA
Mounted on a bare frame

Tandem Trailer Axle Suspension

7 Aug 95
Suspension: 4-Spring/Taper(1)

Data file: NHTSAT11.ERD

Trailing Axle Lateral Force Compliance

Suspension Load: 10000 lb.

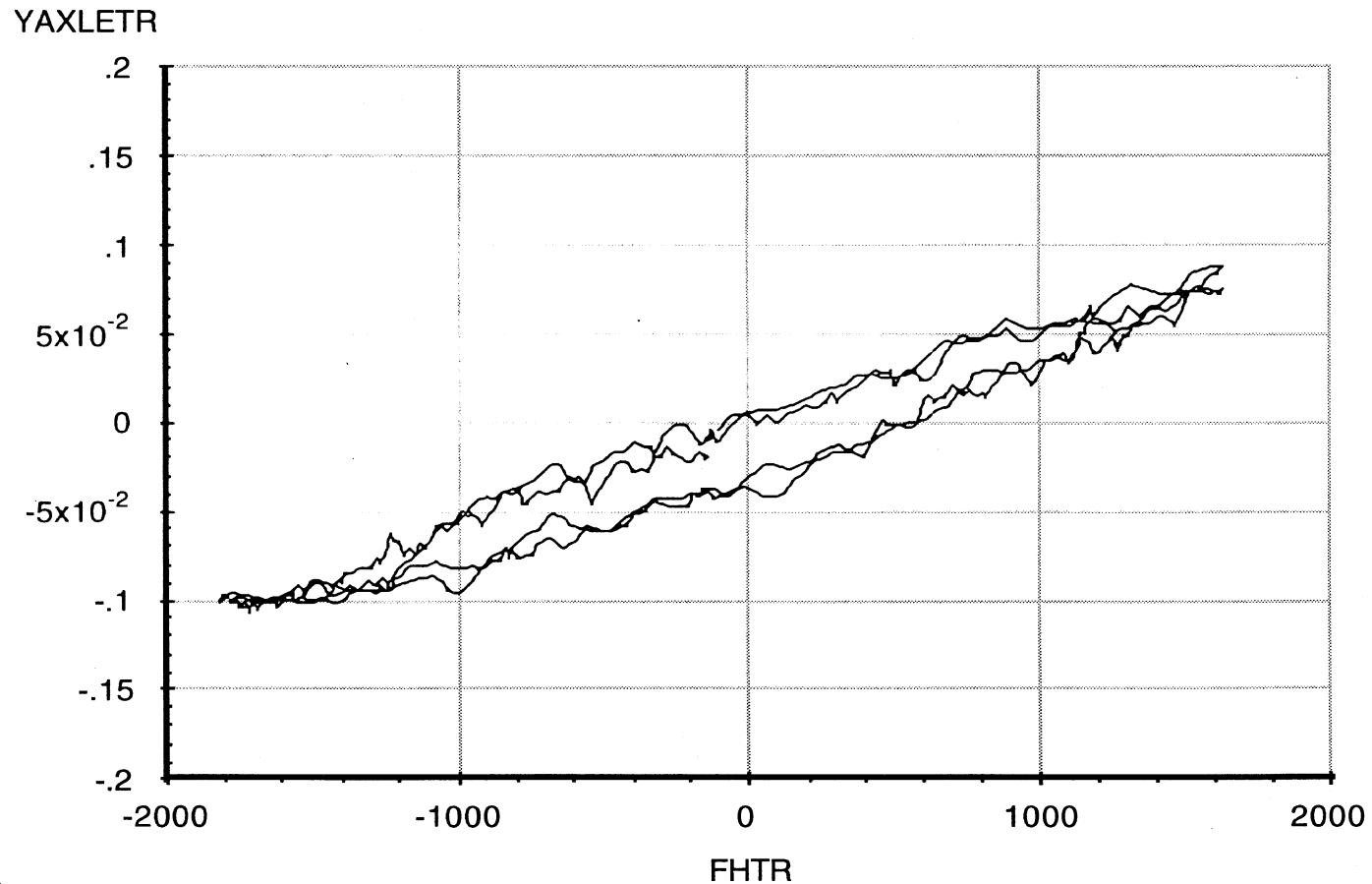

A-114

Abscissa (X): Total trailing axle lateral force (FHTR); pounds per axle; applied to both axles simultaneously; force applied toward right, positive.

Ordinate (Y): Trailing axle lateral translation (YAXLETR); inches; motion toward right, positive.

*Note: Brakes on. Position control.

Measured by **UMTRI** for NHTSA
Mounted on a bare frame

7 Aug 95
Suspension: 4-Spring/Taper(1)

Tandem Trailer Axle Suspension

Data file: NHTSAT11.ERD

Leading Axle Lateral Force Steer

Suspension Load: 10000 lb.

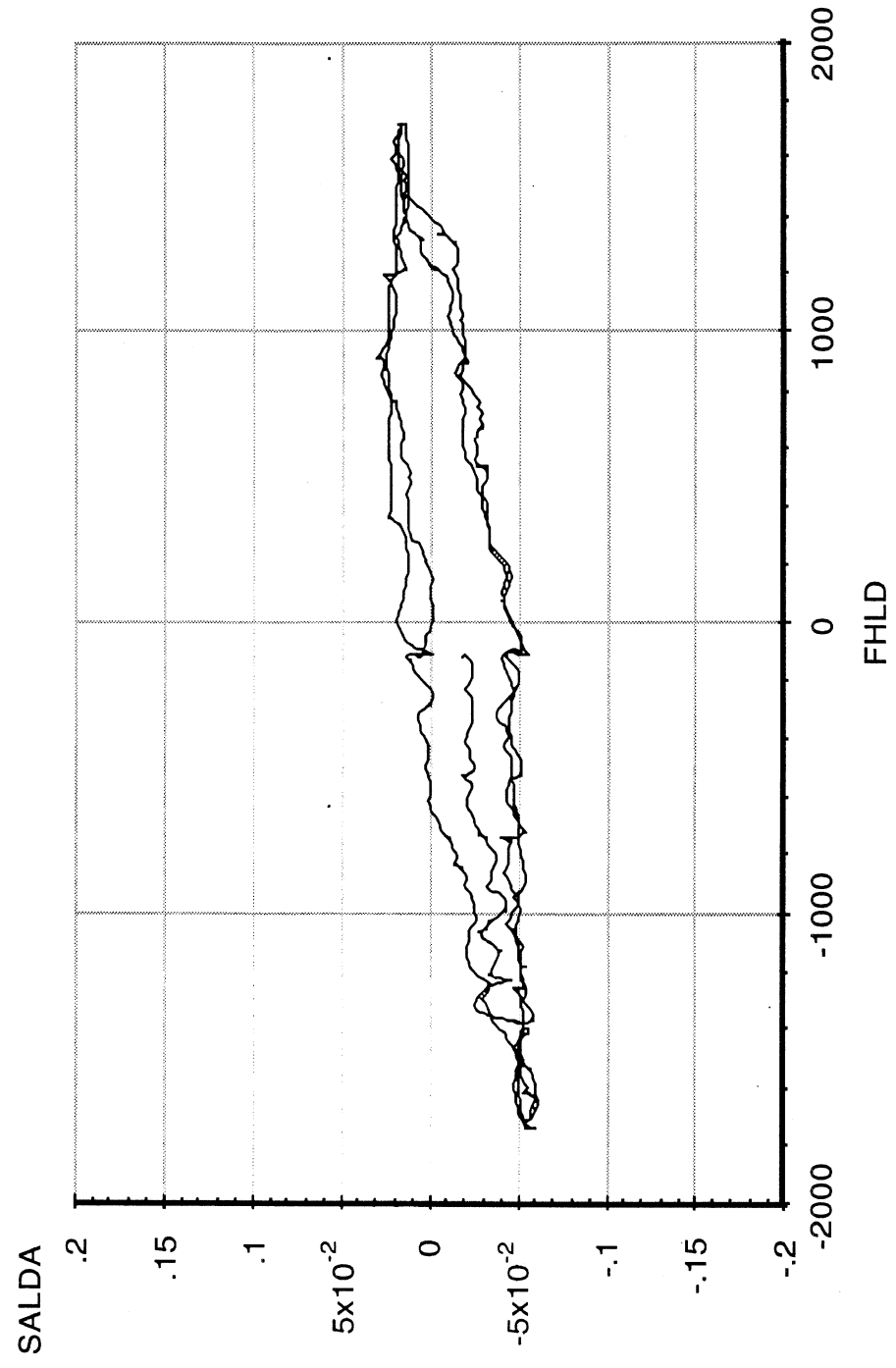

Abscissa (X): Total leading axle lateral force (FHLD); pounds per axle; applied to both axles simultaneously; force applied toward right, positive.

Ordinate (Y): Average leading axle steer angle (SALDA); degrees; steer toward right, positive.

*Note: Brakes on. Position control.

Measured by **UMTRI** for NHTSA
Mounted on a bare frame

Data file: NHTSAT11.ERD

Tandem Trailer Axle Suspension
Trailing Axle Lateral Force Steer

7 Aug 95
Suspension: 4-Spring/Taper(1)

Suspension Load: 10000 lb.

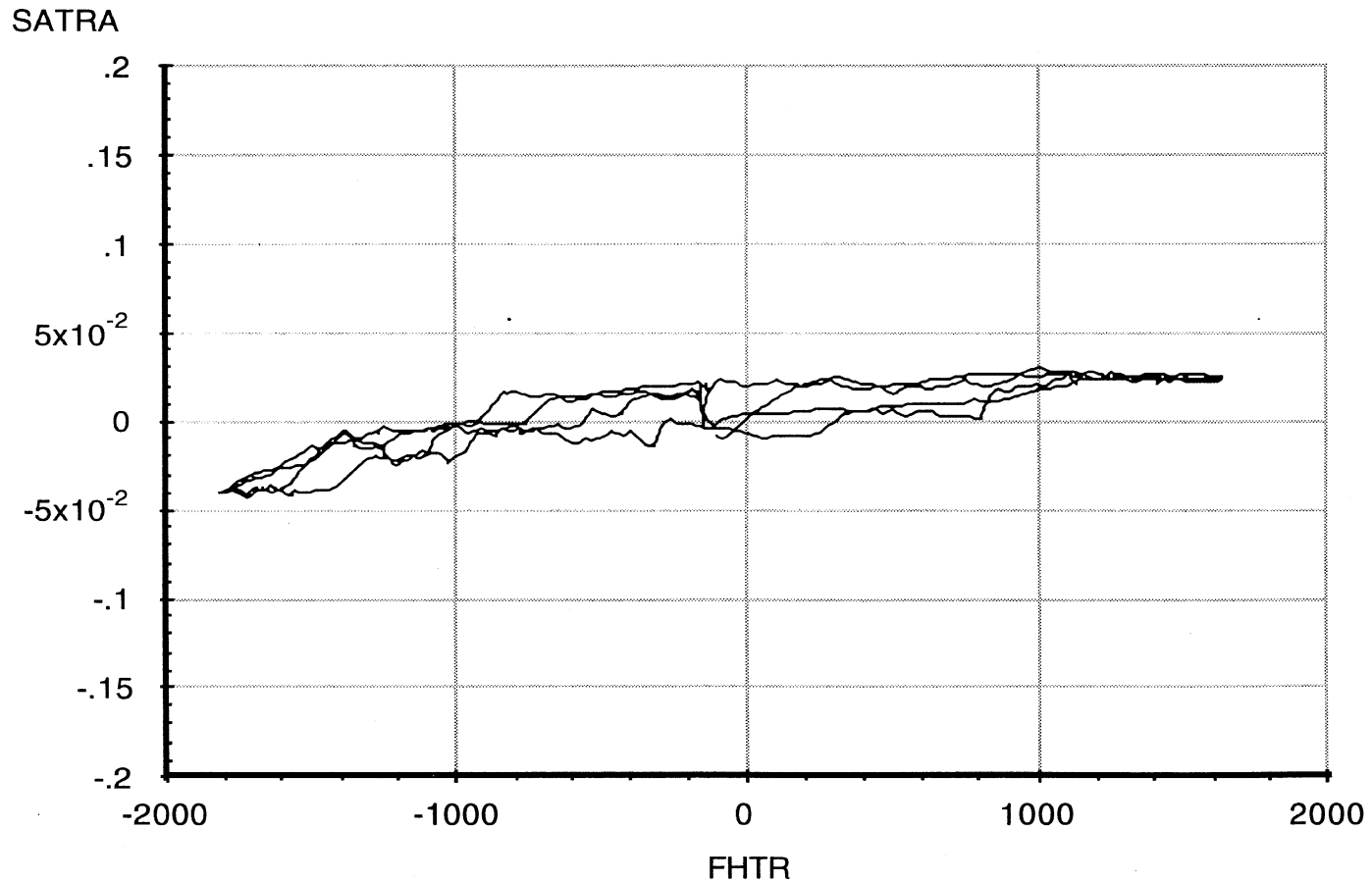

A-116

Abscissa (X): Total trailing axle lateral force (FHTR); pounds per axle; applied to both axles simultaneously; force applied toward right, positive.

Ordinate (Y): Average trailing axle steer angle (SATRA); degrees; steer toward right, positive.

*Note: Brakes on. Position control.

Measured by **UMTRI** for NHTSA
Mounted on a bare frame

Tandem Trailer Axle Suspension

7 Aug 95
Suspension: 4-Spring/Taper(1)

Data file: NHTSAT12.ERD

Leading Axle Aligning Moment Compliance Steer

Suspension Load: 10000 lb.

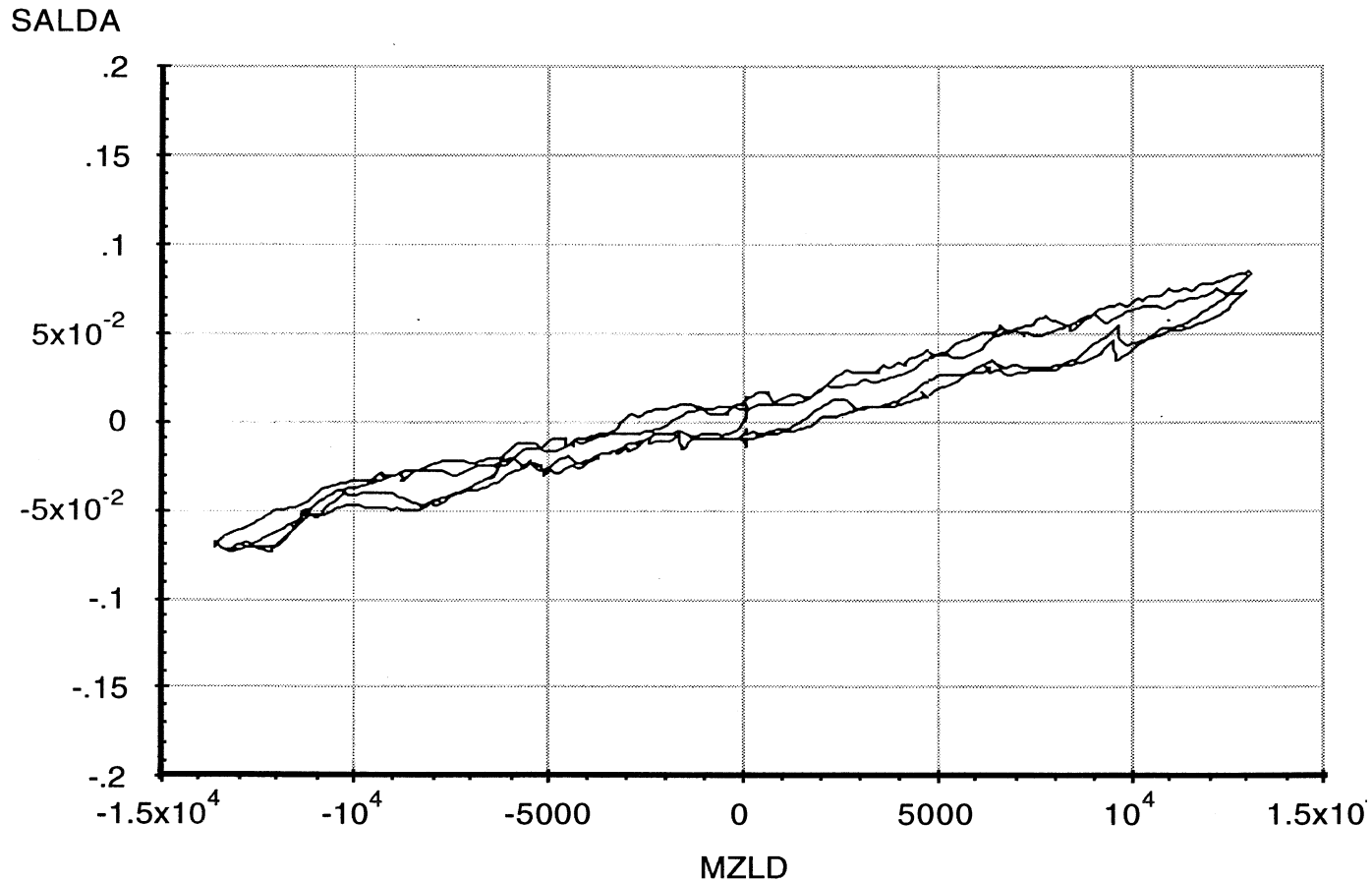

A-117

Abscissa (X): Total leading axle aligning moment (MZLD); in-lb per axle; applied to both axles simultaneously; downward (right hand rule) moment vector, positive.

Ordinate (Y): Average leading axle steer angle (SALDA); degrees; steer toward right, positive.

*Note: Brakes on. Position control.

Measured by **UMTRI** for NHTSA
Mounted on a bare frame

Tandem Trailer Axle Suspension

7 Aug 95
Suspension: 4-Spring/Taper(1)

Data file: NHTSAT12.ERD

Trailing Axle Aligning Moment Compliance Steer

Suspension Load: 10000 lb.

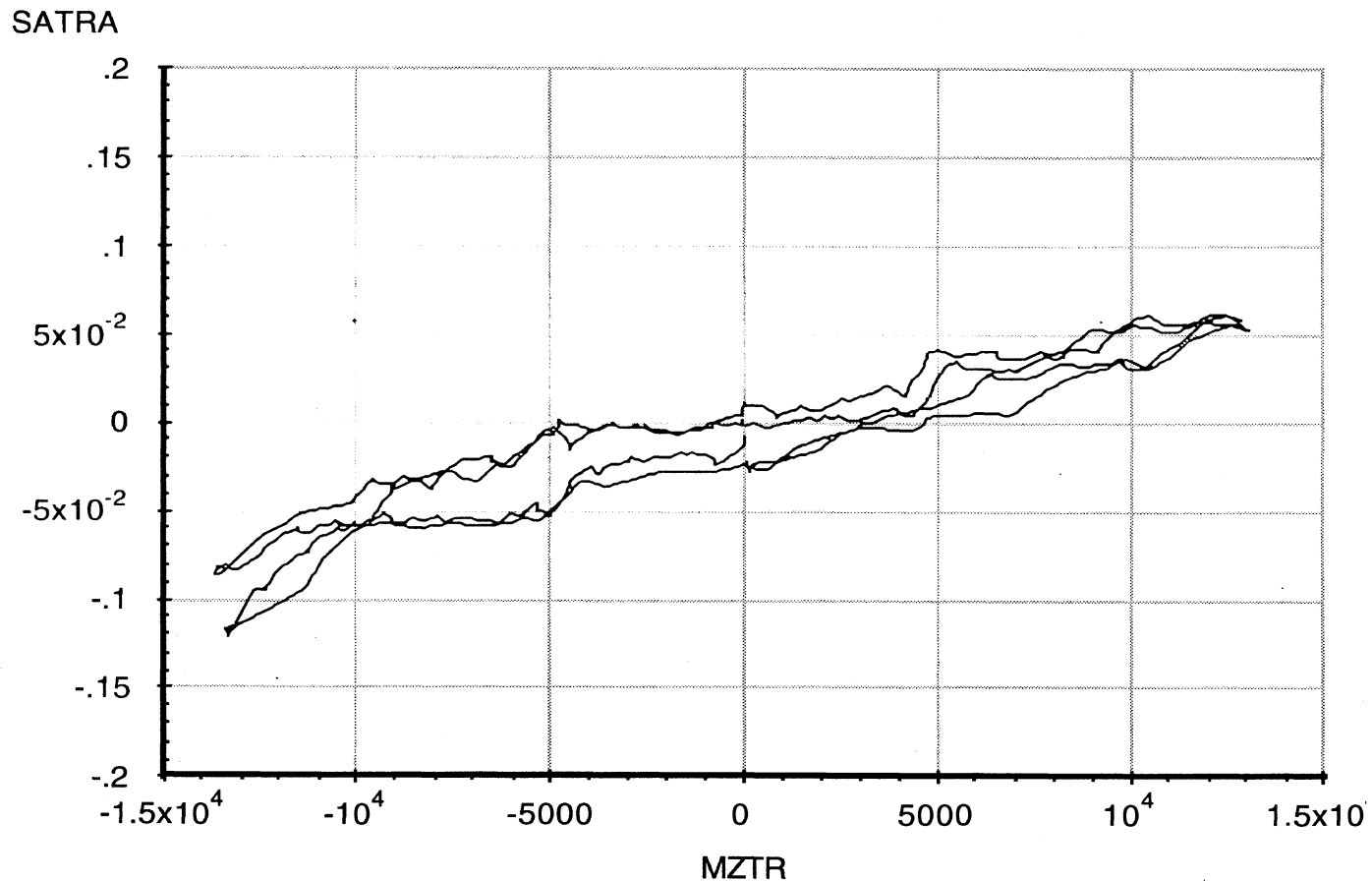

A-118

Abcissa (X): Total trailing axle aligning moment (MZTR); in-lb per axle; applied to both axles simultaneously; downward (right hand rule) moment vector, positive.

Ordinate (Y): Average trailing axle steer angle (SATRA); degrees; steer toward right, positive.

*Note: Brakes on. Position control.

Measured by **UMTRI** for NHTSA
Mounted on a bare frame

Tandem Trailer Axle Suspension

7 Aug 95
Suspension: 4-Spring/Taper(1)

Data file: NHTSAT13.ERD

Inter-Axle Load Transfer Due to Braking

Suspension Load: 10000 lb.

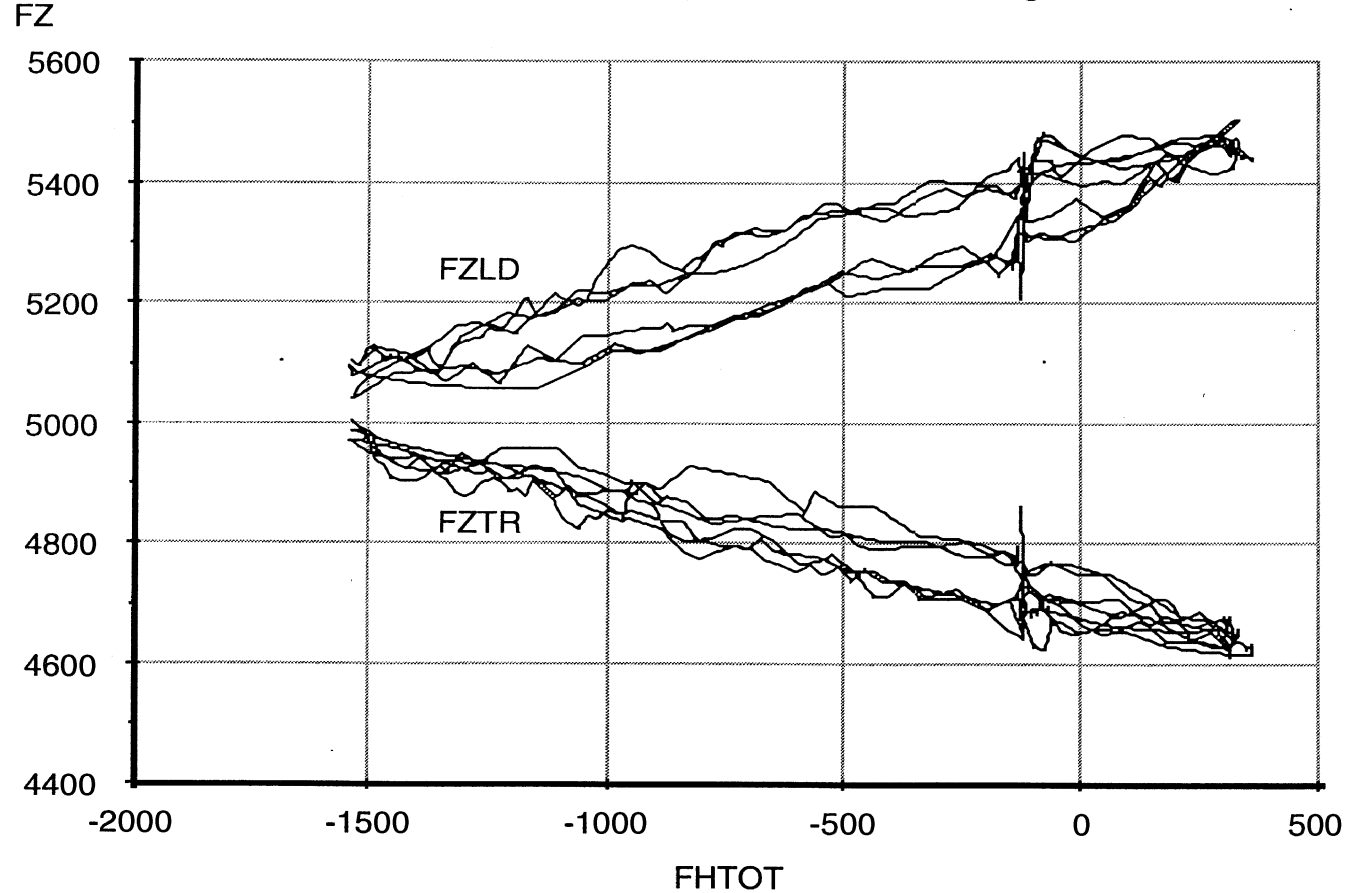

A-119

Abscissa (X): Total longitudinal force (FHTOT); pounds; applied to all four wheel sets simultaneously; force applied toward front, positive.

Ordinate (Y): Total leading axle vertical wheel load (FZLD); pounds; spring compression, positive.
Total trailing axle vertical wheel load (FZTR); pounds; spring compression, positive.

*Note: Brakes on. Force control.

Measured by **UMTRI** for NHTSA
Mounted on a bare frame

Data file: NHTSAT14.ERD

Tandem Trailer Axle Suspension

Leading Axle Roll Rate

7 Aug 95

Suspension: 4-Spring/Taper(1)

Suspension Load: 10000 lb.

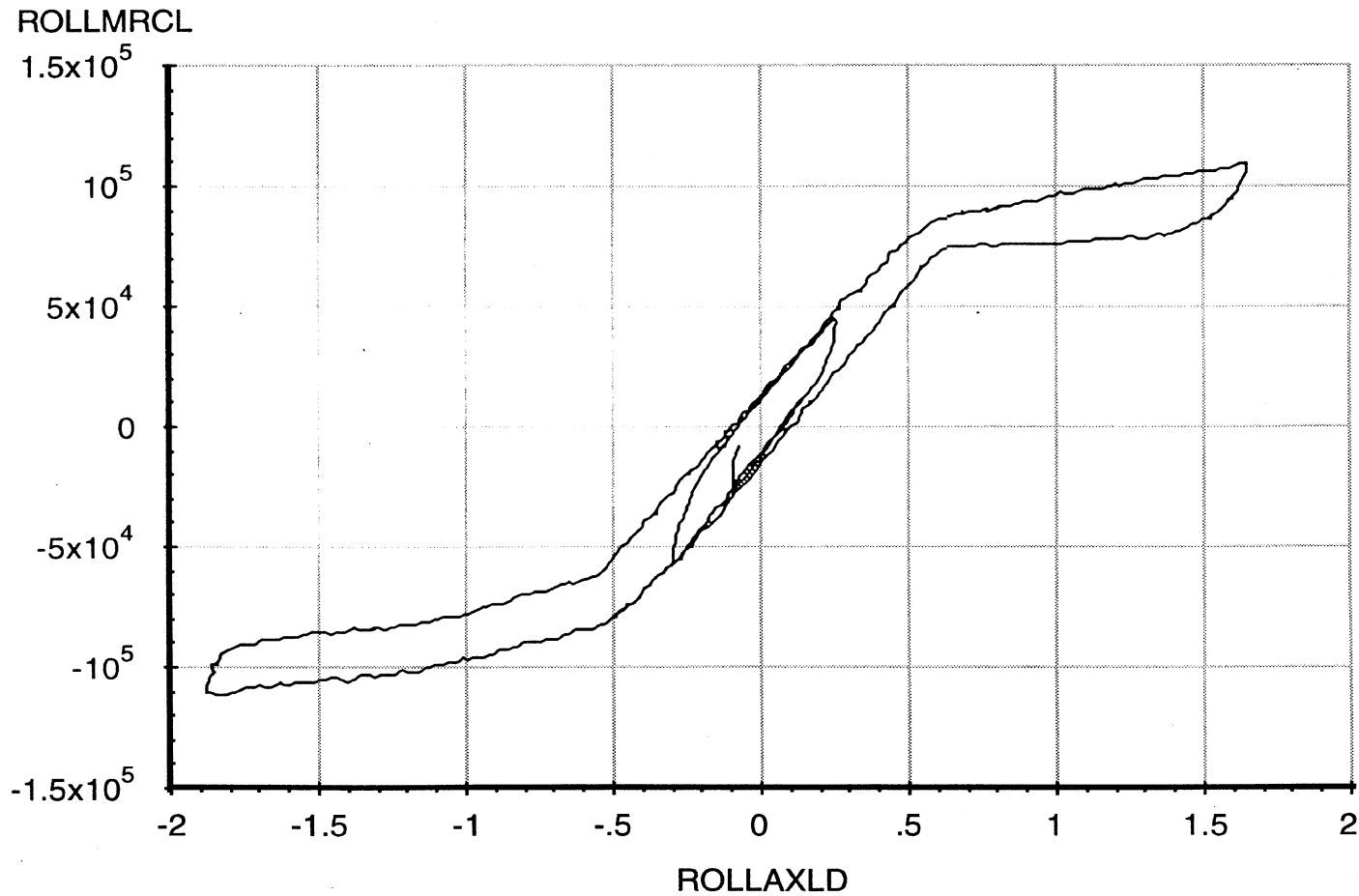

A-120

Abscissa (X): Leading axle roll angle (ROLLAXLD); degrees; right side compressed, positive.

Ordinate (Y): Leading axle roll moment about the roll center (ROLLMRCL); in-lb; right side compressed, positive.

*Note: Brakes on. Force control.

Measured by **UMTRI** for NHTSA
Mounted on a bare frame

Tandem Trailer Axle Suspension

7 Aug 95
Suspension: 4-Spring/Taper(1)

Data file: NHTSAT14.ERD

Trailing Axle Roll Rate

Suspension Load: 10000 lb.

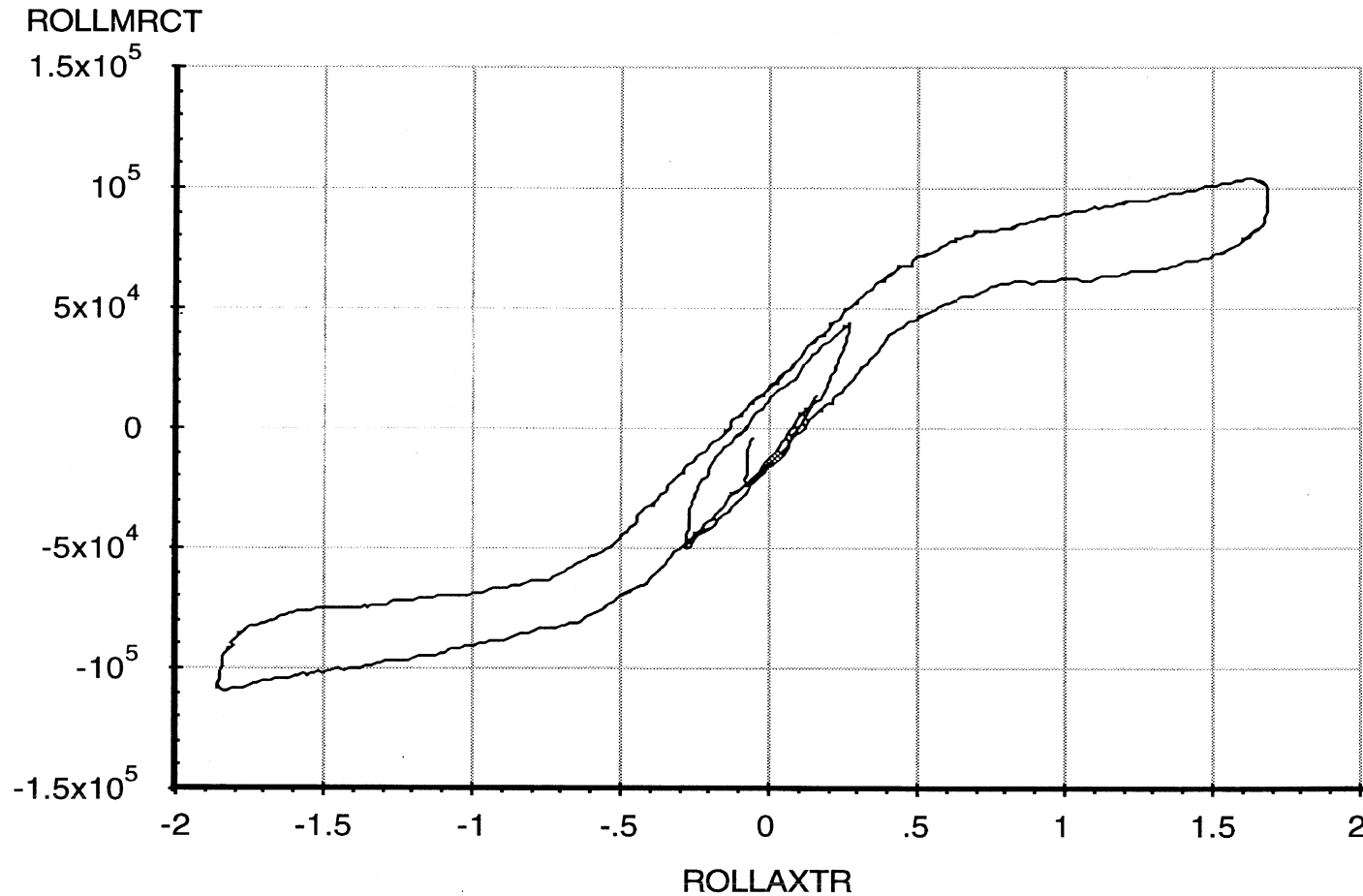

A-121

Abscissa (X): Trailing axle roll angle (ROLLAXTR); degrees; right side compressed, positive.

Ordinate (Y): Trailing axle roll moment about the roll center (ROLLMRCT); in-lb; right side compressed, positive.

*Note: Brakes on. Force control.

Measured by **UMTRI** for NHTSA
Mounted on a bare frame

Data file: NHTSAT14.ERD

Tandem Trailer Axle Suspension
Leading Axle Roll Center Height

7 Aug 95
Suspension: 4-Spring/Taper(1)

Suspension Load: 10000 lb.

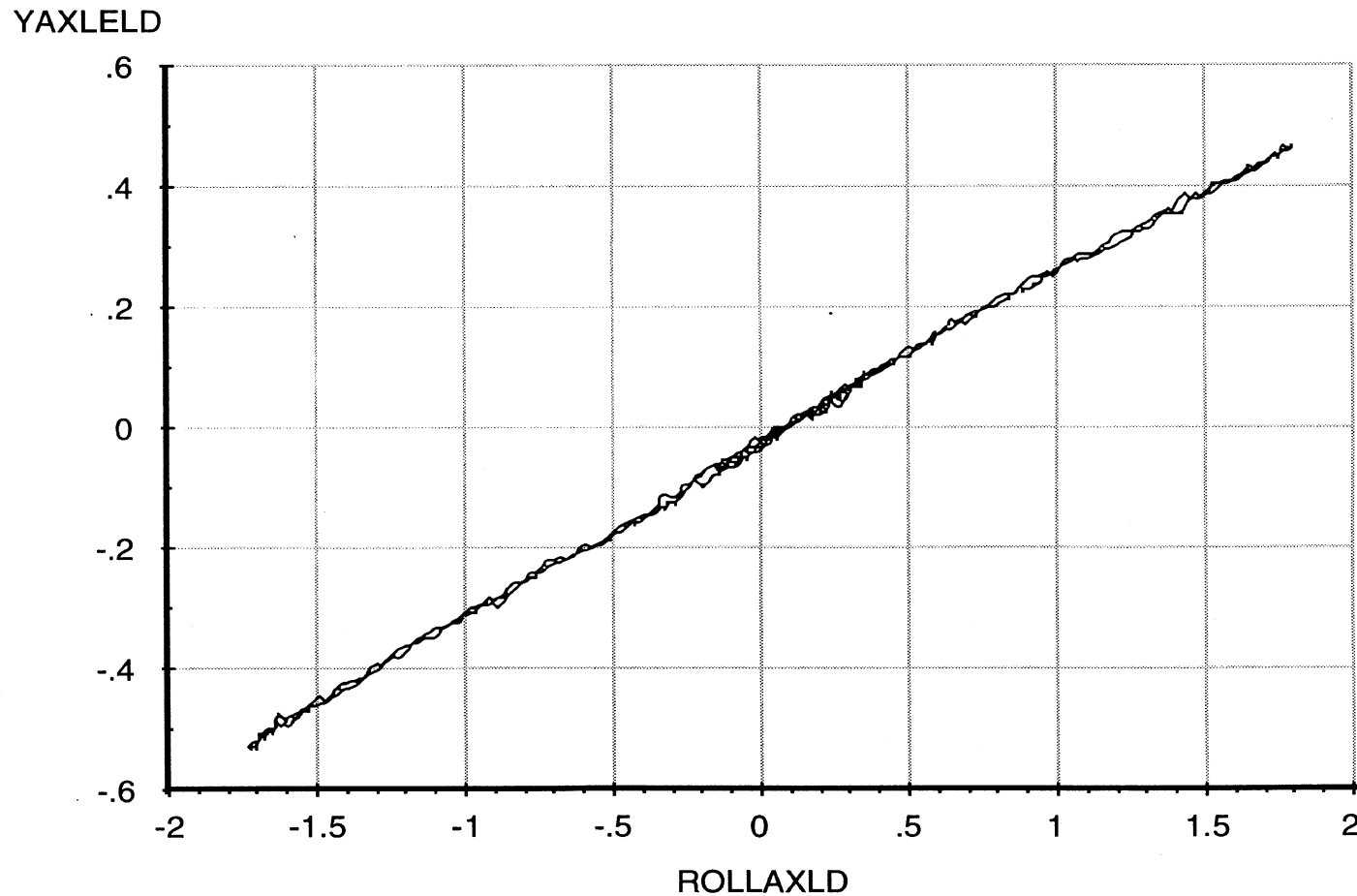

A-122

Abscissa (X): Leading axle roll angle (ROLLAXLD); degrees; right side compressed, positive.

Ordinate (Y): Leading axle reference point lateral translation (YAXLELD); inches; motion toward right, positive.

*Note: Brakes on. Force control. Reference height of 13.56 inches.

Measured by **UMTRI** for NHTSA
Mounted on a bare frame

Data file: NHTSAT14.ERD

Tandem Trailer Axle Suspension
Trailing Axle Roll Center Height

7 Aug 95
Suspension: 4-Spring/Taper(1)

Suspension Load: 10000 lb.

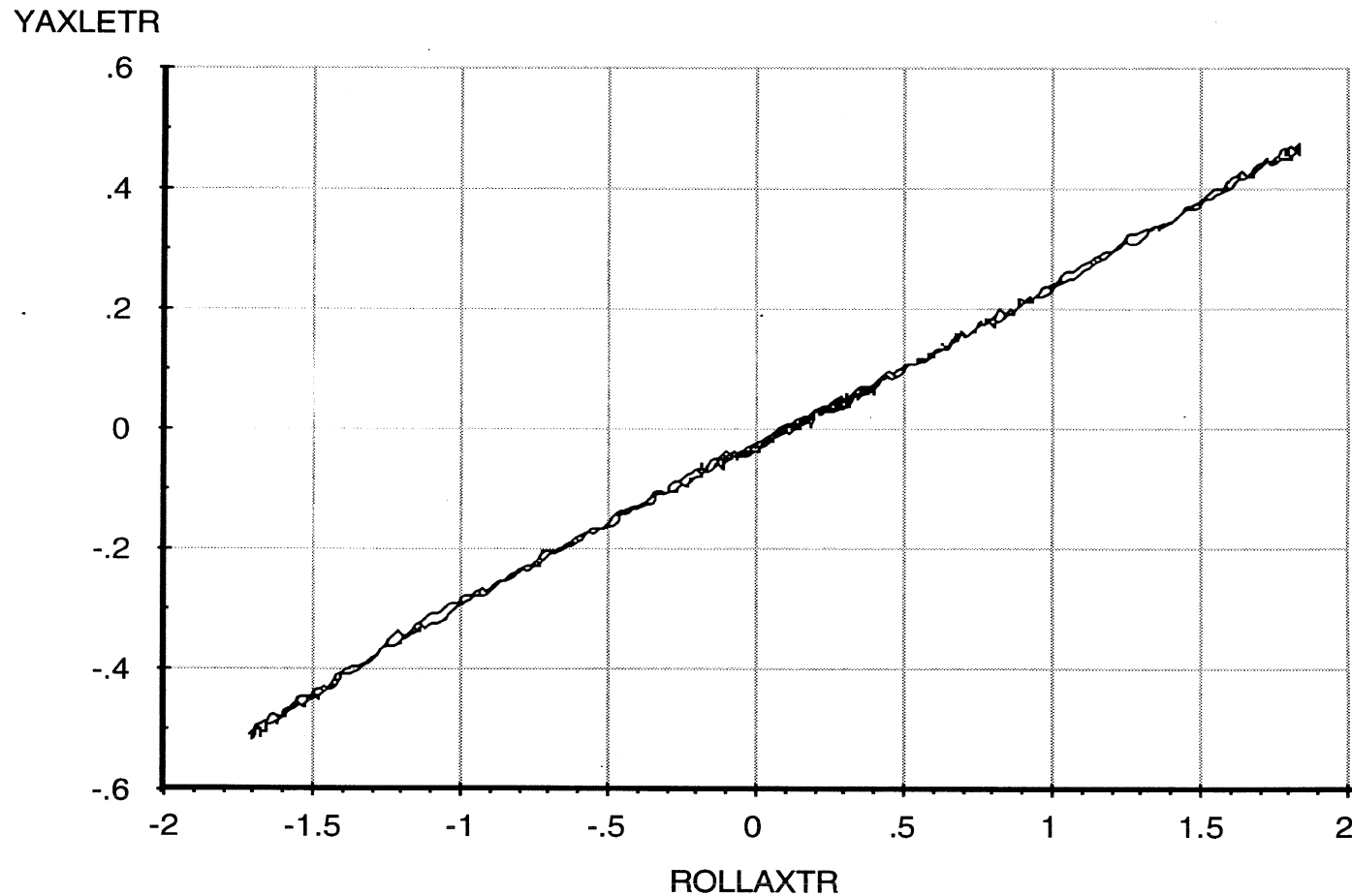

A-123

Abscissa (X): Trailing axle roll angle (ROLLAXTR); degrees; right side compressed, positive.

Ordinate (Y): Trailing axle reference point lateral translation (YAXLETR); inches; motion toward right, positive.

*Note: Brakes on. Force control. Reference height of 13.50 inches.

Measured by **UMTRI** for NHTSA
Mounted on a bare frame

Tandem Trailer Axle Suspension

7 Aug 95
Suspension: 4-Spring/Taper(1)

Data file: NHTSAT14.ERD

Leading Axle Roll Steer

Suspension Load: 10000 lb.

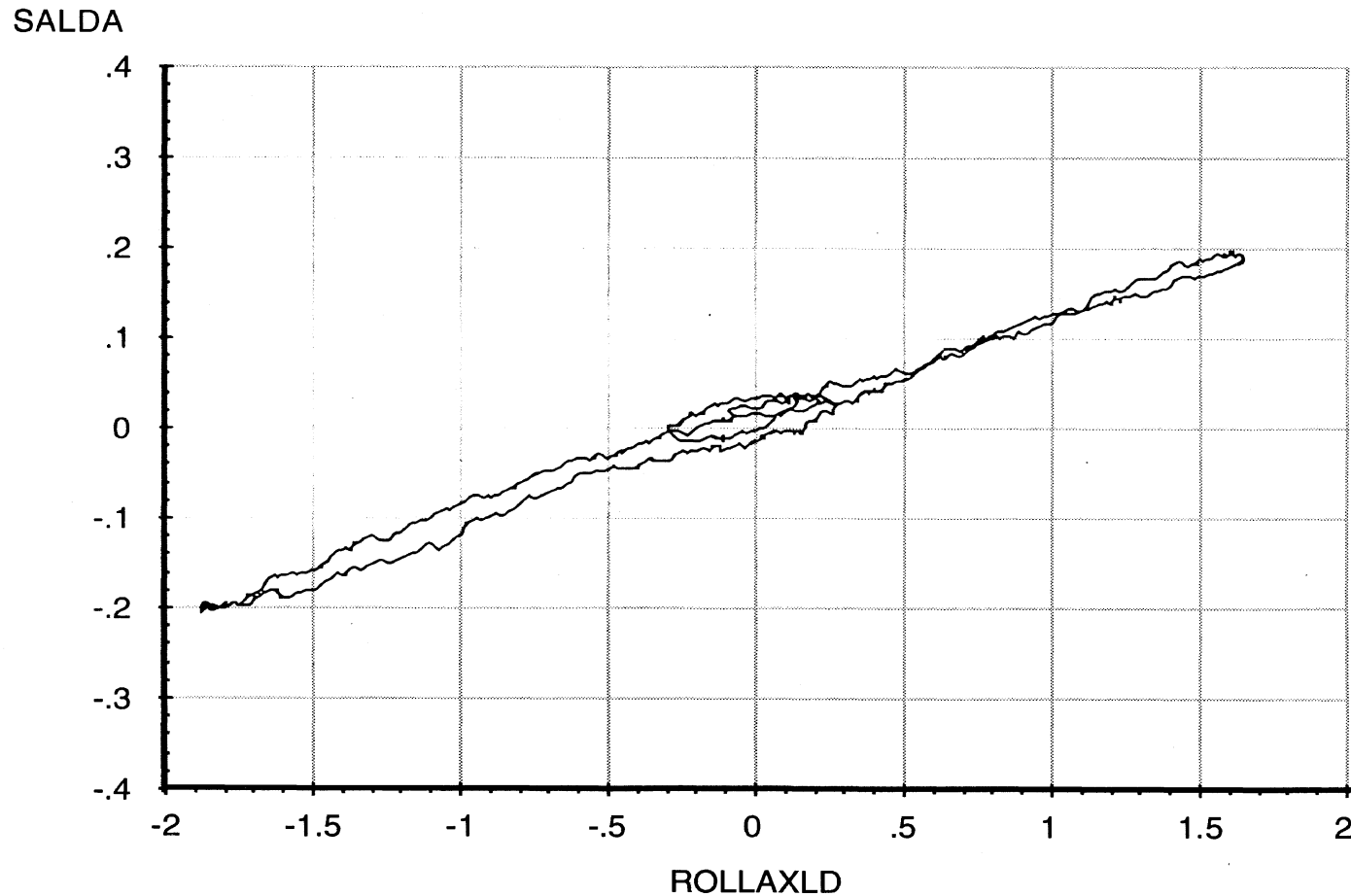

A-124

Abscissa (X): Leading axle roll angle (ROLLAXLD); degrees; right side compressed, positive.

Ordinate (Y): Average leading axle average steer angle (SALDA); degrees; steer toward right, positive.

*Note: Brakes on. Force control.

Measured by **UMTRI** for NHTSA
Mounted on a bare frame

Data file: NHTSAT14.ERD

Tandem Trailer Axle Suspension

Trailing Axle Roll Steer

7 Aug 95

Suspension: 4-Spring/Taper(1)

Suspension Load: 10000 lb.

SATRA

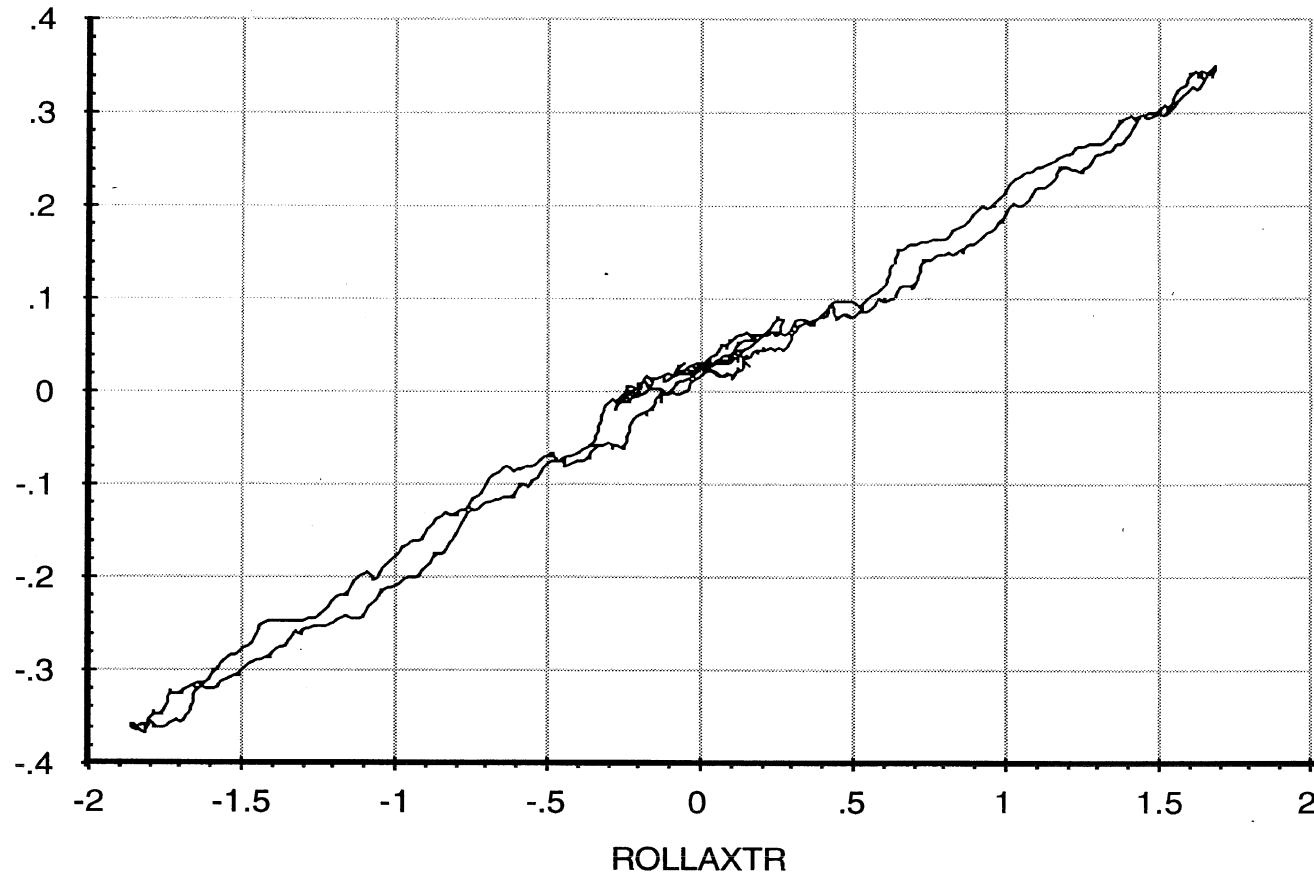

A-125

Abscissa (X): Trailing axle roll angle (ROLLAXTR); degrees; right side compressed, positive.

Ordinate (Y): Average trailing axle average steer angle (SATRA); degrees; steer toward right, positive.

*Note: Brakes on. Force control.

