

NUCLEAR POWER

James J. Duderstadt

Chihiro Kikuchi

Department of Nuclear Engineering

The University of Michigan

Ann Arbor, Michigan



## OUTLINE

FOREWORD: Nuclear Power: A Model for Developing a New Technology for Societal Use

### CHAPTER 1: An Assessment of Electrical Power Requirements

Introduction: energy crisis, miniprofile of state, overview of alternatives

- 1.1 Energy Needs vs. Energy Consumption
  - Basic Energy Needs
  - Energy Consumption
  - Energy Consumption in a Technological Society
  - Exponential Growth in Energy Demand
- 1.2 Energy Resources
  - Nonrenewable World Energy Resources
  - Local Energy Resources
  - Local Energy Consumption
  - Projected Needs for Electrical Power
  - Prophets of Doom
  - Concluding Remarks

### CHAPTER 2: Some Facts and Fantasies in Energy Planning

Introduction: feasible vs. viable alternatives, overview of decision criteria

- 2.1 Scientific Feasibility vs. Social Viability
  - Scientific Research vs. Engineering Development
  - An Example: Windpower
  - An Example: Solar Photovoltaic Power
- 2.2 Resources
- 2.3 Environmental Impact
- 2.4 Public Safety--Benefit vs. Risk
- 2.5 Economics
- 2.6 Near Term Alternatives
  - Liquid Fossil Fuels
  - Hydroelectric Power Generation
  - Coal
  - Nuclear Fission Power
  - Conservation
- 2.7 Long Range Alternatives
  - Solar Energy Resources
  - Geothermal Energy
  - Controlled Thermonuclear Fusion

## CHAPTER 3: Electrical Power Generation

- 3.1 Basic Concepts
  - Energy, Power (Definition, Units, Types)
  - Transformation of Energy from One Form to Another
  - Some Basic Limitations (Thermodynamics)
- 3.2 The Generation of Electrical Power
  - What is Electricity?
  - How is it Made?
  - How is it Distributed?
- 3.3 Electrical Generating Plants
  - A Tour of a Coal-Fired Generating Plant
  - Coal vs. Nuclear Plants
  - Oil Fired Plants
  - Hydroelectric Plants
  - Types of Generating Plants (Base-Load, Peaking, Storage)
- 3.4 Electrical Distribution Networks
  - General Problems of Distribution
  - Impact on Generating Plant Siting
  - Large Electrical Grids
- 3.5 Electrical Utilities
  - Basic Organization and Regulation
  - Utility Economics and Rate Structures
  - Decisions and Planning Activities

## CHAPTER 4: A Brief History of the Development of Nuclear Power

- 4.1 The Early Years--The Manhattan Project
  - Early Nuclear Research, Pre WWII Years
  - The Manhattan Engineering District
  - Development of the Bomb
- 4.2 Postwar Activities--The Atomic Energy Commission
  - Domestic Legislation
  - Transfer from the MED to the AEC
  - Transition to a Peacetime Program
  - Military Participation in Nuclear Weapons Development
  - The Super
  - Atomic Power Development
  - Evolution of the Atomic Energy Commission
  - The Need for Special Control of Atomic Energy
- 4.3 Growth in the Opposition to Nuclear Power
  - Early Opposition to Nuclear Power
  - Shift to Environmental Issues
  - Brief History of Evolution in Nuclear Opposition Concerns
- 4.4 The Nuclear Power Debate
  - Review Popular Pro's and Con's
  - Importance of Responsible Criticism--Accountability

Scientific Integrity vs. Cargo-Cult Science; Science vs. Technology  
Role of the Layman in Influencing Technical Decisions

CHAPTER 5: Basic Concepts of Nuclear Energy Release

5.1 Nuclear Fission and Nuclear Fusion

Atoms and Nuclei: Atomic Structure and Atomic Physics; Nuclear Structure and Nuclear Physics

Radioactivity: Types, Decay Law, Half-Life, Chart of Nuclides

Nuclear Reactions: Types, Cross Section

Nuclear Fission and Fission Chain Reactions: Nuclear Fission; Fission Chain Reactions; Power Generation and Utilization

Nuclear Fusion and Controlled Thermonuclear Fusion Reactions; Thermonuclear Fusion Physics; Controlled Thermonuclear Fusion Schemes

5.2 Nuclear Fission Reactors

General Introduction

Fission Chain Reactions and Nuclear Criticality: Neutron Balance, Multiplication, Thermal vs. Fast Neutrons, Conversion and Breeding

Fuel Loading and Fuel Types

Nuclear Reactor Components and Reactor Types

Reactor Control and Operation

Radiation Produced in Nuclear Fission Reactors

5.3 Radioactivity and Radiation

Introduction

Interaction of Radiation with Materials

Radiation Dose and Exposure Units

Radiation Monitoring

5.4 Radiological Health Physics

Man's Radiation Environment

Biological Effects of Radiation

Radiation Standards

Bioconcentration, Biorejection, and Biosubstitution

Some Illustrations of Radiological Health Physics in Nuclear Power

Applications: Pathways of I-131 to Man, Tritium in the Environment, Statistical Fluctuations of Death Rates; Nuclear and Leukemia

CHAPTER 6: Nuclear Power Generation

6.1 The Nuclear Steam Supply System

Introduction

Steam Generation: The Primary Loop

Thermal Cycles

The Balance of Plant

6.2 Nuclear Power Plants

An Imaginary Tour Through a Nuclear Power Plant

Nuclear Power Plant Siting

Nuclear Plant Operation

6.3 Nuclear Power Plant Safety  
What Can Happen?  
The Licensing and Regulation of Nuclear Power Plants  
An Assessment of the Public Risk from Nuclear Power Plants

6.4 Environmental Impact of Nuclear Power Plants  
Environmental Impact Statements  
Discharges to the Environment  
Radioactivity Releases from Nuclear Power Plants  
Environmental Impact Evaluation of Power Plant Siting

#### CHAPTER 7: The Nuclear Fuel Cycle

7.1 An Overview of the Nuclear Fuel Cycle  
Introduction

7.2 Heat End Fuel Operations  
Mining and Milling  
Conversion  
Enrichment: Gaseous Diffusion, Ultracentrifuges and Nozzles, Laser  
Isotope Separation, Further Comments  
Fuel Element Fabrication

7.3 In-Core Fuel Management

7.4 Tail-End Fuel Operations  
Removal and Storage of Spent Fuel Elements  
Transportation of Spent Fuel Elements  
Spent Fuel Reprocessing  
Radioactive Waste Disposal

7.5 Nuclear Power, Sabotage, and the Bomb

7.6 Plutonium Toxicity

7.7 International Aspects of Nuclear Power  
Introduction  
Diversion of Strategic Nuclear Materials from the Fuel Cycle  
International Safeguards Against Nuclear Weapons Proliferation  
Some Concluding Remarks

#### CHAPTER 8: Alternatives

8.1 Introduction

8.2 Conservation

8.3 Petroleum-Based Energy Resources

8.4 Coal-Based Energy Resources  
Introduction  
Mining and Transportation  
Direct Combustion of Coal from Electrical Power Generation

Coal Liquefaction and Gasification  
Concluding Remarks

8.5 Geothermal Energy Resources

8.6 Solar Electric Power

Direct Uses of Solar Energy to Produce Electricity: Solar Thermal  
Conversion; Photovoltaic Conversion; Major Constraints

Indirect Uses of Solar Energy to Generate Electricity: Hydroelectric  
Power; Wind Power; Ocean Thermal Energy Conversion

Concluding Remarks

8.7 The Fast Breeder Reactor

Breeder Reactor Development

Safety and Environmental Aspects of Breeder Reactors

8.8 Thermonuclear Fusion

Introduction

Magnetic Confinement Approaches: Basic Concepts, Fusion Reactor Concepts

Inertial Confinement: Basic Concepts, High Powered Lasers, Electron and

Ion Beam Fusion, Reactor Concepts

Concluding Remarks







## FOREWORD

### NUCLEAR POWER: A MODEL FOR DEVELOPING A NEW TECHNOLOGY FOR SOCIETAL USE

#### I. What Would You Do?

If you had been living in 1900 and had just invented the internal combustion engine and the car, how would you have gone about developing the automotive industry? If you had been the Wright brothers and had just completed the Kitty Hawk flight in 1903, how would you have gone about developing this new technology? Or to come to more recent times, if you had been Enrico Fermi and had just succeeded in demonstrating the feasibility of nuclear fission technology in 1942, what steps would you have taken to insure that man would be benefited by this new technology? Or perhaps an even more pertinent question is: If you become the one to show that controlled thermonuclear fusion power is feasible, then what steps would you take to make sure that this new technology will not repeat the mistakes of other technologies?

These are not idle questions. These are the questions being asked by many in the forefront of the technology of today. Questions like "What should a biologist do if he discovers how to engineer human genes?" are being asked. Admittedly, we do not have the answers, and even when that day comes, we would probably not see all of the critical issues and probably again make many mistakes. But our hope is that next time we will do a better job.

In an effort to provide partial answers to the above questions, we would like to begin by briefly tracing the history of nuclear fission technology, pointing out some of the milestones, some of the far-sighted policy decisions made by the early leaders and then outline some of the steps taken in the planning of a modern nuclear power plant.

It should be stressed at the outset of this preface that we will be defending certain past policy decisions on nuclear power. Our attitude is that one good decision with a few minor faults is better than none at all. Unless we begin to commend the doers--like the

engineers and the policy makers--for their constructive actions, we will discourage public servants from making decisions, we will be turning students away from engineering, and we will be reduced to a leaderless society of non-doers, critics, and cynics. After all, it is very easy to be a non-doer and a critic, because it is impossible for them to make mistakes!

## II. Is the New Technology Necessary?

To answer this, we need to go back to the 1947-1949 period when the United States Atomic Energy Commission was created, and it began to assess the potential of the peaceful atom. Keep in mind that the early leaders of the atomic energy program were fully aware of the dangers of this technology as well as its potentialities. For example, the potential biological effects of plutonium were known from studies that started in 1942 under the war time agency known as the Manhattan Project. Consequently in 1947, following the dissolution of the Manhattan Project and the transfer of its activities to the newly created Atomic Energy Commission, one of the first actions taken was to study the possible United States energy needs and the energy sources available to meet these demands. Accordingly, in 1949, Palmer Putnam, a consulting engineer and the author of books and articles such as Power From The Wind, Solar Energy, and Windmills and Wind Power, was commissioned to study what our future energy needs might be. The intent of the AEC is made very clear in the foreword of his report, Energy in the Future, which resulted from this study:

"In 1949, the Atomic Energy Commission requested Mr. Palmer Putnam, Consulting Engineer, to make a study of the maximum plausible world demand for energy over the next 50 to 100 years. The study was envisioned as background for the Commission's consideration of the economic and public policy problems related to the development and use of machines for obtaining electrical power from nuclear fuels."

Anyone reading this book will no doubt be struck by the uncannily accurate predictions of things to come. The book was written around 1950, published in 1953, but it seems that now more than twenty years later the public and press are just beginning to discover what was already known then. Typical excerpts include:

"Certainly a critical stage will be reached in our (coal) economy by 1970."

"Underground gasification of coal"

"Experimental coal gasification plant at Rifle River, Colo."

"Athabasca Rivér tar sands of northern Alberta"

"The recovery from Colorado shales of fluid fuels containing 0.50 of energy would require a lot of scarce water and would create the problem of low-cost disposal of hundreds of billions of tons of ash."

"--coupled with uncertainty about Middle East oil, makes it pretty urgent that we start tapping our resources of oil shale and coal for conversion of fluid fuels."

"He (Putnam) would urge that we continue to explore nuclear reactions other than the fission of uranium and thorium. There is some hope that we can domesticate the fusion reaction that makes hydrogen bombs go. Economical fusion of hydrogen contained in a cubic mile of sea water would be a source of capital energy equal to all conceivable needs for many hundreds of years."

From these comments it is clear that the concern for the environment was not any less than it is now, the coal problem is critical, we still talk about the Canadian tar sands, political problems of the Middle East oil need no comment, and nuclear fusion is still "just around the corner".

Only one thing has changed. Based on these assessments, the AEC plunged into the program of developing both the nuclear fission and fusion technologies. And very wisely, the AEC chose to invest most of its effort in the development of fission technology. The reason for this decision is obvious.

Earlier, Fermi, who had conceived the idea of controlled sustained nuclear fission chain reaction a very short time after the discovery of nuclear fission, submitted a proposal to the Office of Naval Research in April, 1939. The amount he requested was \$1500. The next year the budget for the project was raised to \$6000, and the research cost to demonstrate the feasibility of fission technology was placed at less than one million dollars.<sup>2</sup> We need to keep in mind that since that time, the AEC has invested hundreds of millions of dollars in

thermonuclear fusion research, and the day of nuclear fusion feasibility is not yet in sight.

### III. Worst Case Analysis

The second milestone was the step taken by the AEC in 1957 to assess the public risks of this new technology. This study resulted in the highly publicized, though misunderstood, WASH-740 report on the Theoretical Possibilities and Consequences of Major Accidents in Large Nuclear Power Plants.<sup>3</sup>

The thrust of the report was to analyze the public damage--to property, public health, and human life--should a catastrophic accident occur due to a chain of improbable events. The first point to note is that this study was not the first of its kind. Earlier at the 1955 International Conference on Peaceful Uses of Atomic Energy, two papers on the catastrophic consequences of nuclear plant accidents had been presented.<sup>4</sup> The second point--and possibly the more important one--is that this report dealt with the problem of societal impacts of an accident, in addition to the problems of standard engineering safety analysis.

The point often missed by the public is that all public structures such as buildings, bridges, jet planes, etc. are designed to withstand certain unusual environmental conditions. For example, in the design of the Mackinac Bridge, the frequency and intensities of wind, rain, and snow storms were taken into account. If a high-rise building is to be erected in an earthquake-prone area, then this fact is taken into account by the structural design. This is just standard engineering practice, so that the worst-case analysis is important in identifying certain design features.

What was new about the AEC WASH-740 report was that the analysis was taken one step further by analyzing the societal consequences should a string of improbable events occur. To illustrate this, consider the following scenario for the aviation equivalent of the WASH-740 report. Suppose that on Thanksgiving morning a few seconds after take-off of a 747 jet, aileron malfunction develops, the jet loses altitude, and crashes into a tall building in downtown Detroit just as the Hudson Thanksgiving Day Parade is passing by. Suppose also, because of the

unusually warm weather conditions, the crowd is larger than usual, and the nearby streets and parking lots are filled with cars with full tanks of gasoline. Suppose also that, because the pilot had lost control of the plane, the jet hits another plane hovering over Detroit, the plane bursts into flame, and falls into the middle of oil tanks in south Detroit. The jet wreckage could kill thousands of paraders and spectators, trigger explosions in the parking lots and along the streets, and the oil tanks could also cause more casualties among the people nearby. Note that each is a probable event--jets have crashed shortly after take-off, planes have caused fire, and oil tanks have caught fire. The probability for a single event to occur can be calculated and is known from our personal experience to be small. But the probability of all of these events occurring at the same time is expected to be very small. A layman might say that the event would not occur. However, according to probability theory, it is, in principle, still a possible event, and it is even possible to estimate the joint probability of all of these events occurring (although it will be exceedingly small).

The intent and the concerns of the early leaders of the AEC are made very clear in the cover letter accompanying the WASH-740 report from Harold S. Vance, the then Acting Chairman of the AEC, to Carl T. Durham, who was then the Chairman of the Joint Committee on Atomic Energy. Some of the pertinent comments are as follows:

"This study constitutes a part of the Commission's continuing effort as a broad front to understand and resolve this problem of possible reactor hazards so that we may proceed with an expanding atomic energy industry with full confidence that there will be few reactor accidents and such as do occur will have only minor consequences. This effort and the work of translating the results into affirmative, concrete safeguards for protection of the public will, of course, be continued and expanded."

The following point, brought out in the cover letter is too frequently overlooked:

"We are not aware of such a study having been undertaken for any other industry. We venture to say that if a similar study were to be made for a certain other industry, with the same free rein to the imagination, we might be startled to learn what the consequences of conceivable major catastrophic accidents in those other industries could be in contrast with the actual experience in those industries."

Two further comments deserving notice are:

"First, industry and government are determined to maintain safety and protect the health and property of the public from nuclear hazards. The Congress has authorized, and we in the Commission are carrying out, a program of close and careful regulation and inspection. Thus, the potential hazard of this new industry has been recognized in advance of its development and brought under a strict system of safety control before the occurrence of the incidents which in other fields have marked the birth of new industry and have subsequently led to control."



"--In the third place, multimillion dollar efforts in research and development, both public and private, are directed toward identifying and solving safety problems. We know of no other industry where so much effort has been, and is still being, spent on the definition and solution of safety problems."

And very near the end of this letter the following comment appears:

"Under these assumptions, the chances of a person being killed in any year by a reactor accident would be less than one in 50 million. By contrast, the present odds of being killed in any year by an automobile accident in the United States stand at about one in 5,000."

#### IV. Environmental Report

The third milestone is the precedent set by the AEC of requiring a thorough environmental report for the nuclear plant construction license application. In 1974, the AEC was split into the Energy Research and Development Administration (ERDA) responsible for nuclear development and the Nuclear Regulatory Commission (NRC) which has responsibility for the regulation of nuclear power. The NRC has written an explicit set of instructions, known as the NRC Regulatory Guide 4.2 for the Preparation of Environmental Reports for Nuclear Power Plants. Other industries have begun to be asked for environmental reports, but to date there is no explicit set of instructions. For example, for coal

plant construction, an environmental report is now required, but the instructions are not definite and many utilities tend to take the NRC report as the model in preparing environmental impact statements for fossil-fuel fired plants.

It should be noted that the AEC (NRC) took this step as the result of the July 23, 1971 Supreme Court decision concerning the environmental impact of a nuclear plant under construction at Calvert Cliffs, Maryland. Until then, the AEC (now NRC) maintained that it had jurisdiction only over radiological impacts on the environment. The result of this landmark decision was to require the NRC to weigh the total environmental impacts of the nuclear power plant. Subsequent court decisions in 1976 require the NRC to consider as well the environmental impact of the entire nuclear fuel cycle for the plant.

A point that should be made is that this environmental report is concerned with more than just clean air, clean water, and clean land. This can be seen by glancing through the section headings of Chapter 2, The Site, of the Regulatory Guide 4.2. The headings are:

- 2.1 Site location and layout
- 2.2 Regional demography, land, and water use
- 2.3 Regional historic, scenic, cultural, and natural landmarks
- 2.4 Geology
- 2.5 Hydrology
- 2.6 Meteorology
- 2.7 Ecology
- 2.8 Background radiological characteristics
- 2.9 Other environmental features

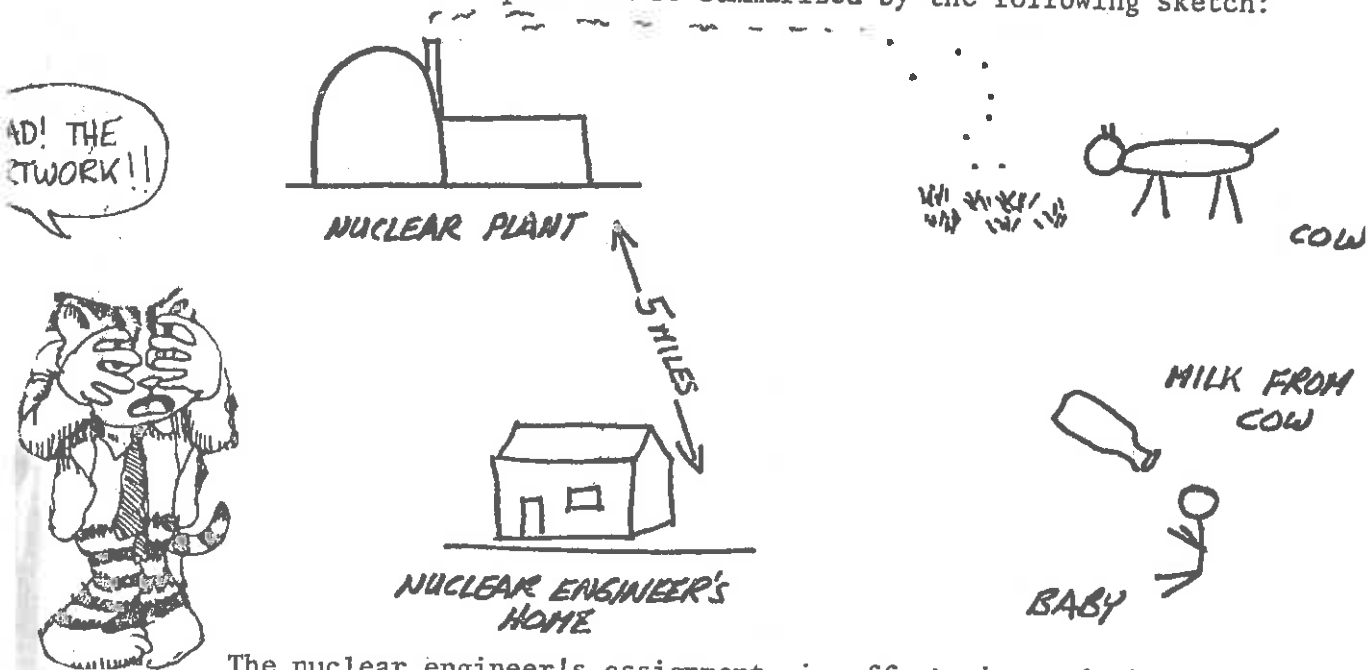
In Section 2.3, the suggestion is made that the applicant for the construction of the nuclear plant consult such sources as the National Register of Historic Places, the National Registry of Natural Landmarks, and the Federal Register. In the Detroit Edison Greenwood Energy Center Environmental Report<sup>6</sup>, for example, there are brief comments about two French priests in 1670 sailing down what is now the St. Clair River, about the acquisition of 24,000 acres by a British soldier, Patrick Sinclair, from the Indians in 1760, and the establishment of St. Clair

County, such as the spot where young Tom Edison was thrown off the train, locations of early oil wells, Indian burial mounds, and the first salt mine in the County.

One very unusual provision of the environmental report is the requirement for the applicant to analyze the impacts of the construction process. These matters are to be discussed in Chapter 8, on the Economical and Social Effects of Plant Construction and Operation. In Section 8.2 on costs, the following comments appear under the paragraph heading Examples of Temporary External Costs.

Shortages of housing; inflationary rentals or prices; congestion of local streets and highways; noise and temporary aesthetic disturbances; overloading of water supply and sewage treatment facilities; crowding of local schools, hospitals, or other public facilities, overtaxing of community services; the disruption of people's lives or the local community caused by the acquisition of land for the proposed site.

In brief, the NRC Regulatory Guide 4.2, on which the environmental report is based, calls for a detailed, in-depth planning document involving both engineering and human factors. The basic intent of the environmental report can be summarized by the following sketch:



The nuclear engineer's assignment, in effect, is to design a nuclear power plant assuming that the plant will be located 5 miles away from his home, that he is starting a family, and that the baby in his family needs to depend on the milk from a cow in a nearby pasture.



## V. Nuclear Power and the Environment

As the result of these stringent regulations, the Nuclear Regulatory Commission and the Environmental Protection Agency, contrary to a widespread impression, have had relatively amicable relations. Although the EPA has been highly critical of coal-fired generating plants, the automotive industry, and others, there have been very few quarrels with the NRC or ERDA. The EPA has studied the radiological characteristics of nuclear power plants, and their measurements confirm what the NRC has been asserting. On at least one occasion, the EPA has come out unequivocally on the side of the NRC, when citizen groups raised charges that a certain nuclear power plant had been releasing excessive amounts of radioactive materials.<sup>7</sup> In general, the EPA has concluded that the environmental impact of nuclear plants is quite minimal.

Although there are a number of nuclear plant environmental safeguards, we shall point out only one of them here as an illustration of why the environmental impact of such plants is comparatively rather small. First, we note that an electrical power plant consists of two parts, the part that generates the electricity and the part that makes the heat to produce the steam that drives the turbine-generators. The first part is the same for both nuclear and coal plants. For the second part, in coal plants, the heat is generated by burning coal, and for this air is needed. This is why pollutants from coal escape into the atmosphere. For nuclear plants, in contrast, the air is not needed; the nuclear fuel is sealed in metal cans, and steps are taken to prevent the escape of the metal can contents into the outside world. As nuclear reaction proceeds, the metal cans get hot, so that water flowing past the outside surface of the cans becomes hot and subsequently generates the steam to run the electrical turbine. This water, called the primary coolant, is surprisingly clean. For example, according to EPA measurements the amount of radioactive iodine-131 contained in 50 gallons of primary coolant water is about what a doctor would give to his patient for thyroid tests.<sup>8</sup>

Furthermore, if the nuclear plant is of the type utilizing a pressurized water reactor, the primary coolant remains entirely inside the dome which contains the reactor and only the secondary coolant,

heated indirectly by the hot primary coolant, gets to the outside turbine building. Hence, the radioactivity of the steam is expected to be much less; EPA measurements indicate that such is indeed the case. The condenser water, which cools the steam leaving the turbine and goes through the cooling pond or the cooling tower, is expected and found to be effectively radioactivity free. A related point to note is that we live in a radioactive world so that the radiation dose we get from the natural environment is substantially larger than from nuclear radiations. For example, we list the allowed\* public radiation versus natural exposures:<sup>9</sup>

International (safe limit)	5,000 mrems/yr/person
EPA (public-at-large) one person	500 mrems/yr/person
population average	170 mrems/yr/person
AEC N-plant (at site boundary)	10 mrems/yr/person
Natural Environmental Radioactivity	130 mrems/yr/person

#### VI. Citizen Responsibility

The milestone yet to come is the day when the public will become a responsible member of the public policy making body. The NRC, more than any other Federal agency, has encouraged public participation. The nuclear industry has been unique in involving public opinions. But unfortunately, the novelty of this public involvement has allowed critics and intervenors to take irresponsible actions to sway public opinion to their side.

One very well known example is the case involving a number of serious (although totally misinformed) charges<sup>10</sup> concerning radioactive emissions from the Shippingport nuclear power plant near Pittsburgh. EPA studies have shown that the AEC regulation of this plant has been quite proper, and the EPA went further to say the "Shippingport is a very clean plant".<sup>11</sup> A fact-finding committee appointed by the Governor of Pennsylvania reported that there was very little substance in the allegations.<sup>12</sup> Furthermore, the American Society of Health Physicists thoroughly reputed and discredited these accusations (although they are occasionally still referred to by the more irresponsible critics of nuclear power even today).<sup>13</sup>

\*Of course, the actual exposures are far below these limits.

One of the unfortunate victims of this controversy was a physician from Petoskey who inadvertently released a preliminary copy of a report giving cancer and leukemia statistics of Charlevoix County to the Shippingport critics who in turn gave this report an unwarranted amount of publicity.<sup>14</sup> Copies of the report were sent to Congressmen, to the commissioners of the AEC, and to the Joint Committee on Atomic Energy so that the Argonne National Laboratory was eventually called in to look into the matter. Subsequently Argonne released a report which in effect refutes the assertion that there have been increases of cancer and leukemia cases attributable to nuclear plant emissions. Actually, the intent of the physician's report was made very clear in the closing paragraph, namely

"Admittedly these statistics are based on very small numbers. However, since all five categories show disturbing changes which could relate to increased radioactivity, caution and more detailed study would appear to be indicated."

It was unfortunate that those who issued this report had not noted this comment.

We make this comment to point out that not only will irresponsible actions reduce the credibility of the critics in the eyes of the public, but they also hurt others who are honestly trying to look into some of the public health aspects of nuclear power.

Another example of irresponsible intervenor action is the reporting of the August 19, 1973 "accident" involving the Palisades nuclear power plant in western Michigan in which a small release of radioactive iodine-131 occurred during a plant repair operation.<sup>15</sup> This was certainly a problem of public concern; the intervenors had the sympathy of the press, so that they could have taken the opportunity to educate the public. But instead they chose to release some highly inaccurate statements. As an example, consider the statement made by one of the intervenors to the Department of Natural Resources<sup>16</sup>

"Yet the actual release of iodine-131 was finally reported by Consumers Power to be three times the annual average release rate guide lines for the nine days. Of this total, approximately 30 times the suggested annual release rate was released in an initial 15 hour peak period. The Atomic Energy Commission says that the release was 900 to 6000 per cent over AEC limits.

"If the Public Health Department's monitoring system is not able to pick up an accidental release of this magnitude and prepared to take immediate action against the utility and also to warn the people of the surrounding area, just what does their monitoring record accomplish?"

It should be kept in mind that these comments and questions were raised about six months after the accident occurred. There was ample time to check the public records, as indicated by the fact that reference is made to an AEC report. What was known by this time was that during the accident wind was blowing over Lake Michigan, carrying the released gases away from the monitoring instruments (the State's concern is with the radiation exposure of Michigan residents in and around the South Haven area). The second point is that at no time was the radioactivity level anywhere close to the AEC limit as implied by the statement. The calculated peak post value was about one-fifth ( $2 \times 10^{-11}$  microcurie/ml) of the AEC standard ( $1 \times 10^{-10}$ ), and the measured value was even smaller, being only 0.034 ( $3 \times 10^{-14}$ ) of AEC standard. The third point is that public health hazards were minimal. According to the AEC report, iodine-131 contents of several milk samples were measured and even the sample taken on August 18 had only 5.0 pCi/liter, and that drinking this milk would produce a child thyroid dose of about 2 mrem. This is roughly the radiation dose from watching TV for one hour daily for one year. Furthermore, the iodine-131 concentration was only about 10% of the EPA limit, and another fact to be kept in mind is that milk is itself radioactive to the amount of about 1200 pCi/liter due to the high concentration of the naturally radioactive K-40.

The impression that larger quantities of radioactive iodine-131 were released when in fact the AEC annual limit was not exceeded was created by confusing several narrowly defined technical terms, such as annual release limit, annual release rate, and 10 minute release rate (which we will discuss in Chapter 5). The amount released, which is the important quantity, depends on the release rate times the duration. Furthermore, by omitting the key words "10-minute", confusion resulted.

## VII. Concluding Comments

Thus, we have indicated some of the milestones of nuclear technology, in order to point out what sort of problems we engineers might face if we were suddenly faced with the task of developing a new technology for societal use. Engineers have been criticized for being socially insensitive. We are convinced that they are not. Rather the socially calloused ones are the irresponsible critics and intervenors who never propose socially workable alternatives. But there is still room for improvements, and by continually asking the question of what and how to develop new technologies and how to plan for the future, we can encourage the development of even better engineers and engineering methods than we have today.



## CHAPTER 1

## AN ASSESSMENT OF ELECTRICAL POWER REQUIREMENTS IN MICHIGAN

It is becoming increasingly evident that there is a serious imbalance between our ever-growing energy consumption and our capacity for producing this energy. This imbalance is due to many factors, including the energy-intensive nature of our society and way of life, the depletion of existing energy sources (oil and natural gas), and the slow development of new energy sources (advanced schemes for mining and burning coal, nuclear power, solar power, etc.). This imbalance poses a very serious problem for our society; the "energy crisis" is very real. For example, at the present time this country is importing over half of its crude oil requirements even as it rapidly depletes its own reserves of oil and natural gas.<sup>1</sup> Most serious students of the energy problem are in agreement that a new balance between energy uses and sources of supply must be achieved, and that this can be accomplished only by simultaneously stressing energy conservation while developing new sources of energy.

Yet the public continues to increase its demand for energy, to purchase and drive large automobiles, and to adopt life styles based on energy-intensive appliances (e.g., air conditioners, self-cleaning ovens and refrigerators, electric toothbrushes, hot-combs, and so on). Interestingly enough, studies<sup>2</sup> have indicated that this continuation of the traditional pattern of rapidly escalating energy consumption is not due to the reluctance of the public to accept a more energy-conservative life style. Rather the continued growth in energy consumption is due, in a large degree, to the fact that the American public fails to believe that the energy crisis is real. Indeed, disbelief in all societal institutions has reached the point that it has become almost impossible for the Federal government or private industry or universities to convince the public of the seriousness of the imbalance between energy use and production. For example, it has been apparent for some time that the prices of oil and natural gas should be deregulated and allowed to increase dramatically

to more accurately reflect the impending shortage of these liquid fossil fuels.<sup>3</sup> Yet any attempt to do so immediately meets cries that such price increases are merely ploys to increase the profits of oil companies or utilities. The same public skepticism meets the inevitable increases in electrical utility rates. A skepticism which interprets the "energy crisis" as either a fabrication designed to delude the public into accepting higher prices or perhaps simply a temporary imbalance between supply and demand which has been exaggerated by government bureaucrats is extremely dangerous. Such attitudes destroy the incentive for conservation. Furthermore, a public which is not convinced of the seriousness of the energy crisis will not bring the necessary pressure to bear on its political representatives to enact legislation which will result in a more rational energy policy.

CONSERVATION?



Effective action to alleviate the imbalance between energy demand and supply can be achieved only if the nation becomes broadly and pervasively aware of the energy problem, the nature of energy useage, the available resources and their limitations, and rationally approaches the various options available to our society. As one step in this effort to achieve public understanding, we have chosen to analyze in detail the energy problem for a single representative state, Michigan, and in particular, to examine the role that nuclear power might play in such a state. In particular, this will allow us to study in detail how a developing technology is accepted (or rejected) by the public in meeting the needs of society.

As a highly-industrialized, high-income state, Michigan is particularly dependent upon adequate supplies of energy.<sup>4,5</sup> Unfortunately, Michigan is among the "have-nots" with regard to local energy resources. Indeed, only about 4% of Michigan's energy needs are produced from state energy resources (petroleum, gas, and hydroelectric). Yet the energy consumption in Michigan is very close to the national average, and the economic welfare of Michigan depends quite strongly upon the availability of energy which must be brought in from outside. In this sense, it is clear that the Michigan energy problems cannot be separated from those of the United States (or world) in general. This dependence is reinforced



by the rather unique dependence of the state on a single industry, the automobile industry, which is extremely sensitive to the national energy situation (one needs only recall the slump in the state's economy following the Arab oil boycott in 1973). The automobile industry provides employment to almost half a million people in Michigan, and accounts for an annual payroll of over \$4 billion. This industry provides about 20% of all direct wages and salaries paid in the state.

We will examine Michigan's energy resources to see what options are actually available for the near future. We should stress here that the options available to Michigan are not necessarily the same options available to other regions of the country. For example, California has substantial geothermal sources; the state of Washington, hydroelectric power; Montana, coal; while states such as Arizona may be able to make better use of solar power and so on. Furthermore, the energy "problem" for even a specific locality cannot be solved by one set of recommendations given at one instant of time.

First, however, let us examine the whole question of energy needs and energy consumption patterns which have led to an imbalance between energy supply and demand.

### 1.1 Energy Needs Vs. Energy Consumption

The applicant for the construction license of a nuclear power plant needs to justify the need for such a plant. The usual argument is that the demand for electric power has been growing exponentially, doubling approximately every 10 years. This trend has continued for a number of decades and no doubt will continue for the decade to come. For example, the Detroit Edison projection<sup>6</sup> for 1983 is 65 billion Kwhr, compared to the demand for 38 billion Kwhr for 1973. But obviously this exponential growth cannot continue, there will be a limit, and our task is to see what can be done to curb the rate of energy consumption.

For this, we shall first discuss our minimal energy needs, examine energy consumption in typical societies, attempt to assess the available energy resources, and then look at the startling facts of exponential growth.

### 1.1.1 Basic Energy Needs

We shall define basic energy needs as the energy needed to keep an individual alive. Dieticians would tell us that the food energy we need is about 3000 "big" calories per day per person. A big calorie is one Kcal, so that this amounts to 3 Mcal/day/person. We shall introduce the acronym, "ben", for Basic Energy Needs, as the basic unit, i.e.,

$$1 \text{ ben} = 3 \text{ Mcal/day/person}$$

If we were to convert this into watts, this would amount to 145 w/person. Thus, if we could convert all of this energy into light energy, a person would be about as "bright" as two 75 watt light bulbs, or perhaps a medium fluorescent lamp. Stated somewhat differently, the value of 3 Mcal is about the amount of heat released by burning 0.1 gallon of gasoline.

The energy consumption of 1 ben would be typical of a human society possibly 1 to 2 million years ago--namely the days of the Java and Peking man. Then there were no energy-consuming textile factories to make clothing, no steel mills needed to make steel tools, etc. Then Man ate merely to keep alive. Clearly the hunting man had no luxury. Also, the population density then was quite low since it took about one square mile to support one hunting man.<sup>7,8</sup>

### 1.1.2. Energy Consumption

Somewhat higher in energy consumption and also typical of a society providing a few luxuries is the primitive agricultural society. An example is the Tsenbaga tribe in the mountainous interior of New Guinea.<sup>9</sup> The energy consumption of this tribe is reported to be about 4 bens so that in this New Guinea society, individuals enjoy a few comforts and luxuries. The population density is about 64 per square mile in comparison to the 1 per square mile for the primitive man. (These values are to be compared, for example, to Ann Arbor, with a population of about 100,000 in an area of 23 square miles corresponding to a population density of about 4000/square mile.) The limited luxuries and higher population density for the New Guinea society became possible because of the very high ratio of harvested food energy to the energy input.

The ratio is reported to be about 16:1. Because of the high harvest to input energy ratio, excess food can be produced, so that about one half of the food crop is used to feed pigs. They enjoy a certain amount of leisure, find the time to build shelters, and even enjoy occasional barbecued pig feasts.

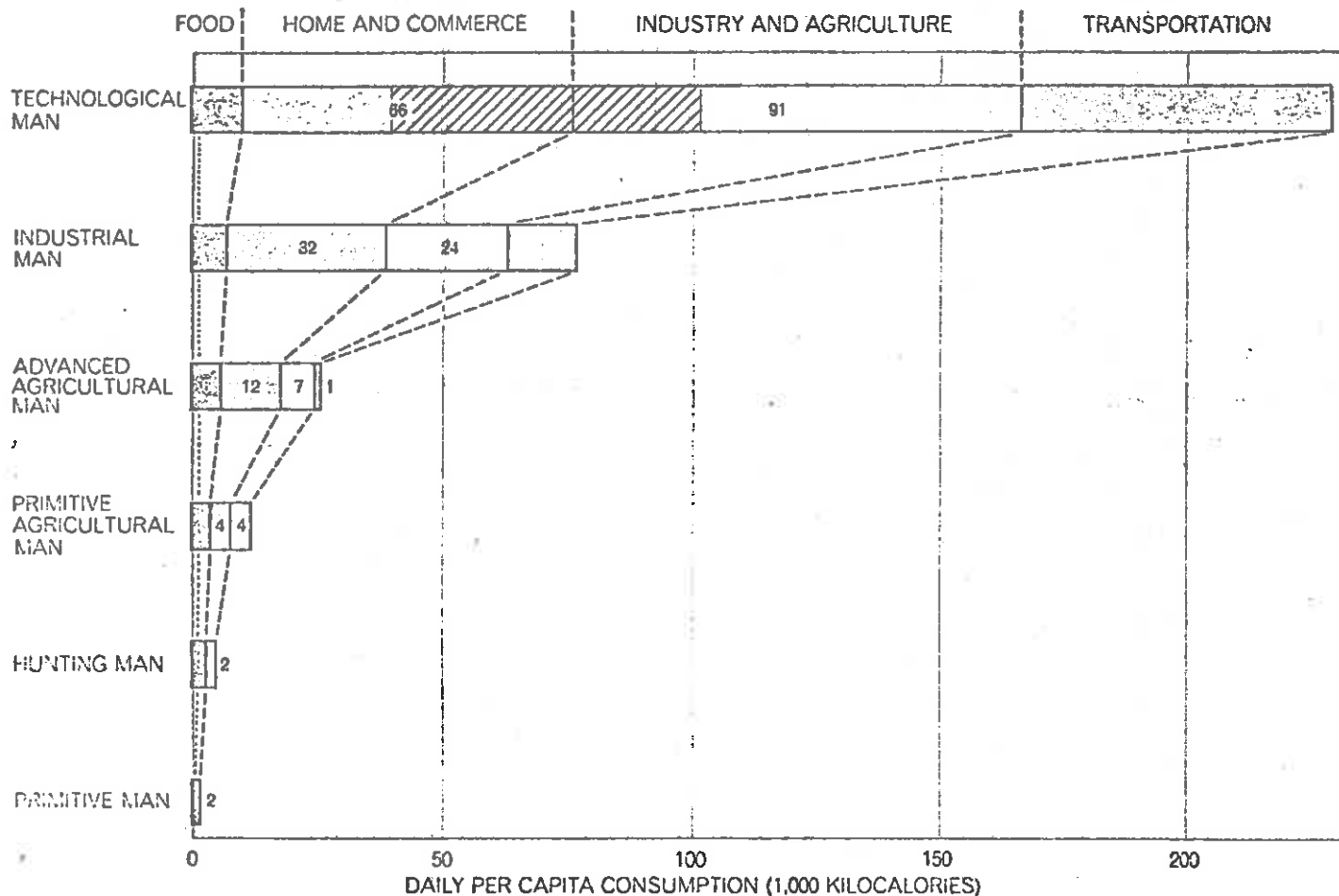
We need to note that this society is dependent completely on solar energy. The price for this is that it takes about 10 years' growth of vegetation to fertilize the soil; at any one time about 10% of the arable land is under cultivation, while during the remaining 90% of the time the land is left fallow for vegetation to grow. Even when the land has been cleared, seedlings are protected. The Tsenbagans are almost as irritated when a visitor accidentally damages a tree seedling as when he carelessly tramples on a crop plant.

In passing, perhaps we should note that the high harvest effort ratio of 16:1 for the New Guinea society is very high even in comparison to U.S. standards. This ratio for U.S. "factory farming" is 1:20.<sup>10</sup> The reason for this startling small ratio is that huge quantities of fossil fuel (e.g., petroleum) are needed to harvest the products of solar energy. No doubt the per capita productivity of the U.S. farmer is exceedingly high, but this is achieved at the price of very high fossil energy consumption. Rene Dubos<sup>11</sup> warns that "The present practices of agriculture are only possible as long as cheap sources of power are available. After the world supplies of fossil fuels are exhausted, the modern farmer will become ineffective". The Chinese farmer is far more efficient; for the Chinese practice of wet rice farming, the energy harvest to effort ratio is about 50:1, or energy-wise about 1000 times as our U.S. farming method.

#### 1.1.8. Energy Consumption in Technological Society

In an advanced agricultural society and in an industrial society, the energy consumption rates are about 9 and 26 bens, respectively; but in a technological society such as the United States, energy consumption is substantially higher, being about 77 bens (see Figure 1).<sup>7</sup> Stated differently, we can think of ourselves as having about 76 bens of luxuries; in other words, we are living as masters of 76 slaves.

Figure 1-1



DAILY CONSUMPTION of energy per capita was calculated by the author for six stages in human development (and with an accuracy that decreases with antiquity). Primitive man (East Africa about 1,000,000 years ago) without the use of fire had only the energy of the food he ate. Hunting man (Europe about 100,000 years ago) had more food and also burned wood for heat and cooking. Primitive agricultural man (Fertile Crescent in 5000 B.C.) was grow-

ing crops and had gained animal energy. Advanced agricultural man (northwestern Europe in A.D. 1400) had some coal for heating, some water power and wind power and animal transport. Industrial man (in England in 1875) had the steam engine. In 1970 technological man (in the U.S.) consumed 230,000 kilocalories per day, much of it in form of electricity (hatched area). Food is divided into plant foods (far left) and animal foods (or foods fed to animals).

(Earl Cook, Scientific American 224, 134 (1971) )

IT IS RUMORED THAT THERE ARE CERTAIN SUBSPECIES OF MODERN MAN (KNOWN AS "ULTRA-MODERN" OR "FAR-OUT" MAN) WHICH ARE CHARACTERIZED BY ENERGY CONSUMPTIONS-- AS WELL AS LIVING HABITS-- SIMILAR TO THOSE OF PRIMITIVE MAN.



Of the 77 bens, transportation consumes about 21 bens, industry and agriculture another 30 bens, 22 more bens for home and commerce, and as much as 3 bens for food. The bulk of the 21 bens is consumed by cars, trucks, and buses. Of the 30 bens for industry and agriculture, more than half are used for blast furnaces, smelters, oil refining and mining. Aluminum is an example of a heavy societal energy burden. About 28 million Btu's, or the equivalent of 15 tons of coal, are required to produce just 1 ton of the metal from 2 tons of alumina. The present U.S. aluminum consumption is possibly near the 5 Mton/year mark and accounts for about 10% of the industrial energy consumption.

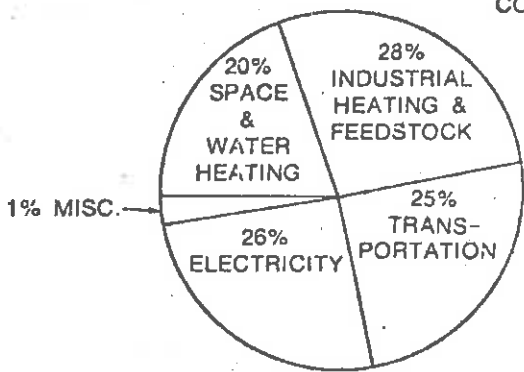
Another wasteful process is the use of electric power for space heating, cooking, and water heaters. The efficiency of conversion of energy from fossils, like coal, oil, and gas, into electrical energy is quite low--about 32%. A much more energy-wise economical method would be to use these fuels directly for heating purposes.

The energy consumed to produce an automobile is about 37,000 Kwhr, or about 32,000 Mcal/car. Multiply this by the number of cars produced each year (10 million), and we can begin to get a glimpse of the staggering energy cost to maintain just this one industry. Of course, keep in mind that the above energy cost does not include the energy cost of gasoline.

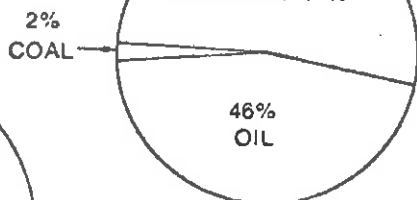
And finally, further energy savings can be affected by reducing per capital meat consumption. Note that in the U.S. energy economy, the food energy consumed is 3 bens. The reason for this is that about 2 bens are used to feed animals, which are effectively low efficiency protein factories. Of the 10 Mcal/day (3.3 bens) of gross food production, about 15% is wasted in handling and processing. Of the remaining 8.5 Mcal, 212 Mcal is consumed directly as human food but 6.3 Mcal go to feed animals that produce about 0.9 Mcal of meat. Since animals do not make proteins--they merely concentrate proteins in plants--they can be thought of as 14% efficient protein concentration factories. Furthermore, by eating meat we add to the transportation energy cost. For example, soy beans grown in Michigan are shipped to feed lots near Denver, and the processed soy bean protein, in the form of beef or pork,

**MAJOR USES OF ENERGY IN THE U.S.**

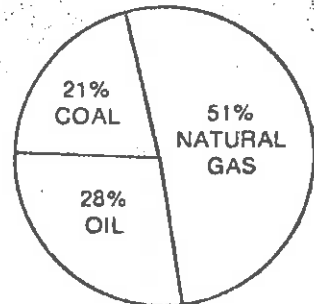
**HOW OUR ENERGY IS USED**



(a) TOTAL ENERGY USAGE

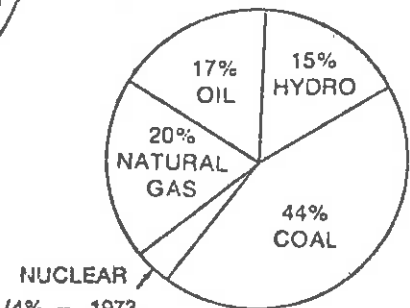


(b) SPACE & WATER HEATING

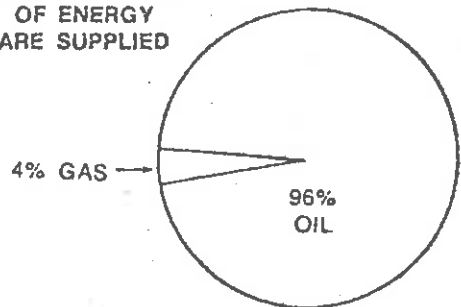


(c) INDUSTRIAL HEATING & FEEDSTOCK

**HOW OUR USES OF ENERGY ARE SUPPLIED**



(d) ELECTRICITY

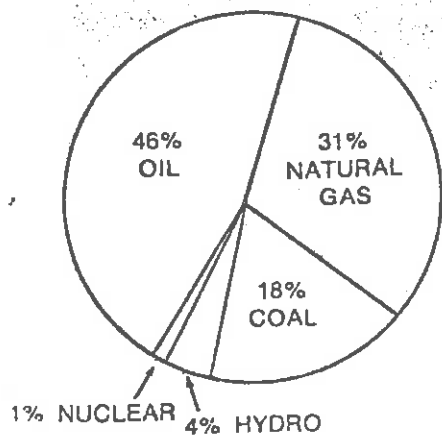


(e) TRANSPORTATION

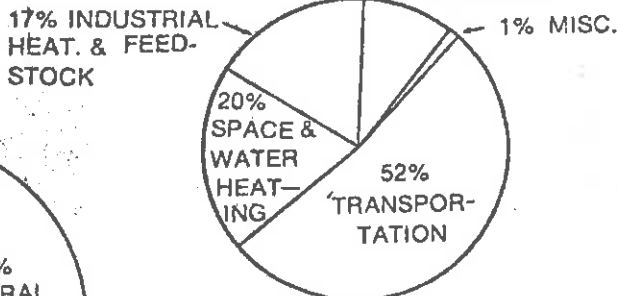
Energy use in the U.S. and how major uses are supplied

**HOW U.S. ENERGY NEEDS ARE SUPPLIED**

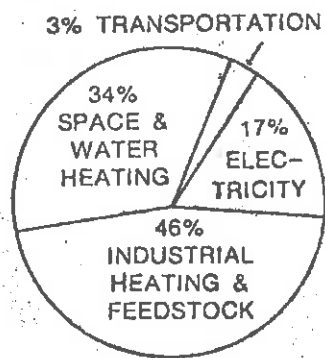
**HOW MUCH OF OUR ENERGY COMES FROM EACH SOURCE**



(a) TOTAL ENERGY SUPPLY

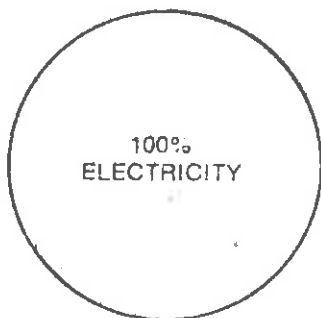


(b) OIL

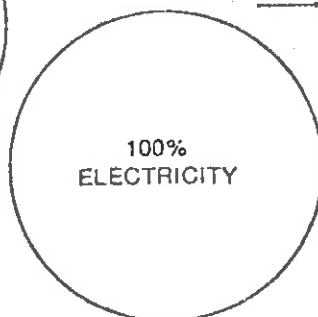


(c) NATURAL GAS

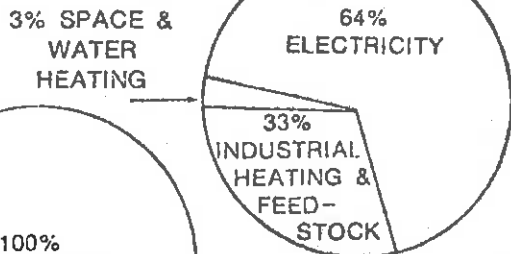
**HOW THE RESOURCES ARE USED**



(e) NUCLEAR



(f) HYDRO



(d) COAL

Energy resources supply U.S. needs in these proportions

*MAN, THAT CHART'S SO COMPLICATED THAT IT MAKES MY BRAIN SORE!*



Task Force on Energy, "U.S. Energy Prospects: An Engineering Viewpoint," National Academy of Engineering (1974).

"Energy Alternatives: A Comparative Analysis," Science and Public Policy Program, University of Oklahoma, Norman, Oklahoma (May 1975).

is shipped back to Detroit. Substantial savings in energy can be brought by consuming directly locally produced soybean protein.

The issue at hand is to check the growth of energy demands by having fewer cars, less beer from cans, and less meat. The alternative is to face the consequences of explosive exponential growth of energy and power requirements.

#### 1.1.4. Exponential Growth in Energy Demand

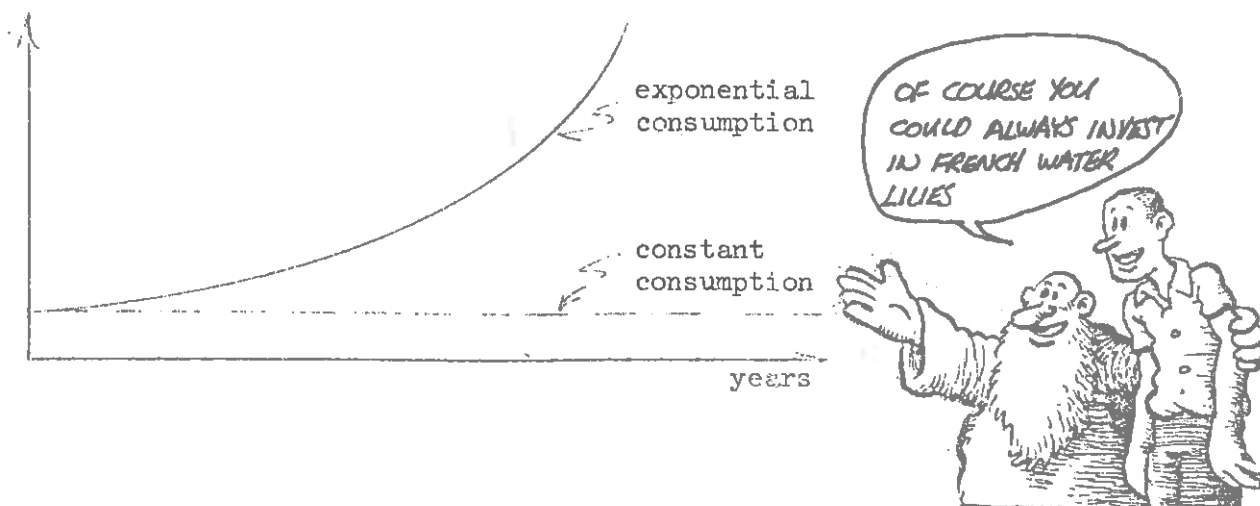
The words "exponential growth" are bandied about carelessly because many are not fully aware of the consequences. In The Limits to Growth,<sup>12</sup> by D. H. Meadows, et al., the following comment appears:

"A French riddle for children illustrates another aspect of exponential growth - the apparent suddenness with which it approaches a fixed limit. Suppose you own a pond on which a water lily is growing. The lily plant doubles in size each day. If the lily were allowed to grow unchecked, it would completely cover the pond in 30 days, choking off the other forms of life in the water."

The known coal reserves in the United States is about 1.5 trillion tonnes (Metric ton).<sup>13</sup> The rate of consumption of coal in 1970 was about 3 billion tonnes. If we were to continue to use coal at this constant rate, the known reserves would last for 500 years. This is the number that is often quoted, and we need to stress that the assumption is uniform rate of consumption. Consider, however, the case for exponential rate of consumption. If we let R represent the rate of coal consumption in one year, and further assume 10 years for the doubling time, then clearly

$$R = 3 \times 10^9 (2^{t/10})$$

This can be presented graphically as follows:



The dotted straight line is for constant rate of consumption; the area of this rectangle, of course, is just the known reserves. If the growth is exponential, the area under this curve again is just the known reserves. If we calculate this area, we find that the length of time required to exhaust known coal reserves is

$$T = \frac{10}{\log 2} \log [1 + 50 \ln 2] = 52 \text{ years}$$

There are two points to be made. The first one is that this time to exhaust a natural resource is comparable to the lead-time needed to develop a technology. The engineering research and development lead-time (pilot-plant) lead time) is about 10 years with another 10 years required for on-line planning and development. To this we need to add the very uncertain scientific research lead-time. Hence, the time from scientific conception to on-line date is about 30 years or more.

There is, however, another point. According to the above assumptions, at the end of 42 years, we will have exhausted 1/2 of the known resources, and the temptation would be to relax because there is still one half of the resources left. But we need to realize that the remaining one-half will be used up on just 10 years. If, in the meantime, the known reserves are doubled--for some reason or another--the equivalent of the newly discovered reserve will be used up during the following 10 years!

Thus, in an exponential energy economy, coal alone would last 52 years, but even coal and nuclear fuel using light water reactors would give us only 62 years to exhaustion.

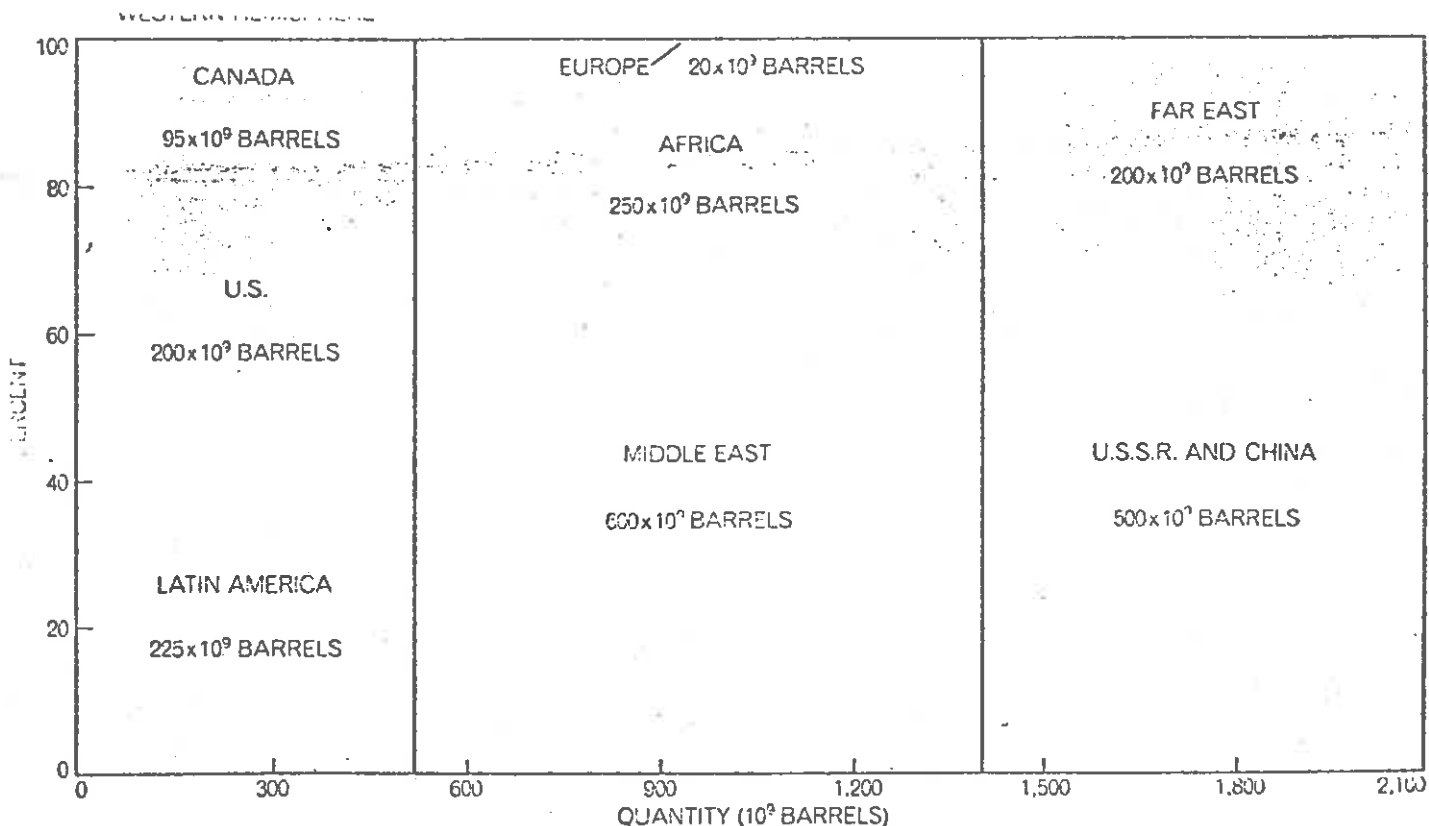
We might examine the effect of extending the exhaustion time by increasing available energy reserves. Let

- K - Known energy reserves
- R - Energy consumption rate
- $T_2$  - Doubling time
- $R_0$  - Energy consumption rate now

Then we can find

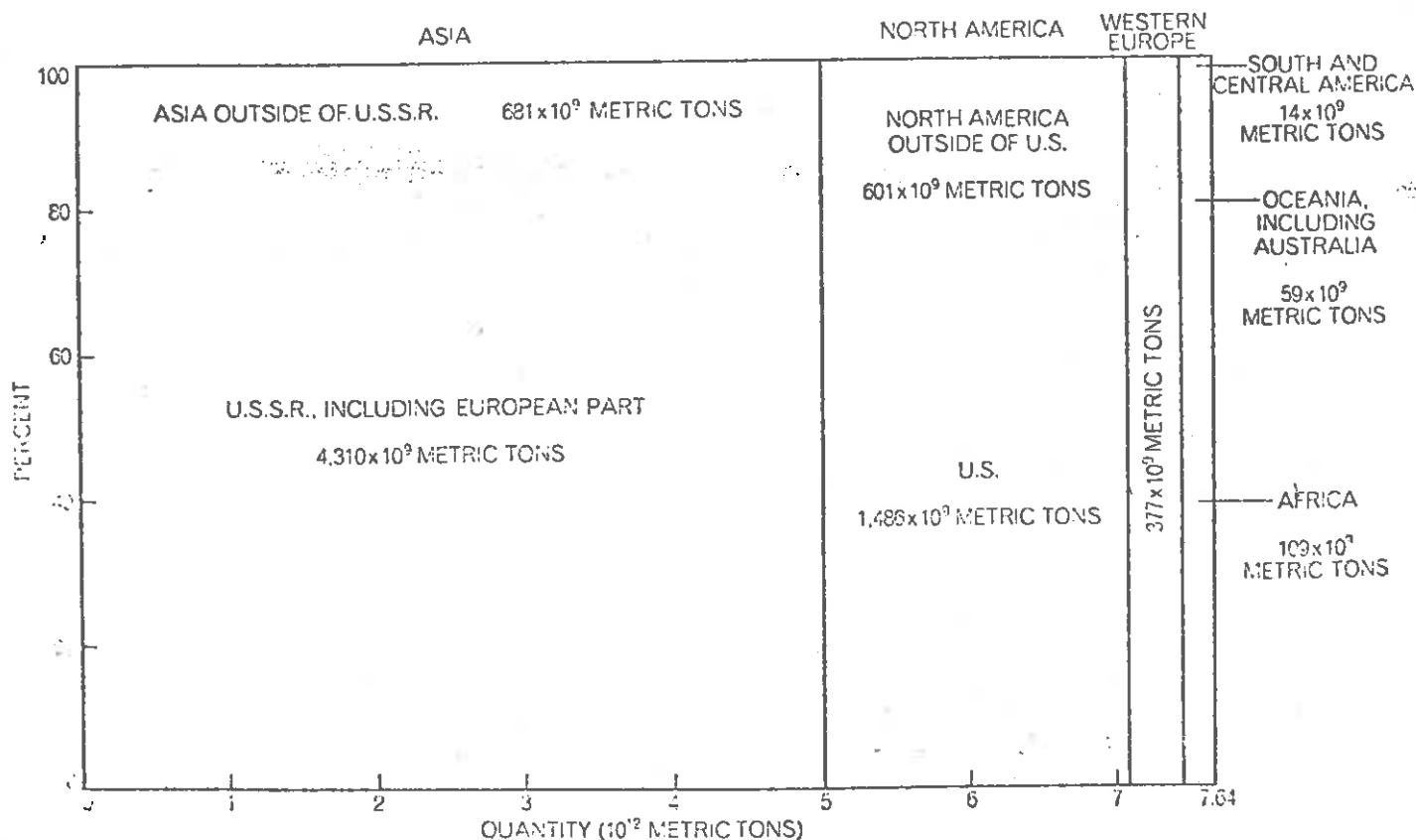
$$T = \frac{T_2}{\ln 2} \ln \left[ 1 + \frac{K}{T_2 R_0} \ln 2 \right] \approx \frac{T_2}{\ln 2} \left[ \frac{K}{T_2 R_0} \ln 2 \right]$$





PETROLEUM RESOURCES of the world are depicted in an arrangement that can be read in the same way as the diagram of coal supplies on the opposite page. The figures for petroleum are derived from estimates made in 1967 by W. P. Ryman of the Standard

Oil Company of New Jersey. They represent ultimate crude-oil production, including oil from off-shore areas, and consist of oil already produced, proved and probable reserves, and future discoveries. Estimates as low as  $1,350 \times 10^9$  barrels have also been made.



COAL RESOURCES of the world are indicated on the basis of data compiled by Paul Averitt of the U.S. Geological Survey. The figures represent the total initial resources of minable coal, which is defined as 50 percent of the coal actually present. The horizontal

scale gives the total supply. Each vertical block shows the apportionment of the supply in a continent. From the first block, for example, one can ascertain that Asia has some  $5 \times 10^{12}$  metric tons of minable coal, of which about 86 percent is in the U.S.S.R.

The above exhaustion time  $T$  is based on the known reserve  $K$ . For example, we have found that if  $K = 1.5$  trillion tonnes, then the time to exhaustion is 52 years. But suppose that luckily through discoveries of new reserves, technological advancement, and even scientific breakthroughs, the effective known reserves were to increase by some factor, say  $r$ . For example, we have noted that if nuclear fuel for light water reactors are included, then the effective reserve is doubled, or  $r = 2$ . Then the time to exhaustion is

$$T + \Delta T = \frac{T_2}{\ln 2} \left[ \ln \left( \frac{rK}{T_2 R_0} \right) \ln 2 \right] = T + T_2 \ln r / \ln 2.$$

Thus, the time to exhaustion is postponed by

$$\Delta T = T_2 (\ln r / \ln 2) = 10 (\ln r / \ln 2),$$

in which we are assuming that the doubling time is 10 years. Then

$r$	$T$ (years)
2	10 (light water reactor)
100	66 (Breeder)
$10^6$	200 (Fusion)

The message is very clear: exponential growth cannot go on for long. But to avert catastrophic consequences, brakes to growth have to be applied several doubling periods earlier. For this, some far-sighted planning and decisions are essential.

## 1.2 Energy Resources

"Energy needs will have to be weighed against environmental and societal costs; a decision to set a pollution standard or to ban the internal-combustion engine or to finance nuclear power development can have major economic and political effects. Democratic societies are not noted for their ability to take a long view in making decisions. Yet indefinite growth in energy consumption, as in human population, is simply not possible."

OO MUCH  
MATH!!



### 1.2.1. Nonrenewable World Energy Resources

The point most frequently overlooked is that almost all of the energy we consume today is nuclear in origin. Only a small fraction, however, comes directly from the nucleus (about 3% of the U.S. gross energy consumption comes from nuclear power plants). The rest can be traced to the sun, which is a huge, lethal, highly radioactive nuclear reactor. The so-called fossil fuel is nothing but re-stored nuclear energy, because the energy was released long ago in the interior of the sun, radiated from the sun, captured and stored by plants and animals several million years ago.

The second point we need to bear in mind is that this so-called fossil-fuel epoch is relatively short and transitory, viewed over the longer span of human history. Man has been in existence for about 2,000,000 years or so, and possibly fossil fuels will be of importance to man for only about 2000 years.

It is interesting to note that at one time coal was thought to be a curse and have questionable value. During the Middle Ages in England, people thought it filled the air with dangerous poisons that were injurious to health. In 1306, King Edward I of England issued a proclamation declaring the use of coal punishable by death, and at least one person was executed for breaking the law.<sup>4</sup> In the United States, coal mining began about 1760, but for a time it was believed to be useless and in some places the sale of coal was declared a fraud punishable by law.

It appears that there is very little coal in Africa, Western Europe, and South America; the bulk of the known reserves are located in Asia and North America. Of the known reserves, the lion's share are owned by Russia and the United States. The estimated amounts are as follows:<sup>13</sup>

Russia	4.3 x 10 <sup>2</sup>	(Metric ton)
Asia, outside Russia	0.68	" "
U.S.	1.5	" "
N. Amer. (except U.S.)	0.6	" "

As for oil, we have already begun to feel the effects of short supply. In a recent advertisement, EXXON depicted a map of the world

in which the size of a nation or nations is represented by the amount of oil reserves.

According to this map, the Middle East is very large, with 53% of known reserves. Russia and Africa are comparable in size, with 15% and 16% of the known reserves. But the combined size of North and South Americas is less than Africa. Venezuela, with about 2% of the known world reserves takes up most of South America. The United States, including Alaska, has only about 5%. Japan is not even on the map.

There are a number of interesting commentaries on the history of petroleum in the World Book.<sup>15</sup> In 1854, when an entrepreneur, George H. Bissell of New Haven, Conn., formed the Pennsylvania Rock Oil Company, investors were reluctant to buy stocks. About five years later, when Bissell and others formed another company, the Seneca Oil Company, drilling finally got underway and struck oil at 69.5 feet!

For many years, kerosene from lamps was the main product of the oil industry, and the lighter liquid, called gasolene, was explosive so that refiners often dumped gasolene into creeks and rivers to get rid of it.

There seems to be some gross misconceptions about nuclear fuel reserves. This source of energy is none too plentiful if used only for light water reactors.<sup>16</sup> In Figure 1-3 we have compared the uranium ore reserve estimates against commitments for nuclear power plants for the next several decades. It is apparent that there may be a shortfall in uranium ore production by the end of this century (and probably much earlier).



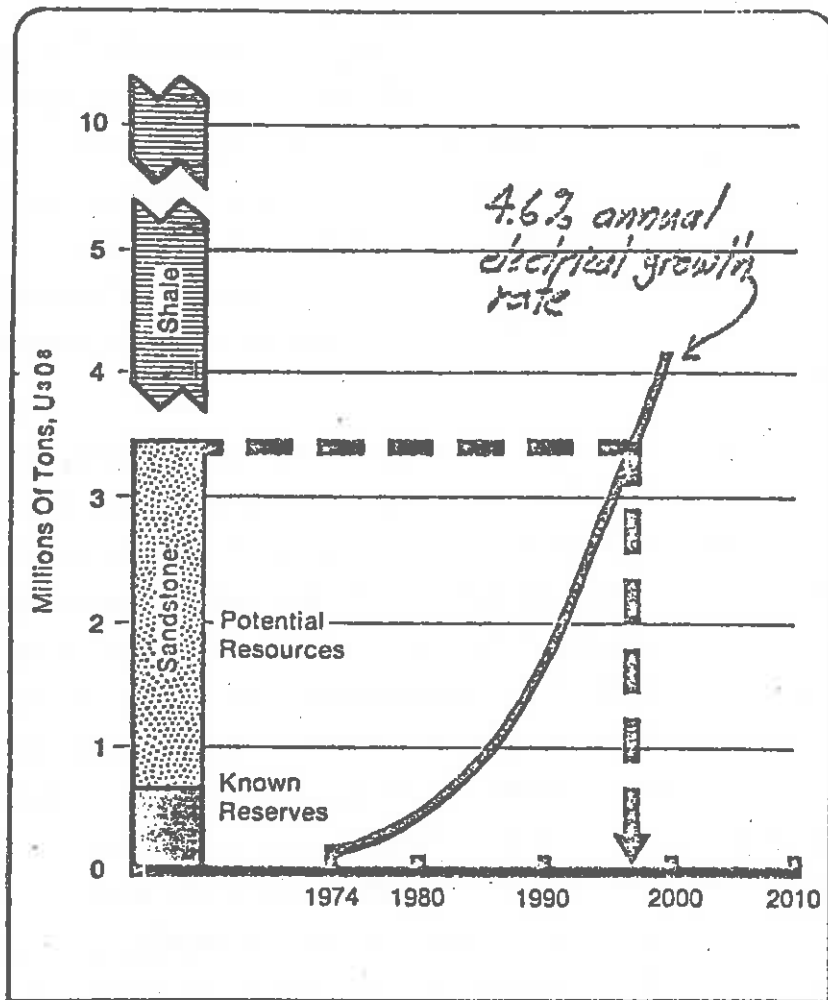


Figure 1-3: Uranium Ore Reserves ( $U_3O_8$ ) versus Commitments for Nuclear Power Plants under Construction (assuming 40 year operating lifetime) (ERDA, 1975)



Thus, by extracting nuclear energy in light water reactors we merely double the available energy resources. As we have seen, this doubling adds only 10 years to the time of exhausting known reserves of energy resources if energy consumption increases exponentially.

### 1.2.2. Michigan Energy Resources

As we have noted, Michigan is among the "have-nots" in energy resources. It must import over 90% of its petroleum and natural gas requirements and all of its coal and uranium needs at the present time. Although it does have significant oil, coal, and uranium deposits-- e.g., in shale--at present, these resources cannot be recovered economically (and would require a several-fold increase in alternative supply prices accompanied by the development of new mining and processing technologies).

To understand the reasons behind this energy poverty, it is interesting to detour briefly and examine the geological history of Michigan.<sup>17</sup> The Michigan area has had exceptional geological stability for millions of years, with no major rock deformation since the Paleozoic Era. Stratigraphs indicate that the Precambrian bedrocks lie at a depth of about 5000 ft. above which lie mostly Paleozoic layers with a thin layer of Cenozoic glacial drift on top, amounting to no more than a 300 ft. thickness. After the Paleozoic deposits, there are the deep salt deposits of the Silurian Period occurring at depths of about 3000 feet. The limestone and the dolomite deposits, which were formed later during the Devonian period are located at depths of about 2000 feet. A significant point brought out by the stratigraph is that the Pennsylvanian layer is missing. It will be recalled that the vegetation growth of this period was responsible for the rich and high-grade coals of Pennsylvania.

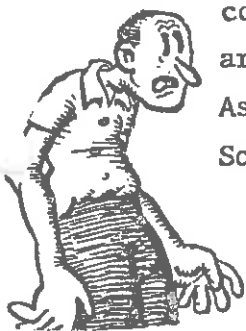
To appreciate fully the exceptional geologic stability of Michigan, we need to look at the past geologic activities in other parts of the world. The part that is now Michigan rose, sank, and rose again. In the geologic past, this was once a shallow tropical sea, when the line extended from Hudson Bay to Mexico was the Equator. To understand how these geologic changes have come about, geologists have developed the

plate tectonics theory of land masses and oceans. The earth consists of an outer shell, called the lithosphere, which consists of several large pieces, called the tectonic plates. There are, for example, the North American Plate, the Pacific Plate, the South American Plate, the African Plate, etc. The Pacific Plate meets the North American Plate along the West Coast, and the mountain formation and the seismic activities along the Pacific Coast is due to the motion of the North American Plate over the Pacific Plate. The two plates meet along the San Andreas Fault, so that the part that is on the Pacific Plate, like Baya California and Los Angeles is drifting slowly northward. In about 10 million years, geologists estimate that Los Angeles will have moved northward to the same latitude as San Francisco, and another 50 million years or later will be off the coast of Alaska, and eventually disappear underneath Alaska.

The tectonic plates are floating on an inner mantle of material constituting the so-called asthenosphere. The plates perhaps can be compared to ice floes. Or perhaps a better analogy would be the slag floating on molten iron. The solidified earth slag, i.e., the tectonic plates, floating on the asthenosphere, move about, collide with each other, or even slip by each other. For example, the North American Plate was in the tropics, with the Equator running diagonally across from the Hudson Bay area to Mexico. At that time, the part that is now the Sahara Desert was at the South Pole; this has been estimated to be about 440 million years ago. In terms of Michigan geology this was after the iron deposits in the Upper Peninsula had been formed, the outflow of lava and copper along the Keweenaw Peninsula had stopped, and the land began to rise to form the salt layers that we know of today.

During the following 200 million years or so, it seems that the continental land masses drifted together, merged, and formed what geologists call Pangea. At that time the land masses we know today were stuck together, interlocked, like pieces of a jig-saw puzzle. Geologists' concept of Pangea can be found in several sources, such as in Newell's article on The Evolution of Reefs.<sup>18</sup> Then North America was connected to Asia by Europe, Africa nestled along the eastern edges of North and South America, Antartica was attached to the southeastern edge of Africa,

EITHER THIS  
SECTION IS OUT  
OF PLACE --  
OR I AM...



and Australia, one end of which stuck to Antarctica, formed the outport of Pangea. An interesting fact is that a triangular land mass, which is now India, was wedged in between Africa and Antarctica. But about 200 million years ago, Pangea broke up into several pieces, and the African Plate, the Antarctic Plate, and the Australian Plate caused these lands to drift apart.

What happened in Michigan while these continents were drifting apart will probably never be known. The reason is that the deposits for the Mesozoic Era are almost completely missing for Michigan, possibly due to glacial actions.

But in what is now the Indian Ocean some dramatic events were taking place. The Indian Plate broke off from Antarctica about 75 million years ago--about the time when dinosaurs were roaming over what is now Colorado--and a scant 45 million years ago, the Indian land mass collided with the Eurasian Plate, forming the Himalayas that we know of today. This was also about the time the Alps were formed, but the Rockies, arising from the collision of the North American and Pacific Plates came somewhat later--about 31 million years ago. The relation of these two plates gave rise to the series of mountain ridges along the Pacific Coast and the Sierra Nevadas which were formed as recently as 18 million years ago.

The rest is almost recorded history. During the Ice Age (2,000,000 years ago) in the Pleistocene Period, sheets of ice swept across Michigan, wiping out geologic landmarks, and causing the earth's crust near the center of Michigan to sag under the enormous weight of sheets of ice. This sagging accounts for the outcrops of old geologic formations near the top of the Lower Peninsula or in the southeast corner of Michigan, whereas the most recent geologic formations are found near the center--in the pocket of the catcher's mitt.

Most of Michigan has been flat and geologically inactive for a long, long time. The exception possibly is the Keweenaw Peninsula where there were volcanic activities about 700 million years ago, just about the time living organisms were beginning to adapt themselves to life on dry land. Before then, the atmospheric oxygen content was too



low, and the protective ozone layer to absorb the lethal ultraviolet radiations from the sun had not yet formed. Since then, Michigan has floated about over the surface of the earth, but there has been no major rock deformation.

The reason for the limited production of oil and essentially zero production of coal seems to stem from the fact that Michigan has been dry, or nearly so, for the last 280 million years. The evidence for this is that the rocks of the Permian Period (the later of the Paleozoic) all of the Mesozoic Era (age of the dinosaurs) except a trace of the Jurassic Period, and most of Cenozoic Era (age of mammals) are missing. As noted earlier, while Michigan was flat and dry, continents drifted, the Atlantic Ocean was formed, and mountain ranges appeared.

In Michigan, as well as in other parts of the U.S., there are vast quantities of oil in the form of heavy hydrocarbons in the Antrim shale. The deposits extend from Port Huron to Muskegon and from Jackson to Grayling. The estimated oil reserve is put at about 500 billion barrels. The obstacle to its use, of course, is extraction.

About 4% of the natural gas used in Michigan is produced from in-state wells. The gas is obtained by drilling into the Niagaran Reefs, located at depths of the order of 7000 feet. The bulk of the gas used in Michigan comes from Canada and the southern states like Texas, Oklahoma, and Louisiana.

The Niagaran Reefs are also the source of crude oil, produced within the state and amounts to about 8% of the state consumption. The Niagaran Reefs are part of the formations of the Silurian Period, which lasted from about 405 to 425 million years ago.

The story of Michigan coal is an interesting one. The highest annual production was 2 million tons back in 1907. The last commercial production was in 1949, when the output had dropped to 11,500 tons. This amount is about a 2 day supply for a modern 1000 MWe coal plant.

### 1.3 Michigan Energy Consumption

Michigan per capita energy consumption is only a trifle below the U.S. average as we indicate in the Table below:<sup>4,6</sup>

<u>Michigan</u>	<u>1960</u>	<u>1970</u>
Energy Consumption ( $10^{12}$ BTU)	1756	2814
Population (millions)	7.82	8.88
Per capita consumption ( $10^6$ BTU)	224.5	316.9
<u>U.S.A.</u>		
Energy consumption ( $10^{12}$ BTU)	44960	67220
Population (millions)	179.3	203.2
Per capita consumption ( $10^6$ BTU)	250.8	330.8
<u>Michigan/U.S.A. (per cent)</u>		
Energy consumption	3.9	4.2
Population	4.4	4.4

Note that Michigan population fraction has not changed, but that the per capita energy consumption appears to have increased somewhat over the last decade.

The annual per capita usage of energy in Michigan is presently 317 MBTU which is about 7% below the national average of 331 MBTU. These figures reflect the balance of several factors: major energy-intensive industries tend to locate near energy sources (e.g., coal fields, hydro-electric plants, etc.); space heating requirements in Michigan are somewhat higher than the national average; and Michigan's major industry, automobile manufacturing, uses energy at a rate near the national average per capita use. Total energy consumption in Michigan has been increasing over the past 20 years at about the national average of 3.5%.

Michigan electrical use has grown considerably faster over the past 20 years at an annual rate of 7%, which is also the approximate national growth rate. The three principal sources of electrical power in the state are coal, oil, and nuclear power plants. There has been a rather interesting variation in these sources during the past 20 years as shown in Table 1-1. For example, as recently as 1964, the electrical utilities in the state (Detroit Edison, Consumer's Power, and the Michigan-Indiana Power Company) generated over 98% of their power from coal. However, the pressure from emerging environmental concerns during the late 1960's

Table 1-1

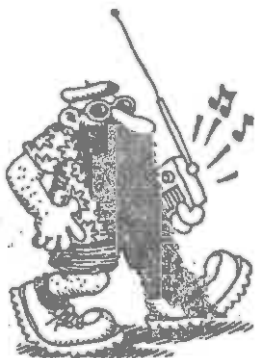
MICHIGAN

CONTRIBUTION TO TOTAL CONSUMPTION BY FORM OF PRIMARY ENERGY

(PERCENT)

<u>Year</u>	<u>Coal and Coke</u>	<u>Natural Gas</u>	<u>Oil and Petroleum Products</u>	<u>Electrical Imports, Hydro &amp; Nuclear Generation</u>
1947	60.4	7.7	30.1	1.8
1954	42.5	13.6	41.6	2.3
1960	37.9	21.4	38.7	2.0
1965	39.1	25.1	34.0	1.8
1970	33.8	30.4	34.2	1.5
1971	30.4	31.3	36.7	1.6
1972	30.5	29.9	37.5	2.1

(P. W. McCracken and W. G. Rosenberg, Report to the Governor by the Special Commission on Energy in Michigan, 1974, p. 65)



forced the massive substitution of cleaner burning natural gas and oil for coal to the point where fossil fuels accounted for 23% of the electrical generating capacity in 1973. (A coal-fired unit can be converted rather easily to liquid fossil fuels--unfortunately, the conversion back to solid fuels is far more difficult and usually requires rebuilding a sizeable portion of the power plant.) In hindsight, we can see how disastrous this replacement has been. The impending depletion of natural gas reserves has eliminated this fossil fuel as a viable source of energy for electrical power generation (most utility companies can no longer buy natural gas). Furthermore, since the Arab boycott of 1973, the price of electrical power generated from crude oil has tripled. Hence, Michigan utilities have now been forced into a massive plant construction program to replace oil-fired units and keep pace with the increasing demand for electricity by building both coal-fired and nuclear generating units.

#### 1.4 Projected Needs for Electrical Power in Michigan

Projections of future energy needs play a very important role in energy policy since they determine the magnitude and timing of the investment required to develop new energy generating capacity. For example, Michigan utilities are now forecasting an average annual increase in peak load demand of 5.6% per year through 1985 (somewhat below the historical rate of 7.4%). (See Figure 1-5.) This means that Michigan utilities must bring on line one new 1000 MWe generating plant each year for the next 10 years to meet anticipated electrical needs--a rather staggering requirement, since such a plant costs over \$1 billion and takes roughly 10 years to build (which explains the need for such long term projections of electrical demand).

But of course the first question we should ask is why? Why do we need more electricity? Certainly, if the public becomes convinced of the seriousness of the energy problem faced by this country, then it can be persuaded to conserve energy and thereby eliminate--and perhaps even reduce--the demand for electrical energy.

Unfortunately, life is not that simple. First we should keep in mind that on a national scale<sup>19</sup>, some 28% of our total energy consumption

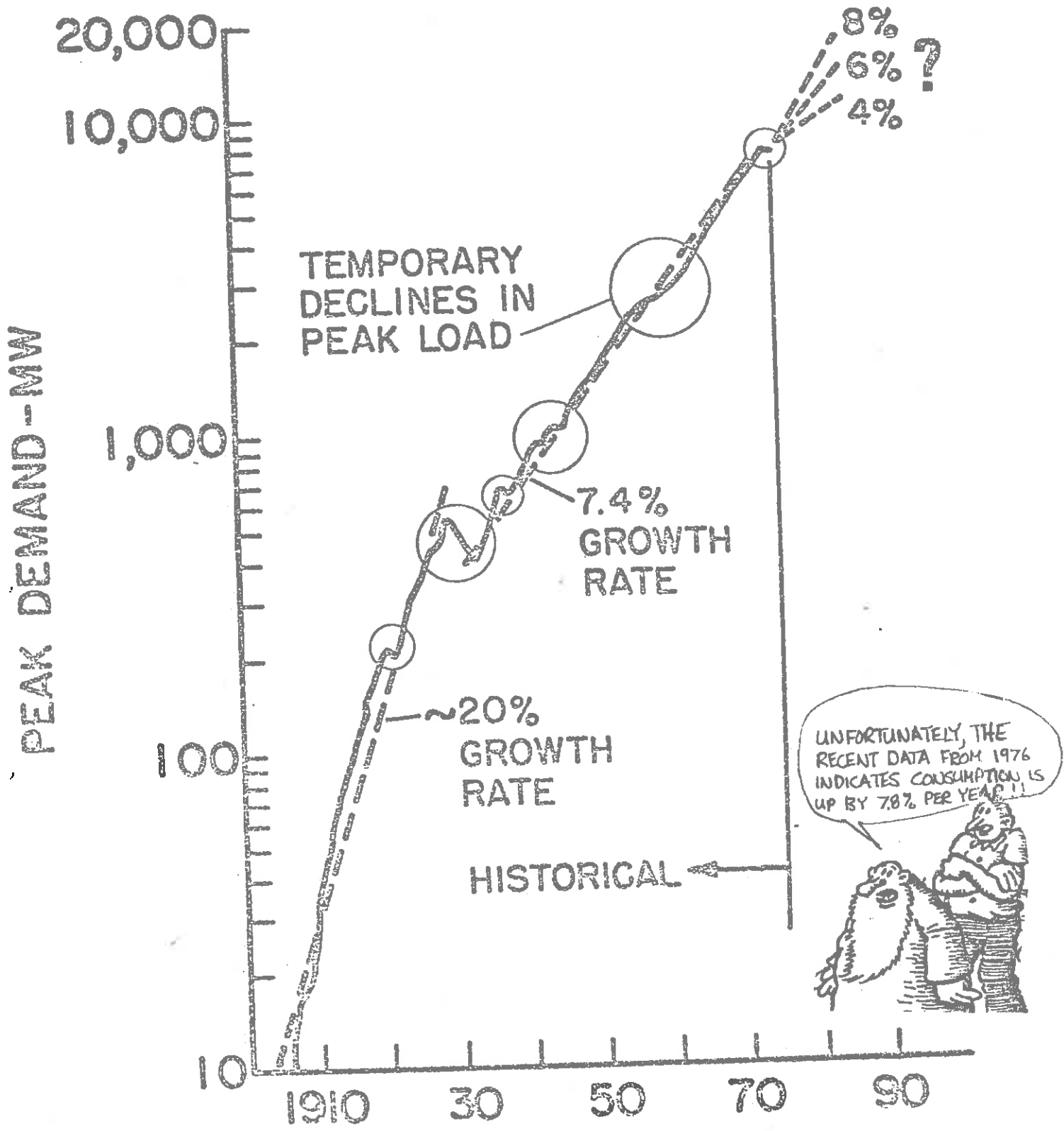
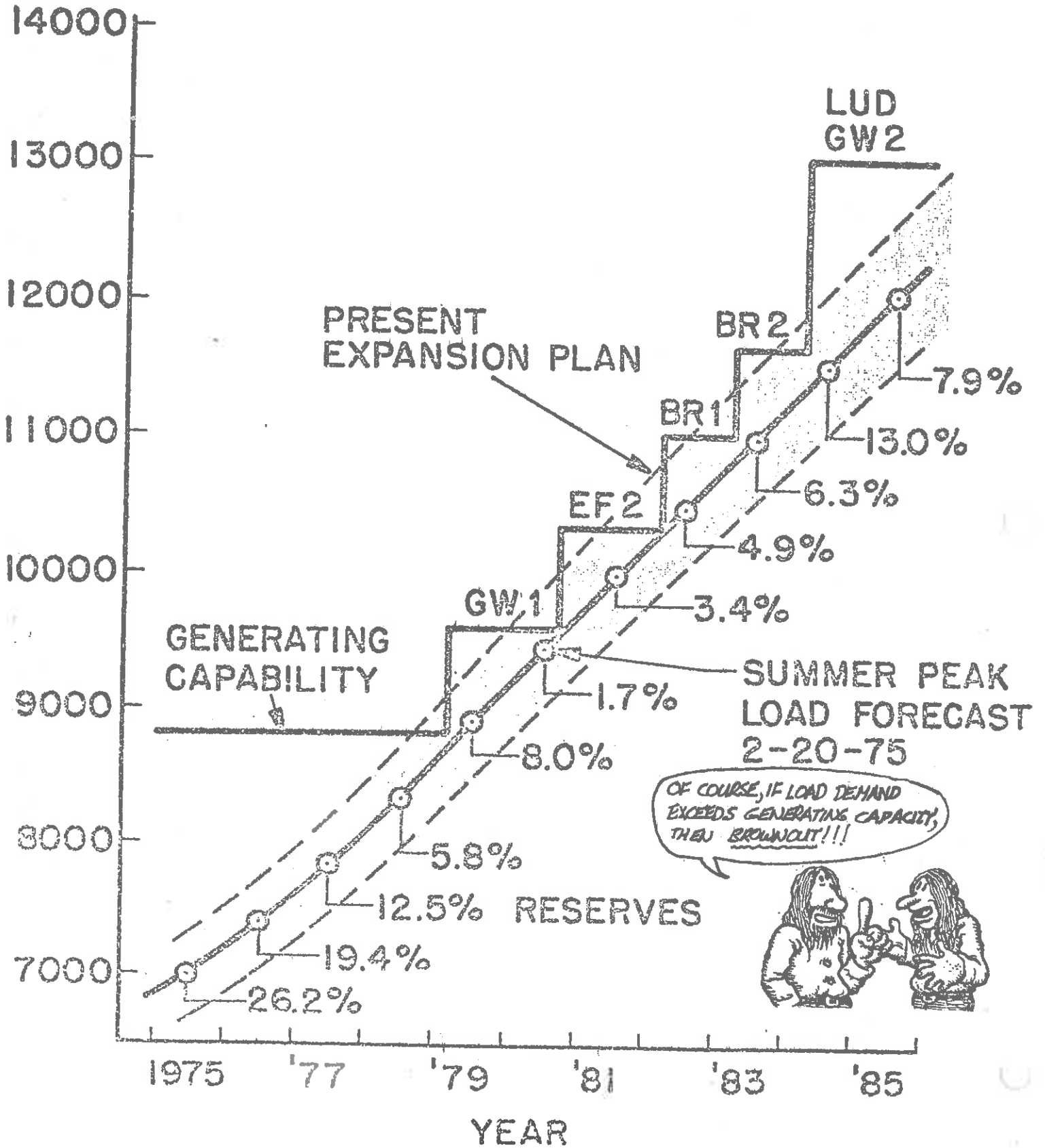


Figure 1-5: Projected Growth in Peak Load Demand for Southeastern Michigan (presented by J. R. Hamann, President, Detroit Edison before Governor's Advisory Commission on Electric Power Alternatives, 1975)

Figure 1-6:

# DETROIT EDISON PEAK LOADS AND CAPABILITIES



is supplied by electrical power generation. As our technology advances, there is an inevitable trend towards the substitution of electricity for other sources of energy, and many estimates forecast that some 37% of our total energy consumption will be as electricity by 1985. This tendency is dramatically reinforced by the recognition that some 75% of our total energy requirements are currently supplied by liquid fossil fuels (oil and natural gas)--of which more than 50% is imported. Hence, the pressure to replace liquid fossil fuels by solid fuels (coal and uranium--i.e., electrical power generation) is unavoidable.

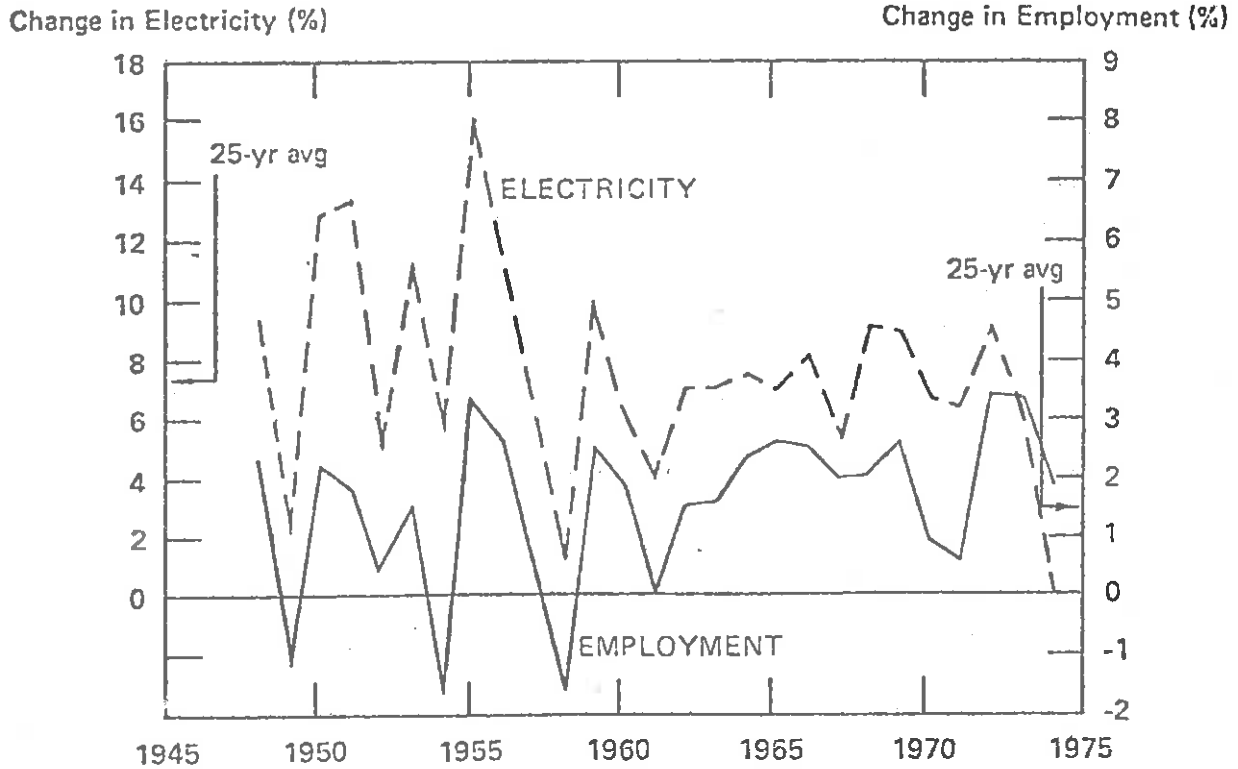
But there are other reasons behind the forecast of increasing electrical power needs. Over 50% of the electricity generated in Michigan is used by heavy industry (with some 17% going to commercial uses, 28% to residential customers, and 5% to other uses). Hence, it is not surprising to find that electrical power consumption is directly proportional to industrial production--to gross national product--and therefore to such economic indicators as employment, per capita income, etc. The demand for electricity is in lockstep with the economy.

This was made dramatically clear during the recession of 1973-74 (which was induced by the Arab oil embargo). During these years there was a slight drop in demand for electricity. Although this drop was at first interpreted as due to an increased awareness on the part of the consumer of the need for conservation measures, in fact the drop was almost entirely due to the cutback in industrial production which accompanied the sagging economy. For example, during 1974 in Michigan,<sup>6</sup> although industrial electricity demand dropped 8.4%, the residential use increased by 4%. And since mid 1975, electrical consumption has resumed its historical growth pattern (at about a 6% per year clip).

Hence, at least for the near term, one must be very cautious in any reliance upon conservation measures to stem our demand for energy. Since energy useage--particularly electrical energy useage--is so intimately related to industrial production and the economy, a major change in energy consumption will be rather difficult to achieve without a major restructuring of our economy (and hence our society). Most optimistic estimates of the effects of a major conservation program

Figure 1-7

## Percentage Change of Electricity and Employment



(C. Starr, in Conf. on Magnitude and Deployment Schedule of Energy Resources, Oregon State University, 1975)

MAYBE I COULD GET  
A JOB WITH RALPH  
MAUER OR THE  
SIERRA CLUB...





project eventually decrease total energy growth to about 1.5%/year and electrical growth to 5.5%/year (about what Michigan utilities are projecting)<sup>20</sup>.

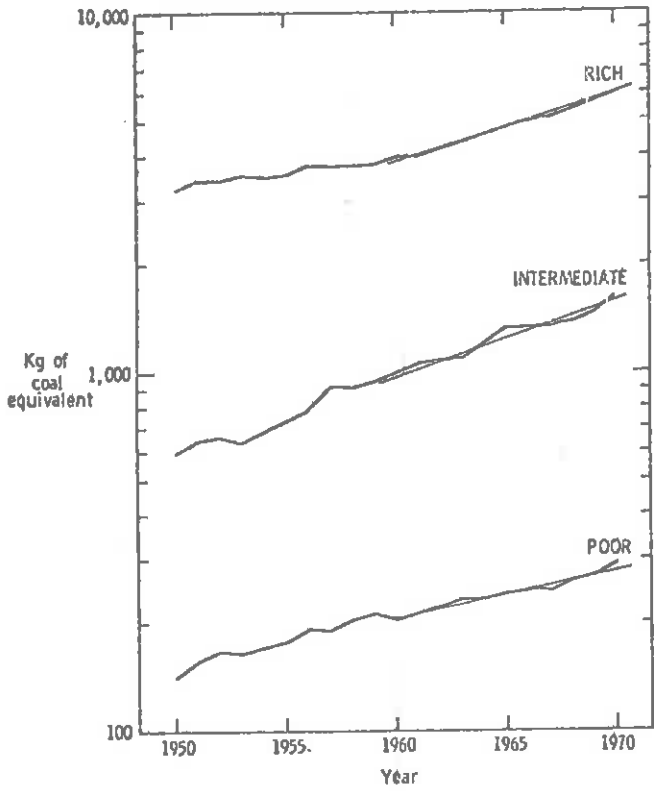
Of course, from a world-wide perspective, the energy situation appears even more serious. The need for new sources of energy are far more imperative, for we must remember that the world's population continues to grow at a rather rapid rate ( $\sim 2\%$  per year), while at the same time, those fossil fuel sources which maintain most of the world at barely a subsistence standard of living are running out. Although the United States, with large reserves of coal and uranium and one of the highest standards of living, can afford the luxury of debating which alternative energy sources to develop, the rest of the world cannot wait, but rather must make a commitment to its only alternative: nuclear power. And, on a world-wide basis, the commitment to nuclear power has assumed massive proportions.

Hence, there is little doubt that electrical energy demand will increase, and additional facilities for electric power generation and transmission will be required in Michigan and elsewhere in the nation. Such facilities require long lead times (typically 7-10 years) for construction due to the complex nature of the machinery and equipment and the magnitude of the project, as well as the lead time necessary to obtain the many permits, approvals, and licenses required for the project.

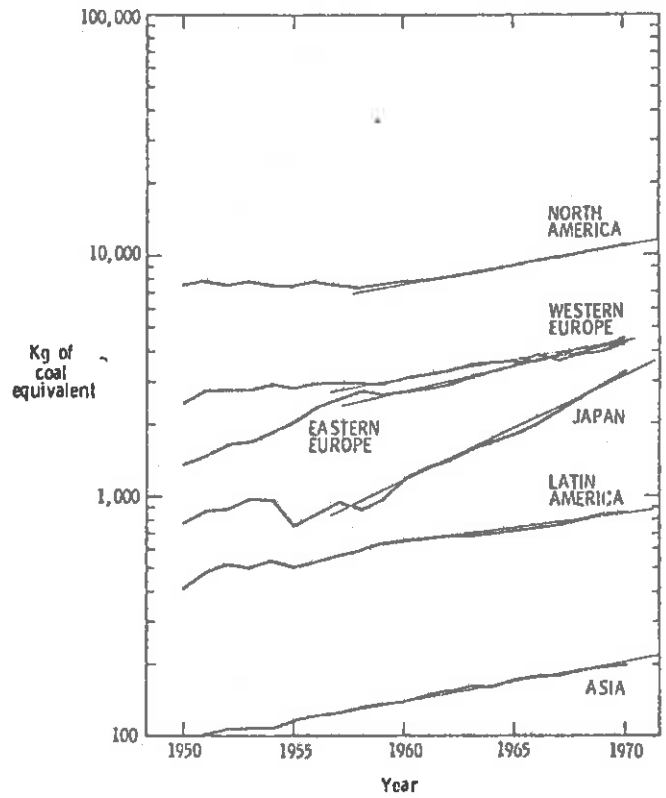
The magnitude of funds required for such projects often exceed all the construction costs in a utility's history. These large construction programs involve huge capital requirements which are spread out over almost a decade at a time of exceptionally high interest rates. For example, Detroit Edison and Consumer's Power project that their capital investments required to meet increased demand will be \$14 billion over the next ten years.

These enormous capital requirements represent one of the most serious obstacles to meeting future energy demands. For if a utility is to raise such capital, it must project sufficient financial integrity to attract prospective investors. But, of course, the earnings of the

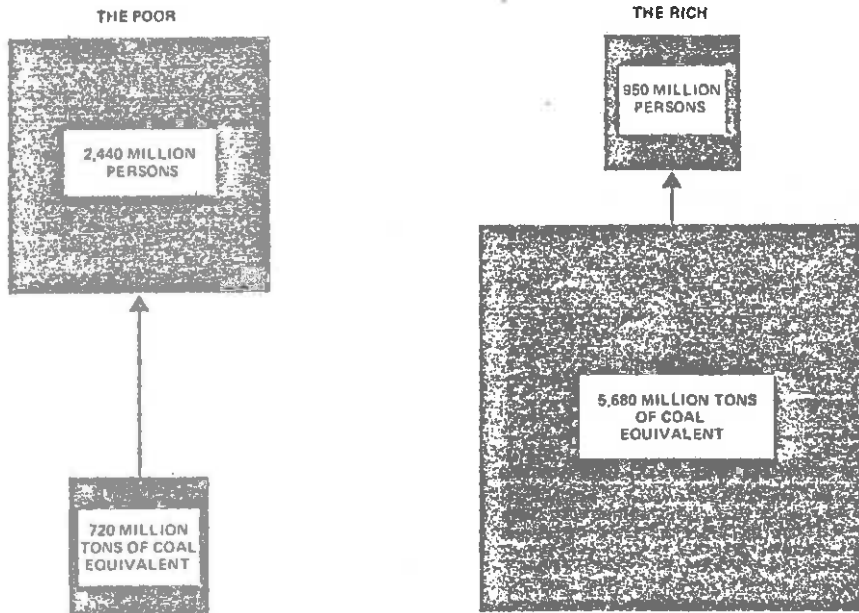
Figure 1-8



Per capita consumption of energy by economic grouping.



Regional per capita consumption of energy.



Energy consumption and population in the rich and poor nations.

Average population and consumption levels for energy and steel in 1970

	Classification of Nations		
	Rich	Intermediate	Poor
Population (millions)	954	234	2440
Energy (10 <sup>6</sup> metric tons)	5680	384	717
Steel (10 <sup>6</sup> metric tons)	507	38	51
Per capita energy (kg/person)	6010	1610	293
Per capita steel (kg/person)	537	158	21
Per capita GNP (US dollars 1973)	2720	846	169

BUT HOW WAS I. TO KNOW?



utility depend sensitively upon the rate structure allowed the utility by state public service commissions which regulate public utilities. It is the duty of these commissions to achieve a proper balance between the protection of the consumer and the approval of rates that are substantial enough to maintain the financial integrity of the utility and allow them to pursue needed construction programs.

The utility rate structure allowed by the public services commission in Michigan has deteriorated to the point where the major electrical utilities in the state found it necessary to completely halt all major construction projects in the Fall of 1974. Such action was brought about by poor earnings which resulted in the downgrading of utility bond ratings from Aa/AA to Baa/BBB and made it almost impossible to obtain needed long term capital.<sup>5</sup> For example, Detroit Edison's Greenwood I oil-fired power plant and their Fermi II nuclear plant were halted at 30% and 40% completion, respectively. These two projects represented over \$700 million of partially completed construction, idling thousands of workers, and eating up interest charges of roughly \$80 million a year. Furthermore, as the projections of demand versus generation capacity shown in Figure 1-6 indicate, unless such construction is resumed rapidly, the electrical utilities in the state of Michigan will be unable to meet projected electrical demand within 5-10 years.

Fortunately, on a short term basis, electricity can be bought from neighboring utilities. For example, if an electrical utility were entirely isolated it would need roughly 40-50% reserve capacity to maintain service reliability. By utilizing electrical interconnections with neighboring utilities, this reserve can be reduced to a 20-25% level. It may be possible to reduce reserves to as low as 10% by a combination of inverted rate structures and planned outages. Unfortunately, the reserves projected by Michigan utilities for the early 1980's will drop far below even this level unless major construction can be put back on schedule. Since a similar capital squeeze has caused neighboring utilities to defer or cancel construction of their own new power generating facilities, the likelihood of substantial help from these utilities has been greatly reduced.

The sad fact that must be faced by the consumer is that utility rates are of necessity going to increase--elsewise utility service will disintegrate rather dramatically over the next five to ten years. The consumer must realize that all energy costs will increase--in fact, most projections indicate that the cost of electricity will effectively double over the next ten years.<sup>21</sup> Adequate rate relief from public regulatory agencies is of vital necessity if the utilities are to resume construction programs and thereby bring new units into service on a schedule design to meet increases in electrical needs and replace old and inefficient equipment.

### 1.5 Prophets of Doom

The report "The Limits to Growth"<sup>22</sup> for the Club of Rome's Project on the Predicament of Mankind may very well turn out to be one of the more authoritative accounts of the fate facing our modern technological society. The study program that led to the dire predictions was started in April 1968, when an international group of experts from a variety of disciplines met in the Academic dei Lincei in Rome--and hence the name Club of Rome--to discuss some of the compelling global problems. For the first phase, they chose the Project on the Predicament of Mankind and focused on five major global trends, namely accelerating industrialization, rapid population growth, wide-spread malnutrition, depletion of non-renewable resources, and deterioration of the environment. The Club of Rome's prediction is that for awhile the world population and the needed food supply will continue to increase, but during this period--between now and the end of this century--the non-renewable resources will decrease at an accelerating rate, which will have a catastrophic effect upon our food supply and hence upon the world population. Some critics no doubt will quarrel with some of the details of the predictions, but qualitatively the predictions are not too surprising.

This report, and others like it, have triggered a flood of hard-backs and paperbacks, magazine articles and newspaper editorials, etc., predicting the coming of doomsday. One of the most recent ones is The Coming Dark Age: What Will Happen When Modern Technology Breaks Down?, by Roberto Vacca.<sup>23</sup> According to this book, the prediction is that transportation, power, and other systems upon which we depend on

in our modern industrial society will start to break down between 1985 and 1994, beginning first in the United States and Japan, leading to world-wide catastrophic collapse. The point that Vacca makes is that our modern technological systems are hopelessly overloaded, poorly planned, and badly managed, and that the unthinking public is "like a prisoner in a crowded, locked freight car who complains about the uncomfortable ride and gives no thought to the extermination camp that awaits him".<sup>23</sup>

Some of us, and even experts in the field, might disagree with the details of these predictions. But this is not the point. Sooner or later, we will begin to exhaust our non-renewable resources, and if we do not make dramatic changes in consumption, then because of inflexibilities in our social, economic, political, and legal systems, our industrial organization and the population will continue to grow for awhile--"overshoot" as systems engineers will say--and then suddenly collapse.

The recent so-called energy crisis has given us a mini-example of the catastrophic consequences of socio-economic growth without far-sighted planning. The experts saw that the energy crisis was coming but were unable to avert it, because it was too late; to avert it, planning would have to have started 20 to 30 years ago. And keep in mind the suddenness with which the energy crisis struck the public, for just a few years earlier the general topic of conversation was the affluent society.

#### 1.6 Concluding Remarks

In summary then, the energy problem is real--the energy "crisis" is indeed a crisis. Overall national energy consumption continues to increase at a 3.5% growth rate, and many knowledgeable experts are convinced that this growth will continue for at least another decade. If such a demand were to continue until the turn of the century, it would require the development of all available energy resources--including coal, gas, oil, shale, hydroelectric, nuclear, solar, and geothermal power. To meet this extrapolated demand at the year 2000, the Alaskan pipeline must be completed, all available geothermal sources must be

developed, coal mining must be tripled, hydroelectric plants must be located in national parks like the Grand Canyon, one thousand nuclear generating units must be operating, offshore oil in the Santa Barbara Channel, Gulf of Mexico, and the Atlantic Ocean must be exploited. And, these sources would still be inadequate, and oil imports would have to be tripled over the current levels at a cost of more than \$30 billion per year.<sup>24</sup>

Although vigorous resource development will be required in any event, it is doubtful if this expansion in energy supply is feasible, either in terms of economic or environmental costs. It is obvious that this nation must limit its growth in energy demand while it prudently develops all reasonable resources consistent with emerging standards of environmental protection.

A somewhat more optimistic projection shown in Figure 1-9 assumes that stringent energy conservation measures can be implemented immediately to reduce the average growth rate of 1.9%. This would assume, for example, that our cars will get 20 mpg by 1985 (compared to their present 12-13 mpg), that we will better insulate our homes and businesses, that we will use heat pumps, and that industry will decrease its energy use from the historical growth projections by 22% in 1985 and 43% in 2000. Even if these optimistic projections can be achieved, we will still come up with an energy debt that must be made up by foreign oil imports. Without conservation and imports, our society will enter a profound crisis which may shake our political and social institutions.

There are other severe aspects of the energy crisis. Among these are the needs for unprecedented amounts of capital devoted to energy. Nuclear proponents want the dollar equivalent of 1-2 GNP by the year 2000 to develop the 25-30 percent of the energy they will have to supply. Oil developers need 200 billion dollars in the next ten years to meet their goals. The coal industry will need close to 100,000 new underground coal miners in the next ten years.<sup>24</sup>

One of the major difficulties in formulating policies to deal with the energy crisis is a very considerable disagreement over what our energy goals should be, and which agencies should administer these

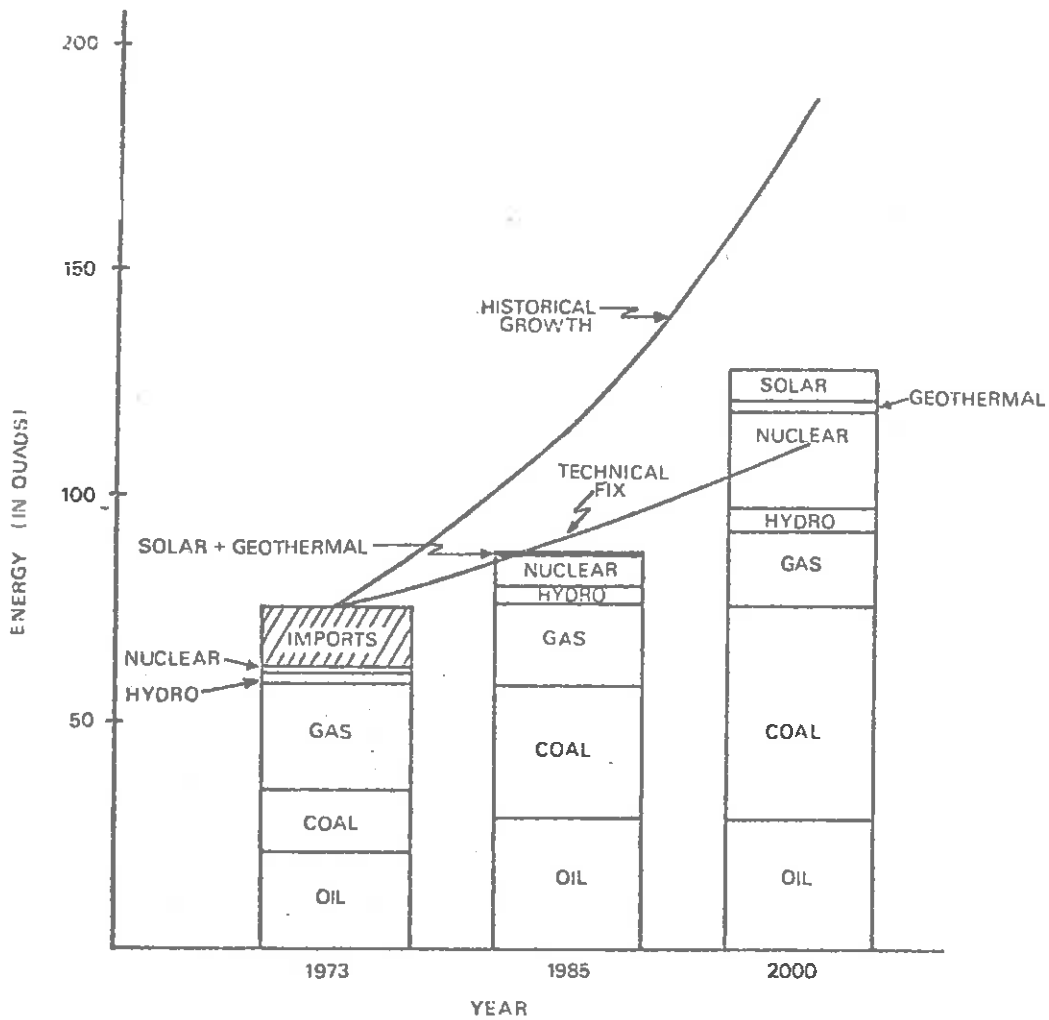


Figure 1-9: Projected energy demand and supply during the next 25 years.

(W. D. Loveland, in Conference on Magnitude and Deployment Schedule of Energy Resources, Oregon State University, 1975, p. 2)



policies. Energy issues are particularly complex because they frequently are comprised of a variety of conflicting smaller issues. For example, how much in the way of energy efficiency are we willing to sacrifice for minimizing environmental impact? How should we allocate our scarce fossil fuel resources? To what degree should we defer the implementation of existing technologies (e.g., coal or nuclear fission) in favor of developing longer range alternatives (e.g., solar or nuclear fusion power)? Certainly some hard choices are going to be required during the next few years.





## CHAPTER 2

## SOME FACTS AND FANTASIES IN ENERGY PLANNING

There seems little doubt that Michigan, just as the rest of the nation, will face growing requirements for electricity during the next several decades. Most electrical utilities in this country are anticipating a yearly growth factor of 5% to 6%.<sup>1</sup> For Michigan this growth in demand will require an effective doubling of total electrical generating capacity over the next decade corresponding to a capital investment in excess of \$15 billion. Furthermore, because of the long lead-time necessary for construction of electrical generating stations, decisions concerning the type, size, and location of future generating facilities must be made as soon as possible, and the preliminary commitments for obtaining the construction permits necessary for such facilities cannot be postponed much longer.

But what type of electrical facilities are most appropriate for Michigan? Which energy sources are most capable of meeting anticipated power requirements while at the same time ensuring maximum public safety and minimal environmental impact? To answer such questions, we must consider not only the broad range of alternatives for electrical power generation, including fossil fuels (oil, natural gas, and coal), nuclear fission, hydroelectric, geothermal, solar, thermonuclear fusion, and wind power, but as well what degree of conservation efforts represent realistic goals for the state. We must examine carefully a number of extremely important factors which are involved in selecting among energy alternatives and arriving at a rational and realistic energy policy.

Certainly the first consideration should be given to the viability of the energy alternative for the state of Michigan during the time frame of the next ten to twenty years. Here one must take care not to confuse the scientific feasibility of a given alternative with its economic viability for massive implementation. For example, although the scientific feasibility of electrical power generation using solar electric cells has been demonstrated and utilized on a small scale for a number of years (e.g., in satellites), there seems little chance that the massive

implementation of solar electric power generation can be achieved on an economical basis until at least well after the turn of the century. As yet another example, although controlled thermonuclear fusion is frequently touted as an attractive long range source of energy, it has yet to reach even the stage of scientific feasibility--far less that of economic viability. Such considerations will motivate us later to classify energy alternatives as either short range or long range options, depending on whether they can achieve economic viability by the turn of the century.

A second factor involves the natural resources available for a given type of energy source. For example, while liquid fossil fuels (oil and natural gas) provide over 75% of our present energy requirements, their economic viability is expected to diminish as the reserves of such fuels are depleted over the next several decades. By way of contrast, solar power, controlled thermonuclear fusion, and (incidentally) the fast breeder reactor all represent essentially infinite sources of energy since the estimated reserves required for each of these alternatives is sufficient to supply mankind's energy needs for thousands (perhaps tens of thousands) of years. Unfortunately, all three of these alternatives must be viewed as long range options. For the short range we are forced to look instead at alternatives which exhibit more immediate economic viability but unfortunately more limited fuel resources. This class includes solid fuels such as coal and uranium as well as options which are based on rather limited natural conditions such as hydroelectric and geothermal power generation.

A third factor which must be considered in any energy program is public safety. Certainly any form of electrical power generation will entail some degree of public risk. For example, the public risks from nuclear power generation (e.g., low level radiation release or possible accidents have been widely publicized over the past several years. Not so widely publicized are the rather substantial public risks associated with hydroelectric power generation (massive dam failures are not an uncommon phenomenon) and the generation of electricity by burning coal (underground coal mining is perhaps the most hazardous profession in this country today, and the pollutants emitted by coal-fired generating plants are

estimated to be a contributing factor in thousands of fatalities every year due to bronchial failure)<sup>2</sup>. Indeed, even conservation has associated with it a rather substantial public risk since it frequently entails the relaxation of anti-pollution controls and in some cases the removal of expensive safety equipment (an excellent example is automobile fuel economy). It is extremely important in any consideration of various energy alternatives to estimate as realistically as possible the public risk from each alternative and to balance these risks against public benefits.

A fourth area of considerable concern is environmental impact. All energy generation will perturb the environment to some degree. There is no way to entirely eliminate this impact. For example, the effects of strip mining both coal and uranium are well known, as is the environmental impact on air pollution from burning fossil fuels. Perhaps not so widely known are the enormous environmental impacts of seemingly benign sources of energy such as geothermal power (which releases large quantities of noxious gases and liquids to the environment, causes substantial ground settlement and seismic activity, and generates very high noise levels) and solar electric power generation (both in a direct sense by modifying the reflectivity of the earth's surface, and in an indirect sense due to the impact of energy collection and storage devices).

Of course the final and usually deciding consideration will be that of economics. In our society most features of any technology, including resources, safety, and environmental impact, are usually assigned a quantitative measure--the dollar. In the particular case of electrical power, the quantitative measure is taken as the cost of generating a certain quantity of electricity, usually expressed in terms of "mills per kilowatt-hour", where one mill is one-tenth of a cent and kilowatt-hour is a measure of electrical energy. (For example, the average homeowner in Michigan utilizes roughly 500 kwhr per month of electricity. Hence, if the cost of this electricity is 15 mills/kwhr--as it presently is--his monthly charge for generating this electricity will amount to \$7.60.<sup>3</sup> Of course one must add transmission costs and service charges which typically double this to a level of \$20 to \$30). In this sense then, the economic viability or attractiveness of a particular energy alternative will usually reflect all other aspects involved in selecting that alternative.

If our society decides upon a certain minimal level of environmental impact and public risk, then an energy source must be equipped with sufficient environmental controls and safety systems (usually at a rather significant additional cost) to meet these requirements. Usually the determination of such generating costs is extremely complicated, and the projection of future generating costs is subject to considerable uncertainty, depending on both time and location of the projected energy source.

Unfortunately, all of these factors are very highly interdependent and frequently conflicting. For example, the efficiency of any energy source will be dramatically affected by environmental controls; hence conservation can usually only be purchased by a certain degree of environmental impact. The safety equipment necessary to reduce public risk to even lower levels will lead to even higher electricity bills. There will always be a tradeoff. There is no such thing as a free lunch.

In an ideal society all such comparisons of the various factors involved in choosing alternatives, their advantages and their disadvantages, would be carefully weighed in a rational manner and an optimum choice would be made. Unfortunately in our society such decisions are usually made in the most irrational of atmospheres, subjected to a variety of emotional, political, or economic pressures, and conceptual misunderstandings. Indeed, it is stretching the imagination somewhat to even pretend that either the state of Michigan or this country, or indeed the world, presently has a rational and coordinated energy policy.

Certainly much of the confusion in approaching energy issues is due to the numerous agencies--particularly at the federal level--which attempt to regulate and enforce policy decisions involving energy production and utilization. For example, the Federal Power Commission regulates the prices of interstate natural gas sales, the Federal Energy Administration regulates oil production, the Interstate Commerce Commission regulates pipelines, the Nuclear Regulatory Commission regulates nuclear power, the Environmental Protection Agency regulates the environmental aspects of all power generation, and so on. The conflicting goals and regulations of these and various similar states and municipal agencies can have disastrous effects. For example, the 1971 Clean Air Act required that coal burning utilities switch to cleaner burning oil or natural gas, which



put even more pressure on the already scarce resources of these liquid fossil fuels. As a result, the 1976 Energy Policy and Conservation Act reversed this and ordered that natural gas burning utilities switch back to oil or coal. Needless to say, such inconsistency causes havoc with the long range investment and planning decisions of electrical utilities.

## 2.1 Scientific Feasibility Versus Social Viability

"Large scale use of petroleum was still in the future, however, Whale oil was still being used for lighting and lubrication, though it was becoming scarce. A new source of oil was desperately needed. Some French scientists in 1895 had developed a small production of oil by heating a kind of rock called oil shale. James Young of England found a way of getting oil from coal and oil shale in 1850. Soon afterward Great Britain had 130 plants making shale oil. About 1854 Abraham Gesner of Nova Scotia, a chemist, patented an improved oil for lighting, distilled from coal. By 1859 there were 64 plants in the United States producing oil from coal and shale. Even the whaling port of New Bedford, Mass. had a plant making oil from coal shipped from Scotland. This "coal oil" was expensive to produce, but it became popular for lighting."

Petroleum, World Book<sup>4</sup> (6243b)

The language used by scientists and engineers has often been at the root of controversies concerned with the implementation of a new technology. The American public as a whole is aware that lawyers have a language of their own so that in the reporting of crimes, for example, the distinction is made between felony and misdemeanor. Fortunately or unfortunately, the involvement of the public and the mass media in technical matters is relatively new, so that there have been frequent loose uses of certain technical terms, and this has resulted in confusion of technical information. The distinction between the words "feasibility" and "viability" has caused a particularly large amount of public misunderstanding concerning potential energy sources.

For example, the scientific feasibility of energy release through a controlled and sustained nuclear fission chain reaction was demonstrated in December, 1942, through the pioneering experiments by Enrico Fermi and his associates at the University of Chicago. Subsequently, this feasible technology was developed into a viable technology during the ensuing twenty years or so through a series of steps, including the energy need analysis by the AEC consultant and windpower advocate, P. C. Putnum, then the catastrophic accident risk analysis of WASH-740, or the so-called Brookhaven report, which led to the design philosophy of "defense in depth" and to the requirement of the safety reports for the licensing and operation of nuclear power plants; and the research programs during the war years and in the early 1950's on the biological and environmental effects of radioactivity, which paved the way for the AEC to take the lead in starting to carry out the intent of the National Environmental Policy Act of 1969.

The impact of this systematic procedure for developing a new technology for societal use is beginning to be felt in other technologies, such as for coal and oil. Certainly the same pattern will be used for the developing of windpower and solar-electric technology, so that here we can visualize what will need to be done to make these well known feasible technologies into viable technologies.

Scientists tend to use the word feasible while most engineers use the word viable. One reason for this difference is that scientists will often be referring to one phase in the development of a technology, whereas engineers will be referring to another. Another reason is that a clear-cut precise distinction is very difficult to make. Consequently, we shall start by discussing certain specific examples. Consider then the following list of electric energy technologies for Michigan:

<u>Energy Alternative</u>	<u>Feasible?</u>	<u>Viable for Michigan, 1985?</u>
Oil	yes	Maybe, maybe not
Natural gas	yes	Maybe, maybe not
Coal	yes	yes
Nuclear fission	yes	yes
Breeder	yes	no
Nuclear fusion	no	no
Solar electric	yes	no
Wind	yes	no
Geothermal	yes	no

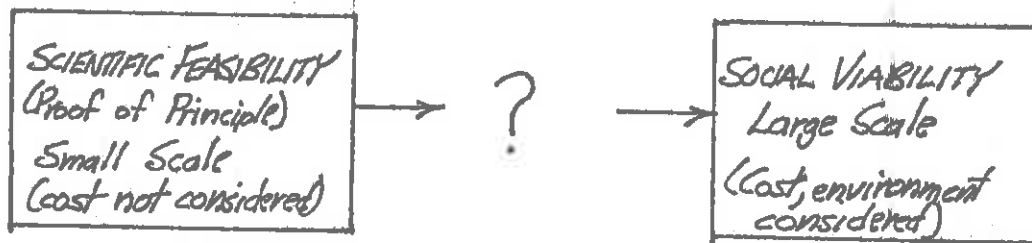


Loosely speaking, a technology is said to be feasible if it can be done on a small scale, say in a laboratory, whereas for the same technology to be viable, it must be workable and acceptable on a large scale, say to a population group of one million people. One example is making oil from shale. It is certainly a feasible technology because it is possible to extract a test-tube full of oil from shale in the laboratory; however, the problem of making millions of barrels of oil from shale deposits in Colorado is a different matter. Or the viability of a technology could change with time. As noted earlier, once, around 1850, coal and shale were regarded as a viable technology.

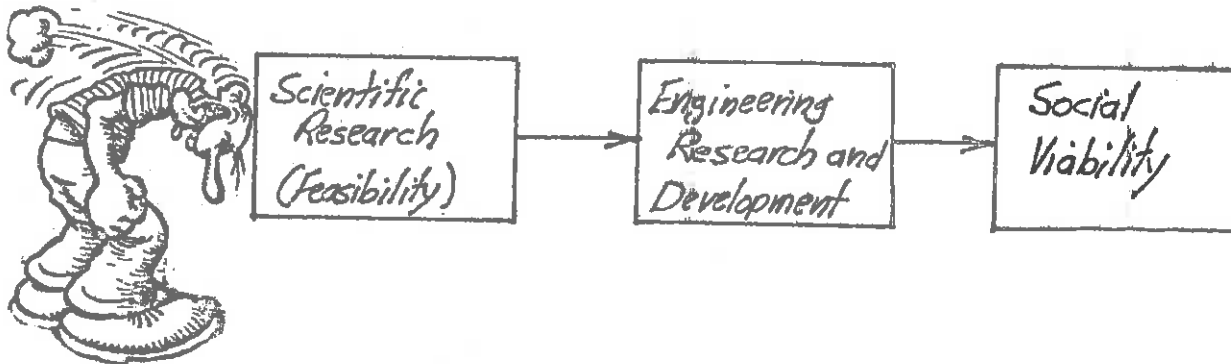
For electricity, a technology might be said to be feasible if it can be used to light a single 100 watt light bulb for two hours, whereas for it to be viable it must be able to make enough electricity for one million light bulbs at costs within reach of the million people at acceptably low environmental risks. For example, in Michigan today, windpower, solar-electric, and geothermal power are unquestionably feasible methods for making electricity; however, the problem is that only a few can today afford the luxury of having a windmill (at \$10,000 a crack), even fewer would have the money to buy a solar-electric generator, and it is doubtful that there is a single person in Michigan who would be willing to dig a hole deep enough, down into the hot bedrocks, to make steam to run a small turbine generator. We notice also that viability is site-dependent. Although geothermal energy is not a viable alternative for Michigan now and possibly for a long time to come, it could be a viable means in California or Iceland. Viability is time dependent. What is viable today might not be so ten years hence. An example is the use of natural gas for generating electricity. In Michigan the use of natural gas for making electricity started in the early 1930's and for about 30 to 40 years it was a viable means of making electricity, but it looks doubtful that this practice will continue beyond 1985. In contrast, the fast breeder reactor technology is one that is today merely feasible but sometime in the future it might become a viable one. Viability could depend on certain legal-institutional peculiarities. For example, because of the peculiarities of cost-accounting, it pays for the University of Michigan to have its own electric generator and to use the "waste

steam" for heating purposes. By means of this method, the efficiency of energy utilization is almost doubled; but it appears that this method would not work, for example, for the city of Ann Arbor because of certain private utility financing requirements and tax structures.

The purpose of the above comments is to point out that the step from scientific feasibility to social viability might be a large one. This perhaps can be depicted as follows:



This gap is bridged by the so-called engineering research and development phase, as indicated by the following diagram:



This phase is variously referred to as the pilot plant study, demonstration plant study, etc. Whereas scientists devote their efforts to the scientific feasibility programs, engineers on the whole are most frequently involved in the intermediate phase. Because of this difference, there could be some difference of opinion. This difference could lead to apparent differences in information and opinion. There could be marked increase in cost going from the scientific phase to the engineering R & D phase. For example, in the development of fission technology, E. Fermi, in 1939, requested \$1,500 from the Office of Naval Research, the next year the budget was raised to \$6,000, and the total cost to demonstrate the scientific feasibility of controlled fission chain



reactions is estimated to be less than one million dollars. The cost for the next step towards social viability was substantially more, estimated to be over one billion dollars. The reason for this, of course, is that pilot plants, which are costly, had to be designed, built, and tested. In addition there were the various environmental, institutional, and legal questions that needed to be examined and answered.

In light of these discussions, perhaps a few comments should be made about nuclear fusion. Note first of all that controlled fusion has not yet been demonstrated, despite the fact that the idea has been around for about four decades. That the nuclear fusion of hydrogen is responsible for the solar energy was shown near the end of the 1920's, and shortly afterwards, in the mid-1930's, there was a flurry of activities in nuclear fusion, the word "thermonuclear fusion" was coined about then, but activities in this field were completely eclipsed by nuclear fission for a period of about ten years from about 1940 to 1950. The important historical fact to be kept in mind is that the feasibility of nuclear fusion has been "just around the corner" for at least 30 years. Consequently, from the standpoint of societal planning it would be prudent to assume that if the day of feasibility were to be demonstrated this year, the day of a city of a million population being lit by fusion energy would still be quite far in the future; for a pilot plant would need to be designed and built, the economics analyzed, materials tested, and the environmental issues associated with tritium must be examined. Thus, if feasibility were demonstrated this year, then by 1995 there could be a string of lights lit by fusion power in southside Ann Arbor, but the day of nuclear fusion providing 1000 Megawatts of electric power is more likely to be near the year 2020.

#### 2.1.1. Windpower: From Feasibility to Viability

Windpower is a feasible technology; but the central issue is its viability in our present society. To illustrate the variety of issues that could arise in the large scale use of windpower, we shall assume the scenario of building a large number of small windmills to supply electricity for a million families in a metropolitan-suburban area, such as Farmington and/or Redford. (The reason for selecting these areas

is that just a few miles to the southeast from the Telegraph-Grand River intersection a small windmill can be bought from Environmental Energies, Inc.) Let it be stated, however, that the following comments are not intended as judgement on windpower, but rather merely to illustrate the variety of issues that our experience with implementing nuclear technology would suggest we raise and ask ourselves before plunging into a large scale application of a particular technology. Some might contend that the scenario is a trivial one because it is obvious that electricity for a metropolitan-surburban area cannot be supplied by windpower alone. But it is just for this reason that we shall go through the following exercise. Because the scenario is trivial, the problems will be apparent, so that the technical, environmental, institutional, legal, and other issues can be readily identified. We shall call this exercise the SAEP, Suburban Aeolion Electrification Plan.

a. Number of Windmills. The population segment of one million was chosen because a single large nuclear plant will make enough electricity to serve about a million customers. To get this number we assume that the output of a large nuclear plant is about 1000 Mwe, that it is on line about 70% of the time, and that the average electrical energy consumption is about 500 Kwhr per month. This consumption rate (of 500 Kwhr per month) would suggest that the small windmill on Grand River might not be adequate for a single family. The Jacobs windmill shown there is rated at 3 Kw capacity, but as the attendant at Environmental Energies, Inc. will point out, the output from the single windmill at the site is about 250 to 300 Kwhr per month: in other words the efficiency, i.e., the ratio of output to rated capacity, is about 14%.

Thus, for our SAEP (Suburban Aeolian Electrification Plan) we will need to have roughly one million windmills of roughly twice the capacity of the Grand River model.

b. Catastrophic Accidents. At least an article a day (or so it seems) appears in the press concerning a possible catastrophic accident of a nuclear plant. The central issue surrounding the debate on the University of Michigan campus on recombinant DNA is about the catastrophic consequences of a man-made organism escaping into the environment. Noel

Moster's book, Supership<sup>9</sup>, mentions that the devastation caused by the explosion of a supertanker might be worse than that caused by the Hiroshima bomb, namely:

"A supertanker moored a few hundred yards from the southern tip of Manhattan...would threaten such buildings as the World Trade Center...The result of the wind... would be a shattered and blazing city...The force of the explosion would suck people from their windows, drag automobiles along like toys, .destroy subway systems and create a massive loss of life."

Since catastrophic accidents are the order of the day, we need to consider the worst possible accident that might occur if there were a million windmills. This information is needed for the design of safeguards and the estimation of public risks. One very serious source of danger is hydrogen released during the charging of batteries used to store electricity for "doldrum days". So let us assume that the wind had been blowing steadily and that the batteries had become over-charged, giving rise to large amounts of hydrogen release. We will assume that for all the million homes, the storage batteries were placed in the basement, so that the released hydrogen accumulated in the attic. Of course, the homeowners were extremely energy conservation conscious so that the attics were well insulated, leading to an unusually high buildup of hydrogen concentration. But it happened that Sunday afternoon, John Smith was aware of loose connections around his batteries, so he went down to the basement, and just as he stretched the screw driver to tighten the battery lead clip, there was a spark, igniting the hydrogen escaping from the battery; John Smith's house explodes; the flying ignited pieces from the first house start a series of explosions, like a string of firecrackers. If we assume that 50% of the homes explode during this chain reaction, and that most family members were home at the time of the explosions, and assume \$30,000 damage per home, then the consequences could amount to one million casualties accompanied by \$15 billion property damage.

The possibility of this catastrophic accident suggests immediately that certain safeguards and safety measures will need to be included in the plan. One recommendation is that the batteries must not be

kept in the basement; in fact, the batteries should be kept in a separate wall ventilated shed (more \$). At the Environmental Energies, Inc., it will be pointed out that to minimize such dangers, there are today on the market catalytic hydrogen converter battery caps. Such caps can be bought at Environmental Energies, Inc. (even more \$).

c. Environmental Impact. The impact of a single windmill might be negligible, but not necessarily so for a million of them. Large arrays of windmills might cause some significant alternations of surface wind patterns. For example, it might lead to increased air-conditioning loads in the summer. Perhaps the effects of increased releases of hydrogen may need to be examined. Since the molecular diffusion rate of hydrogen is greater than that of oxygen, hydrogen will tend to rise faster, causing a greater concentration in the upper atmosphere, thereby jeopardizing the ozone. The chemical reaction



suggests that the doubling of hydrogen concentration could lead to an eight-fold decrease of ozone concentration.

Another factor that should not be overlooked is the danger associated with sulfuric acid in the storage batteries. Aside from the potential effects of the cumulative effects of extremely small releases from each of the millions of batteries, there are the hazards associated with sulfuric acid spills and leads around the battery sheds to children playing in their yards.

Furthermore, the ways and means of disposing of old batteries will need to be developed.

d. Cost. According to the Environmental Energies, Inc. brochure, the per family cost of installing a windmill might be quite high, namely:



Jacobs Complete:

3 KW 110VDC  
 375 AH Battery System (5 year warranty)  
 3KW Inverter (solid state)  
 40 foot tower (three leg angle iron)  
 Tower prints, generator schematics footing  
 Data and electrical blue prints included  
 Plus, tax, F.O.B. Detroit. . . \$9,500.00

As pointed out earlier, the capacity needed for the average household would need to be twice the above, the cost of the shed is not included, and in addition there would be the installation costs. Furthermore, the 40 foot tower might not be high enough in residential areas with tall shade trees. Therefore, an amount of \$20,000 per family might not be too high. If this amount is to be taken out as a 20 year mortgage loan, the monthly payments will be roughly 1% of the loan or about \$200 per month.

It is instructive to compare these figures with the financing of nuclear plants. Very roughly, the cost of a single nuclear plant is about one billion dollars so that the capital investment per customer amounts on the average to about \$1,000. The cost to borrow this amount to "invest" in the power plant would amount to again 1%, or \$10 per month. In addition, for nuclear plants there are the fuel costs, distribution, maintenance, and operation charges amounting to about \$10 per month, leading to the monthly bill of about \$20 per month.

Thus from the standpoint of present day economics, if a person has \$40,000 it would pay to keep the amount in the bank and use only a part of the interest to pay the electric utility bills.

e. Technical Issues. One of the costly items for a windpower system is the inverter, to convert the windpower generated direct current to 110 volt alternating current. The reason for this is all electric appliances made in the United States are geared to the 110 v , 60 cycle AC. There is no technical reason why this is necessary; in fact it would technically be a very simple matter to design all appliances for DC, at whatever voltage that would be most suited for windmill driven turbines. However, to make such a change on a society-wide basis would be very difficult, so that if changes are to be made the plans for the changes will need to be worked out carefully. A case in point is Japan, where one half of the nation is on 60 cycles per second and the other half on 50. So far no satisfactory plan has been conceived to put the entire nation on

60 cycles per second.

In any event, if any serious thought is to be given to obtain appreciable energy from the wind and the sun, it would be worth considering going to DC at voltages less than 110 volts, possibly in the neighborhood of 50 volts.

f. Institutional Problems. One immediate critical problem that would arise is how an individual family would be able to borrow \$20,000 to build windmills. At present it is possible to get loans to buy cars because cars can be repossessed. Also home mortgage loans are possible because banks can hold the title to the house. But for windmills it is a different matter, and there appears to be no way to borrow money for the specific purpose of erecting windmills. There is a windmill off of Dexter Road just to the west of Ann Arbor. To finance it, the owner had to mortgage his second house. At the present time there is a mechanism for a single party, say an electric utility, to borrow \$1 billion, but there is no way for one million customers to borrow \$20,000 each to put up windmills.

g. Price-Anderson Act for Windmills. The Price-Anderson Act under which an electrical utility purchases a certain percentage of the liability insurance carried on a nuclear power plant from the federal government is often cited as unwarranted support for nuclear power. The question we need to ask is: Would large scale windpower be able to get under way without a similar act? Private insurance companies will insure property, say the nuclear power plant, so that property owners will no doubt be able to insure their own windmills. But it is doubtful that insurance companies will issue windmill liability policies for catastrophic accidents. The main reason for this is that, just as there are no statistics for catastrophic nuclear accidents, there are no statistics for catastrophic windmill accidents.

What we need to keep in mind is that premiums for insurance policies depend on accident statistics, and insurance companies do not issue policies where such accidents do not exist. Insurance companies will insure actresses' legs because many women break legs, so that the statistics for such an accident are available. Also doctors can get malpractice insurance because of the past record of malpractice cases and suits. In contrast, apparently an insurance company will not underwrite malpractice

insurance for a consulting engineer; apparently there have not been any such suits so an insurance company would not know what premium to charge. At the time John Glenn made the first orbital space flight, much to-do was made of the fact that no insurance company (even Lloyds of London) would underwrite a policy; the reason for this was that at the time there were no space flight accident statistics.

h. Other Institutional and Legal Problems. There could be a number of other issues, such as limiting the height of shade trees, staggering heights of windmill towers, redesigning television sets to filter out the interference generated by rotating windmill blades, etc., but these will be left to the fertile imagination of the reader.

#### 2.1.2. Solar Electric Energy: The Photovoltaic Cell

It would be interesting to speculate about what course the AEC might have taken, if the discovery of transistor action had come about the same time as nuclear fission. The report of the first germanium transistor was made in 1948<sup>10</sup>; shortly thereafter interests shifted to silicon because of its greater abundance, and the first report of the silicon p-n junction photovoltaic cell was published in 1954.<sup>11</sup> This publication appeared at a time when the field of conversion of solar energy into electrical energy was at a stalemate, for the letter by Chapin, Fuller, and Pearson<sup>12</sup> cites only two references, namely the 1937 publication by Forsythe<sup>13</sup> on the measurement of radiant energy and Maria Telkes's paper<sup>14</sup> on the metal-metal junction thermoelectric conversion.

In scientific circles there was the optimism that at last a cheap method of converting solar energy into electrical energy had been found.

For the reason that the silicon photovoltaic cell had not yet been developed, there is no mention of this in Putnam's 1953 publication of Energy in the Future.<sup>15</sup>

a. Dollar Cost. Despite its scientific feasibility and its viability for space-craft systems, the photovoltaic cells have not been fabricated for large scale societal use because of the high dollar cost and the related energy cost. Silicon, as pointed out earlier, is the second most abundant element in the earth's crust, amounting to about

28% (major constituent of glass, sand, etc.) so that metallurgical-grade material is relatively inexpensive, about \$600 per ton. Electronic-grade silicon, on the other hand, calls for extremely high purity, the basic production process involves numerous steps, including repeated melting and solidifying silicon, even after "single crystals" have been prepared. Subsequently, the high purity silicon needs to be cut, polished, impurity indiffused, more cutting and polishing, and eventually the contacts are applied. Another important point not to be overlooked is the fact that a large fraction of the very high purity silicon is lost during these preparatory procedures.

As the result, the initial silicon cost turns out to be about \$80 per pound, or \$160,000 per ton.<sup>16</sup> This price is to be compared to 50¢ per pound of aluminum, the third most abundant element in the earth's crust, and \$40 per pound for uranium. The cost of space-craft solar panels is estimated to be between \$200,000 and \$300,000/KWE; in comparison, the capital costs for oil, coal, and nuclear plants are about \$850/KWE, and \$900/KWE respectively. An article in Aviation Week and Space Technology (1975) suggests that a solar array today might cost about \$20,000/KWE but might drop to about \$500/KWE by 1980.<sup>17</sup> The cost of solar electrical energy to the consumer at present is perhaps a trifle below the cost of penlights and flashlights, being about \$5/KWHR, \$15/KWHR, and \$35/KWHR respectively.

b. Energy Cost. Dollar cost reflects the energy cost. According to one estimate,<sup>18</sup> 40 years of operation would be required to recover the energy investment.

Even a cursory examination of the chemical processes in making pure silicon will make this point clear. The first step involves the reduction of silicon dioxide ( $\text{SiO}_2$ ) to elemental silicon (Si) and carbon. (Note that industrial carbon is made by burning natural gas.) This process yields metallurgical-grade silicon of about 93 to 95% purity. The silicon is then ground, dissolved, and washed in such acids as aqua regia, hydrogen flouride, sulfuric acid, and hydrochloric acid, leading to 99.9% purity with electrical conductivity of about 1 ohm-cm.



This material is then converted to  $\text{SiCl}_4$ , evaporated at temperatures between  $950$  and  $1000^\circ \text{C}^\circ$  ( $1700 \text{ F}^\circ$ ), and silicon is deposited out as the vapor reaction of  $\text{SiCl}_4$  and Zn, namely



Alternatively  $\text{SiCl}_4$  is heated in a hydrogen atmosphere to give



which yields Si of 100 to 150 ohm-cm purity. The ultimate purification is attained by repeated melting and recrystallization, called zone purification.

One way to estimate the energy recovery time, that is, the time required for the silicon cell to generate as much energy as was used to produce it, is to estimate the time required to recover the heat of formation of  $\text{SiO}_2$ . For the chemical reaction



the energy needed to prepare silicon is theoretically about 210 Kcal/mole, or about 882 Kjoules/mole. From the density of silicon ( $2.42 \text{ gm/cm}^3$ ) and assuming 1 mm for the thickness of the photocell, we find that one mole of silicon (about 28 grams) can be made into a photovoltaic panel of  $0.016 \text{ m}^2$ .

With the Skylab solar panel the heat of formation can be recovered in about 6.4 days. Taking the solar constant to be  $1.37 \text{ KW/m}^2$ , and 10% efficiency, the electric power generated turns out to be

$$(1.37) (0.10) (0.0116) = 1.59 \times 10^{-3} \text{ KW}$$

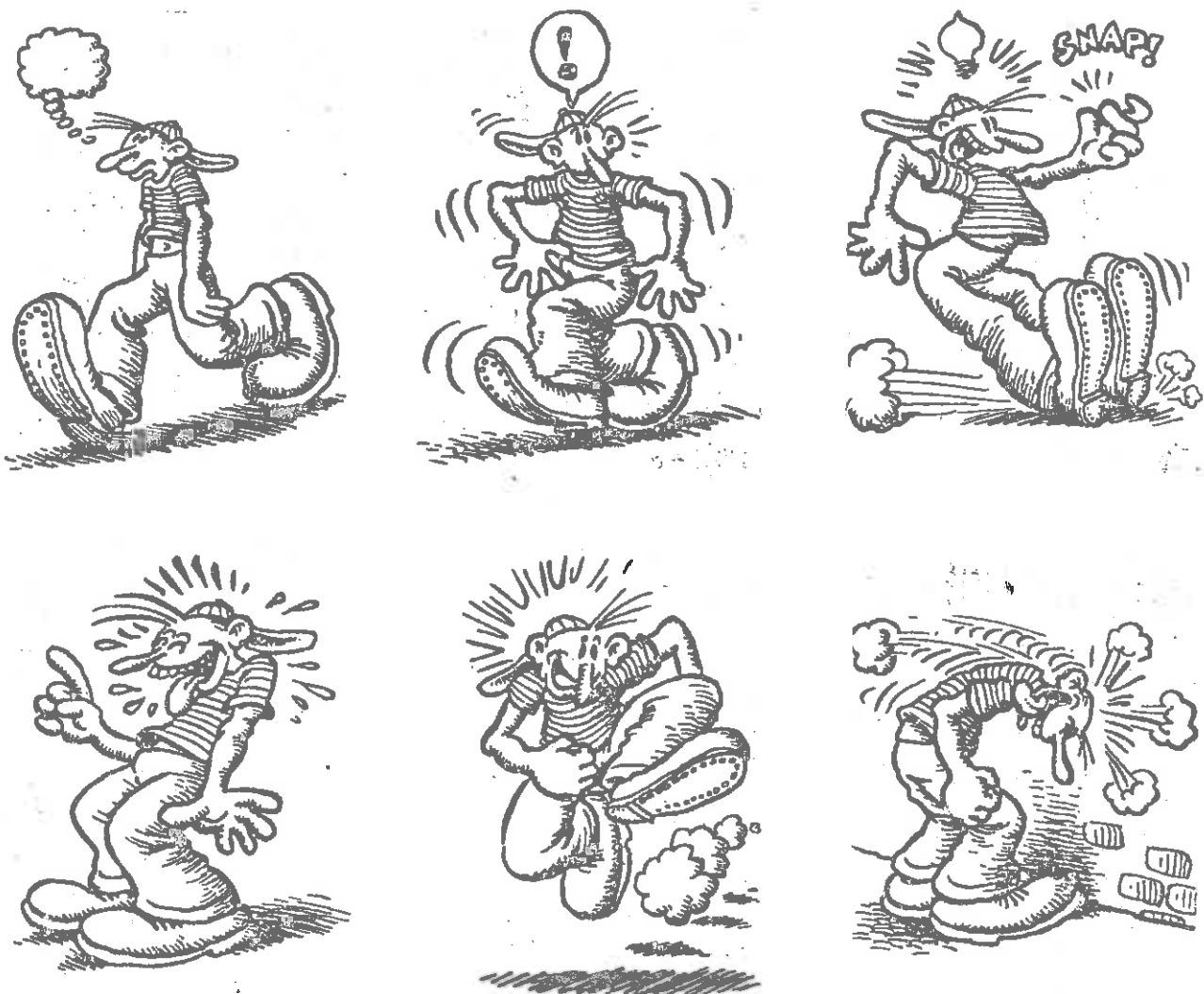
so that the energy recovery time is given by

$$\frac{882 \text{ Kjoule}}{1.59 \times 10^{-3} \text{ KW}} = 5.5 \times 10^5 \text{ SEC} = 6.4 \text{ DAYS}$$

For a solar panel operating on the surface of the earth, several important corrections need to be made. One is the atmospheric attenuation of solar radiation; this increases the energy recovery time by about 2. There is the diurnal variation; this introduces another factor of  $\pi$ . And finally there are the latitude and cloudiness corrections, each of which introduce a correction factor of about 2. Therefore,

Energy Recovery Time =  $6.4(2)(\pi)(2)(2) \approx 160$  days  
 or very roughly one half of a year. If we assume that the total energy investment is 10 times the heat of formation, the energy recovery time turns out to be about 5 years. The service lifetime of the silicon cells would then need to be from 10 to 20 years. It is doubtful that the photo-cells will last that long.

FIGURE 2-1a: HOW ENERGY POLICY IS MADE.



## 2.2 Resources

It is an unfortunate fact of modern day life that our consummable energy sources are being depleted very rapidly. The seriousness of the situation can be shown quite dramatically by comparing the available reserves of various domestic energy sources in Figure 2-1. This figure presents the relative magnitudes of each of our nonrenewable energy sources as well as giving estimates of the size of these resources in units of quads =  $10^{15}$  BTU  $\approx 10^{18}$  joules. Perhaps an even more dramatic comparison is given in Table 2-2 where the relative lifetimes of each of these sources of energy is compared.<sup>19</sup>

The first rather alarming feature of these comparisons is the paucity of domestic gas and petroleum reserves. Indeed these reserves are apparently even smaller than scientists had projected in past estimates. Significant gains in annual production of liquid fossil fuels seem highly unlikely, and in fact, the lifetime of domestic reserves of these fuels is at most several decades. For example, at present consumption rates natural reserves are not expected to last more than 10-20 years. Even with Alaskan North Slope and continental shelf reserves counted, our domestic petroleum reserves will probably be depleted by 2010-2020. On a worldwide level, the situation is equally dismal, with liquid fossil fuel reserves expected to last only until 2030 or so. While the oil shale and tar sands of North America are present in relatively large quantities, their exploitation poses huge environmental and economics problems. The net energy gain in their conversion to crude petroleum is also uncertain, and the resultant crude may well be more expensive than the current international price of crude petroleum. In any case, it should be recognized that the actual amounts known to be in place would, if utilized, only suffice for a few decades at current rates of petroleum and natural gas usage.

One must add to this the added impact of the necessity to preserve some fraction of the world's supply of petroleum for future use in petrochemical synthesis. The larger that bite is, the more acute and soon the petroleum energy crisis becomes.

The abundant reserves of coal in North America stand out in sharp contrast. Certainly coal is one of our greatest national assets. Unfortunately, as we will see later, there are numerous problems associated

Available Energy in Quads ( $10^{15}$  Btu)  
Shown Graphically by Area

Total U.S. Energy Consumption in 1974  
Was 73 Quads

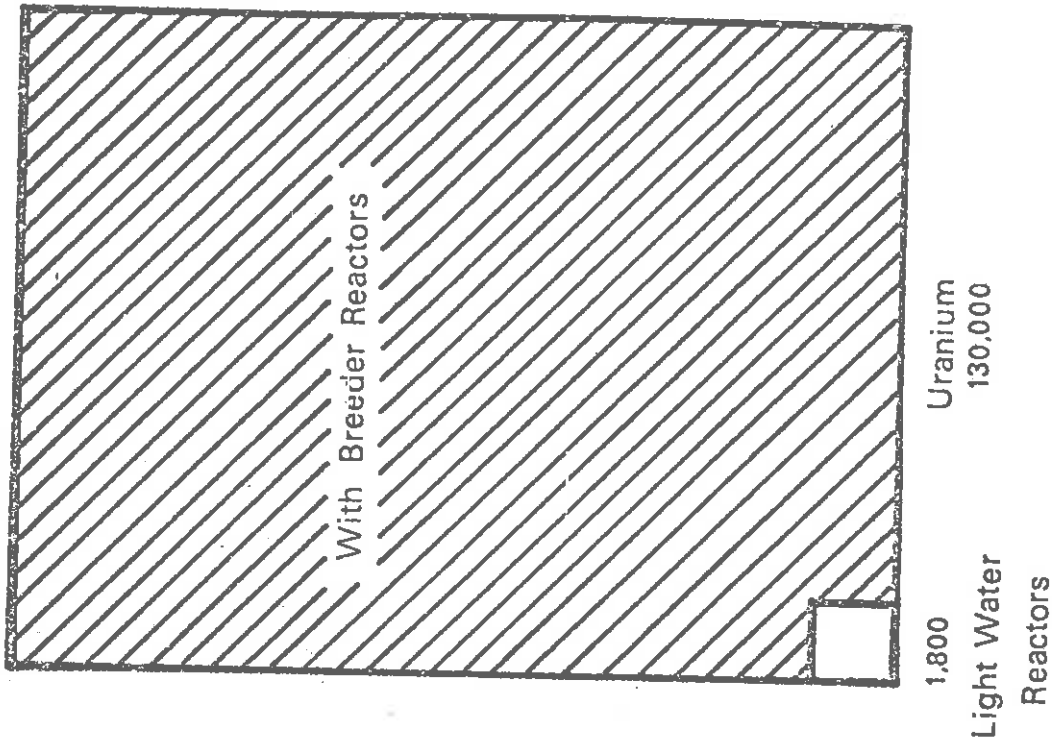
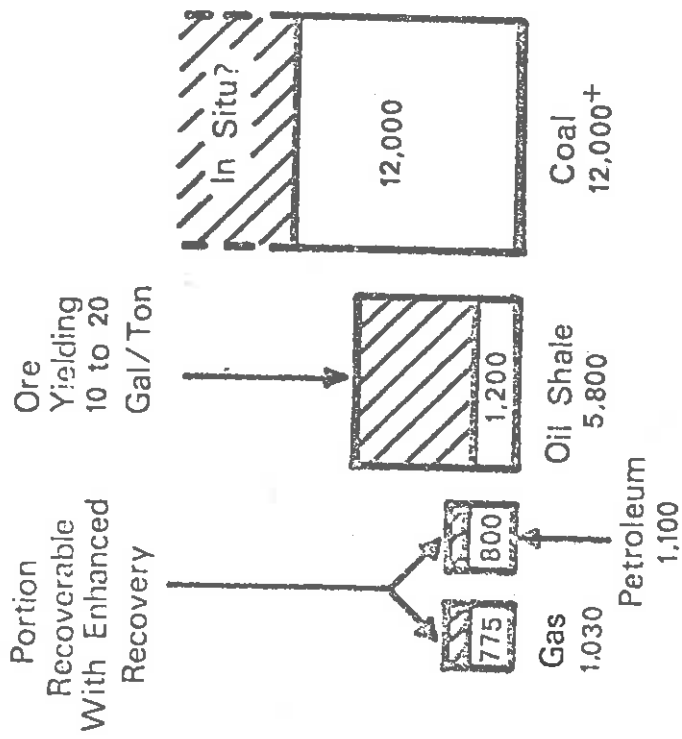
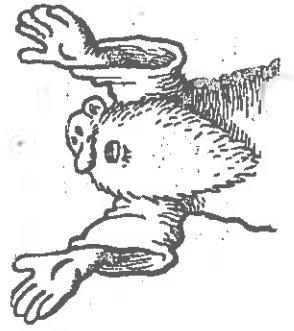


Figure 1: Available energy from recoverable domestic resources.

(Leonard J. Koch, in Conf. on Magnitude and Deployment of Energy Resources, Oregon State University, 1975, p. 160)



### CONSUMABLE ENERGY SOURCES

Resource	Relative Life <sup>a</sup> (years)	
	Recoverable <sup>b</sup>	Total <sup>c</sup>
Coal	125	1300
Petroleum	5	280
Natural gas	5	110
Oil shale	—	2500
Fission without breeder	2.3	82
Fission with breeder	115	4100
Fusion	—	~10 <sup>6</sup>
Geothermal steam and hot water	0.2	>60
Geothermal hot rocks	—	>600

- <sup>a</sup> Lifetime if all 1973 U.S. energy consumption (11 billion barrels of oil equivalent per year) were supplied from that source.
- <sup>b</sup> Those known and available as of 1973.
- <sup>c</sup> Estimated total resources (may not be recoverable).

### RENEWABLE ENERGY SOURCES

Resource	Fraction or Multiples of Current U.S. Energy Consumption
Solar	740
Wind	5
Sea thermal	>6
Hydro	0.14
Photosynthesis	0.23
Organic waste	0.1
Tidal	0.1

GAO! I THOUGHT WE HAD PLENTY LEFT!!



A.L. Hammond, W.D. Metz, and T.H. Maugh III, "Energy and the Future," American Association for the Advancement of Science, Washington, D.C. (1973).

H. Lustig, "Solar Energy: The State of the Art and the Art of the States," A Report to the UNESCO-SC/WS/575 reported in testimony before the Joint Committee on Atomic Energy, U.S. Congress (May 7-8, 1974).

"Solar Energy," Background Info, Atomic Industrial Forum (July 1975).

with its increased exploitation. Strip mining carries with it large environmental problems (particularly in the arid west where most reserves are located). Underground mining is extremely hazardous. And the transportation of the massive amounts of coal required for electrical power generation (one 1,000 MWe plant burns 8,000 tons an hour) puts added stresses on our already obsolete and over burdened rail systems. Furthermore, projections of the rate of depletion of oil and natural gas supplies compared with the potential rate of growth of coal production strongly suggest that the latter resource will not fill the energy gap left by the former, particularly if the national demand for energy continues to grow.

Our domestic sources of uranium are also quite limited. Present estimates place these reserves at roughly the same magnitude as our natural gas and petroleum reserves, if the uranium is to be used in the present type of fission reactors (light water reactors). However there are two caveats here. First, the size of uranium reserves depends sensitively upon the price one is willing to pay for the concentrated uranium ore (lower concentrations will require more refining and hence cost more, but they are available in far larger quantities than high concentration deposits). Furthermore, it should be kept in mind that the present generation of light water reactors can effectively utilize only 1% of the mined uranium to generate power. If we should decide to deploy the fast breeder reactor which can use upwards of 70% of the available uranium, then our actual uranium reserves become considerably larger. Furthermore, the economics of breeder reactors are relatively insensitive to uranium ore costs, and therefore it would be economically feasible to utilize very low concentration uranium ores (possibly even shale deposits or separation of uranium from sea water), in which case the uranium reserves become very large indeed (several hundred thousand quads). However, until such advanced reactor types are introduced, uranium reserves must certainly be viewed as rather limited.

Such considerations provide great impetus to develop so-called renewable energy sources such as solar power (including wind and ocean-thermal power), thermonuclear fusion, and the fast breeder reactor. However, it must be born in mind that although the source of such energy

is renewable, the materials utilized to collect, concentrate, and distribute this energy may in fact have rather limited reserves--that is, the massive implementation of these so-called "free" or infinite energy sources may be restricted by our supplies of the materials needed to exploit such sources. (An example would be the limited supplies of exotic metals such as vanadium and niobium that may be necessary in controlled thermonuclear fusion reactors.) When considering the resources available for different energy alternatives, one must consider not only intrinsic resources characterizing the energy itself, but as well sources of materials necessary to exploit the energy source.

### 2.3 Environmental Impact

"We the people of the United States, in order to form a more perfect union, establish justice, insure domestic tranquility, provide for the common defense, promote the general welfare, and secure the blessings of liberty to ourselves and our posterity, do ordain and establish this Constitution for the United States of America."

#### Preamble, Constitution of the United States

Most of us, no doubt, still remember Earth Day, April 22, 1970, when millions of Americans in more than 2000 colleges, 2000 community groups, and 22,000 schools joined in clean-up campaigns, mass meetings, and parades, to protest against environmental pollution and to shout ecology, eco-system, biota, quality of life, etc. Since then however much of this emotional outburst of enthusiasm has abated, blunted possibly by the facts of life and time. The ecology centers, recycling centers and others sprouted out over night but closed down one after another. And today many seem to have been turned off by the environmental movement. Euell Gibbons is gone.

Despite these seeming reversals in the environmental movement, we need to keep in mind that the impact of the National Environmental Policy Act of 1969 (NEPA) will continue to be felt. Every American should read and study the Act and in particular note the words appearing in the section on the Declaration of National Environmental Policy, which reads:

"The Congress, recognizing the profound impact of man's activity on the interrelations of all components of the natural environment, particularly the profound influences of population growth, high-density urbanization, industrial expansion, resource exploitation, and new and

expanding technological advances and recognizing further the critical importance of restoring and maintaining environmental quality to the overall welfare and development of man, declares that it is the continuing policy of the Federal Government, in cooperation with State and local governments, and other concerned public and private organizations to use all practicable means and measures, including financial and technical assistance, in a manner calculated to foster and promote the general welfare, to create and maintain conditions under which man and nature can exist in productive harmony, and fulfill the social, economic, and other requirements of present and future generations of Americans.

The formal involvement of the Nuclear Regulatory Commission (formerly AEC) with environmental impact assessment is relatively more recent, stemming from the Calvert Cliffs court decision of July 23, 1971.<sup>20</sup> Until then the NRC confined itself to radiological questions surrounding the nuclear power plant. It claimed that it had no jurisdiction over non-radiological questions. Hence, to comply with NEPA, the AEC depended on certification of compliance by other agencies. The substance of the Calvert Cliffs decision is that the NRC is now required to determine the impact, radiological and non-radiological of nuclear power effluents such as thermal discharge, and weigh the benefits against the environmental costs.

The environmental legislations, the court decision, and the NRC's interpretation of the court decision will undoubtedly in the long run have a profound impact on the procedures for planning new technologies for societal use. To see what it might mean, compare for example, the licensing procedures for building a house today to what the procedures might become, if the implications of the Calvert Cliffs decisions were to be extended to private home construction in suburban areas, say in the township. At present, the builder needs to go to different township, city, and country offices to get the building permit, water permit, sewage permit, and many others. When the house is completed, the technicalities of the existing codes and regulations will have been met, as interpreted by the officers in charge of issuing the permits and inspection. But there is no assurance that the end product, the finished house, will meet the expectations and standards of the intent of the codes and



regulations. The builders will no doubt follow the letter of the codes and regulations, but there may be ambiguities and loop holes, and hence the finished house might fall short of expectations. To prevent this, the court would contend, a single central office needs to assess the environmental impact of the house. This would mean that this new office is to be held responsible not only for the soundness of the mechanical structure of the house, but also for the impact of the occupants upon water contamination and drainage, appropriateness of land use, the added fuel and energy burden that such a dwelling would impose upon the community, and may even be compelled to assess the impact of such suburban construction upon urban decay. There is no question that this would be the way to go, but to do so will require man-power, money, and time. The public will need to be re-educated to the new hierarchy of values, even to such matters as building private houses.



#### 2.4 Public Safety--Benefit Versus Risk

Every technology carries with it a certain degree of risk to the public. The risk associated with exposure to the low levels of radiation which result from radioactive discharges from nuclear power plants as well as the risk due to possible accidents in such plants have been highly publicized concerns in recent years. While perhaps not quite so widely recognized, comparable (and probably far larger) risks are associated with other types of power generation, including flooding resulting from the failure of hydroelectric dams, fire and explosions which invariably occur during the transportation and use of liquid fossil fuels, the

occupational risks associated with coal mining and the risk associated with the atmospheric pollution caused by fossil fuel fired generating plants. Since all of these technologies present certain dangers to the public, why don't we simply avoid them altogether and revert to a society with only modest energy requirement (a few logs on the fire now and then)?

Because, of course, the absence of sufficient energy supplies gives rise to public risks that are infinitely more serious than the risks associated with energy technology. Unfortunately, we have ample evidence of the far greater susceptibility of energy poor nations to catastrophic events such as famine, war, natural disasters. Even on a personal level, a quick glance around will indicate how highly dependent we are upon energy in our society and how difficult it would be to revert to a low energy society. For a world already overwhelmed with 4 billion people, with millions more being born every week, such a proposal is clearly ridiculous.

Certainly the public is used to accepting (at least implicitly) a certain degree of risk accompanying a new technology if the benefits which can be gained by implementing that technology are sufficiently large, or if the risks incurred by failing to implement the technology are appreciably greater. As with everything in life, one is faced with balancing benefit versus risk.

With this in mind, it is useful to give a somewhat more precise definition of "risk" since a misunderstanding of this concept is frequently the source of much confusion in debates on nuclear reactor safety. For example, recent studies have suggested that it is conceivable (barely) that a large nuclear power plant could suffer an accident which would release radioactive material with the potential of causing thousands of casualties. Similar studies have indicated that massive dam failures or explosions of liquified natural gas tankers could cause casualties of similar magnitude. Yet the maximum possible consequence of possible accidents associated with a given technology is not sufficient in itself to imply the risk associated with that technology. One must also consider the probability or the frequency of occurrence of such accidents.

For example, the probability of a reactor accident in which several thousand casualties occur is estimated to be less than one such occurrence every four billion years of plant operation.<sup>21</sup> Similarly the probability of massive dam failure is commonly estimated at one every ten thousand years per dam<sup>22</sup> (such failures are usually associated with a natural initiating event such as an earthquake). Public risk depends not only on the consequences which might occur as the result of a new technology but also on the probability that such consequences will occur. That is, risk must be defined as the probable frequency of events multiplied by the magnitude of the consequences of the events:

$$\begin{array}{l} \text{Risk} = \text{Consequences} \\ \text{(e.g., casualties)} \end{array} \quad \times \quad \begin{array}{l} \text{Probable frequency} \\ \text{of occurrence} \end{array}$$

For example, if 4000 people are killed (on the average) in each major reactor accident, and the probability of such an accident occurring is one every 4 billion years, the the risk to the population would be one casualty per million years for each reactor built.

Only by performing careful estimates of consequences of various accidents and their probability of occurrence can one arrive at a rational measure of risk from various technologies. Although it is sometimes difficult to arrive at an absolute quantitative estimate of societal risk from a given technology, it is usually possible to use such quantitative estimates to make comparisons of the relative risks from alternative technologies. This particular approach has been applied in a rather sophisticated manner to nuclear power technology, and the methodology developed for this application is now being extended to examine the risks associated with alternative technologies<sup>22</sup> (see Chapter 6). Only in this way can we develop data sufficient for a rational determination of benefit versus risk to be used in energy policy decisions.

## 2.5 Economics

Ultimately, the choice among various alternative forms of energy will be dictated by economics, since all other factors involved in such comparisons including resource availability, environmental impact, and public safety are eventually quantified in terms of cost. For example, the environmental impact of coal-fired generating plants eventually

appears as the added cost of reclamation of strip-mined land and pollution abatement equipment which must be installed on the plants themselves. The public concern about nuclear reactor safety inevitably results in increased costs due to additional engineered safeguards which are installed on the plants, delays in plant construction due to changes in safety regulations and backfitting requirements, and both public and private funding of nuclear safety research programs. Hence the ultimate justification for one type of power plant over another usually boils down to a question of economics.

The cost of electrical power can be broken down into a number of factors, including the capital cost of constructing the generating plant, the annual costs of operating and maintaining the plant, and the annual costs for fuel. By way of example, the average cost of generating electricity during 1975 is compared for various types of generating plants in Table 2-3. For purposes of reference, we have also provided in Fig. 2-2 recent projections of electrical generating costs for the next decade. A cursory examination of these Tables indicates that operating and maintenance costs account for only a small fraction of the total cost of producing electricity. In fossil-fuel fired plants fuel charges comprise a significant fraction of total power costs. This means that the economics of fossil fuel fired units are extremely sensitive to fuel prices. For example, during the two year period from 1973 to 1975, the cost of generating electricity using oil-fired plants almost tripled due to the very rapid escalation of crude oil prices. In a similar manner the rapid escalation of coal prices has led to a sharp increase in coal-fired electrical generating costs.

By way of contrast, nearly 80% of the electrical generating costs of nuclear units can be attributed to the capital cost of the plant (including interest charges). Fuel charges themselves contribute only about 15% of the costs, and of this, only 5% can be attributed to the uranium ore prices. Therefore nuclear power plants are somewhat less sensitive to fluctuations in fuel costs, but their capital-intensive nature makes them much more sensitive to the health of the economy (as the numerous deferrals or cancellations of planned nuclear plant construction projects during the recent recession has indicated).

Table 2-3: Electrical Generating Costs (mills/kwhr)

<u>Plant type</u>	<u>1975</u>	<u>1985</u>
Oil	33.45	55.1
Coal	17.54	42.0
Nuclear	12.27	38.3

A Breakdown of Electrical Generating Costs for the Year 1985

	<u>Oil</u>	<u>Coal</u>	<u>Nuclear</u>
Capital cost	13.7	20.8	25.2
Fuel cost	39.7	17.0	10.0
Operating & maintenance cost	<u>1.7</u>	<u>4.2</u>	<u>3.1</u>
Total	55.1	42.0	38.3



The AIF survey shows that the average total cost of a kilowatt hour produced by nuclear in 1975 was 12.27 mills. This is 63% less than oil (33.45 mills), 30% less than coal (17.54 mills), and 50% less than oil and coal combined. Nuclear units

A summary of averages for 1975 is shown below:

	Nuclear	Oil	Coal	Oil/Coal
Availability Factor	73.8%	70.3%	79.5%	76.4%
Capacity Factor	64.4%	42.5%	54.8%	49.7%
Forced Outage Rate	13.7%	26.9%	11.1%	15.2%

## STEAM-ELECTRIC GENERATION COST PROJECTION (75% Capacity Factor)

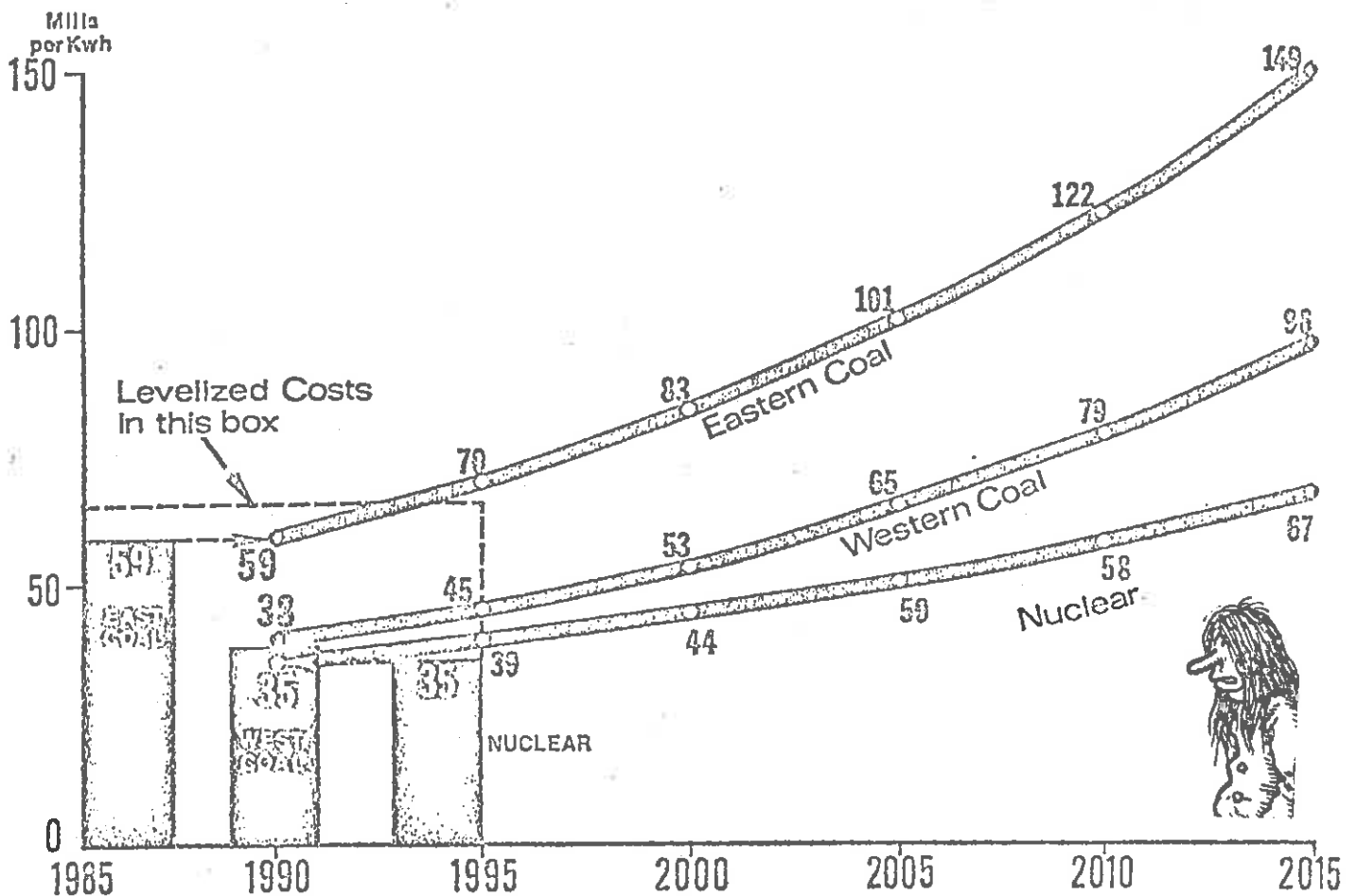


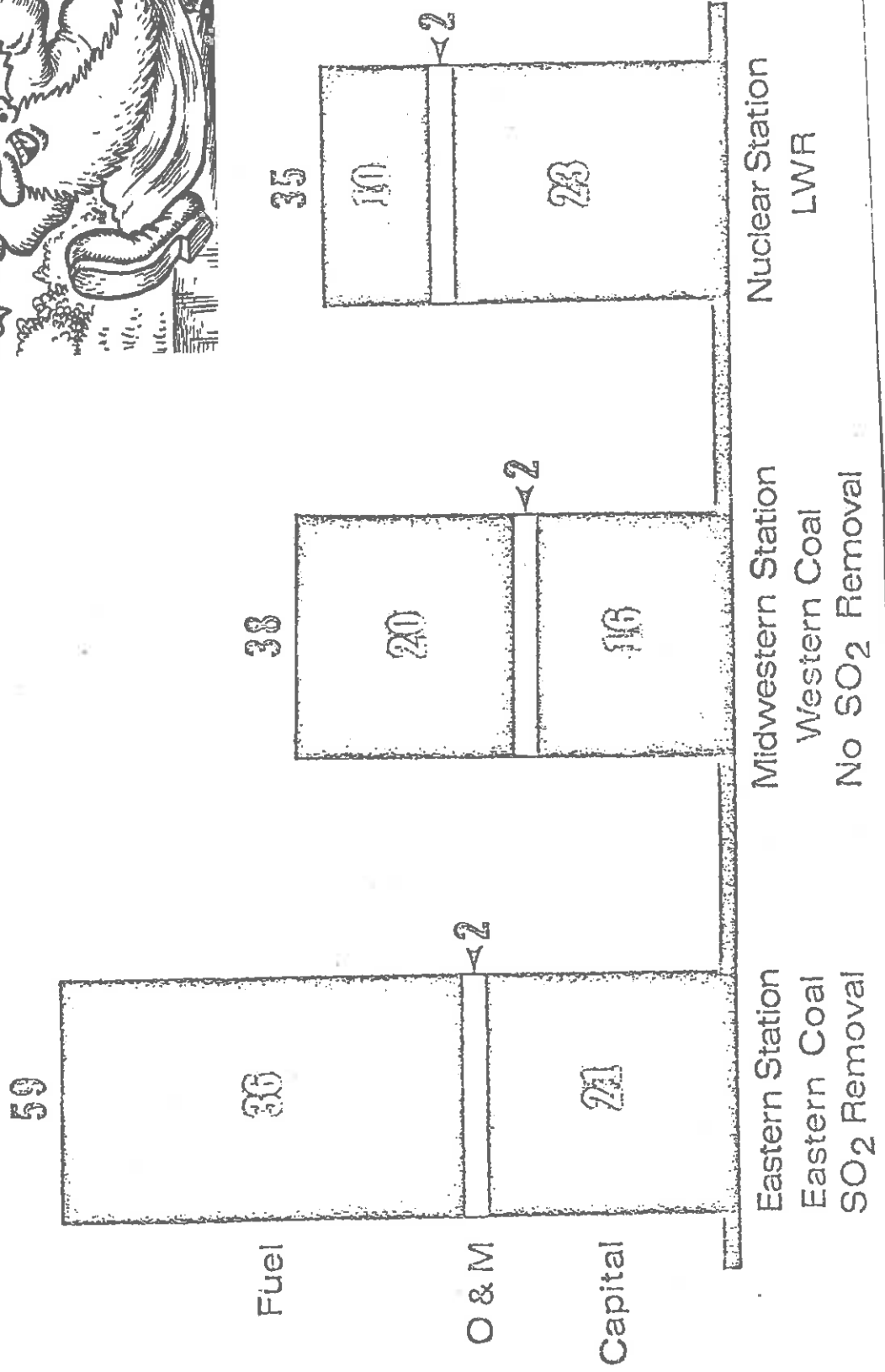
Figure 2-2: Cost Projections for the Next Several Decades (J. Reichle, Ebasco Services, presented to N.Y. Society of Security Analysts, 1975)

Table 2-3:

# STEAM-ELECTRIC STATION GENERATION COSTS—MILLS/KWH

10 Year Levelized 1983-95 15% F.C. 75% O.P.F.

(L. Reichle, Ebasco Services, presented to N.Y. Society of Security Analysts, 1975)



Since the cost of most fuels (both nuclear and fossil fuels) has been increasing at a far more rapid rate than even construction costs, nuclear power has been widening its economic advantages over more conventional types of electrical generating plants during recent years. From a relative standpoint, the economic attractiveness of nuclear power is expected to become even more dramatic during the next few decades, although of course the absolute level of electrical power generation costs will continue to increase significantly.

Our discussion thus far has been concerned with the general economics of various types of electrical generating plants, without regard to specific details. Of course the detailed economics of a particular plant will depend sensitively on the location of the plant, its particular function (e.g., one must distinguish between so-called base load plants designed to operate at full capacity at all times and peaking units designed to tailor their output to match the fluctuations in load demand). The economics of electrical power generation also depends sensitively upon the type of the utility building and operating the plant (e.g., private vs. public), how the plant is financed, plant performance, and a host of other factors.

For example, the electrical generating costs of a coal fired unit located near the great deposits of low-sulfur coal in the western states (Montana and Wyoming) will naturally be far less than coal-fired plants located in the east which must burn high-sulfur content eastern coal and hence must be equipped with considerably more sophisticated pollution control devices and face considerably higher coal transportation charges. For example, the average cost of generating electricity in New York state is roughly twice that of Michigan and some four times greater than that of the Pacific Northwest states (which can utilize large hydroelectric units).<sup>23</sup>

The subject of electrical generating costs is understandably an extremely complicated one, subject to considerable controversy and misunderstandings. However because of its central importance in evaluating the suitability of various alternative energy sources, we feel it advisable to pull out our pocketknife and attack the Gordian knot of power plant economics in Chapter 3.



## 2.7 Near Term Alternatives

So what alternatives does Michigan have available to meet projected demand for energy over the next several decades? Since it takes roughly thirty to forty years to implement a new source of energy, to take it from scientific feasibility to social viability, it is clear that we must temporarily rule out long range alternatives such as solar-electric power and thermonuclear fusion. In fact, the only alternatives for the next several decades appear to be a vigorous exploitation of solid fuels (coal and uranium) coupled with a massive conservation program. But first let us look in more detail at various possible short range options.

### (i) Liquid Fossil Fuels (petroleum and natural gas)

As we have noted, liquid fossil fuel reserves are insufficient to supply an appreciable portion of our energy requirements for more than a few more decades. Hence every attempt is presently being made to shift away from liquid fossil fuels. However, since at present over 75% of our energy consumption is supplied by liquid fossil fuels, and some 35% of our electrical generation comes from this source, our society will remain heavily dependent upon this energy source as our own domestic resources are depleted and will become increasingly dependent upon the import of foreign petroleum and natural gas (and indeed, since early 1976 we have been importing over 50% of our liquid fossil fuel requirements<sup>24</sup>). Although we will continue to use liquid fossil fuels as a major energy source, it would be foolhardy to plan on installing new electrical capacity based on gas or oil fired plants. Indeed, at the present time there is insufficient natural gas for use in central station electrical power generation (Michigan utilities have been unable to obtain natural gas for some time now), and the rapid increase of petroleum prices has caused the cost of oil-generated electricity to escalate to the point where it is now almost a factor of three times more expensive than either coal or nuclear generated electricity.<sup>25</sup>

### (ii) Hydroelectric Power Generation

Certainly hydroelectric power immediately comes to mind when one thinks of the generation of electricity. However potential hydroelectric sites are rather limited and already have been developed to a large degree. At the present time hydroelectric power generates somewhat less

than 10% of our national electrical capacity, amounting to some 55,000 MWe capacity (about 55 large nuclear power plants worth)<sup>26</sup>. Although the projected potential of hydroelectric capacity is roughly twice this, 114,000 MWe, it is rather doubtful that this potential can be achieved because of the serious environmental opposition to hydroelectric development. Furthermore hydroelectric sites are located in only a few regions and certainly would not be appropriate for the vast majority of the country. Ironically enough, however, hydroelectric power generation will nevertheless represent the largest contribution from "solar" energy sources before the turn of the century (since, in fact, this source of power eventually traces back to the sun as its fundamental source of energy). The development of further hydroelectric generating capacity is not a technological problem but rather it is a political and a societal question, and in the light of recent environmental concerns, it is not anticipated to provide much in the way of additional generating capacity in the near term.

(iii) Coal

As we have noted, our nation's coal supplies are quite abundant. There is little doubt that coal will have the largest impact on our impending energy shortages over the next two decades and will continue to supply a large portion of our needs throughout the next century. We will expand coal production as rapidly as possible. Indeed, most projections anticipate doubling the production of coal over the next ten years.<sup>27</sup> However doubling coal capacity is going to be a major job. Over the next ten years this goal will require the opening of some 400 new mines, the employment of an additional 150,000 new miners in underground coal mining (doubling the present number), the development of a whole new rail network and perhaps the longer range development of slurry pipeline systems to transport coal, and even then the rate at which coal production can be expanded is a subject of rather serious concern.

The use of coal will be limited as well by a number of environmental concerns. For example, our major sources of coal are found in the west in regions where the water supply is often insufficient to assure re-

habitation of strip mined land--much less to permit coal gasification and liquification. For the short term direct combustion of coal for the generation of electricity seems the most likely use of this fossil fuel. The attendant pollution which will inevitably result from burning large quantities of coal represents a serious national health problem. It will also require the development of new technology, for example, for burning the high sulfur content coal obtained from eastern mines. And in any event, the cost of energy from coal will rise substantially as more and more pollution abatement equipment is installed on generating plants. Similar technological and environmental concerns will restrict the development of coal gasification and liquification.

(iv) Nuclear Fission Power

At present, roughly 10% of the electricity generated in this country is generated by nuclear fission reactors--nuclear power has proven to be capable of generating large quantities of electricity more cheaply than any alternative methods with minimal environmental impact. Indeed, the principal environmental impact from nuclear power is from its fuel supply in the strip mining of uranium necessary to fuel the power reactor and the reprocessing of spent fuel discharged from nuclear plants. Since less than 1% as much overburden material must be moved to mine uranium as required for coal with comparable energy content,<sup>18</sup> it is clear that uranium has a significant environmental advantage. Furthermore, the safety record of the nuclear power industry has been spotless. In over 300 years of commercial power reactor experience, there has never been a single incident of public injury or damage to private property. Nevertheless, the rapid expansion of nuclear power is meeting with a number of serious difficulties. First on the list is the public acceptance of nuclear power, primarily because of a number of misconceptions of various aspects of this major new source of energy. Moreover, the enormous complexity of the federal and state regulation process used in licensing nuclear power plants has greatly added to their construction time requirements (now approaching ten years) and hence their cost. Furthermore, the capital-intensive nature of nuclear power generation makes this particular energy source extremely sensitive to the health of the economy since rather massive quantities of capital (money) must be generated to build

such plants (roughly a billion dollars apiece). Furthermore critics have focused on a number of other "drawbacks" of nuclear power generation including low level radiation releases, nuclear reactor safety, radioactive waste disposal, terrorism, sabotage, and theft of nuclear materials, and so on, all of which have combined to create an atmosphere ripe for public misunderstanding and hysteria.

(v) Conservation

Regardless of how rapidly we develop additional energy sources such as by expanding coal production or building nuclear power plants, we will nevertheless need to make a rather substantial commitment to conservation in order to balance our energy needs and demands with our energy supply. However as we have noted earlier, our present society is highly dependent upon energy, and a rapid phaseover to a less energy intensive economy would probably have such a severe economic impact as to obviate any advantages of such an approach. Conservation measures must be introduced gradually, must be stimulated with government policies, in such a way as to cause minimal perturbation of existing lifestyles and the economy. In fact perhaps the most effective method of stimulating conservation is to allow energy prices to gradually rise to more natural levels. For example, if petroleum were allowed to rise to levels more in line with those throughout the rest of the world, then there would be more incentive to improve the efficiency of the transportation industry. By the same token, there is general agreement that natural gas prices must be allowed to rise dramatically to more realistic levels and hence force demand for natural gas more in line with existing supplies.<sup>19</sup> The higher fuel costs will be an economic incentive for the improvement of electrical generating and transmitting processes, lower consumption by industry, and more judicious use by commercial and individual consumers. Furthermore, higher energy costs will have the positive effect of stimulating energy sources and production methods which are now considered to be economically marginal and thus increase supplies. Of course there is little doubt that energy at bargain prices will no longer be readily available. Other factors aside from resource depletion will add to the growing price of energy. National and state laws now mandate a program of clean energy, and costs previously born as environmental damage must now be born to a greater extent by energy users.

It should be kept in mind that it often costs less to conserve energy than to increase supply. However, we must not pin too many hopes on conservation. Even in the short term it is questionable whether energy conservation can match demand with supply while maintaining our present standard of living, providing for our growing population, and an improved standard of living for the disadvantaged segment of our society. And on a longer time scale, it is clear that conservation alone can at best delay the time when diminishing worldwide energy resources will threaten society and civilization as we know it.

In summary then, it appears that for the short term any realistic energy policy both for Michigan and the United States must recognize that there are only three viable short range alternatives: coal, nuclear power, and conservation. Because of basic limitations of each of these sources, it appears highly unlikely that we can rely on only one or even two of the three. All three alternatives must be implemented as rapidly as possible. We must open more coal mines, improve our coal transportation network, and conduct an intensive program concerned with pollution abatement from coal burning to allow us to burn as much coal as rapidly as possible. At the same time, we must implement nuclear power as rapidly as possible, mounting extensive programs of public education to overcome public misunderstanding and fears, streamline regulatory processes, and improve methods used to finance nuclear power plant construction. And finally we must use every possible avenue to stress the importance of energy conservation to the public and provide sufficient incentives for massive conservation efforts.

## 2.8 Long Range Alternatives

Let us now turn our attention to renewable or nondepletable energy sources with longer range potential such as solar power, geothermal power, and controlled thermonuclear fusion. Although we will consider each of these particular alternatives in some detail in the last chapter of this book, it is useful to briefly summarize the status and potential of each option in this chapter so that we can present a more vivid comparison with near term alternatives. It should be kept in mind when discussing such long range options that there are a great many barriers which must be overcome before such options can be deployed on a massive

scale. It seems highly unlikely that these barriers can be surmounted before the turn of the century, and therefore these alternatives must be regarded as yet as unproven.

(i) Solar Energy Resources

The total amount of solar energy falling upon the United States is huge, representing 600 times our current energy consumption rate. In addition, there are huge resources of wind and ocean energy. Conceivably, such resources could supply all of our energy requirements many times over. But solar energy is certainly not free and judging from past experience, will almost certainly not be completely clean--at least in the sense that it will have no environmental impact.

Certain aspects of solar energy are technologically feasible today. For example, solar heating and cooling could be implemented rapidly if sufficient economic incentive could be provided to build up a demand and hence stimulate a manufacturing industry (although present cost estimates range from \$4,000 to \$20,000 per home with backup units additional). However, at the present time, an undeveloped market demand and unproven technology (on a commercial scale) and relatively high production cost (without mass production methods) has inhibited implementation of solar heating.

Of more direct concern to us is the use of solar energy to generate electricity. Here there are several options, including the use of photovoltaic cells on a massive scale, solar thermal plants in which huge mirrors are used to focus the sun's rays on boilers which then produce steam for a conventional steam electrical generating plant, huge solar collectors stationed in space which would beam their power down to earth, windmill electrical generators, using the thermal gradients which occur in ocean currents to power a thermal electrical plant, and so-called "biomass conversion" in which large quantities of vegetation are grown and then converted into liquid or gaseous fuels by chemical conversion processes. Unfortunately, as we have already noted, these schemes which use solar energy to produce electricity face many hurdles before they can be deployed on a massive scale.

One of the major barriers is simply the question of economics. Can high technology items such as photovoltaic cells be manufactured cheaply enough to make solar electric power economically viable? Can gigantic mirror complexes which must continually track the position of the sun be mass-produced in an inexpensive and reliable fashion? Furthermore, the environmental impact of such systems has not been extensively studied at the present time (e.g., the climatic influence of a large array of solar collectors). For these reasons, present projections are that the total equivalent energy obtained from solar power will amount to perhaps 5 to 7 quads in 1985 and 10 to 25 quads/yr by 2000-- and this will be dominated primarily by hydroelectric capacity (which is also a form of solar power).<sup>31</sup> When hydroelectricity is subtracted, the "new" solar energy supplied will be about 1 quad in 1985 and about 10 quad in the year 2000, amounting to less than 7% of our energy production at that time. These numbers are somewhat smaller than earlier estimates of several years ago, and they represent a continuing re-evaluation of the technology and economics of each of these applications. Unfortunately, often as we get closer to implementation and hence smarter, we uncover new problems. Clearly, solar power will not be of appreciable help to our short term energy problems unless miraculous "technological breakthroughs" occur and these estimates are exceeded. (And since technological "breakthroughs" are a myth in any event and merely represent the rapid public recognition of many years of hard, grungy engineering and scientific work, it is not very prudent to formulate an energy plan by counting on such developments.)

(ii) Geothermal Energy

Geothermal energy may be considered to be the thermal energy contained in the upper ten kilometers of the earth's crust.<sup>32</sup> Unfortunately, most geothermal heat is too diffuse to be exploitable on a wide basis. Hence, resources suitable for commercial exploitation are usually regarded as localized geological deposits of heat concentrated available depths and confined volumes and sufficient temperatures for intended utilization. To date, the most developed type of geothermal resources are natural sources of high temperature dry steam (such as the Geysers plant in

northern California). However, there has been some consideration given to using wet steam sources or tapping large volumes of trapped geofluids which are under high pressure and temperature, or perhaps even circulating water through dry hot rock formations (suitably fractured).

Certainly, however, geothermal resources are limited, and the consensus of many experts is that geothermal energy capacity might reach 5,000 MWe by 1985 and 63,000 MWe by the year 2000 (comparable to hydroelectric capacity).<sup>33</sup> Because of the low grade nature of the heat produced by geothermal deposits, the thermal energy extracted cannot be transported very far and must be used directly at the reservoir site or converted into transportable form (such as electricity). The low temperature of such sources leads to a rather low efficiency and hence large quantities of waste heat. Furthermore, geothermal energy plants incur rather enormous environmental impact since they release a significant amount of noxious gases (e.g., H<sub>2</sub>S), liquids, and solids. They cause a substantial amount of land settlement (up to tens of centimeters per year) and seismic activity as well. Furthermore, a geothermal reservoir is quite limited in capacity, and experience has shown that the output from geothermal sites decreases rather significantly after 10 to 20 years of exploitation.

Hence, although geothermal sources will certainly contribute to our electrical generating capacity during the next few decades, they cannot be expected to have major impact and, indeed, should not be regarded as having the same potential as the so-called non-depletable energy sources such as solar or fusion power.

### (iii) Controlled Thermonuclear Fusion

Thermonuclear fusion is frequently touted as the ultimate answer to mankind's energy problems for all eternity. Theoretically, at least, it is characterized by an infinite fuel supply, and its proponents suggest that it should exhibit marked advantages in safety and minimize environmental impact. However, thermonuclear fusion is not the panacea it might first appear to be.

Of course, the major drawback of fusion is that we have yet to demonstrate the scientific feasibility of this scheme--and we will probably not be able to do so for several years yet. Beyond that



demonstration, it will take at a minimum several decades of engineering research and development to bring fusion power to an economically viable level. In many ways, fusion will exhibit safety and environmental impact features similar to those of conventional nuclear fission power. For example, fusion plants will contain a rather high inventory of radioactive material. They will utilize thermal cycles to generate electricity with their intrinsic inefficiencies. They will give rise to (hopefully) very small radiation releases. And they will produce radioactive waste which must be disposed of in some suitable manner.

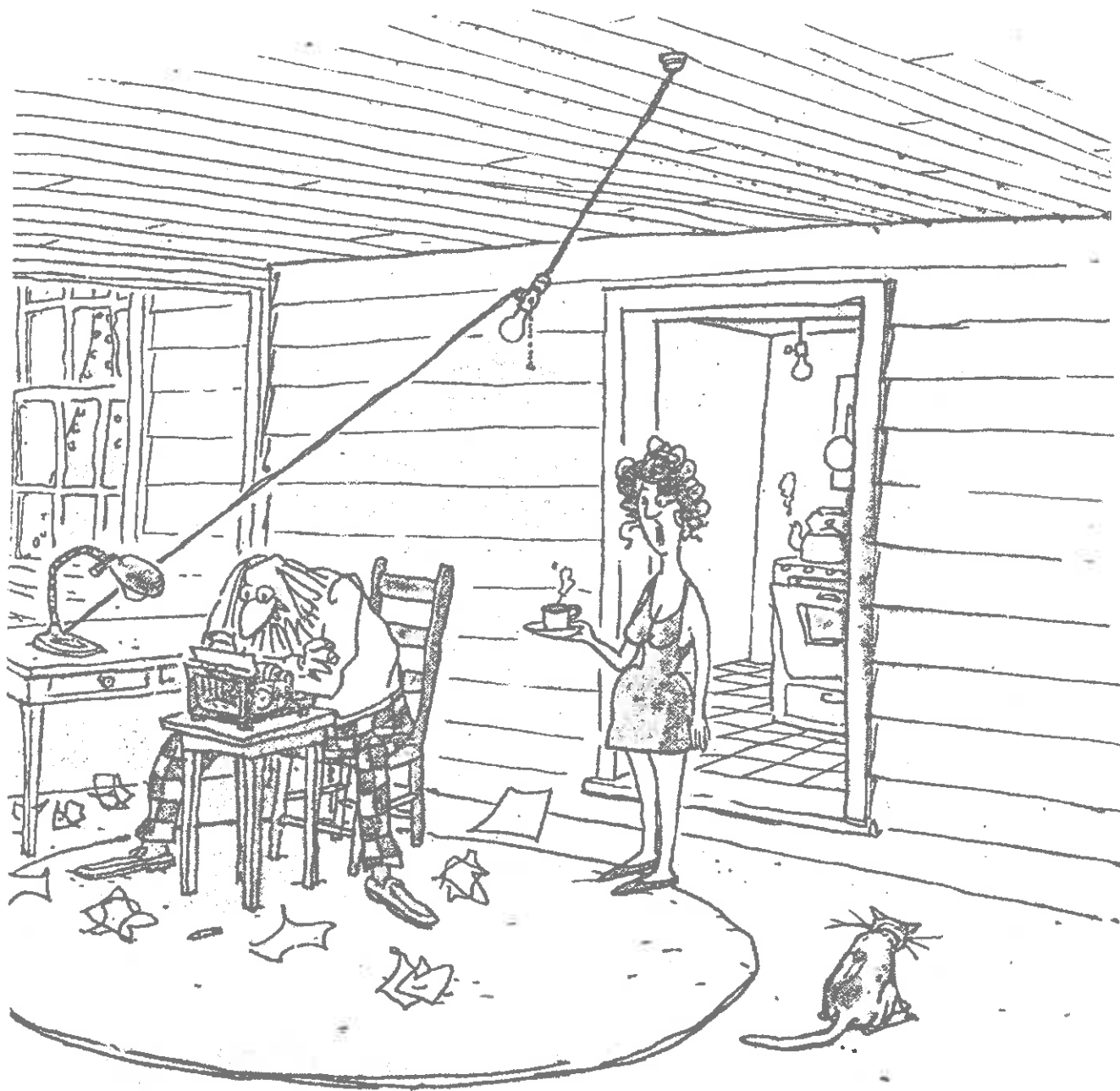
Looking ahead at large fusion power reactors, one is almost overwhelmed by their apparent complexity. Indeed, fusion reactors are expected to represent an increase in complexity from fission reactors which is roughly comparable to that fission reactors presented in comparison with coal-fired plants. Furthermore, such reactors are expected to be economically viable only in rather large sizes--typically 5,000 MWe or five times the size of a modern nuclear plant, costing upwards of 10 billion dollars a crack.<sup>3A</sup>

Hence, fusion certainly must overcome a host of problems before it can make a substantial contribution to alleviating the world's energy problems.

This rather pessimistic picture of long range alternatives is not intended to discourage the reader but rather to put in perspective the enormous problems that must be faced and overcome by any new developing technology. These problems must be faced realistically and must be taken into account in the planning of energy policy. Massive deployment of future energy technology will require an enormous commitment of intellect, manpower, and money--and even then will require several decades and a good deal of luck. The extent of this commitment should not be taken lightly. One cannot magically bring solar power or fusion to the stage of social viability simply by pouring an enormous quantity of money and manpower into its development. Rather one must regard these options as possible long range energy alternatives, and make plans for the near term accordingly. It would be foolhardy to rely upon false (or at best, unsubstantiated) hopes of these long range technologies

and postpone the massive implementation of the presently viable energy sources--coal and nuclear power--to meet short term energy needs.





BOOTH

*"I'll run through it again. First, the exhilaration of a work completed, followed by the excitement of approaching pub date. Reviews pouring in from everywhere while the bidding for the paperback rights soars to insane figures. An appearance on Merle Griffin or Dick Cavett, sandwiched in between like Engelbert Humperdinck and Juliet Prowse. Finally, a flood of letters from people to whom your name, yesterday unknown, now has the shimmer of national renown. Hit those keys!"*

## CHAPTER 3

## ELECTRICAL POWER GENERATION

In this chapter, we will introduce the reader to the basic concepts and ideas involved in the generation of electrical power. We will begin with a brief review of the fundamental physical concepts of energy and power and introduce the basic units in which these quantities are measured. The transformation of energy from one form to another will be discussed, beginning with the conversion of energy from its most primitive form, chemical or nuclear energy, into the thermal energy of hot steam, then into the mechanical energy involved in a spinning turbine shaft, and finally into electrical energy. In the process, we will introduce a couple of fundamental laws of nature which characterize energy transformation, the so-called first and second laws of thermodynamics. Since our primary concern is the study of how electricity is generated in nuclear power plants, we will spend some time discussing the basic concepts involved in the generation and use of electrical energy. For example, what is electricity? How is it made? How is it distributed? How does it make things work?

With these fundamental concepts in mind, we will then take an imaginary tour of a large electrical generating plant. In particular, we will follow the path of energy transformation from its entrance to the plant in the form of fresh fuel (e.g., coal shipments or nuclear fuel assemblies) through to the generation of electricity. In this way, we can introduce the reader to the variety of equipment and processes found in such power plants and illustrate the immense scale involved in central station electrical power generation. It will also prove convenient at this point to classify the various types of power plants as to function, for example, base-load vs. peaking vs. storage units, and as to type, e.g., coal vs. oil vs. natural gas vs. nuclear vs. hydroelectric.

But our discussion will not be complete at this point, because to understand electrical power generation, we must continue to follow the electricity as it is transmitted from the plant and distributed to consumers. In particular, we will study the general topic of electrical

distribution networks, the transmission and utilization of electricity, as well as several of the considerations involved in projecting needs for additional generating capacity.

As a final topic we will consider the electrical utilities which produce and distribute electrical energy. In particular, we will consider their basic organization and their regulation, contrasting private versus public utilities, and examine how these utilities are regulated by public service commissions. We will consider the general topic of the economics of electrical power generation and discuss how electrical rate structures are determined and regulated. Finally, we will try to look how a utility makes decisions involving electrical power generation needs and plans future activities.

### 3.1 Basic Concepts

If we are going to discuss the general topic of electrical power generation, we first must decide on more precise definitions of concepts such as "energy" and "electricity". Here we will revert to the basic concepts and language of the physicist. Now although physics is frequently regarded by the layman as a devious and mystical body of scientific theology designed to confuse and intimidate mere mortals, in fact, it does prove remarkably useful and almost indispensable for our purposes. We will attempt to keep our forage into basic science mercifully brief, and we will take great pains to avoid the introduction of a barrage of confusing mathematical notation--an habitual tendency of most physicists.

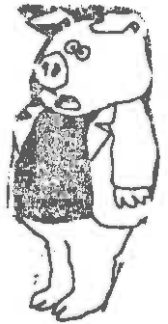
Before we can define energy, we must first give a precise definition of the concept of work. Now of course we all know what work is. It is that unpleasant activity that occupies us for some 40 hours a week--usually preventing us from doing things we would rather do--and, in fact, is frequently defined as the opposite of "play". But this definition is not sufficient for our purposes. Physicists define work in a more precise fashion as the action of a force in moving an object. For example, if I exert ten newtons of force while pushing my stalled Volkswagen 100 meters to the nearest gas station, then I have done 1,000 newton-meters = 1,000 joules of work. In this particular case, the forces involved were mechanical--hence the type of work I performed is



referred to as mechanical work (even though it was accomplished by sweat and muscle).

A physicist uses the concept of energy to describe the capacity for performing work. Actually, there are two distinct types of energy: potential energy and kinetic energy. To illustrate, suppose we were to hoist a barrel of beer, say 10 kg in weight, to a height of 10 meters. Obviously, if the barrel were opened at this height, the beer would be acted upon by the force of gravity as it fell the distance 10 meters. The elevated barrel therefore exhibits the potential capability of performing work--that is, it possesses a potential energy, in this case corresponding to  $E = \text{mass} \times \text{gravitational constant} \times \text{height} = 10 \text{ kg} \times 9.8 \text{ m/s}^2 \times 10 \text{ m} = 980 \text{ joules}$ . Incidentally, it should be noted that such gravitational potential energy is just the form of energy exploited in a hydroelectric plant which uses the gravitational potential energy of water in a reservoir to turn hydraulic turbine-generators and thereby produce electricity.

AND YOU  
DROPPED IT ?!



Suppose one now were to release the beer barrel and allow it to fall ten meters. At that instant, just before it smashes on the ground, it no longer possesses any potential energy, but since it is moving with a certain speed it is still capable of performing work. We refer to the capacity of a moving body to perform work as its kinetic energy. The kinetic energy possessed by an object of mass  $m$  moving with a speed  $v$  is  $E_{\text{kinetic}} = 1/2 m v^2$ . In the particular case of our falling beer barrel, after dropping ten meters, the barrel will have acquired a speed of 14 meters per second and hence will have a kinetic energy of  $1/2 (10)(14)^2 = 980 \text{ joules}$ . But note that this is the same amount of energy that the barrel possessed as potential energy just before it was dropped.

Hence, the action of an object falling merely corresponds to a transformation of potential energy into kinetic energy. The total energy of the barrel is the same throughout its fall. Under a wide variety of circumstances, the total energy of an object or a system remains constant, even though this energy may be transformed from one form to another. This principle of conservation of energy is sometimes referred to as the first law of thermodynamics. (There is also a second law of thermodynamics which places certain limitations on the efficiency with which

energy can be converted from one form into another. We will consider these limitations momentarily.)

It is customary to characterize energy also by the type of force involved. In the above example, since gravitational forces were involved, it is natural to refer to the energy of an elevated object as gravitational energy, and in fact gravitational energy is the principal source of hydroelectric power. Similarly, if electrical forces are involved, we refer to electrical energy, nuclear forces correspond to nuclear energy. There are still other types of energy such as that released in combustion or chemical reactions or the mechanical energy possessed by the rotating shaft of a turbine. But these latter types of energy can be reidentified in terms of more fundamental classifications. For example, the primary forces involved in chemical reactions are really electrical in nature--hence, chemical energy is really just electrical energy on a microscopic scale. (Actually, the same is true for certain types of nuclear energy such as nuclear fission.) The rotating shaft of a turbine is similarly just a form of kinetic energy.

There is yet another very important distinction which can be made regarding various types of energy which can best be illustrated by considering two examples. Consider first the kinetic energy of the directed motion of an object moving with a speed  $v$ . This mechanical energy of directed motion possess the capability of performing an amount of work identical to the object's kinetic energy. Now consider, by way of contrast, the energy of the steam expanding against the blades of a turbine. This steam is also capable of performing work by moving the turbine blades, but in fact it is not capable of converting all of its energy into the mechanical energy of turbine shaft rotation. To see why, we must examine this process from a more microscopic point of view.

The basic energy present in the steam is usually referred to as thermal energy because it arises due to the fact that the steam has been heated to high temperature--for example, in a power plant the steam would be supplied by the heat generated by a boiler or a nuclear reactor--and since the pressure exerted by the steam (or any gas on the walls of its container) is proportional to its temperature, and

## THE LAWS OF THERMODYNAMICS

### The First Law of Thermodynamics:

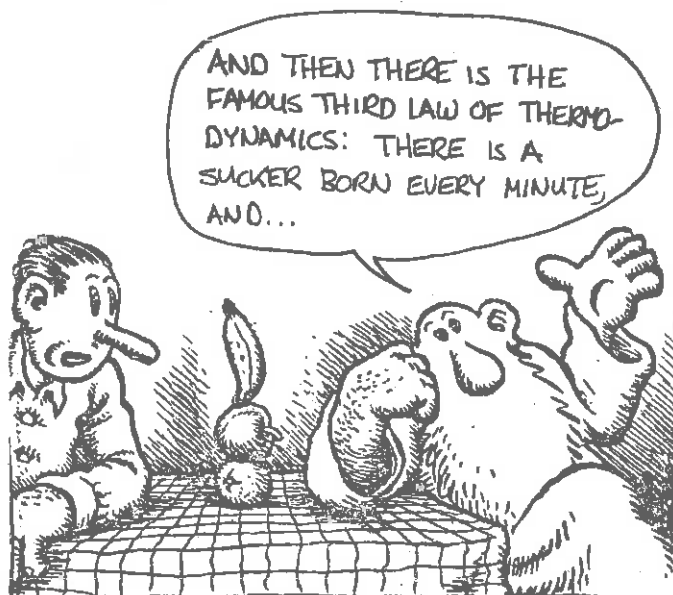
Energy can neither be created nor destroyed, but it can change form. ("You can't get something for nothing, you can only break even.")\*

### The Second Law of Thermodynamics:

It is impossible to convert a given quantity of heat completely into work. In any macroscopic process involving energy conversion, some energy is always degraded in quality, so that the ability to do work is lessened. ("you can't break even, you can only lose.")

---

\*L. Schipper, in Ann. Rev. Energy 1, 457 (1976)





since pressure is a force, then increasing the temperature of the steam increases its capacity for performing work, thereby increasing its energy. The energy associated with the temperature of a substance is referred to as its thermal energy. But, in fact, this is really just a form of kinetic energy, for if we look at a gas on a microscopic level, we find that temperature is merely a measure of the average speed of the molecules that make up the gas. One can relate temperature to the average kinetic energy of the gas molecules if each molecule has a mass  $m$ , then the average kinetic energy is given by

$$E_{\text{ave}} = \frac{3}{2} k T = \frac{1}{2} m v_{\text{ave}}^2$$

where  $k = 3.168 \times 10^{-16}$  joule/°K is known as Boltzmann's constant. Note that we can solve for the average speed of molecules in a gas at a temperature  $T$  as  $v_{\text{ave}} = (3kT/m)^{1/2}$ . On this microscopic level we can also easily understand the nature of the pressure exerted by the gas on the walls of its container or turbine blades in a power plant. This pressure arises from microscopic collisions of gas molecules with the walls or turbine blades. As the temperature increases the molecules move more rapidly and therefore exert more force on the turbine blades when they bounce off of them--i.e., exert more pressure as the temperature increases. In this sense it looks as if thermal energy is simple mechanical energy on a microscopic level.

But there is one extremely important difference between thermal energy and mechanical energy. The molecules in a gas do not all move in the same direction, but rather move in a variety of directions with a variety of speeds. On the average most molecules will not make head-on collisions with the turbine blades, but rather they will suffer only oblique or grazing collisions. For that reason, thermal energy is somewhat different from mechanical energy (which would correspond to a gas in which all of the molecules were moving with a single speed in a single direction) in its ability to be converted into mechanical work. For example, although the thermal energy of 1 kg of steam at a temperature of 300 °C is identical in magnitude to a 1 kg object moving with a speed of 1000 m/s, an energy corresponding to 1000 joules, there is

a sharp difference in the capability of performing mechanical work by letting the moving object dissipate its kinetic energy in a single collision with the turbine blades. In the latter case all of the motion is directed in a single direction and can be entirely converted into the motion of the turbine blades. In the former case, the thermal energy is distributed in a random fashion among billions upon billions of molecules, and therefore only a limited fraction of the energy content of the steam can be converted into the directed motion of the turbine blades.

How much thermal energy can be converted into mechanical energy? Over a century ago the French engineer Carnot<sup>1</sup> demonstrated that the maximum efficiency which could be achieved in such a conversion of heat into mechanical work could be written in terms of the temperature of the steam as it enters the turbine to its temperature passing out of the condenser as

$$\text{Efficiency} = \frac{\text{Mechanical Energy Output}}{\text{Thermal Energy Input}} = 1 - \frac{T_{\text{out}}}{T_{\text{in}}}$$

where these temperatures are expressed in absolute units ( $^{\circ}\text{K}$ ). In the steam turbines typical of electrical power plants the inlet steam temperature is usually about  $365^{\circ}\text{C}$ , the outlet temperature is about  $30^{\circ}\text{C}$ , and therefore the maximum achievable efficiency is roughly 50%. In practice, intrinsic inefficiencies in the turbine and pumps reduce this to about 40%. From a practical point of view this means that in converting thermal energy into the mechanical energy used to drive an electrical generator, we are limited to converting only 40% of the produced thermal energy into electrical energy. The rest of this energy must be rejected as being unsuitable for performing mechanical work. In a large power plant this so-called waste heat energy is withdrawn by the cooling water used to condense the steam back into "feedwater" to be circulated back through the boilers or reactor. This cooling water carries the waste thermal energy to cooling towers where it is rejected into the atmosphere.

We must always keep in mind the unfortunate but very fundamental limitation of basic physics that any plant that any attempt to generate

electricity using the heat produced by chemical or nuclear reactions (as essentially all do) is capable of converting at most 40% of this heat energy into electricity. The remaining 60% of the heat generated must be rejected into the environment. It should be stressed that this limitation is due to a fundamental law of physics, not to the inefficiencies of imperfect engineering design or plant operation.

The generation of electrical power involves the transformation of energy through many different forms. To illustrate this more clearly, let us briefly trace the chain of energy transformations involved in the generation of electricity from nuclear fission reactions. (See Fig. 3- 1). We begin with a fission event in which a uranium nucleus fissions into two chunks which fly off with very high kinetic energies (due to the electrical repulsions of the like charges on each fragment). Hence, we begin with the transformation of nuclear (or electrical) into the kinetic or mechanical energy of the moving fission fragments. These fission fragments rapidly collide with adjacent atoms in the uranium fuel, and their kinetic energy is transferred to the recoil kinetic energy of these adjacent atoms. Because of the random nature of these recoils, this kinetic energy is converted effectively into the heat energy of the fuel--i.e., the fuel temperature is increased by the fission events. Then by flowing a coolant through the bundles of fuel, one can extract this heat energy and use it to turn water into steam. This steam can then be allowed to expand against the blades of a turbine, thereby converting thermal energy into the mechanical energy of the turbine shaft. This spinning shaft then drives the rotor of an electrical generator to produce electricity--converting mechanical energy into the mechanical energy of the turbine shaft. This spinning shaft then drives the rotor of an electrical generator to produce electricity--converting mechanical energy into electrical energy. So, in fact, all we have really done is to transform the original electrical energy which pushes the pieces of a fissioning nucleus apart into the electrical energy which appears at the output terminals of the power plant transformers--losing 60% of the energy in the process as waste heat.

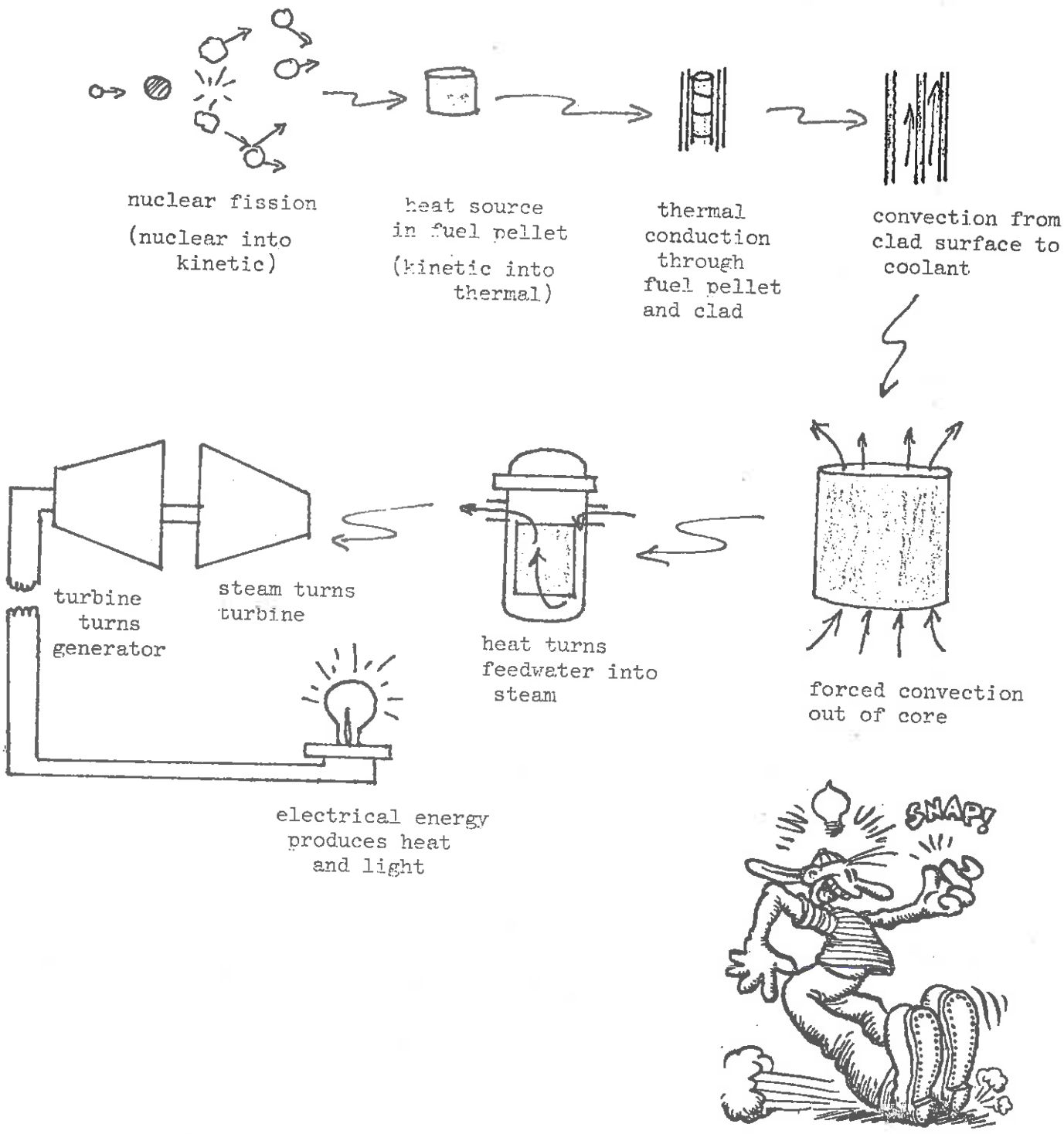


Figure 3-1: The Energy Transformations Involved in Nuclear Power

The final concept we wish to introduce is that of power--the rate of producing or expending energy. If we produce energy at the rate of 1 joule per second, then a power of 1 watt is produced. Unfortunately, the unit of joule for energy or watt for power is far too small for most energy applications. For example, a typical light bulb uses a power of 100 watts--that is, it will expend an energy of 3600 joules per hour of operation. For that reason the most common unit of power in energy applications is the kilowatt and the most common unit of energy is the kilowatt hour (kwhr). For example, the average homeowner utilizes roughly 500 kwhr of electrical energy per month. But even this unit is far too small to use when discussing electrical energy generation. The most useful unit in which to measure energy generation is the megawatt-day (MWD), the energy produced when generating a power of 1 megawatt for one day. By way of example, the present U.S. generating capacity is roughly  $10^{12}$  watts. Therefore, during one year the U.S. generates  $3.65 \times 10^8$  MWD of electrical energy ( $32 \times 10^{17}$  joules or 32 quads).

### 3.2 The Generation of Electrical Power

Electrical power makes use of the forces which arise between charged particles. It is common knowledge that on a microscopic level, subatomic particles are frequently characterized by an electrical charge (e.g., protons have a charge of +1 unit and electrons have a charge of -1 unit). Particles of like charge repel one another, particles of opposite charge attract. The electrical forces between charged particles are frequently referred to as Coulomb forces or electrostatic forces to distinguish them from the types of forces that act on moving particles which can be identified as magnetic forces. Since atoms are made up of a number of negatively charged electrons and a positively charged nucleus, and since matter is made up of billions upon billions of atoms, we might expect that all matter would be subject to electrical forces of enormous magnitudes. In fact, since atoms are electrically neutral, the total charge of their electrons just balancing the positive charge of the atomic nucleus, matter on a macroscopic level tends to be electrically neutral and therefore will not be subject to electrical forces under ordinary circumstances. However, if one can

separate charges of a few atoms, that is, built up a net positive or negative charge in a piece of material, it will experience electrical forces. The classical demonstration of such a charged body is a glass rod that has been rubbed with silk, thereby acquiring a positive electrical charge. By way of contrast, if we rub a hard rubber rod with fur, we can build up a negative electrical charge. In this particular case the glass rod and the rubber rod will be attracted to one another.

Such electrical forces are capable of doing work in exactly the same manner as the mechanical forces we are more accustomed to in our everyday experience. (That is, if I could place a large negative charge on my Volkswagen while placing a positive charge on a nearby gas station, then electrical forces could accomplish the same work pulling my stalled car in as the sweat and toil of my body.) Hence, to utilize electrical forces, we must cause a slight imbalance in the charge neutrality of objects so that they will be subject to such forces.

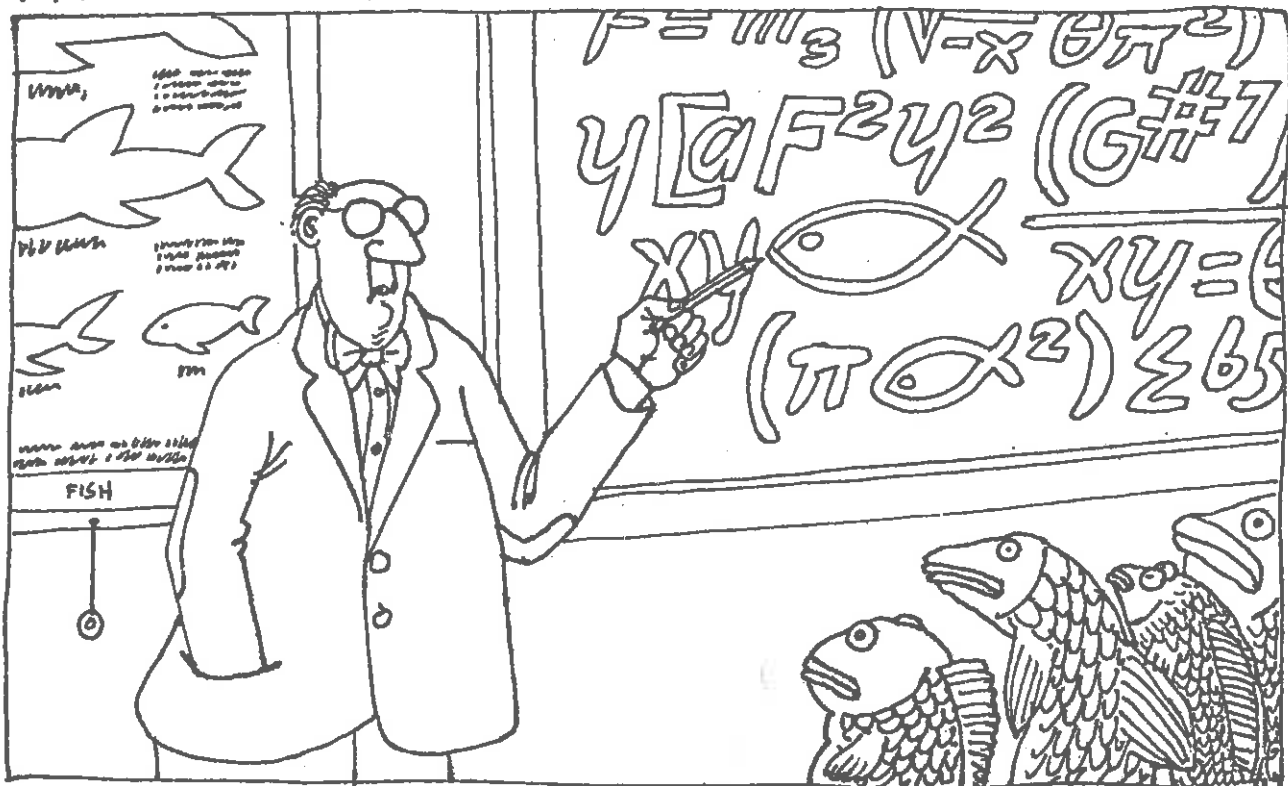
There is yet another way to utilize electrical energy. When a charged particle moves through a magnetic field it will experience a force. Since an electrical current is, in fact, nothing more than the flow of a large number of charged particles (electrons), then current carrying conductors will interact with magnetic fields. This phenomenon can be turned around. A time-varying magnetic field will cause or induce currents to flow in wires or similar conductors. Since there will be some resistance to this flow (electrons tend to bang into atoms as they flow through a material), the magnetic field must give the electrons a push if they are to flow. This push is a form of potential energy and is referred to as electrical potential or voltage.

We are now in a position to discuss how electricity is generated. For in a power plant, the turbine shaft is used to turn the rotator of an electrical generator which consists of a large magnet which rotates : inside of a large number of fixed wires known as a stator. As the magnet moves within the wires, it induces a current in them--that is, the rotating magnetic field induces a flow of electrons in the wires of the electrical generator, and in effect produces an excess charge or voltage at the power station which tends to push other electrons

along the power distribution network, the push being passed along the electrical transmission lines. At the consumer's end of the transmission lines, this electrical potential or voltage can be used to push electrons through resistive wires such as the filament of a light bulb which will then produce light or heat. Such light bulbs are usually designed to require an electrical potential difference of 100 volts. The electric power required by such a bulb is typically 100 watts which corresponds to an electrical current of 1 ampere. Alternatively one may use the electrical potential to drive an electrical motor--which is, in fact, nothing more than the reverse of an electrical generator. In the motor the electric currents push magnets to turn a shaft and perform work. Note that in effect, the generator-motor set merely transforms mechanical energy into electrical energy and back again. This can be reversed, since a motor-generator set can be used to convert electrical energy into mechanical energy and back again--for example, to change its voltage.

Of course, actual electrical power generation and distribution is a little bit more complicated than we have described. Rather than using the simple direct current flows that we have been discussing, we tend to use alternating currents which continually change their flow from one direction to another at a rate of 60 times per second. The advantage of such alternating currents are that they can be very easily stepped up or down in voltage by using a transformer which is essentially just a stationary set of wires (to accomplish the same task using direct current would require expensive motor-generator sets). The incentive for such voltage changes arises because the resistance losses in an electrical wire are proportional to the current which flows in the wire--not to the voltage which drives the current. Hence, we can transmit large power at high voltages and small currents, thereby minimizing resistance losses. The general scheme then is to increase the voltages in transformers at the generating station to rather high levels (approaching 1 million volts), transmit the electrical energy over long distances, then step down the voltages through a series of transformers near the point of utilization to the much lower voltages typical of most electrical appliances (110 volts).

# PROVING THE EXISTENCE OF FISH





### 3.3 Electrical Generating Plants

Let us now look in detail at the layout and components of large central station electrical generating plants. Since most electricity in this country is supplied by fossil fuel fired units, that is, units which derive their energy from the combustion of oil and coal, it is appropriate that we begin our discussion by looking in detail at one of these plants.

In Fig. 3-2 we have depicted in schematic form the essential components and processes involved in the generation of electrical power by burning fossil fuels. Of course, on a very simple level, the heat produced by the combustion of coal or oil is used to turn water into steam which is then allowed to expand against the blades of the turbine causing the turbine shaft to spin, thereby driving an electrical generator. Hence, the basic operation of such a plant is rather simple. But the scale of this operation is truly staggering.

To be more specific, let us consider a coal fired plant such as the 4 unit, 2,000 MWe Monroe Plant owned and operated by the Detroit Edison Company at Monroe, Michigan. This plant uses roughly two train loads (150 carloads) of coal every day--corresponding to the consumption of some 1200 tons of coal every hour--during its operation. This coal is first delivered to the plant in crushed form by train or barge and stockpiled in storage yards adjacent to the plant (because of the enormous amount of the coal required for plant operation, it is difficult to build an inventory of more than several weeks operating requirements at any one time). The coal is carried by conveyors to pulverizing units which consist of giant grinders which reduce the coal to the consistency of talcum powder. The coal is then blown at high velocities through hot air forced nozzles into feed the fires in the furnaces of the boilers. The walls of the furnaces are lined with steel tubes which contain the circulating feedwater. As the water flows through the tubes, it absorbs the heat generated by the coal combustion and turns into steam.

The boiler units are truly staggering in size, being some 220 ft. tall by 40 ft. wide and 43 ft. deep. Roughly 5,000,000 pounds of steam

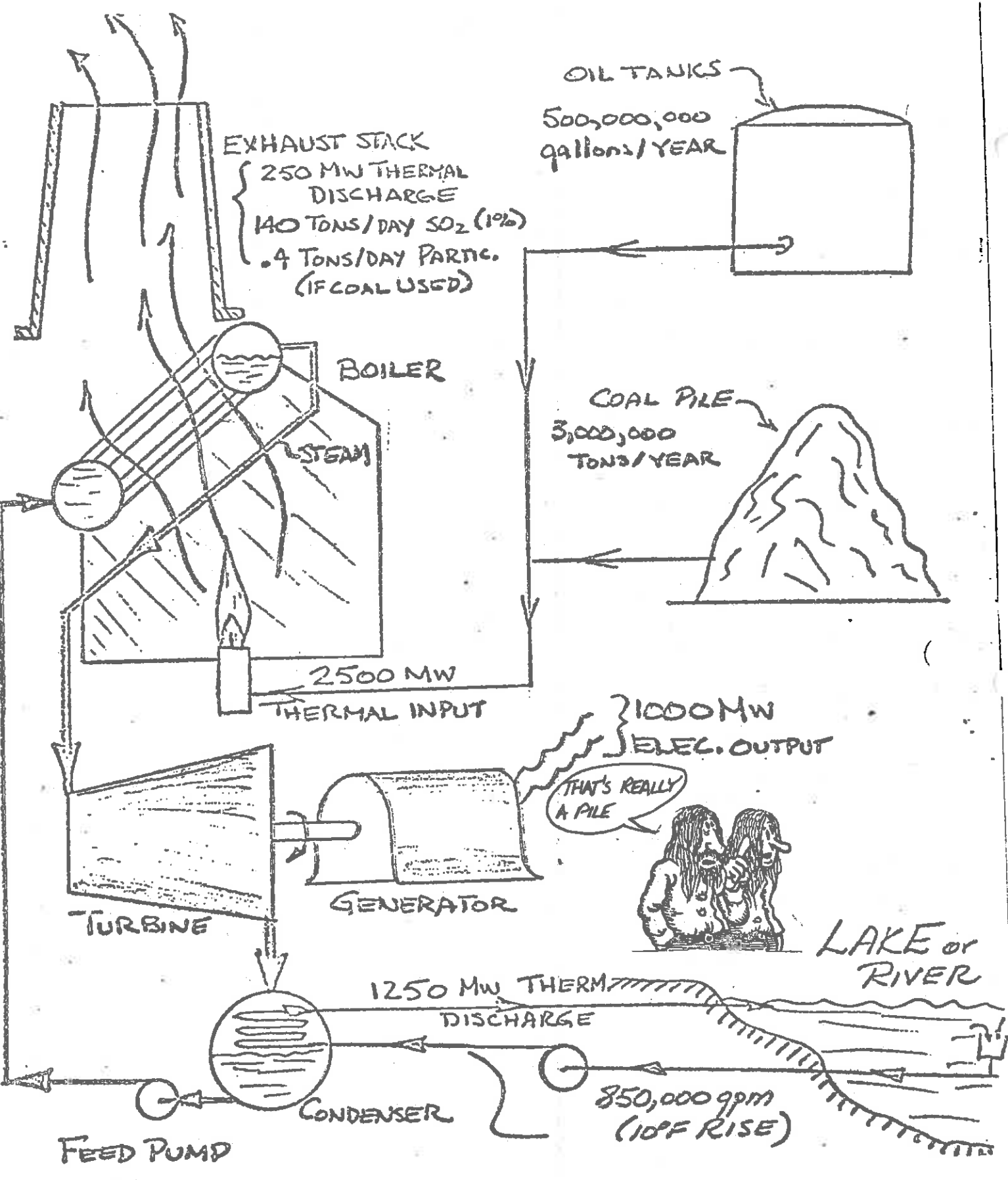


Figure 3-2: A Diagram of a Fossil-Fueled Electrical Power Plant

at 2655 psi and 1000°F are produced by each boiler. The steam then enters a drum unit and is then piped over to drive the turbine-generator itself. It is then allowed to expand against the blades of the turbine, performing work by turning the turbine shaft. The turbine itself is enormous, typically being some 200 ft. long and developing over 1 million horsepower required to turn the generators which produce 1,000 MWe of electricity each. Typically these large turbines consist of several stages--that is, multiple sets of turbine blades, all mounted on the same shaft.

After the steam has expended its useful energy in work on the turbine blades, it then must be recondensed into water before it can be pumped back to the boiler. The unit in which this condensation occurs is called the condenser, and it consists of thousands upon thousands of tubes containing much cooler water upon which the steam rejected from the turbine condenses and then flows to the bottom of the condenser well to be pumped back as feedwater to the boiler. The cooling water for the condenser carries away the waste heat which must be rejected to the environment. (For we recall that only 35-40% of the heat generated by the power plant can be converted to electricity. The remaining heat must be rejected to the environment.)

In modern plants this cooling water is supplied from a large reservoir adjacent to the plant. The waste heat is extracted from the cooling water by large cooling towers. Such cooling towers are designed to induce a large natural draft of air (about 20 mph) to flow up through the tower. The cooling water is then sprayed over baffles in the tower and the air flows through these baffles extracting the heat. The water is then collected at the base of the tower and pumped back to the reservoir for eventual use once again in the condenser. Since much of the water evaporates in the cooling tower, makeup water at a rate of some 10,000 gal/min must be drawn from some external body of water (e.g., a nearby lake or river). However, it should be stressed that with such cooling towers, there is essentially no waste heat rejected to the external bodies of water. Rather this heat is rejected directly to the atmosphere. The cooling towers themselves are enormous concrete structures (see Fig. 3- 3 ), typically rising some 400 ft in



Figure 3-3: Cooling Towers for Power Plants

height and having a base diameter of some 400 ft. In fact, when approaching a power plant, one typically can spot the plant cooling towers 10 to 20 miles before arriving at the plant.

It should be stressed that the feedwater used in the steam cycle is physically isolated from the cooling water used in the condensers. The feedwater must be of extremely high purity. It must be cleaned by filtration and demineralized to the point where it is roughly 1000 times more pure than drinking water, otherwise it will tend to foul up the boiler tubes. By way of contrast, the condenser-cooling tower-reservoir cycle can use water with only modest treatment (sufficient to prevent algae growth).

There is yet one other process that is extremely important in a fossil-fuel power station. This involves the treatment of the coal combustion products which are produced in the boiler. Typically, some 2 1/2 million cubic feet of air is circulated through each boiler every minute to supply the oxygen required for the coal combustion. Then this air is passed up and out exhaust stacks towering over the plant (up to 800 ft. in height). Of course as the air passes through the boiler, it will pick up numerous combustion products including solid materials such as fly ash and various gases such as SO<sub>2</sub>, CO, CO<sub>2</sub>, NO, and so on. The majority of the fly ash particulates are separated out using electrostatic precipitators in which the particles are given a surface electrical charge from high voltage electrodes at the base of the stack, and then these charged particles are attracted to collecting plates. Once a layer of fly ash builds up, the plates are cleaned by striking them with an air powered hammer. Such precipitators can separate out over 99% of the fly ash. Nevertheless, a good deal of fly ash will be exhausted to the environment (6 tons/day). Further air pollution control equipment must be installed on modern coal plants such as scrubbers which attempt to remove some of the gas contaminants such as SO<sub>2</sub> (typical emissions will still be excess of 70 tons of SO<sub>2</sub> per day). Such pollution equipment is extremely expensive, comprising some 20% of the overall plant costs and furthermore significantly reduces the efficiency of a modern plant from its nominal level of 40% down to 35% or even lower.<sup>2</sup> As air quality standards become more stringent (evidence

the Clean Air Act of 1976), the costs of air pollution control equipment for such coal-fired plants will increase dramatically.

By way of contrast, in Fig. 3-4 we have shown schematically the layout of a typical nuclear power plant (in this case, utilizing a light water reactor). Such a nuclear plant is actually rather similar to a fossil-fuel fired plant except that it replaces the coal-fired boiler by a nuclear reactor which generates heat by sustaining a fission chain reaction in a suitable lattice of fuel material. These fission chain reactions act just as coal combustion in generating heat. One then flows water through the fuel to withdraw the heat, thereby turning the water into steam. Actually we should be a bit more precise here since it is only in the boiling water reactor that the steam is produced directly in the reactor where the fission heat is produced. In a somewhat more popular type of reactor, the pressurized water reactor, the water that passes through the fuel is kept under high pressure so that it will not turn to steam--it will only increase in temperature as it is heated. The heat withdrawn by this water is then passed through a heat exchanger where it is used to turn water in a second coolant loop into steam.

Hence, from a superficial point of view, the primary difference between fossil-fuel fired and nuclear plants is in their steam supply system--that is, the energy source which supplies steam to drive the turbine-generators. The remainder of the plants are remarkably similar--both in the size and types of turbine-generators, cooling tower requirements, associated plant layouts, and so on. In both plants the steam supply system itself contributes only a relatively modest fraction of the total capital cost of the plant (typically about 20%). However, as we will see later, the type of steam supply system is of central concern because it not only dictates the design of the remainder of the plant, but also the procedures required for plant construction and operation. Of course, there are numerous dramatic differences between fossil-fuel and nuclear generating stations. For example, whereas a 1,000 MWe fossil fuel plant consumes roughly 15,000 tons of coal per day, a comparable sized nuclear unit consumes only about 1 kg of uranium fuel per day. Furthermore, a fossil fuel fired plant rejects tens of

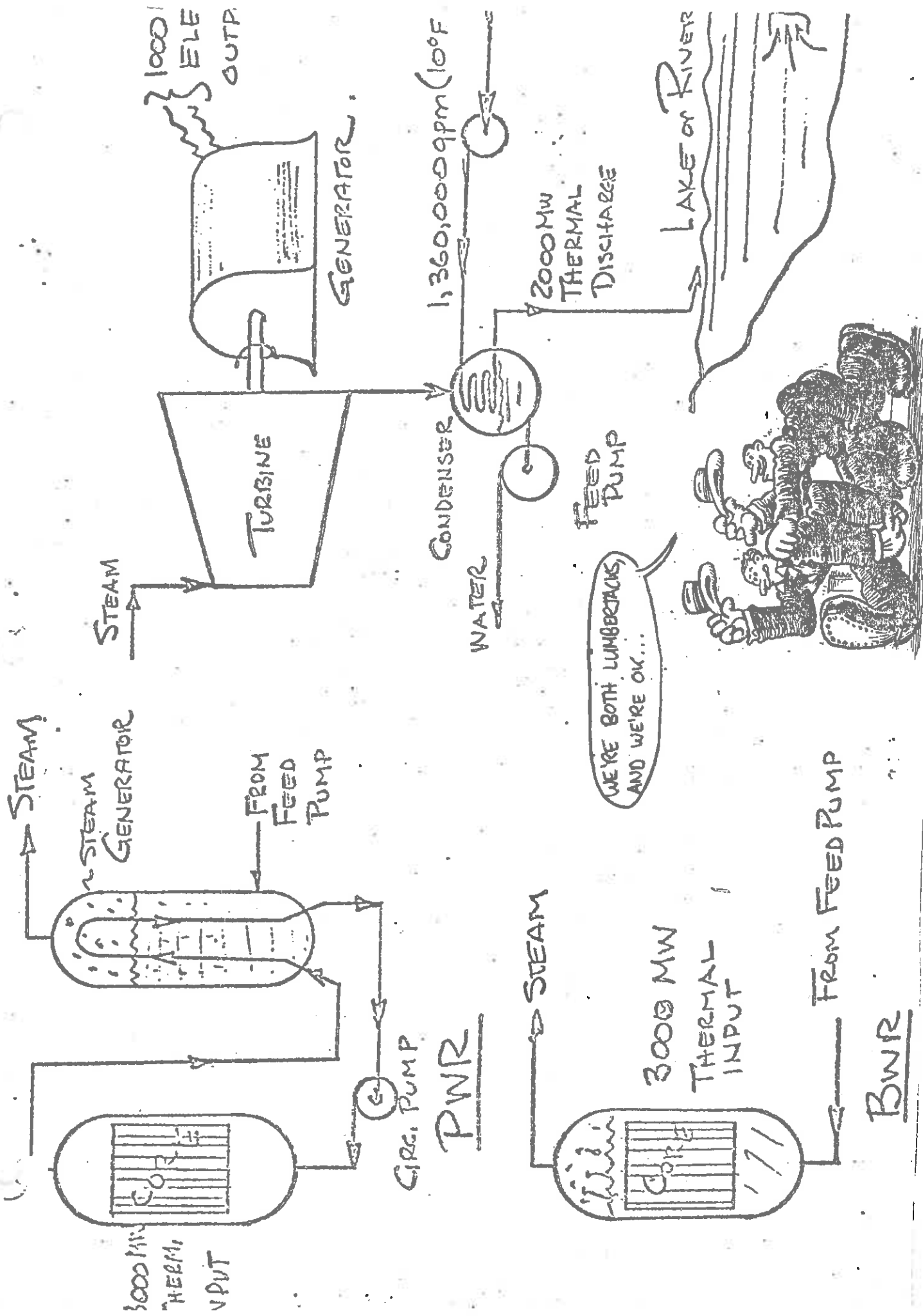


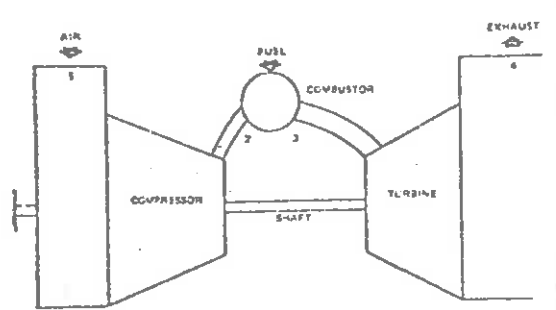
Figure 3-4: A Diagram of a Nuclear Power Plant

thousands of tons of pollutants up its stack directly into the environment each year, whereas nuclear units release essentially nothing to the environment. Of course, a nuclear unit contains a rather sizeable inventory of radioactive material, and therefore safety precautions and licensing requirements tend to be many times more stringent than those characterizing fossil-fuel fired plants. We will return later in Chapter 6 to discuss in much more detail the similarities and contrasts between nuclear and fossil-fuel fired generating stations. At this point, however, we will continue on to discuss other types of central station power plants.

Oil-fired electrical generating units are rather similar to coal-fired units except for the fact that they burn crude oil. Actually, it is rather easy to convert coal-fired units over to oil since one must merely remove the fly ash collectors and replace the pulverized coal injection nozzles in the furnaces by oil burners. And, in fact, during the 1960's a great many coal-fired plants were converted over to oil so that they could more easily meet the increasingly stringent air quality laws regarding plant emissions. This massive conversion has backfired in a rather alarming manner as the price of oil has skyrocketed during the 1970's. Unfortunately, it is extremely difficult to convert an oil-fired boiler back to coal. Usually the expense associated with this conversion is sufficiently high that it is preferable to simply build a new generating unit.

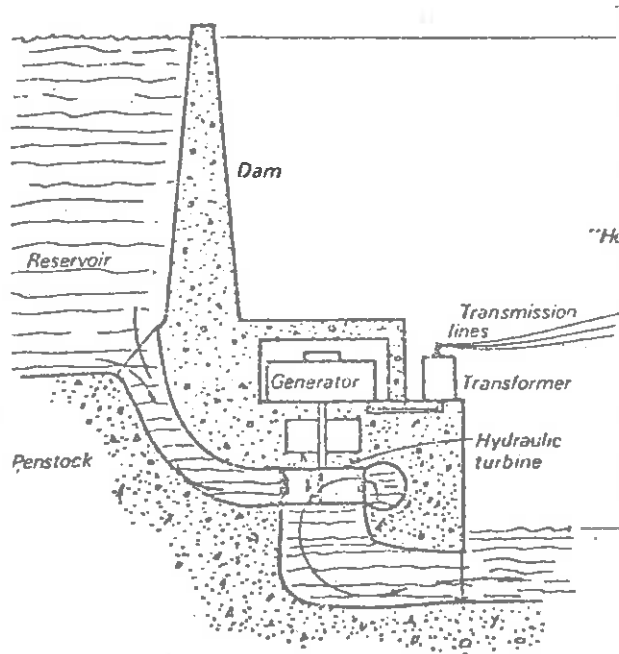
A considerably different fossil-fuel fired unit is the combustion turbine as shown in Fig. 3- 5 which consists of a compressor, a combustion chamber, and a turbine (and is essentially identical to jet aircraft engines). In this device, air is drawn into the inlet duct and enters the compressor. As it is forced through the compressor, its pressure is raised to about 10 atm. After leaving the compressor, it is routed to the combustion chamber where natural gas is added for combustion. The combustion products are then allowed to expand in the turbine, turning the turbine shaft, thereby converting the thermal energy produced by combustion into the mechanical shaft energy of the turbine. Although the turbine shaft is used to drive an electrical generator, almost 2/3 of its energy must be used to drive the compressor itself.





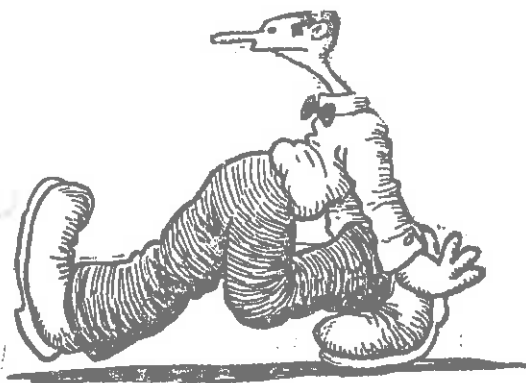
Schematic diagram of a gas turbine.

Figure 3-5



Schematic cross sectional view of a modern hydroelectric plant.

Figure 3-6

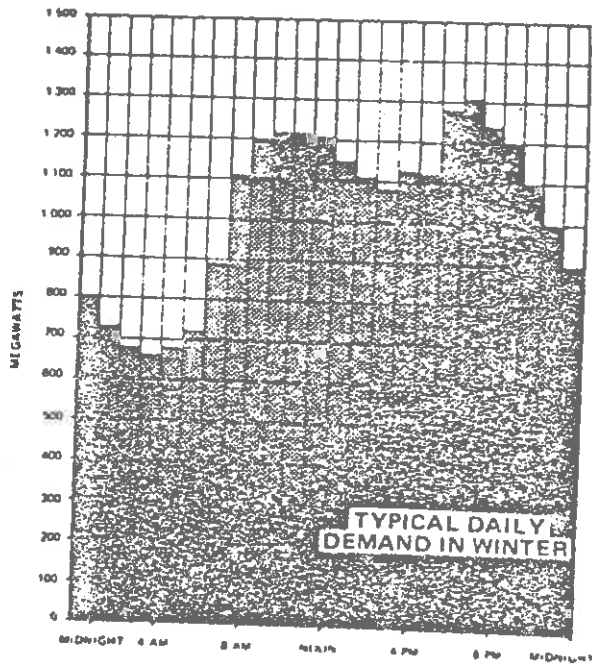


Such gas turbine units present a number of advantages over coal or oil fired units since they typically are far more acceptable from an environmental standpoint, having essentially nonexistent particulates and very low SO<sub>2</sub> emissions. Their capital cost requirements are quite low, and the economics of such units are not so sensitive to scale which allows them to be built in small sizes (50-100 MWe), thereby allowing small lead times for construction. They are also capable of almost instantaneous startup, being able to go from zero to full power in less than 5 minutes. There is one major disadvantage of gas turbine units, however--the availability of their fuel. As we noted earlier, natural gas resources are extremely limited, and in many states electrical utilities are unable to buy natural gas to drive such units. Therefore, gas turbine units are used only for standby or for power peaking (which we will explain momentarily) or in those regions of the country in which natural gas shortages have not become quite so imminent.

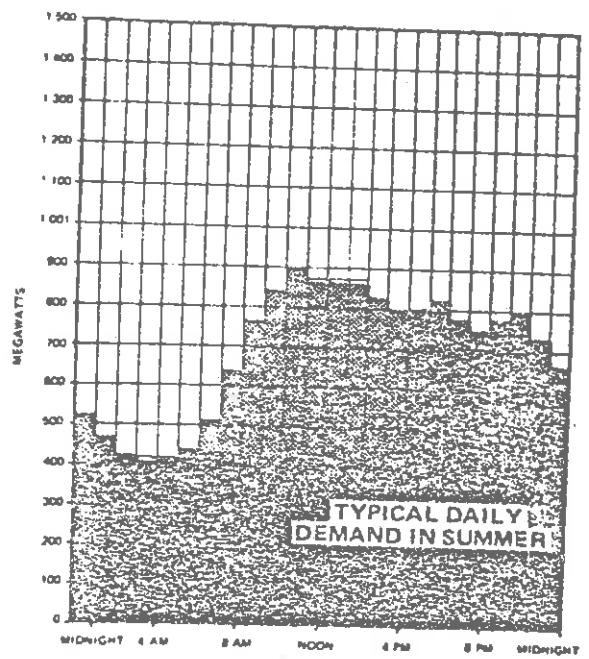
The final major source of electrical power generation is that of hydroelectric power. The major components of a hydroelectric station include a dam, reservoir, penstock, hydraulic turbine, generator, transformer, and distribution lines. (See Fig. 3- 6 ). The operation of the unit is very straightforward: the water is allowed to run down the penstock and through the hydraulic turbine, forcing it to rotate, driving the generator and producing electricity. Superficially, it would seem that such units are certainly the cleanest form of electrical energy since they produce no combustion products, and furthermore, do not use up scarce resources of non-renewable fuels. But, of course, there are other severe difficulties with hydroelectric power. First and foremost is the limited number of remaining hydroelectric sites which can be developed. As we have noted, at present about 10% of our total electrical generating capacity is supplied by hydroelectric sources. The most optimistic projections<sup>3</sup> are that there remains an undeveloped or potential capacity of roughly the same magnitude (50,000 MWe). However, few of these new potential sites are acceptable to modern day environmental standards. And, in fact, further hydroelectric development has been essentially blocked by environmental groups.

Thus far we have been discussing the principal types of present day electrical generating stations which have been classified as to type of fuel--fossil fuel fired units based upon coal, oil, or natural gas, nuclear units, and hydroelectric units. We have chosen not to discuss power units based upon more exotic energy sources such as geothermal or solar power, since the technology of such sources is in a developmental stage (and in any event we will return to consider these alternative future energy sources in Chapter 8 ). There is yet another classification of electrical power stations which involves the design function of the plant as opposed to its fuel type. The need for some functional variation in power plants is caused by the variations in demand for electricity from hour to hour, day to day, or season to season. For example, in Figure 3- 7 we have presented a typical demand curve for a 24 hour period. On the curve you will note the peak in electrical demand occurs just before noon, while the minimum demand occurs in the early morning hours. We can relate such a demand curve to the living and working habits of the typical consumer: As people rise in the morning and prepare for work, they use hot water and electricity for cooking. As industry cranks up at 8:00 a.m., the demand for electricity rises sharply and remains fairly constant until about 6:00 p.m., when people leave work and arrive home. We see another increase in demand due to dinner preparation, hot water consumption, television useage, lighting, etc. By 10:30 or 11:00 p.m. the commercial load begins to decrease until at midnight only street lighting, minor residential loads, electric signs and displays, industrial three-shift operations, and nightowls are using electricity, and the demand curve bottoms out.

There is also a rather considerable fluctuation in electrical demand from day to day and from season to season. For example, one would expect that weekend levels would be somewhat below weekday electrical demands. Furthermore, the rather heavy electrical requirements of air conditioning in summer or heating in winter would cause peaks during these seasons. A typical annual demand curve is shown in Figure 3- 7 .

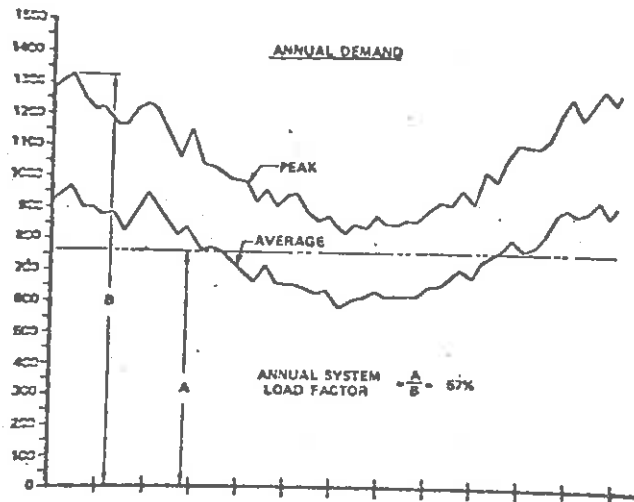


Typical electrical demand curve for a summer day

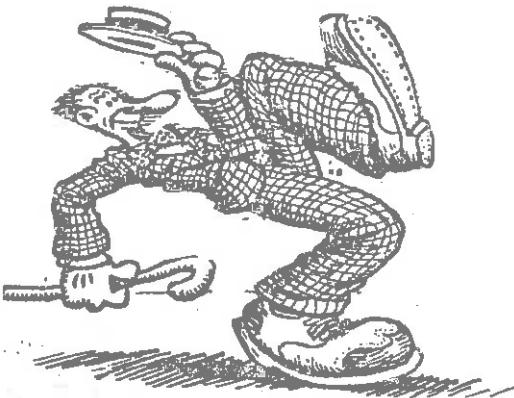


Typical electrical demand curve for a winter day

Figure 3-7: Variations in Load Demand with Hour and Season



Annual electrical demand curve



An electrical utility must be prepared to meet the peak demand of its customers. For that reason it utilizes a variety of different kinds of electrical generating units, including base load units which are designed to operate continually at full capacity to meet the bulk of the electrical demand and peaking units designed to follow the rise and fall of electrical demand on an hour to hour, day to day basis. Typically, a utility will assign base load operation to its most efficient units; that is, those units which produce electricity most cheaply and reliably will naturally be run at full capacity as much as possible. Peaking units tend to be either less efficient (e.g., older) or smaller, rapid response (e.g., gas turbine) units. Since there are periods of time when the demand may actually drop below the capacity of the base load units, yet a third type of electrical generating facility is sometimes useful: a pumped storage hydroelectric station as shown in Figure 3- 8 . This consists of a lower and upper reservoir, a waterway tunnel, and a powerhouse containing generators and hydraulic turbines, similar to those of conventional hydroelectric facilities--except for the fact that in a pumped storage station, the generator is also designed to be run "backwards" as a motor, driving the turbine as a pump to raise water from the lower to the upper reservoir. During the period of time when peak demand occurs, water is run through the turbine from the upper to lower reservoir, and electricity is generated in a conventional manner. During periods of low demand, the excess electrical power supplied by base load units is used to pump water back to the upper reservoir, thereby storing this energy (as potential energy) for future use. Of course there is a certain amount of inefficiency in this process--roughly 1.4 kw of pumping is needed to supply 1 kw of generated electricity--nevertheless such pumped storage units can be quite valuable in evenly distributing the electrical generating capacity of a utility. In Michigan, a large pumped storage station owned jointly by Consumers Power and Detroit Edison is located near Luddington.

All large (greater than 500 MWe) nuclear units and coal-fired units are designed to be operated as base load units--that is, they are designed to be run at full capacity as much as possible. This not

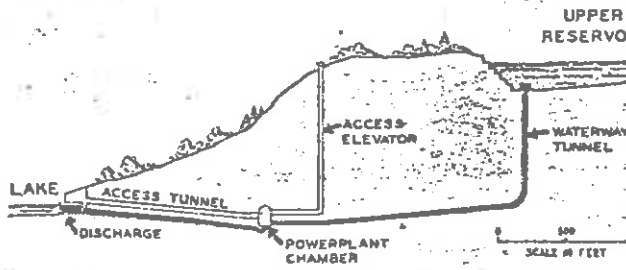


Figure 3-8: Cross-sectional view of a typical pumped storage facility.

MEET:

*Genghis & Sylvia Khan*



only makes for the most prudent use of their relatively lower generating costs but as well minimizes the wear and tear on plant components due to startup, shutdown, and power level changes. Unfortunately, the enormous size of modern nuclear stations has frequently caused them to exceed the base load requirements of a given utility, and such plants occasionally are required to follow load fluctuations--that is, to serve a dual role as both a base load and peaking unit. Such a departure from the original design function of the plant can lead to a decrease in plant reliability. For example, the Palisades nuclear plant in western Michigan was originally intended as a baseload unit for Consumers Power with its excess capacity to be routed to the Luddington pumped storage station during low demand periods. Unfortunately, due to material shortages and construction delays, the Luddington plant was not completed until several years after the Palisades unit began operation. Therefore, the Palisades unit was required to load-follow, and this has led to a marked decrease in plant performance (which is stating it mildly). Hence, there can sometimes be a conflict between the increased economic attractiveness and reliability of very large base load units and the actual mode of operation they may receive from a given utility.

In view of the scheduling difficulties utilities frequently have in effectively utilizing the enormous generating capacity of modern nuclear plants, one might well wonder why the electrical capacity of such plants has increased so dramatically during the past ten years (from typical capacities of 200-300 MWe in the early 1960's to 800-1,000 MWe by 1970 to 1,200-1,300 MWe at the present time). The size of a nuclear generating station is dictated quite simply by economics. Experience has shown that as the electrical capacity of a power plant increases, the total construction cost of the plant per unit of power generated (e.g., expressed in \$/kw) shows a significant decrease. For example, an increase in capacity from 500 to 1,200 MWe decreases unit construction costs by a factor of about two. This trend is also observed in a variety of other industries in which similar economics of scale arise. A number of factors contribute to this decreasing construction cost per unit power of capacity. There

are a variety of costs associated with the plant such as site acquisition and preparation, plant instrumentation, fuel handling and storage equipment, and other auxiliary systems which do not depend sensitively on plant size. Furthermore, significant economies may be realized by locating more than one generating unit on the same site, and in many modern nuclear plants, two to four units are located at each generating station.

Of course, we should be cautious here because there are also disadvantages associated with very large units as well. We have already noted that the enormous size of such units is frequently incompatible with existing utility generating and distribution networks in the sense that a forced outage of a very large unit may exceed the reserve capacity of the utility. Furthermore, with each significant increase in generating capacity, one must push the technology associated with steam supply systems, turbine-generators, and support equipment a bit further, and therefore will invariably encounter temporary decreases in system reliability until experience with these large units has been acquired. For example, it is a virtually universal practice in the United States to employ only a single turbine-generator with each steam supply system--regardless of the size of the unit. Therefore, as nuclear reactor sizes increase, there must be a corresponding increase in turbine-generator sizes and an extension of turbine-generator technology. In fact, there has recently been some concern that perhaps the present level of large nuclear units (1300 MWe) has already reached the point of diminishing returns in balancing lower construction costs against decreased plant reliability--at least until a substantial amount of additional experience is gained in operating such large units.

It is useful at this point to introduce several concepts which will prove useful in further discussions of power plant performance:

- 1) Plant thermal power (MWt): The total heat produced by the steam supply system.
- 2) Plant electrical output (MWe): Net electrical power generated by the plant.



- 3) Net plant efficiency (%):  $\frac{\text{Plant electrical output}}{\text{Plant thermal power}}$
- 4) Plant capacity factor: Actual energy production during a given period divided by the energy production during the same period if the plant had operated continuously at the manufacturer's rated capacity.
- 5) Plant load factor: Ratio of the average load during a specified time period to the peak load.
- 6) Plant availability factor: Ratio of the total megawatt-hour output capability for a given period to the total rated megawatt-hours during the period.

### 3.4 Electrical Distribution Networks

Electrical utilities are responsible not only for generating electrical power, but as well for distributing that power to customers. Distribution is accomplished through both bulk transmission systems on which electrical energy is transmitted at high voltage from generating stations to large scale users or load centers and secondary distribution systems designed to distribute electrical energy at much lower voltages to large numbers of small users. Indeed, roughly a third of the electrical power costs born by the consumer are attributable directly to transmission systems.

An electrical utility is obligated to provide electricity to a consumer in its service area at any time and place he desires it. It must be prepared to supply not only the projected base load requirements of electrical customers, but as well must meet hour to hour, day to day fluctuations in load demand and respond to momentary surges that require very rapid changes in the generating capacity of the system. Furthermore, it must plan for sufficient reserve capacity to ensure a reliable source of electrical power.

For that reason, most utilities have adopted a rule of thumb that a given generating unit should not constitute more than 10-15% of the total system capacity, so that if it should suffer an outage, sufficient reserve capacity can be brought on line to continue to meet

demand. However, we have noted that most nuclear power units being installed today range in the 1000-1300 MWe class, and there are very few utilities in the United States with installed capacity in excess of 7,000 MWe.<sup>5</sup> For that reason, many nuclear plants today are being constructed and operated by a number of electrical utilities in a pool arrangement. Furthermore, as we have noted, electrical utilities' distribution networks are highly interdependent, and in fact, utilities routinely sell or buy power from neighboring utilities during periods of peak or off load. Therefore, when considering the balance in generating facilities for a given utility, one must consider as well the generating capacity of neighboring utilities since all will interact to a high degree.

There will certainly be a tradeoff between the cost of transmission and the economics of scale exhibited by large nuclear plants. For this reason, every attempt is presently made to design bulk electrical transmission networks capable of transmitting enormous quantities of electrical power with the lowest possible transmission rates consistent with high reliability. For example, it is now common to utilize extremely high voltage transmission lines in the 350-765 kilovolt class, and future technology based on superconducting lines may allow even higher concentrations of generating stations.<sup>6</sup> Furthermore, since environmental and public health considerations limit the number of potential sites close to load centers (e.g., cities), low cost transmission lines will make the use of somewhat more remote sites economically acceptable.

The ever-increasing interconnection and interdependence among large electrical distribution grids requires a rather sophisticated degree of coordination and control to achieve high reliability. Of course, we can all recall rather dramatic examples of the consequences of the failure of such systems. For example, during the later 1960's, a series of failures in the New York electrical power grid propagated backwards through interconnected networks of adjacent utilities and eventually knocked out a main relay point near Niagara Falls<sup>7</sup>, thereby isolating the Northeastern United States from the utilities of the Midwest, South, and Canada. This domino effect led to the infamous

blackout of the Northeastern corridor of 1967. Similar blackouts have occurred as a result of individual generating plant outages or transmission system failures which have propagated through an electrical grid, tripping relays, and leading to significant power outages.

To protect against such massive failures, most utilities are now utilizing elaborate computer systems to control both the generating and distribution of electrical power. For example, Detroit Edison and Consumers Power jointly own and operate a major control center located just outside of Ann Arbor, Michigan which operates all of the generating plants of both utilities and can arrange for buying and selling power to adjacent utilities in Ohio, Illinois, Pennsylvania, Canada, and so on. Similar power pool control centers are located at various other points in the country, and provided the generating reserve of various regional electrical networks are kept sufficiently large, such control systems should reduce the possibility of occurrence of major blackouts. However, if reserve capacity is allowed to drop too low, then this extremely high degree of interdependence may backfire as it did in the 1967 eastern blackout and will contribute to the propagation of forced outages.

### 3.5. Electrical Utilities

The responsibility for generating and distributing electrical energy belongs to the electrical utilities. Most of the utilities in the United States are private, investor-owned companies, the remainder being owned and operated by either federal agencies (e.g., TVA) or as public power districts operated by municipal or state governments. Electrical utility companies do not compete with one another as traditional business enterprises, but rather must provide service to all customers in their particular area of operation. Since the usual pressures of competition in the free enterprise system are absent, government regulation of utilities is used to ensure customer service at reasonable rates.

The regulation of electrical utilities by state commissions or

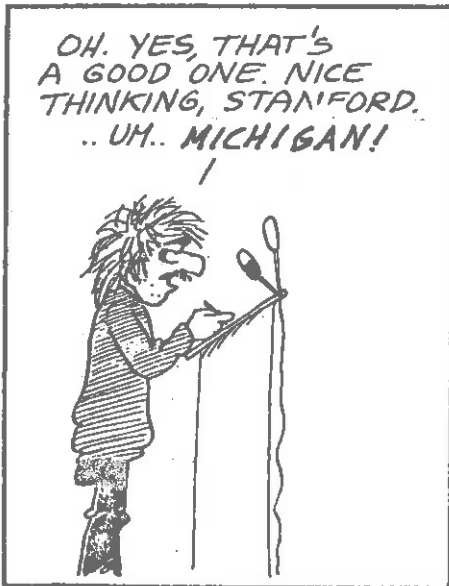
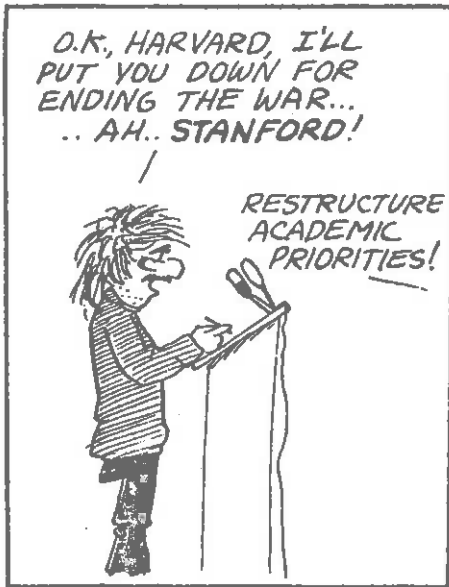
federal agencies is an extremely laborous process involving a variety of rather complicated economic factors and public pressures (since the regulation process is always subject to public scrutiny and intervention). In many cases, electrical rate regulation has become essentially a political process, subject to all of the pressures and logic (or absence thereof) that abound in government bureauracy.

The capital investment represented by electrical generating plants comprises almost 2% of our national wealth, and the gross revenue of electrical utilities is about 5% of our total manufacturing income. Hence the stakes involved in the ballgame of utility regulation are very high indeed and extremely vulnerable to a variety of pressures.

NOTE: This section is incomplete.

- 3.5. Electrical Utilities
  - Basic Organization and Regulation
  - Utility Economics and Rate Structures
  - Planning Activities and Decision Making





## CHAPTER 4: A BRIEF HISTORY OF THE DEVELOPMENT OF NUCLEAR POWER

The awesome potential of the atom for both military and peaceful applications has had a major impact on modern society. It was recognized quite early that an extraordinary degree of care would be required in both the domestic and international control of atomic energy. To quote the preface to the Atomic Energy Act of 1946,

"The effect of the use of atomic energy for civilian purposes upon social, economic, and political structures of today cannot now be determined. It is reasonable to anticipate, however, that tapping this new source of energy will cause profound changes in our present way of life." <sup>1</sup>

In this chapter, we will describe and analyze the development of the policies of domestic control and leadership of the American atomic energy program. Although this will be done primarily from an historical viewpoint, the final objective will be to examine the decisions reached during this historical development with particular emphasis directed towards their relevance to the contemporary issues of nuclear power.

As is so often the case, the attempt to analyze any particular subject by isolating it from the flow of history is a rather artificial procedure. Certainly the relationship between the development of international and domestic control of atomic energy is very strong and interdependent. Yet only a brief mention will be made in this chapter of the formation of international policy which ran parallel to and determined to a very large degree domestic atomic energy legislation. Then too, the mood of the American people after World War II most surely affected the issues, and yet this mood could only be clearly shown and understood through the introduction of additional historical events which would take us too far afield.

#### 4.1. The Early Years--The Manhattan Project\*

It seems ironic and rather frightening that the initial stumble into the world of nuclear fission should have occurred in Nazi Germany. But late in 1938, Otto Hahn and Fritz Strassman, two radiochemists at the

\*In this section we will occasionally make use of concepts of nuclear physics which are more fully explained in Chapter 5.

Kaiser Wilhelm Institute in Berlin, discovered traces of radioactive barium in samples of uranium that they had been bombarding with neutrons.<sup>2</sup> Although Hahn suspected that a new type of nuclear reaction might be involved, he communicated the results of these experiments to a former colleague, Lise Meitner who, together with her nephew Otto Frisch, interpreted the presence of the barium as an indication that the heavy uranium nucleus had fissioned into two smaller nuclei, each roughly one-half its original weight, and calculated that some 200 million electron volts of energy (some 100 million times the amount of energy released in a chemical reaction) would have been released in each such nuclear fission reaction.

The foundations for this discovery had been laid more than two decades earlier when Rutherford and Bohr first demonstrated that atoms were composed of a massive, positively charged nucleus surrounded by a cloud of negatively charged electrons, and that these nuclei could be transformed or transmuted from one type to another by bombarding them with other nuclei or subatomic particles. In 1932, Chadwick identified a neutral subatomic particle, the neutron, which interacted quite strongly with nuclei and was particularly adept at inducing nuclear transmutations. During the 1930's, many physicists began to bombard materials with neutrons to see what type of nuclear transformations would occur. As early as 1934 in Rome, Enrico Fermi was studying the interactions of slow neutrons with uranium and noted that when a uranium nucleus captured a neutron, it would suffer a radioactive decay into a new element, neptunium (if he had watched the neptunium for awhile longer, he would have discovered that it would also decay into yet another element--plutonium).

Hence, when the reports of Hahn and Strassman's discovery of the nuclear fission reaction reached the United States in early 1939, there was already a considerable effort in nuclear physics research underway in this country, and several groups immediately conducted experiments to confirm the discovery. Indeed, American scientists were already conducting experiments that would almost certainly have led them to the discovery of fission within a few weeks after the German announcement.

The enormous energy released in such fission reactions caused considerable excitement among the physics community. However of comparable

significance was the discovery by Hahn and Strassman that each fission reaction not only produced energy and fission fragment nuclei, but as well knocked loose several neutrons. Hence physicists immediately recognized that it might be possible to use the neutrons produced in the fission reaction to induce further fission reactions, thereby releasing energy and still more neutrons and achieving a fission chain reaction capable of releasing enormous quantities of energy. (Hahn was extremely depressed by this since he realized that his discovery might lead to weapons of enormous destruction.)<sup>2</sup> Tremendous excitement gripped the physics community, particularly in the United States, and over 100 papers were published on the subject of nuclear fission during 1939.

Physicists Enrico Fermi (now in the United States) and Leo Szilard saw in the fission process the potential of a self-sustaining chain reaction leading to a tremendous source of power. Szilard saw a far more frightening potential, since the nuclear fission reaction might make possible an explosive weapon capable of incredible destruction. He felt an all-out effort to evaluate the possibility of such an "atomic bomb" was adviseable even in the face of strong doubts as to its feasibility. Together with other scientists, Szilard drafted a letter to this effect which was signed by Albert Einstein and delivered to President Roosevelt on October 11, 1939.<sup>3</sup> (We have reproduced the text of this letter in an Appendix.) Alerted to the potential of the atom, Roosevelt appointed an Advisory Committee on Uranium to monitor the country's atomic research.<sup>4</sup> This committee fell under the auspices of the National Defense Research Committee under the direction of Vannevar Bush. Its main thrust was directed towards confirming the possibility of a fission chain reaction.

To achieve a self-sustaining chain reaction, it was necessary for at least one of the neutrons emitted in a fission reaction to induce yet another reaction in the uranium sample. But such neutrons could also be absorbed (without inducing fission) or simply leak out of the uranium. Thus the initial goal was to see if an assembly of uranium could be designed in which the chain reaction would propagate--that is, to design a nuclear "reactor."

There were several very important questions which had to be answered. First among these was to measure the number of neutrons emitted by each



fission reaction and to determine which isotope of uranium was actually being fissioned. For it was known at the time that natural uranium consisted primarily of two isotopes, being 99.3% U-238 and 0.7% U-235. Since it was quickly learned that an average of 1.7 neutrons were emitted for each neutron absorbed in natural uranium, then if indeed the fissions were all occurring in the minute fraction of U-235 in the sample, a chain reaction (and perhaps even a weapon) could be achieved by increasing the concentration of this isotope. Scientists at Columbia confirmed in March 1940, that U-235 was the fissile isotope, and preliminary research into the separation of this isotope from natural uranium began.

But the separation or concentration of the uranium isotopes U-235 and U-238 was to prove enormously difficult. For the chemical properties of these isotopes were essentially identical. Only their masses differed, and hence any separation process would have to depend upon this mass difference. Unfortunately, the mass difference was so small (less than 1%) that more traditional methods, such as centrifuge separation, proved impractical due to the exceptionally high rotation rates that would be required. Rather it was decided to attempt to separate uranium isotopes using either very large mass spectrometers (so-called electromagnetic separation) or gaseous diffusion methods (which take advantage of the fact that gases tend to diffuse through porous membranes at rates inversely proportional to their masses).

But there was yet a third option. In February of 1941, Seaborg discovered that if uranium was bombarded by neutrons, it could eventually be transmuted into a new element, plutonium, which was fissile just as U-235. Hence, if a copious source of neutrons could be obtained in a fission chain reaction, then these neutrons could be used to convert natural uranium into plutonium which could then be separated out for use in a weapon.

There were numerous other questions which needed to be answered. For example, it had been known that "slow" neutrons were most apt to induce fission reactions. That is, when neutrons first appeared in a fission event, they were characterized by very large speeds. However, Fermi learned that if these "fast" neutrons were allowed to rattle around a bit in a material composed of light nuclei, such as water or graphite,

then the fast neutrons would slow down as they transferred some of their energy by collisions to the host nuclei, and that these slow neutrons were far more capable of sustaining a chain reaction. But it also was known that any explosive device would have to rely upon fast neutrons in order for the chain reaction to build up rapidly enough to release a large amount of energy before the weapon blew itself apart. Hence, the big question was whether a chain reaction would work with fast neutrons. Because of these and other unanswered questions most scientists felt that while fission might provide a large source of power, the possibility of an explosive fission device was rather remote. Nevertheless, it was decided in the summer of 1940 to ban all further publications on nuclear fission because of its military potential.

As research continued through 1940 and into 1941, more definite ideas concerning possible military applications were developed. In May of 1941, Bush's committee defined three possible military objectives:<sup>5</sup> (i) the production and release (by plane) of radioactive fission products over enemy territory, (ii) the development of a nuclear reactor to propel submarines and ships, and (iii) the possible development of a bomb--but there were so many "ifs" associated with this last application that it appeared highly uncertain--indeed doubtful.

On June 28, 1941 a reorganization and expansion of the committee occurred under the newly formed Office of Scientific Research and Development. S-1, as the reorganized section was now coded, now lay under the protective wing of the executive branch, and during July, 1941 the program rapidly accelerated. After discussing the state of atomic research once more with Bush and noting the optimism of British scientists and also that of a report prepared by a National Academy of Sciences committee under Arthur Compton, the President approved the full scale effort towards finding a method of separating U-235 and making plutonium on October 9, 1941. Thus by the time the United States was catapulted into the war by Pearl Harbor, the commitment had already been towards the development of the weapon. It was recognized early, however, that the separation process would be quite difficult and expensive, and Bush felt that after the preliminary research and design work had been accomplished by S-1, the Army should take over full-scale construction and operation of production

facilities. A Planning Board, after exploring electromagnetic, gaseous diffusion, and centrifuge separation methods during early 1942, was unable to decide on any one superior process. The committee finally decided that the safest procedure would be to begin work on all three types of U-235 separation installations as well as an installation to produce plutonium.

Bush had approached the Army concerning takeover of the program as early as March, 1942. Both he and Roosevelt had been particularly interested in Army supervision for several reasons. Besides the fact that research under military direction had been quite successful during WWI, the mere magnitude of the atomic program would necessitate a body capable of controlling immense operations. Because of the security demands, it was necessary to limit the program to one service. Since Roosevelt had been at odds with the Navy for some time, the Army seemed from the beginning the logical choice as a wartime manager.

Although the Army was somewhat reluctant to begin on all four methods of production of fissionable materials, they agreed on June 10, 1942 to follow initially the OSRD program. During the early construction period, the Army and the OSRD were to work together in direction of the program. The Army decided to put the project under their Corps of Engineers and selected Col. James C. Marshall as Director and agreed to take over development, engineering design, procurement of materials, and site selection. The OSRD would continue with research.

Flaws in the arrangement appeared immediately. It soon became obvious that the research and engineering functions could not be separated quite so easily as had been anticipated. Within the Army the project had little prestige, and the OSRD's influence on military decisions was negligible. There was no higher authority to which the Army and OSRD could appeal to resolve differences. As with most programs under separate but parallel management, the project suffered from an alarming lack of coordination.

The Army was facing problems of its own, however. Slowness in the establishment of the Oak Ridge, Tennessee site and an inability to secure a top priority on wartime materials complicated the plans for construction. Marshall attempted to direct the project from his headquarters in New

York (thus the title Manhattan Engineering District), and communications with Washington suffered. To resolve the material and appropriation problems, it was finally decided to place the project under the Services of Supply, and Colonel Leslie Groves was appointed director of the entire program on September 17, 1942.

Groves had been following the development of the MED for some time prior to his appointment. Within 48 hours he had resolved the site difficulty and secured a top priority for the program. He brought added vigor and direction to the Manhattan District as well as the absolute command which the wartime pace demanded. He was assisted in his decisions by a Military Policy Committee suggested by Bush and containing representatives from the Army, Navy, and OSRD.

During the remainder of 1942, the MED program jelled into a firm commitment to the development of the weapon. Scientific achievements came rapidly. Fermi had been given the job of demonstrating the feasibility of a fission chain reaction by building a nuclear reactor using natural uranium (in the form of uranium oxide) and using graphite as a "moderator" to slow down the neutrons. Although the original plan was to build this reactor at an isolated site in the Argonne National Forest to the west of Chicago, a construction strike caused a delay in the necessary facilities, and it was decided to go ahead with the experiment in the squash courts under the old Stagg Field West Stands. (Compton didn't dare clear this with the Army or the University administration, but simply went ahead with the experiment in a rather interesting example of wartime expedience). The reactor Fermi built was quite literally a "pile" of graphite blocks, each containing holes into which cylindrical rods of natural uranium oxide were inserted. As the pile became larger and larger, the balance between neutron production via fission reactions and loss via leakage or absorption approached more closely the necessary conditions for a chain reaction. On December 2, 1942, Fermi's group achieved the first sustained chain reaction with the pile. When Fermi called Compton to tell him the news, he merely said that "You'll be interested to know that the Italian navigator has just landed in the new world".<sup>6</sup>

Interestingly enough, the Germans were also well on the way to constructing a nuclear reactor similar to Fermi's at this time, but they had decided to use heavy water,  $D_2O$ , rather than graphite, to slow down the neutrons because of its somewhat smaller tendency to absorb neutrons from the chain reaction. At one time during this program, the Germans (unknown to the United States until after the war) were at least six months ahead to the American program.<sup>7</sup> Fortunately, a British commando raid on the heavy water plant at Venork, Norway coupled with several scientific setbacks slowed the German effort.

E. O. Lawrence continued his development of a device which was to electromagnetically separate the uranium isotopes. A decision was reached to abandon the struggling centrifuge separation program. On December 28, 1942 Presidential approval marked the transition from research to the all-out production effort. The S-1 committee had completed its task and was eventually dissolved in March. The formal civilian direction of the program had come to a necessary close, and the military assumed the mantle of control. From reliance upon the scientific ability of the country, the program now shifted to reliance upon the American industrial and engineering might. The United States was well along the road that would eventually lead to Hiroshima.

The MED directed itself towards two objectives: the production of fissionable materials and the design and fabrication of the weapon itself. To provide fissionable material for the weapon, the nation had to undertake the most ambitious technical project in its history under the binding restrictions of wartime security. The production facilities themselves gave evidence of the tremendous scope and complexity faced by the MED.

In Oak Ridge the isotope separation plants were under construction to separate U-235 from natural uranium. Most hope rested with Lawrence's electromagnetic process. This used a series of mass spectrometers (the "calutrons") to separate the isotopes as a result of their differences in atomic mass. The plant itself, coded Y-12, was a huge complex of intricate electronic equipment which required continual engineering adjustments and refinements for its sustained operation.

In another area of the Tennessee site, the gaseous diffusion plant (K-25) was being erected. This relied upon the fact that gaseous U-235 and U-238 would diffuse at different rates through a suitable barrier. Although the barrier material had yet to be perfected, the huge building which would contain the hundreds of barriers in series was under construction quite early.

The third path to the weapon involved producing the element plutonium artificially in a nuclear reactor, such as the one Fermi had built in Chicago. Initial work was begun on the Clinton laboratories, and the X-10 complex at Oak Ridge to determine the design of the production reactors. Construction of the production facility on a barren desert site on the Columbia River near Hanford, Washington was begun. Besides the production reactors, the Hanford site also contained vast chemical facilities for separating the plutonium from the slugs of uranium irradiated within the reactors. The first of the production reactors achieved criticality on September 27, 1944.

Although these three operations suffered many disappointments and frustrations, there was little doubt that some fissionable material could be produced eventually (although there was concern until late 1944 as to whether enough material for a weapon could be processed before the end of the war). To ensure that a weapon design would be ready, the MED established a top secret laboratory high in the mountains of northern New Mexico in early 1943. Robert Oppenheimer, the first director of the laboratory which was to become known as Los Alamos, began the difficult task of recruiting scientists to work at the mesa top facility. During the laboratory's early organization there was some concern over whether its operation was to be civilian or military. It was eventually decided to have a civilian staff with military support. There was occasional friction over this, as there was trouble over the scientists' refusal to follow the policy of compartmentalization established by Gen. Groves. The staff of the Los Alamos Laboratory was eventually to include the most brilliant array of nuclear scientists ever assembled--and indeed, most of the leaders of America's post-war scientific program were at one time residents "on the hill". It is also amusing to note that the Los Alamos staff was characterized not only by its brilliance,

but as well by its exceptional youth. Oppenheimer himself was only 40 at the time, and most of his staff (Bethe, Teller, von Neumann, Feymann, Christy, Kistiakowsky, etc.) were even younger.<sup>8</sup> This group immediately brought its enormous talents and energy to bear on the difficult design of the weapon itself.

The essential idea involved in the design of the nuclear explosive was to assemble very rapidly a supercritical mass of fissile material so that a fission chain reaction could grow sufficiently fast to release a large amount of energy before the system was blown apart by the force of the explosion. It was of paramount importance to minimize stray neutron production which might prematurely trigger a fission chain reaction before the weapon was thoroughly assembled and cause a fizzle (a two billion dollar fizzle!).<sup>9</sup>

The first scheme for achieving this rapid assembly was to use an artillery cannon to fire one subcritical piece of fissile material into another to produce the supercritical configuration. It was recognized at an early stage that such a "gun-type" design would only be of use in a U-235 weapon, because this type of assembly was too slow to overcome the high spontaneous neutron emission rates present in plutonium. The design for the plutonium weapon instead utilized an "implosion" scheme in which a subcritical plutonium core was surrounded by carefully designed high explosive charges. When these charges were detonated, the core was imploded into a supercritical mass, and the chain reaction was then triggered by a polonium-beryllium neutron source. Although it was initially thought that as much as 100 kg of fissile material might be needed for the weapon, as the detailed design work progressed, it became apparent that roughly 10 kg of material would suffice.

Throughout 1944, the atomic weapons program gained momentum, although barrier problems continued to plague the K-25 plant while the Y-12 plant was unable to achieve sustained production. The production reactors at Hanford also ran into some unforeseen difficulties which limited the early production of plutonium.

However, by spring of 1945 the first appreciable quantities of plutonium and U-235 were delivered to Los Alamos for fabrication into

weapons. Although the Los Alamos scientists were reasonably certain that the gun-type uranium weapon would work, it was decided that a test of the more sophisticated implosion-plutonium device was needed. On July 16, 1945, an implosion device was tested near Alamogordo, New Mexico in a desolate region of desert known as Jornada del Muerto (Spanish for "journey of death", appropriately enough). Although an explosive yield of only about 5,000 tons of TNT equivalent was expected, the test device proved far more efficient and produced a yield of 20,000 tons. The era of nuclear war had arrived. But even before the Trinity Test, many were looking forward, past the war to the years of peace ahead. Questions were being raised concerning the use of the weapon--in fact, whether it might not be better to avoid using it at all.

The potential implications of the atomic weapons program were apparent to Bush and Conant quite early. No one could foresee what the consequences of nuclear weapons or nuclear power would be to the postwar world. For this reason, Bush had resisted all policies which might have influenced the future of the atomic energy program as the result of wartime decisions alone. Not only the weapon, but the entire program would require extraordinary measures of control during the ensuing years. Other scientists joined Bush and Conant in their concern for the control of the program after the war. There were international questions of security, collaboration with the rest of the world, and eventual world control of the weapon to be considered. Yet the scientific community became more and more frustrated as they felt that "statesmen who did not realize the atom had changed the world were laying futile plans for peace while scientists who knew the facts stood helplessly by".<sup>10</sup>

Secretary of War Stimson, alerted the President to the growing concern over the postwar control issue. An Interim Committee was authorized on May 4, 1944 to explore the issues and begin postwar planning. Although it was immediately apparent that international control would be a serious problem, both foreign and domestic atomic energy programs were proposed and investigated.

First proposals stressed the scientists' concern for freedom of research, the possibility of a combine of democratic powers for control



of the weapon, and most importantly, an understanding with the Soviet Union. Oppenheimer saw the primary need for an extremely broad program that would blanket any future developments in the field. An extension of the MED seemed advisable for a time, although Compton felt it was necessary to begin preparations to replace it. The concern over the use of the weapon brought out other ideas which related to the philosophies of postwar control. Many felt that since the future of the world would rest on international control of the weapon, any attempt to use the weapon directly against Japan could only jeopardize postwar cooperation. They felt that military tacticians alone should not be responsible for the decision to use the weapon, and that even from the isolated viewpoint of winning the war itself, bombing Japan was undesirable. However, these questions were weighed against the military questions involved, and the decision was made to use the weapon directly against the enemy. Szilard made one last try to alter this decision with a petition from the scientists, but to no avail. The 509th Composite Wing was ordered to attack Japan with the weapon on the earliest possible date.

On August 6, 1945 the weapon destroyed Hiroshima and, shortly after, Nagasaki. The Japanese surrender followed three days later. Other than brief comments by the President and Secretary Stimson, the first public release of information concerning the MED appeared in the Smyth report,<sup>11</sup> a semi-scientific account of much of the previous four years prepared by Henry Smyth at the request of the President. One of the keys to the issue of postwar control was stated in the preface of the report: "the ultimate responsibility rests with the citizens of the United States. The people of the country must be informed if they are to discharge their responsibilities wisely."<sup>11</sup> They alone had to decide the future of the weapon and the role it would play in the postwar world.

#### 4.2 Postwar Activities - The Atomic Energy Commission

##### DOMESTIC LEGISLATION

The pressure had been on the Interim Committee to study postwar domestic control long before Japan had surrendered. Bush and Conant had suggested that a 12-man commission composed of scientists and military officers be established. The need for comprehensive federal control was stressed since even relatively small-scale nuclear experiments could

be extremely dangerous. They urged the Interim Committee to continue the study of international control, since any attempt to formulate domestic policies had to be compatible with international plans.

Kenneth C. Royall and William L. Marbury, lawyers with the War Department, were assigned the task of drawing up a preliminary draft for a 9-man part-time commission to be assisted in its work by various advisory committees. It would be granted the sweeping powers Bush, Conant, and Oppenheimer had considered so vital, and most activities outside of the commission's control would be prohibited. The commission would also receive the benefits of political isolation. However, members of the Interim Committee noticed faults with the plan. There was a worry about restriction and over-control of research. The plan bore many similarities to a wartime operation--an extension of the Military Policy Committee itself. Before the Interim Committee could agree on revisions, however, the weapon was dropped on Hiroshima and the wartime program became a public issue.

Royall and Marbury were quick to get the State Department to agree to help sponsor their proposals. But as the War Department worked to get its bill presented, forces were beginning to swell within the MED itself to counter the effort. Scientists had become more and more irritated at the failure of the Army to consult them on their own ideas. The continued security regulations after V-J day only served to compound this frustration. Groves asked the scientists to confine their discussion to private circles in order not to jeopardize the War Department's proposals. The scientists felt no inclination to comply, however, since they didn't even know what these proposals were. The first of the movements towards the organization of scientific opinion began with the foundation of the Atomic Scientists of Chicago in September, 1945.

The Marbury-Royall proposal gained momentum within the War Department as Robert Patterson took over from Secretary Stimson. Sen. Edwin Johnson and Rep. Andrew May agreed to introduce a bill in their respective houses, hoping to get the measure referred to the Military Affairs Committee. Although May succeeded, Johnson's attempt in the Senate was blocked by Sen. Vandenberg on October 4 and was eventually referred to a special

committee under Sen. Brien McMahon of Connecticut. Later the House committee got bogged down over the proposal when several members objected to the proposed commission's exemption from congressional influence. The hope for quick action had been dimmed before the measure had gotten off the ground. The bill was hopelessly ensnarled in congressional committees.

The scientists were alarmed by the May-Johnson bill and kept a steady stream of public opposition directed towards it. The Army was charged with attempting to ram the bill through Congress. The Army, on the other hand, blamed the scientists for thwarting the bill's passage, but the real barriers lay much deeper within the changing American attitude towards the military after the war. Years of rationing and regulation had created a suspicion of the intentions of the armed services which would have blocked any proposal for atomic legislation initiated by the War Department.



With the May-Johnson bill entangled in Congress, forces within the administration went to work. James R. Newman of the Office of War Mobilization and Recovery realized that the struggle in Congress represented the first attempt to incorporate an incredibly dangerous and mysterious force into the life of the nation. The May-Johnson bill had overemphasized the military aspects of atomic power. The peacetime uses of the atom deserved much more consideration than they had received. They would require that the commission be composed of men with varied backgrounds. It was also desirable to have a full-time commission appointed by the President, thus putting atomic control under the executive branch of the government. The President, as well as other sources within the administration felt as Newman did, and on October 23, 1945, Truman officially withdrew his support from the May-Johnson bill.<sup>12</sup>

In the meantime, the May committee had adjourned with only a majority report. The Senate Special Committee on Atomic Energy, proposed and chaired by Sen. McMahon, seemed like the ideal place to introduce the administration's ideas. Newman began work with Byron S. Miller on a new draft while McMahon began the critical task of educating his committee in the matter over which they were considering legislation.

The draft prepared by Newman and Miller proposed a commission of nine appointed by the President with a full range of powers. The commission would have the responsibility and power to encourage and support atomic research, but not to control it. To limit control over research and yet ensure adequate power over production, the commission was given control over all production and use of fissionable materials. This also limited its powers to impose and enforce security regulations which had worried scientists. Contracts and licensing became the method of controlling private activities within the security area.

Attacks were organized against the May-Johnson bill concentrating on the vaguely defined powers and congressional independence of its proposed commission. The scientists continued to develop national lobbies and put their power behind Newman and McMahon. The showdown was quick in coming.

McMahon requested that his committee have access to classified information; Groves refused. Although Truman eventually backed Groves in his decision, McMahon became infuriated. Newman now shifted to demanding complete military exclusion from the commission. In its testimony before the McMahon committee, the military countered with an attack upon the qualifications of full-time commissioners, the advisability of excluding the military in the light of national security, and the absolute monopoly on fissionable materials recommended by the McMahon proposal. However, public sentiment was against the military. McMahon and Newman continued to work on their proposal, and on December 20, McMahon introduced their result as a bill similar in content to the earlier Newman-Miller drafts which proposed that a commission of five be appointed by the President with advisory committees in the areas of research, production, materials, and military application. The scientists were quite pleased with this bill, particularly since it seemed compatible with their proposals for international control.

The battle lines over the McMahon bill seemed quite clear--at least on the surface. The newspapers exploited the civilian vs. military issue by warning of the danger of military control. Much of the bitterness voiced by the scientists was directed personally against Groves who seemed to embody all of the restrictions that had annoyed



them so much during the war years. Supporters of the McMahon bill saw opportunities to use the issue to direct public sentiment behind their measure. They stressed civilian supremacy as a first principle of American government. With the administration falling in behind the measure and Henry Wallace joining in the fire directed at the military, McMahon seemed to have attained the desired public support for his bill.

Yet the same theatrics concerning the civilian-military controversy that had attracted public support on the outside, tended to turn the conservative members of McMahon's committee against him. The idea of complete military exclusion seemed ridiculous. There was additional concern over the approach to patents and security. Although the committee proved receptive to the ideas of such a monopoly of fissionable materials in a free enterprise system because they anticipated the spectacular innovations atomic energy could bring, they were stubborn on the civilian-military issue.<sup>14</sup>

Patterson presented the War Department's criticisms of the McMahon bill in a report to Truman. Although this was suppressed within the administration, Patterson skillfully used Truman's own interpretations of the proposal to swing the tide against McMahon. The Army's position gained back public sentiment with the Pontecorvo spy affair.<sup>15</sup> People even began to see an argument for retaining Groves' security system, and eventually the general was invited to speak before McMahon's committee. Although McMahon badgered Groves, he only succeeded in turning more of the committee against himself. Military exclusion was doomed. National security demanded military participation, and all of the pressure McMahon and the scientists brought against the committee was in vain.

Vandenberg introduced an amendment establishing a military liaison board to review commission activities and with a right of appeal to the President. McMahon tried to defeat this, but after heavy failure, decided to seek a compromise. The Vandenberg Amendment was passed, although the military board was limited to review of military matters and appeal only to the Secretaries of War and State. Although the scientists continued to protest, many thought that the military issue had just served as a scapegoat. The amended bill was introduced and passed unanimously by the Senate on June 1, 1946.

The bill ran into difficulty in the House, as many on the Military Affairs Committee were against any governmental control. Although the House proceeded to cripple the Senate's bill with amendments, it was eventually passed and referred back to a special inter-house committee.

In committee, both Houses agreed to compromise. An amendment on international exchange of information was tempered to allow industrial information exchange while the Senate version of the patent policy (using an "exclusion" clause on restricted discoveries) was accepted. The Vandenberg Amendment was also agreed upon with the final commission being civilian with the military liaison board acting as advisors. The bill was finally sent to the President and signed into law on August 1, 1946. As the drafters of the legislation remarked, "Never before in the peacetime history of the United States has Congress established an administrative agency vested with such sweeping authority and entrusted with such portentous responsibilities. The Act creates a government monopoly of the sources of atomic energy and buttresses this position with a variety of broad governmental powers and prohibitions on private activity. The field of atomic energy is made an island of socialism in the midst of a free enterprise economy".<sup>16</sup>

With the enactment of the McMahon bill and the appointment of the first commissioners, a new era in the domestic control of the atomic energy program had dawned. But before actual transfer from the MED to the Atomic Energy Commission could occur, many preparations and decisions were necessary. The MED was instructed to continue its supervision of the program in the meantime until such a transfer could be effected. Yet since the end of the war, Groves had been struggling to keep the wartime machinery intact during the struggle over domestic legislation.

Production had settled into a routine with more and more material being prepared at Oak Ridge and Hanford. However, trouble had developed at the strategic research centers in Chicago and Los Alamos. The scientists were leaving for better positions now that they felt their duty had been completed. The production and design of weapons had slowed almost to a standstill. Groves realized that definite plans had to be made quickly to save the program even though these might result in commitments severely restricting the future commission. Although the production

complex retained top priority, improvements were desperately needed at Los Alamos. Groves appointed a new director of the laboratory and authorized work on "super", the thermonuclear weapon, to provide the laboratory with a new goal. Both housing and research facilities were also improved on a much more permanent basis.<sup>17</sup> Groves made commitments to the expansion of research with new laboratories at Brookhaven, L.I., Argonne, Illinois, and a proposed laboratory in northern California. By October, 1946, although the MED had suffered, it was apparent that Groves had done remarkably well in preserving the wartime machinery.

#### TRANSFER

We have seen the sweeping powers that were granted to the directors of the atomic energy program both during and after the war. It is evident that the personalities and philosophies of these men would be reflected in the policies pursued in the program. Perhaps one of the most effective approaches to analyzing the transition between military and civilian control lies in a comparison of the men that directed the atomic program during these crucial times. In Gen. Leslie Groves and David Lilienthal, we have embodied most of the contrast and most of the change that took place in the months of transition from the Manhattan Engineering District to the Atomic Energy Commission.

The success of the wartime program was ample evidence of the effectiveness of Groves' leadership. His form of rigid military discipline had worked well during the war years. He himself attributed the success and efficiency of the MED to compartmentalization, the clear-cut direction of authority, and the benefit of a clearly defined specific objective and a specific task.<sup>18</sup> The MED had become an extremely powerful and efficient machine by mid 1945. Yet we have also seen the problems Groves ran into following the war while Congress battled over domestic atomic legislation.

It was particularly fortunate that the first civilian chairman of the AEC had strength and purpose similar in intensity to that of Gen. Groves. David Lilienthal had been well-versed in the control of mammoth federal enterprises during his years as director of the TVA. His service as chairman of an earlier advisory panel on atomic energy had equipped him with much of the necessary knowledge and insight into the program.



Probably no other person in the country was more suitably prepared to take over the reins from Groves and effect the transition from military to civilian control.

And yet perhaps because of his indirect relationship to the problems faced by Groves, Lilienthal developed a broader perspective of the future role of the commission. One can see his TVA heritage in his early thoughts on control: "Industry will try to get control and at first will be successful. But as it goes on, it will be clear that no such control over the destinies of us all can be left in the hands of private corporations".<sup>19</sup> Since the first time that he had heard the incredible story of the MED, he had realized that the director of the atomic energy program was probably to be one of the most powerful men in the world. He recognized the extremely important consequences of the peaceful uses of atomic power, the silver lining in the nuclear cloud. Perhaps most important, however, was his belief that "Atomic energy development is more important as a stimulus to the imagination, an awakening force, than are any of its foreseeable applications".<sup>20</sup>

Both Groves and Lilienthal were extremely dedicated and dynamic men. Yet many of their ideas on methods of domestic control were incompatible. It was only natural that conflict would develop during the transition period between the MED and the AEC.

With nothing but press support and an excellent array of commissioners, the AEC began the preparations for transfer late in 1946. At the first meeting of the commission on October 29, Lilienthal expressed his feelings, "The last words of the oath of office which each of us has taken are these, 'So help me God'. These words were never more appropriately used. So help us God. We will need that help".<sup>21</sup> After a brief period of initial orientation, the commission began planning for transfer from the MED. Both Lilienthal and President Truman realized that it was very important to get the whole business in civilian hands quickly to quiet for fears stirred up during the congressional battle over legislation. Lilienthal felt that the "only way to learn to swim is to get wet", and thus the commission set transfer for December 31, 1946 and requested Groves to prepare an accounting of the MED's holdings.<sup>22</sup> Groves indicated that such an accounting would be impossible. He became more and more irritated at



the idea of holding responsibility while carrying out the decisions of the commission.

Conflict between the MED and AEC came to a climax when Groves raised the issue of weapon custody. The Army wished to retain its weapon stockpile and assembly facilities. After initial discussion, the AEC finally demanded complete transfer, subject to Presidential order. Other disagreements occurred over the issues of personnel security and information control. The AEC desired a complete break with the MED and worked vigorously to this end. Yet on the night of December 31, 1946 transfer occurred smoothly and on schedule. The AEC had inherited "a carefully conceived, well-organized system". The new era in domestic control had dawned without event.

But when transfer occurred, the status of the American atomic energy program was actually in a rather advanced state of decay. Stockpiles of nuclear weapons were surprisingly small, due to a lack of critical parts and men who could assemble them. There were few, if any, nuclear weapons immediately available for use.

Even with transfer completed, the battle over domestic control was far from over. The AEC had created many enemies during its formation, and these enemies were to continue to harass it and block its actions in every possible way. By early February, Lilienthal was discouraged and weary, fearing that the military would continue to cut the ground from under the commission while continuing to criticize and condemn it. With the mood of the American people approaching that which had existed shortly after World War I, the danger of a "Red Scare" concerning the AEC became even more menacing.

The flames of this unrest were fanned by Lilienthal's personal enemies in the Senate. The essence of the struggle was to continue through the first years of the commission. Problems came from other quarters as well. It was extremely difficult to recruit qualified personnel for the commission's operation because of the pay and working conditions. Many of the AEC's activities as prescribed by law were incompatible with hopes for international control. Lilienthal saw the irony in this situation when he wrote "It was our purpose to maintain

IT'S ANOTHER AFTERNOON AT THE ADMISSIONS OFFICE. AS ALAN THE AMAZING ADMISSIONS OFFICER CONTINUES WITH HIS CONTROVERSIAL NEW SCREENING PROCESS THAT ALLOWS US TO ACCEPT OR REJECT BORDERLINE CASES..



4-7

AH, MRS. WASSERMAN... IF THE NEXT CANDIDATE IS READY, COULD YOU PLEASE SEND HER IN.



HI! I WANT TO... COME TO MICHIGAN!



ACCEPT.



GBTmdean

and increase the lead of the United States, whereas the international agency, if established, would take over all aspects of national agencies' activities in this field that related to weapons".<sup>23</sup>

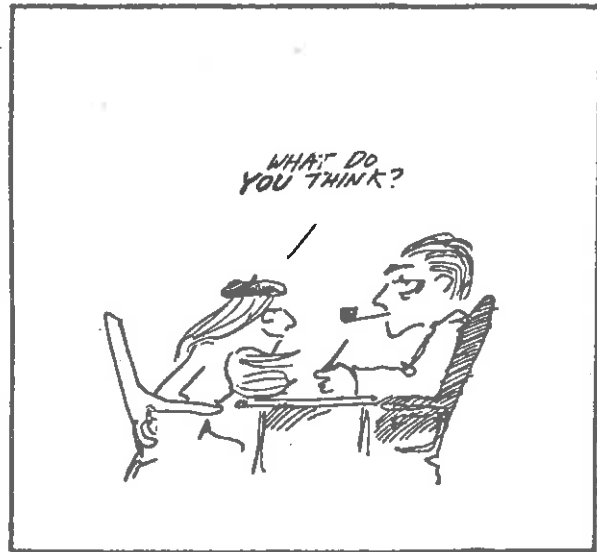
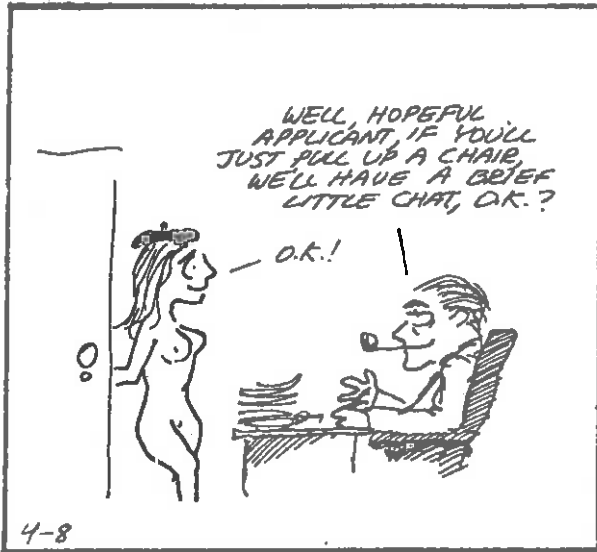
But the outstanding problem faced by the fledgling commission was that of the temper of the country itself. Lilienthal recognized the vital importance of public awareness. The image presented by the AEC to the people of the country would determine much of its success in the future. As Henry Smyth had noted in his report,<sup>24</sup> the public had to be informed if it were to act wisely in future issues of atomic control. And fears could only be quieted by knowledge.

The new body of control, the Atomic Energy Commission, was the first attempt at a new type of civilian control bordering on totalitarianism. It was only natural that it would experience many failures. The problems it faced were tremendous in scope, ranging from the internal problems of recruiting qualified personnel to combating the suspicions of the American people themselves. Although the AEC had the advantage of competent leaders, its future was still very much a questionmark in 1947.

Perhaps if there is any one thread that can pull the history of domestic atomic control together, it would be suggested in an idea of David Lilienthal's. To Lilienthal the entire issue of domestic control of science had the earmarks of earlier struggles over economic and social control such as the Populist and Progressive movements. However, "perhaps even the question of who shall 'control' science is no longer greatly relevant as the center of a struggle, for the control before was a matter of possession. But technology can only be controlled by those who know, rather than by those who possess".<sup>25</sup> Henry Smyth had agreed that the key to civilian control was knowledge. Yet it was paradoxical that the nature of the early program itself prevented the public from attaining the state of knowledge necessary to "discharge their responsibilities wisely".<sup>26</sup>

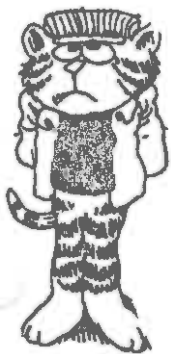
#### TRANSITION TO A PEACETIME PROGRAM

In the years following World War II, American faced the complicated task of converting her wartime atomic weapons program into comprehensive peacetime activities directed toward general atomic energy development.



This development was to be concentrated in three areas: weapons, power, and scientific tools. The Atomic Energy Act of 1946 created the Atomic Energy Commission to design and administer the peacetime program and bestowed enormous powers to continue the wartime monopoly of fissionable materials and production facilities. And although the Act had created ties between the AEC and Congress through the Joint Committee on Atomic Energy (JCAE), the military through the Military Liason Committee (MLC), and the executive branch through a system of Presidential appointment of commissions coupled with other specific powers, the civilian Commission operated, in fact, as a relatively autonomous entity in its formulation and direction of atomic policy matters within this country. Since "in essence, the [American] approach to the postwar atom was one of rigid government control administered by civilian officials",<sup>27</sup> one needs to concentrate primarily upon the development of the Commission itself to follow the postwar development of domestic administration and control of atomic energy.

The problems of transition to a peacetime program were particularly complicated by the dual role which atomic energy had to play in the American society. Men had long recognized the importance of developing the peaceful side of the atom even though such development was closely related to weapon technology. But because of the continuing threat of war after 1946, there were many questions concerning the relative importance of the benign applications of atomic energy. Chairman Lilienthal had stated that "every new knowledge raises a question of its net worth; in the case of atomic energy we have such a huge addition to knowledge of our environment, such an increase in our control over it, and chief of all, such a stimulus to more understanding, that the balance of the useful or beneficial will almost certainly outweigh the nonbeneficial or destructive".<sup>28</sup> But in those early years after the war, he was forced to admit that the most important single aspect would have to remain the military program. The dominating role of weapon development in our atomic energy program has never changed. The threat of nuclear war has never vanished-- and the peaceful uses of the atom have never become the "paramount objective" of our domestic atomic energy program. Secondary though it was, however, the program to develop the peaceful aspects of the atom grew to a position of considerable importance affecting our national development and security.



## MILITARY PARTICIPATION IN NUCLEAR WEAPONS DEVELOPMENT

The primary responsibility of the AEC during its early years was to maintain and improve the vast weapon development facilities inherited from the Manhattan Engineering District. Of central importance to the success of the AEC in this venture was its relationship with the military. The nature of this relationship was the subject of much controversy during the late 1940's and early 1950's.

The civilian vs. military control issue had received much attention during the Congressional struggle over the McMahon bill. Yet it soon became apparent that most of this debate was not concerned with who should run the program--it was generally felt that civilian control was desirable--but rather the extent of military participation in the formulation of nuclear policy and weapon development. The Vandenberg Amendment had established the Military Liaison Committee to provide for communication between the military and the AEC. The intent was that the Joint Chiefs of Staff would determine their military needs, communicate these to the President, and then he, in turn, would issue a directive to the Commission specifying the number and types of weapons desired. All details concerned with the actual development, production, and custody of nuclear weapons were to remain under the jurisdiction of the AEC, subject to special Presidential order.

There were several factors working against such an arrangement, however. Many Americans realized that because of the volatile nature of world politics following the war, we would never again be able to retreat into the isolationism of the 1920's and 1930's. The necessity of a military establishment capable of rapid mobilization became apparent. Thus the military came to achieve a position of prominence it had never before held in peacetime American society. Its increased participation in all facets of national policy was unlike any ever before experienced by an American government in times of peace. Thus it is easy to see why the military came to question its role of responsibility without authority in its relationship with the AEC. The military had directed the atomic program in the years of the Manhattan District, and yet in the late 1940's they had been forced to relinquish most of their control over atomic development and policy decisions.

Men such as General Leslie Groves did little to ease the situation. On several occasions the commissioners found themselves at odds with the former director of the MED. Groves retained his influence with the atomic energy program through positions on the MLC and the Armed Forces Special Weapons Project. He frequently opposed the decisions made by the AEC and seemed to be of the honest opinion that the Commission was "no damn good".<sup>29</sup> The antagonism between the General and the Commission was symptomatic of the tension between the military and the AEC in 1947 and 1948.

The military seemed unable to remain within the limits of its authority as prescribed by the Atomic Energy Act of 1946. "Too frequently the military was suggesting not simply WHAT the AEC should do, but also HOW it should be done".<sup>30</sup> This was resisted vigorously by the Commission since it had become clear that the AEC could best conduct its production duties without military interference. Lilienthal had long felt that the military conception of the bomb was also at fault. To them, it seemed like just another weapon. Secretary of Defense Louis Johnson and others seemed to regard the Commission as simply "munition makers".

When the issue of weapon custody flared up again in 1948, many of the issues and problems surrounding the AEC-military relationship were revealed. The military had been pressing for custody of the weapon since the end of the war. This wasn't an easy question to resolve. Many felt the important issue of civilian control was involved. Indeed, it seemed as if perhaps the more general issue of civilian participation in any military policy had been involved by statements from Secretary Johnson such as "A unanimous military judgement of the Joint Chiefs is something the President HAS to follow".<sup>31</sup> Thus, even the nature of the President's role in military decisions was in need of clarification. A statement by President Truman in July, 1948 upheld the intention of the McMahon Act: "As long as I am in the White House, I will be opposed to taking atomic weapons away from the hands they are now in [AEC], and they will be delivered to the military by particular order of the President issued at the time when they are needed".<sup>32</sup>

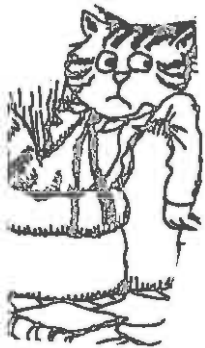
The debate continued, however, and eventually reached a climax at a meeting between the military, the AEC, and the President on July 21, 1948. The most interesting (and amusing) account of this meeting is given by Lilienthal himself. During the discussion he had emphasized the risk involved in any change in the current system of custody. President Truman remarked, "You have to understand that the bomb isn't a military weapon". It was a weapon to be directed against civilian personnel, not troops. However, Secretary of the Air Force Symington appealed, "Our fellas need to get used to handling it...Yeah, our fellas, they let them take out bombs without the hot stuff; afraid of a real bomb, I guess". Secretary of the Army Royall topped off the argument for military custody with "We have been spending 98% of all money for atomic energy on weapons. Now if we aren't going to use them, that doesn't make any sense".<sup>35</sup>



President Truman later issued a public statement: "Since a free society places the civilian authority above the military power, the control of atomic energy properly belongs in civilian hands".

However in 1950 the Department of Defense and the AEC agreed to assign prominent roles in the design of non-nuclear weapon components to the military. As the size and character of the weapon stockpile continued to change, it became necessary to re-evaluate the custody issue again in 1952. As weapons development branched out to include tactical nuclear weapons, it became desirable to locate stockpiles closer to utilization points to facilitate military readiness capability. Although the AEC still opposed outright military custody, it did agree to transfer weapons to storage sites abroad or to advanced delivery bases under AEC custody and responsibility.

With the increasing development of tactical weapons and more advanced delivery systems, it eventually became necessary to disperse weapons to an extent resulting in effective military custody. Yet ultimate control over these weapons still rested with the Commission, and decisions concerning their use could only come from the President. Control of the weapons thus continued to remain in civilian hands during the late 1950's, although the weapons themselves were gradually integrated into the military arsenals.





The basic goal of the United States postwar nuclear weapons program was intended to be the retention of the American monopoly of atomic weapons until an international control system had been established. However in 1949 this goal and our national security were severely jeopardized by Soviet advances in nuclear weapon development.

Most accepted sources had placed the USSR from 10 to 20 years behind the United States in nuclear weapons technology. However, AEC Commissioner Lewis Strauss had been able to persuade the Commission to institute a nuclear explosion detection system involving atmospheric sampling shortly after the war. In August, 1949, one of these samples showed traces of "Joe One", the first Soviet atomic explosion. This was reported immediately to Sec. Johnson. However, the new Secretary was readying an effort to reduce military expenditures and being a strong proponent of the more pessimistic views of Russian technology, at first chose to disbelieve the report. The detection was quickly confirmed by the AEC, however, and President was informed, and subsequently the Soviet test was announced to the public.

"Joe One" had drastic effects on our military policy. Before the Russian device we had regarded our monopoly of nuclear weapons as a counter to Soviet troop buildups in Europe. Now the possibility of a Russian stockpile of strategic weapons endangered our military position. This prompted Strauss to renew the issue of thermonuclear weapon development (the "super") and reach the conclusion that development should be initiated immediately. Yet this topic had been a much debated issue in earlier years, and thus when Strauss presented his recommendation in 1949, the AEC voted against it. As Chairman Lilienthal said, "I am one who hates force and has no faith in military power as a solution to anything." <sup>34</sup>

#### THE SUPER

As early as 1942, a number of American physicists including Fermi, Oppenheimer, and Teller suspected that a potentially more powerful nuclear reaction involving the fusion of light isotopes (as opposed to the fission of heavy isotopes) might be possible. It was known that if two light nuclei such as deuterium could be slammed hard enough together, they would fuse into a heavier nucleus such as helium, emitting energy in

the process. The only problem was that one had to slam the two nuclei together hard enough to overcome the repulsion between their positive electrical charges (in sharp contrast to a nuclear fission reaction in which one merely has to let a neutron wander close enough to a uranium nucleus to be gobbled up). But recall from Chapter 3 that the temperature of a material is a measure of how rapidly the atoms in the material are moving about. Hence it was suspected that if one could heat a suitable fuel of light isotopes up to high temperatures, then the nuclei of the fuel might attain speeds sufficient to induce fusion reactions when they collided with one another.

Unfortunately, the temperatures required for such "thermonuclear fusion reactions" to occur were known to be of the order of several hundred-million degrees. To heat the fuel to this enormous temperature before it blew itself apart would require an extraordinary source of energy--and the only obvious candidate was a fission bomb. Hence, it was decided during 1942 to mothball the idea of a thermonuclear weapon and proceed ahead with the development of a fission weapon first.

Although a very low level of effort on the "super" weapon, as it was called, continued after WWII, there was a considerable amount of disagreement within the scientific community on whether such a weapon should be developed.

The principal opposition to "super" came from the atomic scientists themselves. Robert Oppenheimer voiced the feelings of many when he said, "In some crude sense, which no vulgarity, no humor, no overstatement can quite extinguish, the physicists have known sin and this is a knowledge which they cannot lose".<sup>35</sup> He and others suspected that the weapon was possible, but as the General Advisory Committee of the AEC reported on November 29, 1949, "We all hope that by one means or another, the development of these weapons can be avoided. We are all reluctant to see the United States take the initiative in precipitating this development. We are all agreed that it would be wrong at the present moment to commit ourselves to all-out efforts toward its development."<sup>36</sup>

Backing Strauss, however, were scientists such as Edward Teller and J. O. Lawrence. Strauss turned to the DOD and Johnson to mobilize opinion,

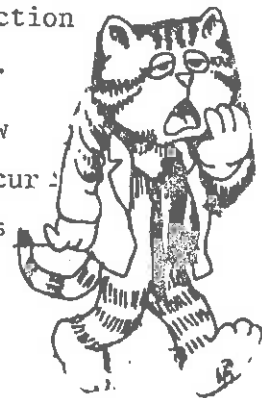
while Sen McMahon, another advocate of the "super" program, convinced the JCAE. When Truman learned of the conflicting views of the AEC on one hand and the DOD and JCAE on the other, he asked the special committee of the National Security Council to study the question further.

As fate would have it, the Fuchs spy incident occurred on January 27, 1950 while this study was in progress. The special committee decided 2 to 1 against Lilienthal to advise the President to direct commencement of the thermonuclear program. Truman agreed, and on January 31, 1950, made a public announcement to that effect. The battle was far from over, however. Sentiment at Los Alamos was strongly opposed to the weapon. Teller recognized that many technical problems had to be overcome before the weapon could be built, and these problems could be surmounted only by a concerted effort on the part of the atomic scientists. Among these technical problems was that of determining the design of a "dry" weapon, one that wouldn't require massive refrigeration components to keep the deuterium-tritium (D-T) fuel for the thermonuclear reaction in liquid form.

However, development proceeded with the immediate goal as Operation Greenhouse, the Pacific test of the D-T trigger itself. Many felt that if this test failed, the entire program would be abandoned. This feeling arose from claims that the "super" program was interfering with the effort to develop tactical weapons at Los Alamos. However, the Greenhouse test was a complete success in May, 1951 and demonstrated the essential feasibility of thermonuclear explosions.

As the program to develop the super shifted into high gear, it soon became apparent that the original idea of using a fission bomb to ignite a fusion chain reaction in a deuterium-tritium fuel would not work since the deuterium-tritium fusion reaction releases some 70% of its energy in the form of neutrons which would not readily transfer this energy to ignite adjacent fuel material. It was felt that such a fusion reaction would quickly die out after ignition before much fuel was consumed.

However, in 1951, Teller and Stanislaw Ulam came up with a new idea, "a brilliant discovery--a stroke of genius which does not occur in the normal development of ideas" which overcame the difficulties inherent in the original approach.



Concern about the growing friction at Los Alamos had prompted Teller to press for a new laboratory in which to continue the work. After three refusals from the GAC and AEC, pressure behind Teller overcame objections and the Livermore division of the Lawrence Radiation Laboratory was set up. Its main function was regarded by many as merely spurring Los Alamos on through competition, since the latter laboratory eventually completed most of the development work on the hydrogen bomb.

On November 1, 1952 the "Mike" shot was detonated at Eniwetok. This was the first true thermonuclear device and was of 3 megaton (MT) magnitude. It was still not a "dry" weapon, however, although the concept of using LiD solid fuel in the weapon and then relying on fission neutrons to transmute Li into tritium to supply the fuel for D-T fusion reactions was well known at this time. Soon afterwards on August 12, 1953 the United States detected a Soviet blast of thermonuclear nature. Analysis later showed the Soviet weapon to be of the "dry" variety. For the first time the United States faced the prospect that she might possibly be behind in the weapons race. The United States tested her first dry weapon in Operation Castle in March, 1954. The magnitude was miscalculated, and the device resulted in an explosion of 15 MT. However, never again could the United States assume a technical advantage in nuclear weapons development. Although many considered as fortunate indeed the set of circumstances that enabled us to develop our thermonuclear weapon before the Soviets had gained an actual weapons advantage, it appears in retrospect that a decision to forego immediate development of thermonuclear weapons without first attempting to negotiate a ban on their development with the Soviet Union was probably incorrect.<sup>37a</sup> Our stockpile of fission type weapons was sufficiently large to counter any Soviet breakthrough on thermonuclear weapons for a sufficient time to allow our own program to be developed at a later stage. Furthermore, the development of thermonuclear weapons was not as significant as it seemed at the time, since the evolution of ICBM delivery systems has placed a premium on small warheads. Finally, even though it is uncertain whether an overture to Stalin in 1950 to discuss nuclear arms limitations would have had any effect, at least it would have opened such a dialogue some ten years earlier, long before massive commitments to strategic nuclear weapons had been made.

The development of the thermonuclear weapon was a "milestone" of sorts in our nuclear weapons program. Perhaps an even more significant development began during 1951 and has continued throughout most of our weapon development to date. This was the "third generation" of nuclear weapons, the tactical or antipersonnel weapon. Scientists had broken through the size limitations on weapons. During the 1950's, they began developing "fractional crit" bombs in the low kiloton range. Although this paper is not directly concerned with military strategy, the strategic implications of the tactical weapon are obvious. Prior to their development, we had balanced our stockpile of strategic weapons against the Soviet troop buildup. With the Soviet nuclear weapon stockpile, the stalemate disappeared since our conventional military forces had been reduced to a fraction of their wartime strength. The tactical weapon brought us into a position of balance once more since it could be used (or so we hoped) in a "limited" war.

Weapons development was important in fields other than military strategy, however. With the billions of dollars spent and thousands of men employed within the atomic weapons program, changes in weapon production had powerful effects on the non-military sectors of the American society. The expansion of production facilities played an important role in the early 1950's. It was decided in 1950 to expand production facilities with new plants in Savannah River, S.C., Paducah, Ken., and enlargement of Oak Ridge, with three billion dollars in expenditures. Then in 1952, another plant was built in Portsmouth, Ohio and further modifications in existing facilities took place requiring four billion dollars. The motives behind these expansions were two-fold: the thermonuclear program and the desire for a more diverse family of tactical weapons. These programs, coupled with the desire to disperse weapon stockpiles--both for physical security and to have the weapons nearer points of use--greatly increased the demand for fissionable materials. These expansions were jointly requested by the DOD and the AEC with final approval coming from the NSC, thus illustrating the developing cooperation between the military and the Commission in the early 1950's.

The work on tactical weapons continued through the 1950's. The growing ICBM program prompted additional work aimed at reducing

weight-to-yield ratios for warheads. With growing interest in test ban negotiations, the Vela programs were instituted to study nuclear test detection methods. The nuclear weapon development program was then slowed down appreciably by the self-imposed moratorium on nuclear testing adopted by the United States in 1958. By 1960, the Commission and other agencies had become quite concerned about this policy. They felt that weapon development was on the verge of significant advances, yet these could only be achieved through testing. To adopt a unilateral ban on testing was to severely jeopardize our military position.<sup>38</sup>

Public attention during the early 1960's was still preoccupied with the so-called "missile gap" and focused upon delivery system aspects of the United States defense effort. Nuclear weapons development had gradually lost the notoriety it had attracted during the early stages of the thermo-nuclear weapons program. Indeed, there were many of the opinion that nuclear weapons had reached a point of technical stagnation and further developments would have relatively small military consequences. It was true that the self-imposed test moratorium had slowed down the weapons program, but the AEC's weapons laboratories at Los Alamos, Livermore, and Sandia continued work developing and modifying various weapons designs.

The new requirements of the Polaris and Minuteman programs created demands for small 0.5 MT warheads. These programs, coupled with demands for 5 MT devices for the Atlas and Titan systems, and other tactical and strategic needs kept the AEC production facilities occupied until early 1964. (At this time substantial reductions in  $\text{Pu}^{239}$  and  $\text{U}^{235}$  production rates were announced.) Actual weapons tests were begun again in April, 1962 with the Dominic Pacific test series shortly after the Russians resumed testing. This test series, consisting primarily of effects and proof-tests (of complete weapons systems), was particularly significant since it proved the feasibility of weapon design extrapolation. Weapons that had been designed using the maximum extrapolation possible from the data provided by the 1958 Hardtack test series were proof-tested and shown to be entirely satisfactory. This ability to extrapolate nuclear weapons design was to have particular significance after the limited test ban agreement in 1963. The Dominic series provided considerable data on the various "blackout" effects of nuclear radiation upon electronic



systems. The tests approached a level of sophistication far beyond any previous series of either the United States or the USSR and were indicative of the American progress in weapons technology.

Thus, when Secretary of Defense, Robert McNamara, testified before the Senate Foreign Relations Committee during the Test Ban Treaty hearings in 1963, he was able to state the "The net of the relevant factors is that the United States' nuclear forces is manifestly superior to the Soviet Union's". Warhead stockpiles had been increased 100% since 1960. And although the USSR appeared to have a slight edge in very high yield weapon technology, the United States was clearly superior in the weapons range below a few megatons. And even the slight Soviet lead in high yield weapons was not alarming since it had resulted from an AEC-DOD decision in the late 1950's to forego the development of high yield weapons because of their questionable military advantages over smaller nuclear weapons. The U.S. had performed many more tests and had developed a superior weapons capability in a spectrum extending from tens of MT down to sub-KT ranges.

Yet nuclear weapons development continued at a rapid pace. The continued effort towards increasing specific yield occupied much of the program. Work continued towards the development of "clean" weapons (devices creating negligible fallout) for tactical use. Effort was begun on the development of the anti-ballistic missile (ABM) warhead. And there was much discussion, at least in the press, concerning the feasibility of a fission-free fusion weapon, the "neutron bomb".<sup>39</sup>

Progress was made for the first time in the international control of nuclear weapons development with the Limited Test Ban Treaty of 1963. This agreement, prohibiting nuclear explosions in the atmosphere, outer space, and underwater, was signed in Moscow on August 5, 1963. The treaty was to have profound effects upon the development program of the AEC, and the congressional hearings concerning its ratification greatly illuminated the U.S. program in nuclear weapons development.

The advantages of the treaty were clear. McNamara testified that the test ban would retard the spread of nuclear weapons. He stressed that even undetected clandestine testing by the USSR would not alter the

present military balance, and that by limiting the Soviets to underground testing, we would prolong the duration of our own technological superiority.<sup>40</sup>

The test ban did pose several problems, however. McNamara himself recognized the risk of euphoria such as that which had occurred during the 1958 to 1960 period when the nation had relaxed its atmospheric test capability. Many critics of the treaty raised technical questions concerning the development of high-yield weapons, an ABM warhead, the continued strength of our weapons laboratories, and ill effects on peaceful programs like Plowshare. McNamara and others testified that the ABM warheads could be developed through underground testing, while the military position on high-yield weapons was still against their development (although he indicated that we already had the technology to develop a 60 MT weapon). It would be necessary to maintain strong programs in the laboratories as well as a capability for rapid resumption of atmospheric testing should the treaty be violated. Programs such as Plowshare would contribute to the laboratories' vitality when coupled with a vigorous program in underground weapons testing.

There were other worries, however. Dr. John S. Foster, Director of the Livermore Laboratory, testified that<sup>41</sup> "Without atmospheric testing, I doubt that we can develop and maintain the requisite skill in the important area of effects of nuclear weapons". Dr. Edward Teller suggested that the treaty would prevent ABM development, raise barriers between the U.S. and her allies, and inhibit the development of peaceful uses of atomic energy.<sup>42</sup> But these criticisms of the treaty were outweighed by considerations such as those contained in a letter from America's Nobel Laureates, "We believe that this treaty marks a significant, if minimal, first step in reducing the tensions of a continued nuclear arms race, thereby enhancing the security of the United States". The majority of those concerned were led to the same conclusions as Dr. Norris Bradbury, Director of Los Alamos, "I am of the opinion and belief that the proposed treaty banning nuclear tests in the atmosphere, space, and underwater may be ratified by the Senate with only mild risks to our national defense posture, but with the possibility of taking the first real, even if small, step in the direction of the prevention of a nuclear war".<sup>44</sup>

NOTE: Additional material will be inserted covering the period from 1965-1975.

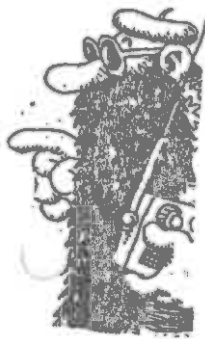


The preoccupation of the atomic energy program with nuclear weapons development during its first two decades gave rise to broad secrecy requirements and inadequate publicity that isolated the program from the public. It was in the area of policy issues that the public's lack of information was most disturbing. "Instead of man controlling the atom, the atom had threatened to control man".<sup>45</sup> But were the demands for secrecy so great as to jeopardize public opinion and control in atomic energy matters?

Unfortunately in the post-war years, they were. It was many times impossible to give information to the public without also giving it to those who could use it against us. "The objective is to give out certain basic information upon which reasonable and responsible people can reach valid conclusions and withhold information that would help out possible enemies more than it would help us" said Commissioner Gordon Dean.<sup>46</sup> But in tying the hands of the enemy, we sometimes tied our own. The "need to know" principle many times kept information from people in positions of responsibility in the atomic energy program itself, thus creating perplexing problems and mistakes. Examples were numerous. Lilienthal frequently described situations where numbers were so secret that they were communicated by word of mouth alone and never written down. Even General MacArthur had very vague knowledge of our atomic capabilities during his Korean campaign.

There was much disagreement and debate over the value of such secrecy. During hearings before the JCAE, Lilienthal remarked that any effort to suppress or to conceal information that was not concerned with weapons would lead the nation in a very dangerous direction. "The chance of keeping the important core of secrecy inviolate depends upon not discrediting and making foolish the whole system of secrecy".<sup>47</sup> He called the notion that atomic energy was too "technical" or secret for public information and discussion "plain nonsense and dangerous nonsense". Yet until the public knew more, they could not understand why secrecy was, at times, such an illusion and hobble. Misinformation and sensationalism ruled. The public was being scared more by the press than they ever were by the Russians. Secrecy had still other adverse effects. Since the McMahon Act all information exchange between the U.S. and her

NO TIME  
TO LOSE??



wartime allies had been forbidden, causing tension between the U.S. and the United Kingdom. Yet because of laxness in the British security system, we felt that there was a definite risk in exchanging information with them.

Many like Lewis Strauss saw these problems, but continued to remain in favor of secrecy. "When security is found to be excessive, it can always be relaxed".<sup>48</sup> But the converse was not always so true. However, others argued that secrecy was becoming a matter of illusion. Both the U.S. and the USSR were approaching similar levels of nuclear technology in the early 1950's. Spectacular lapses in personnel security such as the Fuchs and Pontecorvo spy incidents had damaged confidence in the system. Ambiguity in the portions of the 1946 Act concerned with personnel security inhaled an effective security system. Mountains of wartime classified documents threatened to engulf the AEC staff workers. Over one-half million people were investigated for security clearances in the first seven years of the Commission.

The temper of the early 1950's did not help the reorganization of this security system, however. McCarthy and others had created a national hysteria which hindered responsible action. The peak of the controversy over personnel security was focused in 1954 on the cancellation of Robert Oppenheimer's clearance for classified data. Since the years of dispute over the thermonuclear weapon program, Oppenheimer and other influential scientists who had opposed "super" had born the brunt of the attack from the program's supporters. Many feel today that the Oppenheimer hearing was an attempt to focus the "blame" for the delay in the United States' program on one man. However, there were other considerations involving Oppenheimer's personal affiliations which influenced the final decision against him. As Arthur Schlesinger wrote, "There is no easy answer to the conflict of principles between civil liberties and national security in the field of government employment".<sup>49</sup> Let it be said, however, that this hearing seemed to cast genuine doubts about the effectiveness of the personnel security system in the early 1950's.

#### ATOMIC POWER DEVELOPMENT

Since the early years of the atomic energy program, people had anticipated the beneficial potential of the atom. The responsibility

for developing this potential was assigned to the AEC by the Atomic Energy Act of 1946. The primary goal was that of atomic power, yet the difficulties that lay between this objective in 1946 and the first operation of a civilian power reactor some ten years later were very real and complex. The whole field of knowledge upon which reactor technology was based was strongly interlaced with our weapons program. There were many questions of reactor safety and regulation to be answered. Since the 1946 Act had given the Commission absolute monopoly over atomic materials, all of the early development work had to be conducted within the government program. Yet it was not until April, 1949 that the Commission was finally able to convince the Appropriations Committee that power development was a program of such importance that it had to be coupled with and coequal to weapon development. Thus, early progress toward Einstein's "almost certain" goal of atomic power was erratic, at best.

We have seen the basis of nuclear technology laid during the war years. From Fermi's first pile in Chicago, the MED progressed to the massive Hanford plutonium production reactors, and then on to more sophisticated designs for research. "By the end of the war era, there had been built, operated or studied by people within the United States nearly every kind of a reactor that anyone has ever thought of then or now"<sup>50</sup>. In 1946, the MED launched the first atomic power program with decisions to proceed with an early power design, the Daniels Pile, as well as establishing naval and air force military reactors projects. However, this program was reviewed by the AEC after its takeover in 1947 and eventually was halted because of growing pessimism concerning the possibility of achieving economically competitive atomic power. A decision was made to concentrate all reactor work at the Argonne Laboratories, thus uprooting existing facilities at Oak Ridge. It was not until 1948 that a new program was formulated. This involved work on a materials testing reactor, a land-based submarine reactor, an experimental breeder reactor, and design work on a full scale land-based power plant. These programs were all quite successful, although in several cases they duplicated the earlier MED work, as did an expansion in the program in 1950 which renewed work on the air force and naval reactor studies.

IT'S ABOUT TIME  
THIS CHAPTER  
WAS FINISHED!



To establish an atomic power program on a firm basis, it was recognized early that private industry must be allowed to enter the field. Prior to 1950, however, little had been done to attract the private sector. The 1946 Act had created a government monopoly in atomic development. The government also controlled the reactor market since most of the early reactor designs were for military power. The designers of the McMahon Act had recognized the desire to relax the government monopoly at a future date to allow for private development. Yet they failed to allow for the gradual entrance of private enterprise. The nation had yet to create a climate, both technical and legal, in which private atomic power development could be realized.

Further complicating the transfer to private development was the ever-present "private vs. public power" issue. Lilienthal had commented early that it was very important that big business not be allowed to get a stranglehold on this new great natural resource "as they did in electrical power". Intense as this debate was, however, it only tended to obscure the real issues. Because of the immense capital investments and technical experience necessary to enter the atomic power field, government assistance and subsidy was mandatory if a private atomic power industry were ever to be formed. To overcome private industry's fears of government monopoly in electric power and to introduce them to the atomic technology, the AEC issued an important statement in 1953: "It is the judgement of the Commission that now is the time to announce a positive policy designed to recognize the development of economic nuclear power as a national objective. An important element of this policy is to promote and encourage free competition and private investment in the developmental work, while at the same time accepting on the part of the government certain responsibilities for further technical progress in this field to provide a necessary basis for such development..."<sup>51</sup>.

A further important step was taken with the 1954 Atomic Energy Act. This Act allowed private ownership of nuclear materials and reactors and revised the patent laws to create higher personal incentives towards development; but the Eisenhower administration failed to follow it up with the necessary action-- and in many respects, simply slackened government efforts, thus slowing down progress toward a civilian atomic power industry.

During the 1953-58 period, the AEC made several new attempts to engage private industry in atomic power. Known as the Five-Year Program, this effort

consisted largely of small experimental reactors aimed to provide a basis for further technology, although it also included the authorization of a land-based civilian reactor at Shippingport, Pa., which later became our first full scale power reactor in 1957. A Power Demonstration Reactor Program was launched in 1955, and several completely privately financed proposals were entertained and approved. As final testimony to the willingness of the AEC to allow private development, Chairman Strauss discouraged legislation in 1956 aimed at authorizing the AEC to build and operate power plants.

In 1959, the Dresden power plant went critical while two other larger power facilities (Indian Point, N.Y. and Rowe, Mass.) were finished in 1960. The Commission continued its policy of developing prototypes while encouraging private industry to handle the major installations. Thus, by the end of the 1950's, the American atomic power program was broadened to include increased participation from private industry and appeared to have a sound technical foundation.

The evolution in nuclear reactor development from the rather primitive graphite-natural uranium pile constructed by Fermi to the enormous power reactors which generate much of the electricity used by the world today provides an excellent example of the various stages involved in taking a new technology from scientific feasibility through to economic viability. During the early period of nuclear power development there was quite a variety of reactor types which appeared to possess strong potential for commercial development. In Table I, we have listed 19 reactor concepts<sup>52</sup> which received attention during the 1950's. Millions of dollars were invested in the development of each of these systems, and, in fact, eleven of these reached the point where experimental reactors were built to demonstrate their technology. In many cases, the shortcomings which eliminated a concept from further study did not appear until rather late in its development program. For example, the organic liquid cooled reactor looked extremely attractive until it was discovered in an experimental reactor prototype that the organic coolant decomposed rather rapidly in the intense radiation field present in the reactor core. Efforts on most of the other reactor concepts were similarly abandoned as they encountered technical difficulties, although in many cases, rather considerable amounts of money and manpower were invested. The development of the majority of these reactor types was unsuccessful because of technical, economic, or political problems whose severity was underestimated or unknown during the early developmental stages.

**TABLE I**  
**YESTERDAY'S ADVANCED NUCLEAR SYSTEMS:**  
**REACTOR CONCEPTS**  
**PROPOSED IN LATE 1950's**

BWR	Single cycle; no steam generators or pressurizers
PWR	Closed radioactive loop; no radiation at turbine
Organic	Low induced radioactivity; little shielding, carbon steel
D <sub>2</sub> O	Low neutron absorption; natural uranium
Organic-D <sub>2</sub> O	Virtues of both organic and D <sub>2</sub> O
H <sub>2</sub> O-graphite	Tube type: no pressure vessel, monitor each assembly
Organic-graphite	Virtues of organic and graphite
Gas-graphite	High temperature, better safety
Supercritical D <sub>2</sub> O	High efficiency; good fuel economy
Sodium-graphite	Good neutron economy; good heat transfer, high efficiency
Sodium-D <sub>2</sub> O	Good heat transfer; good neutron economy
Homogeneous	No fuel fabrication; near breeder
Molten salt	No fuel fabrication
HTGR	High conversion ratio; use of thorium resource; high efficiency
H <sub>2</sub> O superheat	High efficiency
Steam breeder	Breeder with water coolant and component technology
Mixed-spectrum Superheater	Superheater combined virtues of LWR and breeder
Scott R	High efficiency, high conversion ratio
LMFBR	Infinite fuel supply

**TABLE II**  
**ECONOMIC POTENTIAL OF NUCLEAR**  
**POWER AS OF 1959 (FROM TID-8517)**  
**mills/kWh**

Reactor Type	Current	Potential
Pressurized water	9.28	7.80
Boiling water	9.61	7.45
Gas-cooled (enriched fuel)	10.36	7.98
Fast breeder	13.25	7.46
Heavy water	12.50	8.20
Light water, superheat	—	6.71
Organic-cooled	11.45	6.67
Sodium-graphite	11.22	7.42
Aqueous homogeneous	—	11.33
Gas-cooled (natural uranium)	11.89	—
Coal-fired plants:		
35¢/10 <sup>9</sup> Btu fuel cost (33¢/GJ)	7.0	
25¢/10 <sup>9</sup> Btu fuel cost (23.6¢/GJ)	6.0	



The list of potential commercial reactor types was eventually narrowed down to two light water reactor concepts: pressurized water reactors (PWR) and boiling water reactors (BWR). Certainly a very major factor in the success of the light water reactor program was the extensive technical experience acquired through the naval reactors program. The Shippingport nuclear power plant in Pennsylvania was the first demonstration power plant and used a pressurized water reactor which was very similar to that used in nuclear submarines, such as the Nautilus. Both Westinghouse and General Electric, in cooperation with the utility industry, built upon an extensive experience gained through the naval reactors program and the AEC test reactor program (such as the Experimental Boiling Water Reactor--EBWR) to build a series of demonstration plants, including the Yankee Rowe, Dresden I, and Indian Point I power plants which demonstrated the suitability of nuclear power for central station utility use, as well as demonstrating the capability of American industry to supply the necessary components. At the same time other reactor types were carried through to the demonstration plant stage, including the gas-cooled reactor (Peach Bottom), the sodium-cooled, graphite-moderated reactor (Hallam), and the liquid metal cooled fast breeder reactor (Enrico Fermi I).

At the time when most of these demonstration plants went into operation in the early 1960's, the nuclear industry was already giving serious thought to the next generation of power reactors which would be designed to be commercially viable and to compete economically against fossil-fuel fired plants. Unfortunately, the industry set very unrealistic goals by demanding that such plants achieve power costs in the 6 - 7 mills/kwhr range. Both General Electric and Westinghouse committed themselves to the construction of a number of introductory plants on a "turnkey" basis -- that is, they signed agreements to provide the plants at a fixed price which would result in power costs at this level. But such plants never did produce the 6 mills/kwhr projected for them; the two reactor manufacturers eventually poured more than a billion dollars in unanticipated costs into providing the plants. Nevertheless, it was the commitment of the turnkey plants which transformed nuclear power from a series of costly single demonstration units to a commercially viable industry. It permitted the development of standardized engineering techniques and the buildup of the necessary engineering force, transforming the industry into more of an assembly line type of operation than a one-of-a-kind endeavor.

Gradual increases in the cost of fossil-fuel generated electricity from 7 mills/kwhr in the early 1960's to 10 mills/kwhr by 1970 to its present level of 15 - 20 mills/kwhr, cast a much different light on the economic attractiveness of nuclear power. The economics of scale became more evident, and the capacity of nuclear units was upgraded from several 100 MWe to 1000 - 1300 MWe. One of the early milestones along the road to economic viability was the Oyster Creek power plant which is usually regarded as the first commercially viable nuclear unit, and the Brown's Ferry plant which contained two of the first 1000 MWe units.

As the economic attractiveness of nuclear power became more evident during the late 1960's, there was a flurry of activity as utilities began to order such plants in large numbers and the industry built up the necessary manufacturing capacity to supply such plants at a rate of 40 - 50 plants per year. (At this time, roughly one of every two new power plants ordered was nuclear.)

The maturing nuclear power industry established several new patterns for the implementation of new technology. One of the major milestones involved environmental impact assessment of nuclear power plants. Prior to 1971, the primary responsibility for regulating nuclear power plants, for issuing construction and operating licenses, rested with the Atomic Energy Commission, and they confined their regulation of such plants primarily to the areas of nuclear plant safety and radiation releases. In a landmark court case involving the Calvert Cliffs nuclear plant in Maryland, the Supreme Court ruled that the AEC was also responsible for ensuring that the environmental impact of nuclear power plants was consistent with the National Environmental Protection Act (NEPA) of 1969. Since that time, the AEC and its successor, the Nuclear Regulatory Commission (NRC) has broadened its regulatory responsibilities to include not only questions of radiological safety, but as well, environmental impact assessment and legal studies (e.g., examining possible antitrust implications for the operating utility). Since there had been very little experience in regulating any industry across such a broad spectrum, the AEC-NRC was forced to develop a whole new set of regulatory standards, guidelines, and procedures (which will be discussed in detail in Chapter 6).

As the industry matured, however, it began to encounter far more serious problems. The capital-intensive nature of nuclear power plants (some 80% of their generating costs was attributed to construction and interest charges,





15% to fuel charges) made the economic attractiveness of nuclear power extremely sensitive to the whims of the economy, the availability of investment capital, inflation, shortages of materials, and so on. The cost of nuclear power plants rose dramatically during the early 1970's and continues to rise at a rapid pace. The prospects of bringing nuclear power plants on line for several hundred dollars per kilowatt capacity have faded to the status of wishful thinking as most utilities now project capital costs in excess of \$1000/kwe for plants ordered during the next few years. (But it should be noted that the construction costs of fossil fuel fired plants has risen at a similarly dramatic pace, and, in fact, today a coal-fired plant equipped with necessary exhaust "stack" scrubbers costs in only slightly below a comparably sized nuclear unit.) This dramatic escalation of capital costs, coupled with the economic recession which occurred in 1973-74, led to a slowdown in the construction of plants already on order as electrical utilities found it harder and harder to raise the enormous amounts of capital required to construct such plants.

Perhaps the most serious problem faced by the nuclear power industry during recent years has been that of public acceptance. As the commitment to nuclear power has grown, so too has grown the public opposition to this new technology. What was once regarded as a panacea for the ills of society is now viewed by many as, at best, unnecessary and, at worst, one of the most significant dangers in our society. One should not underestimate the importance of public acceptance of a new technology, for no matter how much effort or concern scientists and engineers invest in bringing a technology to fruition, and no matter how committed private industry and government may be to its implementation, in the long run, the public will decide--and indeed, the public should decide--whether it will accept the technology as an integral part of its everyday life. For it alone will create the atmosphere which will either encourage or discourage the development and implementation of such technologies.

For that reason it is particularly important that we later examine the evolution of public opposition to nuclear power and try to identify the issues involved in the public debate concerning its deployment. It will provide an important lesson in how new technology is embraced or rejected by modern society.

But before turning to this very important topic, let us first consider in a more critical light the special structure that was set up to control the atom in our society, the Atomic Energy Commission, and its successors, the Energy Research and Development Administration and the Nuclear Regulatory Commission.

#### THE ATOMIC ENERGY COMMISSION<sup>±</sup>

The Atomic Energy Act of 1946 placed the American atomic energy program under the direction of an "independent" civilian commission possessing enormous powers to monopolize and regulate the new field. The AEC was expected to carry out a highly complex managerial and technical undertaking on which the world's future might well depend.

Many were pessimistic about the ability of five men to work together in managing the vast complex inherited by the Commission, yet in the first 500 decisions made by the Commission over a period of seven years, there were only 12 dissents.

It was soon apparent that a far more serious problem concerned the immense managerial duties which threatened to overcome the Commissioners with day-to-day routine. It became necessary to broadly delegate authority, yet ultimate responsibility always rested with the Commissioners themselves. The Chairman's office soon became the nerve center of the complex operation. These considerations prompted Lilienthal and others to suggest in the 1950's the adoption of executive powers for the Chairman with the rest of the Commissioners serving on a part-time basis. However, the majority of opinion was against this idea, and the only step taken in this direction was the designation of the Chairman as the "principal spokesman" for the Commission in the Atomic Energy Act of 1954.

The Commission was not alone in formulating nuclear policy. The McMahon Act had placed the AEC within a specific framework (Figure 1) which tied the Commission to the President, Congress, the military, the scientific community, and the public. The nature of the relationship between the AEC and each of these groups was quite varied and changed occasionally during the ensuing

---

<sup>±</sup>NOTE: This section will be updated later to include the Energy Reorganization Act of 1974, which split the AEC into ERDA and the NRC.

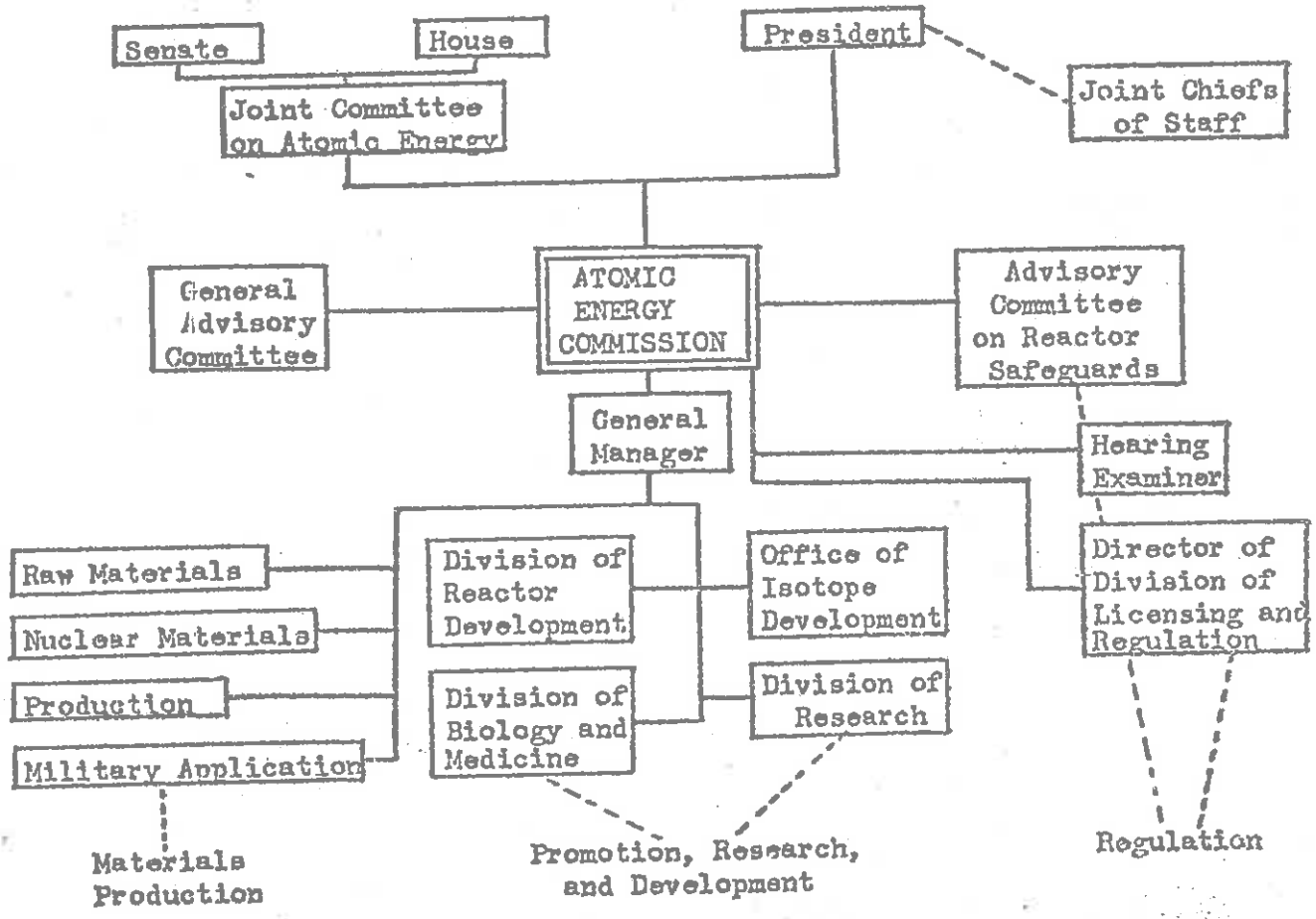


Figure 1: Administrative Structure of the Atomic Energy Commission



years. It is useful to examine each of these relationships separately to trace the development of control through the years following World War II.

Final authority over the AEC rested with the President. He was authorized by the 1946 Act to appoint the five Commissioners and to designate their chairman. He was assigned special powers and duties with respect to the Commission, such as issuing production directives and was the final authority in any disagreement between the AEC and the DOD. The executive branch had further control since the Bureau of the Budget processed all requests for Commission appropriations. Yet much authority had been left with the Commission. The 1946 Act ensured the independent status of the Commissioners by specifying five year terms and removal only for "inefficiency, neglect of duty, or malfeasance in office"<sup>53</sup>. Most of the comprehensive directives concerning the actual atomic program originated within the Commission. But the importance of executive control was most emphasized by the position of the President as elected representative of the public. It was his duty to "uphold the principle of civilian supremacy, not only through his role as Commander-in-Chief, but also as the leading catalyst of an informed, rational judgment by the American people on issues which touch them vitally as atomic energy does"<sup>54</sup>.

It was only natural that Congress should ensure a means of communication between itself and the AEC. The McMahon Act established the Joint Committee on Atomic Energy, consisting of nine members from each house, to make continuing studies on the activities of the AEC and problems relating to the development, use, and control of atomic energy. It was responsible for all legislation concerning the atomic energy program. Although many saw its purpose as more sinister (it was once tabbed the "Watch Lilienthal Committee")<sup>55</sup>, it provided the necessary link between the Commission and the legislative body.

The JCAE became an extremely active partner of the Commission, even in the exercise of purely executive functions. Through the process of Congressional hearings and legislation, it exercised powerful influence over the formulation of national nuclear policy. At times, a state of harmony existed between the AEC and the JCAE, but at other times, friction erupted. Investigations during the late 1940's into the efficiency of the Commission were brutal and resulted in a "political mauling of the atom".

The status of the AEC was rather anomalous. Although the Commission's primary functions were of the type usually subject to Presidential control,

the AEC actually occupied an undefined constitutional limbo between the President and Congress. Although the tie to Congress through the Joint Committee on Atomic Energy was rather strong, all powers of appointment rested with the President. Yet the absence of strong Presidential interest tended to isolate the Commission. Consequently the AEC "without a supporting constituency, and with few relationships with Congress, came to rely upon the JCAE for sympathy and support"<sup>56</sup>. The JCAE moved into this power vacuum and must be recognized as a major policymaking force in the United States' atomic energy program. It became one of the most powerful congressional committees in history -- and certainly the only permanent congressional joint committee.

Although the Committee played a rather passive role during the late 1940's, it began to expand its powers during the 1950's as it gained experience in the formulation of nuclear policy. The 1954 Act increased the Committee's influence by strengthening the requirement that the AEC keep it "fully informed" on all nuclear matters. It gained control over the authorization of plant construction and property acquisition, and later authority over other AEC appropriations in 1957. It assumed not only a legislative policy role but part of the executive responsibility as well.

Many of the members of the Committee studied hard and conscientiously to attain sufficient background in nuclear matters to enable themselves to execute their responsibilities competently. Indeed, during the 1950's, the JCAE was perhaps the prime mover behind the civilian power program and spurred the AEC much further along these lines that it would normally have gone on its own. As one committeeman stated, "The JCAE is doing work the Commission should be doing."<sup>57</sup>

Yet this does not appear to justify the later status of the Committee. It had influence extending into areas of security, diplomacy, and international trade policy that have traditionally been primary legislative responsibility of the Committees on Foreign Relations and the Armed Services. It retained its power based upon the assumptions of 1946. "The largely out-dated but still potent aura of secrecy about the atom sustains the JCAE's position of exclusiveness and expertness in relation to other committees and other individual members of Congress."<sup>58</sup>

The JCAE was originally intended to be a check on Commission activities. It tended to become a formulator and defender of the program instead of a probing

critic. "The shakiness of this advocate or promoter-judge role is compounded when the JCAE's eagerness to press a nation-wide atomic power plant program is added to the balance of considerations."<sup>59</sup>

Yet Congressional influence was very definitely limited. "It is difficult for a legislative body to compel an independent commission to push through vigorously a program which the commission does not like" noted Commissioner Thomas Murray<sup>60</sup>. And nonpolitical policy decisions could only be ensured by an independent commission.

One of the principal duties of the AEC was to direct the United States' nuclear weapons program. A close relationship with the military was necessary, yet we have seen the antagonism between these two groups on matters of weapon custody and policy. In the early days of the Commission, the principal link between them, the MLC, served only as a watchful eye over AEC activities. The only channel of communication was unilateral and indirect. The Joint Chiefs would submit their requests to the President who would then forward them to the Commission. The AEC was in a position of tacitly accepting the requirements presented to it and was unable to question the assumptions behind these requirements since it frequently didn't even know them. The problem concerning the relationship between the AEC and the military--indeed between the civilian sector in general and the military--lay in the lack of an effective channel of communication with the Joint Chiefs which could inject the civilian point of view before any of their decisions on military policy had crystallized. The "main problem...is the lack of real cooperation--under the present system--between the military and civilian authorities of the government in national defense policy".<sup>61</sup> This situation was modified in 1949. President Truman, under advice from the National Security Council, initiated a new measure of civilian participation with the decision to include executive staff work involving the Secretary of State, the Bureau of the Budget, and the AEC on any future proposals concerning atomic demands from the Joint Chiefs before these were sent on to the Commission for execution. The decision to expand AEC production facilities in August of 1949 felt the influence of this new cooperation. Later in 1953, the Eisenhower administration adopted a policy enabling the AEC chairman to inject opinion through the NSC during atomic weapon policy discussions. These steps were indicative of the growing recognition that cooperation between civilian and military agencies was vital to national security in the postwar years.

The General Advisory Committee provided a necessary link between scientists and the Commission. Composed of many of the nation's top scientists, the GAC was responsible for advising on both technical matters and policies within the field of atomic energy. Its influence over policy decisions was clearly illustrated in the discussion preceding the thermonuclear program. Many felt that it was only proper that the scientists who had given the atom to man should retain some influences over decisions concerning its use.

The scientific community used other methods to influence the Commission. Organizations, such as the Federation of Atomic Scientists and The National Committee on Atomic Information were strong forces in motivating public and congressional opinion. The participation of scientists in policy formulation had originated during the war years, and as technology and scientific development continued to play a dominant role after the war, so too did the nation's scientists continue to become involved in the formation of policies affecting national security. The growing number of advisory panels and committees was evidence of this trend. And the GAC was one of the strongest and most important of these groups during the late 1940's and 1950's.

The relationship between the AEC and the public was of major importance to an effective system of democratic control of the atom. It is unfortunate that this link has always remained the weakest and most indirect. As Chairman Dean remarked, "The participation of every citizen in policy-making has always been important in our democracy, in a world that contains the unleashed atom, it is vital."<sup>62</sup>

The shroud of secrecy surrounding the American atomic energy program tended to leave the public uninformed on the very matters of policy on which their opinion was so necessary. There were numerous instances during which the people responsible for decisions were denied access to information influencing these decisions. From the early days of 1946 when congressmen struggled to enact legislation concerning a subject to which only a handful of them had been exposed, to situations in the late 1950's when much information was available, but unpublicized, the inadequacy of the knowledge upon which to base public opinion has been apparent. It has only been during recent years that we have begun to accomplish the true institution of the atomic program into our democratic process.



The need to preserve traditional lay controls over both the operational and regulatory aspects of the nuclear energy program has never been fully satisfied. Several factors contributed to this problem. Lack of popular participation has been caused by the technological complexity of the issues involved, their far-removed nature from the life experiences of the American public, and the still apparent concern for technical secrecy. The complex and hazardous nature of the substances and processes involved in nuclear work have forced dependence upon the judgment of the scientist, both as administrator and policy-maker .

Traditionally, controls over such technical experts have been exercised by the executive through the power to make regulations and budget control. The recent rise to power of the JCAE has contributed to this control. But even they must rely upon technical advice. The only true safeguard against pre-emption of power by politically irresponsible experts is the existence of countervailing sources of influences. "No expert should be placed in a position where he alone has access to the highest political authority."<sup>63</sup> And an informed public is necessary to interpret such technical advice.

Thus the problem of democratic control becomes two-fold: "first in setting up specialized atomic energy authorities outside the conventional system of departments, how to maintain the normal controlling functions of the executive and the legislature; second, the more subtle problem, how to preserve the traditional authority of politically responsible laymen over the scientist-administrator."<sup>64</sup>

The relationship between the AEC and private industry has always been an important issue. With the growing civilian atomic power program, this relationship becomes particularly significant. The initially monopolistic position of the Commission had been thought necessary for national security. As these considerations became of lesser importance, the realization that private participation was necessary for a successful atomic power program motivated some loosening of the monopoly in the 1954 Act. Yet when the Kennedy administration assumed executive power in 1960, three dominant issues remained:

- 1) the amount and kind of public assistance to be given to private enterprise,
- 2) how best to circumvent the public vs. private power issue and proceed with reactor development, and
- 3) the respective government and industry responsibilities for prototype construction.

There was also the question of private



ownership of nuclear fuels to be reckoned with. Yet the true and great barrier to full private operation of the atomic energy industry remained, and still remains, the huge production facilities of the Commission.

These problems continue to face the nation today. The desire of industry is to see the AEC-ERDA get out and leave the atomic energy field to private enterprise. The AEC similarly feels that the time has come for industry to begin playing a larger role, particularly in the production of fissionable material. Yet the Commission was not so sure that the manufacturers of equipment and the utility industry will supply the nation's future needs without federal intervention. "The AEC worries that an impending fuel shortage may be upon us while industries are still having their economists calculate expected break-even points."<sup>65</sup>

Other steps should be taken, however. As the Atomic Industrial Forum recommended in 1962<sup>66</sup>, "the government should not undertake new manufacturing of service activities or new facilities which can be provided by industry, and should review all of its present manufacturing and service activities with a view to having these carried out by industry whenever no continuing major penalty to the taxpayer is involved." The government should rely on greater indirect financial assistance as an alternative to AEC construction and subsidy. And the federal government should ensure that the precedent it has set in shepherding the new atomic power technology through to competitive commercial feasibility--at times without assuming full administrative responsibility--is not repeated. Future developments in fields, such as thermonuclear power, should be developed as much as possible in the private sector .

The relationship of the atomic energy program to science in America is also of vital importance. The postwar activities in weapons development and its effect upon basic scientific research has put a premium on huge "programmatic" technical enterprises rather than true research. Many are worried because scientists seem to spend more time dreaming up mammoth research projects than conducting actual research. The requirements program for the government--need must precede development--has turned many potentially beneficial scientific programs into engineering studies. The tendency of the AEC to use universities as directors of its research activities has tended to involve educational institutions in non-educational functions by appealing to their patriotism. Far too much of our technical and scientific manpower has become involved in the

atomic energy program. These influences on the scientific community are quite dangerous.

The future of the Commission's own research facilities is also an important issue. The mammoth laboratories, such as those at Los Alamos, Oak Ridge, Argonne, and Livermore, represent enormous investments, both in facilities and manpower. Yet they were designed for specific weapons programs. As Dr. A. M. Weinberg, Director of Oak Ridge, has observed<sup>67</sup>, "It is therefore unlikely that the problems big enough to challenge big laboratories will continue to be in the areas of technology for which the laboratories were originally organized... the institutions must inevitably be prepared to move into areas outside their original interests if they are to retain immortality". Solutions to this problem have been suggested. One involves putting the NSF in charge of the research laboratories, such as Argonne and Brookhaven, while transferring the weapons groups at Livermore, Los Alamos, and Sandia to the DOD . This would limit the AEC to production and regulation alone, thus limiting its influence on scientific research.

#### THE NEED FOR SPECIAL CONTROL OF ATOMIC ENERGY

In 1946, the United States met the challenge of the atomic age with a unique precedent in government agencies, the Atomic Energy Commission. We have traced the wartime development of the atomic energy program and the legislative battle prior to the Atomic Energy Act of 1946. We have also examined the role played by the AEC in the development and control of the atom during the years following World War II. Now the time has arrived for us to critically examine this role and the effectiveness of the American effort to control the atom in modern society.

Why was a special type of control even needed? This can best be summarized in one word, ambivalence. The atom plays significant roles in both war and peace. To separate these roles is sometimes hazardous and always artificial. "This combination of purposes in a single agency is perhaps the most striking administrative feature of the atomic energy program and helps explain the need for a separate, specialized agency"<sup>68</sup>. Thus, when the United States established a special agency in 1946 to administer the atomic program, it was responding to three sources of motivation , each revolving around the ambivalent nature of atomic energy: First, the awesome destructive capacity of the atom gave rise

to many worries--chief among these, the worry that the military would dominate atomic energy. But then it was also felt desirable to retain the American nuclear monopoly of the war years, at least until international control could be achieved. Secondly, the nature of atomic development had been a tightly guarded secret during the war years. It was felt necessary to continue to safeguard these secrets with a government monopoly over all technical development of atomic energy. And finally, the future of the atomic program was uncertain and capable of revolutionary changes in peacetime technology. A special new agency was thought necessary to prepare and plan for these dynamic changes. These unique qualities of atomic energy induced the nation to establish the civilian AEC in 1946. And instead of placing the agency under the existing executive and legislative controls of the government, it was placed in a unique and independent position between both branches. Today, the AEC-ERDA-NRC bears the imprint of these original concerns for the wartime potential of the atom and the expectation of peaceful atomic developments.

But what is the validity of these three premises in the light of present day developments? It is true that a primary role of the AEC-ERDA continues to be the development, production, and testing of nuclear weapons. The hope for international nuclear weapons control has diminished, despite such minor steps as the Partial Test Ban Treaty and SALT agreements. However, we have also seen that while the civilian-military weapons custody and development issue was still relevant in the late 1940's, the evolution of the American defense arsenal has led to effective military custody (as evidenced by the complete transfer of weapons storage facilities to the DOD in 1961) coupled with growing cooperation in the weapons development effort. Nuclear weapons themselves are only a part of the complexities of a modern weapons system, such as an ICBM, and although assuredly a most important part, are no reason to give the Commission any independent judgement in systems design and policy. "Realistically, the AEC essentially is not too different from any major technical contractor to the Defense Department in the area of missiles, say, or some other weapons system."<sup>69</sup> Thus, it has become more difficult to separate civilian and military roles in nuclear weapons development, and also to identify the advantages of a civilian government agency in this program. .

Then, too, there is also the rather incongruous nature of the technical secrecy issue. As the Russian nuclear arsenal has grown, the value of such

secrecy has diminished. There is still a need for technical secrecy in much of the weapons program, primarily to avoid international proliferation of weapons technology for as long a time as possible. But it does not appear that the issue of technical secrecy is any longer sufficient reason in itself for an independent civilian agency, such as the Atomic Energy Commission.

The initial function of the AEC was to produce fissionable material for weapons use, to develop and manufacture these weapons for the military, and to explore peaceful atomic development while maintaining the government monopoly in atomic energy. This almost exclusively operational role was the AEC's sole duty until the 1954 Atomic Energy Act. At this time, the AEC acquired new responsibility for promoting and encouraging private investment in atomic activities as well as for regulating and licensing the fledgling nuclear power industry. The 1954 Act compelled the AEC to act at the same time as "partner, employer, promoter, rival, and the policeman..."<sup>70</sup>. The operational, promotional, and regulatory functions of the Commission will now be examined as the first step in analyzing its effectiveness.

Of the some \$2.5 billion in funds appropriated to the AEC each year, almost 3/4 was devoted to the operational duties of fissionable materials production and weapons fabrication. Thus, the military function which was essentially the exclusive responsibility of the Commission from 1946 until 1954 continued to be its primary activity. Since the United States' program was aimed at developing civilian, as well as military, atomic energy, the attempt to exploit the peaceful side of the atom became inseparably linked to the international demands upon national security. This union, as we have seen, greatly retarded peaceful developments in this country. Research facilities and personnel which might have been utilized in peaceful pursuits were expended in the military nuclear weapons program. Secrecy and red tape surrounded much of the information vital to civilian power development. Thus, the operational duties of the AEC complicated and conflicted with its promotional responsibilities.

Because of the enormous complexity and expense of atomic power development, the federal government had to assume a much more active role than has been characteristic in exploiting other forms of energy. Both research and development work had to be executed simultaneously without the usual time lag between pure research, its experimental application in prototypes, and its ultimate



commercial applications. The government found it necessary to play a major role in the promotion of the civilian atomic power industry.

The promotional role of the AEC in the civilian atomic power industry has been a major activity since the Atomic Energy Act of 1954. Through contract and grant, the Commission encouraged research in universities and industry. The prototype and power reactor demonstration programs were phases of promotional activities.

Gradually, the AEC began the transfer of operational activities to private concerns. By loosening regulations, the Commission encouraged private participation. Understandably the duty of promotion was to conflict with the final responsibility of the AEC, regulation. The activities which reinforced promotion, created regulatory problems of severe complexity.

Atomic energy is unique in requiring maximum regulation of its every aspect. There are features of the substances used, the processes involved, and the end products themselves which imposed a regulatory role on the AEC. Regulation demands arise from, 1) the military uses of fissionable material, 2) the hazardous nature of nuclear materials, and 3) the war-engendered atmosphere of secrecy. Yet it was questionable whether it is necessary for the Commission to assume exclusive responsibility for regulation of atomic energy.

It may be that the psychological impact of the awesome destructive power of the atom has induced an exaggerated need for strict regulation to calm the anxieties of the public. This fact is aggravated by the widespread public ignorance of the nuclear science and technology concerning the nature and extent of necessary regulation. To ensure maximum public protection, the regulating agency must have ready access to the most up-to-date technical information, and at the present time, this information frequently is only available within a nuclear agency, such as the AEC-ERDA.

The early forms of regulation were quite simple--the Commission merely owned all nuclear materials and their production and use facilities. However, it was apparent that such an absolute monopoly was incompatible with the hopes for a civilian power industry. Consequently, the 1954 Atomic Energy Act sought to loosen this monopoly with increased civilian participation. Even then, however, Congress insisted, "It is essential to the common defense and security that title to all special nuclear material be in the United States while such

material is in the United States"<sup>71</sup>. Thus, the monopolistic position of the government was not merely a by-product of efforts to ensure supplies for the military effort, but also to enable it, for safety and security reasons, to know who had the material or where and to whom it was being transferred. Private owners and operators of nuclear reactors could only lease nuclear materials from the Commission (until 1964).

The trend for the past two decades has been towards greater and greater private participation in atomic energy development. Yet to the extent that the government manages to divest itself of direct operating responsibilities in the field of research and development, the problems of regulation become more complex. Increasing private participation magnifies the regulatory responsibilities. To this extent, promotional activities tended to complicate regulatory duties.

The conflict between the promotional and regulatory duties of the Commission were much broader, however. Many felt that these two responsibilities were incompatible within the same agency. There was always the danger that regulations might be drafted and executed with too firm an eye on the operating necessities of the Commission. Perhaps the crucial point was not so much the propriety of blending two separate and superficially incompatible functions, however, but rather the determination of how and by whom the regulations themselves should be framed. This matter was complicated, as we have noted, by the requirement that the regulating agency have access to the best technical information. The situation was further complicated by the fact that the AEC deemed it necessary to assume operating responsibilities as a means of regulating several facets of the atomic program (although it seemed questionable that the government should have monopolized mining, refining, processing, and fabrication in order to achieve complete surveillance over fissionable materials).

A final difficulty with the regulatory activities of the AEC stemmed from the fact that the AEC was surrounded by agencies with long-established claims to jurisdiction over at least some elements of the regulation of atomic energy. Further complications arose since much of the health and safety regulation was assigned to the state and local government. There was an acute need to coordinate the regulation of atomic with the policing powers of other agencies.

We have now followed the history of the American atomic energy program and its administration from the days of the Manhattan District up to the present. Perhaps as David Lilienthal observed some 20 years after the creation of the MED, the present status of the atom in our society is based on a myth, a myth composed of the worries and fears of 1946. These obsessions led us to assign to the atom, a separate and unique status in the world. In those days, the development of the Bomb seemed to be the ultimate breakthrough in scientific achievement, in the control of physical matter; and thus, it even seemed possible that we could make similarly radical departures in dealing with those problems in human affairs which the Bomb so greatly intensified. This has proved, in retrospect, to be false. Today the atom has not justified the special treatment accorded it in 1946. "The Atom has NOT been the single necessary weapon. It has NOT revolutionized industrial society. It has NOT produced revolutionary advances in medicine or industry. The peaceful atom has NOT ushered in a new world, but has rather become a part, and quite a minor part, of the old one."<sup>72</sup> Perhaps the present program in peaceful atomic development is as much a product of a compulsion on the part of the nation to find some peaceful use for so terrible a weapon as it is a response to actual needs for atomic power.



As Lilienthal correctly remarked, "Atomic energy achievements represent a very high degree of imagination and creativity, but also a high point in the fragmentation of knowledge and responsibility for knowledge".<sup>73</sup> In attempting to control and administer the atom, people have tended to look at fragments. One cannot treat problems in weapons development, civilian atomic power, or international development of the atom separately. But then the only manner in which such a wide variety of considerations can be integrally dealt with is through the American democratic process of government--not by special agency or commission. It seems reasonable to conclude that the main effort in controlling the atomic energy program could best be handled by removing it from special authorities and placing it instead into the normal processes which govern the rest of American society.

#### 4.3 GROWTH IN THE OPPOSITION TO NUCLEAR POWER

The roots of the present opposition to nuclear power can be traced back to the early days of the atomic energy program. A number of the scientists involved in the Manhattan Project were strongly opposed to the use of the first

atomic weapons against Japan. This opposition to the development and deployment of nuclear weapons grew during the late 1940's and early 1950's. We have noted the bitter debate that took place concerning the development of thermonuclear weapons--the "super"--and the role that nuclear scientists played on both sides of this controversial issue. Although the decision was eventually made to proceed with the development of these weapons, organized opposition to nuclear weapons development continued to grow and eventually played a leading role in stimulating and approving a treaty banning atmospheric testing of nuclear weapons in the early 1960's. Scientific opposition to nuclear weapons development has continued to be influential in shaping government policy on a number of significant issues, such as the decision to avoid massive deployment of anti-ballistic missiles and to push for more significant arms limitations in the SALT talks.

Scientists played the leading role in opposing further nuclear weapons development during the decades following WWII. It was, therefore, natural that many of these same scientists would come to re-examine the peaceful role of atomic energy, to question whether the atom would really prove to be the enormous benefit to society that had been promised during its early development. Although the vast majority of scientists were in general agreement that the potential benefits to be gained from nuclear power far outweighed its possible drawbacks, there were nevertheless several scientists who expressed some opposition to a massive nuclear power development program, even during the early 1960's.<sup>74</sup>

A number of events occurred during the latter part of the decade that tended to stimulate opposition to nuclear power. One leading factor was the growth of the environmental movement and the growing awareness of the damage that man could cause to his environment. This was accompanied by a heightened public involvement and reaction to technological change. Indeed, it became quite popular to question the benefits of science and technology in general. And, in fact, for a period of time our society developed almost an anti-technology psychosis when all technology was viewed as evil and basically harmful to man and his environment. The country was swept by a "return to the simple life" mood, by grassroots efforts tried to turn back the clock 100 years to a time when the air was clean and the cities were safe (although it was rarely recognized that the simple life of bygone years was also shorter,

PLE  
LIFE??





disease endemic, illiteracy high, child labor and suffering widespread, and comforts limited)<sup>75</sup>. This suspicion of technology was accompanied by a number of social upheavals (e.g., Vietnam, Watergate) which led to a mood in which all societal institutions were questioned. The public has lost confidence in all established institutions--particularly federal agencies. More significantly, there was a general willingness to listen and give credence to any critics of "the establishment", regardless of their qualifications. It was only natural that the growing nuclear power industry would become a prime target for such concerns. After all, wasn't nuclear power simply one more scheme fostered on the public by big business and federal government? It was particularly vulnerable since the rather rapid increase in electrical utility rates in the late 1960's and early 1970's created the impression of utilities as monoliths with myopic concerns for profit and little concern for the public interest.

Hence, the relatively token scientific opposition to nuclear power which had been present since the early days of its development was joined by new crusaders from both the environmental movement as well as that segment of our society which harbored suspicions of big business or government or the establishment or technology or almost anything else they did not have absolute personal control over. And as the opposition to nuclear power began to swell, the character of this opposition began to change dramatically. Indeed, many of those who had originally opposed nuclear power, gradually reversed their attitudes as they learned more about the moderate risks and substantial benefits characterizing this new energy source. But they were rapidly replaced by a new breed of critics.

During the early years, most of the critics came directly from the scientific ranks (indeed, many of these had been directly involved in the wartime atomic energy program) and tended to base their opposition upon a direct knowledge of the scientific and technical facts involved in nuclear power generation. As the anti-nuclear power movement grew during the 1960's, it was joined by large numbers of critics with little scientific background or training. Certainly many concerned individuals in this movement recognized their severe limitations in evaluating issues which involved sophisticated technology such as nuclear power, and therefore they sought to rely upon the advice and interpretations of several scientists whose opposition to

nuclear power was well known. Unfortunately, the confusion and misunderstanding which resulted when laymen tried to interpret scientific debate and then to re-express this in a manner more acceptable to the public at large significantly changed the course of the nuclear power debate away from issues based upon technology and more toward emotional issues frequently based upon misconceptions and misinterpretations of scientific principles. The development of a variety of new laws and regulations governing the implementation of a new technology (e.g., NEPA) has further contributed to the confusion by setting up numerous public hearing procedures which were ready-made for legal maneuvering and delay. Hence, the anti-nuclear movement, to a large degree, has been taken over by lawyers, and as we will see later, the original scientific dialogue has now been replaced by legalistic maneuvers and political oratory which usually have very little relevance to the original issues involved.

We can illustrate this shift of the anti-nuclear movement from a scientific towards a political orientation by glancing over the past decade and noting the change in the nature of the issues raised by critics of nuclear power. The earliest arguments to achieve a high degree of public visibility were those concerned with low level releases of radioactivity from nuclear plants. Several biological scientists, including Sternglass,<sup>76</sup> Gofman, and Tamplin<sup>77</sup> received great public attention by proclaiming that the low level radiation released during normal operation of nuclear power plants could cause thousands of cases of cancer every year. We will examine the actual radiation releases from nuclear plants and the public health implications of these releases in considerable detail in Chapters 5 and 6. However, we should note that the claims of these critics have been thoroughly discredited by the radiological health physics community as being scientifically quite incorrect<sup>78</sup>--and the individuals involved have been admonished for faulty scientific procedures. Nevertheless, the public concern generated by these frightening (if incorrect) statements forced the federal government to lower the allowable limits on nuclear plant radiation emissions to a level 100 times below that applied to any other sources of radiation--even though there is absolutely no scientific evidence whatsoever to indicate that the lower limits provide any additional public safety.<sup>79</sup> That is to say, at present, nuclear power plants are allowed to release only one-hundredth as much radiation as, for example, the nuclear medicine unit in a hospital or the radiochemist in his research laboratory are allowed to release.

Indeed, the limits on nuclear plant releases have been pushed so low that it is extremely difficult even to detect such releases, and this greatly complicates the task of verifying that these limits have not been exceeded.

It has taken the scientific community a number of years to repair the damage to public confidence caused by such irresponsible claims. But gradually the public has become aware that the routine radiation releases from nuclear plants are sufficiently low to eliminate concerns for public health. (Indeed, the public receives far less exposure from nuclear power plants than it does from a variety of less publicized sources, such as television sets or dental x-rays.)

As the debate over low level radiation releases waned, the opponents of nuclear power turned their attention to a new issue: nuclear reactor safety. Although commercial nuclear power plants have never experienced an accident in which a member of the public was harmed, there is always a remote possibility that an accident will occur, and nuclear critics quickly seized upon several preliminary studies that the AEC had performed<sup>80</sup> attempting to estimate the maximum possible consequences of a catastrophic reactor accident which had been prepared during the early days (late 1950's) of the power reactor development program in their effort to persuade the public of the "enormous dangers" of nuclear power. Of course, the AEC was partly to blame in this instance since it had deferred research on light water reactor safety during the 1960's in favor of funding fast breeder reactor development at just that time when light water reactors were being deployed commercially on a massive scale by electrical utilities throughout the country. Although a number of scientists had expressed genuine concern about the lack of experimental data on the performance of nuclear plant safety systems<sup>81</sup> (and indeed, were partly responsible in goading the nuclear power industry and federal government into accelerating their research program on reactor safety), the public debate over nuclear reactor safety shifted into higher gear when Ralph Nader, fresh from his slaying of the General Motor's dragon ("Unsafe at Any Speed"), seized upon nuclear reactor safety as his next target and began a series of highly emotional, yet carefully organized attempts<sup>82</sup> to pass legislation or initiatives which were aimed at prohibiting the construction of nuclear power plants on the basis of their presumed dangers. Unfortunately, as the Nader forces entered what had been primarily a technological debate, scientific reason seemed to have departed,

and today we are faced with a highly emotional battle between groups with very limited technical backgrounds, very little understanding of the technical issues involved in nuclear reactor safety (which will receive major attention in Chapter 7), but exceptional skills in gaining the attention of both legislators and the public. The effort to identify the nuclear power debate as a moral issue has been particularly unfortunate and has led to several rather amazing public actions. For example, recently the National Council of Churches was persuaded to condemn atomic element 94 (plutonium) on supposed moral grounds (kind of a 20th Century Salem witchhunt).<sup>23</sup>

Most recently, nuclear critics have broadened their aim to encompass the entire nuclear industry rather than simply the nuclear power plants themselves. Particularly loud criticism has been leveled at the nuclear fuel cycle.<sup>24</sup> A variety of allegations have been made concerning the inadequacy of domestic uranium ore supplies, the reliability of the nuclear power plants themselves, whether nuclear power will be capable of producing net energy with the enormous investment required in plant construction and fuel processing, and so on, but most criticism has been directed at the "tail-end" of the nuclear fuel cycle, at the reprocessing of fuel discharged from nuclear power plants, the possible use of the plutonium separated out from spent fuel in nuclear weapons on both a domestic (e.g., organized crime or terrorist) or international level, and the dangers that such reprocessing might present to the public. Perhaps most concern has been directed at the disposal of the radioactive waste generated by nuclear power plants. All of these issues will be examined in some detail in later chapters of this text.

Hence, as the composition of the movement opposing nuclear power changed, so too changed the nature of the criticism of this new technology. The token opposition voiced by several scientists that had been directly involved in the early atomic energy program gradually gave way to an anti-nuclear movement composed of non-nuclear scientists (e.g., with backgrounds in the natural, medical, or social sciences) along with a number of highly concerned, but relatively uninformed laymen. As the opposition to nuclear power became more highly publicized, it became rather fashionable for those opposed to social change to include opposition to nuclear power as yet another aspect of their own particular crusades. This was particularly true of the environmental movement, since it appears that many environmentalist groups have



embraced claims that nuclear power would do severe damage to the environment (for example, the Sierra Club<sup>85</sup> or the Friends of the Earth<sup>86</sup>) and mounted massive campaigns to block nuclear plant construction. (Ironically enough, one of the original motivations behind the development of nuclear power was the recognition that it presented probably the least environmental impact of any method of generating electricity. In fact, as we will note later, nuclear power continues to present rather enormous environmental advantages over present generation fossil fuel, hydroelectric facilities, or even advanced concepts, such as solar or geothermal power.)

The battle over nuclear power quickly attracted large numbers of political activists whose primary target was not so much nuclear power itself as rather the entire industrial-government control over nuclear energy development and the awkwardness with which federal agencies such as the AEC interacted with the public, nuclear power presented a rather vulnerable target. For many of those in the anti-nuclear movement, opposition to nuclear power was merely a vehicle for forcing major social change--it was only the first of many battles to be fought on this front. For example, some of those opposing nuclear power are actually not at all concerned about nuclear reactor safety, environmental impact, or economic viability, and furthermore, grant that nuclear power is vitally necessary if we are to meet the projected growth in the demand for electrical energy over the next several decades. However, they feel that by blocking the implementation of nuclear power, they can effectively refuse to satisfy the growing appetite of our society for energy, thereby forcing massive conservation efforts which, in the long run, will lead to a less energy-intensive society. Certainly those in opposition to nuclear power are far from united in either the degree or the nature of their concerns.

#### 4.4 The Nuclear Power Debate

It is difficult these days to pick up a newspaper or turn on a television without being confronted with some aspect of the controversy over nuclear power. (An interesting exercise is to choose any newspaper or magazine with a reasonable coverage of national and international events, and simply count the number of articles relating to nuclear power which appear in a week. It tends to average about one article a day for most papers.) Why all the fear and emotion, the "controversy" over nuclear power? Certainly one reason is that it has become a very prominent target. Since 1966, nuclear power plants have

presented a viable economic source of electrical power. The energy crisis and the shortage of liquid fossil fuels has only increased the incentive to switch to nuclear plants for generating electricity. For example, during 1975, electrical generating costs for nuclear power were over 40% less than coal and over 160% less than oil-fired plants amounting to a savings of some 2 billion dollars (with only 40 nuclear plants in operation).<sup>87</sup> The utilities are convinced that nuclear power presents a safe and clean source of electrical energy which is capable of massive implementation today. Since they feel that nuclear power is cheaper, cleaner, safer, and possesses greater immediate potential than any other presently viable alternative for electrical power generation, they have chosen to make staggering commitments to nuclear plant construction (having already invested \$100 billion with an additional commitment of \$150 billion to date).

A second factor which contributes to the ease with which opposition can be voiced against nuclear power involves the ready availability of information relating to nuclear plant safety and environmental impact. These data have been accumulated over the past several decades by the rather extensive research programs sponsored by the federal government and private industry, and they stand out amid the paucity of data characterizing alternative methods of electrical power generation. This material provides ample fuel for those who would selectively attack various aspects of this new technology.

Finally, and probably most significantly, nuclear power is still rather mysterious to the public. The haunting memory of Hiroshima continues to hang over our society. We can even see evidence of public fears in the language used to describe nuclear power: "invisible" radiation, radioactive "waste" disposal, sabotage and terrorism--this even seems to carry over to the language used by the scientists themselves, such as in the word "plutonium" ("Pluto" = devil). This mystery, these fears, contribute to the very emotional and frequently irrational debate which surround nuclear power.

So what are the issues in this debate? In Table 4-3 we have attempted to list and compare some of the various PRO's and CON's concerning nuclear power, and the remaining chapters of this text will examine these items in great detail. Perhaps a few words of explanation are useful at this point, however,

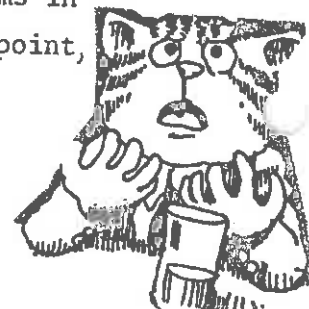


Table 4-3: The Pros and Cons of Nuclear Power

PROS

Cheaper  
Safer  
Cleaner  
Available now  
Necessary to  
meet demand  
Sizeable reserves

CONS (popular press)

Concern over nuclear reactor safety  
Radiation releases  
Environmental impact  
Radioactive waste disposal  
Sabotage and nuclear theft  
Nuclear weapons proliferation  
Economics, reliability, energy payback

CONS (subconscious)

Legacy of Hiroshima (guilt complex)  
Nuclear = strange, new, invisible  
A means to force conservation  
Natural suspicion of technology  
Anti-establishment  
Macho

REAL PROBLEMS

Public acceptance  
Lack of federal energy policy  
Complexities of federal regulations  
Financing all types of energy development  
International aspects



In the PRO column, we have listed the claims that nuclear power is cheaper, safer, and cleaner than other presently viable alternatives and that it is available for immediate massive implementation (as evidenced by the fact that some 10% of our present electrical capacity is nuclear, some 25% is expected to be nuclear by 1985, and some 50% by 2000). The proponents of nuclear power claim that the past decade of nuclear plant operation has demonstrated these advantages. Nuclear power plants have proven by actual operation to generate electrical power significantly more cheaply than fossil-fuel fired plants. During their operation, there is essentially no release of material (such as combustion products) to the environment. Furthermore, in over 300 years of commercial reactor experience, there has never been a single instance of public injury or damage to private property (which certainly must be regarded as one of the most outstanding safety records in the history of American industry). The proponents will furthermore claim that nuclear power is necessary if we are to meet the electrical demands of our society during the next several decades, and that sufficient domestic uranium reserves are available to make the present type of light water reactor a viable source of energy until well after the turn of the century and with the introduction of the fast breeder reactor will represent essentially an unlimited source of energy.

We have chosen to separate the arguments against nuclear power into three different groups. The public is probably most aware of the issues listed in the first group which have become the rallying cry of most nuclear critics. These include concern over nuclear reactor safety and low level radiation releases, the environmental impact of both nuclear plants and their associated fuel cycle, the disposal of the radioactive waste produced by such plants, the possibilities of sabotage of nuclear power plants and theft of nuclear materials which might be suitable for nuclear weapons fabrication, the degree to which nuclear power accentuates the international proliferation of nuclear weapons, and concerns about the economics, reliability, and the energy efficiency of nuclear power. (This list looks rather imposing, doesn't it?)

But there are also a number of subconscious factors involved here. Certainly nuclear power continues to be burdened by the legacy of Hiroshima. Many in our society are driven by a suppressed guilt complex engendered by the role our nation played in the development and military use of nuclear weapons. Perhaps their opposition to nuclear power is simply a manifestation



of their deep-rooted horror and revulsion with nuclear weapons. They approach nuclear power as if by dismantling the nuclear power industry, they can return us to a world without the bomb, without the possibility of nuclear war. But, unfortunately, the nuclear genie is out of the bottle, and there is very little that unilateral actions by this country can do to cram him back in it again. As we will see later, any country with a reasonable technological base has the capability to develop nuclear weapons, and it is unrealistic to think that any action on our part can remove this capability. Rather we should focus our efforts toward removing the incentive to develop such weapons by encouraging international cooperation and seeking meaningful disarmament agreements among the charter members of the "nuclear club". Indeed, to deprive the world of a technology capable of answering its very real energy needs would only push it closer towards the precipice of nuclear war.

Certainly, too, the overwhelming emphasis of the early atomic energy program on military applications contributed to the public's view of all nuclear technology as a mysterious and sinister force whose destructive potential probably far outweighed any peaceful benefits. Although this emphasis has certainly changed during the past decade as the peaceful atomic energy industry grew, the aura of the military's nuclear weapon program remains, and nuclear power is far more likely to trigger the image of a mushroom cloud in the public mind than that of a clean, efficient power plant generating much needed electrical energy.

There are certainly other subconscious elements involved in the opposition to nuclear power. As we have noted, there is certainly a segment of the anti-nuclear movement that views any technology with great suspicion and whose real goals are to force our society back to a simpler way of life in which dependence on technology is minimized. To these individuals, the opposition to nuclear power is merely the first beachhead of a more general battle against all technology. For example, during the emotional debate concerned with a legislative initiative aiming at blocking nuclear power development in California in early 1976, there was a parallel (and successful) effort to block the construction of a major coal-fired plant (the Kaparowits plant in Utah) which, in fact, represented the only viable alternative to nuclear power at this time for California. This natural suspicion of technology is present not only in the layman, but in many scientists as well. In this sense, one must be careful to



distinguish scientists who are usually concerned with idealized studies of fundamental scientific principles from the engineer who must deal with the highly complex applications of science and technology to society. Since few scientists have experience or training in engineering design or applications, they frequently find it difficult to accept that anyone can deal with the myriad of technical problems, conflicting goals, with real and complex systems which are required in practical applications and which are routinely dealt with by the engineer.

And finally, there is a certain degree of "macho", of face-saving, which surfaces in any public debate. That is, whenever proponents or opponents of nuclear power have basked in the limelight of public attention and have been accepted as a source of great wisdom on a given subject, it becomes very difficult for them to change their stance, even if it becomes evident that either due to changing situations or the inadequacy of their earlier reasoning, their arguments have become irrelevant or incorrect. The spotlight of public attention is probably flattering to all scientists and engineers, most of whom spent the dominant portion of their professional lives engaged in lonely research or analysis in the laboratory. Certainly the fame and notoriety of being accepted as an "expert" on a given subject is not easily discarded. It is perhaps the most difficult task of all to admit that one is wrong in a public debate (as the examination of any political campaign will quickly verify).



But we can certainly not dismiss the opposition to nuclear power as simply an emotional manifestation of suppressed fear or guilt concerning nuclear weapons or a general reaction against technology. There are some very real problems which must be overcome if nuclear power is to realize its potential. Certainly public acceptance, or the lack thereof, presents the major barrier to the massive deployment of nuclear power, both in this country and abroad. Moreover, the process by which nuclear power is regulated, licensed, and controlled continues to flounder in a unwieldy mass of red tape and bureaucratic delay. The rapid escalation of the already staggering cost of central station power plants--both nuclear and fossil-fueled--may very well exceed the ability of our society to finance such construction from the private sector. Certainly too, the international aspects associated with the spread of nuclear technology--particularly that associated with the nuclear fuel cycle--is intimately related to the proliferation of nuclear weapons capability and requires immediate and serious attention.

We will consider all of these issues later in this text, and hopefully provide the reader with sufficient technical background and sources of information to allow him to perform his own evaluation of the role nuclear power should play in our society. But before we begin this task, we feel it wise to provide the reader with several cautions that should be kept in mind whenever attempting to evaluate aspects of the nuclear power debate:

First, it should be kept in mind that nuclear power generation is an extremely broad subject. Any single individual can only (honestly) claim expertise in only a very narrow subfield. Hence, perhaps the first important consideration which should be given in evaluating any statements pertaining to the nuclear power debate is to carefully examine the credentials and the qualifications of those who would make such statements. For example, one should be cautious in giving too much credence to statements concerning nuclear reactor safety which are made by lawyers or utility executives. Indeed, a grain of salt should be added to statements involving engineering technology by scientists as well, since scientists are usually unaccustomed to dealing with complex systems, the "dirty" problems involving practical applications that are faced daily by engineers. One should also be wary of broad generalizations that are made concerning a complex new technology such as nuclear power. In summary then, one should only accept statements made by an individual that obviously lie within his area of expertise, and even then, such acceptance should be approached with some caution.

Credibility is always a problem in any emotional debate. This is particularly true of the debate concerning nuclear power, since almost by definition, most of those individuals with extensive experience in nuclear power generation have strong ties to either the nuclear power industry or the federal government. It is certainly natural to be suspicious of anything big and to transfer this suspicion to those associated with the atomic energy program. But we must remember that the electrical utilities, the federal government, and those proponents of nuclear power from universities are not (necessarily) (i) stupid, or (ii) out to screw the public. Rather, they appear to be making a conscientious and honest effort to arrive at correct decisions concerning how to meet our future needs for energy. These individuals will be affected by these decisions in a very personal manner, just as members of the public. They too have families. They too are concerned about questions of safety and environmental



impact. And, interestingly enough, few of the proponents are likely to reap vast fortunes from its implementation (in sharp contrast to the attorneys who stand to benefit from enormous legal fees in the variety of lawsuits and public intervention cases conducted against the nuclear power industry). These individuals appear to be genuinely concerned about your future.

Finally, the reader should keep in mind that the decision to implement nuclear power (or to discard it) should be based upon scientific or technical fact--not emotion. There is a very important principle to be kept in mind when evaluating such debates. It is the principle of scientific integrity. When a scientist discusses an issue, he is obligated to present all known aspects of a subject--not simply those aspects that support his own beliefs. That is to say, if he is aware of technical facts which would tend to counter his argument, he is obligated to present these facts in his discussion. This should be contrasted with the advocate system of law in which an individual present only those facts which support his side of a given case. This is particularly important since so many lawyers have entered the debate over nuclear power and have changed significantly the nature of this debate. Unfortunately, when the advocate system is applied to science, it tends to throw out scientific integrity and replaces science by essentially a pseudo-science--as Richard Feynman<sup>88</sup> would say, a "cargo-cult science"--which has led to a very considerable confusion on the part of the public. (And for this reason, it is probably time to get the lawyers out of the technical debate over nuclear power--to cast the thieves and gamblers from the temple).

The importance of responsible criticism during the development of any new technology cannot be understressed, however. Certainly there have been numerous examples during the development of nuclear power in which responsible critics have played a vital role in stimulating changes in the direction of the program, additional research, and have pointed out a number of problems which had been overlooked by others. There is a very real danger, however, that such responsible critics are being overwhelmed by the emotional outbursts of those with only a marginal understanding of the technical concepts relevant to nuclear power generation, but with almost evangelistic zeal for alerting society to the enormous "dangers" and "follies" of nuclear power. Indeed, it is rather easy to become a dedicated critic of technology, provided you refuse to allow yourself to be bothered with concepts such as scientific integrity,

with the need to acquire a sufficient technology, or with providing the public with viable alternatives to the technology you are criticizing. (In Table IV we have listed several steps which will take you well along the road to becoming such a critic.)<sup>21</sup>

It is unfortunate that while society (rightly) holds technical experts accountable for the accuracy of their statements, this accountability is usually not extended to lay-critics who frequently are allowed to make the most ridiculous statements without being taken to task when they are later proved to have been wrong.

The role of the layman in influencing technical decisions is extremely important, since public funds, issues involving the environment, political and societal effects, and long term public welfare are frequently at stake. Some means must be found to enable the layman to effectively respond to legitimate questions without paralyzing the efforts necessary to obtain valid and supportable answers. Unfortunately, the complexity of the issues is frequently beyond those who have not had training, education, or experience in the field, and it is little wonder that the layman frequently gets confused.

Certainly some exposure to the technical facts is necessary if the public is to make correct decisions. Fortunately in many cases a few basic concepts, combined with the knowledge of sources of further information, can go a long way. It is possible to learn how to ask the right questions of those debating a particular technical issue--to distinguish the expert from the charlatan, and to identify individuals with valid concerns. One of the primary goals of this text will be to provide the reader with sufficient technical background and introduce him to sources of further information so that he can rationally conduct his own examination of the nuclear power issue.







## CHAPTER 5

BASIC CONCEPTS OF NUCLEAR ENERGY RELEASE

Whenever we produce energy, or transmit it from one place to another, or utilize it to run our machines or light our homes, we are actually exploiting a variety of processes which occur on the microscopic level of atoms and atomic nuclei. For example, the burning of fossil fuels such as coal involves the rearrangement of atoms from one molecular form (e.g., methane and oxygen) to another (e.g., carbon dioxide and water) which results in a release of energy. (Note that in this sense, the burning of coal should actually be interpreted as a form of "atomic energy" since it involves reactions among atoms.) In a similar manner, the "burning" of nuclear fuels such as uranium involves reactions among atomic nuclei in which the constituents of uranium nuclei (protons and neutrons) rearrange themselves to form new types of nuclei (i.e., when a uranium nucleus "fissions" into two nuclei) and release "nuclear energy".

Hence, it should not be surprising that some introduction to the simpler aspects of atomic and nuclear physics is useful--indeed, necessary--for an understanding of how man produces and utilizes various types of energy.

## 5.1 NUCLEAR FISSION AND NUCLEAR FUSION

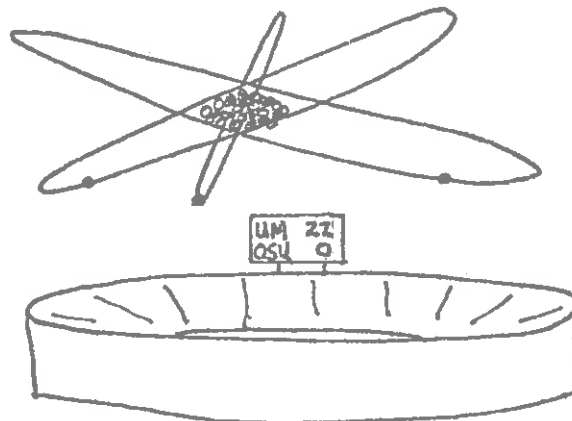
## 5.1.1 ATOMS AND NUCLEI

Atomic Structure and Atomic Physics

Fundamental to our study will be the concept that all matter is composed of microscopic particles known as atoms which are typically about a billionth of a centimeter in diameter (more precisely, between  $1 - 5 \times 10^{-8}$  cm). But these atoms also have a structure, consisting of a very tiny (but massive) charged atomic nucleus surrounded by several negatively charged electrons. Atoms are frequently pictured (by both physicists and commercial artists alike) as kind of a miniature solar system, with the electrons orbiting about the nucleus, much as



the planets orbit about the sun. Although the atomic nucleus contains essentially all of the mass of the atom (99.9%), it is only about one ten-thousandth as large as the atom (about  $10^{-12}$  cm in diameter). To illustrate this comparison between atomic and nuclear sizes, if we were to magnify a uranium atom to the size of Michigan Stadium, then the uranium nucleus would be about the size of a football (and, incidently, about the same shape as a football, as well).



The atomic nucleus is made up to two types of particles: protons which carry a positive charge and neutrons which are electrically neutral. We denote the number of protons in the atomic nucleus by the atomic number Z. There will be an identical number Z of negatively charged electrons orbiting about the positive nucleus, attracted to it by the electrical (or Coulomb) forces which occur between charged objects. Since the electron charge is equal and opposite to that of the proton, the atom itself will be electrically neutral.

Atoms can interact with one another via the electrical forces which arise between their electrons and nuclei. They can bang into each other, knocking electrons loose, or acquiring or sharing electrons with one another. Such electrical forces can cause the atoms to stick or bind together into groups of atoms or molecules. Indeed, the binding together of atoms into molecules is essentially the subject of chemistry. It seems logical that since the interaction among atoms depends on their electrical charge, atoms with the same atomic number Z will behave identically from a chemical standpoint. The chemical properties of such chemical elements are essentially determined by the number of electrons

in the outermost orbit (or shell) of the atom, since these are the electrons which participate in atomic (or chemical) reactions. This gives rise to a classification scheme of chemical properties of the chemical elements which is most conveniently displayed by the Periodic Table of the Elements<sup>1</sup> (a familiar tool to any chemistry student). (We will later find that a very similar scheme exists for nuclear properties.)

Whenever atoms interact to form molecules, or molecules interact to form new types of molecules, there is either a release or an absorption of energy. In particular, if a reaction requires that we add energy to cause it to occur (e.g., by heating the chemical mixture), we refer to the process as endothermic. If the reaction liberates energy, it is exothermic. Obviously, exothermic reactions are of most interest in energy generation schemes.

The energy released in such reactions arises from the electrical forces between electrons and nuclei. For a given atomic reaction, the amount of energy involved is very small--sufficiently small, in fact, that we need special units with which to express it. Atomic energies are conventionally measured in a unit called the electron volt (eV), which is defined to be the energy required to push a single electron through a potential difference of one volt. In more familiar units, this corresponds to  $1.6 \times 10^{-19}$  joules. Although a single atomic or chemical reaction will liberate at most only several eV of energy, we must keep in mind that an enormous number of such reactions will occur in any chemical process. For example, when we burn 1 kilogram of coal, we induce  $10^{21}$  reactions, each of which liberates 2 eV of energy, for a total energy yield of  $10^3$  joules.

We have noted that atoms can bind together to form more complicated objects known as molecules. In a similar manner, either atoms or molecules can be attracted together to form macroscopic-sized samples of matter. At low temperatures, the atoms will bind to each other in a more or less rigid pattern which corresponds to a solid material. Of course, even though solids appear to be quite rigid and inanimate forms

Figure -1

PERIODIC TABLE OF PROPERTIES OF THE ELEMENTS

IA		IIA		IIIB		IVB		VB		VIB		VIIB		VIII, VIII		IIB		IIIA		IVA		VA		VIA		VIIA		INERT GASES							
HYDROGEN 1.00794		BERYLLIUM 9.0122		LITHIUM 6.941		SODIUM 22.98977		MAGNESIUM 24.304		ALUMINUM 26.981538		SILICON 28.0855		PHOSPHORUS 30.973762		SULFUR 32.065		CHLORINE 35.453		ARGON 39.948		KRYPTON 83.80		XENON 131.29		RADON 222		HELIUM 4.002602		NEON 20.1797					
1		2		3		4		5		6		7		8		9		10		11		12		13		14		15		16		17		18	
1		2		3		4		5		6		7		8		9		10		11		12		13		14		15		16		17		18	
1		2		3		4		5		6		7		8		9		10		11		12		13		14		15		16		17		18	

ATOMIC WEIGHTS BASED ON CARBON-12 (IUPAC, 1961)

**KEY**

DENSITY, G/CCY  $\rho$   
 ATOMIC NUMBER  $Z$   
 SYMBOL  $X$   
 ELECTRON SHELLS  $e$   
 ATOMIC WEIGHT  $A$   
 VALENCES  $v$   
 MELTING POINT, °C  $t_m$   
 BOILING POINT, °C  $t_b$

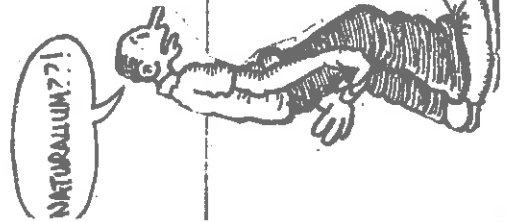
†At room temperatures for gases, G/Liter at NTP.

(1) = Solubility

\*Also Called NIOBIUM (Nb)

\*\*LANTHANIDE SERIES

\*\*ACTINIDE SERIES



of matter, on a microscopic level the atoms are in vigorous motion, vibrating about a fixed position in the solid structure (in the language of physics, the crystal lattice). As the solid is heated to higher temperatures, these vibrations become more agitated until the atoms break away from their lattice position and begin to move about in a random fashion. At this point the solid loses its structure, its rigidity. We find on a macroscopic level that the solid has melted; it has become a liquid.

PLASMA ???

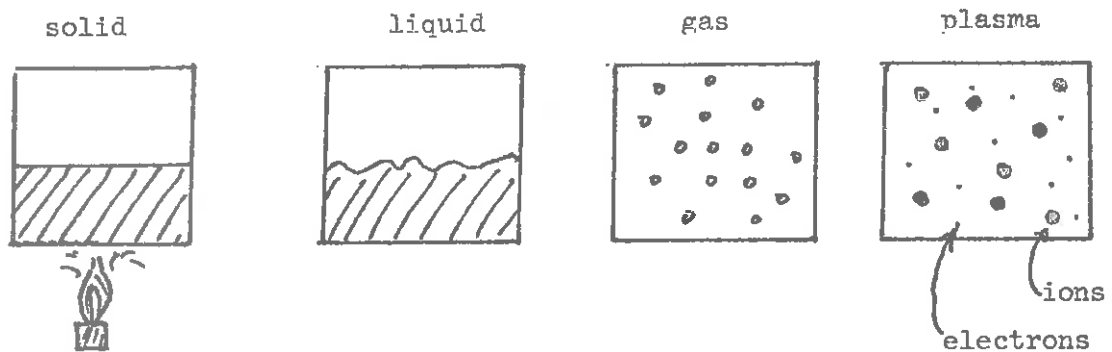


Figure 5-2

Suppose we continue to heat the liquid to still higher temperatures. The atoms move more and more rapidly until they reached speeds which are too high to allow them to be attracted to each other and clump together. The liquid vaporizes into the gas phase. Hence, we see that the form taken by matter--the state or phase of the matter--depends sensitively upon its temperature--that is, the speed of motion of the atoms or molecules which comprise its microscopic structure. We are used to thinking of matter as existing in one of these three states: solid, liquid, or gas.

But there is yet another fundamental state of matter. Suppose we continue to heat the gas to still higher temperatures. Eventually, we will supply sufficient energy to the molecules of the gas that they will knock each other apart when they collide--they will dissociate into individual atoms. If we continue to add energy, eventually the collisions will become so violent that the electrons are stripped off of the atomic nuclei (ionization), and we find that the gas has become a collection of free electrons and positively charged nuclei or ions.

Such an ionized gas is referred to as a plasma. Plasmas are not ordinarily encountered (or at least recognized) in our daily experiences since the temperatures required to ionize a gas are enormous, typically ranging upwards of  $10,000^{\circ}\text{C}$ . Nevertheless, plasmas are quite common in physics. For example, the glow in a neon light is a plasma. On a more grandiose scale, the sun--indeed, all stars-- is a giant blob of plasma. In fact, on an astrophysical scale, the most common form of matter is as a plasma. We will return later to discuss plasmas when we consider the enormous temperatures required to produce thermonuclear fusion reactions.

### Nuclear Structure and Nuclear Physics

Since the amount of energy released by a macroscopic chunk of material will depend upon how many atoms in the material are undergoing reactions, it is important to learn how to estimate the number of atoms in the material, or more commonly, the number of atoms per unit volume of material-- the atomic number density. This can be easily calculated if we know the mass density ( $\text{g}/\text{cm}^3$ ) and atomic weight of the material. (in grams) of  $6.02 \times 10^{23}$  atoms (Avogadro's number). For example, uranium has an atomic weight of 238.0. Hence,  $6.02 \times 10^{23}$  atoms of uranium would weigh 238 g. If we now note that uranium metal has a density of  $10 \text{ g}/\text{cm}^3$ , then we can calculate the atomic number density of uranium as

$$\begin{aligned} \text{atomic} &= N = \frac{(\text{mass density})(\text{Avogadro's number})}{(\text{atomic weight})} \\ \text{number} & \\ \text{density} &= \frac{(10)(6.02 \times 10^{23})}{(238)} = 4.8 \times 10^{22} \text{ cm}^{-3} \end{aligned}$$

As yet another example, helium in gaseous form has a density of  $0.00018 \text{ g}/\text{cm}^3$ . Since its atomic weight is 4.003, we find that the atomic number density of helium gas is  $2.7 \times 10^{19}$ . (It might be noted that these atomic number densities of  $10^{22}$  and  $10^{19}$  are rather typical for solids and gases, respectively.)

Let us consider in more detail the atomic nucleus itself. We noted earlier that the atomic nucleus is composed of two types of subnuclear particles, the proton and the neutron, whose respective mass and charge are

proton:  $m_p = 1.67252 \times 10^{-24}$  g, charge = +1  
 neutron:  $m_n = 1.67482 \times 10^{-24}$  g, charge = 0

These particles, referred to collectively as nucleons, are packed tightly together in a roughly spherical structure of essentially uniform density to form the atomic nucleus. As we have noted, the size of a nucleus is extremely small and its radius is given roughly by

$$\text{Radius (cm)} = 1.4 \times 10^{-13} A^{1/3}$$

where A is the total number of nucleons in the nucleus.

The number of protons and neutrons in a nucleus can be used to develop a classification scheme. To be more specific, let us define:

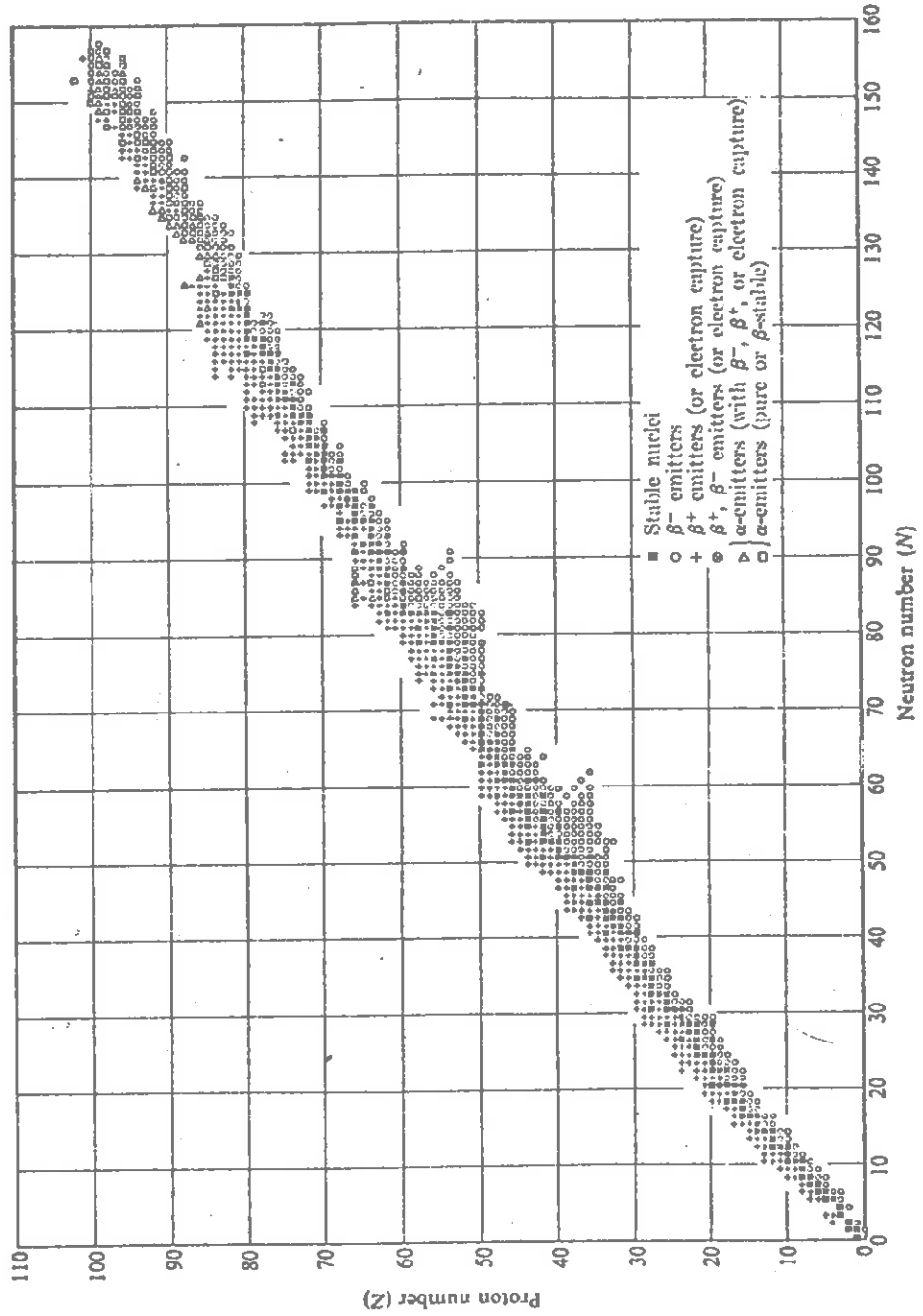
Number of protons: Z (atomic number)  
 Number of neutrons: N  
 Total number of nucleons:  $A = N + Z$  (mass number)

(A is referred to as the "mass number" of the nucleus since it is essentially the mass of the nucleus in atomic mass units (amu), where  $1 \text{ amu} = 1.67252 \times 10^{-24}$  g.) The notation most commonly used to label a specific type of nucleus or nuclide is

$${}^A_Z \text{Chemical Symbol}$$

For example,  ${}^1_1\text{H}$ ,  ${}^{12}_6\text{C}$ , and  ${}^{238}_{92}\text{U}$  are notations for three such nuclides. (Since Z determines the chemical symbol, this notation is a bit redundant, and we will occasionally revert to an alternative notation such as H-1, C-12, or U-238.) This notation can also be applied to subatomic particles. For example, a proton would be  ${}^1_1\text{P}$  (although it could also be written as  ${}^1_1\text{H}$ , of course), a neutron by  ${}^1_0\text{n}$ , and an electron by  ${}^0_{-1}\text{e}$  (since an electron has nearly zero mass in comparison with a nucleon and a negative charge).





The chart of the nuclides, showing stable and unstable nuclei. (Based on S. E. Liverhart, *Elementary Introduction to Nuclear Reactor Physics*. New York: Wiley, 1960.)



Figure 5-3

Although in general the number of neutrons in a nucleus is comparable to the number of protons, one commonly finds that each element (that is, each  $Z$ ) actually appears in several nuclide forms which differ in their neutron number and hence in their mass number  $A$ . Nuclides with the same  $Z$  but different  $A$  are referred to as isotopes. For example, the isotopes of hydrogen are  ${}^1_1\text{H}$ ,  ${}^2_1\text{H}$ , and  ${}^3_1\text{H}$ , while heavy elements such as uranium may exhibit a number of isotopic forms, e.g.,  ${}^{233}_{92}\text{U}$ ,  ${}^{234}_{92}\text{U}$ ,  ${}^{235}_{92}\text{U}$ ,  ${}^{236}_{92}\text{U}$ ,  ${}^{238}_{92}\text{U}$ . Naturally occurring elements are actually a composition of several isotopes. For example, uranium occurs predominantly in the form of U-238 (99.3%) with 0.7% U-235 and a trace amount of U-234.

A very convenient scheme for presenting data about various nuclides is to plot them on a chart (a Chart of the Nuclides) in which neutron number  $N$  is plotted on the horizontal axis, and proton number (atomic number)  $Z$  is plotted on the vertical axis. (See Figure 5-3.) Then all isotopes of the same element lie on a horizontal line. Presently well over 3000 distinct nuclides have been identified (in sharp contrast to the relatively modest number of 105 distinct elements).

The reader might question why nuclides with only certain combinations of neutron and proton number have been found. A superficial answer is that other combinations of neutrons and protons cannot be bound together to form a nucleus. Indeed, the vast majority of the nuclides indicated on the Chart of the Nuclides are "unstable" and will eventually disintegrate into other types of nuclides.

The phenomenon of nuclear stability or instability is easy to understand when it is recalled that the protons in the nucleus are all positively charged and will strongly repel one another. Hence, these electrical forces of repulsion must be counteracted by another type of attractive force, a nuclear force, if the nucleus is to bind together. The relative balance between the electrical repulsion of the protons forcing the nucleons apart and the nuclear forces pulling the nucleons together determine the stability of the nucleus.



In a crude sense, the neutrons act as the "glue" which causes these nuclear forces to work and bind the nucleons together. Too few neutrons, and the nucleus won't stick together. On the other hand, a nucleus with too many neutrons cannot stick together either. As the Chart of the Nuclides indicates, roughly the same number of neutrons and protons are needed for light nuclei, while for heavier nuclei a few more neutrons are needed (about half again as many neutrons as protons) for the heaviest nuclides, such as U-238.

One frequently encounters nuclides which, although unstable, will hang together long enough to be of some importance. Eventually, these unstable nuclei will turn into another type of nuclide by shedding a few excess neutrons and protons, converting a neutron into a proton (and kicking out an electron), or just disintegrating into smaller nuclei. Such unstable nuclei are referred to as radioactive, their disintegration as radioactive decay, and the pieces they throw off during the decay as radiation. Radioactive nuclei may decay very rapidly (millionths of second after they are formed) or may hang around for quite awhile before decaying. For example, U-238 is radioactive, but it takes roughly 4 billion years for a U-238 nucleus to disintegrate--so we needn't wait around.

Even stable nuclei can be induced into transmuting or changing into different nuclides by bombarding them with nuclear particles. Such nuclear reactions are in fact very similar to the chemical reactions which occur between atoms and molecules--with one very important difference. Whereas the average energy release in a reaction between atoms is typically of the order of an electron volt, the average energy involved in nuclear reactions is more than a million times larger--on the order of millions of electron volts or MeV. This is a consequence of the enormous strength of the nuclear forces which determine the strength with which nucleons are bound together in an atomic nucleus.

For example, consider those hydrogen isotopes with  $Z = 1$ . In nature, we find both hydrogen  ${}^1_1\text{H}$  and deuterium  ${}^2_1\text{D}$  as stable nuclides. A third isotope, tritium  ${}^3_1\text{T}$  does not occur in nature, but it can be

made by adding a neutron to deuterium. However, tritium has the wrong ratio of neutrons to protons ( $N/Z = 2$ ) and is unstable. After a period of about 12 years, it will decay by converting one of its neutrons into a proton and an electron, thereby becoming a helium isotope  ${}^3_2\text{He}$ .

Although the energy which binds each nucleon into a nucleus is roughly comparable (about 8 MeV) from nuclide to nuclide, there is a very important trend which can be seen by plotting the average binding energy per nucleon versus the mass number  $A$  (see Figure 5-4). It is apparent that the nucleons are most tightly bound together in nuclides of intermediate mass number. But this suggests something rather interesting: if we could somehow convert light nuclei or very heavy nuclei into nuclei of intermediate mass number, we would make available as excess energy the difference between the binding energies of the nuclei.

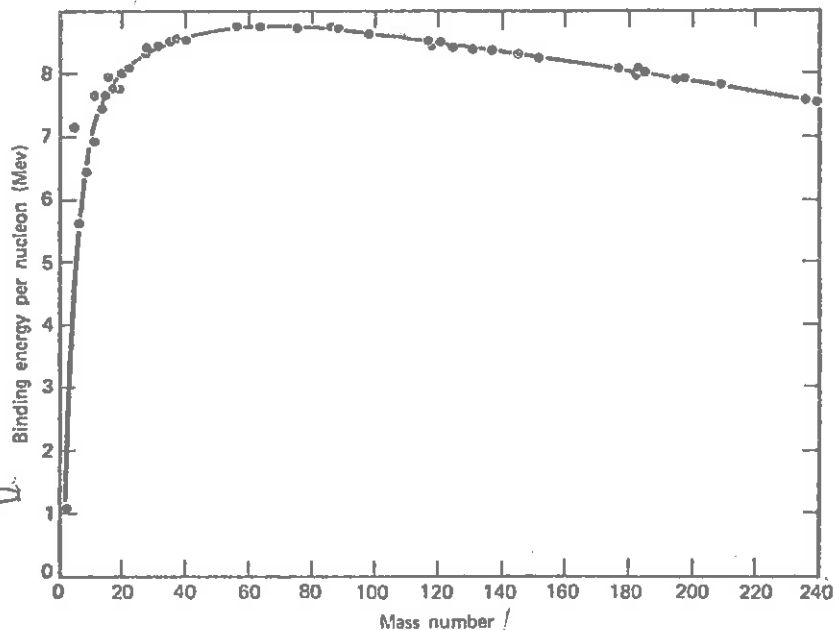


Figure 5-4

To be more specific, suppose we could combine or "fuse" together two light nuclei to make a heavier nucleus. Then the average binding energy per nucleon increases, which would imply a net energy release. An important example of such a nuclear fusion reaction involves fusing two isotopes of hydrogen,  ${}^2_1\text{D}$  (deuterium) and  ${}^3_1\text{T}$  (tritium) together to make helium  ${}^4_2\text{He}$  and a neutron. This fusion reaction releases roughly 17 MeV of energy. Such reactions are of considerable interest in achieving net energy production. Unfortunately, this fusion reaction is a bit difficult to stimulate since the light nuclei are positively

STICK WITH ME,  
DOLL, AND YOU'LL  
LEARN ABOUT FUSION  
AND FISSION BOTH!



charged and will strongly repel one another. To get them to fuse, we must somehow slam them together hard enough to overcome the electrical repulsion.

An alternative scheme to produce nuclear energy is to try to split up or "fission" very heavy nuclei into two lighter nuclei, each with larger binding energy per nucleon. Then we could achieve a net energy production by means of such nuclear fission reactions. But how do we split up a heavy nucleus? Well, from our previous discussion of fusion reactions, it is apparent that we cannot just slam two heavy nuclei together and hope they will break apart since their charge would strongly repel one another. An alternative idea is to slam a neutral particle (which will not be repelled by the nuclear charge) into a big "overweight" nucleus and hope that this splits it. An ideal candidate for the incident particle is the neutron. Indeed, experiments have shown that certain nuclei have an enormous appetite for neutrons, but after swallowing them, suffer from a case of violent indigestion which causes them to fission. As an example of such a reaction, one can bombard the uranium isotope U-235 with neutrons to induce fission into two fission product nuclei, several neutrons and other assorted radiation, and roughly 200 MeV worth of energy. The fission product nuclei emerge with most of this energy in the form of kinetic energy of motion, and this kinetic energy is rapidly converted into heat as the fission products collide with neighboring nuclei. But just as significantly, the fission reaction kicks loose a few neutrons which can then go on to induce still more fission reactions. In this way, one can use neutrons to propagate a "chain" of fission reactions. This, of course, is the scheme utilized in the nuclear reactors which power large electrical generating plants.

### 5.1.2 RADIOACTIVITY

As we have noted, a great many nuclei are unstable (radioactive) in the sense that they may spontaneously undergo a transformation into a different nuclide, accompanied by the emission of energetic particles ("radiation"). Such a spontaneous nuclear transformation is referred to as radioactive decay, and it is a very common process in nature

since traces of naturally occurring radioactive elements can be found in the minerals of the earth, in air and water, and in plants and animals (including man, of course).

The three most common types of radioactive decay found in naturally occurring nuclides include alpha decay in which a nucleus casts off a chunk containing 2 protons and 2 neutrons (i.e., a helium nucleus  ${}^4_2\text{He}$ ) which is referred to as an alpha particle; beta decay which corresponds to a nucleus converting one of its neutrons into a proton and emitting an energetic electron (or beta ray) and another subatomic particle known as a neutrino; and gamma decay in which an unstable or excited nucleus emits one or more high energy photons or gamma rays as it decays to a more stable configuration. However, other types of radioactive decay are possible in nuclear devices since many unstable nuclides are produced in nuclear reactions such as fission or fusion which do not occur in nature. For example, certain nuclei such as  ${}^{87}_{36}\text{Kr}$  may decay by emitting a neutron. (We will later find that this particular type of decay process is extremely important for nuclear reactor operation.)

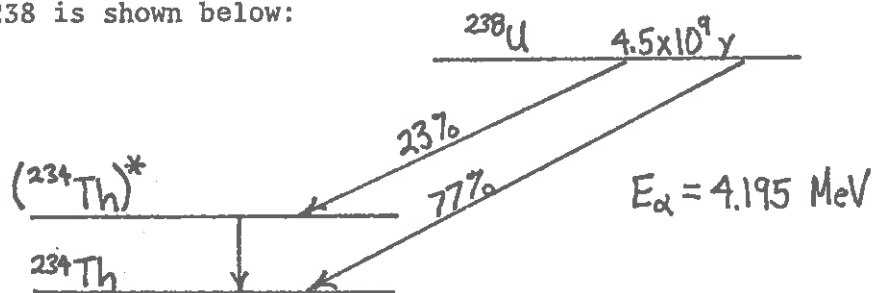
Radioactive decay is a statistical or random phenomenon; we cannot predict with certainty precisely when a given nucleus will decay. If we were able to watch one nucleus, it might decay within a second, or perhaps a few hours, or perhaps after a million years. However, if we were to observe a large number of identical nuclei, we would find that the probability that a given nucleus will decay in a given time interval is essentially constant, independent of the age of the nucleus or its environment, dependent only upon the type of the nucleus itself. Thus we can characterize each nuclide by an average lifetime,  $\bar{t}$ , prior to radioactive decay.

The reciprocal of the average lifetime,  $\lambda = \bar{t}^{-1}$  is known as the radioactive decay constant.

A closely related concept is the radioactive half-life,  $T_{1/2}$ , of a nuclide. This is defined to be the time required for one-half of the original number of nuclei present in a sample to decay. For example, tritium,  ${}^3_1\text{T}$ , is a radioactive beta emitter with a half-life of 12.3

years. That means that, on the average, half of a sample of tritium nuclei will decay within 12.3 years. After an additional 12.3 years, half of the remaining tritium will have decayed, and so on. One can express the half-life in terms of either the average lifetime or radioactive decay constant as  $T_{1/2} = \frac{.673}{\lambda} = .673\bar{t}$ .

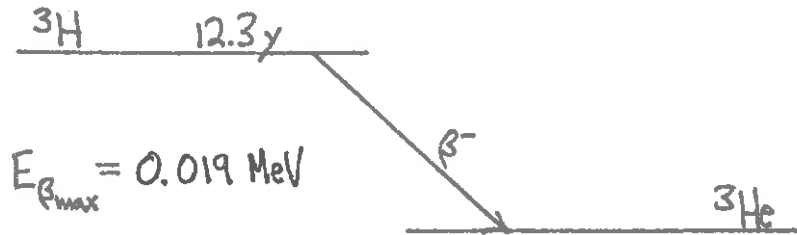
Each radioactive nuclide is characterized by a specific half-life (which may be as short as millionths of a second or as long as billions of years) and radioactivity (e.g., alpha, beta, or gamma radiation). Actually, most radioactive decay processes are a bit more complicated than those we have described, since the original nucleus may decay into another nuclide which is itself radioactive and subject to further decay. Hence, we can have a "chain" of sequential radioactive decay events. A very convenient manner in which to present information concerning the radioactive decay of a given nuclide is to use a graphical representation known as a radioactive decay scheme. These decay schemes are tabulated in sources such as the Table of Isotopes<sup>2</sup> and contain information on the decay mode, kind, energy and relative frequency of the emitted particles and the half-life. For example, the decay scheme for U-238 is shown below:



Each nuclide in the decay process is indicated by a line--if more than a single line appears in the column for a given nuclide, this indicates that the nuclide may be formed in an excited or energetic state--from which it may decay further by gamma emission. In this particular case, we see that U-238 is radioactive with respect to alpha emission with a very long half-life of 4.5 billion years. Some 77% of the time it will emit an alpha particle of 4.195 MeV as it decays to Th-234. In 23% of the decays, however, it will emit an alpha of slightly less energy

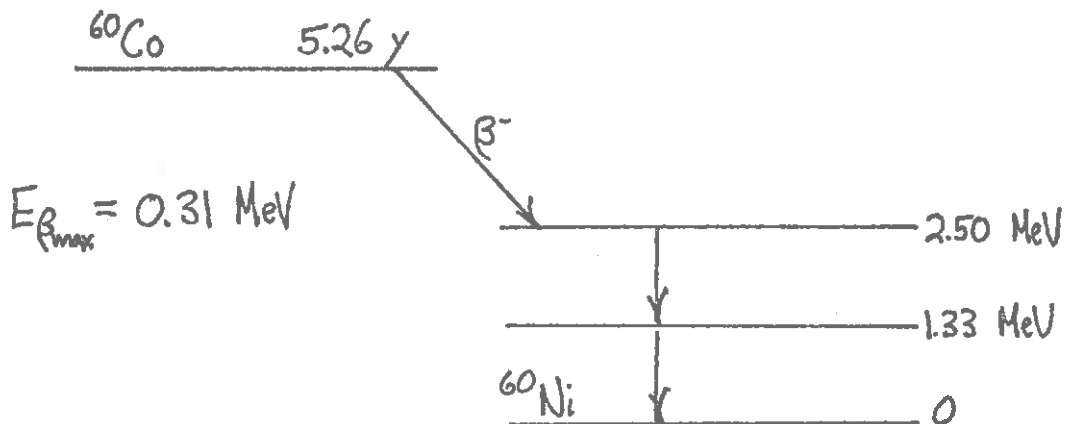
( $4.195 - 0.048 = 4.147$  MeV) and decay to an excited state of Th-234. This excited nuclide will then decay the rest of the way by emitting a 0.048 MeV gamma ray.

As yet another example, consider the beta decay of tritium



Here, tritium decays to  ${}^3_2\text{He}$  by emitting an electron (beta ray). However, since there is also another particle emitted (a neutrino), we cannot say with certainty what the energy of the emitted electron is, only that its maximum energy is 0.019 MeV.

A slightly more complicated example of beta decay is shown below for the decay of Co-60 to Ni-60. In this instance, the initial beta decay is to an excited state of Ni-60, which then decays to stable Ni-60 by emitting two gamma rays of 1.27 and 1.33 MeV, respectively.



Yet another concept of some importance is that of the activity characterizing a sample of radioactive material. This quantity is simply the total number of disintegrations occurring per second in the sample. If we know the half-life of the radioactivity and the number of nuclei  $N$  in the sample, we can compute the activity as

$$\text{Activity} = \lambda N = (0.673/T_{1/2}) N.$$

The activity of a sample is measured in the unit of the Curie (Ci) where one curie is defined to be  $3.70 \times 10^{10}$  disintegrations per second. (This is roughly the activity of 1 g of radium.) Hence, if you want to express how "radioactive" a given chunk of stuff is, you give its activity in terms of curies.

To better illustrate the concept of activity, let us consider several examples:

EXAMPLE 1: One of the most hazardous of the fission products produced in a nuclear reactor is strontium-90. Let us calculate the amount of Sr-90 produced by a power reactor operating continuously for one year. A list of the production rates of important fission products in a reactor is given, for example, in the Radiological Health Handbook.<sup>3</sup> According to this source, the radioactivity from Sr-90 produced in a reactor is 1430 Ci per MWe of power. This same source also tells us that the half-life of Sr-90 is 27.7 years. Since 1 year =  $31 \times 10^6$  seconds, we can calculate the radioactivity decay constant as  $\lambda = 0.693/(27.7)(31 \times 10^6) = 8.1 \times 10^{-10}$ . Hence, we can return to our definition of activity to find the number of strontium atoms required to produce 1430 Ci of activity as

$$N = \frac{A}{\lambda} = \frac{1430(3.7 \times 10^{10})}{8.1 \times 10^{-10}} = 6.5 \times 10^{22} \text{ Sr-90 nuclei} = 11 \text{ moles of Sr-90} = 30 \text{ Kg}$$

Thus for a 1000 MWe power plant, whose efficiency is about 33%, the annual Sr-90 production can amount to 30 Kg.

EXAMPLE 2: By way of comparison, let us calculate the radioactivity of a nuclear fusion power plant. According to Steiner and Fraas<sup>4</sup>, the tritium inventory of such a plant is estimated to be about 6 g/MWt. Since the atomic weight of tritium is 3 g/mole, the number of tritium atoms per MWt is  $(6/3) \times (6.03 \times 10^{23}) = 12.06 \times 10^{23}$ . The half life of tritium was noted earlier to be 12.3 years. Hence, we can compute the activity as

$$A = \lambda N = \frac{0.693}{(12.3)(31 \times 10^6)} \frac{12.06 \times 10^{23}}{3.7 \times 10^{10}} = 6.5 \times 10^4 \text{ Ci/Mw(t)}$$

If the efficiency of the plant is again assumed to be about 33%, the radioactivity for tritium alone for a 1000 MWe fusion power plant would be about 195 million Ci. (By way of comparison, the total fission product activity in an operating power fission reactor is 3.83 Ci/w(t).) Hence, a 1000 MWe fission reactor would have a radioactivity inventory of  $3.83 \times 3 \times 10^9 = 12$  billion Ci. Hence, while the fusion plant fuel is somewhat less radioactivity than a fission plant, it still has a sizeable radioactivity inventory (and we should note that tritium is far more difficult to contain than most radioactive fission products).

EXAMPLE 3: In assessing radiological hazards, we must keep in mind that the curie alone is not a complete description; we also need to know the amount of energy released per disintegration. If we refer again to the Radiological Health Handbook<sup>3</sup>, we find that the decay of Sr-90 involves the emission of two betas with an average total energy of 1.1 MeV. Hence, the rate of energy generated by the radioactive decay of Sr-90 in a 1000 MWe reactor is

$$\begin{aligned} \text{Radioactive power} &= 1430 (3.7 \times 10^{10})(11) \times (3000) = \\ &1.74 \times 10^{17} \text{ MeV/sec} = 27.9 \text{ kW} \end{aligned}$$

We might compare this to another important fission product, I-131, which is produced at a rate of 25,200 Ci/MWt. Since its energy



release per disintegration is 0.6 MeV, it would give rise to a radioactivity power of

$$\begin{aligned} \text{Radioactive power} &= (25,200)(3.7 \times 10^{10})(.6) \times 3000 = \\ &1.68 \times 10^{18} \text{ MeV/sec} = 267 \text{ kW} \end{aligned}$$

almost ten times larger.

One of the most useful sources of information on radioactive materials is the Chart of the Nuclides (see Figure 5-3). As we noted earlier, those nuclides having the same number of protons are called isotopes. Isotones are nuclides having the same number of neutrons, and isobars are those having the same number of nucleons. The isotopes, isotones, and isobars are displayed on the Chart along the horizontal, vertical, and diagonal, respectively. As an example, consider the isotopes, isotones, and isobars associated with I-131 (which happens to be a heavy fission fragment). The isotopes of iodine ( $Z = 53$ ) range from I-115 to I-141, the set of isotones consists of the nuclides starting from In-127 at the bottom to Sm-140 at the top of the vertical line for  $N = 78$ . The set of isobars for  $A = N + Z = 131$  lie along the diagonal starting with In-131 at the lower right to Ce-131 at the upper left.

We also need to note that the stable nuclides occur near the centers of the isotope, isotone, and isobar lines, and these stable nuclides lie very roughly on a diagonal line extending from the lower left to the upper right of the Chart. This line of stable nuclides is referred to as the stability line. This, it will be noted, divides radioactive nuclides roughly into two groups, those that lie above and below the stability line.

When nuclides undergo beta-decay, whether by electron or positron emission, the daughter product is another isobar. If the decay is by beta-minus, i.e., an electron is emitted, the daughter product is the adjacent upper left isobar, whereas for beta-plus decay, i.e., if positron is emitted, then the daughter nuclide is the one to the lower

140Sm

<sup>131</sup>Ce

<sup>115</sup>I

<sup>131</sup>I

<sup>141</sup>I

isotopes

Z=53

<sup>127</sup>In

<sup>131</sup>In

isobars

N=78

isotones

THAT'S SIMPLE! I SLIPPED \$5 TO DUDERSTADT.



Table of isotopes and isobars for elements Ce, Pr, Nd, Pm, Sm, Eu, Gd, Tb, Dy, Ho, Er, Tm, Yb, Lu, Hf, Ta, W, Re, Os, Ir, Pt, Au, Hg, Tl, Pb, Bi, Po, At, Rn, Fr, Ra, Ac, Th, Pa, U, Np, Pu, Am, Cm, Bk, Cf, Es, Fm, Md, No, Lr. Includes atomic numbers, masses, and half-lives.

60

59

0.53

0.8

~1.7

Detailed table of isotopes and isobars for elements Ce through Lr, showing atomic numbers, masses, and half-lives.

right. Furthermore, note that the positron emitters lie above the stability line and the electron emitters below. Nuclear fission gives rise to fragments that lie below the stability line, so that they decay by the beta-minus process. For example, for the isobars of  $A = 131$ , the only ones resulting from fission are the nuclides Sn-131, Sb-131, and Te-131, and of these, Sb-131 has the highest yield. The radioisotope I-131 then is produced mainly by the beta-minus decay of Sb-131, into Te-131, and then into I-131.

For nuclear fission technology, there are three main regions of interest, which we might call the island of light fission fragments, the island of heavy fission fragments, and the island of the actinides.

The yields for fission of U-235 are indicated in % at the lower right end of the diagonal lines and are given for isobars spanning from  $A = 72$  to  $A = 162$ . A fortunate fact to note is that most fission fragment nuclides have short half-lives. The accompanying table lists those having half-lives of one year or longer. To give an indication of the radioactive-waste management problem, the table also lists the approximate weight of such nuclides produced in a large 1000 MWe plant, and also the volumes when in the elemental form. The total volume of these fission fragments amount to only a little over 20 quarts. This, of course, is not the complete picture, but it does give some indication of the magnitude of the waste disposal management problem.

The weights of the radioactive wastes were calculated by first noting that approximately one tonne (metric ton, one million grams, approximately one ton) of U-235 is burned in one year in a modern 1000 MWe plant. The weight then in grams is given by

$$10^6 \frac{AY}{235}$$

in which  $A$  is the mass number and  $Y$  is its fission yield.

One very important fission product, I-131, is not listed in Table 1 because its half-life is only 8.041 days; it is a problem

AH, DON'T GET SO UPSET. I'LL HAVE HIM PUT IN FOUNTAINUM!



93	Po223 222.0466 2.9ms 0.796	Th222 222.0155 2.9ms 0.796	Ac222 222.0155 2.9ms 0.796	Ac223 223.0113 2.9ms 0.796	Ra221 223.0113 2.9ms 0.796	Ra222 223.0113 2.9ms 0.796	Ra223 223.0113 2.9ms 0.796	Ra224 223.0113 2.9ms 0.796	Ra225 223.0113 2.9ms 0.796	Ra226 223.0113 2.9ms 0.796	Ra227 223.0113 2.9ms 0.796	Ra228 223.0113 2.9ms 0.796	Ra229 223.0113 2.9ms 0.796	Ra230 223.0113 2.9ms 0.796	Ra231 223.0113 2.9ms 0.796	Ra232 223.0113 2.9ms 0.796	Ra233 223.0113 2.9ms 0.796	Ra234 223.0113 2.9ms 0.796	Ra235 223.0113 2.9ms 0.796	Ra236 223.0113 2.9ms 0.796	Ra237 223.0113 2.9ms 0.796	Ra238 223.0113 2.9ms 0.796	Ra239 223.0113 2.9ms 0.796	Ra240 223.0113 2.9ms 0.796	Ra241 223.0113 2.9ms 0.796	Ra242 223.0113 2.9ms 0.796	Ra243 223.0113 2.9ms 0.796	Ra244 223.0113 2.9ms 0.796	Ra245 223.0113 2.9ms 0.796	Ra246 223.0113 2.9ms 0.796																																											
94	Np227 227.0239 1.0m	U227 227.0239 1.0m	Po226 226.0155 1.0m	Th226 226.0155 1.0m	Ac226 226.0155 1.0m	Ac227 227.0239 1.0m	Ac228 228.0299 1.0m	Ac229 229.0359 1.0m	Ac230 230.0419 1.0m	Ac231 231.0479 1.0m	Ac232 232.0539 1.0m	Ac233 233.0599 1.0m	Ac234 234.0659 1.0m	Ac235 235.0719 1.0m	Ac236 236.0779 1.0m	Ac237 237.0839 1.0m	Ac238 238.0899 1.0m	Ac239 239.0959 1.0m	Ac240 240.1019 1.0m	Ac241 241.1079 1.0m	Ac242 242.1139 1.0m	Ac243 243.1199 1.0m	Ac244 244.1259 1.0m	Ac245 245.1319 1.0m	Ac246 246.1379 1.0m	Ac247 247.1439 1.0m	Ac248 248.1499 1.0m	Ac249 249.1559 1.0m	Ac250 250.1619 1.0m																																												
95	Am232? 232.0379 1.9m	Am233 233.0439 1.9m	Pu232 232.0379 1.9m	Np231 231.0319 1.9m	Np232 232.0379 1.9m	Np233 233.0439 1.9m	Np234 234.0499 1.9m	Np235 235.0559 1.9m	Np236 236.0619 1.9m	Np237 237.0679 1.9m	Np238 238.0739 1.9m	Np239 239.0799 1.9m	Np240 240.0859 1.9m	Np241 241.0919 1.9m	Np242 242.0979 1.9m	Np243 243.1039 1.9m	Np244 244.1099 1.9m	Np245 245.1159 1.9m	Np246 246.1219 1.9m	Np247 247.1279 1.9m	Np248 248.1339 1.9m	Np249 249.1399 1.9m	Np250 250.1459 1.9m	Np251 251.1519 1.9m	Np252 252.1579 1.9m	Np253 253.1639 1.9m	Np254 254.1699 1.9m	Np255 255.1759 1.9m	Np256 256.1819 1.9m	Np257 257.1879 1.9m	Np258 258.1939 1.9m	Np259 259.1999 1.9m	Np260 260.2059 1.9m	Np261 261.2119 1.9m	Np262 262.2179 1.9m	Np263 263.2239 1.9m	Np264 264.2299 1.9m	Np265 265.2359 1.9m	Np266 266.2419 1.9m	Np267 267.2479 1.9m	Np268 268.2539 1.9m	Np269 269.2599 1.9m	Np270 270.2659 1.9m	Np271 271.2719 1.9m	Np272 272.2779 1.9m	Np273 273.2839 1.9m	Np274 274.2899 1.9m	Np275 275.2959 1.9m	Np276 276.3019 1.9m	Np277 277.3079 1.9m	Np278 278.3139 1.9m	Np279 279.3199 1.9m	Np280 280.3259 1.9m	Np281 281.3319 1.9m	Np282 282.3379 1.9m	Np283 283.3439 1.9m	Np284 284.3499 1.9m	Np285 285.3559 1.9m	Np286 286.3619 1.9m	Np287 287.3679 1.9m	Np288 288.3739 1.9m	Np289 289.3799 1.9m	Np290 290.3859 1.9m	Np291 291.3919 1.9m	Np292 292.3979 1.9m	Np293 293.4039 1.9m	Np294 294.4099 1.9m	Np295 295.4159 1.9m	Np296 296.4219 1.9m	Np297 297.4279 1.9m	Np298 298.4339 1.9m	Np299 299.4399 1.9m	Np300 300.4459 1.9m
96	Am237 237.0439 2.4m	Am238 238.0499 2.4m	Am239 239.0559 2.4m	Am240 240.0619 2.4m	Am241 241.0679 2.4m	Am242 242.0739 2.4m	Am243 243.0799 2.4m	Am244 244.0859 2.4m	Am245 245.0919 2.4m	Am246 246.0979 2.4m	Am247 247.1039 2.4m	Am248 248.1099 2.4m	Am249 249.1159 2.4m	Am250 250.1219 2.4m	Am251 251.1279 2.4m	Am252 252.1339 2.4m	Am253 253.1399 2.4m	Am254 254.1459 2.4m	Am255 255.1519 2.4m	Am256 256.1579 2.4m	Am257 257.1639 2.4m	Am258 258.1699 2.4m	Am259 259.1759 2.4m	Am260 260.1819 2.4m	Am261 261.1879 2.4m	Am262 262.1939 2.4m	Am263 263.1999 2.4m	Am264 264.2059 2.4m	Am265 265.2119 2.4m	Am266 266.2179 2.4m	Am267 267.2239 2.4m	Am268 268.2299 2.4m	Am269 269.2359 2.4m	Am270 270.2419 2.4m	Am271 271.2479 2.4m	Am272 272.2539 2.4m	Am273 273.2599 2.4m	Am274 274.2659 2.4m	Am275 275.2719 2.4m	Am276 276.2779 2.4m	Am277 277.2839 2.4m	Am278 278.2899 2.4m	Am279 279.2959 2.4m	Am280 280.3019 2.4m	Am281 281.3079 2.4m	Am282 282.3139 2.4m	Am283 283.3199 2.4m	Am284 284.3259 2.4m	Am285 285.3319 2.4m	Am286 286.3379 2.4m	Am287 287.3439 2.4m	Am288 288.3499 2.4m	Am289 289.3559 2.4m	Am290 290.3619 2.4m	Am291 291.3679 2.4m	Am292 292.3739 2.4m	Am293 293.3799 2.4m	Am294 294.3859 2.4m	Am295 295.3919 2.4m	Am296 296.3979 2.4m	Am297 297.4039 2.4m	Am298 298.4099 2.4m	Am299 299.4159 2.4m	Am300 300.4219 2.4m									
97	Bk 234.0439 2.4m	Cm 235.0499 2.4m	Cm236 236.0559 2.4m	Cm237 237.0619 2.4m	Cm238 238.0679 2.4m	Cm239 239.0739 2.4m	Cm240 240.0799 2.4m	Cm241 241.0859 2.4m	Cm242 242.0919 2.4m	Cm243 243.0979 2.4m	Cm244 244.1039 2.4m	Cm245 245.1099 2.4m	Cm246 246.1159 2.4m	Cm247 247.1219 2.4m	Cm248 248.1279 2.4m	Cm249 249.1339 2.4m	Cm250 250.1399 2.4m	Cm251 251.1459 2.4m	Cm252 252.1519 2.4m	Cm253 253.1579 2.4m	Cm254 254.1639 2.4m	Cm255 255.1699 2.4m	Cm256 256.1759 2.4m	Cm257 257.1819 2.4m	Cm258 258.1879 2.4m	Cm259 259.1939 2.4m	Cm260 260.1999 2.4m	Cm261 261.2059 2.4m	Cm262 262.2119 2.4m	Cm263 263.2179 2.4m	Cm264 264.2239 2.4m	Cm265 265.2299 2.4m	Cm266 266.2359 2.4m	Cm267 267.2419 2.4m	Cm268 268.2479 2.4m	Cm269 269.2539 2.4m	Cm270 270.2599 2.4m	Cm271 271.2659 2.4m	Cm272 272.2719 2.4m	Cm273 273.2779 2.4m	Cm274 274.2839 2.4m	Cm275 275.2899 2.4m	Cm276 276.2959 2.4m	Cm277 277.3019 2.4m	Cm278 278.3079 2.4m	Cm279 279.3139 2.4m	Cm280 280.3199 2.4m	Cm281 281.3259 2.4m	Cm282 282.3319 2.4m	Cm283 283.3379 2.4m	Cm284 284.3439 2.4m	Cm285 285.3499 2.4m	Cm286 286.3559 2.4m	Cm287 287.3619 2.4m	Cm288 288.3679 2.4m	Cm289 289.3739 2.4m	Cm290 290.3799 2.4m	Cm291 291.3859 2.4m	Cm292 292.3919 2.4m	Cm293 293.3979 2.4m	Cm294 294.4039 2.4m	Cm295 295.4099 2.4m	Cm296 296.4159 2.4m	Cm297 297.4219 2.4m	Cm298 298.4279 2.4m	Cm299 299.4339 2.4m	Cm300 300.4399 2.4m						
148	U233 233.0439 2.4m	U234 234.0499 2.4m	U235 235.0559 2.4m	U236 236.0619 2.4m	U237 237.0679 2.4m	U238 238.0739 2.4m	U239 239.0799 2.4m	U240 240.0859 2.4m	U241 241.0919 2.4m	U242 242.0979 2.4m	U243 243.1039 2.4m	U244 244.1099 2.4m	U245 245.1159 2.4m	U246 246.1219 2.4m	U247 247.1279 2.4m	U248 248.1339 2.4m	U249 249.1399 2.4m	U250 250.1459 2.4m	U251 251.1519 2.4m	U252 252.1579 2.4m	U253 253.1639 2.4m	U254 254.1699 2.4m	U255 255.1759 2.4m	U256 256.1819 2.4m	U257 257.1879 2.4m	U258 258.1939 2.4m	U259 259.1999 2.4m	U260 260.2059 2.4m	U261 261.2119 2.4m	U262 262.2179 2.4m	U263 263.2239 2.4m	U264 264.2299 2.4m	U265 265.2359 2.4m	U266 266.2419 2.4m	U267 267.2479 2.4m	U268 268.2539 2.4m	U269 269.2599 2.4m	U270 270.2659 2.4m	U271 271.2719 2.4m	U272 272.2779 2.4m	U273 273.2839 2.4m	U274 274.2899 2.4m	U275 275.2959 2.4m	U276 276.3019 2.4m	U277 277.3079 2.4m	U278 278.3139 2.4m	U279 279.3199 2.4m	U280 280.3259 2.4m	U281 281.3319 2.4m	U282 282.3379 2.4m	U283 283.3439 2.4m	U284 284.3499 2.4m	U285 285.3559 2.4m	U286 286.3619 2.4m	U287 287.3679 2.4m	U288 288.3739 2.4m	U289 289.3799 2.4m	U290 290.3859 2.4m	U291 291.3919 2.4m	U292 292.3979 2.4m	U293 293.4039 2.4m	U294 294.4099 2.4m	U295 295.4159 2.4m	U296 296.4219 2.4m	U297 297.4279 2.4m	U298 298.4339 2.4m	U299 299.4399 2.4m	U300 300.4459 2.4m					

148

148

148

148

148

148

148

148

148

148

148

148

148

148

148

148

148

148

148

Table 5-1

## Long-Lived Fission Fragment Nuclides (Half-Life &gt; 1 Year)

Nuclide	Half-Life	Yield	Weight (gms)		Volume	
			gms	cm <sup>3</sup>	quarts	
Se-79	6,500	0.06	.202	45	0.047	
Kr-95	10.7	1.33	4,800	-	-	
Sr-99	29	5.9	22,600	8,700	9.2	
-93	95,000	6.4	25,400	4,000	4.2	
Te-99	213,000	6.1	25,700	2,570	2.7	
Ru-106	1	0.39	1,760	144	0.15	
Pd-107	6,500,000	0.2	910	30	0.08	
Sn-121	50	0.018	92	16	0.02	
Sb-125	2.73	0.025	133	20	0.02	
I-120	15,900,000	0.9	4,900	1,000	1.05	
Cs-135	2,300,000	6.7	38,500	20,600	2.16	
Cs-137	30.1	6.23	36,400	19,500	2.06	
Pm-147	2.6	2.26	14,100	-	-	
Sm-151	93	0.42	2,700	350	0.35	
Eu-154	8.6	0.071	465	90	0.09	
Eu-155	4.8	0.033	218	41	<u>0.04</u>	

22 quarts

MAYBE RAQUELWELCHIUM....  
OR LOVELACIUM... OR  
KIKUCHIUM!



for concern, however, because it could escape into the atmosphere, settle on pastures, reconcentrate in milk, and be reconcentrated further in the thyroids of human beings consuming milk.

The fission yield for A = 131, according to the Chart is 2.77%. From this number, the rate of production and the total inventory of I-131 can be easily calculated.

As indicated earlier, very roughly, the rate of U-235 consumption of a 1000 MWe plant is about 1 tonne/year, so that the rate of I-131 production is given by

$$10^6 \frac{131(.0277)}{235} \frac{1}{31 \times 10^6} = 5 \times 10^{-4} \text{ gm/sec}$$

But the radioactivity of 1 gram of I-131 is given by

$$\frac{6 \times 10^{23}}{131} \frac{0.693}{8(24)(3600)} \frac{1}{3.7 \times 10^{10}} = 1.24 \times 10^{+5} \text{ Ci/gm}$$

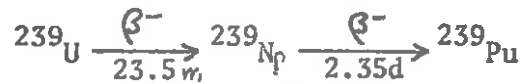
Hence, the I-131 radioactivity generation rate is about 60 Ci/sec. The radio-iodine-131 inventory is this quantity divided by the decay constant, which is

$$\lambda = \frac{\ln 2}{T_{1/2}} = \frac{0.693}{8(24)(3600)} = 10^{-6}/\text{sec}$$

giving them the I-131 inventory of about 60 MCi. We will return later to examine the implications of this large inventory for nuclear reactor safety.

Another important region of the Chart of the Nuclides is the island of the actinides which, strictly speaking, refers to the elements beyond actinium ( $Z > 89$ ), such as thorium, uranium, neptinium, plutonium, etc. For the sake of limiting the discussions, we shall consider plutonium only, for the moment.

The element plutonium is produced when the non-fissionable uranium isotope U-238 captures a neutron and then undergoes a chain of  $\beta$ -decays:



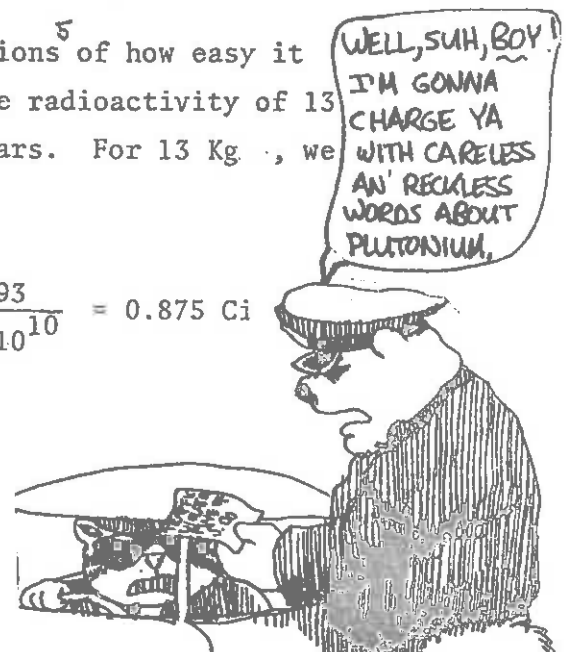
The last nuclide has a half-life of about 24,000 years, so that once Pu-239 is produced in the reactor core, it will upon neutron capture undergo fission or become another plutonium isotope, Pu-240. This Pu-240 can become Pu-241, so that the so-called reactor-grade plutonium, produced in fuel elements that remain in the reactor core for about three years, is actually a mixture of the isotopes Pu-238, -239, -240, -241, -242, -243, and -244. Typically, the isotopic constitution of reactor-grade plutonium is about as shown below:

<u>Isotope</u>	<u>Half-Life (Years)</u>	<u>gm/tonne</u>	<u>Ci/tonne</u>
Pu-238	86	230	4,000
-239	24,400	3,100	500
-240	6,580	2,900	650
-241	13	1,300	150,000
-242	379,000	510	2
Total		13,040 g	155,152 Ci

Thus the radioactivity of 13 Kg of reactor-grade plutonium is about 155,000 curies. Note that the bulk of this radioactivity comes from the 13 year half-life Pu-241.

Since there have been some careless discussions<sup>5</sup> of how easy it is to make a plutonium bomb, let us calculate the radioactivity of 13 Kg of U-235, whose half-life is 710 million years. For 13 Kg, we have

$$A = \frac{13 \times 10^3}{235} \frac{6 \times 10^{23}}{710 \times 10^6 (31 \times 10^6)} \frac{0.693}{3.7 \times 10^{10}} = 0.875 \text{ Ci}$$



Thus 13 Kg of U-235 can be handled easily, whereas the handling of the same weight of reactor-grade plutonium is a substantially more difficult (and lethal) problem. But more on this topic of atomic bomb building in Chapter 6.

### 5.1.3. NUCLEAR REACTIONS

Nuclear reactions are processes in which changes in atomic nuclei occur as the result of a collision between nuclei and/or nuclear particles. An example of such a collision reaction is the nuclear fission event which occurs when a neutron smashes into a heavy uranium nucleus. Such collision reactions depend not only upon the properties of the colliding particles, e.g., the neutron and the uranium nucleus, but as well upon the relative velocity with which they strike one another.

There are many similarities between nuclear reactions and chemical (or atomic) reactions. For example, the study of nuclear collision reactions can be formulated in a manner very similar to that used to describe chemical reactions. Indeed, the familiar notation for a chemical reaction



is frequently adopted to describe nuclear reactions. However, since in nuclear reactions, one particle is usually considered to be a projectile while the other particle is taken as a target, one sometimes uses the more detailed notation

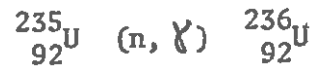


As an example, the reaction





would be written as



The general class of such reactions would be simply denoted as  $(n, \gamma)$  reactions.

Furthermore, just as in chemical reactions, there are a number of conserved quantities such as momentum and energy. In addition, there is conservation of the number of nucleons involved in the reaction and conservation of the total charge. One can easily check to verify that these quantities are conserved by adding up mass numbers  $A$  and atomic numbers of the reacting particles and comparing these against the totals of  $A$  and  $Z$  for the reaction products.

Both nuclear and chemical reactions are generally accompanied by either the absorption or emission of energy. However, as we have noted, the energies involved in nuclear reactions are millions of times larger than those involved in chemical reactions. One can calculate the energy released (or required for) a given reaction by using the important result from the theory of relativity,  $E = mc^2$ , where  $c = 3.0 \times 10^{10}$  cm/s is the speed of light and  $m$  is the mass converted into energy in a reaction. The appropriate quantity to use for the variable  $m$  that appears in this formula is the mass difference between the interacting particles before and after collision. For example, in a nuclear fission reaction in which some 200 MeV of energy is liberated, roughly 1/5 of the mass of a single nucleon has been converted into energy. Hence, the conversion of even a very small fraction of the mass of a nucleus yields an enormous energy. This is the energy exploited in nuclear power applications.

There are an enormous variety of possible nuclear reactions (with some 3000 known nuclides and a variety of subnuclear particles including protons, neutrons, electrons, photons, alphas, deuterons, etc., this is easily understandable). Of primary concern to the present types of nuclear reactors used to generate power is the utilization of the

energy or radiation released by a controlled chain reaction of nuclear fission reactions maintained within the uranium fuel of the reactor. Such fission reactions occur when a heavy atomic nucleus such as uranium-235 captures a neutron and then fissions into two lighter nuclei with an attendant release of both energy and radiation. The fission reaction also kicks loose a few neutrons which can then go on to induce more fission reactions. Hence, we can use the neutrons to propagate a "chain" of fission reactions. In this sense, then, the neutron plays the role of the "chain carrier" while the fission reactions supply the desired energy.

But, of course, there are other possible nuclear reactions a neutron can undergo which do not lead to fission and, hence, are unproductive in nature. Indeed, since there are usually two or three neutrons emitted in each fission reaction, it should be apparent that if each neutron resulted in another fission, the chain reaction would quickly grow without bound. One such parasitic reaction involves the capture of the neutron by a nucleus which then emits a gamma ray (kind of a nuclear belch) rather than fissioning. Another possible reaction involves the neutron simply bouncing or scattering off of a nucleus. After several such scattering reactions, the neutron might eventually leak out of the uranium core of the reactor. Such processes remove neutrons from the reactor and tend to inhibit the chain reaction.

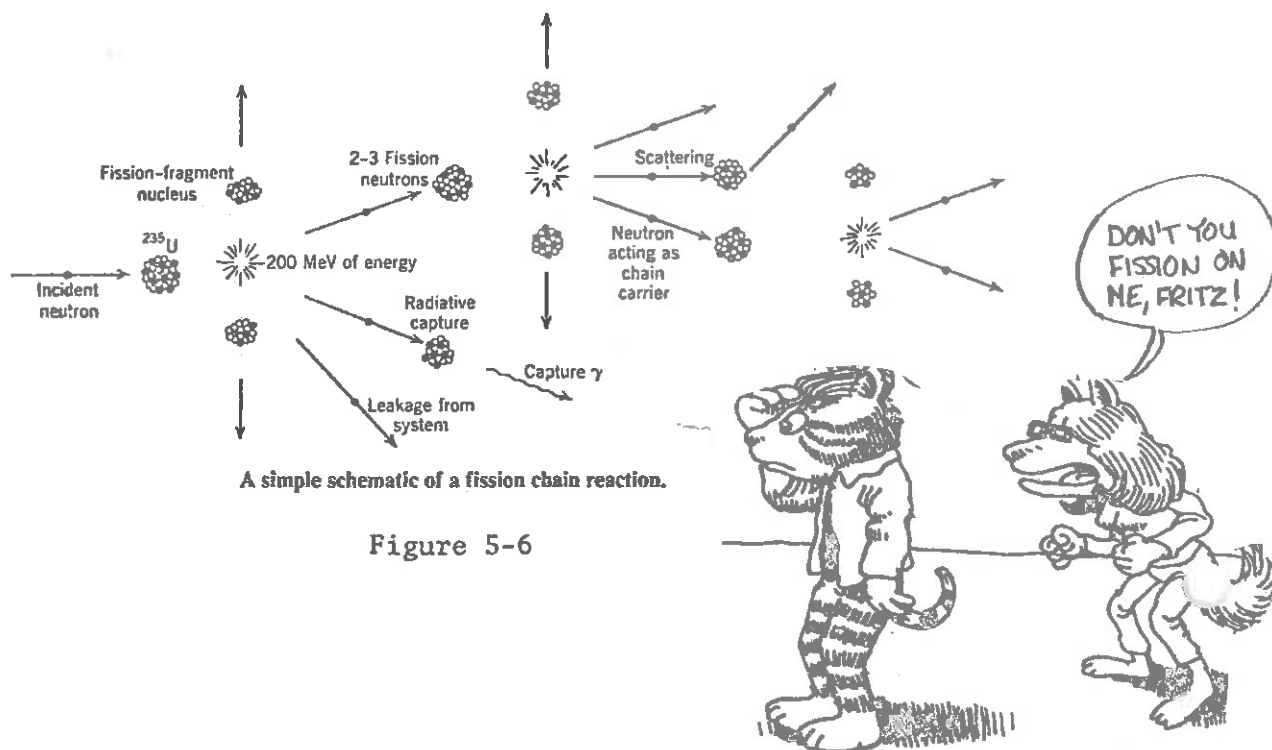
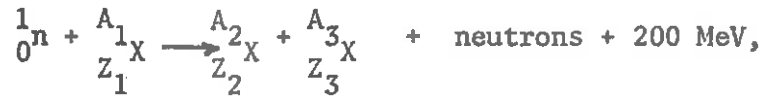


Figure 5-6

We can summarize the neutron-nuclear reactions of most importance to nuclear fission reactors:

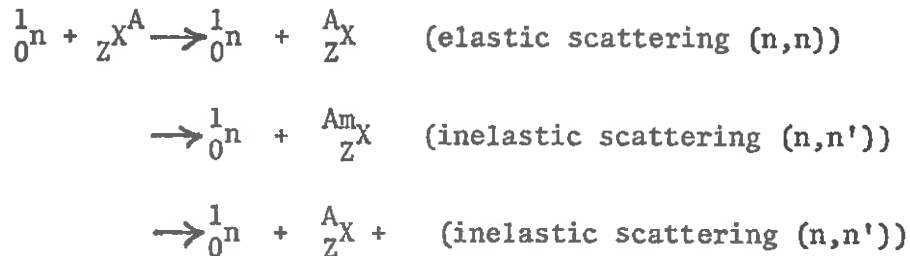
nuclear fission (n,fission):



radiative capture (n, $\gamma$ ):



scattering (n,n) or (n,n'):



BUT I WAS PROMISED THAT THERE WOULDN'T BE ANY EQUATIONS IN THIS COURSE!



We have already discussed the nuclear fission reaction. In radiative capture the incident neutron is absorbed by the target nucleus to form a new nuclide of mass number  $A + 1$ . This "compound" nucleus is formed in an excited state. In a radiative capture reaction, it will eventually decay to its ground state by radiating a high energy photon, i.e., a gamma ray. An alternative type of capture reaction of some importance in reactor control is the (n, $\alpha$ ) reaction which occurs in  ${}^{10}\text{B}$ , for example.

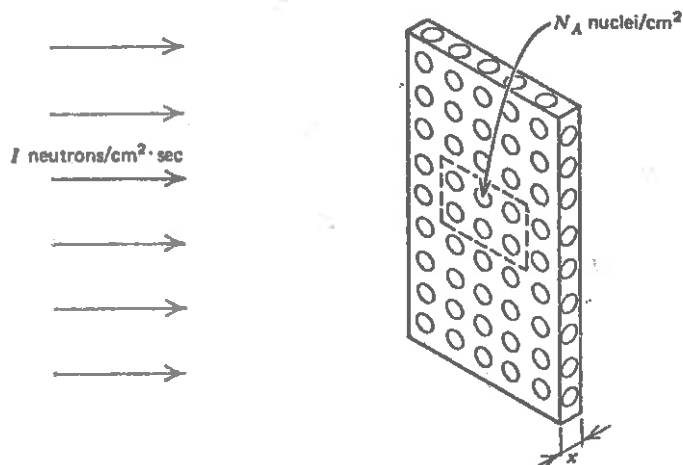
The third reaction of importance is scattering. In this reaction the neutron simply scatters off of the nucleus, (n,n), although in some cases, it may first combine with the nucleus to form a compound nucleus for a short time before being reemitted and will frequently leave the nucleus in an excited state from which it later decays by gamma emission.

The importance of the fission reaction to nuclear reactor operation is obvious. Both radiative capture and scattering are also extremely important since they influence the neutron economy and hence the chain reaction.

The above discussion clearly indicates the importance of being able to determine the rate at which various types of neutron-nucleus reactions occur within the reactor. It is important to keep in mind, however, that there are enormous numbers of neutrons (typically  $10^8$  per  $\text{cm}^3$ ) and even larger numbers of nuclei ( $10^{22}$  per  $\text{cm}^3$ ) in the reactor. Hence, we really need concern ourselves only with the average behavior of the neutrons and nuclei in the reactor in a statistical sense. That is, we wish to calculate the probabilities that various types of neutron-nuclear interactions will occur. These reaction probabilities are expressed in terms of parameters called nuclear cross sections.

These cross sections represent the fundamental data utilized by the nuclear engineer in his analysis of a nuclear reactor, much in the same way that thermal or structural data are used by the mechanical engineer or circuit device parameters are used by the electrical engineer.

The probability for a neutron-nuclear reaction to occur is characterized by a quantity called a nuclear cross section. Let us first define this quantity operationally by considering a beam of neutrons, all travelling with the same speed, which is incident normally upon and uniformly across the face of a target of material. If the target is sufficiently thin (say, one atomic layer thick), then no nuclei in the target will be shielded by other nuclei from the incident neutron beam.



A monoenergetic neutron beam incident normally upon a thin target.

In this case we would expect that the rate of neutron-nuclear reactions in the target will be proportional both to the incident neutron beam intensity,  $I$  (in units of number of neutrons/cm<sup>2</sup>-sec) and the number of target atoms per unit area,  $N_A$  (#/cm<sup>2</sup>). If we call the constant of proportionality  $\sigma$ , then we can write the rate at which reactions occur per unit on the target as

$$\text{Rate} \equiv R = \sigma I N_A$$

$$\left[ \frac{\#}{\text{cm}^2\text{-sec}} \right] \left[ \text{cm}^2 \right] \left[ \frac{\#}{\text{cm}^2\text{-sec}} \right] \left[ \frac{\#}{\text{cm}^2} \right]$$

We have indicated the units of each of these quantities since they imply that the proportionality factor  $\sigma$  must have the units of an area.

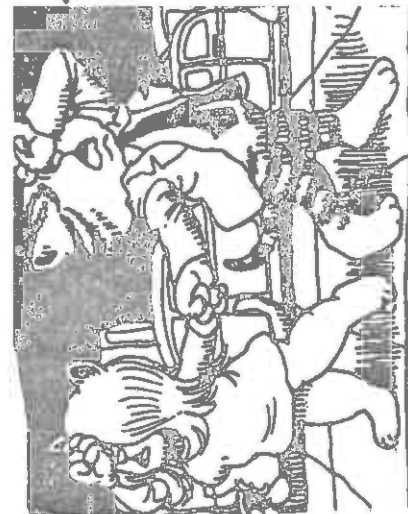
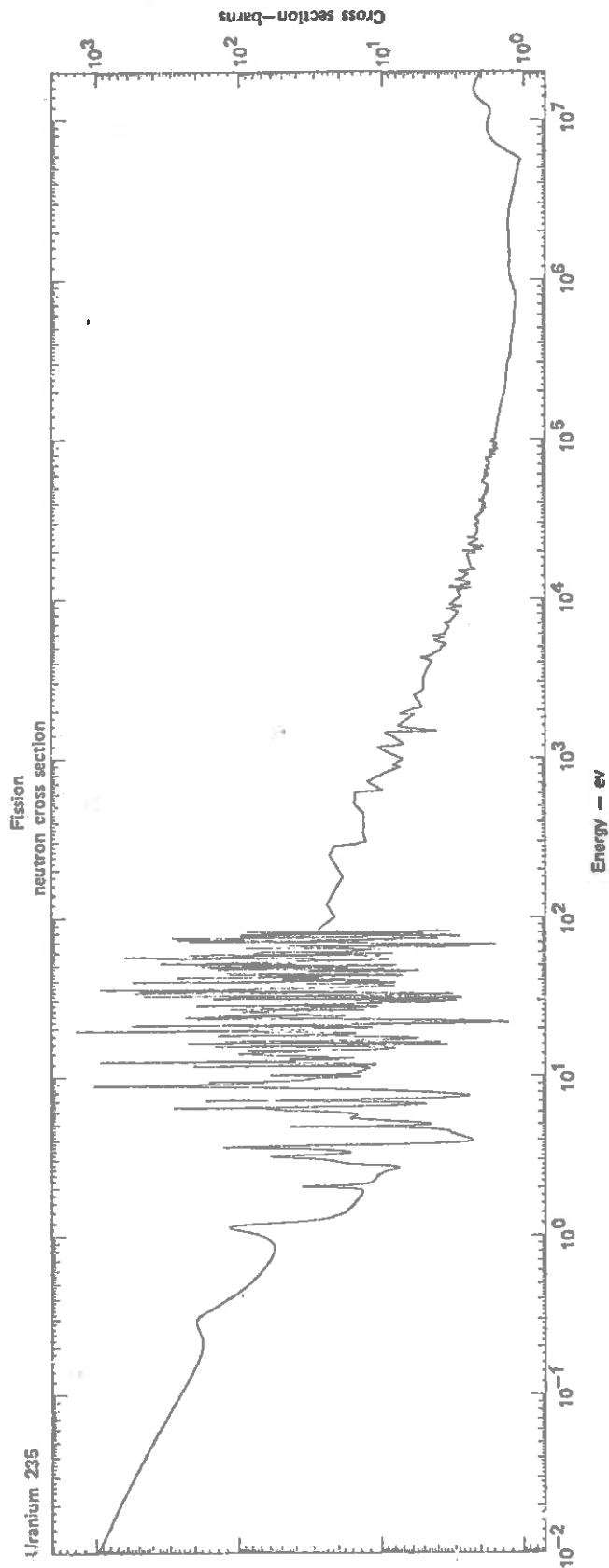
If the incident neutrons and target nuclei could be visualized as classical particles, then  $\sigma$  would quite naturally correspond to the cross sectional area presented by each of the target nuclei to the beam. For this reason,  $\sigma$  is known as the microscopic cross section characterizing the probability of a neutron-nuclear reaction for the nucleus. We might continue to think of  $\sigma$  as the effective cross sectional area presented by the nucleus to the beam of incident neutrons. Since the nuclear radius is roughly  $10^{-12}$  cm, the geometrical cross sectional area of the nucleus is roughly  $10^{-24}$  cm<sup>2</sup>. Hence, we might expect that nuclear cross sections are of the order of  $10^{-24}$  cm<sup>2</sup>, and in fact, microscopic cross sections are usually measured in units of this size called barns. This geometrical interpretation of a nuclear cross section can frequently be misleading, however, since  $\sigma$  can be much larger (or smaller) than the geometrical cross section of the nucleus due to resonance effects which, in turn, are a consequence of the quantum mechanical nature of the neutron and the nucleus. For example, the absorption cross section of <sup>135</sup>Xe for slow neutrons is almost a million times larger than its geometrical cross sections; it can reach way out to eat a neutron.

Thus far we have been discussing the concept of a nuclear cross section in a rather abstract sense without actually specifying the type of reaction we have in mind. Actually, such cross sections can be used to characterize any type of nuclear reaction. We can define a microscopic cross section for each type of neutron-nuclear reaction and each type of nuclide. For example, the appropriate cross sections characterizing the three types of reactions we discussed earlier, fission, radiative capture, and scattering, are denoted by

$\sigma_f$	fission
$\sigma_r$	radiative capture,
$\sigma_s$	scattering

In a similar sense we can define the absorption cross section  $\sigma_a$  characterizing those events in which a nucleus absorbs a neutron. There are a number of possible types of absorption reactions including fission, radiative capture, (n,p) reactions, and so on. (Actually, one could argue that fission is not really an absorption reaction since several neutrons are created in the fission reaction. It has become customary, however, to treat fission as an absorption event and then add back in the fission neutrons released in the reaction at another point, as we will see later.) Finally, we can introduce the concept of the total cross section  $\sigma_t$  which characterizes the probability that any type of neutron-nuclear reaction will occur. Obviously  $\sigma_t = \sigma_a + \sigma_s$ .

Recall that we defined the concept of a microscopic cross section by considering a beam of neutrons of identical speeds incident upon the surface of a target. But it is certainly conceivable that such cross sections will vary, dependent upon the incident neutron speed (or kinetic energy). And indeed, one finds in practice that neutron cross sections depends very sensitively indeed upon the neutron energy. For example, the fission cross section for U-235 is sketched as a function of the incident neutron energy in Figure 5-8 . Two features of this

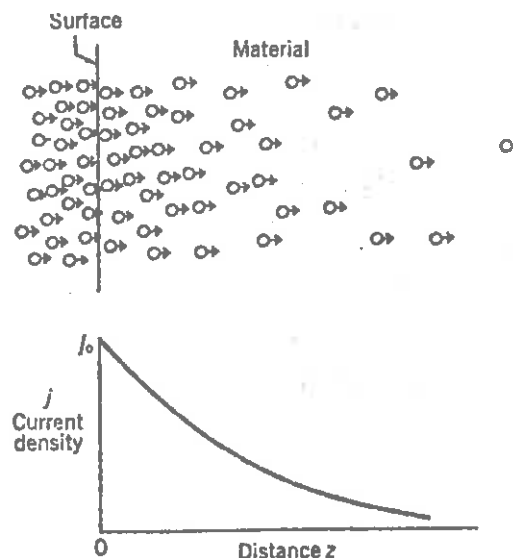


I JUST CAN'T  
TAKE MUCH MORE  
OF THIS COMPLEXITY.

behavior should be noted for future reference. First, note that the cross section is almost 100 times smaller at large neutron energies in the MeV range than it is at small neutron energies in the eV range. That means that the probability of a fission reaction occurring are 100 times more probable if we use low energy or "slow" neutrons than if we use high energy or "fast" neutrons.

Note further that the detailed dependence of the cross section on the neutron energy is very complicated indeed, showing lots of peaks and valleys. A peak in the cross section is referred to as a "resonance" (and, in fact, is closely related to the kind of resonances that occur when you vibrate a mechanical object at just the right frequency). At the neutron energies corresponding to such resonances, the probability of neutron reactions occurring are greatly enhanced. This has extremely important consequences for fission reactor operation, as we will see later.

Thus far we have confined our attention to the interaction of a beam of neutrons with a single nucleus and defined the concept of a cross section to describe the probability that the neutrons in the beam would interact with that nucleus. But, of course, we are really more interested in the probability that the neutrons will interact with any of the billions upon billions in a macroscopic sized chunk of material. In particular, if a beam of neutrons is incident upon such a target, the nuclei deeper into the target are shielded from the incident beam





by the nuclei near the surface since interactions remove neutrons from the beam. In fact, one finds that the intensity of the incident beam drops off exponentially as  $\exp(-N\sigma x)$  as a function of the distance  $x$  into the target. Here,  $N$  is the atomic number density of the target. The product of  $N$  and  $\sigma$  occurs so frequently in nuclear applications that it has become customary to give it a special name by defining

$$N\sigma = \Sigma \equiv \text{"macroscopic cross section"}$$

The term "macroscopic" arises from the recognition that  $\Sigma$  characterizes the probability of neutron interaction in a macroscopic chunk of material (the target), whereas the microscopic cross section characterizes the probability of interaction with only a single nucleus.

It should be noted that  $\Sigma$  is not really a "cross section" at all, however, since its units are inverse length. A more appropriate interpretation of  $\Sigma$  is as the probability per unit distance traveled by a neutron into the target that it will undergo an interaction with a nucleus in the target. In this same sense, we can interpret the inverse of the macroscopic cross section,  $\Sigma_t^{-1}$ , as the average distance a neutron will travel in a material before suffering an interaction with a nucleus. For this reason,  $\Sigma_t^{-1}$ , is referred to as the mean free path of the neutron since it essentially measures the average distance a neutron is likely to stream freely between collisions with nuclei.

The reader has probably noticed the similarity of this analysis to our earlier treatment of radioactive decay. Both the spatial attenuation of a neutron beam passing through a sample of material as well as the temporal decay of a sample of radioactive nuclei are similar types of statistical phenomena in which the probability of an event occurring which removes a neutron or nucleus from the original sample depends only upon the number of neutrons or nuclei present at the position or time of interest. It should be stressed that both the mean free path as well as the mean lifetime for decay are very much average quantities. There will be statistical fluctuations about these mean values.

Thus far our discussion has been restricted to total macroscopic cross sections which characterize the probability that a neutron will undergo any type of reaction. We can generalize this concept by formally defining the macroscopic cross section for any specific reaction as just the microscopic cross section for the reaction of interest multiplied by the number density  $N$  characterizing the material of interest. For example, the macroscopic fission cross section would be defined as

$$\Sigma_f = N\sigma_f$$

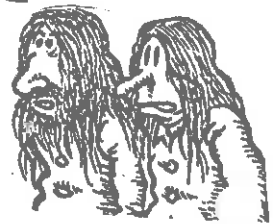
In a similar fashion we can define

$$\Sigma_a = N\sigma_a, \quad \Sigma_s = N\sigma_s$$

Notice also that

$$\Sigma_t = \Sigma_a + \Sigma_s$$

YOU KNOW, THIS SIGMA NOTATION IS CONFUSING AS HELL! HOW DO THEY WRITE A SUMMATION?



The concept of a macroscopic cross section can also be generalized to homogeneous mixtures of different nuclides. For example, if we have a homogeneous mixture of three different species of nuclides,  $X$ ,  $Y$ , and  $Z$ , with respective atomic number densities  $N_X$ ,  $N_Y$ , and  $N_Z$ , then the total macroscopic cross section characterizing the mixture is given by

$$\Sigma_t = N_X\sigma_t^X + N_Y\sigma_t^Y + N_Z\sigma_t^Z$$

where  $\sigma_t^X$  is the microscopic total cross section for nuclide  $X$ , and so on. It should be noted that such a prescription for determining the macroscopic cross section for a mixture arises quite naturally from our interpretation of such cross sections as probabilities of reactions.

In summary then, nuclear cross sections can be used to characterize the probability of various types of neutron-nuclear reactions occurring. They obviously will be a very basic ingredient in any study of fission chain reactions. The determination of such cross sections is the task of the nuclear physicist and involves both experimental measurement and theoretical calculations. The enormous amount of cross section information required for nuclear reactor analysis has been (and is still being) obtained in nuclear research centers throughout the world. This cross section data is compiled, evaluated, and then organized into data sets to be used by nuclear engineers.

EXAMPLE: As a specific illustration, let us calculate the mean free path for a thermal neutron in graphite. According to the table in Appendix A, carbon is nearly a pure scatterer with microscopic cross sections  $\sigma_s = 4.8$  b and  $\sigma_a = 3.2 \times 10^{-3}$  b. If we assume a mass density of  $1.66 \text{ gm/cm}^3$ , then we can calculate the atomic number density in graphite as

$$\begin{aligned} N &= \frac{1.66 \text{ (gm/cm}^3\text{)} \cdot 6.02 \times 10^{23} \text{ (atoms/gm-atom)}}{12 \text{ (atoms/gm-atom)}} \\ &= 0.833 \times 10^{24} \text{ (cm}^{-3}\text{)} \end{aligned}$$

Consequently the macroscopic scattering and absorption cross sections are

$$\Sigma_s = N \sigma_s = 0.400 \text{ cm}^{-1}, \quad \Sigma_a = N \sigma_a = 2.66 \times 10^{-4} \text{ cm}^{-1},$$

and the total cross section is

$$\Sigma_t = 0.4 \text{ cm}^{-1} \sim \Sigma_s.$$

The mean free path is therefore

$$\lambda = 1/\Sigma_t = 2.5 \text{ cm}.$$

Notice how small the absorption cross section in graphite is compared to its scattering cross section. Indeed, since  $\Sigma_s/\Sigma_a = 1.5 \times 10^3$ , one can infer that a thermal neutron in graphite will make some 1500 scattering collisions on the average before being absorbed. This very low absorption cross section makes graphite an ideal material for nuclear reactor applications.

#### 5.1.4. NUCLEAR FISSION AND FISSION CHAIN REACTIONS

##### Nuclear Fission

We have noted that nuclei of intermediate mass number tend to be the most tightly bound together. The binding energy per nucleon in the nucleus reaches a maximum of 8.7 MeV for nuclear mass numbers of about 50. Hence, it is possible to produce more tightly bound nuclei and thereby release energy by either fusing together lighter nuclei (nuclear fusion) or inducing a heavy nucleus into fission into two nuclei of intermediate mass number (nuclear fission). But the question now arises as to why all heavy nuclei don't spontaneously fission into lighter nuclei, if indeed the latter are more tightly bound and therefore represent a more stable state. After all, many very heavy nuclei are found to occur in nature, for example uranium and thorium. What prevents these nuclei from breaking apart?

The observed stability of heavy nuclei against spontaneous fission is evidence of the fact that the short range nuclear forces which bind the nucleons together must give rise to an energy "barrier" which must be overcome if the nucleus is to fission. Experiments have shown that the size of this "fission barrier" in heavy nuclei is typically 6-9 MeV. Hence, to induce nuclear fission, one must add a sufficient amount of energy to the heavy nucleus to overcome this fission barrier.

This can be done in a variety of ways. One could simply slam an energetic particle (with kinetic energy greater than the fission barrier) into the nucleus. An example of such a reaction would be photofission in which a high energy gamma strikes a heavy nucleus, thereby inducing fission. An alternative scheme would be to let the

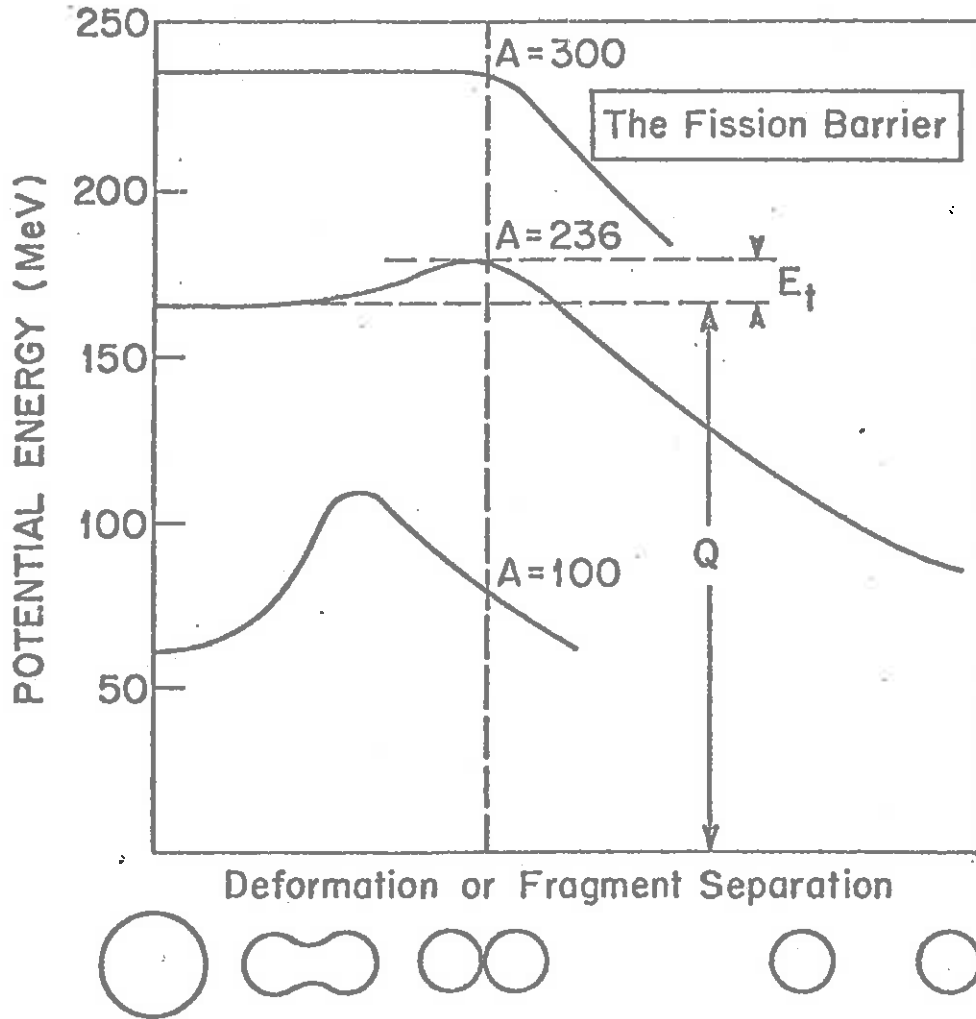


Figure 5-10

AND YOU SAY THAT THE  
LAST THING YOU REMEMBER  
AT THE ANS CHRISTMAS  
PARTY WAS ...



heavy nucleus capture a neutron. Then the binding energy of the added neutron might itself be sufficient to overcome the fission barrier and induce fission.



This later process can, in fact, occur in certain heavy nuclei such as  $^{233}\text{U}$ ,  $^{235}\text{U}$ ,  $^{239}\text{Pu}$ , and  $^{241}\text{Pu}$ . Such nuclides which can be induced to fission with neutrons of essentially zero kinetic energy (or of more relevance to nuclear reactor applications, slow neutrons which have very small kinetic energies, at least compared to nuclear energies) are referred to as fissile nuclides. We will see later that such fissile nuclides represent the principal fuels used in fission chain reacting systems.

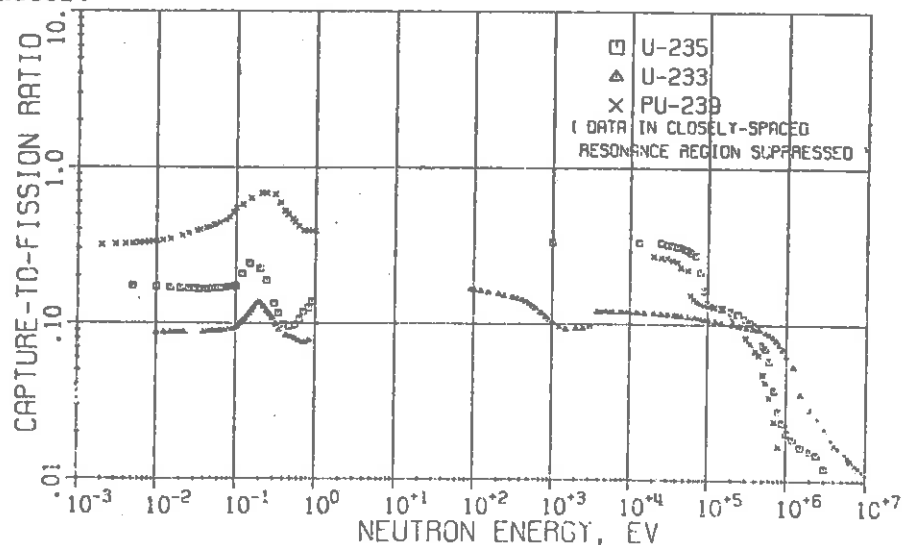
With most heavy nuclides, the additional binding energy provided by a captured neutron is not sufficient to push the heavy nucleus over the fission barrier. Frequently, however, one can add a dash of extra energy to the neutron, say, by giving it a kinetic energy of an MeV or so, and this is sufficient to lift the nucleus the rest of the way over the barrier to cause fission. Nuclides which can be fissioned with such fast neutrons are referred to as fissionable. Examples are  $^{232}\text{Th}$ ,  $^{238}\text{U}$ , and  $^{240}\text{Pu}$ . Although such fissionable nuclides do play an important role as nuclear fuels, they, by themselves, are unable to sustain a stable fission chain reaction, and hence must always be used in combination with a fissile nuclide such as  $^{235}\text{U}$  or  $^{239}\text{Pu}$ .

There is also a small possibility that certain heavy nuclei will fission spontaneously via the barrier penetration mechanism familiar from quantum mechanics. However, the probability for such an event is quite low in most nuclides of interest as nuclear fuels. For example, the half-life for spontaneous fission in  $^{238}\text{U}$  is some  $5.5 \times 10^{15}$  years. However, even this very slow spontaneous fission rate can be of importance in nuclear systems, since even a few neutrons from such spontaneous fission can be rapidly multiplied to appreciable numbers in a growing chain reaction.

When a neutron is absorbed by a fissile isotope such as  $^{235}\text{U}$ , it may induce that isotope to fission. But it is also possible that the compound nucleus formed by the neutron absorption,  $^{236}\text{U}^*$ , might simply decay to its ground state by gamma emission. The relative balance between the probability of fission and radiative capture is an extremely important factor in nuclear reactor applications. We characterize this balance by the capture-to-fission ratio defined by

$$\alpha \equiv \sigma_c / \sigma_f$$

This ratio depends not only upon the isotope of interest, but as well upon the incident neutron energy  $E$ . It is plotted in Figure 5-11 for the three primary fissile nuclides. It can be seen that most neutron absorption in such isotopes leads to fission events (with the exception of a small range of  $\alpha > 1$  for  $^{235}\text{U}$ ). It should be noticed that decreases quite appreciably above 0.1 MeV. This latter fact will prove to be of considerable importance when we discuss the concept of a fast breeder reactor.



THE DETAIL BETWEEN  
1 AND 100 EV IS  
JUST TOO hideous  
TO SHOW!



Let us consider in a bit more detail the sequence of events which occur in nuclear fission. To be specific, suppose a neutron is captured by a heavy, fissile isotope such as U-235. Then the extra binding energy of the added neutron is available to the newly formed "compound" nucleus, U-236. This extra energy caused the U-236 to vibrate violently away from its stable state. If we imagine the U-236 nucleus to roughly resemble a drop of liquid, then the binding energy of the added neutron causes this drop to deform away from a spherical shape. In fact, the nucleus may eventually deform into a dumbbell like shape



At this point, the two pieces of the nucleus which have partially separated are sufficiently far apart that the very short range nuclear forces are no longer sufficient to overcome the repulsive electrical forces, and the two pieces fly apart, being accelerated by the electrical forces to very large kinetic energies (the nucleus is pushed over the fission barrier). At the same time, a variety of other reaction products are thrown off, including several neutrons, numerous gammas, betas, and neutrinos, and, of course, a considerable amount of energy. Indeed, a glance at the binding energy per nucleon before and after the fission reaction (see Figure 5-4) suggests that on the order of 200 MeV will be released in each fission reaction.

The fission product nuclei (the two pieces of the original nucleus) are typically found to have mass numbers ranging from 75 to 160, with the most probable appearing with  $A = 92$  and  $144$ , respectively. To be specific, consider the fission of U-235 into Kr-90 and Ba-144:



The fission fragment nuclei produced by the fission reaction are both highly charged and highly energetic (they are moving very fast). They slow down via collisions with adjacent atoms, losing energy and charge



(by picking up electrons) in the process. This is, in fact, the principal mechanism by which the fission energy eventually appears as heat generated in the fuel of a nuclear reaction. But these fission products are usually quite unstable as well, being somewhat neutron rich, and will subsequently decay, usually via beta emission. For example, consider the fission product Ba-144. Now the most common naturally occurring isotope of Ba in nature is Ba-137. Hence, Ba-144 has 7 extra neutrons. It can remedy this by turning 4 neutrons into protons by a sequence of beta decays until it becomes the stable nuclide Nd-144. The energy released in such radioactive decay reactions can amount to as much as 4-5% of the total energy released in the fission reaction. Since such "decay heat" will appear with an appreciable time delay corresponding to the half-lives of the various nuclei involved, it can lead to difficulties unless properly anticipated in fission reactor design.

But just as significant as the energy released in the fission reaction is the fact that several neutrons are also produced in the reaction. These neutrons can be used to propagate a fission chain reaction. Most of these fission neutrons appear essentially instantaneously (within  $10^{-17}$  sec) of the fission event. These neutrons are referred to as prompt. However, a very few neutrons (less than 1%) appear with an appreciable time delay from the subsequent decay of radioactive fission products. Although only a very small fraction of the fission neutrons are delayed, these delayed neutrons are vital for the effective control of the fission chain reaction.

The total number of neutrons (both prompt and delayed) released in a fission reaction will vary. However, in most nuclear applications we only need concern ourselves with the average number of neutrons released per fission which we denote by  $\nu$ . This quantity will depend both upon the nuclear isotope involved as well as the incident neutron energy, generally tending to increase with increasing neutron energy. It is typically about 2.5. The neutrons produced in the fission reaction emerge with a distribution of energies, with the average fission neutron energy being roughly 2 MeV.

The energy released in a nuclear fission reaction is distributed among a variety of reaction products. We have classified these reaction products both as to range and time of emission, and indicated the approximate percentage of the fission energy (some 200 MeV) carried by each:

Table 5-2

<u>Reaction Product</u>	<u>% Energy</u>	<u>Range</u>	<u>Time Delay</u>
kinetic energy of fission fragments	80%	< .01 cm	instantaneous
fast neutrons	3%	10-100 cm	"
fission gamma energy	4%	100 cm	"
fission product decay	4%	short	delayed
neutrinos	5%	nonrecoverable	"
nonfission reactions due to neutron capture	4%	100 cm	"

The majority of the fission energy appears as the kinetic energy of the fission fragments and is deposited essentially at the point of fission in the nuclear fuel. Note, however, that some of the fission energy appears as kinetic energy of neutrons (3%) and gammas (4%) which have relatively long ranges. This energy will be distributed over the core of the reactor and adjacent material such as shielding.

Furthermore, it should be noted that some 4% of the fission energy appears in the form of heat generated by the decay of radioactive fission products. If the nuclear reactor were to be suddenly shut down, this decay heat would continue to be produced and would have to be removed; otherwise the reactor core temperature would rise dramatically, causing fuel element melting and failure. The removal of such decay heat is one of the most serious problems in reactor safety studies. Notice also that a sizeable amount of energy (as much as 20 MeV per fission) may be liberated by the high energy gammas produced in radiative capture ( $n, \gamma$ ) reactions.

It is customary to use an effective energy release per fission in determining the portion of the total energy of fission which can be recovered by a coolant and hence contributes to the thermal power output of the reactor. Although this energy will vary somewhat, depending upon the type of reactor and the detailed core composition, it is typically of the order of 192 MeV.

Of this 192 MeV, some 168 MeV appears as fission fragment energy, while 7 MeV appears as beta energy. These short range contributions deposit their energy in the nuclear fuel. If we also take into account the energy (some 7%) deposited in the fuel due to fast neutrons and gammas, we find that some 97% of the recoverable fission energy is deposited directly in the fuel material. The remainder is deposited in the coolant or structural materials by neutrons and gamma radiation, with less than 1% typically being deposited in shielding due to gamma radiation.

We can translate the fission energy release into more useful units by noting 192 MeV corresponds to  $3.04 \times 10^{-11}$  J. But even this is not a very useful unit of energy when we are considering a large power plant. Instead it is conventional to measure the energy produced in units of megawatt-days (MWD)--that is, the energy produced per megawatt of power level in one day's operation. Using the energy release per fission, we find that the number of fissions required to produce 1 MWD is

$$\frac{(10^6 \text{ W})(86,400 \text{ sec/day})}{3.04 \times 10^{-11} \text{ J}} = 2.85 \times 10^{21} \text{ fissions}$$

To translate this into more meaningful terms, if we note that the number of U-235 atoms in 1 gm is  $(6.02 \times 10^{23}/235)$  then we can compute the mass of U-235 which must be fissioned to produce 1 MWD of energy as

$$\frac{(2.85 \times 10^{21})(235)}{6.02 \times 10^{23}} = 1.11 \text{ g}$$



That is, fissioning 1 g of U-235 produces 1 MWD of energy. Actually, this must be increased slightly since only 85% of neutron captures in U-235 lead to fission (the rest form U-236). Hence, a more correct estimate is that 1.3 g of U-235 is consumed to produce 1 MWD of energy. For a typical nuclear power plant rated at 1,000 MWe or 3,000 MWt, this corresponds to a U-235 fuel consumption of 4 kg/day. A similar sized coal plant would consume 14,400 tons of coal each day.

Our previous discussion has indicated that there are a number of possibilities available for fueling a fission chain reacting system. In particular, we have noted that the principal fissile nuclides of interest for nuclear reaction applications are:

fissile nuclides:  $^{233}\text{U}$ ,  $^{235}\text{U}$ ,  $^{239}\text{Pu}$ ,  $^{241}\text{Pu}$

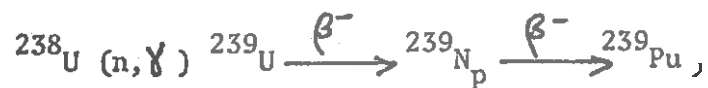
while those susceptible to fast neutron fission are:

fissionable nuclides:  $^{232}\text{Th}$ ,  $^{238}\text{U}$ ,  $^{240}\text{Pu}$ ,  $^{242}\text{Pu}$

Because of the energy threshold which neutrons must exceed in order to induce fission in fissionable nuclides, as well as because of the relatively large value of  $\alpha$  characterizing such nuclides, only the first class of nuclides are capable of sustaining a fission chain reaction. Of these isotopes, only  $^{235}\text{U}$  is found in nature--and then, only as 0.711% of natural uranium (which is composed primarily of  $^{238}\text{U}$ ). Although reactors can be fashioned out of natural uranium with even this low concentration of  $^{235}\text{U}$  if one is sufficiently clever, most present day reactor types are fueled with uranium in which the percentage of  $^{235}\text{U}$  has been increased or enriched above its natural value. As we will see later, such uranium enrichment is an extremely complicated and expensive process.

There is yet another way to obtain fissile isotopes, however. It is found that when certain nuclides absorb neutrons, they then undergo a sequence of radioactive disintegrations which eventually

result in the formation of a fissile isotope. The two most important examples of such neutron transmutation reactions are



Such isotopes which can be transmuted into fissile nuclides via neutron capture are referred to as fertile. The fertile isotopes of most interest are  ${}^{238}\text{U}$  and  ${}^{232}\text{Th}$  which are in abundant supply throughout the world.

But where does one find the neutrons necessary for this process? In a nuclear reactor. Indeed, since most present day reactors are fueled with low enrichment uranium which may contain as high as 98%  ${}^{238}\text{U}$ , such transmutation processes will occur quite naturally. In fact, in the present generation of light water reactors, fuel is initially loaded into the reactor with a composition of roughly 3%  ${}^{235}\text{U}$  and 97%  ${}^{238}\text{U}$ . However, after a year or so of operation, there is as much plutonium formed (about 1%) as there is remaining  ${}^{235}\text{U}$ . Certain reactors have been specifically designed to produce plutonium from  ${}^{238}\text{U}$ . Such "converter" reactors utilize excess neutrons from the fission chain reaction to accomplish this "conversion" of  ${}^{238}\text{U}$  into  ${}^{239}\text{Pu}$  (or  ${}^{241}\text{Pu}$ ).

The key parameter in such processes is the number of neutrons produced in each fission reactor per neutron absorbed in the fuel nuclei. (Here we must remember that not all neutron absorptions in the fuel lead to fission--some result in radiative capture.) we will define

$$\eta \equiv \text{average number of neutrons produced per neutron absorbed in fuel}$$

For a fuel composed of a single fissile isotope, we can write

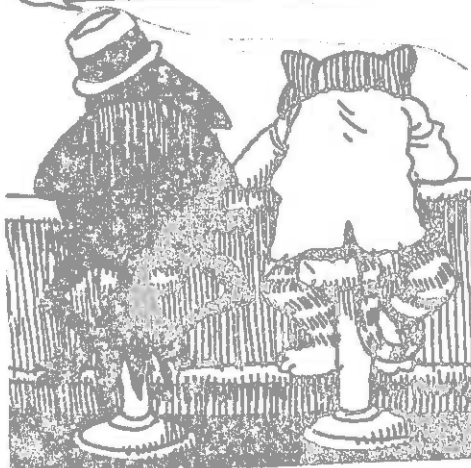
$$\eta = \nu \sigma_f^F / \sigma_a^F = \nu / (1 + \alpha).$$

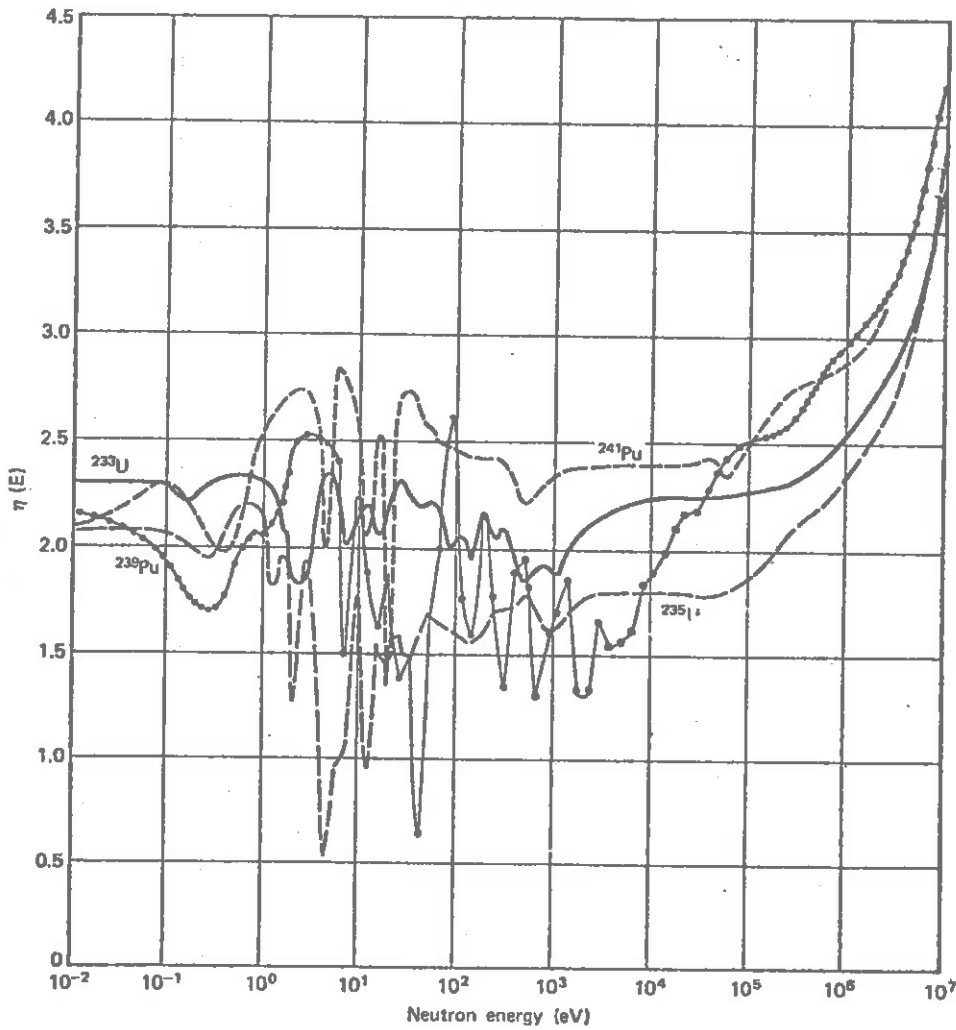
Most fuels, however, contain a mixture of isotopes. In this case, we would use the macroscopic fission and absorption cross sections characterizing each isotope to write

$$\eta = \frac{\sum_j \nu_j \Sigma_f^j}{\sum_j \Sigma_a^j}.$$

The dependence of this very important quantity upon energy  $E$  is shown for the three principal fissile isotopes in Figure 5-12. It should be noted that  $\eta(E)$  is generally of the order of 2 for low energy neutrons, but increases with energy above 0.1 MeV as the capture-to-fission ratio  $\alpha$  falls off. If we are to attempt to utilize the neutrons "left over" from the chain reaction to convert fertile isotopes into fissile material, then it is apparent that we require  $\eta(E)$  to be at least greater than 1, since one neutron per fission is needed to sustain the chain reaction. Of course, a certain fraction of the fission neutrons will be absorbed in non-fuel materials, and others will leak out of the reactor and be lost to the chain reaction. Nevertheless, it is apparent that  $\eta(E)$

LOOK, I KNOW YOU NUCLEAR GUYS TAKE ALOT OF PIPE THESE DAYS. BUT COAL ALSO CATCHES ITS SHARE OF CRAP.



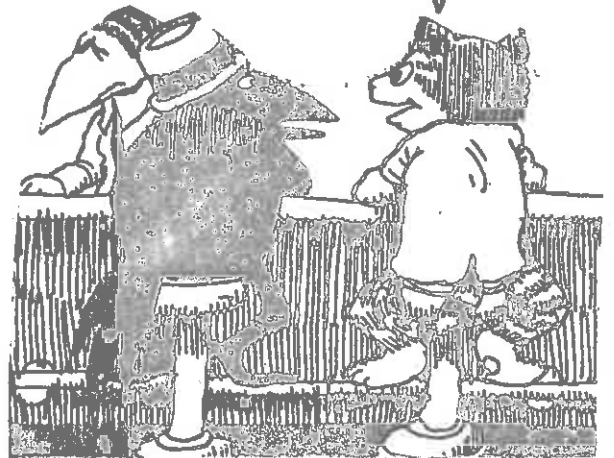


Variation of  $\eta$  with energy for  $^{233}\text{U}$ ,  $^{235}\text{U}$ ,  $^{239}\text{Pu}$  and  $^{241}\text{Pu}$ .

Figure 5-12

WHY, HELL, EVEN ROBERT REDFORD JUMPED ON US WHEN WE TRIED TO BUILD A PLANT TOO CLOSE TO HIS SKI RESORT IN UTAH.

YEAH. BUT JOHN DENVER IS AGAINST NUCLEAR POWER!



is sufficiently greater than unity that appreciable conversion should be possible using any of these isotopes.

Indeed, it might even be possible to produce more fissile material than one depletes in maintaining the fission chain reaction. For this to occur, one would have to operate with fissile isotopes and neutron energies for which  $\eta$  (E) was greater than two, since one neutron would be needed to maintain the chain reaction, while one neutron would be used to produce a new fissile nucleus to replace the one destroyed in the fission reaction. Any excess over this (and over the number of neutrons lost to the chain reaction via nonproductive capture or leakage) could then be used to produce or breed new fissile material.

It is apparent from Figure 5-12 that the most favorable situation for accomplishing this would involve relatively fast neutrons in the 0.1 to 1 MeV range. The most suitable fuel would be  $^{239}\text{Pu}$ . Such is the motivation behind the development of the fast breeder reactor which operates with a chain reaction in a  $^{239}\text{Pu}/^{238}\text{U}$  fuel mixture maintained by fast neutrons in order to achieve this large value of  $\eta$ .

But if we recall the energy dependence of the fission cross section itself, then it is apparent that one takes a beating in using fast neutrons to sustain the chain reaction since the cross sections for fast fission are some two orders of magnitude smaller than those characterizing thermal neutrons. This suggests that it might be easier to achieve a sustained chain reaction using slow neutrons, since then the probability of fission is appreciably larger. But we must remember that the neutrons produced in the fission reaction are quite energetic with average energies in the MeV range. Hence, in order to take advantage of the large fission cross sections for slow neutrons, one must slow down the fast fission neutrons to thermal energies ( $< 1$  eV). As we will see in the next section, this can be accomplished rather easily by using elastic scattering collisions.

#### Fission Chain Reactions

In the preceding sections we indicated that an essential idea involved in tapping the energy released in nuclear fission was to use



the fission neutrons from one fission reaction to induce yet another fission reaction. In this way one could propagate a chain of such reactions, using the neutron as a chain carrier. It should be apparent that if we wish to maintain a stable or steady-state chain reaction, i.e., one which does not grow or decay away with time, then we must arrange things so that precisely one neutron from each fission will induce another fission event. The remaining fission neutrons will then either be absorbed in capture reactions or will leak out from the system. We must design the nuclear reactor to achieve this very delicate balance between fission reactions and neutron capture and leakage, as we indicate schematically in Figure 5-6.

It is useful to express this requirement in mathematical form. Since the neutrons play the central role in maintaining the fission chain reaction, let us focus our attention on them for a moment. A given neutron will be "born" in a fission event and will then usually scatter about the reactor until it meets its eventual "death" in either an absorption reaction or by leaking out of the reactor. Certain numbers of these neutrons will be absorbed by fissile nuclei and induce further fission, thereby leading to the birth of new fission neutrons, that is, to a new "generation" of fission neutrons. Suppose that we could somehow measure the number of neutrons in two successive fission neutron generations. Then we would define the ratio of these numbers as the multiplication factor,  $k$ , characterizing the chain reaction.

$$k \equiv \text{multiplication factor} \equiv \frac{\text{number of neutrons in one generation}}{\text{number of neutrons in preceding generation}}$$

Actually, since the number of fission neutrons in any generation is proportional to the number of fission events spawning that generation (recall that each fission reaction releases, on the average,  $\nu$  fission neutrons), we could have just as easily have defined  $k$  using the number of fission events in each generation. However, since we are primarily concerned with monitoring the number of neutrons present in the reactor

in order to study the chain reaction, we will find it more convenient to use the definition above.

Now notice that if  $k = 1$ , the number of neutrons in any two consecutive fission generations will be the same, and hence the chain reaction will be time-independent. We refer to a system characterized by  $k = 1$  as being critical. Obviously if we have been fortunate enough to have chosen just that reactor configuration and composition so that the reactor is critical with  $k = 1$ , then the number of neutrons in the reactor will always remain the same.

By a similar argument, we can conclude that if  $k < 1$ , the number of neutrons decreases from generation to generation, and hence the chain reaction dies out. We then refer to the system as being subcritical. Finally, if  $k > 1$ , then the chain reaction grows without bound as the number of neutrons in each successive generation is larger. Such a system is said to be supercritical.

In summary

$k < 1$  subcritical  
 $k = 1$  critical  
 $k > 1$  supercritical.

Hence, the first objective of the nuclear engineer is to design the nuclear reactor so that it is critical. One possible approach would be to choose a particular reactor material composition and configuration, then calculate  $k$  for this choice, and if  $k$  is not unity (and, of course, it usually won't be on the first try), readjust the reactor design until the criticality condition,  $k = 1$ , is achieved.

Actually, life is a bit more complicated than this. Some method has to be provided by which the neutron population can be built up to appreciable levels in the core (about  $10^9$  neutrons/cm<sup>3</sup>) to yield the required power generation. In principle, this could be done by merely inserting a source of neutrons into a critical assembly. Then any source neutrons appearing in the reactor would tend to induce

fission reactions, thereby producing fission neutrons, which would have their progeny maintained by the chain reaction. But most neutron sources are sufficiently weak that it would take a very long time to build up an appreciable neutron population in a reactor using this method. Instead, one can simply make  $k$  temporarily greater than unity so that the reactor is supercritical, say by withdrawing some absorbing material to alter the balance between fission and absorption. The neutron population in the reactor will then grow. Once the desired neutron population has been reached, then the reactor can be returned to critical, e.g., by reinserting the absorbing material. A very similar procedure can be used to lower the neutron population in the reactor. The reactor is taken subcritical until the desired neutron population is reached and then restored to critical once again. Altering the multiplication factor  $k$  characterizing a reactor in this way is known as nuclear reactor control. It is a very important aspect of nuclear reactor analysis.

It should be apparent by this time that the multiplication factor  $k$  plays an extremely important role in determining nuclear reactor behavior. The definition of the multiplication constant,  $k$ , in terms of successive fission neutron generations is sometimes known as the "life cycle" point of view because of its similarity to biological population growth. This definition is a bit awkward, however, since it is usually rather difficult to determine the neutron generation time. For example, some neutrons may induce fission immediately after their birth in a fission reaction. Others may first slow down to low energies before inducing fission. Some neutrons may not induce fission reactions at all, but will instead be absorbed in nonproductive capture or leak out of the system.

A somewhat more practical definition of the multiplication factor  $k$  can be given in terms of a neutron balance relation by defining

$$k \equiv \frac{\text{rate of neutron production in reactor}}{\text{rate of neutron loss (absorption plus capture) in reactor}} \equiv \frac{P}{L}$$

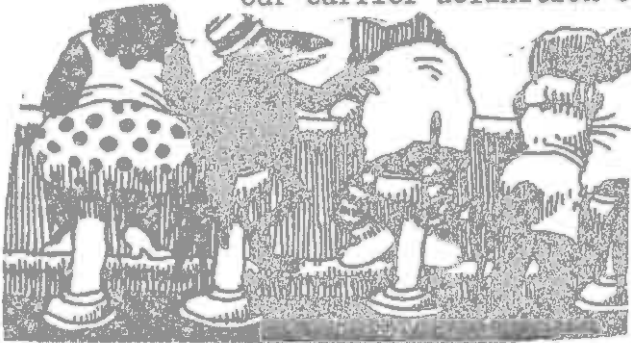
We can then define the average neutron lifetime,  $\ell$ , in an unambiguous fashion as

$$\ell \equiv \frac{N(t)}{L(t)}$$

where  $N(t)$  is the total neutron population in the reactor at a time  $t$ . This latter approach is particularly convenient for studying the time behavior of the neutron population in a reactor.

Using the concept of neutron balance, it is straightforward to demonstrate<sup>‡</sup> that the number of neutrons in a reactor, and hence the reactor power level, behaves in an exponential fashion in time as  $\exp[(k-1)t]$ . Thus for  $k$  greater than one, the neutron population increases with time; for  $k$  less than one, the population decreases, and for  $k = 1$ , the population remains unchanged--in agreement with our earlier definition of reactor criticality (see Figure 5-13). ;

IT COULD BE WORSE, PAL. WOODY HAYES HAS COME OUT IN SUPPORT OF COAL POWER!



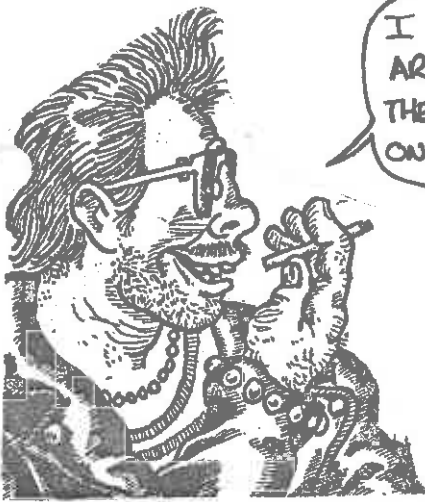
<sup>‡</sup>Imagine that somehow we could count the number of neutrons,  $N(t)$ , in a nuclear reactor at a time  $t$ . Then obviously the time rate of change of  $N(t)$  is given by

$$\frac{dN}{dt} = P(t) - L(t) = (k-1) L(t)$$

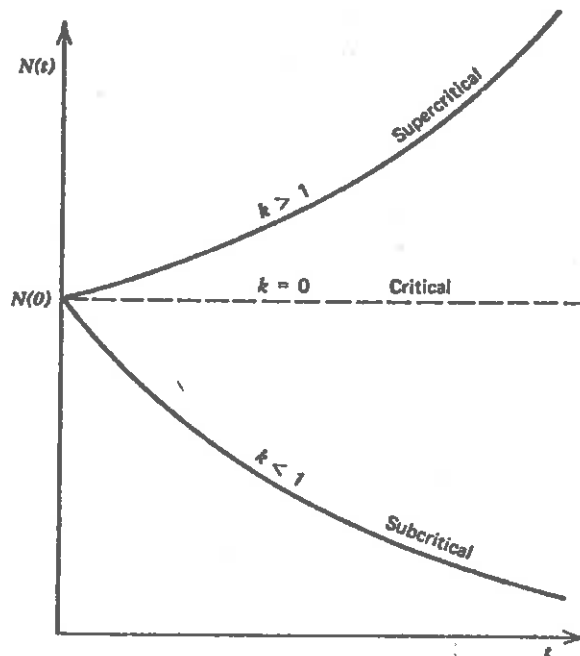
where we have used our definition of the multiplication factor  $k$ . To proceed further, use the definition of the neutron lifetime to write

$$\frac{dN}{dt} = \left( \frac{k-1}{\ell} \right) N(t)$$

If there are initially  $N_0$  neutrons in the reactor at time  $t = 0$ , then we can solve this equation to find that  $N(t) = N_0 \exp\left[\frac{(k-1)}{\ell} t\right]$ .



I THINK COAL AN' NUKES  
ARE JUST GREAT! ME AN'  
THE GANG USE 'EM REGULARLY..  
ONCE A DAY.



Time behavior of the number of neutrons in a reactor.

Hence, the growth or decay of the neutron population in a reactor obeys an exponential growth law. Such exponential growth is quite commonly found in the study of population dynamics. Indeed, the study of the "neutron" population in a reactor core is mathematically rather similar to the study of biological populations, and hence the terminology of the latter field is frequently adopted in reactor physics (e.g., generation, birth, life, death, virgin, daughter, etc.).

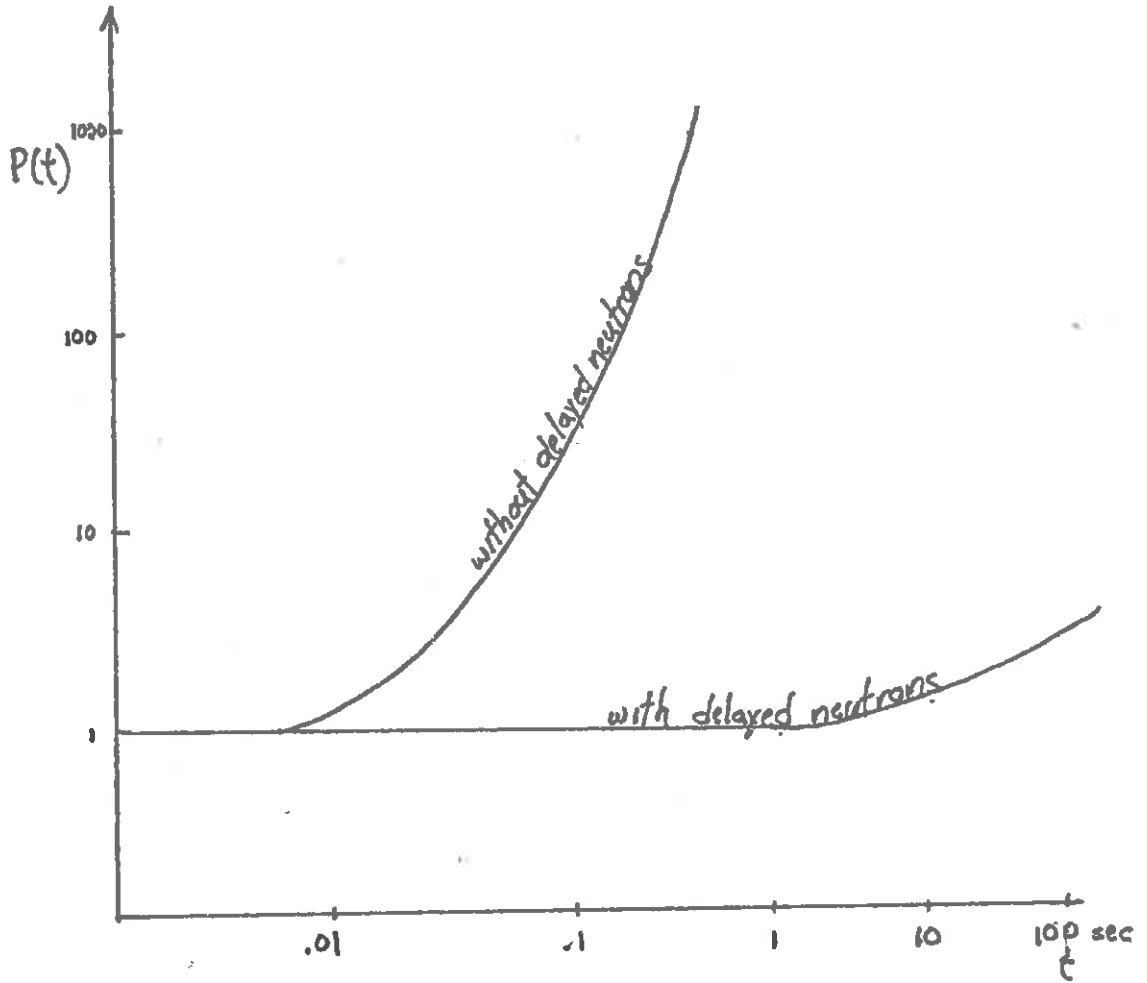
We will later find that the power level of a nuclear reactor is essentially proportional to its neutron population. Hence, we can also regard the time behavior of the reactor power level as being exponential with a time constant or reactor period  $T$  given by

$$T = \frac{\ell}{k-1}$$

That is, the power level will change by a factor of  $e = 2.73$  in a time  $T$ . In particular, it should be noted that as the multiplication factor  $k$  approaches unity, the reactor period  $T$  approaches infinity which corresponds to a time-independent neutron population or reactor power level.

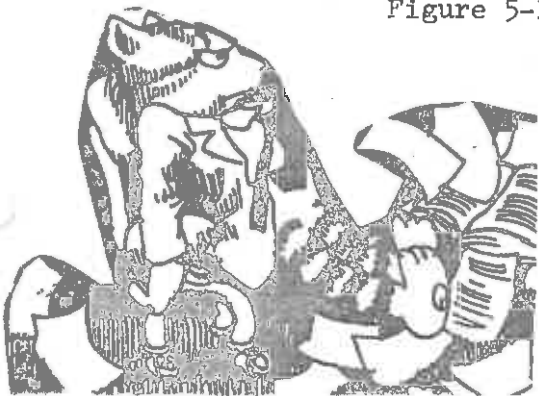
But suppose that  $k$  is not equal to unity. Then how rapidly might we expect the power level of the reactor to change? Suppose, for the sake of illustration, we increased  $k$  to make the reactor ever so slightly supercritical by an amount of  $k = 1.001$ . Since the neutron lifetime in a typical power reactor is about  $10^{-4}$  seconds, we find this corresponds to a reactor period of  $T = 0.1$  seconds. Hence, in one second the power level of the reactor will increase by a factor  $e^{10} = 22,000$ . Thus, it appears that the reactor will respond very rapidly to changes in the multiplication factor. In fact, if the reactor did indeed respond this rapidly, then it would essentially be impossible to control it, for a 0.1% change in the multiplication factor is rather common. Fortunately, we have left something out of this simple model which tends to greatly increase the neutron lifetime  $\ell$  and hence  $T$ , thereby slowing down the reactor time response. This is the effect of delayed neutrons upon the chain reactions. For we recall that a very small fraction ( $\sim 0.7\%$ ) of the fission neutrons are emitted with an appreciable time delay as the result of the radioactive decay of fission products. Although these delayed neutrons are only of minor significance in steady-state critical reactors, they are extremely important for reactor time behavior.

We can give a crude estimate of the influence of delayed neutrons upon the reactor time behavior by noting that the effective lifetime of



THAT GRAPH SURE GOT SCREWED UP!

Figure 5-14: Reactor Power Time Behavior with and without Delayed Neutron Contribution



such neutrons is given by their prompt neutron lifetime  $\ell$  plus the additional delay time  $\lambda^{-1}$  which characterizes the beta decay of the fission product which gives birth to them. If we weight both the prompt and delayed neutrons by their respective fractional contribution, we can estimate an average neutron lifetime  $\langle \ell \rangle$  which characterizes all fission neutrons

$$\langle \ell \rangle = (99.3\%) \ell + 0.7\% [\ell + \lambda^{-1}].$$

Since the average half-life of the beta decays which lead to delayed neutrons is about 12 sec, we find that the average neutron lifetime is typically  $\langle \ell \rangle \sim 0.1$  sec which is very much longer than the prompt neutron lifetime  $10^{-6} - 10^{-4}$  sec. Now a multiplication factor of 1.001 would yield a reactor period of 100 seconds. Therefore, delayed neutrons substantially increase the time constant of a reactor so that effective control is possible.

This fact suggests a related idea: Suppose we consider a reactor which is very slightly subcritical when only prompt neutrons are considered. Suppose further that the fraction of delayed neutrons provides just enough extra multiplication to achieve criticality. Then this fraction, will in fact, control the criticality--and hence the time constant. However, if  $(k-1)$  is greater than this fraction, the reactor will be critical (or supercritical) on prompt neutrons alone, and the reactor period will become very short since the delayed neutrons are not needed to sustain the chain reaction. Obviously we should design a reactor such that this situation will never occur (a rather easy task).

But the size of the multiplication factor is not the entire story. For, as we will see later, modern power reactors are designed with an excess amount of fuel (to compensate for fuel burnup and allow for long term operation) sufficient, in theory at least, to yield a multiplication factor as large as  $k = 1.25$ . But such large multiplications could never be achieved in practice because there are inherent mechanisms in a nuclear reactor which limit the amount of multiplication which can

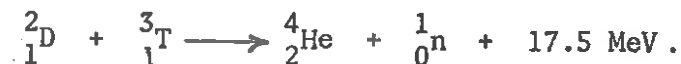


occur. For example, we will find that as the temperature of a reactor increases, the multiplication decreases rather markedly.

In fact, we might carry this analysis to the limit and recall our earlier discussion of the development of the atomic bomb during World War II in Chapter IV. For we noted there that one of the principal concerns was whether one would be able to assemble a sufficient amount of fissile material rapidly enough so that the chain reaction could release an appreciable amount of energy before the weapon blew itself apart. In the language of chain reactions, the goal was to assemble the fuel mass rapidly enough that an appreciable value of multiplication  $k$  could be achieved before the pressures generated by the fission energy production caused a fuel expansion and a corresponding decrease in multiplication. Extremely elaborate techniques (e.g., gun or implosion assembly schemes) were necessary to yield multiplications sufficient for appreciable energy release prior to disassembly. Moreover, such multiplications could only be achieved with high concentrations of fissile material (90% U-235 or Pu-239)--certainly not with the low fissile concentration in natural uranium (0.7%) or power reactor fuel (2-3%).

#### 5.1.5. NUCLEAR FUSION AND CONTROLLED THERMONUCLEAR FUSION REACTIONS

Let us now examine the other extreme of nuclear energy--combining or fusing together light isotopes to generate more tightly bound heavier isotopes and releasing energy in the process. An example of such a reaction is that which occurs between the two heavier isotopes of hydrogen, deuterium  ${}^2_1\text{D}$  and tritium  ${}^3_1\text{T}$ :



This fusion reaction releases 17.5 MeV of energy which appears as the kinetic energy of the reaction products (14 MeV with the neutron, 3.5 MeV with the alpha particle). That such reactions are capable of generating enormous energies is obvious. One need only to look at the sun (or any star) to see a massive example of fusion energy release. There is one hangup to this reaction, however. Both light nuclei are

positively charged and repel each other quite strongly. Hence, one must slam the two nuclei together at high velocities to make the reaction go. One way of doing this is to take a mixture of deuterium and tritium and heat it to a sufficiently high temperature that the velocities of thermal motion of the nuclei is sufficient to overcome charge repulsion and initiate the fusion reaction. Such a scheme is naturally referred to as a "thermonuclear fusion" reaction. Unfortunately the necessary temperature is quite high--roughly 100,000,000 degrees. In fact, the interior of the sun is at just such a temperature. Until quite recently, man had imitated the sun in only a rather violent way--by using a nuclear fission bomb to create the necessary high temperatures, with the result being the hydrogen bomb.

But more recently there has been considerable hope that we may be able to produce such temperatures and initiate such controlled thermonuclear reactions (CTR) in a controlled way. Actually it is not too difficult to heat a gas to these temperatures--but it is as hard as hell to contain it long enough to get an appreciable amount of fusion energy out. The sun uses the enormous force of solar gravity to accomplish this. Scientists on earth have taken a necessarily different approach by noting that such high temperature gases become ionized and hence charged, i.e., a plasma, and can be confined in a magnetic field--maybe. Actually, nobody has been able to confine a high temperature plasma in a magnetic field<sup>‡</sup> for long enough to get an appreciable fusion energy release yet--but there is every hope that the scientific feasibility of this approach will be demonstrated within several years.

---

<sup>‡</sup>One scientist likened containing a plasma in a magnetic field to trying to hold a blob of jello with a bunch of rubber bands--the jello deforms, stretching the rubber bands, and eventually oozes its way out--just as a plasma will ooze out of its magnetic container.



There is yet another way to skin this cat. Just forget about confining the plasma and hope that one can heat it so fast that it ignites and burns in a thermonuclear reaction before it has a chance to expand. [That's the idea behind the H-bomb, of course.] So how do we heat up a plasma that fast? [It turns out you need to do it in about one-billionth of a second.] You use a very big laser. By focusing the energy in the laser light beam on a small pellet of deuterium-tritium fuel, one can heat and compress it to induce a thermonuclear explosion. The heat produced in this explosion can then be used to produce steam--just as the fission events in a nuclear reactor.

#### Thermonuclear Fusion Physics

To understand these approaches and their likelihood of success, let us consider in more detail the underlying physics of thermonuclear fusion reactions. To begin with, there are a very large number of possible fusion reactions. However, only fusion reactions among the lighter nuclides are of interest for practical applications because of the strong electrical repulsion of heavier nuclides. For recall that the basic forces that bind together nucleons and hence make fusion reactions possible, the attractive nuclear forces, are quite short range. Hence, for these forces to be effective in a fusion reaction, the reacting nuclei must approach each other quite closely. But to approach closely, the nuclei must first overcome the much longer range electrical forces which repel like charges. The strength of these repulsive forces increases in direct proportion to the charge of each of the reacting nuclei--that is, the strength of repulsion is proportional to the atomic numbers  $Z$ . To overcome this repulsion and approach closely together, the nuclei must collide with each other at high velocities. The larger the charge, the more energetic must be the collision. Since the lighter nuclei have the smallest charge, it is easiest to get these to react. Even with the lightest nuclides, i.e., those isotopes of hydrogen, the nuclei must collide with each other with kinetic energies of 100,000 eV or so for there

to be an appreciable probability of a fusion reaction. In the language of nuclear physics, the microscopic cross section for nuclear fusion reactions only becomes appreciable when the kinetic energy of the incident nucleus is 100,000 eV or larger. For nuclei of larger  $Z$ , the required kinetic energies become even larger.

Hence most attention has been directed to achieving fusion with light nuclides. Of most interest, have been fusion reactions among hydrogen isotopes:



Those reactions involving deuterium are of particular interest since this isotope occurs in nature at a concentration of .015%. That is, one out of every 6500 hydrogen nuclei is deuterium. Now this may sound like a low concentration, but in fact there is enough deuterium in the oceans to provide mankind with fusion power for millions of years. The heavier isotope tritium does not occur in nature<sup>‡</sup> (obviously, since it is radioactive with a half-life of 10.3 years). Fortunately, it can be produced rather easily by bombarding lithium with neutrons, as we will see later.

The next question concerns how we can get these nuclei to run into each other at high enough speeds (or energies) to induce fusion reactions. On the surface, this would seem to be a straightforward task since one can easily accelerate charged particles to high energies (e.g., the picture tube of your TV set accelerates electrons to 25,000 eV). Hence, one could imagine accelerating tritium to several 100,000 eV and bombarding a deuterium target to extract 17 MeV per fusion reaction. But there is a big flaw in this scheme. Most of the time, when deuterons run into tritons they simply bounce off. Put more precisely, the cross section for scattering for these nuclei is about  $10^{-18} \text{ cm}^{-2}$ . But the fusion cross section (as for most cross sections involving nuclear forces) is of the order of 1 barn =  $10^{-24} \text{ cm}^2$ . Hence, scattering collisions are a million times more probable than fusion reactions. So what that means

<sup>‡</sup>aside from very small quantities produced by cosmic radiation.

is that we are going to have to arrange for the nuclei to collide with each other millions of times or they will probably not fuse together.

A different approach is necessary. One way to bring the nuclei up to the speeds required for fusion reactions is to heat them up, for we recall that temperature is a measure of the average kinetic energy (and hence speed) of the atoms in a material. In fact, physics tells us that a gas at a temperature  $T$  is characterized by average particle energies of  $3/2 kT$  where  $k$  is Boltzmann's constant. Hence, what we must do is heat the fuel mixture, say of deuterium and tritium since the DT reaction is the easiest to induce, to a temperature such that the average atom velocities are 100,000 eV or so. But if you stick in numbers (1 eV corresponds to  $10,000^{\circ}\text{C}$ ), you find that this implies that the fuel must be heated to the enormous temperature of billion degrees! Actually, things aren't quite so bad, since there will be a spread of energies about  $3/2 kT$  and even at a temperature of  $100,000,000^{\circ}$  there will be enough energetic nuclei to get an appreciable number of fusion reactions. Nevertheless, this is a truly staggering temperature requirement. Certainly no fuel heated to this temperature could remain in a liquid or even a gaseous state. In fact, at these temperatures, the atoms ionize, and we have a very high temperature plasma, an ionized gas.

This scheme of heating the fuel to a sufficiently high temperature to induce fusion reactions is called, naturally enough, thermonuclear fusion. It is the nuclear analogue of many chemical reactions in which the reacting products must be heated before the reaction will proceed at an appreciable rate.

But there is one additional problem. We have seen that the nuclei must collide with each other millions of times before fusion reactions will occur. Hence, we must contain the fuel at this very high temperature for a period of time if we are to release an appreciable amount of fusion energy. But how do we contain a gas--more correctly, a plasma--at a temperature of  $100,000,000^{\circ}$ ? The pressures generated are truly enormous. In fact, if you were to heat up the air you are breathing to this temperature, it would exert a pressure of 100 million atmospheres. No container on earth could hold it together.

Hence, to achieve thermonuclear fusion energy release, we must solve two problems:

- (i) Produce and heat a plasma fuel (e.g., D-T or D-D) to "thermonuclear" temperatures ( $\sim 10$  keV or  $100,000,000^\circ\text{C}$ )
- (ii) Confine it for a sufficiently long time that you get out more fusion energy than you invested in heating the fuel to that temperature in the first place.

These twin requirements are usually expressed by a mathematical relation known as the Lawson criterion which essentially expresses the balance between thermonuclear energy production and heating energy. This criterion can be expressed as a condition on the product of the fuel density times the time of plasma fuel confinement:

$$\begin{array}{ll} \text{D-T:} & n\tau > 10^{14} \text{ sec/cm}^3 & (T = 10 \text{ keV}) \\ \text{D-D:} & n\tau > 10^{16} \text{ sec/cm}^3 & (T = 100 \text{ keV}) \end{array}$$

(Here we have noted that this criterion depends on the type of fusion reaction, and we have given the criterion for the two most commonly studied fusion reactions.) It should be noted that this criterion is only a balance between fusion and thermal energy. The Lawson criterion which would characterize a successful fusion reactor--when all of the intrinsic energy losses are taken into account--is some 10 to 100 times larger. Hence, the criterion given above is sometimes referred to as "scientific breakeven", since its achievement will indicate the scientific feasibility of a thermonuclear fusion scheme.

#### Controlled Thermonuclear Fusion Schemes

But how are we to accomplish the twin goals of heating and confinement in such a way as to satisfy the Lawson criterion?

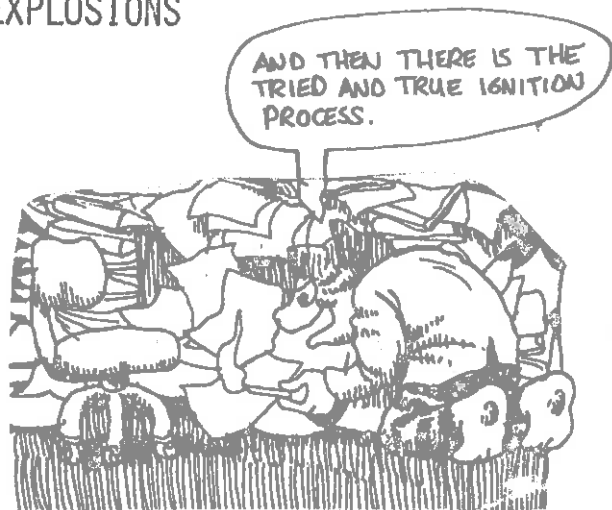
In a star, the enormous mass ( $10^{33}$  g) causes gravitational forces which both confine the reacting plasma as well as compress and heat it. Certainly we cannot expect gravity to do the job here on earth.

In thermonuclear weapons, no attempt is made to confine the reacting fuel. Rather one merely attempts to heat it to thermonuclear temperatures so fast that an appreciable number of reactions occur before it is blown apart. This scheme is known as inertial confinement since it is the inertia of the reacting fuel that keeps the plasma fuel from blowing apart prematurely. But to heat an appreciable mass of fuel to such high temperatures requires an extremely large energy source, and the source used in thermonuclear weapons is a fission

Figure 5-15

### THERMONUCLEAR REACTION SCHEMES:

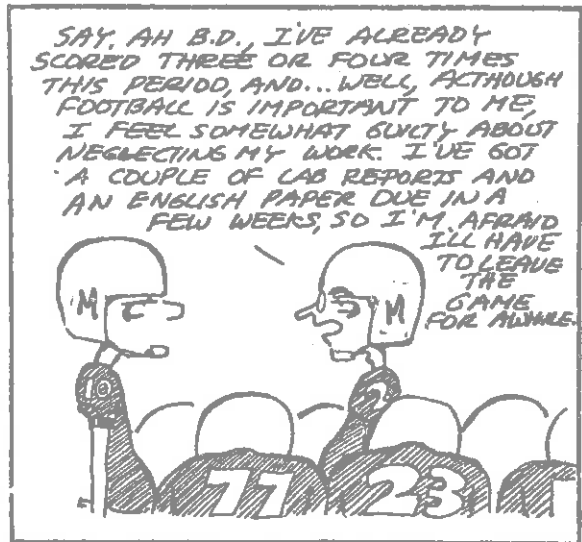
	<u>CONFINEMENT</u>	<u>HEATING</u>
STARS:	GRAVITATION	GRAVITATION SELF HEATING
WEAPONS:	INERTIAL	FISSION REACTIONS
MAGNETIC CONFINEMENT:	MAGNETIC "BOTTLES"	ELECTRIC CURRENTS NEUTRAL INJECTION MAGNETIC COMPRESSION LASERS
HIGHLY COMPRESSED MICRO- EXPLOSIONS	INERTIAL	LASER OR ELECTRON BEAMS HYDRODYNAMIC COMPRESSION,





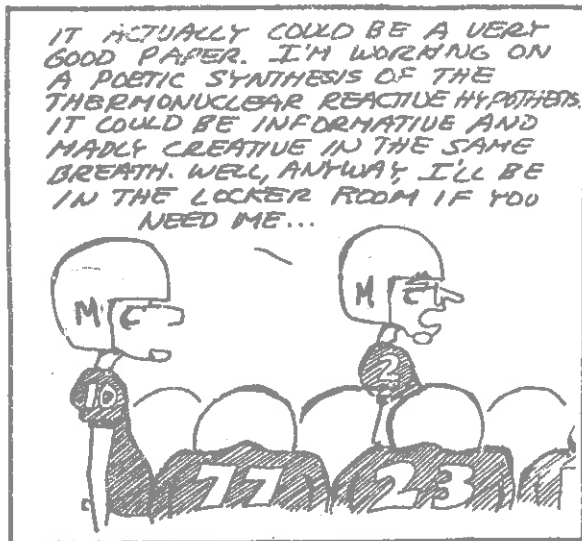
I THINK WE NEED A LITTLE MORE WORK ON THE SHORT PASS, SO...

AH..B.D.?



SAY, AH B.D., I'VE ALREADY SCORED THREE OR FOUR TIMES THIS PERIOD, AND... WELL, ALTHOUGH FOOTBALL IS IMPORTANT TO ME, I FEEL SOMEWHAT GUILTY ABOUT NEGLECTING MY WORK. I'VE GOT A COUPLE OF LAB REPORTS AND AN ENGLISH PAPER DUE IN A FEW WEEKS, SO I'M AFRAID

I'LL HAVE TO LEAVE THE GAME FOR AWHILE.



IT ACTUALLY COULD BE A VERY GOOD PAPER. I'M WORKING ON A POETIC SYNTHESIS OF THE THERMONUCLEAR REACTIVE HYPOTHESIS. IT COULD BE INFORMATIVE AND MADLY CREATIVE IN THE SAME BREATH. WELL, ANYWAY, I'LL BE IN THE LOCKER ROOM IF YOU NEED ME...



...AND THE LEGEND OF THE STUDENT ATHLETE LIVES ON...

G.B. Jensen



reaction. That is, an atomic bomb is used to heat the thermonuclear fuel to ignition temperatures. Again, this approach is highly unsuitable for a controlled application.

Instead, the approaches which have been taken work with far smaller quantities of thermonuclear fuel. For the past 20 years, the primary effort has been to use the charged nature of the plasma fuel as the basis for its confinement in a strong magnetic field. It is well known that charged particles have difficulty moving across magnetic field lines and instead spiral along them. Hence, it is possible to design a magnetic "bottle" which contains the plasma fuel. Traditionally, such schemes have worked with very low plasma densities ( $10^{14}$  cm<sup>-3</sup>--which is a darn good vacuum) in an effort to minimize pressure forces and have attempted to achieve confinement times of the order of a second to satisfy the Lawson criterion. Typically the magnetic field containers have taken one of three forms:

- (i) toroidal machines: (shaped like donuts)--examples being the Stellerator developed in the U.S. and the Tokamak developed in the U.S.S.R.
- (ii) magnetic mirrors: These machines use electrical currents to generate a magnetic field which increases away from the center of the plasma in an effort to confine it.
- (iii) pinch machines: In a pinch, the plasma is confined, compressed, and heated by a large current which generates a magnetic field which squeezes down upon the plasma.

To date, the most successful results have been obtained in the Tokamak<sup>‡</sup>, with current densities of  $10^{14}$  and confinement times of .05 seconds. Large machines are under construction which should be capable of exceeding the Lawson criterion for scientific breakeven in the near future. These will be discussed in the last chapter of this book.

A very exciting recent alternative to the magnetic confinement approach is an inertial confinement scheme similar to that used in thermonuclear weapons, but which uses high powered lasers or charged particle beams to

---

<sup>‡</sup>A Russian abbreviation for toroidal (to), chamber (ka), magnetic (mak).

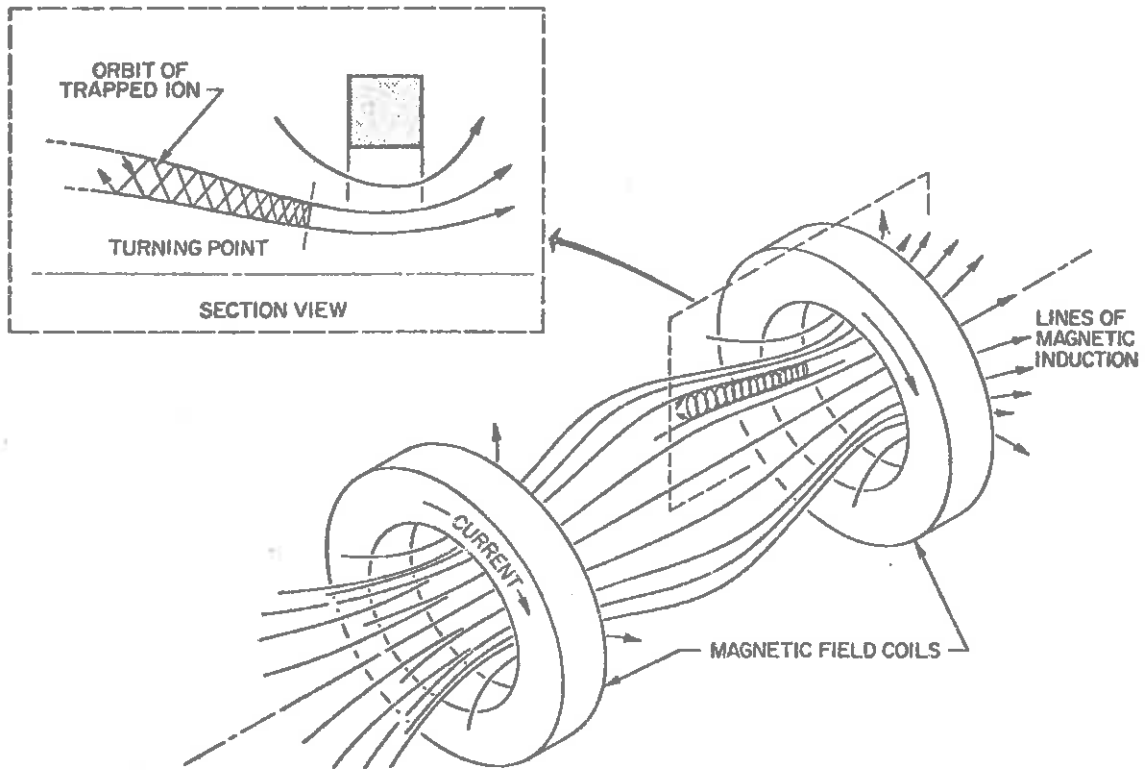
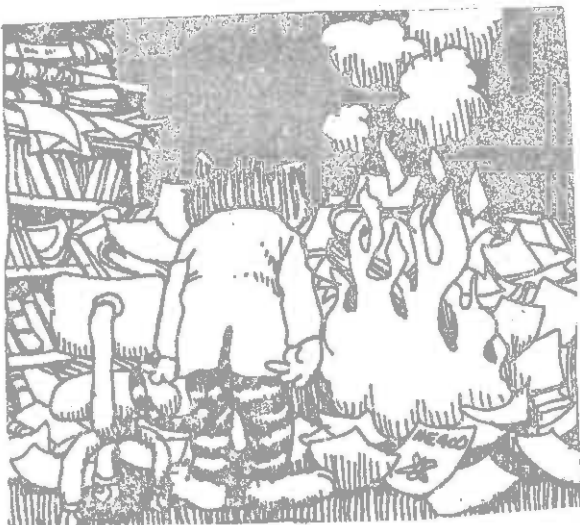


Figure 5-16: Confinement of Plasmas in Magnetic Fields



OH, BOY. I JUST REMEMBERED.  
THOSE ARE MY COURSE NOTES!!!

ignite tiny pellets which then yield megajoules (rather than megatons) of fusion energy.

The inertial confinement approach can be regarded as essentially the "internal combustion engine" approach to controlled thermonuclear fusion (and, in the same sense, most proponents of this approach regard magnetic confinement such as a Detroit automobile engineer regards the Stanley steamer). In the engine of your car, the essentials of the energy generation process involves (see Figure 5-17):

- (i) injection of fuel (air plus gas) into the cylinder
- (ii) the compression of the fuel mixture by a piston
- (iii) the ignition of the fuel mixture
- (iv) the combustion of the fuel mixture causing a small explosion which drives the piston down and hence turns the crankshaft (converting chemical energy into mechanical energy).

In inertial confinement fusion schemes, the scenario is as follows:

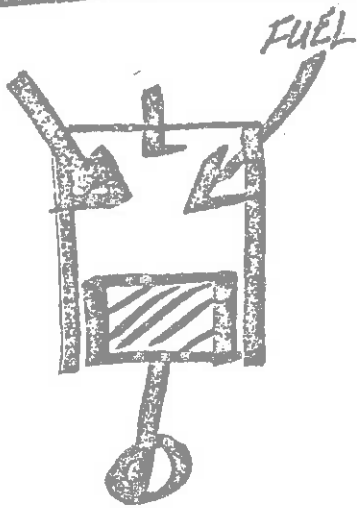
- (i) a tiny fuel pellet (say, D-T) is injected into a blast chamber
- (ii) the pellet is compressed to high density with either laser or charged particle beams
- (iii) this ignites a thermonuclear reaction
- (iv) the thermonuclear burn or "micro-explosion" generates energetic reaction products (neutrons and alpha particles) whose energies can be converted into heat and hence used to power a steam cycle to produce electrical energy.

Such an inertial confinement "internal combustion engine" would use a series of micro-thermonuclear explosions (about 100 per second, each generating the energy equivalent of several kilograms of high explosives) to generate electrical power.

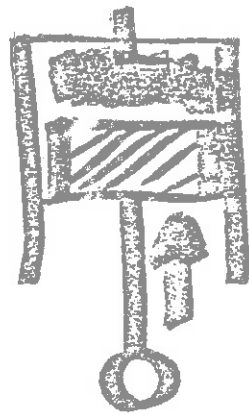
We will return much later in Chapter 8 when we address the topic of alternative nuclear energy sources to discuss the practical potential of both magnetic and inertial confinement schemes for large scale electrical power generation.

# DETROIT

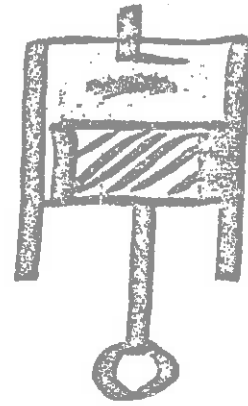
Figure 5-17: The Laser-Fusion "internal" combustion engine



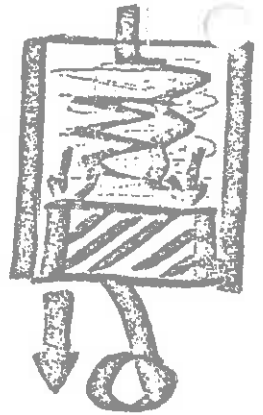
FUEL INJECTION  
(air & gas)



COMPRESSION  
(by piston)

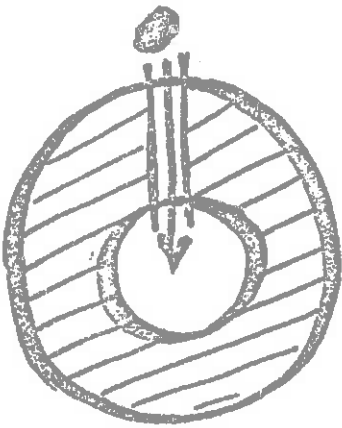


IGNITION  
(by spark plug)

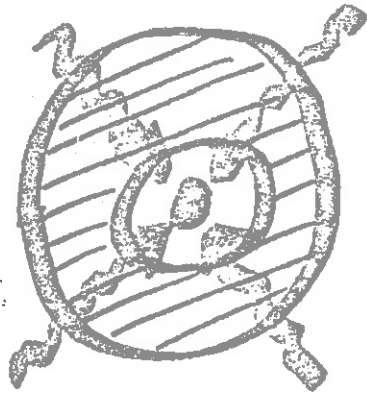


COMBUSTION  
(drives piston & cam)

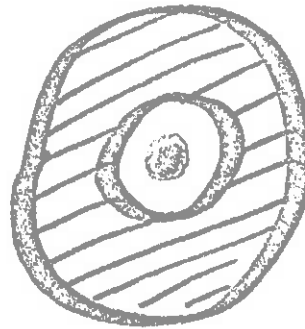
# LIL-LASER-KHS---



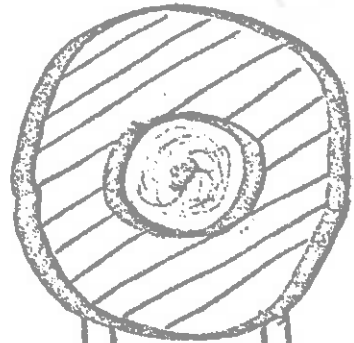
FUEL PELLET  
INJECTION  
(DT + other  
stuff)



COMPRESSION  
(by laser,  
E-beam, or  
ion beam)



IGNITION  
(by  
compression)



BOY, YOU SURE DO HAVE  
THE CRAZIEST IDEAS  
SOMETIMES!!



THERMONUCLEAR  
BURN  
(heat extraction  
by steam cycle)

↑ water  
↓ steam

## 5.2 Nuclear Fission Reactors

The term nuclear reactor will be used in these notes to refer to devices in which controlled nuclear fission chain reactions can be maintained. (Later in Chapter 8 we will broaden this definition to include thermonuclear fusion nuclear reactors--for now, however, we restrict ourselves to nuclear fission reactors.) In such a device, neutrons are used to induce nuclear fission reactions in heavy nuclei. These nuclei fission into lighter nuclei (fission products) accompanied by the release of energy (some 200 MeV per event) plus several additional neutrons. These fission neutrons can then be utilized to induce still further fission reactions, thereby inducing a chain of fission events. In a very narrow sense then, a nuclear reactor is simply a sufficiently large mass of appropriately fissile material (e.g., uranium-235 or plutonium-239) in which such a controlled fission chain reaction can be sustained. Indeed, a small sphere of uranium-235 metal slightly over 8 cm in diameter could support such a chain reaction and hence would be classified as a nuclear reactor.

But a modern power reactor is a considerably more complex beast. It must not only contain lattice of very carefully refined and fabricated nuclear fuel, but it as well must provide for cooling this fuel during the course of the chain reaction as fission energy is released, while maintaining the fuel in a very precise geometrical arrangement with appropriate structural materials. Furthermore, one must provide some mechanism to control the chain reaction, shield the surroundings of the reactor from the intense nuclear radiation generated during the fission reactions, and provide for replacing nuclear fuel assemblies when the fission chain reaction has depleted their concentration of fissile nuclei. If the reactor is to produce power in a useful fashion, it must also be designed so that it will operate both economically and safely. Such engineering constraints make the actual nuclear configuration quite complex indeed (as a quick glance ahead to the illustrations in Chapter 6 will indicate).

Nuclear reactors have been used for over 30 years in a variety of applications. They are particularly valuable tools for nuclear research since they produce copious amounts of nuclear radiation, primarily in the form of neutrons and gamma rays. Such radiation can be used to probe the microscopic structure and dynamics of matter (neutron or gamma spectroscopy).

The radiation produced by reactors can also be used to transmute nuclei into artificial isotopes which can then be used, for example, as radioactive tracers in industrial or medical applications. Reactors can use the same scheme to produce nuclear fuel from non-fissile materials. For example, uranium-238 can be irradiated by neutrons in a reactor and transmuted into the nuclear fuel plutonium-239. This is the process utilized to "breed" fuel in the fast breeder reactors currently being developed for commercial application in the next decade.

Small, compact reactors have been used for propulsion in submarines, ships, aircraft, and rocket vehicles. Indeed, the present generation of light water reactors used in nuclear power plants are little more than the very big brothers of the propulsion reactors used in nuclear submarines.<sup>6</sup> Reactors can also be utilized as small, compact sources of long term power, such as in remote polar research stations or in orbiting satellites.

But by far the most significant application of nuclear fission reactors is in large, central station power plants. A nuclear power plant is actually very similar to a fossil-fueled power plant, except that it replaces the coal or oil-fired boiler by a nuclear reactor, which generates heat by sustaining a fission chain reaction in a suitable lattice of fuel material. Of course, there are some dramatic differences between a nuclear reactor and, say, a coal-fired boiler. But the useful quantity produced by each is high temperature, high pressure steam which can then be used to run turbo-generators and produce electricity. At the center of a modern nuclear plant is the nuclear steam supply system (NSSS), composed of the nuclear reactor, its associated coolant piping and pumps, and the heat exchangers ("steam generators") in which water is turned into steam. The remainder of the power plant is rather conventional.

But we must not let the apparent similarities between nuclear and fossil-fueled power plants overshadow the very significant differences between the two systems. For example, in a nuclear plant, sufficient fuel must be inserted into the reactor core to allow operation for very long periods of time (typically a year). The nuclear fuel cycle itself is extremely complex, involving as it does fuel refining, fabrication, reprocessing after utilization in the reactor, and eventually the disposal of radioactive fuel wastes. The safety aspects of nuclear plants are also quite different, since one must

be concerned with avoiding possible radiological hazards. Furthermore, the licensing required by a nuclear plant before construction or operation demands a level of sophisticated analysis totally alien to fossil-fueled plant design.

Therefore, even though the NSSS contributes only a relatively modest fraction of the total capital cost of a nuclear power plant (presently, about 20%), it is of central concern since it not only dictates the detailed design of the remainder of the plant, but as well the procedures which must be followed in plant construction and operation. Furthermore, it is the low fuel costs of the NSSS which are responsible for the economic advantages presently enjoyed by nuclear power generation.

The principal component of the NSSS is, of course, the nuclear reactor itself. In this section we will concern ourselves with the basic concepts involved in nuclear reactor design and operation.

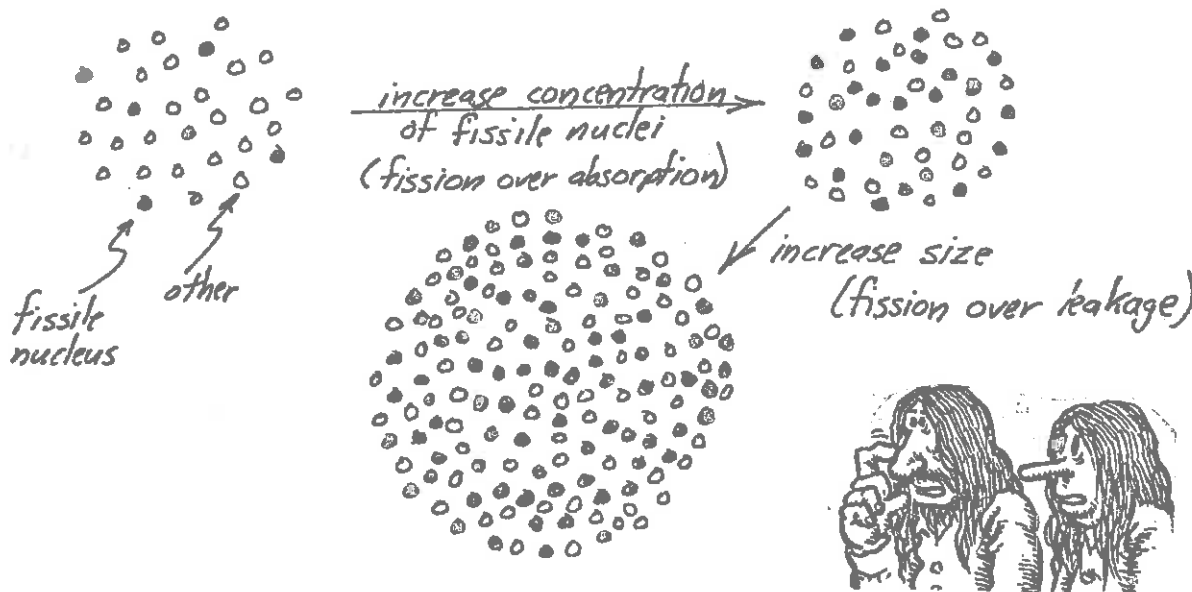
#### 5.2.1. Fission Chain Reactions and Nuclear Criticality

In order to understand the principal concepts underlying nuclear reactor operation, we need to look once again at the fission chain reaction. In order to maintain a stable fission chain reaction, we must design a nuclear reactor so that on the average, exactly one neutron from each fission will induce yet another fission reaction. That is, we must balance neutron production against neutron destruction so that we achieve a multiplication factor of  $k = 1$ --a critical system.

Therefore, let us now turn our attention to the calculation of the multiplication factor for, say, a pile of uranium that we wish to make into a nuclear reactor. We probably should add some coolant to remove fission heat and perhaps some structural material to hold the reactor together. However, we will assume for the moment that we can treat these materials as mixed together so that the composition of the reactor is uniform.

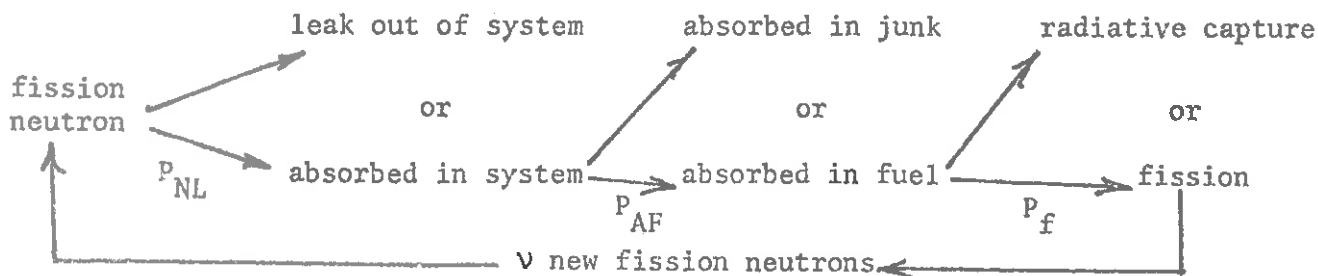
Now to calculate  $k$  we must determine the possible fate of neutrons in a given fission generation. Fortunately this is rather easy to do since there are only two possible alternative destinies available to the neutron. First it might leak out of the reactor and be lost to the chain reaction. If it does not leak out, then it must eventually be absorbed. This absorption may correspond to a nonproductive capture event in either fuel or other materials, or the absorption may induce a fission reaction, in which case a new fission neutron generation is produced.

To picture this more clearly, suppose we represent the reactor as a bunch of nuclei. Then neutrons produced in fission reactions will wander through this bunch, banging into nuclei, possibly being absorbed, possibly just being scattered, in which case they continue on until they are either absorbed or leak out of the system.



Now suppose in the particular system we are considering, more neutrons are lost by leakage and absorption than are produced in fission. Then the multiplication factor  $k$  is less than one, and the system is subcritical. One way to alter the system so that there is a more favorable balance between production and destruction is simply to make it bigger. Then the probability that a neutron will leak out before being absorbed by a nucleus is decreased (the average neutron has to travel farther to leak out--hence, will suffer more collisions on the way). An alternative way to increase the multiplication is to increase the relative concentration of fissile nuclei. By adjusting the fuel concentration and size of the reactor, we can balance neutron production and loss and achieve a critical system.

To be a bit more precise, we can represent the various possible destinies of a neutron schematically as shown below:





$P_{NL}$  = probability that neutron will not leak out of the system before absorption

$P_{AF}$  = probability that if neutron is absorbed, it is absorbed in fuel

$P_f$  = probability that if neutron is absorbed in fuel, it will induce a fission reaction

These latter two probabilities are easily calculated. If we recall that the probability for absorption of a neutron in a sample of material was proportional to the macroscopic absorption cross section  $\Sigma_a$  for that material, then it is evident that the relative probability that the neutron will be absorbed in the fuel (rather than something else) is just the ratio of the macroscopic absorption cross sections for the fuel  $\Sigma_a^F$ , and for the fuel plus the rest of the material in the core (which we label as  $\Sigma_a$ ):

$$P_{AF} = \Sigma_a^F / \Sigma_a$$

It is customary in nuclear reactor terminology to refer to this quantity as the "utilization" factor  $f$  since it effectively measures how effective the fuel is in competing with other materials in the reactor for the absorption of neutrons.

The relative probability for inducing a fission reaction in the fuel can also be expressed in terms of cross sections. In this case we simply take the ratio of the fission cross section to that of the absorption cross section (due to both fission and radiative capture) in the fuel material:

$$P_f = \Sigma_f^F / \Sigma_a^F = \sigma_f^F / \sigma_a^F$$

We are now ready to utilize these probabilities to determine the multiplication factor  $k$  for a reactor. All we have to do is to play a game of "follow the neutron". For suppose we start with a number  $N_1$  neutrons present in the reactor in a given fission generation. Then with the help of the above probabilities and our diagram, we can compute the number of neutrons in the next generation:

$$N_2 = \nu (P_f (P_{AF} (P_{NL} N_1)))$$

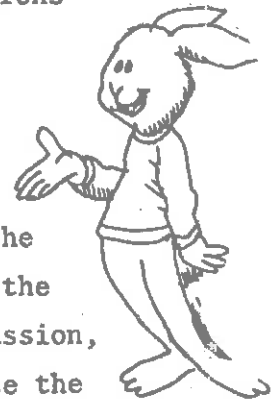
or

$$N_2 = \eta f P_{NL} N_1$$

where we have recalled that  $\eta = \nu \sigma_f^F / \sigma_a^F$  is the number of fission neutrons produced per absorption in the fuel. We can now use our definition of the multiplication factor  $k$  as being the ratio of the number of neutrons in two successive fission generations to write

$$k = \frac{N_2}{N_1} = \eta f P_{NL}$$

This, then, is the result we are after. If we can calculate each of the factors  $\eta$ ,  $f$ , and  $P_{NL}$  we can determine the multiplication factor for the system of interest. But of far more significance for our present discussion, by examining each of the terms in our expression for  $k$ , we can introduce the various considerations which enter into reactor design and operation.



#### Reactor Geometry ( $P_{NL}$ ):

First, examine the nonleakage probability since this is essentially determined by the size of the reactor. Actually, although this is the hardest quantity to compute (usually requiring rather elaborate mathematics and the use of large computers), it is easy for us to dismiss it from consideration here by recognizing that most modern power reactors are so large that very few neutrons leak out. In fact, in the vast majority of the power reactors built in this country, less than 3% of the neutrons leak out so that  $P_{NL} = 0.97$ . Actually, the size of a power reactor is determined not by the desire to minimize leakage, but rather to provide enough space for coolant flow to adequately remove the enormous heat produced by the fission reactions. Indeed, in any reactor design, one first determines how large the reactor core must be built to accommodate adequate cooling for a desired power output. Then the nuclear designer determines that fuel concentration which will yield a reactor of the desired size critical.

#### Fuel Type ( $\eta$ ):

The next parameter of interest is the number of neutrons produced per neutron absorbed in the fuel,  $\eta$ . As we have noted, this parameter depends

only on the type of fuel--e.g., U-233, U-235, or Pu-239--and upon the average kinetic energies of the neutrons sustaining the chain reaction. Since it is evident that both the utilization  $f$  and the nonleakage probability  $P_{NL}$  are less than 1, we require  $\eta$  to be substantially greater than 1 if a critical fission chain reaction is to be possible. Fortunately, as we can see from Figure 5-12, this condition is not only satisfied, but in fact for many energies one finds that  $\eta > 2$ . Hence, we appear to have an extra neutron. This "bonus" neutron can be put to good advantage if we recall that certain "fertile" isotopes can be transmuted into fissile material via neutron capture. In particular, U-238 can be transmuted into Pu-239, and Th-232 can be transmuted into U-233. Hence, if we load the core of a reactor with such fertile material, we can use the extra neutron to produce a few fissile fuel material. This process is frequently referred to as conversion, and nuclear reactors whose principal job is to produce Pu-239 or U-233 are known as "converter" reactors.

Actually, all modern power reactors are converter reactors in a sense, although this is not their primary function, since they contain substantial amounts of U-238 which will be transmuted into Pu-239 via neutron capture during normal operation. For example, a light water reactor will contain a fuel mixture of roughly 3% U-235 and 97% U-238 in a freshly loaded core. After a standard operating cycle (usually one year), this core will contain roughly 1% U-235 and 1% Pu-239 which can then be separated out of the spent fuel and re-fabricated into fresh fuel elements for reloading (so-called "plutonium recycle").

These considerations suggest that it might in fact be possible to fuel a reactor with Pu-239 and U-238 and then produce directly the fuel (Pu-239) needed for future operation. Indeed, it might even be possible to produce more Pu-239 than is burned--that is, to "breed" new fuel. This is the essential idea behind the concept of a breeder reactor.

To discuss this concept in more detail, it is useful to define the conversion ratio:

$$CR = \frac{\text{average rate of fissile atom production}}{\text{average rate of fissile atom consumption}}$$

This quantity is also referred to as the breeding ratio (BR) if it is greater than one. If we have conversion, then consuming  $N$  atoms of fuel during reactor operation will yield  $CR \cdot N$  atoms of new fissile isotopes. For example, most

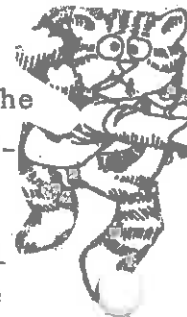


modern light water reactors are characterized by a conversion ratio of  $CR \sim 0.6$ . By way of contrast, gas cooled reactors have somewhat higher conversion ratios of  $CR \sim 0.8$  and hence are sometimes referred to as advanced converter reactors.

For breeding to occur we require that the conversion ratio be greater than unity,  $CR = BR > 1$ . Of course, for this to happen we must have  $\eta > 2$  since slightly more than one fission neutron is needed to maintain the chain reaction (some neutrons will leak out or be absorbed in parasitic capture) while one neutron will be needed to replace the consumed fissile nucleus by converting a fertile into a fissile nucleus.

If we now look back at Figure 5-12, we see that fortunately  $\eta$  is greater than 2 for certain neutron energies. Hence, if we can design the reactor to operate with neutrons of the right energy, then breeding will be possible.

But how do we adjust the energy of the neutrons in the fission chain reaction? As we have noted, the neutrons produced in the fission reaction appear with very high energies in the MeV range. But we have also noted that the probability of a neutron inducing fission (i.e., the fission cross section) is largest at very low neutron energies comparable to 0.1 eV or so. Hence, it is obviously to our advantage to try to slow down, or in the language of nuclear engineers, moderate the fast fission neutrons to take advantage of the fact that slow neutrons are more likely to induce fission reactions. This can be accomplished rather easily, simply by letting the fast neutrons scatter off nuclei. For, as the pool sharks among our readers will affirm, whenever a fast moving particle collides with a stationary particle, it will lose energy (which is transferred to the recoiling target particle). In particular, the lighter the nucleus, the more kinetic energy per collision that will be lost on the average by the neutron and hence the more effective the slowing down or moderation. In fact, the best nucleus to use to slow down neutrons is hydrogen, which is fortunately quite commonly available in the form of  $H_2O$ . If we just let the fast neutrons rattle around in water for a bit, they will quickly slow down to the desired energy (in 20 collisions or so). Indeed, the slowing down is so effective that the neutrons will come into thermal equilibrium with the nuclei in the reactor at the same temperature as the reactor itself. For this reason, slow neutrons are sometimes referred to as thermal neutrons, and reactors which contain moderating materials such as water, are known as thermal reactors. Most reactors in the world today are thermal reactors,



and the most common moderating materials are water ( $H_2O$ ), heavy water ( $D_2O$ ), and graphite (C).

If we now return to our graph of  $\eta$  versus neutron energy, we see that the only attractive breeding cycle for low-energy or thermal neutrons involves U-233--that is, the Th-232/U-233 process. A far more attractive breeding cycle is based upon U-238/Pu-239, but we can see that this would require keeping the neutrons quite high in energy, above 100 keV. Reactors which are designed to run on fast neutrons so that breeding will occur are known naturally enough as fast breeder reactors.

In such fast reactors,  $\eta$  is quite large and one can use the "extra" neutrons available in a fission chain reaction maintained by such fast neutrons to convert or breed new fuel. However, since the fission cross section is much smaller (almost 100 times smaller than in a thermal reactor), one needs far more fuel to sustain the chain reaction. Furthermore, to keep the neutron energy high, one wants to utilize only high mass-number materials in the core (as coolant or structure) to keep neutron slowing down to a minimum. This motivates the use of liquid metal coolants such as sodium.

#### Fuel Loading and Reactor Control (f):

The third parameter, the utilization  $f$ , is determined both by the concentration of fuel in the reactor as well as by the presence of other absorbing materials. In particular, as the fuel concentration is increased,  $\Sigma_a^F$  increases, and  $f$  increases. By way of contrast, if we were to introduce a nonfuel absorbing material into the reactor,  $f$  would decrease as would the multiplication factor  $k$ .

As we have noted, the reactor size and geometry for a power reactor are dictated by thermal considerations, for instance, the size of the reactor necessary to produce a given power output while being provided with sufficient cooling so that the temperature of the reactor materials will not become excessively high. The primary design variable at the disposal of the nuclear engineer is the reactor fuel composition. In particular, he can vary the composition (enrichment) and shape of the fuel, the ratio of fuel to moderator density, the type of moderator, coolant, and structural materials used, or the manner in which reactor multiplication is controlled. One refers to the amount of fuel required to achieve a critical chain reaction as the critical mass of fuel for the reactor.



In reality, however, a nuclear reactor is always loaded with much more fuel than is required merely to achieve  $k = 1$ . For example, a light water reactor is typically loaded with sufficient fuel to achieve a multiplication of about  $k = 1.25$ . This extra multiplication is required for several reasons. First, if the reactor is to operate at power for a period of time, one must provide enough excess fuel to compensate for those fuel nuclei destroyed in fission reactions during the power production. Since most contemporary reactors are run roughly one year between refueling, a sizeable amount of excess fuel is needed to compensate for fuel burnup. A second motivation arises from the fact that the multiplication of a reactor tends to decrease as the reactor power level and temperature increase from ambient levels to operating levels. Additional multiplication is needed to compensate for this effect. Finally, one must include enough extra multiplication to allow for reactor power level changes. For example, we have seen that if we wish to increase the reactor power level, we must temporarily adjust  $k$  to a value slightly greater than 1 so that the reactor is supercritical. The reactor can then be returned to critical when the desired power level has been reached.

Of course, when this excess multiplication is not being used, some mechanism has to be provided to cancel it out to achieve reactor criticality. This is the function of reactor control mechanisms.

### 5.2.3. Nuclear Reactor Components and Reactor Types

We have noted that the primary difference between fossil fuel and nuclear generating stations is that the steam used to power the turbine-generators is supplied by an oil or coal fired boiler in the former and a nuclear reactor in the latter. In a nuclear power plant, the nuclear steam supply system consists of essentially three distinct components:

- (i) a nuclear reactor which supplies the fission heat energy,
- (ii) several primary coolant loops and primary coolant pumps which circulate a coolant through the nuclear reactor to extract the fission heat energy, and
- (iii) heat exchangers or steam generators which use the heated primary coolant to turn feedwater into steam.

A very simplified diagram of such a NSSS with a single primary coolant loop is shown in Figure 5-19

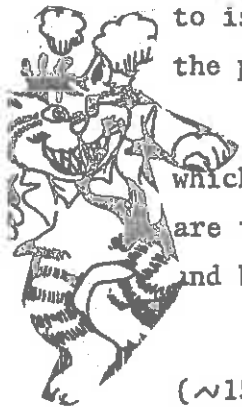


A variety of possible coolants can be used in the primary loops of NSSS's. Indeed, nuclear reactor types are usually characterized by the type of coolant they use, such as light water reactors or gas cooled reactors. There are also a variety of possible NSSS configurations. For example, one may actually produce the steam in the reactor core itself. Or one may use a single phase primary coolant such as water or helium to transfer the fission heat energy to a heat exchanger where it is used to produce steam (such as in Figure 5-19). In liquid metal cooled NSSS s, an intermediate coolant loop must be utilized to isolate the steam generator from the very high induced radioactivity of the primary coolant loop passing through the reactor.

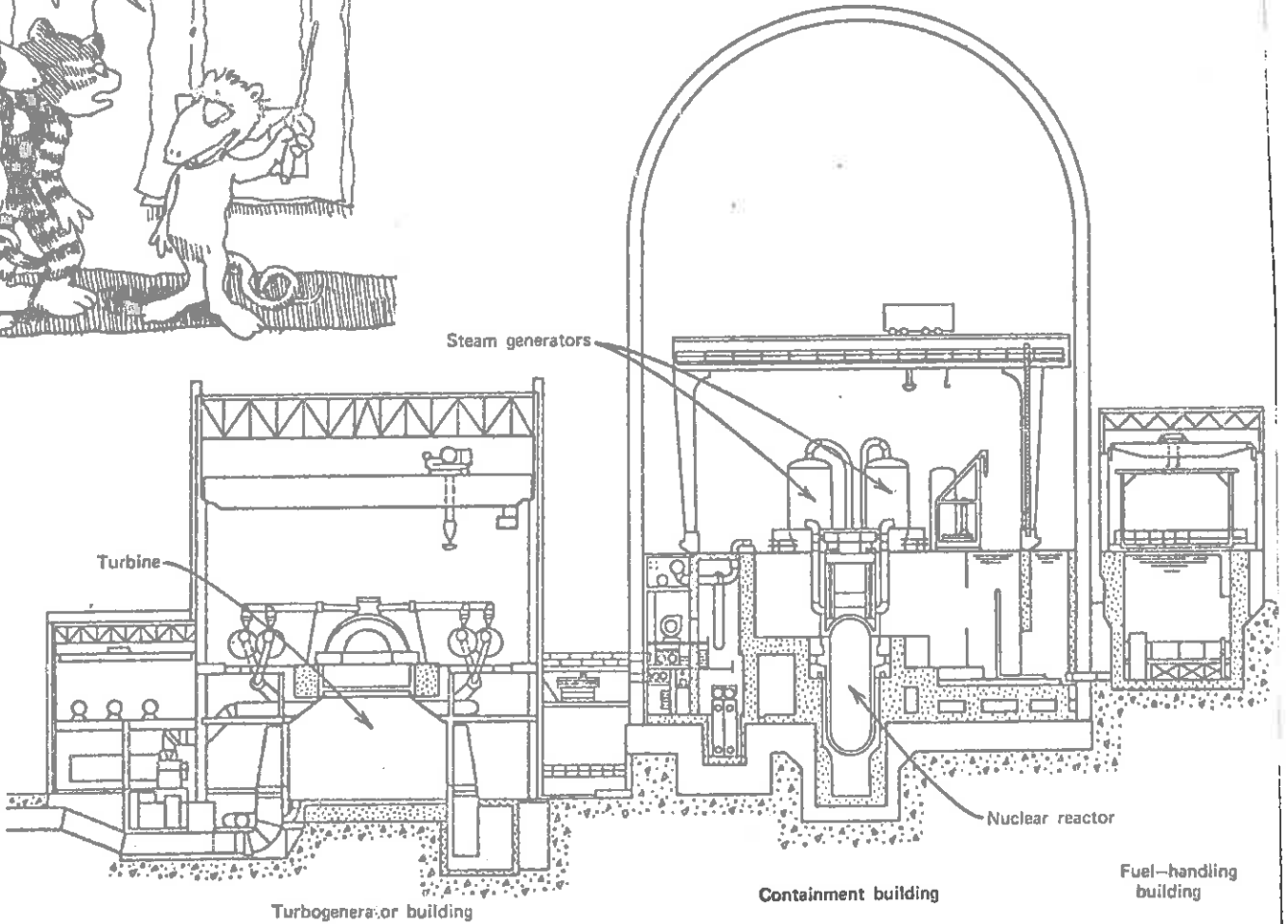
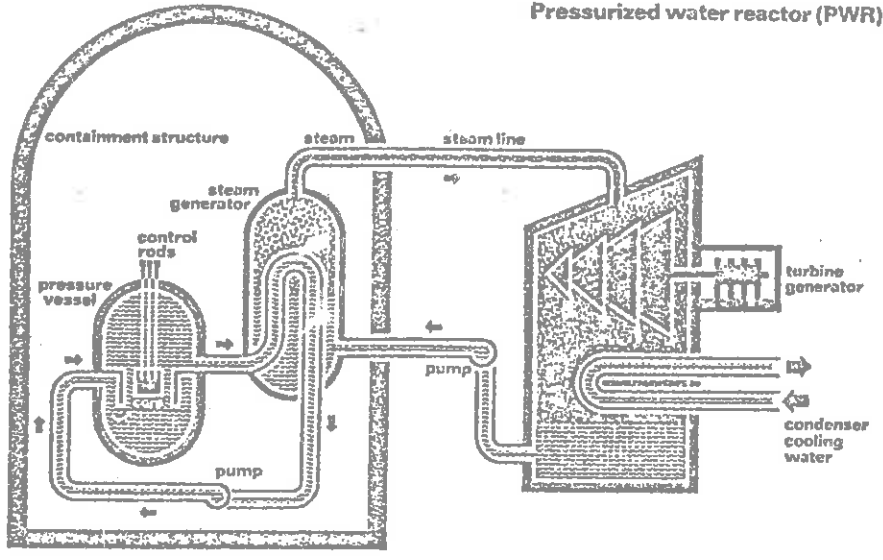
The most common coolant used in power reactors today is ordinary water which serves as a coolant and as a moderating material in the reactor. There are two major types of light water reactors: pressurized water reactors (PWR's) and boiling water reactors (BWR's).

In a PWR the primary coolant is water kept under very high pressure ( $\sim 150$  bar) to allow high coolant temperatures without steam formation within the reactor. The heat transported out of the reactor core by the primary coolant is then transferred to a secondary loop containing the "working fluid" by a steam generator. The diagram in Figure 5-19 would essentially characterize a PWR NSSS. Such systems typically contain from two to four primary coolant loops and associated steam generators.

In a boiling water reactor, the primary coolant water is maintained at a sufficiently low pressure ( $\sim 70$  bar) that appreciable boiling and steam formation occurs within the reactor core itself. In this sense, the reactor itself serves as the steam generator, thereby eliminating the need for a secondary loop and heat exchanger. In both the PWR and BWR, the nuclear reactor itself and the primary coolant are contained in a large steel pressure vessel which is designed to accomodate the high coolant pressures and temperatures. In a PWR, this pressure vessel must be fabricated with thick steel walls to contain the very high primary coolant pressures. Typical PWR pressure vessel dimensions are 11 m x 5 m with 25 cm thick walls. By way of contrast, the BWR pressure vessel need not be so thick, but must be much larger to contain both the nuclear reactor as well as steam drying equipment. Typical BWR pressure vessel dimensions are 22 m x 6 m x 15 cm thick.



Pressurized water reactor (PWR)



A schematic diagram of a nuclear power plant.<sup>4</sup>



A very closely related class of reactors utilizes heavy water as both moderator and primary coolant. The most common type of such heavy water reactors utilizes the pressure tube concept in which each coolant channel in the reactor is designed to accommodate the primary system pressure which is again kept high to prevent boiling. As with a PWR, the primary coolant thermal energy is transferred via a steam generator to a secondary loop containing light water as the working fluid.

Yet another type of reactor uses gas coolants. Although  $\text{CO}_2$  has been used as the coolant in the MAGNOX class of natural uranium fueled, graphite moderated reactors for many years in the United Kingdom, most present interest is directed at high temperature gas cooled reactors (HTGR) which use helium under high pressure to cool a reactor fueled with enriched uranium and moderated by graphite. The helium coolant then is passed through steam generators to transfer the thermal energy on to a secondary loop containing water as a working fluid. It should also be mentioned that such HTGR's have the potential of being combined with gas turbines (rather than steam turbines), thereby eliminating the steam cycle altogether.

Gas coolants have also been proposed for use in fast breeder reactors-- the gas cooled fast reactor (GCFR). Because of the very high power densities required by such reactors, extremely high coolant flow rates would be required. Nevertheless, the rather large breeding ratios ( $\text{BR} \sim 1.5$ ) achievable in the GCFR make it appear a very promising alternative to other fast reactor designs.

The final class of nuclear reactors utilizes liquid metals such as sodium as a primary coolant. Although sodium could be used in thermal reactors, its primary advantages occur in fast breeder reactors which require a primary coolant with low moderating properties and excellent heat transfer characteristics. The liquid metal cooled fast breeder reactor (LMFBR) NSSS actually uses two sodium loops: first, a primary sodium loop is used to remove fission heat from the reactor; this coolant is then passed through an intermediate heat exchanger in which it transfers its heat energy to a secondary sodium loop, which, in turn, carries heat to a steam generator. The intermediate loop isolates the steam generator from the intensely radioactive primary sodium coolant.

The NSSS of a modern nuclear power plant is completely contained within a reactor containment structure which is designed to prevent the release of

radioactivity to the environment in the event of a gross failure of the reactor coolant system. This nuclear island within the plant is usually fabricated out of steel-lined concrete and contains not only the reactor itself (and its associated pressure vessel), but as well the primary coolant system including the primary pumps, steam generators, piping, and auxiliary systems. A glance back at the schematic diagram of a nuclear power plant in Figure 5-20 can quickly identify the containment building and the NSSS contained within it.

At the heart of the NSSS is the nuclear reactor itself. Far from being just a relatively simple "pile" of fuel and moderator a la Fermi, a modern power reactor is an enormously complicated system designed to operate under the most severe conditions of temperature, pressure, and intense radiation. To introduce the general components of a typical power reactor, we will consider the specific example of a modern large pressurized water reactor as illustrated in Figure 5-21. The reactor itself consists of a core containing the fuel itself, coolant channels, structural components, control elements, and instrumentation systems. In this particular example, the core is a cylindrically-shaped lattice roughly 350 cm in diameter by 370 cm in height consisting of long fuel assemblies or bundles. These assemblies consist of a large number of long, narrow fuel rods or fuel elements which are metallic tubes containing the nuclear fuel in the form of ceramic pellets. Individual fuel elements and assemblies for such a pressurized water reactor are shown in Figure 5-22.

In the reactor core one induces and maintains the nuclear fission reactions which produce the desired heat. The core itself is contained in a much larger container, a reactor pressure vessel, which is designed to withstand the enormous pressures of the coolant (up to 155 bar) as well as to isolate the reactor core from the remainder of the NSSS.

Before we conclude this brief introduction to nuclear reactors, however, it is useful to make a short list of the various components of nuclear reactor systems as well as to introduce some of the standard nomenclature used in nuclear reactor engineering:

Fuel: Any fissionable material. This can either be fissile material such as  $^{233}\text{U}$ ,  $^{235}\text{U}$ ,  $^{239}\text{Pu}$ , or  $^{241}\text{Pu}$  or fissionable material such as  $^{232}\text{Th}$ ,  $^{238}\text{U}$ , or  $^{240}\text{Pu}$ . Most modern power reactors utilize this fuel in a ceramic form-- either as an oxide such as  $\text{UO}_2$ , a carbide such as UC, or a nitride such as UN.

Fuel Element: The smallest sealed unit of fuel. In LWR's and LMFBR's, the fuel element is a metal tube containing ceramic pellets of fuel (such as  $UO_2$ ). [See Figure 5-22]

Fuel Assembly or Bundle: The smallest unit which combines fuel elements together into an assembly. For example, in a LWR, the fuel assembly is composed of several hundred fuel elements which are fastened together at top and bottom with coolant nozzle plates and with several spring clip assemblies along the length of the fuel. [See Figure 5-22]

Moderator: Material of low mass number which is inserted into the reactor to slow down or moderate neutrons via scattering collisions. Typical moderators include light water, heavy water, graphite, and beryllium.

Coolant: A fluid which circulates through the reactor removing fission heat. The coolant can be either liquid, e.g., water or sodium, or gaseous, e.g., helium or  $CO_2$ . It may also serve a dual role as both coolant and moderator, such as in light water reactors.

Coolant Channel: One of the many channels through which coolant flows in the fuel lattice.

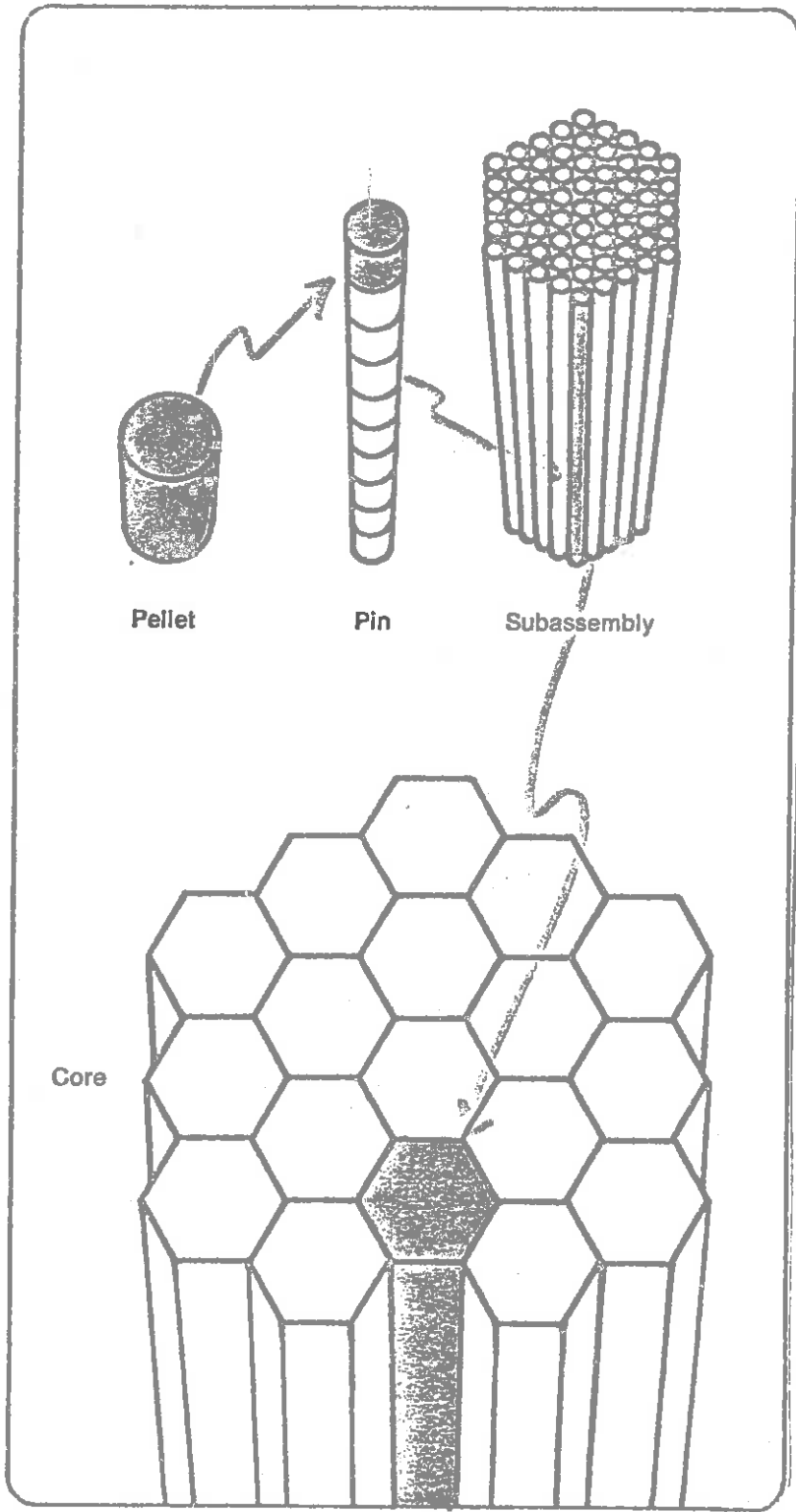
Structure: The geometry and integrity of the reactor core is maintained by structural elements such as support plates, spacer grids, or the metallic tubes which are used to clad the fuel in some reactor designs.

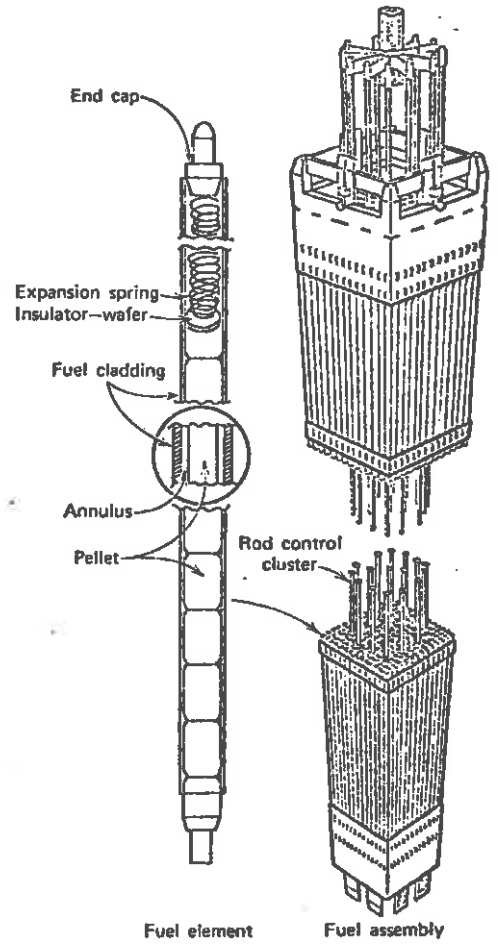
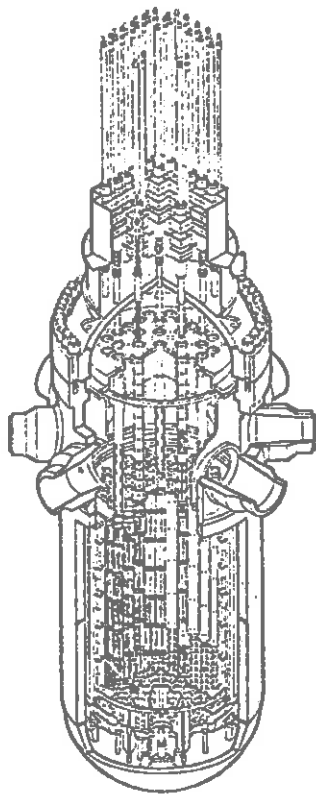
Control Elements: Absorbing material which is inserted into the reactor to control core multiplication. Although most commonly thought of as moveable rods of absorber, control elements may also consist of fixed absorbers or absorbing materials dissolved in the coolant. Common absorbing materials include boron, cadmium, gadolinium, and hafnium.

Reactor Core: The total array of fuel, moderator, and control elements.

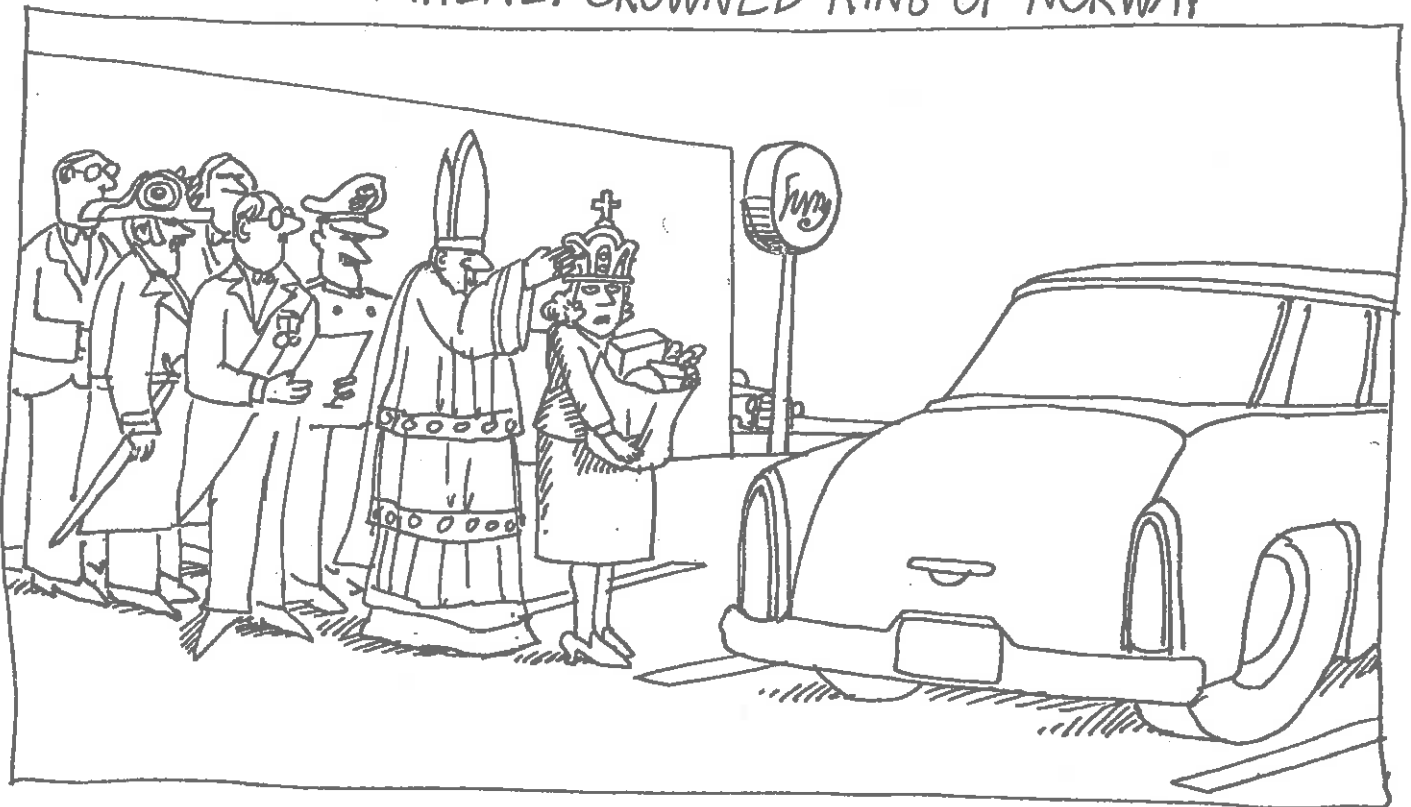
Reactor Blanket: In a breeder or high conversion reactor the core is usually surrounded by a blanket of fertile material which makes more effective use of the neutrons leaking out of the core.

Reflector: A material characterized by a low absorption cross section which is used to surround the core in order to reflect or scatter leaking neutrons back into the core.





# CYNTHIA IS MISTAKENLY CROWNED KING OF NORWAY



Shielding: The reactor is an intense source of radiation. Not only must operating personnel and the public be shielded from this radiation, but reactor components must as well be protected. Hence, absorbing material is introduced to attenuate both neutron and gamma radiation. Thermal shielding is used to attenuate the emergent core radiation to levels which do not result in significant heat generation and hence damage in reactor components. Biological shielding reduces the radiation still further to acceptable levels for operating personnel.

Support Structure: The support plates which serve to maintain the core geometry.

Reactor Pressure Vessel: Provides high pressure containment for reactor and associated primary coolant system.

### 5.2.2. Reactor Control and Operation

Reactor control is achieved by introducing into the reactor core materials characterized by large neutron absorption. This lowers the utilization  $f$  and reduces multiplication (i.e., it absorbs neutrons from the chain reaction). A variety of types of reactor control are used in power reactors. For example, the neutron absorber might be fabricated into rods which can then be inserted into or withdrawn from the reactor at will to vary multiplication. Such moveable control rods are most commonly used to regulate the power level of the reactor. Sometimes the absorber is fabricated directly into the fuel itself and is designed such that it will burn up as the fuel burns up over a period of time. Or the absorber may be dissolved in the reactor coolant. When such control absorbers are used to hold down the excess multiplication introduced to compensate for fuel burnup, one refers to them as shim control. They may also be used to force the reactor subcritical in the case of an emergency; then they are known as scram control.

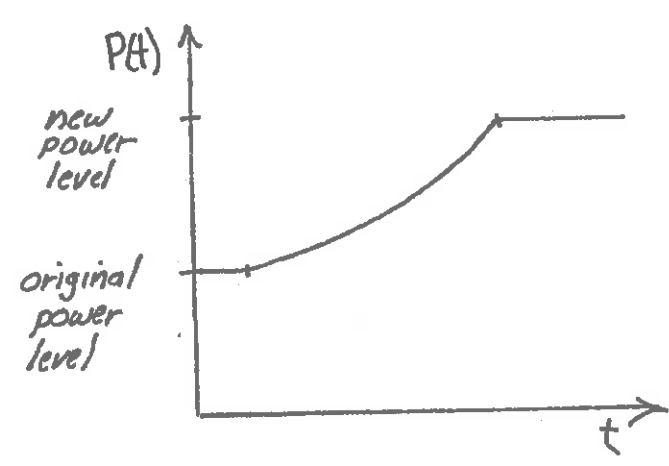
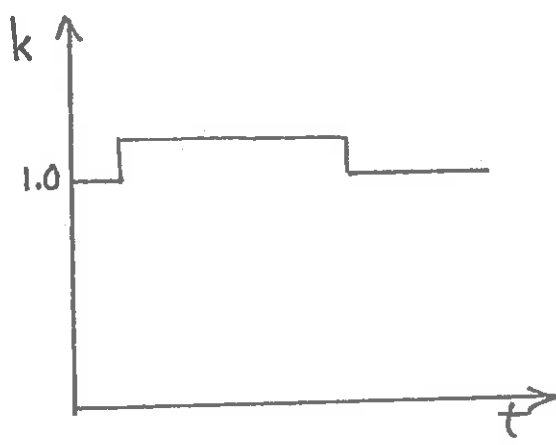
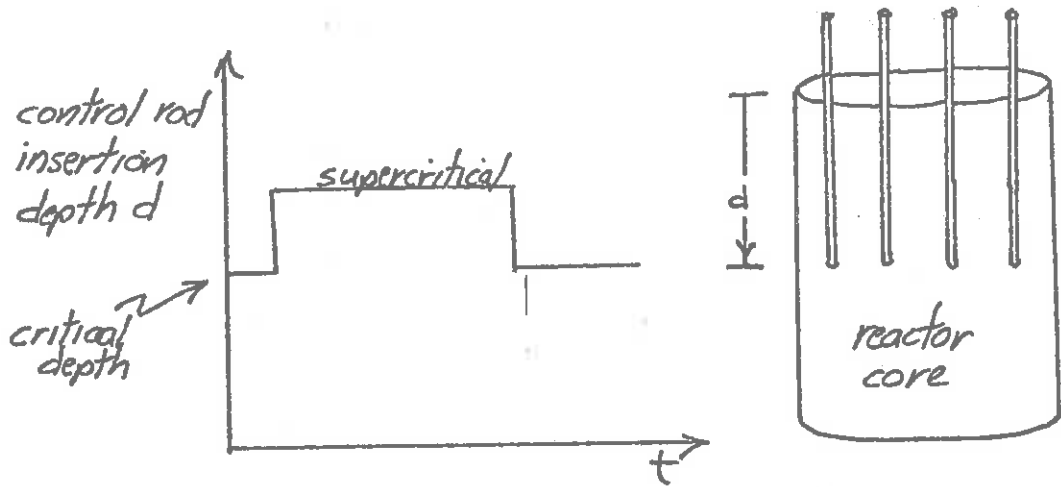
The ease with which such control elements can control the fission chain reaction will depend on how rapidly the reactor responds to variations in multiplication. Since fuel burnup occurs over very long periods of time (typically weeks or months), a rapid response of shim control is not required-- which is fortunate because rather large amounts of multiplication must be manipulated (typically changes of 10 - 20% in  $k$ ). The normal power variations in the reactor are due to much smaller changes in multiplication ( $< 0.1\%$ ) and are characterized by essentially the reactor period  $T$  which, in turn, is

proportional to the neutron lifetime  $\ell$ . Although the prompt neutron lifetime is quite short, typically  $10^{-4}$  sec, the effective neutron lifetime is greatly increased by the presence of delayed neutrons to a value more like 0.1 sec, which results in a reactor period well within the control capability of a reactor control system.

To illustrate these aspects of reactor control, let's run through the various procedures necessary to start up a nuclear power plant. Consider first the nuclear reactor itself. Suppose the reactor fuel has been loaded in. Since one obviously does not desire a chain reaction during fuel loading, all of the control rods (the neutron absorbers) are fully inserted to keep the core subcritical, hence preventing a chain reaction. To start up the reactor, one now slowly withdraws the control rods. At some point of withdrawal, enough absorber will have been removed from the core to yield a critical reactor--that is, one with a multiplication factor  $k = 1$ . At this point, the reactor can maintain a steady chain reaction. However, the power level in the core is still quite low, since any chain reactions are starting only from spontaneous or background radiation (or perhaps neutron sources) and are not being amplified. To increase the power to the desired level, one must allow the chain reaction to build up. Hence, the control rods must be withdrawn a bit further to make the core supercritical. Then the fission rate (or power level) will begin to increase exponentially. When the power has reached the desired level, one inserts the rods back in until the core is critical once again. This desired power level will then remain constant.

To shut the reactor down, one merely inserts the control rods further into the core, hence, resulting in a subcritical reactor in which the power level decreases. Thus, by withdrawing and inserting control rods, one can control the power level of the reactor.

There are a number of complications to this simple picture. First, note that as fission reactions occur,  $U^{235}$  nuclei will be used up (the fuel will be "burned"). After a period of operation, there will no longer be enough fuel to sustain a critical chain reaction (as we say, there will no longer be a "critical mass"). At this point one must withdraw the control rods a bit further to re-establish criticality. One continues this procedure until the control rods are fully withdrawn. Further operation will force the reactor subcritical, since even with no control absorbers inserted, the fuel is



BUT, MR. NATURAL,  
DO YOU THINK  
NUCLEAR POWER  
IS SAFE?

Figure 5-23: Control Rod Withdrawal Sequence Leading to Increase In Reactor Power Level





sufficiently depleted that a stable chain reaction is impossible. One must now discharge the used (or "spent") fuel and replace it with fresh fuel. This refueling operation is usually performed in a power reactor once a year. In light water reactors, typically one-third of the core will be replaced at each refueling.

A very important facet of reactor operation concerns the stability of the reactor. It happens that the nuclear cross sections characterizing neutron-nuclear reactions depend quite sensitively upon the temperature of the reactor core. This provides a "temperature feedback" situation which can occur as follows: Suppose the temperature dependence of the cross sections was such that as temperature increased, the multiplication  $k$  also increased. Then the power level would increase, increasing temperature and hence  $k$  even further... and so on. We would have an unstable situation.

Fortunately all reactors can be easily designed with so-called "negative temperature feedback". That is, increasing temperature decreases  $k$ , hence decreasing the power and hence the temperature. Such reactors are self-stabilizing (a very desirable feature in maintaining uniform power outputs). Negative temperature feedback can arise due to a variety of processes. For example, in light water reactors, a temperature increase will cause the water coolant density to decrease (primarily due to bubble formation). Since reduced water density implies reduced neutron moderation, the reactor multiplication will decrease. Yet another important feedback mechanism is the so-called Doppler effect. As the fuel temperature increases, the nuclei in the fuel vibrate more rapidly. This causes an enhanced probability of neutron capture (in cross section resonances which broaden out to the change in relative neutron-nuclear collision velocities) and hence a decrease in multiplication.

Since most changes in core multiplication due to control adjustments or feedback are quite small, it has become useful to define a measure of the departure of the multiplication from unity (i.e., a departure of the reactor from a critical state) known as the reactivity

$$\text{reactivity} \equiv \frac{k-1}{k} \equiv \rho$$

Hence, one refers to "reactivity feedback" or "reactivity control" or positive and negative "reactivity insertions" when discussing perturbations of a nuclear reactor from its critical configuration.

The negative reactivity feedback due to moderator density changes or Doppler effects is so strong that it would be very difficult for a reactor to operate very far above its design power. That is, if excess multiplication were inadvertently inserted into the reactor (e.g., a control rod were accidentally withdrawn while the reactor was operating at full power), the power level of the reactor (and hence the reactor temperature) would increase only slightly before negative reactivity feedback would return the reactor to a critical state (i.e., slow the chain reaction back down).

As a second example, suppose all of the coolant in a reactor operating at full power were lost (e.g., a pipe breaks). The loss of moderator would introduce such a large negative reactivity that the reactor would immediately go far subcritical, and the chain reaction would cease--regardless of what the operator (or automatic control devices) did.

Hence, negative reactivity feedback causes a reactor to operate in an inherently safe manner. It eliminates any possibility of a runaway chain reaction--and removes the concern about possible nuclear accidents (i.e., those involving the chain reaction itself) from nuclear power reactor design and operation.

Nuclear power reactors are designed to produce heat that can be used to generate electrical energy, usually by way of an associated steam thermal cycle. Once we have acknowledged the fact that the primary function of the reactor is really just that of a rather exotic heat source for turning water into steam, it becomes apparent that the thermal behavior of the reactor is very important, indeed. Indeed, the design of a reactor depends as much on thermal as on nuclear considerations. For there is actually no limit to the quantity of heat that a nuclear reactor is capable of generating, so long as adequate cooling is provided to keep the temperatures in the system from exceeding their safe limits. For example, the Ford Nuclear Reactor at The University of Michigan is rated to operate at a power level of 2 MW. But if adequate cooling were provided, the same core could operate at a power level of 20, 200, 2000, or 2,000,000 MW. Hence, in this sense, the nuclear power system is limited by thermal rather than by nuclear considerations.

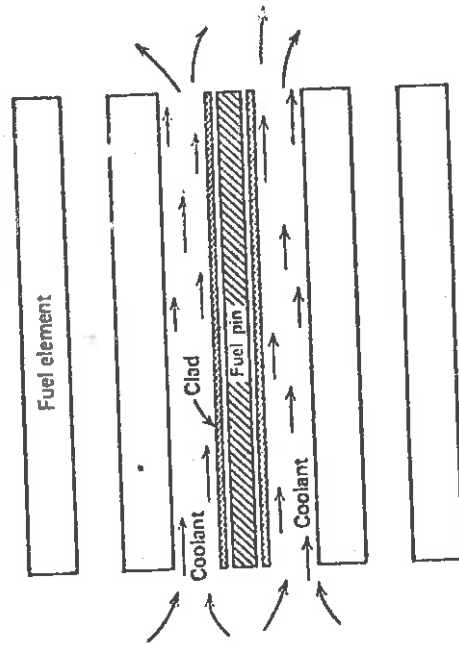
As we have noted, the energy released by the nuclear fission reactions appears primarily as kinetic energy of the various fission reactor products. The bulk of this fission product energy is rapidly deposited as heat in the

fuel material very close to the location of the fission event. This heat is then transported via thermal conduction across the fuel pellet, across the gap separating the fuel from the metal tube (clad) containing the pellet, then across the tube wall. The heat is transferred from the clad wall surface to the coolant by forced convection, and the mass motion of the coolant then carries the thermal energy up and out of the reactor core, either as coolant temperature rise or boiling.



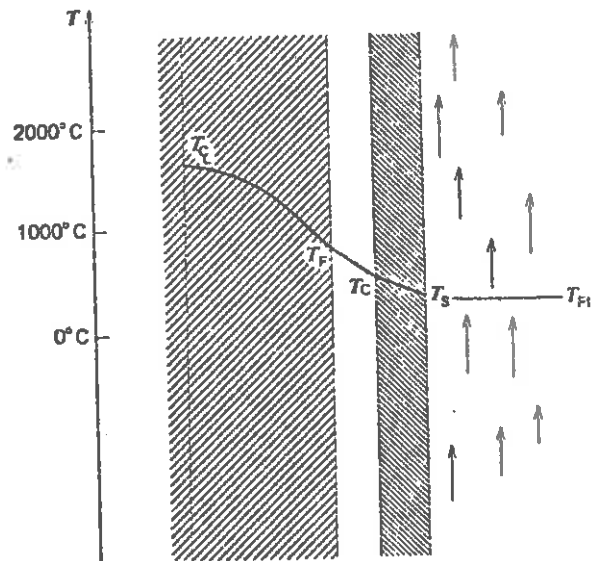
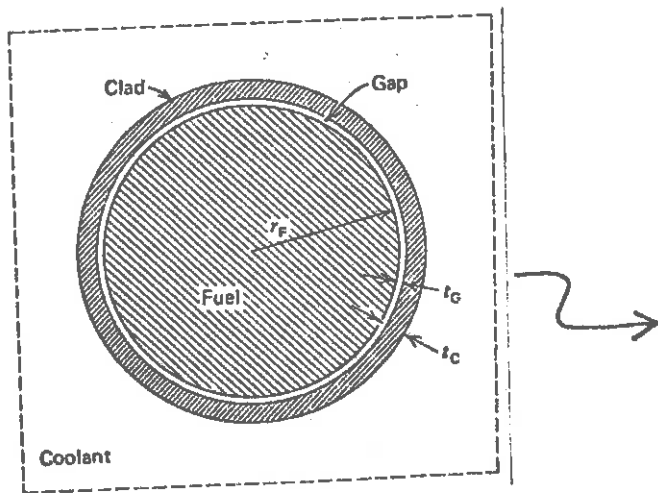
In particular, the thermal output of a nuclear power plant is limited by the maximum operating conditions imposed by the materials or components of the reactor. These take the form of temperature limitations on fuel, structure, or coolant as well as limits on heat flow rates. For example, in power reactors which utilize ceramic fuel material (oxide, carbide, etc.) a maximum fuel temperature ( $\sim 2600^{\circ}\text{C}$ ) is usually established so as to avoid either melting of the ceramic material or some constituent of the fuel if it is in a mixture. These fuel pellets are contained in a metal tube or clad which serves to separate the fuel from the coolant (thereby preventing fission product release into the coolant) and to provide the structural strength and rigidity to the fuel element. Since strength characteristics normally decrease and corrosion rates increase with temperature, limitations are usually placed on clad and structural temperatures ( $\sim 1800^{\circ}\text{C}$ ) as well as upon the fuel pellets themselves.

Modern power reactors are designed to squeeze as much power out of as small a core as possible. Hence, under normal operating conditions, rather large temperature gradients will occur in the reactor core. By way of example, the temperature distribution in the fuel element of a light water reactor is shown in Figure 5-25. However, since we have seen that there is a very



Reactor core cooling.

Figure 5-24



Temperature distribution in a cylindrical fuel pin.

Figure 5-25

strong decrease in core multiplication which accompanies any increase in operating temperature (and therefore a decrease in power output), there is no danger that the core will overheat during operating at full power.

Rather the principal concern stems from the fact that roughly 3 - 5% (typically 150 MW for a 1000 MWe reactor) of the total energy generated in the core appears after an appreciable time delay. This arises because many of the fission fragments are radioactive and generate heat as they eventually decay into stable isotopes. This delayed source of heat is very important, for even if the reactor chain reactor were to be shut down, this "decay heat" would continue to be produced and would have to be removed. As long as the primary coolant system is operable, there is no problem. However, in the event of a massive failure of the primary system (very highly improbable, but nevertheless planned for in a power reactor design), the primary cooling would be inoperable, and therefore a number of auxiliary or emergency core cooling systems are provided. We will return to consider these "engineering safeguards" systems in more detail in the next chapter when we discuss the general subject of nuclear reactor safety.

### 5.2.3. Radiation Produced in Nuclear Fission Reactors

The nuclear fission chain reaction represents a very intense source of radiation. It is important for the nuclear engineer to understand the type and characteristics of radiation produced in a nuclear reactor since he must provide sufficient shielding to limit the radiation exposure to equipment or personnel which must function in proximity to this radiation source. Such radiation is not only potentially harmful to biological organisms, but in fact the radiation generated in a nuclear reactor is sufficiently intense that it can also damage electrical or mechanical equipment either by direct radiation damage mechanisms or by the rather considerable heat that it is capable of depositing in materials.

Although the fission chain reaction emits a variety of forms of radiation, including fission fragments, alpha and beta particles, neutrons, and gamma rays, the most significant radiations of concern in protecting the environment of the reactor are the neutrons and primary gamma rays originating within the core, as well as the secondary gamma rays produced by neutron interactions in material external to the core (in reflectors or shielding, for example).

In Figure 5-26 we have indicated the various types of radiation produced by a nuclear fission reactor. The relative importance of one type of radiation over another as far as shielding considerations are concerned depends not only upon the reactor type, but as well upon the reactor operating history. For example, during reactor operation prompt fission gammas and fast neutrons will usually be most significant, while several hours following reactor shutdown the primary concern will be with fission-product gamma rays and eventually with gamma radiation from activated materials in the vicinity of the reactor core. Frequently in power reactors the most intense gamma radiation penetrating the shield arises from neutron capture in the thermal shield, pressure vessel, or biological shield.

The nuclear engineer must design appropriate shielding against this gamma and neutron radiation. In particular, both primary and secondary gamma radiation must be attenuated, while fast neutrons must be slowed down and then captured. One of the most common shielding materials is ordinary water which is an excellent attenuator of neutron radiation because of its large hydrogen content. The effectiveness of a material for gamma attenuation is roughly proportional to its electron density. For that reason heavy materials, such as lead or uranium, are very effective in shielding against gamma radiation.

A common material used for shielding in reactors is iron which is intermediate in gamma ray attenuation between water and the heavier elements, such as lead. It is primarily used in thermal shields. The other common shielding material is concrete which is used in massive amounts in any central station power reactor as a biological shield.

The major source of radiation of concern in nuclear power generation is due to the enormous quantities of radioactive material produced by the fission chain reaction--either directly as radioactive fission products or indirectly as the radioactivity induced by neutron bombardment. As a rule of thumb, the radioactivity present in the core of an operating power reactor is one curie for every watt (electric) of produced power. Hence, a 1,000 MWe nuclear plant would contain an inventory of roughly 1 billion curies of radioactive material in its core. Needless to say, it is of paramount importance that this radioactivity be contained in the reactor core at all times and not be allowed to escape to the environment.

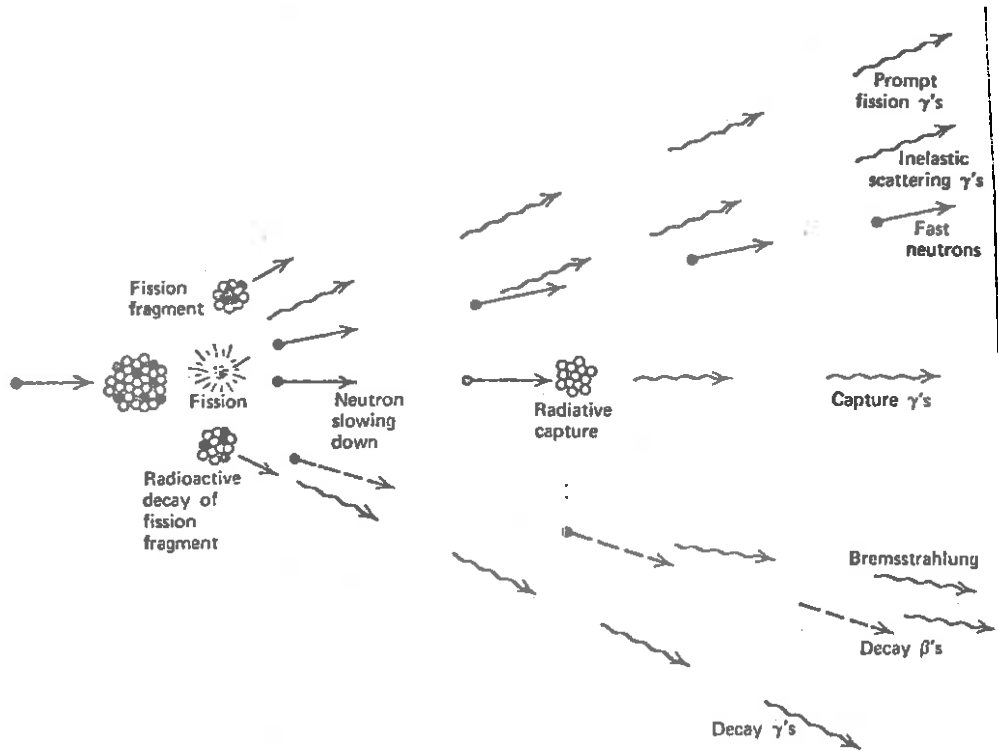
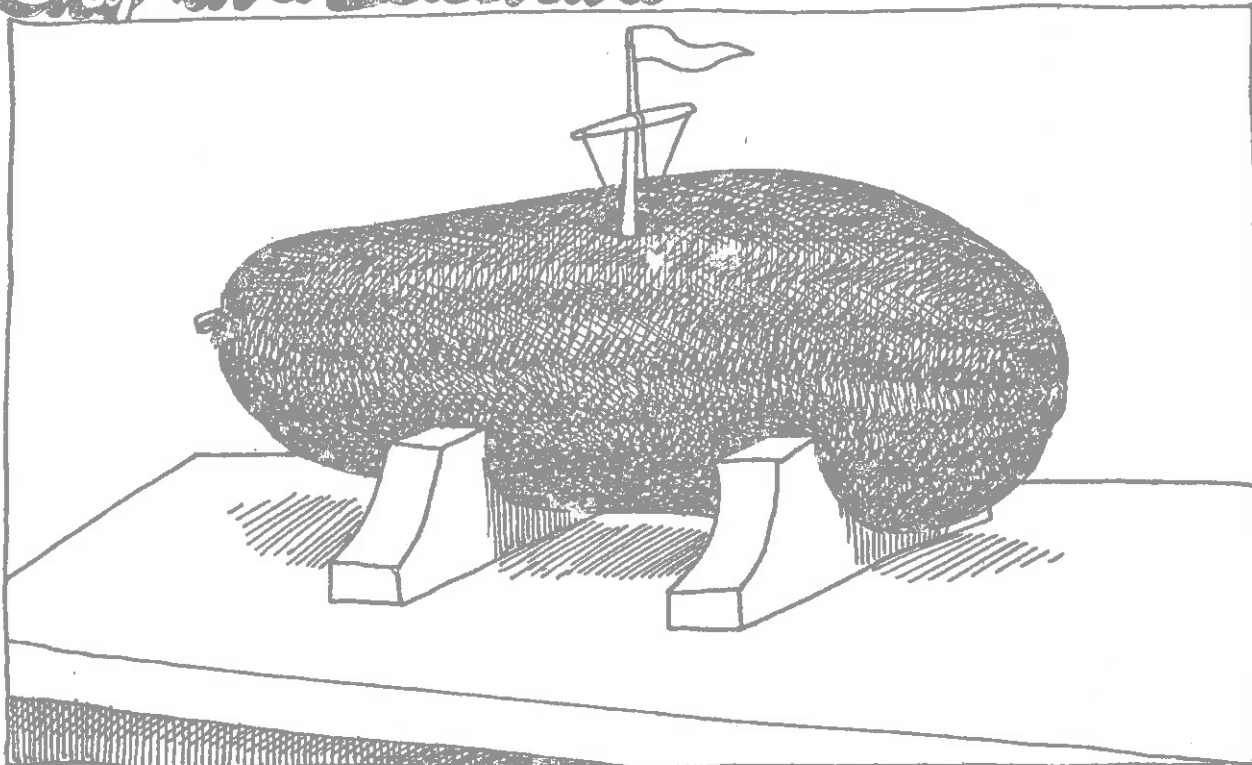


Figure 5-26: Types of radiation produced in a fission chain reaction.

*Ship in a Zucchini*

PALERMO, SICILY



Fortunately, the vast majority of the radioactive fission products are trapped within the fuel pellets. The principal concern involves those fission products which are gaseous and may escape the fuel pellets, diffusing into the coolant and eventually into the atmosphere. A table of the gaseous fission products of most concern is given below. Although the dominant contribution to total inventory is due to Sr-90 and Cs-137, these fission products can be retained rather easily. Instead, the most troublesome fission products are Kr-85 and I-131.

A second extremely important source of radioactivity is that induced in the coolant as it passes through the neutron fluence in the core. The principal reactions of interest in both water and sodium cooled reactors are listed in Table 5-3. The most important such reaction in LWR's involves the production of nitrogen-16. Fortunately, N-16 has a rather short half-life of 7.1 sec and hence the induced radioactivity of the primary coolant decays away quite rapidly. Induced radioactivity is far more serious in sodium cooled reactors, since Na-24 has a half-life of 15 hours.

### 5.3 Radiation and Radioactivity

The terms "radioactivity" and "radiation" are frequently used interchangeably by the layman to refer to the harmful byproducts of nuclear energy. In fact, we have noted that these terms refer to quite different quantities. In particular, radiation refers to any particle emitted in atomic or nuclear processes. For example, the neutrons produced in the fission reaction are one form of radiation, as are the gamma rays emitted by decaying fission products or the X-rays emitted by your TV set. By way of contrast, radioactivity refers to a specific type of nuclear process in which a nucleus spontaneously decays, emitting radiation in the process. And when one refers to the potential danger from radioactive materials, he is actually referring to the danger from the radiation emanating from the decay of such radioactive nuclides.

A variety of nuclear processes produce either radiation directly or radioactive material. For example, both nuclear fission and fusion reactions produce intense radiation in the form of neutrons and gamma rays in addition to radioactive nuclides (both directly as with fission products or indirectly as the result of neutron capture in cooling or structural materials). But great care is taken to ensure that man is shielded from these sources of radiation. Of far more concern are non-nuclear sources of man-made radiation, such



Reaction	Cross section, b	Half-life	Energy of radiation, MeV
$^{16}\text{O}(n,p)^{16}\text{N}$	$1.9 \times 10^{-5**}$	7.1 s	6.13, 7.12 ( $\gamma$ 's)
$^{17}\text{O}(n,p)^{17}\text{N}$	$5.2 \times 10^{-6**}$	4.14 s	1.2, 0.43 (neutrons)
$^{18}\text{O}(n,\gamma)^{19}\text{O}$	$2.1 \times 10^{-4}\dagger$	29 s	0.20, 1.36 ( $\gamma$ 's)
$^{23}\text{Na}(n,\gamma)^{24}\text{Na}$	0.53\dagger	15.0 h	2.75, 1.37 ( $\gamma$ 's)
$^{40}\text{Ar}(n,\gamma)^{41}\text{Ar}$	0.66\dagger	1.83 h	1.29 ( $\gamma$ )

\* Average cross section over fission spectrum; see text.

† Thermal (0.0253 eV) cross section.

Table 5-3: Activation Reactions in Coolants

(J.R. Lamarsh, Introduction to Nuclear Engineering,  
Addison Wesley, 1975, 472)

as the X-ray exposures received in both diagnostic and therapeutic medical procedures. (Indeed, as we will find, medical exposures are thousands of times larger than anticipated exposures from nuclear facilities.)

But the dominant source of radiation in our environment is due to natural sources. For example, the cosmic radiation impinging on the earth accounts for a sizeable fraction of our total radiation exposure. Furthermore, the presence of naturally occurring radioactive nuclides (e.g., radium and thorium) also makes a substantial contribution. To quantify the levels of radiation exposure we receive from each of these many sources, and to understand more fully the significance of such exposures to public health, in this section we will consider a number of topics, including a classification of the types of radiation received from various natural and man-made sources, the way in which this radiation interacts with materials, the manner in which such radiation is detected, and how radiation exposure is quantified. Then we will consider in some detail the various sources of radiation which exist (or may some day exist) in our environment.

### 5.3.1. Interaction of Radiation with Materials

We will refer to any atomic particle emitted in atomic or nuclear reactions as radiation. In particular, we can include as radiation:

- neutrons
- gammas (photons of nuclear origin)
- X-rays (photons of atomic origin)
- betas (electrons or positrons)
- alpha particles (helium nuclei)
- heavy charged particles (e.g., fission products)



Of primary concern is how such radiation interacts with bulk matter (particularly of biological origin).

#### Heavy Charged Particles:

Heavy charged particles, such as alphas, protons, or fission fragments lose their energy very rapidly when travelling through matter by ionizing or exciting atoms and molecules close to their path. When they have lost all of their energy, they are stopped. It is customary to refer to the total length of the path of such particles through matter as the particle range. This range is quite short for heavy charged particles. For example, the range of a 4.2 MeV

alpha particle (emitted in the decay of U-238) in air is 2.7 cm. Such an alpha can be stopped easily by a sheet of paper or the outer layer of the skin of the body. For this reason, it is very easy to shield against alpha radiation.

Heavy charged particles do not present an external health hazard because of their extremely short range. Safe storage of alpha-emitting isotopes is straightforward since thin glass or metal containers will absorb all the alpha radiation being emitted from sources within them. Of far more concern are internal hazards which arise when alpha-radioactive material is ingested or inhaled into the body. Since alpha particles dissipate their energy over a very short range, a very great local damage to body tissue could occur. Moreover, many natural alpha emitters have long half-lives and some (notably radium and plutonium) can be metabolized into bone tissue, considerably increasing the internal hazard. As we will note later, when discussing the subject of radiation protection from alpha emitters, one must be concerned with the maximum permissible concentrations of such radioactive materials in the body.

#### Beta Particles:

Beta particles (electrons), because of their very low mass ( $1/1828$  that of a proton) are much more penetrating than alpha particles. They are also more easily scattered, and hence they do not travel along a straight line through matter as do alpha particles, but rather diffuse. Ranges given for beta particles usually refer to the range of the most energetic beta which can be emitted in a given decay. For example, the maximum range of 2.27 MeV beta particles from the decay of strontium-90 amounts to 0.4 cm in aluminum or 8.5 m of air. At the other extreme, the range of the 0.019 MeV betas emitted in the decay of tritium is 2 micrometers in aluminum and 0.42 cm in air.

Although beta particles do not penetrate very far, they can produce secondary radiation in the form of X-rays which are, in fact, quite highly penetrating. This occurs because whenever one charged particle bounces off another, it will radiate X-radiation referred to as "bremsstrahlung" (German for "braking radiation"). Moreover, if the beta particle is a positron (an "anti-electron"), then when it runs into an electron, the two particles will annihilate each other producing two gamma rays of 0.51 MeV energy, respectively.

Such secondary radiation can actually be more troublesome than the original or primary beta radiation. The biological hazards associated with beta emitters differ considerably, depending upon whether one is considering external or internal hazards. As with alpha particles, the external hazards of beta emitters is not particularly severe since they can be rather easily shielded against. Accidental body surface contamination will normally lead to irradiation of only superficial tissues. Ingested beta emitters pose a greater hazard, and once again, maximum permissible body concentration limits must be set.

### Gamma Rays:

Gamma rays are very highly penetrating. This is because they do not lose their energy in small increments all along their path through matter. Rather they tend to travel through matter for great distances without interacting at all, until eventually they will interact with one atomic electron, transferring all or a substantial part of their energy onto that electron.

If the gamma ray has an energy greater than 1.02 MeV, it may decay into an electron-positron pair. Gamma ray interaction is a statistical process, i.e., there is a certain probability for each gamma ray to interact within a given length of its path. This leads to an exponential relation between the number of gamma rays able to penetrate an absorber of thickness  $x$  and that thickness

$$I(x) = I(0) e^{-\mu x}$$

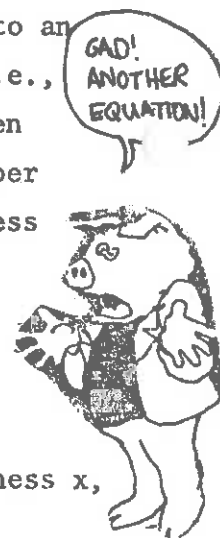
where

$I(x)$  = intensity of gamma rays after penetrating an absorber of thickness  $x$ ,

$I(0)$  = intensity of gamma rays incident on the absorber, and

$\mu$  = absorption coefficient.

The absorption coefficient  $\mu$  depends on the gamma energy (decreasing with increasing energy) and the type of material. Since the intensity of gamma rays decreases exponentially, one cannot quote a finite range for them as with alpha or beta radiation. Instead, the mean range,  $R = \mu^{-1}$  is identified as the absorber thickness which reduces the intensity of the incident gamma ray beam to  $1/e = .39$  of its original value. For example, the mean range of gamma rays with energy 1.33 MeV (the more energetic gamma ray emitted in the decay of cobalt-60) in air is 141 m while in lead it is 1.60 cm.



Because of the very highly penetrating nature of gamma radiation, gamma radioactive materials present a considerable hazard from both an external as well as an internal viewpoint. The entire volume of body tissue can be irradiated from an external gamma source. The radiation effects tend to be distributed over large volumes rather than highly localized as with charged particle radiation. Furthermore, it is more difficult to shield against gamma sources, and thick containers of lead or other dense materials must be used along with remote handling equipment.

### Neutrons:

We have already spent a good deal of time discussing how neutrons interact with matter (motivated by their importance to the fission chain reaction). Like gammas, neutrons are a form of highly penetrating radiation which must be characterized by an average range. We have noted that the dominant neutron interactions of interest are either scattering or absorption. When it is recognized that a scattering collision by a fast neutron will impart thousands of eV of energy to the recoiling target nucleus, then it is apparent that this nucleus will be knocked out of its position in the material, colliding with other nuclei and knocking them out of position as well. This process also causes significant ionization. Hence, it is obvious that fast neutrons can be quite damaging to materials.

Slow neutrons can also be very damaging, not so much from scattering, but rather because they are usually captured by nuclei in the material which then will emit a high energy gamma ray. This secondary gamma emission is itself capable of further interaction. But in addition, the nucleus will recoil with large energy when it emits the gamma, causing further disruption of the microscopic atomic structure of the material.

Since most neutron sources result from nuclear reactions rather than radioactive decay, they pose primarily an external hazard. Shielding against fast neutron damage usually involves massive concrete barriers loaded with a neutron absorber such as boron.

#### 5.3.2. Radiation Dose and Exposure Units

Recall that to characterize the strength of a radioactive sample, we introduced the concept of the activity which was measured in units of Curies, defined as  $3 \times 10^{10}$  disintegrations per second. A similar quantitative

description can be given for the radiation emitted from such sources. Several concepts are useful to characterize radiation:

Materials, living or non-living, localized in a nuclear radiation environment, will absorb a portion of the radiation. The amount of absorbed energy is often in terms of rads. The dose (or absorbed dose) is said to be 1 rad (acronym for radiation absorbed dose) if the absorbed energy is 0.01 joules in one gram of the material. The importance of this quantity stems from the fact that the dose for one gram of any material in a given radiation environment is approximately the same. Thus, if in a radiation environment one gram of water absorbs 0.01 joules or 1 rad, then one gram of human tissue, say, will absorb nearly the same amount of energy. The effects, however, are drastically different. 0.01 joules is only  $0.24 \times 10^{-5}$  cal, so that the temperature rise of one gram of water will be only 0.000,002°C. The specific heat of human tissue is not expected to be very different, so that the temperature rise will be about the same; but the potential biological effects of 1 rad dose will be vastly different.

Although this is a very simple definition, the amount of energy deposited per gram of material is rather difficult to measure. Furthermore, one would usually like to characterize the "strength" of the radiation field rather than the energy deposited in a sample by the radiation. What is most often measured with the instruments available for dose measurements is the ionization produced in air (or another gas) by the incident radiation. Hence, an alternative concept is useful.

### Exposure

Exposure is a quantity expressing the amount of ionization caused in air by X- or gamma radiation. The official definition of exposure as proposed by the International Commission on Radiation Units and Measurements (ICRU)<sup>7</sup> is the following.

“ Exposure,  $X$ , is the quotient of  $dQ$  by  $dm$  where  $dQ$  is the absolute value of the total charge of the ions of one sign produced in air when all the electrons (negatrons and positrons) liberated by photons in a volume element of air having mass  $dm$  are completely stopped in air.

$$X = \frac{dQ}{dm}$$

ISN'T THAT  
A BIT  
FORMAL?



The unit of exposure is the roentgen (R).

$$1 \text{ R} = 2.58 \cdot 10^{-7} \text{ Coulomb/g. } \text{11}^7$$

One can show that in air 1 R of exposure corresponds to the deposition of a dose of 0.87 rad. When referred to human tissue an exposure of 1 R results in an absorbed dose of 0.96 rad. Due to the similarity of the concepts of dose and exposure and to the almost equal magnitude of 1 R and 1 rad in air and even more in tissue, the two concepts as well as their units are quite often used interchangeably. This is, of course, to be discouraged.

A related unit is the exposure rate defined as the amount of ionization produced (exposure) per unit time. Survey meters as used in radiation control usually measure exposure rates in mR/hr (or milliroentgen/hour). For example, a person standing at the railing of the Ford Nuclear Reactor (FNR) of The University of Michigan with the reactor operating at its full power of two Megawatts will be exposed to five to ten mR/hr. As yet another example, the average annual exposure an individual receives from natural sources of radiation is roughly 160 mR/year.

#### Biological Effectiveness of Radiation:

One might expect and indeed one finds, that the biological effects of nuclear radiation are closely related to the absorbed radiation dose. However, if one compares different kinds of radiation, e.g., alpha particles and beta particles, one finds that to achieve the same biological effect, different doses of the two kinds of particles are necessary. While a certain dose of beta particles may be necessary to achieve a certain effect, only about one twentieth of that dose is required if one wants to produce the same effect with alpha particles. One says that different kinds of radiation have a different "relative biological effectiveness" (RBE). Another term which is used for the same concept is the "quality factor" (QF). The quality factor is defined as follows.

$$QF = \frac{\text{physical absorbed dose of 250 kV X-rays to produce a given effect}}{\text{physical absorbed dose of comparison radiation to produce the same effect}}$$

From the definition, it is obvious that 250 kV X-rays are being used as the reference radiation. Table shows a number of quality factors.

Table

<u>Radiation</u>	<u>QF</u>
X- rays and gamma rays	1
Electrons	1
Thermal neutrons	2 - 5
Fast neutrons (10 MeV)	5 - 10
Alpha particles	20
Protons (10 MeV)	10



Because the quality factor varies strongly with the kind of radiation (energy, etc.), the concept of "biological dose" is introduced. The biological dose can be obtained by multiplying the absorbed radiation dose (also referred to as the "physical dose") with the quality factor. The unit of biological dose is then the rem (an acronym for Roentgen equivalent man) and is defined as

$$1 \text{ rem} = \text{QF} \cdot 1 \text{ rad}$$

For example, we can translate the absorbed dose received by every member of the human population per year (160 mrad) into a biological dose by noting that most of this radiation is in the form of gamma rays for which  $\text{QF} = 1$ . Hence, the average biological dose from natural sources is 160 mrem/year.

#### 5.3.4. Radiation Monitoring

"That's what's so frightening about radiation. It's not pink or blue or purple. It's just not visible."

Another Mother For Peace,  
April 1972

The concerns for the effects of radiation on human beings dates back to the end of the last century. The announcement of the discovery of X-rays was made by W. Roentgen on November 8, 1895. But before that date, many individuals were experimenting with high voltage electric discharge in vacuum tubes, and one of the manufacturers of such tubes--called Crookes tube, after the discoverer, Sir William Crookes--was an E. H. Grubbe, who by January 27, 1896 received enough radiation to develop acute dermatitis, which later developed into skin cancer. By 1925, the potential dangers of X-rays were well known.



A grim reminder of the radiation dangers is the monument erected in Berlin in memory of the doctors who died as victims of X-rays.

In 1928, the International Society of Radiology sponsored the International Commission on Radiological Protection (ICRP) which since that date, has been one of the organizations setting and revising radiation standards. But the dose limits that were considered safe in those early days are very high in comparison to modern standards. For example, between 1925 and 1932, the accepted limits of radiation dose was from about 0.04 to 2.0 roentgen/day.

According to the latest standards, the occupational exposure is to be limited to 5000 m rem/yr, the maximum dose rate an individual of the public-at-large is 500 m rem/yr, and the average population exposure is not to exceed 170 m rem/yr. In addition, the recommendation was made that the radioactive emissions from nuclear power plants be kept as "low as practical". This recommendation led the AEC, in June 1971, to set 10 m rem/yr as the so-called nuclear power plant fence-post value.

This reduction in the allowed radioactive emission levels places severe demands upon radiation detection instruments. To date, the electric utilities have relied mostly on the so-called TLD's, i.e., the thermoluminescent detectors, with occasional use of ionization chambers. In the very near future, the ionization chamber will become the standard equipment, augmented by the more sophisticated instruments known as the NaI scintillation detector and the Ge(Li) detector, i.e., the lithium drifted germanium detector. The purpose of the discussion to follow will be to discuss some of the recent developments in radiation detection systems to monitor very low level radiations.

The pressure for the use of more sophisticated detection systems is coming from another direction, namely from the public. The standard comment from the utilities has been that radioactive emissions from their nuclear power plants are too low to be detected beyond the fence-post. At the same time, they point out that their instruments are sensitive enough to detect the increase in atmospheric radioactivity in the spring when farmers plow their fields. But reactions to these comments are, at best, neutral. Intervenors talk about the "invisible" radiations; Ralph Nader made the same comment when addressing a group on The University of Michigan campus. Listening to these and others, some may get the impression that there is a conspiracy to keep the radiations from becoming visible.

The problem of detecting the truly extraordinary low emissions from nuclear plants is not an easy one, because as we will see, the background natural radioactive radiation and the man-made fallout radiations are expected to be very large in comparison to those coming from nuclear power plants. But it can be done, and by doing so, hopefully it will be possible to allay the fears that some have towards nuclear power plants.

The most common device, the thermoluminescent detector, consists of components like LiF and  $\text{CaSO}_4$ . The mechanism for thermoluminescence is briefly as follows. Electrons in the valence band are excited into the conduction band by energetic radiations, such as alpha particles, beta particles, X-rays, and gamma rays. The electrons wander about in the conduction band for a short time, some will return to the valence band but others will become trapped at impurity or even crystal defect sites. We can compare the incoming radiation to a gust of wind, setting up a spray, whose droplets might get caught on a rock, a leaf, or other objects. The electrons trapped on the impurities or at defect sites will slowly return to the valence band, but their return can be accelerated by warming the crystal. This is the reason for the work element "thermo". As the electrons return to the valence band, the excess energy is given off as visible radiation, i.e., the crystal will luminesce.

The usefulness of TLD as radiation dosimeters stem from the fact that the amount of light it gives off after warming--its thermoluminescence--depends upon the radiation dose, i.e., larger the radiation dose, larger is the amount of thermoluminescence. The devices are simple, rugged, and can be small enough to be carried around. It can be used to detect radiation dose of about 1 m rem in one month, so that its limiting sensitivity is comparable to the AEC radiation standards of about 1 m rem/month. But at these low doses, the errors can be quite large if commercially available equipment were used. The estimated uncertainties is about 50 m rems/yr, unless unusual precautions are taken in handling, transportation, and readout of the dosimeters. The other limitation is that the TLD registers the total radiation dose regardless of the source, and hence, would only be useful in areas where the nuclear power plant radioactive emissions are large in comparison to natural radioactivity (e.g., inside the plant containment structure). A TLD is unable to distinguish the radiation from Kr-85, a nuclear fission product from a nuclear power plant, from that of K-40, say, which is part of our environment.

Ionization chamber detectors present an attractive alternative to TLDs since they are capable of sensing doses as low as 1 m rem/yr in comparison to 50 m rem/yr for the latter. The chamber consists of argon gas under high pressure. The incoming radiation ionizes the gas in the chamber, producing a small electric current to flow. The current is directly proportional to the radiation intensity. The usefulness of this device for monitoring total radioactive emissions from nuclear power plants is well-established.

A shortcoming of the ionization chamber is that it measures total radiation and does not distinguish the source type. For example, a farmer working in a nearby field could cause an increase in the instrument readings. Ideally then we also need an instrument that can distinguish the sources from which the radiations are coming.

Even higher sensitivity can be achieved with NaI(Tl) scintillation detectors. The principal merit of this detector is that it is a spectrometer, capable of partially identifying the sources from which radiations arise. This device is rather complex. The detector consists of the luminescent material NaI doped with a small concentration of thallium (Tl), a photocathode, and an electron multiplier. The purpose of NaI is to convert the energy of the incoming radiation, say a gamma ray, into flashes of light, called scintillations. These flashes of light strike the photocathode, causing electrons to be emitted; the mechanism--and even the material--is similar to that of TV cameras. These photoelectrons are then amplified by means of the electron multiplier.

Substantially greater resolutions are obtained by means of a germanium semiconductor. The device is a germanium PN junction and the detection mechanism is somewhat similar to the photovoltaic effect in the silicon solar cells. For these, the energy from the sun is used to create electron and holes, which drift across the PN junction, giving rise to a pulse of current in the external circuit. For the Ge(Li) detector, the energy to create the electrons and holes came from the gamma rays.

With these more advanced detector types, it should be possible to continually monitor nuclear plant emission to even the very low levels required by federal regulations.

## 5.4. Radiological Health Physics

### 5.4.1. Man's Radiation Environment

The environment we live in is radioactive and has been so for as long as life has existed on earth. In fact, as we shall see later, when life started on earth about 2 billion years ago, the environment was substantially more radioactive than it is today. The first discovery of radioactivity was made in Feb. 1896, by the French physicist H. Becquerel, who found that a powerful penetrating radiation emanated from uranium and its compounds, and coined the word "radioactive" to describe the newly discovered effect. In April of the same year, G. S. Schmidt and Mme. Currie announced the radioactivity of thorium. Furthermore, she (Mme. Curie) noticed that the radioactivity of certain uranium minerals, especially pitch blende, showed radioactivity considerably in excess of that to be expected from the amount of uranium they contained. Thereupon the husband and wife--Pierre and Marie Curie--set about their heroic experiments to concentrate the more radioactive ingredients present in pitch blende ores by chemical crystallization methods. In this way the element polonium and then radium were discovered. And by 1918, nearly 40 radioactive isotopes had been found with mass numbers greater than 206 and atomic numbers greater than 80.

Of the 92 or so elements known to exist in nature, almost 30% are known to be radioactive. First there are the elements with atomic numbers greater than 81, that are the results of radioactive decay of uranium and thorium. The atomic numbers of the elements, a typical radioisotope and its half-life are listed below:

	Element	Symbol	Radioisotope	Half-Life
81	Thallium	Tl	Tl - 208	3.10m.
82	Lead	Pb	Pb - 212	10.6 hr.
83	Bismuth	Bi	Bi - 214	19.7 m.
84	Polonium	Po	Po - 218	3.05m.
85	Astatine	At	At - 219	0.9 m.
86	Radon	Rn	Rn - 222	3.82d.
87	Francium	Fr	Fr - 223	22 m.
88	Radium	Ra	Ra - 226	1620 years
89	Actinium	Ac	Ac - 227	21.6 years
90	Thorium	Th	Th - 232	$1.39 \times 10^{10}$ "
91	Protoactinium	Pa	Pa - 231	$3.43 \times 10^4$ "
92	Uranium	U	U - 238	$4.5 \times 10^9$ "

There are other radioisotopes not part of the radioactive series and scattered throughout the periodic table.

Element	Symbol	Radioisotope	Half-life (yrs)
1 Hydrogen	H	H - 3	12.26
6 Carbon	C	C - 14	5770
19 Potassium	K	K - 40	$1.47 \times 10^9$
23 Vanadium	V	V - 50	$4 \times 10^{14}$
37 Rubidium	Rb	Rb - 87	$5.0 \times 10^{10}$
49 Indium	In	In - 115	$6 \times 10^{14}$
57 Lanthanum	La	La - 138	$1 \times 10^{11}$
60 Neodymium	Nd	Nd - 144	$3 \times 10^{15}$
62 Samarium	Sm	Sm - 147	$1.25 \times 10^{11}$
71 Lutetium	Lu	Lu - 176	$4.5 \times 10^{10}$
75 Rhenium	Re	Re - 187	$4 \times 10^{12}$
1001 Naturalium	Nat	Nat - anything	0



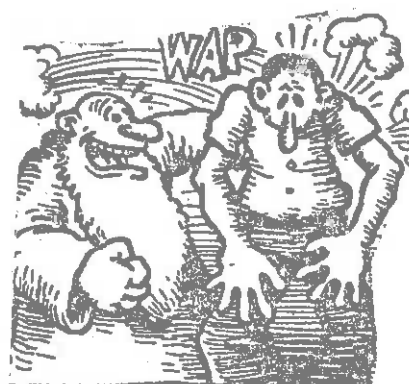
There are two elements whose existence had been suspected because of the gaps in the Periodic Table but which were not discovered until rather recently. The two elements do not occur normally in the earth's crust because their half-lives are short in comparison to the age of the earth. One element is technetium (Tc), atomic number 43, first produced in 1937. Tc-97 and Tc-98 have half-lives of 2.6 and 1.6 million years, respectively. Although this element is not found in the earth's crust, it is one of the common elements in stellar atmospheres, where the Tc isotopes are being produced continuously through a series of nuclear reactions. The other element is astatine (At), atomic number 85, first synthesized in 1940 by bombarding bismuth with alpha particles. All of the isotopes have short half-lives, the longest being At-210, with only 8.3 hour half-life. It occurs between polonium (Po, Z = 84) and radon (Rn, Z = 86) and is one of the decay daughter products of U-233 (At - 217; 0.02 sec) and of U-235 (At - 219, 0.9 min).

In addition, there should be sub-trace amounts of fission products and trans-uramic elements occurring naturally in uranium bearing ores. The reason for this is that both the uranium and thorium isotopes spontaneously undergo fission, producing neutrons as the result. If such neutrons are captured by U-238, for example, Np-239 will be produced, leading to the production of Pu-239. The discovery of Pu in natural uranium was reported rather recently. Np-137 has been found in lunar samples.

The following is a list of the abundances of certain select elements in the earth's crust.

Element	Order of Abundance	Abundance in parts/million
O	1	466,000
Si	2	277,200
Al	3	81,300
Fe	4	50,000
Ca	5	36,300
Na	6	28,300
K	7	25,900
H	10	1,400
Th	39	12
Ge	41	7
U	50	4
I	64	0.3
Ag	67	0.1
Au	73	0.005
Nat	1001	0.0

THERE IT IS AGAIN!



This table shows that although the radioactive elements Th and U are among the rare elements, they rank as number 39 and 50, respectively, and are more abundant than some of the elements familiar to us. For example, the familiar elements silver (Ag) and gold (Au) rank as number 67 and 73, respectively. The biologically essential element iodine (I) is number 64 in abundance.

To get an appreciation for the amount of radioactive materials in the soil, consider as an example the amount of Th and U on Detroit Edison's Greenwood Energy Center 6 square mile site near Port Huron, in the top one foot layer only. Soil specific gravity is about 1.4, and since the density of water is 62.4 lb/ft<sup>3</sup> and 1 sq. mile contains  $2.79 \times 10^7$ , we find for the weight of soil 1 foot deep on the 6 sq. mile site to be

$$(62.4)(1.4)(2.79 \times 10^7)(6) \text{ lbs.}$$

$$= \frac{(62.4)(1.4)(2.79 \times 10^7)(6)}{2000} = 7.3 \times 10^6 \text{ tons}$$

Since the amount of uranium is 4 parts per million, the weight of uranium amounts to

$$(7.3 \times 10^6)(4 \times 10^{-6}) = 29.2 \text{ tons}$$

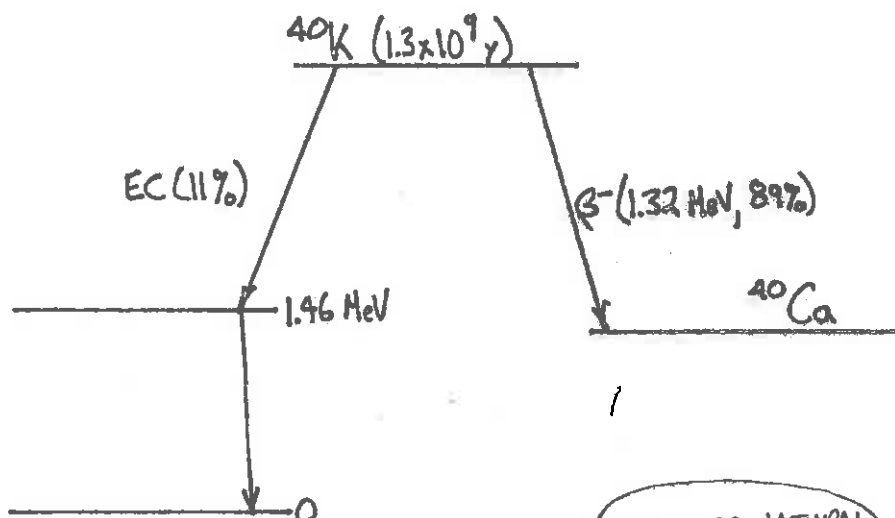
Th is 3 times as abundant so that its weight is about 90 tons, giving a combined weight of 120 tons or so of U and Th. This amount of radioactive Th and U is comparable to the amount of U to be placed in the Greenwood plant nuclear reactor core.

#### Radioactive Potassium

The element which gives the greatest amount of radiation to our body tissues is the potassium isotope, K-40. Radiation from this source is significant because K is an essential element. Potassium is important for crop yield; potash, which is mainly potassium is used as fertilizer. Potassium concentrates mostly where the action is--in muscles and nerve cells. Lack of potassium leads to certain syndromes, such as lack of muscle tone or heart disorders. The amount of potassium in an average person is about 140 grams, compared to 105 gms of radium. And significantly, K is inside the cell--in the intercellular fluid--whereas Na is outside the cell--in the

intercellular cell. Potassium consists mostly of K-39 (93.1% isotopic abundance) and K-41 (6.88% isotopic abundance), but also contains K-40 (0.0118%), whose half-life is 1.3 billion years.

The following diagram summarizes the relevant nuclear properties for K-40



EVEN MR. NATURAL  
IS RADIOACTIVE!



We notice that 89% of K-40 decays by emitting a 1.32 MeV beta particle. This charged particle is readily absorbed, so that its energy is deposited in a small region where it originated. The gamma ray of energy 1.46 MeV resulting from the electron capture is not easily absorbed so that much of it could escape to the outside. Thus, as has been pointed out, in a crowd, the absorbed dose from the K-40 radiation will increase. [When your friend enters the room, he increases your radiation dose from K-40.]

An interesting application of K-40 radioactivity is often pointed out, as for example in the AEC booklet, The Natural Radiation Environment,<sup>15</sup> Potassium is muscle seeking so that it is possible to assess the lean-to-fat ratio of beef cattle by means of whole-body counters. It is hoped in this way to breed cattle that will produce leaner meat.



The last numbers apply to residents within a 50 mile radius from the plant. Note that the radiation dose is comparable to that from miscellaneous sources, such as TV, luminous dials, etc.

It is, therefore, understandable why the applicant for a nuclear power plant license is required to report regional radiological data. The reason for this is that unless the preoperational background radiation characteristics are known, it would not be possible to evaluate the amount of radioactive materials released during the plant operation. It happens that in general, the bulk of the radiation is expected to be due to natural radioactivity. Next in magnitude is the radiation from fallout fission products. The radioactive emissions from nuclear power plants, according to AEC standards, are to be about 1/10 of the natural radioactivity radiations.

#### 5.4.2. Biological Effects of Radiation

"Thus, although from a general point of view all ionizing radiation exposure to the individual is potentially harmful, and although radiation damage in man always appears to increase with the amount of exposure, man has managed to survive and evolve to his present state of development in spite of background exposure, if not because of it."

K. Z. Morgan and J. E. Turner  
Principles of Radiation Protection<sup>20</sup>

#### Radiation Biology<sup>20,21,22</sup>

Since we all live in a radioactive environment, subject to significant levels of radiation exposure from natural sources (which are far in excess of exposures from man-made sources due primarily to diagnostic medical procedures), it is incumbent upon us to examine the effects of radiation on man. As we have seen, when radiation passes through matter, it causes ionization and disruption of the microscopic structure of the material. Hence, it is understandable that ionizing radiation might have some effect on a bioorganism in general-- and upon man in particular.

There have been numerous examples of the harmful effects of radiation from misadventures during the early days of application of radiation. For example, early radiologists suffered X-ray burns and occasional instances of radiation-induced leukemia. Miners in pitchblende and cobalt mines

# COMPUTE YOUR OWN RADIATION DOSE

We live in a radioactive world. Radiation is all about us and is part of our natural environment. By filling out this form, you will get an idea of the amount you are exposed to every year.

	Common Source of Radiation	Your Annual Inventory	Percent*
WHERE	Location: Cosmic radiation at sea level (Ref. 5-4): Elevation: Add 1 for every 100 feet of elevation .....	44 —	29.7
YOU	Typical elevations: Pittsburgh 1200; Minneapolis 815; Atlanta 1050; Las Vegas 2000; Denver 5280; St. Louis 455; Salt Lake City 4400; Dallas 435; Bangor 20; Spokane 1890; Chicago 595. (Coastal cities are assumed to be zero, or sea level.)		
LIVE	House construction (based on 3/4 of time indoors) (Ref. 5-5).  <div style="display: flex; justify-content: space-between; margin-left: 20px;"> <span>Brick</span><span>45</span> </div> <div style="display: flex; justify-content: space-between; margin-left: 20px;"> <span>Stone</span><span>50</span> </div> <div style="display: flex; justify-content: space-between; margin-left: 20px;"> <span>Wood</span><span>35</span> </div> <div style="display: flex; justify-content: space-between; margin-left: 20px;"> <span>Concrete</span><span>45</span> </div>	—	
	Ground: (based on 1/4 of the time outdoors): U.S. average.	15	10.1
WHAT YOU EAT, DRINK, & BREATHE	Water,  Food, U.S. average  Air, (Ref. 5-9)	25	16.9
	Weapons test fallout (Ref. 5-4)	4	2.7
HOW YOU LIVE	X ray diagnosis (Ref. 5-7). Chest X ray            ___ x 9 Gastrointestinal tract X ray   ___ x 210	—	13.5
	Jet airplane travel (Ref. 5-8). Number of 6000-mile flights ___ x 4.	—	100
	Television viewing (Ref. 5-6). Number of hours per day ___ x 0.15.	—	
	Compare your annual dose to the U.S. Annual Average of 148 mrem.	—	
HOW CLOSE YOU LIVE TO A NUCLEAR PLANT	At site boundary: Annual average number of hours per day ___ x 0.2 One mile away: Annual average number of hours per day ___ x 0.02 Five miles away: Annual average number of hours per day ___ x 0.002 Over 5 miles away: None	— — —	Less Than 0.1%
			mrem Total

One mrem per year is equal to: Moving to an elevation 100 feet higher.  
Increasing your diet by 4%.  
Taking a 4- to 5-day vacation in the Sierra Nevada Mountains.

\*Table 5-II The bar graph (at the right) shows the source percentages of the 148 mrem, U.S. average annual radiation dose. Use the table to compute and compare with them your own dose and its make-up. (Nuclear Power and the Environment, American Nuclear Society, 1976)

experienced a much higher level of lung cancer than that experienced by the public in general. The unfortunate use of radium and thorium injections in certain medical procedures during the 1930's also took their toll. Numerous other examples of the harmful nature of large radiation doses can be found during these early years.

The particular effect of radiation upon a biological organism will depend upon a number of factors:

- (i) type of radiation (alpha, beta, gamma, neutrons)
- (ii) type of exposure (external--radiation incident on body from outside; internal--radiation from radionuclides which have entered the body)
- (iii) amount and rate of exposure or dose
- (iv) tendency to bioconcentrate radioactive substances
- (v) type of biological organism (or organ)

The major effect that disrupts the cellular structure of an organism is ionization--whether by primary or secondary radiation. As a rule of thumb, each 32 eV of energy deposition will ionize one atom. Hence, a 4 MeV alpha could produce 100,000 ions. Such ionization can have direct effects since it can rupture the molecular bonds in the organism, thereby producing new molecules (e.g., altering genetic material--DNA). It can also have indirect effects, however. Since the body is mostly water, radiation can produce free radicals such as H, OH, H<sub>2</sub>O<sub>2</sub>, HO<sub>2</sub>, which can undergo chemical reactions in a cell.

Of course, such damage to a single (or several) cells is imperceptible. It happens continually due to the background radiation level--and indeed, there is even some evidence that such a low level of cell destruction by radiation may even be necessary for life since it may stimulate genetic repair mechanisms.

But damage to large numbers of cells can affect the organism. One usually separates the observed medical effects of radiation exposure into two classes: acute effects which would appear within 30 days following exposure, and chronic effects which would not appear for 30 days or longer. One can further distinguish between somatic effects (affecting tissue) or genetic effects (affecting genetic material).

A rough list of observed somatic effects of massive doses of radiation (in excess of 100 rads) includes:

temporary skin reddening (radiation burn or erythema)

general impairment of bodily functions:

edema (swelling due to fluid accumulation)

epilation (loss of hair)

loss of white cell blood count

cataract formation

congenital defects

carcinogenesis (leukemia)

The primary manifestation of genetic effects--that is, damage to genetic cells due to gonadal exposure--is the presence of an abnormally high number of mutations in future generations. However, these genetic effects appear to be induced by only very high radiation dose levels in excess of 100 rads.

As we have noted, the biological effect depends sensitively upon the type of tissue or organ exposed (e.g., the hand is far less sensitive to radiation dose than bone marrow) and the type of radiation (e.g., alpha radiation is easily absorbed by the outer skin layers, whereas gamma or neutron radiation penetrates the body into sensitive tissue, such as bone marrow or reproductive organs).

The observed biological effect also depends very sensitively upon the dose received. Contrary to common belief, there is probably more hard evidence on the effects of radiation on human beings than the effects of any of the other myriad of harmful agents which we face in our environment. Indeed, it is the fact that radiation can be so easily detected at even minute levels which makes it so suitable for biological studies.

Experience has shown that the following symptoms usually appear for a given whole body radiation dose at very high dose levels:

- 0-25 rads - No observable effects produced directly,
- 25-50 rads - Blood change, as manifested by blood count,
- 50-100 rads - Symptoms of radiation sickness, temporary blood change, full recovery of body function within a few days,
- 100-200 rads - Radiation sickness in about 25% of exposed group. Probably no death attributable to radiation. Possibly disability due to radiation effects.

- 200 rads - 50% radiation sickness, about 2% death.
- 300 rads - 90% radiation sickness, 25% radiation death.
- 400-500 rads - Lethal dose to 50%.
- 600 or more rads - Nearly all exposed expected to die within 30 days.

The acute toxicity of radiation is usually expressed in terms of the lethal dose at which 50% of the individuals exposed will die--the so-called LD-50 dose--which for man is taken to be 450 rems. Actually, man happens to be one of the most sensitive organisms to radiation. The LD-50 for other species are as follows:

guinea pig	175 - 250
dog	325
goat	350
man	400 - 450
mouse	530
rabbit	800
weevil	1,000 - 2,000
bacteria (spore-forming)	20,000 - 50,000
virus	50,000 - 1,000,000



[Note that extremely large radiation doses are required to sterilize a material.]

To obtain a better feeling for these radiation doses, we need to keep in mind that within a radius of about 3 Km of an exploding atomic bomb, the radiation dose can be between 200-600 rem. For the 23 Japanese fishermen on the tuna trawler, Lucky Dragon 5, which had become accidentally contaminated by the fallout from the March 1, 1954 H-Bomb test, the radiation dose is estimated to be about 200 rem; one fisherman died about six months later from causes "diagnosed as liver disorder". ‡ 23

‡ There is also an amusing side to the fishermen story. Japanese scientists analyzed the radioactive ashes on Lucky Dragon 5, identified a radioisotope Np-237, which is produced by the (n, 2n) reaction of U-238, as had been discovered by Prof. Nishina before the outbreak of World War II. From the existence of Np-237, the Japanese worker inferred that the cheap U-238 had been used to increase the explosive power of the atomic weapon. The results were published, discussed by scientists all over the world, and by U.S. scientists who were not connected with the bomb development. The ones who had worked on the project, however, were unable to discuss the matter because the information was still classified.

Hence, our experience with radiation exposures to human beings is quite extensive. Great care has been taken to evaluate and document the physical effects resulting from such exposures. We can summarize some four to five decades<sup>14</sup> of detailed studies and experience as follows:

- (i) There is well-documented information concerning the effects of large, acute (short term) doses of radiation in excess of 10-20 rem.
- (ii) Because the effects are so rare (if in fact they exist at all), there are only limited data showing positive effects of
  - (a) acute doses of up to 10-20 rem which are not repeated
  - (b) acute doses up to a few rem and repeated occasionally

By way of contrast, there is no substantive evidence indicating harmful effects (either somatic or genetic) of radiation at dose levels below several rem.

Actually, there is some evidence that low levels of radiation can be beneficial--indeed, possibly even necessary--to sustain life.

An intriguing experiment, suggesting the need of nuclear radiation to sustain life, has been reported by Hungarian investigators, E. Bernst, J. Tigyi, and A. Niedetzky at the 1958 Second U. N. International Conference on the Peaceful Uses of Atomic Energy.<sup>15</sup> The following comments appear in their paper:

"In our experiment, the isolated frog heart (Straub) was promptly arrested by changing over from normal Ringer to a solution in which a corresponding amount of NaCl was replaced by 0.3% KCl. If this K-rich Ringer solution is replaced by another of the same composition, but containing K-42, the arrested heart starts beating. The heart can be repeatedly arrested and restarted by replacing the potassium-rich Ringer without K-42 with another of the same potassium concentration containing K-42. The K-42 can be replaced by Na-24 or P-32.

--The sensitivity of individual hearts varies greatly, and in many experiments negative results were obtained. Nevertheless, the 250 experiments performed during all seasons of the year indicate that radioactivity, and especially the beta rays of K-42, Na-24, and P-32, are responsible for restarting the heart arrested by a potassium-rich solution."

Note that the human body contains slightly more K than Na, namely about 140 gms and 105 gms, respectively, whereas K/Na ratio in sea water is about 0.038. Sodium consists 100% of the non-radioactive Na-23 isotope. Potassium, on the other hand, consists of K-39 (93.08%), K-40 (0.0119%), and K-41 (6.91%),

of which the first and last are stable, but K-40 is radioactive with half-life of about 1.25B years. K-42, referred to in the quoted paper is radioactive having a half-life of about 12 hours. It would be interesting to check the experiment.

#### 5.4.3. Radiation Standards

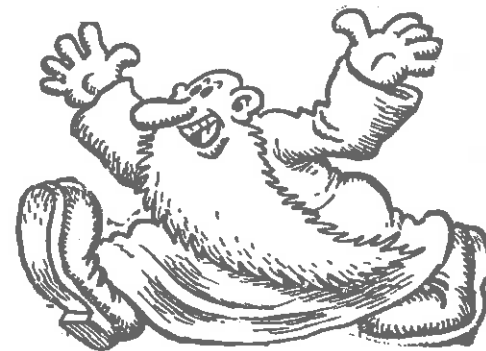
Recently there have been heated discussions and debates on the significance of low level radioactivity releases from nuclear power plants. Unfortunately, in many instances such discussions have been often fruitless because the parties on the two sides of the issue frequently had very little understanding of what is meant by radiation standards. Consequently, the purpose of this section is to look into the radiological standards that have been set by the ICRP (International Commission on Radiological Protection).

The fact to be kept in mind is that the so-called permissible level of radiation is not significantly higher than the radiation dose rate from the natural environment. Measurements taken in 1960 indicate that in the U.S., the background radiation varied from the low of 73 mrad/yr at New Haven, Conn., to the high of 197 mrad/yr at Colorado Springs. In some areas of the world the radiation background is exceptionally high. In the region of Karala, India, about 100,000 natives live in huts and sleep in direct contact with sand containing about 0.1% thorium and its daughter products. The dose to these inhabitants varies from about 0.2 to 2.6 r/year. In certain parts of Brazil, the radiation level is about 12 r/year. Keep in mind that according to the present standards, the limit for whole body dose for a worker in a nuclear industry is 5 rems/year, 5 rems in 30 years or 0.17 rems/year for the general population average.

#### The Standard Man

Biological calculations are based on the standard man. Tables giving the "specs" of the standard man can be found in such references as the ICRP (International Commission on Radiological Protection) by D. F. Rees, Radiological Health Handbook,<sup>27</sup> and others. The quantities of interest to us for the discussion here are:

Total body	70,000 grams
Bones (without marrow)	7,000 grams
Water intake	2,200 cm <sup>3</sup> /day
Air intake	2 x 10 <sup>7</sup> cm <sup>3</sup> /day



Another concept that enters into the calculation is the biological half-life, or the retention time in the human body. For example, the biological half-life of Sr is about  $1.3 \times 10^4$  days (35.6 yrs) compared to 70 days for Cs. The two long-lived isotopes produced in nuclear fission are Sr-90 with  $T_{1/2} = 28$  yrs and Cs-137 with  $T_{1/2}$  of about 30 yrs. Both have comparable radioactive half-lives, but the problem of Cs contamination is not as serious because of the shorter biological half-life. This is reflected in the ICRP standards, in which the maximum permissible concentration of Cs-137 is set at  $2 \times 10^{-4} \mu\text{Ci}$  compared to the value of  $10^{-6} \mu\text{Ci}$  for Sr-90.

Another factor is that not all ingested radioactive material is assimilated. For Sr, the fraction assimilated is about 21%, but for Cs it is about 100%.

#### Body Burden

The question we want to ask and to answer is, "What is considered to be the safe amount of radioactive materials in the body?" This, of course, is determined by both external and internal sources of radiation and the total, according to ICRP standards, is not to exceed (occupational exposure)

$$\text{Dose} = 5(N-18) \text{ (rem)}$$

in which  $N$  is the age of the person. The rate then is 5 rem/year or about 0.1 rem/wk. This means that the average energy deposition in the human body from radioactive sources is not to exceed

$$\frac{(0.01)(100)}{(168)(3600)} = 1.65 \times 10^{-5} \text{ ergs/g-sec} = 10.3 \text{ MeV/g-sec}$$

The rate at which energy is released from radioactive materials in the body is given by

$$\frac{(\lambda N) E_{\text{ave}}}{W}$$

in which  $\lambda N$  gives the number of nuclei disintegrating in a second,  $E_{\text{ave}}$  is the average energy absorbed in the human body when a single nucleus disintegrates, and  $W$  is the weight of the organ in which the radioactive material is located. The ICRP standards require that



$$\frac{(\lambda N)(E_{ave})}{W} \leq 10.3 \text{ MeV/g-sec.}$$

Suppose then we consider Sr-90, which concentrates in the bone system. For the standard man, then  $W = 7000$  gm. The half-life of Sr-90 is 28 years, so that

$$\lambda = \frac{\ln 2}{T_{1/2}} = \frac{0.693}{28 (31 \times 10^6)} \text{ sec}^{-1}$$

As indicated before, the average energy per disintegration is estimated from the radioactive decay scheme. When Sr-90 decays, electrons are given off with a maximum energy of 0.546 MeV, and this is followed by the decay of Y-90 upon emission of another electron of maximum energy of 2.26 MeV. The total maximum energy released is then about 2.80 MeV. The average energy released is about 0.4 of the maximum value, or about 1.1 MeV. Therefore,

$$\lambda N \leq \frac{(10.3)(7000)}{1.1} = 6.5 \times 10^{14} \text{ disintegrations/sec} = 2 \mu\text{Ci}$$

This is the maximum permissible body burden of Sr-90 in the human body. The ICRP standards recommend then that the total amount of Sr-90 accumulating in the human body in 50 years should not exceed this value.

The accumulation rate obviously depends upon the rate of Sr intake from the environment. Sr-90 is contained in the food we eat, the air we breathe, and the water we drink. To simplify the analysis, we shall assume that the Sr intake comes entirely from drinking water. Then

$$\text{Accumulation Rate} = \text{Intake} - \text{Loss Rate}$$

If  $N$  is the number of Sr-90 in the human system, then

$$\text{Accumulation Rate} = \frac{dN}{dt}$$

The loss rate depends upon two mechanisms, one due to the radioactive decay of nuclei and the other due to the elimination given by

$$\text{Radioactive Loss Rate} = \lambda N$$

$$\text{Biological Loss Rate} = \lambda_B N$$

The intake rate depends upon the concentration in water, the rate of drinking water, and the fraction assimilated by the body, so that

$$\text{Intake Rate} = C \frac{2200}{(24)(3600)} f = 0.0054 C = P$$

When the maximum amount of Sr-90 has been accumulated in the body, the intake rate will just balance the loss rate; thus

$$0.0054 C = \lambda N + \lambda_B N = (\lambda + \lambda_B) N$$

The concentration  $C$  is the number of radioactive Sr-90/cm<sup>3</sup>; the concentration in curies is obtained by multiplying by  $\lambda$ . Then

$$\lambda C = (\lambda + \lambda_B) \frac{\lambda N}{(0.0054)}$$

If we now recall that the limit on the body burden implies  $\lambda N < 2 \mu\text{Ci}$ , then taking the biological half-life of Sr to be 35.6 years, we find that

$$\lambda + \lambda_B = \frac{\ln 2}{T_{1/2}} + \frac{\ln 2}{T_B} = \frac{0.693}{16.4} \frac{1}{(31 \times 10^6)}$$

MORE EQUATIONS!



Therefore

$$\lambda C = \frac{2}{0.0054} \frac{0.693}{(16.4)(31 \times 10^6)} = 0.52 \times 10^{-6} \mu\text{Ci}/\text{cm}^3.$$

The above sample calculations were carried through to show how the maximum body burden and  $(\text{MPC})_w$  for Sr-90 is obtained ICRP standards for other radioactive nuclei are obtained in the same way.

#### Bioconcentration, Biorejection, and Biosubstitution

"It can be seen that a concentration factor is not a fixed number. It is a variable which is dependent upon existing chemical conditions and will change if the chemical parameters of the environment change."

R. A. Copeland, R. H. Beethe, and Wm. W. Prater  
Trace Element Distributions in Lake Michigan  
Fish, March 1973<sup>28</sup>

Radioactivity is a fact of life, and so are bioconcentration, biorejection and biosubstitution. The bioconcentration of the naturally radioactive potassium has been going on in the Great Lakes since they were first formed, about 12,000 years ago. Some plants, like Brazil nut trees, have affinity for barium and consequently concentrate radium along with it. The biochemistry of accumulation or rejection of certain elements is quite complex so that no attempt will be made to go into the details. Rather, certain principles concerning the biochemistry of elements will be considered.

##### (i) Bioconcentration

This becomes a public concern because living organisms have the ability to concentrate certain minerals essential for their existence. But this is a complex phenomena and depends upon a number of different factors.

The following table, which gives the concentration factors for marine and fresh-water fish, gives an indication of the complexity of the problem:

Element	Conc. in Sea Water	Conc. Factor Soft	Factor Skel.	Conc. in fresh water Conc. in sea water	Fresh water Conc. Factor
Na	$10^7$	0.07	1	$6.3 \times 10^{-4}$	100
K	$3.8 \times 10^5$	5	20	$6.0 \times 10^{-3}$	4400
Cs	0.3	10		$6.7 \times 10^{-2}$	9000
Ca	$4.1 \times 10^5$	1	200	$3.7 \times 10^{-2}$	350
Sr	$8 \times 10^3$	1	200	$1 \times 10^{-2}$	20,000
Fe	3	1000	5000	200	100
P	90	40,000	2M	.2	100,000

From the above table, we notice that the concentration factors in fresh water are high if the mineral concentration is low. Thus, for Na in sea water, the soft tissue actually rejects it (concentration factor is less than 1) whereas in fresh water, it is concentrated. For Cs the concentration factor is high because K concentration in fresh water is generally low. An interesting point to note is that the K/Na ratio in sea water where living organisms originate is about 0.038, whereas living tissues require about the same amounts. For P, the fresh water/sea water ratio is not very different from 1, so that the problem of P-32 assimilation by marine animals and plants becomes important. For Fe, we note that the concentration factor in sea water is greater than in fresh water.

The concentration factor depends upon a complex set of conditions, such as the chemical and physical state of the elements in the environment, chemical composition of the organisms, concentration in the environment, specific activity (radioactive isotope/all isotope of same element), presence of other elements, etc., so that there does not appear to be any simple countermeasure.

On land, radio-concentration also occurs, and the problem of I-131 and Sr-90 has been investigated in considerable detail. Some possible countermeasures are discussed in the monograph by Garner on the "Transfer of Radioactive Materials from the Terrestrial Environment to Animals and Man",<sup>21</sup>

The concentration factor also depends upon the position of the element in the Periodic Table of Chemical Elements. It is well known that elements in the same column of the Periodic Table have similar chemical properties. Consider for example the Group IA elements, which includes Na, K, Rb, and Cs. Living organisms need Na and K, so that if the environment is deficient in these minerals, other elements in Group IA will be concentrated along with them. Another example is Ca, which is in Group IIA, consisting of Ca, Sr, Ba, and Ra. Hence, if the environment is deficient in Ca, Sr will tend to be concentrated. It appears that Brazil nut trees have affinity for Ba, so that in the process of assimilating barium, radium is absorbed and concentrated.

Notice also that this so-called bioconcentration does not continue to propagate up the food chain. Consider, for example, the concentration factor for potassium. For man, the amount of potassium is about 140 gms of the total body weight of about 70 Kgms, the potassium content is about 2 parts per thousand. In sea water, the potassium concentration is about  $3.8 \times 10^5$  or  $3.8 \times 10^4$  gmK/gm water, which is about a factor of 5 smaller than in human tissue. In fresh water, if the potassium concentration is lower than  $6 \times 10^{-3}$ , the concentration factor would need to be about 1000. This is roughly the measured value of organisms in Lake Michigan. The potassium concentration in Lake Michigan is about 1.6 parts per million. The concentration factors reported for phytoplankton and zooplankton are reported to be 453 and 606.

A critical mineral is iodine. In Lake Michigan, its concentration is one part per billion; in sea water, it is 60 parts per billion.

But how about biological fractionation of isotopes, i.e., is there any biological preference for certain isotopes of elements? For example, can organisms distinguish stable isotopes from radioactive isotopes? Studies seem to indicate that this biological fractionation of isotopes is dependent only on the differences in mass between the isotopes, so that for all practical purposes, the effect is not significant for elements of atomic numbers greater than 16 (sulfur). For lighter elements, like hydrogen, this biological fractionation can take place. But for this case, studies indicate that biological systems have a slight preference for the ordinary hydrogen isotope.

### Environmental Radioactivity

Before taking up examining nuclear radiations in our environment, it might be helpful to look at the "background" of electromagnetic radiation in which we live. Sunlight, like gamma and X-radiations, is electromagnetic radiation. Without it, we would perish, but we also need to remind ourselves that sunlight would be injurious to most human tissues, were it not for the protective layer of the skin. Skin is less than 0.5 mm thick, of which about 0.17 mm is the epidermis. The absorption coefficient of visible and ultra-violet radiation is in the neighborhood of  $10^{-5}/\text{cm}$ , so that the bulk of the solar radiation is absorbed in the skin and very little penetrates deeper (excepting possibly long wave length infra-red radiation). The solar radiation absorbed in the skin warms it, thereby giving us the feeling of well-being when in the sun.

Earlier, we discussed the rad as the unit of absorbed dose. Let us then estimate the rad equivalent of solar radiation. The solar constant is about  $2 \text{ cal/cm}^2/\text{min}$ ; this is the amount of energy flux through an area of  $1 \text{ cm}^2$  at the top of the earth's atmosphere. The amount reaching the earth's surface is about one-half of the above value. In addition, there is another possible loss of about 50% due to reflection from skin. The rate of energy absorption then is about  $0.5 \text{ cal/min}$  of  $1 \text{ cm}^2$  of skin, or about  $0.035 \text{ w/cm}^2$ . For the standard man, the mass of the skin and subcutaneous tissue is taken to be about 6,100 gm; the skin area is considered to be about  $18 \text{ ft}^2$ , or about  $18,000 \text{ cm}^2$ , which gives

$$\frac{6,100 \text{ g}}{18,000 \text{ cm}^2} = 0.34 \text{ g/cm}^2$$

This amount of human tissue absorbs  $0.035 \text{ w/cm}^2$  or  $35 \times 10^4 \text{ ergs/cm}^2/\text{sec}$ , so that we obtain

$$\frac{35 \times 10^4 \text{ ergs/cm}^2\text{-sec}}{0.34 \text{ g/cm}^2} \sim 10^6 \text{ ergs/g-sec} \sim 10,000 \text{ rads/sec}$$



For X-rays or gamma-rays, the human tissue is almost transparent, and the skin offers no protection. The mass absorption coefficient of water for 50 keV X-rays (medical and dental) is about  $0.2 \text{ cm}^2/\text{gm}$ . Since the density of water is  $1 \text{ gm/cm}^3$  (also the approximate density of human tissues), the above quantity implies that the X-ray penetration depth is about 5 cm, i.e., the body is effectively transparent, and therefore no part of the body is shielded from the X-radiation.

The radioactivity of our environment stems from the fact that a large fraction of naturally occurring isotopes is radioactive. All isotopes of elements with  $Z > 82$  (Pb) are radioactive. In addition, there are H-3, C-14, K-40, V-50, Rb-87, In-115, Sb-123, Te-130, I-129, La-138, Nd-144, Su-147, Lu-176, W-178, and Re-187; of these, the 0.0118% abundant K-40 gives the most significant contribution to internal radiation. In the table below we have listed (values for radiation dose rates stemming from radioactive deposits in our bodies:

Radioactive Nuclei	Dose Rate (mrad/year)
K-40	20
Rb-87	0.3
C-14	1.
Ra-226, -228	1.
H-3	<u>2.</u>
Total Internal	24 mrad/yr

In addition, we receive some external radiation. This can vary over a large range of values. As noted earlier, in parts of Brazil, the background radiation is as high as 12,000 mrad/yr. Cosmic rays can contribute a significant fraction of our external radiation dose; at sea level this is almost zero, but at 20,000 feet the dose is estimated to be about 1500 mrad/yr. The radiation background in Denver, Colorado is higher than it is in Detroit. Medical X- radiation provides additional radiation dose, amounting to about 30 mrad/year, and because of the past atomic bomb tests there is as much as 30 mrad/year coming from fallouts. In any case, the background external radiation, exclusive of medical and fallout radiation, is taken to be about 100 mrad/year.

Often, the average total (external plus internal) radiation dose rate coming from natural sources is taken to be about 125 mrem/yr.

### Emissions of Radioactive Material from Nuclear Power Plants

As an example, let us consider the radiation from the stack of a nuclear reactor, to illustrate the comment in the NAS-NRC report that "it would be physically impossible for the U.S. population averages to approach anywhere near the level of 0.17 rem/year from such sources".<sup>30</sup>

For this, let us analyze the comments by M. Eisenbud appearing in Nuclear Power and the Public,<sup>31</sup> in which the statement is that the annual per capita average dose for population density of 1000 per square kilometer are 1.9, 0.28, and 0.04 mrad, respectively.

First note that this assumed population density is not very different from, say, that of Ann Arbor. The area is 23 square miles or about 6-square Km ( $1 \text{ mi}^2 = 2.59 \text{ Km}^2$ ), the population is about 100,000, so that the population density is about

$$100,000/6 = 1700 / \text{km}^2$$

Using

$$\pi R^2 (1000) = \text{population,}$$

we find that the population of  $10^5$ ,  $10^6$ , and  $10^7$  will be living within 5.7 Km (3.5 mi), 17.7 Km (11 mi), and 57 Km (35 mi) of the nuclear power plant.

The dose rate at the fence post (100 m from the stack) is to be 17 mrad/year, and the dose rate, according to Eisenbud, falls as the 1.8 power of the distance from the stack. Hence,

$$\text{Dose Rate} = 17 \left( \frac{0.1}{R} \right)^{1.8} \text{ mrad/yr}$$

where R is in Km. Using this relation, we obtain the results shown in Figure 5-

The average dose rate can be calculated from

$$\langle \text{Dose Rate} \rangle = \frac{\int_{0.1}^R 17 \left( \frac{0.1}{R} \right)^{1.8} 2\pi R dR}{\int_{0.1}^R 2\pi R dR}$$





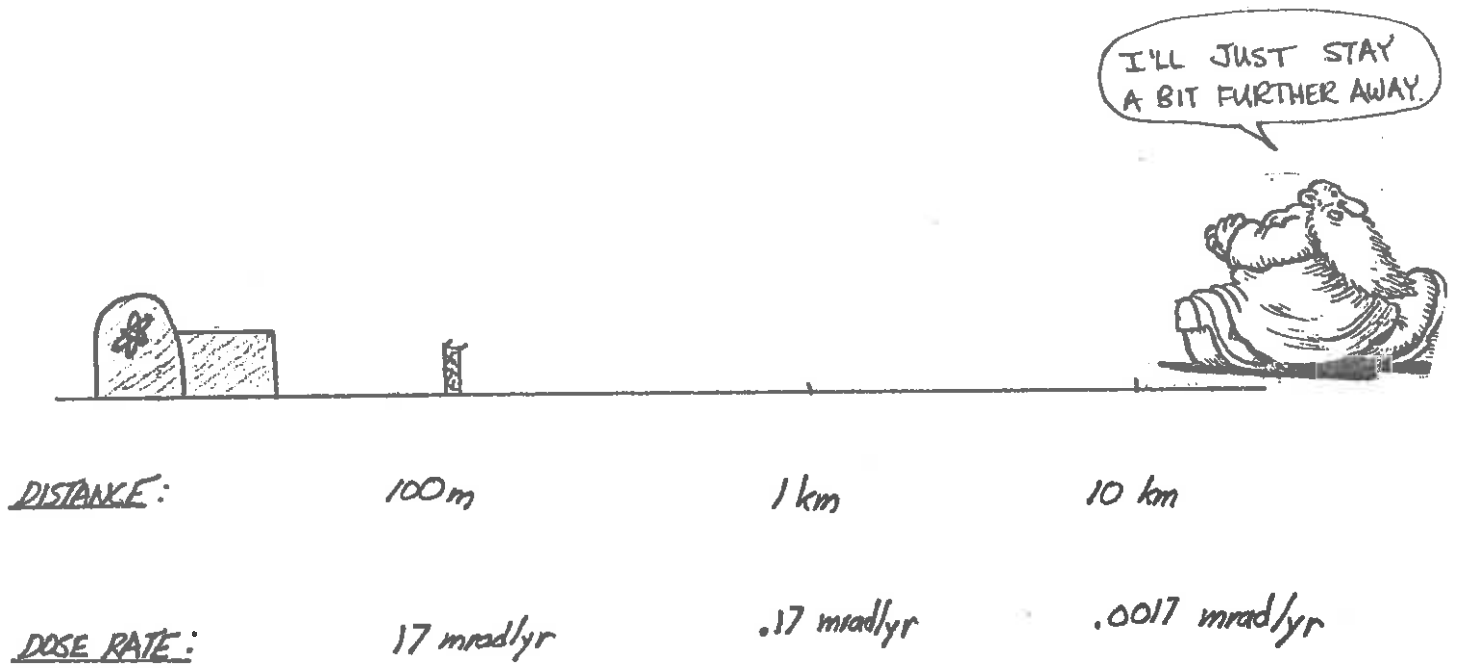


Figure 5-28: Falloff in Dose Rate with Distance from a Nuclear Plant

Carrying out the integration, we find that

$$\langle \text{Dose Rate} \rangle = 0.34 (\text{Dose Rate at } R) - 1.72/R^2$$

For  $R = 5.7$  Km, we find

$$\langle \text{Dose Rate} \rangle = 0.07 \text{ mrad/yr.}$$

Of course, in the above analysis, we are assuming that the nuclear power plants are very far apart, so that only the radiation from a nearby power plant need to be taken into account.

#### Radioactive Effluents from Fossil Fuel Power Plants

As mentioned earlier, there are radioactive nuclei all around us, and in particular, small concentrations of radium occur in the food we eat and the water we drink. Consequently, fossil fuels contain a small concentration of radium, which inevitably get into the flyash from fossil fuel power plants. M. Eisenbud and H. G. Petrow<sup>32</sup> have analyzed the radium content of fly-ash and have reported that about 29 nCi of radium is released into the atmosphere from a 1000 MW power station. It happens that from the standpoint of health physics, radium is much deadlier than the gases released from nuclear power plants. The indication of this is the so-called (MPC)<sub>a</sub> (maximum permissible concentration in air), taken to be as follows:

<u>Nuclei</u>	<u>(MPW) (MCi/cm<sup>3</sup>)</u>
Ra-226	$5 \times 10^{-12}$
Ra-228	$10 \times 10^{-12}$
Kr-85	$3,000,000 \times 10^{-12}$
I-131	$3,000 \times 10^{-12}$

They find then that the 28 mCi of Ra is equivalent to about 200 Ci of Kr-85 and 200 mCi of I-131. Compared to this, in 1961, the gaseous radioactive discharge from the Yankee plant amounted to about 1.9 mCi,

Another interesting comment made by them is that the radium content in soft tissues of New York City residents is substantially greater than those of Rochester, New York.

#### 5.4.4. Some Illustrations of Radiological Health Physics in Nuclear Power Applications

##### Pathways of I-131 to Man

One of the concerns of nuclear power is the radioactive fission product I-131 which could escape into the atmosphere and add to human radiation dosage. The problem arises because iodine is essential for life but its normal concentration is extremely low. The amount of iodine in the human body is about 0.03 gms for a standard man (70 kg), giving a concentration of about 0.43 ppm by weight. In the environment, the iodine concentration is frequently very low and hence often needs to be augmented in our diet. The abundance of iodine in the earth's crust is only about 0.3 ppm and ranks 63 among the elements. For comparison, note that thorium, uranium, silver, and gold rank 39 (12 ppm), 50 (4 ppm), 67 (0.1 ppm), and 73 (0.005 ppm), respectively.

The nuclear fuel, and hence the fission products, are largely contained in the fuel element cladding, but through several mechanisms, a portion of the I-131 in the reactor core will escape to the outside. The ventilation stack exhausts some of the radioactive materials such as I-131 that have escaped into the turbine building and other structures. The radioactive I-131 is dispersed in the air, but as it spreads, part of it settles to the ground. Suppose a part of it is deposited in farm land, say a pasture. Cows grazing on this pasture will reconcentrate the radioactive I-131, because iodine is an essential mineral. A portion of this reconcentrated I-131 will appear in the milk they give. If a child drinks this milk, the radioactive iodine could again be further reconcentrated. [See Figure 5-29 .]

The question of most direct concern involves what concentration of I-131 in the milk will be safe enough for the child to drink and what must be the I-131 releases at the stack to be below this safe-enough limit. A related question, of course, is how this calculated "safe-enough" release compares to the amounts actually released from nuclear power plants.

The pictorial diagram in Figure 5-29 is rather awkward so that it is customary to discuss the various pathways of radionuclide to man by means of an alternative schematic:

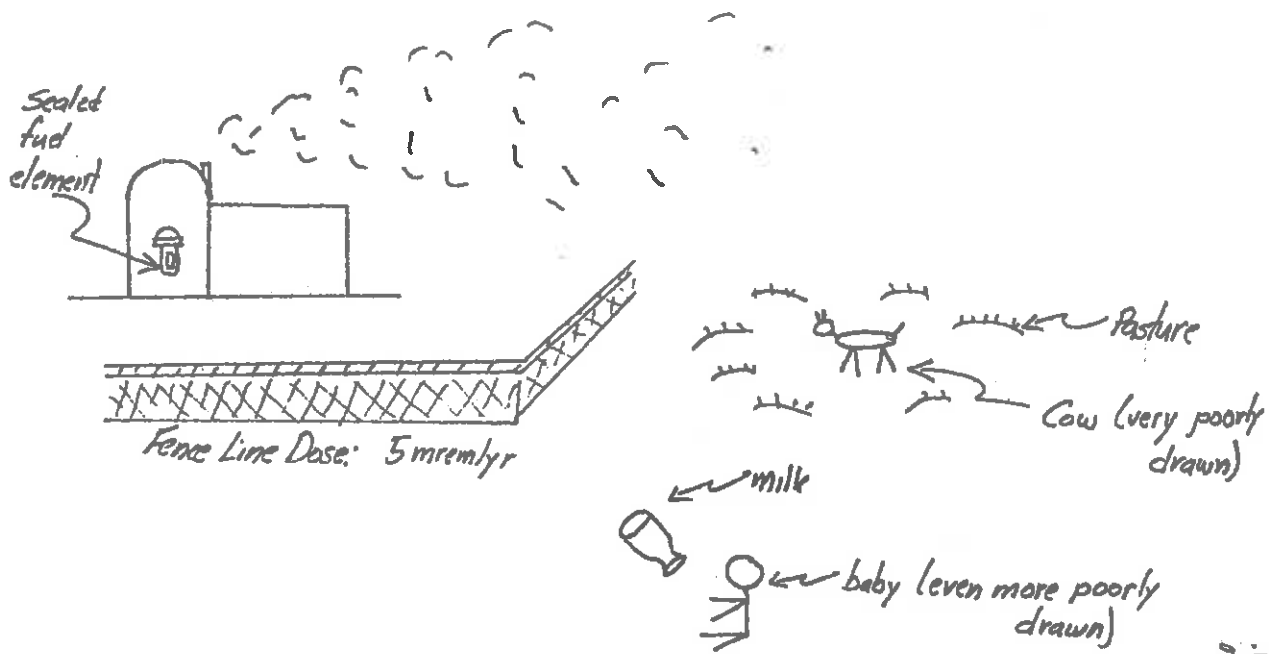


Figure 5-29: Pathway of I-131 to Man

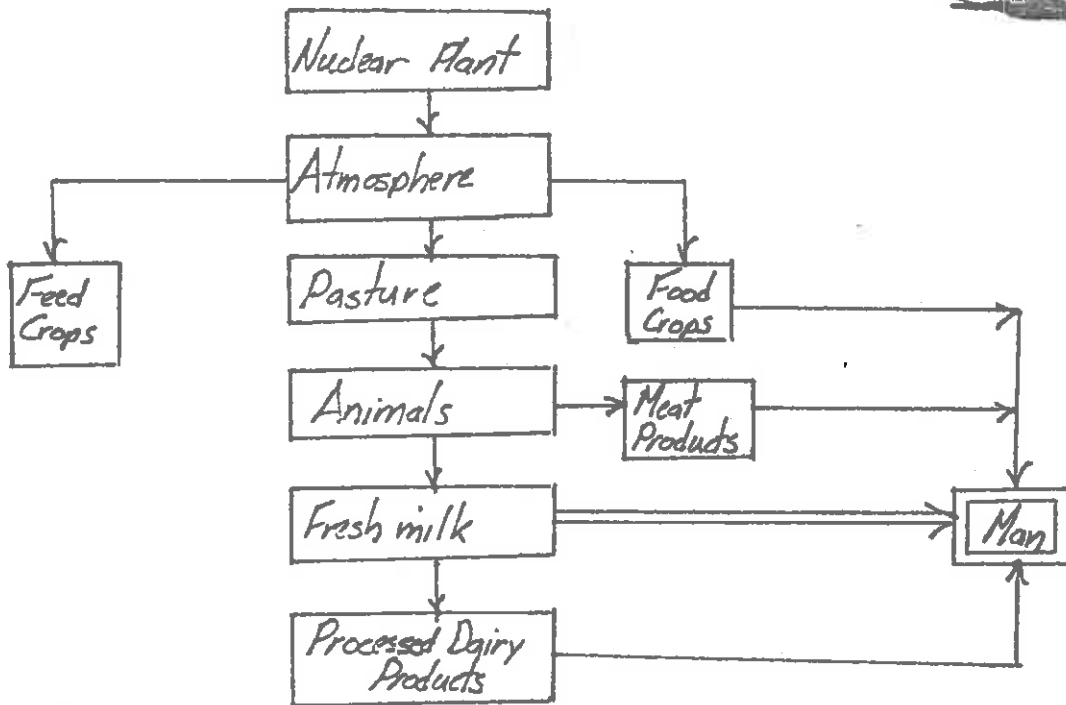
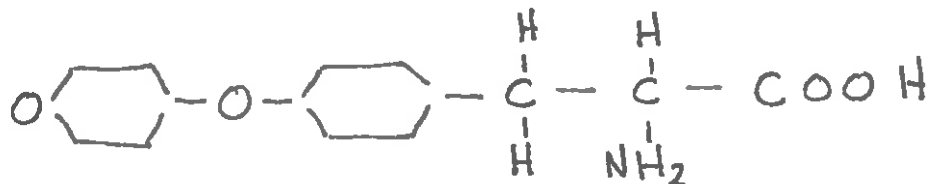


Figure 5-30: Schematic of I-131 Pathways to Man

Of the various possible pathways, the pasture-cow-milk-child one is considered to be the most critical, so that we shall analyze it in detail. We also need to notice that the above diagram does not include the effects of external radiation, such as the gamma rays from the radioactive cloud passing by overhead, or being immersed in a radioactive atmosphere.

As indicated earlier, the average amount of iodine in the human body is about 0.03 g, or about 30 mg. The iodine concentration is about 0.35 mg/g thyroid. The thyroid of an adult is taken to be 20 g, giving 7 mg for iodine in the thyroid glands. For a year-old baby, the thyroid gland is only about 2 g, but the total iodine uptake is about the same, so that if the iodine is radioactive, the activity will be 10 times greater for such children.

Iodine is needed for thyroxine for which the chemical formula is  $C_{15}H_{14}I_4NO_4$  and the structural formula is



Note that this is an amino acid and is one of the hydrolytic products of proteins. However, it is not an essential amino acid.

Young children treated with X-rays in the neck region for enlarged thymus or for other benign head and neck conditions have had a significantly higher incidence of tumors, including thyroid carcinoma, than have children in control groups.<sup>33</sup> Radiation doses to the thyroid found to be associated with thyroid carcinoma under these conditions, range upwards from about 150,000 mrad. Experience with exposure of the thyroid to large doses of radiation from I-131 for therapeutic reasons is extensive but is almost entirely confined to adults. The report of the panel of experts of the NAS-NRC committees<sup>34</sup> states that, although therapeutic doses of I-131 to the thyroid have been in the range of a few thousand rads upward, I-131 has not been identified in a causative way with the development of thyroid cancer in humans, except in one doubtful case. X-ray dose to the thyroid appears to be from 5 to 15 times as effective in producing biological changes as I-131.

Let us translate these into equivalent internal doses of I-131. The standards set by the ICRP (International Committee on Radiation Protection) for I-131 are

Occupational Exposure	700	Ci/thyroid/yr
Public-at-Large Exposure	70	"
Child	7	"

The number 700 Ci results in radiation dose of about 30 rads to the thyroid. The I-131 equivalent of X-ray dose of 150 rads then is 3500 pCi, and 5 to 15 times this last amount are 17,500 pCi and 52,500 pCi, respectively. To appreciate a little more fully the degree of safety built into the radiation standards, we should note that the medical standards are about.

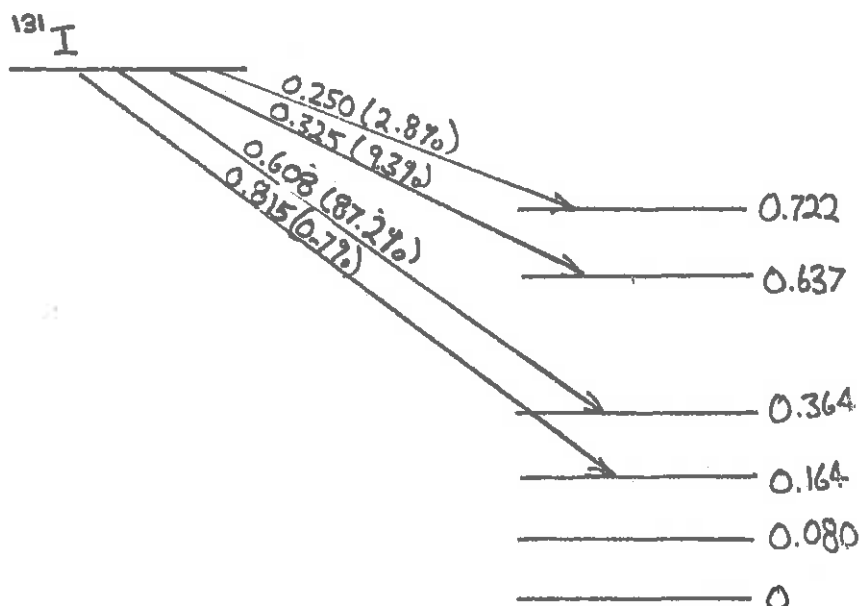
Diagnosis	2,000,000 pCi
Therapy	1,000,000,000 pCi

But how do these numbers compare with the I-131 releases from nuclear power plants? An excellent discussion of this is given in the paper by Stigall, Fowler, and Krieger<sup>35</sup>, who studied the I-131 releases from the boiling water reactor, Dresden Unit I (200 MW (e)) (a rather old plant). According to their measurements, the radioactivity of I-131 accounts for about 72 ppb (parts per billion) of the total radioactivity released from the stack. The total release which is mostly noble gases, results in radiation of about 5 mrad/yr at the power plant fence line. Hence, the contribution from I-131 is about  $72(5) = 360$  pCi/yr.

The decay scheme leading to I-131 production is



The decay scheme of I-131 to stable Xe-131 is somewhat complex.



The numbers 0.608 (87.2%), for example, mean that the maximum energy of the beta particle is 0.608 MeV and the decay from I-131 to Xe-131 takes place through this transition about 87.2% of the time. The maximum energies averaged over all beta transitions then is 0.573 MeV. This is the maximum beta particle energy. In beta decay, the electron energy varies continuously from 0 to  $E_{\max}$ , and the average energy is frequently taken to be about 0.4 of the maximum value or 0.23 MeV. This is the amount of energy deposited in the tissue if one I-131 were to undergo decay. Then for 1 curie of I-131 in one gram of tissue, we would have a dose rate of 136 rad/sec.

Another question is "how much I-131 is produced in a nuclear power plant?" To answer this question, one convenient number to remember is that a 1000 MW(e) nuclear power plant "burns" roughly 1 tonne of U-235 per year. When U-235 undergoes fission, both light and heavy fission fragments are produced, and about 2.9% of the heavy fission fragments result in I-131. Hence we can calculate the production rate of I-131 as  $P = 64.3 \text{ Ci/sec}$ . From this quantity we can estimate the I-131 inventory in the core of a reactor that has been running for a period long in comparison to the radioactive half-life of 8.05 days as  $P/\lambda = 64 \times 10^6 \text{ Ci}$  of I-131.

Let us now estimate the amount of radioactive iodine-131 that escapes from a nuclear power plant. The actual numbers for the Dresden plant are:

Inventory	15,100,000 Ci
Production rate	15 Ci/sec
In primary coolant	0.418 Ci
Stack discharge	0.000,000,84 Ci/sec
Noble gas discharge rate	0.0116 Ci/sec

The following numbers were reported for the environmental concentration of I-131:

Cattle thyroids*	0.45 p Ci/gm
Milk	
Measured**	0.67 p Ci/liter
Estimated	1.09 p Ci/liter
Calculated	0.038 p Ci/liter

\*Average of three cattle thyroids from a farm 2.3 Km east of the plant

\*\*Dairy farm 3.4 Km west of the Dresden stack

We notice that the above values for I-131 concentration in milk is very small in comparison to the FRC (Federal Radiation Council) standard of 100 pCi/liter of milk. To appreciate the margin of safety in this standard, we shall retrace the calculations to see how they are set.

(a) Occupational Exposure. For workers in nuclear facilities (nuclear power plants, nuclear accelerators, etc.), radiation dose of 0.6 rem/week to the skin and thyroid is considered safe enough. Even if exposed continuously at this rate, the dose in one year would amount to 30 rads/year. As indicated earlier, X-ray induced thyroid carcinoma stems from radiation doses of 150 rads and upward.

To calculate the amount of I-131 that will deposit 0.6 rad/week in the human adult thyroid, we need

- (1) Disintegration energy, 0.23 MeV
- (2) Adult thyroid mass, 20 grams
- (3)  $1 \text{ Ci} = 3.7 \times 10^{10}$  disintegration/sec
- (4)  $1 \text{ rad} = 100 \text{ erg/gm thyroid}$
- (5)  $1 \text{ MeV} = 1.6 \times 10^{-6} \text{ erg}$
- (6)  $1 \text{ week} = 6.05 \times 10^5 \text{ sec}$
- (7)  $T = 8.05 \text{ days}$
- (8)  $T = 130 \text{ days in thyroid}$
- (9)  $T_{\text{eff}} = 7.6 \text{ days}$

THAT'S ALL YOU NEED!



The disintegration energy from 1 Ci of I-131 then is  $8.2 \times 10^9$  ergs/wk. Suppose that the amount of I-131 in the thyroid is  $10^{-6}$  Ci. The dose rate (per gram thyroid) then is 4.1/rad/wk. Thus, to meet the 0.6 rem/wk standard, the so-called body burden of I-131 of a worker continuously taking in the radioactive material should not be more than  $0.14 \mu\text{Ci}$ , or 140,000 pCi/thyroid.

For a worker spending only a part of his time in a nuclear facility, the maximum permissible burden is taken to be 700,000 pCi/thyroid.

( Keep in mind that there is no evidence that this amount of I-131 is harmful to the thyroid.)

(b) Public-at-Large. The standard is that the individual exposure is not to exceed 0.5 rem/yr, or about 0.01/rem/wk. The maximum permissible body burden then is  $\frac{140,000}{60} = 2,300 \text{ pCi/thyroid}$ .



(c) Child. The thyroid mass of a one-year-old infant is taken to be 2 gm or one-tenth of the adult thyroid. Consequently, the maximum permissible body burden for children is taken to be 230 pCi/child thyroid,

(d) Concentration in Milk. Children drink between 1 pint and 1 quart of milk per day. One quart is approximately a liter (1 qt. = 0.946 liter). If I-131 is taken up from this source, then the amount accumulated in the thyroid should just balance the loss from the thyroid by radioactive decay and elimination. About 30% of the intake of I-131 is accumulated in the thyroid, so that the accumulation rate for a child drinking 1 liter of milk is 0.3 C, where C is the I-131 concentration per liter of milk. The loss rate through radioactive decay and elimination is 70 pCi/liter. If a child drinks only 0.5 liter of milk (1 pint), then the concentration could be 140 pCi/liter. The value 100 pCi/liter is adopted as the standard.

A cow can become contaminated with I-131 through the air it breathes and the water it drinks, but the principal source is the pasturage it consumes. Fortunately for humans, much of the I-131 is accumulated in the cow's thyroid, and only about 10% appears in milk.

Studies indicate that 1 pCi/m<sup>2</sup> of pasture will result in about 0.1 pCi/liter of milk. Hence, to meet the FRC standard of 100 pCi/liter, the pasture contamination should not exceed 1000 pCi/m<sup>2</sup>.

#### Atmospheric I-131 Concentration

Pasture contamination results from the settling of I-131 in the air above it. The deposition rate is given by  $\lambda v_d$  in which  $\lambda$  is the concentration in air, while  $v_d$  is the deposition velocity. However, the deposition rate is opposed by the disappearing rate, part of which comes from radioactive decay (8 days) and others by being washed off, etc. The effective half-life of I-131 on the pasture is then taken to be about 5 days. Then the I-131 loss rate from the pasture surface is given by  $\lambda P$  in which P is the pasture I-131 surface density and

$$\lambda = \frac{0.693}{T_{\text{eff}}} = \frac{0.693}{5(8.64 \times 10^4)} = 1.6 \times 10^{-6} / \text{sec}$$

Then

$$\begin{aligned} \lambda v_d &= P = (1.6 \times 10^{-6} \text{ sec}) (1060 \text{ pCi/m}^2) \\ &= 1.6 \times 10^{-3} \text{ pCi/m}^2 / \text{sec} \end{aligned}$$

Measurements indicate that the deposition velocity is about 1 cm/sec, or about 0.01 m/sec. Then

$$\chi = \frac{1.6 \times 10^{-3}}{0.01} \text{ pCi/m}^3 = 1.6 \times 10^{-13} \text{ Ci/m}^3$$

In passing, it should be noted that this is a very small amount of I-131. The specific activity of I-131 is  $1.24 \times 10^5$  Ci/g, so that  $C = 1.6 \times 10^{-13} / 1.24 \times 10^5 = 1.3 \times 10^{-18}$  g I-131/m<sup>3</sup>.

The smallness of the I-131 concentration can perhaps be appreciated by comparison with the noble rare gases in the atmosphere. The rare gases are He, Ne, Ar, Kr, Xe, and Rn. The last is the radioactive gas radon, which occurs naturally. Its concentration inside buildings, where the concentration is highest, is about 0.5 pCi/liter, or about 500 pCi/m<sup>3</sup>. In London, on clear days, the radon concentration has been shown to be 2000 pCi/m<sup>3</sup>; the high concentration is due to burning of coal.<sup>36</sup> In an open field, away from coal-burning plants, the radon activity is typically in the range from 100 to 500 pCi/m<sup>3</sup>. Thus, the I-131 concentration that would give the maximum permissible concentration in children is about one-millionth of the very rare radioactive gas radon.

#### Palisades Nuclear Plant "Accident"

"The Atomic Energy Commission says that the release was 900 to 6,000 percent over AEC limits."

Statement made to the Michigan Department of Natural Resources, April 1974.<sup>37</sup>

The above sentence, taken from a statement made to the Michigan Department of Natural Resources, gives the impression that the accidental release of radio-iodine-131 during the August 11-20, 1974 Palisades accident was quite large. Yet a study of the AEC document, from which the statement was lifted, shows that the actual amount of iodine-131 released was quite small, amounting to about only 8% of the annual release limit, and that the possible radiation dose to child thyroids, for example, could not have been more than what a person would get by watching TV for a few hours a day.

What we shall show is that the contradictory interpretation of the AEC document arose from the misinterpretation and omission of certain key words.

The point to be stressed is that technical terms, like those in law, have precise narrowly-defined meanings so that gross misinterpretations could arise if the significance of certain key words are overlooked,

Radiation standards are in some ways like speed limits; it is important to distinguish the difference between safe and legal limits. Strictly speaking, of course, there is no safe speed limit, because, for example, rolling cars have been known to cause accidents. But from experience, it is felt that a divided 4-lane highway is safe enough at speeds of 70 miles per hour. Yet the legal limit today is 55 miles per hour.

The "safe enough" radiation standards have been set by the ICRP (International Commission on Radiation Protection) and by certain other Federal agencies. The safety limit has been set at 5000 mrems/year. This standard applies to workers in radiation facilities, such as X-ray laboratories, high-energy atom-smashers, nuclear power plants, etc. An MD preparing patients for radiation diagnosis and/or therapy is guided by these "safe" enough standards.

It is interesting to note that these "safe enough" values have, at times, caused problems, not because of technical reasons but rather by social factors. Unborn fetus is considered to be more sensitive to the effects of radiation, so that efforts have been made to reduce the radiation standards for pregnant women. However, such efforts ironically are being opposed by women's rights organizations. An interesting commentary on this problem appeared in the UM News, April 14, 1975 in "To Avoid Radiation Hazard to Unborn, 'U' Seeking Cooperation of Pregnant Employees".

The "safe enough" standards for the American public has been set at one-tenth of the ICRP values. For example, the allowed radiation dose for a person living near a radiation facility, say right at the plant site limit, but not working in one, is 500 mrems/year, with the further stipulation that the average dose to the population segment is not to exceed 170 mrems/year. This last stipulation comes from genetic considerations.

Nuclear power plants, in contrast, come under the legal restrictions of the so-called "as low as practicable" rule. In June 1971, the AEC interpreted this to be the following,<sup>30</sup>

- (1) 10 mrems as the integrated dose over a year's time, at any point on the site boundary, from noble gas emission.

- (2) 5 mrems as the maximum calculated dose to any person over a year's time, as the result of discharge of liquid wastes,
- (3) 5 mrems as the maximum annual dose to any organ as the result of discharge of long-lived activities (defined for half-life 8 days or more).

We notice then that these legal limits set by the AEC (now the NRC) is only 1% of the EPA individual limit, and only 0.1% of the ICRP-NCRPM safety limit.

The point to note is that even if the legal "as low as practicable" limits are exceeded, the radioactive releases could be substantially below the safety limit. We make this comment to stress that there is a very large, very conservative margin of safety between the safety and legal limits.

A point that cannot be stressed enough is that during the Palisades accident, the radio-iodine-131 release was only 8% of the legal limit and therefore only a very small fraction of the safety limit.

One other point to be kept in mind is that the AEC-NRC legal limit of 5 mrems/year to a specific organ, such as the thyroids, is again only a small fraction of radiation dose that one gets from medical treatment. By way of comparison, there has been recent concern about children who received X-ray treatment to the thymus, throat, and thyroids during the 1930's, 1940's, and 1950's. The X-ray doses to such children appear to have ranged from about 20,000 to 30,000 mrems.

In comparison, as we shall see presently, the child thyroid radiation dose from radio-iodine-131 in the milk from a dairy near the Palisades plant was calculated to be about 2 mrems.

The erroneous impression that large quantities of iodine-131 were released was created by confusion of the terms "amount" and "rate". The relation between the two, of course, is

$$\text{amount} = \text{rate} \times \text{time}$$

To make clear the distinction between the two quantities, consider, as an example, a family having a net income of \$10,000 spending \$500 one Saturday afternoon between 1:00 and 5:00 p.m. The spending rate would be \$500/4 hours = \$1,095,000/year. Obviously this family could not keep up this rate of spending,

because the annual average rate of spending needs to be  $\$10,000/(365)(24) = \$1.15/\text{hr}$ .

Likewise, for radioactive releases, the annual average rate of release is set, which in turn determines the amount that can be released in one year. For the Palisades plant, the annual average rate of release of iodine-131 is determined from

$$\frac{Q_i}{\text{mCi}} = \frac{Q_i}{10^{-10} \frac{\text{Ci}}{\text{ml}} \frac{1}{700}} \leq 5 \times 10^{11} \text{ ml/sec},$$

in which  $Q_i$  is the annual average rate of I-131 release. The "700" factor takes into account that the radio-iodine-131 could be bioconcentrated by a cow grazing right at the fence line. The number  $10^{-10}$  microcuries/ml is the maximum permissible concentration in air at the N-plant fence line. This relation then gives  $Q_i = 2,200 \text{ mCi/yr}$ . Thus, an electric utility is legally required to keep I-131 release in one year below 2,200 millicuries, or 2,200,000 microcuries.

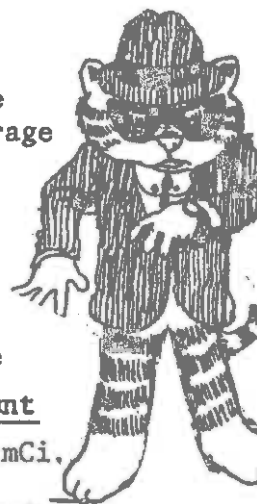
Legal requirements set by the AEC set not only the amount of iodine-131 that can be released in one year but also in addition restricts the rate at which it can be released. This additional legal requirements is stated explicitly in the Summary of Findings, Paragraph B, of the AEC report, dated Nov. 12, 1973, Docket No. 50-255.<sup>39</sup> It states:

Technical Specification 3.9.12 states that the gaseous release rate over any 15-minute period shall not exceed 10 times the yearly average limit.

Contrary to the above, radio-iodine release during purging of the steam generator on Aug. 15, 1973 appeared to have exceeded the 15-minute release limit by a factor between 9 and 60 (Paragraph 13.e).

Thus, it is clear from the above statement that the rate of release should not exceed  $R = 10Q_i = 0.71 \text{ microcurie/sec}$ . At this rate the amount released in any 15-minute period should not exceed  $(0.71)(60)(15) = 639 \text{ mCi}$ .

The second sentence in the AEC report states that the amount released in a 15-minute period could have been between 5,760 and 38,400 microcuries, Note, however, that these are small fractions of the annual legal limit of 2,200,000 microcuries.



The AEC report also indicates that the iodine-131 concentration in air was never alarmingly high. Its concentration inside the containment building, i.e., inside the power plant dome, was reported to have been about  $1.8 \times 10^{-8}$  microcuries/ml. The maximum permissible concentration inside the dome for occupational exposure is about  $9 \times 10^{-9}$  microcuries/ml. During the accident then for a short period of time, the iodine-131 concentration was only about twice the maximum permissible value.

Because of this fact, the radio-iodine-131 concentration in air at the site boundary was expected to be quite small. According to the AEC report, the maximum concentration was calculated to be  $40 \times 10^{-10}$  microcuries/ml, and the calculated average value was  $0.2 \times 10^{-10}$  microcuries/ml. The latter value is 20% of the legal limit.

The measured value was found to be  $0.0003 \times 10^{-10}$  microcuries/ml.

As further evidenced of the minimal public health hazard, consider the iodine-131 content in the milk from a nearby cow (1.5 miles away) shortly after the accident. The measurements given in the AEC report are as follows:

<u>Sample Date</u>	<u>I-131 (picocuries/liter)</u>
8/19	8.0
9/8	2.0
9/16	0.2

Because the bulk of the I-131 release took place on Aug. 15, it is reasonable to assume that the I-131 concentration peaked 4 or 5 days later, i.e., around Aug. 19.

The maximum allowed value in milk is taken to be 100 picocuries/liter.

The AEC report further notes that a child drinking this milk could have received a thyroid radiation dose of about 2 mrems. A point to be kept in mind is that milk contains about 1400 picocuries/liter of the naturally radioactive potassium-40, and that the radiation dose to the thyroids is about 20 mrems/yr. Or stated differently, the radiation dose of 2 mrems is the amount expected from watching color TV for one hour every day for one year.

As baseline data, consider the following results for milk, reported by the Michigan Department of Health back in 1963.<sup>40</sup>

Saginaw Milk		October 1963
Nuclide	Picocuries/liter	Source
Potassium-40	1300	Natural
Strontium-90	12	Bomb Tests
Iodine-131	20	Bomb Tests
Cesium-137	122	Bomb Tests
Ba-La-140	5	Bomb Tests

The AEC report indicates that the amount of iodine-131 released was about 180 millicuries. This is about 8% of the annual release limit.

#### Radioactive Hydrogen (Tritium) in the Environment

"Nuclear physical data indicate the cosmic ray neutrons produce C-14 and H-3 from atmospheric nitrogen, the radiocarbon being the principal product."

W. F. Libby, Phys. Rev. 69, 671 (1946) <sup>41</sup>

We shall examine here the question of whether or not the radioactive hydrogen isotope, tritium, released from nuclear power plants presents any serious water pollution problem for the Great Lakes area. The impression often given is that large quantities of tritium are produced and released into the Great Lakes waters. And associated with releases is the mistaken notion that the tritium will be reconcentrated up the food chain by biochemical processes. What we shall show is that the N-plant tritium releases at the present time are very small in comparison to the tritium production rate by cosmic ray neutrons and the amount already in the environment. Furthermore, not only is tritium not reconcentrated biochemically, there is evidence that living organisms tend to reject tritium, causing tritium concentration in human food to be less than in the environment.

In an attempt to assess the genetic radiation dose effects, we shall present a very rough estimate, indicating that even if tritium concentrations were to increase 20-fold over the present level (approximately 500 picocuries per liter of water at present), the radiation dose to the chromosomes would not be any larger than the radiation dose from the naturally occurring radiocarbon-14, which also exists naturally in the environment. Because of the critical role of carbon in constituting the "backbone" of genetic materials,

the baseline for radiation dose to the chromosomes should be the amount coming from radio-carbon-14.

It should perhaps be noted that some of these concerns stem from forgetting that radio-carbon-dating used in archeology depends upon the fact that the remains of living organisms, such as the body of an Egyptian Pharaoh or wood burned at an abandoned Indian camp site, contain a certain concentration of radio-carbon-14, which decreases with time.

As mentioned before, the baseline to assess the degree of radioactive contamination is the amount of natural radioactivity already present in the environment. For the case of tritium, it has, long before the advent of the A- and H-bombs, been one of the radioactive constituents of the atmosphere and of water.

Although there is some uncertainty in the rate of tritium production by cosmic ray particles, a reasonably good number seems to be about 1 tritium/cm<sup>2</sup>/sec. To put this quantity into somewhat concrete terms, consider the amount of tritium produced in the atmosphere over Michigan and therefore constantly "raining" down in Michigan, and flowing into the Great Lakes. The area of Michigan is about 58,200 square miles, making it about 151 billion square meters. Consequently, the amount produced over Michigan amounts to about 2,300 Ci/yr. For the last step, we used the fact that one gram of tritium is about 10,000 curies. If we take the area of the Great Lakes drainage basin to be about 10 times the area of Michigan, the amount collecting into the Great Lakes waters is about 20,000 curies per year.

Compared to this amount, the tritium discharges from nuclear plants are quite small. For example, the tritium releases from the Big Rock plant are in the neighborhood of 50 curies/year; the tritium discharges from the Palisades Plant are not much larger.

The existence of tritium in the environment and that its origin is in the earth's atmosphere were demonstrated by a series of interesting experiments carried out by S. Kaufman and W. F. Libby<sup>41</sup> before 1954, just prior to the test explosions of the H-bombs. They found that the tritium-hydrogen ratio in water varies between about  $1 \times 10^{-18}$  to about  $10 \times 10^{-18}$ . The first figure gives 0.003 picocuries/ml for the natural tritium concentration. The present



tritium concentration in the Great Lakes is about 0.5 picocuries/ml. The large increase resulted from the H-bomb tests carried out during the late 1950's and early 1960's.

To prove that tritium in water originates in the atmosphere, Kaufman and Libby measured the tritium content of bottled water, and in particular examined vintage wine, the idea being that in bottled water or wine, tritium is not produced so that the tritium content is expected to decrease with age. This was confirmed experimentally.

The oldest wines bottled around 1929 showed the least amount of tritium, or about one quarter that of the newer wines.

In passing, it should be noted that even in scholarly and sedate publications like the Physical Review, there are occasionally humorous comments.

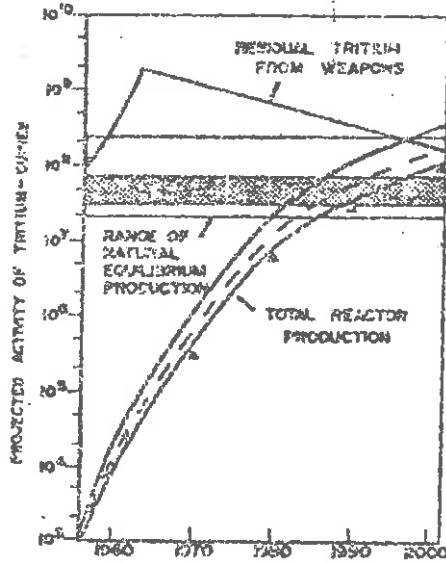
Kaufman and Libby concluded their paper with the following acknowledgements:

"The vintage wines were selected...and were furnished by the cooperation of vinters, wholesalers, and tax authorities. We wish to thank all of these and in particular Mr. William Widmer who furnished the New York wines."

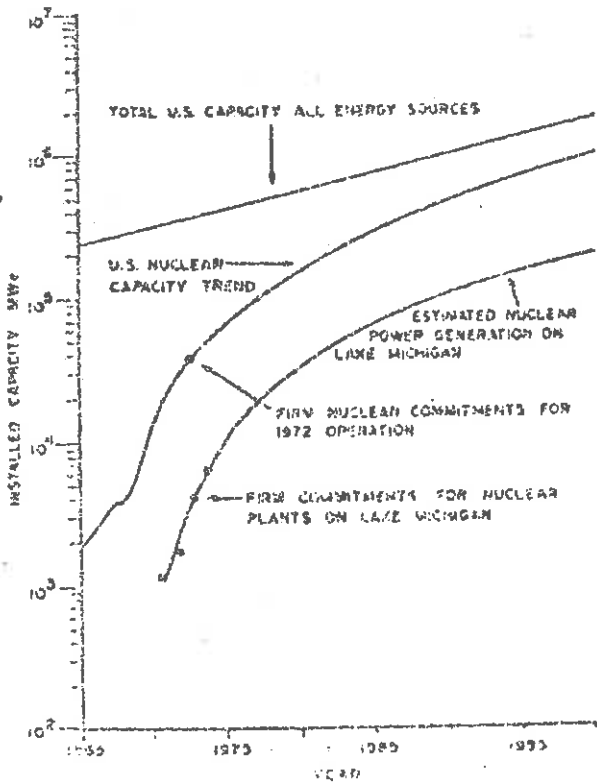
We should note next that the concern about tritium discharges into the Great Lakes is now new, and has been the subject of continued discussions and analyses for a number of years. Back in 1969, for example, Peterson, Martin, Weaver, and Harward<sup>43</sup> presented at an international conference in Vienna, a paper on the tritium accumulation in Lake Michigan. This paper is reproduced as Appendix 13 in the records of the Congressional Hearings held in 1969. The first figure, which was taken from page 765 of the Congressional Hearing record, shows the contribution of different sources to the world inventory of tritium. The cross-hatched band indicates the world inventory of tritium due to natural sources; this amount is about 80 million curies. The plot given by the broken lines near the top shows the tritium from thermonuclear bomb tests, i.e., from the H-bombs. Notice that in the early 1960's, the world inventory rose to a value exceeding a billion curies. The plot shows that the tritium coming from this source is slowly decreasing. The plot near the bottom shows the estimated contribution from nuclear fission plants. Keep in mind that these projections were made in 1969, and therefore the actual amount in the environment today coming from N-plants is substantially smaller. The second figure, taken from page 764 of the Congressional report, indicates

AH, GALLO  
REC, 1976.  
A FINE  
YEAR..

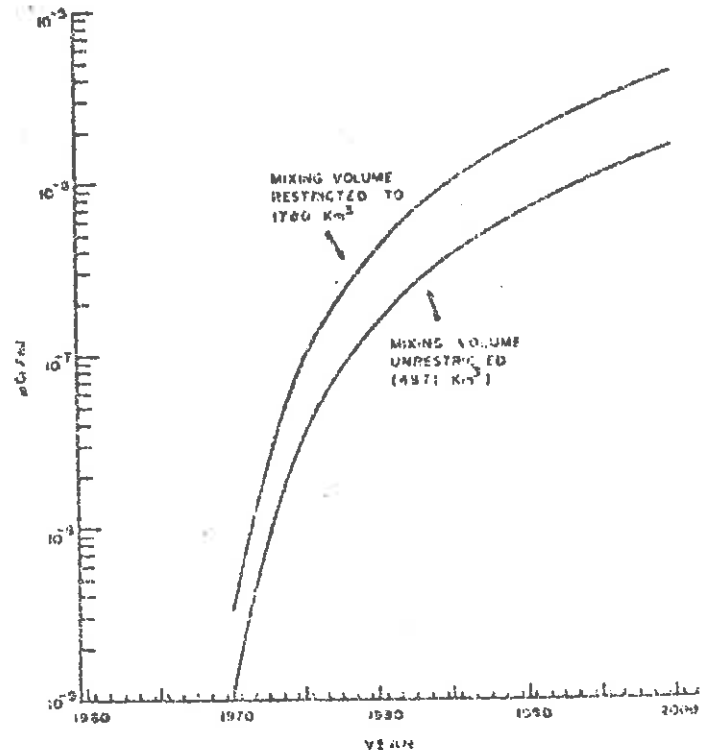




Comparison of tritium activity from: (a) natural production (wide range = all estimates; narrow range = most probable estimate); (b) residual weapons fall-out; (c) US reactor production; and (d) workable reactor production (A) estimated in Ref. [58].



Projected power generating capacity from nuclear reactors discharging into Lake Michigan in comparison with total US power projections [4].



Estimates of future tritium concentration in Lake Michigan from nuclear reactor operation. These values are in addition to tritium from fall-out and natural sources.

what the tritium concentration in Lake Michigan could become. The plot is based on the assumption that by year 2000 there will be about one hundred and eighty 1000 MWE nuclear power plants rimming Lake Michigan, and that each will release about 5,000 curies per year. Even for these high estimates, the increase in tritium concentration will amount to only a few tens of trillionths of a curie. The baseline number for Lake Michigan at present is about 0.5 picocuries per cubic centimeter.

When discussing the potential environmental impacts of tritium release, it is important to keep in mind that tritium is not bioconcentrated, as it is often mistakenly reported by some. The reason for this is that the biochemistry of living organisms cannot distinguish one isotope of an element from another. For example, the bioconcentration of Sr-90 takes place because the chemical effects of radioactive Sr-90 are the same as those of other stable Sr isotopes, so that Sr-90 is concentrated along with the stable Sr. On the other hand, hydrogen is not concentrated, because all cells live in water, so that tritium in turn is not bioconcentrated. There is, however, a small effect because the mass of the tritium nucleus is three times that of ordinary hydrogen. The net effect, fortunately, is for tritium to be rejected rather than to be assimilated. An example is the results published in the paper on "accumulation of tritium in various species of fish reared in tritiated water", by Patzer, Moghissi, McNelis in the IAEA publication<sup>44</sup> on the Environmental Behavior of Radionuclides Released in Nuclear Industry.

Tritium is sometimes considered to be relatively harmless as an external source of radiation because the average energy of the electron given off during its radioactive decay is only 5.7 keV. As we shall see, the electrons striking the surface of the TV picture tube is a much more potent external source of radiation. The beta-decay process takes place according to the relation



The beta particle energies vary from zero to its maximum value, and for tritium the average value is known to be about 01057 MeV, or about 5.7 keV. This is the energy that an electron would have if accelerated through a voltage of

5.7 kilovolts. The electron accelerating voltage of TV picture tubes vary from about 10 kV for black-and-white sets to about 20 kV for color sets,

Since the TV picture is known to be a source of X-rays (see, for example, J. Griffiths, Silent Slaughter<sup>45</sup> also Troubleshooting Color TV<sup>46</sup>, IEEE Spectrum, June 1975, p. 57) electrons stopped at the screen surface produce x-rays, and according to comments made earlier, the radiation dose from having color TV sets on for one hour every day is about 2 mrems per year.

An intriguing question then is "what is the tritium curie equivalent of the TV picture tube while it is on?" To simplify the analysis we shall not take into account that the energy of the tritium electrons is smaller than those of the TV set and focus only on the numbers of curies needed to produce the same number of electrons as in the picture tube beam current. This beam current is in the neighborhood of 100 microamperes. Since the electron charge is  $1.6 \times 10^{-19}$  coulombs, the rate of electrons striking the screen is about

$$\frac{100 \times 10^{-6}}{1.6 \times 10^{-19}} \sim 10^{15} \text{ electrons/sec.}$$

The number of curies needed to produce this many electrons is

$$\frac{10^{15}}{3.7 \times 10^{10}} \sim 3 \times 10^4 \text{ Ci.}$$

Thus, very roughly about 30,000 curies of tritium will need to be painted on the inside of the picture tube to produce the normal brightness and also the normal amount of X-rays. Stated differently, this means that the TV set, when on, is equivalent to a 30,000 curie source.

But what if tritium is inside the cell? In particular, what might be the effects to genetic materials if tritium is a part of it?

Unquestionably these are legitimate concerns, but again the effects need to be assessed against the baseline of the ubiquitous natural radioactivity. Radioactive materials occur not only in the environment outside of us, but also inside of us, even in the genetic materials we carry. It would be correct to say that even chromosomes are radioactive, because two of the essential constituent elements, namely carbon and hydrogen. The radioactive isotopes are carbon-14 and hydrogen-3, or tritium. And these radio-nuclides have existed naturally in the environment at least as long as the human race has existed.

The fact that carbon is radioactive is very well known in another context. The word is radiocarbon dating, and this method has been used to date archeological objects, such as the Egyptian mummies. The basic principle of radiocarbon dating depends upon the fact that the carbon-14 concentration of an organism at the time of death is the same as in the environment. This radiocarbon isotope is produced in the atmosphere by the neutron component of cosmic radiations interacting with nitrogen-14 in the atmosphere. The carbon-14 then becomes a part of the atmospheric carbon dioxide, is involved in part of the photosynthetic cycle, and eventually becomes a part of animal food. But once the organism dies, the intake of carbon-14 stops. To be sure there is a small amount of nitrogen in the animal remains, but the amount is infinitesimally small in comparison to that in the entire atmosphere. The carbon-14 radioactivity slowly decreases with time, and the age of mummies, or of the charred remains of an abandoned Indian camp site, can be determined from the amount of carbon-14 left in the dead organic material.

The specific activity of carbon in living biological substance is known to be about  $7.5 \pm 2.7$  picocuries per gram of carbon. The total carbon content of an average person is about 12.6 Kgm, so that the C-14 content is about 0.1 microcuries. Therefore that rate of carbon disintegration is about

$$0.1 \times 10^{-6} (3.7 \times 10^{10}) = 3.7 \times 10^3 \text{ disintegrations/sec.}$$

The protoplasm of a plant or animal cell contains about 75 to 85 percent of water, 10 to 20% of protein, 2 to 3% of lipid, 1% of carbohydrate and 1% of inorganic material. Carbon is tied up with the organic constituents of the cell and the genetic materials of DNA and RNA protoplasm. Consequently, a reasonable estimate of the carbon-14 disintegrations taking place in the DNA and RNA is about 300 disintegrations per second.

Like radio-carbon-14, tritium is also a natural constituent of the environment. As mentioned earlier, tritium is produced by cosmic ray neutrons, and the radioactivity of water from tritium before the advent of the H-bomb is estimated to have been between 5 and 20 picocuries per liter of water. We shall take 10 picocuries per liter as the average value. This gives 0.09 picocuries of tritium per gram of hydrogen. The amount of hydrogen in the average person is about 7000 grams, so that the tritium activity is about 630 picocuries, or about 0.000,63, microcuries, compared to the 0.1 microcuries

of carbon-14. We estimate that about 3% of the DNA and RNA weight is hydrogen. This estimate was obtained by noting that a nucleotide, a basic building block of the RNA and DNA, consists of about 10 hydrogens, 1 phosphorus, 6 oxygens, 5 nitrogens, and 10 carbons. Since genetic materials constitute about 1% of the cell protoplasm, and of the genetic materials only 3% is hydrogen, we estimate that about 0.3% of the total body hydrogen is associated DNA and RNA, giving 0.000,002 microcuries for the tritium contribution to the chromosome radioactivity. The tritium disintegration rate for the above quantity is very roughly 0.1 disintegrations per second.

Thus, this rough analysis suggests that even a 1000-fold increase over the natural tritium concentration would yield genetic radiation effects only comparable to those of radio-carbon-14. A thousand times 10 picocuries per liter gives 10,000 picocuries per liter, which is about 20 times the tritium activity in the Great Lakes waters. The tritium concentration in the Great Lakes water is about 500 picocuries per liter.

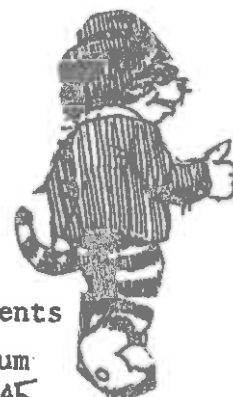
The following table then is intended to put the cellular tritium radiation effects into perspective:

	picocuries per liter water
Before H-bomb tests	10
Tritium equivalent of carbon-14	10,000
Great Lakes tritium (after H-bomb tests)	500
Fish experiments (tritium rejected)	1,000,000
Mutation experiments	100,000,000,000

These numbers speak for themselves. The number for the fish experiments was taken from the paper by Patzer, Moghissi, and McNelis,<sup>44</sup> who kept tritium concentration in aquaria and pools at 1 nanocurie per milliliter. Wimber,<sup>45</sup> in his paper on the Effects of Intracellular Irradiation with Tritium, indicates that lethals were looked for in larvae grown on 100 microcuries per milliliter culture media.

The point to be made is that the observation on the biological effects of tritium were made in solutions with enormously high concentrations of tritium compared to those found in the environment and to be expected in the foreseeable future.

THAT'S ALL,  
FOLKS.



## REFERENCES

1. e.g., O. Oldenberg and N. C. Rasmussen, Modern Physics for Engineers (McGraw-Hill, New York, 1966)
2. C. M. Lederer, J. M. Hollander, and I. Perlman, Table of Isotopes, 6th Edition (John Wiley, New York, 1968)
3. Radiological Health Handbook
4. D. Steiner, Nuc. Sci. Eng. 58, 107 (1975)
5. J. McPhee, The Curve of Binding Energy (Ballantine, New York, 1975)
6. J. Duderstadt and L. Hamilton, Nuclear Reactor Analysis (John Wiley, New York 1976)
7. W. J. Price, Nuclear Radiation Detection (McGraw-Hill, New York, 1964)
8. R. Hewlett, Nuclear Navy ( , 1974)
9. R. Lapp and H. L. Andrews, Nuclear Radiation Physics (Prentice Hall, 1972)
10. D. J. Rees, Health Physics (MIT Press, 1967)
11. K. Z. Morgan and J. E. Turner, eds., Principles of Radiation Protection (John Wiley, New York, 1967)
12. early history of radiation effects
13. L. S. Taylor, Radiation Protection Standards
14. G. F. Knoll, Nuclear Measurements (John Wiley, New York, 1977)
15. The Natural Radiation Environment, USAEC Pamphlet (1970)
16. J. C. Ayers, Lake Michigan Environmental Survey, Special Report No. 49, November, 1970
17. M. Eisenbud, Environmental Radioactivity, 2nd Ed. (Academic Press, 1973)
18. J. A. Leiberman, Physics Today 24, 32 (1971)
19. S. Wiedner, J. E. Logsdon, and C. P. Froom, Rad. Data and Rep. 13, No. 3 (1972)
20. Lapp and Andrews, op. cit.
21. Rees, op. cit.
22. Morgan and Turner, op. cit.
23. J. Shubert and R. E. Lapp, Radiation (Addison Wesley, 1975) Ch. 7

24. J. Lamarsh, Introduction to Nuclear Engineering (Addison Wesley, 1975)
25. E. Ernst, T. Tigyi, A. Niedetzky, Conf. on Peaceful Uses of Atomic Energy (IAEA, Geneva, 1958) Vo. 24, p. 189
26. M. Eisenbud, op. cit.
27. D. F. Rees, Health Physics (MIT Press, 1967)
28. R. A. Copeland, R. H. Beethe, W. W. Prater, Trace Element Distributions in Lack Michigan Fish, March, 1973
29. R. J. Garner, Transfer of Radioactive Materials from the Terrestrial Environment to Animals and Man
30. NAS-NRC Report on The Effects on Population of Exposure to Low Levels of Ionizing Radiation, November, 1972
31. M. Eisenbud, Nuclear Power and the Public
32. M. Eisenbud and H. G. Petrow, Science 144, 288 (1964)
- 33.
34. Background Material for the Development of Radiation Protection Standards, Report No. 5, U.S. Federal Radiation Council, 1964
35. G. L. Stigall, T. W. Fowler, and H. L. Krieger, Health Physics 20, 593 (1971)
36. M. Eisenbud and H. G. Petrow, op. cit.
37. USAEC Docket No. 50-255, November 12, 1973 (addressed to R.L. Haueter, Consumers' Power Company)
38. Title 10 of the Code of Federal Regulations, Part 50, Appendix I
39. USAEC Docket No. 50-255, November 12, 1973 (addressed to R. L. Haueter, Consumers' Power Company)
40. Michigan Milk Network, November 1962-December 1964, Rad. Health Data 6, 487 (1965)
41. W. F. Libby, Phys. Rev. 69, 671 (1940)
42. S. Kaufman and W. F. Libby
43. H. T. Peterson, J. E. Martin, C. L. Weaver, E. D. Haward, Congressional Hearings, 1969, Appendix 13



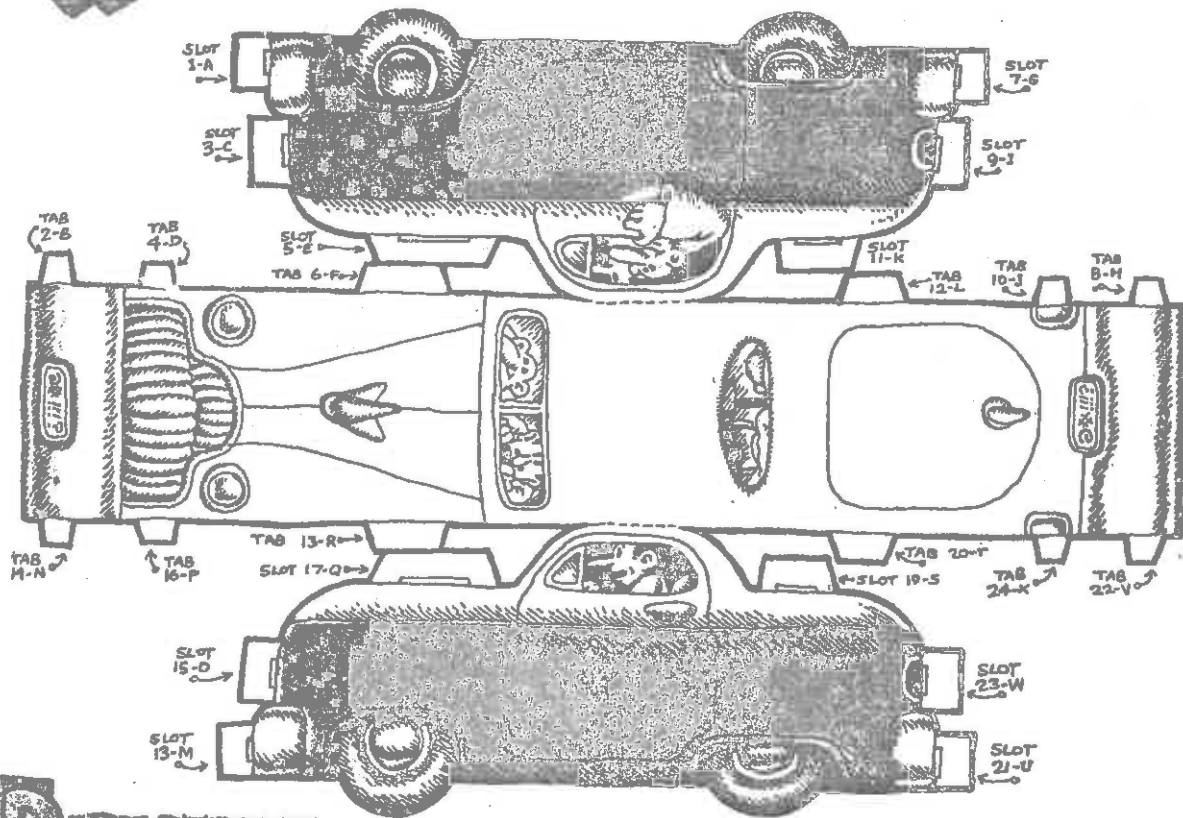
44. R. G. Patzer, A. A. Moghissi, D. N. McNeilis, Environmental Behavior of Radionuclides Released in the Nuclear Industry (IAEA, 1973) p. 403
45. D. E. Wimber, Adv. Rad. Biology 1, 85 (1964)

**HERE THEY COME!!**  
 It's your favorite comic characters,  
**MR. NATURAL** and **FLAKEY FOOT**  
 in their very own

# AUTOMOBILE



**A REAL NIFTY MODEL "BUSINESS COUP" EXACTLY AS PICTURED ABOVE, WITH THOSE TWO LOVABLE NUTS, MR. NATURAL AND FLAKEY FOOT, RIDING INSIDE!!**  
 TAKES ONLY A FEW MINUTES TO ASSEMBLE THIS BEAUTIFUL, AUTHENTICALLY DETAILED SCALE MODEL!



## DIRECTIONS

**READ AND FOLLOW DIRECTIONS CAREFULLY TO AVOID MISTAKES!**

FIRST, FIND AN EMPTY CEREAL BOX OR ANY PIECE OF CARDBOARD THAT CAN BE CUT WITHOUT DIFFICULTY. A SHARP CARDBOARD WILL DO. CUT BACK COVER OFF OF YOUR MR. NATURAL COMIC BOOK AND MOUNT ON CARDBOARD WITH ELMERS GLUE, ALLOWING SUFFICIENT TIME FOR IT TO DRY OUT COMPLETELY.

CAREFULLY CUT OUT THE AUTOMOBILE, BEING SURE TO FOLLOW THE HEAVY BLACK OUTLINE AROUND THE EDGE.

CUT OUT LOWER HALF OF REAR LICENSE PLATE. CUT OUT ALL SLOT AREAS SHOWN BY POKING A SHARP KNIFE POINT OR SCISSOR BLADE THROUGH THEM, BEING CAREFUL NOT TO CUT TOO WIDE A SLOT AS TO CUT THE ENTIRE SLOT OFF ON ONE SIDE OR THE OTHER.

NOW YOU ARE READY TO BEGIN FOLDING. FIRST FOLD SIDES OF AUTOMOBILE DOWN FROM ROOF ALONG DOTTED LINES. THESE ARE SHARP FOLDS. NEXT FOLD FRONT AND REAR DOWN FROM ROOF, MAKING "SOFT" FOLDS TO ALLOW FOR CURVING SLOPE OF STREAMLINE DESIGN. "SOFT" FOLDING HERE IS VERY IMPORTANT FOR THE AUTHENTICITY OF THE MODEL. FOLD FRONT OF HOOD DOWN, MOLDING THE CURVE OF THE HOOD WITH THE FINGERS. DO THE SAME WITH THE REAR TRUNK AREA.

FOLD THE TOP LINE OF THE FRONT BUMPER UP, CREATING IT AGAINST THE GRILL AREA. THEN FOLD CURVED AREA OF BUMPER DOWN TO FORM THE ROUNDED CURVE OF THE BUMPER. DO THE SAME WITH REAR BUMPER. DON'T FORGET TO "SOFT" FOLD FOR CURVED EFFECT ON REAR BUMPER ALSO.

... THE MAJOR FOLDING HAVING BEEN COMPLETED. YOU CAN BEGIN

CONNECTING THE SLOTS AND TABS.

IF YOU FIND YOU ARE HAVING DIFFICULTY INSERTING CERTAIN TABS INTO CERTAIN SLOTS, AND THE DIFFICULTY IS NOT ENTIRELY YOUR OWN FAULT, BUT CAUSED BY MISCALCULATIONS IN THE PLACEMENT OF THE SLOTS AND TABS BY THE DESIGNER OF THE AUTOMOBILE, YOU MAY FIND IT NECESSARY TO MAKE ADJUSTMENTS BY EITHER TRIMMING THE TABS OR ALTERING THE SLOTS TO MAKE THEM FIT BETTER.

FIRST FOLD ALL SLOTS AND TABS INWARD, SO AS TO MAKE THEM TUCK UNDER THE OUTER SURFACE OF THE AUTOMOBILE, THIS HIDING THEM FROM VIEW. INSERT TABS OVER SLOTS.

NOW INSERT TAB 6-F INTO SLOT 5-E. INSERT TAB 13-R INTO SLOT 17-Q. INSERT TAB 20-T INTO SLOT 19-S. INSERT TAB 4-D INTO SLOT 3-C. INSERT TAB 10-P INTO SLOT 15-O. INSERT TAB 10-J INTO SLOT 9-I. INSERT TAB 24-K INTO SLOT 23-W.

NOW INSERT TAB 2-B INTO SLOT 1-A. INSERT TAB 14-N INTO SLOT 13-M. INSERT TAB 8-H INTO SLOT 7-G. INSERT TAB 22-V INTO SLOT 21-U.

AT THIS POINT, IF THE DIRECTIONS HAVE BEEN READ CORRECTLY AND FOLLOWED CAREFULLY AND IF THE AUTOMOBILE WAS DESIGNED CORRECTLY IN THE FIRST PLACE, WHICH IS SOMEWHAT UNCERTAIN, YOU SHOULD HAVE YOUR COMPLETED MODEL AUTOMOBILE, WHICH CAN NOW BE PLACED PROUDLY ON DISPLAY ON YOUR DESK OR BOOKSHELF.

## CHAPTER 6

### NUCLEAR POWER GENERATION

#### 6.1. The Nuclear Steam Supply System

Nuclear power reactors are designed to produce heat which can then be used to generate electrical energy, usually by way of an associated steam thermal cycle. In this sense the primary function of a reactor is really just that of an exotic heat source for turning water into steam. Aside from the nuclear reactor and its associated coolant system, nuclear power plants are remarkably similar to large fossil fuel fired power plants. Only the source of the heat energy differs-- nuclear fission versus chemical combustion. Hence most of the components of large central station power plants are common to both nuclear and fossil fuel power units. A very crude diagram of the major components of an electrical power plant is given in Figure 6-1 . As we have sketched this diagram, the steam supply system could be either a fossil-fuel-fired boiler or a nuclear reactor and its associated coolant loops.

The current generation of power plants operate on a steam cycle (a so-called Rankine cycle) in which the heat generated by combustion or fission is used to produce high temperature, high pressure steam. This steam is then allowed to expand against the blades of a turbine. In this way, the latent energy of the steam is converted into the mechanical work of turning the turbine shaft. This shaft is connected to a large electrical generator that converts the mechanical turbine energy into electrical energy that can then be distributed over an electrical power grid. The low pressure steam leaving the turbine must be recondensed into liquid in a steam condenser so that it can be pumped back to the steam supply system to complete the cycle. The condenser requires large quantities of ambient temperature cooling water which is usually obtained from artificial cooling ponds or cooling towers.

This is a very oversimplified description of the major components of a power plant, but it does serve to illustrate that these components are quite similar for both nuclear and fossil-fueled stations. Actually as

BUT THEY BOTH  
LOOK THE SAME  
TO ME!

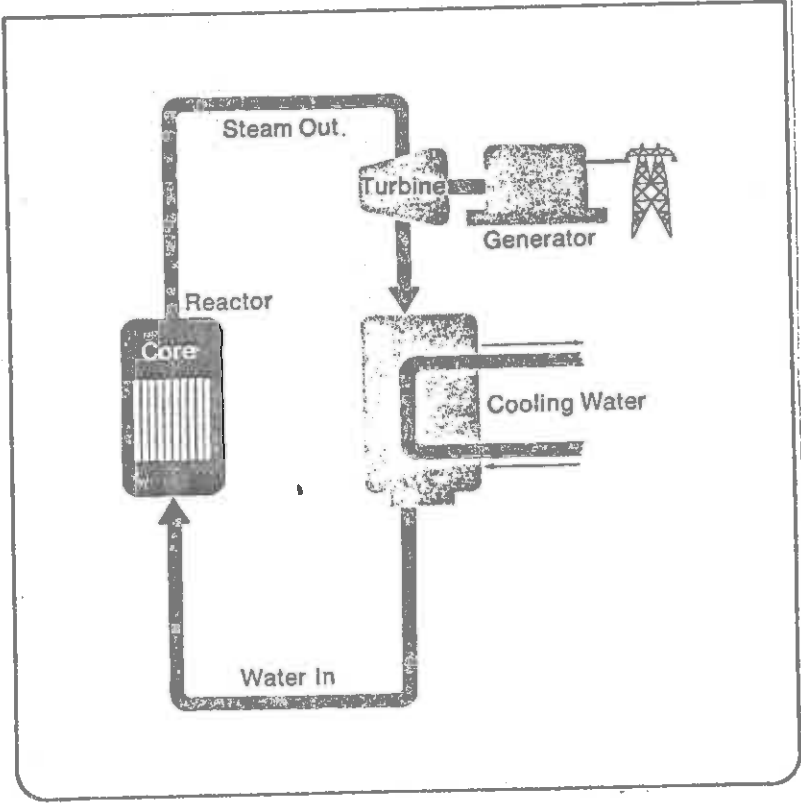
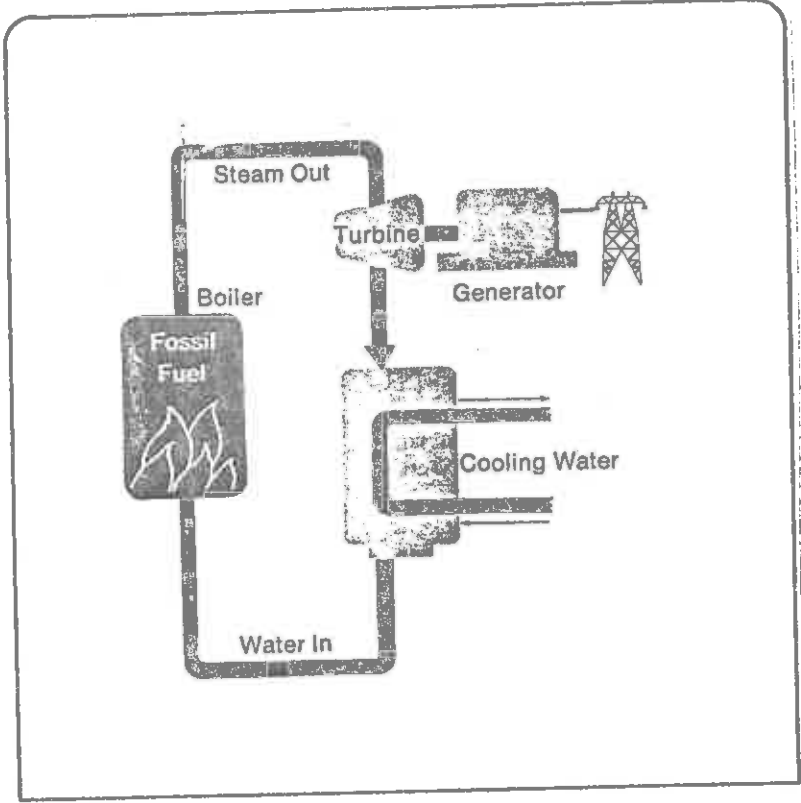


Figure 6-1: Components of Electrical Generating Plants

far as the steam cycle itself is concerned, the primary difference between these two types of plants is that the fossil-fueled units supply slightly higher temperature, higher pressure steam, thereby reducing the design requirements on the turbine (although as pollution abatement equipment drag down the efficiency of fossil fueled units, while advanced reactor types such as the high temperature gas cooled reactor or the liquid metal cooled fast breeder increase the "quality" of the nuclear supplied steam, these differences will eventually disappear).

At the center of a nuclear plant is the nuclear steam supply system (NSSS) which produces the steam used to run the turbine-generator. The NSSS consists of three major components: (i) the nuclear reactor which supplies the fission heat energy, (ii) several primary coolant loops and pumps which circulate a coolant through the nuclear reactor to extract the fission heat, and (iii) heat exchangers or steam generators which use the heated primary coolant to turn feedwater into steam. The NSSS in a modern nuclear power plant is completely enclosed within a containment building designed to prevent the release of radioactivity to the environment in the event of a gross failure of the primary coolant system. This nuclear island within the plant is the analogue to the boilers of a fossil-fueled unit.

At the heart of the NSSS is the nuclear reactor. Far from being just a simple "pile" of fuel and moderator a la Fermi, a modern power reactor is an enormously complicated system designed to operate under the most severe conditions of temperature, pressure, and radiation. The energy released by nuclear fission reactions appears primarily as kinetic energy of the various fission fragments. The bulk of this fission product energy is rapidly deposited as heat in the fuel pellet very close to the location of the fission event. This heat is then transported via thermal conduction across the fuel pellet and then across the metal clad containing the fuel to the coolant. The mass motion of the coolant then carries the thermal energy up and out of the reactor core either as sensible heat (i.e., temperature increase) or as latent heat (i.e., thermally-induced phase change--boiling).

The transfer of the fission heat energy from the fuel pellet to the coolant involves a thermal conduction process driven by the temperature difference between the pellet and the coolant. To achieve the large thermal power output characteristic of modern power reactors requires enormous temperature differences across the fuel element (see Figure 6-2). The coolant temperature in the reactor is limited by turbine or condenser design--for example, the average coolant temperature in LWRs is around 300 °C. This implies that in order to achieve the maximum power output from a given core design, one must operate the reactor fuel at as high a temperature as possible, consistent with melting limitations. For this reason the fuel of modern power reactors is fabricated of ceramic materials such as  $UO_2$  or UC which are characterized by very high melting temperatures (2800 °C). Nevertheless, the power densities achieved in power reactors are sufficiently high that the fuel pellet centerline (where the maximum fuel temperatures usually occur) could approach its melting point if care is not taken in the reactor design or operation. It should be stressed that nothing catastrophic will happen if a few (out of the hundreds of thousands) of fuel pellets in a reactor core temporarily exceed melting temperatures. Rather fuel elements subjected to temperatures sufficiently high to induce centerline fuel melting will experience a somewhat higher probability of failure--swelling or cracking of the clad leading to some fission product release into the coolant--and for this reason considerable care is taken to ensure that these limits are not exceeded during normal operating conditions.

A somewhat more serious situation could occur if coolant flow through the core were stopped, say, due to a rupture in the primary coolant system or a flow blockage within the core. Although such loss of coolant accidents (LOCA) are easily detectable allowing for immediate shutdown of the fission chain reaction, the radioactive fission products which continue to decay in the fuel after reactor shutdown will generate a significant amount of heat which must be removed if fuel temperatures are to be kept below melting. For this reason auxiliary cooling systems are always provided which are capable of cooling the reactor core in the event of failure of the primary system. We will return to discuss



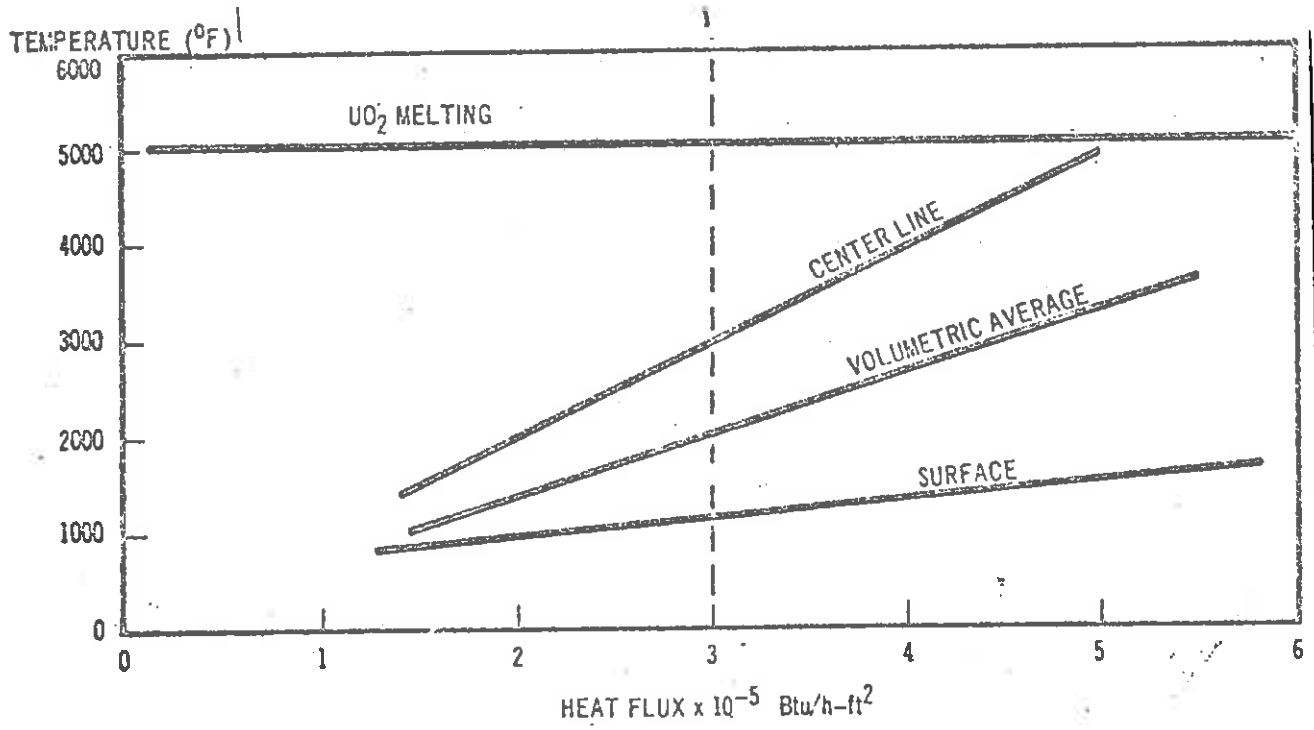
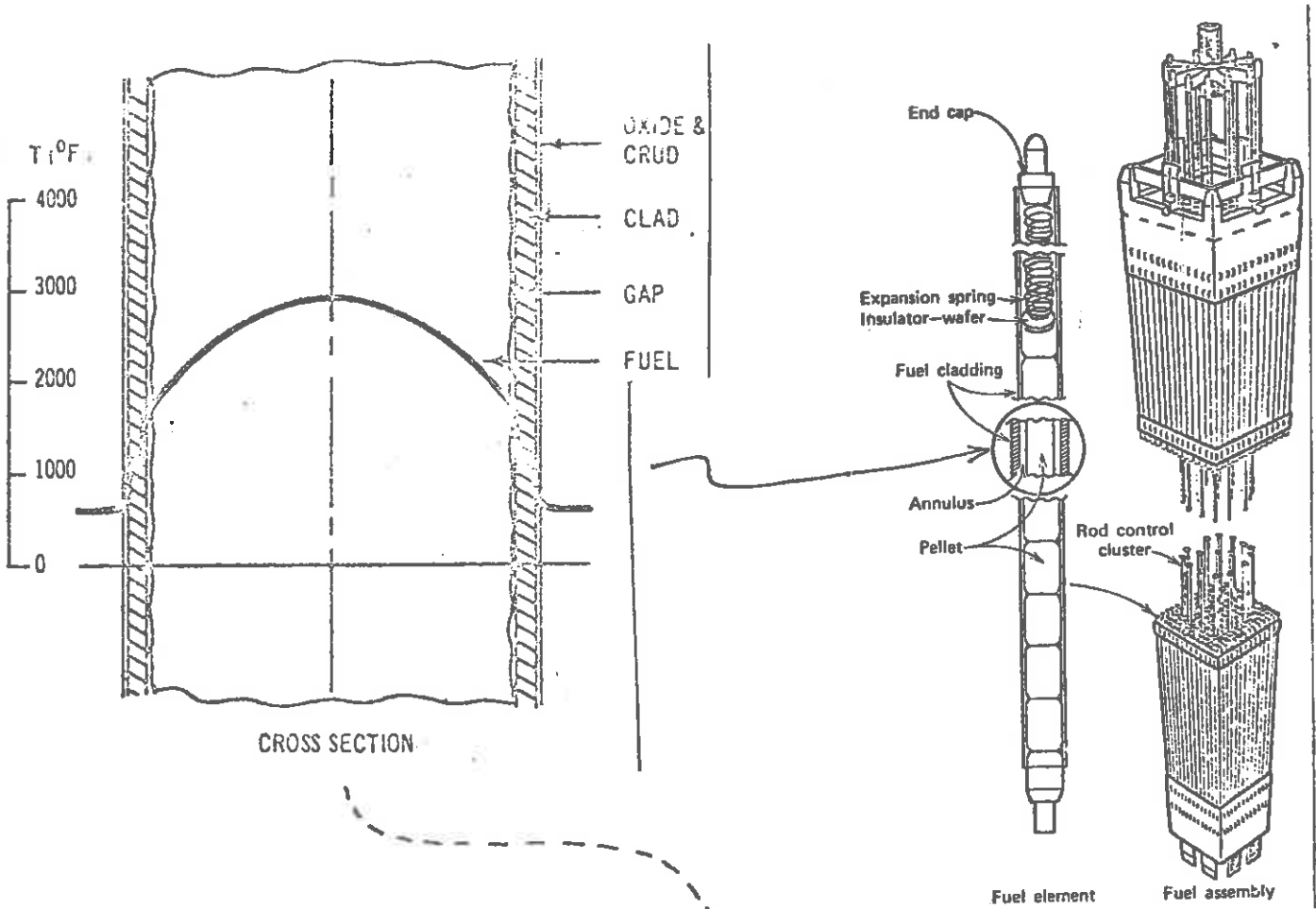


Figure 6-2: Temperature Variations Across Reactor Fuel Elements

such emergency core cooling systems (ECCS) in great detail when we consider the subject of nuclear reactor safety later in this chapter.

### 6.1.1. STEAM GENERATION--THE PRIMARY LOOP

The fission heat energy produced in the nuclear reactor core is converted first into mechanical energy by a thermal cycle in which a fluid is vaporized by the fission heat energy, then expands against the blades of a turbine to produce mechanical energy, and is finally recondensed into liquid again before being pumped back through the cycle. The turbine is used to power an electrical generator to convert this mechanical energy into electrical energy. In essentially all large nuclear power plants, the "working fluid" used to drive the turbine is high temperature steam. The nuclear steam supply system then plays the role of a "boiler" in the power plant.

Of course there is considerable variation among the NSSS characterizing different reactor types. For example, one may actually produce the steam in the reactor core itself, as in a boiling water reactor, or one may use a single phase primary coolant, as in pressurized water reactors or liquid metal cooled fast breeder reactors, to transfer the fission heat energy to a heat exchanger outside the reactor pressure vessel where it is used to produce steam. We will discuss briefly the actual components comprising the NSSS and their functions by considering several specific examples.

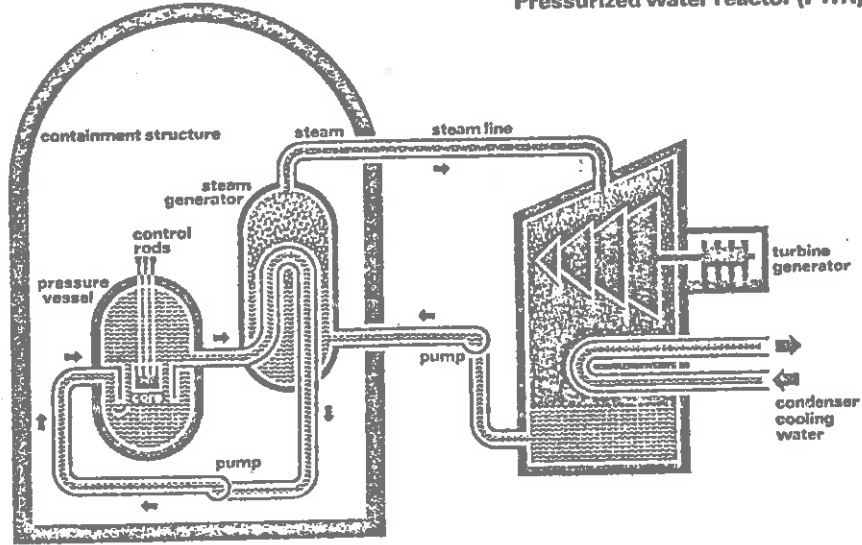
#### Pressurized Water Reactors

In a pressurized water reactor, water serves as both coolant and moderator. But its functions as a primary coolant and a working fluid are separated by using a multiple loop cooling system as shown in Figure 6-3. In the primary coolant loop water is kept under very high pressure ( $\sim 155$  bar) to allow high coolant temperatures without steam formation (aside from a small amount of subcooled boiling to facilitate heat transfer). The heat transported out of the reactor core by the



Figure 6-3: Nuclear Steam Supply Systems for Light Water Reactors

Pressurized water reactor (PWR)

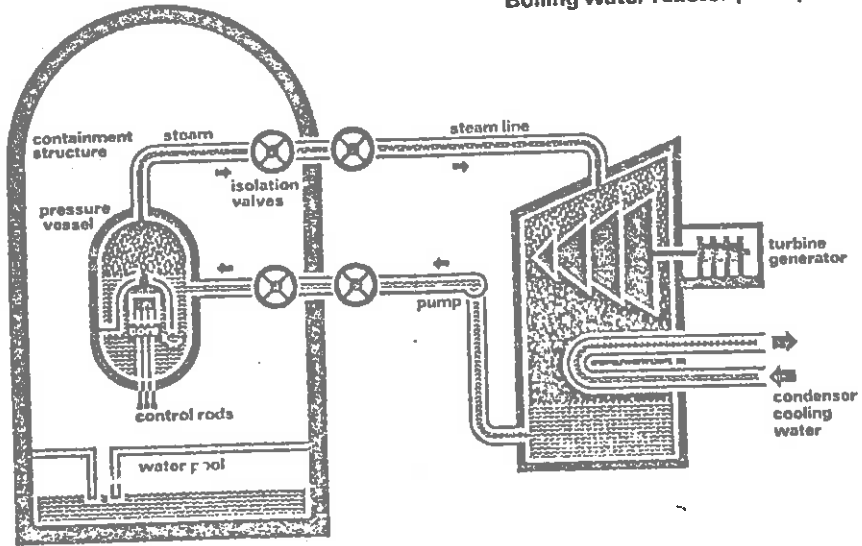


BUT COULDN'T FISSION PRODUCTS LEAKING INTO THE COOLANT BE CARRIED OUT OF CONTAINMENT IN A BWR?



DON'T WORRY! FAST ACTING ISOLATION VALVES WILL CLOSE IF RADIOACTIVITY BUILDS UP IN THE COOLANT.

Boiling water reactor (BWR)



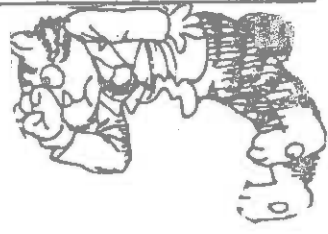
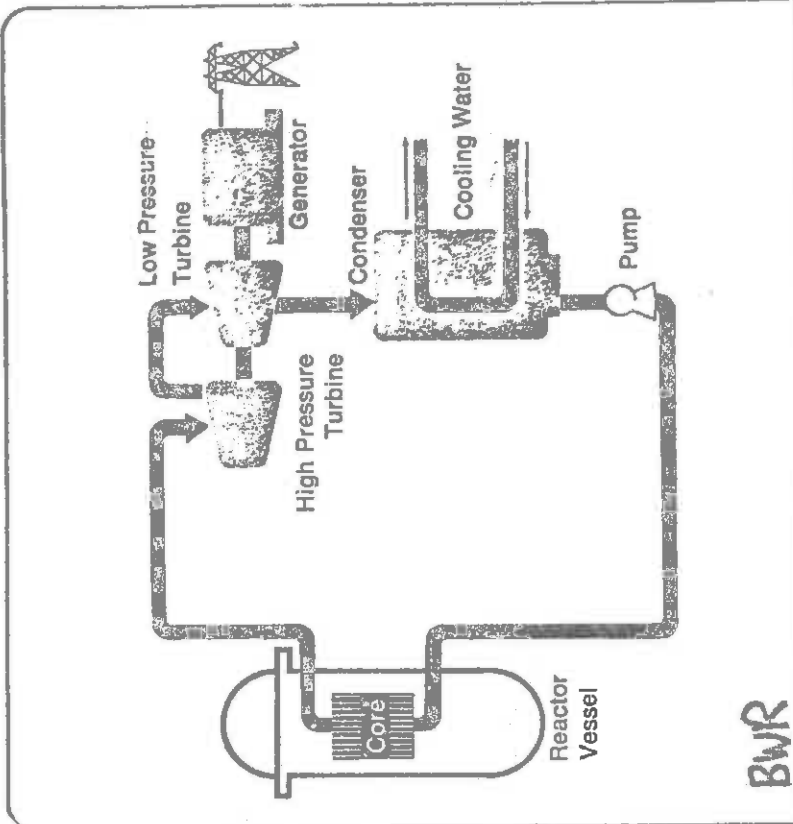
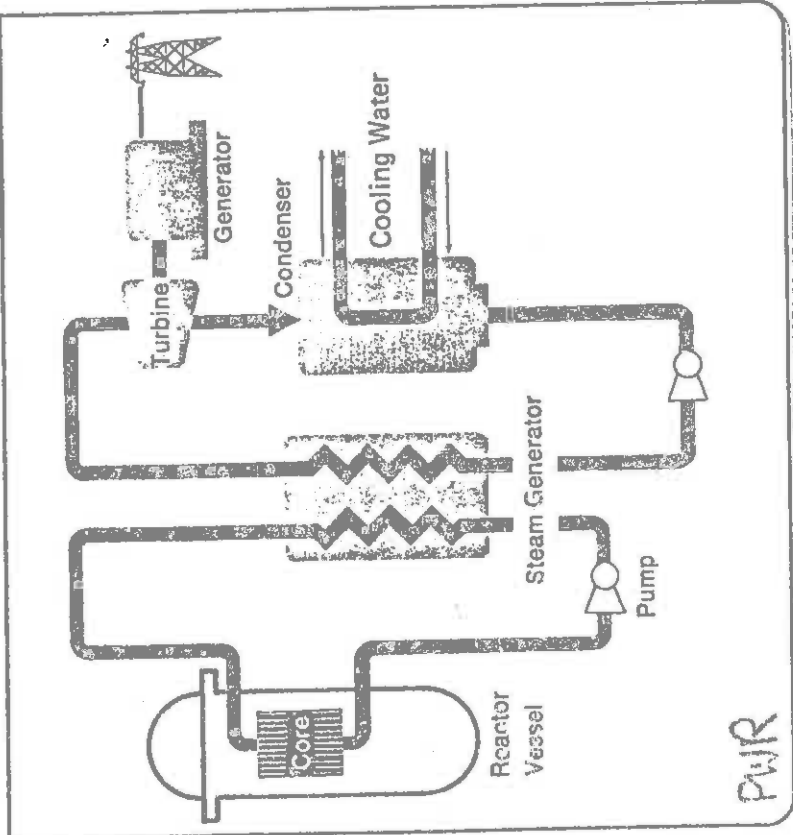
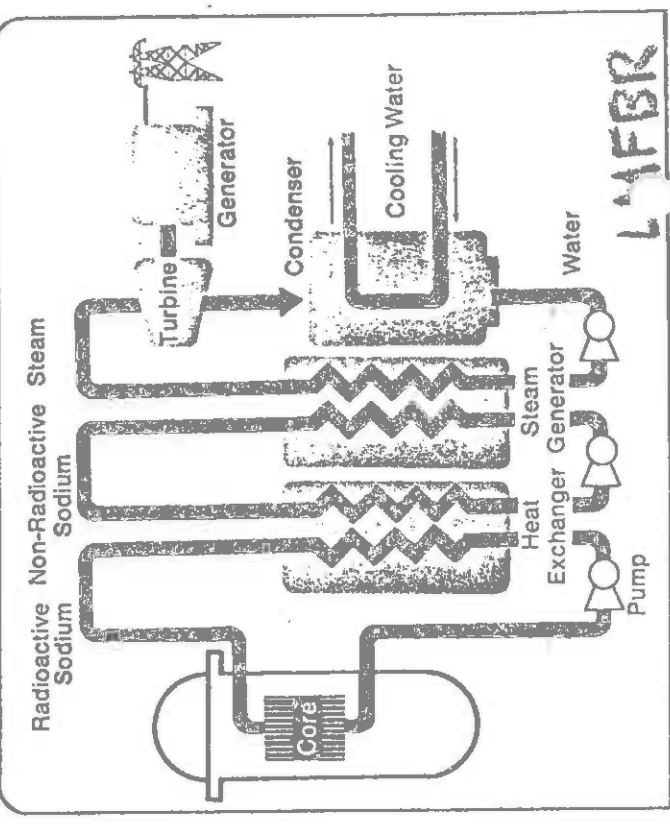
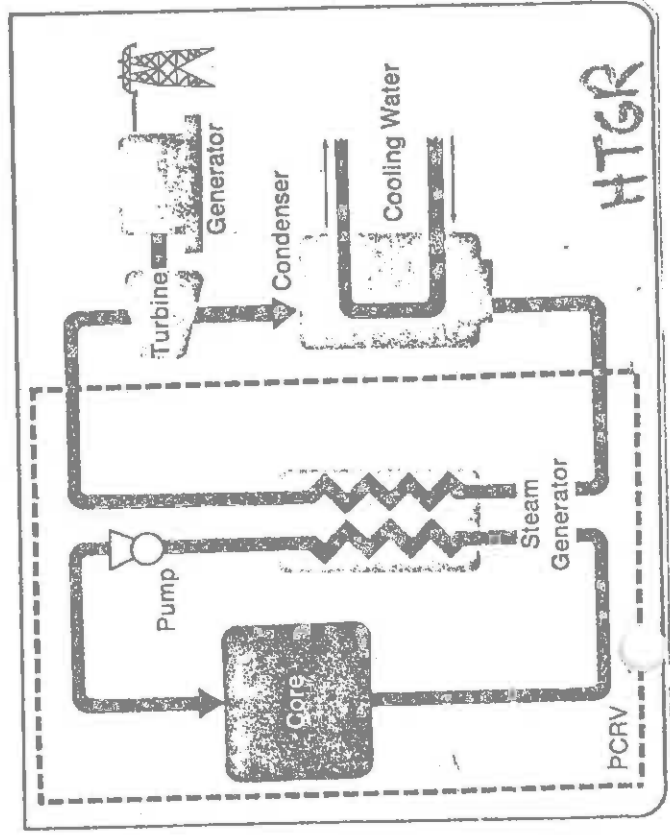


Figure 6-3a: Principal Types of Nuclear Steam Supply Systems



HTGR

primary coolant is then transferred to a secondary loop containing the working fluid by a heat exchanger known as a steam generator since it is within this component that the inlet feedwater is converted into steam. In addition a surge chamber or pressurizer is added into the primary coolant loop (see Figure 6-4) to maintain the very high system pressure as well as to accommodate coolant volume changes in the primary loop. The primary coolant loop also contains primary coolant pumps, as well as auxiliary systems to control coolant purity, to inject makeup primary coolant water, and so on.

The reactor core itself, the structures which support the core fuel assemblies, control assemblies, coolant circulation channels, and radiation shields are all contained in the reactor pressure vessel. The pressure vessel is designed with inlet and outlet nozzles for each primary coolant loop. The cap or head of the vessel is designed so that it can be removed for refueling and maintenance. The vessel is fabricated out of low alloy carbon steel designed to accommodate the high coolant pressures and temperatures, as well as to withstand radiation damage from fast neutrons and gammas which escape the core. A "thermal" shield is inserted between the core and the pressure vessel to protect the vessel from excessive radiation flux and to reduce the thermal stresses in the vessel resulting from gamma heat deposition. This also serves to form an annular flow channel which routes coolant to the core.

The internal structure of the reactor vessel includes lower and upper support structures as well as instrumentation support structure. The lower core structure supports the core barrel, the lower core plate and support column (and thereby the core fuel assemblies) and the thermal shield. It also provides passageways for coolant flow and facilitates coolant flow distribution.

Since the primary coolant in a PWR does not serve as a working fluid and remains in its liquid phase at all times, large heat exchangers are required to generate steam in the secondary loop. Such steam generators use the heat drawn off the core by the primary coolant (pressurized water) to convert lower pressure feedwater in the secondary loop

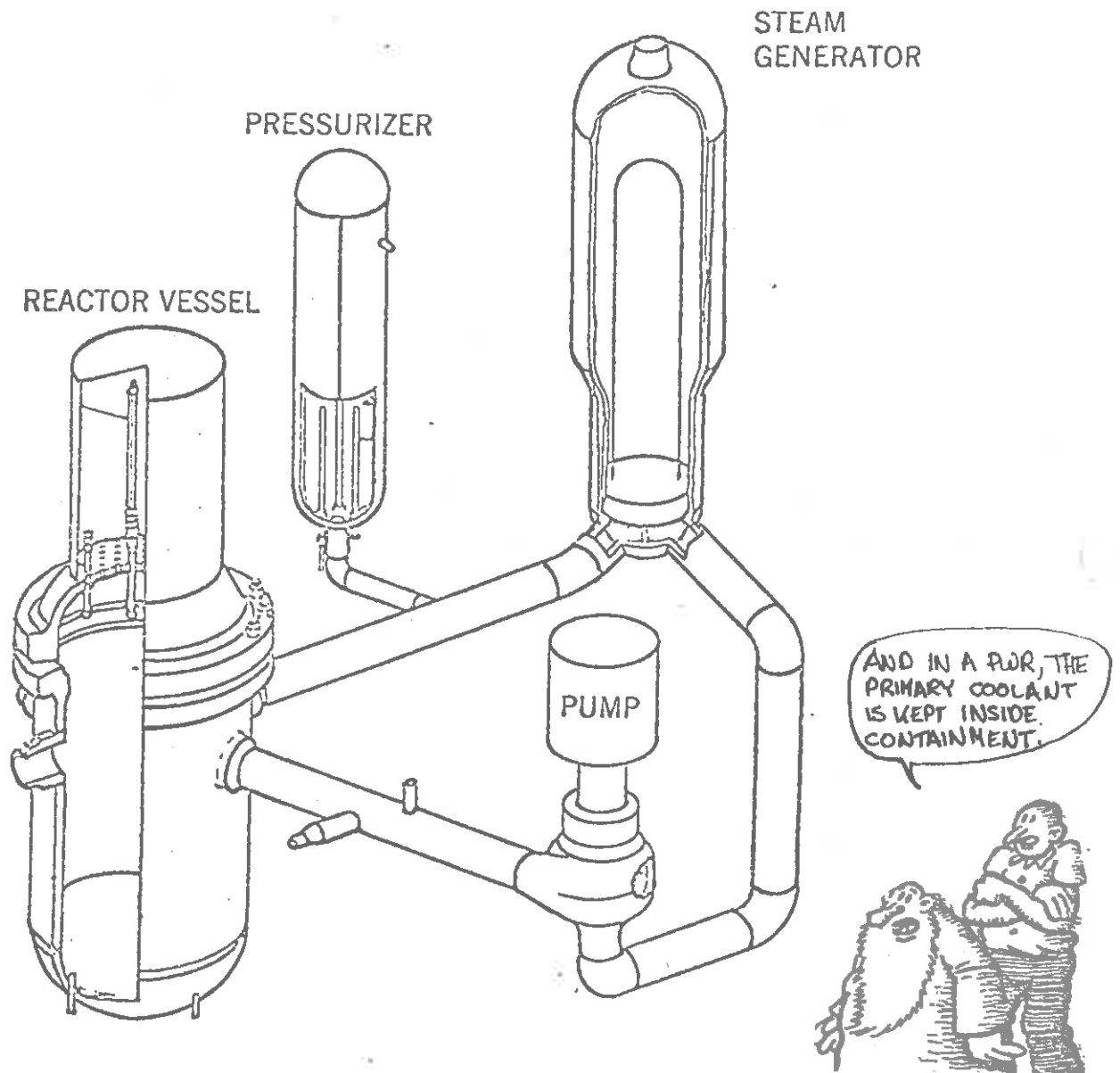
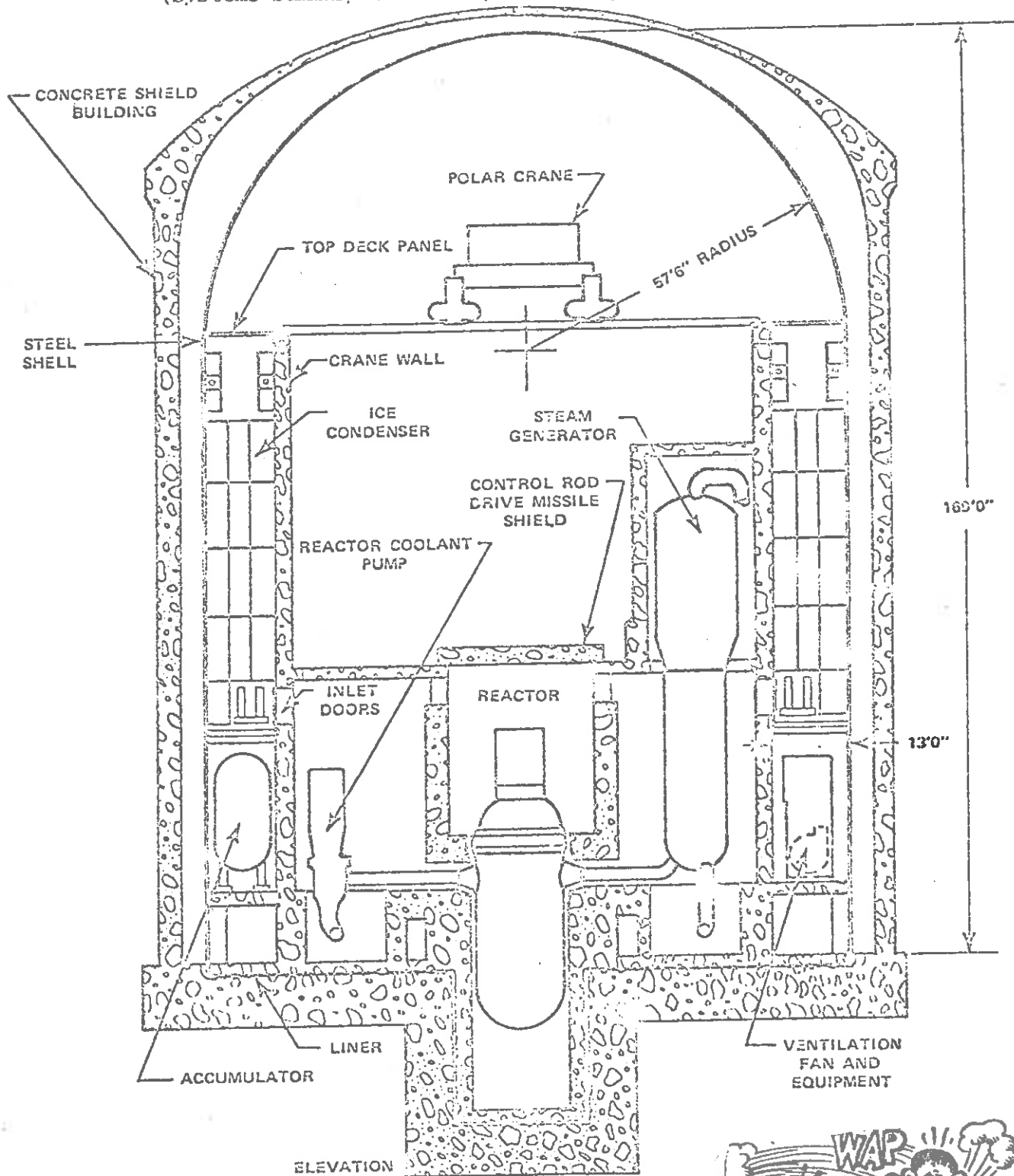


FIGURE 6-4: A Nuclear Steam Supply System including a nuclear reactor, a coolant loop, and a steam generator (Systems Summary of a Westinghouse PWR Nuclear Power Plant, G. Masche, 1971)

FIGURE 6-5: Cross section of the Westinghouse PWR nuclear steam supply system (inside of its containment structure)  
 (Systems Summary of Westinghouse PWR, G. Masche, 1971)



SEE ALL THAT CONTAINMENT, BOY?



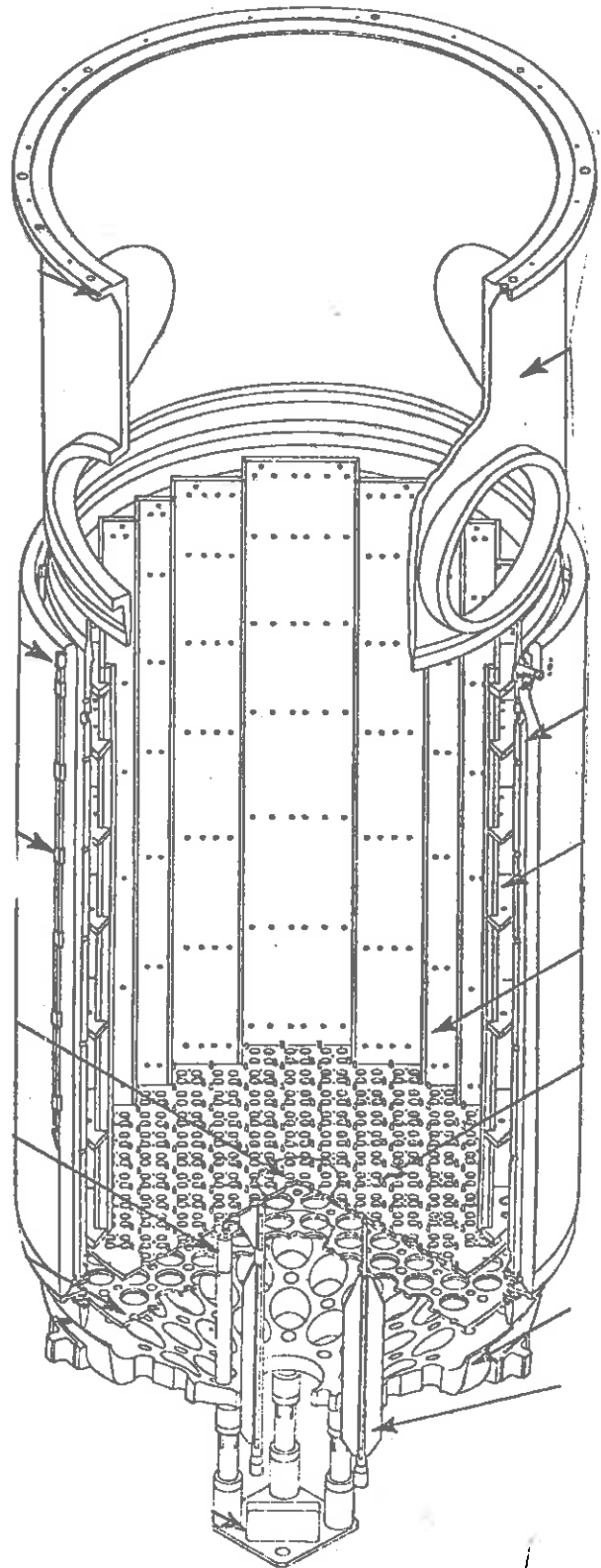
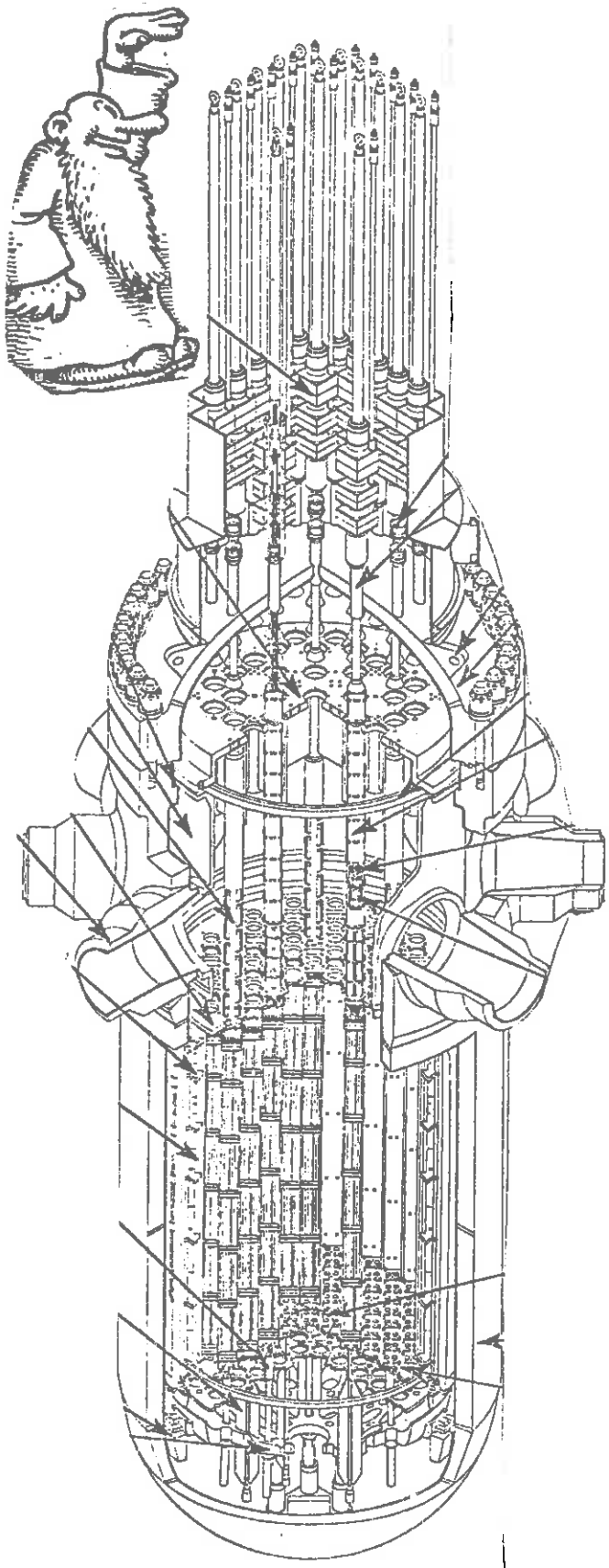
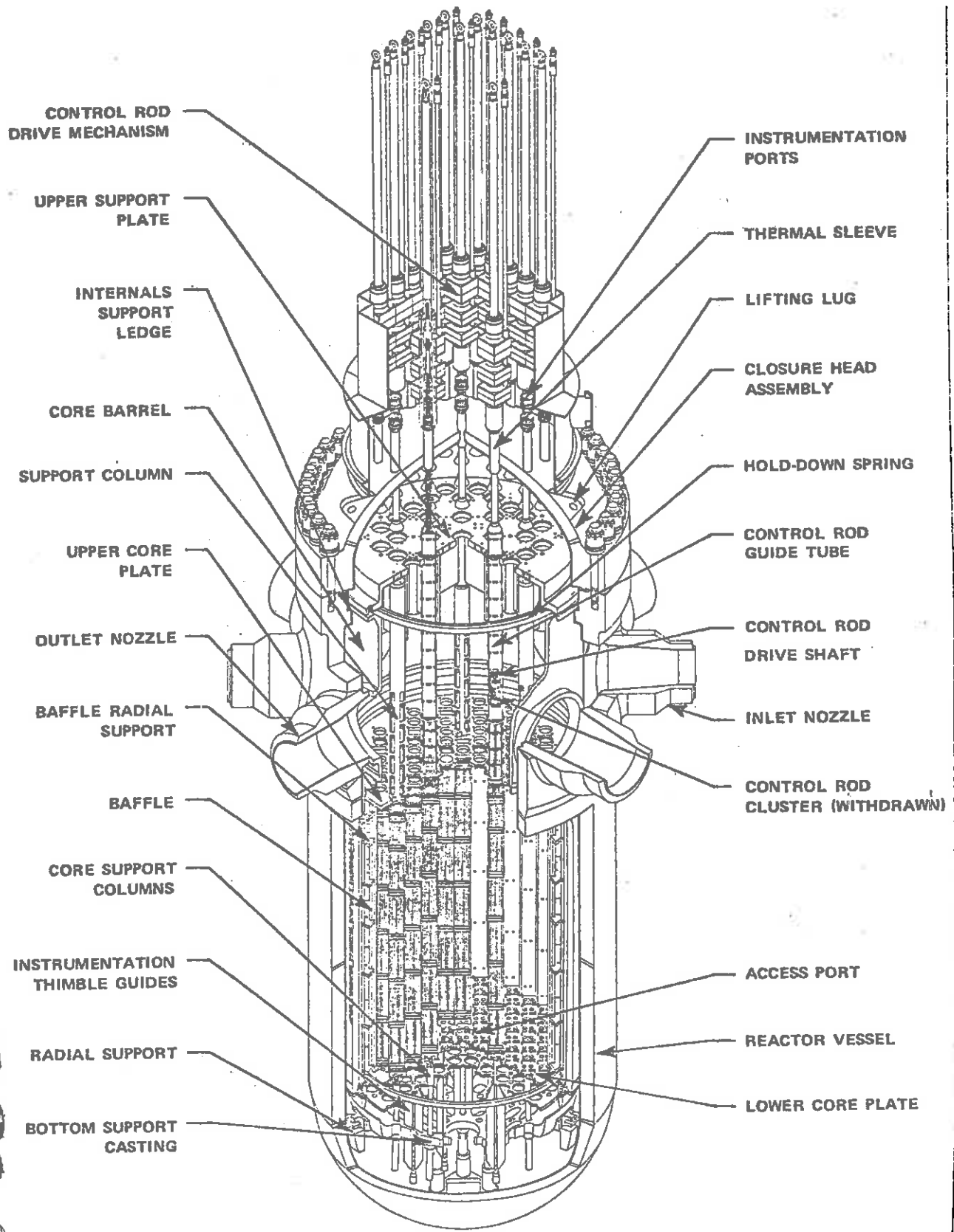


Figure 6-6: A Pressurized Water Reactor and Core Barrel Assembly  
(G. Mascho, Westinghouse Systems Summary, 1971)



Reactor Vessel Internals



into steam for use in the turbine-generator. These steam generators assume mammoth proportions, as the illustrations in Figure 6-4,7 indicate. They are customarily divided into evaporator sections in which the boiling occurs, and moisture separator sections in which dry saturated steam is separated out and flows on to the turbine, while saturated water leaves the separators, flows back down the sides of the steam generator, and is mixed with entering feedwater.

Since liquids are practically incompressible, small changes in volume due to changes in coolant temperature (such as from load changes) can cause severe pressure changes in the primary loop. For example, if pressure increases occur, component damage may result. A decrease in local pressure could cause local flashing of water into steam. Hence it is necessary to provide a surge chamber or pressurizer to ride out such volume changes. Such pressurizers not only act to limit pressure changes in the primary coolant loop, but as well to maintain the required system pressure, both in startup and under normal operating conditions. The pressurizer consists of a tank inserted into the hot leg of the primary coolant loop in which, under normal conditions, a 60% water, 40% vapor volume composition is maintained. A combination of automatically controlled sprays and electric heaters are used to regulate system pressure. During a positive surge in coolant volume, the vapor component is compressed, thereby preventing pressure surges. The spray valves are also automatically activated to limit any attendant pressure rise. A negative surge in coolant volume decreases the liquid volume in the pressurizer, expanding the vapor region and causing a momentary reduction in the pressure within the pressurizer which causes some flashing of the liquid into steam. Electric heaters are used to maintain the overall system pressure.

The pumps required to pump the primary coolant through the core are truly massive and complicated machines. Their principal components include an electrical driving motor, a seals assembly, and a hydraulic pumping unit. The coolant is pumped by an impeller attached to the bottom of the rotor shaft.



Figure 6-7: A Nuclear Steam Generator (Combustion Engineering System SO Description, 1974)

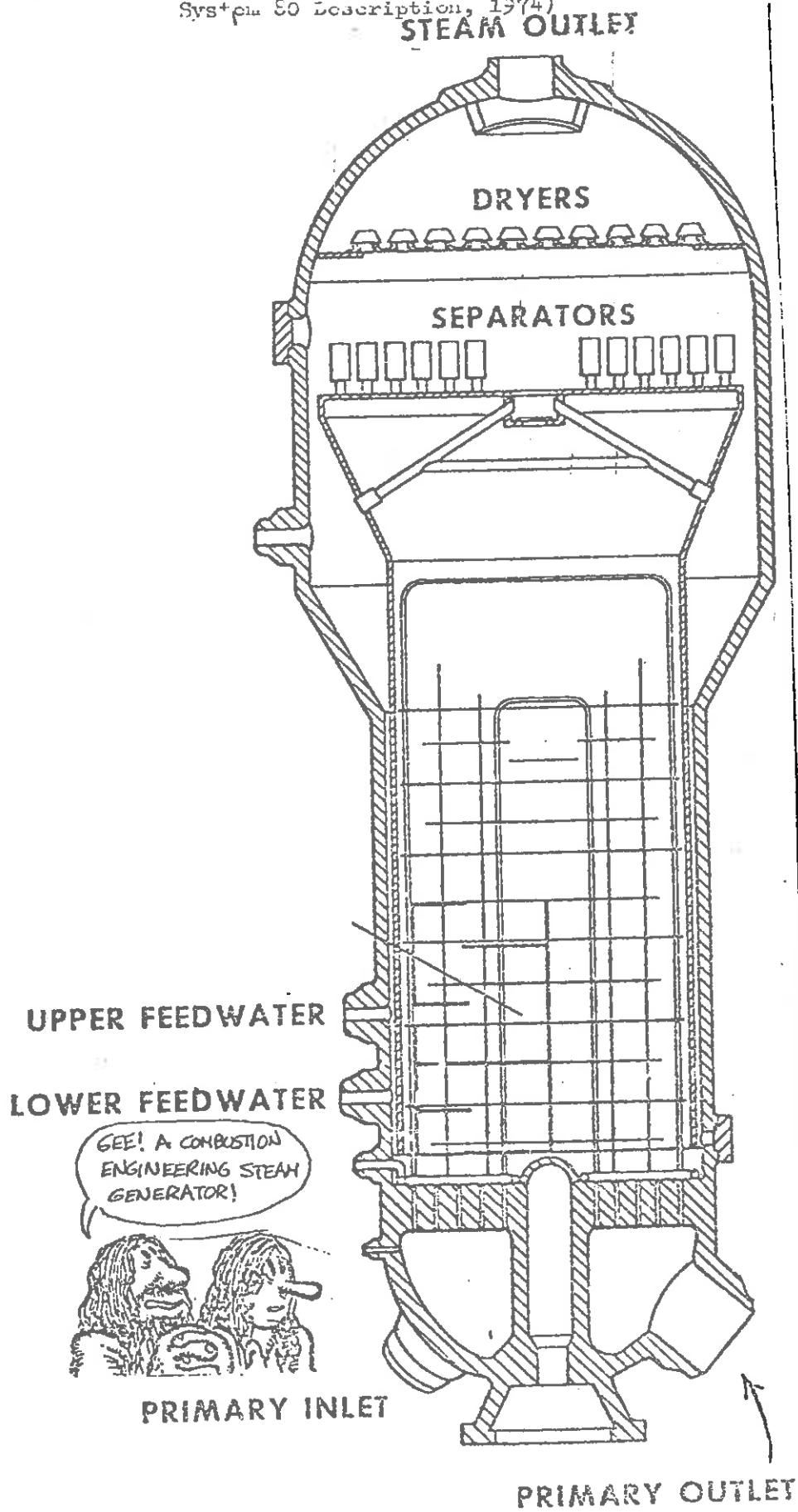


Figure 6-8: A PWR Pressurizer  
 (G. Masche, Westinghouse  
 Systems Summary, 1971)

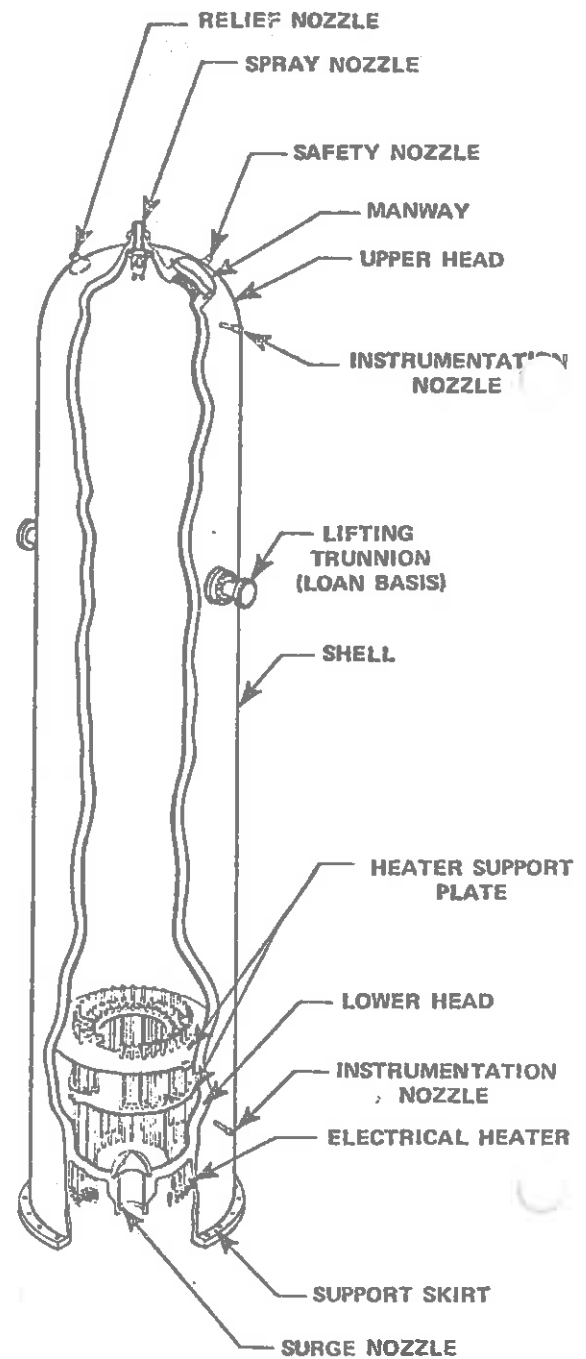
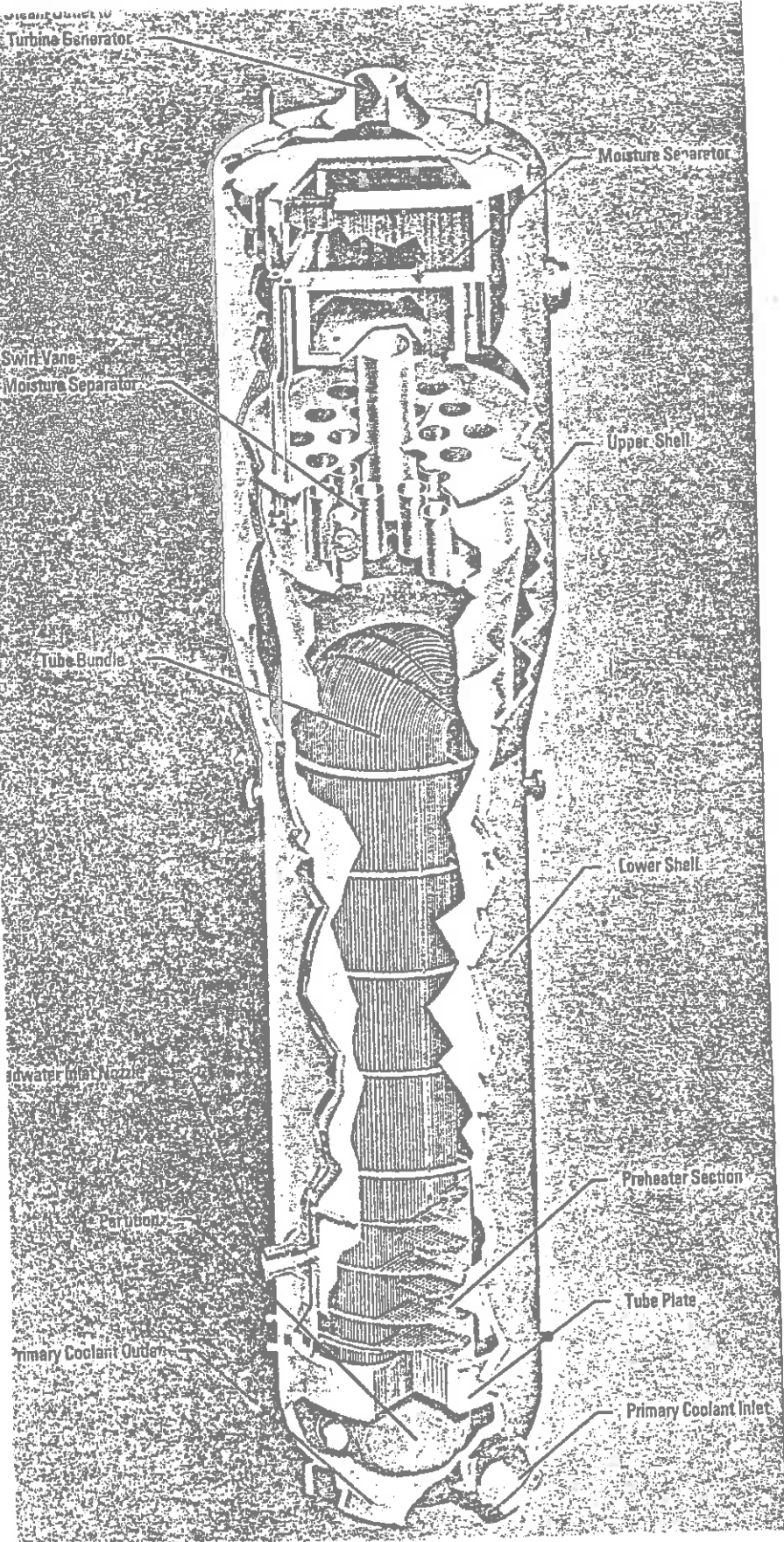
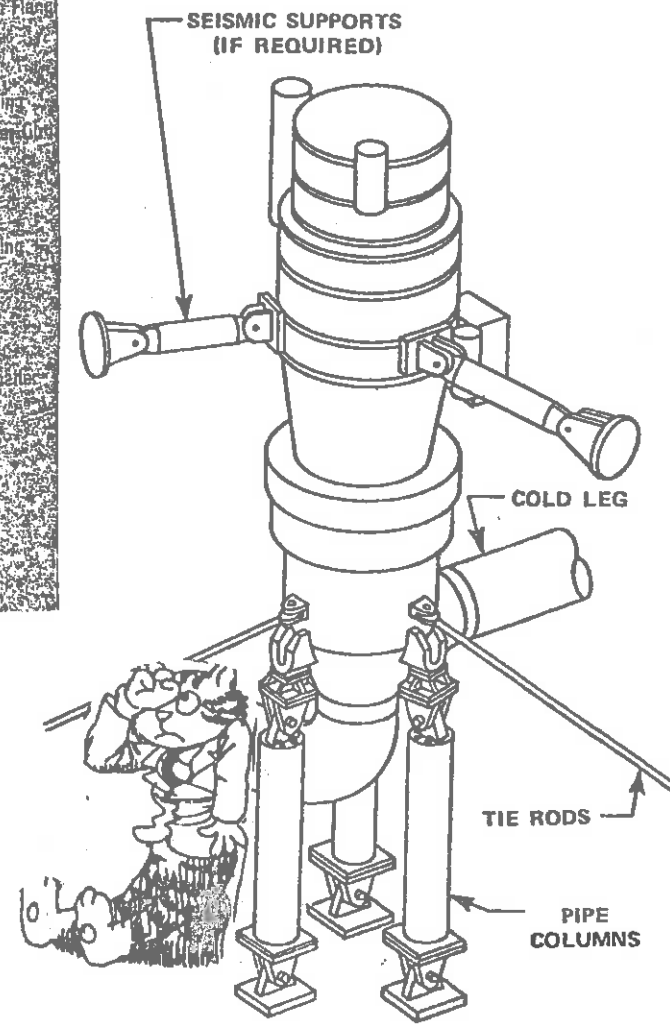
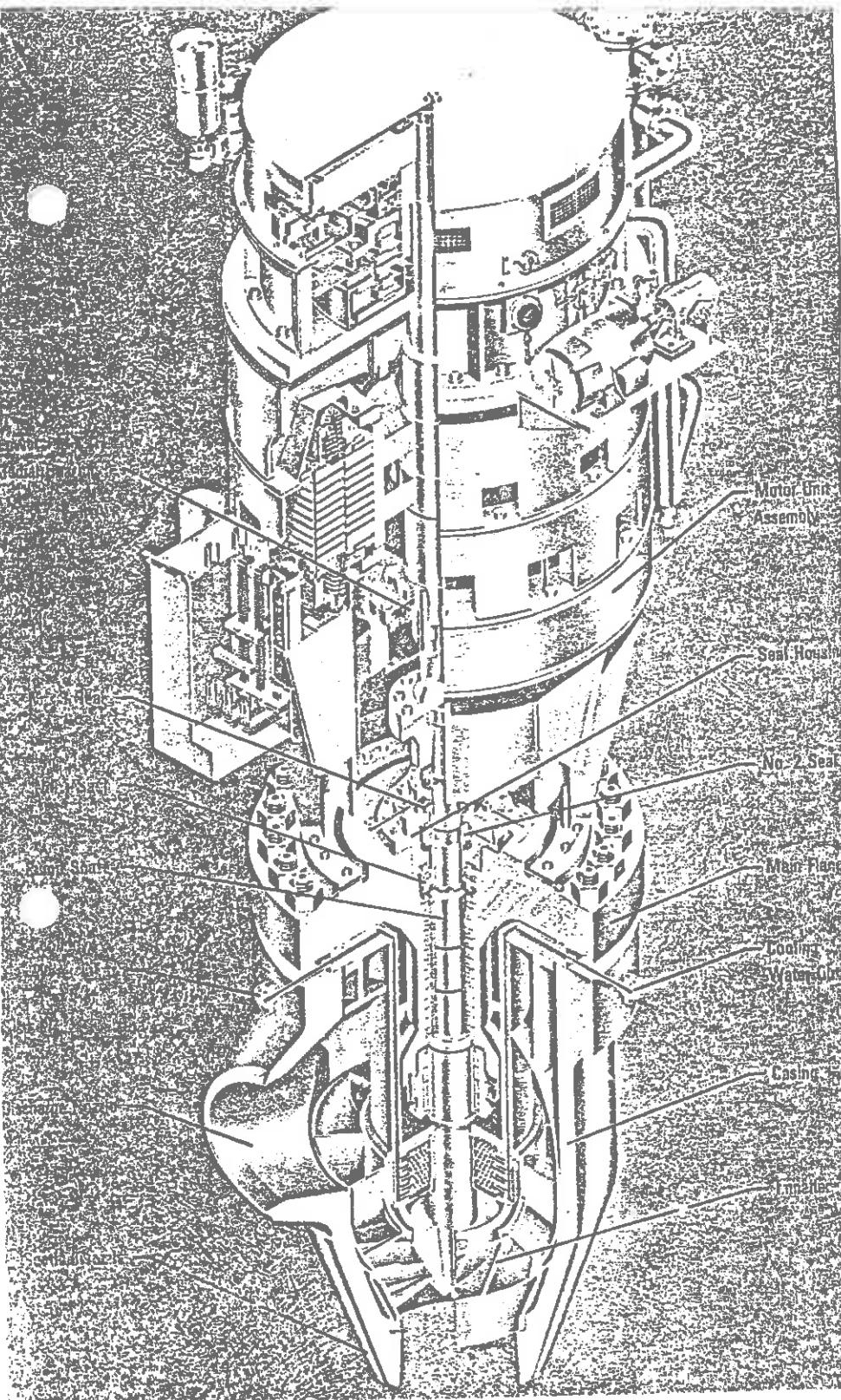


Figure 6-9: The Primary Pump for a PWR Nuclear Steam Supply System (G. Masche, Westinghouse Systems Summary, 1971)



A variety of auxiliary systems are interconnected with the primary loop of the NSSS. These include: (i) a water purification system, (ii) a system to inject a neutron absorbing poison (boric acid) into the coolant to assist in reactor control, (iii) a system to add makeup water into the loop, and (iv) an emergency backup system to supply core cooling capability in the event of a rupture of the primary loop.

There are a variety of different NSSS layouts which differ in the number and manner in which the primary loops are arranged. Diagrams of the particular NSSS configurations presently marketed by each of the major suppliers of PWRs are illustrated in Figure 6-10.

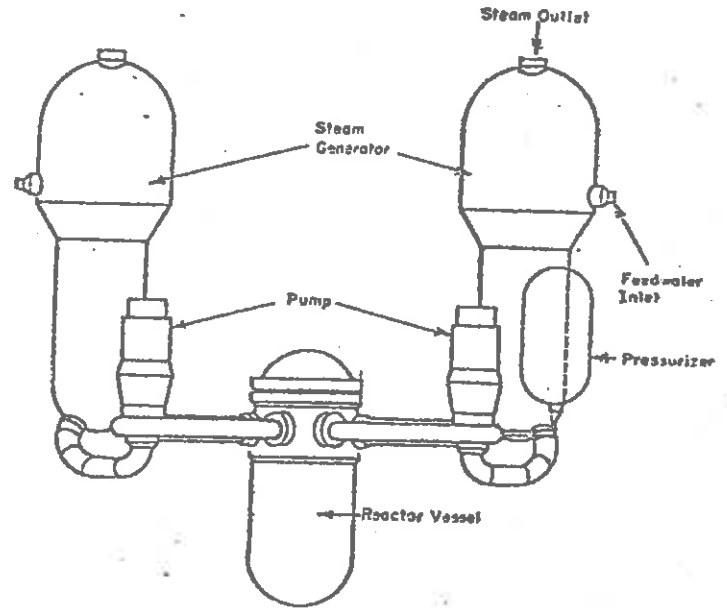
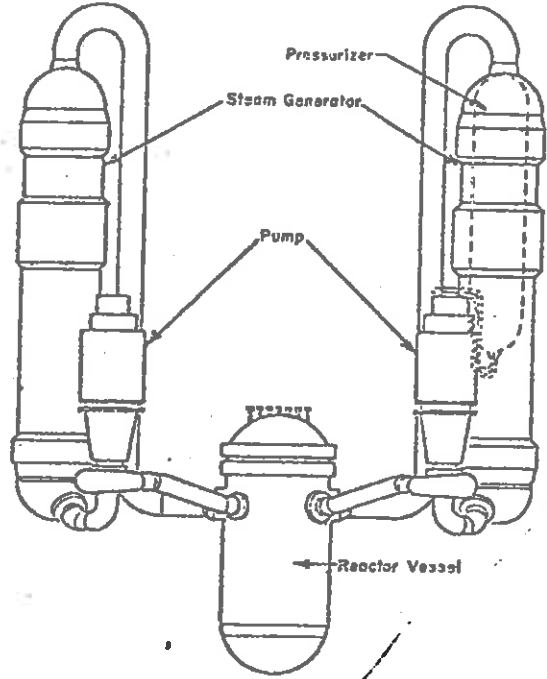
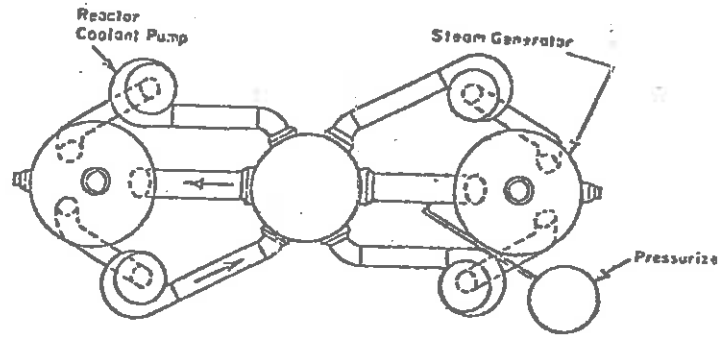
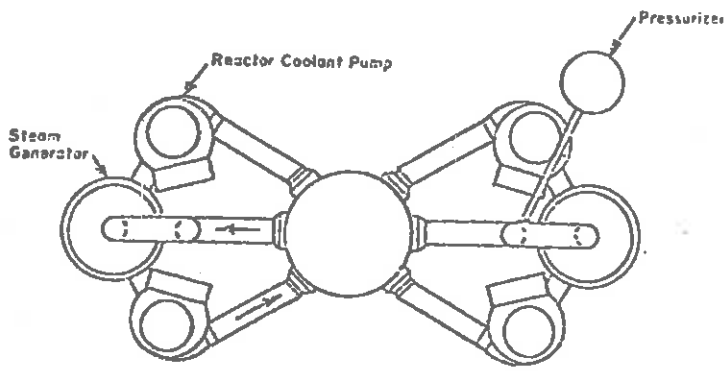
### Boiling Water Reactors

In a boiling water reactor the primary coolant water not only serves as moderator but also as the working fluid since boiling is allowed to occur in the reactor core. Hence only a single coolant loop is required, as shown in Figure 6-1. The need for a separate steam generator is eliminated. Also since there is an appreciable steam volume in the primary loop, a pressurizer tank is not required to accommodate pressure surges.

The coolant water rising to the top of the BWR core is a very wet mixture of liquid and vapor. Hence moisture or steam separators must be used to separate off the steam which is then piped outside the reactor pressure vessel to the turbine, then through the condenser, before it is pumped back into the core as liquid condensate. The saturated liquid that is separated off by the moisture separators flows downward around the core and mixes with the return condensate. This natural recirculation is assisted by recirculation pumps.

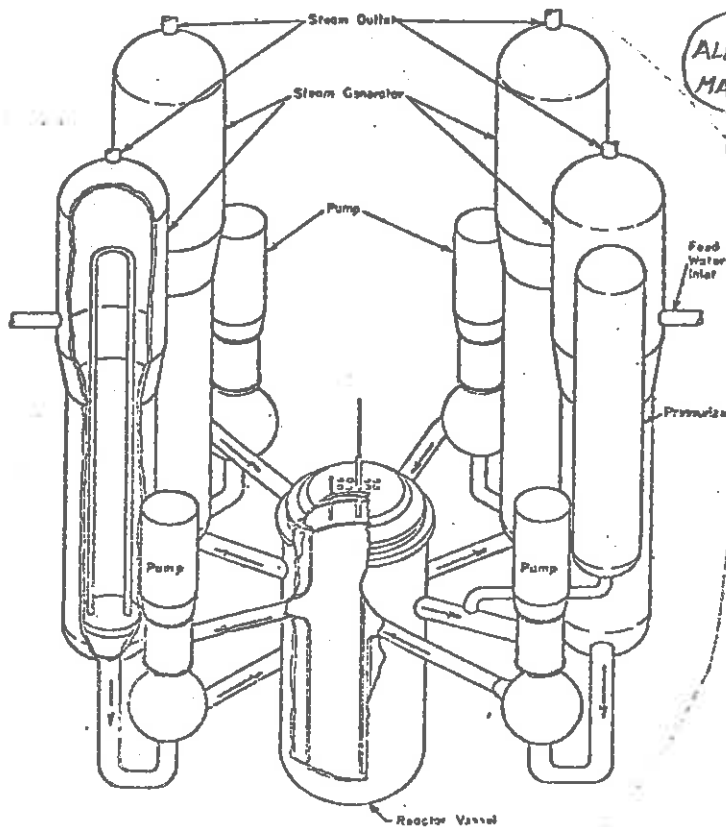
Since boiling in the BWR core is desired, these reactors are operated at much lower system pressures than PWRs ( $\sim 70$  bar) with an attendant reduction in pressure vessel requirements. However the necessary for steam separating equipment at the top of the core results in somewhat larger pressure vessel sizes (about twice as tall as PWR vessels).

Figure 6-10: Various types of PWR NSSSs from U.S. Reactor Vendors



Babcock & Wilcox

Combustion Engineering



ALL RIGHT NOW!  
MAKE A CHOICE.

BUT THEY  
ALL LOOK THE  
SAME TO ME!

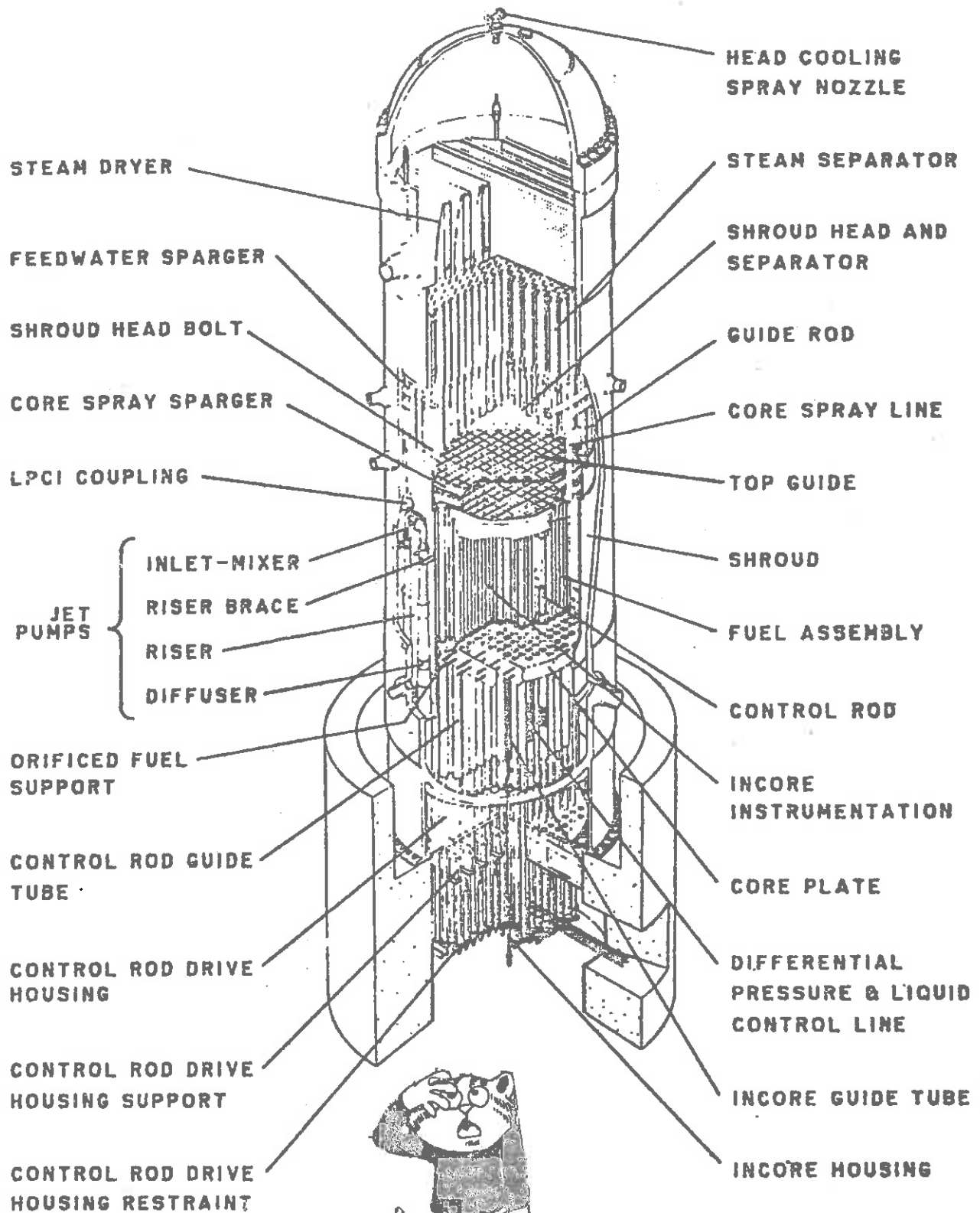


Various NSSS's  
Marketed in the  
United States

Westinghouse

Figure

Figure 6-11: A Boiling Water Reactor (General Electric BWR/6 Systems Description, 1975)



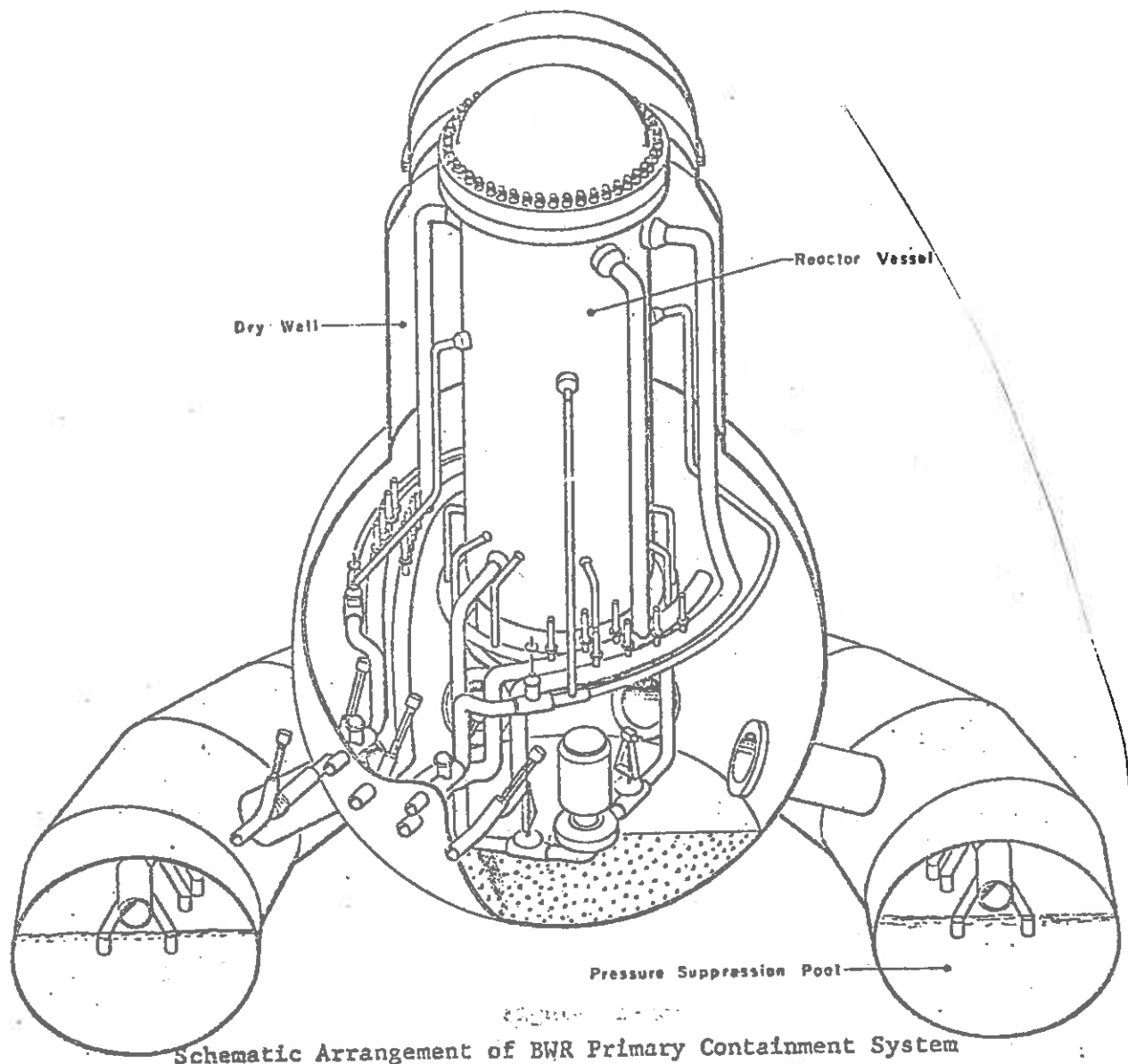
There are other disadvantages to the direct cycle of the BWR. Since the working fluid actually passes through the reactor core before passing out of the containment structure and through the turbine, one must be particularly careful to avoid radiation hazards. For example, the primary coolant water must be very highly purified to avoid impurities which might be subject to radioactive activation when exposed to the high neutron fluxes in the core. Even so, the primary coolant will exhibit significant induced radioactivity, and therefore the turbine building must be heavily shielded, which increases construction costs and complicates maintenance activities.

Yet another problem involves a procedure for handling rapid decreases in load demand. Suppose, for example, that the electrical load on the turbogenerators suddenly disappears. Obviously one cannot instantaneously lower the core and primary coolant temperatures. Hence, for a short period of time, one is faced with the headache of disposing of some 4,000 Mwt of live steam. In a PWR in which the steam is generated in a secondary loop, a bypass valve can be opened which shunts this steam past the turbines, dumping it directly into the condenser.

In a direct cycle BWR NSSS, however, the radioactivity of the steam produced in the primary loop necessitates that it be disposed of within radioactive containment in the event of loss of load or failure of the coolant system. Hence BWRs must be equipped with elaborate steam dump suppression systems such as the torus shaped tank shown in Figure 6-12.

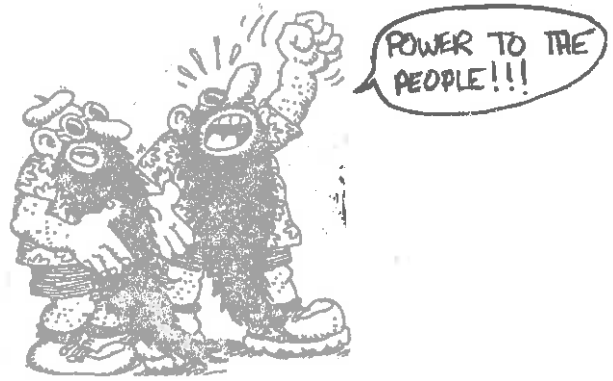
#### High Temperature Gas Cooled Reactors

Gas cooled nuclear reactors have been used for central station power generation for many years. The earliest such power plants were the Magnox reactors in the United Kingdom which used  $\text{CO}_2$  as the coolant for a natural uranium fueled, graphite-moderated core. More recently interest has been directed towards the HTGR which uses high pressure helium to cool an enriched uranium-graphite core. To date all such reactors have been operated using a two loop thermal cycle similar to that of a PWR in which the primary helium coolant loop transfer thermal energy via steam generators to a secondary loop containing water as the working fluid. The



Schematic Arrangement of BWR Primary Containment System

Figure 6-12: A BWR Drywell and Pressure Suppression Torus





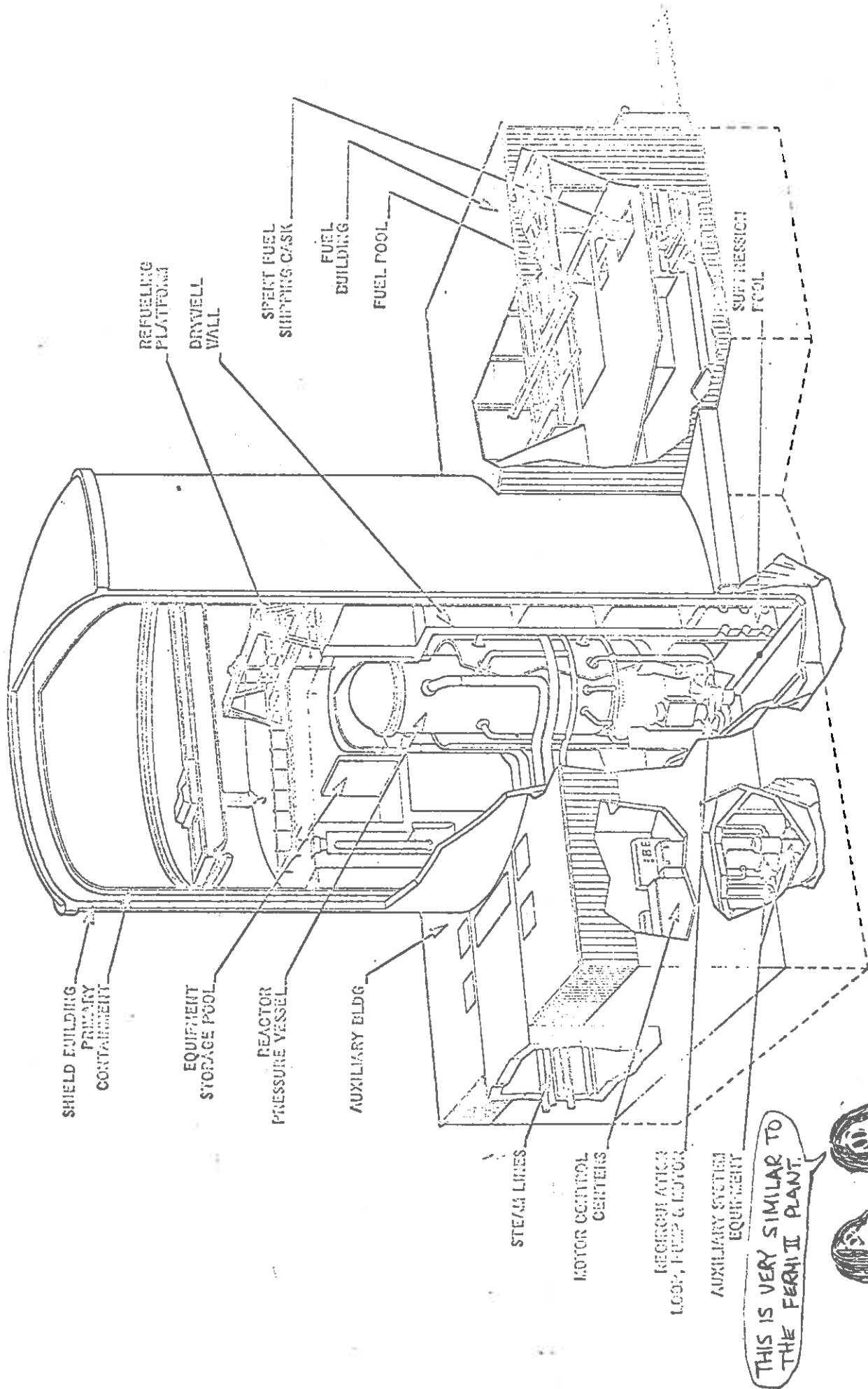


Figure 6-13: A BWR Nuclear Steam Supply System

THIS IS VERY SIMILAR TO THE FERMI II PLANT.



high pressure steam produced in this loop is then used to power a turbogenerator. Such a NSSS is shown in Figure 6-2,14.

The HTGR is capable of operating at relatively high temperature, thereby producing high temperature (400 °C), high pressure (~ 60 bar) steam with the attendant increase in thermodynamic efficiency and easing of turbine requirements. Moreover, HTGRs have the potential of being run in a direct cycle configuration in which high temperature helium is used directly to drive a gas turbine. This would result in even higher thermal efficiencies (approaching 50%).

The HTGR exhibits numerous other advantages. For example, it can be operated using a thorium/U-233 fuel cycle. The use of helium as a coolant not only allows higher operating temperatures at moderate pressures, but as well provides flexibility in the selection of the optimum coolant temperature, pressure, and flow rate conditions. It also effectively eliminates that scourge of all reactor designers, the loss of coolant accident. Since the coolant always remains in the same phase, the worst that can happen in the event of a rupture of the primary coolant loop is a loss of pressure, that is, a depressurization of the primary reactor system to one atmosphere. And in an HTGR even natural circulation of helium at atmospheric pressure is sufficient to remove the radioactive decay heat given off by the core following shutdown.

But the gas coolant also implies low power densities and hence large core sizes. Indeed, core sizes are sufficiently large that steel pressure vessels would be highly impractical. Hence a very significant breakthrough in the successful development of the HTGR was the design of large prestressed concrete reactor vessels (PCRV). The steel lined PCRV is used to contain all of the major components of the primary system including the reactor core, steam generators, and helium circulators. It also provides the necessary biological shielding. Such PCRV produce compact installations and can be field erected, thereby reducing transport problems. But their major advantage lies in the safety they inherently provide by eliminating major external primary coolant piping. This obviates the possibility of coolant accidentally escaping from the large, inter-connecting piping such as that found in light water reactor NSSSs.

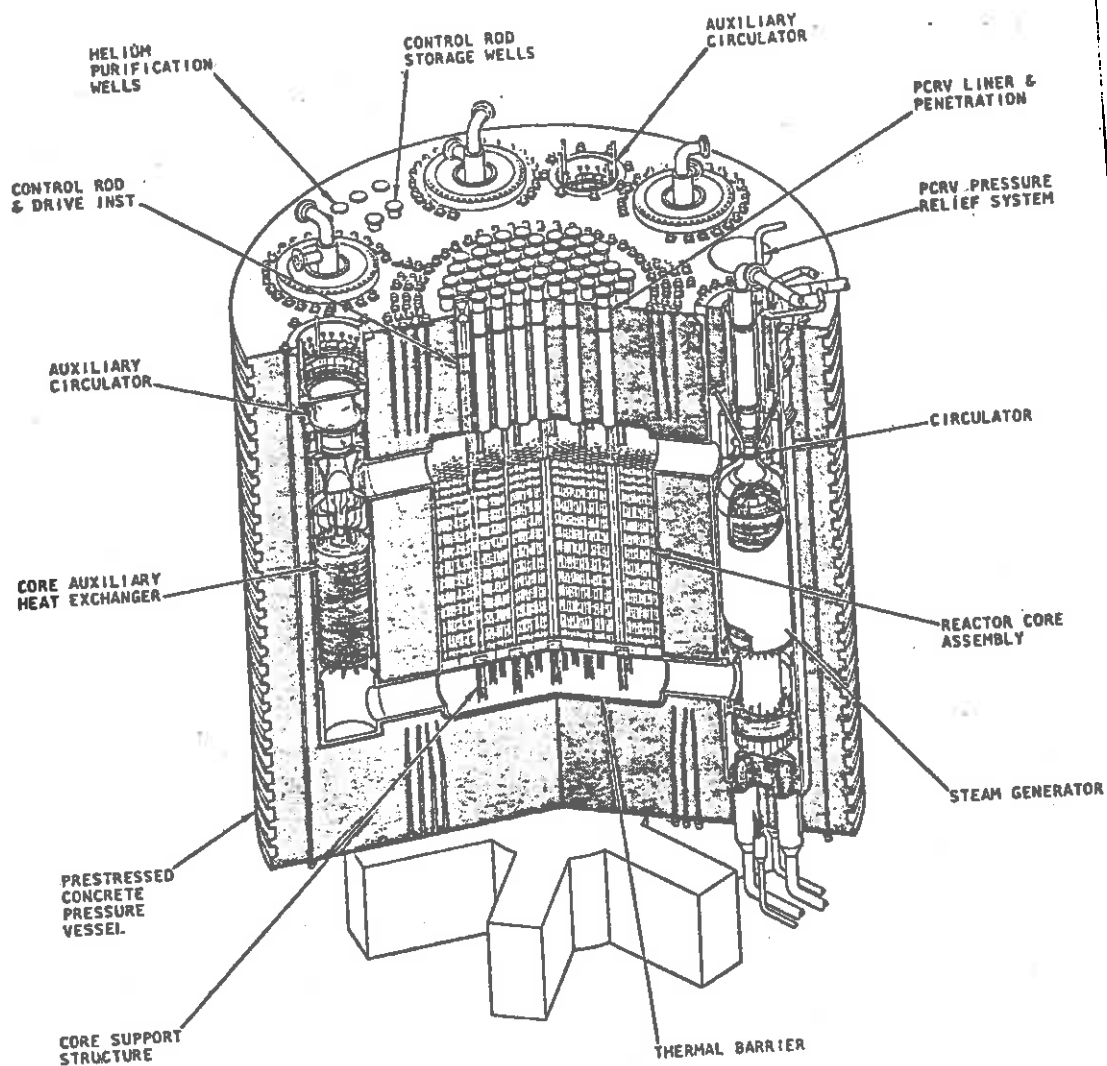
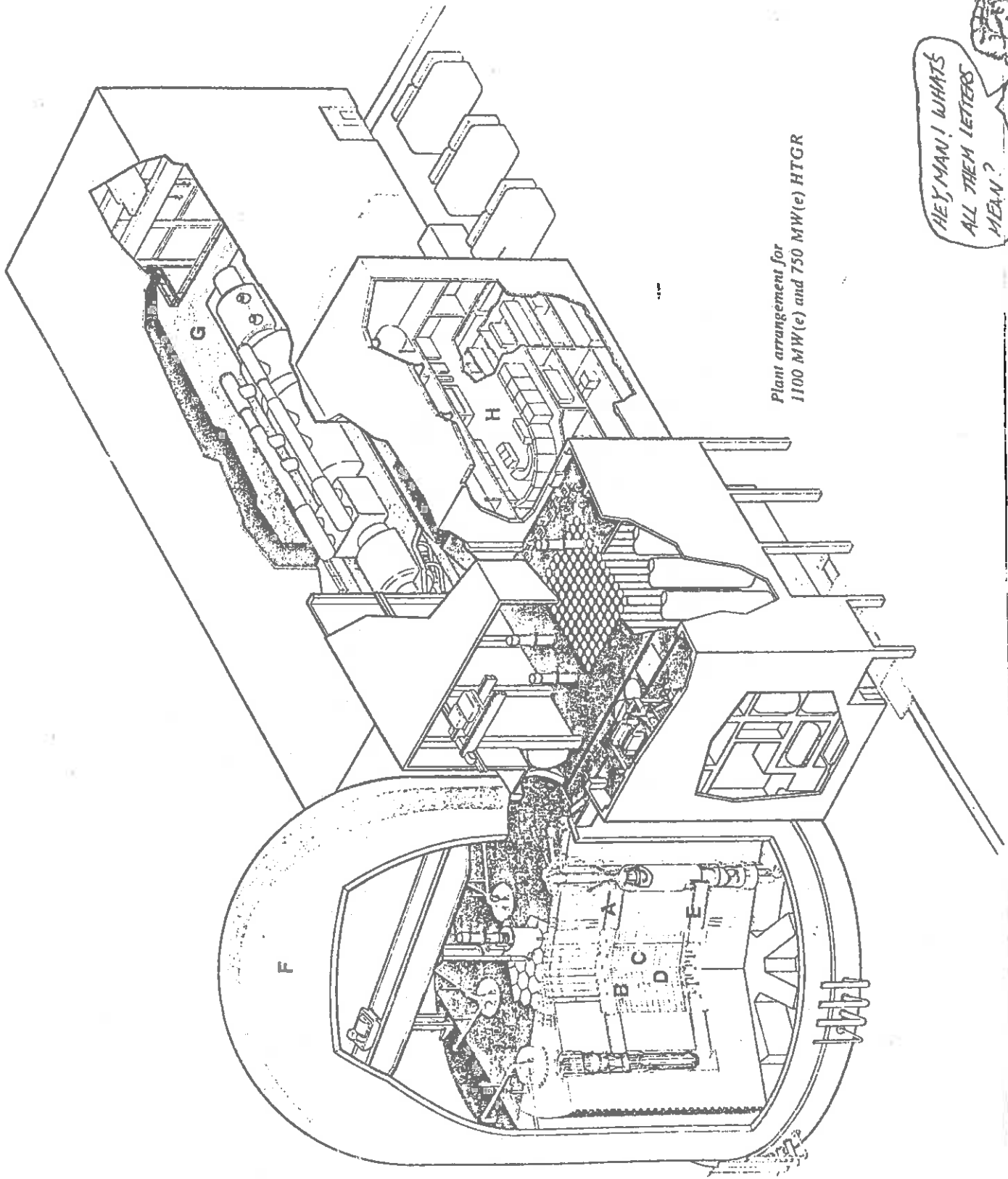


Figure 6-14: General Arrangement of Large HTGR Nuclear Steam Supply System. (Gulf General Atomics System Description, 1974)





JUST THAT  
ADD F. D.  
FORGOT TO  
INCLUDE  
THE CAPTION  
AGAIN!



HEY, MAN! WHAT'S  
ALL THEM LETTERS  
MEAN?

Figure 6-15: HTGR Nuclear Power Plant Layout

Such PCRV incorporate a multiplicity of steel tendons within and around their concrete walls which are tensioned before pressurizing the vessel. The compressive stresses in the concrete exceed the tensile stresses generated by the internal system pressure. Thus the concrete vessel is held in compression under all operating conditions. At operating system pressures, the net stresses in the concrete are small in magnitude. The PCRV contains a central cavity for the core which is surrounded by a series of smaller cavities, each of which houses a steam generator and circulator.

The HTGR primary coolant system operates at moderate pressures ( $\sim 60$  bar). The helium coolant is circulated by axial flow compressors which force it down through the core where it reaches an exit temperature of  $500^{\circ}\text{C}$ . It then passes through steam generators where it transfers its heat to water in the secondary system before being re-circulated through the core.

The helium circulators are powered by steam turbines driven by steam bled off of the steam generators. The total power requirements for such circulators are quite large in comparison with other types of NSSS, as shown in the Table below:

<u>Reactor Type</u>	<u>Pumping Power Requirements</u>
PWR	20 - 25 MWe
BWR	14
HTGR	60
LMFBR	45



### Liquid Metal Cooled Fast Breeder Reactors

We have already seen the motivation behind the nuclear design of the fast breeder reactor and the arguments advanced for the use of liquid sodium as a coolant (such as high core power densities, the desire for a coolant with low moderating properties). We will concentrate here on the NSSS for such reactors. There are two basic approaches one can take to designing the NSSS for an LMFBR. One could follow a design similar

to that of the PWR in which the primary sodium loop is brought outside the pressure vessel to a heat exchanger. Such a "loop" design has been chosen for the United States LMFBR demonstration plant. The alternative approach submerges all of the primary system in a "pot" within the pressure vessel.

The high induced radioactivity of the sodium in the primary loop requires an intermediate coolant loop. The particular system diagramed in Figure 6-16 corresponds to the United States demonstration plant. A key component in this system is the steam generator in which hot sodium is used to produce steam. Because of the explosive interaction between water and sodium, this element requires a very careful design and may be the most critical design problem in future commercial LMFBRs.

The high primary coolant temperatures ( $450^{\circ}\text{C}$ ) which can be achieved using sodium, even under moderate pressures, allow some degree of super-heating, as shown by the multiple steam generator loops in Figure 6-16.

#### Nuclear versus Fossil-Fueled Steam Supply Systems

Nuclear steam supply systems exhibit more similarities to fossil-fueled systems than differences, particularly insofar as they influence the design of the remainder of the power plant. For example, the actual operation of a nuclear power station is no more complicated than that of a modern fossil fueled plant. There are some important differences in steam properties, however. For example, a typical PWR-NSSS produces steam at temperatures of  $300^{\circ}\text{C}$  and pressures of 70 bar. By way of contrast, a modern fossil fueled plant produces steam at  $350^{\circ}\text{C}$  and 200 bar. Hence the relatively wet steam produced by NSSS places more stringent requirements on steam turbine design and results in somewhat lower system efficiencies (33% as compared to 40%). However this difference will be eliminated by the introduction of HTGR or LMFBR plants with their higher operating temperatures, and the loss in efficiency resulting from additional pollution abatement equipment (e.g., stack gas scrubbers) which must be installed on fossil fueled units.

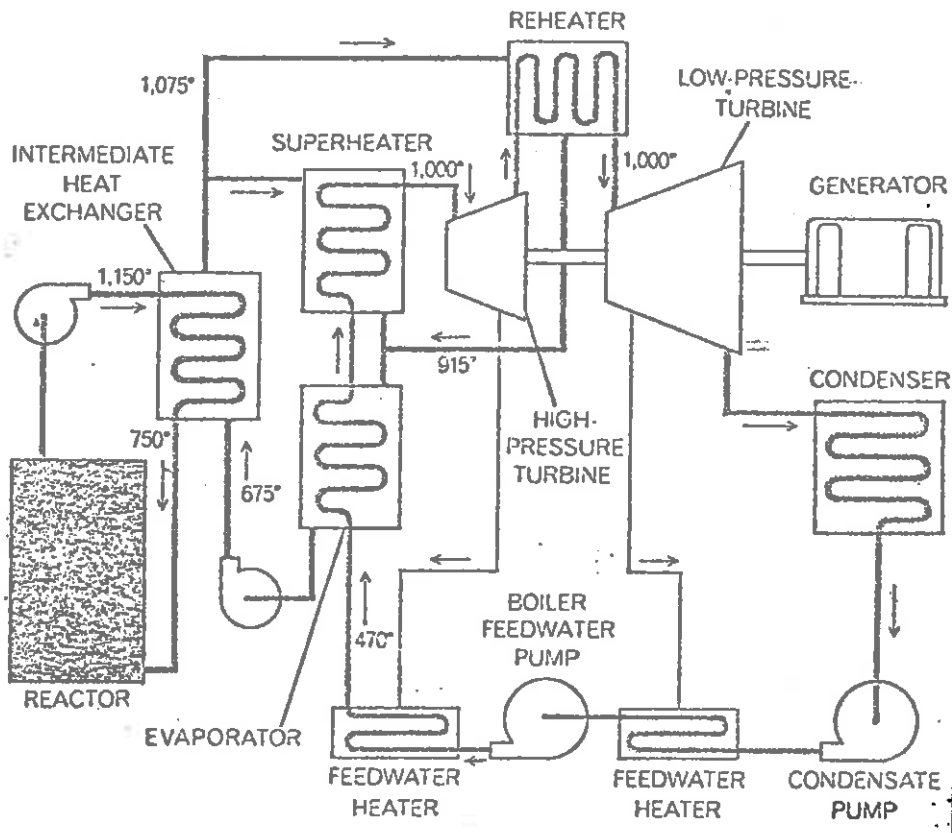


Figure 6-16: NSSS Layout for the Clinch River Breeder Reactor



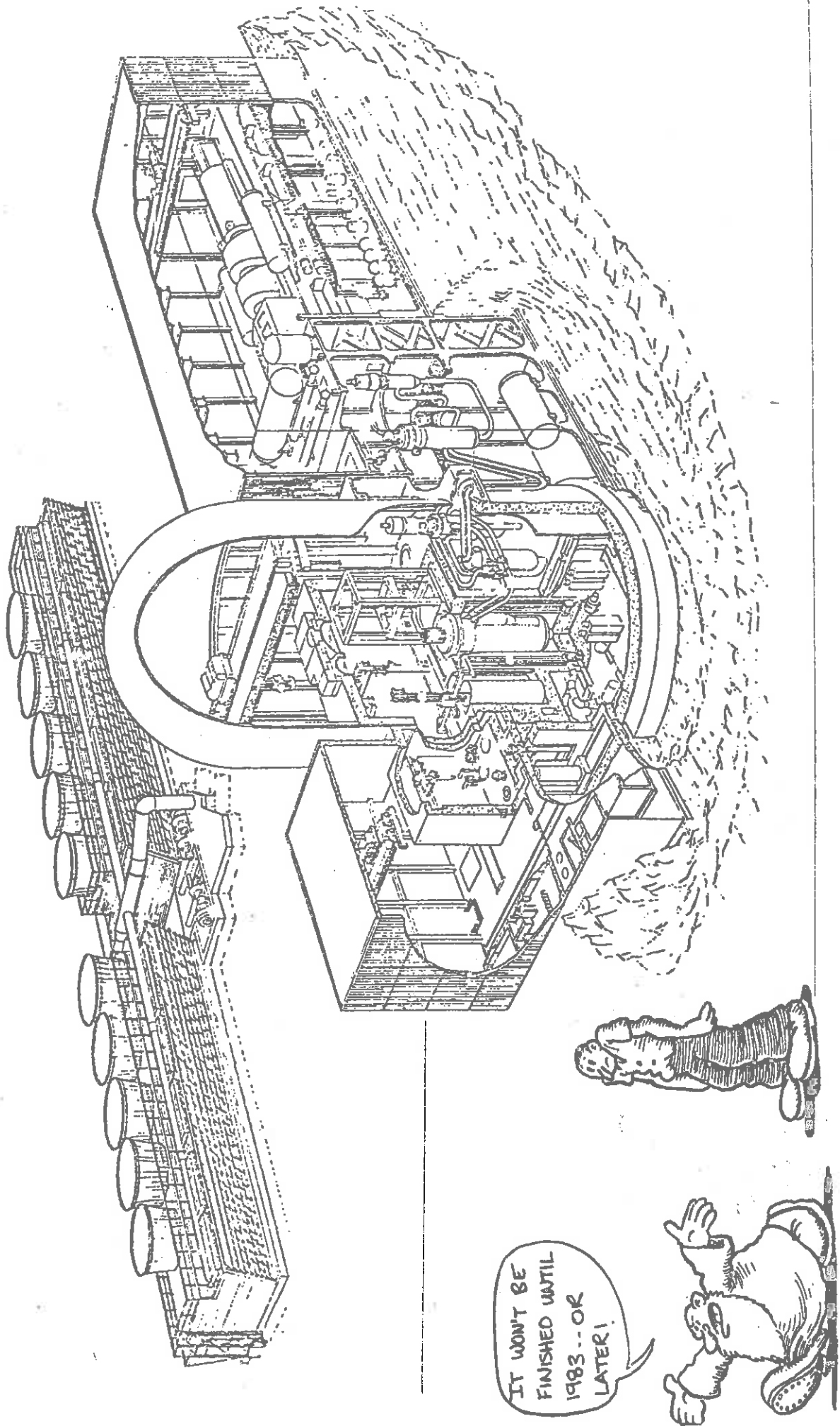


Figure 6-17: The Clinch River Breeder Reactor Demonstration Project



The more dramatic differences between nuclear plants and fossil plants lie in their analysis, design, and particularly in their licensing. The extensive testing of designs and equipment prior to licensing of a nuclear plant is unprecedented in the construction of conventional fossil fueled plants.

### 6.1.2. THERMAL CYCLES

All nuclear power systems use a thermal cycle to convert fission heat into useful mechanical energy. These cycles involve the utilization of a "working fluid" which absorbs this heat and then expands doing work against the blades of a turbine. Such processes are governed by well-known laws of thermodynamics, and for that reason, the use of a fluid to convert thermal energy into mechanical energy is known as a "thermodynamic cycle".<sup>1</sup> As we have noted, one of the more frustrating aspects of the laws of thermodynamics is that they restrict the efficiency with which thermal energy can be converted into mechanical energy. The highest efficiency is achieved by the idealized Carnot cycle and can be expressed in terms of the temperatures at which heat is added to or rejected from the working fluid,  $T_A$  and  $T_R$ , as

$$\text{Efficiency} \equiv \eta = 1 - T_R / T_A$$

(where these temperatures are expressed in absolute units, i.e., °K). The goal of every red-blooded thermal cycle is to achieve an efficiency as close as possible to the Carnot cycle. In a nuclear power system, the maximum temperature at which heat can be added to the working fluid is usually limited by the melting point of the fuel or the fuel element cladding. The minimum temperature  $T_R$  at which the waste heat can be rejected is dictated by whatever condensor coolant is available, usually the ambient temperature of the power plant environment. For example, in a PWR producing steam at 300 °C and rejecting waste heat at 40 °C, the maximum achievable efficiency is  $\eta = 1 - (273 + 40)/(273 + 300) = 46\%$ . Of course no power plant can achieve this theoretical maximum because of the impossibility of ever achieving a Carnot cycle and because of irreversible processes which enter into any actual thermal cycle. To



be more specific, a Carnot cycle involves heat transfer to the working fluid with zero temperature difference. But we know that heat can only be transferred as the result of a temperature difference, so isothermal heat addition or rejection is clearly impossible. Furthermore, the Carnot cycle assumes that no fluid friction occurs in the working fluid as it expands and contracts during the cycle. This is once again clearly an idealization.

The actual thermal cycle used in essentially all power plants is a Rankine cycle in which the working fluid is water, and as heat is added, the water turns to steam. Then the steam is allowed to expand against the turbine blades performing mechanical work. Next the steam rejects heat to condenser cooling water as it is condensed back into liquid. Finally it is pumped once more back to absorb more heat. There are actually a couple of modifications that are usually made to the Rankine cycle in an actual steam power plant. In the true Rankine cycle the expansion of the working fluid will give rise to a mixture of vapor and a considerable amount of liquid in the lower pressure stages of the turbine. This would result in turbine inefficiency and could cause damage to turbine blades. To prevent this, one bleeds off wet steam from the high pressure turbine stage and then reheats it by passing it through another heating device, known as a reheater, before reinserting it into the low pressure stages for further expansion. The heat for the reheater is supplied by live steam directly from the NSSS.

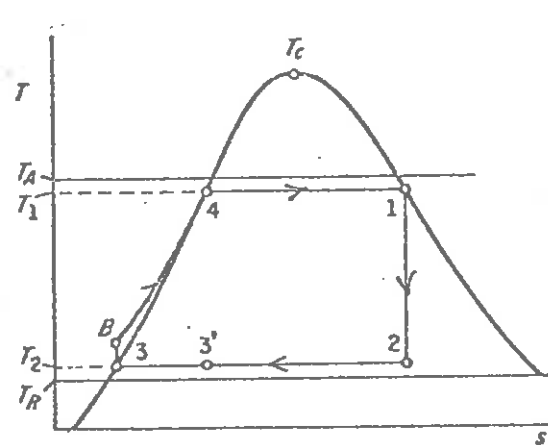
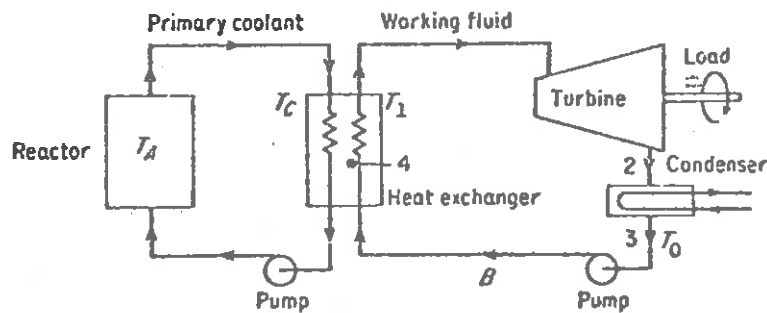
Yet another modification made to the Rankine cycle is introduced to avoid as much heat addition to the feedwater at low temperatures as possible, since this would give rise to a considerable loss in efficiency (recall our formula for the efficiency of the ideal Carnot cycle). One instead uses a regenerative cycle in which heat is transferred reversibly from the working fluid in the turbine to the passing feedwater. A series of such feedwater heaters is used to increase the condensate feedwater temperature both before and after it passes through the feedwater pumps on its way back to the nuclear steam supply system.

Figure 6-18

The Rankine cycle consists of the following processes:

- 1→2: Saturated vapor at  $T_1$  expands adiabatically in a turbine
- 2→3: The vapor is condensed at  $T_2$  at constant pressure
- 3→B: It is then pumped to higher pressure (the same pressure as at point 1 before entering the turbine).
- B→4→1: It is then heated in a heat exchanger at constant pressure, receiving "sensible heat" from B→4 and "latent heat" from 4→1.

For a PWR steam supply system, the corresponding points on a system diagram are shown below:



THIS IS SOMETIMES CALLED A "T-S" DIAGRAM ... AND, IN FACT, IT IS RATHER DIFFICULT TO EXPLAIN.



### 6.1.3. THE BALANCE OF PLANT

The overall arrangement of a typical plant--in this case, a PWR system-- is shown in Figure 6-19 . The nuclear steam supply system is located within steel-lined concrete containment structure designed to withstand and contain the contents of the primary reactor coolant system in the unlikely event of a loss-of-coolant accident, thereby preventing the possible leakage of radioactive materials to the environment. The containment building houses the reactor itself, the primary coolant system, including the primary pumps, steam generators, pressurizer, piping, and the safety injection equipment. It is designed for all credible conditions of loading, including normal loads, loads during loss-of-coolant accidents, test loads, and loads due to adverse environmental conditions (e.g., earthquakes or tornados or errant Boeing 747s). Typical containment structures have concrete walls up to 1 m in thickness with a leak-tight steel liner of 10 cm.

Of primary concern in the design of the containment structure is that it will be able to safely withstand the overpressure and temperature resulting from any rupture of the primary cooling system up to and including the severance of a reactor coolant pipe. Transients resulting from the design basis accident analysis and other lesser accidents serve as the basis for a containment design overpressure of 4 bar. Such an overpressure can be reduced by a factor of four by using an ice condensor system in which the steam released in a rupture of the primary coolant system is condensed on an ice bed located within the containment structure.<sup>2</sup> Such a passive engineered safeguard system has a very high reliability.

Yet another engineered safeguard system within containment is a spray system designed to limit the pressure of the containment atmosphere to below containment design pressure and to remove radioactive I-131 from the containment atmosphere to limit the off-site and site boundary doses.

The main steam system carries the steam produced by the steam generators out of the containment building and to the various system components in the turbine building. Although the principal utilization of the steam

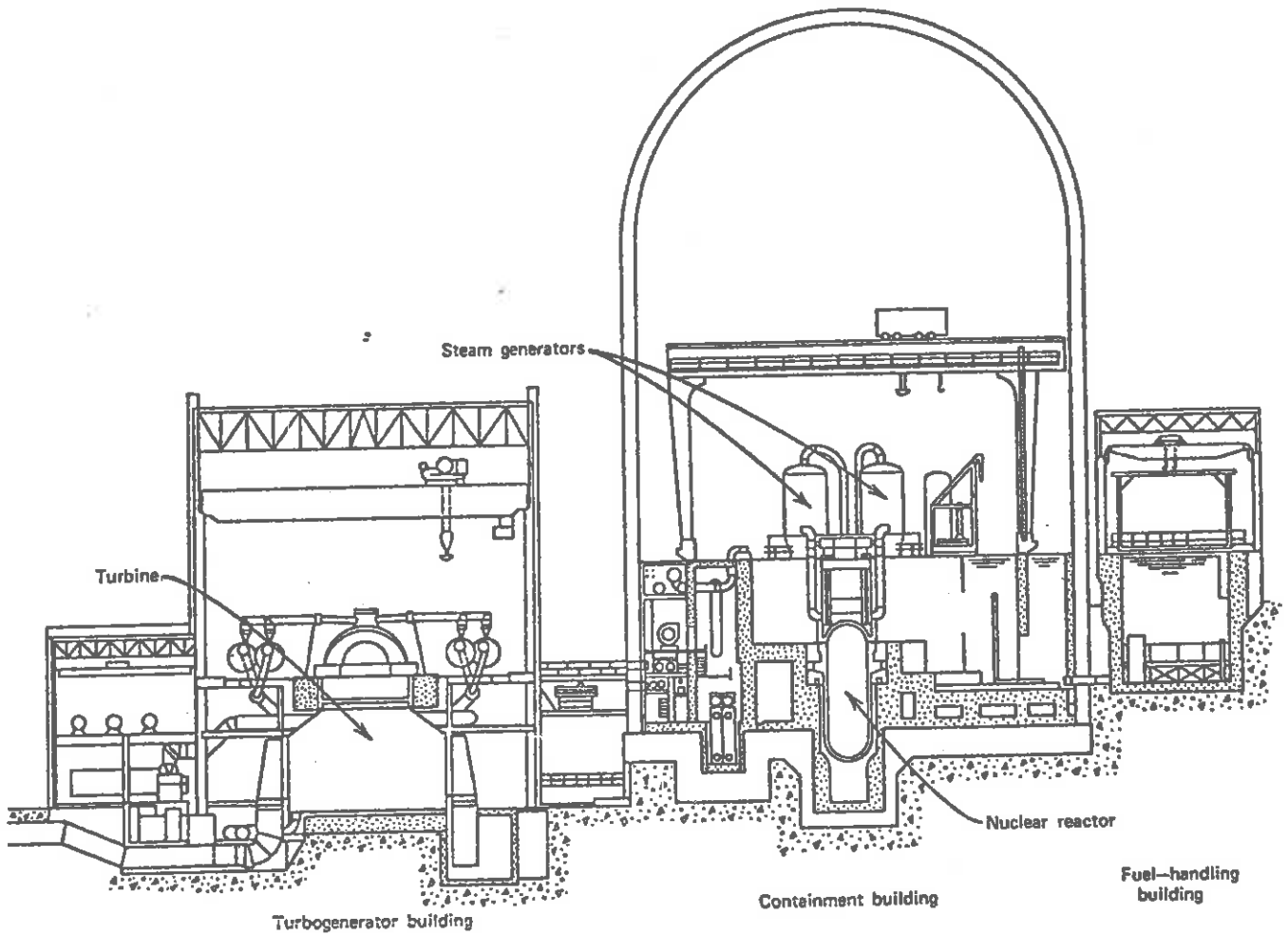


Figure G-19: A schematic diagram of a nuclear power plant.<sup>4</sup> (G. Masche, Westinghouse Systems Summary, 1971)



produced by the NSSS is to drive the turbine-generator, it is also used for a variety of other purposes, including turbinedrives for the main and auxiliary feedwater pumps and steam jet air ejectors, shaft steam seals, and systems associated with steam generator pressure relief such as the steam dump valves.

A typical multistage steam turbine is shown in Figure 6-20 . This particular turbine consists of one double flow high pressure stage in tandem with three double-flow low-pressure stages. Between the high and low pressure stages, combination moisture-separator steam reheater systems are used to dry and superheat the steam. Steam inlet to the high pressure stage is controlled by governor valves with quick acting stop valves ahead of them for rapid isolation in an emergency. The pressure after the first expansion stage is monitored as a load index for the reactor control system.

Upon leaving the high pressure turbine, the steam has an appreciable moisture content of approximately 10%. Not only is such a high moisture content undesirable from the point of view of turbine efficiency, but it also could lead to appreciable damage of the blades of the low pressure turbines. Hence upon leaving the high pressure stage, the steam is passed through a moisture separator and reheater to remove about 10% of the exhaust steam as moisture. The remaining 90% of the steam flow receives about 60 °C as superheat from the reheaters. A typical moisture-separator reheater system is shown in Figure 6-21 . In such a system, the wet steam from the high pressure turbine enters the moisture removal section and rises through chevron-type moisture-separators where the water is removed and drained to the feedwater heater system. The dried steam then passes through the reheater section where it is reheated by a portion of the main steam which is withdrawn before the turbine throttle valves and passed through the tube bundles where it condenses in the tubes and is drained to the feedwater heater. The reheated steam goes to the low-pressure turbines and to the main feedwater pump turbines.

The main condenser is actually just a large heat exchanger connected to the low pressure turbine exhaust. Cooling water passes through tubes in the condensor unit with the condensing steam flowing over the outside

TOO MUCH  
DETAIL AGAIN!

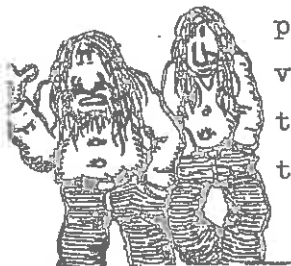


Figure 6-20: A Multistage Turbine

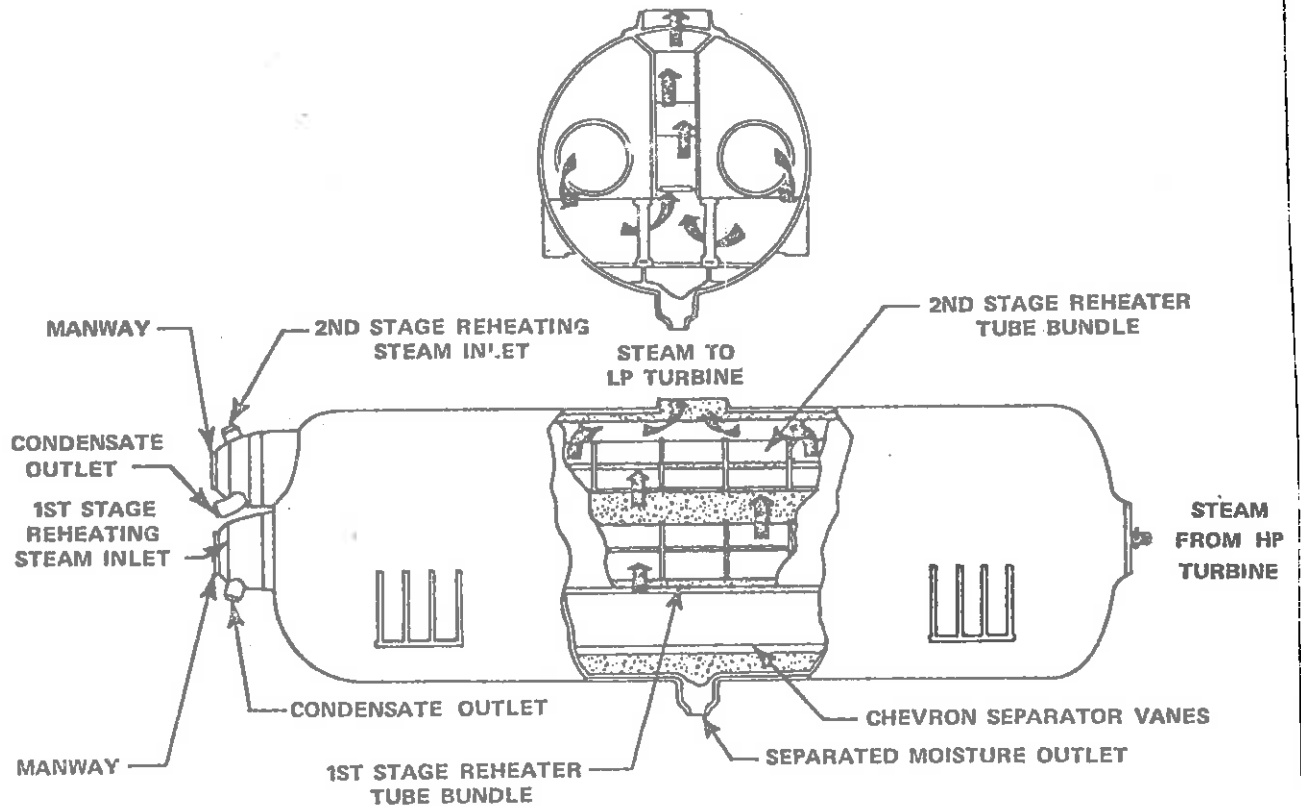


Figure 6-21: A Reheater (G. Masche, Westinghouse Systems Summary, 1971)

COULDN'T FIND A PICTURE! YET!



Figure 6-22: A Feedwater Heater



of the tubing. Condensate is then collected in a chamber called a hotwell. The main condensor also handles the exhaust from the feedwater pump turbiens.

Steam is bled off of the turbines and used to heat the condensate feedwater in feedwater heaters in order to achieve a more nearly isothermal steam generation process. The steam condensate is pumped through several stages of low pressure feedwater heaters before passing through the main feedwater pumps. The water discharge from the feedwater pumps is then passed through one stage of high-pressure heaters and then into the steam generators. The main feedwater pumps are turbine driven with hot reheat steam, although usually one feedwater pump is motor-driven to be used in startup or for reserve pumping capability.

There are a variety of auxiliary systems in the plant. For example, it is necessary to provide a system for injecting neutron absorbing poisons (boric acid) into the primary coolant water as well as for purifying the coolant water and providing new makeup water. These functions are performed by the chemical and volume control system which maintains a continuous feed-and-bleed stream of coolant water to the reactor coolant system (at flow rates of several hundred liters per minute). There is also a residual heat removal system to transfer heat energy from the core and primary coolant system during plant shutdown and refueling operations. The residual heat removal system also is utilized in conjunction with the safety injection system for emergency core cooling during a LOCA. It consists of dual heat exchangers and circulating pumps plus associated piping.

A variety of auxiliary cooling water systems are used to supply cooling functions to the many types of equipment in the plant. For example, the service water system supplies all the equipment cooling water for the plant. The component cooling system removes heat from the heat exchangers, pumps, and waste disposal systems. The spent fuel pool cooling systems provide cooling to remove the decay heat generated by spent fuel elements during on-site storage.

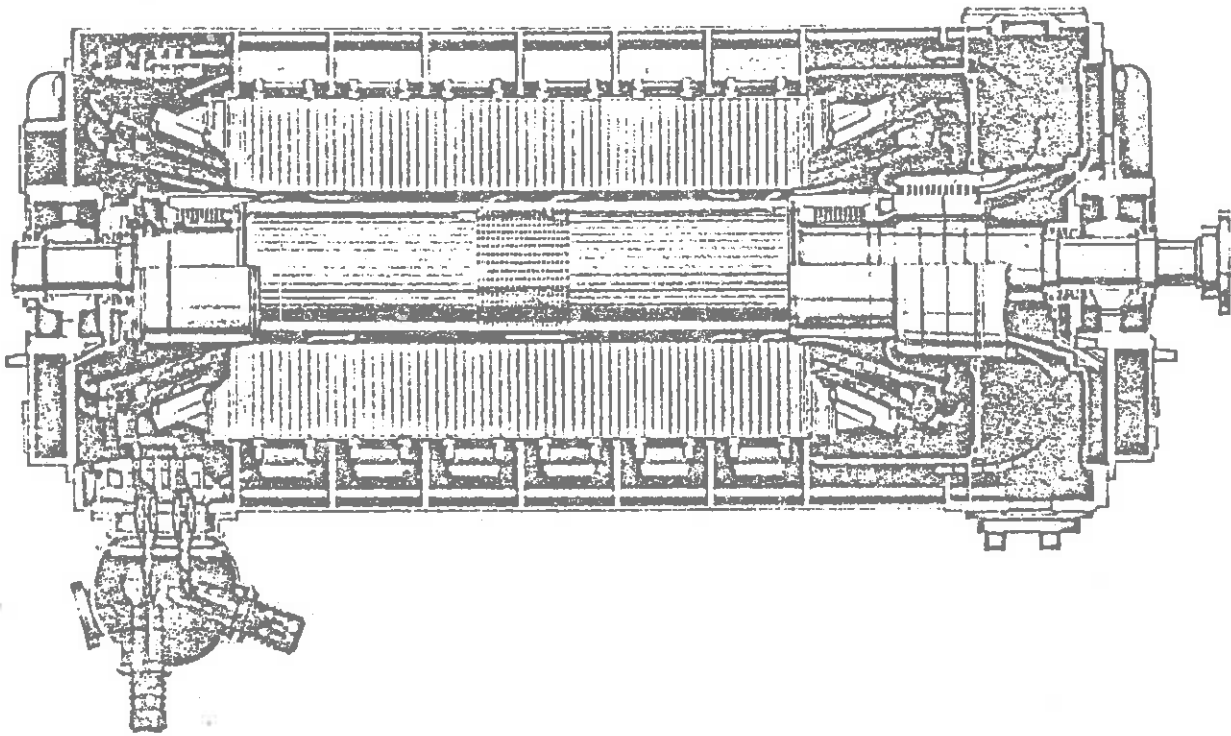
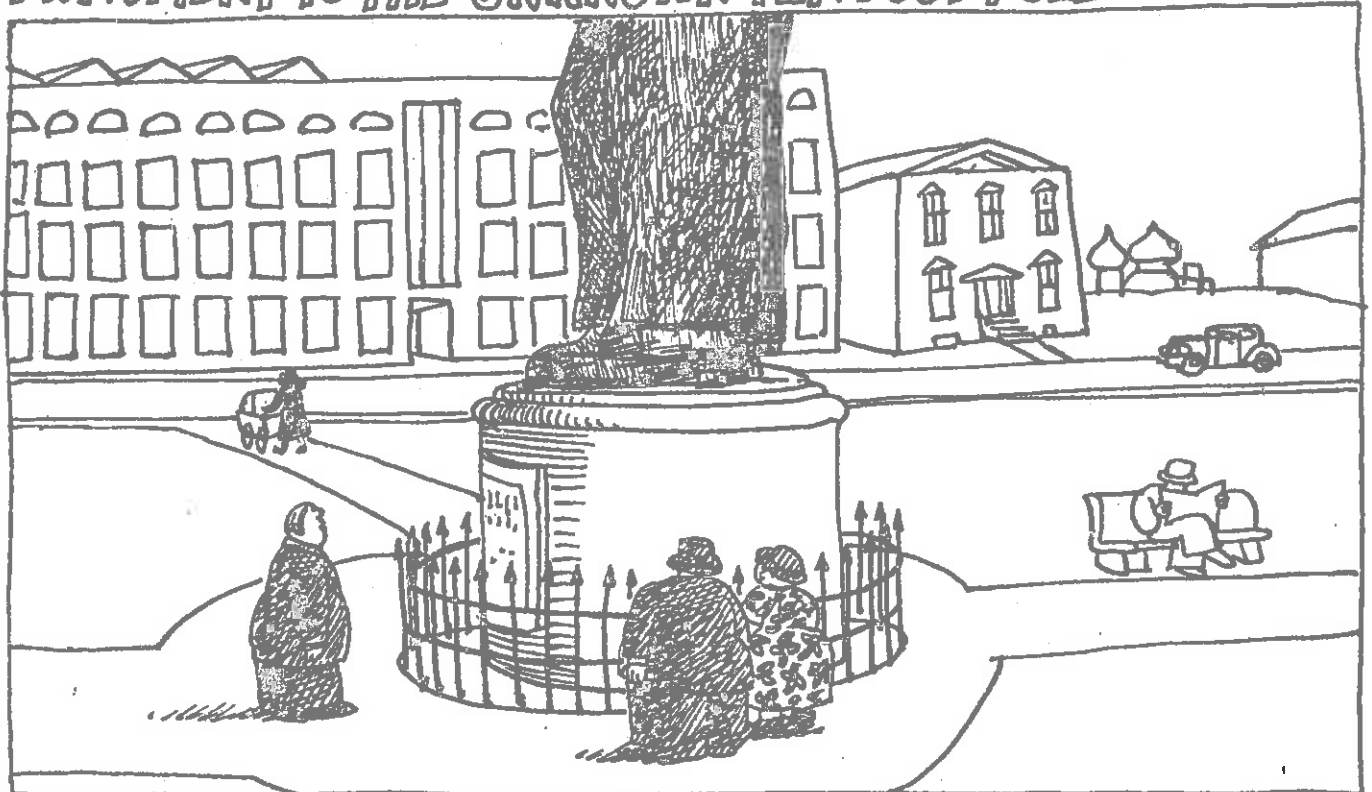


Figure 6-23: An Electrical Generator for a Large Power Plant (G. Masche, Westinghouse Systems Summary, 1971)

## MONUMENT TO THE UNKNOWN TEN FOOT POLE





## 6.2. Nuclear Power Plants

### 6.2.1. AN IMAGINARY TOUR OF A NUCLEAR POWER PLANT

It is difficult--if not impossible--to realize the staggering scale involved in nuclear power generation without an actual visit to a modern nuclear power station. Fortunately most electrical utilities that own and operate nuclear power plants maintain elaborate public information centers adjacent to these plants. Furthermore, many utilities will arrange special tours of nuclear facilities for interested groups. However since few of the readers of this book are likely to have visited a nuclear plant, it is probably a useful exercise to describe what a "walk-through, look-but-don't-touch" tour of a plant would reveal.

To be a bit more specific, let us pretend that we have arranged a tour of Detroit Edison's Fermi II nuclear powerplant which is under construction on the Lake Eire shoreline some 30 miles south of Detroit, Michigan. (Incidentally, Fermi I was a prototype liquid metal cooled fast breeder reactor that operated during the late 1960s. It was shut down and decommissioned in 1972. Detroit Edison originally planned to build a third facility, Fermi II, on the same site, but the utility was forced to cancel this unit when it encountered severe financial difficulties during the recession of 1973-74.)

Imagine ourselves, then, driving through the flat farmlands and marshes characteristic of southeastern Michigan towards the Fermi II site. While we are still some ten miles away from the site, we can already begin to make out on the horizon the twin natural draft cooling towers which rise some 400 feet in height. Indeed, such cooling towers have become a common landmark to signal the location of nuclear power plants. (If one sails eastward into Lake Eirie far enough for the shoreline to disappear from view, then the only objects which can be seen on the western horizon are the two cooling towers of the Fermi II plant, and then gazing southward, the cooling tower of Toledo Edison's Davis-Besse nuclear plant some 30 miles to the south. Perhaps some day in the far future these cooling towers will stand as monuments to our civilization

just as the pyramids of ancient Egypt. Some future archaeologist may try to reconstruct the legends that motivated 20th century man to build these towers across the countryside, to appease the primitive god EPA.) While still approaching the Fermi II site, one can look to the south and spot the twin stacks of the coal-fired Monroe Power Station which rise some 800 feet into the air. This plant consists of four 500 MWe boiler units and was for a time the largest fossil-fuel-fired electrical generating plant in the world.

Several miles further on we leave the main highway and travel along the approach road leading through the plant exclusion zone to the site proper. We can now make out the mammoth plant buildings, dotted with construction cranes, which tower almost ten stories in height. The plant site is surrounded by high security fences which are patrolled by armed security guards and used to control access to the plant area. In fact, before we can proceed into the site, we must be checked through an inspection gate, required to sign insurance waivers, and issued individual hardhats (since the plant is still under construction). After the first impressions of the immense size and scale of the plant buildings and cooling towers wears off, we next notice the enormous quantities of equipment scattered about the site: acre upon acre of pipes, pumps, and valves, massive pieces of disassembled equipment, cranes, and a host of other types of strange machinery dot the landscape. This equipment represents an investment of roughly a quarter of a billion dollars. Since a construction project of this magnitude takes some ten years from start to finish, equipment delivery may occur years before actual installation is scheduled, and so the site serves as an enormous warehouse for much of this equipment.



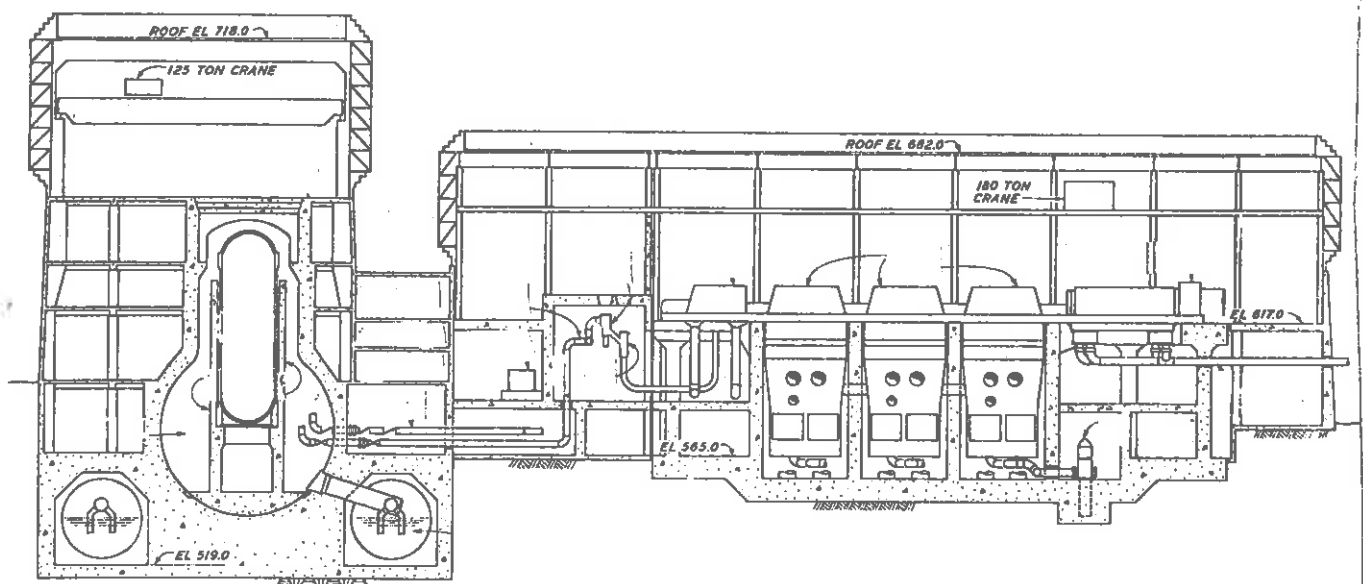
Before entering the plant itself, we are first ushered by guides into a temporary construction building containing a large scale model (3 m tall) of the nuclear steam supply system. This model serves not only to orient visitors to the plant, but also as a key tool in the construction of the plant since it can be used to monitor construction progress and design changes, to determine where piping, wiring, and various support structures will be located.

The Fermi II plant will utilize a boiling water reactor NSSS supplied by the General Electric Company to produce 1,065 MWe of electrical power. The plant itself is actually spread throughout three buildings which are sketched in Figure 6-24. The first building contains the NSSS itself. Next to this is the auxiliary building which contains the plant control room, plant computers, and associated service equipment. The final building contains the main steam turbine, generator, condensor bank, feedwater heaters, and other equipment associated with the steam cycle.

As we are led across the site to the reactor building itself, the impression of the immense scale of the power generation facility becomes even more apparent. Standing in sharp contrast is a small cluster of buildings off to one side of the Fermi II site that look almost like the temporary construction service buildings that are scattered about the site. We are told that these buildings house the decommissioned Enrico Fermi fast breeder reactor. They are dwarfed by the Fermi II nuclear power plant.

We enter the reactor building at ground level at a point some two stories below the bottom of the reactor pressure vessel. But we cannot see the pressure vessel yet, for in such BWR systems, the reactor is contained within a large, steel-lined concrete bottle known as the dry-well which provides primary containment, much as the large cylindrical containment building characteristic of PWR power plants. At this intermediate state of construction, we are fortunate to be able to actually enter the dry-well through an airlock and look up at the 500 ton BWR pressure vessel suspended high above our heads. Below us we can see the capped exit ports which lead to the pressure suspension torus several floors below. In a PWR we would also be dwarfed by the enormous steam generators which tower tens of meters above the reactor vessel.

Leaving the dry-well, we are next led down some three stories below ground level beneath the steam suppression torus which now towers above us, being some ten meters in diameter and 40 meters across. At this level we can also view the various safety cooling systems used to provide



Section of reactor and turbine-generator buildings

ACTUALLY, THIS IS A DIAGRAM OF THE BROWN'S FERRY PLANT BECAUSE THEY COULDN'T FIND ONE OF FERMI II.

Figure 6-24: Plant Layout for the Fermi II Nuclear Power Plant



emergency core cooling in the event of a rupture of the primary coolant system. But our tour of the reactor building is not complete at this point, for we must again climb back upwards, back past ground level, and on upwards five more stories until we reach the top of the pressure vessel. At this level, all fuel handling will occur. During the refueling operation, the floor above the pressure vessel head is flooded with water and becomes a fuel handling pool. The head of the pressure vessel would then be unbolted and lifted off, and spent fuel assemblies would be hoisted out of the reactor core and then transferred to a fuel storage pool where they would be stored for a period of several months while their intense radioactivity decayed to more acceptable levels.

Climbing back down to ground levels, we next pass through the steam tunnel which will contain the primary steam piping which carries hot steam from the reactor to the turbine building. We enter the turbine building at ground level and immediately come upon one end of the condenser bank where the thousands of tubes which will carry condenser coolant water through the condenser to condense the wet steam rejected from the turbine are clearly visible. At this level we also note numerous pumps and valves which will handle the primary coolant water as it passes through the turbine. We are told that the turbine itself is some five stories above us (as Figure 6-20 indicates). Throughout the turbine building we note that many pieces of equipment have been isolated in rooms with massive concrete walls several meters in thickness. This concrete acts as heavy shielding against the radiation which is induced in the primary coolant as it passes through the reactor core. (This shielding would not be required in a PWR plant turbine building since the primary loop is isolated from the steam cycle.)

As we work our way up to the turbine hall on the fifth floor, we are again overwhelmed by the immense scale of the plant. Even equipment such as feedwater heaters take whole floors and are tens of meters in length. Entering the turbine hall, we immediately spot the main steam turbine, stretching some 50 meters in length with an enormous electrical generator at one end. At this point during plant construction, the turbine is only partially assembled, and the various components of the low and



high pressure turbine stages rest on support pedestals about the hall. The blades and shaft of the low pressure turbines tower five meters above us.

Passing back down through the turbine building, we notice the enormous number of pipes, pumps, valves, of cables and cable trays for instrumentation, which run throughout the plant. As we leave the turbine building, we are again struck by the acres and acres of equipment that lie scattered about the site. The engineers conducting the tour note that all of this equipment has been carefully inspected and catalogued, and a closer examination reveals that attached to each piece of equipment, to each pipe, to each valve, is a sheaf of documents containing records of fabrication, specifications, inspection dates, and an array of other information necessary for the quality assurance program for the plant.

The final stop on the tour takes us to the enormous cooling towers which rise 50 stories into the sky above us. We are led through a small door into the base of one of the towers and notice to our amazement that the tower is completely open inside. The Pontiac Silverdome could easily be fit into the interior of the tower. The smooth concrete walls of the interior of the tower curve upwards above us and create a confusing pattern of echos as we walk across the concrete floor of the tower. At the base of the tower we can see the massive inlet piping for the condensor cooling water and the enormous baffles over which the water will flow as it cascades through the natural draft to the bottom of the tower where it will be collected and pumped back to a storage reservoir until it is pumped back through the condensor.

A BIT  
EXAGGERATED  
I'D SAY.




Thus our tour has been able to follow essentially the path from generation of energy in the reactor through the turbine-generator-condensor steam cycle and finally to the cooling towers where the waste heat is rejected into the atmosphere. We cannot help but be left with the impression of the enormous scale required to translate the rather simple physical concepts of a steam thermal cycle into a modern electrical generating plant.

Unfortunately, words are never able to convey the enormous scale of nuclear power generation. A single plant such as Fermi II represents a capital investment in excess of one billion dollars--one day of plant operation is worth \$400,000. The construction of these facilities employs a work force of several thousand men for a period of up to ten years. It is particularly unfortunate that most of those involved in the nuclear power debate have never even seen this enormous scale of nuclear power plants nor can they fully appreciate the detail and effort that goes into such construction. For only by seeing for oneself the staggering magnitude involved in electrical power generation can one really appreciate how far the laboratory scale research and development efforts of alternative sources of energy such as nuclear fusion and solar power are from practical implementation.

#### 6.2.2. NUCLEAR POWER PLANT SITING (Or, "So you really want to build a power plant?")

The decision to build a nuclear power plant is made only after the electrical utility has conducted a very careful study of its ability to meet projected electrical demand, and has carefully compared the relative advantages and disadvantages of different types of generating stations. Once the decision has been made to proceed with the construction of a nuclear plant, the utility must then begin the rather arduous task of selecting a suitable site for the plant. A great deal of evaluation and study will go into the site selection process. Not only must one be concerned with the technical requirements of the plant, such as adequate cooling water supply, suitability as an electrical transmission point, and so on, but one must also consider very carefully the environmental impact of the plant as well as evaluate the site characteristics with a mind towards plant safety.

The utility will interact with a variety of federal agencies such as the Nuclear Regulatory Commission (NRC), the Environmental Protection Agency (EPA), and the Federal Power Administration (FPA), as well as with state agencies such as state energy authorities, departments of



natural resources and public health, public service commissions, and so on. Voluminous documentation must be prepared to convince these agencies that both the site and the plant itself will meet environmental impact and safety requirements, both during its construction and operation. Typically, the utility must obtain over 50 different permits and licenses to construct and operate the plant.

In Table 6-2 we have listed a number of the basic criteria involved in nuclear power plant siting.<sup>3</sup> We have chosen to group these into three different classes: technical and economic considerations, environmental impact, and safety considerations.

#### Technical and Economic Considerations

Obviously the first consideration that should be given is whether the plant is needed to meet future electrical demand. Since the lead time required for nuclear plant construction is some ten years, and the planned operating lifetime of most power plants is some 30 to 40 years, it is obvious that the electrical utility must be capable of projecting electrical power requirements far into the future. Certainly it will have to give careful consideration to its existing generating capacity and the capacity of neighboring utilities, as well as to the possible implementation of energy conservation measures.

Certainly an electrical utility would like to choose the location of an electrical power plant in such a manner as to minimize distribution costs. Hence there is strong motivation to choose the site as closely as possible to the center of the electrical network it will supply. However such a desire is usually in conflict with other site requirements--particularly the safety requirements which prohibit building nuclear power plants close to large population centers. Furthermore as the electrical grid networks of neighboring utilities become more intermeshed, it becomes more likely that the electrical power produced by the plant will be distributed over an area very much larger than the network it was originally intended to supply. Hence, a central electrical distribution location is not usually a dominant consideration

Table 6-2: Basic Criteria in Nuclear Plant Site Selection  
(J.C. Ringle, in Electric Power Generation,  
Oregon State University, 1973)

A. TECHNICAL

Electrical Demand - Load Growths  
Reliability of Service  
Population Density  
Land Requirements & Availability  
Geological Formation  
Seismology  
Hydrology  
Protection for Natural Hazards  
Access (rail, water highway) -  
Construction & Operational  
Power Transmission Provisions  
Effect on Air Navigation  
Plant Security  
Plant Operational Safety  
Fuel Cycle Considerations  
Waste Disposal  
Multipurpose Use of Plant

B. ENVIRONMENTAL

Air Pollution - Meteorology  
Thermal Pollution  
Noise Pollution  
Chemical Pollution  
Radiation Release  
Recreational Resources  
Effect on Flora and Fauna  
Effect on Human Health  
Aesthetics  
Conservation of Nonrenewable  
Resources

C. ECONOMIC

Plant Costs - Capital & Operating  
Proximity to Load Center vs.  
Transmission Cost  
Multiple Uses of Water  
Utilization of Waste Heat  
Effect on Rural and Urban  
Development  
Taxes



in choosing the site for a nuclear power plant.

Next, consideration should be given to land requirements and availability. A typical nuclear plant will require some 200 to 400 acres of site area--as contrasted with some 1200 acres needed for a comparable-sized coal fired station (because of the coal storage requirements). The site should be characterized by a high degree of geological stability. That is, one needs soil conditions suitable for supporting the enormous weight of the power plant. Furthermore the site must have good drainage (you don't want to build a power plant in a swamp--although many swamps have been filled in for power plant construction). As we will see later in our discussion of nuclear plant safety, the seismology of the site is a very major factor in site selection, as is the susceptibility of the site to other types of natural hazards such as floods, tornados, hurricanes, and so on.

Certainly access will play a major role in site selection because an enormous amount of material must be brought in to build the plant. Since the major plant components such as the reactor vessel and steam generators weigh hundreds of tons and generally have to be brought in by barge, water access will be needed. Once the plant is in operation, access is not nearly so important since fuel shipments amount to only a few truckloads per year.

One must also give careful consideration to the land requirements of power transmission lines which will carry electricity away from the plant, since these high voltage lines will typically require some 100 to 150 acres of land per mile of lines for right-of-way.

A variety of other considerations must be given during the early stages of site selection. The economics involved in plant construction and subsequent operation requires careful evaluation. For example, how much will it cost to construct the plant (plenty), how easily can investment be raised to finance the plant construction (not very), and what will the effect of such a massive commitment be to the financial health of the utility (compared to its health if it "browns out" the

consumer). Furthermore, can the utility satisfy itself that there will be sufficient fuel available to operate the plant for its planned lifetime? Will there be sufficient fuel reprocessing capacity by the time the plant begins discharging spent fuel? These and many other factors must be considered at a very early stage of planning for a nuclear power plant.

Furthermore, the impact of the plant on the economy of the surrounding area must be considered. For example, it may be possible to implement a multi-purpose use of the plant. An excellent example here is the twin unit nuclear power plant at Midland, Michigan, which not only supplies electricity for central Michigan, but also supplies process steam for the Dow Chemical Company plant in Midland. Moreover the construction of the plant will create a large number of jobs and give a rather considerable boost to the economy of the adjacent area. Once construction has ended, many of these jobs will disappear, but since the plant will have a net worth of a billion dollars or so, it will pay a hefty amount of taxes which will benefit both the local area and the state in general.

JUST THINK,  
BOY, NO MORE  
PROPERTY TAX!

#### Environmental Impact Considerations

Although we will consider the environmental impact of nuclear power plants in some detail later in this chapter, let us simply list the considerations which must be given the environmental impact of the plant. Certainly any billion dollar construction project will cause a substantial impact on the site itself. Since the construction project will last up to ten years, the impact of thousands of workers travelling to and from the plant site and the shipment of large quantities of materials to the plant will invariably affect the surrounding area as well.

Once the plant is in operation, there will continue to be impact on the environment. Fortunately nuclear power plants release no combustion products to the environment as do fossil fueled units, so one is not nearly so concerned with degradation of air or water quality due to the plant. However nuclear facilities, like any large power stations, will discharge appreciable amounts of waste heat into the environment,

usually directly into the atmosphere via natural draft cooling towers, and the effects of this "thermal pollution" must be taken into account (although it should be noted that any moderately sized city rejects far more waste heat into the environment than any power plant). Furthermore there will be some discharge of chemicals (e.g., chlorine) used to treat cooling water.

All nuclear facilities will release minute quantities of radioactive material into the environment, and the routine emission of radiation must be carefully monitored and limited. Certainly too, the aesthetics of the power plant site should be considered, and every effort should be made to blend the plant harmoniously into its environment. Careful consideration should be given to the possible impact of the plant on all manner of wildlife, flora, and fauna, and other organisms that inhabit the environment, including man himself. One must also determine whether the plant will affect some natural or historical landmark.

In summary, one must balance off the environmental impact of the plant against the environmental impact of alternative methods of meeting the needed electrical demand. For example, what would be the environmental impact of a comparable sized coal-fired station, or the impact of conservation efforts needed to "save" this amount of electrical power (say, by increasing industrial efficiency by removing anti-pollution devices)?

#### Safety Aspects

A host of factors must be taken into account that could affect the safety of the plant. For example, the federal government sets criteria on the population densities in the vicinity of the plant. The plant itself must be contained within an exclusion area under the direct control of the owner of the plant, then surrounded by a low population zone extending out for 5 to 10 kilometers, and then the site must be a minimum distance (typically about 40-50 km) from any large population center.

The geology of the site must be carefully studied to determine the suitability of the soil and rock conditions for the massive weight of the station. The seismic behavior of the site area must be carefully traced back as far as possible to determine the potential for earthquakes. The hydrology must be examined for potential flooding or wave damage. A very thorough meteorological study must be conducted to determine the frequency and intensity of severe storms, as well as the prevailing wind conditions which could have an important bearing on the consequences of a breach of containment accident. We will examine each of these factors in some detail later in the chapter.

### 6.2.3. NUCLEAR PLANT OPERATION

#### Nuclear Plant Startup and Testing

Nuclear power plants are subjected to a degree of testing prior to operation which is quite different from that required for conventional power plants. Prior to the issuance of an operating license, a formal field test program must be conducted to verify the satisfactory operation of each and every component of the nuclear plant. Such field test programs will vary from one reactor type to another, as will the detailed procedures followed in reactor operation. However, for purposes of illustration, we will briefly consider several phases of a field test program<sup>4</sup> which might be conducted on a modern PWR plant:

- (i) Precritical testing: Prior to fuel loading, the nuclear steam supply system is subjected to a number of tests of nonnuclear components. The general sequence of such a testing program includes: 1) inspection of system components, 2) tests of electrical equipment and circuitry, 3) instrumentation tests, 4) hydrostatic tests (all fluid components and systems), 5) functional tests (in which all components are operated), 6) operation tests (in which systems are operated under conditions as close to the normal operating condition as possible). Following the functional tests of each system component, the reactor coolant system is brought to a hot standby condition in which system temperature and pressure are raised to

DON'T WORRY.  
THEY TEST THEM  
VERY CAREFULLY.





zero power levels using the primary coolant pumps as a heat source. (It should be stressed that there is still no fuel in the core.) There then follows a period of simulated operational testing with the reactor coolant system in a hot standby condition.

(ii) Fuel loading and zero-power testing: Prior to fuel loading, neutron detectors and sources are loaded into the core. Fuel loading then takes place with the reactor vessel and fuel handling pool filled with water at ambient temperature containing 2000 ppm boron to ensure a nuclear multiplication factor of less than 0.90. (Even if all of the control rods were removed, the boron content is chosen such that the core multiplication during fuel loading would never exceed 0.99.) At this point, fuel loading begins. Throughout the fuel loading, frequent measurements are made of core multiplication, and frequent pauses are taken to relocate sources and neutron monitors with frequent checks on results until all of the core fuel assemblies are in place. After fuel loading, one begins low power critical testing. The initial heating and pressurization of the primary coolant system is accomplished as in the precritical tests using the heat generated by the primary coolant pumps. After the NSSS has reached operating temperatures, the reactor is brought to criticality at low power, and a variety of nuclear measurements is performed.

(iii) Power testing: The reactor is then brought to somewhat higher power levels (e.g., 15% of rated power) at normal operating temperatures and pressures, with the steam generated dumped to the condenser through the turbine bypass system. Instrumentation is checked and calibrated, and the plant computer programming necessary to handle reactor operation is checked out. Finally the plant is brought to 100% of rated power, and a variety of tests are performed. The plant performance characteristics are evaluated at steady state. The reactivity coefficients are measured. The plant transient response is evaluated by initiating various step and ramp load changes and measuring the plant load following characteristics. Many other tests are performed as well to learn the operating characteristics of the plant.

DID YOU REMEMBER TO CHECK WITH RALPH NADER TO SEE IF HE WILL LET YOU START THE PLANT UP?



### Reactor Startup under Normal Operating Conditions

A modern nuclear power plant is an incredibly complicated system. One cannot start up such a plant by simply throwing a switch which withdraws a bank of control rods. Instead a complicated, but well-prescribed, sequence of operations must be followed in the startup procedure. The actual startup procedures that are followed will depend on whether the reactor coolant is in a hot, standby condition at operating temperature and pressure, or in a cold condition in which the coolant systems must first be pressurized and heated to operating conditions before reactor criticality can be initiated. Hence a hot startup actually comprises a subset of the cold startup procedure. The initial parameters characterizing the coolant system prior to cold and hot startup are given below:

<u>Parameter</u>	<u>Cold</u>	<u>Hot</u>
Reactor coolant temperature	60 °C	292 °C
Reactor coolant pressure	27 bar	155 bar
Pressurizer level, % full	100%	25%
Pressurizer temperature	60 °C	344 °C

We will furthermore assume that all pre-startup testing of system components has been completed.

A table<sup>5</sup> giving the steps and the approximate time required for each step in both hot and cold startup procedures is given in Table 6-3. In Figures 6-25 and 6-26 we have sketched the primary coolant temperature and pressure and the reactor power level as functions of time during the startup operation. A more detailed description of the individual steps involved in the startup procedure follows:

- Step 1: The pressurizer heaters are energized to start the heatup of the pressurizer necessary in drawing the steam bubble.
- Step 2: The reactor coolant pumps are started sequentially, and the pump heat is used to raise the temperature and pressure of the primary coolant loop.
- Step 3: Boron dilution in the coolant is then started to bring the boron concentration from its shutdown level to that required for the cold shutdown criticality condition.
- Step 4: When the pressurizer temperature reaches saturation, steam forma-

Table 6-3

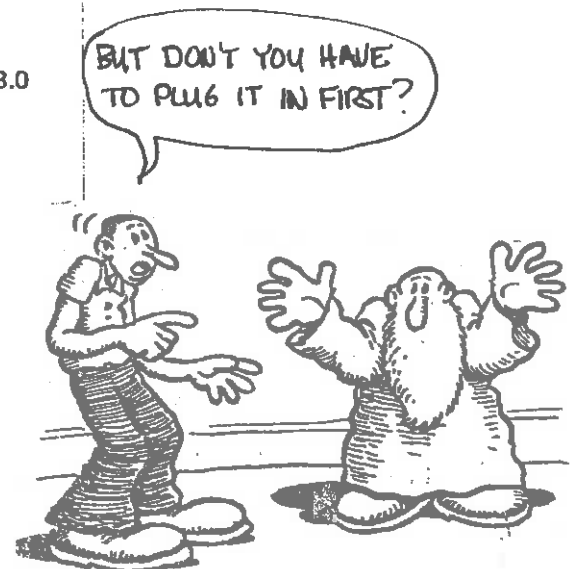
**ESTIMATED STARTUP TIME  
IN HOURS REQUIRED BY NSSS**

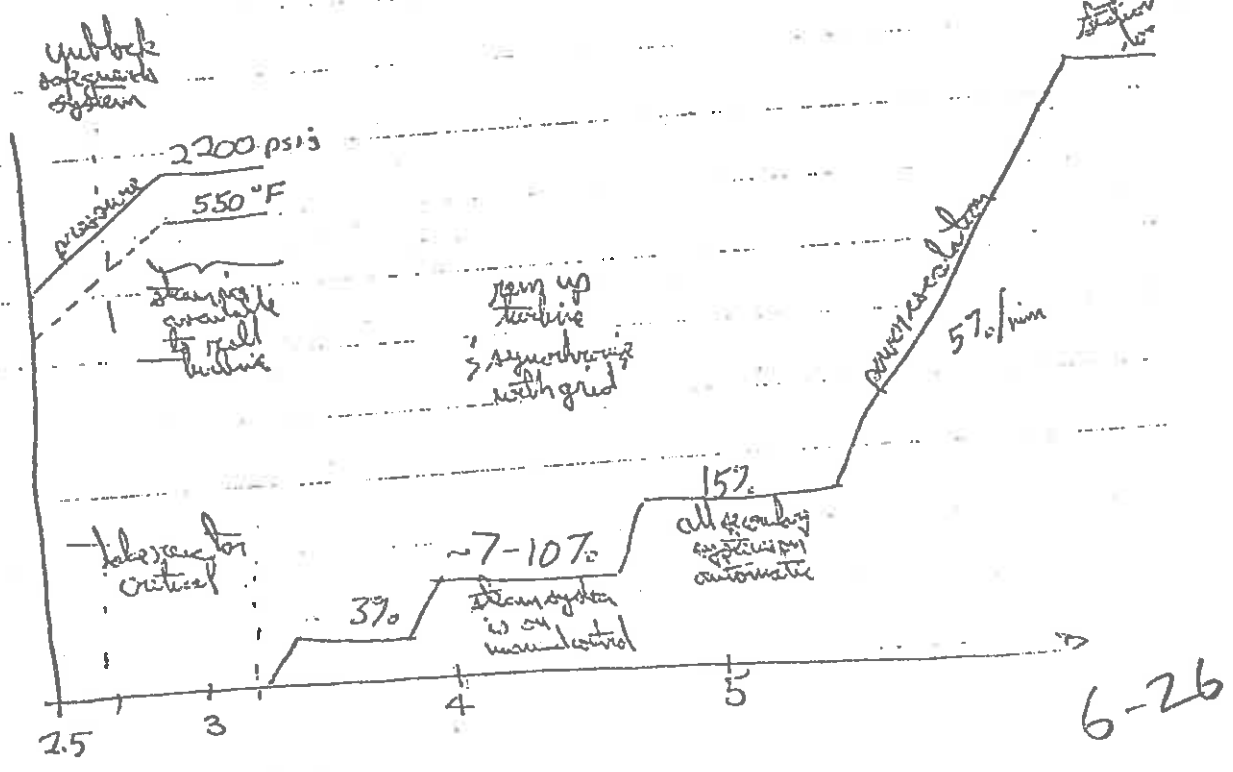
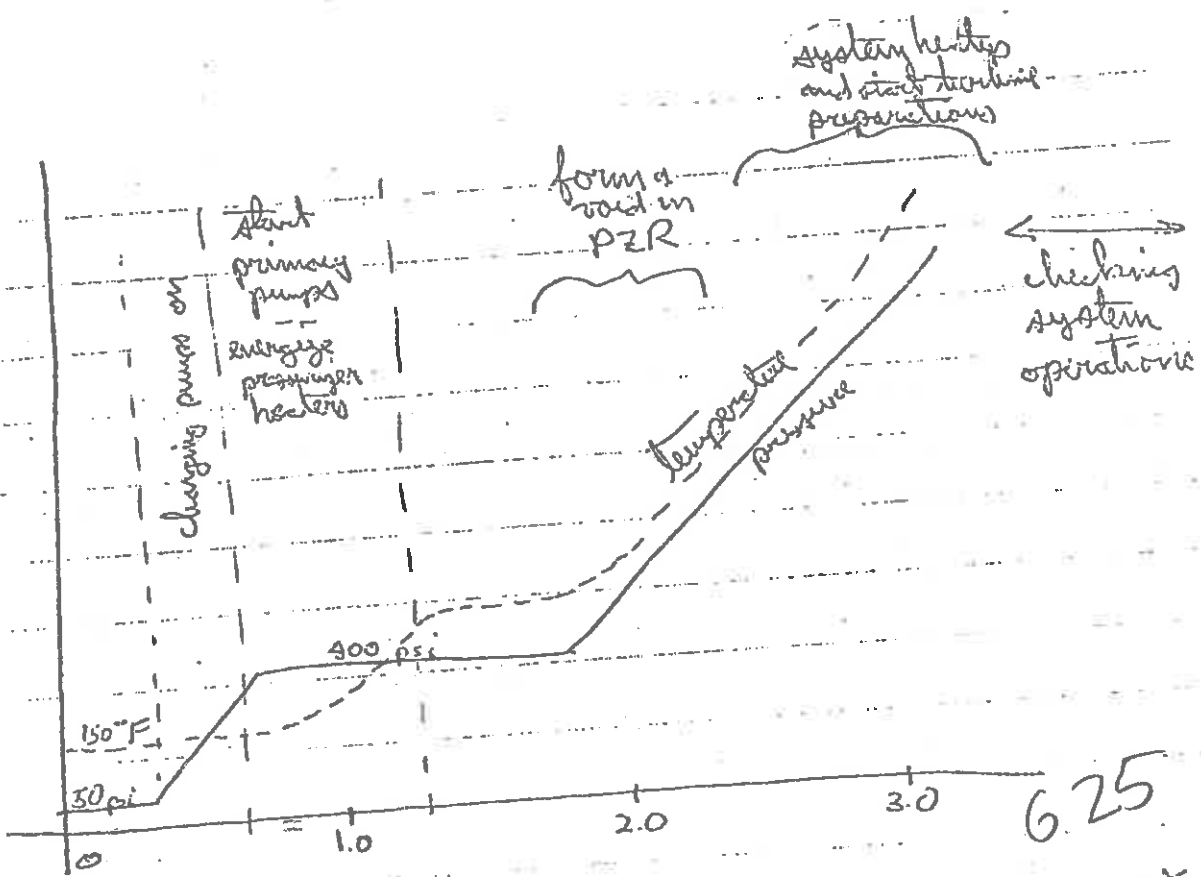
Operation	Hot*	Cold**
1. Raise primary system pressure to 400 psig and raise pressurizer temperature to saturation at 400 psig	—	6.5
2. Drain pressurizer to no-load operating level, maintaining system pressure at 400 psig	—	2
3. Withdraw rods to criticality and raise output to power range level	0.5	0.5
4. Raise RCS to no-load conditions ( $T_{avg} = 557^{\circ}F$ , system pressure 2250 psia)	—	3.5
<p>Secondary plant operations, such as drawing a vacuum in the main condenser and rolling the turbine, can be done before the RCS reaches no-load conditions.</p>		
5. Raise the NSSS output to full power (5 percent per minute)	0.5	0.5
<p>The loading rate is restricted by turbine considerations. The cold startup time given above represents the NSSS capability.</p>		
Total	1.0	13.0

\* Hot—557°F RCS temperature, 2250 psia, no-load pressurizer level.

\*\*Cold—Less than 140°F RCS temperature, 140°F in "solid" pressurizer.

(G. Masche, Westinghouse Systems Summary, 1971)





tion in the pressurizer begins. The primary coolant system is maintained at 27 bar by adjusting the pressurizer heater and/or pressurizer sprays.

- Step 5: At this point the shutdown bank of control rods is withdrawn and criticality is achieved. A startup rate of about 0.5 decades per minute is established, and power is increased to the level at which a heatup rate of 30 °C per hour is maintained in the primary system.
- Step 6: When the primary coolant temperature exceeds 200 °C, steam is drawn in the main condensers, and some steam is put on to begin to slowly roll the turbine shaft.
- Step 7: The primary system heatup and pressurization continues until a zero load coolant temperature of about 300 °C and a pressure of 155 bar are reached. At this point the plant is in a hot standby condition, and the hot startup procedure is followed.
- Step 8: The turbine-generator is brought up to synchronization speed and paralleled to the main electrical grid. The reactor is then brought manually to about 15% of full power, at which point the system is switched to automatic control and plant loading is continued to full power at a rate not exceeding 5% of full power per minute.

#### Normal Operation of Nuclear Power Plants

By normal operation we are referring to power generation at normal system operating temperatures and pressures. In a PWR system, the operating pressure is maintained by the pressurizer control system, while the system temperature is controlled by an automatic control system. Load changes on a nuclear power station initially appear as load demand on the turbine-generator. Small load changes can be accommodated by the natural load following capability of the NSSS. However any electrical power plant will be subjected to more dramatic variations in load. For example, a reference daily load cycle usually involves plant operation at full power for 12 hours, followed by a load reduction to approximately 50% of full power in 3 hours, remaining at 50% for 6 hours, and then returning to full power in 3 hours. Such load level changes require a

corresponding change in reactivity control involving both control rod motions and chemical shim control.

For example, following a change in load demand, the reactor power level may be changed using control rod adjustment. However boron concentration adjustments in the coolant will usually be made as well to compensate for slow reactivity changes and to prevent the control rods from approaching the limits of their maneuvering band. During the last 15% of the fuel cycle, the boron reserve is sufficiently low that the control rods are usually allowed to drift out of their maneuvering band to compensate for reactivity changes, with some accompanying decrease in load following capability.

A very important aspect of power reactor operation is to provide a system with the capability to withstand a loss of the turbine load without reactor scram. This is accomplished by controlled dumping of the turbine throttle steam either directly to the main condenser or to the atmosphere. The steam dump serves as a short-term artificial load which allows the reactor to automatically cut back power without scrambling. The steam dump can be controlled to reduce NSSS load as rapidly as the reactor control can reduce core power level without allowing system variables to exceed allowable operating limits.

#### Reactor Shutdown

If the plant is operating at some power level in excess of 15%, the initial shutdown step is to unload the turbogenerator. As the power output decreases to 15%, the reactor control and steam generator water level control are transferred to manual operation. The station auxiliary electrical loads are transferred from the turbogenerator to the outside source, and the turbogenerator is then completely unloaded, disconnected from the grid, and taken out of service. The control rods are then inserted to reduce power level and place the coolant system in a hot standby condition. Steam dump may be required initially to remove residual heat.

If it is desired to take the plant to a cold shutdown state, boration of the primary coolant water is initiated to bring the boron concentration to the cold shutdown value. Steam dump is adjusted to start a cooldown rate of 30 °C per hour. When the reactor coolant reaches 95 °C, the secondary side of the steam generators is filled. After assuring that the boron concentration is at the proper cold shutdown value, the remainder of the control rods are inserted and unlatched. Reactor coolant pumps are run only as needed to assure uniform loop cooldown and to provide spray for pressurizer cooldown. Eventually the system is completely depressurized by letdown. The time required for complete plant cooldown is approximately 20 hours.

#### Core Refueling

Nuclear power systems differ dramatically from conventional fossil fueled plants since they must be shut down and dismantled before refueling can commence. At the designated time of refueling, the reactor is shut down, cooled down, and depressurized, much as described above. When the reactor coolant system pressure has been reduced sufficiently, the system is vented, and the coolant level is lowered to a point just below the flange separating the pressure vessel and the vessel head. The control rod drive service lines and other attachments to the head are disconnected, the control rod drives are decoupled, and the mechanisms holding the head in place are detensioned and removed. The pressure vessel head is then lifted from the vessel. At this time the area above the open vessel is flooded with water to provide a radiation shield. As the upper core support structure is removed, the core is exposed and refueling commences. The spent fuel assemblies of the core are removed first and transferred to the underwater storage pool, where they will be stored for several months before they are shipped off for reprocessing. The partially spent fuel assemblies are then transferred to new locations, and the new fuel assemblies are loaded into the core.

In a similar manner, spent control rods will be replaced and necessary core maintenance will be carried out. Following refueling and main-

tenance, the reactor is reassembled by the reverse of the disassembly procedure.

Before the system is repressurized and brought to operating temperature, a battery of precritical tests is again performed, as well as a subsequent series of critical zero-power and low power tests. The total down time requirements for refueling presently range up to one month (although the actual fuel handling time is usually much shorter--on the order of a week or so).

### 6.3. Nuclear Power Plant Safety

#### 6.3.1. WHAT CAN HAPPEN?

We now turn our attention to situations in which a nuclear power plant may be subjected to abnormal operating conditions caused, for example, by component malfunction, operator error, or a host of other possible events which could lead to a nuclear reactor accident. The principal safety problems inherent in nuclear reactor operation do not arise because of the possibility of a nuclear explosion. Nuclear reactors cannot explode like an atomic bomb because they are fundamentally very different devices. As we have seen, bombs require highly concentrated U-235 or plutonium to be rapidly assembled into a supercritical configuration. However in a nuclear reactor, the fuel concentration is far too dilute (amounting to only about 3% enrichment in light water reactors) to allow for an explosive reaction.

Furthermore, reactors possess a number of inherent mechanisms which act to turn the chain reaction off automatically if the power level increases substantially. These mechanisms are referred to as negative temperature coefficients of reactivity. Perhaps the most important such mechanism in light water reactors arises from the fact that an increase in power level will cause a corresponding increase in core temperature which will lower coolant density. But since the water coolant in these



reactors also serves as a moderator, lowering its density will decrease moderation and therefore lower core multiplication tending to shut the chain reaction down. This is an extremely strong feedback mechanism and certainly would act to prevent any nuclear excursion.

There are still other feedback mechanisms of comparable importance which tend to "brake" the chain reaction. In both light water reactors and fast breeder reactors the "Doppler effect", which involves the increased tendency of U-238 to absorb neutrons as the core temperature rises, will act to inhibit any increase in core power level and control the chain reaction. In many reactor types, the expansion in the fuel and corresponding decrease in fuel density which accompany temperature increases will reduce core multiplication. There are a number of other feedback mechanisms, all of which act to shut down the chain reaction before any inadvertent power level increase can occur.

The principal concern in nuclear reactor safety is rather the large inventory of radioactive fission products which accumulate in the reactor fuel during operation. An operating power reactor builds up an inventory of some ten billion curies of radioactive material in its fuel. Although there are other sources of radioactive materials in the plant such as in the spent fuel storage pools, a quick glance at Table 6-4<sup>6</sup> indicates that the major contribution is from the reactor core itself. As long as the radioactive fission products remain in the fuel, they represent no hazard. However should they be released and transported to populated areas, significant damage could occur. Nuclear reactors must be designed so that under no credible--or even incredible--operating situation could such radioactive material be released from the core. To achieve this guarantee, not only must the nuclear reactor and coolant system be carefully designed against every imaginable accident situation, but as well auxiliary systems must be incorporated into the design to ensure core integrity in the event that such accidents should occur.

The containment of radioactive fission products is accomplished by designing into a nuclear power plant a series of physical barriers which

TABLE 9

## TYPICAL RADIOACTIVITY INVENTORY FOR A 1000 MWe NUCLEAR POWER REACTOR

Location	Total Inventory (Curies)			Fraction of Core Inventory		
	Fuel	Gap	Total	Fuel	Gap	Total
Core <sup>1</sup>	$8.0 \times 10^9$	$1.4 \times 10^3$	$8.1 \times 10^9$	$9.8 \times 10^{-1}$	$1.8 \times 10^{-2}$	1
Spent Fuel Storage Pool (Max.) <sup>2</sup>	$1.3 \times 10^9$	$1.3 \times 10^7$	$1.3 \times 10^9$	$1.6 \times 10^{-1}$	$1.6 \times 10^{-3}$	$1.6 \times 10^{-1}$
Spent Fuel Storage Pool (Avg.) <sup>3</sup>	$3.6 \times 10^8$	$3.8 \times 10^6$	$3.6 \times 10^8$	$4.5 \times 10^{-2}$	$4.8 \times 10^{-4}$	$4.5 \times 10^{-2}$
Shipping Cask <sup>4</sup>	$2.2 \times 10^7$	$3.1 \times 10^5$	$2.2 \times 10^7$	$2.7 \times 10^{-3}$	$3.8 \times 10^{-5}$	$2.7 \times 10^{-3}$
Refueling <sup>5</sup>	$2.2 \times 10^7$	$2 \times 10^5$	$2.2 \times 10^7$	$2.7 \times 10^{-3}$	$2.5 \times 10^{-5}$	$2.7 \times 10^{-3}$
Waste Gas Storage Tank	—	—	$9.3 \times 10^4$	—	—	$1.2 \times 10^{-5}$
Liquid Waste Storage Tank	—	—	$9.5 \times 10^1$	—	—	$1.2 \times 10^{-8}$

<sup>1</sup>Core inventory based on activity 1/2 hour after shutdown.

<sup>2</sup>Inventory of 2/3 core loading; 1/3 core with three day decay and 1/3 core with 150 day decay.

<sup>3</sup>Inventory of 1/2 core loading; 1/6 core with 150 day decay and 1/3 core with 60 day decay.

<sup>4</sup>Inventory based on 7 PWR or 17 BWR fuel assemblies with 150 day decay.

<sup>5</sup>Inventory for one fuel assembly with three day decay.

inhibit or prevent the release of fission products. This sequence of barriers is shown in Figure 6-27 . The first line of defense is the ceramic fuel pellet itself which entrains most of the nongaseous fission products and greatly inhibits the diffusion of gaseous fission products out of the fuel. The fuel pellets are contained in metallic tubes or cladding of zirconium or stainless steel which are designed to retain even the gaseous fission products which build up in the gap between the fuel pellet surface and the cladding tube. The fuel elements are contained within a 20 cm thick steel pressure vessel which serves as yet a third barrier to fission product release. The primary coolant loop piping is some 8 to 10 cm thick, and the coolant water itself is continuously circulated through filtering traps to separate out any radioactive material. The pressure vessel is surrounded by 2 to 3 meter thick concrete shielding and is located within a containment building which consists of one meter thick concrete walls lined with a 10 cm thick, leak-tight steel shell which is designed to prevent the release of radioactivity in the event of a major rupture of the primary coolant system. The plant itself is contained within an exclusion area over which the operating utility controls access and which separates the plant from the public. Finally the plant site is located intentionally within a low population zone some distance from any major population center.

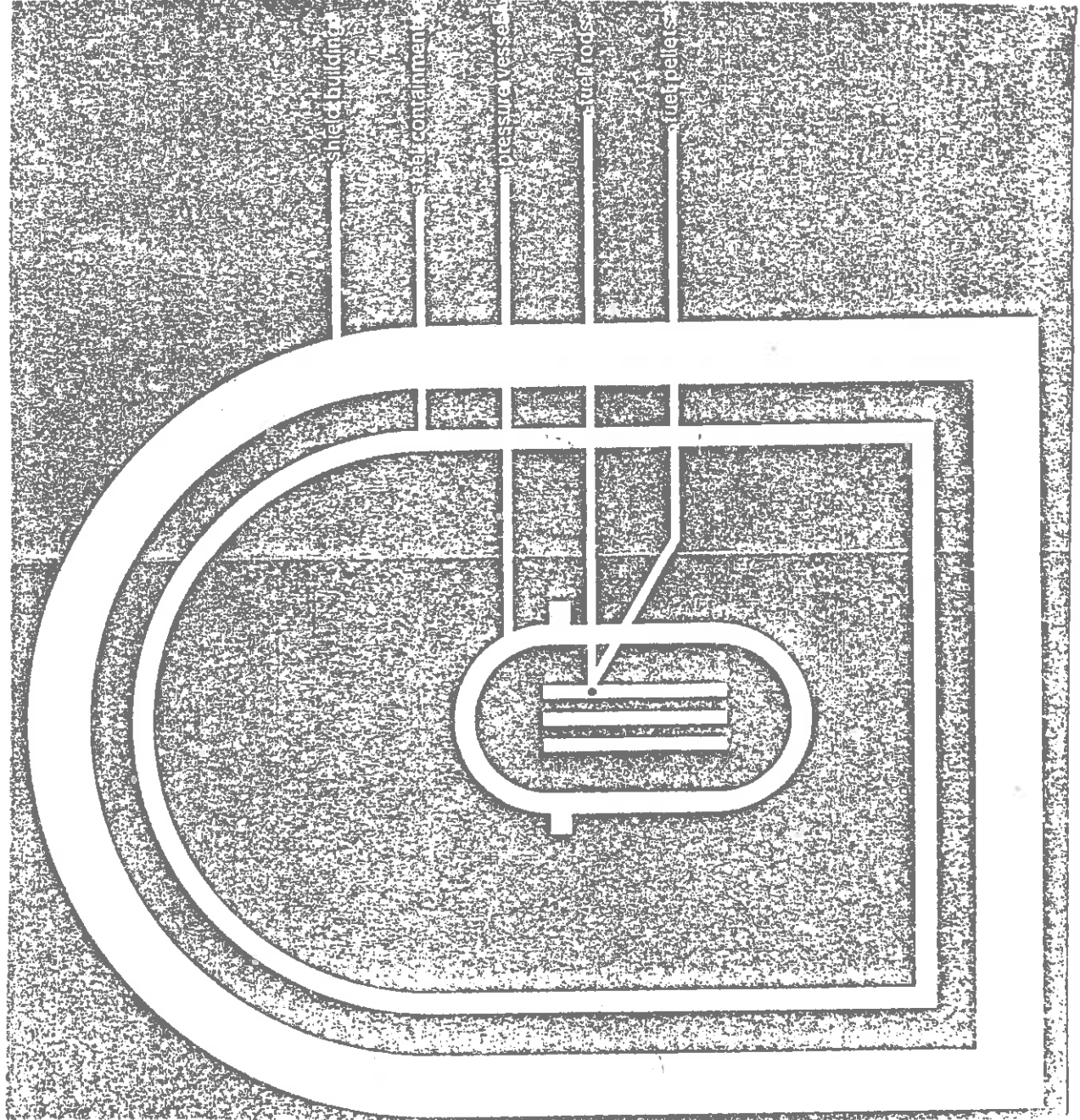
But there are still other precautions which are taken to ensure nuclear reactor safety. Major lines of defense include:

- (i) quality assurance to guarantee that all components of the plant have been manufactured and assembled to required design specifications;
- (ii) highly redundant and diverse safety systems designed to protect against abnormal operating conditions;
- (iii) engineered safeguards systems designed to protect against the consequences of highly unlikely but potentially catastrophic accidents (e.g., a loss of coolant accident) including equipment failures, human error, and severe natural events (earthquakes, tornadoes, floods, etc.)

WE DO GOOD WORK....



Figure 6-27: Barriers to Fission Product Release in Nuclear Plants



### MULTILAYERED PROTECTION FROM FISSION PRODUCTS IN NUCLEAR POWER PLANTS

Barrier or Layer	Function
1. Ceramic fuel pellets	Only a fraction of the gaseous and volatile fission products are released from fuel pellets.
2. Metal fuel tubes (cladding)	These contain the fission products released from the pellets. During the life of the fuel, less than 0.5 percent of the tubes may develop pinhole sized leaks through which some fission products escape.
3. Reactor vessel and piping	The 8- to 10-inch-thick steel vessel and to 4-inch-thick steel piping contain the reactor cooling water. A portion of the circulating water is continuously passed through a filtering trap to keep the radioactivity low.
4. Concrete shield	Operators and equipment are protected from high levels of core radiation by concrete 7 to 10 feet thick.
5. Domed containment building	The entire reactor part of the plant is enclosed to prevent release of radioactive in case of reactor cooling water pipe leakage or rupture.
6. Exclusion area	A designated area around each plant separates the plant from the public. Entrance is restricted.
7. Plant separation distance	Plants are located at a distance from population centers.

This approach to nuclear plant safety is sometimes referred to as "defense in depth".<sup>7</sup> It implies that nuclear engineers must do everything possible to prevent accidents from happening, through conservative design and safety systems. Then to cover the possibility that some of these systems will not work as intended, they must add on engineered safeguards systems to minimize the consequences of any accident which might occur. All of these features are then augmented by complete and detailed testing and inspection procedures for the various systems in the plant.

One of the most important aspects of nuclear reactor safety involves a careful analysis of the consequences of hypothetical accidents which is then factored into the plant design to provide acceptable protection to the public in the event that such an accident occurs. This design process is continued, considering more and more improbable events, until a point is reached at which it is agreed by both designers and regulators that the situation assumed is impossible or incredible. The extremely unlikely, almost impossible accident just short of that point is termed the "design basis accident" (DBA). A nuclear power plant must then be designed with sufficient safety margin to withstand the design basis accident without endangering the public. This provides assurance that the plant has a design margin to withstand any accident that might occur.

The typical DBA for light water reactors involves a massive rupture of the primary coolant system in which all of the coolant is rapidly voided from the core. The loss of moderation immediately shuts the chain reaction down, but the residual decay heat from radioactive fission products would tend to raise fuel temperatures quite rapidly (within several seconds) leading to clad failure and the release of fission products from the primary coolant system unless auxiliary cooling is provided.

To be a bit more precise, let us describe the loss of coolant accident (LOCA) as postulated by those devious minds who dream up such accident scenarios to challenge the sanity of reactor engineers.<sup>8</sup> One begins by assuming that the reactor has been operating at full design power for

some time when a double-ended fracture of the cold leg of the primary coolant piping occurs. (A double-ended break is assumed to yield the most rapid voiding of coolant.) The coolant in the pressure vessel rapidly depressurizes and blows out of the rupture as a two-phase mixture of water and steam. The voiding of coolant from the core is referred to as the "blowdown" phase of the LOCA. The reactor goes subcritical as soon as significant boiling occurs since the reduction in the coolant density corresponds to a decrease in moderation.

However the decay heat generated in the core continues to be substantial (about 5% of the operating power level) and will lead to rapid fuel element cladding temperature rise unless auxiliary cooling is provided. To this end, the nuclear steam supply system is equipped with an emergency core cooling system (ECCS) to protect against fuel element melting and failure. Both active and passive systems are used. Large tanks of borated water called accumulators are maintained at pressures somewhat below the operating system pressure such that in the event of a LOCA, the water from the accumulators will be discharged into the reactor vessel when the system pressure drops below that of the accumulator tanks. These devices operate in a completely passive way in that no separate control device is required in order to activate them.

The ECCS also contains active systems utilizing both low and high pressure coolant injection pumps. The high pressure injection pumps are designed to provide the source of coolant during LOCA resulting from small area breaks. The low pressure injection pumps are much higher capacity and are intended for a large LOCA and to provide for long term core cooling.

A very important task of nuclear design is to demonstrate that following the LOCA, the fuel clad temperature is maintained below a critical limit (for zirconium this limit is 1600 °C) by the ECCS.<sup>1</sup>

Nuclear power plants are equipped with numerous other engineered safeguards. In fact the containment systems themselves are regarded as engineered safeguards systems since they are designed to contain the

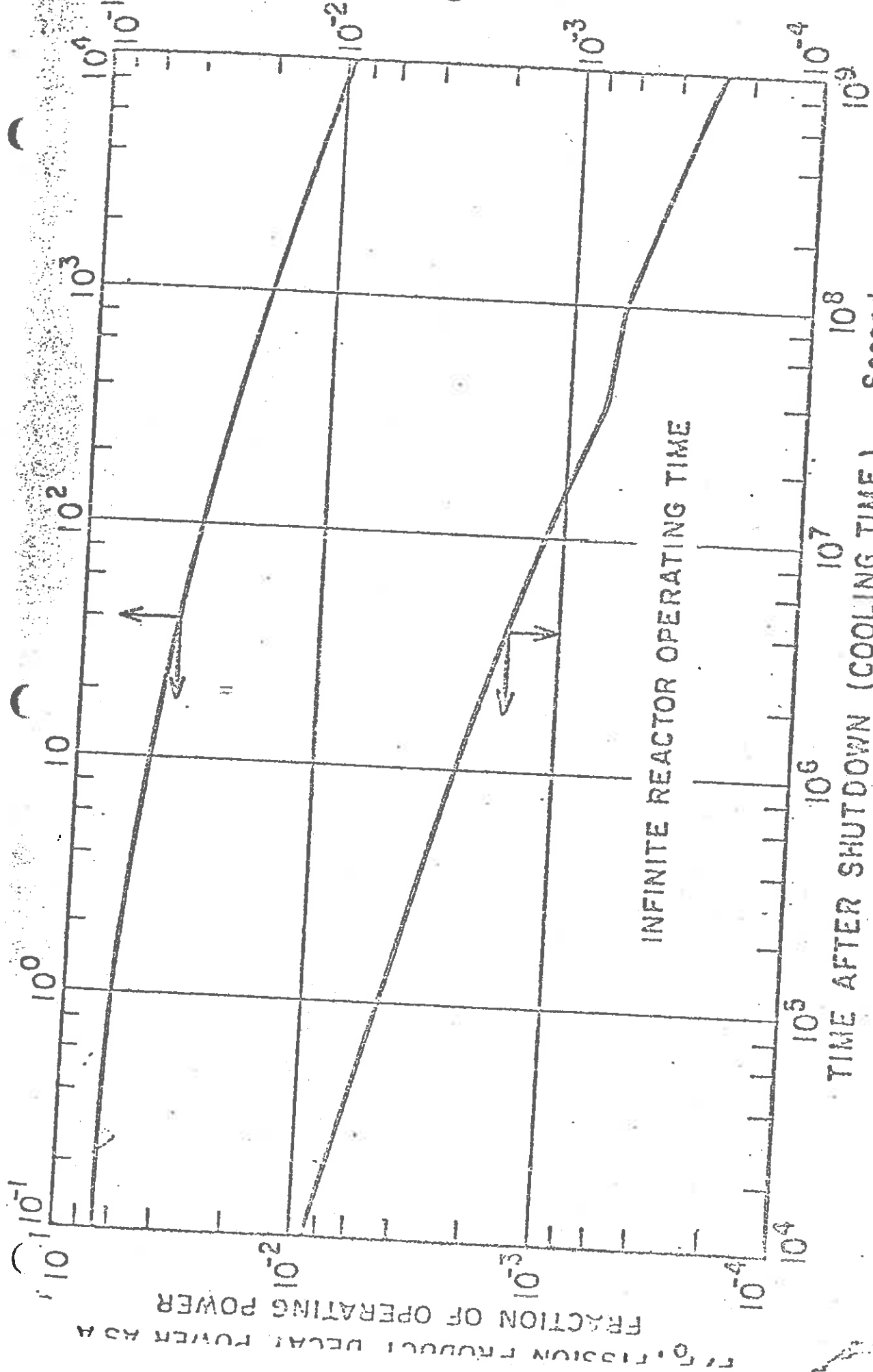
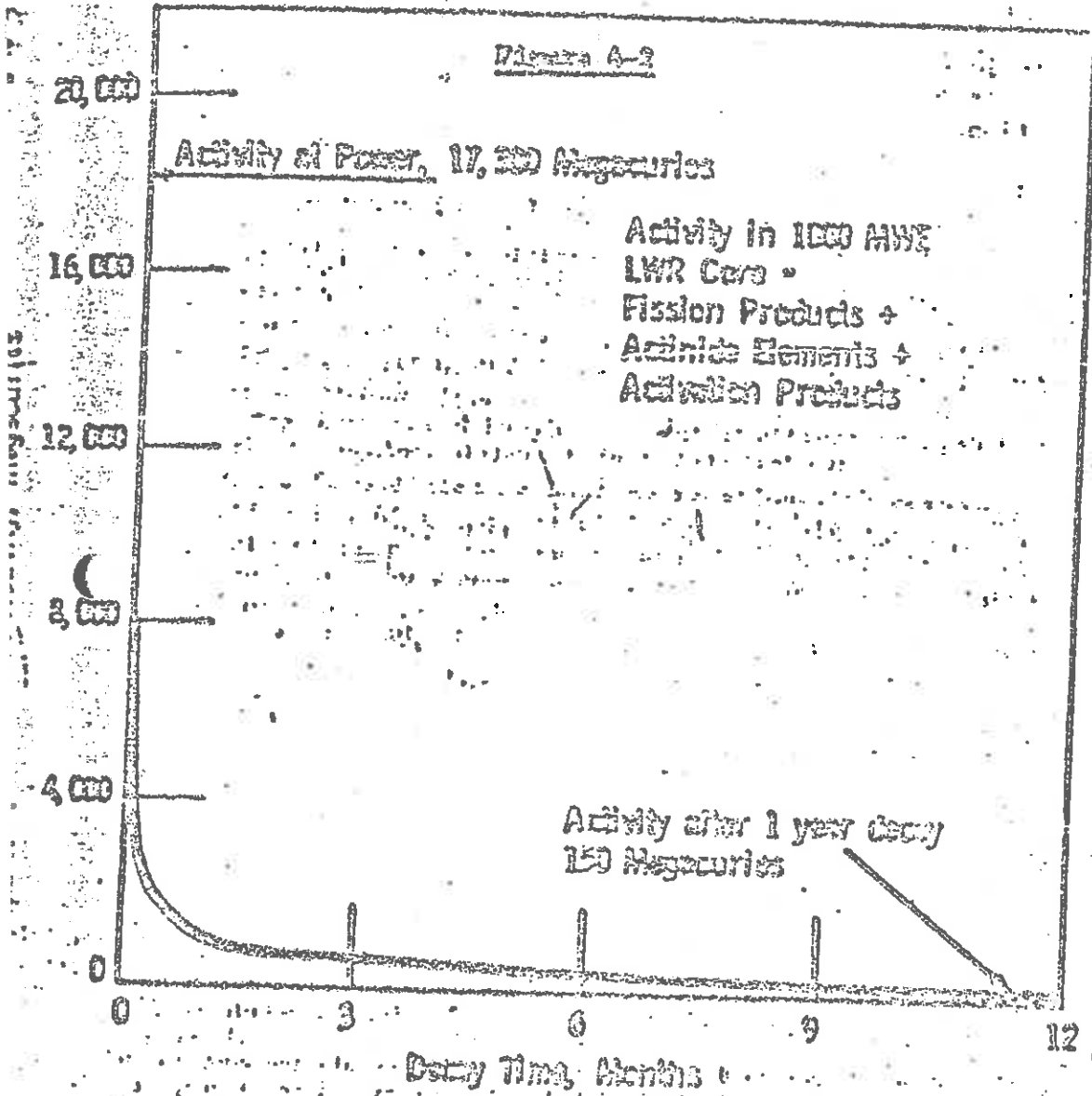


FIG. 1 STANDARD FISSION-PRODUCT DECAY HEAT CURVE

Figure 4-2





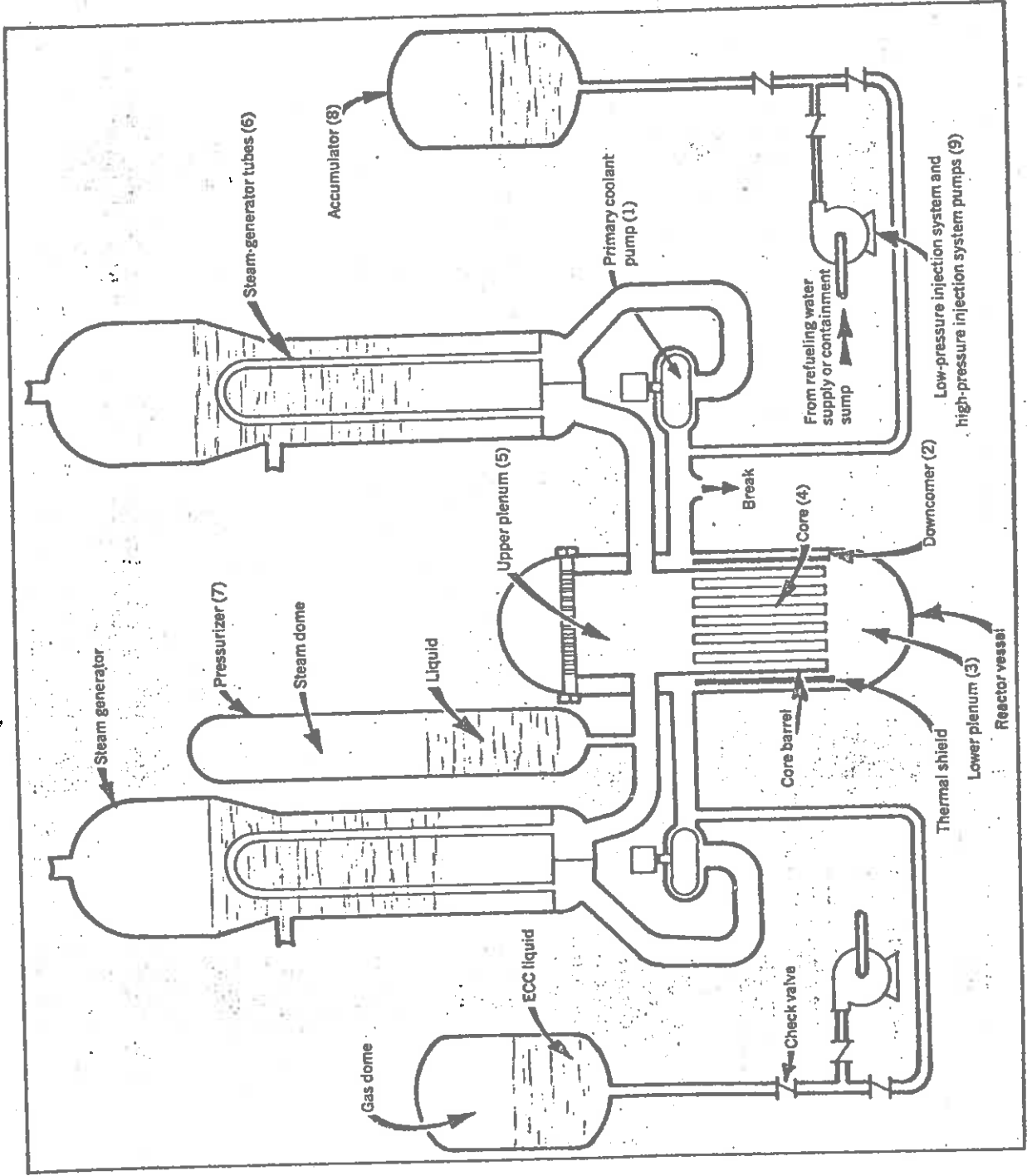
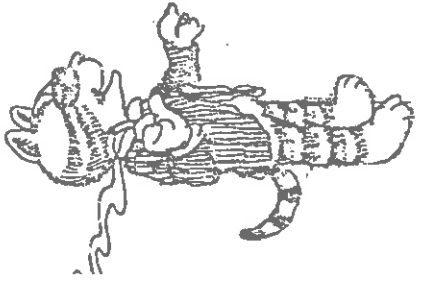
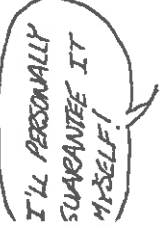
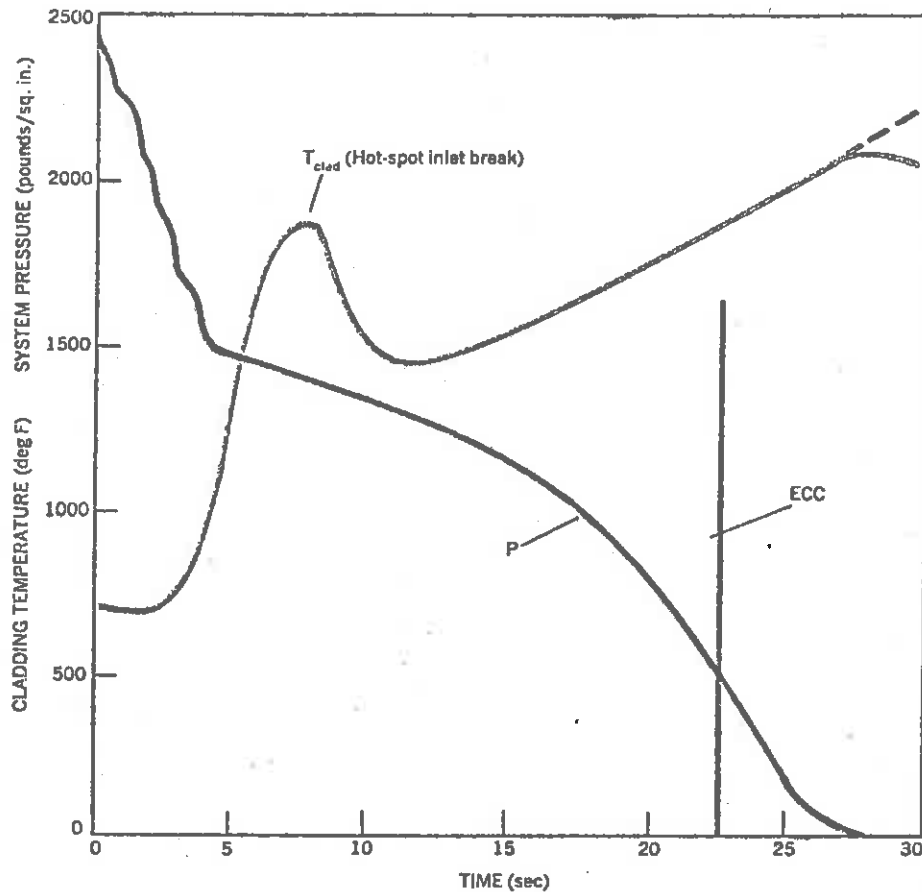


Figure 6-29: ECCS for a PWR Plant (Physics Today, )

Pressurized-water reactor. In this schematic view items 1 through 7 form a primary cooling loop. Should a break occur in this system, emergency core cooling is provided by liquid from the accumulators (8) and auxiliary injection pumps (9). This drawing shows two primary coolant loops; actual plants have as many as four.





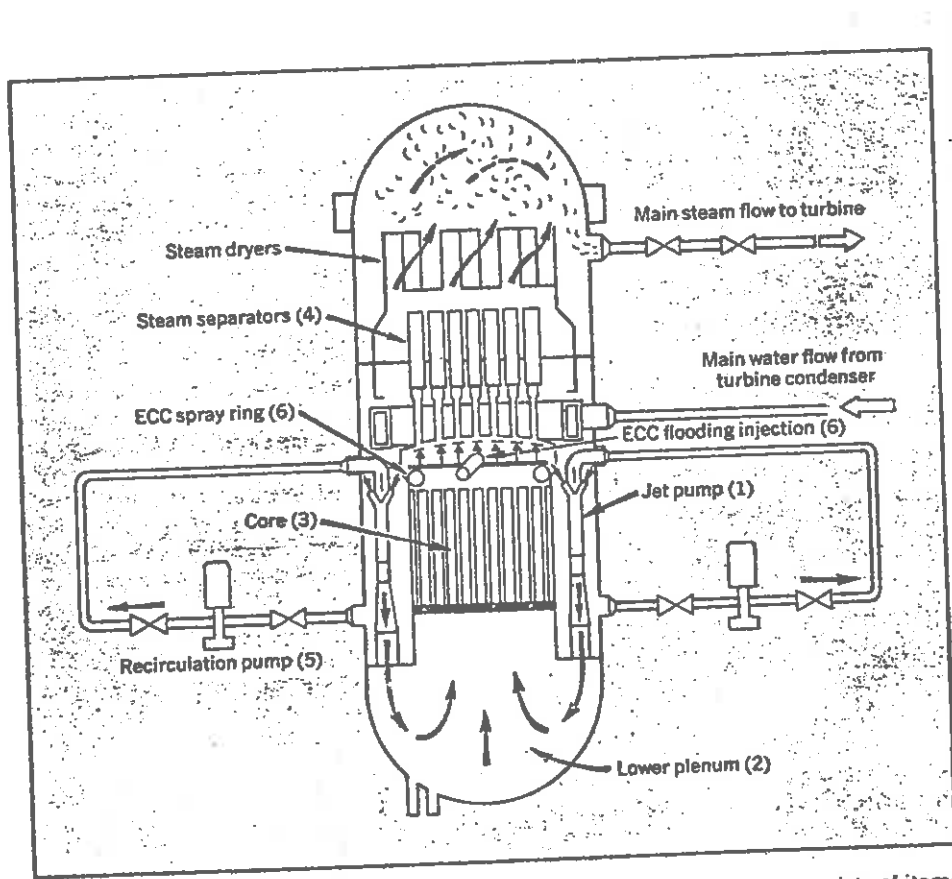
During a loss-of-coolant accident, the pressure in the primary cooling system would fall rapidly as high-pressure water flashes into the containment building. When the primary-system pressure has fallen to the saturation pressure at approximately 300°C (the operating temperature), a mixture of steam and water blows out of the break until the system reaches containment pressure. The temperature of the fuel cladding would rise rapidly at first, as steam blankets the fuel elements and reduces the cooling. Ensuing changes in the cooling conditions result in a brief period when the temperature falls, followed by a period of steady temperature rise. Emergency core cooling, which begins shortly before the system reaches containment pressure, reduces the temperature and brings the system under control; auxiliary pumps then provide long-term cooling.

Figure 6-30: Temperature Behavior following a Loss of Coolant Accident (Physics Today, )

IN FACT, STUDIES INDICATE THAT THE CLAD TEMPERATURES WILL ALWAYS REMAIN FAR BELOW MELTING POINT.



Figure 6-31: ECCS for a BWR Nuclear Power Plant (Physics Today,



Boiling-water reactor, shown schematically. The primary cooling system consists of items 1 through 5. Spray systems (6) provide emergency core cooling in the event of a loss-of-coolant accident downstream from the recirculating pump.

DON'T WORRY!  
IT'S GOT A  
90-DAY FREE  
TRIAL PERIOD.



the entire contents of the primary coolant loop in the event of a rupture of this system. In a pressurized water reactor, the primary containment is provided by the containment building itself which is usually designed to withstand an overpressure of some 4 bar resulting from a failure of the primary coolant loop. Such containment structures are equipped with ice-condensator and spray systems to decrease these pressures. In a boiling water reactor, the primary containment is provided by the drywell itself, a steel-lined concrete bottle which contains the BWR pressure vessel. Below this drywell is the pressure suppression pool which would act as a steam dump in the event that the main steam valves to the turbine building would have to be closed. There is also a secondary containment provided by the reactor building itself which is airtight, but not designed to contain high pressures.

One of the principal concerns voiced by critics of nuclear reactor safety involves what they perceive as inadequate testing of engineered safeguards systems in actual power plant environments.<sup>10</sup> Since such systems are designed to protect the public in the event of a catastrophic accident, it would be extremely difficult and expensive to subject a commercial-sized power reactor to a major loss of coolant accident just to see how the emergency core cooling system would function. Such a major test of the ECCS on an operating power reactor has never been conducted, and for this reason one occasionally hears the complaint that these engineered safeguards systems are untested, and therefore, by inference, unreliable.

In fact, however, there have been extensive tests of both the individual components and various subsystems of the ECCS.<sup>11</sup> Furthermore the federal government has constructed a rather elaborate test facility (the loss of flow test or LOFT) to simulate loss of coolant accidents in operating power reactors and test the ECCS and more specifically to confirm the predictions of analytical models used to design and analyze these systems.<sup>12</sup>

There remains however the difficulty of adequately demonstrating to the public that such systems will perform as designed, that nuclear

reactors are indeed safe. If critics of nuclear power reactor safety are unconvinced by the spotless safety record achieved in over 300 years of commercial power reactor experience and by the extensive testing of the components which go into such plants, then it is not unreasonable to question whether a full-scale LOCA test of the ECCS on a commercial power reactor (with an attendant cost of hundreds of millions of dollars) would provide any further assurance. Indeed, any competent scientist would readily admit that such an uncontrolled experiment would yield very little information since it would only test the response of one given ECCS to one type of accident and initiating event, when in fact there are a large variety of diverse and redundant safety systems in nuclear power plants designed to protect against any conceivable accident situation. The argument that only a full-scale test of the ECCS on a commercial power reactor will provide acceptable evidence of nuclear reactor safety is somewhat akin to demanding that we crash a number of 747s in order to test the safety systems on these aircraft. Very little would be learned from such tests, and indeed, from a scientific viewpoint, most information is gained from a series of tests performed on components and subsystems. An intensive program of research on nuclear reactor safety, particularly concerned with light water reactors, is presently underway and will no doubt lead to increased safety of these reactor types.

### 6.3.3. THE LICENSING OF NUCLEAR POWER PLANTS

The responsibility for nuclear power plant safety rests with the Nuclear Regulatory Commission (NRC) which has the authority to issue permits to construct nuclear plants and licenses to operate the nuclear plants. The procedure involved in applying for a construction permit for a nuclear power plant is outlined in Table 6-5<sup>13</sup>. The application for this permit must contain a detailed description of the plant, its site, and the utility's financial and technical qualifications for constructing and operating the plant, a justification for the new plant, and two voluminous reports: a Preliminary Safety Analysis Report (PSAR)

# Steps in the Licensing of a Power Reactor (Safety Related)

1. Applicant makes application for CP with a PSAR submitted to NRC (DES submitted concurrently).
2. NRC staff reviews, and on basis of review, which may include correspondence and meetings with applicant, prepares SER.
3. ACRS does review of application making use of PSAR, SER and meetings which include NRC staff and applicant. ACRS writes report to NRC.
4. ASLB with PSAR, DES, ACRS letter, holds public hearings and may take comments and testimony. It recommends (for or against) granting of CP. Recommendation goes to NRC which can reverse ASLB.
5. If things are OK, go for a construction permit is granted which permits applicant to build plant.
6. Near the end of construction applicant prepares and submits FSAR (also FES) above review process is repeated.
7. If safety, antitrust & environmental reviews are OK, NRC grants OL!

consisting of 10 to 20 volumes of analysis of the safety of the proposed power plant and an Environmental Impact Report (EIR) consisting of 5 to 10 volumes evaluating the impact of the plant upon its surrounding environment. These documents are examined in great detail by the staff of the NRC. They are advised by an independent panel, the Advisory Committee on Reactor Safeguards (ACRS) composed of experts from a wide variety of technical disciplines from outside the NRC. The evaluation of the application for a construction permit will typically take about two years. During this time there will be several public hearings at which members of the public can present testimony before the Atomic Safety and Licensing Board within the NRC and may intervene by cross-examining the testimony of others. Indeed, recent legislation has been introduced in Congress which would require the NRC to provide both funding and technical support for organized intervenor activities in the licensing process. Usually the evaluation process is one of iteration, in that the NRC will return to the applicant with a number of questions concerning the PSAR and the EIR, and the applicant must then respond satisfactorily to these questions, frequently by agreeing to implement changes in the proposed design or possibly changing the location of the proposed site. Occasionally the applicants have chosen to withdraw the application for a construction permit altogether at this point.

If the amended application is found to be acceptable, the NRC issues a construction permit to the applicant who then proceeds with construction of the plant. As the construction proceeds, a second major safety report, the Final Safety Analysis Report (FSAR) and an updated EIR are prepared and submitted to the NRC. These reports include all of the supplements and changes that were made in the original PSAR and EIR and essentially document the final design of the plant. The review procedure then begins once again, utilizing both the internal staff of the NRC and outside consultants while allowing for public hearings. If the applications are approved, then an operating license is issued.

But the NRC's responsibility is not ended at this point for it must maintain continual onsite inspection to ensure that the plant is operating consistent with its operating license. As technology evolves, the

NRC may require that the utility retrofit the plant to upgrade safety systems or operating procedures. Hence the safety design of the plant should not be considered as fixed, but rather a constantly evolving process that always must be brought up to date with existing knowledge and experience.

The PSAR-FSAR must not only present a detailed evaluation of the design of the nuclear plant and its various safety systems, but it must also carefully consider the safety aspects of the site itself. It must estimate the population in the vicinity of the plant over its operating lifetime. Furthermore it must carefully evaluate the geological characteristics and seismic activity of the site, as well as the site hydrology and meteorology.

Certainly great consideration is given to the seismic history of the site. Nuclear power plants are never knowingly sited near active geological faults. Occasionally during ground excavation or subsequent surveys, additional faults may be discovered. If this should occur after a construction permit or even an operating license has been issued, the suitability of the site must once again be carefully examined in this new light by the NRC. Such considerations have forced certain sites to be abandoned (e.g., the Bodega Head and Malibu Canyon sites in California).<sup>4</sup>

Nuclear power plants are designed to be able to ride out earthquakes of major intensity. That is, by a combination of structural analysis and testing during plant design, plant structures and equipment important to safety are built so that they can withstand the most severe earthquake deemed possible at the site. Indeed, since the electricity produced by such plants would be most urgently needed following a major earthquake, nuclear plants are designed so that they would not even need to be shut down during quakes of moderate intensity and could be restarted immediately following a major quake, unlike conventional plants which would probably be destroyed by such earthquakes. Plants located on seacoasts must be surrounded by breakwaters to protect them from possible tsunamis, that is, tidal waves generated by earth-



quakes. The only operating experience of nuclear plants during earthquakes has been that of the San Onofre plant just north of San Diego which remained in operation during the rather serious earthquake that hit southern California in 1971.<sup>15</sup>

A number of other safety factors must be considered in site selection. The site must be protected against possible flooding. For example, nuclear sites downstream from large dams must be protected from the consequences of possible dam failures. Furthermore the design must be capable of withstanding violent storms such as tornados or hurricanes. The containment structure must be capable of withstanding the impact of debris hurled by such storms. Special considerations must be given to off shore sites in which a nuclear plant is constructed on a mammoth barge, towed several miles out to sea and anchored, and then surrounded by a massive breakwater.<sup>16</sup> The breakwater must be capable of withstanding not only large tidal waves and storms, but as well the direct impact of a large ship (such as the USS Enterprise slamming into it at full speed).

#### 6.3.4. AN ASSESSMENT OF THE PUBLIC RISK FROM NUCLEAR POWER PLANTS

We have seen that one of the milestones involved in the development of nuclear power was the effort made by the AEC to assess public risk that might result from this new technology. As part of this program, in 1957 it commissioned a group of physicists at Brookhaven National Laboratory to examine both the probabilities of occurrence and the possible consequences of major accidents in large nuclear power plants. The report which resulted from this study, WASH-740,<sup>17</sup> not only represented a milestone in the concern for the public safety from a developing technology, but unfortunately also has come to represent a milestone in misquotation and misunderstanding.

In this report the Brookhaven group considered the consequences of accidents in a 200 MWe nuclear plant located about 30 miles upwind of a major city with a population of one million. They examined several accident scenarios. In the mildest case, the group assumed that although

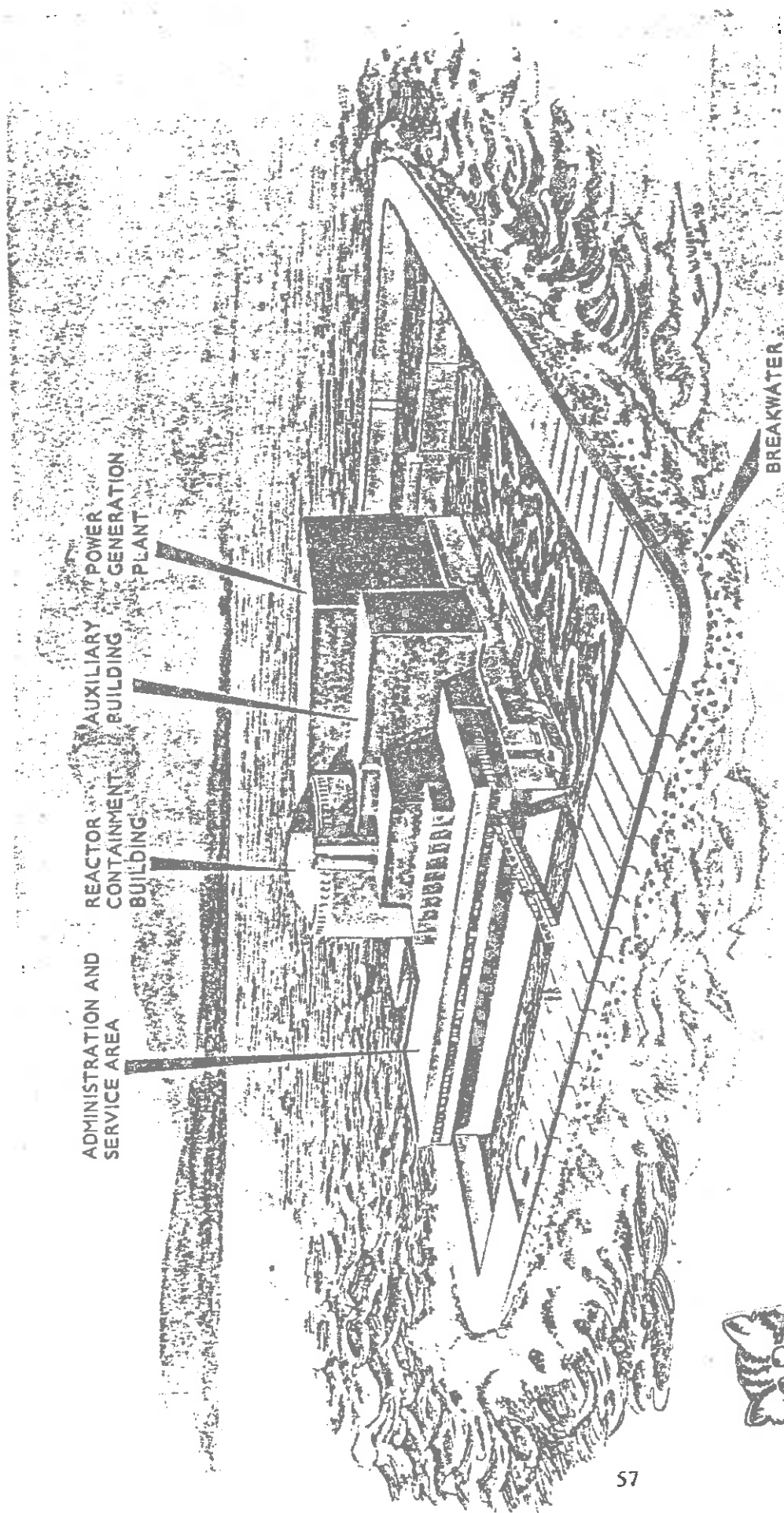


Figure 6-32: A Floating (Offshore) Nuclear Power Plant



all fission products in the core somehow vaporized and escaped the primary coolant system, they were contained by the containment building and hence there was no radiation released to the environment. They concluded that there would be no lethal exposures from such an accident.

Many nuclear critics<sup>18</sup> take great delight in pointing to the most serious accident examined by this group which postulated that 50% of all of the fission products contained in the core would not only be released (which is quite impossible), but that meteorological conditions would be such as to disperse these fission products over the nearby city. Needless to say, the corresponding causality estimates were very large indeed, amounting to 3,400 fatalities, 43,000 injuries, and \$7 billion in property damage. During the mid 1960s there was a small, tentative effort to upgrade the WASH-740 report to reflect the increased size of power reactors.<sup>19</sup> Unfortunately, this update simply scaled causality figures as proportionally larger due to the increased reactor size without making any significant effort to re-examine the unrealistic nature of assumptions made in the original WASH-740 report.

Stimulated by the increasing public concern over nuclear reactor safety and the flagrant misuse of WASH-740, in 1972 the AEC commissioned an independent study under Norman Rasmussen of MIT to assess as accurately as possible the public risk from commercial power reactors of the type likely to be in operation during the next several decades. The Rasmussen group examined not only the consequences of nuclear reactor accidents, but in addition they attempted to estimate the probable frequency of occurrence of these types of accidents. By using a combination of statistical and computer methods, they were able to estimate the relative risks from various types of nuclear plant accidents. Their report,<sup>20</sup> referred to as WASH-1400 or the Reactor Safety Study (RSS), concluded that "the risks to the public from potential accidents in nuclear power plants are very small". In particular,

- (a) "The consequences of potential reactor accidents are no larger, and in many cases, are much smaller than those of non-nuclear

accidents. These consequences are smaller than people have been led to believe by previous studies which deliberately maximized risk estimates.

- (b) The likelihood of reactor accidents is much smaller than many non-nuclear accidents having similar consequences. All non-nuclear accidents examined in this study, including fires, explosions, toxic chemical releases, dam failures, airplane crashes, earthquakes, hurricanes, and tornadoes, are much more likely to occur and can have consequences comparable to or larger than nuclear accidents."

Some of the calculated consequences and frequencies of occurrence of nuclear plant accidents are shown in Table 6-6 and a comparison with non-nuclear accident risks is given in Table 6-7 .

Naturally, appearing as it did at a time of greatly heightened debate over nuclear reactor safety, this report was immediately attacked by nuclear critics and embraced by proponents,<sup>21,22</sup> although in most cases neither group digested even a fraction of the detailed analysis outlined in its 14 volumes. Since this reaction was anticipated, the AEC issued the report in draft form in early 1974 and invited large numbers of outside groups to evaluate the report. Although in some cases, aspects of the data and methodology used in the report were questioned, by and large the response of most of these groups (including the American Physical Society,<sup>23</sup> the Environmental Protection Agency,<sup>24</sup> the Nuclear Regulatory Commission,<sup>25</sup> and NASA) agreed with the major conclusions of the report. Much of their constructive criticism was incorporated in the final version of the report issued in 1975.

A great many scientists and engineers have come to regard WASH-1400 as a milestone in the assessment of public risks from new technologies. This report emphasized the importance of careful evaluation and comparison of the relative risks associated not only with a given technology, but also with alternatives to that technology. In fact, this study is now serving as a model for risk assessment in other fields.

Before we leave the topic of nuclear reactor safety, we should comment upon one additional issue that has become a source of great public confusion: nuclear liability and insurance. Nuclear critics frequently make the statement that there is a nuclear exclusion clause



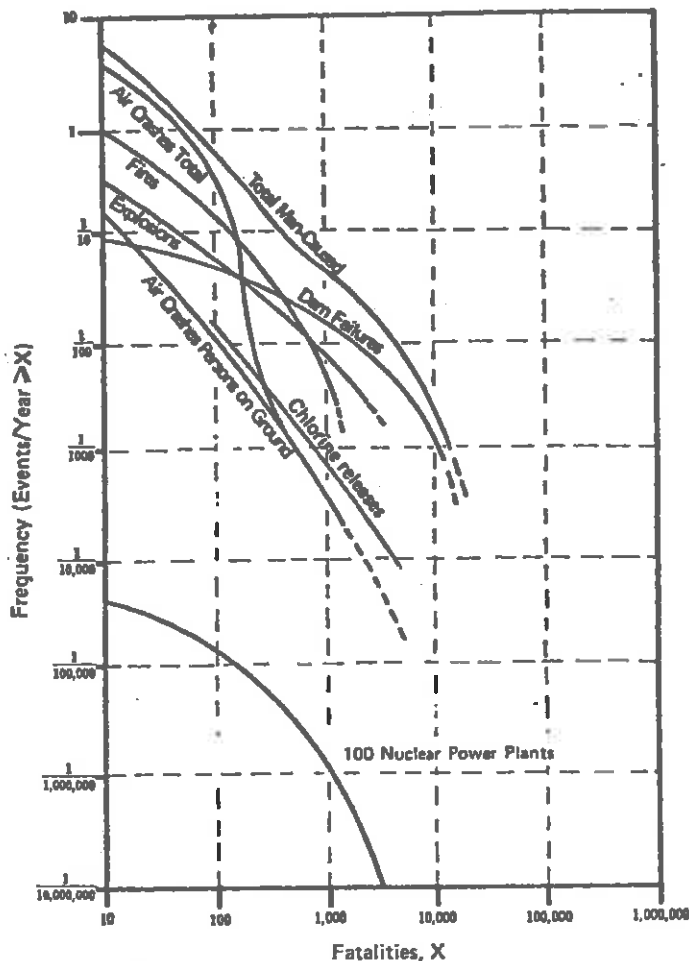


Figure 6-33: Frequency of man-caused events involving fatalities is compared to predicted consequences of nuclear plant accidents (WASH-1400)

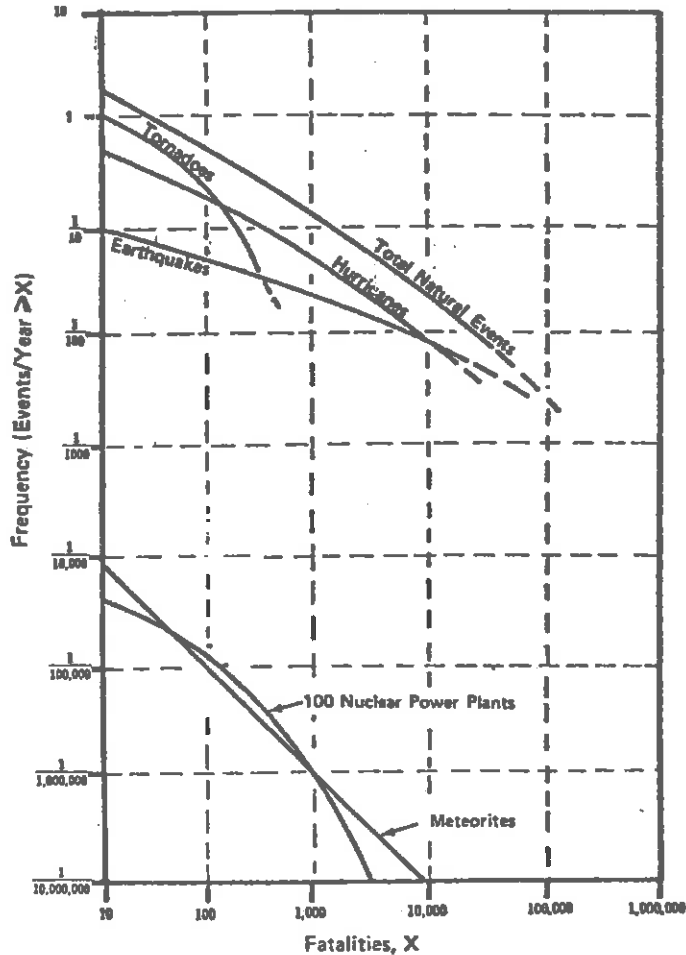


Figure 6-34: Frequency of natural events involving fatalities is compared to predicted consequences of nuclear plant accidents (WASH-1400)

Table 6-6

Calculated Consequences of Nuclear Plant Accidents

Consequence	Frequency for 100 Operating Reactors
10 acute fatalities	Once in 30,000 years <sup>a</sup>
1000 acute fatalities	Once in 1,000,000 years
10 acute illnesses	Once in 1600 years
1000 acute illnesses	Once in 30,000 years
10 latent cancers	Once in 500 years
1000 latent cancers	Once in 1,400,000 years
10 genetic effects	Once in 600 years
1000 genetic effects	Less than once in 10,000,000 years
10 thyroid illnesses	Once in 700 years
1000 thyroid illnesses	Once in 5000 years
\$1 million property damage	Once in 200 years
\$100 million property damage	Once in 600 years
\$560 million property damage	Once in 5200 years

<sup>a</sup> For example, these values indicate that an accident that would produce the listed consequences might be expected once in 30,000 years if 100 reactors of present design were in operation.

Table 6-7

ACCIDENTAL DEATH STATISTICS FOR U.S.—1973

	Total Deaths <sup>a</sup>	Deaths Per Million Persons Per Year
Motor vehicles	55,511	270
Air pollution	20,000 <sup>c</sup>	98
Falls	16,506	80
Drowning	7,152	35
Fire	6,503	32
Poisoning (liquids and solids)	3,683	18
Fossil fuel plant air pollution	2,500 <sup>b</sup>	17
Accidents in therapeutic medical and surgical procedures	3,258	16
Firearms	2,618	13
Mechanical suffocation	2,218	11
Poisoning (gases and vapors)	1,652	8
Electric current	1,149	6
Railway accidents	789	4
Cataclysm (earthquake, flood, etc.)	193	1
Explosion of pressure vessel	73	1
Bites and stings (venomous animals and insects)	49	1
Radiation and radioactivity	0	0

<sup>a</sup> Abstracted from Ref. . . .  
<sup>b</sup> Calculated in Ref. : . . .  
<sup>c</sup> Estimate by J. Golman quoted by R. Lapp (Ref. . . .)

in the insurance policy of most homeowners. Furthermore, the Price-Anderson Act passed by Congress in 1955 and renewed in 1975 restricts the liability of an electrical utility in the event of a nuclear accident to \$560 million. So how can nuclear power possibly be safe if no one will insure it?

It is certainly true that there is a nuclear exclusion clause in most homeowners' policies--in addition to exclusions for landslides, earthquakes, and so on. The reason for the nuclear exclusion is quite simple: if your property is damaged by a nuclear accident, the plant operators are responsible for the damage, not you. Therefore the nuclear facility must carry liability insurance against any property loss it might cause. Your property is certainly insured against nuclear damage, but the responsibility for obtaining this insurance belongs to the utility. The Price-Anderson Act demands that nuclear power plants carry \$560 million of liability insurance, of which \$125 million is obtained from a private insurance pool, while the remaining \$435 million is purchased in the form of an indemnity from the federal government.

This is a form of "no-fault" insurance in the sense that you must only demonstrate damage to your property as a result of a nuclear accident--not fault on the part of the operating utility--to receive compensation. The limit of \$560 million was set for several reasons. First there must be some limit set on the amount of liability insurance that any industry is going to be required to carry. There is no such thing as an unlimited insurance coverage. Since the probability of an accident incurring damages in excess of this amount is very remote (less than once every 500,000 years of operation of the plant), it seems unnecessary for utilities to be required to carry additional insurance. Even if damage in excess of this coverage should occur, the spirit of the Price-Anderson Act was that the federal government would provide the additional relief (as it has for other disasters such as floods, dam failures, etc.)

Frequently people question why the government supplies part of this indemnity coverage (at a very considerable expense to the utilities). The reason is again quite simple: since there has never been a nuclear plant

accident, there are no available statistics of the type required by private insurance companies in underwriting various activities. Furthermore insurance companies are limited to the amount of their assets they can risk losing in one major event. This principle applies not only to nuclear insurance, but also to fires, explosions, earthquakes, and other types of catastrophes. The \$125 million liability coverage provided for each nuclear power plant by private insurance companies is the maximum amount of liability that such companies will underwrite for any single risk--whether due to oil refineries, super-tankers, aircraft, or whatever.

Although the amount of coverage available from the private sector is slowly increasing, the amended Price-Anderson Act of 1975 will replace the government supplied indemnity gradually by assessing each new nuclear plant \$3 million to build up an indemnity pool provided by the reactor owners themselves. As this pool builds up, it will be allowed to rise above the \$560 million liability limit presently in effect.<sup>26</sup>

#### 6.4. Environmental Impact of Nuclear Power Plants

By the time bulldozers first appear on a nuclear power plant construction site, the electrical utility will have spent two years or more making detailed plans, preparing two major reports (the PSAR and EIR), a large number of federal and state committess will have met to study the reports, no doubt many supplementary reports will have followed, visits and telephones calls to Washington and other locations will have been made, and public hearings will have been conducted. The Preliminary Safety Analysis Report is a lengthy, complex technical report, and as the name implies, is concerned primarily with the safety aspects of the proposed nuclear power plant.

The Environmental Impact Report can also run into volumes, at a cost of several million dollars to the electric utility and hence to the consumer.

THE COURTS NOW SAY  
YOU HAVE TO CONSIDER  
EVERYTHING -- INCLUDING  
THE ENTIRE FUEL  
CYCLE.



The formal involvement of the AEC-NRC with the environmental report is relatively new, stemming from the Calvert Cliffs court decision of July 23, 1971.<sup>17</sup> Until then the AEC confined itself to radiological questions surrounding the nuclear power plant. It claimed that it had no jurisdiction over non-radiological questions. Hence, to comply with the National Environmental Policy Act of 1969 (NEPA), the AEC depended on certification of compliance by other agencies. The substance of the Calvert Cliffs decision is that the AEC is now required to determine the impact, radiological and non-radiological, of nuclear power effluents, such as thermal discharges, and weight the benefits against the environmental costs.

The environmental legislations, the court decisions, and the AEC's interpretation of the court decision will undoubtedly in the long run have a profound impact on the procedures for planning new technologies for societal use.<sup>18</sup> To see what it might mean, consider for example, the licensing procedures for building a house today to what the procedures might become if the implications of the Calvert Cliffs decision were to be extended to private home construction in suburban areas, say in the township. At present the builder needs to go to different township, city, and county offices to get the building permit, water permit, sewage permit, and many other permits. When the house is completed, the technicalities of the existing codes and regulations will have been met, as interpreted by the officers in charge of issuing the permits and inspection. But there is no assurance that the end product, the finished house, will meet the expectations and standards of the intent of the codes and regulations. The builders will no doubt follow the letter of the codes and regulations, but there may be ambiguities and loopholes, and hence the finished house might fall short of expectations. To prevent this, the court would contend, a single central office needs to assess the environmental impact of the house. This would mean that this new office is to be held responsible not only for the soundness of the mechanical structure of the house, but also for the impact of the occupants upon water contamination and drainage, appropriateness of land use, the added fuel and energy burden that such a dwelling would



impose upon the community, and may even be compelled to assess the impact of such suburban construction upon urban decay. There is no question that this would be the way to go, but to do so will require manpower, money, and time. The public will need to be re-educated to the new hierarchy of values, even to such matters as building private houses.

The table of contents and the first page of the NRC Regulatory Guide<sup>29</sup> for the preparation of the Environmental Impact Report are reproduced in Table 6-8 to convey an appreciation for the intent and scope of this report. The point to note is that the word environment, as used by the Regulatory Guide, includes the social, cultural, economic, and political effects in addition to the physical impacts. The 10 chapters or so of the environmental report can be grouped into facility justification and site selection, the environmental impacts of plant construction and operation, the effects of accidents, the economic and social effects of plant construction and operation, and alternative energy sources.

For example, in the facility justification chapter<sup>30</sup> for the Detroit Edison Greenwood Energy Center, the utility notes that for 1963 the electrical demand in southeastern Michigan was 18 billion Kwhr and this rose to 38 billion kwhr for 1973. They estimate that the demand for 1983 will amount to 65 billion kwhr. In chapter 2, the applicant is required to consult such sources as the National Register of Historic Places and the National Register of National Landmarks for possible regional historic, scenic, and cultural landmarks near the site. Section 2.4 involves site geology, Section 2.8, measurements on the background radiological characteristics of the site, and so on.

Chapters 8, 9, and 10 are concerned with certain general aspects of nuclear power plant construction and operation. Chapter 8 involves economic and social effects of plant construction. For example, the following statements appear under Examples of Temporary External Costs:

Shortages of housing; inflationary rentals or prices; congestion of local streets and highways; noise and temporary aesthetic disturbances;

Table 6-8: Table of Contents of NRC Regulatory Guide 4.2

overloading of water supply and sewage treatment facilities; crowding of local schools, hospitals, or other public facilities; overtaxing of community service; the description of people; lives in the local community caused by acquisition of land for the proposed site.

Chapter 9 is concerned with alternative energy sources and sites. Words like coal, oil, gas, hydroelectric, geothermal are mentioned, but significantly the words solar and nuclear fusion do not appear. The implication, of course, is that at the present these are not possible sources of electrical power.

Thus the intention of the NRC to carry out the lofty aims enunciated in the National Environmental Policy Act is very clear. The problem, however, is that the methods by which the aims are to be carried out are not clear, so that at times it seems that "applicants" have not always acted and reacted most intelligently. The cost to the electric utility to prepare the report can range from \$2 to \$4 million. Some of this money is spent in counting deer, pheasants, and field mice. One company in California went to the expense of removing very carefully undersized abalones from sea beds near the construction site to another bed some distance away at an estimated cost of \$8 per moved abalone!<sup>31</sup> Another example is the nature center being planned for the Detroit Edison Greenwood Energy Center. The center is described in a brochure entitled "Nature Conservation, Environment, and Electric Power".<sup>32</sup> Visitors to the Center in 1985--if there is enough gas by then--will no doubt be able to enjoy the facilities. But the question is whether or not there are better ways to spend the amount of money that would be needed to build and maintain this facility.

#### 6.4.1. DISCHARGES TO THE ENVIRONMENT

The major source of environmental impact of any power plant is caused by the various types of discharges that such plants release to the environment. We need only glance up at the stacks towering above a fossil-fueled power plant to realize that such plants discharge substantial quantities of combustion products in both gaseous and solid forms directly to the

atmosphere, as well as discharging waste materials into adjacent bodies of water. Although nuclear plants are not characterized by such combustion product releases and therefore are environmentally far superior to fossil-fueled units from this perspective, they do release minute quantities of of radioactive materials into the environment. Furthermore all large power plants discharge significant quantities of waste heat to the environment, either directly into adjacent bodies of water or into the atmosphere. We will examine each of these factors in assessing the environmental impact of nuclear power plants. However in order to place such an analysis in perspective, it is useful to summarize at the same time the environmental impact of comparable sized fossil-fueled units.

#### Thermal Discharges from Power Plants

We have noted that any electrical power plant based upon a thermal cycle will reject some 60 to 70% of the thermal energy it produces directly into the environment as waste heat. To be more specific, a 1,000 MWe nuclear plant will typically discharge 2,000 MW of waste heat into the environment. A comparable sized fossil-fueled plant, because of its somewhat higher efficiency, will discharge 1250 MW. Hence while thermal discharge problems are not unique to nuclear power plants, they are somewhat more significant in this type of generating unit.

In older nuclear power plants, once-through cooling cycles were used in which condenser cooling water was drawn directly from an adjacent lake or river, passed through the condenser, and then discharged at somewhat higher temperatures back into the body of water. It rapidly became evident that such discharges could significantly modify the local aquatic environment.<sup>33</sup> To determine whether this modification was measurably harmful or beneficial, it was necessary to carefully analyze the particular aquatic environment and its inhabitants. There have been instances of fish kills which occurred when a power plant suddenly raised the discharge temperature of its cooling water, and a large group of fish were trapped in the higher temperature discharge waters. Such a kill could also occur

TO KEEP THIS IN PERSPECTIVE, FISHERMEN HAVE KNOWN FOR YEARS THAT THE BEST FISHING IS NEAR POWERPLANT DISCHARGE PIPES.



**OCCUPATIONAL HEALTH AND SAFETY  
OF ELECTRIC POWER PLANTS**

	PLANT FUEL <sup>a</sup>			
	Coal	Oil	Natural Gas	Nuclear
Occupational Health (man days lost per year)	600	Unknown	Unknown	480
Occupational Safety Fatalities (deaths/year)	1.1- 4	0.17-0.35	0.08-0.2	0.1-0.15
Nonfatal injuries (number/year)	46.8	13.1	5.3	6.0-7.0
Total man days lost per year	3770 <sup>b</sup> -9250 <sup>c</sup>	1725-3600	780-1990	270-1000

<sup>a</sup> Based on 1000-MW(e) power plants operating 75% of the time.

<sup>b</sup> Surface strip-mined coal.

<sup>c</sup> Deep-mined coal.

**PUBLIC HEALTH EFFECTS FROM COAL, OIL,  
AND NUCLEAR POWER PLANTS**

Plant Type	Pollutant	Relative Hazard Index <sup>a,b</sup>
Coal	Sulfur dioxide	32,000
	Particulates	1,100
	Nitrogen oxides	4,530
Oil	Sulfur dioxide	11,960
	Particulates	176
	Nitrogen oxides	4,450
Nuclear Pressurized water reactor	Krypton-85 and xenon-133	1
	Iodine-131	19
Boiling water reactor	Krypton-85 and xenon-133	1 <sup>c</sup>
	Iodine-131	20 <sup>d</sup>

<sup>a</sup> As an example, a relative hazards index of 4,450 from the nitrogen oxide emitted from an oil-fired plant means that the nitrogen oxide emissions from an oil-fired plant should have 4,450 times the public health impact of the krypton-85 and xenon-133 emissions from the same sized nuclear plant.

<sup>b</sup> Relative hazards indices based on risk factors given in Refs.

<sup>c</sup> Corrected for removal of short-lived noble gases by the boiling water reactor cryogenic charcoal-trapping system (48-hour holdup for krypton and 42-day holdup for xenon) (Ref. 19-10).

<sup>d</sup> Corrected from data in the reference for holdup of offgas system (Ref.

**FUEL CONSUMPTION AND WASTE  
— 1000-MEGAWATT POWER PLANT\***

	Hourly	Daily	Annual
<b>FUEL CONSUMPTION</b>			
Coal	690,000 lbs.	8,300 tons <sup>a</sup>	2,300,000 tons
Uranium	0.3 lbs.	7.4 lbs.	about 1 ton
<b>WASTE PRODUCTION</b>			
Coal (ashes)	69,000 lbs.	830 tons <sup>b</sup>	230,000 tons
Uranium (total)	2.7 lbs.	64 lbs.	11.6 tons
High-level fission product waste	0.26 lbs.	6.1 lbs.	1.1 tons
Other waste	2.4 lbs.	58 lbs.	10.5 tons

\*1000 megawatts is enough electricity for a city of about 1 million people

<sup>a</sup> Equivalent to a 100-car trainload every day.

<sup>b</sup> Equivalent to a 33-car trainload every day (not including airborne wastes)



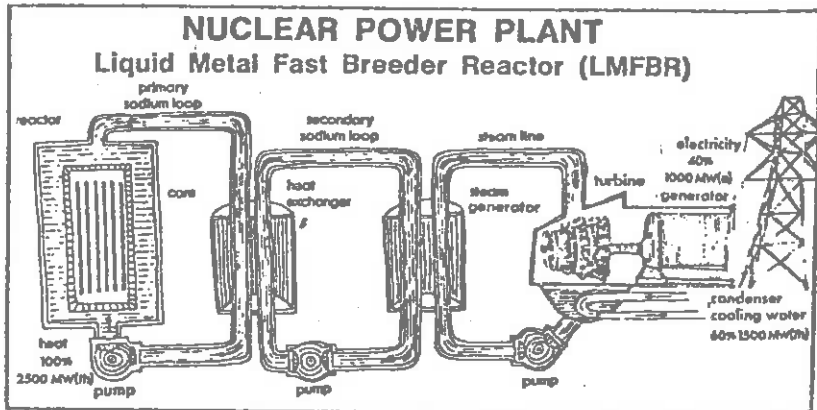
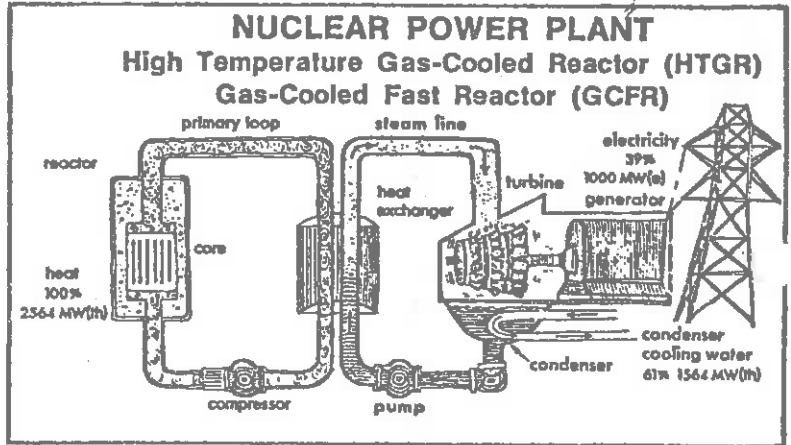
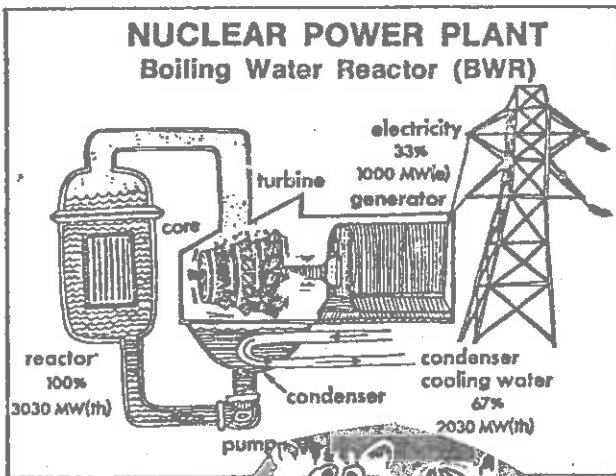
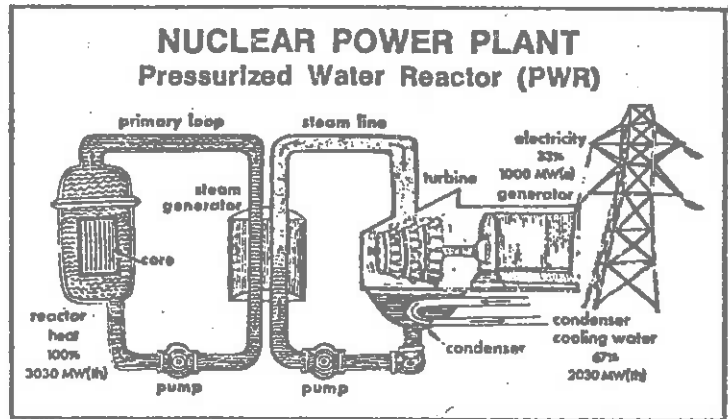
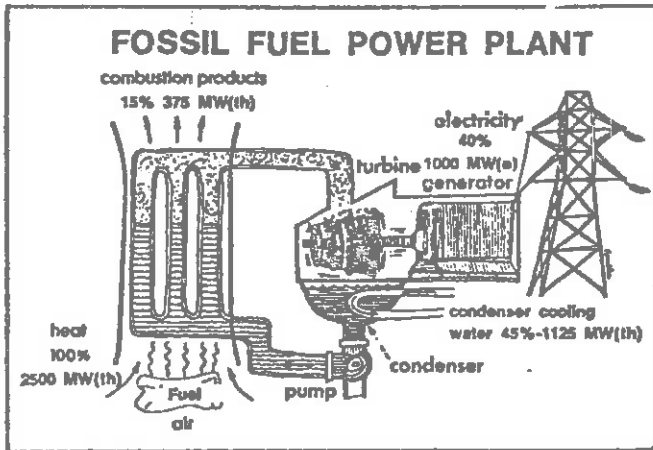


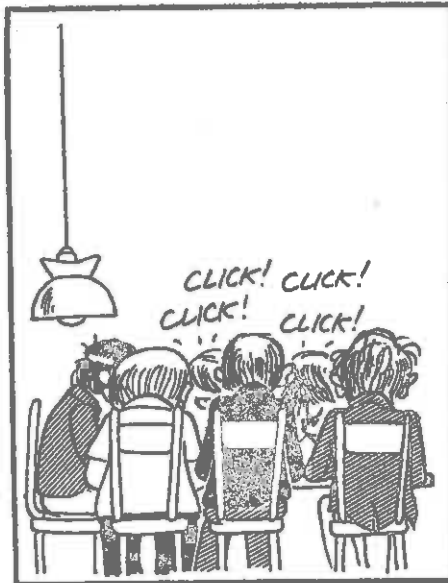
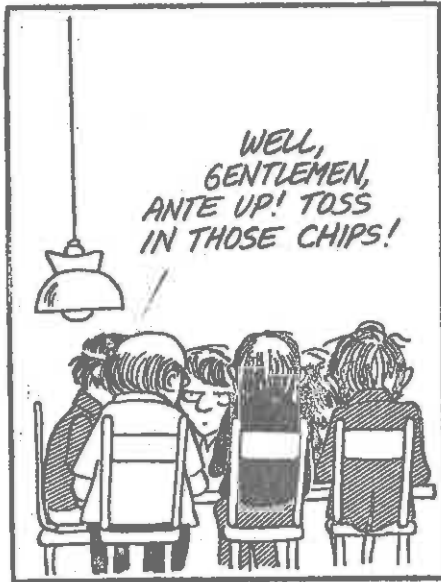
Fig. 6-35: Comparison of thermal discharges from fossil-fueled and nuclear power plants.

(Nuclear Power and the Environment, American Nuclear Society, 1976)

#### EFFICIENCIES OF STEAM-ELECTRIC POWER PLANTS

Type of Plant	Efficiency (%)
Modern coal-, gas- or oil-fueled	40
Average <sup>a</sup> coal-, gas-, or oil-fueled	33
Water-cooled nuclear reactors	33
Gas-cooled nuclear reactors	39
Future breeder reactors (projected)	38-42

<sup>a</sup> Average of existing plants, including some older plants built when attainable efficiencies were lower.



if a power plant had been operating for a substantial period of time which allowed the fish in the general area of the discharge to acclimate themselves to the increased temperature of the discharge water. Then if the plant were suddenly shut down, the fish would be thermally shocked by the cold water of the lake or river. Other problems attributable to once-through cooling include the increased growth of algae at higher temperatures, concern for temperature sensitive species of fish such as trout, and direct fish kills due to sucking fish up the cooling water intake tubes.

Therefore most modern nuclear plants are designed with closed cooling cycles, usually based upon natural draft cooling towers, which discharge waste heat directly into the atmosphere. However even these (rather expensive) closed cycles can have significant environmental impact. For example, the "make-up" water requirements for a 1,000 MWe plant will be of the order of some 50,000 gallons per minute which must be drawn as a permanent drain from a nearby body of water. Moreover the thermal discharge from these enormous plants directly into the atmosphere can have effects on the local meteorology (e.g., causing fogs). Finally, there has been some concern that the chemicals used to treat condenser cooling waters (e.g., chlorine) may find their way into the environment with harmful effects. Indeed, there are many ecologists who regard the relatively small temperature increases (1 to 2 °C) associated with once-through cooling as preferable to the closed-cycles based upon cooling towers.

#### Liquid, Solid, and Gaseous Wastes

Fossil-fueled electrical generating plants discharge enormous quantities of combustion products directly into the atmosphere. For example, the wastes discharged up the stack of a modern 1,000 MWe coal plant are listed in Table 8-4 on p. 8-13. It is interesting (and somewhat alarming) to note that some 24,000 tons of SO<sub>2</sub> are discharged each year from such a plant which, upon contact with water vapor, can be converted into sulfuric acid which can significantly damage the environment. Nitrous oxide can significantly damage lung tissue. Carbon monoxide is



a significant pollutant from fossil fueled plants. Although the 6,000,000 tons of CO<sub>2</sub> discharged from such a plant each year do not present a significant direct health hazard, the large quantities of CO<sub>2</sub> generated by fossil-fueled plants could cause an increase in the atmospheric concentration of CO<sub>2</sub> leading to a rise in average global temperatures (the "greenhouse" effect). Furthermore, significant quantities of toxic materials such as arsenic, lead, mercury, and even radioactive materials such as radium are released up the stack of coal plants.

Burning coal typically produces between 10% to 20% ash which amounts to some 250,000 tons of flyash per year which must be removed. Unfortunately engineers have not been particularly successful at finding a use for this enormous quantity of waste material, and it is typically trucked off and used as landfill.


Although nuclear power plants do not release waste to the environment in an uncontrolled fashion, they do produce significant quantities of radioactive materials, radioactive "waste", during the fission chain reaction which must be carefully removed from the plant, reprocessed, and eventually deposited in some suitable waste disposal facility. Although the mass of such waste is typically quite small (several tons per year per plant), it nevertheless requires great care in handling and treatment. We will return to consider the topic of radioactive waste disposal in detail in Chapter 7.

#### Radioactivity Releases from Nuclear Plants

It is inevitable that small quantities of radioactive material will be released from nuclear power plants into the environment. It is impossible to have zero release of radioactive materials from such plants just as it is impossible to achieve zero release of pollutants from fossil-fueled--or any other process, for that matter. However nuclear power plants are designed such that these releases are kept far below not only those levels which might have significance to public health, but in addition "as low as practicable" (as the wording in the NRC regulation 10CFR50--

Appendix I puts it) with present technology. Indeed, the radioactivity emissions from nuclear power plants are so low that it is extremely difficult to even detect them.<sup>35</sup>

The principal sources of radioactive material which might be released from the plant during normal operation include: (i) radioactive fission products (primarily gases) produced in the fuel which leak out of the fuel elements through tiny cracks in the cladding into the coolant of the reactor system, and subsequently leak past valves, fittings, packing, and other mechanical sealing devices into the containment building, (ii) radioactive materials in the coolant of boiling water reactors which can be carried into the turbine building where it may again leak past mechanical sealing devices, and (iii) a number of radioactive materials produced by neutron activation of impurities in the coolant water or by the slow corrosion of components in the reactor core and dispersed through the primary coolant system.



Most of the solid radioactive waste produced in the reactor core remains entrained within the fuel pellets and does not escape from the fuel elements. However when the reactor is refueled, the spent fuel elements containing these solid wastes must be withdrawn and re-processed, and the radioactive waste disposed of in some suitable manner.

The minute quantities of radioactive materials which escape from the fuel elements into the coolant take both gaseous and liquid forms. The gaseous radioactive material<sup>37</sup> is usually collected by filters, compressed, and held in storage tanks until a large fraction of its radioactivity decays out. At some later time when its activity is sufficiently low, it is then released from the building ventilation system in a controlled manner and dispersed into the atmosphere. Similarly all liquid radioactive materials are separated out by filtration systems and are held up to allow decay and then eventually released to the condenser water discharge and are dispersed by that means into large bodies of water. Federal regulations restrict both the amount of radioactivity, and the concentration at which it may be released into the environment. They

also dictate the amount of processing of the radioactive effluent that is required, the time period for which it must be held up, and the rate it is discharged as a plant effluent.<sup>38</sup> Presently, the release levels of liquid radioactive wastes are restricted such that the exposure of an individual in an unrestricted area due to discharged liquids is no greater than 3 mrem per year. Gaseous releases are restricted such that exposures to mythical individuals sitting on the site boundary fence for 24 hours a day, 365 days a year, will be less than 5 mrem, and the average neighbor of the plant can receive no more than 1 mrem per year. To place these exposures in perspective, the natural background radiation exposures are typically between 100 to 150 mrem (with fluctuations of about 20 to 30 mrem) and medical exposures received by the public amount to some 70 to 80 mrem per year. Hence the radioactivity released from nuclear plants is restricted so that the increased exposure to an individual in the vicinity of the plant is less than 1% of the exposure he would receive from natural sources-- indeed, the exposure from nuclear plants is less than the fluctuation in this natural exposure. Members of the public living some distance from the plant would receive far lower exposures. Experience has shown that nuclear power plants generally operate far below even these very low levels.<sup>39</sup>

It might be pointed out that fossil-fueled plants also emit radioactivity since small quantities of radium and its radioactive decay products will occur in coal and will be emitted as soot, flyash, or smoke from the plant.<sup>40</sup> A rather interesting illustration of the radioactivity emission from coal plants was encountered several years ago when Michigan State University first began to operate their small research reactor. One day during its operation the radioactivity monitors near the reactor began to record significant levels of radiation exposure. As first the MSU scientists worried that perhaps one of the reactor fuel elements was leaking radioactive fission products. But more careful examination indicated that the detected radiation was not due to fission products, but rather due to the decay products of radium--which could not have been released by the reactor. After a good deal of puzzle-

ment, one of the MSU scientists happened to glance out of the window and spotted the smoking stack of the coal-fired MSU electrical generating plant a mile down the road. After some further checking it was confirmed that the measured radioactivity was coming not from the reactor but from the coal plant.

It is generally accepted by the radiological health physics community that there is absolutely no evidence of public health risk from the low levels of emission of radioactive materials from nuclear power plants.<sup>41</sup> Indeed, a number of radiological health physicists are concerned that the exceptionally low federal standards set for radiation emissions from nuclear power plants are illogical and set a dangerous precedent for future environmental standards. The essential philosophy that has been adopted by federal regulators is that if the technology is available to reduce radioactivity releases to these incredibly low levels, then the nuclear plants must be designed to operate routinely below these levels regardless of the cost or difficulty in monitoring the compliance with these limits. Such standards almost totally ignore the fact that there is no evidence whatsoever indicating that operating the plant at 100 or even 1000 times larger releases would cause any detectable health effect. Furthermore the limits applied to nuclear power plants are almost a factor of 100 more stringent than those applied to medical or industrial applications of radioactive materials. But since nuclear power has developed (at enormous expense) the capability of pushing releases down to these very low levels, they are not required by law to operate below these levels. No doubt after some experience has been gained in operating at these levels, the limits on radioactive emissions will be reduced even further (although there is no reason from the public health standpoint for doing this), corresponding to larger and larger investments in radioactive materials treatment equipment in nuclear plants.

NOW I KNOW  
WHY YOU  
GUYS ACT  
SO PARANOID  
AT TIMES



#### 6.4.2. ENVIRONMENTAL IMPACT EVALUATION OF POWER PLANT SITING

Certainly any large electrical power plant will have some effect on its environment. Very careful considerations must be given to minimize such environmental impact. Let us briefly summarize the various factors which must be considered in assessing the environmental impact of a power plant: <sup>42,43</sup>

Air quality studies: First one must determine what the air quality would be without the presence of the plant by studying both present and anticipated population distributions, existing and projected industrial development of the area, and the associated emissions from such industries. Other factors such as meteorological surveillance, prevailing wind directions and velocities, precipitation measurements, temperature variations, temperature inversions, and so on must be evaluated. A system for monitoring air quality must be developed. Since nuclear plants release essentially nothing to the atmosphere air quality studies are of minor significance in the siting of nuclear units.

Water quantity and quality studies: One must determine whether sufficient availability of water exists for either once-through or closed cooling systems. In particular, the average and maximum flow of streams or lakes supplying this water must be measured, as must ground water supplies. The physical and chemical properties of the water must be determined, as must the biological population--either plant or animal life--which might be affected by the site. Careful analysis of the effects of thermal discharges on adjacent bodies of water must be made.

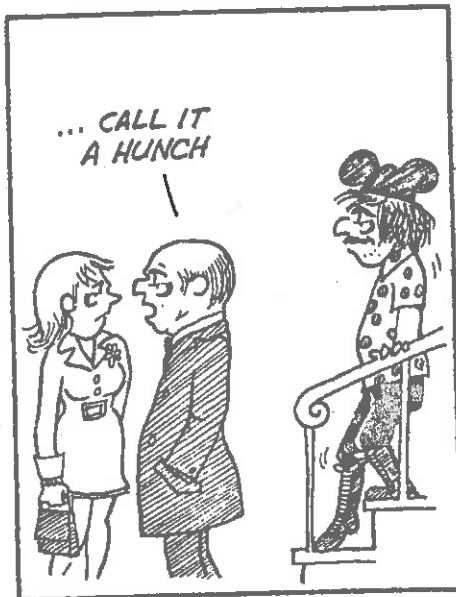
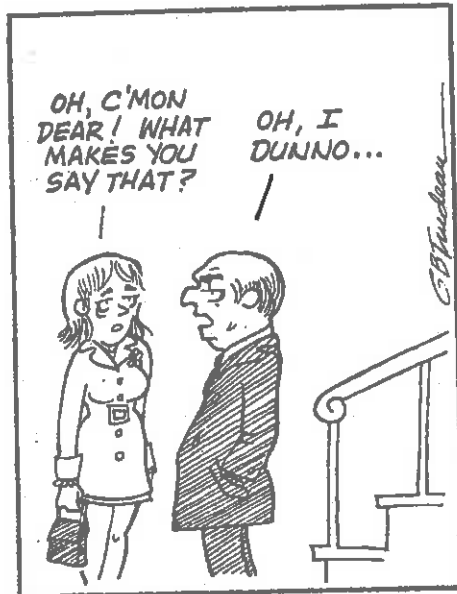
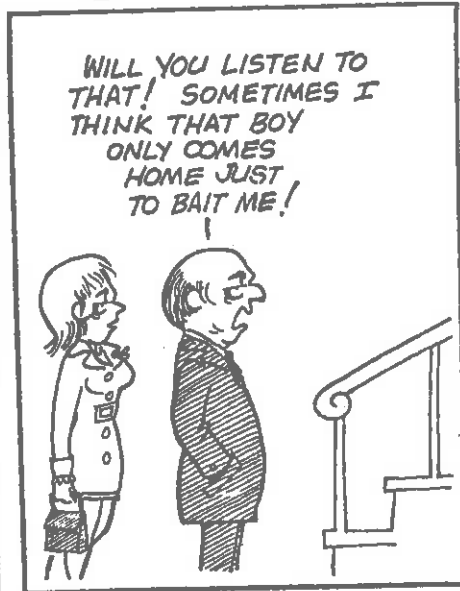
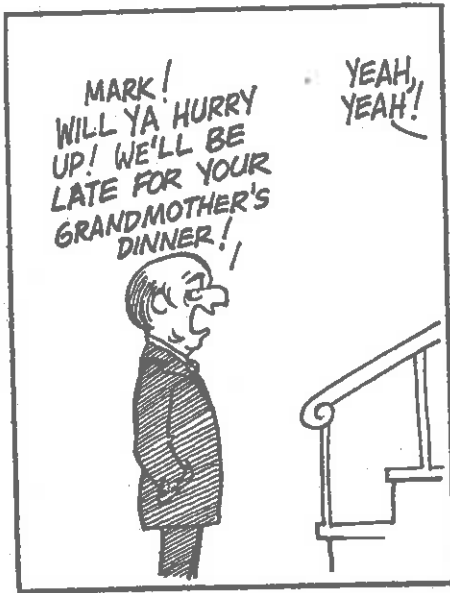
Radioactive waste studies: One must carefully evaluate the proposed releases of radioactive materials based upon site conditions including background levels of radiation, weather characteristics, and related factors. Careful monitoring programs must be set up, including determination of stations where radiation levels will be measured. Considerable care must be given to the measurement of background radiation (since the utility must be capable of resolving plant emissions out of the far larger background sources if it is to demonstrate compliance with

federal standards).

Land use studies: The site must have sufficient area to support the plant and operating services and must have a location consistent with federal regulations (i.e., exclusion/low population zones). One must examine the physical characteristics of the site, including its geology, seismology, hydrology, and meteorology. The effect of the plant on all historical or cultural areas in the neighborhood of the site must be assessed. The plant site must conform to state and regional land-use plans, and consideration must be given to recreational uses of the site. Finally the architectural design should blend with surrounding areas, and the plant construction should be accompanied by appropriate landscaping.

Of course many of these site criteria are contradictory in nature. Recently a utility engineer made the exasperated observation<sup>44</sup> that "an ideal site for a nuclear plant is one for which there is no evidence of seismic activity for the past millenium, is not subject to hurricanes, tornadoes, or floods, is an endless expanse of unpopulated desert with an abundant supply of cold water flowing nowhere and containing no aquatic life. And it should be located near a major population center."





## REFERENCES

1. M. Zemansky, Heat and Thermodynamics (McGraw Hill, 1957)
2. G. C. Masche, Systems Summary of a Westinghouse Pressurized WATER Reactor Nuclear Power Plant, Westinghouse Electric Corporation, 1971
3. J. C. Ringle, in Electric Power Generation (Oregon State University, 1973) p. 115
4. Nuclear Regulatory Commission Regulatory Guide on Field Testing Procedures
5. G. C. Masche, op. cit., p. 228
- 6.
7. D. G. Meighan, New York Times Magazine (June 20, 1976) p. 8; R. Lapp, The New Republic (January 23, 1971) p. 18; Nuclear Reactor Safety Issue, Bull. Atom. Sci. (September, 1975) pp. 15-41
8. Reactor Safety Study, WASH-1400 (1975)
9. APS Safety Study, Rev. Mod. Phys. 14, Supp. 1, 546 (1975)
10. H. Kendall and D. Ford, Environment 14 (September, 1972); R. Gillette, Science 177, 771, 867, 970, 1080 (1972)
11. H. J. Kouts, Bull. Atom. Sci. (September, 1975) p. 32
12. Reactor Safety Research Program, Nuclear Regulatory Commission, NUREG-75/058 (1975)
13. Title 10, Code of Federal Regulations, Part 50; S. H. Bush, Nuc. Safety 13, 1, (1972)
14. D. Nelkin, Bull Atom. Sci. 30, 29 (1974); T. F. Laneich and N. S. Stike, ORNL-NSIC-28 (1970)
15. R. B. Matthiesen, Earthquake Effects at Nuclear Reactor Facilities from the San Fernando Earthquake of Fedruaby 9, 1971 (UCLA Report, 1971)
16. J. A. Ashworth, Nuc. Tech. 22, 170 (1974); L. J. Carter, Science 183, 1063 (1974)
17. Theoretical Consequences of Major Accidents in Large Nuclear Power Plants, WASH-740 (USAEC, 1957)
18. H. Kendall and D. Ford, Environment 14 (September, 1972)
19. WASH-740, Revision 1 (1966) (USAEC)



20. Reactor Safety Study, USNRC Report WASH-1400 (1975)
21. H. W. Kendall, S. Moglewer, Preliminary Review of AEC Reactor Safety Study (Sierra Club and Union of Concerned Scientists, 1974)
22. N. C. Rasmussen, Bull. Atom. Sci. (September, 1975) p. 25
23. APS Reactor Safety Study, Rev. Mod. Phys. 14, Supp. 1, 546 (1975)
24. EPA Evaluation of WASH-1400, 1976
25. NRC Evaluation of WASH-1400, 1975-1976
26. Extension and Phase-Out of Price Anderson Act of 1975, Public Law 94-197 (1975)
27. Calvert Cliffs Coordinating Committee vs. USAEC, U.S. District Court of Appeals, District of Columbia Circuit Court, 1971
28. Nuc. News 19, 29 (1976)
29. USNRC Regulatory Guide 4.2 on Preparation of Environmental Impact Reports.
30. Environmental Impact Report, Greenwood Energy Center (Detroit Edison Company, 1974)
- 31.
32. Nature Conservation, Environment, and Electric Power, Detroit Edison Company, 1974
33. Nuclear Power and the Environment, American Nuclear Society, 1976, pp. 68-72; G. G. Eichholz, Environmental Aspects of Nuclear Power, (Ann Arbor Science Publishers, 1976) pp. 207-260
34. F. L. Parker and P. A. Krenkl, Physical and Engineering Aspects of Thermal Pollution (CRC Press, 1970)
35. Amendments to Title 10, Code of Federal Regulations, Part 50, Appendix I 40, Rederal Register 19439 (May 5, 1975)
36. P. Plato, lectures presented at ERDA Workshop on Nuclear Power, Ann Arbor, June, 1976
37. G. G. Eichholz, op. cit., pp. 261-349
38. Proposed Standards for Radiation Protection for Nuclear Power Operation, Title 10, Code of Federal Regulations, Part 190, Federal Register, Vol. 40, 104 (May 29, 1975)
- 39.
40. A Study of Social Costs for Alternative Means of Electric Power Generation for 1980 and 1990, ANL-8092 (1973)

41. G. H. Whipple,
42. B. Cohen,
43. G. G. Eichholz, Environmental Aspects of Nuclear Power, (Ann Arbor Science Publishers, 1976)
44. J. C. Ringle, in Electric Power Generation (Oregon State University, 1973) p. 115

## CHAPTER 7

### THE NUCLEAR FUEL CYCLE

The safety and environmental impact of nuclear power plants have become the subjects of increased public concern during the past decade. But the generating plants themselves are only one aspect of nuclear power generation, and recently public attention has been shifting to the entire nuclear fuel cycle, to the operations involved in the preparation, utilization, reprocessing, and disposing of nuclear fuels.<sup>1</sup>

It is important to recognize that nuclear fuels are totally different from fossil fuels in several very important respects. Nuclear fuel (e.g., uranium) requires a number of sophisticated and expensive processing operations before it is inserted into the reactor core. It is then "burned" in the reactor for several years before being removed. Even after several years of use in a reactor, the fuel still possesses a significant concentration of fissile material. Therefore it can be removed from the reactor core, reprocessed, and refabricated into new fuel elements. The byproduct waste from the reprocessed fuel is highly radioactive, and its disposal requires great care.

The safety and environmental impact of each of these activities must be examined very carefully in any consideration of the role of nuclear power in meeting our present and future energy needs. Moreover, since the primary economic advantages exhibited by nuclear plants are a consequence of their extremely low fuel costs, the economics of nuclear fuel preparation and reprocessing must also be considered.

#### 7.1. An Overview of the Nuclear Fuel Cycle

##### 7.1.1. INTRODUCTION

Those operations involved in the extraction of uranium ore and the preparation, utilization, and reprocessing of nuclear reactor fuels are referred to as the nuclear fuel cycle and are depicted in schematic form in Figure 7-1.<sup>2</sup> The various stages of the fuel cycle can be identified as:

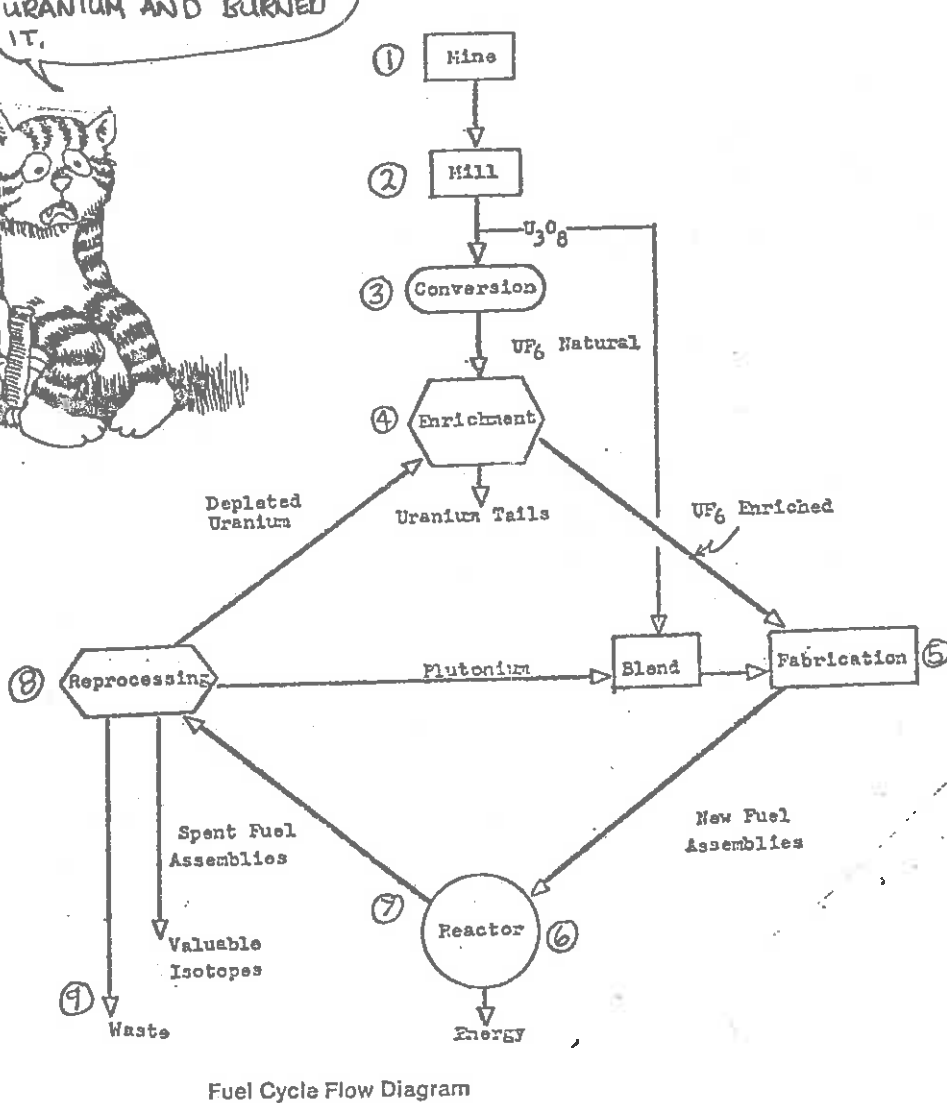
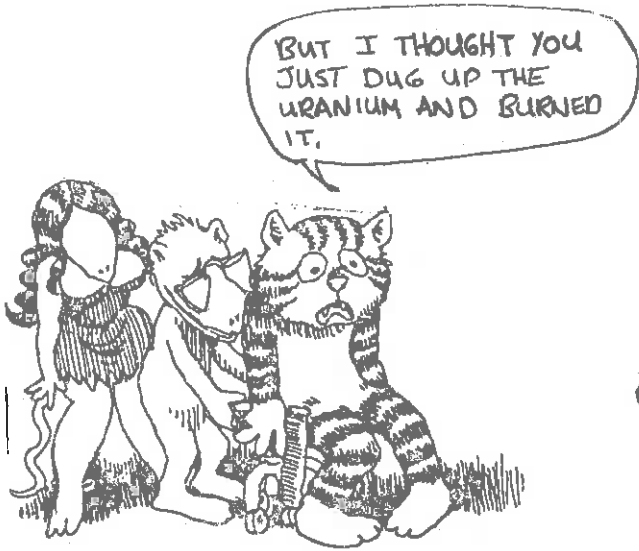


Figure 7-1a: The Nuclear Fuel Cycle  
 (E.A. Mason, in Education and Research in the Nuclear Fuel Cycle, Oklahoma University Press, 1970)

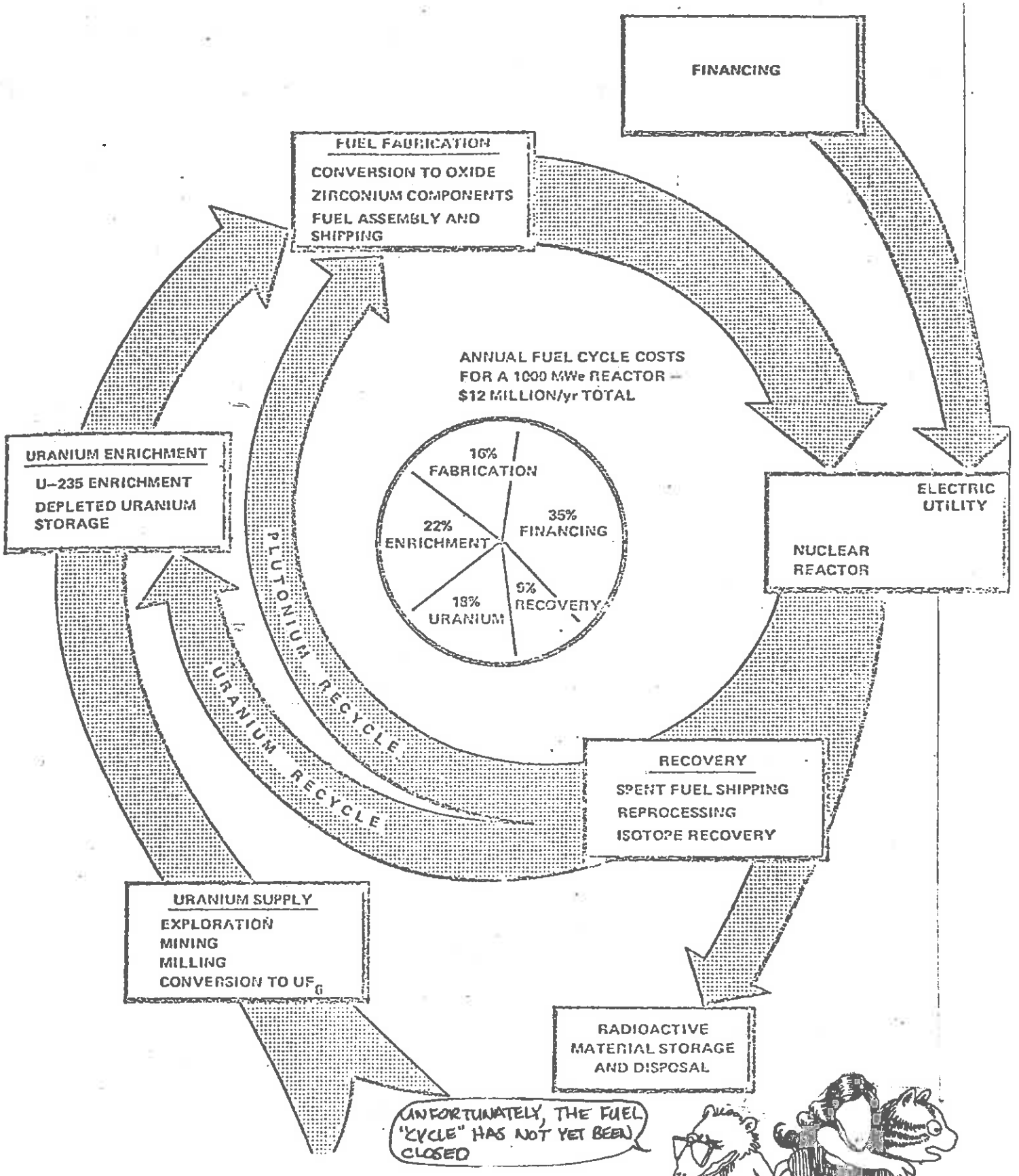


Figure 7-1b: The Nuclear Fuel Cycle



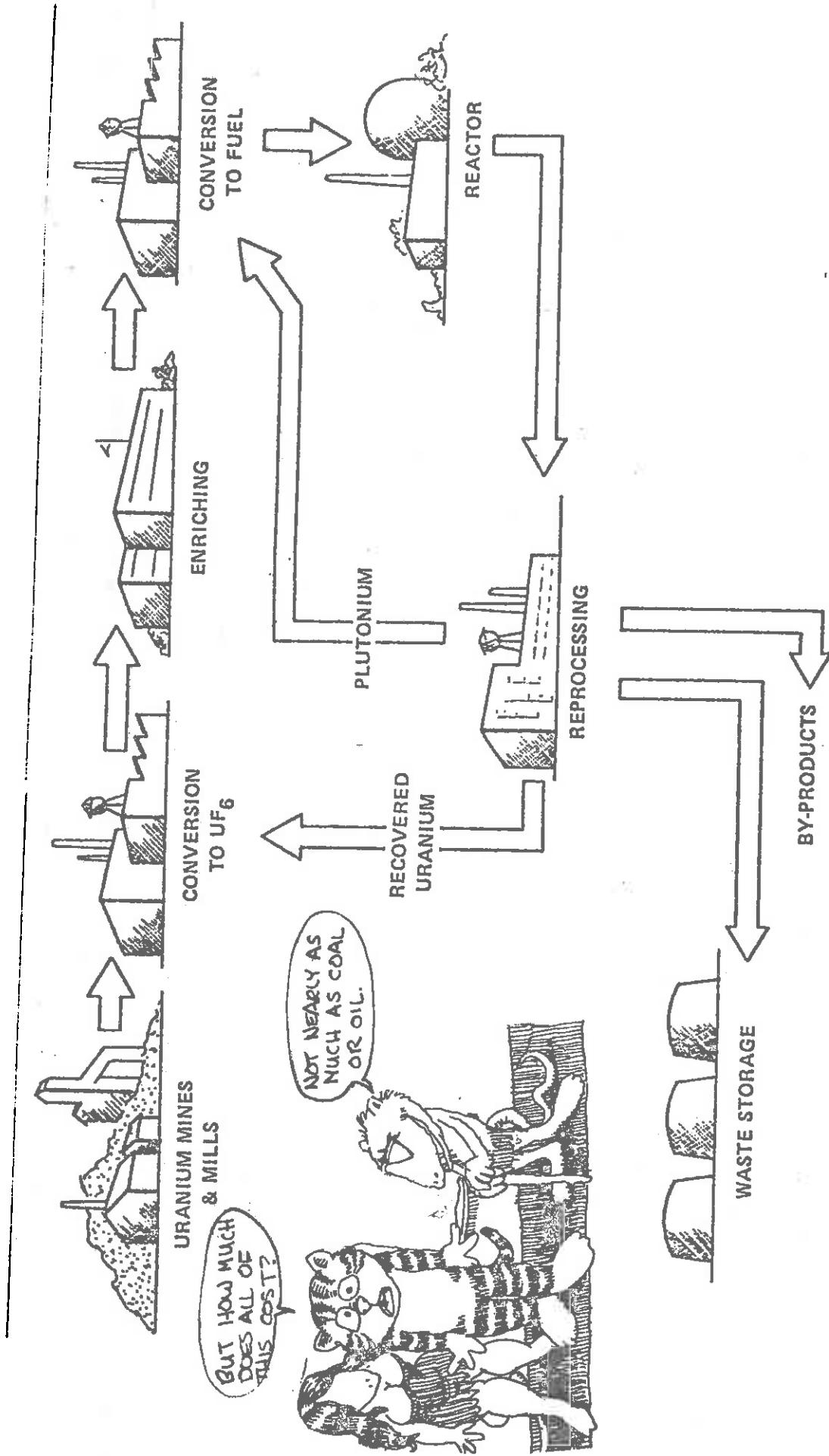


Figure 7-1a: The Nuclear Fuel Cycle (The Nuclear Industry, USAEC Report WASH-1174-73 (1973))

1. Mining: Both underground and open pit techniques are used to mine uranium ore in a manner similar to that used in other low grade ore mining. The ore obtained from mines in this country averages about 0.25% uranium oxide ( $U_3O_8$ ).
2. Concentration: Milling is necessary to extract and concentrate uranium from the raw ore. The ore is first pulverized and leached with sulfuric acid to dissolve the  $U_3O_8$ , and then solvent extraction is used to recover the dissolved  $U_3O_8$ . Calcination (roasting) is then performed to produce yellow cake, a crude oxide containing some 70-90%  $U_3O_8$ . Yellow cake is the form of uranium most commonly traded in commodity markets. Further calcination and solvent extraction is used to refine the yellow cake to essentially pure  $UO_3$ .
3. Conversion: Hydrogenation is used to convert  $UO_3$  to  $UO_2$ . Then reacting  $UO_2$  with hydrogen fluoride produces  $UF_4$  which can then be converted into uranium hexafluoride,  $UF_6$ , by adding fluorine salt.
4. Enrichment: Essentially all power reactors (with the exception of heavy-water reactors or the early gas-cooled, graphite moderated reactors) utilize enriched uranium, that is, uranium with higher than the natural 0.7% concentration of U-235 (at least in their initial core loading). The enrichment of uranium is a very difficult and expensive process since it involves separating two isotopes, U-235 and U-238, with very little mass difference and essentially no chemical difference. A variety of separation techniques have been used or proposed:
  - (i) electromagnetic separation: Large mass spectrometers can be used to separate charged uranium isotope ions of different masses.
  - (ii) gaseous diffusion: Since the diffusion rate for a gas to pass through a porous membrane is inversely proportional to the square-root of its molecular mass, one can pass the  $UF_6$  gas through thousands of porous barriers to separate the  $UF_6$ (U-235) from  $UF_6$ (U-238).
  - (iii) ultracentrifuges: Very high speed centrifuges can be used to separate the two isotopic forms of  $UF_6$ .
  - (iv) laser photochemistry: A more recent approach uses high powered lasers to selectively excite  $UF_6$  or uranium atomic vapor isotopes by tuning the laser wavelength to select out the isotopic mass shift

in the electronic energy levels of the compounds. Then standard chemical or physical separation techniques can be used to skim off the excited species.

The gaseous diffusion method has been the principal technique used for uranium enrichment for the past 30 years. Recently, however, developments in ultracentrifuge and high-powered tunable laser design have suggested that these latter methods eventually may be superior to gaseous diffusion techniques.

5. Fabrication: Following enrichment, the  $UF_6$  is then chemically converted into the form to be used in the fuel element. This is usually a ceramic such as  $UO_2$  or UC. The resulting ceramic powder is then compacted (and sintered) into small pellets which are then loaded into metallic tubes (cladding).
6. Fuel Burnup in the Reactor Core: The fuel assemblies are loaded into the reactor core for power production. These assemblies are typically irradiated in the core for a period of several years. The fuel burnup or lifetime is limited by either reactivity considerations (i.e., the multiplication of the core drops too low for further power production) or by radiation damage to the fuel element material which is subjected to very high radiation exposures. It is usually the latter limitation which determines the lifetime of fuel in today's high-burnup design reactor cores.
7. Spent Fuel Storage and Decay: After being irradiated in the reactor core, the fuel is intensely radioactive due to fission product buildup. The used or spent fuel is removed from the core and stored in water pools for several months to allow the short-lived fission products to decay out.
8. Reprocessing: The spent fuel is then shipped to reprocessing facilities to reclaim unused uranium (which can be recycled back as  $UF_6$ ) and plutonium.
9. Waste Disposal: Finally the radioactive waste products remaining after reprocessing are converted into either liquid or solid forms for storage and are shipped to various depositories for burial (and surveillance).



The above outline is a description of only the uranium-plutonium fuel cycle used in most modern power reactors. However other possible fuel cycles have been considered for future reactor types, such as the thorium/U-233 cycle proposed for high temperature gas-cooled reactors. We will discuss these cycles in more detail in the next section.

The nuclear fuel cycle extends over a period of several years, and the costs associated with nuclear fuels must be monitored over this period of time. In this sense nuclear fuel costs are much different fossil fuel costs, since a number of charges other than direct materials costs are involved which may lead or lag utilization of the fuel material by several years:

- (i) Costs of net isotope consumption which result from the conversion of uranium and plutonium into fission products and from the reduction in the U-235 enrichment of the uranium remaining in the spent fuel. These costs are associated with the exploration, mining, and enrichment of the uranium.
- (ii) Processing costs, such as those incurred in uranium purification, conversion, fuel fabrication, and reprocessing.
- (iii) Financing costs associated with the large working capital requirements of the nuclear fuel cycle.

The magnitudes of each of these components can best be illustrated by considering the fuel cycle cost projection for a typical PWR nuclear power plant rated at 1,000 MWE scheduled to go on line during the 1980s and assumed to operate with a 75% capacity factor (see Table 7-1).<sup>3</sup> For purposes of comparison, we have also shown the projected cost increases for each item in the nuclear fuel cycle for the next two decades in Table 7-2.<sup>3</sup> These costs have been levelized over a ten year period.

Table 7-1<sup>3</sup>

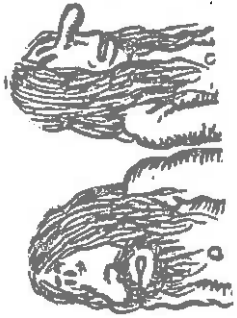
# NUCLEAR FUEL COST

(Levelized 1985-95, 16% F.C. 75% P.F.)

(L. Reichle, Ebasco Services, presented to N.Y. Soc. of Security Analysts, 1975)

Fuel Expense - Mills/kWh	10 Year Levelized			Total
	Burnup	Carrying Charges		
Uranium (UF6)	2.74	2.25		4.99
Enrichment	1.58	1.46		3.04
Fabrication	0.74	0.30		1.04
Recovery <sup>1</sup>	1.93	(0.91)		1.02
Pu Credit	(1.36)	0.87		(0.49)
	<u>5.63</u>	<u>3.97</u>		<u>9.60</u>

Fuel Investment - \$/kwe	10 Year Levelized	
	Initial	
Uranium	66.32	92.35
Enrichment	40.49	60.08
Fabrication	15.71	12.40
Recovery <sup>1</sup>	-	(37.29)
Pu Credit	-	35.58
	<u>122.52</u>	<u>163.12</u>



<sup>1</sup> Fuel reprocessing, transportation, and waste disposal

Table 7-2<sup>8</sup>

# NUCLEAR FUEL COST PROJECTION

(L. Reichle, Ebasco Services, presented to N.Y. Soc. of Security Analysts, 1975)

Item	Unit	Escalation Per Year	Projected Costs (\$)				
			1975	1980	1985	1990	1995
Yellow Cake	\$/lb U <sub>3</sub> O <sub>8</sub>	7 %	25	35	49	69	97
Conversion to UF <sub>6</sub>	\$/KgU	4 %	3.50	4.25	5.17	6.30	7.65
UF <sub>6</sub> Cost	\$/KgU	6.9 %	69	96	135	189	265
Enrichment	\$/SWU	4 %	80	98	119	144	176
Fabrication	\$/KgU	3 %	91	105	122	141	164
Recovery	\$/KgU	4 %	180	219	266	324	394
Pu Credit	\$/gm	6.2 %	22	28	36	47	60

YOU CAN'T HAVE  
YOUR YELLOWCAKE  
AND EAT IT TOO  
(OR AFFORD ANY-  
THING ELSE).



Such a 1,000 MWe plant would require 100 metric tons of fuel with an initial incore value of \$122 million. The annual fuel cycle bill for such a reactor is \$163 million. Of this the cost of the materials consumption and processing amounts to \$103 million and the financing costs to \$60 million.

The figures in Table 3-2 and 7-1 indicate the sharp contrast in fuel costs between fossil fuel and nuclear power generation. For example, in coal-fired plants, fuel costs represent 36% of power generation costs, while capital costs account for some 56% of these costs. For a nuclear plant, fuel costs account for only 14% of power generation costs, while capital costs account for 79%. Such figures certainly bear out the contention that the primary economic advantage enjoyed by nuclear power generation lies in its very low fuel costs.

The various processes involved in the nuclear fuel cycle can be broken conveniently into three groups of activities:

- (i) head-end fuel operations: mining, conversion, enrichment, fuel fabrication,
- (ii) in-core fuel operations: evaluation of reactivity and control requirements, power distribution analysis, core capability evaluation,
- (iii) tail-end fuel operations: fuel storage, shipping, reprocessing, waste disposal.

We will consider each of these activities in some detail in later sections of this chapter. However it is first useful to consider in more detail the various fuel cycles of interest in power reactor operation.

## 7.1.2. POWER REACTOR FUEL CYCLES

### Light Water Reactors

The fuel cycle for a typical light water reactor of the 1,000 MWe class is diagrammed in Figure 7-2.<sup>4</sup> We recall that such reactors are fueled with enriched uranium (from 2-3%) in oxide form ( $UO_2$ ). The spent fuel discharged from the core has a U-235 concentration of roughly 0.8%. The conversion of U-238 has resulted in a plutonium concentration of about the same magnitude. This plutonium is recovered by fuel reprocessing.

URANIUM REQUIREMENTS FOR A 1000 MWe PWR

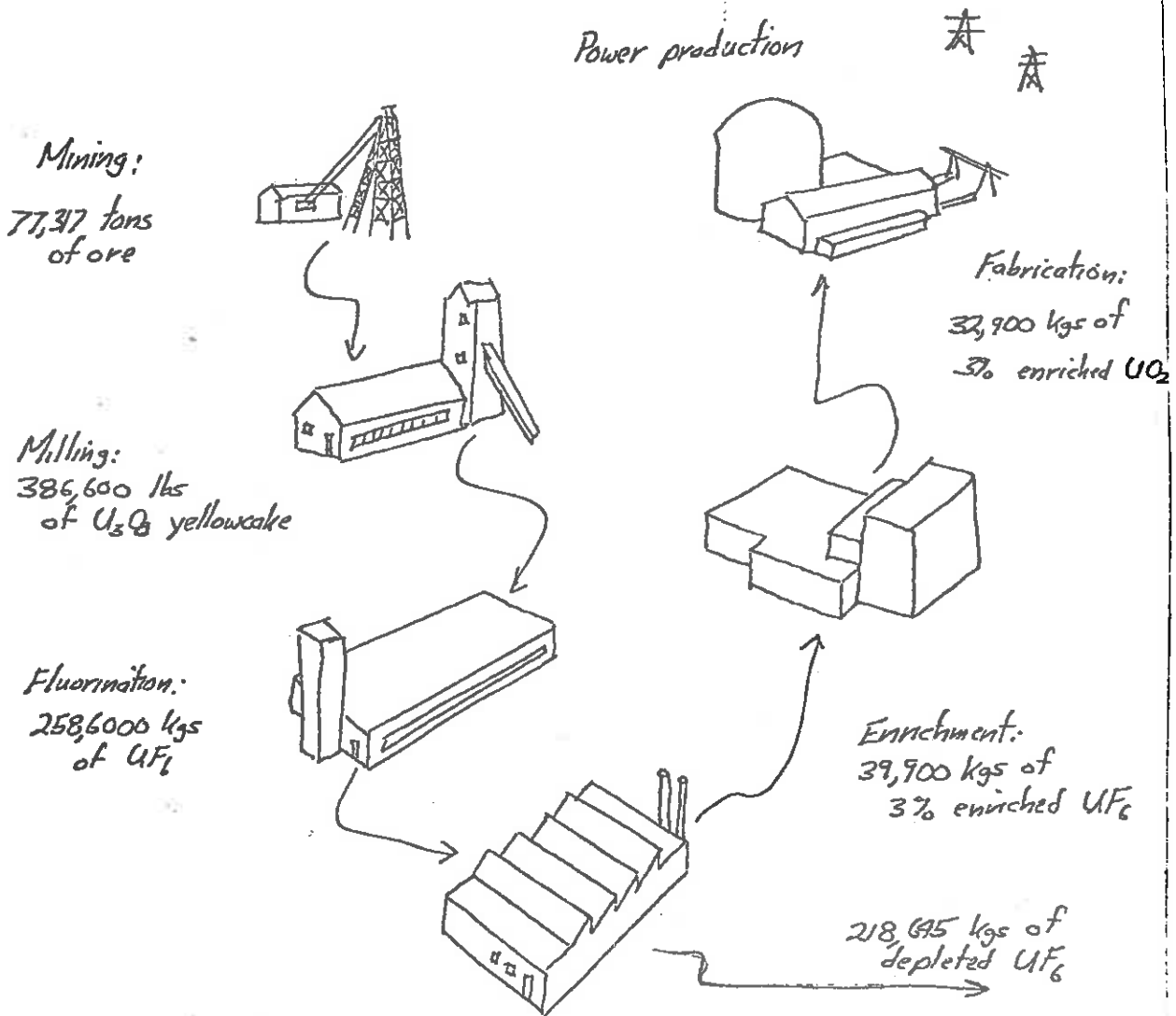
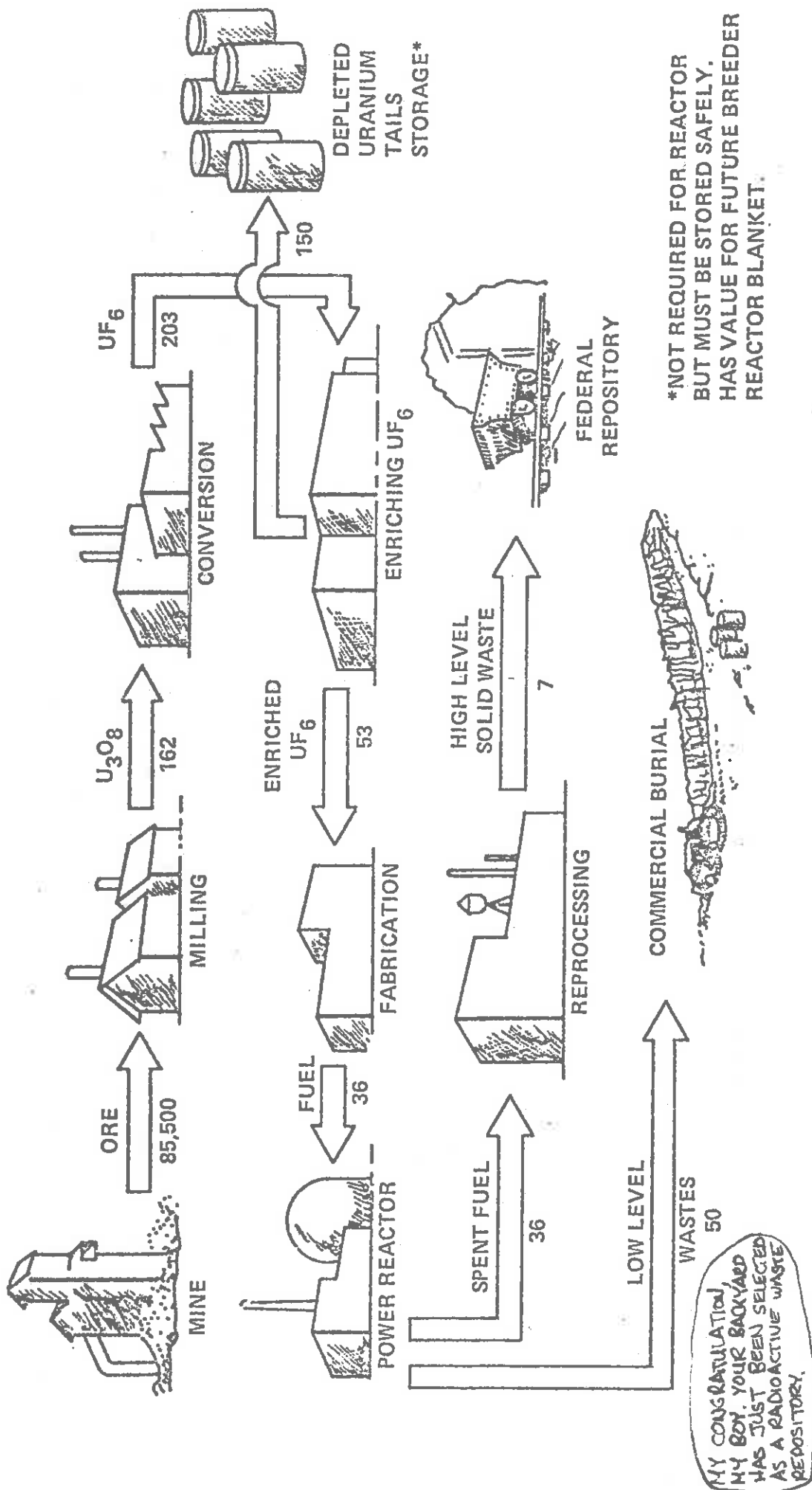


Figure 7-2: Fuel Cycle Requirements for a 1,000 MWe PWR<sup>4</sup>

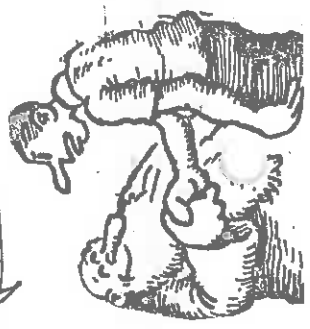


OF COURSE, YOU MUST REMEMBER THAT 1 kg OF U-235 WILL PRODUCE AS MUCH ENERGY AS 14,000 TONS OF COAL!



\*NOT REQUIRED FOR REACTOR  
BUT MUST BE STORED SAFELY.  
HAS VALUE FOR FUTURE BREEDER  
REACTOR BLANKET.

Annual Quantities of Fuel Materials Required for Routine (Equilibrium) Operation of 1,000 Mwe Light Water Reactor  
(The Nuclear Industry, USAEC Report WASH-1174-73 (1973))



MY CONGRATULATION,  
MY BOY, YOUR BACKYARD  
HAS JUST BEEN SELECTED  
AS A RADIOACTIVE WASTE  
REPOSITORY.

At the present time the plutonium recovered from spent fuel elements is simply stockpiled. However there is strong incentive to recycle the plutonium back into the light water reactor fuel cycle, as shown in Figure 7-3<sup>1</sup>, since this would reduce the requirement for uranium feed by approximately 40%. There are several technical problems involved in plutonium recycling, including the complications of fabricating plutonium ( a very toxic and radioactive material) and matching the nuclear performance of a mixed oxide fuel ( $\text{PuO}_2$  and  $\text{UO}_2$ ) with enriched uranium fuel in a reactor core. Such problems do not seem formidable, however, and the large inventory of plutonium which is beginning to accumulate from the existing generation of large power reactors (coupled with the lagging commercial development of the fast breeder reactor, which would provide an alternative market for this plutonium) provide strong incentives for implementing plutonium recycle.

#### High Temperature Gas Cooled Reactor Fuel Cycles

The fuel cycle of the HTGR is quite different than that of light water reactors since it is based upon a thorium/U-233 conversion cycle. As the fuel cycle diagram in Figure 7-4<sup>2</sup> indicates, the initial loading of the HTGR core is with highly enriched uranium ( $\sim 93\%$  U-235) in the form of uranium carbide mixed with thorium oxide or carbide as the fertile material. The thorium is then converted to U-233 which is recovered and cycled back (eventually) to be mixed into reload fuel. The motivation behind using such a fuel cycle is primarily due to nuclear considerations. The number of neutrons produced per neutron absorbed in U-233 is some 10% larger than that characterizing U-235. Hence it is possible to achieve much higher conversion ratios using U-233 (indeed, such "advanced converter" reactors are capable of operating with a conversion ratio as high as 0.8).

The fuel design of the HTGR is much different than that of either the LWR or the LMFBR in order to facilitate high temperature operation. The fuel composition is of small pellets of UC or  $\text{ThO}_2$  coated with graphite and loaded into graphite blocks. Such a fuel design leads to much higher

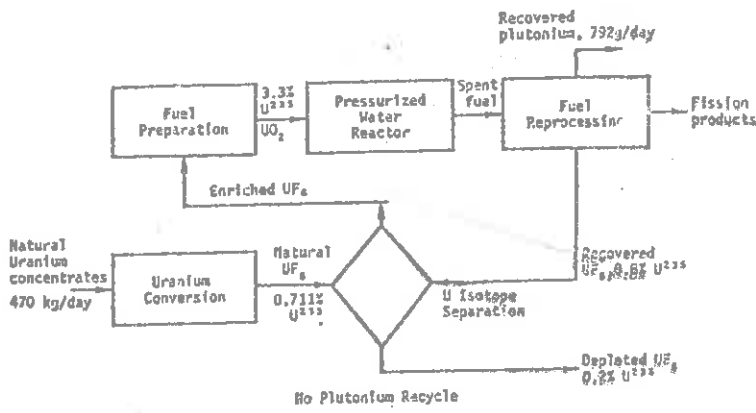


Figure 7-2<sup>2</sup>

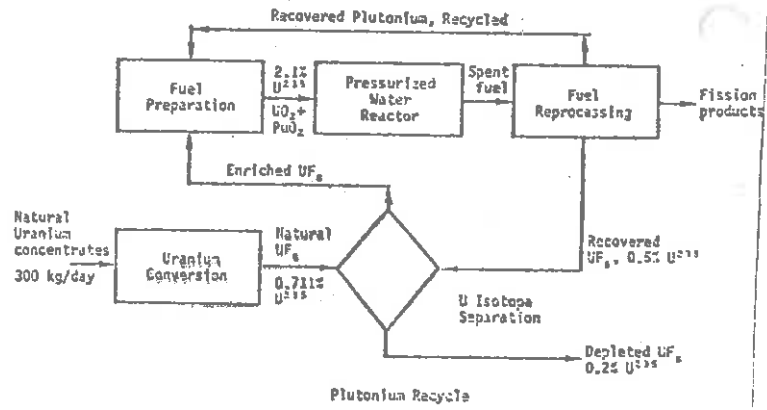
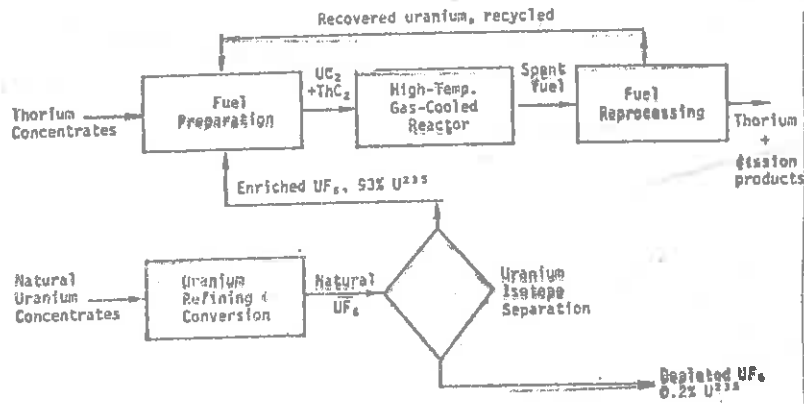


Figure 7-3<sup>2</sup>



High-Temperature Gas-Cooled Reactor

Figure 7-4<sup>2</sup>

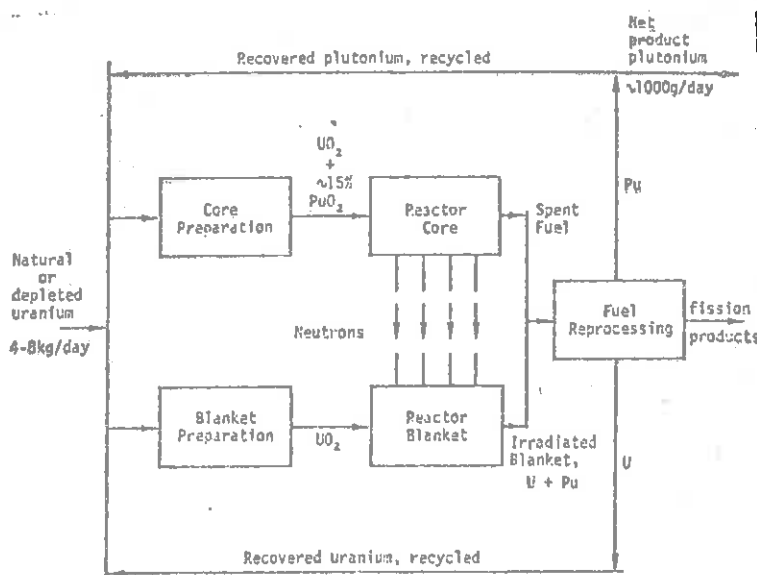


Figure 7-5<sup>2</sup>





fabrication costs however, and hence the fuel elements of an HTGR must be run to much higher burnups (some 80,000 MWD/MTU for the HTGR as compared to 30,000 MWD/MTU for a LWR or 100,000 MWD/MTU for the LMFBR). The higher conversion ratio of the HTGR leads to a more efficient utilization of uranium. In fact an HTGR requires only about half the U-235 fuel feed as an LWR of similar power rating.

#### LMFBR Fuel Cycles

The fuel cycle of the fast breeder reactor differs from that of the LWR and HTGR in that the larger conversion ratio allows a net gain in the amount of fissile material produced during core operation. It is estimated that the LMFBR can utilize some 60 to 70% of the energy available in natural uranium (taking account of the transmutation of U-238 to Pu-239). The more efficient utilization of available fuel resources is the primary justification for the LMFBR, although there are side benefits such as higher coolant temperatures (and hence lower waste heat release).

A typical fuel cycle for the LMFBR is sketched in Figure 7-5<sup>2</sup> in which it is noted that most of the transmutation of U-238 into Pu-239 will occur in the reactor blanket, while the fuel burnup and power production will occur in the reactor core. The LMFBR can be fueled either with natural uranium or depleted uranium from the tails of the isotope separation plants.

#### Interaction Among Fuel Cycles

It should be recognized that there will be a very substantial interaction among these various fuel cycles in a mature nuclear power industry. For example, the substantial amounts of plutonium produced by LWRs can be directly recycled or can be used to fuel the first generation of fast breeder reactors. Similarly the excess of plutonium produced by the LMFBR can be used to fuel either future LMFBRs or it can be fed back into the LWR fuel stream.

There will also be strong interaction with the fuel cycle of advanced converter reactors such as the HTGR which can be used to stretch out the usefulness of available fuel without having to carry the high fissile fuel inventory of the fast breeder. Such interactions will determine to a very

1-0

large degree the cost of the nuclear fuel cycle, since they not only influence the cost of the fresh fuel loading, but as well determine the value of the spent fuel (i.e., the value of the plutonium produced in the core). Such interactions are quite complicated and no doubt will lead to even more uncertainty in the future fuel costs of nuclear power plants.

## 7.2. Head End Fuel Operations

### 7.2.1. MINING AND MILLING

Most of the uranium ore mined in the United States comes from the sedimentary sandstone and mudstone deposits of the Colorado Plateau, the Wyoming Basin, and the Gulf Coastal Plain and yields about 0.1% to 1%  $U_3O_8$  (in contrast to the pitchblende deposits found in Canada, Czechoslovakia, and central Africa which can yield up to 20%  $U_3O_8$ ). The exploration for and development of new uranium reserves has been closely geared to demand. The uranium mining industry grew very rapidly during the 1950s in response to the military requirements for fissionable material. But the cutback in government requirements for uranium in the mid-1960s, accompanied by the lagging development of commercial power reactors, caused a corresponding leveling off in uranium production which is only now beginning to pick up again as the demands of the nuclear power industry become more apparent.

There is some uncertainty (and much disagreement) about the extent of our domestic uranium ore reserves.<sup>5</sup> The magnitude of these reserves depends sensitively upon how much one is willing to invest in mining low concentration deposits. For example, the most recent ERDA estimates<sup>6</sup> project that domestic reserves of relatively high concentration uranium ore are sufficient to fuel some 300 GWe of nuclear plant capacity (500 GWe with plutonium recycle) for the projected plant lifetimes of 40 years--which also happens to be the projected installed capacity by the year 2000. But, as Table 7-3<sup>7</sup> indicates, the reserves of lower concentration ore are considerably larger. It should be noted that some scientists<sup>8</sup> have taken issue with these estimates and project reserves as low as one-third of

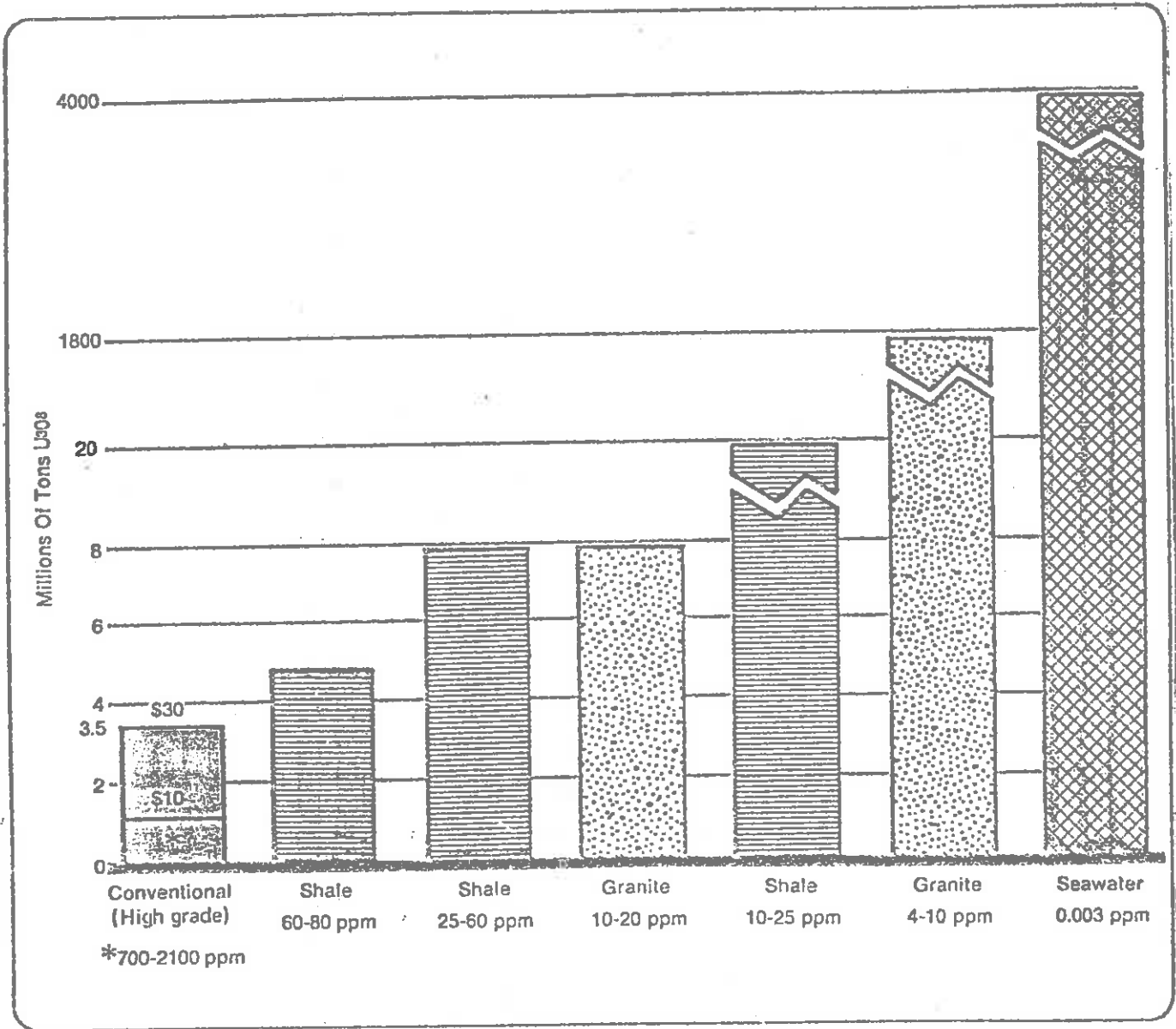


Table 7-3: Projected Uranium Ore Reserves (Domestic)<sup>7</sup>



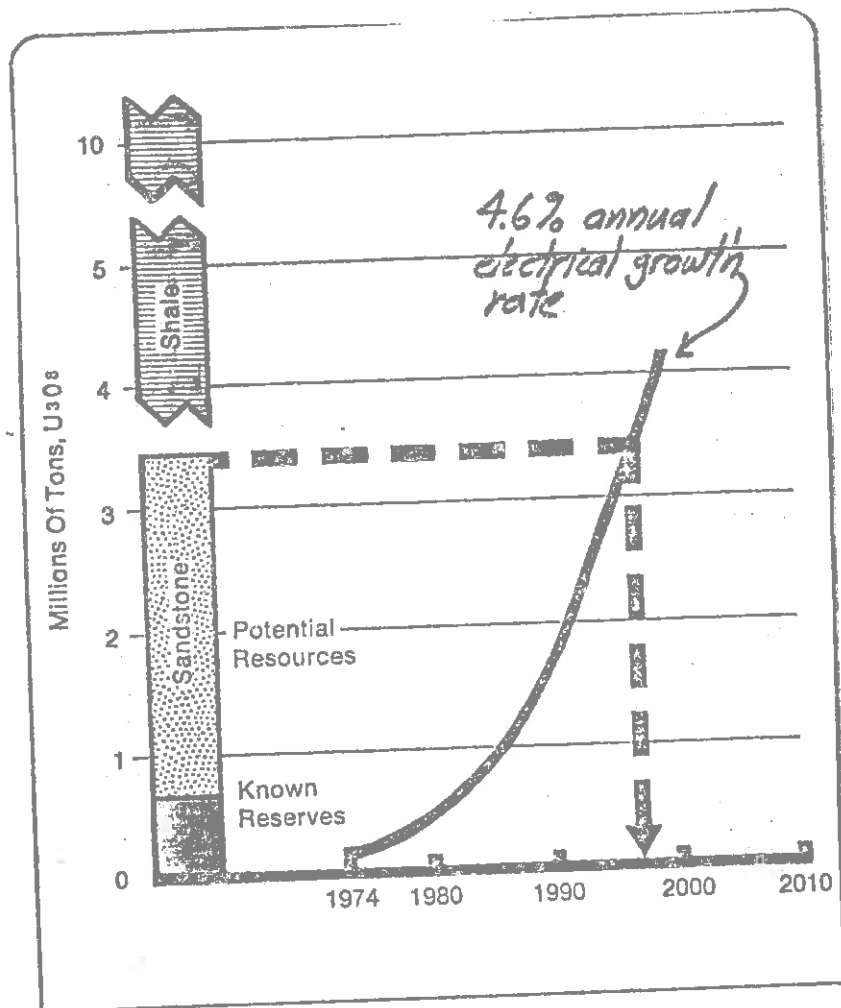


Figure 7-6:<sup>7</sup> Uranium Ore Requirements for Committed Nuclear Power Plants (40 year lifetime) versus Uranium Ore Reserves (Domestic)



the ERDA estimates. There is presently a major federal program underway to determine more accurately the true extent of our uranium ore reserves.

However there does seem to be general agreement that domestic ore resources can be developed at such a rate as to ensure an adequate supply of low cost ( < \$50/lb) uranium to meet nuclear power requirements at least into the 1990s. Although present production levels are roughly 20,000 tons of  $U_3O_8$  per year, future industry requirements are expected to reach the level of 35,000 tons per year by 1980 and will require a buildup in uranium mining and processing capability. It should be emphasized, however, that the exploration for and development of uranium resources, like most other metals, will never be more than a few years in advance of production because such advanced development is costly, risky, and uneconomical for the producer. To compound this uncertainty is the artificial price structure of uranium ore set by the earlier government demand for and control over fissionable material. For the first time in history a metal has become a source of energy, and this in itself has led to added uncertainty and price fixing in the metals commodity market. It is becoming increasingly apparent that utilities must plan very carefully to ensure adequate uranium supplies over the 30-40 year operating lifetime of a nuclear power plant.

Of course the significance of such estimates of uranium reserves depends sensitively upon the reactor type. For example, if breeder reactors could be introduced, then there would be sufficient uranium (in this case, U-238) available in the "tails" stockpiles at the uranium enrichment plants alone to supply our energy needs for hundreds of years. Furthermore, the relative insensitivity of the breeder to uranium ore costs might allow the exploitation of very low concentration deposits such as in shales or granites (although, interestingly enough, the energy content of shale containing 50-70 ppm uranium is about the same as coal when the uranium is burned in light water reactors).

Much of the technology involved in the exploration and production of uranium has been adopted from other mineral industries. Uranium, however, has one characteristic not common to other metals--radioactivity. This characteristic has created the possibility of novel approaches for the exploration for uranium--but has also created new problems for mining,

milling, and waste disposal.

The mining techniques used include both underground and open pit mining, the choice depending on the depth, size of the ore body, assay, and type of rock formation in which the ore is found. One usually exploits surface or shallow deposits first, using underground techniques only for deeper deposits.

Mills are located near the mines for concentrating the uranium ore (and thereby reducing transportation costs associated with shipping the ore to facilities where further processing is performed). The mined ore is first milled or crushed to a sugar-like consistency. Water is added in the last crushing step to create a slurry. The uranium in this slurry is then extracted by a process known as solvent extraction. First the slurry is pumped to large tanks where sulfuric or nitric acid is added until all the uranium present in the ore is dissolved. The sand or tailings is physically separated by either centrifugal or rake-type classifiers. The  $U_3O_8$  is then extracted from the solvent by adding ammonia and air and heating the mixture to precipitate out the  $U_3O_8$ . The slurry from the settling tanks is then dried or calcinated to produce "yellow cake", a crude oxide concentrate assaying some 70-90%  $U_3O_8$ . As we mentioned earlier, it is this yellow cake which is regarded as the commodity form of uranium ore for trading. A diagram of the various mining and milling processes is shown in Figure 7-7<sup>4</sup>.

Recently public attention has been directed at possible dangers arising from the residual radioactivity released by the uranium "tailings" which result from the milling process.<sup>9,10</sup> The tailings residue from the uranium ore milling is typically stockpiled adjacent to the milling facilities. These uranium tailings will release small quantities of gaseous radon-222 which can escape into the atmosphere (although to keep this release in perspective, it should be noted that the radon level further than one km from such tailings piles is indistinguishable from the natural background level of this isotope).

During the early days of the uranium mining industry, these tailings which have a consistency of fine sand were carted off by local contractors and used in mixing concrete for building foundations (most notably in the Grand Junction, Colorado area). It was discovered in the 1960s that the

MINING AND MILLING

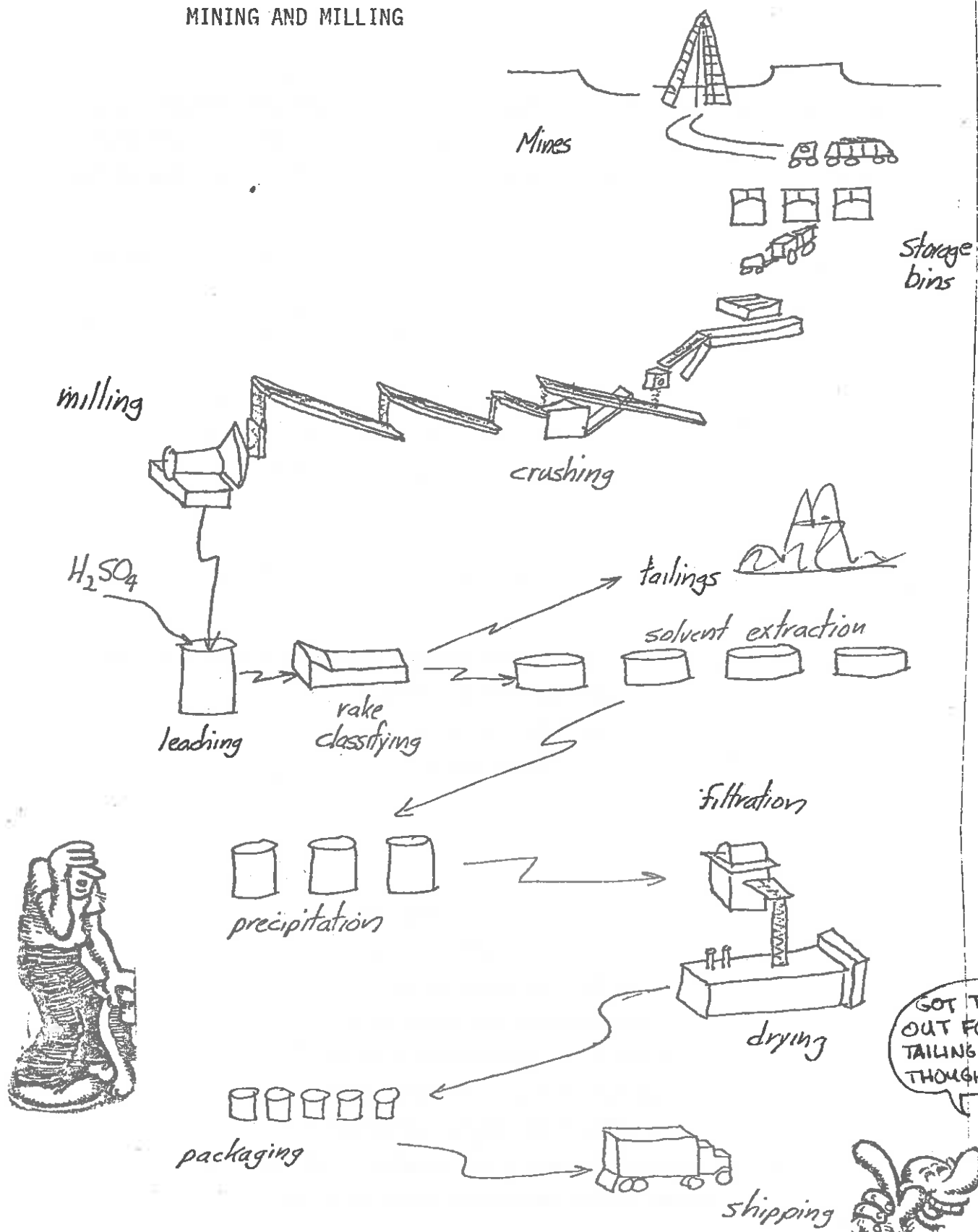
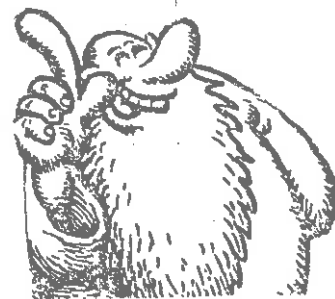


Figure 7-7: Mining and Milling of Uranium Ore<sup>4</sup>



radon level in buildings constructed on such foundations occasionally reached excessive levels. Therefore not only was this practice discontinued, but moreover these foundations were laborously replaced at the federal government's expense.

More recently concern has been voiced over the fact that the radon-222 escaping from the tailings piles themselves could have an adverse effect on public health.<sup>9</sup> To put this problem in perspective, we must realize that the total activity released by all of the tailings generated by the nuclear power industry until well after the year 2000 is estimated to be less than 0.2 Ci/sec of radon.<sup>10</sup> This represents less than 0.4% of the radon release level from natural sources (which mankind has always been exposed to). Indeed, it is estimated<sup>10</sup> that the radon releases from uranium tailings will always be considerably smaller than that released by the flyash generated by burning coal (amounting to some two billions tons to date).

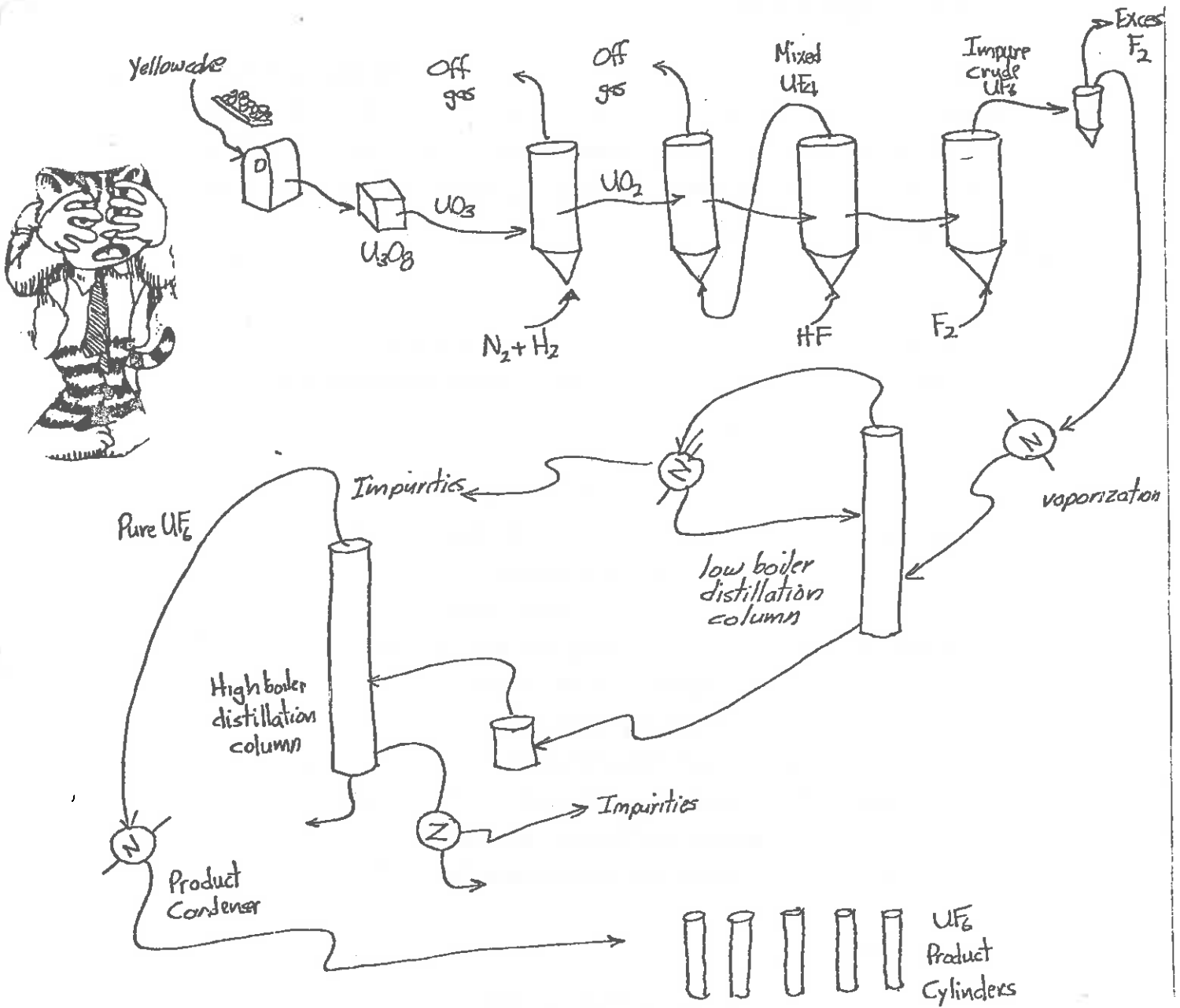
Nevertheless, in an effort to control even these very low levels of radioactivity release, the Nuclear Regulatory Commission has given serious consideration to requiring the uranium milling industry to cover or pave over the tailings piles to reduce radon emission to natural background levels.

### 7.2.2. CONVERSION

Most modern power reactors (with the exception of heavy water reactors) utilize uranium in which the concentration of U-235 has been enriched above its natural value of 0.7%. In order to achieve the enrichment of natural uranium, one must first convert the uranium compound to a gaseous form. Typically this conversion is accomplished by using either the dry fluoride volatility process or the refining fluorination process to convert yellow cake into uranium hexafluoride ( $UF_6$ ). Although  $UF_6$  is a solid under normal conditions, at somewhat higher temperatures it becomes a gas. The purity of the  $UF_6$  produced in the conversion process is exceptional--about 99.97%.



Figure 7-8: Conversion of  $U_3O_8$  to Uranium Hexafluoride ( $UF_6$ )<sup>4</sup>



### 7.2.3. ENRICHMENT

An essential step of the nuclear fuel cycle is the enrichment of uranium from its natural concentration of 0.7% U-235 to the higher concentrations required in modern power reactor fuels (e.g., 2-3% for LWRs, 93% for HTGRs). In the two principal processes in use today, gaseous diffusion and ultracentrifuge techniques, this separation is achieved by utilizing the small mass difference between the two isotopic forms of  $UF_6$  to separate the uranium isotopes. Since this mass difference is very small, the amount of separation which can be achieved in a given device is similarly quite small. Hence to achieve appreciable separation, a large number of separation devices must be arranged in series or "cascades". Such a separation operation is extremely expensive, accounting for some 30% of the total fuel cycle costs. The facilities necessary for the separation process require an enormous capital investment and have been under the exclusive control of the federal government until very recently (although private enterprise has been encouraged on occasion to move into the nuclear fuel enrichment field). In this section we will examine three alternative methods for uranium enrichment: gaseous diffusion, ultracentrifuges, and laser photochemistry. The fourth technique, electromagnetic separation, has not been utilized since the days of the Manhattan Project. The principal technique in use today is still gaseous diffusion, although there is substantial activity and hope for both the ultracentrifuge and laser methods.

#### Gaseous Diffusion

The gaseous diffusion separation method utilizes the difference in the rates at which gases of different molecular weights diffuse through a porous membrane or barrier. Consider a mixture of two gases of molecular weights  $m_1$  and  $m_2$  confined in a container with a porous wall. If both gases are maintained at the same temperature and pressure, then the lighter gas molecules in the mixture move more rapidly (since their average velocity  $\langle v \rangle \sim (3kT/m)^{1/2}$ ) and therefore strike the porous barrier

more frequently, thereby escaping the container at a more rapid rate.

Since the rate of diffusion is inversely proportional to the square-root of the molecular weight, it is apparent that the best separation that can be achieved by diffusion through a single membrane is

$$\alpha = \sqrt{\frac{M_2}{M_1}} = \sqrt{\frac{\text{mass } ({}^{228}\text{UF}_6)}{\text{mass } ({}^{235}\text{UF}_6)}} = 1.0043.$$

(Here,  $\alpha$  is termed the "separation factor" for the process.) It is evident that since the enrichment per stage is very small, a large number of stages in series or cascade is required to produce significant enrichment. For example, the production of 3% enrichment from natural uranium feed requires about 1,500 stages in cascade.

The effort involved in separating isotopes is referred to as separative work and is measured in separative work units (SWU). A quantitative definition of the SWU requires more effort than is warranted here,<sup>11</sup> so suffice it to illustrate this concept using the data<sup>4</sup> in Table 7-4. The separative work required for enrichment is proportional to both the flow rate through the separative device, and to  $(\alpha - 1)^2$ . Evidently if the separation factor  $\alpha$  is close to unity (e.g.,  $\alpha = 1.0043$ ), then the flow rate must be large to achieve appreciable enrichment.

The basic separation stage in a gaseous diffusion plant is shown in Figure 7-8. High pressure  $\text{UF}_6$  is fed into tubes made of the porous barrier material (a nickel-chromium powder). The  $\text{UF}_6$  diffusing through these barriers is slightly enriched ( $< 1.0043$ ) due to the difference in isotopic diffusion rates. This slightly enriched  $\text{UF}_6$  is drawn off at lower pressure, while the remaining material (which is now slightly depleted of the U-235 isotope) is drawn off from the end of the stage. It is apparent that the separation stage must contain three components:

- (i) the barriers themselves (the converter),
- (ii) a compressor to maintain the pressure differential across the barriers,
- (iii) a heat exchanger to remove the heat of compression.

These stages are coupled together into a cascade as shown in Figure 7-9. To understand the flow in such a cascade, consider  $\text{UF}_6$  gas entering stage B. About one-half of the  $\text{UF}_6$  passes through the barrier and is enriched, flowing on to the next stage A. The remaining (and now depleted) gas is

Table 7-4

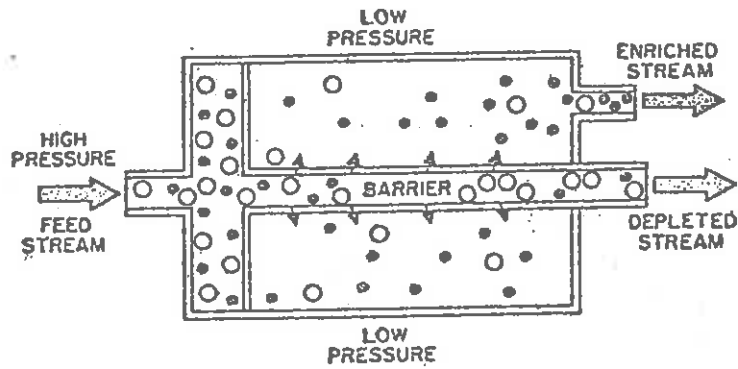
ENRICHED URANIUM DATA<sup>4</sup>

Enrichment	Kg. Natural U Feed Material to Diffusion Plant	Lbs. U <sub>3</sub> O <sub>8</sub> to be Purchased*	Equivalent Units of Separative Work†
% Weight U-235	Per Kg of Enriched Uranium Product		
Nat. 0.711	1.000	2.613	0.000
0.8	1.174	3.068	0.104
0.9	1.370	3.580	0.236
1.0	1.566	4.092	0.380
1.2	1.957	5.114	0.698
1.4	2.348	6.136	1.045
1.6	2.740	7.160	1.413
1.8	3.131	8.182	1.797
2.0	3.523	9.206	2.194
2.1	3.718	9.716	2.397
2.2	3.914	10.228	2.602
2.3	4.110	10.740	2.809
2.4	4.305	11.250	3.018
2.5	4.501	11.762	3.229
2.6	4.697	12.274	3.441
2.7	4.892	12.784	3.656
2.8	5.088	13.296	3.871
2.9	5.284	13.808	4.088
3.0	5.479	14.318	4.306
3.1	5.675	14.830	4.526
3.2	5.871	15.342	4.746
3.3	6.067	15.854	4.968
3.4	6.262	16.364	5.191
3.5	6.458	16.876	5.414
3.6	6.654	17.388	5.638
3.7	6.849	17.898	5.864
3.8	7.045	18.410	6.090
3.9	7.241	18.922	6.316
4.0	7.436	19.432	6.544

\*0.5% U<sub>3</sub>O<sub>8</sub> to UF<sub>6</sub> conversion losses included  
 †Tails assay at 0.2% weight U-235

I JUST CAN'T FIGURE THIS STUFF OUT!





YOU'RE RIGHT!!  
 THAT REALLY WAS A  
 GASEOUS DIFFUSION  
 PLANT!

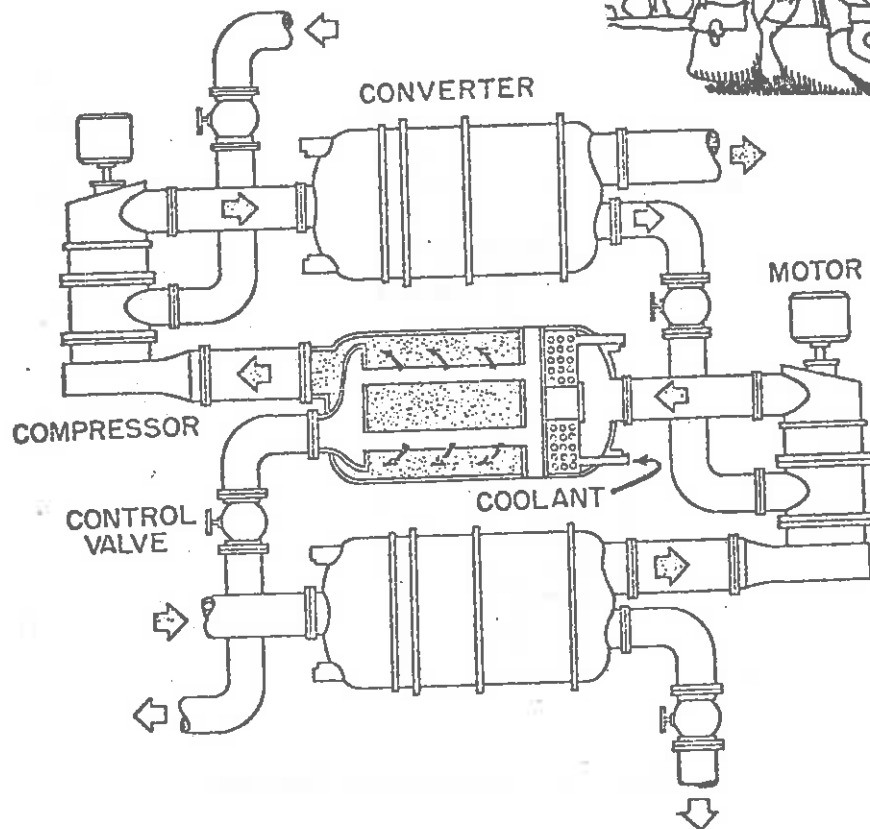
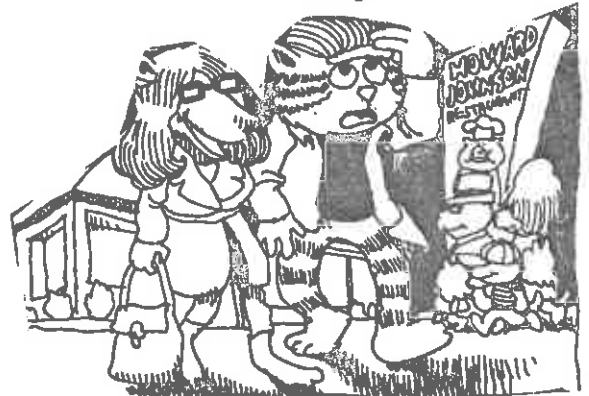


Figure 7-8: Separation Stages for Gaseous Diffusion

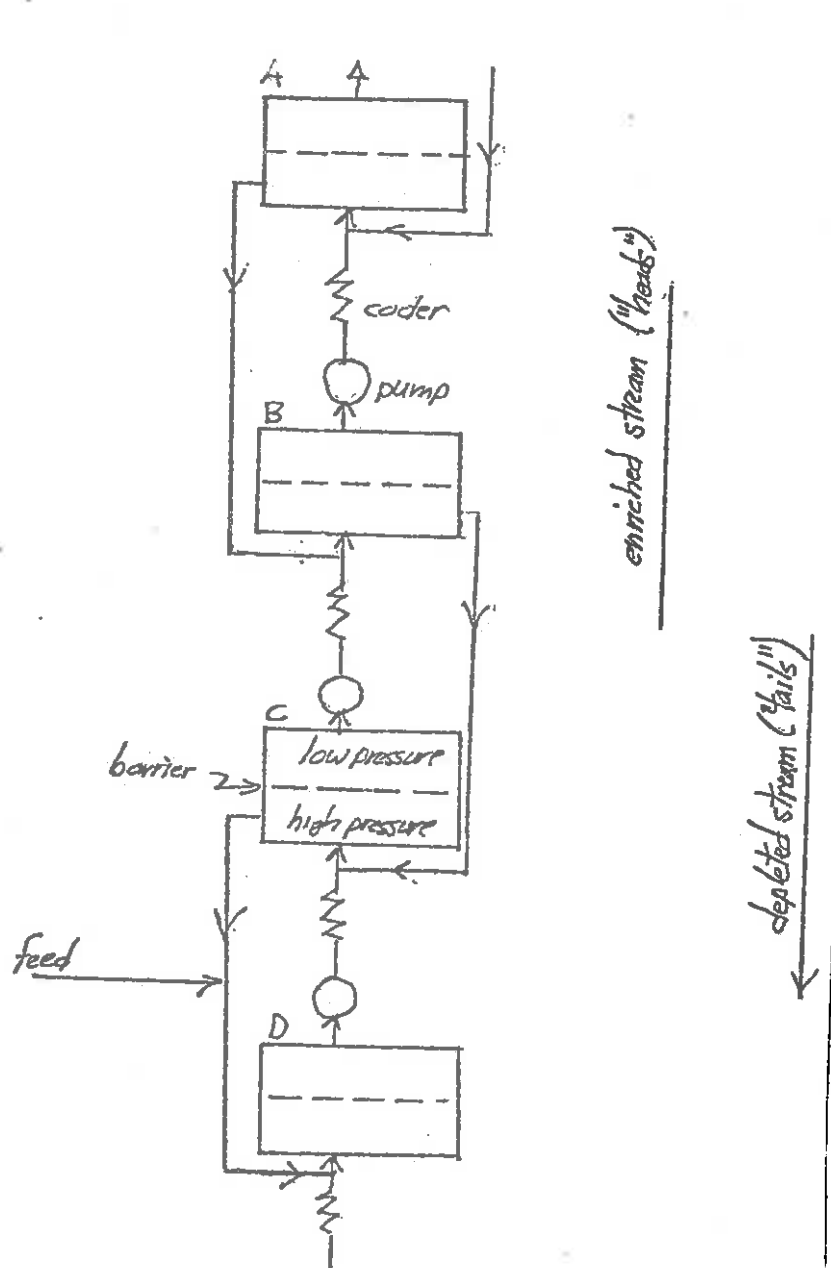
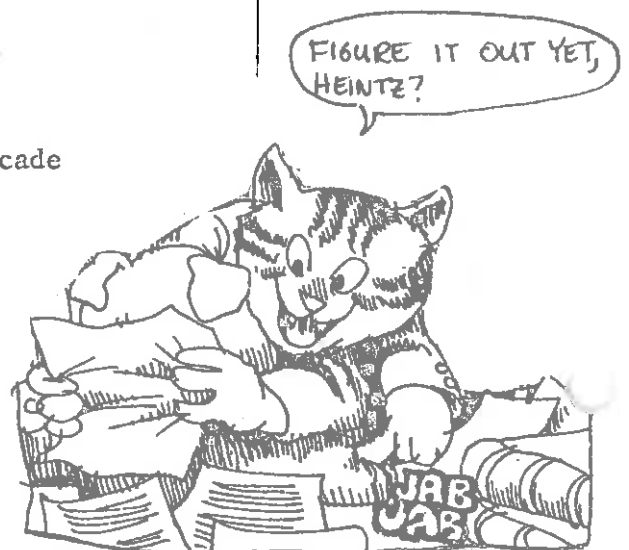
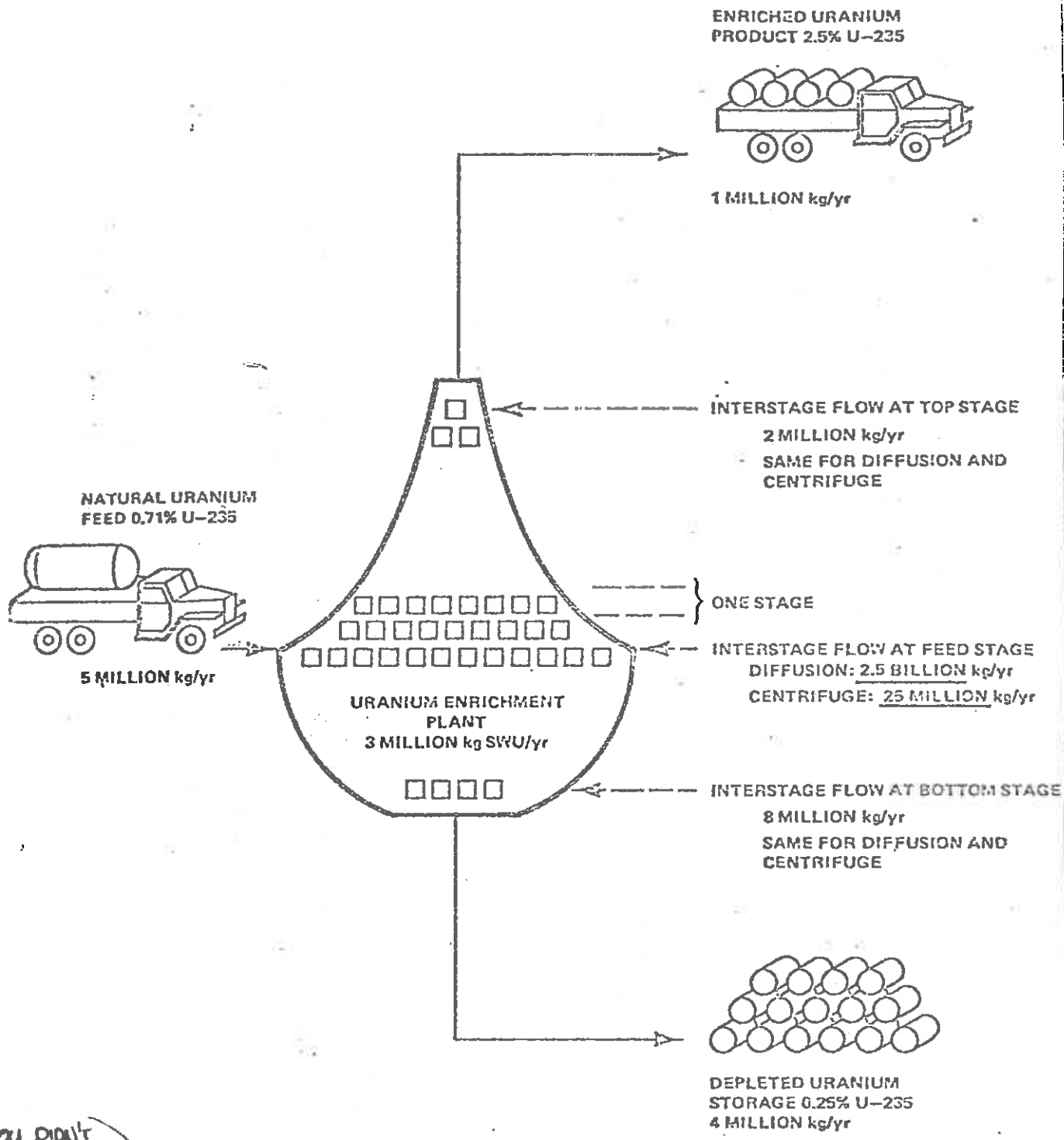


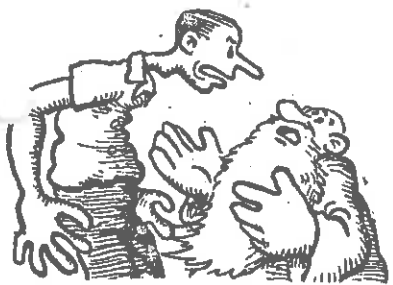
Figure 7-9: Enrichment Cascade





BUT YOU DIDN'T TELL ME THAT EACH PLANT WOULD COST 2 BILLION DOLLARS!

Figure 7-10: Plant Flow Requirements



stages are characterized by much larger separation factors ranging from  $\alpha = 1.1$  to 1.4. Only a relatively few centrifuges need be connected in series to achieve substantial enrichment. However, since the flow rates possible in centrifuges are much lower than in gaseous diffusion stages, large numbers of centrifuges in parallel are required for appreciable enrichment capability. A schematic of an ultracentrifuge stage is shown in Figure 7-11.

There is very considerable activity in the development of centrifuge separation facilities, both in this country and abroad. This scheme utilizes only some 10-15% of the power required by gaseous diffusion techniques, and it appears to be capable of competing quite favorably with the latter method in the overall cost of separative work.

Closely related to the centrifuge is the Becker nozzle separation method<sup>14</sup> (sometimes referred to as a "fixed centrifuge") developed by West Germany. In this device the feed gas is forced at high speed through a nozzle as shown in Figure 7-12. The heavier isotope will then experience a larger centrifugal force towards the outer wall and can be "scrapped" off by a blade. Although this scheme is rather energy-inefficient (even more so than gaseous diffusion), it requires only modest technology aside from the high precision blade machining (e.g., no barriers or high speed centrifuge components). West Germany recently caused quite a bit of concern when they sold a nozzle enrichment plant as part of a nuclear power package deal to Brazil. South Africa is also actively developing an enrichment method<sup>15</sup> (the ENCOR process) closely related to the centrifuge and nozzle methods.

#### Laser Isotope Separation

It has long been known that monochromatic light of the right wavelength can selectively excite the energy levels of gas molecules. With the recent development of powerful tunable lasers, it has now become possible to tune the wavelength of the light incident on a gas so that it can selectively excite the gas atoms or molecules of one isotopic species in preference to another (since there is a slight shift in the



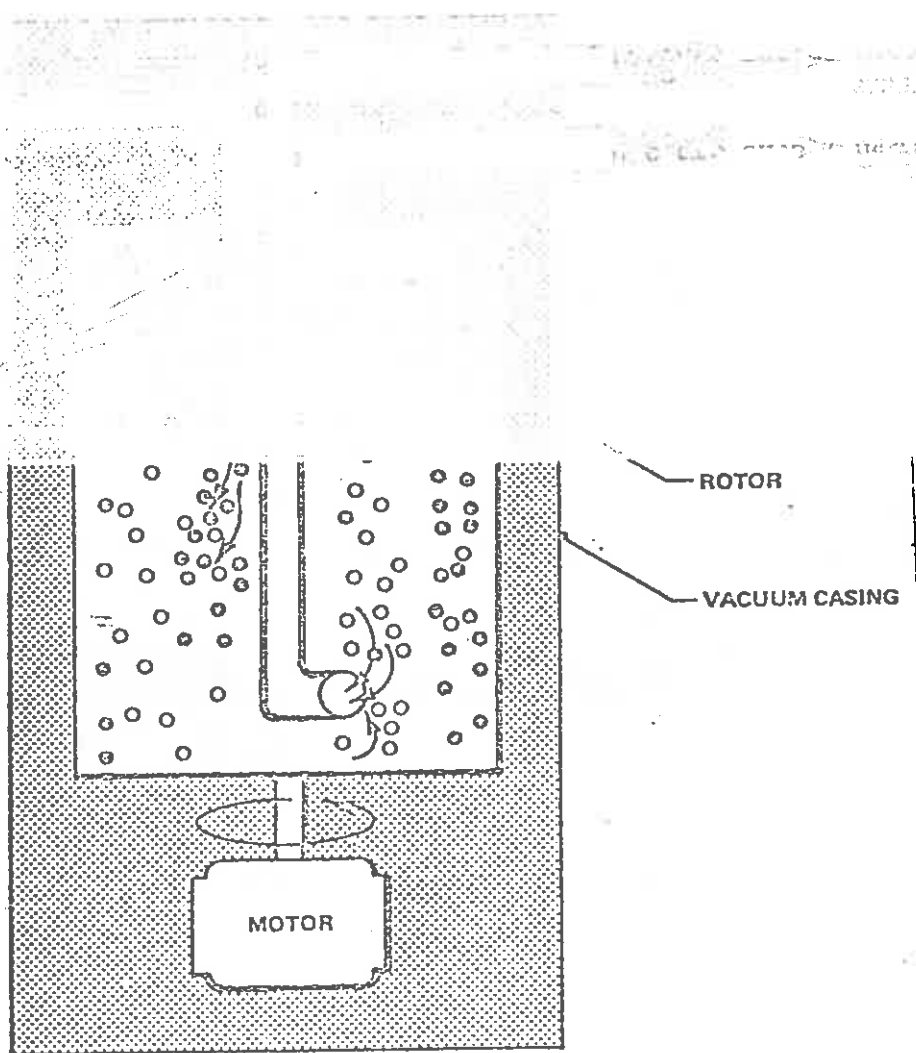
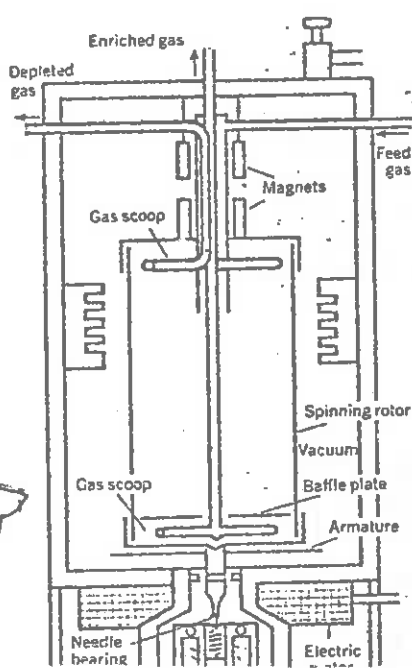


Figure 7-11: Separation Stage for Ultra Centrifuge



GOT ANY OTHER NEAT ENRICHMENT IDEAS?



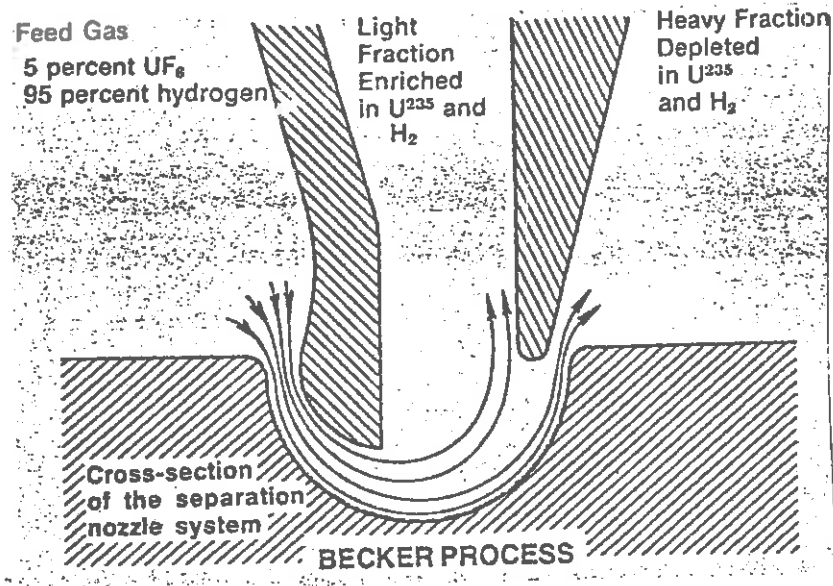


Figure 7-12: The Becker Nozzle Enrichment Process

AND THERE IS ALSO  
THE SOUTH AFRICAN  
PROCESS, WHICH IS SO  
SECRET I DON'T  
EVEN HAVE A PICTURE  
OF IT!



molecular energy levels due to the isotopic mass difference). Once excited, the molecules can be easily separated from the unexcited molecules by conventional physical or chemical separation methods.

The two approaches to laser photochemical separation of uranium isotopes which have received the most attention are:

- (i) two-step photoionization of uranium metal vapor in which a carefully tuned laser beam is first used to selectively excite U-235 vapor atoms; then this excited species is photoionized (for example, by using xenon flashlamps); and finally the ionized species is separated out by passing the vapor beam through an electromagnetic field to deflect out the charged ions.
- (ii) two-step photodissociation of UF<sub>6</sub> in which the tuned laser beam selectively excites one isotopic form of the compound; this excited molecule is then dissociated using ultraviolet or infrared laser beams; and then chemical separation techniques are used to separate out the dissociated isotope.

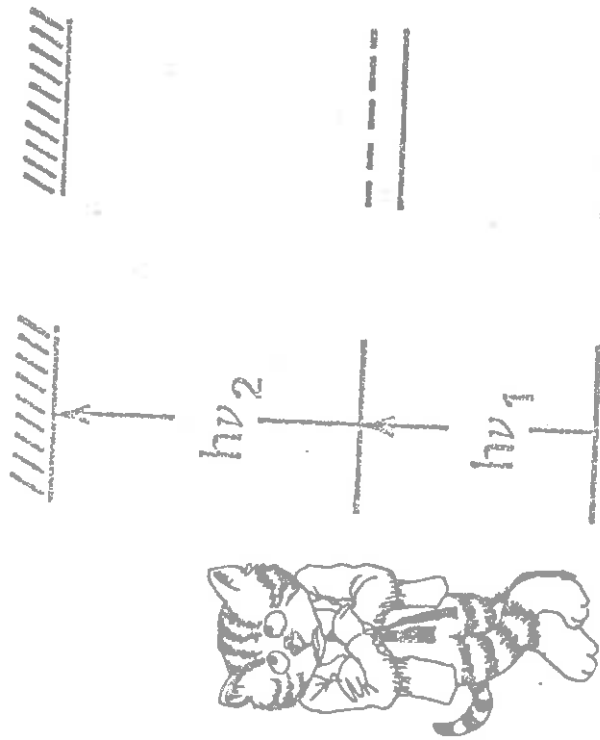
The potential advantages of laser photochemistry for isotope separation include rather large separation factors (as large as  $\alpha = 10$ ), rather modest power requirements, and (hopefully) significantly lower separation costs. The principal disadvantages appear as the significant technical problems which must be overcome before laser isotope separation can be applied on a commercial scale.

For example, the corrosiveness of high-temperature uranium vapor coupled with the tendency of ionized U-235 atoms to recombine before they can be physically separated pose major problems. Furthermore, the spectroscopy of both uranium atoms and UF<sub>6</sub> molecules is quite complicated. The most significant hurdles involve the development of large, efficient laser sources--at the 100 watt power level (rather than the present 100 microwatt level)--which operate at the precise wavelengths required.

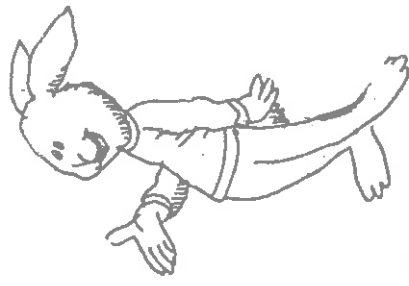
Because of the early fears that laser isotope separation technology might be rather simple to achieve (in comparison with gaseous diffusion or ultracentrifuge methods), most research and development on this technique have been highly classified. However it is becoming more apparent

Figure 7-13

# ISOTOPE SEPARATION BY PHOTOIONIZATION

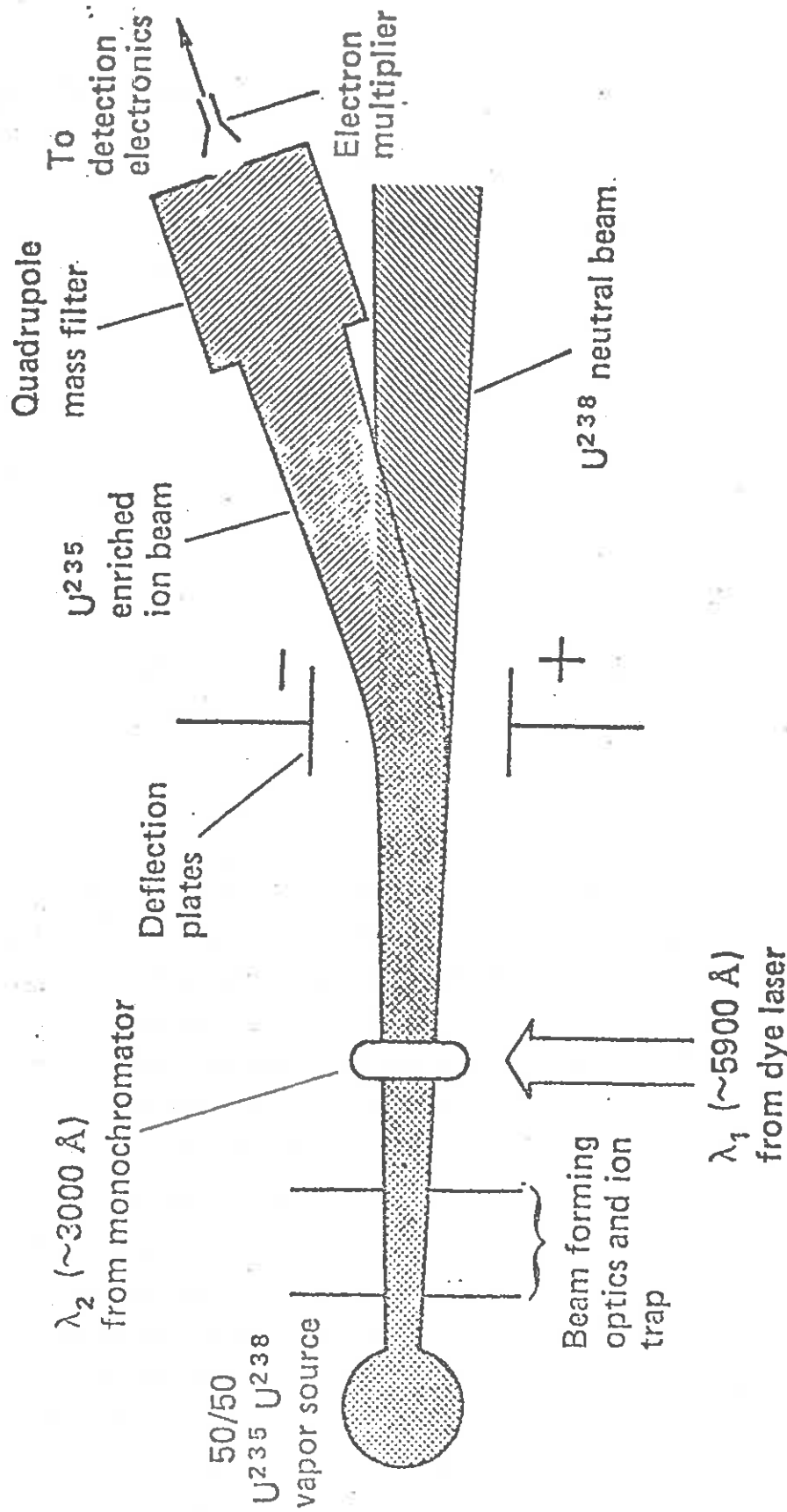


1. Irradiation of gaseous isotopic mixture with  $h\nu_1$  selectively excites isotope "A"
2. Irradiation with  $h\nu_2$  produces "A" ions, leaves "B" unaffected
3. Ions can be separated from neutrals by electromagnetic fields



# SEPARATION OF URANIUM ISOTOPES BY TWO-STEP PHOTOIONIZATION

Figure 7-14



that the scaling of the method from its present milligram capability to the 5,000 ton capacity of a commercial plant will not be straightforward. In all probability the danger of nuclear weapons proliferation from the spread of laser methods is no greater than that characterizing the more conventional ultracentrifuge technology.

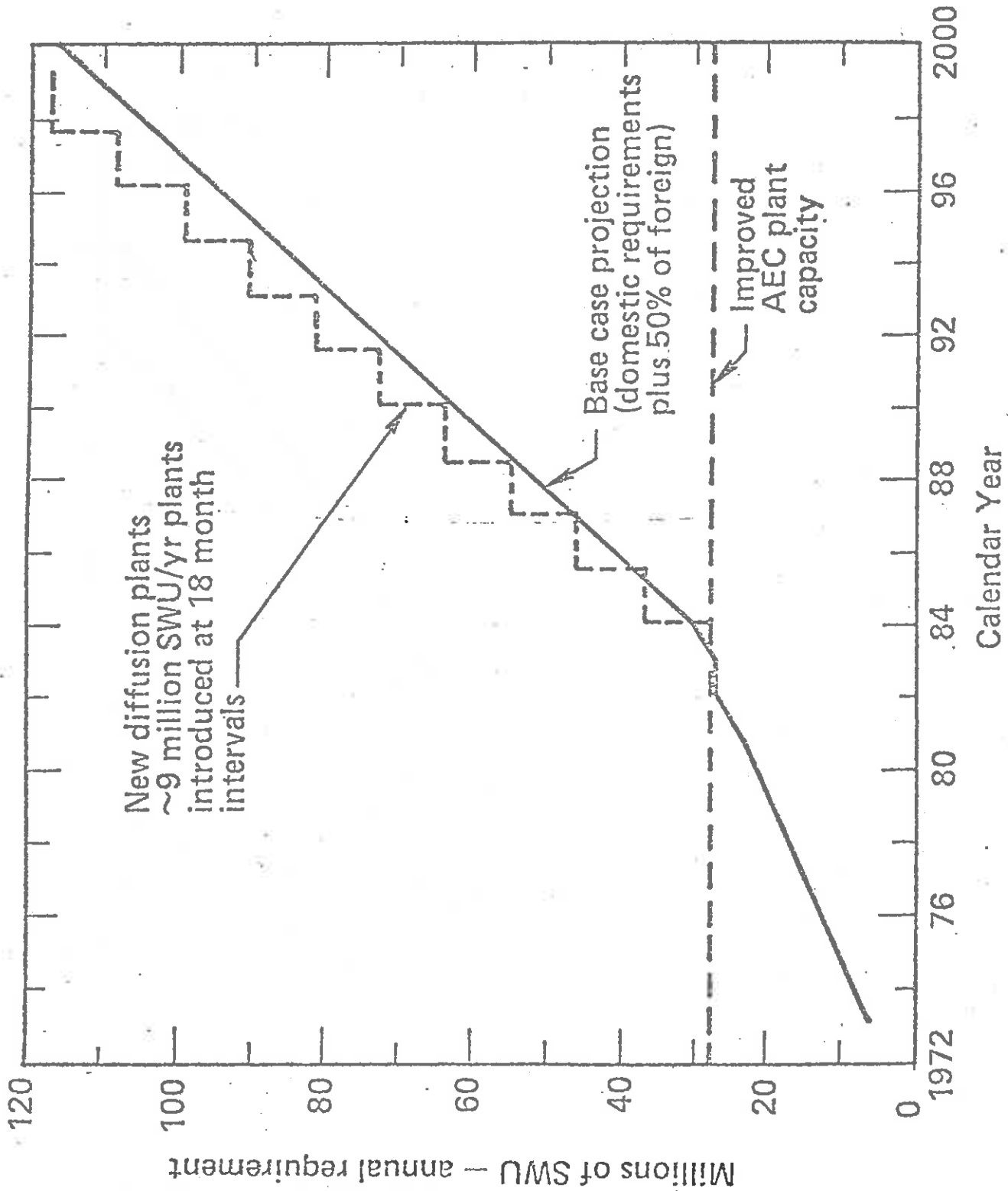
#### Some Further Comments on Uranium Enrichment

Future needs for enrichment capacity depend sensitively upon a number of factors, including the projected estimates of nuclear generating capacity (both domestic and foreign) and the capability of the uranium mining industry to supply feed material. At the present time the vast majority of world uranium enrichment requirements are met by the three United States government gaseous diffusion plants. Although the capacity of these plants exceeds present demand, it is projected that by the early 1980s this capacity will be insufficient, and additional enrichment capacity will be needed.

Of course the need for further enrichment capacity depends sensitively upon a number of factors. For example, the success of the European gaseous diffusion and ultracentrifuge programs will strongly affect foreign demand. Furthermore, since the enrichment output of a plant can be significantly increased by merely feeding in more uranium ore and operating at a higher tails assay (say, at 0.30% rather than 0.20%), the capacity of the present U.S. gaseous diffusion plants can be artificially increased--although at the considerable expense of larger uranium ore feed requirements from an already overburdened mining industry.

The long lead time necessary for plant construction coupled with the projected growth in the nuclear power industry has provided a strong incentive to make a commitment to the construction of new enrichment capacity. There is a strong belief that all future expansions in capacity should occur in the private sector. Unfortunately, the enormous capital investments required for such facilities combined with the uncertainty surrounding both future technological developments (such as ultracentrifuge and laser separation techniques) and government policy has inhibited the entrance of private industry into uranium enrichment.

Figure 7-15: REJECTED DEMAND ON U.S. ENRICHMENT FACILITIES<sup>16</sup>



WHERE ARE YOU GOING TO GET ENOUGH ENRICHMENT CAPACITY?



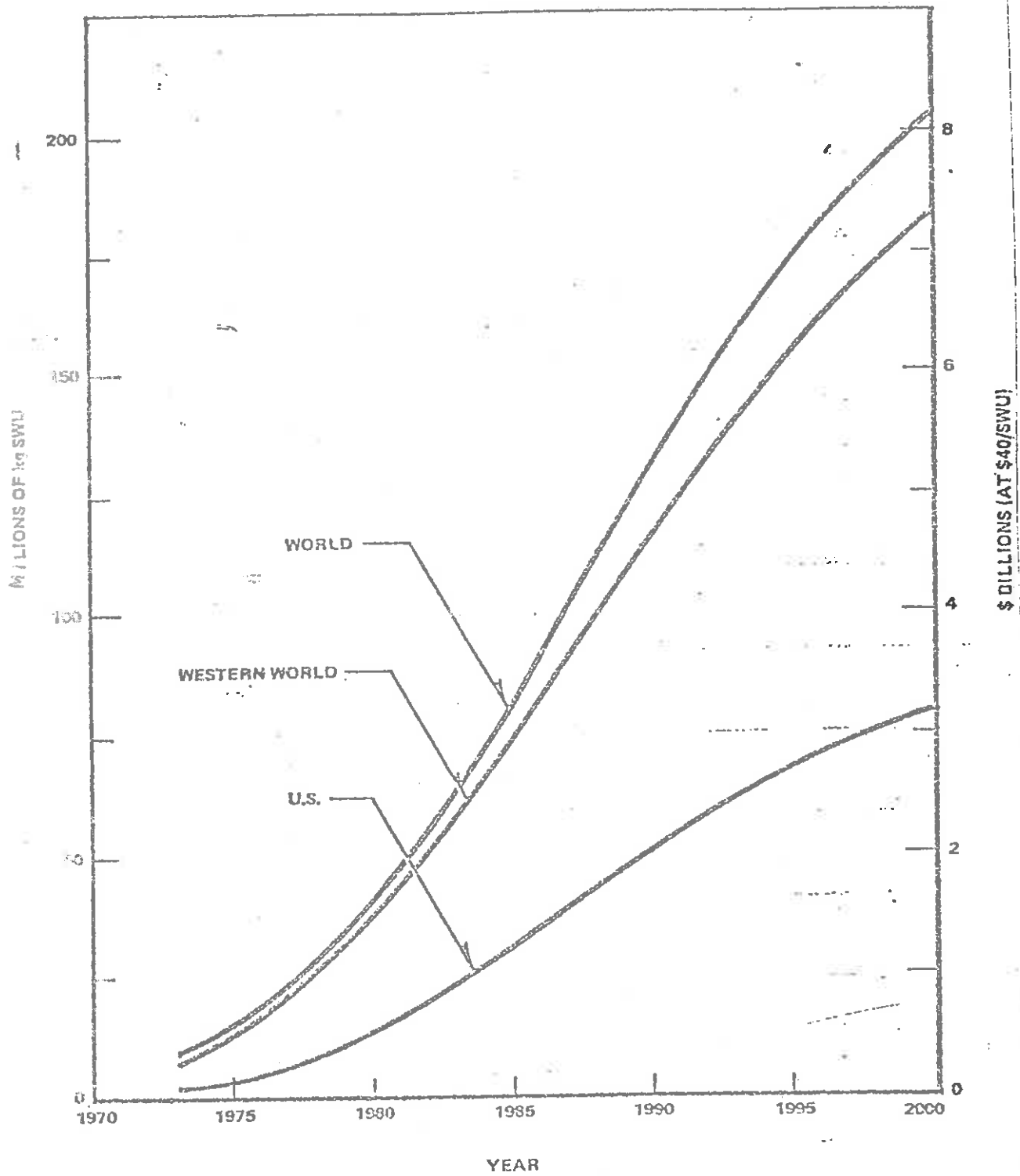


Figure 7-16: Annual Uranium Enrichment Requirements<sup>12</sup>



For example in Table 7-3 we have compared the projected cost and performance factors for the three enrichment methods we have discussed.<sup>17</sup> It should be evident that the significant potential advantages of laser or centrifuge methods over gaseous diffusion might inhibit a massive investment in the older technology. Nevertheless, the federal government recently has decided to begin construction of yet a fourth government gaseous enrichment plant while at the same time providing sufficient guarantees to induce a consortium of companies (Uranium Enrichment Associates led by the Bechtel Corporation) to build yet another gaseous diffusion plant with an anticipated cost of \$3.4 billion.

#### 7.2.4. FUEL ELEMENT FABRICATION

The next step in the fuel cycle is the conversion of the enriched  $UF_6$  to a solid ceramic or metallic form and then the fabrication of this material into fuel elements. As we have seen, the fuel assemblies in a modern power reactor are extremely complex. Each assembly is, in effect, not only a source of fission energy, but as well a heat exchanger which transfers fission heat to the coolant and which must operate in a severe radiation and thermal environment without failure for a period of several years. These assemblies must be manufactured to very fine tolerances in order to optimize core nuclear and thermal performance. Hence it is understandable why fuel fabrication costs account for almost 20% of the total fuel costs.

The first step in the fuel fabrication process is the conversion of gaseous  $UF_6$  to solid form. The enriched  $UF_6$  from the isotope separation plant is received as a frozen solid at ambient temperatures in high pressure cylinders. It must be converted into the form to be utilized in the reactor fuel. For modern power reactors, this form is a ceramic: usually  $UO_2$  or UC (although nitrides have been proposed for advanced fast breeder reactor fuels). For example, for light water reactor fuels, the  $UF_6$  gas is reacted with water to form a  $UO_2F_2$  solution which is then mixed with ammonia water to precipitate the uranium out as yellow ammonium diurate. The precipitate is dried, calcinated to  $U_3O_8$ , and reduced to  $UO_2$  with hydrogen. (This is known as the ammonium diurate or ADU process.) The product of this process is a fine oxide power containing

Costs and performance factors for three types of uranium enrichment. The basic measure of uranium enrichment is the separative work unit (SWU); 1000 SWU is equivalent to 1 metric ton. The laser estimates refer to methods for separating uranium atoms, but not uranium molecules. [Source: Richard H. Levy, Exxon Nuclear Corporation]

	laser	Centri- fuge	Diffu- sion
Separation factor	10		1.0043
Energy require- ment (kilowatt- hour/SWU)	170	210	2100
Capital cost (\$/ SWU)	195	233	388
Economic size (metric tons)	3000	3000	9000
Process area (acres)	8	20	60
Possible comple- tion date	1986	1982	1985

Table 7-5 <sup>17</sup>



88.15% uranium with a theoretical density of  $10.97 \text{ g/cm}^3$ .

The  $\text{UO}_2$  powder is milled, blended to a uniform powder batch, and dry pressed to the shape of right cylinders. These are then sintered in hydrogen at  $1,650^\circ \text{C}$  and finally ground to the required final diameter.

The fuel pellets are then loaded into cladding tubes (either zircaloy or stainless steel), which are evacuated to high vacuum, and backfilled with helium or a helium-argon mixture and sealed with end plugs. These individual fuel elements are then assembled together using grid plates and spacer grids to create a fuel assembly. At each stage of the fabrication process, the fuel is inspected by a variety of techniques to ensure quality control. A sketch<sup>4</sup> of the various steps in the fabrication of the fuel assemblies is given in Figure 7-17.

Very similar steps are followed for the mixed oxide fuel which results from plutonium recycle. The pelletized  $\text{UO}_2\text{-PuO}_2$  recycle fuel is produced and encapsulated into fuel rods by very similar processes and then fabricated into fuel assemblies. The major variations occur in the method of producing the mixed oxide feed and in handling the plutonium, since this requires the use of gloveboxes and remote handling equipment.

### 7.3. In-Core Fuel Operations

Perhaps the most important responsibility of the nuclear engineer concerned with the nuclear fuel cycle is the management of the fuel in the reactor core. This includes the selection of refueling schedules, fuel loading patterns, the prediction (and measurement) of fuel burnup and isotope buildup, and so on in an effort to satisfy both nuclear and economic constraints.

During fuel irradiation, not only is the original fissile material (U-235) depleted, but new fissile material (plutonium) is produced as fertile material captures neutrons and is transmuted. As Figure 7-18<sup>4</sup> indicates, the plutonium concentration towards the end of fuel life is

Figure 7-17: Process Flow for Fuel Fabrication<sup>4</sup>

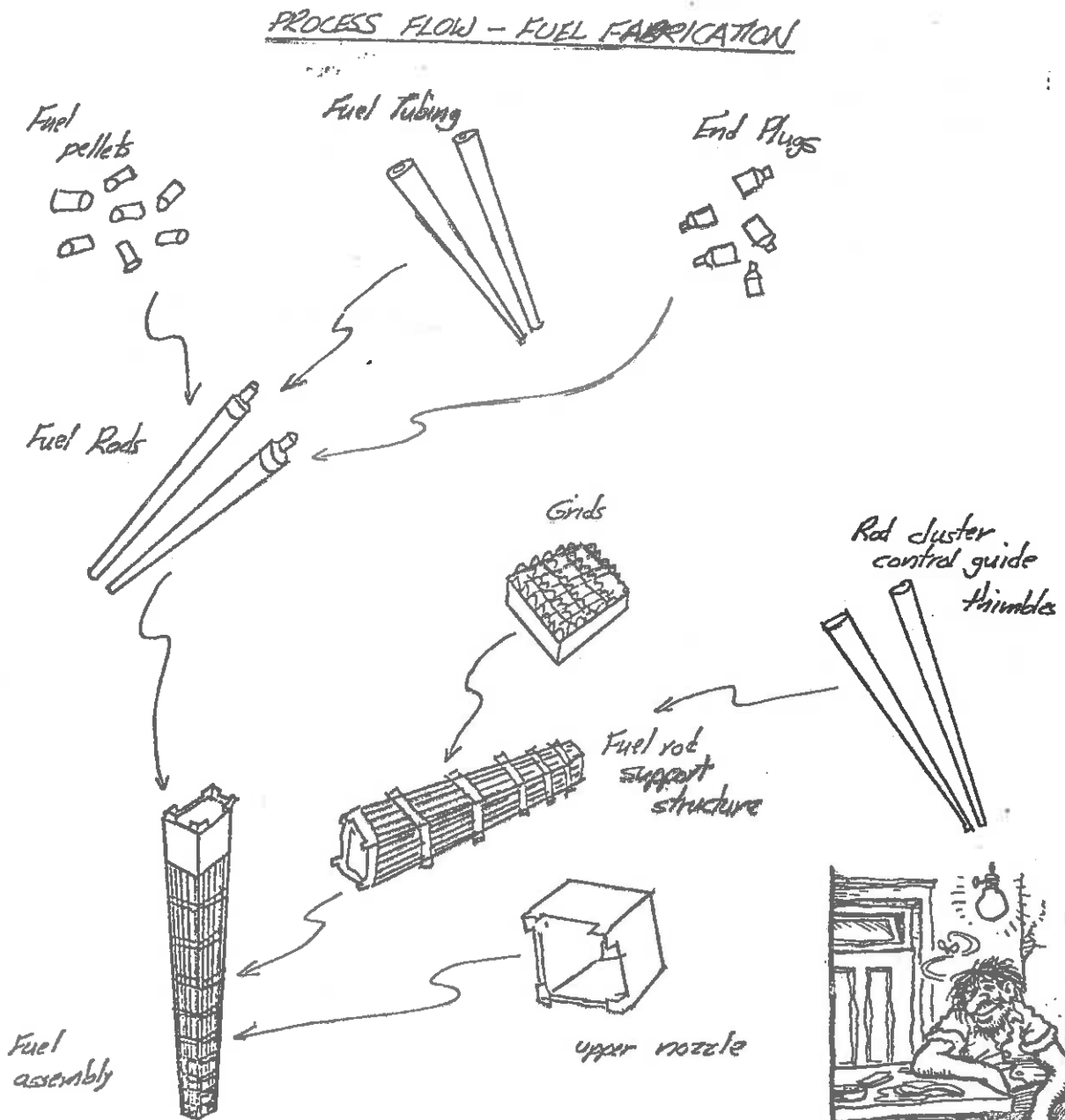


FIGURE 7-17a: QUALITY CONTROL INSPECTORS ARE CHOSEN WITH GREAT CARE....

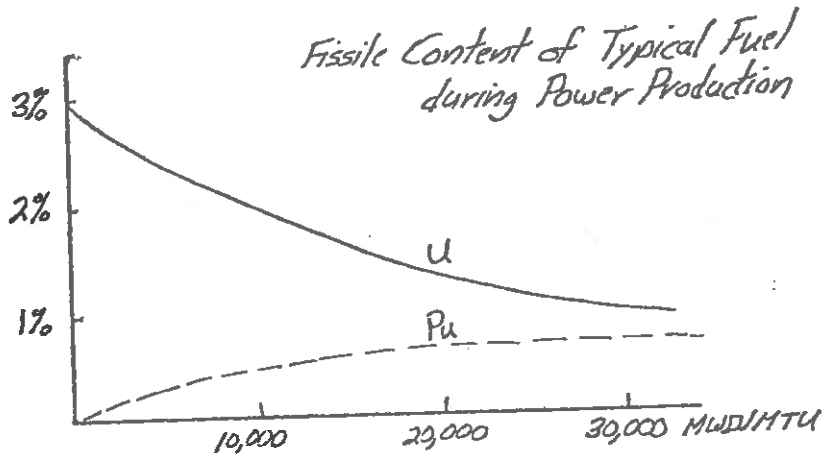


Figure 7-18: Fissile Content of Fuel during Power Production<sup>4</sup>

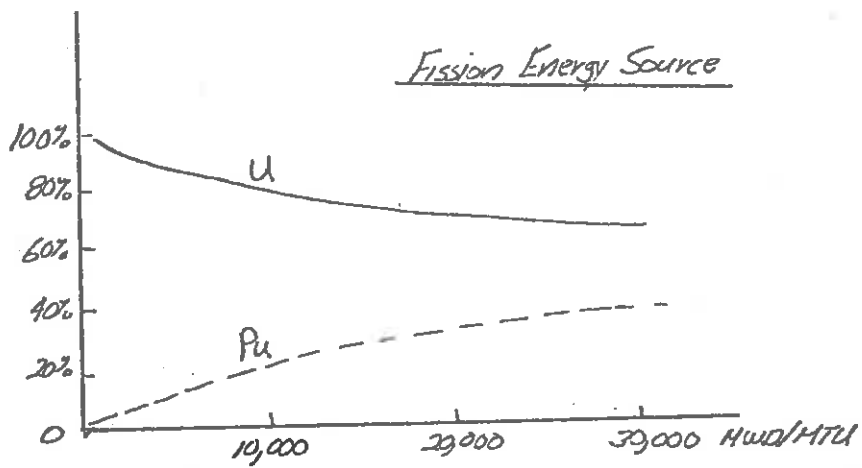


Figure 7-19: Energy Production<sup>4</sup>

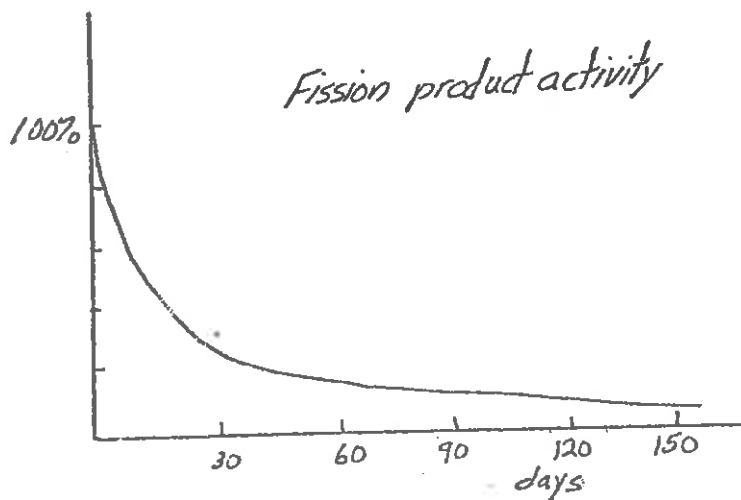


Figure 7-20: Decay of Fission Product Activity<sup>4</sup>



comparable to that of U-235. In fact, during the latter stages of fuel life, the plutonium is producing more power than the U-235 isotope.

The primary goal during in-core fuel operations is to achieve minimum fuel costs consistent with nuclear and thermal constraints on the core performance. This requires an optimum distribution of fuel enrichment for both the initial as well as later reload cores. The refueling period and reload strategy must be specified very carefully along with the control management of both moveable rods and shim (soluble and burnable poisons).

The task of determining the optimum arrangement of fuel assemblies and loading is extremely complex, involving as it does the core geometry and composition, reactivity control, and operational requirements. In a typical core design, the core size, fuel assembly design, control devices, and coolant conditions will be fixed before the detailed in-core fuel management scheme is determined. One has considerable flexibility in varying the enrichment of fresh fuel assemblies, the frequency of fuel reloading, the reloading patterns, and the associated control management program. A number of constraints on in-core fuel management must always be adhered to, however. For example, the reactor core must be capable of operating at its rated power level throughout the reactor cycle without exceeding temperature limitations. Since the core power distribution will change over core life as fuel depletion occurs, one must be able to predict the local power density throughout the cycle. This is an extremely expensive and time consuming aspect of in-core fuel management. The reactivity control system must always be capable of controlling the excess reactivity loaded into the core to compensate for fuel depletion. Although this excess reactivity is usually larger in the initial core loading (since all of the fuel is fresh), one can use burnable poisons and/or chemical shim to adequately control it. In later reload cores, there are fewer alternatives available, since, for example, burnable poisons cannot be easily inserted into irradiated fuel assemblies. Such considerations impose serious upper limits on the allowable fuel burnup of a reactor core.

Fuel burnup is limited to some degree by the amount of radiation damage the fuel can withstand without experiencing appreciable probability of failure. For example, fuel irradiation can induce swelling of the fuel which places a strain on the cladding. Furthermore, the buildup of gaseous fission products within the fuel element can cause a stress on the clad which leads to a plastic deformation of the fuel rod at high temperature (high temperature creep). The enormous thermal gradients across the fuel pin and cladding, combined with the variations in temperature which occur during reactor startup and shutdown (thermal cycling) can also lead to clad fracture in the intense radiation environment of the core. Such fuel failure limitations on fuel burnup are particularly significant when very high burnups are required, such as in the LMFB.

There are frequently external requirements placed upon the scheduling of core refueling. For example, one wishes to avoid a reactor shutdown for refueling during periods of peak power demand (e.g., in the middle of the summer or winter months)--particularly in light of the fact that one day of reactor downtime costs a utility roughly \$400,000. For this reason, refueling is coordinated with plant maintenance operations. Rarely does one replace the entire core of a reactor in a refueling operation. Rather only a fraction of the core is replaced with fresh fuel at any one time. The time period between such refuelings is referred to as a "reactor cycle", and in any partial refueling scheme, the complete fuel cycle will consist of a number of such reactor cycles. Although the fuel inventory required for a given energy production decreases as the frequency of partial refueling increases, there is a tradeoff since more frequent core refueling will lead to increased shutdown time and hence increased costs due to power outage. Most nuclear plants tend to be refueled on a yearly basis.

THE INTEREST CHARGES ON A BILLION DOLLAR PLANT AT 15% ARE 400,000 PER DAY!



## 7.4. Tail End Fuel Operations

### 7.4.1. REMOVAL AND STORAGE OF SPENT FUEL ELEMENTS

At the end of each reactor cycle, a certain fraction of the irradiated fuel in the core will be removed. Since this fuel still contains an appreciable concentration of fissile material (for a typical LWR, the spent fuel contains approximately 1% U-235 and 1% Pu), it is still of considerable value if properly reprocessed. However, the spent fuel is also very highly radioactive due to the large concentration of radioactive fission products contained in it. Such radioactivity represents a formidable problem in both shielding and removal of the associated decay heat of the spent fuel.

The spent fuel elements are removed from the core and transferred to water-filled storage pools in the plant where they are kept for a period of roughly three months to let the shorter-lived fission products decay out. (A rough sketch of fission product activity versus time after discharge is given in Figure 7-21.) The underwater storage not only serves as a shield against the spent fuel radioactivity, but also as a means to remove the considerable amount of decay heat produced in such assemblies. A very useful estimate of the magnitude of the decay heat generated by spent fuel assemblies is given by

$$P(t) = 0.012 P_0 t^{-1.2}$$

where  $P_0$  is the operating power generated by the fuel element, while the time  $t$  is measured in seconds. For longer times, the decay heat load of the spent fuel levels out at about 0.1% of the fuel operating power. It is this residual decay heat which must be contended with when shipping the spent fuel assemblies to reprocessing facilities.

### 7.4.2. TRANSPORTATION OF SPENT FUEL ELEMENTS

The spent fuel is allowed to cool in the onsite storage pools for about three months. It is then loaded into heavily shielded and cooled



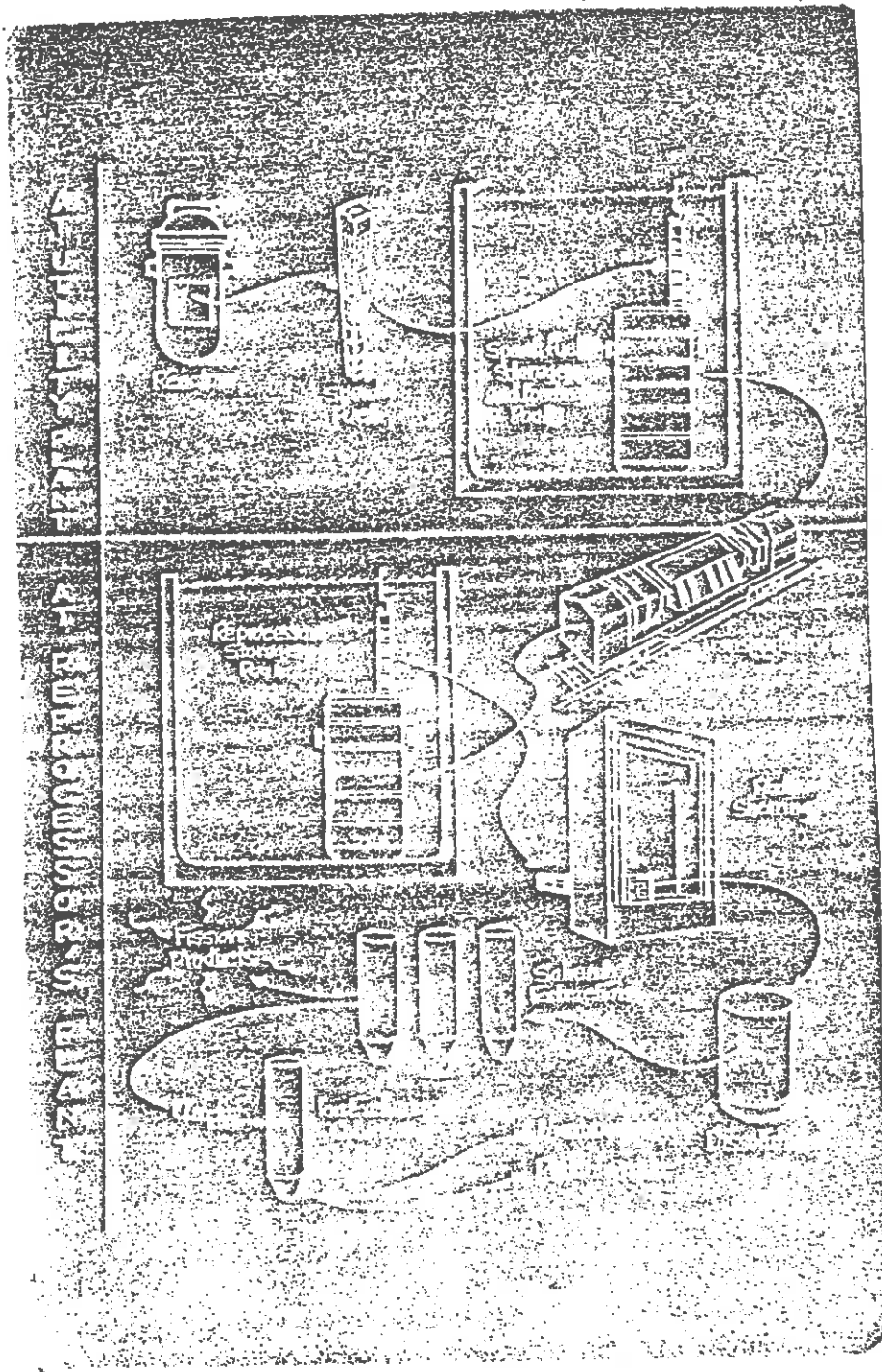


Figure 7-22: Process of Spent Fuel Unloading, Storage, Transportation, and Reprocessing<sup>4</sup>

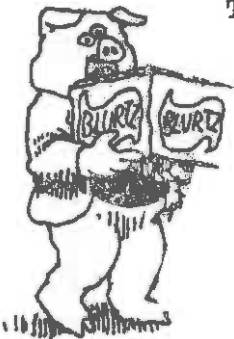
casks for shipping to reprocessing facilities by either truck or rail. Throughout handling, storage, and shipping the fuel must always be kept in configurations such that inadvertent criticality can be avoided. In fact, the number of fuel assemblies in a shipping container is usually limited by criticality considerations.

The shipping containers must be carefully designed to ensure their integrity in the event of any conceivable shipping accident. Despite the care taken in the design of shipping casks and in the shipping of spent fuel, there is still a great deal of public debate concerning the shipment of such radioactive materials. Unfortunately, the distinction is not usually made between the relatively frequent shipments of low level radioactive materials (over a million such shipments are made every year without incident) and the far less frequent shipments of high level radioactive materials. For example, fresh nuclear fuel assemblies have very low activities and can be touched and handled with bare hands. A typical nuclear plant will discharge roughly 200 drums of low-level wastes each year which require only modest shielding and which can be shipped by ordinary heavy duty trucks. In sharp contrast, a single spent fuel assembly will typically be characterized by an activity as high as 2 million Ci, and a spent fuel shipping cask might contain as much as 14 million Ci.

Packaging requirements for the transportation of radioactive materials falls into several categories, depending upon the quantity and type of radioactive material involved. In Table 7-6 we have listed the packaging requirements for the various transport groups:

Table 7-6 : Package Quantity Limits

Transport Group	Type A (Curies)	Type B (Curies)
I	0.001	20
II	0.05	20
III	3	200
IV	20	200
V	20	5,000
VI, VII	1,000	50,000



The transport group numbers range from Group I which contains the highly radiotoxic alpha emitters such as americium, plutonium, and radium to the higher transport group numbers that contain the less radiotoxic substances such as tritium. Each radioactive isotope is delegated to a transport group. As we can see from Table 7-6, the more radiotoxic the substance, the smaller the allowable quantity for a given package type. Special form materials are those whose physical form is such that although they may present a hazard due to direct radiation, they pose little hazard as a result of their radiotoxicity, or contamination. "Large quantities" are those that exceed type B quantity limits.

Federal regulations specify that Type A packaging must be designed so that the package will maintain its integrity when subjected to "normal" transport conditions. The Type A package must also be designed so that there is no loss or dispersal of its radioactive contents, and so that the package will maintain its shielding properties under normal conditions. The performance tests used to verify Type A "normal" conditions of transport are specified in Federal Shipping Container Specifications.

Type B packaging must also be designed so that it can withstand normal transport conditions. In addition, however, Type B packaging must meet certain performance criteria intended to simulate stresses that might be encountered under accident situations. The principal torture tests include:

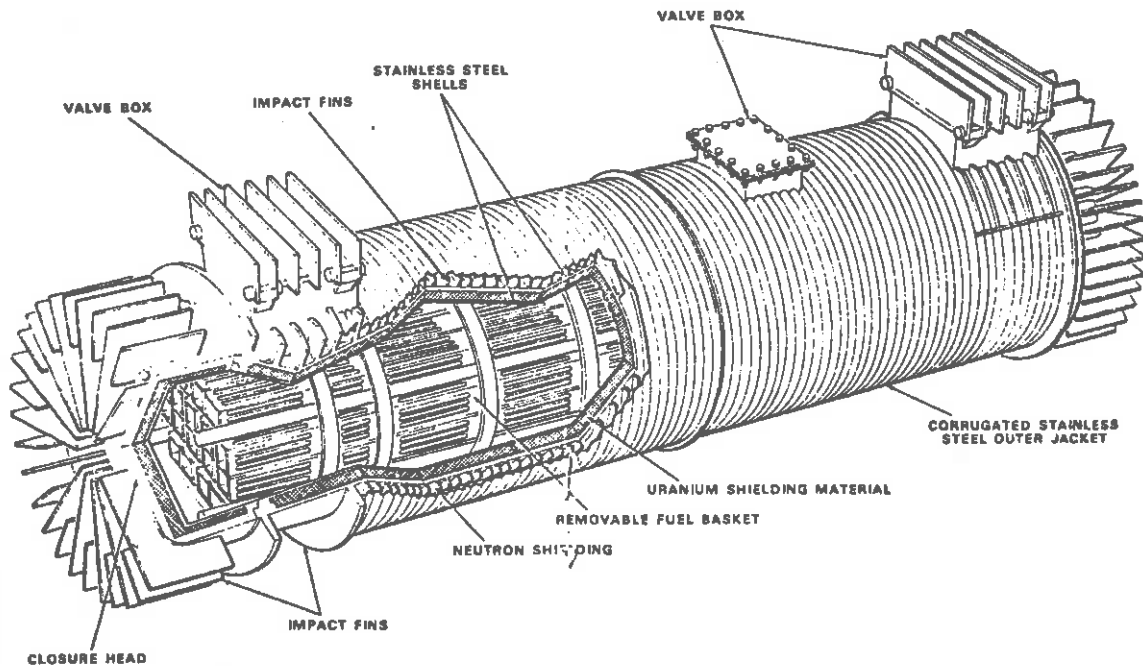
- (i) A 30 foot fall onto an unyielding surface. Test drops must be made in a variety of orientations. The Type B package must withstand the drop while absorbing through deformation all of the energy of impact.
- (ii) The Type B container is dropped from a height of 1 m onto a 10 cm diameter pin. The pin must be long enough to be capable of puncturing the container. To successfully pass the test, the package must survive the fall without permitting the puncturing of even the outer shell. The drop is made in such a way that the point of impact is directly below the center of gravity.

- (iii) The Type B package is subjected to a fire test. This requires that the container survive 30 minutes of uniform thermal exposure at 1000 °C.
- (iv) For Type B packages designed to carry fissile material, an 8 hour immersion test in 1 m of water is performed.

Irradiated fuel casks qualify as "large quantity" shipments. The casks must be able to satisfy all Type B packaging requirements. In addition they must meet a number of other provisions, such as decay heat dissipation, potential leakage of contaminated heat transfer medium, and heavier shielding.

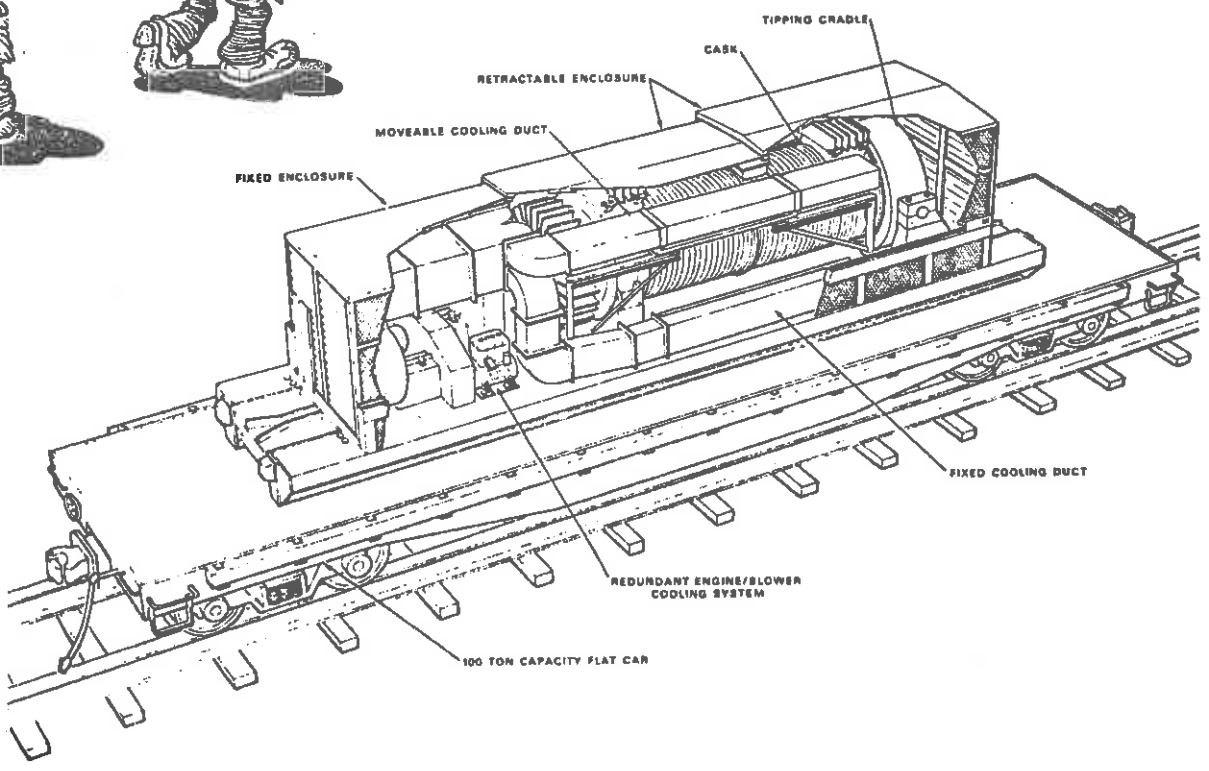
By way of illustration, consider the IF 300 Irradiated Fuel Shipping Cask produced by the General Electric Company which is an intermodal cask designed to be shipped for short distances by truck to the nearest rail loading ramp. The cask is then shipped by rail to a fuel reprocessing plant. The IF 300 cask is capable of carrying 18 BWR or 7 PWR fuel assemblies irradiated at design operating levels. The inner cavity of the IF 300 has an inside diameter of 1 m with an inner wall of 1.5 cm stainless steel. The middle shell consists of a 10 cm thick wall of depleted uranium shielding. The uranium wall material is composed of 8 interlocking segments, each approximately 50 cm in length. These are shrink-fitted to the inner cavity for good thermal contact. A copper diffusion layer is used at all uranium/steel interfaces to prevent the formation of a low melting point uranium/steel alloy. The uranium serves as a gamma shield. The outer shell is composed of a 3 cm stainless steel wall shrink-fitted to the uranium shell. The outer shell has an inner diameter of 1.25 m. A 1 cm thick corrugated jacket surface serves to improve heat transfer capabilities and to increase the resistance of the outer surface to damage. The water contained within the corrugated stainless steel jacket functions as a fast neutron shield.

Encircling the cask are 4 circumferential impact fins. Each fin is 15 cm high and 3 cm thick. They serve as impact fins, support for the water jack, and lifting rings. On both the lower end of the cask and the cask head are 32 radially mounted impact fins. Each fin is 20 cm high and 3 cm thick. For further protection all valve boxes are equipped with impact fins.



JUST LOAD IT IN THE TRUNK OF YOUR CAR AND HAUL IT AWAY.

Above, the shipping casks for spent fuel are built to withstand even a major accident. Below, the cask is shown on a railway flatcar.



The exterior cooling system consists of two fans driven by two diesel engines. Each engine/blower unit is independent of the other. Although in normal operation both units operate at the same time, either engine/blower unit is capable of supplying sufficient cask cooling by itself.

The total loaded weight of the IF 300 cask is, depending upon the fuel, 65-70 tonnes. An additional 7 tonnes is added to the unit by the cooling system and skids. The IF 300 Irradiated Fuel Shipping Cask complies with all Type B fissile material package regulations and performance criteria.

Spent fuel is primarily transported by truck and rail, although barge shipments may be made in the future. To date some 4,000 shipments of irradiated fuel casks have been made, and there have been only two accidents to date which have involved loaded casks, with no release of radioactivity.

#### 7.4.3. SPENT FUEL REPROCESSING<sup>33</sup>

As we have noted, the spent fuel discharged from a nuclear power reactor contains a significant quantity of unused uranium and plutonium which could be reloaded into fresh fuel elements. The value of the fissile material remaining in the spent fuel elements discharged by a 1,000 MWe plant is estimated to be from \$4-5 million per year. Hence there is strong incentive to reprocess the spent fuel and extract the unused uranium and plutonium. Such reprocessing is also necessary in order to concentrate the radioactive fission product wastes into small volumes for eventual disposal.

The principal scheme used for commercial recovery of uranium, plutonium, and neptunium from low enrichment,  $UO_2$  type LWR fuels is the hybrid aqueous-fluorination or Purex process. The spent fuel is received at the reprocessing plant, unloaded from its shipping cask, and stored under water until processing. It is then mechanically disassembled, sheared into short segments, and the  $UO_2$  fuel is leached from the cladding. The

leached cladding hulls are then rinsed and removed as waste.

The dissolver solution (typically nitric acid) is next treated and sent to a solvent extraction step which results in the separation of more than 99.9% of the fission product waste activity from the uranium and plutonium products. The aqueous stream from this extraction step is then concentrated. Chemical adjustments are made, and the stream is then passed through a semi-continuous anion exchange unit where the plutonium is extracted as aqueous plutonium nitrate solution. The remaining aqueous uranium nitrate is concentrated and calcined to  $UO_3$  in a fluid bed calciner. It then passes to the fluid bed fluorinator where it is fluorinated using elemental fluorine. The  $UF_6$  is passed through a series of purification steps and loaded directly into  $UF_6$  cylinders for shipment to an enrichment facility.

The plutonium nitrate solution will be converted into plutonium oxide powder and returned to a fuel fabrication facility to be blended with uranium oxide to produce new fuel pellets for use in either light water or fast breeder reactors, thereby completing the nuclear fuel cycle. The recycling of the plutonium produced in power reactors has become an extremely controversial subject because of the public perception of the toxicity and sabotage potential of this material (which we will consider in some detail later in this chapter). Since nuclear fuel costs contribute only 10-15% of the overall electrical generating costs, one might well question why there is a strong incentive to close the fuel cycle by utilizing "mixed oxide" fuels in light water reactors--particularly considering the degree of public controversy.

Actually, the idea of not recycling plutonium but rather discarding it as "radioactive waste" (an open-ended or "throwaway" fuel cycle) is a technological absurdity.<sup>19</sup> The motivation is not so much due to direct cost savings (although these would amount to some \$17 billion by 2000), but rather due to the massive savings in uranium ore feed requirements which plutonium recycle would yield. By recycling both the remaining uranium and plutonium present in spent fuel elements using even the most conservative recycling schemes (e.g., using the same fuel designs for reload cores), one can reduce uranium feed requirements by 40% (e.g., from 1,400,000 mt without recycle to 1,025,000 mt with recycle through

ANOTHER BRILLIANT  
DECISION IN  
KEEPING WITH THE  
GREAT TRADITION  
OF AMERICAN  
POLITICS.



the year 2000). In the face of our limited uranium ore reserves (amounting to at most 3,500,000 mt), such a savings is quite significant.

An alternative approach would be to save the plutonium produced in light water reactors for eventual utilization in fast breeder reactors (where the superior neutronic characteristics of the breeder make plutonium some three times more valuable than it would be if used in light water reactors). However since commercial breeder reactors will not be deployed in this country for some two decades or more, when one discounts the value of plutonium produced today and stored until this time (at 15% per year), it quickly becomes apparent that it is far more economical to recycle the plutonium as it is produced back into light water reactors.

#### 7.4.4. RADIOACTIVE WASTE DISPOSAL

Most public attention concerning the nuclear fuel cycle has been directed towards the disposal of high-level radioactive waste produced by nuclear power reactors. As we have seen, a nuclear power reactor will build up an inventory of radioactive fission products during its operation amounting to billions of curies of activity. Although most of this radioactivity will decay out quite rapidly following reactor shut-down and removal of spent fuel elements from the reactor core, a significant fraction of the high-level radioactivity induced in the fuel is characterized by half-lives of decades or longer, and therefore radioactive waste products extracted during the fuel reprocessing operation must be carefully isolated from the environment for a significant period of time. Indeed, since the radioactive waste produced by power reactors will contain minute quantities of transuranium isotopes with half-lives as long as thousands of years (e.g., Pu-239 which has a half-life of 24,500 years), one commonly encounters the claim that such wastes will have to be isolated and guarded for hundreds of thousands of years. Such claims are usually accompanied by a sense of indignation at the immorality of leaving a legacy of radioactive waste as a potential hazard for future generations (an argument which turns the concern over radio-



active waste disposal from a technical issue into a matter of public conscience and emotion.

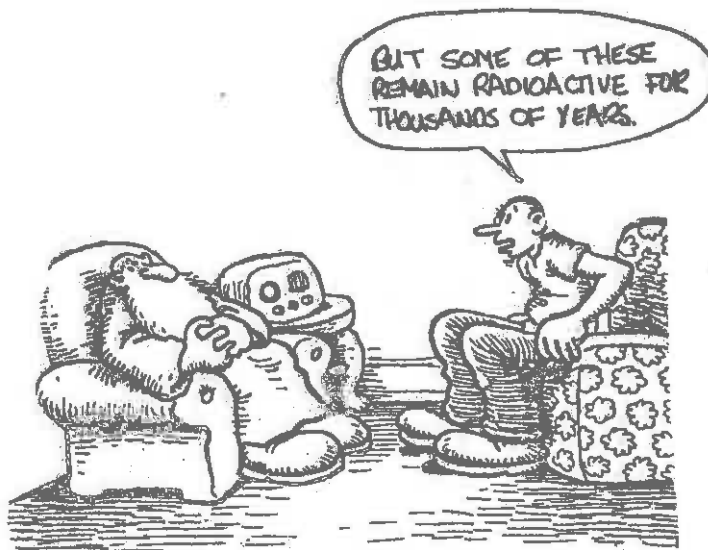
To place some of these concerns in perspective, it is important to recognize that the physical quantity of radioactive waste produced by nuclear power reactors is actually quite small. For example, the volume of radioactive waste produced during a year's operation of a large power reactor is only about 2 cubic meters. All of the radioactive waste that will be generated by the entire U.S. nuclear power industry until the year 2000 would fit into a cube about 80 m on a side, and of that, the high-level wastes would occupy a cube only about 15 m on a side.<sup>10</sup> When compared to the enormous volume of wastes produced by other types of electrical generating plants (e.g., it takes a train of 33 carloads a day just to remove the ashes from a modern coal plant), it is apparent that the volume of radioactive waste is actually quite small.

Rather the principal concern involves the toxicity of these wastes, and therefore they must be disposed of in a manner which ensures that they are isolated from the human environment for a sufficient time to allow them to decay to harmless levels. Although a variety of radioactive materials are produced in nuclear reactors (see Table 7-7<sup>4</sup>), most of the activity of radioactive wastes is due to fission products such as Sr-90 and Cs-137 which are characterized by half-lives of up to 30 years and which will decay to harmless levels in several hundred years (as a rule of thumb, in 10 half-lives). However radioactive wastes produced in power reactors will also contain trace amounts of heavy radioactive elements (actinides) such as plutonium, neptunium, and americium which have half-lives of thousands of years. Therefore radioactive wastes will exhibit a residual radioactivity for a much longer period. However the magnitude of this very slowly decaying component is usually rather small. For example, the processed high-level radioactive wastes from a nuclear power plant will decay to essentially the same radiotoxicity level as natural uranium ore after several hundred years<sup>21</sup> (see Figure 7-24). Hence the toxicity of such wastes drops dramatically after this period. Indeed, one would have to eat several hundred grams of such wastes to do himself bodily harm after this time period.<sup>20</sup> (This should be contrasted with other

Table 7-7: Fission Products Produced during Operation <sup>4</sup>

SIGNIFICANT FISSION PRODUCTS

<u>Isotope</u>	<u>Weight</u>	<u>Half-Life*</u>	<u>Radiation</u>
Barium	140	12.8 days	B,Y
Cerium	141	32.5 days	B,Y
Cerium	144	590 days	B,Y
Cesium	137	33 years	B,Y
Iodine	129	17 million years	B,Y
Iodine	131	8 days	B,Y
Krypton	85	9.4 years	B,Y
Lanthanum	140	40 hours	B,Y
Niobium	95	35 days	B,Y
Praseodymium	143	13.8 days	B,Y
Praseodymium	144	17 minutes	B
Promethium	147	2.26 years	B
Rhodium	106	30 seconds	B,Y
Ruthenium	103	39.8 days	B,Y
Ruthenium	106	1 year	B
Strontium	89	54 days	B
Strontium	90	25 years	B
Technetium	99	500,000 years	B
Tellurium	129	34 days	B,Y
Xenon	133	7.5 days	B,Y
Zirconium	95	65 days	B,Y



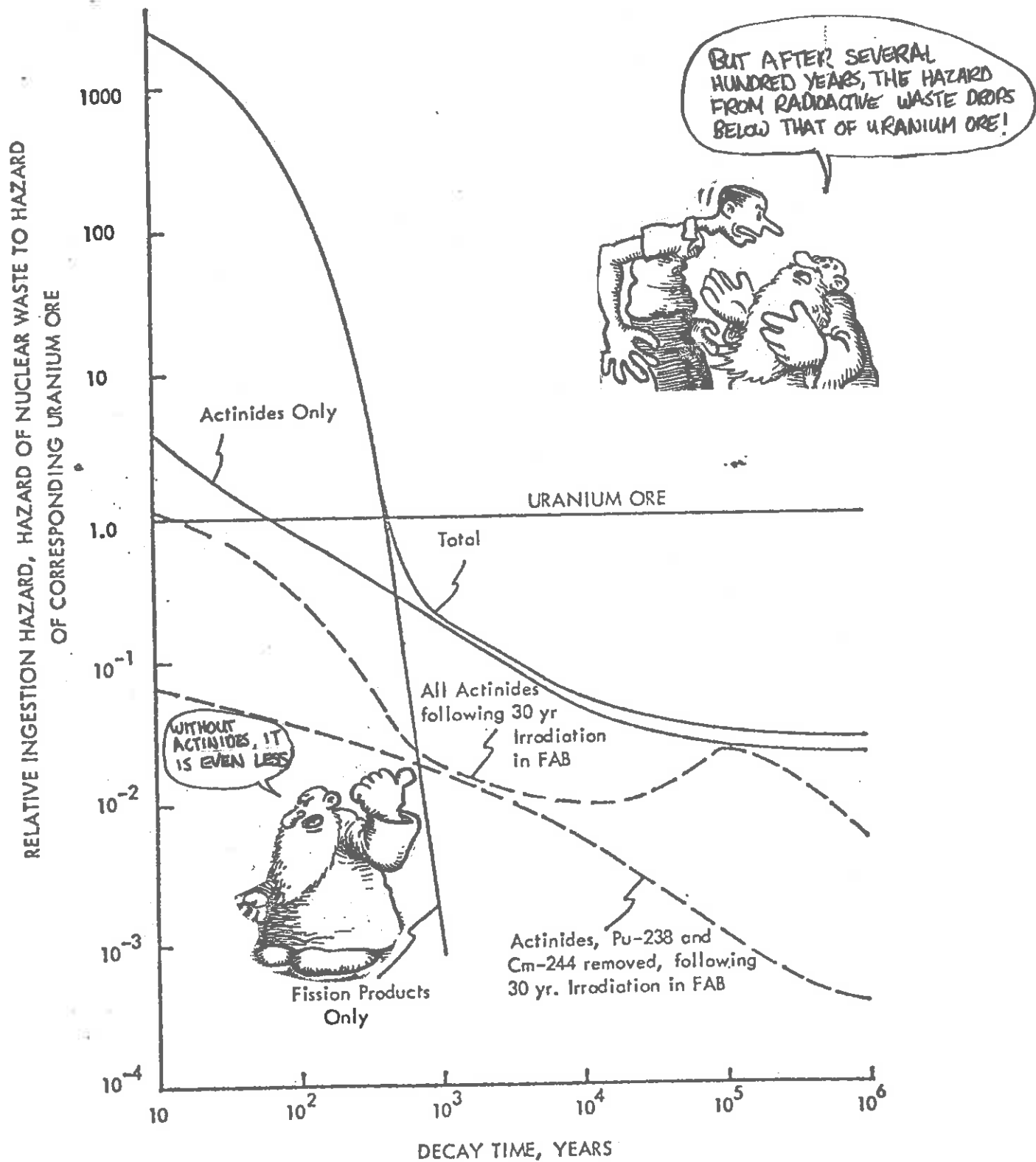


Figure 7-24: Relative Ingestion Hazards of High Level Radioactive Wastes for Typical LWR-U Fuel Cycle 21

toxic substances such as arsenic or lead which we reject in an uncontrolled fashion into our environment which will never decay to a benign level.)

The present procedure for treating high-level radioactive wastes first stores them as a liquid waste solution following fuel reprocessing for a period of up to five years in large underground storage tanks to allow the bulk of the fission product activity and heat generation to decay to substantially lower levels (both for handling safety and to facilitate chemical processing during further treatment of the waste). These storage tanks are fabricated with double-lined stainless steel walls and monitored continually to prevent any leakage to the environment.

Federal regulations require that the liquid waste solution be converted into a stable solid form--either a glass or a cement--and encapsulated in a water-impervious inert container within five years of their generation and then shipped to a federal waste depository within another five years. The present plan for permanent disposal (i.e., permanent isolation from the environment so that no further surveillance or other monitoring or processing efforts are required) envision that these wastes will be solidified into an inert glassy form and encapsulated in cylindrical steel canisters roughly 30 cm in diameter and 3 m in length.

The most promising scheme for permanently disposing of high-level solidified wastes is to bury them deep beneath the earth in rock formations which exhibit exceptional geological stability. Most attention has been directed at salt formations which remain geologically undisturbed for millions of years, although serious consideration has also been given to burial deep beneath the ocean floor or polar ice caps in stable rock formations. A relatively small amount of land would be required for such a waste depository. For example, a typical power plant would produce ten canisters of high level waste per year. If we suppose that these canisters are stored in rows, ten meters apart, then only about 10 square miles would be needed to accommodate all of the radio-

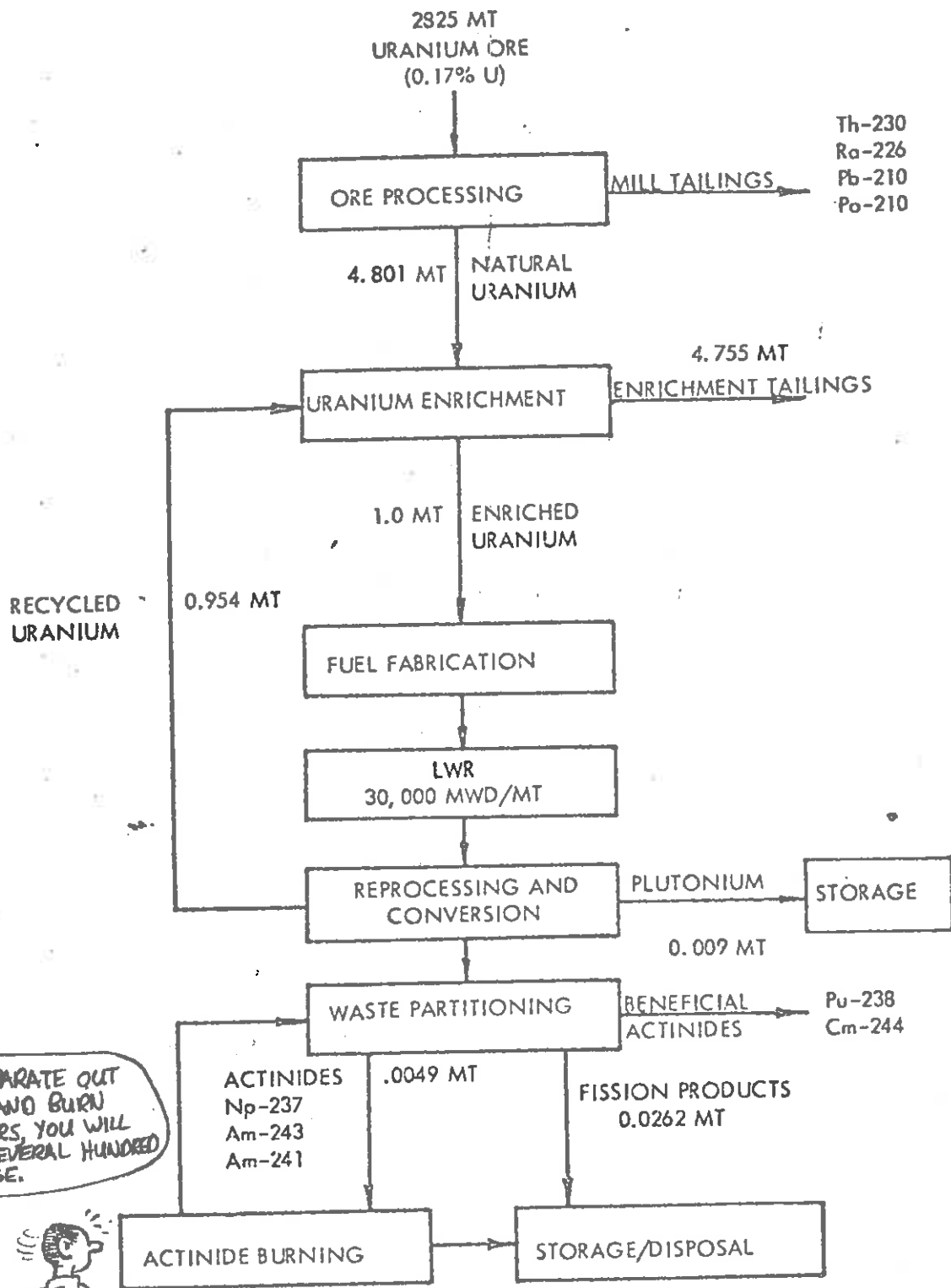


Figure 7-25: Typical LWR Fuel Cycle and Nuclear Waste Management with Actinide Burner

decades, and despite the fact that the final results from the intensive research programs concerned with waste disposal methods are not yet available. Such uninformed pressures to make a premature commitment to specific permanent disposal schemes decades before they are needed seems most unfortunate.

### 7.5. Nuclear Power, Sabotage, and the Bomb

Engage any of your friends in a conversation about nuclear power and you are bound to encounter eventually statements such as:

"Nuclear power plants are easy to sabotage!"

"Today, the knowledge and equipment required to make atomic bombs are easy to obtain. Any competent scientist or engineer (even a bright undergraduate) can build one in his basement."

"To protect against nuclear sabotage or the theft of nuclear materials, we will be forced into a police state."

The popular press has implanted in the public mind the image of nuclear power plants churning out tons of weapons grade plutonium which can be assembled rather easily to make thousands of atomic bombs. Such an impression is most unfortunate and incorrect, for as we will demonstrate:

- (i) A nuclear power plant is one of the most difficult (and ineffective) targets for a terrorist group bent on public havoc. (It is far easier to attack alternative targets such as dams, water supplies, large buildings, airplanes,...)
- (ii) A nuclear weapon is far from trivial to build. Even using the correct materials (pure U-235 or Pu-239 metal), it would require many highly trained scientists, engineers, and technicians and a variety of sophisticated equipment and materials.
- (iii) The type of plutonium discharged by power reactors used in this country (light water reactors) cannot be fabricated into a weapon without a high degree of sophistication.
- (iv) To protect against nuclear theft or sabotage will require a security force which is only a fraction of that used already for the protection of banks, armored cars, and other valuables.

ALL WE NEED ARE A FEW MORE MOVIES ON NUCLEAR PLANT SABOTAGE.



To support these claims, let us examine each of these apparent "dangers" of the peaceful atom in more detail.

#### 7.5.1. SABOTAGE OF NUCLEAR POWER PLANTS

First we must ask ourselves just what a group of terrorists could do to a nuclear power plant.<sup>22</sup> Of course they could disrupt its electrical power output and cause substantial damage to the plant (although a nuclear plant is far less vulnerable to terrorist attack than a fossil-fueled plant or a hydroelectric dam, for example). But could they endanger the public?

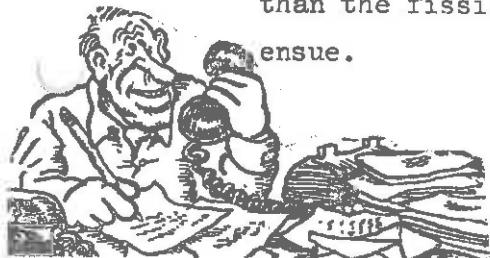
First we must remember that a nuclear reactor cannot be made to explode like a bomb. Rather the principal concern would be whether sabotage could cause a release of radioactive fission products to the environment. To accomplish this, one would have to

- (i) gain access to the plant by breaking through security barriers and overcoming a security force,
- (ii) then disable all engineered safeguards designed to prevent fission product release (which would require a rather high degree of expertise on the part of the saboteur), and finally
- (iii) they would have to blow up the reactor itself (which, we must remember, is contained in a 20 cm thick steel wall pressure vessel surrounded by a 4 meter thick concrete shielding and further contained in a steel-lined, meter-thick concrete containment structure).

Even if these tasks could be accomplished, the probability that substantial public damage or injury would occur is still quite small (recall WASH-1400 which indicated that the probable consequences of a LOCA were quite minimal).<sup>23</sup>

Of course the reader might dream up more indirect schemes such as bombing the plant or crashing a plane into it. But we must remember that the reactor containment structure is built to withstand plane crashes, and the explosive force necessary to penetrate this containment would no doubt cause far more destruction if dropped directly on a population center than the fission product release that might (with a very low probability) ensue.

YOU'RE GOING TO CRASH YOUR MOTORCYCLE INTO THE PLANT UNLESS WE PAY YOU ONE MILLION DOLLARS?



After a little bit of thought, it soon becomes evident that our society is chocked full of countless far more vulnerable targets for terrorist attack. For example, it is (unfortunately) rather easy to plant a bomb in a large building or public place (such as an airport terminal). Public water and food supplies are quite vulnerable. (Recently a city was threatened with having fuel oil dumped in its water supply.) Furthermore there are massive dams, football stadiums, airplanes, and so on whose sabotage would undoubtedly cause far greater consequences than a nuclear power plant.

But our society has faced the ever-present threat of such terrorism without downgrading technology (although occasionally additional security precautions were taken, such as with airport inspection procedures). To refuse to implement a new technology simply because of a threat of terrorism (and in the case of nuclear power, a very small threat indeed) is tantamount to surrendering our sovereignty and freedom of action to those who would use such means to achieve their ends.

#### 7.5.2. THE AMATEUR ATOMIC BOMB BUILDER

The myth that any competent scientist or engineer could build an atomic bomb in his basement--provided he could obtain bomb-stuff like plutonium--with only a few visits to his local library and hardware store has pervaded much of the debate over nuclear power in recent years. It is important that we examine this topic in some detail.

First, we must determine just what kind of and how much "bomb-stuff" is needed for an atomic bomb. The ideal materials are either pure U-235 or Pu-239 metal. But the oxide form of either isotope would suffice, as would a less-than-100% concentration. To get some idea of the amount of material required, in Table 7- 8 we have listed the amount of each type of material necessary to achieve a critical mass<sup>24</sup> (but not necessarily to fabricate a weapon). It should be noted that we have not bothered to include uranium with enrichments below 10% since this low concentration of U-235 could not be made into an explosive device (regardless of how clever one is).



DON'T WORRY. THERE'S A BIG DIFFERENCE BETWEEN MAKING A CRITICAL MASS AND A BOMB!

Table 7-8<sup>2a</sup>

<u>Type of Material</u>	<u>Quantity Required for Critical Mass</u>
pure Pu-239	4 kg
pure U-235	17 kg
reactor grade Pu	8 kg
20% enriched U	250 kg
10% enriched U	1,000 kg



The next question is "where does the amateur bomb builder get this material?" Obviously from the nuclear fuel cycle (unless he has the nerve to break into a military weapons depot--which is an entirely different kettle of fish unrelated to nuclear power development). We have sketched a very simple diagram of the nuclear fuel cycle in Figure 7-26 to indicate those points at which "strategic nuclear materials"--an official-sounding name for bomb-stuff--could be diverted. As we have noted, the 3% enriched uranium utilized by light water reactors is too dilute for explosive devices, so we can rule out U-235 as an available material. Instead we must somehow use the plutonium produced in the reactor. Although an appreciable quantity of plutonium is produced during the operation of a power reactor, we must remember that this plutonium comprises at most only 1% of the irradiated fuel and therefore must be separated out before it will be of any use. Hence the spent fuel discharged from power reactors is useless as bomb material. Only the plutonium separated out during fuel reprocessing is suitable--hence the only vulnerable stage of the nuclear fuel cycle is the reprocessing step.

Of course we can now see that there are many ways to thwart the diversion of plutonium at this stage. For example, we could locate fuel reprocessing plants next to fuel fabrication facilities so that the reprocessed plutonium is immediately mixed back in with slightly enriched uranium to make fresh fuel elements. Or we could "denature" the plutonium extracted from spent fuel, say, by mixing it with U-238 or other materials which are strong neutron absorbers and would inhibit its effectiveness for a weapon. Or we could simply "harden" both reprocessing facilities and

transportation vehicles to prevent diversion. (For some time now U.S. military special forces units have been used to test the security of plutonium storage facilities and transportation vehicles.) The safeguards designed to prevent diversion of strategic nuclear materials are very intensive. Since plutonium is presently worth about \$250 an ounce, it is about twice as valuable as gold and protected accordingly.

IF THE PRESS WERE MORE RESPONSIBLE, THEY WOULD POINT OUT HOW HARD IT IS TO HAVE A BOMB OUT OF REACTOR-GRADE PLUTONIUM



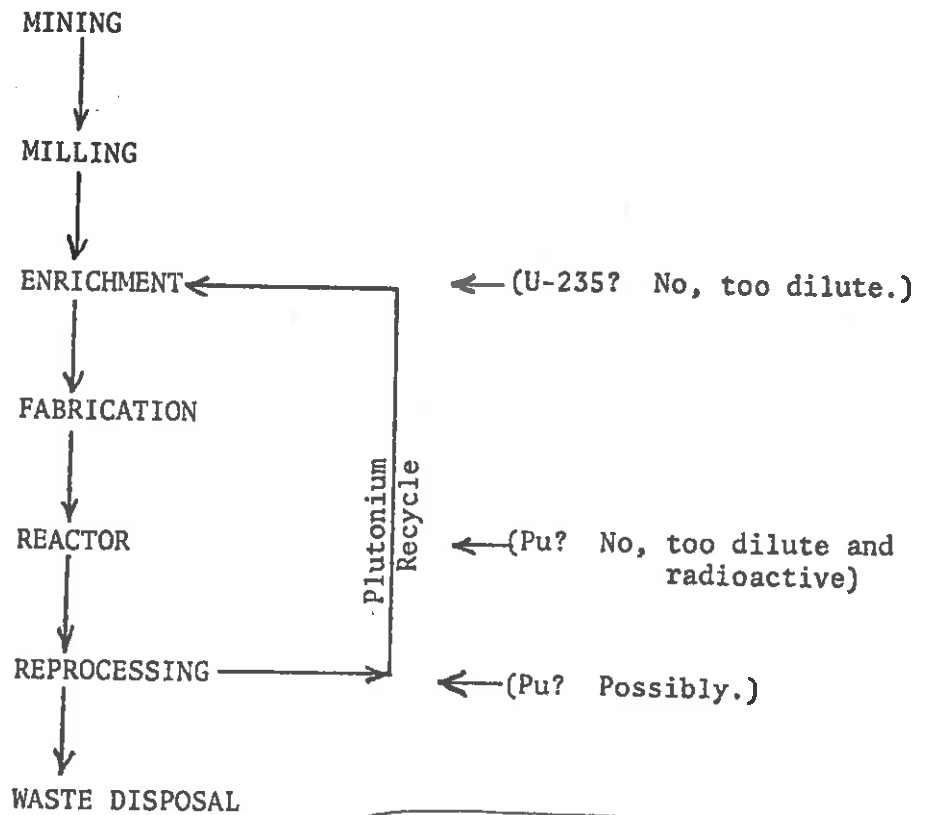
But let us suppose that our basement bomb builder has managed, somehow, to get ahold of some plutonium from reprocessed spent reactor fuel. Even then it would be extremely difficult for him to use this in an explosive device because of the isotopic composition of reactor grade plutonium. Typically, the plutonium discharged from light water reactors has a composition as follows:

- 2% Pu-238
- 62% Pu-239 (bomb-stuff)
- 22% Pu-240 (high spontaneous fission rate)
- 10% Pu-241 (highly radioactive)
- 4% Pu-242

The first problem that must be faced by the amateur bomb builder is that reactor grade plutonium is highly radioactive due to the presence of Pu-241 (with a typical activity of 10,000 Ci per kg of plutonium). For example, the dose rate from  $k$  kg of this plutonium is about 17 rem/hr.<sup>25</sup> Hence remote handling would be required.

The second problem is even more serious. Both Pu-240 and Pu-241 give rise to large neutron emission rates. For example, the spontaneous fission of Pu-240 yields  $10^6$  neutrons/sec-kg, while the ( $\alpha, n$ ) reactions which are induced by the alpha emission of Pu-241 in impurities generate an additional  $10^6$  neutrons/sec-kg.<sup>25</sup> The significance of this is quickly recognized when we recall that it is important to minimize stray neutron production in a weapon design which might trigger the chain reaction prematurely before the pieces of the bomb are completely assembled into their most supercritical configuration. Stray neutron production will lead to a premature fizzle.

We have noted in Chapter 4 that rather sophisticated methods (i.e., implosion schemes) were needed to overcome the spontaneous neutron emission



BUT HOW ARE YOU GOING TO KEEP TERRORISTS FROM STEALING PLUTONIUM?

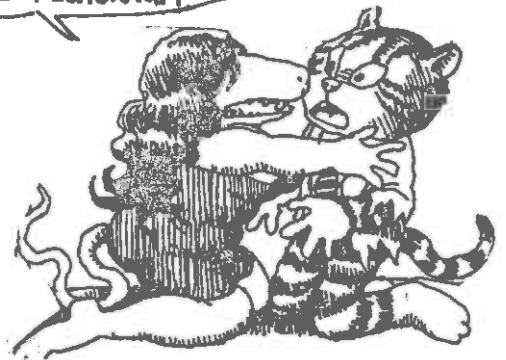


Figure 7-26: Points at which Strategic Nuclear Materials Might be Diverted from the Nuclear Fuel Cycle

from relatively pure Pu-239. And the activity of Pu-241 is 500 times larger than that of Pu-239. Hence it would require an extremely sophisticated design to avoid predetonation. Even then, in most designs one would probably get more oompf from the explosives used to drive the implosion than from the fission chain reaction itself.

Indeed, the task of fabricating a weapon from light water reactor grade plutonium is probably beyond the capability of many technically advanced countries--and even further beyond the capability of terrorist groups or our basement bomb builder.

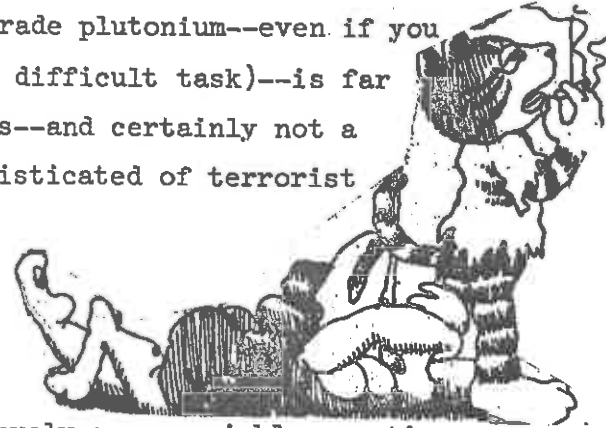
As a parenthetical remark, we might note that those weapons that have been fabricated out of plutonium, such as the device exploded by India in 1974, utilized plutonium produced in reactors which could be refueled in such a way as to minimize the buildup of Pu-240 and Pu-241. For example, in heavy water reactors, one can continuously refuel, thereby achieving only short exposures of U-238 and producing primarily the lower mass isotope of plutonium, Pu-239. In light water reactors, refueling is conducted at yearly intervals; hence a significant buildup of Pu-240 and Pu-241 cannot be avoided without tampering significantly with the refueling schedule.

The amateur bomb builder will have to face still other hurdles. For example, even fabricating a weapon from optimum materials (e.g., Pu-239) is extremely difficult, requiring sophisticated electronics and timing circuitry, explosives, machining, fabrication, and handling. Furthermore handling plutonium (particularly reactor grade plutonium) is a hazardous game--particularly if you don't know what you are doing. The radioactive heat generated by plutonium is sufficient to melt most plastic explosives used in implosion devices. Furthermore, the bomb design is extremely sensitive to the isotopic composition of the plutonium, and this composition is usually not known to the accuracy required for weapons design for spent fuel plutonium (without extremely sophisticated measurements). Finally, contrary to popular belief, much of the information involved in fission weapons design is not available in the open literature

--and the majority of that which is unclassified is still rather hard to come by.

IT'S JUST TOO TOUGH A JOB FOR MOST PEOPLE!

Hence we must come to the conclusion that the fears of plutonium diversion and basement bomb-building have been greatly overexaggerated. Manufacturing an atomic bomb from reactor grade plutonium--even if you can get ahold of the stuff (which is a very difficult task)--is far beyond the capabilities of most laboratories--and certainly not a straightforward task for even the most sophisticated of terrorist groups.



#### 7.6. Plutonium Toxicity

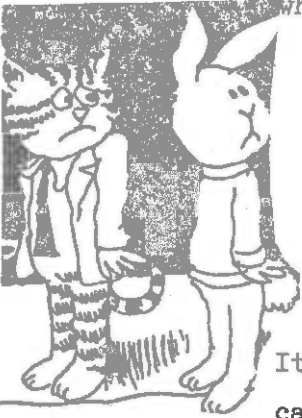
The fact that the nuclear fuel cycle involves appreciable quantities of plutonium has given rise to public concerns in addition to those voiced about the diversion of plutonium for clandestine nuclear weapons manufacture. One occasionally encounters the reference to plutonium as "the most toxic substance known to man". If this statement were indeed true, and the probability of plutonium being released into the environment and finding its way to man was significant, then this in itself would be a major argument against the massive implementation of nuclear power.<sup>27</sup>

There is little doubt that plutonium is highly toxic, although it is certainly not the most toxic substance that our society encounters. In fact, the high toxicity of plutonium is not due to its chemical properties (as is the case with other highly toxic materials in our environment), but rather because it is radioactive. Furthermore, since this radioactivity is in the form of alpha radiation that cannot penetrate the skin, plutonium must be ingested or inhaled to be hazardous. Fortunately, plutonium is not readily absorbed by the body. The absorption of plutonium through the skin is very small (although absorption through wounds or abrasions is more of a problem). Ordinarily, any plutonium that enters the body through the digestive tract is all excreted. In fact, the amount of plutonium which would have to be ingested to yield

a 50% fatality probability is some 3 g--only a tenth of the ingestion toxicity of materials such as arsenic or lead.<sup>35</sup> Rather, inhalation of plutonium into the respiratory tract is the major mechanism by which plutonium enters the body. For this reason, most concerns are directed towards studies of the tendency of plutonium (or other actinides) to damage lung tissue.

Since there have never been any known deaths attributable to plutonium poisoning (although large numbers of plutonium workers have been monitored for several decades in an effort to assess the effects of plutonium on health), all of the data available concerning the radio-toxicity of plutonium has been obtained from experiments performed upon animals. Nevertheless we know more about the toxicity of plutonium by means of such studies than another other element in the period table.

Perhaps the origin of the statement that plutonium is the "most toxic substance known" can be traced to an early study by Geesaman<sup>29</sup> in which he stated that:



"Plutonium is a fuel that is toxic beyond human experience. It is demonstrably carcinogenic to animals in a microgram quantity (pure plutonium-239 in this amount would be roughly the size of a pollen grain). One millionth of a gram injected intradermally in mice has caused local cancer. A similar amount injected into the blood system of dogs has induced a substantial incidence of bone cancer because of the element's affinity for bone tissue. It is fortunate that the body maintains a relatively effective barrier against the entry of plutonium into the blood system."

It is important to note the key words "intradermal" injection and "local" cancer as well as the fact that the bone cancer in dogs was induced by injecting plutonium directly into the blood stream. As we have noted, it is highly unlikely that appreciable quantities of plutonium can enter humans via these particular mechanisms.

More relevant studies involve the effects of plutonium inhalation on beagles. These studies have demonstrated that plutonium inhalation can indeed lead to lung cancer. To understand the implications of such experiments and to assess the risks presented by plutonium utilized in the nuclear fuel cycle, we must be a bit more precise in our terminology.

Although we have referred to the "toxicity" of plutonium, we must recognize that this term is usually reserved for the adverse biological effects of toxic chemicals. For example, a millionth of a gram of botulism toxin is considered to be lethal, and vinyl chloride in concentrations of a few parts per million in air is considered injurious to health. However for radiological effects, the term "toxicity" is generally not used. Instead the accepted technical term is "body burden".

For example, in Table 7- 9 we have listed the body burden of several radioactive nuclides in terms of both activity and weight as well as indicated their half-lives and specific activities:

Table 7- 9

<u>Nuclide</u>	<u>Half-life</u>	<u>gm/Ci</u>	<u>Bone body burden</u>	
			<u>(mCi)</u>	<u>(gm)</u>
Th-232	$14 \times 10^9$	$9.0 \times 10^6$	0.04	0.36
U-238	$4.5 \times 10^9$	$3.0 \times 10^6$	0.06	0.3
U-235	$0.7 \times 10^9$	$0.5 \times 10^6$	0.06	0.028
Pu-239	$2.4 \times 10^4$	16.2	0.04	$0.65 \times 10^{-6}$
Ra-226	1600	1	0.1	$0.1 \times 10^{-6}$
Sr-90	27.7	$7.0 \times 10^{-3}$	2.0	$0.014 \times 10^{-6}$
Pu-241	15	$10^{-3}$	0.9	$0.0009 \times 10^{-6}$

From this table we note that the body burden in curies varies only over a small range of values, being of the order of 100 to 1000 nanocuries (nCi). (We recall that a nanocurie corresponds to 37 radioactive disintegrations per second.) But the body burden in grams varies over a very wide range of values. For Th-232, the bone body burden is about 0.36 g, in comparison to one-billionth of a gram for Pu-241.

The International Commission on Radiation Protection has set the permissible body burden for plutonium at 40 nCi for workers in contact with plutonium and under continual monitoring. For members of the general public who are not monitored, the allowable body burden is set a factor of ten lower at 4 nCi. The maximum lung burden is set at 16 nCi for occupational exposure and 1.6 nCi for the general public.

28  
Table 7-10

AN OVERVIEW ON PLUTONIUM

<b>PLUTONIUM PROCESSED AND PLUTONIUM RELEASED TO DATE (μCi)</b>	
Released from weapons fallout	500,000,000,000
Released from spacecraft equipment burning	17,000,000,000
Processed to date for military purposes (approx.)	15,000,000,000,000
<b>EXPOSURES OF THE U.S. POPULATION (μCi)</b>	
Pu inhaled (per person/yr)	
1963 (peak year)	0.000012
1972	0.000001
Pu consumed in diet and water	
(per person/yr, New York City, 1972)	0.000002
Body burden (per person)	
1964 (peak year)	0.000004
1973	0.0000025
<b>ESTIMATED HEALTH EFFECTS (μCi)</b>	
Estimated amount of <sup>239</sup> Pu inhaled per person that could induce 1% incidence of cancer	1
<b>ESTIMATED ACTIVITY IN A NUCLEAR POWER INDUSTRY (μCi/1000-Mwe.plant/yr)</b>	
Pu Flow Throughs	
Light Water Reactor—Uranium Cycle (Pu discharged)	150,000,000,000
Light Water Reactor—Plutonium Cycle (avg. of charge)	500,000,000,000
Liquid Metal Fast Breeder Reactor (and discharge)	700,000,000,000
Releases From Nuclear Power Plants	
Light Water Reactors—Uranium Cycle	
• Reprocessing and fabrication plants	
Past practice	1,000
Current capability	10
Future capability	0.001
• Reactor accidents (statistical estimation)	10,000
Light Water Reactors—Plutonium Cycle	
• Reprocessing and fabrication plants	
Current capability	24
Future capability	0.003



In recent years there has been concern voiced that such radiation standards may be too high. For example, several scientists have claimed on theoretical grounds that plutonium particles of a certain size are 100,000 times more hazardous than the same amount of plutonium distributed uniformly throughout tissue.<sup>30</sup> If this so-called "hot particle" theory of plutonium toxicity were indeed true, then the permissible lung burden limit would have to be very significantly lowered (and this would be extremely difficult since they are already set almost as low as our ability to detect these very small amounts of radioactivity). Most health physicists disagree with this hot particle theory since experiments seem to indicate that a uniform distribution of radio-toxic material is far more likely to induce tumor formation than concentrations of radioactive material (particles).<sup>17</sup> There will probably continue to be a debate over the permissible body and lung burden of plutonium for some time to come, however, as well as for other radioactive materials.

To put this debate in perspective, however, we first must recognize that all of us already have some plutonium in our bodies and in our lungs, in particular. During the days of atmospheric nuclear weapons testing, over 6 tons of plutonium (some 340 kilocuries) were dispersed into the atmosphere. Moreover we are continually exposed to other radioisotopes of comparable toxicity which occur in nature. For example, all of us are exposed to Ra-226 which has a specific activity some 5 times that of Pu-239 (although recent experiments have suggested that Pu-239 is somewhat more toxic, curie for curie, than Ra-226). Furthermore those of us who smoke inhale significant quantities of polonium-210 from tobacco, and indeed, there has been some speculation that the presence of this radionuclide in cigarette smoke may be one of the causes of lung cancer in smokers. Finally we must keep in mind that all of us are exposed to a natural background radiation level of some 100 mrem per year. The exposure of the general public to plutonium is negligible by comparison.

Certainly the toxicity of plutonium requires stringent methods of control, particularly as the inventories of this material build up in the nuclear reactor fuel cycle. However some 30 years of experience have indicated that plutonium can be safely handled and isolated from our environment, and that it represents a very low level of risk in comparison with other carcinogenic hazards we face daily in our environment.

## 7.7. International Aspects of Nuclear Power

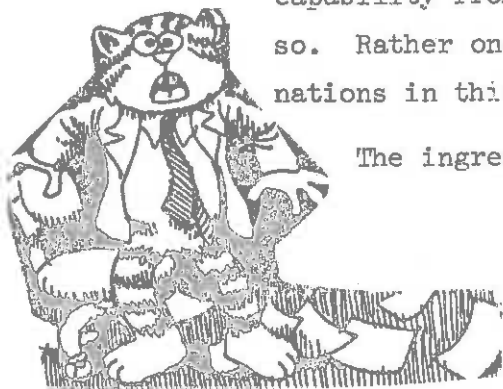
On May 18, 1974 the world was shocked by India's successful underground explosion of a "peaceful" nuclear device (although there is no essential technological difference between a "peaceful" nuclear explosive and a nuclear weapon). This event signalled the beginning of a second "nuclear era" in which nuclear technology will spread from a very few nations of high technological capability (e.g., the United States, the USSR, Great Britain, France, and China) to many nations, including poor underdeveloped countries such as India. The proliferation of nuclear weapons capability has become one of the most serious threats to world peace in recent years. Although it may be several more years before another country explodes a nuclear device, there are at least a dozen countries that have the technological capability of joining the "nuclear club" any time they choose, and another dozen with the capability of joining this group within the next five years. Indeed the Indian test demonstrated that even a poor country can accomplish the sophisticated task of successively developing and testing an underground nuclear device.<sup>31</sup>

The proliferation of nuclear weapons capability is intimately related to the spread of nuclear power technology, and therefore merits a careful consideration in any overview of the nuclear fuel cycle. To reduce this threat, worldwide controls of nuclear fuels and radioactive materials must be established and maintained. Without such controls, the probability of nuclear violence, including nuclear war or the use of nuclear weapons by terrorists, will become unacceptably large.

It should be stressed at the outset that nuclear weapons proliferation is both a political as well as a technical problem. Hence controls over nuclear technology, regardless of how stringent, will not be sufficient in themselves to prevent nations with a moderate degree of technological capability from developing nuclear weapons if they are determined to do so. Rather one must at the same time remove the pressures which drive nations in this direction.

The ingredients for a nuclear weapons program include basic informa-

ADI AMIN?



tion on nuclear weapons design, a group of skilled scientists, engineers, and technicians who can design and fabricate the device, production and assembly facilities, a variety of non-nuclear components including sophisticated conventional explosives and electronics, and most significantly, strategic nuclear materials which can be used as the "bombstuff" in a fission explosive. In sharp contrast to the days of the Manhattan project, the basic information concerning nuclear weapons design is now openly available in the technical literature. That is, the basic concepts of fission chain reactions, and many of the concepts of explosive fission devices, are now common knowledge. Of course, many of the specific details on weapons parameters, dimensions, and materials are still classified. However a reasonably competent scientific team should be capable of designing a crude fission device without an extensive research program. Certainly any country with a moderate technological base will have a number of scientists and engineers with the necessary technical training in the basic concepts, and many countries may have a number of scientists more specifically trained in nuclear energy release (i.e., nuclear engineers) as a result of the rather considerable number of foreign students educated in American universities during the past two decades.

The key ingredient in a weapons development program is the access to strategic nuclear materials, i.e., fissile material such as highly enriched uranium, plutonium, or U-233. Most of the effort involved in the Manhattan project was to design and build the enormous uranium enrichment and plutonium production facilities required to make a relatively small amount of material needed for the first nuclear weapons. To acquire fissile material from such programs from the ground up would be extremely difficult for all but the most sophisticated nations.

Unfortunately, the rush of the world community to adopt nuclear power has greatly increased the ease with which fissile material can be obtained. The nuclear fuel cycle which supplies and reprocesses power reactor fuel can be adapted to the production of weapons material. The key points in the nuclear fuel cycle at which strategic nuclear material may be obtained

are indicated in Figure 7- 26.

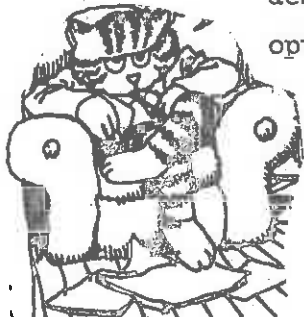
The same enrichment facilities designed to produce low enrichment uranium for power reactors could as well (with some modification) produce highly enriched uranium suitable for nuclear weapons. This approach, although difficult and expensive, might be attractive to a nation which wishes to make only a few weapons for diplomatic leverage or blackmail since such uranium can be used in relatively crude gun-type weapons.<sup>4</sup>

However the far more likely, and therefore sensitive, point in the nuclear fuel cycle at which strategic nuclear materials can be obtained is in the reprocessing of spent reactor fuel. For as we have noted, the fuel discharged from power reactors contains a significant amount of plutonium which can be separated out by chemical methods and processed into a form suitable for weapons designs. In a like manner, the spent reactor fuel elements from thorium fuel cycles can be reprocessed to extract U-233 which could also be used in a weapon.

Hence the key to the development of nuclear weapons capability and therefore to the control and prevention of nuclear weapons proliferation lies in the controls that are placed upon strategic nuclear materials.

#### 7.7.1. DIVERSION OF STRATEGIC NUCLEAR MATERIALS FROM THE NUCLEAR FUEL CYCLE

As we have noted, the most difficult path to nuclear weapons development is the attempt to acquire the independent capability to enrich uranium to the levels necessary for weapons applications (greater than 20%). Of course such an approach would be capable of producing only a small amount of fissile material. Furthermore, the technology of uranium enrichment (unlike that of spent fuel reprocessing) has been heavily classified, and much of this information is not available in the open technical literature. Nevertheless, highly enriched uranium does have the advantage that it requires a far less sophisticated weapons design than does plutonium and therefore might present a more desirable option to a country determined to obtain a limited weapons capability.



It should be noted that there are many enrichment processes that might be utilized in the production of strategic nuclear materials. The elaborate complexes required for uranium enrichment utilizing gaseous diffusion or ultracentrifuge processes most likely would be beyond the capability of most nations to construct or operate. However less demanding techniques such as the Becker nozzle method or thermal diffusion methods might present attractive alternatives. Furthermore the successful development of exotic new methods such as laser isotope separation (with its single enrichment stage capability) would change this picture dramatically and would certainly have profound implications for nuclear weapons proliferation.

Although this country has been extremely reluctant to export enrichment technology, other countries such as West Germany and France have recently agreed to provide this technology to countries such as Brazil and South Africa. Any export policies which affect enrichment technology must therefore take into account not simply diversion potentials of particular processes, but as well the hazards that failure to satisfy the demands of the international market may cause. For example, to refuse enrichment technology to a country may trigger a large scale research effort to develop an independent enrichment capability. It might also drive the country to construct plutonium production reactors of the Hanford type.

The technology required to reprocess spent reactor fuel elements and recover plutonium is easier to acquire. In particular the technical details of several reprocessing techniques were made public at international meetings during the mid-1950s, and a number of countries have acquired limited reprocessing capability. However this particular approach to weapons development is not quite as straightforward as it might first appear because of the particular isotopic composition of reactor grade plutonium. We have noted that the plutonium obtained from power reactors contains appreciable concentrations of Pu-240 and Pu-241 (because of the long fuel lifetimes of most power reactor designs), and these isotopes

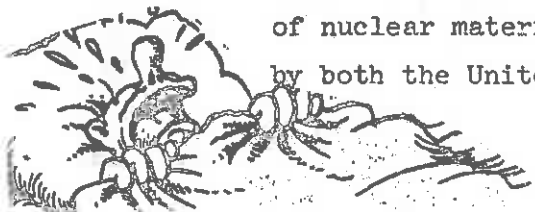
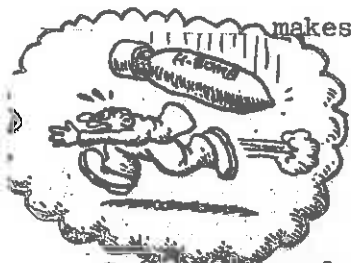
are characterized by significant spontaneous neutron emission (and radioactive heat) which can lead to predetonation of an explosive device unless extreme care is taken in its design.

Although this particular feature of reactor grade plutonium presents a significant barrier to the small terrorist group aimed at "amateur bomb building", a determined nation with competent scientific capability should be able to design an (albeit inefficient) explosive weapon from even reactor grade plutonium. Furthermore, by appropriately tampering with the reactor fuel cycle (reload frequency) one can significantly reduce the percentage of the higher plutonium isotopes in spent reactor fuel. For only a modest investment (\$30-35 million) a determined nation could obtain "nice, clean" Pu-239 by reprocessing research reactor fuel (which is considerably easier than reprocessing spent power reactor fuel). Here one should recall that the Indian government tampered with the fuel cycle of a Canadian supplied research reactor to produce fissile material for their first nuclear device. In fact, every nuclear weapon in the world today has used plutonium produced in either a Hanford type production reactor or a research reactor.

Hence we must conclude that any nation bent on obtaining strategic nuclear materials could do so by acquiring a modest independent spent fuel reprocessing capability and tampering with reactor fuel cycles to prepare a more suitable form of plutonium--although to do so would probably be tantamount to the announcement of a national intent to acquire nuclear weapons. In this sense, then, the rapid spread of nuclear power technology makes a relatively modest contribution to nuclear weapons proliferation.

#### 7.7.2. INTERNATIONAL SAFEGUARDS AGAINST NUCLEAR WEAPONS PROLIFERATION

The first significant international effort to halt the spread of nuclear weapons resulted in the adoption of the Treaty on the Nonproliferation of Nuclear Weapons in 1968. This treaty banned the acquisition of explosive nuclear devices by nonnuclear states, set up a program of international safeguards and inspections to detect unauthorized diversion of nuclear materials, and was accompanied by commitments to disarmament by both the United States and the USSR. The nuclear states also pledged



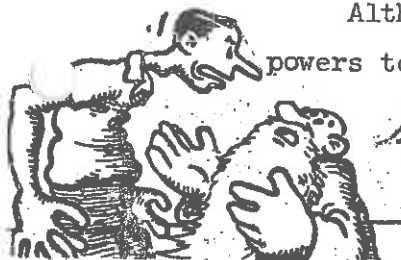
to assist the signers of the treaty with assistance in the development of peaceful applications of the atom.

To date some 98 countries have signed this treaty. But more notably, such countries as Argentina, Brazil, India, Israel, and South Africa which possess not only the technology but as well the inclination to develop nuclear weapons have not signed the treaty, along with major nuclear power such as France and China. Moreover, Egypt, Japan, and Pakistan, along with 12 other signatories, have continued to withhold ratification of the treaty.

The safeguards procedures established by the Nonproliferation Treaty are administered by the International Atomic Energy Agency (IAEA). However such safeguards do not provide any physical control over nuclear materials, but rather merely are aimed at providing a warning in the instance that such material is diverted for an illicit purpose. The safeguards consist of both accounting procedures to keep track of nuclear materials accompanied by occasional international inspection (e.g., of nuclear power facilities) to verify their location. The basic purpose of such safeguards is to attempt to deter the diversion of strategic nuclear materials by posing a risk of detection and providing a basis for international action against any violator. The safeguards are regarded as a "burglar alarm, but not a lock".<sup>31</sup>

In the same sense that India's successful explosion of a nuclear device in 1974 signalled the beginning of an era in which nuclear weapons capability could be easily acquired by almost any determined country, it also signalled the failure of the Nuclear Nonproliferation Treaty. There were numerous reasons why such a treaty was doomed to failure, including the nature of the safeguards systems themselves and the fact that any signatory country could back out of the treaty after only 90 days notice. But the most significant drawback was its failure to attract the participation of those very countries which were most likely to develop independent nuclear capability.

Although superficially one can point to the failure of the super-powers to live up to their pledges of significant nuclear weapons



NO NUCLEAR WEAPON HAS EVER  
BEEN BUILT FROM PLUTONIUM  
PRODUCED IN A POWER REACTOR

disarmament along with a significant degree of assistance in the development of peaceful nuclear technology, perhaps the most significant reason for the failure of the Nuclear Nonproliferation Treaty was that it failed to take account of the strong political pressures on nations to acquire nuclear weapons. Certainly the experience of India has indicated that the motives behind a country's decision to acquire nuclear arms have very little to do with the arms race between the superpowers. Rather they arise for reasons such as the fear of neighboring countries, the use of nuclear weapons as a regional status symbol, or the fear engendered by disintegrating alliances or the low confidence in such alliances. Certainly too there is the mistaken belief in the security conferred by unsophisticated nuclear forces. Furthermore, the experience of India has indicated to many nations that there are substantial psychological advantages which accompany nuclear weapons capability. Certainly the majority of world opinion concerning India's actions has ranged from neutral tolerance to admiration. The only significant criticism has come from India's neighbors (Pakistan) who most directly feel threatened by her nuclear capability.

Unfortunately, there are several other countries which will in all probability follow India's example, including countries of high technology such as Israel (which probably already has a significant nuclear weapons capability) as well as other countries such as Taiwan, South Africa, Argentina, Brazil, Chile, Egypt, Iran, Pakistan, and Spain which may feel external or internal political pressures to develop such weapons.

### 7.7.3. SOME CONCLUDING REMARKS

So what is to be done? How can the spread of nuclear weapons be halted? Certainly a significant effort should be made to restrict the international spread of strategic nuclear materials. One suggestion which has received considerable attention in this country involves restrictions on the export of nuclear power technology. To the extent that such restrictions would be applied to the export of the nuclear power plants themselves, this particular approach would be self-defeating. For as we have seen, the pressures in many parts of the world to acquire such technology has become overwhelming due to the pressures of ever-increasing





populations accompanied by the depletion of existing reserves of fossil fuels. Furthermore there are now a number of foreign nuclear equipment manufacturers who are only too anxious to supply nuclear power plants to any potential customer, including France, West Germany, the USSR, Great Britain, Canada, Sweden, and Japan. As a consequence,

the number of reactors exported by U.S. companies has decreased dramatically in recent years, and in fact we are in significant danger of losing our foreign market for nuclear equipment. Certainly we cannot hope to be effective at placing controls on nuclear materials produced in the reactors of foreign manufacturers. Furthermore, we have noted that the light water reactors exported by this country are perhaps the "safest" type to export from the point of view of nuclear weapons proliferation since the grade of plutonium they produce is rather awkward to use in explosive nuclear devices. Finally, by refusing to export a technology such as nuclear power which is clearly capable of easing the blow from the impending fossil fuel shortages faced by many parts of the world, we are in effect pushing such nations closer to the brink of international conflict.

Certainly a more rational approach would be to restrict the export of the fuel cycle technology rather than the power plants themselves. For example, greater care should be taken in the export of plutonium reprocessing technology. Any export of the technology required to separate plutonium from spent reactor fuel elements should be accompanied by the most stringent of controls, preferably administered by an international organization such as the IAEA. Indeed there have been recent proposals that reprocessing technology should not be exported at all. For example, one possible alternative would be to refuse to sell foreign governments reactor fuel outright, but rather lease it to them for utilization in their power reactors and then reclaim the spent fuel for reprocessing or disposal in this country. That is to say, we would only sell energy to foreign governments, not fuel (which might be utilized to obtain strategic nuclear materials). As an extension of this particular approach, there have been recent suggestions (primarily from the arms control community) that the effort to separate plutonium out from spent fuel elements (pluto-

nium recycle) should be abandoned, at least for an interim period, to prevent the spread of nuclear weapons. In this approach the spent fuel elements would be returned to this country and stored without reprocessing. However neither of these alternatives could be implemented unilaterally by the United States, but rather would require an agreement among all of the nations supplying nuclear equipment. And only the most naive would seriously propose that resource limited countries such as Europe or Japan abandon plutonium recycle without some type of compensation.

For example, a recent proposal was made by the United States to establish multinational nuclear centers that would both reprocess and fabricate fuel elements. An alternative suggestion involves setting up international cartels of nations which would divide up the world market into regions and maintain much closer control over the technology in each region.

Of course any approach to preventing or at least slowing down the spread of nuclear weapons must give careful consideration to future technological developments. For example, the successful development and deployment of the fast breeder reactor will significantly complicate nonproliferation strategies since these reactors utilize high plutonium content fuel (15-20%) and require a substantial amount of plutonium reprocessing, fabrication, and transportation. Furthermore the development of more exotic enrichment techniques such as laser isotope separation may make the acquisition of enriched uranium far easier.

It is important to approach the topic of nuclear weapons proliferation and its relationship to the nuclear power industry in a very pragmatic fashion. However frightening it may be to admit it, we must face the fact that the nuclear genie is already out of the bottle, and it is probably impossible to shove him back in again. Many countries have nuclear weapons capability already--if not in actuality, at least in substance--whether or not they choose to take advantage of it, since they have significant nuclear power industries and reprocessing or enrichment facilities. Because

of the natural evolution of nuclear technology it will be extremely difficult to prevent a nation determined enough from acquiring nuclear weapons.

The only realistic approach to preventing the further spread of nuclear weapons is to demonstrate clearly to nonnuclear states that it is not in their best interests to go nuclear. But how is this to be done? Certainly not by international sanctions or disapproval. India has already demonstrated that international opinion is not a significant factor in influencing a national decision to acquire nuclear capability. Rather we must attempt to reduce those pressures which push nations in this direction by providing them with the necessary technology and assistance to meet their own internal needs for energy, for food, and for industrial development, and by encouraging international cooperation including formal agreements or treaties.

In the long run, the strongest pressures on nations to acquire nuclear weapons will be caused by their impending shortages of basic resources, food and energy, at a time of exploding populations. A starved world is a dangerous world.

#### 7.8. Some Final Remarks

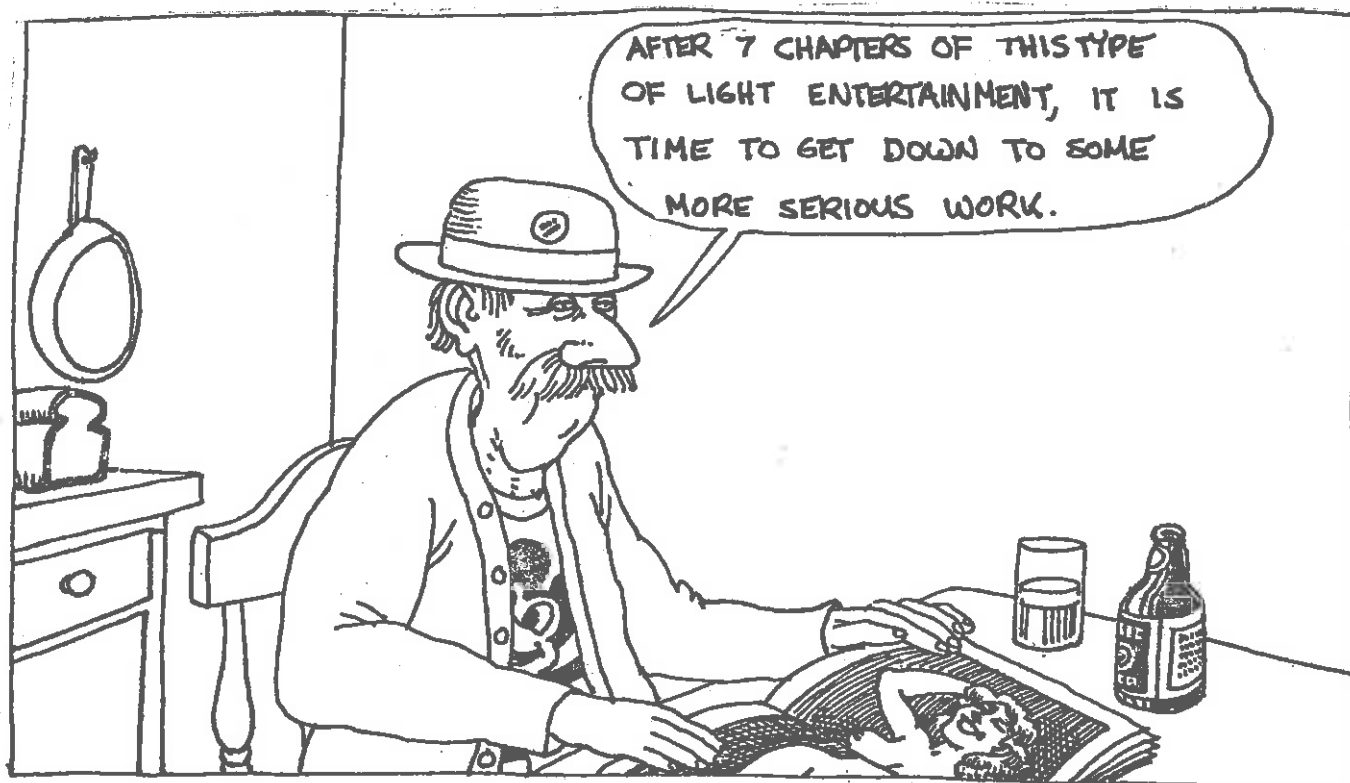
It has become apparent that the nuclear fuel "cycle" in this country will not be closed for a number of years. Although the technology involved in spent fuel reprocessing, plutonium recycle, and radioactive waste disposal has been clearly demonstrated for a number of years, the commercial implementation of these activities faces a number of major social and political barriers. Indeed, the debate over plutonium recycle and radioactive waste disposal has become so emotional (and wandered so far afield from technical issues) that the federal government has been forced into a position of blocking the further development of the commercial nuclear fuel industry (much to the dismay of the electrical utilities who have committed some \$250 billion to nuclear plant construction). For example, both President Ford and President Carter called in 1976 for a moratorium on plutonium recycling for several years (pointing to the

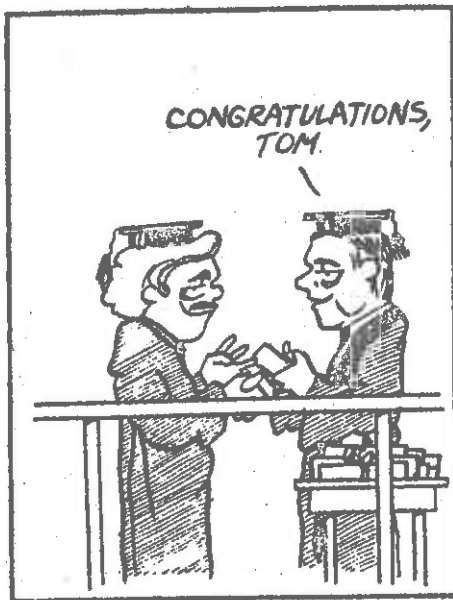
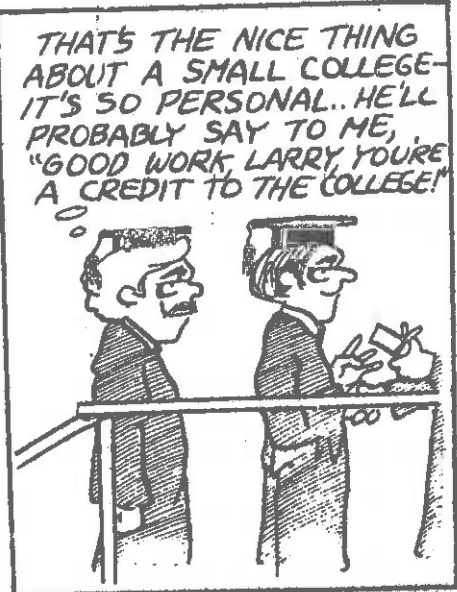
international implications of a world plutonium market). The only reprocessing facility presently under construction in this country (the Allied Chemical plant at Barnswell, South Carolina) has recently been downgraded from a commercial to a demonstration plant status. The earliest date for a demonstration radioactive waste storage facility has been deferred to 1985 or later. To compound this dismal situation, recent government policies have further discouraged the development of private uranium enrichment facilities.

But the rest of the world is not waiting for the faltering United States nuclear fuels programs, but rather many highly industrialized nations are rapidly developing their own nuclear fuel technology. For example, the first of two large multinational gaseous diffusion enrichment plants (EURODIF and COREDIF) will go into operation late this decade in Europe. The French have just completed (1977) a large, commercial fuel reprocessing plant at Marcoule. West Germany has begun the disposal of high level radioactive wastes in salt mines. And both the French and Germans have made impressive strides in fast breeder reactor development.

The reason for this dramatic difference between the United States and the rest of the world is obvious. Our enormous coal resources coupled with the fat of an energy-intensive society which can presumably be trimmed to some extent by conservation measures have provided us with apparent (although questionable) alternatives to an immediate, massive commitment to nuclear power and the development of the nuclear fuel cycle. The rest of the world is not so fortunate. They do not have fossil fuel resources of any appreciable magnitude (aside from the coal reserves of the Soviet Union and the oil of the Middle East). Since their economies have developed (or are developing) during a period of significantly higher energy prices, they have not been trapped into an energy-intensive society to the extent of ours--but by the same token they do not have the option of conservation. Hence a strong, immediate commitment to nuclear power is unavoidable. Furthermore, since most countries do

not have appreciable uranium reserves, they must move to close the nuclear fuel cycle--e.g., utilize plutonium recycle--and develop advanced reactor types such as the fast breeder reactor to minimize dependence on uranium imports as rapidly as possible.





## REFERENCES

1. The Nuclear Fuel Cycle, Union of Concerned Scientists (M.I.T. Press, Cambridge, 1975)
2. E. A. Mason, in Education and Research in the Nuclear Fuel Cycle, ed. by D. M. Elliot and L. E. Weaver (Oklahoma University Press, Norman, 1970)
3. Leonard F. C. Reichle, Ebasco Services, Inc., Presented to the New York Society of Security Analysts, 1975
4. Nuclear Fuel, Westinghouse Electric Corporation, 1968
5. R. D. Nininger, S. H. Bowie, Trans. Am. Nucl. Soc. 24, 5 (1976)
6. R. C. Seamans, Trans. Am. Nucl. Soc. 24, 6 (1976)
7. Nuclear Industry 23, 11 (1976)
8. M. A. Liebermann, Science 192, 431 (1976)
9. R. O. Pohl, Nuclear Energy: Health Effects of Th-230 (Department of Physics Report, Cornell University, 1975)
10. B. L. Cohen, Bull. Atom. Sci. (February, 1976) p. 61
11. M. Benedict and T. Pigford, Nuclear Chemical Engineering (McGraw-Hill New York, 1957)
12. G. Gyorey, private communication (1974)
13. D. Olander, Adv. Nuc. Sci. Tech. 6 (1972)
14. Bull. Atom. Sci. (September, 1976)
15. M. Benedict, Trans. Am. Nuc. Socl 24, 8 (1976)
16. B. Snavely, Separation of Uranium Isotopes by Laser Photochemistry, USAEC Report UCRL-75725 (1974)
17. Science 192, 866 (1976)
18. G. C. Eichholz, Environmental Aspects of Nuclear Power (Ann Arbor Science Publishers, 1977) pp. 477-500
19. B. Spinrad and E. Evans, Trans. Am. Nucl. Soc. 24, 10 (1976)
20. B. Cohen, Physics Today (January, 1976) p. 9; Rev. Mod. Phys., in press (1977)
21. J. Hamstra, Nuc. Safety 16, 2 (1975)

22. M. Flood, Bull. At. Sci. 32, 29 (1976); D. B. Smith and I Waddoups, Power Eng. 80, 36 (1976)
23. Reactor Safety Study, U. S. Nuclear Regulatory Commission Report WASH-1400 (1976)
24. T. Taylor and M. Willrich, Nuclear Theft: Risks and Safeguards (Ballinger, Cambridge, 1974); J. McPhee, The Curve of Binding Energy (Ballantine, New York, 1975)
25. W. C. Roesch, IAEA Conf. on Peaceful Uses of Atomic Energy, Vol. 15, 755 (1955)
26. T. Taylor, Adv. Nuc. Sci. Tech. 9, 407 (1975)
27. J. T. Edsall, Bull. Atom. Sci. (September, 1976)
28. Plutonium Toxicity, Electric Power Research Institute Report (1976)
29. D. P. Geesamen, Bull. Atom. Sci. 27, 33 (1971)
30. A. R. Tamplin and T. B. Cochran, New Scientist 66, 497 (1975)
31. F. Ilke, Bull. Atom. Sci. (October, 1976) p. 15; B. Feld, Phys. Today (July, 1975) p. 23
32. W. Epstein, Sci. Am. 233, 18 (1975)
33. W. P. Beggington, Sci. Am. 235, 30 (1976)
34. For an excellent review, see Plenary Papers presented at American Nuclear Society Meeting, Washington, 1976 (to be published by the American Nuclear Society, 1977); Summaries in Transactions of the American Nuclear Society 24, 1976)
35. B. Cohen, Health Phys., in press (1977)
36. A. L. Hammond, Science 193, 126, 217 (1976)



## CHAPTER 8

### ENERGY ALTERNATIVES

To illustrate the various factors which arise in applying a new technology to meet the needs of society, we have considered in some detail the role that nuclear power might play in our future. We began by noting that the "energy crisis" that has come about because of the reliance of this nation on energy resources (petroleum and natural gas) which are rapidly being depleted has made it necessary to develop alternative sources of energy for the very near future. We have examined those features of nuclear power generation which make it suitable as a near term source of electrical power, and we have also attempted to analyze several of the more controversial aspects of nuclear power generation.

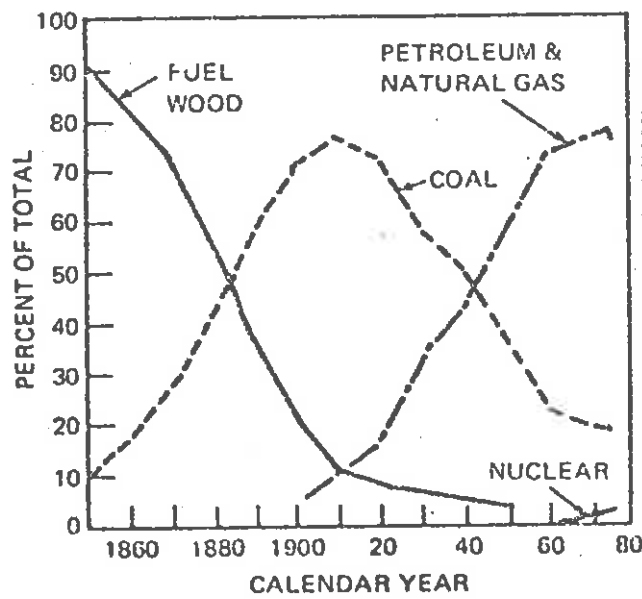
However any attempt to assess the desirability of nuclear power generation as a significant component of our future energy capability is incomplete without some consideration of the alternatives to this option. Unfortunately, a detailed comparison of the various alternatives available to meet a particular need of society is all too often absent from a public debate such as that concerning nuclear power. Both those who criticize as well as those who support a strong commitment to nuclear power generation usually avoid mentioning alternatives to such a commitment (perhaps because a consideration of the various alternatives requires a much broader background and considerably more effort than most participants are willing to devote).

The consideration of alternatives is not only necessary if we are to come to a rational decision regarding the role of nuclear power, but it is also required by law. For the National Environmental Protection Act demands that one justify any proposed action which might impact on the environment, such as the construction of a nuclear power plant, by carefully considering not only the need for such a project, but as well carefully considering and demonstrating that there are no more suitable

alternatives available to meet this need. Of particular importance is a detailed consideration of the role that conservation might play in eliminating the need for new electrical generating capacity. Such an analysis must be a part of any Environmental Impact Statement submitted in support of a nuclear power plant construction permit application (as recent federal court decisions have clearly demonstrated).

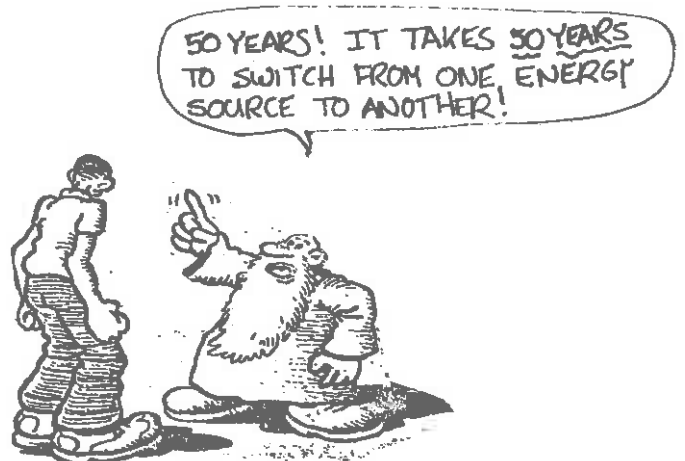
Therefore in this chapter we will examine in more detail the various alternatives that possess potential for meeting or reducing the energy needs of our society. In particular we will examine short term alternatives including further development of liquid fossil fuel resources (petroleum and natural gas) and coal technology (including synthetic fuels). We will also consider longer term possibilities including geothermal and solar energy development as well as alternative nuclear power sources such as breeder reactors and controlled thermonuclear fusion. In each instance we must assess the viability of a particular option in terms of a variety of criteria including its abundance, its impact on public safety and the environment, and its projected economics. Of particular concern will be the suitability of conservation (energy efficiency) technologies which must be ranked on a level with the supply technologies at the highest priority for both near and far term development.

To provide any of these alternatives to liquid fossil fuels, we will see that a major development program is necessary which will be both technologically difficult and costly. The problems of a transition to any new energy source (or conservation technology) are difficult and require an appreciable period of time as history has shown (see Figure 8-1). Although the more exotic long term alternatives such as solar power, breeder reactors, or fusion power represent significantly larger sources of energy (see Figure 8-2), they also present major economic, environmental, social, and technological problems which must be solved before these new energy sources can become viable for our society. In the meantime we must depend on existing domestic alternatives based upon solid fuels (coal and uranium) accompanied by a significant commitment to conservation.



SOURCE: HISTORICAL STATISTICS OF THE UNITED STATES BUREAU OF THE CENSUS. U.S. BUREAU OF MINES, 1974

Figure 8-1: United States Energy Consumption Patterns (EPDA 76-1, A National Plan for Energy Research, Development, and Demonstration, Vol. 1: Summary)



ENERGY AVAILABLE AND REQUIREMENTS IN QUADS ( $10^{15}$  BTU) SHOWN GRAPHICALLY BY AREA

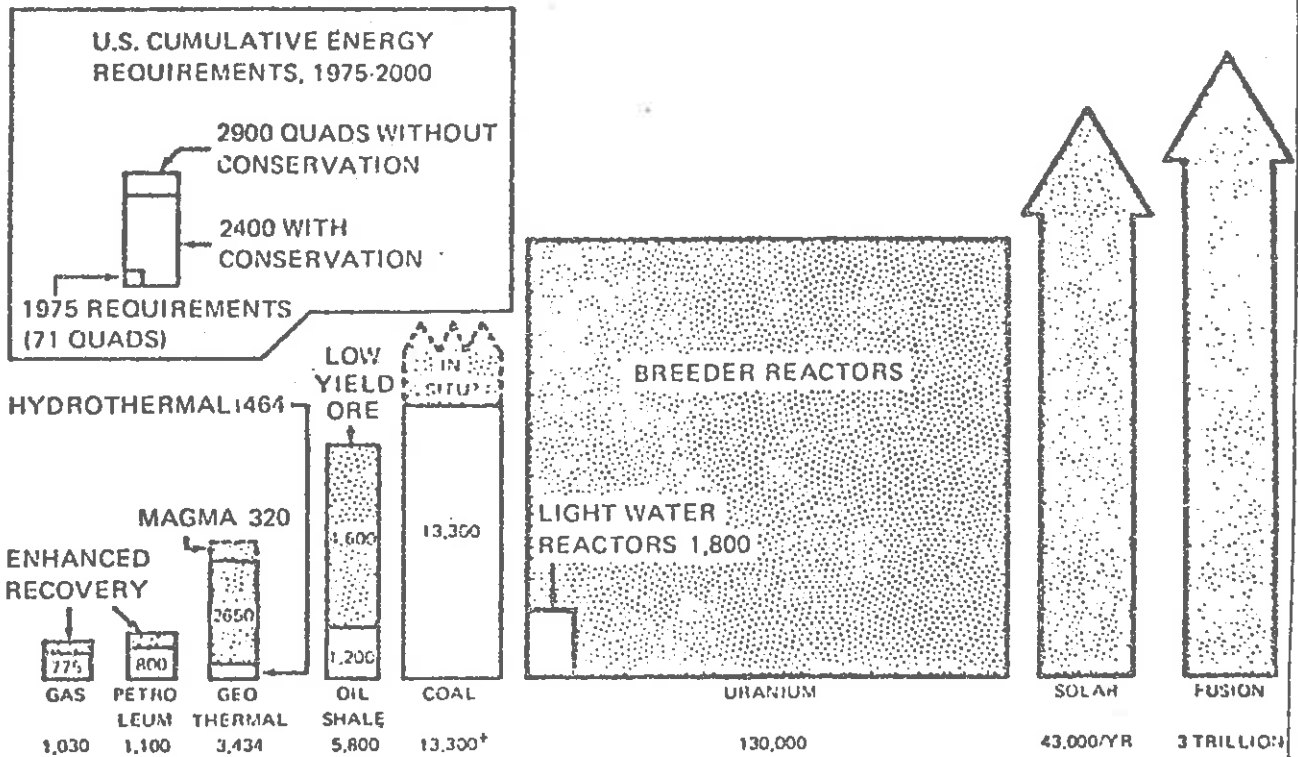


Figure 8-2: Potentially Recoverable Domestic Energy Resources (ERDA 76-1, A National Plan for Energy Research, Development, and Demonstration, Vol. 1: Summary)



### Technologies Now Available for Pursuing Major Energy Technology Goals

The last column of this table presents data from ERDA-48. It represents the maximum impact of the technology in any scenario measured in terms of additional oil which would have to be marketed if the technology were not implemented. Basis for the calculation is explained in Appendix B of ERDA-48. These data are being reexamined, and changes will be made when analysis is completed. In a number of cases, revised projections of impacts will be lower.

Technology	Term of Impact*	Direct Substitution For Oil & Gas**	RD&D Status	Impact in Year 2000 In Quads
<b>GOAL I: Expand the Domestic Supply of Economically Recoverable Energy Producing Raw Materials</b>				
Oil and Gas—Enhanced Recovery	Near	Yes	Pilot	13.6
Oil Shale	Mid	Yes	Study/Pilot	7.3
Geothermal	Mid	No	Lab/Pilot	3.1-5.6
<b>GOAL II: Increase the Use of Essentially Inexhaustible Domestic Energy Resources</b>				
Solar Electric	Long	No	Lab	2.1-4.2
Breeder Reactors	Long	No	Pilot/Demo	3.1
Fusion	Long	No	Lab	—
<b>GOAL III: Efficiently Transform Fuel Resources Into More Desirable Forms</b>				
Coal—Direct Utilization Utility/Industry	Near	Yes	Pilot/Demo	24.5
Waste Materials to Energy	Near	Yes	Comm	4.9
Gaseous & Liquid Fuels from Coal	Mid	Yes	Pilot/Demo	14.0
Fuels from Biomass	Long	Yes	Lab	1.4
<b>GOAL IV: Increase the Efficiency and Reliability of the Processes Used in the Energy Conversion and Delivery Systems</b>				
Nuclear Converter Reactors	Near	No	Demo/Comm	28.0
Electric Conversion Efficiency	Mid	No	Lab	2.6
Energy Storage	Mid	No	Lab	—
Electric Power Transmission and Distribution	Long	No	Lab	1.4
<b>GOAL V: Transform Consumption Patterns to Improve Energy Utilization</b>				
Solar Heat & Cooling	Mid	Yes	Pilot/Demo	5.9
Waste Heat Utilization	Mid	Yes	Study/Demo	4.9
Electric Transport	Long	Yes	Study/Lab	1.3
Hydrogen in Energy Systems	Long	Yes	Study	—
<b>GOAL VI: Increase End-Use Efficiency</b>				
Transportation Efficiency	Near	Yes	Study/Lab	9.0
Industrial Energy Efficiency	Near	Yes	Study/Comm	8.0
Conservation in Buildings and Consumer Products	Near	Yes	Study/Comm	7.1
* Near—now through 1985 Mid—1985 through 2000 Long—Post 2000				
** Assumes no change in end-use device.				

Figure 8-2a: ERDA Assessment of the Viability of Various Energy Alternatives (EPDA 76-1, A National Plan for Energy Research, Development, and Demonstration, Vol. 1:

Summary)



THESE GOVERNMENT STUDIES REALLY GET TO YOU AFTER AWHILE.

In comparing these various alternatives we must be particularly careful to recognize the operation of a new form of Parkinson's law: The farther away in time and probability a given technology is, the more certain are the predictions concerning its practical and economic feasibility.

### 8.1. Conservation

Certainly a major factor in the energy crisis has been the inherent inefficiency and wastefulness in our utilization of energy. Since energy has always been cheap and plentiful, our society has tended to substitute energy-intensive technologies for labor-intensive processes. Today the average American consumes energy at a rate some 6 times the world average and over 80 times the average in many underdeveloped countries. But this dependence on cheap energy and energy-intensive processes has led us into an "energy trap".<sup>2</sup> For by taking for granted the extremely low energy costs of fossil fuels such as petroleum and natural gas, we have placed a low priority on research programs aimed at developing alternative energy sources and have not invested adequate capital in known technological processes using such alternative sources on a substantial scale.

It has become apparent that not only must we redirect much of our national effort to the development of such alternative technologies, but moreover we must make a massive commitment to conserving energy. Such conservation can take one of two forms:<sup>3</sup> It might simply take the form of curtailment, which will most probably occur in any event as the inevitable shortages of fossil fuels begin to set in later in this century, thereby limiting our energy consumption in a most dramatic fashion. Such curtailment will inevitably have an adverse effect, as the OPEC oil boycott of 1973 made all too apparent.

A more constructive approach is to achieve conservation by means of increased efficiency, both in the production and in the utilization of energy. It has become apparent that conservation through increased effi-

ciency is extremely cost-effective. It is far better to invest in the end-point of energy use to conserve than to invest in additional energy production capacity to supply inefficient uses. A barrel of oil saved is worth several barrels at the well. Furthermore, energy conservation (at least up to roughly 30-40% of our present consumption levels) can have a net beneficial environmental impact since there will be less pollution as we are able to mine, transport, transform, and consume less fuel for the same end result. (Beyond 30-40% savings, the payoff is unclear since we cannot project the total impact of such conservation measures on our life-styles.)<sup>4</sup>

What steps should we take to conserve energy? What areas of our society can we identify as being energy-inefficient and therefore suitable targets for a conservation program? If we regard energy conservation programs as strategies for adjusting and optimizing energy using or producing systems and procedures in order to reduce energy requirements per unit of output (e.g., goods or social well-being)<sup>5</sup>, then we can identify three ways in which energy conservation can be implemented: (i) One could reduce the quantities of energy resources our society requires by technological advances in energy production which would lead to more efficient utilization of these resources. (ii) We could make an effort to shift our society away from energy-intensive goods and services and improve the efficiency of energy utilization. (iii) Finally, if we recall the strong correlation between economic growth and energy consumption, we recognize that we could place artificial constraints on economic growth which would limit consumption. (This rather severe form of conservation by curtailment will probably not be acceptable to our society--at least in the foreseeable future. As a rule of thumb, the drop in energy consumption by one barrel of oil a day eliminates one job in the labor market.)<sup>6</sup>

Hence the most effective energy conservation measures will attempt to improve the delivery of energy and reduce the energy requirements of specific processes or systems, as well as to modify the tasks or goals of energy use. In this sense we must recognize that conservation will require the substitution of other economic resources for energy, including

both capital and labor. In this sense, conservation can be viewed as an investment which should exhibit a certain rate of return in the way of decreased energy cost, or environmental impact.<sup>7</sup>

We can easily identify the major targets for an energy conservation program by looking at those sectors of our society in which major energy consumption occurs. As Figure 3-3<sup>8</sup> indicates, the lion's share of energy consumption occurs in industrial processes (42%), transportation (25%), and residential use (20%). Hence the three most important energy conservation targets are usually identified as (i) the implementation of more energy-efficient processes in industrial applications (e.g., utilizing the waste heat from adjacent power plants to supply process heat for chemical production), (ii) better heating and cooling of buildings (e.g., by using increased insulation, substituting heat pumps for electrical-resistive heating), and (iii) reducing the fuel consumption in transportation (e.g., lowering driving speeds, reducing automobile body weight).

An effective energy conservation program must also examine the thousands upon thousands of additional ways in which energy is used in our society and determine whether these processes can be improved. This latter task will be rather difficult since our nation has been built as if clean, cheap, and convenient energy will always be available. Indeed, our present society has many builtin impediments to energy conservation which must be overcome if this approach is to successfully limit our energy consumption

Although it is relatively easy to identify technical schemes for conserving energy, the implementation of these schemes generally run into nontechnological barriers, the most serious of which involve the attitudes and personal desires of people and the inadequacy of institutions.<sup>9</sup> Energy conservation programs must be implemented within a complex framework of economic and societal considerations. Indeed, our entire economy must be redesigned away from energy inefficiency since it has traditionally been built on the ready availability of high quality, low cost fuels. A couple of examples make the nature of these barriers



**MAJOR USES OF ENERGY IN THE U.S.**

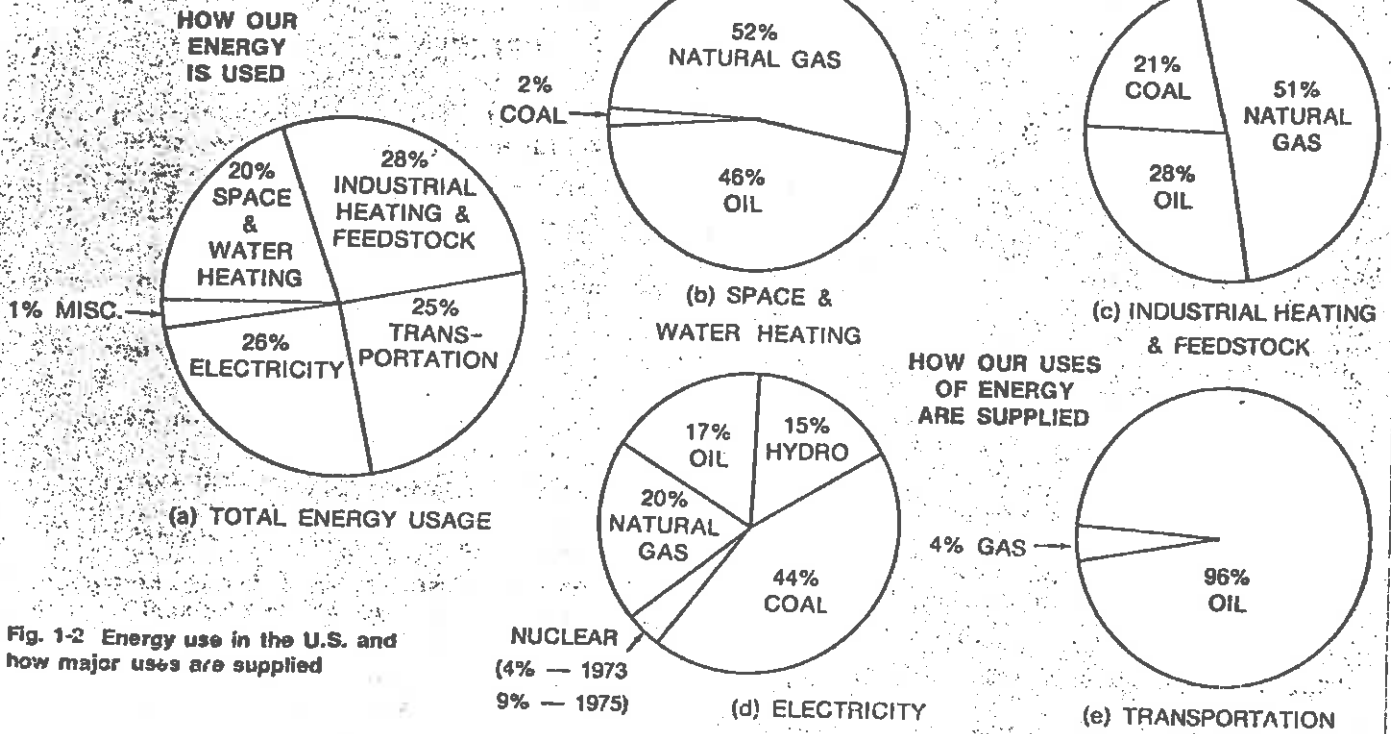
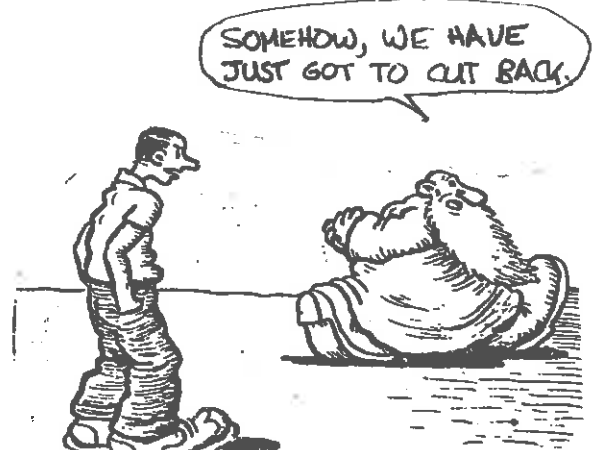


Fig. 1-2 Energy use in the U.S. and how major uses are supplied

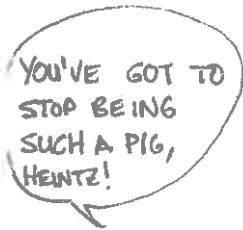
Figure 8-3: Major Uses of Energy in the United States (Nuclear Power and the Environment, American Nuclear Society, 1976; Compiled from Task Force on Energy, National Academy of Engineering, 1974)



more apparent:<sup>4</sup> The heating and cooling energy requirements of buildings can be significantly reduced by taking greater care in their design and construction. However most buildings are built on a speculative basis in which low initial cost is at a premium and later operating costs are secondary. Therefore builders are reluctant to invest more in the construction of a building to save later lifetime operating expenses. A similar philosophy frequently applies in the appliance market since usually energy-efficient appliances have a somewhat higher initial cost. Of course this latter problem is compounded by the lack of information available to the consumer on the energy use characteristics of various appliances.

Hence much of conservation will depend not upon technological advances but rather must await changes in socio-economic patterns, habits, and laws. We must force manufacturers to provide the necessary information on energy-use characteristics. Furthermore we must implement an adequate research and demonstration program on energy efficient processes and make available capital for the implementation of these processes. In any conservation decisions we must be careful not to rely simply on estimates of direct uses of energy, but also must take into account indirect energy inputs required to fabricate, maintain, or recycle elements of a particular energy system. That is, we must implement an "energy accounting" system aimed at minimizing overall energy consumption.<sup>3</sup> Finally we must recognize that conservation is something that can be stimulated by the federal government, but for it to be successful it must be accepted and implemented by private industry and the individual consumer. Conservation simply won't work until the public accepts, or better yet, demands it. But of course this means that the public will have to perceive some kind of benefit in conserving. We must convince the people that implement the conservation decisions, local governments, businessmen, and individual consumers, that conservation is a good thing.

If our society can be persuaded to undertake a massive energy conservation program, the potential reductions in energy consumption could



become quite significant. For example, Tables 8-1 and 8-2 indicate that the energy saving potential due to the implementation of new, more efficient energy use equipment and procedures could result in as much as 20% of our total energy consumption by 1985.<sup>10</sup> Furthermore, a number of studies including those conducted by ERDA estimate that we could reduce our expected future energy demand by perhaps 30-40% by 1990 using a massive energy conservation program.<sup>11</sup>

However we must be careful in interpreting these figures. First of all, most energy conservation measures will require years or perhaps even decades to achieve significant results, and during this time our demand for energy will continue to rise. Hence conservation measures will appear as a slower growth in energy demand rather than an actual decrease in consumption. Even with a 40% reduction in future consumption, we will still experience a growth in energy demand of about 1.5% per year.

It is probably unrealistic to expect that energy conservation will actually succeed in reducing our energy consumption growth to zero or result in a decrease in our energy requirements, although one could certainly project as a goal the examples of highly industrialized European nations such as Sweden and Germany which have achieved a standard of living (at least measured in per capita GNP) comparable to ours with only half the per capita energy consumption.<sup>12</sup> However we must keep in mind that there are a number of rather significant differences between these societies and our own. For example, the far higher population densities in European nations lead to vertical living patterns (e.g., apartments rather than single family dwellings) thereby reducing construction and transportation requirements significantly. Furthermore these societies tend to be far more service than product-oriented as our own society. Certainly we can look forward to a rather significant change in our society and way of life as the impact of the energy crisis becomes more severe. For example, as fuel prices continue to increase, the cost of commuting will become intolerable, thereby forcing people to move from suburbia back into the cities. However such basic changes in the fabric of our society will take time and certainly will be resisted to a major

POTENTIAL FOR NEW ENERGY SAVING EQUIPMENT — 1985	
Measure	Savings (million barrels per day)
SMALLER, MORE EFFICIENT CARS	2.0
OTHER TRANSPORTATION EQUIPMENT	1.1
BETTER BUILDING INSULATION	1.1
RESIDENTIAL AND COMMERCIAL EQUIPMENT	0.4
INDUSTRIAL PROCESSES	1.0
(or approximately 13% of total consumption) <b>TOTAL 5.6</b>	

Table 8-1: Potential for New Energy Saving Equipment--1985

POTENTIAL ENERGY SAVING BY CONSERVATION — 1985	
Measure	Savings (million barrels per day)
INDUSTRIAL MEASURES	1.5
LOWER DRIVING SPEEDS, CAR POOLING	1.0
BETTER APPLIANCE LOAD FACTORS	0.3
COMFORT CONTROL	1.0
(or approximately 9% of total consumption) <b>TOTAL 3.8</b>	

Table 8-2: Potential Energy Savings by Conservation--1985 (ERDA Goals: 7 to 15 quad by 1985, 27 quads/yr by 2000) (ERDA 48: A National Energy Plan for Research, Development, and Demonstration--Vol. 1 the Plan, 1975)



Table 8-2a: Electricity Projections to Year 2000

Assumption		Year 2000 Levels				
Doubling Time (Years)	Growth (%/yr)	Kwhrs	Coupled GNP (1)		GNP per worker (2)	
		(billions)	Ratio to 1974	Growth (%/yr)	Ratio to 1974	Ratio to 1974
10	7.18	11220	6.07	3.19	2.26	1.66
12	5.95	8310	4.49	2.65	1.97	1.45
13	5.48	7400	4.00	2.43	1.87	1.38
15	4.73	6150	3.32	2.10	1.72	1.27

1974 base =  $1850 \times 10^9$  kwhrs electricity (utility generation only).

(1) Assumes electricity growth is 2-1/4 times GNP growth.

(2) Labor force ratio: 2000 to 1974 = 1.36.

(Conf. on Magnitude and Deployment Schedule of Energy Resources, Oregon State University, 1975)

JUST LOOK AT HOW CLOSELY COUPLED ELECTRICAL GROWTH IS TO GNP.



extent by most of the American public.

Hence we must be realistic when we attempt to evaluate the effects of energy conservation programs on our future needs for new energy sources. This is particularly true of the demand for electrical energy, for many conservation measures which aim at improving energy utilization efficiency actually will result in an increase in electrical demand. For example, technical developments such as an inexpensive electrical heat pump or compact storage batteries for electric automobiles will certainly increase electrical demand. Thus it should be apparent that we cannot depend on conservation measures by themselves to solve the energy crisis our society faces as our supplies of petroleum and natural gas run dry. Rather we must simultaneously turn out attention towards alternative sources of energy production.

## 8.2. Petroleum-Based Energy Resources

During the first half of the twentieth century our society made a transition from wood and coal as its primary energy sources to petroleum and natural gas because of the exceptionally low cost and convenience of these fuels. However today our increasing energy consumption has pushed both the United States and the world towards the limit of their liquid fossil-fuel resources, and we now must face the fact that the days of inexpensive and abundant oil and natural gas are over. Nevertheless, society has come to depend so heavily upon liquid fossil fuels that it is certain that petroleum will remain the world's dominant energy source for the next ten to twenty years, and this will only accelerate the depletion of world fossil fuel resources.

Certainly the days of significant increases in domestic petroleum production are over (see Figure 8-4). Although the development of the Alaskan North Slope and offshore continental shelf oil reserves could increase domestic production slightly from 10-11 million barrels (bbl) per day to 13 million bbl/day, this will fall far short of even present day consumption levels of 17 million bbl/day, and indeed there is considerable reason to suspect that even this modest increase in production

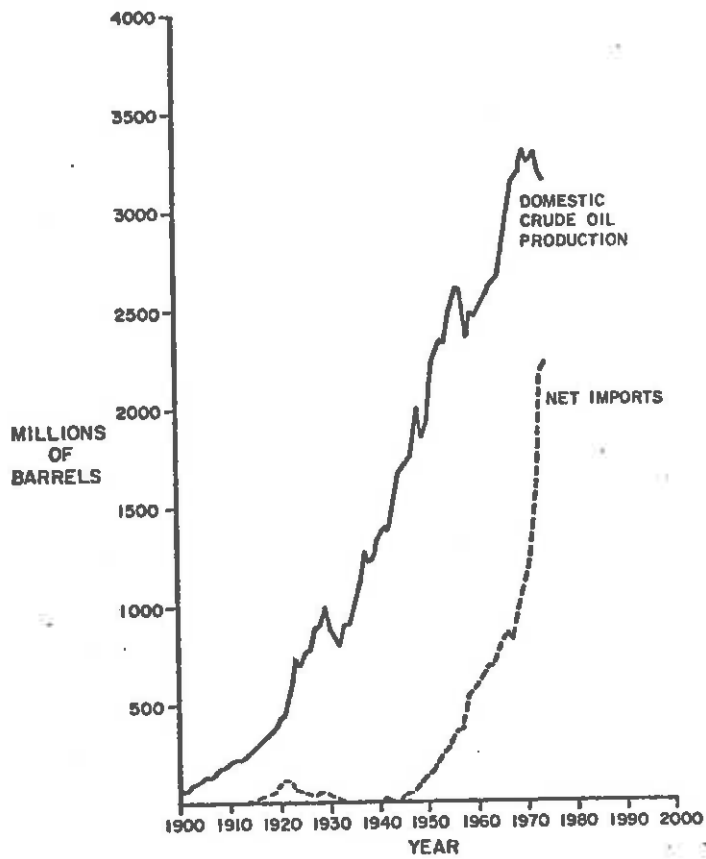


Figure 8-4: Domestic Petroleum Production versus Demand  
 (H. Brown, Ann. Rev. of Energy, Vol. 1, 1 (1976))

GAD! EVEN MY PENS RUN OUT OF INK!



## WORLD PETROLEUM PRODUCTION BY REGION

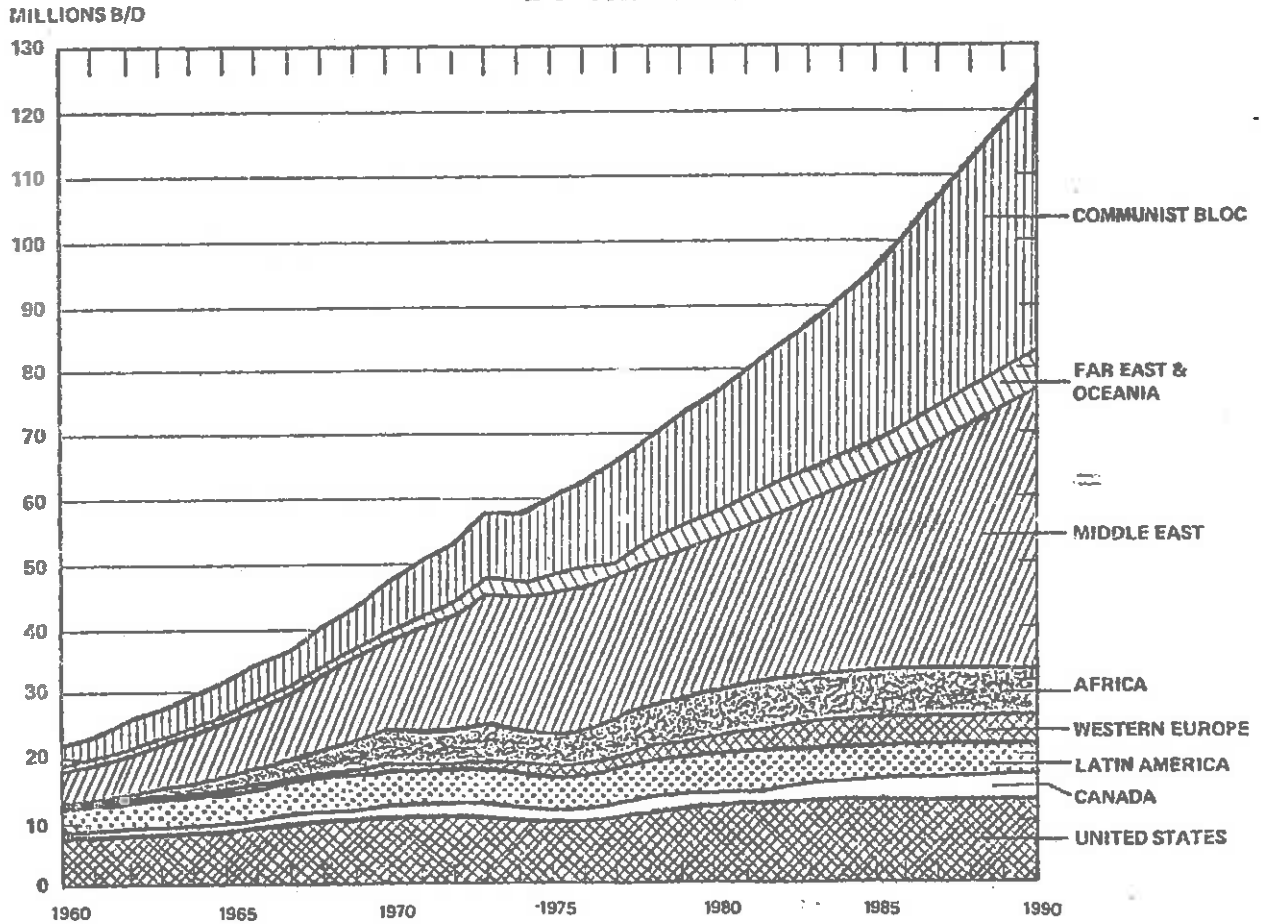


Figure 8-4a: World Petroleum Production by Region  
(J. N. Garrett, Conf. on Magnitude and Deployment  
Schedule of Energy Resources, Oregon State University, 1975)





may be illusory since the rather substantial efforts of oil exploration and enhanced recovery of oil from existing fields during the past two years has not led to any significant addition to production.<sup>13, 14</sup> Moreover the small amount of additional oil provided by this effort has priced in at \$20-25/bbl, roughly twice that of imported oil.

Hence we must face the fact that the shortfall in our domestic production will have to be met by ever-increasing reliance on petroleum imports, primarily from the Middle East. Even with improved efficiency in automotive design and building heating and cooling, this dependence on oil imports can only grow. Such a dependence is aggravated by environmental standards which force the use of petroleum in the absence of clean alternative fuels, pollution controls which adversely affect energy efficiency, and natural increases in our population (particularly in the 20-35 year old age group which tend to be the heaviest energy consumers).

Although there is some disagreement concerning the magnitude of our domestic petroleum reserves,<sup>15</sup> an upper estimate would project exhaustion of these resources by the turn of the century (even assuming 35% oil imports) with worldwide resources being exhausted some ten to twenty years later. The situation for natural gas is even more dismal, since our consumption of natural gas has exceeded the development of additional reserves since 1966 causing a precipitous decline in this energy resource (see Figure 8-5).<sup>16</sup> Natural gas is not expected to remain a viable fuel for more than a decade.

An alternative source of petroleum is found in the rich oil shale deposits in the Green River formation of Colorado, Wyoming, and Utah. Next to coal, oil shale is our nation's largest fossil fuel resource, and it represents our best long term bet for oil. Unfortunately, the recovery of oil from shale is dubious with existing technology, and the forecast is that production will only reach a relatively modest level of 330,000 bbl/day by 1985 (compared with the present consumption rate of 17 million bbl/day).<sup>17, 18</sup> Significant government participation will be required to assist private industry in developing a capability to achieve even this modest

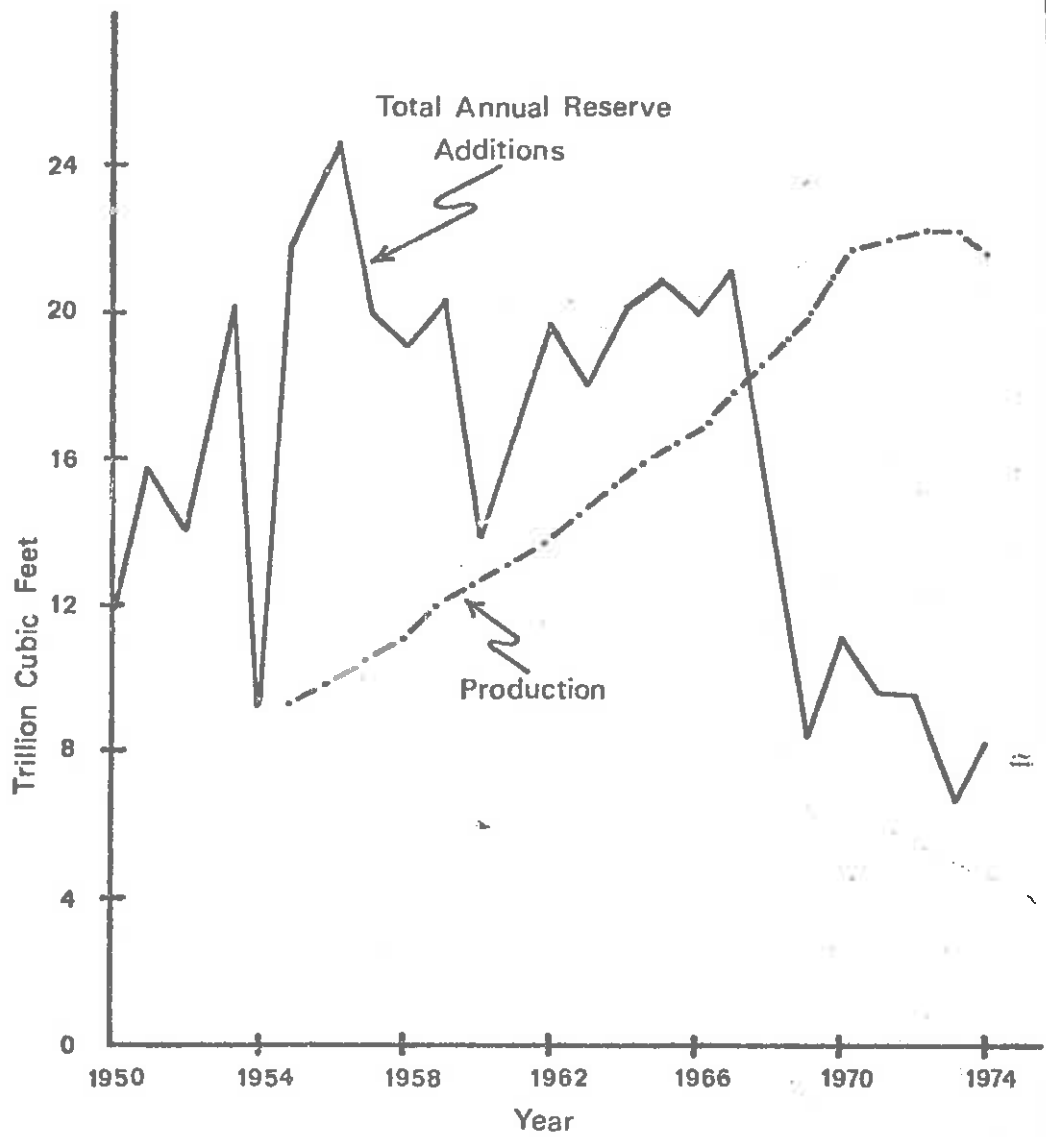
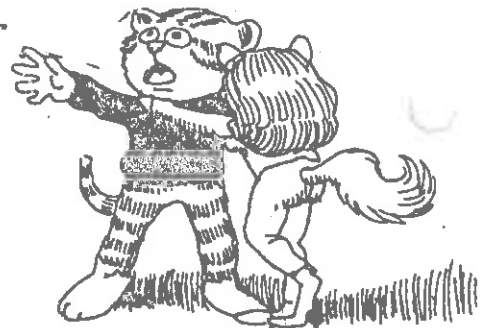


Figure 8-5: Annual Reserve Additions and Production of Natural Gas (L. W. Bierbaum, Conf. on Magnitude and Deployment Schedule of Energy Resources, Oregon State University, 1975, p. 117)

GAD! WE'VE BEEN DEPLETING OUR RESERVES SINCE 1966!



production level.

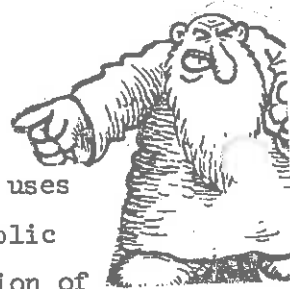
Yet another alternative petroleum source lies in the tar sands of western Canada. But the increasing petroleum needs of this country, coupled with the difficulty in developing technology to exploit this resource, make it highly unlikely that any oil production from these tar sands would be made available for export.

Hence it appears that neither shale oil or tar sands can be counted on for substantial quantities of oil to fill the gap between U.S. oil production and demand between now and 1985, although they may provide strategic leverage in dealing with overseas oil suppliers by the late 1980s and 1990s. Ultimately such sources of hydrocarbons will be needed as conventional sources are depleted. Furthermore, the cumulative demand on materials, labor, and capital required for the development of these petroleum sources, coupled with those required for other energy sources including coal and nuclear power will probably restrict this development in any event.

Therefore although petroleum will continue to be our primary source of energy in the near future, there seems to be little hope that we can avoid a serious petroleum energy shortage. All we can hope to do is to alleviate the impact of this shortage by rapidly implementing conservation measures and developing alternative energy sources as rapidly as possible.

### 8.3. Coal-Based Energy Resources

The proven United States coal reserves are enormous, amounting to some 5,400 quads which is some 12 times our domestic petroleum and natural gas reserves. <sup>19,20</sup> At the present time we consume only some 14 quads per year of coal-supplied energy, 9 quads for the generation of electrical power. Hence there is strong motivation to expand our coal production, and the present goal is to double coal production by 1985, and triple coal production to 39 quads by the year 2000.



Unfortunately, coal is a dirty, inconvenient fuel for most uses which causes significant environmental impact and dangers to public health due to the pollutants released during the direct combustion of this fuel (flyash particulates,  $SO_2$ ,  $CO_2$ , NO, etc.), materials handling problems, and the environmental and health problems associated with coal mining. Any significant expansion in our utilization of coal must be accompanied by technical improvements to reduce the pollution from direct coal burning, minimize mining and transportation problems, and establish a synthetic fuels industry based upon coal liquefaction and gasification.

### 8.3.1. MINING AND TRANSPORTATION

Probably the principal bottleneck to rapid increases in coal production involves the expansion of both underground and surface mining capacity and the establishment of an efficient rail network capable of transporting enormous quantities of coal from mines to utilization points. At least for the foreseeable future the expansion of coal production and utilization will be based on the increased use of existing technology, although advanced technology through intensified research and development is necessary and desirable to improve coal mine productivity, health, and safety. Significant changes in this industry will probably not occur until the latter part of the 1980s.<sup>19</sup>

Most coal production to date has involved the relatively high sulfur content, high heating value coals occurring east of the Mississippi which require underground mining for their development. Only recently have we begun to develop the lower sulfur, lower heating value coal fields occurring in the northern Great Plains states which are recoverable by surface mining techniques. The bulk of U.S. recoverable coal reserves, at least for the near future, will continue to require underground mining methods. Indeed, to meet the goal of doubling coal production by 1985 will require the opening of some 400 new coal mines, an increase in coal mining employment from 158,000 to 250,000 men, and a cumulative investment in coal mines of \$20 billion.<sup>19</sup>

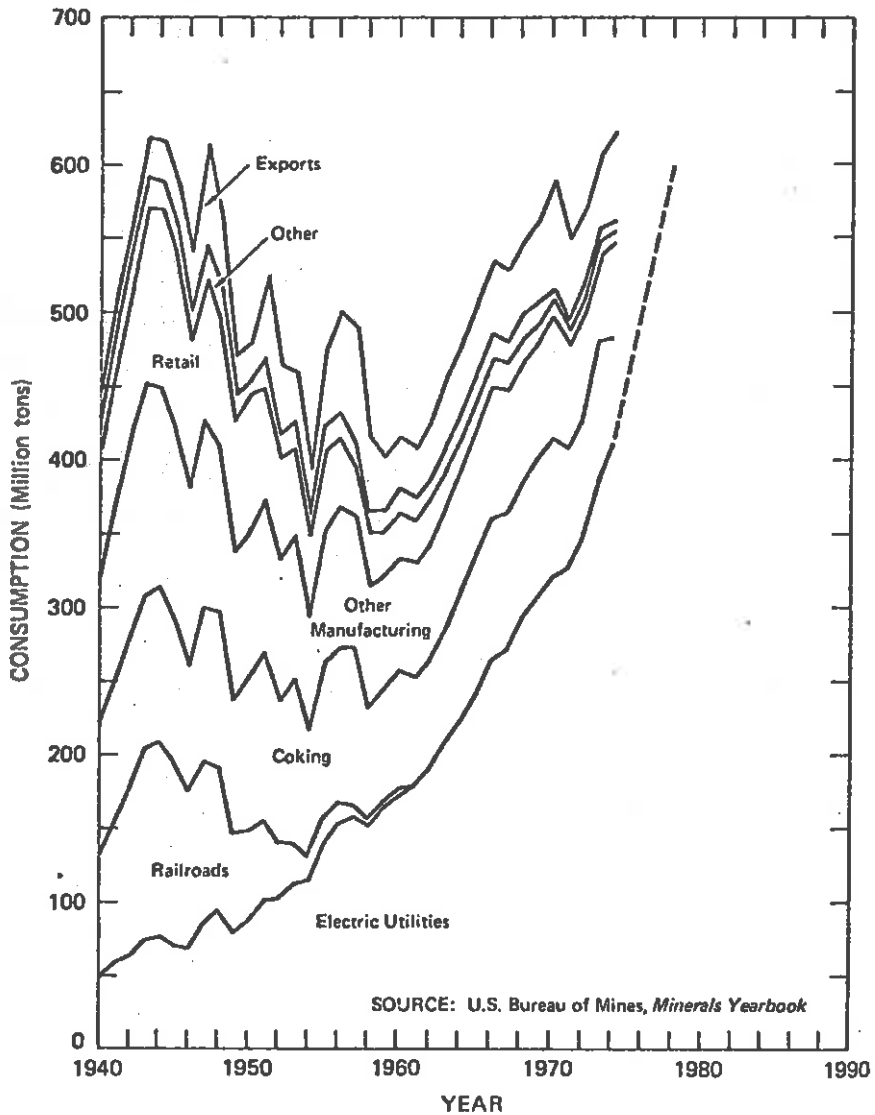


Figure 8-6: Patterns of coal consumption in the United States.

(R. A. Schmidt and G. R. Hill, *Ann. Rev. of Energy* 1, 33 (1976))

NOTE THAT OUR PRODUCTION OF COAL IS ABOUT THE SAME NOW AS IT WAS IN 1940.



An important point to be kept in mind here is that coal mining is one of the most hazardous occupations in our society today, both due to direct mining accidents as well as due to lung diseases such as pneumokoniosis (black lung disease). Indeed, it is estimated that at least one death every two years can be attributed to a 1,000 MWe coal-fired power plant due to mining accidents, and an additional 100 miners will be disabled due to lung disease each year in producing the coal for this plant.<sup>21</sup> Certainly an expansion of coal production will require a major program (at government expense) to provide additional protection to miners from the health and safety hazards of coal mining such as improved ventilation, control of methane gases, prevention of fires and explosions, and suppression of high dust levels.

Of course the enormous environmental impact of surface or strip mining hardly needs mention. This is particularly severe in the coal fields of the northern Great Plains region in which land reclamation is made difficult due to the arid climate.<sup>22</sup> Indeed, there have been several major confrontations between environmental groups and the coal mining industry in these western states which will almost certainly delay the timely development of this energy resource.

Finally, it should be noted that the transportation of the enormous quantities of coal which will be required over the next several decades poses a formidable challenge to our antiquated rail system. It will necessitate a major improvement of this system, accompanied by alternative transportation systems such as slurry pipelines (in which the coal is suspended in water which is then pumped through the pipeline). There are frequently conflicts which must be resolved, such as the reluctance of the railroads to allow slurry pipelines to be built across their right-of-way, or the environmental impact of such massive transportation systems.<sup>23</sup>



MAN, COAL IS JUST  
GONNA BE ONE BIG  
HASSLE!

### 8.3.2. DIRECT COMBUSTION OF COAL FOR ELECTRICAL POWER GENERATION

At present over 98% of coal production is used for direct combustion processes, either for electricity generation or industrial process heat. The magnitude and deployment schedule for the direct combustion of coal is shown in Table 8-3:<sup>19</sup>

Table 8-3

<u>Quads per year</u>	<u>1975</u>	<u>1986</u>	<u>2000</u>
For electric generation	9	16	18
For industrial use	5	9	17
Commercial/residential	<u>0</u>	<u>2</u>	<u>4</u>
Total Direct Combustion	14	27	39

The main controlling technical issue associated with the use of coal involves the atmospheric pollutants such as SO<sub>2</sub>, NO, CO<sub>2</sub>, and particulates in the power plant effluents. The removal of solid particulates from stack gases is common practice. Electrostatic precipitators can take as much as 99.8% of the particulates by weight out of the effluent, although they will still allow a significant release to the atmosphere.

More attention has been devoted to the control of SO<sub>2</sub> emissions which can range as high as 26,000 tons per year for a 1,000 MWe coal-fired power plant.<sup>24</sup> The primary concern involves the oxidation of the SO<sub>2</sub> effluent into sulfuric acid which can then be blown across the landscape by prevailing winds. Although there is considerable uncertainty as to the actual level of SO<sub>2</sub> emission or sulfate concentrations which could represent a public health hazard, there has been strong motivation to reduce the emission of this pollutant to far lower levels. This has created a great demand for low sulfur coal (less than 1% sulfur concentration) such as that present in the western states. The average sulfur content of the coal produced from eastern coal mines ranges from

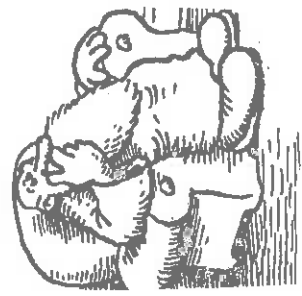
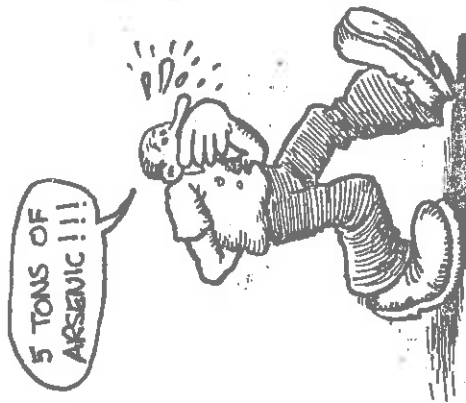
Table 8-4: Annual Effect of 100C MWe Coal-Fired Power Plant Operation in 1980

	Mining	Transportation	Power Plant	Total
<b>Conventional costs (10<sup>6</sup> \$)</b>				
Fuel	21	8		29
Capital O & M			55	55
Occupational accidents			7	7
deaths	0.98 <sup>a</sup>	0.055	0.03	1.1
nonfatal injuries	40.5 <sup>a</sup>	5.1	1.5	47.1
mandays lost	8330 <sup>a</sup>	570	350	9250
<b>Mining<sup>a</sup></b>				
Land disturbance by stripping (acres)	300			
Land subsidence, underground mining (acres)	200			
Mine drainage, tons	10,000			
Sulfuric acid in drainage, tons	80			
Dissolved iron in drainage, tons	20			
<b>Rail Transportation</b>				
Public Death		0.55		0.55
Injury		1.17		1.17
Days Lost		3,500		3,500
<b>Transportation and Handling loss, tons</b>				
Ash collected, tons			250,000	250,000
Sulfur retained, tons			46,000	46,000
Waste storage area, acres			5	5
Thermal Discharge, 10 <sup>10</sup> kWh(t)			0.89	0.89
Stack Discharge, 10 <sup>10</sup> kWh(t)			0.16	0.16
<b>Air Emissions, tons:</b>				
Flyash			2,000	2,000
Sulfur dioxide			24,000	24,000
Carbon dioxide			6,000,000	6,000,000
Carbon monoxide			700	700
Nitrogen oxides (as NO <sub>2</sub> )			20,000	20,000
Mercury			5	5
Beryllium			0.4	0.4
Arsenic			5	5
Cadmium			0.001	0.001
Lead			0.2	0.2
Nickel			0.5	0.5
Radium 226, Ci			0.02	0.02
Radium 228, Ci			0.006	0.006
<b>Facilities land use, acres<sup>b</sup></b>				150

a - 50% of production from strip mining and 50% from underground mining.

b - Facilities are for two generating units at a site and include fuel preparation but exclude transportation area.

(A Study of Social Costs for Alternative Means of Electric Power Generation, ANL-8092 (1975) p. 19)





3-5% and requires significant treatment of stack gases (e.g., scrubbers) to reduce the amount of  $SO_2$  released to the environment.

Not a great deal is known about the health effects of low levels of nitrous oxide in the atmosphere,<sup>21</sup> and relatively little attempt has been made to control the emission of this pollutant from power plants. Similarly, massive quantities of  $CO_2$  are released into the atmosphere (over 6 million tons per year from a 1,000 MWe plant--see Table 8-4). It has been speculated that a buildup of  $CO_2$  could result over the long term leading to a "greenhouse effect" causing a warming trend.<sup>25</sup> The average  $CO_2$  level in our atmosphere has already increased from its natural level of 290 ppm to 322 ppm by 1970 and is expected to reach a level of 375 ppm by the year 2000, resulting in an average temperature increase of 0.6%. The long term effects of such a global temperature rise could be quite serious.

Unfortunately, adequate means of burning coal cleanly are either not yet available or troublesome enough that environmental standards such as those for  $SO_2$  emissions are going to pose a considerable barrier to a rapid expansion of this energy source. The two principal technologies which exhibit the potential of significantly reducing pollution from direct coal combustion involve the treatment of stack gases by scrubbers to remove pollutants after combustion in conventional boilers and using more advanced designs such as fluidized-bed boilers.<sup>26</sup>

Stack gas scrubbers utilize an aqueous slurry of lime as a scrubbing agent. Combustion gases from the boiler are piped to a vessel in which a lime slurry is sprayed through the stack gases to absorb the  $SO_2$ . The liquid from these vessels is drained off to holding tanks where more lime is added to precipitate out a sludge composed primarily of  $CaSO_4$ . After a drying operation, the stack gas, which is now relatively cool, must be reheated to about 175 ° so that when it is released from the stack, an exhaust plume will rise high enough in the air to prevent fogging on the ground and disperse the remaining gas contaminants at a sufficiently low concentration. (Some scrubber units reheat with oil or natural gas, which is rather inconsistent with the desire to use coal as a replacement for these liquid fossil fuels.)

Scrubber units have a number of drawbacks, including their enormous expense, amounting to \$75-\$125/kwe capacity, as well as their tendency to lower the efficiency of the plant significantly (consuming some 5% of the power output of the generating plant). But the most serious problem concerns the disposal of the enormous amount of sludge waste which results from the scrubbing process, some 10 ft<sup>3</sup> produced per ton of coal burned, or about 80,000 ft<sup>3</sup> /day for a 1,000 MWe plant. For example, to dispose of the sludge from the scrubbers of a large coal-fired plant under construction at Shippingport, Pa., the operating utility is damming up a 5 mile long valley which it expects to fill with sludge to a depth of 400 ft over the next 25 years.<sup>26</sup> Hence there is strong incentive to develop a regenerable scrubbing process that does not produce such enormous quantities of sludge material, but such a process is not yet available at the present time.

The alternative to scrubbers involves using an advanced boiler design known as the "fluidized-bed" process, in which a flow of air up through the boiler suspends or fluidizes a bed of fine particles, normally coal and limestone, and therefore removes SO<sub>2</sub> during the combustion process directly as CaSO<sub>4</sub> solid which is far more amenable to disposal than scrubber sludge. Unfortunately, fluidized-bed boiler units do not appear capable of removing more than about 90% of the sulfur in coal and are limited in their ability to control emission of small particulates.

Although serious plans are being made to implement both fluidized-bed and scrubber technology on the next generation of coal-fired plants, evolving environmental standards may require the control of additional pollutants. This could alter or obviate the need for the application of these devices.

Of course the final alternative to direct combustion of coal is to convert coal into a cleaner, more convenient fuel using coal liquefaction or gasification processes.



### 8.3.3. COAL LIQUEFACTION AND GASIFICATION

Coal can be converted to both liquid (crude oil for petroleum refining) and gaseous (substitute natural gas) forms using existing technology. In fact, both coal liquefaction and gasification are relatively ancient arts (Germany ran much of its war machine during WW II on coal-derived synthetic fuels). Unfortunately, such synthetic fuels will cost several times that of the coal (per energy equivalent) and nearly twice the highest prices we now pay for natural petroleum.<sup>27</sup> Furthermore, the conversion process loses about 30% of the original energy content of the coal. Although there is some hope that further research and development on advanced processes may reduce production costs, there seems to be considerable doubt whether more than a 20% reduction in costs can be achieved. Hence coal-derived synthetic fuels will always be rather expensive. Therefore the success of coal conversion is much more an economic issue than a technical issue. Since coal burns quite efficiently in its original form, one must wonder whether our economy can afford to pay this extra cost for clean fuels, at least until the price of naturally occurring liquid fossil fuels rise to substantially higher levels.<sup>28</sup>

But there are other problems as well. There is still a great deal unknown about the safety and environmental impact of synthetic fuel processes.<sup>21</sup> However what is known is that synthetic fuel plants will almost certainly be more expensive to bring to the same degree of occupational and environmental safety that is now achieved at petroleum refineries.

Although the technology of coal liquefaction and gasification is well known, these processes have yet to be implemented on a massive scale in this country. Indeed, government actions have actually blocked rather than encouraged the development of a commercial synthetic fuel industry. The most optimistic projections of synthetic fuel production range around 300,000 bbl/day by 1985.<sup>29</sup> Certainly as the price of natural liquid fossil fuels continues to increase, synthetic fuels will become

more competitive. But it has become apparent that the lead time required to build up a synthetic fuel industry cannot await such a price increase, but rather must be stimulated immediately by federal government action.

#### 8.3.4. CONCLUDING REMARKS

Of all the domestic energy sources considered in this chapter, coal will have the largest impact on resolving the energy crisis faced by this country during the next two decades, and it can continue to supply a large portion of our energy needs for the next century. It offers more choices than other resources. If burned directly, even with stack cleanup, it will cost only moderately more than current energy price levels, and moreover it can be converted into a cleaner, more convenient form if we are willing to pay the price of coal liquefaction or gasification processes.

Unfortunately, the coal industry faces a number of rather significant hurdles if it is to achieve this potential. Only a part of this is due to the highly uncoordinated nature of the present coal technology research program in this country at present. There is also a significant amount of ambivalence about the role that coal should play in meeting our energy needs. For example, the same environmentalists that are strongly opposed to nuclear power are also usually opposed to coal-fired plants as well. Furthermore, American industry is reluctant to exchange the convenience of oil and gas for the unfamiliar complexities of the equipment necessary to clean up coal or to convert it into a form useable in their existing plants. In fact, coal has still not made a significant impact in replacing oil and gas in electrical power generation since nearly 30% of the new fossil fuel fired plants to be built in the next five years will be based on liquid fossil fuels.<sup>20</sup> Nevertheless there is little doubt that the pressure generated by the depletion of liquid fossil fuels and the difficulties faced by the nuclear power industry will eventually force us into using as much of our coal resources as we can get into production, almost regardless of the cost and environmental impact.<sup>30</sup>

#### 8.4. Geothermal Energy Resources

The thermal energy which is contained in the upper 10 km of the earth's crust represents an immense source of untapped energy. <sup>31-35</sup> Such geothermal energy is produced by the decay of radioactive materials and frictional forces deep within the earth. Unfortunately, in most places geothermal energy is far too diffuse to be exploitable as a viable energy source. Only those geothermal sites which exist as localized geological deposits of heat at attainable depths and sufficiently high temperatures will be suitable for commercial exploitation. Therefore geothermal energy will not allow much of a siting option, since the thermal energy of the source must either be used directly on site or converted to a more transportable form such as electrical energy. Furthermore there are relatively few geothermal sites which can be developed with present technology.

One can classify essentially four different types of geothermal resources: <sup>31,35</sup> dry steam, wet steam, hot igneous rocks associated with recent volcanism but lacking sufficient fluids for steam formation, and geopressurized basins containing large volumes of trapped geofluids under abnormally high temperature and pressure. The most accessible geothermal resources are dry steam fields which can be (and have been for some time) tapped by conventional steam thermal cycle technology. For example, the Geysers plant in northern California is presently producing 500 MWe of electrical energy from a dry steam field. Unfortunately, this particular geothermal resource is a rather rare geological occurrence, and if geothermal energy is to provide a significant contribution to our future energy needs, we must learn how to exploit its alternative forms.

The greatest midterm potential of geothermal energy involves wet steam fields which are some 20 times more abundant than dry steam resources. In such reservoirs, water is heated to high temperature under pressure. As the heated fluid flows to the surface, the pressure drop causes it to turn to a mixture of water and steam producing geysers,

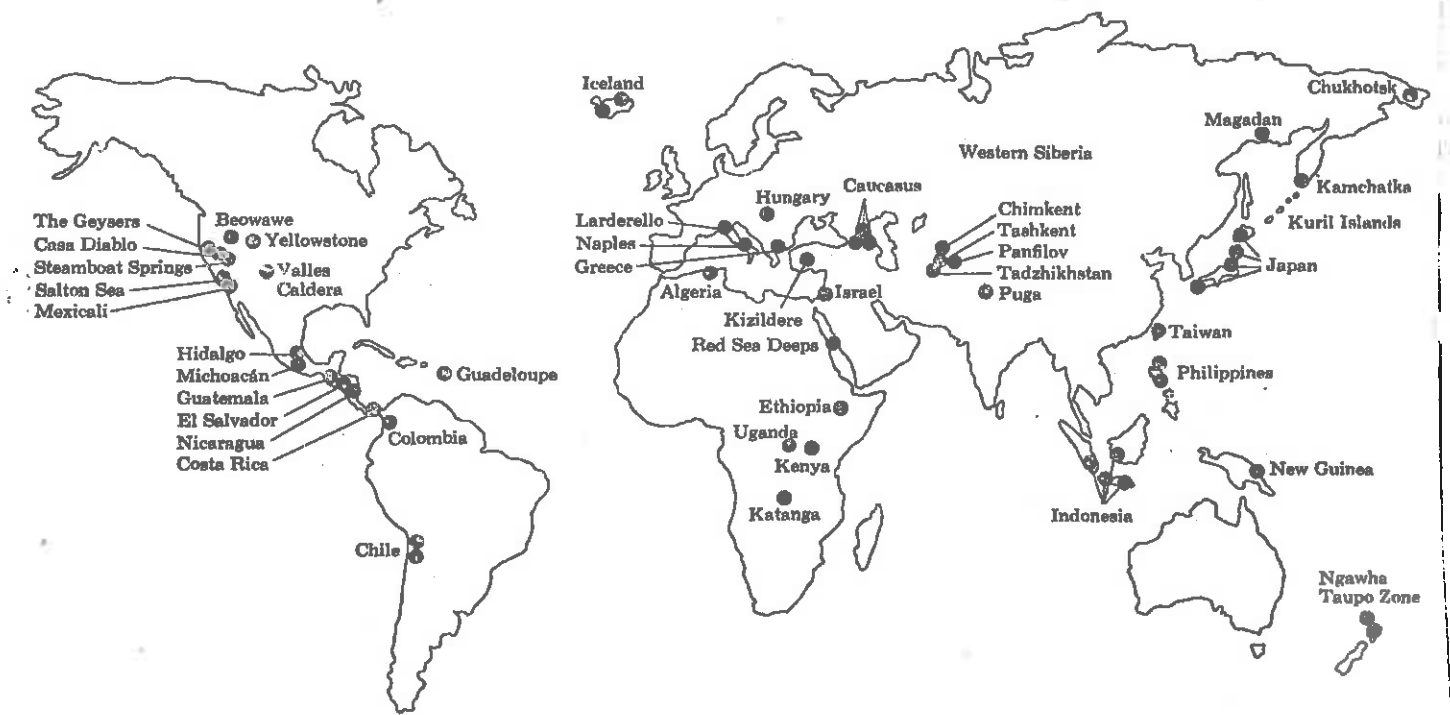


Figure 8-7: Dots Indicate the Major High-temperature Hydrothermal Areas of the World. (A. J. Ellis, American Scientist 63, 510 (1975))



hot springs, fumaroles, and so on (Old Faithful). The development of such wet steam resources requires the use of moisture separators and special turbine designs. Some experience has been gained in the exploitation of wet steam fields in New Zealand, Russia, and Japan.

Dry, hot rock geothermal sources may be the most abundant domestic geothermal resource. To exploit such formations, the rock must first be fractured, usually by fluid injection (or nuclear explosives), and then pressurized water must be circulated through the fractured rock to extract the thermal energy. To achieve sufficient temperature gradients, one must drill to depths of 4-5 km or deeper, and this is economically prohibitive at the present time.

The fourth source of geothermal energy consists of hot porous sands saturated with high pressure, high temperature brine or hot water such as those that exist along the gulf coast of the United States. The energy potential of these formations is truly immense, but the technology required to convert this thermal energy into electrical energy is not yet available.

Aside from its appreciable resource base, one of the major advantages claimed for geothermal energy is its minimal environmental impact. There has been sufficient experience obtained in the exploitation of both dry and wet steam geothermal resources to assess this feature. Since most geothermal sites are located in remote areas, their environmental impact is primarily confined to the site vicinity. However on a local level, the environmental impact of a geothermal power station may be quite severe.<sup>36</sup>

First it should be noted that in contrast to conventional power plants, there will continue to be effluent rejected to the environment from a geothermal site whether electricity is produced or not. Geothermal fluids withdrawn from the earth contain a variety of noxious substances, including significant amounts of  $\text{CO}_2$ ,  $\text{H}_2\text{S}$ , silica, arsenic, mercury, high saline wastes, and yes, Virginia, even radioactive materials which can be rejected into adjacent bodies of water or the atmosphere unless care is taken.

Probably the most noticeable of the geothermal effluents is hydrogen sulfide which is not only highly noxious (rotten egg gas) but highly toxic as well. The  $\text{CO}_2$  release can be as much as ten times that of a coal-fired plant (per unit energy production). An estimate of the discharge of effluents from the Wairakei plant is given below in Table 8-5

Table 8-5 : Discharges from the Wairakei Plant (100 MWe)<sup>36</sup>

Alkali, chlorides	100,000 tons/yr
$\text{SO}_2$ , $\text{NH}_4$ , Br, and F	100-1000 tons/yr each
$\text{SiO}_2$	10,000 tons/yr
$\text{CO}_2$	10,000-100,000 tons/yr
$\text{H}_2\text{S}$	1,000-10,000 tons/yr

Because of the rather low operating temperature of such plants, their thermal efficiency is extremely low, averaging well below 10%. Hence the waste heat rejection from geothermal plants is considerable.

To place the environmental impact of geothermal plants in perspective, the Wairakei plant in New Zealand discharges roughly 6 times as much waste heat, 5 times as much water vapor, about half the amount of sulfur, and a comparable amount of  $\text{CO}_2$  per unit energy production as a modern coal-fired plant. It also contaminates adjacent bodies of water with  $\text{SO}_2$ ,  $\text{CO}_2$ , arsenic, mercury, and other minerals in concentrations that could have adverse effects on the surrounding population.

There are still other environmental disadvantages of geothermal power, including the intense noise level (90 db) from geothermal steam fields and land subsidence (the New Zealand site has experienced a subsidence of up to 40 cm per year). Furthermore, the injection of high pressure fluids into dry rock formations may induce seismic activity.

It should be stressed that the technology exists to greatly minimize the environmental impact of geothermal energy facilities. However it must be kept in mind that geothermal energy is not the benign and clean energy source it is frequently claimed to be, and it will require a substantial effort to minimize its environmental impact.





There are a number of other issues that must be overcome if geothermal energy resources are to be successfully developed. Many of these are nontechnical in nature. There is still a rather major lack of confidence on the part of the energy utilization industry in geothermal energy as a viable long term source. Given the choice, industry would far rather depend upon (and invest in) coal or nuclear technology to provide long term needs than geothermal development.

There are a variety of institutional, legal, and environmental problems associated with the development of geothermal resources including vested interests, historical precedence, public acceptance, overlapping jurisdiction, and so on which may prove to be the major constraints on the growth of geothermal energy resources in the long run.<sup>32</sup> For example, about half of the identifiable geothermal resources in the United States are on federal lands. The ownership of steam fields on public lands where mineral rights are reserved for the federal government is still under consideration by the courts. Another major difficulty is where to obtain the enormous supplies of equipment which will be required for geothermal development, since this will invariably involve competition with the petroleum industry for adequate supplies of drilling rigs, piping, and so on. Geothermal development will be similar to the petroleum industry in yet another way since it requires significant expenditure before it can be determined if a given site will be economically viable. This feature will certainly tend to inhibit geothermal energy development to a major degree. And of course to these institutional problems we must add the unsolved technical problems which must be overcome if geothermal energy is to be developed in an environmentally acceptable manner.

The projections of the contributions to electrical power production by geothermal resources vary widely, depending sensitively upon both government and private development activities. In Table 8-6 we have presented the consensus of a number of geothermal experts<sup>32</sup> who project a total geothermal electric power capacity of 5,000 MWe by 1985 and 63,000 MWe by the year 2000. Of course, if the anticipated geothermal development

program were to be significantly increased during the next few years, these projections would be expected to rise somewhat.

Table 8-6 Estimated Geothermal Electric Power Capacity<sup>32</sup>

	<u>1985</u>	<u>2000</u>
Hydrothermal	2500 - 5000	7000 - 50,000
Geopressurized	-	0 - 3,000
Dry Hot Rock	<u>0 - 100</u>	<u>0 - 10,000</u>
Total	2500 - 5100	7000 - 63,000

It should be apparent that although geothermal energy will be extremely important as an alternative energy source for certain areas of the country (primarily the western states), its development will take several decades and even then will provide only a relatively small fraction of our overall energy requirements by the year 2000.

### 8.5. Solar Electric Power

For the past few years there has been growing a feeling on the part of the public that solar energy will eventually replace both fossil and nuclear fuels in meeting our future energy needs. Solar energy is frequently touted as an inexhaustible resource of clean and cheap energy. There seems to be an implicit faith in the capability of science and technology to develop solar energy resources if sufficient funding is provided.<sup>31</sup>

Certainly the potential magnitude of this renewable resource is enormous. The rate at which solar energy falls on the United States is 600 times our current consumption rate.<sup>38</sup> To this we can add the large resources of hydroelectric, wind, and ocean thermal energy. Furthermore, it appears that solar energy may present significant environmental advantages over other energy alternatives.



However, although solar energy may be both plentiful and clean, it will certainly not be cheap. Solar energy is highly diffuse, and it is usually not available at a constant or predictable rate. One must collect, concentrate, and convert solar energy into useful forms, and this will require a rather significant investment. In fact, the main barrier to massive implementation of solar energy production is not scientific or technological, but rather consists of a number of economic and institutional barriers. Certainly solar energy is scientifically feasible today since such energy systems have been designed, constructed, and operated for a number of years. However the more serious issue is whether solar energy will be commercially viable as a practical component of our nation's energy production capacity in competition with alternative means for providing the same energy.

I JUST WISH  
PEOPLE WOULD BE  
A BIT MORE  
REALISTIC ABOUT  
SOLAR POWER.



One of the strengths of solar energy resources lies in their great diversity, since even if one particular approach should fail, other solar energy technologies may prove viable. For our purposes we find it convenient to classify solar energy resources into one of three groups: (i) direct thermal applications (e.g., space heating and cooling), (ii) the production of fuels from organic materials, and (iii) the use of solar energy to generate electricity. Although our concern is primarily with the third of these applications, it is useful to consider briefly solar heating and cooling and the production of fuels from organic materials. The successful development of these solar technologies will certainly affect the future demand for solar electric power.

The use of solar hot water heaters was quite common several decades ago, but these were gradually phased out as cheap natural gas became available. With the rapid increase in fossil fuel prices, however, it is not surprising that this particular application of solar energy should receive new attention. Although solar hot water heaters are once again commercially available, they still require an initial investment several times that of conventional gas or electric units, and it takes several years to pay off this investment in reduced fuel bills.

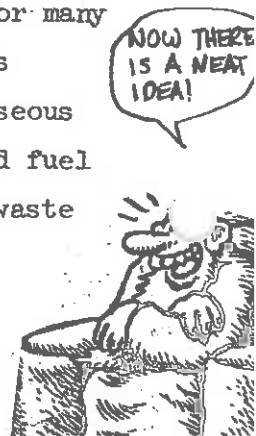
Similarly, solar space heating systems are presently available for heating both homes and buildings. Unfortunately, the large initial

investment required for such systems plus the expense of maintaining them has greatly limited their economic viability. For example, it is presently estimated that a solar heating system for a home would range between \$5,000 to \$10,000, not including a backup heating system (another \$2,000 to \$3,000) required for long periods of sunless days.<sup>39</sup> Very few of the present day units would save enough fuel to amortize out their initial investment and maintenance costs.

For solar heating to achieve economical viability, the price of conventional fuels (oil or gas) must continue to rise, and furthermore, the selling price of solar units must decrease substantially. Since this latter decrease can only come about through mass production, it has become apparent that significant government support will be required (e.g., through tax incentives) to stimulate a market for solar heating equipment.

A rather interesting alternative is the bioconversion<sup>40</sup> of solar energy into organic matter which is then subsequently converted into useable fuels. Of course in a sense all fossil fuels were formed by such processes millions of years ago. However the idea here is to grow particular types of organic matter with strong photosynthesis capability or to utilize waste organic matter.

Although organic wastes are a limited resource and are characterized by the low efficiency of capturing solar energy by photosynthesis, they nevertheless may be capable of providing some relief for our rapidly vanishing fossil fuel resources. The conversion of organic matter to fuels could be enhanced by using solar furnaces to drive chemical reactions.<sup>42</sup> For example, many organic materials can be converted into solid fuels using phrolysis in which the solid wastes are heated in a closed container with a limited amount of air. An example here that has been used for many years is the production of charcoal brickettes. If the pyrolysis is operated at higher temperature with increased air supply, then a gaseous component can be produced which can then be used to produce a liquid fuel such as methanol. Gaseous fuels can also be produced from organic waste by anaerobic digestion of sewage sludge or animal waste.



Such bioconversion processes present a number of advantages, even though they tend to be rather inefficient. For example, they would not lead to a net atmospheric buildup of CO<sub>2</sub> as does the burning of fossil fuels since on the average organic material would be grown as fast as it is burned.<sup>40</sup> Furthermore, the potential production of solar-derived fuels is significantly greater in humid tropical regions in which traditional agriculture is rather difficult. Of course the direct production of organic matter for fuels will have to compete with food and fiber products for arable land and water. Nevertheless, it may be possible to coordinate these activities to such a degree that bioconversion may provide a significant amount of energy in the future.

#### 8.5.1. DIRECT USES OF SOLAR ENERGY TO PRODUCE ELECTRICITY.

There are two distinct approaches to using solar radiation for producing electricity. In solar thermal conversion systems the solar radiation is collected and then converted to thermal energy by focusing the collected light onto a central receiver where the energy is absorbed as heat in a working fluid such as steam which can then drive a turbine and produce electricity. In photovoltaic conversion systems the solar energy incident on a photosensitive material such as silicon or cadmium sulfide converts some fraction of the incident solar energy directly into electrical energy.

##### Solar Thermal Conversion

To achieve the high temperatures necessary for an efficient thermal cycle, solar thermal power plants generally utilize a large distributed array of collectors known as heliostats which consist of mirrors mounted on bidirectional tracking systems to focus solar radiation on a central receiver atop a tall tower ("tower power").<sup>43,44</sup> Temperatures in the central receiver can range as high as 1000 °C and are used to drive a conventional thermal cycle to produce electricity. Because only direct sunlight can be used for such systems, solar thermal conversion plants are restricted to desert-like climates such as those characterizing the southwestern United States. They furthermore require large areas of land--probably in excess

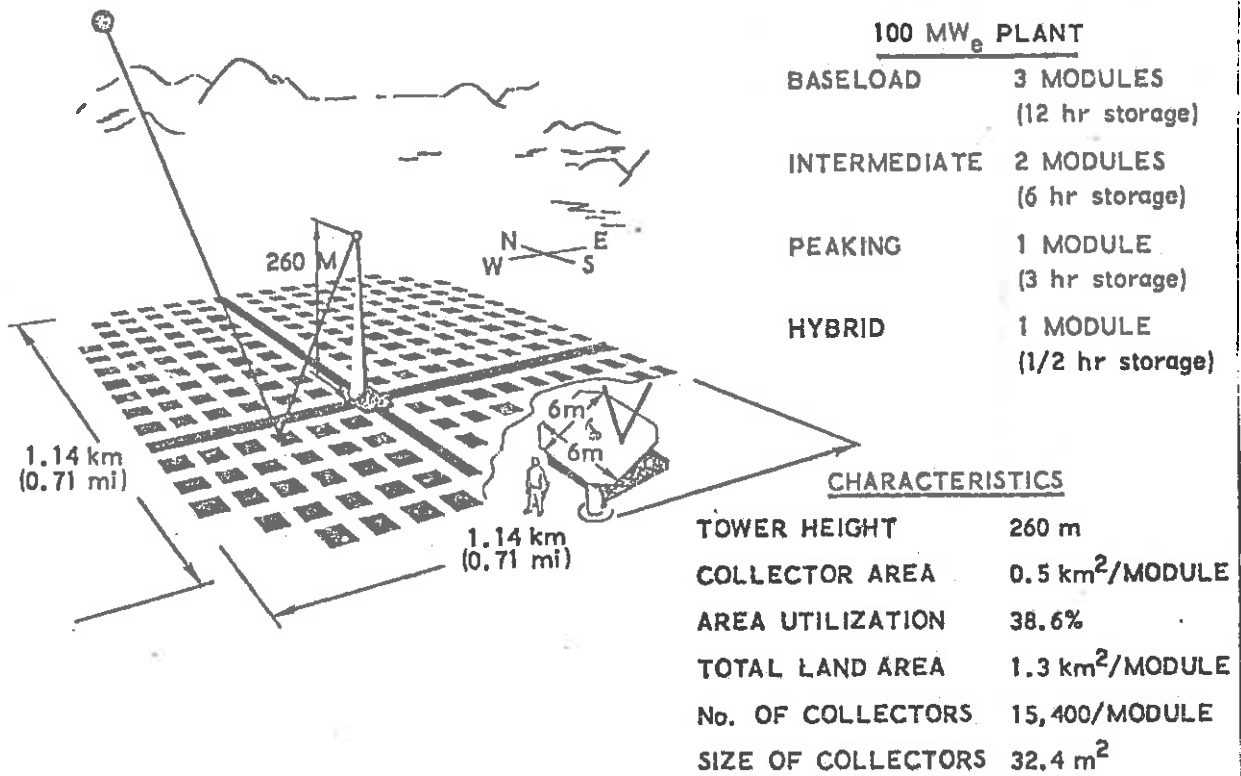
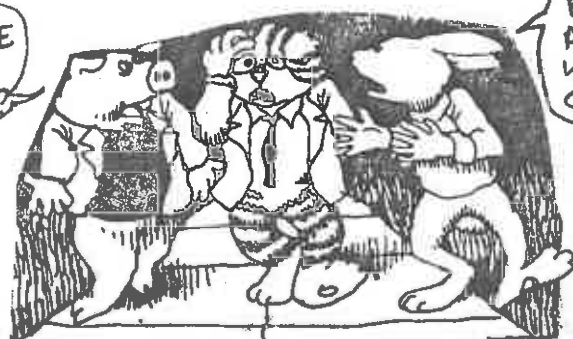


Figure 8-8: A Solar Thermal Conversion Array  
 (L. L. Vant-Hull, Conf. on Magnitude and Deployment  
 Schedule of Energy Resources, Oregon State University  
 1975, p. 30)

BUT WHAT ELSE ARE YOU GOING TO USE THOSE DESERTS FOR?



BESIDES "TOWER POWER" IS KIND OF A CATCHY PHRASE.

of 10 square miles for a 1,000 MWe facility--and large quantities of cooling water because of their intrinsic inefficiency.<sup>37</sup>

### Photovoltaic Power Systems

Photovoltaic power systems make use of the fact that an electrical voltage is generated when light falls on photosensitive materials such as silicon, germanium, cadmium sulfide, or gallium arsenide. Such photovoltaic conversion of solar energy into electricity has been used for a number of years in the solar cells used to power artificial satellites, highway emergency call boxes, microwave relay stations, and so on. One can therefore imagine deploying large arrays of such solar cells to generate appreciable quantities of electricity.

The principal barrier to such a scheme is the present high price of solar cells which runs to \$20,000 per peak kwe, some 30 times the cost of coal or nuclear generated electricity.<sup>45</sup> Before photocells can produce electricity competitively, capital cost reductions are going to have to occur, along with improvements in the ease of maintenance, reliability, and cell lifetime.

Since there do not appear to be the significant economies of scale for photovoltaic systems, it may be possible to install solar cells close to the point of electricity utilization (on tops of buildings, etc.) rather than concentrate them in large central station power units.

One of the more elaborate approaches to photoelectric energy production involves placing an extremely large photovoltaic solar array into geosynchronous orbit some 30,000 km above the earth.<sup>47</sup> The electrical energy produced by such an array would then be converted into microwave energy and beamed down to earth. However a quick calculation indicates that even in space, a 1000 MWe unit would require in excess of 1 square mile of solar collectors, and the assembly of an array of this size together with associated equipment for energy collection and transmission represents a monumental task. In fact, it has been estimated that the intensive space shuttle activity required to place such arrays in orbit

YOU CALL THIS  
AN ALTERNATIVE?



could itself have rather harsh environmental consequences. For example, the chlorine produced by rocket exhaust of the shuttles would produce roughly the same depletion of the atmospheric ozone layer as the present ground level release of freon. Furthermore the estimates for developing and placing into orbit such stations range from \$2 to \$5 billion per 1,000 MWe unit.<sup>48</sup> Needless to say, this particular approach is given only an outside shot for success in the near future.

### Major Constraints of Solar Electric Systems<sup>37</sup>

Solar electric power systems encounter certain fundamental limitations due to their very nature. First, both solar thermal and photovoltaic energy systems are characterized by extremely low efficiencies in the conversion of solar energy into electricity. This effectively restricts their siting to areas of high sunshine such as the desert southwest. Second, the low intensity of solar radiation implies an enormous land area requirement for the collection of an appreciable quantity of solar energy. For example, even on southwestern desert sites, an area of 10 square miles would be required to produce 1,000 MWe, and considering that such a plant is a rather small component of a large electrical power network, these large land area requirements will present a major stumbling block to large scale deployment of solar electric power. Finally, the intermittent nature of solar energy due to both climate and diurnal variations makes solar energy sources rather awkward for the production of central station electrical power. Even on the sunniest sites, power can only be generated some 40% of the time. Therefore solar electric plants will either have to be augmented by other types of generation facilities such as hydroelectric or fossil fueled units, or they will have to be provided with large energy storage facilities, for example, using pumped storage reservoirs or more exotic chemical or mechanical storage devices (fused salts or flywheels) at a considerable expense. It is estimated that the capital cost of solar power stations equipped with pumped storage facilities is effectively double that of a station without storage. The use of battery storage would increase this cost several times more.



Hence it is apparent that the direct use of the sun is not a very effective way to produce electricity on demand.

Furthermore it is also apparent that for solar energy to compete with even the projected costs of coal or nuclear units over the next several decades will require the reduction of photocell costs by at least a factor of 100 as well as the capability of producing 25 ft<sup>2</sup> heliostats for as little as \$50-\$100 and the provision of adequate maintenance of mirrors over the lifetime of the plant. These constraints make it rather unlikely that electrical utilities will opt for solar electric power stations instead of more conventional coal or nuclear plants-- at least in the foreseeable future--since the investment in solar systems appears to be excessive, and there is presently little assurance that such systems could achieve the usual 30 year lifetime of conventional generation units without major loss.<sup>37</sup>



#### 8.5.2. INDIRECT USES OF SOLAR ENERGY TO GENERATE ELECTRICITY

The construction of sophisticated wind turbines or ocean thermal energy conversion plants has recently caught the public fancy. However it should be kept in mind that man has been using both water and wind power to produce mechanical energy for thousands of years, and more recently has used hydroelectric power to produce substantial quantities of electricity for several decades. All of these sources derive their fundamental energy from solar power, either through air or ocean currents driven by solar-induced thermal differences or the transport of water vapor to higher elevations.

##### Hydroelectric Power Generation

Although one rarely thinks of hydroelectricity as a form of solar energy, this particular resource will continue to dominate the contribution from all other forms of solar energy until at least the end of this century. Therefore it is somewhat surprising that in assessing the possible role of various energy alternatives in meeting future energy needs, one rarely considers hydroelectric power. Perhaps this is

Table 8-7: U.S. Hydroelectric Capacity

	(000) MW Peak Capacity	Million MWh Energy Production	% of Total U.S. Capacity
1. <u>Actual</u> at end of 1970	51	253	15%
2. <u>Actual</u> at mid 1974	55	260	
<p>Since 1970 potentials for adding new capacity have declined, as shown here:</p>			
3. <u>Projected</u> , additions by 1990:			
a. As estimated in 1970 (Total)	27 (82)	59 (319)	7%
b. As estimated in mid 1974 (Total)	23 (78)	48 (308)	
<p>Beyond these levels, the <u>most critical issue</u> is the potential of added hydro capacity and related energy supply (<u>not now seriously proposed</u>); such as:</p>			
4. <u>Projected potential</u> additions beyond (3.b. above) (Total)	36* (114)	100* (408)	

\* A projection of Federal Power Commission Staff, May 1974.

(F. H. Warren, Conf. on Magnitude and Deployment Schedule of Energy Resources, Oregon State University, 1975, p. 37)

HOW ABOUT A FEW MORE DAMS?



BUT WHERE ARE YOU GOING TO BUILD THEM?

largely due to the fact that hydroelectric power was the first serious target of the environmental movement since it does utilize large land areas and has significant environmental impact. Indeed, it is clear today that although we could probably double our hydroelectric generation capacity, it is highly unlikely that such an expansion would be allowed in the face of strong environmental opposition (although such an expansion might actually be less damaging to the environment than generating a comparable amount of energy using fossil-fuel fired plants).<sup>49,50</sup>

### Wind Power

Windmills have been used to produce mechanical energy for many centuries and to generate electrical energy for at least four decades. Although wind power technology was abandoned during the early 1940s in favor of cheaper fossil-fuel generated electrical power, this approach to power generation has been revived during recent years in the face of increasing energy costs and diminishing fuel reserves. The technology of building large windmills is not particularly complex, and the use of wind power is probably closer to economic viability than any other form of solar energy (aside from hydroelectricity).<sup>51,52,53</sup>

However one must be cautious in assessing the potential of this form of energy. For example, the use of windmills to generate large quantities of electrical power on demand does not appear to be viable since it would require an enormous array of massive windmills augmented by elaborate energy storage or backup generation facilities. Some 30,000 windmills, each towering over 200 feet in the air, would be required to produce the output of one 1,000 MWe plant. Furthermore because of the intermittent nature of wind, either alternative energy production facilities or energy storage systems would be required. Although there are sections of the country such as the western Great Plains or the Aleutians where high wind velocities occur on a reliable basis, these locations are far from the point of energy utilization. Moreover, cost reductions of at least a factor of two to four in wind equipment would be necessary

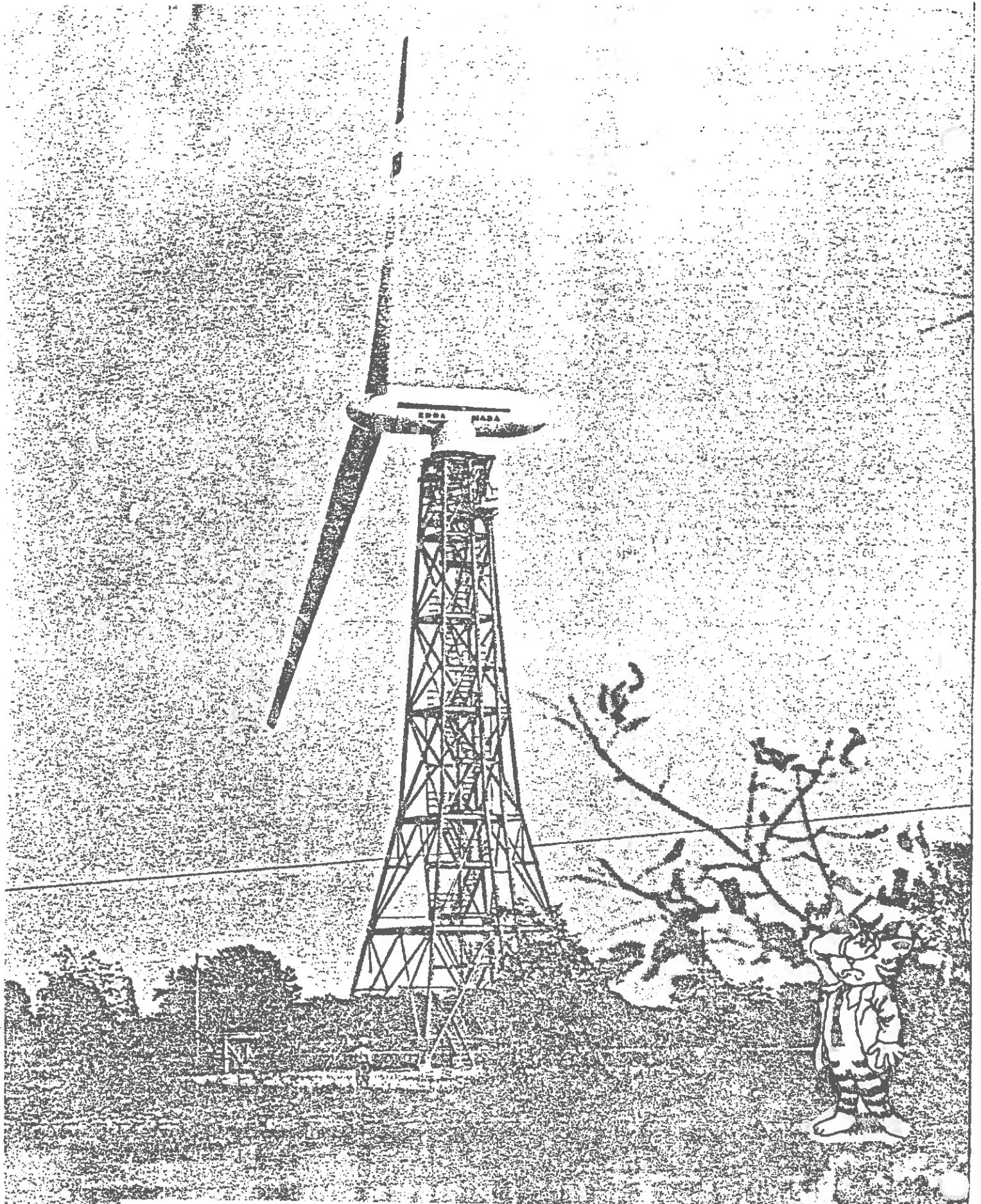


Figure 8-9: A Large Windmill Experiment at NASA-Lewis.

(G. Kaplan, IEEE Spectrum (December, 1975) p. 54)

before wind power could compete economically with alternative sources of electricity.

Therefore it appears that the role of wind generated electricity in existing electrical networks will probably involve their use to augment conventional power peaking units (e.g., gas turbines or pumped storage reservoirs) or in remote locations as small, self-contained generating units, and not as large, central station generation facilities.<sup>37</sup>

### Ocean Thermal Energy Conversion Systems (OTEC)

One of the more exotic approaches to the use of solar energy to generate electrical power is to utilize ocean temperature differences between warm surface waters and cooler waters in the ocean depths.<sup>54,55</sup> The basic idea is to use this vertical temperature difference to vaporize a working fluid such as ammonia which would drive a turbogenerator. The technical feasibility of such a closed Rankine cycle at even these low temperature differences has been demonstrated. However if we remember the basic limits on thermodynamic efficiency imposed by the temperature difference in the cycle, we will recognize that these plants would be extremely inefficient (about 2% as compared to the 35-40% of conventional plants). Furthermore they will require enormous components to generate an appreciable amount of electrical power. The major technological problems with OTEC plants involve the design of their heat exchangers which must be gigantic in order to operate effectively using such a small temperature difference. In fact, the heat exchangers tend to dominate the capital cost of this type of plant, and their maintenance may prove to be a rather significant problem due to the highly corrosive nature of sea water and fouling from sea organisms. There are numerous other problems which must be solved if this particular approach is to become viable, including transmission of electrical energy to shore, excessive capital costs of such plants (currently estimated at \$2000 to \$3000/kwe), and environmental impact.

GAD! HARDLY A DAY GOES BY WITHOUT ANOTHER ONE OF THESE "REVOLUTIONARY" NEW SCHEMES APPEARING.



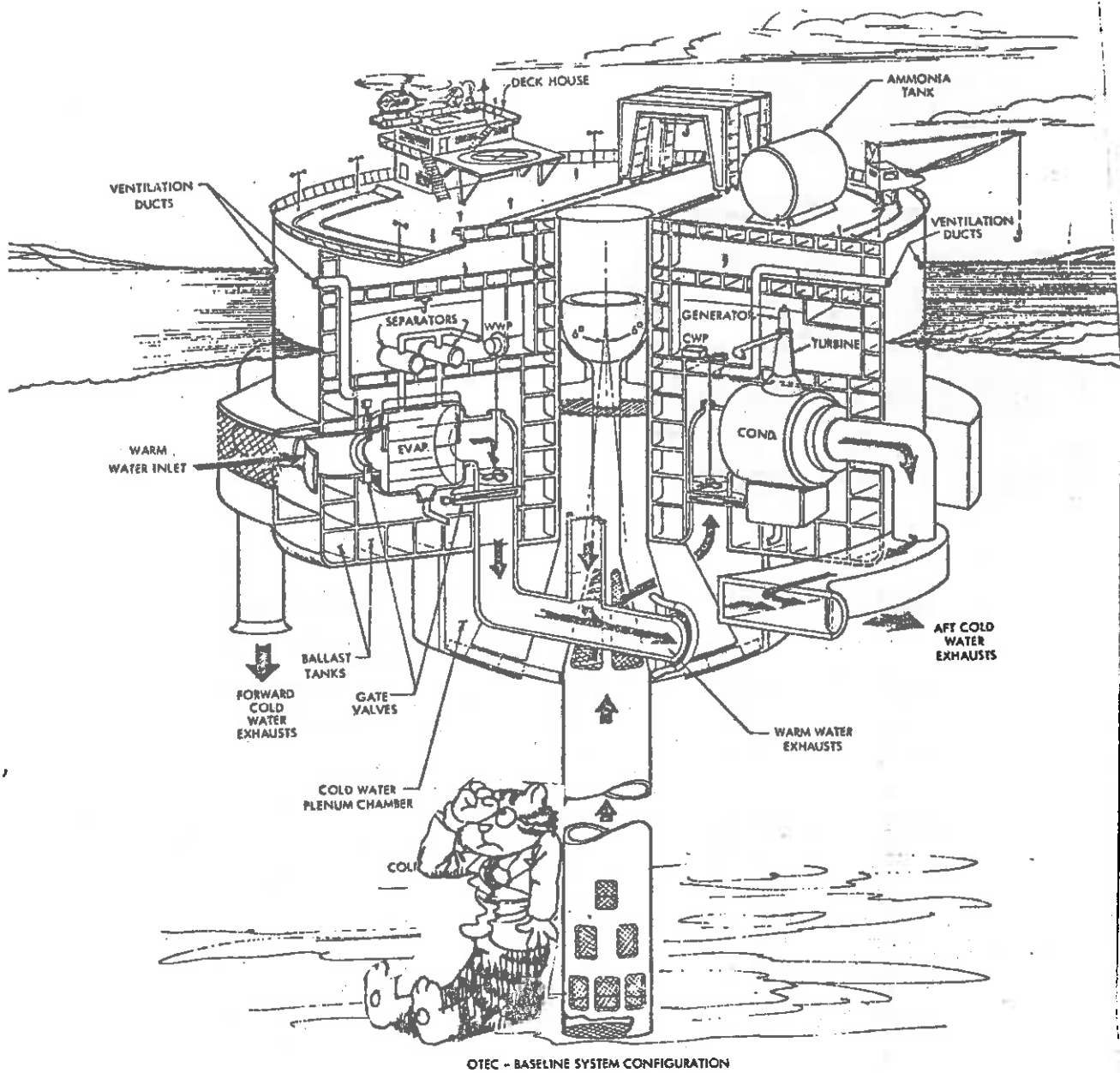


Figure 8-10: Ocean Thermal Energy Conversion Plant  
 (C. Zener, Bull. Atomic Scientists (January, 1976) p. 17)

### 8.5.3. CONCLUDING REMARKS

Certainly the sun represents an abundant source of clean energy which may some day prove sufficient to supply mankind's energy needs, and for this reason the technology involved in exploiting solar energy resources should be developed most vigorously. However, as we have seen, the successful development of solar energy as a viable alternative will require the solution of some rather significant problems of technological as well as economical and institutional nature. Clearly solar energy technologies have a long way to go before they will be capable of realizing even a fraction of their enormous potential.

A rather significant fraction of our national effort will be directed towards the development of solar energy resources during the next decade. In Table 8-8 we have listed the ERDA projections for solar energy development for the next several decades.<sup>56</sup> However it should be apparent from this table that even with a massive development effort, solar energy is capable of making only a modest contribution to our energy needs by the turn of the century. In fact, the projections of the contribution expected from solar energy by the year 2000 seem to be decreasing with each year of additional experience. Unfortunately, as we learn more about solar technology, we uncover new problems and are forced to revise earlier, more optimistic estimates. It should be clear that solar energy will certainly not solve our short term energy problems, and there is considerable doubt concerning which of the various solar energy approaches (if any) will eventually prove viable on even longer time scales.

Since solar energy is a diffuse, intermittent source, it requires extremely capital intensive systems in order to capture and convert this energy to useful form. Since these capital intensive systems must have operating lifetimes of 20-30 years in order to pay off their construction costs, it is apparent that their development represents both a significant technological as well as economic challenge. Furthermore, it is important to recognize that solar energy systems will never be "stand alone"

SO IF SOLAR  
AIN'T SO HOT,  
THEN WHAT IS  
LEFT?





Solar technology	1985	2000	2020
<b>Direct thermal applications (in units of 10<sup>15</sup> Btu = 1 Q per year)</b>			
Heating and cooling	0.15 Q	2.0 Q	15 Q
Agricultural applications	0.03	0.6	3
Industrial applications	0.02	0.4	2
<b>Total</b>	<b>0.2 Q</b>	<b>3 Q</b>	<b>20 Q</b>
<b>Solar electric capacity (in units of 10<sup>9</sup> watts = 1 Gwe)</b>			
Wind	1.0 Gwe	20 Gwe	60 Gwe
Photovoltaic	0.1	30	80
Solar thermal	0.05	20	70
Ocean thermal	0.1	10	40
<b>Total</b>	<b>1.3 Gwe</b>	<b>80 Gwe</b>	<b>250 Gwe</b>
Equivalent fuel energy	0.07 Q	5 Q	15 Q
Fuels from biomass	0.5 Q	3 Q	10 Q
Total solar energy	~1 Q	~10 Q	~45 Q
Projected U.S. energy demand	100 Q	150 Q	180 Q

Table 8-8: Estimates of the Heat, Electric Power, and Fuels to be Supplied by Solar Energy in the United States as projected by ERDA. (ERDA, National Solar Energy Research Development, and Demonstration Program, August, 1975)



systems because of the intermittent nature of the energy supply. There will always be a need for "back up" systems, be it fossil-fuel or nuclear, as well as storage devices which will significantly increase the capital costs of solar energy systems.

To be more specific, the prospects for the direct use of solar energy for heating water or space heating and cooling of buildings looks extremely attractive, even on a short term basis.<sup>37</sup> The long range prospects for the production of fuels from organic matter (utilizing photosynthesis of solar energy) also looks quite favorable. However, both the direct and indirect use of the sun for the generation of large quantities of electricity for electrical networks will almost certainly not present a viable alternative until well after the turn of the century. More specifically, the rather enormous costs of both solar thermal and photovoltaic electric power generation will limit the implementation of these systems to a level somewhat less than 10,000 to 20,000 MWe by the year 2000. The intermittent nature of windpower will limit its suitability to that of augmenting more conventional generation units during peak load periods. The problems of ocean thermal energy systems look formidable, and there will probably not be any significant penetration of this application until well after the year 2000.

In summary, then, we find ourselves in agreement with the conclusions of Pollard<sup>38</sup>:

"It is unfortunate that so many people continue to entertain such high hopes for satisfying all our needs for electricity through direct or indirect means of generating it from the sun. In remote locations, where cost is not a factor, a small amount may be produced with wind or solar cells and battery storage, and the potential for small, self-contained total energy systems for rural homes and farms is significant. But for any appreciable contribution to future national requirements for central-station electricity, neither direct nor indirect solar energy (other than hydroelectric) is really suitable. There is practically no chance of realizing such a contribution regardless of how vigorously it is promoted and funded Congress in response to public aspirations."

REMEMBER THE  
THIRD LAW...



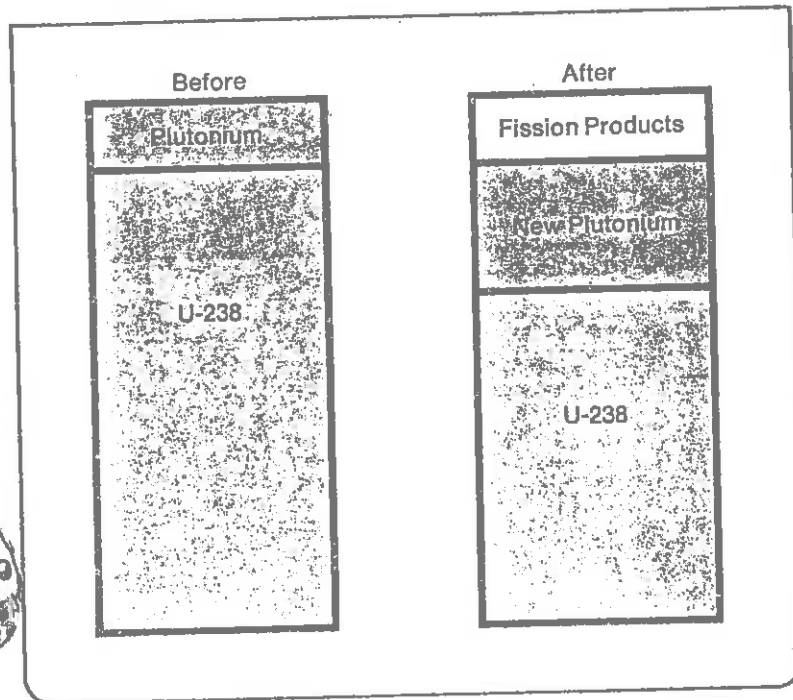
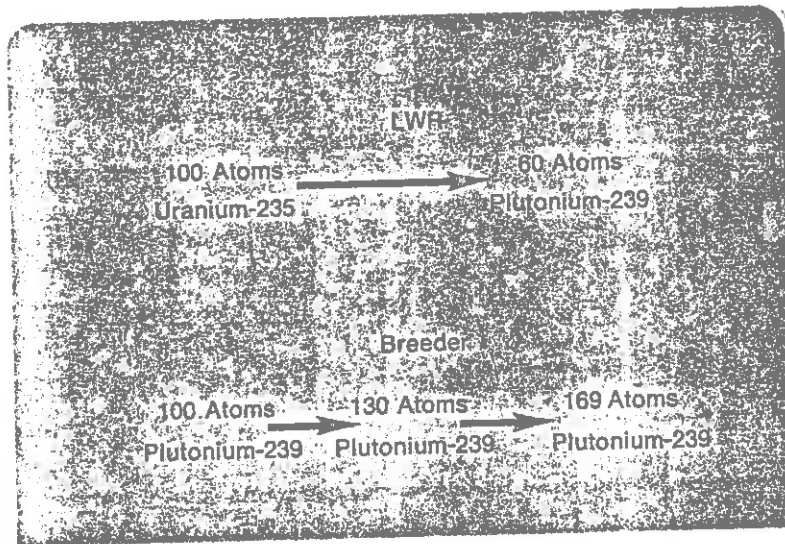
## 8.6. The Fast Breeder Reactor

The present generation of light water fission reactors can effectively utilize only about 1% of our uranium ore resources (corresponding essentially to the U-235 component of these resources). Hence the effective resource base available to this type of reactor is rather limited, being about the same magnitude as the U.S. resources of petroleum and natural gas. Although these reserves should prove sufficient to fuel several hundred of these power plants for their operating lifetimes, it should be apparent that the use of this type of nuclear reactor must be regarded as only an interim and relatively short range option.

Of course all reactors are partially fueled with fertile materials such as U-238 or Th-232, and during their operation they will transmute some of this material into fissile material such as plutonium via neutron capture. Hence there is strong incentive to design a power reactor in such a way as to maximize this conversion process. Unfortunately, there is a conflict in design objectives here since the conversion of fertile into fissile material is accomplished most efficiently using fast neutrons, while the chain reaction operates with a minimum fuel inventory (lowest critical mass) using thermal neutrons.

For this reason, the first generation of power reactors was designed to minimize fuel inventory requirements by using low mass number materials (water) to moderate or slow down the fission neutrons and therefore is relatively poor at converting fertile into fissile material. They are characterized by a conversion ratio, namely, a ratio of production of new fissile material to destruction of original fissile material, of only about 0.5-0.6. More advanced reactor designs have been proposed which achieve larger conversion ratios and therefore utilize fuel more efficiently. One such "advanced converter" reactor type is the high temperature gas cooled reactor which achieves a conversion ratio of 0.8 which results in a fuel requirement approximately half that of the light water reactor.

However the real long range goal is to design a reactor with a conversion ratio greater than one since this would result in more fuel



COME ON, RITZ. I'VE GOT THIS COUSIN WHO'S THE FASTEST BREEDER YOU'VE EVER SEEN!

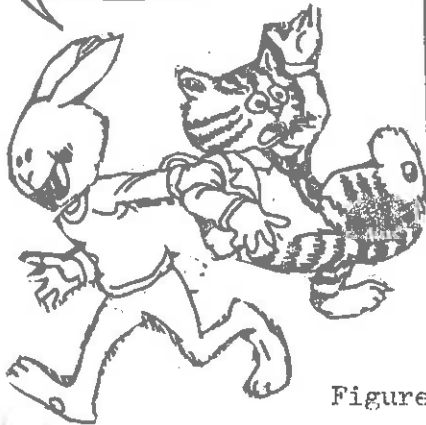


Figure 8-11: Breeding Fissile Fuel from Fertile Material

being produced by conversion during reactor operation than consumption by fission. Such a "breeder" reactor would be able to utilize as much as 70-80% of the available uranium reserves by converting U-238 into plutonium which could then be reprocessed into fuel for either the original or additional breeder reactors. The most common breeder reactor design uses fast neutrons to sustain the chain reaction and achieves a conversion (or breeding) ratio of 1.3 to 1.5. Either liquid sodium or helium are utilized as coolants.

The fuel resources available to the breeder reactor are enormous since these involve common fertile materials such as U-238 or Th-232. (In this sense, the fissile materials in the reactor such as plutonium which actually sustain the chain reaction can be regarded as essentially a "catalyst" in the transmutation process.) The reserves of high grade uranium and thorium ores are sufficient to supply a fast breeder reactor economy for thousands of years. In fact, we already have stockpiled over 200,000 tons of U-238 as the "waste" products of the uranium enrichment plants used in the light water reactor program. Furthermore, sufficient plutonium has been produced in light water reactors to provide the initial fuel charge for several breeder reactors.

The overwhelming motivation for developing and implementing breeder power reactors involves their ability to utilize our reserves of uranium and thorium almost 100 times more efficiently than the present generation of light water reactors. Since the resource base characterizing this latter reactor type will begin to become significantly depleted within the next several decades, there is some urgency to develop and deploy breeder reactors well before the turn of the century.

#### 8.6.1. BREEDER REACTOR DEVELOPMENT

Unlike many of the other energy alternatives we have discussed, the scientific feasibility, technical feasibility, and to some extent even the commercial viability of the fast breeder reactor has already been established. The fundamental concept of breeding was first demonstrated

in 1946 at Los Alamos in a small reactor experiment known as Clementine. A subsequent program developed the Experimental Breeder Reactor I (EBR-I) which was the first nuclear reactor to produce electricity in 1951. A number of follow-on prototype fast breeder reactors have been constructed both in this country and abroad, during the ensuing two decades (see Table 8-9 )

Of particular significance here has been the evolution of the breeder reactor development program from a series of small experimental facilities, to much larger prototype power reactors, and eventually to commercial demonstration plants. France, the United Kingdom, and the Soviet Union are presently operating such demonstration and have full-scale commercial breeder reactors either underconstruction or in the advanced design stage.

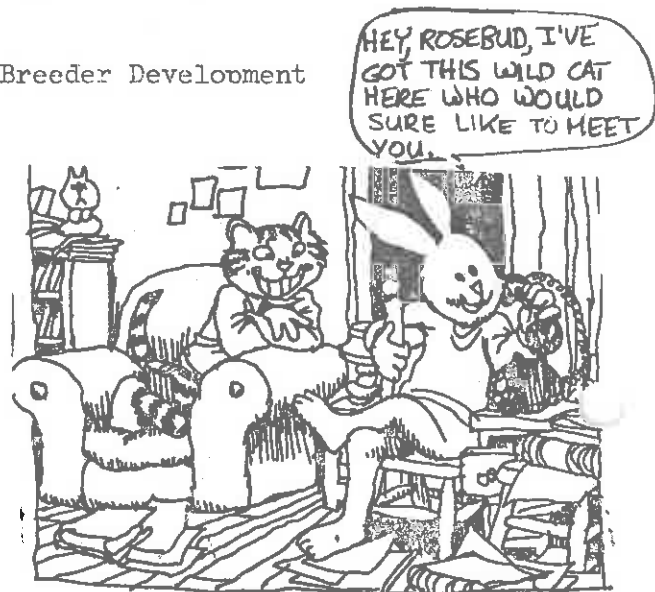
Although the United States was the early leader in breeder reactor development, the past decade has seen a significant erosion in this effort. If we measure the success of the breeder program in terms of the timetable to achieve demonstration breeder reactor, then the United States is presently some ten years behind the French, British, and the Russians since the U.S. demonstration plant, the Clinch River Breeder Reactor Project, is not expected to begin operation until 1983 (or later).<sup>57</sup> The reasons for this lag in breeder reactor development are complex and involve a host of factors including past technical decisions, political considerations related to licensing and funding of breeder reactors, the resolution of policy questions associated with the nuclear fuel cycle, and the willingness of the American public to proceed with the development of this energy alternative. The last factor is of particular importance since the breeder reactor program is currently projected to cost in excess of \$10 billion in public funds in contrast to the \$2 billion public investment in light water reactor development. The public must decide whether it is willing to support such a program, whether it is willing to accept the fast breeder reactor as a practical and beneficial energy alternative which merits further development.

**STATUS OF INTERNATIONAL DEVELOPMENT OF  
BREEDER REACTORS\*  
(AS OF JANUARY 1975)**

NATION	DEMONSTRATION PLANT			COMMERCIAL PLANT		
	YEAR	REACTOR	SIZE [MW(e)]	YEAR	REACTOR	SIZE [MW(e)]
U.S.A.	1970	Fermi	60	—	—	—
USSR	1972	BN-350	150	1976	BN-600	600
France	1973	Phenix	250	1980	Super Phenix	1200
U.K.	1974	PFR	250	1982	CFR	1300
F.R.G.	1980	SNR	300	~1988	SNR-2	2000
Japan	1981	Monju	300	~1989	—	—
U.S.A.	1983	Clinch River	380	~1992	—	~1500
U.S.A.	1986	GCFR	300	~1992	—	~1500

\*All except the GCFR (gas-cooled fast breeder reactor) are LMFBRs.

Table 8-9: Status of International Breeder Development



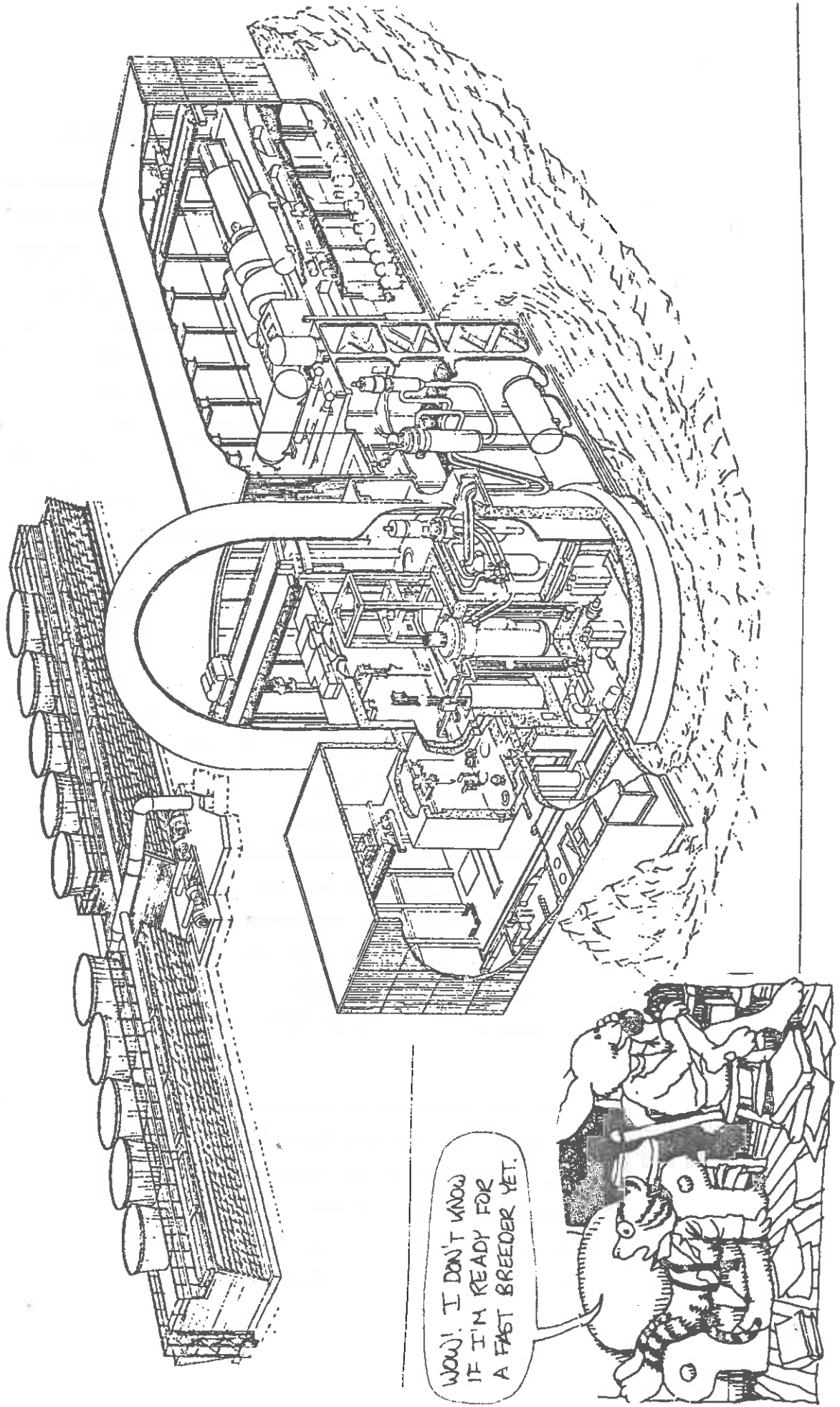


Figure 8-12: The Clinch River Breeder Reactor Demonstration Project

### 8.6.2. SAFETY AND ENVIRONMENTAL ASPECTS OF BREEDER REACTORS

One of the principal reasons for public reluctance to support the development of the fast breeder reactor involves the perception that such reactors are inherently more dangerous than light water reactors. The term "fast" conveys an impression that such reactors might be harder to control. (Actually, it is true that fast reactors exhibit a more rapid response to reactivity variations, but they can be designed with sufficiently strongly negative feedback mechanisms such as the Doppler effect that control problems do not arise.) Rather the primary concern revolves around the fact that the fuel in a fast breeder is not arranged in its most reactive configuration (to facilitate cooling and fuel handling), and therefore it is possible to conceive of an accident in which the fuel would move into a more reactive configuration, leading to a supercritical excursion and significant energy release.<sup>54</sup> That is, the significantly higher concentration of fissile material in a fast reactor leaves open the possibility of a nuclear explosion--a possibility which is clearly absent in light water reactor designs. Although the current feeling among nuclear reactor engineers is that it is physically impossible to achieve such a supercritical reassembly of fuel, it has not been possible to fully confirm this postulate.<sup>60</sup> Therefore a hypothetical core disruptive accident (HDCA) continues to dominate the subject of fast reactor safety. Fortunately, even if such a reassembly event were to occur, the energy release could easily be contained by the reactor pressure vessel (as verified by tests on scale models). Furthermore, fast reactor designs contain numerous protective systems which act to prevent such core disruptive accidents in the first place.

Other aspects of fast reactor safety are similar to considerations involved in water reactors. For example, although the loss of coolant accident is mitigated somewhat by the superior heat transfer characteristics of liquid sodium, it is nevertheless a concern in design. Operational difficulties in working with liquid metals (e.g., steam generator design) are of concern as well. Nevertheless, it is the opinion of the





nuclear community that there is no fundamental reason why fast breeder reactors will be any less safe than light water reactor designs (although it may be difficult to convince the public on this point).

The environmental impact of a breeder power plant will be quite similar to that of more conventional nuclear power plants. Indeed, since it will operate at somewhat higher temperatures and therefore greater thermodynamic efficiency, it will discharge less waste heat. The reduced fueling requirements of the breeder are also an environmental plus since they imply reduced mining and milling requirements. The breeder will produce an amount of radioactive waste comparable to that of light water reactors, although the higher fuel burnups will imply somewhat higher actinide concentrations.

Perhaps the major concern involves the fuel cycle of the breeder reactor which utilizes larger amount of plutonium as fuel (although we should keep in mind that towards the end of core life, even a light water reactor is burning as much plutonium as U-235). This will pose a problem from the viewpoint of the proliferation of strategic nuclear materials--a problem which is similar in nature but considerably more serious than that posed by light water reactors and plutonium recycle.<sup>61</sup>

## 8.7. Thermonuclear Fusion

Probably the most glamorous of our long range energy possibilities is controlled thermonuclear fusion. The proponents of fusion have claimed frequently that it will present a safe, clean, and abundant source of energy (sounds like the claim for solar power, doesn't it). They point out that there is sufficient deuterium (a possible fusion fuel) in the world's oceans to satisfy mankind's energy needs for hundreds of billions of years (many times the life of the universe). Furthermore one frequently hears the claim that nuclear fusion offers the best, and perhaps the only, long term solution to the complex set of energy related problems

that man will face in the future.<sup>61</sup> The infectious nature of this enthusiasm for fusion power has spread both to the public as well as to those involved in energy policy planning to the extent that one occasionally hears the suggestion that we halt our national effort to develop nuclear fission power (particularly the fast breeder reactor) and coal technology in favor of a significantly larger effort aimed at developing nuclear fusion power.<sup>63</sup>

It is extremely important that we recognize that nuclear fusion is not yet a scientifically feasible energy source--far less a technologically viable source--since the fundamental scientific experiments that will demonstrate that a controlled thermonuclear fusion reaction can generate more energy than it consumes during its production have yet to be performed. Nuclear fusion is in the unique position of being the only technology which has been identified as an energy option long before it has demonstrated that it can result in net energy production.<sup>64</sup>

Research activities concerned with peaceful applications of nuclear fusion were begun in parallel with the thermonuclear weapons program in this country as well as in the USSR and the UK in the early 1950s. This effort was declassified by international agreement in 1958, and since that time there has been extensive cooperation among the nations involved in fusion research. Although there was initially a very high degree of optimism<sup>65</sup> that a successful nuclear fusion reactor could be developed at an early date, as actual fusion experiments began to be performed, it became evident that the high temperature form of the fusion fuel was a considerably more mysterious substance than scientists had originally thought. The "plasma" fuel was extremely difficult to confine in any device aimed at generating fusion power. Although a significant amount of fusion research effort continued, prospects for an early solution dimmed during the early 1960s. The major event which turned these dismal prospects around was the successful development in the Soviet Union of a somewhat different approach to confining the plasma fuel known as the "tokamak", and the success of the experiments using this type of machine have given new impetus to the fusion research effort, both in the

Soviet Union and in this country as well (which began to frantically build tokamaks shortly after the Russian announcement). Since the 1960s, the United States fusion program has grown from a level of \$30 million per year to its present level of \$200 million per year and currently claims the attention of a rather large segment of the physics community.

The basic goals remain the same as they always have: to heat a small quantity of thermonuclear fuel to ignition temperatures (roughly  $100,000,000$  °K), then confine this fuel at this temperature long enough for the fusion energy release to exceed the energy required to heat the fuel to ignition, and finally to convert the fusion energy released into useful form as electricity. The mathematical statement of this goal is given in terms of the Lawson criterion<sup>66</sup> which simply amounts to balancing the fusion energy released by the reacting plasma fuel against the energy required to heat the fuel to thermonuclear temperatures:

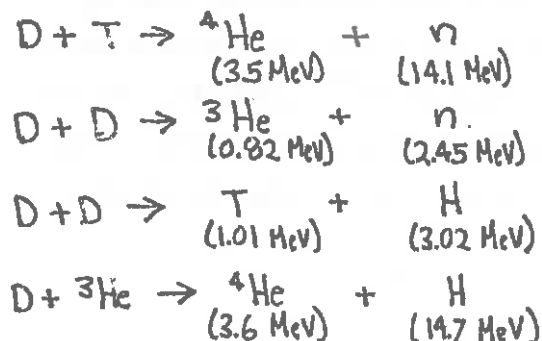
$$n_1 n_2 \langle v \sigma_f \rangle w_f \tau = 3 (n_1 + n_2) k_B T .$$

After some rearrangement, this relation yields a requirement on the product of the fuel number density  $n$  times the confinement time  $\tau$  which is necessary for the achievement of a "breakeven" condition between fusion energy released and energy invested:

$$n\tau > 12 (k_B T / \langle v \sigma_f \rangle w_f) .$$

The magnitude of the required  $n\tau$  product depends sensitively on the type of plasma fuel.

Although there are a great many possible fusion reactions which occur in nature or can be induced in a laboratory, the particular fusion reactions of most interest to controlled fusion applications are listed below, along with the amount of energy carried off by each reaction product:



THERE NOW,  
SURELY THESE  
EQUATIONS  
CAN'T BE  
THAT BAD.



As we noted earlier in Chapter 5, the D-T reaction is characterized by the largest fusion reaction cross section and therefore results in the most accessible Lawson criterion of  $n\tau > 10^{14}$ . This particular fuel cycle is complicated by the fact that the fusion fuel tritium is not naturally occurring and therefore must be produced artificially. In most fusion reaction designs, this is accomplished by surrounding the fusion reaction chamber with a lithium blanket in which tritium can be produced by fusion neutrons via the reactions



and



The D-D-He<sup>3</sup> cycle is more difficult to achieve, corresponding to  $n\tau > 10^{16}$ . However this cycle does not require tritium and therefore presents some advantages. Several other fusion fuel cycles have been proposed, but these generally involve heavier nuclei (such as the  $p + {}^{11}_5\text{B} \rightarrow 3 {}^4_2\text{He}$  reaction) which carry a larger electrical charge and therefore are characterized by significantly higher ignition temperatures (i.e., to give them sufficient kinetic energy to overcome electrostatic repulsion and fuse together). These more exotic fusion fuel cycles will almost certainly be far beyond the capability of most early generation reactor systems.

Fusion research efforts have concentrated on two classes of approaches to meeting the Lawson criterion and achieving thermonuclear fusion energy production. Most of the research activities over the past twenty years have sought to confine a very low density plasma fuel in a carefully shaped magnetic field. In such magnetic confinement systems, the goal would be to achieve a containment of up to 1 second of a plasma fuel with a density of  $10^{14}$  particles/cm<sup>3</sup>. This is in sharp contrast to a much more recent approach which attempts to compress a tiny pellet of thermonuclear fuel to enormous densities of  $10^{26}$  or larger (a thousand times solid state density) very rapidly so that appreciable thermonuclear energy is released before the dense, compressed pellet blows itself apart on times of the order of  $10^{-11}$  seconds. We will examine the basic concepts involved in both of these approaches in some detail below and discuss as well possible reactor designs based upon these approaches.

## 8.7.1. MAGNETIC CONFINEMENT APPROACHES

Basic Concepts of Magnetic Confinement

A high temperature plasma will exert an outward pressure which must be balanced by the magnetic field "pressure" that one is using to confine the burning plasma fuel. If we note that the plasma pressure is given by the ideal gas law

$$P_{\text{plasma}} = n k_B T$$

where  $n$  is the particle density of the fuel and  $T$  is its temperature, while the magnetic field pressure is given by

$$P_{\text{field}} = B^2 / 8\pi$$

where  $B$  is the magnetic field strength (in gauss), then we can define a confinement parameter for magnetic "bottles" in terms of the ratio of plasma pressure to field pressure:

$$\beta \equiv P_{\text{plasma}} / P_{\text{field}} = 8\pi n k_B T / B^2$$

To confine the plasma, we obviously require that  $\beta$  be less than one. In fact, as we will see in a moment, the most successful fusion devices to date have utilized a low-beta confinement scheme with beta as low as 0.01.

The plasma fuel density is limited by two principal factors. First, the pressure exerted by the high temperature plasma on the confining magnetic fields will cause forces on the coils which generate this field, as well as on their support structures. Even for a density as low as  $3 \times 10^{14}$  particles/cm<sup>3</sup> (which is one millionth of atmospheric density), at a temperature of  $10^8$  °K, the plasma will exert a pressure of some 10 atmospheres. Since most plasma devices utilize a value of beta significantly less than one, the forces exerted on the coils and their supports will be even higher than those due to the plasma pressure alone. The fuel density will therefore be limited primarily by engineering and technological limits of the material strength of these components.





A variety of different types and shapes of magnetic bottles have been proposed to confine thermonuclear plasmas. <sup>67-69</sup> These can be roughly classified as either "open" or "closed" field geometries. As we noted in Chapter 5, magnetic confinement of the plasma arises because charged particles tend to spiral about magnetic field lines and are constrained from moving across these lines. However in an open system, the field lines actually leave the system and hence particles moving along these lines could escape. To prevent this, one constricts the magnetic field lines by making the field stronger at the ends of the device which acts effectively as a "mirror" by reflecting particles back into the center of the device.

An alternative approach is to close the magnetic field lines by adopting a toroidal geometry--that is, a donut-shaped geometry in which the field lines close upon themselves. Unfortunately such simple confinement geometries are not sufficient to confine the plasma because the electric and magnetic fields exerted by the motion of the charged plasma particles act to push the plasma out of the magnetic bottle. As Post has put it, <sup>62</sup> the collective motion of plasma particles is somewhat akin to the unpredictable (and usually destructive) behavior of a mob compared with the more predictable behavior of a single individual. Therefore more sophisticated field geometries must be used for both closed and open magnetic confinement devices.

To overcome the intrinsic leaks from magnetic mirror devices, the original configuration of the simple magnetic bottle has been redesigned to achieve a "magnetic well" geometry in which the magnetic field seen by a charged particle is weakest at the center of the device and strengthens as particles move outward towards the edge. Such configurations are known as "minimum-B" geometries and result in a magnetic field coil geometry which is similar to that of the seams on a baseball (or the Chinese symbol Yin-Yang)--hence the name used for the "baseball" or "Yin-Yang" field geometries of present day magnetic mirror devices which are illustrated in Figure 8-13. Such mirror devices operate in a steady-state mode in which continuous energy input must be required to



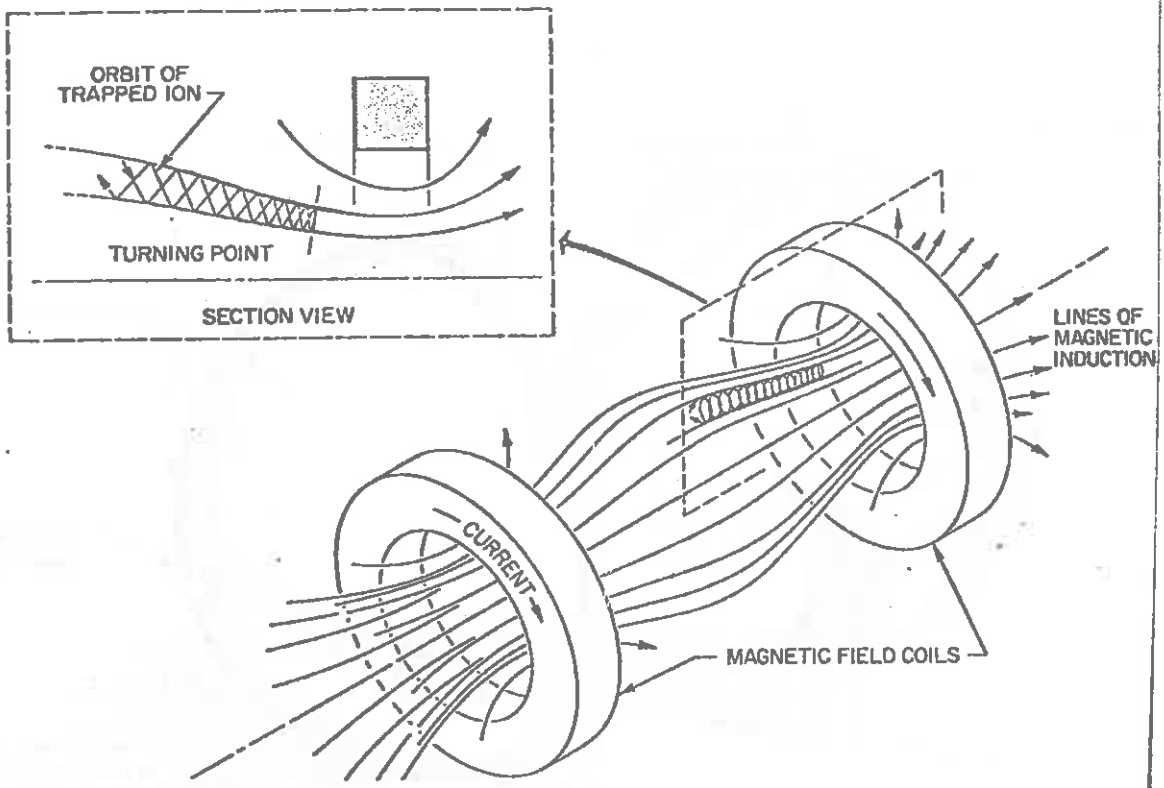
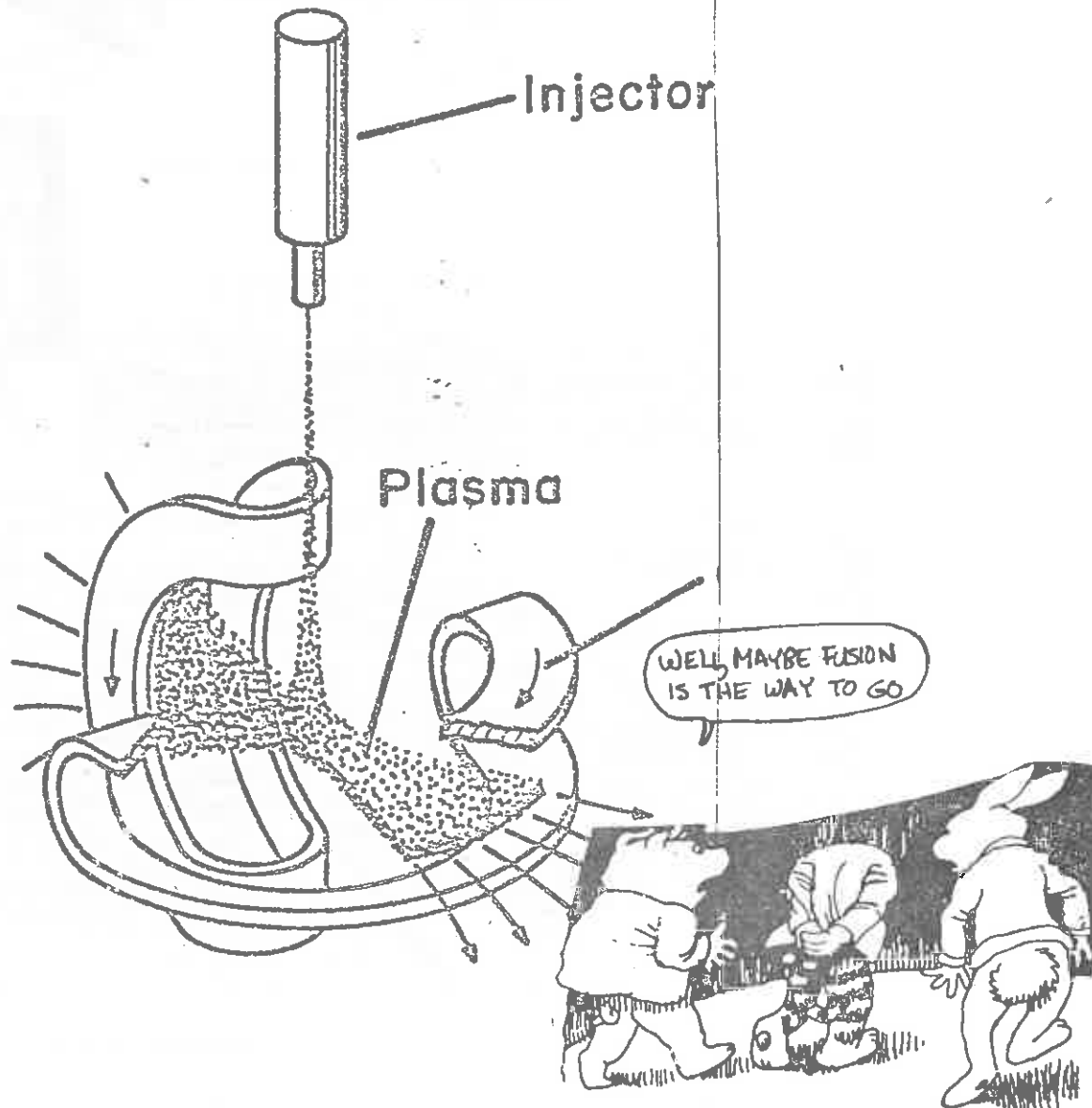
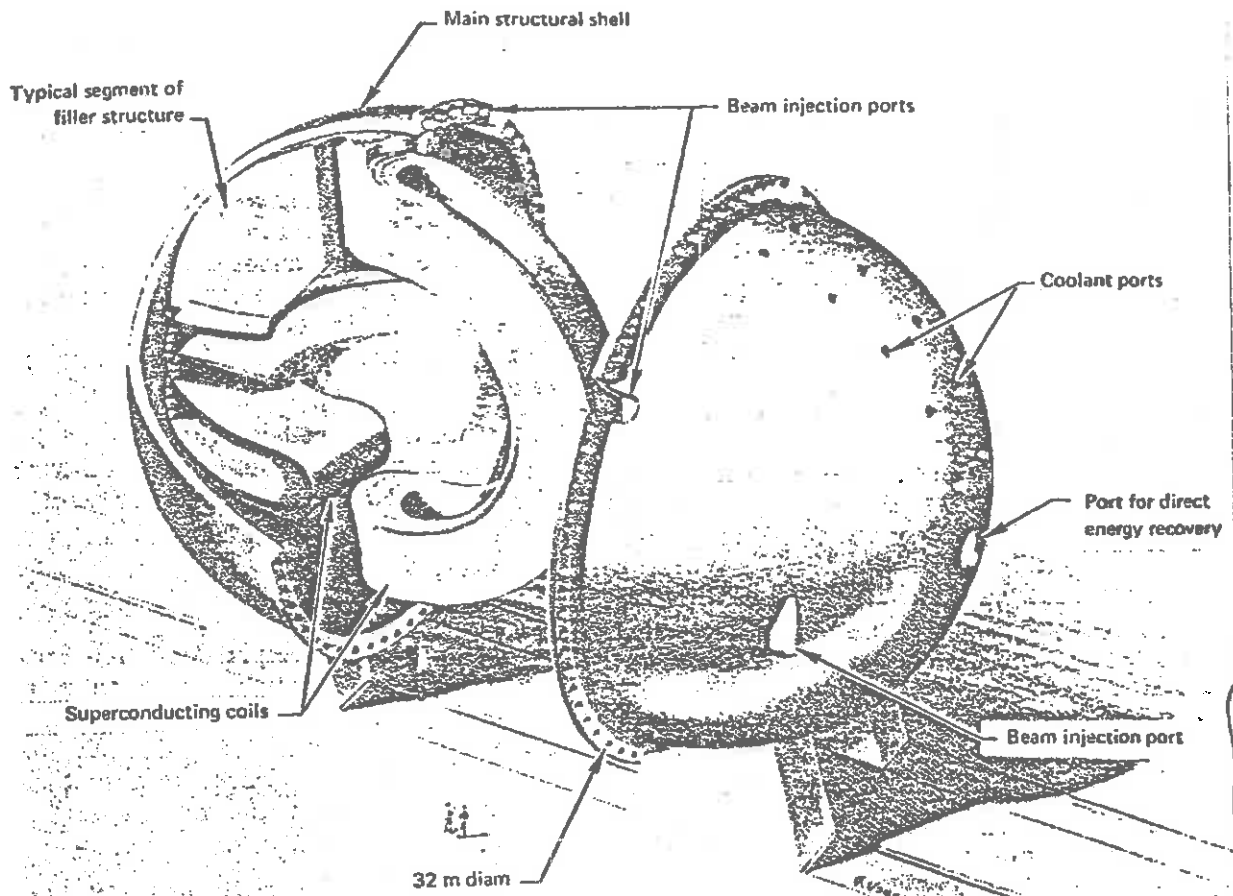


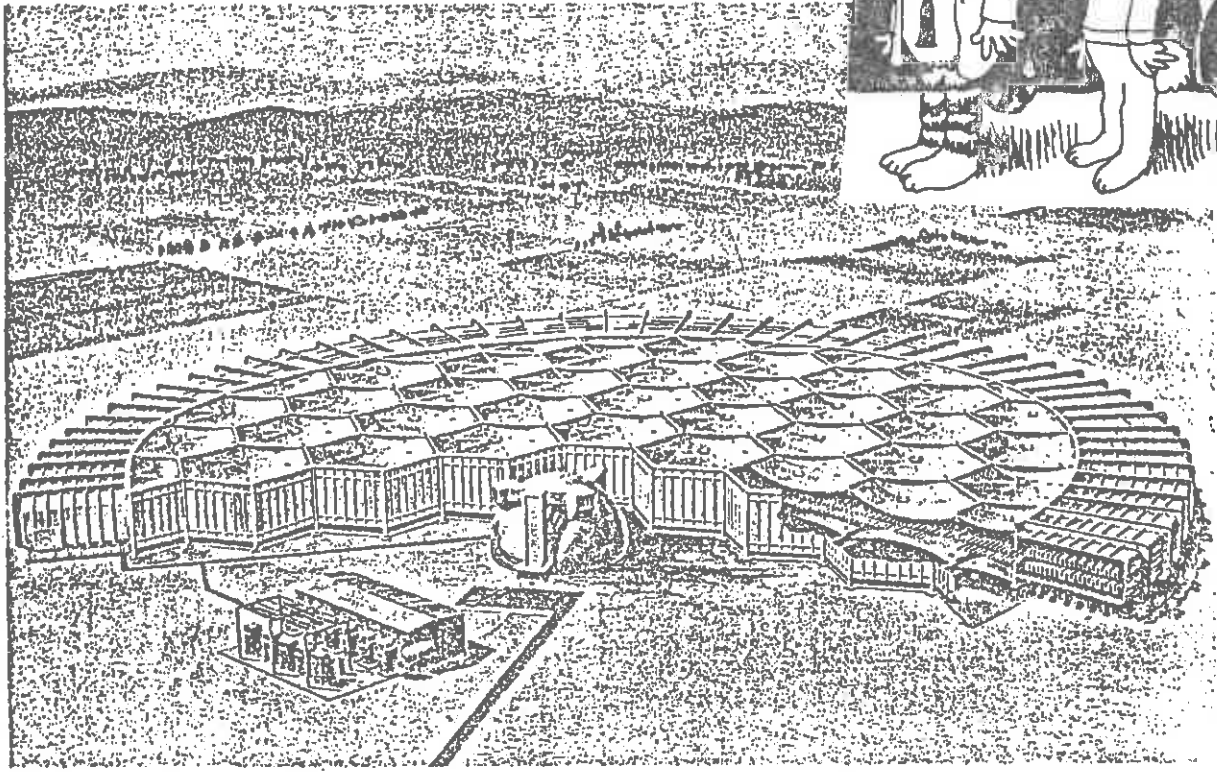
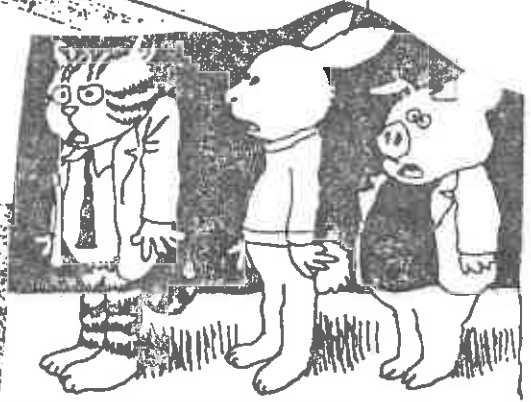
Figure 8-13: Magnetic Mirror Field Geometries





DOPS! I DIDN'T KNOW IT WOULD BE THIS COMPLICATED!

The mirror reactor model.



A fusion reactor with an attached direct conversion facility.

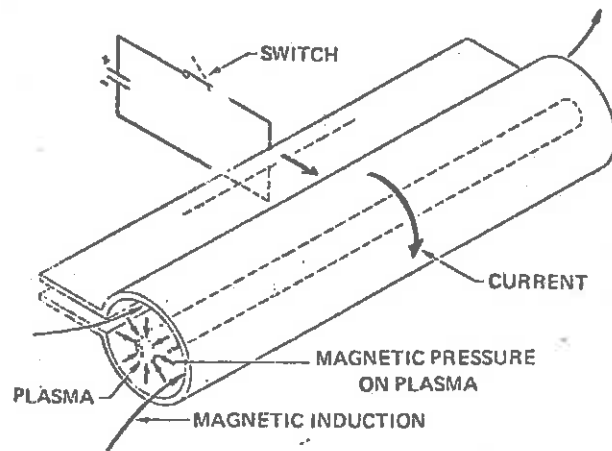
Figure 8-14: Reactor Concepts Based on Mirror Geometries (R. F. Post, ...)

sustain a thermonuclear reaction. This could be accomplished by injecting into the device an energetic beam of neutral particles which then ionize as they interact with the plasma fuel. The combustion products of the fusion reaction must then be continuously removed. Since a significant amount of the power leaving a mirror device is in the form of energetic charged particles (these devices are viewed as operating on a D-D- $^3\text{He}$  fuel cycle), most reactor designs based on this concept employ a direct energy conversion cycle which extracts energy from the escaping charged particles by slowing them down in an electrostatic field.

A much different approach utilizes a pulsed magnetic field for both heating and confining the plasma. In the most common of these schemes, the  $\theta$ -pinch, an axial magnetic field is induced in the device by discharging a current through a conductor wrapped around the plasma (see Figure 8-15). This field constricts or "pinches" the plasma, compressing it to higher densities and thermonuclear temperatures. Although a significant amount of work has been performed on such pinch devices, including the large toroidal Syllac pinch machine at Los Alamos, this particular geometry is still plagued by plasma instabilities which cause the plasma to rapidly leak out of the field.

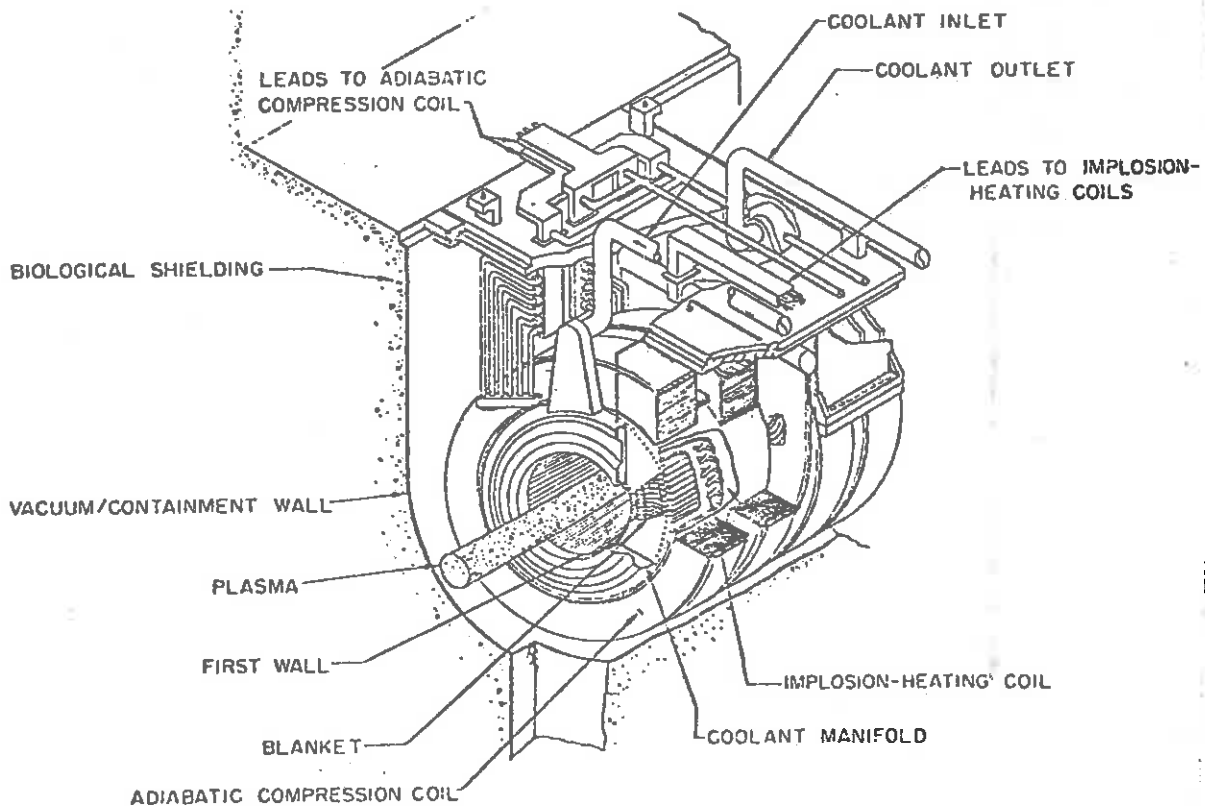
The most successful magnetic confinement approach utilizes a toroidal geometry in which additional coils are wrapped around the toroid to induce a current in the plasma which produces a shear in the magnetic field lines. This results in an average "minimum-B" effect which leads to increased confinement times. This particular approach was developed by the Russians who named the device Tokamak (To = toroidal, ka = chamber, and mak = magnetic). Since the successful Soviet experiments with this approach during the late 1960s, a large number of these devices have been built around the world (see Table 8-10), and significant progress towards achieving required confinement times have been achieved.

As presently envisioned, a Tokamak reactor would operate in a quasi-steady-state mode in which fueling would be accomplished by injecting



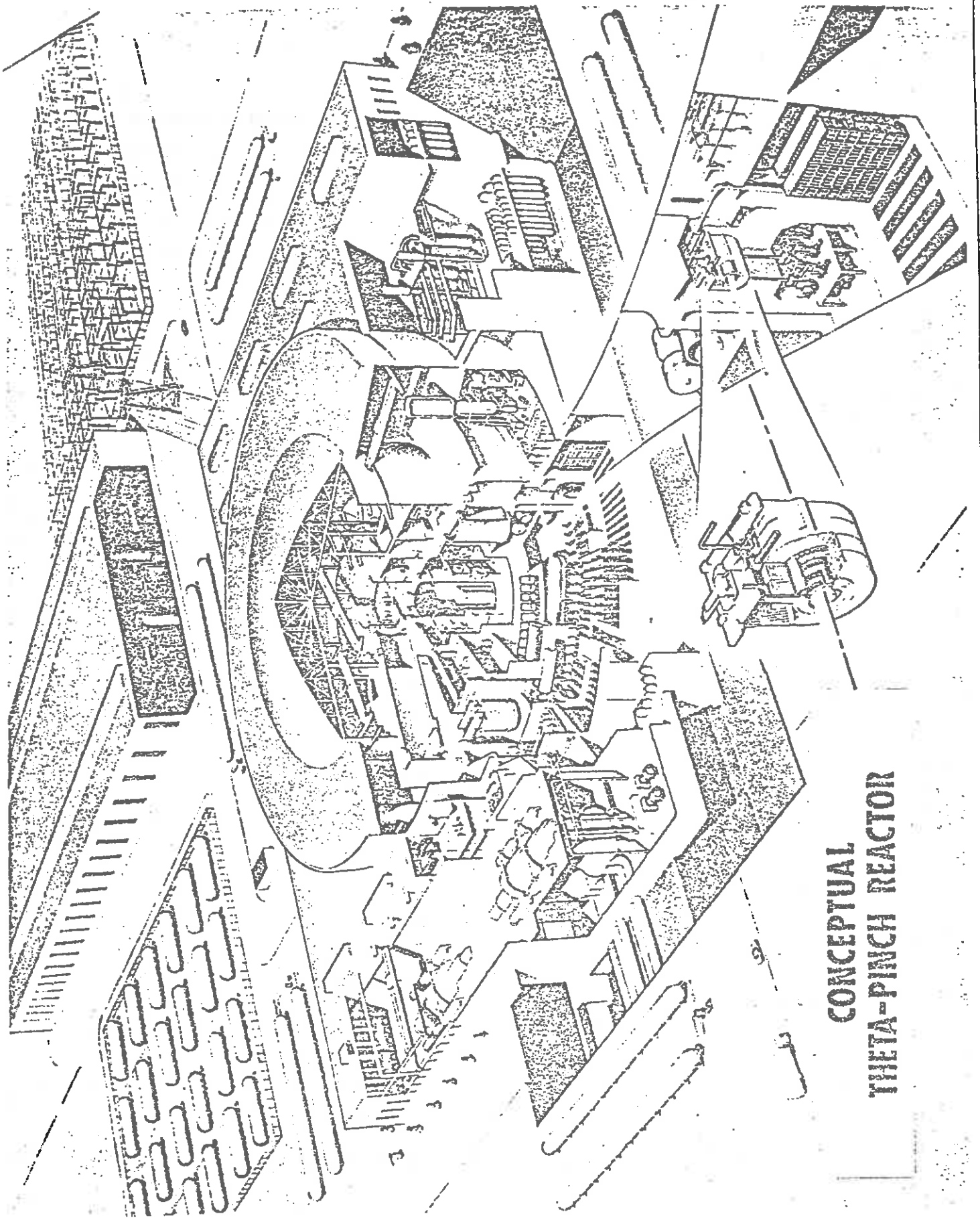
Principles of the theta-pinch confinement scheme.

Figure 8-15:  $\theta$ -Pinch Geometries (D. Steiner, Nuc. Sci. & Eng. 58, 107, 1975)



The reference theta-pinch reactor (RTPR): cutaway view of a 2-m-long RTPR module.

Figure 8-16:  $\Theta$ -Pinch Reactor Design (F. L. Ribe, Recent Developments in the Design of Conceptual Fusion Reactors, LA-UR-76-2165, 1976)







solid D-T pellets into the plasma, and spent fuel would be removed by guiding charged particles out of the plasma chamber along diverted magnetic field lines generated by special coils ("divertors"). The Tokamak approach does suffer from one very major disadvantage, however. Unlike the mirror or  $\theta$ -pinch devices, which are relatively high-beta machines, the tokamak design must operate with a low-beta field (as low as  $\beta = 0.01$  to  $0.1$ ). This is very significant since the fusion power density in the reacting plasma fuel scales as  $\beta^2$ . Therefore reactors based on the tokamak approach will of necessity be extremely large to achieve the required power output with a very low power density.

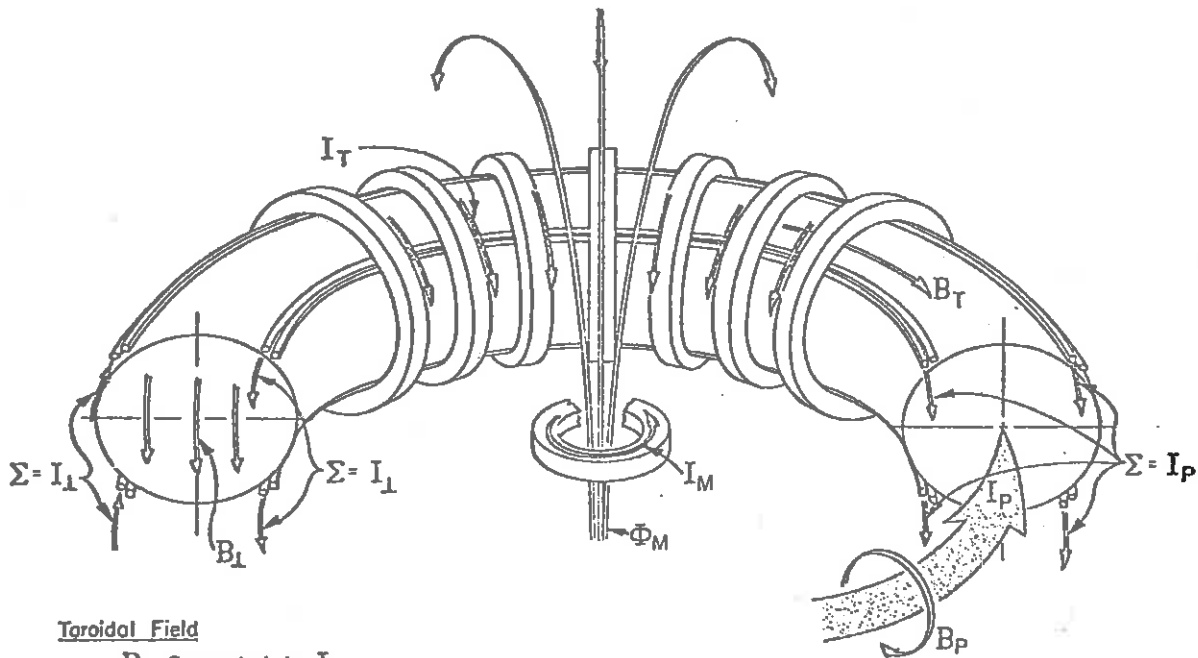
It should be noted that all of these magnetic confinement designs continue to be plagued with complicated plasma instabilities which lead to confinement times significantly shorter than those required by the Lawson criterion. It is hoped that as the basic physics of these loss mechanisms is more adequately understood, modifications can be made in the design which will increase the confinement time significantly. However it is important to recognize that there is still an enormous amount of basic scientific research required on the confinement of very high temperature plasmas in magnetic fields before a "breakeven" experiment can be performed to demonstrate the scientific feasibility of thermonuclear fusion power.

#### Fusion Reactor Concepts

Although there is still a great deal of uncertainty about the specific design of a fusion power reactor, one thing is certain: It will be enormous in size and extremely expensive. For as we have seen, the most successful plasma containment geometry, the Tokamak, is plagued by low values of beta and hence by low power densities which implies large plasma volumes. Furthermore such systems will involve an extremely complex and novel technology, even compared to present day fission reactors.

To indicate this more clearly, let us run through quickly one of





Toroidal Field

$B_T$  Generated by  $I_T$

Poloidal Field

$B_P$  Generated by plasma current  $I_P = \text{sum of external currents}$

Transverse Field

$B_1$  Generated by external current  $I_1$

Magnetizing Flux

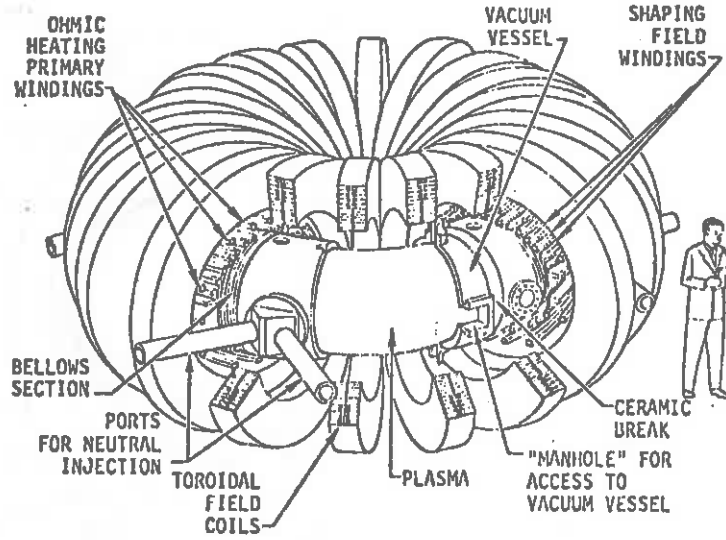
$\Phi_M$  Generated by the magnetizing current  $I_M$

Figure 8-16: Principles of the Tokamak confinement scheme.  
(D. Steiner, Nuc. Sci. Eng. 58, 107 (1975))



the preliminary conceptual designs<sup>71</sup> of a fusion power reactor based on the tokamak concept which is illustrated in Figure 8-17. The torus itself in this particular design is some 44 m in diameter containing a plasma several meters in thickness. The tokamak reactor is contained in a 2 m thick primary containment shield some 40 m high and 55 m in diameter. This is housed in a circular building some 120 m in diameter and 100 m in height with an adjoining structure containing turbine-generators and such (truly a massive facility, even compared to a modern nuclear power plant). Such a reactor is designed to produce a thermal power of 5,000 MWt corresponding to an electrical output of 1,500 MWe. The reactor torus is surrounded by a complicated blanket of stainless steel cells containing liquid lithium which is designed to both capture the energy of the 14 MeV neutrons produced in the fusion reaction as well as to use these neutrons to produce tritium which can then be separated out and later reinjected into the plasma fuel.

This particular design utilizes a semi-steady-state burn cycle which begins when a large transformer produces an electrical discharge in the gas (D-T) contained in the torus to produce a plasma and build up toroidal current. A number of large neutral beam injection guns are then fired into the plasma (injecting both high energy deuterium and tritium). These beams not only serve to inject fuel into the plasma, but more significantly they raise the plasma fuel temperature to the thermonuclear ignition point. As the thermonuclear fusion reaction begins, the alpha particles released in the D-T reactions heat the plasma fuel still further until it reaches the designed operating level (5,000 MWt) where the reactor will continue to operate for some 90 minutes. During this period the reactor is continually refueled by injecting small pellets of deuterium and tritium ice into the plasma. The burn cycle time is limited by the ability of the transformer to sustain the toroidal plasma current, as well as the buildup of impurities in the plasma fuel. At the end of the burn cycle, impurities are injected into the plasma to shut off the fusion reaction. The induced currents and magnetic fields



(The Princeton large-torus PLT.)

RADIUS (cm)	NAME	FIELD (kG)	CURRENT (kA)	YEAR
150	T-10	50	1070	'75
130	PLT	45	1400	'75
112	DITE	30	280	'74
109	ST	50	180	'70
100	T-4	50	290	'70
98	TFR	60	490	'73
90	JFT-2	10	180	'72
90	CLEO	20	150	'72
82	FRASCATI	100	1170	'75
80	ORMAK	25	340	'71
72	PETULA	15	105	'74
70	T-6	15	270	'71
70	PULSATOR	28	95	'73
60	TTT	35	90	'72
60	TO-1	20	95	'72
59	DOUBLET II	10	320	'72
54	ALCATOR	120	640	'73
40	TM-3	25	80	'63
36	10.7-17 ATC	20-50	130-315	'72

○ OPERATING  
 ⊙ IN DESIGN OR CONSTRUCTION

Table 3-10: A comparison of tokamak parameters throughout the world. (R.F. Post, Ann. Rev. Energy 1, 213 (1974))



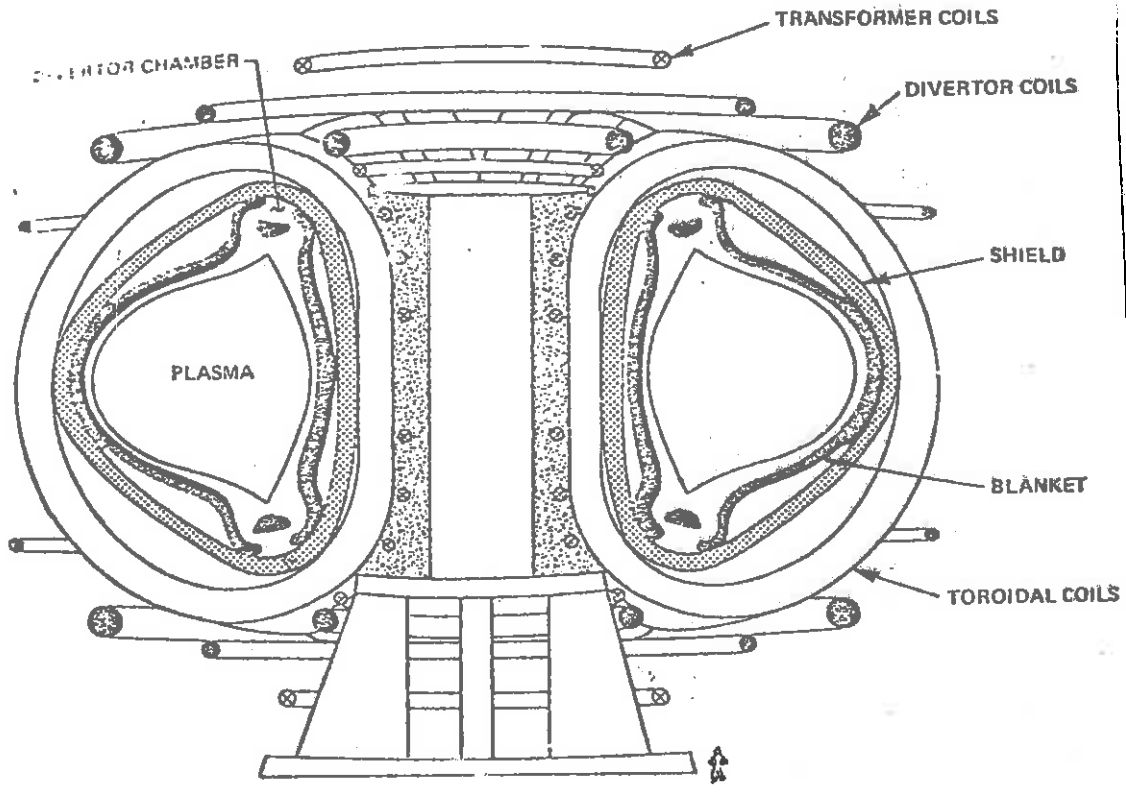
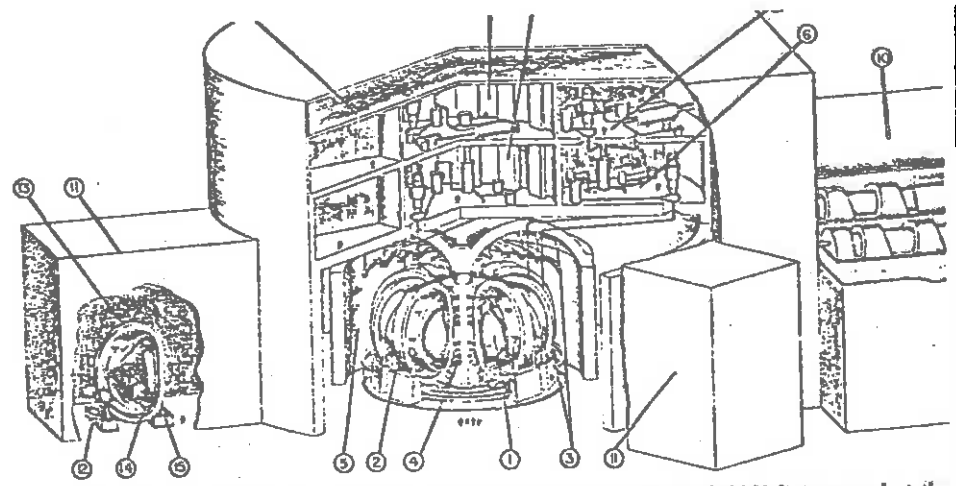


Figure 8-17: The Tokamak reactor model, cross-section view.

(B. Badger et al., Wisconsin Tokamak Reactor Design, U. of Wisconsin Report UWFDM-68) 1974



Conceptual design of a 1483-Mw tokamak fusion reactor (UWMAK-1) prepared at the University of Wisconsin. The toroidal reactor is made of 12 massive components, one seen in the repair area at left. The various components of the reactor are the plasma (1), the toroidal field coils (2), the divertor coils (3), and the transformer coil (4). Other plant components are the primary containment building (5), the liquid lithium and liquid sodium secondary systems (6 and 7), the turbogenerator building (10), and repair hot cells (11). The reactor torus is 27 m tall, and four human figures are reduced to dots in front of it.

MY GOD! I JUST DON'T BELIEVE IT...



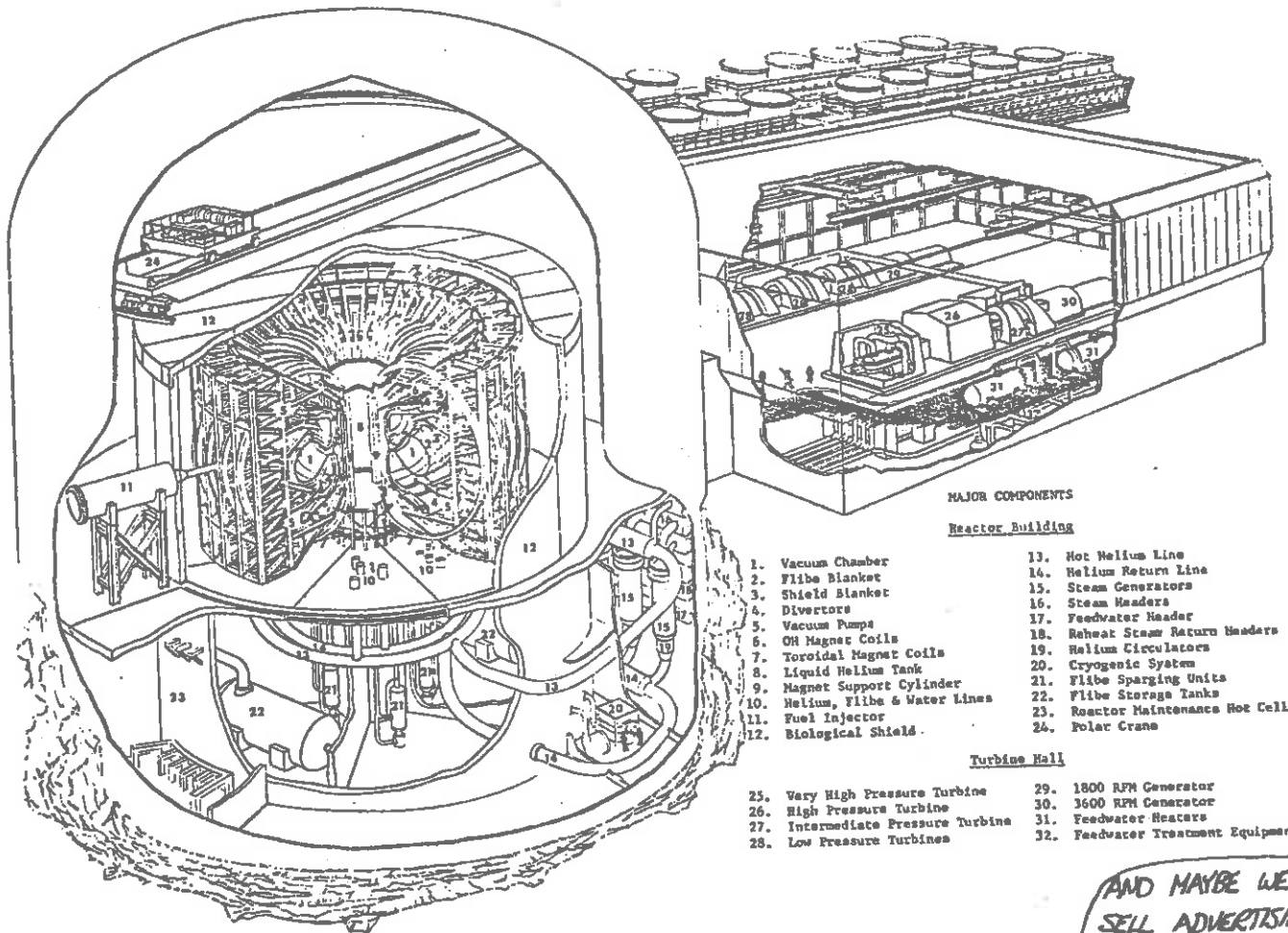


Figure 8-18: Tokamak Fusion Reactor Design (R. G. Wills, Princeton Plasma Physics Laboratory Report MAST-1050, 1975)

BUT FRITZ, WE CAN USE ALL OF THE FISSION REACTOR TECHNOLOGY!



AND MAYBE WE CAN SELL ADVERTISING SPACE ON THE CONTAINMENT BUILDING WALLS...

are reduced, and the reactor chamber is pumped empty of all gases and then refilled with fresh D-T gas to ready it for the next cycle.

The neutron energy deposition in the lithium blanket acts as a volumetric heat source which is withdrawn by a secondary coolant such as sodium or helium and used as the heat source for a steam thermal cycle to generate electrical power. It should be noted that some 20% of this electrical power is used to provide magnetic fields for confinement, the toroidal current, and to drive the neutron beam injection. Therefore there is a rather considerable amount of energy circulation within a nuclear fusion reactor plant.

The successful design of such a fusion reactor will require the solution of a number of rather imposing technical problems. Perhaps the most severe problem involves the extensive radiation damage done to the wall of the reactor chamber (the "first wall" problem) as well as to structural material.<sup>72</sup> Indeed, the neutron flux generated by a controlled fusion reactor will be some 10 times larger than even that of a fast breeder reactor. To put this in perspective, over the 30 year operating lifetime of the plant, every single atom in the first wall would be displaced over 500 times by fast neutron collisions. To design a wall material which can withstand such damage is no easy task. It will no doubt be necessary to periodically replace the wall liner as well as a significant amount of the blanket structural material perhaps as frequently as every two years. For this reason, most present conceptual designs break up the torus into a number of pie-shaped modules, each of which can be removed and replaced when necessary. As we will note later, the extremely high neutron flux levels induce a substantial amount of radioactivity in materials adjacent to the reactor chamber. Therefore such maintenance operations will be difficult and will require remote handling techniques. A variety of other materials problems including the thermal stress resulting from the frequent temperature pulses experienced by the reactor will make this design even more difficult.

A fusion reactor does exhibit an intrinsic safety advantage over

fission systems in that there can be no uncontrolled runaway of the fusion reaction since it can only burn that amount of fuel which is in the reacting chamber at one time (less than 1 gm). Nevertheless there will be a considerable hazard from the radioactive inventory contained in the plant. First of all, we must recognize that whenever there are nuclear reactions, the radiation which results from these reactions can induce radioactivity in adjacent materials. In this particular case, the enormous neutron flux generated by the D-T fusion reaction will cause a substantial activation of first wall and structural materials and will create a radioactive inventory which will range between  $10^9$  and  $10^{10}$  curies for a 1,000 MWe plant (see Table 8-11).<sup>73</sup> Furthermore this radioactivity will lead to a decay heat removal problem which is qualitatively similar to that experienced by fission reactors and will require emergency cooling capability similar to the ECCS on large nuclear power plants. (Although it should be stressed that the decay heat problem is nowhere nearly as serious for a fusion system as it is for a fission system since there is not the danger of a core meltdown in the fusion reactor.)

The activated structural materials in a fusion reactor will also give rise to a radioactive waste problem, since the half-life of this radioactivity is usually several decades, and therefore activated structural material will retain its toxicity for at least a century. Furthermore, a fusion power plant will produce some 10 times more volume of radioactive waste than that produced by a comparable fission plant. However in terms of radioactive hazard (that is, activity), this will still be at least an order of magnitude below that produced by fission reactors.

Perhaps the most serious hazard associated with fusion reactors involves the substantial inventory of radioactive tritium which these reactors will contain. Although the tritium inventory in the reacting plasma itself will be less than 1 gm, the total tritium inventory in the plant, including both the lithium blanket and the tritium recovery system, will be as high as 50 kg corresponding to some  $10^9$









DON'T WORRY, FRANK. I'LL  
 CALCULATE  
 IF IT IS  
 SAFE OR  
 NOT!!



Table 8-11

Radioactive Inventories of Fission and Fusion Reactors  
 Megacuries per GWe (2.5 GWe) versus time after shutdown

	<u>LMFBR</u> <u>Fission</u>	<u>316SS</u> <u>Fusion</u>	<u>V-Ti</u> <u>Fusion</u>
<u>at shutdown</u>			
fission products/tritium	11,200	250	250
structural activation	100	2700	3100
coolant activation <sup>a</sup>	110	<75 <sup>b</sup>	<75 <sup>b</sup>
actinides	4000	--	--
<u>10<sup>4</sup> sec (2.77 h) after shutdown</u>			
fission products/tritium	5,200	250	250
structural activation	83	1500	150
coolant activation	96	<60 <sup>b</sup>	<60 <sup>b</sup>
actinides	1800	--	--
<u>1 day after shutdown</u>			
fission products/tritium	2,900	250	250
structural activation	70	1200	130
coolant activation	37	<50 <sup>b</sup>	<50 <sup>b</sup>
actinides	1400	--	--
<u>30 days after shutdown</u>			
fission products/tritium	920	250	250
structural activation	53	800	11
coolant activation	1	<40 <sup>b</sup>	<40 <sup>b</sup>
actinides	70	--	--

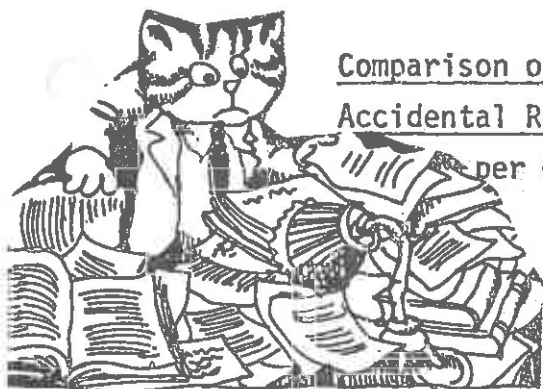
<sup>a</sup>Assumes pool-type LMFBR and liquid Li coolant in CTR. Loop-type LMFBR has 4-fold smaller coolant activation. Helium cooled CTR has negligible coolant activation 1 sec after shutdown.

<sup>b</sup>Detailed calculations for fusion coolant activation not complete.

GUESS I'D BETTER CHECK HEINTZ'S CALCULATIONS,

Table 8-12

Comparison of Biological Hazard Potentials with Reference to Accidental Releases to Air. Million cubic kilometers of air per GWe (2.5 GWt) versus time after shutdown.



	LMFBR <u>Fission</u>	316SS <u>Fusion</u>	V-Ti <u>Fusion</u>
<u>at shutdown</u>			
FP/tritium	>2900 <sup>a</sup>	1.25	1.25
structural activation	55	390	68
coolant activation	26	NA	NA
actinides	13,500	--	--
<u>10<sup>4</sup> sec (2.77 h) after shutdown</u>			
FP/tritium	2700	1.25	1.25
structural activation	55	360	45
coolant activation	24	NA	NA
actinides	13,400	--	--
<u>1 day after shutdown</u>			
FP/tritium	2300	1.25	1.25
structural activation	54	320	38
coolant activation	12	NA	NA
actinides	13,300	--	--
<u>30 days after shutdown</u>			
FP/tritium	1100	1.25	1.25
structural activation	47	200	15
coolant activation	5	NA	NA
actinides	13,200	--	--

NA = not available

<sup>a</sup>35 isotopes (omits much short half-life activity)

Table 8-13

Stored Energy in a 1 GWe Tokamak Fusion Reactor  
(1 significant figure)

<u>Energy Form</u>	<u>Gigajoules</u>
Chemical energy in liquid lithium	60,000
Magnetic field energy	300
Complete fusion of fuel in plasma	70
Pressure-volume work in vacuum	20
Kinetic energy in plasma	≤ 1

YOU KNOW, IT LOOKS LIKE A FUSION REACTOR MAY BE SAFER -- IF HEINTZ'S CALCULATIONS ARE RIGHT

Biological Hazard Potentials of Long-Lived Wastes  
with Reference to Releases to Water. Cubic kilometers of water per GWe-yr versus time after shutdown.



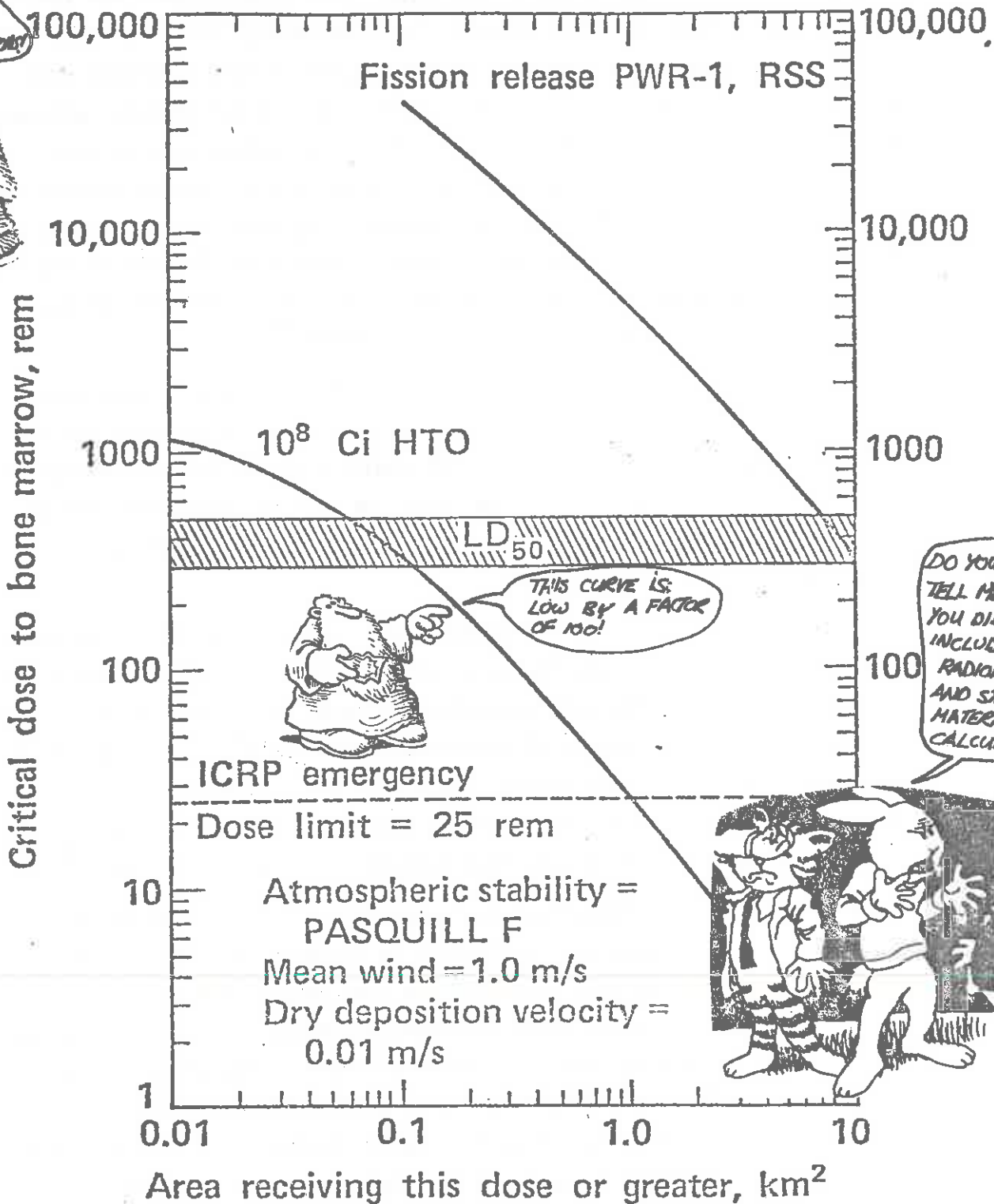
	<u>Fusion 316SS activation</u>	<u>LMFBR fission products</u>	<u>LMFBR actinides<sup>a</sup></u>
1 year	1400	10,000	100
10 years	49	3600.	28
30 years	9.0	2100.	24
100 years	2.7	330.	20
1000 years	1.1	0.020	4.7
10000 years	0.9	0.018	0.52

(J.P. Holdren, Trans. Am. Nucl. Soc., 24, 32 (1976))

Figure 8-19

# CRITICAL DOSE TO BONE MARROW VS AREA FOR HYPOTHETICAL FISSION AND FUSION ACCIDENTS

I THINK THAT SOMETHING HAS BEEN LEFT OUT OF THESE CALCULATIONS!



THIS CURVE IS LOW BY A FACTOR OF 100!

DO YOU MEAN TO TELL ME THAT YOU DIDN'T INCLUDE THE RADIOACTIVE WALL AND STRUCTURAL MATERIALS IN THIS CALCULATION?!!



curies of activity (see Table 8-11).<sup>69,73,74</sup> The escape of even a part of this inventory from the plant would constitute a major radiological hazard and, no doubt, safe operation of the plant will require that the routine release of tritium from the plant be kept extremely low. But that will be quite difficult since tritium diffuses quite readily through most metals at high temperatures and therefore can diffuse through containment walls or fluid piping into the surrounding atmosphere or into the coolant and steam supply systems. To achieve a tritium release rate from fusion power plants which is comparable to that of present day fission reactors will necessitate a very significant advance in tritium handling techniques which must achieve a tritium containment in the blanket and fluid piping in excess of 99.9999%.<sup>69</sup>

Hence such fusion reactor designs not only involve a remarkable increase in scale and complexity over present fission reactor systems, but also require a rather significant development of new technology if the problems posed by radioactive materials control, radiation damage, and effective plant maintenance in high radiation environments are to be solved.

It has become apparent over the past 20 years that the successful development of controlled fusion power (if it occurs) will stand as one of the major scientific and technological accomplishments of our civilization. The difficulties of achieving practicable fusion power cannot be understated. For this reason there has been recent interest in combining nuclear fusion with conventional fission reactor technology in order to reduce the design requirements of a fusion system.<sup>75,76</sup>

One of the distinguishing characteristics of fusion reactors is that they will be "neutron rich"--that is to say, they will produce roughly four times as many neutrons per unit energy output as a fission reactor. Hence there has been considerable thought given to using the fusion reaction not so much as a power source but rather as a high intensity neutron source which can then drive a blanket (subcritical) of fissile material surrounding the fusion reactor. In this way, the fusion energy production can be multiplied several-fold by the fission

energy induced by fusion neutrons. Furthermore, these fast neutrons can be used to breed new fissile material from fertile material, so we might visualize a fusion system as providing a neutron source to produce fuel for conventional fission reactors. Such hybrid fission-fusion systems certainly relax somewhat the requirements on achieving a breakeven fusion reaction (i.e., the Lawson criterion). However they also may combine the bad points of both fission and fusion systems (e.g., high inventories of radioactive materials, plutonium, the complexity of achieving a sustained thermonuclear fusion reaction, high tritium inventory, and so on).

#### 8.7.2 INERTIAL CONFINEMENT (LASER FUSION)

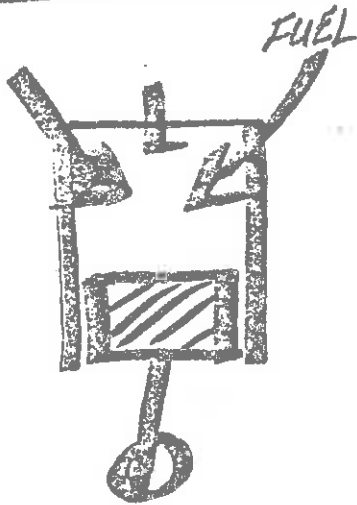
An alternative approach to achieving controlled thermonuclear fusion involves heating a tiny pellet of fuel (for example, a frozen droplet of deuterium and tritium) to thermonuclear temperatures so rapidly that it ignites and burns (via thermonuclear reactions), releasing appreciable energy before it can blow itself apart. In this scheme, the only confinement of the burning plasma fuel is provided by its own inertia. Here the premium is placed on the very rapid heating of the pellet which is provided by high intensity laser beams (or electron or ion beams).

Inertial confinement can be regarded as essentially the "internal combustion engine" approach to fusion<sup>77</sup> (and, in the same sense, most proponents of this approach regard magnetic confinement much as a Detroit automobile engineer regards the Stanley Steamer). To make the analogy more precise, recall that the internal combustion engine of your car is based on a 4 stage combustion cycle (see Figure 8-20):

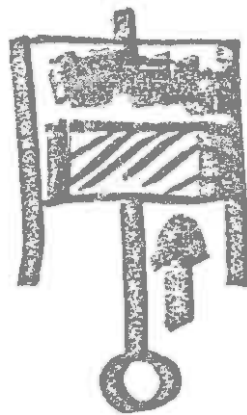
- (i) injection of fuel (gas and air) into the cylinder
- (ii) compression of the fuel mixture by a piston
- (iii) ignition of the compressed fuel by a spark plug
- (iv) combustion of the fuel mixture causing a small explosion which drives the piston and hence the crankshaft (conversion of chemical energy into mechanical energy).

# DETROIT

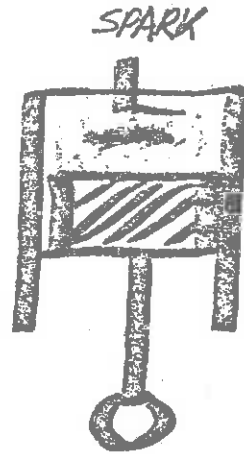
Figure 8-20: Internal Combustion Engines



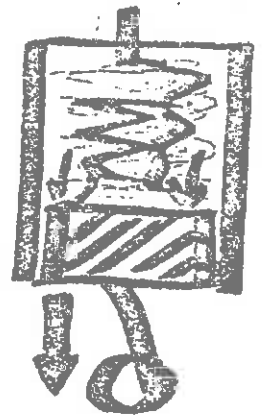
FUEL INJECTION  
(air & gas)



COMPRESSION  
(by piston)

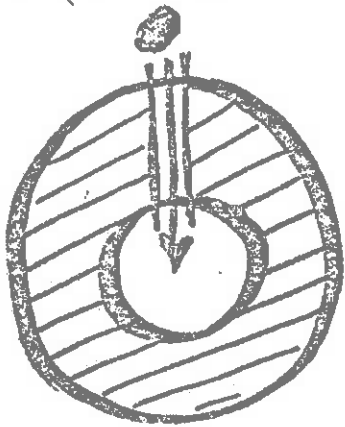


IGNITION  
(by spark plug)

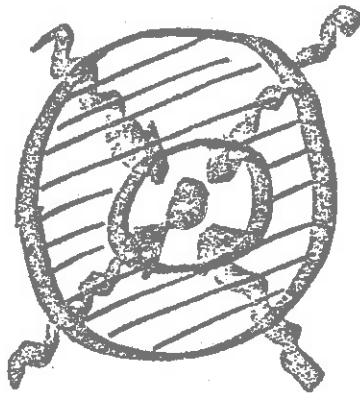


COMBUSTION  
(drives piston & cam)

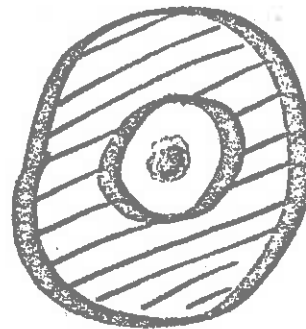
# 'LL-LASL-KHS---



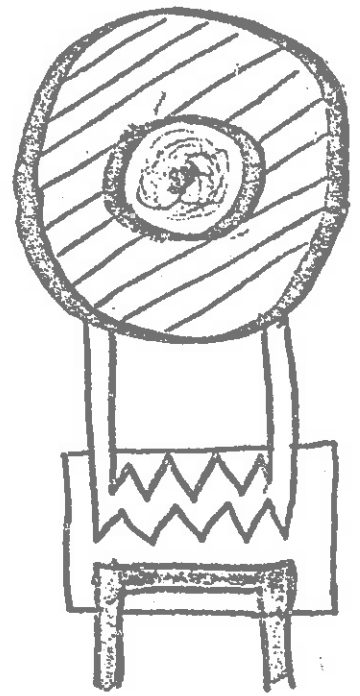
FUEL PELLET  
INJECTION  
(DT + other  
stuff)



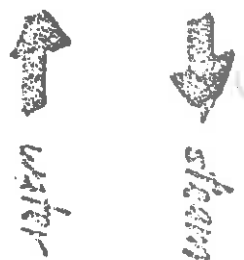
COMPRESSION  
(by laser,  
E-beam, or  
ion beam)



IGNITION  
(by  
compression)



THERMONUCLEAR  
BURN  
(heat extraction  
by steam cycle)



I CAN SEE ANOTHER  
GREAT DETROIT INDUSTRY





In direct analogy, inertial confinement fusion schemes are based on the following sequence:

- (i) a tiny fuel pellet (of D-T isotopes) is injected into a blast chamber;
- (ii) the pellet is compressed to very high density using intense laser, electron, or ion beams;
- (iii) the high density (and compression heat) induces the ignition of a thermonuclear reaction;
- (iv) the thermonuclear energy carried by reaction products (neutrons, X-rays, and charged particles) is deposited as heat in a blanket which then acts as a heat source for a steam thermal cycle for electricity production (conversion of nuclear energy into electrical energy).

Hence the laser fusion "internal combustion" engine will use a series of micro-thermonuclear explosions (from 10 to 100 per second, each generating the energy equivalent of several pounds of high explosive) to generate electrical power.

The general ideas behind inertial confinement schemes have been around for a long time (at least since the discovery of the laser in 1960). However because of their intimate relationship to the physics of nuclear weapons, most of the relevant details of the scheme were shrouded in the blanket of security classification until very recently (~1972). Largely through the efforts of Edward Teller, Keith Brueckner, and John Nuckolls, most of the details of laser fusion have been declassified, and more recently a considerable amount of research in this area is shifting into the open literature. <sup>78-81</sup> Indeed, there has been a veritable explosion of publications in the laser fusion area (partly due, no doubt, to an "I did it first" complex which arises when a number of independent classified research projects suddenly find their work declassified). Although a detailed survey of this literature (even since 1972) would be quite voluminous, a representative list of several of the more definitive references has been provided at the end of the chapter.

In this introduction to laser (E-beam or ion-beam) fusion, we will begin with a discussion of the principal concepts involved in inertial confinement schemes (contrasting these with magnetic confinement), then discuss the development of high powered laser, electron, or ion beam devices, and finally review possible schemes for fusion reactors based on this approach.

### Basic Concepts

Recall that the basic requirements of the fusion game involve heating a plasma fuel (e.g., D-T or D-D) to thermonuclear temperatures ( $\sim 10$  keV) and then confining this high temperature fuel for a sufficiently long time that it produces more fusion energy than the energy invested in its heating and confinement. The scoreboard for this game is the Lawson criterion which demands a certain minimum value of the product of number density  $n$  and confinement time  $\tau$  --for example, the "scientific feasibility" criterion for a D-T fuel is

$$n \tau > 10^{14} \text{ sec/cm}^3.$$

As we have noted, the traditional fusion approach has been to attempt to confine a very low density plasma fuel (at  $n \sim 10^{14} \text{ cm}^{-3}$ ) for a relatively long time ( $\tau \sim 1$  sec) in a suitably shaped magnetic field (e.g., toroidal fields such as in the tokamak, magnetic mirror, or  $\theta$ -pinch devices).

The inertial confinement scheme takes the opposite approach. Here we attempt to heat a dense fuel to thermonuclear temperatures extremely rapidly so that an appreciable thermonuclear reaction energy will be generated before the fuel blows itself apart. To see what we are up against, consider a small pellet of radius 1 mm. The "disassembly time"  $\tau$  required for the heated pellet to blow itself apart is roughly just the time required for a sound wave to traverse the pellet. Since the speed of sound in a 10 keV D-T plasma is roughly  $10^8$  cm/sec, the disassembly time  $\tau \sim 0.1/10^8 = 10^{-9}$  sec = 1 ns. Hence to satisfy the Lawson criterion, we must use a fuel density in excess of  $n = 10^{14}/\tau = 10^{23} \text{ cm}^{-3}$  --which is roughly solid state density.



Therefore the new game we must play in inertial confinement schemes is to heat a small, solid density D-T pellet to thermonuclear temperatures before it has a chance to expand--that is, in 1 ns or one-billionth of a second! But how can we heat the fuel this rapidly? This is where the laser comes in. For not only can a laser focus large amounts of energy onto very tiny spots, but it can also zap this energy in a very short time--easily within 1 ns (indeed, laser pulses as short as  $10^{-12}$  sec = one-trillionth of a second have been achieved).

So if we use the laser as just a very big flashlight to zap the fuel pellets to fusion temperatures very rapidly, we can visualize that a laser fusion system might work something as shown in Figure 8-21.<sup>82</sup> Here the laser light is focussed on the pellet, heating it rapidly to thermonuclear temperatures and thereby inducing a thermonuclear micro-explosion. The energy from this explosion is then captured and converted to electricity through a steam thermal cycle. After using part of this energy to re-energize the laser, the remaining energy is then distributed to the electrical power grid.

So far, so good! And this was essentially the public image presented by the laser fusion effort in the B.D.C. days ("before declassification") prior to 1972. But this simple-minded scheme had a fatal flaw which became apparent when one tried to estimate the laser energy required to produce such a micro-explosion.

Suppose (because of laser and thermal cycle inefficiencies) we require the thermonuclear energy produced by the pellet to be  $M$  times the incident laser energy (where  $M$  will typically be at least 10 or so):

$$E_{\text{fusion}} = M E_{\text{laser}}$$

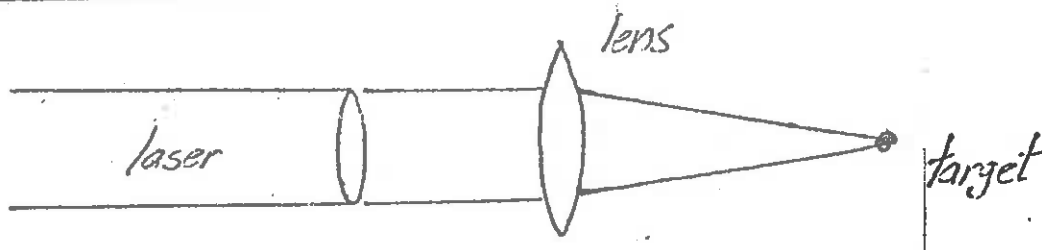
Since not all of the laser energy incident on the pellet will be converted into thermal energy, we must also write

$$E_{\text{thermal}} = \epsilon_L E_{\text{laser}}$$

where  $\epsilon_L$  is the laser light "coupling efficiency". If we factor these expressions into the Lawson criterion, it now becomes

$$n\tau > \left(\frac{M}{\epsilon_L}\right) \times 10^{14} \text{ sec/cm}^3.$$

HEATING WITH HIGH POWERED PULSED LASERS:

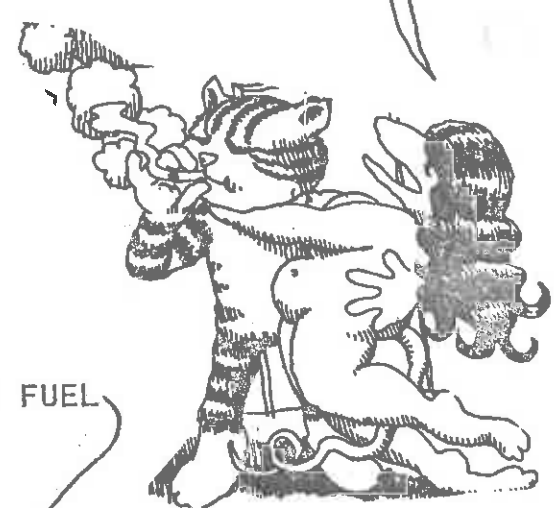
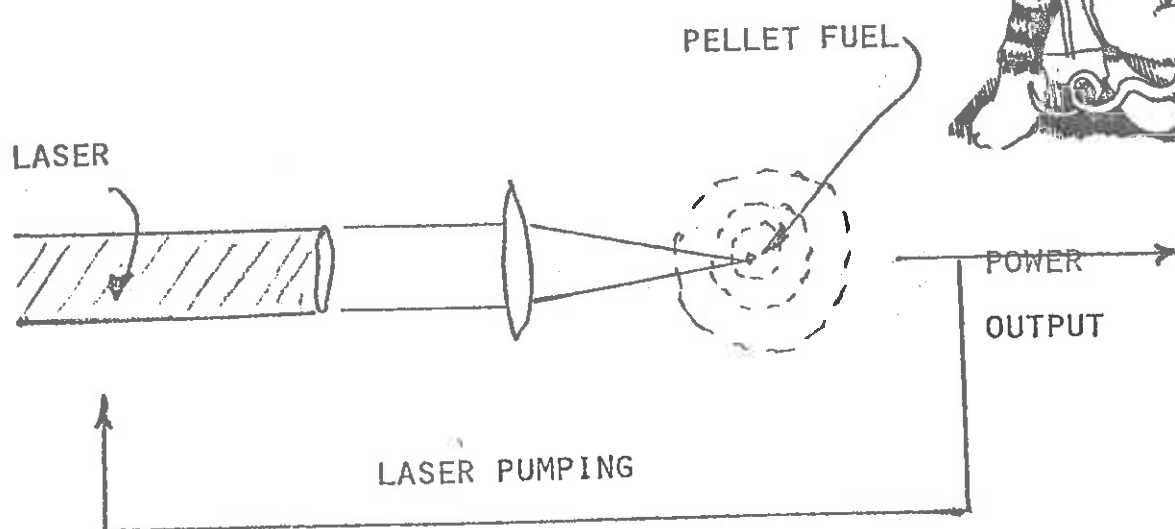


- ADVANTAGES OF THE LASER:
- 1.) CAN BE FOCUSED (  $\sim 100 \mu\text{m}$  )
  - 2.) LOTS OF ENERGY (  $> 1000 \text{ J}$  )
  - 3.) SHORT PULSE WIDTHS (  $< 10^{-9} \text{ SEC}$  )

A "TYPICAL" LASER:	ENERGY:	1000 JOULES
	PULSE WIDTH:	$10^{-10} \text{ SEC}$
	FOCAL SPOT:	$10^{-4} \text{ CM}^2$
	FOCUSED INTENSITY:	$10^{17} \text{ WATTS/CM}^2$

I JUST CAN'T TELL YOU HOW EXCITED I GET WHENEVER I HEAR ABOUT LASER FUSION!

LASER-PELLET FUSION CYCLE



But we are not through yet. Recall that  $\tau$  for inertial confinement schemes is taken to be just the disassembly time,  $\tau \sim R/c_s$ . Furthermore the thermal energy needed to heat a pellet of radius  $R$  to a temperature  $T$  is

$$E_{\text{thermal}} = \left(\frac{4}{3}\pi R^3\right) \left(\frac{3}{2} n k T\right).$$

If we put all of this together (including the appropriate numbers for a 10 keV plasma), we find that the laser energy required to satisfy the modified Lawson criterion is

$$E_{\text{laser}} = \frac{M^3}{\epsilon_L^4} \left(\frac{n_s}{n}\right)^2 \times 10^7 \text{ joules}$$

where  $n_s$  is the number density for a solid ( $4.5 \times 10^{22} \text{ cm}^{-3}$  for D-T).

Let us now apply this estimate to calculate the laser energy required for both scientific feasibility and technical viability (i.e., a reactor). For feasibility, that is, a "naive" breakeven experiment, we would set  $M = 1$ ,  $\epsilon_L = 1$ ,  $n = n_s$  so that

$$E_{\text{laser}} = 10^7 \text{ joules} \quad (\text{naive breakeven})$$

To place this number in perspective, the largest laser in the world today (a \$20 million monster at the Lawrence Livermore Laboratory known as Shiva) can produce a pulse of only  $10^4$  joules---a thousand times too small. For a reactor, we would have to require  $M = 10$  which implies

$$E_{\text{laser}} = 10^{10} \text{ joules} \quad (\text{naive reactor})$$

---clearly hopelessly large. So viewed in this light, laser fusion is clearly a fool's quest.

Or is it? We mentioned that this was the "naive" or B.D.C. approach. We must be a bit more sophisticated in our analysis. Let us begin by re-examining the criterion for achieving net fusion energy release in a somewhat different light. We can identify two times of major significance for inertial confinement schemes:<sup>83</sup>

$$\text{disassembly time} \cong \tau_d \sim R/c_s \sim R/T^{1/2},$$

$$\text{thermonuclear burn time} \cong \tau_b \sim 1/\rho \langle v \sigma_f \rangle \sim 1/\rho T^{1/2},$$

where  $R$  is the pellet radius, and  $\rho$  is its mass density, while we have noted that the speed of sound  $c_s$  and the fusion reaction frequency  $\langle v \sigma_f \rangle$  are both proportional to  $T^{1/2}$  in the temperature range of interest.

If we regard  $\tau_b$  as a measure of the time required to burn a pellet of density  $\rho$ , and  $\tau_d$  as the time during which the thermonuclear reaction will occur, then evidently we find that the "thermonuclear burn efficiency" is just

$$\epsilon_b \equiv \text{thermonuclear burn efficiency} \sim \frac{\tau_d}{\tau_b} \sim \rho R.$$

If we re-insert the appropriate numerical constants, we find that an alternative to the Lawson criterion which is far more appropriate for inertial confinement schemes becomes

$$\rho R > 1 \quad [\text{g/cm}^2]$$

(Actually, if we are a bit more careful and take into account fuel depletion during thermonuclear burn, we find that the burn efficiency becomes<sup>84</sup>

$$\epsilon_b = \frac{\rho R}{6 + \rho R}.$$

Hence for  $\rho R = 1$ , we find that a fraction  $\epsilon_b = 1/7$  will be burned.)

To understand the implications of this result, note that for a 1 mm pellet,  $\rho R = 1$  implies a fuel density of  $\rho = 10 \text{ gm/cm}^3$ , or since the solid state density of D-T is only  $\rho_s = 0.2 \text{ g/cm}^3$ , we must somehow compress the pellet to at least 50 times its solid density.

Hence the key to inertial confinement is apparently high compression. The more we compress the fuel, the larger  $\rho R$  becomes, and hence the more efficient the thermonuclear burn becomes (and hence the energy release). To see how this affects our earlier estimates of required laser energy, if we can achieve a compression of  $(n/n_s) = 1,000$ , we find

$$E_{\text{laser}} = 10 \text{ joules} \quad (\text{high compression breakeven, } M = 1, \epsilon_L = 1)$$

$$E_{\text{laser}} = 1000 \text{ joules} \quad (\text{high compression reactor, } M = 10, \epsilon_L = 1)$$

Actually these estimates are a bit too optimistic since we have ignored the laser coupling efficiency by setting  $\epsilon_L = 1$ . Nevertheless they do indicate

the very important concept that the required laser energy is inversely proportional to the square of the compression

$$E_{\text{laser}} \sim 1 / (\text{compression})^2.$$

So the only remaining question is "how"? How do we achieve such enormous compressions? Certainly not by normal mechanical forces. Neither will chemical explosives do the job (they are limited to  $n/n_s \approx 10$  by the strength of interatomic forces). Densities as large as 1000 times solid state are not common even on an astronomical scale, occurring only in very dense white dwarf stars.

The trick involves using the laser itself. The basic scenario is shown in Figure 8-22 and goes something as follows: The intense laser light is focussed by a number of laser beams onto the pellet surface. As the pellet absorbs this intense light, its surface is rapidly vaporized, ionized, and heated to high temperature, blowing off into the vacuum surrounding the pellet. This blowoff or ablation of the pellet surface drives a shock wave back into the pellet (recall Newton's third law--or better yet, picture the ablation as you would the thrust from a rocket). As this shock wave implodes in towards the center of the pellet, it compresses it to high density and thermonuclear temperatures so that ignition occurs. At these very high densities the energetic alpha particles produced in D-T fusion reactions are absorbed in the fuel, heating it to still higher temperatures and causing the fuel to burn even more rapidly. After only a few picoseconds, a significant fraction of the imploded pellet fuel has burned, and the very high energy release blows the pellet apart, thereby terminating the reaction.

This simple picture is complicated somewhat by the fact that laser light cannot penetrate into a very dense plasma very far without being reflected. In fact, if the plasma density is above  $10^{21} \text{ cm}^{-3}$ , the incident light will not penetrate. Hence during the actual laser heating, a low density cloud or atmosphere ablates off and surrounds the pellet core, shielding it from direct laser irradiation. The laser energy absorbed in this atmosphere is then transported into the denser regions of the pellet by thermal conduction to drive the imploding shock wave. (See Figure 8-22)

Figure 8-22:

SCENARIO

INITIAL ABLATION

D-T FUEL PELLET

INCIDENT LASER LIGHT

COMPRESSION

PLASMA BLOWOFF (ABLATION)

UNDERDENSE PLASMA

OVERDENSE PLASMA

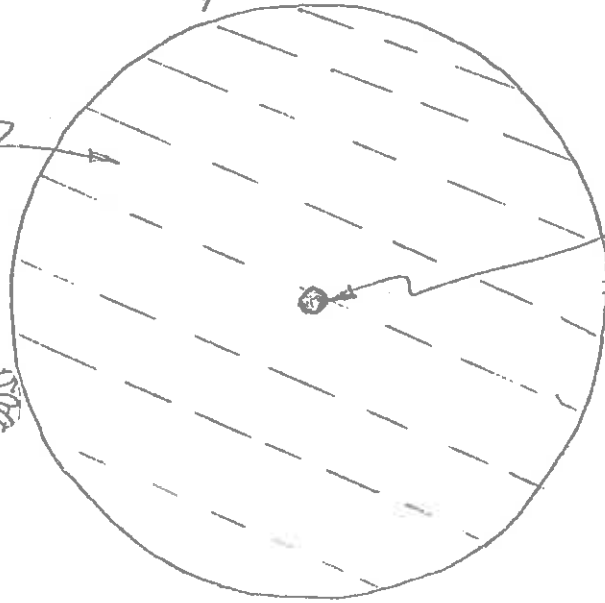
IMPLODING SHOCK

IGNITION

BLOWOFF

- i) COMPRESSION TO  $10^3 N_S$
- ii) IGNITION
- iii) THERMONUCLEAR BURN DUE TO ALPHA SELF-HEATING

THEN, BLAM!





Although this scheme sounds rather far-fetched, it has actually been demonstrated in laboratory experiments.<sup>85</sup> In such experiments, laser beams were focussed by specially designed mirrors onto the surface of pellets which consisted of tiny glass shells (50  $\mu\text{m}$  in diameter and 1  $\mu\text{m}$  in thickness) containing D-T gas at up to ten atmospheres pressure. (See Figure 8-23 .) By carefully studying the X-rays emerging from these irradiated pellets, scientists have verified compressions of perhaps as large as 1,000 accompanied by the emission of thermonuclear neutrons.

However the success of such experiments should not be interpreted as a demonstration of scientific feasibility for laser fusion. Indeed, present estimates are that the achievement of  $\rho R \sim 1 \text{ g/cm}^2$  will require an absorbed laser energy of roughly 1000 joules in the pellet (roughly two orders of magnitude above that achieved in the laboratory to date) delivered in such a manner as to induce a compression of some 10,000 times solid state density. For a laser fusion reactor, the requirements become even more severe, with  $\rho R \sim 5$  corresponding to an absorbed laser energy of tens of thousands of joules.

These goals present a very difficult challenge to high powered laser technology, as the list of laser requirements for both breakeven and reactors in Table 8-14 makes very apparent. Although 10,000 joules may not sound like a great deal of energy (about the release of a small firecracker), when it is delivered in  $10^{-10}$  seconds it corresponds to a power level of  $10^{14}$  watts (which, incidently, is roughly 100 times the power generating capacity of the entire United States). To understand the implications of these requirements for laser design, it is useful to take a short detour into the subject of high powered lasers.

#### High Powered Lasers

A laser is simply a device which can convert electrical (or chemical or gasdynamic) energy into light energy. But the light it generates is "coherent" (in phase) and hence can be transmitted very long distances (e.g., to the moon) and focussed to very tiny spots. To introduce the basic concepts involved in laser operation,<sup>86</sup> we will consider the inter-

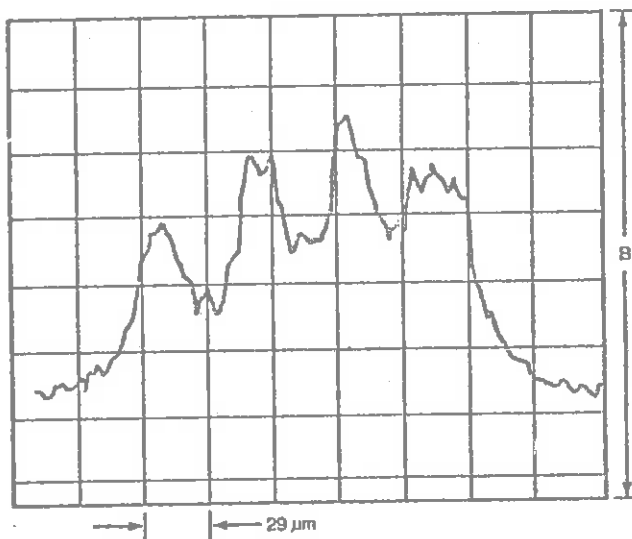
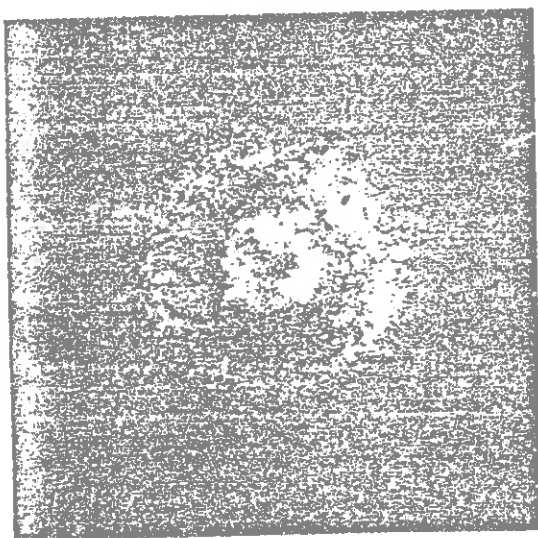
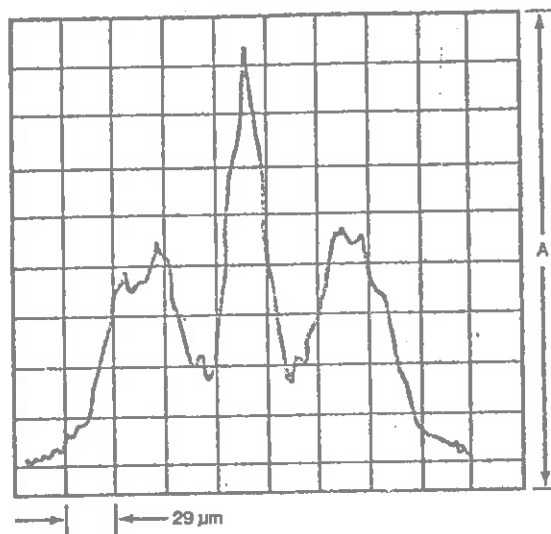
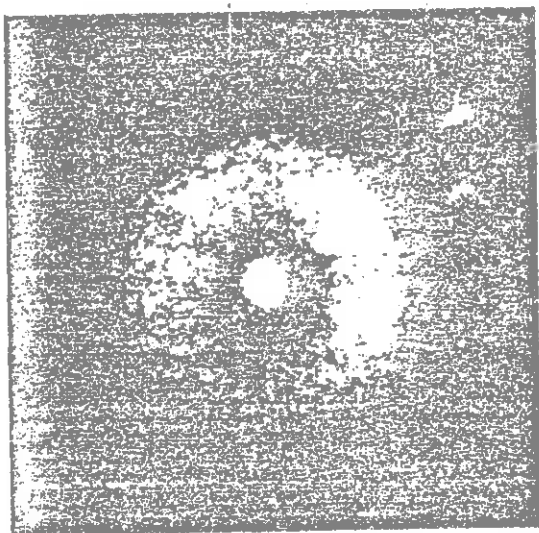
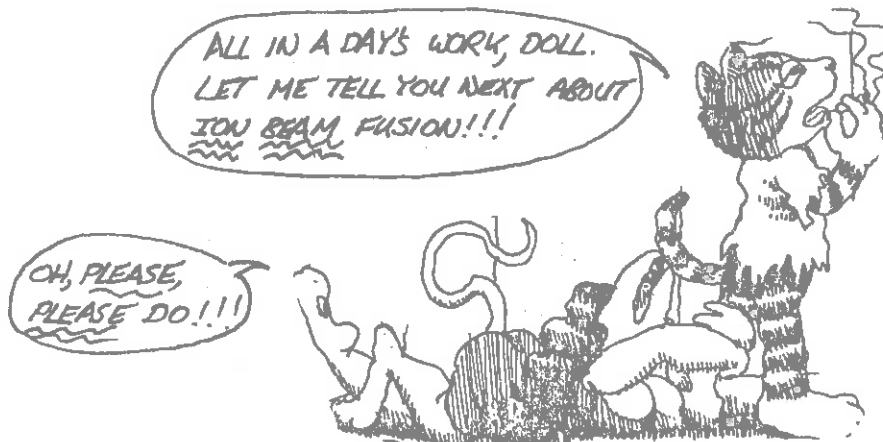


Fig. 5. Image-intensified x-ray pinhole photographs, shown with corresponding diametric microdensitometer traces, were obtained during compression of (top) unfilled spherical glass shell with outside diameter of 120 micrometres, wall thickness 1 micrometre, and (below) DT-filled (30 atm) spherical glass shell with 117-micrometre outside diameter, 0.7-micrometre wall.

Figure 8-23: Experimental Evidence of High Compressions in Laser Irradiated Microballoon Targets at KMS Fusion.

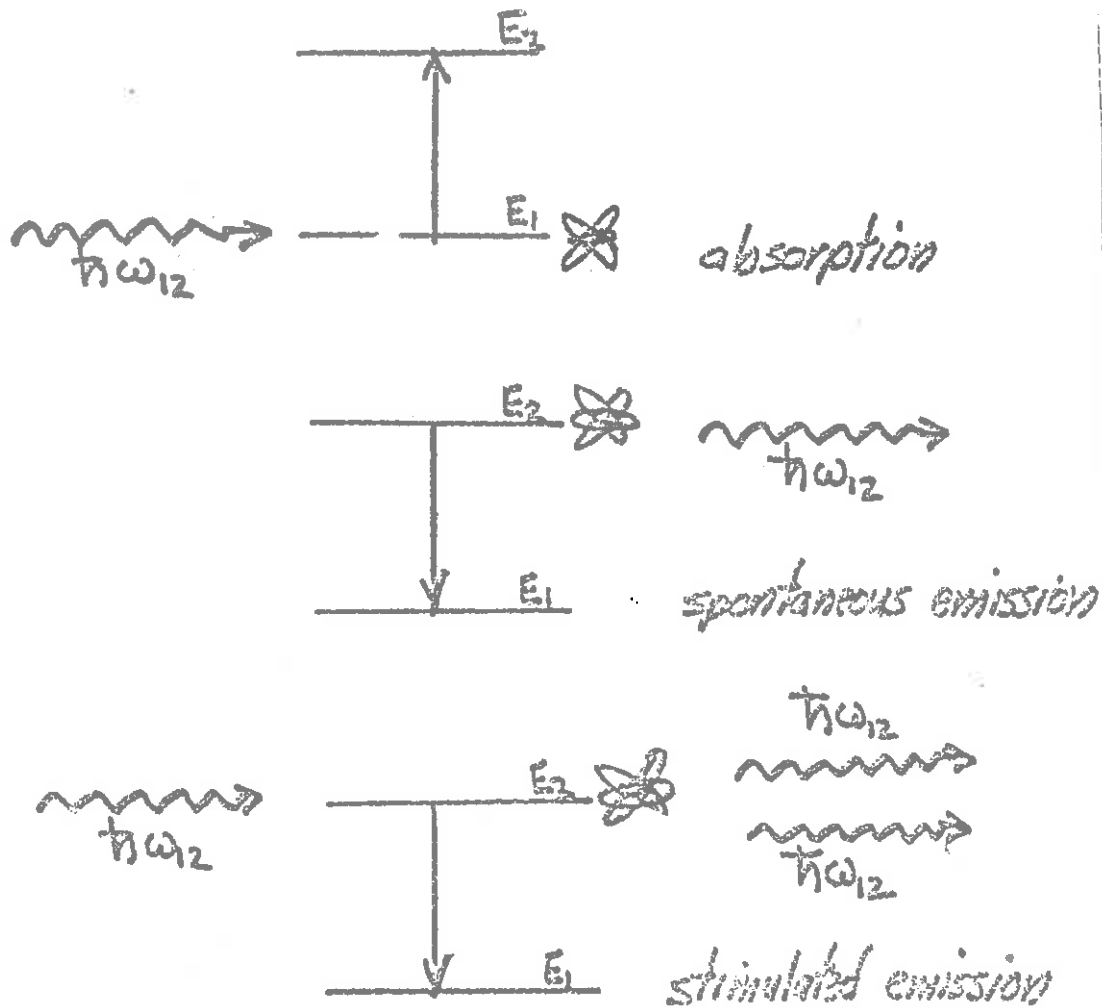


action of light with a very simple system: a single atom which can exist in one of only two possible energy states (see Figure 8-24 ). Incident light photons with a frequency  $\nu_{12}$  such that  $h\nu_{12} = E_2 - E_1$  (where  $h$  is Planck's constant) can interact with the atom in one of three ways: absorption, spontaneous emission, and stimulated (as shown in Figure 8-24 ). If we now consider a system of many such two-state atoms, most of which are in their ground state, then it is evident that a photon of frequency  $\nu_{12}$  incident upon the system would be absorbed. Suppose, however, that most of the atoms were in their excited state,  $E_2$ . Then one could induce a growing cascade of photons of frequency  $\nu_{12}$  using the stimulated emission process. That is, one could achieve light amplification by stimulated emission of radiation.

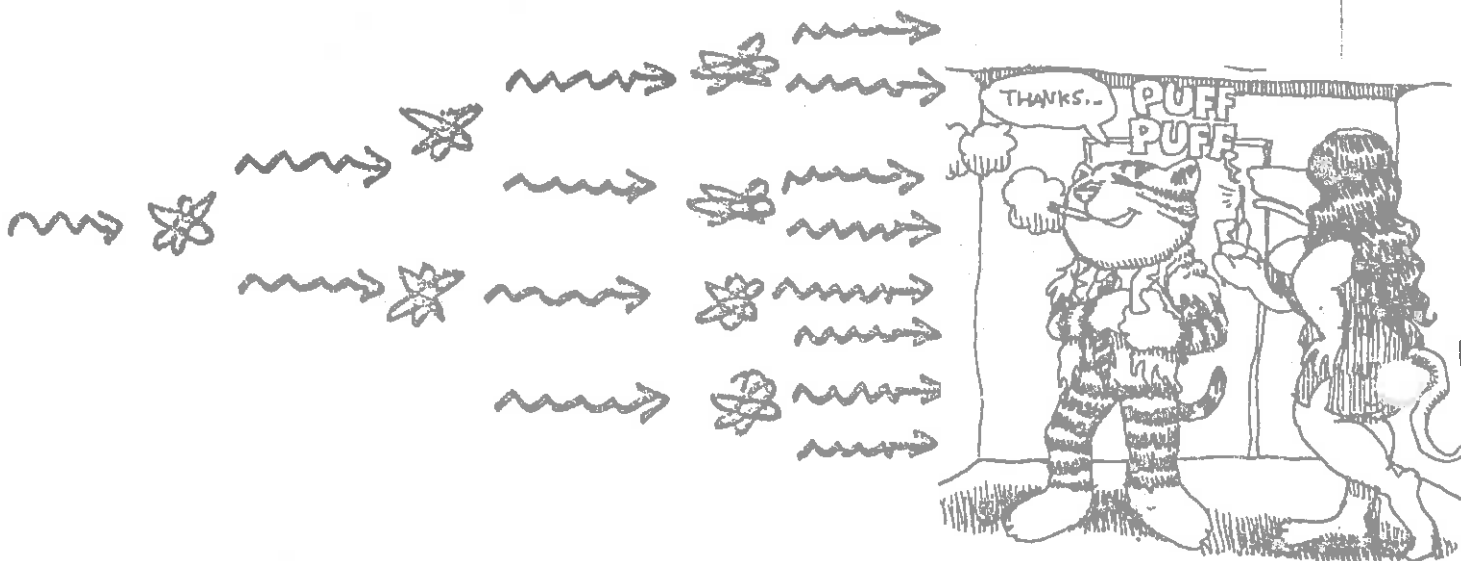
Under normal circumstances, there will be many more atoms in the lower energy state (usually the ratio of population densities goes as  $\exp [-(E_2 - E_1)/k_B T]$  where  $k_B$  is Boltzmann's constant and  $T$  is the temperature of the medium). Hence we must somehow achieve a "population inversion" (that is, prepare the medium so that more atoms are in the upper state) so that an incident photon will stimulate the emission of other photons rather than being absorbed.

How does one obtain such a population inversion? Obviously not by trying to directly excite atoms from  $E_1$  to  $E_2$  since this would require absorption from the light beam one wished to amplify. Instead, additional energy levels must be used. The simplest scheme is a 3-level laser which was first applied in the ruby laser. The idea is to irradiate the lasing material (in this case, the chromium ions in ruby) with flash lamps to excite them into the upper state 3 (see Figure 8-25 ). Since the light from the flash lamps is not monochromatic, only a small fraction of the incident photons will be absorbed to excite the atoms. For this reason, one wishes the upper level to have as large a line width as possible, so as to cover a broad frequency range and hence "catch" as many of the flash lamp photons as possible. The atoms in the upper level 3 then decay very

Figure 8-24: Interaction of Light Photons with a Two-Level Atom



Light amplification by stimulated emission of radiation



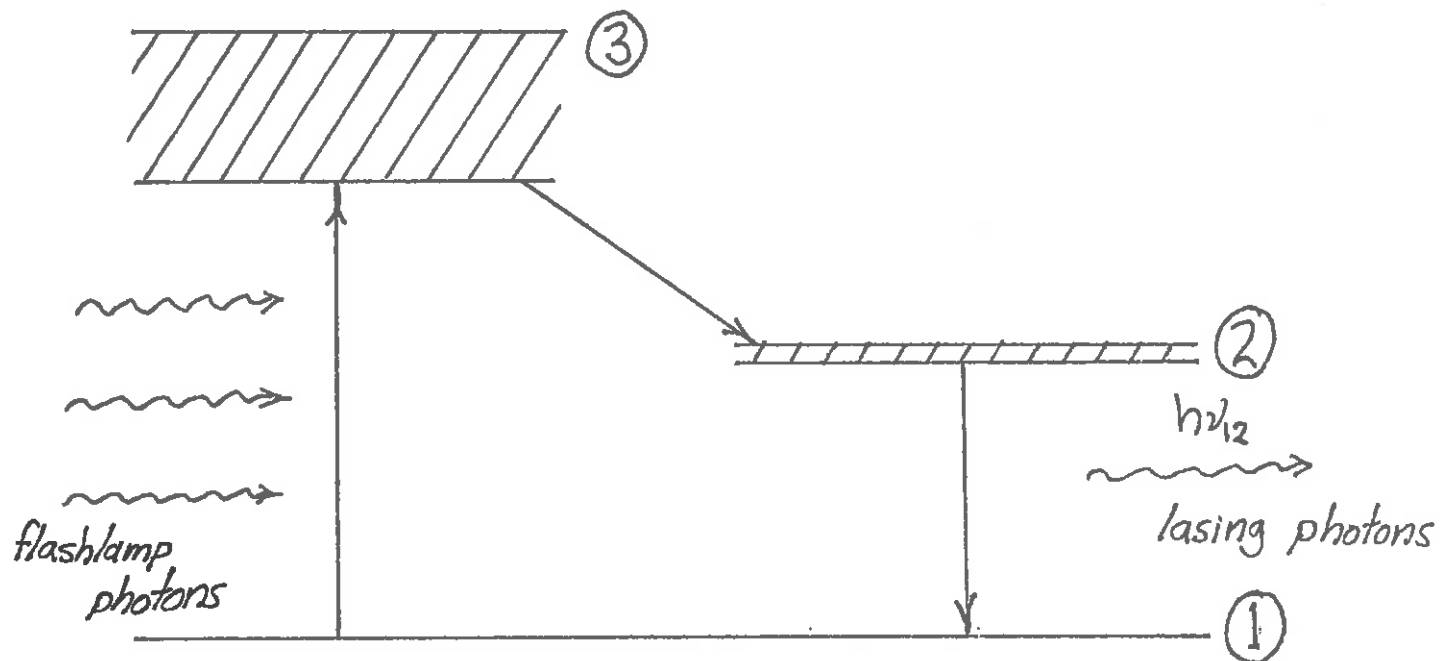


Figure 8-25: Lasing Transitions in a 3-level Laser



rapidly via fast radiationless transitions into the intermediate level 2 which has a very narrow line width and a relatively long lifetime for spontaneous emission. Hence by using sufficiently intense flash lamp irradiation, one can prepare a population inversion in which the number of atoms in state 2 exceeds that in the ground state 1. The transition between states 2 and 1 is then used as the lasing transition for stimulated emission.

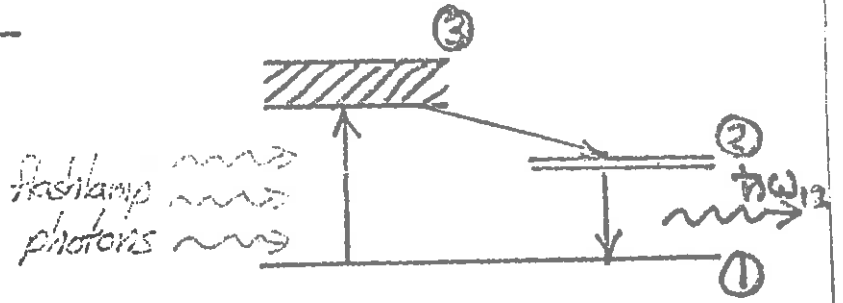
The three level laser is only one of a huge variety of level schemes used to excite atoms or molecules into suitable population inversions for lasing (and is very similar to the scheme used in the neodymium glass lasers used in laser fusion research). Other excitation mechanisms of particular interest in gas lasers include:

- (i) direct excitation by charged particle collisions: If one maintains an electrical discharge in the lasing medium, then inelastic collisions between free electrons and atoms or molecules can create excited states. Such excited states can then transfer energy to the upper lasing level by collisions. This combination of electron excitation and collisional energy transfer is the principal mechanism used in the  $\text{CO}_2$  laser.
- (ii) excitation through resonant or near resonant energy transfer: The excitation present in a particular species can be selectively transferred to a particular state (or narrow band of states) in another species by resonant collisions in which the relative energy between the colliding atoms is very close to the energy level spacing of their excited states.
- (iii) excitation by gas dynamical processes: Rapid heating or cooling of a molecular gas can generate a population inversion (such as by expanding a heated gas through a nozzle). An example here is the large  $\text{CO}_2$  gasdynamic laser.
- (iv) excitation by chemical processes: It is well known that in many chemical reactions the reaction products are formed in excited states. Hence chemical reactions can be used to create population inversions of molecular gases. In practice, a rather considerable fraction of the available chemical reaction energy can be coupled to the radiation field. An example is the HF chemical laser.

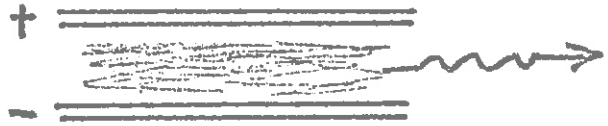
Figure 8-26: Pumping Mechanisms in Lasers

## PUMPING MECHANISMS

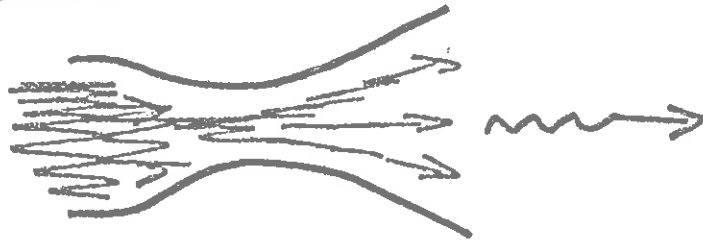
(i) optical (flashlamps)  
[Nd, ruby]



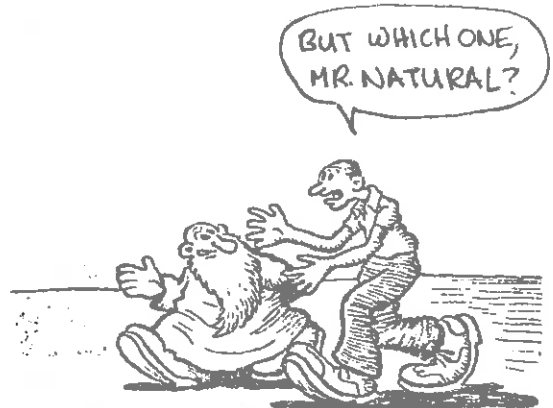
(ii) charged particle collisions  
(gas discharges)  
[CO<sub>2</sub>, CO, HeNe]



(iii) gas dynamical processes  
[CO<sub>2</sub>]



(iv) chemical reactions  
[HF]



One can define the efficiency with which a laser converts the excitation energy supplied to create a population inversion into light energy in two ways:

$$\text{quantum efficiency} = \frac{\text{energy emitted in lasing transition}}{\text{excitation energy}}$$


$$\text{working efficiency} = \frac{\text{output power of laser beam}}{\text{input power (of flashlamps or electrical discharge)}}$$

Most solid state lasers (e.g., ruby or neodymium glass) are extremely inefficient ( $\sim 0.1\%$ ) due to the inefficiency of flashlamp pumping. By way of contrast, gas lasers can be quite efficient. For example, the working efficiency of  $\text{CO}_2$  lasers approach their quantum efficiency of 40%.

Most high energy laser facilities designed for laser fusion research utilize large, Nd glass lasers which emit infrared light at a wavelength of  $1.06 \mu\text{m}$ . To date these lasers have been restricted by glass damage considerations to energies less than 1,000 joules per beam. Several laboratories, both in the United States and abroad, have large, multi-beam Nd glass lasers in the 10,000 joule per pulse range under construction. However, since these lasers must be pumped using flashlamp techniques, they are intrinsically very inefficient (less than 0.1%) and therefore would not be suitable for any reactor design.

To achieve the high efficiencies required by reactor application, it will probably be necessary to use gas lasers. For example,  $\text{CO}_2$  lasers have been operated at efficiencies as high as 40% and are capable of extremely large energies (see Figure 8-27). However they operate at rather long wavelengths for laser fusion applications ( $10.6 \mu\text{m}$ ) and are more difficult to operate at very short pulse lengths than solid state lasers. Actually, the "brand-X" type laser which is most suitable for laser fusion applications has not been developed yet<sup>87</sup>--but the assumption is usually made that given sufficient time and money, laser physicists are capable of designing a system to meet these requirements.

We have attempted to summarize the status of high powered laser development (circa 1976) for laser fusion applications in Table 8-15.



BUT YOU TOLD ME YOU  
KNEW HOW TO DO IT!



Table 8-14 : Laser Requirements for Successful Laser Fusion

Energy: 1000 joules absorbed for breakeven  $\Rightarrow$  10,000 joule laser  
100,000 to 1,000,000 joule laser for a reactor

Focal spot size: 100 microns in diameter

Pulse length: 100 picoseconds (carefully shaped to within 10 picoseconds)

Repetition rate: 10 to 100 per second

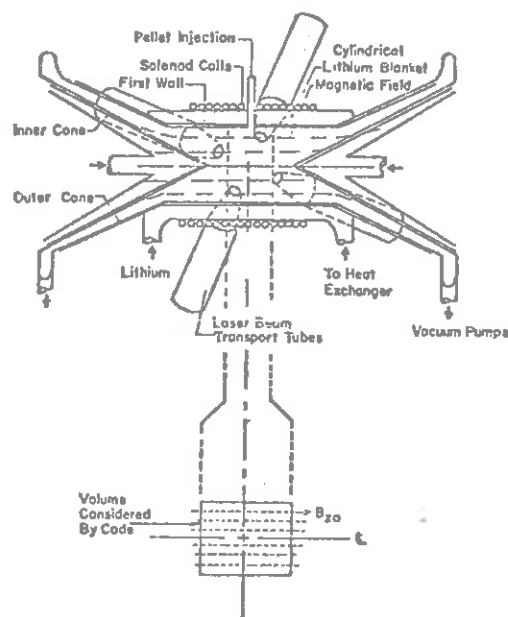
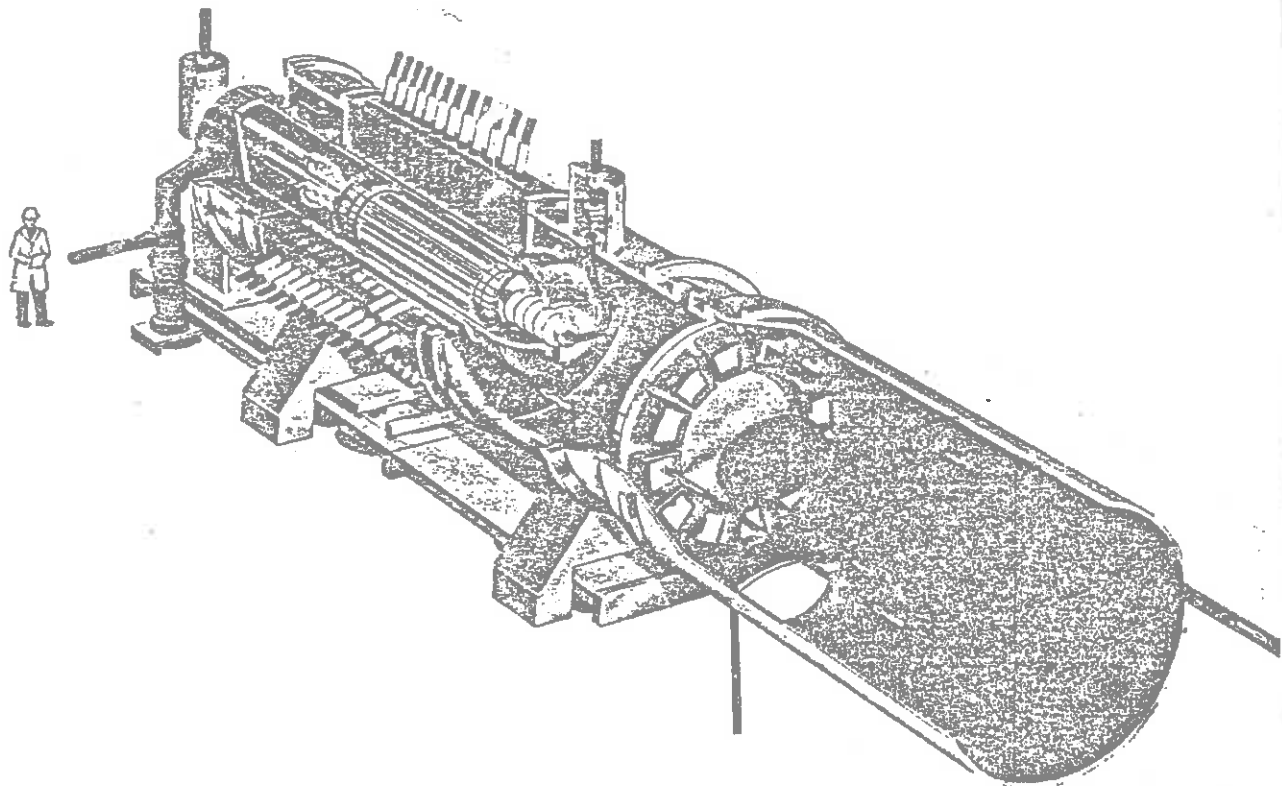
Laser efficiency: 10% (or higher, if possible)

Laser wavelength: preferably in the range 0.3 to 0.8 microns (in the visible)

...AND ADD A TAPE-DECK, STEREO,  
WET BAR, & RACING STRIPES...

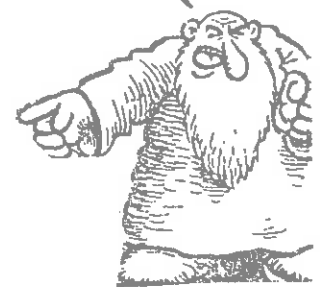


Figure 8-26: A Large CO<sub>2</sub> Laser Amplifier under Development at LASL



Magnetically protected laser-fusion reactor.

THIS PICTURE IS IN THE WRONG PLACE. IT BELONGS ON PAGE 8-61.



A GUESSTIMATE OF LASER DEVELOPMENT STATUS

	<u>Type</u>	<u>Present Capability</u>	<u>Under Development</u>
LLL	Nd	$\sim 500j^*$	10,000j (1977)
LASL	CO <sub>2</sub> Nd	$\sim 1000j^{**}$ $\sim 100j^*$	10,000j (1977)
KMSF	Nd	$\sim 800j^*$	2,000j (1976)
Rochester	Nd	$\sim 500j^*$	10,000 (1977)
NRL	Nd	$\sim 100j^*$	
Lebedev (USSR)	Nd	$\sim 500j$	10,000 (?)
Limeil (Fr)	Nd	$\sim 100j^*$	2,000 (1976)
Garching (Ger)	Nd	$\sim 100j$	
	Iodine	$\sim 1000j$	4,000 (1977)

all systems use multiple beam irradiation

\*  $\leq 100$  psec

\*\* 1 nsec

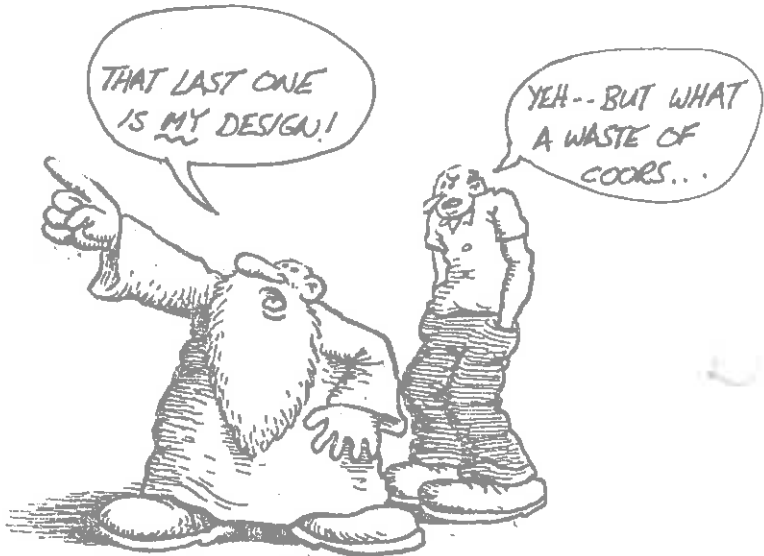


STATUS OF HIGH POWERED LASER DEVELOPMENT

1.) Nd GLASS:            WAVELENGTH:        1.06  $\mu$ M  
                              OPTICALLY PUMPED (FLASHLAMPS)  
                              EFFICIENCY: 0.1%  
                              ENERGY: 2000 JOULES (LIMITED BY GLASS DAMAGE)  
                              PULSE WIDTH:  $10^{-12}$  TO  $10^{-8}$  SEC

2.) CO<sub>2</sub> GAS:            WAVELENGTH:        10.6  $\mu$ M  
                              E-BEAM PUMPING  
                              EFFICIENCY: 30% - 40%  
                              ENERGY: VERY LARGE (LIMITED BY GAS BREAKDOWN)  
                              PULSE WIDTH:  $10^{-9}$  -  $10^{-7}$  SEC

3.) OTHER:            CO GAS        (0.2  $\mu$ M)  
                              COPPER VAPOR  
                              H-F CHEMICAL LASER  
                              HCN (300  $\mu$ M)  
                              IODINE  
                              BEER LASERS



SOME PARAMETERS CHARACTERIZING <sup>BIG</sup> LASERS

LASER PARAMETERS:

1,000 JOULE PULSE  
 $10^{-10}$  SEC PULSE WIDTH  
 $10^{-4}$  CM<sup>2</sup> FOCAL SPOT

FOCAL SPOT PARAMETERS:

FOCUSED INTENSITY:  $10^{18}$  W/CM<sup>2</sup>  
ENERGY DENSITY:  $3 \times 10^6$  JOULES/CM<sup>3</sup>  
PHOTON DENSITY:  $3 \times 10^{25}$  PHOTONS/CM<sup>3</sup>  
ERMS:  $10^{10}$  VOLTS/CM  
BRMS: 50 MEGAGAUSS

KINETIC ENERGY OF  
ELECTRON OSCILLATING: 50 KEV  
IN LASER FIELD



### Electron Beam and Ion Beam Fusion

There are alternatives to high powered lasers as the "piston" to achieve pellet implosion. <sup>89,91</sup> In particular, accelerator designers have been capable of producing extremely energetic electron or ion beams for some time now. In fact if we compare the breakeven requirements with present capability (see Table 8-16), electron beam sources are closer to achieving the required energy than laser sources. Furthermore, both electron and ion beams are quite efficient at converting an appreciable fraction of electrical energy into beam energy (40% or better).

There are (needless to say) problems, however. For example, our usual understanding of electron interactions would predict that high energy electrons would penetrate right through a pellet without depositing their energy to drive the implosion process. Fortunately, experiments have indicated (for some reason that we don't fully understand, as yet) that such electrons are readily absorbed by the pellet. However, such "anomalous" behavior is a source of some concern in designing suitable pellets. Furthermore, it will not be a trivial task to develop electron beams with the very short pulse lengths required by pellet implosion applications (less than 10 ns in length).

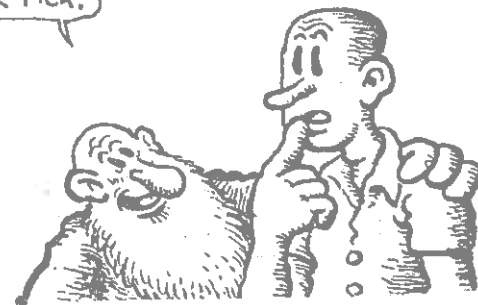
To overcome the absorption problem, one can go to heavy charged particles such as ions. Preliminary studies considered using proton or deuteron beams to compress the pellet. <sup>87</sup> Once again, however, the beams are found to penetrate too readily to the core of the pellet, thereby preheating it and reducing the compression. Instead, more recent proposals <sup>90</sup> have been based on using heavy ion beams (using ions of mass number all the way from  $A = 153$  (iodine) to 238 (uranium)). Although the status of heavy ion beam sources is still very far from the requirements of pellet fusion (even using storage rings in which groups of very energetic ions can be accelerated and stored until they are diverted out and focussed onto the pellet target), such a scheme would appear to possess some potential for inertial confinement fusion.

Table 8-16

# ALTERNATIVES TO LASER PELLET IMPLOSION

	<u>Breakeven Requirements</u>	<u>Present Capability</u>
Lasers	1-10 kJ 0.1 nsec $10^{13}$ Watts	500-1000 J 0.1 nsec $\approx 10^{12}$ Watts
Electron Beams	100 kJ - 1 MJ 10 nsec $10^{13}$ - $10^{14}$ Watts	3 MJ * 100 nsec $10^{13}$ Watts
Ion Beams	100 kJ 10 nsec $10^{13}$ - $10^{14}$ Watts	100 J 10-100 nsec $10^{10}$ Watts

JUST TAKE YOUR PICK.



### Reactor Concepts

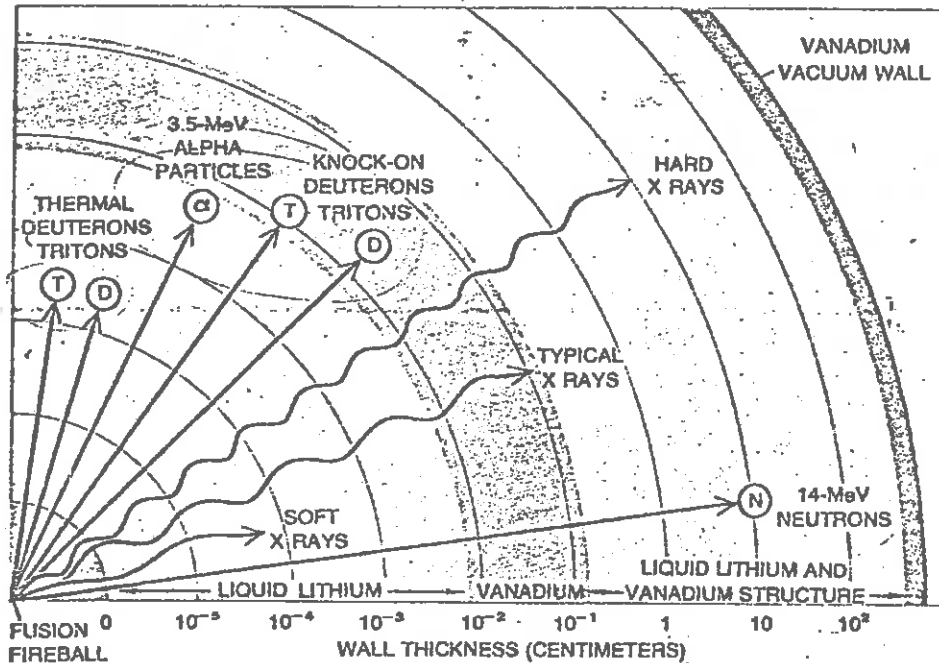
Let us leave the questions of just how such thermonuclear micro-explosions can be generated, and turn to a consideration of how such explosions can be used to produce useful energy in some kind of a reactor device. In a typical design, the pellet implosion is assumed to yield some  $10^8$  joules (about 50 lbs of high explosive worth of energy). If such explosions are repeated 30 times a second, the reactor will yield 3000 Mwt of thermal power corresponding to a thermal cycle output of 1000 MWe.

The thermonuclear explosion energy appears as various types of radiation emitted from the exploding pellet. Typically (for a D-T pellet) some 75% of the energy will appear as fast, 14 MeV neutrons, 24% as energetic charged particles, and 1% as X-rays. Surprisingly enough, it is relatively easy to design a blast chamber than can withstand the force of such a blast. This is because the force generated on the walls of the chamber is proportional to the square root of the explosion debris mass, and since a thermonuclear explosion utilizes a mass almost a million times smaller than a chemical explosion of similar energy yield, the blast force generated is rather small (a firecracker's worth).

Rather, the principal concern is the damage that the incident radiation can do to the chamber wall. For example, both soft X-rays and charged particles can damage the wall surface, spalling it off into the blast chamber. The energetic neutrons will cause significant damage to both wall and structural materials. However by careful design--for example, by wetting the wall surface with a thin film of lithium to absorb the X-rays and charged particles or using magnetic fields to shield the walls from charged particle damage, it should be possible to design a blast chamber to contain such pellet implosions.

Most of the explosion energy would be carried by fast neutrons, and therefore the blast chamber would be surrounded by a blanket--such as lithium--designed to absorb the neutron energy (and perhaps produce tritium for further refueling as well). This blanket would then be cooled using

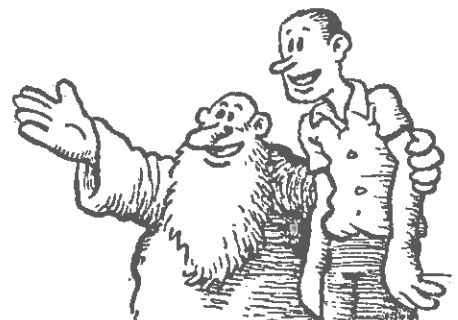


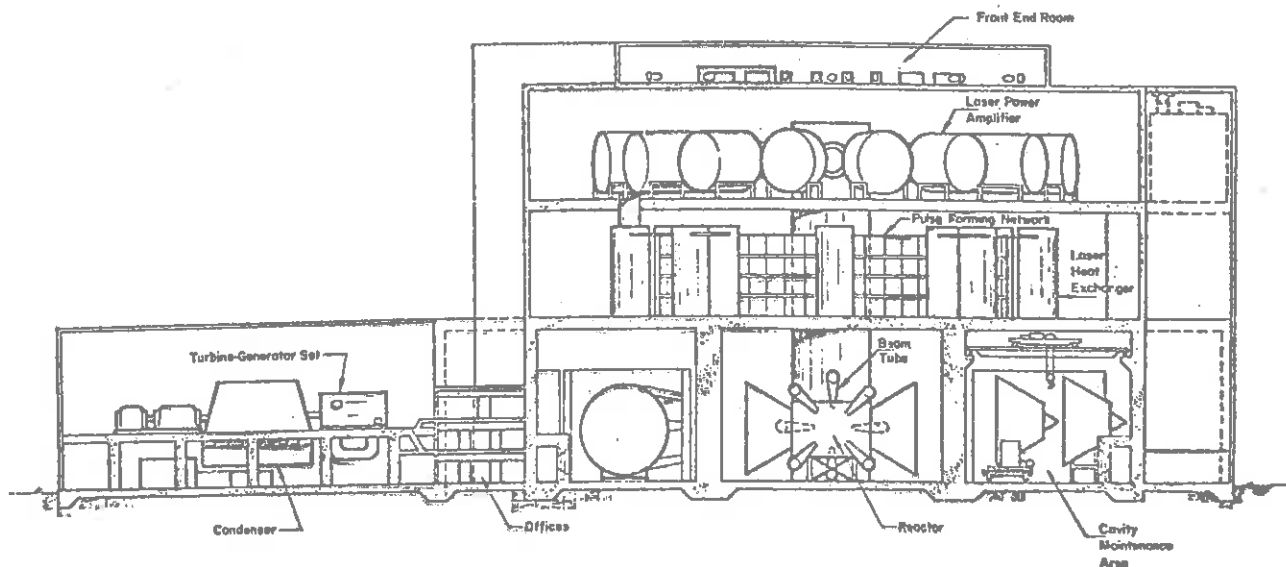


**FUSION RADIATIONS STRIKING FIRST WALL** of a thermonuclear combustion chamber will penetrate to different depths depending on their energy. The wall must be designed accordingly to minimize damage to its structure. Roughly 70 percent of the energy released by the fusion of deuterium and tritium is carried by 14-MeV (million-electron-volt) neutrons, about 25 percent by charged particles (deuterons, tritons and alpha particles) and a few percent by X rays. Deuterons and tritons that carry only the normal fireball energy, equivalent to 10<sup>9</sup> degrees K., are called thermal. "Knock on" deuterons and tritons have been accelerated to energies about 100 times higher through collisions with neutrons in the fireball. The film of liquid lithium bathing the surface of the first wall will stop the softest X rays as well as all charged particles capable of aggregating into bubbles. Vanadium will probably be used as the structural material because it produces least radioactivity under neutron bombardment of any high-temperature material compatible with liquid lithium.

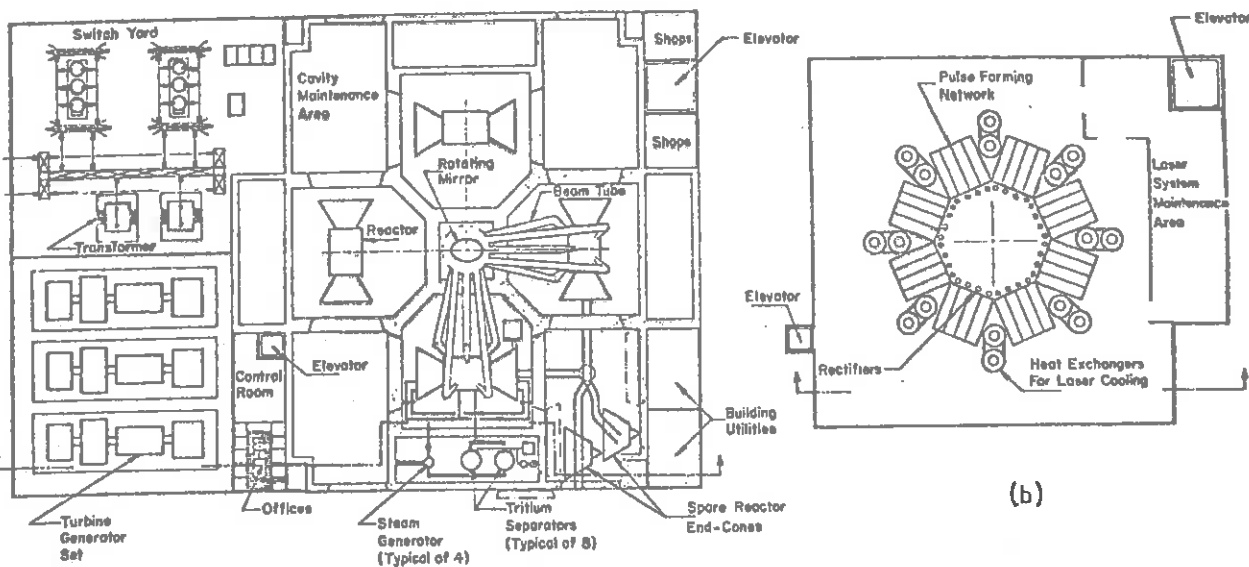
Figure 8-27: Reaction Products from a Laser Fusion Reactor  
 (J. Emmett, J. Nuckolls, L. Wood, Sci. Am. (June, 1974) n. 24)

OF COURSE, THERE ARE A FEW MINOR PROBLEMS SUCH AS RADIATION DAMAGE...





Electric generating station utilizing magnetically protected laser-fusion reactors and CO<sub>2</sub> laser technology



(a)

(b)

Electric generating station utilizing magnetically protected laser-fusion reactors: (a) first-level, reactor and energy-conversion systems area, plan view; (b) second-level, power-supply room, plan view.

Figure 8-28: A Laser Fusion Reactor Conceptual Design  
(L. A. Booth, D. A. Freiwald, T. G. Frank, and P. T. Finch,  
Proc. IEEE 64, 1460 (1976))



conventional techniques, and the heat withdrawn by a coolant would be used to produce steam for a turbogenerator.

Since laser fusion systems should be capable of producing large quantities of neutrons, it has been suggested that alternative uses of these devices may be of interest. For example, the neutrons could be used to convert fertile material (e.g., uranium -238) into fissile material (plutonium) for use in conventional fission reactors. Or perhaps they could be used to transmute long-lived radioactive waste (actinides) into shorter lived or stable isotopes. Yet another application would be to use the neutrons to radiolytically decompose water into hydrogen and oxygen, and then use the hydrogen in chemical processes to produce methane that can supplement our vanishing natural gas reserves.

Whatever the application, it should be evident that the successful development of a viable laser (or E-beam or ion beam) fusion reactor is still many years down the road. Indeed, we are still several years away from the demonstration of scientific feasibility--just as we are with magnetic confinement approaches.

### 8.7.3. CONCLUDING REMARKS

Proponents of fusion power have promised that it will provide a virtually inexhaustible supply of clean and cheap energy. They point to the fact that nuclear fusion reactors will use as fuel the almost unlimited quantities of deuterium in the oceans that can be separated out so inexpensively as to make this fuel almost free. Furthermore they stress that since a fusion reactor will only contain a very small quantity of fuel during its operation, there is no danger of a nuclear runaway accident, and therefore a nuclear fusion reactor should be inherently safer than a fission reactor. They point to the fact that the total inventory of radioactive material in such reactors will be significantly smaller than fission reactors. Since fusion reactors will not utilize materials which can, in and of themselves, be made into nuclear weapons, there is not the danger of proliferation or diversion of strategic



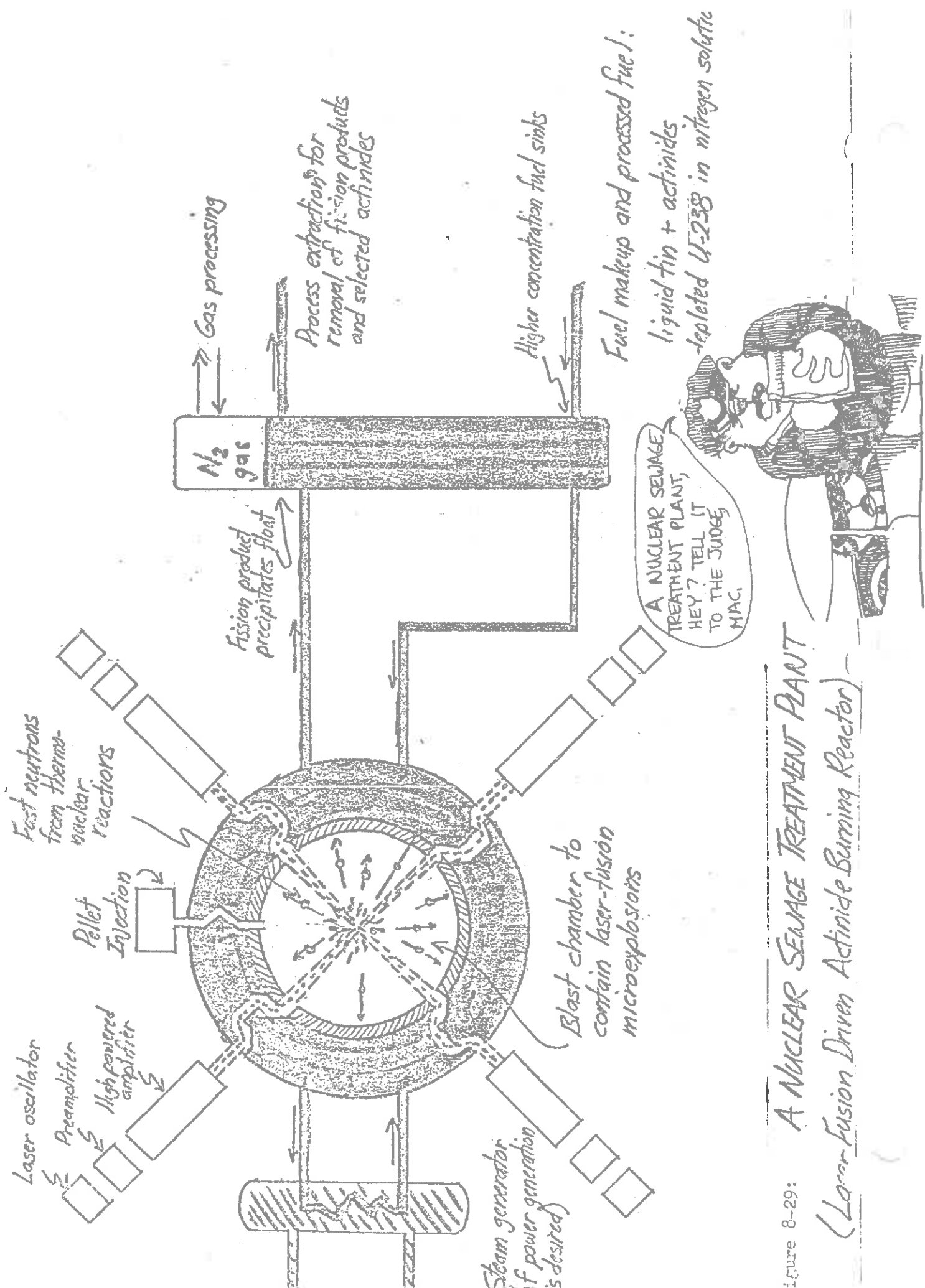


Figure 8-29: A NUCLEAR SEWAGE TREATMENT PLANT  
 (Laser-Fusion Driven Actinide Burning Reactor)

nuclear materials with such an energy source. Furthermore, fusion systems are capable of improved thermal efficiencies through higher temperature operation and hold out the possibility of direct conversion of fusion energy into electrical energy. In summary then, fusion energy proponents maintain that this approach to energy generation will present a smaller hazard and demand on the environment than another other major power source with the possible exception of solar power.

But it is important that we examine these claims more critically before we cast aside other alternatives in favor of embracing fusion power. First it should be noted that nuclear fusion is not alone in possessing an inexhaustible fuel supply. Both solar power and the fast breeder reactor are also characterized by vast energy resources. Furthermore, although the deuterium in the oceans does indeed represent an inexhaustible fuel supply for a D-D-<sup>3</sup>He fueled fusion reactor, we must keep in mind that the first generation of fusion reactors will most probably be based on a D-T reaction which requires substantial quantities of lithium (for conversion into tritium).<sup>42</sup> Lithium resources are far less abundant than those of deuterium. Furthermore, the demand made by the fusion power economy on the supply of exotic metals such as vanadium or niobium will be severe and may in fact become the major resource limitation on fusion power.<sup>43</sup>

Certainly to date nuclear fusion power has achieved an exceptional safety record--and well it should have since it hasn't worked yet! But as we have pointed out, fusion power will be plagued by many problems similar to those characterizing fission reactors. For example, we have noted that fusion reactors will produce large quantities of neutrons which will activate structural and blanket materials adjacent to the reactor and lead to a very significant radioactive inventory. Although the magnitude of this induced radioactivity will be somewhat less than that characterizing fission systems, it will nevertheless require serious attention. Furthermore the significant tritium inventory, corresponding to some  $10^{10}$  curies, in a fusion system will present a radiological hazard during normal plant operation which is comparable to that presented by

FISSION AND  
FUSION...  
FUSION AND  
FISSION...  
DA TA DAH,  
TA DAH...



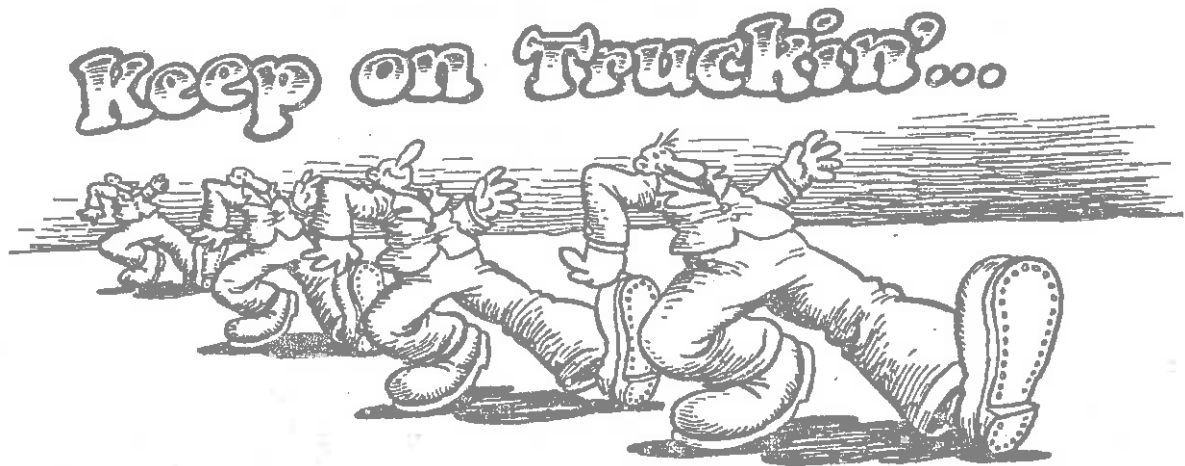
nuclear fission reactors, and it will require a significant improvement in the present techniques used to isolate and handle this radioactive nuclide. We have also noted that fusion power plants will utilize a significant amount of electrical energy production just to sustain the fusion reaction itself, and this rather significant energy circulation within the system could present a safety problem. In summary, although the radiological hazards presented by fusion systems have the potential of being somewhat less than those of fission systems, they are nevertheless of sufficient magnitude to require a comparable level of attention in the design of engineered safeguards systems.

The early generation of fusion power plants will utilize a thermal cycle which is identical to that of fission reactors, and therefore they will be limited to the same thermodynamic efficiencies. In fact, if the materials problems caused by radiation damage to the first wall of the reactor chamber cannot be alleviated through design, it may be necessary to operate fusion power plants at significantly lower temperatures, thereby reducing thermal efficiency.<sup>61</sup>

But perhaps of most significance is the recognition that a nuclear fusion reactor will be an extremely expensive and complicated device. In fact the increase in complexity in passing from the present generation of fission reactors to fusion systems is comparable to that characterizing the transition from coal-fired boilers to nuclear reactors.<sup>75</sup> The engineering problems which must be overcome before fusion power becomes a viable source of energy appear staggering at the present time.

There is little doubt that fusion reactors will be at least as expensive as advanced fission reactor types such as the fast breeder, and many studies have indicated that they will be several times more expensive in their capital cost. Since essentially all of the cost involved in generating electrical power from nuclear fission plants can be traced to the capital cost of the plant itself (fuel costs are very small), this implies that it is extremely unlikely that fusion power will be cheaper--and far more likely that it will be significantly more expensive than present day fission power.<sup>75</sup>

In summary then, we must approach the claims made in favor of nuclear fusion with some degree of skepticism if we are to arrive at a realistic assessment of its potential to meet our future energy needs. Certainly fusion power will present several environmental and resource advantages over fission power--but these will be obtained only with a very considerable expense, and only after a very considerable amount of further scientific research and engineering development. Indeed, there is some feeling that the present approaches to nuclear fusion power (e.g., the Tokamak, magnetic mirror, or laser fusion devices) are sufficiently unattractive that it may be wise to avoid making a commitment to the next stage of development along these lines (which is anticipated to involve prototype test reactors costing close to a billion dollars apiece), and instead rechannel this effort into basic scientific research in an effort to arrive at more attractive approaches to fusion power. Certainly we should not let the glamour of fusion power blind us to its very real difficulties, or prevent us from adequately funding research into less exotic energy alternatives such as solar power or the fast breeder reactor.<sup>94</sup>



## REFERENCES

1. Nuc. News 19, 29 (1976)
2. H. Brown, Ann. Rev. Energy 1, 1 (1976)
3. L. Schipper, Ann. Rev. Energy 1, 455 (1976)
4. J. S. Kane, Conf. on Magnitude and Deployment Schedule of Energy Resources (Oregon State University, 1975) p. 249
5. see references contained in papers by L. Schipper; P. Craig, J. Darmstadter, and S. Rattien in Ann. Rev. Energy 1, pp. 455-552 (1976)
6. R. C. Seamans, Trans. Am. Nuc. Soc. 24, 3 (1976)
7. L. Schipper, Ann. Rev. Energy 1, 455 (1976)
8. Nuclear Power and the Environment, American Nuclear Society (1976) p. 3
9. letter to the editor, , Science (1976)
10. Nuclear Power and the Environment, American Nuclear Society (1976) pp. 14-15
11. A National Energy Plan for Research, Development, and Demonstration, Vol. I: The Plan, ERDA 48 (1975)
12. L. Schipper and A. J. Lichtenberg, Science 194, 1001 (1976)
13. J. N. Garrett, in Conf. on Magnitude and Deployment Schedule of Energy Resources (Oregon State University, 1975) p. 95
14. P. H. Abelson, Science 192, 429 (1976)
15. D. Shapley, Science 187, 1064 (1975)
16. L. W. Bierbaum, in Conf. on Magnitude and Deployment Schedule of Energy Resources (Oregon State University, 1975) p. 116
17. S. Blackstone, *ibid.*, p. 105
18. Science 193, (1976)
19. G. R. Hill, in Conf. on Magnitude and Deployment Schedule of Energy Resources (Oregon State University, 1975) p. 123; A. A. Bartlett, Phys. Today (December, 1976) p. 9
20. A. L. Hammond, Science 193, 665, 873 (1976)
21. D. J. Rose, P. W. Walsh, L. L. Leskovjan, Am. Scien. 64, 291 (1976)
22. G. Atwood, Sci. Am. 233, 23 (1975)

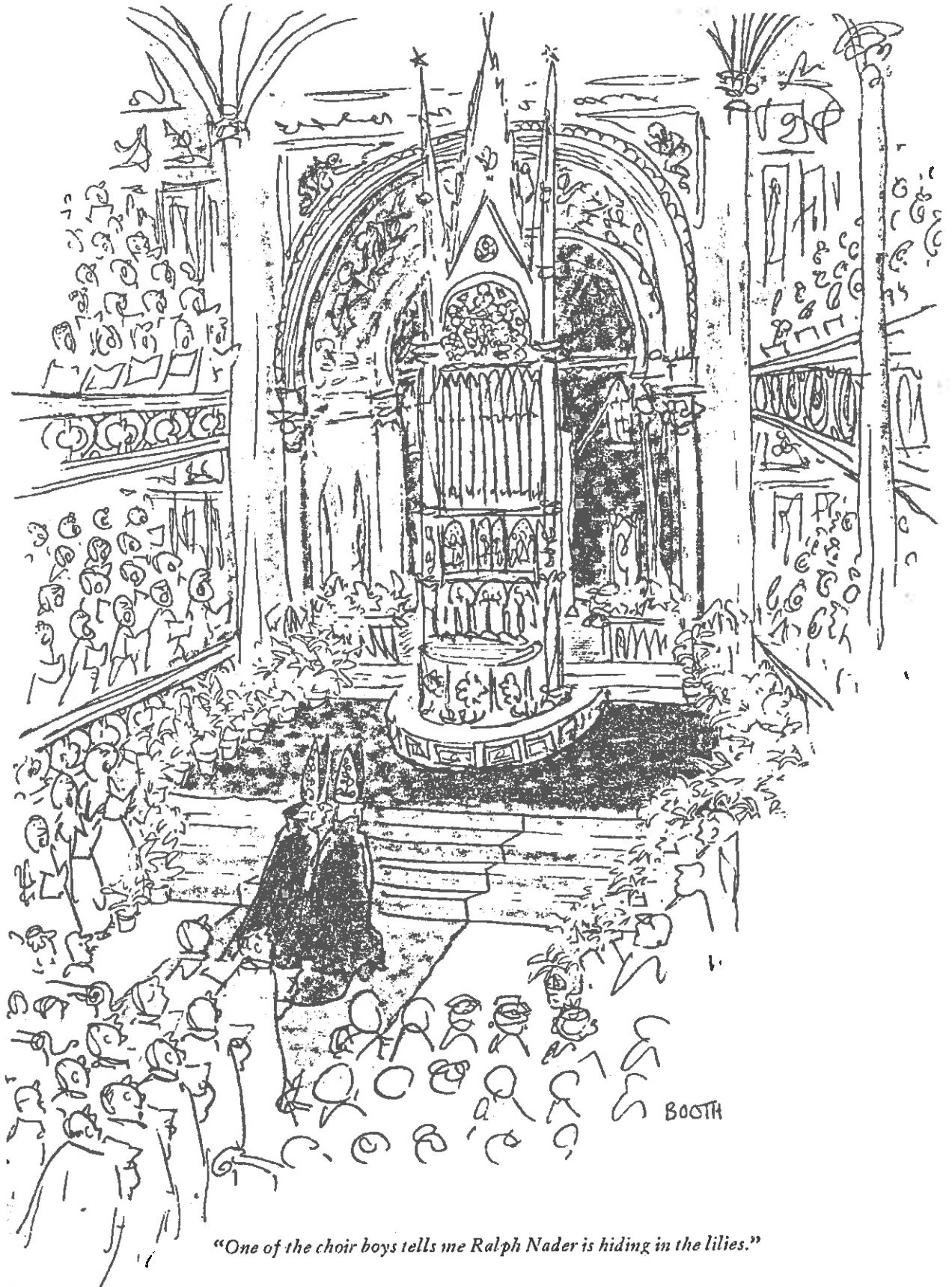


23. slurry pipelines
24. A Study of Social Costs for Alternative Means of Electrical Power Generation, ANL-8092 (1973)
25. J. M. Mitchell, in *The Changing Global Environment*, ed. by S. F. Singer (Reidel, Boston, 1975); R. M. Garrels, A. Lerman, F. T. Mackenzie, *Am. Sci.* 64, 306 (1976)
26. A. L. Hammond, *Science* 193, (1976)
27. A. L. Hammond, *Science* 193, 873 (1976); H. Perry, *Sci. Am.* 230, 19 (1974)
28. E. H. Reichl, in *Conf. on Magnitude and Deployment Schedule of Energy Resources* (Oregon State University, 1975) p. 137
29. A National Plan for Energy Research, Development, and Demonstration, Vol. I, ERDA 76-1 (1976)
30. J. W. Simpson, address to ANS/INEN Meeting, Mexico City, September 29, 1975
31. A. A. Bartlett, *Phys. Today* (December, 1976) p. 9
32. P. Kruger, in *Conf. on Magnitude and Deployment Schedule of Energy Resources* (Oregon State University, 1975) p. 59
33. P. Kruger, *Ann. Rev. Energy* 1, 159 (1976)
34. J. Barnea, *Sci. Am.* 226, 70 (1972)
35. A. J. Ellis, *Am. Sci.* 63, 510 (1975)
36. R. C. Axtmann, *Science* 187, 795 (1975)
37. W. G. Pollard, *Am. Sci.* 64, 424 (1976)
38. R. S. Greeley, in *Conf. on Magnitude and Deployment Schedule of Energy Resources* (Oregon State University, 1975) p. 9
39. A. Cohen, *ibid.*, p. 15
40. W. G. Pollard, *Am. Sci.* 64, 509 (1976)
41. M. Calvin, *Am. Sci.* 64, 260 (1976)
42. M. J. Antal, *Bull. At. Sci.* (May, 1976) p. 59
43. L. L. Vant-Hull, in *Conf. on Magnitude and Deployment Schedule of Energy Resources* (Oregon State University, 1975) p. 22

44. A. F. Hildebrandt, NSF/RANN/SE/GI-39456/PR/74 (1974)  
G. Kaplan, IEEE Spectrum (December, 1975), p. 47
45. F. Von Hippel and R. H. Williams, Bull. Atom. Sci. (November, 1975) p. 25
46. G. Kaplan, IEEE Spectrum (December, 1975) p. 47
47. D. Glaser, IEEE Spectrum (March, 1973) p. 38
48. F. Von Hippel and R. H. Williams, Bull. Atom. Sci. (November, 1975) p. 25
49. F. H. Warren, in Conf. on Magnitude and Deployment Schedule of Energy Resources (Oregon State University, 1975) p. 37
50. L. R. Arnoldi, Electric Power Generation (Oregon State University, 1973), p. 15
51. B. Sorenson, Bull. Atom. Sci. (September, 1976)p. 38; Science 189, 255 (1975)
52. D. R. Inglis, Bull. Atom. Sci. (October, 1975)
53. L. W. Zelby, Bull. Atom. Sci. (March, 1976) p. 59
54. C. Zener, Bull. Atom. Sci. (January, 1976) p. 17
55. E. L. Leventhal, Conf. on Magnitude and Deployment Schedule of Energy Resources (Oregon State University, 1975) p. 47
56. ERDA 76-1 (1976); A. H. Hammond, Science 189, 539. (1976)
57. Testimony presented before Joint Committee on Atomic Energy on the Environmental Impact of the Fast Breeder Reactor, 1975
58. M. Levenson, P. M. Murphy, and C. P. Zaleski, Nuc. News (April, 1976) p. 54
59. G. Seaborg, Sci. Am. (1971)
60. W. H. Hannum, J. D. Griffith, Trans. Am. Nuc. Soc. 22, 483 (1975)
61. H. Bethe, Sci. Am. (1975)
62. R. F. Post, Ann. Rev. Energy 1, 213 (1976)
63. T. B. Cochran, J. G. Speth, A. R. Tamplin, Natural Resources Defense Council (1975); R. F. Post and F. L. Ribe, Science 186, 397 (1974)
- 64.
65. D. Rose, Science 172, 797 (1971)
66. S. Glasstone and R. H. Loveberg, Controlled Thermonuclear Reactions (Van Nostrand, 1960)

67. F. L. Ribe, Trans. Am. Nuc. Soc. 24, 32 (1976); LA-UR-76-2165
68. R. F. Post and F. L. Ribe, Science 186, 397 (1974)
69. D. Steiner, Nuc. Sci. Eng. 58, 107 (1975)
70. W. D. Metz, Science 192, 1320 (1976); 193, 38 (1976); P. H. Abelson, Science 193 (July, 1976)
71. B. Badger, UWPIAK-I, CONF-740402, 38 (1974); R. G. Mills, MATT 1050 (1974)
72. D. Steiner, Nuc. Sci. Eng. 58, 146-154 (1975)
73. J. P. Holdren, Trans. Am. Nuc. Soc. 24, 32 (1976); UCRL-78759
- 74.
75. W. D. Metz, Science 193, 307 (1976)
76. B. R. Leonard, Nucl. Tech. 20, 161 (1973); L. Lidský, Nuc. Fusion 15, 151 (1975)
77. E. Teller, address presented at IQE Conference, Montreal, 1972
78. J. Nuckolls, L. Wood, A. Thiessen, G. Zimmerman, Nature 239, 139 (1972)
79. J. L. Emmett, J. Nuckolls, L. Wood, Sci. Am. , 24 (1974)
80. K. Brueckner, Rev. Mod. Phys. 46, 325 (1974)
81. J. S. Clarke, H. N. Fisher, R. J. Mason, Phys. Rev. Let. 30, 89 (1972)
82. A. Fraas and M. Lubin, Sci. Am. , 21 (1971)
83. K. Boyer, Aero. and Astro. ( , 1973) p. 28
84. A. Thiesson, G. Zimmerman, T. Weaver, J. Emmett, J. Nuckolls, and L. Wood, UCRL-74802 (1973)
85. P. M. Cambell, G. Charatis, and G. R. Montry, Phys. Rev. Let. 34, 74 (1975)
86. T. J. Burgess, IEEE Trans. Plas. Sci. 2, 26 (1973)
87. J. Wilson and D. O. Ham, Laser Focus 12, 38 (1976)
88. G. Yonas, et. al., Nuc. Fusion 14, 731 (1975)
89. J. W. Shearer, Nuc. Fusion 15, 952 (1975)
90. W. D. Metz, Science 194, 307 (1976)
91. L. A. Booth, D. A. Freiwald, T. G. Frank, and F. T. Finch, Proc. IEEE 64, 1460 (1976)

92. R. D. Nininger, S. H. Bowie, Trans. Am. Nuc. Soc. 24, 5 (1976)
- 93.
94. P. H. Abelson, Science 193 (July, 1976) editorial



*"One of the choir boys tells me Ralph Nader is hiding in the lilies."*

