

31850

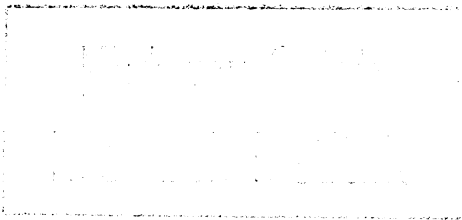

WHOLE BODY RESPONSE  
RESEARCH PROGRAM

First Year Final Report  
(July 1, 1973 - August 31, 1974)

by

John W. Melvin  
Joseph B. Benson  
Nabih M. Alem

Biomechanics Department  
Highway Safety Research Institute  
The University of Michigan  
Ann Arbor, Michigan 48105

Sponsor:

General Motors Research Laboratories  
Biomedical Science Department  
Warren, Michigan 48090



BIBLIOGRAPHIC DATA IEET	1. Report No. UM-HSRI-BI-75-1	2.	3. Recipient's Accession No.
Title and Subtitle WHOLE BODY RESPONSE RESEARCH PROGRAM First Year Final Report			5. Report Date March 11, 1975
Author(s) J. W. Melvin, J. B. Benson, and N. M. Alem			6.
Performing Organization Name and Address Biomechanics Department Highway Safety Research Institute The University of Michigan Ann Arbor, Michigan 48105			8. Performing Organization Rept. No. UM-HSRI-BI-75-1
Sponsoring Organization Name and Address General Motors Research Laboratories Biomedical Science Department Warren, Michigan 48090			10. Project/Task/Work Unit No. 320316
			11. Contract/Grant No. ORA-73-1096-KB1
Supplementary Notes			13. Type of Report & Period Covered 7-1-73 to 8-31-74 Final Report 74
			14.

Abstracts

The general objectives of the program are to obtain data on human whole body kinematics under controlled test conditions which represent realistic automotive impact environments. The test subjects in the program are unembalmed male human cadavers which are suitably instrumented and subjected to the test environments at various levels of crash severity. Prior to testing, anthropometric measurements, including x-ray anthropometry, are made on each subject to quantify the subject's geometric characteristics and to locate the test instrumentation with respect to anatomical landmarks. The results of the test program are being analyzed to provide information for the development of scaling laws for percentile rating of response data and for prescribing performance requirements for dummy response evaluation.

Key Words and Document Analysis. 17a. Descriptors

Whole Body Kinematics, Cadaver Anthropometry, X-Ray Anthropometry, Motion Analysis.

Identifiers/Open-Ended Terms

COSATI Field/Group

Availability Statement

19. Security Class (This Report) UNCLASSIFIED	21. No. of Pages 84
20. Security Class (This Page) UNCLASSIFIED	22. Price

## TABLE OF CONTENTS

	Page
1.0 INTRODUCTION	1
2.0 BACKGROUND AND APPROACH	2
2.1 PROGRAM DESCRIPTION	2
2.1.1 Initial Test Development	2
2.1.2 Cadaver Anthropometry Development	7
2.1.3 Cadaver and Dummy Testing Program	7
2.1.4 Test Data Analysis and Synthesis	8
3.0 EXPERIMENTAL PROCEDURES	11
3.1 TEST PREPARATION SCHEDULE	11
3.2 SANITARY PREPARATION	11
3.3 HEAD PREPARATION	11
3.3.1 Installation of Anatomical Markers	11
3.3.2 Installation of Accelerometer Headset	13
3.4 INSTALLATION OF THORACIC ACCELEROMETER FIXTURE	15
3.5 INSTALLATION OF PELVIC ACCELEROMETER FIXTURE	17
3.6 CLOTHING	17
3.7 INSTALLATION OF FEMUR TARGETS	19
3.8 PRE-IMPACT X-RAYS	19
3.8.1 X-Ray Seating Fixture	19
3.8.2 Head X-Rays	20
3.8.3 Full Body X-Rays	20
3.9 IMPACT TESTING	24
3.9.1 Instrumentation Data	24
3.9.2 Camera Coverage	24
3.9.3 Positioning	24
3.9.4 Targeting	28
3.9.5 Belt Anchor Position Data	28
3.9.6 Calibration	28

TABLE OF CONTENTS (continued)

	Page
3.9.7 Post Impact Belt Length	29
3.10 POST IMPACT X-RAYS	29
3.11 ANTHROPOMETRY	29
3.12 CADAVER CONFIGURATION	29
4.0 DATA ANALYSIS PROCEDURES	38
4.1 HEAD MOTION DETERMINATION	38
4.1.1 Introduction	38
4.1.2 Theoretical Analysis of Head Motion	38
4.2 THREE DIMENSIONAL X-RAY TECHNIQUE	45
4.2.1 Introduction	45
4.2.2 Method	46
4.2.3 Definitions	47
4.2.4 X-Ray Measurements of a Single Point	50
4.2.5 Experimental X-Ray Procedure	52
4.2.6 Computational Procedure	57
4.3 PHOTOMETRIC ANALYSIS	62
4.3.1 Introduction	62
4.3.2 Cameras and Film	62
4.3.3 Synchronization	64
4.3.4 Magnification Calibration	64
4.3.5 Coordinates Reading	64
4.3.6 Analysis of a Typical Run - A-725	65
4.3.7 Rigid-Body Photometric Analysis	67
5.0 PROGRAM SUMMARY AND RECOMMENDATIONS	73
5.1 PRELIMINARY SLED PULSE EVALUATION	73
5.2 CADAVER INSTRUMENTATION AND PREPARATION TECHNIQUES	73
5.3 DATA ANALYSIS TECHNIQUES	78
5.4 CADAVER TEST PROGRAM	79

TABLE OF CONTENTS (continued)

	Page
5.5 PROGRAM RECOMMENDATIONS	80
5.5.1. Accelerometer Headset	80
5.5.2 Anthropometry	80
5.5.3 Targeting	80
5.5.4 X-Rays	83
5.5.5 Positioning	83
5.5.6 Future Program Plans	84

## LIST OF TABLES

		Page
TABLE I.	TEST INSTRUMENTATION SUMMARY	5
TABLE II.	TEST CINEMATOGRAPHIC COVERAGE SUMMARY	6
TABLE III.	WHOLE BODY RESPONSE TEST SCHEDULE	12
TABLE IV.	X-RAY CHECKLIST (SEATED)	21
TABLE V.	HEAD X-RAY DATA SHEET	23
TABLE VI.	FULL BODY X-RAY CHECK LIST	25
TABLE VII.	INSTRUMENTATION WORKSHEET	27
TABLE VIII.	BELT DATA - Anchor Positions and Belt Lengths	30
TABLE IX.	CADAVER ANTHROPOMETRY	32
TABLE X.	SUMMARY TABLE OF PHOTOMETRIC ANALYSIS FOR RUN A-725	66
TABLE XI.	WHOLE BODY RESPONSE PROGRAM - SUMMARY OF TESTING TO DATE	74
TABLE XII.	DUMMY TEST COMPARISON	75
TABLE XIII.	DUMMY TEST DATA COMPARISON	76
TABLE XIV.	ANTHROPOMETRY MEASUREMENTS	81

## LIST OF FIGURES

		Page
Figure 1.	Positioning Diagram	3
Figure 2.	Targeting Diagram	4
Figure 3.	Accelerometer Headset Mounted on HSRI Dummy (Two of three Entran biaxial accelerometers shown mounted)	14
Figure 4.	Thoracic Accelerometer Fixture Installation	16
Figure 5.	Pelvic Accelerometer Fixture Installation	18
Figure 6.	Pre-Test Configuration Right Side Lateral View Test A-725	34
Figure 7.	Pre-Test Configuration Front View - Test A-725 (The small strap under arms is for pre-test position only; it is not used during the test)	35
Figure 8.	Post-test Configuration, Right Side Lateral View Test A-725	36
Figure 9.	Post-test Configuration, Front View - Test A-725	37
Figure 10.	Rigid Body in Space	39
Figure 11.	2-2-2 Combination	42
Figure 12.	Instrumentation Coordinate System for the Head	48
Figure 13.	Anatomical Points Defining the Frankfort Plane	49
Figure 14.	Simplified X-Ray Set-up for a Single Point	51
Figure 15.	Calibration of X-Ray Set-up	53
Figure 16.	Lead Plate for Pre-Recording of Optical Center	55
Figure 17.	Typical Photometric Setup of a Sled Run	63
Figure 18.	Excursions relative to sled, of a typical target obtained from photometric analysis. [Thorax, Run A-725]	68
Figure 19.	Inertial $\hat{I}$ -coordinates (A-P) of 3 head targets, obtained from photometric analysis of Run A-725	69
Figure 20.	Inertial $\hat{J}$ -coordinates (R-L) of 3 head targets, obtained from photometric analysis of Run A-725	70
Figure 21.	Inertial $\hat{K}$ -coordinates (I-S) of 3 head targets, obtained from photometric analysis of Run A-725	71



## 1.0 INTRODUCTION

This report is a final report on the first year of the Whole Body Response Research Program conducted by the Biomechanics Group of the Highway Safety Research Institute (HSRI) of The University of Michigan under the sponsorship of the General Motors Research Laboratories. The general objectives of the program are to obtain data on human whole body kinematics under controlled test conditions which represent realistic automotive impact environments. The test subjects in the program are unembalmed male human cadavers which are suitably instrumented and subjected to the test environments at various levels of crash severity. Prior to testing, anthropometric measurements, including x-ray anthropometry will be made on each subject to quantify the subject's geometric characteristics and to locate the test instrumentation with respect to anatomical landmarks. The results of the test program are being analyzed to provide information for the development of scaling laws for percentile rating of response data and for prescribing performance requirements for dummy response evaluation.

The following sections of the report discuss the program progress during the first program period (July 1, 1973 to August 31, 1974) and the analytical and experimental techniques developed to perform the testing and data analysis required in the program.

A total of seven sled tests were run during the time period -- four dummy tests and three human cadaver tests. These tests are summarized in Section 5.0. The head motion determination technique based on six-accelerometers (Section 4.1) has been shown to be subject to computational instabilities. A discussion of this problem and its suggested solution by the inclusion of three redundant accelerometers can be found in Section 5.3.

## 2.0 BACKGROUND AND APPROACH

### 2.1 PROGRAM DESCRIPTION

The first year program of the Whole Body Response Research Program involved four phases of work:

1. Initial test development
2. Cadaver anthropometry development
3. Cadaver and dummy testing program
4. Test data analysis and synthesis

The requirements in each phase are detailed in the following sections.

#### 2.1.1 Initial Test Development

The test configuration used in the first year program was that of a three-point belt restraint system as described in the detailed GMR outline entitled Anthropometric Dummy - Human Cadaver Dynamic Response Calibration Program, dated October 18, 1972. This configuration is shown schematically in Figures 1 and 2. The test instrumentation requirements for this test configuration are listed in Table I and the test cinematographic coverage requirements are listed in Table II.

The test program utilizes the HSRI Impact Sled Facility, and, since the program is part of a larger program involving dummy tests on the GM Research sled and embalmed cadaver tests on the Wayne State University sled, the first step in developing test procedures at HSRI was to determine the equivalence of the HSRI sled environments with the other sled environments. Two levels of impact severity were chosen for the tests -- a low severity level consisting of 23 mph velocity change with a 22-inch stop (approximately 10 G average deceleration) and a high severity level consisting of 33 mph velocity change with a 22-inch stop (approximately 20 G average deceleration). The high severity level was chosen for the equivalence testing and two runs

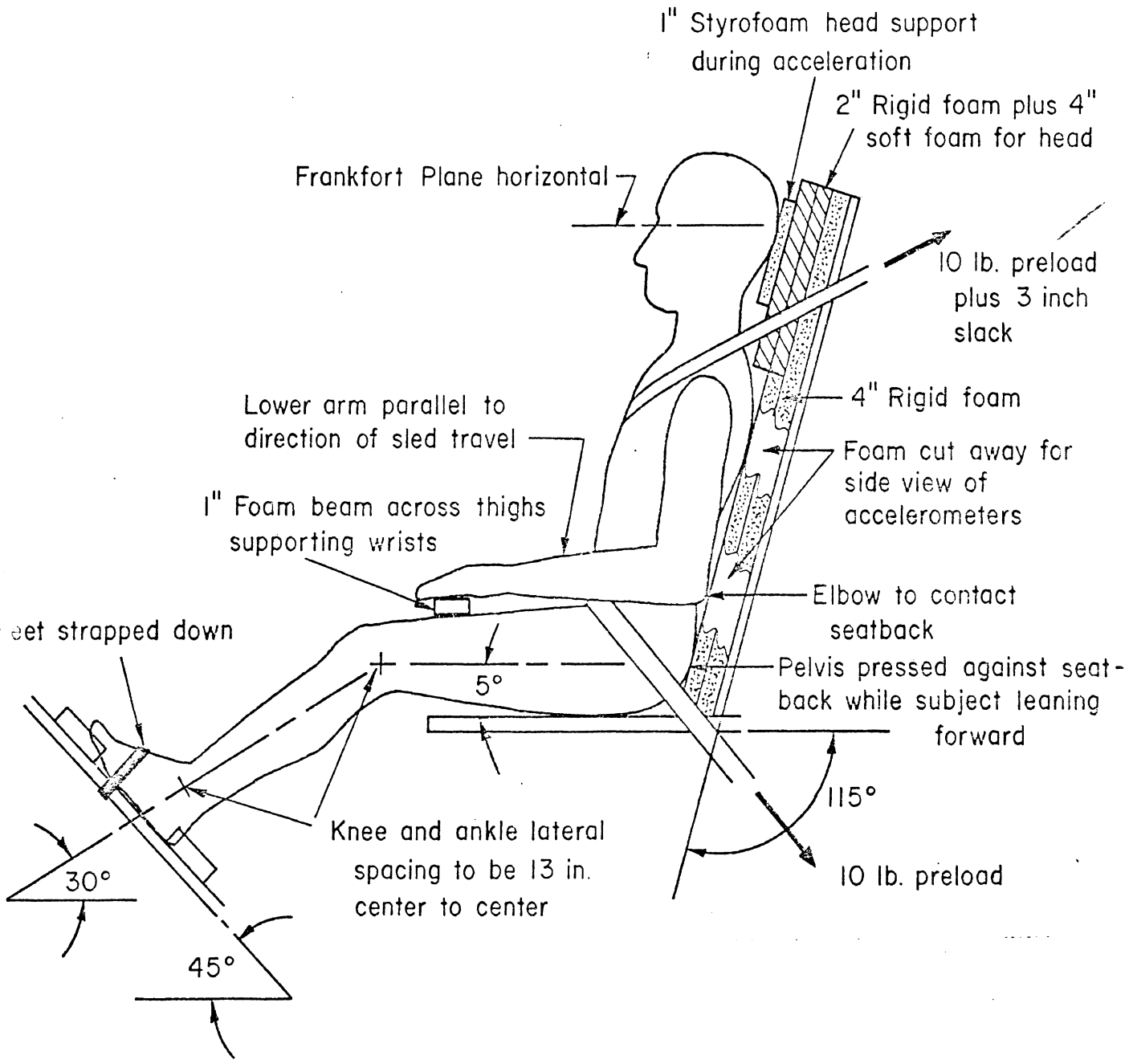

Figure 1  
 POSITIONING DIAGRAM

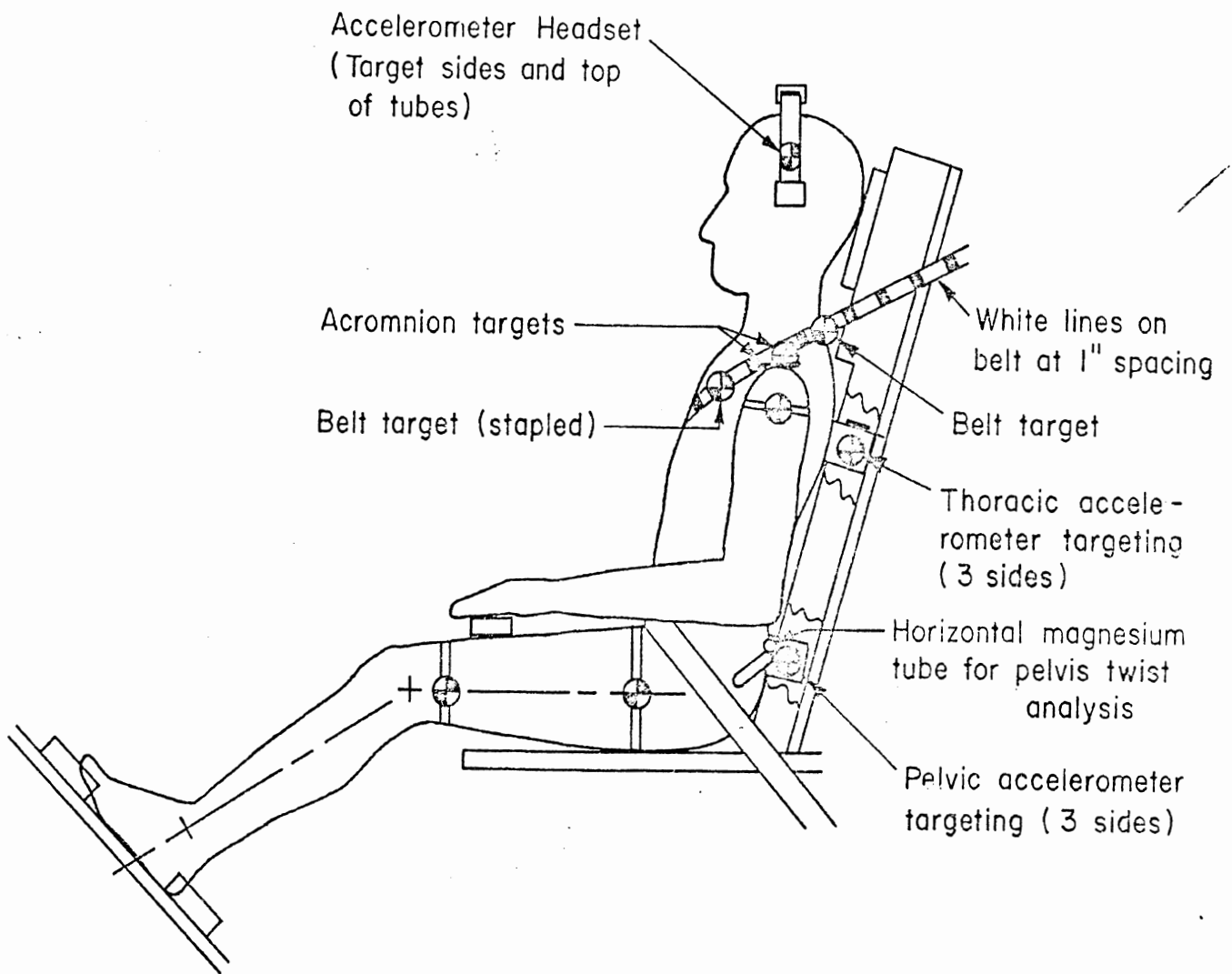

Figure 2  
TARGETING DIAGRAM

TABLE I. TEST INSTRUMENTATION SUMMARY

1. All Channels recorded on tape, unfiltered.
2. Sled velocity and deceleration.
3. Film/tape sync. by strobe flash using photoelectric cell to generate voltage spike on tape from strobe light flash.
4. Lap and shoulder belt webbing force transducers (four)
5. Head accelerometers -- 3 Entran biaxial accelerometers, mounted on tubular magnesium headset.
6. Cadaver chest accelerometers -- AP, SI, and LR at MVSS 208 level, potted to spinous process.
7. Cadaver pelvis accelerometers -- AP and SI at H-point level, attached to posterior of sacrum.
8. Dummy instrumentation to be provided by GMR.
9. Recapitulation of Transducer Requirements

Test No. 1

Sled velocity and acceleration:	1 channel
Film/tape sync:	1 channel
Belt forces:	4 channels
Occupant accelerations:	<u>11 channels</u>
TOTAL	17 channels

TABLE II. TEST CINEMATOGRAPHIC COVERAGE SUMMARY

CAMERA COVERAGE

1. Lateral, left and right, 1000 frames/sec.
2. Overhead, in midsagittal plane, vertical, 1000 frames/sec.
3. Front, 1000 frames/sec.
4. Color film; 1000 Hz timing marks

TARGETING (See Fig. 2)

1. Targets located relative to skeletal landmarks by means of x-ray radiography
2. Targets attached to the skeletal structure
3. Head -- Lateral X, Y,  $\theta$ ; left and right sides
4. Thorax -- Lateral X, Y,  $\theta$  at C<sub>7</sub>/T<sub>1</sub> interspace; left and right
5. Thorax -- Overhead X, Y,  $\theta$  at C<sub>7</sub>/T<sub>1</sub> interspace
6. Pelvis -- Lateral X, Y,  $\theta$  at H-points; left and right
7. Pelvis -- Overhead measurement of H-point axis.
8. Femur -- Lateral
9. Shoulder (acromion) -- Overhead, X, Y; left and right
10. Sled -- Lateral and overhead X, Y; also scale factor targets for film analysis.

were made with the GMR supplied Hybrid II dummy.

The main part of the initial test development was concerned with the development of the specialized cadaver preparation techniques and instrumentation fixtures necessary for the performance of the project. ~~These~~ techniques, fixtures and procedures are detailed in Section 3.0 EXPERIMENTAL PROCEDURES.

### 2.1.2 Cadaver Anthropometry Development

The characterization of the physical geometry of the human cadaver test subjects used in the test program required the development of a comprehensive set of anthropometric measurements.

Two types of direct measurements are made, one represents classic anthropometry and serves to allow classification of the cadaver with respect to its percentile size ranking in the U.S. population and other measurements are special measurements aimed at defining those dimensions of particular importance to dummy classification and performance. In addition to the direct measurements, x-ray anthropometry is also used to allow determination of the skeletal features of interest and to locate test targets. All of the special techniques and equipment necessary to perform these tasks were developed during this phase of the program. Many of the measurements are made with the cadaver supine. However, many of the non-classical measurements and the x-ray anthropometry are made with the cadaver seated in a chair that is representative of the test configuration. The list of measurements is detailed in Section 3.11.

### 2.1.3 Cadaver and Dummy Testing Program

Following completion of the development of the testing and anthropometric techniques necessary to successfully perform the required testing, the test program was to be initiated. The thoroughness with which each cadaver was to

be measured, targeted and tested and the subsequent data analyzed, and the limited time that a fresh cadaver can be worked with, precluded large numbers of multiple tests with the same cadaver. Instead, it was decided that two sled runs be made with each cadaver -- a low severity run (23 mph, 10 G) followed by a high severity run (33 mph, 20 G). Due to the extensive data analysis which was to be performed on the test data and the random nature of cadaver availability, it was decided to use ten male cadavers in the first year program. Thus, a total of twenty sled tests of unembalmed human cadavers was planned. These tests were to be followed by twelve Hybrid II dummy runs under identical conditions.

#### 2.1.4 Test Data Analysis and Synthesis

Concurrent with the test program, the test results are to be reduced and analyzed at HSRI using inhouse data analysis facilities. The data that is recorded on the tape recorder is to be analyzed in the following manner:

1. A-to-D conversion of all acceleration and force data. Digitized data will be stored on punched cards, and store original analog tape.
2. Light beam oscillograph records from the original analog tape will be made. M1650 galvos will be used on all channels, except for an M100 galvo on the sled deceleration channel.
3. Apply MVSS 208 filtering to head and chest acceleration data.
4. Apply MVSS 208 filtering to pelvis acceleration and belt force data.
5. Compute head angular accelerations versus time using filtered data.
6. Compute head and chest resultant accelerations versus time using filtered data.
7. Compute Gadd Severity Index (GSI) and Head Injury Criterion (HIC) for the head and chest, using filtered data, as follows:
  - a. Head -- GSI and HIC for AP, SI, and LR components, and for the resultant.



b. Chest -- GSI versus time for the AP, SI, and LR components, and for the resultant.

8. Use computer graphics package to plot output.

In general, the cinematographic data is to be analyzed in the following manner:

1. Analyze films using the Vanguard Motion Analyzer.
2. Compute film speed.
3. Synchronize film time base to tape time base by recording frame number for strobe flash.
4. Geometric scale factor determination -- Measure length of scale factor target on sled. Use in conjunction with camera-to-occupant target distances to compute geometric scale factors.
5. Measure X, Y, and  $\theta$  as a function of frame number for every 100 Hz timing mark and a frame approximately midway between marks. All targets indicated in Table II are to be analyzed.
6. Analyze data by computer to obtain the following data as a function of time. (Displacements are relative to the sled. Corrections will be made for misplaced targets.):
  - a. Head cg displacement from initial position (X, Y,  $\theta$ ).
  - b. Head cg displacement relative to thorax (X, Y,  $\theta$ ).
  - c. Thorax displacement from initial position (X, Y,  $\theta$ ).
  - d. Pelvis displacement from initial position (X, Y,  $\theta$ ).
  - e. Pelvis/thorax angle change.
  - f. Femur/pelvis angle change.
  - g. Shoulder displacement relative to thorax (overhead).
7. Differentiate the above quantities once to obtain velocities.
8. Use computer graphics package to plot output.

With respect to the test configuration, the data analysis is to produce the following information:

1. MVSS 208 acceleration response, belt load response, and 3-dimensional head angular acceleration response.
2. Displacement and velocity responses -- lineal and angular.
3. Head/thorax angulation and head cg trajectory relative to C<sub>7</sub>/T<sub>1</sub> vertebral interspace (neck response).
4. Pelvis/thorax angulation and C<sub>7</sub>/T<sub>1</sub> vertebral interspace trajectory relative to H-point (lumbar response).
5. Femur/pelvis angulation (hip joint response).
6. Shoulder/thorax response.
7. Torso twist response.
8. Time phasing of onsets and peaks of forces and accelerations.

### 3.0 EXPERIMENTAL PROCEDURES

#### 3.1 TEST PREPARATION SCHEDULE

The successful, effective testing of unembalmed human cadavers requires careful planning and coordination of preparation and testing efforts. The unembalmed human cadavers used in the program are made available for use on a temporary basis and must be prepared and tested within two days of arrival. In order to facilitate the efficient preparation and testing, the schedule shown in Table III has been developed.

#### 3.2 SANITARY PREPARATION

The following procedure is followed for sanitary preparation of the cadaver:

a) All body openings (nose, mouth and anus) are stuffed with absorbent gauze and taped closed. Tampons and duct tape have proven to be suitable materials.

b) The head is shaved with electric clippers to facilitate later surgery.

c) All personnel wear surgical gloves and lab coats while attending to cadaver, and should remove them before leaving surgery area.

d) A disinfectant hand cleanser such as Phisophex is available in the preparation area.

#### 3.3 HEAD PREPARATION

##### 3.3.1 Installation of Anatomical Markers

Four lead pellets (#8 shot) are required to define physiological axes on x-rays. The pellets are to be mechanically deformed as described below for identification purposes. The installation procedures are as follows:

TABLE III. WHOLE BODY RESPONSE  
TEST SCHEDULE

TIME (approx)	Event
8 hours	Cadaver Arrives Place on autopsy table, gather tools and parts, alert personnel, perform sanitary preparation.
	Anthropometry Measurements
	Begin Surgery - Install Headset
	Install Thoracic Accelerometer Fixture
	Install Pelvic Accelerometer Fixture
	Clean-up
4 hours	Perform Head Analytical X-Rays
	Perform Body X-Rays
	Seated Anthropometry Measurements
8 hours	Cadaver moved into sled lab and strapped on test fixture
	Install Accelerometers
	Install Belts and Load Cells
	Install Targeting
	Position Subject and Tension Belts
	Begin Sled Checklist
	Perform Tests
	Cadaver Returned to Autopsy Room
	Remove Test Apparatus
Clean-up	

### EYE PELLETS:

Palpation is used to locate inferior orbital structure; an incision to bone is made at the midpoint, and a cubed pellet is bonded in place with Eastman 910.

The procedure is repeated at other eye, taking care to ensure pellets are equidistant from centerline of nose structure. A cubed pellet with lead tang is installed on left side.

The incisions are bonded closed with Eastman 910.

### EAR PELLETS:

A round lead pellet is inserted .75 in. from the outer end of a 1/4 in. OD wood dowel 1.50 in. long so that pellet is flush with the OD of the dowel. The pellet is bonded in place if necessary.

One dowel is inserted in each ear and oriented so that pellet contacts the superior auditory meatus. (Uppermost surface of ear canal).

Care is taken to ensure that the dowels are inserted the same distance into each ear canal.

The left side dowel has a lead tang on the round pellet for identification.

### 3.3.2 Installation of Accelerometer Headset

The accelerometer headset is a rigid magnesium tube weldment by which three Entran biaxial accelerometers are maintained in the B(2-2-2) configuration described in Section 4.1.2. The headset is bolted to three collets that are rigidly clamped to the skull. A complete installation is shown in Figure 3 on the HSRI dummy.

The installation procedure utilizes the headset as a template to locate and mark the desired attachment points on the scalp. The skull is exposed at these three positions by either surgical incisions or coring techniques, and a Stryker bone drill with a 10 mm trephine or cutting tool is used



Figure 3. Accelerometer Headset Mounted on HSRI Dummy (Two of three Entran biaxial accelerometers shown mounted).

to make the three mounting holes in the skull. One of the side positions is drilled first and the collet installed. The headset is positioned on the head, bolted to the side collet, and then the hole center for the other side collet is accurately located. With both side collets installed, the headset is attached to them and the hole center for the uppermost collet on the skull is located. Since the headset is now restricted to rotation about the side collets, both the positioning and angularity of the upper collet is critical for final attachment of the headset. Some adjustment is provided by individually fitted magnesium spacers that are used to take up any clearance between the collets and headset. These spacers allow the final fitting of the headset to the skull-collet system and prevent distortion of the headset when it is tightened to the collets.

#### 3.4 INSTALLATION OF THORACIC ACCELEROMETER FIXTURE

To measure chest accelerations at the  $T_8$  level, an accelerometer fixture was designed to mount directly to the spinous process of  $T_7$ . This fixture accepts two Entran biaxial accelerometers to provide a triaxial configuration and one redundant axis. The fixture consists of a mounting pad with a tubular extension. Attachment of the fixture is effected by putting the tube portion over the spinal process using dental acrylic compound.

Installation requires surgical exposure and thorough scraping of the  $T_7$  process. The dental acrylic compound is then mixed and used to fill the tube of the fixture. When the acrylic is sufficiently set so it will not run, the tube is pushed over the exposed and cleaned process, oriented as symmetrically as possible with respect to the body, and allowed to set. A photograph of an installation with accelerometers is shown in Figure 4. The incision should be closed and sealed carefully, using sutures, surgical tapes, and adhesives to minimize leakage of body fluids. The accelerometers

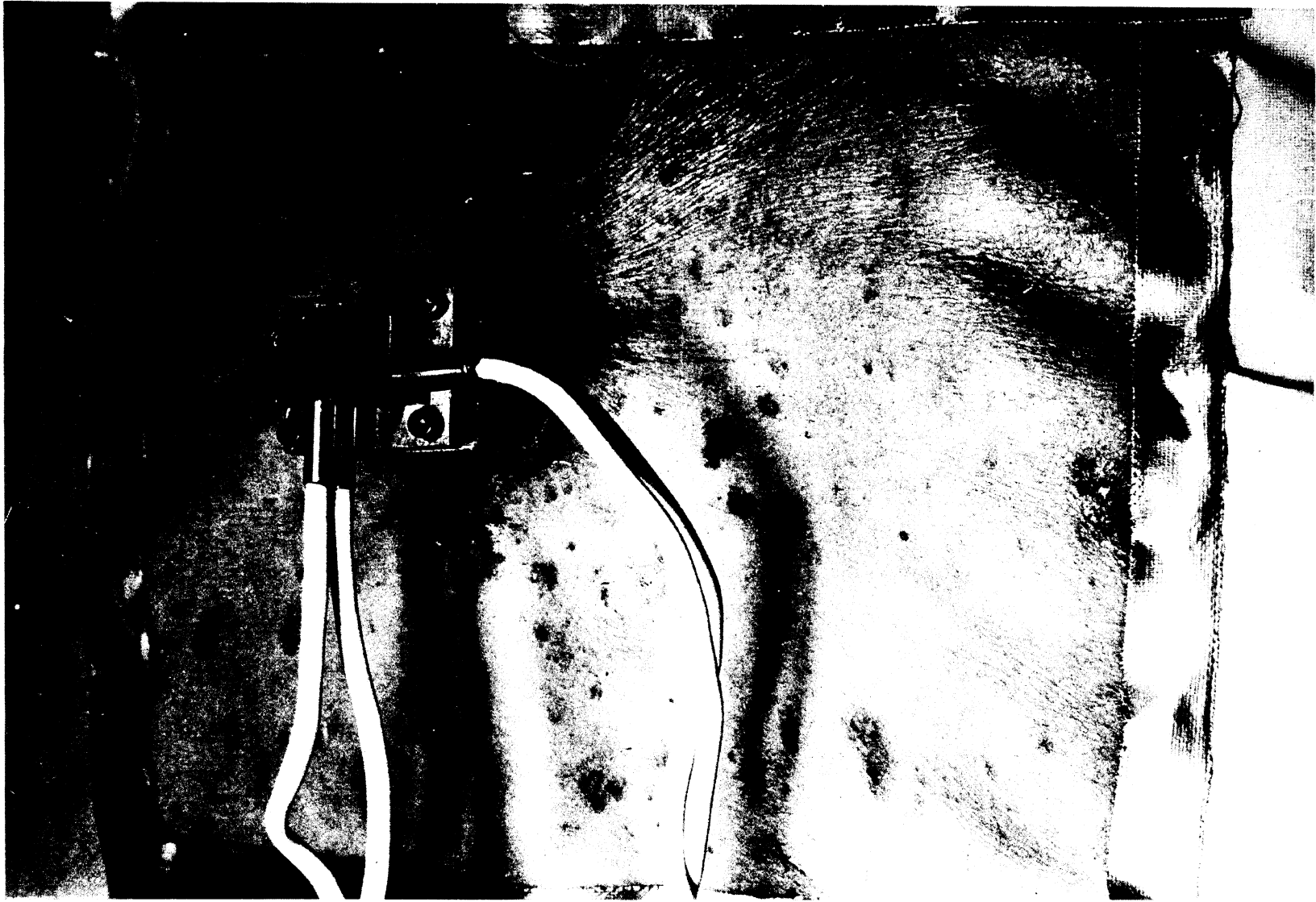

Figure 4. Thoracic Accelerometer Fixture Installation.



are attached to a plate which is mounted to the pad of the fixture by means of four socket head screws. A steel ball is sandwiched between the accelerometer plate and the mounting pad. By differential adjustment of the four screws, fine adjustment of the plate orientation can be made.

### 3.5 INSTALLATION OF PELVIC ACCELEROMETER FIXTURE

Accelerations at the pelvic level are measured in the A-P and S-I directions using two Setra type 113 accelerometers. The mounting fixture is a 5/9 OD magnesium tube that is bent to conform to the lower back contour and attached with four wood screws into the pelvic bone structure. Figure 5 shows the tube attachment and the tube clamping block with the accelerometers fastened.

Installation requires the fitting of the magnesium tube and location of the mounting holes, which are oval shaped to allow for screw angularity. An incision to the bone is made under each hole and a pilot hole drilled in the bone. The tube is then attached by threading the wood screws into the pilot holes. The clamping block is placed around the tube and the two accelerometers are bolted rigidly into place. Again, much care should be taken to close the incisions to prevent bleeding.

### 3.6 CLOTHING

The following clothing is used.

#### Undergarments

Sears 2-Piece Vinyl exercise suit #6-99101.

#### Outerwear

- a) Sears Heavyweight Thermal Circular Knit Angle Length Drawers #33-54507 and long sleeve shirt #33-54506
- b) Cotton stockings
- c) Cotton gloves

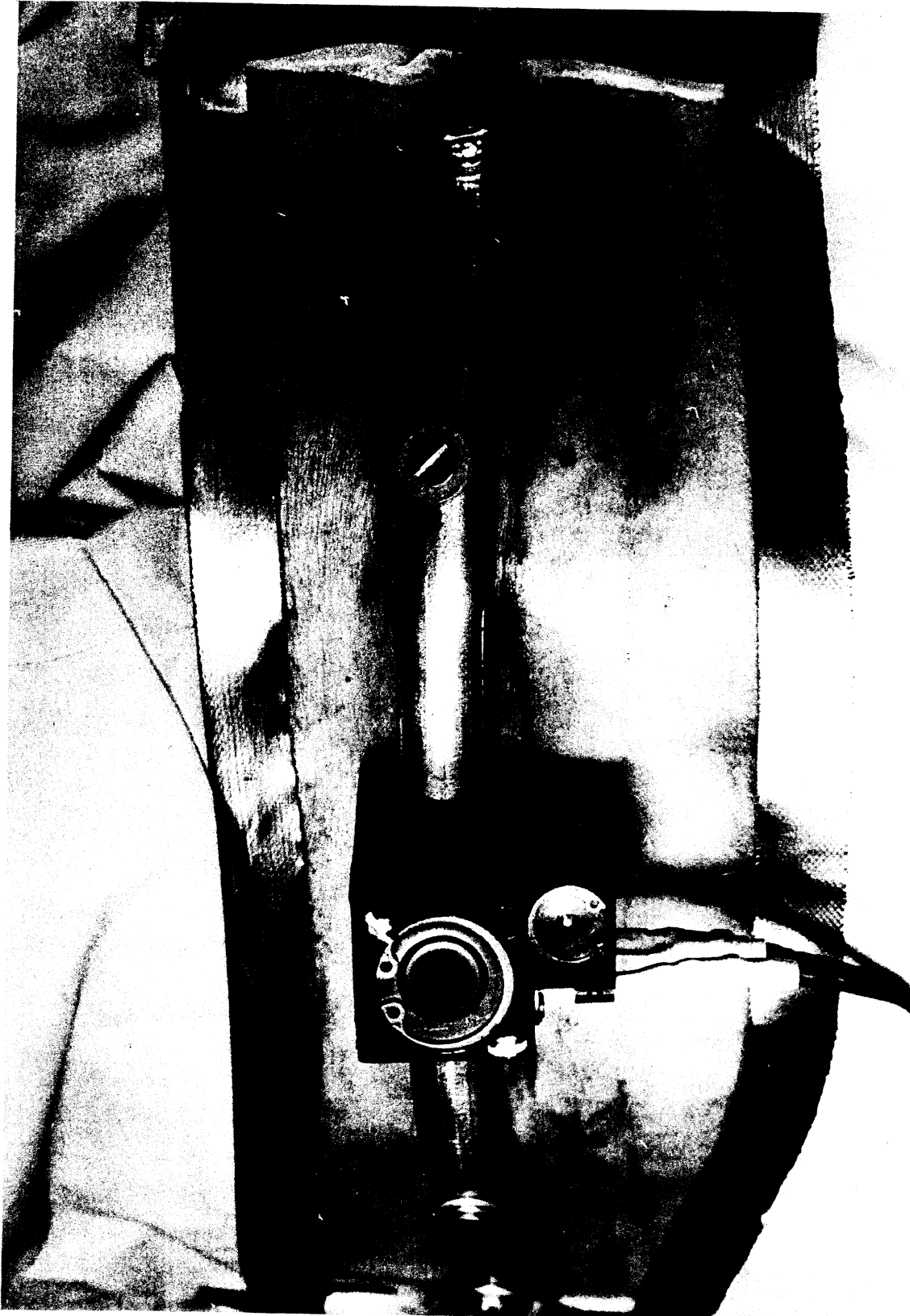

Figure 5. Pelvic Accelerometer Fixture Installation.

d) Surgical hood over face.

NOTE: Seat and lap of sweat suit are sprayed on both sides with Scotch Spray Mount Artist's Adhesive Cat. No. 6065 to eliminate slippage between skin, sweat suit, and thermal drawers. The shirt is treated similarly in area of shoulder belt contact, as is the sweat suit.

The clothing is put on the cadaver following the surgical procedures. It is recommended that the plastic suit top be tucked into the plastic pants and the two taped together securely with duct tape. Likewise, the socks and gloves should be tucked under the knit suit and secured with duct tape. Small openings are made in the suits to allow pelvic and thoracic accelerometers to protrude. The surgical hood is installed to completely cover the face and top of head, with clearance slits for the accelerometer headset collets. The hood is fitted snugly and is sewn together to eliminate looseness or gaps.

### 3.7 INSTALLATION OF FEMUR TARGETS

The femur targets are attached after the clothing is complete. The targets are 2.0 in. diameter aluminum discs with two holes for threading, with nylon wire wraps. Two wire wrap and target assemblies are strapped to each thigh at equal spacing. Adhesive photographic targets are then pasted to each disc.

### 3.8 PRE-IMPACT X-RAYS

#### 3.8.1 X-Ray Seating Fixture

A wooden seating platform was constructed to provide the same positioning of the cadaver as the impact sled test buck. The seating platform is clamped to a movable steel table that is adjustable for height. After the cadaver preparation has been completed, it is lifted onto the seating fixture, strapped securely in place, and rolled into the x-ray room.

### 3.8.2 Head X-Rays

Two orthogonal x-rays of the head are required to define the head accelerometer and physiological axes relationship as described ~~in detail in~~ Section 4.2. The accelerometer positions are provided by aluminum cubes which attach to the headset in place of the accelerometers and position a lead pellet at the effective center of mass of each Entran biaxial accelerometer. The cadaver head should be securely taped in place facing slightly to either side to provide a distinct view of both of the side accelerometer pellets in the lateral x-rays. Orthogonality of the two x-rays is obtained by aligning orthogonal sides of the steel table with the vertical face of the x-ray table. Prior to each head x-ray, the optical center ring should be exposed on the film as detailed in Section 4.2.5. After each x-ray, measurements from the x-ray table to each lead pellet target must be made and entered in the data sheet before the subject is moved. These dimensions are required by the x-ray calibration program to determine the true distances between pellets. The procedure check list and data sheet for the head x-rays are shown in Tables IV and V.

### 3.8.3 Full Body X-Rays

The purpose of the full body x-rays is to provide a complete record of the skeletal structure of the subjects and obtain position and orientation data for the pelvic and thoracic accelerometer. Scaling is accomplished with lead pellets imbedded in long plexiglass strips at two-inch intervals, and the strips placed along the skeletal structure at the same distance from the x-ray screen as the member to be scaled. All the plexiglass scaling strips should be attached prior to beginning the x-rays, should overlap, and have identifying markers such as lead letters in the overlap zone so successive x-rays may be integrated at a later time.

TABLE IV. X-RAY CHECKLIST (SEATED)

1. Head X-Rays

X-Ray Table

X-Ray Table

X-Z Plane

Y-Z Plane

Orthogonal X-Rays of the Head are Required to Define Orientation of Accelerometer to Anatomical Axes.

Checklist

- \_\_\_\_\_ a. Polyethylene sheeting on table
- \_\_\_\_\_ b. X-Ray table and head positioned at maximum separation
- \_\_\_\_\_ c. Film cassette labeled appropriately (W B R - I, I = 1, 2, 3 ...  
= Subject No.)
- \_\_\_\_\_ d. Optical center ring projected on film
- \_\_\_\_\_ e. Subject positioned
- \_\_\_\_\_ f. Plane label taped to table
- \_\_\_\_\_ g. X-Ray subject and record x-ray settings
- \_\_\_\_\_ h. Record dimensions to anatomical and headset lead pellet  
targets from x-ray table.
- \_\_\_\_\_ i. Move subject, install fresh cassette
- \_\_\_\_\_ j. Film cassette labeled appropriately
- \_\_\_\_\_ k. Optical center ring projected on film
- \_\_\_\_\_ l. Subject positioned (90° rotation)
- \_\_\_\_\_ m. Plane label taped to table
- \_\_\_\_\_ n. X-Ray subject and record x-ray settings
- \_\_\_\_\_ o. Record dimensions on data sheet to anatomical and headset  
lead pellet targets from x-ray table.

TABLE IV. DISTANCES FROM X-RAY SCREEN

<u>ANATOMICAL PELLETS</u>	<u>DISTANCE (Inches)</u>	
	X-Z Plane	Y-Z Plane
Right Eye	_____	_____
Left Eye	_____	_____
Right Ear	_____	_____
Left Ear	_____	_____
<hr/>		
<u>HEADSET ACCELEROMETERS</u>		
Right Side	_____	_____
Left Side	_____	_____
Top	_____	_____

Test No. \_\_\_\_\_

TABLE V. HEAD X-RAY DATA SHEET  
(TUBULAR HEADSET)

Position	Accel. P/N	Tape Channel	Distance From X-Ray Table	
			X-Z Plane (Frontal)	X-Z Plane Side View
<u>Accelerometers</u>				
RIGHT SIDE	Q <sub>1</sub>	X	_____	_____
		Y	_____	_____
LEFT SIDE	Q <sub>2</sub>	X	_____	_____
		Y	_____	_____
		X	_____	_____
		Y	_____	_____
<u>PELLETS</u>				
EYE (R)			_____	_____
EYE (L)			_____	_____
EAR (R)			_____	_____
EAR (L)			_____	_____
<u>X-RAY DATA</u>				
VOLTAGE			_____ KV	_____ KV
CURRENT			_____ AMPS	_____ AMPS
TIME			_____ SEC	_____ SEC
SATISFACTORY? (Check if Yes)			_____	_____

Two positions are required for the full body x-rays. The lateral x-rays are obtained while the subject is still fastened in the wooden seating fixture, which provides the same posture as expected for the impact test. The seating fixture is moved back and forth in front of the x-ray screen and the film cassette moved vertically to obtain the desired view. Much care is to be taken to obtain a clear outline of the spinal and pelvic orientations. The frontal views are obtained with the subject lying prone on the horizontal x-ray screen to avoid damaging pelvic and thoracic accelerometer fixtures. The procedure checklist for the full body x-rays is shown in Table VI.

### 3.9 IMPACT TESTING

#### 3.9.1 Instrumentation Data

Table VII is the standard instrumentation worksheet used for the Whole Body Response test program. One page is used for each tape recorder, two of which are presently required to handle the data input. These sheets are to be completely filled out prior to impact testing and serve as a checklist as well as permanent data record.

#### 3.9.2 Camera Coverage

Four camera positions will be utilized for impact testing - right and left side, overhead, and frontal. All cameras will be run at 1000 frames per second and will utilize color film. Camera synchronization is by a strobe flash which is sled actuated at  $T_0$ . A polaroid Graph Check camera is also sled actuated and provides eight sequential exposures of the impact immediately afterward.

#### 3.9.3 Positioning

The positioning diagram shown in Figure 1 is used as a checklist for cadaver orientation in the impact fixture. Care is taken to ensure that



TABLE VI. FULL BODY X-RAY CHECK LIST

2. BODY X-RAYS

A. Body X-Ray Checklist (Seated)

A	B	C	D	E	F

- a. Subject against x-ray table
- b. All targeting in place (Place at center line of section of interest.
- c. Fresh film cassette installed
- d. Cassette labeled appropriately
- e. X-ray unit adjusted for desired view
- f. Cassette aligned
- g. (A-WBR-I, I= 1, 2, 3 = Subj. No.)
- h. Check and record x-ray settings
  - i X-ray voltage
  - j. x-ray current
  - k. x-ray time
  - l. x-ray subject
- m. x-ray satisfactory (check if yes)

TABLE VI. FULL BODY X-RAY CHECKLIST  
(continued)

B. Body X-Ray Checklist (Prone)

X-Ray Position

A	B	C	D	E	F	G

- a. All targeting in place (Position as close as possible to section of interest)
- b. Fresh film cassette installed
- c. Cassette labeled appropriately
- d. X-ray unit adjusted for desired view
- e. Cassette aligned
- f. Check and record x-ray settings
  - x-ray voltage
  - x-ray current
  - x-ray time
- i. x-ray subject
- j. x-ray satisfactory (check if yes)
- k. At completion, remove polyethylene sheeting from x-ray table, remove and discard all other disposables used to handle the test subject.

TEST NO. \_\_\_\_\_

Sled Run \_\_\_\_\_

TABLE VII INSTRUMENTATION WORKSHEET

INPUT	TRANSDUCER		S/N	CALIB. RESISTOR	CALIB. VOLTAGE	CALIB. VALUE	SENSITIVITY
	AXIS	TYPE					
Sled Decel	--	Statham	13587	--	--	--	40.0 G/Volt
Head Q <sub>1</sub> (Rt)	(-) X	Entran					G/Volt
Head Q <sub>1</sub> (Rt)	Y	Entran					G/Volt
Head Q <sub>2</sub> (Lt)	Y	Entran					G/Volt
Head Q <sub>2</sub> (Lt)	(-) X	Entran					G/Volt
Head Q <sub>3</sub> (Top)	X	Entran					G/Volt
Head Q <sub>3</sub> (Top)	Y	Entran					G/Volt
Thorax S-I	X	Entran					G/Volt
Thorax A-P	Y	Entran					G/Volt
Thorax L-R	X	Entran					G/Volt
Sled Vel. Pulse							12" bet. pulses
Time Base							.01 sec/pulse
Sled Decel	-	Statham	13587	--	--	--	40.0 G/Volt
Rt. Lap Belt	-	GSE		--			LB/Volt
Lt. Lap Belt	-	GSE		--			LB/Volt
Up. Shdr. Belt	-	GSE		--			LB/Volt
Low. Shdr. Belt	-	GSE		--			LB/Volt
Pelvis	-	Setra		--			G/Volt
Pelvis	-	Setra		--			G/Volt
Sled Vel. Pulse							12" bet. pulses
Time Base							.01 sec/pulse

the cadaver is seated vertically and symmetrically. Final head positioning is maintained with narrow masking tape. A hole punched in the tape provides a weak section for minimizing spikes on the head accelerometer traces from tape breakage. For the same reason, care is taken to make sure ~~the masking~~ tape does not contact any part of the accelerometer headset.

The knees tend to separate as the lap belt tension is applied. A loop of string around both legs at the knees is used to hold the knees at the correct center spacing before preloading the lap belt.

#### 3.9.4 Targeting

The targeting diagram in Figure 2 shows the positioning of the photographic targets on the properly positioned cadaver. The distances between femur targets are recorded for both right and left sides. Flood lighting is positioned so the pelvic and thoracic accelerometer targets are well illuminated at  $T_0$  so their motion may be analyzed throughout the impact.

A scaling target is provided on the sled and a Newtonian reference target is hung above the sled centered in the impact area.

#### 3.9.5 Belt Anchor Position Data

To provide a record of belt positioning, the chart in Table VIII was developed for listing the anchor point dimensions. This chart is completed after both lap and shoulder belts are in final adjustment and correctly tensioned.

#### 3.9.6 Calibration

Calibration of transducers is to be performed just prior to impact after all set up work on the cadaver is completed. The following items are followed in the calibration procedure:

- a) All calibration signals are recorded simultaneously on magnetic tape.

- b) Calibration signals are recorded for a minimum of six feet on the magnetic tape.
- c) A zero level signal is recorded on all channels simultaneously for a minimum of six feet on the magnetic tape.
- d) All calibration values are entered on the instrumentation data sheet.

### 3.9.7 Post Impact Belt Length

After impact, the lap and seat belts are removed from the seating fixture and measured for length. A ten pound tension is applied to each belt and the overall length between the belt centers of the clevis hardware measured. Care is taken not to change the positioning of the belt hardware while removing the belts from the test fixture. The belt length data is recorded on the chart shown in Table VIII.

### 3.10 POST IMPACT X-RAYS

Following impact testing, the procedure outlined in Section 3.8 for prone full body x-rays is repeated. The emphasis is on detecting any skeletal damage resulting from the impact loads, although none is anticipated with the low severity testing in this program.

### 3.11 ANTHROPOMETRY

Anthropometry measurements are taken after the sanitary preparation is complete and the cadaver is lying on the surgery room table. Seated measurements may be taken while the cadaver is in the x-ray seating fixture or positioned on the sled. The anthropometry form in Table IX lists the measurements to be taken.

### 3.12 CADAVER TEST CONFIGURATION

Following all the preparations discussed above, the tests are performed on the HSRI Impact Sled with the cadaver seated in the test buck supplied by GMR. The pretest and post test configurations for test number A-725 are shown in Figures 6 through 9.

Test No. \_\_\_\_\_

TABLE VIII. BELT DATA

ANCHOR POSITIONS

<u>SEAT BELT</u>		<u>SHOULDER BELT</u>
<u>Right Side</u>	<u>Left Side</u>	
A = _____	A = _____	E = _____
B = _____	B = _____	F = _____
C = _____	C = _____	G = _____
D = _____	D = _____	H = _____
		K = _____
SEPARATION	J = _____	L = _____

---

BELT LENGTHS

(Ten Pound Preload Applied)

	<u>With Load Cell</u>	<u>Without Load Cell</u>
Right Side Lap Belt	_____	_____
Left Side Lap Belt	_____	_____
Shoulder Belt	_____	_____

# BELT DATA ANCHOR POSITIONS

Side

Top

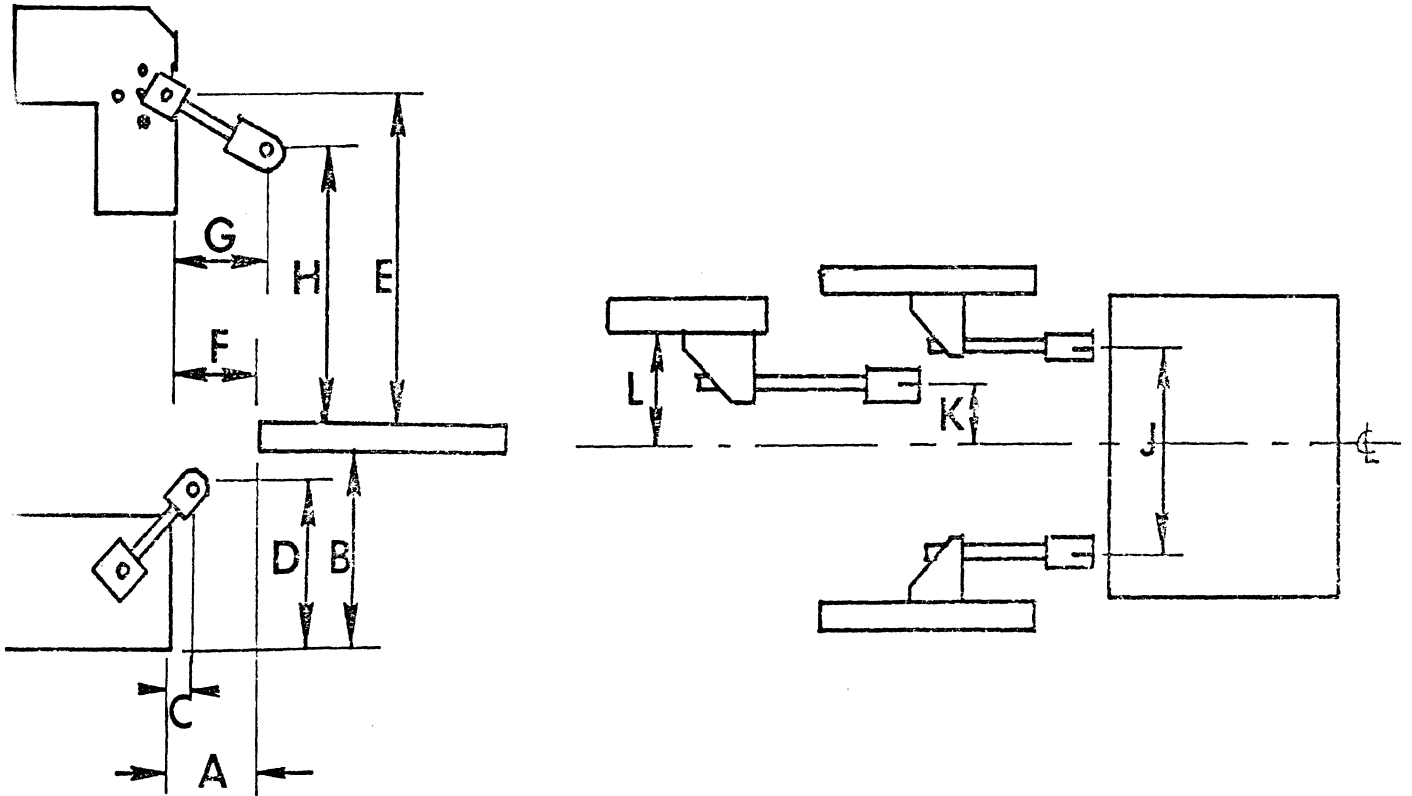

Mark adjustment holes used

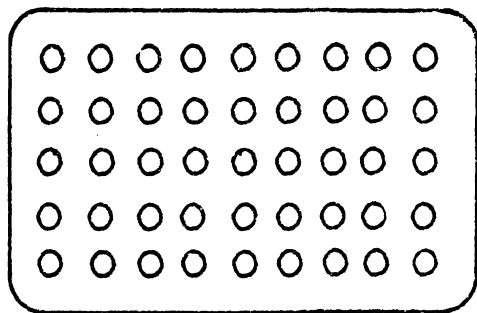

Upper Plate

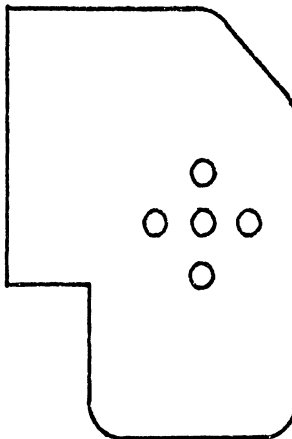

Lower Plate

Side

Top

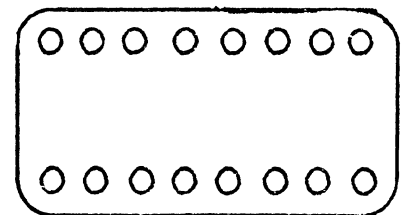

TABLE IX. CADAVER ANTHROPOMETRY

Subject No. \_\_\_\_\_

Date \_\_\_\_\_

CADAVER ANTHROPOMETRY

RA = Regular anthropometer  
 CA = Curved anthropometer  
 T = Steel tape

I. Prone

- RA 1. Waist height (from top of head)..... \_\_\_\_\_
- RA 2. Elbow breadth - R ..... \_\_\_\_\_
- RA 3. Elbow breadth - L ..... \_\_\_\_\_
- RA 4. Knee breadth (femoral biepicondylar) - R ..... \_\_\_\_\_
- 5. Knee breadth - L ..... \_\_\_\_\_

II. Neutral

- RA 1. Cervicale height (from top of head)..... \_\_\_\_\_
- CA 2. Chest depth (at exilla) ..... \_\_\_\_\_
- CA 3. Chest depth (at xiphoid)..... \_\_\_\_\_
- CA 4. T-12 (chest depth) ..... \_\_\_\_\_
- CA 5. Waist depth (at superior ridge of pelvis) ..... \_\_\_\_\_
- CA 6. Hip depth (at level of trochanter) ..... \_\_\_\_\_

III. Supine

- RA 1. Stature ..... \_\_\_\_\_
- RA 2. Biacromial breadth ..... \_\_\_\_\_
- RA 3. Chest breadth (at exilla) ..... \_\_\_\_\_
- RA 4. Chest breadth (at xiphoid) ..... \_\_\_\_\_
- RA 5. T-12 chest breadth..... \_\_\_\_\_
- RA 6. Waist breadth (at superior ridge of pelvis) ..... \_\_\_\_\_
- RA 7. Hip breadth (at level of trochanter) ..... \_\_\_\_\_
- RA 8. Bideltoid breadth ..... \_\_\_\_\_
- CA 9. Head breadth ..... \_\_\_\_\_
- CA 10. Head length (max. cranium) ..... \_\_\_\_\_
- RA 11. Head height (inion - glabella) ..... \_\_\_\_\_
- T 12. Head (sagittal arc length) ..... \_\_\_\_\_
- T 13. Head (coronal arc length) ..... \_\_\_\_\_
- RA 14a. Ball of humerus - radiale length - R ..... \_\_\_\_\_
- RA 14b. Ball of humerus - radiale length - L ..... \_\_\_\_\_
- RA 15a. Radiale - stylian length - R ..... \_\_\_\_\_
- RA 15b. Radiale - stylian length - L ..... \_\_\_\_\_
- RA 16a. Lower leg length (femoral condyle - sphyerian) - R ... \_\_\_\_\_
- RA 16b. Lower leg length - L ..... \_\_\_\_\_



TABLE IX  
(continued)

IV. Circumferences (all use steel tape - T)

1. Chest (at axilla) .....
2. Chest (at xiphoid) .....
3. Waist (at superior ridge of pelvis) .....
4. Neck (at mid-line) .....
5. Hips (at level of trochanter) .....
6. Left thigh (at crotch) .....
7. Right thigh .....
8. Lower thigh (above patella) - R .....
9. Lower thigh - L .....
10. Upper calf (below patella) - R .....
11. Upper calf - L .....
12. Mid-calf (maximum circumference) - R .....
13. Mid-calf - L .....
14. Lower leg (at ankle) - R .....
15. Lower leg - L .....
16. Upper arm (at axilla) - R .....
17. Upper arm - L .....
18. Biceps - R .....
19. Biceps - L .....
20. Elbow - R .....
21. Elbow - L .....
22. Lower arm - R .....
23. Lower arm - L .....
24. Wrist - R .....
25. Wrist - L .....
26. Head .....

V. Anthropometric Sled Seat Measurements

- A. Weight .....
- B. Seated
  1. T-12 height (from seat bottom) .....
  2. Cervical height (from seat bottom) .....
  3. Waist height (from seat bottom) .....
  4. Pelvic height (anterior iliac spine height) - R .....
  5. Pelvic height - L .....
  6. Acromion height (shoulder height) - R .....
  7. Acromion height - L .....
  8. Femur length - R .....
  9. Femur length - L .....
  - (Femur length should be taken using board in front of abdomen to femoral condyle)
  10. Buttock to knee length .....
  11. Elbow to elbow breadth .....
  12. Knee to knee breadth .....
  13. Hip breadth .....

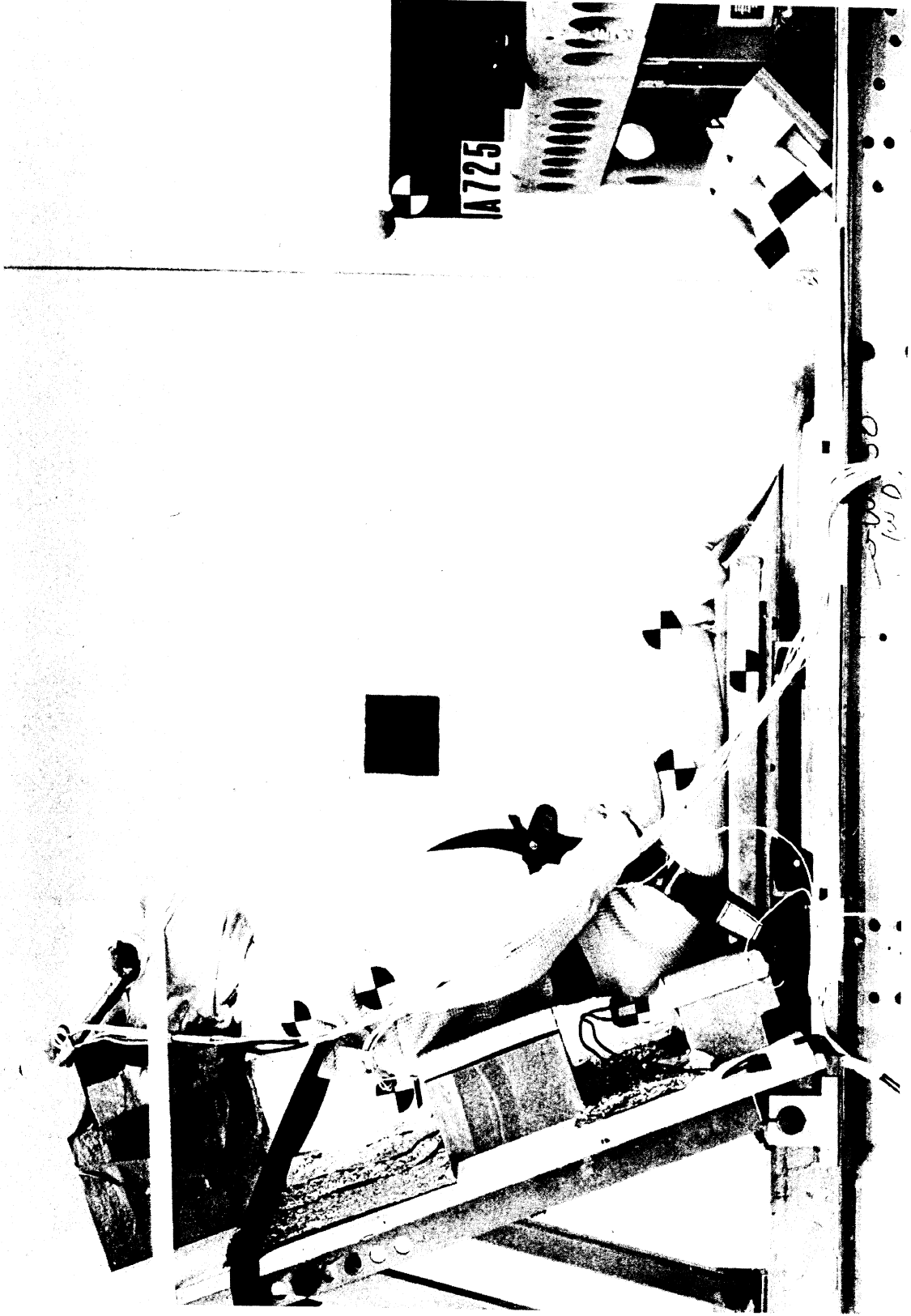

Figure 6. Pre-test Configuration Right Side Lateral View Test A-725.

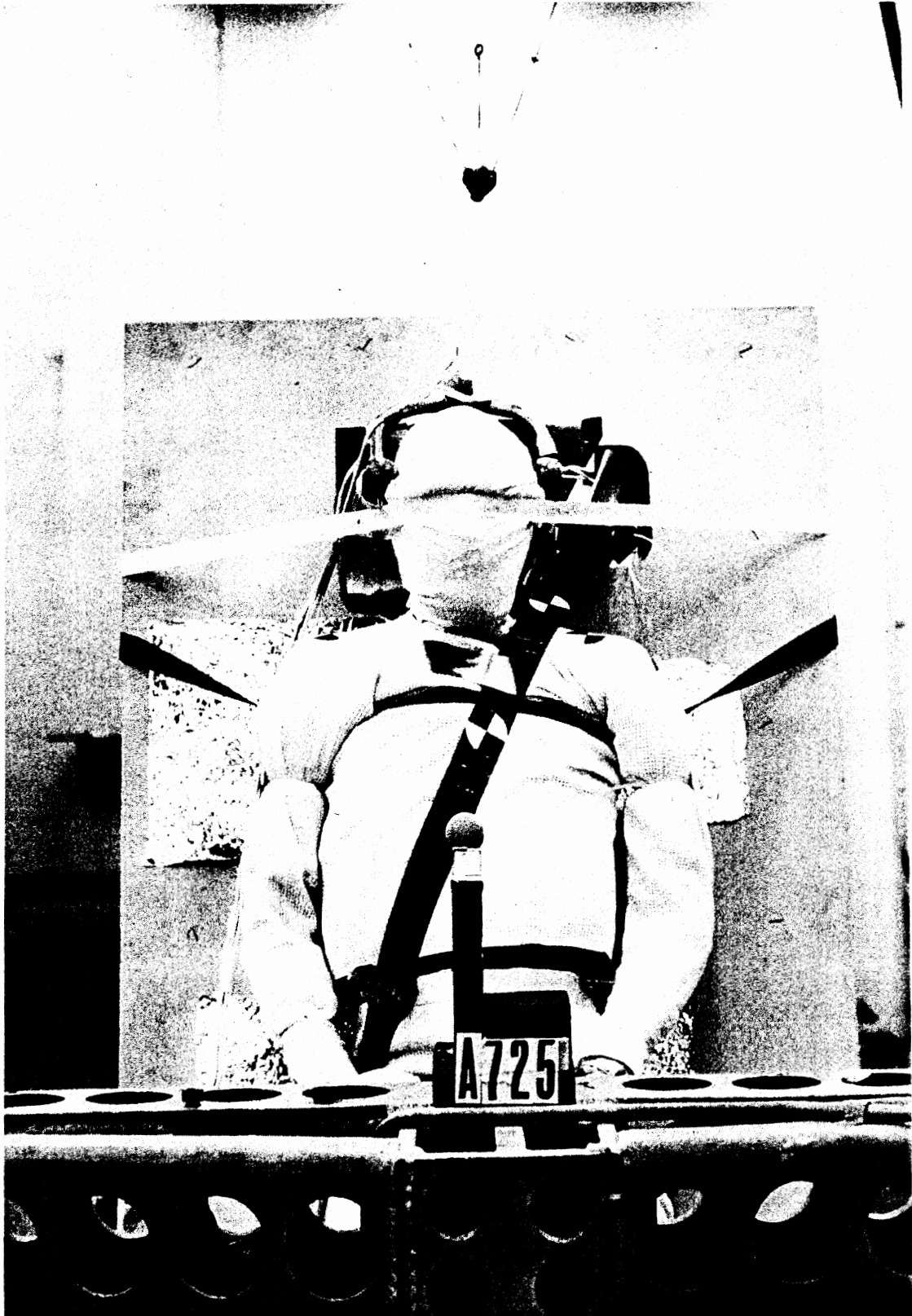

Figure 7. Pre-test Configuration Front View- Test A-725 (The small black strap under arms is for pre-test positioning only, it is not used during the test).

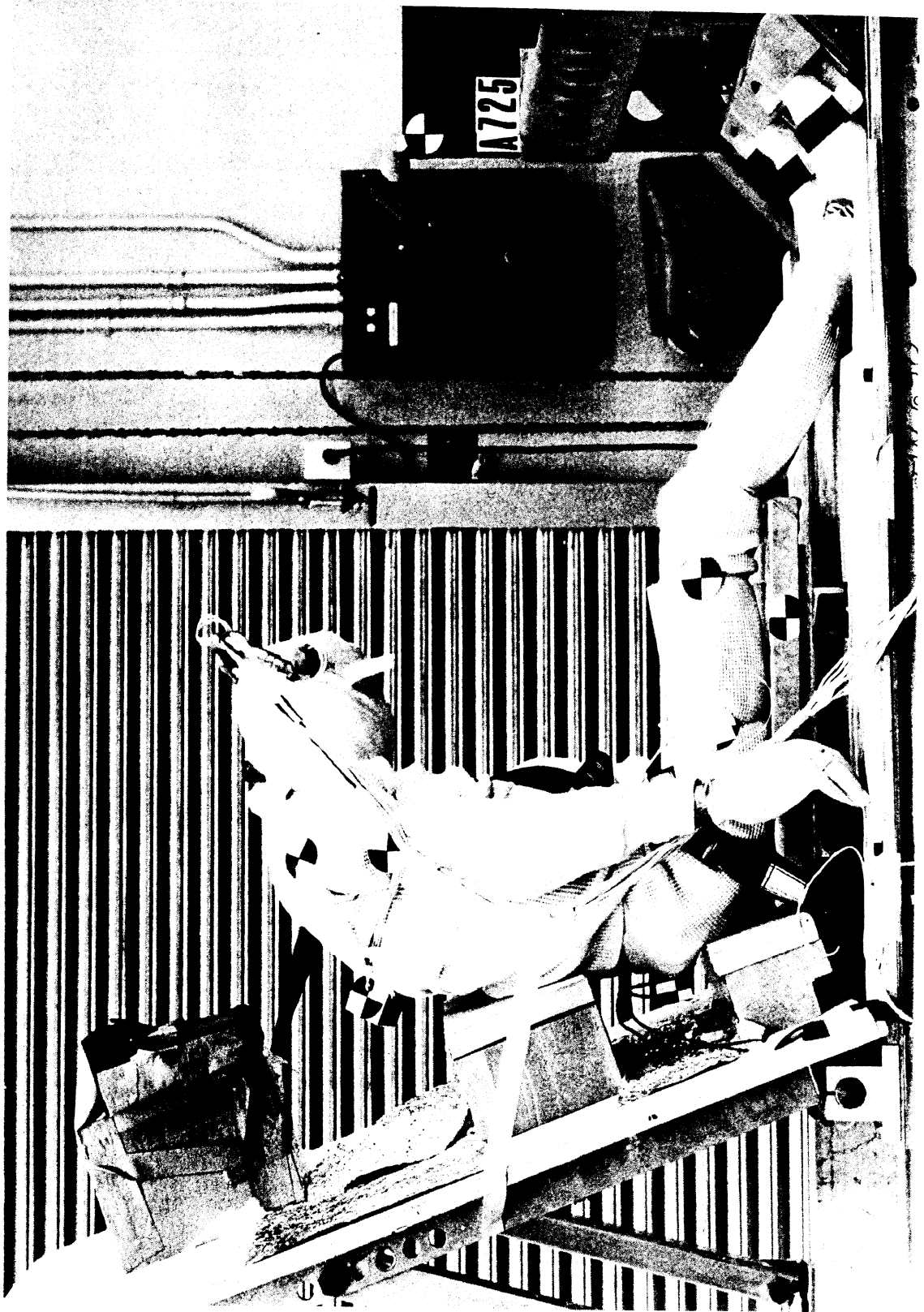

Figure 8. Post-test Configuration Right Side Lateral View-Test A-725.

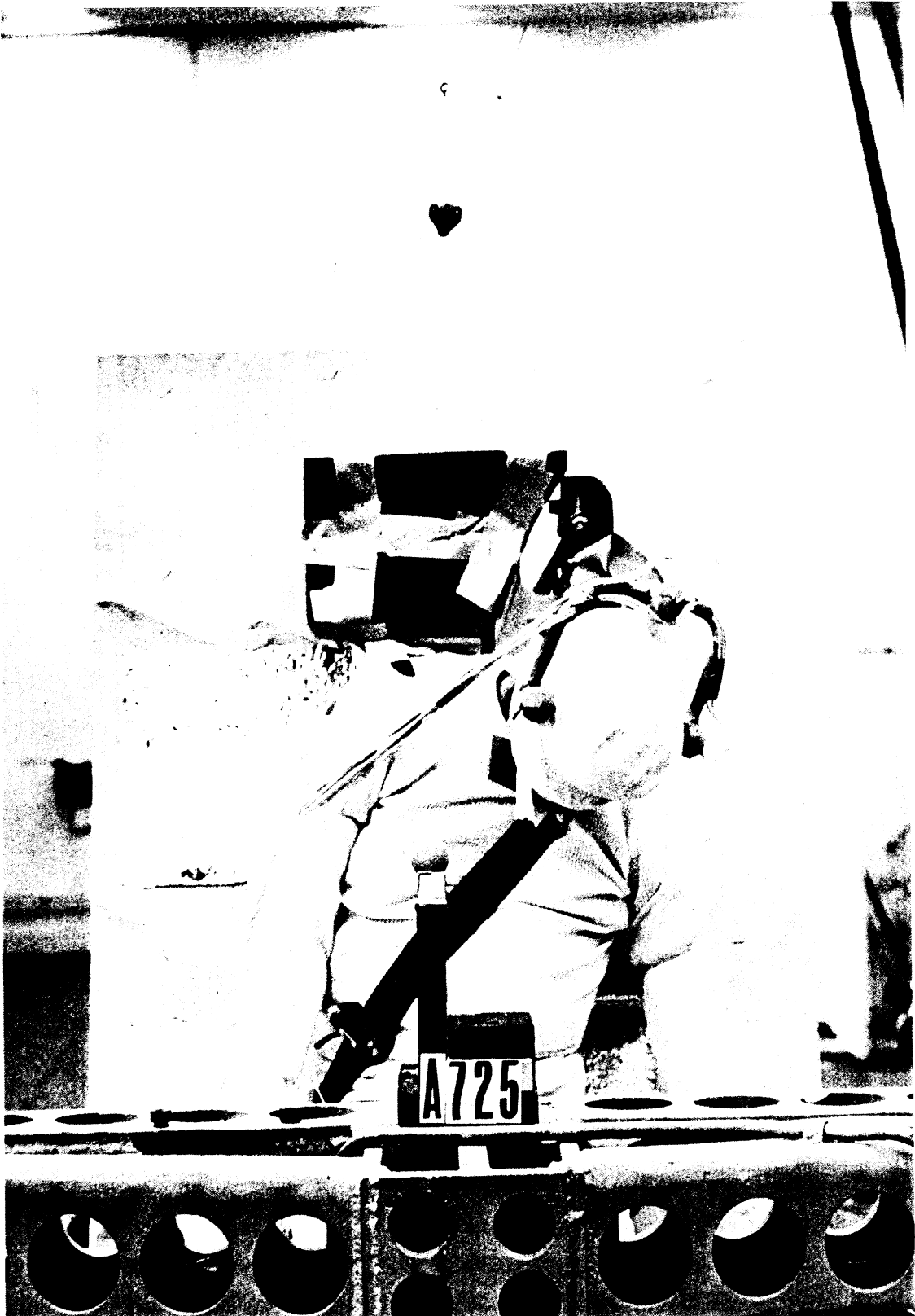

Figure 9. Post-test Configuration Front View - Test A-725.

## 4.1 HEAD MOTION DETERMINATION

## 4.1.1 Introduction

The experimental determination of the three-dimensional rigid body motion of the head required the development of three basic techniques:

1. An appropriate theoretical analysis technique to calculate the overall motion based on accelerometer information.
2. An appropriate method for installing and locating the accelerometers on the head.
3. An appropriate radiographic technique for locating the accelerometers with respect to anatomical landmarks.

These three techniques are detailed in the following sections

## 4.1.2 Theoretical Analysis of Head Motion

A number of accelerometers attached to a rigid body can provide enough information to completely determine its motion with respect to an inertial reference frame, provided the following conditions are met:

- (1) A minimum of 6 accelerometers are used.
- (2) They are distributed over at least 3 different non-collinear locations.
- (3) Their respective directions must be such that the axes of at least one pair of accelerometers be parallel to the axes of an arbitrarily chosen orthogonal coordinate system on that body. (An orthogonal coordinate system is chosen for convenience only.)

For the minimum 3 locations,  $Q_1$ ,  $Q_2$ ,  $Q_3$  on a rigid body, nine scalar equations can be used to describe the motion of the rigid body with respect to an inertial frame.

For the rigid body shown in Figure 10,

FIGURE 10

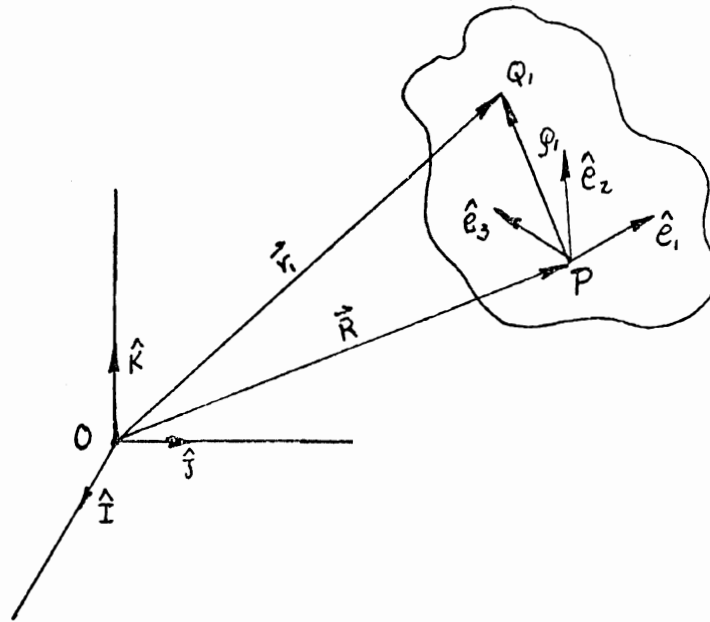

where \$O(\hat{I}, \hat{J}, \hat{K})\$: inertial point and frame

\$P(\hat{e}\_1, \hat{e}\_2, \hat{e}\_3)\$: particular point and moving frame on the rigid body

\$Q\$ : general point on the rigid body

\$\vec{\omega}\$ : absolute average velocity of rigid body (relative to inertial)

\$\dot{\vec{\omega}}\$ : absolute average acceleration of rigid body

\$\vec{OP} = \vec{R}\$ : vector position point \$P\$ (absolute)

\$\vec{PQ}\_1 = \vec{p}\$ : position of \$Q\$ relative to \$(e\_1, e\_2, e\_3)\$

\$\vec{OQ}\_1 = \vec{r}\_1\$ : position of \$Q\$, absolute

$$\begin{aligned} \vec{R} &= g_1 \hat{e}_1 + g_2 \hat{e}_2 + g_3 \hat{e}_3 & \vec{\omega} &= \omega_1 \hat{e}_1 + \omega_2 \hat{e}_2 + \omega_3 \hat{e}_3 \\ \dot{\vec{r}} &= b_{11} \hat{e}_1 + b_{21} \hat{e}_2 + b_{31} \hat{e}_3 & \dot{\vec{\omega}} &= \alpha_1 \hat{e}_1 + \alpha_2 \hat{e}_2 + \alpha_3 \hat{e}_3 \end{aligned}$$

The nine scalar equations for points \$Q\_1, Q\_2, Q\_3\$ are:

For \$P\$ & \$Q\_1\$:

$$\text{Set I} \begin{cases} (g_1 - b_{11}) + (\alpha_2 \rho_{31} - \alpha_3 \rho_{21}) + \omega_1 (\omega_2 \rho_{21} + \omega_3 \rho_{31}) - \rho_{11} (\omega_2^2 + \omega_3^2) = 0 \\ (g_2 - b_{21}) + (\alpha_3 \rho_{11} - \alpha_1 \rho_{31}) + \omega_2 (\omega_1 \rho_{11} + \omega_3 \rho_{31}) - \rho_{21} (\omega_1^2 + \omega_3^2) = 0 \\ (g_3 - b_{31}) + (\alpha_1 \rho_{21} - \alpha_2 \rho_{11}) + \omega_3 (\omega_1 \rho_{11} + \omega_2 \rho_{21}) - \rho_{31} (\omega_1^2 + \omega_2^2) = 0 \end{cases}$$

For P & Q<sub>2</sub>:

$$\text{Set II} \begin{cases} (g_1 - b_{12}) + (\alpha_2 \rho_{32} - \alpha_3 \rho_{22}) + \omega_1 (\omega_2 \rho_{22} + \omega_3 \rho_{32}) - \rho_{12} (\omega_2^2 + \omega_3^2) = 0 \\ (g_2 - b_{22}) + (\alpha_3 \rho_{12} - \alpha_1 \rho_{32}) + \omega_2 (\omega_1 \rho_{12} + \omega_3 \rho_{32}) - \rho_{22} (\omega_1^2 + \omega_3^2) = 0 \\ (g_3 - b_{32}) + (\alpha_1 \rho_{22} - \alpha_2 \rho_{12}) + \omega_3 (\omega_1 \rho_{12} + \omega_2 \rho_{22}) - \rho_{32} (\omega_1^2 + \omega_2^2) = 0 \end{cases}$$

And for P & Q<sub>3</sub>:

$$\text{Set III} \begin{cases} (g_1 - b_{13}) + (\alpha_2 \rho_{33} - \alpha_3 \rho_{23}) + \omega_1 (\omega_2 \rho_{23} + \omega_3 \rho_{33}) - \rho_{13} (\omega_2^2 + \omega_3^2) = 0 \\ (g_2 - b_{23}) + (\alpha_3 \rho_{13} - \alpha_1 \rho_{33}) + \omega_2 (\omega_1 \rho_{13} + \omega_3 \rho_{33}) - \rho_{23} (\omega_1^2 + \omega_3^2) = 0 \\ (g_3 - b_{33}) + (\alpha_1 \rho_{23} - \alpha_2 \rho_{13}) + \omega_3 (\omega_1 \rho_{13} + \omega_2 \rho_{23}) - \rho_{33} (\omega_1^2 + \omega_2^2) = 0 \end{cases}$$

The 6 accelerometers may be distributed over 3 points in either of 2 combinations:

	Q <sub>1</sub>	Q <sub>2</sub>	Q <sub>3</sub>
Combination A	3	2	1
Combination B	2	2	2

Depending upon the particular combination and accelerometer orientation used (in accordance to the aforementioned rules), 6 of the 9 values,  $b_{11}$ ,  $b_{21}$ ,  $b_{31}$ ,  $b_{12}$ ,  $b_{22}$ ,  $b_{32}$ ,  $b_{13}$ ,  $b_{23}$ ,  $b_{33}$ , will be known, as well as the components of  $\vec{p}_1$ ,  $\vec{p}_2$ ,  $\vec{p}_3$ .

After some manipulations, 3 of the 9 equations above can be used to find  $\alpha_{1,2,3}$  and  $\omega_{1,2,3}$ .



Then, Euler Angles  $\theta$ ,  $\psi$ ,  $\phi$  can be defined at point P giving the following relation.

$$\begin{Bmatrix} \dot{\theta} \\ \dot{\psi} \\ \dot{\phi} \end{Bmatrix} = [\Lambda]^{-1} \begin{Bmatrix} \omega_1 \\ \omega_2 \\ \omega_3 \end{Bmatrix}$$

where

$$[\Lambda] = \begin{bmatrix} \cos\phi & \sin\theta\sin\phi & 0 \\ \sin\phi & -\sin\theta\cos\phi & 0 \\ 0 & \cos\theta & 1 \end{bmatrix}$$

Numerical integration of this set of equations would give  $\theta$ ,  $\psi$ , &  $\phi$ , the Euler angles for the rigid body.

Next, by using  $\theta$ ,  $\psi$ , and  $\phi$  the Euler Transformation from  $\hat{e}_1 \hat{e}_2 \hat{e}_3$  to  $\hat{i} \hat{j} \hat{k}$  can be calculated. Then, using this transformation, expressions for  $\ddot{x}$ ,  $\ddot{y}$ ,  $\ddot{z}$  can be written for any point on the rigid body in terms of the known acceleration components at that point relative to  $\hat{e}_1 \hat{e}_2 \hat{e}_3$ .

In particular, for point P,

$$\begin{aligned} \ddot{x} &= g_1(\cos\psi\cos\phi - \cos\theta\sin\phi\sin\psi) + g_2(-\sin\psi\cos\phi - \sin\theta\sin\phi\cos\psi) + g_3(\sin\theta\cos\phi) \\ \ddot{y} &= g_1(\cos\psi\sin\phi + \cos\theta\cos\phi\sin\psi) + g_2(-\sin\psi\sin\phi + \cos\theta\cos\phi\cos\psi) + g_3(-\sin\theta\cos\phi) \\ \ddot{z} &= g_1(\sin\psi\sin\theta) + g_2(\cos\psi\sin\theta) + g_3(\cos\theta) \end{aligned}$$

Two single numerical integrations of these equations will then give linear absolute velocities and accelerations as well as the x, y, z, absolute position of that point.

Hence, the orientation of the head (treated as a rigid body), its angular velocity and angular acceleration, and the linear absolute velocities and accelerations of the 3 points on the head may be determined from a minimum of 6 accelerometers located on the head.

B- 2-2-2 Combination

Figure 11. 2-2-2 Combination

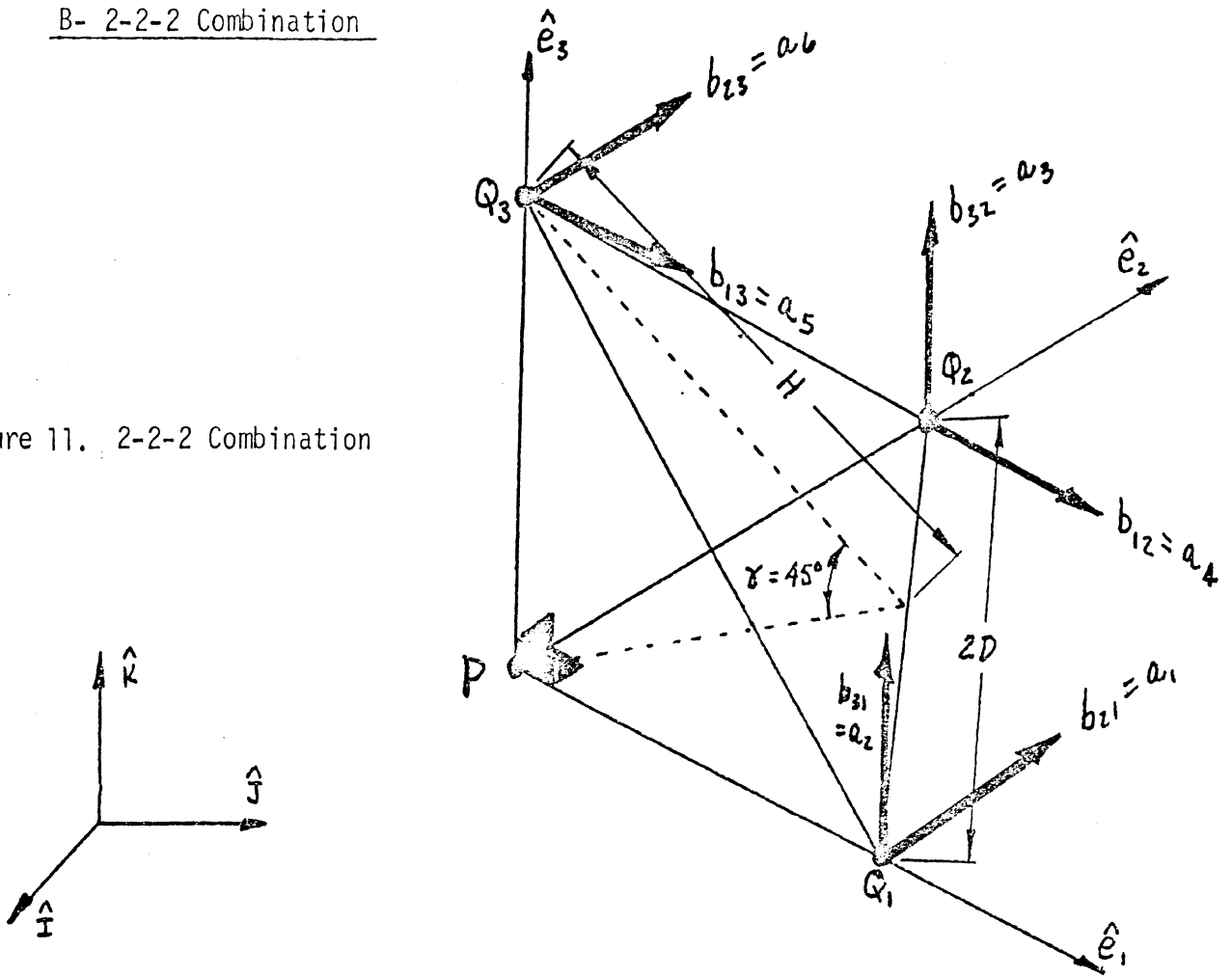

For the B(2-2-2) combination shown in Fig. 11,

$$\left. \begin{aligned} \overrightarrow{PQ_1} &= \rho_{11} \hat{e}_1 + \rho_{21} \hat{e}_2 + \rho_{31} \hat{e}_3 \\ \overrightarrow{PQ_2} &= \rho_{12} \hat{e}_1 + \rho_{22} \hat{e}_2 + \rho_{32} \hat{e}_3 \\ \overrightarrow{PQ_3} &= \rho_{13} \hat{e}_1 + \rho_{23} \hat{e}_2 + \rho_{33} \hat{e}_3 \end{aligned} \right\} \text{reduce to } \left\{ \begin{aligned} \overrightarrow{PQ_1} &= \rho_{11} \hat{e}_1 \\ \overrightarrow{PQ_2} &= \rho_{22} \hat{e}_2 \\ \overrightarrow{PQ_3} &= \rho_{33} \hat{e}_3 \end{aligned} \right.$$

and for  $\gamma = 45^\circ$ ,

$$\rho_{11} = \sqrt{D^2 + H^2/2}$$

$$\rho_{22} = \sqrt{D^2 + H^2/2}$$

$$\rho_{33} = \sqrt{H^2/2}$$

Dropping terms not containing  $\rho_{11}, \rho_{22}, \rho_{33}$  in the original 9 scalar equations relative to point P and subtracting the resulting equations (by sets) in the manner (II,I), III-II), & (I-II) gives nine equations which do not contain  $g_1, g_2, g_3$ ;

(II-I):

$$I' \begin{cases} (b_{11}-b_{12}) + g_{22}(\omega_1\omega_2 - \alpha_3) + g_{11}(\omega_2^2 + \omega_3^2) = 0 \\ (b_{21}-b_{22}) - g_{22}(\omega_1^2 + \omega_3^2) - g_{11}(\omega_2\omega_1 + \alpha_3) = 0 \\ (b_{31}-b_{32}) + g_{22}(\omega_3\omega_2 + \alpha_1) - g_{11}(\omega_3\omega_1 - \alpha_2) = 0 \end{cases} *$$

(III-II):

$$II' \begin{cases} (b_{12}-b_{13}) + g_{33}(\omega_1\omega_3 + \alpha_2) - g_{22}(\omega_1\omega_2 - \alpha_3) = 0 \\ (b_{22}-b_{23}) + g_{33}(\omega_2\omega_3 - \alpha_1) + g_{22}(\omega_1^2 + \omega_3^2) = 0 \\ (b_{32}-b_{33}) - g_{33}(\omega_1^2 + \omega_2^2) - g_{22}(\omega_3\omega_2 + \alpha_1) = 0 \end{cases} *$$

(I-III):

$$III' \begin{cases} (b_{13}-b_{11}) - g_{11}(\omega_2^2 + \omega_3^2) - g_{33}(\omega_1\omega_3 + \alpha_2) = 0 \\ (b_{23}-b_{21}) + g_{11}(\omega_2\omega_1 + \alpha_3) - g_{33}(\omega_2\omega_3 - \alpha_1) = 0 \\ (b_{33}-b_{31}) + g_{11}(\omega_3\omega_1 - \alpha_2) + g_{33}(\omega_1^2 + \omega_2^2) = 0 \end{cases} *$$

Selecting the 3 starred equations which can be solved for  $\alpha_1$ ,  $\alpha_2$  and  $\alpha_3$

from the 6 accelerometer readings gives after rearrangement:

- ①  $\alpha_1 g_{22} + \alpha_2 g_{11} = (b_{32} - b_{31}) + \omega_3(\omega_1 g_{11} - \omega_2 g_{22})$
- ②  $\alpha_2 g_{33} + \alpha_3 g_{22} = (b_{13} - b_{12}) + \omega_1(\omega_2 g_{22} - \omega_3 g_{33})$
- ③  $\alpha_3 g_{11} + \alpha_1 g_{33} = (b_{21} - b_{23}) + \omega_2(\omega_3 g_{33} - \omega_1 g_{11})$

And using the substitutions,

$$\begin{array}{ll} g_{11} = \alpha_1 & b_{21} = \alpha_1 \\ g_{22} = \alpha_2 & b_{32} = \alpha_2 \\ g_{33} = \alpha_3 & b_{13} = \alpha_3 \end{array}$$

these 3 equations become:

$$\textcircled{1} \quad \omega_1 = \alpha_1 = \frac{-(\alpha_5 - \alpha_4)\alpha_1 + (\alpha_1 - \alpha_6)\alpha_2 + (\alpha_3 - \alpha_2)\alpha_3}{2\alpha_2\alpha_3} \quad \frac{\omega_1\alpha_1(\omega_2\alpha_2 - \omega_3\alpha_3)}{\alpha_2\alpha_3}$$

$$\textcircled{2} \quad \dot{\omega}_2 = \alpha_2 = \frac{(a_5 - a_4)d_1 - (a_1 - a_6)d_2 + (a_3 - a_2)d_3}{2d_1d_3} - \frac{\omega_2 d_2 (\omega_3 d_3 - \omega_1 d_1)}{d_1 d_3}$$

$$\textcircled{3} \quad \dot{\omega}_3 = \alpha_3 = \frac{(a_5 - a_4)d_1 + (a_1 - a_6)d_2 - (a_3 - a_2)d_3}{2d_1d_2} - \frac{\omega_3 d_3 (\omega_1 d_1 - \omega_2 d_2)}{d_1 d_3}$$

These, then, can be numerically integrated given the values

<u>Initial Conditions</u>	<u>Geometry</u>	<u>Acceleration Values</u>
$\omega_1(0)$	$d_1$	$(a_5 - a_4)$
$\omega_2(0)$	$d_2$	$(a_1 - a_6)$
$\omega_3(0)$	$d_3$	$(a_3 - a_2)$

to give  $\omega_1$ ,  $\omega_2$  &  $\omega_3$ .

Next, the absolute acceleration components,  $g_1$ ,  $g_2$ ,  $g_3$  transformation can be calculated from known quantities.

$$g_1 = \frac{1}{2} [a_4 + a_5 + d_2 (\omega_3^2 + \omega_1^2) + d_3 (\omega_1^2 + \omega_2^2)]$$

$$g_2 = \frac{1}{2} [a_1 + a_6 - d_1 (\alpha_3 + \omega_3 \omega_1) - d_3 (\alpha_2 + \omega_1 \omega_3)]$$

$$g_3 = \frac{1}{2} [a_2 + a_3 - d_1 (\omega_3 \omega_1 - \alpha_2) - d_2 (\omega_3 \omega_2 - \alpha_3)]$$

and  $x$ ,  $y$ ,  $z$  can be determined.

The method of head motion determination chosen for application in the Whole Body Response program is the B(2-2-2) arrangement of three biaxial accelerometers. The features of the experimental fixture for mounting the accelerometers are discussed in Section 3.3.2.

## 4.2 THREE DIMENSIONAL X-RAY TECHNIQUE

### 4.2.1 Introduction

In measuring accelerations of points on the head, it is difficult to locate and orient the accelerometers in standard anatomical locations and directions. It is therefore more convenient to resolve quantities measured in an arbitrary coordinate system into components in the standard anatomical directions. All that is needed is an accurate description of the mathematical transformation between the two coordinate systems.

Let  $(\hat{e}_1, \hat{e}_2, \hat{e}_3)$  be an arbitrary coordinate system used in instrumenting the head, and let  $(\hat{i}, \hat{j}, \hat{k})$  be the standard anatomical coordinate system, commonly referred to as the (A-P), (L-R) and (S-I) axes. Both systems may be termed body-axes triads, which are fixed one relative to the other, but moving with the head. An inertial frame  $(\hat{I}, \hat{J}, \hat{K})$  is used as a reference to both moving frames. Then

$$\begin{pmatrix} \hat{e}_1 \\ \hat{e}_2 \\ \hat{e}_3 \end{pmatrix} = [E] \begin{pmatrix} \hat{I} \\ \hat{J} \\ \hat{K} \end{pmatrix} \quad (1)$$

and

$$\begin{pmatrix} \hat{i} \\ \hat{j} \\ \hat{k} \end{pmatrix} = [A] \begin{pmatrix} \hat{I} \\ \hat{J} \\ \hat{K} \end{pmatrix} \quad (2)$$

where  $[E]$  and  $[A]$  are the direction cosines matrix relative to the inertial frame of the instrumentation and the anatomical coordinate systems, respectively.

The objective is to obtain a transformation matrix between  $(\hat{e}_1, \hat{e}_2, \hat{e}_3)$  and  $(\hat{i}, \hat{j}, \hat{k})$ :

$$\begin{Bmatrix} \hat{e}_1 \\ \hat{e}_2 \\ \hat{e}_3 \end{Bmatrix} = [R] \begin{Bmatrix} \hat{i} \\ \hat{j} \\ \hat{k} \end{Bmatrix} \quad (3)$$

From (2), an expression for  $(\hat{I}, \hat{J}, \hat{K})$  is obtained:

$$\begin{Bmatrix} \hat{I} \\ \hat{J} \\ \hat{K} \end{Bmatrix} = [A]^{-1} \begin{Bmatrix} \hat{i} \\ \hat{j} \\ \hat{k} \end{Bmatrix} \quad (4)$$

Equation (4) is then substituted into equation (1)

$$\begin{Bmatrix} \hat{e}_1 \\ \hat{e}_2 \\ \hat{e}_3 \end{Bmatrix} = [E] [A]^{-1} \begin{Bmatrix} \hat{i} \\ \hat{j} \\ \hat{k} \end{Bmatrix} \quad (5)$$

By comparing equations (3) and (5):

$$[R] = [E][A]^{-1} \quad (6)$$

#### 4.2.2 Method

To obtain  $[R]$ , one must obtain  $[E]$  and  $[A]$  which involve the following steps:

- a. define  $(\hat{e}_1, \hat{e}_2, \hat{e}_3)$
- b. define  $(\hat{i}, \hat{j}, \hat{k})$
- c. devise a method to compute the direction cosine matrix  $[E]$  of  $(\hat{e}_1, \hat{e}_2, \hat{e}_3)$  relative to an arbitrary inertial frame.
- d. devise a method to compute the direction cosine matrix  $[A]$  of  $(\hat{i}, \hat{j}, \hat{k})$  relative to the same arbitrary inertial frame.
- e. compute the matrix product  $[E] [A]^{-1}$  to obtain the direction cosines matrix  $[R]$  of  $(\hat{e}_1, \hat{e}_2, \hat{e}_3)$  relative to  $(\hat{i}, \hat{j}, \hat{k})$ .

### 4.2.3 Definitions

Instrumentation Definitions - The configuration of the 6 accelerometers necessary to measure the head motion was chosen so that they lie on the 3 axes of the instrumentation coordinate system. Each pair is located at a known distance from the origin P of this system as in Figure 12. Thus:

$$\vec{PQ}_1 = \rho_1 \hat{e}_1 \Rightarrow \hat{e}_1 = \frac{\vec{PQ}_1}{|PQ_1|} \quad (7)$$

$$\vec{PQ}_2 = \rho_2 \hat{e}_2 \Rightarrow \hat{e}_2 = \frac{\vec{PQ}_2}{|PQ_2|} \quad (8)$$

$$\vec{PQ}_3 = \rho_3 \hat{e}_3 \Rightarrow \hat{e}_3 = \frac{\vec{PQ}_3}{|PQ_3|} \quad (9)$$

Anatomical Definitions - The standard definition of the (A-P), (L-R) and (S-I) axes, or alternately the ( $\hat{i}$ ,  $\hat{j}$ ,  $\hat{k}$ ) system is based on the Frankfort plane. This plane is defined by the four points (see Figure 13).

$P_1$  : superior edge of the right auditory meatus,

$P_2$  : superior edge of the left auditory meatus,

$P_3$  : right infraorbital notch, and

$P_4$  : left infraorbital notch.

Let C be the midpoint between  $P_1$  and  $P_2$ , and M the mid-point between  $P_3$  and  $P_4$ , then

a. the anatomical center is defined as point C

b. the A-P axis is defined as:

$$\hat{i} = \frac{\vec{CM}}{|CM|} \quad (10)$$

c. the L-R axis is defined as:

$$\hat{j} = \frac{\vec{CP}_2}{|CP_2|} \quad (11)$$

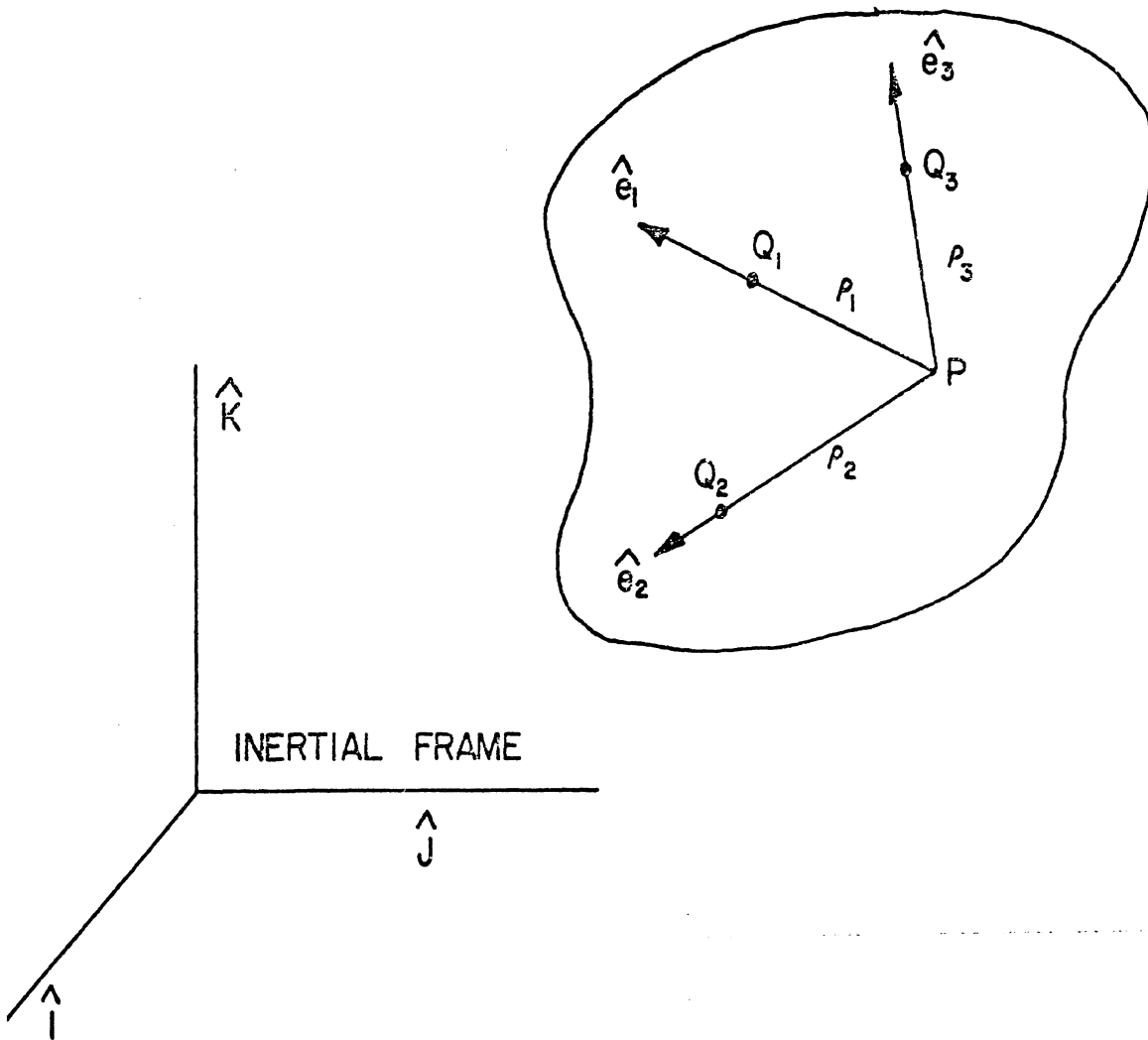

FIGURE 12 INSTRUMENTATION COORDINATE SYSTEM FOR THE HEAD.



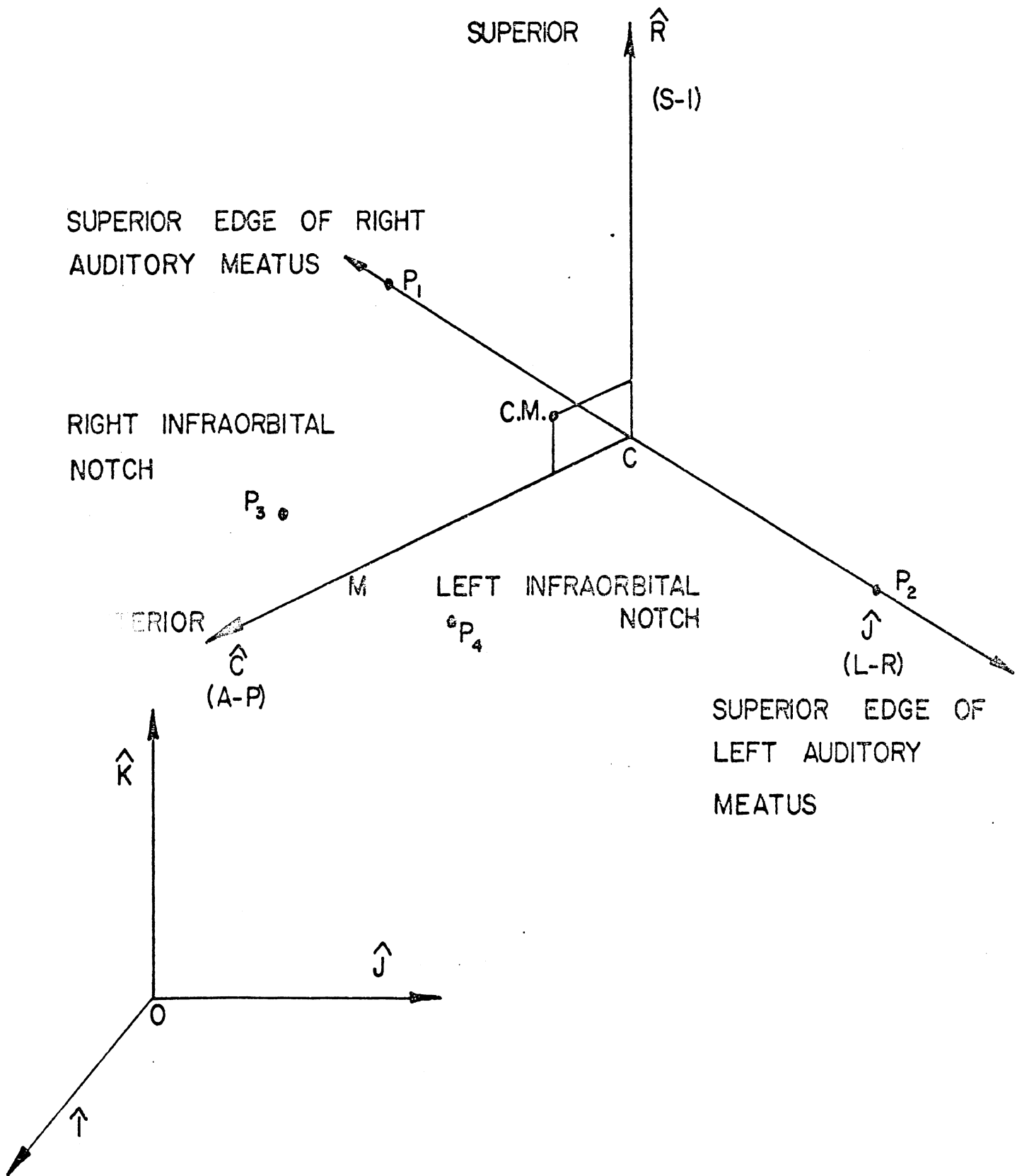

FIGURE 13 ANATOMICAL POINTS DEFINING THE FRANKFORT PLANE.

d. the S-I axis is defined by the cross product

$$\hat{k} = \hat{i} \times \hat{j} \quad (12)$$

#### 4.2.4 X-Ray Measurements of a Single Point

Two-dimensional coordinates - The x-ray photograph of an object is simply the shadow of that object captured on a photo-sensitive film and generated by a near-point source of x-rays.

It is proposed to obtain the true coordinates (x,z) of an object (see Figure 14) given the x-ray photo itself, and relevant characteristics of the x-ray set-up which produced it.

A typical x-ray set-up is simplified in the diagram of figure 14. The x-ray table is vertical in this case, and the film cassette is located behind the table at a distance B. The distance between the table and the x-ray source is A, and between the table and the object is D. After the film has been developed, the trace O of the optical axis is physically located on the film and the distances X and Z are measured.

Given the measured X and Z, the radial distance R and the angle  $\theta$  may be computed:

$$R = \sqrt{X^2 + Z^2} \quad (13)$$

$$\theta = \tan^{-1} \left[ \frac{Z}{X} \right] \quad (14)$$

Now the true radial distance r may be obtained from the geometrical property:

$$\frac{r}{R} = \frac{A-D}{A+B} = \left( \frac{A}{A+B} \right) - \left( \frac{1}{A+B} \right) D \quad (15)$$

or

$$r = [\alpha - \beta D]R \quad (16)$$

The constants  $\alpha$  and  $\beta$  depend solely on the x-ray set-up and are the same for any object at any distance D from the x-ray table.

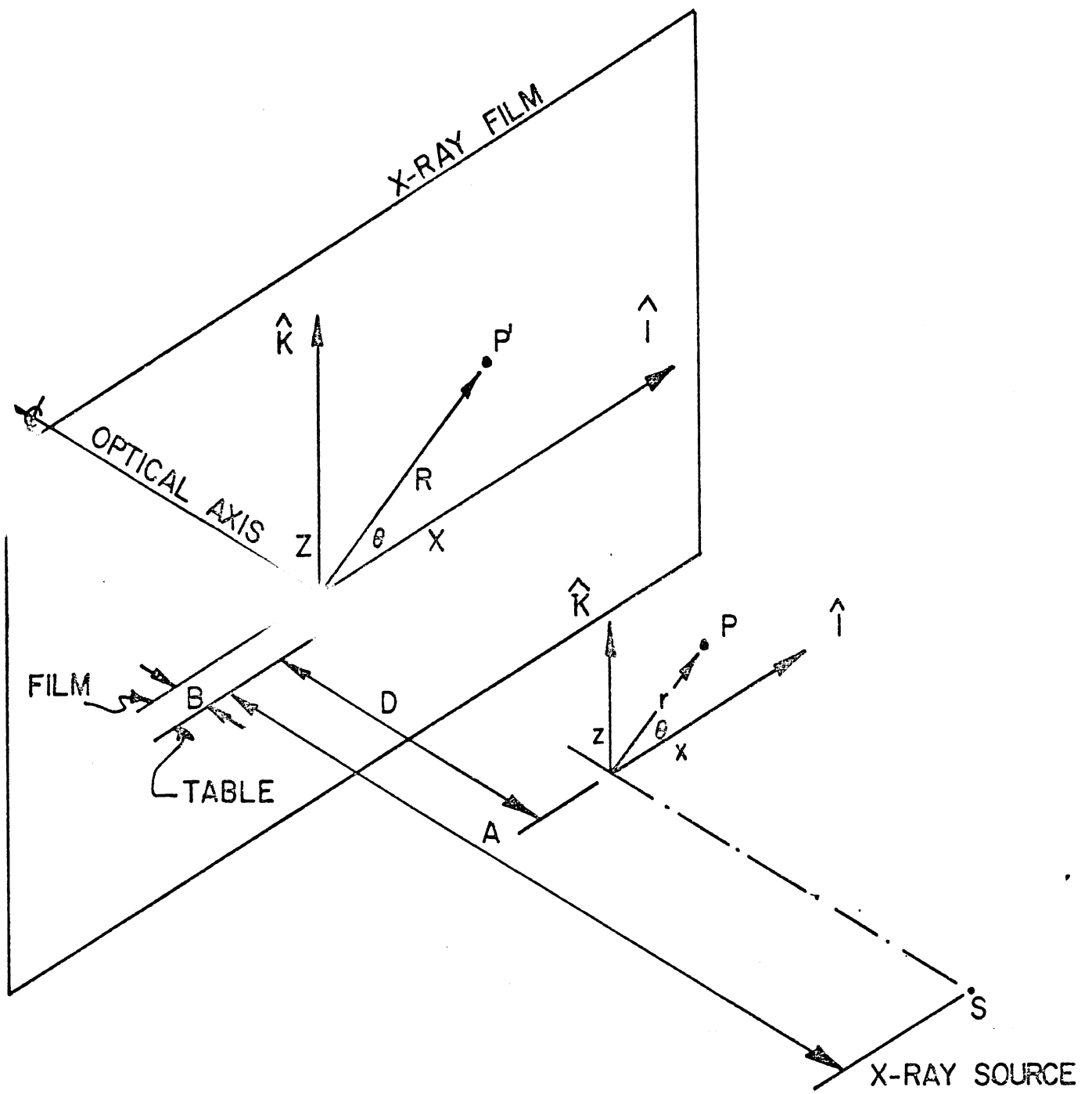

FIGURE 14 SIMPLIFIED X-RAY SET-UP FOR A SINGLE POINT

The relationship of equation (16) was experimentally determined and is shown in figure 15. Note that this parametric calibration curve is valid for the x-ray set-up at HSRI and will vary depending on the A and B distances.

Now that the true radial distance is known, the true coordinates are:

$$x = r \cos\theta \quad (17)$$

$$z = r \sin\theta \quad (18)$$

Three-dimensional coordinates - To obtain complete 3-D coordinates of an object point, the procedure followed in the previous section may be repeated for the (Y-Z) plane. This can be done simultaneously with the (X-Z) measurement which requires two separate x-ray sources and two separate film planes, which are mutually perpendicular. A simpler method is to x-ray the (X-Z) plane first, then rotate the object 90° and obtain a new x-ray which would be of the (Y-Z) plane. The analysis of the two x-rays would yield true (x,z) and (y,z) coordinates. The z-coordinate would be the average of the two values obtained, since experimental errors would normally result in slightly different values.

The inertial coordinate reference system is formed by the optical axis going once through the (x,z) plane, then going again through the (y,z) plane of the head. Therefore, care must be taken to keep the head at the same elevation with respect to the optical axis when it is being rotated. This elevation may, however, be arbitrary.

#### 4.2.5 Experimental X-Ray Procedure

The experimental procedure in x-raying the head must be oriented toward an accurate measurement of the transformation matrix between the instrumentation and the anatomical coordinate system. This procedure is described and justified in the following paragraphs.

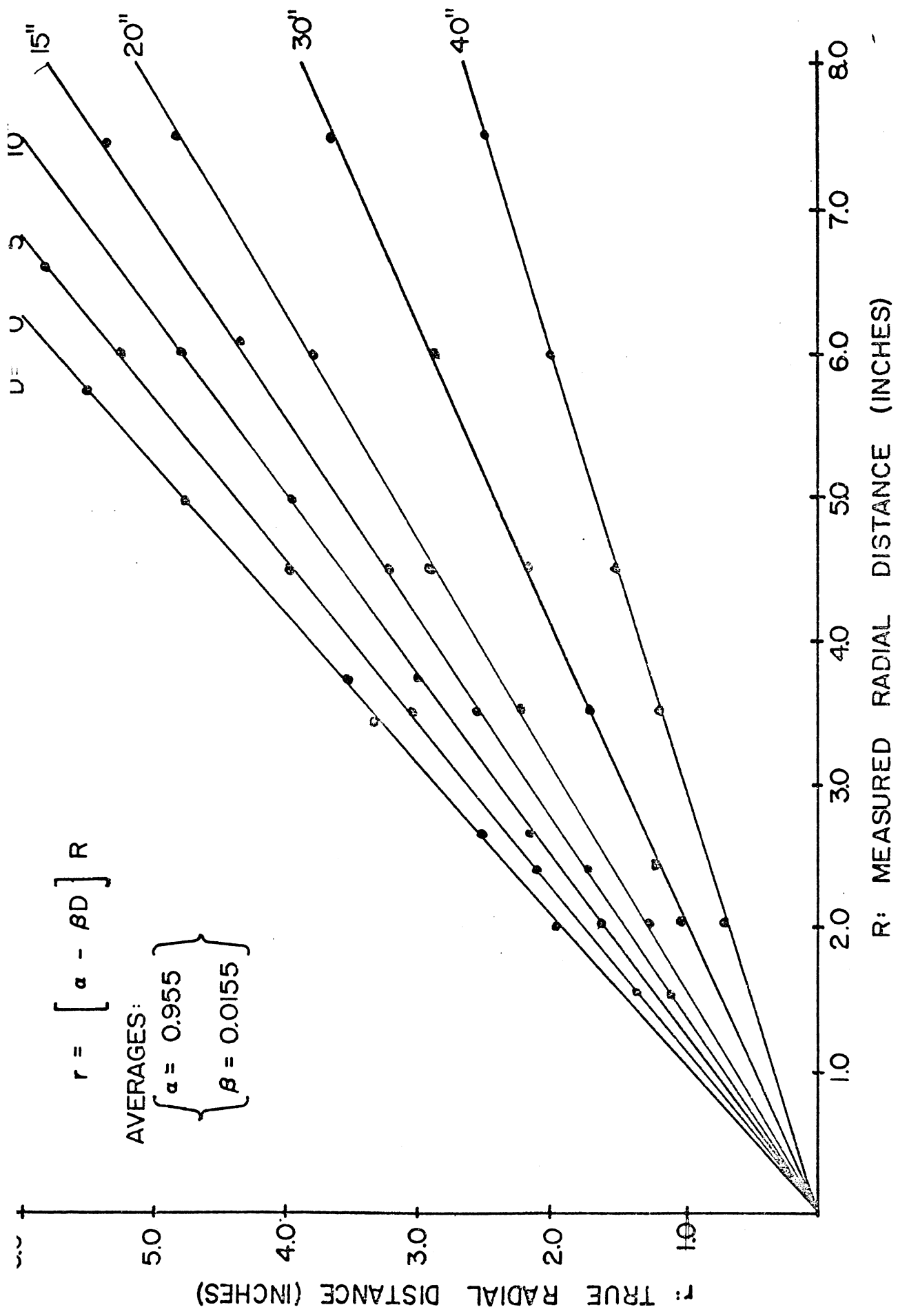

FIGURE 15 CALIBRATION OF X-RAY SET-UP

On each x-ray, the optical (inertial) reference frame must be defined. For this purpose, a special lead plate, Figure 16, was machined to fit precisely over the window of the x-ray source. This plate will allow a thin circular ring of x-rays to pass through and be recorded on the film, prior to taking the x-ray of the head. Careful machining ensures that the optical center is the same as the center of the ring. A vertical axis was obtained on the film by hanging a weight from a long lead wire and taping the top end of the wire onto the x-ray table. Thus, the optical center as well as the vertical and horizontal optical axes may accurately be drawn on the film and used to measure the (X, Y, Z) coordinates of any given point.

In order to identify the 4 anatomical points of the Frankfort plane, lead pellets with distinctive tabs are used as follows. The lowest points on the two orbital cavities are exposed by small incisions and, using Eastman-910 cement, two pellets are cemented directly on the bone at the lowest point of each orbital cavity. This is the closest approximation to the two infraorbital notches  $P_3$  and  $P_4$  used in defining the Frankfort plane. To approximate the other two points of this plane,  $P_1$  and  $P_2$ , two wooden plugs (short cylinders) are used to carry lead pellets so that, when these plugs are inserted in the auditory meati, the lead pellets would approximate the superior edges of the two meati.

Finally, to identify the 3 points  $Q_1$ ,  $Q_2$ ,  $Q_3$  which represent the centers of mass of the 3 pairs of accelerometers, 3 aluminum dummy blocks are machined to replace the 3 pairs of accelerometers during the x-raying. Each dummy block contains a pellet, so located as to precisely fall on the c.m. of the accelerometer-pair which is being replaced.

Once the seven pellets are properly mounted on the head, the subject whose head is being x-rayed is then placed (or seated) on a rolling chair

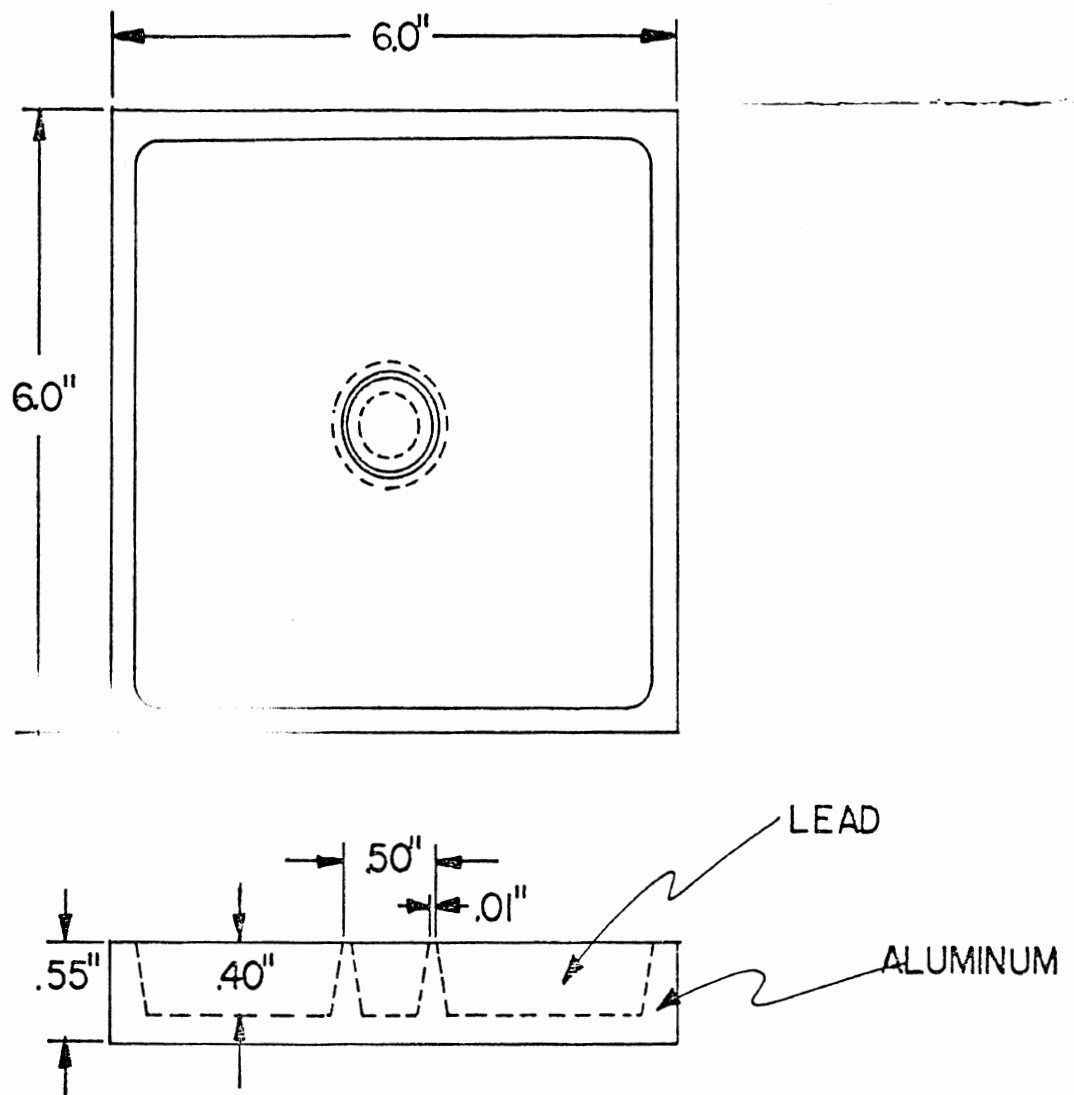

FIGURE 16 .LEAD PLATE FOR PRE-RECORDING OF OPTICAL CENTER.

or platform and the following steps are taken:

- Step 1. With the subject outside the x-ray field, expose the film with the circular ring.
- Step 2. Place the subject in the x-ray field, and obtain and record the distances of seven pellets from the x-ray table.
- Step 3. Expose the film to obtain the x-ray of the head structure and the vertical lead wire. This gives the x-ray of the ( $\hat{J}$ - $\hat{K}$ ) plane.
- Step 4. Remove the subject from the x-ray field, and change the film cassette.
- Step 5. Expose the film to obtain the circular ring.
- Step 6. Replace the subject to exactly the same previous elevation and in the x-ray field.
- Step 7. Rotate the platform carrying the subject through  $+90^\circ$  about the  $\hat{K}$ -axis.
- Step 8. Obtain and record the seven distances between the x-ray table and the individual pellets.
- Step 9. Expose the head and the vertical lead wire to obtain an x-ray of the ( $\hat{X}$ , $\hat{K}$ ) plane.

Once the two orthogonal x-rays have been developed, the optical center and axes are drawn and the seven pellets labeled on each x-ray, then for each pellet,  $(X,Z)$  and  $(Y,Z)$  pairs are measured directly from the x-rays. These pairs are supplemented with the corresponding distances from the x-ray table obtained earlier during steps 2 and 8 of the x-raying procedure. Each pellet will then have  $(X, Z, D_{xz})$  and  $(Y,Z,D_{yz})$  which can be used to obtain true  $(x,y,z)$  coordinates with respect to an arbitrary reference frame, given the calibration constants  $\alpha$  and  $\beta$  of the x-ray set-up.



#### 4.2.6 Computational Procedure

A computer program, XRAY, was written to carry the necessary steps toward the evaluation of the transformation matrix [R] between the instrumentation and the anatomical coordinate systems.

Instrumentation Frame - The inertial vector position of the 3 accelerometer pellets may be obtained:

$$\begin{aligned}\overrightarrow{OQ}_1 &= x_1 \hat{I} + y_1 \hat{J} + z_1 \hat{K} \\ \overrightarrow{OQ}_2 &= x_2 \hat{I} + y_2 \hat{J} + z_2 \hat{K} \\ \overrightarrow{OQ}_3 &= x_3 \hat{I} + y_3 \hat{J} + z_3 \hat{K}\end{aligned}\tag{19}$$

and

$$\overrightarrow{OP} = x_p \hat{I} + y_p \hat{J} + z_p \hat{K}$$

But

$$\begin{aligned}\overrightarrow{OP}_1 &= \overrightarrow{OP} + \overrightarrow{PQ}_1 \\ \overrightarrow{OQ}_2 &= \overrightarrow{OP} + \overrightarrow{PQ}_2 \\ \overrightarrow{OQ}_3 &= \overrightarrow{OP} + \overrightarrow{PQ}_3\end{aligned}\tag{20}$$

where

$$\begin{aligned}\overrightarrow{PQ}_1 &= \rho_1 \hat{e}_1 \\ \overrightarrow{PQ}_2 &= \rho_2 \hat{e}_2 \\ \overrightarrow{PQ}_3 &= \rho_3 \hat{e}_3\end{aligned}\tag{21}$$

The first step in solving the problem is to obtain the inertial coordinates of point P, origin of the instrumentation triad. Solving for  $\overrightarrow{PQ}_1$ ,  $\overrightarrow{PQ}_2$  and  $\overrightarrow{PQ}_3$  from equation (20) and substituting the values in equation (21) yields:

$$\begin{aligned}\rho_1 \hat{e}_1 &= \overrightarrow{OQ}_1 - \overrightarrow{OP} = (x_1 - x_p) \hat{I} + (y_1 - y_p) \hat{J} + (z_1 - z_p) \hat{K} \\ \rho_2 \hat{e}_2 &= \overrightarrow{OQ}_2 - \overrightarrow{OP} = (x_2 - x_p) \hat{I} + (y_2 - y_p) \hat{J} + (z_3 - z_p) \hat{K} \\ \rho_3 \hat{e}_3 &= \overrightarrow{OQ}_3 - \overrightarrow{OP} = (x_3 - x_p) \hat{I} + (y_3 - y_p) \hat{J} + (z_3 - z_p) \hat{K}\end{aligned}\tag{22}$$

Equations (22) may be written in scalar form by dot multiplying each equation by itself:

$$\begin{aligned}\rho_1^2 &= (x_1-x_p)^2 + (y_1-y_p)^2 + (z_1-z_p)^2 \\ \rho_2^2 &= (x_2-x_p)^2 + (y_2-y_p)^2 + (z_2-z_p)^2 \\ \rho_3^2 &= (x_3-x_p)^2 + (y_3-y_p)^2 + (z_3-z_p)^2\end{aligned}\quad (23)$$

Equations (23) may be manipulated to obtain the following linear simultaneous equations:

$$\begin{bmatrix} (x_1-x_2) & (y_1-y_2) & (z_1-z_2) \\ (x_2-x_3) & (y_2-y_3) & (z_2-z_3) \\ (x_3-x_1) & (y_3-y_1) & (z_3-z_1) \end{bmatrix} \begin{Bmatrix} x_p \\ y_p \\ z_p \end{Bmatrix} \begin{Bmatrix} (x_1^2 + y_1^2 + z_1^2 - \rho_1^2) - (x_2^2 + y_2^2 + z_2^2 - \rho_2^2) \\ (x_2^2 + y_2^2 + z_2^2 - \rho_2^2) - (x_3^2 + y_3^2 + z_3^2 - \rho_3^2) \\ (x_3^2 + y_3^2 + z_3^2 - \rho_3^2) - (x_1^2 + y_1^2 + z_1^2 - \rho_1^2) \end{Bmatrix} \quad (24)$$

Finally this set of equations is solved by subroutine LOCOR to yield  $(x_p, y_p, z_p)$ .

The next step is simple and involves computing the direction cosines of each of the vectors  $\vec{PQ}_1, \vec{PQ}_2, \vec{PQ}_3$  which are identical with those of the unit vectors  $\hat{e}_1, \hat{e}_2, \hat{e}_3$ . Thus:

$$\begin{aligned}\hat{e}_1 &= \frac{\vec{PQ}_1}{|\vec{PQ}_1|} = \frac{x_1-x_p}{\rho_1} \hat{I} + \frac{y_1-y_p}{\rho_1} \hat{J} + \frac{z_1-z_p}{\rho_1} \hat{K} \\ \hat{e}_2 &= \frac{\vec{PQ}_2}{|\vec{PQ}_2|} = \frac{x_2-x_p}{\rho_2} \hat{I} + \frac{y_2-y_p}{\rho_2} \hat{J} + \frac{z_2-z_p}{\rho_2} \hat{K} \\ \hat{e}_3 &= \frac{\vec{PQ}_3}{|\vec{PQ}_3|} = \frac{x_3-x_p}{\rho_3} \hat{I} + \frac{y_3-y_p}{\rho_3} \hat{J} + \frac{z_3-z_p}{\rho_3} \hat{K}\end{aligned}\quad (25)$$

or simply

$$\begin{Bmatrix} \hat{e}_1 \\ \hat{e}_2 \\ \hat{e}_3 \end{Bmatrix} = [E] \begin{Bmatrix} \hat{I}_1 \\ \hat{J}_2 \\ \hat{K}_3 \end{Bmatrix} \quad (26)$$

Anatomical Frame - Using the same notation for the anatomical pellets,  
the inertial position vectors of the four anatomical pellets are:

$$\begin{aligned}
 \vec{OP}_1 &= x_1 \hat{I} + y_1 \hat{J} + z_1 \hat{K} \\
 \vec{OP}_2 &= x_2 \hat{I} + y_2 \hat{J} + z_2 \hat{K} \\
 \vec{OP}_3 &= x_3 \hat{I} + y_3 \hat{J} + z_3 \hat{K} \\
 \vec{OP}_4 &= x_4 \hat{I} + y_4 \hat{J} + z_4 \hat{K}
 \end{aligned}
 \tag{27}$$

First define the direction cosines of  $\hat{j}$ -axis or the L-R axis. This may be done by one of two methods:

$$\hat{j} = \frac{\vec{P_1P_2}}{|\vec{P_1P_2}|} = \ell_1 \hat{I} + m_1 \hat{J} + n_1 \hat{K}$$

or

$$\hat{j} = \frac{\vec{P_3P_4}}{|\vec{P_3P_4}|} = \ell_2 \hat{I} + m_2 \hat{J} + n_2 \hat{K}$$

The two methods are equivalent within some experimental error. To minimize this error, the average is taken as the final direction cosines of unit vector  $\hat{j}$ , i.e.:

$$\hat{j} = \frac{\ell_1 + \ell_2}{2} \hat{I} + \frac{m_1 + m_2}{2} \hat{J} + \frac{n_1 + n_2}{2} \hat{K}
 \tag{28}$$

Next, define the S-I or  $\hat{k}$ -axis. This axis is perpendicular to the Frankfort plane defined by the 4 anatomical pellets. The unit vector  $\hat{k}$  must be along the cross product of the vector  $\hat{j}$  and any vector  $\vec{P}$  lying in the Frankfort plane. Thus:

$$\begin{aligned}
 \hat{k} &= \frac{\hat{j} \times \vec{P_3P_1}}{|\hat{j} \times \vec{P_3P_1}|} = \ell_1 \hat{I} + m_1 \hat{J} + n_1 \hat{K} \\
 \text{or } \hat{k} &= \frac{\hat{j} \times \vec{P_4P_1}}{|\hat{j} \times \vec{P_4P_1}|} = \ell_2 \hat{I} + m_2 \hat{J} + n_2 \hat{K} \\
 \text{or } \hat{k} &= \frac{\hat{j} \times \vec{P_3P_2}}{|\hat{j} \times \vec{P_3P_2}|} = \ell_3 \hat{I} + m_3 \hat{J} + n_3 \hat{K}
 \end{aligned}$$

$$\text{or } \hat{k} = \frac{\hat{j} \times \overrightarrow{P_4 P_2}}{\hat{j} \times \overrightarrow{P_4 P_2}} = l_4 \hat{I} + m_4 \hat{J} + n_4 \hat{K}$$

The average is then :

$$\hat{k} = \frac{l_1+l_2+l_3+l_4}{4} \hat{I} + \frac{m_1+m_2+m_3+m_4}{4} \hat{J} + \frac{n_1+n_2+n_3+n_4}{4} \hat{K} \quad (29)$$

Finally, the direction cosines of the A-P or  $\hat{i}$ -axis are obtained by the cross product:

$$\hat{i} = \hat{k} \times \hat{j} \quad (30)$$

Equations (28), (29) and (30) may be written compactly as:

$$\begin{pmatrix} \hat{i} \\ \hat{j} \\ \hat{k} \end{pmatrix} = [A] \begin{pmatrix} \hat{I} \\ \hat{J} \\ \hat{K} \end{pmatrix}$$

Transformation matrix [R] - Since the transformation matrix [R], defined by

$$\begin{pmatrix} \hat{e}_1 \\ \hat{e}_2 \\ \hat{e}_3 \end{pmatrix} = [R] \begin{pmatrix} \hat{i} \\ \hat{j} \\ \hat{k} \end{pmatrix},$$

is the desired result, it is simply obtained by:

$$[R] = [E] [A]^{-1}$$

The matrix [A] is an orthogonal transformation, therefore, its inverse is equal to its transpose.

$$[A]^{-1} = [A]^T$$

Thus,

$$[R] = [E] [A]^T \quad (31)$$

The matrix multiplication in Equation (31) is straightforward.

Translation of the two origins - In addition to the transformation matrix between the instrumentation and the anatomical coordinate systems, the location of the instrumentation origin P must be known relative to the anatomical coordinate system, i.e.

$$\overline{CP} = d_1 \hat{i} + d_2 \hat{j} + d_3 \hat{k}. \quad (32)$$

This vector can be computed from

$$\overline{CP} = \overline{OP} - \overline{OC}$$

then expressed in the anatomical system. First, the vector  $\overline{OC}$  is by definition (section 4.2.3).

$$\begin{aligned} \overline{OC} &= \frac{1}{2}[\overline{OP}_1 + \overline{OP}_2] \\ \overline{OC} &= \frac{x_1+x_2}{2} \hat{i} + \frac{y_1+y_2}{2} \hat{j} + \frac{z_1+z_2}{2} \hat{k} \end{aligned} \quad (33)$$

or 
$$\overline{OC} = x_c \hat{i} + y_c \hat{j} + z_c \hat{k}$$

and 
$$\overline{OP} = x_p \hat{i} + y_p \hat{j} + z_p \hat{k}$$

therefore 
$$\overline{CP} = (x_p - x_c) \hat{i} + (y_p - y_c) \hat{j} + (z_p - z_c) \hat{k} \quad (34)$$

To obtain  $(d_1, d_2, d_3)$ , the anatomical components of  $\overline{CP}$ , we express  $\overline{CP}$  in the anatomical system:

$$\overline{CP} = \begin{bmatrix} (x_p - x_c) & (y_p - y_c) & (z_p - z_c) \end{bmatrix} \begin{Bmatrix} \hat{i} \\ \hat{j} \\ \hat{k} \end{Bmatrix}$$

Using equation (2),  $(\hat{i}, \hat{j}, \hat{k})$  is substituted to obtain:

$$\begin{bmatrix} d_1 & d_2 & d_3 \end{bmatrix} = \begin{bmatrix} (x_p - x_c) & (y_p - y_c) & (z_p - z_c) \end{bmatrix} [A]^T \quad (35)$$

## 4.3 PHOTOMETRIC ANALYSIS

### 4.3.1 Introduction

The purpose of high-speed camera coverage is to monitor the ~~3-dimensional~~ motion of the test subject. This means obtaining the three cartesian ( $\hat{I}, \hat{J}, \hat{K}$ ) coordinates of a single point-target and/or the 6 degrees-of-freedom of a rigid-body segment.

In principle, two cameras are sufficient to provide this coverage. Thus, one may use camera I (right side) to obtain the  $\hat{I}$  and  $\hat{K}$  coordinates of a target, and camera IV (top) to obtain the  $\hat{I}$  and  $\hat{J}$  coordinates of the same target. The four coordinates obtained from two cameras are then combined, resulting in a triplet of ( $\hat{I}, \hat{J}, \hat{K}$ ) coordinates of that target. However, another target may not be visible from camera I or IV, a possibility which necessitates the use of alternate and/or additional camera coverage.

The set up used for Run A-725, shown in Figure 17, is typical. It consists of 4 synchronized high-speed cameras, which will capture the following coordinates:

camera I .... right side ....  $X = \hat{I}, Y = \hat{K}$

camera II .... left side ....  $X = -\hat{I}, Y = \hat{K}$

camera III .... front view ....  $X = \hat{J}, Y = \hat{K}$

camera IV .... top view ....  $X = \hat{J}, Y = -\hat{I}$

With this setup, the chance of a target being obstructed from view in one camera is compensated by its visibility in one or more other views.

### 4.3.2 Cameras and Film

Three Photosonics 1-B cameras and one Hycam 2004E camera were used in the tests.

The Hycam had a wide-angle lens because of space limitations.

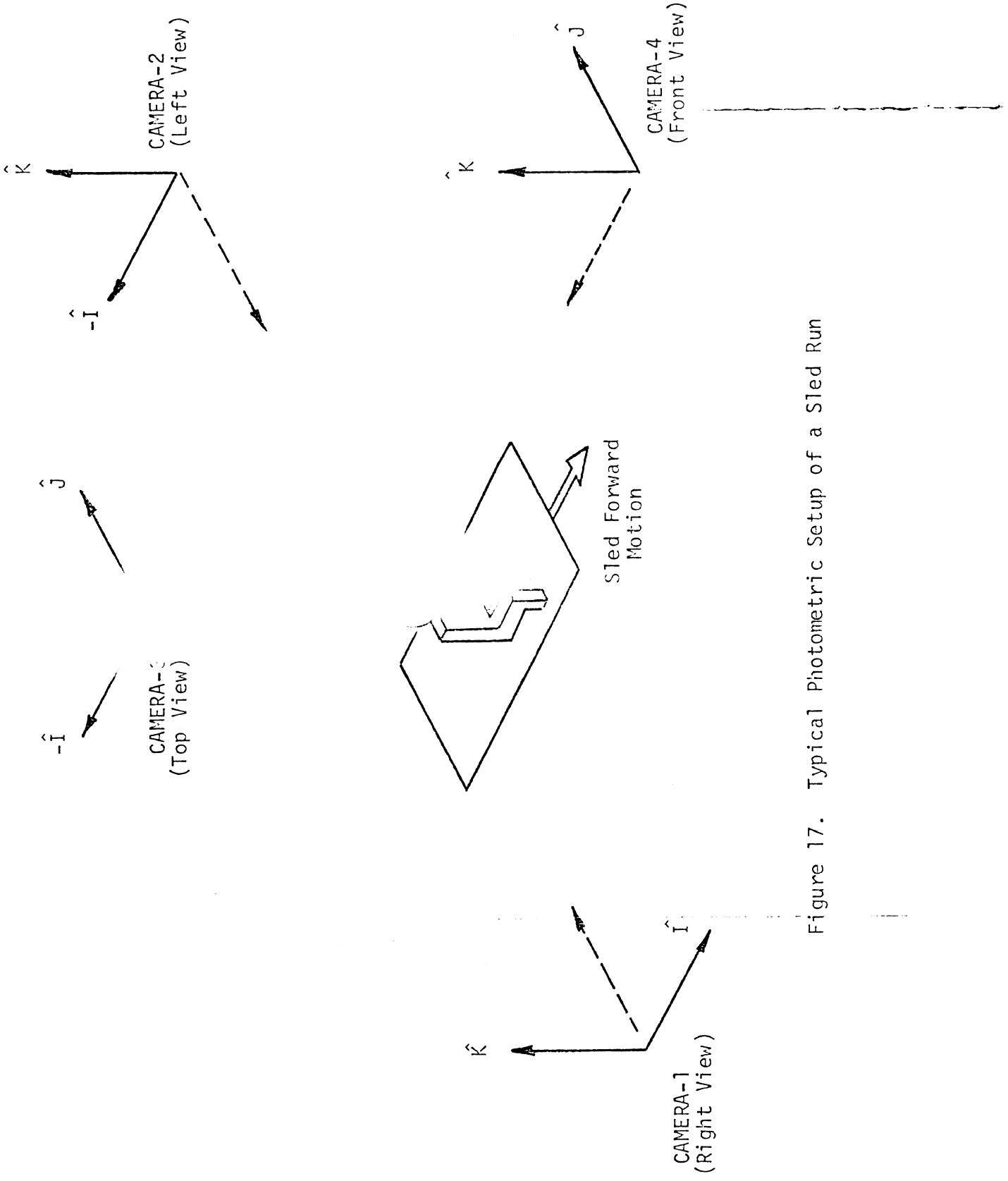

Figure 17. Typical Photometric Setup of a Sled Run

The film used was Kodak Ektachrome 7242 EF.

#### 4.3.3 Synchronization

All cameras were run at a nominal speed of 1000 frames/second. Using the same timing source, timing lights were put on the edges of all films at the rate of 1000 pulse per second, with double-pulses each 10 msec and triple-pulses each 100 msec. In addition, a powerful strobe was flashed at time = zero, which was visible in all 4 views, and was picked up and recorded on analog tape for the synchronization of film with the analog data.

#### 4.3.4 Magnification Calibration

The size of distances captured on each film were calibrated by installing a known scale in the object-plane of each camera. Thus, a scale is recorded on film, along with all the other targets, and will undergo the same magnification as the other targets.

This procedure has proven satisfactory when the camera-target distance is large, when the target is in the vicinity of the optical center, and when the motion of the target is essentially in the plane of the calibration "scale."

If the departure from the above conditions is significant, i.e., if the motion is in-and-out of a given object plane, or if the target being analyzed is too far from the optical axis, or when the lens used is a wide-angle one, under these conditions, compensation and corrections must be introduced to the simple X-Y coordinates obtained on the screen of a film analyzer.

#### 4.3.5 Coordinates Reading

Each film is analyzed separately using the Vanguard Film Analyzer. The (X-Y- $\theta$ ) coordinates of all visible targets are recorded, along with those of a target fixed on the sled and an inertial target fixed to the ceiling of the laboratory.



At the same time, the actual camera speed is measured by counting the number of frames between two timing lights of known separation. Finally, several measurements are made of a known distance between two targets, from which an average magnification factor (actual inches per Vanguard inch) is obtained.

The number of frames analyzed and the number of targets in each frame varies with each film depending on the field of view of each camera and the visibility of the various targets. Analysis is begun as many as 20 frames prior to the  $t = 0$  strobe flash. Since only positions were desired in the analysis, analysis was carried on each 5 frames. However, if velocities and accelerations were to be obtained by numerical differentiation, each frame must be analyzed.

#### 4.3.6 Analysis of a Typical Run - A-725

Photometric analysis was performed for Run A-725. The raw data consisted of 4 decks of cards, each of which contains:

- 1 - Test ID and description of view
- 2 - camera speed (frames per second)
- 3 - magnification factor (actual inches per screen inch)
- 4 - up to 6 target names/identifications
- 5 - a deck of cards (one card for each frame) containing the frame number, and up to 6 triplets  $(X,Y,\theta)$  measured for each of the analyzed targets.

These decks were subsequently processed by a general-purpose Vanguard analysis program to obtain the inertial (I,J,K) coordinates of the various targets, or their coordinates relative to the sled. The coordinates analyzed are described in Table X .

TABLE X . SUMMARY TABLE OF PHOTOMETRIC ANALYSIS FOR RUN A-725

		Camera-1 Right View			Camera-2 Left View			Camera-3 Top View			Camera-4 Front View		
frames/second		15.94			11.02			10.38			12.21		
actual inches per screen		900			950*			952			950*		
TARGET		$\hat{I}$	$\hat{K}$	$\theta$	$-\hat{I}$	$\hat{K}$	$\theta$	$\hat{J}$	$-\hat{I}$	$\theta$	$\hat{J}$	$\hat{K}$	$\theta$
Inertial Point	1	0**	0	-	0	0	-	0	0	-	0	0	-
Sled Point	2	1	1	-	1	1	-	1	1	-	1	1	-
Right Ear	3	2	2	-	-	-	-	-	-	-	2	2	-
Left Ear	4	-	-	-	2	2	-	-	-	-	2	2	-
Top of Head	5	-	-	-	-	-	-	1,2	1,2	-	2	2	-
Thorax	6	2	2	-	2	2	-	2	2	-	-	-	-
Pelvis	7	2	2	-	2	2	-	2	2	0	-	-	-
Thigh	8	-	-	0	-	-	0	2	2	-	-	-	-

Numbers in boxes indicate that positions were obtained relative to that target number.

Notes: \* Frame rates estimated - Timing marks lost.  
 \*\* "0" indicates analysis done relative to Vanguard screen reference system,  
 "-" indicates no analysis performed.

The program output is tabulated  $x(t)$ ,  $y(t)$ , and  $\theta(t)$ , which were then manually plotted. Translation of axes (shifting curves) was necessary to account for using different sled targets as reference points; and occasionally averaging of several curves was done manually since the same coordinate was obtained from more than one view. Some of the results are shown in Figures 13 through 21 .

Normally, photometric analysis is presented in two types of time-position histories: Type-1 is intended to describe the positions, relative to a sled point, of a single target such as the pelvis. The sled point is chosen to be the point where the target in question was located at time zero. Thus, at time = zero, the position of the pelvis is zero, and any subsequent motion would be the "excursion" of the pelvis inside the simulated vehicle.

Type-2 graphs are intended to be used for the 3-D rigid-body motion analysis of the head. These consist of  $\hat{I}$ ,  $\hat{J}$  and  $\hat{K}$  plots of three points on the head. Initial conditions (inertial positions and velocities) are obtained from these graphs at time = zero and are used as input to the 6 or 9 accelerometer 3-D motion analysis. Checkpoints may be obtained to verify the results of the acceleration analysis and to validate the computational procedure.

It should be noted that the 3-D photometric analysis is a tedious process and should be used sparingly, and only for verification of the 3-D acceleration analysis.

#### 4.3.7 Rigid-Body Photometric Analysis

Once the inertial coordinates  $(x, y, z)$  of 3 points on the head are plotted out, and "digitized" manually to obtain 9 coordinates, it is possible

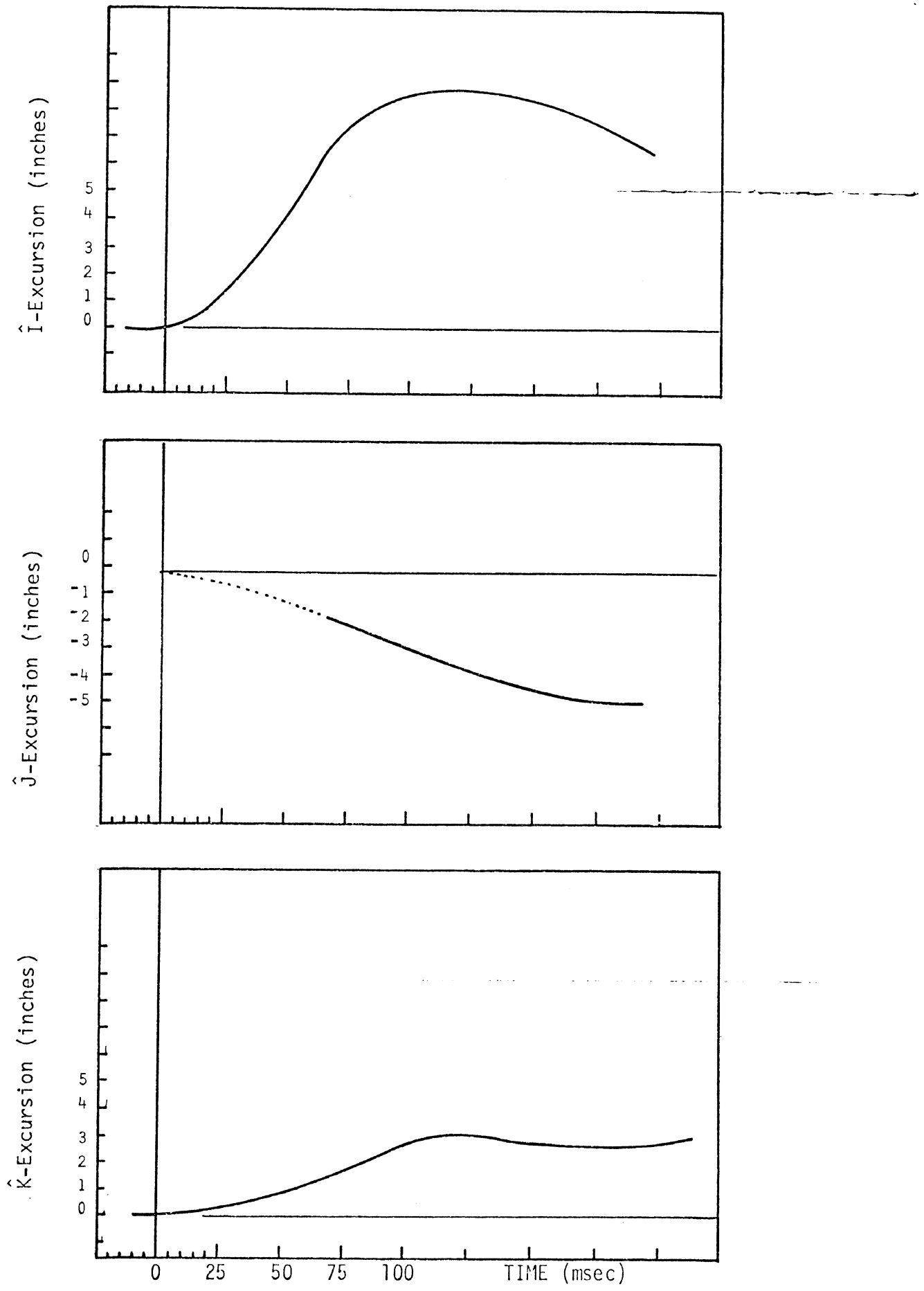

Figure 18. Excursions relative to sled, of a typical target obtained from photometric analysis. [Thorax, Run A-725]

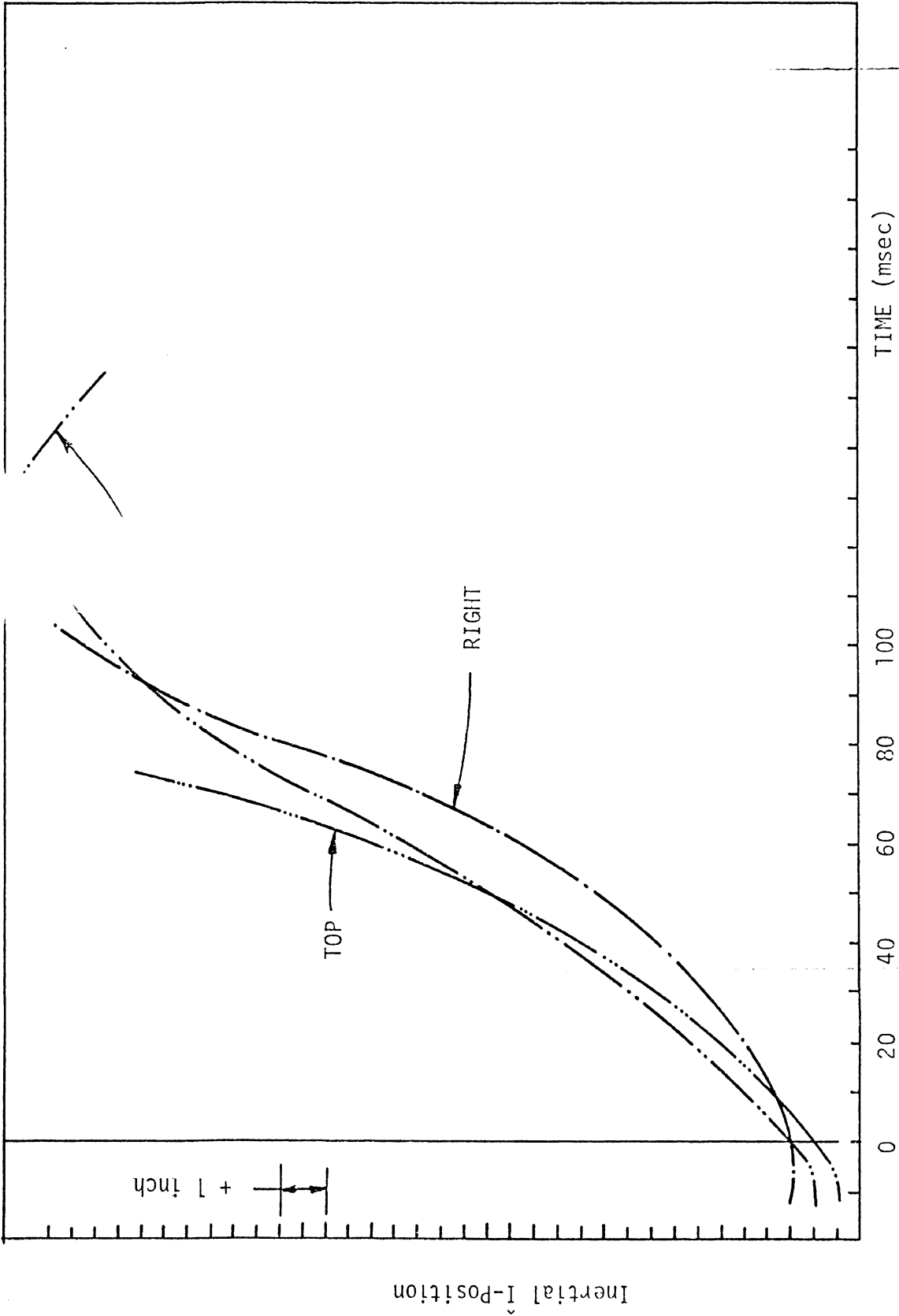

Figure 19. Inertial  $\hat{I}$ -coordinates ( $\Lambda$ -P) of 3 head targets, obtained from photometric analysis of Run A-725

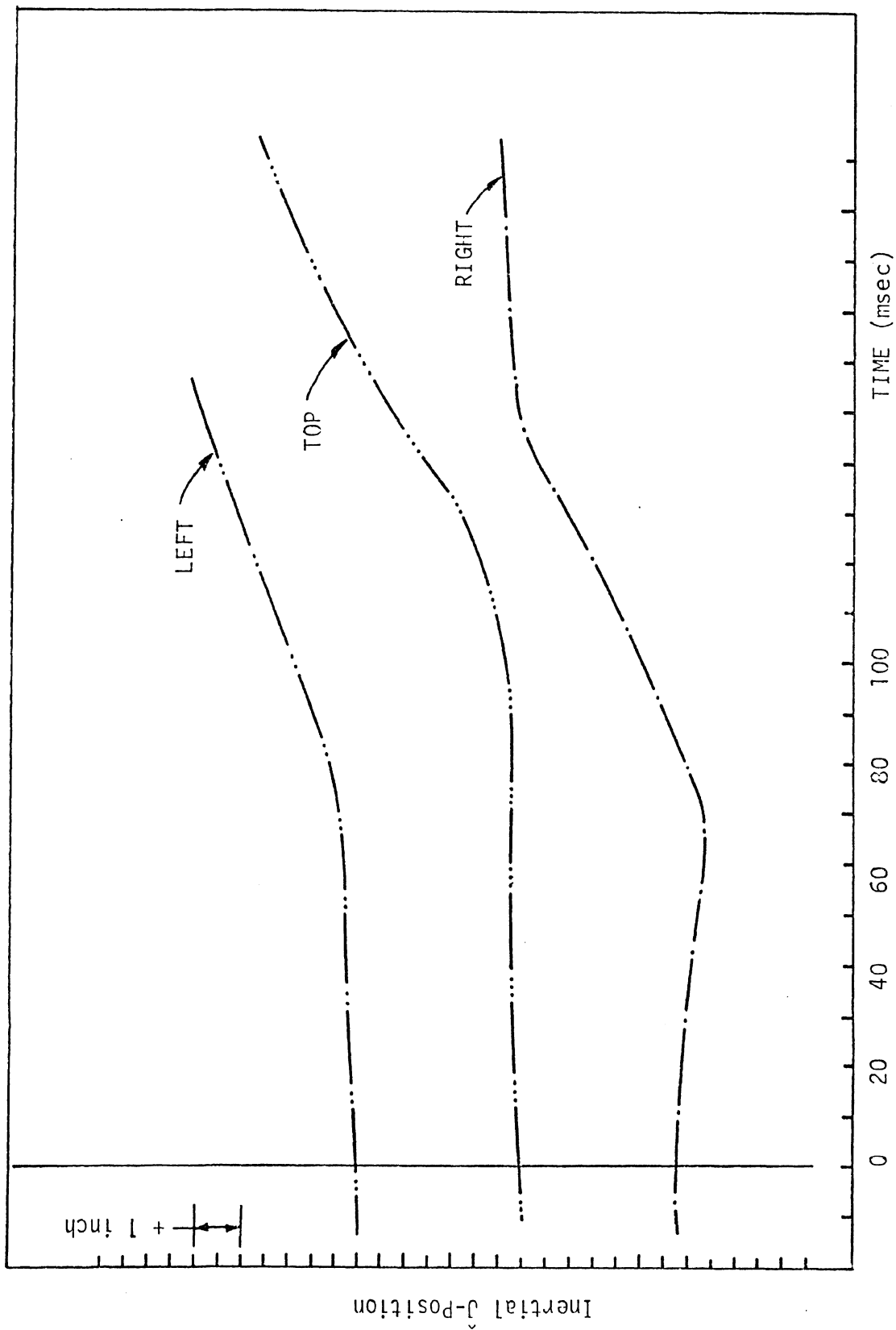

Figure 20. Inertial  $\hat{J}$ -coordinate (R-L) of 3 head targets, obtained from photometric analysis of Run A-725

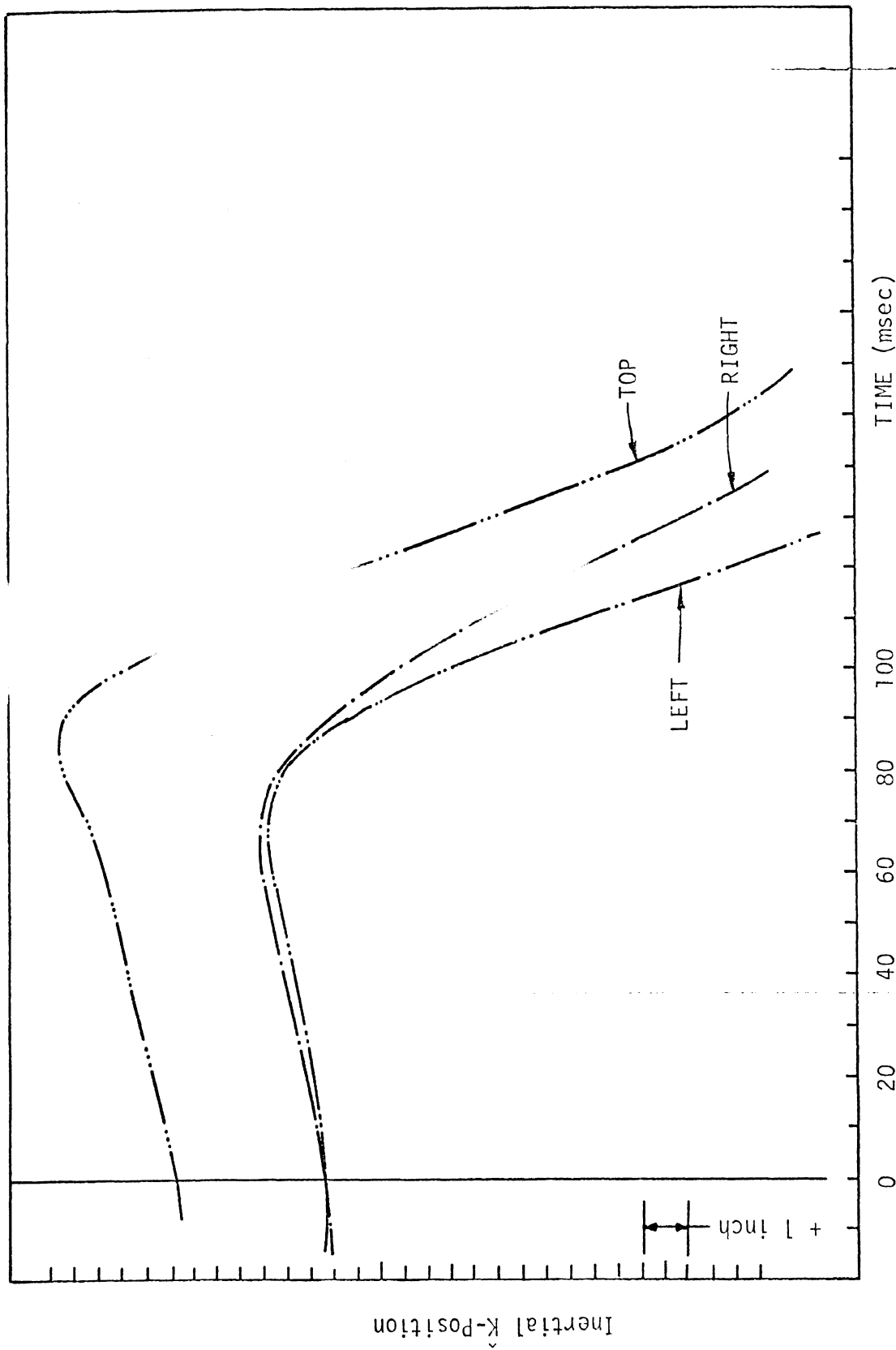

Figure 21. Inertial  $\hat{K}$ -coordinates (I-S) of 3 head targets, obtained from photometric analysis of Run A-725.

to compute the 6 degrees-of-freedom of any point on the head, given the location of these points (from X-rays). The procedure is simple and it follows these steps:

- 1) given  $(x_1, y_1, z_1)$ ,  $(x_2, y_2, z_2)$ ,  $(x_3, y_3, z_3)$  as well as  $\phi_1, \phi_2, \phi_3$
- 2) compute  $(x_c, y_c, z_c)$
- 3) compute the direction cosines of  $(e_x, e_y, e_z)$ , resulting in the Euler transformation matrix
- 4) compute the pitch, yaw and roll from the elements of the Euler matrix.

A detailed write-up on this procedure is given in the paper, "Motion Measurement of a Rigid Body in Three Dimensions," by D. H. Robbins, B. M. Bowman, and N. M. Alem, Society of Photo-optical Instrumentation Engineers, Nov. 1972.



## 5.0 PROGRAM SUMMARY AND RECOMMENDATIONS

The progress of the program in terms of number of tests performed has been less than originally planned. A summary of the tests made during the first year of the program is shown in Table XI. Significant progress has been made in terms of developing the sophisticated measurement techniques and data analysis capabilities necessary for providing the quality of data required for effective performance of the program. The progress on the various aspects of the program are discussed in the following sections.

### 5.1 PRELIMINARY SLED PULSE EVALUATION

Two sled runs, A-716 and A-717, were performed at HSRI using GMR supplied Hybrid II dummy and instrumentation. The tests were to be compared to similar GMR tests S-558, S-559 and S-560. The test conditions are listed in Table XII and the comparative peak value data is listed in Table XIII. The results indicate that, in general, the HSRI sled pulse gives very comparable dummy response to that of the GMR facility in terms of peak accelerations of the head and chest, peak belt loads, and head angular and linear displacements. It would appear that the HSRI pulse produces the peak values somewhat sooner in time than the GMR pulse. This difference in time phasing and duration, plus the slightly lower test velocity in the HSRI tests, produced lower GSI values than the GMR data.

### 5.2 CADAVER INSTRUMENTATION AND PREPARATION TECHNIQUES

The development of appropriate and effective techniques for preparing and instrumenting the cadavers for testing took significantly greater time than originally anticipated. It is felt, however, that the techniques described in Section 3.0 are well thought out and, with slight modification

TABLE XI WHOLE BODY RESPONSE PROGRAM

## SUMMARY OF TESTING TO DATE

TEST NO.	SUBJECT	VEL. (MPH)	DECEL. (G's)	DATE OF TEST	PURPOSE OF TEST	COMMENT
A-716	GM Hybrid II Dummy	31.9	21	11-6-73	First run on test buck to determine Hybrid II performance with HSRI Sled Pulse	
A-717	GM Hybrid II Dummy	31.9	21	11-6-73	Rerun of A-716 to determine repeatability	
A-719	HSRI Dummy	32.35	21	12-21-73	Comparison of headset triax to dummy head triax	
A-720	Cadaver I	24.6	10	3-21-74	First Whole Body Response subject	
A-725	Cadaver II	21.6	10	5-9-74	Second Whole Body Response Subject - Low speed test	
A-726	Cadaver II	30.0	20	5-9-74	Second Whole Body Response Subject - High speed test	Shoulder belt failed
A-757	HSRI Dummy	30.7	18	8-12-74	Dummy head triax and headset triax data to verify 3-D motion analysis routine	

TABLE XII DUMMY TEST COMPARISON

TEST CONDITIONS: GM Hybrid II Dummy in GM Supplied 3 point test fixture.

10 lb. lap belt preload

10 lb. shoulder belt preload + 3" slack

Teflon on seat -- cotton clothes

HSRI tests run at 31.9 mph with 21 G deceleration

GM tests run at 33 mph with 21 G deceleration

DATA FILTERING: For Head X, Y, Z and Resultant -- SAE Channel Class 1000

For Chest X, Y, Z and Resultant -- SAE Channel Class 180

For Lap Belt Loads -- SAE Channel Class 1000

TABLE XIII DUMMY TEST DATA COMPARISON SUMMARY

INSTRUMENTATION TEST SUMMARY

ITEM	Test Number				
	A-716	A-717	S-558	S-559	S-560
<u>Head Resultant</u>					
G.S.I.	330	360	468	532	491
Max G's	39	40.8	43.02	51.10	40.28
@ Time (ms)	59	60	94.1	96.3	85.5
<u>Head X Axis</u>					
Max G's	-38	-35	-31.64	-38.90	-39.95
@ Time (ms)	207	218	226.6	221.3	220.9
<u>Head Y Axis</u>					
Max G's	5	7.5	7.09	-10.68	4.92
@ Time (ms)	91	93	108.1	74.0	107.6
<u>Head Z Axis</u>					
Max G's	35	37	40.77	49.31	38.26
@ Time (ms)	61	62	94.1	96.3	85.0
<u>Chest Resultant</u>					
Max G's	35.0	39.2	44.24	45.58	40.16
@ Time (ms)	60	57	60.0	70.0	63.3
<u>Chest X Axis</u>					
Max G's	40	39	43.16	44.19	38.25
@ Time (ms)	55	57	60.0	59.6	63.2
<u>Chest Y Axis</u>					
Max G's	17.5	13	12.69	-23.27	12.64
@ Time (ms)	75	68	96.2	84.9	69.5
<u>Chest Z Axis</u>					
Max G's	10	-13.5	-21.40	-25.75	-18.01
@ Time (ms)	68	87	67.8	70.1	68.7

ITEM	Test Number				
	A-716	A-717	S-558	S-559	S-560
<u>Lo Shoulder Belt</u>					
Max Lb.	1200	1250	1214.44	1196.32	<del>1214.87</del>
@ Time (ms)	61	67	67.1	65.1	72.1
<u>Up Shoulder Belt</u>					
Max Lb.	-1800	-1730	-1517.38	-1581.12	-1536.37
@ Time (ms)	63	65	69.1	68.4	73.1
<u>Right Lap Belt</u>					
Max Lb.	2900	2950	-2826.51	-2968.25	-2833.76
@ Time (ms)	63	64	68.1	68.5	69.4
<u>Left Lap Belt</u>					
Max Lb.	2250	2340	2265.09	2408.36	2256.81
@ Time (ms)	63	63	60.3	68.1	70.3

TEST SUMMARY

MAXIMUM HEAD EXCURSIONS

Test No.	Horizontal	Vertical	Angular
S-558	25.5 in.	-10.0 in.	92.5°
S-559	25.8 in.	-10.1 in.	95°
S-560	25.7 in.	- 9.7 in.	94.4°
A-716	24.5 in.	-10.9 in.	94.8°
A-717	25.7 in.	-12.9 in.	101.7°

as more experience is gained during the continuation of the program, will provide the high quality of data required for detailed response evaluation.

### 5.3 DATA ANALYSIS TECHNIQUES

With the exception of the three dimensional head motion analysis, the data analysis requirements of the program are generally straightforward. However, the large number of data channels to be processed and analyzed as a total package required the upgrading of existing data handling techniques and the development of new and improved computer analysis programs at HSRI to efficiently handle the analog-to-digital conversion of the data and the subsequent analysis and presentation of the data.

Early in the cadaver testing program, certain problems arose in the analysis of the six accelerometer method of determining three-dimensional motion. An instability in the computations occurred which led to a careful and time consuming re-evaluation of the theoretical formulation and the computer program used in the analysis. As a result, it was found that the formulation for six accelerometers is subject to instability due to error buildup in the integration to determine angular velocities. The cause of the instability is not fully determined, but probable sources are the instability of the Jacobian of the system under certain conditions (notably, near-constant velocity motion), coupled with round-off errors in even the most stable integration routines.

After much study, it is felt that, for the case where the event of interest is the initial high acceleration phase of head motion, the six accelerometer method is adequate. For long duration events in which both the forward motion and the rebound motion are to be determined as in the Whole Body Response Program, it is necessary to utilize redundant accelerometers to accomplish the analysis. A system of three triaxial accelerometers

has been recently analyzed and proven to eliminate the instability on a theoretical basis at HSRI. Future tests on this program will utilize the nine-accelerometer technique for obtaining three dimensional head motion.

#### 5.4 CADAVER TEST PROGRAM

As indicated in Table XI, tests have been performed on two cadavers meeting the requirements of the program (that is, male cadavers near the 50th percentile in size). A temporary reduction in the availability of cadavers during the latter part of the program prevented additional tests from being performed.

Review of the test results from the first cadaver test, A-720, was conducted in conjunction with GMR personnel in order to evaluate procedures and revise them where necessary. Problem areas which were evident in the test included a tendency for the subject to rotate out of the shoulder belt, difficulty in attaining the correct upper leg position due to insufficient foot support adjustment, and marginal pelvic lateral x-ray. Other areas discussed were increased targeting at the shoulder and the thorax, improved seat back angle, the use of an underwear shirt, and femur target visibility in pre-test x-rays. Due to the data analysis difficulties discussed in Section 5.3, complete data analysis for this test is not available yet.

The second cadaver test series, A-725 and A-726, was conducted with many of the above problem areas corrected. Test A-725 was a very successful low severity test, while test A-726, a high severity test, was a failure due to a shoulder belt rupture which was traced to inappropriate belt threading instructions. As in test A-720, the complete data analysis is not available yet. (Photometric analysis of test A-725 can be found in Section 4.3.6). However, evaluation of the quick-look data traces was made in conjunction

with GMR personnel and a test critique made. Recommendations for future tests based on the completed tests are discussed in the following section.

## 5.5 PROGRAM RECOMMENDATIONS

Based on the experience acquired with the Whole Body Response tests already run, the following improvements are suggested for incorporation into the future program.

### 5.5.1 Accelerometer Headset

The problems encountered to date include a ringing phenomenon of the tubular assembly even when securely fastened to the skull - an extremely critical and time consuming installation procedure - and cable damage during impact. An alternate method for attaching head accelerometers is presently being designed which utilizes three individual collets clamped to the skull with an accelerometer potted to each collet in the correct orientation. An adjustable installation fixture holds the accelerometers properly positioned while the potting material sets, and measurement of the fixture provides the coordinates of the accelerometers. By aligning all cables inward toward the top of the head, it is hoped that the damage caused by contact with the arms during impact will be minimized.

In conjunction with this attachment change, the accelerometer configuration will be changed from three biaxial to three triaxial accelerometers to provide three redundant accelerometer readings as a means of reducing the instability encountered in the equations for head motion analysis.

### 5.5.2 Anthropometry

A revised and corrected list of anthropometry measurements is shown in Table XIV.

### 5.5.3 Targeting

- a) Improved targeting to permit measurement of rotational and translational



TABLE XIV. ANTHROPOMETRY MEASUREMENTS

The following measurements are proposed for future Whole Body Response

Testing:

Whole Body

1. Stature
2. Weight

Head

3. Head Breadth
4. Head Length
5. Head Circumference
6. Head, Mid-Sagittal Arc Length
7. Head, Coronal Arc Length
8. Head, Tragion-Vertex Height
9. Head, Menton-Vertex Height

Additional Alternative Measurements: Head

10. Bitragion Diameter
11. Bigonial Diameter
12. Menton Diagonal
13. Mastoid Diagonal

Neck

14. Mid-Neck Circumference
15. Nuchale - Vertex Height
16. Mastoid - Vertex Height

Torso

17. Biacromial Diameter
18. Bideltoid Breadth
19. Chest Breadth at T4
20. Chest Depth at T4
21. Chest Circumference at T4
22. Chest, T4 Vertex Height
23. Chest Breadth at T8
24. Chest Depth at T8
25. Chest Circumference at T8
26. Chest, T8 - Vertex Height
27. Chest Breadth at T12
28. Chest Depth at T12
29. Chest Circumference at T12
30. Chest, T12
31. C7 - Vertex Height
32. Hip Breadth, Iliocristale

Torso (continued)

33. Hip Depth, Iliocristale
34. Iliocristale - Vertex Height
35. Hip Circumference, Iliocristale
36. Bispinous Diameter, Anterior Iliac Spine
37. ASIS - Vertex Height
38. Rt. ASIS
39. Lt. ASIS
40. Bitrochanteric Diameter
41. Buttocks Depth, Trochanterion
42. Buttocks Circumference, Trochanterion
43. Trochanterion - Vertex Height

Upper Arm

44. Acromion - Radiale Length
45. Ball of Humerus - Radiale Length
46. Upper Arm Circumference, Axilla
47. Upper Arm Circumference, Mid-Biceps
48. Upper Arm Circumference Humeral Condyles
49. Humeral Biepocondylar Breadth

Lower Arm

50. Radiale - Stylium Length
51. Olecranon - Stylium Length
52. Maximum Forearm Circumference
53. Wrist Circumference

Hand

54. Hand Length
55. Hand Breadth
56. Hand Depth

Upper Leg

57. Femur Length
58. Upper Thigh Circumference
59. Mid Thigh Circumference

TABLE XIV (continued)

Upper Leg (continued)

- 60. Lower Thigh Circumference
- 61. Femoral Biépicondylar Breadth

Lower Leg

- 62. Tibia Length
- 63. Fibula Length
- 64. Maximum Calf Circumference
- 65. Ankle Circumference

Foot

- 66. Foot Length
- 67. Foot Breadth

motion is to be incorporated at the pelvic and thoracic accelerometer locations, and at the T<sub>7</sub> position.

b) A spherical target is to be incorporated at the acromion on each side.

c) The method of attaching femur targets with plastic tie-wraps has proven unsatisfactory since the lap target positions may change between the x-rays and final positioning on the sled and the tie-wraps themselves have shown a tendency to fracture during impact. Revised femur targeting utilizing wood screws directly into the femur will be used in future testing.

#### 5.5.4 X-Rays

Future improvements will be directed towards better resolution in the pelvic area in the lateral seated x-rays. Particular emphasis will be placed on defining the seated orientation of the pubic crest, iliac crests, and the outlines of the acetabulums. If required, lead pellets will be surgically implanted to assist in identifying these landmarks. Contact print copies of all x-rays will be supplied for each test subject.

#### 5.5.5 Positioning

Generally, additional effort is to be directed towards more accurate positioning of the cadaver in the test fixture, particularly such items as maintaining the torso vertical, keeping the lower arms parallel, and the subject symmetrically situated with respect to both his own and the test fixture axes. The tendency to slump and the interaction of the adjustments are the principal factors impeding ideal positioning, and if necessary, additional taping or the use of strings with electric rope cutters will be adopted to maintain the cadaver in place. The head is to be positioned after all other adjustments are finished. This will consist of taping the head in the most neutral fore and aft position with narrow masking tape weakened for low effort breakage.

#### 5.5.6 Future Program Plans

The second year continuation of this program involves completion of the original cadaver and dummy test matrix and additional testing with other configurations. The progress made during the first year program in overcoming many of the experimental and analytical difficulties involved in this type of testing will provide a solid basis for the effective implementation of the second year effort.