

New Perspectives on ACL Injury: On the Role of Repetitive Sub-Maximal Knee Loading in Causing ACL Fatigue Failure

Edward M. Wojtys,^{1,#} Mélanie L. Beaulieu,^{2,3} James A. Ashton-Miller^{2,#}

¹MedSport, Department of Orthopedic Surgery, University of Michigan, Ann Arbor, Michigan 48109, ²Biomechanics Research Laboratory, Department of Mechanical Engineering, University of Michigan, Ann Arbor, Michigan 48109, ³Department of Radiology, University of Michigan, Ann Arbor, Michigan 48109

Received 28 April 2016; accepted 15 September 2016

Published online 3 October 2016 in Wiley Online Library (wileyonlinelibrary.com). DOI 10.1002/jor.23441

ABSTRACT: In this paper, we review a series of studies that we initiated to examine mechanisms of anterior cruciate ligament (ACL) injury in the hope that these injuries, and their sequelae, can be better prevented. First, using the earliest in vitro model of a simulated single-leg jump landing or pivot cut with realistic knee loading rates and trans-knee muscle forces, we identified the worst-case dynamic knee loading that causes the greatest peak ACL strain: Combined knee compression, flexion, and internal tibial rotation. We also identified morphologic factors that help explain individual susceptibility to ACL injury. Second, using the above knee loading, we introduced a possible paradigm shift in ACL research by demonstrating that the human ACL can fail by a sudden rupture in response to repeated sub-maximal knee loading. If that load is repeated often enough over a short time interval, the failure tended to occur proximally, as observed clinically. Third, we emphasize the value of a physical exam of the hip by demonstrating how limited internal axial rotation at the hip both increases the susceptibility to ACL injury in professional athletes, and also increases peak ACL strain during simulated pivot landings, thereby further increasing the risk of ACL fatigue failure. When training at-risk athletes, particularly females with their smaller ACL cross-sections, rationing the number and intensity of worst-case knee loading cycles, such that ligament degradation is within the ACL's ability to remodel, should decrease the risk for ACL rupture due to ligament fatigue failure. © 2016 Orthopaedic Research Society. Published by Wiley Periodicals, Inc. *J Orthop Res* 34:2059–2068, 2016.

Keywords: anterior cruciate ligament; fatigue failure; muscle; tibial rotation; repetitive loading

DIFFERENT APPROACHES FOR STUDYING ACL INJURY MECHANISMS

Successful injury prevention efforts usually require a detailed understanding of the mechanism(s) of injury. The fact that anterior cruciate ligament (ACL) injuries continue to occur at a high rate in young athletes means that those mechanisms have remained elusive. Many reports of ACL injury describe a noncontact landing from a jump or a pivot maneuver while changing direction.^{1,2} The direction of movement and body and lower extremity positions have naturally then become the focus of analyzing injury mechanisms. However, while in vivo experiments might seem preferable, we have been reticent to ask athletes to perform the very maneuvers known to cause these injuries for obvious ethical reasons. Adding to our reticence is the fact that all in vivo field studies involve the use of surface markers or sensors that cannot accurately record the underlying skeletal kinematics.³ While animal studies are an alternative option, the external validity of transferring findings from quadrupeds to humans can be problematic. In silico approaches are another alternative but they require physiological kinematic data. That leaves in vitro studies with cadaver limbs as offering potential for exploring ACL injury mechanisms, as long as the rate and type of loading, the presence of muscle forces,

and dynamic loads can be simulated in a physiologic manner. This then was the starting point for the studies that we shall now review.

DEVELOPMENT OF AN IN VITRO KNEE TESTING SYSTEM

To accomplish the task of simulating ACL injury scenarios during a landing, a custom dynamic knee loading frame was designed and built (Fig. 1) to hold knee specimens in 15° of knee flexion using physiologic trans-knee muscle tension to simulate the most common position of a lower extremity when it lands a jump, when pivoting, or when suddenly stopping.⁴ Each of 11 knees (five male, six female) was rapidly loaded with an impact force two to four times the body weight, a flexion moment, and trans-knee muscle forces to simulate the time course of forces during a landing.⁵ During that landing, the increase in anteromedial ACL relative (AM-ACL-R) strain was found to be proportional to the increase in quadriceps force ($r^2 = 0.74$; $p < 0.00001$) and knee flexion angle ($r^2 = 0.88$; $p < 0.00001$) but interestingly did not correlate with the impact force ($r^2 = 0.009$; $p = 0.08$) (Fig. 2). This study also provided the first recordings of AM-ACL-R strain at the realistically high strain rates characteristic of a jump landing (Fig. 2).⁴ Forced knee flexion induced the stretch-related quadriceps force that strongly influenced the relative strain on the AM bundle of the ACL. These results suggest that during jump landings, the increase in quadriceps force required to arrest knee flexion can place the ACL at risk for large strains.⁶ It is also true that trans-articular knee flexor muscles can limit ACL strain.⁷ But if the balance between the large knee muscle forces is temporarily disrupted, there could be an increased risk for ligament injury.

#An invited submission related to the Kappa Delta Award 2016. Grant sponsor: PHS grants; Grant numbers: R01 AR 054821, P30 AG 024824; Grant sponsor: National Football League (NFL) Charities.

Correspondence to: Edward M. Wojtys (T: 734-232-9902; F: 734-232-9622; E-mail: edwojtys@umich.edu)

© 2016 Orthopaedic Research Society. Published by Wiley Periodicals, Inc.

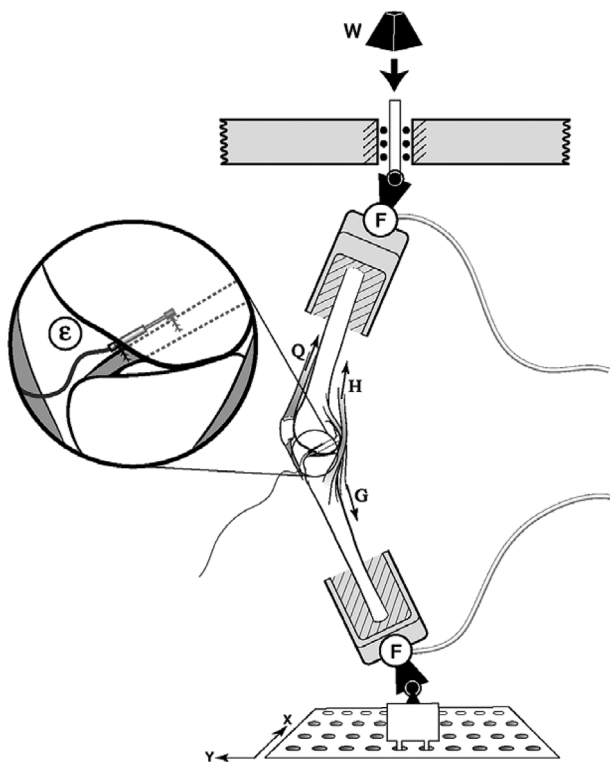

Figure 1. Schematic of the testing device. W, weight; F, force; Q, quadriceps; H, hamstrings; G, gastrocnemii. The inset depicts the strain gage mounted on the anteromedial fibers of the ACL. Reproduced from Withrow et al.⁴

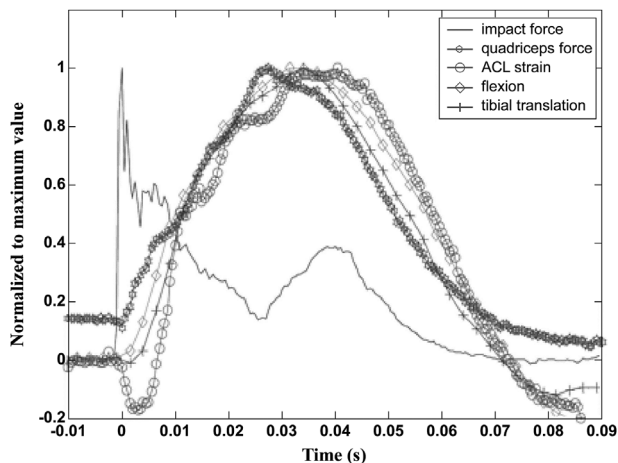

Figure 2. Temporal behavior of the applied impact force, along with the resulting quadriceps force, knee flexion angle, tibial translation, and ACL relative strain from test specimen #31535. Note how the time course of the ACL strain matches that of the quadriceps force rather than applied impact force because of the patellofemoral mechanism. For ease of comparison, measurements are normalized to their peak values in the trial. Pertinent values: Maximum impact force, 1,353 N; maximum quadriceps force, 1,135 N; ACL relative strain range, 0–3%; knee flexion range, 25–31°; tibial translation range, 0–4.6 mm. Reproduced from Withrow et al.⁴

PROTECTIVE MUSCLE ACTIVITY: HAMSTRINGS

As more became known about ACL strain patterns,⁸ our interest turned toward whether preferred muscle activity patterns could attenuate ACL strains. In vivo studies had shown previously that ACL strain is significantly affected by relative hamstring and quadriceps muscle activity.⁸ A critical component of many ACL injury prevention programs is developing hamstring muscle strength to limit anterior tibial translation, thereby limiting ACL strain.⁹ Indeed, we demonstrated that increasing hamstring force during the knee flexion landing phase using the cadaver in vitro testing system decreased the peak ACL-R strain by more than 70% compared to baseline, during which the hamstring force decreased during this phase ($p = 0.005$).¹⁰

Factors that affect the magnitude of hamstring force in vivo include muscle length, muscle moment arms, knee and hip joint angles and their rate of change (angular velocity), training and conditioning, muscle activation, and fatigue.^{9,11} The position of the

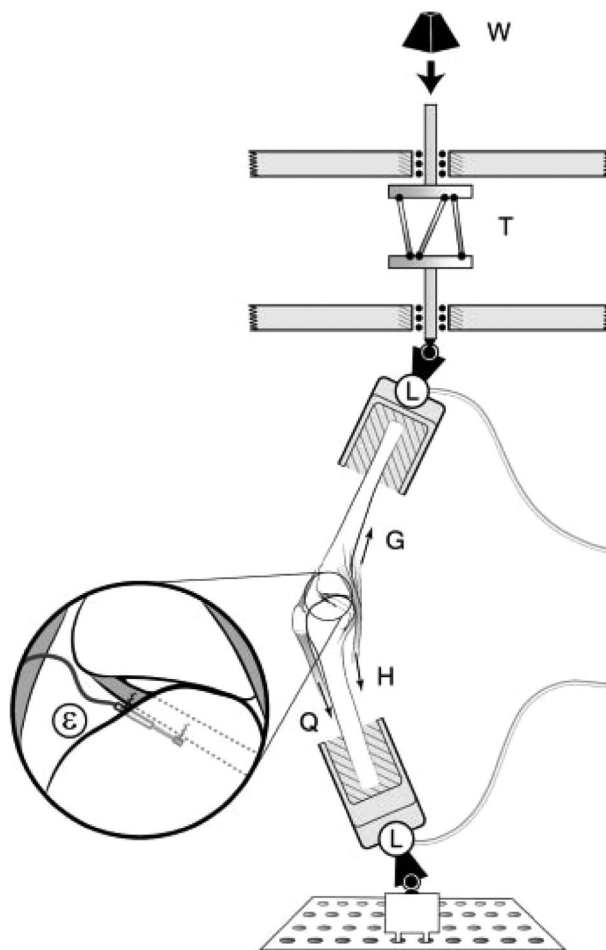

Figure 3. Schematic of testing apparatus with the addition of the torsional device (T). A weight (W) is dropped through a standard height onto an impact rod in series with the torsional device. Six-axis load cells (L) are located on distal tibia and proximal femur to measure knee input and output loads. Quadriceps (Q), hamstrings (H), and gastrocnemius (G) muscle forces are simulated. Reproduced from Oh et al.¹⁴

Table 1. Mean (\pm SD) Values for the Input Force and Moment, as Well as the Primary and Secondary Outcome Measurements by Trial Block ($N = 12$ Specimens)

	BASE1	Internal Tibial Torque	External Tibial Torque	BASE2
Input force				
Impulsive compressive force (N)	1,286.9 \pm 203.4	852.4 \pm 98.5	991.9 \pm 123.0	1,256.5 \pm 193.3
Input moment				
Axial tibial torque (Nm) ^a	—	17.3 \pm 3.7	-18.0 \pm 2.1	—
Primary outcomes				
AM-ACL relative strain (%)	3.0 \pm 2.0	5.4 \pm 3.7	3.1 \pm 2.8	2.9 \pm 1.7
AM-ACL relative strain rate (%/s)	184.2 \pm 112.0	252.4 \pm 160.1	179.4 \pm 109.9	196.1 \pm 101.3
Secondary outcomes				
Quadriceps force (N)	1,091.4 \pm 305.5	1,093.5 \pm 253.7	1,089.2 \pm 349.8	1,181.3 \pm 344.8
Knee flexion angle ($^{\circ}$)	4.6 \pm 1.4	4.8 \pm 1.3	2.8 \pm 1.3	4.5 \pm 1.2
Anterior tibial translation (mm)	1.3 \pm 1.0	3.6 \pm 2.6	0.8 \pm 0.6	1.3 \pm 1.0
Axial tibial rotation ($^{\circ}$) ^a	1.8 \pm 1.5	12.2 \pm 3.1	-11.8 \pm 3.7	1.7 \pm 1.2

In this table and Figure 4, “BASE1” and “BASE2” refer to baseline pre- and post-testing trial blocks, respectively. Reproduced from Oh et al.¹⁴

^aPositive value represents internal tibial torque or rotation.

trunk and pelvis also has an effect on hamstring activation.¹¹ Since hip flexion lengthens the hamstrings and knee flexion shortens them, ACL strain can be reduced by a lengthening hamstrings (eccentric) contraction during the knee flexion phase of a jump landing by flexing the hip substantially more than the knee.

Therefore, it might be possible for athletes to proactively limit the peak ACL strain during the knee flexion phase of jump landings by accentuating hip flexion, causing the active hamstrings to lengthen eccentrically. However, this has yet to be demonstrated in vivo.

WHICH KNEE LOADING DIRECTION CAUSES THE GREATEST ACL STRAIN DURING A JUMP LANDING?

The media frequently shows videos of high profile athletes injuring their ACL during a forceful knee abduction loading with axial rotation near full knee extension.¹ So, over the past decade ACL injury prevention programs have focused on reducing knee abduction loading during jump landings.^{12,13} But the relative contribution of transverse plane tibial rotation to ACL injury has actually not been possible to measure on video because of soft tissue motion artifact. Thus, while post hoc injury video analyses can provide valuable information on gross body or limb postures and movements,² they cannot reliably provide the detailed kinematics of the tibia and femur especially in terms of bone axial rotations. In effect, the role of tibial torque and rotation on ACL strain during a landing remained unknown because it had never been systematically studied.

So we modified our original in vitro apparatus to add an adjustable axial torsional transformer device (Fig. 3) in series with the distal tibial fixture.¹⁴ This transformed the linear momentum of the drop-weight at impact into a combination of a phasic axial knee

compressive force, a flexion moment and a phasic axial torque simultaneously applied to the distal tibia. Here, axial torque is defined as a torque applied about the longitudinal axis of the tibia, referred hereafter as “internal tibial torque” or “external tibial torque” depending on the direction of the applied torque. Using this testing system, which included the trans-knee muscle forces as before, we demonstrated that the mean (\pm SD) peak AM-ACL-R strains were $5.4 \pm 3.7\%$ and $3.1 \pm 2.8\%$ in response to internal and external tibial torque, respectively (Table 1). The normalized mean peak AM-ACL-R strain and strain

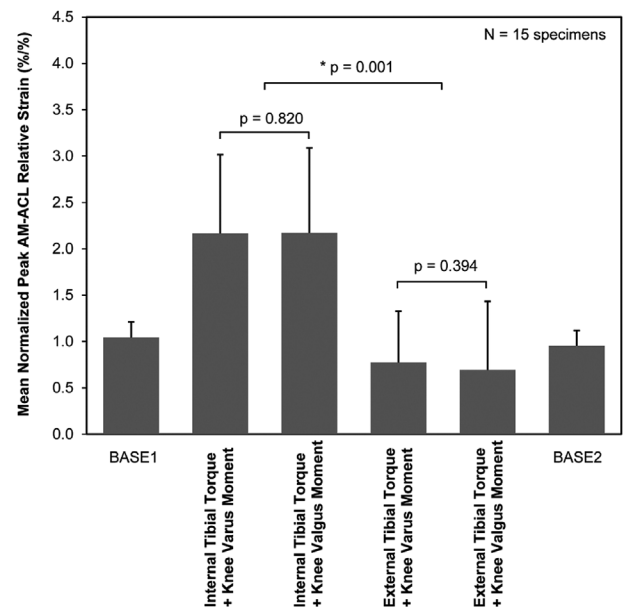

Figure 4. Mean (SD, represented by error bars) normalized peak AM-ACL relative strain values under each loading condition. The asterisk indicates a significant difference. Regardless of the direction of the frontal plane moment, the mean normalized peak AM-ACL relative strain was greater under the internal tibial torque than under the external tibial torque. Reproduced from Oh et al.¹⁶

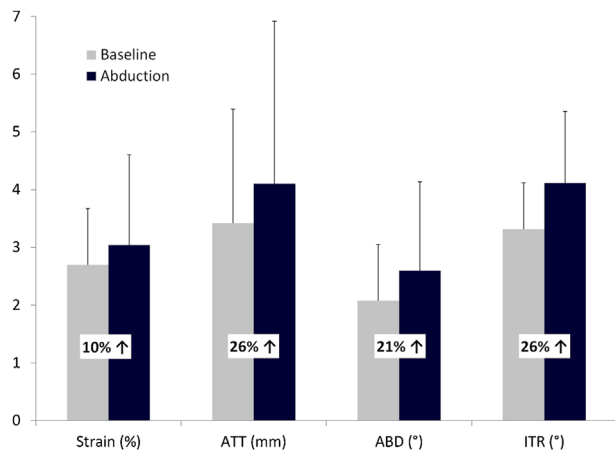

Figure 5. Mean (SD, represented by error bars) values of peak AM-ACL relative strain, peak relative anterior tibial translation (ATT), peak relative abduction (ABD), and peak relative internal tibial rotation (ITR) during in vivo simulated landings under baseline (gray: knee compression force) and abduction (dark blue: knee compression force+knee abduction moment) conditions. Percentages represent the increases from the baseline to the abduction condition.

rate were 70% and 42% greater in response to internal than in response to external tibial torque, respectively ($p = 0.023$, $p = 0.041$; Table 1; Fig. 4). Peak AM-ACL-R strain was 192% greater ($p < 0.001$) in response to the internal tibial torque combined with a knee adduction or abduction moment (7.0% [3.9%] and 7.0% [4.1%], respectively) than in response to external tibial torque with the same moments (2.4% [2.5%] and 2.4% [3.2%], respectively). These insights refute previous work¹⁵ by showing that when tibial axial torques are combined with compression and flexion moments, they induce the highest strain on the ACL, regardless of whether an abduction or adduction moment acts (Fig. 4). However, knee abduction moments can slightly augment the AM-ACL-R strain because of the mechanical coupling with internal tibial rotation induced by the lateral femoral condyle bearing down on the sloped lateral tibial plateau. Evidence for this mechanical

coupling comes from the in vitro simulated landings with a knee abduction moment which showed that internal tibial rotation was significantly greater than during landings without this moment, with no internal tibial torque being applied in either landings (Fig. 5). However, the direction of the frontal plane moment did not significantly affect peak AM-ACL-R strain when the axial tibial torque was simultaneously applied with the impulsive compression and flexion moment knee loading. So the combination of loads applied to the knee that causes the greatest ACL strain during a landing is gravito-inertial knee compression, trans-knee muscle forces and a knee flexion moment combined with an internal tibial torque. Such a torque can arise externally from the transverse plane shear moment between a foot shod with a high-friction sole and the ground, and partially from coupled internal rotation about the long axis of the tibia caused by the lateral femoral condyle interacting with the lateral tibial slope (Fig. 6).¹⁶

IS ACL RUPTURE A FAILURE DUE TO A SINGLE CATASTROPHIC OVERLOAD OR A FAILURE DUE TO REPETITIVE SUB-MAXIMAL KNEE LOADING?

The prevailing dogma has been that most ACL tears occur during a jump landing, cut or stop that places an abnormally large abduction moment on the knee. But we have seen in the last section that an abduction moment does not necessarily place a large strain on the ACL. Is it possible that an ACL can fail for a completely different reason? Sub-maximal repetitive loading is known to cause fatigue microdamage to accumulate, and cause complete rupture, in other soft tissues, so is it possible for that to occur in the ACL? Although partial ACL tears have been seen clinically (Fig. 7),¹⁷ the possibility of ACL fatigue failure had not been considered clinically or experimentally. We hypothesized that ACL fatigue failure could actually occur after realizing that many injury events occur during unremarkable jump-landings and pivot-cut maneuvers that have been executed routinely in the

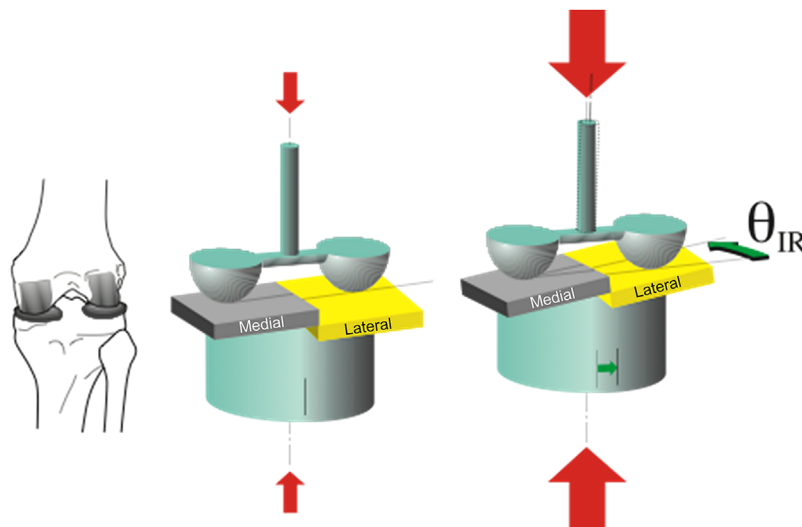

Figure 6. How landing forces can induce internal tibial rotation? (Left) A postero-superior three-quarter view of a right knee. (Center) A similar view of a schematic diagram of the right knee showing loading by a compression force (small red arrows) derived from the trans-knee muscle forces prior to the foot impacting the ground during a jump landing. (Right) Similar view of the knee showing the large knee compression forces resulting from the gravito-inertial forces and trans-knee muscle forces (large red arrows), and the resulting coupled internal axial rotation of the tibia (θ_{IR}) resulting from the lateral tibial slope, caused by the lateral femoral condyle pushing the sloped lateral tibial plateau forward and thereby causing internal tibial rotation about the medial plateau. For simplicity, the knee flexion moment that acts after landing is not shown. Modified from Appendix 5 in Oh et al.¹⁶

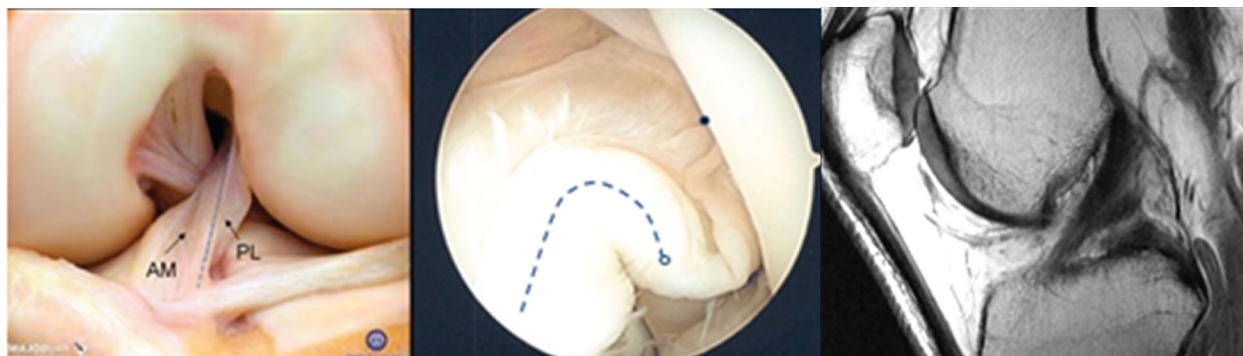

Figure 7. (Left) Anteromedial view of intact ACL showing intact anteromedial (AM) and posterolateral (PL) fibers. (Center) Intraoperative view of a femoral avulsion of the PL ACL fibers (indicated by dashed line ending with open circle) from the femoral enthesion (marked with filled circle). Scar tissue partially fills the gap. (Right) MRI section through an ACL with torn PL fibers.

course of athletic participation. Collagenous structures such as ligaments and tendons are known to be susceptible to fatigue failure in response to repetitive loading if the loading is large enough.¹⁸ So a fatigue failure of the substance of the ACL could explain why a seemingly innocuous athletic maneuver performed the same way hundreds of times before could suddenly rupture an ACL. We set out to test this hypothesis.

A series of jump landings of three or four body-weight of force, with this force representing the peak ground reaction force during a landing, was simulated in 10 cadaveric pairs of knees (five female) of similar age, height, and weight.¹⁹ First, knees were imaged with 3-T MRI to measure lateral tibial slope and ACL cross-sectional area. Then, one knee from each pair was randomly selected to be subjected to repeated three times body weight load ($3\times BW$), while the other knee was subjected to a $4\times BW$ load, via combined impulsive compression, flexion moment, and internal tibial torque with realistic trans-knee muscle forces. The loading cycle was repeated until the ACL failed, or a minimum of 50 cycles was reached. A Cox regression showed that the number of cycles to ACL failure was influenced by the simulated landing force ($p=0.012$) and ACL CSA ($p=0.022$; Table 2). These results show for the first time that the human ACL is susceptible to fatigue failure, as is clearly shown by the negative slopes of the lines connecting each pair of knees in Figure 8. Furthermore, an ACL with a

smaller CSA was found to be at greater risk for fatigue failure because the female ACL is 21–34% smaller in CSA,²⁰ is 17–27% smaller in volume,^{20,21} and has a 22% lower tensile modulus of elasticity. Hence, females may be more susceptible to fatigue failure due to a smaller ACL per unit body size (measured as stature times body weight) as well as the ACL tissue being less stiff than males.

In summary, the ligament fatigue hypothesis that is supported by the results in the preceding paragraph covers the possibility that a given ACL can fail in response to a single abnormally large load, 10 smaller yet still large loads applied repeatedly, or 100 yet smaller large loads applied repeatedly during a given time interval. A logical way to reduce the risk of fatigue failure in at-risk athletes would be to reduce during practice either the magnitude or the number of loading cycles, or both, in the given time interval,

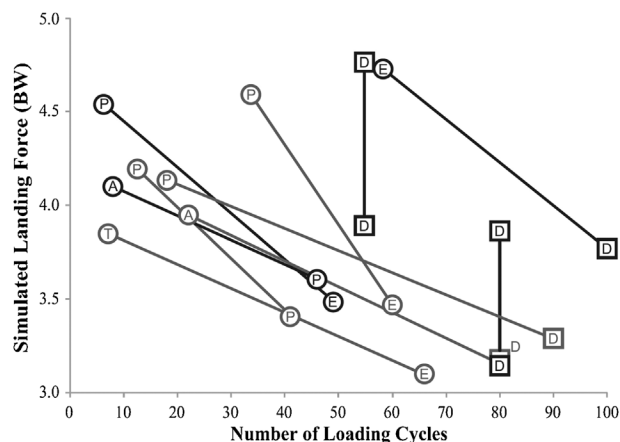

Figure 8. Scatterplot showing the simulated landing force (recorded as the compressive force on the femoral load cell) versus the number of loading cycles for the anterior cruciate ligament (ACL). A circle represents an ACL failure. A square represents a knee with an intact ACL at the conclusion of testing. The black markers are male knees, the gray markers are female knees, and the matched pair of each donor is connected with a line. Abbreviations within the marker denote the type of ACL failure: A, tibial avulsion; P, partial ACL tear; T, complete ACL tear; E, permanent elongation of the ACL determined by a 3-mm increase in cumulative anterior tibial translation; D, a knee that did not fail. Reproduced from Lipps et al.¹⁹

Table 2. Cox Regression Results for 20 Knees With Shared Frailty Term (Theta) to Control for Matched Pairs

Regressor	Hazard Ratio	95%CI	<i>p</i> -Value
Landing force	32.27	2.13–487.7	0.012*
Sex	0.95	0.05–19.7	0.98
ACL CSA	0.63	0.42–0.93	0.022*
LTS	0.90	0.55–1.45	0.67
Theta	2.97		0.006*

Reproduced from Lipps et al.¹⁹ ACL, anterior cruciate ligament; CSA, cross-sectional area; LTS, lateral tibial slope. *Significant *p*-value.

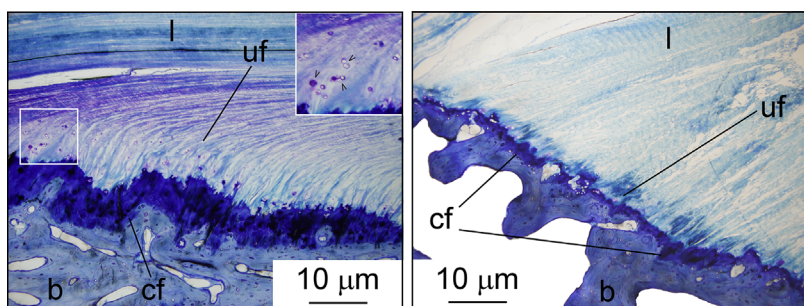

Figure 9. Human ACL entheses histology. (Left) Femoral entheses have four zones of tissue: Ligamentous tissue (l), uncalcified fibrocartilage (uf), calcified fibrocartilage (cf), and bone (b). Note how the ligamentous tissue transitions into uncalcified fibrocartilage and curves to insert into the calcified tissue at a less acute angle. Inset: High-power view of tissue outlined in white showing uncalcified fibrocartilage with its fibrocartilage cells (arrow heads). (Right) Tibial entheses also have four zones of tissue, but with less fibrocartilage. Toluidine blue stain. Modified from Beaulieu et al.²³

much as the pitch count is used to ration fast pitches thrown by Little League pitchers. The goal would be to maintain the homeostasis of the ACL by limiting the rate of ligament microdamage accumulation to be less than or equal to its rate of remodeling. If ligament degradation is within the ACL’s ability to adapt, accumulation of microdamage, and thus injury can be prevented. In closing, the answer to the question posed as the heading to this section is that while a single catastrophic overload can cause ACL failure, so can repeated sub-maximal knee loading of a certain type cause ACL failure. With the advent of wearable sensors, it should be possible to ascertain the number and severity of knee loading cycles that is appropriate for the sex and age of an athlete.

ACL ENTHESIS HISTOLOGY

After it became apparent that mechanical fatigue was a possible, ACL failure mechanism and that clinically most ACL tears are seen in the proximal third,²² near the ACL femoral enthesis, we conducted histology studies to start to understand why this attachment site is more susceptible to injury than the tibial enthesis.^{23,24} The microscopic structure of the femoral enthesis was compared to that of the tibial enthesis in 15 unembalmed human knee specimens using standard histological methods that included light microscopy, toluidine blue stain, and image analysis.

The femoral enthesis showed a 3.9-fold more acute ligament attachment angle, 43% greater calcified fibrocartilage area and 226% greater uncalcified cartilage

depth than the tibial enthesis (Fig. 9).²³ Determining the mechanical properties of various regions of the femoral and tibial entheses should yield insight into how microscopic anatomy is related to failure risk. Examining the enthesal shape and strain distributions can also identify regions of strain concentration, thereby yielding useful insights into why microscopic damage may accumulate to cause ACL failure.^{23,24}

HIGH RISK ATHLETES: THOSE WITH LIMITED HIP INTERNAL ROTATION

After examining the structural and mechanical factors that increase ACL strain and thereby injury risk, we turned our attention to groups of athletes that might be at high risk. Examining large groups of athletes from the same sport can uncover combinations and correlations that are unique. So during the 2012 National Football League (NFL) Scouting Combine, a showcase during which collegiate football players perform various physical and psychological assessments, 324 athletes were examined.²⁵ Thirty-four had already had ACL reconstructions. An unusual relationship was noted between restricted hip internal rotation (e.g., due to femoroacetabular impingement [FAI]) and those with previous ACL tears: Those with limited internal rotation at the hip had a very high incidence of ACL tears (Fig. 10).

Surprisingly, these in vivo results demonstrated that a reduction in internal rotation of the hip was associated with a statistically significant increased odds of ACL injury in the ipsilateral or contralateral

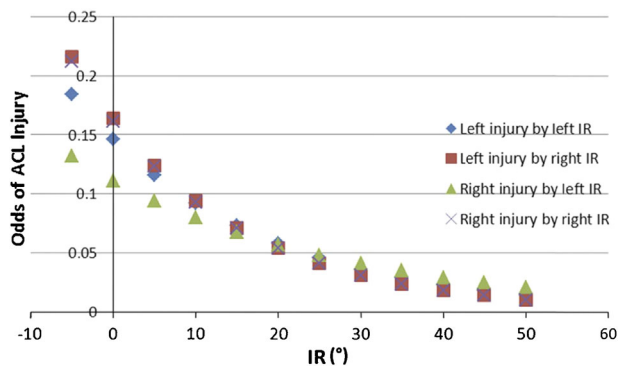

Figure 10. Estimated odds of anterior cruciate ligament (ACL) injury based on hip internal rotation (IR) degrees. Reproduced from Bedi et al.²⁵

Table 3. Logistic Regression of Internal Rotation (IR) as a Predictor of Anterior Cruciate Ligament (ACL) Injury Group by Side, From Generalized Estimating Equations Adjusted for Clustering by Surgeon

	Odds Ratio	95% Confidence Interval	p-Value
ACL (L)			
IR left	0.95	0.93–0.98	0.0001
IR right	0.95	0.93–0.97	<0.0001
ACL (R)			
IR left	0.97	0.92–1.02	NS
IR right	0.95	0.89–1.01	NS

Reproduced from Bedi et al.²⁵ NS, not significant.

Table 4. Estimated Odds Ratios for Internal Rotation (IR)=0, Compared to Specified IR, From Post-Estimation Calculations

	IR = 10	IR = 20	IR = 30	IR = 40
ACL (L)				
IR left	1.59	2.52	4.06	6.35
IR right	1.74	3.04	5.29	9.11
ACL (R)				
IR left	1.39	1.95	2.71	3.83
IR right	1.73	2.98	5.19	8.94

Reproduced from Bedi et al.²⁵

knee (OR 0.95, $p=0.0001$ and $p < 0.0001$, respectively). A post hoc calculation of the odds ratio for ACL injury based on a deficiency in hip internal rotation demonstrated that a 30° reduction in left hip internal rotation was associated with 4.06 and 5.29 times greater odds of ACL injury in the ipsilateral and contralateral limbs, respectively (Tables 3 and 4).

An in silico model (Fig. 11) demonstrated that restricted hip internal rotation (Fig. 12) systematically increased the peak ACL strain predicted during the

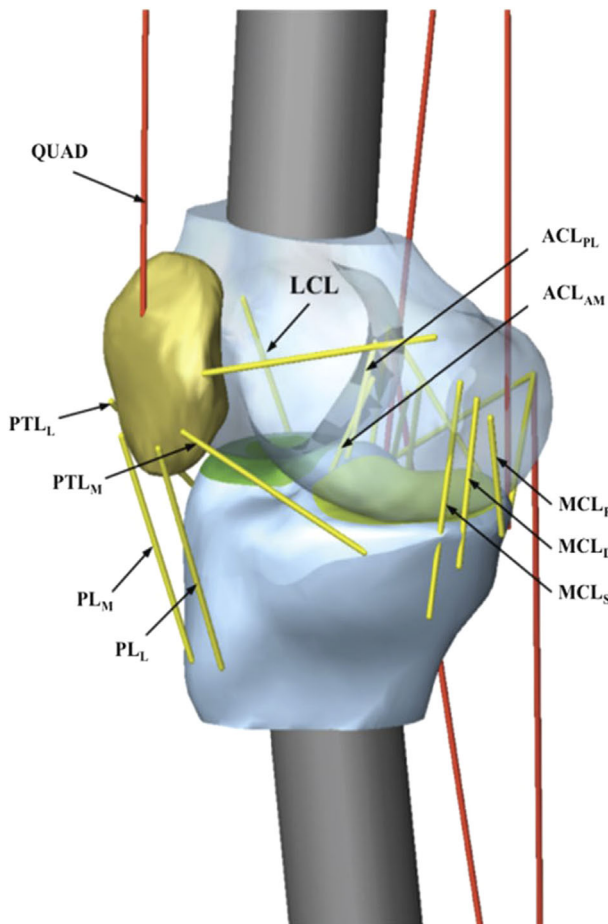
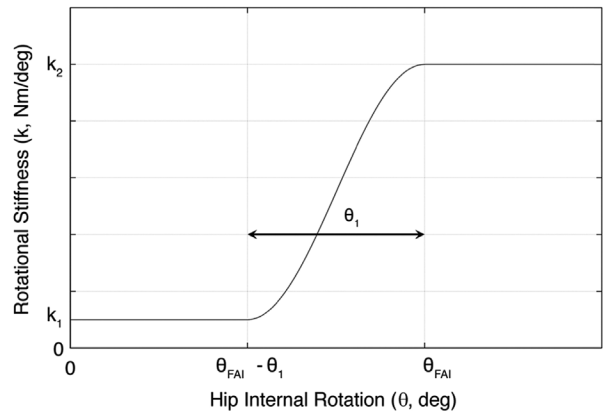

Figure 11. Schematic diagram of the in silico knee model. Reproduced from Bedi et al.²⁵



$$k = \begin{cases} k_1, & \theta \leq \theta_{FAI} - \theta_1 \\ \frac{1}{2} \times (k_2 - k_1) \times \left\{ \cos\left(\frac{180^\circ}{\theta_1} \times (\theta - \theta_{FAI})\right) + 1 \right\}, & \theta_{FAI} - \theta_1 < \theta \leq \theta_{FAI} \\ k_2, & \theta > \theta_{FAI} \end{cases}$$

Figure 12. The axial hip rotational stiffness versus angular rotation (FAI), where θ is the hip internal rotation angle; θ_{FAI} is the hip internal rotation angle at the end of the range of motion secondary to impingement; θ_1 is the hip internal rotation angle where the impingement begins and is set to 5°; k_1 is the stiffness coefficient when the impingement does not occur and is set to 0.5 Nm/degree; and k_2 is the stiffness coefficient when the hip internal rotation angle exceeds θ_{FAI} and is set to 5 Nm/degree. Reproduced from Bedi et al.²⁵

pivot landing (Fig. 13). The results predicted that if an individual lands with the hip near its terminal range of internal rotation, the peak ACL strain will be systematically larger than if the hip is initially in a mid-range of internal rotation. So this can help explain why restricted hip internal rotation can increase the risk for ACL failure. It was the first time that the adverse effect of limited internal rotation about the

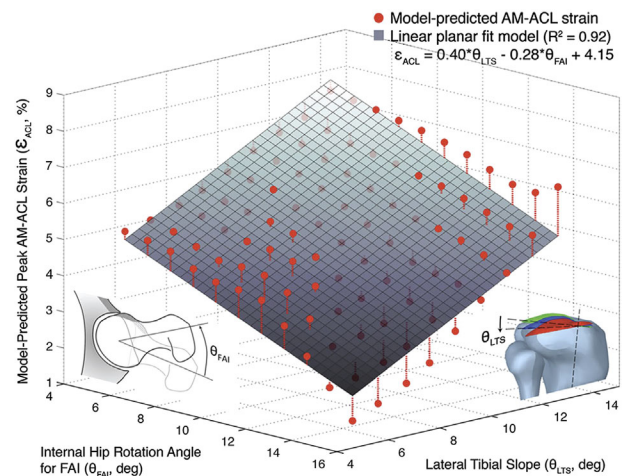

Figure 13. In silico model predictions for peak anteromedial bundle–anterior cruciate ligament (AM-ACL) strain during a simulated jump landing: As the available range of hip internal rotation is reduced, the peak AM-ACL strain in the knee increases. The linear planar fit model (shown as the gray plane) demonstrates how peak AM-ACL strain is predicted to be a function of both available axial hip range of motion and lateral tibial slope. Reproduced from Bedi et al.²⁵

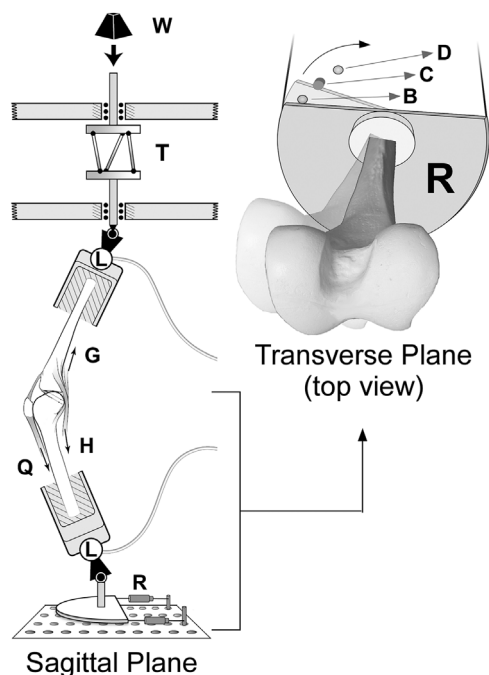

Figure 14. Sagittal plane diagram (left) of the in vitro testing apparatus that simulated a single-leg pivot landing, with a top view (right) of the femoral rotation device, R. The solid portions represent the starting position of the specimen and device; meanwhile, the transparent portions represent their end position during a trial for which terminal internal femoral rotation was set to $\sim 7^\circ$ (block C of the testing protocol). B, position of steel stop for block B of the repeated-measures protocol (locked); C, position of steel stop for block C of the repeated-measures protocol (hard stop at $\sim 7^\circ$); D, position of steel stop for block D of the repeated-measures protocol (hard stop at $\sim 11^\circ$); G, gastrocnemii tendons; H, hamstring tendons; L, 6-axis load cell; Q, quadriceps tendon; R, femoral rotation device; T, tibial torsion device; W, weight dropped. Note: Positions of steel stops are not to scale to allow better visualization. Reproduced from Beaulieu et al.²⁶

longitudinal axis of the femur (referred hereafter as “internal femoral axial rotation”), due to FAI for example, on ACL strain was demonstrated in any model, whether in vivo, in vitro, or in silico. The

results have implications for improving jump and pivot-landing techniques and injury prevention strategies if these address limited internal femoral rotation.

After recognizing the relation between ACL injury and decreased internal femoral axial rotation, the hypothesis that peak AM-ACL-R strain during a simulated single-leg pivot landing is inversely related to the available range of internal femoral axial rotation was tested in the in vitro testing system (Fig. 14).²⁶ This hypothesis was tested with a linear mixed-effects statistical model to predict peak AM-ACL-R strain, with range of internal femoral rotation, sex of donor, and age included as fixed effects and knee specimen and knee donor as random effects. Results showed that peak AM-ACL-R strain was inversely related to the available range of internal femoral axial rotation ($R^2 = 0.91$; $p < 0.001$), with strain increasing 1.3% for every 10° decrease in rotation; this represented a 20% increase in peak relative strain, given an average range of femoral axial rotation of 15° upon landing in healthy athletes.

These studies had two clinical implications. First, it matters where the femur is in its range of internal femoral axial rotation when ground contact occurs during a landing or plant-and-cut maneuver. The closer the femur is to its terminal range of internal rotation, the more likely it is that bone-on-bone contact will occur between the femoral neck and the acetabular rim, thereby decreasing femoral axial rotation and increasing peak ACL strain. Therefore, efforts to improve the functional range of internal axial rotation available at the hip, either nonsurgical or possibly surgical, are likely justified if the athlete cannot learn to cope by operating far enough from his/her end range of hip internal rotation motion. Second, screening for restricted internal rotation at the hip on physical exam is critical for ACL injury prevention programs, as well as for individual risk assessment. With a simple examination of passive internal hip

Table 5. Relative Importance of Selected ACL Injury Risk Factors Ranked by the Percentage Increase in Peak AM-ACL Strain of the At-Risk Group (Females), Knees (Those With Small ACL Cross-Sectional Area and Steep Lateral Tibial Plateau Slope), or Testing Condition (Knees Having Fully Restricted Internal Femoral Rotation) Relative to the Reference Group (Male), Knees (Average ACL Cross-Sectional Area; Average Lateral Tibial Plateau Slope), or Group (Unrestricted Internal Femoral Rotation) During In Vitro Simulated Pivot Landings

Injury Risk Factors	Mean (SD) AM-ACL Strain Value in the Reference Group/Knees/Condition	Mean (SD) AM-ACL Strain Value in the At-Risk Group/Knees/Condition	% Increase in Peak AM-ACL Strain of At-Risk Group/Knees/Condition ^a	Reference
Sex	Male 3.3% (1.9%)	Female 6.4% (2.5%)	95	27
ACL cross-sectional area (CSA)	Average CSA 4.9% (2.8%)	Small CSA ^b 7.2% (1.6%)	47	27
Lateral tibial plateau slope	Average slope 4.9% (2.8%)	Steep slope ^c 7.1% (2.5%)	43	27
Internal femoral rotation	Unrestricted rotation 6.3% (3.1%)	Fully restricted rotation 7.8% (3.8%)	24	26

^aIn relation to AM-ACL strain of the reference group/knees/condition. ^bKnees having lower-third CSA values. ^cKnees having upper-third tibial plateau slope values.

range of motion before preseason training, at-risk athletes can be identified and targeted for injury prevention interventions.

WHAT IS THE RELATIVE IMPORTANCE OF THE ACL INJURY RISK FACTORS EXAMINED IN THESE STUDIES?

One way to compare the relative importance of the risk factors considered in our studies is rank-order the measured mean peak AM-ACL strain values in, for example, those knees having smaller ACLs than average, and those knees having higher tibial slopes than average (Table 5).

The results show that female gender had the greatest effect (95%), followed by a smaller ACL CSA (47%), steeper lateral tibial slope (43%), and restricted internal femoral rotation (24%) (Table 5). The reference knees and condition were defined such that they reflected what is deemed normal; and thus, the average peak AM-ACL strain of all knees (i.e., average CSA; average slope) and that during the unrestricted rotation condition were selected as the reference strain values. Given that much of the gender difference in peak AM-ACL strain can be attributed to differences in ACL size and lateral tibial slope between males and females,²⁷ evidence for the potential of training to hypertrophy the ACL²⁸ warrants further investigation. Even though restricted internal femoral rotation ROM ranked fourth on the list, it definitely should not be dismissed. For one, it can be easily determined on a physical exam; and second, it is modifiable.

SUMMARY

- (1) In this series of studies, internal tibial rotation in the presence of knee impulsive compression and a knee flexion moment, along with large trans-knee muscle forces, was identified as inducing the largest ACL strains during a pivot landing. A steeper lateral tibial plateau slope and smaller ACL cross-sectional area contributed to higher ACL strain in females relative to males having the same stature and body weight.
- (2) We showed that the ACL can fail, often at or near the proximal entheses, due to ligament fatigue failure in response to the combination of repetitive sub-maximal knee loads described above (Summary point 1).
- (3) The possibility that the ACL can fail in response to sub-maximal repetitive knee loading represents a clear opportunity for intervening to prevent the injury. For example, with the advent of wearable sensors, one could ration the number and intensity of knee loading cycles, or both, during practices such that ligament degradation is within the ACL's ability to remodel. Furthermore, better imaging techniques may be able to be developed to detect the earliest stages of the ACL overuse injury at the proximal entheses.
- (4) The systematic microarchitectural differences between the ACL femoral and tibial entheses may be important for understanding the susceptibility of the proximal third of the ACL to failure in response to repetitive loading.
- (5) A simple check on the range of hip rotation should be made a routine part of an athlete's physical exam in order to determine who may be at high risk.
- (6) The hypothesis that partial ACL failures represent direct evidence of an ACL fatigue failure in progress may be worth testing.
- (7) While the methodological approaches described in this paper have their limitations, and these are discussed in the original publications, we believe the main findings reviewed in this paper offer new insights into ACL injuries.

AUTHORS' CONTRIBUTIONS

All authors were involved in manuscript drafting and editing, and have read and approved the final submitted manuscript.

ACKNOWLEDGMENTS

Much of the work reported in this paper is based on the doctoral dissertations defended by Thomas J. Withrow, Youkeun Oh, David B. Lipps, and Mélanie L. Beaulieu at the University of Michigan in Ann Arbor.

REFERENCES

1. Olsen OE, Myklebust G, Engebretsen L, et al. 2004. Injury mechanisms for anterior cruciate ligament injuries in team handball: a systematic video analysis. *Am J Sports Med* 32:1002–1012.
2. Boden BP, Torg JS, Knowles SB, et al. 2009. Video analysis of anterior cruciate ligament injury: abnormalities in hip and ankle kinematics. *Am J Sports Med* 37:252–259.
3. Benoit DL, Ramsey DK, Lamontagne M, et al. 2005. Effect of skin movement artifact on knee kinematics during gait and cutting motions measured in vivo. *Gait Posture* 24:152–164.
4. Withrow TJ, Huston LJ, Wojtys EM, et al. 2006. The relationship between quadriceps muscle force, knee flexion, and anterior cruciate ligament strain in an in vitro simulated jump landing. *Am J Sports Med* 34:269–274.
5. Dufek JS, Bates BT. 1991. Biomechanical factors associated with injury during landing in jump sports. *Sports Med* 12:326–337.
6. Fleming BC, Renström PA, Beynon BD, et al. 2001. The effect of weightbearing and external loading on anterior cruciate ligament strain. *J Biomech* 34:163–170.
7. Beynon BD, Fleming BC. 1998. Anterior cruciate ligament strain in vivo: a review of previous work. *J Biomech* 31:519–525.
8. Shelburne KB, Pandy MG, Torry MR. 2004. Comparison of shear forces and ligament loading in the healthy and ACL-deficient knee during gait. *J Biomech* 37:313–319.
9. Shultz SJ, Perrin DH. 1999. The role of dynamic hamstring activation in preventing knee ligament injury. *Athl Ther Today* 4:49–53.
10. Withrow TJ, Huston LJ, Wojtys EM, et al. 2008. Effect of varying hamstring tension on anterior cruciate ligament strain during in vitro impulsive knee flexion and compression loading. *J Bone Joint Surg Am* 90:815–823.

11. Worrell TW, Perrin DH, Denegar CR. 1989. The influence of hip position on quadriceps and hamstring peak torque and reciprocal muscle group ratio values. *J Orthop Sports Phys Ther* 11:104–107.
12. Hewett TE, Myer GD, Ford KR, et al. 2005. Biomechanical measures of neuromuscular control and abduction loading of the knee predict ACL injury risk in female athletes: a prospective study. *Am J Sports Med* 33:492–501.
13. Myer GD, Ford KR, Hewett TE. 2004. Rationale and clinical techniques for anterior cruciate ligament injury prevention among female athletes. *J Athl Train* 39:352–364.
14. Oh YK, Kreinbrink JL, Wojtys EM, et al. 2012. Effect of axial tibial torque direction on ACL relative strain and strain rate in an in vitro simulated pivot landing. *J Orthop Res* 30:528–534.
15. Hewett TE, Myer GD, Ford KR, et al. 2005. Biomechanical measures of neuromuscular control and abduction loading of the knee predict ACL injury risk in female athletes: a prospective study. *Am J Sports Med* 33:492–501.
16. Oh YK, Lipps DB, Ashton-Miller JA, et al. 2012. What strains the anterior cruciate ligament during a pivot landing? *Am J Sports Med* 40:574–583.
17. Dejour D, Ntagiopoulos PG, Saggin PR, et al. 2013. The diagnostic value of clinical tests, magnetic resonance imaging, and instrumented laxity in the differentiation of complete versus partial anterior cruciate ligament tears. *Arthroscopy* 29:491–499.
18. Thornton GM, Schwab TD, Oxland TR. 2007. Cyclic loading causes faster rupture and strain rate than static loading in medial collateral ligament at high stress. *Clin Biomech (Bristol, Avon)* 22:932–940.
19. Lipps DB, Wojtys EM, Ashton-Miller JA. 2013. Anterior cruciate ligament fatigue failures in knees subjected to repeated simulated pivot landings. *Am J Sports Med* 41:1058–1066.
20. Chandrashekar N, Mansouri H, Slauterbeck J, et al. 2006. Sex-based differences in the tensile properties of the human anterior cruciate ligament. *J Biomech* 39:2943–2950.
21. Chaudhari AM, Zelman EA, Flanigan DC, et al. 2009. Anterior cruciate ligament-injured subjects have smaller anterior cruciate ligaments than matched controls: a magnetic resonance imaging study. *Am J Sports Med* 37:1282–1287.
22. Kocher MS, Micheli LJ, Zurakowski D, et al. 2002. Partial tears of the anterior cruciate ligament in children and adolescents. *Am J Sports Med* 30:697–703.
23. Beaulieu ML, Carey G, Schlecht S, et al. 2015. A quantitative comparison of the microscopic anatomy of the human ACL femoral and tibial entheses. *J Orthop Res* 33:1811–1817.
24. Beaulieu ML, Carey GE, Schlecht SH, et al. 2016. On the heterogeneity of the femoral enthesis of the human ACL: microscopic anatomy and clinical implications. *J Exp Orthop* 3:14.
25. Bedi A, Warren RF, Wojtys EM, et al. 2016. Restriction in hip internal rotation is associated with an increased risk of ACL injury. *Knee Surg Sports Traumatol Arthrosc* 24:2024–2031.
26. Beaulieu ML, Oh YK, Bedi A, et al. 2014. Does limited internal femoral rotation increase peak anterior cruciate ligament strain during a simulated pivot landing? *Am J Sports Med* 42:2955–2963.
27. Lipps DB, Oh YK, Ashton-Miller JA, et al. 2012. Morphologic characteristics help explain the gender difference in peak anterior cruciate ligament strain during a simulated pivot landing. *Am J Sports Med* 40:32–40.
28. Grzelak P, Podgorski M, Stefanczyk L, et al. 2012. Hypertrophied cruciate ligament in high performance weightlifters observed in magnetic resonance imaging. *Int Orthop* 36:1715–1719.