

Laboratory and In-Situ Assessment of Liquefaction of Gravelly Soils

by

Jonathan F. Hubler

A dissertation submitted in partial fulfillment
of the requirements for the degree of
Doctor of Philosophy
(Civil Engineering)
in The University of Michigan
2017

Doctoral Committee:

Associate Professor Adda Athanasopoulos-Zekkos, Chair
Professor Roman D. Hryciw
Professor Yin Lu Young
Associate Professor Dimitrios Zekkos

Jonathan F. Hubler

jhubler@umich.edu

ORCID iD: [0000-0002-0145-1036](https://orcid.org/0000-0002-0145-1036)

© Jonathan F. Hubler 2017

DEDICATION

For Chrissy

ACKNOWLEDGEMENTS

First, I would like to thank my advisor, Professor Adda Athanasopoulos-Zekkos, for her guidance and support over the past five years. She has been a great mentor and encouraged me to grow not only as a researcher but as a person. She has set an example for me of what an educator, researcher, and advisor should be and I appreciate all that she has done for me.

I would also like to thank Professor Dimitrios Zekkos, who was involved in much of this thesis research, and has been a great mentor to me. Professor Zekkos was always available to answer any questions that I had about research or career advice. Professor Adda and Professor Zekkos - I will miss our meetings together. I learned a lot about how to present research and think critically. You both have been very supportive of me and helped to push me to accomplish my goals.

I would like to thank my committee members Professor Hryciw and Professor Young for serving on my committee and providing helpful feedback on my research. I would also like to thank the other geotechnical faculty members at Michigan, including Professor Michalowski and Professor Woods. They are excellent teachers and I had the pleasure to learn from them. I would also like to thank former staff members Bob Fischer and Rick Burch for the many times that they helped to build or design a new laboratory component for me.

While at Michigan, I have had the pleasure of meeting and working alongside of many other exceptional students. I feel as though we always made being at the office or in the laboratory a fun time, no matter what we were working on. These students include Athena Gkrizi, Josh Colley, Adam Lobbestael, Clinton Carlson, Sid Nadukuru, Xunchang Fei,

Andhika Sahadewa, Will Greenwood, Andy Burton, Eric Warner, Zhijie Wang, Junxing Zheng, and Nina Zabihi, among others. Thank you for the support and the laughs over the years.

All of this would not be possible though without the mentors that I have had along the way that offered me a glimpse into research as a undergraduate student at Drexel University. Dr. Gallagher, Dr. Spatari, and Dr. Hsuan - thank you for introducing me to research and encouraging me to pursue a PhD.

I would also like to acknowledge the agencies that helped to fund this research. This work was supported in part by the National Science Foundation CAREER Grant No. 1351403 and by the National Science Foundation Graduate Research Fellowship under Grant Number DGE 1256260. The United States Society on Dams also provided a scholarship that helped to support this research.

Finally, I would like to thank my friends and family for their support throughout graduate school. My parents, Rich and Sandy, and brothers, Rick and Chris, have always supported me and instilled in me the importance of working hard to achieve your goals. Amy and Kate, thank you for your support. And most importantly, my wife Christine who has been alongside me pursuing a PhD of her own while listening to me talk about the excitement of gravel. You are a constant source of love and support and I could not have accomplished this (and many other goals of mine) without you.

TABLE OF CONTENTS

DEDICATION	ii
ACKNOWLEDGEMENTS	iii
LIST OF FIGURES	viii
LIST OF TABLES	xxvi
LIST OF APPENDICES	xxviii
ABSTRACT	xxix
CHAPTER	
1. Introduction	1
1.1 Background and Motivation	1
1.2 Research Objectives	2
1.3 Organization of Dissertation	3
2. Literature Review	4
2.1 Undrained Response of Cohesionless Soils	4
2.2 Soil Liquefaction Triggering Charts	11
2.3 Post-Liquefaction Residual Shear Strength	19
2.4 Liquefaction of Gravelly Soils in the Field	31
2.5 Gravel Laboratory Testing	45
2.6 Gravel-Sand Mixtures and Gravelly Soil Testing in the Laboratory	50
2.7 Pore Pressure Generation of Gravelly Soils	77
2.8 Review of Direct Simple Shear Testing	79
2.8.1 Limitations of Direct Simple Shear Testing	82
2.8.2 Shear Strength Interpretation of Direct Simple Shear	
Testing Results	85
2.9 Conclusions	86

3. Large-Size Cyclic Simple Shear Device	89
3.1 Introduction	89
3.2 Development of the Large-Size Direct Simple Shear Device	90
3.3 Description of the Shear Wave Velocity (V_S) Measurement Instrumentation	94
3.3.1 Bender elements	95
3.3.2 Accelerometers	104
3.4 Large-Size Direct Simple Shear Validation Test Results	114
3.4.1 Shear Wave Velocity Test Results and Validation	117
3.4.2 Constant Volume Monotonic Test Results and Validation	125
3.4.3 Constant Volume Cyclic Test Results and Validation	127
3.5 Conclusions	131
4. Monotonic, Cyclic, and Post-Cyclic Response of Uniform Gravels	132
4.1 Introduction	132
4.2 Test Materials	133
4.3 Test Procedure	134
4.4 Test Results	148
4.4.1 Shear Wave Velocity	148
4.4.2 Monotonic Constant Volume Simple Shear	153
4.4.3 Cyclic Simple Shear	170
4.4.4 Post-Cyclic Monotonic Simple Shear	189
4.5 Conclusions	196
5. Monotonic, Cyclic, and Post-Cyclic Response of Gravel-Sand Mixtures	198
5.1 Introduction	198
5.2 Assessment of Minimum and Maximum Density of Gravel-Sand Mixtures	198
5.2.1 Development of Method for Maximum Density Evaluation	201
5.3 Test Materials	218
5.4 Test Procedures	222
5.5 Laboratory Test Results	223
5.5.1 Shear Wave Velocity (V_S)	223
5.5.2 Monotonic Simple Shear Results	229
5.5.3 Cyclic Simple Shear Results	267
5.5.4 Pore Pressure Generation	289
5.5.5 Post-Cyclic Simple Shear Results	297
5.5.6 Post-Cyclic Undrained Shear Strength	300
5.5.7 Post-Cyclic Volumetric Strain	308
5.6 Conclusions	322
5.6.1 Specimen Preparation	322

5.6.2	Monotonic Response	323
5.6.3	Cyclic Response	324
5.6.4	Post-Cyclic Response	326
6.	Field Response and Liquefaction Analysis of Gravelly Soils	328
6.1	Introduction	328
6.2	Cephalonia Earthquakes	329
6.3	Field Test Equipment	332
6.3.1	Chinese Dynamic Penetration Test	332
6.3.2	Dynamic Penetration Testing in this study	335
6.3.3	Shear Wave Velocity Measurement Equipment and Procedures	351
6.4	Cephalonia Field Testing	355
6.4.1	Lixouri Port	355
6.4.2	Argostoli Port	378
6.5	Millsite Dam - Ferron, Utah Field Testing	393
6.5.1	Correlation of N_{120} and V_S	405
6.6	Assessment of Liquefaction Triggering for Gravelly Soils	409
6.6.1	Lixouri Port	414
6.6.2	Argostoli Port	419
6.6.3	Comparison of Cephalonia Liquefaction Data with Existing Data	424
6.7	Development of new Liquefaction Triggering Chart for Gravelly Soils	428
6.8	Conclusions	442
7.	Conclusions	443
7.1	Large-Size Monotonic and Cyclic Simple Shear Testing	443
7.2	Monotonic Simple Shear Response of Uniform Gravels and Gravel-Sand Mixtures	444
7.3	Cyclic Simple Shear Response of Uniform Gravels and Gravel-Sand Mixtures	449
7.4	Post-Cyclic Shear Strength and Volumetric Strain (Post-Cyclic Settlement)	453
7.5	Field Response and Liquefaction Analysis of Gravelly Soils	456
7.6	Recommendations for Future Research	463
APPENDICES	464
BIBLIOGRAPHY	1058

LIST OF FIGURES

Figure

2.1	Summary of Undrained Response of Cohesionless Soils to Monotonic Loading (<i>Vaid and Chern, 1985</i>)	7
2.2	Monotonic Undrained Response of Fraser River Sand in Simple Shear at varying void ratios (<i>Sivathayalan, 1994</i>)	8
2.3	Summary of Undrained Response of Cohesionless soils to Cyclic Loading (<i>Vaid and Chern, 1983</i>)	9
2.4	Cyclic Undrained Response of Fraser River Sand in Simple Shear (<i>Sivathayalan, 1994</i>)	10
2.5	SPT Liquefaction Triggering Chart for Sands (<i>Idriss and Boulanger, 2006</i>)	12
2.6	CPT Liquefaction Triggering Chart for Sands (<i>Idriss and Boulanger, 2006</i>)	13
2.7	V_S -based Liquefaction Triggering Chart for Sands (<i>Andrus and Stokoe, 2000</i>)	13
2.8	Probabilistic V_S -based Liquefaction Triggering Chart for Sands (<i>Kayen et al., 2013</i>)	14
2.9	V_S -based Liquefaction Triggering Chart for Sands, Silty Sands, and Gravels (<i>Andrus and Stokoe, 2000</i>)	15
2.10	Probabilistic SPT Liquefaction Triggering Chart for Sands (<i>Cetin et al., 2004</i>)	15
2.11	Probabilistic CPT Liquefaction Triggering Chart for Sands (<i>Moss et al., 2006</i>)	16
2.12	Comparison of Penetrometers for Gravel Soil Testing (<i>DeJong et al., 2016</i>)	16
2.13	BPT to SPT Correlation for gravelly soils from <i>Harder Jr and Seed</i> (1986) (top) and <i>Harder Jr.</i> (1997) (bottom)	17
2.14	DPT liquefaction triggering chart for gravelly soils <i>Cao et al.</i> (2013) . . .	17
2.15	V_S -based liquefaction triggering chart for gravelly soils <i>Cao et al.</i> (2011) .	18
2.16	Comparison of CRR versus V_{S1} for Sands (<i>Tokimatsu et al., 1986</i>)	19
2.17	Comparison of CRR versus V_{S1} for Sands and Silts (<i>Baxter et al., 2008</i>) .	19
2.18	Post-Liquefaction Stress Paths from Laboratory Testing (<i>Sivathayalan and Yazdi, 2013</i>)	21
2.19	Pre-Liquefaction and Post-Liquefaction Stress-Strain Response (<i>Vaid and Thomas, 1995</i>)	21

2.20	Comparison of Liquefied Shear Strength from Various Laboratory Tests with <i>Seed and Harder</i> (1990) (<i>Sivathayalan and Yazdi</i> , 2013)	22
2.21	Comparison of Liquefied Shear Strength Ratio from Various Laboratory Tests with <i>Stark and Mesri</i> (1992) (<i>Sivathayalan and Yazdi</i> , 2013)	22
2.22	Residual Undrained Shear Strength versus Equivalent Clean Sand Blow count (<i>Seed and Harder</i> , 1990)	24
2.23	Mobilized Undrained Critical Shear Strength Normalized by Initial Vertical Stress (<i>Stark and Mesri</i> , 1992)	24
2.24	Undrained Critical Shear Strength Normalized by Initial Vertical Stress for Field and Laboratory Data (<i>Stark and Mesri</i> , 1992)	25
2.25	Undrained Shear Strength versus V_{S1} for various Sands (<i>Fear and Robertson</i> , 1995)	25
2.26	Undrained Shear Strength versus V_{S1} for Sands based on lateral spreading case histories (<i>Özener</i> , 2012)	26
2.27	Undrained Shear Strength Normalized by Initial Vertical Stress versus V_{S1} for Sands based on lateral spreading case histories (<i>Özener</i> , 2012)	26
2.28	Post-Liquefaction Volumetric Strain for Sands based on D_r and Maximum Strain during Shearing (<i>Ishihara and Yoshimine</i> , 1992)	27
2.29	Post-Liquefaction Volumetric Strain for Sands based on D_r and Maximum Strain during Shearing and Factor of Safety for Liquefaction (<i>Ishihara and Yoshimine</i> , 1992)	28
2.30	Post-Liquefaction Volumetric Strain based on SPT blow counts and CSR (<i>Tokimatsu and Seed</i> , 1987)	29
2.31	Post-Liquefaction Volumetric Strain for Sands based on V_{S1} and Maximum Strain during Shearing (<i>Yi</i> , 2010)	29
2.32	Post-Liquefaction Volumetric Strain for Gravelly Soils (<i>Kokusho et al.</i> , 2004)	30
2.33	Post Cyclic Settlement for various gravelly and reclaimed soils (<i>Hara et al.</i> , 2012)	30
2.34	Shear wave velocity measured at a gravelly soil liquefaction site from 1964 Alaska earthquake (<i>Koester et al.</i> , 2000)	32
2.35	Grain size distributions of ejected materials found following the 1983 Borah Peak earthquake (<i>Youd et al.</i> , 1985)	33
2.36	Ejected soils, including sand and gravel, observed following the 1983 Borah Peak earthquake (<i>Youd et al.</i> , 1985)	34
2.37	Ground fissure observed following the 1983 Borah Peak earthquake (<i>Youd et al.</i> , 1985)	34
2.38	Ground fissure observed following the 1983 Borah Peak earthquake (<i>Youd et al.</i> , 1985)	35
2.39	Grain size distributions of tested materials taken from test pit (<i>Andrus et al.</i> , 1992)	35
2.40	Shear wave velocity results for test sites from 1983 Borah Peak earthquake (<i>Andrus et al.</i> , 1992)	36

2.41	Comparison of gravelly soil liquefaction sites from 1983 Borah Peak earthquake with sandy soil liquefaction triggering curve (<i>Andrus et al., 1992</i>)	36
2.42	Liquefaction of roadway embankment, 1988 Armenia earthquake (<i>Yegian et al., 1994</i>)	38
2.43	Sand boil observed near roadway embankment, 1988 Armenia earthquake (<i>Yegian et al., 1994</i>)	38
2.44	Soil Profile of roadway embankment, 1988 Armenia earthquake (<i>Yegian et al., 1994</i>)	39
2.45	Grain size distributions of roadway embankment and foundation soils, 1988 Armenia earthquake (<i>Yegian et al., 1994</i>)	39
2.46	Liquefaction of railway embankment, 1988 Armenia earthquake (<i>Yegian et al., 1994</i>)	40
2.47	Soil Profile of railway embankment, 1988 Armenia earthquake (<i>Yegian et al., 1994</i>)	40
2.48	Grain size distributions of railway embankment and foundation soils, 1988 Armenia earthquake (<i>Yegian et al., 1994</i>)	41
2.49	Observed gravelly soils ejected from the ground during liquefaction, 1995 Kobe earthquake (<i>Hamada, 2014</i>)	42
2.50	Cyclic Triaxial Results of gravelly Masado soil from 1995 Kobe earthquake (<i>Cubrinovski et al., 2001</i>)	42
2.51	Observed gravelly soils ejected from the ground during liquefaction, 2008 Wenchuan earthquake (<i>Cao et al., 2013</i>)	43
2.52	Soil Profile of Chengdu Plain which saw significant gravel liquefaction during 2008 Wenchuan earthquake (<i>Cao et al., 2013</i>)	44
2.53	Grain size distributions of liquefied and non-liquefied gravelly soils during 2008 Wenchuan earthquake (<i>Cao et al., 2013</i>)	44
2.54	Observed gravelly soils ejected from the ground during liquefaction, 2014 Cephalonia earthquake (<i>Nikolaou et al., 2014</i>)	45
2.55	Effect of particle breakage on principal stress ratio (<i>Marsal, 1967</i>)	47
2.56	Effect of Confining Pressure on Friction Angle of Rockfill (<i>Marachi, 1969</i>)	48
2.57	Variation of Friction Angle for Rockfill Materials as a function of Normal Pressure in Triaxial Tests (<i>Leps, 1970</i>)	49
2.58	Effect of Particle Size on Friction Angle for Rockfill (<i>Barton and Kjaernsli, 1981</i>)	49
2.59	Effect of Gravel Content on Total and Effective Friction Angle (<i>Donaghe and Torrey III, 1985</i>)	51
2.60	Definition of Global, Sand Skeleton, and Gravel Skeleton Void Ratios (<i>Chang and Phantachang, 2016</i>)	52
2.61	Effect of Gravel Content and Vertical Stress on Shear Stress Ratio (<i>Chang and Phantachang, 2016</i>)	53
2.62	Effect of Gravel Content on Friction Angle for poorly-graded materials (<i>Chang and Phantachang, 2016</i>)	53

2.63	Effect of Vertical Stress on Shear Stress Ratio (<i>Chang and Phantachang, 2016</i>)	54
2.64	Effect of Gravel Content on Friction Angle for well-graded materials (<i>Chang and Phantachang, 2016</i>)	54
2.65	The Effect of Particle Size on the Cyclic Stress Required to Cause 2.5% Axial Strain at 30 cycles (<i>Wong et al., 1974</i>)	56
2.66	Pore Pressure Generation of Oroville Gravel (<i>Banerjee et al., 1979</i>)	56
2.67	The Effect of Aging on the Cyclic Resistance of Oroville Gravel (<i>Banerjee et al., 1979</i>)	57
2.68	The Effect of Sluicing on the Cyclic Response of Gravel (<i>Evans and Seed, 1987</i>)	57
2.69	Pore Pressure Generation of Watsonville Gravel (<i>Evans and Seed, 1987</i>)	58
2.70	Comparison of Gravelly Soil Liquefaction Resistance with Toyoura Sand (<i>Hatanaka et al., 1997</i>)	59
2.71	Liquefaction and Re-Liquefaction Response of Gravelly Soils (<i>Hatanaka et al., 1997</i>)	59
2.72	Measurement of Post-Liquefaction Volumetric Strain for Gravelly Soil Specimens (<i>Hatanaka et al., 1997</i>)	60
2.73	Comparison of Gravelly Soil Blow count for Liquefied Specimens with existing Sand Liquefaction Triggering Curve (<i>Suzuki et al., 1993</i>)	60
2.74	Monotonic Undrained Shear Stress versus Axial Strain for Gravelly Sand 60% (<i>Rashidian, 1995</i>)	62
2.75	Monotonic Undrained Stress Path for Gravelly Sand 60% (<i>Rashidian, 1995</i>)	62
2.76	Various Gravelly Soils Quasi Steady State Line (<i>Rashidian, 1995</i>)	63
2.77	Normalized Peak Shear Strength versus Gravel Percent (<i>Rashidian, 1995</i>)	63
2.78	V_S and V_{S1} measurements during Monotonic Undrained Shear Test (<i>Rashidian, 1995</i>)	64
2.79	Compilation of V_S and V_{S1} measurements during Monotonic Undrained Shear Tests (<i>Rashidian, 1995</i>)	64
2.80	CSR versus Initial Shear Modulus for Sands and Gravelly Soils (<i>Rashidian, 1995</i>)	65
2.81	CSR versus Initial Shear Modulus for Reconstituted and Undisturbed Gravelly Soils (<i>Rashidian, 1995</i>)	66
2.82	CSR versus Initial Shear Modulus for Angular and Round Sands (<i>Rashidian, 1995</i>)	67
2.83	Cyclic Stress Ratio versus Number of Cycles to Liquefaction for Sand-Gravel Composites at $D_r = 40\%$ (<i>Evans and Zhou, 1995</i>)	68
2.84	Cyclic Stress Ratio versus Void Ratio for Sand-Gravel Composites at $D_r = 40\%$ (<i>Evans and Zhou, 1995</i>)	69
2.85	The Effect of Initial Vertical Stress of Liquefaction Resistance of Sand-Gravel Composites (<i>Amini and Chakravarty, 2003</i>)	69
2.86	Comparison of V_S and N_{60} for Holocene Gravels (<i>Rollins et al., 1998</i>)	70
2.87	V_S as a Function of Void Ratio for Various Gravelly Soils and Sands (<i>Kokusho and Yoshida, 1997</i>)	70

2.88	The Effect of Coefficient of Uniformity on V_S (<i>Kokusho and Yoshida, 1997</i>)	71
2.89	Cyclic Triaxial Test Results for a Gravelly Soil Specimen with V_S Measurements during Testing (<i>Flora and Lirer, 2013</i>)	72
2.90	Comparison of Cyclic Resistance of Reconstituted and Undisturbed Gravelly Soils (<i>Fioravante et al., 2012</i>)	73
2.91	The Effect of (a) Increasing Gravel Content in a Sand Specimen and (b) Increasing Sand Content in a Gravel Specimen (<i>Chang et al., 2014</i>)	74
2.92	(a) Cyclic Resistance versus Increasing Sand Content for a Gravel Specimen and (b) Cyclic Resistance Normalized by Cyclic Resistance of Gravel versus Increasing Sand Content for a Gravel Specimen (<i>Chang et al., 2014</i>)	75
2.93	Comparison of Gravelly Soil Data with <i>Andrus and Stokoe</i> (2000) Liquefaction Triggering Relationship for Gravels (<i>Chang et al., 2014</i>)	76
2.94	Cyclic Resistance of Gravelly Soil as a function of Plastic Fines Content (<i>Qi et al., 2015</i>)	77
2.95	Pore Pressure Generation Ratio of Gravelly Soil (<i>Haeri and Shakeri, 2010</i>)	79
2.96	Comparison of Stresses Imposed on Ideal Simple Shear and Realistic Simple Shear (<i>DeGroot et al., 1994</i>)	83
2.97	Normal Stresses at Horizontal Boundaries of Simple Shear Tests in Rectangular and Circular Apparatuses (<i>Budhu, 1984</i>)	84
2.98	Interpretations of Friction Angle in Simple Shear (<i>Zekkos and Fei, 2016</i>) .	86
3.1	Schematic of Large-Size Cyclic Simple Shear Device	91
3.2	Cyclic Simple Shear Device	92
3.3	Bender element system (a) schematic, (b) housing units, (c) measurement of travel distance, and (d) placement of bender element in the bottom plate	98
3.4	Types of bimorph elements (a,b) X-poled and (c) Y-poled (<i>Sahadewa, unpublished</i>)	98
3.5	Bender elements in (a) X-poled series and (b) Y-poled parallel configurations (<i>Sahadewa, unpublished</i>)	99
3.6	Extender elements in (a) X-poled parallel and (b) Y-poled series configurations (<i>Sahadewa, unpublished</i>)	99
3.7	Piezoceramic bimorph elements: (a) original dimension of 303X and 303Y and (b) modified dimension (<i>Sahadewa, unpublished</i>)	100
3.8	Tools and supplies to build the bender/extender elements (<i>Sahadewa, unpublished</i>)	100
3.9	Wire connections in bender/extender elements (<i>Sahadewa, unpublished</i>) .	101
3.10	Bender/extender element coating: (a) polyurethane, (b) Teflon tape, and (c) aluminum tape (<i>Sahadewa, unpublished</i>)	101
3.11	Design of bender/extender element housing (<i>Sahadewa, unpublished</i>) . .	102
3.12	P-waves and S-wave generated by bender element transmitter (<i>Sahadewa, unpublished</i>)	103
3.13	Function Generator and Linear Amplifier used for Bender Element excitation	103

3.14	Typical S-wave output signal: (A) first deflection, (B) first trough/peak maximum, (C) zero after first trough/peak, (D) major first peak/trough (Sahadewa, unpublished - after <i>Lee and Santamarina</i> (2005))	104
3.15	Accelerometer system (a) schematic, (b) mounted on the bottom plate, (c) ADXL203EB , and (d) placement of accelerometers on bottom plate and top cap	108
3.16	Schematic and photograph of ADXL203EB	108
3.17	ADXL203EB location of capacitors and size	109
3.18	Tools used for replacement of capacitors on ADXL203EB	110
3.19	Removal of capacitors on ADXL203EB	111
3.20	Replacement of capacitors on ADXL203EB	111
3.21	Wire and pin connection used for accelerometers	112
3.22	DAQ and Power Supply for Accelerometers	112
3.23	Rubber and Plastic Mallets used for impulse generation for accelerometers	113
3.24	Results of Monotonic Shear Test of Water Specimen	116
3.25	Results of Cyclic Shear Test for device compliance	117
3.26	Measurement of Bender Element signal arrival for frequencies from 2-17 kHz for Ottawa C109 Sand at 100 kPa (Test ID: V ₅₃)	119
3.27	Bender element signals for Pea Gravel tested at 100 kPa and 2 kHz input frequency (Test ID: M194)	119
3.28	Bender element signals for Pea Gravel tested at 400 kPa and 3 kHz input frequency (Test ID: M194)	120
3.29	Accelerometer Signals for Pea Gravel tested using Rubber Mallet (Test ID: M194)	120
3.30	Accelerometer Signals for Ottawa C109 Sand tested using Rubber Mallet (Test ID: M199)	121
3.31	Bender Element Signals for Ottawa C109 Sand tested at a frequency of 6 kHz (Test ID: M199)	121
3.32	Accelerometer Signals for 80% Ottawa C109 Sand and 20% 8-mm Crushed Limestone tested using a Rubber Mallet (Test ID: M308)	122
3.33	Accelerometer Signals for 80% Ottawa C109 Sand and 20% 8-mm Crushed Limestone tested using a Rubber Mallet (Test ID: M308)	122
3.34	Comparison of shear wave velocity using bender elements and accelerometers	123
3.35	Comparison of shear wave velocity for Ottawa C109 Sand with existing relationships	124
3.36	Comparison of constant volume monotonic simple shear response for Ottawa C109 Sand from this study using and Silica C109 Sand from <i>Yazdi</i> (2004) using a small-size simple shear for (a) stress-strain response, (b) stress path response, and(c) phase transformation (Test ID: M156, M157)	128
3.37	Comparison of constant volume monotonic simple shear response for Ottawa C109 Sand with different constant volume testing parameters (Test ID: M156, M155, M153)	128

3.38	Comparison of constant volume monotonic simple shear response for Pea Gravel with different constant volume testing parameters (Test ID: M180, M194, M196)	129
3.39	Cyclic Simple Shear Test Results for Ottawa C109 Sand (Test ID: C258) .	129
3.40	Comparison of constant volume cyclic simple shear response for Ottawa C109 Sand from this study and (<i>Bhatia</i> , 1982) using a small-size simple shear (Test ID: C102, C121, C123, C124)	130
4.1	Photograph of Pea Gravel, 8 mm Crushed Limestone (CLS8), and 5 mm Crushed Limestone (CLS5)	134
4.2	Grain size distributions of test materials	135
4.3	Bottom pedestal of baseplate for CSS device	138
4.4	Teflon coated stacked ring for CSS device	139
4.5	Membrane and O-ring for CSS device	140
4.6	Placement of membrane and O-ring on bottom pedestal of baseplate . . .	141
4.7	Placement of stacked rings during specimen preparation	142
4.8	Membrane and stacked rings before specimen placement into rings	143
4.9	Small shovel used for preparation of loose specimens	144
4.10	Example placement of Pea Gravel in the loose state using small shovel . .	145
4.11	5.5 kg drop weight used for preparation of dense specimens	146
4.12	Example compaction of Pea Gravel in the dense state using drop weight .	147
4.13	Specimen setup for sedimentation through water	148
4.14	View of Specimen after sedimentation of Pea Gravel through 12" of water	149
4.15	After draining of water used for sedimentation	150
4.16	Comparison of τ versus γ by different specimen preparation techniques for Pea Gravel in the loose state ($D_r = 47\%$)	150
4.17	Comparison of τ versus γ by different specimen preparation techniques for Pea Gravel in the dense state ($D_r = 87\%$)	151
4.18	Shear wave velocity of uniform gravels at (a) $D_r = 47\%$ and (b) $D_r = 87\%$	153
4.19	Monotonic Constant Volume Simple Shear data (Test ID: M228, M226, M227, M224) for 8 mm Crushed Limestone at $D_r = 47\%$ for (a.) Stress-Strain, (b.) Stress Path, (c.) τ/σ'_{v0} vs. γ , and (d.) τ/σ'_v vs. γ	155
4.20	Monotonic Constant Volume Simple Shear data (Test ID: M233, M235, M231, M230) for 8 mm Crushed Limestone at $D_r = 87\%$ for (a.) Stress-Strain, (b.) Stress Path, (c.) τ/σ'_{v0} vs. γ , and (d.) τ/σ'_v vs. γ	156
4.21	Monotonic Constant Volume Simple Shear data (Test ID: M193, M191, M184, M171) for Pea Gravel at $D_r = 47\%$ for (a.) Stress-Strain, (b.) Stress Path, (c.) τ/σ'_{v0} vs. γ , and (d.) τ/σ'_v vs. γ	157
4.22	Monotonic Constant Volume Simple Shear data (Test ID: M192, M205, M206, M201) for Pea Gravel at $D_r = 87\%$ for (a.) Stress-Strain, (b.) Stress Path, (c.) τ/σ'_{v0} vs. γ , and (d.) τ/σ'_v vs. γ	158
4.23	Monotonic Constant Volume Simple Shear data (Test ID: M212, M213, M210, M211) for 5 mm Crushed Limestone at $D_r = 47\%$ for (a.) Stress-Strain, (b.) Stress Path, (c.) τ/σ'_{v0} vs. γ , and (d.) τ/σ'_v vs. γ	159

4.24	Monotonic Constant Volume Simple Shear data (Test ID: M217, M220, M216, M215) for 5 mm Crushed Limestone at $D_r = 87\%$ for (a.) Stress-Strain, (b.) Stress Path, (c.) τ/σ'_{v0} vs. γ , and (d.) τ/σ'_v vs. γ	160
4.25	Comparison of (a.) Peak, (b.) Phase Transformation and (c.) Ultimate State lines for 3 Uniform Gravels at $D_r = 47\%$	162
4.26	Comparison of results for PT of $D_r = 47\%$ Gravels and Ottawa C109 Sand from this study with existing data from the literature for Frasier River Sand and Silica C109 Sand	163
4.27	(a.) Peak Shear Stress, (b.) Shear Stress at Phase Transformation and (c.) Shear Stress at Ultimate State versus Shear Wave Velocity for Three Uniform Gravels	164
4.28	Peak Shear Strength versus Shear Wave Velocity for mixtures for three Uniform Gravels	166
4.29	Phase Transformation Shear Strength versus Shear Wave Velocity for mixtures for three Uniform Gravels	167
4.30	Ultimate State Shear Strength versus Shear Wave Velocity for mixtures for three Uniform Gravels	168
4.31	Comparison of 3 Uniform Gravels for: (a.) τ_p/σ'_v versus V_{S1} (b.) τ_{PT}/σ'_v versus V_{S1} and (c.) τ_{US}/σ'_v versus V_{S1}	170
4.32	Cyclic Data for Pea Gravel at $D_r = 47\%$ (Test ID: C187) and $D_r = 86\%$ (Test ID: C185) at CSR = 0.14 and $\sigma'_{v0} = 100$ kPa	173
4.33	Comparison of Cyclic Stress Path (Test ID: C185) with Peak, PT and US lines taken from Monotonic Stress Path Data for Pea Gravel	174
4.34	Comparison of 3 Uniform Gravels CSR versus Number of Cycles to Liquefaction	175
4.35	Determination of alpha and beta parameters based on CRR vs. N_L	176
4.36	Overburden stress correction factors calculated from test data for Pea Gravel, CLS5, and CLS8	177
4.37	Magnitude Scaling Factor calculated from test data for Pea Gravel, CLS5, and CLS8 vs (a) Earthquake Magnitude and (b) Number of cycles	178
4.38	Comparison of existing data for Magnitude Scaling Factor with data from this study for uniform gravels	179
4.39	Comparison of uniform gravel laboratory data with field data for gravelly and sandy soil liquefaction for CSR vs. V_{S1}	180
4.40	Pore pressure generation comparison for Pea Gravel at 100, 200, and 400 kPa (Test ID: C179, C176, C175)	182
4.41	Pore pressure generation comparison for CLS5 at 100, 200, and 400 kPa (Test ID: C195, C194, C193)	183
4.42	Pore pressure generation comparison for CLS8 at 100, 200, and 400 kPa (Test ID: C217, C214, C216)	184
4.43	Pore pressure generation comparison for Pea Gravel at $D_r = 47\%$ (Test ID: C176) and $D_r = 87\%$ (Test ID: C169)	185
4.44	Pore pressure generation comparison for CLS5 at $D_r = 47\%$ (Test ID: C195) and $D_r = 87\%$ (Test ID: C209)	186

4.45	Pore pressure generation comparison for CLS8 at $D_r = 47\%$ (Test ID: C217) and $D_r = 87\%$ (Test ID: C230)	187
4.46	Pore pressure generation comparison for CLS8, CLS5, and Pea Gravel at $D_r = 47\%$ and 100 kPa (Test ID: C176, C195, C217)	188
4.47	Comparison of Monotonic (Test ID: M231) and Post-Cyclic (Test ID: C214) (a.) Stress-Strain and (b.) Stress Path for $D_r = 47\%$ 8 mm Crushed Limestone	192
4.48	Comparison of US for Monotonic and Post-Cyclic Tests of 3 Uniform Gravels at (a.) $D_r = 47\%$ and (b.) $D_r = 87\%$	192
4.49	Comparison of Post-Cyclic Stress-Strain Response of 3 Uniform Gravels .	193
4.50	Post-Cyclic comparison of shear wave velocity and normalized shear stress ratio with strain	194
4.51	Comparison of post-cyclic shear stress with existing data from the literature	195
5.1	60% Ottawa C109 Sand and 40% Pea Gravel	204
5.2	60% Ottawa C109 Sand and 40% Pea Gravel after placement into mold .	205
5.3	60% Ottawa C109 Sand and 40% Pea Gravel after vibration table test . .	206
5.4	60% Ottawa C109 Sand and 40% Pea Gravel settlement after vibration table test	207
5.5	40% Ottawa C109 Sand and 60% Pea Gravel	208
5.6	40% Ottawa C109 Sand and 60% Pea Gravel after placement into mold .	209
5.7	40% Ottawa C109 Sand and 60% Pea Gravel after vibration table test . .	210
5.8	Cylinder used for rapid tamping of sand-gravel mixtures	211
5.9	Humphres' Method for maximum density prediction of Ottawa C109 Sand and Pea Gravel	212
5.10	Comparison of Laboratory Test data and prediction methods for maximum density determination for Ottawa C109 sand and Pea Gravel	213
5.11	Humphres' Method for maximum density prediction of Ottawa C109 Sand and CLS8	214
5.12	Comparison of Laboratory Test data and prediction methods for maximum density determination for Ottawa C109 Sand and CLS8	215
5.13	Minimum and Maximum void ratio for Ottawa C109 Sand and Pea Gravel mixtures	216
5.14	Minimum and Maximum void ratio for Ottawa C109 Sand and CLS8 mixtures	217
5.15	Grain Size Distributions for Ottawa C109 Sand and Pea Gravel Mixtures .	219
5.16	Grain Size Distributions for Ottawa C109 Sand and CLS8 Mixtures . . .	220
5.17	Funnel used for loose placement of sand-gravel mixtures	221
5.18	Comparison of Shear Wave Velocity as a function of Mixture Percentage and initial vertical stress for (a.) Ottawa C109 Sand and Pea Gravel and (b.) Ottawa C109 Sand and CLS8	227
5.19	Comparison of Shear Wave Velocity as a function of Mixture Percentage for Ottawa C109 Sand and Pea Gravel at $\sigma'_{v0} = 100, 200, \text{ and } 400 \text{ kPa}$. .	227
5.20	Comparison of Shear Wave Velocity as a function of Mixture Percentage for Ottawa C109 Sand and CLS8 at $\sigma'_{v0} = 100, 200, \text{ and } 400 \text{ kPa}$	228

5.21	Comparison of Shear Wave Velocity as a function of Mixture Percentage for Ottawa C109 Sand and Pea Gravel at $D_r = 47\%$ and 87% at $\sigma'_{v0} = 100$ kPa	228
5.22	Comparison of Shear Wave Velocity as a function of Mixture Percentage for Ottawa C109 Sand and CLS8 at $D_r = 47\%$ and 87% at $\sigma'_{v0} = 100$ kPa	229
5.23	Monotonic Constant Volume Simple Shear data (Test ID: M301, M262, M268, M296, M191) for Pea Gravel/Ottawa C109 Sand mixtures at $D_r = 47\%$ at $\sigma'_{v0} = 100$ kPa for (a.) Stress-Strain, (b.) Stress Path, (c.) τ/σ'_{v0} vs. γ , and (d.) τ/σ'_v vs. γ	231
5.24	Monotonic Constant Volume Simple Shear data (Test ID: M160, M329, M330, M331, M205) for Pea Gravel/Ottawa C109 Sand mixtures at $D_r = 87\%$ at $\sigma'_{v0} = 100$ kPa for (a.) Stress-Strain, (b.) Stress Path, (c.) τ/σ'_{v0} vs. γ , and (d.) τ/σ'_v vs. γ	232
5.25	Monotonic Constant Volume Simple Shear data (Test ID: M302, M275, M281, M295, M184) for Pea Gravel/Ottawa C109 Sand mixtures at $D_r = 47\%$ at $\sigma'_{v0} = 200$ kPa for (a.) Stress-Strain, (b.) Stress Path, (c.) τ/σ'_{v0} vs. γ , and (d.) τ/σ'_v vs. γ	233
5.26	Monotonic Constant Volume Simple Shear data (Test ID: M149, M277, M280, M282, M171) for Pea Gravel/Ottawa C109 Sand mixtures at $D_r = 47\%$ at $\sigma'_{v0} = 400$ kPa for (a.) Stress-Strain, (b.) Stress Path, (c.) τ/σ'_{v0} vs. γ , and (d.) τ/σ'_v vs. γ	234
5.27	Monotonic Constant Volume Simple Shear data (Test ID: M301, M305, M313, M316, M226) for CLS8/Ottawa C109 Sand mixtures at $D_r = 47\%$ at $\sigma'_{v0} = 100$ kPa for (a.) Stress-Strain, (b.) Stress Path, (c.) τ/σ'_{v0} vs. γ , and (d.) τ/σ'_v vs. γ	236
5.28	Monotonic Constant Volume Simple Shear data (Test ID: M160, M333, M320, M216) for CLS8/Ottawa C109 Sand mixtures at $D_r = 87\%$ at $\sigma'_{v0} = 100$ kPa for (a.) Stress-Strain, (b.) Stress Path, (c.) τ/σ'_{v0} vs. γ , and (d.) τ/σ'_v vs. γ	237
5.29	Monotonic Constant Volume Simple Shear data (Test ID: M302, M308, M310, M318, M227) for CLS8/Ottawa C109 Sand mixtures at $D_r = 47\%$ at $\sigma'_{v0} = 200$ kPa for (a.) Stress-Strain, (b.) Stress Path, (c.) τ/σ'_{v0} vs. γ , and (d.) τ/σ'_v vs. γ	238
5.30	Monotonic Constant Volume Simple Shear data (Test ID: M149, M307, M314, M315, M224) for CLS8/Ottawa C109 Sand mixtures at $D_r = 47\%$ at $\sigma'_{v0} = 400$ kPa for (a.) Stress-Strain, (b.) Stress Path, (c.) τ/σ'_{v0} vs. γ , and (d.) τ/σ'_v vs. γ	239
5.31	Comparison of (a.) Peak, (b.) Phase Transformation and (c.) Ultimate State lines for Pea Gravel/Ottawa C109 Mixtures at $D_r = 47\%$	241
5.32	Comparison of (a.) Peak, (b.) Phase Transformation and (c.) Ultimate State lines for CLS8/Ottawa C109 Mixtures at $D_r = 47\%$	241
5.33	(a.) Peak Shear Stress, (b.) Shear Stress at Phase Transformation and (c.) Shear Stress at Ultimate State versus Shear Wave Velocity for Pea Gravel/Ottawa C109 Sand Mixtures	242

5.34	(a.) Peak Shear Stress, (b.) Shear Stress at Phase Transformation and (c.) Shear Stress at Ultimate State versus Shear Wave Velocity for CLS8/Ottawa C109 Sand Mixtures	243
5.35	Friction Angle Comparison at Peak, Phase Transformation and Ultimate State as a function of Mixture Percentage for Ottawa C109 Sand and Pea Gravel at loose and dense states	245
5.36	Friction Angle Comparison at Peak, Phase Transformation and Ultimate State as a function of Mixture Percentage for Ottawa C109 Sand and CLS8 at loose and dense states	246
5.37	Friction Angle Comparison at Peak, Phase Transformation and Ultimate State as a function of Mixture Percentage for Ottawa C109 Sand and CLS8 at initial vertical stress = 100, 200, and 400 kPa for $D_r = 47\%$. . .	248
5.38	Friction Angle Comparison at Peak, Phase Transformation and Ultimate State as a function of Mixture Percentage for Ottawa C109 Sand and CLS8 at initial vertical stress = 100, 200, and 400 kPa for $D_r = 47\%$. . .	249
5.39	Peak and PT shear strengths at global void ratio, sand skeleton void ratio, and gravel skeleton void ratio for loose and dense mixtures of Ottawa C109 Sand and Pea Gravel	251
5.40	Peak and PT shear strengths at global void ratio, sand skeleton void ratio, and gravel skeleton void ratio for loose and dense mixtures of Ottawa C109 Sand and CLS8	252
5.41	Shear Wave Velocity as a function of global void ratio, sand skeleton void ratio, and gravel skeleton void ratio for loose and dense mixtures of Ottawa C109 Sand and Pea Gravel	254
5.42	Shear Wave Velocity as a function of global void ratio, sand skeleton void ratio, and gravel skeleton void ratio for loose and dense mixtures of Ottawa C109 Sand and CLS8	255
5.43	Peak Shear Strength versus Shear Wave Velocity for mixtures for Pea Gravel/Ottawa C109 Sand Mixtures	257
5.44	Phase Transformation Shear Strength versus Shear Wave Velocity for mixtures for Pea Gravel/Ottawa C109 Sand Mixtures	258
5.45	Ultimate State Shear Strength versus Shear Wave Velocity for mixtures for Pea Gravel/Ottawa C109 Sand Mixtures	259
5.46	Peak Shear Strength versus Shear Wave Velocity for mixtures for CLS8/Ottawa C109 Sand Mixtures	260
5.47	Phase Transformation Shear Strength versus Shear Wave Velocity for mixtures for CLS8/Ottawa C109 Sand Mixtures	261
5.48	Ultimate State Shear Strength versus Shear Wave Velocity for mixtures for CLS8/Ottawa C109 Sand Mixtures	262
5.49	Peak Shear Strength versus Shear Wave Velocity for mixtures for Uniform Gravels and Gravel/Sand Mixtures	264
5.50	Phase Transformation Shear Strength versus Shear Wave Velocity for mixtures for Uniform Gravels and Gravel/Sand Mixtures	265
5.51	Ultimate State Shear Strength versus Shear Wave Velocity for mixtures for Uniform Gravels and Gravel/Sand Mixtures	266

5.52	Summary Data for 40% Ottawa C109 Sand/60% Pea Gravel at CSR = 0.09 and initial vertical stress of 100 kPa (Test ID: C232)	267
5.53	Comparison of Shear Strain versus Number of Cycles to Liquefaction for Pea Gravel/Ottawa C109 Sand mixtures of varying percentage (Test ID: C258, C246, C244, C232, C179)	269
5.54	Comparison of Shear Strain versus Number of Cycles to Liquefaction for CLS8/Ottawa C109 Sand mixtures of varying percentage (Test ID: C258, C261, C265, C217)	270
5.55	Comparison of CSR versus Number of Cycles to Liquefaction for Pea Gravel/Ottawa C109 Sand mixtures of varying percentage	273
5.56	Comparison of CSR versus Number of Cycles to Liquefaction for CLS8/Ottawa C109 Sand mixtures of varying percentage	274
5.57	Shear Modulus versus Shear Strain for Gravelly Soil Mixtures (Lin et al. 2000)	275
5.58	Comparison of Effects of Increasing Gravel Content to 20% for Pea Gravel and CLS8 Mixtures (Test ID: C258, C246, C261)	276
5.59	Comparison of Effects of Increasing Gravel Content to 40% for Pea Gravel and CLS8 Mixtures (Test ID: C258, C244, C265)	277
5.60	Comparison of Effects of Increasing Gravel Content to 60% for Pea Gravel and CLS8 Mixtures (Test ID: C258, C232, C268)	278
5.61	Effect of Initial Vertical Effective Stress on Number of Cycles to Liquefaction for 40% Ottawa C109 sand and 60% Pea Gravel Mixture (Test ID: C232, C231, C235)	280
5.62	Effect of Initial Vertical Effective Stress on Number of Cycles to Liquefaction for 60% Ottawa C109 sand and 40% CLS8 Mixture (Test ID: C265, C290)	281
5.63	Effect of Relative Density on Number of Cycles to Liquefaction for 40% Ottawa C109 sand and 60% Pea Gravel Mixture (Test ID: C232, C287)	283
5.64	Effect of Relative Density on Number of Cycles to Liquefaction for 60% Ottawa C109 sand and 40% CLS8 Mixture (Test ID: C265, C292)	284
5.65	Comparison of CSR versus V_{S1} for Pea Gravel/Ottawa C109 Sand mixtures of varying percentage	286
5.66	Comparison of CSR versus V_{S1} for Pea Gravel/Ottawa C109 Sand mixtures of varying percentage with data from Tokimatsu et al. (1986) and Baxter et al. (2008)	287
5.67	Comparison of CSR versus V_{S1} for CLS8/Ottawa C109 Sand mixtures of varying percentage	288
5.68	Pore pressure generation comparison for Pea Gravel/Ottawa C109 Sand Mixtures $D_r = 47%$ and 100 kPa (Test ID: C258, C246, C244, C232, C179)	291
5.69	Pore pressure generation comparison for Pea Gravel/Ottawa C109 Sand Mixtures $D_r = 87%$ and 100 kPa (Test ID: C279, C298, C299, C287, C169)	292
5.70	Pore pressure generation comparison for CLS8/Ottawa C109 Sand Mixtures $D_r = 47%$ and 100 kPa (Test ID: C258, C261, C265, C268, C217)	293
5.71	Pore pressure generation comparison for CLS8/Ottawa C109 Sand Mixtures $D_r = 87%$ and 100 kPa (Test ID: C279, C300, C292, C230)	294

5.72	Pore pressure generation comparison for gravelly soils	295
5.73	Excess pore pressure ratio as a function of C_u for gravelly soils	296
5.74	Stress-Strain Comparison of Monotonic, Cyclic, and Post-Cyclic Response of 80% Ottawa C109 Sand and 20% CLS8 (Test ID: C261, C262, M305)	298
5.75	Stress Path Comparison of Monotonic, Cyclic, and Post-Cyclic Response of 80% Ottawa C109 Sand and 20% CLS8 (Test ID: C261, C262, M305)	299
5.76	Post-Cyclic Shear Strength without re-consolidation for Pea Gravel/Ottawa C109 Sand of varying percentage at initial vertical stress of 100 kPa and $D_r = 47%$ (Test ID: C258, C246, C244, C232, C179)	302
5.77	Post-Cyclic Shear Strength without re-consolidation for CLS8/Ottawa C109 Sand of varying percentage at initial vertical stress of 100 kPa and $D_r = 47%$ (Test ID: C258, C261, C265, C217)	303
5.78	Post-Cyclic Shear Strength without re-consolidation for Pea Gravel/Ottawa C109 Sand compared with Monotonic US Shear Results	304
5.79	Post-Cyclic Shear Strength without re-consolidation for CLS8/Ottawa C109 Sand compared with Monotonic US Shear Results	305
5.80	Post-Cyclic Shear Strength Ratio for Pea Gravel/Ottawa C109 Sand compared with Monotonic US Shear Strength Ratio Result versus V_{S1}	306
5.81	Post-Cyclic Shear Strength Ratio for CLS8/Ottawa C109 Sand compared with Monotonic US Shear Strength Ratio Results versus V_{S1}	307
5.82	Post Cyclic Settlement for Pea Gravel/Ottawa C109 Sand mixtures of varying percentage at initial vertical stress of 100 kPa and $D_r = 47%$ (Test ID: C253, C248, C245, C233, C180)	309
5.83	Post Cyclic Settlement for CLS8/Ottawa C109 Sand mixtures of varying percentage at initial vertical stress of 100 kPa and $D_r = 47%$ (Test ID: C253, C262, C266, C272)	310
5.84	Effect of D_r on Post Cyclic Settlement for Pea Gravel at initial stress of 100 kPa (Test ID: C180, C281)	312
5.85	Effect of D_r on Post Cyclic Settlement for CLS8 at initial stress of 100 kPa (Test ID: C272, C283)	313
5.86	Effect of D_r on Post Cyclic Settlement for Ottawa C109 Sand at initial stress of 100 kPa (Test ID: C253, C280)	314
5.87	Effect of D_r on Post Cyclic Settlement for 60% Pea Gravel/40% Ottawa C109 Sand at initial stress of 100 kPa (Test ID: C233, C288)	315
5.88	Effect of D_r on Post Cyclic Settlement for 40% CLS8/60% Ottawa C109 Sand at initial stress of 100 kPa (Test ID: C266, C291)	316
5.89	(a) Post-Cyclic Settlement as a function of mixture percentage for Ottawa C109 sand and Pea Gravel mixes at loose and dense states and (b) corresponding change in V_s measured before and after liquefaction at 100 kPa (a negative change in V_s means that the V_s measured after liquefaction and reconsolidation was lower than the V_s value measured before after initial consolidation and before liquefaction)	319

5.90	(a) Post-Cyclic Settlement as a function of mixture percentage for Ottawa C109 sand and CLS8 mixes at loose and dense states and (b) corresponding change in V_S measured before and after liquefaction at 100 kPa (a negative change in V_S means that the V_S measured after liquefaction and reconsolidation was lower than the V_S value measured before after initial consolidation and before liquefaction)	320
5.91	Post Cyclic Settlement comparison with <i>Yoshimine et al.</i> (2006) data based on relative density	321
5.92	Post Cyclic Settlement comparison with <i>Yi</i> (2010) data based on V_S	322
6.1	Seismotectonic features of the Cephalonia Area. The Cephalonian Transform Fault is shown in the black boxed area. (From (<i>Nikolaou et al.</i> , 2014) modified after Scordilis et al. 1984)	330
6.2	Damage observed in Argostoli during 1953 Earthquake (<i>Nikolaou et al.</i> , 2014)	330
6.3	Observations of damage at Lixouri Port (a) 1953 Earthquake and (b) 2014 Earthquake (<i>Nikolaou et al.</i> , 2014)	331
6.4	Observations of liquefaction at Lixouri Port (<i>Nikolaou et al.</i> , 2014)	331
6.5	Observations of gravelly soil liquefaction at Lixouri Port (<i>Nikolaou et al.</i> , 2014)	332
6.6	DPT apparatus used in <i>Cao et al.</i> (2013) study (<i>Cao et al.</i> , 2013)	333
6.7	Photograph of DPT apparatus used in <i>Cao et al.</i> (2013) study (<i>Cao et al.</i> , 2013)	334
6.8	DPT Test Rig - Cephalonia, Greece	337
6.9	DPT Test Rig - Cephalonia, Greece	338
6.10	Cone Tip and rods used for DPT	339
6.11	Cone Tips with adapters for connection to drill rods	340
6.12	Larger Cone Tip (top) and Smaller Cone Tip (bottom)	341
6.13	Instrumented rod used for energy measurements	342
6.14	Instrumented rod placed in drill rig for energy measurement	343
6.15	PDA energy measurement computer	344
6.16	Screenshot of PDA with typical energy measurement data for one blow	345
6.17	Energy Transfer Ratio measured at DPT-4 versus (a) Blow Number and (b) Blow Counts (per 10 cm layer)	346
6.18	Energy Transfer Ratio measured at DPT-4.3 using the small cone versus (a) Blow Number and (b) Blow Counts (per 10 cm layer)	347
6.19	Energy Transfer Ratio measured at DPT-5 versus (a) Blow Number and (b) Blow Counts (per 10 cm layer)	348
6.20	Energy Transfer Ratio measured at DPT-6 versus (a) Blow Number and (b) Blow Counts (per 10 cm layer)	349
6.21	Energy Transfer Ratio measured at DPT-8 versus (a) Blow Number and (b) Blow Counts (per 10 cm layer)	350
6.22	MASW Equipment Setup in the Field (<i>Sahadewa</i> , 2014)	352
6.23	Seismograph and Geophones used in MASW testing (<i>Sahadewa</i> , 2014)	353
6.24	MASW setup with 1 m geophone spacing and 3 m hammer offset	354
6.25	Site map of Lixouri Port area with test locations marked	356

6.26	Generalized site profile used for data interpretation	357
6.27	Setup of DPT at Location 1 in planter box	359
6.28	MASW setup for V_S measurements at Location 1	360
6.29	DPT uncorrected blow counts and V_S versus depth at Location 1	361
6.30	Setup of DPT at Location 2	362
6.31	MASW setup for V_S measurements at Location 2	363
6.32	DPT uncorrected blow counts and V_S versus depth at Location 2	364
6.33	Setup of DPT and V_S Measurements at Location 3	366
6.34	Energy measurement setup at Location 3	367
6.35	DPT uncorrected blow counts and V_S versus depth at Location 3	368
6.36	Comparison of Large and Small cone tip for DPT at Location 3	369
6.37	Setup of DPT at Location 4	370
6.38	MASW setup for V_S measurements at Location 4	371
6.39	DPT uncorrected blow counts and V_S versus depth at Location 4	372
6.40	Setup of DPT at Location 5	373
6.41	MASW setup for V_S measurements at Location 5	374
6.42	DPT uncorrected blow counts and V_S versus depth at Location 5	375
6.43	Comparison of DPT test results for Lixouri Port at Locations 1, 3, 2, 4, and 5	377
6.44	Comparison of V_S test results for Lixouri Port at Locations 1, 3, 2, 4, and 5	377
6.45	Site map of Argostoli Port area with test locations marked	379
6.46	Setup of DPT at Location 11	380
6.47	MASW setup for V_S measurements at Location 11	381
6.48	DPT uncorrected blow counts and V_S versus depth at Location 11	382
6.49	Setup of DPT at Location 12	384
6.50	MASW setup for V_S measurements at Location 12	385
6.51	DPT uncorrected blow counts and V_S versus depth at Location 12	386
6.52	Setup of DPT-10 at Location 13	387
6.53	MASW setup for V_S measurements at Location 13 with 3 m spacing	388
6.54	DPT uncorrected blow counts and V_S versus depth at Location 13	389
6.55	Comparison of DPT test results for Argostoli Port at Location 11, 12, and 13	391
6.56	Comparison of V_S test results for Argostoli Port at Location 11, 12, and 13	392
6.57	Map of Millsite Dam testing locations for V_S measurements	393
6.58	Soil Profiles used for data interpretation based on SPT tests from the Utah Division of Water Resources	394
6.59	MASW setup for V_S measurements at Location 2 - Millsite Dam	395
6.60	DPT uncorrected blow counts and V_S versus depth at Location 2 - Millsite Dam	396
6.61	MASW setup for V_S measurements at Location 3 - Millsite Dam	397
6.62	DPT uncorrected blow counts and V_S versus depth at Location 3 - Millsite Dam	398
6.63	MASW setup for V_S measurements at Location 4 - Millsite Dam	399
6.64	MASW setup for V_S measurements at Location 4 - Millsite Dam	400

6.65	DPT uncorrected blow counts and V_S versus depth at Location 4 - Millsite Dam	401
6.66	MASW setup for V_S measurements at Location 5 - Millsite Dam	402
6.67	DPT uncorrected blow counts and V_S versus depth at Location 5 - Millsite Dam	403
6.68	Comparison of DPT test results for Millsite Dam	404
6.69	Comparison of V_S test results for Millsite Dam	405
6.70	Correlation of N_{120} and V_S based on field testing in this study	407
6.71	Correlation of N_{120} and V_S based on field testing in this study and <i>Cao et al.</i> (2011) data	408
6.72	Location of Liquefaction observed in Lixouri following 2014 Cephalonia earthquakes (<i>Papathanassiou et al.</i> , 2016)	410
6.73	Liquefaction observed in Argostoli following 2014 Cephalonia earthquakes (<i>Nikolaou et al.</i> , 2014)	410
6.74	Location of Strong Motion Recording Stations in Cephalonia (<i>Papathanassiou et al.</i> , 2016)	413
6.75	Comparison of N'_{120} and V_{S1} -based liquefaction methods at Location 1 - Lixouri	414
6.76	Comparison of N'_{120} and V_{S1} -based liquefaction methods at Location 2 - Lixouri	415
6.77	Comparison of N'_{120} and V_{S1} -based liquefaction methods at Location 3 - Lixouri	416
6.78	Comparison of N'_{120} and V_{S1} -based liquefaction methods at Location 4 - Lixouri	416
6.79	Comparison of N'_{120} and V_{S1} -based liquefaction methods at Location 5 - Lixouri	417
6.80	Comparison of N'_{120} -based liquefaction methods at for all locations at Lixouri Port	418
6.81	Comparison of V_{S1} -based liquefaction methods at for all locations at Lixouri Port	419
6.82	Comparison of N'_{120} and V_{S1} -based liquefaction methods at Location 11 - Argostoli	420
6.83	Comparison of N'_{120} and V_{S1} -based liquefaction methods at Location 12 - Argostoli	420
6.84	Comparison of N'_{120} and V_{S1} -based liquefaction methods at Location 13 - Argostoli	421
6.85	Comparison of N'_{120} -based liquefaction methods at for all locations at Argostoli Port	422
6.86	Comparison of V_{S1} -based liquefaction methods at for all locations at Argostoli Port	423
6.87	Comparison of N'_{120} Data from Cephalonia with <i>Cao et al.</i> (2013) for 1st Cephalonia Earthquake	425
6.88	Comparison of N'_{120} Data from Cephalonia with <i>Cao et al.</i> (2013) for 2nd Cephalonia Earthquake	427

6.89	Comparison of V_{S1} Data from Cephalonia with <i>Cao et al.</i> (2011) for 1st Cephalonia Earthquake	427
6.90	Comparison of V_{S1} Data from Cephalonia with <i>Cao et al.</i> (2011) for 2nd Cephalonia Earthquake	428
6.91	DPT-based Liquefaction Triggering Chart with $CSR - N'_{120}$ curves developed from field data from this study and the literature (<i>Cao et al.</i> , 2013) .	433
6.92	Comparison of $CSR - N'_{120}$ from this study with <i>Cao et al.</i> (2013)	434
6.93	V_S -based Liquefaction Triggering Chart with $CSR - V_{S1}$ curves developed from field data from this study and the literature (<i>Andrus and Stokoe</i> , 2000; <i>Cao et al.</i> , 2013)	435
6.94	Comparison of $CSR - V_{S1}$ curves developed from field data from this study with <i>Cao et al.</i> (2011)	436
6.95	V_S -based Liquefaction Triggering Chart with $CSR - V_{S1}$ curves developed from laboratory and field data from this study	437
6.96	Comparison of $CSR - V_{S1}$ curves developed from laboratory and field data from this study with <i>Cao et al.</i> (2011)	438
6.97	V_S -based Liquefaction Triggering Chart with $CSR - V_{S1}$ curves developed from laboratory and field data from this study and the literature (<i>Andrus and Stokoe</i> , 2000; <i>Cao et al.</i> , 2013)	439
6.98	Comparison of $CSR - V_{S1}$ curves developed from laboratory and field data from this study and the literature with <i>Cao et al.</i> (2011)	440
6.99	Comparison of $CSR - V_{S1}$ curves developed from this study with existing curves (<i>Andrus and Stokoe</i> , 2000; <i>Cao et al.</i> , 2013; <i>Kayen et al.</i> , 2013) . .	441
7.1	Comparison of constant volume monotonic simple shear response for Ottawa C109 Sand with different constant volume testing parameters (Test ID: M156, M155, M153)	444
7.2	Peak Shear Strength versus Shear Wave Velocity for mixtures for Uniform Gravels and Gravel/Sand Mixtures	447
7.3	Phase Transformation Shear Strength versus Shear Wave Velocity for mixtures for Uniform Gravels and Gravel/Sand Mixtures	448
7.4	Comparison of CSR versus V_{S1} for Pea Gravel/Ottawa C109 Sand mixtures of varying percentage	451
7.5	Comparison of CSR versus V_{S1} for CLS8/Ottawa C109 Sand mixtures of varying percentage	452
7.6	Comparison of post-cyclic shear stress with existing data from the literature after SPT is correlated to V_S	454
7.7	Stress Path Comparison of Monotonic, Cyclic, and Post-Cyclic Response of 80% Ottawa C109 Sand and 20% CLS8 (Test ID: C261, C262, M305) .	455
7.8	Correlation of N_{120} and V_S based on field testing in this study and <i>Cao et al.</i> (2011) data	457
7.9	DPT-based Liquefaction Triggering Chart with $CSR - N'_{120}$ curves developed from field data from this study and the literature (<i>Cao et al.</i> , 2013) .	459
7.10	Comparison of $CSR - N'_{120}$ from this study with <i>Cao et al.</i> (2013)	460

7.11 V_S -based Liquefaction Triggering Chart with $CSR - V_{S1}$ curves developed from laboratory and field data from this study and the literature (*Andrus and Stokoe, 2000; Cao et al., 2013*) 461

7.12 Comparison of $CSR - V_{S1}$ curves developed from this study with existing curves (*Andrus and Stokoe, 2000; Cao et al., 2013; Kayen et al., 2013*) . . 462

LIST OF TABLES

Table

2.1	Comparison of Field Testing Techniques for Liquefaction Assessment (after <i>Youd et al. (2001)</i>)	12
2.2	Test Results of Penetration Resistance and Shear Wave Velocity (after <i>Andrus et al. (1992)</i>)	33
2.3	Common Simple Shear Devices used in literature	81
3.1	CSS Device settings for Monotonic and Cyclic Testing	94
3.2	Ottawa C109 Sand Monotonic Tests	115
3.3	Ottawa C109 Sand Cyclic Tests	115
3.4	Pea Gravel Monotonic Constant Volume Response Comparison Tests . . .	116
4.1	Summary of Test Material Properties	136
4.2	Uniform Gravel Monotonic Tests	151
4.3	Uniform Gravels Cyclic Tests	152
4.4	Summary of Equation Parameters for V_S	153
4.5	Summary of Peak, Phase Transformation, and Ultimate State Friction Angle for 3 Uniform Gravels	163
4.6	Equation Parameters for Uniform Gravels	166
5.1	Material Properties for Pea Gravel and Ottawa C109 Sand Mixtures . . .	218
5.2	Material Properties for CLS8 and Ottawa C109 Sand Mixtures	219
5.3	Monotonic Tests for Pea Gravel and Ottawa C109 Sand Mixtures	223
5.4	Cyclic and Post-Cyclic Tests for Pea Gravel and Ottawa C109 Sand Mixtures	224
5.5	Monotonic Tests for CLS8 and Ottawa C109 Sand Mixtures	224
5.6	Cyclic and Post-Cyclic Tests for CLS8 and Ottawa C109 Sand Mixtures .	225
5.7	Equation Parameters for V_S for Pea Gravel-Ottawa C109 Sand Mixtures at $D_r = 47\%$	226
5.8	Equation Parameters for V_S for CLS8-Ottawa C109 Sand Mixtures at $D_r = 47\%$	226
5.9	Equation Parameters for Pea Gravel Mixtures	256
5.10	Equation Parameters for CLS8 Mixtures	256
5.11	Equation Parameters for all Gravelly Soils in this study	263
6.1	Summary of Field tests at Lixouri Port	356
6.2	Summary of Field tests at Argostoli Port	380

6.3 Locations of Liquefiable layers in Argostoli and Lixouri 425
6.4 Locations of Non-liquefiable layers in Argostoli and Lixouri 426

LIST OF APPENDICES

Appendix

- A. Test Data Sheets for Chapter 3 465
- B. Test Data Sheets for Chapter 4 540
- C. Test Data Sheets for Chapter 5 772

ABSTRACT

To date, most research in soil liquefaction has focused on sands, as they have been observed to liquefy in the field and can be readily tested under controlled conditions in the laboratory. However, the response of gravelly soils during earthquake loading is not well understood due to fewer well-documented case histories of field liquefaction as well as the unavailability of large-scale laboratory test devices that can accurately capture material response of large-size particles.

This thesis presents the results of laboratory and in-situ field tests of gravelly soils. A prototype large-size Cyclic Simple Shear (CSS) device was utilized to perform constant volume monotonic, cyclic, and post-cyclic shear tests of uniform gravels and gravel-sand mixtures. Bender elements and miniature accelerometers were used to measure shear wave velocity for every tested specimen. Three uniform gravels (Pea Gravel, 8 mm Crushed Limestone, and 5 mm Crushed Limestone) were first tested at loose and dense states and a range of initial vertical stresses (100 to 400 kPa) to evaluate the effects of particle morphology on shear response. Particle angularity was shown to be an important parameter that affects peak, phase transformation (PT), and ultimate state (US) response of uniform gravels. As particle angularity increased, peak, PT, and US friction angles increased. Particle size was shown to have a lesser impact on these friction angles. Results of cyclic tests on uniform gravels in this study showed that gravels will liquefy at normalized shear wave velocities (V_{S1}) of up to approximately 230 m/s. Increasing particle size, angularity, and relative density led to an increase in post-cyclic shear strength.

Monotonic, cyclic, and post-cyclic tests were also performed for mixtures of Pea Gravel and Ottawa C109 Sand and 8 mm Crushed Limestone and Ottawa C109 Sand. Mixtures

of varying percent sand and gravel compositions were tested at loose and dense states and at vertical stresses from 100 kPa to 400 kPa. Test results showed that there is an optimum mixture percentage (40% Sand for Pea Gravel mixtures and 60% Sand for 8 mm Crushed Limestone mixtures) that exhibits the highest V_S value, peak shear strength, and liquefaction resistance. Results also showed that gravels will liquefy at V_{S1} values of up to approximately 240 m/s. Post-cyclic tests revealed that particle morphology and density of the gravel skeleton has a significant effect on the post-liquefaction undrained shear strength as well as the post-liquefaction volumetric strain (found to be less than that expected for sands).

The field testing component of this study focused on three sites where gravelly soils were present, and in the case of Cephalonia, liquefied during the 2014 earthquakes (Ports of Lixouri and Argostoli in Cephalonia, Greece and Millsite Dam in Ferron, Utah). The field tests included the Chinese Dynamic Penetration test (DPT) and the Multi-Channel Analysis of Surface Waves (MASW) test. A correlation was developed between DPT and V_S combining data from this study and data from the literature. Furthermore, new DPT and V_S -based liquefaction triggering charts were developed based on laboratory CSS test data for uniform gravels and gravel-sand mixtures from this study, field data collected in this study from the sites in Cephalonia, Greece, and existing data for gravelly soil liquefaction from the literature.

CHAPTER 1

Introduction

1.1 Background and Motivation

Earthquakes are among the most deadly and costly natural disasters affecting our society. These events can cause damage to critical infrastructure, crippling of an economy, and above all else, loss of life, as has been unfortunately witnessed during several recent events. One of the leading causes of damage during earthquakes are seismically-induced displacements due to soil liquefaction. Soil liquefaction is a sudden and often catastrophic loss of strength in soil as the cyclic loading of the earthquake causes the transfer of stress from the solid particles to the pore water between the soil grains. In particularly severe cases, formerly solid ground loses strength completely and becomes a fully fluidized mass of water mixed with soil. This can have devastating consequences as buildings can fail in bearing and punch into the ground; slopes and level ground near free faces (e.g. harbor frontages, river banks, etc.) can become unstable and translate large distances; and major dams can suffer stability failures and sudden releases of water from their reservoirs.

Understanding and evaluating the response of coarse-grained liquefiable soils during earthquake events is critical to predicting infrastructure behavior. To date, most soil liquefaction research has focused on sands, as they have been observed to liquefy in the field and can be readily tested under controlled conditions in the laboratory. However, the response of gravelly soils during earthquake loading is not well understood due to fewer

well-documented case histories of field liquefaction as well as the unavailability of large-scale laboratory test devices that can accurately capture material response of large-size particles. Recent earthquakes (2008 Wenchuan, China and 2014 Cephalonia, Greece) have reiterated that gravelly soils can liquefy during earthquakes, and have presented interesting case-histories allowing for further study of the response of such soils during seismic events.

1.2 Research Objectives

The focus of this research is the evaluation of gravelly soil response during and after earthquake events through a combination of high-end laboratory testing and field measurements. The goal of this study is to develop improved methods for assessing and predicting liquefaction triggering and post-liquefaction response of gravelly soils. The limited available correlations (*Andrus and Stokoe, 2000; Cao et al., 2011*) show conflicting predictions of gravel liquefaction triggering in the field. Additionally, data for post-liquefaction residual shear strength and associated volumetric strains for gravelly soils is sparse. Therefore, further study of the field and laboratory response of these soils is needed to understand the parameters that affect behavior during and after seismic events.

The specific objectives of this research were to: (1) Develop and validate a large-size cyclic simple shear device capable of performing constant volume monotonic and cyclic simple shear tests of gravelly soils with shear wave velocity (V_S) measurements for each specimen, (2) Evaluate the monotonic, cyclic, and post-cyclic simple shear response of uniform gravels, with an emphasis on the effects of particle size and angularity, (3) Evaluate the monotonic, cyclic, and post-cyclic simple shear response of gravel-sand mixtures and the parameters that affect their response, (4) Develop a correlation between Chinese Dynamic Penetration test data and V_S measurements of gravelly soils by combining test results from three sites, two in Cephalonia, Greece and one at Millsite Dam in Ferron, Utah, and (5) Utilize the results of field and laboratory testing to develop improved DPT and V_S -based liquefaction triggering charts for gravelly soils.

1.3 Organization of Dissertation

This dissertation is organized as follows:

Chapter 2 presents a review of soil liquefaction in the laboratory and field and the current methods available for liquefaction and post-liquefaction assessment for sands and gravelly soils. Laboratory testing of gravels and gravelly soils are also reviewed with an emphasis on the undrained cyclic response of these soils. Background information and the framework for interpreting results from a cyclic simple shear laboratory test is presented.

Chapter 3 describes the prototype large-size cyclic simple shear (CSS) device that was validated in this research by comparing its results with that of conventional-size cyclic simple shear devices. The development of custom bender element and accelerometer systems for the device is also discussed.

Chapter 4 presents results from constant volume monotonic, cyclic, and post-cyclic simple shear testing of three uniform gravels varying in particle size and particle angularity. Comparisons are made with existing liquefaction charts used for triggering and post-liquefaction residual shear strength.

In **Chapter 5** the monotonic, cyclic, and post-cyclic response of gravel-sand mixtures is evaluated. Different mixtures of gravel and sand percentages are tested and results are compared with existing liquefaction triggering and post-liquefaction volumetric strain charts for sandy and gravelly soils.

Chapter 6 summarizes the field testing of gravelly soils in Cephalonia, Greece and at Millsite Dam in Ferron, Utah. Chinese Dynamic Penetration testing and shear wave velocity measurements were performed at several locations at each site. New liquefaction triggering charts for gravelly soils based on laboratory and field data are developed and presented.

Chapter 7 presents a summary of the conclusions of this study and offers some recommendations for future research.

CHAPTER 2

Literature Review

Liquefaction is defined as the transformation of a soil from the solid state to a liquefied state due to increased pore water pressure and reduced effective stress (*Marcuson, 1978*). Soil liquefaction most readily occurs in loose to moderately dense granular soils due to the tendency of these materials to contract and develop excess pore water pressure during cyclic loading. In particular, loose granular soils may significantly soften during cyclic loading, which can lead to large flow-type deformations. Dense granular soils, on the other hand, have the tendency to dilate during shearing; therefore, large deformations are inhibited (*Youd et al., 2001*). Much of our understanding of soil liquefaction has been from laboratory tests which allow for the study of specific parameters that affect undrained shear response. This will be discussed in the next section. Sandy soils have long been known to liquefy; however, the response of gravelly soils during undrained loading conditions is not fully understood. The focus of this literature review will be on the previous study of soil liquefaction with an emphasis on gravelly soil liquefaction in the field and laboratory.

2.1 Undrained Response of Cohesionless Soils

Many researchers have studied the undrained shear behavior of cohesionless soils in the laboratory (*Vaid and Sivathayalan, 1996; Seed and Peacock, 1968; Vaid and Chern, 1983, 1985; Wijewickreme et al., 2005; Boulanger et al., 1993; Vucetic, 1994; Finn, 1985; Por-*

cino et al., 2008). Figure 2.1 depicts the general behavior of cohesionless materials under undrained monotonic loading conditions. Figure 2.1a illustrates shear stress-strain response for a soil at three different void ratios. Response (1) has the highest void ratio, Response (2) has an intermediate void ratio, and Response (3) has the lowest void ratio. Response (1) is characterized by reaching a peak strength and then exhibiting a strain-softening behavior towards a steady state. Response (1) type of behavior would be associated with flow liquefaction. Response (2) reaches a peak and softens over a limited strain range before gaining strength and hardening as strain increases. In Response (2), the phase transformation (PT) point is shown. The phase transformation occurs when the soil switches from contractive (softening) to dilative (hardening) behavior. In Response (2) limited liquefaction would describe the brief softening behavior seen in the intermediate strain range. Response (3) reaches a peak and never displays softening behavior; it continues to gain strength with increasing strain. Figure 2.1b displays the excess pore pressure behavior during the three tests. As expected, the excess pore pressure is greatest for Response (1), which exhibits the lowest residual strength. Figure 2.1c shows the stress paths followed during the three tests. All tests develop excess pore pressure (lose normal effective stress) until the PT is reached. Response (1) loses all vertical effective stress and follows the steady state/PT line, while Response (2) and (3) show recovery of the lost stress and further go to the ultimate state. The critical stress ratio point is the peak shear strength obtained during the test, and the critical stress ratio line is obtained by drawing a line through the critical stress ratio point for each test. Example monotonic stress-strain and stress path responses are shown in Figure 2.2 for Fraser River Sand tested in a direct simple shear device. The locations of the phase transformation line (α_{PT}) and the ultimate failure line (α_f) are shown on the stress path plot.

The cyclic response of a contractive and saturated cohesionless soil is shown in Figure 2.3. Figure 2.3a depicts the shear stress versus strain and shows several cycles of loading followed by the decrease of the shear strength to steady state. The shear strength

in the steady state is also referred to as the residual undrained shear strength. Figure 2.3b shows behavior that is consistent with Response (2) in Figure 2.1. This limited liquefaction type response shows the steady state being reached briefly over intermediate strains before strain hardening occurs and shear strength increases. Figure 2.3c shows the stress path for a cyclic test plotted with the critical stress ratio and PT lines determined from the monotonic test. When the shear stress reaches the critical stress ratio line, it “collapses” and softens until it reaches the PT line where it subsequently gains strength until it again reaches the peak shear strength. The specimen then cycles along the PT line, making the traditionally identified butterfly loop. Figure 2.3d shows the strain accumulation for different responses (true liquefaction, limited liquefaction, and cyclic mobility). Figures 2.1 and 2.3 emphasize the importance of understanding both the monotonic and cyclic behavior of cohesionless materials to evaluate the potential for strain softening associated with large deformations and loss of strength. Example cyclic undrained response is shown in Figure 2.4 for Fraser River Sand tested in a direct simple shear device.

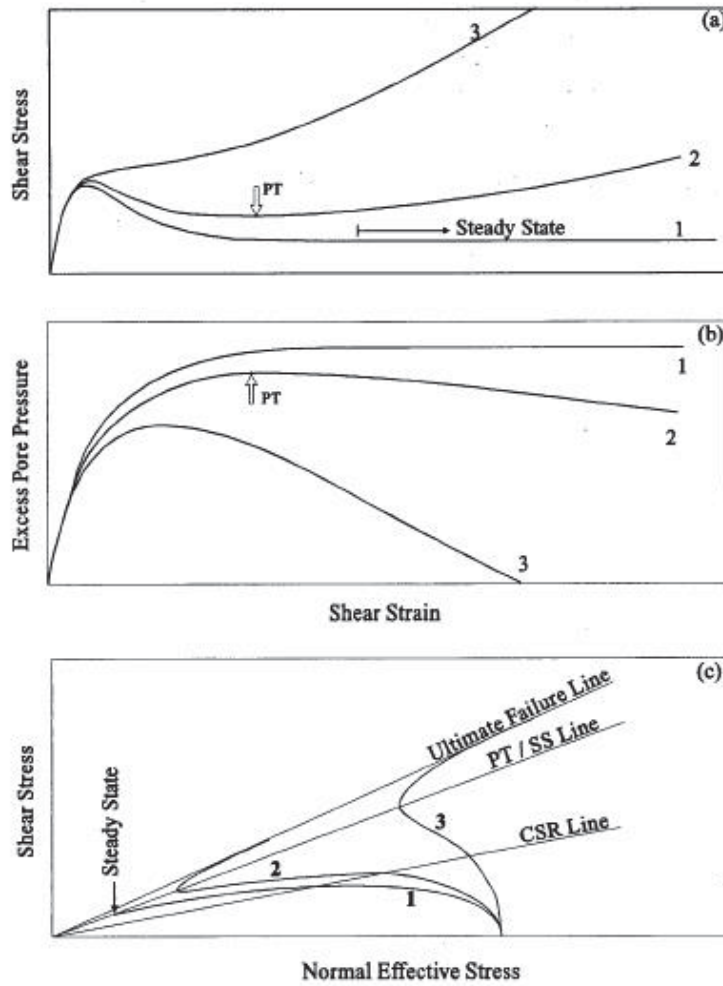

Figure 2.1: Summary of Undrained Response of Cohesionless Soils to Monotonic Loading (Vaid and Chern, 1985)

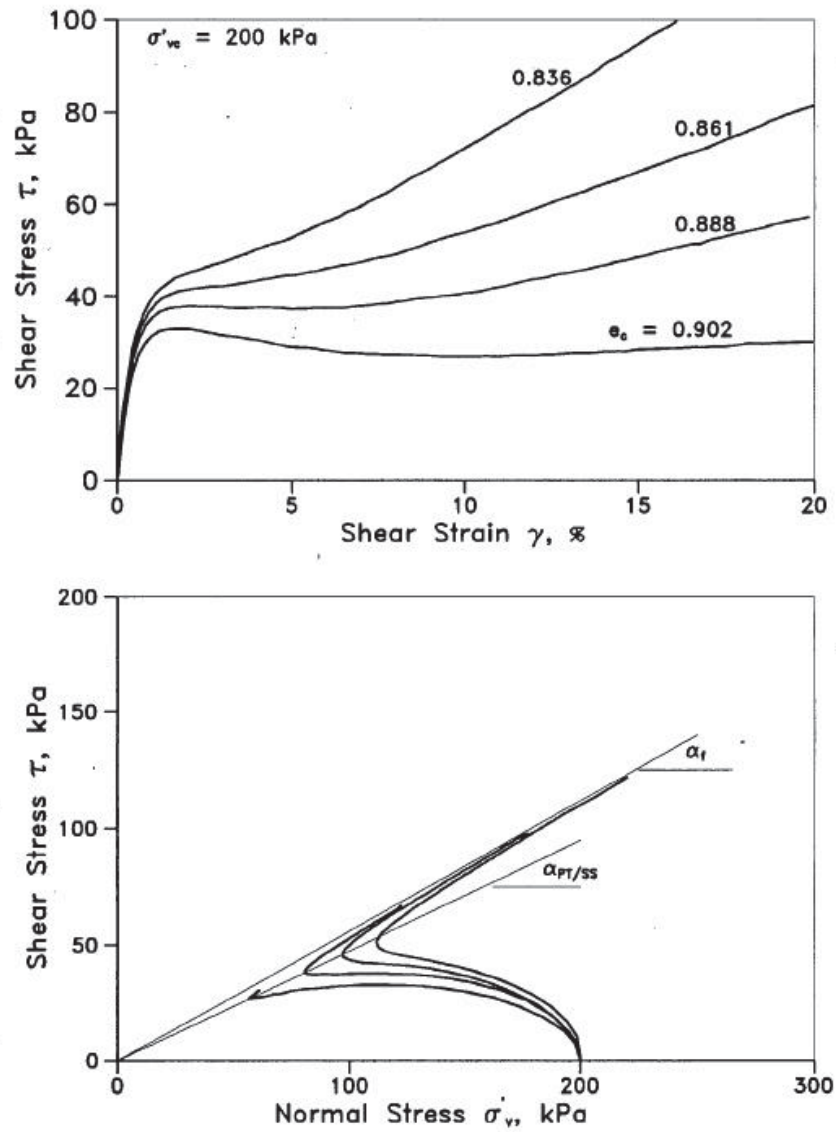

Figure 2.2: Monotonic Undrained Response of Fraser River Sand in Simple Shear at varying void ratios (Sivathayalan, 1994)

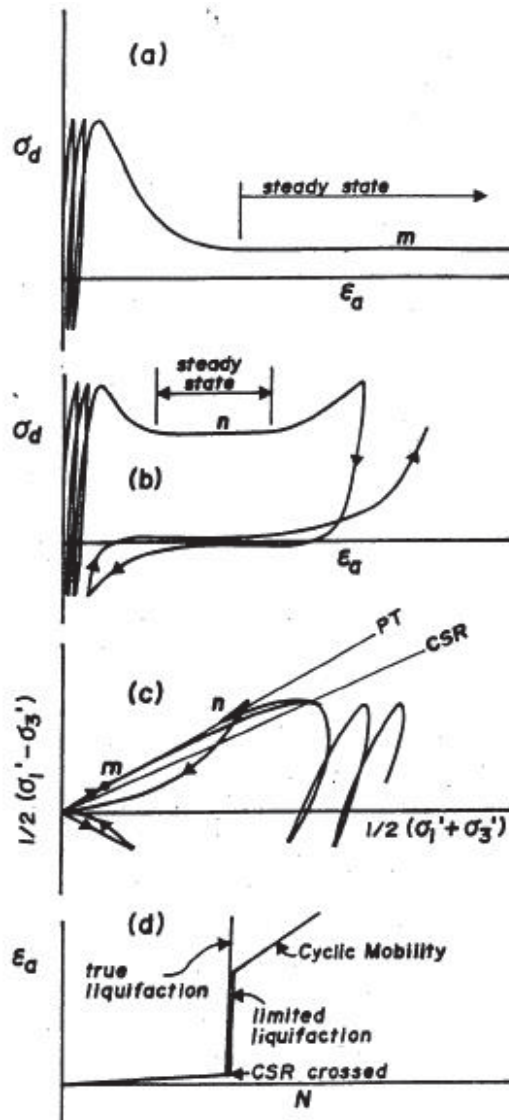

Figure 2.3: Summary of Undrained Response of Cohesionless soils to Cyclic Loading (Vaid and Chern, 1983)

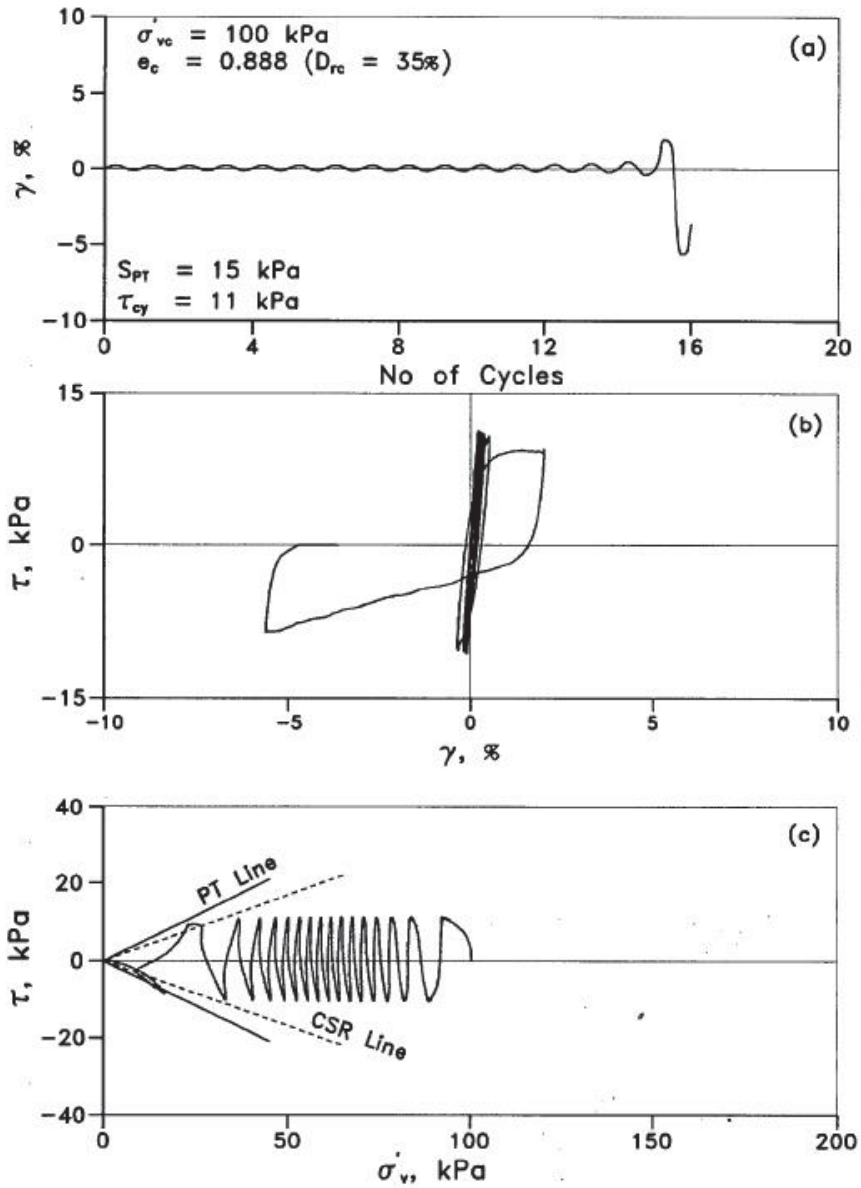

Figure 2.4: Cyclic Undrained Response of Fraser River Sand in Simple Shear (Sivathayalan, 1994)

2.2 Soil Liquefaction Triggering Charts

Assessment of liquefaction potential and behavior is crucial to many engineering projects. The triggering of liquefaction is often assessed using simplified procedures that usually rely on Standard Penetration Test (SPT), Cone Penetration Test (CPT), or shear wave velocity (V_S) measurements in the field. The relative advantages and applicability of these tests was summarized by *Youd et al.* (2001) in Table 2.1. Results of these in-situ tests are compared to the estimated cyclic stress ratio (CSR), which is the uniform cyclic shear stress divided by the initial effective confining stress, for the site of interest to determine the liquefaction susceptibility of the site. An example liquefaction triggering chart for the SPT with several curves from various authors is shown in Figure Figure 2.5, while an example chart for the CPT is shown in Figure 2.6. Several charts have also been developed for sandy soils based on V_S . These charts utilize the overburden stress corrected shear wave velocity, V_{S1} , which is defined using the following equation:

$$V_{S1} = V_S C_V = V_S \left(\frac{P_a}{\sigma'_v} \right)^{0.25} \quad (2.1)$$

Where P_a is atmospheric pressure (101.3 kPa) and σ'_v is the vertical effective stress.

The chart developed by *Andrus and Stokoe* (2000) is shown in Figure 2.7, while the chart developed by *Kayen et al.* (2013) is shown in Figure 2.8. For sandy soils, the V_{S1} value above which liquefaction is not predicted is approximately 200 m/s. *Andrus and Stokoe* (2000) also developed similar charts for sandy and silty soils, as well as gravels as shown in Figure 2.9. For gravelly soils, the same curve that was used for sandy soils was adopted since it fit the data; however, the data on which this chart is based is limited compared to sands. Liquefaction triggering charts have also been placed in a probabilistic framework. *Cetin et al.* (2004) developed probability of liquefaction curves for SPT liquefaction triggering charts as shown in Figure 2.10, while *Moss et al.* (2006) developed probability of liquefaction triggering charts for CPT tests as shown in Figure 2.11. The

Table 2.1: Comparison of Field Testing Techniques for Liquefaction Assessment (after *Youd et al. (2001)*)

Feature	Test Type			
	SPT	CPT	V_S	BPT
Past measurements at liquefaction sites	Abundant	Abundant	Limited	Sparse
Type of stress-strain behavior influencing test	Partially drained, large strain	Drained, large strain	Small strain	Partially drained, large strain
Quality control and repeatability	Poor to good	Very good	Good	Poor
Detection of variability of soil deposits	Good for closely spaced tests	Very good	Fair	Fair
Soil types in which test is recommended	Nongravel	Nongravel	All	Primarily gravel
Soil sample retrieved	Yes	No	No	No
Test measures index or engineering property	Index	Index	Engineering	Index

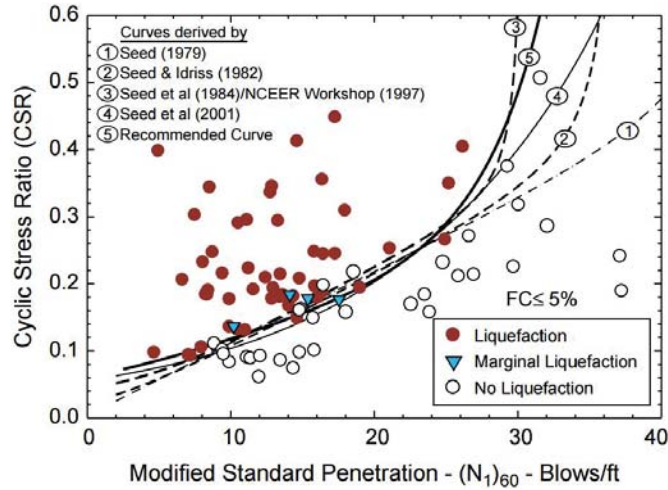

Figure 2.5: SPT Liquefaction Triggering Chart for Sands (*Idriss and Boulanger, 2006*)

Kayen et al. (2013) relationship shown in Figure 2.8 is also probability based.

Since gravelly soils are the focus of this study, it is interesting to note that SPT and CPT can be unreliable for gravelly soils. In order to assess gravelly soils in-situ, several different test methods have been used, including the Becker Penetration Test (BPT), Chinese Dynamic Penetration Test (DPT), and shear wave velocity. Although the use of SPT is not recommended for gravelly soils, *DeJong et al. (2016)* recommends screening the site for gravels as all gravels might not affect SPT blow counts. Additionally, SPT blow counts have been measured in 1 inch increments to try and account for gravelly soils (*DeJong et al., 2016*). The Becker Penetration Test utilizes a closed-end hammer with a diameter of 16.8 cm, and is the only penetrometer that significantly exceeds gravel particle size and has sufficient driving energy for both loose and dense deposits (*DeJong et al., 2016*). A comparison of large penetrometer tests is shown in Figure 2.12 (*DeJong et al., 2016*). However,

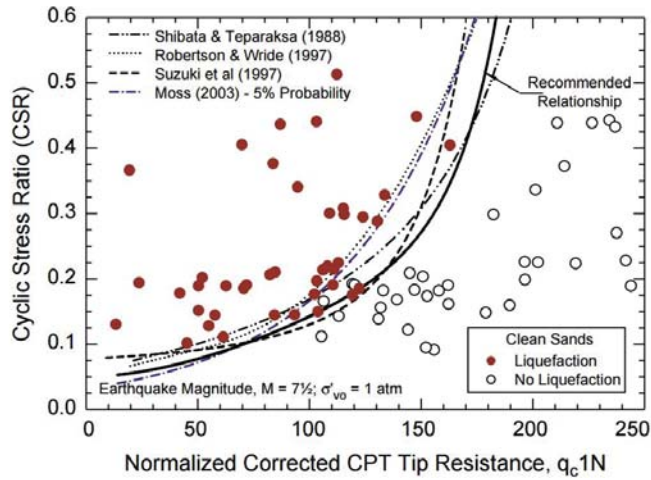

Figure 2.6: CPT Liquefaction Triggering Chart for Sands (*Idriss and Boulanger, 2006*)

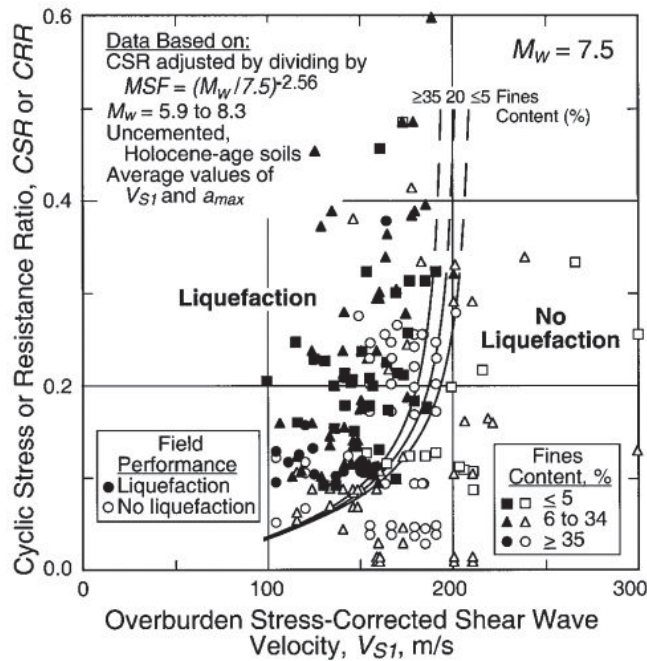

Figure 2.7: V_S -based Liquefaction Triggering Chart for Sands (*Andrus and Stokoe, 2000*)

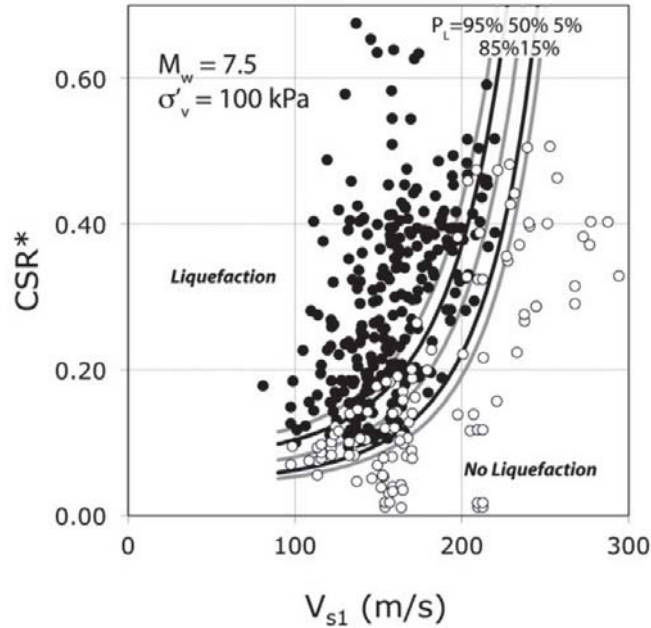

Figure 2.8: Probabilistic V_S -based Liquefaction Triggering Chart for Sands (*Kayen et al.*, 2013)

the BPT can be expensive and difficult to mobilize at project sites and also requires a correlation to SPT N-values for use in liquefaction triggering charts due to lack of BPT data at liquefaction sites. *Harder Jr and Seed* (1986) developed correlations between the BPT and SPT so that SPT liquefaction triggering charts could be utilized using BPT data as shown in Figure 2.13a and updated the figure with more data in Figure 2.13b (*Harder Jr.*, 1997).

The Chinese Dynamic Penetration Test (DPT) offers an alternative to BPT testing, and has been used for the liquefaction assessment of gravelly soils. The DPT is described in further detail in Chapter 6. *Cao et al.* (2013) used the DPT to perform tests at 47 sites following the 2008 Wenchuan earthquake and developed a probabilistic liquefaction triggering chart based on DPT blow counts as shown in Figure 2.14. In addition, *Cao et al.* (2011) measured V_S at the same sites as the DPT and developed a V_S -based liquefaction triggering chart, which shows liquefaction of gravelly soils at V_{S1} values up to approximately 270 m/s (Figure 2.15). This value is much higher than the cutoff of approximately 200 m/s that was proposed in the *Andrus and Stokoe* (2000) chart.

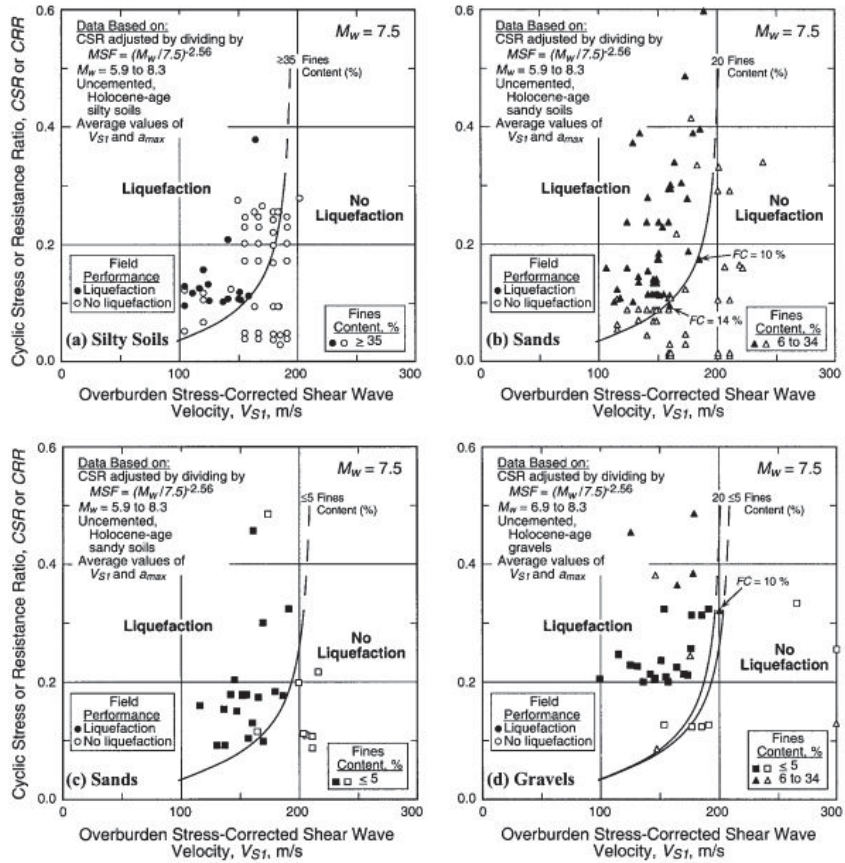

Figure 2.9: V_S -based Liquefaction Triggering Chart for Sands, Silty Sands, and Gravels (Andrus and Stokoe, 2000)

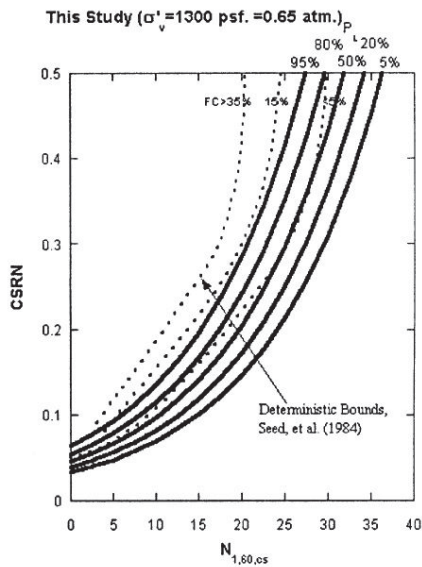

Figure 2.10: Probabilistic SPT Liquefaction Triggering Chart for Sands (Cetin et al., 2004)

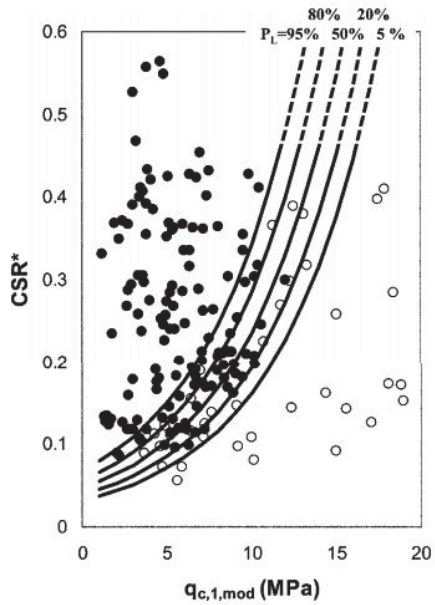

Figure 2.11: Probabilistic CPT Liquefaction Triggering Chart for Sands (*Moss et al., 2006*)

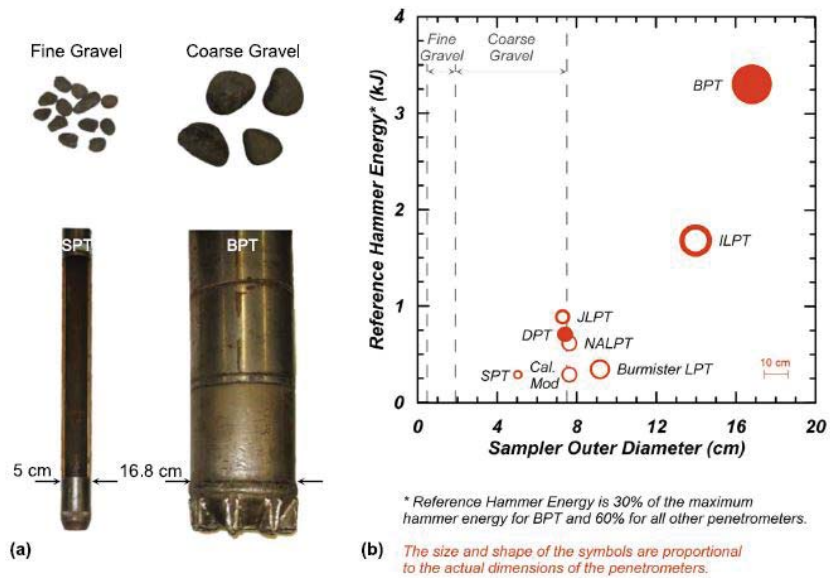

Figure 2.12: Comparison of Penetrometers for Gravel Soil Testing (*DeJong et al., 2016*)

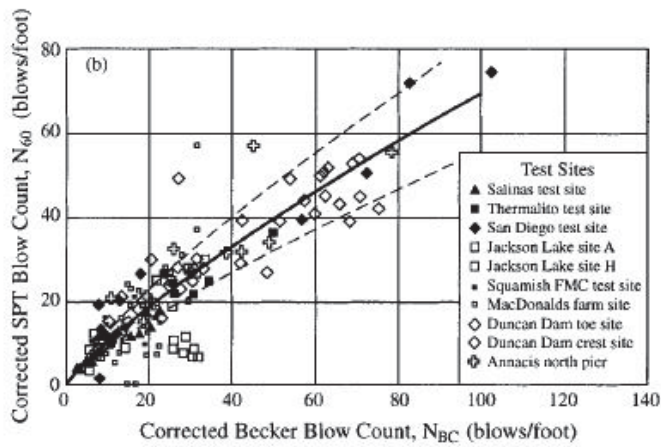
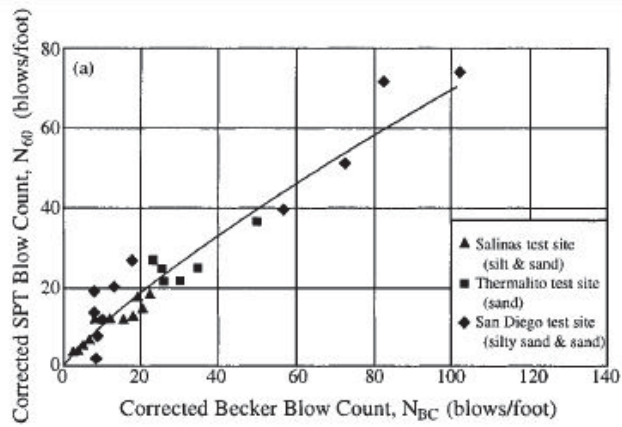

Figure 2.13: BPT to SPT Correlation for gravelly soils from *Harder Jr and Seed* (1986) (top) and *Harder Jr.* (1997) (bottom)

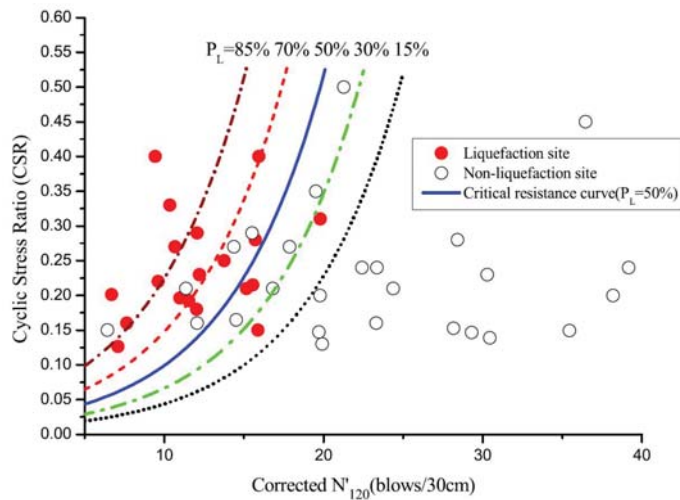

Figure 2.14: DPT liquefaction triggering chart for gravelly soils *Cao et al.* (2013)

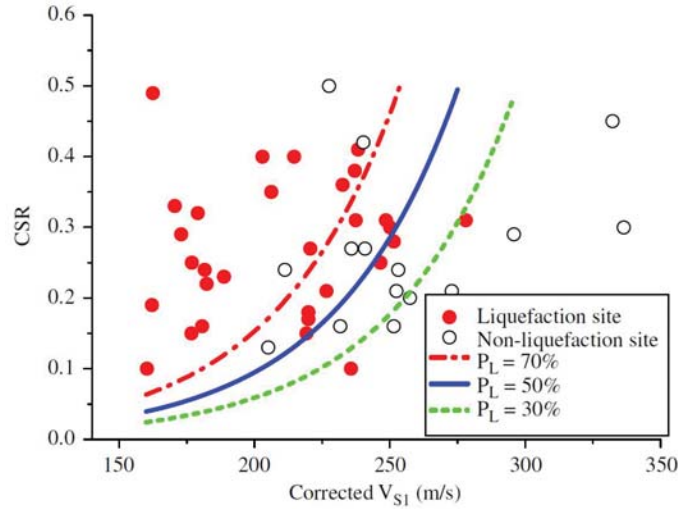

Figure 2.15: V_S -based liquefaction triggering chart for gravelly soils *Cao et al.* (2011)

V_S has been used to assess liquefaction susceptibility in soils since both V_S and liquefaction resistance are influenced by many of the same factors (i.e. void ratio, soil fabric, geologic age, and prior earthquake strains) (*Andrus and Stokoe, 2000; Chen et al., 2005; Dobry et al., 2014*). Shear wave velocity measurement also offers some advantages, including being able to measure properties at a site that is difficult to sample, such as gravelly soils where penetration tests can be unreliable (*Andrus and Stokoe, 2000*). Shear wave velocity can also be measured in the laboratory using bender elements or accelerometers. Previous researchers have shown that the $CRR - V_{S1}$ relationship lines are material dependent (*Tokimatsu et al., 1986; Baxter et al., 2008*). Data for sands from *Tokimatsu et al.* (1986) are shown in Figure 2.16, while data for sands and silts compiled by *Baxter et al.* (2008) are shown in Figure 2.17. This laboratory based data all falls slightly below the field derived relationships; however, these are material dependent. For Niigata Sand tested by (*Tokimatsu et al., 1986*) the laboratory data would have correctly predicted liquefaction from the field charts. Therefore, each material can have a different line that may be different than the overall field derived liquefaction triggering relationships, which are based on many different sand types (i.e. different particle morphology). The comparison between laboratory and field data shows that laboratory based relationships are reliable and can be compared

with field derived relationships, but may fall above or below field relationships based on the material tested in the laboratory (*Baxter et al., 2008*).

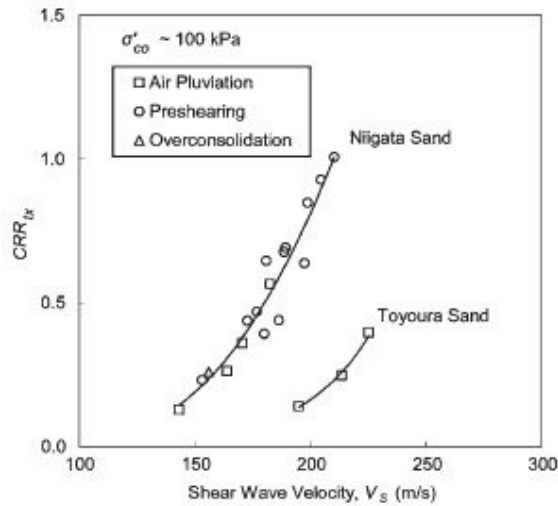

Figure 2.16: Comparison of CRR versus V_{S1} for Sands (*Tokimatsu et al., 1986*)

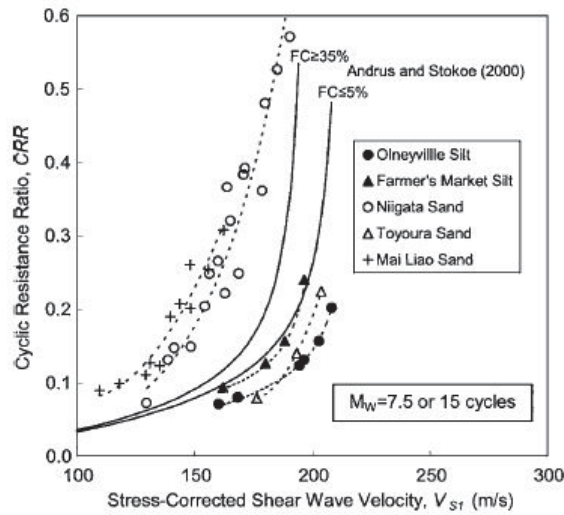

Figure 2.17: Comparison of CRR versus V_{S1} for Sands and Silts (*Baxter et al., 2008*)

2.3 Post-Liquefaction Residual Shear Strength

After assessing that a site is susceptible to liquefaction, it is equally important to evaluate the post-liquefaction undrained shear strength (or residual shear strength) as well as

volumetric strains (i.e. settlements) following liquefaction. The post-liquefaction strength can be determined by sampling and laboratory testing (if possible) or most commonly by using simplified charts based on back calculation of field case histories with in-situ index tests (*Seed et al., 2003*).

Laboratory testing can provide valuable insight into the material response; however, the testing conditions influence the results. It has been shown that simple shear testing provides lower undrained residual strength values than the triaxial compression test. Another issue with laboratory testing of undrained residual strengths, as well as other laboratory shear tests, is sample disturbance from transport or reconstitution in the laboratory (*Seed et al., 2003*). Shear wave velocity measurements before sampling and after consolidation in the laboratory can aid in comparing the laboratory specimen to the in-situ soil. Post-liquefaction shear strength has been evaluated in the laboratory for sands (*Vaid and Thomas, 1995; Vaid and Sivathayalan, 1997; Sivathayalan and Yazdi, 2013*) to provide further understanding of parameters that affect its response. Three distinct phases were observed during post-liquefaction shearing as shown in Figure 2.18. Initially (Phase I) the soil has nearly zero shear strength following liquefaction. Upon further shearing, the specimen begins to gain shear strength (Phase II) until it reaches a constant modulus at larger strains (Phase III). Data from *Vaid and Thomas (1995)* shows that the modulus at larger strains is very similar for pre-liquefaction and post-liquefaction tests (Figure 2.19) *Vaid and Thomas (1995)* found that post-liquefaction strength is dependent on the confining stress level as well as relative density. *Sivathayalan and Yazdi (2013)* found that the liquefied shear strength depends on relative density, loading mode, and consolidation stress as well as the maximum shear strain during cyclic loading (although to a lesser extent). The liquefied shear strength measured in triaxial testing was significantly higher than that of simple shear testing, which highlights the importance of using the correct laboratory test (*Sivathayalan and Yazdi, 2013*). Results from *Sivathayalan and Yazdi (2013)* from simple shear testing of sands gave values of liquefied shear strength that plotted near or above the

relationships from *Seed and Harder* (1990) and *Stark and Mesri* (1992) as shown in Figure 2.20 and Figure 2.21, respectively. Particle angularity was also shown to have an effect, with the angular Fraser River Sand exhibiting higher liquefied shear strength values than rounded silica sand.

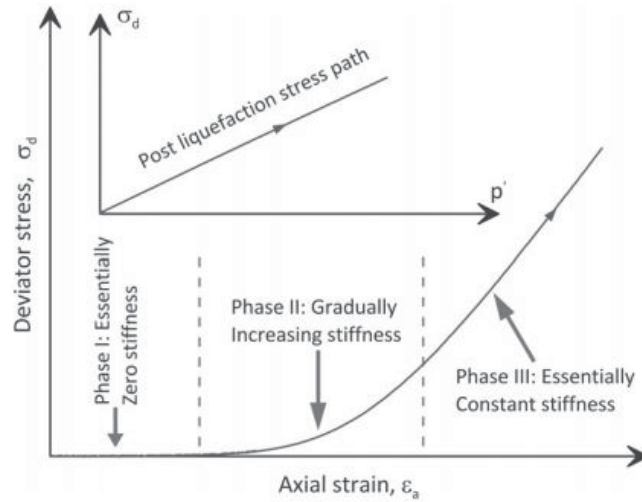

Figure 2.18: Post-Liquefaction Stress Paths from Laboratory Testing (*Sivathayalan and Yazdi, 2013*)

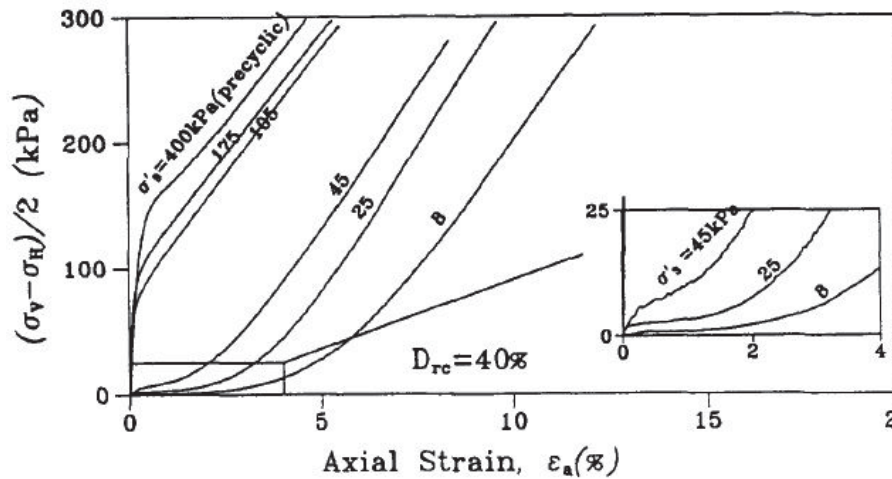

Figure 2.19: Pre-Liquefaction and Post-Liquefaction Stress-Strain Response (*Vaid and Thomas, 1995*)

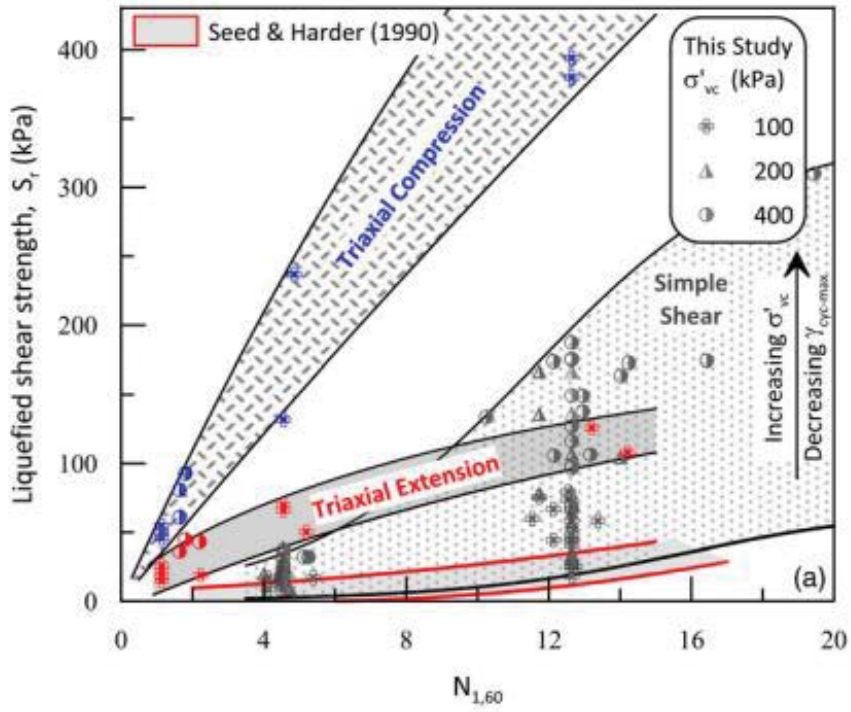

Figure 2.20: Comparison of Liquefied Shear Strength from Various Laboratory Tests with *Seed and Harder (1990)* (*Sivathayalan and Yazdi, 2013*)

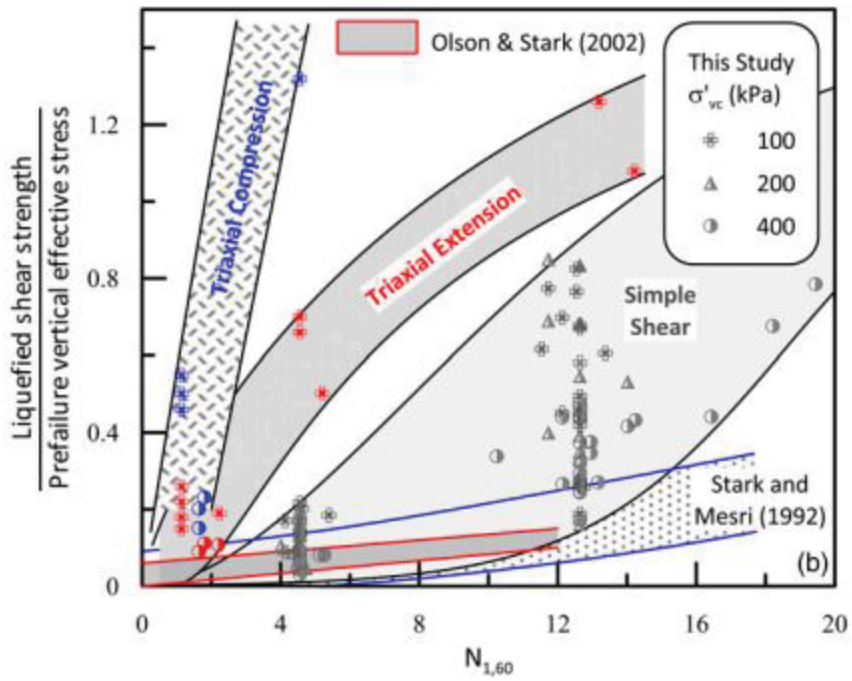

Figure 2.21: Comparison of Liquefied Shear Strength Ratio from Various Laboratory Tests with *Stark and Mesri (1992)* (*Sivathayalan and Yazdi, 2013*)

Simplified charts have also been developed to estimate the post-liquefaction undrained residual strength. These charts are based on back-analysis of liquefaction case histories where values of the undrained critical shear strength are calculated. *Seed and Harder* (1990) developed a relationship shown in Figure 2.22 for the residual undrained shear strength versus the equivalent clean sand SPT blow count. There are 17 data points on this chart (10 from field cases where SPT and residual shear strengths were available, 5 from cases where data was estimated, and 2 from construction induced liquefaction). Alternatively, *Stark and Mesri* (1992) normalized the residual shear strength (or critical undrained shear strength in their case) by the initial vertical effective stress. The advantage of the normalized approach is that stress dependency can be incorporated in a post-liquefaction stability analysis. The chart developed by *Stark and Mesri* (1992) is shown in Figure 2.21. *Stark and Mesri* (1992) also combined laboratory data with the field case histories and showed the ability to estimate the undrained critical strength ratio through laboratory or field data (shown in Figure 2.23). These relationships utilize SPT blow counts; however, relationships have also been explored based on V_S measurements. *Fear and Robertson* (1995) developed a similar chart based on laboratory triaxial tests and measurements of V_S based on bender elements in the laboratory for sands as shown in (Figure 2.25). The authors noted that their strength values were higher than *Seed and Harder* (1990), which is expected since they were performing triaxial compression tests which *Sivathayalan and Yazdi* (2013) showed to give much higher values of liquefied shear strength. *Özener* (2012) compiled case history data for lateral spreads and plotted undrained residual shear strengths and V_{S1} values from the field. Values from existing relationships that utilized SPT were converted to V_S values through existing relationships. *Özener* (2012) concluded that the use of the undrained residual shear strength normalized by the initial vertical effective stress resulted in a stronger correlation with V_{S1} than the non-normalized undrained residual shear strength value. The plots developed by *Özener* (2012) are shown in Figures 2.26 and 2.27.

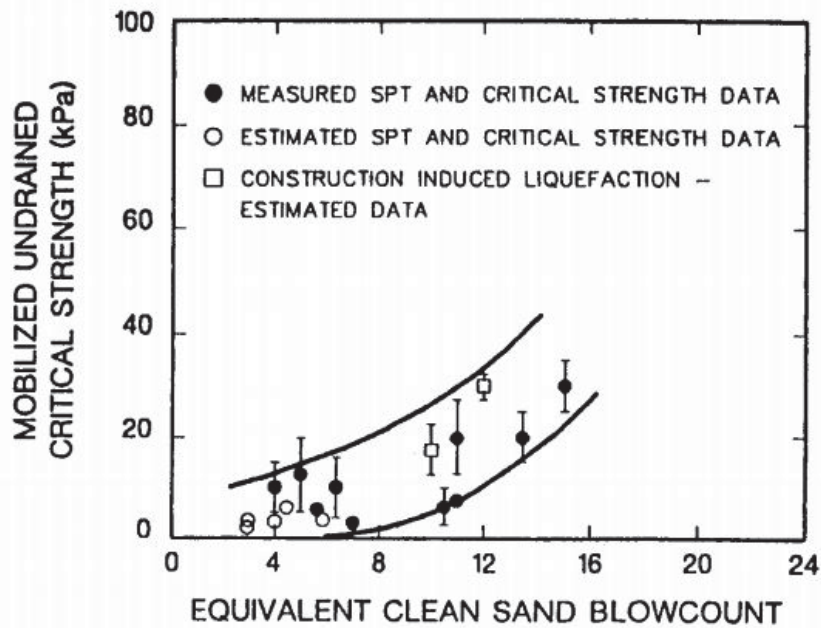

Figure 2.22: Residual Undrained Shear Strength versus Equivalent Clean Sand Blow count (*Seed and Harder, 1990*)

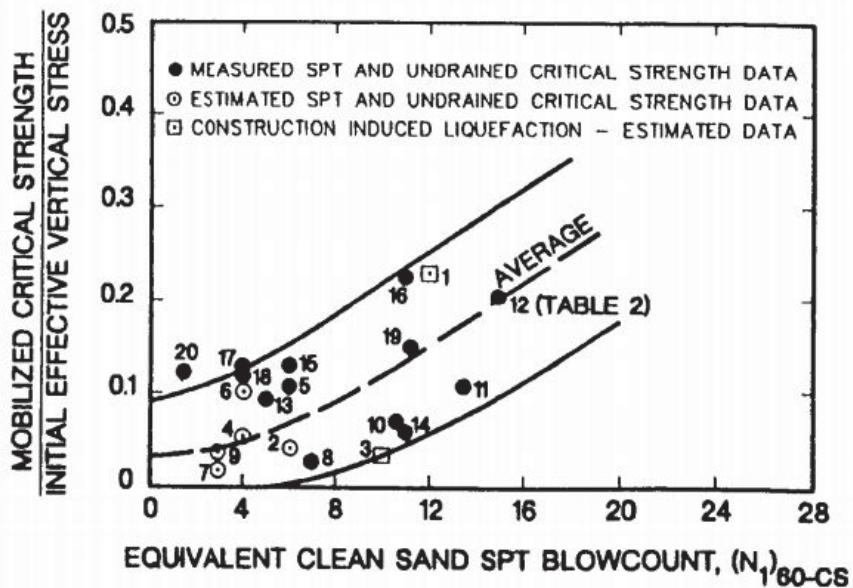

Figure 2.23: Mobilized Undrained Critical Shear Strength Normalized by Initial Vertical Stress (*Stark and Mesri, 1992*)

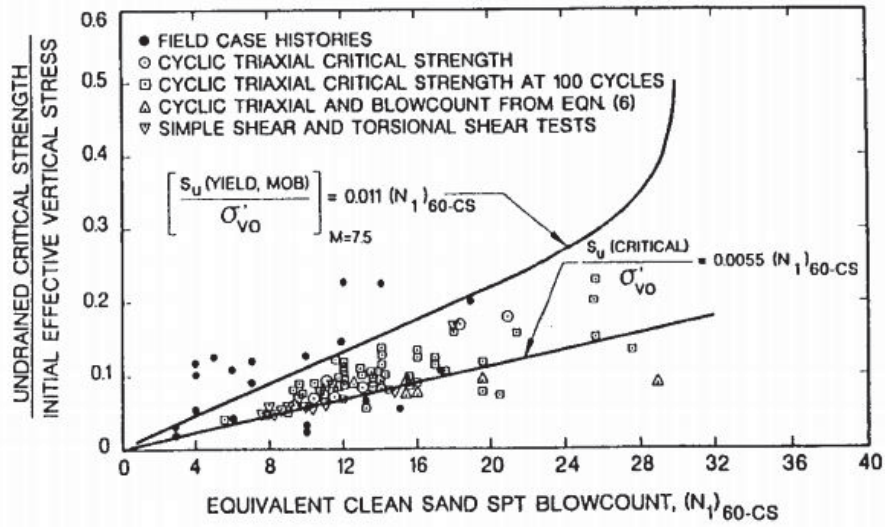

Figure 2.24: Undrained Critical Shear Strength Normalized by Initial Vertical Stress for Field and Laboratory Data (*Stark and Mesri, 1992*)

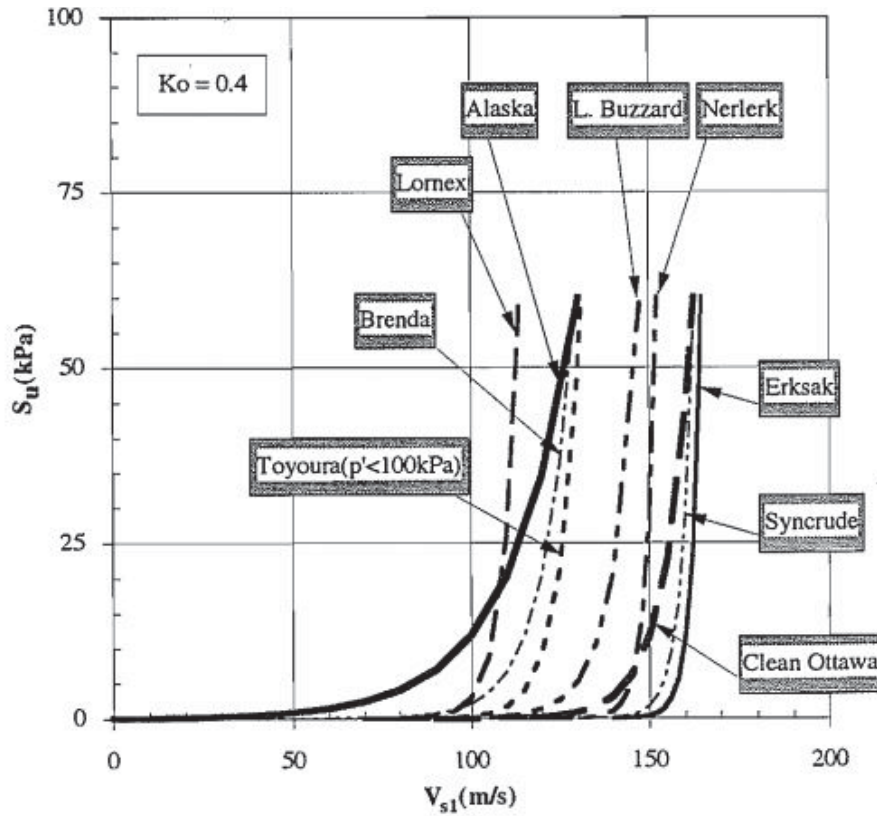

Figure 2.25: Undrained Shear Strength versus V_{s1} for various Sands (*Fear and Robertson, 1995*)

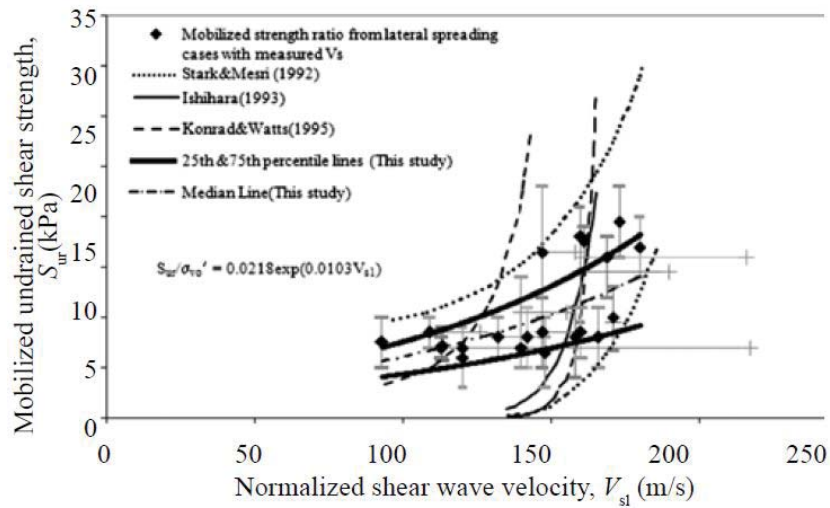

Figure 2.26: Undrained Shear Strength versus V_{S1} for Sands based on lateral spreading case histories (Özener, 2012)

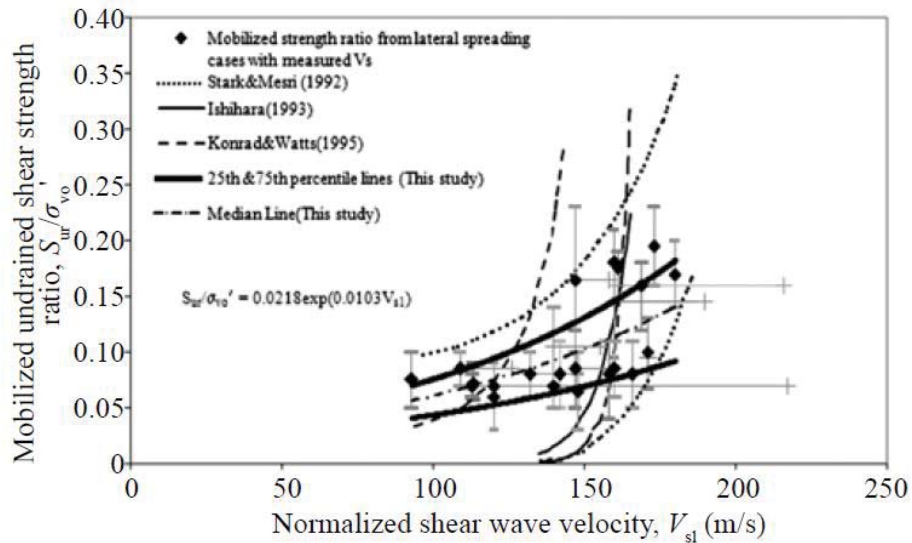

Figure 2.27: Undrained Shear Strength Normalized by Initial Vertical Stress versus V_{S1} for Sands based on lateral spreading case histories (Özener, 2012)

Estimation of post-liquefaction volumetric strain (settlement) is also important for liquefaction analysis at a site. Charts have been developed for sands for evaluating the expected settlement at a liquefied site. Common charts include the *Ishihara and Yoshimine* (1992) (Figures 2.28 and 2.29) and *Tokimatsu and Seed* (1987) (Figure 2.30). *Ishihara and Yoshimine* (1992) found post-liquefaction volumetric strain to depend on relative density and maximum shear strain during the cyclic tests. *Yi* (2010) converted *Yoshimine et al.* (2006) data and developed a new chart based on V_{S1} instead of relative density (Figure 2.31) These relationships are for clean sands and limited data exists for gravelly soils. *Kokusho et al.* (2004) performed some post-liquefaction recompression tests on gravelly soils as shown in Figure 2.32. *Hara et al.* (2012) also performed post-liquefaction reconsolidation tests and found the amount of reconsolidation to depend on the coefficient of uniformity for gravelly soils (Figure 2.33).

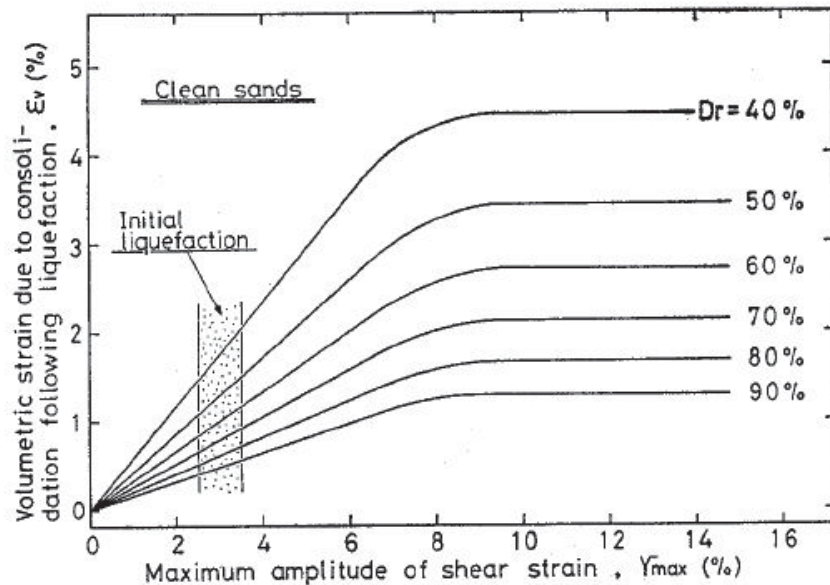

Figure 2.28: Post-Liquefaction Volumetric Strain for Sands based on D_r and Maximum Strain during Shearing (*Ishihara and Yoshimine, 1992*)

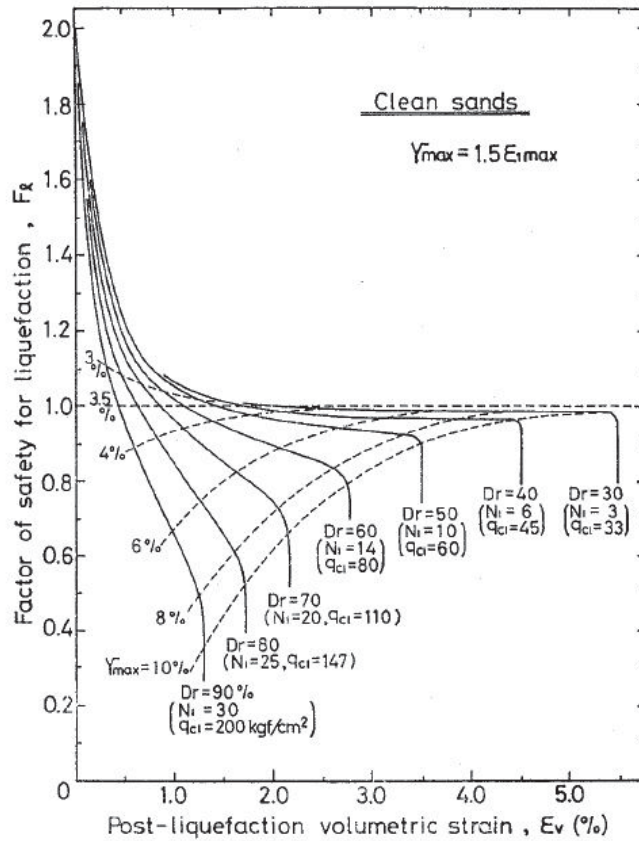

Figure 2.29: Post-Liquefaction Volumetric Strain for Sands based on D_r and Maximum Strain during Shearing and Factor of Safety for Liquefaction (Ishihara and Yoshimine, 1992)

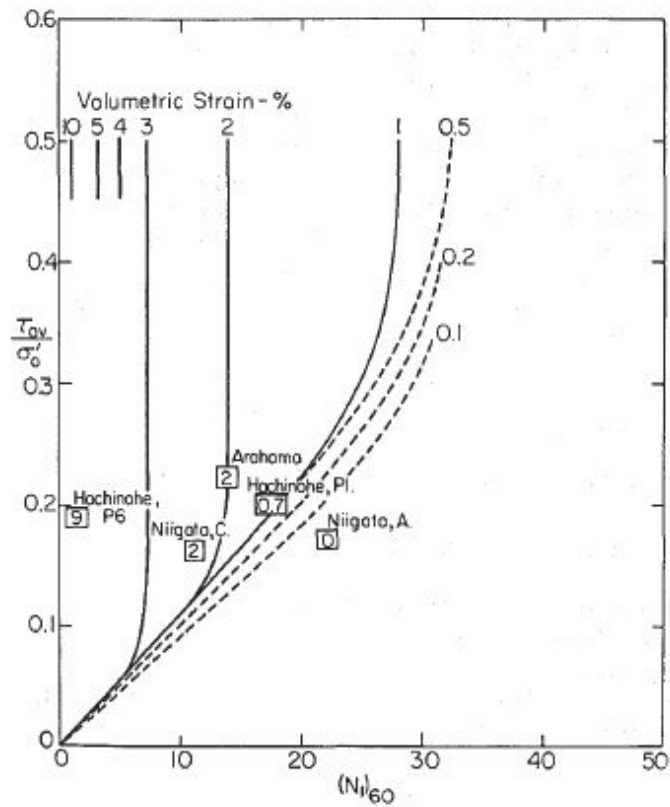

Figure 2.30: Post-Liquefaction Volumetric Strain based on SPT blow counts and CSR (Tokimatsu and Seed, 1987)

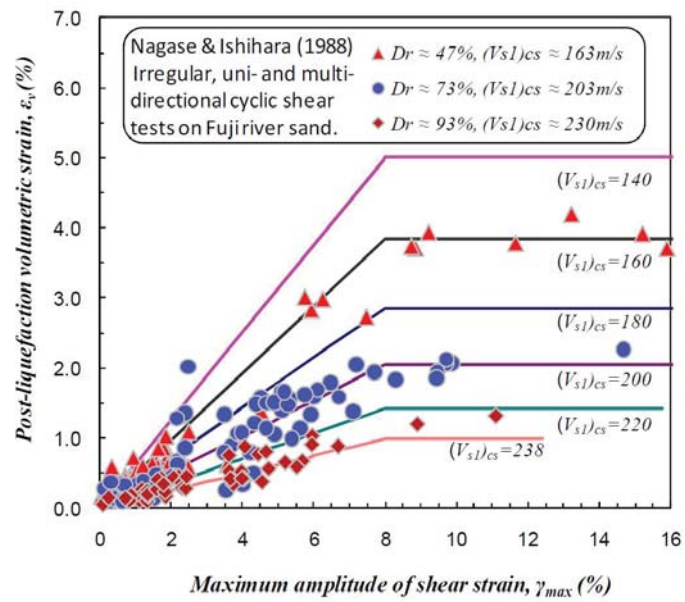

Figure 2.31: Post-Liquefaction Volumetric Strain for Sands based on V_{S1} and Maximum Strain during Shearing (Yi, 2010)

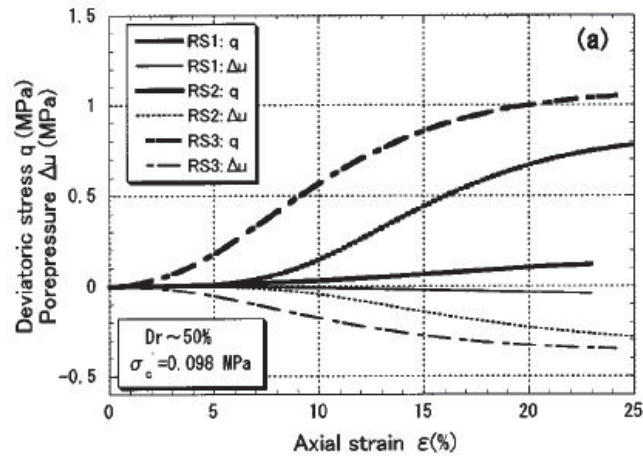

Figure 2.32: Post-Liquefaction Volumetric Strain for Gravelly Soils (*Kokusho et al., 2004*)

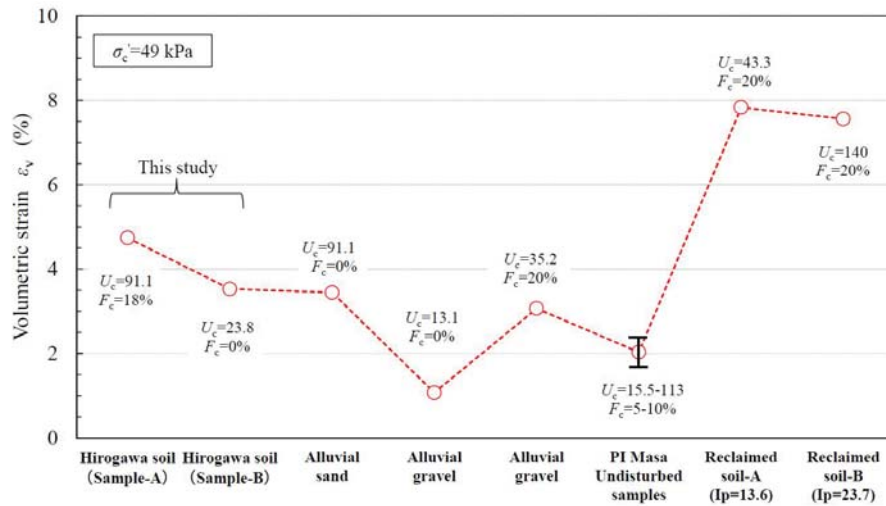

Figure 2.33: Post Cyclic Settlement for various gravelly and reclaimed soils (*Hara et al., 2012*)

2.4 Liquefaction of Gravelly Soils in the Field

Historical and recent earthquakes have shown that gravelly soils can liquefy during an earthquake. In this section, brief overviews of case histories that report gravel liquefaction will be discussed. *Kishida* (1969) and *Tokimatsu and Yoshimi* (1983) report that a clean gravelly sand liquefied during the Mino-Owari 1891 earthquake ($M = 7.9$). Liquefaction occurred in the town of Unuma and Osage pond near the Kiso River in Japan. The soil that liquefied was approximately 25% gravel and had a mean grain size of 0.7 mm - which would be indicative of a sand. It was reported that the gravelly soil was capped by a clayey soil layer that was 2-3 m thick. *Youd and Hoose* (1978) summarized that liquefaction of gravelly soils occurred during the 1906 San Francisco Earthquake ($M=8.3$) near the Russian River. It was reported that there was a blow-hole (from water and soil blowing out of the ground due to pore pressures) that was 4.5 ft wide and 2 feet deep where coarse river gravel came up. *Berrill et al.* (1988) reported that coarse sand which included pebbles up to 15 to 30 mm in diameter were included in the ejected at Anderson's Farm during the 1929 Murchison Earthquake in New Zealand ($M = 7.6$). *Ishihara* (1985) reported that gravelly soils liquefied near the epicenter of 1948 Fukui earthquake ($M = 7.3$) in a fan deposit.

Gravelly soil liquefaction was also observed during the 1964 Alaska Earthquake (*Walsh et al.*, 1995). *Walsh et al.* (1995) reported that at some sites the gravel matrix dominated (gravel particles formed soil structure) and these sites still liquefied. Other sites that observed liquefaction had gravel particles floating in the matrix of the finer soil. The authors observed 150 clastic dikes and sills in the Portage and Twentymile River area that were attributed to liquefaction during the 1964 earthquake (of the 150 dikes, 27 contained pebble-sized gravel). The coarsest grained dike had a mean grain size diameter of 4 mm and was approximately 78% gravel content. *Koester et al.* (2000) visited gravelly soil liquefaction sites from the 1964 Alaska earthquake in Seward, Alaska and performed in-situ penetration tests and crosshole shear wave velocity measurements in gravelly soils. Results of V_S measurements are shown in Figure 2.34, where V_{S1} values were all above 200 m/s and as

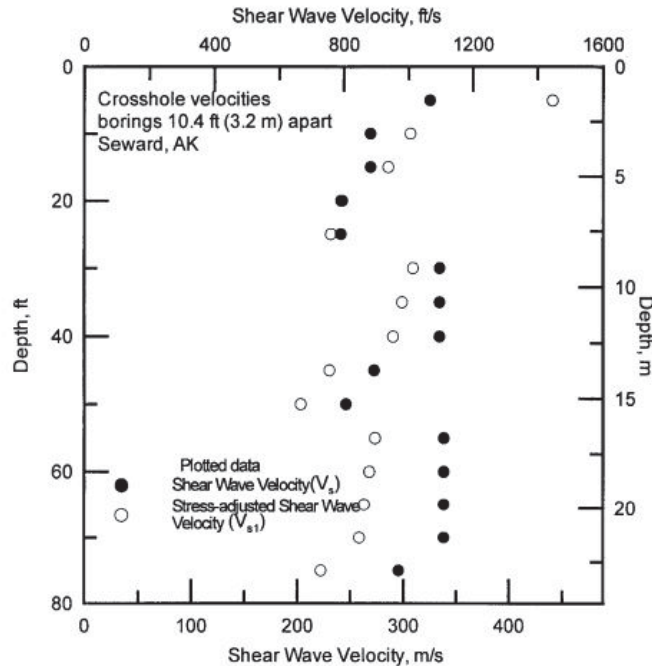

Figure 2.34: Shear wave velocity measured at a gravelly soil liquefaction site from 1964 Alaska earthquake (Koester *et al.*, 2000)

high as 300 m/s. The authors note that these values are above the generally accepted value of 215 m/s as a V_S value cut-off for soils with less than 5% fines (Youd *et al.*, 2001). This 215 m/s cut-off roughly corresponds to an $N_{1,60}$ value of 30 blow counts, which would be indicative of no liquefaction. However, Rollins *et al.* (1998) found a V_S of approximately 232 m/s corresponding to a $N_{1,60}$ value of 30.

Wang (1984) reported that the upstream sand and gravel shell of the Shimen Dam liquefied during the 1975 Haichang earthquake ($M = 7.3$). Wang (1984) also reported liquefaction in the upstream gravelly sand slope of the Baihe Dam during the 1976 Tangshan earthquake ($M = 7.8$). The earthquake caused a slide of 150,000 cubic meters of gravelly soils.

Youd *et al.* (1985) described the liquefaction of gravelly soils that were observed during the 1983 Borah Peak earthquake in Idaho. This case-history represents the first well-documented case-history of gravelly soil liquefaction where comprehensive geotechnical investigations were performed following the earthquake. Figure 2.35 shows the grain size

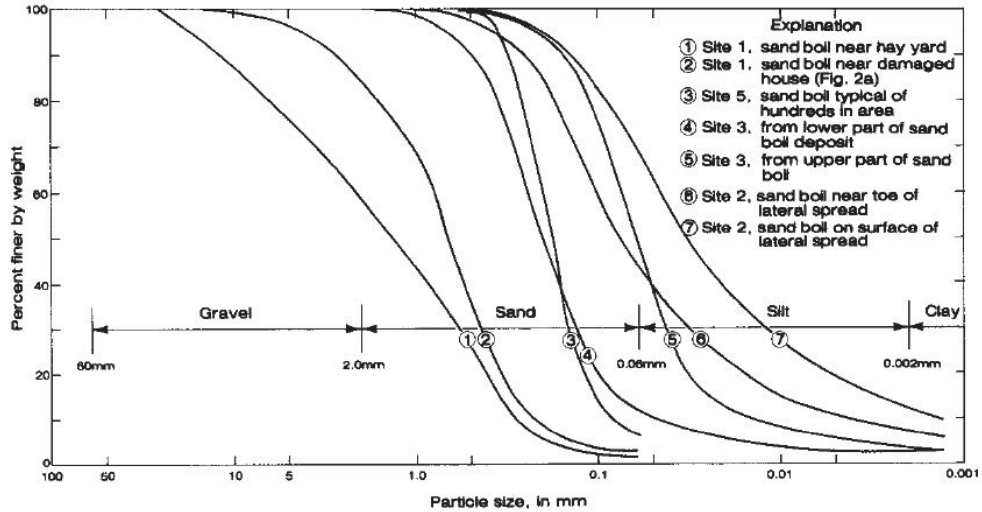

Figure 2.35: Grain size distributions of ejected materials found following the 1983 Borah Peak earthquake (Youd *et al.*, 1985)

Table 2.2: Test Results of Penetration Resistance and Shear Wave Velocity (after Andrus *et al.* (1992))

Site	Depth (m)	V_S (m/s)	CPT q_c (MPa)	SPT N (blows/ft)
Pence Ranch	1.5 - 3.3	92 - 150	3 - 18	3 - 16
Andersen Bar	1.0 - 3.2	87 - 130	-	-
Whiskey Springs	1.8 - 4.0	172 - 190	1 - 15	3 - 14
Larter Ranch	2.0 - 4.5	157 - 190	6 - 18	5 - 18

distributions of various sand boils that were found after the earthquake. Site 1 had gravelly soils present in the ejected soils. The effects of the gravelly soil liquefaction are shown in Figures 2.36, 2.37, and 2.38. Andrus *et al.* (1992) performed Spectral Analysis of Surface Waves (SASW) and crosshole seismic tests at four sites where gravelly soil liquefaction was observed during the 1983 Borah Peak earthquake. The grain size distributions of the materials at the four sites are shown in Figure 2.39. The V_S profiles for the sites are shown in Figure 2.40 and test results for penetration and V_S tests are given in Table 2.2. The measured V_S at the sites was fairly low, with V_S values all below 190 m/s. Andrus *et al.* (1992) plotted the gravelly soil liquefaction points with the Finn (1991) relationship for liquefaction in Figure 2.41 and found that the sandy soil liquefaction curve correctly predicted liquefaction for the gravelly soils that were tested.



Figure 2.36: Ejected soils, including sand and gravel, observed following the 1983 Borah Peak earthquake (*Youd et al.*, 1985)



Figure 2.37: Ground fissure observed following the 1983 Borah Peak earthquake (*Youd et al.*, 1985)



Figure 2.38: Ground fissure observed following the 1983 Borah Peak earthquake (*Youd et al., 1985*)

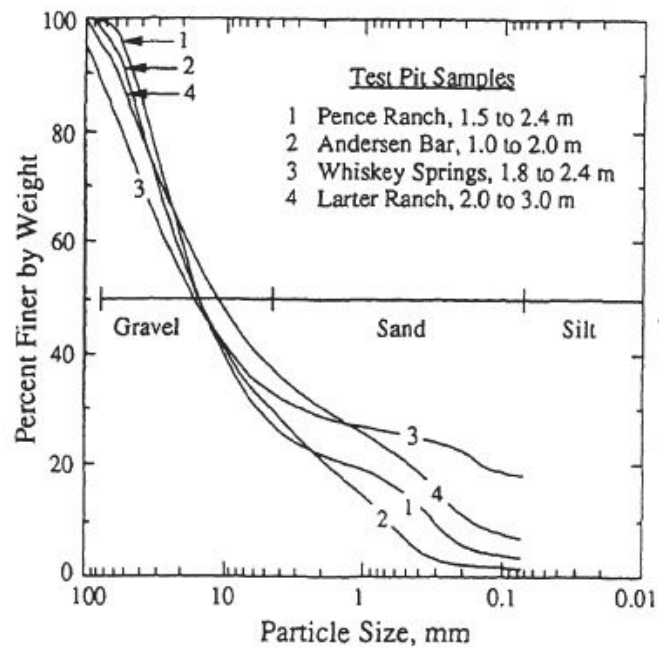

Figure 2.39: Grain size distributions of tested materials taken from test pit (*Andrus et al., 1992*)

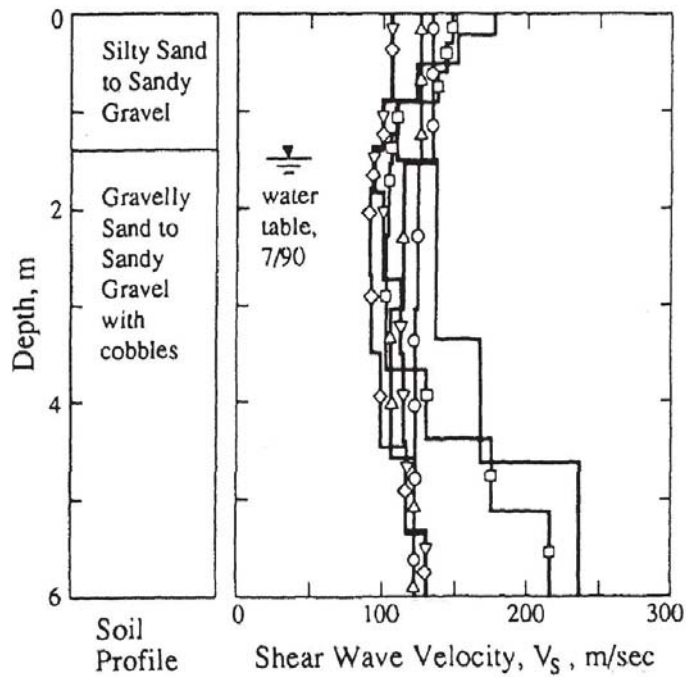

Figure 2.40: Shear wave velocity results for test sites from 1983 Borah Peak earthquake (Andrus et al., 1992)

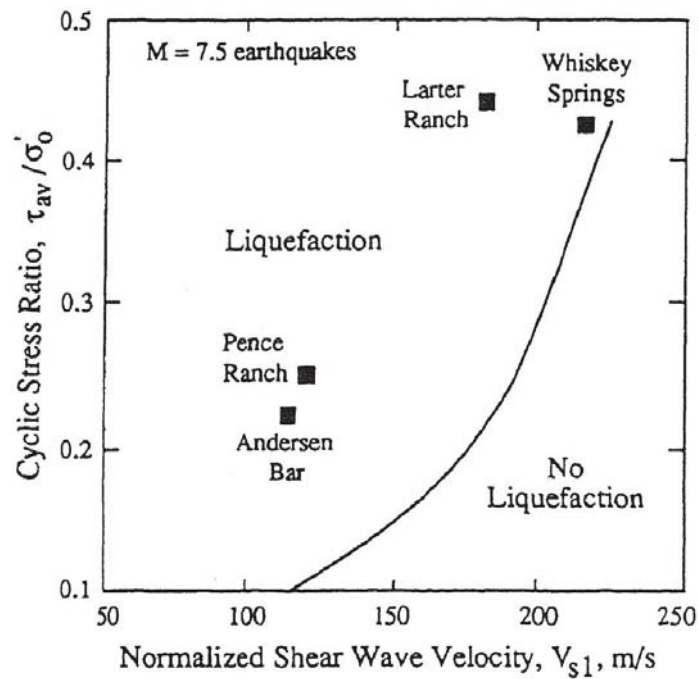

Figure 2.41: Comparison of gravelly soil liquefaction sites from 1983 Borah Peak earthquake with sandy soil liquefaction triggering curve (Andrus et al., 1992)

Yegian et al. (1994) reported the liquefaction of gravelly soils during the 1994 Armenia earthquake ($M=6.8$) at two sites. The first site was a highway embankment that failed due to the liquefaction of gravelly soils. The embankment failure is shown in Figure 2.42, while nearby sand boils are shown in Figure 2.43. Gravel particles were reported to be lodged in the sand boil hole. A profile of the embankment is shown in Figure 2.44 and the grain size distributions of the materials at the site are shown in Figure 2.45. *Yegian et al.* (1994) performed a post-liquefaction stability analysis and found that the gravelly soils had a residual shear strength that was similar to that of clean sands (5-13 kPa); however, the SPT N-value for these gravelly soils was approximately 12 blows/ft while the SPT N-value for clean sands with a residual shear strength of 5-13 kPa is 2-4 blows/ft. This shows that although the gravelly soils have a significantly higher N-value, they exhibit residual shear strengths near that of clean sands. Similar results were also observed at a second site, where a railway embankment failed as shown in Figure 2.46. A profile of the embankment is shown in Figure 2.47 and the grain size distributions of the gravelly soils that liquefied are plotted in Figure 2.48. A post-liquefaction stability analysis was also performed at this site and the residual shear strength was estimated to be between 5 and 6.2 kPa. Similar to site 1, the SPT N-values were 4-14 blows/ft, which are significantly greater than clean sands with a residual shear strength of 5-6.2 kPa. In both cases where liquefaction of gravelly soils was observed, there was an impermeable layer preventing drainage above the gravelly sand layer.

Kokusho et al. (1995) reported liquefaction of gravelly soil deposits during the Hokkaido-Nansei-Oki earthquake ($M = 7.8$). The authors tested the gravelly soils in situ using V_S methods and the large penetration test (LPT) and also obtained frozen samples of the gravelly soil to test in the laboratory. Average V_S values measured in the field were 100 m/s and based on the laboratory tests, the authors concluded that the gravelly soil was susceptible to liquefaction.

Liquefaction of gravelly soils was also observed during the 1995 Kobe earthquake in



Figure 2.42: Liquefaction of roadway embankment, 1988 Armenia earthquake (*Yegian et al., 1994*)



Figure 2.43: Sand boil observed near roadway embankment, 1988 Armenia earthquake (*Yegian et al., 1994*)

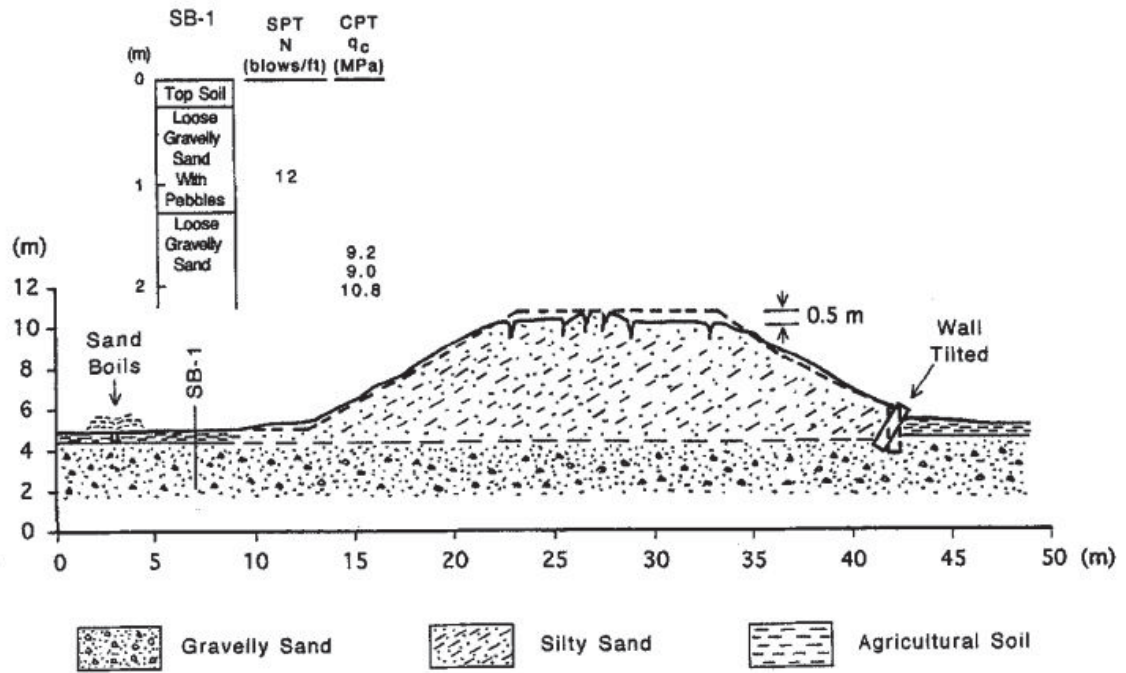

Figure 2.44: Soil Profile of roadway embankment, 1988 Armenia earthquake (Yegian et al., 1994)

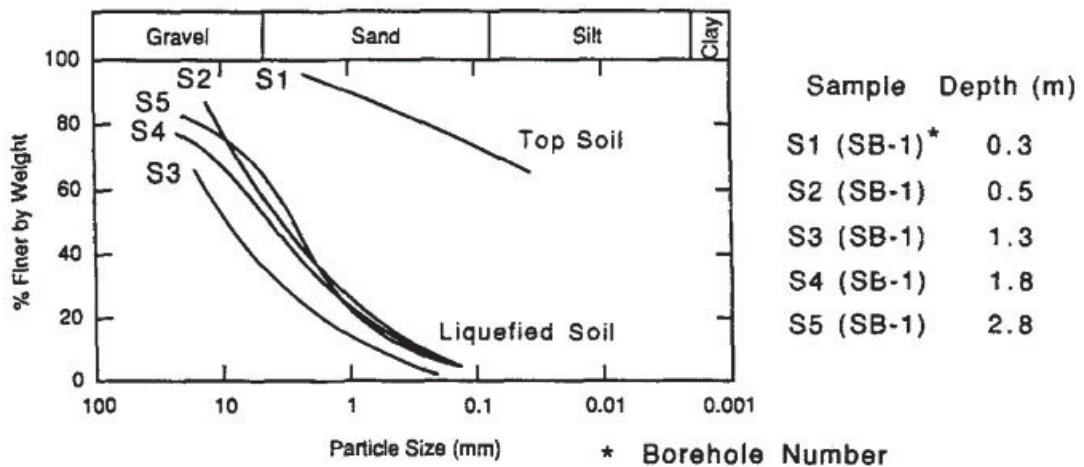

Figure 2.45: Grain size distributions of roadway embankment and foundation soils, 1988 Armenia earthquake (Yegian et al., 1994)



Figure 2.46: Liquefaction of railway embankment, 1988 Armenia earthquake (Yegian *et al.*, 1994)

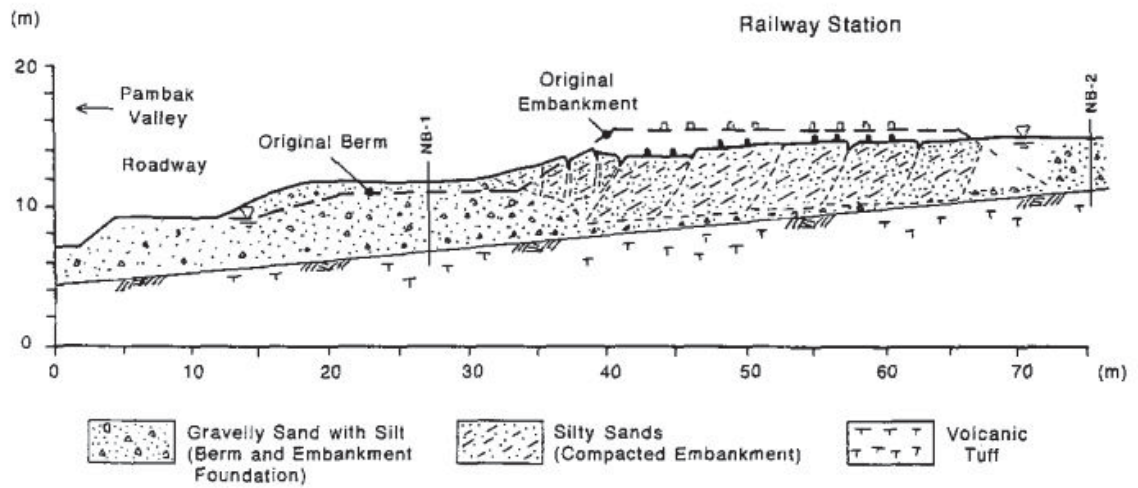

Figure 2.47: Soil Profile of railway embankment, 1988 Armenia earthquake (Yegian *et al.*, 1994)

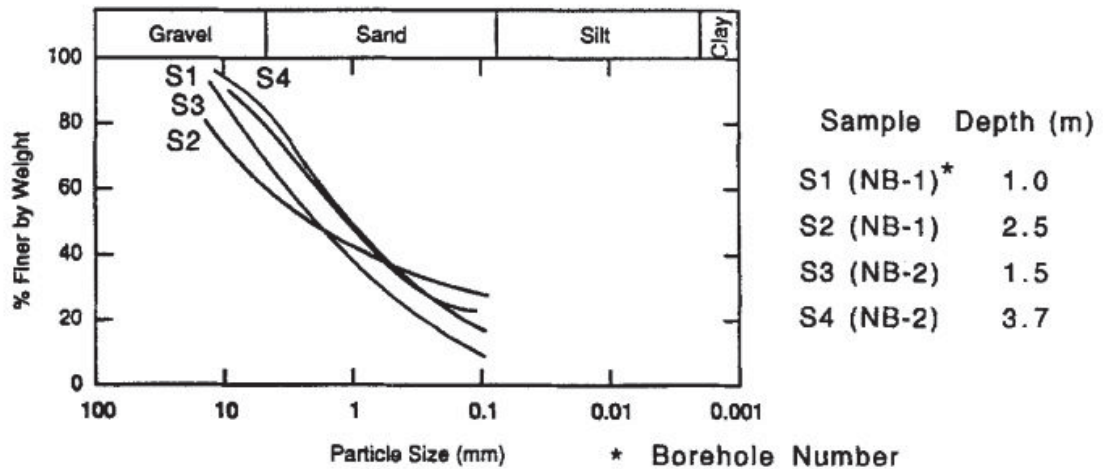

Figure 2.48: Grain size distributions of railway embankment and foundation soils, 1988 Armenia earthquake (Yegian *et al.*, 1994)

Japan. Figure 2.49 shows gravelly soils that were ejected from the ground during the Kobe earthquake (Hamada, 2014). Cubrinovski *et al.* (2001) investigated some of the gravelly soils that liquefied during the earthquake and found that the soil is well-graded and contained sand, some fines, and a large portion of gravel (35-60%). Results of cyclic triaxial tests of these soils are shown in Figure 2.50. Soga (1998) reported that gravelly soil fill materials on Port and Rokko islands settled 20-50 cm and that large lateral displacements occurred (as much as 5 m).

Liquefaction of gravelly soils has also been observed in more recent earthquakes, including the 2008 Wenchuan earthquake in China (Cao *et al.*, 2011, 2013), the 2011 Tohoku earthquake in Japan (Towhata *et al.*, 2014), and the 2014 Cephalonia Earthquake in Greece (Nikolaou *et al.*, 2014). Significant liquefaction of gravelly soils was observed during the 2008 Wenchuan earthquake, and a typical liquefaction boil is shown including gravelly soils in Figure 2.51 (Cao *et al.*, 2011, 2013). A profile of the Chengdu plain where gravelly soil liquefaction occurred is shown in Figure 2.52, and grain size distributions of liquefied gravelly soils and non-liquefied gravelly soils are plotted in Figure 2.53. Extensive investigation of 47 sites was performed after the earthquake using Chinese Dynamic Penetration Testing (DPT) and V_S measurements (Cao *et al.*, 2011, 2013). Liquefaction



Figure 2.49: Observed gravelly soils ejected from the ground during liquefaction, 1995 Kobe earthquake (*Hamada, 2014*)

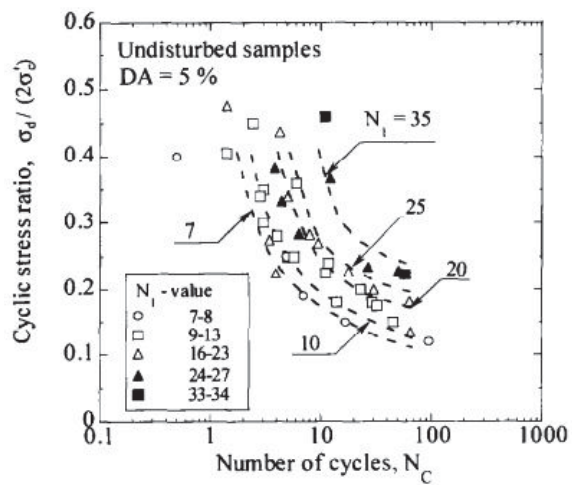

Figure 2.50: Cyclic Triaxial Results of gravelly Masado soil from 1995 Kobe earthquake (*Cubrinovski et al., 2001*)



Figure 2.51: Observed gravelly soils ejected from the ground during liquefaction, 2008 Wenchuan earthquake (*Cao et al.*, 2013)

triggering charts were developed based on these tests, as was discussed previously. The 2014 Cephalonia earthquakes occurred on January 26 and February 3, 2014 in Cephalonia, Greece. Significant liquefaction was observed in the ports of Lixouri and Argostoli. A photograph of ejected soils, which included gravel particles, is shown in Figure 2.54. The liquefaction of the ports of Lixouri and Argostoli will be more extensively examined in Chapter 6. The observations from these historical and recent earthquakes, show that gravelly soils can liquefy during earthquakes, but the behavior of these soils during earthquake events is still not fully understood.

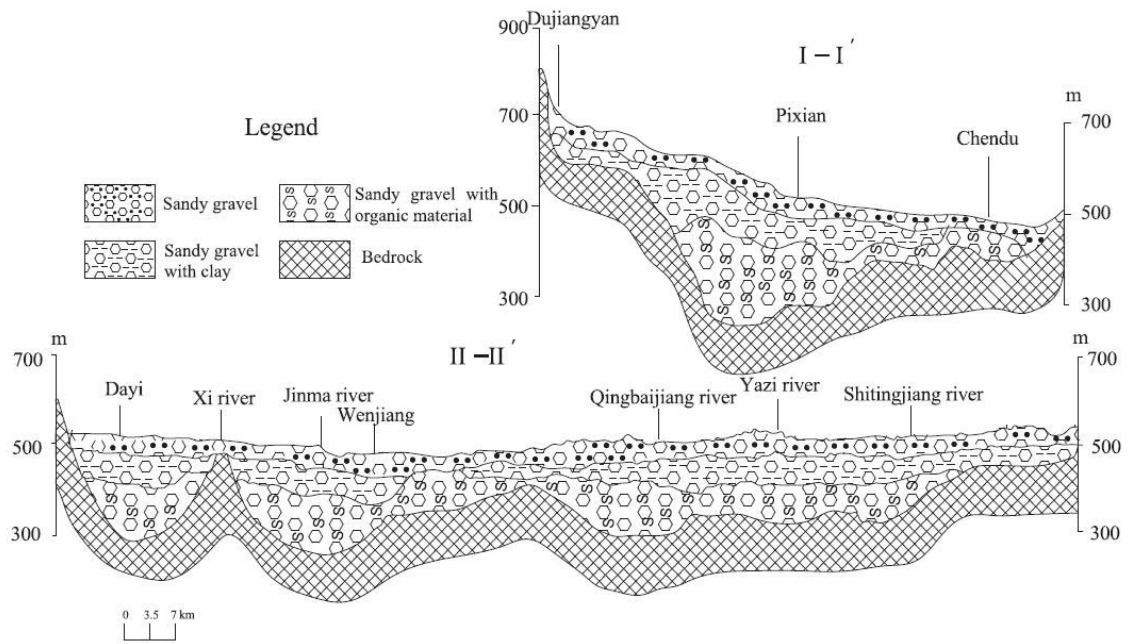

Figure 2.52: Soil Profile of Chengdu Plain which saw significant gravel liquefaction during 2008 Wenchuan earthquake (Cao et al., 2013)

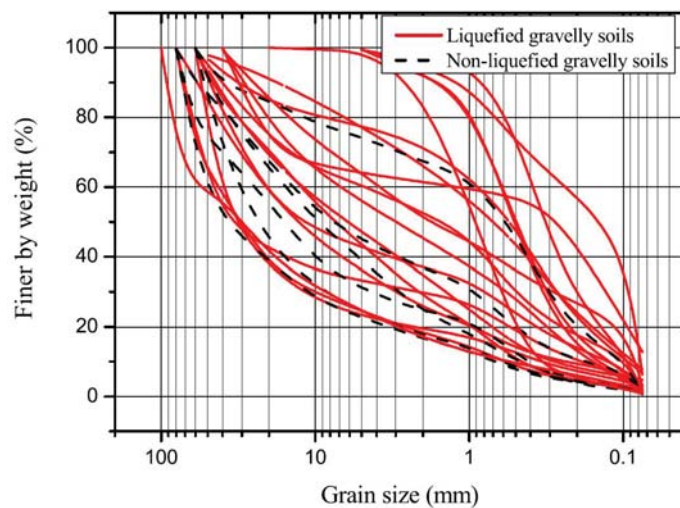

Figure 2.53: Grain size distributions of liquefied and non-liquefied gravelly soils during 2008 Wenchuan earthquake (Cao et al., 2013)



Figure 2.54: Observed gravelly soils ejected from the ground during liquefaction, 2014 Cephalonia earthquake (*Nikolaou et al.*, 2014)

2.5 Gravel Laboratory Testing

Despite the extensive testing of sandy soils, the undrained shear behavior of gravels and gravel-sand mixtures has been less extensively studied due to the unavailability of devices large enough to accurately capture the material behavior. Field case histories have provided insights into undrained gravelly soil response; however, laboratory study of the undrained shear response of gravelly soils, particularly uniform gravels, is limited and could provide further explanation of gravelly soil shear response by targeting specific parameters that may affect it. Most testing on gravels (as well as the larger size particles commonly referred to as rockfill) and gravelly soils in the laboratory has been conducted under drained conditions (*Marsal, 1967; Marachi, 1969; Leps, 1970; Skermer and Hillis, 1970; Charles and Watts, 1980; Barton and Kjaernsli, 1981; Moroto and Ishii, 1990; Yasuda and Matsumoto, 1994; Matsuoka and Liu, 1998; Matsuoka et al., 2001; Varadarajan et al., 2003; Anderson and Fair, 2008; Strahler et al., 2015*), since these materials are considered to be free-draining.

Marsal (1967) tested rockfill materials in a large-size triaxial device and found particle breakage to be a significant factor in strength and compressibility (Figure 2.55). *Marsal* (1967) also found that shear strength is larger in well-graded materials with a low void ratio, regardless whether the rockfill is of alluvial origin or quarry blasting and that materials with similar gradations can have large variations in shear strength (probably due to intrinsic characteristics of the particles). *Marachi* (1969) tested rockfills using a triaxial testing device (Figure 2.56) and found that specimen size affected friction angle (as specimen diameter decreased from 36" to 2.8" friction angle increased 3 to 4 degrees). Volumetric strain during consolidation was also found to increase at the same confining pressure with an increase in particle size. *Leps* (1970) provided a review of shearing strength of rockfill and summarized that the friction angle of rockfill varies as a function of normal stress as shown in Figure 2.57. At normal stresses of about 10 psi, rockfill friction angles ranged from 45 degrees to 60 degrees, with an average of 50 degrees. If compacted well, the friction angle can increase to approximately 55 degrees. The stability of low rockfill dams are attributed to these high values of friction angle at relatively low values of confining stresses. *Skermer and Hillis* (1970) performed drained triaxial tests on four cohesionless soils (sands, gravels, and mixtures). The main findings of the study were that as a result of breakdown and closer particle packing, an initially uniformly graded gravel can develop a peak shear strength as high as that of a well-graded gravel. The strain required for the uniform gravel to reach peak is four times that of the well-graded gravel. Additionally, it was found that there is a decrease in initial friction angle with an increase in confining pressure, but that this effect largely disappears when a correction for dilatancy is applied. *Charles and Watts* (1980) found similar results to other studies, that the drained friction angle decreased with increasing confining pressure for rockfill materials in triaxial compression. *Barton and Kjaernsli* (1981) note that shear strength reduces with increasing particle size as shown in Figure 2.58. *Matsuoka and Liu* (1998) tested gravelly soils using a large-size direct shear box and found a large dependency of friction angle on relative density (void

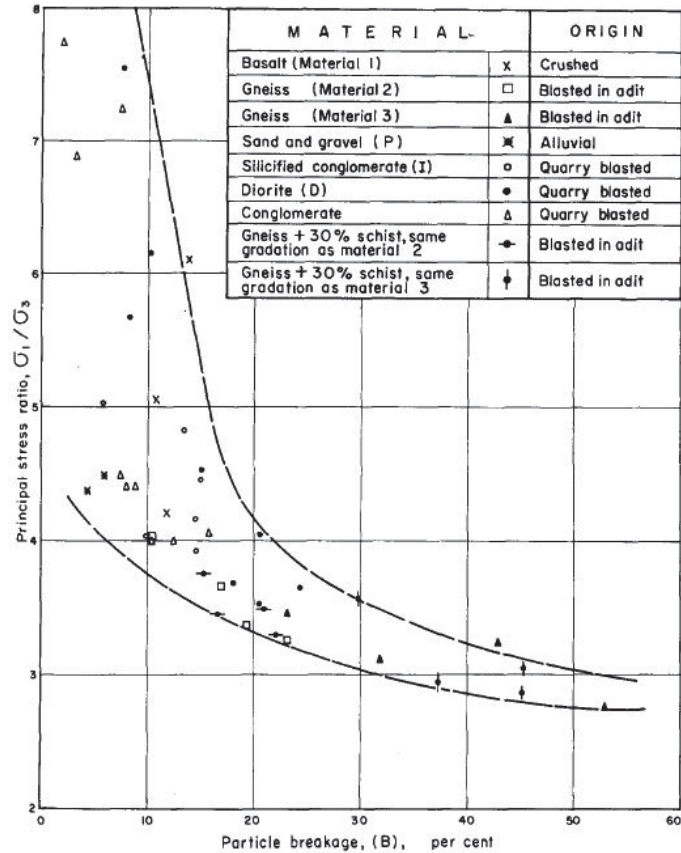

Figure 2.55: Effect of particle breakage on principal stress ratio (Marsal, 1967)

ratio), with friction angle increasing with decreasing void ratio. Friction angles of 37 to 55 degrees were reported for the same material at looser and denser states. *Strahler et al.* (2015) performed drained triaxial and plane strain tests on a well-graded gravel and found that the plane strain shear modulus, friction, and dilation angle values of the tested material and values commonly used in practice for sandy gravels are significantly higher than those measured in triaxial compression. Considerable effort has focused on the effect of confining stress and particle breakage on the shear response (*Xiao et al.*, 2014a,b, 2015a,b) as well as development of constitutive models (*Liu et al.*, 2014; *Xiao et al.*, 2014c; *Sun and Xiao*, 2016; *Xiao and Liu*, 2016). The effect of particle size and shape on shear strength has been investigated and results have shown that angular particles have greater shear strength than sub-rounded particles (*Holtz and Gibbs*, 1956).

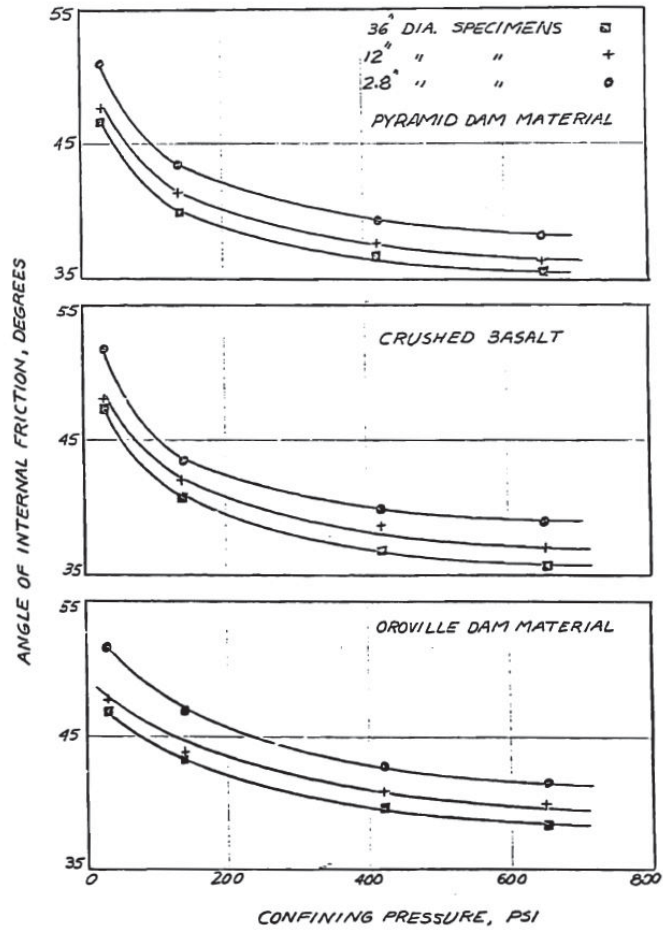

Figure 2.56: Effect of Confining Pressure on Friction Angle of Rockfill (Marachi, 1969)

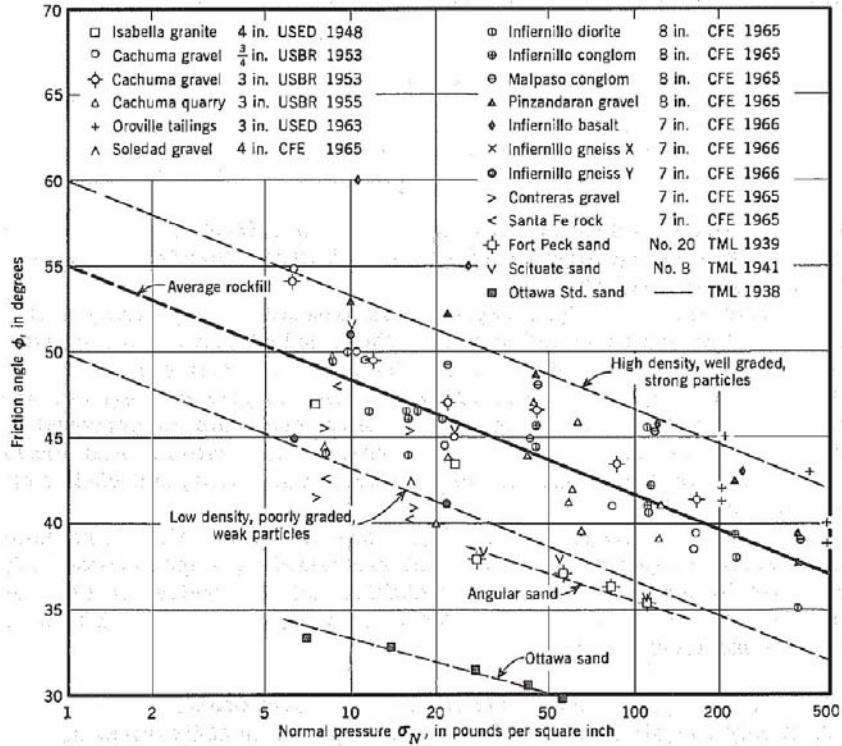

Figure 2.57: Variation of Friction Angle for Rockfill Materials as a function of Normal Pressure in Triaxial Tests (Leps, 1970)

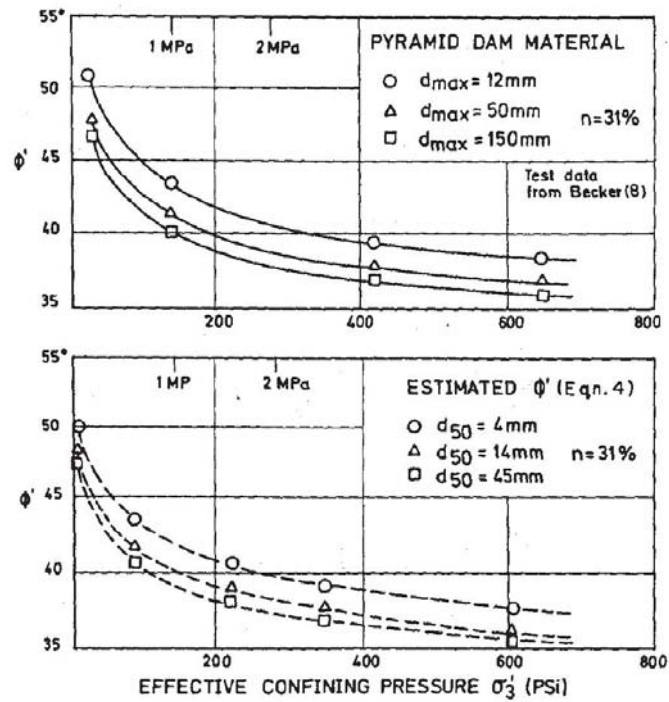

Figure 2.58: Effect of Particle Size on Friction Angle for Rockfill (Barton and Kjaernsli, 1981)

2.6 Gravel-Sand Mixtures and Gravelly Soil Testing in the Laboratory

The monotonic and cyclic response of gravel-sand mixtures has been studied in the laboratory. *Holtz and Gibbs* (1956) performed consolidated drained triaxial test on sand and gravel mixtures with gravel contents of 20%, 35%, 50%, and 65% by weight. A constant relative density, either 50% or 70%, was used to compare specimens. The authors found that shear strength of gravelly sand increased with increasing gravel content up to 50-60%, and beyond this value the shear strength did not increase (in some cases it decreased). The authors also concluded that increasing the maximum particle size from 19 mm to 77 mm did not have a significant effect on shear strength, but that the shape of the gravel particles had a significant effect on the shear strength, with angular particles having higher shear strength than subrounded to subangular particles. *Donaghe and Torrey III* (1985) tested mixtures of gravel, clay and sand in a 15 inch diameter triaxial apparatus. Subrounded to subangular mortar sand (SP) was mixed with clay and subrounded to subangular gravel (GP). Clay content was held constant at 25% while gravel content varied from 20% to 40% to 60%. The authors report low values of ϕ which ranged from 13.6 to 18 degrees for total stresses. The effect of gravel content on friction angles can be seen in Figure 2.59 .

Chang and Phantachang (2016) tested angular crushed aggregate with poorly-graded sand and well-graded sand in various mixture percentages. A direct simple shear device was used to perform drained tests on the various mixtures at initial vertical stresses of 50-150 kPa. The authors concluded that gravelly soils can be categorized as sand-like or in-transition depending on their gravel content (GC) and transition gravel content (TGC), and that gravelly soils can be placed in the intergrain framework as shown in Figure 2.60. The authors found that GC in sand-like gravelly soils had little effect on the normalized stress-strain curve for both mixtures with poorly-graded and well-graded sand as shown in Figure 2.61. A difference is observed though once the mixture transitions to a gravel-like

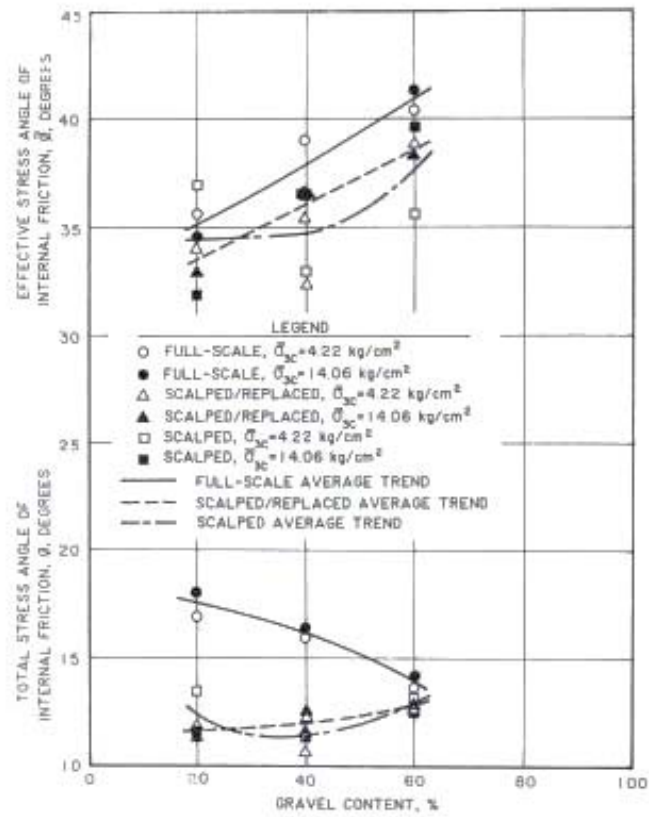

Figure 2.59: Effect of Gravel Content on Total and Effective Friction Angle (*Donaghe and Torrey III, 1985*)

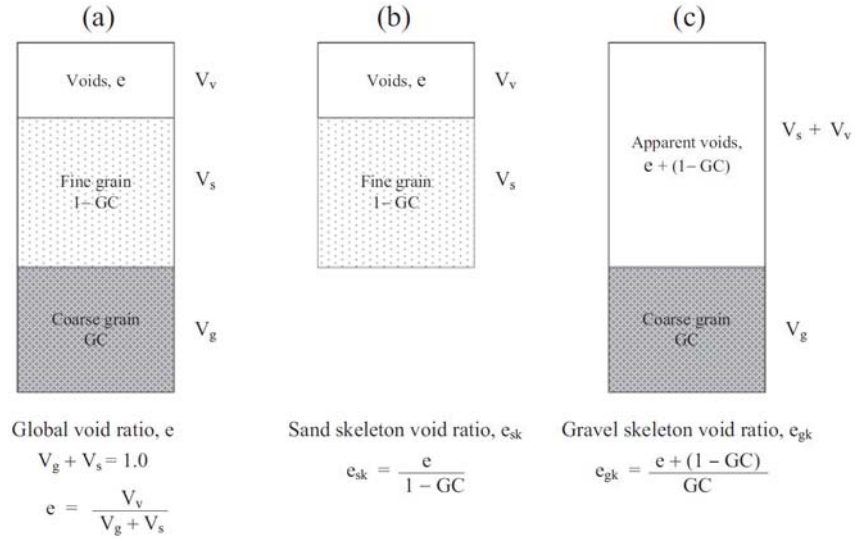

Figure 2.60: Definition of Global, Sand Skeleton, and Gravel Skeleton Void Ratios (*Chang and Phantachang, 2016*)

material. Based on this finding, the authors concluded that the binary packing model is applicable to gap-graded, sand-like gravelly soils. In the poorly-graded sand mixtures, gravel particles generally reduced the shear resistance as GC increased (Figure 2.62). Initial vertical stress was shown not to effect the normalized shear stress ratio as shown in Figure 2.63. In the well-graded sand mixtures, gravel particles generally reduced the shear resistance as GC increased (Figure 2.64). Normalized shear stress ratios ranged from 0.40 to 0.60 for most tests in the study.

Wong et al. (1974) studied the liquefaction of gravelly soils by performing large-scale triaxial tests. They concluded that uniform gravels exhibit slightly higher resistance to liquefaction than well-graded gravelly soils at the same strain, but that this could have been due to membrane compliance effects. The authors further concluded that gravelly soils exhibit quick dissipation of excess pore pressures, thereby increasing their liquefaction resistance. The cyclic stress required to cause 2.5% strain in a cyclic triaxial test was shown to increase with increasing particle size by *Wong et al. (1974)* as shown in Figure 2.65. *Banerjee et al. (1979)* performed cyclic triaxial test on dense gravelly soils from Oroville dam and found that the dense Oroville gravel exhibited many similarities to dense sand

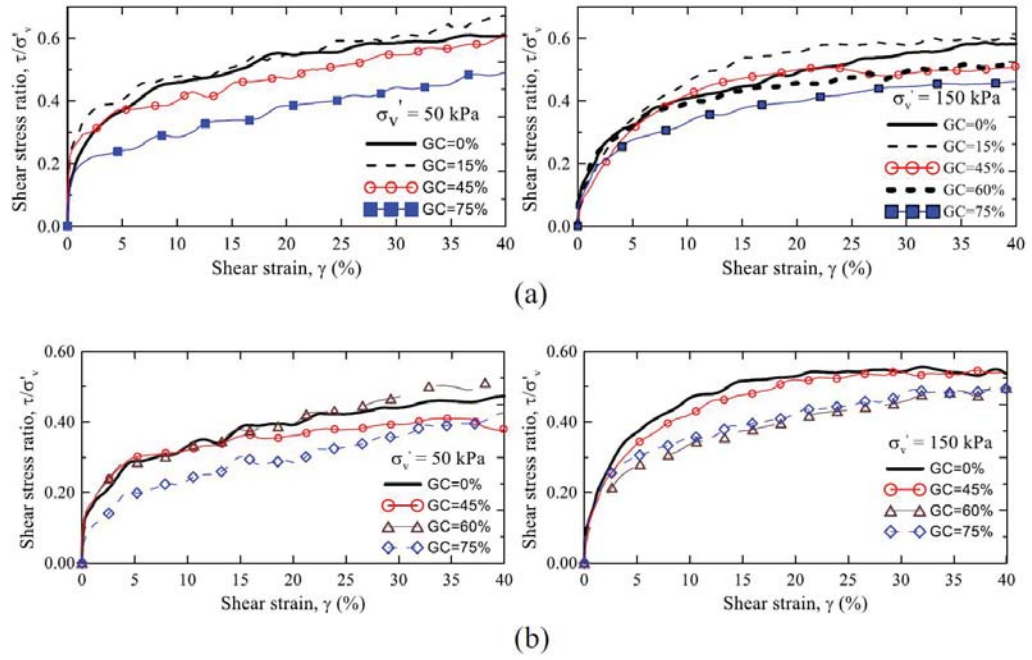

Figure 2.61: Effect of Gravel Content and Vertical Stress on Shear Stress Ratio (*Chang and Phantachang, 2016*)

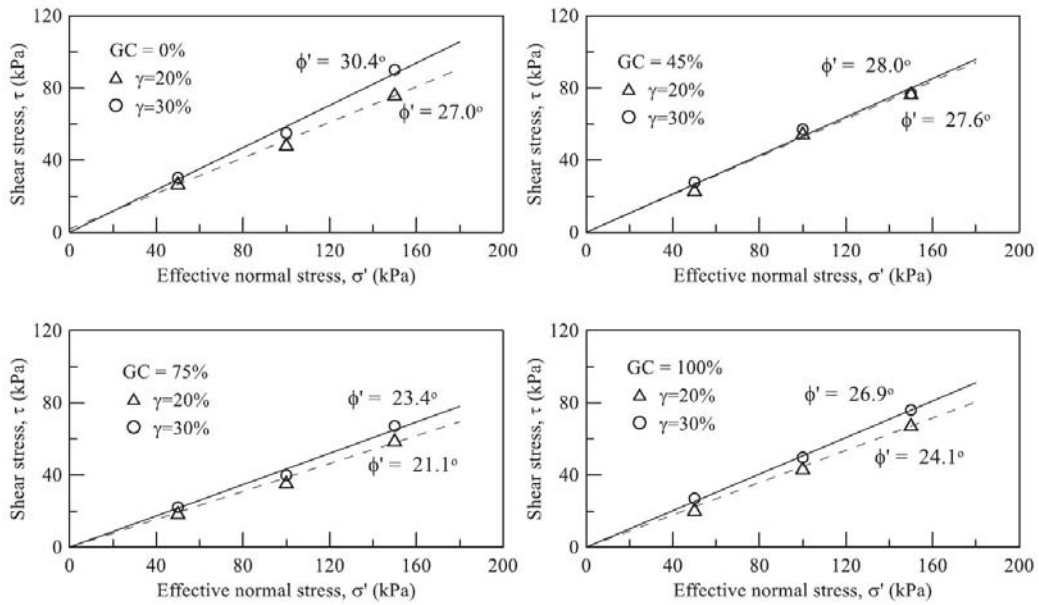

Figure 2.62: Effect of Gravel Content on Friction Angle for poorly-graded materials (*Chang and Phantachang, 2016*)

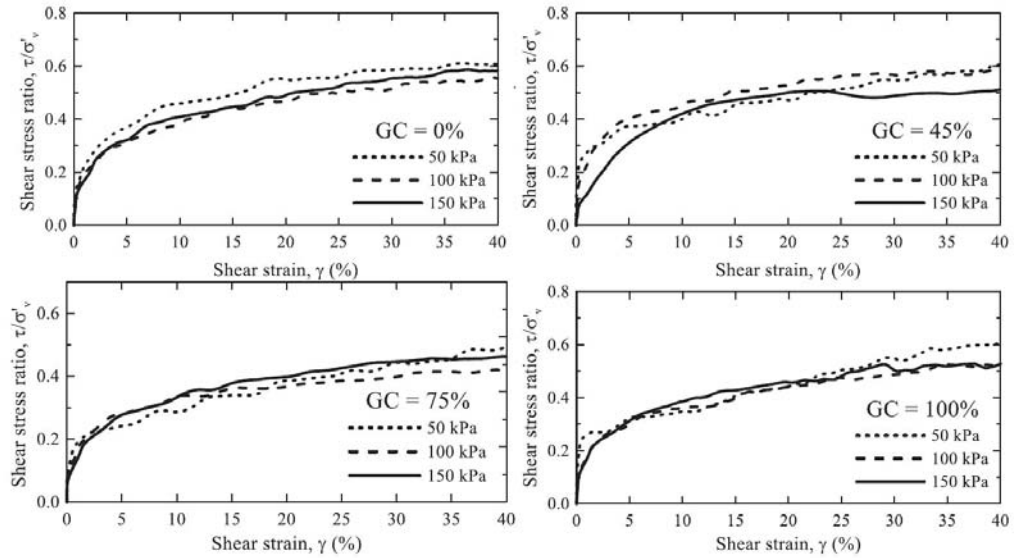

Figure 2.63: Effect of Vertical Stress on Shear Stress Ratio (*Chang and Phantachang, 2016*)

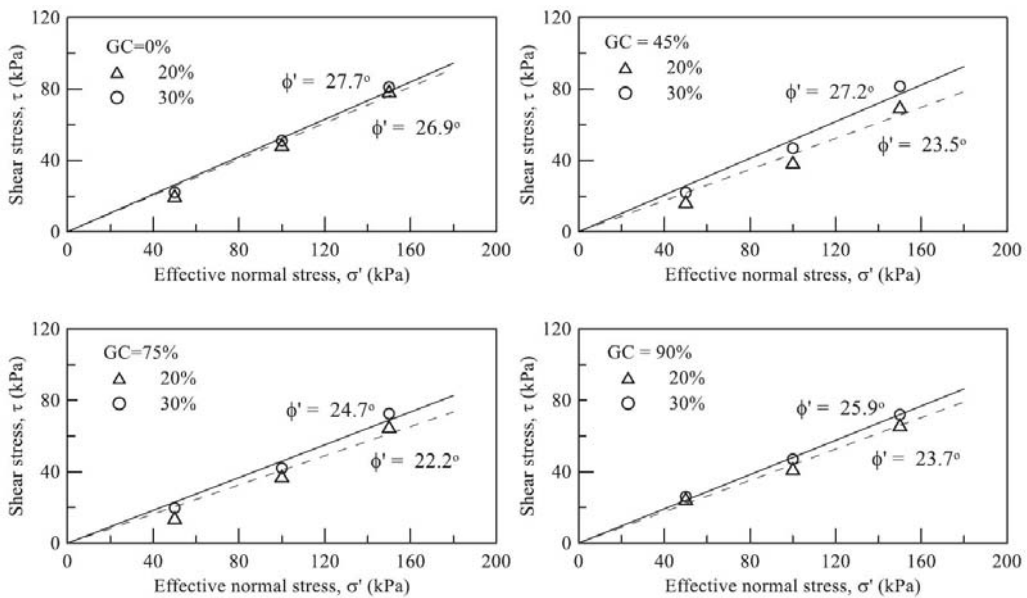

Figure 2.64: Effect of Gravel Content on Friction Angle for well-graded materials (*Chang and Phantachang, 2016*)

under cyclic loading. The pore pressure generation was found to be very different than that of sands under cyclic loading (Figure 2.66). The effect of specimen preparation method was also shown to have little effect on shear response, which is different than observations for sands where specimen preparation can have significant effect on dynamic behavior. *Banerjee et al.* (1979) also evaluated the effect of aging on gravelly soils and found that cyclic resistance increased with prolonged consolidation of 10 weeks as shown in Figure 2.67. *Evans and Seed* (1987) tested uniform Watsonville gravel in triaxial devices, and developed a method of sluicing specimens with sand to decrease membrane compliance in triaxial testing of large particles. The effect of sluicing on cyclic resistance is shown in Figure 2.68, where it can be seen that the CSR at liquefaction in 10 cycles is only 0.143 in the triaxial device which is relatively low and liquefaction could be expected during a reasonably sized earthquake. The pore pressure generation plots of the Watsonville gravel are shown in Figure 2.69, which show a different response than noted by *Banerjee et al.* (1979). *Evans et al.* (1992) showed that membrane compliance in the triaxial test could cause as much as 40% overestimation of the liquefaction resistance in 12-inch diameter specimens of gravel. This further supports the use of cyclic simple shear for gravel testing since membrane compliance is eliminated when stacked rings are used.

Hatanaka et al. (1988) performed cyclic undrained triaxial tests of undisturbed and reconstituted Tokyo gravel. They found that the V_S value of the reconstituted specimens was 30% lower than the frozen and thawed undisturbed specimens, and the liquefaction resistance of the reconstituted specimens was approximately 50% less. *Hatanaka et al.* (1997) performed cyclic undrained triaxial tests of frozen gravel samples from the Masado fill which liquefied during the 1995 Kobe earthquake. The results of the triaxial tests show that the gravelly fill material, despite its high dry density and gravel content, liquefies at CSRs from 0.15 to 0.23 which is similar to Toyoura sand at a relative density of 70% as shown in Figure 2.70. *Hatanaka et al.* (1997) also performed second liquefaction tests to test the response of the gravelly soils to re-liquefaction. It was found that the gravelly fill was more

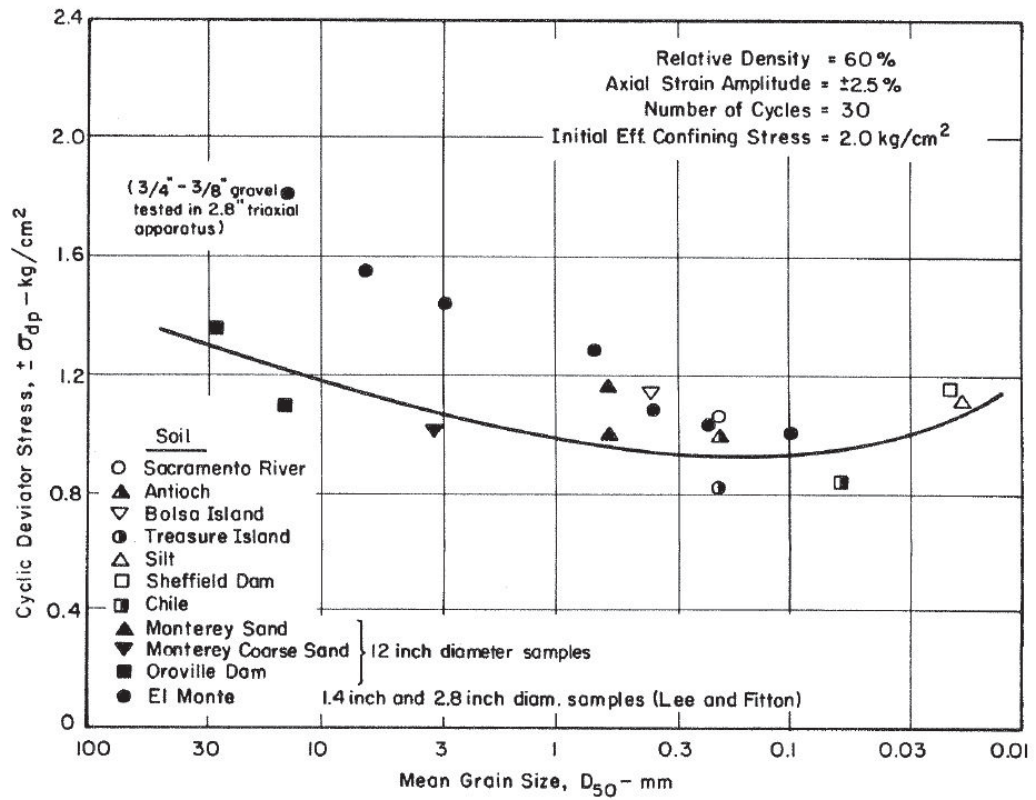

Figure 2.65: The Effect of Particle Size on the Cyclic Stress Required to Cause 2.5% Axial Strain at 30 cycles (*Wong et al., 1974*)

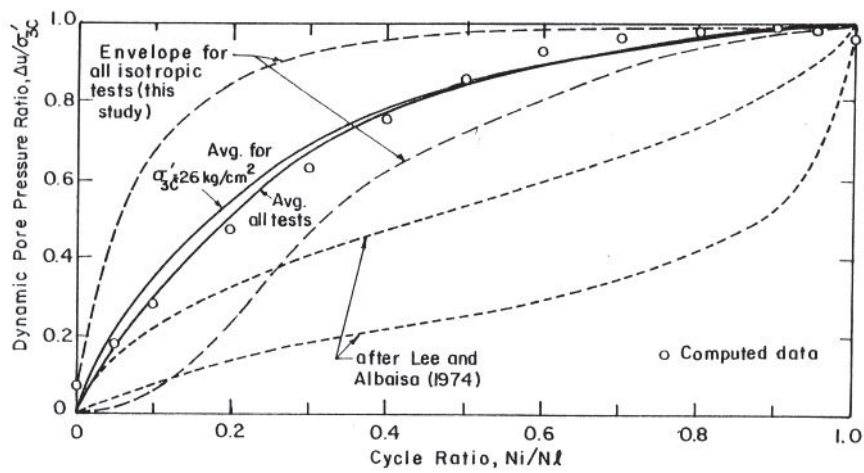

Figure 2.66: Pore Pressure Generation of Oroville Gravel (*Banerjee et al., 1979*)

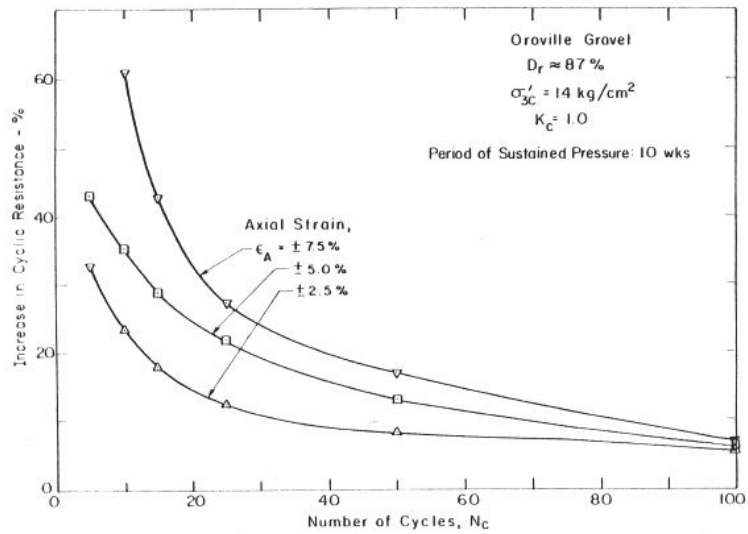

Figure 2.67: The Effect of Aging on the Cyclic Resistance of Oroville Gravel (*Banerjee et al.*, 1979)

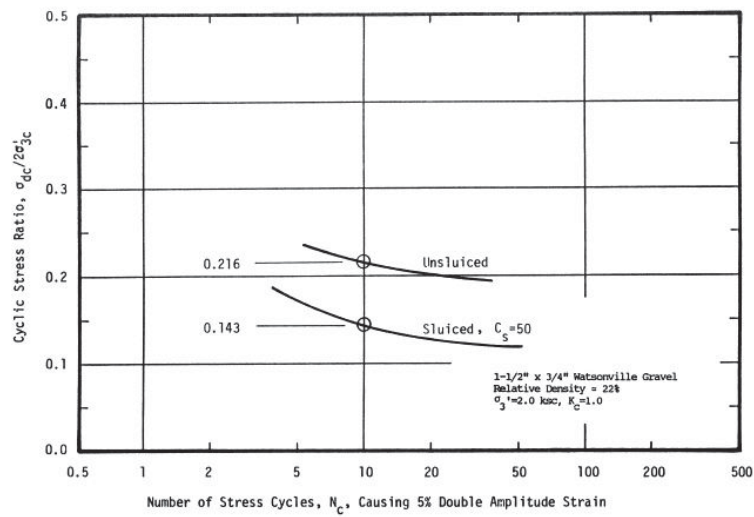

Figure 2.68: The Effect of Sluicing on the Cyclic Response of Gravel (*Evans and Seed*, 1987)

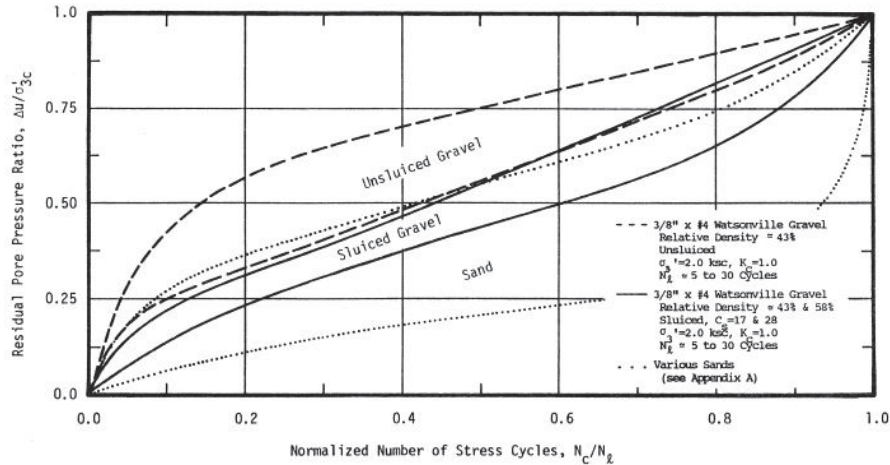

Figure 2.69: Pore Pressure Generation of Watsonville Gravel (*Evans and Seed, 1987*)

resistant to liquefaction upon a second test as shown in Figure 2.71. The post-liquefaction volumetric strain was also measured and found to be similar to the values found in *Ishihara and Yoshimine (1992)* (Figure 2.72). *Suzuki et al. (1993)* tested gravelly soils in the field and laboratory and found that the cyclic resistance of gravels would be overestimated for N_1 values (particularly larger than 30) if compared with the sand liquefaction relationship as shown in Figure 2.73.

Rashidian (1995) performed monotonic and cyclic tests of gravel-sand mixtures in a triaxial device and measured V_S for each specimen. Results of the monotonic tests show that very loose gravelly soils, with even up to 90% gravel, can have contractive behavior and be susceptible to large flow failures. Figure 2.74 shows a series of gravelly sand 60% (a specimen of 40% sand and 60% gravel) tests at a range of initial confining stresses. The stress-strain response shows that the lowest confining stress test is fully softening and as confining stress increases the specimens reach a peak, soften slightly, and then strain harden. The corresponding stress path plots for these tests are shown in Figure 2.75. It is interesting to note that each specimen has the same phase transformation and ultimate state ratio. Additionally, the specimens have significant reduction in vertical stress (positive pore water pressure generation) until the phase transformation point it reached. The phase transformation points (or quasi steady state points) are plotted in Figure 2.76 and show that for

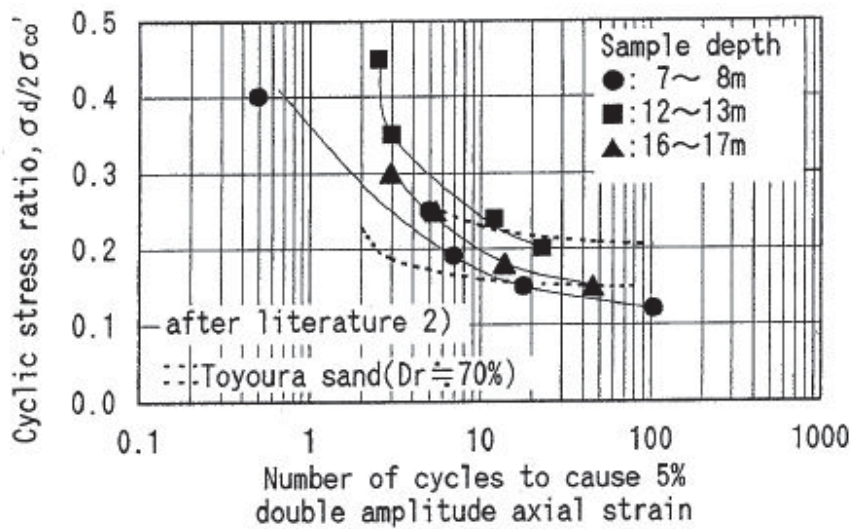

Figure 2.70: Comparison of Gravelly Soil Liquefaction Resistance with Toyoura Sand (Hatanaka et al., 1997)

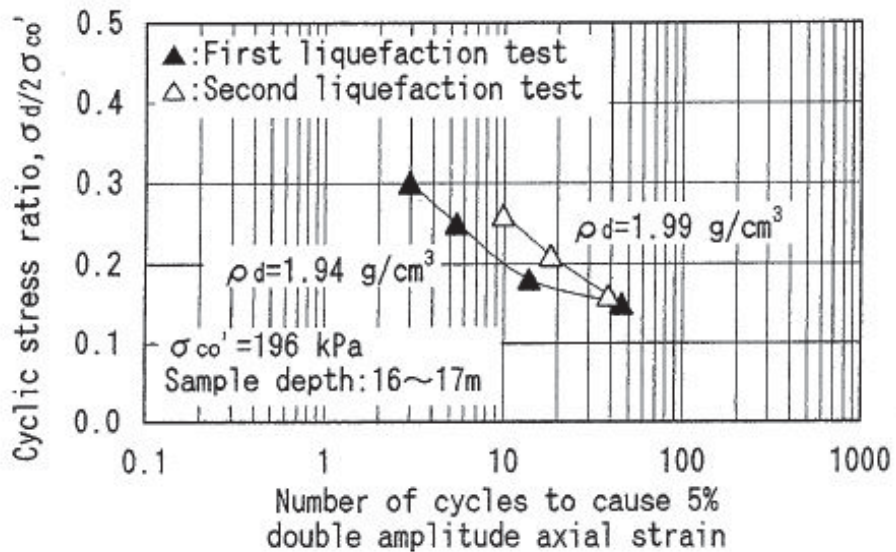

Figure 2.71: Liquefaction and Re-Liquefaction Response of Gravelly Soils (Hatanaka et al., 1997)

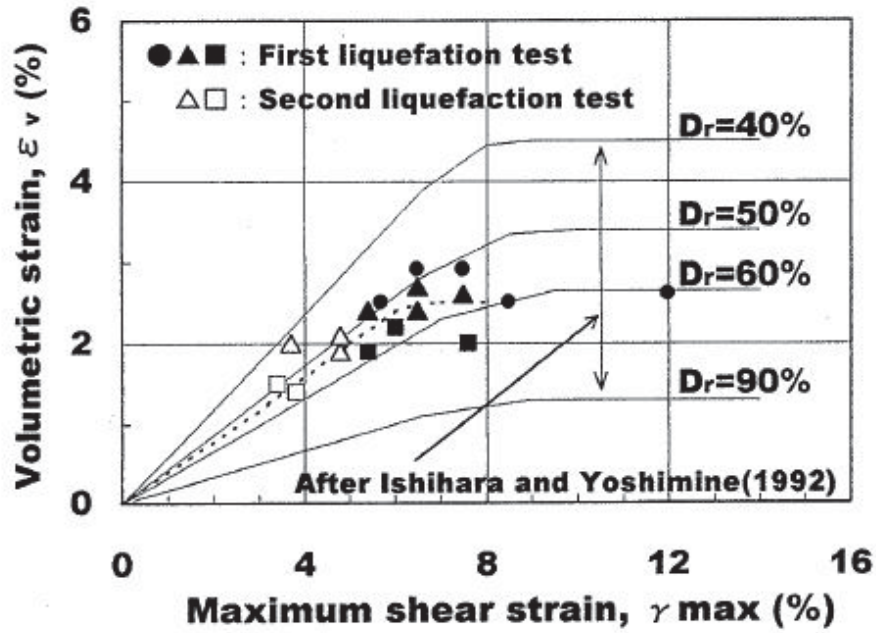

Figure 2.72: Measurement of Post-Liquefaction Volumetric Strain for Gravelly Soil Specimens (*Hatanaka et al., 1997*)

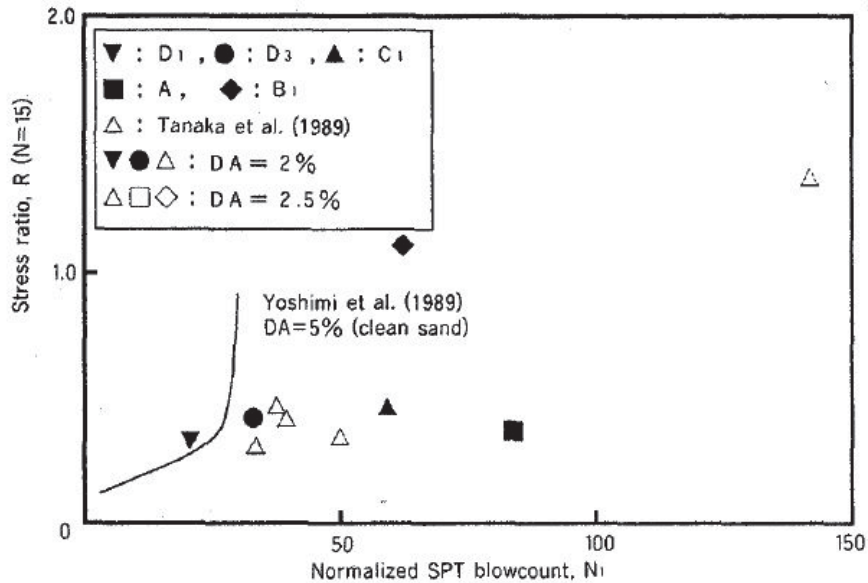

Figure 2.73: Comparison of Gravelly Soil Blow count for Liquefied Specimens with existing Sand Liquefaction Triggering Curve (*Suzuki et al., 1993*)

a variety of gravel-sand mixtures the quasi steady state line can be considered constant for the mixtures tested. *Rashidian* (1995) also normalized the peak shear strength by the initial confining stress and found that the ratio decreased as the gravel content increased to a level of 60%. After this minimum point the ratio increased again until 90% gravel (Figure 2.77). V_S was measured in each specimen before and during shearing as shown in Figures 2.78 and 2.79. The results show that V_{S1} decreases with shearing until it reaches a fairly constant value. *Rashidian* (1995) also compiled gravelly soil liquefaction data from the laboratory cyclic triaxial tests on both undisturbed and reconstituted specimens. Figure 2.80 shows a summary of this data for angular sands, rounded sands, and gravelly soils. The rounded sands have the lowest initial shear modulus values, while the angular sands and gravelly soils have higher values of initial shear modulus. The shear modulus of the gravelly soils and angular sands are similar. The lower bound liquefaction curve for sands is actually shifted further to the right (higher initial shear modulus) than the gravelly soils due to the angular sands. Figure 2.81 shows only the gravelly soils on the same type of chart but now distinction is made between reconstituted and undisturbed specimens. The data shows that there is no discernible difference between the two specimen preparation techniques for this type of chart. Figure 2.82 shows the sands only and how particle angularity can significantly increase the initial shear modulus, but not necessarily the CSR to liquefaction at 20 cycles.

Evans and Zhou (1995) performed undrained triaxial compression tests of gravel-sand composite mixtures at gravel contents ranging from 0% to 60% and concluded that the inclusion of gravel particles increased the liquefaction resistance of the specimen as shown in Figures 2.83 and 2.84. *Amini and Chakravarty* (2003) evaluated the cyclic resistance of sand gravel composites using a triaxial device. The results showed the liquefaction resistance of sand-gravel composites decreased with increasing confining stress as shown in Figure 2.85. It was also found that there was little effect on cyclic resistance between specimens that were layered or mixed uniformly. Moreover, it was found that specimen

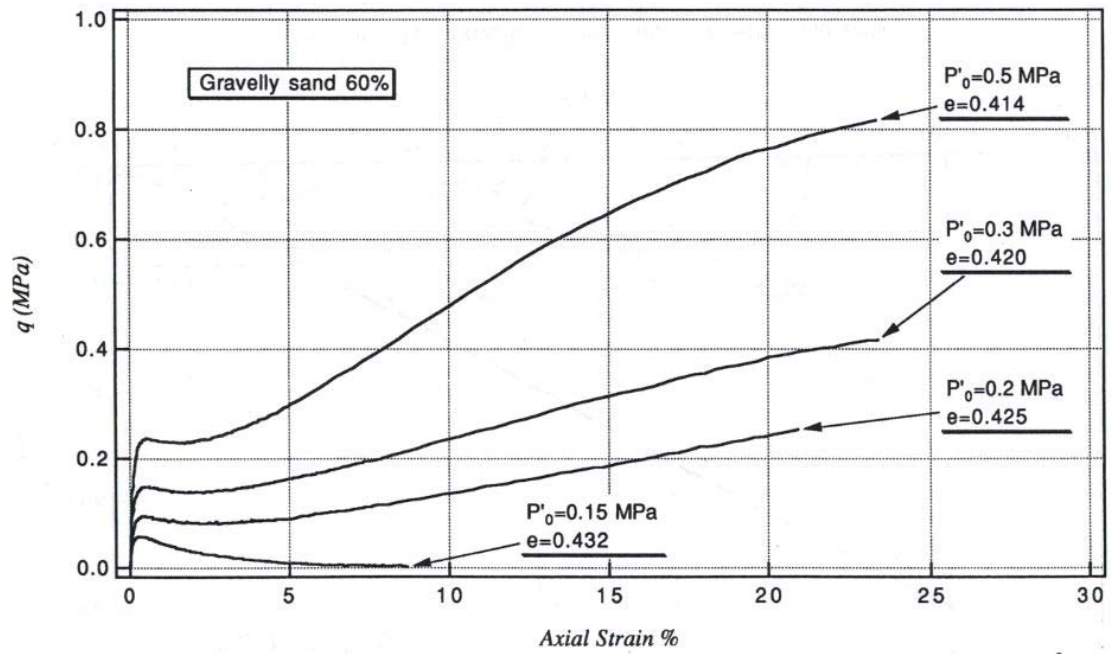

Figure 2.74: Monotonic Undrained Shear Stress versus Axial Strain for Gravelly Sand 60% (Rashidian, 1995)

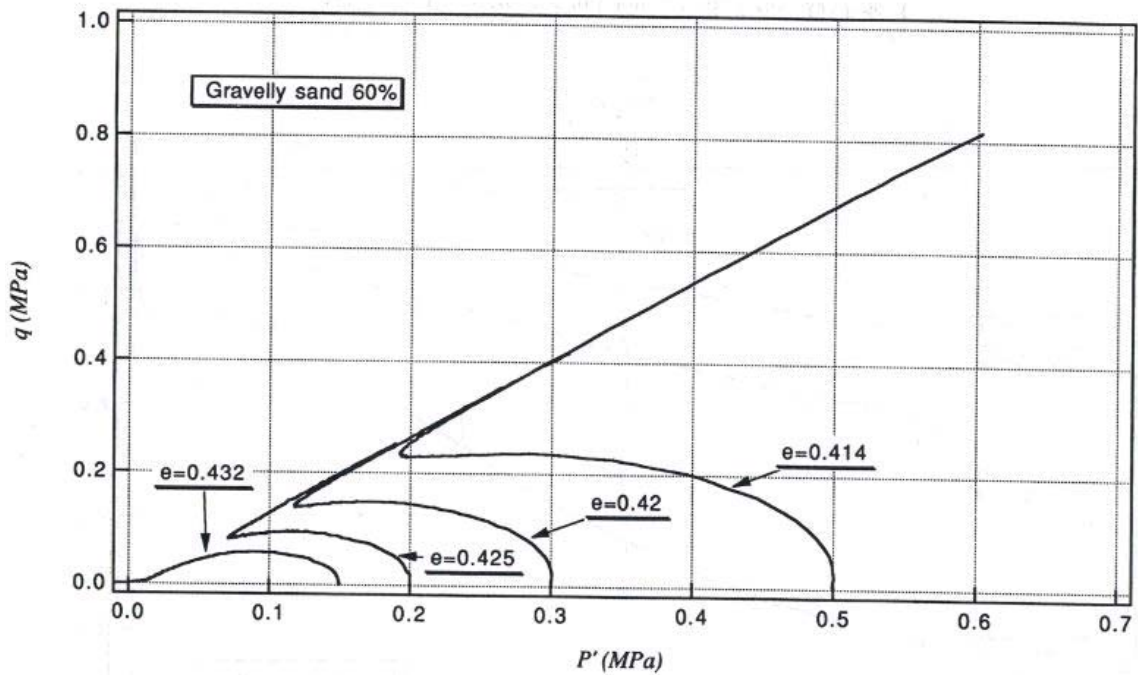

Figure 2.75: Monotonic Undrained Stress Path for Gravelly Sand 60% (Rashidian, 1995)

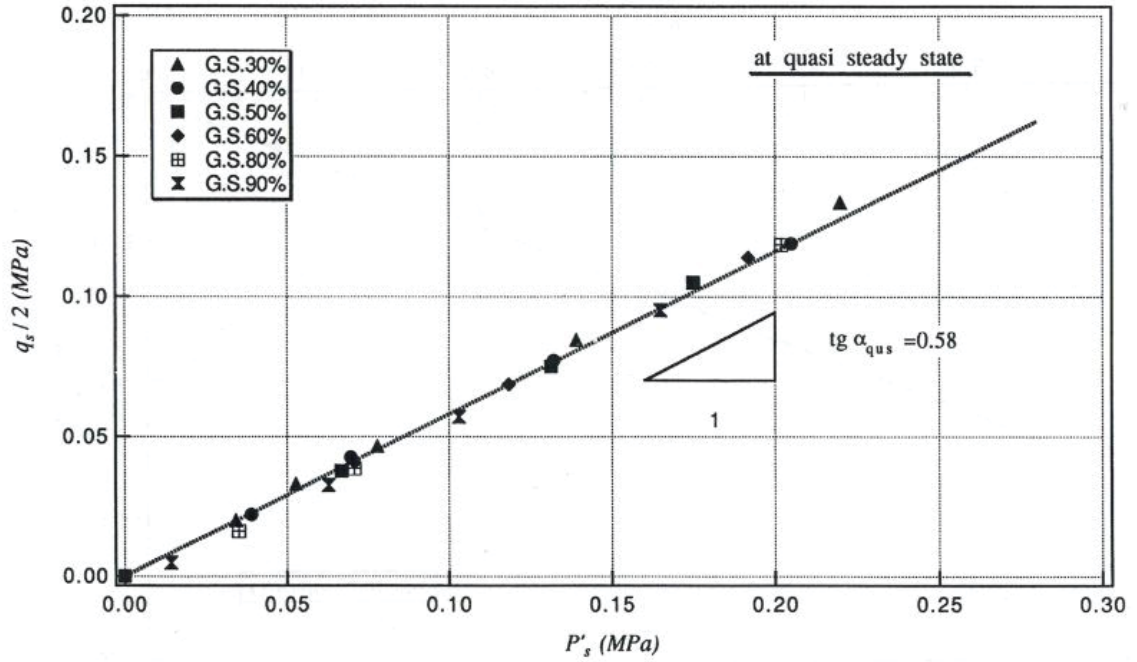

Figure 2.76: Various Gravelly Soils Quasi Steady State Line (*Rashidian, 1995*)

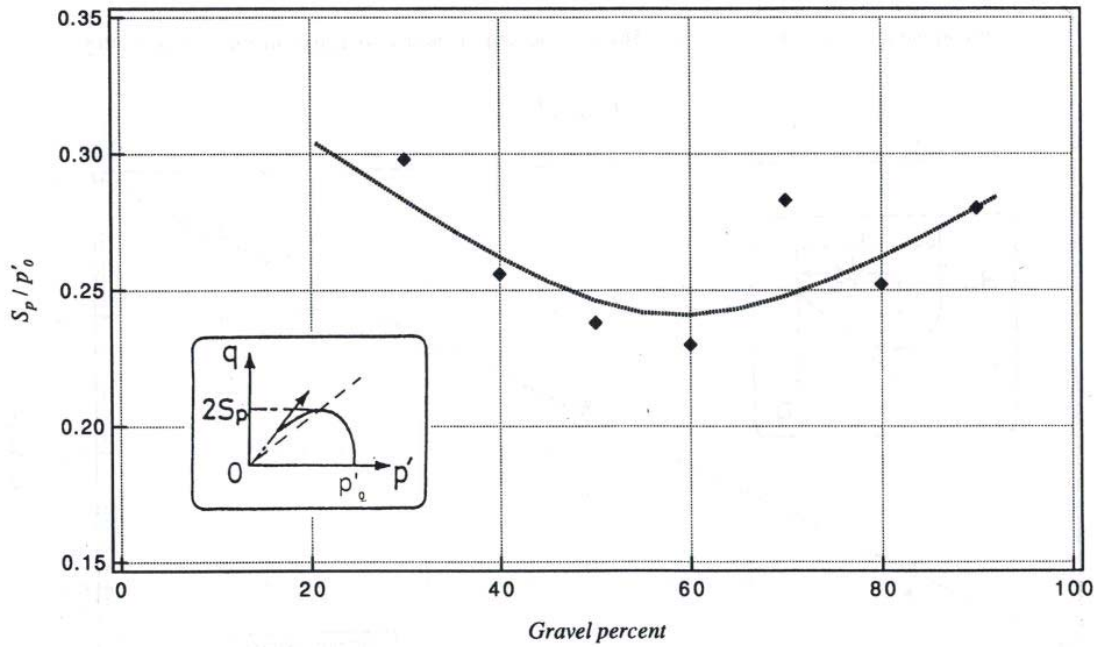

Figure 2.77: Normalized Peak Shear Strength versus Gravel Percent (*Rashidian, 1995*)

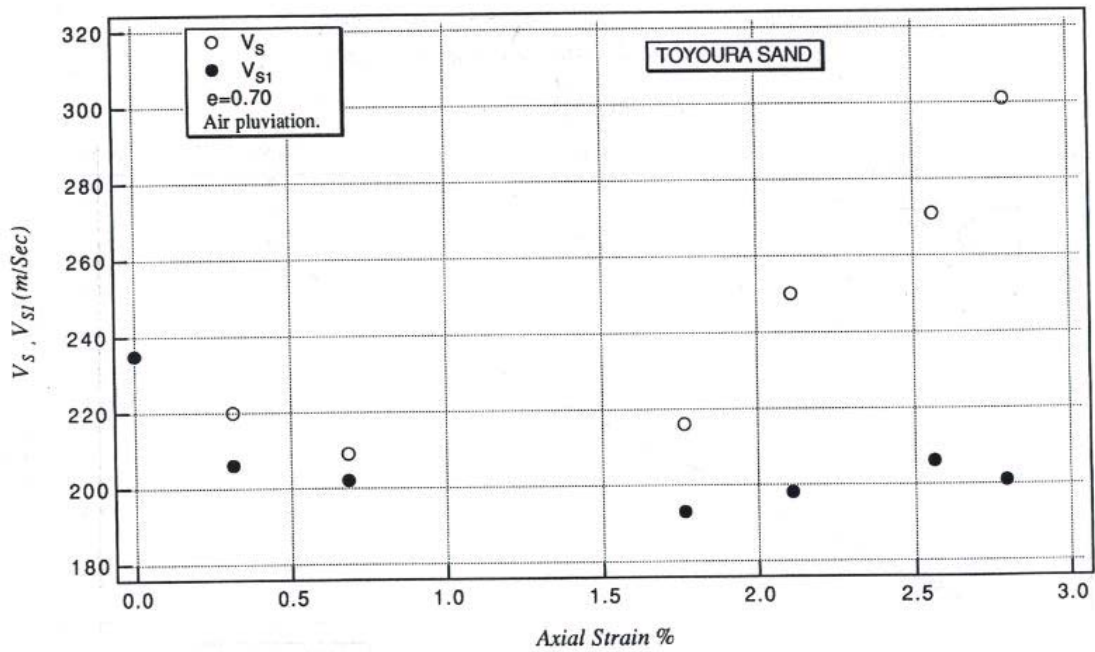

Figure 2.78: V_S and V_{S1} measurements during Monotonic Undrained Shear Test (Rashidian, 1995)

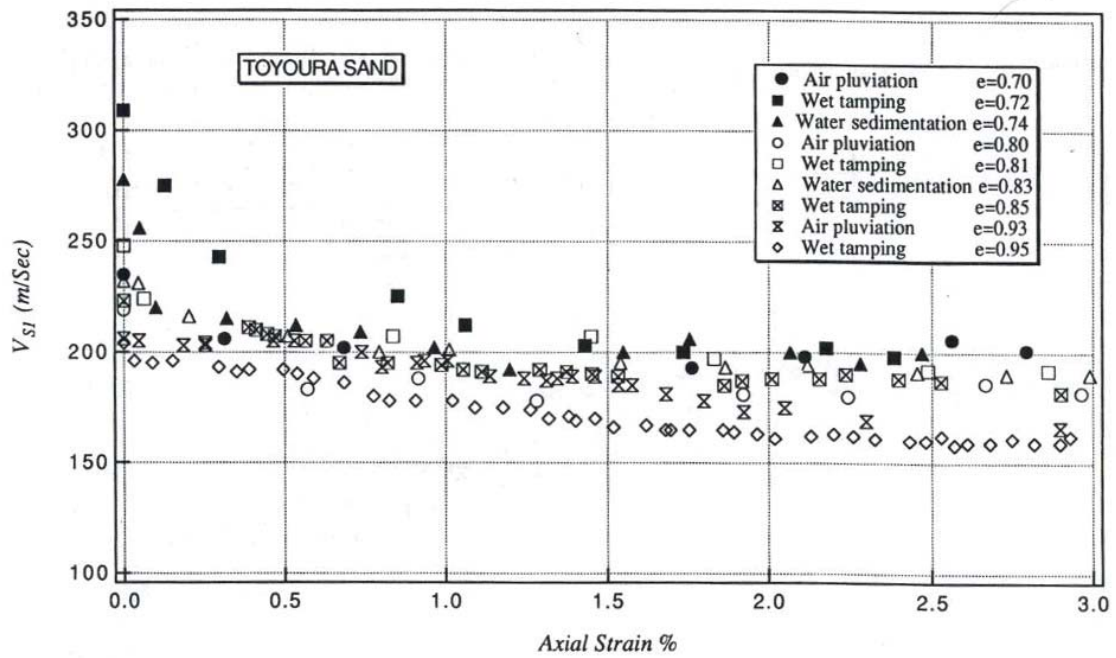

Figure 2.79: Compilation of V_S and V_{S1} measurements during Monotonic Undrained Shear Tests (Rashidian, 1995)

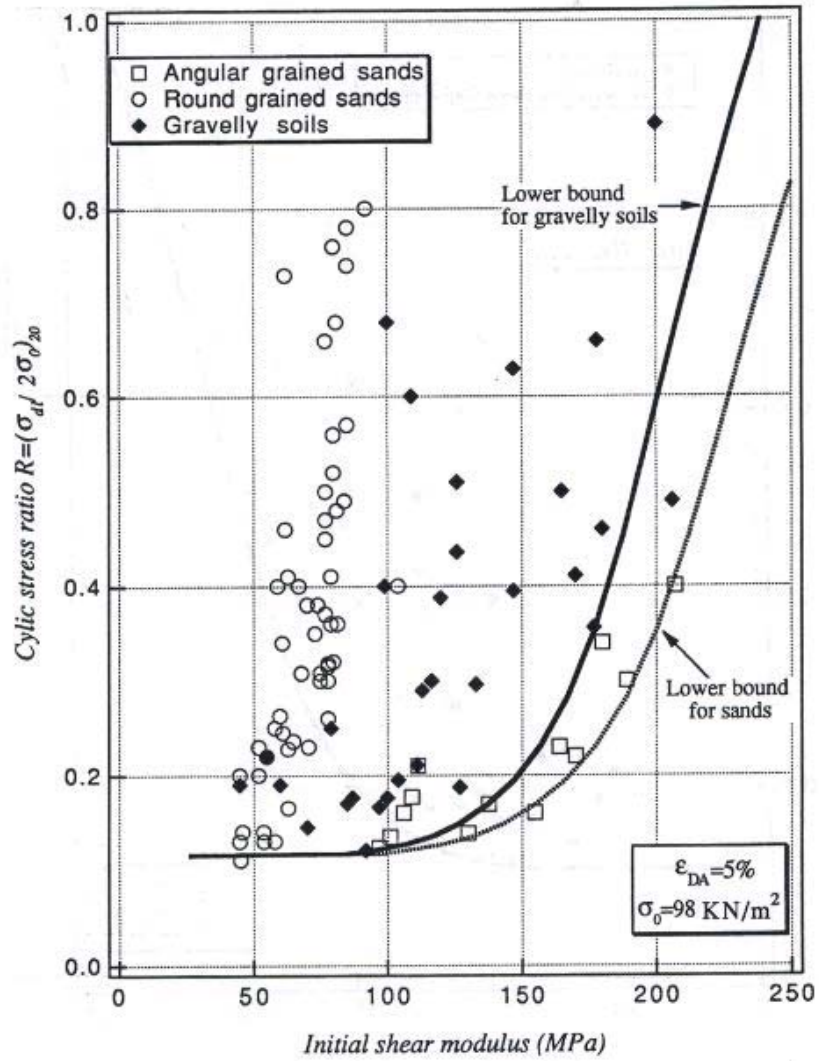

Figure 2.80: CSR versus Initial Shear Modulus for Sands and Gravelly Soils (Rashidian, 1995)

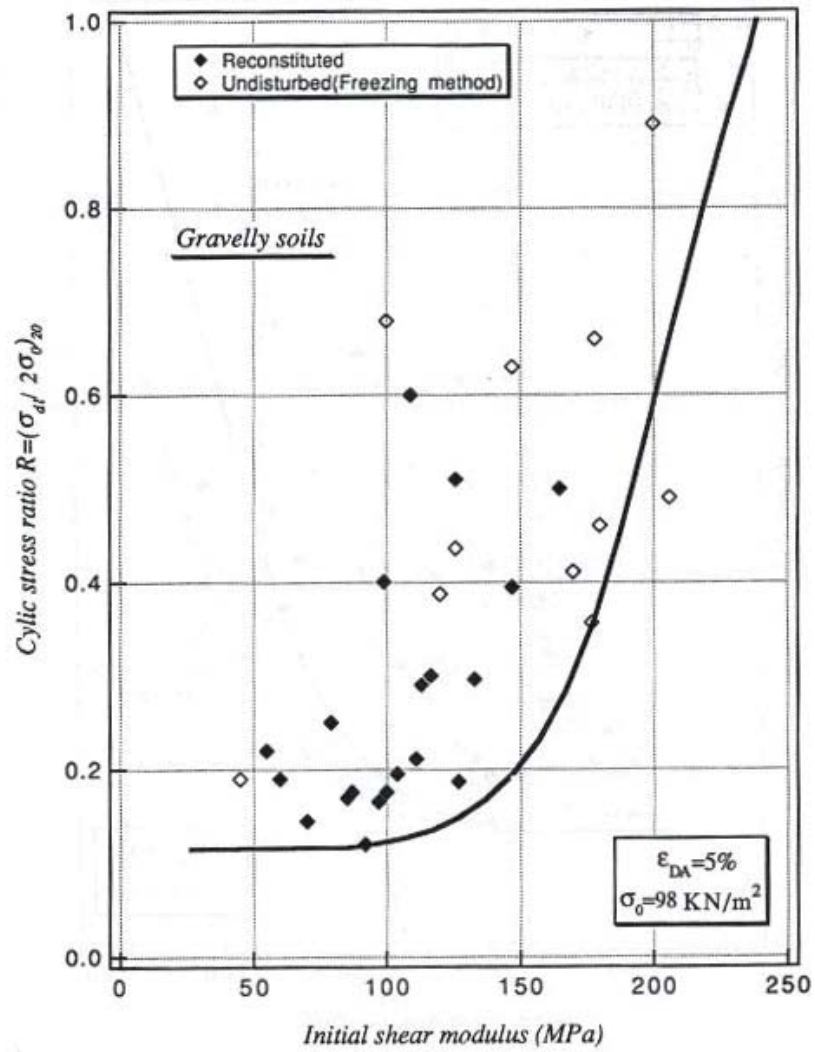

Figure 2.81: CSR versus Initial Shear Modulus for Reconstituted and Undisturbed Gravelly Soils (Rashidian, 1995)

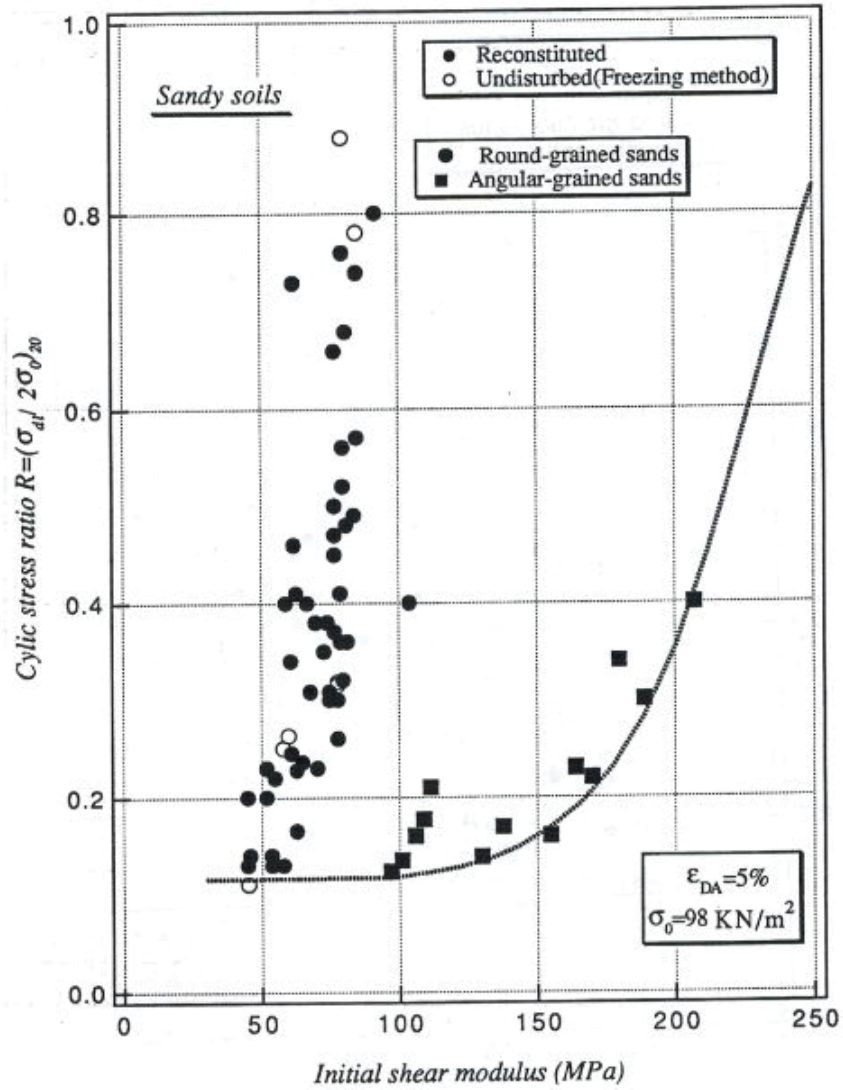

Figure 2.82: CSR versus Initial Shear Modulus for Angular and Round Sands (*Rashidian, 1995*)

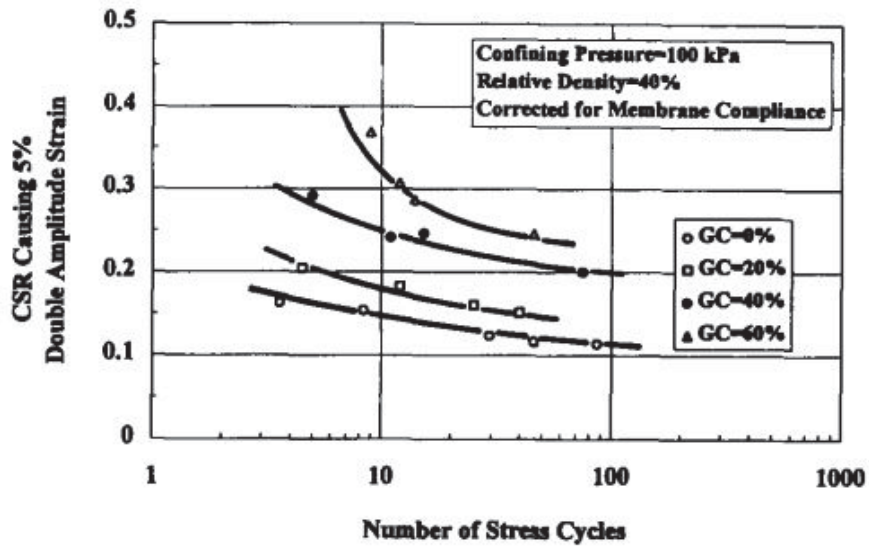

Figure 2.83: Cyclic Stress Ratio versus Number of Cycles to Liquefaction for Sand-Gravel Composites at $D_r = 40\%$ (Evans and Zhou, 1995)

preparation (air pluviation versus water pluviation) did not have a significant effect on the cyclic resistance of sand-gravel composites.

Rollins *et al.* (1998) provided a comprehensive study of the dynamic behavior of gravels. By combining previous data and new laboratory data, relationships were further developed for gravel shear wave velocity as a function of N_{60} as shown in Figure 2.86. Kokusho and Yoshida (1997) measured the V_S and SPT N-value of gravels in the laboratory and found that even though well-graded gravelly soils may have a much higher density than sand it may exhibit a V_S value and N-value as low as poorly graded loose sand if the relative density of the gravel is low enough. The V_S measurement results of various gravelly soil mixtures are shown in Figure 2.87. Kokusho and Yoshida (1997) also found that V_S values for gravelly soils were dependent on the coefficient of uniformity as shown in Figure 2.88.

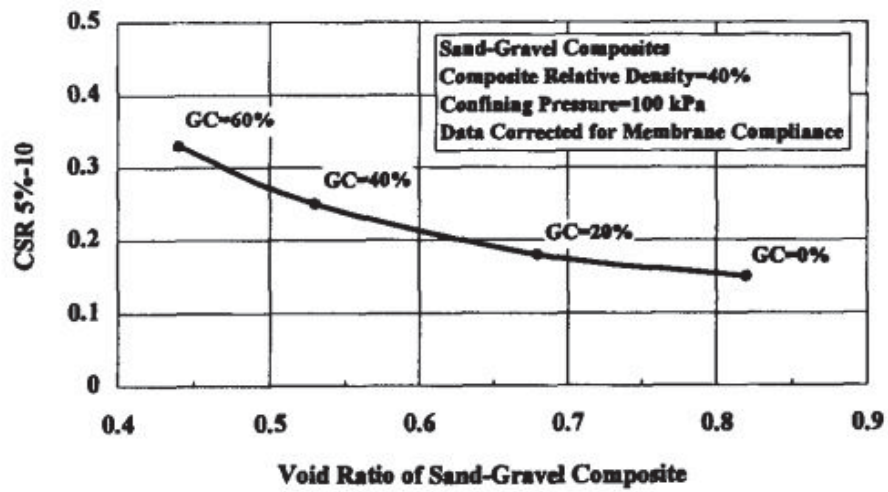

Figure 2.84: Cyclic Stress Ratio versus Void Ratio for Sand-Gravel Composites at $D_r = 40\%$ (Evans and Zhou, 1995)

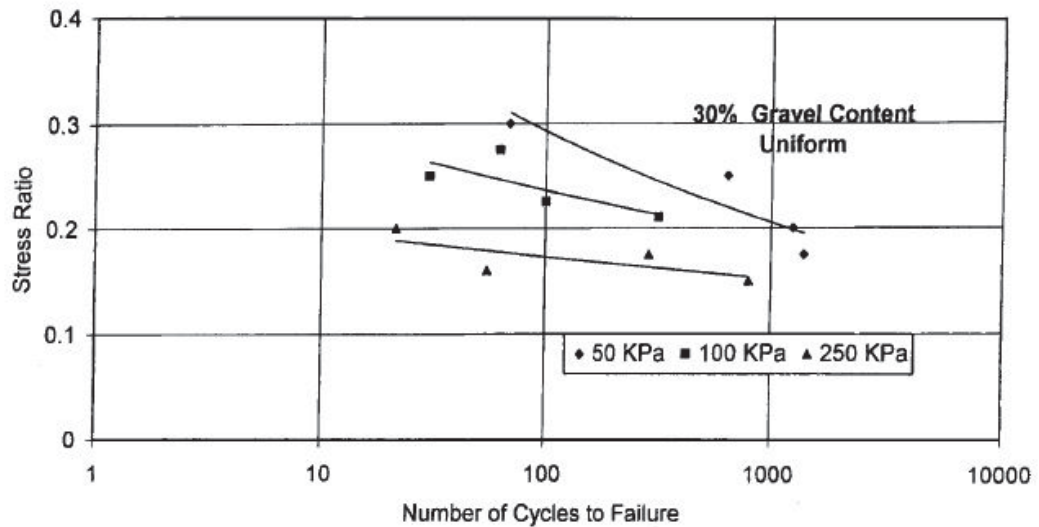

Figure 2.85: The Effect of Initial Vertical Stress of Liquefaction Resistance of Sand-Gravel Composites (Amini and Chakravarty, 2003)

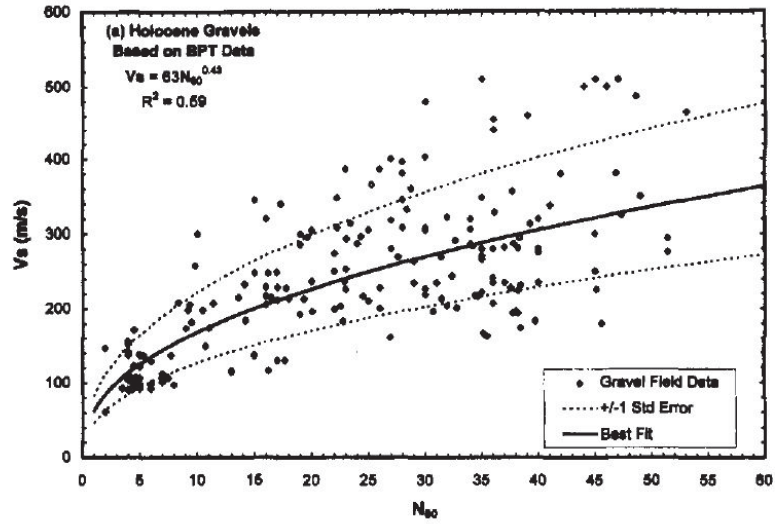

Figure 2.86: Comparison of V_s and N_{60} for Holocene Gravels (Rollins et al., 1998)

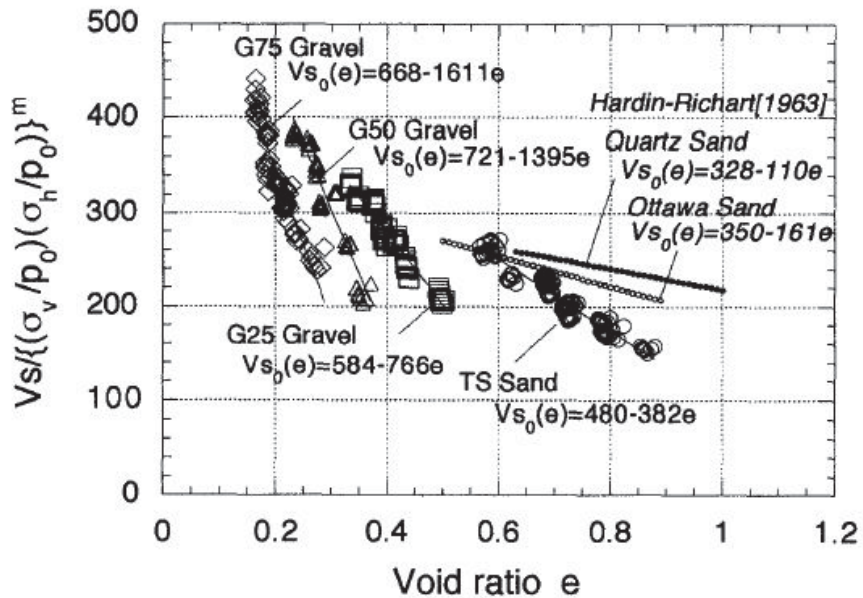

Figure 2.87: V_s as a Function of Void Ratio for Various Gravelly Soils and Sands (Kokusho and Yoshida, 1997)

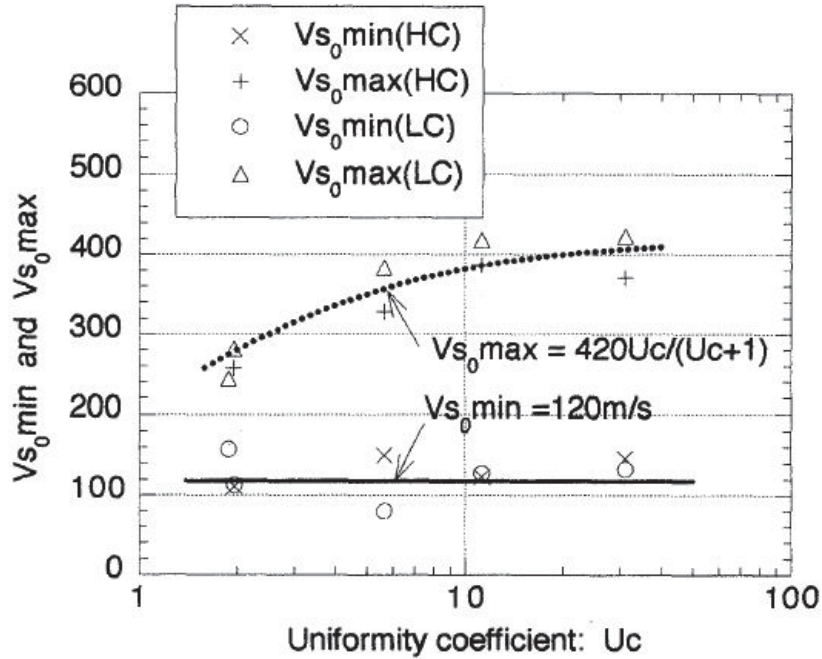

Figure 2.88: The Effect of Coefficient of Uniformity on V_S (Kokusho and Yoshida, 1997)

Kokusho *et al.* (2004) performed a series of undrained triaxial compression tests on granular soils and found that the undrained monotonic shear strength defined at larger strains was at least eight times larger for well-graded soils than poorly-graded sand despite the same relative density. Kokusho *et al.* (2004) concluded that devastating failures with large post-liquefaction soil strain are less likely to develop in well-graded granular soils when compared to poorly-graded granular soils at the same relative density even though they are both almost equally liquefiable. Kokusho *et al.* (2004) also suggested that the liquefaction strength of granular soils can be roughly evaluated by relative density, despite large differences in particle gradations.

Flora *et al.* (2012) carried out monotonic and cyclic triaxial tests on undisturbed gravelly soils that were sampled by in-situ freezing. The results showed that the coarser and more well-graded gravel had a larger ultimate state friction angle than the sandy soil and that when the gravel is floating in the sand matrix the specimen will behave similarly to the matrix material. Flora and Lirer (2013) performed V_S measurements before and after

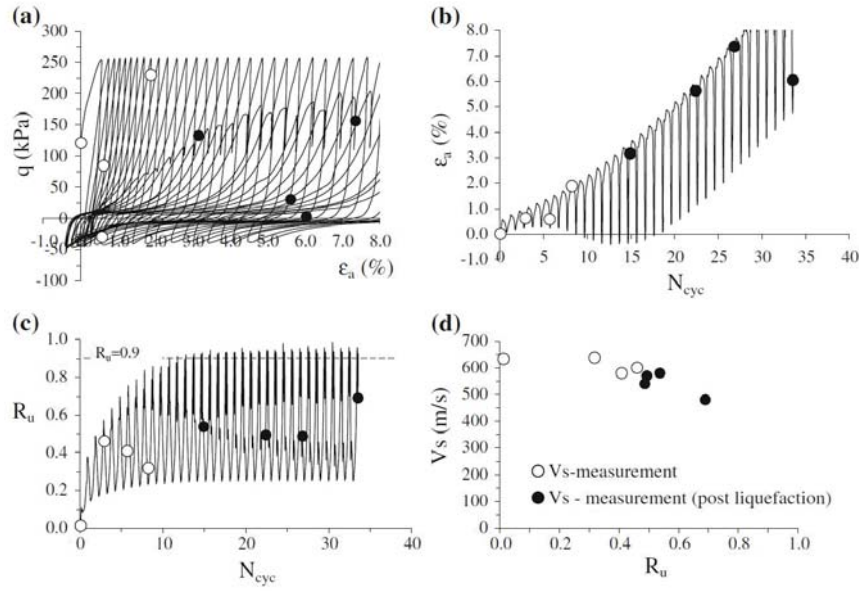

Figure 2.89: Cyclic Triaxial Test Results for a Gravelly Soil Specimen with V_S Measurements during Testing (*Flora and Lirer, 2013*)

liquefaction (liquefaction defined as 5% double amplitude strain) on gravelly soils from the same site at *Flora et al. (2012)* and found that V_S before and after liquefaction in a triaxial specimen is dependent on the pore pressure generation at the time of V_S measurement as shown in Figure 2.89. The authors suggest that this decrease in V_S is not affected by the attainment of liquefaction and that the structure of the soil therefore has no effect on its mechanical behavior. *Fioravante et al. (2012)* performed monotonic and cyclic triaxial tests on specimens from the Messina Strait and found that the V_S measured in the laboratory for undisturbed specimens and the field compared very well and that there was little effect on the cyclic resistance of the gravelly soil whether reconstituted or undisturbed (Figure 2.90).

Chang et al. (2014) performed cyclic simple shear tests of gravel-sand mixtures. The gravel had a D_{50} of 5.3 mm, slightly over the threshold for a gravel based on the Unified Soil Classification System. *Chang et al. (2014)* summarizes that sand-gravel mixtures can be categorized as sand-like, gravel-like, or in-transition and that the shear response will be dictated by which portion is dominating. They suggest that the sand-like and gravel-like void ratios are therefore better indicators of response than overall void ratio for the gap-

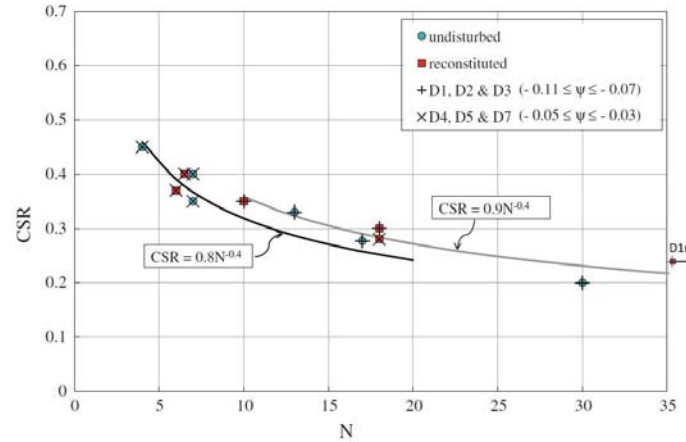

Figure 2.90: Comparison of Cyclic Resistance of Reconstituted and Undisturbed Gravelly Soils (*Fioravante et al.*, 2012)

graded gravelly soils that they tested. They found the transition zone for sand to gravel behavior to be at a gravel content of 50 to 70%. The V_S was for sand-like soils increased with increasing gravel content. The same response was observed for the addition of sand to gravel-like specimens as shown in Figure 2.91. Increasing the sand content of gravel-like soils was also shown to increase the cyclic resistance of the gravel-sand mixtures (Figure 2.92). The authors plotted their data for comparison with *Andrus and Stokoe* (2000) on a liquefaction triggering chart and suggest that the *Andrus and Stokoe* (2000) relationship should be shifted to lower values of V_{S1} as shown in Figure 2.93. *Qi et al.* (2015) tested mixtures of gravel and plastic fines, and found that the cyclic resistance initially decreases with increasing fines content and then reverses and increases with further increasing fines content as shown in Figure 2.94.

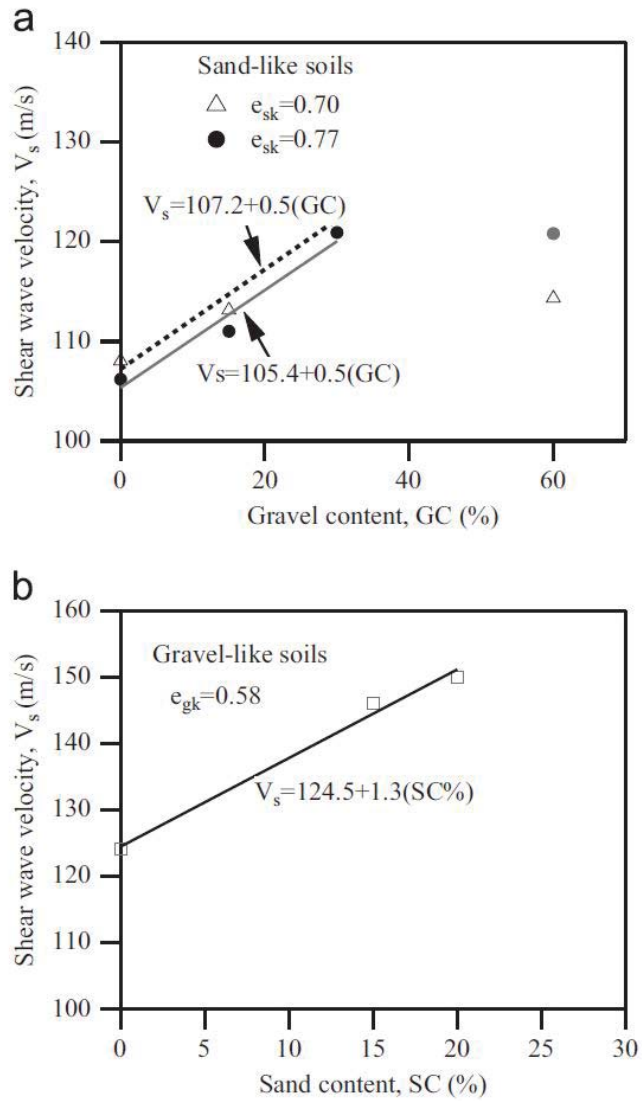

Figure 2.91: The Effect of (a) Increasing Gravel Content in a Sand Specimen and (b) Increasing Sand Content in a Gravel Specimen (*Chang et al.*, 2014)

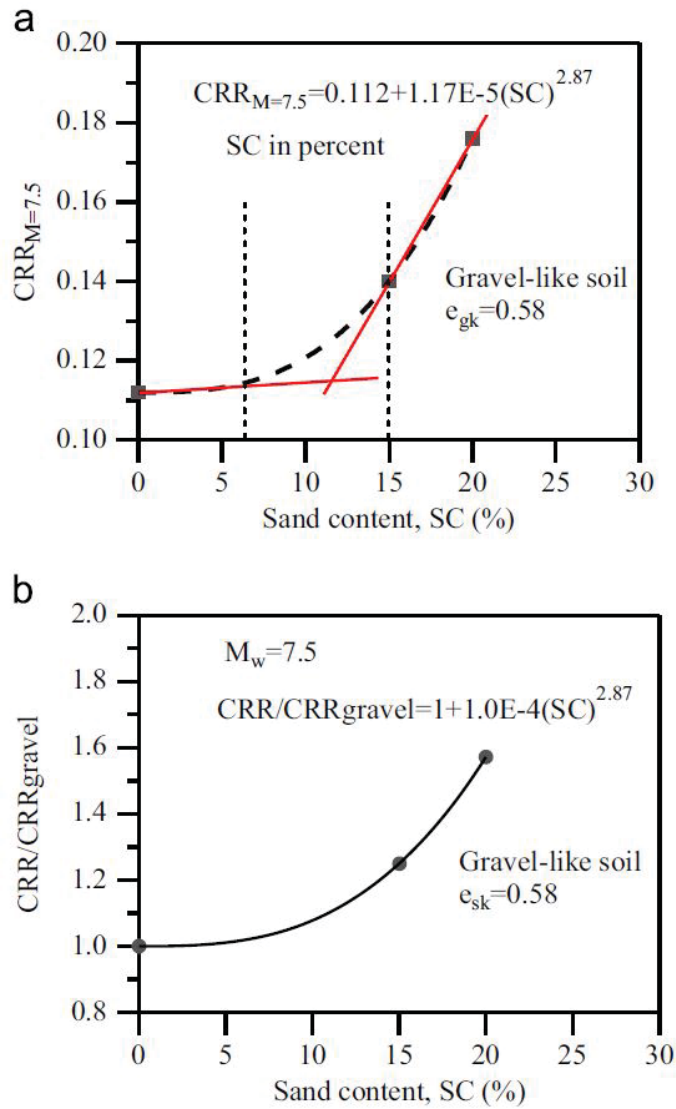

Figure 2.92: (a) Cyclic Resistance versus Increasing Sand Content for a Gravel Specimen and (b) Cyclic Resistance Normalized by Cyclic Resistance of Gravel versus Increasing Sand Content for a Gravel Specimen (*Chang et al., 2014*)

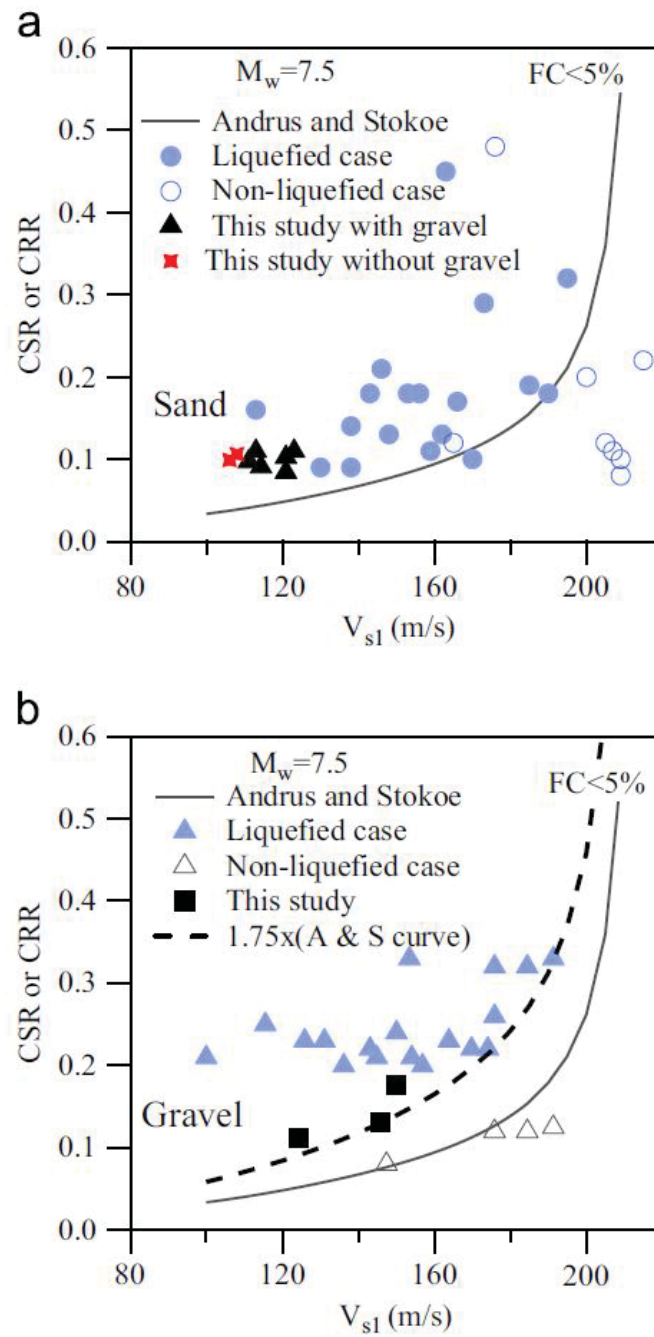

Figure 2.93: Comparison of Gravelly Soil Data with *Andrus and Stokoe* (2000) Liquefaction Triggering Relationship for Gravels (*Chang et al.*, 2014)

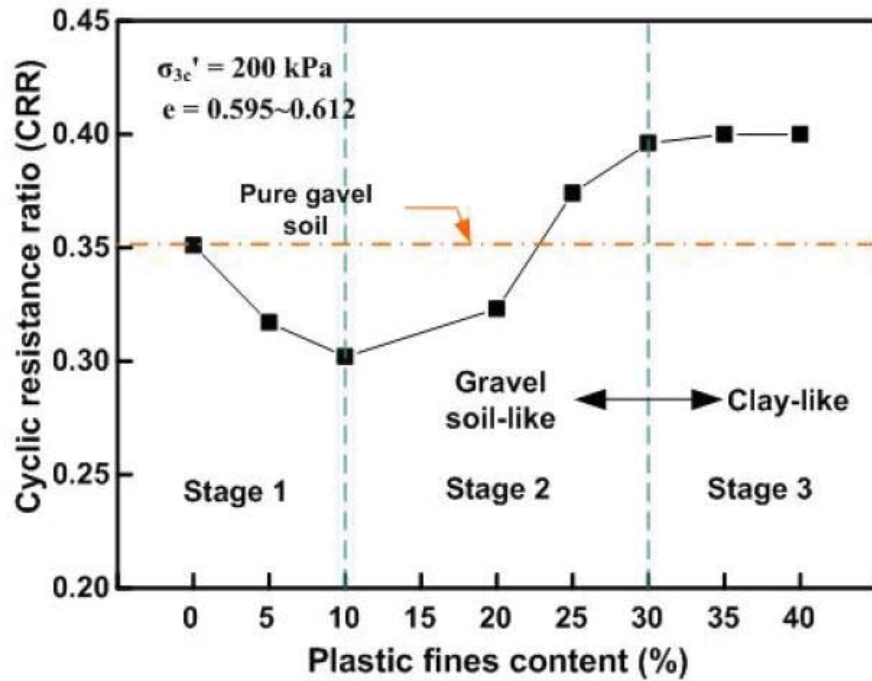

Figure 2.94: Cyclic Resistance of Gravelly Soil as a function of Plastic Fines Content (*Qi et al.*, 2015)

2.7 Pore Pressure Generation of Gravelly Soils

In soil liquefaction analysis, it is critical to understand the generation and dissipation of excess pore pressures. During undrained loading, excess pore pressures develop due to rearrangement of soil particles, which cause a reduction in effective confining stress and therefore a loss in soil stiffness. Many researchers have studied this response in sands (*Lee and Albaisa*, 1974; *De Alba et al.*, 1975; *Martin et al.*, 1975; *Seed et al.*, 1975; *Dobry et al.*, 1982; *Kammerer et al.*, 2004; *Wu et al.*, 2004) and silt and sand-silt mixtures (*Green et al.*, 2000; *Polito and Martin II*, 2001; *Polito et al.*, 2008).

Various models have been developed to predict excess pore pressure generation. *Seed et al.* (1975) developed a stress-based model using data from, undrained, stress-controlled cyclic tests on sand. An empirical model for the pore pressure ratio, $r_u (u/\sigma'_{v0})$ in Equation 2.2, was developed using the relationship between excess pore pressure generation (r_u) and the cyclic ratio (N/N_L), which is the number of cycles normalized by the number of

cycles to liquefaction.

$$r_u = \frac{1}{2} + \frac{1}{\Pi} \arcsin \left(2 * \frac{N}{N_L} \right)^{(1/\alpha)} - 1 \quad (2.2)$$

where α is an empirical constant that is a function of the soil properties and test conditions. A best fit for the sand data in *Seed et al. (1975)* was found using an α value of 0.70. Other researchers have since developed models that are stress-based (*Polito et al., 2008*), strain-based (*Martin et al., 1975; Dobry et al., 1985*), and energy-based (*Green et al., 2000*).

These models have all been developed using sand and silty soils. The pore pressure generation of gravels and gravelly soils has been less extensively studied due to the unavailability of large-size laboratory devices that can accurately capture pore pressure generation. Moreover, many of the existing laboratory studies for gravelly soils have utilized triaxial testing devices, which are susceptible to membrane compliance issues when testing gravelly soils. Several studies (*Evans and Seed, 1987; Haeri and Shakeri, 2010*) have assessed the effects of membrane compliance on pore pressure generation and developed corrections; however, there is no agreed upon method for correction. *Banerjee et al. (1979)* tested well-graded Oroville gravel with a maximum particle size of 2 using a large-size triaxial apparatus and found gravel pore pressure generation increase to be different from that of sands. The excess pore pressure generation for gravels increased very rapidly in the first few cycles and then very slowly in following cycles. These results agreed with previous tests of well-graded Oroville gravel tested by *Wong et al. (1974)*. *Evans and Seed (1987)* tested gravel in a large-size triaxial (307 mm diameter) and a smaller-size triaxial apparatus (71 mm diameter) and sluiced specimens with sand to minimize membrane compliance. Non-compliant (unsluiced) specimens were found to increase cyclic resistance by 55% and have different pore pressure response than the sluiced specimens and previous sand results. Sluiced specimens, which were noted to more accurately represent true non-compliant response, generated excess pore pressures greater than sands and near the upper

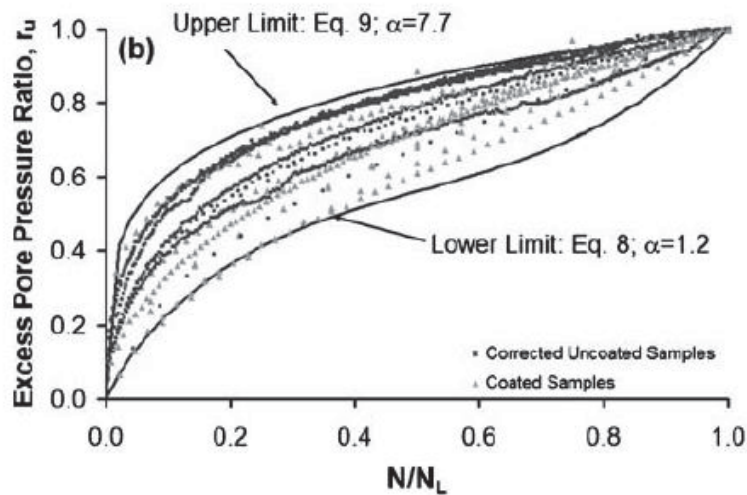

Figure 2.95: Pore Pressure Generation Ratio of Gravelly Soil (*Haeri and Shakeri, 2010*)

bound of the *Lee and Albaisa (1974)* data for sand. *Hynes (1988)* tested Folsom gravel in a large-size triaxial apparatus and found pore pressure generation at cyclic shear strain levels of 1% to be independent of initial confining stress, relative density, overconsolidation ratio, and anisotropic consolidation conditions. *Haeri and Shakeri (2010)* tested Tehran Alluvium and found similar pore pressure generation response as *Banerjee et al. (1979)* as shown in Figure 2.95. *Chang et al. (2014)* presented cyclic simple shear data for the liquefaction response of gap-graded gravelly soils and found pore pressure generation to be similar or below that of sands. Increasing gravel content was shown to increase pore pressure generation.

2.8 Review of Direct Simple Shear Testing

The simple shear test is an attractive laboratory element test since it models many common field loading conditions by allowing for rotation of principal stresses during plane-strain shearing (*DeGroot et al., 1994; Boulanger et al., 1993; Budhu, 1988; Finn, 1985*). It was developed to test soil samples under simple shear strains, which can reasonably approximate a state of pure shear strain. The studies presented in this Chapter have mainly utilized triaxial devices for the testing of gravelly soils due to the wider availability of these

devices even though it has been known that the simple shear test in many cases is more representative of field performance of soils under earthquake loading (*Finn, 1985; Vaid and Sivathayalan, 1996*). Simple shear tests are also not affected by membrane compliance unlike the triaxial test.

The simple shear test begins with one-dimensional consolidation of the test specimen in approximately K_0 conditions. Lateral expansion of the specimen is prevented by one of several methods. The Cambridge-type simple shear device (*Roscoe, 1953*) uses rigid boundary platens while the Norwegian Geotechnical Institute (NGI)-type device (*Bjerrum and Landva, 1966*) utilizes a wire-reinforced membrane. The NGI-type device was a modification of the Swedish Geotechnical Institute (SGI)-type device (*Kjellman, 1951*), which used a series of stacked rings to prevent lateral expansion. Some NGI-type devices have been modified with pressurized cells (similar to the triaxial test cell) to allow for back pressure saturation, pore pressure measurements and lateral confinement of the specimen (*Franke et al., 1979; Boulanger et al., 1993; Doherty and Fahey, 2011*). The first simple shear devices were used to perform monotonic simple shear tests; however, many devices are now capable of running monotonic, cyclic, or multi-directional cyclic tests. Significant study of the cyclic response of sands, silts, and clays has been completed using the simple shear device (*Peacock and Seed, 1968; Silver and Seed, 1971; Vaid and Chern, 1983, 1985; Vucetic and Dobry, 1988; Azzouz et al., 1989; Vaid and Sivathayalan, 1996; Wijewickreme et al., 2005; Sanin and Wijewickreme, 2006; Porcino et al., 2008*). Other materials such as gravels (*Shaw and Brown, 1986; Chang and Hong, 2008; Chang et al., 2014*), municipal solid waste (*Matasovic and Kavazanjian Jr, 1998; Kavazanjian Jr et al., 1999; Pelkey et al., 2001*) and peat (*Boylan and Long, 2008; Den Haan and Grognet, 2014*) have limited simple shear test data.

Common specimen sizes for simple shear tests are listed in Table 2.3. This is a partial list and does not represent every simple shear device; however, it does highlight the general specimen sizes used in research and practice. Most tests have utilized small-scale devices

Table 2.3: Common Simple Shear Devices used in literature

Specimen Diameter or Size (mm)	Specimen Height (mm)	D/H Ratio	Lateral Confinement Method	Reference
80	10	8	Stacked Rings	Kjellman (1951)
60 x 60 square	20	3	Rigid Platens	Roscoe (1953)
80	10	8	Wire Reinforced Membrane	Bjerrum and Landva (1966)
60 x 60 square	20	3	Rigid Platens	Peacock and Seed (1968)
51 x 51 square	29	1.8	Rigid Platens	Finn et al. (1970)
80	20	4	Wire Reinforced Membrane	Silver and Seed (1971)
210 x 140	30	-	Rigid Platens	Ansell and Brown (1978)
75	20	3.75	Chamber Pressure	Frank et al. (1979)
305	25, 51 and 102	12, 6 and 3	Stacked Rings	Kovacs and Leo (1981)
50, 80 and 115	16	3, 5 and 7	Wire Reinforced Membrane	Vucetic and Lacasse (1982)
100 x 100 square	20	5	Rigid Platens	Budhu (1984)
110	20	5.5	Wire Reinforced Membrane	Budhu (1984)
80	20	4	Wire Reinforced Membrane	Atkinson and Lau (1991)
102	25.4	4	Chamber Pressure and/or Wire Reinforced Membrane	Boulanger et al. (1993)
71	20	3.6	Wire Reinforced Membrane	Vaid and Sivathayalan (1996)
457	-	-	Stacked Rings	Matasovic and Kavazanjian (1998)
80	20	4	Wire Reinforced Membrane	Porcini et al. (2008)
102	30	3.4	Stacked Rings	Chang and Hong (2008)
70 x 70 square	20	3.5	Plastic Platens	Boylan and Long (2009)

with specimen diameters of approximately 80 mm and heights ranging from 10-30 mm. Very few simple shear devices allow for testing soils with larger particles and inclusions (i.e. gravels or waste). *Matasovic and Kavazanjian Jr* (1998) used a cyclic simple shear with a diameter of 457 mm to test municipal solid waste (MSW). *Kovacs and Leo* (1981) and *Amer et al.* (1987) used a 305 mm cyclic simple shear device; however, testing was done on sands and not materials with larger particle sizes. *Shaw and Brown* (1986) modified the device developed by *Ansell and Brown* (1978) and tested crushed limestone of 1.5 and 3 mm nominal sizes. *Chang and Hong* (2008) and *Chang et al.* (2014) used a 102 mm diameter simple shear to test gravel-clay and gravel-sand mixtures. The specimen height in these tests was approximately 30 mm while the maximum particle size was approximately 6 mm. According to ASTM D6528 (ASTM, 2007), the specimen height should not be less than ten times the maximum particle diameter.

Constant volume simple shear testing is used to test dry soil specimens at undrained conditions. This method is commonly used in simple shear testing due to the difficulties of achieving undrained conditions in many simple shear devices. A constant volume is forced by restraining movement in the vertical direction. According to ASTM D6528 (ASTM,

2007), to achieve a constant volume in a simple shear device, vertical strain should not exceed 0.05% during shearing. By using this method, the change in vertical stress is assumed to be equal to the change in pore pressure in the specimen that would develop in an undrained test (*Bjerrum and Landva, 1966; Finn, 1985; Vaid and Sivathayalan, 1996; Wijewickreme et al., 2005*). Therefore, this allows for dry materials to be tested in undrained conditions yielding results that correspond to an undrained test. This assumption has been verified for both clays (*Dyvik et al., 1987*) and sands (*Finn, 1985*).

2.8.1 Limitations of Direct Simple Shear Testing

As with any laboratory testing device, the simple shear does have shortcomings that need to be recognized and considered in test result interpretation. The simple shear test is known to impose non-uniform normal and shear stresses on the specimen (Figure 2.96) because complementary shear forces are not applied to the sides of the specimen (*Prevost and Høeg, 1976; La Rochelle, 1981; Finn, 1985; Budhu, 1988; De Josselin de Jong, 1988; Dounias and Potts, 1993; DeGroot et al., 1994; Dabeet et al., 2015*). *DeGroot et al. (1994)* analyzed these stress non-uniformities by analysis of elastic and cohesive materials in the laboratory and found that the difference measured between the top and middle of the specimen was 7%. *Budhu (1984)* instrumented both rectangular and circular simple shear devices to measure the specimen non-uniformities (Figure 2.97). *Budhu (1984)* concluded that rigid walls lead to less stress non-uniformity than wire-reinforced membranes, and that the difference in measured stress due to non-uniformities can cause error of 6 to 12%. These non-uniformities may be decreased by the application of larger vertical stresses (*DeGroot et al., 1994*). *DeGroot et al. (1994)* concluded that non-uniformities probably have little effect on the peak strength since this typically occurs at small values of shear strain. *Vucetic and Lacasse (1982)* concluded that the theoretical elastic analysis of the simple shear test offers a pessimistic view of the influence of strain non-uniformities because it does not take into account the yielding of soil. They further conclude that the simple shear

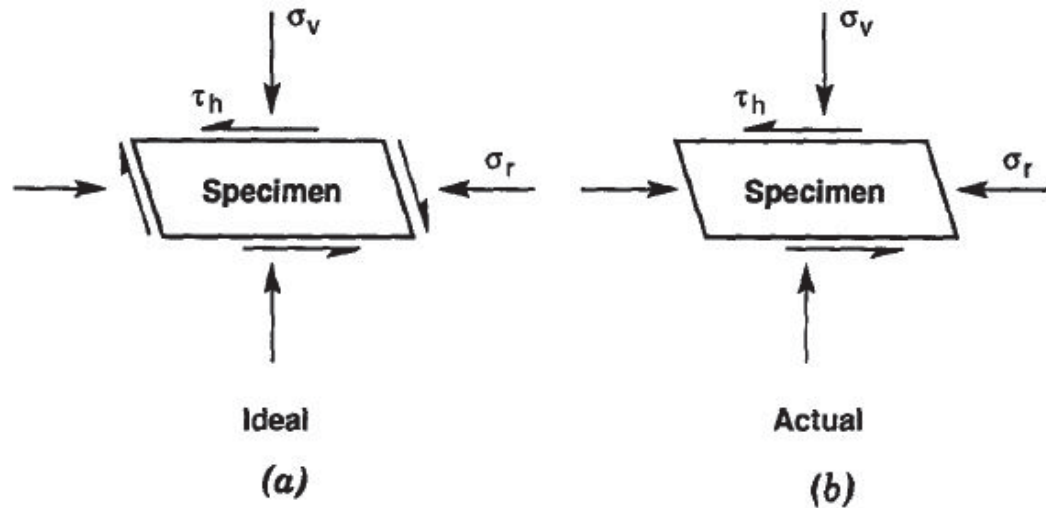

Figure 2.96: Comparison of Stresses Imposed on Ideal Simple Shear and Realistic Simple Shear (*DeGroot et al.*, 1994)

is one of the most valuable tools for determining the stress-strain behavior of soils. *Dabeet et al.* (2015) used a discrete element model of the simple shear and found a fairly uniform stress ratio distribution throughout the shearing phase as well as reasonably uniform shear strains within the middle two-thirds of the specimen.

In order to decrease stress-strain nonuniformities during simple shear testing, a large diameter to height (D/H) ratio has been used. *Kovacs and Leo* (1981) used a 305 mm diameter cyclic simple shear device to test dry sand samples to study the effect of D/H ratio on cyclic behavior. They found that D/H ratio effects shear modulus and damping data at small strains (less than 1%). *Amer et al.* (1987) utilized a larger-scale cyclic simple shear (CSS) to study the effects of diameter and height on small-strain shear modulus of dry sand. Three different diameters (76 mm, 152 mm, and 305 mm) were used while height was also varied from 6 mm to 102 mm to allow for D/H ratios of 12, 9, 6, and 3. The authors found that the values of shear modulus and damping stabilized at a diameter of 203 mm and a D/H ratio of about 8-9. This specimen had uniform shear stresses distributed over 85% of the cross-sectional area. *Vucetic and Lacasse* (1982) performed monotonic simple shear tests of medium-stiff clay using an NGI-type device to study the effect of D/H ratio. Specimen

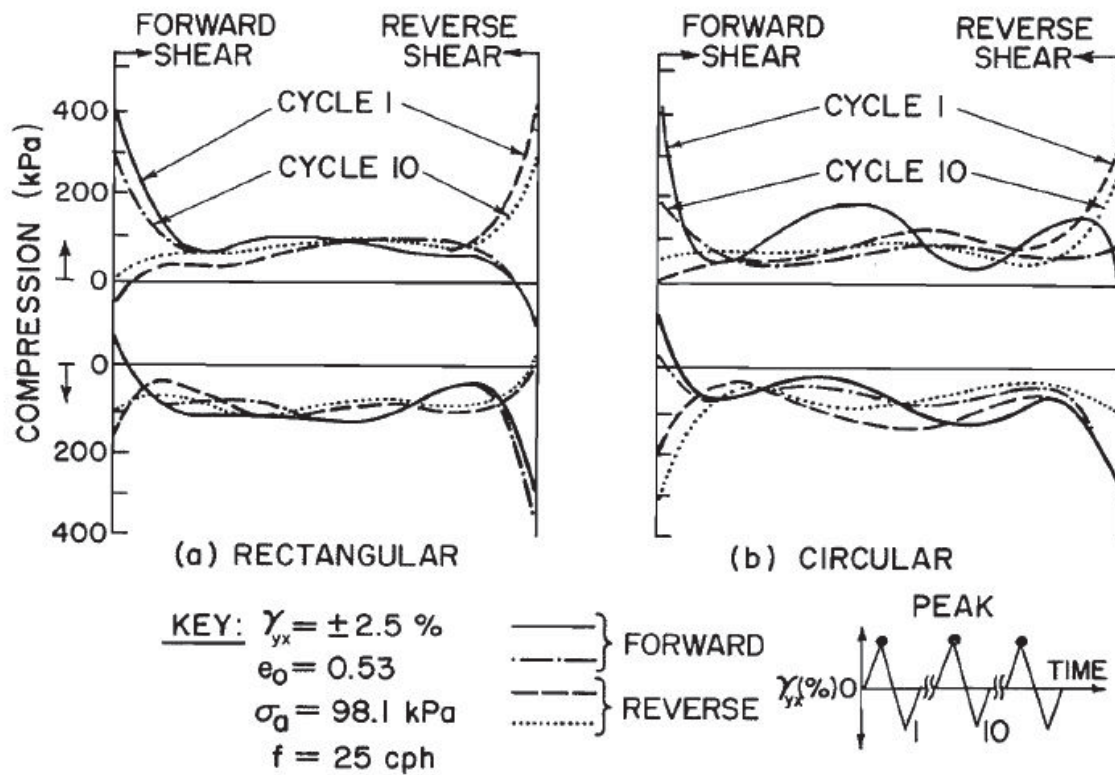

Figure 2.97: Normal Stresses at Horizontal Boundaries of Simple Shear Tests in Rectangular and Circular Apparatuses (*Budhu, 1984*)

diameter was varied between 50 mm, 80 mm and 115 mm, while specimen height was kept constant at 16 mm. The results showed that D/H ratio did not have a significant influence on the monotonic stress-strain behavior.

2.8.2 Shear Strength Interpretation of Direct Simple Shear Testing Results

The direct simple shear test results are most commonly presented in terms of shear stress versus shear strain, where shear stress is the horizontal load divided by the specimen area and shear strain is the horizontal displacement divided by the specimen height during shearing. The maximum shear stress is defined as the shear strength. Interpretation of the direct simple shear results becomes more complex, if the objective is to estimate the effective friction angle of the tested material. This is because only a single stress point (σ'_v, τ_h) on the Mohr circle is measured during the test and thus, the Mohr circle (i.e., the specimens stress state) is poorly defined. An extensive discussion of these issues has been made by others, particularly *DeGroot et al.* (1992).

An assumption for the stress state at failure of the specimen needs to be made in order to estimate the friction angle of the material. *DeGroot et al.* (1992) discussed seven alternative assumptions. One common assumption is that the horizontal plane is the failure plane, i.e., the plane of maximum obliquity. In that case, the friction angle of the soil is given by the following equation:

$$\phi = \beta = \tan^{-1} \left(\frac{\tau_{hf}}{\sigma'_{vf}} \right) \quad (2.3)$$

where τ_{hf} is the measured horizontal shear stress at failure, and σ'_{vf} is the measured vertical effective stress at failure. This assumption is generally considered incorrect (*Roscoe et al.*, 1967; *Airey et al.*, 1985; *DeGroot et al.*, 1992), but is widely used in practice because it yields a low, and thus conservative, friction angle. The second theory assumes that the horizontal plane is the plane of maximum shear stress. *Roscoe et al.* (1967) suggested that this theory was valid for drained tests on medium loose sand, but not for tests on dense

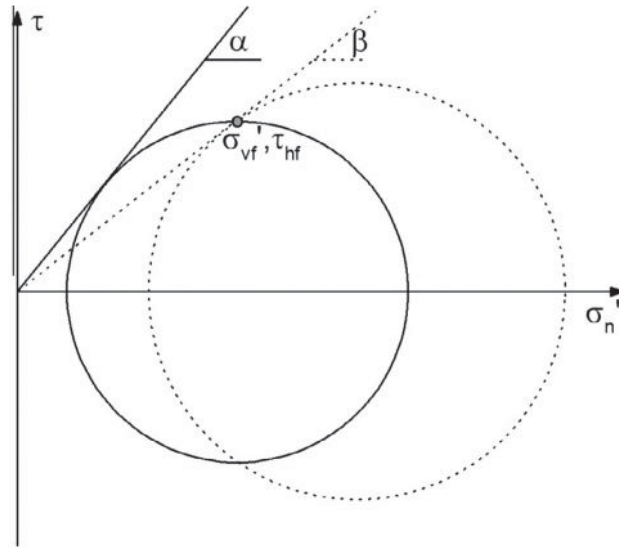

Figure 2.98: Interpretations of Friction Angle in Simple Shear (Zekkos and Fei, 2016)

sand and was also reasonable for undrained tests on sands regardless of void ratio. In this case, the friction angle of the soil is given by the following equation:

$$\phi = \alpha = \sin^{-1} \left(\frac{\tau_{hf}}{\sigma'_{vf}} \right) \quad (2.4)$$

where τ_{hf} is the measured horizontal shear stress at failure, and σ'_{vf} is the measured vertical effective stress at failure.

2.9 Conclusions

After reviewing existing literature on soil liquefaction, gravelly soil liquefaction, the shear response of gravelly soils in the laboratory, and cyclic simple shear laboratory testing, several conclusions can be made:

- A review of historical and recent case-histories of gravelly soil liquefaction was performed and showed that gravelly soil liquefaction has occurred, but there are few well-documented case-histories. Many cases of gravelly soil liquefaction were attributed to a low permeability layer above the gravel layer preventing drainage.

- Existing liquefaction triggering charts exist for gravelly soils based on DPT and V_S measurements in the field. The DPT-based chart developed by *Cao et al. (2013)* includes only sites that liquefied during the 2008 Wenchuan earthquake, and therefore is based on limited data compared to existing sandy soil liquefaction triggering charts. V_S -based charts exist for gravelly soils; however, the cut-off value of V_{S1} at which liquefaction will or will not occur has conflicting values in the literature.
- Post-cyclic response of gravelly soils is not well understood due to limited field and laboratory data. *Yegian et al. (1994)* calculated the post-liquefaction residual shear strength of gravelly soils that liquefied during the 1988 Armenia earthquake and found these values to be similar to sands, but with higher SPT N-values. Laboratory measurement of post-liquefaction shear strength and volumetric strain is limited, but volumetric strain of gravelly soils has been shown to be similar to sands. Post-liquefaction volumetric strain was hypothesized to be dependent on the coefficient of uniformity by *Hara et al. (2012)*.
- Shear wave velocity has been measured in the field and laboratory for gravelly soils. *Kokusho and Yoshida (1997)* measured the V_S and SPT N-value of gravels in the laboratory and found that even though well-graded gravelly soils may have a much higher density than sand it may exhibit a V_S value and N-value as low as poorly graded loose sand if the relative density of the gravel is low enough. Field measured V_S has a wide range of values depending on the site, with values where liquefaction has occurred ranging from approximately 85 - 300 m/s, which suggests that liquefiable gravelly soils may have a wider range of V_S values than sandy soils.
- Most cyclic testing of gravelly soils in the laboratory have been performed using cyclic triaxial devices, even though the simple shear device has been shown to more closely represent field loading conditions during an earthquake. In addition, the simple shear device does not need correction for membrane compliance issues that are

present in triaxial testing of coarse-grained soils. There is very limited data of grav-
elly soil undrained response in monotonic or cyclic simple shear conditions.

CHAPTER 3

Large-Size Cyclic Simple Shear Device

3.1 Introduction

The simple shear test is an attractive laboratory element test since it models many common field loading conditions by allowing for rotation of principal stresses during plane-strain shearing (*DeGroot et al.*, 1994; *Boulanger et al.*, 1993; *Budhu*, 1988; *Finn*, 1985). It was developed to test soil samples under simple shear strains, which can reasonably approximate a state of pure shear strain. Different types of simple shear devices have been developed and many advances have been made since the first simple shear studies were conducted in the 1950s. Significant study of the monotonic and cyclic response of sands, silts, and clays has been completed using the simple shear device (*Peacock and Seed*, 1968; *Silver and Seed*, 1971; *Vaid and Chern*, 1983, 1985; *Vucetic and Dobry*, 1988; *Azzouz et al.*, 1989; *Vaid and Sivathayalan*, 1996; *Wijewickreme et al.*, 2005; *Sanin and Wijewickreme*, 2006; *Porcino et al.*, 2008). Other materials such as gravels (*Shaw and Brown*, 1986; *Chang and Hong*, 2008; *Chang et al.*, 2014), municipal solid waste (*Matasovic and Kavazanjian Jr*, 1998; *Kavazanjian Jr et al.*, 1999; *Pelkey et al.*, 2001) and peat (*Boylan and Long*, 2008; *Den Haan and Grognet*, 2014) have limited simple shear test data, as these materials require larger devices. This chapter will describe the development and validation of a large-size cyclic simple shear device.

3.2 Development of the Large-Size Direct Simple Shear Device

A prototype large-size cyclic direct simple shear (CSS) device has been developed as part of a cooperation between the University of Michigan and Geocomp Corporation. The device was designed to enable testing of larger sized particles, including gravels. A schematic of the device is shown in Figure 3.1 and a photograph is shown in Figure 3.2. The device allows for the performance of monotonic and cyclic direct simple shear tests with a cylindrical specimen that has a nominal diameter of 307.5 mm and a maximum height of 137 mm, thus the minimum D/H ratio is 2.2. In the testing in this study, specimen height ranged from approximately 105 mm to 115 mm. Therefore D/H ratios were approximately 0.35, which meets the criteria for simple shear testing in ASTM D6528 (ASTM, 2007) and allowed for testing of particles with an approximate maximum particle size of 11 mm. This maximum particle is recommended not to exceed 1/10 of the specimen height according to ASTM D6528 (ASTM, 2007).

The specimen is prepared within a stack of 6.35 mm thick, Teflon-coated circular aluminum rings (shown in Figure 4.4) that have minimal friction against each other. Stacked rings are used because reinforced membranes of that size are not generally available and are very expensive to manufacture. An unreinforced membrane was used in this study to prevent gravel particles from damaging the stacked rings.

The CSS device is a self-contained, standalone system comprised of two independent control and data logging units, each controlling one of the vertical and horizontal axis. The vertical motion is generated by a geared screw-jack coupled to a stepper motor running in a high resolution micro-stepped mode. The top cap is attached to the 44 kN low-profile Interface load-cell with a resolution of 2.4 N through a very rigid steel loading piston. The load-cell itself is fixed on top of the vertical frame. The top cap assembly is supported against lateral movements through four low friction steel rollers located on the main chassis frame (Figure 3.1). The top cap can easily move upwards or downwards and not rock or tilt as a result of horizontal movement of the specimen at the bottom. The average upward

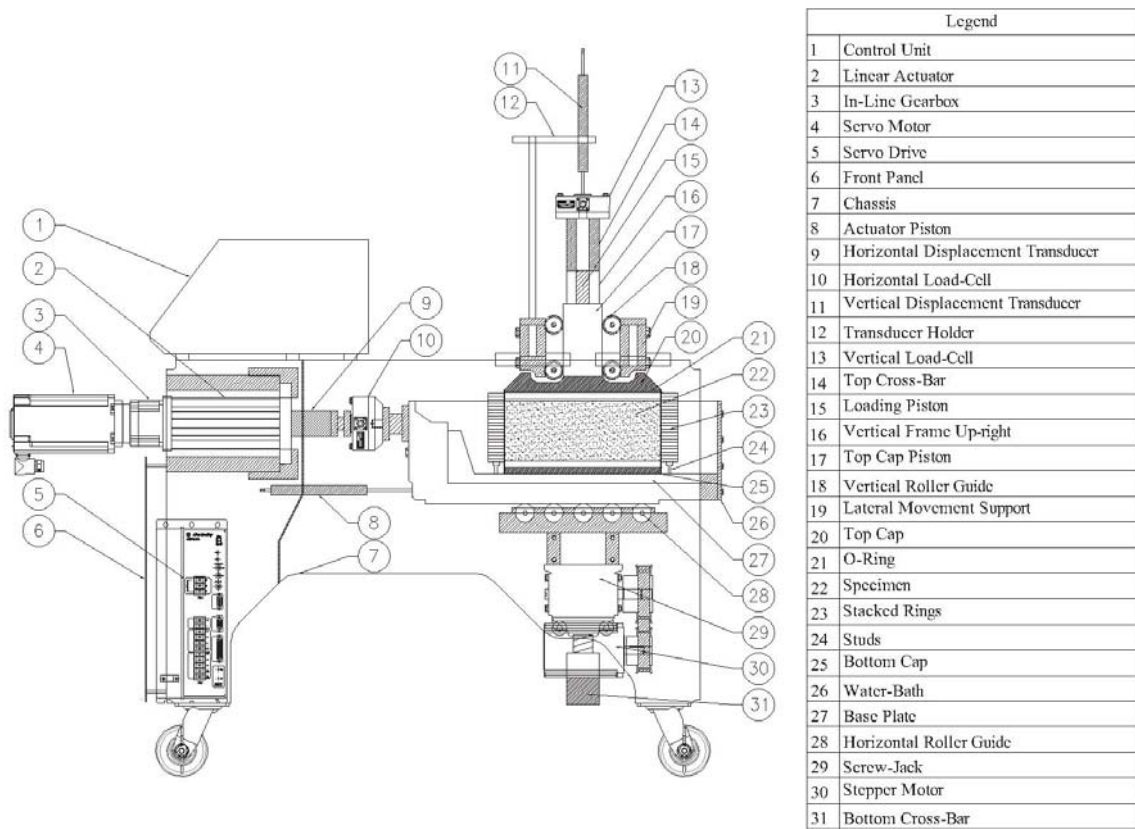

Figure 3.1: Schematic of Large-Size Cyclic Simple Shear Device

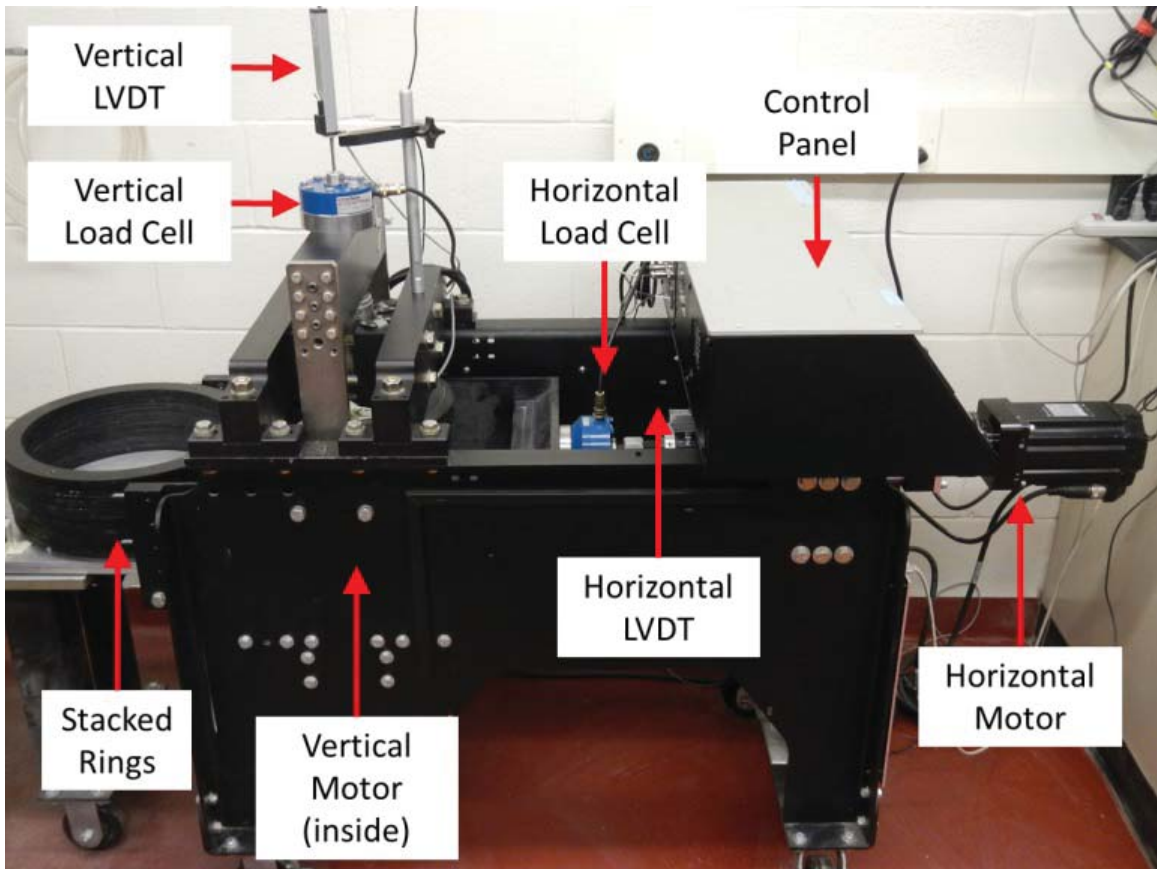

Figure 3.2: Cyclic Simple Shear Device

and downward movement of the top cap can be measured using the vertical displacement transducer on top.

The horizontal motion is generated using a servo system. The Servo motor is a 5 kW, high torque low inertia MPL series model powered by a 3 phase Ultra 3000 digital servo drive (Both manufactured by Allen Bradley). The servo motor is connected to a 5:1 ultra-low backlash in-line gearbox driving a high velocity low friction linear actuator. The linear actuator is connected directly to a 22 kN low-profile Interface load-cell with resolution of 1.2 N and can move the water-bath back and forth. The water baths precision ground steel pedestal rests on a set of 6 steel rollers and is supported against vertical and unwanted lateral movements. The bottom cap is fixed on the base plate that can be inserted inside the water-bath and locked once the specimen and stacked rings are placed on. The average horizontal displacement can be measured using a displacement transducer, connected to the water bath (Figure 3.1). The displacement transducers have a range and resolution of 100 mm and 0.0015 mm, respectively.

All of the sensors are read at 1 kHz with a 24 bit simultaneous (non-multiplexed) data acquisition system (only 16 bit is used) to eliminate phase lag and enable high speed closed loop control for the cyclic tests. The controllers are connected to a PC that runs the fully automated CSS software via a high speed industrial Arcnet communication network. The servo motor encoder is read at very high resolution and is used with an advanced adaptive control algorithm specifically developed to control monotonic and cyclic horizontal load and displacement application on specimens of different type without loss of control. The vertical axis is controlled by a closed loop Proportional-Integral-Derivative (PID) controller with feedback either provided by the load-cell or the displacement transducer to provide load or displacement control.

The tuning of the control and feedback of the device took many iterations to obtain testing parameters that gave desired testing results. For the horizontal motor, different testing parameters were used for monotonic and cyclic testing. For monotonic testing, the

Table 3.1: CSS Device settings for Monotonic and Cyclic Testing

Test	Horizontal Motor				Horizontal Load			Vertical Load			Horizontal Diags Output Scale
	Encoder	P	I	D	P	I	D	P	I	D	
Monotonic	4096	200	66	0	1	1	0	2	3	0	x256
Cyclic (Liquefaction) - Consolidation	512	200	0	0	1	1	0	2	3	0	x128
Cyclic (Liquefaction) - After Consolidation/Before Shearing	512	200	0	0	1	1	0	10	15	0	x128

motor did not need to be as aggressive since the shear rate was relatively slow (1% shear strain per minute), while for the cyclic liquefaction tests the motor was tuned to be more aggressive and to maintain the specified CSR at larger strains (as shown in Figure 3.39). The majority of cyclic tests were completed at a frequency of 0.33 Hz, which represents a faster loading condition than the monotonic shear rate. After several trial tests, it was found that the 0.33 Hz rate ensured testing specifications were met. The device is capable of running cyclic tests with frequencies ranging from 0.05 Hz to 2 Hz. Those ranges were tested during trial runs, and it is possible that the device can test beyond those values. The rate of horizontal loading also affected the vertical constant volume response. It was much easier to maintain constant volume conditions during a slow monotonic test than a liquefaction test. Therefore, vertical PID controls were changed for monotonic and cyclic loading conditions. A summary of the testing parameters used for monotonic and cyclic tests is given in Table 3.1. This table gives the settings used for the horizontal motor, horizontal load PID, vertical load PID, and the output scale for the horizontal load.

3.3 Description of the Shear Wave Velocity (V_S) Measurement Instrumentation

Custom-built bender element and accelerometer systems were integrated into the CSS device. The development and use of these two types of laboratory V_S measurement techniques will be described in the following sections.

3.3.1 Bender elements

Bender elements have become an attractive method for measuring V_S in the laboratory and have been implemented in a wide variety of geotechnical testing devices, such as the resonant column (*Dyvik and Madshus, 1985*), oedometer (*Thomann and Hryciw, 1990; Fam and Santamarina, 1995; Kawaguchi et al., 2001*), triaxial (*Bates, 1989; Brignoli et al., 1996; Pennington et al., 2001*), and cubical triaxial (*Agarwal and Ishibashi, 1991*). A pair of hybrid piezo-ceramic elements were incorporated into the CSS device as shown in Figure 3.3. These piezo-ceramic elements are capable of acting as bender as well as extender elements to measure V_S and V_p , respectively, but are mainly configured in the bender element mode to measure V_S . The bender element is a bimorph element that is made from two piezo-ceramic layers that are rigidly bonded along the two sides of a conductive thin center shim (as shown in Figure 3.4). A pair of bender elements is installed as a cantilever at two different points, at the bottom and top cap of the device. One bender element serves as a transmitter and the other one serves as a receiver. The bender elements are manufactured and wired differently for use as either transmitter or receiver elements. The bender elements are made from T220-A4SS-303X (used as S-wave receiver) and T220-A4SS-303Y (used as S-wave transmitter) that are manufactured by Piezo Systems Inc. The polarity and voltage input and outputs for bender and extender elements are shown in Figures 3.5 and 3.6.

Before use the bender elements were trimmed to specified length so that their protrusion into the specimen was approximately 3.81 mm. A trimmed bender element is shown in Figure 3.7. Sanding of the bender element was required in the bottom corner of the bender element for wiring purposes. The tools used for preparing the bender elements (wiring and soldering) are shown in Figure 3.8. The connection of the wires after soldering is shown in Figure 3.9. It is important to ensure that during this step that the soldering iron is not too hot, or the bender element could be damaged. After completion of the wire connections, the bender elements are coated to provide for waterproofing and electromagnetic shield-

ing. The elements are coated using air-drying solvent-thinned polyurethane or M-Coat A (Vishay Precision Group). The bender elements are dipped in the polyurethane and then dried for 24 hours. This process is repeated once, and then Teflon and aluminum tape are added to the bender element for protection (as show in Figure 3.10). Bender elements are inserted in the top and bottom plates of the CSS device using aluminum housing (as shown in Figure 3.3b). This housing was custom designed and built for the CSS device. A schematic of the housing unit, which is made from aluminum 6061 T6, is shown in Figure 3.11. The bender elements are mounted inside the housing with a protrusion length of 3.81 mm. Epoxy adhesive is used to fix the position of the bender/extender elements in the housing. Subsequently, each housing is inserted into the top and bottom plates (Figure 3.3c). The S-wave transmitter/P-wave receiver is installed in the bottom plate, whereas the P-wave transmitter/S-wave receiver is installed in the top plate. The gap between the plate and the housing is sealed using a 732 Multi-purpose silicone sealant (Dow Corning Corp.). It should be noted that the bender elements are installed in such an orientation that the deflections of S-wave transmitter and receiver are parallel to the shearing direction imposed by the direct simple shear device.

The transmitting bender element is excited with a supply voltage to generate waves that will be sensed by the receiver. For a known distance between the elements and by measuring the wave travel time, wave propagation velocity can be calculated. A 33510B function generator (Agilent Tech.), shown in Figure 3.13 is used to excite the bender elements using a predetermined waveform type, amplitude, frequency, and number of cycles. In this study, a sinusoidal waveform was used and input signal pulses were sent until the received signal stabilized and showed no further changes with further signal stacking. An EPA-104 linear amplifier (Piezo System Inc.), shown in Figure 3.13, is utilized to amplify the excitation voltage from the function generator. A Handyscope HS4 Diff-25 oscilloscope (TiePie Engineering), shown in Figure 3.22 is utilized to digitize data from bender elements and store the data in a PC. This USB-based oscilloscope has 4 channels and has a maximum

sampling rate of 25 MSamples/second in ADC 12-bit mode. In this study, the ADC setting was set to 16-bit mode to improve signal resolution, but, at this mode the sampling rate is limited to 195 KSamples/second.

According to *Lee and Santamarina (2005)*, the S-wave transmitter generates S-wave frontal lobe and two P-wave side lobes normal to their plane as shown in Figure 3.12. The reflected P-wave arrival may disturb the S-waves arrival at the receiver. *Arroyo et al. (2006)* reported that the effect of the reflected P-wave is more pronounced in small-diameter specimens. *Sawangsurriya et al. (2006)* recommended that the distance (R) of bender elements to the boundary should be greater than approximately 0.4 the direct travel distance between the bender elements L_t . The distance of bender/extender elements to the boundary in the CSS device is 15 cm and the maximum L_t is approximately 12 cm. Thus, R is always greater than $0.4 L_t$ in the CSS device.

Significant research has focused on the interpretation of the arrival time of shear waves using bender elements in common laboratory testing devices. Figure 3.14 shows points where wave arrivals have been chosen and examined as the S-wave arrival in the literature. Points A and B although easy to detect may be biased by reflected P-wave arrival as well as near-field effects (*Dyvik and Madshus, 1985; Fam and Santamarina, 1995; Leong et al., 2005; Viggiani and Atkinson, 1995a,b; Jovičić et al., 1996*). Point C or any point between B and D have shown similar results with a continuous sinusoidal signal and with cross-correlation of crosshole seismic testing and an arrival in this range is most suitable for a single sinusoidal signal (*Blewett et al., 1999, 2000; Bartake et al., 2008; Kawaguchi et al., 2001; Greening and Nash, 2004*). In this study, arrival time of the S-wave was evaluated at two points, Point D and in between points B and C. In most cases the velocity between the chosen points was nearly identical (with differences of less than 10 m/s). An example of arrival time selection is shown in Figure 3.27.

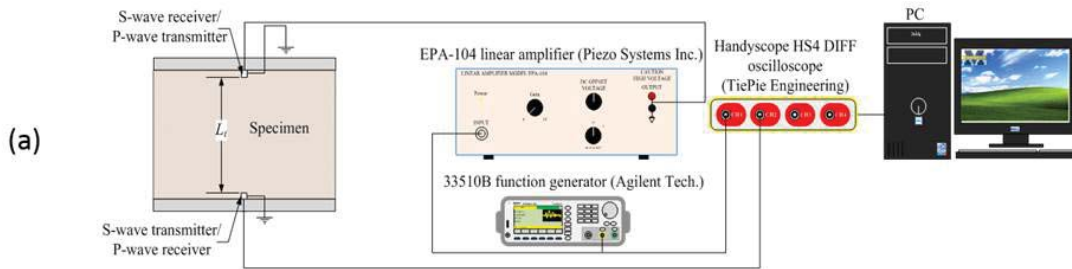

Figure 3.3: Bender element system (a) schematic, (b) housing units, (c) measurement of travel distance, and (d) placement of bender element in the bottom plate

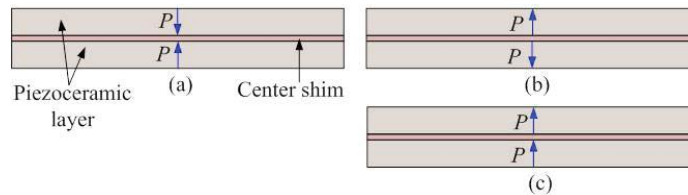

Figure 3.4: Types of bimorph elements (a,b) X-poled and (c) Y-poled (Sahadewa, unpublished)

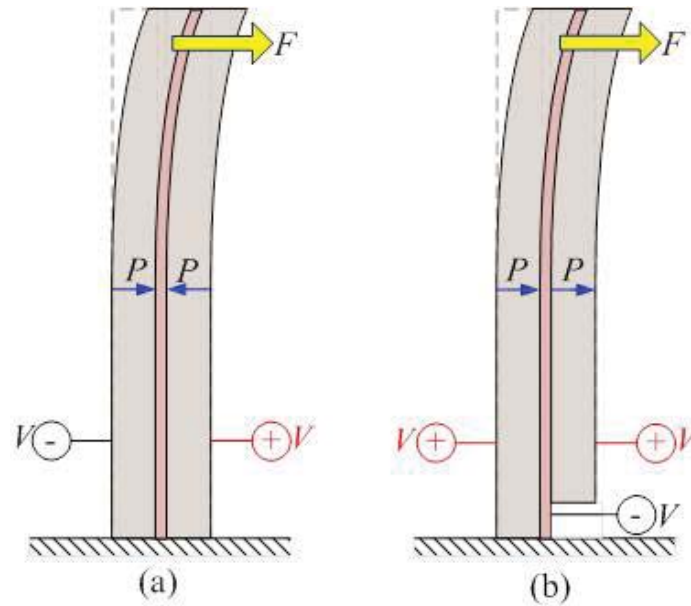

Figure 3.5: Bender elements in (a) X-poled series and (b) Y-poled parallel configurations (Sahadewa, unpublished)

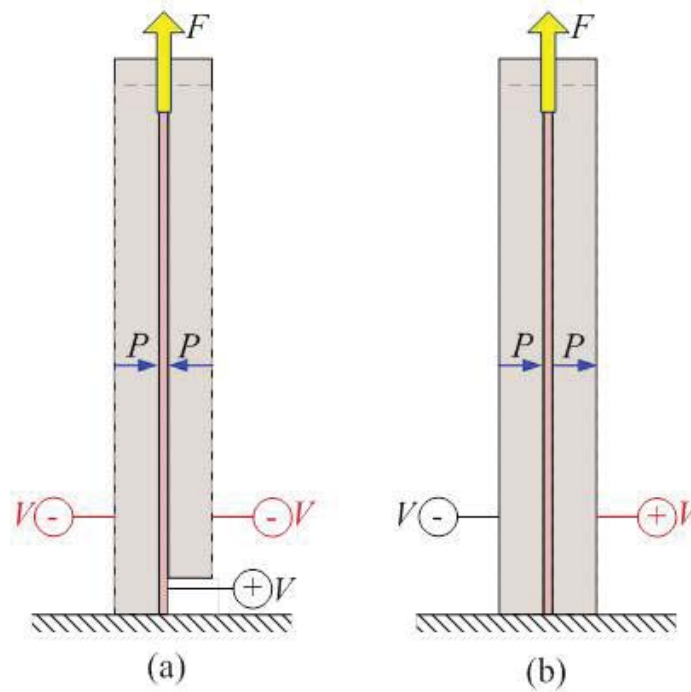

Figure 3.6: Extender elements in (a) X-poled parallel and (b) Y-poled series configurations (Sahadewa, unpublished)

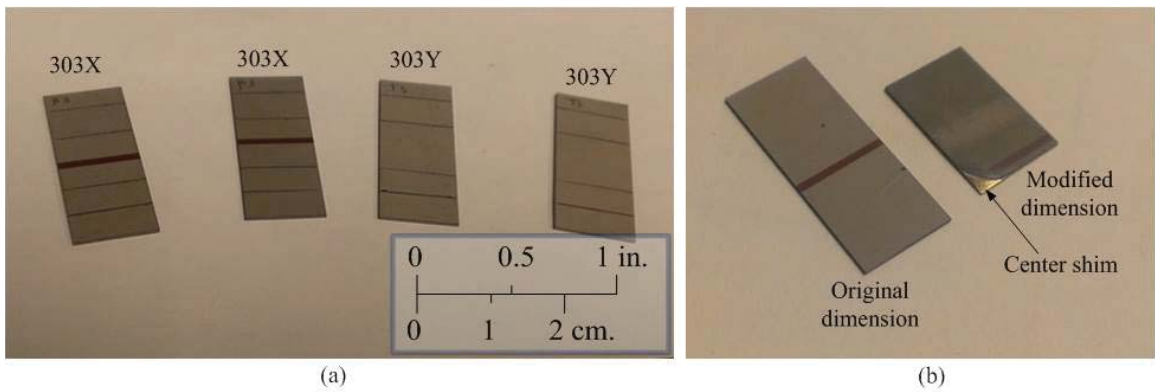

Figure 3.7: Piezoceramic bimorph elements: (a) original dimension of 303X and 303Y and (b) modified dimension (Sahadewa, unpublished)



Figure 3.8: Tools and supplies to build the bender/extender elements (Sahadewa, unpublished)

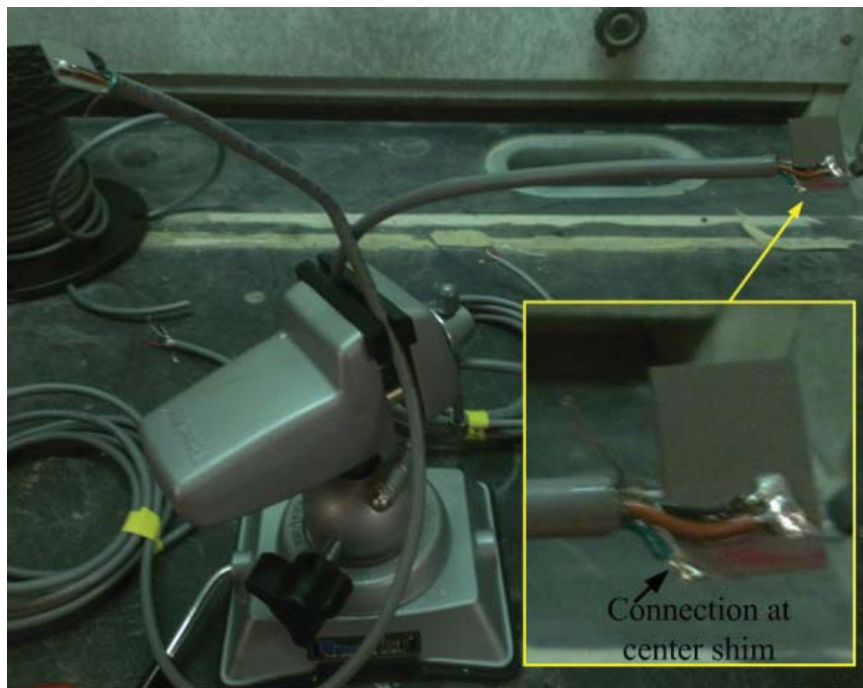

Figure 3.9: Wire connections in bender/extender elements (Sahadewa, unpublished)

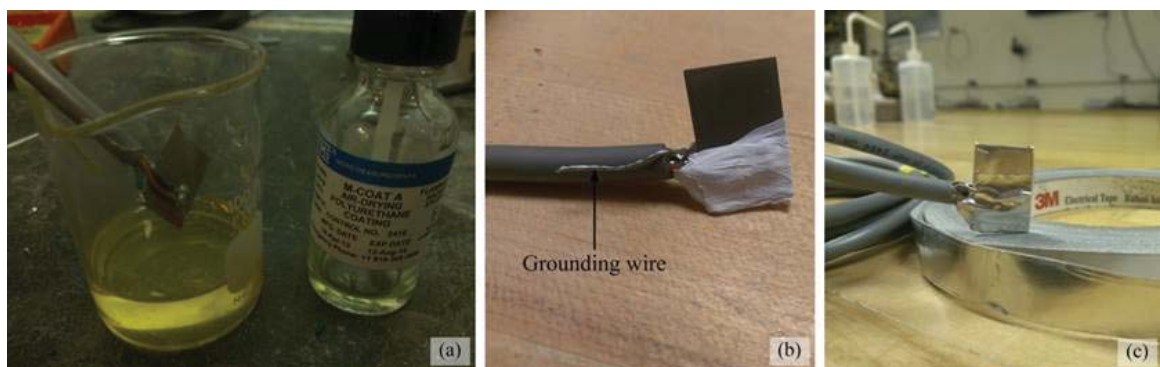
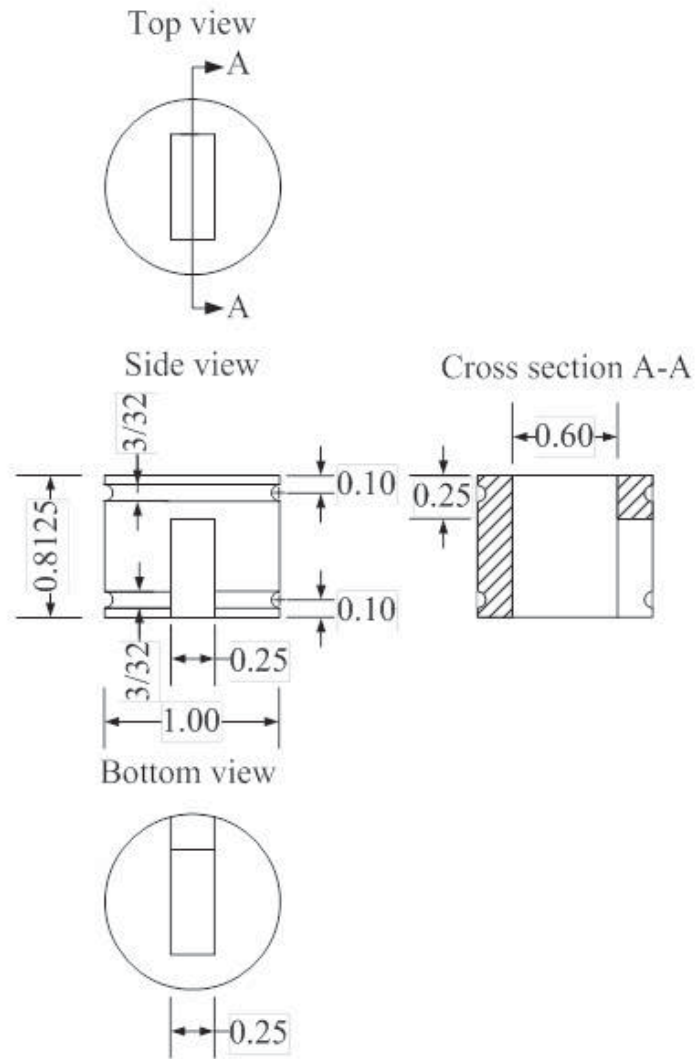

Figure 3.10: Bender/extender element coating: (a) polyurethane, (b) Teflon tape, and (c) aluminum tape (Sahadewa, unpublished)



Dimensions in inch

Figure 3.11: Design of bender/extender element housing (Sahadewa, unpublished)

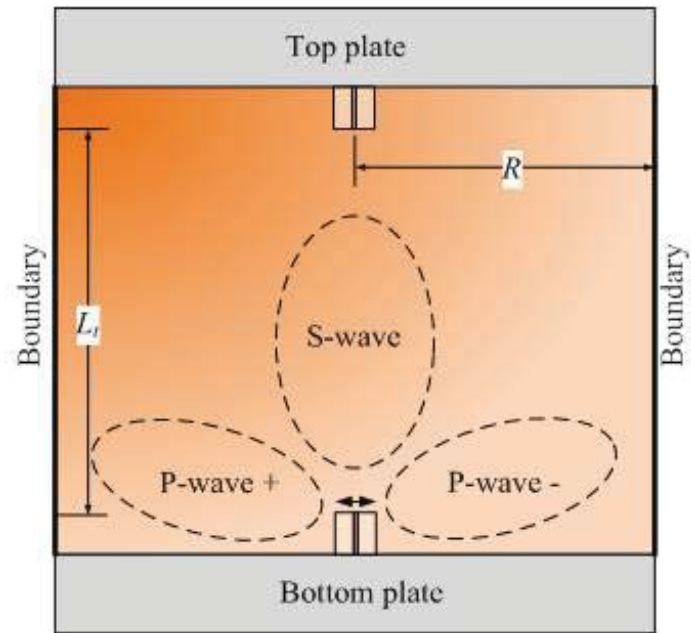

Figure 3.12: P-waves and S-wave generated by bender element transmitter (Sahadewa, unpublished)

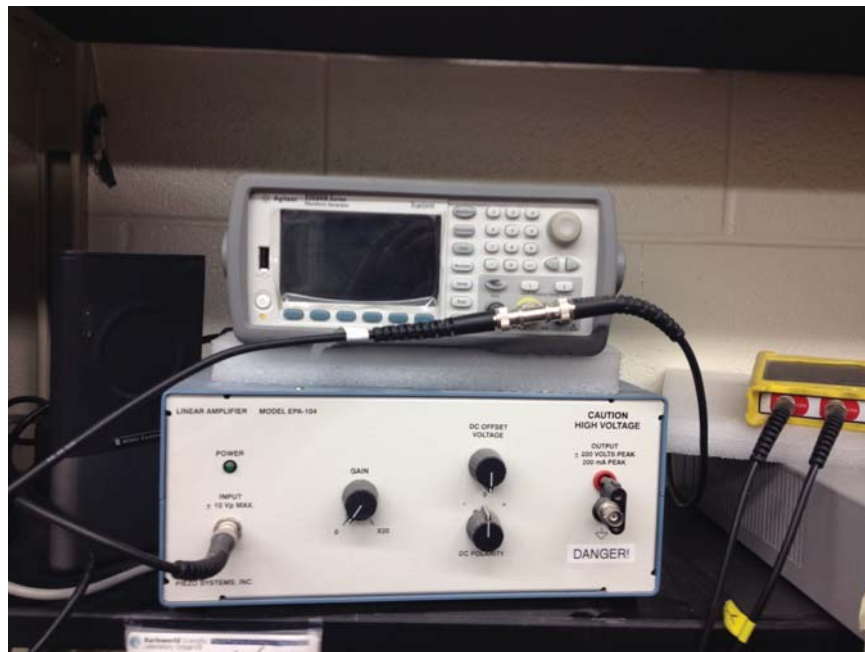

Figure 3.13: Function Generator and Linear Amplifier used for Bender Element excitation

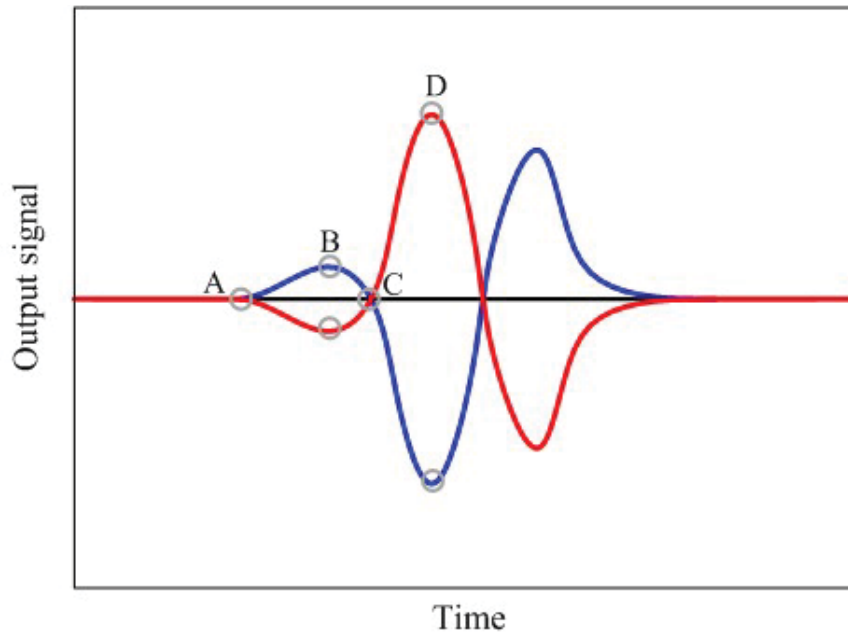

Figure 3.14: Typical S-wave output signal: (A) first deflection, (B) first trough/peak maximum, (C) zero after first trough/peak, (D) major first peak/trough (Sahadewa, unpublished - after *Lee and Santamarina (2005)*)

3.3.2 Accelerometers

Accelerometers offer another method of V_S measurement in the laboratory and have several advantages compared to bender elements for the testing of gravels. For gravelly soils, coupling of the bender element with the gravel specimen can be difficult, and damage can easily occur to the bender element, rendering it unusable after only a few tests. Therefore, the use of accelerometers for V_S measurement was evaluated in this study. Accelerometers have been used in previous laboratory studies to measure V_S , including with gravel specimens. *Nishio and Tamaoki (1988)* measured V_S in diluvial gravel samples under triaxial conditions using accelerometers attached to the outside of the test specimen. The authors found that the V_S measured using accelerometers was about 5% greater than the shear moduli measured at small strains in the triaxial device. *Arulnathan et al. (2000)* tested sand and peat in a centrifuge and used accelerometers to measure V_S . Different interpretations of the wave arrival (first deflection, peak to peak) were evaluated and it was found that for the accelerometers there was no difference in the V_S using several interpretation methods.

Camacho-Tauta et al. (2011) compared measurements of V_S using resonant column, bender element, and miniature accelerometer tests and found the estimated V_S to compare well. The authors placed the accelerometers within the sand specimen and used the accelerometers to study the bender element wave signal travel throughout the specimen. *Wicaksono et al.* (2008) measured V_S in the laboratory for Toyoura sand and Hime gravel using trigger accelerometers and bender elements, and found the value of V_S estimated using the trigger accelerometer to be slightly higher than the bender element estimate. *Rashidian* (1995) utilized accelerometers to measure V_S of gravelly soils tested in a triaxial device, and found the accelerometers to be suitable for the testing of gravelly soils.

The experimental setup for the shear wave velocity measurements using accelerometers in the CSS device is shown in Figure 3.15. Two ADXL203EB accelerometers are used and are mounted on the top cap and base cap of the CSS device. The ADXL203EB is a dual-axis, temperature-stable, low-noise MEMS accelerometer that consists of an evaluation board (20mm x 20mm) with the ADXL203 accelerometer placed on it (Analog Devices, 2016). The ADXL203 accelerometer is capable of measuring both static (i.e. gravity) and dynamic (i.e. vibrations) acceleration and contains a polysilicon-micro-machined sensor and signal conditioning circuitry. The ADXL203EB has a 5-pin connector that enables easy connection to a standard plug (shown in Figure 3.16) and measures acceleration on scaled ranges of 1.7g with a sensitivity of 1000 mV/g. The analog bandwidth of the accelerometers can range from 0.5 Hz to 2.5 kHz, depending upon the capacitor used for signal conditioning on the evaluation board (Analog Devices, 2016). The ADXL203EB, shown in Figure 3.17, comes with 100 nF capacitors installed for the X and Y axes, which results in a usable bandwidth of 50 Hz. To accommodate a larger bandwidth for measurement of V_S in the CSS device, the 100 nF capacitors were removed and replaced with 2000 pF capacitors allowing for a 2.5 kHz bandwidth.

The essential equipment used to replace the capacitors are the mounting frame and the Three-Unit Zephyrtronics Kit (Figure 3.18), which includes the automatic dispensing

system, the airbath, and the pin point soldering system. The automatic dispensing system allows for precise distribution of soldering fluid. It includes an adjustable air pressure and a digital pulse timer (for automatic dispensing), as well as a footpedal (for manual dispensing). The accelerometer should be placed to fit in the mounting frame and secured using the two screws on each side of the frame (Figure 3.19). The frame should be adjusted so that the accelerometer is slightly above the airbath unit. The airbath unit can then be powered on to the preheat setting at approximately 130°F (temperature fluctuations are expected). Next, the soldering system is set to 4.5 temperature control and approximately 3/4 air control and the air control can be adjusted as needed. Once the existing solder that is holding the capacitors on is heated, the capacitors (C2 and C3) can be removed by using tweezers and the pin point soldering system to apply additional heat as needed. To apply the new capacitors, the automatic dispensing unit is used in the manual setting. In this setting, vacuum should be turned to minimum and air pressure to approximately 65. The soldering paste dispensing is controlled using the foot pedal as shown in Figure 3.20. When pressed, the pedal will dispense solder. Solder should be placed on the evaluation board where the new capacitors will be placed. Once placed, the solder should air dry for a few minutes and the connection can be checked.

After testing several mounting methods (epoxy, putty, and electrical tape) it was determined that electrical tape adequately held the accelerometers in place and allowed for easy placement and removal so that accelerometers are not damaged during testing by the stacked rings or moisture. After placement of the accelerometers onto the bottom and top caps, they can be connected using the 4 pin connector shown in Figure 3.21. The ADXL203EB has 5 pins; however, one pin (the self test (ST)) pin is not used. The pin connector and wire connect to the DAQ and power supply. The accelerometers are each powered using a 5V power source as shown in Figure 3.22. The same data acquisition system used for the bender elements, the Handyscope HS4 Diff-25 oscilloscope (TiePie Engineering), is utilized to digitize and store data from the accelerometers. To hook up

the accelerometers, first make sure the power supply is turned off and insert pin connectors to each of the 4 accelerometer prongs (G, X, Y, and V), aligning the black or green wire (depending on cable used) to the ground prong labeled as G, and the red wire to the voltage prong labeled as +V. Assure that the wires are properly aligned before turning on the power supply, otherwise, the accelerometers could be damaged. Next, insert the appropriate bottom and top accelerometer wire cables into the DAQ. Turn on the power supply, but leave the red and black cables from the accelerometers unplugged while the voltage is checked. Press the C1 and C2 buttons and adjust each channel to 5V using the dial knob. Turn off the power supply and plug in voltage cables again (red to positive, black to negative) and then power on. The accelerometers are ready for testing at this point.

In order to capture the waves generated from a manual impulse, the data acquisition software is set to record data in 3.35 second block intervals at a rate of 39.1 KSamples/second. Two different mallets (Figure 3.23), one made of rubber and one made of hard plastic, are used to generate a shear wave by lightly tapping the baseplate. The rubber mallet creates a wave with lower frequency content than the hard plastic mallet (approximately 300-500 Hz peak frequency). The first arrival is selected manually for each accelerometer based on the first significant change in voltage. Since the signal noise is low, the wave arrivals are clear at each accelerometer. Interpretation of the arrival of the waves is easier for the accelerometers than the bender elements, and is one of the advantages of using accelerometers. Measurements are performed with both mallets for comparison. For sands and gravels, the arrival times and resulting velocities are frequency independent. The higher frequency wave (using the hard plastic mallet - a peak frequency of approximately 1.5 kHz) often had a stronger signal, making for unambiguous selection of arrival time. V_S is calculated using the distance between the accelerometers and the time difference between the arrival of the shear wave at each accelerometer. Corrections in the travel time are made for the travel time of the wave through the base plate and top cap. This correction time was found to be 8.4 microseconds after placing two accelerometers on the baseplate and mea-

asuring the travel time through the aluminum that is used in the baseplate and topcap. This travel time is very small, but can have an impact on measured V_S (difference approximately 5 m/s).

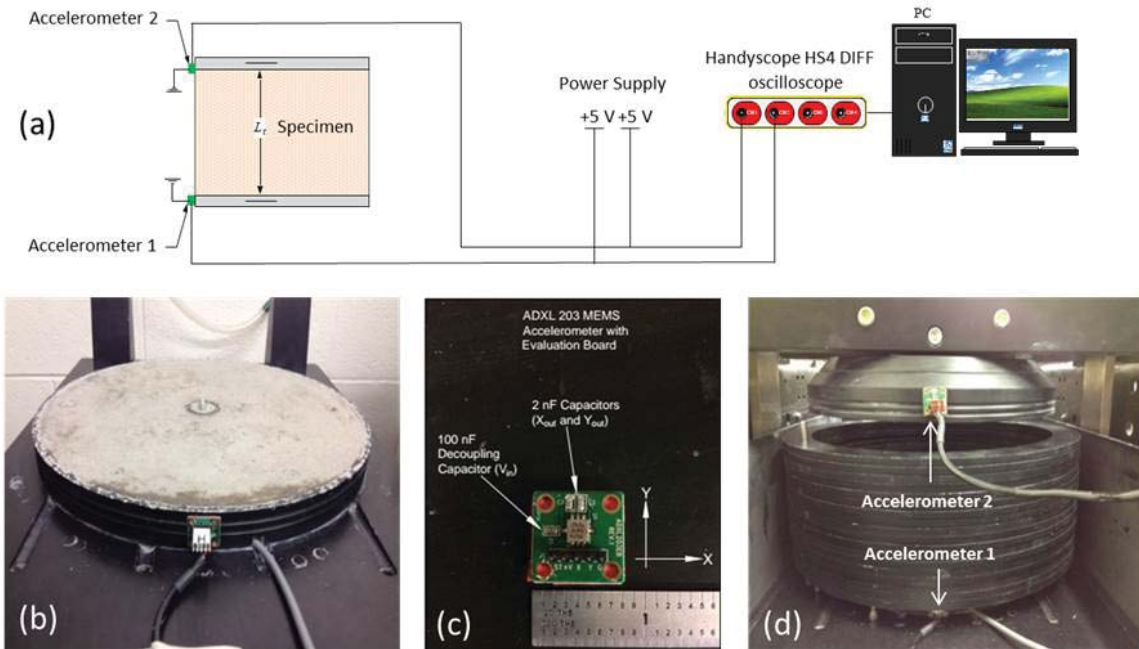

Figure 3.15: Accelerometer system (a) schematic, (b) mounted on the bottom plate, (c) ADXL203EB , and (d) placement of accelerometers on bottom plate and top cap

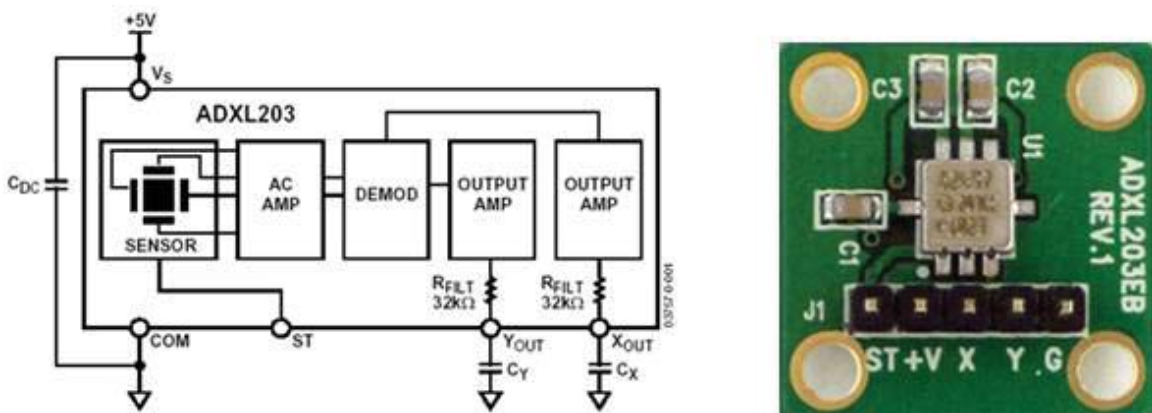

Figure 3.16: Schematic and photograph of ADXL203EB

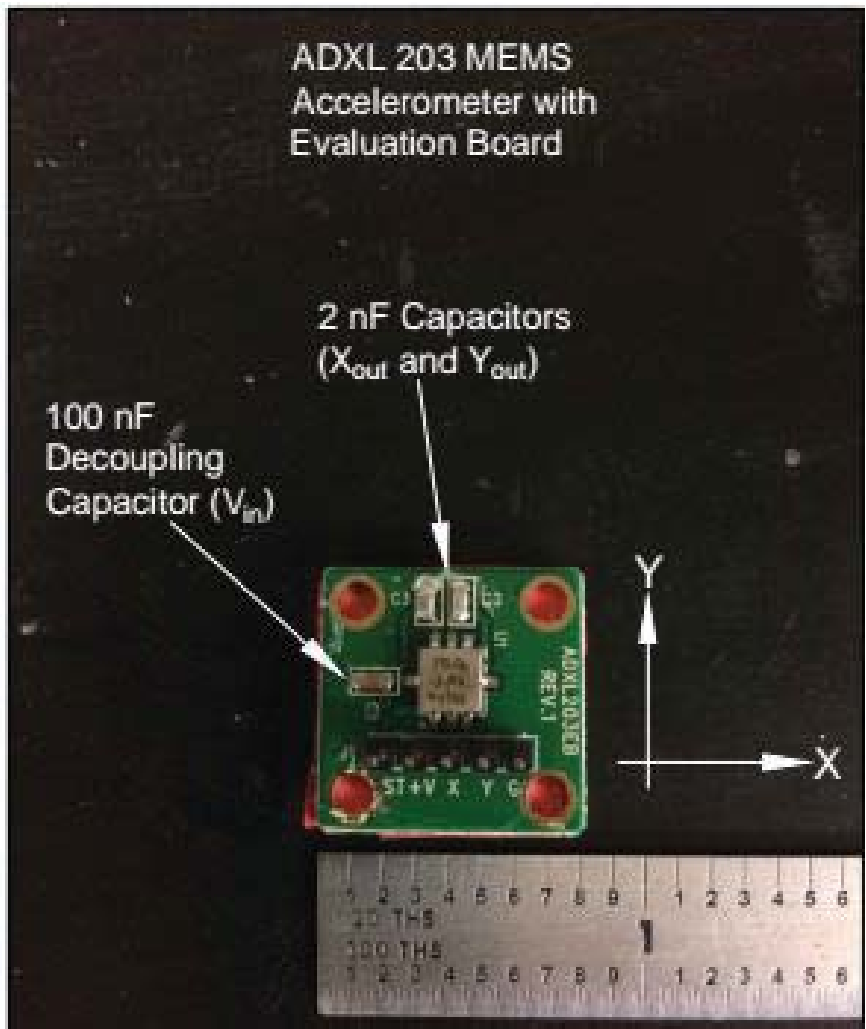

Figure 3.17: ADXL203EB location of capacitors and size



Figure 3.18: Tools used for replacement of capacitors on ADXL203EB



Figure 3.19: Removal of capacitors on ADXL203EB

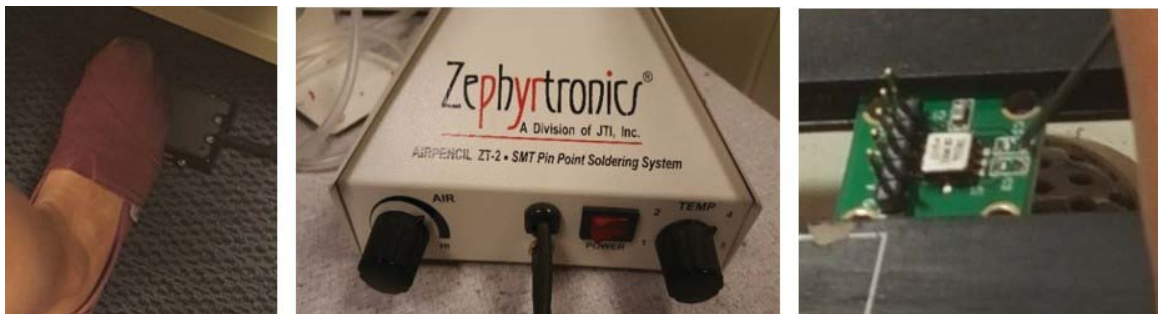

Figure 3.20: Replacement of capacitors on ADXL203EB

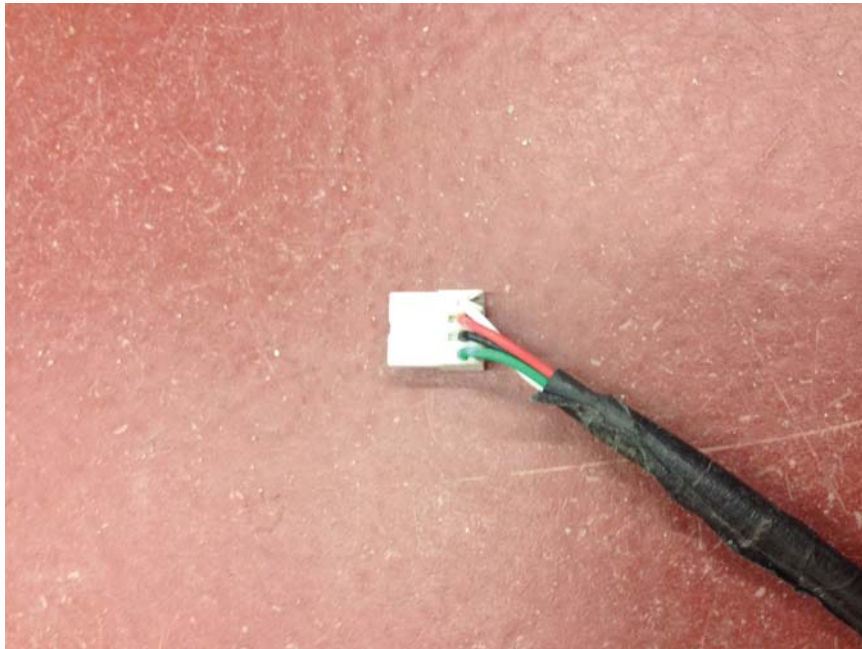

Figure 3.21: Wire and pin connection used for accelerometers

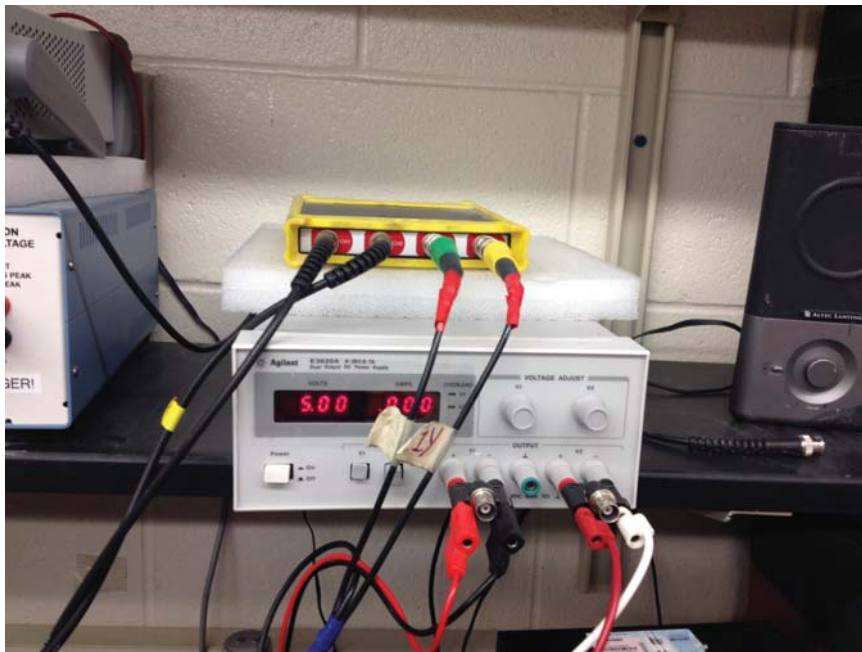

Figure 3.22: DAQ and Power Supply for Accelerometers



Figure 3.23: Rubber and Plastic Mallets used for impulse generation for accelerometers

3.4 Large-Size Direct Simple Shear Validation Test Results

A series of CSS tests were conducted on Ottawa C109 Sand to validate the results generated by the large-size cyclic direct simple shear against conventional size direct simple shear devices and the results are presented in the sections that follow. Table 3.2 summarizes the monotonic tests and Table 3.3 summarizes the cyclic tests. Ottawa C109 Sand was selected because of the availability of the material itself as well as of direct simple shear test data in the literature. Some test results for Pea Gravel, which was tested in this study for constant volume response and extensively in Chapter 4, will also be presented (tests used in this Chapter given in Table 3.4). The properties of the Pea Gravel and Ottawa C109 Sand are given in Table 4.1 and Figure 4.2.

The compliance of the CSS device was first measured by performing a monotonic test on a sealed specimen that was filled with water. Since water does not have any shear strength, this test allowed for the assessment of shear stress due to the device itself (movement of the water-bath on the rollers as well as friction among the stacked rings). Figure 3.24 shows the results of this monotonic test. Upon initial loading there is an immediate 0.60 kPa load due to friction of the shear box and motor. With further shearing, there is an additional 0.60 kPa of shear stress that builds up by 15% shear strain. This additional compliance is due to the motor, shear box, and the stacked rings. The stacked rings are Teflon coated and were considered to not be a significant contributor to the compliance. The stacked rings were regularly cleaned and coated with a lubricant to maintain minimal friction. The overall compliance of the device was therefore evaluated to be 1.2 kPa. For cyclic tests, a few strain controlled tests were performed to evaluate the compliance of the shear box and rollers and again this value as found to be approximately 1.2 kPa as shown in Figure 3.25. For monotonic test data the shear data was corrected using the results of the water test. Since the cyclic tests in this study were stress-controlled and a stress-controlled compliance test is not feasible, test data was corrected only by reporting a CSR value that accounted for the 1.2 kPa of device compliance.

Table 3.2: Ottawa C109 Sand Monotonic Tests

Test ID	Test Date	Vertical Stress (kPa)	Consolidated void ratio	Consolidated D_r (%)	V_S (m/s)
M137	11/10/2014	100	0.686	30%	200
M139	11/10/2014	50	0.692	27%	165
M140	11/10/2014	200	0.678	33%	225
M141	11/10/2014	400	0.671	37%	-
M142	11/11/2014	100	0.673	36%	184
M143	11/11/2014	50	0.672	36%	163
M144	11/13/2014	100	0.662	41%	189
M145	11/13/2014	100	0.666	39%	183
M147	11/17/2014	400	0.656	43%	-
M149	12/2/2014	400	0.648	46%	277
M150	12/3/2014	100	0.644	49%	209
M151	12/3/2014	200	0.655	44%	236
M152	12/4/2014	100	0.589	73%	216
M153	12/4/2014	100	0.649	46%	206
M154	12/6/2014	100	0.658	42%	206
M155	12/6/2014	100	0.657	43%	209
M156	12/7/2014	100	0.657	43%	206
M157	12/7/2014	200	0.654	44%	236
M158	12/8/2014	100	0.605	66%	221
M159	12/9/2014	100	0.595	71%	210
M160	12/9/2014	100	0.574	80%	205
M161	12/9/2014	200	0.597	70%	247
M162	12/9/2014	400	0.623	58%	280
M163	12/11/2014	200	0.623	58%	241
M164	12/11/2014	200	0.603	67%	242
M165	12/11/2014	100	0.602	67%	209
M166	12/11/2014	100	0.614	62%	210

Table 3.3: Ottawa C109 Sand Cyclic Tests

Test ID	Test Date	Vertical Stress (kPa)	Consolidated Void Ratio	Consolidated D_r (%)	V_S (m/s)	CSR	NL
C102	9/19/2014	200	0.664	40	242	0.097	8
C121	12/1/2014	200	0.657	43	240	0.057	211
C123	12/12/2014	200	0.65	46	237	0.071	37
C124	12/12/2014	200	0.654	44	252	0.127	3

Table 3.4: Pea Gravel Monotonic Constant Volume Response Comparison Tests

Test ID	Test Date	Vertical Stress (kPa)	Consolidated void ratio	Consolidated D_r (%)	V_S (m/s)
M180	3/10/2015	400	0.702	35%	278
M194	4/21/2015	400	0.695	39%	274
M196	4/24/2015	400	0.692	40%	279

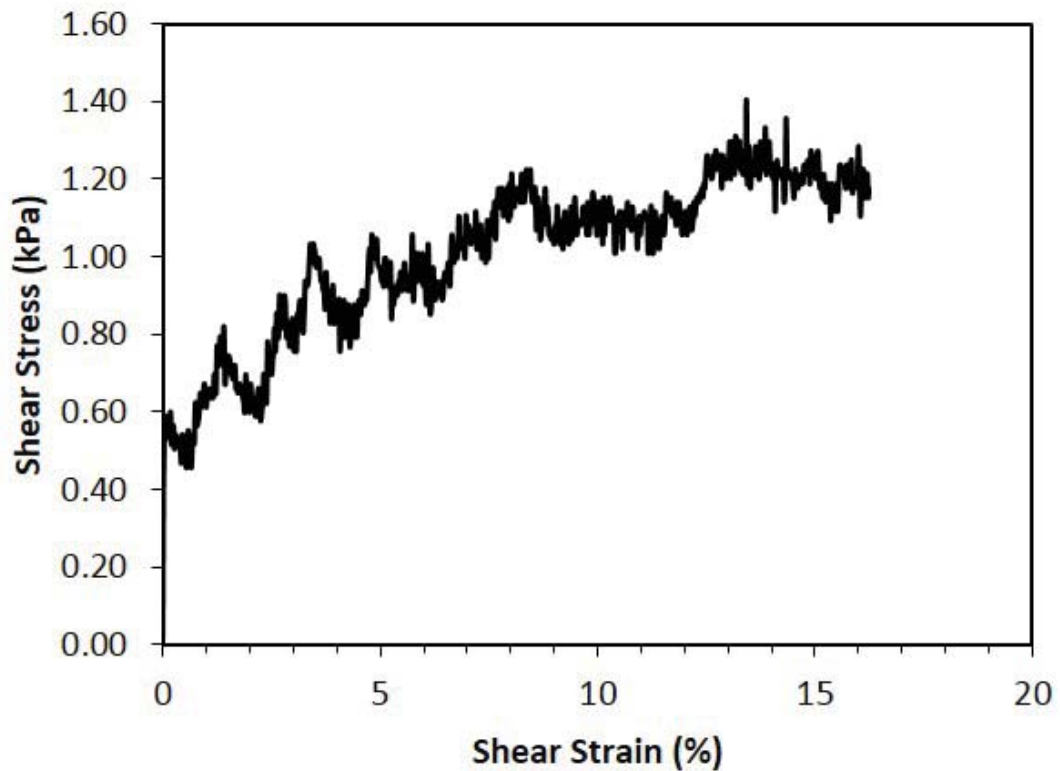

Figure 3.24: Results of Monotonic Shear Test of Water Specimen

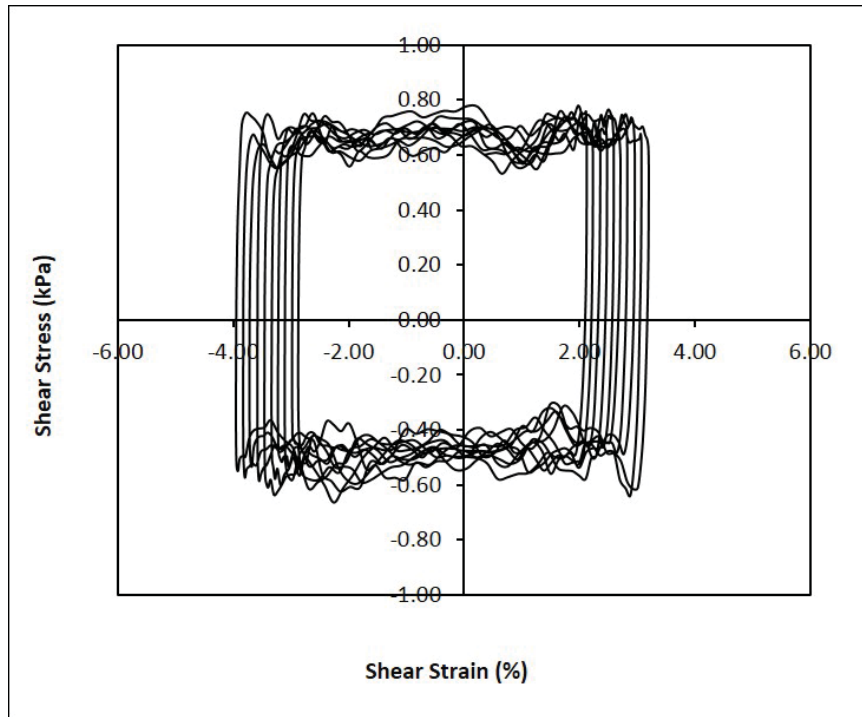

Figure 3.25: Results of Cyclic Shear Test for device compliance

3.4.1 Shear Wave Velocity Test Results and Validation

Shear wave velocity measurements were performed for the Ottawa sand specimens using both bender elements and accelerometers. Bender element tests at frequencies ranging from 2 kHz to 17 kHz conducted on Ottawa sand at $D_r = 39\%$ and $\sigma'_{v0} = 100$ kPa are shown in Figure 3.26. As expected, the signals are not always excellent for the entire range of frequencies, but the arrival of the shear wave can be discerned. The shear wave velocity measured for this material at a vertical stress of 100 kPa is equal to 203 m/s and is frequency independent. Results of V_S measurements for Pea Gravel at 100 kPa and 400 kPa are shown in Figures 3.27 and 3.28, respectively. The 100 kPa test had an input frequency of 2 kHz, while the 400 kPa test had an input frequency of 3 kHz. It was found that as vertical stress increased, a higher frequency input wave resulted in a clearer signal. The V_S measured in the 100 kPa test was 189 m/s, while the V_S measured using accelerometers on the same specimen was 191 m/s as shown in Figure 3.29. These results show that the V_S measured using bender elements and accelerometers is essentially the same. Figures 3.30

and 3.31 show similar results for Ottawa C109 Sand. For these tests at $D_r = 54\%$ and $\sigma'_{v0} = 100$ kPa, the V_S measured using accelerometers was 211 m/s, while the V_S using bender elements was 214 m/s (using the first rise point). Figures 3.32 and 3.22 show the results of using different mallets for the source input for accelerometers for a mixture of 80% Ottawa C109 Sand and 20% 8-mm Crushed Limestone (this mixture is used in Chapter 5) at $D_r = 44\%$ and $\sigma'_{v0} = 200$ kPa. The results show that while the frequencies of the generated and received waves are different for the different mallets, the V_S is the same. Figure 3.34 compares the V_S measurements for the Ottawa sand using the bender elements and the accelerometer setup at two different relative densities. It also shows data for the Pea Gravel at two different relative densities. The results plot essentially on the 1:1 line indicating that the two different techniques yield nearly identical V_S results. The V_S results from the measurements are also compared against the *Hardin and Richart* (1963) and *Robertson et al.* (1995) models for the V_S of sands in Figure 3.35. The results from this study are found to be generally consistent with these two recommendations with deviations of about 10% only. The results of these validation tests for sands and gravels showed that V_S was frequency independent and the same using either bender elements or accelerometers

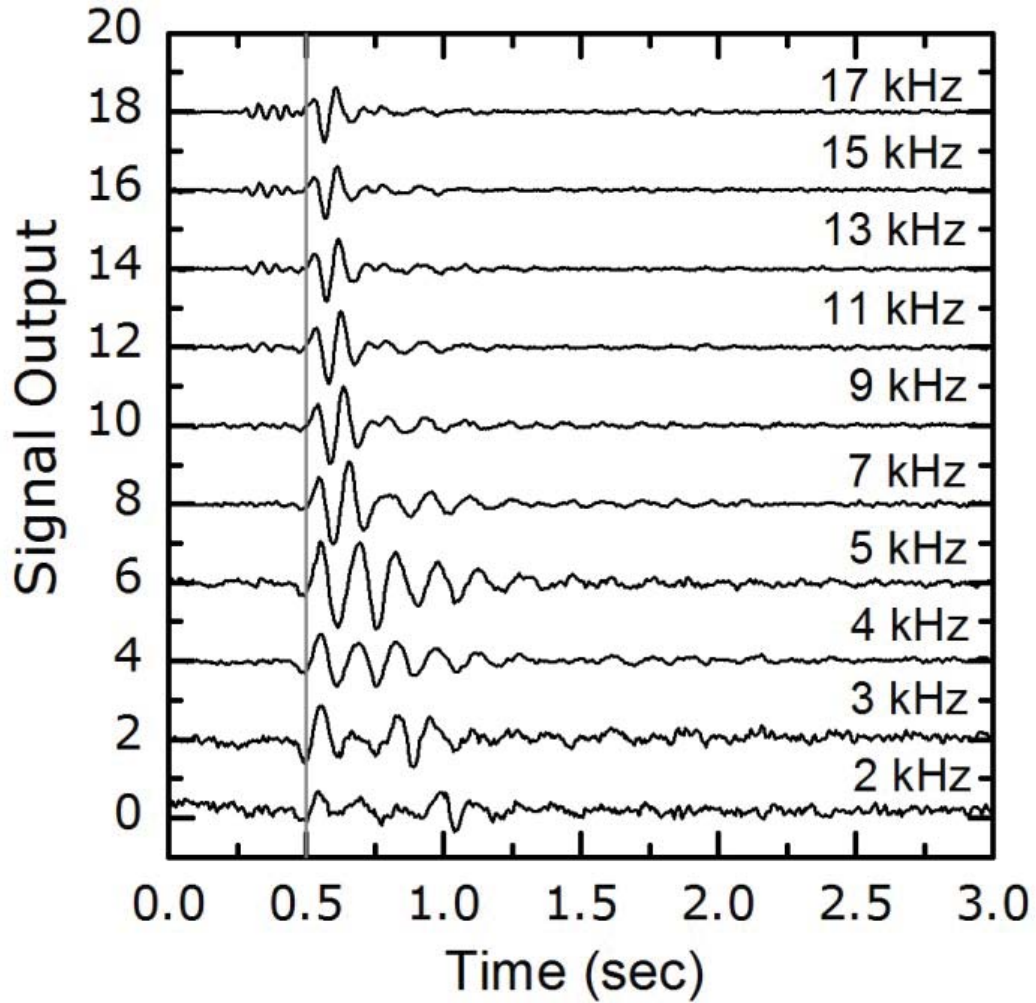

Figure 3.26: Measurement of Bender Element signal arrival for frequencies from 2-17 kHz for Ottawa C109 Sand at 100 kPa (Test ID: V_{S3})

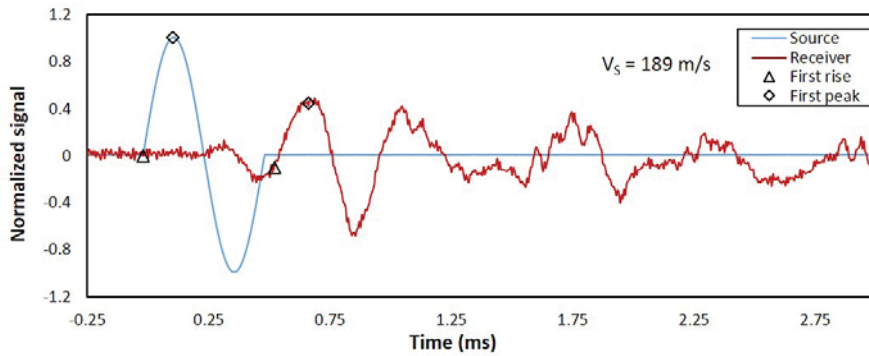

Figure 3.27: Bender element signals for Pea Gravel tested at 100 kPa and 2 kHz input frequency (Test ID: M194)

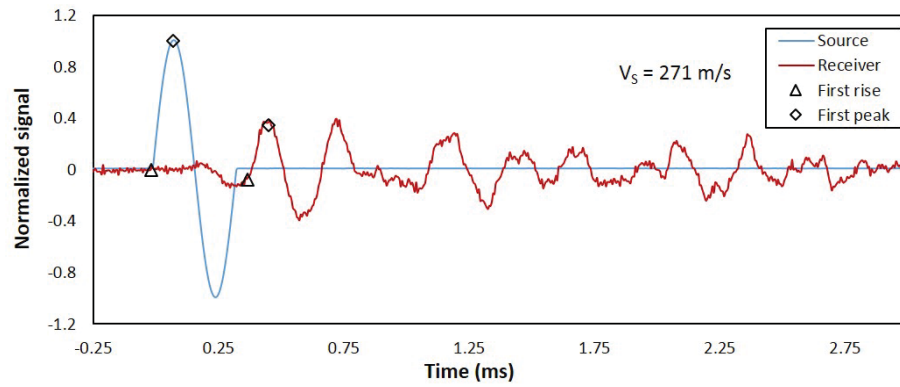

Figure 3.28: Bender element signals for Pea Gravel tested at 400 kPa and 3 kHz input frequency (Test ID: M194)

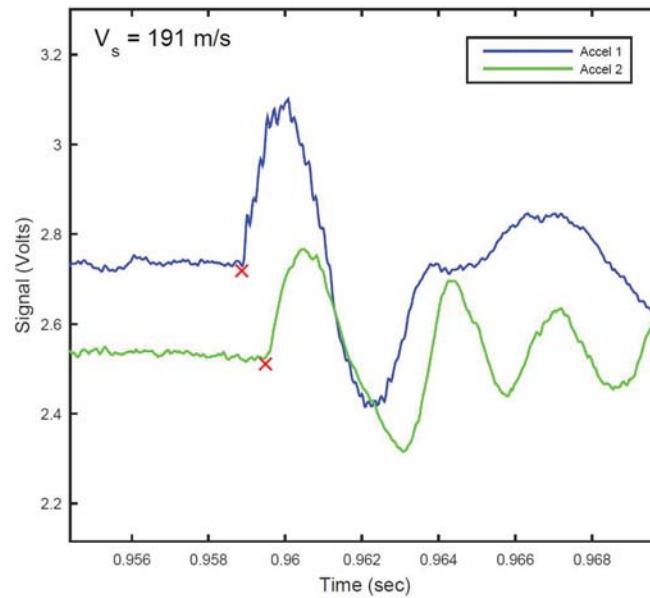

Figure 3.29: Accelerometer Signals for Pea Gravel tested using Rubber Mallet (Test ID: M194)

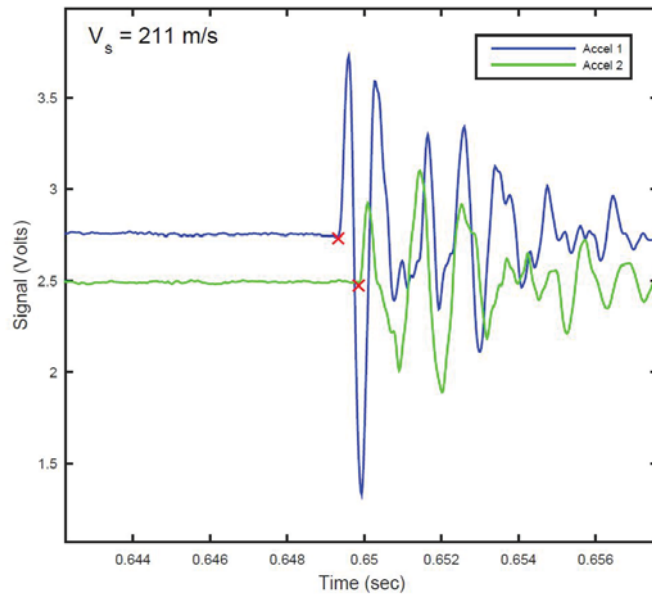

Figure 3.30: Accelerometer Signals for Ottawa C109 Sand tested using Rubber Mallet (Test ID: M199)

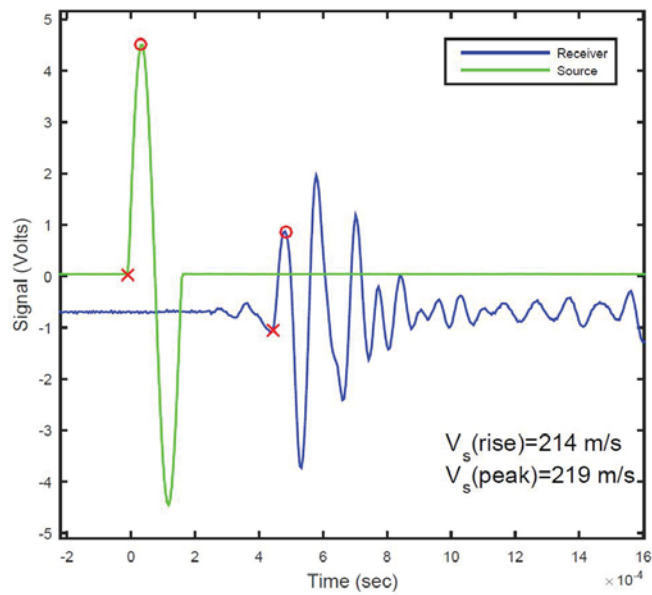

Figure 3.31: Bender Element Signals for Ottawa C109 Sand tested at a frequency of 6 kHz (Test ID: M199)

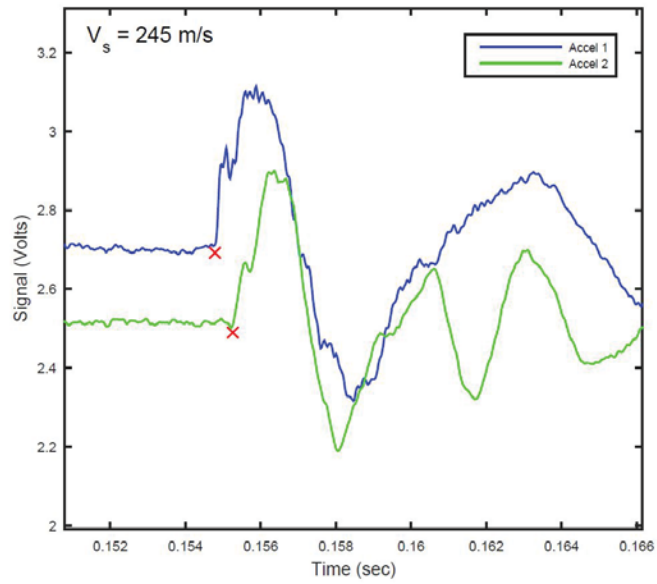

Figure 3.32: Accelerometer Signals for 80% Ottawa C109 Sand and 20% 8-mm Crushed Limestone tested using a Rubber Mallet (Test ID: M308)

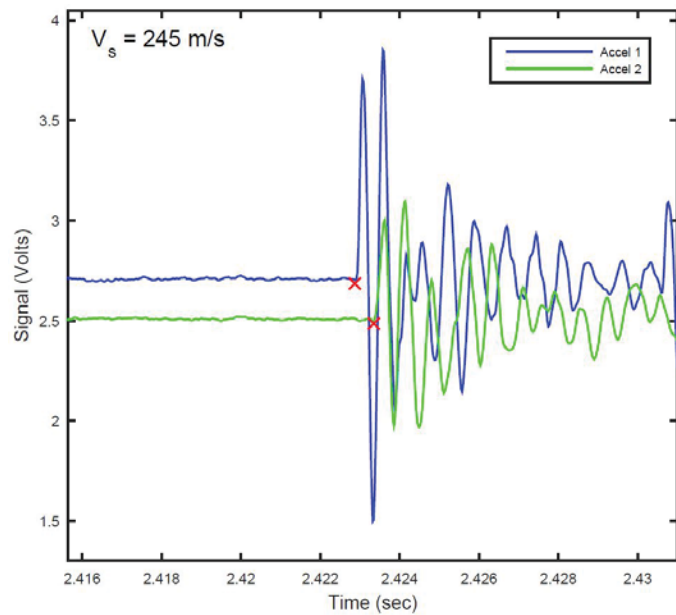

Figure 3.33: Accelerometer Signals for 80% Ottawa C109 Sand and 20% 8-mm Crushed Limestone tested using a Rubber Mallet (Test ID: M308)

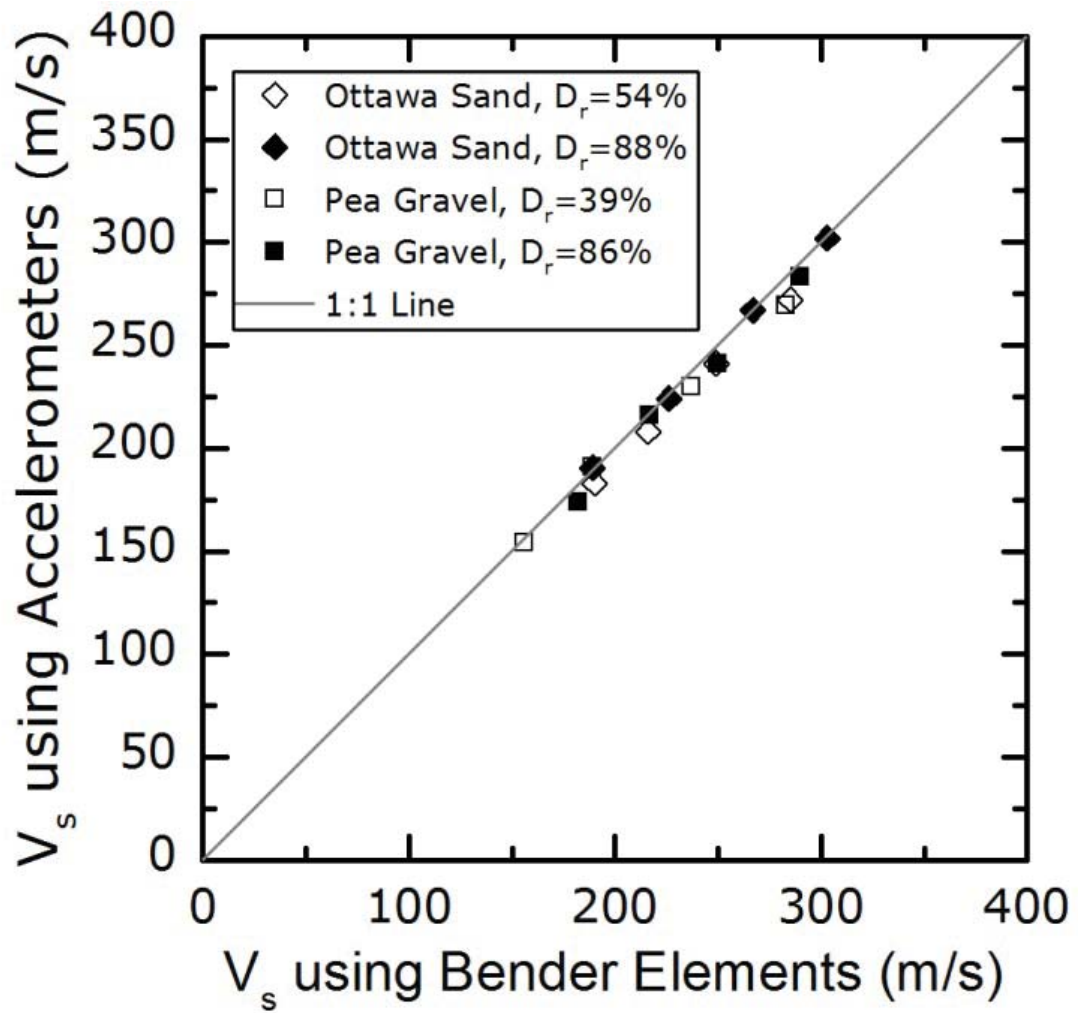

Figure 3.34: Comparison of shear wave velocity using bender elements and accelerometers

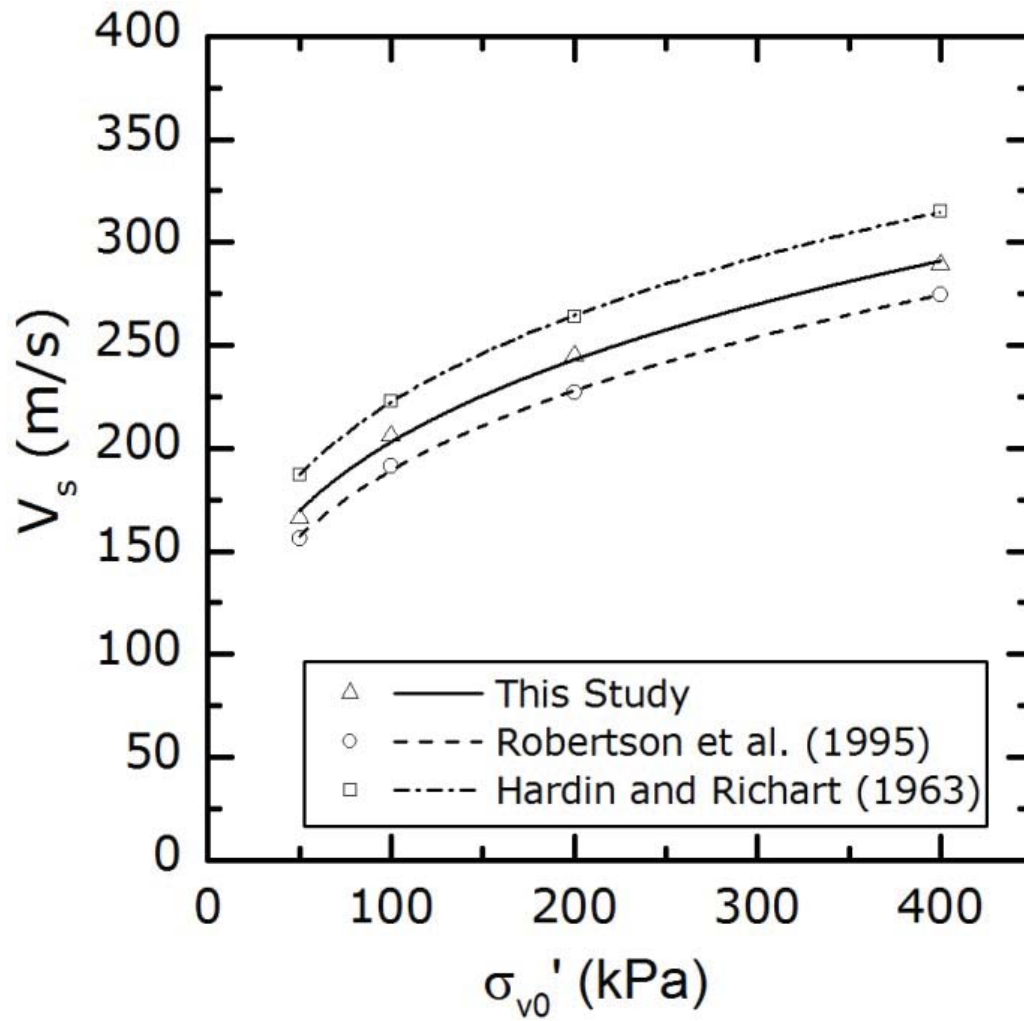

Figure 3.35: Comparison of shear wave velocity for Ottawa C109 Sand with existing relationships

3.4.2 Constant Volume Monotonic Test Results and Validation

A series of monotonic tests were conducted in the large-size CSS under constant volume conditions. Ottawa C109 Sand tests were performed under identical conditions to *Yazdi* (2004), i.e., at σ'_{v0} of 100 kPa and 200 kPa at $D_r = 43-45\%$ for a specimen with a diameter of 70 mm. The sand tested by *Yazdi* (2004) was Silica C109 Sand from the Illinois River which is considered to be very similar to Ottawa C109 Sand (*Yazdi*, 2004; *Sivathayalan and Yazdi*, 2013). Figure 3.36 shows that the results are nearly identical in terms of the stress-strain response (Figure 3.36a), the stress path (Figure 3.36b) and the phase transformation points (Figure 3.36c) highlighting the ability of the large-size CSS device to replicate constant volume testing of sand in conventional sized simple shear devices under monotonic loading conditions.

In the development of the device and the testing control systems, a significant level of effort was invested to ensure that constant volume conditions were truly maintained during the execution of constant volume shear testing. The constant volume testing condition is maintained in the CSS by a feedback loop control that restrains movement of the vertical cap. If the vertical cap does move, the feedback loop will signal the cap to move back to its original position. ASTM D6528 (*ASTM*, 2007) specifies that for a constant volume test to be valid, vertical strain should be less than 0.05%. Figure 3.37 presents constant volume monotonic shear test results on Ottawa C109 Sand using different control parameters for the feedback loop that applies gains to the vertical cap response. All three tests shown easily meet the ASTM requirement of 0.05%, and the maximum vertical displacement is significantly lower than 0.05%. The differences observed however are not insignificant. The peak shear stress varies as much as 15% at shear strains of less than 1% despite the fact that all the tests meet the ASTM specifications. Therefore, larger vertical strain (movement of the top cap) during constant volume shearing, even when it remains below the ASTM specification of 0.05%, resulted in a higher peak shear stress, and lower generation of equivalent pore pressure.

The effect of constant volume response was also investigated for Pea Gravel as shown in Figure 3.38. A series of monotonic tests were performed using different control parameters to investigate the effect of vertical strain during a CV test on stress-strain and stress path response. Three tests were performed using Pea Gravel with different strain control parameters so that maximum vertical strains of approximately 0.09%, 0.05% and 0.01% are achieved as shown in Figure 3.38c, respectively. The control parameters affect not only the maximum vertical strain, but also its evolution during shearing, as shown in Figure 3.38c. The effect of vertical strain control on the stress-strain and stress path responses is shown in Figure 3.38a and Figure 3.38b, respectively. The peak shear stress for the CV test that most closely adheres to true CV conditions (i.e., it has a maximum vertical strain of 0.01%) is approximately 14% lower than the test with 0.09% maximum vertical strain. Although there will be small differences between tests due to repeatability, a 14% difference in peak shear strength is a significant difference that is attributed to control of vertical strain during shearing. The tests with 0.05% and 0.09% maximum vertical strain also do not return to 0% vertical strain until after the peak shear stresses are reached (i.e. they still have significant vertical strains until 2% and 4% shear strain). The test specimens with 0.05% and 0.09% vertical strain have similar values of peak shear strength, with the test with 0.05% maximum vertical strain exhibiting a slightly lower peak shear strength. Note that the test with 0.05% maximum vertical strain would be considered a valid test according to ASTM D6528 (ASTM, 2007); however, the specimen exhibits an 8% higher peak shear strength than the test with 0.01% maximum vertical strain. Therefore, the amount of vertical strain during a CV test can have significant impact on stress-strain and stress path response. The impact diminishes once the vertical strain returns to near 0%, as seen in Figure 3.38b where the stress paths for all tests have the same phase transformation (PT) and ultimate state (US) lines.

These observations are important not only in terms of material behavior, but may also at least partially explain, differences in constant volume direct simple shear test results re-

ported in the literature. Thus, it is recommended that the evolution of the axial strain during constant volume shearing be reported when presenting constant volume direct simple shear experimental results and that the acceptable threshold value for the vertical strain is reduced to no higher than 0.025% compared to the currently accepted of 0.05%.

3.4.3 Constant Volume Cyclic Test Results and Validation

Cyclic tests were also conducted on Ottawa C109 Sand under constant volume conditions and were compared to data generated by *Bhatia* (1982) on 51 mm square specimens. An example cyclic test for specimen C258 is shown in Figure 3.39. The results, presented in terms of Cyclic Stress Ratio (CSR) versus number of cycles to liquefaction, are shown in Figure 3.40. Liquefaction is defined in these tests as 3.75% single amplitude shear strain, which is a common threshold value that has been used in cyclic simple shear testing to define liquefaction (*Vaid and Sivathayalan, 1996; Sivathayalan, 2000; Porcino et al., 2008*). The observed relationships are generally comparable, although the large-diameter cyclic direct simple shear tests show a slightly lower resistance to liquefaction (5-10% lower CSR required for liquefaction at a given number of cycles). Overall, these differences are small and the ability of the large-size CSS to capture cyclic response was demonstrated.

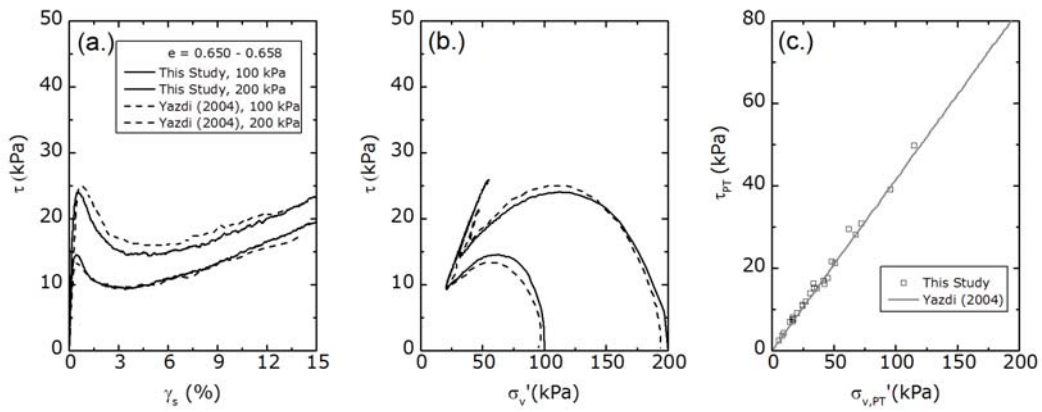

Figure 3.36: Comparison of constant volume monotonic simple shear response for Ottawa C109 Sand from this study using and Silica C109 Sand from Yazdi (2004) using a small-size simple shear for (a) stress-strain response, (b) stress path response, and (c) phase transformation (Test ID: M156, M157)

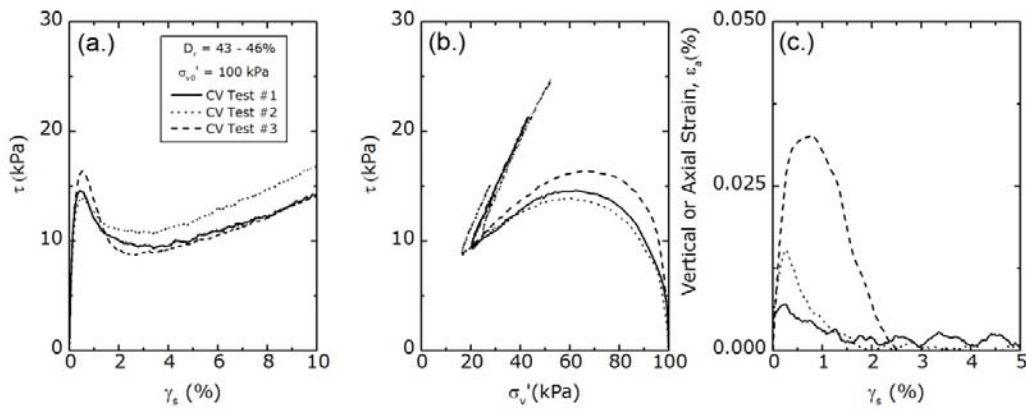

Figure 3.37: Comparison of constant volume monotonic simple shear response for Ottawa C109 Sand with different constant volume testing parameters (Test ID: M156, M155, M153)

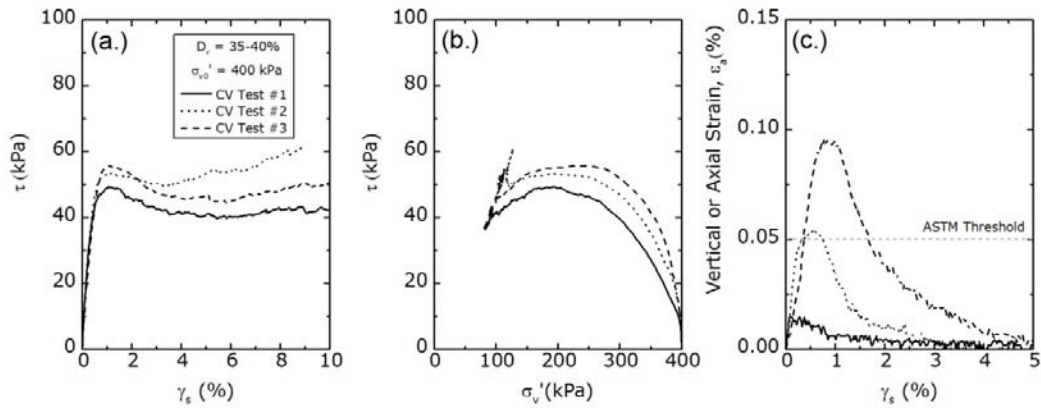

Figure 3.38: Comparison of constant volume monotonic simple shear response for Pea Gravel with different constant volume testing parameters (Test ID: M180, M194, M196)

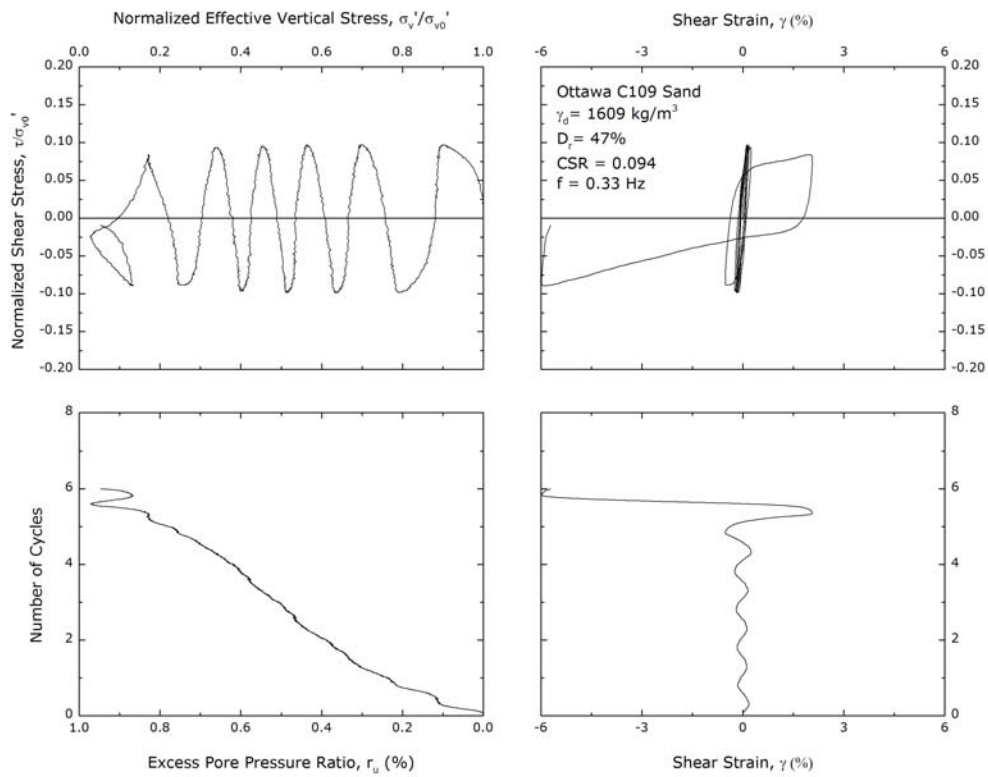

Figure 3.39: Cyclic Simple Shear Test Results for Ottawa C109 Sand (Test ID: C258)

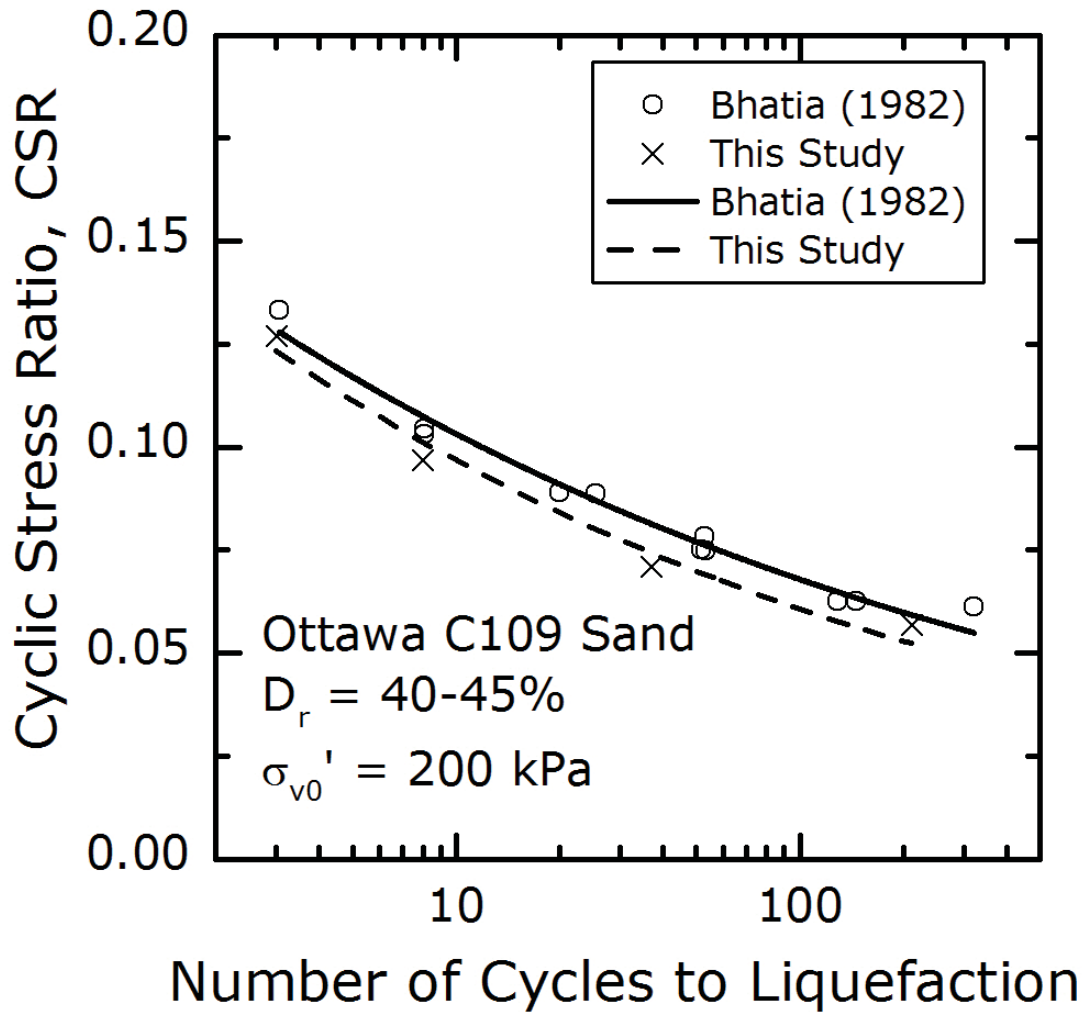

Figure 3.40: Comparison of constant volume cyclic simple shear response for Ottawa C109 Sand from this study and (*Bhatia*, 1982) using a small-size simple shear (Test ID: C102, C121, C123, C124)

3.5 Conclusions

A prototype large-size cyclic direct simple shear (CSS) device has been developed as part of a cooperation between the University of Michigan and Geocomp Corporation. Custom-built bender element and accelerometer systems were designed and implemented within the CSS device for V_S measurement of test specimens. The CSS device and V_S measurement systems were tested and validated. The following conclusions were made:

- The large-size CSS device is capable of performing stress or strain controlled monotonic and cyclic simple shear tests.
- Bender element and accelerometer systems were developed for measuring the V_S for each tested specimen and validated by comparing test results for Ottawa C109 Sand with existing data from the literature. Results from both systems were consistent with each other and with reported values in the literature.
- Constant volume monotonic and cyclic test results performed using the 12" diameter CSS device were compared to simple shear results from conventional-size devices for the same material (Ottawa C109 Sand) and showed similar response, confirming that the large-size device replicates the simple shear response observed for soils in the literature.
- It was shown that the ASTM specified constant volume threshold for axial strain of 0.05% is not sufficient (ASTM, 2007). The peak shear strength for tests that met the ASTM constant volume criteria of 0.05% axial strain can be up to 15% larger than that for a smaller axial strain allowance. It is therefore recommended that the variation of axial strain should be reported for every constant volume test and the axial strain should be no more than 0.025%.

CHAPTER 4

Monotonic, Cyclic, and Post-Cyclic Response of Uniform Gravels

4.1 Introduction

Many researchers have investigated the undrained shear response of sandy soils in the laboratory (*Vaid and Sivathayalan, 1996; Porcino et al., 2008; Sivathayalan and Yazdi, 2013*). However, the undrained shear response of gravels and gravel-sand mixtures has been less extensively investigated due to the unavailability of devices large enough to accommodate the larger particle sizes. Field case histories have provided insights into undrained gravelly soil response; however, laboratory study of the undrained shear response of gravelly soils, particularly uniform gravels, is limited and could provide further explanation of gravelly soil shear response by targeting specific parameters that may affect it. Most testing on gravels (as well as the larger size particles commonly referred to as rockfill) and gravelly soils in the laboratory has been conducted under drained conditions (*Marsal, 1967; Marachi, 1969; Leps, 1970; Skermer and Hillis, 1970; Charles and Watts, 1980; Barton and Kjaernsli, 1981; Moroto and Ishii, 1990; Yasuda and Matsumoto, 1994; Matsuoka and Liu, 1998; Matsuoka et al., 2001; Varadarajan et al., 2003; Anderson and Fair, 2008; Strahler et al., 2015*), since these materials are considered to be free-draining. Considerable effort has focused on the effect of confining stress and particle breakage on the shear

response (Xiao *et al.*, 2014a,b, 2015a,b) as well as development of constitutive models (Liu *et al.*, 2014; Xiao *et al.*, 2014c; Sun and Xiao, 2016; Xiao and Liu, 2016). Laboratory shear response of gravel and gravel-sand mixtures under undrained conditions has been studied by several researchers, but data is sparse (Wong *et al.*, 1974; Evans and Seed, 1987; Evans and Zhou, 1995; Choi *et al.*, 2007; Flora *et al.*, 2012; Zhao *et al.*, 2012; Chang *et al.*, 2014).

This chapter presents the results of an experimental study of the monotonic, cyclic, and post-cyclic shear response of three uniform gravels tested using a large-size cyclic simple shear (CSS) device. While it is recognized that uniform gravels are not typically encountered naturally in the field, they are used as engineering fills, including in ports, embankments, buttresses, submerged tunnels, and retaining walls. The objective of this chapter was to comprehensively study the undrained shear response of these gravels with a focus on the influence of particle size and shape. V_S was measured for each specimen so that laboratory tests and field conditions could be compared. Results from the conducted tests were compared with existing design charts for liquefaction susceptibility to gain further insight into gravelly soil response compared to existing design charts commonly used in engineering practice for sands and gravels.

4.2 Test Materials

Pea Gravel, 8 mm Crushed Limestone (CLS8) and 5 mm Crushed Limestone (CLS5) were tested in this study and are shown in Figure 4.1. The Crushed Limestone (CLS) materials are referred to as 8 mm and 5 mm as these values represent the approximate d_{50} values for these materials. Table 4.1 summarizes the material properties for each gravel as well as Ottawa C109 sand. Grain size distributions for each material are shown in Figure 4.2. Pea Gravel, which has rounded to sub-rounded particles, has the largest particle size, with a maximum particle size of 15 mm. CLS8, which has a maximum particle size of 12 mm, has angular to sub-angular particles and has a particle size distribution that is similar and slightly smaller than Pea Gravel. CLS5 also has angular to sub-angular particles

and has the smallest particle size, with a maximum particle size of 7 mm. Roundness (R) values were estimated using existing charts and methodologies (*Krumbein, 1941; Powers, 1953; Youd, 1973*) for each gravel material and values are listed in Table 1. The R value that was used for Ottawa C109 sand was the value reported in *Youd (1973)*. All three gravels are uniform and are classified as poorly graded gravels (GP) per the Unified Soil Classification System (USCS). The gravels were selected to investigate the influence of particle size and shape. Minimum and maximum densities were determined using ASTM D4254 (*ASTM, 2006*) while specific gravity was determined using ASTM C127 (*ASTM, 2012a*). The Translucent Segregation Table (TST), described by *Ohm and Hryciw (2013)*, was used to assess grain size distribution.



Figure 4.1: Photograph of Pea Gravel, 8 mm Crushed Limestone (CLS8), and 5 mm Crushed Limestone (CLS5)

4.3 Test Procedure

The large-size CSS described in Chapter 3 was utilized to perform monotonic and cyclic simple shear tests of the uniform gravels in this study. Specimens were prepared at two target relative densities (D_r) for each material: $D_r = 47 \pm 3\%$ and $D_r = 87 \pm 3\%$. Photographs in Figures 4.3, 4.4, 4.5, 4.6, 4.7, and 4.8 show the setup of the baseplate and stacked rings during specimen preparation. Specimens were prepared at $D_r = 47\%$ by using a small shovel to place the gravel at a loose state as shown in Figure 4.9 and Figure 4.10. In some cases, the specimen baseplate was tamped with a rubber mallet to achieve the target density. Specimens were prepared at $D_r = 87\%$ by dropping a 5.5 kg weight with a circular diameter

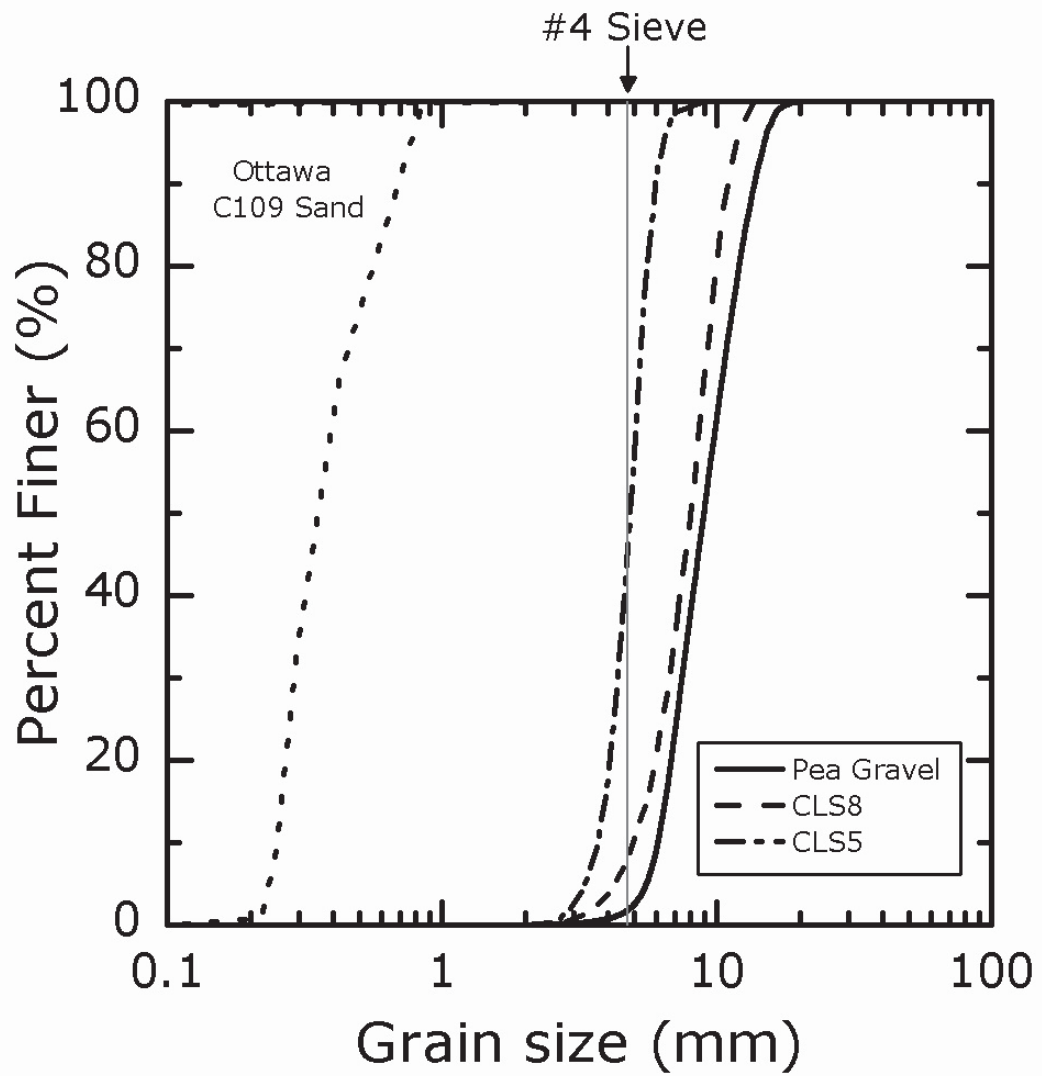

Figure 4.2: Grain size distributions of test materials

Table 4.1: Summary of Test Material Properties

Parameter	Materials			
	<i>Pea Gravel</i>	<i>8 mm Crushed Limestone</i>	<i>5 mm Crushed Limestone</i>	<i>Ottawa C109 Sand</i>
G_S	2.74	2.65	2.65	2.65
$\gamma_{d \max}$ (kg/m ³)	1741	1751	1667	1733
$\gamma_{d \min}$ (kg/m ³)	1546	1357	1276	1512
e_{\max}	0.772	0.953	1.077	0.752
e_{\min}	0.574	0.513	0.590	0.529
D_{60} (mm)	9.8	8.6	5.1	0.40
D_{30} (mm)	7.4	6.7	4.3	0.30
D_{10} (mm)	6.1	5.0	3.7	0.25
C_u	1.6	1.7	1.4	1.6
C_c	0.9	1.1	1.0	0.9
Roundness	0.55	0.28	0.28	0.42
USCS	GP	GP	GP	SP

of 150 mm from a height of 50-75 mm as shown in Figure 4.11 and Figure 4.12. For the Pea Gravel, an average of 25 drops in 3 layers was used; however, for the CLS gravels, the average drops increased for decreasing initial vertical stress and ranged from 30-60 drops in 5 equal layers to reach the target density. A small drop height was used to minimize particle damage during specimen preparation (this was also confirmed visually) and a greater number of drops was used for successive layers to ensure specimen uniformity.

Alternative specimen preparation techniques were also evaluated and compared with the methods described in the previous paragraph. Specifically, sedimentation of gravel through water was performed to assess any effects of specimen preparation technique on shear strength. The system that was used for water sedimentation is shown in Figure 4.13. Gravel was gently dropped through 12" of water and allowed to settle into a preferred structure. Once the gravel reached the appropriate height at the top of the stacked rings, the water was drained out the bottom of the baseplate through a port as shown in Figure 4.14 and Figure 4.15. The plastic cylinder was then removed from the inside of the membrane. This movement did not alter the specimen or cause movement of the gravel structure that was formed from the water sedimentation process. After removal of the cylinder, the specimens were monotonically sheared in the CSS device and results were compared with monotonic shear results for specimens prepared using the small shovel in the dry state (air pluviation). For comparisons to be made between these tests, void ratio values were calculated that accounted for the void space in the wet gravel specimens. Figure 4.16 and Figure 4.17 show that for both loose and dense cases, the response for air pluviation (AP) (with a small shovel) and water sedimentation (WS) were nearly identical. For the loose specimens the WS specimen was not as strain hardening as the AP specimen, but this difference is not significant. The void ratios and V_S values for the AP and WS specimens were similar for both the loose and dense cases. The V_S values for the loose AP and WS specimens were 232 m/s and 228 m/s, while the V_S values for the dense AP and WS specimens were 247 m/s and 249 m/s. These results suggest that specimen preparation technique has little effect

on uniform gravel material shear response.

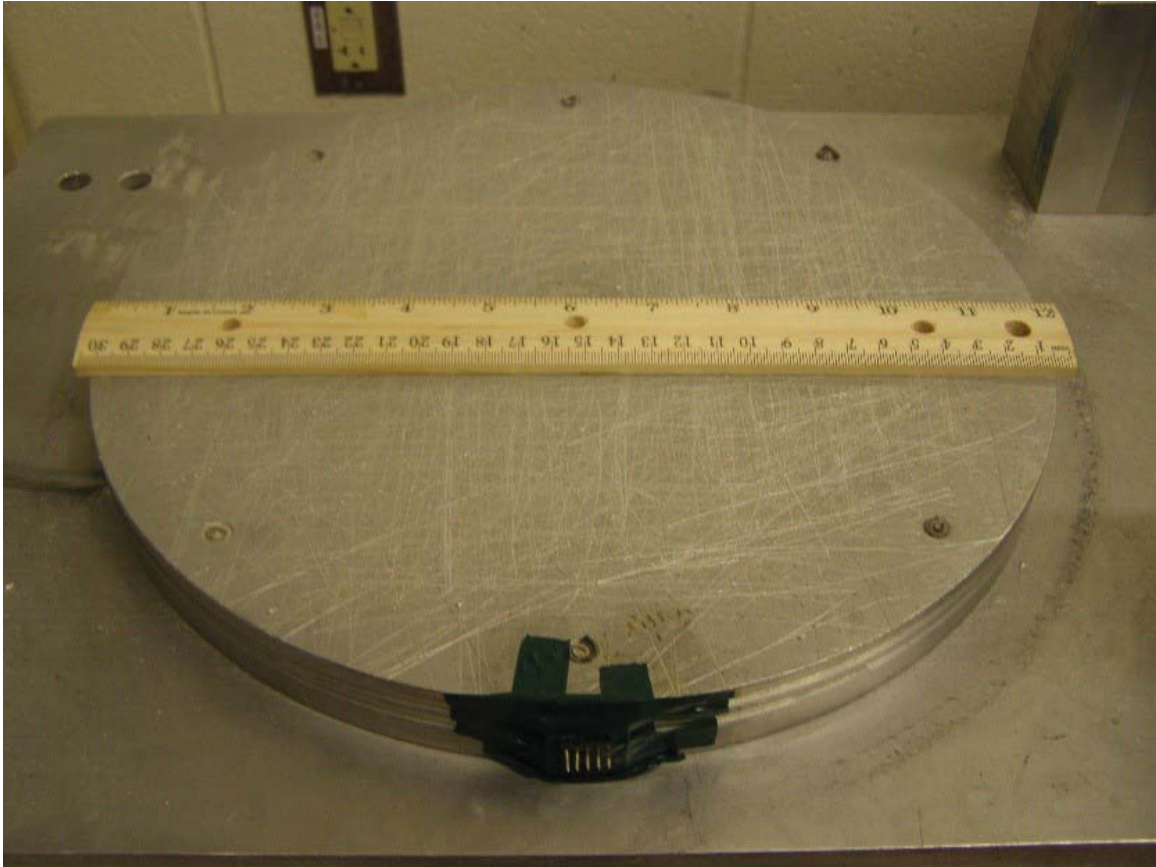

Figure 4.3: Bottom pedestal of baseplate for CSS device

In total, 101 simple shear tests were performed in this study (24 Monotonic, 53 Cyclic, and 24 Post Cyclic) and are summarized in Table 4.2 and Table 4.3. Monotonic, cyclic and post-cyclic tests were completed at $D_r = 47\%$ and $D_r = 87\%$ at initial vertical stresses (σ'_{v0}) of 50, 100, 200, and 400 kPa. Specimens were initially consolidated to a specified vertical stress and then sheared either monotonically or cyclically. V_S was measured in each specimen after consolidation to a specified vertical stress and prior to shearing. Monotonic and post-cyclic monotonic tests were strain-controlled and sheared at a rate of approximately 0.3% per minute, which enabled precise control of constant volume conditions and was similar to other strain rates used in simple shear testing of sands (Sivathayalan, 2000). Cyclic tests were stress-controlled with different CSRs ranging from 0.04 to 0.19 and a loading frequency of 0.33 Hz for most tests. Post-cyclic monotonic tests immediately

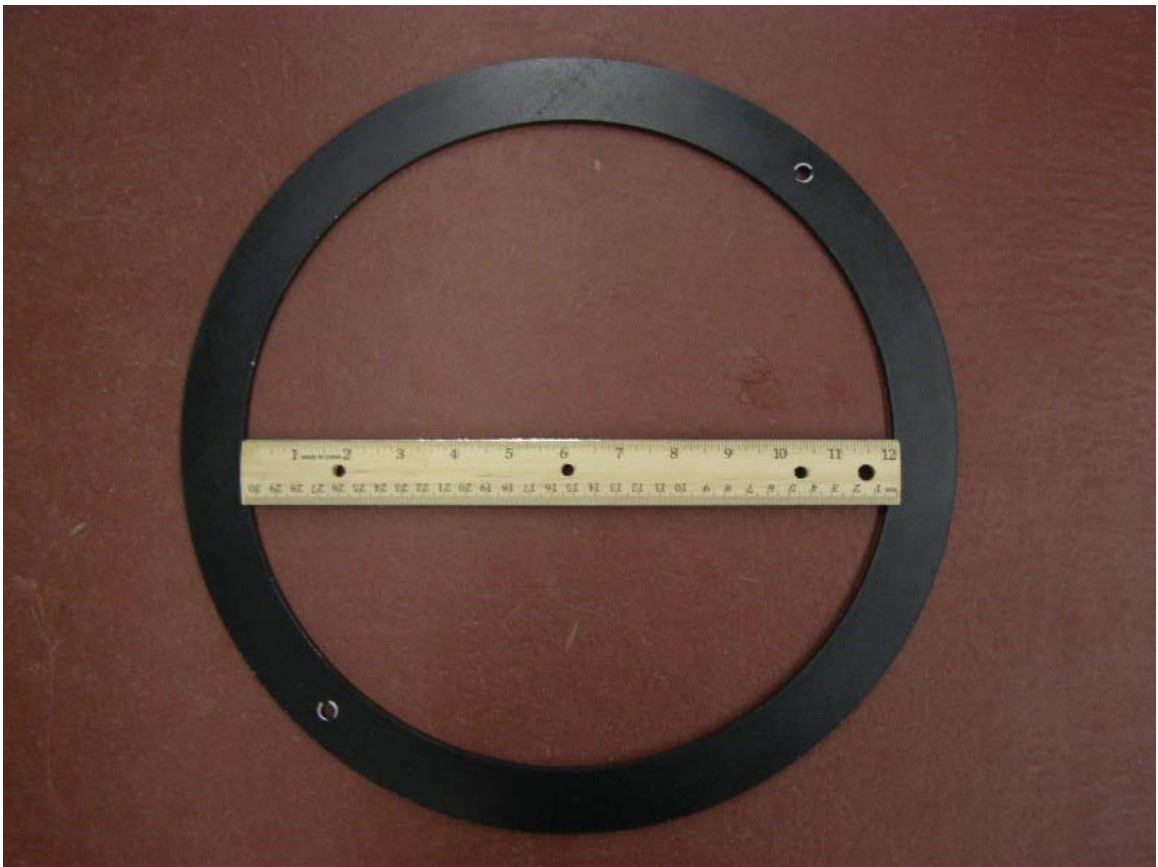

Figure 4.4: Teflon coated stacked ring for CSS device



Figure 4.5: Membrane and O-ring for CSS device



Figure 4.6: Placement of membrane and O-ring on bottom pedestal of baseplate

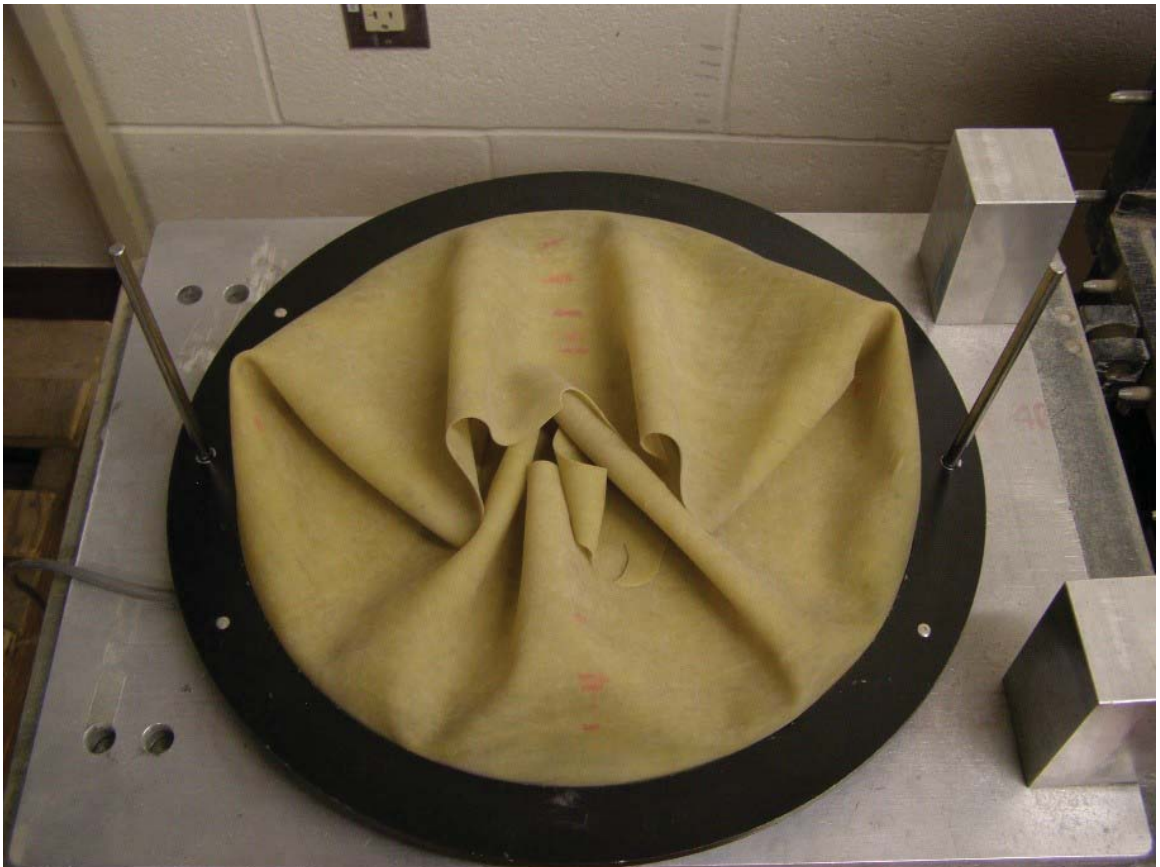

Figure 4.7: Placement of stacked rings during specimen preparation

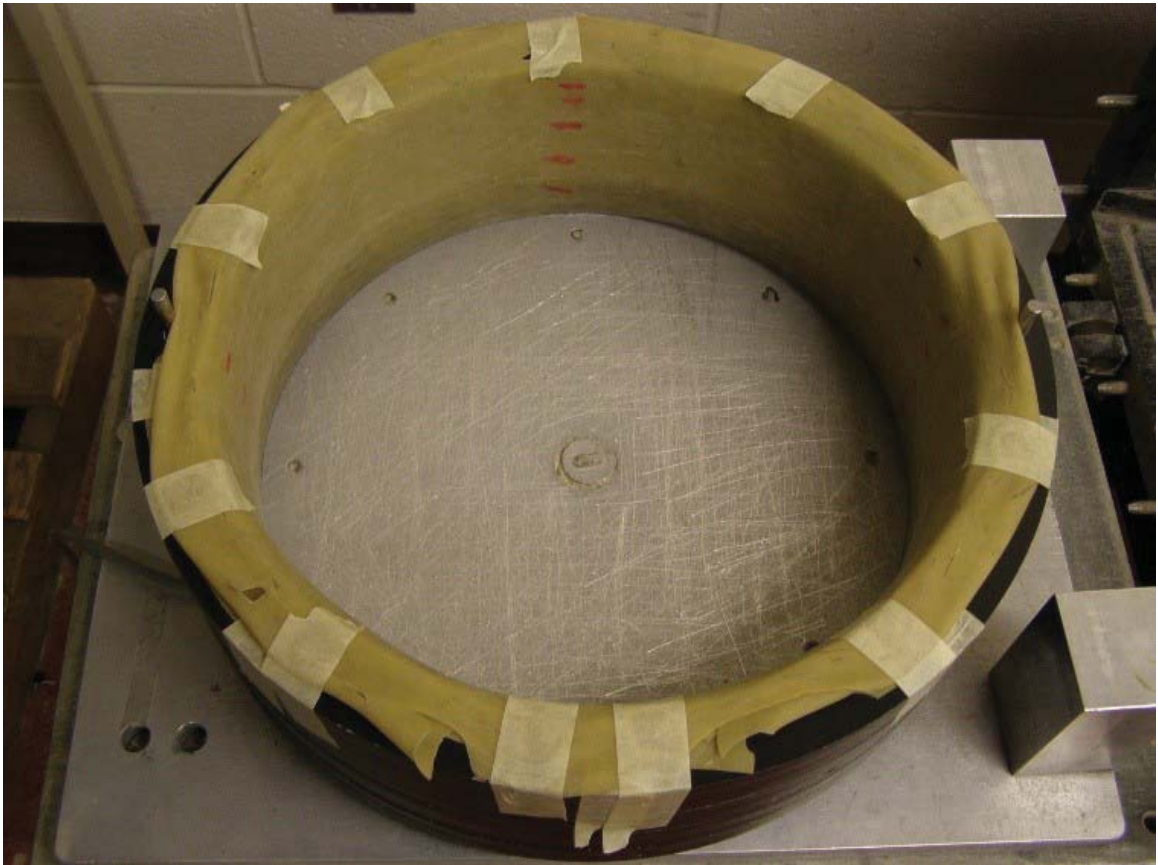

Figure 4.8: Membrane and stacked rings before specimen placement into rings



Figure 4.9: Small shovel used for preparation of loose specimens



Figure 4.10: Example placement of Pea Gravel in the loose state using small shovel



Figure 4.11: 5.5 kg drop weight used for preparation of dense specimens



Figure 4.12: Example compaction of Pea Gravel in the dense state using drop weight

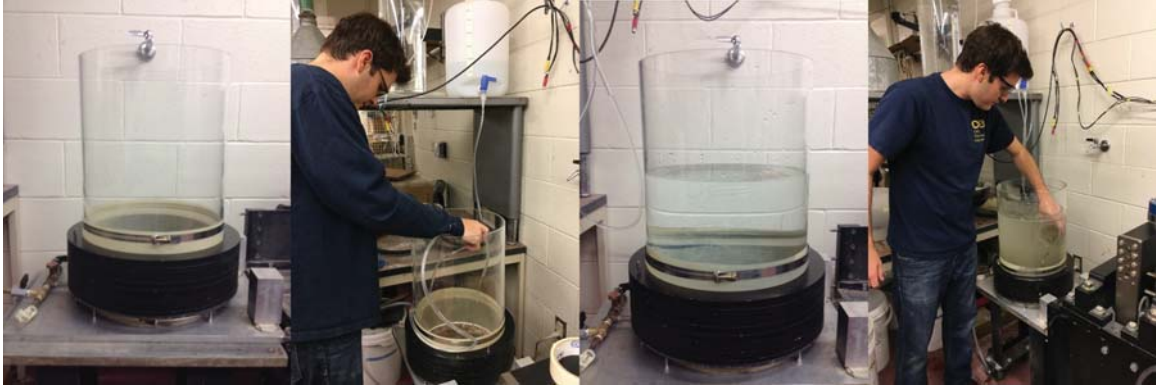

Figure 4.13: Specimen setup for sedimentation through water

followed cyclic tests without reconsolidating the specimen. Monotonic and cyclic simple shear tests were all performed at a constant volume. It has been shown in previous studies (Dyvik *et al.*, 1987) that the measured change in vertical stress in a constant volume simple shear test is considered to be equal to the pore pressure that would develop in an undrained test. ASTM D6528 (ASTM, 2007) specifies a vertical strain limit criterion of 0.05% for constant volume test validity. Constant volume was maintained by a feedback loop and active control of vertical stress during shearing.

4.4 Test Results

4.4.1 Shear Wave Velocity

Results of V_S measurements are presented in Figure 4.18 for both the $D_r = 47\%$ and $D_r = 87\%$ specimens. For each gravel tested, V_S increased with increasing σ'_{v0} and increasing D_r . CLS8 and CLS5 had higher V_S values than Pea Gravel for both $D_r = 47\%$ and $D_r = 87\%$. Power functions of the form in Equation 4.1 were fit to the data and values determined for the α and β parameters are presented in Table 4.4. The V_S value can be predicted by:

$$V_S = \alpha \left(\frac{\sigma'_{v0}}{1 \text{ atm}} \right)^\beta \quad (4.1)$$

Where α (V_S in m/s at 1 atm (101.3 kPa)) and β are fitting parameters determined from



Figure 4.14: View of Specimen after sedimentation of Pea Gravel through 12" of water



Figure 4.15: After draining of water used for sedimentation

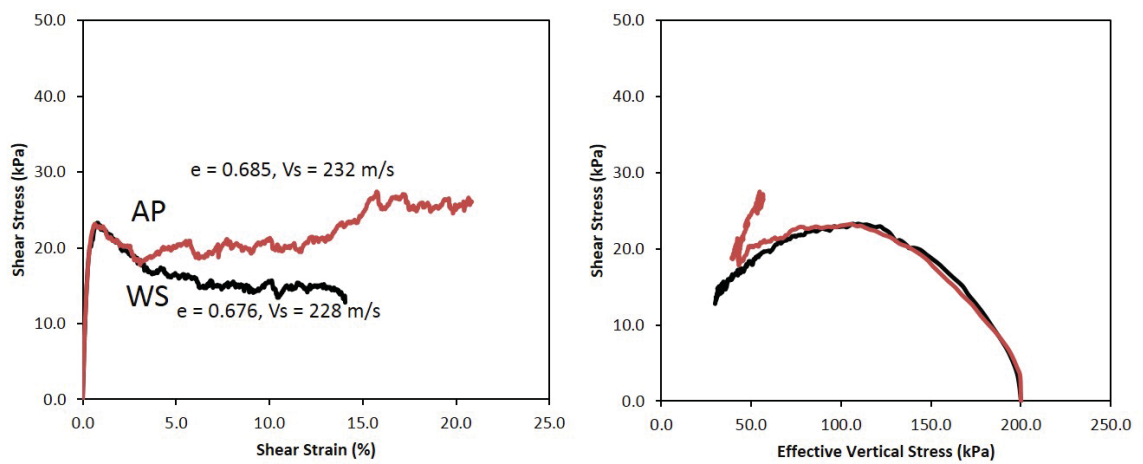

Figure 4.16: Comparison of τ versus γ by different specimen preparation techniques for Pea Gravel in the loose state ($D_r = 47\%$)

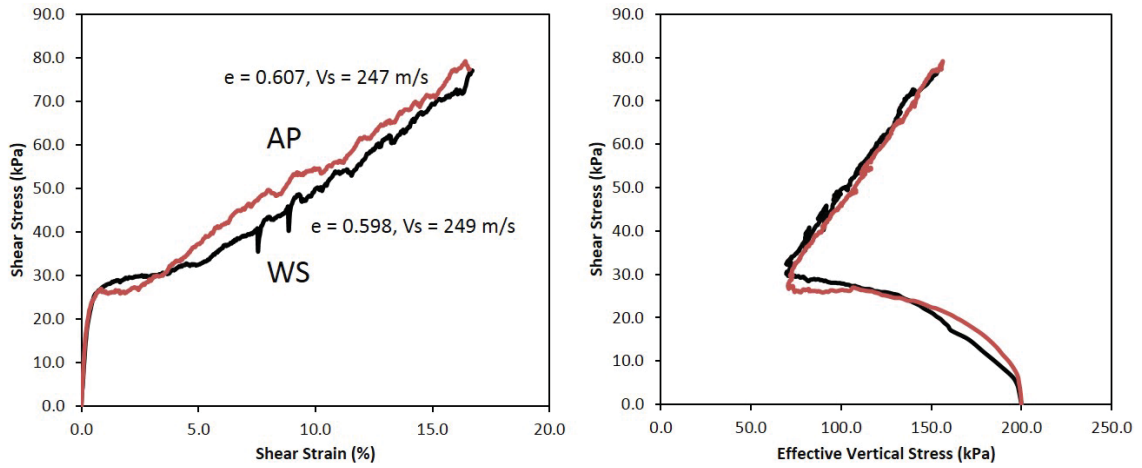

Figure 4.17: Comparison of τ versus γ by different specimen preparation techniques for Pea Gravel in the dense state ($D_r = 87\%$)

Table 4.2: Uniform Gravel Monotonic Tests

Test ID	Test Material	Test Date	Vertical Stress (kPa)	Consolidated void ratio	Consolidated D_r (%)	V_s (m/s)
M193	Pea Gravel	4/13/2015	50	0.674	50%	157
M191	Pea Gravel	4/8/2015	100	0.685	44%	193
M184	Pea Gravel	3/22/2015	200	0.681	46%	232
M171	Pea Gravel	1/12/2015	400	0.682	46%	268
M212	CLS5	7/16/2015	50	0.857	45%	175
M213	CLS5	7/16/2015	100	0.849	47%	203
M210	CLS5	7/15/2015	200	0.858	45%	250
M211	CLS5	7/15/2015	400	0.834	50%	278
M228	CLS8	8/16/2015	50	0.738	49%	180
M226	CLS8	8/16/2015	100	0.756	45%	212
M227	CLS8	8/16/2015	200	0.747	47%	253
M224	CLS8	8/14/2015	400	0.748	47%	293
M192	Pea Gravel	4/13/2015	50	0.595	90%	173
M205	Pea Gravel	6/9/2015	100	0.592	91%	213
M206	Pea Gravel	6/10/2015	200	0.598	88%	247
M201	Pea Gravel	6/3/2015	400	0.593	90%	283
M217	CLS5	7/26/2015	50	0.639	90%	196
M220	CLS5	7/29/2015	100	0.637	90%	227
M216	CLS5	7/26/2015	200	0.653	87%	258
M215	CLS5	7/25/2015	400	0.658	86%	305
M233	CLS8	8/18/2015	50	0.572	87%	191
M235	CLS8	8/20/2015	100	0.575	86%	216
M231	CLS8	8/18/2015	200	0.569	87%	257
M230	CLS8	8/18/2015	400	0.574	86%	308

Table 4.3: Uniform Gravels Cyclic Tests

Test ID	Test Material	Test Date	Vertical Stress (kPa)	Consolidated Void Ratio	Consolidated D_r (%)	V_s (m/s)	CSR	NL
C174	Pea Gravel	6/15/2015	50	0.68	46	159	0.088	5
C190	Pea Gravel	7/13/2015	100	0.684	45	196	0.194	1
C176	Pea Gravel	6/18/2015	200	0.680	46	222	0.097	6
C175	Pea Gravel	6/16/2015	400	0.686	44	266	0.099	9
C165	Pea Gravel	6/10/2015	50	0.589	92	171	0.088	11
C169	Pea Gravel	6/12/2015	100	0.589	92	204	0.094	8
C166	Pea Gravel	6/10/2005	200	0.596	89	227	0.097	11
C167	Pea Gravel	6/11/2015	400	0.59	92	297	0.099	33
C179	Pea Gravel	6/22/2015	100	0.686	44	185	0.094	6
C184	Pea Gravel	6/30/2015	100	0.599	87	220	0.044	287
C185	Pea Gravel	6/30/2015	100	0.602	86	217	0.144	8
C186	Pea Gravel	7/1/2015	100	0.681	46	192	0.044	240
C187	Pea Gravel	7/1/2015	100	0.68	47	185	0.144	6
C191	Pea Gravel	7/13/2015	100	0.59	92	221	0.194	2
C192	CLS5	7/17/2015	50	0.844	48	164	0.088	47
C195	CLS5	7/20/2015	100	0.863	44	198	0.094	45
C194	CLS5	7/20/2015	200	0.856	45	235	0.097	35
C193	CLS5	7/17/2015	400	0.838	49	279	0.099	30
C199	CLS5	7/29/2015	50	0.642	89	197	0.088	185
C209	CLS5	8/10/2015	100	0.655	87	233	0.094	162
C198	CLS5	7/26/2015	200	0.654	87	267	0.097	91
C201	CLS5	7/30/2015	400	0.637	90	328	0.099	90
C196	CLS5	7/20/2015	100	0.87	42	193	0.144	7
C197	CLS5	7/23/2015	100	0.875	42	200	0.044	1000 (N/A)
C213	CLS5	8/11/2015	100	0.657	86	229	0.144	9
C215	CLS8	8/20/2015	50	0.749	46	176	0.088	13
C217	CLS8	8/21/2015	100	0.755	45	204	0.094	25
C214	CLS8	8/20/2015	200	0.741	48	-	0.097	24
C216	CLS8	8/20/2015	400	0.738	49	296	0.099	33
C225	CLS8	9/3/2015	50	0.563	89	198	0.088	48
C230	CLS8	9/17/2015	100	0.581	85	223	0.094	58
C224	CLS8	9/2/2015	200	0.567	88	274	0.097	45
C222	CLS8	9/2/2015	400	0.577	85	316	0.099	74
C218	CLS8	8/21/2015	100	0.747	47	197	0.044	500 (N/A)
C219	CLS8	8/21/2015	100	0.751	46	211	0.144	5
C226	CLS8	9/3/2015	100	0.58	85	238	0.094	170
C227	CLS8	9/17/2015	100	0.581	85	220	0.144	7

Table 4.4: Summary of Equation Parameters for V_s

Parameter	Pea Gravel		8 mm Crushed Limestone		5 mm Crushed Limestone	
	$D_r = 47\%$	$D_r = 87\%$	$D_r = 47\%$	$D_r = 87\%$	$D_r = 47\%$	$D_r = 87\%$
α (m/s)	193	206	208	229	200	235
β	0.25	0.24	0.23	0.22	0.23	0.21

laboratory testing. As relative density increased, α values increased and β values decreased slightly for all three uniform gravels. CLS5 had the largest increase in α from 200 to 235 as D_r increased from 47% to 87%.

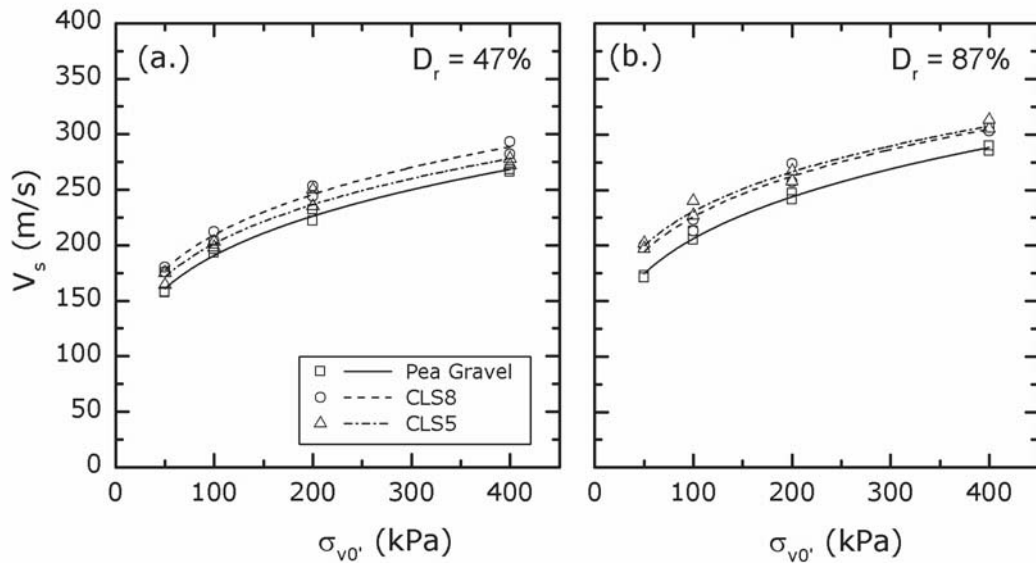

Figure 4.18: Shear wave velocity of uniform gravels at (a) $D_r = 47\%$ and (b) $D_r = 87\%$

4.4.2 Monotonic Constant Volume Simple Shear

Monotonic constant volume simple shear response of the three uniform gravels was evaluated. Example data for CLS8 at a $D_r = 47\%$ is presented in Figure 4.19. Figure 4.19a shows the shear stress-strain relationship for $\sigma'_{v0} = 50, 100, 200$ and 400 kPa. As vertical stress increased, peak shear strength (τ_p) increased. τ_p occurs at shear strains (γ) in the 0-

2% range for all three uniform gravels. All tests for CLS8 at $D_r = 47\%$, regardless of initial vertical stress, displayed a similar post-peak strain hardening response at a similar shear modulus, which would indicate that this material would not be susceptible to large flow-type deformations. The stress path for each initial vertical stress is shown in Figure 4.19b. Lines on this plot show the location of the peak shear stress, phase transformation (PT) and ultimate state (US) lines. The PT is the point of minimum vertical effective stress. Figure 4.19c shows the shear strength normalized by the initial vertical stress (τ/σ'_{v0}) versus shear strain. All tests for CLS8 at $D_r = 47\%$ had a similar peak value in the 0.15 range and all initial vertical stresses show strain-hardening response. However, as initial vertical stress increased the rate at which τ/σ'_{v0} increased post-peak, decreased (i.e. the $\sigma'_{v0} = 50$ kPa test had the highest value of τ/σ'_{v0} at larger strains ($\gamma > 2\%$)). Figure 4.19d shows shear stress normalized by vertical effective stress (τ/σ'_v) versus shear strain. For CLS8 at $D_r = 47\%$, this ratio reached a constant value as shear strain increased. The results for CLS8 at $D_r = 87\%$ are shown in Figure 4.20. Similar response was seen for all three uniform gravels in this study at a given D_r . Pea Gravel results are shown in Figure 4.21 for $D_r = 47\%$ and Figure 4.22 for $D_r = 87\%$. Loose Pea Gravel tests display a strain-softening response at lower initial vertical effective stress values (100 and 200 kPa), which would be associated with large flow-type deformations. CLS5 results are shown in Figure 4.23 for $D_r = 47\%$ and Figure 4.24 for $D_r = 87\%$.

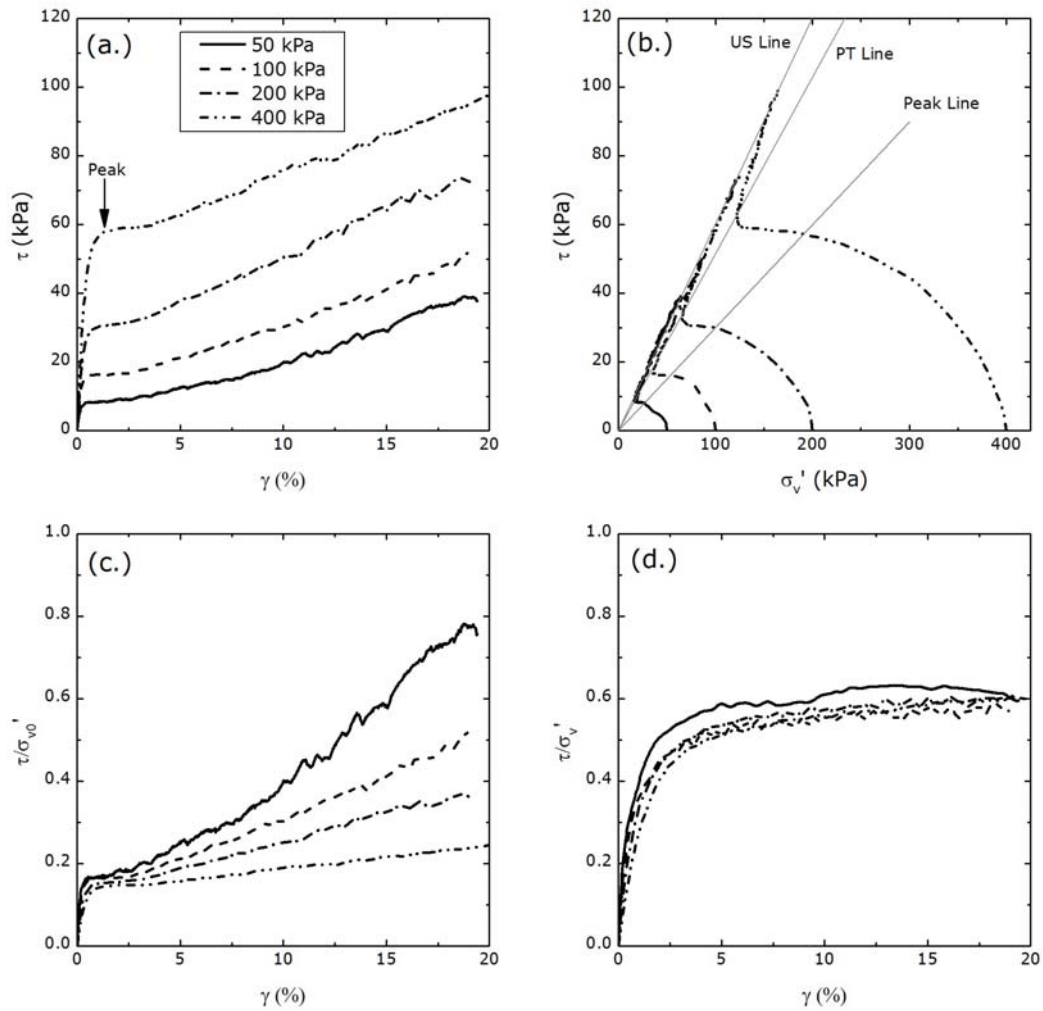

Figure 4.19: Monotonic Constant Volume Simple Shear data (Test ID: M228, M226, M227, M224) for 8 mm Crushed Limestone at $D_r = 47\%$ for (a.) Stress-Strain, (b.) Stress Path, (c.) τ/σ'_{v0} vs. γ , and (d.) τ/σ'_v vs. γ

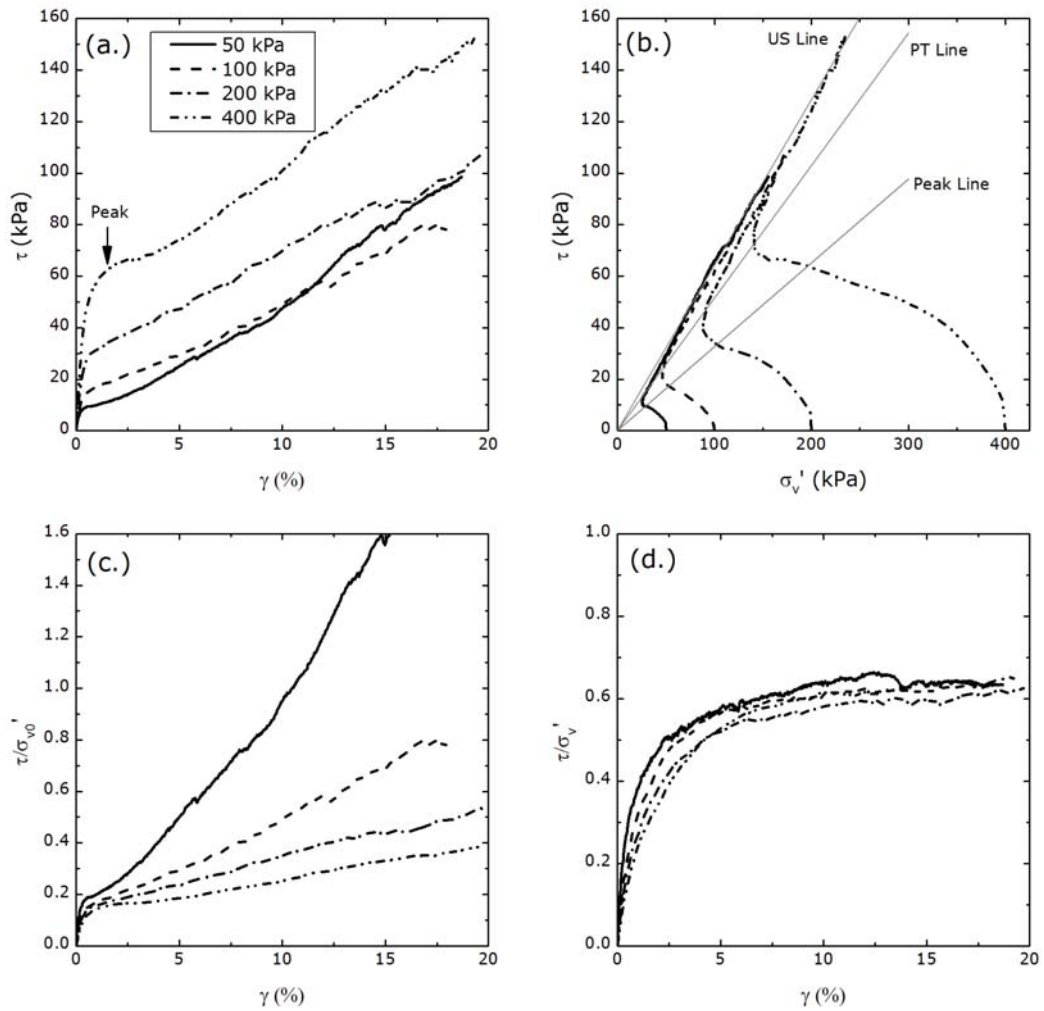

Figure 4.20: Monotonic Constant Volume Simple Shear data (Test ID: M233, M235, M231, M230) for 8 mm Crushed Limestone at $D_r = 87\%$ for (a.) Stress-Strain, (b.) Stress Path, (c.) τ/σ'_{v0} vs. γ , and (d.) τ/σ'_v vs. γ

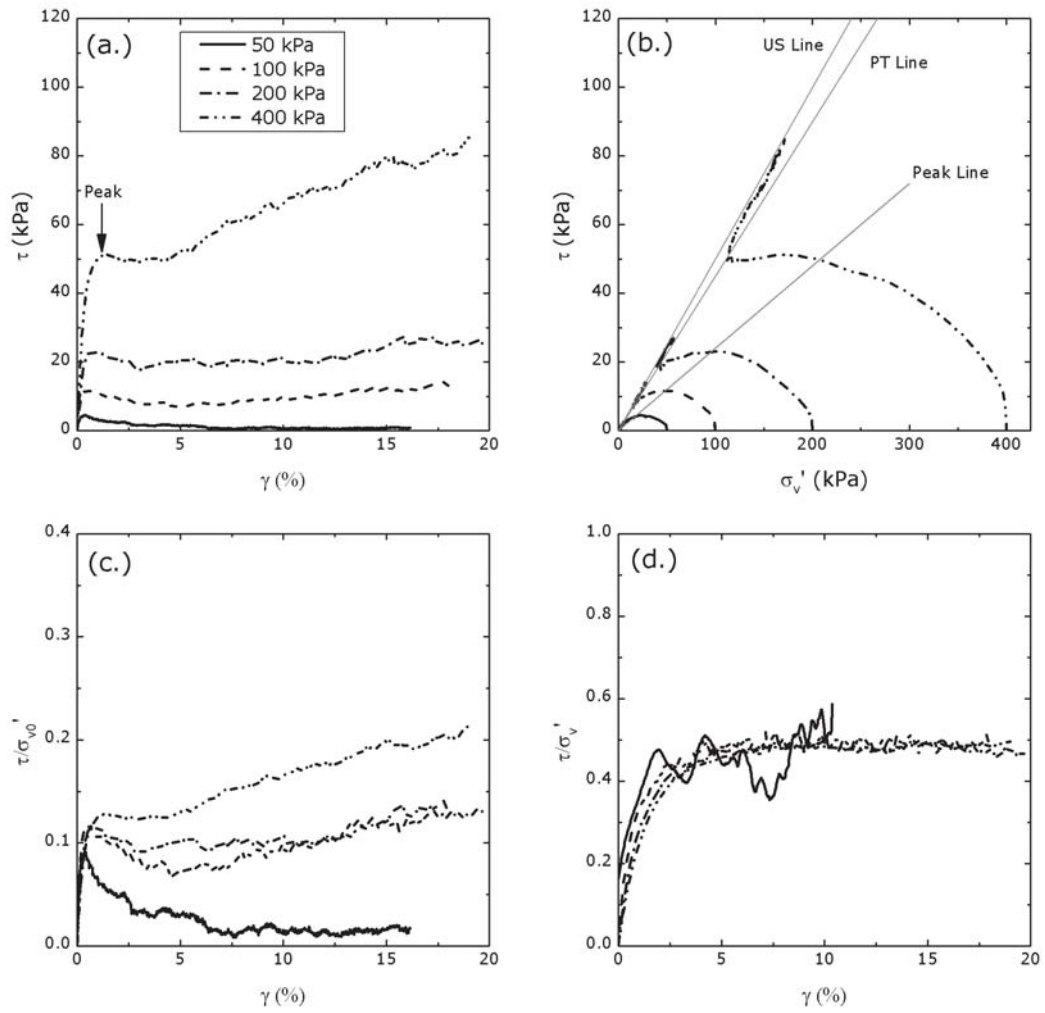

Figure 4.21: Monotonic Constant Volume Simple Shear data (Test ID: M193, M191, M184, M171) for Pea Gravel at $D_r = 47\%$ for (a.) Stress-Strain, (b.) Stress Path, (c.) τ/σ'_{v0} vs. γ , and (d.) τ/σ'_v vs. γ

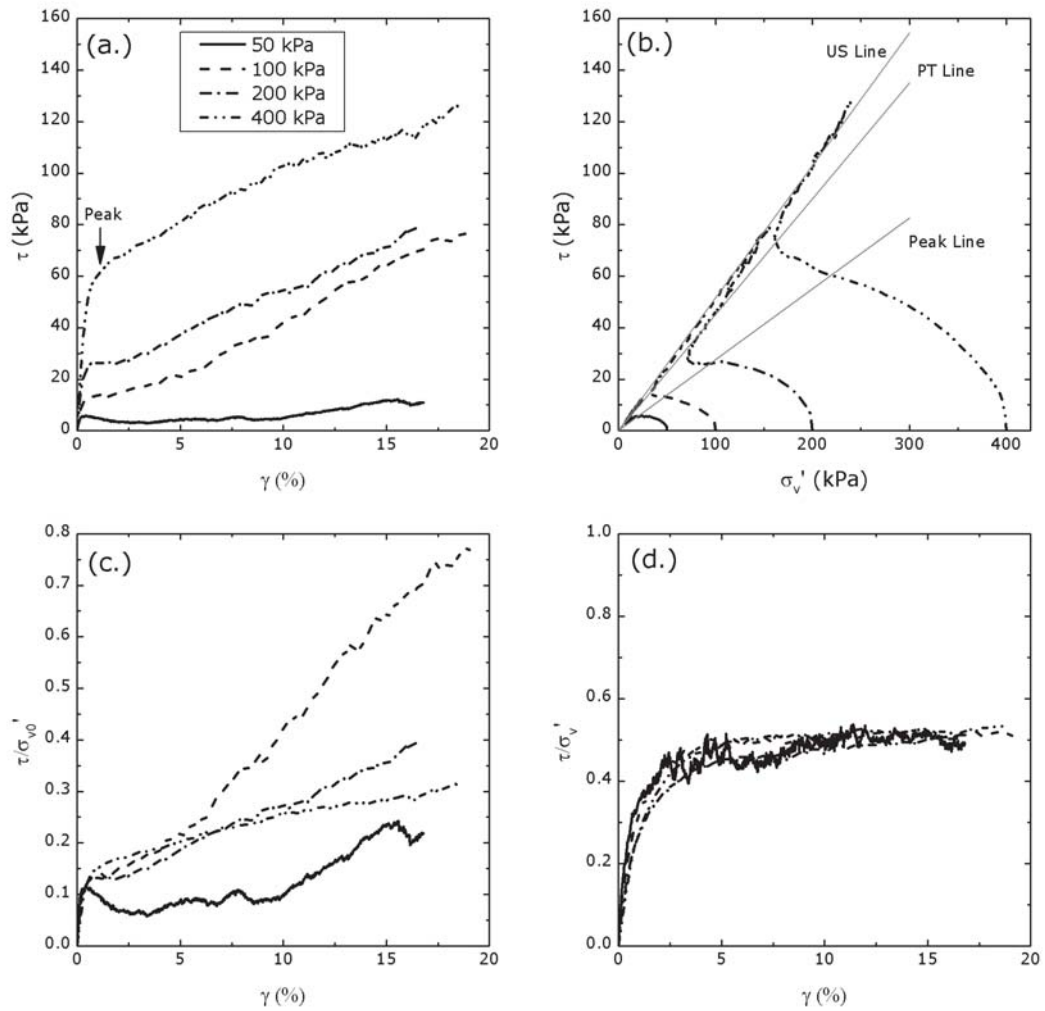

Figure 4.22: Monotonic Constant Volume Simple Shear data (Test ID: M192, M205, M206, M201) for Pea Gravel at $D_r = 87\%$ for (a.) Stress-Strain, (b.) Stress Path, (c.) τ/σ'_{v0} vs. γ , and (d.) τ/σ'_v vs. γ

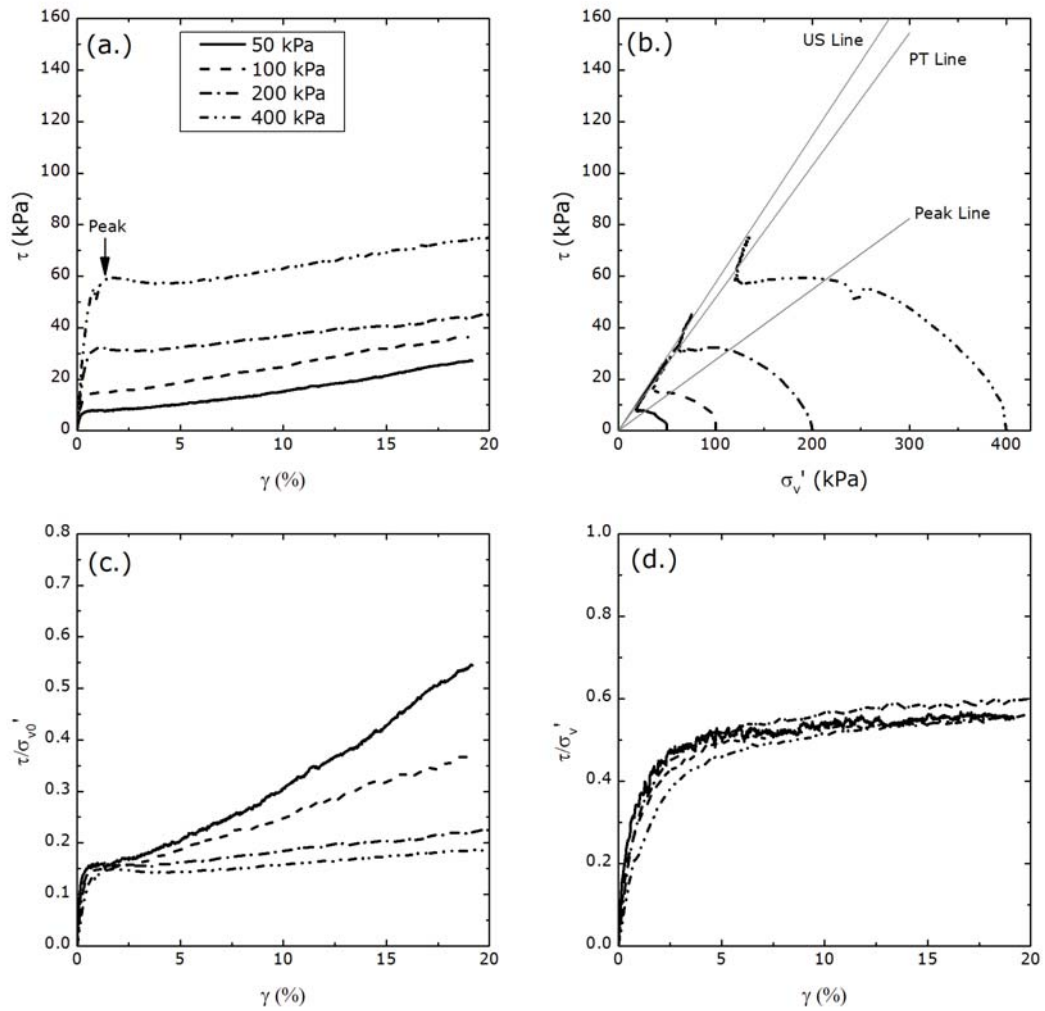

Figure 4.23: Monotonic Constant Volume Simple Shear data (Test ID: M212, M213, M210, M211) for 5 mm Crushed Limestone at $D_r = 47\%$ for (a.) Stress-Strain, (b.) Stress Path, (c.) τ/σ'_{v0} vs. γ , and (d.) τ/σ'_v vs. γ

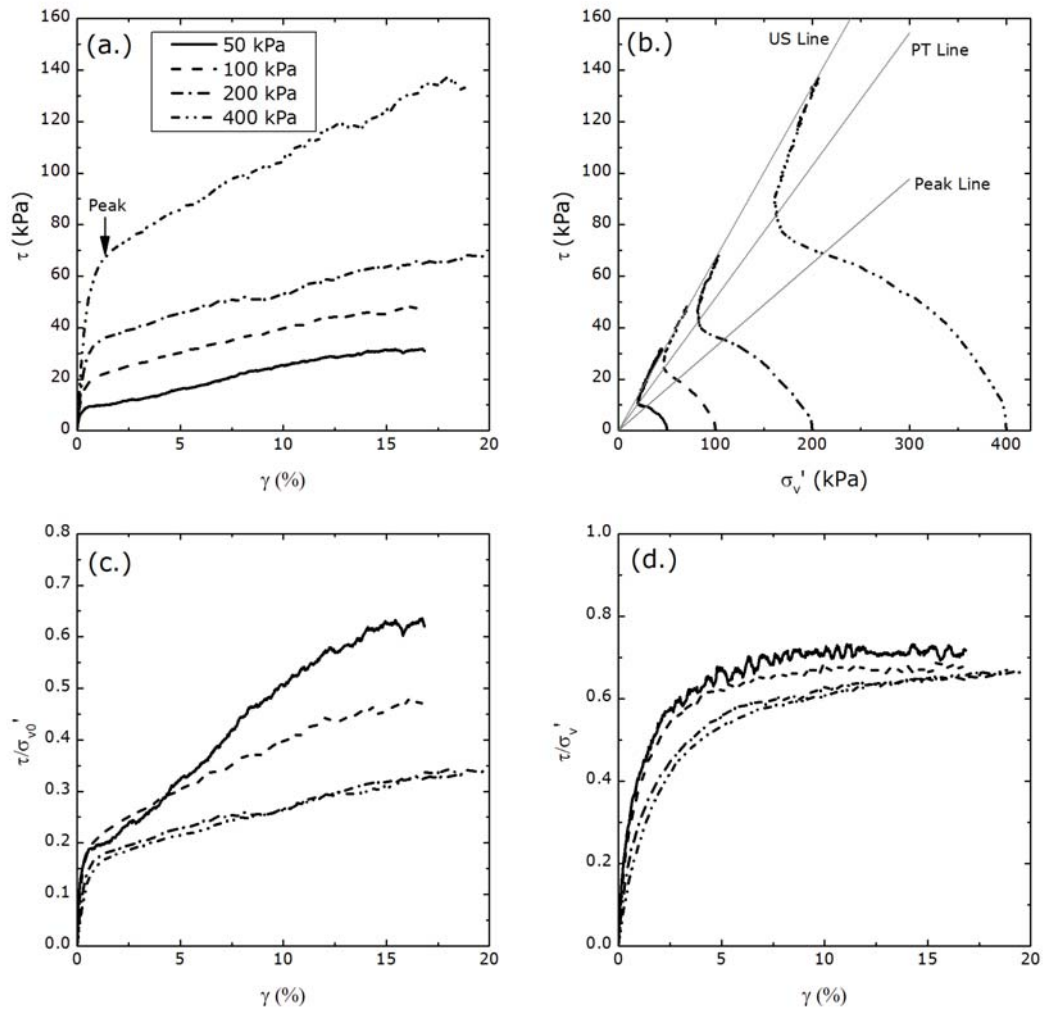

Figure 4.24: Monotonic Constant Volume Simple Shear data (Test ID: M217, M220, M216, M215) for 5 mm Crushed Limestone at $D_r = 87\%$ for (a.) Stress-Strain, (b.) Stress Path, (c.) τ/σ'_{v0} vs. γ , and (d.) τ/σ'_v vs. γ

Peak, PT, and US lines for Pea Gravel, CLS8 and CLS5 at a $D_r = 47\%$ are shown in Figure 4.25. Table 4.5 presents the calculated friction angles for $D_r = 47\%$ and $D_r = 87\%$ for all three uniform gravels at peak, PT and US. Note that to calculate the friction angle for a simple shear test, an assumption for the stress state of the specimen must be made because the stress state in simple shear is only known for the horizontal plane. Two commonly accepted interpretations of the simple shear test that are used to calculate the friction angle are: (1) the horizontal plane is the plane of maximum obliquity and (2) the horizontal plane is the plane of maximum shear stress (Roscoe, 1970). In this study it was assumed that the horizontal plane was the plane of maximum shear stress. This assumption has been used by others in simple shear testing interpretation of sands (Vaid and Sivathayalan, 1996; Porcino et al., 2008). The friction angle is therefore given by the following equation:

$$\phi = \alpha = \sin^{-1} \left(\frac{\tau}{\sigma'_v} \right) \quad (4.2)$$

Where τ is the shear stress and σ'_v is the vertical effective stress at the point of interest.

Figure 4.25a shows that the peak friction angle can be considered constant for the angular CLS material at a given relative density, independent of initial vertical stress; however, the rounded Pea Gravel peak friction angle increased with increasing initial vertical stress. CLS8 had the highest peak friction angle, followed by CLS5 and Pea Gravel. Figure 4.25b displays the PT lines for all three uniform gravels at $D_r = 47\%$. CLS8 and CLS5 had identical PT friction angles of 31° at $D_r = 47\%$, while Pea Gravel had a PT friction angle of 27° . The angular CLS materials had a higher PT friction angle than the rounded Pea Gravel. Particle size did not have an effect on PT friction angle, since CLS8 and CLS5 had the same PT friction angle. Relative density did not affect the PT friction angle for these three uniform gravels. Figure 4.25c shows the US line for each uniform gravel material. CLS8 had the highest US friction angle (37°) at $D_r = 47\%$, followed by CLS5 (35°) and Pea Gravel (30°). The US friction angle increased with increasing D_r for each uniform gravel; however, the increase was only 1° for Pea Gravel, 3° for CLS8, and 7° for CLS5. The

angular CLS materials had higher US friction angles compared to the rounded Pea Gravel.

Figure 4.26 compares the results for the PT line for gravels with Ottawa C109 sand tested in this study, Silica C109 Sand (Yazdi, 2004) and Frasier River Sand (Sivathayalan, 1994). The plot shows that the PT line for the sub-rounded Ottawa C109 sand and sub-rounded Silica C109 sand were similar to the sub-rounded to rounded Pea Gravel, while the PT line for the sub-angular Frasier River Sand was similar to the PT lines of the sub-angular to angular CLS materials. This data shows that the PT lines for uniform gravels and sands were similar, which suggests that particle size did not affect PT lines, but particle angularity did. As particle angularity increased, the slope of the PT line increased.

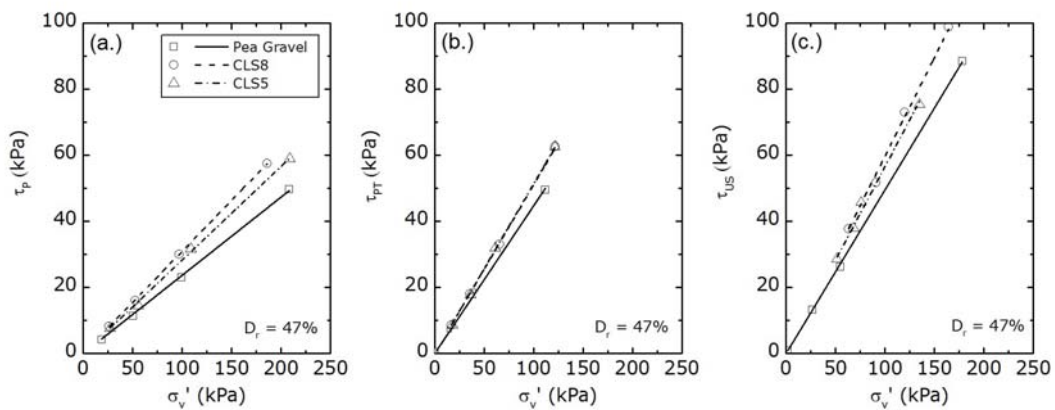

Figure 4.25: Comparison of (a.) Peak, (b.) Phase Transformation and (c.) Ultimate State lines for 3 Uniform Gravels at $D_r = 47\%$

Table 4.5: Summary of Peak, Phase Transformation, and Ultimate State Friction Angle for 3 Uniform Gravels

Material	Friction Angle (Degrees)					
	Peak		Phase Transformation		Ultimate State	
	$D_r = 47\%$	$D_r = 87\%$	$D_r = 47\%$	$D_r = 87\%$	$D_r = 47\%$	$D_r = 87\%$
Pea Gravel	14	16	27	27	30	31
CLS5	16	19	31	32	35	42
CLS8	18	19	31	31	37	40

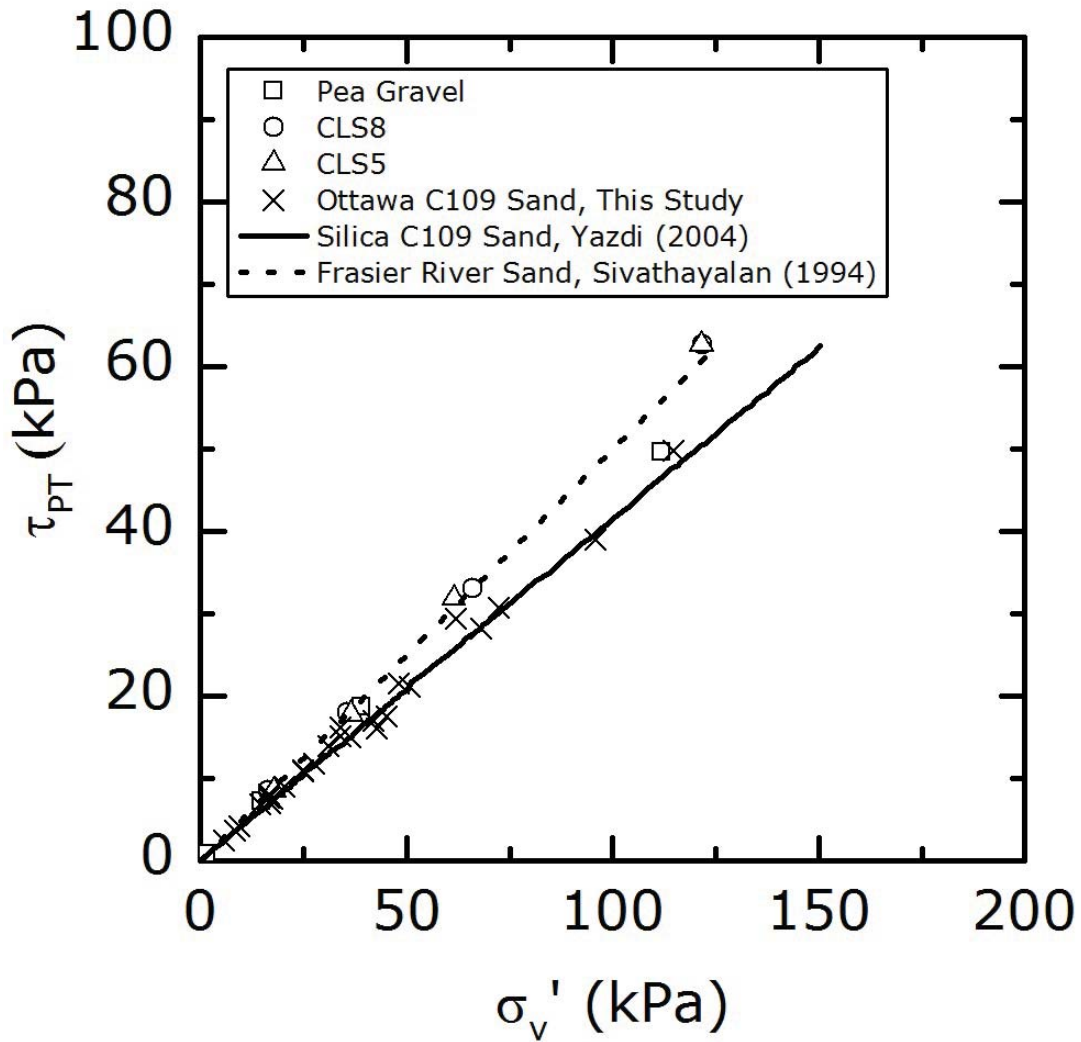

Figure 4.26: Comparison of results for PT of $D_r = 47\%$ Gravels and Ottawa C109 Sand from this study with existing data from the literature for Frasier River Sand and Silica C109 Sand

Peak, PT, and US shear stress versus V_S is presented in Figure 4.27. As shown in Figure 4.27a, as V_S increased, peak shear strength increased. The data falls within a small range, independent of particle size and shape. As V_S increased the PT shear strength also increased (Figure 4.27b). The data again falls into a still narrow, but increasing, range. Figure 4.27c shows that as V_S increased the US shear strength increased; however, in this case more scatter was observed. The scatter in the data of Figure 4.27c can be attributed to effects of initial vertical stress and density. The US has been thought to be constant (*Vaid and Sivathayalan, 1996; Porcino et al., 2008*), while others have shown that density affects the ultimate state (*Miura and Toki, 1982*). For rockfill materials, the ultimate state has been shown to depend on initial vertical stress and less significantly on initial void ratio (*Xiao et al., 2015b*). These observations are supported by Figure 4.19c that shows that initial vertical stress had a significant effect on the dilative response at larger strains for CLS8. In Figure 4.19c, Peak and PT occurred at smaller strains (0-3%) and the ratio of τ/σ'_{v0} was similar for all tests; however, the specimens dilated at different rates increasing variability between tests at the US, explaining why V_S correlated well with Peak and PT but not as well with US.

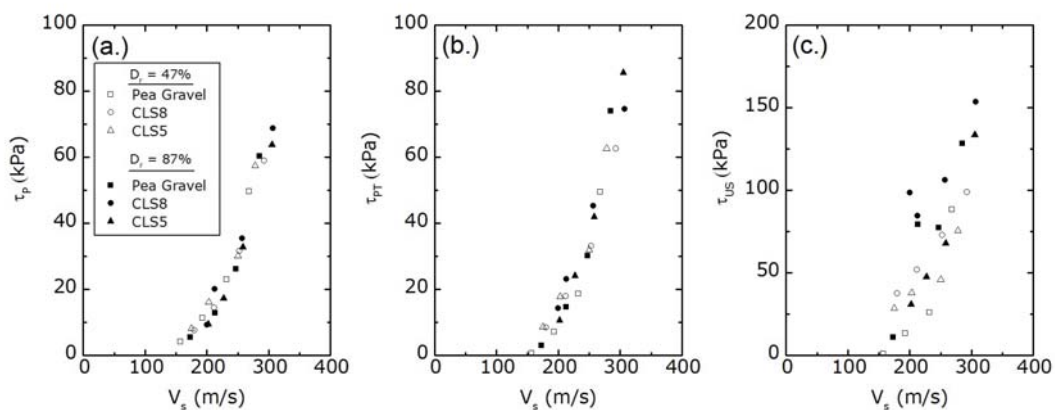

Figure 4.27: (a.) Peak Shear Stress, (b.) Shear Stress at Phase Transformation and (c.) Shear Stress at Ultimate State versus Shear Wave Velocity for Three Uniform Gravels

The correlation between V_S and shear strength was further explored by fitting a power function to the data for the three uniform gravels that was presented in Figure 4.27. In this section power functions of the form:

$$y = a * x^b \quad (4.3)$$

were fit to the data points for uniform gravels so that shear strength (τ) at Peak, PT, and US could be predicted using V_S . Therefore, the shear strength (τ) at Peak, PT, and US can be predicted using the following equation.

$$\tau = a * (V_S)^b \quad (4.4)$$

Figures 4.28, 4.29, and 4.30 plot Peak, PT, and US shear strength versus V_S measured after consolidation and before shearing for Uniform Gravels. Data from tests at initial vertical stresses from 50 to 400 kPa and $D_r = 47$ and 87% are included. The data was grouped for $D_r = 47$ and 87% since D_r did not change the regression. Power functions of the form in Equation 4.3 were fit to the data for Peak and PT and values of the a and b parameters are reported in Table 4.6. R^2 values are also reported for the fit with Peak and PT shear strength. The parameters in Table 4.6 can be used with Equation 4.4 to predict the shear strength (τ) at either Peak or PT if the value of V_S is known. After initial fitting, the US had a weaker correlation and therefore equation parameters are not reported. The correlation between US and V_S is expected to be weak since V_S is measured before shearing and the US is at approximately 20% shear strain. The strongest relationships between shear strength and V_S exist for the Peak and PT shear strengths as evidenced by their high R^2 value of 0.96.

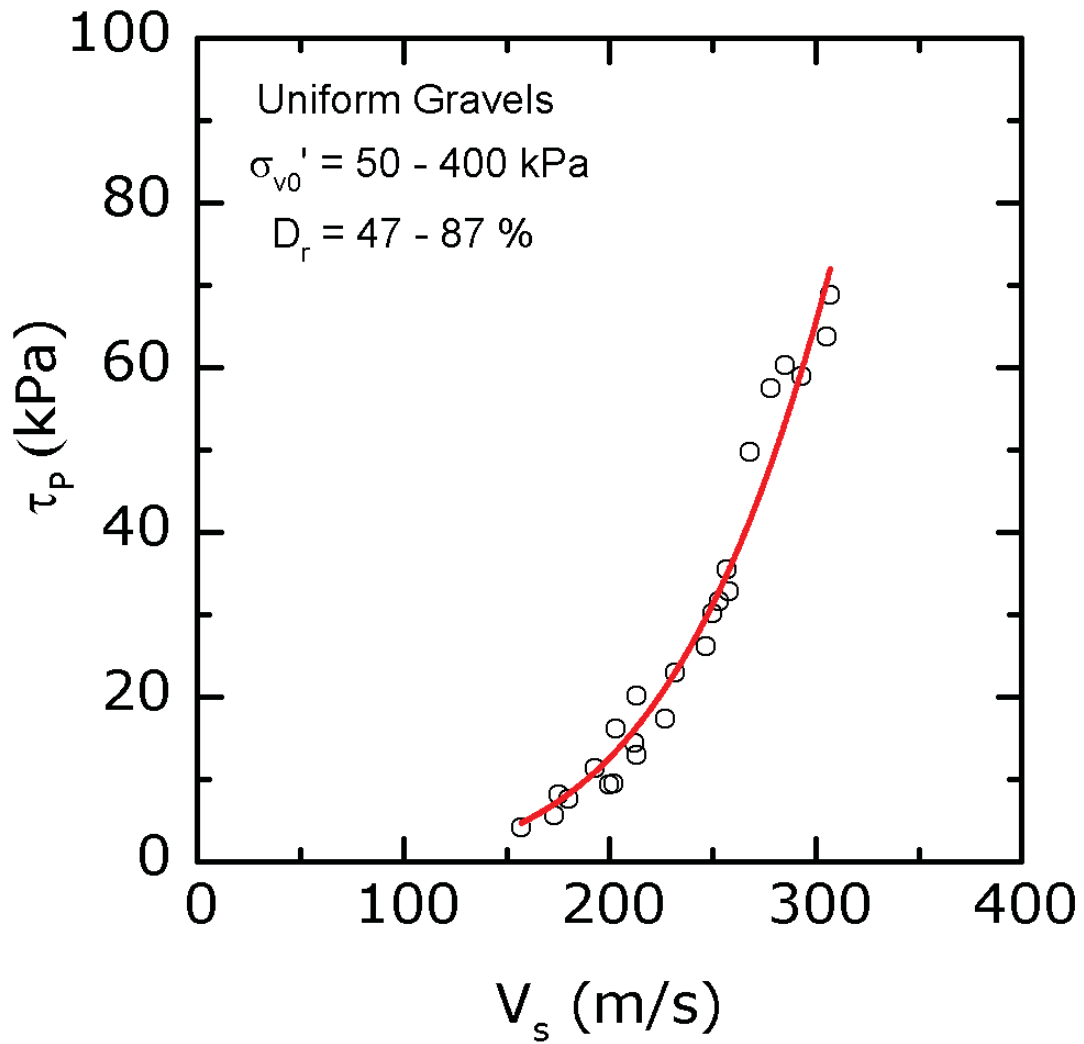

Figure 4.28: Peak Shear Strength versus Shear Wave Velocity for mixtures for three Uniform Gravels

Table 4.6: Equation Parameters for Uniform Gravels

Parameter	Uniform Gravels		
	a	b	R^2
Peak	5.97E-09	4.05	0.96
PT	1.98E-09	4.27	0.96

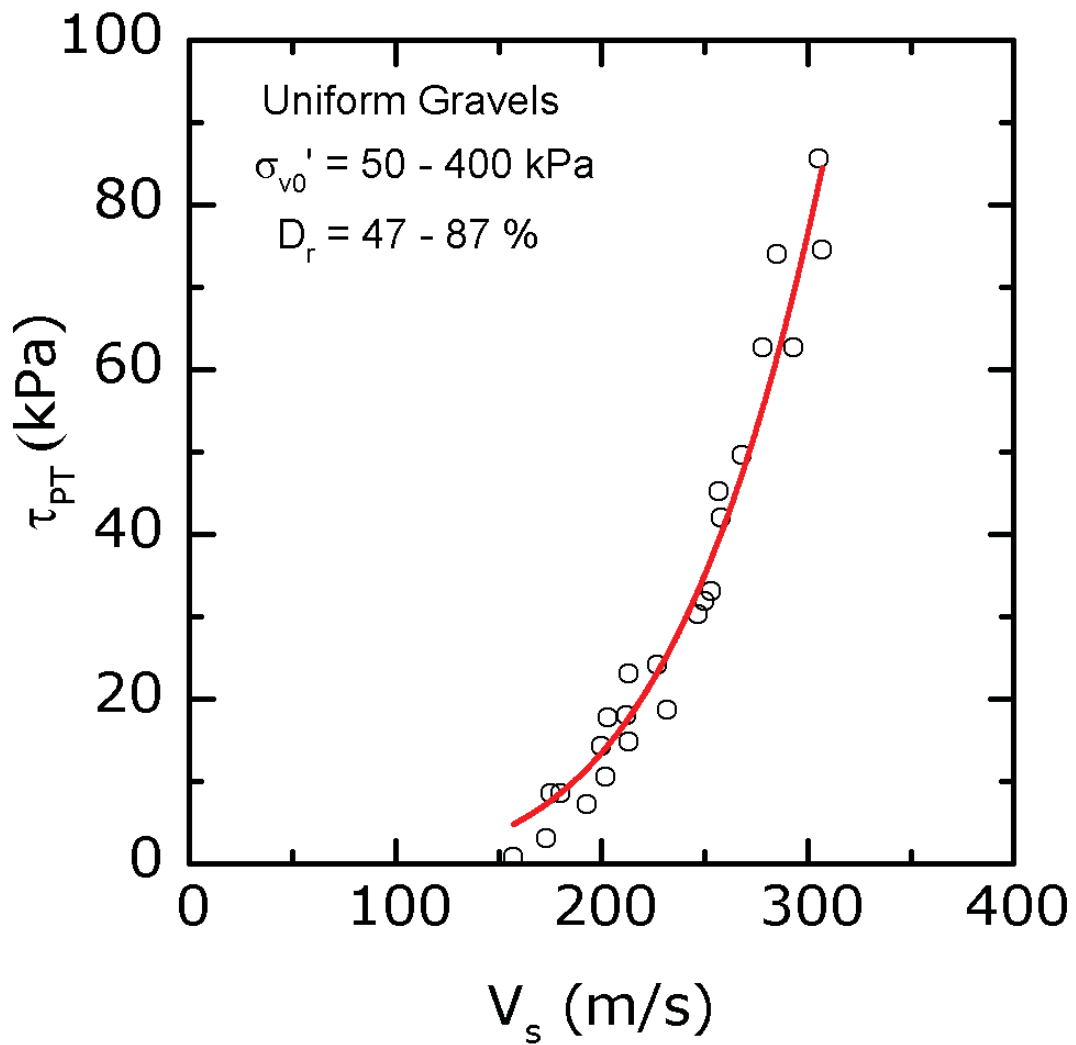

Figure 4.29: Phase Transformation Shear Strength versus Shear Wave Velocity for mixtures for three Uniform Gravels

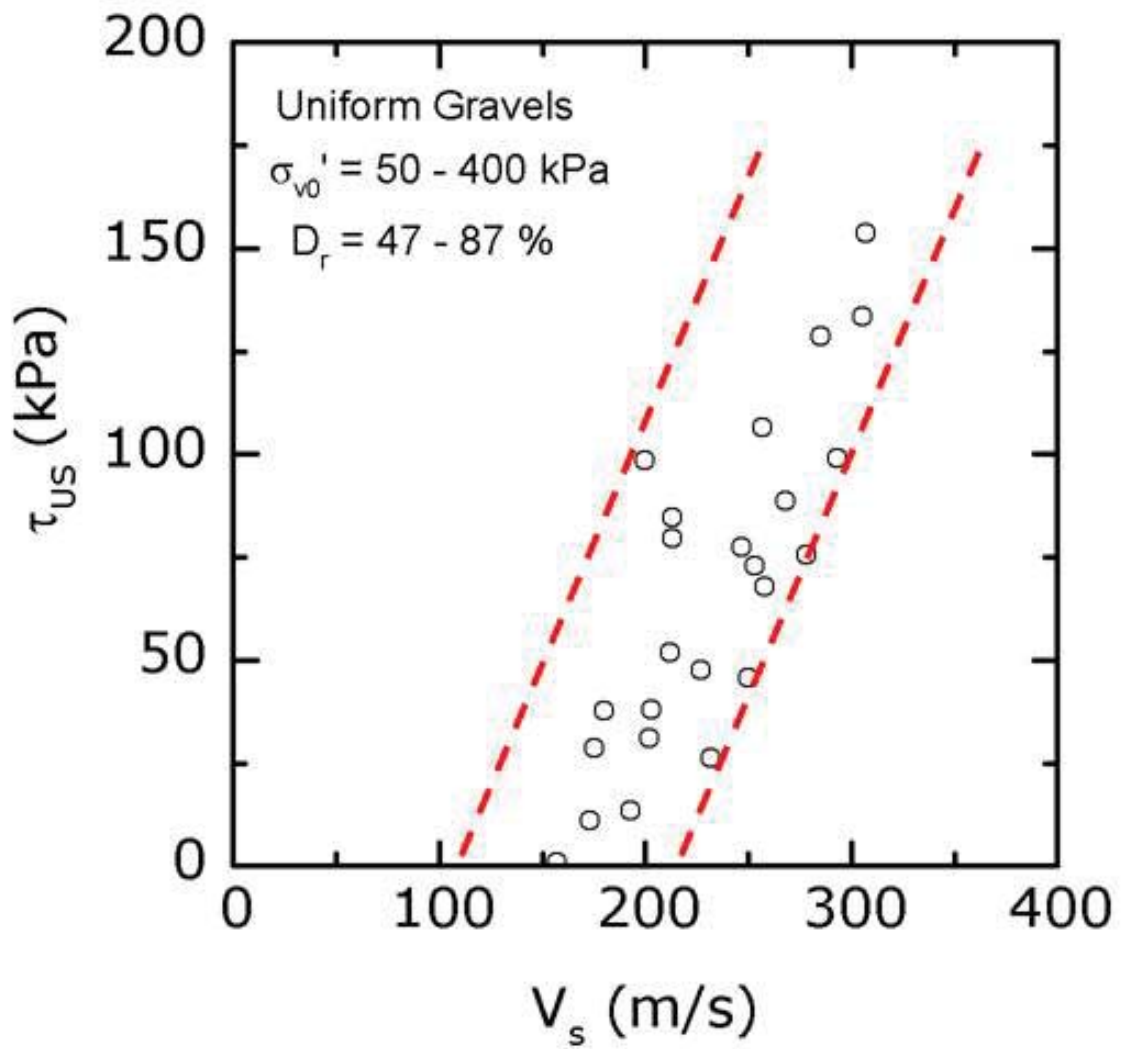

Figure 4.30: Ultimate State Shear Strength versus Shear Wave Velocity for mixtures for three Uniform Gravels

Figure 4.31 presents normalized shear stress ratio (τ/σ'_v) versus stress corrected shear wave velocity (V_{S1}), which was calculated using the following equation:

$$V_{S1} = V_S C_V = V_S \left(\frac{P_a}{\sigma'_v} \right)^{0.25} \quad (4.5)$$

Where P_a is atmospheric pressure (101.3 kPa) and σ'_v is the vertical effective stress. The exponent value of 0.25 was used (instead of the derived values based on the laboratory data in this study) for consistency.

The τ/σ'_v ratio was used to calculate friction angle, and is plotted in Figure 4.31 to compare the mobilized shear strength at Peak, PT and US with V_{S1} . Figure 4.31a peak shear stress was normalized by vertical effective stress (τ_p/σ'_v) and shows that as V_{S1} increased from approximately 175 m/s to 240 m/s, the ratio τ_p/σ'_v increased from approximately 0.20 to nearly 0.45. Pea Gravel displayed a greater increase in τ_p/σ'_v as D_r increased compared to the angular CLS materials. Figure 4.31b plots the PT shear stress normalized by the vertical effective stress (τ_{PT}/σ'_v) versus V_{S1} , and shows that as V_{S1} increased the τ_{PT}/σ'_v for each material remained nearly constant. This is consistent with the previous observation that PT is unique for a material and not dependent on initial vertical effective stress or density. Figure 4.31c plots US shear stress normalized by vertical effective stress (τ_{US}/σ'_v) versus V_{S1} , and shows that as V_{S1} increased from approximately 175 m/s to 240 m/s, τ_{US}/σ'_v increased from approximately 0.45 to 0.70. τ_{US}/σ'_v remained constant for Pea Gravel as V_{S1} increased, but increased as V_{S1} increased for the CLS materials. This response could be attributed to greater particle interlocking (and dilation in the denser specimens) with angular particles. *Sadrekarami and Olson (2011)* noted that US friction angle (reported as peak friction angle *Sadrekarami and Olson (2011)*) includes both dilation and particle interlocking which are influenced by density and confining stress. Furthermore, increasing particle angularity, increases particle interlocking which makes particle rearrangement more difficult (and therefore τ_{US}/σ'_v is increased). This increase in τ_{US}/σ'_v with V_{S1} for the angular CLS is important because in post-cyclic tests, the stress path follows the US line.

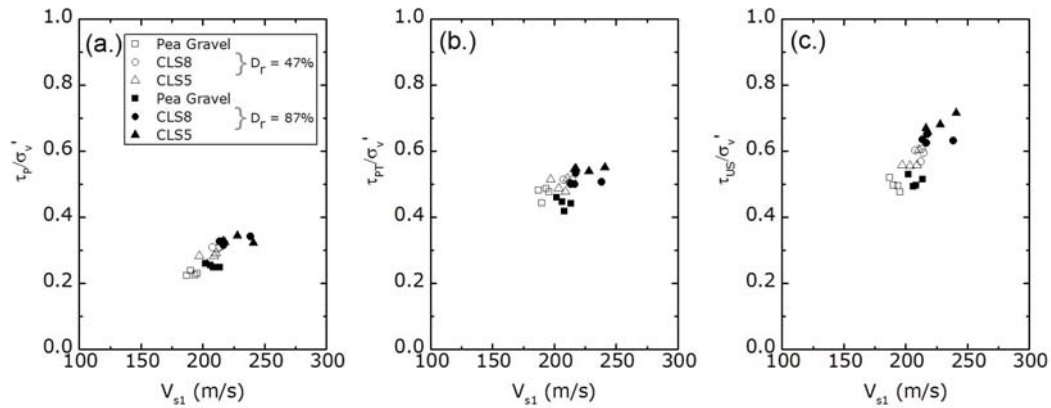

Figure 4.31: Comparison of 3 Uniform Gravels for: (a.) τ_p/σ'_v versus V_{S1} (b.) τ_{PT}/σ'_v versus V_{S1} and (c.) τ_{US}/σ'_v versus V_{S1}

4.4.3 Cyclic Simple Shear

Cyclic simple shear response was evaluated for CLS8, CLS5, and Pea Gravel to assess liquefaction susceptibility of these three uniform gravels. CSRs varying from 0.04 - 0.19 were applied during stress-controlled constant volume tests at $\sigma'_{v0} = 50, 100, 200$ and 400 kPa. In laboratory testing of soils, the onset of liquefaction has been based on different criteria, including, amount of excess pore pressure, shear strength, or development of shear strain (*Wu et al.*, 2004). In this study, a specimen was considered to have liquefied when 3.75% single amplitude shear strain was reached, which is a common threshold value that has been used in cyclic simple shear testing to define liquefaction (*Vaid and Sivathayalan*, 1996; *Sivathayalan*, 2000; *Porcino et al.*, 2008). Typical results from these tests are shown in Figure 4.32 for Pea Gravel at $D_r = 47\%$ (Test ID: C187) and $D_r = 86\%$ (Test ID: C185) at a CSR = 0.14 and $\sigma'_{v0} = 100$ kPa. The test data shows that density did not have a significant effect on the cyclic response of the Pea Gravel.

Monotonic shear response can provide insights into the cyclic shear response as shown in Figure 4.33, which plots the Peak, PT, and US lines from monotonic tests and the stress

path from the cyclic shear test of Pea Gravel at $D_r = 86\%$ and $\sigma'_{v0} = 100$ kPa. Before reaching the peak line, the specimen was contractive in each cycle and generated positive pore pressure that was expressed as a reduction in vertical stress needed to maintain constant volume conditions. As the specimen reached the PT line, the specimen response switched from contractive to dilative. The US line was followed during the last cyclic loops of the test as the specimen dilated and gained strength before again contracting upon stress reversal. This type of response has been previously noted for sands (Sivathayalan, 1994; Vaid and Sivathayalan, 1996; Porcino et al., 2008) and is now also shown for these uniform gravels.

The effect of D_r and CSR on the number of cycles to liquefaction (N_L) is shown in Figure 4.34. As the CSR increased, N_L decreased and as D_r increased, N_L increased for all three uniform gravels. Particle angularity was also observed to have an effect on the results at CSR values of 0.10 and below. Above a CSR = 0.10 the three uniform gravels liquefied at a similar number of cycles; however, below CSR = 0.10, the angular CLS materials exhibited more resistance to liquefaction than the rounded Pea Gravel.

Existing liquefaction susceptibility charts for gravelly soils are based on limited data compared to susceptibility charts for sands due to the unavailability of detailed case histories of gravelly soil liquefaction. Specimens from the laboratory tests in this study were separated into liquefaction or no-liquefaction based on whether they liquefied in 15 cycles (equivalent number of cycles for $M_w = 7.5$ earthquake). CSR values from the laboratory cyclic simple shear tests were first corrected for overburden stress and two-directional shaking so that data could be compared to existing field-based liquefaction susceptibility charts. Specimens were corrected for overburden stress by first determining the CSR (or CRR) value at 15 cycles at an initial vertical stress of 100 kPa for each of the uniform gravels in Figure 4.35. These plots were used to evaluate the a and b parameters used in calculating the overburden stress correction ($CRR = a * N^{-b}$). The b parameter was used to calculate the magnitude scaling factor (MSF) from ($MSF = (15 \text{ cycles}/N_L)^b$). The MSF

values obtained for the uniform gravels are shown in Figure 4.37 and compared to existing values in the literature based on field and laboratory data in Figure 4.38. The data from this study for uniform gravels compares well with the existing data for sands as shown in Figure 4.38. Since not all tests liquefied at 15 cycles, this calculation was necessary to compare all data at a $M_w = 7.5$ or 15 uniform cycles. The corresponding CRR at 15 cycles for each test was then calculated and compared to the CRR at 15 cycles at $\sigma'_{v0} = 1$ atm (101.3 kPa) using Equation 4.6. Previous studies on sand have also used a laboratory-based approach for overburden stress correction evaluation (Vaid and Sivathayalan, 1996).

$$K_{\sigma} = \frac{CRR_{\sigma'_{v0}}}{CRR_{\sigma'_{v0}=1atm}} \quad (4.6)$$

A magnitude scaling factor (MSF) was used to adjust the *Cao et al.* (2011) CRR curves to a $M_w = 7.5$. The following equation was used (*Andrus and Stokoe*, 2000):

$$MSF = \frac{M_w^{-2.56}}{7.5} \quad (4.7)$$

Where M_w is moment magnitude. A 10% reduction in CSR values was used to account for two-directional shaking in-situ. Once the necessary corrections were applied, data from the uniform gravels was plotted in Figure 4.39 for comparison with existing CSR versus V_{S1} relationships from *Andrus and Stokoe* (2000) for gravels, *Kayen et al.* (2013) for sands, and *Cao et al.* (2011) for gravels. The uniform gravels in this study liquefied at V_{S1} values above 200 m/s and as high as 230 m/sec. Every specimen that liquefied would have been predicted as non-liquefiable by the *Andrus and Stokoe* (2000) relationship for gravels and the *Kayen et al.* (2013) relationship for sands. The data from this study for specimens that liquefied fell between the PL=30% and PL=70% lines of the *Cao et al.* (2011) relationship, whereas the data from the specimens that did not liquefy fell to the right of the PL=50% line. The data from this study therefore confirms that uniform gravel was liquefiable in constant volume conditions at higher V_{S1} values than sands. It is important to note that

particle morphology appears to be an important factor, as the rounded Pea Gravel was less resistant to liquefaction when compared to the angular CLS materials. Similar effects of particle angularity have been noted for sands at a confining pressure of 200 kPa (Vaid *et al.*, 1985). The angular CLS materials liquefied at CSR 0.10, whereas the Pea Gravel liquefied at CSR 0.07.

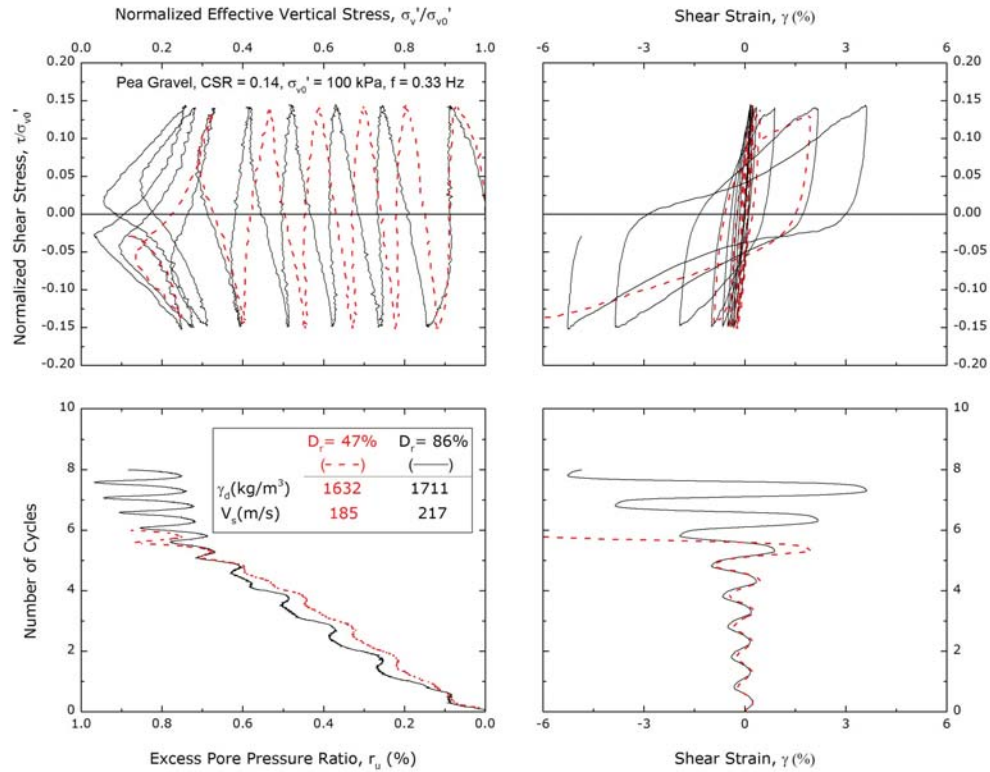

Figure 4.32: Cyclic Data for Pea Gravel at $D_r = 47\%$ (Test ID: C187) and $D_r = 86\%$ (Test ID: C185) at CSR = 0.14 and $\sigma'_{v0} = 100$ kPa

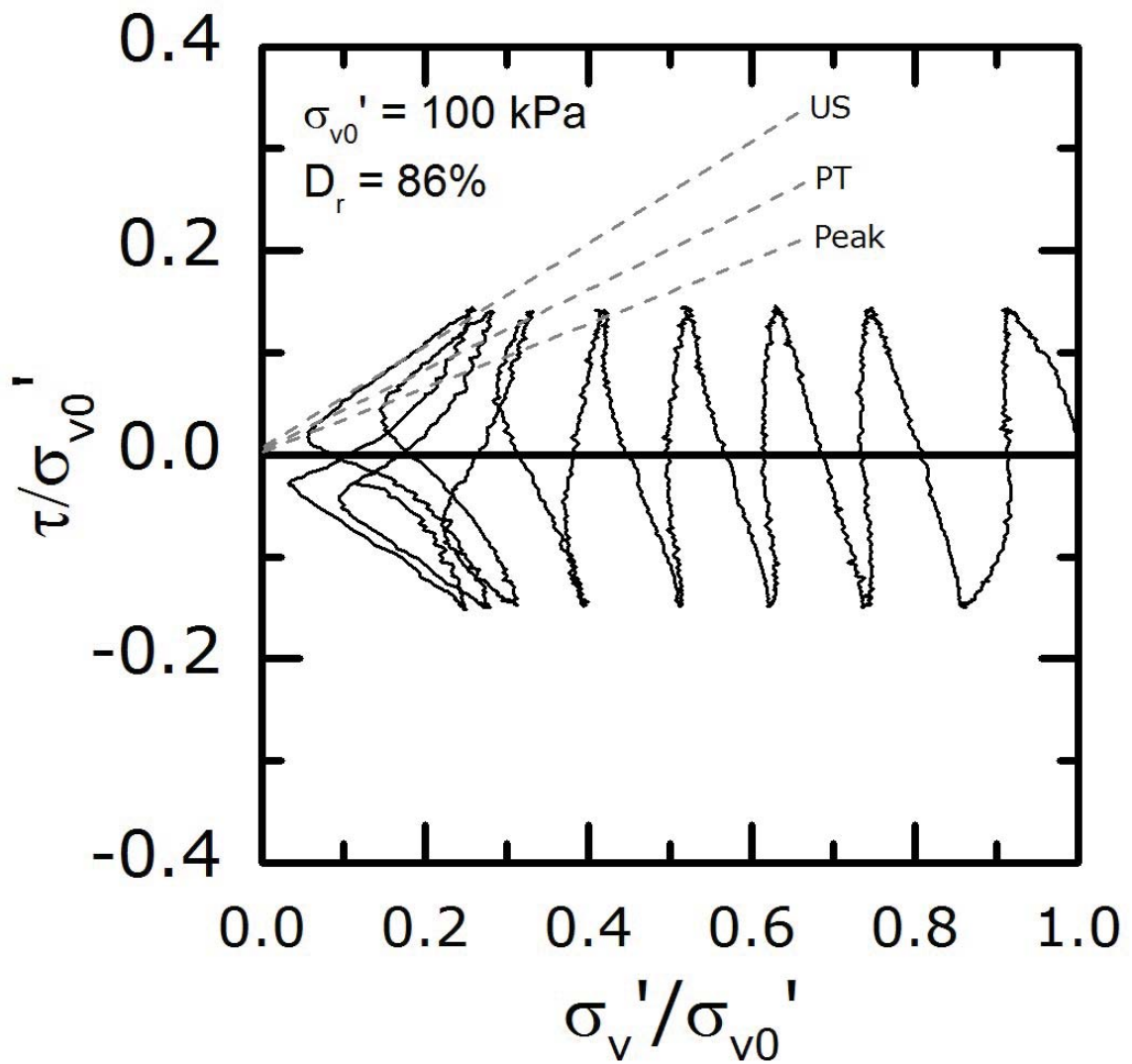

Figure 4.33: Comparison of Cyclic Stress Path (Test ID: C185) with Peak, PT and US lines taken from Monotonic Stress Path Data for Pea Gravel

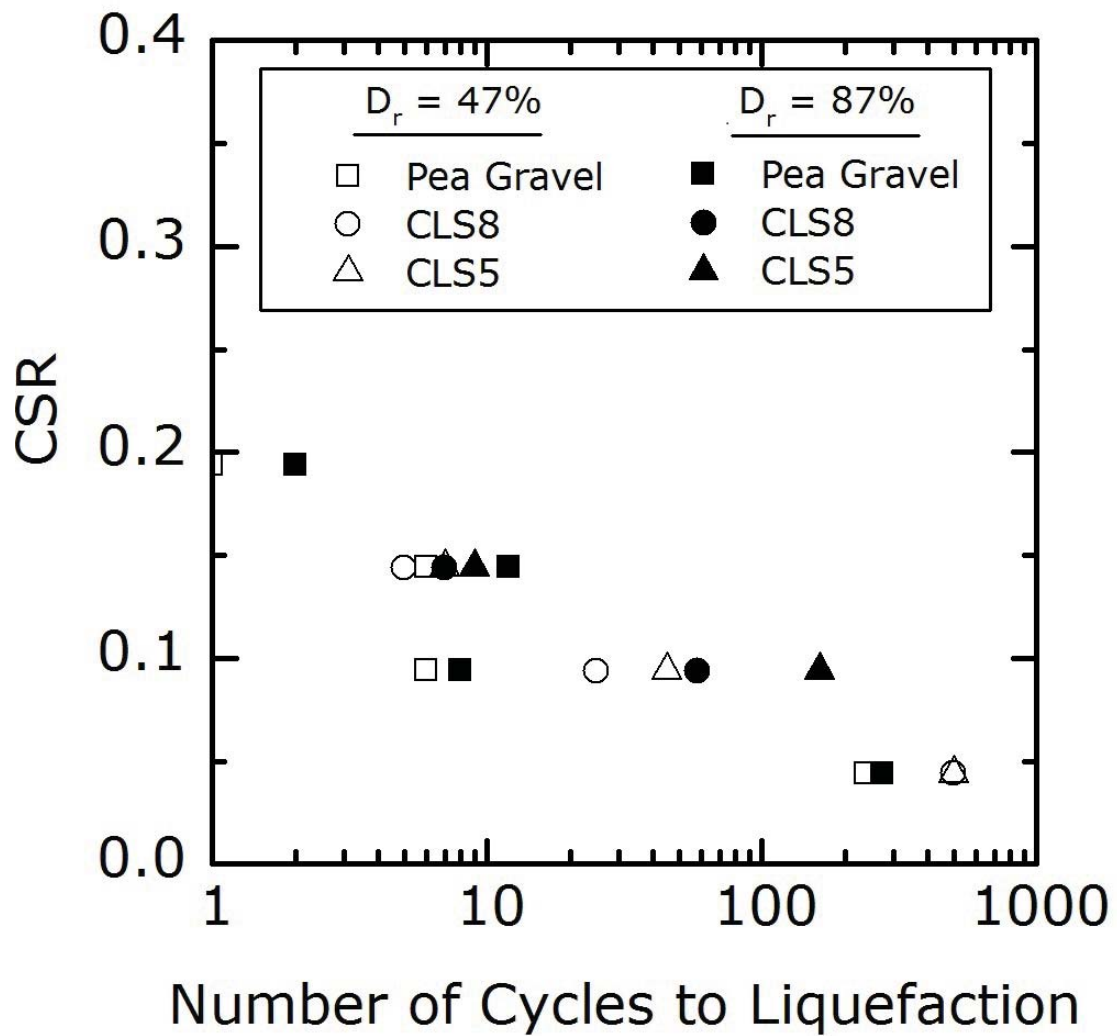

Figure 4.34: Comparison of 3 Uniform Gravels CSR versus Number of Cycles to Liquefaction

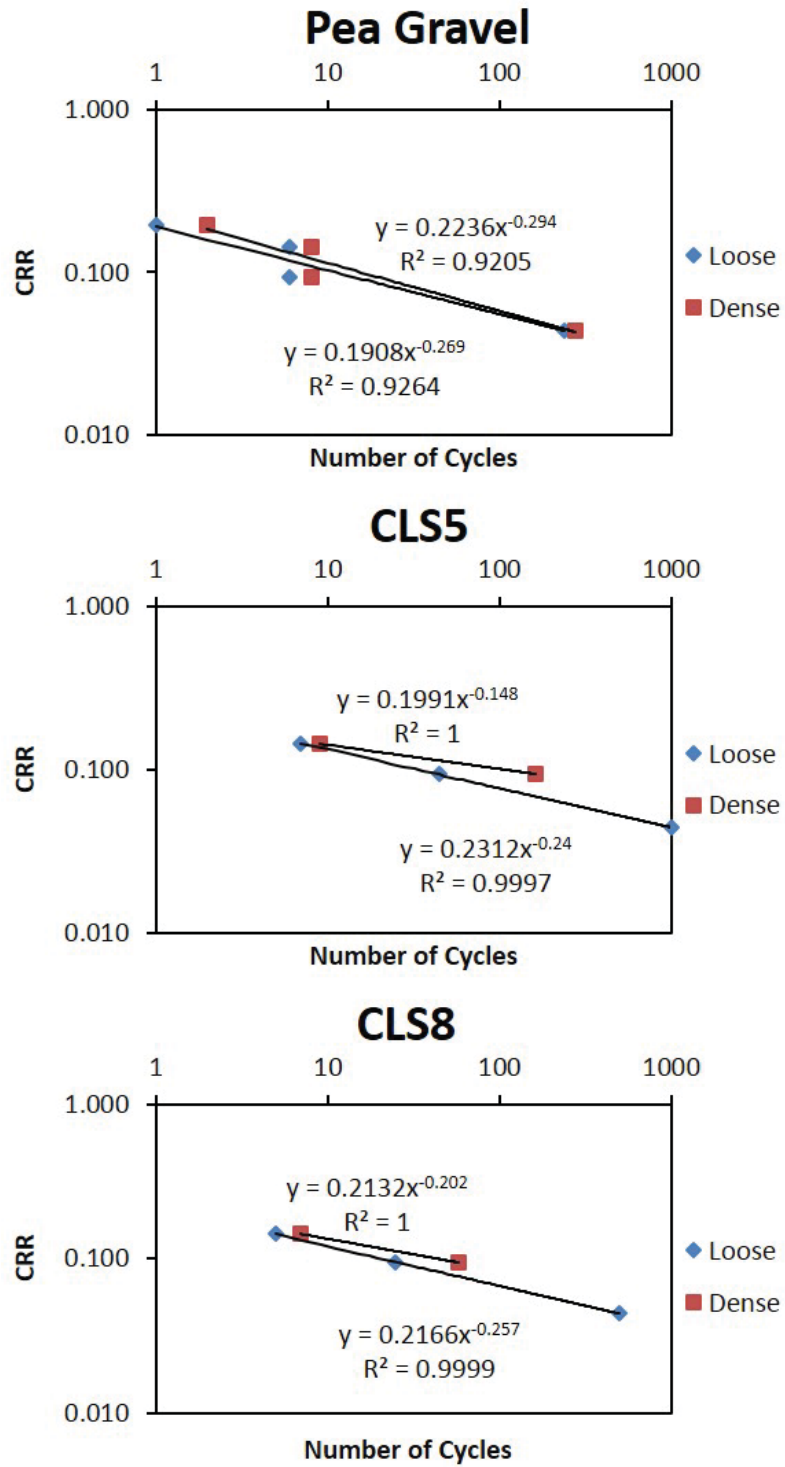
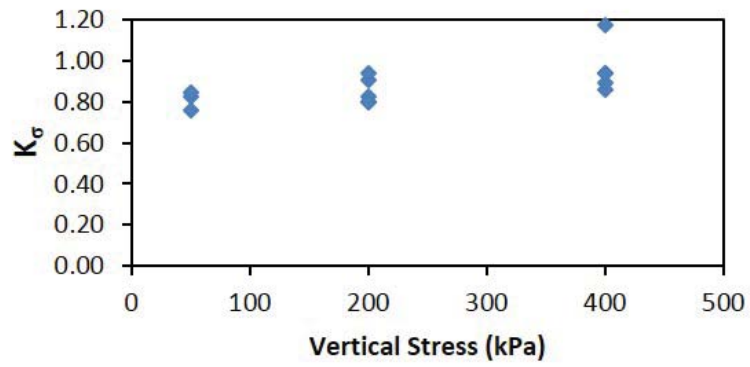
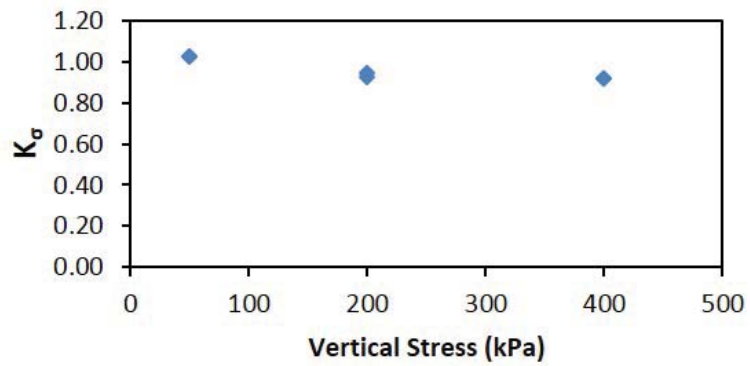

Figure 4.35: Determination of alpha and beta parameters based on CRR vs. N_L

Pea Gravel



CLS5



CLS8

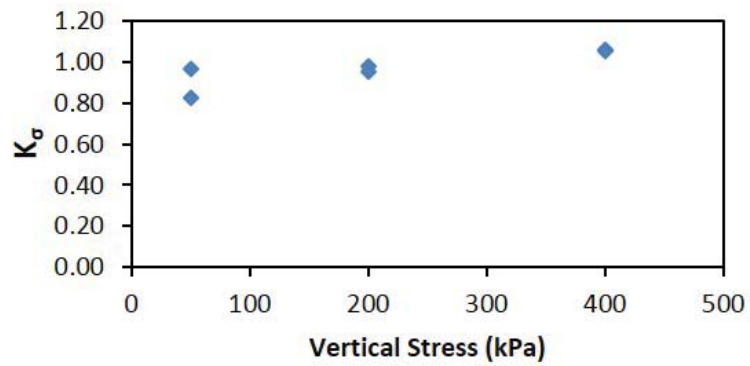

Figure 4.36: Overburden stress correction factors calculated from test data for Pea Gravel, CLS5, and CLS8

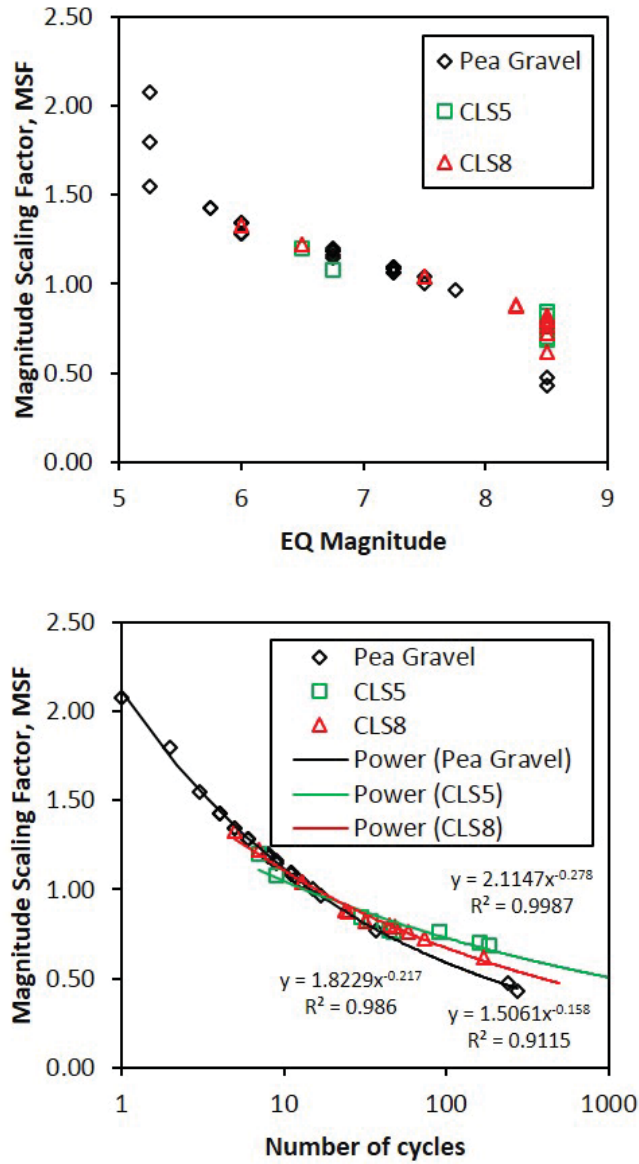

Figure 4.37: Magnitude Scaling Factor calculated from test data for Pea Gravel, CLS5, and CLS8 vs (a) Earthquake Magnitude and (b) Number of cycles

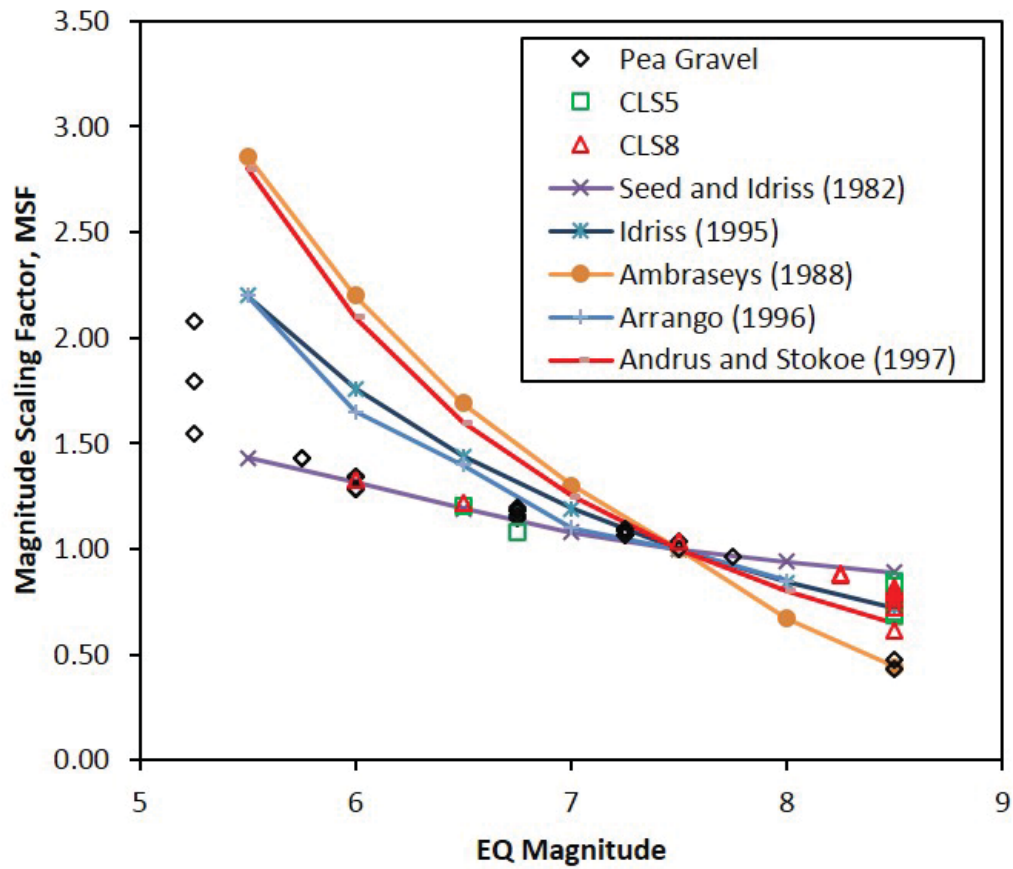

Figure 4.38: Comparison of existing data for Magnitude Scaling Factor with data from this study for uniform gravels

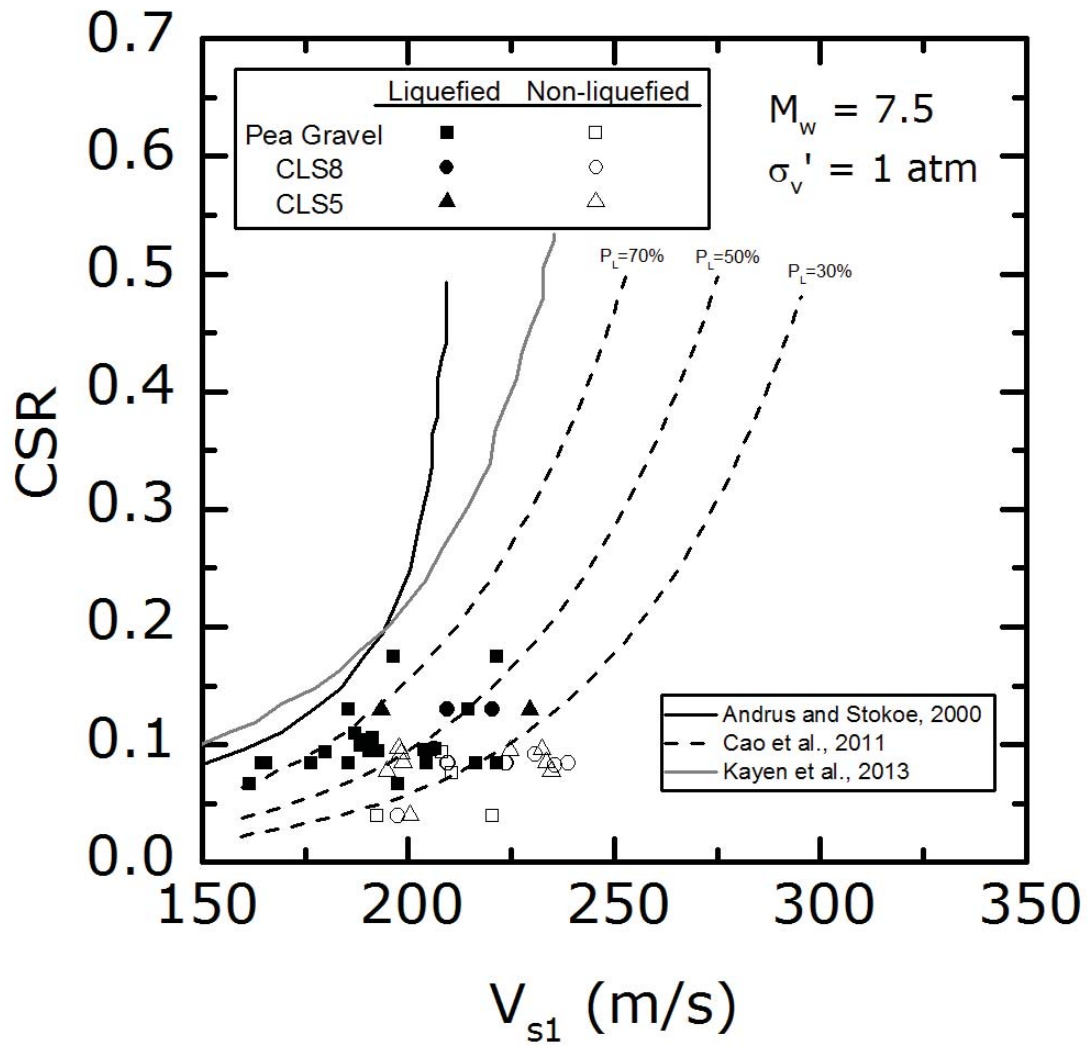

Figure 4.39: Comparison of uniform gravel laboratory data with field data for gravelly and sandy soil liquefaction for CSR vs. V_{s1}

4.4.3.1 Pore Pressure Generation

In soil liquefaction analysis, it is critical to understand the generation and dissipation of excess pore pressures. During undrained loading, excess pore pressures develop due to shearing, which causes a reduction in effective confining stress and therefore a loss in soil stiffness. As previously discussed in Chapter 2, different pore pressure models have been developed to predict excess pore pressure generation during earthquake loading conditions. Different models have been developed to predict excess pore pressure generation. *Seed et al.* (1975) developed a stress-based model using data from undrained, stress-controlled cyclic tests on sand. An empirical model for the pore pressure ratio, r_u (u/σ'_{v0}) in Equation 4.8, was developed using the relationship between excess pore pressure generation (r_u) and the cyclic ratio (N/N_L), which is the number of cycles normalized by the number of cycles to liquefaction.

$$r_u = \frac{1}{2} + \frac{1}{\pi} \sin^{-1} \left(2 \left(\frac{N}{N_L} \right)^{1/\alpha} - 1 \right) \quad (4.8)$$

where α is an empirical constant that is a function of the soil properties and test conditions. A best fit for the sand data in *Seed et al.* (1975) was found using an α value of 0.70.

In this study, data was compared for the three uniform gravels by plotting r_u versus the cyclic ratio (N/N_L). Comparisons were made to assess the effect of initial vertical stress, D_r , and particle morphology (size and shape). Figures 4.40, 4.43, and 4.42 show the effect of initial vertical stress on pore pressure generation for Pea Gravel, CLS5, and CLS8, respectively. These figures show that initial vertical stress has very little effect on r_u for the uniform gravels in this study. Figures 4.41, 4.44, and 4.45 show the effect of D_r on r_u for Pea Gravel, CLS5, and CLS8, respectively. These figures show that as D_r increases, pore pressure generation increases for Pea Gravel and increases slightly for CLS5; however, no effect of D_r on r_u is seen for CLS8. Figure 4.46 shows the effect

of particle morphology on pore pressure generation for the three uniform gravels tested in this study. As particle angularity increased, pore pressure generation increased. CLS5 generated more pore pressure compared to CLS8 in the cyclic ratio range of 0.0 to 0.50.

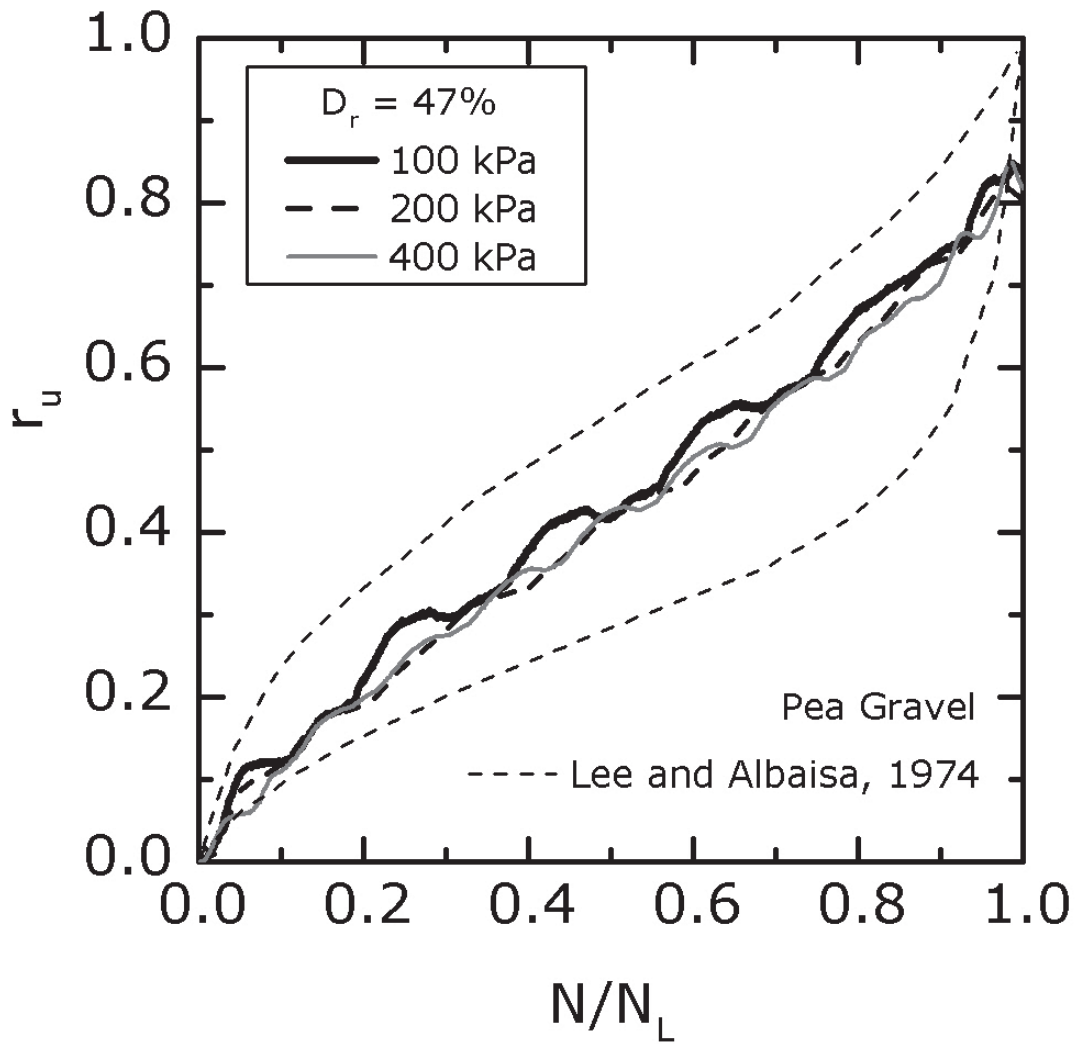

Figure 4.40: Pore pressure generation comparison for Pea Gravel at 100, 200, and 400 kPa (Test ID: C179, C176, C175)

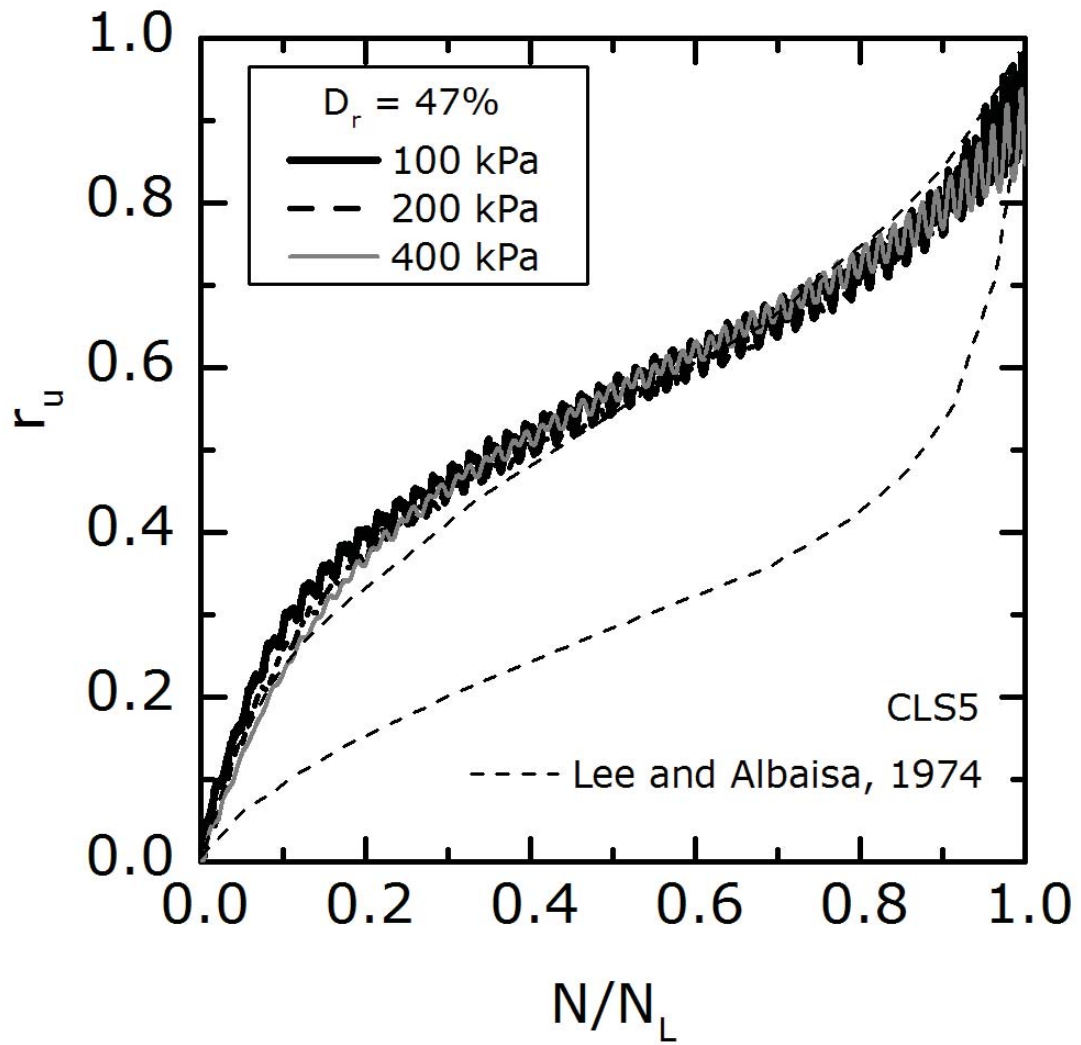

Figure 4.41: Pore pressure generation comparison for CLS5 at 100, 200, and 400 kPa (Test ID: C195, C194, C193)

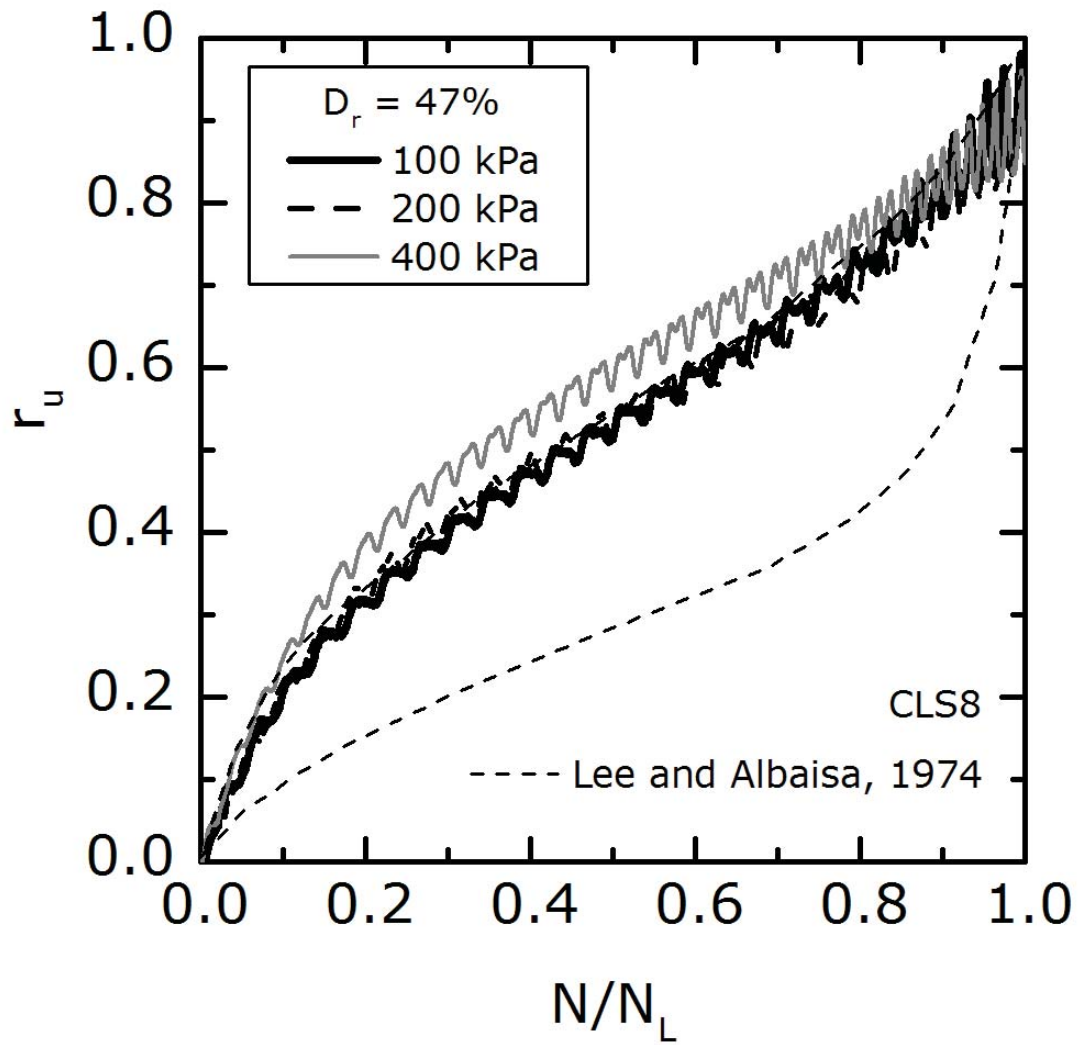

Figure 4.42: Pore pressure generation comparison for CLS8 at 100, 200, and 400 kPa (Test ID: C217, C214, C216)

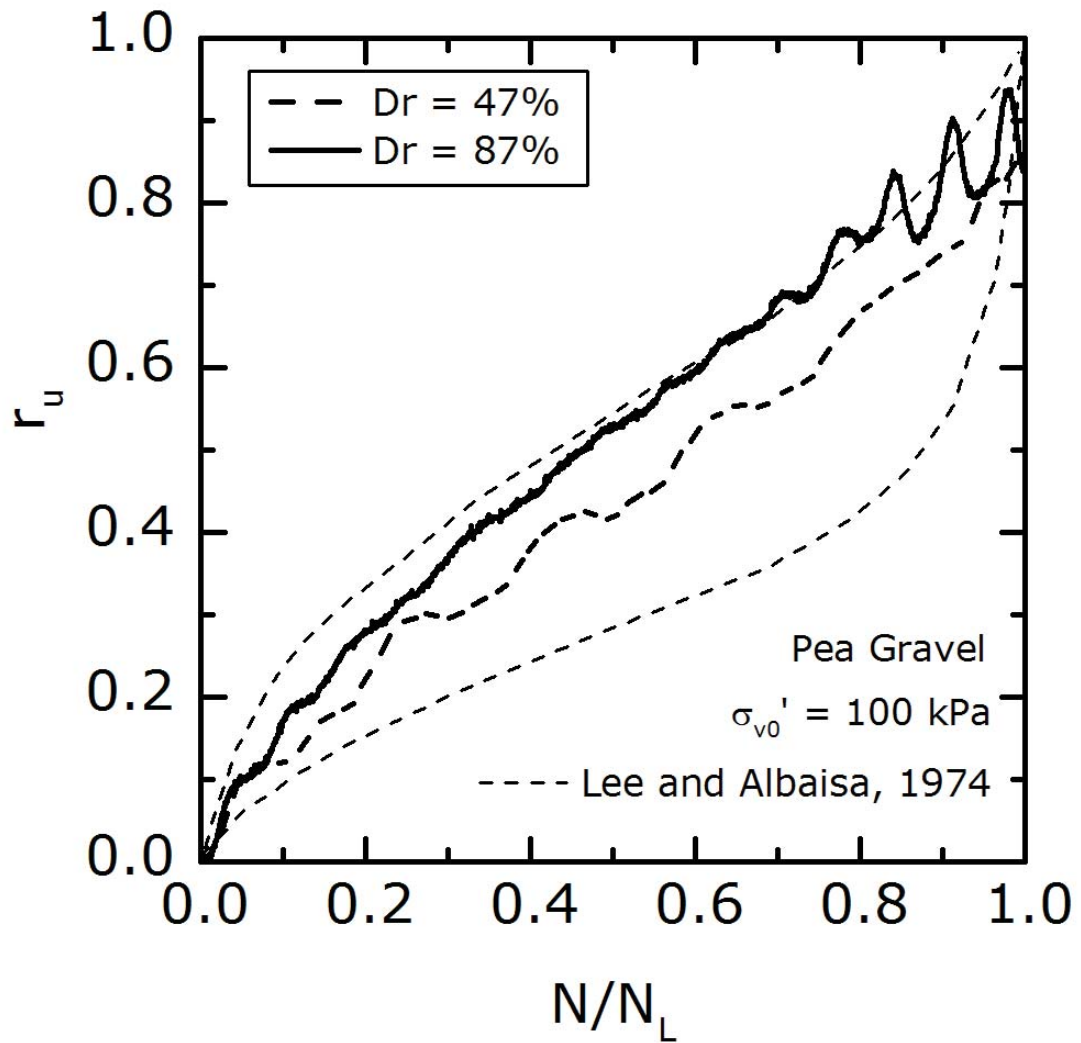

Figure 4.43: Pore pressure generation comparison for Pea Gravel at $D_r = 47\%$ (Test ID: C176) and $D_r = 87\%$ (Test ID: C169)

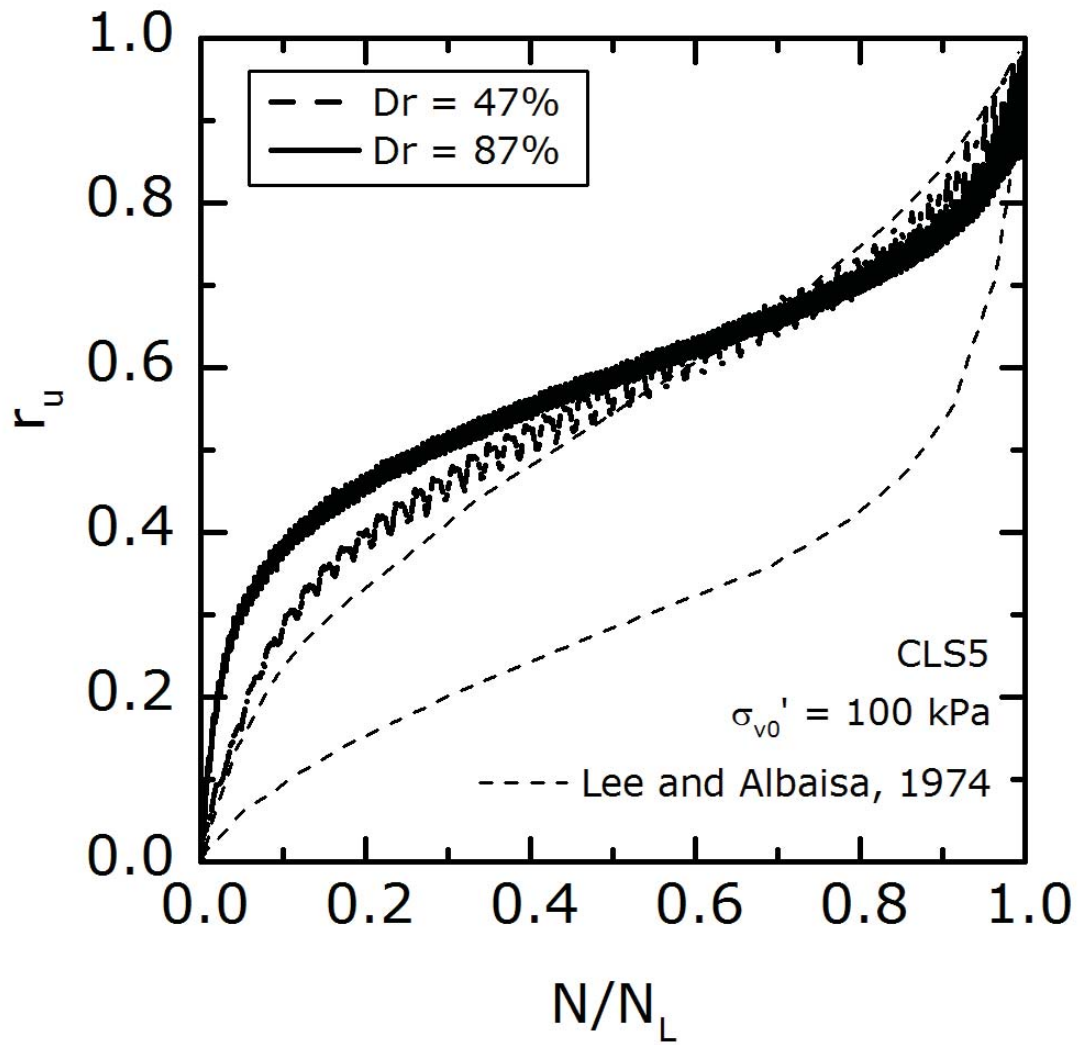

Figure 4.44: Pore pressure generation comparison for CLS5 at $D_r = 47\%$ (Test ID: C195) and $D_r = 87\%$ (Test ID: C209)

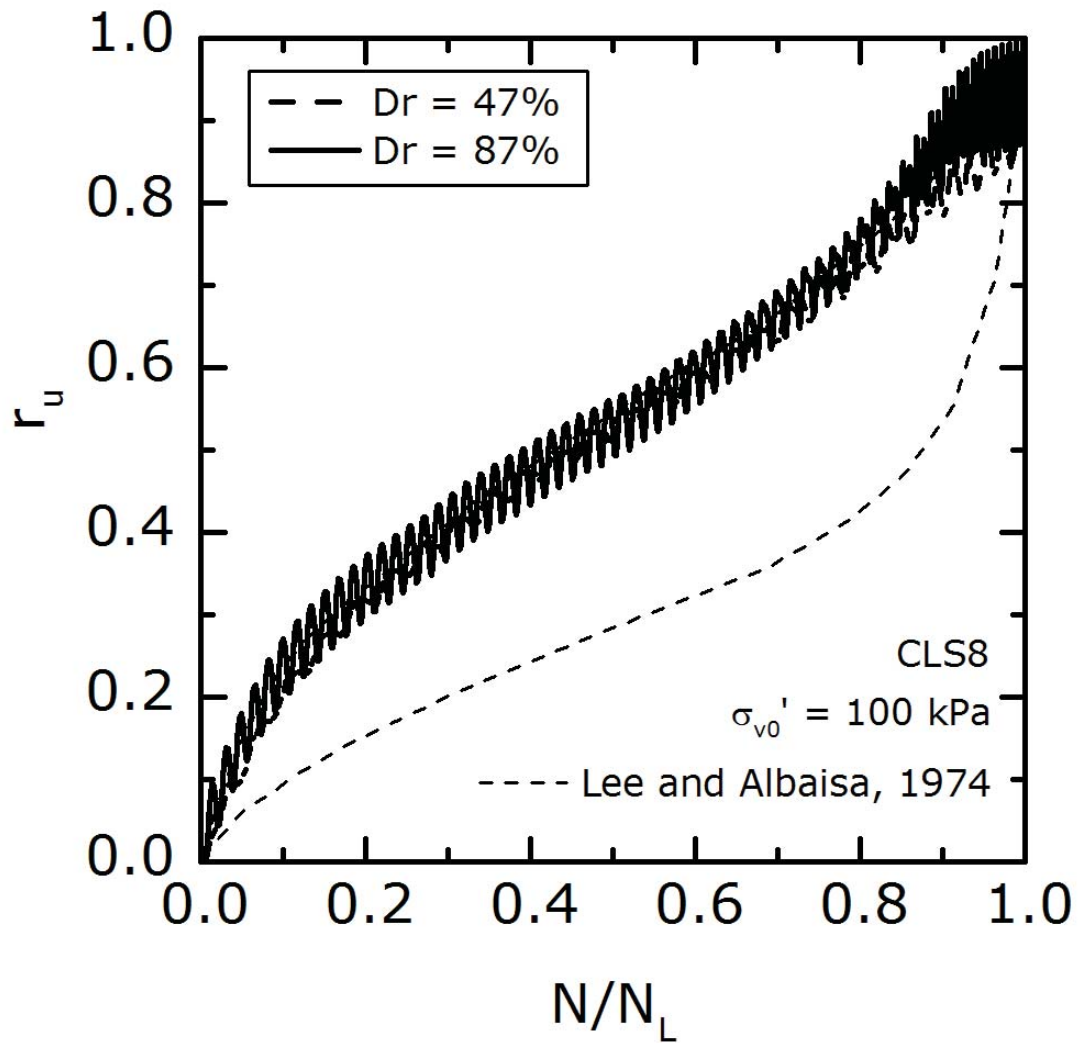

Figure 4.45: Pore pressure generation comparison for CLS8 at $D_r = 47\%$ (Test ID: C217) and $D_r = 87\%$ (Test ID: C230)

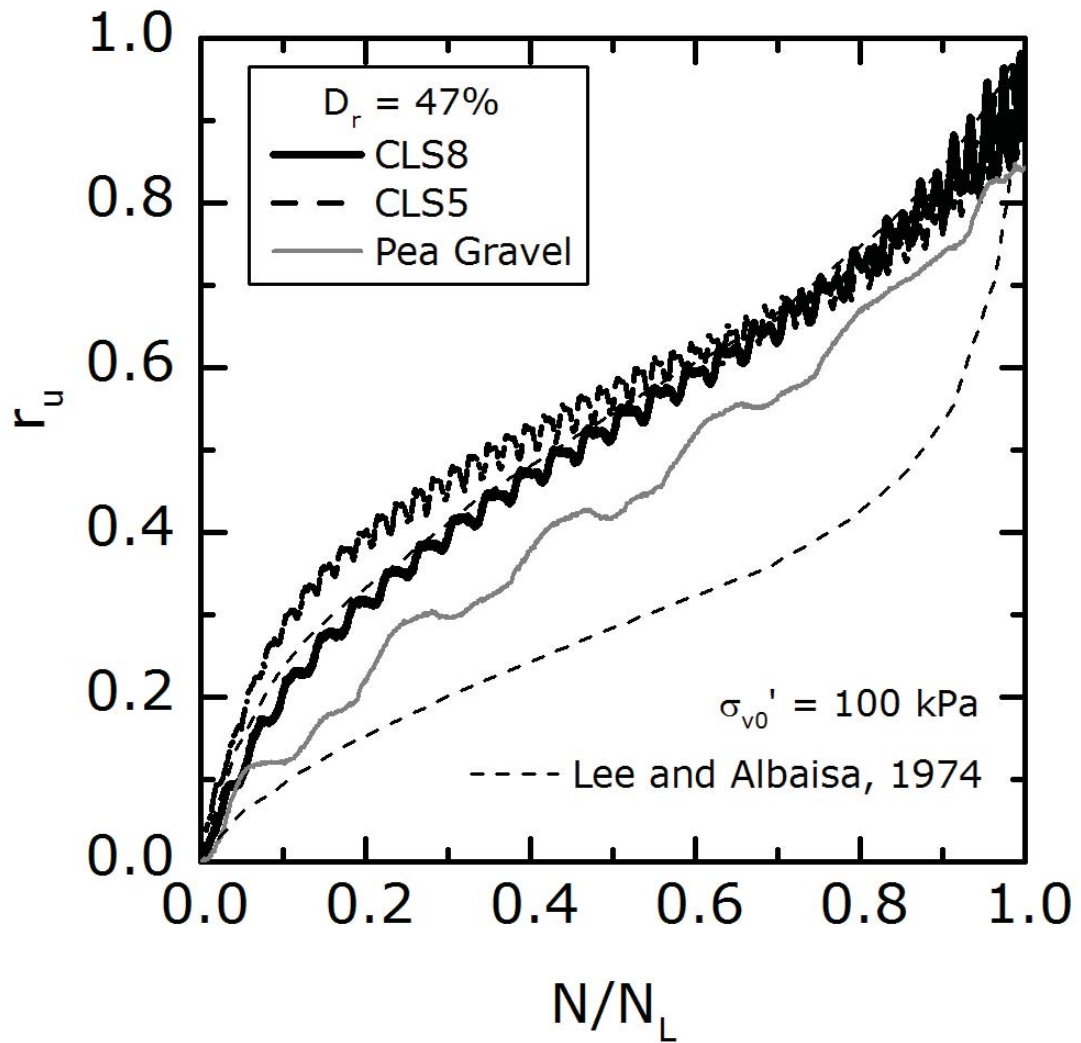

Figure 4.46: Pore pressure generation comparison for CLS8, CLS5, and Pea Gravel at $D_r = 47\%$ and 100 kPa (Test ID: C176, C195, C217)

4.4.4 Post-Cyclic Monotonic Simple Shear

Immediately following the cyclic simple shear tests, post-cyclic monotonic simple shear tests were performed to evaluate the post-cyclic shear response of the three uniform gravels. Specimens were not reconsolidated after the cyclic phase of the test and the post-cyclic shear phase began at the final shear strain of the cyclic test which was usually in the negative 4-8% strain range. Specimens were initially near a state of zero effective stress following liquefaction of the specimen in the cyclic phase. As the specimen was sheared, three distinct phases, as described by *Sivathayalan and Yazdi* (2013), were observed and are shown in Figure 4.47a. Initially (Phase I) the specimen had nearly zero shear strength following liquefaction. Upon further shearing, the specimen began to gain shear strength (Phase II) until it reached a constant modulus at larger strains (Phase III). The shear resistance increase with shear strain, in the 10-20% shear strain range, was very similar to the modulus at larger strains in the monotonic shear test. The stress path response, as shown in Figure 4.47b, shows that the same US was attained in the monotonic and post-cyclic monotonic shear tests. Comparisons for three uniform gravels at the US (selected for this plot as τ at 20% shear strain) from monotonic and post-cyclic monotonic tests are presented in Figure 4.48. Results show that the US line for each uniform gravel in this study is only dependent on the relative density. Values of the US friction angle from post-cyclic tests matched the values from the monotonic tests in Table 4.5, highlighting that the US is not dependent on the stress path. A comparison of post-cyclic shear stress-strain response is displayed in Figure 4.49, and shows that as particle size, particle angularity and D_r increased, the US shear strength increased. Pea Gravel at $D_r = 47\%$ displayed very little post-cyclic shear strength gain.

V_S was measured for each specimen after consolidation and before the cyclic phase of the test as well as immediately following the cyclic phase. For a few post-cyclic monotonic tests, V_S was measured in approximately 1.5% strain intervals for the duration of the test. Figure 4.50a shows the results of one of these tests. Initially following liquefaction V_S has

a low value of approximately 100 m/s for this specimen. The low value can be attributed to the nearly zero vertical effective stress on the specimen. As the specimen is sheared and vertical stress and shear stress increase, V_S increases until it eventually reaches a value near the value taken after consolidation and before the cyclic phase. Figure 4.50b shows the ratio of τ_{US}/σ'_v during the post-cyclic monotonic test. This plot is useful because it shows that once the US is reached (shear strain of 10% in this test) for the specimen the V_S reaches a similar value to the pre-cyclic V_S value. The V_S value then becomes constant as the ratio τ_{US}/σ'_v also remains constant. Therefore, for all post-cyclic tests the value of V_S that was used in analysis was the pre-cyclic value (same as the large-strain post-cyclic value) since the post-cyclic shear strength values used in analysis were at 20% shear strain.

Post-liquefaction shear strength is of importance in stability analyses for geotechnical infrastructure. *Seed and Harder* (1990) developed a chart that is widely used in practice to assess the post-liquefaction undrained shear strength based on the number of equivalent SPT blow counts. *Stark and Mesri* (1992) developed a similar chart but instead normalized the shear strength by the vertical effective stress. These charts are all based on back-calculation of case histories for sandy sites and therefore limited data is available. *Sivathayalan and Yazdi* (2013) showed that it is possible to compare these charts with laboratory data from simple shear tests for further insight into post-cyclic shear behavior. There is currently no design chart that is available for gravelly soil sites to assess post-liquefaction shear strength.

Data from *Seed and Harder* (1990) and *Stark and Mesri* (1992) was converted to corresponding V_S and V_{S1} values and compared to data from this study for Pea Gravel, CLS8 and CLS5 in Figure 4.51. $N_{1,60}$ values from Seed and Harder were converted to V_S values using the relationship from *Imai and Tonouchi* (1982):

$$V_S = 85 * (N_{60})^{0.29} \quad (4.9)$$

Where N_{60} is the energy corrected N-value from a SPT. $N_{1,60}$ values from *Seed and*

Harder (1990) and *Stark and Mesri* (1992) were converted to V_{S1} values using the relationship from *Andrus et al.* (2004):

$$V_{S1} = 87.8 * (N_{1,60})^{0.253} \quad (4.10)$$

Where $N_{1,60}$ is the stress and energy corrected N-value from a SPT. Figure 4.51a shows the post-cyclic undrained shear strength from *Seed and Harder* (1990) and this study plotted versus V_S . As V_S increases the undrained shear strength increases for the *Seed and Harder* (1990) data as well as the three uniform gravels. Pea Gravel specimens at $D_r = 47\%$ did not exhibit significant strength gain during post-cyclic monotonic shearing. Figure 4.51b shows the undrained shear strength now plotted with V_{S1} values. V_{S1} values for the three uniform gravels range from approximately 180-250 m/s. Within this range of V_{S1} values, undrained shear strength ranges from approximately 5 kPa to 90 kPa. V_{S1} values for sandy sites analyzed in *Seed and Harder* (1990) have significantly lower V_{S1} values in the 110-175 m/s range. Figure 4.51c compares τ_{US}/σ'_{v0} data from this study with *Stark and Mesri* (1992) data and plots these values versus V_{S1} values. This plot shows that the *Stark and Mesri* (1992) lower and upper bounds give a reasonable first approximation of undrained shear strength if extended to higher V_{S1} values for the three uniform gravels in this study. However, even using the lower bound would be unconservative since some of the test results from the uniform gravels have τ_{US}/σ'_{v0} values that fall below this extended lower bound. The uniform gravels have higher V_{S1} values, but this does not necessarily correspond to higher undrained shear strengths than the sands from case histories. These results are similar to the cyclic test results in Figure 4.39 that showed that although V_{S1} is higher for gravels than sands it does not correspond to a higher liquefaction resistance (CRR).

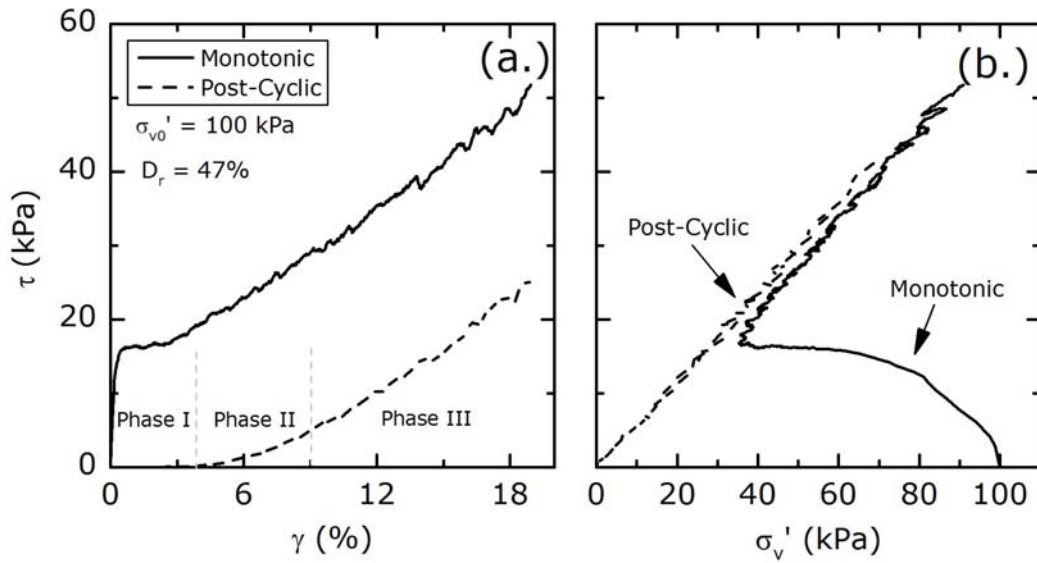

Figure 4.47: Comparison of Monotonic (Test ID: M231) and Post-Cyclic (Test ID: C214) (a.) Stress-Strain and (b.) Stress Path for $D_r = 47\%$ 8 mm Crushed Limestone

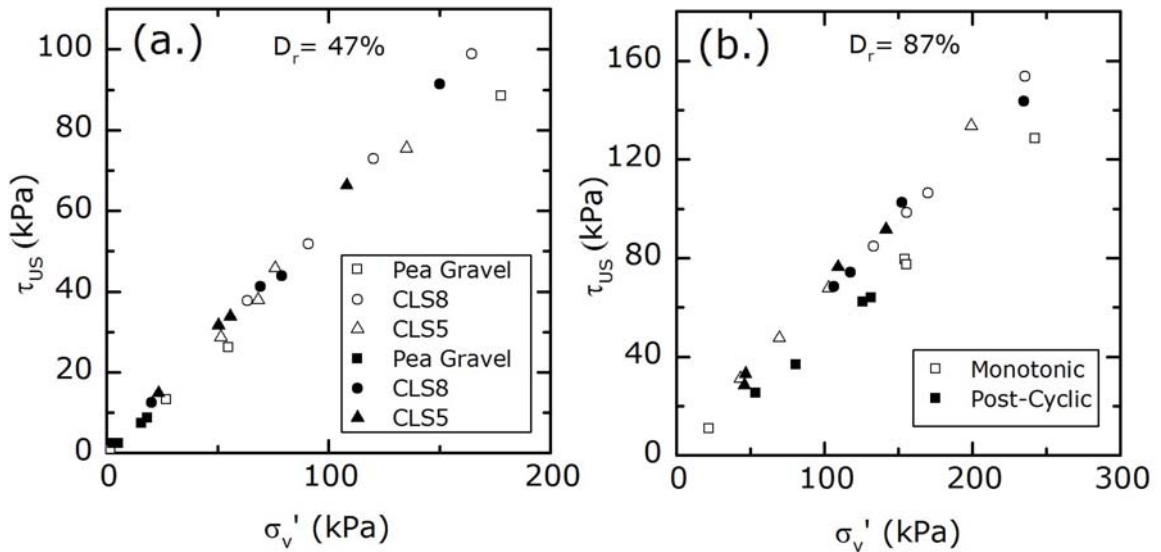

Figure 4.48: Comparison of US for Monotonic and Post-Cyclic Tests of 3 Uniform Gravels at (a.) $D_r = 47\%$ and (b.) $D_r = 87\%$.

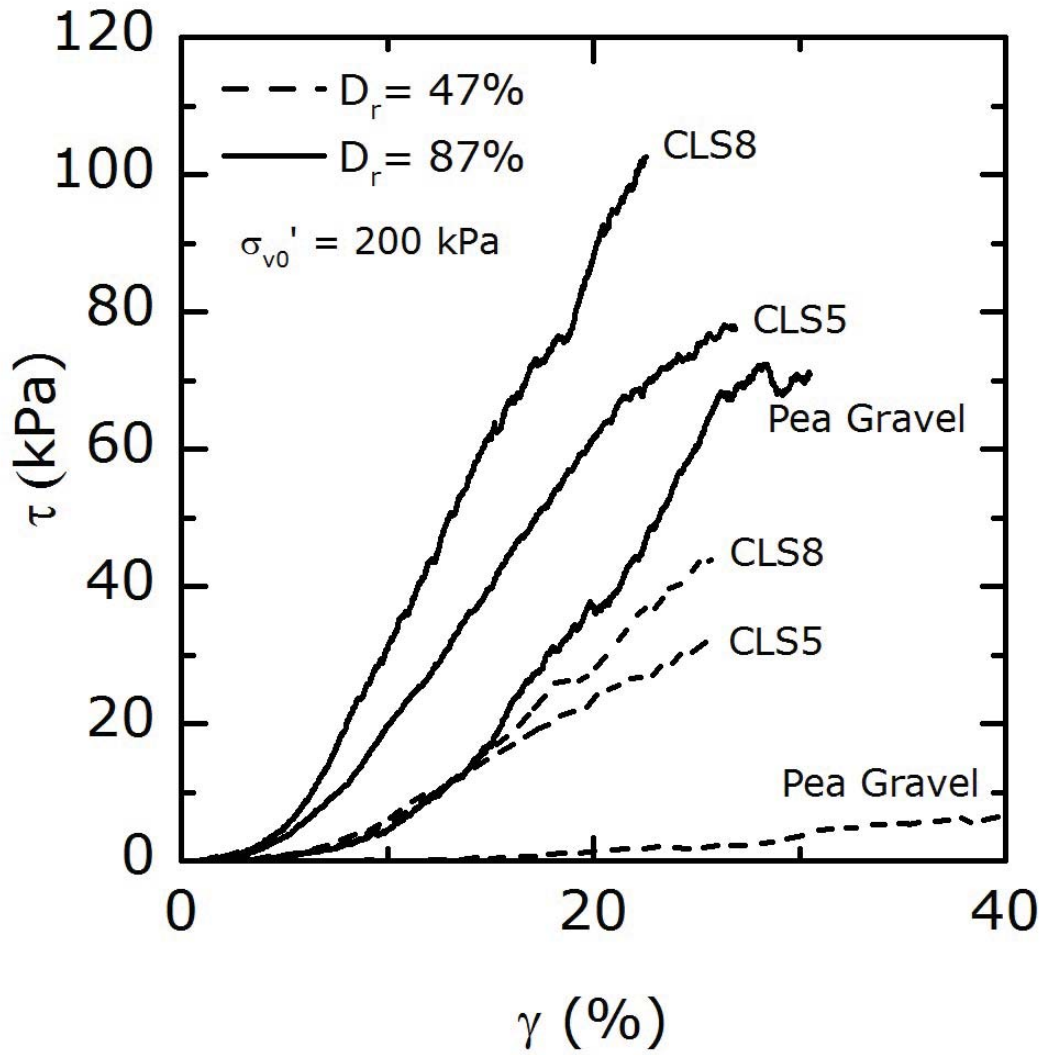

Figure 4.49: Comparison of Post-Cyclic Stress-Strain Response of 3 Uniform Gravels

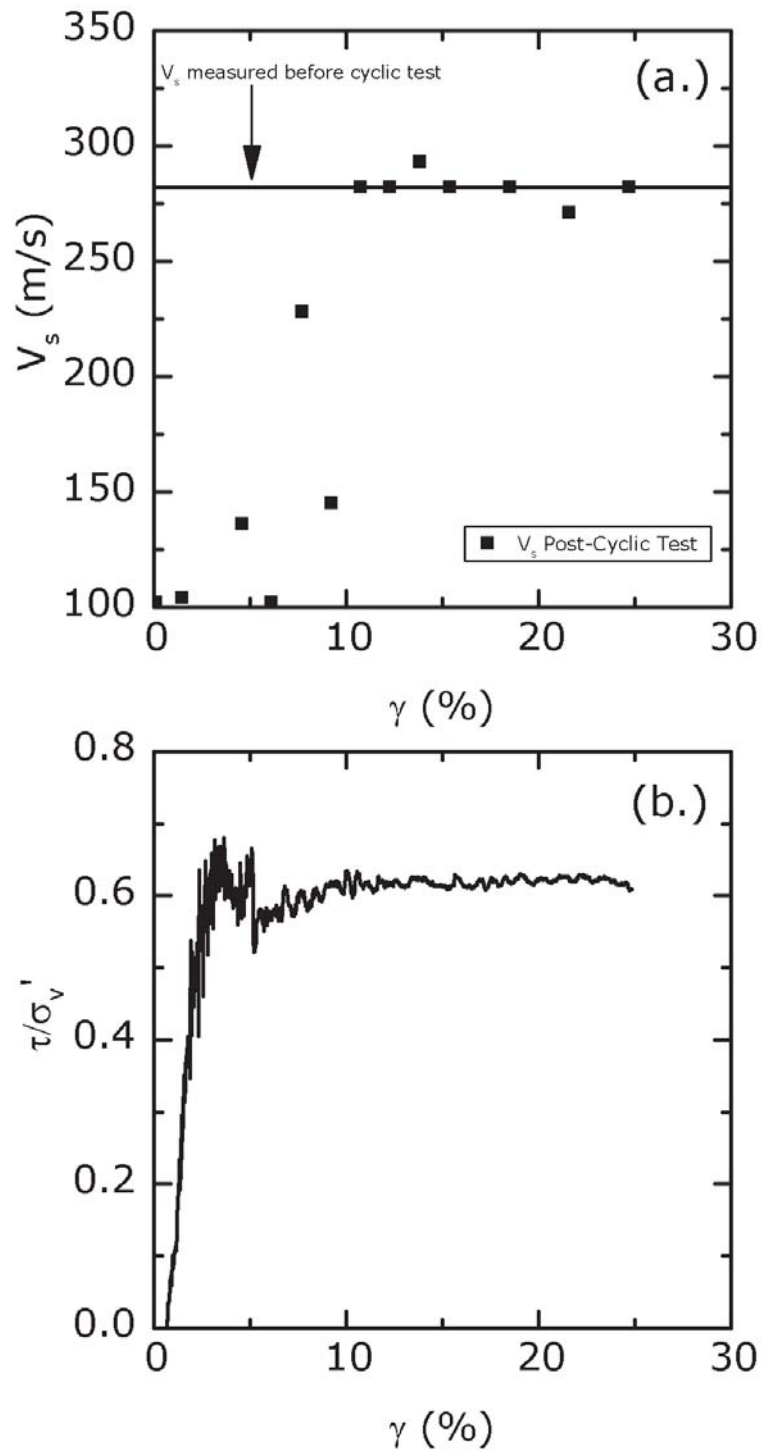

Figure 4.50: Post-Cyclic comparison of shear wave velocity and normalized shear stress ratio with strain

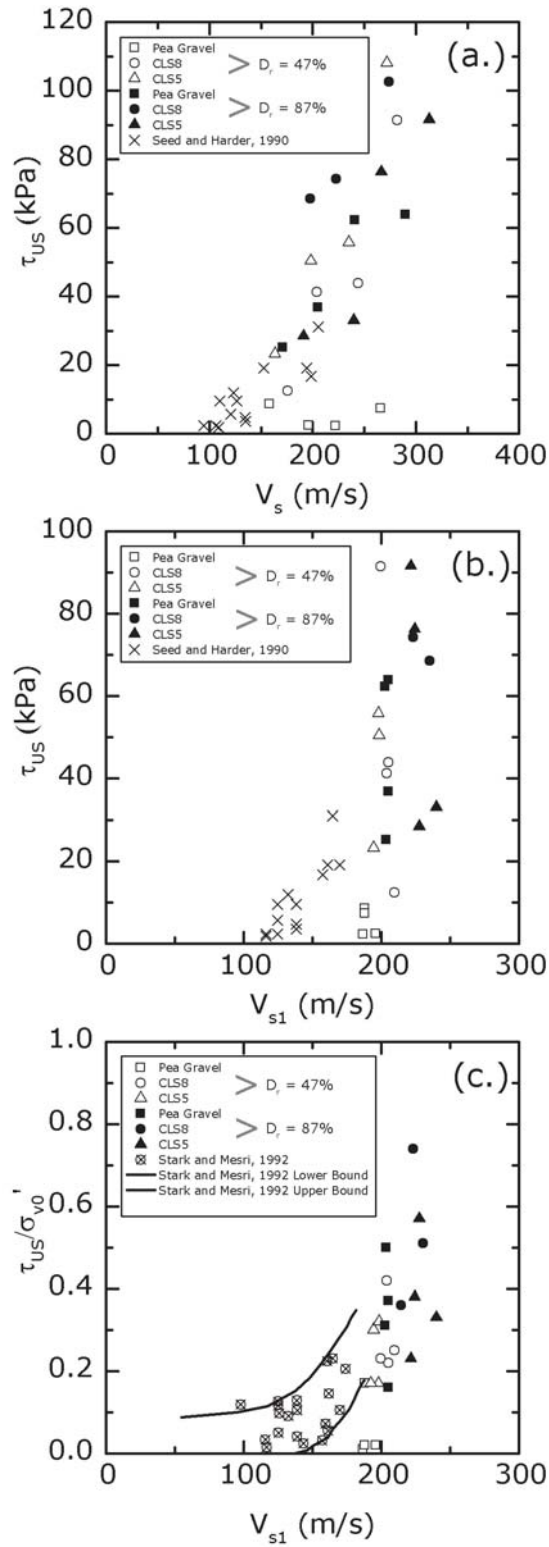

Figure 4.51: Comparison of post-cyclic shear stress with existing data from the literature

4.5 Conclusions

The monotonic, cyclic and post-cyclic shear response of three uniform gravels was evaluated in this study. V_S was measured in each specimen and was used to investigate constant volume monotonic, cyclic and post-cyclic shear response. The main findings were:

- Uniform gravel undrained shear response can be analyzed using existing frameworks developed for sands.
- Particle angularity is an important parameter that affects Peak, PT and US response of uniform gravels. As particle angularity increased Peak, PT and US friction angles increased for the uniform gravels tested in this study. Increasing particle angularity also increased liquefaction resistance for $CSR < 0.10$; above this CSR value, the influence of angularity was less pronounced.
- Particle size had a lesser impact on constant volume shear response of uniform gravels compared to particle angularity. As particle size increased peak friction angle increased; however, particle size had no effect on PT friction angle.
- PT (or τ_{PT}/σ'_v) was unique for each uniform gravel in this study and was not dependent on density. Pea Gravel had a τ_{PT}/σ'_v ratio of 0.45, while the 8 mm and 5 mm CLS had a τ_{PT}/σ'_v ratio of 0.52.
- US (or τ_{US}/σ'_v ratio), which ranged from 0.47 to 0.72, was affected by density and increased with increasing V_{S1} for the angular CLS materials in this study; however, US was not effected by density for the Pea Gravel. This behavior is possibly attributed to increased particle interlocking and dilation in the angular CLS materials compared to the rounded Pea Gravel. The difference in behavior between these uniform gravels at the US is important since post-cyclic stress paths follow the US line after liquefaction.

- Uniform gravels were liquefiable even at relatively dense states and for higher V_{S1} values than sands. Specifically, the three uniform gravels tested in this study liquefied at V_{S1} values as high as 230 m/s.
- Increasing particle size, angularity and D_r led to an increase in post-cyclic shear strength.
- *Stark and Mesri* (1992) lower and upper bounds for SPT, when transferred to V_{S1} using the *Andrus et al.* (2004) correlation, give a reasonable first approximation of undrained shear strength if extended to higher V_{S1} values for the three uniform gravels in this study. However, even the lower bound would be unconservative in the case of loose uniform gravels since some of the test results fall below this lower bound. The uniform gravels have higher V_{S1} values, but this does not necessarily correspond to higher undrained shear strengths than the sands from case histories. This finding is similar to the observations of *Yegian et al.* (1994) that post-liquefaction undrained shear strength of gravelly soils was similar to sands but had higher SPT N-values.

The presented data represent a significant addition to the existing database of large-size monotonic and cyclic shear tests of gravels. Further studies are needed however before developing a general framework for the cyclic and post-cyclic response of gravelly soils.

CHAPTER 5

Monotonic, Cyclic, and Post-Cyclic Response of Gravel-Sand Mixtures

5.1 Introduction

This chapter presents 92 tests that were completed on mixtures of Pea Gravel and Ottawa C109 Sand and CLS8 and Ottawa C109 Sand. Pea Gravel and CLS8 were extensively studied in Chapter 4, and were used as base materials to study the effects of mixing sand with uniform gravels of different particle morphology. These mixtures represent specimens that more closely resemble natural gravelly soils that are encountered in the field. Monotonic, cyclic, and post-cyclic tests were performed in the 12" diameter CSS to evaluate the shear strength, liquefaction response, and post-liquefaction shear strength and settlement of these mixtures.

5.2 Assessment of Minimum and Maximum Density of Gravel-Sand Mixtures

Determining maximum density of gap-graded soils can be difficult and there is no standard method that can be used for these soils over the entire range of mixture percentages (*Polito and Martin II, 2001*). Many studies have used the vibrating table; however, particle

segregation is an issue. *Fragaszy and Sneider* (1991) have shown that different compaction methods lead to different maximum densities. Types of compaction tests include the Vibratory Table (ASTM D4254, *ASTM* (2006)) and Standard (ASTM D698, *ASTM* (2012c)) and Modified Proctor (ASTM D1557, *ASTM* (2012b)).

Impact compaction tests (proctor) continue to be used for determining maximum density of granular soils even though they are not appropriate (*Bergeson et al.*, 1998; *Parsons et al.*, 1992). The United States Bureau of Reclamation says impact compaction tests should not be performed on soils with less than 15% fines (*USBR*, 1990), while AASHTO and ASTM do not include such a constraint on their impact compaction standards. Vibratory field compaction equipment is most effective for compaction of granular soils (*Holtz and Kovacs*, 1981).

For gap-graded gravelly soils, specimens are made up of oversized particles and matrix material that infills between particles. The impact of the presence of oversized particles in a compacted specimen is similar to that of reducing compactive effort applied (i.e. energy is absorbed during reorientation of large particles and thus less compactive energy is imparted to the finer material). Therefore, as the percentage of oversize particles increases, the dry unit weight of the total material will increase, but the dry unit weight of the matrix material will decrease (*Fragaszy et al.*, 1990).

Interference of the compaction of the matrix material begins when oversized content is about 33% of the soil. When the oversized content exceeds around 67%, there is usually insufficient matrix material to fill the voids between the oversized particles (*Holtz and Lowits*, 1957).

The theoretical maximum dry unit weight that may be obtained for soils consisting of oversize particles is (*Holtz and Lowits*, 1957):

$$\gamma_{d,tot} = \frac{1}{(P_f/\gamma_{f,max}) + (P_c/\gamma_c)} \quad (5.1)$$

Where $\gamma_{d,tot}$ is the theoretical dry unit weight of total material, P_f is the percent of

matrix material, by mass, expressed as a decimal, P_c is the percent of oversized material, by mass, expressed as a decimal, $\gamma_{f,max}$ is the maximum dry unit weight of the matrix material, and γ_c is the dry unit weight of the oversized material.

As percentage of oversize particles increases, the actual obtainable dry unit weight begins to deviate from the theoretical value (*Fragaszy and Sneider, 1991*). *Garga and Madureira (1985)* suggest that the deviation between the theoretical and actual dry unit weights is due to particle interference and there being insufficient matrix material to fill all the voids between the oversize particles.

Measured dry unit weights deviate from the theoretical values at lower oversized percentages for sandy matrix material than for clayey matrix material. It was hypothesized that this was due to the plastic matrix material reducing particle interference (and oversize particles can more easily penetrate matrix material which distributes the energy from compaction more uniformly throughout the matrix) (*Holtz and Lowits, 1957*).

Different researchers have compared percentage of oversized particles where deviation from theoretical values begin. When dry unit weight is plotted versus percentage of oversized particles, the total soil usually achieves its highest dry unit weight when the oversized particle percentage is between 60-70% (*Holtz and Lowits, 1957; Garga and Madureira, 1985*).

For materials with more angular and uniform particles, the limiting void ratios increase. *Holtz and Lowits (1957)* performed impact compaction tests on soils with 50% oversized particles and did not find an appreciable difference in maximum dry density when comparing angular crushed rock and rounded river gravel. During vibratory compaction tests *Spanovich (1965)* found that increasing the surcharge decreased the obtainable dry unit weight for angular materials much more than for rounded materials. This can be attributed to interlocking of the angular particles under higher surcharge.

Segregation of particles can occur during laboratory vibration test. *Johnson (1965)* tested two uniform sized spheres and found that segregation did occur and is most pro-

nounced in the upper-portion of the specimen. In order to get a dense, uniformly compacted sample, large particles need to be compacted first, then smaller particles can be added in and vibrated in order to fill all of the voids between the large particles (*Lade et al.*, 1998). *Brand* (1973) showed that resulting relative densities were very inhomogeneous throughout a specimen.

Fragaszy and Sneider (1991) found that Humphres' Method (*Humphres*, 1957) for determining the maximum density as a function of gravel content tends to overpredict the maximum density, especially when there is more than approximately 50% gravel present (up to 8% overprediction). They also found that the AASHTO rock correction method (*AASHTO*, 2010) overpredicts densities from vibratory compaction tests especially at gravel contents greater than 40%. For gravel contents between 0-50%, maximum density can be estimated with reasonable accuracy by interpolating linearly between test results for 0% and 50% gravel. For greater than 50% gravel, a new method (α method) was developed that accounts changes in volume due to soil particle interaction (*Fragaszy et al.*, 1990). *Fragaszy and Sneider* (1991) also found that modified proctor tests on average gave higher densities than vibratory compaction (particle crushing was the hypothesized cause of this). *Fragaszy et al.* (1990) summarized that oversize particles cause changes in density in both near-field (next to particle) and far field (away from particle) matrix density and that density is decreased around the particle. As gravel content increases, the far field matrix density decreases. These matrix densities can be quantified using the α parameter, which can be determined through laboratory testing.

5.2.1 Development of Method for Maximum Density Evaluation

Due to the difficulties of determining the maximum density of gap-graded gravelly soils using traditional methods (vibratory table or proctor) or by using prediction equations (Humphres' Method), an alternative method was developed that closely matched the results from the α method prediction (*Fragaszy et al.*, 1990) and did not induce particle breakage

or particle segregation seen in impact compaction tests and vibratory table tests, respectively. Figure 5.1 shows a mixture of 60% Ottawa C109 Sand and 40% Pea Gravel, and Figure 5.2 shows that mixture after placement into the maximum density compaction mold and before vibratory compaction using ASTM D4254 (ASTM, 2006) methods. Figure 5.3 shows the mixture after vibratory compaction and the significant particle segregation that occurred using this method. Figure 5.4 shows measurement of the gravel layer at the top of the vibrated specimen. In this top 0.9" there was no sand mixed in with gravel, which shows that there was significant particle segregation.

Figures 5.5, 5.6, and 5.7 show the same behavior for a 40% Ottawa C109 Sand and 60% Pea Gravel mixture. Again, significant particle segregation was observed using the vibratory table method. This particle segregation led to values of maximum density that were biased low. Therefore, a new method for determining maximum density was used and validated by comparing with results from prediction equations developed by *Fragaszy and Sneider* (1991) as well as the Humphres' Method. The same mold used for the Pea Gravel and Ottawa C109 sand (in accordance with ASTM D4254 (ASTM, 2006) was used. The new method of obtaining maximum density consisted of placing the gravel-sand mixtures in approximately 25 mm layers, tamping with a rubber mallet 25 times, and applying approximately 100 rapid surface tamps to the gravel-sand mixture using a small cylinder (shown in Figure 5.8). This method resulted in values of maximum density that compared very well with results by *Fragaszy and Sneider* (1991) as shown in Figure 5.10 for Ottawa C109 Sand and Pea Gravel mixtures and in Figure 5.12 for Ottawa C109 Sand and CLS8 mixtures. The Humphres' Method was also used for comparison, and determination of maximum density using this method is evaluated graphically as shown in Figure 5.9 for Ottawa C109 Sand and Pea Gravel mixtures and in Figure 5.11 for Ottawa C109 Sand and CLS8 mixtures. This graphical procedure consists of plotting various density lines and finding intersections of those lines (*Humphres*, 1957). The Humphres' Method results are plotted with the experimental data and the *Fragaszy* prediction in Figure 5.10 for

Ottawa C109 Sand and Pea Gravel mixtures and in Figure 5.12 for Ottawa C109 Sand and CLS8 mixtures. These results reinforce the findings of *Fragaszy and Sneider* (1991) which showed that the Humphres' Method overpredicts the maximum density of sand-gravel mixtures. In addition, the method that was developed for determining maximum density compared well with ASTM D4254 (*ASTM*, 2006) for the 80% sand/20% gravel specimen where particle segregation was not evident.

The α method was used to predict the maximum density for comparison with test data in this study (*Fragaszy et al.*, 1990) The α value was found by following the procedure for estimation outlined in *Fragaszy et al.* (1990). The density based on percent gravel was calculated using the following equation:

$$D_p = \frac{1}{(p/D_s) + (1 - p/D_c)} \quad (5.2)$$

Where D_p is the predicted density at a given gravel percentage (p), D_s is the solids density (G_s x unit weight of water), and D_c is the compacted density of the matrix material (in this case sand). The α value was then used to predict the true density, D_t using the following equation:

$$D_t = \frac{1}{(p/\alpha D_s) + (1 - p/D_c)} \quad (5.3)$$



Figure 5.1: 60% Ottawa C109 Sand and 40% Pea Gravel



Figure 5.2: 60% Ottawa C109 Sand and 40% Pea Gravel after placement into mold



Figure 5.3: 60% Ottawa C109 Sand and 40% Pea Gravel after vibration table test



Figure 5.4: 60% Ottawa C109 Sand and 40% Pea Gravel settlement after vibration table test



Figure 5.5: 40% Ottawa C109 Sand and 60% Pea Gravel



Figure 5.6: 40% Ottawa C109 Sand and 60% Pea Gravel after placement into mold



Figure 5.7: 40% Ottawa C109 Sand and 60% Pea Gravel after vibration table test



Figure 5.8: Cylinder used for rapid tamping of sand-gravel mixtures

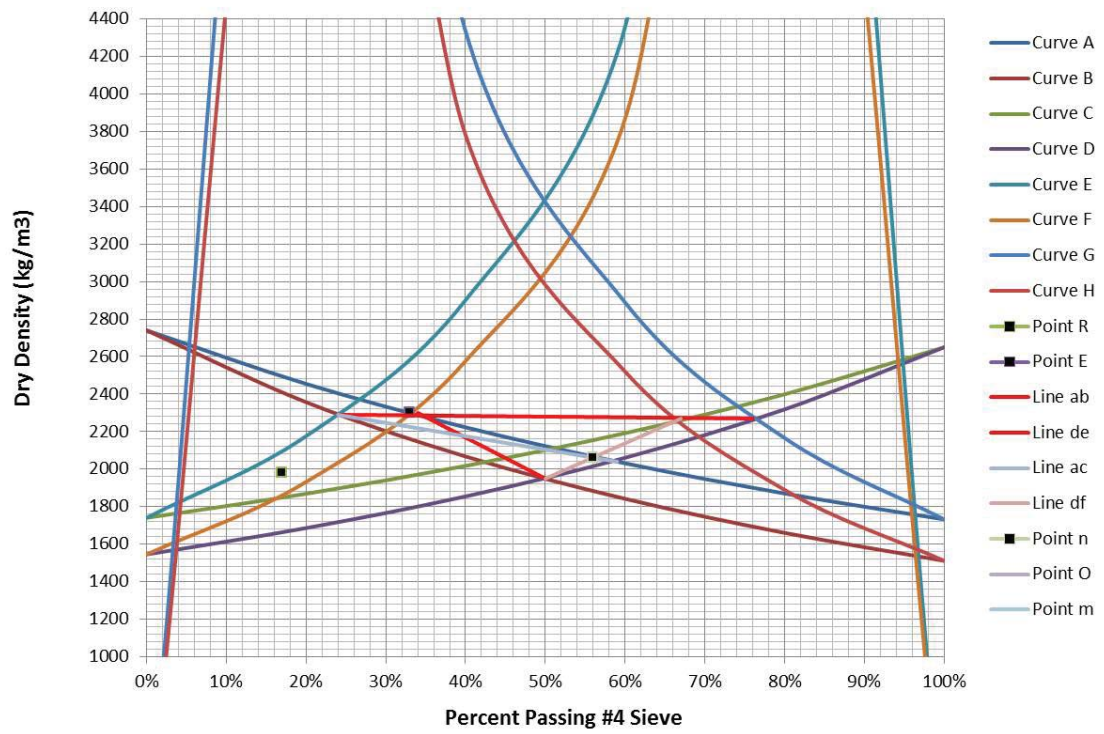

Figure 5.9: Humphres' Method for maximum density prediction of Ottawa C109 Sand and Pea Gravel

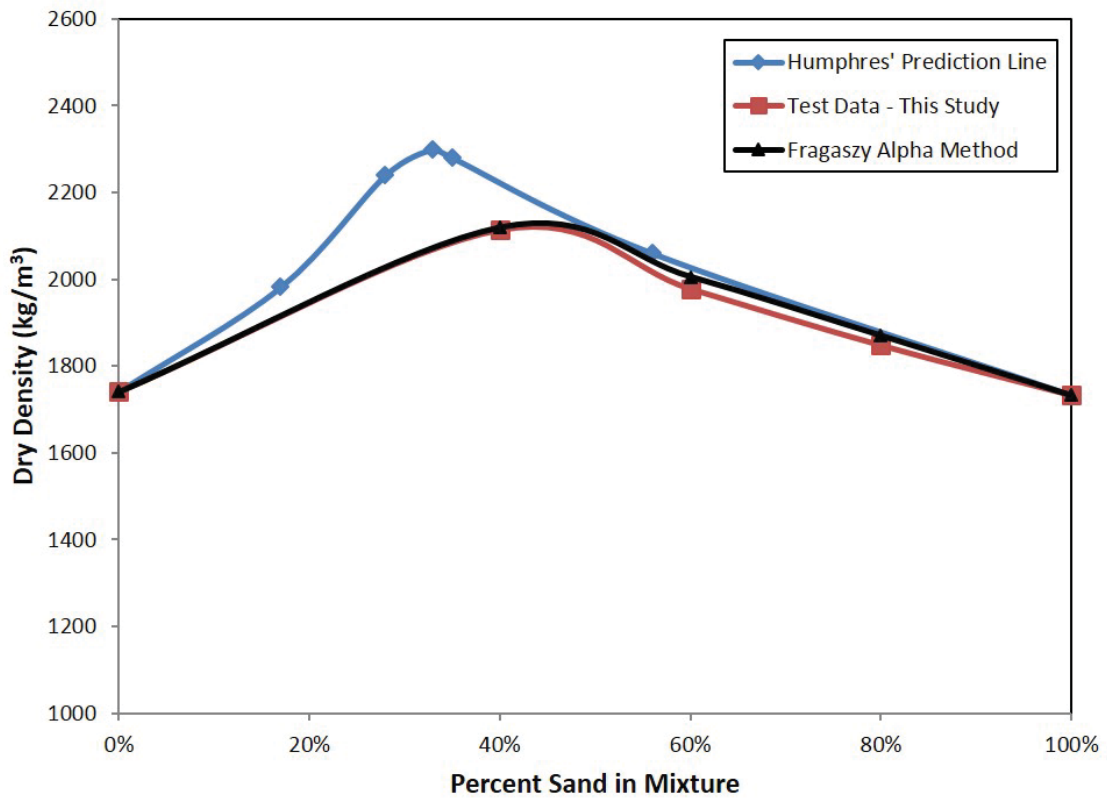

Figure 5.10: Comparison of Laboratory Test data and prediction methods for maximum density determination for Ottawa C109 sand and Pea Gravel

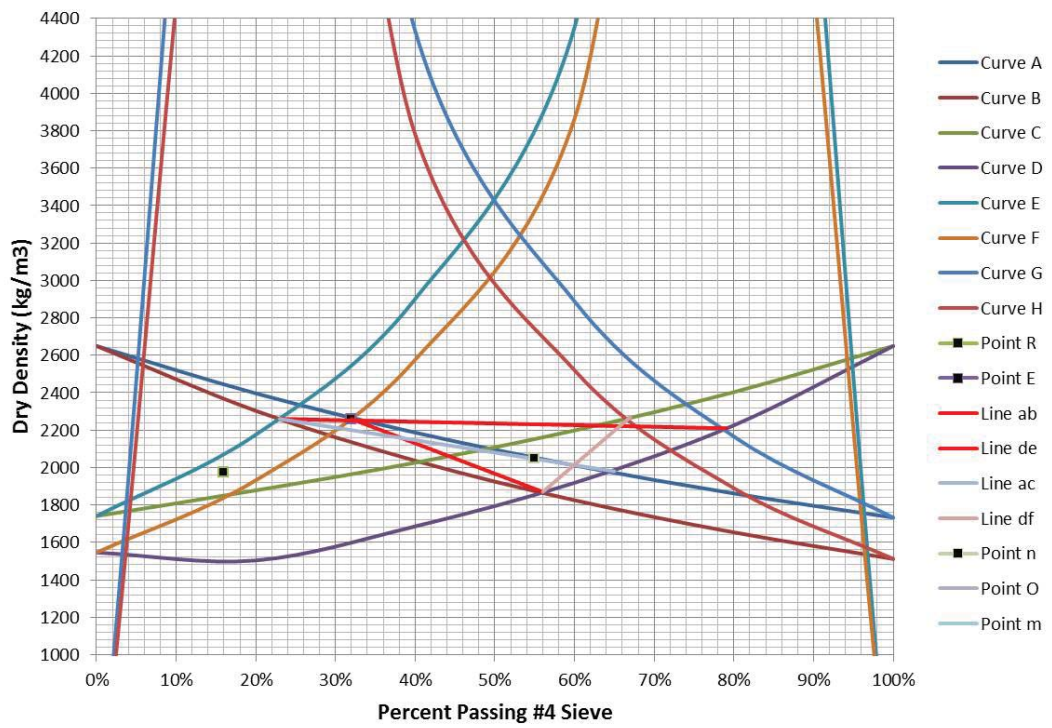

Figure 5.11: Humphres' Method for maximum density prediction of Ottawa C109 Sand and CLS8

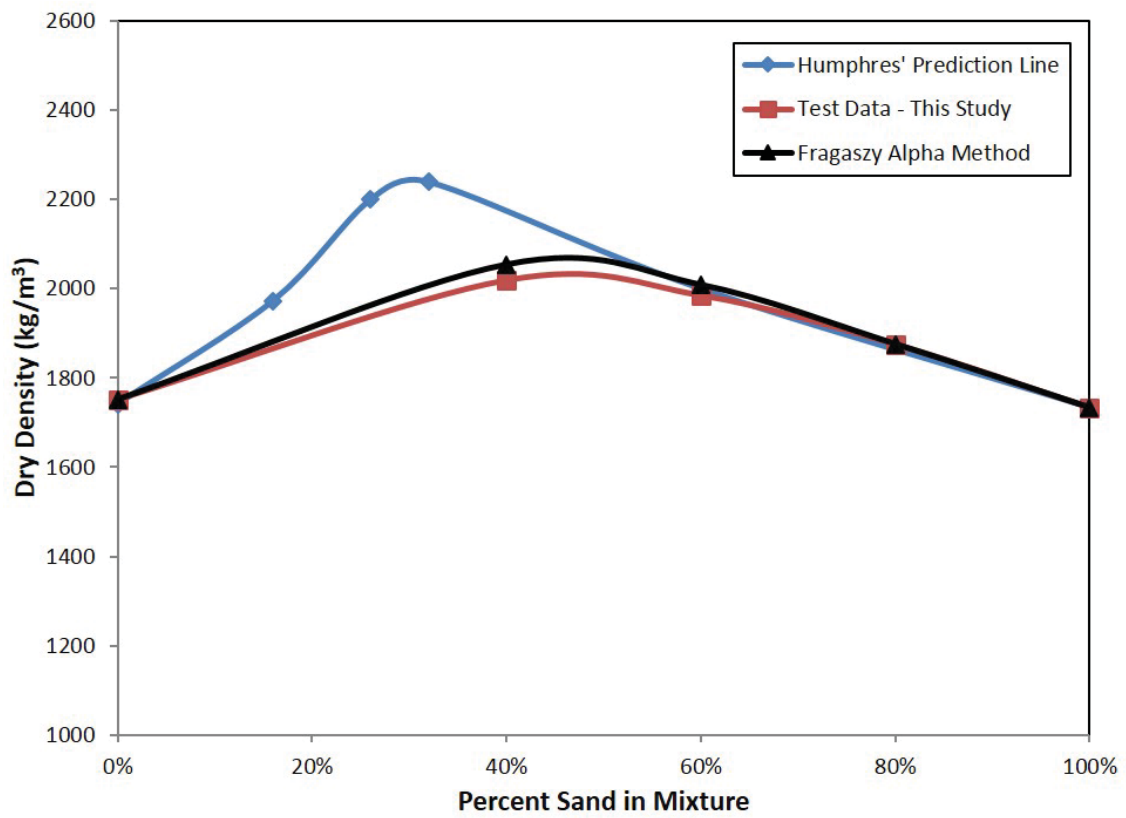

Figure 5.12: Comparison of Laboratory Test data and prediction methods for maximum density determination for Ottawa C109 Sand and CLS8

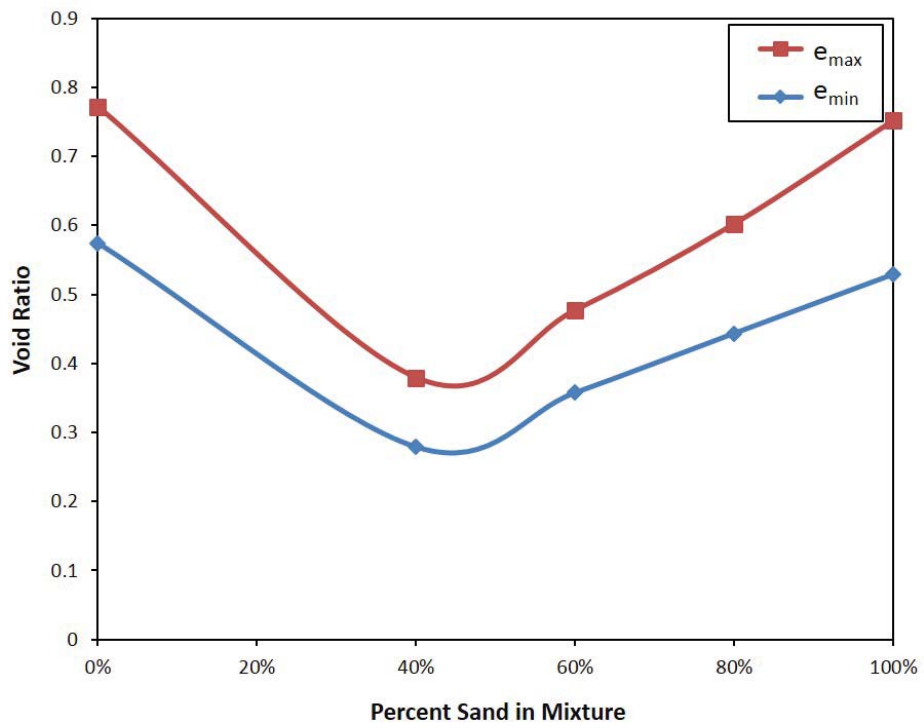

Figure 5.13: Minimum and Maximum void ratio for Ottawa C109 Sand and Pea Gravel mixtures

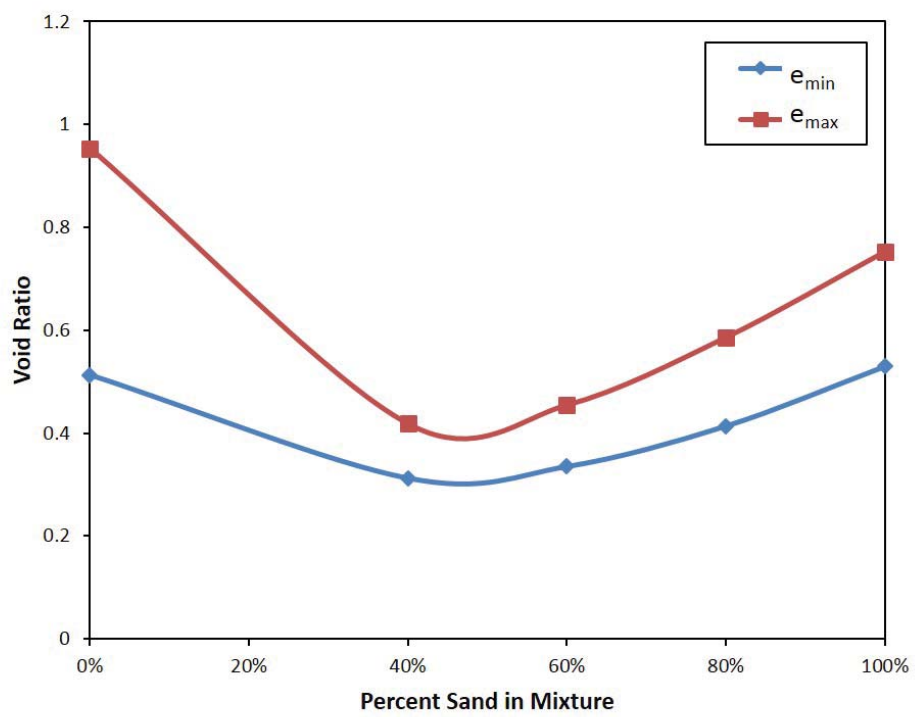

Figure 5.14: Minimum and Maximum void ratio for Ottawa C109 Sand and CLS8 mixtures

5.3 Test Materials

Pea Gravel, 8 mm Crushed Limestone (CLS8), and Ottawa C109 Sand were tested in Chapter 4 and were used in this chapter to prepare gravel-sand mixtures. Mixtures of Pea Gravel and Ottawa C109 Sand and CLS8 and Ottawa C109 Sand were prepared with varying amounts of sand and gravel (100% Sand, 80% Sand/20% Gravel, 60% Sand/40% Gravel, 40% Sand/60% Gravel, and 100% Gravel). Table 1 summarizes the Pea Gravel and Ottawa C109 Sand mixture properties, while Table 2 summaries the CLS8 and Ottawa C109 Sand mixture properties. Grain size distributions for mixtures of Pea Gravel are shown in Figure 5.15, while grain size distributions for CLS8 mixtures are shown in Figure 5.16.

The grain size distribution for Pea Gravel and CLS8 were evaluated using the Translucent Segregation Table (*Ohm and Hryciw, 2013*), while the Ottawa C109 Sand and gravel-sand mixture distributions were evaluated using ASTM D6913 (*ASTM, 2004*). Minimum and maximum densities for uniform Pea Gravel, CLS8, and Ottawa C109 Sand were determined using ASTM D4254 (*ASTM, 2006*), while the method described in the previous section was used to determine the maximum density of the mixtures.

Table 5.1: Material Properties for Pea Gravel and Ottawa C109 Sand Mixtures

Properties	<i>Pea Gravel</i>	<i>60% Gravel/ 40% Sand</i>	<i>40% Gravel/ 60% Sand</i>	<i>20% Gravel/ 80% Sand</i>	<i>Ottawa C109 Sand</i>
G_S	2.74	2.70	2.69	2.67	2.65
$\gamma_{d \max}$ (kg/m ³)	1741	2114	1978	1848	1733
$\gamma_{d \min}$ (kg/m ³)	1546	1960	1818	1665	1512
e_{\max}	0.772	0.379	0.477	0.602	0.752
e_{\min}	0.574	0.279	0.358	0.443	0.529

Table 5.2: Material Properties for CLS8 and Ottawa C109 Sand Mixtures

Properties	CLS8	60% Gravel/ 40% Sand	40% Gravel/ 60% Sand	20% Gravel/ 80% Sand	Ottawa C109 Sand
G_S	2.65	2.65	2.65	2.65	2.65
$\gamma_{d \max}$ (kg/m ³)	1751	2223	2032	1870	1733
$\gamma_{d \min}$ (kg/m ³)	1357	2068	1842	1660	1512
e_{\max}	0.953	0.419	0.455	0.586	0.752
e_{\min}	0.513	0.313	0.335	0.413	0.529

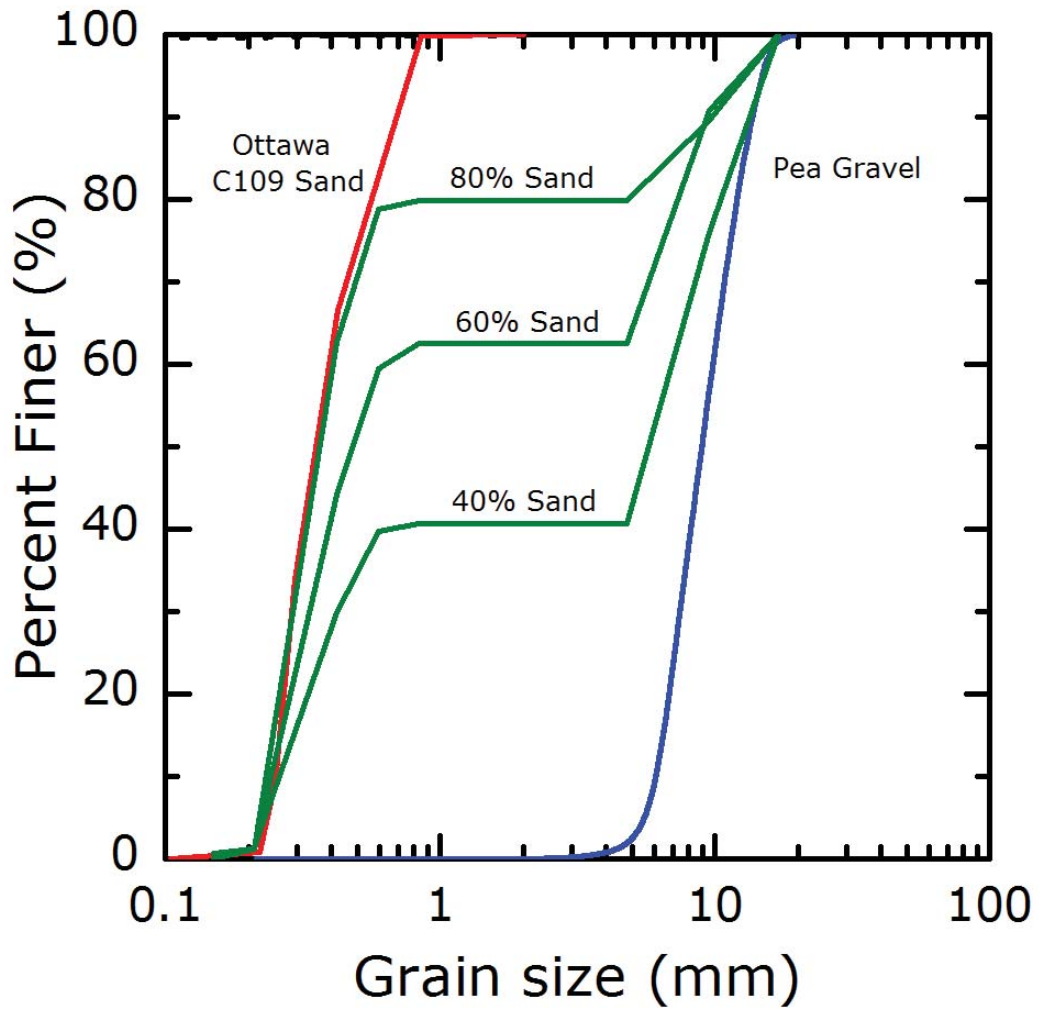

Figure 5.15: Grain Size Distributions for Ottawa C109 Sand and Pea Gravel Mixtures

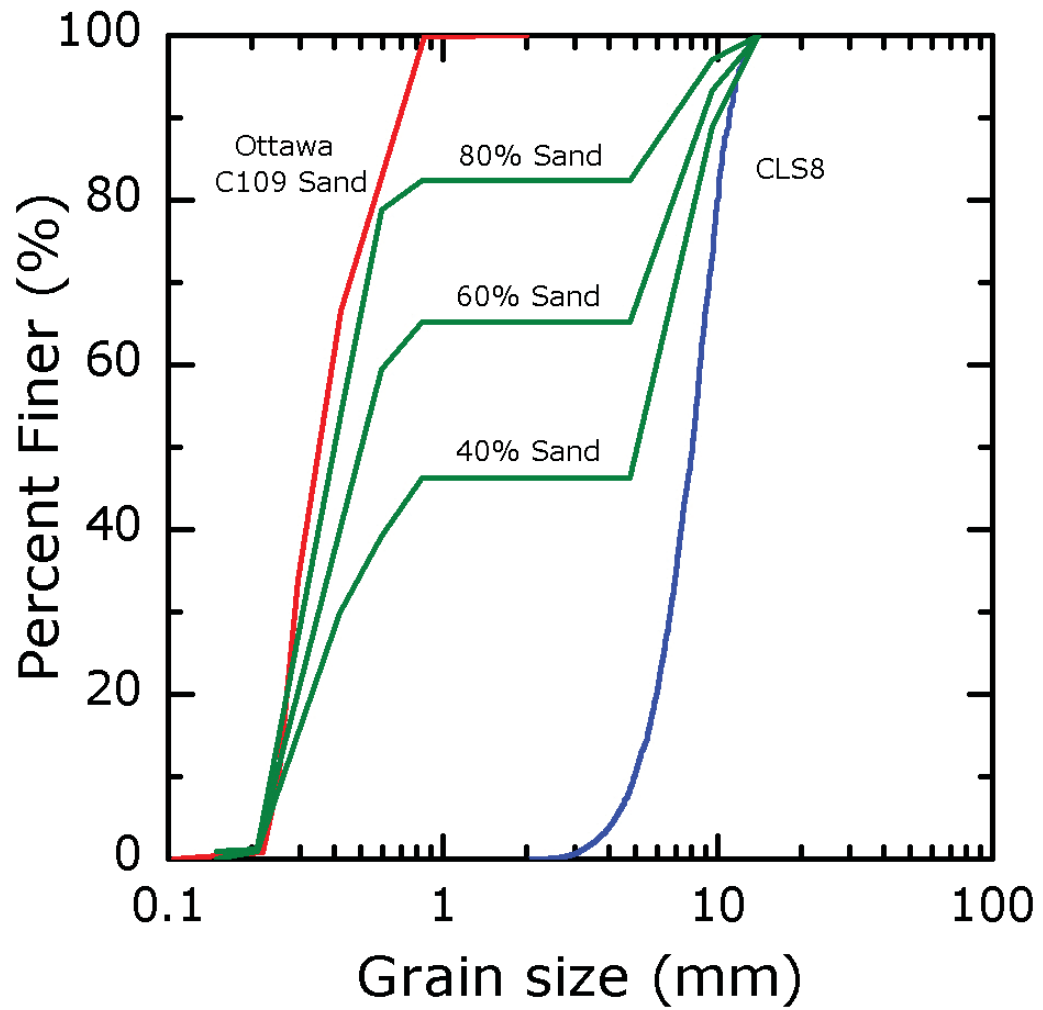

Figure 5.16: Grain Size Distributions for Ottawa C109 Sand and CLS8 Mixtures



Figure 5.17: Funnel used for loose placement of sand-gravel mixtures

5.4 Test Procedures

The large-size CSS described in Chapter 3 was utilized to perform monotonic and cyclic simple shear tests of gravel-sand mixtures. Specimens were prepared at two target relative densities (D_r) for each material: $D_r = 47 \pm 3\%$ and $D_r = 87 \pm 5\%$. These (D_r) values represent global void ratio values for the entire specimen (considering both the gravel skeleton and sand skeleton). Specimens were placed in the stacked rings as shown in Figure 4.8. A large funnel as shown in Figure 5.17 was used to place the gravel-sand mixtures in a loose state (lifts of approximately 1" were used). Specimens were prepared at $D_r = 87\%$ by dropping a 5.5 kg weight with a circular diameter of 150 mm from a height of 50-75 mm. An average of 25 drops per layer in 3 layers (for a total of 75 drops) was used. A small drop height was used to minimize particle damage during specimen preparation (this was also confirmed visually) and a greater number of drops was used for successive layers to ensure specimen uniformity.

Monotonic, cyclic, and post-cyclic simple shear tests were performed for mixtures of Pea Gravel and Ottawa C109 Sand as well as CLS8 and Ottawa C109 Sand. Table 5.3 shows the monotonic tests performed for Pea Gravel and Ottawa C109 Sand mixtures, while Table 5.4 shows the cyclic and post-cyclic tests performed for Pea Gravel and Ottawa C109 Sand mixtures. Table 5.5 shows the monotonic tests performed for CLS8 and Ottawa C109 Sand mixtures, while Table 5.6 shows the cyclic and post-cyclic tests performed for CLS8 and Ottawa C109 Sand mixtures. Specimens were prepared with 100% Sand, 80% Sand, 60% Sand, 40% Sand, and 0% Sand (or 100% Gravel) were tested at $D_r = 47\%$ and $D_r = 87\%$ at initial vertical stresses (σ'_{v0}) of 100, 200, or 400 kPa. Monotonic and post-cyclic monotonic tests were strain-controlled and sheared at a rate of approximately 0.3% per minute, which enabled precise control of constant volume conditions and was similar to other strain rates used in simple shear testing of sands (*Sivathayalan, 2000*). Cyclic tests were stress-controlled with different cyclic stress ratios (CSRs) ranging from 0.04 to 0.14 and a loading frequency of 0.33 Hz. Post-cyclic tests were completed either by shearing

Table 5.3: Monotonic Tests for Pea Gravel and Ottawa C109 Sand Mixtures

Percent Sand	Percent Gravel	Test ID	Initial Vertical Effective Stress (kPa)	V_S (m/s)	Relative Density (%)	Void Ratio
100%	0%	M301	100	191	44%	0.654
100%	0%	M302	200	229	44%	0.655
100%	0%	M149	400	275	46%	0.649
80%	20%	M262	100	198	44%	0.536
80%	20%	M275	200	236	48%	0.53
80%	20%	M277	400	277	45%	0.535
60%	40%	M268	100	199	47%	0.424
60%	40%	M281	200	236	46%	0.425
60%	40%	M280	400	273	47%	0.423
40%	60%	M296	100	204	44%	0.334
40%	60%	M295	200	241	44%	0.333
40%	60%	M282	400	281	44%	0.333
0%	100%	M191	100	189	44%	0.685
0%	100%	M184	200	232	46%	0.681
0%	100%	M171	400	268	46%	0.682
100%	0%	M160	100	211	82%	0.570
80%	20%	M329	100	217	82%	0.475
60%	40%	M330	100	232	82%	0.382
40%	60%	M331	100	243	84%	0.294
0%	100%	M205	100	213	91%	0.598

immediately after liquefaction without reconsolidation or by reconsolidating to the initial vertical effective stress to measure volumetric strain (settlement) and then shearing monotonically. All tests were completed at constant volume conditions as previously discussed in Chapter 2 and Chapter 3.

5.5 Laboratory Test Results

5.5.1 Shear Wave Velocity (V_S)

As mentioned in Chapter 4, measurements of the V_S for each tested specimen have been performed. Results of V_S measurements are presented in Figure 5.18 for specimens of gravel and sand mixtures ($D_r = 47\%$) using both Pea Gravel and CLS8 as the mixing gravels. For each gravel tested, V_S increased with increasing σ'_{v0} from 100 to 400 kPa. For Pea Gravel/Ottawa C109 Sand Mixtures, there was not a significant change in V_S as the mixture percentages changed. This is likely due to the similarity in V_S of the uniform Pea Gravel and uniform Ottawa C109 Sand. The mixture with the highest V_S value was the 40%

Table 5.4: Cyclic and Post-Cyclic Tests for Pea Gravel and Ottawa C109 Sand Mixtures

Test ID	Percent Sand	Percent Gravel	Vertical Stress (kPa)	Relative Density (%)	Void Ratio	V_S (m/s)	CSR	NL	Post-Cyclic Shear	Post-Cyclic Reconsolidation
C257	100%	0%	100	49%	0.643	188	0.044	219		
C258	100%	0%	100	47%	0.646	192	0.094	6	X	
C256	100%	0%	100	50%	0.64	199	0.144	2		X
C280	100%	0%	100	90%	0.534	210	0.144	2		X
C274	100%	0%	400	49%	0.644	252	0.099	6	X	
C279	100%	0%	100	85%	0.563	210	0.094	181	X	
C298	80%	20%	100	86%	0.468	215	0.094	11	X	
C249	80%	20%	100	44%	0.536	208	0.044	518		
C246	80%	20%	100	50%	0.526	205	0.094	7	X	
C248	80%	20%	100	44%	0.537	206	0.144	2		X
C242	60%	40%	100	47%	0.423	205	0.044	49		
C244	60%	40%	100	44%	0.427	217	0.094	8	X	
C245	60%	40%	100	48%	0.423	205	0.144	2		X
C299	60%	40%	100	85%	0.378	226	0.094	15	X	
C243	60%	40%	400	47%	0.423	278	0.099	8	X	
C234	40%	60%	100	50%	0.327	208	0.044	68		
C232	40%	60%	100	44%	0.333	201	0.094	19	X	
C233	40%	60%	100	44%	0.333	203	0.144	4		X
C186	0%	100%	100	46%	0.681	209	0.044	240	X	
C179	0%	100%	100	44%	0.686	180	0.094	6	X	
C187	0%	100%	100	47%	0.68	185	0.144	6	X	
C287	40%	60%	100	93%	0.284	233	0.094	11	X	
C231	40%	60%	200	44%	0.333	234	0.097	20	X	
C235	40%	60%	400	44%	0.334	231	0.099	17	X	
C288	40%	60%	100	92%	0.285	226	0.144	18		X
C169	0%	100%	100	92%	0.519	205	0.094	11	X	
C180	0%	100%	100	50%	0.673	173	0.094	4		X
C281	0%	100%	100	82%	0.61	182	0.144	8		X

Table 5.5: Monotonic Tests for CLS8 and Ottawa C109 Sand Mixtures

Percent Sand	Percent Gravel	Test ID	Initial Vertical Effective Stress (kPa)	V_S (m/s)	Relative Density (%)	Void Ratio
100%	0%	M301	100	191	44%	0.654
100%	0%	M302	200	230	44%	0.655
100%	0%	M149	400	275	46%	0.649
80%	20%	M305	100	208	45%	0.509
80%	20%	M308	200	245	44%	0.509
80%	20%	M307	400	287	42%	0.514
60%	40%	M313	100	224	50%	0.394
60%	40%	M310	200	274	47%	0.398
60%	40%	M314	400	311	44%	0.402
40%	60%	M316	100	201	45%	0.371
40%	60%	M318	200	236	49%	0.366
40%	60%	M315	400	284	45%	0.371
0%	100%	M226	100	212	45%	0.756
0%	100%	M227	200	253	47%	0.747
0%	100%	M224	400	293	47%	0.748
100%	0%	M160	100	211	802%	0.570
80%	20%	M333	100	240	82%	0.444
60%	40%	M320	100	233	92%	0.354
0%	100%	M235	100	216	86%	0.575

Table 5.6: Cyclic and Post-Cyclic Tests for CLS8 and Ottawa C109 Sand Mixtures

Test ID	Percent Sand	Percent Gravel	Vertical Stress (kPa)	Relative Density (%)	Void Ratio	V_S (m/s)	CSR	NL	Post-Cyclic Shear	Post-Cyclic Reconsolidation
C257	100%	0%	100	49%	0.643	188	0.044	219		
C258	100%	0%	100	47%	0.646	190	0.094	6	X	
C256	100%	0%	100	50%	0.64	213	0.144	2		X
C280	100%	0%	100	90%	0.534	215	0.144	2		X
C274	100%	0%	400	49%	0.644	252	0.099	6	X	
C279	100%	0%	100	85%	0.563	210	0.094	181	X	
C261	80%	20%	100	47%	0.507	188	0.094	6	X	
C262	80%	20%	100	44%	0.51	189	0.144	4		X
C263	80%	20%	100	46%	0.506	183	0.044	84		
C300	80%	20%	100	90%	0.431	237	0.094	12	X	
C265	60%	40%	100	44%	0.402	230	0.094	36	X	
C266	60%	40%	100	45%	0.4	229	0.144	4		X
C267	60%	40%	100	49%	0.395	207	0.044	87		
C292	60%	40%	100	90%	0.347	229	0.094	11	X	
C290	60%	40%	400	49%	0.396	290	0.099	22	X	
C291	60%	40%	100	88%	0.35	236	0.144	6		X
C268	40%	60%	100	49%	0.367	199	0.094	8	X	
C269	40%	60%	100	44%	0.371	206	0.144	4		X
C270	40%	60%	100	47%	0.369	202	0.044	146		
C217	0%	100%	100	45%	0.755	204	0.094	25	X	
C218	0%	100%	100	47%	0.747	197	0.044	500	X	
C219	0%	100%	100	46%	0.751	207	0.144	5	X	
C230	0%	100%	100	85%	0.578	223	0.094	58	X	
C272	0%	100%	100	44%	0.761	200	0.144	7		X
C283	0%	100%	100	81%	0.603	215	0.144	10		X

Sand/60% Gravel mixture. Alternatively, mixture percentage had a significant effect on the V_S values for the CLS8/Ottawa C109 Sand mixtures. In this case, the uniform CLS8 and uniform Ottawa C109 Sand had different V_S values. The mixture with the highest V_S value was the 60% Sand/40% Gravel mixture, followed by the 100% Gravel specimen. Power functions of the form in Equation 5.4 were fit to the data and values determined for the α and β parameters are presented in Table 5.7 for Pea Gravel mixes and in Table 5.8 for CLS8 mixes. The V_S value can be predicted by:

$$V_S = \alpha \left(\frac{\sigma_v'}{1 \text{ atm}} \right)^\beta \quad (5.4)$$

Where α (V_S in m/s at 1 atm (101.3 kPa)) and β are fitting parameters determined from laboratory testing. The α value for the Pea Gravel/Ottawa C109 Sand mixtures was the highest for the 40% Sand specimen, while the α value for the CLS8/Ottawa C109 Sand mixtures was the highest for the 60% Sand specimen. The β values for the the Pea Gravel mixtures ranged from 0.23 to 0.26, with lower values of 0.23 for mixtures of 80% Sand, 60% Sand, and 40% Sand. The β values for the the CLS8 mixtures ranged from 0.23 to 0.27, with the 60% Sand mixture having the highest β value of 0.27. These β values are

Table 5.7: Equation Parameters for V_S for Pea Gravel-Ottawa C109 Sand Mixtures at $D_r = 47\%$

Parameter	Ottawa C109 Sand	80% Sand	60% Sand	40% Sand	Pea Gravel
α (m/s)	189	196	199	204	188
β	0.26	0.23	0.23	0.23	0.25

Table 5.8: Equation Parameters for V_S for CLS8-Ottawa C109 Sand Mixtures at $D_r = 47\%$

Parameter	Ottawa C109 Sand	80% Sand	60% Sand	40% Sand	CLS8
α (m/s)	189	206	215	201	210
β	0.26	0.23	0.27	0.25	0.23

reasonable for the soils tested (Menq, 2003).

The change in V_S as a function of the mixture percentage is further shown in Figure 5.19 for Pea Gravel mixtures and Figure 5.20 for CLS8 mixtures. For the Pea Gravel mixtures, V_S increases slightly as gravel is added up to 60% Gravel. After V_S reaches its highest value at 40% Sand/60% Gravel it decreases back to the uniform Pea Gravel value. For the CLS8 mixtures, V_S increases as gravel is added to the sand up to 40% gravel. After V_S reaches its highest value at 60% Sand/40% Gravel it decreases for the 40% Gravel/60% Sand specimen and then increases slightly back up to the 100% CLS8 gravel specimen. The 60% CLS8/40% Ottawa C109 Sand specimen had segregation of sand and gravel particles as there was not enough sand to fill all of the gravel voids. This specimen is not likely to occur in nature, and therefore is only used for comparison and demonstration in this chapter. Figures 5.21 and 5.22 show the effect of relative density on V_S for Pea Gravel mixtures and CLS8 mixtures, respectively. For Pea Gravel mixtures, the $D_r = 87\%$ specimens follow the same trend as the $D_r = 47\%$ mixtures, and have the highest value of V_S at 60% Sand. For CLS8 mixtures, the highest value of V_S for the $D_r = 87\%$ specimens is now at 80% Sand (while it was highest for 60% Sand for the $D_r = 47\%$ specimens).

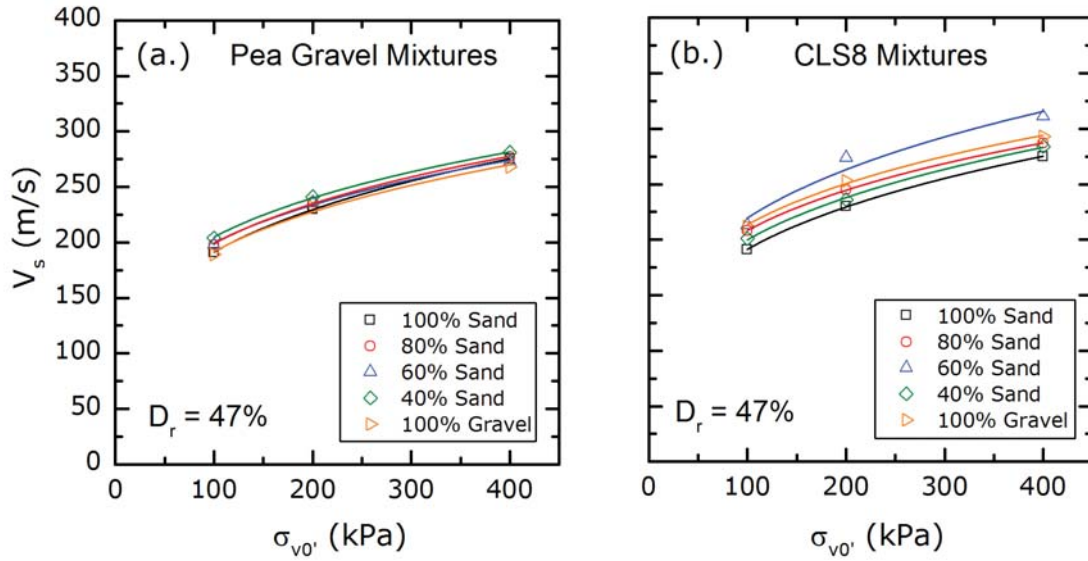

Figure 5.18: Comparison of Shear Wave Velocity as a function of Mixture Percentage and initial vertical stress for (a.) Ottawa C109 Sand and Pea Gravel and (b.) Ottawa C109 Sand and CLS8

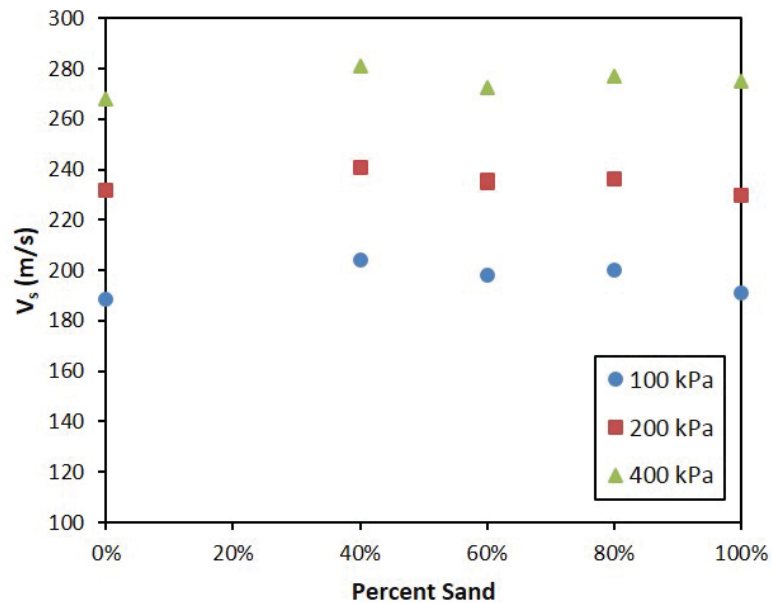

Figure 5.19: Comparison of Shear Wave Velocity as a function of Mixture Percentage for Ottawa C109 Sand and Pea Gravel at $\sigma_{v0}' = 100, 200, \text{ and } 400$ kPa

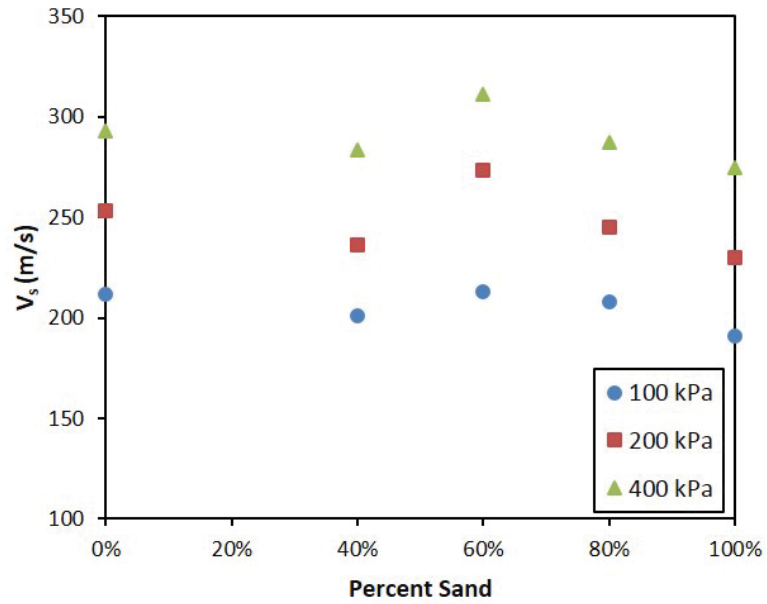

Figure 5.20: Comparison of Shear Wave Velocity as a function of Mixture Percentage for Ottawa C109 Sand and CLS8 at $\sigma'_{v0} = 100, 200, \text{ and } 400 \text{ kPa}$

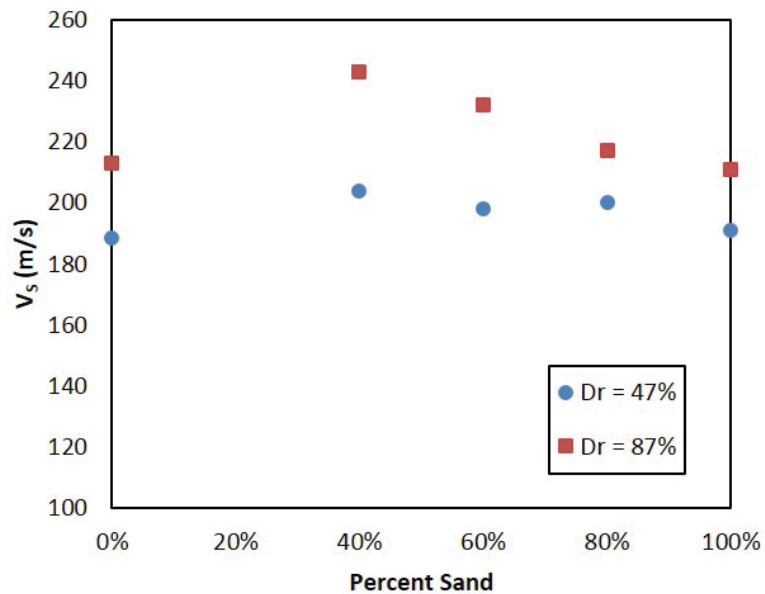

Figure 5.21: Comparison of Shear Wave Velocity as a function of Mixture Percentage for Ottawa C109 Sand and Pea Gravel at $D_r = 47\% \text{ and } 87\%$ at $\sigma'_{v0} = 100 \text{ kPa}$

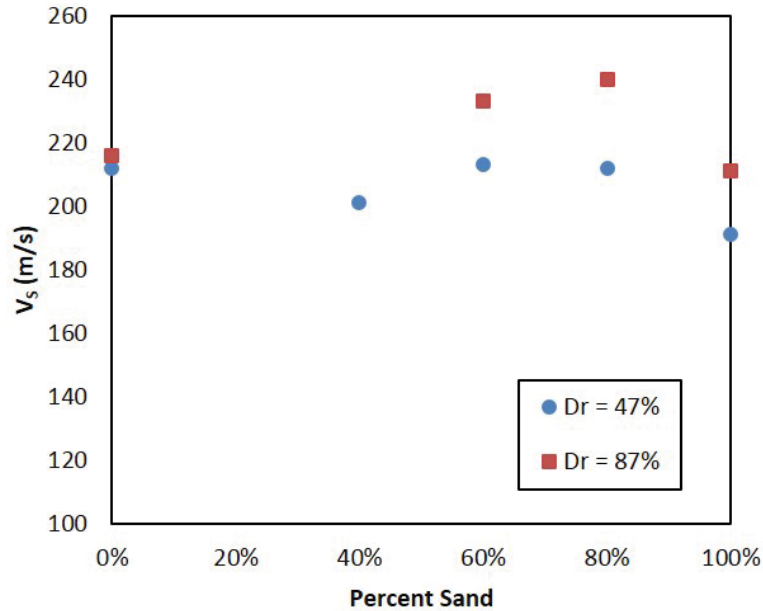

Figure 5.22: Comparison of Shear Wave Velocity as a function of Mixture Percentage for Ottawa C109 Sand and CLS8 at $D_r = 47\%$ and 87% at $\sigma'_{v0} = 100$ kPa

5.5.2 Monotonic Simple Shear Results

A series of constant volume monotonic simple shear tests were performed on mixtures of Pea Gravel and Ottawa C109 sand and CLS8 and Ottawa C109 Sand. Specific parameters, including mixture percentage, initial vertical stress, and relative density, were targeted to provide insight into the effect of these parameters on gravel-sand mixture shear response. Interpretation of the data uses similar framework to Chapter 4 by evaluating the Peak, Phase Transformation (PT), and Ultimate State (US) strengths and corresponding friction angles from the monotonic test data.

Pea Gravel and Ottawa C109 Sand mixtures were tested at mixture percentages of 100% Sand, 80% Sand, 60% Sand, 40% Sand, and 100% Gravel. Monotonic tests results for specimens at $D_r = 47\%$ and $D_r = 87\%$ for initial vertical stresses of 100 kPa are presented in Figures 5.23 and 5.24, respectively. The effect of mixture percentage is more pronounced for tests with $D_r = 47\%$ compared to $D_r = 87\%$ specimens. For example, $D_r = 47\%$ specimens at initial vertical stress of 100 kPa show a significant increase in shear strength for

a mixture percentage of 40% Sand as shown in Figure 5.23; however, for $D_r = 87\%$ specimens shear strength is more tightly grouped with no specific mixture displaying response significantly stronger than other tests (as shown in Figure 5.24). Test results for initial vertical stresses of 200 and 400 kPa for $D_r = 47\%$ specimens are shown in Figures 5.25 and 5.26, respectively. Similar trends to the 100 kPa tests are seen for the 200 and 400 kPa tests, with 40% Sand being the optimum mixture for maximum shear strength. Initial vertical stress does have an effect on the response of 100% Pea Gravel compared to the other mixtures. For the 100 kPa test set, 100% Pea Gravel displays the lowest shear strength both in the peak and post-peak stages of the test; however, for the 200 and 400 kPa test sets, 100% Pea Gravel increases in shear strength relative to the other mixtures. By the 400 kPa test, 100% Pea Gravel has the second highest shear strength of the various mixtures. This shows that as vertical stress increases the 100% Pea Gravel specimen increases in shear strength at a rate greater than the other mixtures.

CLS8 and Ottawa C109 Sand mixtures were tested at mixture percentages of 100% Sand, 80% Sand, 60% Sand, 40% Sand, and 100% Gravel; however, as previously stated the 40% Sand specimen was not tested in all scenarios and is only included for comparison even though it represents a mixture that would not likely occur in nature. Monotonic tests results for specimens at $D_r = 47\%$ and $D_r = 87\%$ for initial vertical stresses of 100 kPa are presented in Figures 5.27 and 5.28, respectively. Figure 5.27a shows that the 60% Sand specimen exhibits the greatest shear strength post-peak. The 60% Sand, 40% Sand, and 100% Gravel specimen have very similar peak shear strength and do not exhibit strain-softening post-peak. This shows that the gravel portion of the specimen is controlling response once the gravel content has reached 40% (in the 60% Sand specimen). Figure 5.27d shows the τ/σ'_v and the effect of mixture percentage on τ/σ'_v ratio as strain increases. All tests reach an US value, with the 60% Sand specimen having the highest τ/σ'_v value. This plot also shows that the gravel portion of the specimen is controlling the τ/σ'_v ratio as strain increases since every specimen that contains gravel, even the 80% Sand, has a higher τ/σ'_v

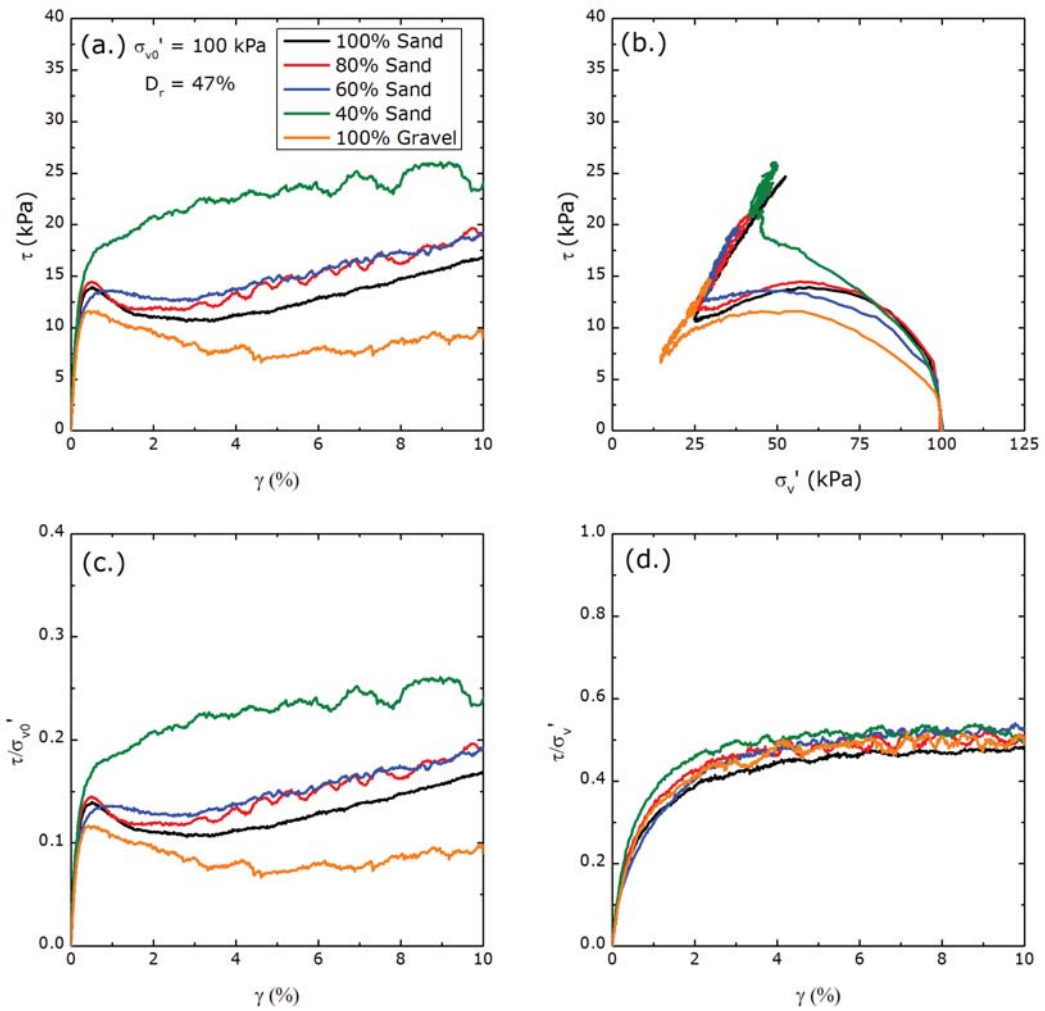

Figure 5.23: Monotonic Constant Volume Simple Shear data (Test ID: M301, M262, M268, M296, M191) for Pea Gravel/Ottawa C109 Sand mixtures at $D_r = 47\%$ at $\sigma'_{v0} = 100$ kPa for (a.) Stress-Strain, (b.) Stress Path, (c.) τ/σ'_{v0} vs. γ , and (d.) τ/σ'_v vs. γ

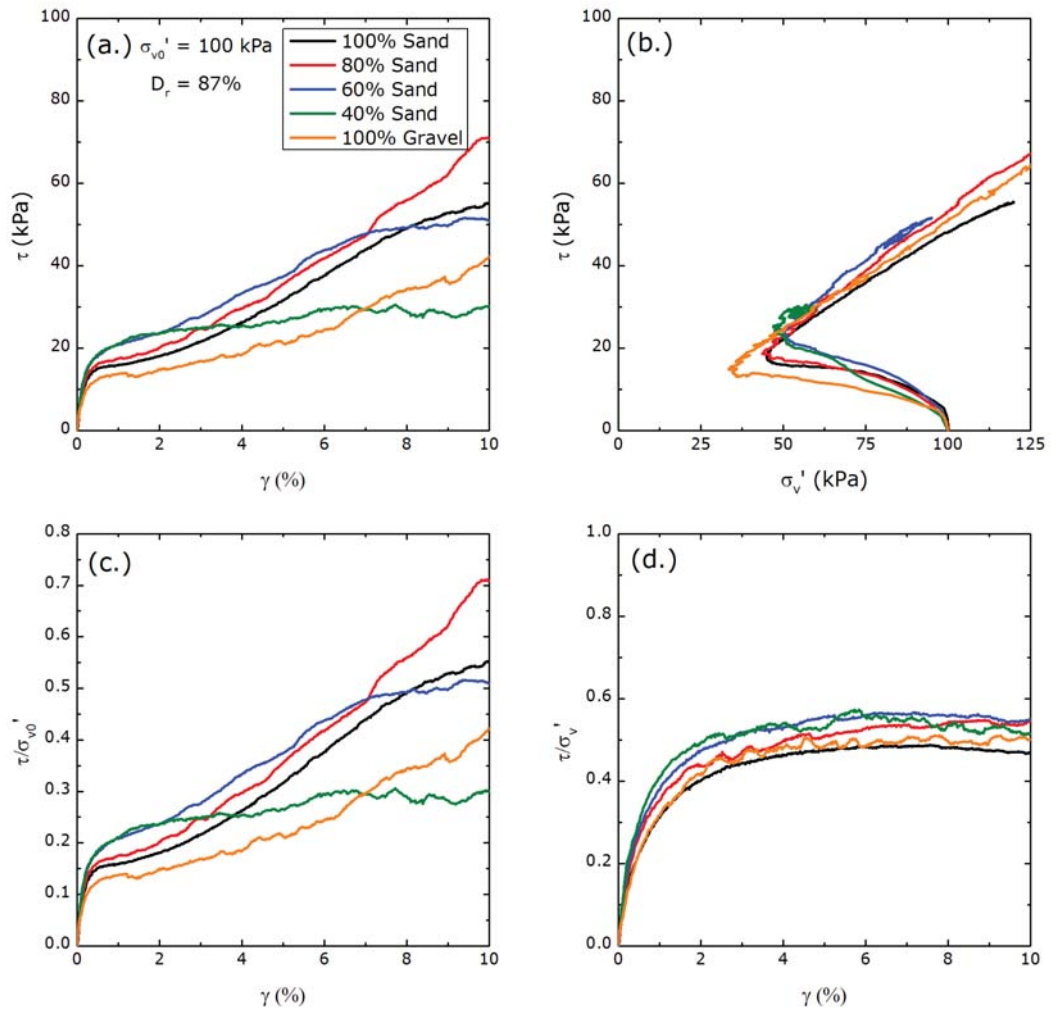

Figure 5.24: Monotonic Constant Volume Simple Shear data (Test ID: M160, M329, M330, M331, M205) for Pea Gravel/Ottawa C109 Sand mixtures at $D_r = 87\%$ at $\sigma'_{v0} = 100$ kPa for (a.) Stress-Strain, (b.) Stress Path, (c.) τ/σ'_{v0} vs. γ , and (d.) τ/σ'_v vs. γ

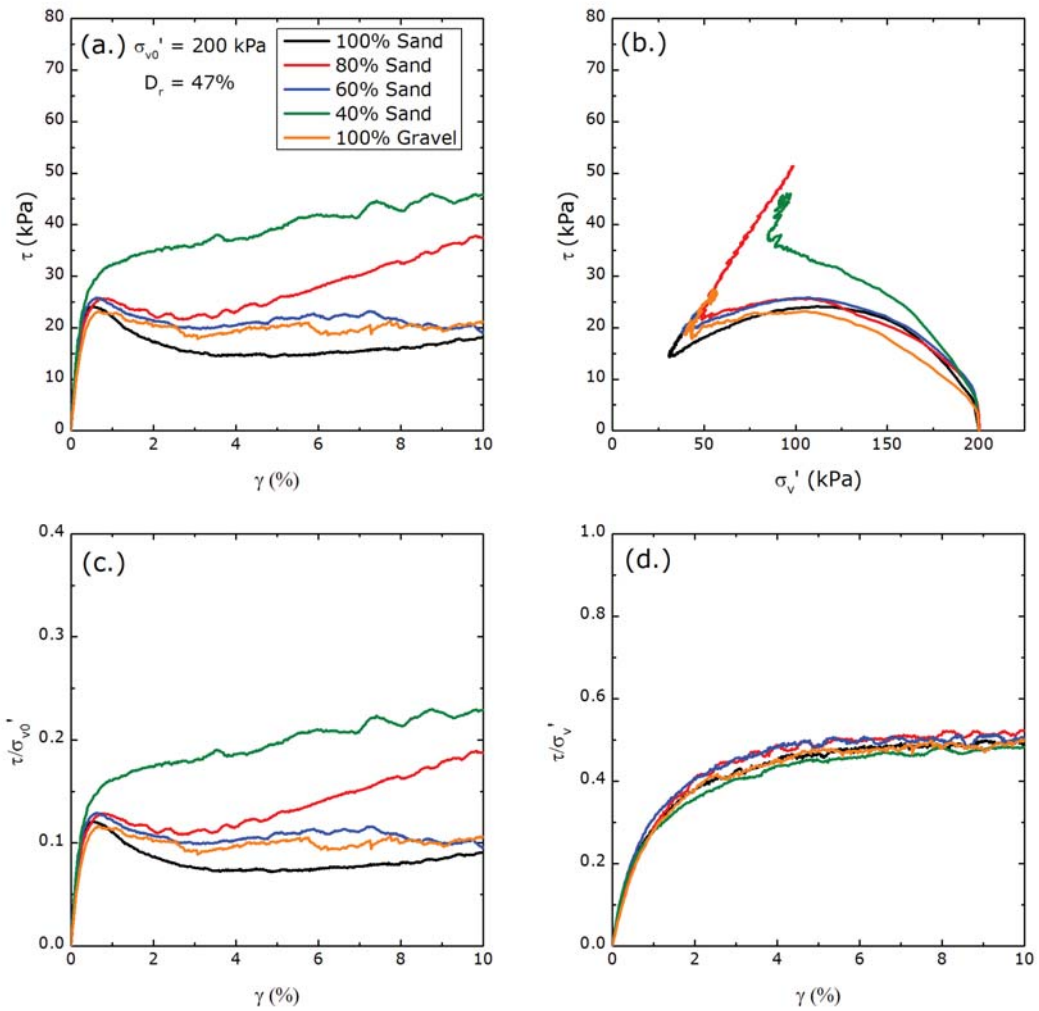

Figure 5.25: Monotonic Constant Volume Simple Shear data (Test ID: M302, M275, M281, M295, M184) for Pea Gravel/Ottawa C109 Sand mixtures at $D_r = 47\%$ at $\sigma'_{v0} = 200$ kPa for (a.) Stress-Strain, (b.) Stress Path, (c.) τ/σ'_{v0} vs. γ , and (d.) τ/σ'_v vs. γ

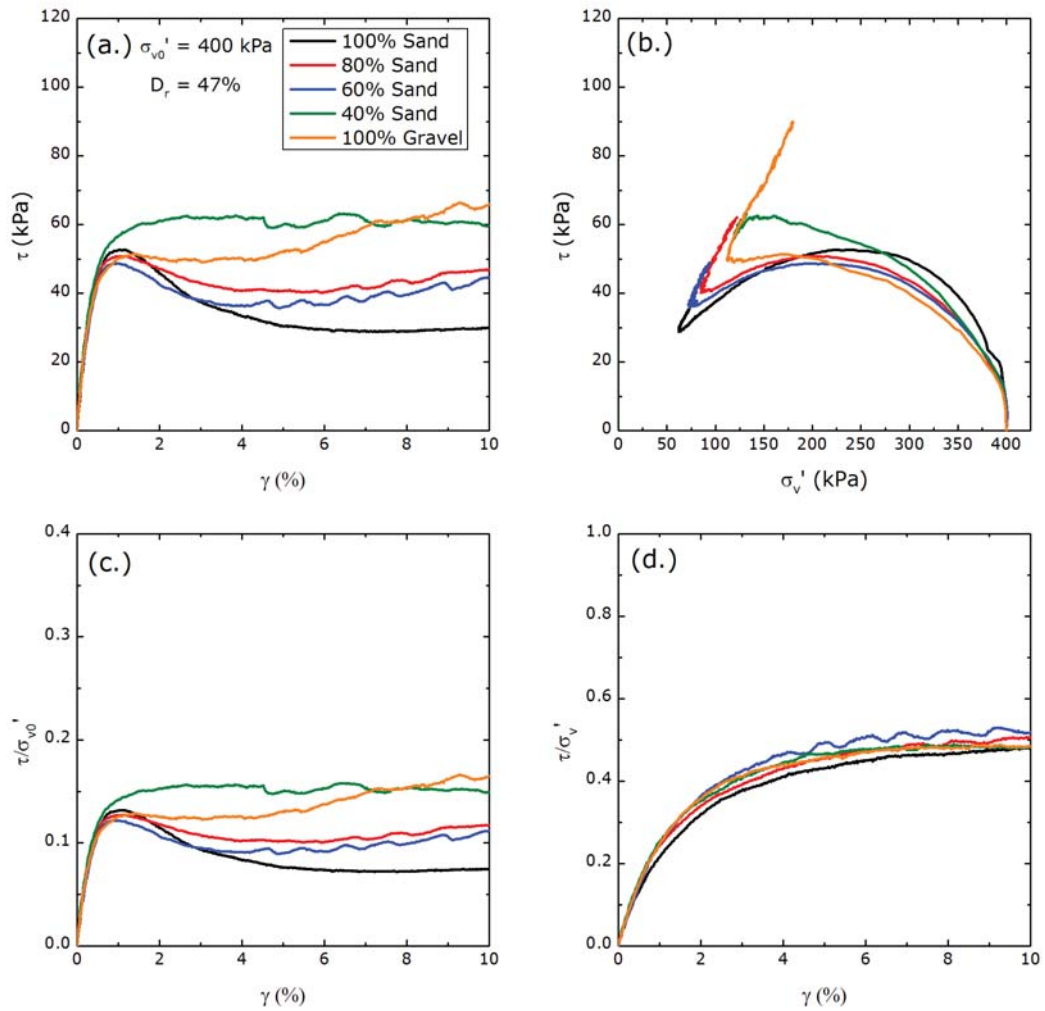

Figure 5.26: Monotonic Constant Volume Simple Shear data (Test ID: M149, M277, M280, M282, M171) for Pea Gravel/Ottawa C109 Sand mixtures at $D_r = 47\%$ at $\sigma'_{v0} = 400$ kPa for (a.) Stress-Strain, (b.) Stress Path, (c.) τ/σ'_{v0} vs. γ , and (d.) τ/σ'_v vs. γ

ratio than the 100% Sand specimen. For the Pea Gravel mixtures, this trend was not as evident since the 100% Gravel and 100% Sand specimens had very similar US τ/σ'_v ratios before mixing as shown in Figure 5.23. Figure 5.28a shows the stress-strain response for $D_r = 87\%$ CLS8 mixture specimens at an initial vertical stress of 100 kPa. In this set of tests the 80% Sand specimen now displays the greatest shear strength both at peak and post-peak, while the 40% Sand specimen, which had the greatest shear strength for the $D_r = 47\%$ tests now had the weakest response. This effect can be explained if the void ratio of the sand skeleton only is examined. The void ratio of the sand only was 0.574, 0.559, and 0.590 for the 100% Sand, 80% Sand, and 60% Sand, respectively. These values explain the response of dense specimens, showing that the sand skeleton void ratio is controlling response. The 80% Sand specimen which had the lowest sand void ratio of 0.559 exhibited the greatest strength, while the 60% Sand specimen had the highest sand void ratio and exhibited the lowest shear strength. The void ratio of the 100% Gravel specimen (global void ratio) was 0.575, and the response of the 100% Gravel specimen was very similar to the 100% Sand specimen which had a void ratio 0.574.

Similar to the Pea Gravel mixtures, an effect of initial vertical stress was observed for the CLS8 mixtures as well. Test results for initial vertical stress of 200 and 400 kPa for $D_r = 47\%$ specimens are shown in Figures 5.29 and 5.30, respectively. Similar trends to the 100 kPa tests are seen for the 200 and 400 kPa tests, with 40% Sand being the optimum mixture for shear strength (in the 200 kPa 60% Sand behaves similar to 100% Gravel). As initial vertical stress increases there is more separation of the gravelly specimens from the sand specimen in the stress-strain plot. Figure 5.29a shows the significant separation of the data that was not as pronounced in the 100 kPa test in Figure 5.27.

Using the test data shown in Figures 5.23, 5.25, 5.26, 5.27, 5.29, and 5.30, Peak, PT, and US points were evaluated and plotted in Figure 5.31 for Pea Gravel mixtures and Figure 5.32 for CLS8 mixtures. Figure 5.31a plots the values of shear strength and vertical effective stress at the peak. Lines were drawn on the figure to show the trends for the

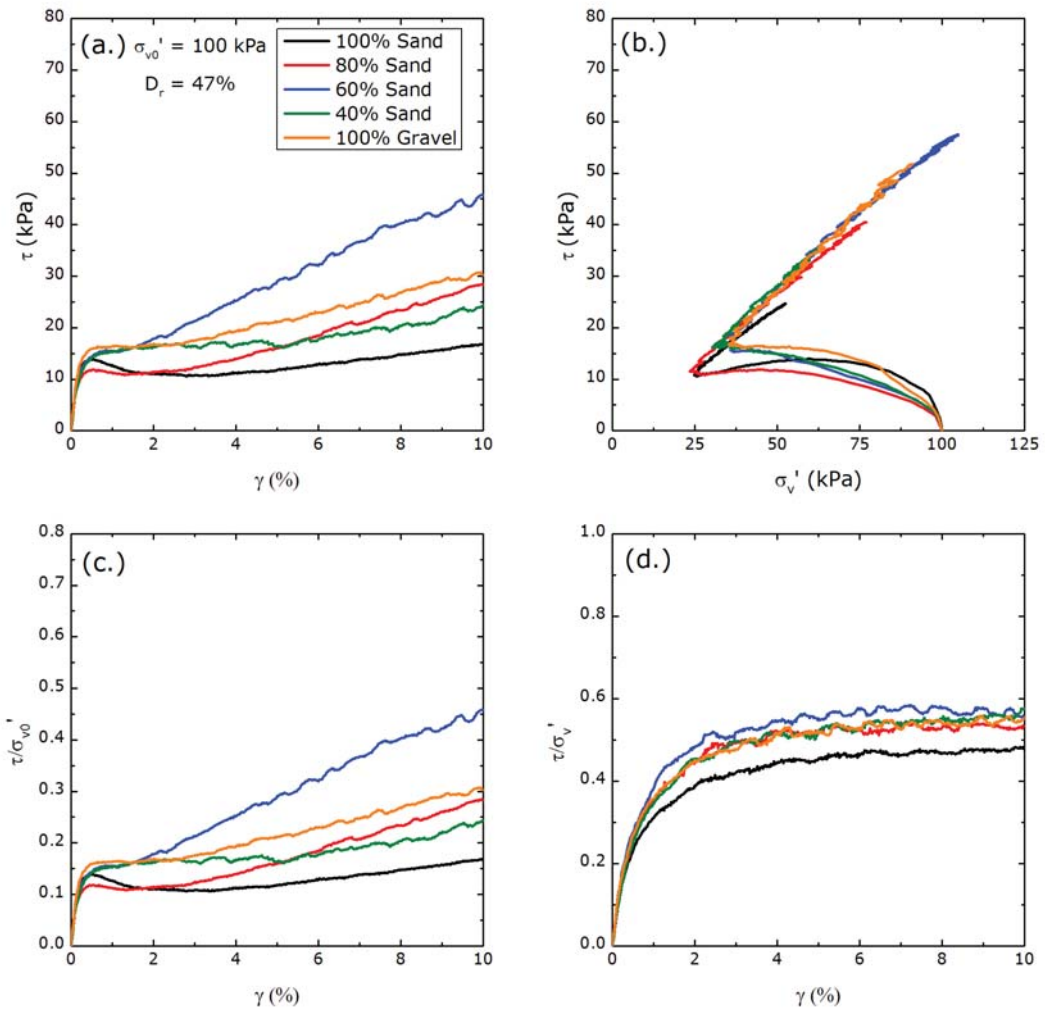

Figure 5.27: Monotonic Constant Volume Simple Shear data (Test ID: M301, M305, M313, M316, M226) for CLS8/Ottawa C109 Sand mixtures at $D_r = 47\%$ at $\sigma'_{v0} = 100$ kPa for (a.) Stress-Strain, (b.) Stress Path, (c.) τ/σ'_{v0} vs. γ , and (d.) τ/σ'_v vs. γ

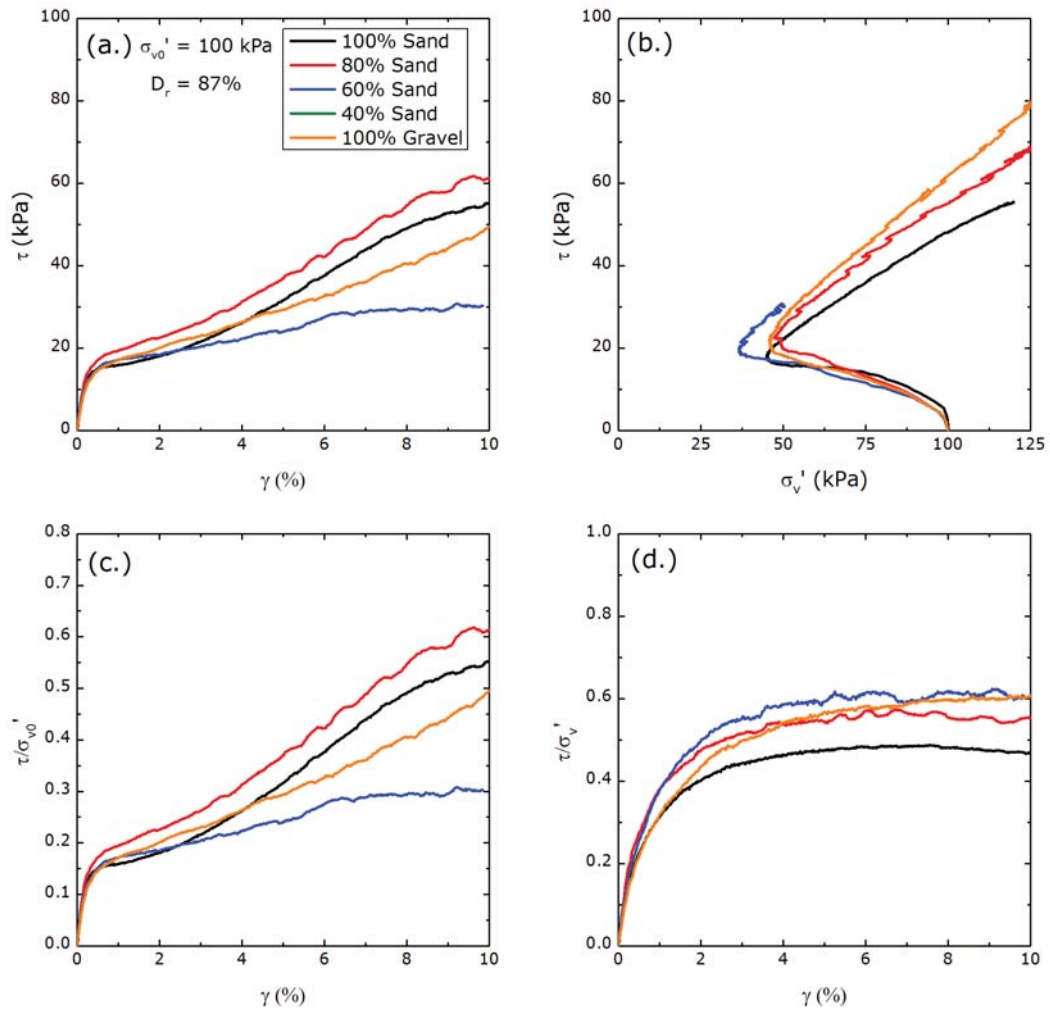

Figure 5.28: Monotonic Constant Volume Simple Shear data (Test ID: M160, M333, M320, M216) for CLS8/Ottawa C109 Sand mixtures at $D_r = 87\%$ at $\sigma'_{v0} = 100$ kPa for (a.) Stress-Strain, (b.) Stress Path, (c.) τ/σ'_{v0} vs. γ , and (d.) τ/σ'_v vs. γ

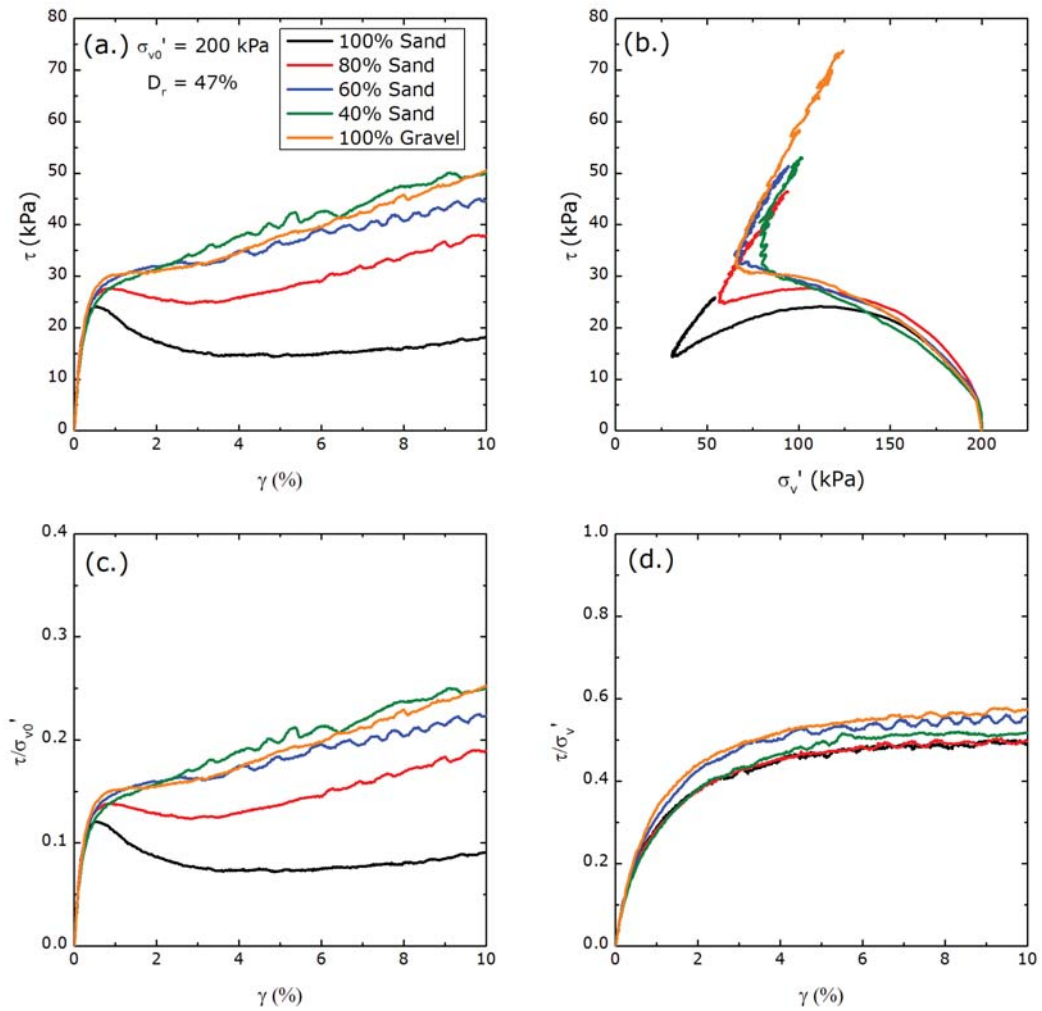

Figure 5.29: Monotonic Constant Volume Simple Shear data (Test ID: M302, M308, M310, M318, M227) for CLS8/Ottawa C109 Sand mixtures at $D_r = 47\%$ at $\sigma'_{v0} = 200$ kPa for (a.) Stress-Strain, (b.) Stress Path, (c.) τ/σ'_{v0} vs. γ , and (d.) τ/σ'_v vs. γ

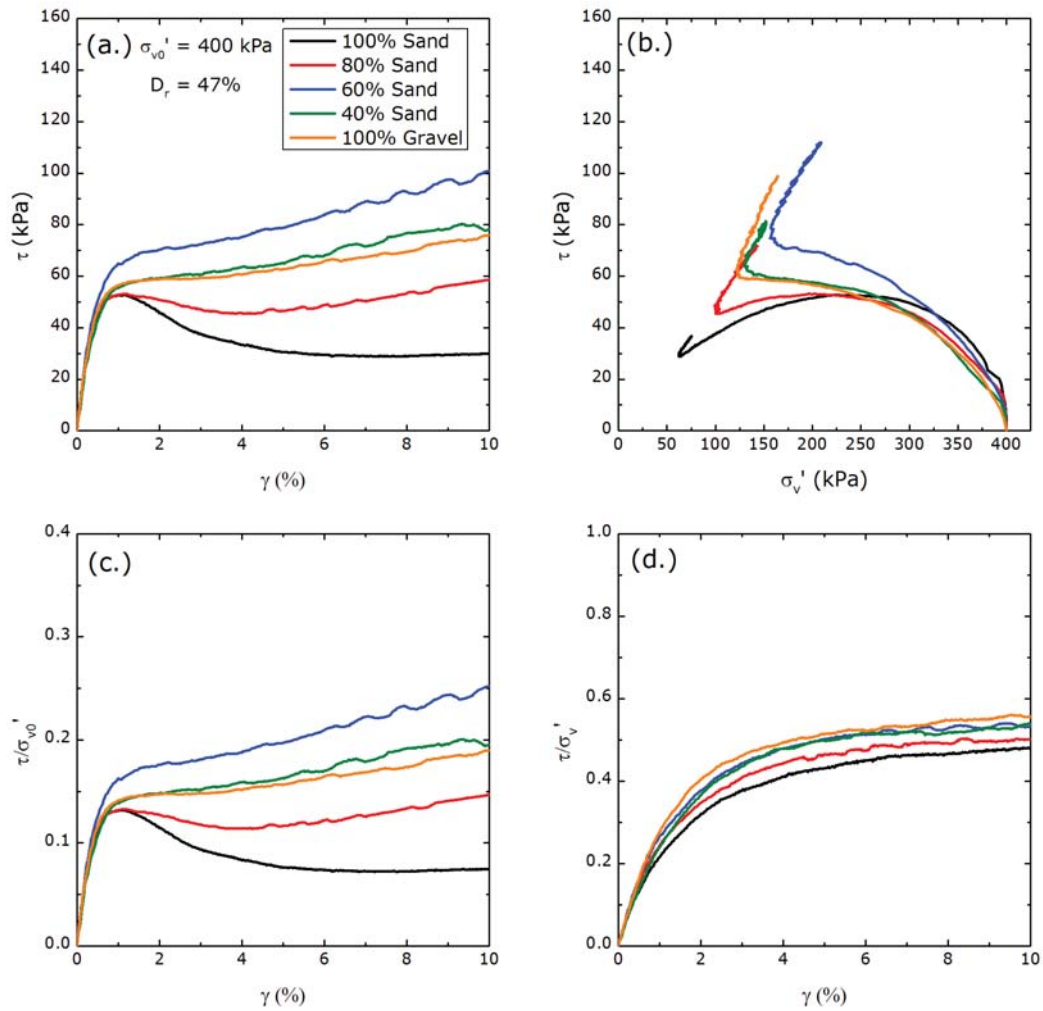

Figure 5.30: Monotonic Constant Volume Simple Shear data (Test ID: M149, M307, M314, M315, M224) for CLS8/Ottawa C109 Sand mixtures at $D_r = 47\%$ at $\sigma'_{v0} = 400$ kPa for (a.) Stress-Strain, (b.) Stress Path, (c.) τ/σ'_{v0} vs. γ , and (d.) τ/σ'_v vs. γ

various mixtures. 40% Sand has the highest peak line while 100% Sand has the lowest peak line. The mixtures of 80% Sand, 60% Sand, and 40% Sand all have lines that fall near or above both 100% Sand and 100% gravel, which shows that when these two uniform materials are mixed peak strength will increase when at $D_r = 47\%$. Figure 5.31b shows that the PT points fall along a very similar line ($\tau/\sigma'_v = 0.47$), which is expected since the 100% Gravel and 100% Sand specimens have similar values to PT friction angle. Similar trends are also seen for the US in Figure 5.31c.

Figure 5.32a plots the values of shear strength and vertical effective stress at the peak for CLS8 mixtures. Lines were drawn on the figure to show the trends for the various mixtures. 60% Sand has the highest peak line while 100% Sand has the lowest peak line. In this case, the 100% CLS8 gravel has different shear response than the 100% Sand (has greater peak line) so different response trends are seen when compared to the Pea Gravel mixtures. For the CLS8 mixtures, the peak line for 80% Sand falls below the 100% Gravel, which was not the case for the Pea Gravel mixtures. There is also a new optimum mixture for the CLS8 mixtures (60% Sand compared to 40% Sand for Pea Gravel mixtures). Figure 5.32b shows that the PT points fall along a very similar line with only slight differences ($\tau/\sigma'_v = 0.53$). There is more scatter among the tests when the US response is evaluated in Figure 5.32c, with 100% Sand specimens having a lower US line compared to 100% Gravel. There is an observed separation of response for the US, with 60% and 40% Sand specimens responding the same as 100% Gravel.

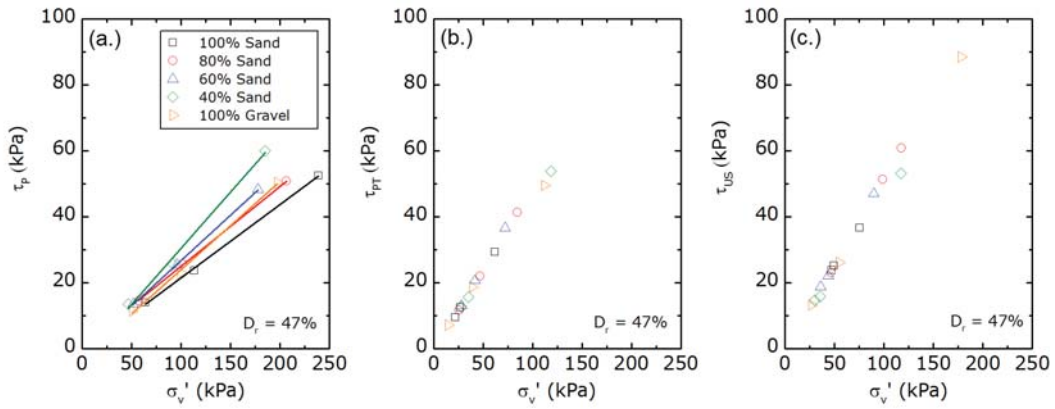

Figure 5.31: Comparison of (a.) Peak, (b.) Phase Transformation and (c.) Ultimate State lines for Pea Gravel/Ottawa C109 Mixtures at $D_r = 47\%$

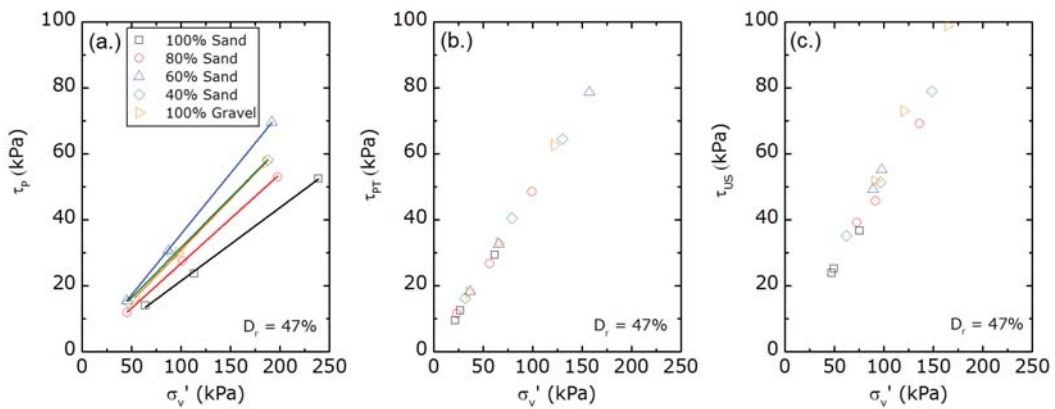

Figure 5.32: Comparison of (a.) Peak, (b.) Phase Transformation and (c.) Ultimate State lines for CLS8/Ottawa C109 Mixtures at $D_r = 47\%$

The shear strength values at Peak, PT, and US are plotted versus the V_S value measured after consolidation and before shearing for Pea Gravel mixtures and CLS8 mixtures in Figures 5.33 and 5.34, respectively. Similar plots were shown for the three uniform gravels in Chapter 4. Figure 5.33 shows that there is very strong correlation of increasing peak shear strength with V_S , a strong trend with increasing PT shear strength, and a fair trend with increasing US shear strength for Pea Gravel mixtures. Scatter within the data increases at shear strain increases; therefore, the relationship between US shear strength and V_S is not as strong as for peak shear strength with V_S (which occurs at 1-2% shear strain). Similar trends were seen for CLS8 mixtures as shown in Figure 5.34, except there was slightly more scatter in the data for the CLS8 mixtures when compared to the Pea Gravel mixtures.

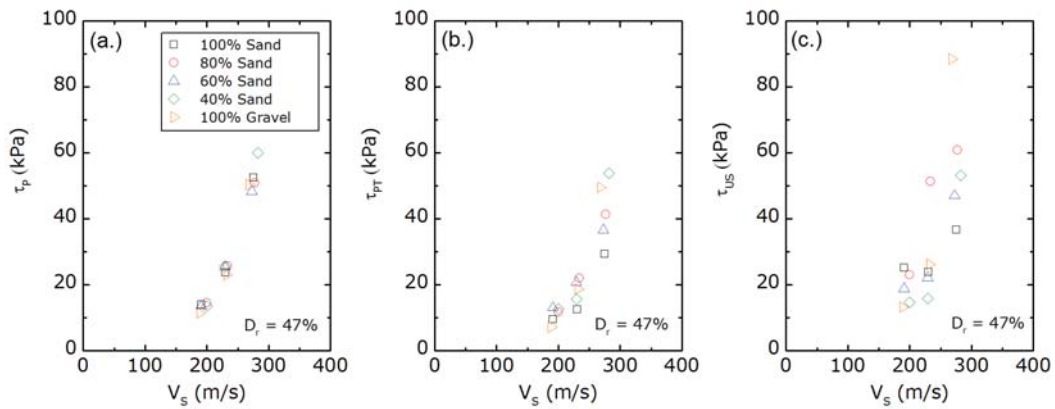

Figure 5.33: (a.) Peak Shear Stress, (b.) Shear Stress at Phase Transformation and (c.) Shear Stress at Ultimate State versus Shear Wave Velocity for Pea Gravel/Ottawa C109 Sand Mixtures

5.5.2.1 Effect of Mixture Percentage and Relative Density

Although the effect of mixture percentage was discussed in the previous section, further comparisons were made for the friction angles at Peak, PT, and US for Pea Gravel and CLS8 mixtures at 100 kPa at $D_r = 47\%$ and $D_r = 87\%$. Figure 5.35 plots the Peak, PT,

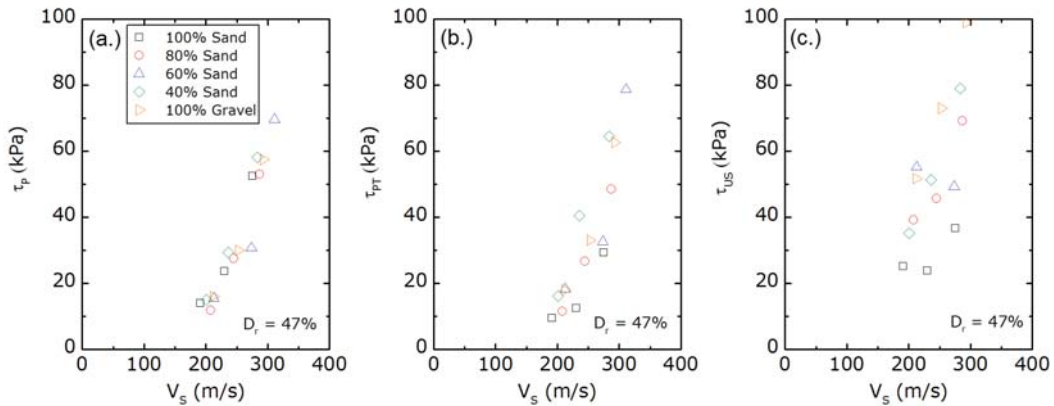

Figure 5.34: (a.) Peak Shear Stress, (b.) Shear Stress at Phase Transformation and (c.) Shear Stress at Ultimate State versus Shear Wave Velocity for CLS8/Ottawa C109 Sand Mixtures

and US friction angles using the interpretation in Equation 4.2 for Pea Gravel/Ottawa C109 Sand mixtures. This plot shows that as relative density increases the peak friction angle increases by a few degrees for every mixture. The peak friction angle increases as gravel is added to the 100% Sand specimen up to a level of 40% Sand. This point is considered the optimum mixture that displays the highest shear strength. After reaching this mixture percentage, the peak friction angle decreases back down to the value at 100% Gravel. The PT friction angle is not affected by relative density for the Pea Gravel mixtures. The PT friction angle increases slightly with the addition of gravel to a 100% Sand specimen, similar to the observation from the peak friction angle; however, this increase is very slight. The US friction angle increases with increasing relative density for mixtures of 80% Sand, 60% Sand, and 40% Sand, while only small changes are seen for 100% Gravel and 100% Sand. The US friction angle for the looser $D_r = 47\%$ specimens is fairly consistent, but increases for the 80% Sand, 60% Sand, and 40% Sand specimens at the denser state ($D_r = 87\%$).

Figure 5.36 plots the Peak, PT, and US friction angles for CLS8/Ottawa C109 Sand

mixtures. The trends observed in the CLS8 mixtures are different than the Pea Gravel mixtures since the CLS8 material has greater strength than Ottawa C109 sand. The peak friction angle increases with increasing relative density for 100% Sand, 80% Sand, and 100% Gravel. As gravel percentage is increased, the peak friction angle increases up to 60% Sand. This point is considered the optimum mixture since it displays the greatest shear strength. After reaching this mixture percentage, the peak friction angle decreases slightly (1-2 degrees) back down to the 100% Gravel value. For Pea Gravel mixtures the difference in peak friction angle between the optimum mixture and the 100% Gravel and 100% Sand was approximately 3 and 6 degrees for $D_r = 47%$, respectively. This difference for CLS8 mixtures at $D_r = 47%$ was approximately 8 degrees between the optimum mixture and 100% Sand and approximately 2 degrees between the optimum mixture and 100% Gravel. The PT is not affected by relative density except for the change at 60% Sand, which is the optimum mixture. This response was also observed for the Pea Gravel mixtures where PT friction angle was only affected by relative density at the optimum mixture. PT friction angle of CLS8 mixtures increased to the value of 100% Gravel for all gravel mixtures, even 80% Sand. The US friction angle of gravels was shown to increase for angular CLS materials in Chapter 4. This behavior was also observed for the 60% Sand mixture, showing that the gravel portion of the mixture is controlling the US response at this mixture. The US friction angle increased with increasing gravel content up to 60% Sand, at which point it reached approximately the same value at the 100% Gravel.

5.5.2.2 Effect of Initial Vertical Stress

Figures 5.37 and 5.38 plot the Peak, PT, and US friction angles versus percent sand for initial vertical stresses of 100, 200, and 400 kPa. Figure 5.37 shows that there is no discernible effect of initial vertical stress on Peak, PT, or US friction angles for Pea Gravel/Ottawa C109 Sand mixtures at $D_r = 47%$. There is a slight increase in peak friction angle for 100% Pea Gravel as initial vertical stress increases from 100 to 400 kPa.

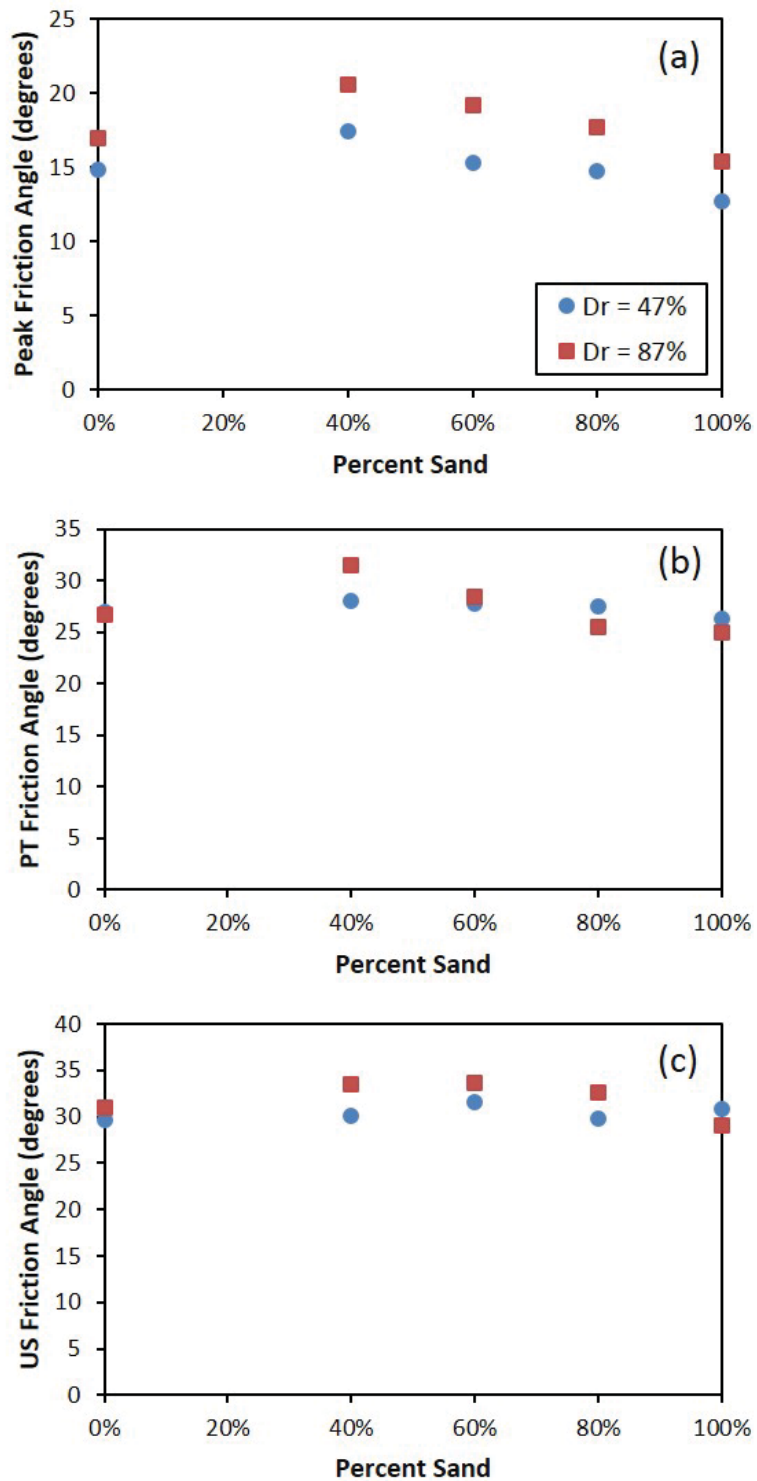

Figure 5.35: Friction Angle Comparison at Peak, Phase Transformation and Ultimate State as a function of Mixture Percentage for Ottawa C109 Sand and Pea Gravel at loose and dense states

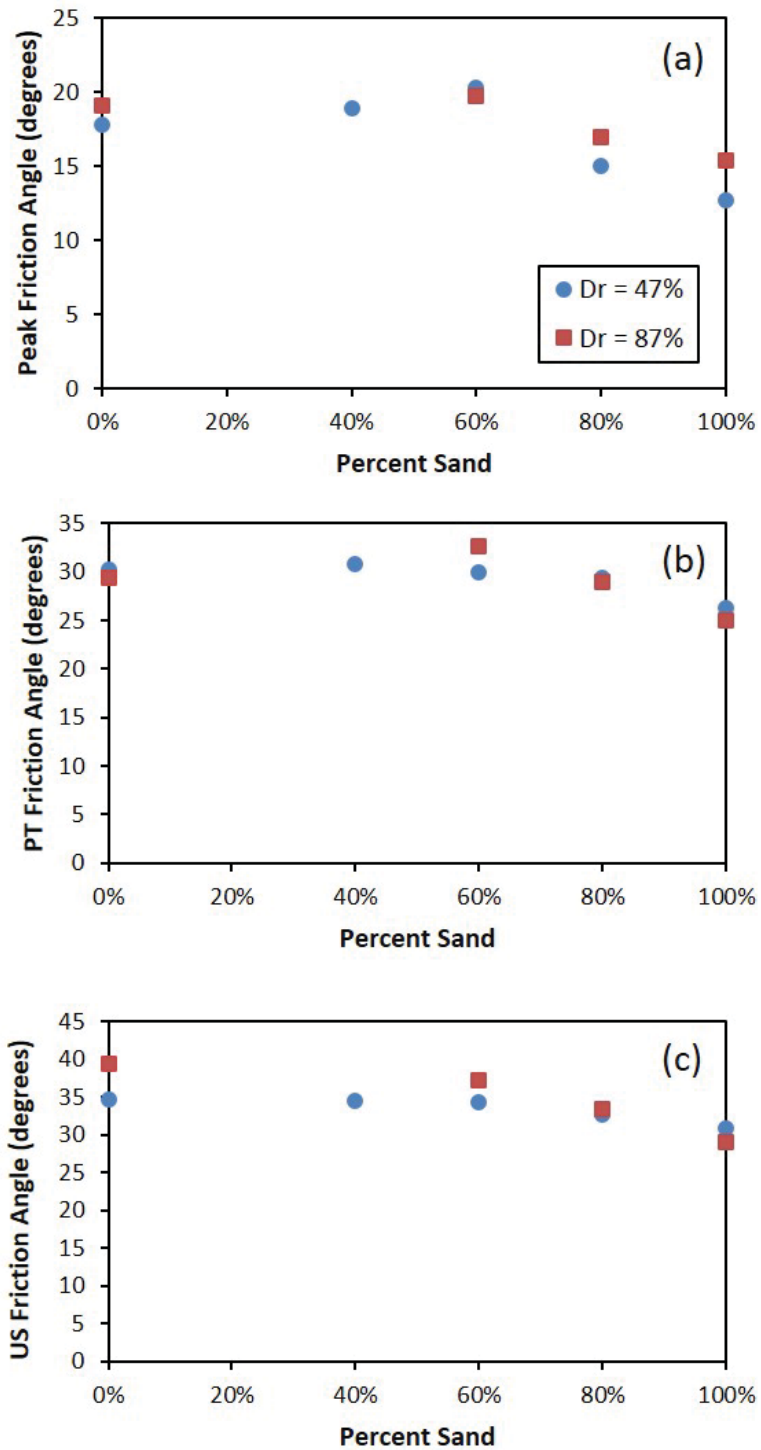

Figure 5.36: Friction Angle Comparison at Peak, Phase Transformation and Ultimate State as a function of Mixture Percentage for Ottawa C109 Sand and CLS8 at loose and dense states

Figure 5.38 shows that there is also no effect of initial vertical stress on Peak, PT, or US friction angles for CLS8/Ottawa C109 Sand mixtures at $D_r = 47\%$.

5.5.2.3 Comparison of Void Ratio

Up to this point, data has been presented using the relative density of the mixture based on the maximum and minimum densities that were determined as described in this chapter. This relative density can be considered the global relative density, as it accounts for the entire mixture of sand and gravel in the specimen. *Evans and Zhou (1995)* referred to this overall relative density as the composite relative density of the specimen. This relative density can also be converted to a global void ratio value from knowing the specific gravity of the mixing materials. The void ratios of the sand skeleton and gravel skeleton can also be defined using the intergrain state framework (*Chang et al., 2014*). A similar framework has been used for sand and silt mixtures (*Thevanayagam, 1998*), where the intergranular and interfine void ratio were defined for sand and silt mixtures. The intergranular void ratio represents the case where the fine grained material is within the void space of the sand and does not actively participate in the transfer of contact forces between the sand grains (*Thevanayagam, 1998*). The interfine void ratio represents the case where the coarser grained sand floats within the finer material, and therefore the coarser grained soil is not contributing to the force chain. *Yang et al. (2015)*, studied the use of global and skeleton void ratio for the means of characterizing the stress-strain behavior of sand-silt mixtures and concluded that the equivalent skeleton void ratio (i.e intergranular void ratio) does not universally provide a means of characterizing stress-strain behavior. This is due to the complex nature of the intergranular contacts. *Yang et al. (2015)* concludes that the global void ratio remains a useful state variable for characterizing stress-strain behavior. Although it is recognized that the stress-strain response of sand-silt mixtures and gravel mixtures is complex, the alternative skeleton void ratios offer an interesting method for interpreting material response and therefore were evaluated in this study. In the interpretation

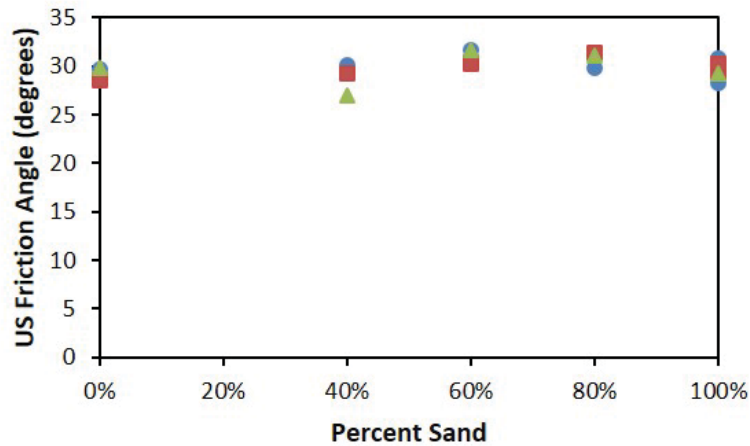
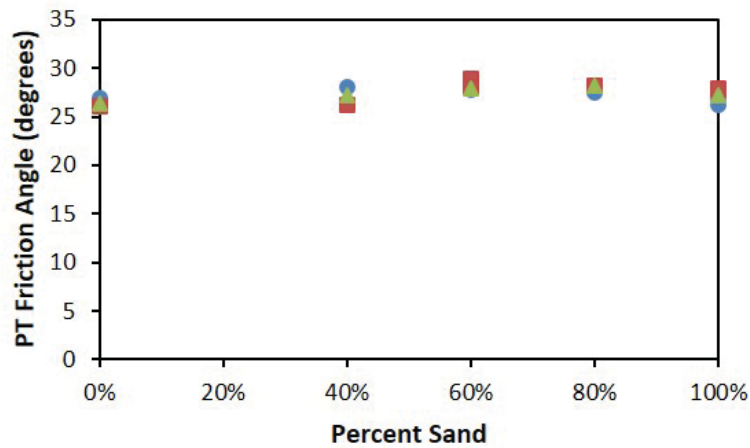
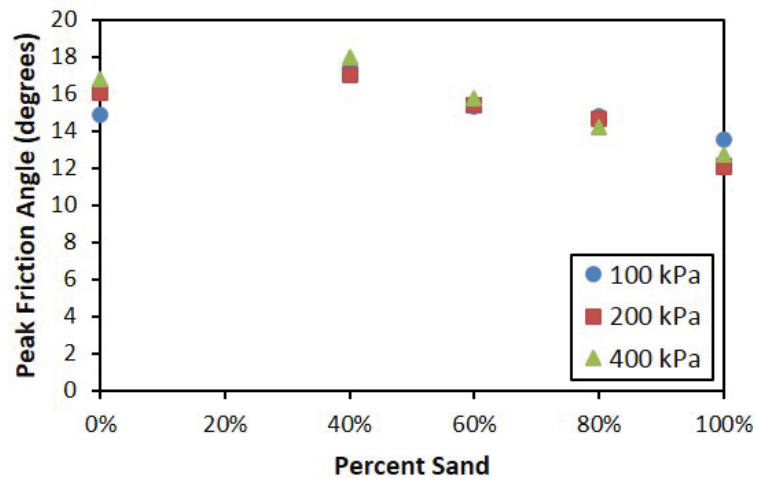

Figure 5.37: Friction Angle Comparison at Peak, Phase Transformation and Ultimate State as a function of Mixture Percentage for Ottawa C109 Sand and CLS8 at initial vertical stress = 100, 200, and 400 kPa for $D_r = 47\%$

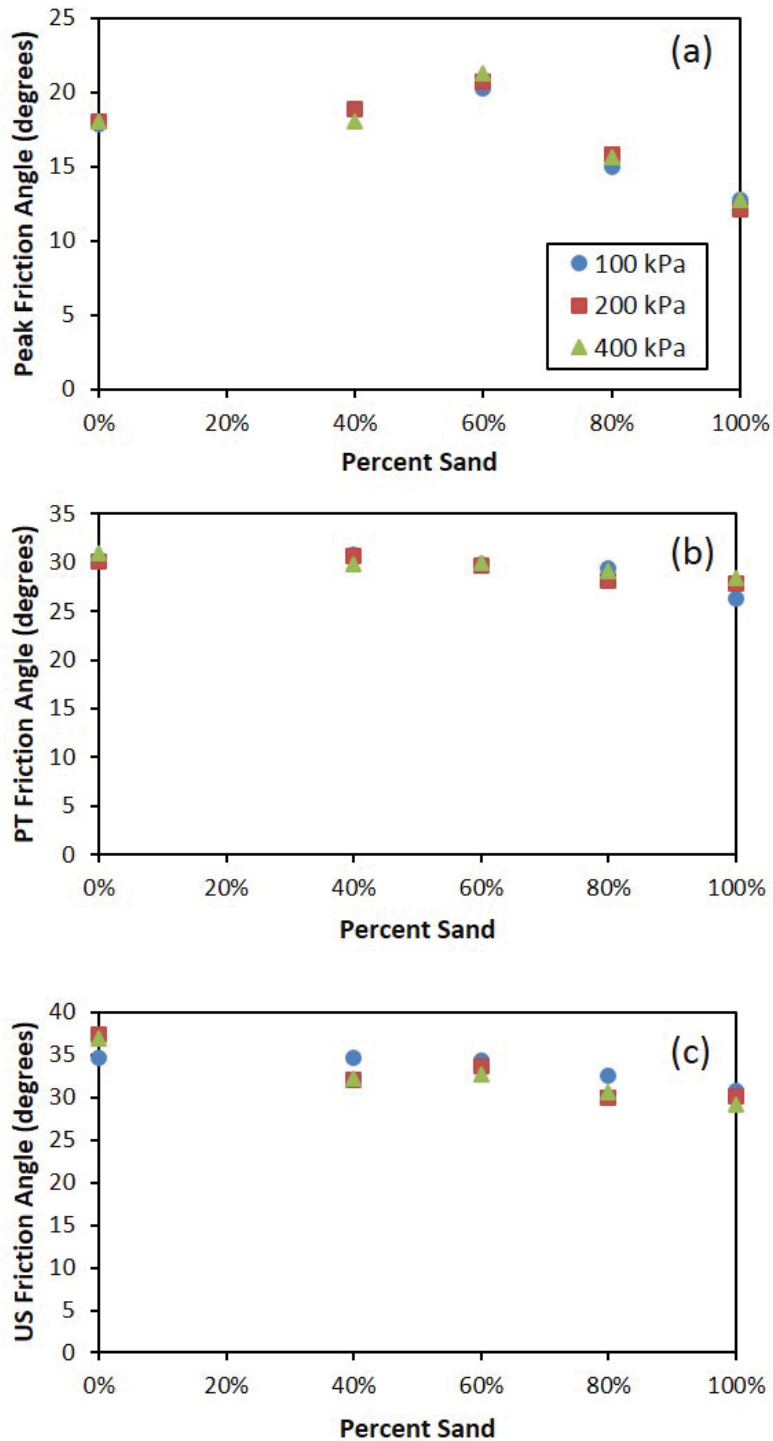

Figure 5.38: Friction Angle Comparison at Peak, Phase Transformation and Ultimate State as a function of Mixture Percentage for Ottawa C109 Sand and CLS8 at initial vertical stress = 100, 200, and 400 kPa for $D_r = 47\%$

for gravelly soils, the sand skeleton void ratio represents the case where the gravel is not contributing to the force chain and the gravel skeleton void ratio represents the case where the sand is within the void space of the gravel and not contributing to the force chain. The sand skeleton void ratio can be defined as:

$$e_{sk} = \frac{e}{1 - GC} \quad (5.5)$$

Where e is the global void ratio and GC is the gravel content in percent.

The gravel skeleton void ratio can be defined as:

$$e_{gk} = \frac{e + (1 - GC)}{GC} \quad (5.6)$$

The usefulness of using global, sand skeleton, and gravel skeleton void ratios for characterization of material response of gravel-sand mixtures was examined in Figures 5.39 and 5.40. Figure 5.39 plots shear strength at Peak and PT for loose ($D_r = 47\%$) and dense ($D_r = 87\%$) specimens of Pea Gravel/Ottawa C109 Sand mixtures versus global, sand skeleton, and gravel skeleton void ratios. Peak shear strength is shown to correlate well with global void ratio. As global void ratio decreases, the peak shear strength increases linearly. Peak shear strength shows an increase with increasing sand skeleton void ratio, which shows the contribution of the gravel particles to the shear strength, even at low percentages of gravel. The correlation between peak shear strength and sand skeleton void ratio is not as strong as with global void ratio. For the gravel skeleton void ratio, peak shear strength is at a maximum at a gravel skeleton void ratio of approximately 1.2, which corresponds to the 40% Sand mixture which was shown to be the optimum mixture. As gravel skeleton void ratio increases, the peak shear strength decreases. Similar response was seen for PT shear strength when compared using the different void ratios. Global void ratio appears to capture the overall material response better than the sand or gravel skeleton void ratios. However, use of the sand and gravel skeleton void ratios can be useful for identifying percentages at

which gravel and sand contribute to material response.

Figure 5.40 plots shear strength at Peak and PT for loose ($D_r = 47\%$) and dense ($D_r = 87\%$) specimens of CLS8/Ottawa C109 Sand mixtures versus global, sand skeleton, and gravel skeleton void ratio. In this case peak shear strength does not show a strong trend with global void ratio as was seen for the Pea Gravel mixtures, which demonstrates the complexity of using one parameter to characterize mixtures that utilize different mixing materials that have different properties (e.g. angularity). Peak and PT shear strength did not show clearly identifiable trends with any of the void ratios for the CLS8 mixtures.

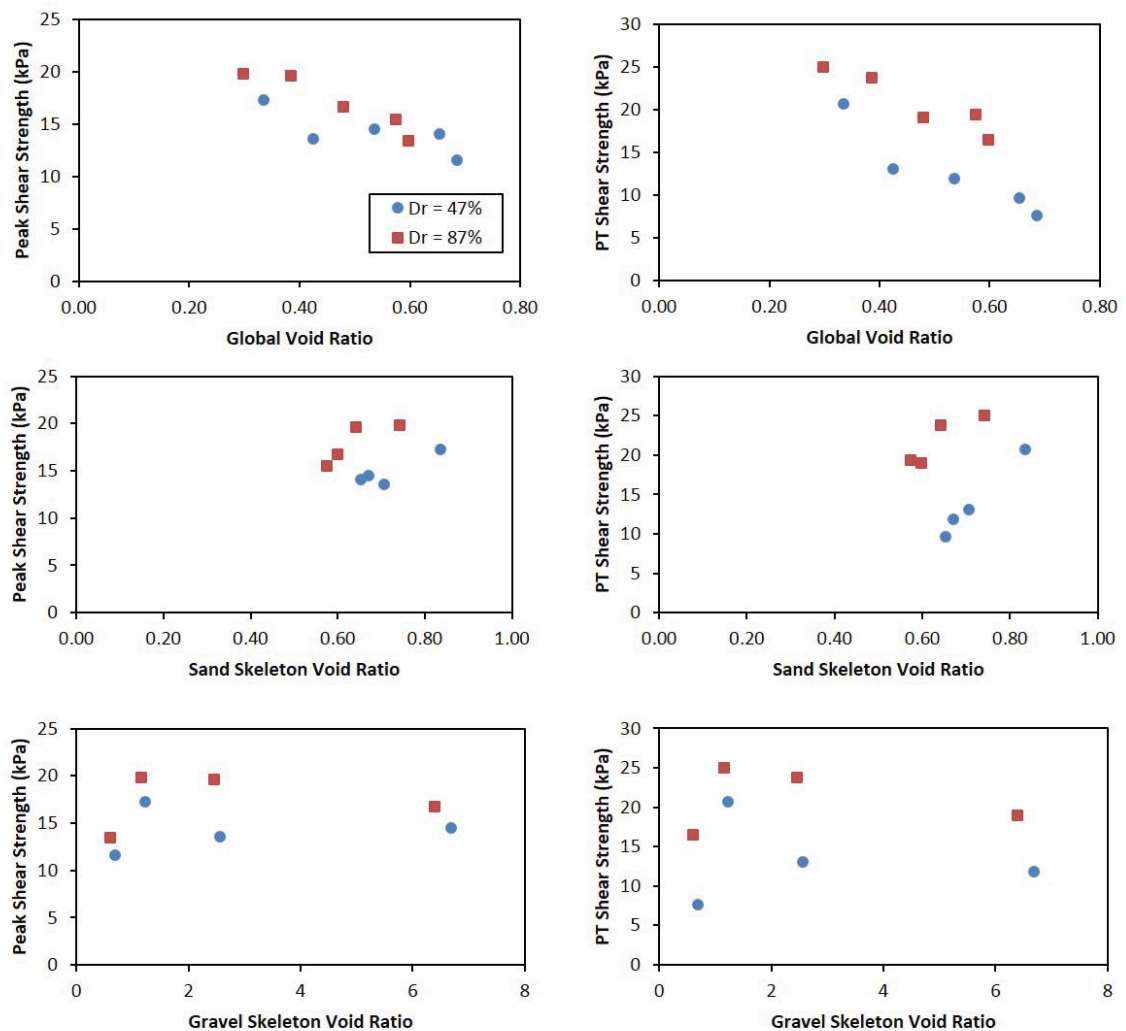

Figure 5.39: Peak and PT shear strengths at global void ratio, sand skeleton void ratio, and gravel skeleton void ratio for loose and dense mixtures of Ottawa C109 Sand and Pea Gravel

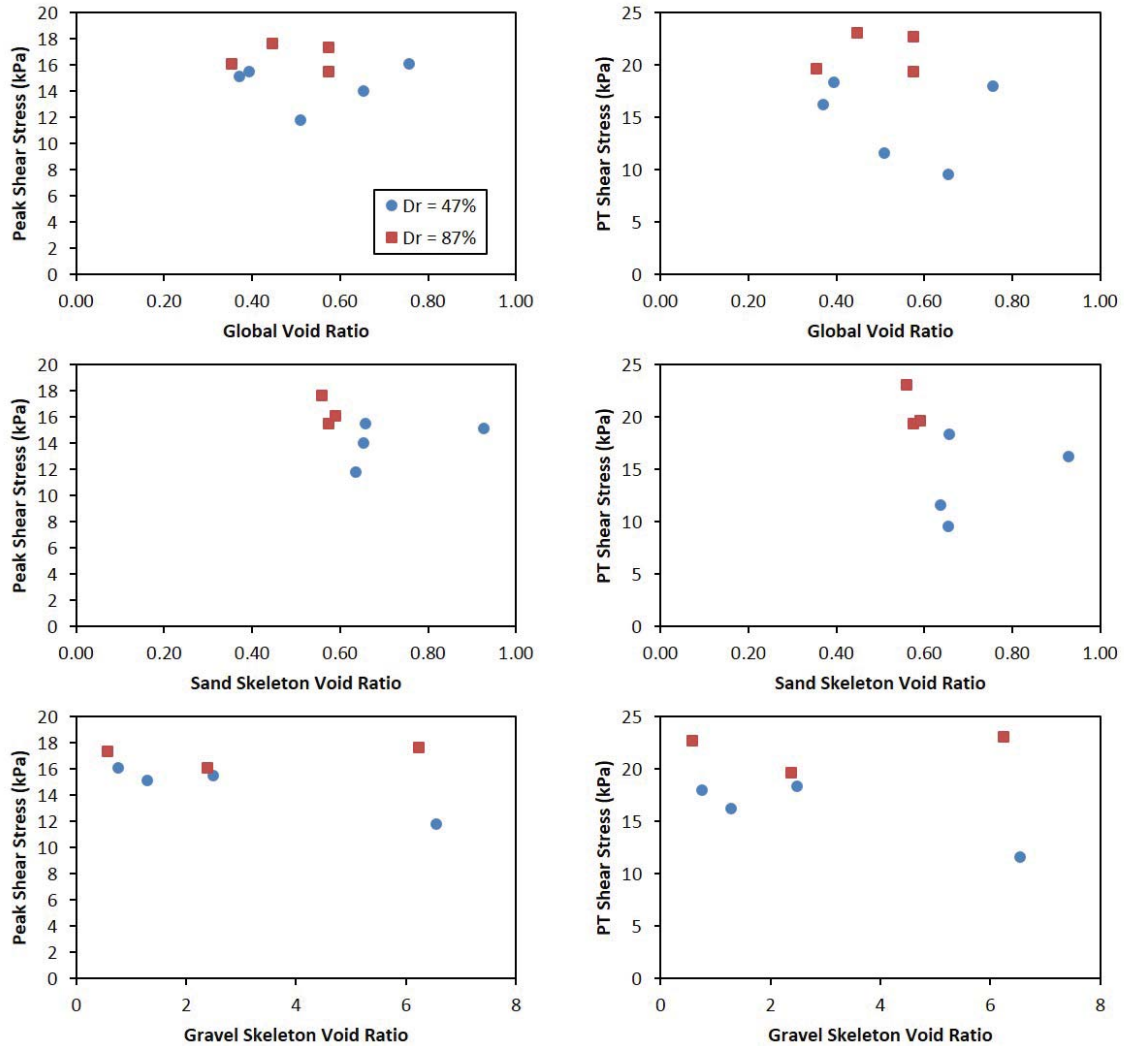

Figure 5.40: Peak and PT shear strengths at global void ratio, sand skeleton void ratio, and gravel skeleton void ratio for loose and dense mixtures of Ottawa C109 Sand and CLS8

For comparison, global, sand skeleton, and gravel skeleton void ratios were also plotted versus V_S for loose ($D_r = 47\%$) and dense ($D_r = 87\%$) specimens of Pea Gravel/Ottawa C109 Sand (Figure 5.42) and CLS8/Ottawa C109 Sand (Figure 5.42) mixtures. Figure 5.42 shows the V_S decreases linearly as global void ratio decreases and that V_S generally increases as sand skeleton void ratio increases for Pea Gravel mixtures. V_S reaches a maximum point for the gravel skeleton void ratio for the 40% Sand specimen, which is the optimum mixture. These trends match the trends observed for peak shear strength and the different void ratios for Pea Gravel mixtures. Figure 5.42 shows that V_S stays approximately

the same or increases slightly as global void ratio decreases for CLS8 mixtures. As sand skeleton void ratio decreases the V_S increases. V_S also stays approximately the same for loose specimens and increases for dense specimens as gravel skeleton void ratio increases. These trends are different than the ones observed for peak shear strength and various void ratios for CLS8 mixtures.

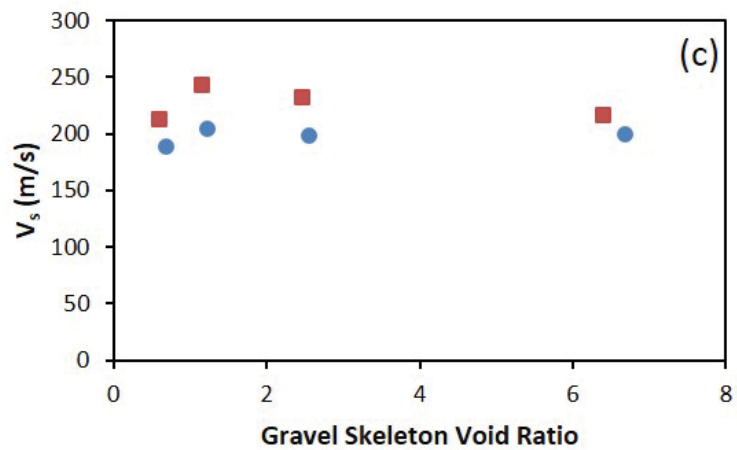
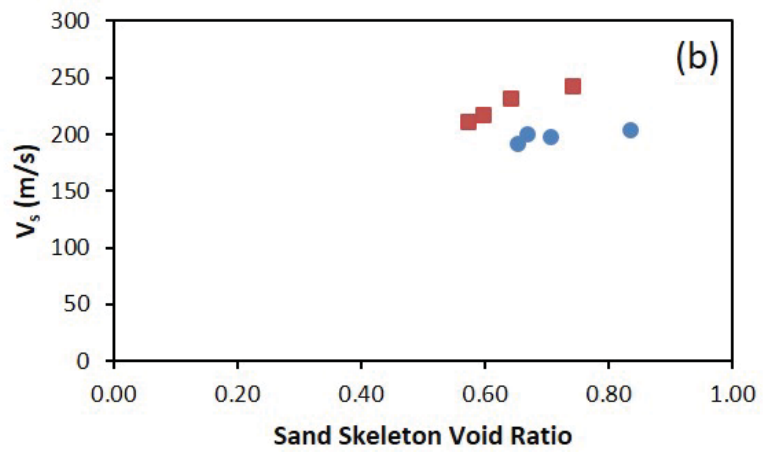
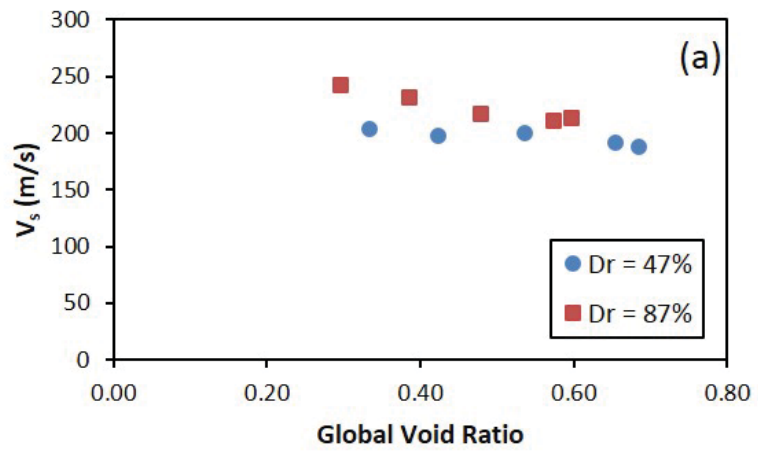

Figure 5.41: Shear Wave Velocity as a function of global void ratio, sand skeleton void ratio, and gravel skeleton void ratio for loose and dense mixtures of Ottawa C109 Sand and Pea Gravel

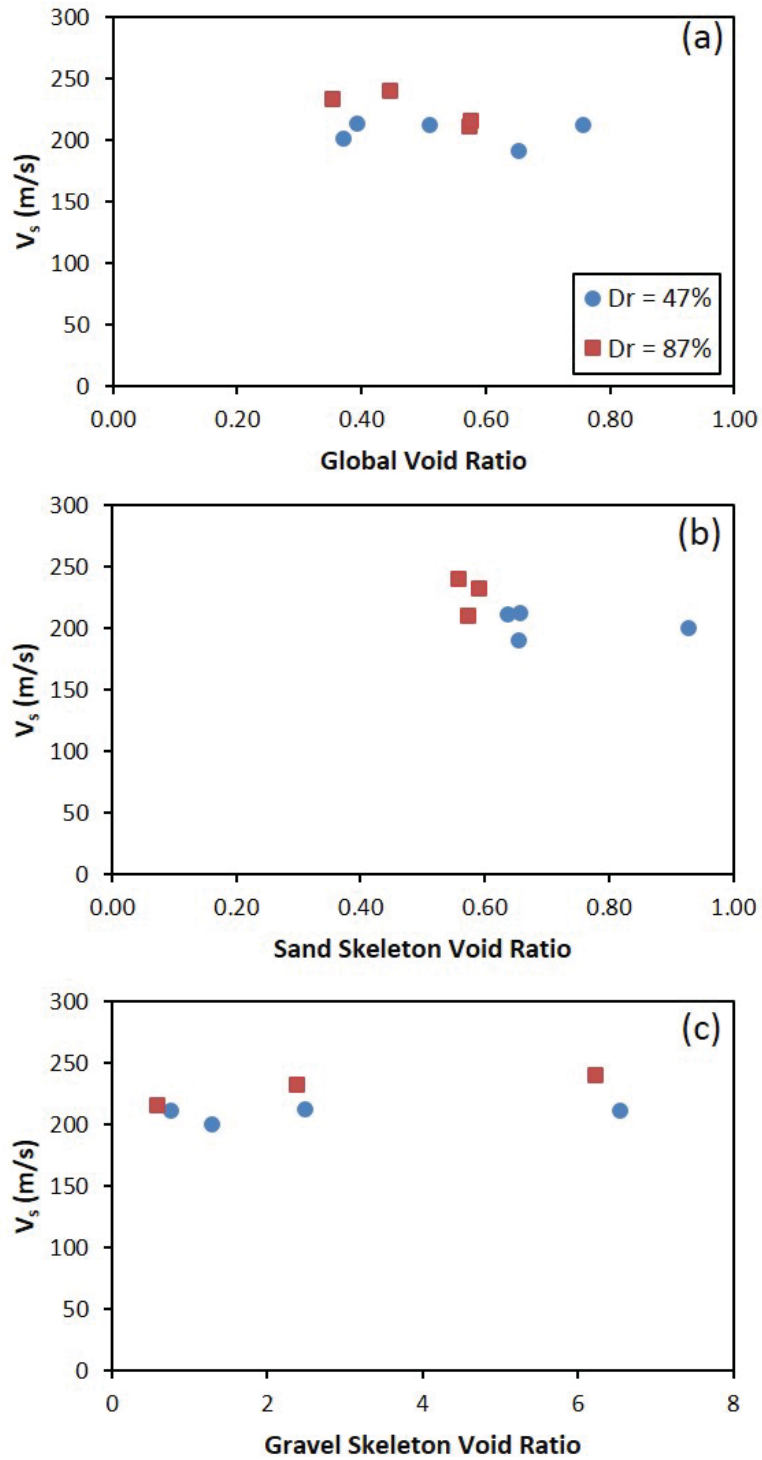

Figure 5.42: Shear Wave Velocity as a function of global void ratio, sand skeleton void ratio, and gravel skeleton void ratio for loose and dense mixtures of Ottawa C109 Sand and CLS8

5.5.2.4 Correlation of Shear Strength with Shear Wave Velocity

Correlations of shear strength with V_S were presented in Chapter 4 for uniform gravels and are explored in this section for Pea Gravel mixtures, CLS8 mixtures, and gravelly soils (combining uniform gravels and sand-gravel mixtures in this study). Power functions of the form in Equation 4.3 were fit to the data and parameters a and b were evaluated.

Figures 5.43, 5.44, and 5.45 plot Peak, PT, and US shear strength versus V_S measured after consolidation and before shearing for Pea Gravel mixtures. Table 5.9 reports the values of the a and b fitting parameters as well as the R^2 for Peak and PT shear strength. Similar results were observed when compared to the uniform gravels, with Pea Gravel mixtures exhibiting more scatter at PT and US than the uniform gravels. There was significant scatter at the US and therefore a power line fit was not included.

Table 5.9: Equation Parameters for Pea Gravel Mixtures

	Pea Gravel Mixtures		
Parameter	a	b	R^2
Peak	6.41E-10	4.47	0.95
PT	8.16E-09	3.98	0.83

Figures 5.46, 5.47, and 5.48 plot Peak, PT, and US shear strength versus V_S measured after consolidation and before shearing for CLS8 mixtures. Table 5.10 reports the values of the a and b fitting parameters as well as the R^2 for Peak and PT shear strength. Similar results were observed when compared to the Pea Gravel mixtures, with CLS8 mixtures have a stronger (but still weak) correlation for the US. Again, a line was shown for the US fit due to weak correlation.

Table 5.10: Equation Parameters for CLS8 Mixtures

	CLS8 Mixtures		
Parameter	a	b	R^2
Peak	6.55E-09	4.03	0.92
PT	4.57E-09	4.10	0.84

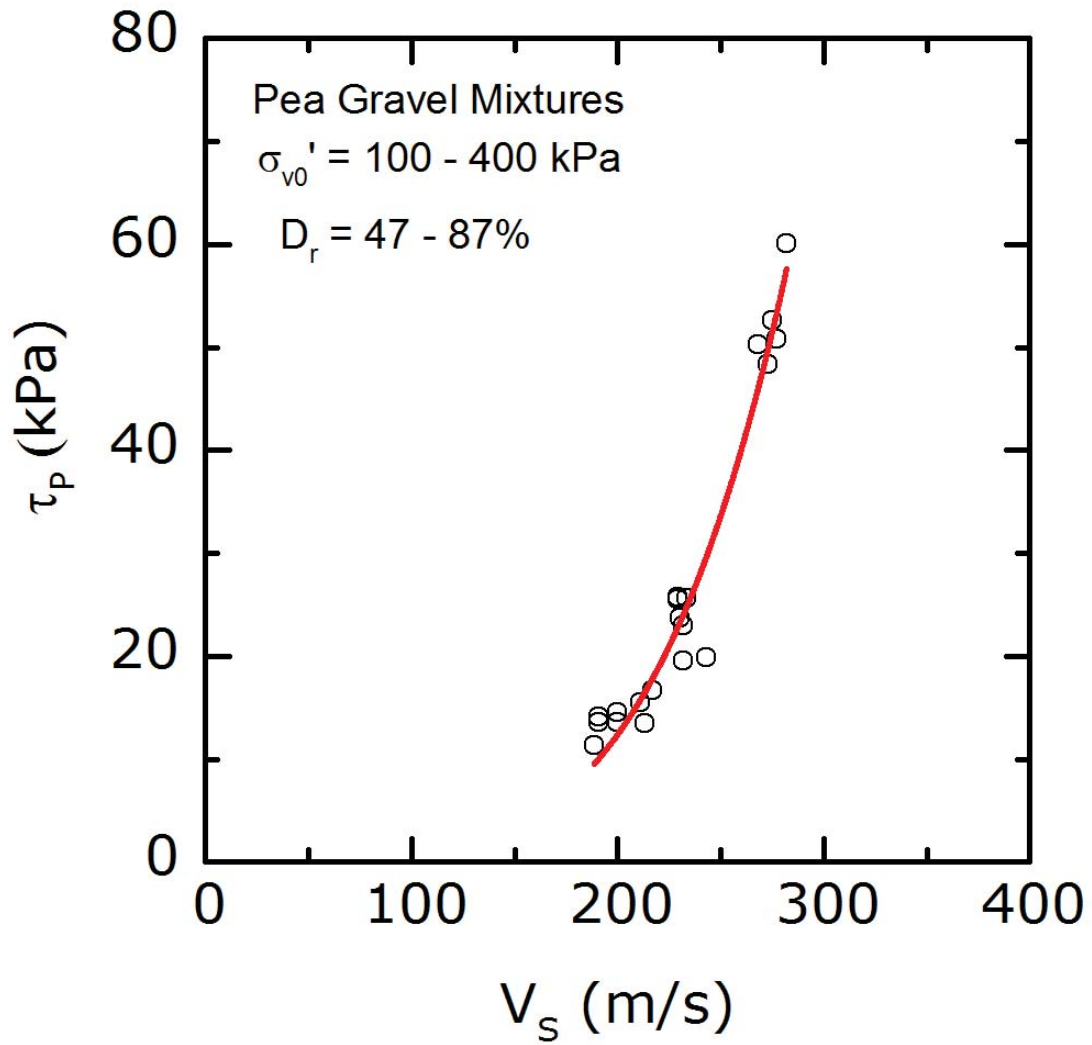

Figure 5.43: Peak Shear Strength versus Shear Wave Velocity for mixtures for Pea Gravel/Ottawa C109 Sand Mixtures

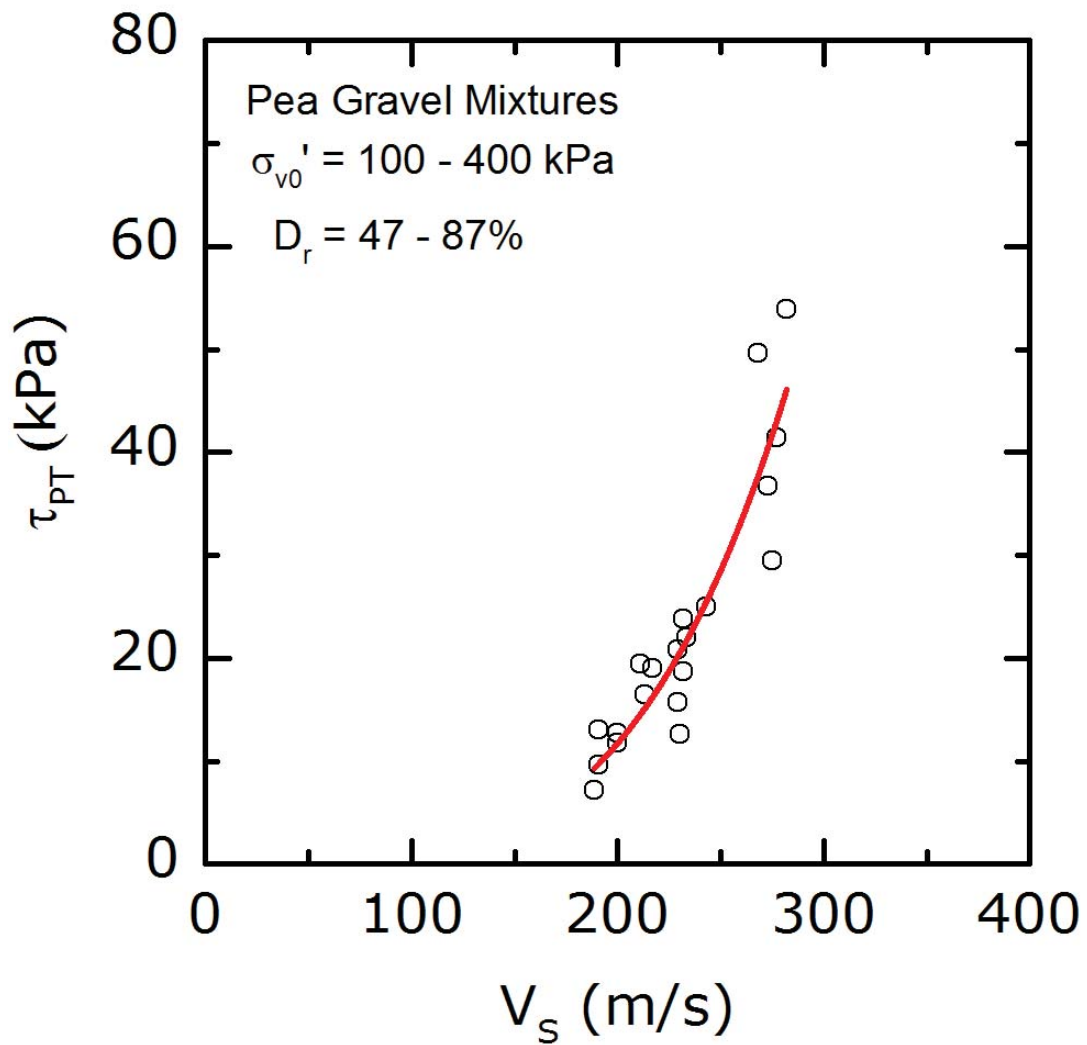

Figure 5.44: Phase Transformation Shear Strength versus Shear Wave Velocity for mixtures for Pea Gravel/Ottawa C109 Sand Mixtures

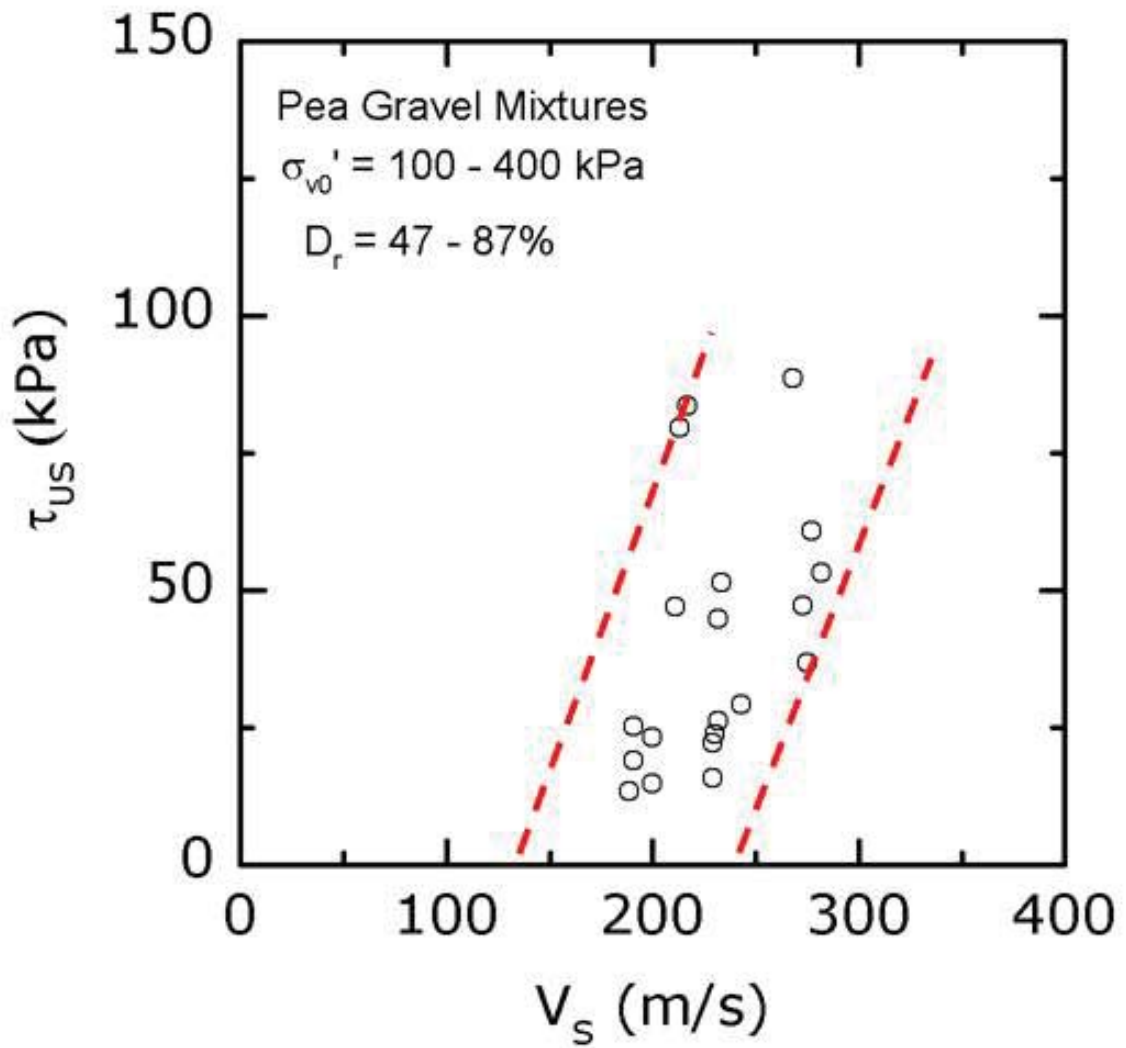

Figure 5.45: Ultimate State Shear Strength versus Shear Wave Velocity for mixtures for Pea Gravel/Ottawa C109 Sand Mixtures

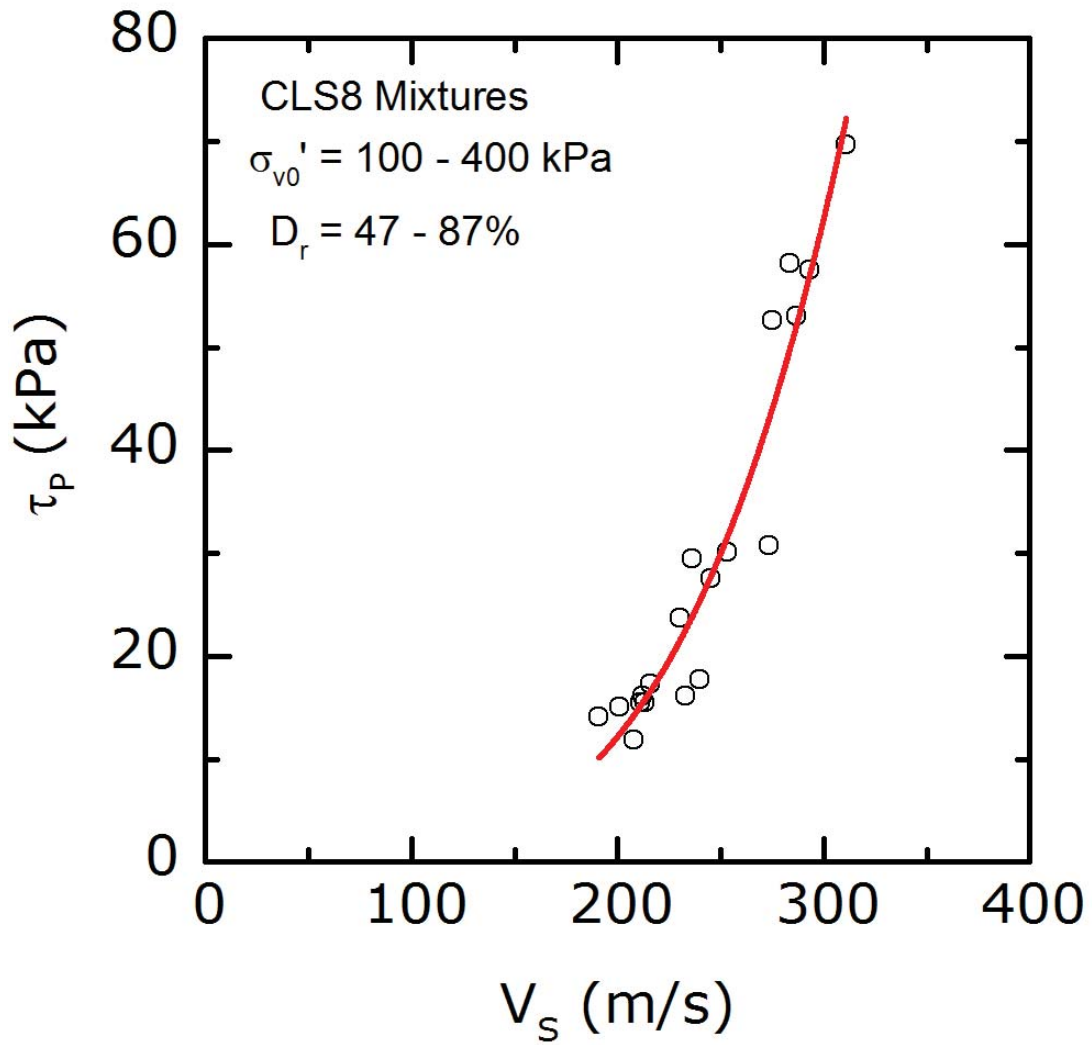

Figure 5.46: Peak Shear Strength versus Shear Wave Velocity for mixtures for CLS8/Ottawa C109 Sand Mixtures

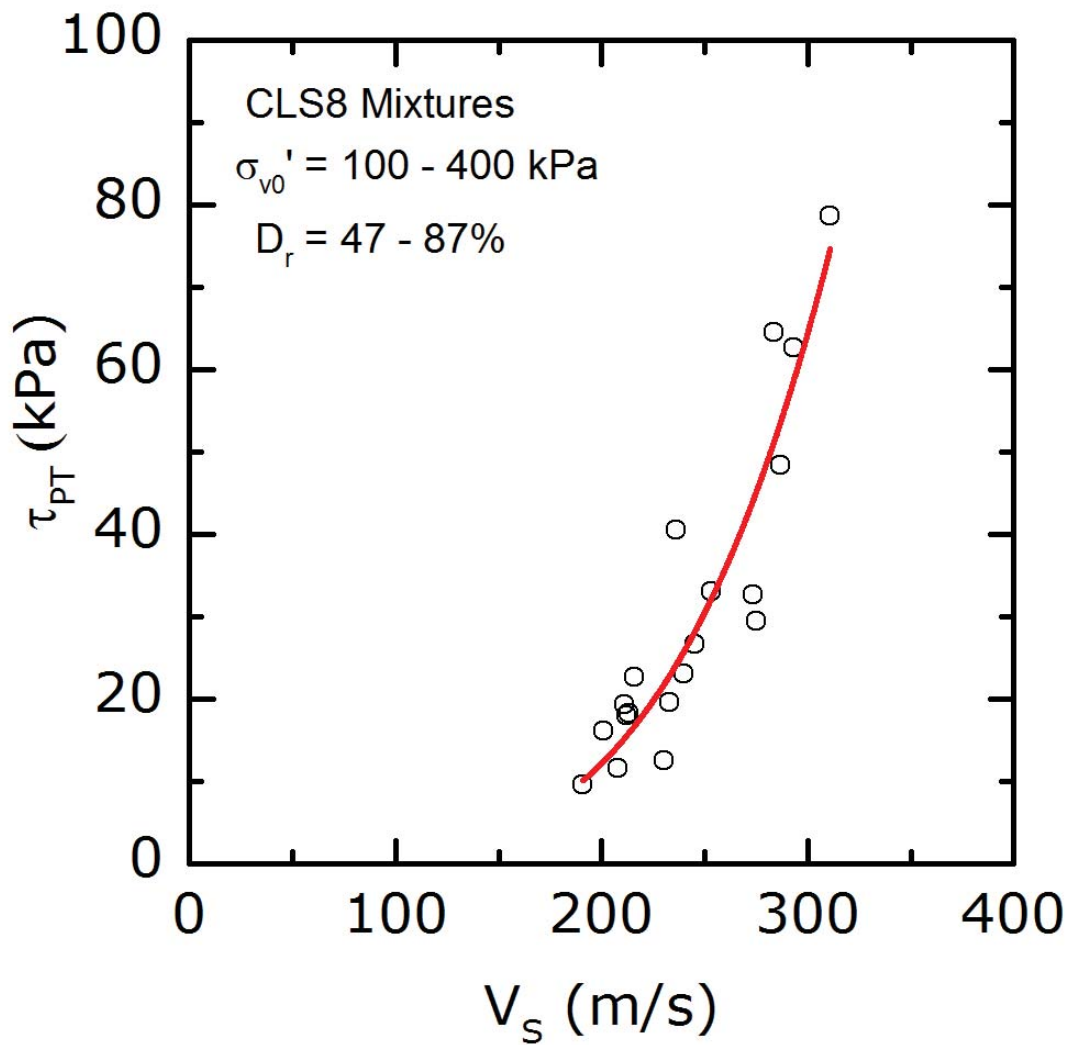

Figure 5.47: Phase Transformation Shear Strength versus Shear Wave Velocity for mixtures for CLS8/Ottawa C109 Sand Mixtures

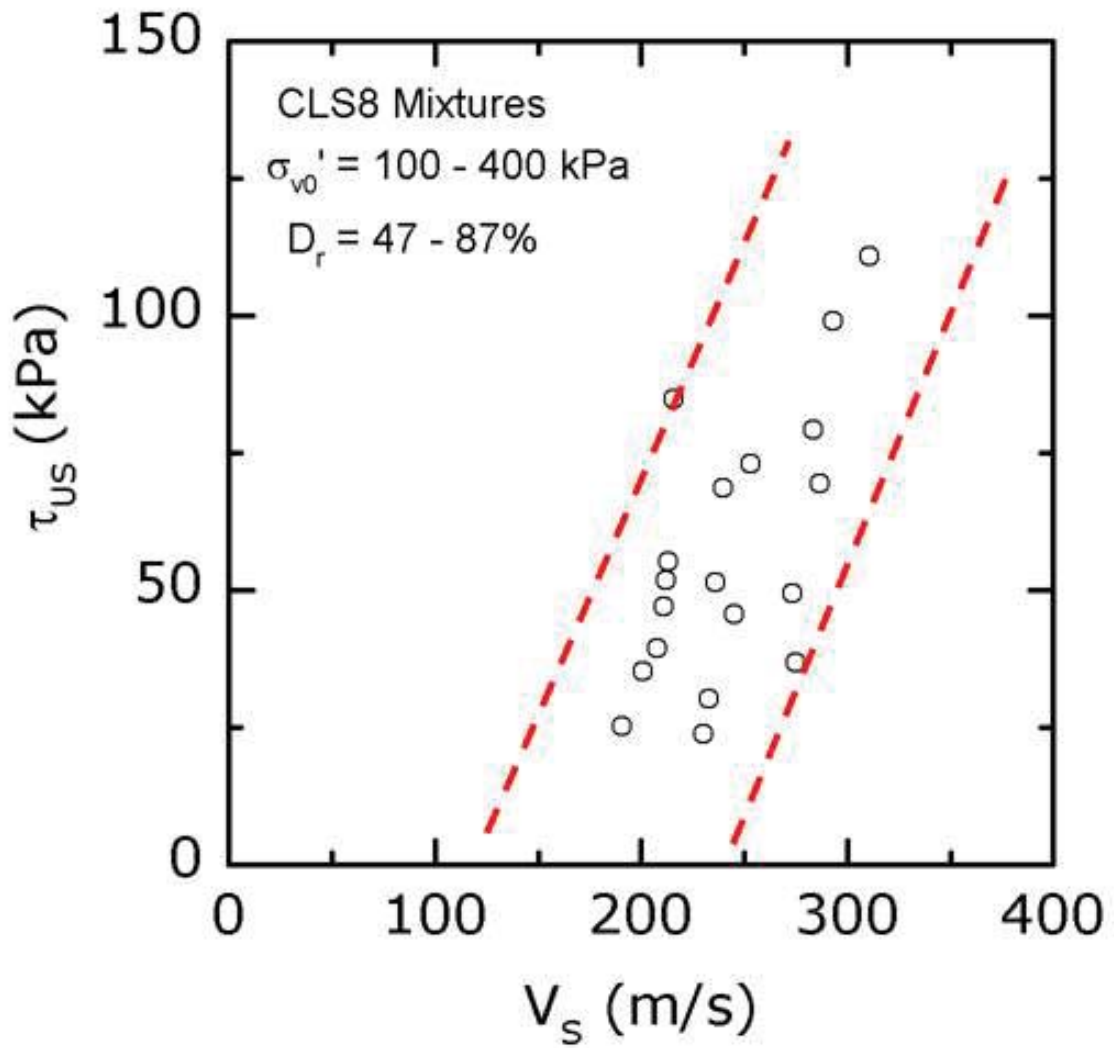

Figure 5.48: Ultimate State Shear Strength versus Shear Wave Velocity for mixtures for CLS8/Ottawa C109 Sand Mixtures

Figures 5.49, 5.50, and 5.51 plot Peak, PT, and US shear strength versus V_S measured after consolidation and before shearing for all gravelly soils tested in this study. Table 5.11 reports the values of the a and b fitting parameters as well as the R^2 for Peak and PT shear strength. Overall, Peak and PT show good correlation with V_S (R^2 values of 0.94 and 0.89, respectively). US shear strength and V_S exhibits more scatter in data and therefore a power fit line was not included. Equations 5.7 and 5.8 are equations that can be used to predict Peak and PT shear strength using V_S for gravelly soils. These shear strengths are undrained shear strengths from monotonic simple shear tests.

$$\tau_p = (7.29 \times 10^{-9}) * (V_S)^{4.02} \quad (5.7)$$

$$\tau_{PT} = (1.28 \times 10^{-9}) * (V_S)^{4.33} \quad (5.8)$$

Table 5.11: Equation Parameters for all Gravelly Soils in this study

	All Gravelly Soils		
Parameter	a	b	R^2
Peak	7.29E-09	4.02	0.94
PT	1.28E-09	4.33	0.89

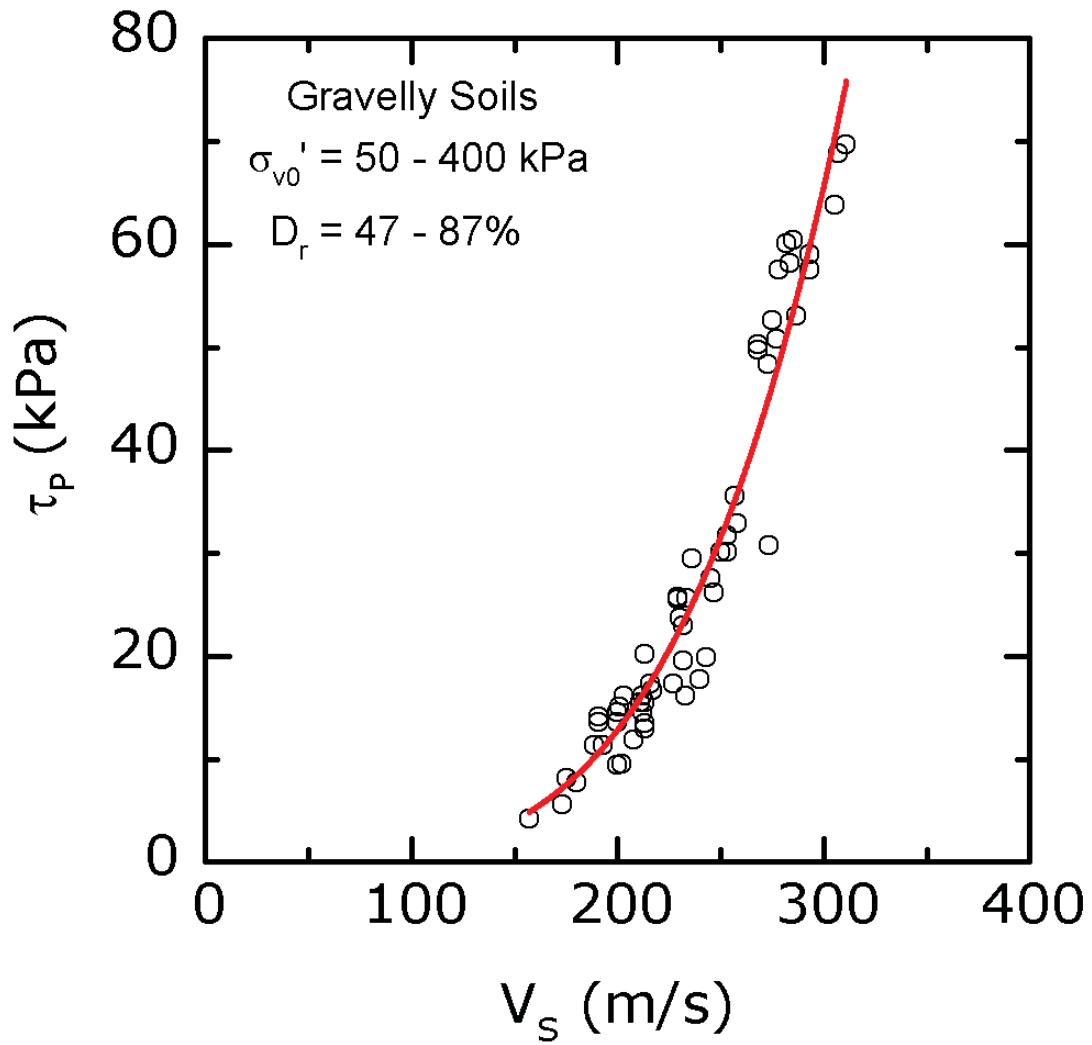

Figure 5.49: Peak Shear Strength versus Shear Wave Velocity for mixtures for Uniform Gravels and Gravel/Sand Mixtures

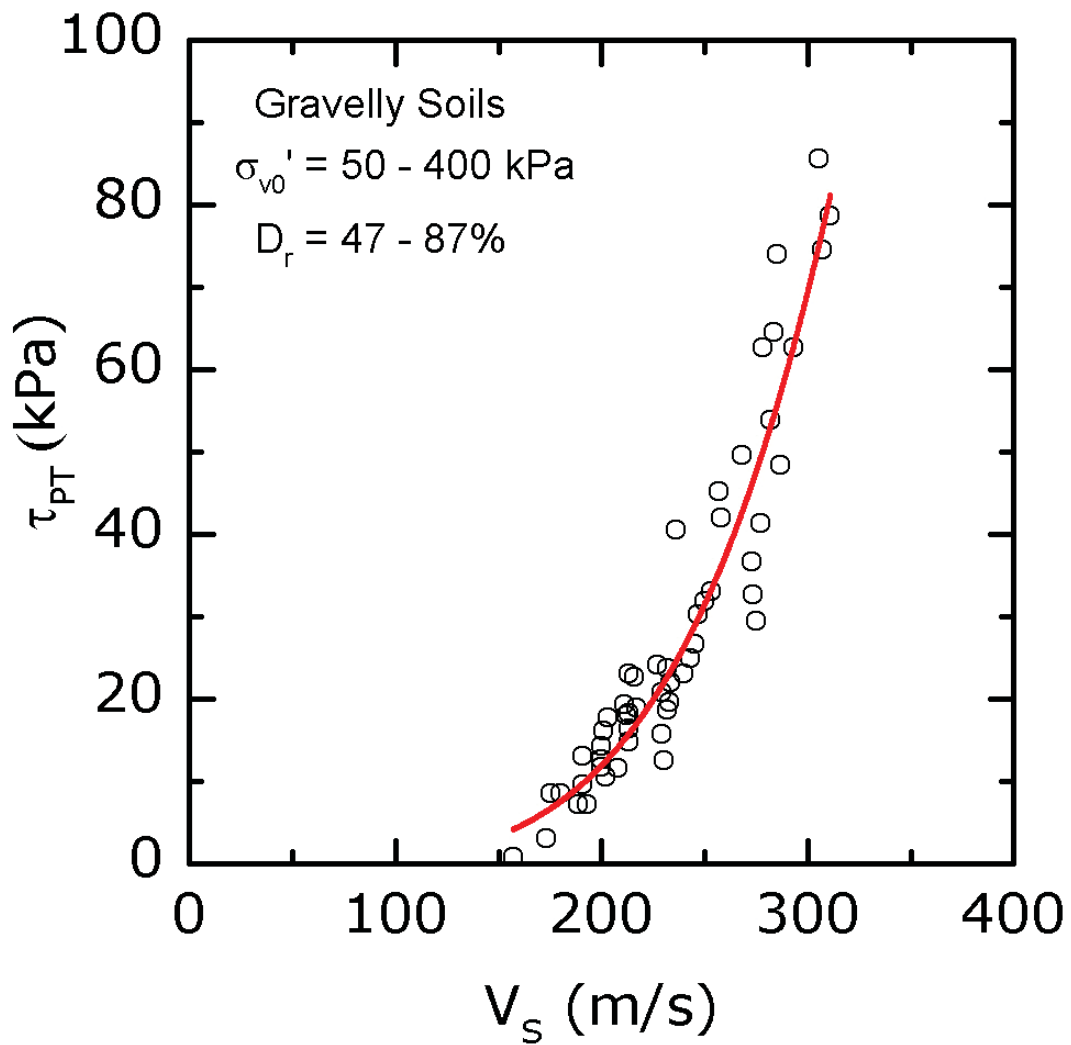

Figure 5.50: Phase Transformation Shear Strength versus Shear Wave Velocity for mixtures for Uniform Gravels and Gravel/Sand Mixtures

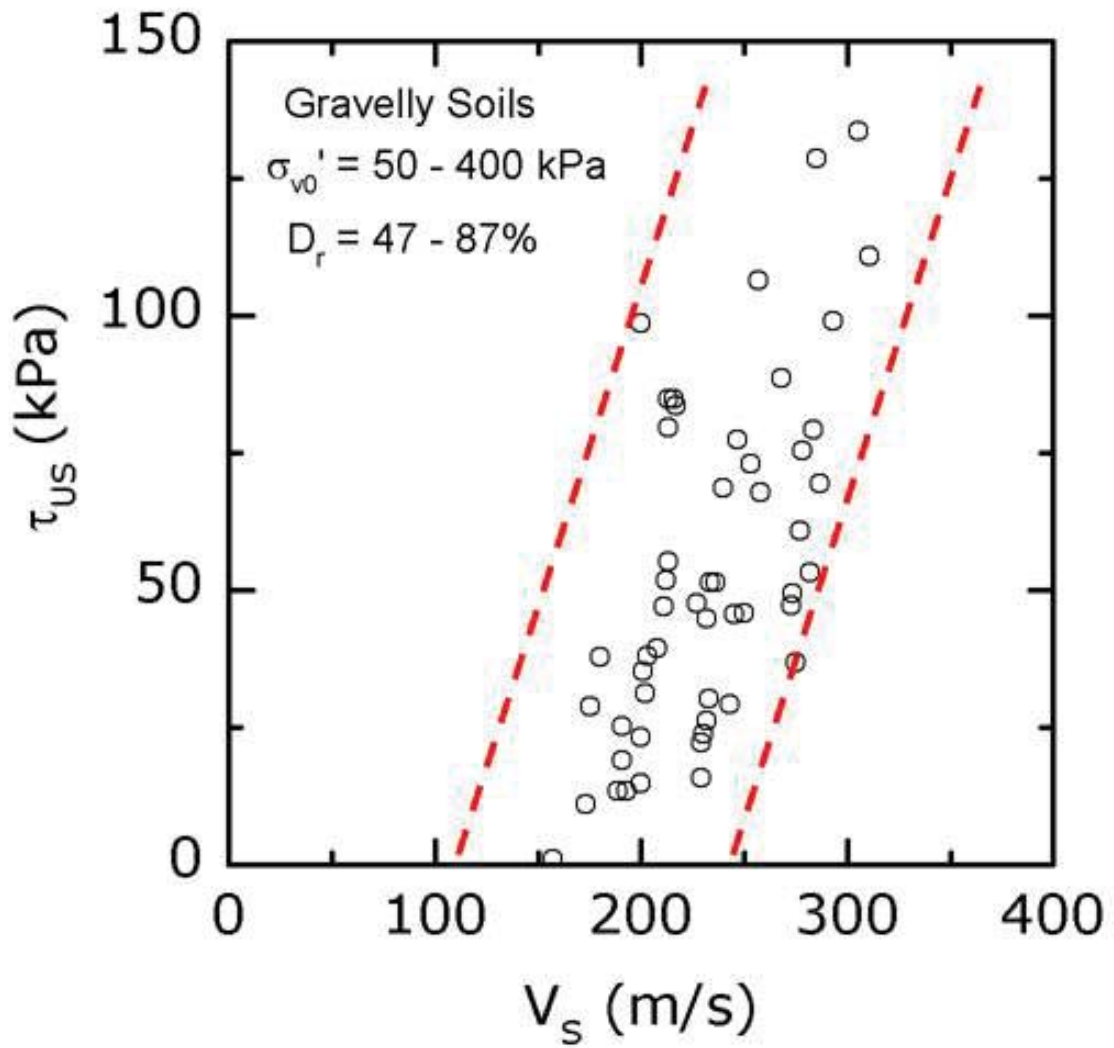

Figure 5.51: Ultimate State Shear Strength versus Shear Wave Velocity for mixtures for Uniform Gravels and Gravel/Sand Mixtures

5.5.3 Cyclic Simple Shear Results

Constant volume cyclic simple shear tests were performed on mixtures of Pea Gravel and Ottawa C109 Sand as well as CLS8 and Ottawa C109 Sand. Specific parameters were targeted for study during testing, including mixture percentage, CSR, initial vertical stress, and relative density. Most tests were performed at CSR = 0.09 and an initial vertical stress of 100 kPa. Example results for a mixture of 40% Ottawa C109 Sand and 60% Pea Gravel are shown in Figure 5.52, where stress-strain, stress path, pore pressure generation, and strain response are evaluated.

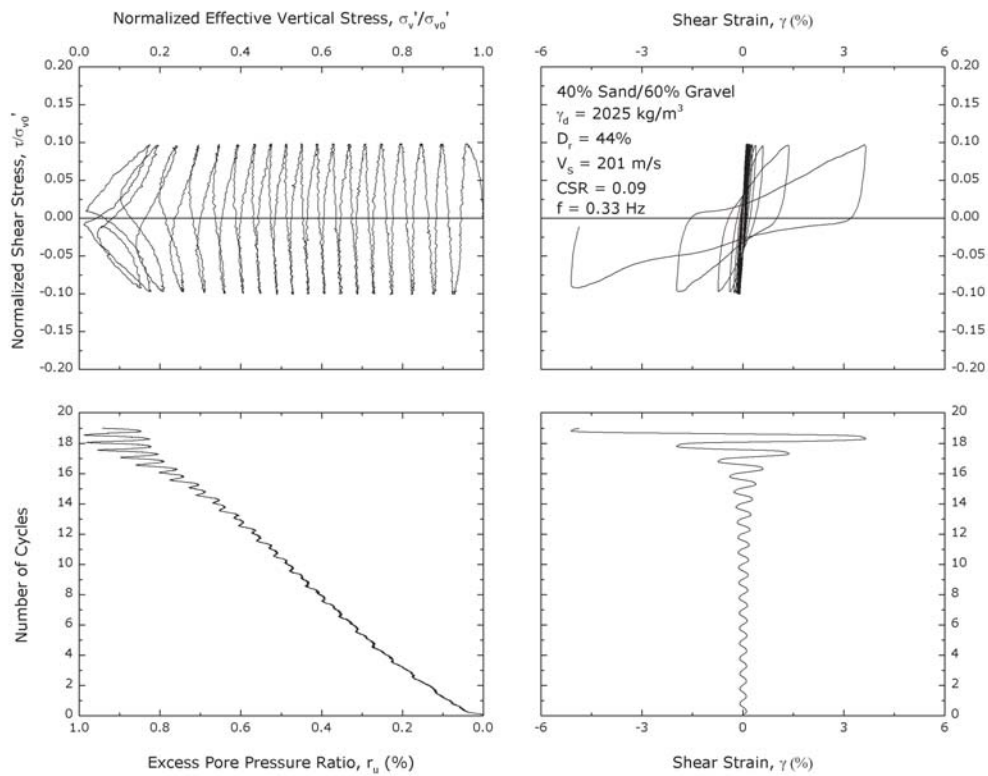

Figure 5.52: Summary Data for 40% Ottawa C109 Sand/60% Pea Gravel at CSR = 0.09 and initial vertical stress of 100 kPa (Test ID: C232)

5.5.3.1 Effect of Mixture Percentage

The effect of mixture percentage was evaluated for Pea Gravel mixtures in Figure 5.53. All tests were initially consolidated to a vertical stress of 100 kPa and a $D_r = 47\%$. A $CSR = 0.09$ was used to compare the test results. Figure 5.53 shows that the optimum mixture percentage that was found from the monotonic test (40% Sand) also exhibits the greatest resistance to liquefaction compared to the other test mixtures. 100% Sand and 100% Gravel liquefy in the same number of cycles (6), which confirms the similarity of these materials from a particle morphology perspective (i.e. roundness). Adding gravel to the sand increases the number of cycles to liquefaction, but only by 1 cycle for 80% Sand and only 2 cycles for 60% Sand.

Similarly, the effect of mixture percentage was evaluated for CLS8 mixtures in Figure 5.54. Again, the optimum mixture of 60% Ottawa C109 Sand and 40% CLS8 found during the monotonic test displayed the greatest resistance to liquefaction. 100% Gravel in this case displays significant resistance to liquefaction and responds quite differently than 100% Sand, which can be explained by their different particle morphology. 80% Sand responds the same as 100% Sand which shows that the gravel skeleton was not involved in the transfer of load under cyclic shearing (it was floating within the sand matrix).

5.5.3.2 Effect of CSR

The effect of CSR was evaluated for Pea Gravel mixtures in Figure 5.55. Tests were initially consolidated to 100 kPa and a $D_r = 47\%$. CSRs of 0.04, 0.09, and 0.14 were used to evaluate the response of the mixtures at various CSR values. Figure 5.55 shows that CSR has an effect on the liquefaction response of Pea Gravel mixtures. For $CSR = 0.14$ tests 60% Sand and 40% Sand display more resistance to liquefaction than the other mixes, while at $CSR = 0.09$ only 40% Sand shows an increase in resistance when compared to the other mixtures. For $CSR = 0.04$ tests 80% Sand, 100% Sand, and 100% Gravel exhibit significantly more resistance to liquefaction compared to the 60% Sand and 40% Sand

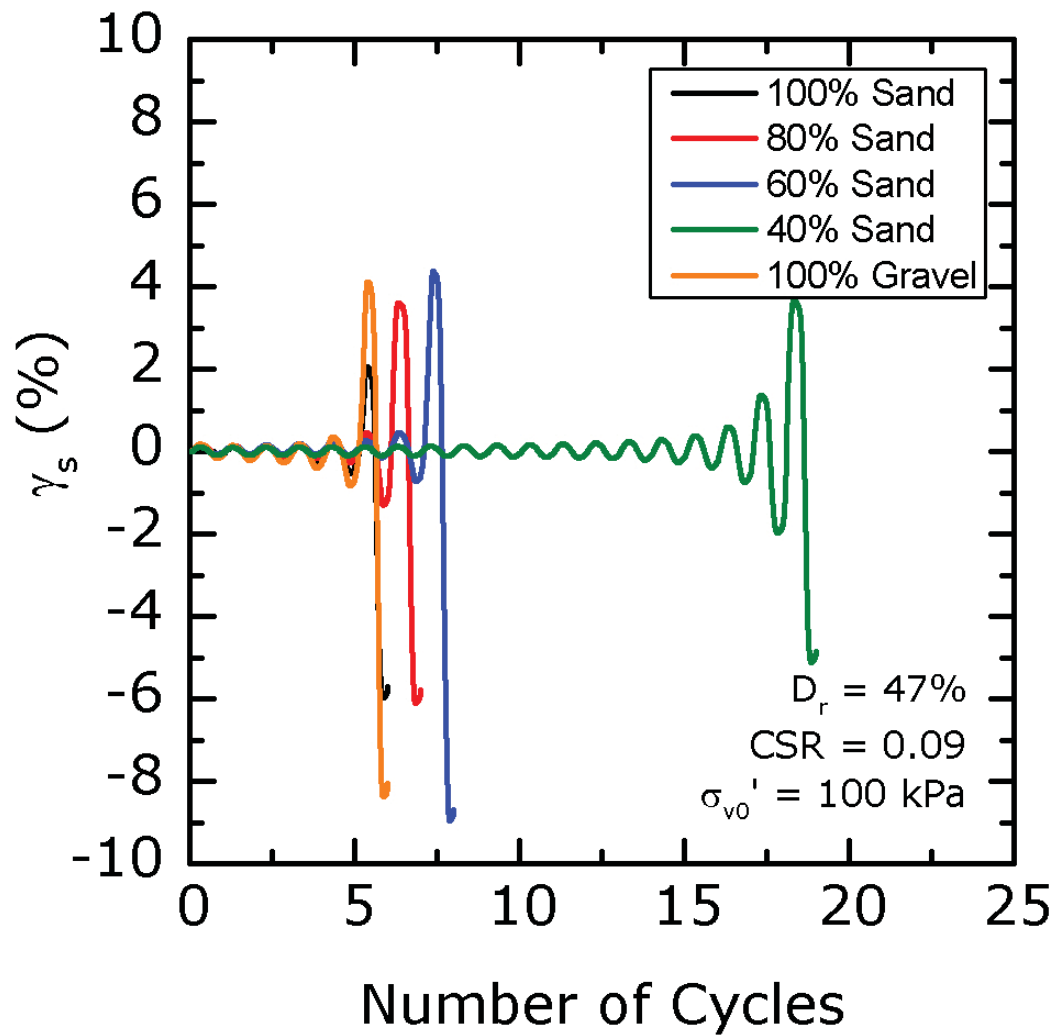

Figure 5.53: Comparison of Shear Strain versus Number of Cycles to Liquefaction for Pea Gravel/Ottawa C109 Sand mixtures of varying percentage (Test ID: C258, C246, C244, C232, C179)

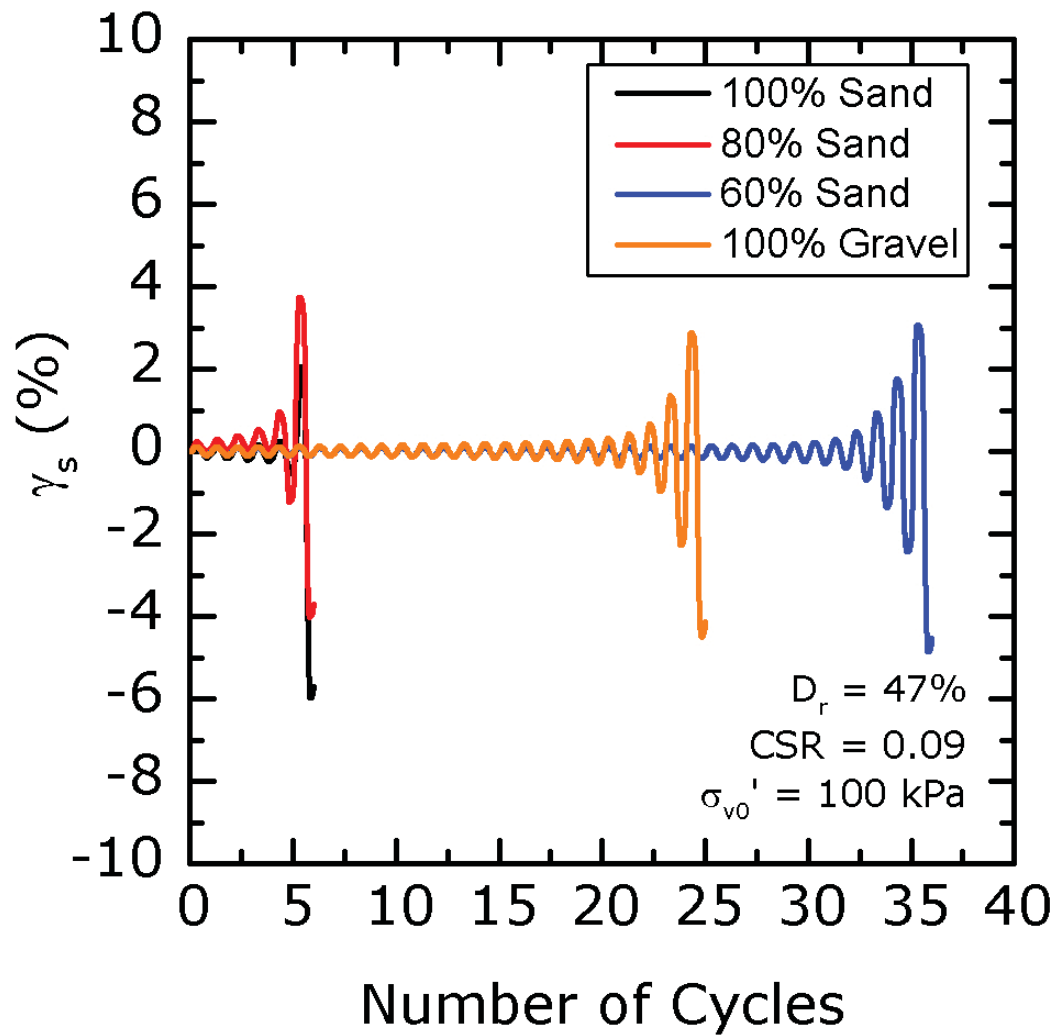

Figure 5.54: Comparison of Shear Strain versus Number of Cycles to Liquefaction for CLS8/Ottawa C109 Sand mixtures of varying percentage (Test ID: C258, C261, C265, C217)

mixtures which liquefied in 52 and 68 cycles, respectively. This observation shows that at lower CSR values for mixtures near the optimum mixture percentage the cyclic resistance is decreased significantly from the uniform sand and uniform gravel. This could possibly be explained by examining the particle interaction between the sand and gravel. It is possible that at the lower CSR value (and therefore lower strain level) the gravel is not engaged in the small cyclic movements (i.e. the sand is controlling the response). In the 60% Sand and 40% Sand specimens, the sand in between the gravel is also in a looser state than at $D_r = 47\%$ ($e = 0.64$), which could explain the fewer number of cycles to liquefaction if the sand is controlling the response. The void ratio for the 60% Sand specimen is 0.70, while the void ratio for the 40% Sand specimen is 0.83. This shows that the sand is likely controlling response and therefore causing liquefaction in fewer cycles than the $e = 0.64$ ($D_r = 47\%$) 100% Sand specimen.

Similarly, the effect of CSR was evaluated for CLS8 mixtures in Figure 5.56. Tests were initially consolidated to 100 kPa and a $D_r = 47\%$. CSRs of 0.04, 0.09, and 0.14 were used to evaluate the response of the mixtures at various CSR values. Figure 5.56 shows that CSR has an effect on the liquefaction response of CLS8 mixtures. For CSR = 0.14 tests 100% Gravel, 60% Sand, and 40% Sand liquefy in a similar number of cycles and display more resistance to liquefaction than 100% Sand. It is interesting that now the 80% Sand is behaving similar to the 100% Gravel and 60% Sand specimens for the CLS8 mixtures because for Pea Gravel mixtures the 80% Sand specimen at CSR = 0.14 responded the same as the 100% Sand. This means that at CSR = 0.14 the angular CLS8 material is contributing to the transfer of loading during cycling even at a mixture percentage of 80% Sand. This is likely due to the larger strains applied during the CSR = 0.14 test. Because there is more strain and likely more movement of particles within the specimen, the CLS8 gravel is likely engaging in gravel to gravel contact which produces more resistance to liquefaction. For CSR = 0.09 tests, the 80% Sand now responds the same as 100% Sand again. This could be due to the smaller strains involved in the loading mechanism, which do not allow for

gravel particles to come into contact and contribute to the force transfer. 60% Sand and 100% Gravel display the most resistance to liquefaction for CSR = 0.09 tests. For CSR = 0.04 tests 100% Sand and 100% Gravel exhibit significantly more resistance to liquefaction compared to the 80% Sand, 60% Sand, and 40% Sand mixtures. The possible reasons for this were explained in the previous paragraph for Pea Gravel mixtures. *Lin et al.* (2000) evaluated the shear modulus versus strain relationship for gravelly soil mixtures (gravel and sand/coarse sand mixtures). Figure 5.57 shows some of the results from *Lin et al.* (2000). It can be seen in this figure that as shear strain increases from 0.1 to 1.0%, the gravelly specimens (greater than 50% gravel) display an increasing shear modulus. Conversely, the sandy soils show the typical reduction of shear modulus with shear strain. These results from *Lin et al.* (2000) could partially explain why a difference in response from gravel-sand mixtures, especially for gravelly mixtures, was observed with varying CSR values in this study. The higher CSR tests begin at a greater initial shear strain, which could mean that the specimen is initially stiffer than for a lower CSR.

5.5.3.3 Effect of Particle Angularity

The effect of using different gravel for the mixtures was evaluated by comparing the response of 100% Sand with 80% Sand, 60% Sand, and 40% Sand mixtures for both Pea Gravel and CLS8. All tests were completed at $D_r = 47\%$, CSR = 0.09, and an initial vertical stress of 100 kPa. Although it was shown in the previous section that CSR can effect the response of gravel-sand mixtures, a CSR = 0.09 was used for comparison since it represents a CSR where specimens liquefy between 5-40 cycles, which is a reasonable number for many larger earthquakes. Figure 5.58 plots the results for mixtures that have 80% Sand. The plot shows that the Pea Gravel has no effect on increasing the number of cycles to liquefaction and that the CLS8 increases the number of cycles to liquefaction by only 1 cycle; therefore, at 20% Gravel, the specimens can be considered to respond the same as sands for practical purposes. Figure 5.59 shows the results for specimens that have 60% Sand. In

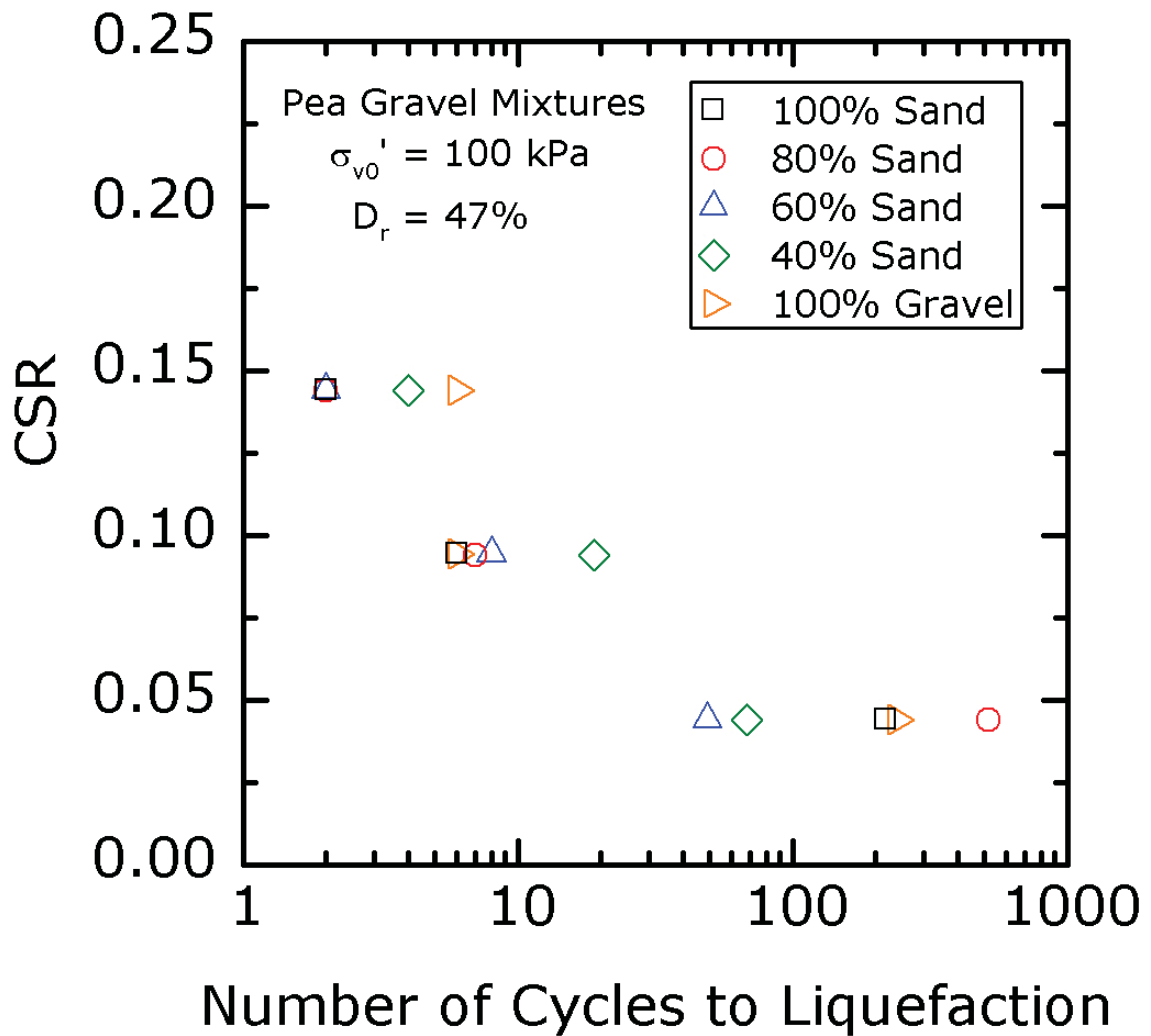

Figure 5.55: Comparison of CSR versus Number of Cycles to Liquefaction for Pea Gravel/Ottawa C109 Sand mixtures of varying percentage

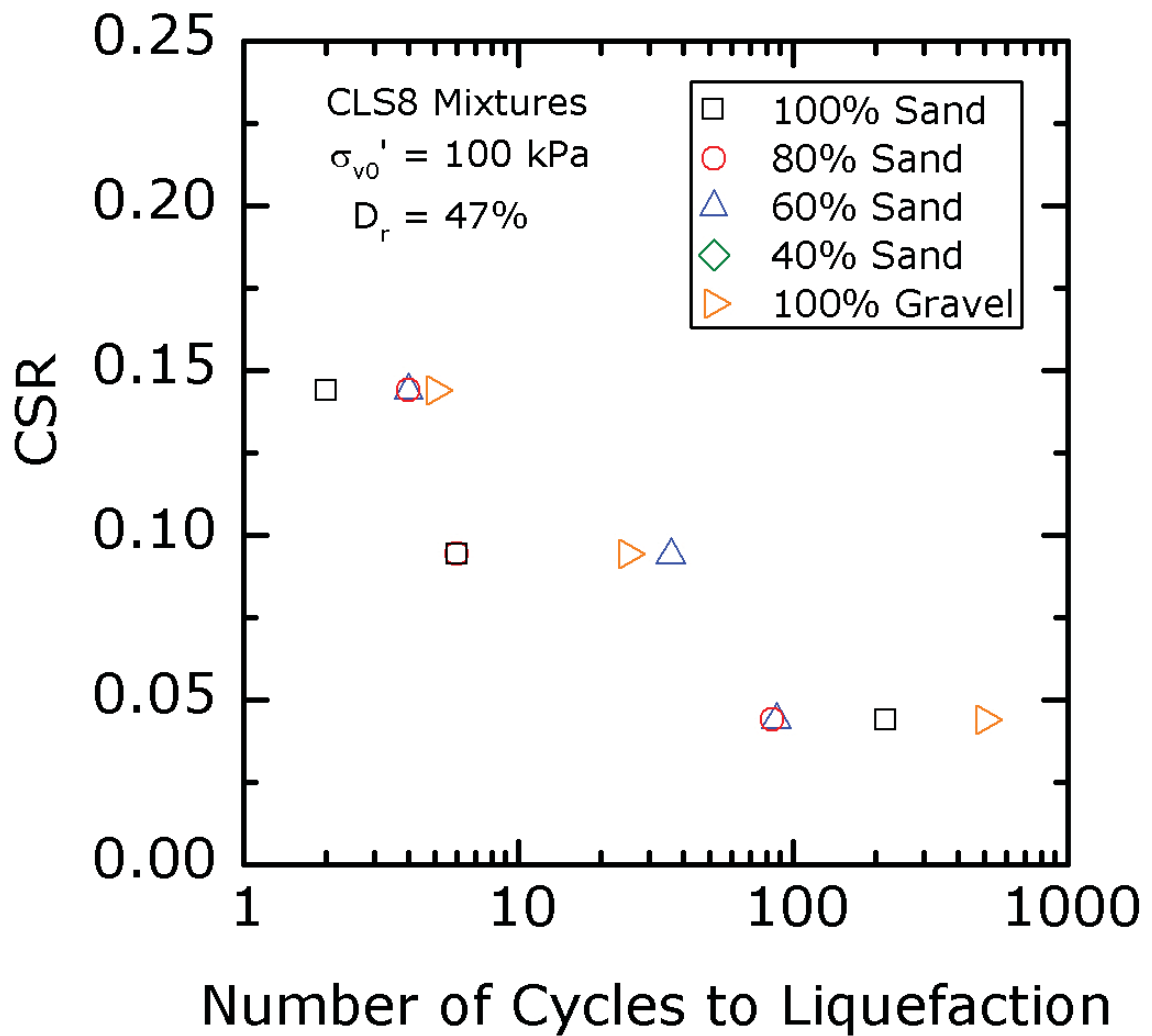

Figure 5.56: Comparison of CSR versus Number of Cycles to Liquefaction for CLS8/Ottawa C109 Sand mixtures of varying percentage

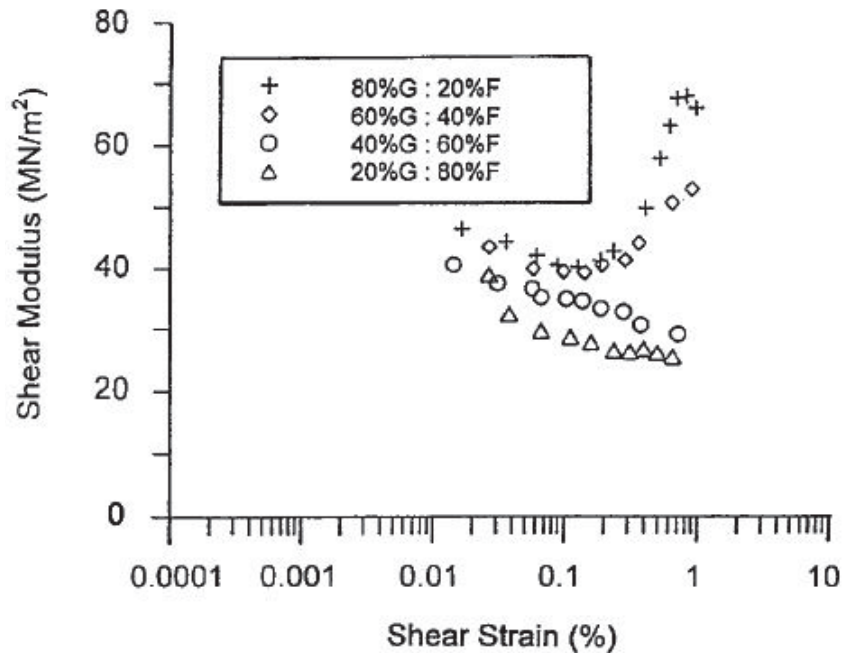

Figure 5.57: Shear Modulus versus Shear Strain for Gravelly Soil Mixtures (Lin et al. 2000)

this case, the addition of 40% CLS8 significantly increases the resistance to liquefaction for the mixture. The 40% Pea Gravel specimen increases the number of cycles to liquefaction by 2 compared to the 100% Sand specimen. Figure 5.60 shows the results for specimens that have 40% Sand. In this case, the addition of 60% Pea Gravel significantly increases the resistance to liquefaction for the mixture. The 40% CLS8 specimen increases the number of cycles to liquefaction by 2 compared to the 100% Sand specimen. This shows that different mixing gravels will result in different response for varying mixture percentages. The Pea Gravel mixture was optimum at 60% Sand while the CLS8 mixture was optimum at 40% Sand. This difference is likely due to the different particle morphology for the Pea Gravel and CLS8. The Pea Gravel is rounded to subrounded while the CLS8 is subangular to angular.

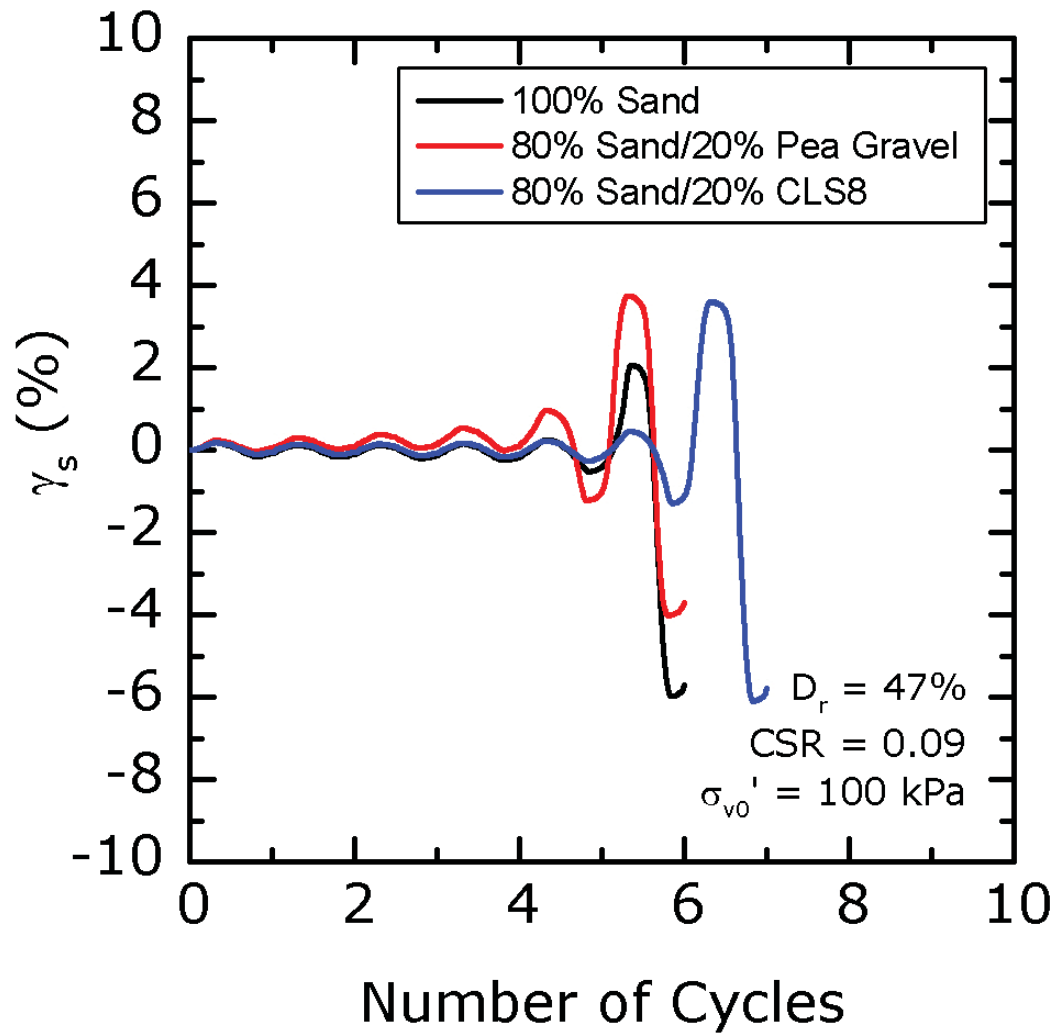

Figure 5.58: Comparison of Effects of Increasing Gravel Content to 20% for Pea Gravel and CLS8 Mixtures (Test ID: C258, C246, C261)

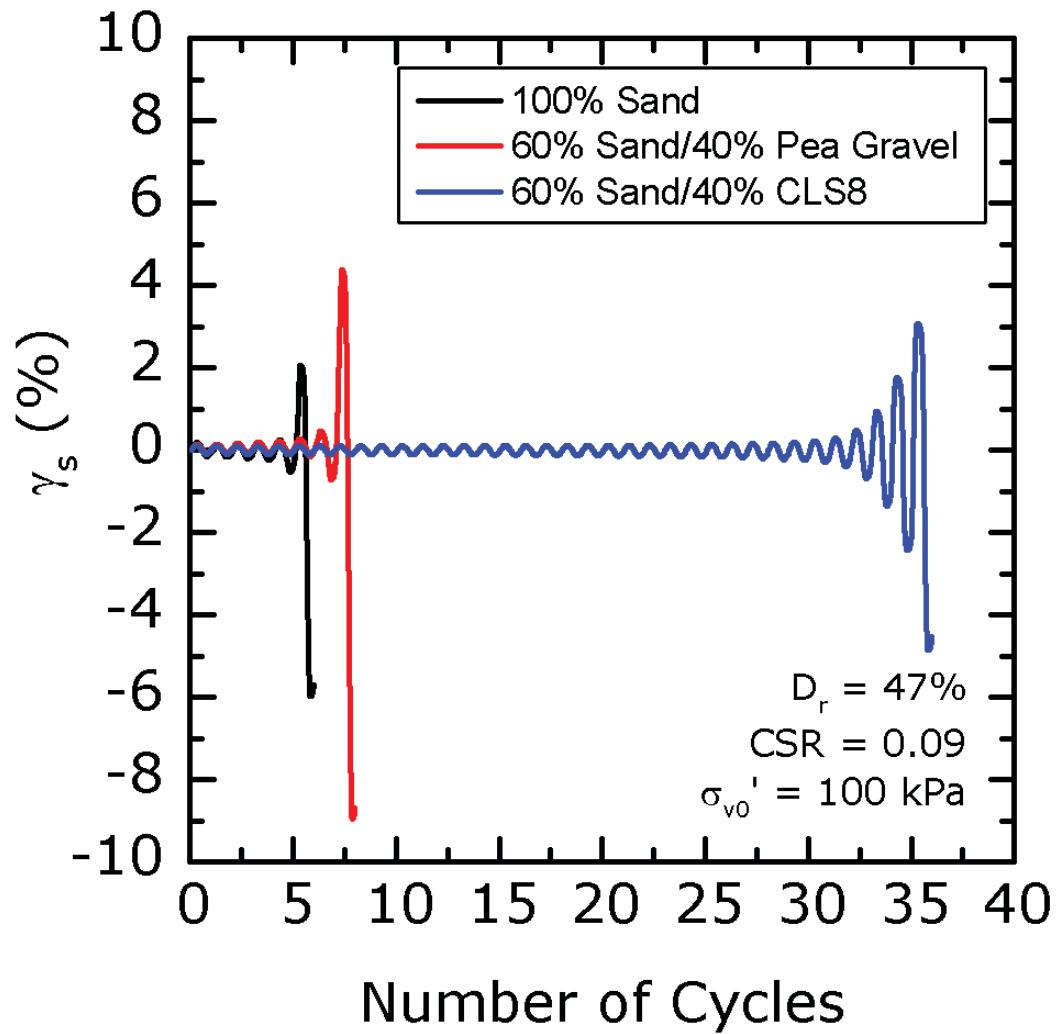

Figure 5.59: Comparison of Effects of Increasing Gravel Content to 40% for Pea Gravel and CLS8 Mixtures (Test ID: C258, C244, C265)

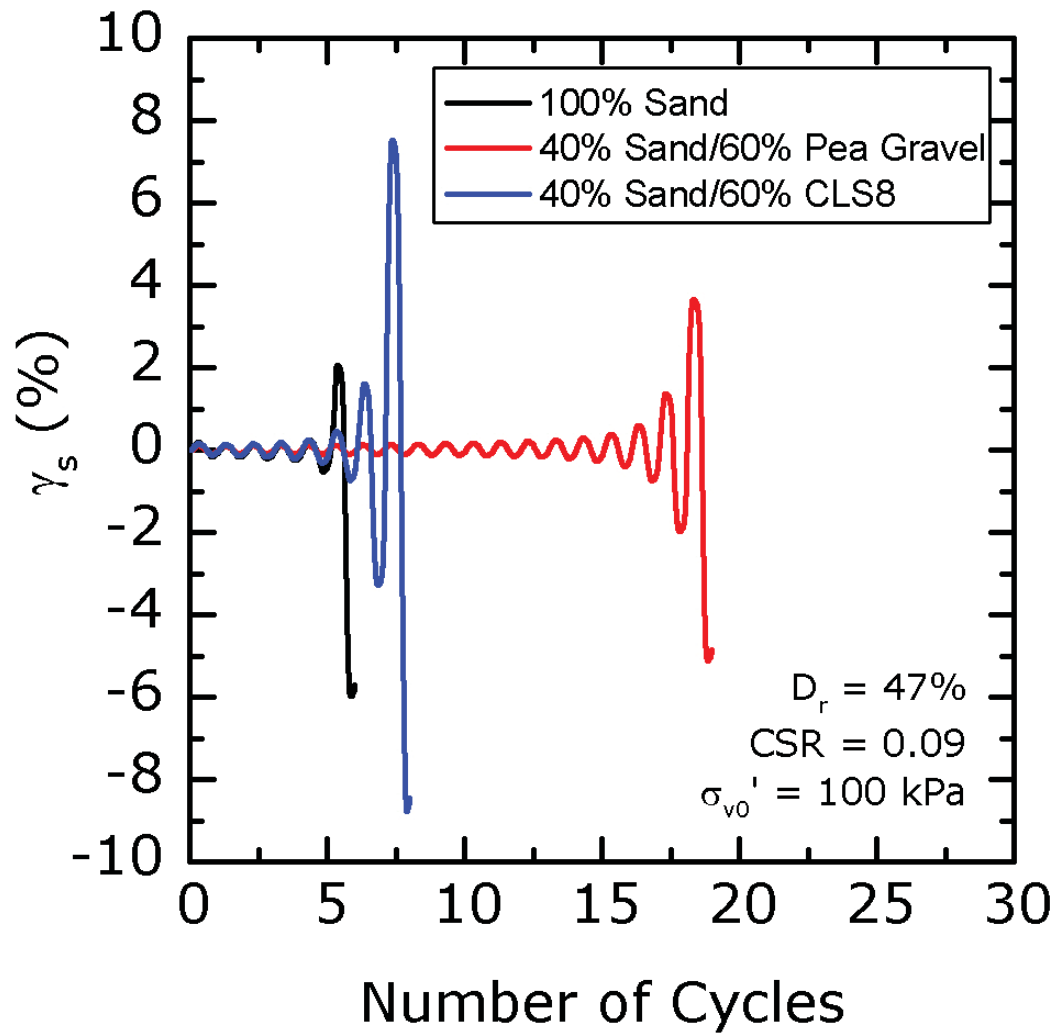

Figure 5.60: Comparison of Effects of Increasing Gravel Content to 60% for Pea Gravel and CLS8 Mixtures (Test ID: C258, C232, C268)

5.5.3.4 Effect of Initial Vertical Stress

The effect of initial vertical stress was evaluated for the optimum Pea Gravel mixture (60% Pea Gravel/40% Ottawa C109 Sand) in Figure 5.61. The tests were performed at a $D_r = 47\%$ and a $CSR = 0.09$ with initial vertical stresses of 100, 200, and 400 kPa. The results in Figure 5.61 show that there is not a significant effect of initial vertical stress on the number of cycles to liquefaction for these three tests. The 400 kPa specimen liquefied in 2 fewer cycles than the 100 kPa specimen and the 200 kPa specimen liquefied in 1 more cycle than the 100 kPa specimen. These differences are not significant and the response can be considered to be independent of initial vertical stress.

Similarly, the effect of initial vertical stress was evaluated for the optimum CLS8 mixture (60% Ottawa C109 Sand/40% CLS8) in Figure 5.62. The results in Figure 5.62 show that there is an effect of initial vertical stress on the number of cycles to liquefaction for the CLS8 mixture. The 100 kPa specimen liquefied in 36 cycles while the 400 kPa specimen liquefied in 22 cycles. This difference in response can be explained by the difference in V_{S1} values between the specimens. The 100 kPa test has a V_{S1} value of 230 m/s while the 400 kPa specimen has a V_{S1} value of 205 m/s, a significant decrease. Therefore, the fabric of the specimens is likely different and led to different V_{S1} values. It is likely that the CLS8 mixtures are also independent of initial vertical stress.

5.5.3.5 Effect of Relative Density

The effect of relative density was evaluated for the optimum Pea Gravel mixture (60% Pea Gravel/40% Ottawa C109 Sand) in Figure 5.63. The tests were performed at a $D_r = 47\%$ and 87% and a $CSR = 0.09$ with initial vertical stresses of 100 kPa. The results in Figure 5.63 show that the $D_r = 47\%$ is more resistant to liquefaction than the $D_r = 87\%$ specimen. This is the opposite trend that would be expected. This could be due to the gravel skeleton of the specimen receiving more of the compaction energy while the portion remained relatively loose. It is possible that during compaction using the drop weight

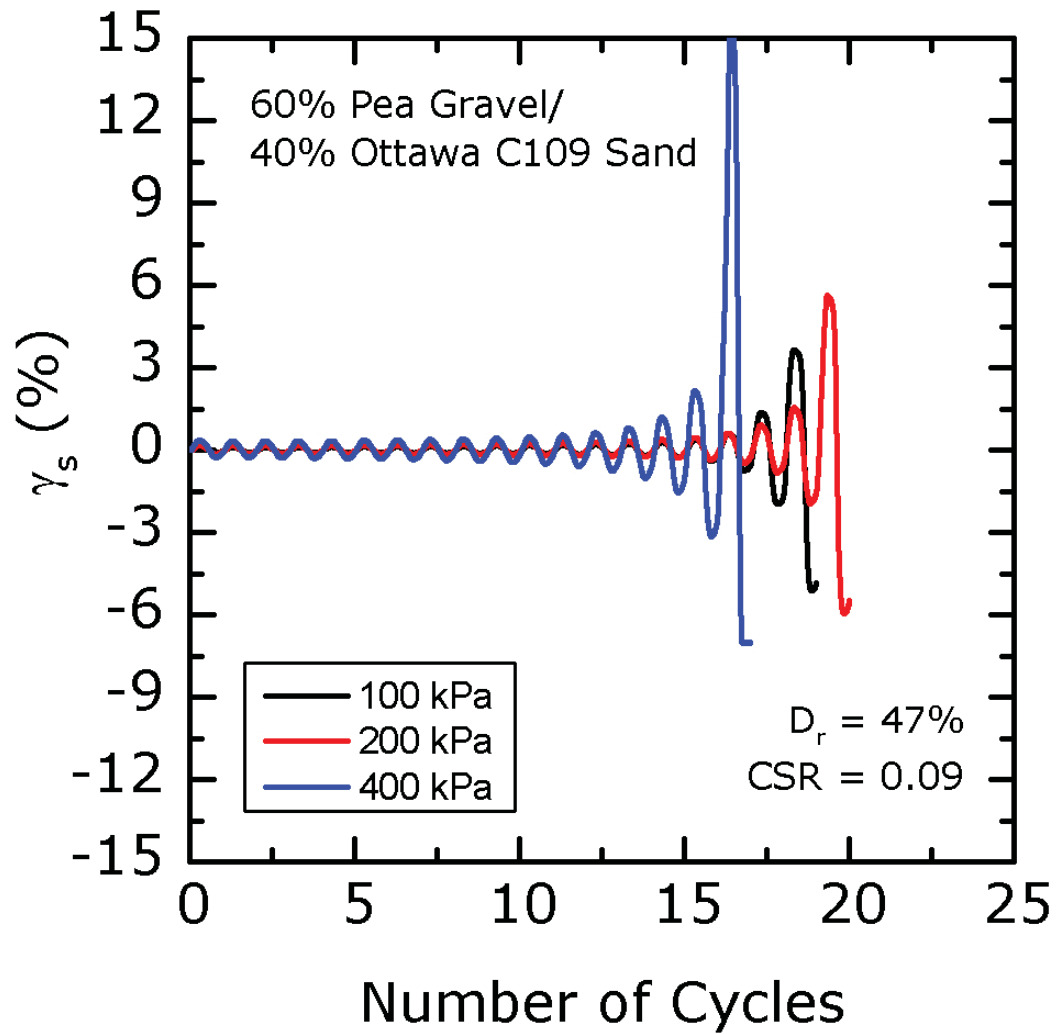

Figure 5.61: Effect of Initial Vertical Effective Stress on Number of Cycles to Liquefaction for 40% Ottawa C109 sand and 60% Pea Gravel Mixture (Test ID: C232, C231, C235)

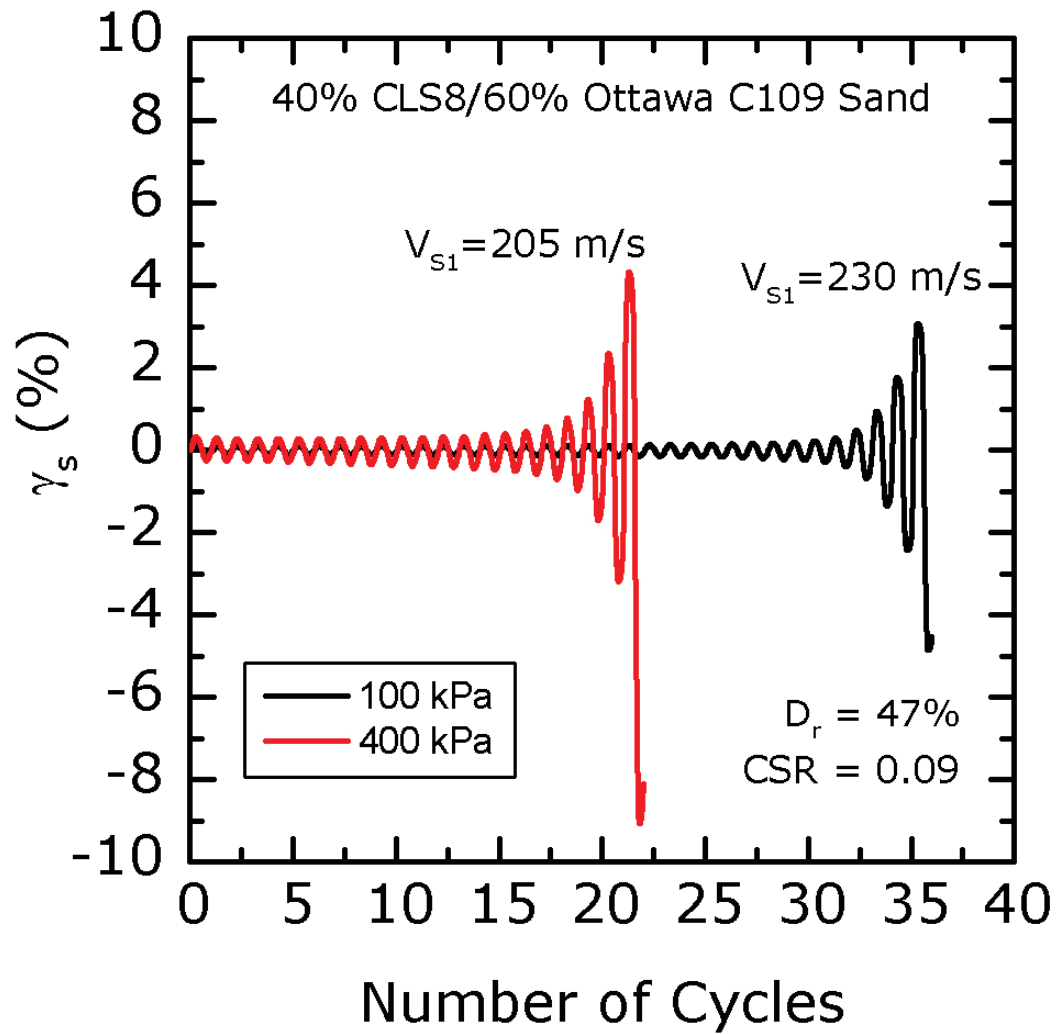

Figure 5.62: Effect of Initial Vertical Effective Stress on Number of Cycles to Liquefaction for 60% Ottawa C109 sand and 40% CLS8 Mixture (Test ID: C265, C290)

that the gravel portion was receiving the compaction energy, while the sand portion was remaining relatively loose. This point could be important to consider when examining gravelly soils in the field that are dense, but may be controlled by the loose sand in between the gravel grains. The global void ratios of the loose and dense specimen are similar with values of 0.333 and 0.284, respectively. The sand skeleton void ratio for the loose specimen was 0.83, while the sand skeleton void ratio of the dense specimen was 0.71. The gravel skeleton void ratio of the loose specimen was 1.22, while the gravel skeleton void ratio of the dense specimen was 1.14. These values suggest that it is possible that the gravel skeleton void ratio was controlling the dense specimen, while the global void ratio was controlling the response of the loose specimen.

Similarly, the effect of relative density was evaluated for the optimum CLS8 mixture (60% Ottawa C109 Sand/40% CLS8) in Figure 5.64. The results in Figure 5.64 show that again the denser specimen ($D_r = 87\%$) was less resistant to liquefaction than the looser specimen. In this case, the V_S values offer some insight into the hypothesis that the sand in between the gravel particles is loose and was not densified through the drop weight method used in this study. The V_S value of the denser specimen is 227 m/s while the V_S value of the looser specimen is 230 m/s. An increase in the V_S value with increasing relative density would be expected, but did not occur. This could possibly be attributed to sand that was very loose in between densely packed gravel. The global void ratios of the loose and dense specimen are similar with values of 0.402 and 0.347, respectively. The sand skeleton void ratio for the loose specimen was 0.670, while the sand skeleton void ratio of the dense specimen was 0.578. The gravel skeleton void ratio of the loose specimen was 1.9, while the gravel skeleton void ratio of the dense specimen was 1.85. Similar to the Pea Gravel mixtures, these values suggest that it is possible that the gravel skeleton void ratio was controlling the dense specimen, while the global void ratio was controlling the response of the loose specimen.

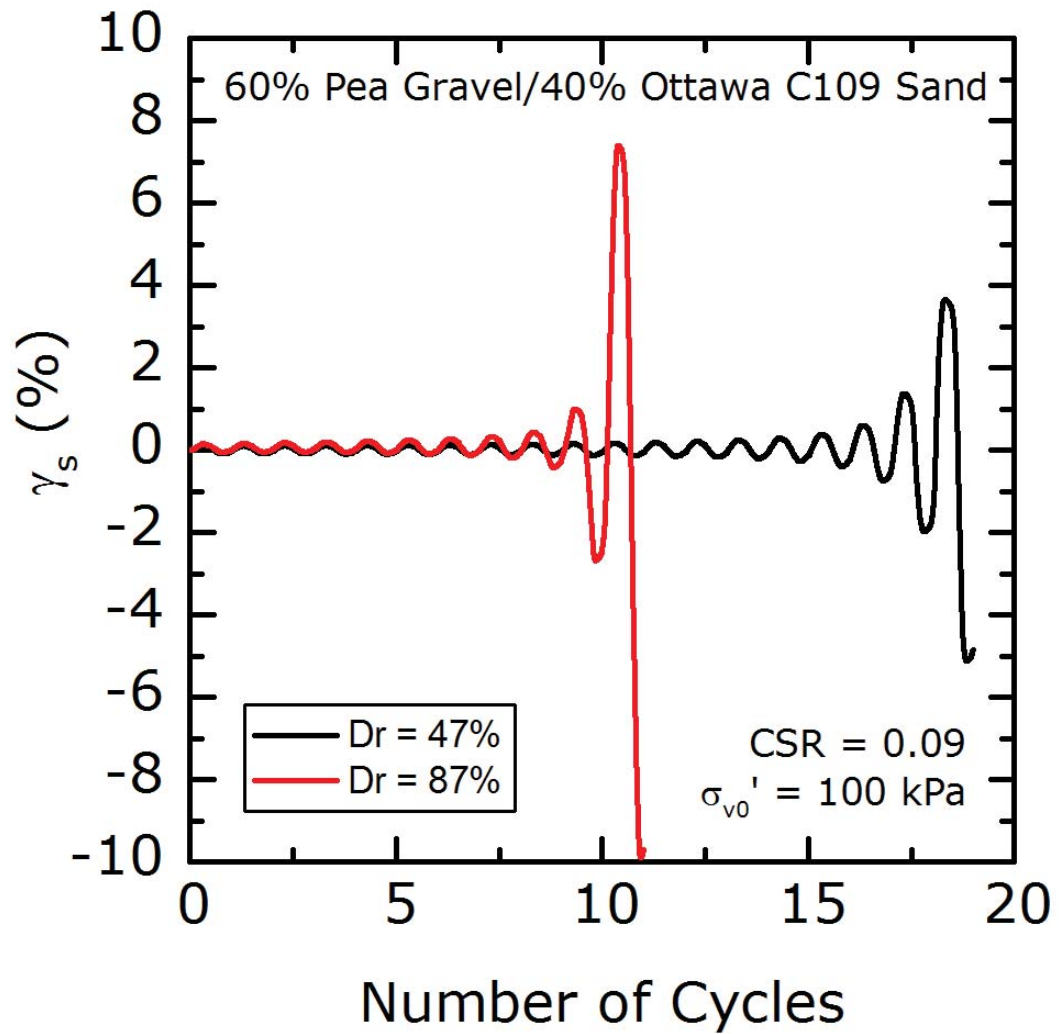

Figure 5.63: Effect of Relative Density on Number of Cycles to Liquefaction for 40% Ottawa C109 sand and 60% Pea Gravel Mixture (Test ID: C232, C287)

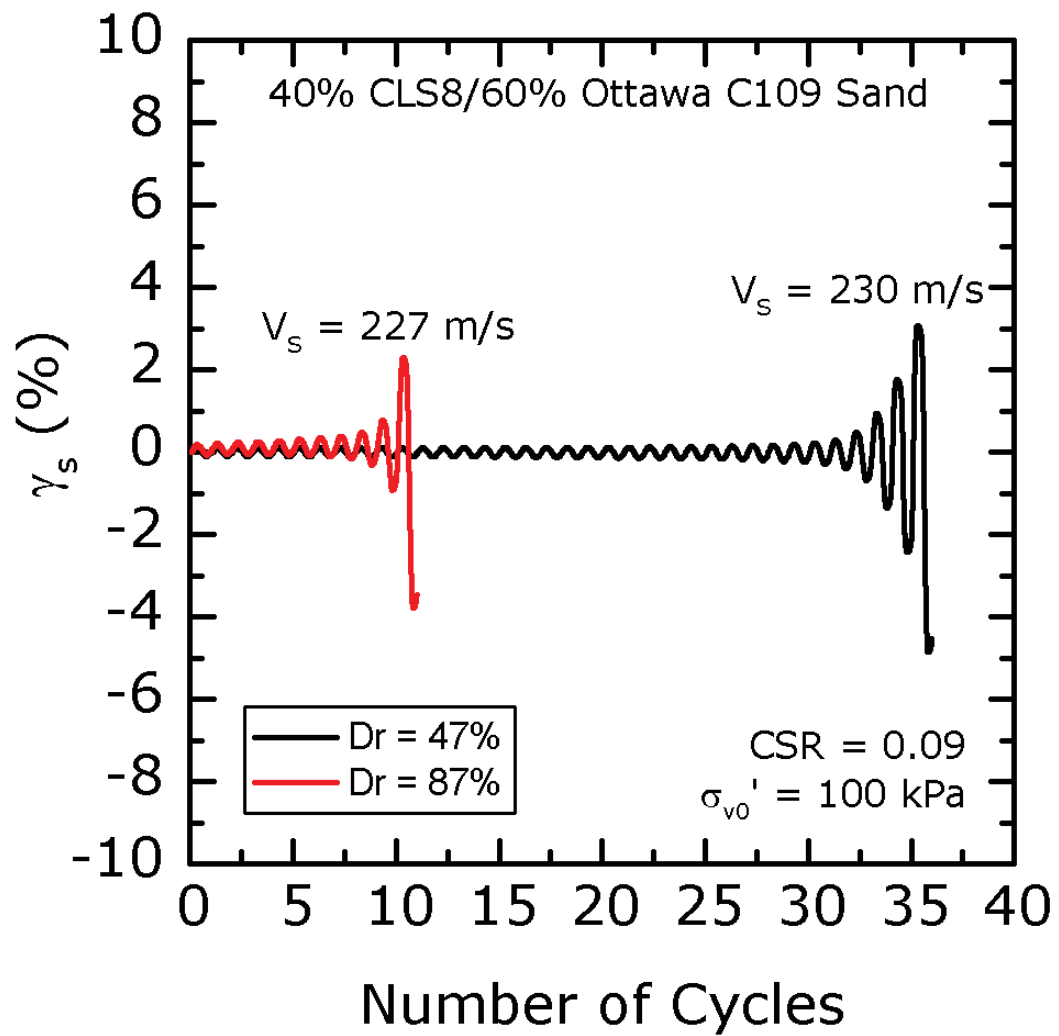

Figure 5.64: Effect of Relative Density on Number of Cycles to Liquefaction for 60% Ottawa C109 sand and 40% CLS8 Mixture (Test ID: C265, C292)

5.5.3.6 Liquefaction Triggering Charts

Using the CSR and V_{S1} data for Pea Gravel mixtures and CLS8 mixtures, a comparison was made with existing liquefaction charts. The same methodology that was used in Chapter 4 was utilized to correct CSR data points for plotting with existing relationships from the literature. Figure 5.65 plots the Pea Gravel mixture data with existing relationships from *Andrus and Stokoe* (2000) for gravels, *Kayen et al.* (2013) for sands, and *Cao et al.* (2011) for gravels. Results show that the Pea Gravel mixtures liquefied at V_{S1} values higher than 200 m/s and as high as approximately 240 m/s. All of the specimens that liquefied, including the 100% Sand, would have been predicted as non-liquefiable according to both *Andrus and Stokoe* (2000) for gravels and *Kayen et al.* (2013) for sands. The 100% Sand specimens fell slightly below the *Kayen et al.* (2013) line. Previous researchers have shown that the $CRR - V_{S1}$ relationship lines are material dependent (i.e. response depends on particle morphology) and may not always fit into the field-based V_S charts (*Tokimatsu et al.*, 1986; *Baxter et al.*, 2008). Data for sands from *Tokimatsu et al.* (1986) was shown in Figure 2.16 in Chapter 2, while data for sands and silts compiled by *Baxter et al.* (2008) was shown in Figure 2.17. Figure 5.66 shows laboratory-based data for Toyoura Sands (*Tokimatsu et al.*, 1986) as well as Olneyville silt (*Baxter et al.*, 2008) compared with the Pea Gravel mixture data from this study. The data from these studies is consistent with the data from our sands. This laboratory-based data all falls slightly below the field derived relationships; however, as previously mentioned these $CRR - V_{S1}$ relationships are material dependent.

Figure 5.67 plots the CLS8 mixture data with existing relationships from *Andrus and Stokoe* (2000) for gravels, *Kayen et al.* (2013) for sands, and *Cao et al.* (2011) for gravels. Results show that the CLS8 mixtures liquefied at V_{S1} values higher than 200 m/s and as high as approximately 230 m/s.

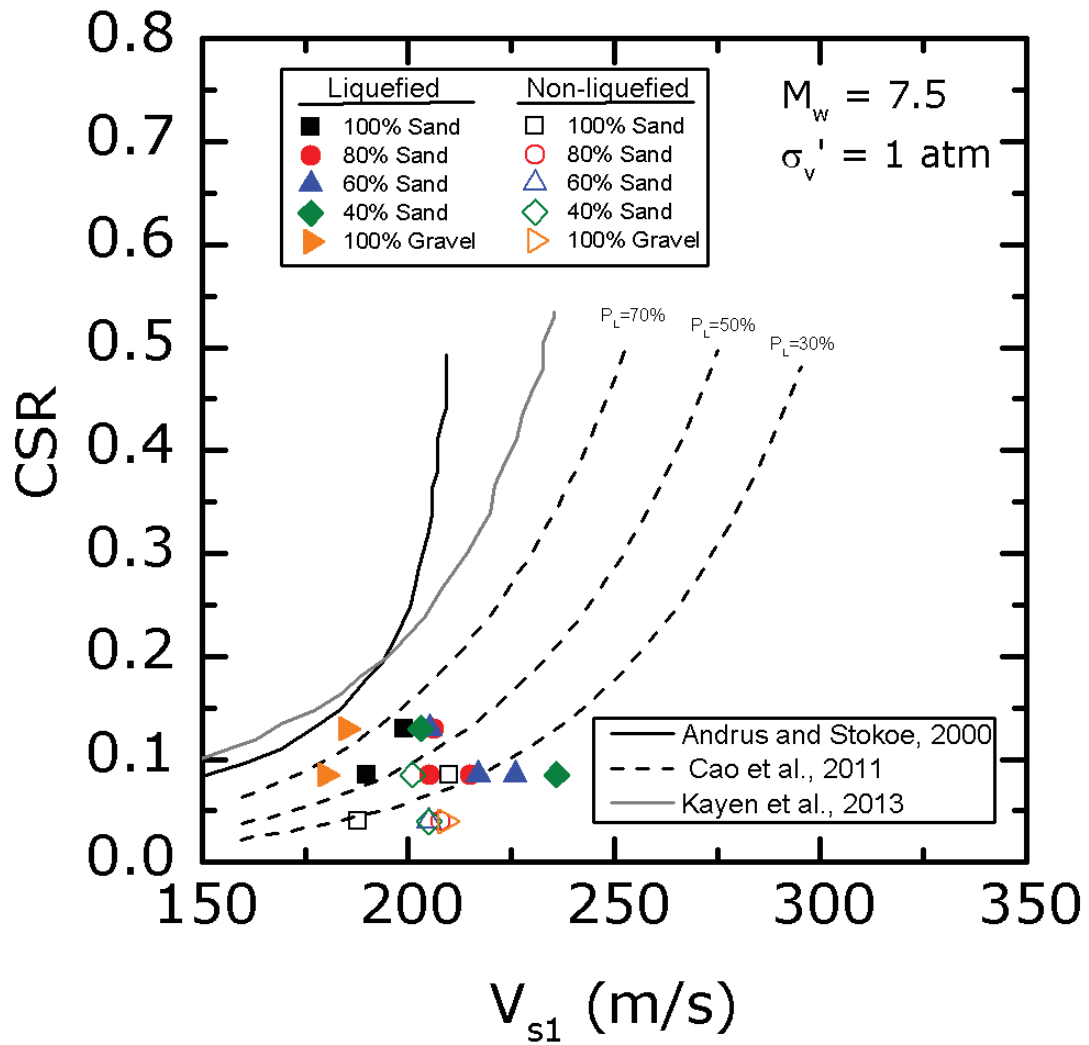

Figure 5.65: Comparison of CSR versus V_{s1} for Pea Gravel/Ottawa C109 Sand mixtures of varying percentage

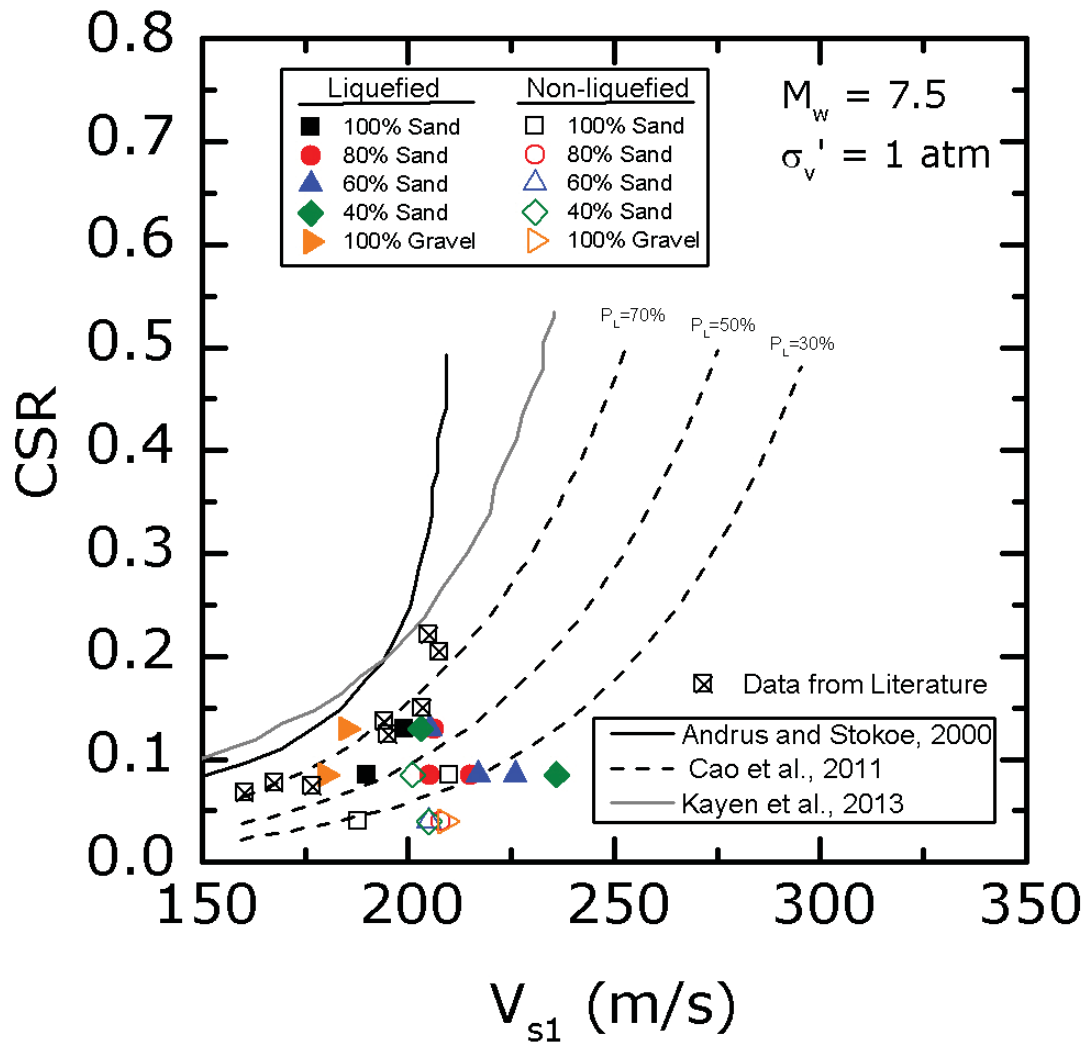

Figure 5.66: Comparison of CSR versus V_{s1} for Pea Gravel/Ottawa C109 Sand mixtures of varying percentage with data from Tokimatsu *et al.* (1986) and Baxter *et al.* (2008)

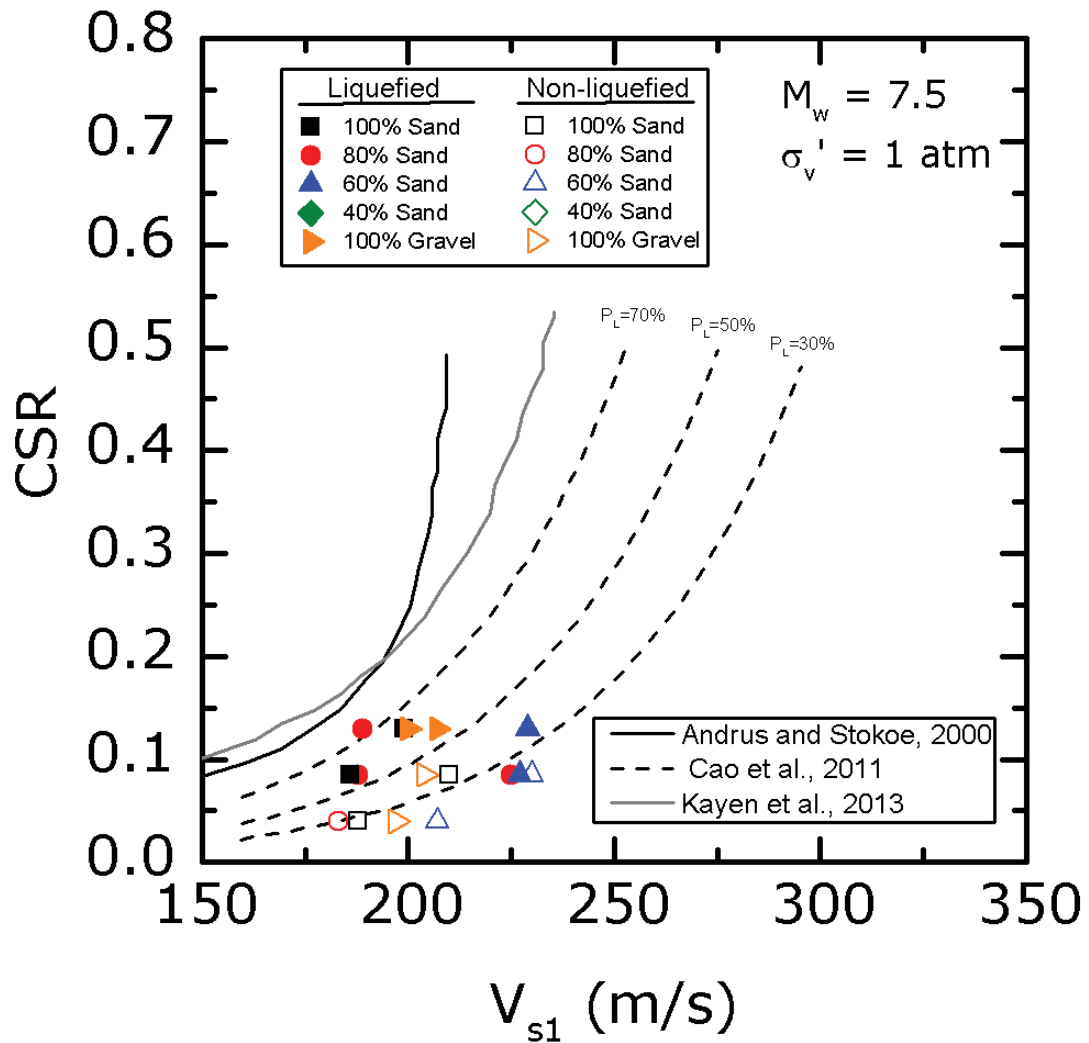

Figure 5.67: Comparison of CSR versus V_{S1} for CLS8/Ottawa C109 Sand mixtures of varying percentage

5.5.4 Pore Pressure Generation

The effect of mixture percentage on pore pressure generation during cyclic loading for gravel-sand mixtures was compared for Pea Gravel mixtures and CLS8 mixtures. Specimens were tested at $\sigma'_{v0} = 100$ for $D_r = 47\%$ and $D_r = 87\%$ and at a $CSR = 0.09$. In Figure 5.68, the data shows that mixture percentage does not have a significant effect on pore pressure generation for Pea Gravel mixtures at $D_r = 47\%$, with only a small increase seen for the 80% sand test. The r_u at $N/N_L = 1$ for the Pea Gravel specimens was between 0.80-0.85, while Ottawa C109 sand was close to 1. For the gravel-sand mixtures, the r_u values were 0.85-0.90 at $N/N_L = 1$.

In Figure 5.69, the data shows that D_r has a significant effect on pore pressure generation for the Pea Gravel mixtures and that the gravel portion of the mixture is controlling the behavior. The pore pressure generation for the 80% Sand, 60% Sand, and 40% Sand mixtures increase from the 100% Gravel specimen. The 80% and 60% Sand specimens have the highest pore pressure ratio values throughout the tests. The 40% Sand specimen falls between these specimens and the 100% Gravel specimen, while the 100% Sand specimen is much lower than the gravel-sand mixtures and 100% Gravel.

Figure 5.70 shows the data for CLS8 mixtures at $D_r = 47\%$. The results are similar to the Pea Gravel mixtures, although the data is shifted slightly upwards toward the upper bound of *Lee and Albaisa (1974)*. Figure 5.71 shows the data for CLS8 mixtures at $D_r = 87\%$. Again, the response is similar to the Pea Gravel mixtures at $D_r = 87\%$, with the mixtures as well as the 100% Gravel specimens having pore pressure generation similar to the *Lee and Albaisa (1974)* upper bound. For the CLS8 mixtures, the 80% Sand displays the highest levels of pore pressure generation.

Data for existing upper and lower bound curves for pore pressure generation are shown in Figure 5.72 for comparison with data from this study for gravel and gravel-sand mixtures. *Lee and Albaisa (1974)* conducted triaxial tests on Monterey and Sacramento River sand. *Evans and Seed (1987)* conducted large-size triaxial tests on Watsonville gravels that were

sluiced with sand to prevent compliance from membrane penetration. *Haeri and Shakeri* (2010) performed triaxial tests on Tehran alluvium that consists of sand and gravel. *Banerjee et al.* (1979) conducted triaxial tests on Oroville gravel, and *Hynes* (1988) conducted triaxial tests on Folsom gravel.

The data from this study falls close to the *Evans and Seed* (1987) data. The lower bound from this study is approximately the middle of the *Lee and Albaisa* (1974) range, while the upper bound from this study falls above the upper bound of the *Lee and Albaisa* (1974) range. The α values predicted from Equation 4.8 (*Seed et al.*, 1975) for the gravel and gravel-sand mixtures were 0.7 for the lower bound and 1.4 for the upper bound. *Polito et al.* (2008) observed similar behavior for sand and silt mixtures, with data falling in the middle to upper region of the *Lee and Albaisa* (1974) range. The *Haeri and Shakeri* (2010) and *Banerjee et al.* (1979) data have upper bounds that are significantly higher than the gravel and gravel-sand mixtures tested in this study. The lower bound from *Haeri and Shakeri* (2010) falls near the upper bound from this study. The *Hynes* (1988) data falls near or above the upper bound from this study. Combining this data shows that gravel and gravelly soil mixtures can have a wide range of pore pressure generation response. These differences may be explained in part by the gradation characteristics of the materials. The coefficient of uniformity ($C_u = D_{60}/D_{10}$) for the Oroville gravel tested by *Banerjee et al.* (1979) was 47, while the C_u of the Tehran alluvium tested in *Haeri and Shakeri* (2010) was 28. The gravels tested by *Hynes* (1988) and *Evans and Seed* (1987) had C_u values of 13 and 1.3, respectively. The C_u value for the Pea Gravel in this study was 1.6. When comparing these values to the pore pressure response in Figure 5.72, the effect of gradation can be observed. As gravelly soils become more well-graded their pore pressure generation increases rapidly in the first few cycles of loading and then flattens after reaching relatively high values of r_u in those first few cycles. The gravel in this study matches the gravel tested in *Evans and Seed* (1987) because they are both poorly-graded with C_u values less than 2. *Hynes* (1988) data falls in the middle because of its intermediate values of C_u compared to

the other gravelly soils in Figure 5.72. Figure 5.73 shows the relationship between r_u and C_u at different N/N_L values. This figure shows that as C_u increases, r_u increases as well for gravelly soils. Many gravelly soils in the field would be expected to have a high value of C_u and therefore a higher rate of pore pressure generation at lower values of N/N_L (i.e. 0.20 and 0.50) than gravelly soils with lower C_u values.

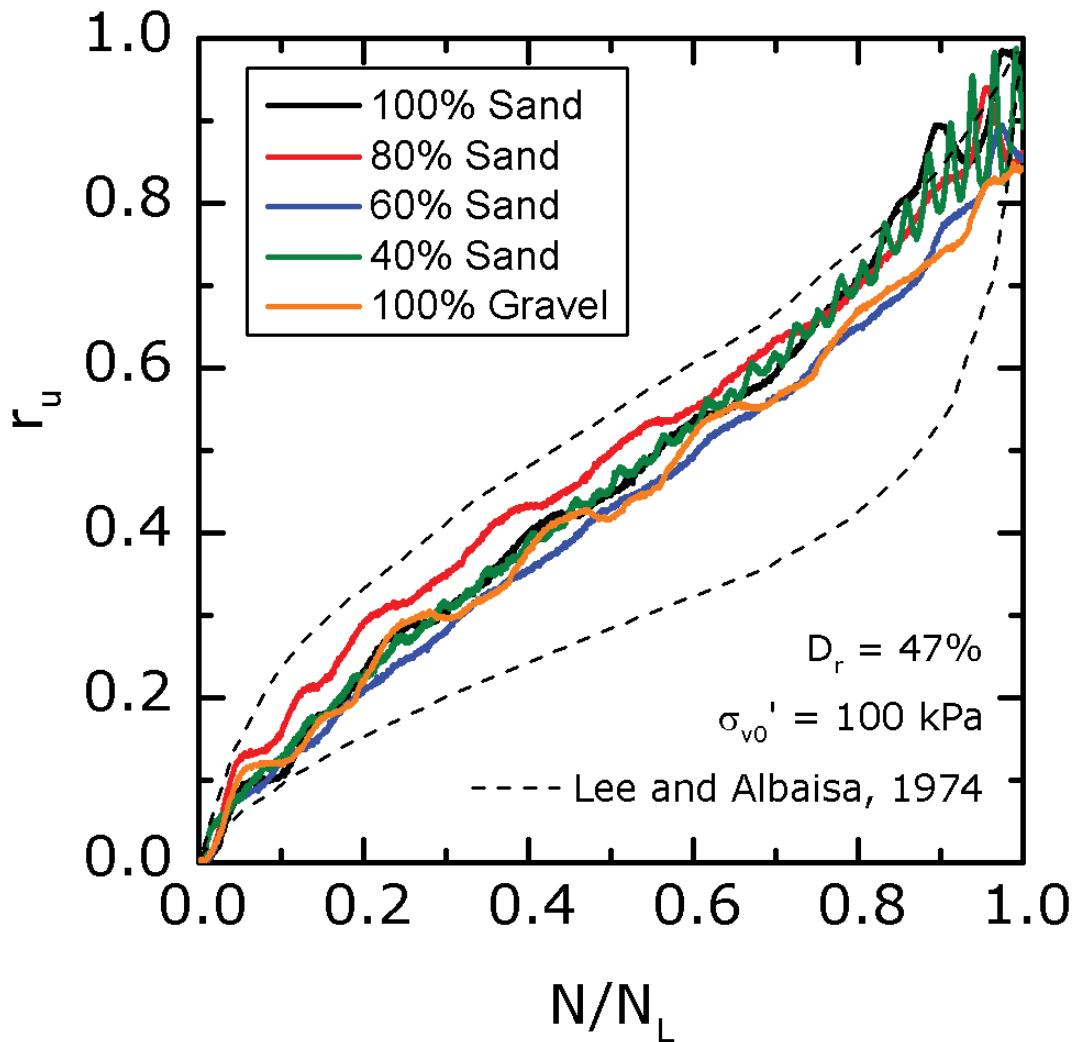

Figure 5.68: Pore pressure generation comparison for Pea Gravel/Ottawa C109 Sand Mixtures $D_r = 47\%$ and 100 kPa (Test ID: C258, C246, C244, C232, C179)

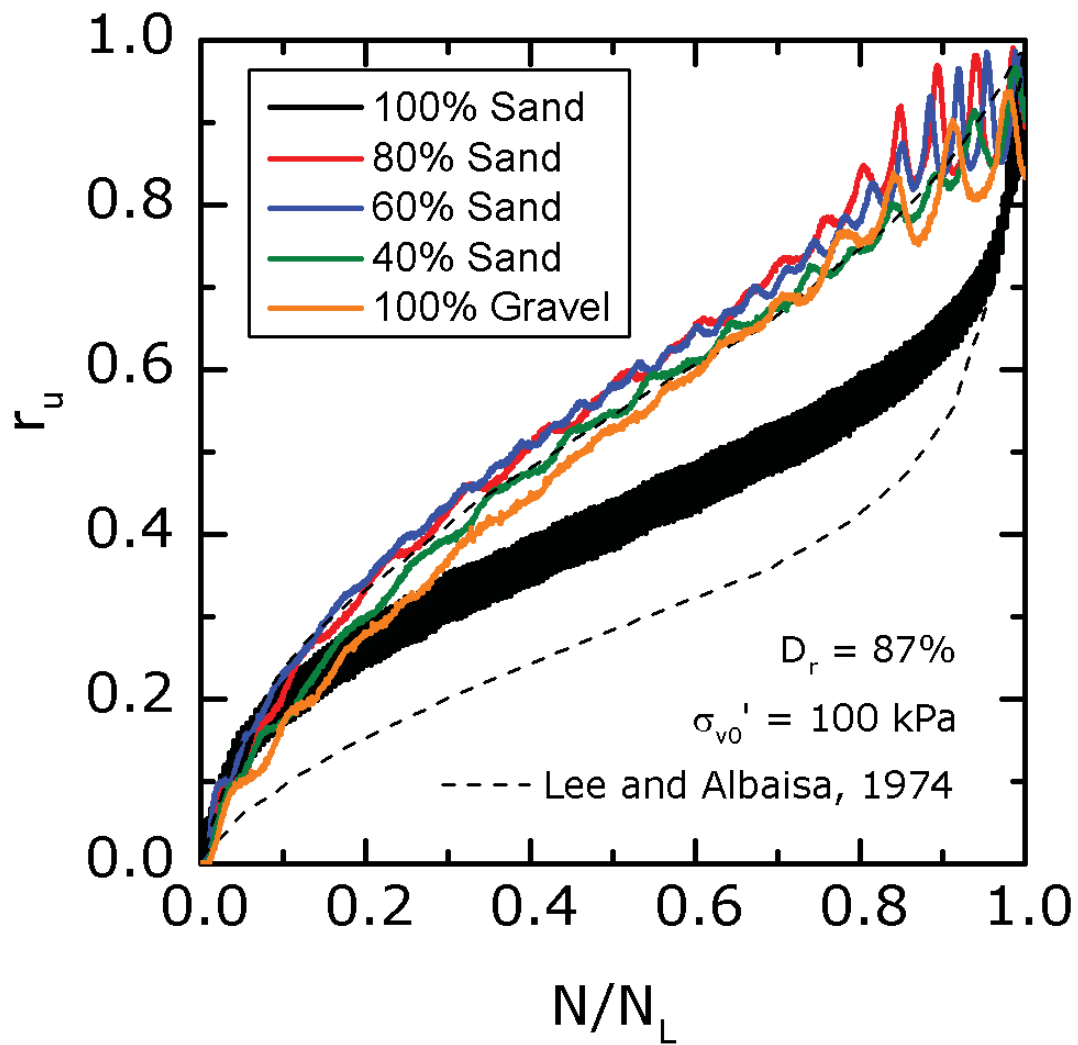

Figure 5.69: Pore pressure generation comparison for Pea Gravel/Ottawa C109 Sand Mixtures $D_r = 87\%$ and 100 kPa (Test ID: C279, C298, C299, C287, C169)

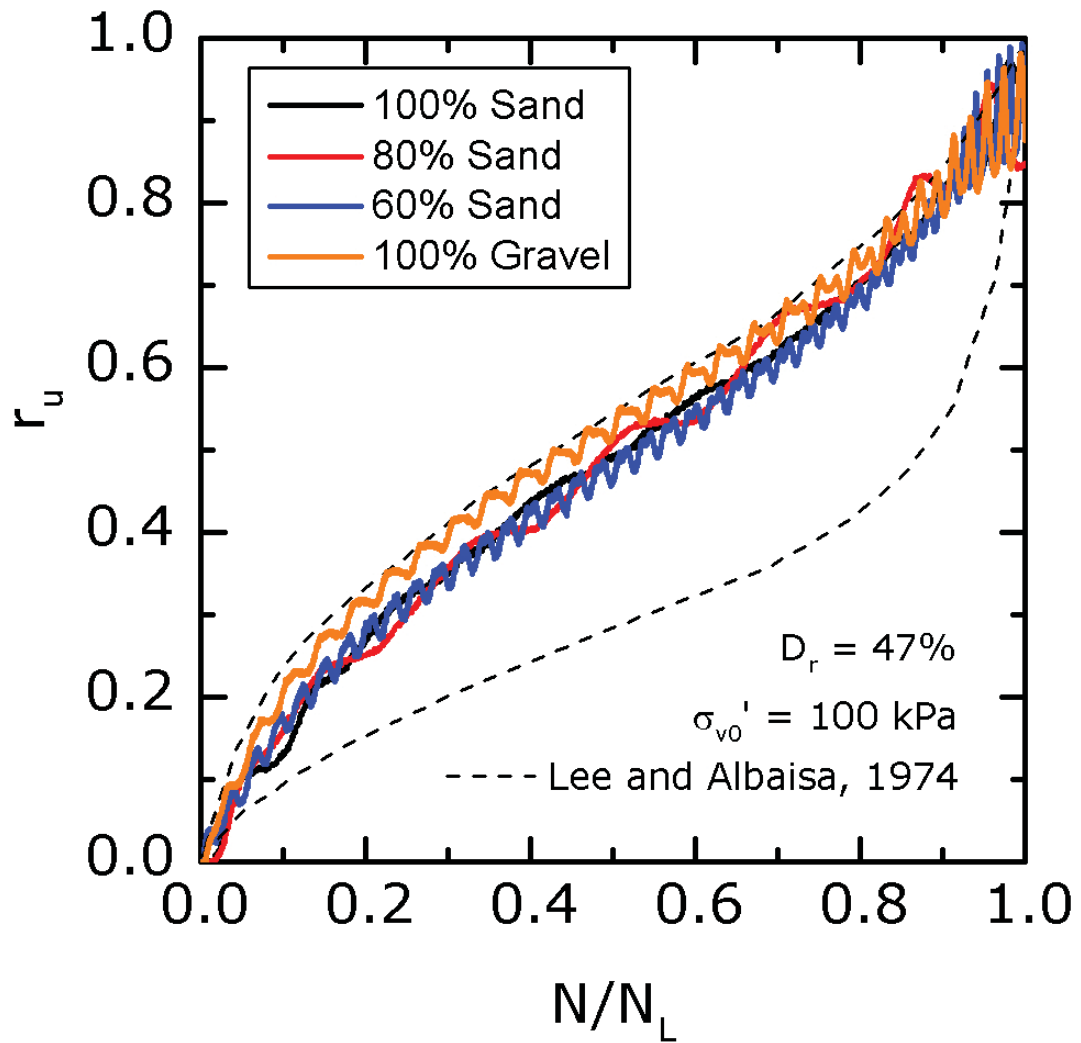

Figure 5.70: Pore pressure generation comparison for CLS8/Ottawa C109 Sand Mixtures $D_r = 47\%$ and 100 kPa (Test ID: C258, C261, C265, C268, C217)

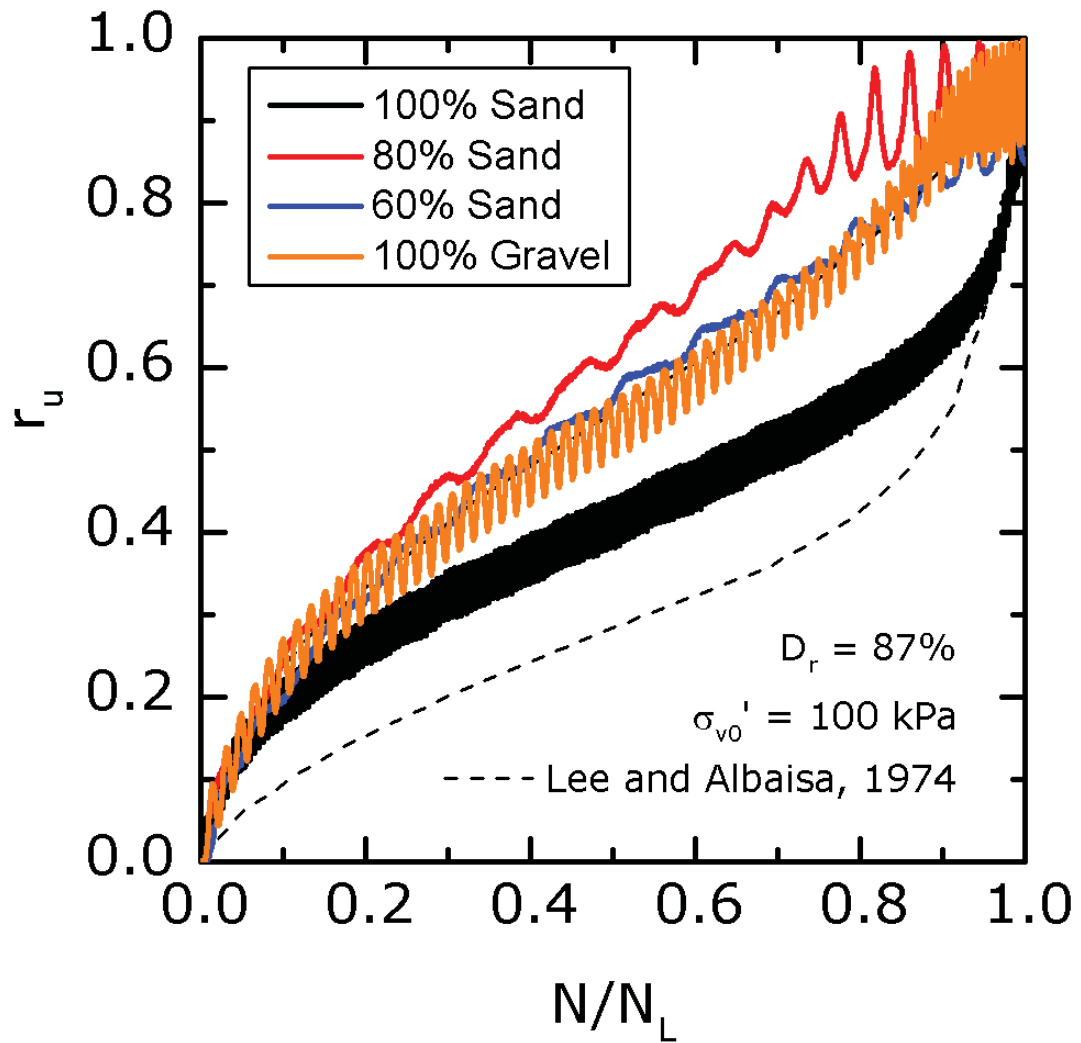

Figure 5.71: Pore pressure generation comparison for CLS8/Ottawa C109 Sand Mixtures $D_r = 87\%$ and 100 kPa (Test ID: C279, C300, C292, C230)

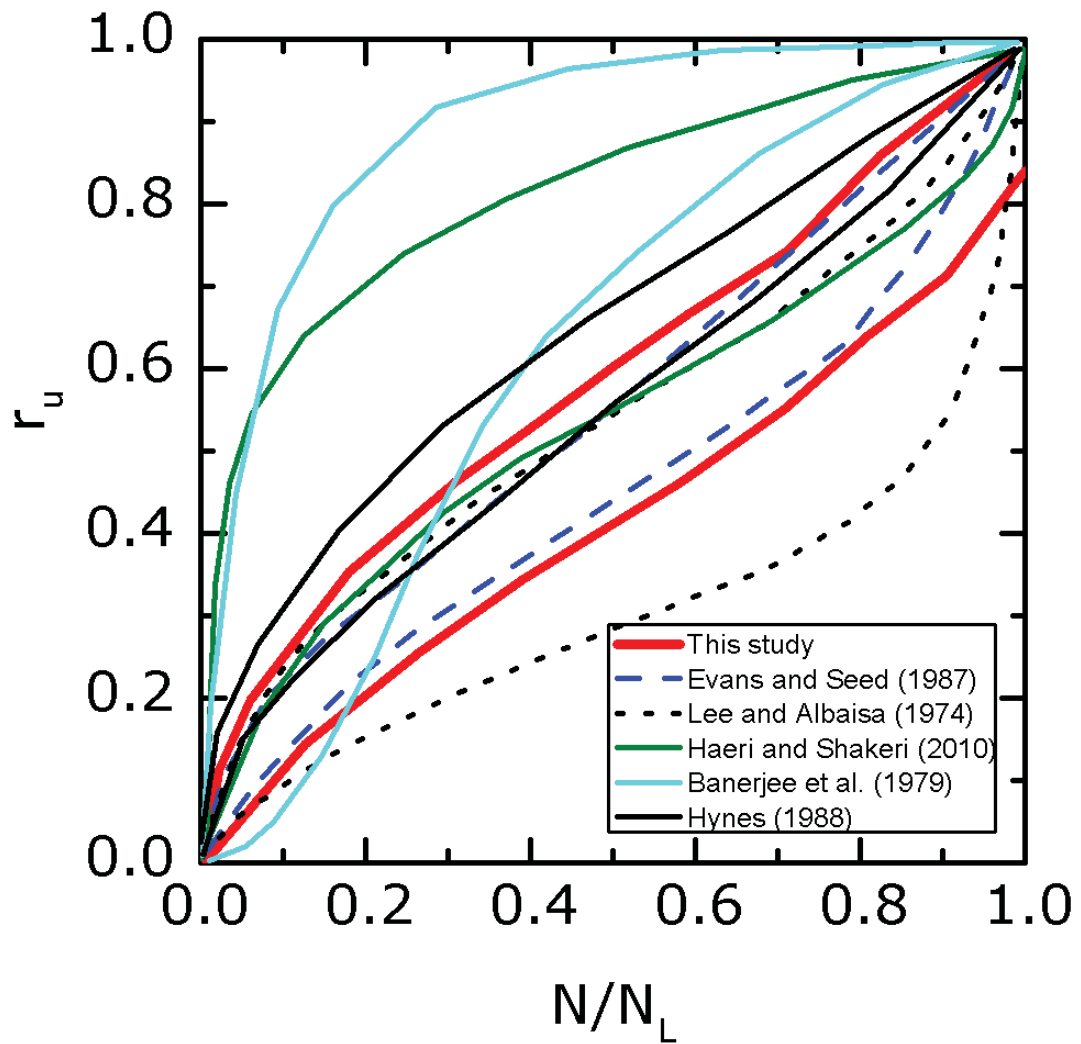

Figure 5.72: Pore pressure generation comparison for gravelly soils

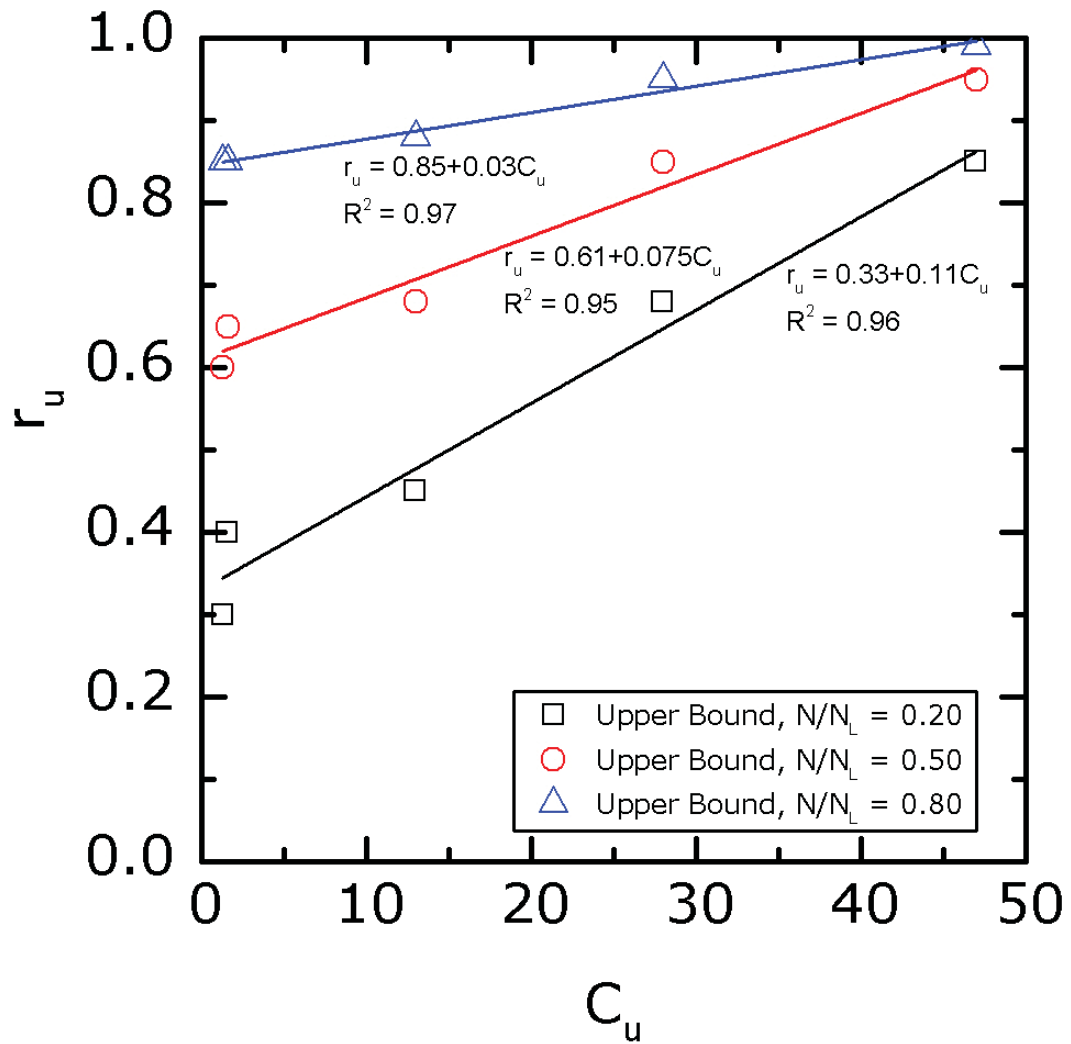

Figure 5.73: Excess pore pressure ratio as a function of C_u for gravelly soils

5.5.5 Post-Cyclic Simple Shear Results

Immediately following liquefaction of the specimen during cyclic shearing post-cyclic tests were performed. Post-cyclic undrained shear strength was evaluated after liquefaction on specimens that were not reconsolidated following liquefaction. Post-cyclic volumetric strain (settlement) was evaluated on specimens that were reconsolidated following liquefaction. In some cases, monotonic shear tests were also performed after reconsolidating the specimen to the initial vertical stress.

Example results for 80% Ottawa C109 Sand/20% CLS8 specimens subjected to different types of loading conditions are shown in Figure 5.74, which compares the normalized shear stress and shear strain response for cyclic, post-cyclic without reconsolidation, virgin monotonic, and post-cyclic with reconsolidation to the initial vertical effective stress. The post-cyclic monotonic test was performed as soon as the liquefaction test ended and without reconsolidation of the specimen. As shown in Figure 5.74, as the post-cyclic test specimen is strained, shear stress does not increase until larger strains (approximately 8%). Once shearing reaches this strain level, shear resistance increases in a nearly linear manner with a tangent shear modulus very similar to the virgin monotonic test at larger strains. This tangent shear modulus is also the tangent shear modulus at larger strains during the cyclic liquefaction test as observed in the last loop of the cyclic test. The specimen that was reconsolidated after cyclic testing increased in D_r by 11% due to settlement (1.22% volumetric strain) following cyclic testing. Therefore, it responds as a denser material as shown by its stiffer post peak stress-strain response compared to the virgin monotonic test. If reconsolidation is expected in the field the residual shear strength will be greater than the monotonic shear strength and the post-cyclic shear strength without reconsolidation.

Figure 5.75 compares the stress paths for the tests shown in Figure 5.74. This figure shows how the monotonic and post-cyclic tests are related. The specimen is cyclically deformed until it reaches the peak friction angle as determined during the monotonic test. The specimen then reaches the PT point and its behavior changes from contractive to dilative.

The last loops then cycle at the ultimate state and follow the ultimate state line as the specimen is sheared. All tests have the same PT and US lines. These lines are unique for this material for the relative densities tested. Therefore, the US ratio (or angle) determined from the virgin monotonic test could be used to predict the US shear strength after liquefaction.

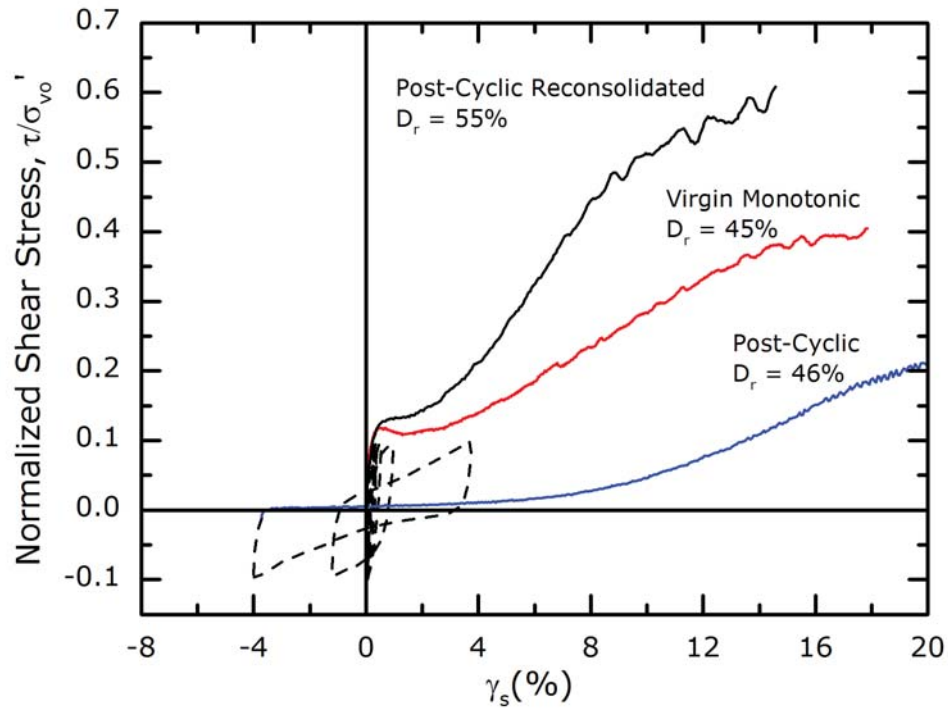

Figure 5.74: Stress-Strain Comparison of Monotonic, Cyclic, and Post-Cyclic Response of 80% Ottawa C109 Sand and 20% CLS8 (Test ID: C261, C262, M305)

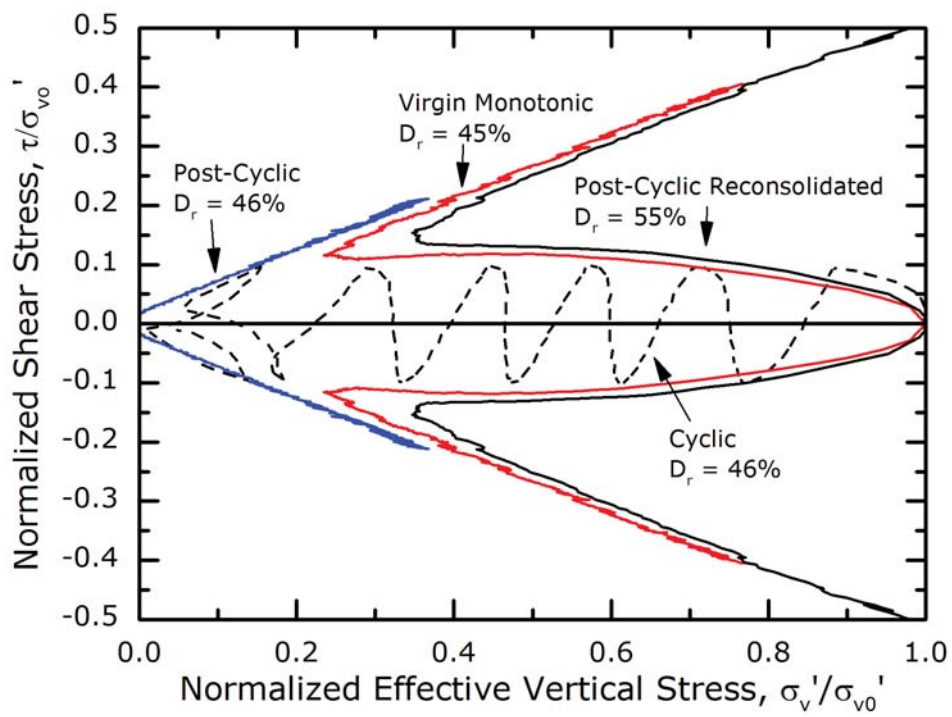

Figure 5.75: Stress Path Comparison of Monotonic, Cyclic, and Post-Cyclic Response of 80% Ottawa C109 Sand and 20% CLS8 (Test ID: C261, C262, M305)

5.5.6 Post-Cyclic Undrained Shear Strength

The post-cyclic undrained shear strength was evaluated after liquefaction and without reconsolidation of the specimen. The results show similar response to the uniform gravels tested in Chapter 4. Figure 5.76 shows the post-cyclic undrained shear strength results for Pea Gravel mixtures at $\sigma'_{v0} = 100$ and $D_r = 47\%$. The post-cyclic shear strength value is highest for the 100% Sand followed by the 40% Sand specimen (which was the optimum mixture percentage for virgin monotonic and cyclic tests). 100% Gravel displays the lowest post-cyclic undrained shear strength, with 80% Sand and 60% Sand falling above the 100% Gravel but below the 40% Sand. This shows that the addition of sand to the gravel increases the post-cyclic strength, compared to the 100% Gravel.

Figure 5.77 shows the post-cyclic undrained shear strength results for CLS8 mixtures at $\sigma'_{v0} = 100$ and $D_r = 47\%$. In this case, the 100% Gravel displays the greatest post-cyclic shear strength and the 100% Sand specimen has the lowest value of post-cyclic shear strength. As gravel is added to the sand, the post-cyclic shear strength increases for the 80% Sand and 60% Sand specimens; however, these values still fall below the 100% Gravel. When comparing these results to the Pea Gravel mixtures the effect of using different mixing gravels can be seen. The angular CLS8 material increases post-cyclic shear strength when mixed with sand, and the rounded Pea Gravel decreases the post-cyclic shear strength when added to the sand. Particle angularity is therefore shown to have a significant effect on post-cyclic shear strength of sand-gravel mixtures, for gravels of the same particle size.

Figure 5.78 plots the US shear strength versus σ'_v for both monotonic tests and post-cyclic monotonic tests of Pea Gravel mixtures. This figure shows that the post-cyclic undrained shear strength falls along the same line as the US shear strength from the virgin monotonic tests. Figure 5.79 plots the US shear strength versus σ'_v for both monotonic tests and post-cyclic tests of CLS8 mixtures. Again, the monotonic and post-cyclic undrained shear strengths at the US fall along the same line. This observation was also previously

shown for uniform gravels in Chapter 4.

Figure 5.80 plots the τ_{US}/σ'_v ratio (data from Figure 5.78) versus the V_{S1} value measured for each Pea Gravel mixture specimen. The results show that the monotonic and post-cyclic tests reach the same (or very similar) τ_{US}/σ'_v ratios. The 60% Sand specimen falls outside the range of the other data, as it has a higher V_{S1} values and τ_{US}/σ'_v ratio. Figure 5.81 plots the τ_{US}/σ'_v ratio (data from Figure 5.79) versus the V_{S1} value measured for each CLS8 mixture specimen. The results show that the monotonic and post-cyclic tests reach the same (or very similar) τ_{US}/σ'_v ratios. The slight changes in the τ_{US}/σ'_v ratios between monotonic and post-cyclic tests could be due to fabric changes during cyclic liquefaction.

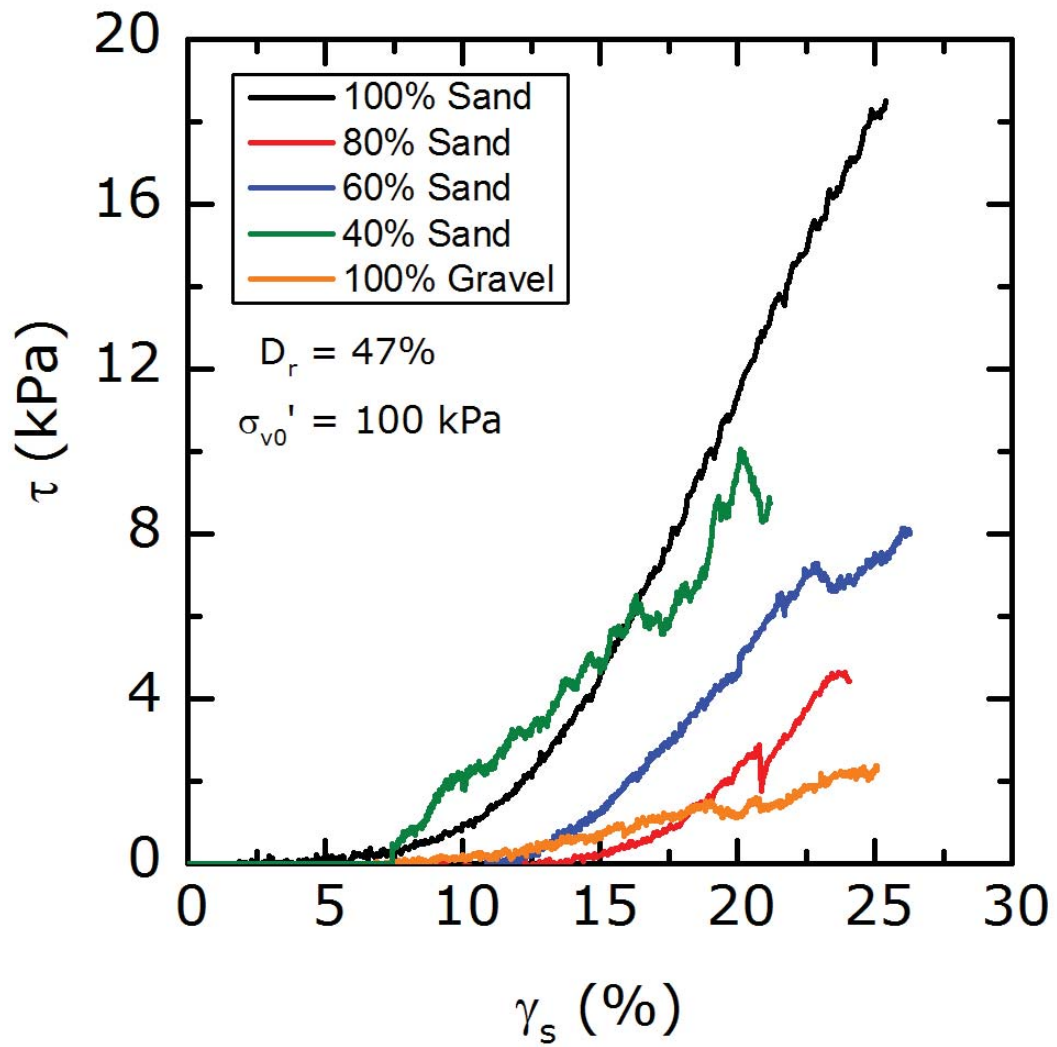

Figure 5.76: Post-Cyclic Shear Strength without re-consolidation for Pea Gravel/Ottawa C109 Sand of varying percentage at initial vertical stress of 100 kPa and $D_r = 47\%$ (Test ID: C258, C246, C244, C232, C179)

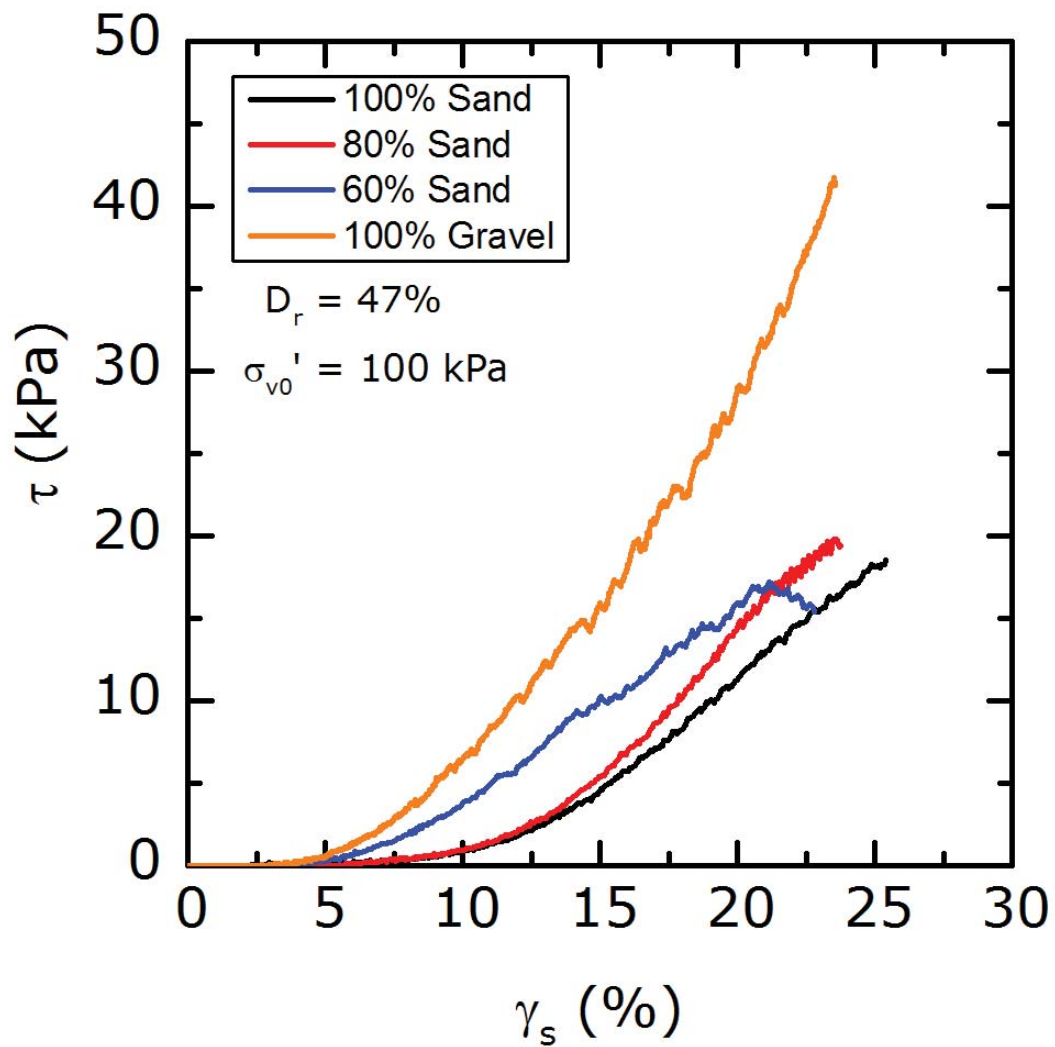

Figure 5.77: Post-Cyclic Shear Strength without re-consolidation for CLS8/Ottawa C109 Sand of varying percentage at initial vertical stress of 100 kPa and $D_r = 47\%$ (Test ID: C258, C261, C265, C217)

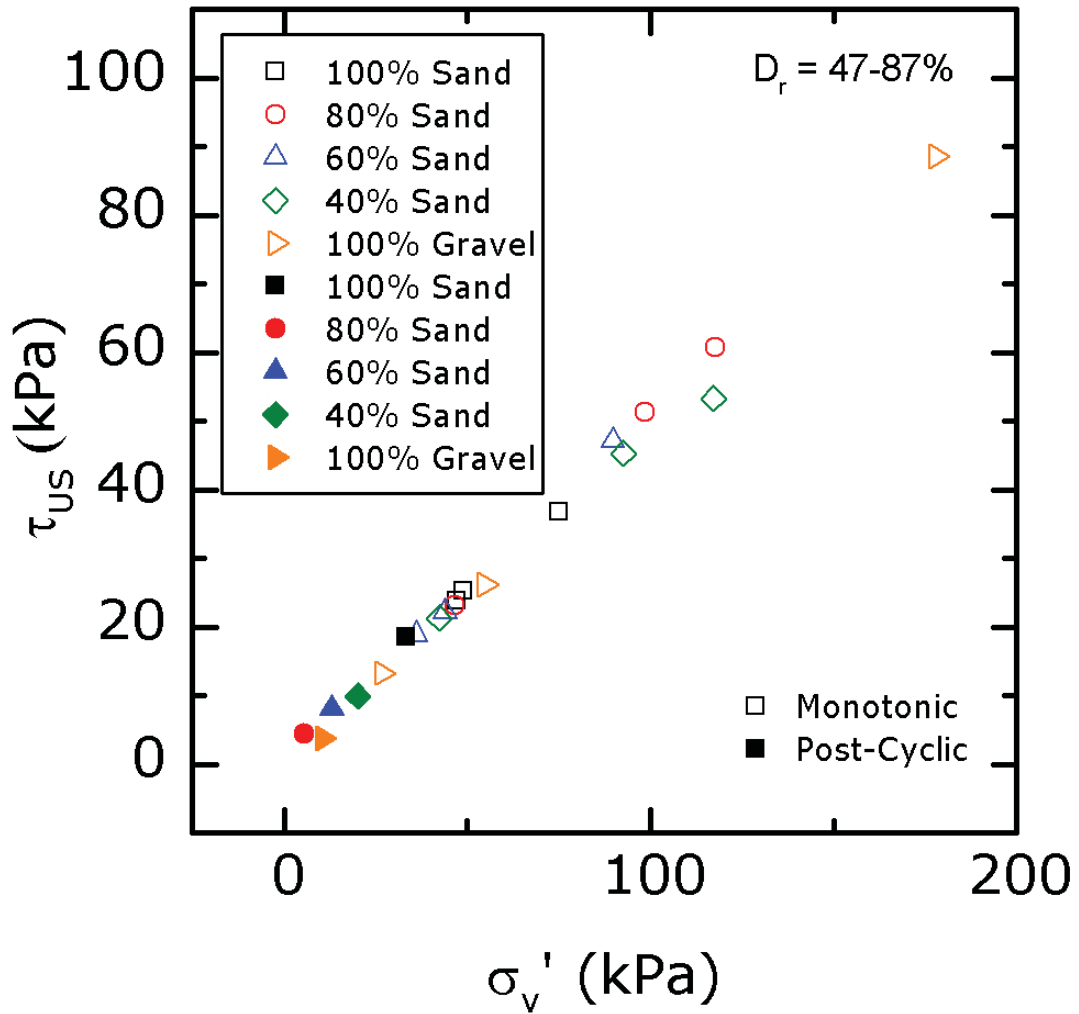

Figure 5.78: Post-Cyclic Shear Strength without re-consolidation for Pea Gravel/Ottawa C109 Sand compared with Monotonic US Shear Results

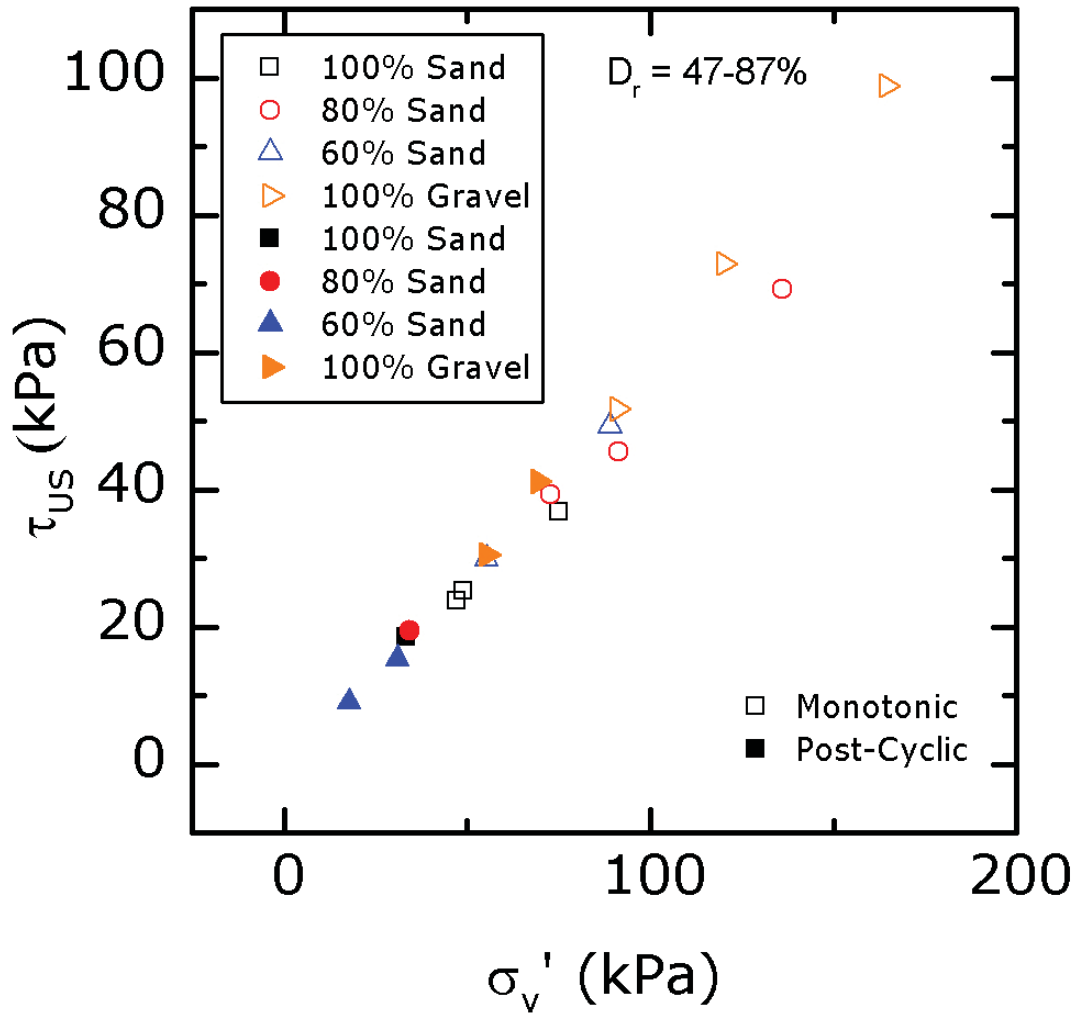

Figure 5.79: Post-Cyclic Shear Strength without re-consolidation for CLS8/Ottawa C109 Sand compared with Monotonic US Shear Results

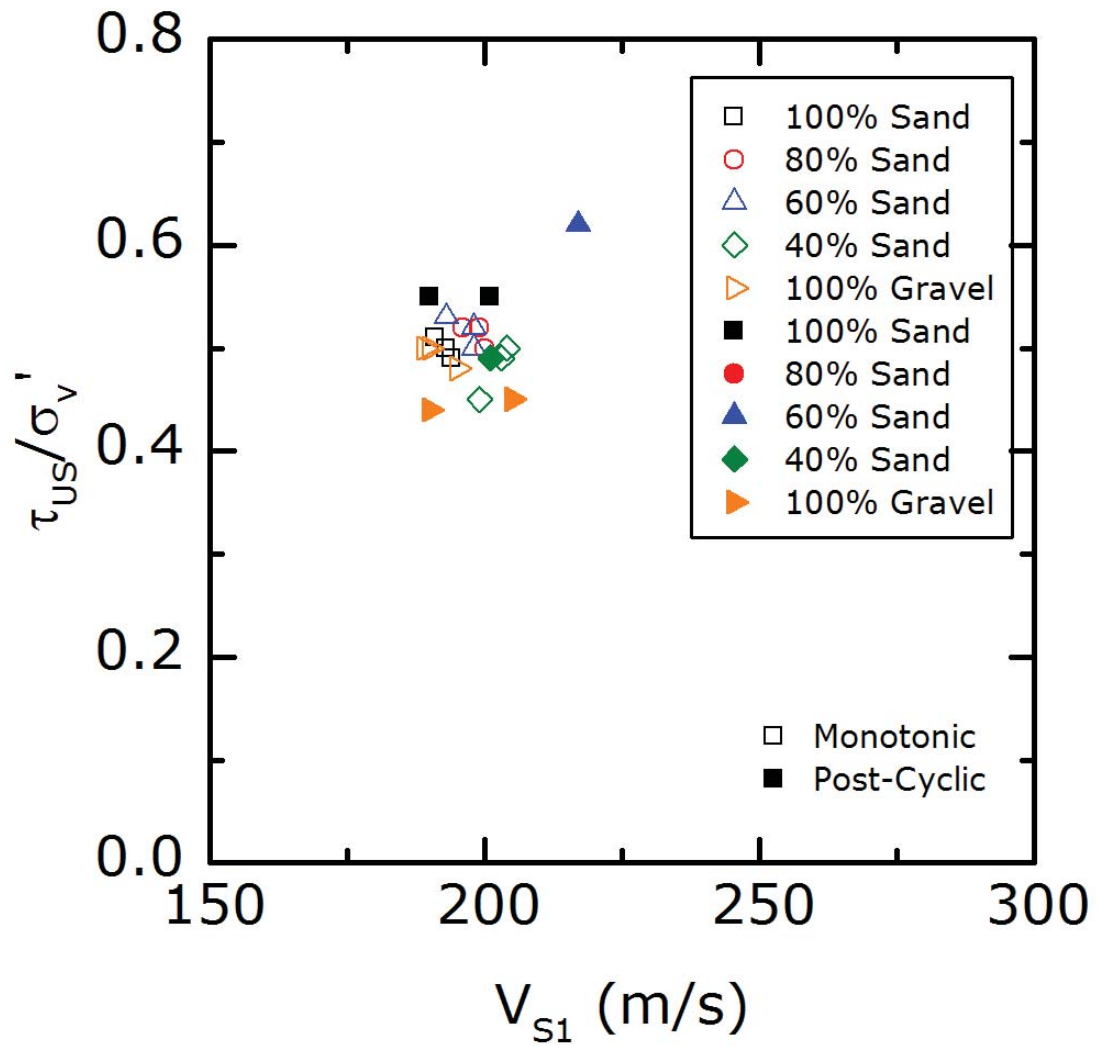

Figure 5.80: Post-Cyclic Shear Strength Ratio for Pea Gravel/Ottawa C109 Sand compared with Monotonic US Shear Strength Ratio Result versus V_{S1}

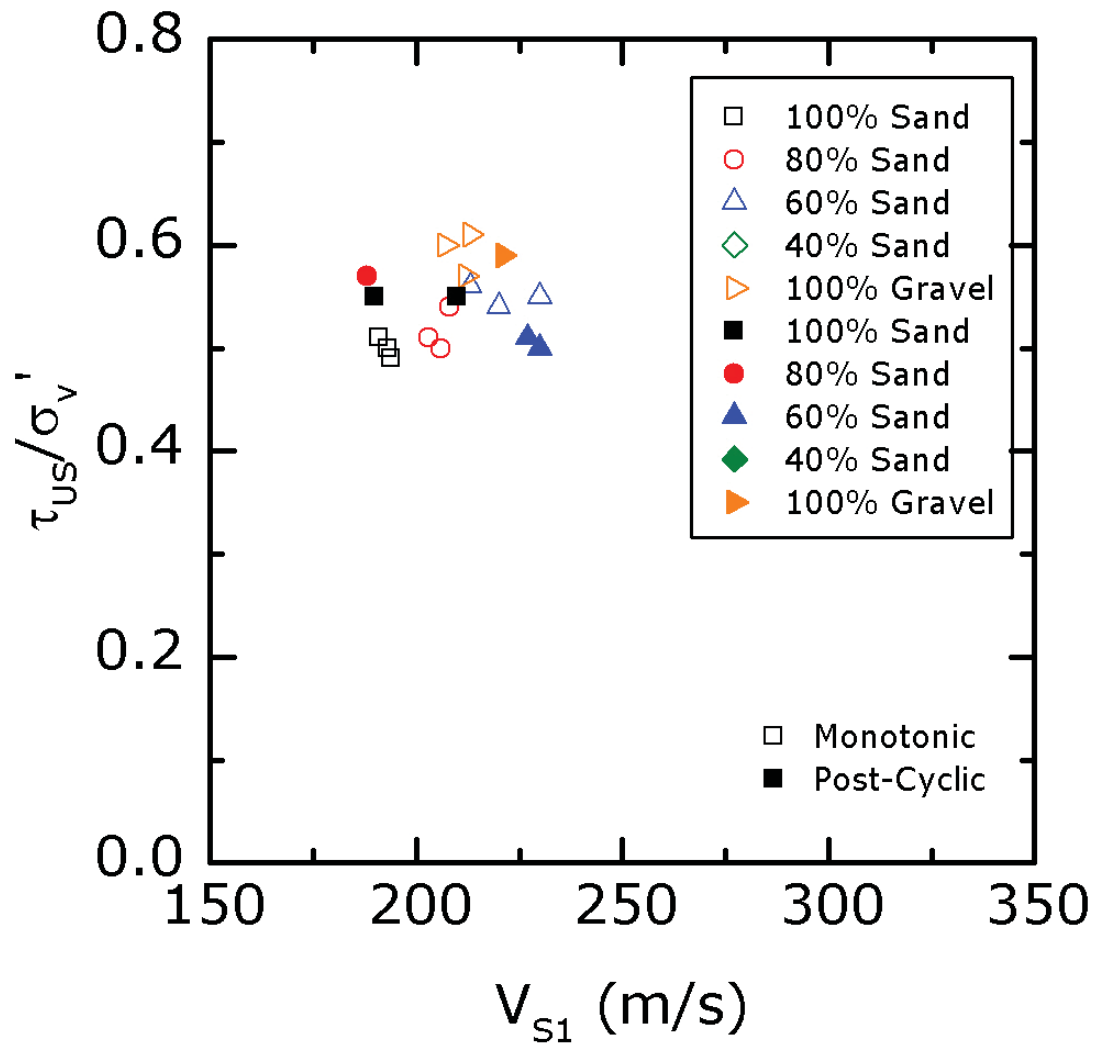

Figure 5.81: Post-Cyclic Shear Strength Ratio for CLS8/Ottawa C109 Sand compared with Monotonic US Shear Strength Ratio Results versus V_{S1}

5.5.7 Post-Cyclic Volumetric Strain

It is important to understand the post-liquefaction volume changes in soils so that accurate predictions of settlement can be made at a site. Post-cyclic volumetric strain tests were performed by reconsolidating specimens after liquefaction. Since our tests were performed at constant volume conditions, axial strain changes are also volumetric strain changes in the specimen (i.e. there is no horizontal strain during one dimensional consolidation). Specimens were usually near the zero shear strain level (the horizontal position after consolidation and before cyclic shearing) when the cyclic test finished. Specimens that were not at or near zero were centered back to the original horizontal position to eliminate the effect of shear strain on the volumetric settlement. This was done with no load on the specimen. Once centered, specimens were reconsolidated to the original vertical stress after consolidation and before cyclic shearing.

5.5.7.1 Effect of Mixture Percentage

Figure 5.82 shows the post-cyclic volumetric strain results for Pea Gravel mixtures at $\sigma'_{v0} = 100$ and $D_r = 47\%$. Results from these figures show that mixtures of gravel and sand (80% Sand, 60% Sand, and 40% Sand specimens) decreased the amount of volumetric strain observed after liquefaction compared to uniform gravels and sands. 100% Sand had the greatest amount of volumetric strain followed by 100% Gravel.

Figure 5.83 shows the post-cyclic volumetric strain results for CLS8 mixtures at $\sigma'_{v0} = 100$ and $D_r = 47\%$. Results from these figures show that the 100% Gravel specimen displays the smallest level of volumetric strain, while the 100% Sand displays the largest volumetric strain following liquefaction. The 80% Sand and 60% Sand specimens fall between the 100% Gravel and 100% Sand specimens. These results show the effect of using a different gravel in the mixture on the volumetric strain. The angular CLS8 material experiences the lowest amount of volumetric strain, while the rounded to subrounded Pea Gravel and subrounded Ottawa C109 Sand have greater levels of post-liquefaction volumet-

ric strain. This shows that particle angularity has a significant effect on post-liquefaction volumetric strain since the gravel particle sizes are about the same.

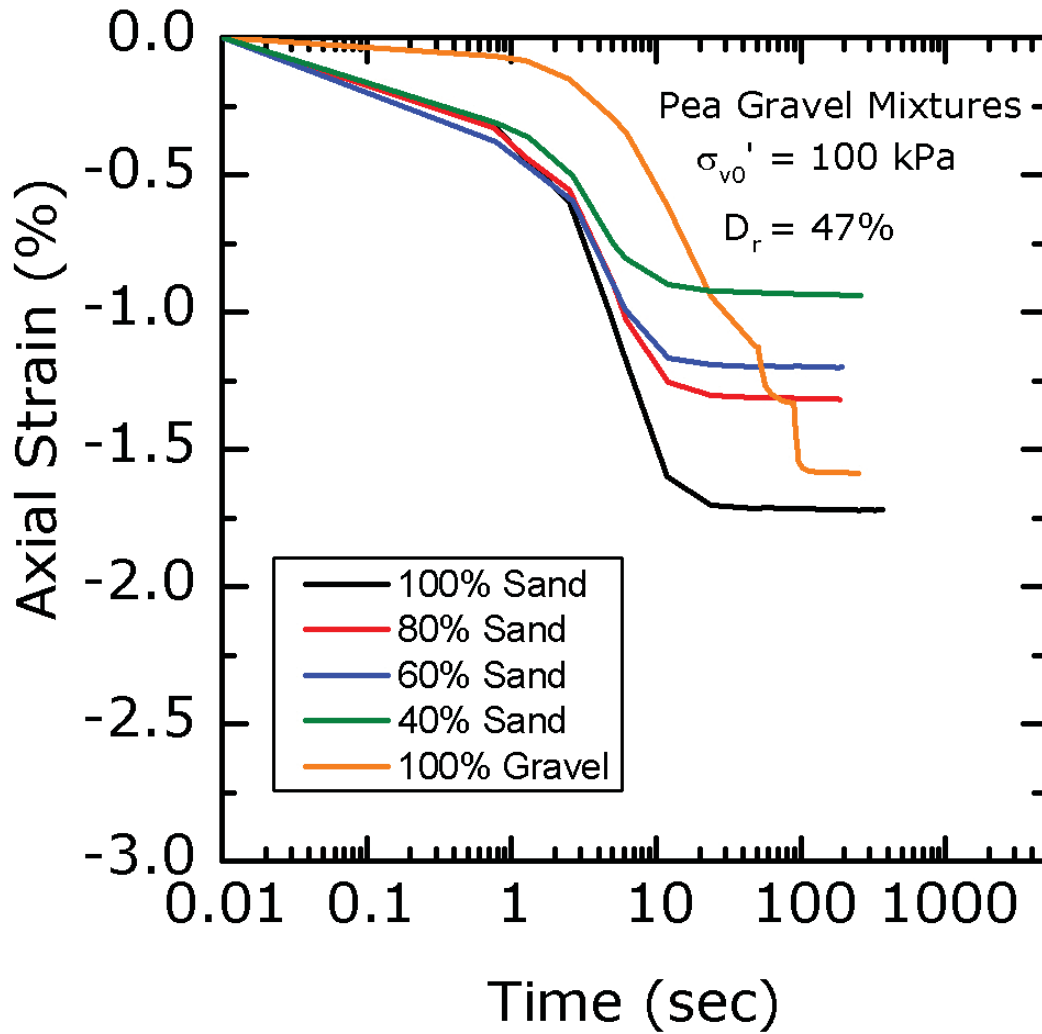

Figure 5.82: Post Cyclic Settlement for Pea Gravel/Ottawa C109 Sand mixtures of varying percentage at initial vertical stress of 100 kPa and $D_r = 47\%$ (Test ID: C253, C248, C245, C233, C180)

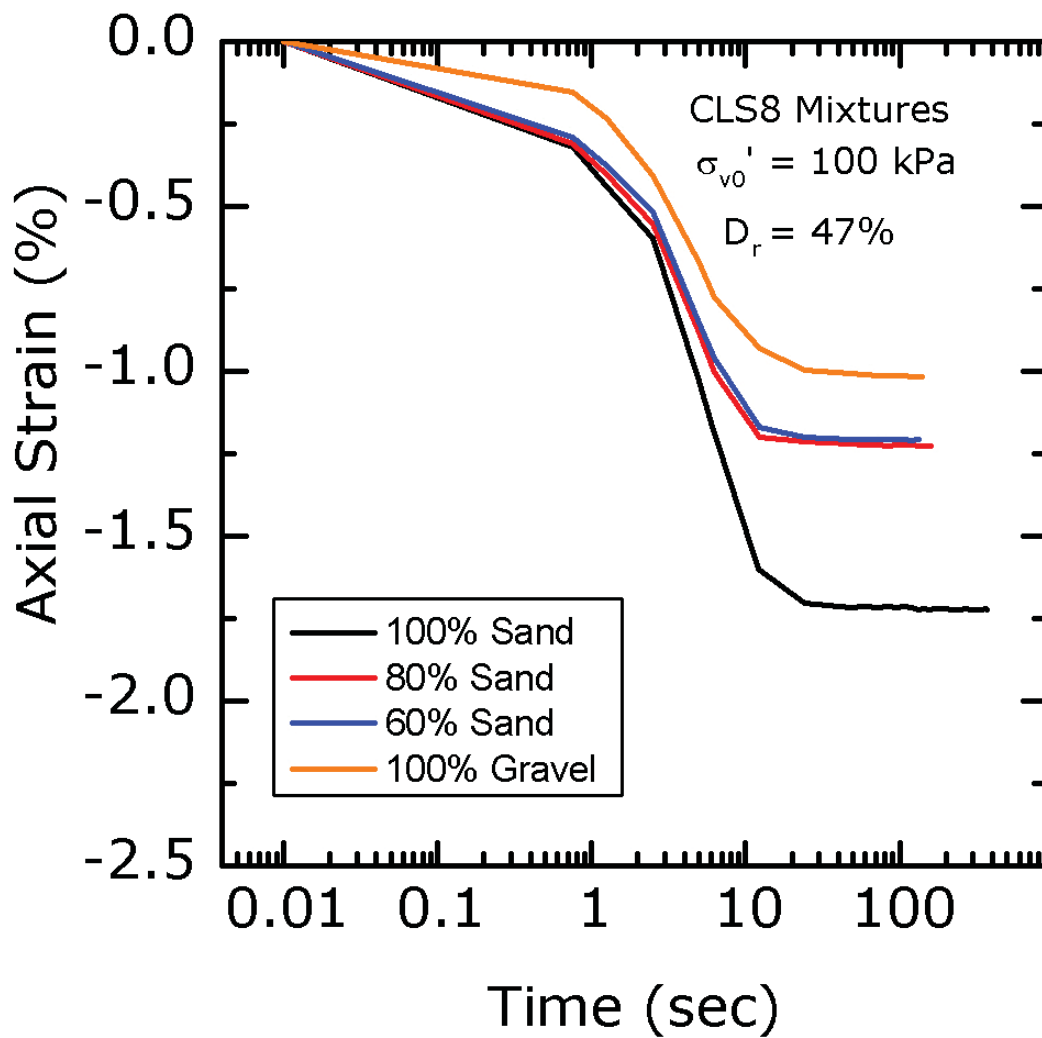

Figure 5.83: Post Cyclic Settlement for CLS8/Ottawa C109 Sand mixtures of varying percentage at initial vertical stress of 100 kPa and $D_r = 47\%$ (Test ID: C253, C262, C266, C272)

5.5.7.2 Effect of Relative Density

The effect of relative density on post-liquefaction volumetric strain was evaluated for Pea Gravel, CLS8, Ottawa C109 Sand, 60% Pea Gravel/40% Ottawa C109 Sand, and 40% CLS8/60% Ottawa C109 Sand. Specimens were compared at $\sigma'_{v0} = 100$ for $D_r = 47\%$ and $D_r = 87\%$.

Figure 5.84 shows the post-cyclic volumetric strain results for Pea Gravel at $D_r = 47\%$ and $D_r = 87\%$. As D_r increases from 47% to 87% the post-cyclic volumetric strain decreases from 1.6% to approximately 1.0%.

Figure 5.85 shows the post-cyclic volumetric strain results for CLS8 at $D_r = 47\%$ and $D_r = 87\%$. As D_r increases no change was seen in the volumetric strain after liquefaction. The void ratio of the $D_r = 47\%$ specimen after consolidation and before cyclic shearing was 0.761, while the void ratio of the $D_r = 87\%$ specimen was 0.597. Therefore, the specimens were different upon initial shearing; however, they exhibited the same amount of volumetric strain upon reconsolidation. This is likely due to the angular gravel particles being difficult to rearrange beyond a certain threshold.

Figure 5.86 shows the post-cyclic volumetric strain results for Ottawa C109 Sand at $D_r = 47\%$ and $D_r = 87\%$. As D_r increases from 47% to 87% the post-cyclic volumetric strain decreases from 1.75% to approximately 1.1%.

Figure 5.87 shows the post-cyclic volumetric strain results for 60% Pea Gravel/40% Ottawa C109 Sand at $D_r = 47\%$ and $D_r = 87\%$. As D_r increases from 47% to 87% the post-cyclic volumetric strain decreases from 0.95% to approximately 0.55%. This mixture had the smallest amount of post-cyclic volumetric strain for $D_r = 87\%$ specimens.

Figure 5.88 shows the post-cyclic volumetric strain results for 40% CLS8/60% Ottawa C109 Sand at $D_r = 47\%$ and $D_r = 87\%$. As D_r increases from 47% to 87% the post-cyclic volumetric strain decreases from 1.25% to approximately 1.05%.

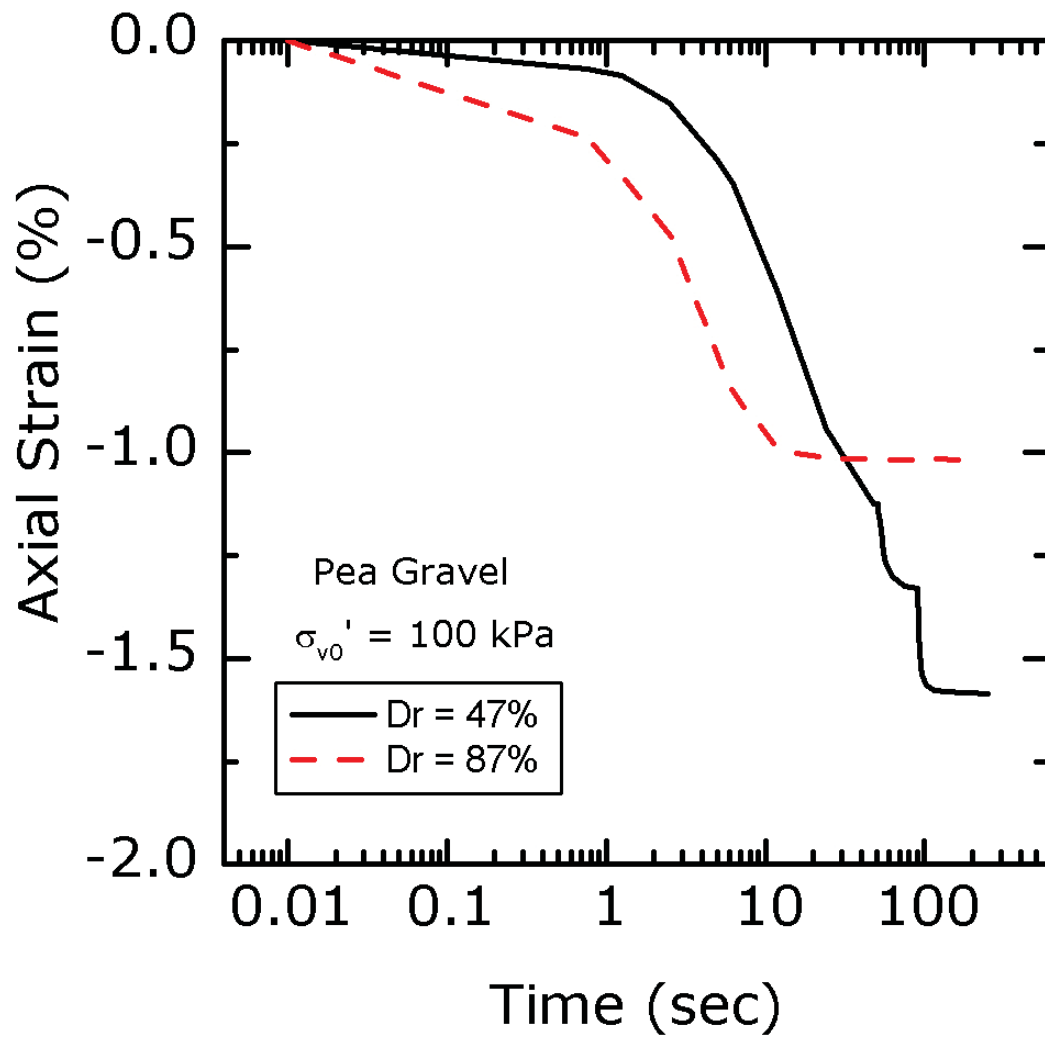

Figure 5.84: Effect of D_r on Post Cyclic Settlement for Pea Gravel at initial stress of 100 kPa (Test ID: C180, C281)

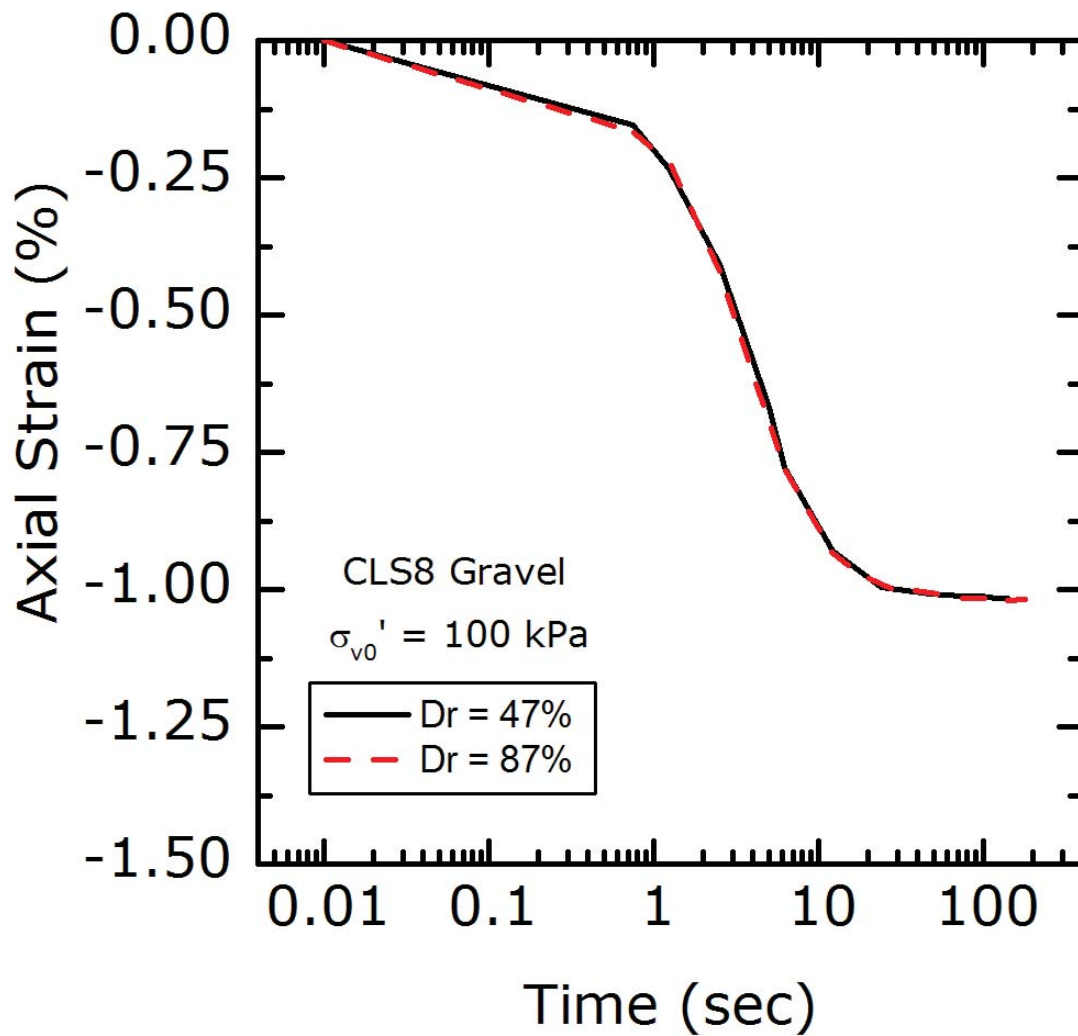

Figure 5.85: Effect of D_r on Post Cyclic Settlement for CLS8 at initial stress of 100 kPa (Test ID: C272, C283)

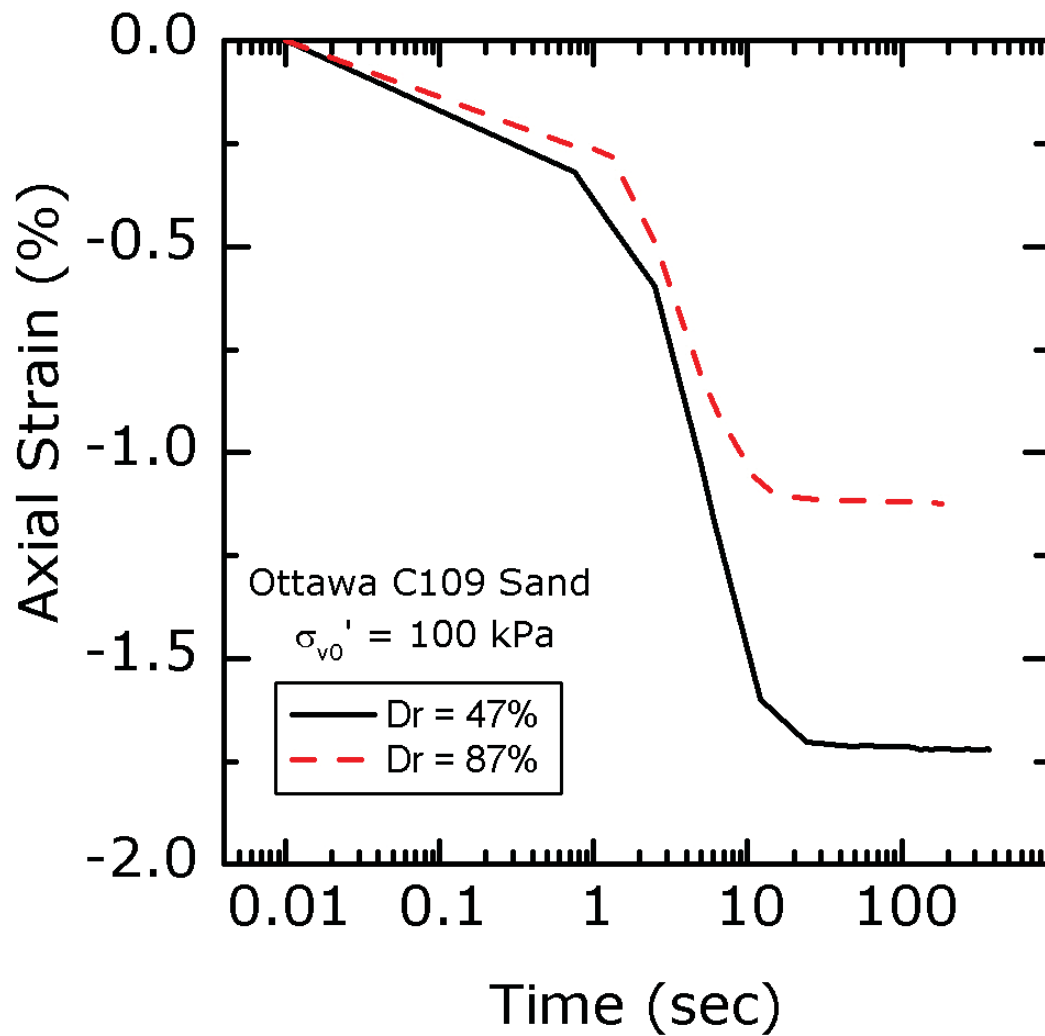

Figure 5.86: Effect of D_r on Post Cyclic Settlement for Ottawa C109 Sand at initial stress of 100 kPa (Test ID: C253, C280)

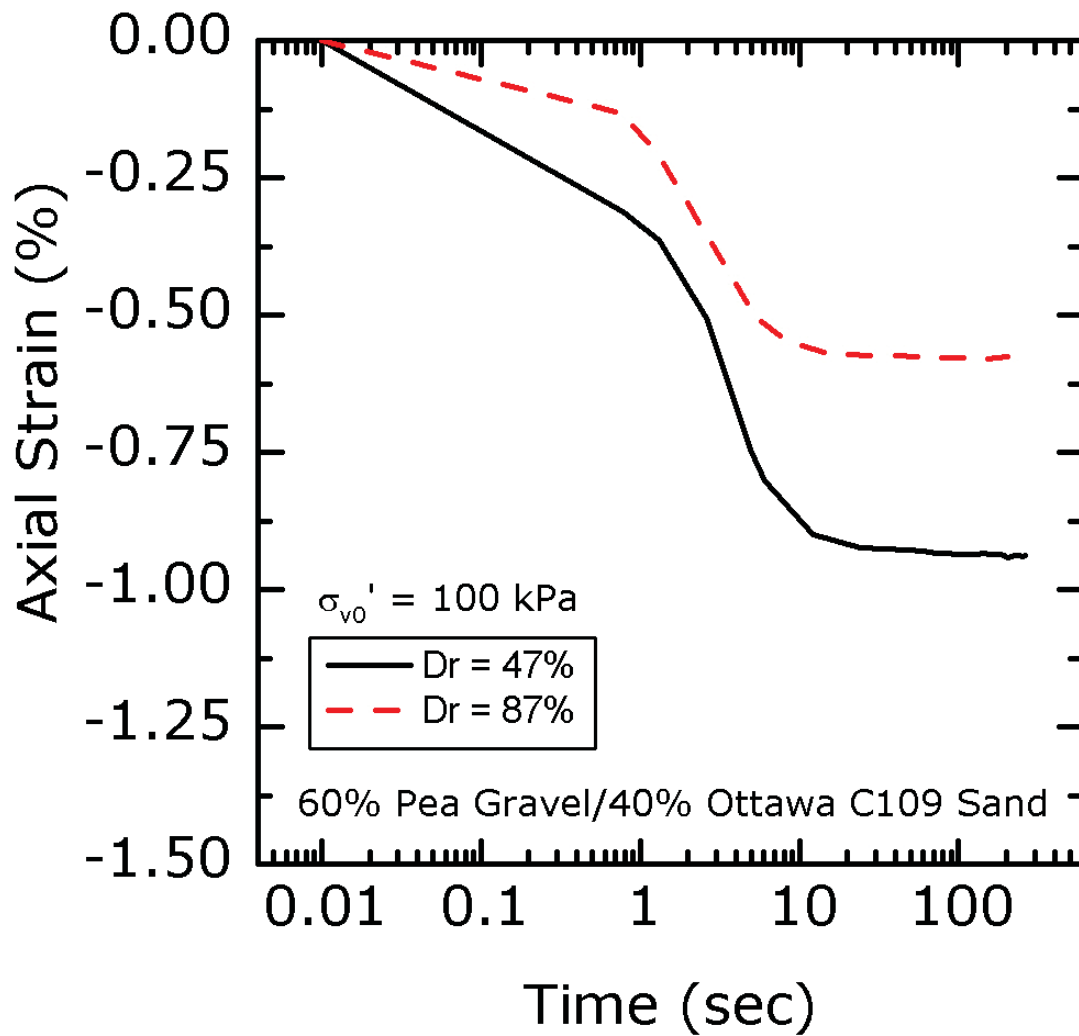

Figure 5.87: Effect of D_r on Post Cyclic Settlement for 60% Pea Gravel/40% Ottawa C109 Sand at initial stress of 100 kPa (Test ID: C233, C288)

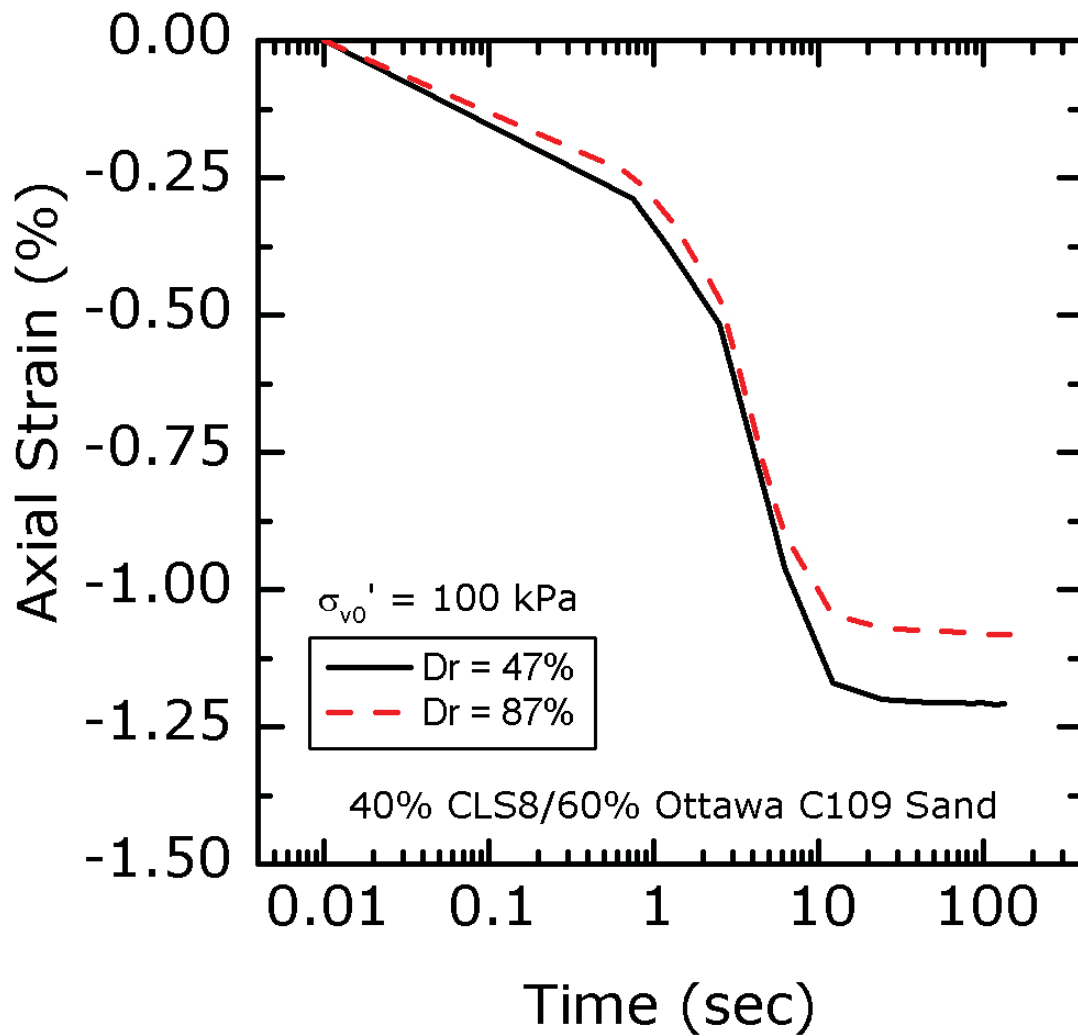

Figure 5.88: Effect of D_r on Post Cyclic Settlement for 40% CLS8/60% Ottawa C109 Sand at initial stress of 100 kPa (Test ID: C266, C291)

5.5.7.3 Comparison of Volumetric Strain with V_S

V_S was measured for each specimen before liquefaction and upon reconsolidation after liquefaction. Since each specimen experienced some volumetric strain, the D_r increased in each specimen when comparing values before and after reconsolidation. Due to this increase in D_r it was hypothesized that V_S would also increase, since V_S has been shown to increase with increasing D_r . However, V_S was found to increase, decrease, or stay roughly the same, even though D_r was increasing upon reconsolidation in each specimen. These differences are discussed below.

Figure 5.89a plots the post-cyclic volumetric strain for $D_r = 47\%$ and $D_r = 87\%$ specimens of Pea Gravel Mixtures. The effect of mixture percentage on post-cyclic volumetric strain is clear. The 100% Gravel and 100% Sand specimens have similar values of volumetric strain, and combining these materials into mixtures results in a decrease in post-cyclic volumetric strain to a minimum for 40% Sand. In Figure 5.89b the change in V_S between the value before and after reconsolidation is shown. A negative value means that the post-cyclic V_S value was lower than the consolidated V_S value, and vice versa. The V_S of the 100% Sand specimens decreased for both $D_r = 47\%$ and $D_r = 87\%$. The decrease was approximately 16 m/s (8% change from initial) for the $D_r = 47\%$ specimen, while it was a 43 m/s decrease (220% change from initial) for the $D_r = 87\%$ specimen. Conversely, V_S of the 100% Gravel increased for the $D_r = 47\%$ specimen by approximately 23 m/s (13% change from initial) and decreased slightly by 6 m/s (3% change from initial) for the $D_r = 87\%$ specimen. Interestingly, an approximately linear trend exists between the 100% Gravel and 100% Sand when comparing with the change in V_S for both $D_r = 47\%$ and $D_r = 87\%$ specimens. This finding is important since most field-based V_S measurements that are used in $CSR - V_{S1}$ liquefaction triggering charts are based on measurements of V_S after an earthquake has occurred and in the long-term. This value is then assumed to be representative of the pre-earthquake V_S value, and therefore engineers in practice use the charts based on V_S values measured in the field at a site. Further study into the factors affecting

this response is required.

Similarly, Figure 5.90a plots the post-cyclic volumetric for $D_r = 47\%$ and $D_r = 87\%$ specimens of CLS8 Mixtures. There is a different response observed in this figure when compared to the Pea Gravel mixtures in Figure 5.89a. 100% Sand displays the greatest amount of post-cyclic volumetric strain at $D_r = 47\%$. As CLS8 gravel is added to the sand, the volumetric strain decreases to an amount that is similar to 100% CLS. For the $D_r = 87\%$ specimens of 100% Gravel, 60% Sand, and 100% Sand, the volumetric strain is almost identical. It appears as though a limiting value is reached for the angular CLS8 material, as both the $D_r = 47\%$ and $D_r = 87\%$ specimens of 100% Gravel have the same volumetric strain value. Again, comparisons were made for the change in V_S between consolidation and reconsolidation following liquefaction. In this case, all materials and mixtures decrease in V_S between consolidation and reconsolidation after liquefaction. The $D_r = 47\%$ specimens for all CLS8 mixtures decreased between 10 and 20 m/s (5-10% change from initial V_S).

Data for the gravel-sand mixtures was plotted with existing relationships from the literature which are used to predict the level of post-liquefaction settlement (volumetric strain) based on D_r and maximum shear strain during testing (*Yoshimine et al.*, 2006) as well as V_{S1} and maximum shear strain amplitude (*Yi*, 2010). These relationships are based on test data for sand, as there is no existing relationships for gravelly soils. Figure 5.92 shows that the data from this study would be characterized as $D_r = 80-90\%$ from the *Yoshimine et al.* (2006) plot. The data labels in this plot show the actual D_r values of the specimens from this study. While some are above $D_r = 80\%$, the $D_r = 47\%$ specimens display significantly less volumetric strain than expected from this prediction plot. *Yi* (2010) took the data from *Yoshimine et al.* (2006) and developed a V_{S1} -based chart (replacing D_r with V_{S1}). When the values of V_{S1} (taken as the ones after consolidation and before liquefaction) are plotted on this chart the data from this study falls in line with the V_{S1} values for the sands, even though our soils are sands, gravels, and sand-gravel mixtures. In this plot, the data labels

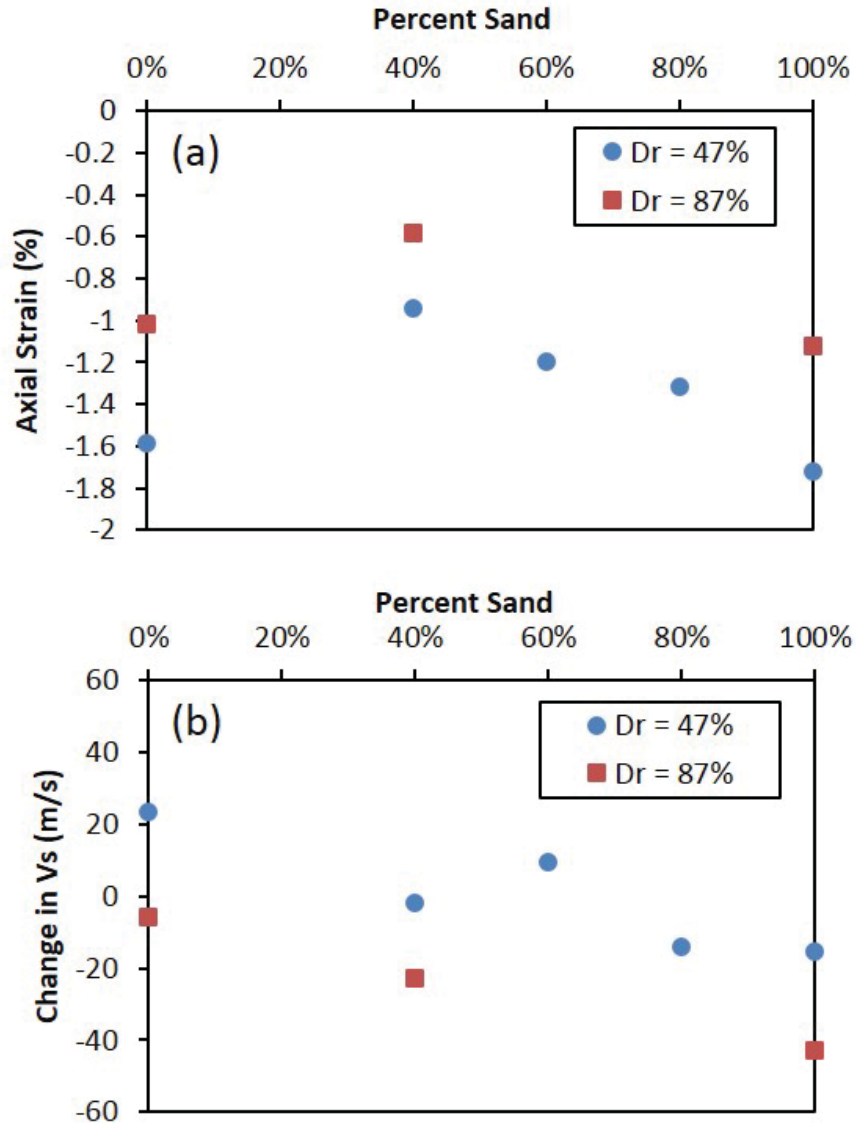

Figure 5.89: (a) Post-Cyclic Settlement as a function of mixture percentage for Ottawa C109 sand and Pea Gravel mixes at loose and dense states and (b) corresponding change in V_s measured before and after liquefaction at 100 kPa (a negative change in V_s means that the V_s measured after liquefaction and reconsolidation was lower than the V_s value measured before after initial consolidation and before liquefaction)

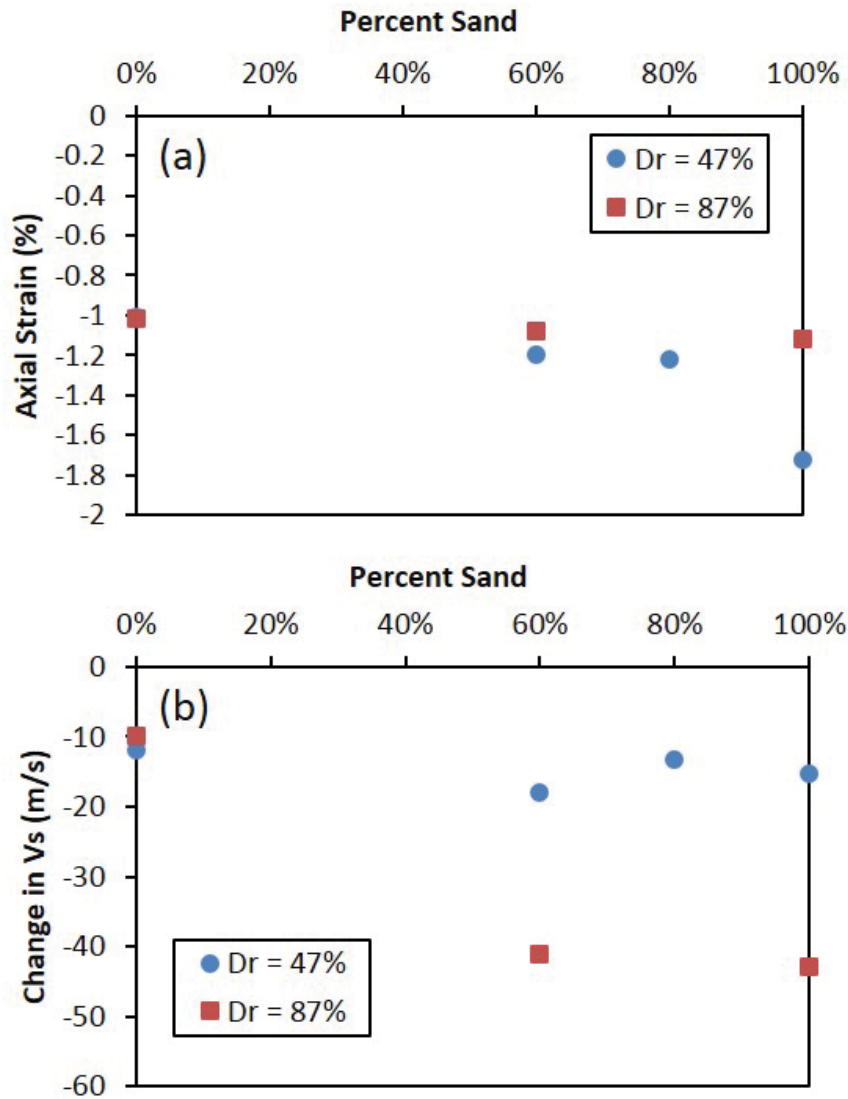

Figure 5.90: (a) Post-Cyclic Settlement as a function of mixture percentage for Ottawa C109 sand and CLS8 mixes at loose and dense states and (b) corresponding change in V_s measured before and after liquefaction at 100 kPa (a negative change in V_s means that the V_s measured after liquefaction and reconsolidation was lower than the V_s value measured before after initial consolidation and before liquefaction)

are the V_{S1} values for each specimen. This finding suggests that D_r might not be the best indicator of gravelly soil post-cyclic volumetric strain, and that a framework based on V_{S1} values could be promising for both sands, gravels, and gravel-sand mixtures.

Figure 2.33 from Chapter 2 gives some perspective on the magnitude of volumetric strain for the gravel and gravel-sand mixtures in this study, as they were observed to be lower than sands. In this figure from *Hara et al. (2012)*, the post-liquefaction volumetric strain is plotted for different soils with different C_u values, including gravels and sands. The results show that well-graded materials will see greater amounts of volumetric strain, while materials like the Alluvial Gravel with C_u of approximately 13 saw volumetric strains less than 2%. This value is similar to the volumetric strains observed in this study for gravels and shows that gravels can display less post-liquefaction volumetric strain than sands and that C_u appears to be an important parameter affecting this response.

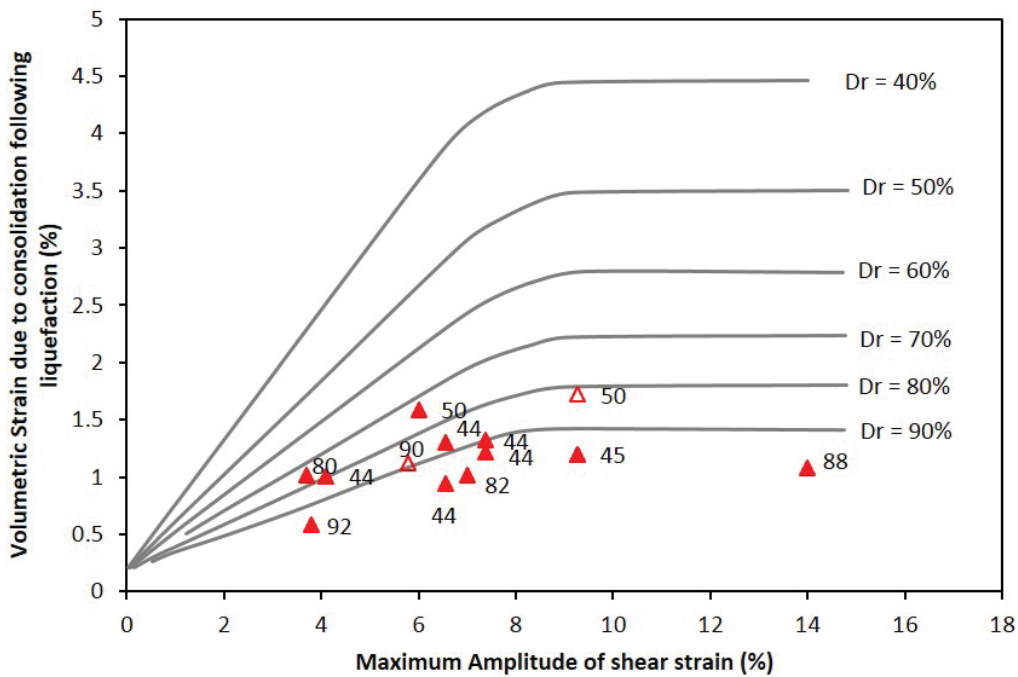

Figure 5.91: Post Cyclic Settlement comparison with *Yoshimine et al. (2006)* data based on relative density

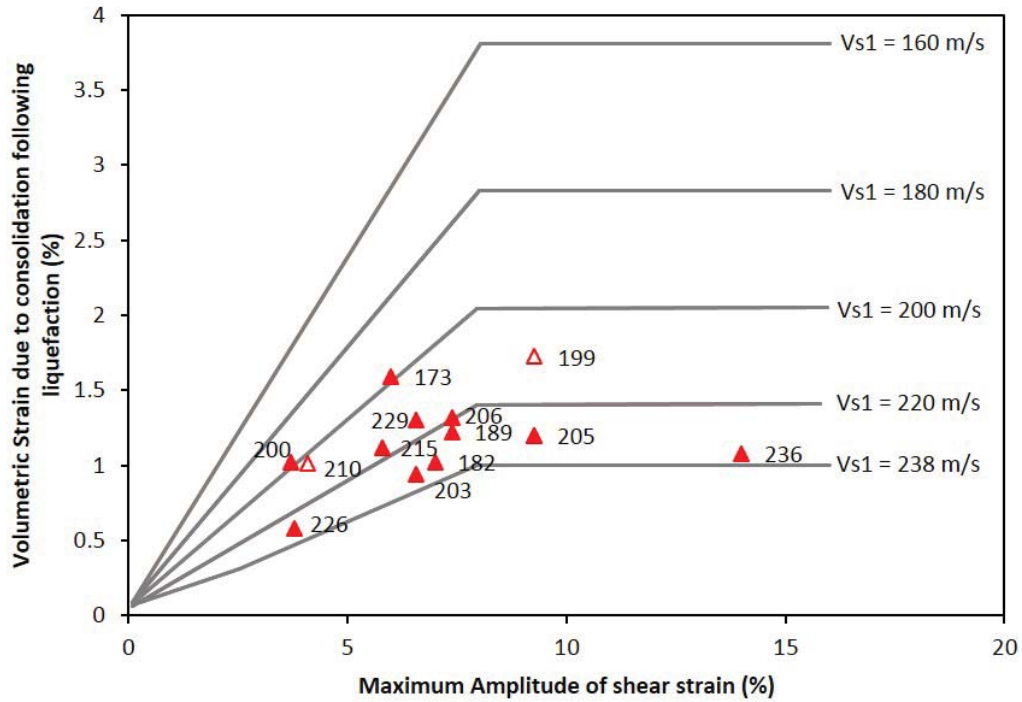

Figure 5.92: Post Cyclic Settlement comparison with Yi (2010) data based on V_S

5.6 Conclusions

The monotonic, cyclic and post-cyclic shear response of gravel-sand mixtures was evaluated in this Chapter. V_S was measured in each specimen and was used to investigate constant volume monotonic, cyclic and post-cyclic shear response. The data presented in this chapter represents some of the first cyclic simple shear data for gravelly soils tested in the laboratory. The main findings were:

5.6.1 Specimen Preparation

- Maximum density of gravel-sand mixtures can be difficult to evaluate using current methods. The vibratory table can cause significant particle segregation. A new method of determining maximum density was developed that compared well with the α method proposed by *Fragaszy et al.* (1990).
- For Pea Gravel/Ottawa C109 Sand Mixtures, there was not a significant change in V_S

as the mixture percentages changed. This is likely due to the similarity in V_S of the uniform Pea Gravel and uniform Ottawa C109 Sand. The mixture with the highest V_S value was the 40% Sand/60% Gravel mixture. Alternatively, mixture percentage had a significant effect on the V_S values for the CLS8/Ottawa C109 Sand mixtures. In this case, the uniform CLS8 and uniform Ottawa C109 Sand had different V_S values. The mixture with the highest V_S value was the 60% Sand/40% Gravel mixture, followed by the 100% Gravel specimen.

5.6.2 Monotonic Response

- The percentage of gravel and sand in a mixture affects the monotonic shear response. There exists an optimum mixture percentage of gravel and sand that maximizes shear strength. The optimum mixture percentage was found to be 60% Pea Gravel/40% Ottawa C109 Sand for Pea Gravel mixtures and 40% CLS8/60% Ottawa C109 Sand for CLS8 mixtures. This optimum mixture had the highest peak friction angle during monotonic testing as well as the highest V_S value. Initial vertical stress was shown to not have an effect on the optimum mixture percentage.
- The Phase Transformation friction angle was not affected by mixture percentage for the Pea Gravel mixtures, but increased to the level of 100% CLS8 gravel with the addition of only 20% CLS8 to the CLS8 mixtures.
- τ/σ'_v ratio was nearly constant (approximately 0.50) at larger strains (i.e. the US) for Pea Gravel mixtures, regardless of mixture percentage; however, for CLS8 mixtures the τ/σ'_v ratio at the US was dependent on mixture percentage. The τ/σ'_v ratio did not change significantly for the Pea Gravel mixtures since the uniform Pea Gravel and Ottawa C109 Sand had similar shear response when tested independently. Conversely, CLS8 and Ottawa C109 had different shear response when tested independently, which led to different results when mixed, highlighting the possible effect of

particle angularity.

- Relative density did not affect the PT or US friction angles for the monotonic tests. Peak friction angle increased with increasing relative density.
- Initial vertical stress did not have an effect on Peak, PT, or US friction angles for monotonic tests.
- The use of global, sand skeleton, and gravel skeleton void ratios was investigated by comparing results for monotonic shear tests. For the Pea Gravel mixtures global void ratio appears to capture the overall material response better than the sand or gravel skeleton void ratios. However, use of the sand and gravel skeleton void ratios can be useful for identifying percentages at which gravel and sand contribute to material response. For CLS8 mixtures, clear trends were not evident.
- Shear strength at Peak and PT was correlated with V_S . Equations were developed that can predict undrained shear strength at Peak (Equation 5.7) and PT (Equation 5.8) for gravelly soils using V_S . Shear strength at Peak and PT correlates well with V_S , while shear strength at US shows a weaker correlation (therefore equations were not developed for US).

5.6.3 Cyclic Response

- Mixture percentage was shown to also affect the cyclic response of gravel-sand mixtures. For tests at $CSR = 0.09$ and $D_r = 47\%$, the optimum mixture that was found from the monotonic shear tests exhibited the greatest resistance to liquefaction.
- The effect of CSR on liquefaction resistance was not the same for all gravel-sand mixtures tested in this study. At $CSR = 0.04$ test, mixtures of 60% Sand and 40% Sand were the least resistant to liquefaction (compared to the other mixtures and the 100% Gravel and 100% Sand), while at $CSR = 0.14$ these mixtures were the most

resistant for both mixtures of Pea Gravel and CLS8. This could possibly be explained by examining the particle interaction between the sand and gravel. It is possible that for certain mixtures at the lower CSR value (and therefore lower strain level) the gravel is not engaged in the small cyclic movements (i.e. the sand is controlling the response). In the 60% Sand and 40% Sand specimens mixed with Pea Gravel, the sand in between the gravel is also in a looser state than at $D_r = 47\%$ ($e = 0.64$), which could explain the fewer number of cycles to liquefaction if the sand is controlling the response. The void ratio for the 60% Sand specimen at $D_r = 47\%$ is 0.70, while the void ratio for the 40% Sand specimen at $D_r = 47\%$ is 0.83. This shows that the sand is likely controlling response and therefore liquefying in fewer cycles than the $e = 0.64$ ($D_r = 47\%$) 100% Sand specimen.

- The particle angularity of the gravel in a gravel-sand mixture affects the response during monotonic and cyclic tests. The subrounded Pea Gravel mixtures had a different optimum mixture percentage than the angular CLS8 gravel mixtures.
- Initial vertical stress was shown to not have a significant effect on the liquefaction resistance of Pea Gravel mixtures. CLS8 mixtures showed an effect of initial vertical stress, but this attributed to differences in specimen V_S .
- Relative density was shown to affect the liquefaction resistance of gravel-sand mixtures in this study. As relative density increased, the liquefaction resistance of the mixtures decreased. It is possible that during compaction using the drop weight, the compaction energy was primarily concentrated on the gravel skeleton, while the sand particles remained relatively loose. These findings suggest that it is possible that the gravel skeleton void ratio was controlling the cyclic response of the dense specimen, while the global void ratio was controlling the response of the loose specimen.
- The *Andrus and Stokoe* (2000) liquefaction triggering correlation for gravels and the *Kayen et al.* (2013) correlation for sands do not compare well with the data for

gravel-sand mixtures tested in this study. The tested gravel-sand mixtures liquefied at V_{S1} values higher than 200 m/s and as high as approximately 240 m/s. All of the specimens that liquefied, including the clean sand, would have been predicted as non-liquefiable according to both existing triggering correlations.

- Pore pressure generation of gravelly soils was shown to be dependent on the coefficient of uniformity (C_u). As the C_u value increases, r_u increases, especially at values of $N/N_L < 0.3$.

5.6.4 Post-Cyclic Response

- The Ultimate State line was found to be independent of previous loading. The US line was the same for virgin monotonic, post-cyclic, and post-cyclic reconsolidated tests on gravel-sand mixtures. The $\tau_{US}/\sigma v'$ ratio was found to be the same for monotonic and post-cyclic shear tests.
- Particle angularity of the mixing gravel was shown to have a significant effect on post-cyclic undrained shear strength of gravel-sand mixtures. The angular CLS8 material increased post-cyclic shear strength when added to sand, and the rounded Pea Gravel decreased the post-cyclic shear strength when added to the sand.
- Post-liquefaction volumetric strain was evaluated for the gravel-sand mixtures. For the uniform materials in the loose state, the angular CLS8 material displayed the lowest amount of volumetric strain (approximately 1%), while the rounded to sub-rounded Pea Gravel and subrounded Ottawa C109 Sand displayed greater levels of post-liquefaction volumetric strain (approximately 1.6% for Pea Gravel and 1.75% for Ottawa C109 Sand). This shows that particle angularity has a significant effect on post-liquefaction volumetric strain. As relative density increased, post-liquefaction volumetric strain decreased, except for 100% CLS8 specimens which showed no change. As gravel was added to 100% Sand, the volumetric strain decreased up to

40% Sand for Pea Gravel Mixtures and up to 100% Gravel for CLS8 mixtures.

- V_S was measured before shearing and after reconsolidation following liquefaction. The values, in some cases, showed significant change (as much as 43 m/s). This finding is important since most field-based V_S measurements that are used in $CSR - V_{S1}$ liquefaction triggering charts are based on measurements of V_S after an earthquake has occurred. This value is then assumed to be representative of the pre-earthquake V_S value, which may not be the case.
- Post-liquefaction volumetric strain data was compared with existing relationships for sands based on D_r and V_{S1} (Yoshimine *et al.*, 2006; Yi, 2010). The gravel-sand mixtures did not fit into the framework developed for sands based on D_r ; however, the mixtures did fit into the framework developed for sands using V_{S1} . This finding suggests that D_r might not be the best indicator of gravelly soil post-cyclic volumetric strain, and that a framework based on V_{S1} values could be promising for both sands, gravels, and gravel-sand mixtures.

CHAPTER 6

Field Response and Liquefaction Analysis of Gravelly Soils

6.1 Introduction

Three sites that include gravelly soils were chosen to conduct in-situ field tests so that comparisons could be made between laboratory and field response of gravelly soils. The sites include Millsite Dam in Ferron, Utah, the port of Lixouri in Cephalonia, Greece and the port of Argostoli in Cephalonia, Greece. The field tests performed include the Dynamic Penetration Test (DPT) and MASW for the assessment of shear wave velocity (V_S). Millsite Dam was chosen for field testing because extensive testing had been performed at the site (including DPT, SPT, BPT) and it offered an opportunity to compare V_S measurements with in-situ penetration tests for a gravelly site. The Cephalonia, Greece, sites were chosen because significant liquefaction of gravelly soils was observed during the 2014 earthquakes. The sites were very well documented following the earthquake, with data available for lateral and vertical displacements as well as instrumented measurements of ground motions. Therefore, it offered a unique site for further testing using in-situ tests for gravelly soil liquefaction analysis.

6.2 Cephalonia Earthquakes

Two earthquakes occurred near the island of Cephalonia on January 26, 2014 and February 3, 2014. The first event had a moment magnitude (M_w) of 6.1, while the second event had a $M_w = 6.0$. Fortunately, no lives were lost during these events; however, significant damage was observed. Liquefaction was observed in the port cities of Argostoli and Lixouri in gravelly soil/rubble fill deposits, and these sites were chosen for further study and evaluation using DPT and V_S field tests.

Cephalonia has a history of seismic activity with 18 earthquakes of $6.3 < M_w < 7.4$ having been observed since the 15th century. The Cephalonian Transform Fault (CTF) is the main seismotectonic feature of the region and is shown in Figure 6.1. The 1953 Ionian Earthquake is of importance because extensive damage occurred in the ports of Lixouri and Argostoli (shown in Figure 6.2). This damage changed the area of the ports through sea reclamation (shown in Figure 6.3 for Lixouri Port) and has implications on the present studies of these ports as will be discussed later. Figures 6.4 and 6.5 show evidence of liquefaction (i.e. soil ejected from the ground due to pore pressure relief) at the Lixouri Port during the 2014 earthquakes. Significant gravelly soil liquefaction was observed as shown in Figure 6.5 where coarse grained soil ejecta can be seen. Liquefaction occurred in both Lixouri and Argostoli during both 2014 earthquake events.

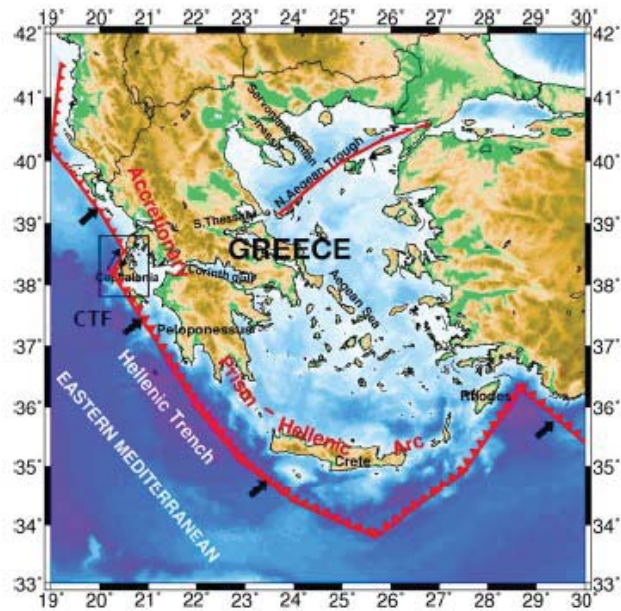

Figure 6.1: Seismotectonic features of the Cephalonia Area. The Cephalonian Transform Fault is shown in the black boxed area. (From (Nikolaou et al., 2014) modified after Scordilis et al. 1984)



Figure 6.2: Damage observed in Argostoli during 1953 Earthquake (Nikolaou et al., 2014)

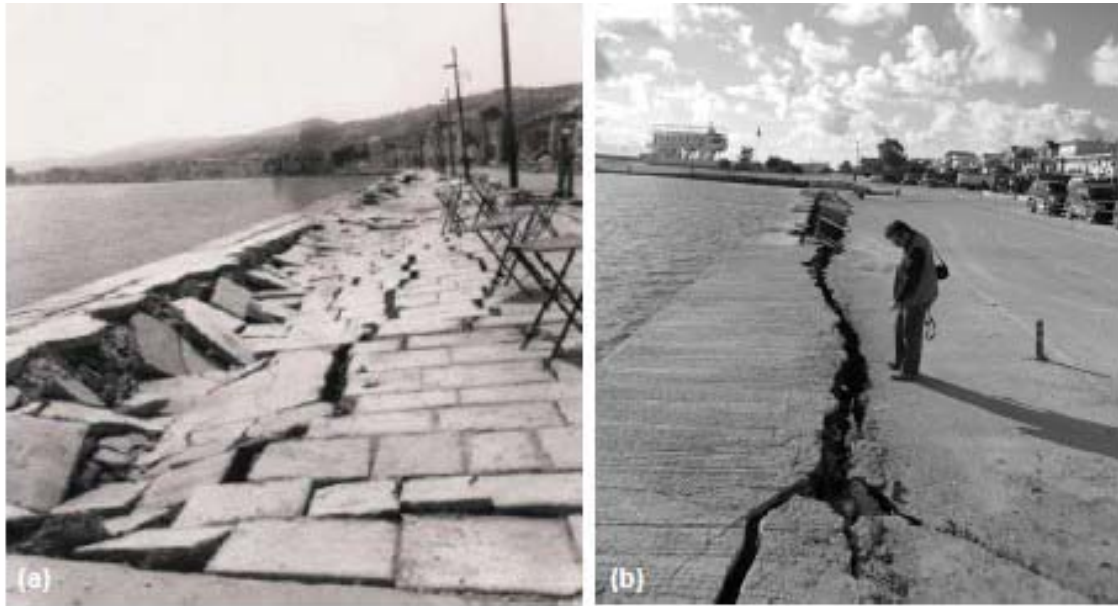

Figure 6.3: Observations of damage at Lixouri Port (a) 1953 Earthquake and (b) 2014 Earthquake (*Nikolaou et al.*, 2014)



Figure 6.4: Observations of liquefaction at Lixouri Port (*Nikolaou et al.*, 2014)



Figure 6.5: Observations of gravelly soil liquefaction at Lixouri Port (*Nikolaou et al.*, 2014)

6.3 Field Test Equipment

6.3.1 Chinese Dynamic Penetration Test

The Dynamic Penetration Test (DPT) was first developed in the 1950s for testing gravelly soils in China as an alternative to Standard Penetration Testing (SPT) and Cone Penetration Testing (CPT) which can be unreliable in gravelly deposits. The DPT was originally designed for use in bearing-capacity analysis for foundation design; however, it has recently been used in liquefaction analyses in China following the 2008 Wenchuan earthquake (*Cao et al.*, 2013). The DPT equipment used by *Cao et al.* (2013) consisted of a 120 kg hammer with a free fall height of 100 cm. The diameter of the drill rods was 60-mm and the solid cone tip had a diameter of 74-mm and a cone angle of 60° (Figure 6.6 and 6.7). The drill rods have a smaller diameter than the cone tip so that rod friction is reduced. It has been shown in Chinese practice that rod friction is negligible for rod depths less than 20 m for all soils except soft clays. Energy measurements were also performed by *Cao et al.* (2013)

using a pile driving analyzer (PDA) to determine the energy transfer ratio (ETR). They obtained ETR values in the 85-90% range for their DPT apparatus.

The number of blows to advance the DPT cone in 10 cm increments is recorded. N_{120} is specified in code applications and is the number of blows to advance the cone 30 cm. This value is obtained by multiplying each 10 cm increment by 3. Furthermore this N_{120} value can be corrected for overburden stress effects using the following equation (Cao *et al.*, 2013):

$$N'_{120} = N_{120} \left(\frac{P_{atm}}{\sigma'_v} \right)^{0.50} \quad (6.1)$$

Where N'_{120} is the overburden corrected DPT resistance measured in blows per 30cm, N_{120} is the measured blows per 30 cm and σ'_v is the effective overburden stress.

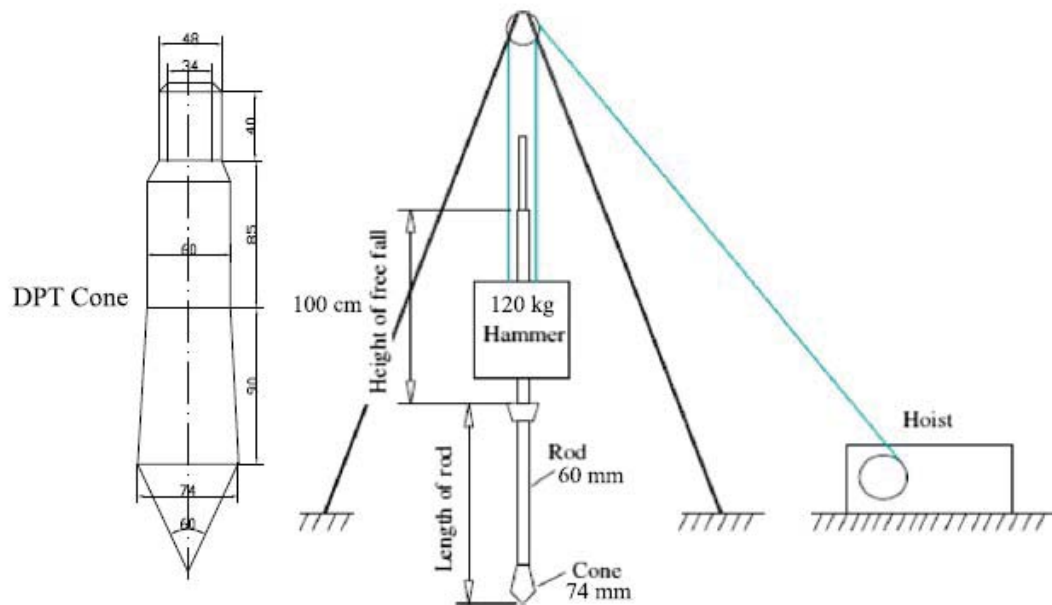

Figure 6.6: DPT apparatus used in Cao *et al.* (2013) study (Cao *et al.*, 2013)

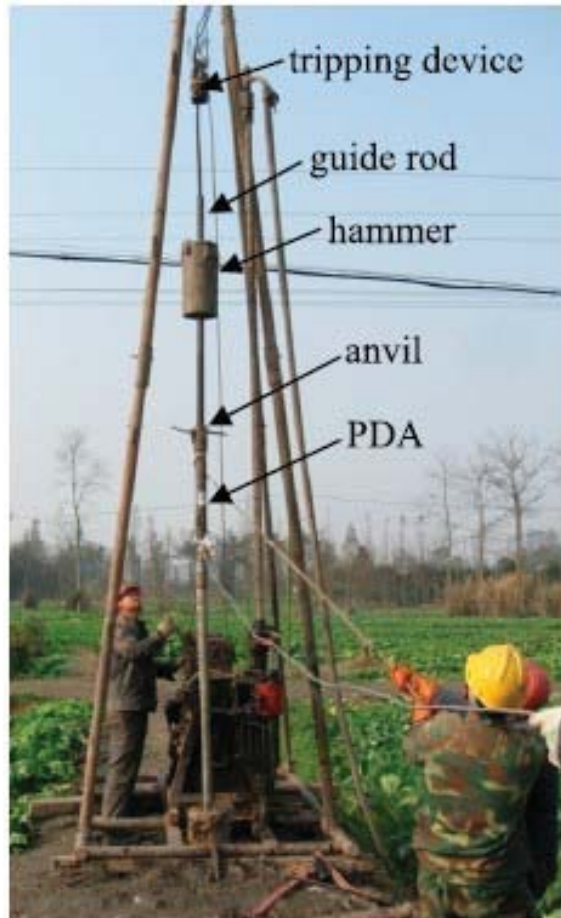

Figure 6.7: Photograph of DPT apparatus used in *Cao et al.* (2013) study (*Cao et al.*, 2013)

6.3.2 Dynamic Penetration Testing in this study

DPT was conducted at all three sites as mentioned previously. The DPT rig used for testing in Cephalonia, Greece is shown in Figures 6.8 and 6.9. The rig was gasoline powered and included a track system for easy maneuvering at the site, two large columns to guide the hammer and drop weight, and three stabilizers for leveling (two in the front of the rig and one in the back). The hammer on the rig weighed 60-kg and had a drop height of 100 cm. It was operated using an automatic pulley system which had a rate of 15 blows per minute. The drill rods (Figure 6.10) were 1 m in length and had a diameter of 32 mm. In order to connect the cone tip to the drill rods, adapters were manufactured as shown in Figure 6.11. The cone tip used in this study was the same as the one used in *Cao et al.* (2013). The diameter was 74-mm with a cone angle of 60° . A smaller diameter cone tip, which is the common size used in Greece, was used at one location so that a comparison could be made between the two cone sizes. The two cones are shown in Figure 6.12. The data for blow counts was recorded in 10 cm increments as is common with the DPT in China (*Cao et al.*, 2013).

Energy measurements were recorded for each hammer blow for four of the test locations using a pile driving analyzer (PDA) system manufactured by Pile Dynamics, Inc. (PDI). This system consisted of an instrumented rod (Figure 6.13) with two strain gauges, which served as the triggers, and two accelerometers mounted in the center of the rod. This rod was 1 m in length and was connected to the drill rods and drill rig as shown in Figure 6.14. The gauges and accelerometers were connected to the PDA computer system shown in Figures 6.15 and 6.16. Measurements of the energy transferred from the hammer to the drill rods were recorded for nearly each blow and the energy transfer ratio (ETR) was calculated. The energy transfer ratio (ETR) is the ratio of the energy that passes through the drill rods to the potential energy of the hammer falling from its specified drop height. This value is expressed as a percentage and typical ETR values for the DPT drill rig used in this study were in the range of 60-70%. Figures 6.17, 6.18, 6.19, 6.20, and 6.21 show the

results of the energy measurements for ETR versus blow number and blow count for sites in Lixouri and Argostoli (Test locations given in Table 6.1 and Table 6.2). The mean ETR from these tests was approximately 65% with a standard deviation of 4%; therefore, this mean value was used to calculate energy corrected N_{120} and N'_{120} values. Figure 6.20 has missing data in the middle of the test because an accelerometer came loose and reported false values of ETR. In some cases, blow count values were very low (less than 3), and the ETR was observed to be low. This is likely due to the lack of resistance from soft layers of soil.



Figure 6.8: DPT Test Rig - Cephalonia, Greece



Figure 6.9: DPT Test Rig - Cephalonia, Greece



Figure 6.10: Cone Tip and rods used for DPT



Figure 6.11: Cone Tips with adapters for connection to drill rods



Figure 6.12: Larger Cone Tip (top) and Smaller Cone Tip (bottom)



Figure 6.13: Instrumented rod used for energy measurements



Figure 6.14: Instrumented rod placed in drill rig for energy measurement



Figure 6.15: PDA energy measurement computer

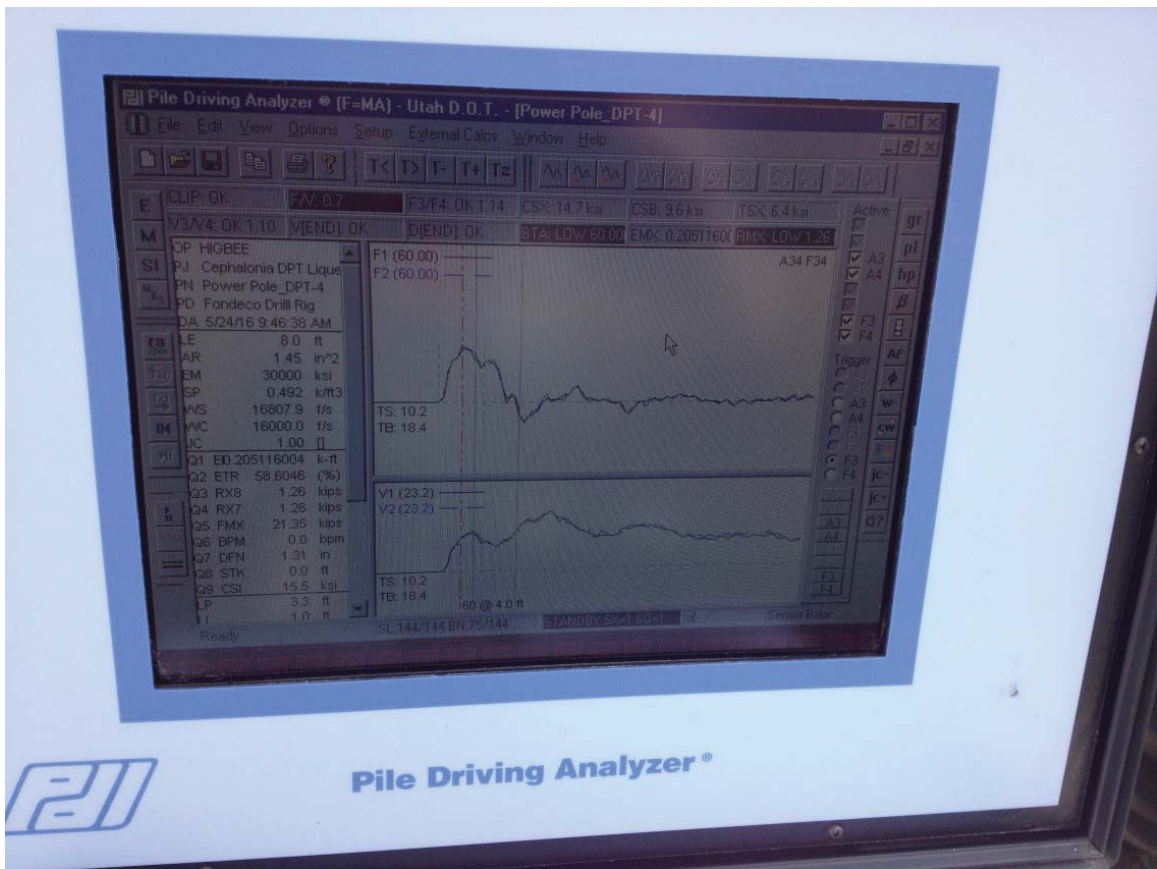

Figure 6.16: Screenshot of PDA with typical energy measurement data for one blow

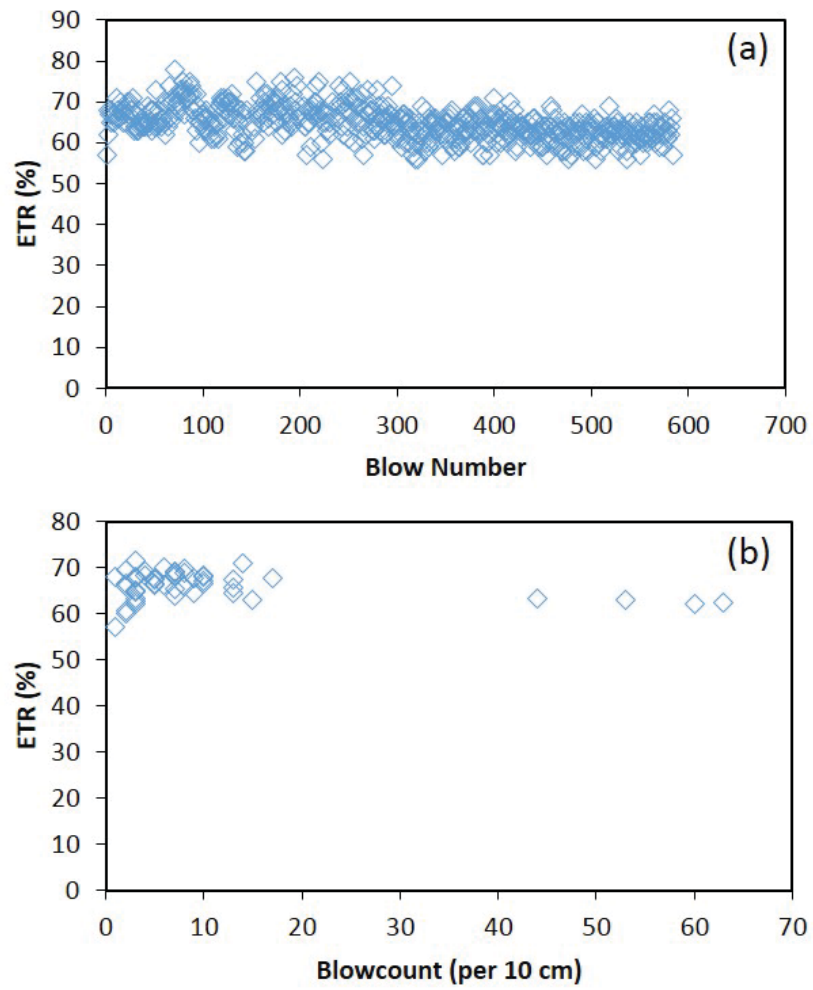

Figure 6.17: Energy Transfer Ratio measured at DPT-4 versus (a) Blow Number and (b) Blow Counts (per 10 cm layer)

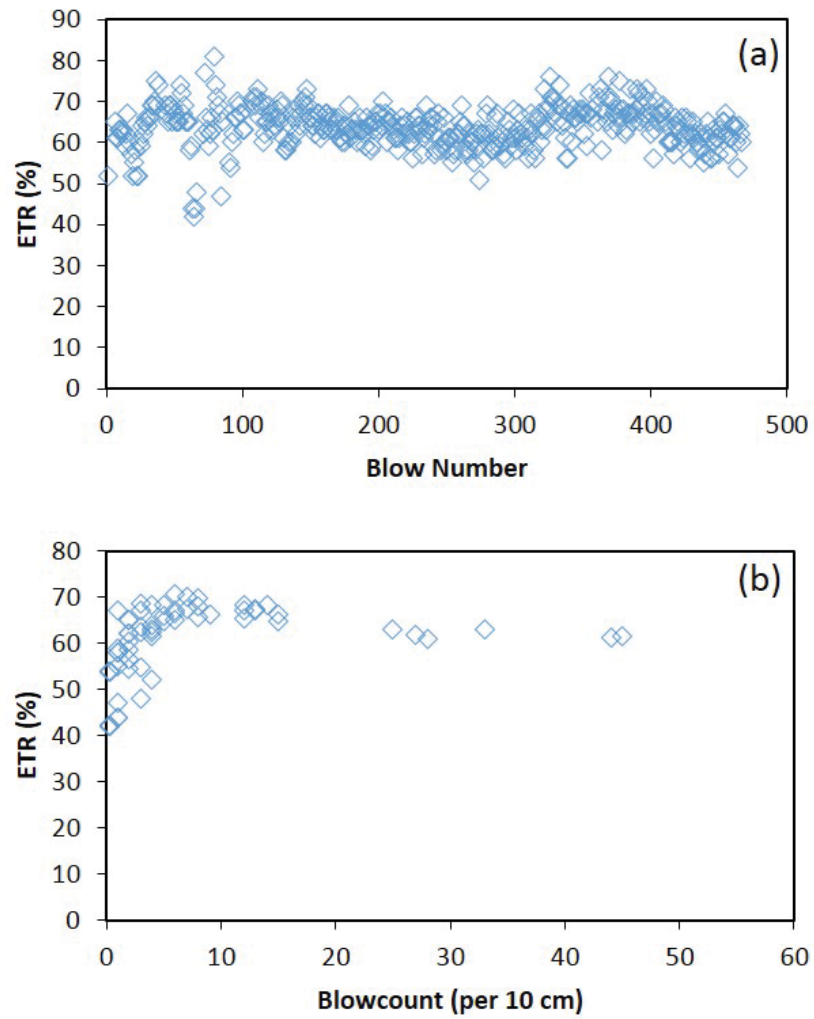

Figure 6.18: Energy Transfer Ratio measured at DPT-4.3 using the small cone versus (a) Blow Number and (b) Blow Counts (per 10 cm layer)

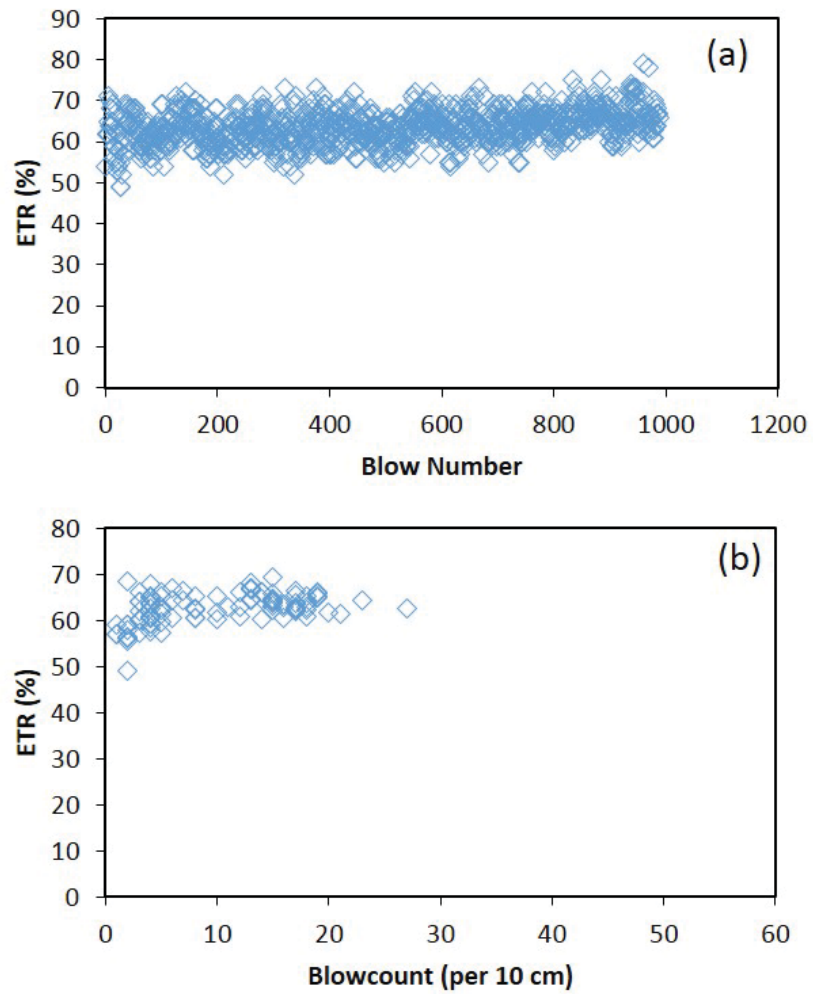

Figure 6.19: Energy Transfer Ratio measured at DPT-5 versus (a) Blow Number and (b) Blow Counts (per 10 cm layer)

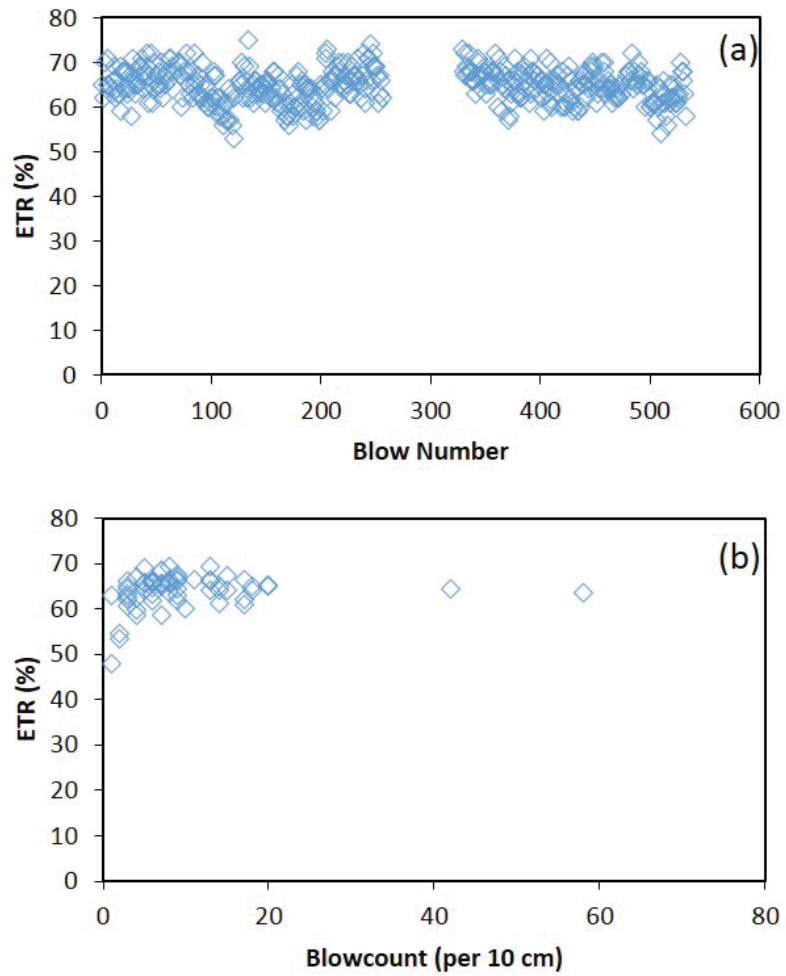

Figure 6.20: Energy Transfer Ratio measured at DPT-6 versus (a) Blow Number and (b) Blow Counts (per 10 cm layer)

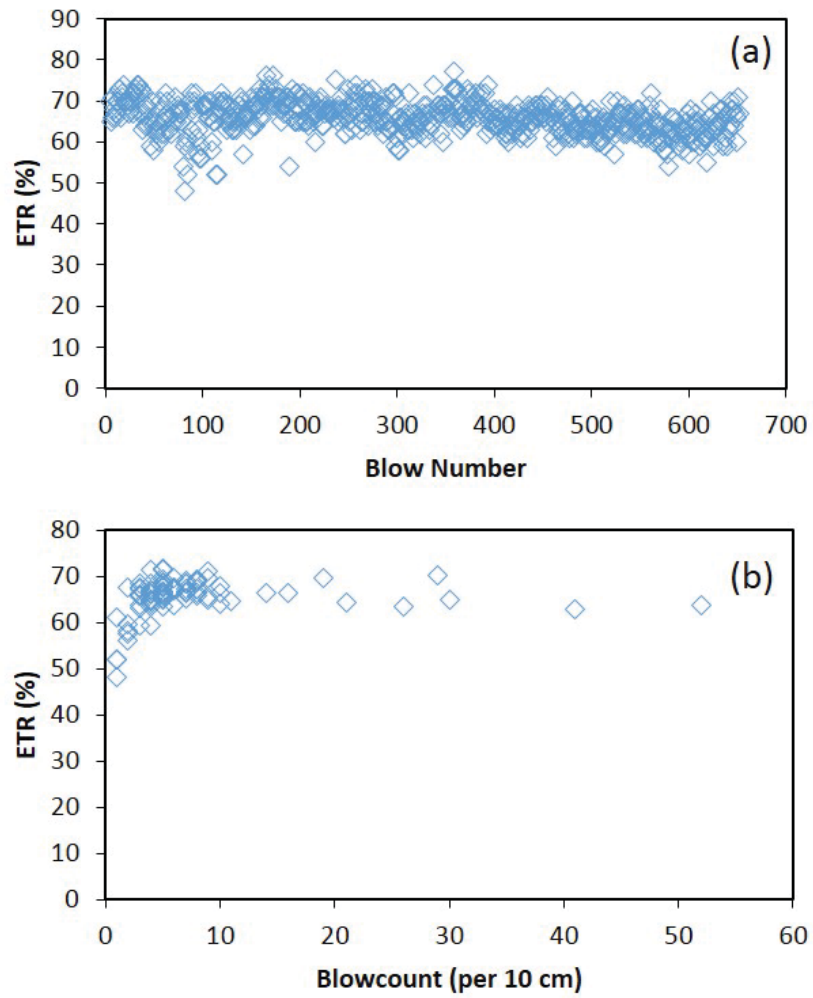

Figure 6.21: Energy Transfer Ratio measured at DPT-8 versus (a) Blow Number and (b) Blow Counts (per 10 cm layer)

6.3.3 Shear Wave Velocity Measurement Equipment and Procedures

Shear wave velocity (V_S) measurements were performed using the Multi-Channel Analysis of Surface Waves (MASW) method. The equipment used for measurement consisted of 16 geophones (4.5Hz), a hammer instrumented with a trigger accelerometer, and a computer with specific software for data recording and analysis as shown in Figure 6.22. The instrumented sledge hammer, which weighed 4.5-kg, was used as an active source to generate surface waves. Vibrations created from this source were measured using the geophone sensors (GS11-D, Geo-Space Technologies). Geophones are inductive sensors that typically consist of a spring-mounted, cylindrical mass that is wrapped with a coil surrounding a magnet. An output voltage is measured when the coil moves relative to the magnet. This output voltage is proportional to particle velocity at the geophone location. The geophones used in this testing had a corner frequency of 4.5 Hz, meaning that lower frequency waves (below 4.5 Hz) are not reliably measured. Geophones were coupled to the ground using either a spike (when testing surface soils) or a tripod (when testing on pavement or rocky surface) as shown in Figure 6.23. The signals from the geophones were transmitted through a 16-channel cable to a multi-channel seismograph that uses a 24-bit analog-to-digital converter recording a maximum of 4096 samples per channel. A 12V battery is used to power the seismograph in the field and digital data is transmitted to a PC (Panasonic Toughbook). The equipment is pictured in Figure 6.23. Spacing of the geophones, either 1 or 3 m, and the offset of the hammer hit, which was typically 15% of the total array length, varied depending on the location and the depth of interest. Active source signals were usually stacked 8 times, with the exception of measurements taken in highly trafficked areas where more stacks (12) were used. Passive measurements, which record signals without an active source, were taken at several sites for comparison with active measurements. A photograph of the MASW equipment setup in the field is shown in Figure 6.24. Specific setups at each location will be discussed in the following sections.

Data analysis for the MASW measurements consisted of developing dispersion curves

from active source signals using the procedure described by *Park et al.* (1998). Spatial auto-correlation was used to develop dispersion curves for the passive site measurements (*Aki, 1957; Okada and Suto, 2003*). For sites where passive data was reliable, dispersion curves for active and passive data were combined to develop a dispersion curve with a broader frequency range (*Park et al., 2005*). For most of the sites, only active data was recorded, so most dispersion curves and site profiles were developed using only active measurements. Results from the DPT and previous SPT results provided by Geoconsult, the geotechnical subcontractor that assisted in the drilling operation in Greece, were used to develop layering for the V_S profiles based on site stratigraphy. The dispersion curves were used to develop V_S profiles with depth using a forward-modeling process. During this process, the V_S profile was used to back-calculate a theoretical dispersion profile. The V_S profile was modified until the back-calculated theoretical dispersion curve matched the field measured dispersion curve. The results generated from this analysis represent average V_S values at depths in the profile.

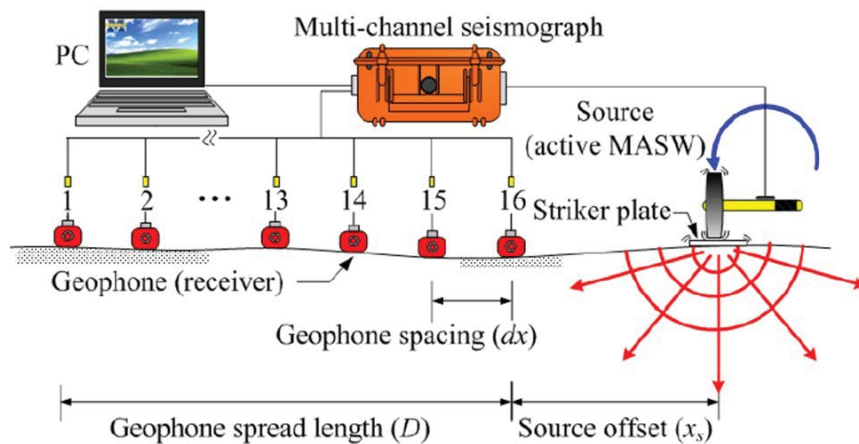

Figure 6.22: MASW Equipment Setup in the Field (*Sahadewa, 2014*)



Figure 6.23: Seismograph and Geophones used in MASW testing (*Sahadewa, 2014*)



Figure 6.24: MASW setup with 1 m geophone spacing and 3 m hammer offset

6.4 Cephalonia Field Testing

6.4.1 Lixouri Port

Field investigation of Lixouri Port occurred during the week of May 23-27, 2016. DPT tests were performed at five locations in the port area that experienced liquefaction and significant lateral displacements. V_S measurements were also performed at each of the DPT locations as well as four additional sites in the Lixouri port. These sites will be described in the following sections and are marked on the map in Figure 6.25 (excluding Loc-8 through Loc-10 which are located outside the range of this map). Table 6.1 presents a summary of the tests that were performed at each site in Lixouri. In this section, focus will be given to the sites where both DPT and V_S measurements were performed. A simplified site profile that was used for interpretation of DPT and MASW test results is shown in Figure 6.26. The DPT results were also used for identifying layers for the V_S profile. The site profile consists of a gravelly fill material (that was created as a result of sea reclamation following the 1953 Ionian earthquake) that overlays the native soil, which is silty sand that transitions to a stiff clay. The results of the DPT measurements confirm the native soil layer in the 4-6 m range, as evidenced by the change in blow counts.



Figure 6.25: Site map of Lixouri Port area with test locations marked

Table 6.1: Summary of Field tests at Lixouri Port

Location	Landmark	DPT	V _S
Loc-1	Hellenic Coast Guard Building	DPT-1	V _S -2 (1 m spacing)
Loc-2	Dock #4	DPT-2.1, DPT-2.2	V _S -10 (1 m spacing)
Loc-3	Between Loc-1 and Loc-2	DPT-4.1 (energy measured), DPT-4.2 (energy measured), DPT-4.3 (smaller cone, energy measured)	V _S -1 (1 m spacing)
Loc-4	Dock #3	DPT-5 (energy measured)	V _S -13 (1 m spacing)
Loc-5	Dock #2	DPT-6 (energy measured)	V _S -3 (1 m spacing)
Loc-6	Dock #1		V _S -8 (1 m spacing)
Loc-7	Main Pier		V _S -9 (1 m spacing, 3 m spacing (active and passive))
Loc-8	City Hall - Strong Motion Station		V _S -11 (1 m spacing, 3 m spacing (active and passive))
Loc-9	Cemetery		V _S -12 (1 m spacing, 3 m spacing (active and passive))
Loc-10	A few blocks west of City Hall		V _S -14 (1 m spacing)

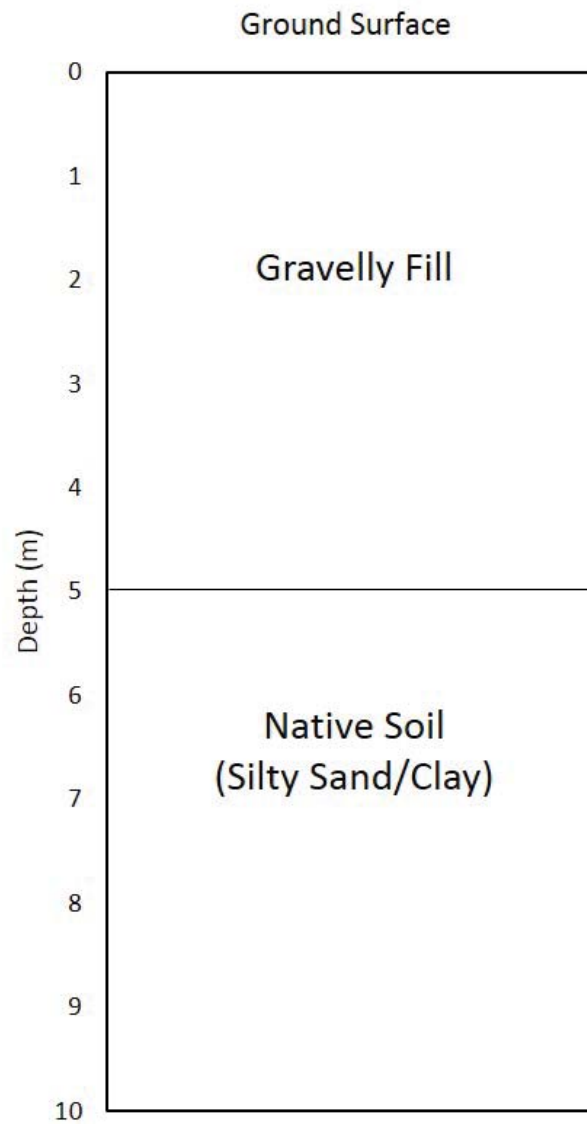

Figure 6.26: Generalized site profile used for data interpretation

6.4.1.1 Location 1

DPT and V_S measurements were performed at Location 1, which was next to the Hellenic Coast Guard Building. The DPT was performed in a planter box as shown in Figure 6.27. Drilling was completed in the planter box so that pre-drilling of concrete or pavers did not have to be completed. The height of the ground in the planter box was measured to be 28 cm (compared to the elevation of the surrounding sidewalk). Upon initial placement of the cone at the ground surface, the self-weight of the hammer pushed the cone into the ground to a depth of 35 cm. The DPT was completed to a depth of 6.6 m, where blow counts increased significantly (3 consecutive 10 cm layers of greater than 50 blow counts) so the test was ended. Upon removing the drill rods and cone tip from the ground, wet green/gray silty sand was observed on the rods. V_S measurements were performed at 1 m spacing at this site, next to the planter box on the sidewalk level. A photograph of the MASW setup at this location is shown in Figure 6.28. The blow counts versus depth as well as the V_S profile are shown in Figure 6.29.

6.4.1.2 Location 2

DPT and V_S measurements were performed at Location 2, which was near Dock 4 at the Lixouri Port. The DPT was performed in a planter box as shown in Figure 6.30. The height of the ground in the planter box was measured to be 25 cm. DPT-2.1 was completed to a depth of only 4.1 m due to wandering rods that became too inclined. The rods and cone tip were removed from the hole and a new hole (DPT-2.2) was started 90 cm away from DPT-2.1. DPT-2.2 was completed to a depth of 9.1 m, which was deemed a sufficient depth for soils of interest in this investigation. V_S measurements were performed at 1 m spacing for this site, next to the planter box on the sidewalk level. A photograph of the MASW setup at this location is shown in Figure 6.31. The blow counts versus depth for DPT-2.2 and the V_S profile are shown in Figure 6.29.



Figure 6.27: Setup of DPT at Location 1 in planter box



Figure 6.28: MASW setup for V_S measurements at Location 1

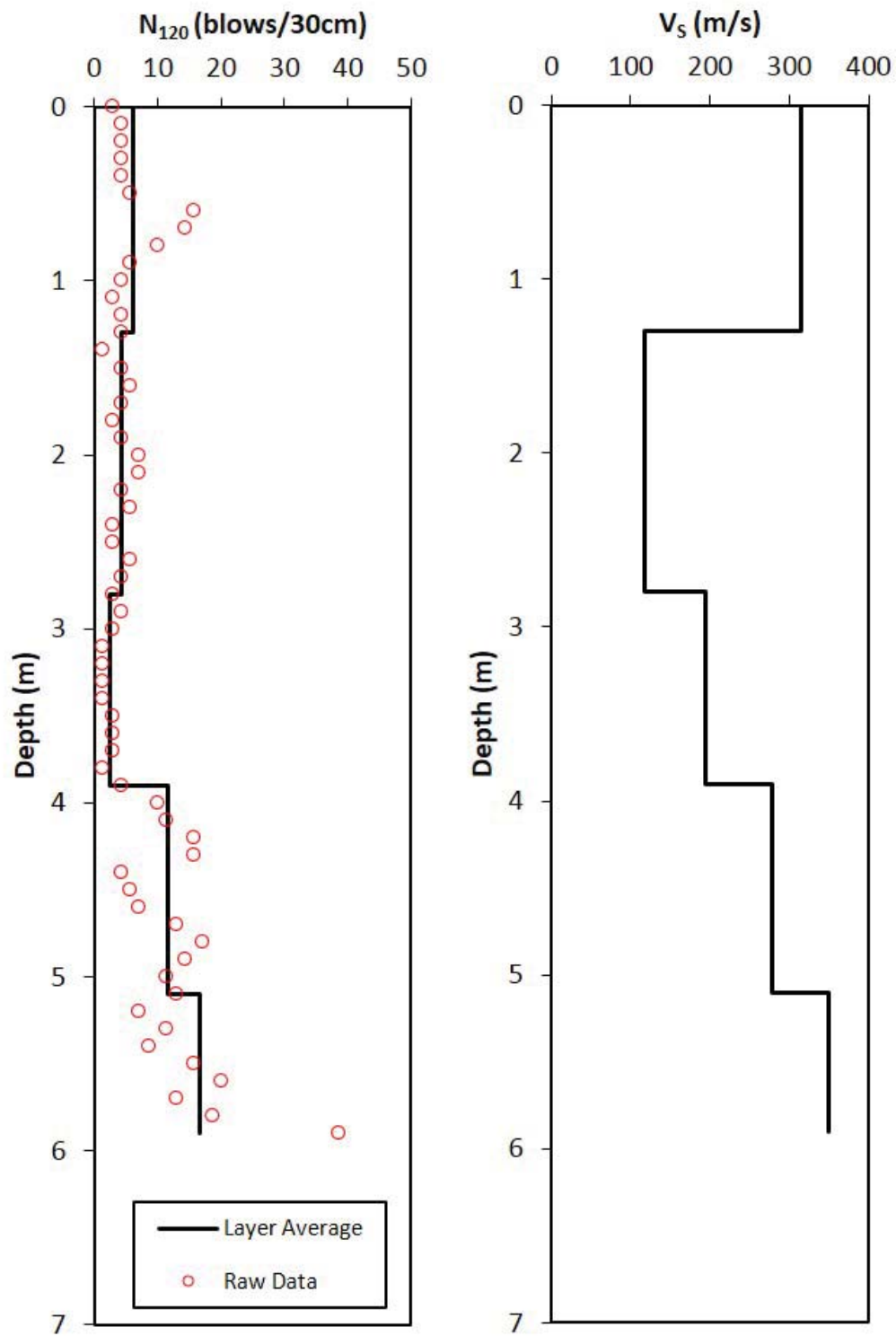

Figure 6.29: DPT uncorrected blow counts and V_s versus depth at Location 1



Figure 6.30: Setup of DPT at Location 2



Figure 6.31: MASW setup for V_S measurements at Location 2

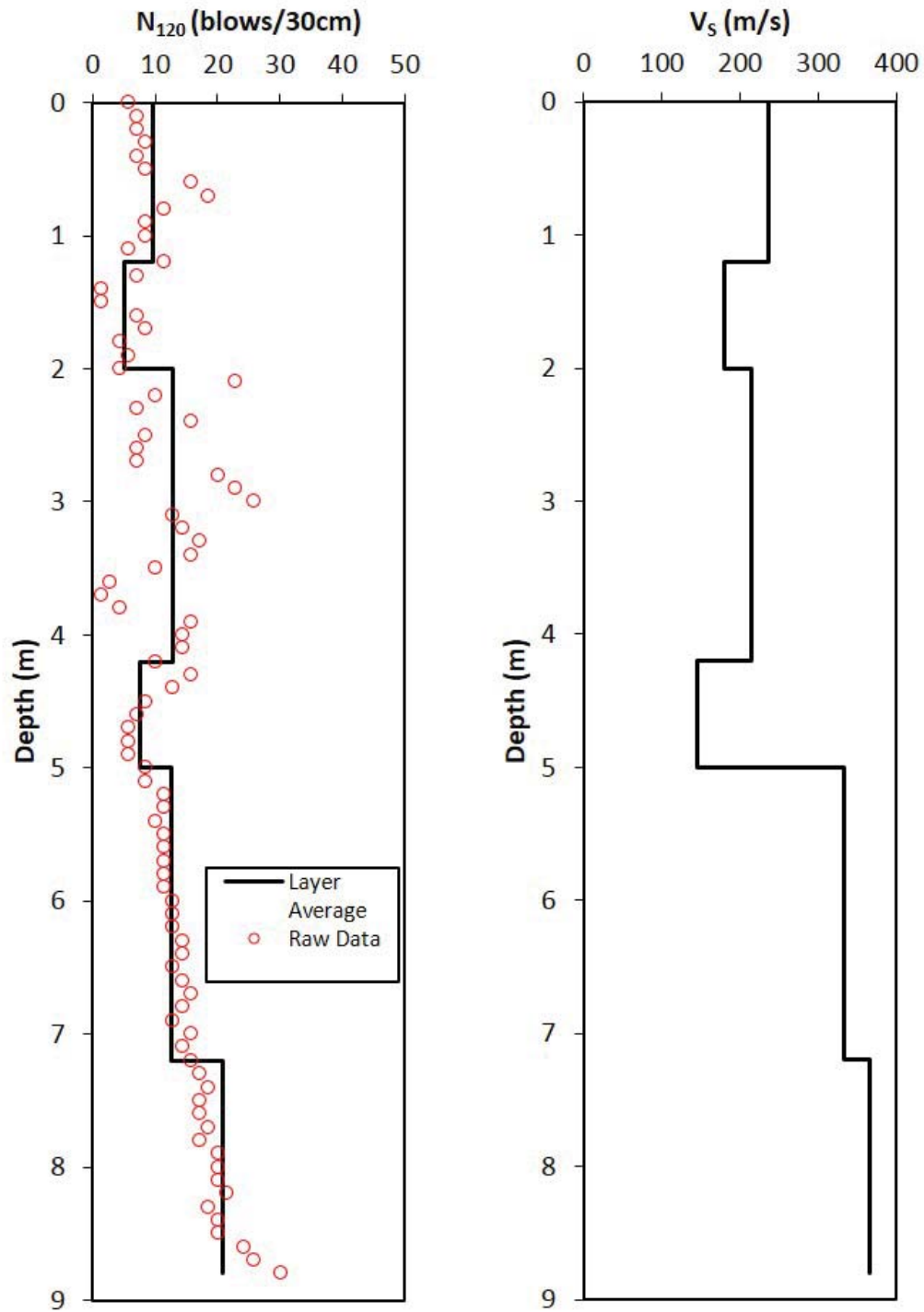

Figure 6.32: DPT uncorrected blow counts and V_s versus depth at Location 2

6.4.1.3 Location 3

DPT and V_S measurements were performed at Location 3, which was in between Locations 1 and 2 at the Lixouri Port. The DPT was performed in a planter box as shown in Figure 6.33. The height of the ground in the planter box was measured to be 29 cm. It was also noted that the location was approximately 70 cm above sea level. This site was the first site where energy measurements were taken with the PDA system and instrumented rod as shown in Figure 6.34. DPT-4.1 was completed to a depth of 5.0 m where a stiff layer was encountered. The DPT rig was then moved approximately 1 m towards the water (i.e. Eastward) so that an identical test could be performed with the smaller cone tip. This was done to evaluate the differences in blow counts and ETR for the larger and smaller cone tips. This was the only location where the smaller cone tip was used for comparison purposes. Penetration started with the smaller cone tip; however, at approximately 1.2 m depth a large cavity/void was encountered and the drill rig became unbalanced. Upon further examination of the site horizontal ground fissures were seen in the planter box. These fissures were likely remnants from the earthquake and were measured to be as deep as 70 cm. It was decided to rotate the drill rig 90° and begin a new hole with the smaller cone tip. This hole (DPT-4.3) was completed to a depth of 6.60 m, which was deemed sufficient for our investigation purposes and comparison with the larger cone tip. The blow counts versus depth for DPT-4.1, as well as the V_S profile, are shown in Figure 6.35. A comparison of the blow counts versus depth for the smaller and larger cone tips is shown in Figure 6.36. As expected, the larger cone has higher blow count values for blow counts less than 20 and when the material becomes stiffer the larger cone blow counts increase significantly compared to the smaller cone. V_S measurements were performed at 1 m spacing for this site, next to the planter box on the sidewalk level. The V_S profile is shown in Figure 6.35.



Figure 6.33: Setup of DPT and V_S Measurements at Location 3



Figure 6.34: Energy measurement setup at Location 3

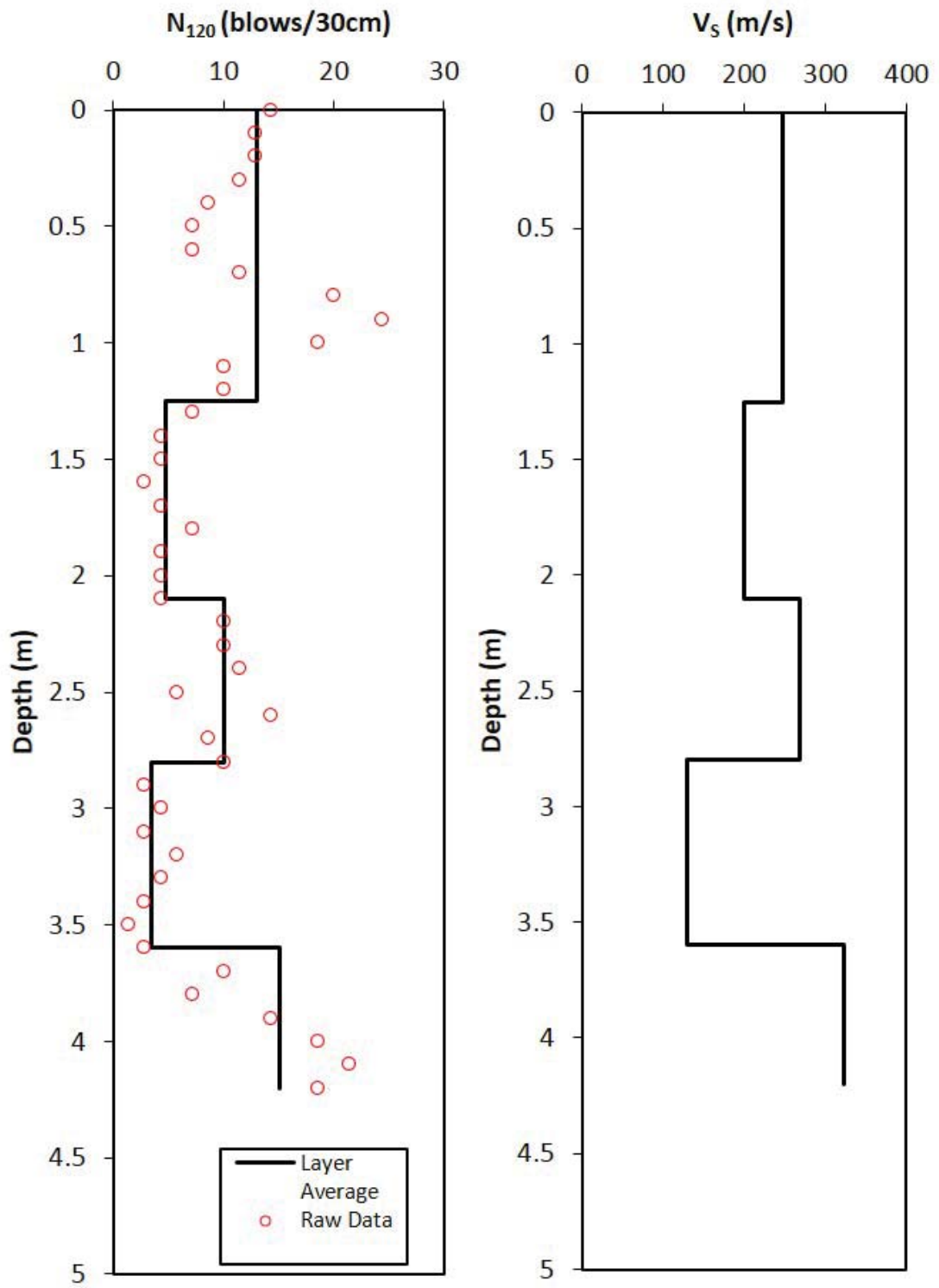

Figure 6.35: DPT uncorrected blow counts and V_s versus depth at Location 3

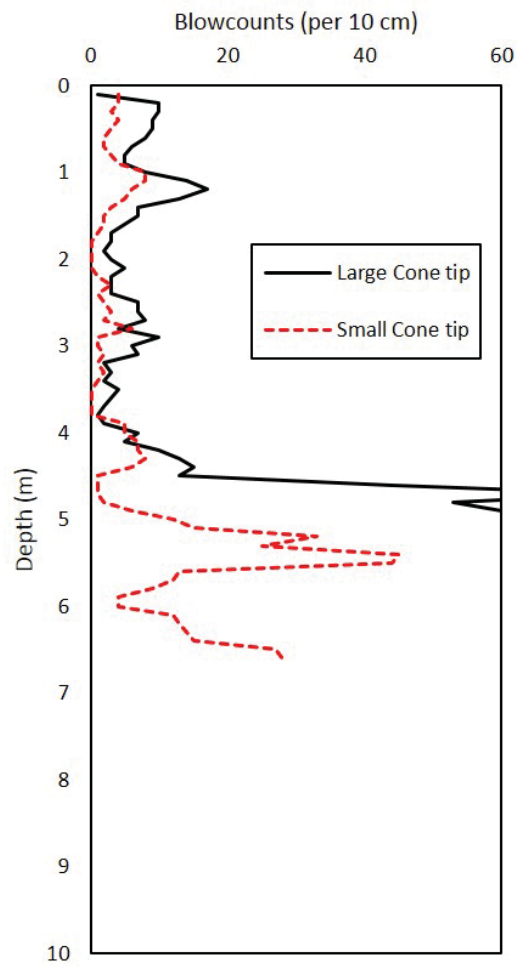

Figure 6.36: Comparison of Large and Small cone tip for DPT at Location 3

6.4.1.4 Location 4

DPT and V_S measurements were performed at Location 4, which was near Dock 3 at the Lixouri Port. The DPT was performed in a planter box as shown in Figure 6.37. The height of the ground in the planter box was measured to be 8 cm. DPT-5 was completed to a depth of 9.9 m. Energy measurements were taken at this site using the PDA system and instrumented rod. V_S measurements were performed at 1 m spacing for this site, next to the planter box on the sidewalk level. A photograph of the MASW setup at this location is shown in Figure 6.38. The blow counts versus depth for DPT-5 and the V_S profile are shown in Figure 6.39.



Figure 6.37: Setup of DPT at Location 4



Figure 6.38: MASW setup for V_S measurements at Location 4

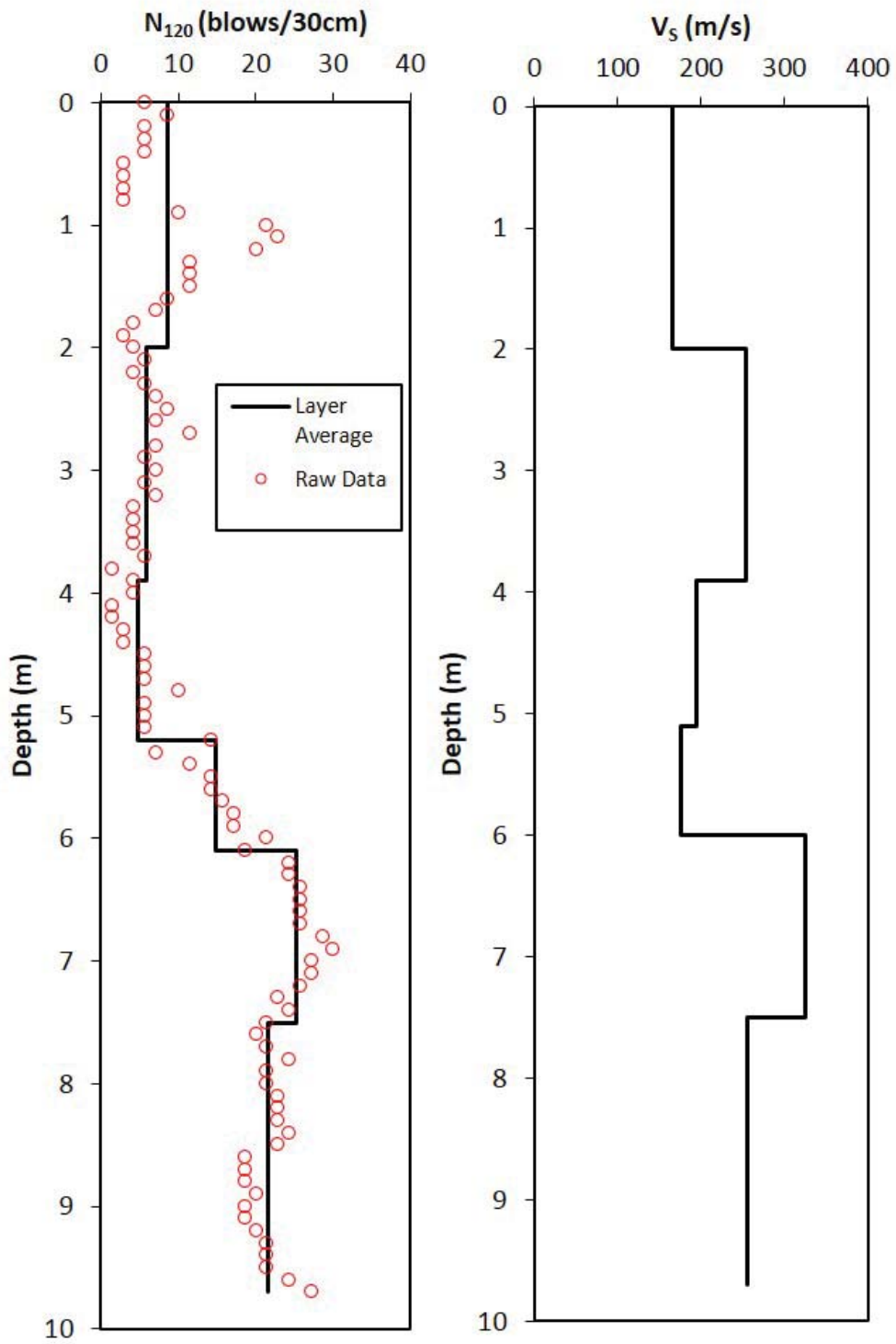

Figure 6.39: DPT uncorrected blow counts and V_s versus depth at Location 4

6.4.1.5 Location 5

DPT and V_S measurements were performed at Location 5, which was near Dock 2 at the Lixouri Port. The DPT was performed in a planter box as shown in Figure 6.40. The height of the ground in the planter box was measured to be 6 cm above the sidewalk and 24 cm above the parking lot. DPT-6 was completed to a depth of 7.0 m where blow counts increased and a suspected sandstone layer was possibly encountered. Energy measurements were taken at this site using the PDA system and instrumented rod. V_S measurements were performed at 1 m spacing for this site in the planter box where the DPT was located. A photograph of the MASW setup at this location is shown in Figure 6.41. The blow counts versus depth for DPT-6 and the V_S profile with depth are shown in Figure 6.42.



Figure 6.40: Setup of DPT at Location 5



Figure 6.41: MASW setup for V_S measurements at Location 5

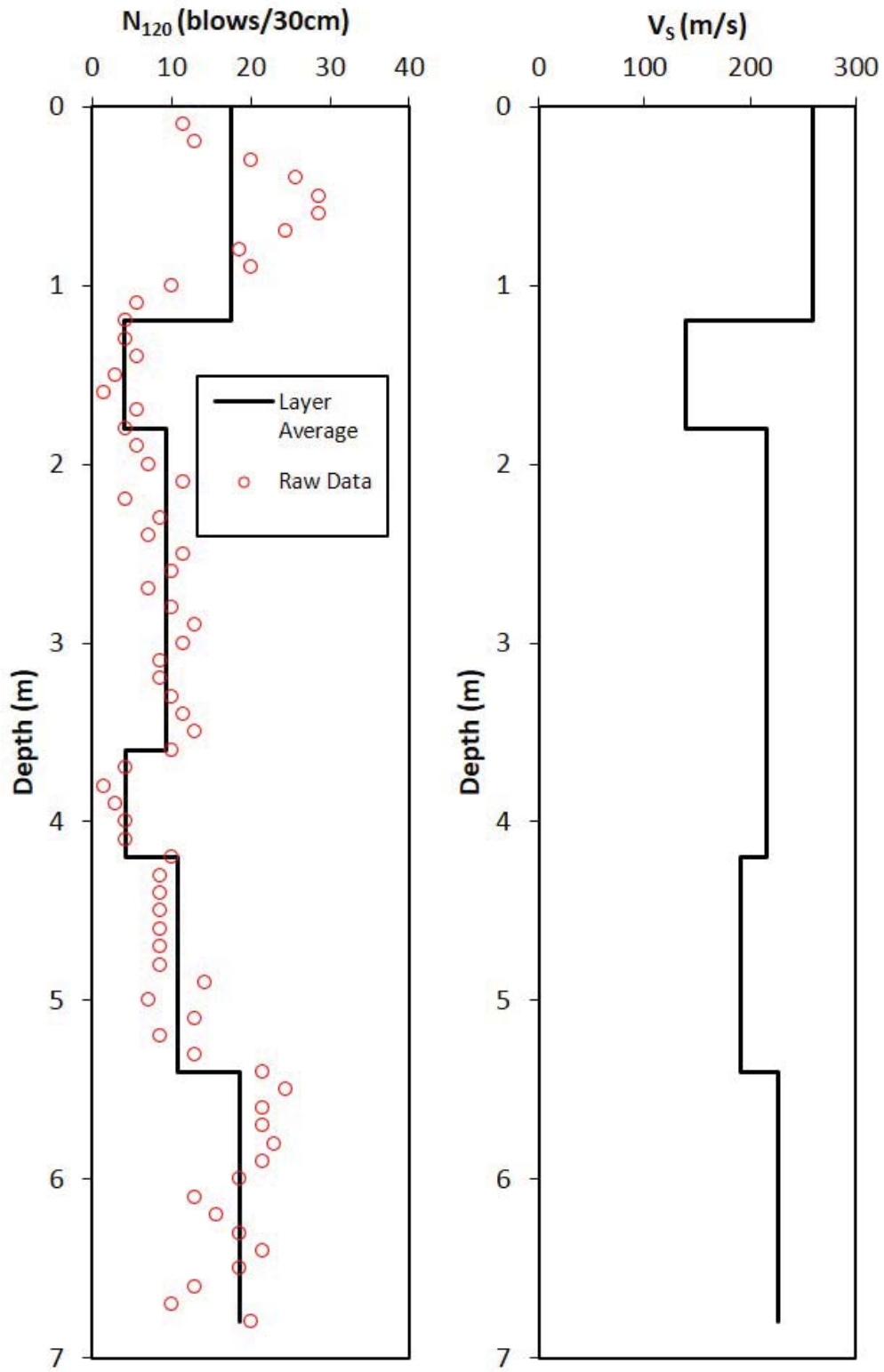

Figure 6.42: DPT uncorrected blow counts and V_s versus depth at Location 5

6.4.1.6 Combined Data - Lixouri

Figure 6.43 shows the DPT test results for the port of Lixouri. In this figure the DPT tests are lined up to represent a cross-section of the port going from South to North (Location 1, 3, 2, 4, and 5). The results show the relatively low N_{120} values at the port, which are lower than 10 blows/30cm for some layers encountered with the DPT. Tests were aborted in the 4 to 9 m range as a stiff layer of native soil was encountered (in some cases this soil was penetrated for more than a meter). There are fluctuations in the N_{120} values with depth due to the gravelly soil, which has the tendency to increase and decrease blow counts as gravel particles are encountered. Figure 6.44 shows the corresponding V_S profiles at the port of Lixouri. In general, the V_S near the surface is higher or nearly as high as the V_S at depth. There appears to be a layer of low V_S in the 1-2 m depth range with V_S values less than 200 m/s for all locations. These low values correspond to the gravelly fill layer at the site that was suspected of liquefying during the earthquakes. There is also a layer of lower V_S in the 3-4 m depth range at Locations 1 and 2 and the 4-5 m depth range at Locations 3, 4, and 5, which correspond to the bottom of the gravelly fill layer.

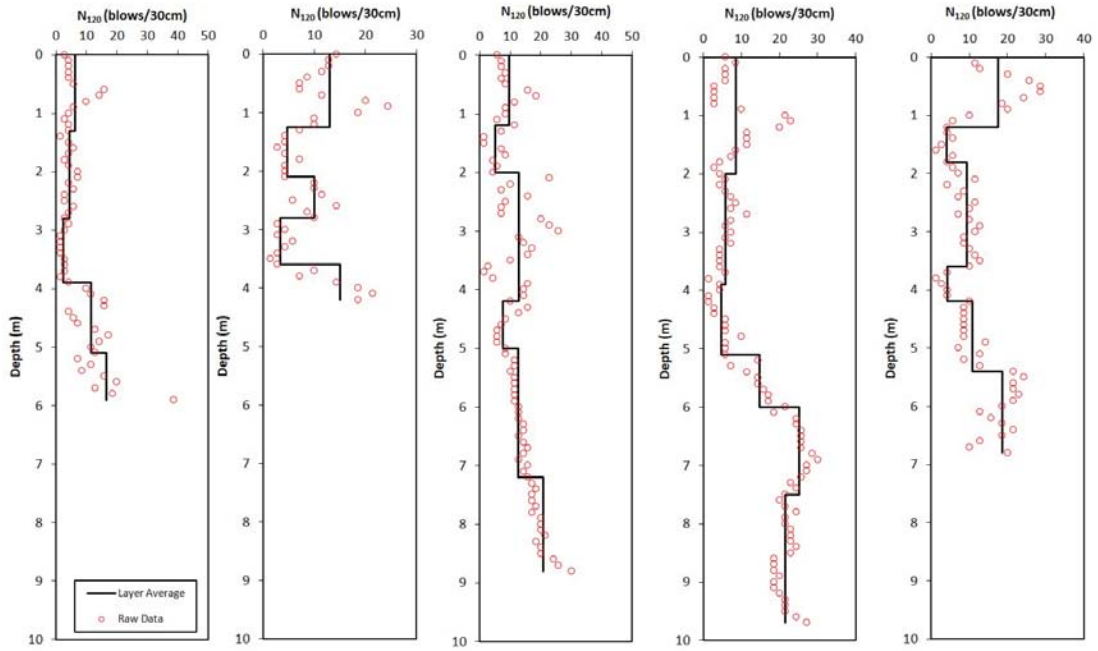

Figure 6.43: Comparison of DPT test results for Lixouri Port at Locations 1, 3, 2, 4, and 5

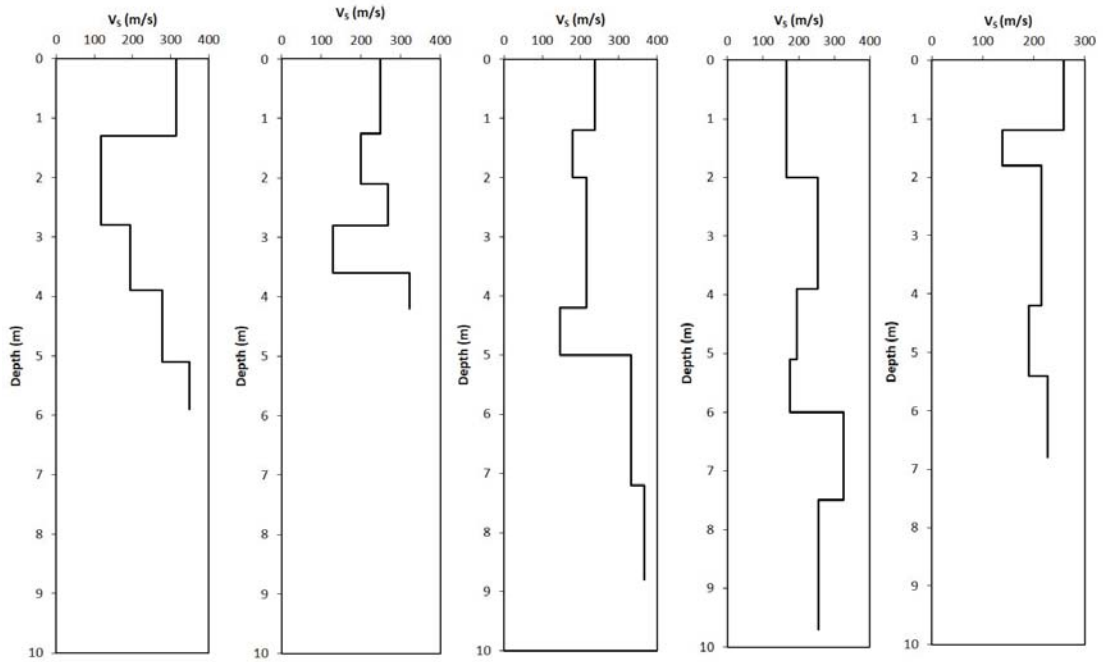

Figure 6.44: Comparison of V_S test results for Lixouri Port at Locations 1, 3, 2, 4, and 5

6.4.2 Argostoli Port

Field investigation of Argostoli port occurred during the week of May 23-27, 2016. DPT tests were performed at three locations in the port area that experienced liquefaction and significant lateral displacements. V_S measurements were also performed at each of the DPT locations as well as one additional site in the Argostoli port area. These sites will be described in the following sections and are marked on the map in Figure 6.45. Table 6.2 presents a summary of the tests that were performed at each location in Argostoli. The site consists of gravelly fill materials throughout the extent of testing depths in this study (approximately 8.5 m at most). DPT measurements confirmed that the stiff layer below the gravelly fill was approximately 6-9 m below the ground surface (encountered at 6.4 m, 8.0 m and 8.6 m).

6.4.2.1 Location 11

DPT and V_S measurements were performed at Location 11, which was located in the northern area of the Argostoli port complex. The DPT was performed in an asphalt lot area as shown in Figure 6.46. The asphalt was pre-drilled to a depth of 22 cm before the DPT began. DPT-7 was completed to a depth of 6.4 m. V_S measurements were performed at 1 m and 3 m spacing for this site on the asphalt lot. A photograph of the MASW setup at this location is shown in Figure 6.47. The blow counts versus depth for DPT-7 and the V_S profile are shown in Figure 6.48.

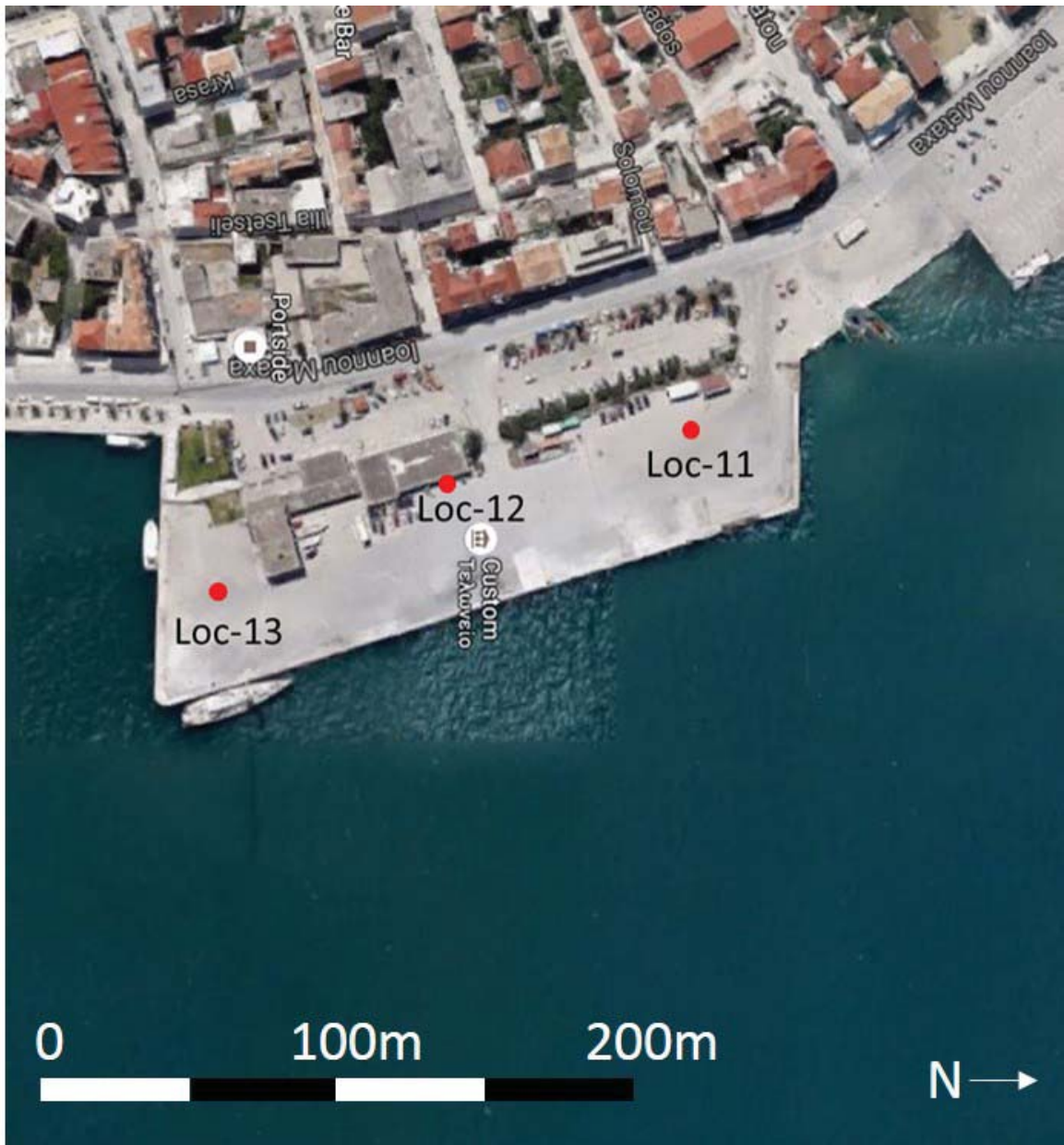

Figure 6.45: Site map of Argostoli Port area with test locations marked

Table 6.2: Summary of Field tests at Argostoli Port

Location	Landmark	DPT	V_S
Loc-11	North Port Complex Area	DPT-7	V_S -4 (1 m spacing, 3 m spacing)
Loc-12	Port Complex Building, Strong Motion Recording Location	DPT-8 (energy measured)	V_S -6 (1 m spacing)
Loc-13	South Port Complex Area	DPT-9, DPT-10	V_S -7 (1 m spacing, 3 m spacing)
Loc-14	Dock/Walkway outside Port Complex		V_S -5 (1 m spacing)



Figure 6.46: Setup of DPT at Location 11



Figure 6.47: MASW setup for V_s measurements at Location 11

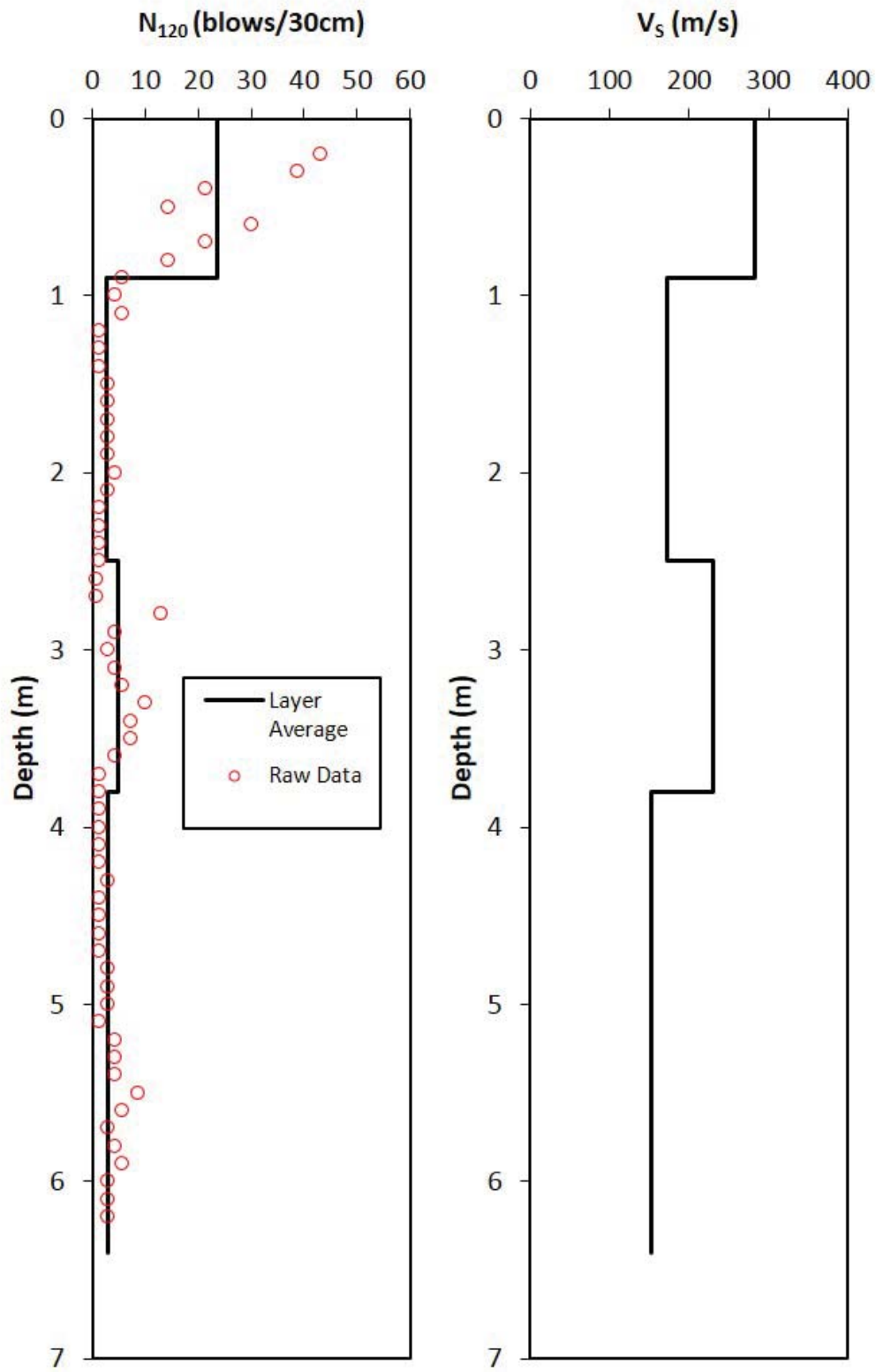

Figure 6.48: DPT uncorrected blow counts and V_s versus depth at Location 11

6.4.2.2 Location 12

DPT and V_S measurements were performed at Location 12, which was located next to the building in the Argostoli port complex. The DPT was performed right next to the building in the port complex in an area with no pavement as shown in Figure 6.49. The testing location was in front of a garage gate at the port complex (inside the garage there was a strong motion station that was installed by the University of Patras). Energy measurements were recorded for each blow. DPT-8 was completed to a depth of 8.5 m. V_S measurements were performed at 1 m spacing for this site on the asphalt lot. A photograph of the MASW setup at this location is shown in Figure 6.50. The blow counts versus depth for DPT-8 and the V_S profile are shown in Figure 6.51.

6.4.2.3 Location 13

DPT and V_S measurements were performed at Location 13, which was located in the southern lot area in the Argostoli port complex. Two DPT tests were performed since the first DPT (DPT-9) at this location was abandoned at a depth of 5.0 m due to rod alignment issues. DPT-10 was performed in the southern asphalt area approximately 20-30 m from DPT-9 as shown in Figure 6.52. V_S measurements were performed at 1 m and 3 m spacing for this site on the asphalt lot. A photograph of the MASW setup at this location is shown in Figure 6.53. DPT-10 was completed to a depth of 9.0 m. The blow counts versus depth for DPT-10 and the V_S profile with depth are shown in Figure 6.54.



Figure 6.49: Setup of DPT at Location 12



Figure 6.50: MASW setup for V_s measurements at Location 12

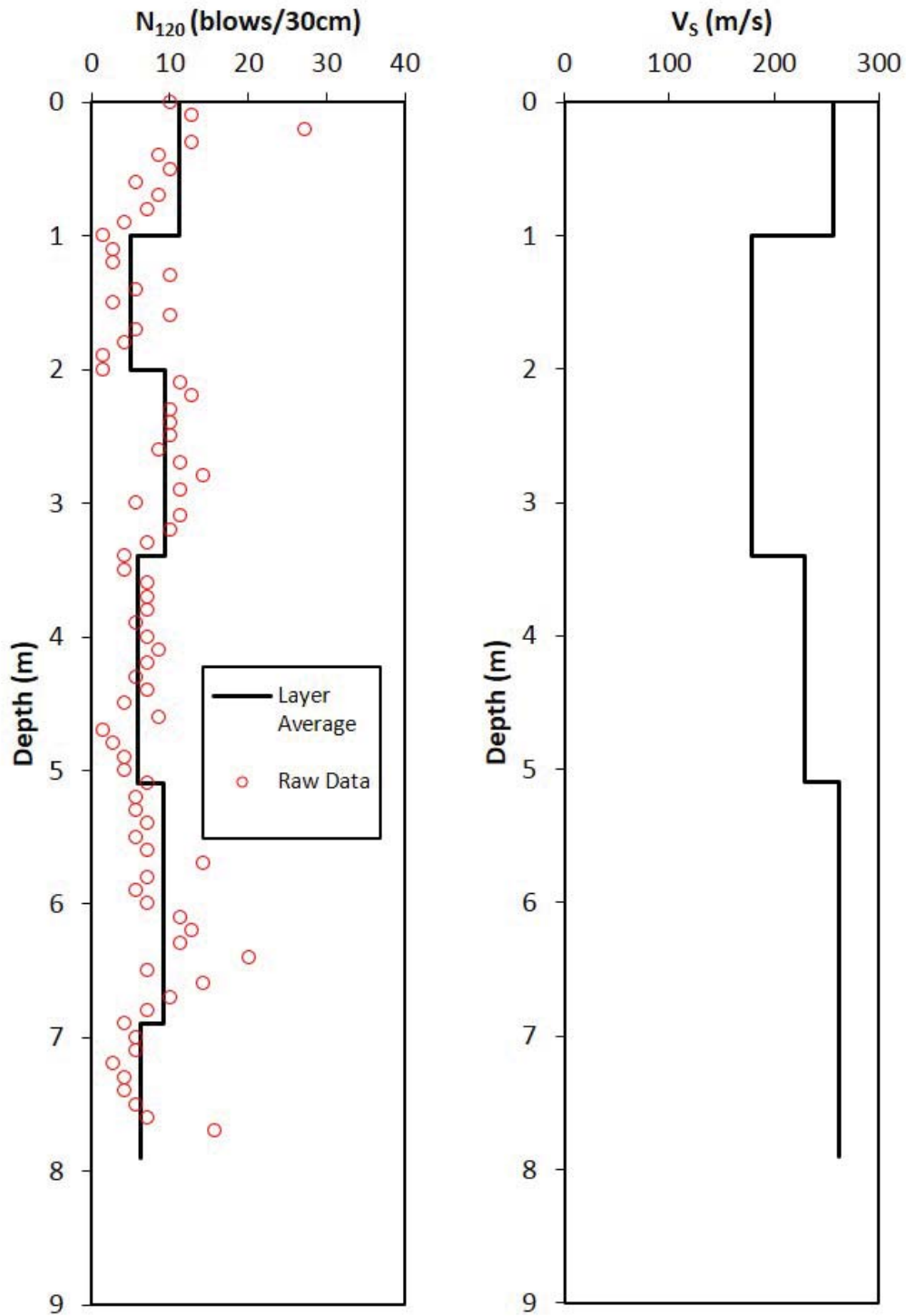

Figure 6.51: DPT uncorrected blow counts and V_s versus depth at Location 12



Figure 6.52: Setup of DPT-10 at Location 13



Figure 6.53: MASW setup for V_s measurements at Location 13 with 3 m spacing

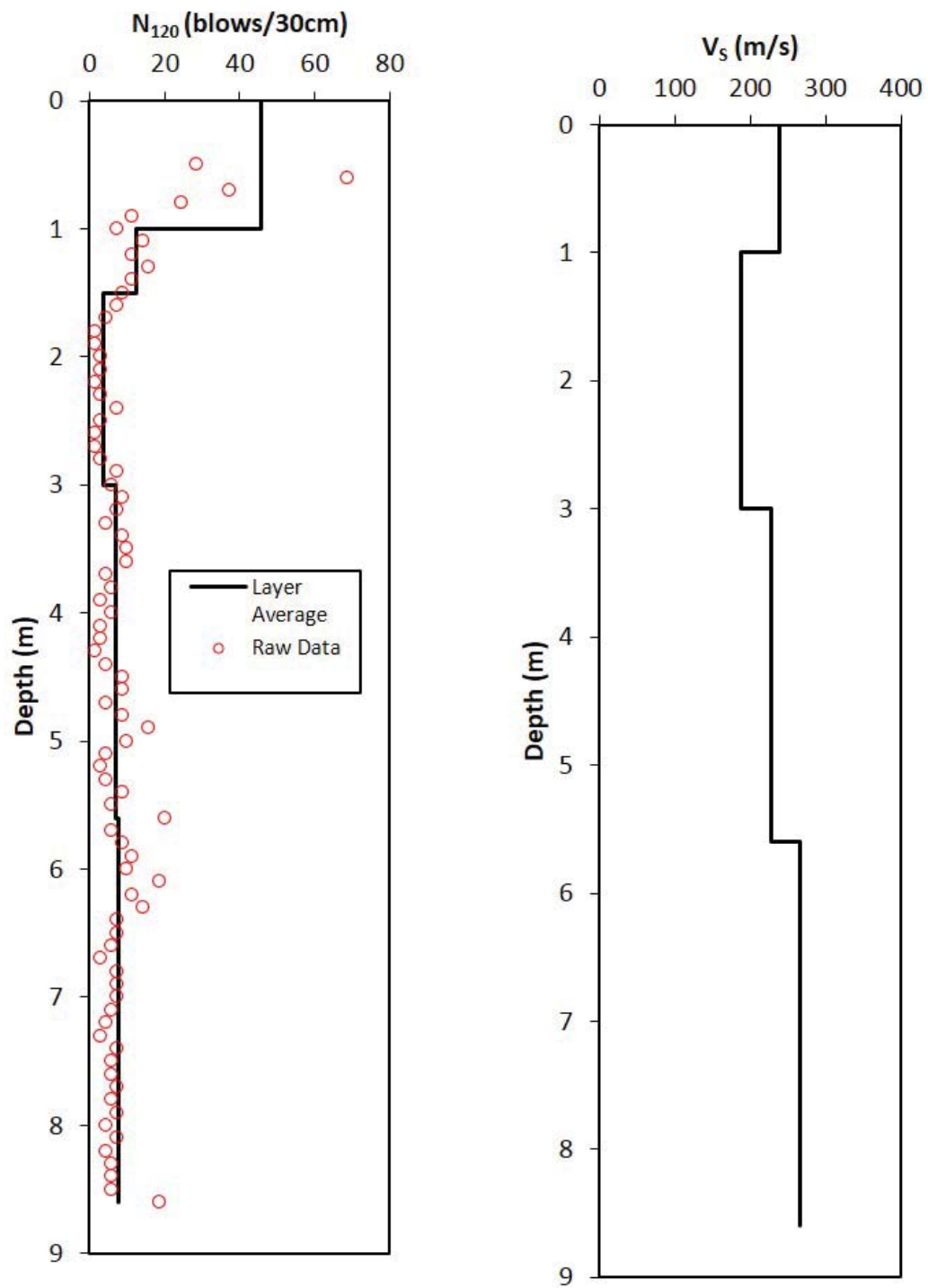

Figure 6.54: DPT uncorrected blow counts and V_s versus depth at Location 13

6.4.2.4 Combined Data - Argostoli

Figure 6.55 combines the DPT test results for Argostoli Port. It is evident that the soil in the port complex is relatively loose, with an N_{120} value of less than 10 blows/30cm at each test location. There is little variation in the blow count value with increasing depth at each location and the blow counts are fairly consistent for the gravelly fill layer at each location (to depths of 6.4 m, 7 m, and 8.5 m). There appears to be a looser layer in the 1-2 m depth range at each location. Figure 6.56 plots the corresponding V_S profiles from the locations in the Argostoli Port. The V_S is generally in the range of 150 - 300 m/s at the port. V_S near the surface is high and then drops down, which could be due to the asphalt layer which had been repaved several times by placing new asphalt on top. The V_S value is lowest in approximately the 1-3 m depth range at Locations 12 and 13, while the V_S is lowest in the 4-6 m depth range at Location 11 (this V_S value is slightly lower than the 1-3 m depth range at Location 11).

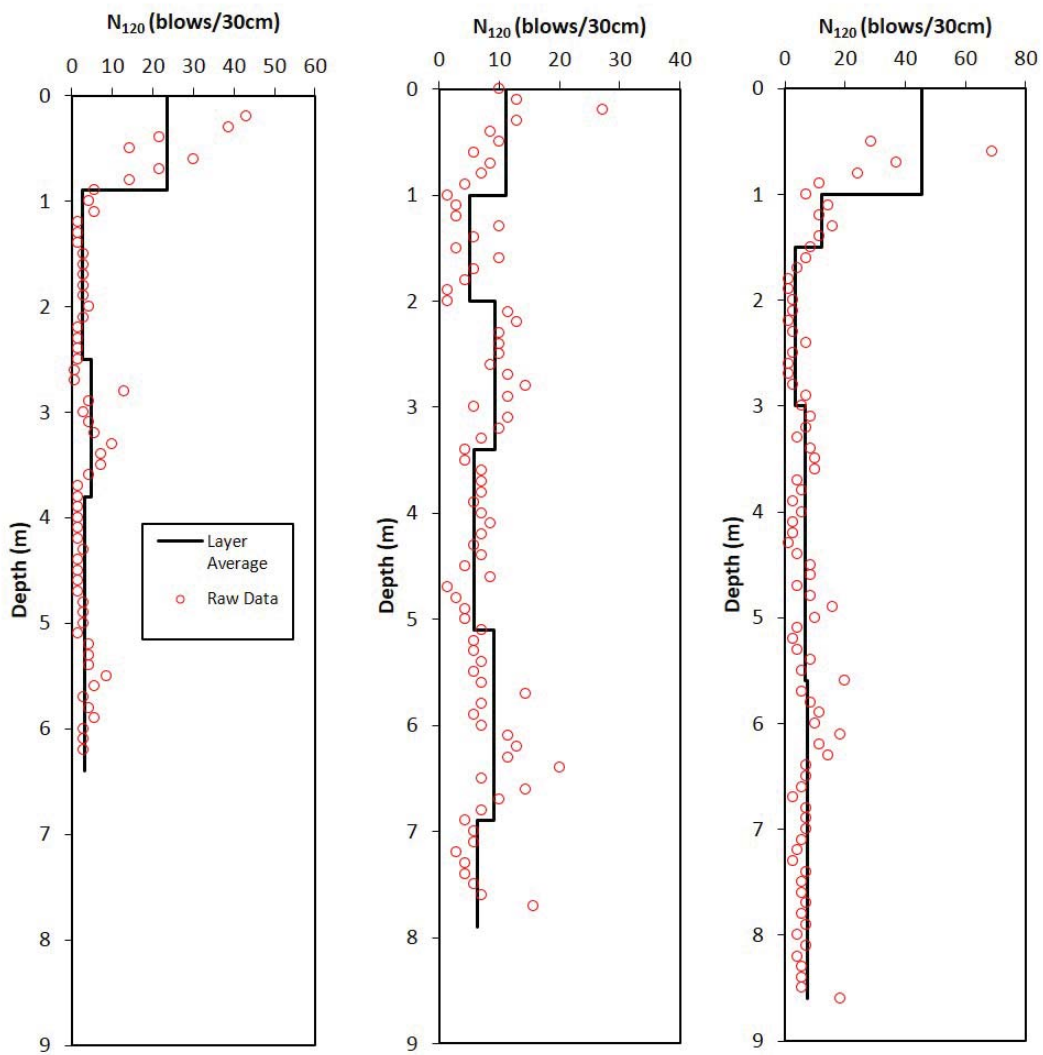

Figure 6.55: Comparison of DPT test results for Argostoli Port at Location 11, 12, and 13

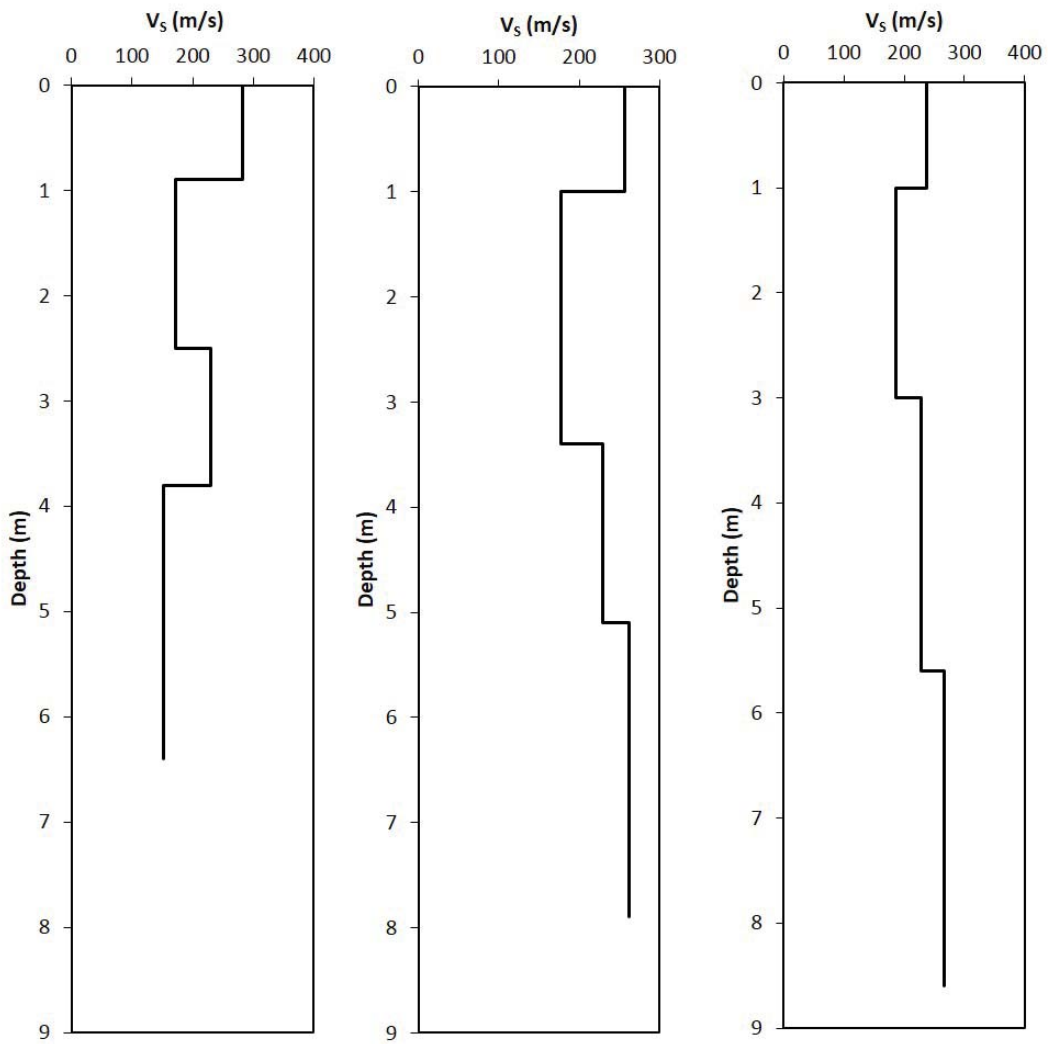

Figure 6.56: Comparison of V_s test results for Argostoli Port at Location 11, 12, and 13

6.5 Millsite Dam - Ferron, Utah Field Testing

Field investigation of Millsite Dam in Ferron, UT occurred on December 16, 2015. V_S measurements were performed using the MASW method at five locations at the toe of Millsite Dam. Millsite Dam was originally designed and built in the late 1960s/early 1970s, and founded on alluvial gravelly soils. Re-examination of the gravelly soils was performed by the Utah Division of Water Resources. SPT, BPT, and DPT tests were performed at the site to evaluate the gravelly soils. Researchers from the University of Michigan traveled to Millsite Dam to evaluate the gravelly soils using the MASW method. Several in-situ field tests have been conducted at this site, so it presents an opportunity for comparison of V_S profiles and penetration tests, specifically the DPT. Figure 6.57 shows the locations where V_S measurements were performed. In this section, Locations 2-5 will be used for data comparison with DPT test data provided by Professor Kyle Rollins at Brigham Young University (Rollins, 2016 - personal communication). The site profiles (Figure 6.58) that were used for the data interpretation were taken from SPT tests that were performed at the site by the Utah Division of Water Resources.

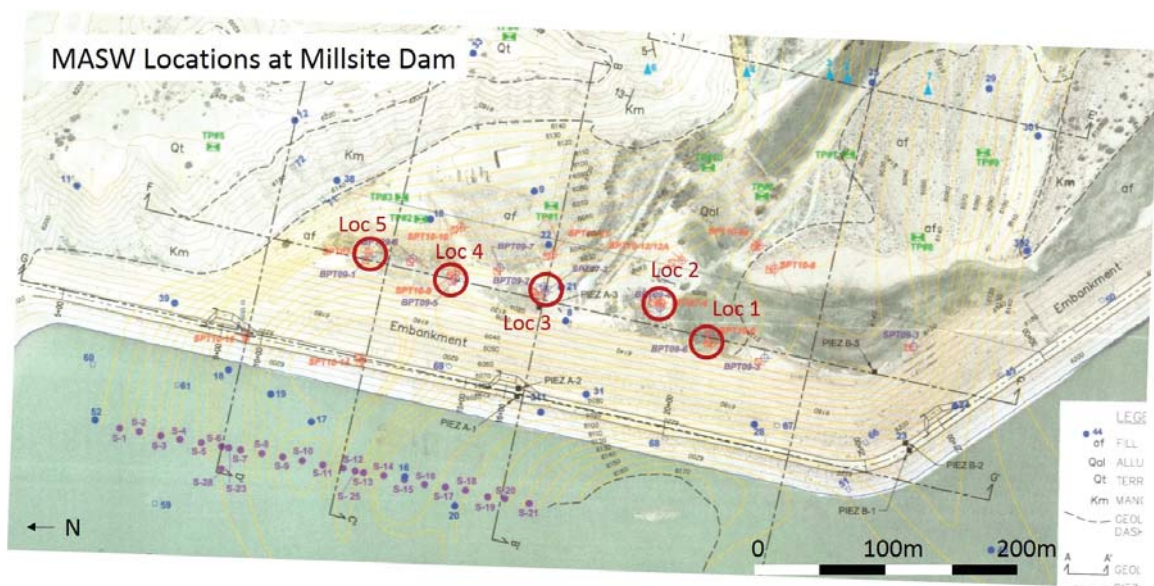

Figure 6.57: Map of Millsite Dam testing locations for V_S measurements

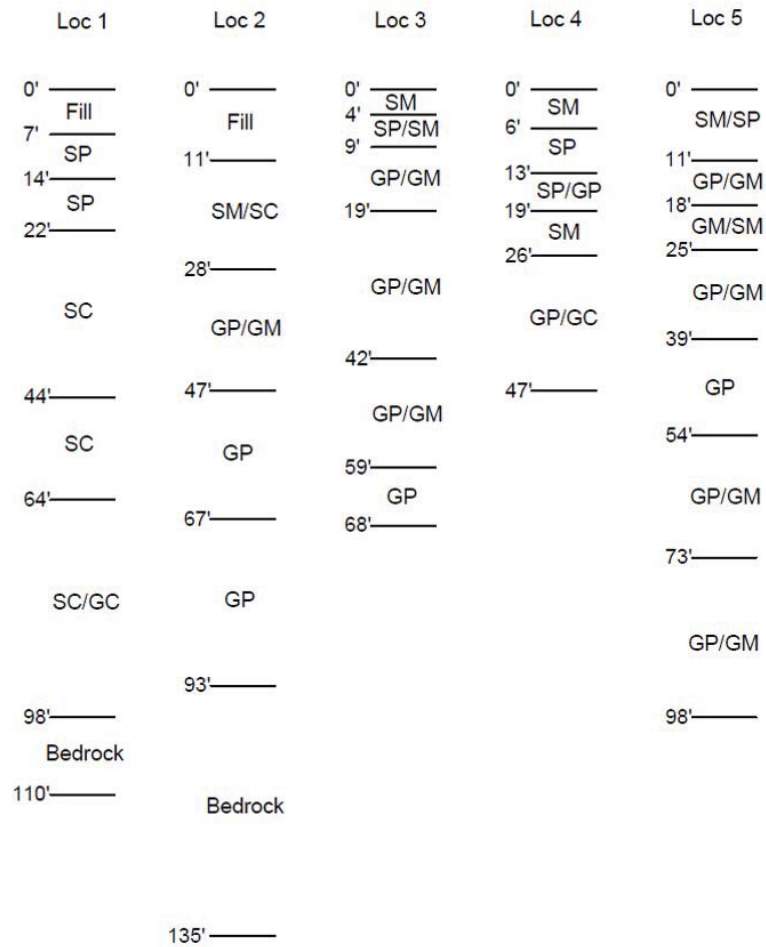

Figure 6.58: Soil Profiles used for data interpretation based on SPT tests from the Utah Division of Water Resources

6.5.0.5 Locations 2, 3, 4, and 5

V_S measurements were performed at 1 and 3 m spacing intervals at Locations 2, 3, 4, and 5. Figure 6.59 shows the MASW setup at Location 2, while Figure 6.60 shows the DPT blow count value and V_S profile versus depth at Location 2. Figure 6.61 shows the MASW setup at Location 3, while Figure 6.62 shows the DPT blow count value and V_S profile versus depth at Location 3. Figures 6.63 and 6.64 show the MASW setup at Location 4, while Figure 6.65 shows the DPT blow count value and V_S profile versus depth at the site. Figure 6.66 shows the MASW setup at Location 5, while Figure 6.67 shows the DPT blow count value and V_S profile versus depth at the Location 5.



Figure 6.59: MASW setup for V_S measurements at Location 2 - Millsite Dam

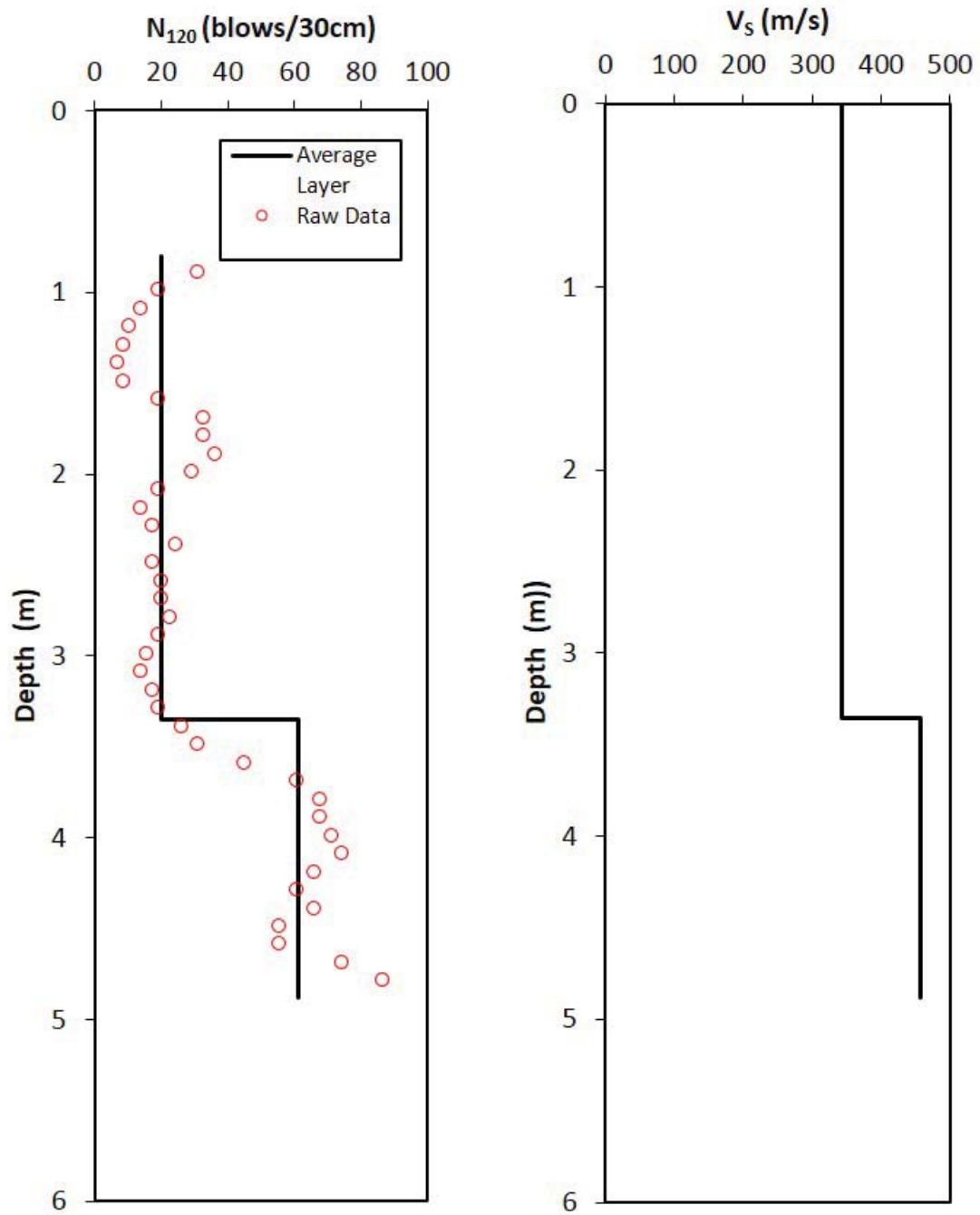

Figure 6.60: DPT uncorrected blow counts and V_s versus depth at Location 2 - Millsite Dam



Figure 6.61: MASW setup for V_S measurements at Location 3 - Millsite Dam

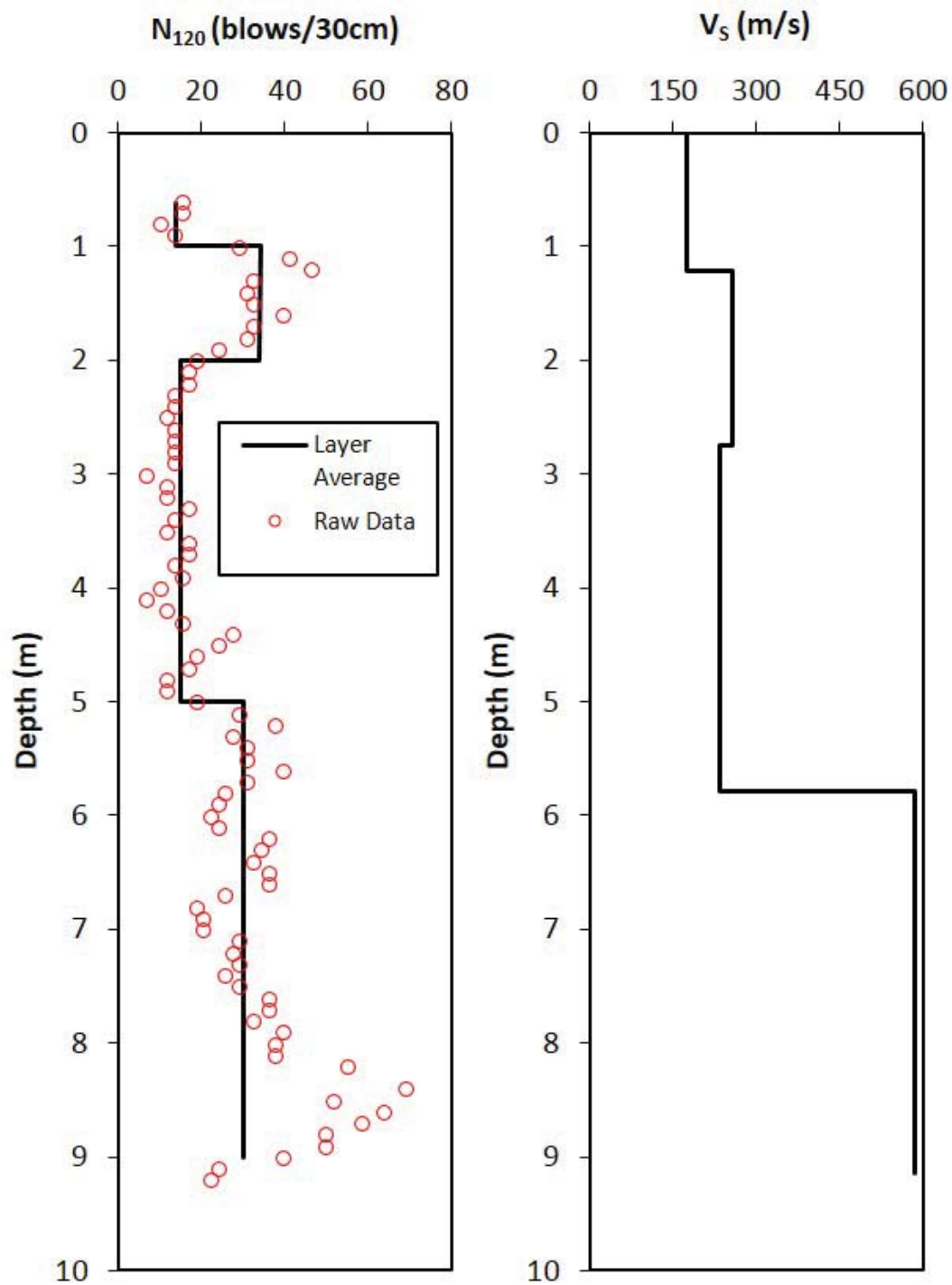

Figure 6.62: DPT uncorrected blow counts and V_s versus depth at Location 3 - Millsite Dam



Figure 6.63: MASW setup for V_S measurements at Location 4 - Millsite Dam



Figure 6.64: MASW setup for V_s measurements at Location 4 - Millsite Dam

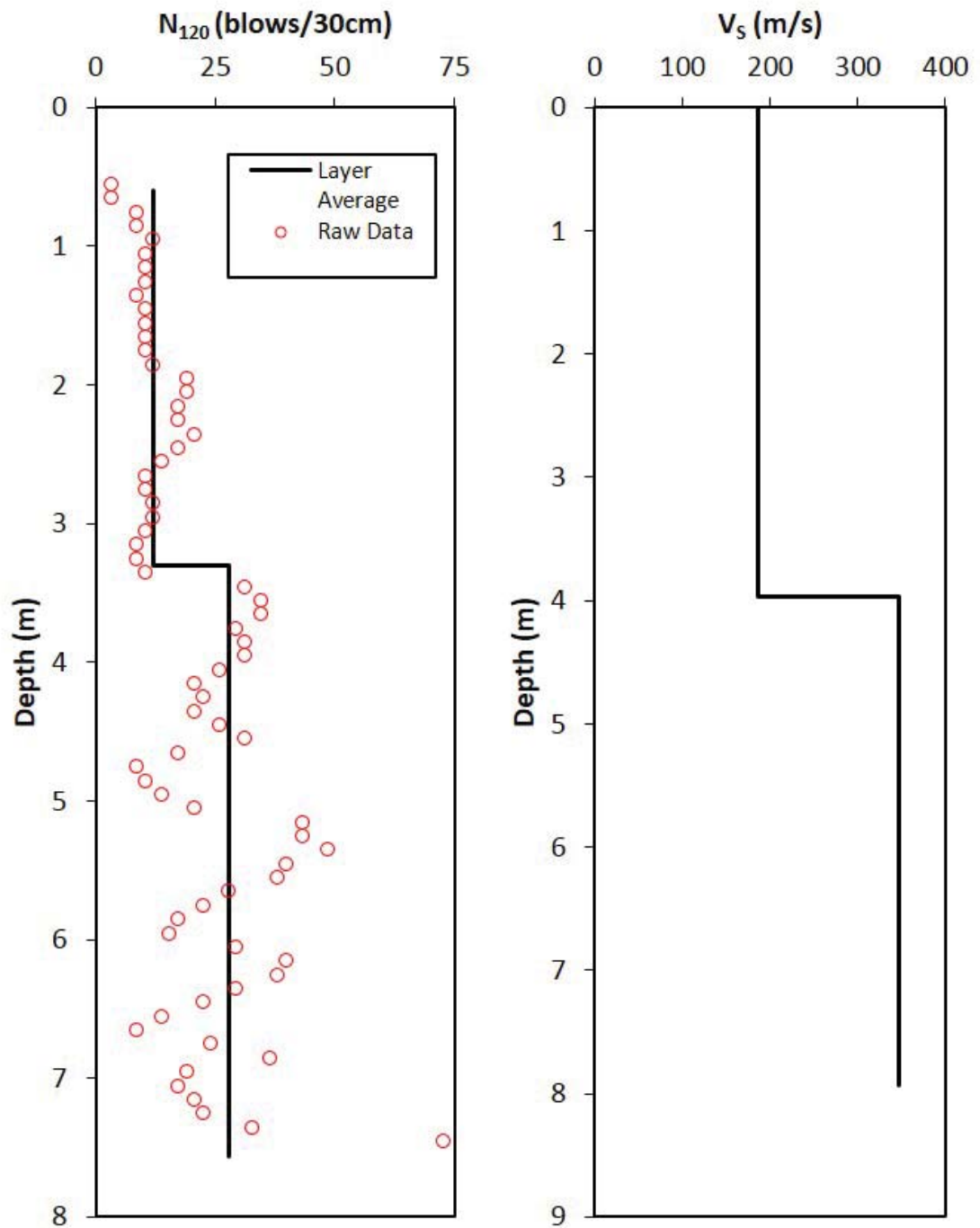

Figure 6.65: DPT uncorrected blow counts and V_s versus depth at Location 4 - Millsite Dam

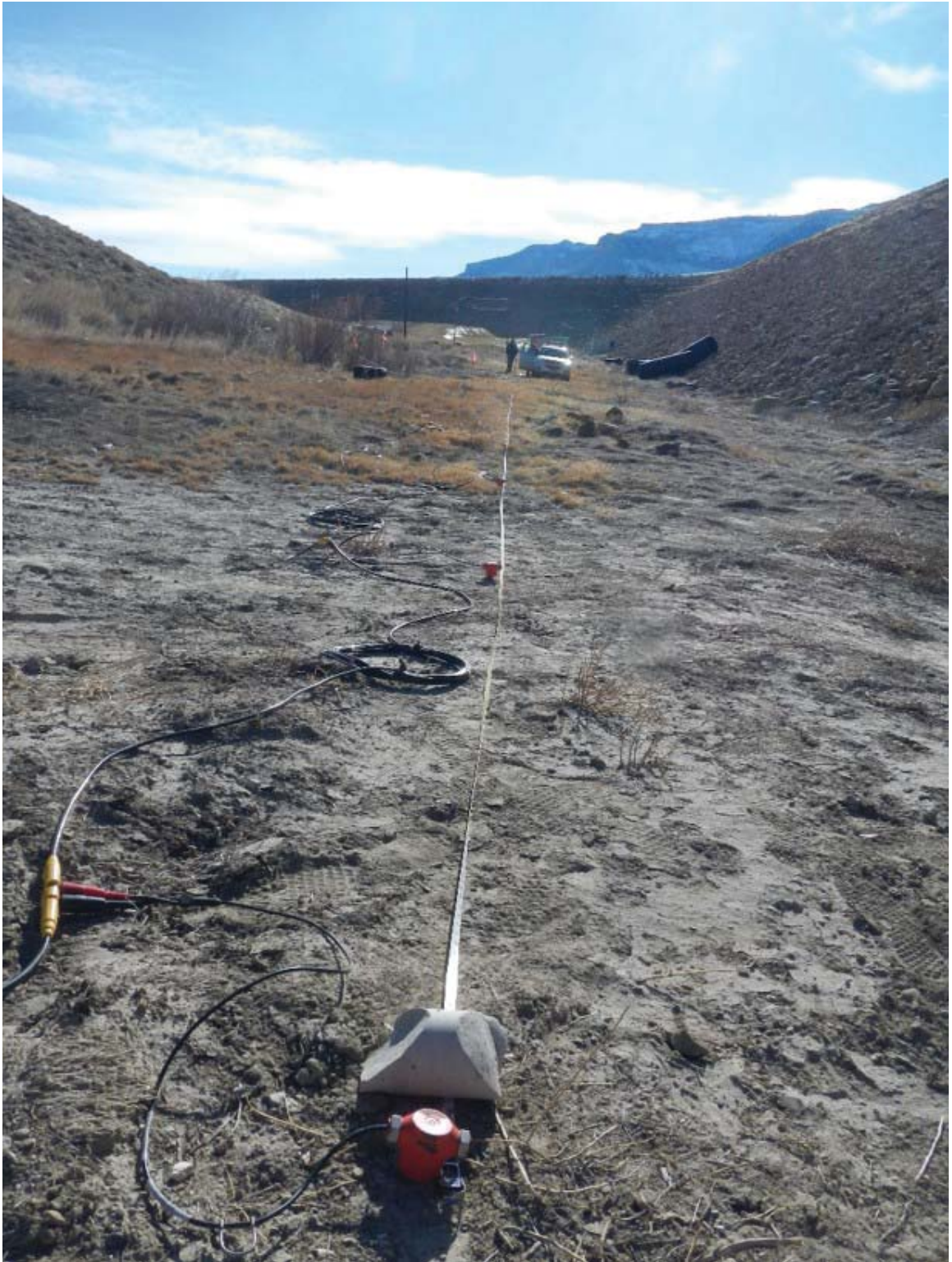

Figure 6.66: MASW setup for V_S measurements at Location 5 - Millsite Dam

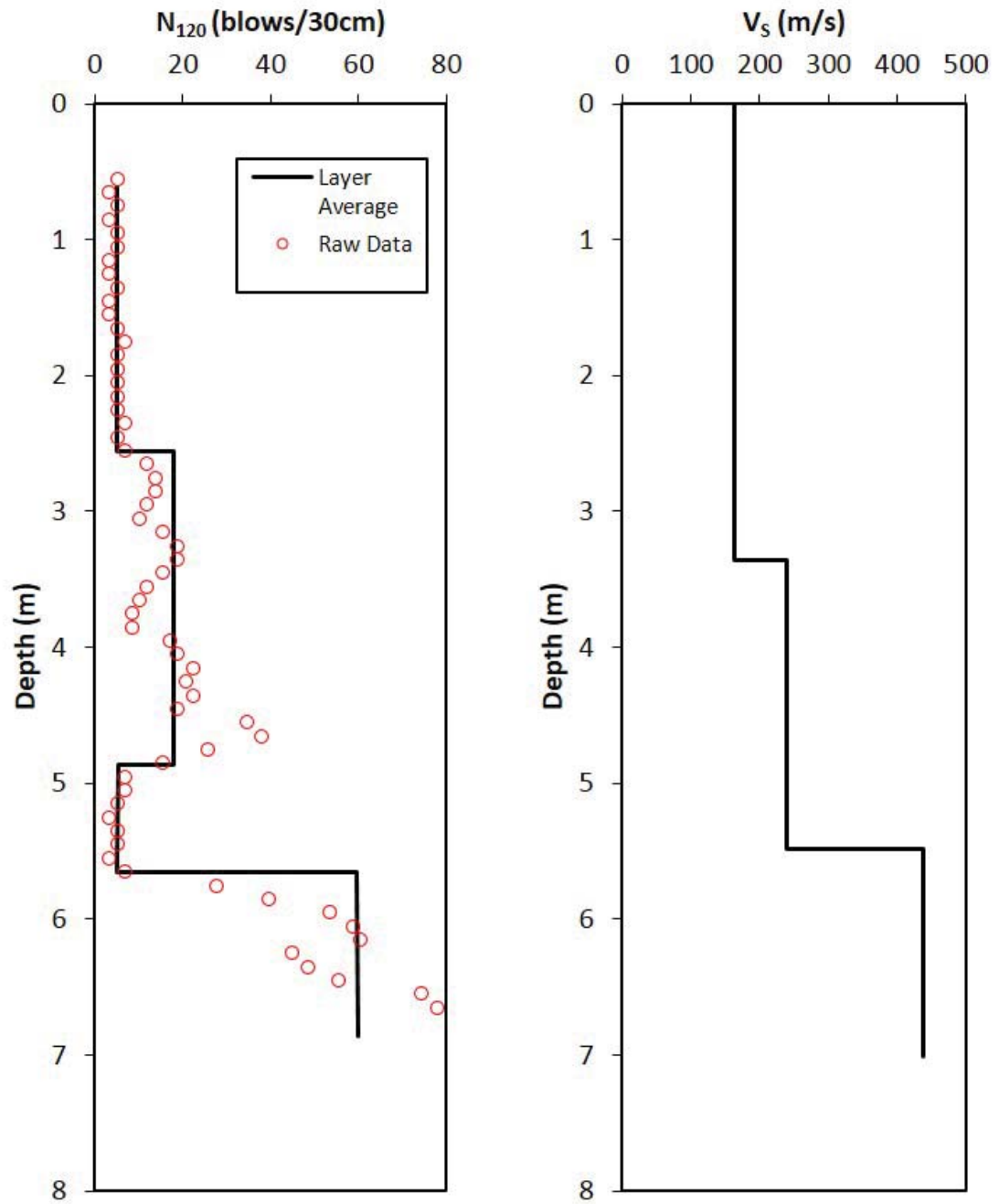

Figure 6.67: DPT uncorrected blow counts and V_s versus depth at Location 5 - Millsite Dam

6.5.0.6 Combined Data - Millsite Dam

Figure 6.68 shows the results of DPT testing at Millsite Dam for all test locations. In general, the N_{120} values increase with depth. The values for Millsite Dam are higher on average than the values measured at the ports of Lixouri and Argostoli in Greece, with values mostly in the range of 20 blows or higher except for at Location 5 which had significantly looser layers. The N_{120} values at Millsite Dam also show more variability than the Cephalonia test values. For example, at Location 4 values fluctuate between 20 to 40 blows. Figure 6.69 shows the V_S profile results of the MASW tests. The V_S values range from approximately 150-600 m/s for the test locations, and V_S increases as depth increases.

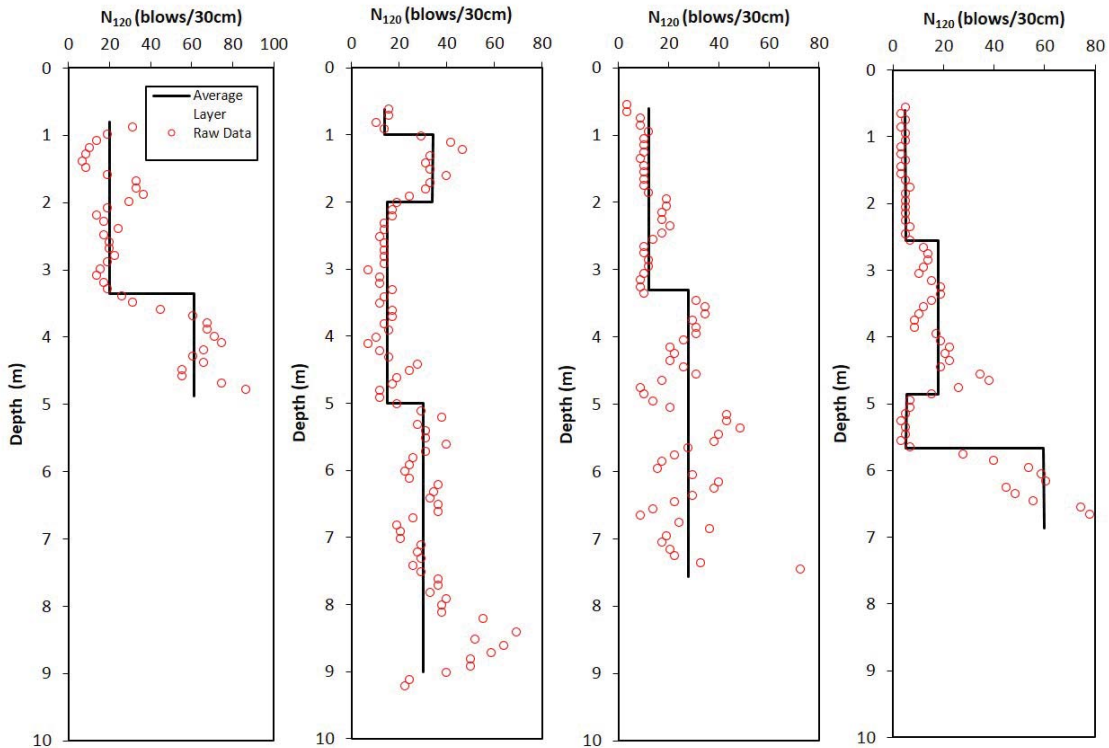

Figure 6.68: Comparison of DPT test results for Millsite Dam

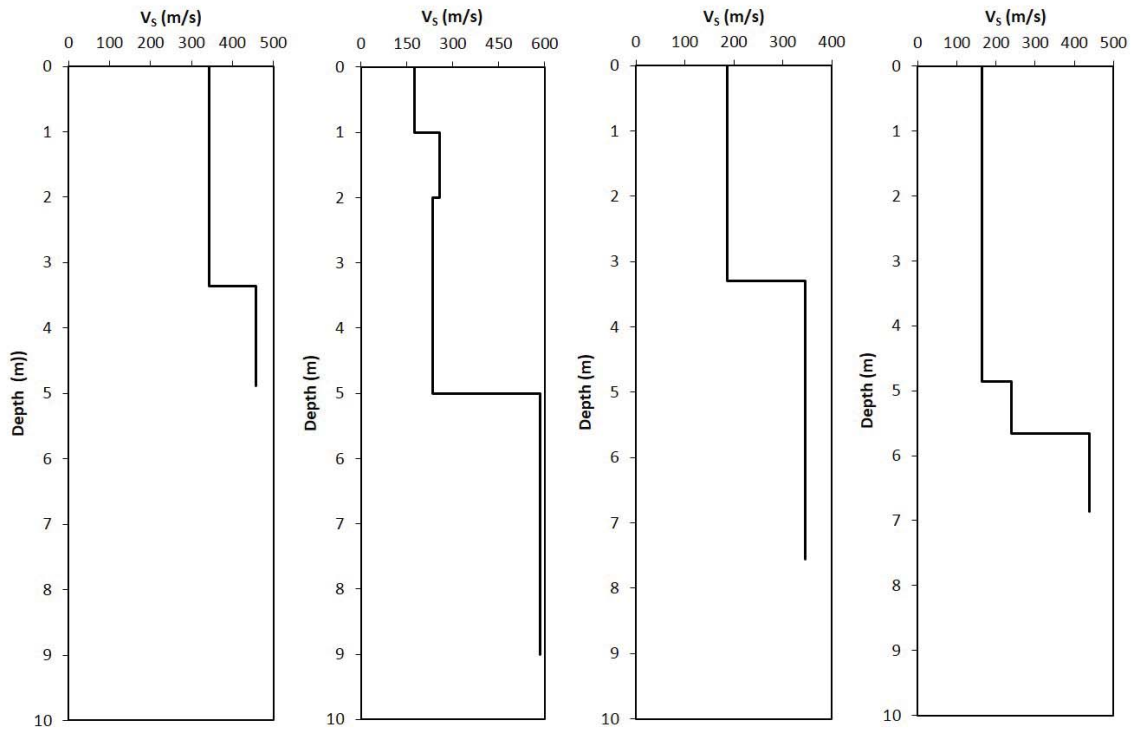

Figure 6.69: Comparison of V_S test results for Millsite Dam

6.5.1 Correlation of N_{120} and V_S

It is often useful to be able to calculate a penetration resistance value if the V_S value is known, and vice versa. Many correlations have been developed for sandy soil sites which relate N_{60} values from the SPT to V_S values (Wair *et al.*, 2012). Rollins *et al.* (1998) developed a correlation for gravelly soils based on BPT test data (that was correlated to N_{60} values) and V_S values. The resulting equation that was developed for Holocene gravelly soils by Rollins *et al.* (1998) was:

$$V_S = 63 * (N_{60})^{0.43} \quad (6.2)$$

Using the DPT and V_S data that was collected as a part of this study a correlation between DPT and V_S has been developed. Additional data from (Cao *et al.*, 2011) was used to supplement the data from this study, which was possible because energy measurements

were taken to correct for hammer energy at each location. First, data from this study was regressed as shown in Figure 6.70, with the resulting equation for the prediction of V_S being:

$$V_S = 122 * (N_{120})^{0.28} \quad (6.3)$$

Second, the data from this study was combined with the *Cao et al.* (2011) and regressed as shown in Figure 6.71, with the resulting equation for the prediction of V_S being:

$$V_S = 115 * (N_{120})^{0.29} \quad (6.4)$$

The data falls in a fairly narrow range with an R^2 value of 0.44 for the data from this study and an R^2 value of 0.51 when combined with *Cao et al.* (2011) data, which is similar to the R^2 value of 0.59 that was found in *Rollins et al.* (1998). The equations are similar to other equations for gravels as summarized in *Wair et al.* (2012).

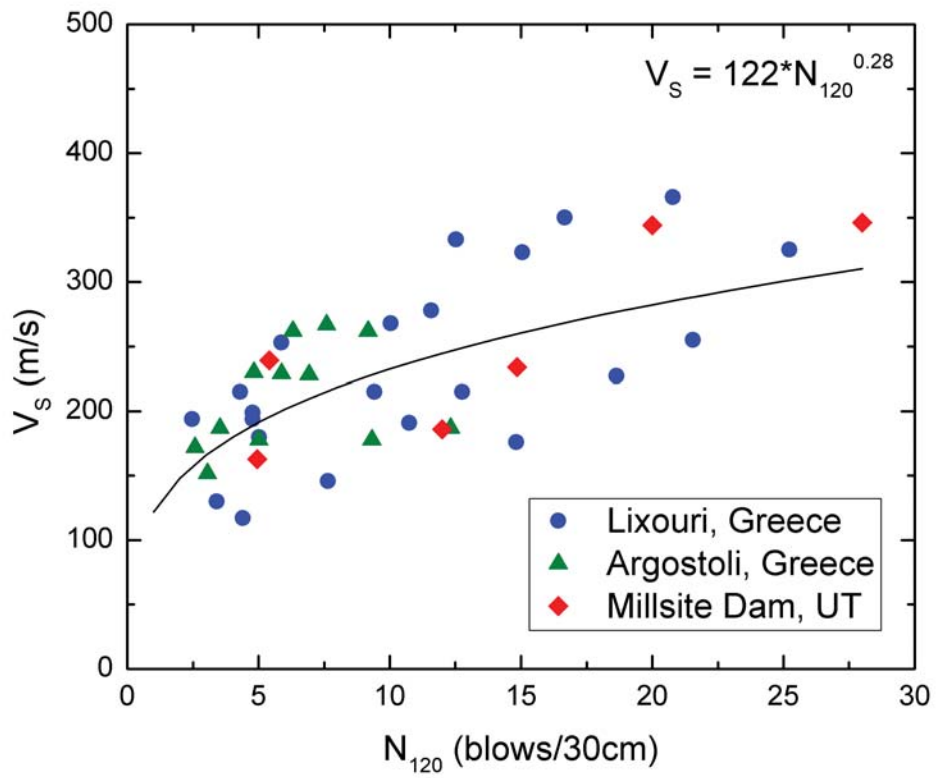

Figure 6.70: Correlation of N_{120} and V_s based on field testing in this study

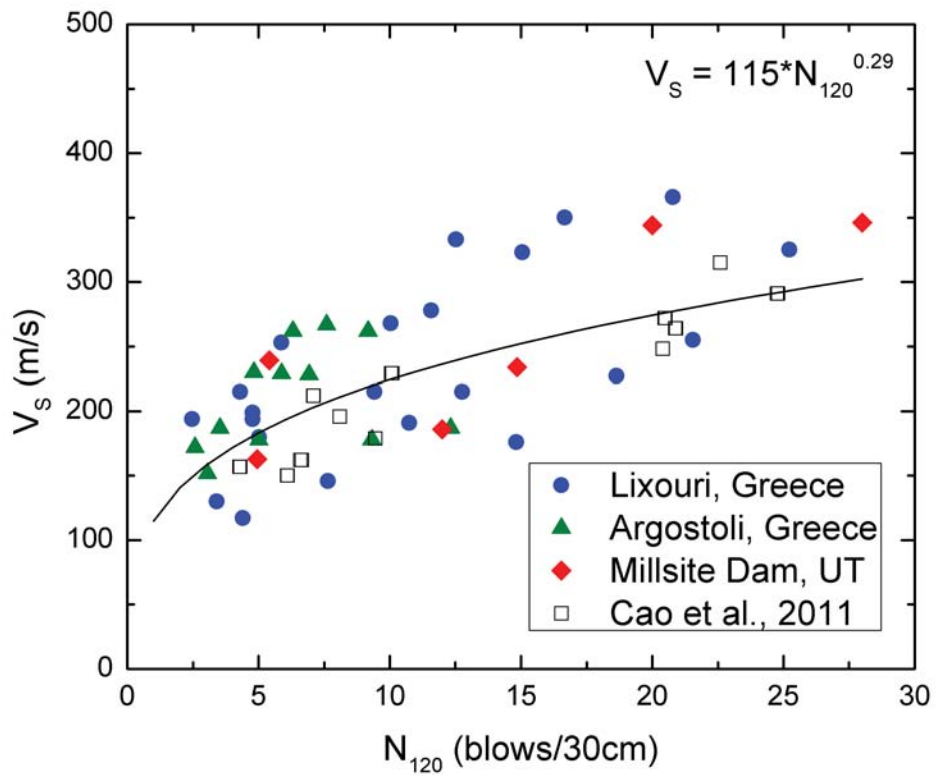

Figure 6.71: Correlation of N_{120} and V_s based on field testing in this study and *Cao et al.* (2011) data

6.6 Assessment of Liquefaction Triggering for Gravelly Soils

The Cephalonia locations that were tested in this study presented a unique opportunity for further study of gravelly soil liquefaction in the field. As previously discussed, significant liquefaction occurred during the 2014 earthquakes, with gravelly soils suspected of liquefying in the ports of Lixouri and Argostoli. Extensive post-earthquake reconnaissance work has produced significant information on lateral spreading and associated displacements following liquefaction. Figure 6.72 shows the locations of the liquefaction through the port of Lixouri. There were many locations that showed surface manifestations of liquefaction, and these areas are the areas where in-situ tests were performed as a part of this study. In addition, significant liquefaction was also observed in gravelly soils in Argostoli as shown in Figure 6.73. Ground motion data was also used from a 1983 earthquake that occurred in Cephalonia. This earthquake, while larger in moment magnitude at 7.0, did not produce liquefaction at the port of Argostoli. The ground motion data from that earthquake was used with the field measurements in this study in Argostoli for additional points of no liquefaction in the Argostoli port. The in-situ testing as a part of this study will further add to the geotechnical data available for this site.



Figure 6.72: Location of Liquefaction observed in Lixouri following 2014 Cephalonia earthquakes (Papathanassiou *et al.*, 2016)



Figure 6.73: Liquefaction observed in Argostoli following 2014 Cephalonia earthquakes (Nikolaou *et al.*, 2014)

Liquefaction analyses were performed for the Cephalonia sites to assess the performance of current prediction methods for triggering of soil liquefaction at gravelly sites. Both V_S and DPT based methods from *Cao et al.* (2011, 2013) were used to evaluate liquefaction using the probability of liquefaction of 50% relationships from these studies. Although another liquefaction triggering relationship exists for gravelly soils (*Andrus and Stokoe*, 2000), the relationship is based on limited data as stated by the authors and therefore the *Cao et al.* (2011) relationship was used in this analysis for comparison. For the Cephalonia sites, widespread liquefaction occurred during both the 1st and 2nd earthquake events in 2014 (but not during the 1983 earthquake). V_S and DPT measurements were taken at various liquefaction sites and CSR was estimated using the simplified procedure described in *Youd et al.* (2001). Corrections for overburden stress and r_d were made. The equation used for calculating the CSR was:

$$CSR = 0.65 \left(\frac{\tau_{max}}{\sigma'_{vc}} \right) = 0.65 \left(\frac{\sigma_{vc}}{\sigma'_{vc}} \right) \left(\frac{a_{max}}{g} \right) r_d \quad (6.5)$$

where a_{max} is the maximum acceleration at the ground surface and r_d is the stress reduction coefficient, which was calculated by using the equation (*Liao and Whitman*, 1986):

$$r_d = 1 - (0.00765 * z) \quad (6.6)$$

where z is the depth in meters.

CSRs were calculated in 0.1 m increments at each test location for the 1st and 2nd Cephalonia earthquakes. The 1st earthquake had a peak ground acceleration (PGA) of 0.53 g in Lixouri, while the 2nd earthquake had a PGA of 0.68 g in Lixouri. In Argostoli, the 1st earthquake had a PGA of 0.40 g, while the 2nd event had a PGA of 0.27 g (*Papathanassiou et al.*, 2016; *Theodoulidis et al.*, 2016). Alternatively, the 1983 earthquake produced a PGA of 0.17 g, as measured in Argostoli (this was the only strong motion recording station on the island in 1983). PGA values were recorded from the generated strong motions using

accelerographs installed in Argostoli (ARG2) and Lixouri (LXR1). The ARG2 accelerograph was installed by EPPO-ITSAK (Earthquake Panning and Protection Organization - Institute of Engineering Seismology and Earthquake Engineering) while the LXR1 accelerograph was installed by the National Observatory of Athens (NOA). The locations of the strong motion recording stations are shown in Figure 6.74. The ARG2 station is located on Pleistocene sediments ($V_{S30} = 440$ m/s) and the LXR1 station is located on Plio-Pleistocene marine deposits ($V_{S30} = 480$ m/s). The accelerographs were installed at the ground level in low rise buildings. The January 26th earthquake had an epicentral distance of 9 km from the ARG2 station and LX1 an epicentral distance of 7 km, while the February 3rd earthquake had an epicentral distance of 11 km from the ARG2 station and 7 km from the LXR1 station. The maximum recorded PGA value for the January 26th earthquake in Argostoli was in horizontal E-W direction, while the Lixouri PGA was also for the horizontal component (*Theodoulidis et al.*, 2016). For the February 3rd earthquake the maximum PGA in Argostoli was in the horizontal N-S direction, while the maximum PGA in Lixouri was in the horizontal E-W direction. These PGA values show that accelerations were higher in Lixouri than Argostoli, especially during the second event; however, both ports still experienced liquefaction. For the liquefaction analyses the ground water table was assumed to be at a depth of 1 m, which was an estimated value based on measurement elevations in the field. The unit weight of the soil was assumed to be 20.5 kN/m^3 . A V_S value was assigned for each layer (based on the DPT and V_S tests) and a corresponding V_{S1} value was calculated as an mean value for that layer.

Liquefaction was assessed at each location using both DPT and V_S relationships from *Cao et al.* (2011, 2013). The line corresponding to a 50% probability of liquefaction was used to calculate the corresponding CRR values based on either N'_{120} or V_{S1} . The CRR values based on the *Cao et al.* (2011, 2013) relationships were then compared to the CSR values at the sites that were computed using Equations 6.5 and 6.6. The results for both the DPT and V_S analyses will be presented in the following sections for each location.

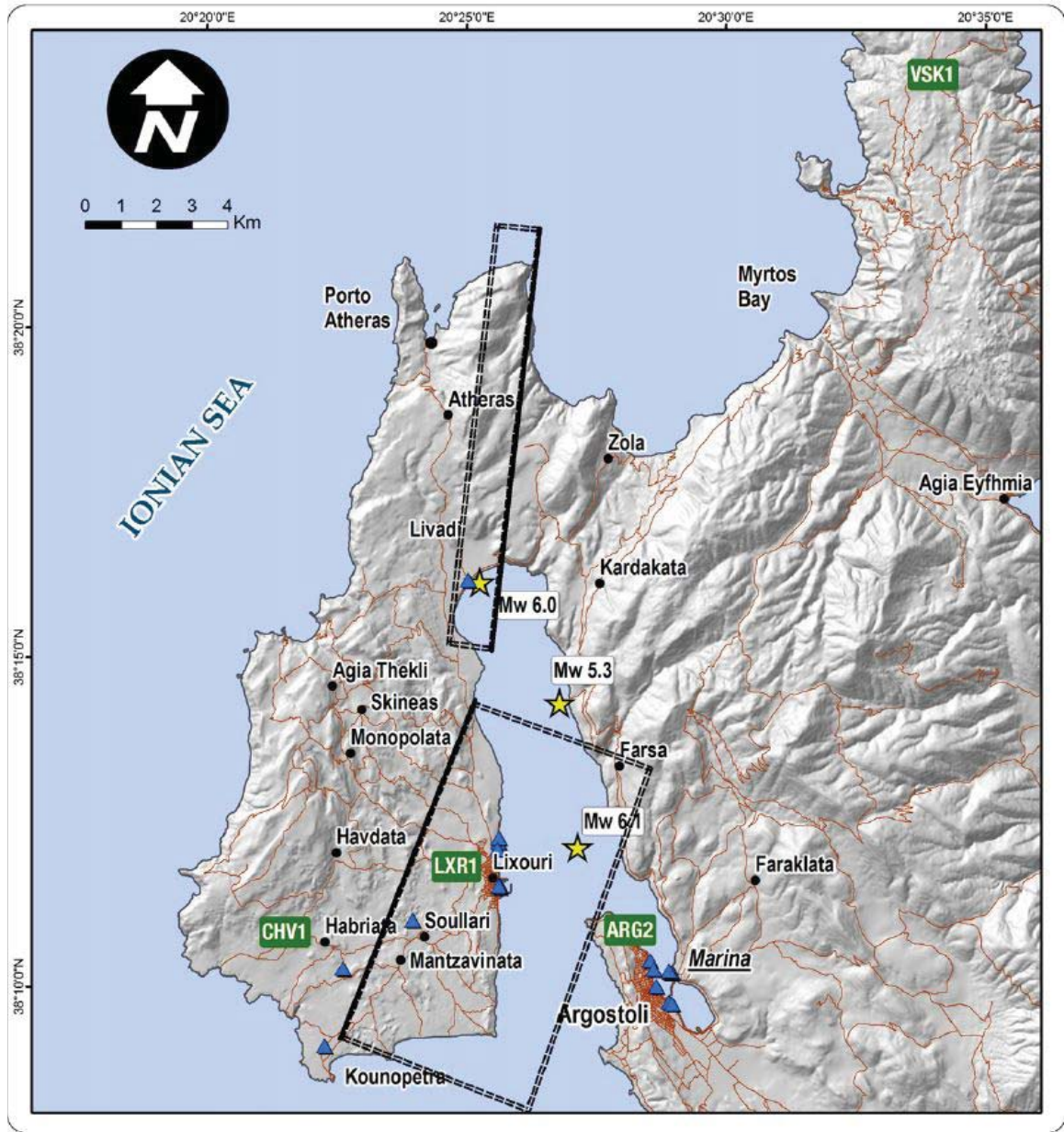

Figure 6.74: Location of Strong Motion Recording Stations in Cephalonia (Papathanassiou et al., 2016)

6.6.1 Lixouri Port

6.6.1.1 Location 1

Figure 6.75 shows the results of the liquefaction analysis performed for Location 1. The plots for the DPT-based analysis and V_S -based analysis both show that liquefaction is expected to occur at a depth of 1-4 m.

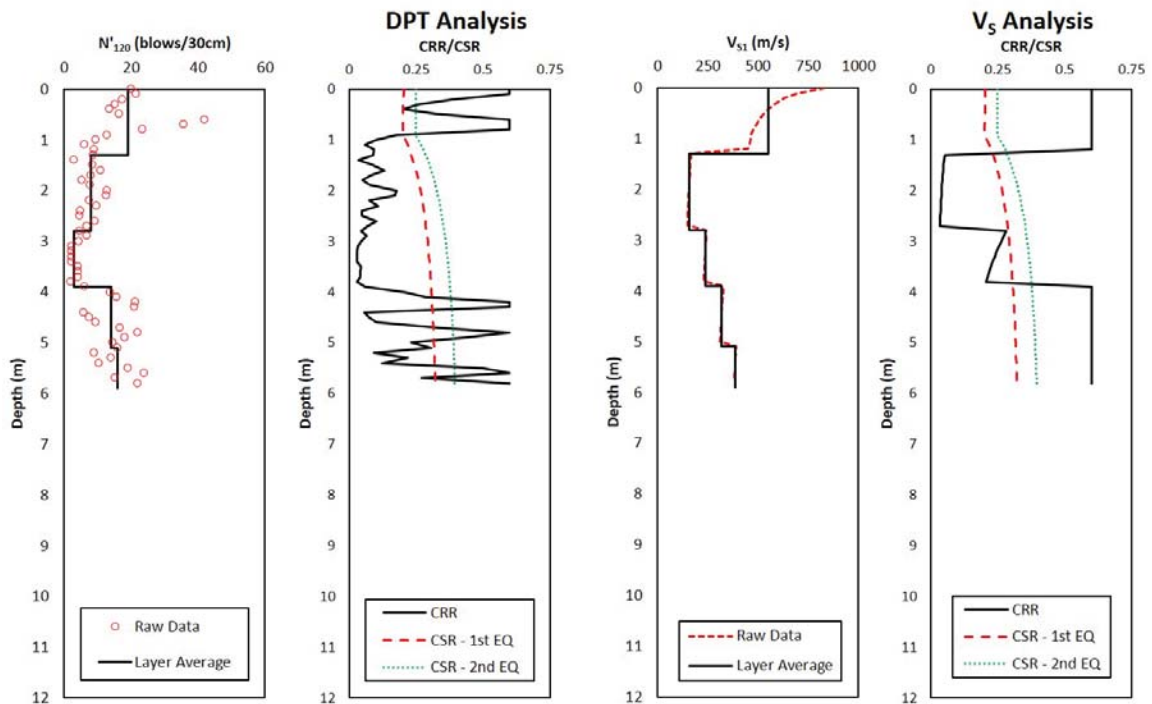

Figure 6.75: Comparison of N'_{120} and V_{S1} -based liquefaction methods at Location 1 - Lixouri

6.6.1.2 Location 2

Figure 6.76 shows the results of the liquefaction analysis performed for Location 2. The plots for the DPT-based analysis and V_S -based analysis show varying results for the depths at which liquefaction occurred. The DPT analysis predicts liquefaction in the 4.5-6.5 m range, with intermittent liquefaction in the 1-4 m range while the V_S -based analysis predicts liquefaction for the 1-2 m range and the 3.5-5 m range.

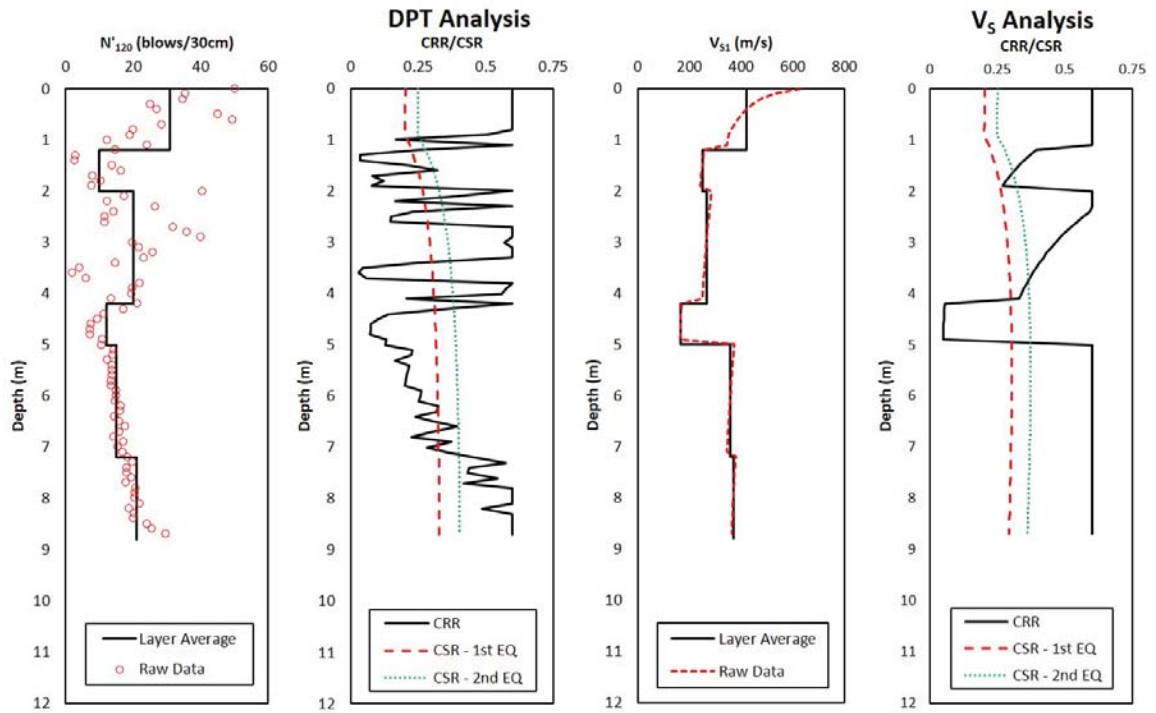

Figure 6.76: Comparison of N'_{120} and V_{S1} -based liquefaction methods at Location 2 - Lixouri

6.6.1.3 Location 3

Figure 6.77 shows the results of the liquefaction analysis performed for Location 3. The plots for the DPT-based analysis and V_S -based analysis show varying results for the depths at which liquefaction occurred. The analyses both predict liquefaction in the 3-4 m range; however, only the DPT analysis predicts liquefaction in the 1-2 m depth range.

6.6.1.4 Location 4

Figure 6.78 shows the results of the liquefaction analysis performed for Location 4. The DPT-based analysis predicts liquefaction in the 1.5-5 m depth range at the site, while the V_S -based analysis predicts liquefaction in the 1-2 m and 4-6 m depth range.

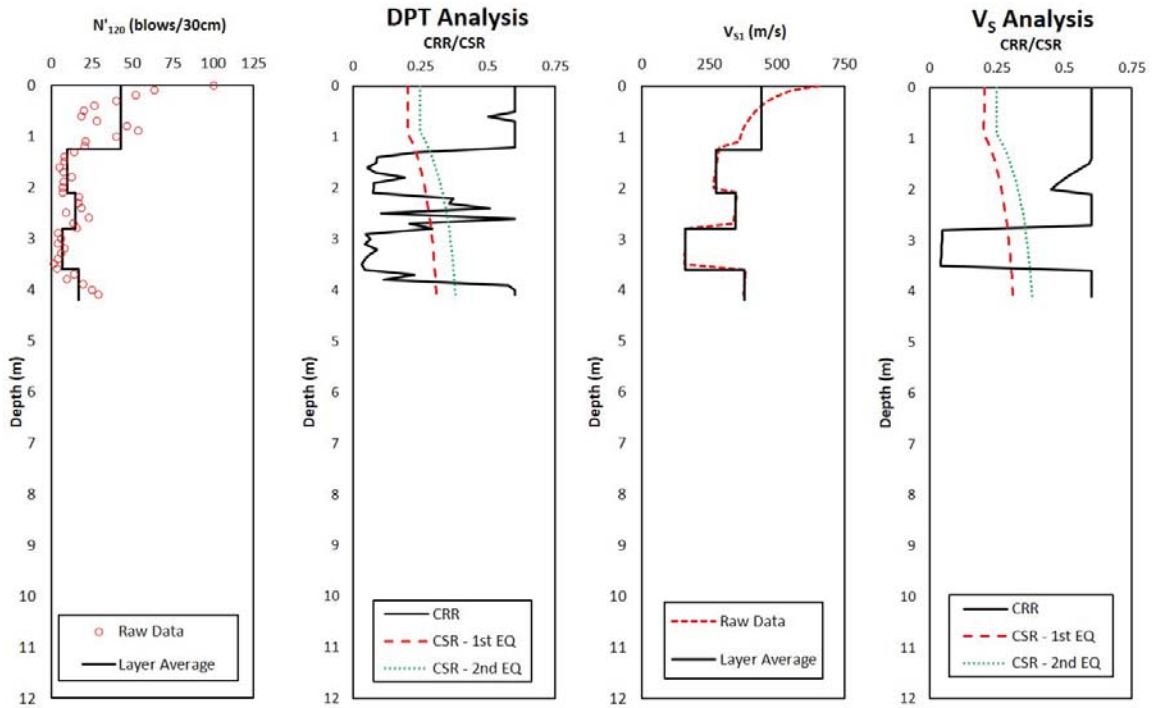

Figure 6.77: Comparison of N'_{120} and V_{S1} -based liquefaction methods at Location 3 - Lixouri

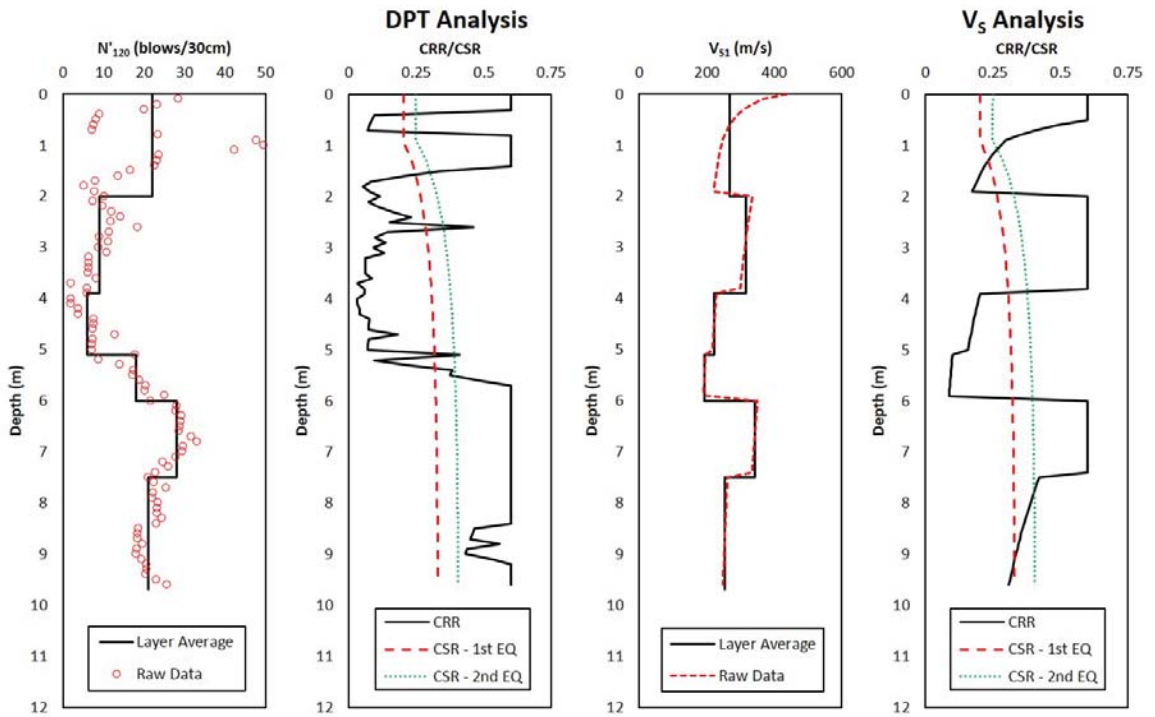

Figure 6.78: Comparison of N'_{120} and V_{S1} -based liquefaction methods at Location 4 - Lixouri

6.6.1.5 Location 5

Figure 6.79 shows the results of the liquefaction analysis performed for Location 5. The plots for the DPT-based analysis and V_S -based analysis show similar results that liquefaction occurred in the 1-2 m and 4-5 m depth range at the site. The V_S analysis also predicts liquefaction at depths greater than 5 m, whereas the DPT analysis shows thin layers of liquefiable material, but not overall layer liquefaction.

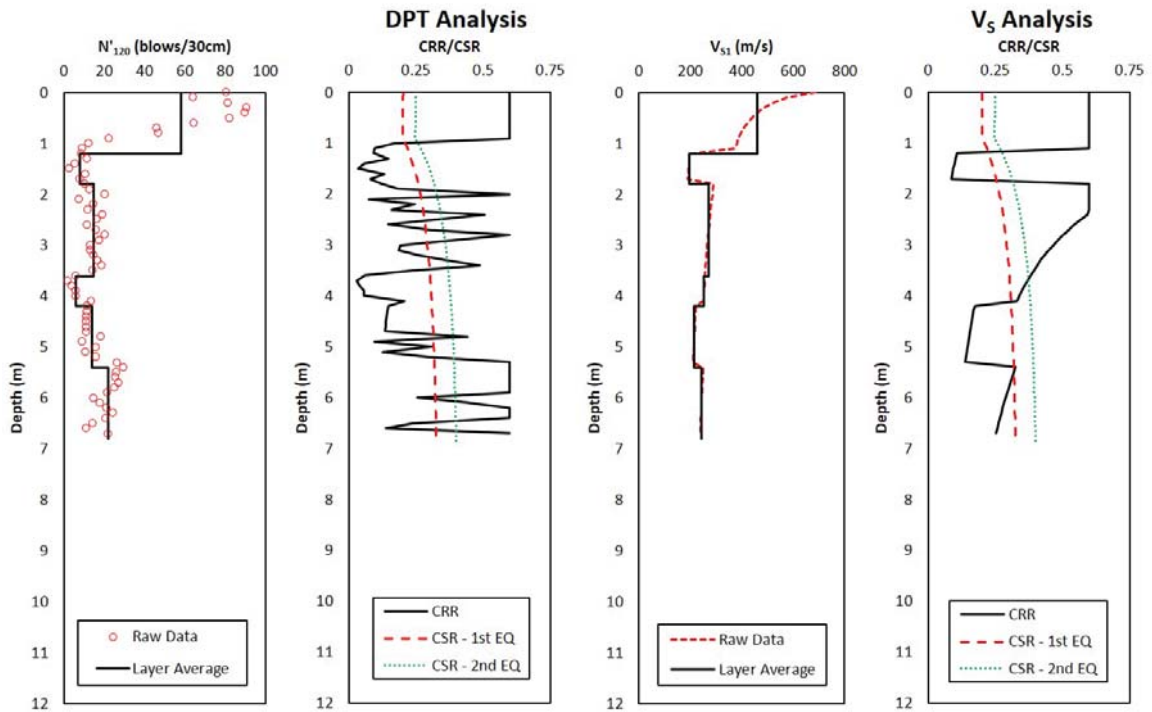

Figure 6.79: Comparison of N'_{120} and V_{S1} -based liquefaction methods at Location 5 - Lixouri

6.6.1.6 Combined Data

Data from the DPT and V_S -based analyses were plotted so that all test locations could be compared in a cross section view of the port. Figure 6.80 shows the DPT liquefaction analysis results for the port of Lixouri. Overall, the DPT analysis shows that liquefaction would be expected to occur at every location. In general, the 1-4 m range appears to be liquefiable at most of the port site. DPT-4, DPT-2, and DPT-6 show a denser layer in the

2-3 m range that could be potentially liquefiable. Figure 6.81 plots the corresponding V_S -based liquefaction analyses, which again predict liquefaction at each location where testing was performed. The V_S analyses generally predict liquefaction in the 1-2 m range (which corresponds to the gravelly fill), except at the location of V_S -1. There is also a deeper layer (3-4 m at V_S -2 and V_S -1; 4-5 m at V_S -10, V_S -13, and V_S -3) where liquefaction is predicted.

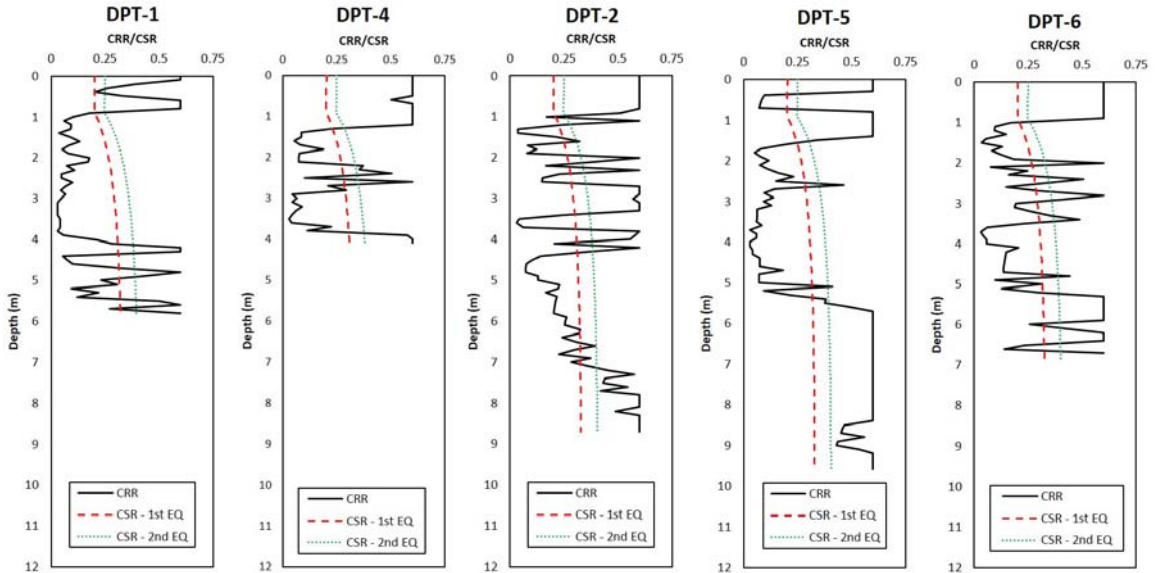

Figure 6.80: Comparison of N'_{120} -based liquefaction methods at for all locations at Lixouri Port

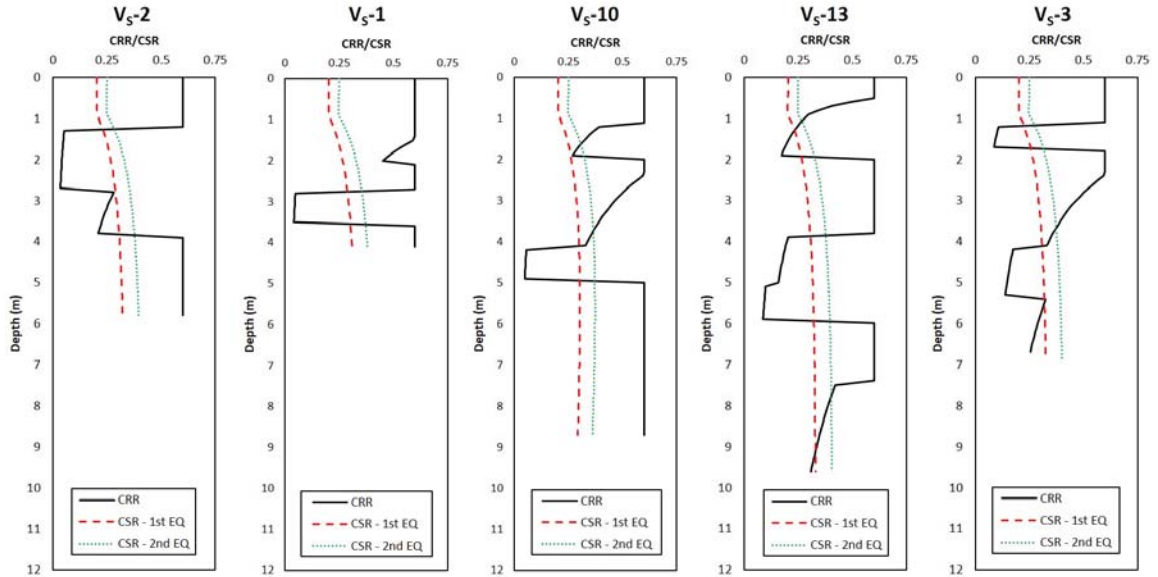

Figure 6.81: Comparison of V_{S1} -based liquefaction methods at for all locations at Lixouri Port

6.6.2 Argostoli Port

6.6.2.1 Location 11

Figure 6.82 shows the results of the liquefaction analysis performed for Location 11. The plots for the DPT-based analysis and V_S -based analysis show similar results that liquefaction occurred in the 4-6 m depth range at the site. The DPT analysis also predicts liquefaction for the 1-2.5 m range, whereas the V_S -based shows marginal liquefaction for this layer. The DPT and V_S both pick up a dense layer (possibly gravel or large cobbles) around 3 m depth.

6.6.2.2 Location 12

Figure 6.83 shows the results of the liquefaction analysis performed for Location 12. The plots for the DPT-based analysis and V_S -based analysis show varying results for liquefaction prediction. The DPT analysis predicts liquefaction for the 3-6 m and 7-8 m depth range, with marginal liquefaction in the 1-2 m range, and 6-7 m range. The V_S analysis predicts liquefaction in the 2-3 m depth range and the 7-8 m depth range.

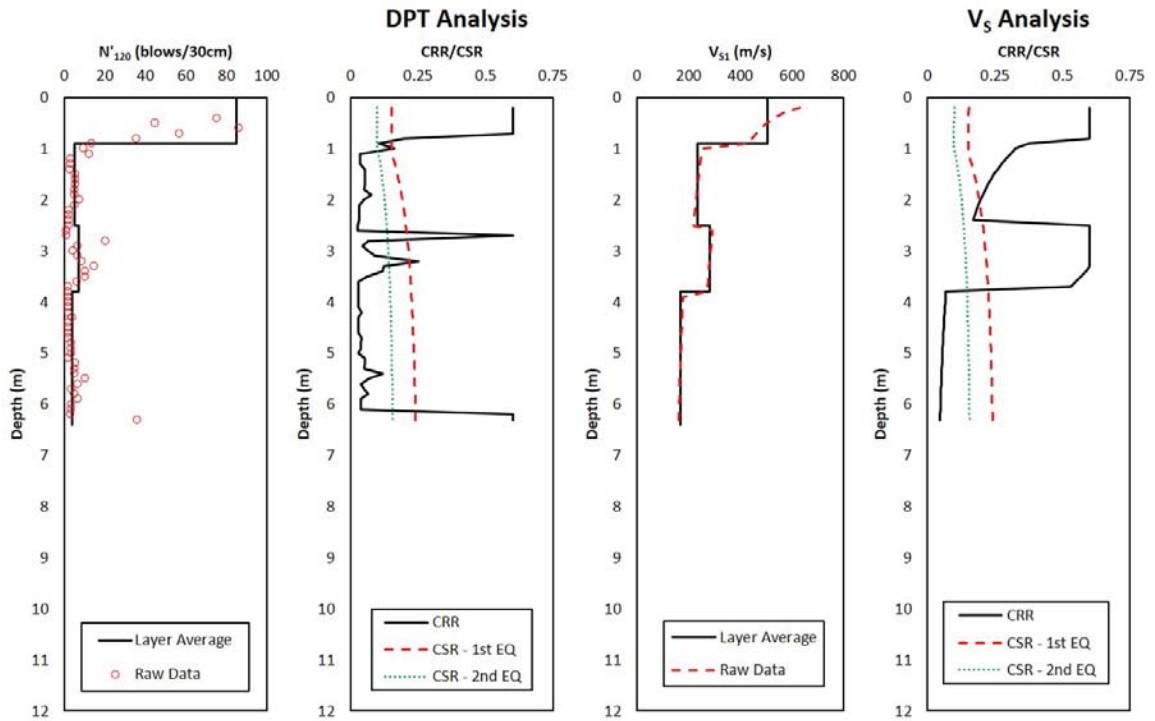

Figure 6.82: Comparison of N'_{120} and V_{S1} -based liquefaction methods at Location 11 - Argostoli

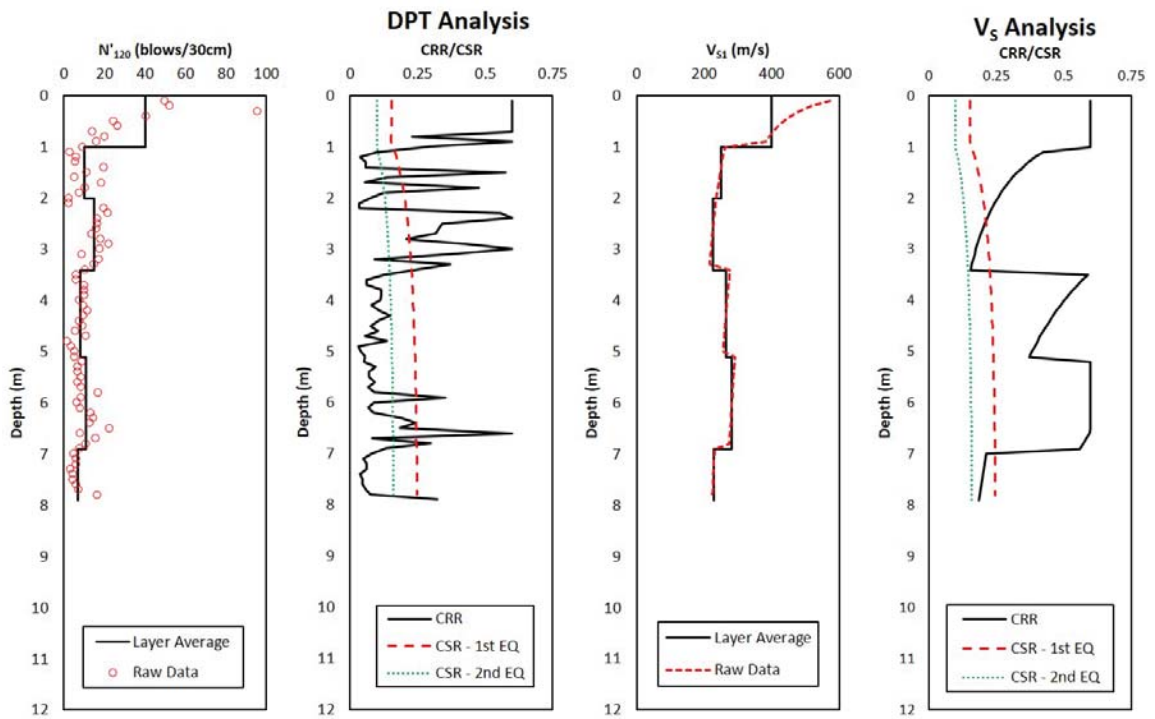

Figure 6.83: Comparison of N'_{120} and V_{S1} -based liquefaction methods at Location 12 - Argostoli

6.6.2.3 Location 13

Figure 6.84 shows the results of the liquefaction analysis performed for Location 13. The plots for the DPT-based analysis and V_S -based analysis show varying results for liquefaction prediction. The DPT analysis predicts liquefaction for the 2-5 m depth range and 6.5-8.5 m depth range, with marginal liquefaction in the 5-6 m and 6-7 m range. The V_S -based analysis predicts no liquefaction; however, the 2-3 m range is very close to being predicted as liquefiable.

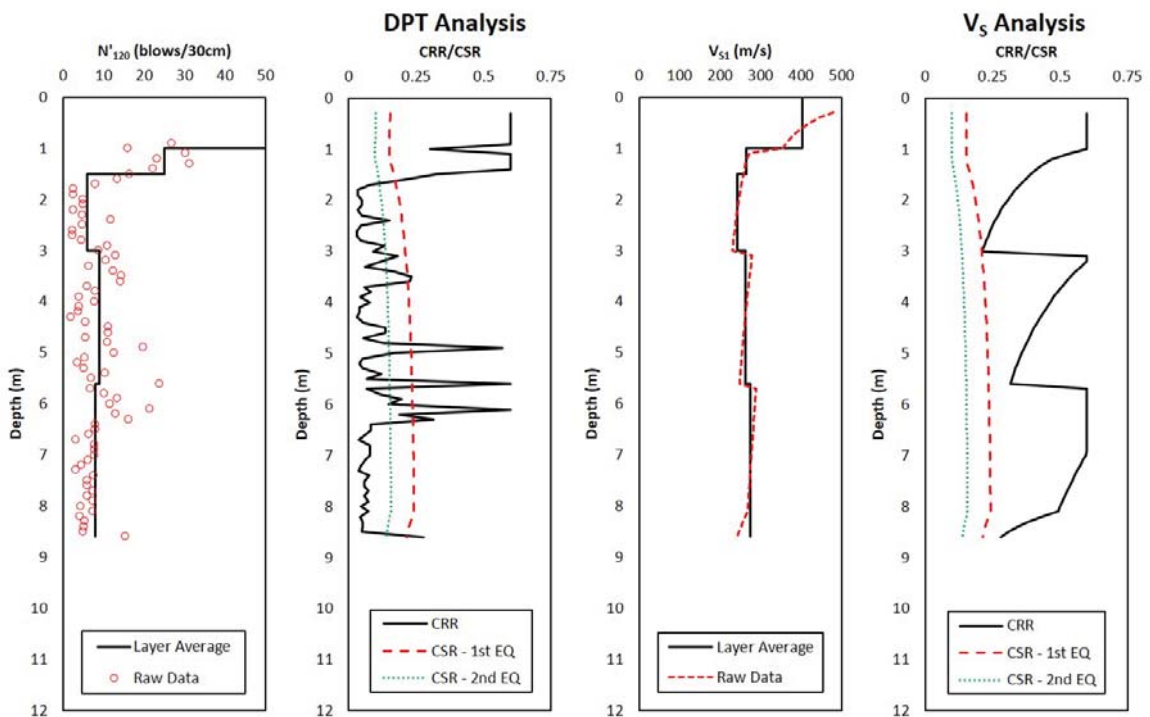

Figure 6.84: Comparison of N'_{120} and V_{S1} -based liquefaction methods at Location 13 - Argostoli

6.6.2.4 Combined Data

Data from the DPT and V_S -based analyses were plotted so that all DPT tests could be compared in a cross section view of the port. Figure 6.85 shows the DPT liquefaction analysis results for the port of Lixouri. Overall, the DPT analysis shows that liquefaction would be expected to occur at every location. In general, there appears to be potentially

liquefiable layers in the 1-3 m range, 4-6 m range, and 7-8 m range. Figure 6.86 plots the corresponding V_S liquefaction analyses, which again predict liquefaction at Locations 12 and 13 (V_S -4 and V_S -6), but no liquefaction at Location 13 (V_S -7). This suggests that the *Cao et al.* (2011) probability of liquefaction of 50% curve is not predicting liquefaction where the DPT does predict liquefaction.

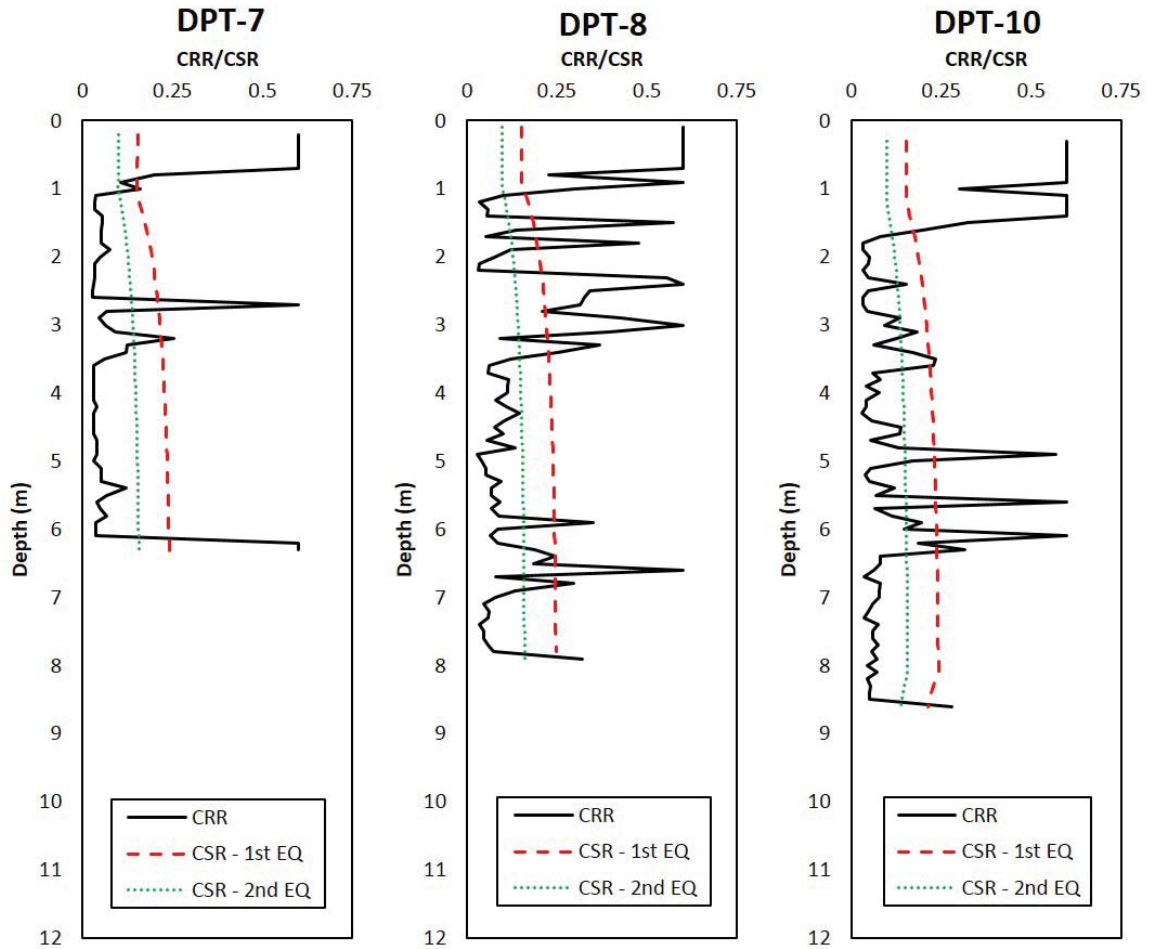

Figure 6.85: Comparison of N'_{120} -based liquefaction methods at for all locations at Argostoli Port

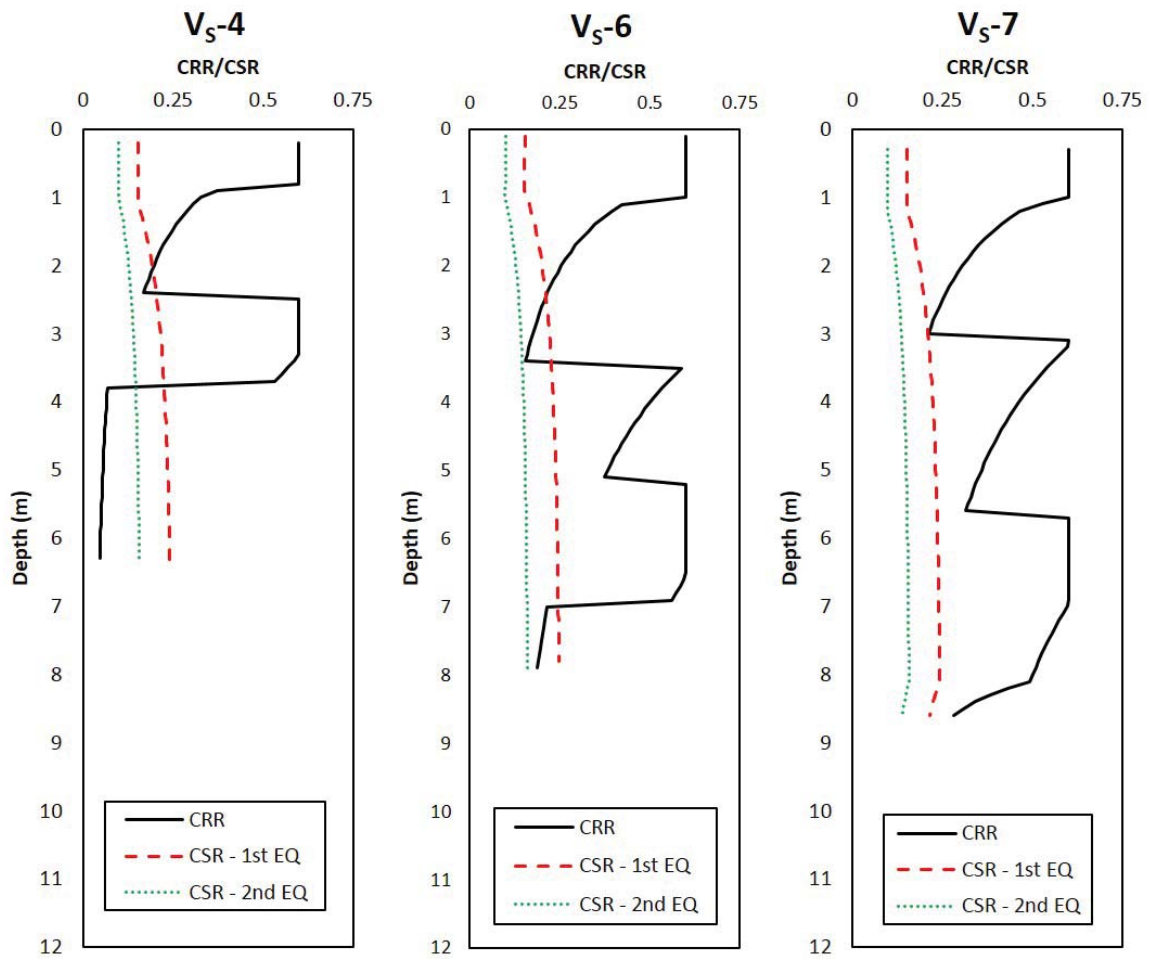

Figure 6.86: Comparison of V_{S1} -based liquefaction methods at for all locations at Argostoli Port

6.6.3 Comparison of Cephalonia Liquefaction Data with Existing Data

The analyses in the previous sections used the *Cao et al.* (2011, 2013) $P_L = 50\%$ curves for a base assessment of liquefaction at the site to evaluate the layers that would be predicted to liquefy during the Cephalonia earthquakes. The DPT analysis did a fairly good job of correctly predicting liquefaction and no liquefaction that was observed at the ports of Lixouri and Argostoli as shown in Figures 6.87 and 6.88. These figures also include data points where liquefaction was not observed following the 1983 earthquake. The *Cao et al.* (2011) $P_L = 50\%$ curves based on V_S also did a good job of predicting liquefiable layers as shown in Figures 6.89 and 6.90. The data for layers that were assumed to liquefy in this study are shown in Table 6.3, while data for layers that were assumed to not liquefy in this study are shown in Table 6.4. As previously stated, the V_{S1} values are mean values for each layer. No single V_{S1} value for a layer varied more than 31 m/s from the mean V_{S1} value, and 85% vary less than 10 m/s from the mean value reported. There were a few points at lower CSR values (less than 0.20) that were incorrectly predicted by the *Cao et al.* (2011) relationship, which could be due to the data from *Cao et al.* (2011) being from one earthquake and one region of China (i.e. limited data). Therefore, a new relationship is developed in the next section that combines laboratory and field data from many sites.

Table 6.3: Locations of Liquefiable layers in Argostoli and Lixouri

Location	Depth	CSR EQ-1	CSR EQ-2	N'_{120} (blows/30cm)	V_{S1} (m/s)
1	1.4-2.8	0.26	0.32	8	156
1	2.9-3.9	0.29	0.36	3	236
2	1.2-2	0.24	0.3	10	250
2	4.2-5	0.3	0.37	12	167
3	1.25-2.1	0.25	0.31	10	275
3	2.9-3.6	0.3	0.36	7	160
4	4-5.1	0.31	0.38	6	223
4	5.1-6	0.32	0.39	18	193
5	1.2-1.8	0.24	0.3	8	195
11	1-2.5	0.18	0.12	5	235
11	3.9-6.4	0.24	0.15	4	170
12	1.1-2.0	0.18	0.12	10	250
13	1.5-3	0.19	0.13	6	242

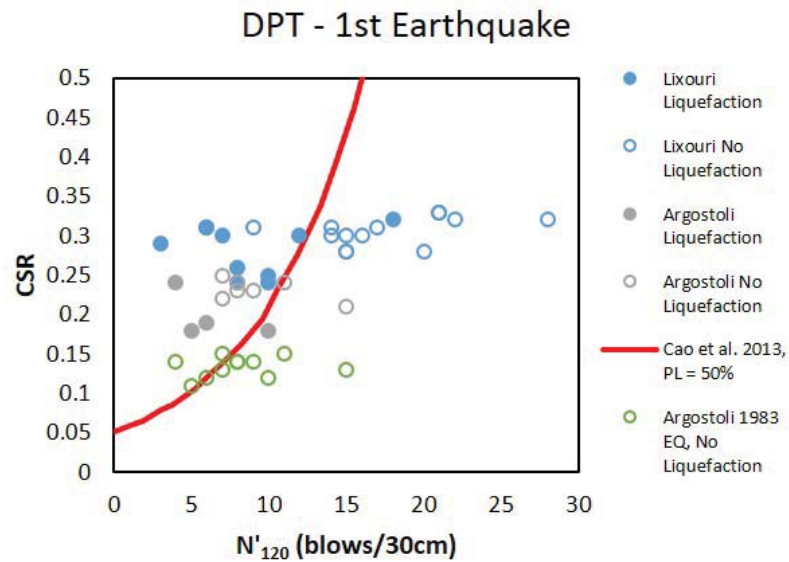

Figure 6.87: Comparison of N'_{120} Data from Cephalonia with *Cao et al.* (2013) for 1st Cephalonia Earthquake

Table 6.4: Locations of Non-liquefiable layers in Argostoli and Lixouri

Location	Depth	CSR EQ-1	CSR EQ-2	CSR - 1983 EQ	N'_{120} (blows/30cm)	V_{S1} (m/s)
1	4-5.1	0.3	0.37		14	319
1	5.1-5.9	0.3	0.37		16	385
2	2-4.2	0.28	0.35		20	266
2	5-7.2	0.3	0.37		15	358
2	7.2-8.8	0.33	0.4		21	371
3	2.1-2.8	0.28	0.34		15	346
3	3.6-4.2	0.31	0.38		17	381
4	2.1-3.9	0.31	0.38		9	316
4	6.1-7.5	0.32	0.4		28	342
4	7.5-9.7	0.33	0.4		21	254
5	1.9-3.6	0.28	0.35		15	273
5	3.6-4.2	0.31	0.38		6	254
5	4.2-5.4	0.31	0.39		14	216
5	5.5-6.8	0.32	0.4		22	244
11	2.6-3.8	0.22	0.14		7	282
12	2-3.4	0.21	0.14		15	226
12	3.4-5.1	0.23	0.15		8	266
12	5.1-6.9	0.24	0.16		11	283
12	6.9-7.9	0.25	0.16		7	228
13	3-5.6	0.23	0.15		9	262
13	5.6-8.6	0.24	0.15		8	274
11	1-2.5			0.11	5	235
11	1.9-4.2			0.13	7	282
11	3.9-6.4			0.14	4	170
12	1.5-2.0			0.12	10	250
12	2-3.4			0.13	15	226
12	3.4-5.1			0.14	8	273
12	5.1-6.9			0.15	11	283
12	6.9-7.9			0.15	7	228
13	1.5-3			0.12	6	242
13	3-5.6			0.14	9	262
13	5.6-8.6			0.14	8	274

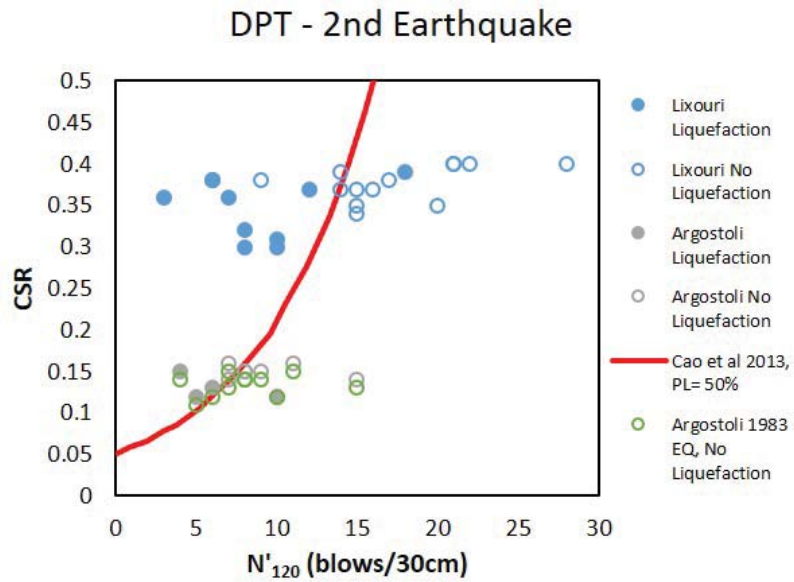

Figure 6.88: Comparison of N'_{120} Data from Cephalonia with *Cao et al.* (2013) for 2nd Cephalonia Earthquake

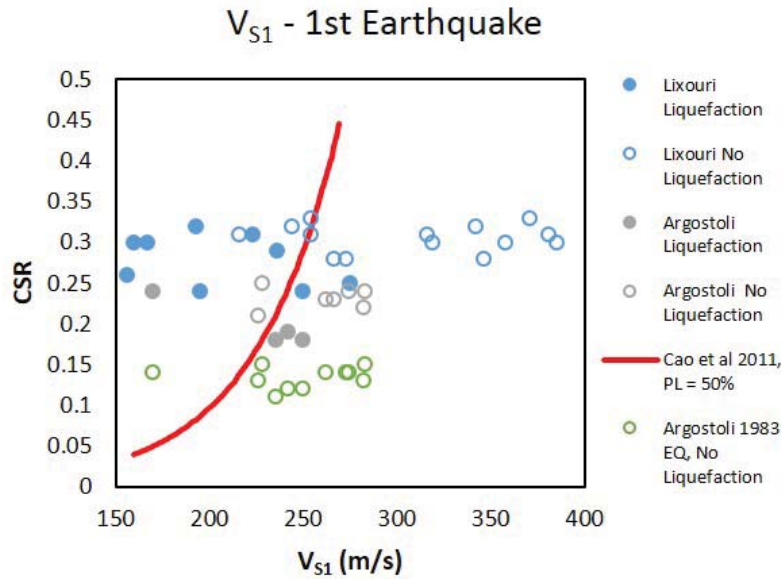

Figure 6.89: Comparison of V_{S1} Data from Cephalonia with *Cao et al.* (2011) for 1st Cephalonia Earthquake

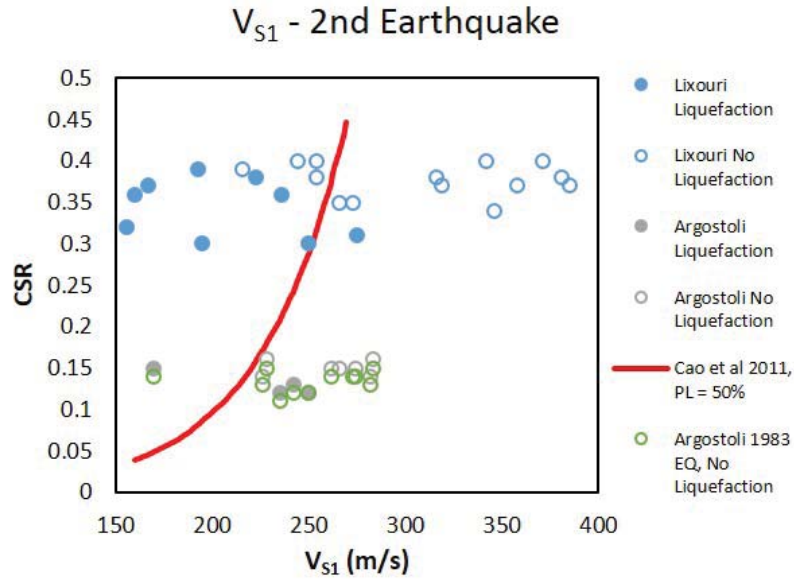

Figure 6.90: Comparison of V_{S1} Data from Cephalonia with *Cao et al.* (2011) for 2nd Cephalonia Earthquake

6.7 Development of new Liquefaction Triggering Chart for Gravelly Soils

Based on the laboratory data for uniform gravels and gravel-sand mixtures as well as the field data from Cephalonia (including the 2014 earthquakes and the 1983 earthquake) and the literature, new liquefaction triggering correlations were developed. The logistic regression method, which was used by *Cao et al.* (2011), was utilized to develop probabilistic $CSR - N'_{120}$ and $CSR - V_{S1}$ curves that can be used for gravelly soil liquefaction prediction. The V_S -based curves are defined using the following equation:

$$P_L(X) = \frac{1}{1 + \exp[-(\theta_0 + \theta_1 V_{S1} + \theta_2 \ln(CSR))]} \quad (6.7)$$

Where $P_L(X)$ is the probability of liquefaction; CSR is the cyclic stress ratio calculated for the earthquake or applied in the laboratory; and $\theta_0, \theta_1, \theta_2$ are model parameters that are determined through logistic regression. The DPT-based curves utilize the same equation except V_{S1} is replaced by N'_{120} in Equation 6.7.

Four different logistic regressions were performed (1 for DPT and 3 for V_S). The first included data from this study for the DPT and data from the literature for the DPT (Cao *et al.*, 2013). The second regression included field data for V_S from this study (2014 and 1983 Cephalonia earthquakes) and data from the literature from previous V_S -based gravelly soil liquefaction charts (Andrus and Stokoe, 2000; Cao *et al.*, 2011). The third regression included all laboratory and field data for V_S and CSR from this study, and the fourth regression included all laboratory and field data from this study with the addition of field data from the literature (Andrus and Stokoe, 2000; Cao *et al.*, 2011). All data points were given an equal weight in the regression analyses. For the first regression of data for the DPT, the model parameters that were determined using logistic regression were:

$$\theta_0 = 6.058; \theta_1 = -0.303; \theta_2 = 2.360 \quad (6.8)$$

For the second regression of data for field V_S from this study and the literature, the model parameters that were determined using logistic regression were:

$$\theta_0 = 9.663; \theta_1 = -0.0327; \theta_2 = 1.500 \quad (6.9)$$

For the third regression of data for field and laboratory V_S from this study, the model parameters that were determined using logistic regression were:

$$\theta_0 = 14.600; \theta_1 = -0.0523; \theta_2 = 1.482 \quad (6.10)$$

For the fourth regression of data for field and laboratory V_S from this study and literature, the model parameters that were determined using logistic regression were:

$$\theta_0 = 10.649; \theta_1 = -0.0379; \theta_2 = 1.154 \quad (6.11)$$

The model parameters from the fourth regression of all laboratory and field data from

this study and literature are similar to the parameters that were found by *Cao et al.* (2011), which were:

$$\theta_0 = 11.97; \theta_1 = -0.039; \theta_2 = 1.77 \quad (6.12)$$

These model parameters can then be used evaluate the probability of liquefaction based on V_{S1} using the following equation:

$$\ln[P_L/(1 - P_L)] = \theta_0 - \theta_1 V_{S1} + \theta_2 \ln(CSR) \quad (6.13)$$

This equation is also used for DPT-based analysis by replacing V_{S1} with N'_{120} .

Based on these model parameters, probability of liquefaction curves (for $P_L = 30\%$, 50% , and 70%) were plotted for each of the four data sets that were regressed. Figure 6.91 shows the curves that were developed based on DPT measurements from this study and DPT measurements from *Cao et al.* (2013). Figure 6.92 shows the curves developed in this study compared to the existing $P_L = 50\%$ curve developed by *Cao et al.* (2013). The *Cao et al.* (2013) curve falls between the $P_L = 30\%$ and $P_L = 50\%$ curves developed in this study.

Figure 6.93 shows the curves that were developed based on field V_S measurements from this study and field V_S measurements by *Cao et al.* (2011) and *Andrus and Stokoe* (2000). Figure 6.94 shows the curves developed in this study compared to the existing $P_L = 50\%$ curve developed by *Cao et al.* (2011). The *Cao et al.* (2011) curve falls between the $P_L = 30\%$ and $P_L = 50\%$ curves developed in this study.

Figure 6.95 shows the curves that were developed based on laboratory and field V_S measurements from this study. Figure 6.96 shows the curves developed in this study compared to the existing $P_L = 50\%$ curve developed by *Cao et al.* (2011). The *Cao et al.* (2011) curve falls above the $P_L = 50\%$ curve from this study at V_{S1} values less than approximately 235 m/s, but falls below the $P_L = 50\%$ curve from this study at V_{S1} values greater than approximately 235 m/s. The *Cao et al.* (2011) curve falls within the range of the $P_L = 30\%$ to $P_L =$

70% curves from this study.

Figure 6.97 shows the curves that were developed based on laboratory and field V_S measurements from this study and the literature (*Andrus and Stokoe, 2000; Cao et al., 2011*). Figure 6.98 shows the curves developed in this study compared to the existing $P_L = 50\%$ curve developed by *Cao et al. (2013)*. The *Cao et al. (2011)* curve falls above the $P_L = 50\%$ curve from this study at V_{S1} values less than approximately 230 m/s, but falls below the $P_L = 50\%$ curve from this study at V_{S1} values greater than approximately 230 m/s. The *Cao et al. (2011)* curve falls within the range of the $P_L = 30\%$ to $P_L = 70\%$ curves from this study.

The curves for $P_L = 50\%$ from Figures 6.93, 6.95, and 6.97 are compared with existing curves for gravelly soils and clean sands from *Andrus and Stokoe (2000)*, *Cao et al. (2011)*, and *Kayen et al. (2013)* in Figure 6.99. The new curves developed in this study are shifted further to the right, to higher values of V_{S1} than the *Andrus and Stokoe (2000)* curve for gravelly soils and the *Kayen et al. (2013)* $P_L = 50\%$ curve for clean sands. The field data curve is shifted to the right of the *Cao et al. (2011)* curve for gravelly soils, while the curves that combine laboratory and field data from this study fall below the *Cao et al. (2011)* curve at CSR values less than approximately 0.20. Above a CSR value of 0.20, the combined field and laboratory curves from this study predict liquefaction at lower V_{S1} values than *Cao et al. (2011)*. The curves developed in this study show that the *Andrus and Stokoe (2000)* curve for gravelly soils and the *Kayen et al. (2013)* for clean sands would not correctly predict liquefaction for the gravelly soils in this study. The curves in this study fall in a similar range to the *Cao et al. (2011)* $P_L = 50\%$ curve which was developed following the 2008 Wenchuan earthquake. The field based curve from this study falls above the curve based on both laboratory and field based data. The laboratory data liquefied at CSR values less than 0.20 and represented a significant number of data points, which adjusted the curve to lower CSR values than the field based curve for V_{S1} values less than approximately 250 m/s.

The data from this study shows that gravelly soils can liquefy at higher V_{S1} values than some existing liquefaction triggering charts suggest (*Andrus and Stokoe, 2000; Kayen et al., 2013*). The curves developed in this study fell in a similar range to *Cao et al. (2011)*, but had different shape due to the addition of laboratory and field data from this study.

It is recommended that for gravelly soils the curves developed from laboratory and field data from this study as well as field data from the literature be used for the evaluation of gravelly soil liquefaction based on V_S . The resulting prediction equation is:

$$\ln[P_L/(1 - P_L)] = 10.649 - 0.0379V_{S1} + 1.154\ln(CSR) \quad (6.14)$$

Alternatively for DPT-based liquefaction assessments, it is recommended that the curves developed based on field data from this study and *Cao et al. (2013)* be used for gravelly soil liquefaction based on N'_{120} . The resulting prediction equation is:

$$\ln[P_L/(1 - P_L)] = 6.058 - 0.303N'_{120} + 2.360\ln(CSR) \quad (6.15)$$

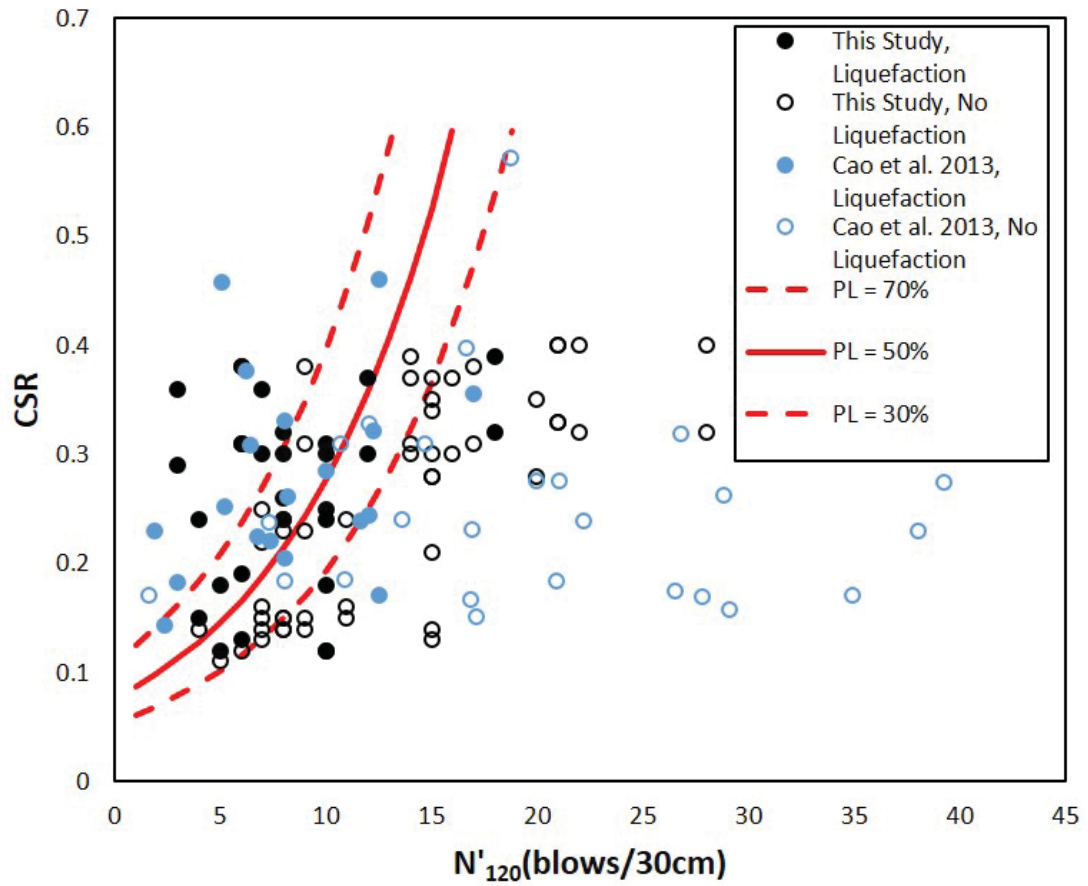

Figure 6.91: DPT-based Liquefaction Triggering Chart with $CSR - N'_{120}$ curves developed from field data from this study and the literature (Cao *et al.*, 2013)

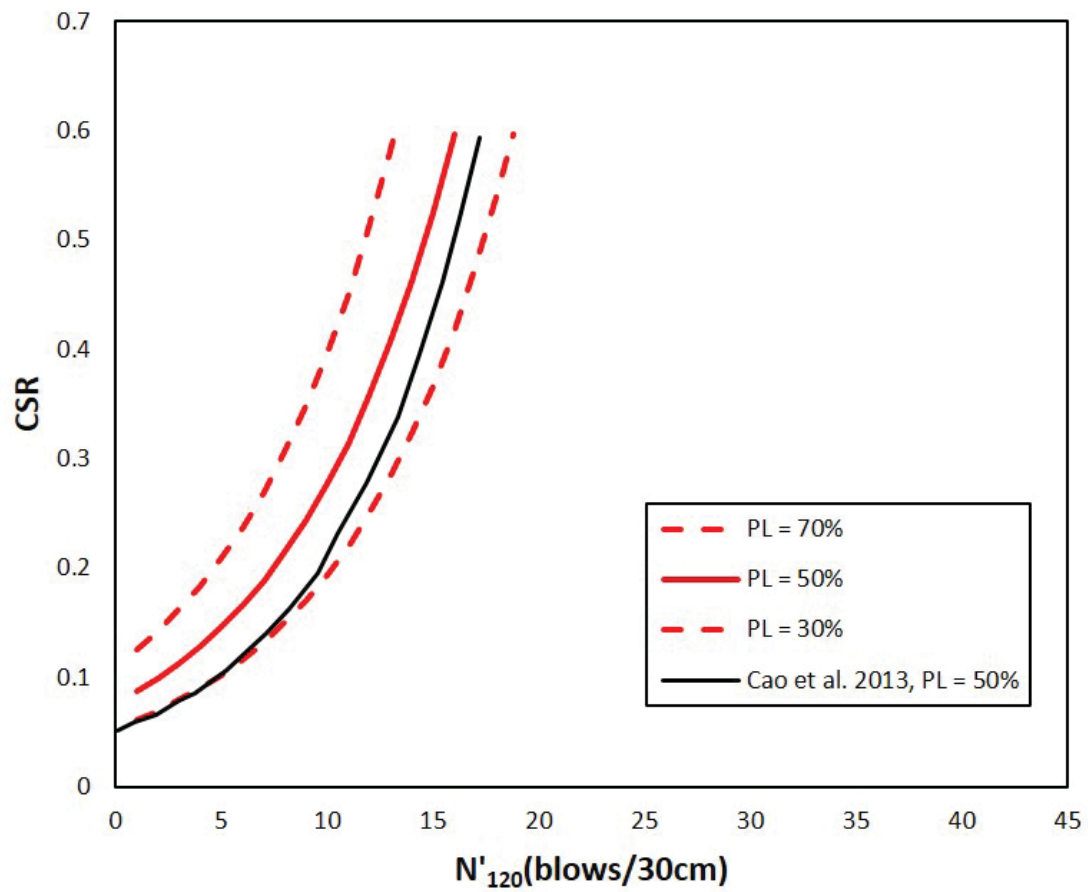

Figure 6.92: Comparison of $CSR - N'_{120}$ from this study with *Cao et al.* (2013)

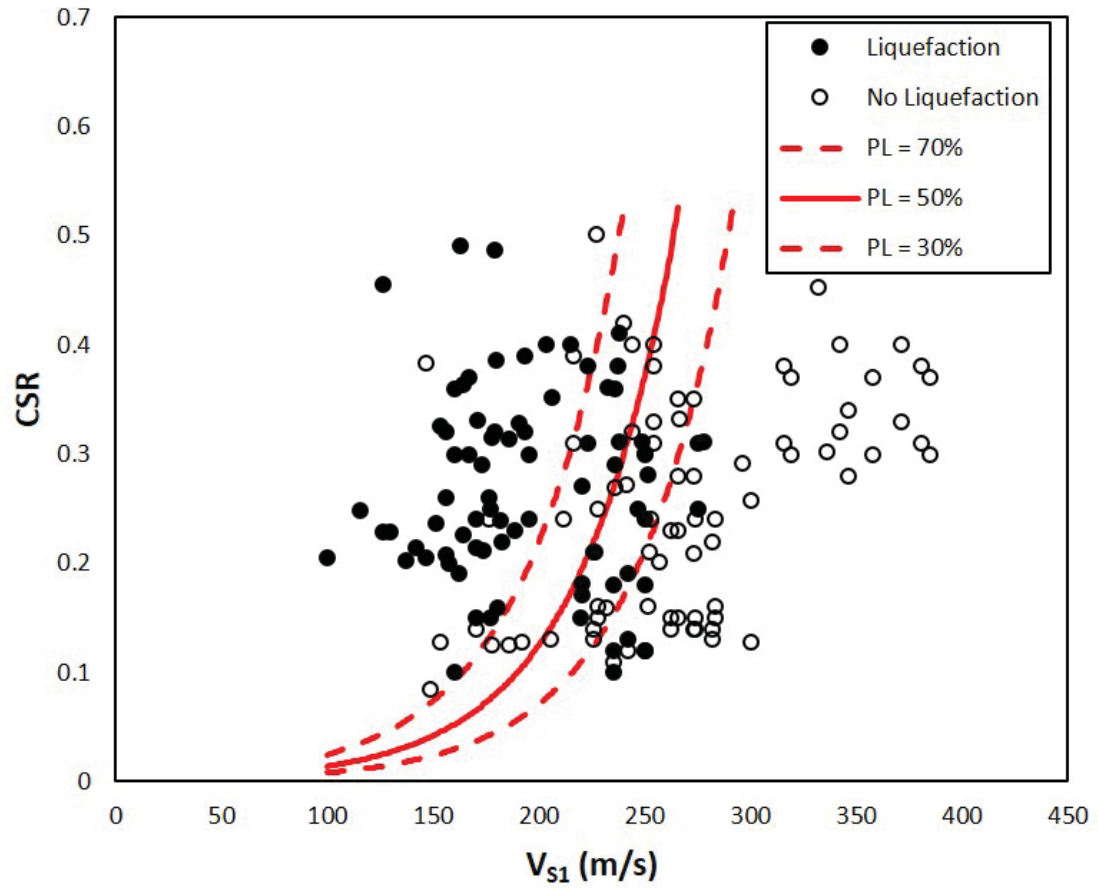

Figure 6.93: V_S -based Liquefaction Triggering Chart with CSR – V_{S1} curves developed from field data from this study and the literature (Andrus and Stokoe, 2000; Cao et al., 2013)

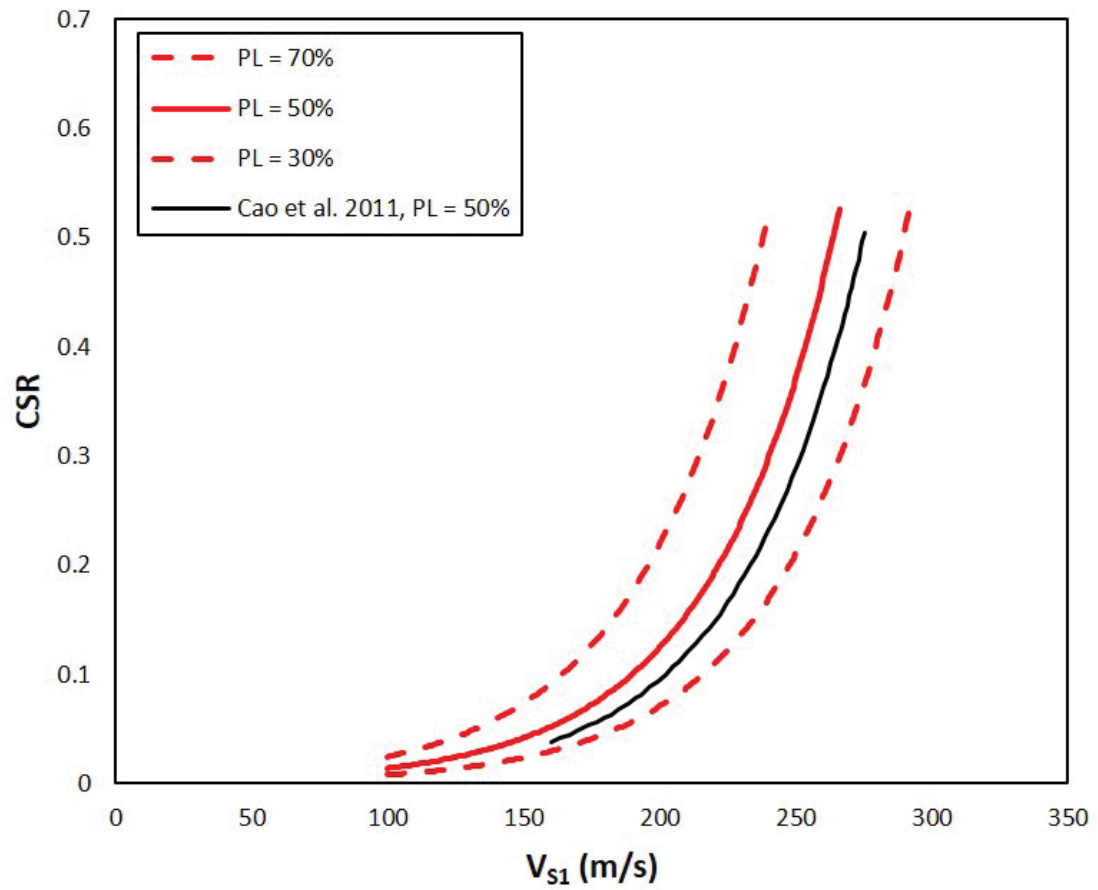

Figure 6.94: Comparison of $CSR - V_{S1}$ curves developed from field data from this study with *Cao et al.* (2011)

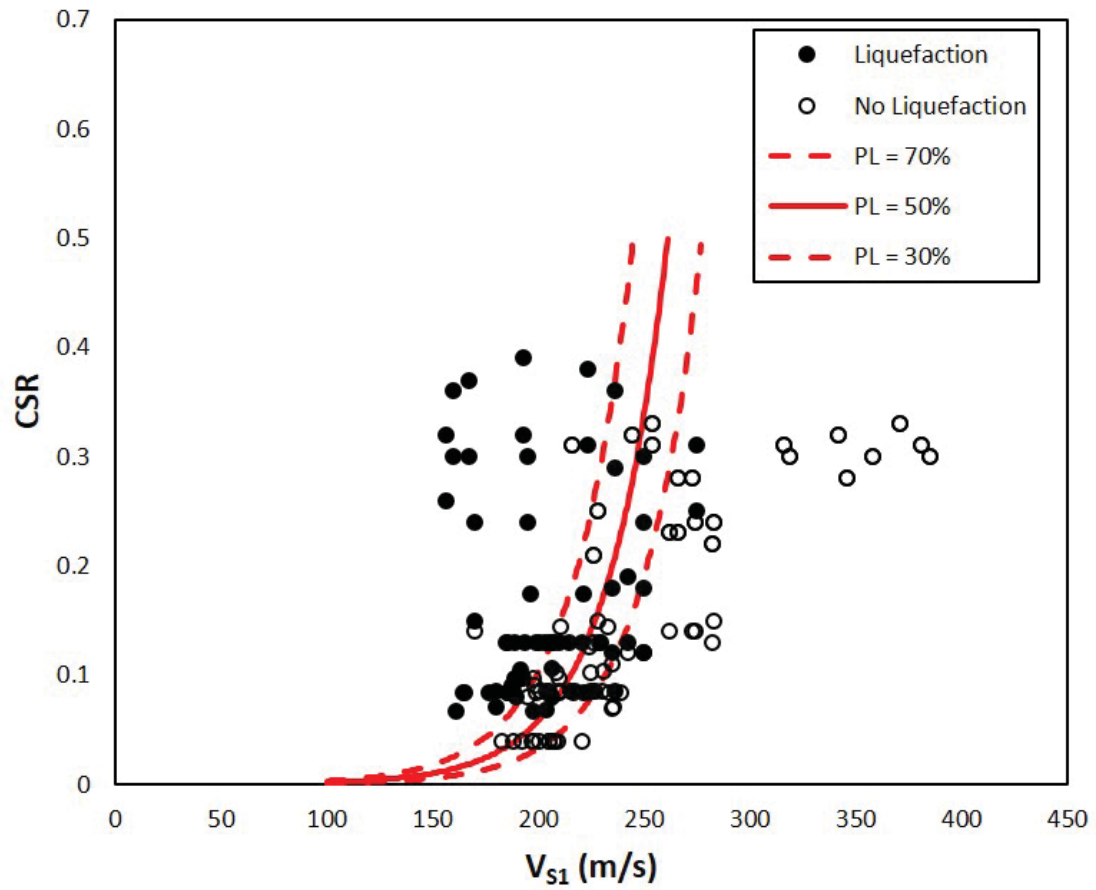

Figure 6.95: V_S -based Liquefaction Triggering Chart with $CSR - V_{S1}$ curves developed from laboratory and field data from this study

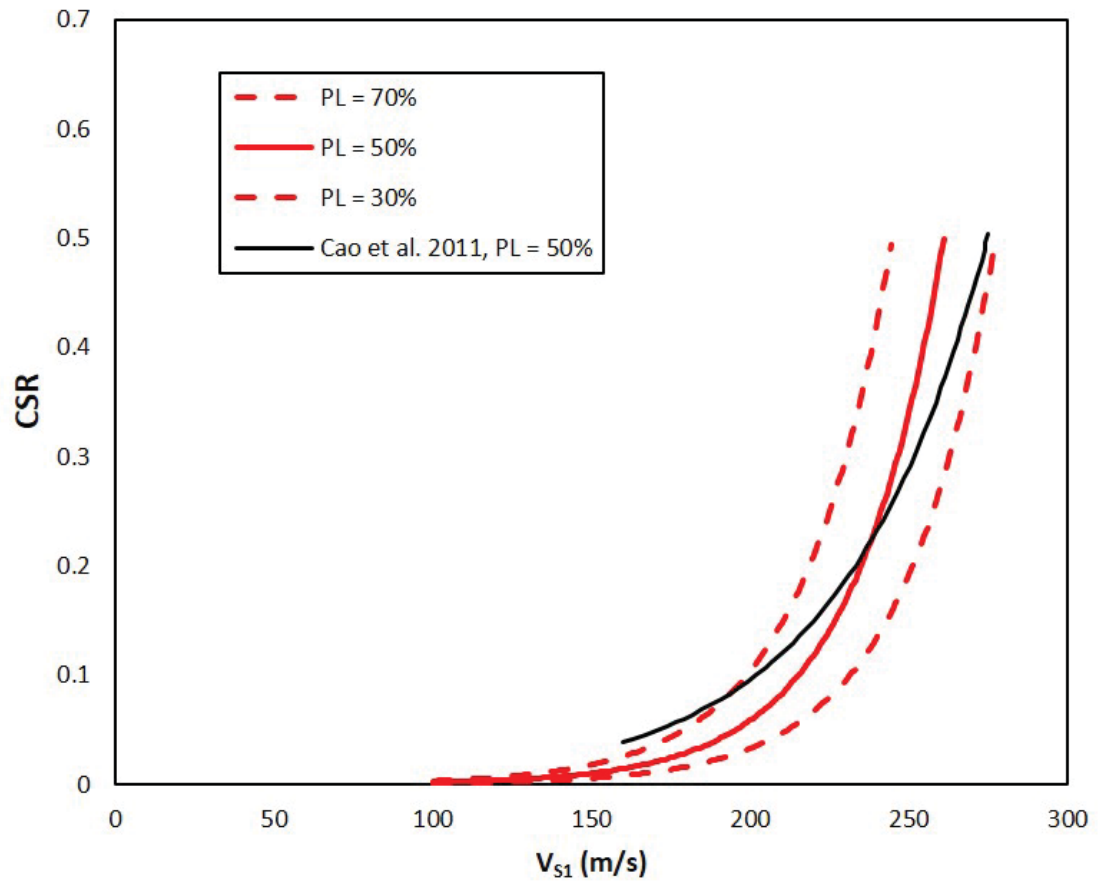

Figure 6.96: Comparison of $CSR - V_{S1}$ curves developed from laboratory and field data from this study with *Cao et al. (2011)*

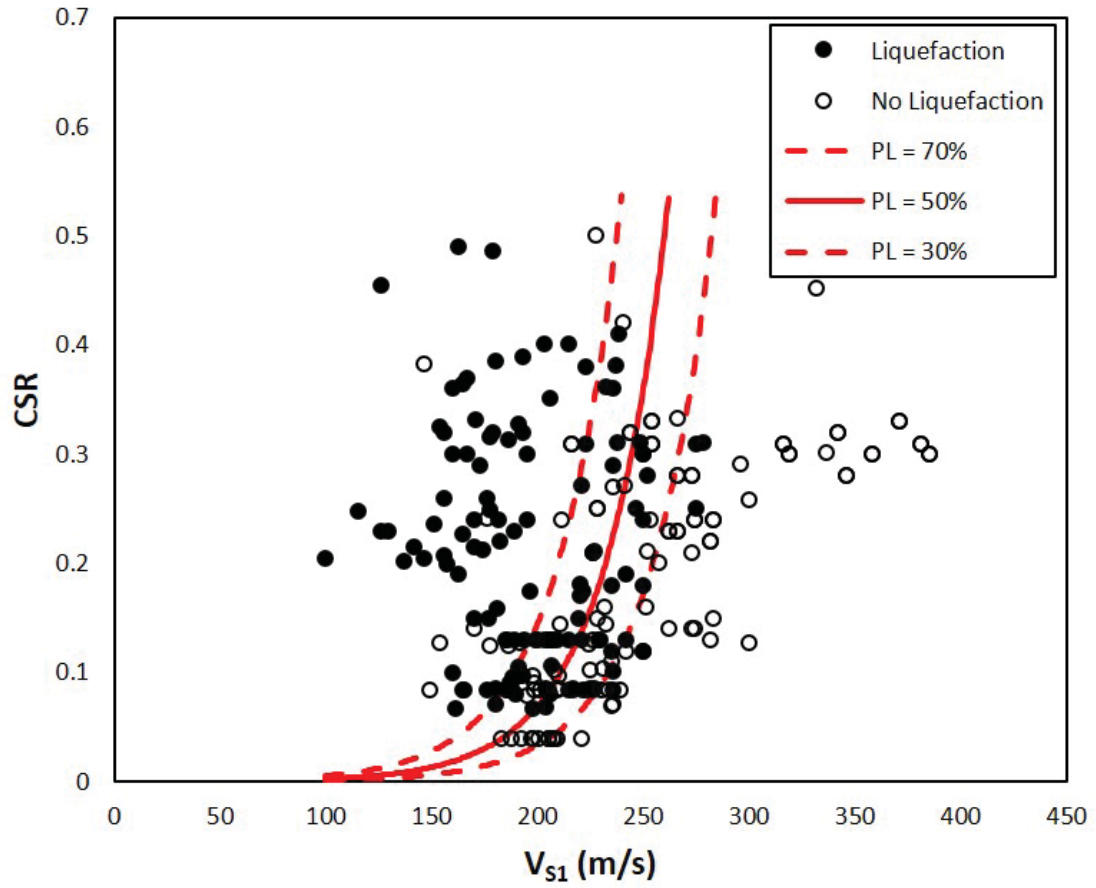

Figure 6.97: V_S -based Liquefaction Triggering Chart with CSR – V_{S1} curves developed from laboratory and field data from this study and the literature (*Andrus and Stokoe, 2000; Cao et al., 2013*)

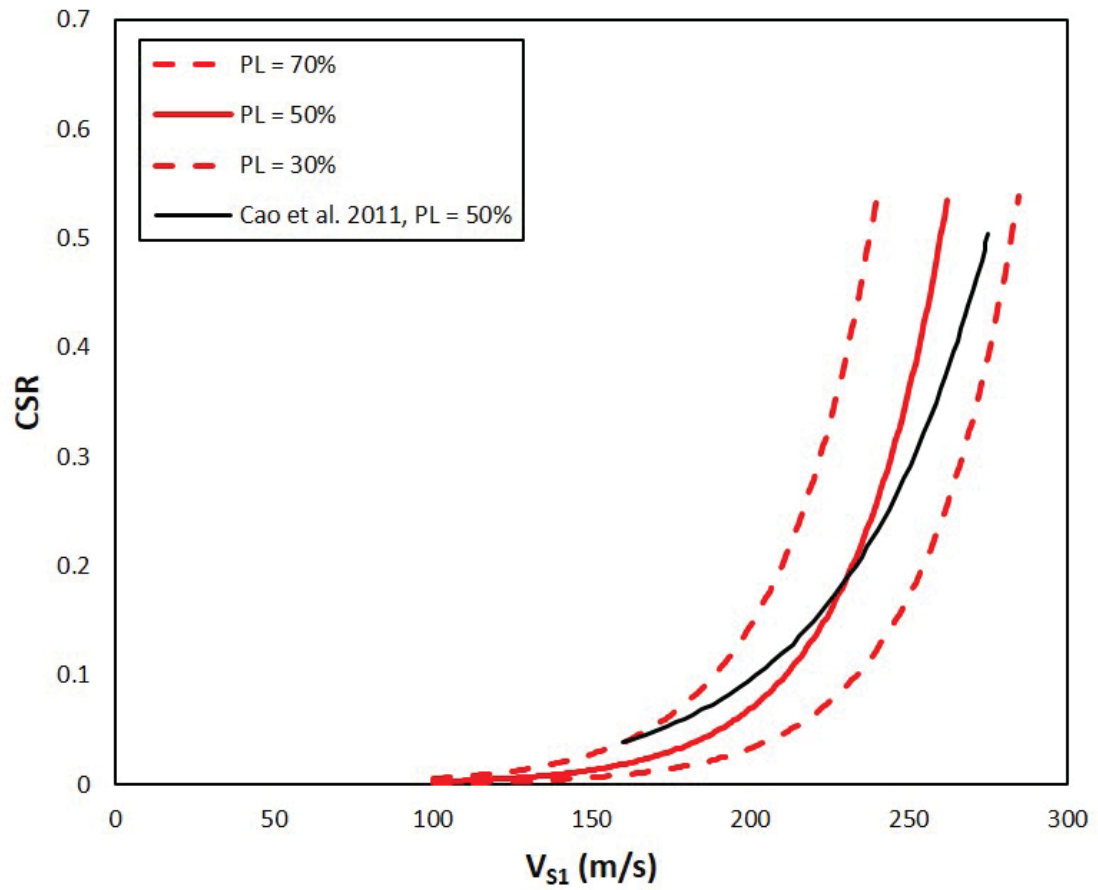

Figure 6.98: Comparison of $CSR - V_{S1}$ curves developed from laboratory and field data from this study and the literature with *Cao et al. (2011)*

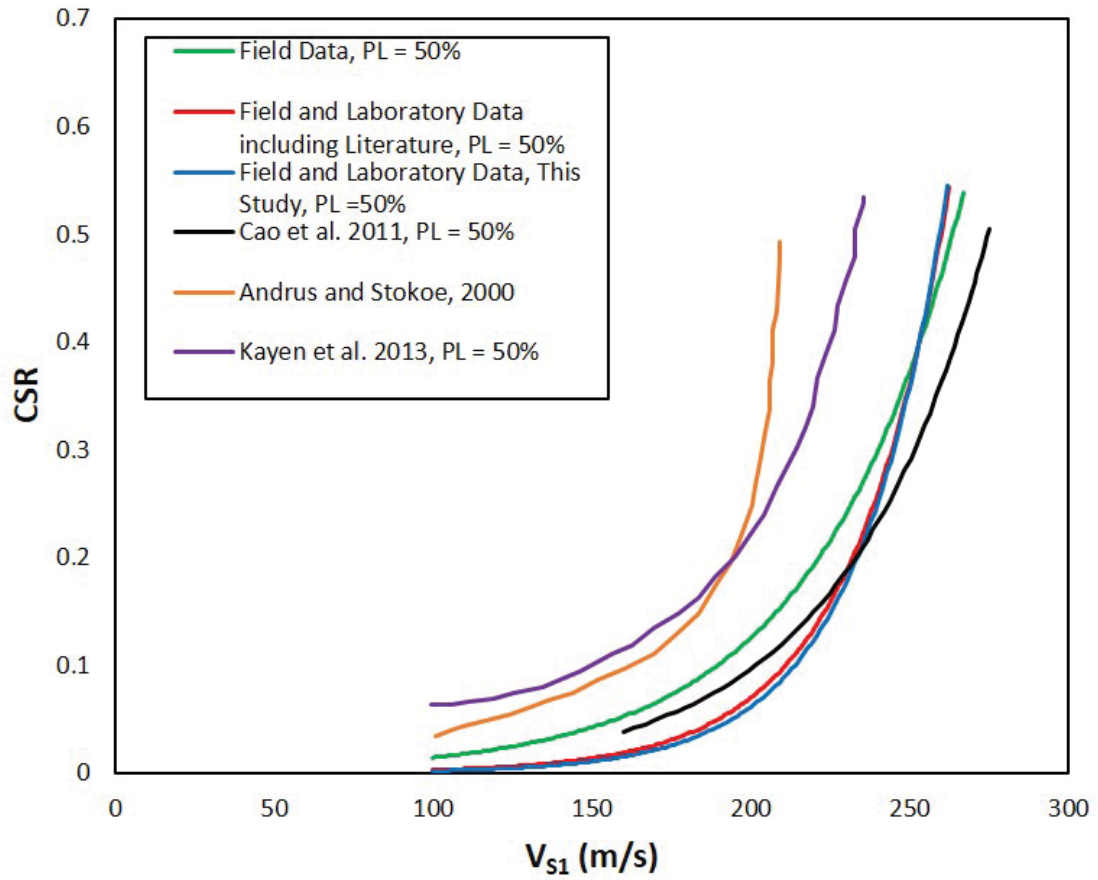

Figure 6.99: Comparison of $CSR - V_{S1}$ curves developed from this study with existing curves (*Andrus and Stokoe, 2000; Cao et al., 2013; Kayen et al., 2013*)

6.8 Conclusions

Gravelly soils were evaluated in the field using DPT and V_S methods at Millsite Dam in Ferron, UT, and the ports of Lixouri and Argostoli in Cephalonia, Greece. The main findings were:

- DPT and MASW in-situ testing produced consistent results for all three sites at a total of 12 testing locations, highlighting the appropriateness and usefulness of these tests at sites with gravelly soils.
- A correlation was developed for N_{120} and V_S that can be used for gravelly soils. The data falls in a fairly narrow range with an R^2 value of 0.51, which is similar to the R^2 value of 0.59 that was found in *Rollins et al.* (1998) for a correlation between V_S and N_{60} . The developed equations are similar to other equations for gravels as summarized in *Wair et al.* (2012) for V_S and N_{60} .
- The *Cao et al.* (2011, 2013) DPT-based and V_S -based triggering correlations do not fully capture the response of gravelly layers at the ports of Lixouri and Argostoli, during the 2014 Cephalonia, Greece, earthquakes.
- New V_S -based and DPT-based probabilistic liquefaction curves were developed for gravelly soils using logistic regression. The curves are based on laboratory data from this study, field data from this study, and field data from the literature. The field data from this study are unique in that they represent two sites that experienced liquefaction as evidenced by the gravel/sand ejecta at the surface after the earthquake, and include ground motion measurements from the seismic event at the site. By performing V_S and DPT measurements, these case studies consist of high quality data with respect to dynamic soil properties, CSR and field performance. The new curves have moved to the right compared to *Andrus and Stokoe* (2000) and are in a similar range to *Cao et al.* (2011).

CHAPTER 7

Conclusions

The main findings of this study are summarized in the following sections:

7.1 Large-Size Monotonic and Cyclic Simple Shear Testing

- Bender element and accelerometer systems were developed for measuring the V_S for each tested specimen and validated by comparing test results for Ottawa C109 Sand with existing data from the literature. Results from both systems were consistent with each other and with reported values in the literature.
- Constant volume monotonic and cyclic test results performed using the 12” diameter CSS device were compared to simple shear results from conventional-size devices for the same material (Ottawa C109 Sand) and showed similar response, confirming that the large-size device replicates the simple shear response observed for soils in the literature.
- It was shown that the ASTM specified constant volume threshold for axial strain of 0.05% is not sufficient (ASTM, 2007). The peak shear strength for tests that met the ASTM constant volume criteria of 0.05% axial strain can be up to 15% larger than that for a smaller axial strain allowance as shown in Figure 7.1. It is therefore

recommended that the variation of axial strain should be reported for every constant volume test and the axial strain should be no more than 0.025%.

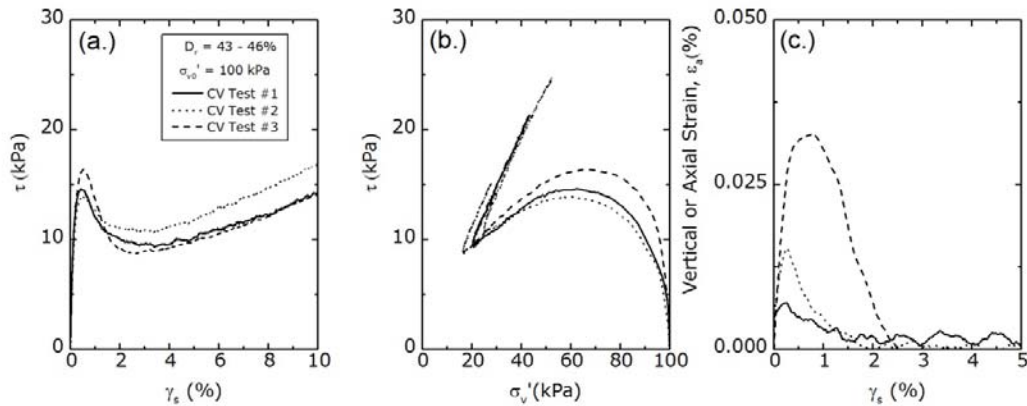

Figure 7.1: Comparison of constant volume monotonic simple shear response for Ottawa C109 Sand with different constant volume testing parameters (Test ID: M156, M155, M153)

7.2 Monotonic Simple Shear Response of Uniform Gravels and Gravel-Sand Mixtures

- Uniform gravel undrained shear response can be analyzed using existing frameworks developed for sands.
- Different specimen preparation techniques, such as air pluviation and water sedimentation, did not have significant effects on shear response for uniform Pea Gravel.
- Particle angularity is an important parameter that affects Peak, PT, and US response of uniform gravels. As particle angularity increased, Peak, PT, and US friction angles increased for the uniform gravels tested in this study.

- Particle size had a lesser impact on constant volume shear response of uniform gravels when compared to particle angularity. As particle size increased peak friction angle increased; however, particle size had no effect on PT friction angle.
- PT (or τ_{PT}/σ'_v) was unique for each uniform gravel in this study and was not dependent on density. Pea Gravel had a τ_{PT}/σ'_v ratio of 0.45, while the 8 mm and 5 mm CLS had a τ_{PT}/σ'_v ratio of 0.52.
- US (or τ_{US}/σ'_v), which ranged from 0.47 to 0.72, was affected by density and increased with increasing V_{S1} for the angular CLS materials in this study; however, US was not effected by density for the Pea Gravel material tested in this study. This behavior is possibly attributed to increased particle interlocking and dilation in the angular CLS materials when compared to the rounded Pea Gravel.
- Maximum density of gravel-sand mixtures can be difficult to evaluate using current methods. The vibratory table can cause significant particle segregation. A new method of determining maximum density was used that compared well with the α method proposed by *Fragaszy et al.* (1990).
- For Pea Gravel/Ottawa C109 Sand mixtures, there was not a significant change in V_S as the mixture percentages changed. This is likely due to the similarity in V_S of the uniform Pea Gravel and uniform Ottawa C109 Sand. The mixture with the highest V_S value was the 40% Sand/60% Gravel mixture. Alternatively, mixture percentage had a significant effect on the V_S values for the CLS8/Ottawa C109 Sand mixtures. In this case, the uniform CLS8 and uniform Ottawa C109 Sand had different V_S values. The mixture with the highest V_S value was the 60% Sand/40% Gravel mixture, followed by the 100% Gravel specimen.
- The percentage of gravel and sand in a mixture affects monotonic shear response. There exists an optimum mixture percentage of gravel and sand that maximizes shear

strength. The optimum mixture percentage was found to be 60% Pea Gravel/40% Ottawa C109 Sand for Pea Gravel mixtures and 40% CLS8/60% Ottawa C109 Sand for CLS8 mixtures. This optimum mixture had the highest peak friction angle during monotonic testing as well as the highest V_S value. Initial vertical stress was shown to not have an effect on the optimum mixture percentage.

- The Phase Transformation friction angle was not affected by mixture percentage for the Pea Gravel mixtures, but increased to the level of 100% CLS8 gravel with the addition of only 20% CLS8 to the CLS8 mixtures.
- τ/σ'_v ratio was nearly constant (approximately 0.50) at larger strains (i.e. the US) for Pea Gravel mixtures, regardless of mixture percentage; however, for CLS8 mixtures the τ/σ'_v ratio at larger strains was dependent on mixture percentage. The τ/σ'_v ratio did not change significantly for the Pea Gravel mixtures since the uniform Pea Gravel and Ottawa C109 Sand had similar shear response when tested separately. Conversely, CLS8 and Ottawa C109 had different shear response when tested separately, which led to different results when mixed.
- Relative density did not affect PT or US friction angles for the monotonic tests of gravel-sand mixtures. Peak friction angle increased with increasing relative density.
- Initial vertical stress did not have an effect on Peak, PT, or US friction angles for monotonic tests of gravel-sand mixtures.
- The use of global, sand skeleton, and gravel skeleton void ratios was investigated by comparing results for monotonic shear tests. For the Pea Gravel mixtures global void ratio appears to capture the overall material response better than the sand or gravel skeleton void ratios. However, use of the sand and gravel skeleton void ratios can be useful for identifying percentages at which gravel and sand contribute to material response. For CLS8 mixtures, clear trends were not evident.

- Shear strength at Peak and PT was correlated with V_S as shown in Figures 7.2 and 7.3. Equations 7.1 and 7.2 were developed that can predict undrained shear strength at Peak and PT for gravelly soils using V_S . Shear strength at Peak and PT correlates well with V_S , while shear strength at US shows weaker correlation (therefore equations were not developed for US).

$$\tau_p = (7.29 \times 10^{-9}) * (V_S)^{4.02} \quad (7.1)$$

$$\tau_{PT} = (1.28 \times 10^{-9}) * (V_S)^{4.33} \quad (7.2)$$

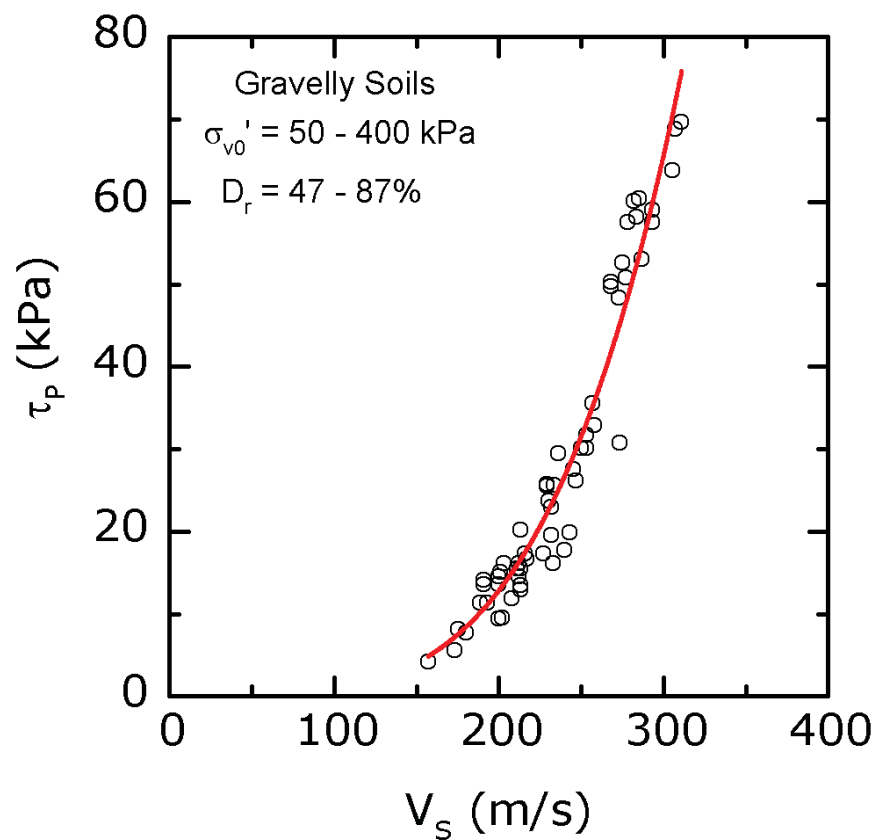

Figure 7.2: Peak Shear Strength versus Shear Wave Velocity for mixtures for Uniform Gravels and Gravel/Sand Mixtures

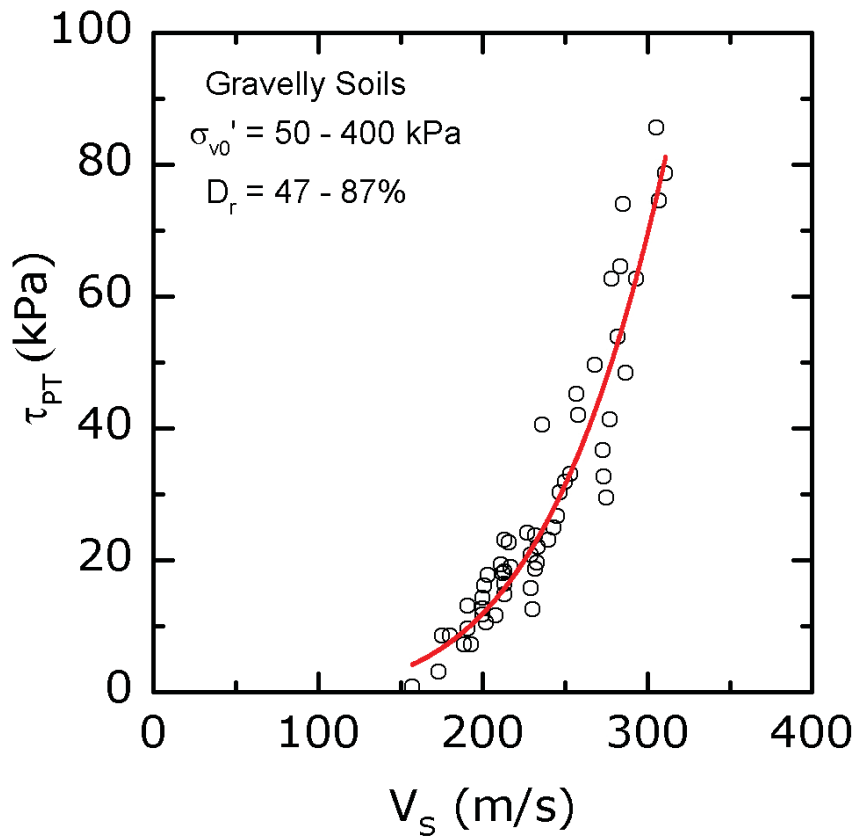

Figure 7.3: Phase Transformation Shear Strength versus Shear Wave Velocity for mixtures for Uniform Gravels and Gravel/Sand Mixtures

7.3 Cyclic Simple Shear Response of Uniform Gravels and Gravel-Sand Mixtures

- Uniform gravels were liquefiable even at relatively dense states and for higher V_{S1} values than sands. Specifically, the three uniform gravels tested in this study liquefied at V_{S1} values as high as 230 m/s.
- Increasing particle angularity increased liquefaction resistance for $CSR < 0.10$; above this CSR value, the influence of angularity was less pronounced.
- Mixture percentage was shown to also affect the cyclic response of gravel-sand mixtures. For tests at $CSR = 0.09$ and $D_r = 47\%$, the optimum mixture that was found from the monotonic shear tests exhibited the greatest resistance to liquefaction.
- The effect of CSR on liquefaction resistance was not the same for all gravel-sand mixtures tested in this study. At $CSR = 0.04$ test, mixtures of 60% Sand and 40% Sand were the least resistant to liquefaction (compared to the other mixtures and the 100% Gravel and 100% Sand), while at $CSR = 0.14$ these mixtures were the most resistant for both mixtures of Pea Gravel and CLS8. This could possibly be explained by examining the particle interaction between the sand and gravel. It is possible that for certain mixtures at the lower CSR value (and therefore lower strain level) the gravel is not engaged in the small cyclic movements (i.e. the sand is controlling the response). In the 60% Sand and 40% Sand specimens mixed with Pea Gravel, the sand in between the gravel is also in a looser state than at $D_r = 47\%$ ($e = 0.64$), which could explain the fewer number of cycles to liquefaction if the sand is controlling the response. The void ratio for the 60% Sand specimen at $D_r = 47\%$ is 0.70, while the void ratio for the 40% Sand specimen at $D_r = 47\%$ is 0.83. This shows that the sand is likely controlling response and therefore liquefying in fewer cycles than the $e = 0.64$ ($D_r = 47\%$) 100% Sand specimen.

- The particle angularity of the gravel in a gravel-sand mixture affects the response during monotonic and cyclic tests. The subrounded Pea Gravel mixtures had a different optimum mixture percentage than the angular CLS8 gravel mixtures.
- Initial vertical stress was shown to not have a significant effect on the liquefaction resistance of Pea Gravel mixtures. CLS8 mixtures showed an effect of initial vertical stress, which is likely due to particle morphology effects and differences in specimen V_S .
- Relative density was shown to affect the liquefaction resistance of gravel-sand mixtures in this study. As relative density increased, the liquefaction resistance of the mixtures decreased. It is possible that during compaction using the drop weight, the compaction energy was primarily concentrated on the gravel skeleton, while the sand particles remained relatively loose. These findings suggest that it is possible that the gravel skeleton void ratio was controlling the cyclic response of the dense specimen, while the global void ratio was controlling the response of the loose specimen.
- The *Andrus and Stokoe* (2000) liquefaction triggering correlation for gravels and the *Kayen et al.* (2013) field correlation for sands do not compare well with the laboratory data for gravel-sand mixtures tested in this study as shown in Figure 7.4 for Pea Gravel mixtures and Figure 7.5 for CLS8 mixtures. The tested gravel-sand mixtures liquefied at V_{S1} values higher than 200 m/s and as high as approximately 240 m/s. All of the specimens that liquefied, including the clean sand, would have been predicted as non-liquefiable according to both existing triggering correlations.
- Pore pressure generation of gravelly soils was shown to be dependent on the coefficient of uniformity (C_u). As the C_u value increases, r_u increases, especially at values of $N/N_L < 0.3$.

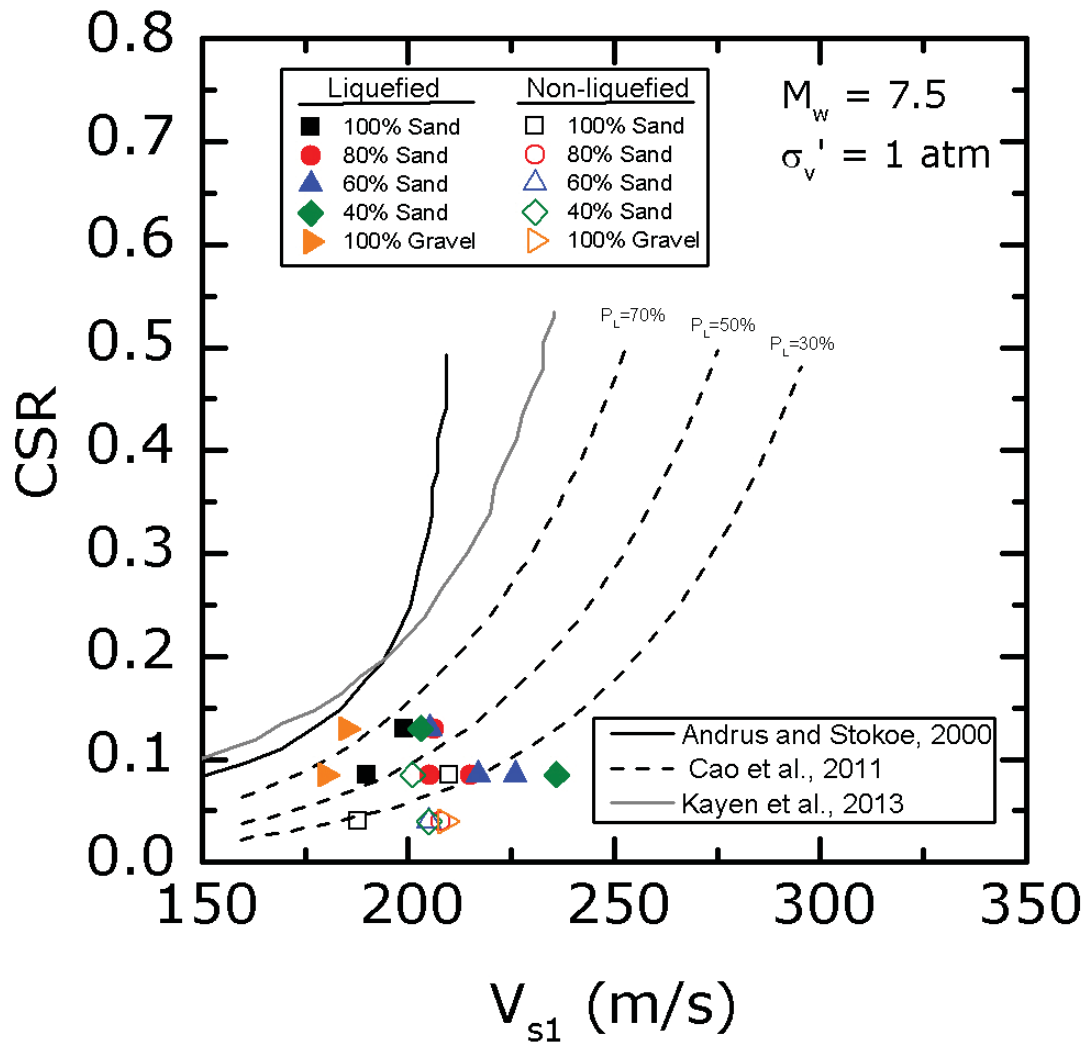

Figure 7.4: Comparison of CSR versus V_{s1} for Pea Gravel/Ottawa C109 Sand mixtures of varying percentage

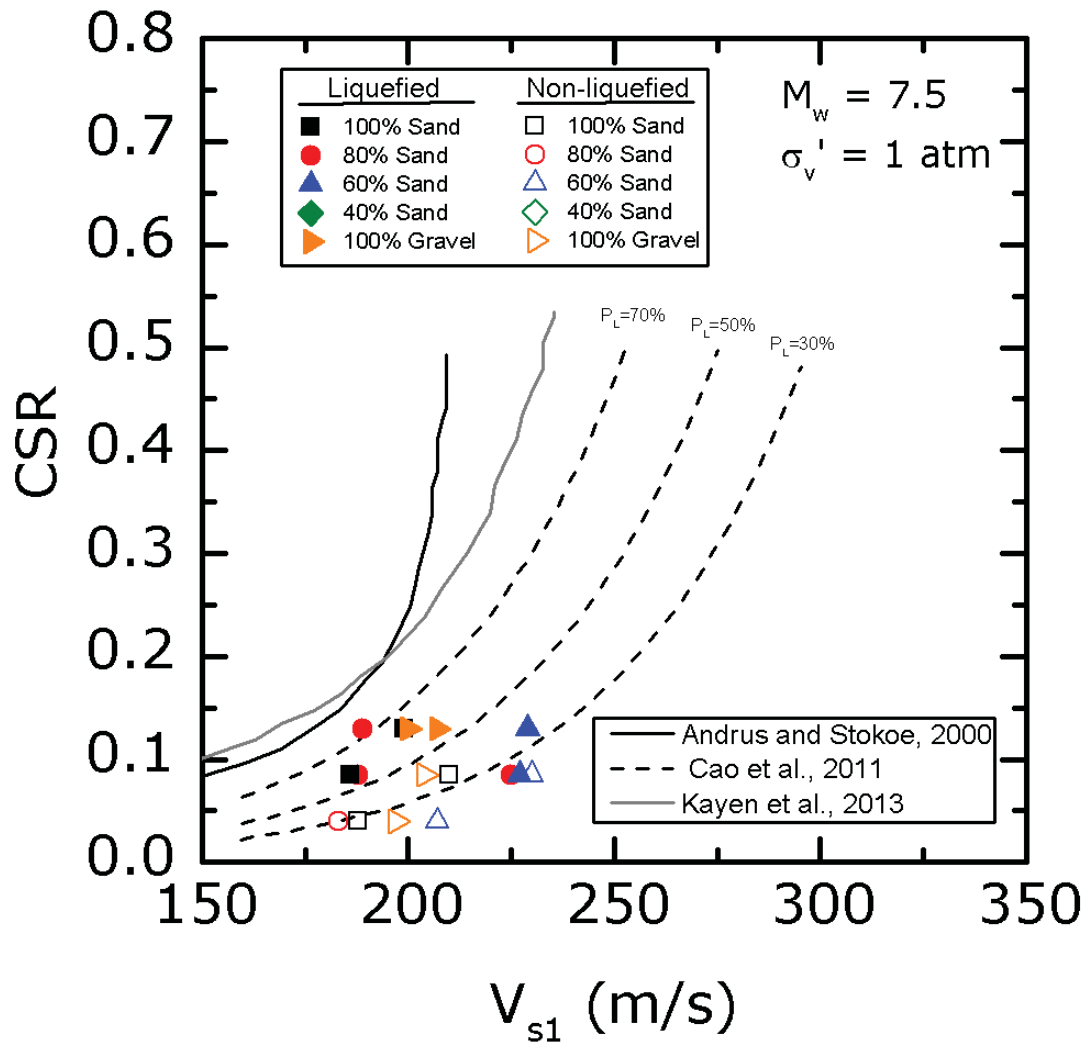

Figure 7.5: Comparison of CSR versus V_{S1} for CLS8/Ottawa C109 Sand mixtures of varying percentage

7.4 Post-Cyclic Shear Strength and Volumetric Strain (Post-Cyclic Settlement)

- Increasing particle size, angularity, and D_r led to an increase in post-cyclic shear strength for the three uniform gravels.
- V_S was measured immediately following liquefaction and in 1.5% strain increments during a post-cyclic monotonic shear test. Initially following liquefaction V_S had a low value which ranged from approximately 60-120 m/s (approximately 30-40% of the initial V_S). This low value can be attributed to the nearly zero vertical effective stress on the specimen. As the specimen was sheared both vertical stress and shear stress increased, V_S increased until it eventually reached a V_S value that was at a similar level to the V_S value after consolidation and before the cyclic phase. The V_S value reached this similar pre-liquefaction level when the US was attained during the post-cyclic monotonic test.
- *Stark and Mesri* (1992) lower and upper bounds for SPT, when transferred to V_{S1} using the *Andrus et al.* (2004) correlation, give a reasonable first approximation of undrained shear strength if extended to higher V_{S1} values for the three uniform gravels in this study (Figure 7.6). However, even the lower bound would be unconservative in the case of loose uniform gravels since some of the test results fall below this lower bound. The uniform gravels have higher V_{S1} values, but this does not necessarily correspond to higher undrained shear strengths than the sands from case histories. This finding is similar to the observations of *Yegian et al.* (1994) that post-liquefaction undrained shear strength of gravelly soils was similar to sands but had higher SPT N-values.

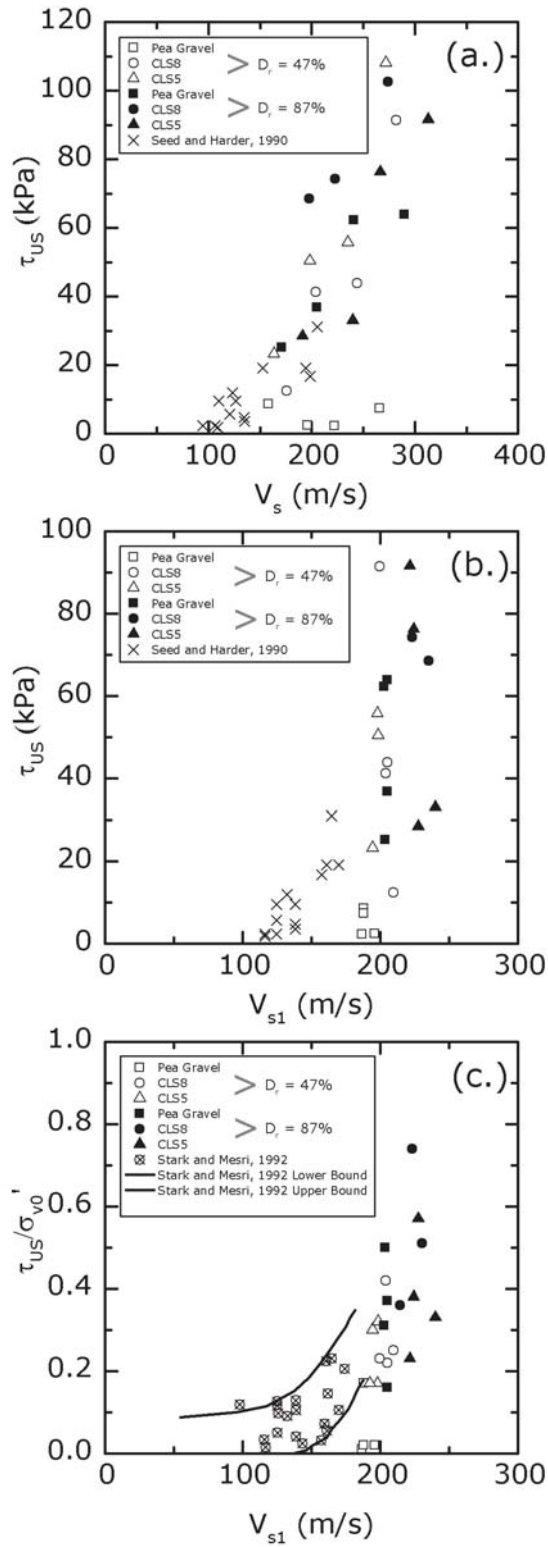

Figure 7.6: Comparison of post-cyclic shear stress with existing data from the literature after SPT is correlated to V_S

- The Ultimate State line was found to be independent of previous loading. The US line was practically the same for virgin monotonic, post-cyclic, and post-cyclic re-consolidated tests on gravel-sand mixtures as shown in Figure 7.7. The τ_{US}/σ'_v ratio was found to be the same for monotonic and post-cyclic shear tests.

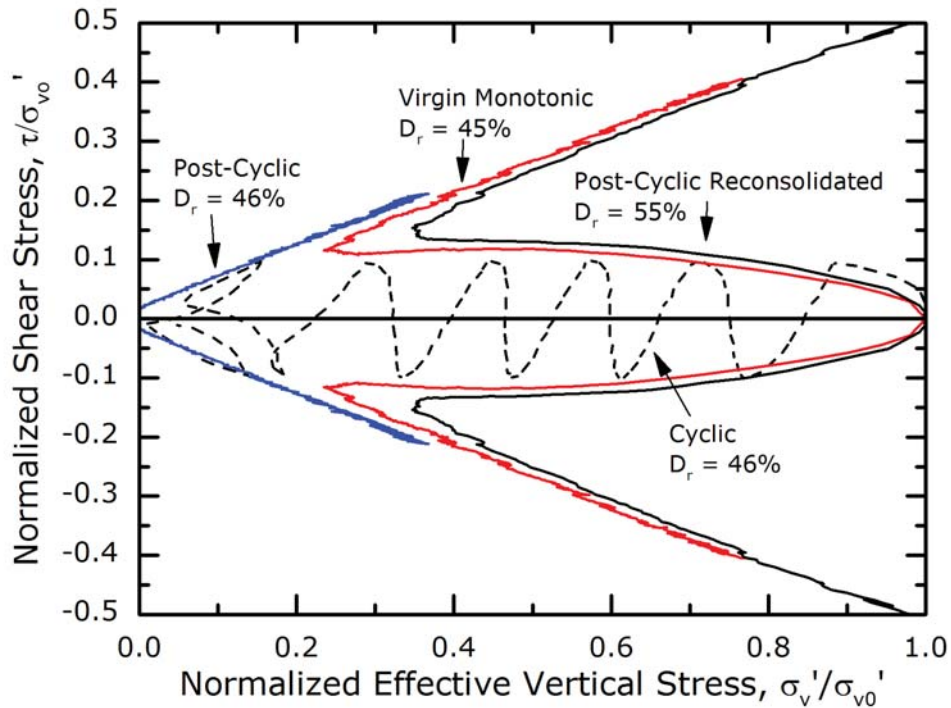

Figure 7.7: Stress Path Comparison of Monotonic, Cyclic, and Post-Cyclic Response of 80% Ottawa C109 Sand and 20% CLS8 (Test ID: C261, C262, M305)

- Particle angularity was shown to have a significant effect on post-cyclic undrained shear strength of gravel-sand mixtures. The angular CLS8/Sand mixtures exhibited increased post-cyclic shear strength compared to Ottawa C109 Sand; however, the rounded Pea Gravel/Sand mixtures had a lower post-cyclic shear strength compared to the clean sand.
- Post-liquefaction volumetric strain was evaluated for the gravel-sand mixtures. For the uniform materials in the loose state, the angular CLS8 material displayed the

lowest amount of volumetric strain (approximately 1%), while the rounded to sub-rounded Pea Gravel and subrounded Ottawa C109 Sand displayed greater levels of post-liquefaction volumetric strain (approximately 1.6% for Pea Gravel and 1.75% for Ottawa C109 Sand). This shows that particle angularity has a significant effect on post-liquefaction volumetric strain. As relative density increased, post-liquefaction volumetric strain decreased, except for 100% CLS8 specimens which showed no change. As gravel was added to 100% Sand, the volumetric strain decreased up to 40% Sand for Pea Gravel Mixtures and up to 100% Gravel for CLS8 mixtures.

- V_S was measured before shearing and after reconsolidation following liquefaction. The values, in some cases, showed a significant decrease (as much as 43 m/s) from the original value. This finding is important since most field-based V_S measurements that are used in CSR- V_{S1} liquefaction triggering charts are based on measurements of V_S after an earthquake has occurred. This value is then assumed to be representative of the pre-earthquake V_S value, which may not always be the case. In some cases, the post-cyclic reconsolidated V_S was 13% higher than the original value, which would result in an unconservative liquefaction analysis.
- The post-cyclic volumetric strain results of the tested gravel-sand mixtures do not compare well with the framework developed for sands based on D_r (Yoshimine *et al.*, 2006). The data agree better with the framework developed for sands using V_{S1} (Yi 2010). This finding suggests that D_r might not be the best indicator of gravelly soil post-cyclic volumetric strain, and that a framework based on V_{S1} values could be promising for both sands, gravels, and gravel-sand mixtures.

7.5 Field Response and Liquefaction Analysis of Gravelly Soils

- DPT and MASW in-situ testing produced consistent results for all three sites at a total of 12 testing locations, highlighting the appropriateness and usefulness of these

tests at sites with gravelly soils.

- A new correlation (Equation 7.3) was developed for N_{120} and V_S that can be used for gravelly soils (Figure 7.8).

$$V_S = 115 * (N_{120})^{0.29} \quad (7.3)$$

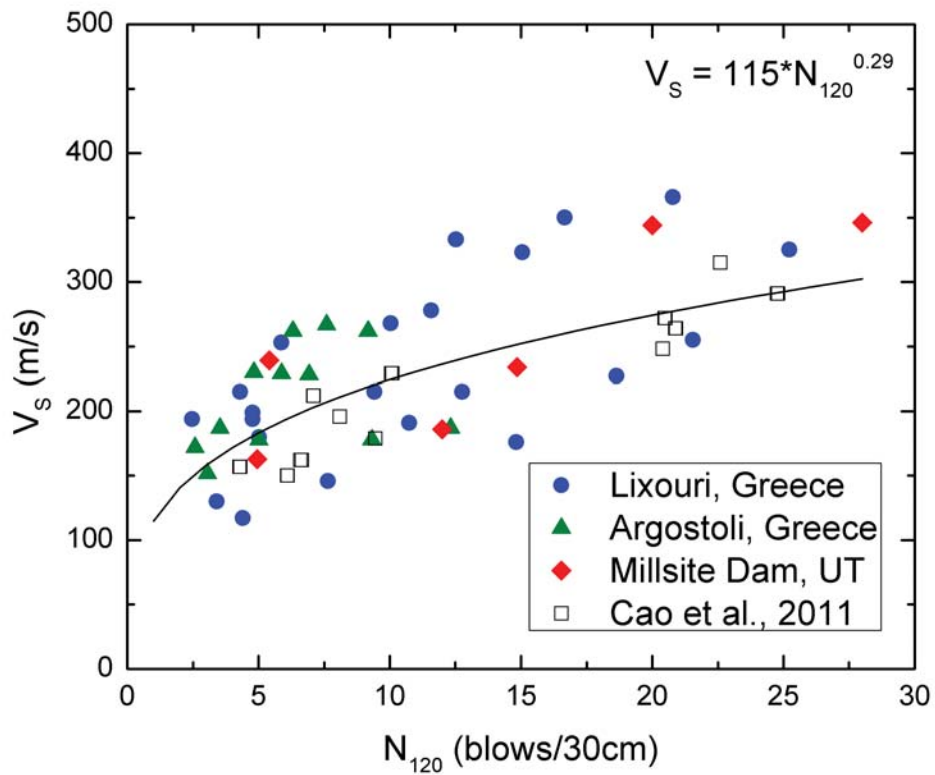

Figure 7.8: Correlation of N_{120} and V_S based on field testing in this study and *Cao et al.* (2011) data

- The *Cao et al.* (2011, 2013) DPT-based and V_S -based triggering correlations do not fully capture the response of gravelly layers at the ports of Lixouri and Argostoli, during the 2014 Cephalonia, Greece, earthquakes.
- New DPT and V_S -based probabilistic liquefaction curves were developed for grav-

elly soils using logistic regression. The curves are based on laboratory data from this study, field data from this study, and field data from the literature. The field data from this study are unique in that they represent two sites that experienced liquefaction as evidenced by the gravel/sand ejecta at the surface after the earthquake, and include ground motion measurements from the seismic event at the site and in-situ V_S and DPT measurements. Figure 7.9 shows the curves that were developed based on DPT measurements from this study and DPT measurements from *Cao et al.* (2013). Figure 7.10 shows the curves developed in this study compared to the existing $P_L = 50\%$ curve developed by *Cao et al.* (2013). Figure 7.11 shows the curves that were developed based on laboratory and field V_S measurements from this study and the literature (*Andrus and Stokoe*, 2000; *Cao et al.*, 2011). The curves developed in this study using field data, laboratory data and field data, and laboratory and field data combined with existing data from the literature are compared with existing curves for gravelly soils and cleans sands from *Andrus and Stokoe* (2000), *Cao et al.* (2011), and *Kayen et al.* (2013) in Figure 7.12. The new curves developed in this study are shifted further to the right, to higher values of V_{S1} than the the *Andrus and Stokoe* (2000) curve for gravelly soils and the *Kayen et al.* (2013) $P_L = 50\%$ curve for clean sands. The curves in this study fall in a similar range to the *Cao et al.* (2011) $P_L = 50\%$ curve which was developed following the 2008 Wenchuan earthquake.

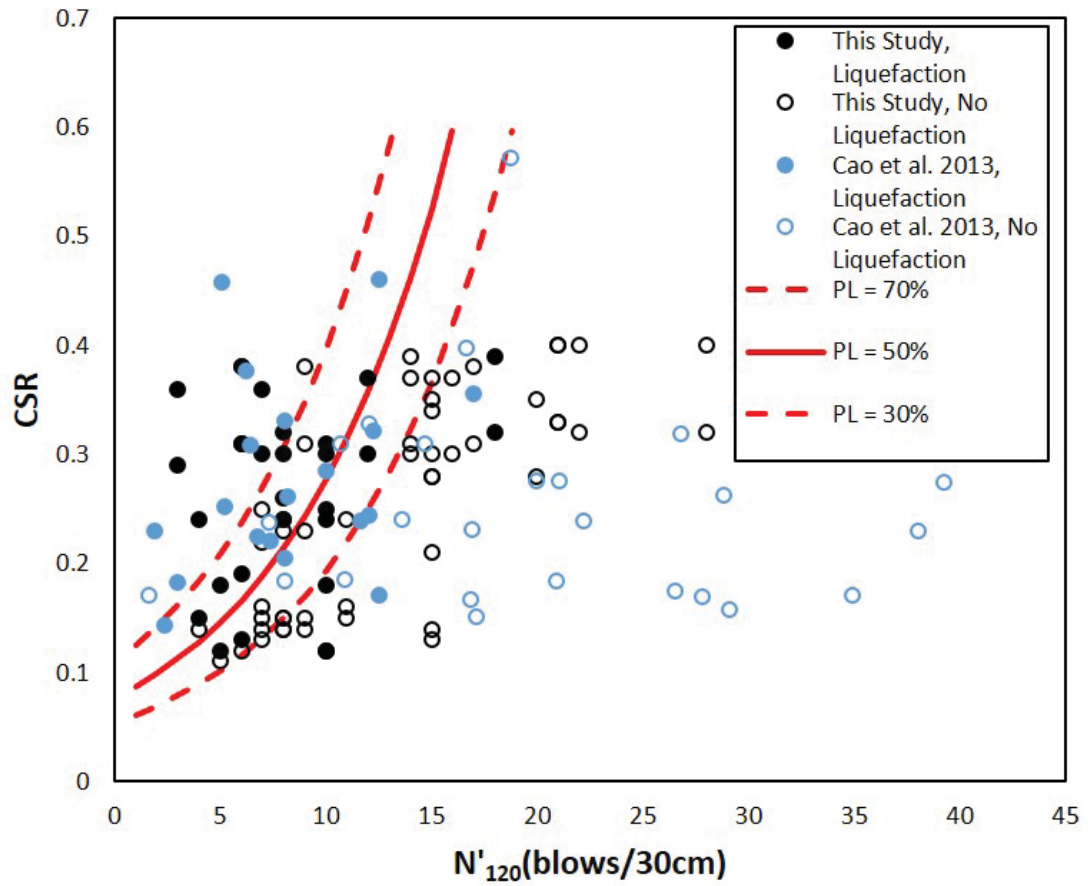

Figure 7.9: DPT-based Liquefaction Triggering Chart with $CSR - N'_{120}$ curves developed from field data from this study and the literature (Cao *et al.*, 2013)

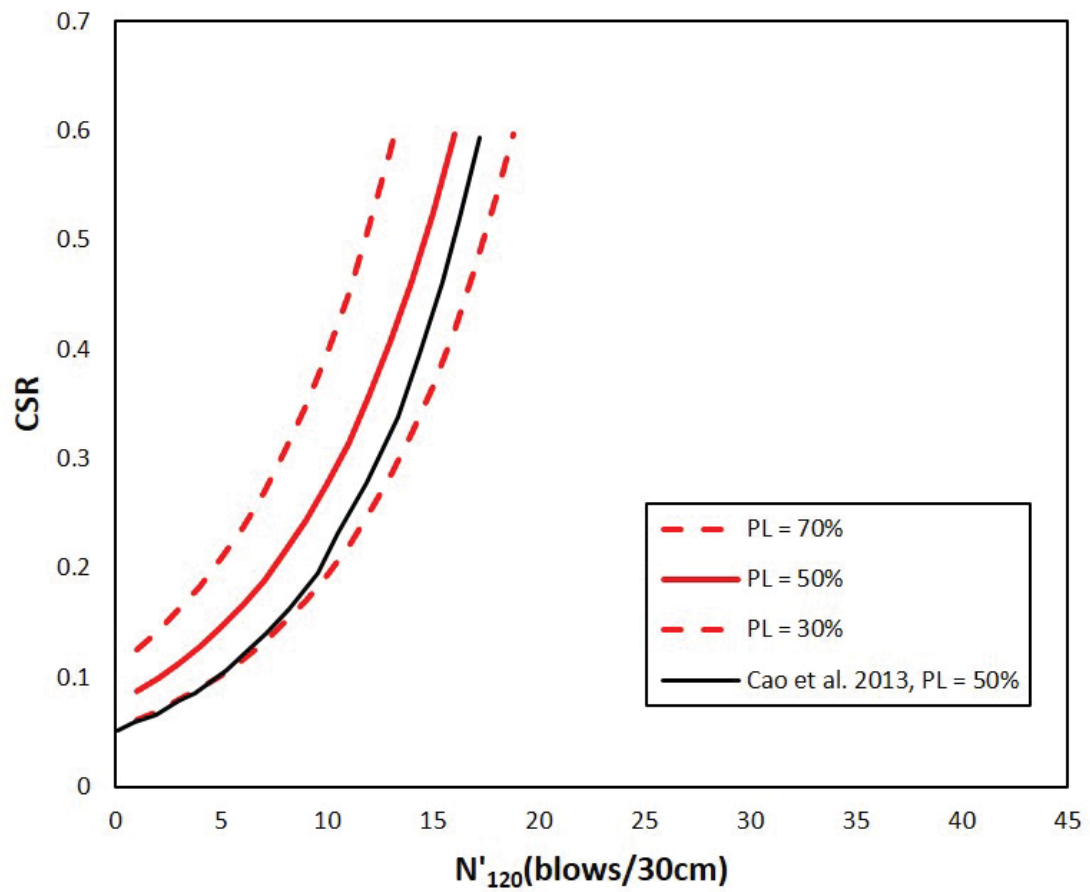

Figure 7.10: Comparison of $CSR - N'_{120}$ from this study with *Cao et al.* (2013)

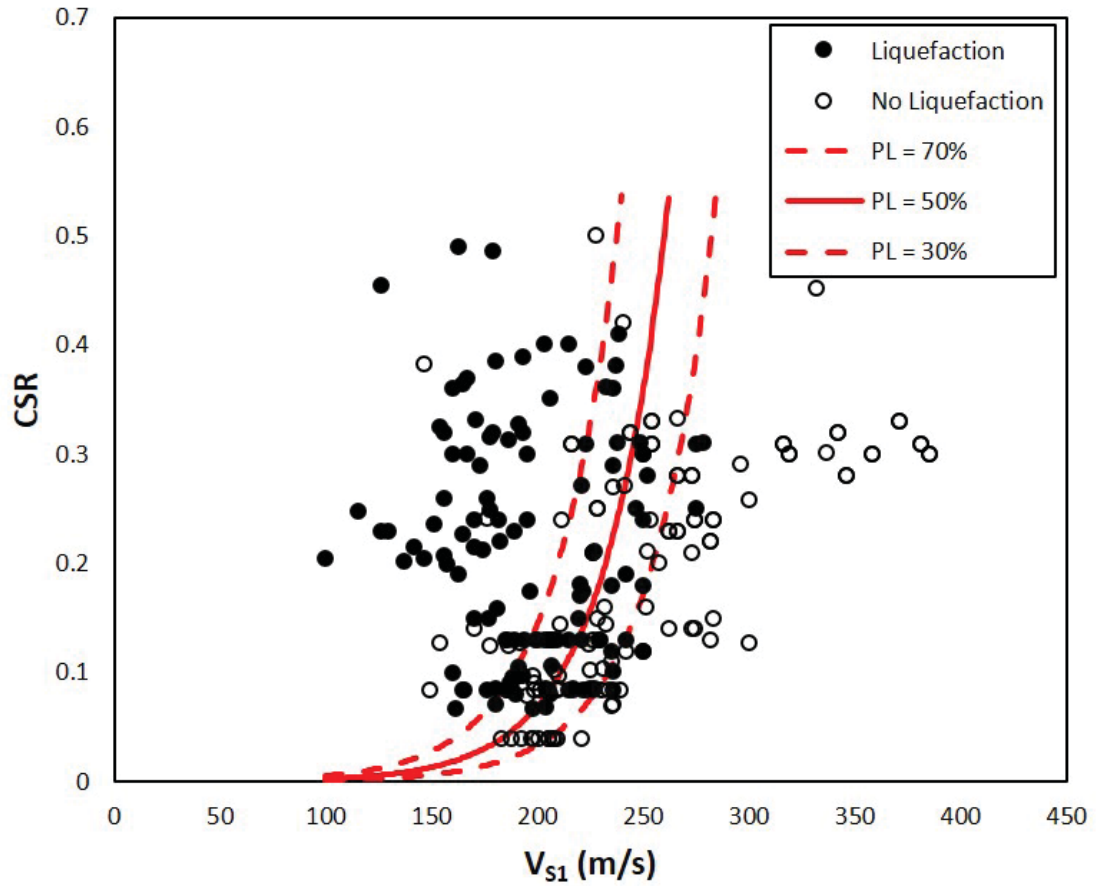

Figure 7.11: V_S -based Liquefaction Triggering Chart with CSR – V_{S1} curves developed from laboratory and field data from this study and the literature (*Andrus and Stokoe, 2000; Cao et al., 2013*)

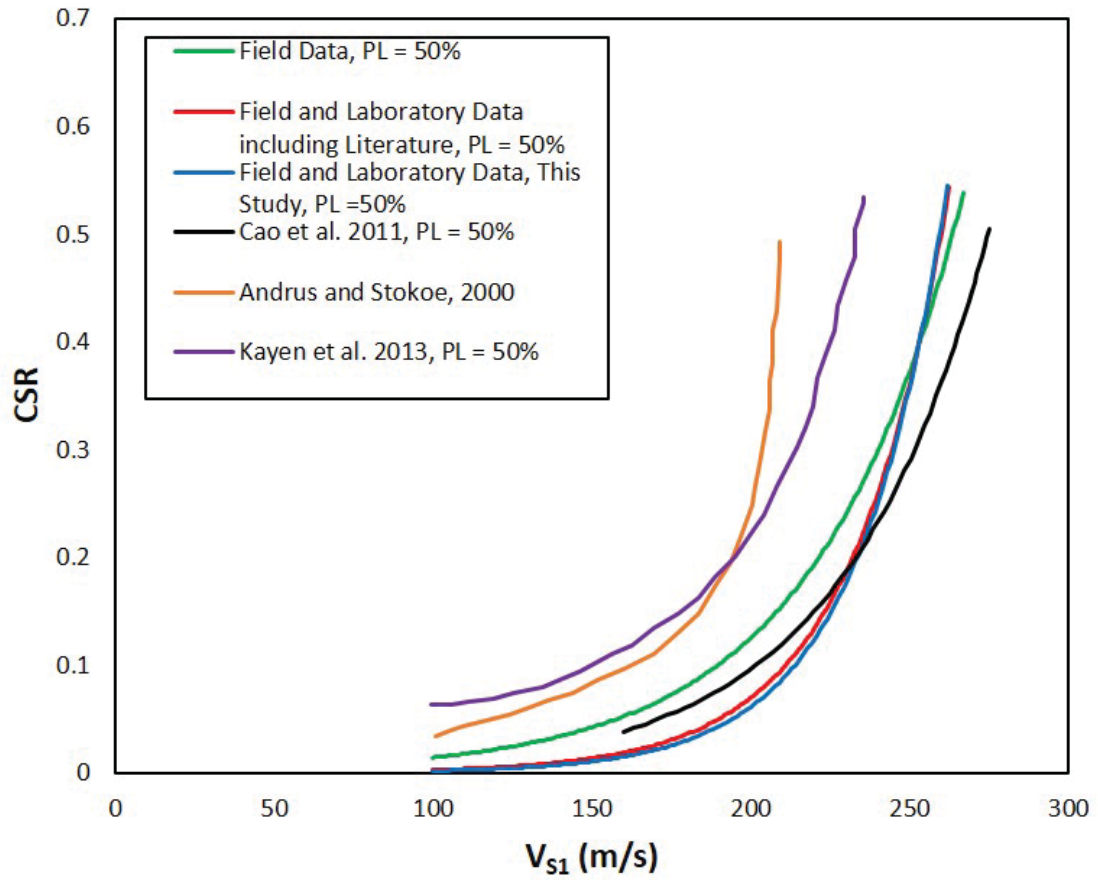

Figure 7.12: Comparison of $CSR - V_{S1}$ curves developed from this study with existing curves (*Andrus and Stokoe, 2000; Cao et al., 2013; Kayen et al., 2013*)

7.6 Recommendations for Future Research

The following section presents some directions for future research:

- In this study, constant volume simple shear tests were performed and assumed to be representative of truly undrained conditions, which has been shown in the literature for monotonic tests (*Dyvik et al.*, 1987). However, further testing that shows the comparison between monotonic and cyclic testing at constant volume conditions and truly undrained conditions for a fully saturated gravel specimen with pore pressure measurements would be beneficial.
- The effect of specimen preparation technique for uniform gravels was evaluated in this study; however, further investigation is needed on the effect of different specimen preparation techniques on the monotonic and cyclic simple shear response of gravel-sand mixtures. The effect of specimen preparation technique on soil fabric, shear wave velocity, monotonic shear response, and cyclic shear response could aid in the comparison of laboratory specimens with field conditions.
- The appropriateness of DPT and V_S measurements for gravelly soil liquefaction triggering evaluation was shown in this study; however, further expansion of the existing database of in-situ testing of gravelly soils using DPT and V_S measurements could improve our understanding of the response of gravelly soils before and after seismic events. Controlled testing in the laboratory could also help to link the response in the field and laboratory.
- Gravel-sand mixtures in this study utilized two types of gravel (Pea Gravel and 8 mm Crushed Limestone) and Ottawa C109 Sand. Testing of different mixtures (including well-graded mixtures and mixtures that include fines) could provide further understanding of gravelly soil dynamic response.

APPENDICES

APPENDIX A

Test Data Sheets for Chapter 3

Data sheets (monotonic or cyclic shear and specimen V_S) corresponding to Tables 3.2, 3.3, and 3.4 are provided in this appendix.

CSS Monotonic Shear Test Report

Geotechnical Engineering Laboratory



10/28/2013_Version 8.0

General Test Info and Sample Preparation

Device:	CSS	Relative Density (%):	16%
Specimen ID:	C109	Void Ratio:	0.716
Test ID:	M137	Height (mm):	111.6
Date of Test:	11/10/2014	Soil-Only Specimen Diameter (mm):	307.50
Test Performed:	Monotonic Shear	Weight (kg):	12.798
Test Material:	Ottawa C109 Sand	Density (kg/m ³):	1544.3
Sample Preparation:	Prepared loose using a funnel with zero drop height.	Membrane Thickness (mm):	0.000
		Moisture Content (%):	0%
		Saturated (Y/N):	N
		Prepared by:	J.Hubler
		Checked by:	J. Hubler

Consolidation Stage

Vertical Stress (kPa):	100
Compression Time (min):	15.1
Relative Density (%):	30%
Void Ratio:	0.686
Height (mm):	109.7
Diameter (mm):	307.50
Weight (kg):	12.798
Density (kg/m ³):	1571.6

Shear Stage

Type of Test:	Constant Volume
Stress or Strain Controlled:	Strain
Shear Strain Rate (%/min):	0.30
Peak Shear Strength (kPa):	11.4

Comments

Used Silver Baseplate. BE1 in BP, BE2 in Top

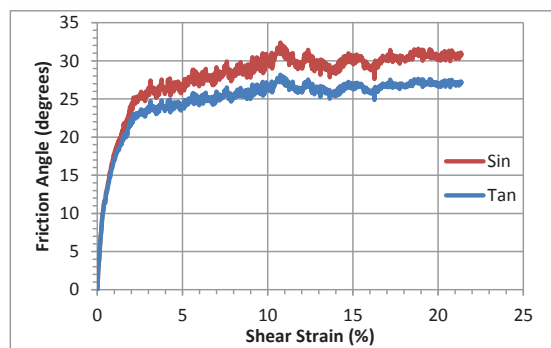
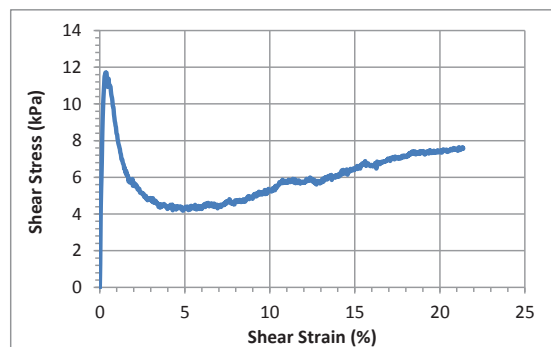
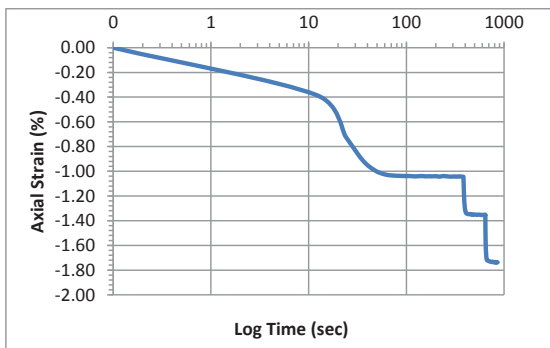
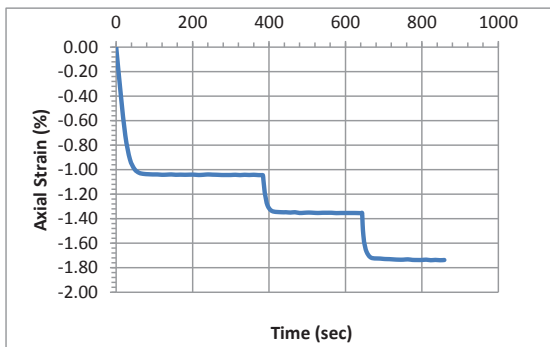

CSS Shear Wave Velocity Measurement Report



Geotechnical Engineering Laboratory

12/18/2013 Version 1.0

General Test Info and Sample Preparation

Device:	CSS	Relative Density (%):	16%
Specimen ID:	C109	Void Ratio:	0.716
Test ID:	M137	Height (mm):	111.6
Date of Test:	11/10/2014	Soil-Only Specimen	307.5
Test Performed:	Undrained Monotonic Shear	Weight (kg):	12.798
Test Material:	Ottawa C109	Density (kg/m ³):	1544.3
Sample Preparation:	Prepared loosely using a funnel with zero drop height	Mem. Thick. (mm):	0.000
		Moisture Cont. (%):	0%
		Saturated (Y/N):	N
		Prepared by:	J. Hubler
		Checked by:	J. Hubler

Consolidation Stage

Shear Wave Velocity Measurement

Vertical Stress (kPa):	100	Signal type	Sinusoidal
Time to Compression	15.1	Signal amp. (Vpp)	4.5
Relative Density (%):	30%	Signal frequency (kHz)	5.0
Void Ratio:	0.686	Sensor spacing (mm)	102.03
Height (mm):	109.7	Average Vs (m/s)	205.1
Density (kg/m ³):	1571.6	Stdev. (m/s)	5.2
First rise		P+V average Vs (m/s)	202.5
Initiation time (ms)	-0.00500	Stdev. (m/s)	3.4
Arrival time (ms)	0.48000	Wavelength (m)	0.041
Vs (m/s)	210.4	Spacing/wavelength	2.5
First peak		First valley	
Initiation time (ms)	0.04000	Initiation time (ms)	0.14000
Arrival time (ms)	0.55000	Arrival time (ms)	0.63800
Vs (m/s)	200.1	Vs (m/s)	204.9

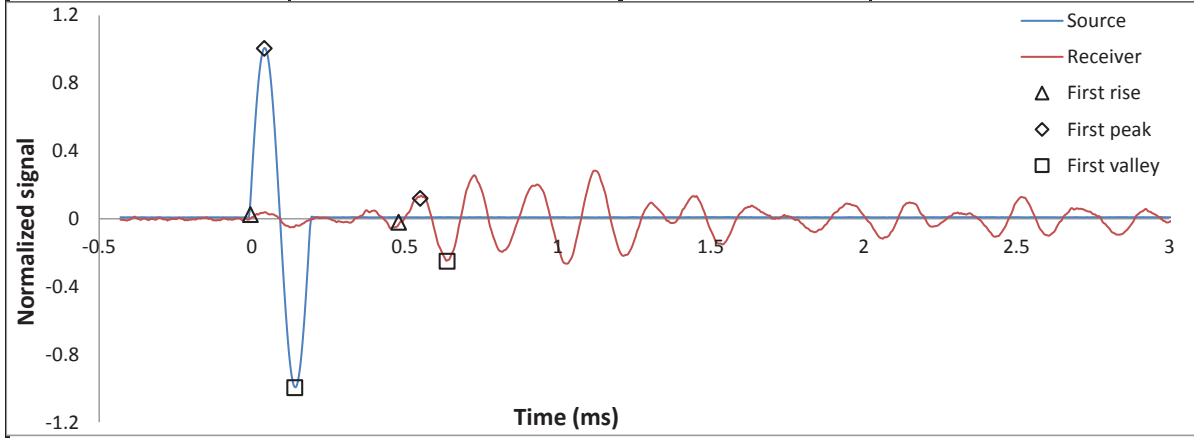

CSS Monotonic Shear Test Report

Geotechnical Engineering Laboratory



10/28/2013_Version 8.0

General Test Info and Sample Preparation

Device:	CSS	Relative Density (%):	15%
Specimen ID:	C109	Void Ratio:	0.719
Test ID:	M139	Height (mm):	111.9
Date of Test:	11/10/2014	Soil-Only Specimen Diameter (mm):	307.50
Test Performed:	Monotonic Shear	Weight (kg):	12.819
Test Material:	Ottawa C109 Sand	Density (kg/m³):	1542.0
Sample Preparation:	Prepared loose using a funnel with zero drop height.	Membrane Thickness (mm):	0.000
		Moisture Content (%):	0%
		Saturated (Y/N):	N
		Prepared by:	J.Hubler
		Checked by:	J. Hubler

Consolidation Stage

Vertical Stress (kPa):	50
Compression Time (min):	7.8
Relative Density (%):	27%
Void Ratio:	0.692
Height (mm):	110.2
Diameter (mm):	307.50
Weight (kg):	12.819
Density (kg/m³):	1566.3

Shear Stage

Type of Test:	Constant Volume
Stress or Strain Controlled:	Strain
Shear Strain Rate (%/min):	0.30
Peak Shear Strength (kPa):	5.2

Comments

Used Silver Baseplate, No Membrane

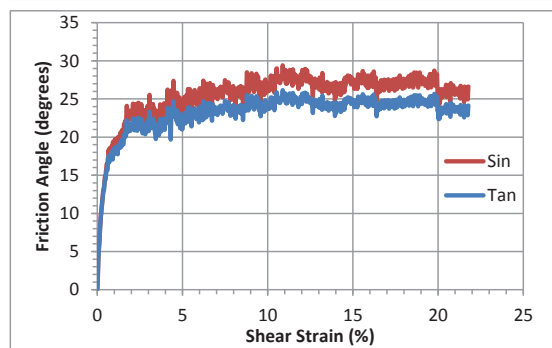
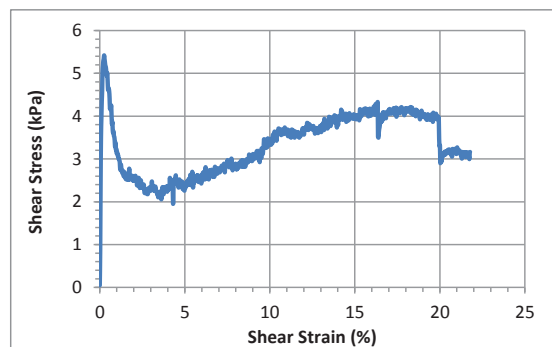
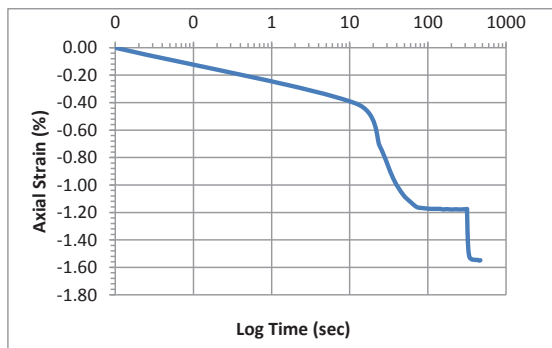
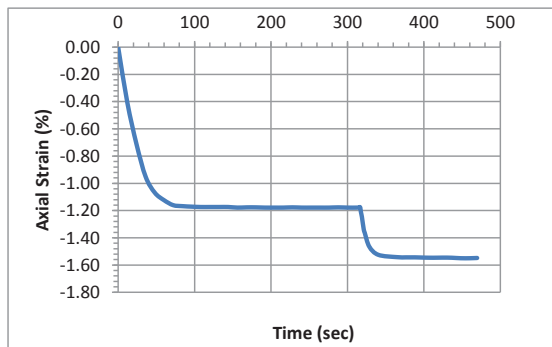

CSS Shear Wave Velocity Measurement Report



Geotechnical Engineering Laboratory

12/18/2013 Version 1.0

General Test Info and Sample Preparation			
Device:	CSS	Relative Density (%):	15%
Specimen ID:	C109	Void Ratio:	0.719
Test ID:	M139	Height (mm):	111.9
Date of Test:	11/10/2014	Soil-Only Specimen	307.5
Test Performed:	Undrained Monotonic Shear	Weight (kg):	12.819
Test Material:	Ottawa C109	Density (kg/m ³):	1542.0
Sample Preparation:	Prepared loosely using a funnel with zero drop height	Membrane Thick. (mm):	0.000
		Moisture Content (%):	0%
		Saturated (Y/N):	N
		Prepared by:	J. Hubler
		Checked by:	J. Hubler
Consolidation Stage		Shear Wave Velocity Measurement	
Vertical Stress (kPa):	50	Signal type	Sinusoidal
Time to Compression	7.8	Signal amplitude (Vpp)	4.5
Relative Density (%):	27%	Signal frequency (kHz)	5.0
Void Ratio:	0.692	Sensor spacing (mm)	102.59
Height (mm):	110.2	Average Vs (m/s)	167.9
Density (kg/m ³):	1566.2	Stdev. (m/s)	3.2
		P+V average Vs (m/s)	168.4
First rise		First valley	
Initiation time (ms)	-0.00500	Stdev. (m/s)	4.4
Arrival time (ms)	0.61000	Wavelength (m)	0.034
Vs (m/s)	166.8	Spacing/wavelength	3.1
First peak		First valley	
Initiation time (ms)	0.04000	Initiation time (ms)	0.14000
Arrival time (ms)	0.66050	Arrival time (ms)	0.73800
Vs (m/s)	165.3	Vs (m/s)	171.5

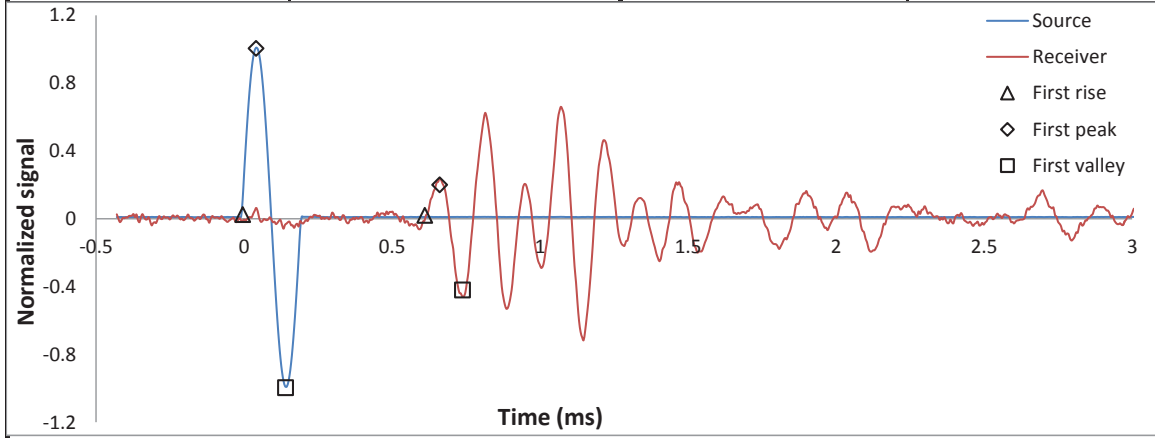

CSS Monotonic Shear Test Report

Geotechnical Engineering Laboratory



10/28/2013_Version 8.0

General Test Info and Sample Preparation

Device:	CSS	Relative Density (%):	13%
Specimen ID:	C109	Void Ratio:	0.723
Test ID:	M140	Height (mm):	111.9
Date of Test:	11/10/2014	Soil-Only Specimen Diameter (mm):	307.50
Test Performed:	Monotonic Shear	Weight (kg):	12.780
Test Material:	Ottawa C109 Sand	Density (kg/m ³):	1538.4
Sample Preparation:	Prepared loose using a funnel with zero drop height.	Membrane Thickness (mm):	0.000
		Moisture Content (%):	0%
		Saturated (Y/N):	N
		Prepared by:	J. Hubler
		Checked by:	J. Hubler

Consolidation Stage

Vertical Stress (kPa):	200
Compression Time (min):	11.3
Relative Density (%):	33%
Void Ratio:	0.678
Height (mm):	109.0
Diameter (mm):	307.50
Weight (kg):	12.780
Density (kg/m ³):	1579.0

Shear Stage

Type of Test:	Constant Volume
Stress or Strain Controlled:	Strain
Shear Strain Rate (%/min):	0.30
Peak Shear Strength (kPa):	22.8

Comments

Used Silver Baseplate, No Membrane

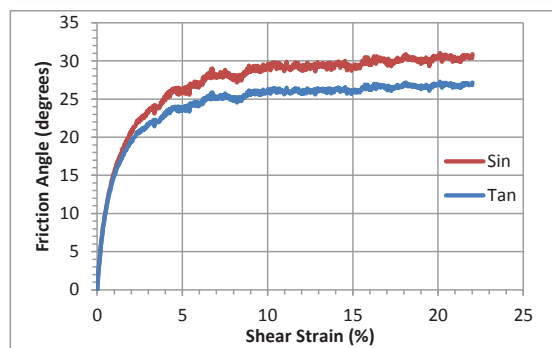
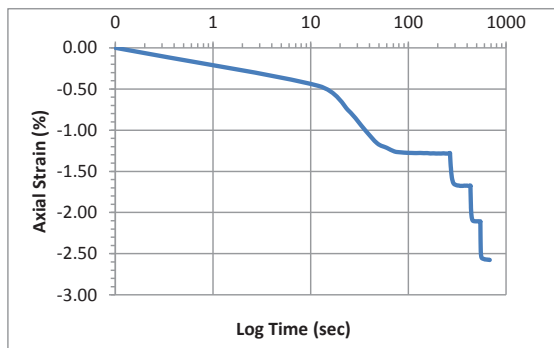
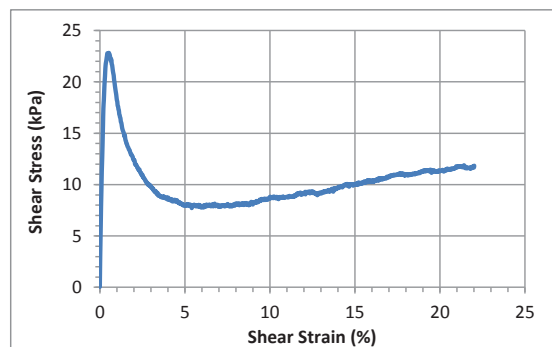
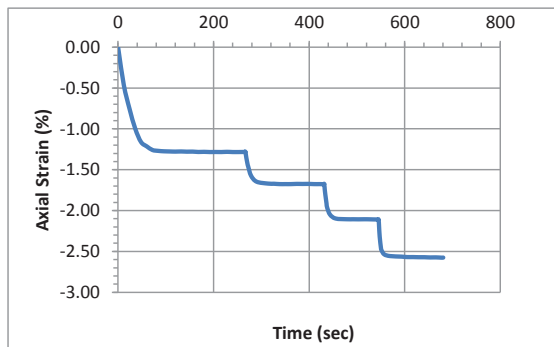

CSS Shear Wave Velocity Measurement Report



Geotechnical Engineering Laboratory

12/18/2013 Version 1.0

General Test Info and Sample Preparation			
Device:	CSS	Relative Density (%):	13%
Specimen ID:	C109	Void Ratio:	0.723
Test ID:	M140	Height (mm):	111.9
Date of Test:	11/10/2014	Soil-Only Specimen	307.5
Test Performed:	Undrained Monotonic Shear	Weight (kg):	12.78
Test Material:	Ottawa C109	Density (kg/m ³):	1538.4
Sample Preparation:	Prepared loosely using a funnel with zero drop height	Membrane Thick. (mm):	0.000
		Moisture Content (%):	0%
		Saturated (Y/N):	N
		Prepared by:	J. Hubler
		Checked by:	J. Hubler
Consolidation Stage		Shear Wave Velocity Measurement	
Vertical Stress (kPa):	200	Signal type	Sinusoidal
Time to Compression	11.3	Signal amplitude (Vpp)	4.5
Relative Density (%):	33%	Signal frequency (kHz)	5.0
Void Ratio:	0.678	Sensor spacing (mm)	101.36
Height (mm):	109.0	Average Vs (m/s)	231.6
Density (kg/m ³):	1579.1	Stdev. (m/s)	11.0
First rise		P+V average Vs (m/s)	
Initiation time (ms)	-0.00500	Stdev. (m/s)	13.4
Arrival time (ms)	0.44500	Wavelength (m)	0.046
Vs (m/s)	225.2	Spacing/wavelength	2.2
First peak		First valley	
Initiation time (ms)	0.04000	Initiation time (ms)	0.14000
Arrival time (ms)	0.49000	Arrival time (ms)	0.55500
Vs (m/s)	225.2	Vs (m/s)	244.2

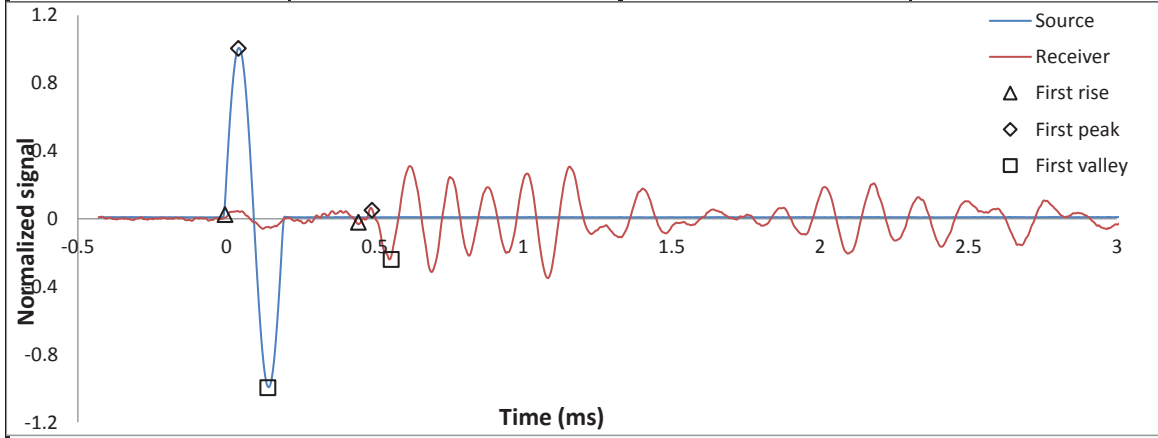

CSS Monotonic Shear Test Report

Geotechnical Engineering Laboratory



10/28/2013_Version 8.0

General Test Info and Sample Preparation

Device:	CSS	Relative Density (%):	15%
Specimen ID:	C109	Void Ratio:	0.719
Test ID:	M141	Height (mm):	111.5
Date of Test:	11/10/2014	Soil-Only Specimen Diameter (mm):	307.50
Test Performed:	Monotonic Shear	Weight (kg):	12.770
Test Material:	Ottawa C109 Sand	Density (kg/m ³):	1541.9
Sample Preparation:	Prepared loose using a funnel with zero drop height.	Membrane Thickness (mm):	0.000
		Moisture Content (%):	0%
		Saturated (Y/N):	N
		Prepared by:	J.Hubler
		Checked by:	J. Hubler

Consolidation Stage

Vertical Stress (kPa):	400
Compression Time (min):	15.7
Relative Density (%):	37%
Void Ratio:	0.671
Height (mm):	108.4
Diameter (mm):	307.50
Weight (kg):	12.770
Density (kg/m ³):	1586.3

Shear Stage

Type of Test:	Constant Volume
Stress or Strain Controlled:	Strain
Shear Strain Rate (%/min):	0.30
Peak Shear Strength (kPa):	46.9

Comments

Used Silver Baseplate, No Membrane

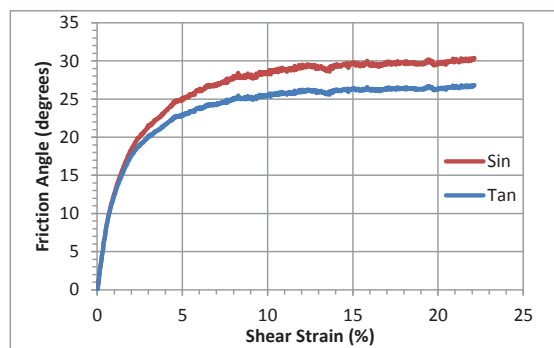
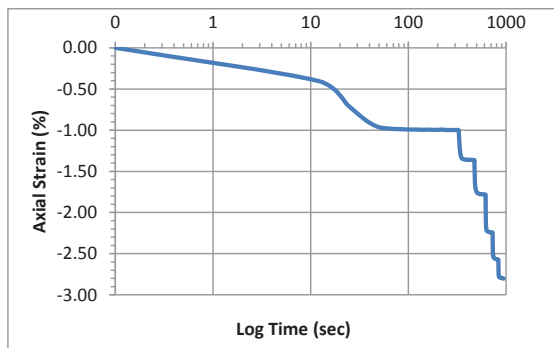
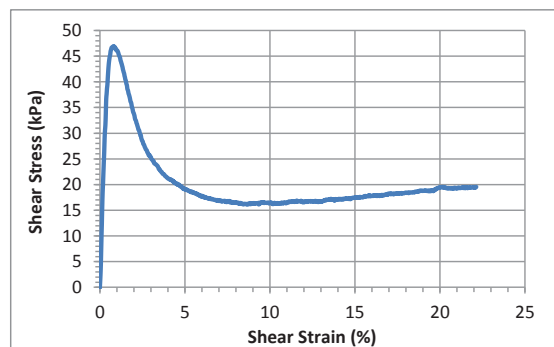
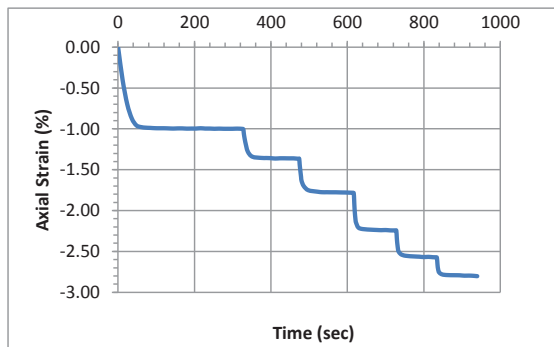

CSS Monotonic Shear Test Report

Geotechnical Engineering Laboratory



10/28/2013_Version 8.0

General Test Info and Sample Preparation

Device:	CSS	Relative Density (%):	20%
Specimen ID:	C109	Void Ratio:	0.707
Test ID:	M142	Height (mm):	112.9
Date of Test:	11/11/2014	Soil-Only Specimen Diameter (mm):	307.50
Test Performed:	Monotonic Shear	Weight (kg):	13.008
Test Material:	Ottawa C109 Sand	Density (kg/m ³):	1552.1
Sample Preparation:	Prepared loose using a funnel with zero drop height.	Membrane Thickness (mm):	0.000
		Moisture Content (%):	0%
		Saturated (Y/N):	N
		Prepared by:	J. Hubler
		Checked by:	J. Hubler

Consolidation Stage

Vertical Stress (kPa):	100
Compression Time (min):	10.6
Relative Density (%):	36%
Void Ratio:	0.673
Height (mm):	110.6
Diameter (mm):	307.50
Weight (kg):	13.008
Density (kg/m ³):	1584.4

Shear Stage

Type of Test:	Constant Volume
Stress or Strain Controlled:	Strain
Shear Strain Rate (%/min):	0.30
Peak Shear Strength (kPa):	12.0

Comments

Used Silver Baseplate, No Membrane

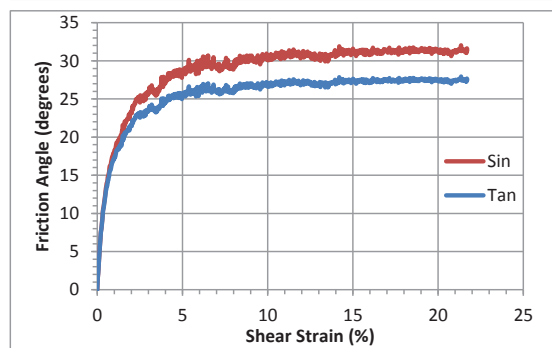
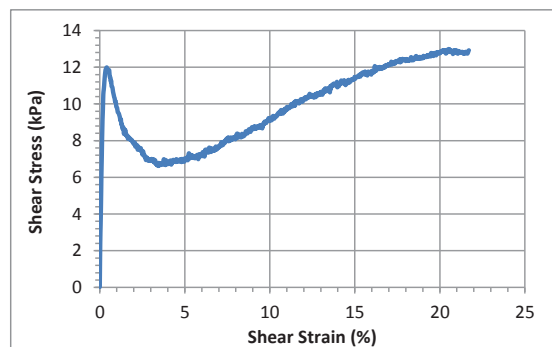
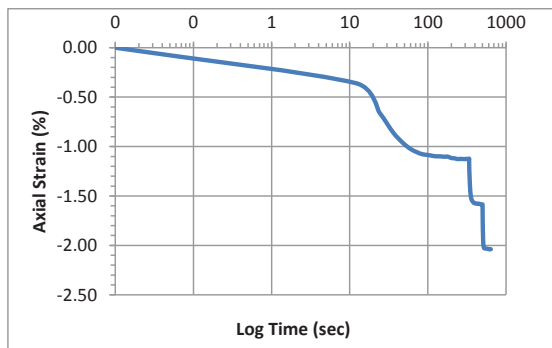
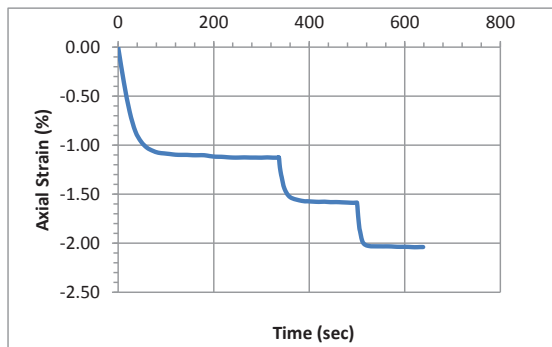

CSS Shear Wave Velocity Measurement Report



Geotechnical Engineering Laboratory

12/18/2013 Version 1.0

General Test Info and Sample Preparation			
Device:	CSS	Relative Density (%):	20%
Specimen ID:	C109	Void Ratio:	0.707
Test ID:	M142	Height (mm):	112.9
Date of Test:	11/11/2014	Soil-Only Specimen	307.5
Test Performed:	Undrained Monotonic Shear	Weight (kg):	13.008
Test Material:	Ottawa C109	Density (kg/m ³):	1552.1
Sample Preparation:	Prepared loosely using a funnel with zero drop height	Membrane Thick. (mm):	0.000
		Moisture Content (%):	0%
		Saturated (Y/N):	N
		Prepared by:	J. Hubler
		Checked by:	J. Hubler
Consolidation Stage		Shear Wave Velocity Measurement	
Vertical Stress (kPa):	100	Signal type	Sinusoidal
Time to Compression	10.6	Signal amplitude (Vpp)	4.5
Relative Density (%):	36%	Signal frequency (kHz)	5.0
Void Ratio:	0.673	Sensor spacing (mm)	102.94
Height (mm):	110.6	Average Vs (m/s)	187.1
Density (kg/m ³):	1584.3	Stdev. (m/s)	4.6
First rise		P+V average Vs (m/s)	
Initiation time (ms)	-0.00500	Stdev. (m/s)	0.9
Arrival time (ms)	0.53000	Wavelength (m)	0.037
Vs (m/s)	192.4	Spacing/wavelength	2.8
First peak		First valley	
Initiation time (ms)	0.04000	Initiation time (ms)	0.14000
Arrival time (ms)	0.60000	Arrival time (ms)	0.69600
Vs (m/s)	183.8	Vs (m/s)	185.1

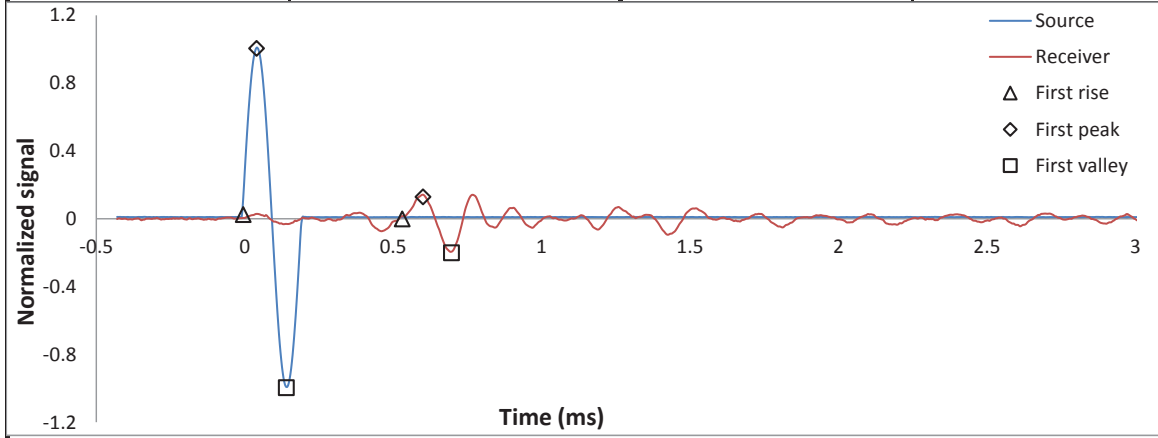

CSS Monotonic Shear Test Report

Geotechnical Engineering Laboratory



10/28/2013_Version 8.0

General Test Info and Sample Preparation

Device:	CSS	Relative Density (%):	17%
Specimen ID:	C109	Void Ratio:	0.714
Test ID:	M143	Height (mm):	113.4
Date of Test:	11/11/2014	Soil-Only Specimen Diameter (mm):	307.50
Test Performed:	Monotonic Shear	Weight (kg):	13.022
Test Material:	Ottawa C109 Sand	Density (kg/m³):	1545.7
Sample Preparation:	Prepared loose using a funnel with zero drop height.	Membrane Thickness (mm):	0.000
		Moisture Content (%):	0%
		Saturated (Y/N):	N
		Prepared by:	J. Hubler
		Checked by:	J. Hubler

Consolidation Stage

Vertical Stress (kPa):	50
Compression Time (min):	12.3
Relative Density (%):	36%
Void Ratio:	0.672
Height (mm):	110.7
Diameter (mm):	307.50
Weight (kg):	13.022
Density (kg/m³):	1584.5

Shear Stage

Type of Test:	Constant Volume
Stress or Strain Controlled:	Strain
Shear Strain Rate (%/min):	0.30
Peak Shear Strength (kPa):	6.8

Comments

Used Silver Baseplate, No Membrane. Densified slightly with a few taps of a mallet.

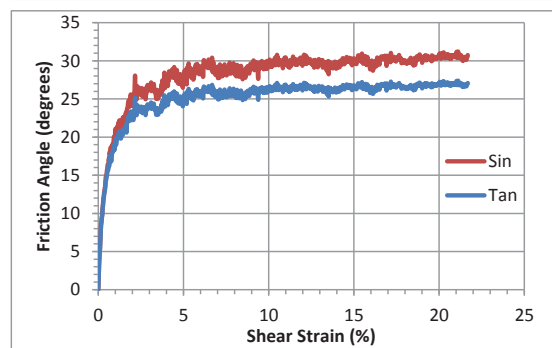
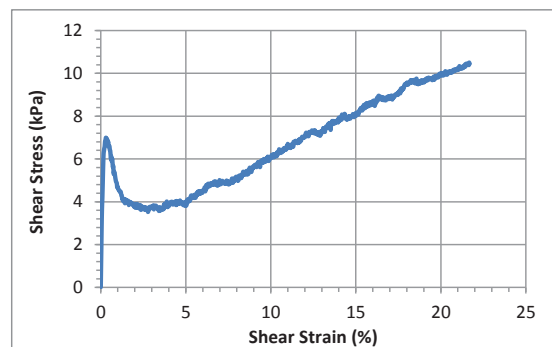
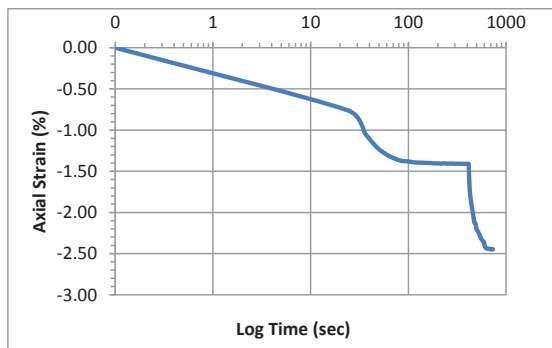
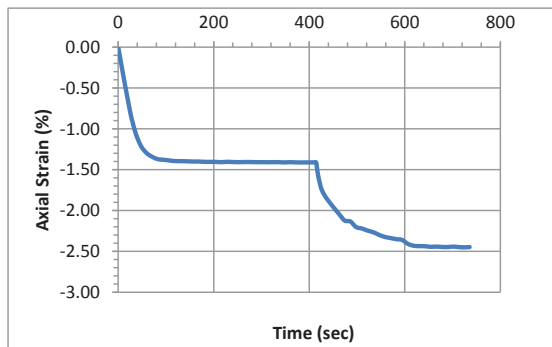

CSS Shear Wave Velocity Measurement Report



Geotechnical Engineering Laboratory

12/18/2013 Version 1.0

General Test Info and Sample Preparation			
Device:	CSS	Relative Density (%):	17%
Specimen ID:	C109	Void Ratio:	0.714
Test ID:	M143	Height (mm):	113.4
Date of Test:	11/11/2014	Soil-Only Specimen	307.5
Test Performed:	Undrained Monotonic Shear	Weight (kg):	13.022
Test Material:	Ottawa C109	Density (kg/m ³):	1545.7
Sample Preparation:	Prepared loosely using a funnel with zero drop height	Membrane Thick. (mm):	0.000
		Moisture Content (%):	0%
		Saturated (Y/N):	N
		Prepared by:	J. Hubler
		Checked by:	J. Hubler
Consolidation Stage		Shear Wave Velocity Measurement	
Vertical Stress (kPa):	50	Signal type	Sinusoidal
Time to Compression	12.3	Signal amplitude (Vpp)	4.5
Relative Density (%):	36%	Signal frequency (kHz)	5.0
Void Ratio:	0.672	Sensor spacing (mm)	103.04
Height (mm):	110.7	Average Vs (m/s)	165.8
Density (kg/m ³):	1584.6	Stdev. (m/s)	2.9
		P+V average Vs (m/s)	165.0
First rise		First peak	
Initiation time (ms)	-0.00500	Initiation time (ms)	0.04000
Arrival time (ms)	0.61000	Arrival time (ms)	0.67400
Vs (m/s)	167.5	Vs (m/s)	162.5
First valley		First valley	
Initiation time (ms)	0.14000	Initiation time (ms)	0.14000
Arrival time (ms)	0.75560	Arrival time (ms)	0.75560
Vs (m/s)	167.4	Vs (m/s)	167.4

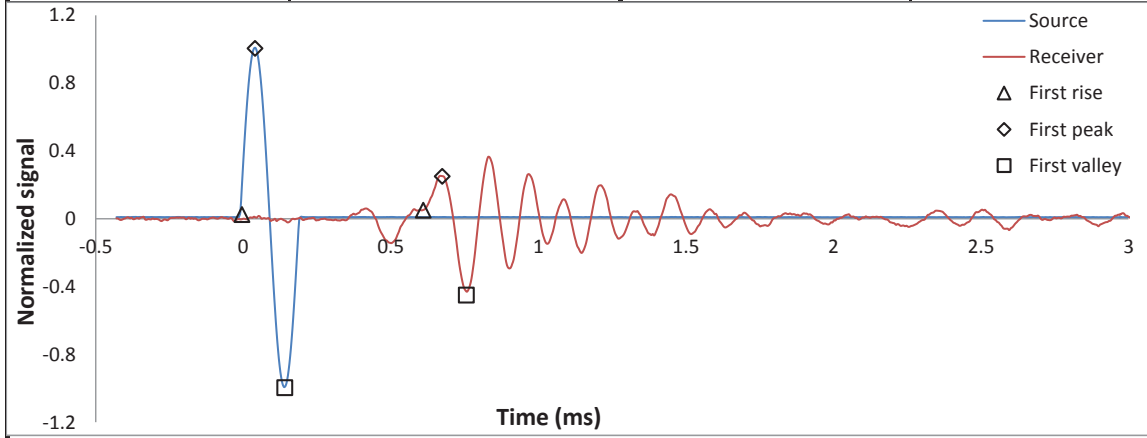

CSS Monotonic Shear Test Report

Geotechnical Engineering Laboratory



10/28/2013_Version 8.0

General Test Info and Sample Preparation

Device:	CSS	Relative Density (%):	25%
Specimen ID:	C109	Void Ratio:	0.698
Test ID:	M144	Height (mm):	113.9
Date of Test:	11/13/2014	Soil-Only Specimen Diameter (mm):	307.50
Test Performed:	Monotonic Shear	Weight (kg):	13.198
Test Material:	Ottawa C109 Sand	Density (kg/m ³):	1560.9
Sample Preparation:	Prepared loose using a funnel with zero drop height.	Membrane Thickness (mm):	0.000
		Moisture Content (%):	0%
		Saturated (Y/N):	N
		Prepared by:	J. Hubler
		Checked by:	J. Hubler

Consolidation Stage

Vertical Stress (kPa):	100
Compression Time (min):	14.6
Relative Density (%):	41%
Void Ratio:	0.662
Height (mm):	111.4
Diameter (mm):	307.50
Weight (kg):	13.198
Density (kg/m ³):	1594.7

Shear Stage

Type of Test:	Constant Volume
Stress or Strain Controlled:	Strain
Shear Strain Rate (%/min):	0.29
Peak Shear Strength (kPa):	13.5

Comments

Silver Baseplate used, No Membrane. Densified slightly with a few taps of a mallet.

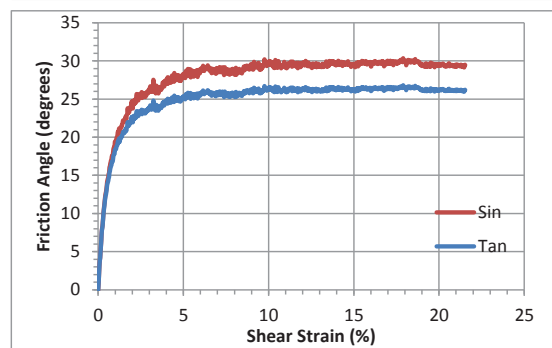
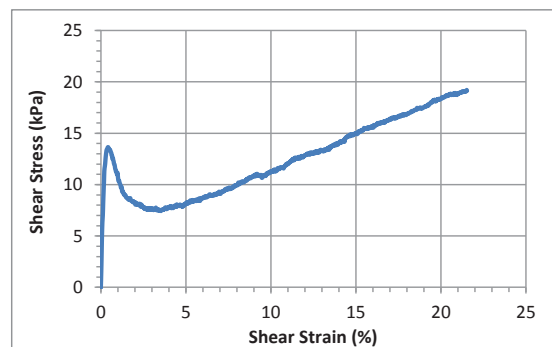
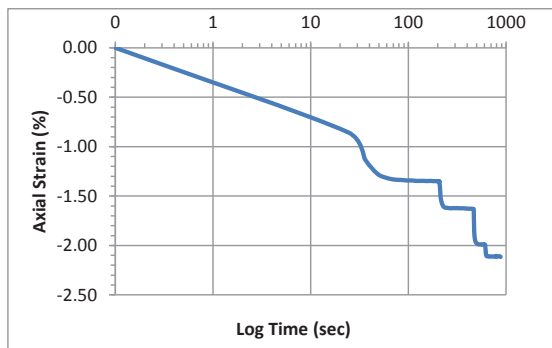
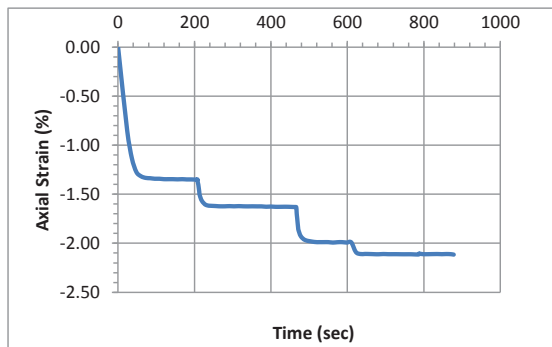

CSS Shear Wave Velocity Measurement Report

Geotechnical Engineering Laboratory



12/18/2013 Version 1.0

General Test Info and Sample Preparation

Device:	CSS	Relative Density (%):	25%
Specimen ID:	C109	Void Ratio:	0.698
Test ID:	M144	Height (mm):	113.9
Date of Test:	11/13/2014	Soil-Only Specimen	307.5
Test Performed:	Undrained Monotonic Shear	Weight (kg):	13.198
Test Material:	Ottawa C109	Density (kg/m ³):	1560.9
Sample Preparation:	Prepared loosely using a funnel with zero drop height	Membrane Thick. (mm):	0.000
		Moisture Content (%):	0%
		Saturated (Y/N):	N
		Prepared by:	J. Hubler
		Checked by:	J. Hubler

Consolidation Stage

Vertical Stress (kPa):	100
Time to Compression	14.6
Relative Density (%):	41%
Void Ratio:	0.662
Height (mm):	111.4
Density (kg/m ³):	1594.7

Shear Wave Velocity Measurement

Signal type	Sinusoidal
Signal amplitude (Vpp)	4.5
Signal frequency (kHz)	5.0
Sensor spacing (mm)	103.96
Average Vs (m/s)	192.0
Stdev. (m/s)	3.7
P+V average Vs (m/s)	192.6
Stdev. (m/s)	5.0
Wavelength (m)	0.038
Spacing/wavelength	2.7

First rise

Initiation time (ms)	-0.00500
Arrival time (ms)	0.54000
Vs (m/s)	190.8

First peak

Initiation time (ms)	0.04000
Arrival time (ms)	0.59000
Vs (m/s)	189.0

First valley

Initiation time (ms)	0.14000
Arrival time (ms)	0.67000
Vs (m/s)	196.2

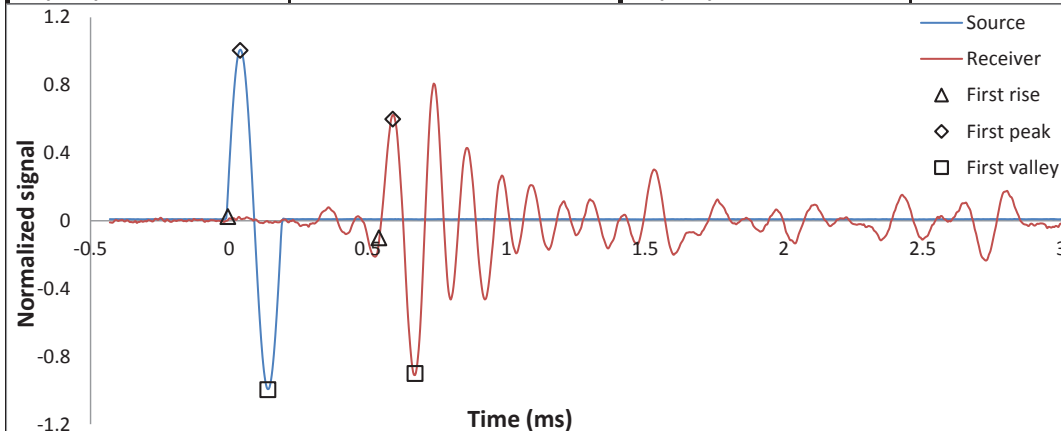

CSS Monotonic Shear Test Report

Geotechnical Engineering Laboratory



10/28/2013_Version 8.0

General Test Info and Sample Preparation

Device:	CSS	Relative Density (%):	27%
Specimen ID:	C109	Void Ratio:	0.693
Test ID:	M145	Height (mm):	111.6
Date of Test:	11/13/2014	Soil-Only Specimen Diameter (mm):	307.50
Test Performed:	Monotonic Shear	Weight (kg):	12.975
Test Material:	Ottawa C109 Sand	Density (kg/m³):	1565.6
Sample Preparation:	Prepared loose using a funnel with zero drop height.	Membrane Thickness (mm):	0.000
		Moisture Content (%):	0%
		Saturated (Y/N):	N
		Prepared by:	J. Hubler
		Checked by:	J. Hubler

Consolidation Stage

Vertical Stress (kPa):	100
Compression Time (min):	5.5
Relative Density (%):	39%
Void Ratio:	0.666
Height (mm):	109.9
Diameter (mm):	307.50
Weight (kg):	12.975
Density (kg/m³):	1590.4

Shear Stage

Type of Test:	Constant Load
Stress or Strain Controlled:	Strain
Shear Strain Rate (%/min):	0.41
Peak Shear Strength (kPa):	47.0

Comments

Silver Baseplate used, No Membrane

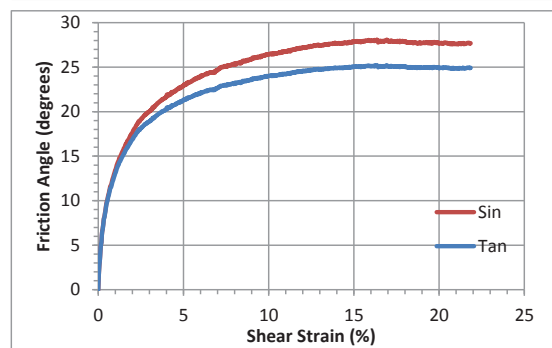
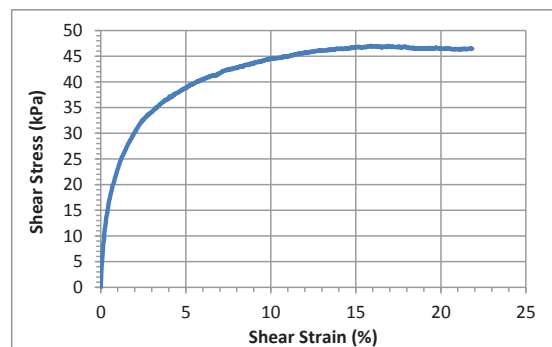
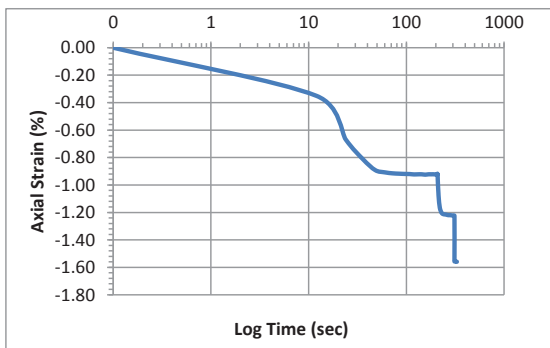
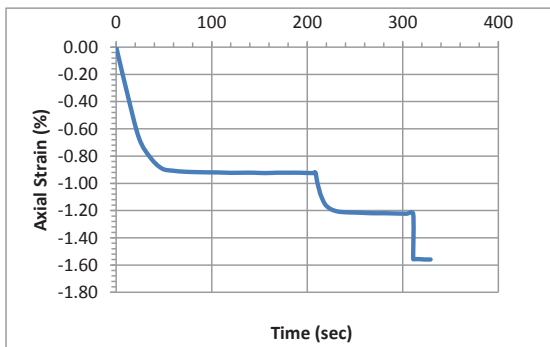

CSS Shear Wave Velocity Measurement Report

Geotechnical Engineering Laboratory



12/18/2013 Version 1.0

General Test Info and Sample Preparation

Device:	CSS	Relative Density (%):	27%
Specimen ID:	C109	Void Ratio:	0.693
Test ID:	M145	Height (mm):	111.6
Date of Test:	11/13/2014	Soil-Only Specimen Diameter	307.5
Test Performed:	Drained Monotonic Shear	Weight (kg):	12.975
Test Material:	Ottawa C109	Density (kg/m ³):	1565.6
Sample Preparation:	Prepared loosely using a funnel with zero drop height	Membrane Thickness (mm):	0.000
		Moisture Content (%):	0%
		Saturated (Y/N):	N
		Prepared by:	J. Hubler
		Checked by:	J. Hubler

Consolidation Stage

Vertical Stress (kPa):	100
Time to Compression	5.5
Relative Density (%):	39%
Void Ratio:	0.666
Height (mm):	109.9
Density (kg/m ³):	1590.4

Shear Wave Velocity Measurement

Signal type	Sinusoidal
Signal amplitude (Vpp)	4.5
Signal frequency (kHz)	5.0
Sensor spacing (mm)	103.96
Average Vs (m/s)	187.0
Stdev. (m/s)	3.9
P+V average Vs (m/s)	185.2
Stdev. (m/s)	3.0
Wavelength (m)	0.037
Spacing/wavelength	2.8

First rise

Initiation time (ms)	-0.00500
Arrival time (ms)	0.54000
Vs (m/s)	190.8

First peak

Initiation time (ms)	0.04000
Arrival time (ms)	0.60800
Vs (m/s)	183.0

First valley

Initiation time (ms)	0.14000
Arrival time (ms)	0.69500
Vs (m/s)	187.3

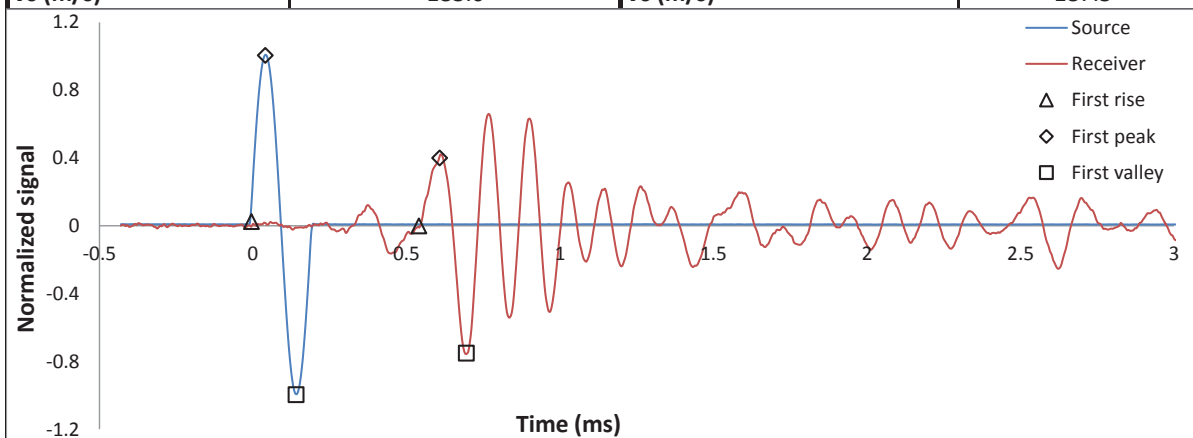

CSS Monotonic Shear Test Report

Geotechnical Engineering Laboratory



10/28/2013_Version 8.0

General Test Info and Sample Preparation

Device:	CSS	Relative Density (%):	27%
Specimen ID:	C109	Void Ratio:	0.693
Test ID:	M147	Height (mm):	113.1
Date of Test:	11/17/2014	Soil-Only Specimen Diameter (mm):	307.50
Test Performed:	Monotonic Shear	Weight (kg):	13.151
Test Material:	Ottawa C109 Sand	Density (kg/m ³):	1565.1
Sample Preparation:	Prepared loose using a funnel with zero drop height.	Membrane Thickness (mm):	0.000
		Moisture Content (%):	0%
		Saturated (Y/N):	N
		Prepared by:	J. Hubler
		Checked by:	J. Hubler

Consolidation Stage

Vertical Stress (kPa):	400
Compression Time (min):	17.7
Relative Density (%):	43%
Void Ratio:	0.656
Height (mm):	110.6
Diameter (mm):	307.50
Weight (kg):	13.151
Density (kg/m ³):	1600.4

Shear Stage

Type of Test:	Constant Volume
Stress or Strain Controlled:	Strain
Shear Strain Rate (%/min):	0.30
Peak Shear Strength (kPa):	45.3

Comments

Used Silver Baseplate, No Membrane. Tamped a few times to make denser.

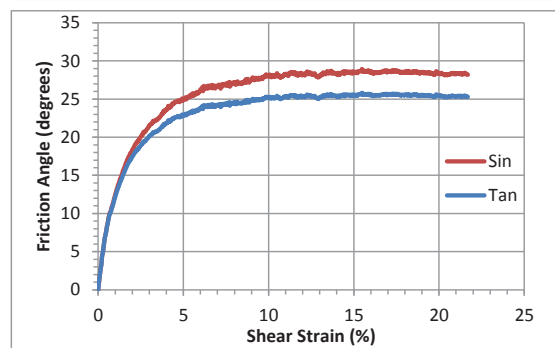
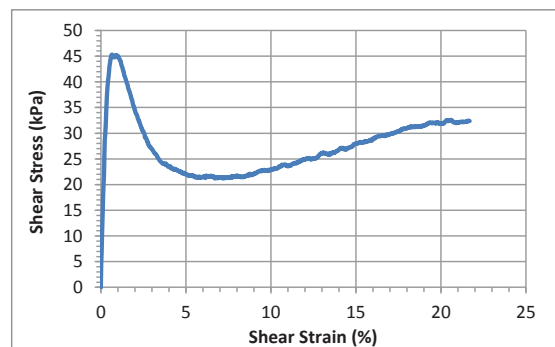
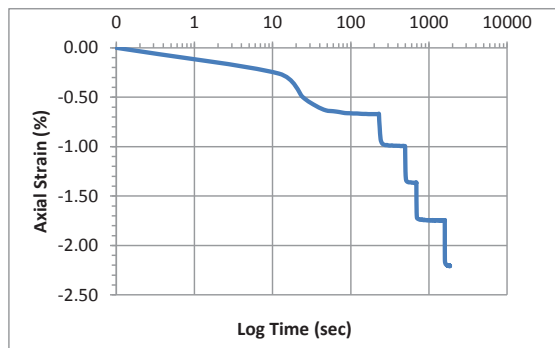
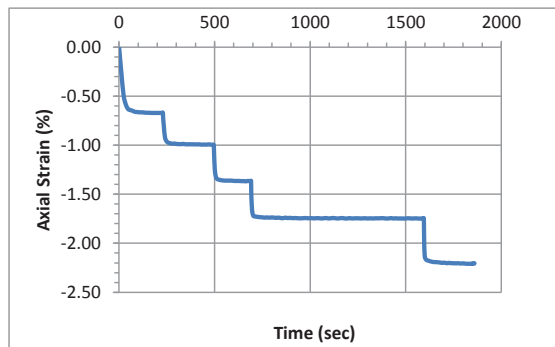

CSS Monotonic Shear Test Report

Geotechnical Engineering Laboratory



10/28/2013_Version 8.0

General Test Info and Sample Preparation

Device:	CSS	Relative Density (%):	30%
Specimen ID:	C109	Void Ratio:	0.685
Test ID:	M149	Height (mm):	113.6
Date of Test:	12/2/2014	Soil-Only Specimen Diameter (mm):	307.5
Test Performed:	Monotonic Shear	Weight (kg):	13.271
Test Material:	Ottawa C109 Sand	Density (kg/m ³):	1573.1
Sample Preparation:	Prepared loosely using the funnel method.	Membrane Thickness (mm):	0.000
		Moisture Content (%):	0%
		Saturated (Y/N):	N
		Prepared by:	R. Thompson
		Checked by:	J. Hubler

Consolidation Stage

Vertical Stress (kPa):	400
Time to Compression (min):	16.0
Relative Density (%):	46%
Void Ratio:	0.649
Height (mm):	111.2
Diameter (mm):	307.5
Weight (kg):	13.271
Density (kg/m ³):	1607.1

Shear Stage

Type of Test:	Constant Volume
Stress or Strain Controlled:	Strain
Shear Strain Rate (%/min):	0.29
Peak Shear Strength (kPa):	52.7

Comments

Silver Baseplate used, No Membrane. Tamped to make slightly denser.

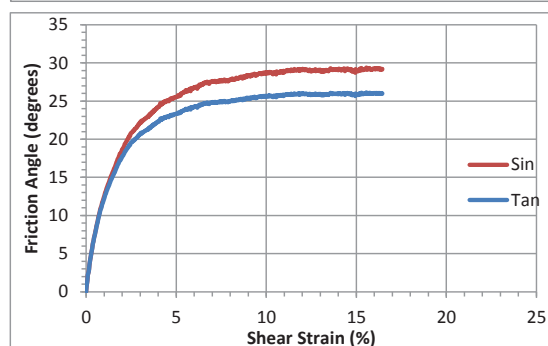
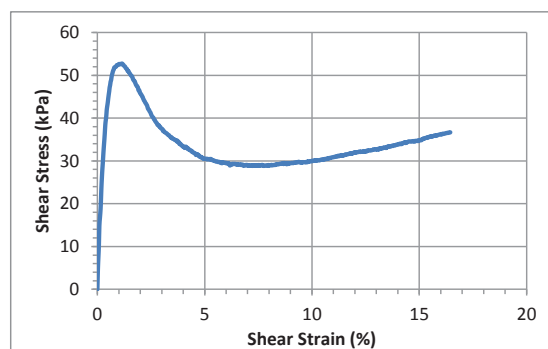
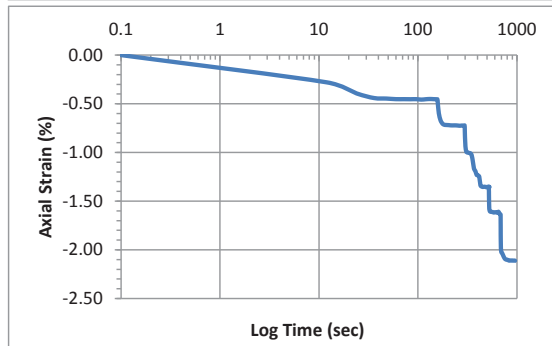
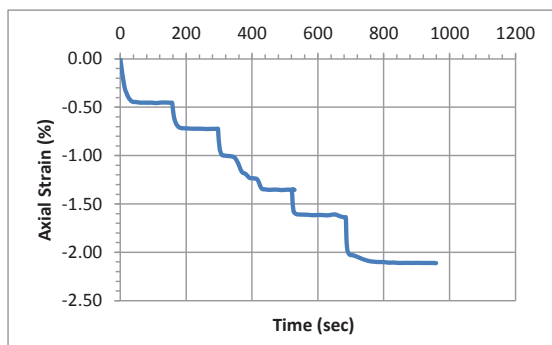

CSS Shear Wave Velocity Measurement Report



Geotechnical Engineering Laboratory

12/18/2013 Version 1.0

General Test Info and Sample Preparation

Device:	CSS	Relative Density (%):	30%
Specimen ID:	C109L	Void Ratio:	0.685
Test ID:	M149	Height (mm):	113.6
Date of Test:	12/2/2014	Soil-Only Specimen	307.5
Test Performed:	Monotonic Shear	Weight (kg):	13.271
Test Material:	C109 Sand	Density (kg/m ³):	1573.06
Sample Preparation:	Prepared loosely using funneling method.	Membrane Thick. (mm):	0.000
		Moisture Content (%):	0%
		Saturated (Y/N):	N
		Prepared by:	R. Thompson
		Checked by:	J. Hubler

Consolidation Stage

Vertical Stress (kPa):	400
Time to Compression	16.0
Relative Density (%):	46%
Void Ratio:	0.649
Height (mm):	111.2
Density (kg/m ³):	1607.01

Shear Wave Velocity Measurement

Signal type	Sinusoidal
Signal amplitude (Vpp)	4.5
Signal frequency (kHz)	5.0
Sensor spacing (mm)	103.52
Average Vs (m/s)	290.1
Stdev. (m/s)	28.3
P+V average Vs (m/s)	300.0
Stdev. (m/s)	31.8
Wavelength (m)	0.058
Spacing/wavelength	1.8

First rise

Initiation time (ms)	-0.00800
Arrival time (ms)	0.37500
Vs (m/s)	270.3

P+V average Vs (m/s)	300.0
Stdev. (m/s)	31.8
Wavelength (m)	0.058
Spacing/wavelength	1.8

First peak

Initiation time (ms)	0.04100
Arrival time (ms)	0.41400
Vs (m/s)	277.5

First valley

Initiation time (ms)	0.14200
Arrival time (ms)	0.46300
Vs (m/s)	322.5

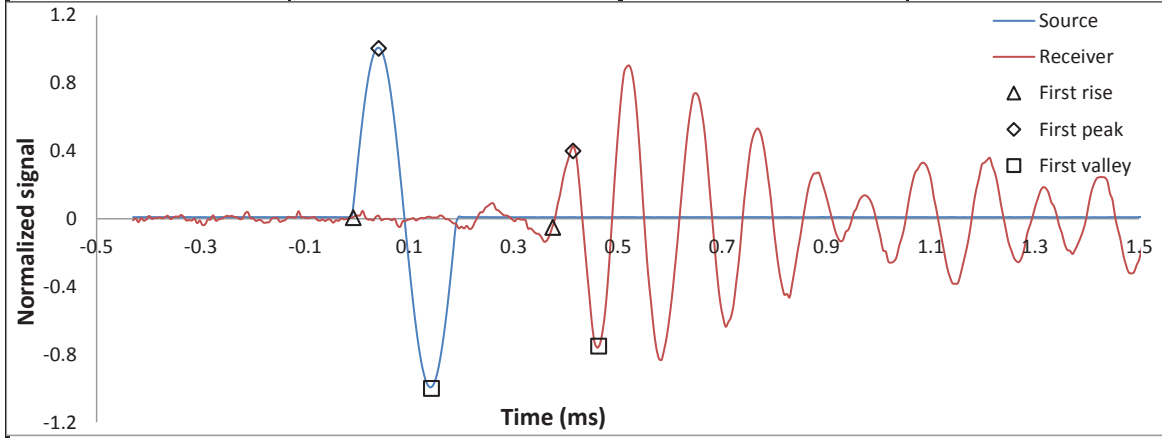

CSS Monotonic Shear Test Report

Geotechnical Engineering Laboratory



10/28/2013_Version 8.0

General Test Info and Sample Preparation

Device:	CSS	Relative Density (%):	39%
Specimen ID:	C109	Void Ratio:	0.666
Test ID:	M150	Height (mm):	113.3
Date of Test:	12/3/2014	Soil-Only Specimen Diameter (mm):	307.50
Test Performed:	Monotonic Shear	Weight (kg):	13.375
Test Material:	Ottawa C109 Sand	Density (kg/m³):	1590.2
Sample Preparation:	Prepared loose using a funnel with zero drop height.	Membrane Thickness (mm):	0.000
		Moisture Content (%):	0%
		Saturated (Y/N):	N
		Prepared by:	J.Hubler
		Checked by:	J. Hubler

Consolidation Stage

Shear Stage

Vertical Stress (kPa):	100	Type of Test:	Constant Volume
Compression Time (min):	9.6	Stress or Strain Controlled:	Strain
Relative Density (%):	49%	Shear Strain Rate (%/min):	0.29
Void Ratio:	0.644	Peak Shear Strength (kPa):	14.7
Height (mm):	111.7	Comments	
Diameter (mm):	307.50	Used Silver Baseplate, No Membrane. Tamped to make slightly denser.	
Weight (kg):	13.375		
Density (kg/m³):	1611.9		

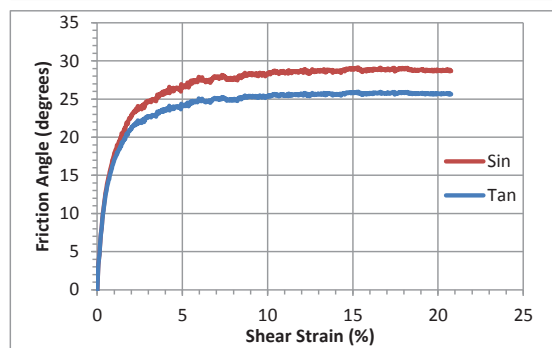
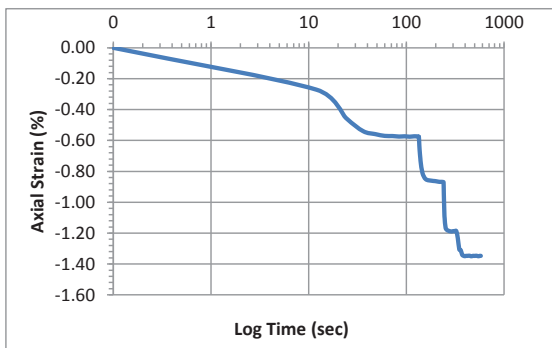
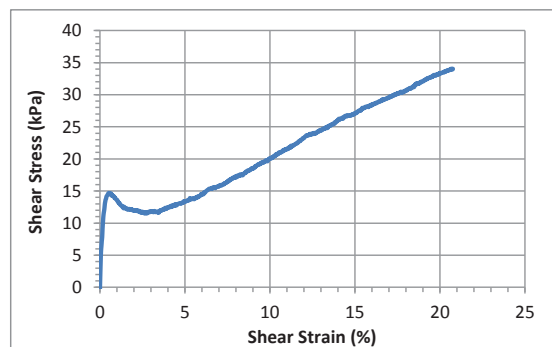
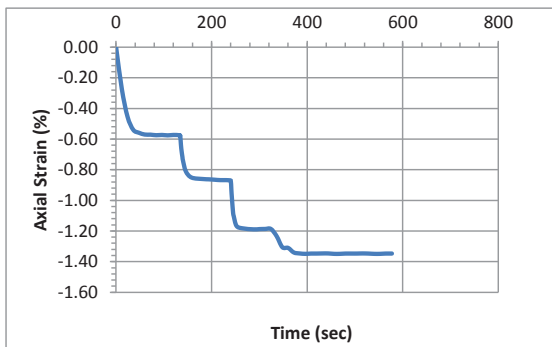

CSS Shear Wave Velocity Measurement Report



Geotechnical Engineering Laboratory

12/18/2013 Version 1.0

General Test Info and Sample Preparation

Device:	CSS	Relative Density (%):	36%
Specimen ID:	C109L	Void Ratio:	0.666
Test ID:	M150	Height (mm):	113.26
Date of Test:	12/4/2014	Soil-Only Specimen	307.5
Test Performed:	Cyclic Shear	Weight (kg):	13.375
Test Material:	C109 Sand	Density (kg/m ³):	1590.1
Sample Preparation:	Prepared loosely using funneling method.	Membrane Thick. (mm):	0.000
		Moisture Content (%):	0%
		Saturated (Y/N):	N
		Prepared by:	J. Hubler
		Checked by:	J. Hubler

Consolidation Stage

Vertical Stress (kPa):	100
Time to Compression	9.6
Relative Density (%):	49%
Void Ratio:	0.644
Height (mm):	111.7
Density (kg/m ³):	1611.9

Shear Wave Velocity Measurement

Signal type	Sinusoidal
Signal amplitude (Vpp)	4.5
Signal frequency (kHz)	5.0
Sensor spacing (mm)	104.11
Average Vs (m/s)	215.1
Stdev. (m/s)	9.8
P+V average Vs (m/s)	217.9
Stdev. (m/s)	11.9
Wavelength (m)	0.043
Spacing/wavelength	2.4

First rise		First peak		First valley	
Initiation time (ms)	-0.00750	Initiation time (ms)	0.04200	Initiation time (ms)	0.14200
Arrival time (ms)	0.49000	Arrival time (ms)	0.53880	Arrival time (ms)	0.60200
Vs (m/s)	209.3	Vs (m/s)	209.6	Vs (m/s)	226.3

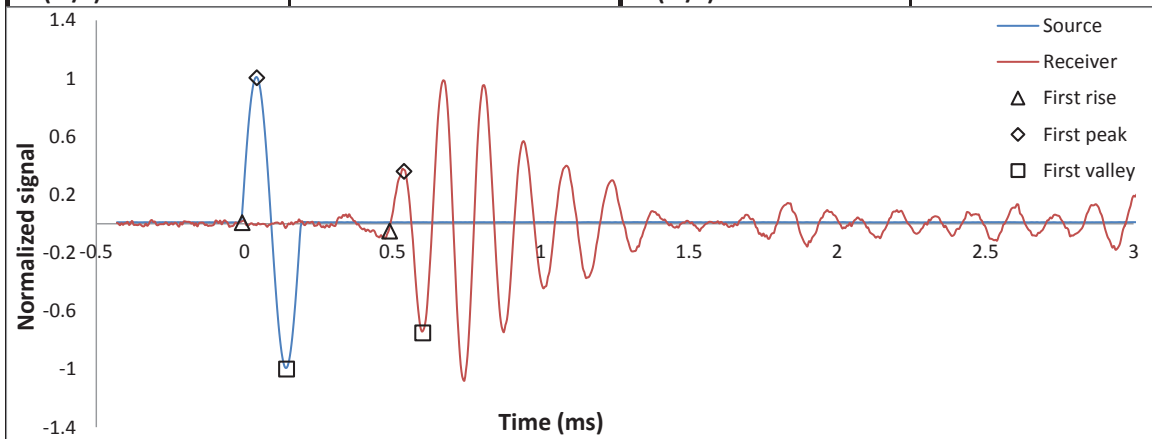

CSS Monotonic Shear Test Report

Geotechnical Engineering Laboratory



10/28/2013_Version 8.0

General Test Info and Sample Preparation

Device:	CSS	Relative Density (%):	23%
Specimen ID:	C109	Void Ratio:	0.701
Test ID:	M151	Height (mm):	112.5
Date of Test:	12/4/2014	Soil-Only Specimen Diameter (mm):	307.50
Test Performed:	Monotonic Shear	Weight (kg):	13.021
Test Material:	C109 Sand	Density (kg/m³):	1558.3
Sample Preparation:	Prepared loose using a funnel with zero drop height.	Membrane Thickness (mm):	0.000
		Moisture Content (%):	0%
		Saturated (Y/N):	N
		Prepared by:	J.Hubler
		Checked by:	J. Hubler

Consolidation Stage

Shear Stage

Vertical Stress (kPa):	200	Type of Test:	Constant Volume
Compression Time (min):	13.6	Stress or Strain Controlled:	Strain
Relative Density (%):	44%	Shear Strain Rate (%/min):	0.30
Void Ratio:	0.655	Peak Shear Strength (kPa):	24.1
Height (mm):	109.5	Comments	
Diameter (mm):	307.50	Used Silver Baseplate, No Membrane. Tamped a few times to make slightly denser. File was moved and data lost after 6% strain.	
Weight (kg):	13.021		
Density (kg/m³):	1601.4		

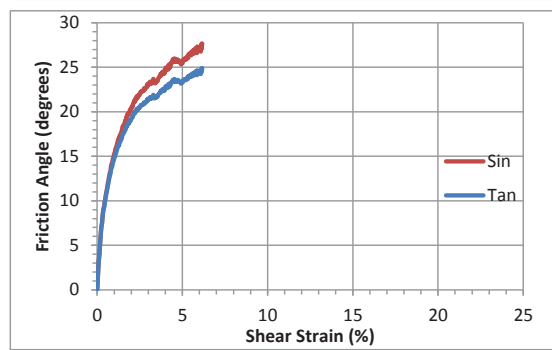
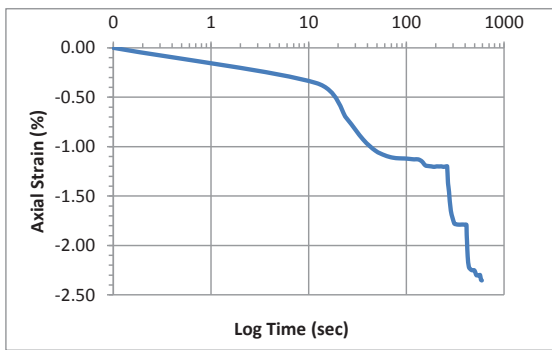
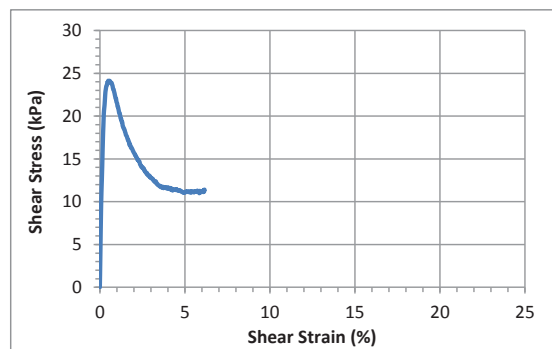
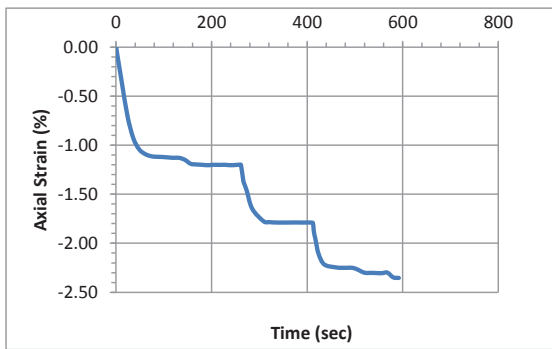

CSS Shear Wave Velocity Measurement Report



Geotechnical Engineering Laboratory

12/18/2013 Version 1.0

General Test Info and Sample Preparation			
Device:	CSS	Relative Density (%):	23%
Specimen ID:	C109L	Void Ratio:	0.701
Test ID:	M151	Height (mm):	113.26
Date of Test:	12/4/2014	Soil-Only Specimen Diameter	307.5
Test Performed:	Cyclic Shear	Weight (kg):	13.021
Test Material:	C109 Sand	Density (kg/m ³):	1548.1
Sample Preparation:	Prepared loosely using funneling method.	Membrane Thickness (mm):	0.000
		Moisture Content (%):	0%
		Saturated (Y/N):	N
		Prepared by:	J. Hubler
		Checked by:	J. Hubler
Consolidation Stage		Shear Wave Velocity Measurement	
Vertical Stress (kPa):	200	Signal type	Sinusoidal
Time to Compression	13.6	Signal amplitude (Vpp)	4.5
Relative Density (%):	44%	Signal frequency (kHz)	5.0
Void Ratio:	0.655	Sensor spacing (mm)	101.87
Height (mm):	109.5	Average Vs (m/s)	245.5
Density (kg/m ³):	1601.4	Stdev. (m/s)	16.1
First rise		P+V average Vs (m/s)	
Initiation time (ms)	-0.00750	Stdev. (m/s)	19.2
Arrival time (ms)	0.42500	Wavelength (m)	0.049
Vs (m/s)	235.5	Spacing/wavelength	2.1
First peak		First valley	
Initiation time (ms)	0.04200	Initiation time (ms)	0.14200
Arrival time (ms)	0.47200	Arrival time (ms)	0.52780
Vs (m/s)	236.9	Vs (m/s)	264.0

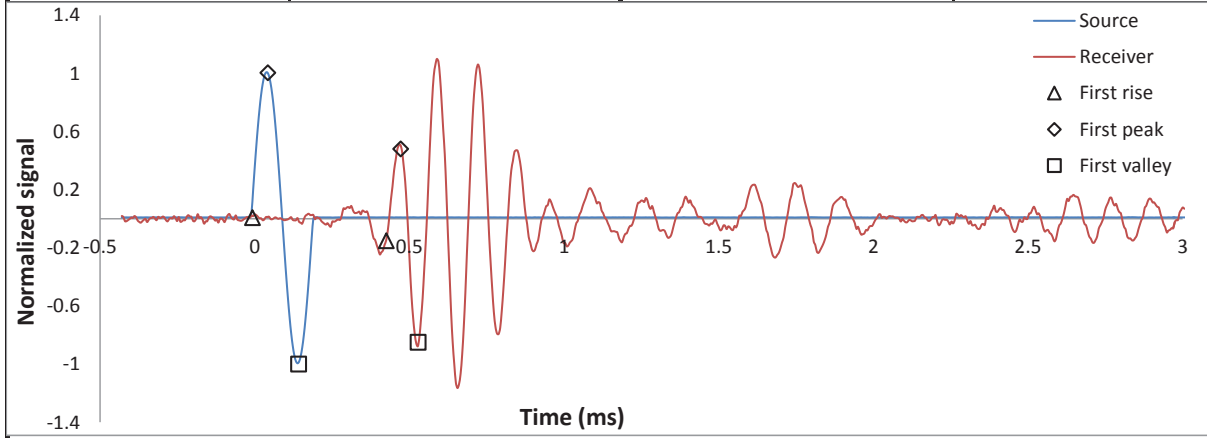

CSS Monotonic Shear Test Report

Geotechnical Engineering Laboratory



10/28/2013_Version 8.0

General Test Info and Sample Preparation

Device:	CSS	Relative Density (%):	66%
Specimen ID:	C109	Void Ratio:	0.604
Test ID:	M152	Height (mm):	117.9
Date of Test:	12/4/2014	Soil-Only Specimen Diameter (mm):	307.50
Test Performed:	Monotonic Shear	Weight (kg):	14.460
Test Material:	Ottawa C109 Sand	Density (kg/m³):	1651.9
Sample Preparation:	Prepared dense by tamping with a rubber mallet to desired density (15x in 3 layers).	Membrane Thickness (mm):	0.000
		Moisture Content (%):	0%
		Saturated (Y/N):	N
		Prepared by:	J. Hubler
		Checked by:	J. Hubler

Consolidation Stage

Vertical Stress (kPa):	100
Compression Time (min):	12.0
Relative Density (%):	73%
Void Ratio:	0.589
Height (mm):	116.8
Diameter (mm):	307.50
Weight (kg):	14.460
Density (kg/m³):	1667.2

Shear Stage

Type of Test:	Constant Volume
Stress or Strain Controlled:	Strain
Shear Strain Rate (%/min):	0.28
Peak Shear Strength (kPa):	14.0

Comments

Used Silver Baseplate, No Membrane

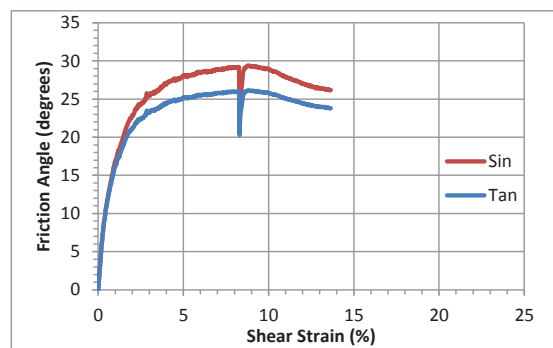
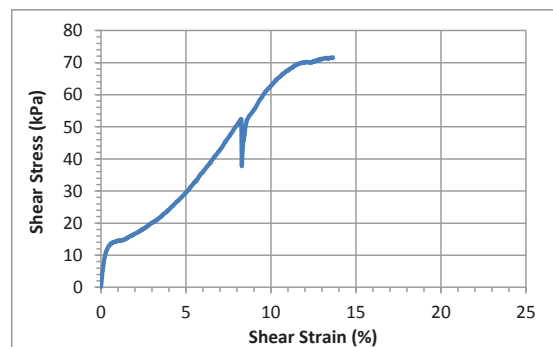
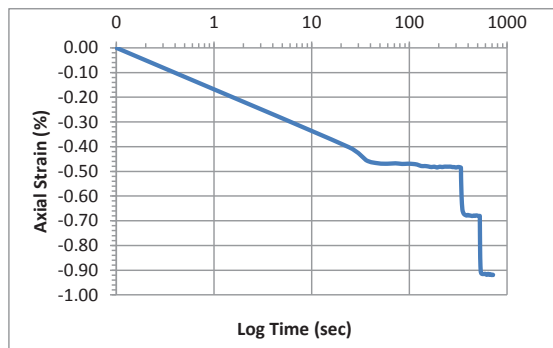
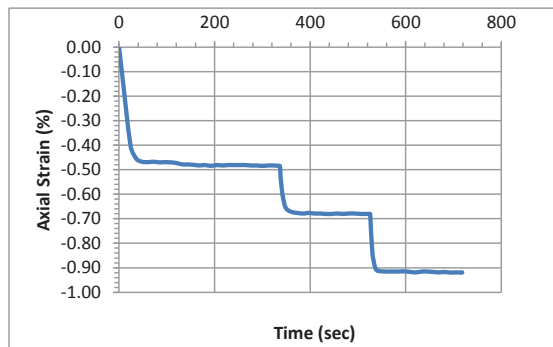

CSS Shear Wave Velocity Measurement Report



Geotechnical Engineering Laboratory

12/18/2013 Version 1.0

General Test Info and Sample Preparation			
Device:	CSS	Relative Density (%):	66%
Specimen ID:	C109D	Void Ratio:	0.605
Test ID:	M152	Height (mm):	117.9
Date of Test:	12/4/2014	Soil-Only Specimen Diameter	307.5
Test Performed:	Monotonic Shear	Weight (kg):	14.46
Test Material:	C109 Sand	Density (kg/m ³):	1651.48
Sample Preparation:	Prepared loosely using funneling method.	Membrane Thickness (mm):	0.000
		Moisture Content (%):	0%
		Saturated (Y/N):	N
		Prepared by:	R. Thompson
		Checked by:	J. Hubler
Consolidation Stage		Shear Wave Velocity Measurement	
Vertical Stress (kPa):	100	Signal type	Sinusoidal
Time to Compression	12.0	Signal amplitude (Vpp)	4.5
Relative Density (%):	73%	Signal frequency (kHz)	5.0
Void Ratio:	0.589	Sensor spacing (mm)	109.18
Height (mm):	116.8	Average Vs (m/s)	221.7
Density (kg/m ³):	1667.04	Stdev. (m/s)	5.6
First rise		P+V average Vs (m/s)	
Initiation time (ms)	-0.00510	Stdev. (m/s)	7.9
Arrival time (ms)	0.48600	Wavelength (m)	0.044
Vs (m/s)	222.3	Spacing/wavelength	2.5
First peak		First valley	
Initiation time (ms)	0.04400	Initiation time (ms)	0.14400
Arrival time (ms)	0.55000	Arrival time (ms)	0.62500
Vs (m/s)	215.8	Vs (m/s)	227.0

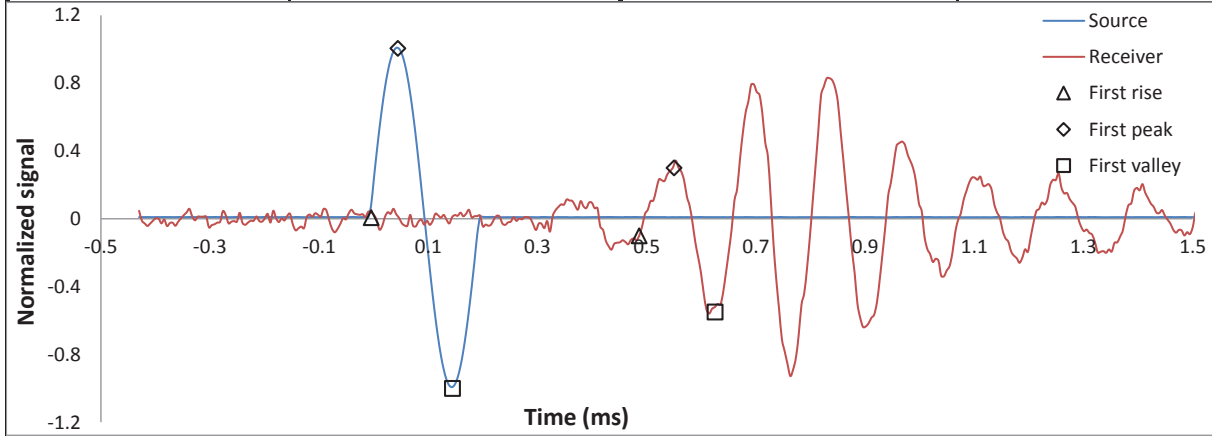

CSS Monotonic Shear Test Report

Geotechnical Engineering Laboratory



10/28/2013_Version 8.0

General Test Info and Sample Preparation

Device:	CSS	Relative Density (%):	29%
Specimen ID:	C109	Void Ratio:	0.688
Test ID:	M153	Height (mm):	114.8
Date of Test:	12/4/2014	Soil-Only Specimen Diameter (mm):	307.50
Test Performed:	Monotonic Shear	Weight (kg):	13.375
Test Material:	Ottawa C109 Sand	Density (kg/m ³):	1569.5
Sample Preparation:	Prepared loose using a funnel with zero drop height.	Membrane Thickness (mm):	0.000
		Moisture Content (%):	0%
		Saturated (Y/N):	N
		Prepared by:	J. Hubler
		Checked by:	J. Hubler

Consolidation Stage

Shear Stage

Vertical Stress (kPa):	100	Type of Test:	Constant Volume
Compression Time (min):	11.1	Stress or Strain Controlled:	Strain
Relative Density (%):	46%	Shear Strain Rate (%/min):	0.29
Void Ratio:	0.649	Peak Shear Strength (kPa):	14.0
Height (mm):	112.1	Comments	
Diameter (mm):	307.50	Used Silver Baseplate, No Membrane. Tamped several times to reach desired density.	
Weight (kg):	13.375		
Density (kg/m ³):	1606.9		

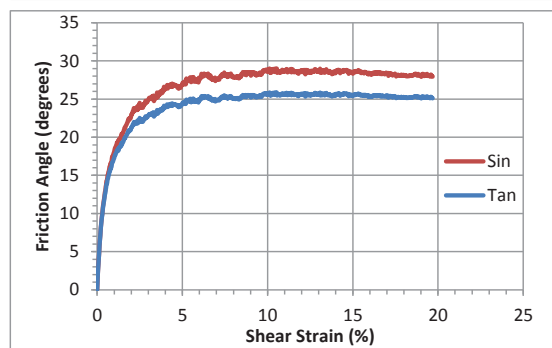
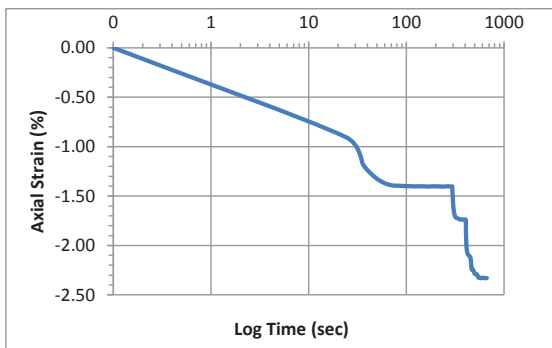
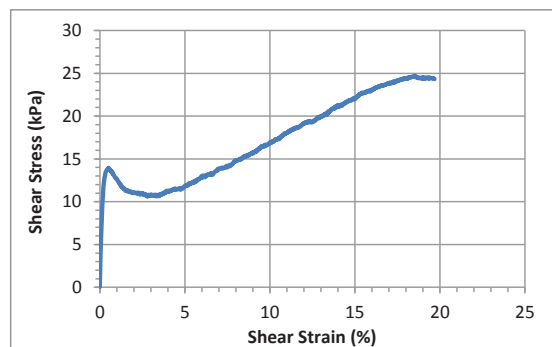
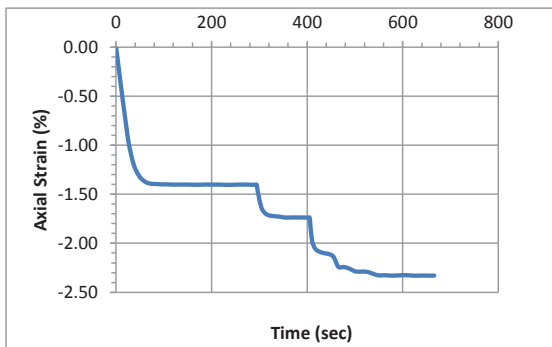

CSS Shear Wave Velocity Measurement Report



Geotechnical Engineering Laboratory

12/18/2013 Version 1.0

General Test Info and Sample Preparation			
Device:	CSS	Relative Density (%):	29%
Specimen ID:	C109L	Void Ratio:	0.688
Test ID:	M153	Height (mm):	114.75
Date of Test:	12/4/2014	Soil-Only Specimen Diameter	307.5
Test Performed:	Cyclic Shear	Weight (kg):	13.375
Test Material:	C109 Sand	Density (kg/m ³):	1569.5
Sample Preparation:	Prepared loosely using funneling method.	Membrane Thickness (mm):	0.000
		Moisture Content (%):	0%
		Saturated (Y/N):	N
		Prepared by:	J. Hubler
		Checked by:	J. Hubler
Consolidation Stage		Shear Wave Velocity Measurement	
Vertical Stress (kPa):	100	Signal type	Sinusoidal
Time to Compression	11.1	Signal amplitude (Vpp)	4.5
Relative Density (%):	46%	Signal frequency (kHz)	5.0
Void Ratio:	0.649	Sensor spacing (mm)	104.46
Height (mm):	112.1	Average Vs (m/s)	212.8
Density (kg/m ³):	1606.9	Stdev. (m/s)	11.5
First rise		P+V average Vs (m/s)	
Initiation time (ms)	-0.00750	Stdev. (m/s)	13.9
Arrival time (ms)	0.50000	Wavelength (m)	0.043
Vs (m/s)	205.8	Spacing/wavelength	2.5
First peak		First valley	
Initiation time (ms)	0.04200	Initiation time (ms)	0.14200
Arrival time (ms)	0.54800	Arrival time (ms)	0.60400
Vs (m/s)	206.4	Vs (m/s)	226.1

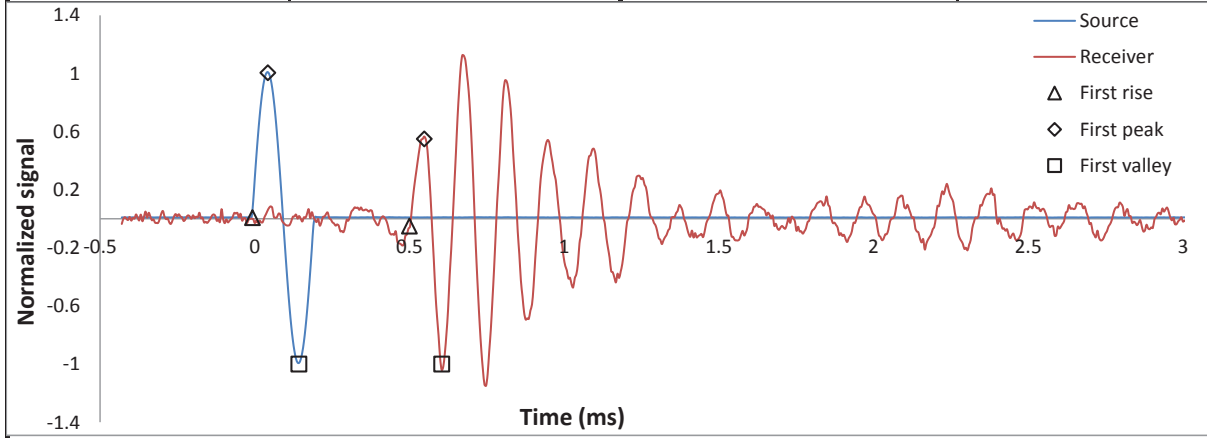

CSS Monotonic Shear Test Report

Geotechnical Engineering Laboratory



10/28/2013_Version 8.0

General Test Info and Sample Preparation

Device:	CSS	Relative Density (%):	30%
Specimen ID:	C109	Void Ratio:	0.686
Test ID:	M154	Height (mm):	113.1
Date of Test:	12/6/2014	Soil-Only Specimen Diameter (mm):	307.50
Test Performed:	Monotonic Shear	Weight (kg):	13.198
Test Material:	Ottawa C109 Sand	Density (kg/m³):	1571.3
Sample Preparation:	Prepared loose using a funnel with zero drop height.	Membrane Thickness (mm):	0.000
		Moisture Content (%):	0%
		Saturated (Y/N):	N
		Prepared by:	J. Hubler
		Checked by:	J. Hubler

Consolidation Stage

Vertical Stress (kPa):	100
Compression Time (min):	9.0
Relative Density (%):	42%
Void Ratio:	0.658
Height (mm):	111.2
Diameter (mm):	307.50
Weight (kg):	13.198
Density (kg/m³):	1597.9

Shear Stage

Type of Test:	Constant Volume
Stress or Strain Controlled:	Strain
Shear Strain Rate (%/min):	0.29
Peak Shear Strength (kPa):	12.9

Comments

Used Silver Baseplate, No Membrane. Tamped several times to reach desired density.

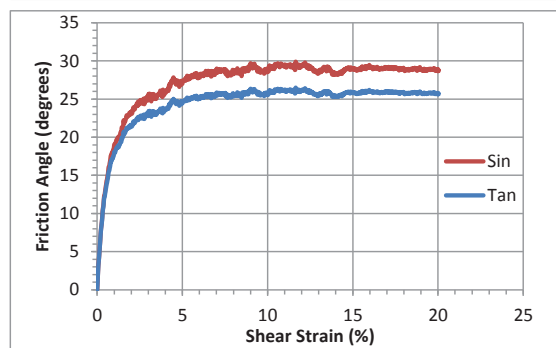
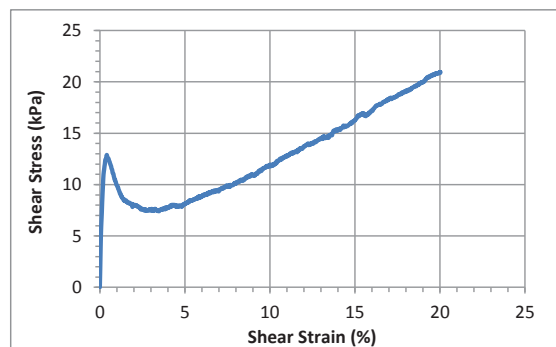
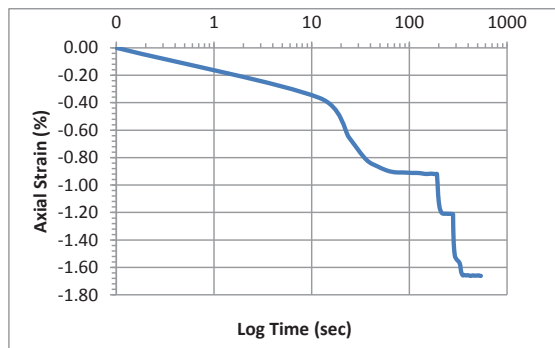
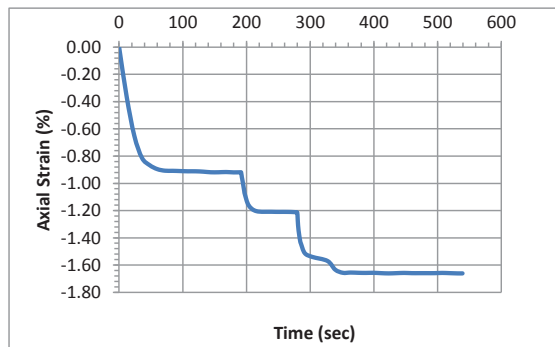

CSS Shear Wave Velocity Measurement Report



Geotechnical Engineering Laboratory

12/18/2013 Version 1.0

General Test Info and Sample Preparation			
Device:	CSS	Relative Density (%):	29%
Specimen ID:	C109L	Void Ratio:	0.686
Test ID:	M154	Height (mm):	113.1
Date of Test:	12/4/2014	Soil-Only Specimen Diameter	307.5
Test Performed:	Cyclic Shear	Weight (kg):	13.198
Test Material:	C109 Sand	Density (kg/m ³):	1571.3
Sample Preparation:	Prepared loosely using funneling method.	Membrane Thickness (mm):	0.000
		Moisture Content (%):	0%
		Saturated (Y/N):	N
		Prepared by:	J. Hubler
		Checked by:	J. Hubler
Consolidation Stage		Shear Wave Velocity Measurement	
Vertical Stress (kPa):	100	Signal type	Sinusoidal
Time to Compression	9.0	Signal amplitude (Vpp)	4.5
Relative Density (%):	42%	Signal frequency (kHz)	5.0
Void Ratio:	0.658	Sensor spacing (mm)	103.60
Height (mm):	111.2	Average Vs (m/s)	212.8
Density (kg/m ³):	1597.9	Stdev. (m/s)	11.6
First rise		P+V average Vs (m/s)	
Initiation time (ms)	-0.00750	Stdev. (m/s)	14.3
Arrival time (ms)	0.49500	Wavelength (m)	0.043
Vs (m/s)	206.2	Spacing/wavelength	2.4
First peak		First valley	
Initiation time (ms)	0.04200	Initiation time (ms)	0.14200
Arrival time (ms)	0.54500	Arrival time (ms)	0.60000
Vs (m/s)	206.0	Vs (m/s)	226.2

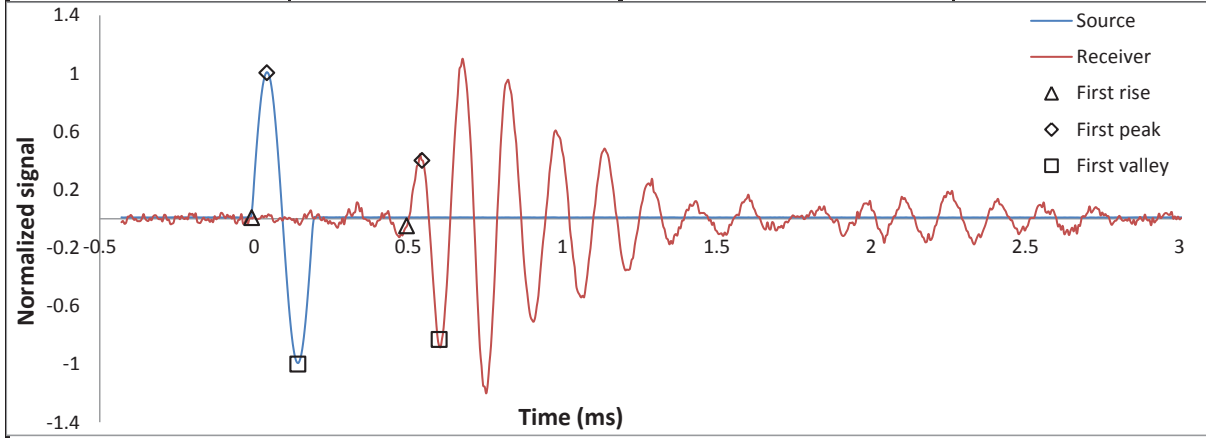

CSS Monotonic Shear Test Report

Geotechnical Engineering Laboratory



10/28/2013_Version 8.0

General Test Info and Sample Preparation

Device:	CSS	Relative Density (%):	32%
Specimen ID:	C109	Void Ratio:	0.681
Test ID:	M155	Height (mm):	113.3
Date of Test:	12/6/2014	Soil-Only Specimen Diameter (mm):	307.50
Test Performed:	Monotonic Shear	Weight (kg):	13.262
Test Material:	Ottawa C109 Sand	Density (kg/m³):	1576.5
Sample Preparation:	Prepared loose using a funnel with zero drop height.	Membrane Thickness (mm):	0.000
		Moisture Content (%):	0%
		Saturated (Y/N):	N
		Prepared by:	J. Hubler
		Checked by:	J. Hubler

Consolidation Stage

Vertical Stress (kPa):	100
Compression Time (min):	8.1
Relative Density (%):	43%
Void Ratio:	0.657
Height (mm):	111.6
Diameter (mm):	307.50
Weight (kg):	13.262
Density (kg/m³):	1599.7

Shear Stage

Type of Test:	Constant Volume
Stress or Strain Controlled:	Strain
Shear Strain Rate (%/min):	0.29
Peak Shear Strength (kPa):	14.7

Comments

Used Silver Baseplate, No Membrane. Tamped several times to reach desired density.

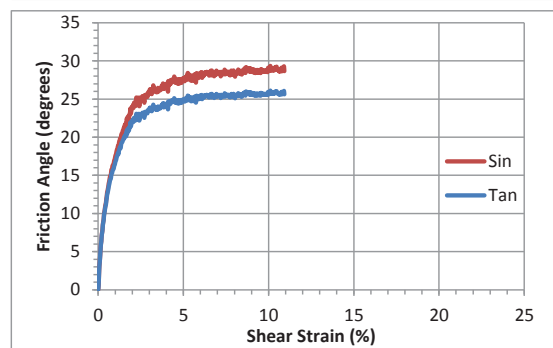
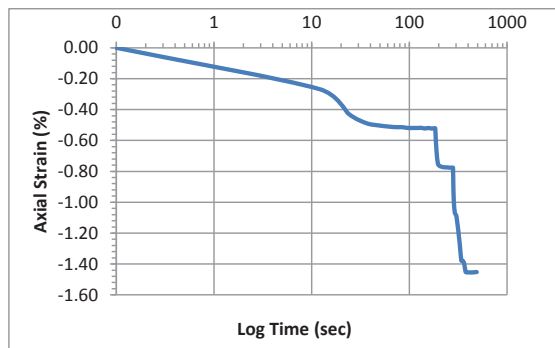
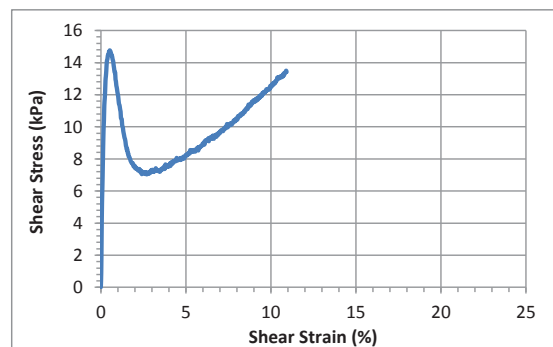
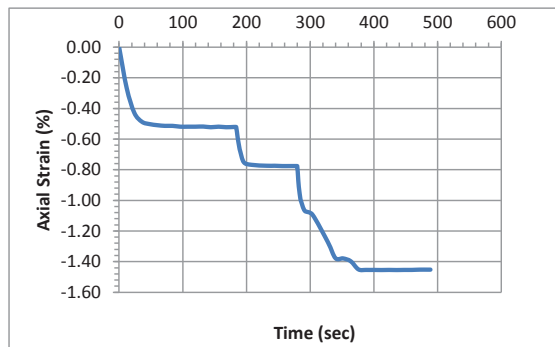

CSS Shear Wave Velocity Measurement Report



Geotechnical Engineering Laboratory

12/18/2013 Version 1.0

General Test Info and Sample Preparation

Device:	CSS	Relative Density (%):	32%
Specimen ID:	C109L	Void Ratio:	0.681
Test ID:	M155	Height (mm):	113.27
Date of Test:	12/4/2014	Soil-Only Specimen Diameter	307.5
Test Performed:	Cyclic Shear	Weight (kg):	13.262
Test Material:	C109 Sand	Density (kg/m ³):	1576.6
Sample Preparation:	Prepared loosely using funneling method.	Membrane Thickness (mm):	0.000
		Moisture Content (%):	0%
		Saturated (Y/N):	N
		Prepared by:	J. Hubler
		Checked by:	J. Hubler

Consolidation Stage

Vertical Stress (kPa):	100
Time to Compression	8.1
Relative Density (%):	43%
Void Ratio:	0.657
Height (mm):	111.6
Density (kg/m ³):	1599.7

Shear Wave Velocity Measurement

Signal type	Sinusoidal
Signal amplitude (Vpp)	4.5
Signal frequency (kHz)	5.0
Sensor spacing (mm)	104.01
Average Vs (m/s)	215.0
Stdev. (m/s)	10.5
P+V average Vs (m/s)	218.0
Stdev. (m/s)	12.9
Wavelength (m)	0.043
Spacing/wavelength	2.4

First rise

Initiation time (ms)	-0.00750
Arrival time (ms)	0.49000
Vs (m/s)	209.1

First peak

Initiation time (ms)	0.04200
Arrival time (ms)	0.54000
Vs (m/s)	208.9

First valley

Initiation time (ms)	0.14200
Arrival time (ms)	0.60000
Vs (m/s)	227.1

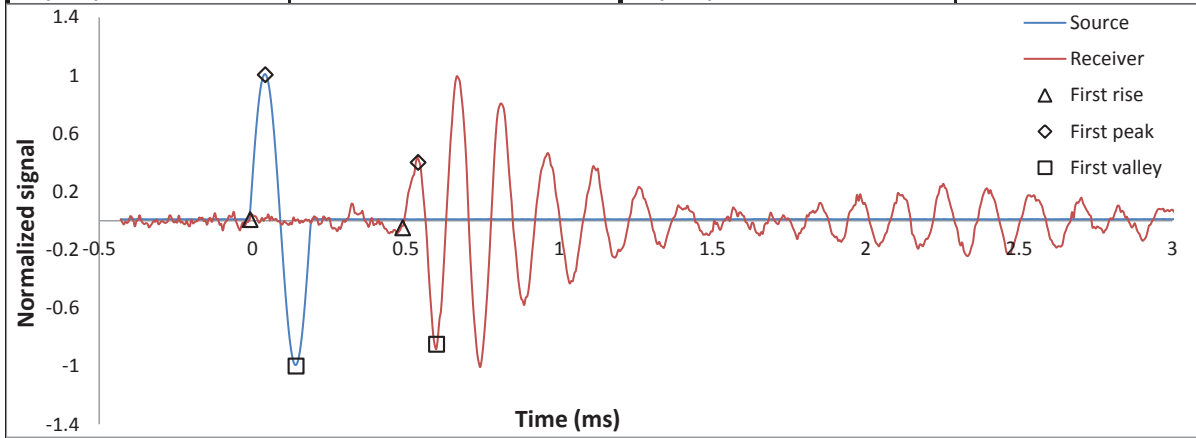

CSS Monotonic Shear Test Report

Geotechnical Engineering Laboratory



10/28/2013_Version 8.0

General Test Info and Sample Preparation

Device:	CSS	Relative Density (%):	31%
Specimen ID:	C109	Void Ratio:	0.683
Test ID:	M156	Height (mm):	113.1
Date of Test:	12/8/2014	Soil-Only Specimen Diameter (mm):	307.50
Test Performed:	Monotonic Shear	Weight (kg):	13.233
Test Material:	Ottawa C109 Sand	Density (kg/m³):	1574.9
Sample Preparation:	Prepared loose using a funnel with zero drop height.	Membrane Thickness (mm):	0.000
		Moisture Content (%):	0%
		Saturated (Y/N):	N
		Prepared by:	J.Hubler
		Checked by:	J. Hubler

Consolidation Stage

Vertical Stress (kPa):	100
Compression Time (min):	10.6
Relative Density (%):	43%
Void Ratio:	0.657
Height (mm):	111.4
Diameter (mm):	307.50
Weight (kg):	13.233
Density (kg/m³):	1599.3

Shear Stage

Type of Test:	Constant Volume
Stress or Strain Controlled:	Strain
Shear Strain Rate (%/min):	0.29
Peak Shear Strength (kPa):	14.2

Comments

Used Silver Baseplate, No Membrane. Tamped several times to reach desired density.

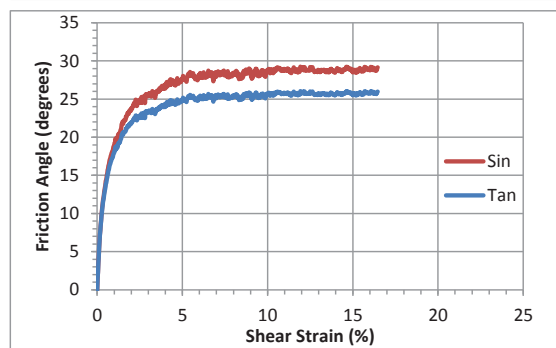
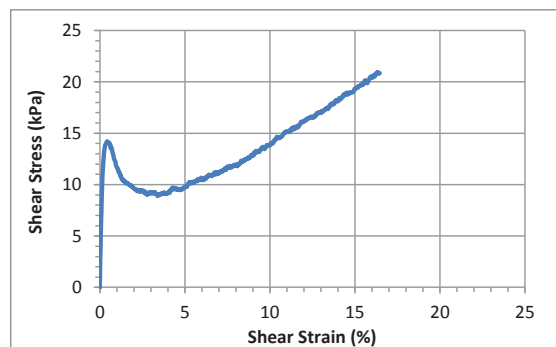
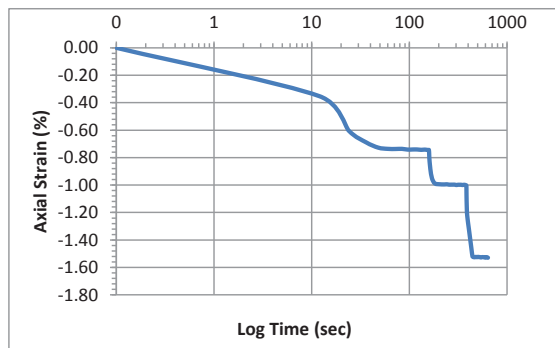
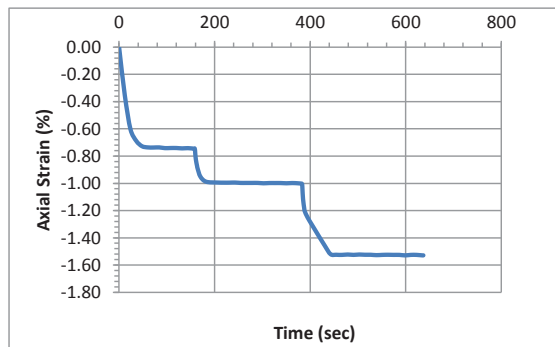

CSS Shear Wave Velocity Measurement Report



Geotechnical Engineering Laboratory

12/18/2013 Version 1.0

General Test Info and Sample Preparation			
Device:	CSS	Relative Density (%):	31%
Specimen ID:	C109L	Void Ratio:	0.683
Test ID:	M156	Height (mm):	113.15
Date of Test:	12/7/2014	Soil-Only Specimen Diameter	307.5
Test Performed:	Cyclic Shear	Weight (kg):	13.233
Test Material:	C109 Sand	Density (kg/m ³):	1574.8
Sample Preparation:	Prepared loosely using funneling method.	Membrane Thickness (mm):	0.000
		Moisture Content (%):	0%
		Saturated (Y/N):	N
		Prepared by:	J. Hubler
		Checked by:	J. Hubler
Consolidation Stage		Shear Wave Velocity Measurement	
Vertical Stress (kPa):	100	Signal type	Sinusoidal
Time to Compression	10.6	Signal amplitude (Vpp)	4.5
Relative Density (%):	43%	Signal frequency (kHz)	5.0
Void Ratio:	0.657	Sensor spacing (mm)	103.80
Height (mm):	111.4	Average Vs (m/s)	211.7
Density (kg/m ³):	1599.1	Stdev. (m/s)	9.5
First rise		P+V average Vs (m/s)	
Initiation time (ms)	-0.00750	Stdev. (m/s)	11.6
Arrival time (ms)	0.49600	Wavelength (m)	0.042
Vs (m/s)	206.1	Spacing/wavelength	2.5
First peak		First valley	
Initiation time (ms)	0.04200	Initiation time (ms)	0.14200
Arrival time (ms)	0.54500	Arrival time (ms)	0.60800
Vs (m/s)	206.4	Vs (m/s)	222.7

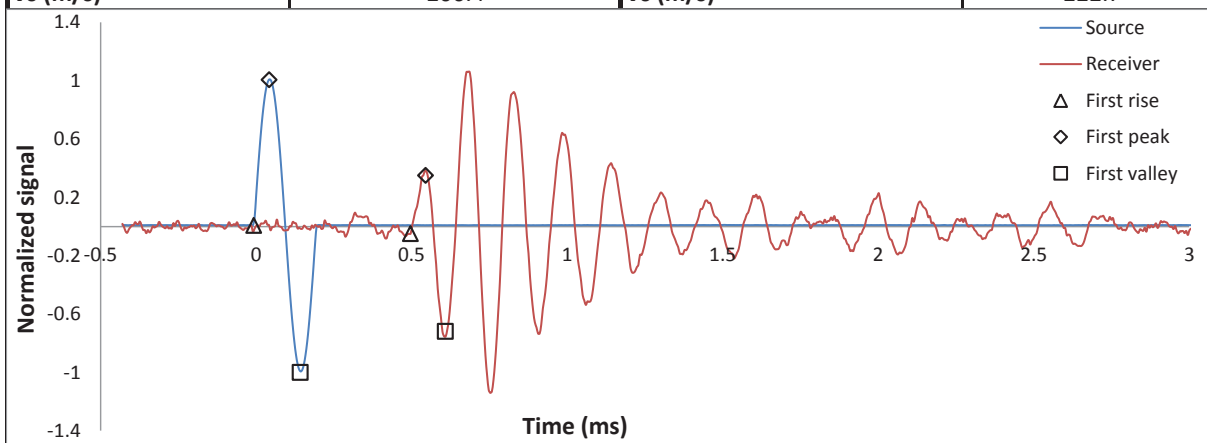

CSS Monotonic Shear Test Report

Geotechnical Engineering Laboratory



10/28/2013_Version 8.0

General Test Info and Sample Preparation

Device:	CSS	Relative Density (%):	26%
Specimen ID:	C109	Void Ratio:	0.694
Test ID:	M157	Height (mm):	113.5
Date of Test:	12/8/2014	Soil-Only Specimen Diameter (mm):	307.50
Test Performed:	Monotonic Shear	Weight (kg):	13.184
Test Material:	Ottawa C109 Sand	Density (kg/m ³):	1564.6
Sample Preparation:	Prepared loose using a funnel with zero drop height.	Membrane Thickness (mm):	0.000
		Moisture Content (%):	0%
		Saturated (Y/N):	N
		Prepared by:	J. Hubler
		Checked by:	J. Hubler

Consolidation Stage

Vertical Stress (kPa):	200
Compression Time (min):	8.6
Relative Density (%):	44%
Void Ratio:	0.654
Height (mm):	110.8
Diameter (mm):	307.50
Weight (kg):	13.184
Density (kg/m ³):	1602.3

Shear Stage

Type of Test:	Constant Volume
Stress or Strain Controlled:	Strain
Shear Strain Rate (%/min):	0.30
Peak Shear Strength (kPa):	23.4

Comments

Used Silver Baseplate, No Membrane. Tamped several times to reach desired density.

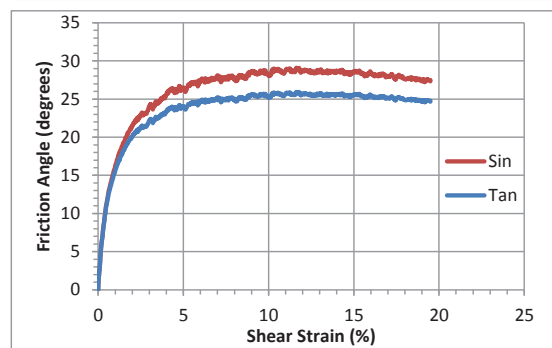
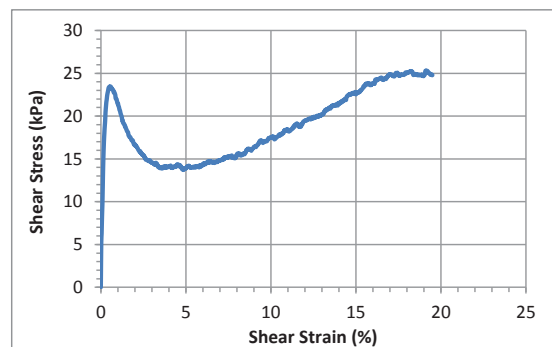
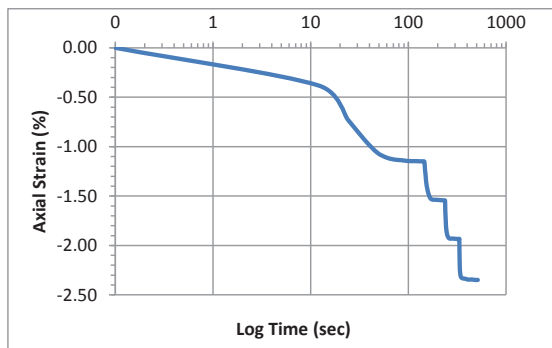
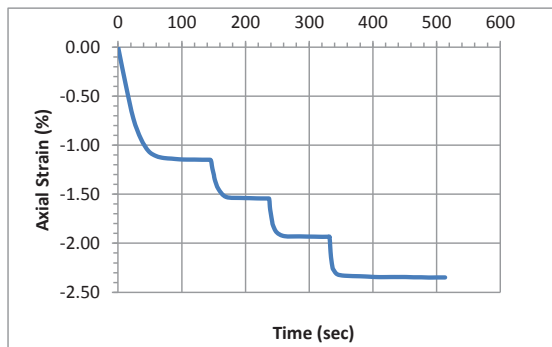

CSS Shear Wave Velocity Measurement Report



Geotechnical Engineering Laboratory

12/18/2013 Version 1.0

General Test Info and Sample Preparation			
Device:	CSS	Relative Density (%):	26%
Specimen ID:	C109L	Void Ratio:	0.694
Test ID:	M157	Height (mm):	113.46
Date of Test:	12/7/2014	Soil-Only Specimen Diameter	307.5
Test Performed:	Cyclic Shear	Weight (kg):	13.184
Test Material:	C109 Sand	Density (kg/m ³):	1564.7
Sample Preparation:	Prepared loosely using funneling method.	Membrane Thickness (mm):	0.000
		Moisture Content (%):	0%
		Saturated (Y/N):	N
		Prepared by:	J. Hubler
		Checked by:	J. Hubler
Consolidation Stage		Shear Wave Velocity Measurement	
Vertical Stress (kPa):	200	Signal type	Sinusoidal
Time to Compression	8.6	Signal amplitude (Vpp)	4.5
Relative Density (%):	44%	Signal frequency (kHz)	5.0
Void Ratio:	0.654	Sensor spacing (mm)	103.18
Height (mm):	110.8	Average Vs (m/s)	243.9
Density (kg/m ³):	1602.2	Stdev. (m/s)	13.3
First rise		P+V average Vs (m/s)	
Initiation time (ms)	-0.00750	Stdev. (m/s)	16.0
Arrival time (ms)	0.43000	Wavelength (m)	0.049
Vs (m/s)	235.8	Spacing/wavelength	2.1
First peak		First valley	
Initiation time (ms)	0.04200	Initiation time (ms)	0.14200
Arrival time (ms)	0.47800	Arrival time (ms)	0.54000
Vs (m/s)	236.6	Vs (m/s)	259.2

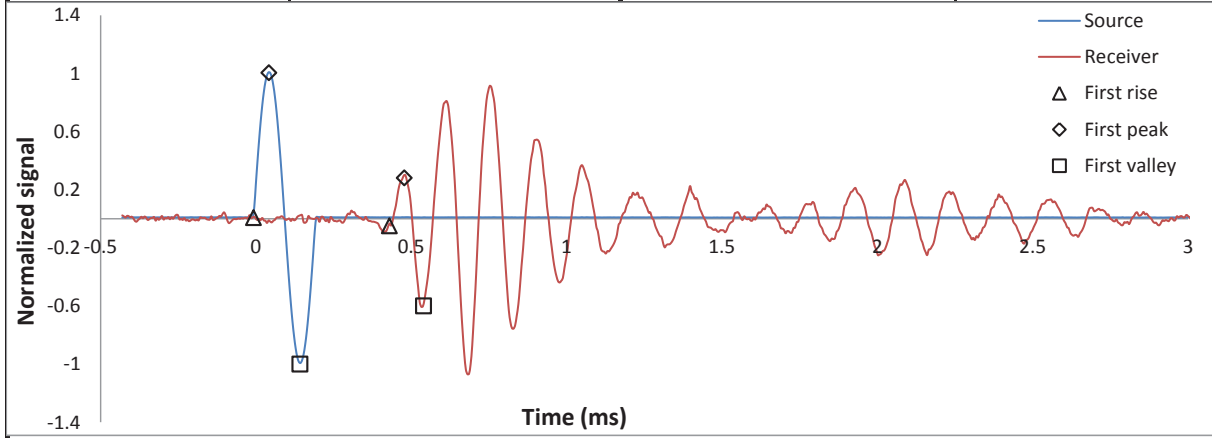

CSS Monotonic Shear Test Report

Geotechnical Engineering Laboratory



10/28/2013_Version 8.0

General Test Info and Sample Preparation

Device:	CSS	Relative Density (%):	48%
Specimen ID:	C109	Void Ratio:	0.645
Test ID:	M158	Height (mm):	115.9
Date of Test:	12/8/2014	Soil-Only Specimen Diameter (mm):	307.50
Test Performed:	Monotonic Shear	Weight (kg):	13.867
Test Material:	Ottawa C109 Sand	Density (kg/m ³):	1611.3
Sample Preparation:	Prepared dense by tamping with a rubber mallet to desired density (15x in 3 layers).	Membrane Thickness (mm):	0.000
		Moisture Content (%):	0%
		Saturated (Y/N):	N
		Prepared by:	J. Hubler
		Checked by:	J. Hubler

Consolidation Stage

Vertical Stress (kPa):	100
Compression Time (min):	11.6
Relative Density (%):	66%
Void Ratio:	0.605
Height (mm):	113.1
Diameter (mm):	307.50
Weight (kg):	13.867
Density (kg/m ³):	1651.4

Shear Stage

Type of Test:	Constant Volume
Stress or Strain Controlled:	Strain
Shear Strain Rate (%/min):	0.29
Peak Shear Strength (kPa):	19.1

Comments

Used Silver Baseplate, No Membrane

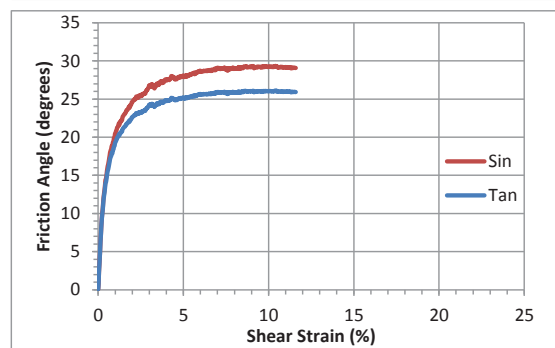
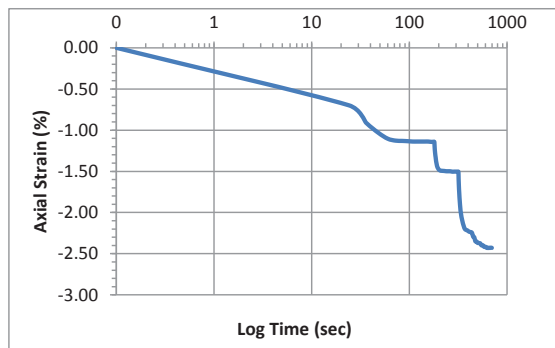
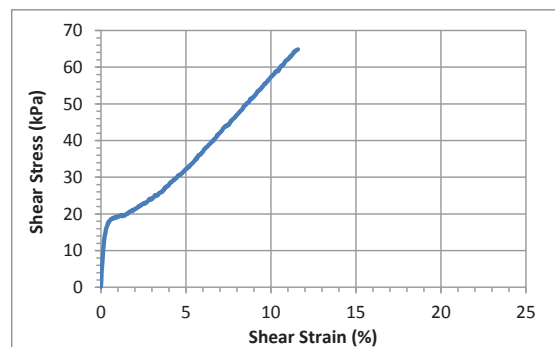
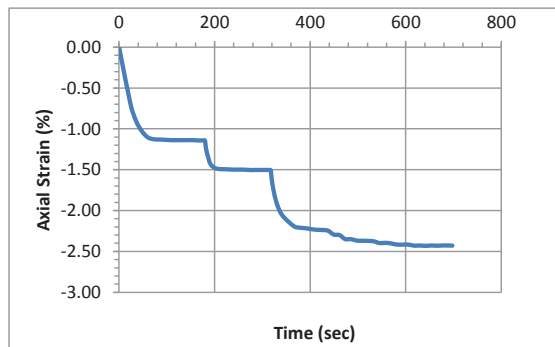

CSS Shear Wave Velocity Measurement Report



Geotechnical Engineering Laboratory

12/18/2013 Version 1.0

General Test Info and Sample Preparation			
Device:	CSS	Relative Density (%):	48%
Specimen ID:	C109L	Void Ratio:	0.645
Test ID:	M158	Height (mm):	115.89
Date of Test:	12/8/2014	Soil-Only Specimen Diameter	307.5
Test Performed:	Cyclic Shear	Weight (kg):	13.867
Test Material:	C109 Sand	Density (kg/m ³):	1611.2
Sample Preparation:	Prepared dense by tamping with a rubber amallet to desired density (15x in 3 layers).	Membrane Thickness (mm):	0.000
		Moisture Content (%):	0%
		Saturated (Y/N):	N
		Prepared by:	J. Hubler
		Checked by:	J. Hubler
Consolidation Stage		Shear Wave Velocity Measurement	
Vertical Stress (kPa):	100	Signal type	Sinusoidal
Time to Compression	11.6	Signal amplitude (Vpp)	4.5
Relative Density (%):	66%	Signal frequency (kHz)	5.0
Void Ratio:	0.605	Sensor spacing (mm)	105.45
Height (mm):	113.1	Average Vs (m/s)	227.4
Density (kg/m ³):	1651.4	Stdev. (m/s)	11.6
First rise		P+V average Vs (m/s)	
Initiation time (ms)	-0.00750	Stdev. (m/s)	14.2
Arrival time (ms)	0.47000	Wavelength (m)	0.045
Vs (m/s)	220.8	Spacing/wavelength	2.3
First peak		First valley	
Initiation time (ms)	0.04200	Initiation time (ms)	0.14200
Arrival time (ms)	0.52000	Arrival time (ms)	0.58000
Vs (m/s)	220.6	Vs (m/s)	240.8

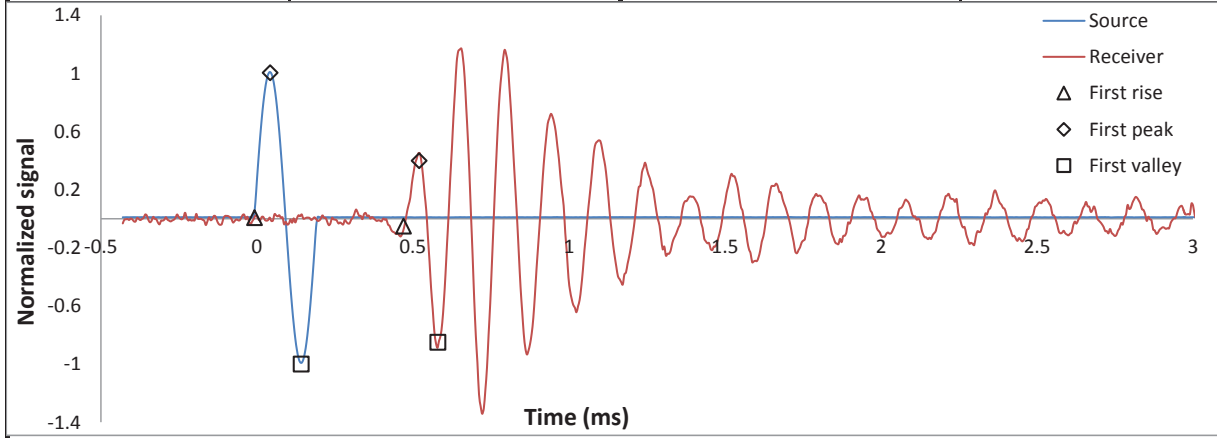

CSS Monotonic Shear Test Report

Geotechnical Engineering Laboratory



10/28/2013_Version 8.0

General Test Info and Sample Preparation

Device:	CSS	Relative Density (%):	56%
Specimen ID:	C109	Void Ratio:	0.628
Test ID:	M159	Height (mm):	117.0
Date of Test:	12/9/2014	Soil-Only Specimen Diameter (mm):	307.50
Test Performed:	Monotonic Shear	Weight (kg):	14.144
Test Material:	Ottawa C109 Sand	Density (kg/m³):	1628.1
Sample Preparation:	Prepared dense by tamping with a rubber mallet to desired density (15x in 3 layers).	Membrane Thickness (mm):	0.000
		Moisture Content (%):	0%
		Saturated (Y/N):	N
		Prepared by:	J.Hubler
		Checked by:	J. Hubler

Consolidation Stage

Vertical Stress (kPa):	100
Compression Time (min):	8.4
Relative Density (%):	71%
Void Ratio:	0.595
Height (mm):	114.6
Diameter (mm):	307.50
Weight (kg):	14.144
Density (kg/m³):	1661.6

Shear Stage

Type of Test:	Constant Volume
Stress or Strain Controlled:	Strain
Shear Strain Rate (%/min):	0.28
Peak Shear Strength (kPa):	13.6

Comments

Used Silver Baseplate, No Membrane

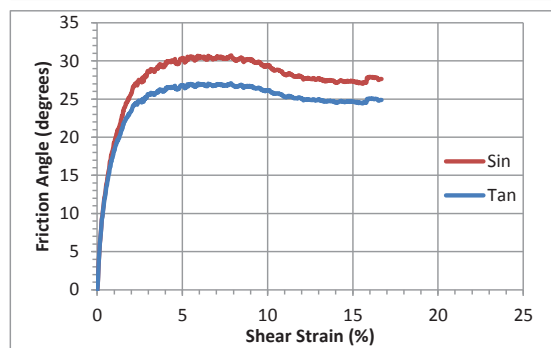
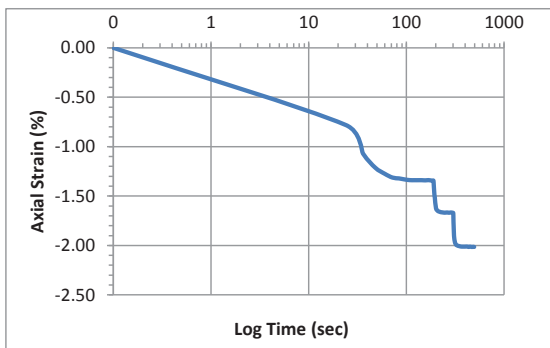
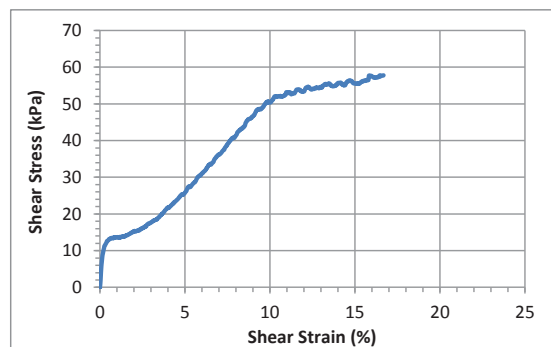
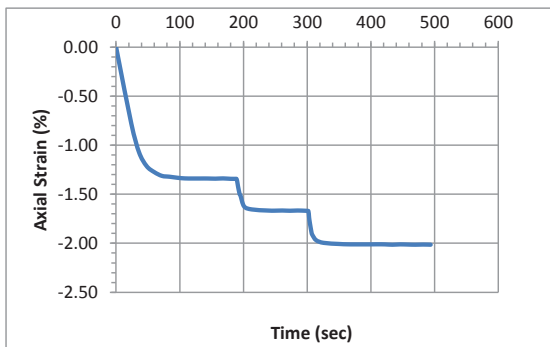

CSS Shear Wave Velocity Measurement Report



Geotechnical Engineering Laboratory

12/18/2013 Version 1.0

General Test Info and Sample Preparation

Device:	CSS	Relative Density (%):	56%
Specimen ID:	C109L	Void Ratio:	0.628
Test ID:	M159	Height (mm):	116.98
Date of Test:	12/9/2014	Soil-Only Specimen Diameter	307.5
Test Performed:	Cyclic Shear	Weight (kg):	14.144
Test Material:	C109 Sand	Density (kg/m ³):	1628.1
Sample Preparation:	Prepared dense by tamping with a rubber mallet to desired density (15x in 3 layers).	Membrane Thickness (mm):	0.000
		Moisture Content (%):	0%
		Saturated (Y/N):	N
		Prepared by:	J. Hubler
		Checked by:	J. Hubler

Consolidation Stage

Vertical Stress (kPa):	100
Time to Compression	8.4
Relative Density (%):	71%
Void Ratio:	0.595
Height (mm):	114.6
Density (kg/m ³):	1661.6

Shear Wave Velocity Measurement

Signal type	Sinusoidal
Signal amplitude (Vpp)	4.5
Signal frequency (kHz)	5.0
Sensor spacing (mm)	108.62
Average Vs (m/s)	213.4
Stdev. (m/s)	8.0
P+V average Vs (m/s)	216.1
Stdev. (m/s)	9.1
Wavelength (m)	0.043
Spacing/wavelength	2.5

First rise

Initiation time (ms)	-0.00750
Arrival time (ms)	0.51500
Vs (m/s)	207.9

First peak

Initiation time (ms)	0.04200
Arrival time (ms)	0.56000
Vs (m/s)	209.7

First valley

Initiation time (ms)	0.14200
Arrival time (ms)	0.63000
Vs (m/s)	222.6

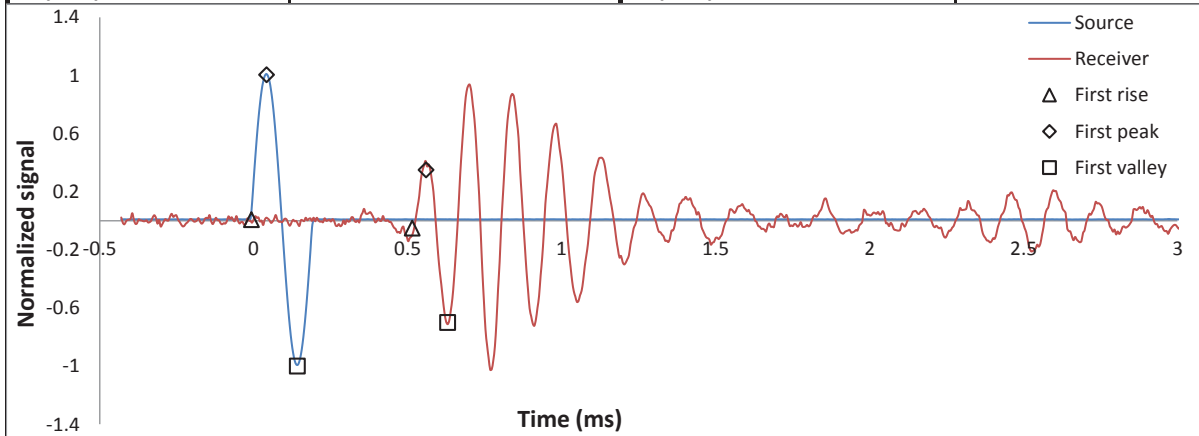

CSS Monotonic Shear Test Report

Geotechnical Engineering Laboratory



10/28/2013_Version 8.0

General Test Info and Sample Preparation

Device:	CSS	Relative Density (%):	70%
Specimen ID:	C109	Void Ratio:	0.595
Test ID:	M160	Height (mm):	122.3
Date of Test:	12/9/2014	Soil-Only Specimen Diameter (mm):	307.50
Test Performed:	Monotonic Shear	Weight (kg):	15.090
Test Material:	Ottawa C109 Sand	Density (kg/m³):	1661.0
Sample Preparation:	Prepared dense by tamping with a rubber mallet to desired density (20x in 3 layers).	Membrane Thickness (mm):	0.000
		Moisture Content (%):	0%
		Saturated (Y/N):	N
		Prepared by:	J.Hubler
		Checked by:	J. Hubler

Consolidation Stage

Vertical Stress (kPa):	100
Compression Time (min):	9.1
Relative Density (%):	82%
Void Ratio:	0.570
Height (mm):	120.4
Diameter (mm):	307.50
Weight (kg):	15.090
Density (kg/m³):	1687.8

Shear Stage

Type of Test:	Constant Volume
Stress or Strain Controlled:	Strain
Shear Strain Rate (%/min):	0.27
Peak Shear Strength (kPa):	15.0

Comments

Used Silver Baseplate, No Membrane

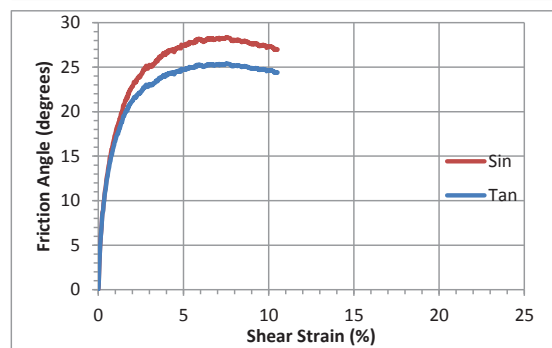
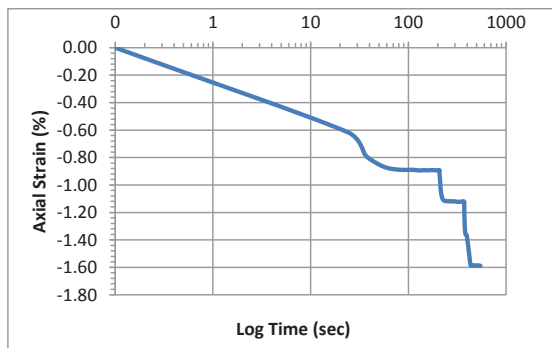
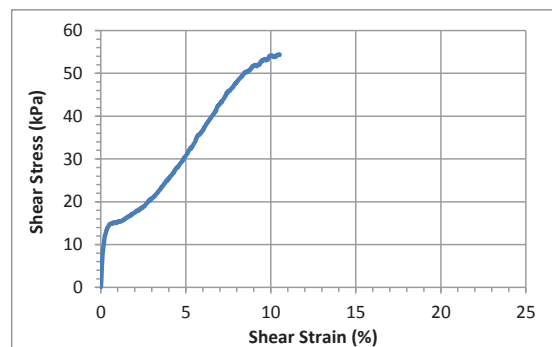
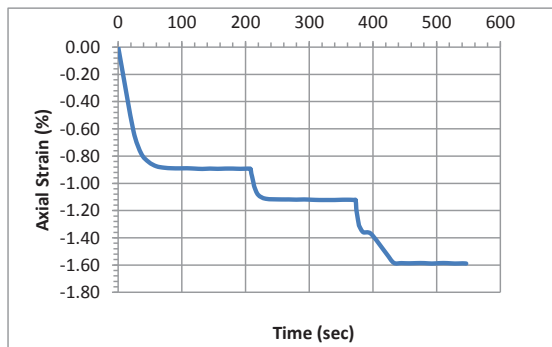

CSS Shear Wave Velocity Measurement Report



Geotechnical Engineering Laboratory

12/18/2013 Version 1.0

General Test Info and Sample Preparation

Device:	CSS	Relative Density (%):	70%
Specimen ID:	C109D	Void Ratio:	0.599
Test ID:	M160	Height (mm):	122.33
Date of Test:	12/9/2014	Soil-Only Specimen Diameter	307.5
Test Performed:	Cyclic Shear	Weight (kg):	15.09
Test Material:	C109 Sand	Density (kg/m ³):	1661.0
Sample Preparation:	Prepared dense by tamping with a rubber mallet to desired density (20x in layers).	Membrane Thickness (mm):	0.000
		Moisture Content (%):	0%
		Saturated (Y/N):	N
		Prepared by:	J. Hubler
		Checked by:	J. Hubler

Consolidation Stage

Vertical Stress (kPa):	100
Time to Compression	9.1
Relative Density (%):	82%
Void Ratio:	0.570
Height (mm):	120.4
Density (kg/m ³):	1687.8

Shear Wave Velocity Measurement

Signal type	Sinusoidal
Signal amplitude (Vpp)	4.5
Signal frequency (kHz)	5.0
Sensor spacing (mm)	112.77
Average Vs (m/s)	211.3
Stdev. (m/s)	6.2
P+V average Vs (m/s)	211.6
Stdev. (m/s)	8.7
Wavelength (m)	0.042
Spacing/wavelength	2.7

First rise

Initiation time (ms)	-0.00750
Arrival time (ms)	0.52760
Vs (m/s)	210.7

Initiation time (ms)	0.14200
Arrival time (ms)	0.66000
Vs (m/s)	217.7

First peak

Initiation time (ms)	0.04400
Arrival time (ms)	0.59300
Vs (m/s)	205.4

First valley

Initiation time (ms)	0.14200
Arrival time (ms)	0.66000
Vs (m/s)	217.7

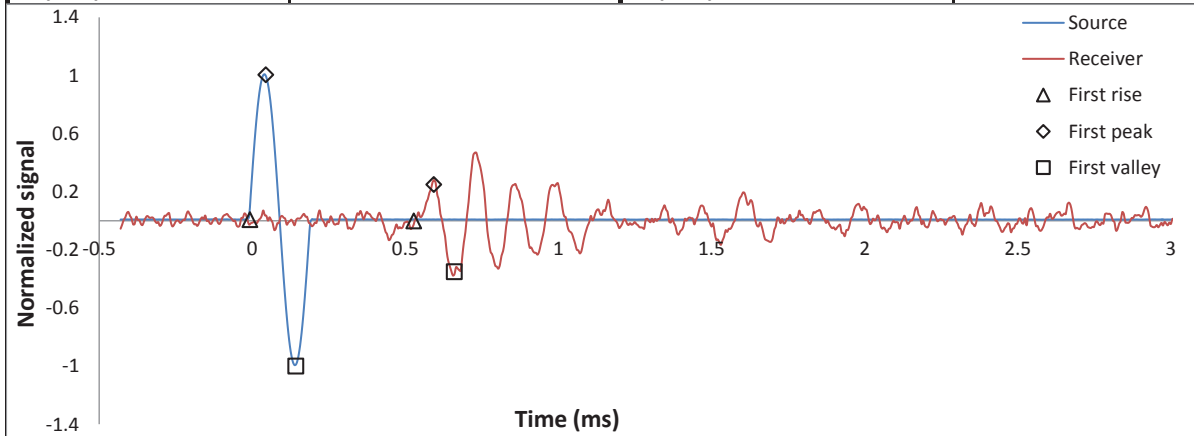

CSS Monotonic Shear Test Report

Geotechnical Engineering Laboratory



10/28/2013_Version 8.0

General Test Info and Sample Preparation

Device:	CSS	Relative Density (%):	61%
Specimen ID:	C109	Void Ratio:	0.615
Test ID:	M161	Height (mm):	115.2
Date of Test:	12/9/2014	Soil-Only Specimen Diameter (mm):	307.50
Test Performed:	Monotonic Shear	Weight (kg):	14.040
Test Material:	Ottawa C109 Sand	Density (kg/m³):	1640.6
Sample Preparation:	Prepared dense by tamping with a rubber mallet to desired density (15x in 3 layers).	Membrane Thickness (mm):	0.000
		Moisture Content (%):	0%
		Saturated (Y/N):	N
		Prepared by:	J.Hubler
		Checked by:	J. Hubler

Consolidation Stage

Vertical Stress (kPa):	200
Compression Time (min):	8.1
Relative Density (%):	70%
Void Ratio:	0.597
Height (mm):	114.0
Diameter (mm):	307.50
Weight (kg):	14.040
Density (kg/m³):	1659.1

Shear Stage

Type of Test:	Constant Volume
Stress or Strain Controlled:	Strain
Shear Strain Rate (%/min):	0.28
Peak Shear Strength (kPa):	34.0

Comments

Used Silver Baseplate, No Membrane

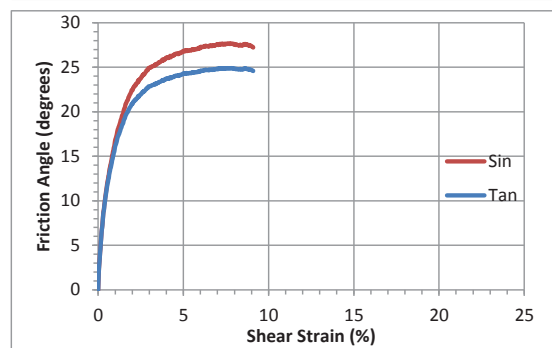
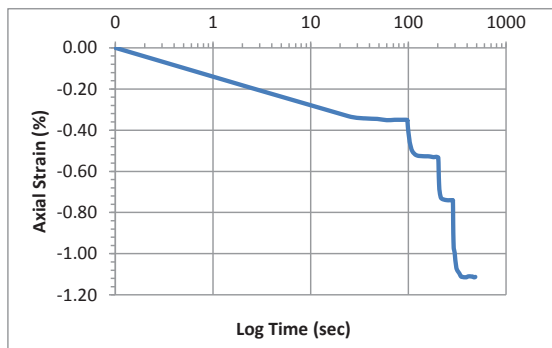
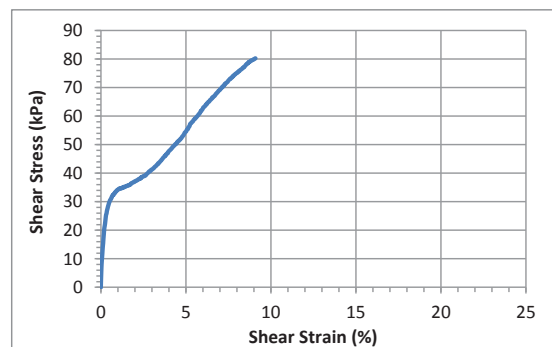
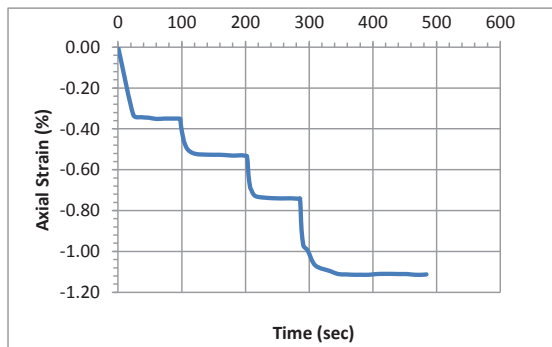

CSS Shear Wave Velocity Measurement Report



Geotechnical Engineering Laboratory

12/18/2013 Version 1.0

General Test Info and Sample Preparation			
Device:	CSS	Relative Density (%):	61%
Specimen ID:	C109D	Void Ratio:	0.615
Test ID:	M161	Height (mm):	115.23
Date of Test:	12/9/2014	Soil-Only Specimen Diameter	307.5
Test Performed:	Cyclic Shear	Weight (kg):	14.04
Test Material:	C109 Sand	Density (kg/m ³):	1640.7
Sample Preparation:	Prepared loosely using funneling method.	Membrane Thickness (mm):	0.000
		Moisture Content (%):	0%
		Saturated (Y/N):	N
		Prepared by:	J. Hubler
		Checked by:	J. Hubler
Consolidation Stage		Shear Wave Velocity Measurement	
Vertical Stress (kPa):	200	Signal type	Sinusoidal
Time to Compression	8.1	Signal amplitude (Vpp)	4.5
Relative Density (%):	70%	Signal frequency (kHz)	5.0
Void Ratio:	0.597	Sensor spacing (mm)	107.00
Height (mm):	114.0	Average Vs (m/s)	254.8
Density (kg/m ³):	1659.1	Stdev. (m/s)	13.6
		P+V average Vs (m/s)	258.5
		Stdev. (m/s)	16.9
Initiation time (ms)	-0.00750	Wavelength (m)	0.051
Arrival time (ms)	0.42500	Spacing/wavelength	2.1
Vs (m/s)	247.4		
First rise		First valley	
Initiation time (ms)	0.04200	Initiation time (ms)	0.14200
Arrival time (ms)	0.47600	Arrival time (ms)	0.53760
Vs (m/s)	246.5	Vs (m/s)	270.5

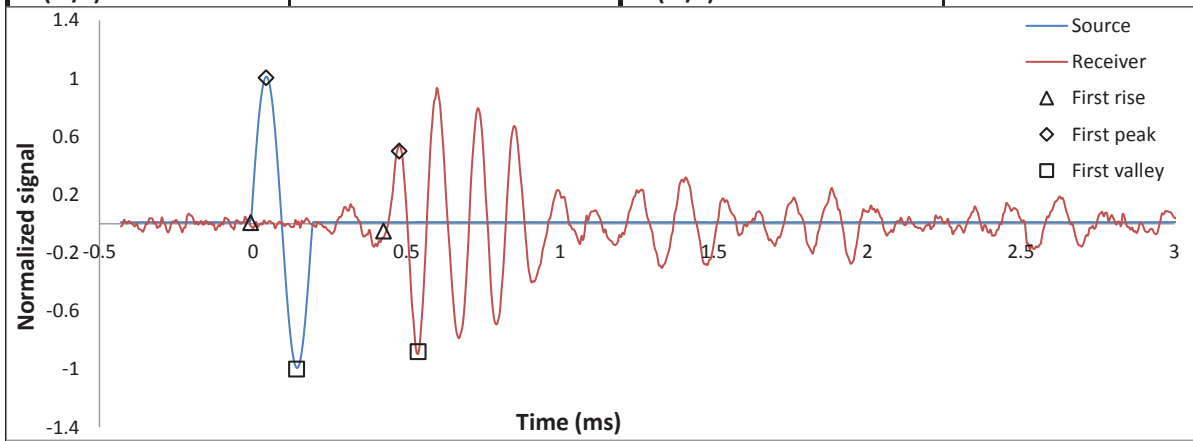

CSS Monotonic Shear Test Report

Geotechnical Engineering Laboratory



10/28/2013_Version 8.0

General Test Info and Sample Preparation

Device:	CSS	Relative Density (%):	44%
Specimen ID:	C109D	Void Ratio:	0.654
Test ID:	M162	Height (mm):	116.2
Date of Test:	12/9/2014	Soil-Only Specimen Diameter (mm):	307.50
Test Performed:	Monotonic Shear	Weight (kg):	13.829
Test Material:	C109 Sand	Density (kg/m³):	1601.9
Sample Preparation:	Prepared dense by tamping with a rubber mallet to desired density (10x in 3 layers).	Membrane Thickness (mm):	0.000
		Moisture Content (%):	0%
		Saturated (Y/N):	N
		Prepared by:	J.Hubler
		Checked by:	J. Hubler

Consolidation Stage

Vertical Stress (kPa):	400
Compression Time (min):	13.6
Relative Density (%):	58%
Void Ratio:	0.623
Height (mm):	114.1
Diameter (mm):	307.50
Weight (kg):	13.829
Density (kg/m³):	1632.5

Shear Stage

Type of Test:	Constant Volume
Stress or Strain Controlled:	Strain
Shear Strain Rate (%/min):	0.29
Peak Shear Strength (kPa):	57.7

Comments

Used Silver Baseplate, No Membrane

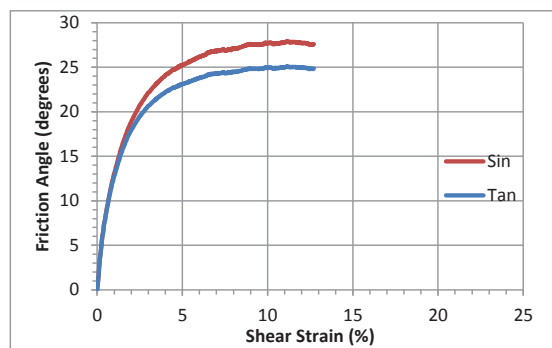
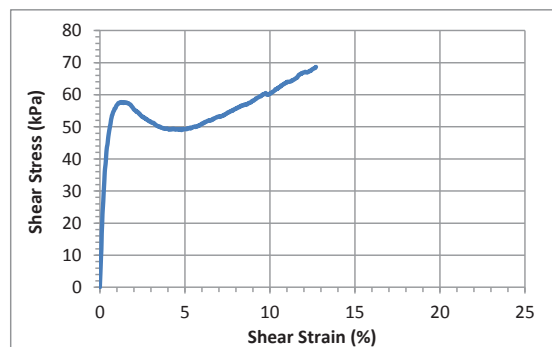
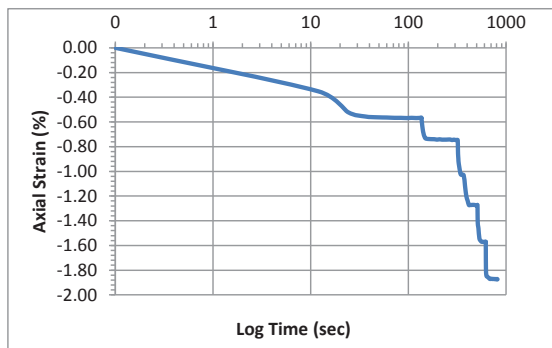
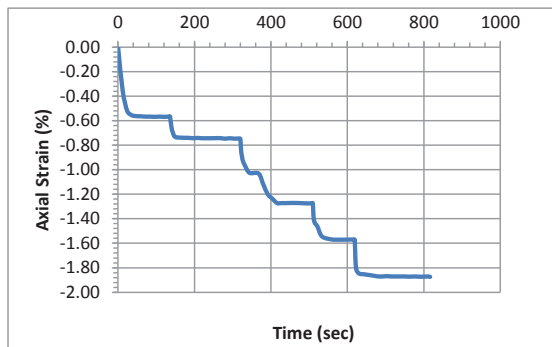

CSS Shear Wave Velocity Measurement Report



Geotechnical Engineering Laboratory

12/18/2013 Version 1.0

General Test Info and Sample Preparation

Device:	CSS	Relative Density (%):	44%
Specimen ID:	C109D	Void Ratio:	0.654
Test ID:	M162	Height (mm):	116.25
Date of Test:	12/9/2014	Soil-Only Specimen Diameter	307.5
Test Performed:	Cyclic Shear	Weight (kg):	13.823
Test Material:	C109 Sand	Density (kg/m ³):	1601.1
Sample Preparation:	Prepared dense by tamping with a rubber mallet to desired density (10x in 3 layers).	Membrane Thickness (mm):	0.000
		Moisture Content (%):	0%
		Saturated (Y/N):	N
		Prepared by:	J. Hubler
		Checked by:	J. Hubler

Consolidation Stage

Vertical Stress (kPa):	400
Time to Compression	13.6
Relative Density (%):	58%
Void Ratio:	0.623
Height (mm):	114.1
Density (kg/m ³):	1631.7

Shear Wave Velocity Measurement

Signal type	Sinusoidal
Signal amplitude (Vpp)	4.5
Signal frequency (kHz)	5.0
Sensor spacing (mm)	106.45
Average Vs (m/s)	291.2
Stdev. (m/s)	24.7
P+V average Vs (m/s)	299.5
Stdev. (m/s)	28.5
Wavelength (m)	0.058
Spacing/wavelength	1.8

First rise

Initiation time (ms)	-0.00750
Arrival time (ms)	0.38000
Vs (m/s)	274.7

First peak

Initiation time (ms)	0.04400
Arrival time (ms)	0.42500
Vs (m/s)	279.4

First valley

Initiation time (ms)	0.14200
Arrival time (ms)	0.47500
Vs (m/s)	319.7

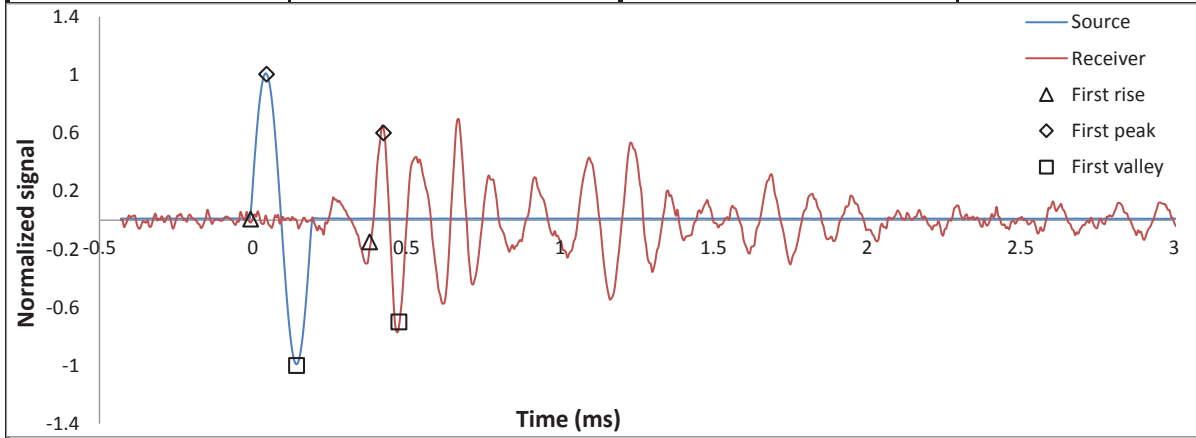

CSS Monotonic Shear Test Report

Geotechnical Engineering Laboratory



10/28/2013_Version 8.0

General Test Info and Sample Preparation

Device:	CSS	Relative Density (%):	46%
Specimen ID:	C109	Void Ratio:	0.649
Test ID:	M163	Height (mm):	114.8
Date of Test:	12/11/2014	Soil-Only Specimen Diameter (mm):	307.50
Test Performed:	Monotonic Shear	Weight (kg):	13.704
Test Material:	Ottawa C109 Sand	Density (kg/m³):	1606.8
Sample Preparation:	Prepared dense by tamping with a rubber mallet to desired density (10x in 3 layers).	Membrane Thickness (mm):	0.000
		Moisture Content (%):	0%
		Saturated (Y/N):	N
		Prepared by:	J. Hubler
		Checked by:	J. Hubler

Consolidation Stage

Vertical Stress (kPa):	200
Compression Time (min):	10.7
Relative Density (%):	58%
Void Ratio:	0.623
Height (mm):	113.0
Diameter (mm):	307.50
Weight (kg):	13.704
Density (kg/m³):	1632.5

Shear Stage

Type of Test:	Constant Volume
Stress or Strain Controlled:	Strain
Shear Strain Rate (%/min):	0.29
Peak Shear Strength (kPa):	30.6

Comments

Used Silver Baseplate, No Membrane

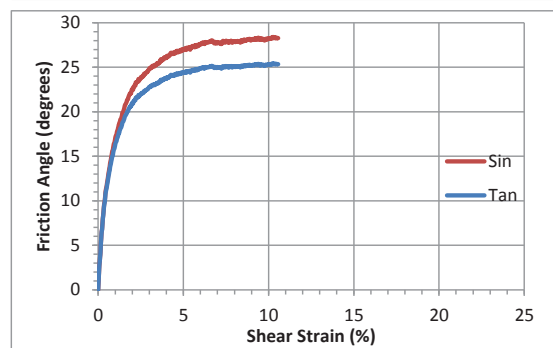
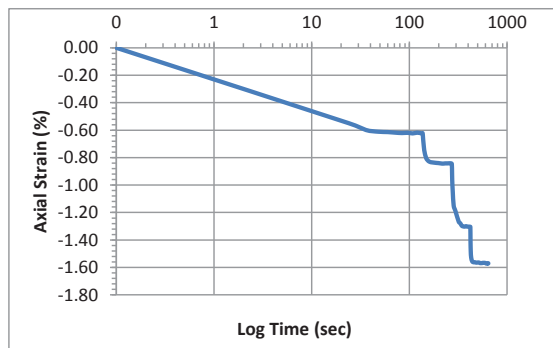
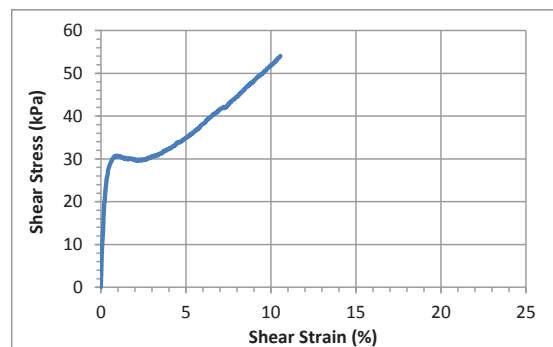
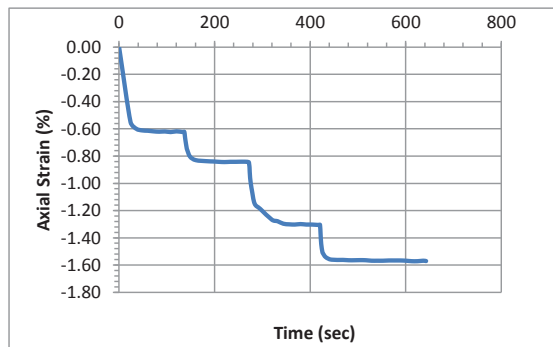

CSS Shear Wave Velocity Measurement Report



Geotechnical Engineering Laboratory

12/18/2013 Version 1.0

General Test Info and Sample Preparation			
Device:	CSS	Relative Density (%):	46%
Specimen ID:	C109D	Void Ratio:	0.649
Test ID:	M163	Height (mm):	114.84
Date of Test:	12/11/2014	Soil-Only Specimen Diameter	307.5
Test Performed:	Cyclic Shear	Weight (kg):	13.704
Test Material:	C109 Sand	Density (kg/m ³):	1606.8
Sample Preparation:	Prepared dense by tamping with a rubber mallet to desired density (10x in 3 layers).	Membrane Thickness (mm):	0.000
		Moisture Content (%):	0%
		Saturated (Y/N):	N
		Prepared by:	J. Hubler
		Checked by:	J. Hubler
Consolidation Stage		Shear Wave Velocity Measurement	
Vertical Stress (kPa):	200	Signal type	Sinusoidal
Time to Compression	10.7	Signal amplitude (Vpp)	4.5
Relative Density (%):	58%	Signal frequency (kHz)	5.0
Void Ratio:	0.623	Sensor spacing (mm)	105.42
Height (mm):	113.0	Average Vs (m/s)	244.9
Density (kg/m ³):	1632.4	Stdev. (m/s)	12.0
First rise		P+V average Vs (m/s)	
Initiation time (ms)	-0.00750	Stdev. (m/s)	12.5
Arrival time (ms)	0.44000	Wavelength (m)	0.049
Vs (m/s)	235.6	Spacing/wavelength	2.2
First peak		First valley	
Initiation time (ms)	0.04200	Initiation time (ms)	0.14200
Arrival time (ms)	0.48000	Arrival time (ms)	0.55000
Vs (m/s)	240.7	Vs (m/s)	258.4

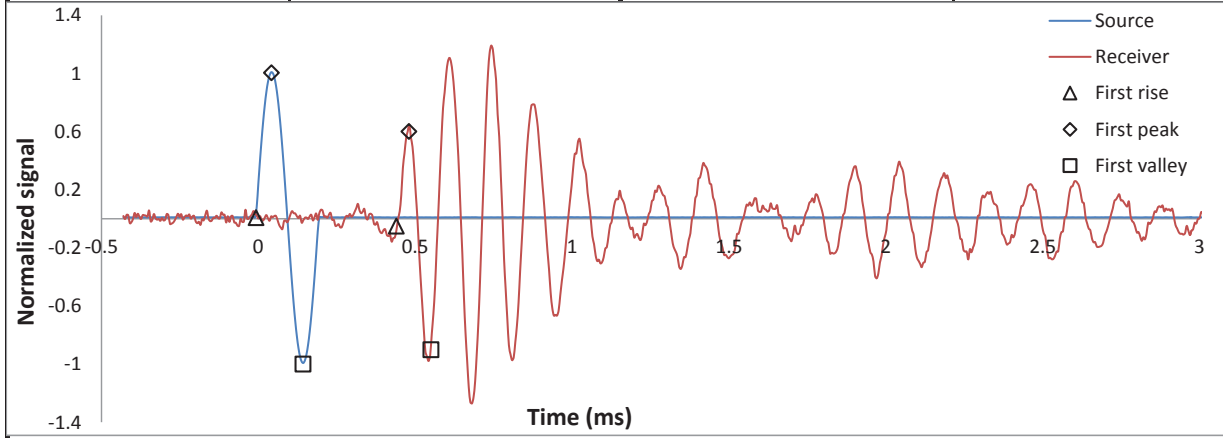

CSS Monotonic Shear Test Report

Geotechnical Engineering Laboratory



10/28/2013_Version 8.0

General Test Info and Sample Preparation

Device:	CSS	Relative Density (%):	56%
Specimen ID:	C109	Void Ratio:	0.627
Test ID:	M164	Height (mm):	115.0
Date of Test:	12/11/2014	Soil-Only Specimen Diameter (mm):	307.50
Test Performed:	Monotonic Shear	Weight (kg):	13.907
Test Material:	Ottawa C109 Sand	Density (kg/m³):	1628.4
Sample Preparation:	Prepared dense by tamping with a rubber mallet to desired density (15x in 3 layers).	Membrane Thickness (mm):	0.000
		Moisture Content (%):	0%
		Saturated (Y/N):	N
		Prepared by:	J.Hubler
		Checked by:	J. Hubler

Consolidation Stage

Vertical Stress (kPa):	200
Compression Time (min):	7.6
Relative Density (%):	67%
Void Ratio:	0.603
Height (mm):	113.3
Diameter (mm):	307.50
Weight (kg):	13.907
Density (kg/m³):	1653.4

Shear Stage

Type of Test:	Constant Volume
Stress or Strain Controlled:	Strain
Shear Strain Rate (%/min):	0.29
Peak Shear Strength (kPa):	26.7

Comments

Used Silver Baseplate, No Membrane

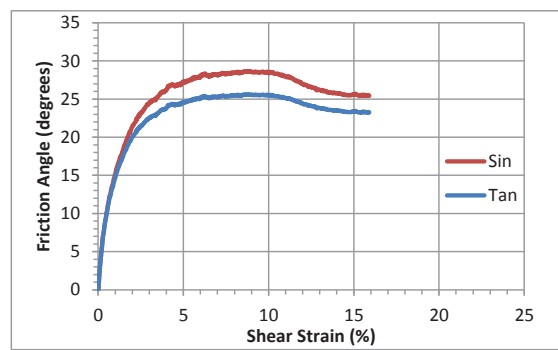
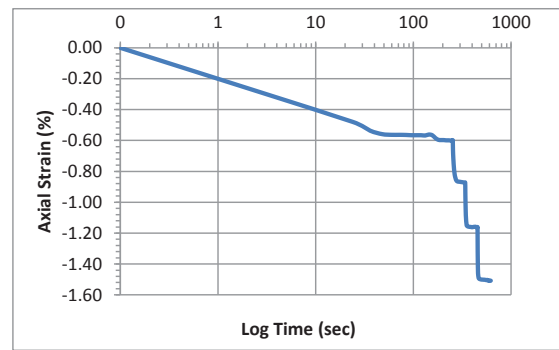
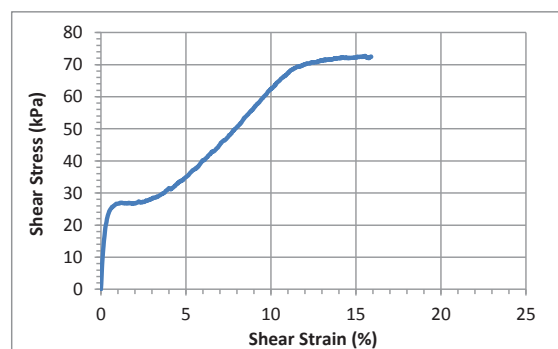
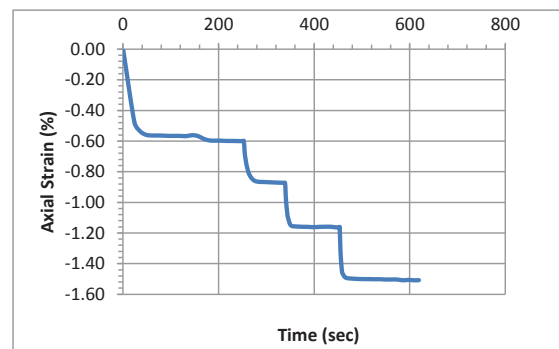

CSS Shear Wave Velocity Measurement Report



Geotechnical Engineering Laboratory

12/18/2013 Version 1.0

General Test Info and Sample Preparation			
Device:	CSS	Relative Density (%):	56%
Specimen ID:	C109L	Void Ratio:	0.627
Test ID:	M164	Height (mm):	115.0
Date of Test:	12/11/2014	Soil-Only Specimen Diameter	307.5
Test Performed:	Monotonic Shear	Weight (kg):	13.021
Test Material:	C109 Sand	Density (kg/m ³):	1524.64
Sample Preparation:	Prepared dense by tamping with a rubber mallet to desired density (15x in 3 layers).	Membrane Thickness (mm):	0.000
		Moisture Content (%):	0%
		Saturated (Y/N):	N
		Prepared by:	R. Thompson
		Checked by:	J. Hubler
Consolidation Stage		Shear Wave Velocity Measurement	
Vertical Stress (kPa):	200	Signal type	Sinusoidal
Time to Compression	10.3	Signal amplitude (Vpp)	4.5
Relative Density (%):	67%	Signal frequency (kHz)	5.0
Void Ratio:	0.603	Sensor spacing (mm)	105.65
Height (mm):	113.3	Average Vs (m/s)	251.6
Density (kg/m ³):	1547.51	Stdev. (m/s)	16.7
First rise		P+V average Vs (m/s)	256.6
Initiation time (ms)	-0.00750	Stdev. (m/s)	20.2
Arrival time (ms)	0.43000	Wavelength (m)	0.050
Vs (m/s)	241.5	Spacing/wavelength	2.1
First peak		First valley	
Initiation time (ms)	0.04200	Initiation time (ms)	0.14500
Arrival time (ms)	0.47800	Arrival time (ms)	0.53500
Vs (m/s)	242.3	Vs (m/s)	270.9

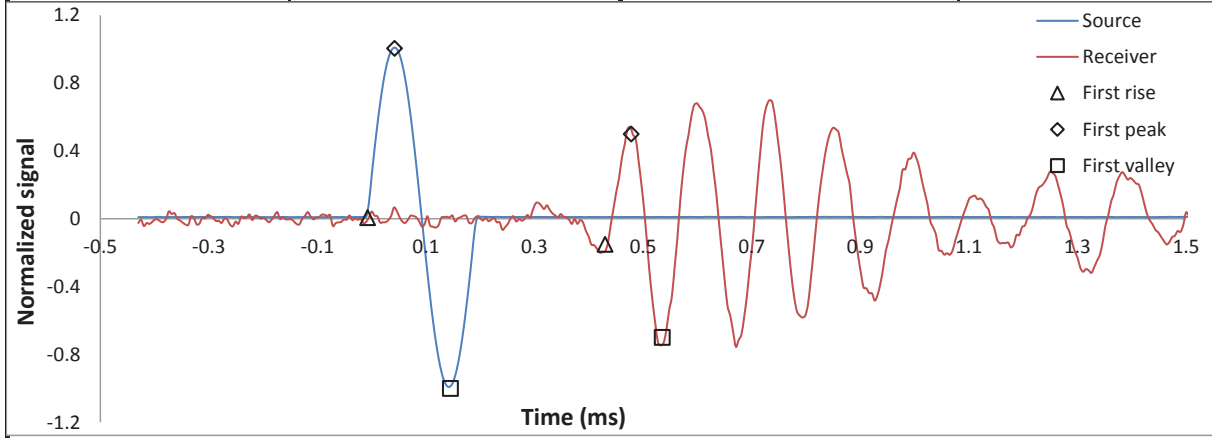

CSS Monotonic Shear Test Report

Geotechnical Engineering Laboratory



10/28/2013_Version 8.0

General Test Info and Sample Preparation

Device:	CSS	Relative Density (%):	61%
Specimen ID:	C109	Void Ratio:	0.615
Test ID:	M165	Height (mm):	116.1
Date of Test:	12/11/2014	Soil-Only Specimen Diameter (mm):	307.50
Test Performed:	Monotonic Shear	Weight (kg):	14.145
Test Material:	Ottawa C109 Sand	Density (kg/m³):	1640.4
Sample Preparation:	Prepared dense by tamping with a rubber mallet to desired density (15x in 3 layers).	Membrane Thickness (mm):	0.000
		Moisture Content (%):	0%
		Saturated (Y/N):	N
		Prepared by:	J.Hubler
		Checked by:	J. Hubler

Consolidation Stage

Shear Stage

Vertical Stress (kPa):	100	Type of Test:	Constant Volume
Compression Time (min):	9.5	Stress or Strain Controlled:	Strain
Relative Density (%):	67%	Shear Strain Rate (%/min):	0.28
Void Ratio:	0.602	Peak Shear Strength (kPa):	13.6
Height (mm):	115.2	Comments	
Diameter (mm):	307.50	Used Silver Baseplate, No Membrane	
Weight (kg):	14.145		
Density (kg/m³):	1653.8		

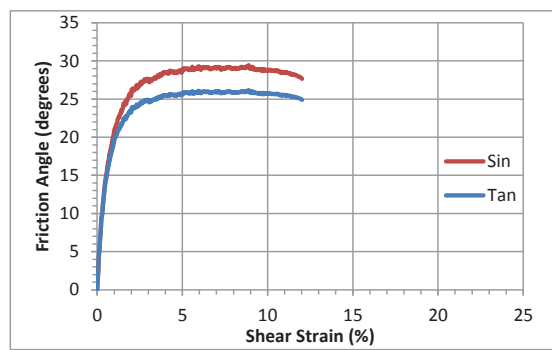
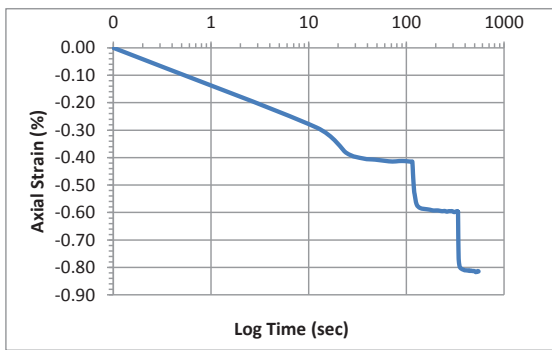
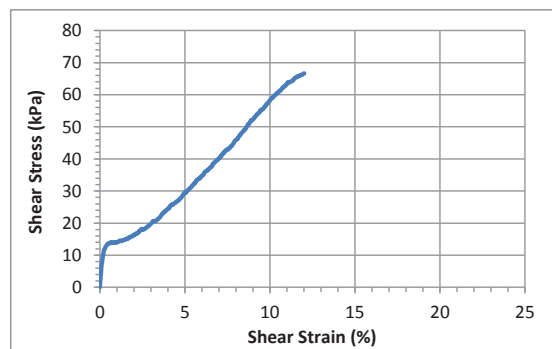
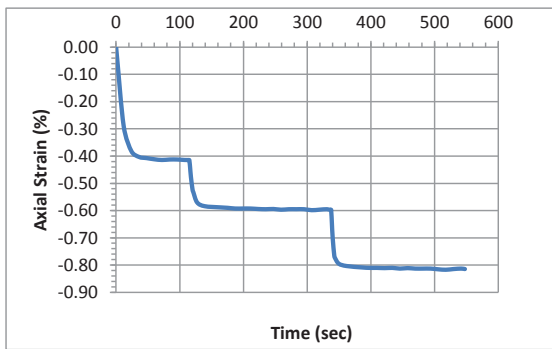

CSS Shear Wave Velocity Measurement Report



Geotechnical Engineering Laboratory

12/18/2013 Version 1.0

General Test Info and Sample Preparation			
Device:	CSS	Relative Density (%):	61%
Specimen ID:	C109L	Void Ratio:	0.615
Test ID:	M165	Height (mm):	116.1
Date of Test:	12/11/2014	Soil-Only Specimen Diameter	307.5
Test Performed:	Monotonic Shear	Weight (kg):	14.145
Test Material:	C109 Sand	Density (kg/m ³):	1640.41
Sample Preparation:	Prepared dense by tamping with a rubber mallet to desired density (15x in 3 layers).	Membrane Thickness (mm):	0.000
		Moisture Content (%):	0%
		Saturated (Y/N):	N
		Prepared by:	R. Thompson
		Checked by:	J. Hubler
Consolidation Stage		Shear Wave Velocity Measurement	
Vertical Stress (kPa):	100	Signal type	Sinusoidal
Time to Compression	9.5	Signal amplitude (Vpp)	4.5
Relative Density (%):	67%	Signal frequency (kHz)	5.0
Void Ratio:	0.602	Sensor spacing (mm)	107.56
Height (mm):	115.2	Average Vs (m/s)	214.5
Density (kg/m ³):	1653.80	Stdev. (m/s)	8.9
		P+V average Vs (m/s)	216.8
First rise		First valley	
Initiation time (ms)	-0.00750	Stdev. (m/s)	11.3
Arrival time (ms)	0.50500	Wavelength (m)	0.043
Vs (m/s)	209.9	Spacing/wavelength	2.5
First peak		First valley	
Initiation time (ms)	0.04100	Initiation time (ms)	0.14150
Arrival time (ms)	0.55600	Arrival time (ms)	0.62000
Vs (m/s)	208.8	Vs (m/s)	224.8

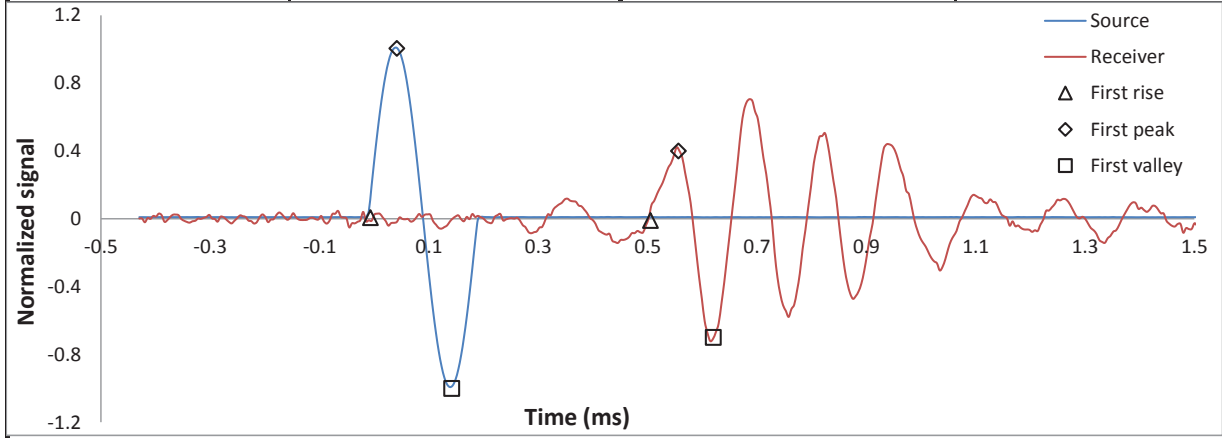

CSS Monotonic Shear Test Report

Geotechnical Engineering Laboratory



10/28/2013_Version 8.0

General Test Info and Sample Preparation

Device:	CSS	Relative Density (%):	56%
Specimen ID:	C109	Void Ratio:	0.627
Test ID:	M166	Height (mm):	114.2
Date of Test:	12/11/2014	Soil-Only Specimen Diameter (mm):	307.50
Test Performed:	Monotonic Shear	Weight (kg):	13.815
Test Material:	Ottawa C109 Sand	Density (kg/m³):	1628.5
Sample Preparation:	Prepared dense by tamping with a rubber mallet to desired density (15x in 3 layers).	Membrane Thickness (mm):	0.000
		Moisture Content (%):	0%
		Saturated (Y/N):	N
		Prepared by:	J.Hubler
		Checked by:	J. Hubler

Consolidation Stage

Shear Stage

Vertical Stress (kPa):	100	Type of Test:	Constant Volume
Compression Time (min):	7.0	Stress or Strain Controlled:	Strain
Relative Density (%):	62%	Shear Strain Rate (%/min):	0.29
Void Ratio:	0.614	Peak Shear Strength (kPa):	15.0
Height (mm):	113.3	Comments	
Diameter (mm):	307.50	Used Silver Baseplate, No Membrane	
Weight (kg):	13.815		
Density (kg/m³):	1642.0		

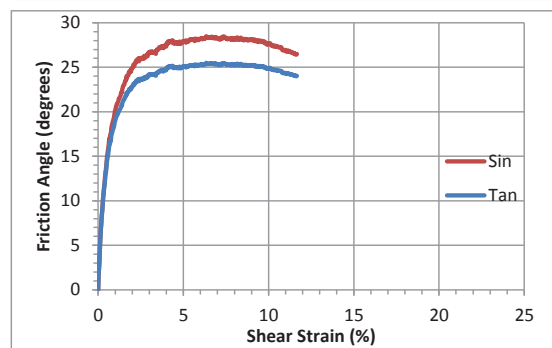
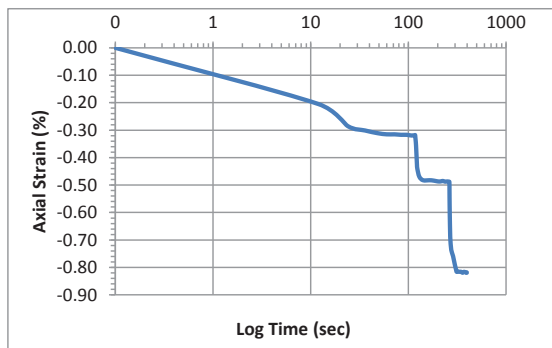
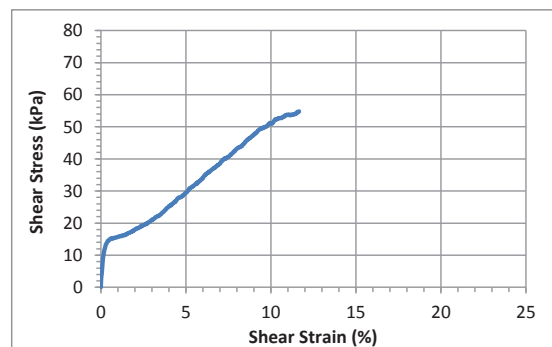
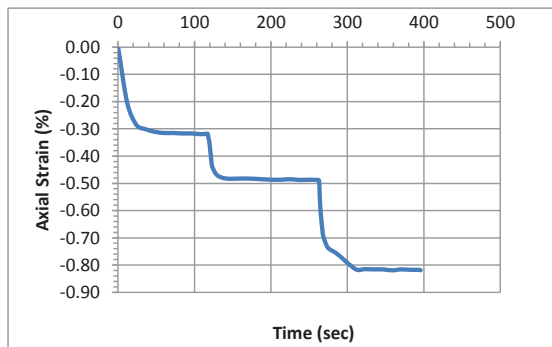

CSS Shear Wave Velocity Measurement Report



Geotechnical Engineering Laboratory

12/18/2013 Version 1.0

General Test Info and Sample Preparation			
Device:	CSS	Relative Density (%):	56%
Specimen ID:	C109L	Void Ratio:	0.627
Test ID:	M166	Height (mm):	114.2
Date of Test:	12/11/2014	Soil-Only Specimen Diameter	307.5
Test Performed:	Monotonic Shear	Weight (kg):	13.815
Test Material:	C109 Sand	Density (kg/m ³):	1628.51
Sample Preparation:	Prepared dense by tamping with a rubber mallet to desired density (15x in 3 layers).	Membrane Thickness (mm):	0.000
		Moisture Content (%):	0%
		Saturated (Y/N):	N
		Prepared by:	R. Thompson
		Checked by:	J. Hubler
Consolidation Stage		Shear Wave Velocity Measurement	
Vertical Stress (kPa):	100	Signal type	Sinusoidal
Time to Compression	7.0	Signal amplitude (Vpp)	4.5
Relative Density (%):	62%	Signal frequency (kHz)	5.0
Void Ratio:	0.614	Sensor spacing (mm)	105.69
Height (mm):	113.3	Average Vs (m/s)	214.8
Density (kg/m ³):	1642.31	Stdev. (m/s)	9.3
		P+V average Vs (m/s)	217.6
First rise		First valley	
Initiation time (ms)	-0.00510	Stdev. (m/s)	11.2
Arrival time (ms)	0.50000	Wavelength (m)	0.043
Vs (m/s)	209.2	Spacing/wavelength	2.5
First peak		First valley	
Initiation time (ms)	0.04100	Initiation time (ms)	0.14150
Arrival time (ms)	0.54500	Arrival time (ms)	0.61000
Vs (m/s)	209.7	Vs (m/s)	225.6

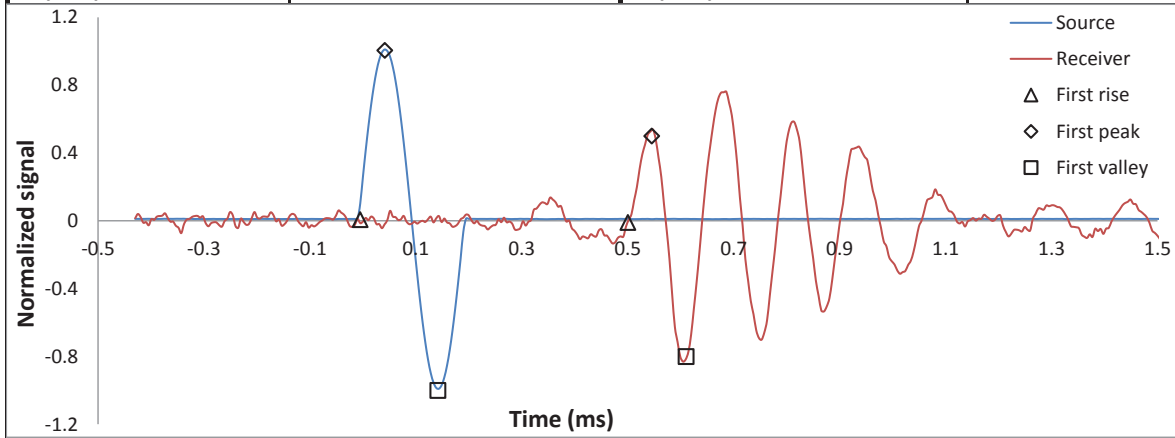

CSS Cyclic Shear Test Report

Geotechnical Engineering Laboratory



Cyclic Shear Test Summary

Device:	CSS	Density (kg/m³):	1592
Specimen ID:	C109	Relative Density (%):	40%
Test ID:	C102	Void Ratio:	0.664
Date of Test:	9/19/2014	Vertical Stress (kPa):	200
Test Performed:	Cyclic Shear	Loading Frequency (Hz):	0.33
Test Material:	Ottawa C109 Sand	Number of Cycles:	8
Sample Preparation:	Prepared Loose using a funnel with zero drop height	Cyclic Stress Ratio:	0.097
		Shear Modulus (kPa):	
		Damping (%):	
Prepared by:	J. Hubler	Shear Strain Single Amplitude (%):	
Checked by:	J. Hubler		

Additional Comments:

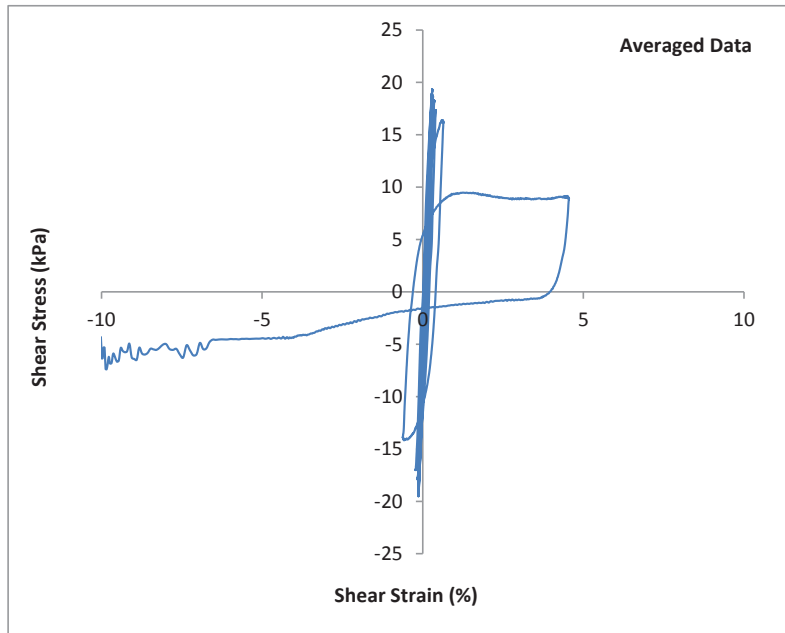
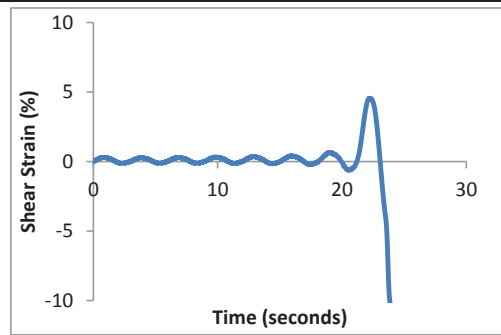
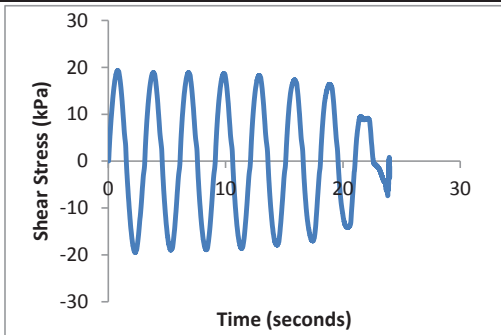

CSS Cyclic Shear Test Report

Geotechnical Engineering Laboratory



Cyclic Shear Test Summary

Device:	CSS	Density (kg/m³):	1592
Specimen ID:	C109	Relative Density (%):	40%
Test ID:	C102	Void Ratio:	0.664
Date of Test:	9/19/2014	Vertical Stress (kPa):	200
Test Performed:	Cyclic Shear	Loading Frequency (Hz):	0.33
Test Material:	Ottawa C109 Sand	Number of Cycles:	8
Sample Preparation:	Prepared Loose using a funnel with zero drop height	Cyclic Stress Ratio:	0.097
		Number of Cycles to Liq:	8
		Maximum ru:	1.00
Prepared by:	J. Hubler		
Checked by:	J. Hubler		

Additional Comments:

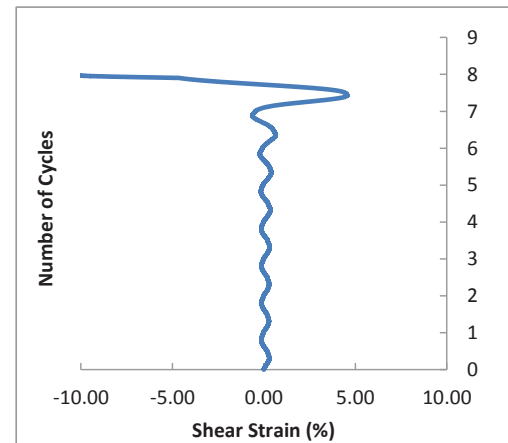
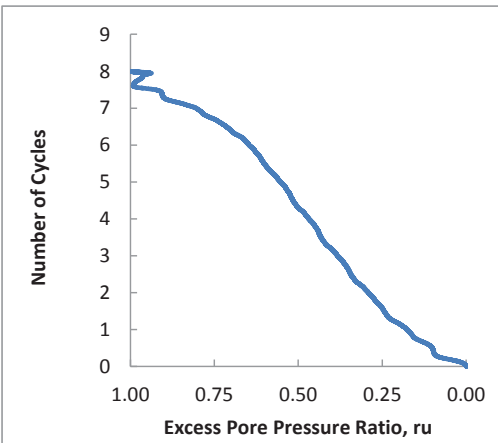
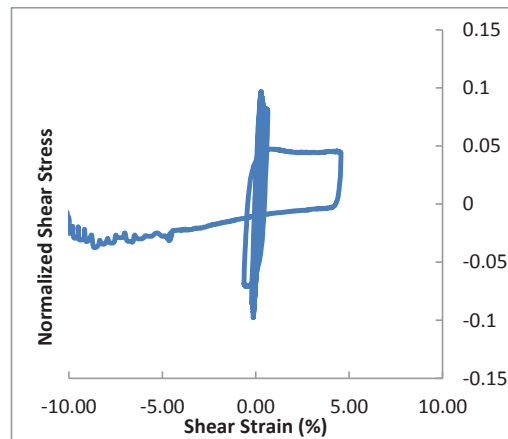
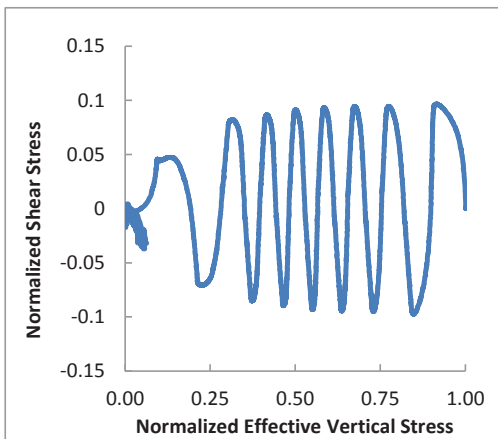

CSS Shear Wave Velocity Measurement Report



Geotechnical Engineering Laboratory

12/18/2013 Version 1.0

General Test Info and Sample Preparation

Device:	CSS	Relative Density (%):	24%
Specimen ID:	C109	Void Ratio:	0.699
Test ID:	C102	Height (mm):	111.46
Date of Test:	9/19/2014	Soil-Only Specimen Diameter	307.5
Test Performed:	Cyclic Shear	Weight (kg):	12.902
Test Material:	Ottawa C109 Sand	Density (kg/m ³):	1558.68
Sample Preparation:	Prepared loosely using funneling method.	Membrane Thickness (mm):	0.000
		Moisture Content (%):	0%
		Saturated (Y/N):	N
		Prepared by:	R. Thompson
		Checked by:	J. Hubler

Consolidation Stage

Shear Wave Velocity Measurement

Vertical Stress (kPa):	200	Signal type	Sinusoidal
Time to Compression	9.1	Signal amplitude (Vpp)	4.5
Relative Density (%):	40%	Signal frequency (kHz)	5.0
Void Ratio:	0.664	Sensor spacing (mm)	105.30
Height (mm):	109.1	Average Vs (m/s)	243.4
Density (kg/m ³):	1592.40	Stdev. (m/s)	2.6
First rise		P+V average Vs (m/s)	241.9
Initiation time (ms)	-0.00750	Stdev. (m/s)	0.2
Arrival time (ms)	0.42000	Wavelength (m)	0.049
Vs (m/s)	246.3	Spacing/wavelength	2.2
First peak		First valley	
Initiation time (ms)	0.04440	Initiation time (ms)	0.14500
Arrival time (ms)	0.48000	Arrival time (ms)	0.58000
Vs (m/s)	241.7	Vs (m/s)	242.1

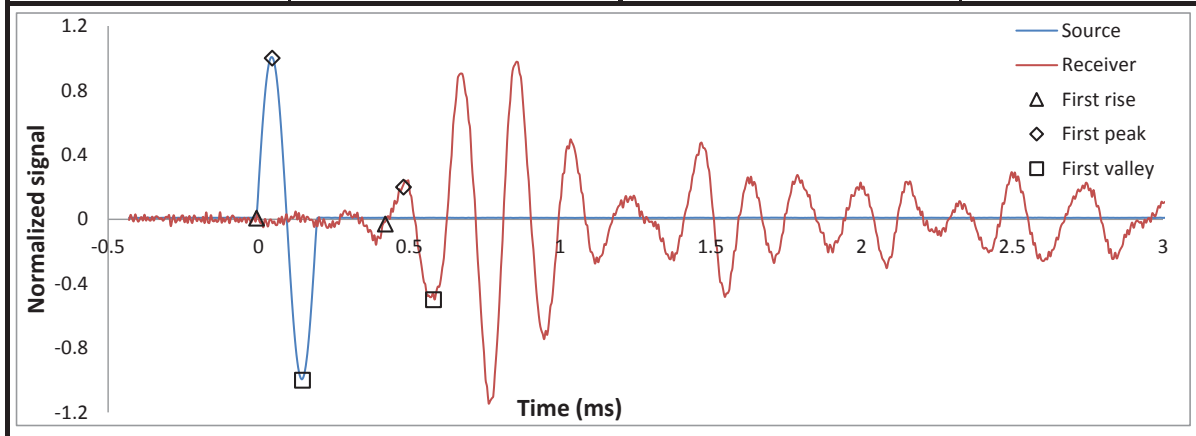

CSS Cyclic Shear Test Report

Geotechnical Engineering Laboratory



Cyclic Shear Test Summary

Device:	CSS	Density (kg/m³):	1599
Specimen ID:	C109	Relative Density (%):	43%
Test ID:	C121	Void Ratio:	0.657
Date of Test:	12/1/2014	Vertical Stress (kPa):	200
Test Performed:	Cyclic Shear	Loading Frequency (Hz):	0.33
Test Material:	Ottawa C109 Sand	Number of Cycles:	212
Sample Preparation:	Prepared Loose using a funnel. Tamped several times until desired density reached.	Cyclic Stress Ratio:	0.057
		Shear Modulus (kPa):	
		Damping (%):	
Prepared by:	J.Hubler	Shear Strain Single Amplitude (%)	
Checked by:	J.Hubler		

Additional Comments:

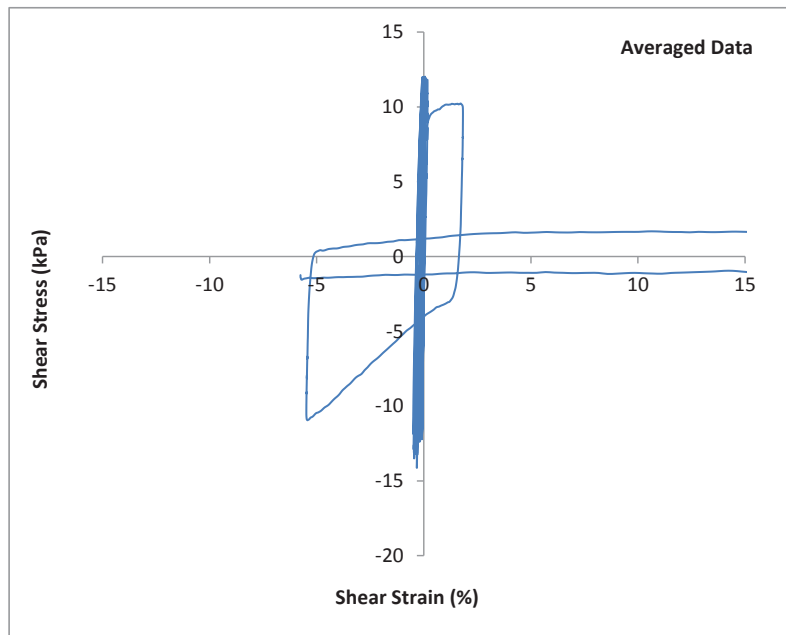
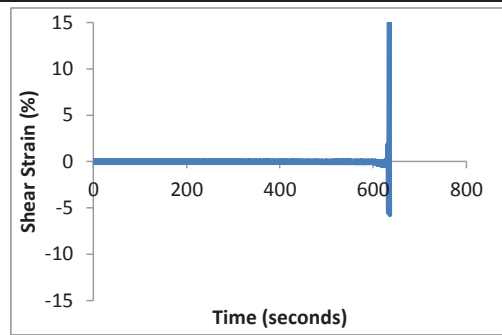
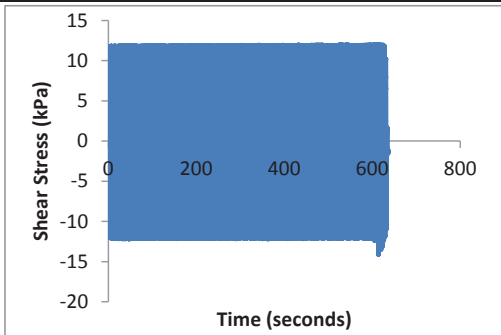

CSS Cyclic Shear Test Report

Geotechnical Engineering Laboratory



Cyclic Shear Test Summary

Device:	CSS	Density (kg/m³):	1599
Specimen ID:	C109	Relative Density (%):	43%
Test ID:	C121	Void Ratio:	0.657
Date of Test:	12/1/2014	Vertical Stress (kPa):	200
Test Performed:	Cyclic Shear	Loading Frequency (Hz):	0.33
Test Material:	Ottawa C109 Sand	Number of Cycles:	212
Sample Preparation:	Prepared Loose using a funnel. Tamped several times until desired density reached.	Cyclic Stress Ratio:	0.057
		Number of Cycles to Liq:	211
		Maximum ru:	1.00
Prepared by:	J.Hubler		
Checked by:	J.Hubler		

Additional Comments:

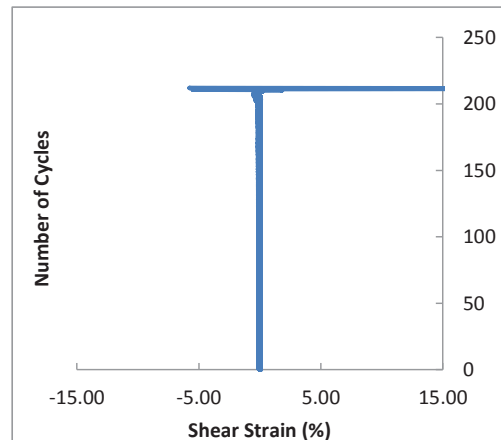
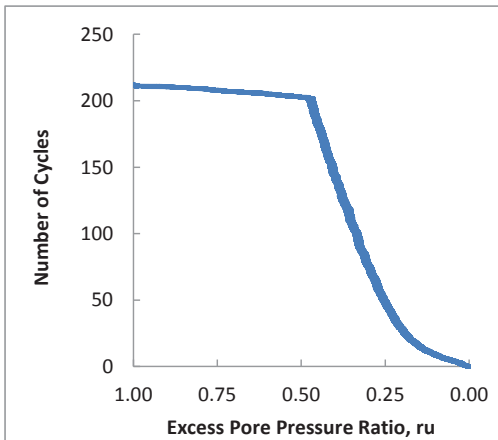
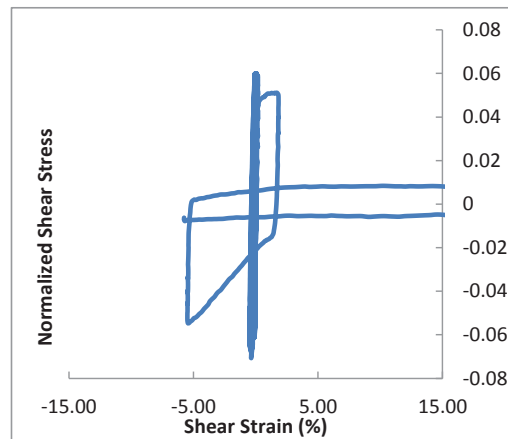
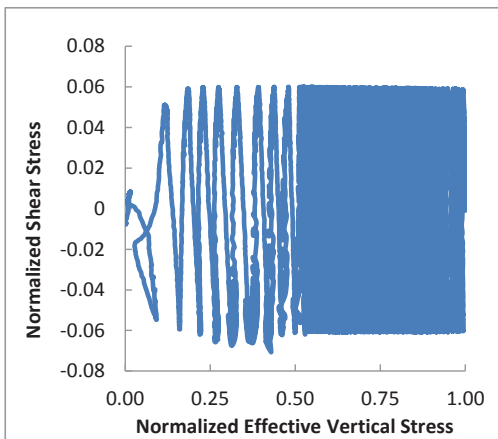

CSS Shear Wave Velocity Measurement Report



Geotechnical Engineering Laboratory

12/18/2013 Version 1.0

General Test Info and Sample Preparation			
Device:	CSS	Relative Density (%):	27%
Specimen ID:	C109L	Void Ratio:	0.693
Test ID:	C121	Height (mm):	112.81
Date of Test:	12/1/2014	Soil-Only Specimen Diameter	307.5
Test Performed:	Cyclic Shear	Weight (kg):	13.113
Test Material:	C109 Sand	Density (kg/m ³):	1565.2
Sample Preparation:	Prepared loosely using funneling method.	Membrane Thickness (mm):	0.000
		Moisture Content (%):	0%
		Saturated (Y/N):	N
		Prepared by:	J. Hubler
		Checked by:	J. Hubler
Consolidation Stage		Shear Wave Velocity Measurement	
Vertical Stress (kPa):	200	Signal type	Sinusoidal
Time to Compression	12.7	Signal amplitude (Vpp)	4.5
Relative Density (%):	43%	Signal frequency (kHz)	5.0
Void Ratio:	0.657	Sensor spacing (mm)	102.77
Height (mm):	110.4	Average Vs (m/s)	248.5
Density (kg/m ³):	1599.4	Stdev. (m/s)	14.2
First rise		P+V average Vs (m/s)	252.5
Initiation time (ms)	-0.00750	Stdev. (m/s)	17.5
Arrival time (ms)	0.42000	Wavelength (m)	0.050
Vs (m/s)	240.4	Spacing/wavelength	2.1
First peak		First valley	
Initiation time (ms)	0.04200	Initiation time (ms)	0.14200
Arrival time (ms)	0.47000	Arrival time (ms)	0.53000
Vs (m/s)	240.1	Vs (m/s)	264.9

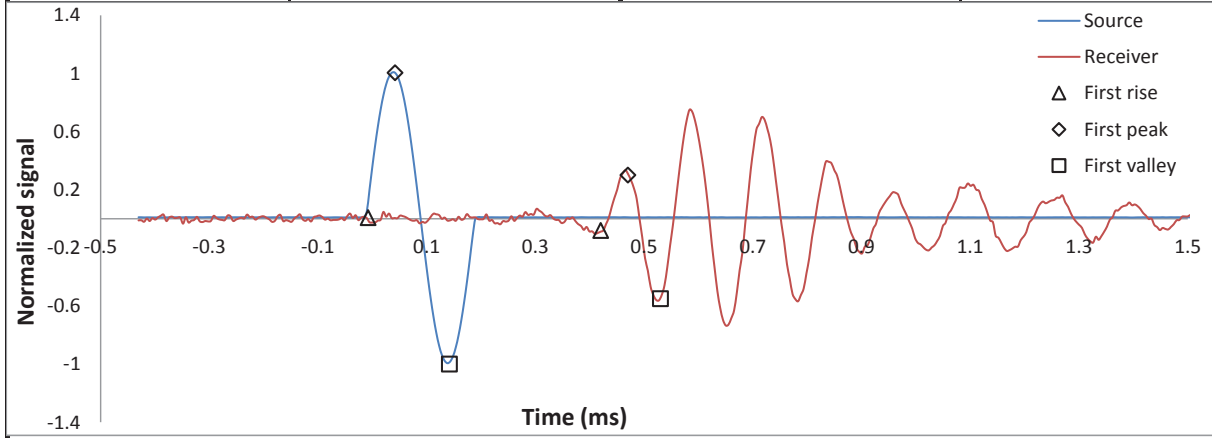

CSS Cyclic Shear Test Report

Geotechnical Engineering Laboratory



Cyclic Shear Test Summary

Device:	CSS	Density (kg/m³):	1606
Specimen ID:	C109	Relative Density (%):	46%
Test ID:	C123	Void Ratio:	0.650
Date of Test:	12/12/2014	Vertical Stress (kPa):	200
Test Performed:	Cyclic Shear	Loading Frequency (Hz):	0.33
Test Material:	Ottawa C109 Sand	Number of Cycles:	37
Sample Preparation:	Prepared loose using zero drop height. Tamped lightly 5 times in 3 layers.	Cyclic Stress Ratio:	0.071
		Shear Modulus (kPa):	
		Damping (%):	
Prepared by:	R. Thompson	Shear Strain Single Amplitude (%)	
Checked by:	J. Hubler		

Additional Comments:

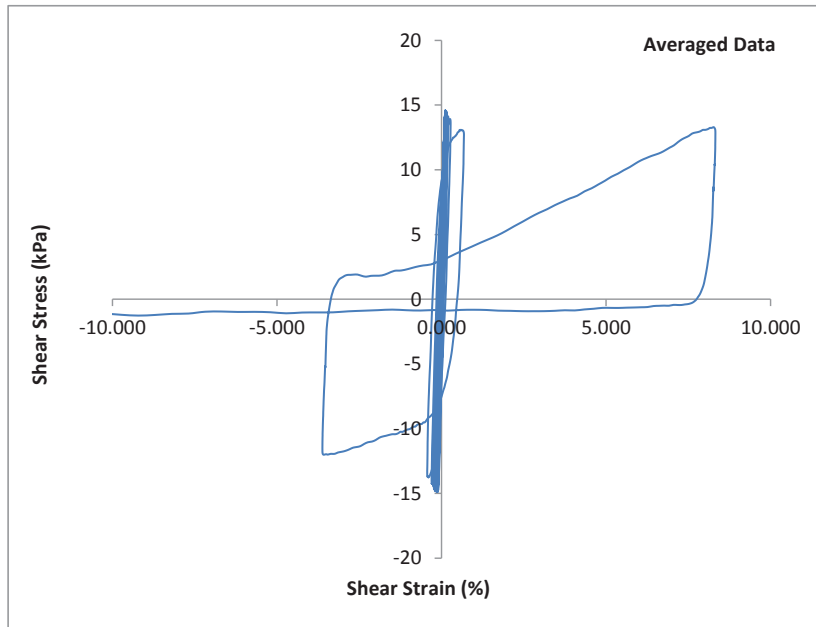
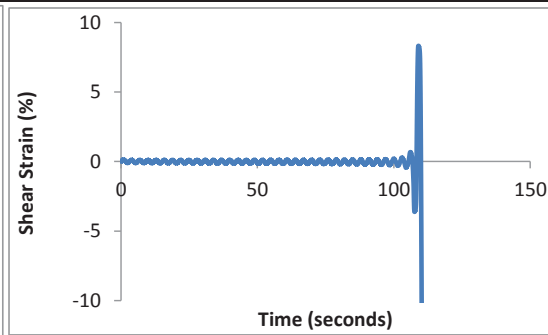
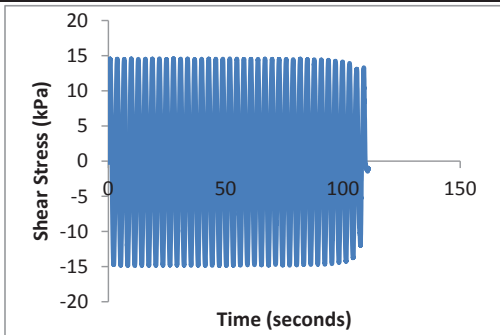

CSS Cyclic Shear Test Report

Geotechnical Engineering Laboratory



Cyclic Shear Test Summary

Device:	CSS	Density (kg/m³):	1606
Specimen ID:	C109	Relative Density (%):	46%
Test ID:	C123	Void Ratio:	0.650
Date of Test:	12/12/2014	Vertical Stress (kPa):	0
Test Performed:	Cyclic Shear	Loading Frequency (Hz):	0.3
Test Material:	Ottawa C109 Sand	Number of Cycles:	37
Sample Preparation:	Prepared loose using zero drop height. Tamped lightly 5 times in 3 layers.	Cyclic Stress Ratio:	0.071
		Number of Cycles to Liq:	36
		Maximum ru:	1.00
Prepared by:	R. Thompson		
Checked by:	J. Hubler		

Additional Comments:

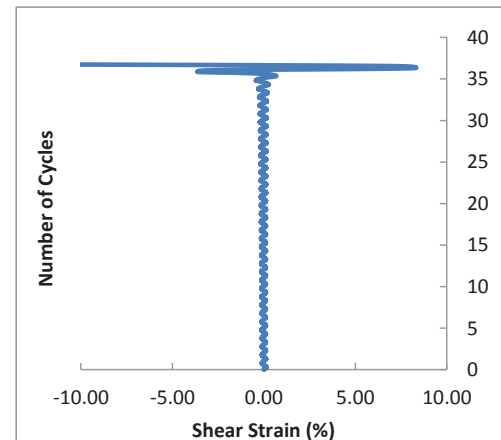
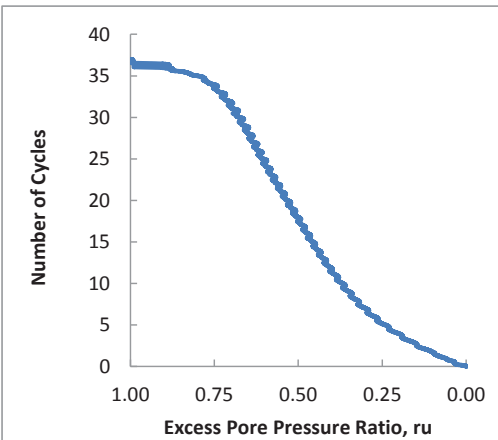
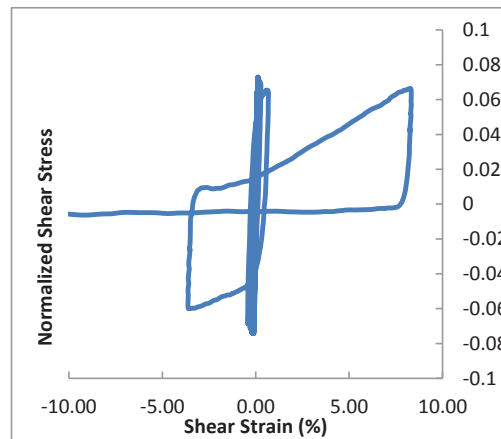
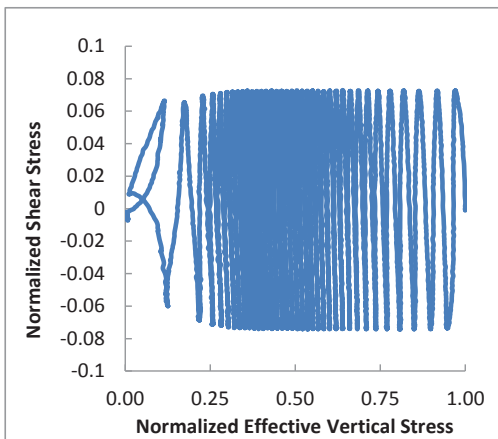

CSS Shear Wave Velocity Measurement Report



Geotechnical Engineering Laboratory

12/18/2013 Version 1.0

General Test Info and Sample Preparation

Device:	CSS	Relative Density (%):	37%
Specimen ID:	C109	Void Ratio:	0.671
Test ID:	C123	Height (mm):	113.8
Date of Test:	12/12/2014	Soil-Only Specimen Diameter	307.5
Test Performed:	Cyclic Shear	Weight (kg):	13.404
Test Material:	Ottawa C109 Sand	Density (kg/m ³):	1586.0
Sample Preparation:	Prepared loosely using funneling method. Tamped lightly 5x in 3 layers.	Membrane Thickness (mm):	0.000
		Moisture Content (%):	0%
		Saturated (Y/N):	N
		Prepared by:	R. Thompson
		Checked by:	J. Hubler

Consolidation Stage

Shear Wave Velocity Measurement

Vertical Stress (kPa):	200	Signal type	Sinusoidal
Time to Compression	12.8	Signal amplitude (Vpp)	4.5
Relative Density (%):	46%	Signal frequency (kHz)	5.0
Void Ratio:	0.650	Sensor spacing (mm)	108.49
Height (mm):	112.4	Average Vs (m/s)	244.5
Density (kg/m ³):	1605.8	Stdev. (m/s)	13.0
First rise		P+V average Vs (m/s)	248.2
Initiation time (ms)	-0.00750	Stdev. (m/s)	16.0
Arrival time (ms)	0.45000	Wavelength (m)	0.049
Vs (m/s)	237.1	Spacing/wavelength	2.2
First peak		First valley	
Initiation time (ms)	0.04200	Initiation time (ms)	0.14200
Arrival time (ms)	0.50000	Arrival time (ms)	0.56000
Vs (m/s)	236.9	Vs (m/s)	259.5

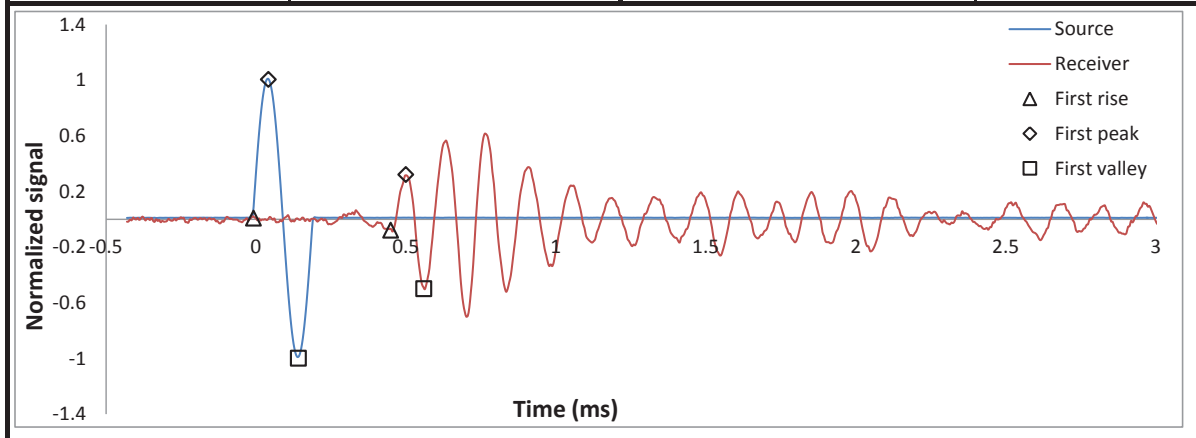

CSS Cyclic Shear Test Report

Geotechnical Engineering Laboratory



Cyclic Shear Test Summary

Device:	CSS	Density (kg/m³):	1602
Specimen ID:	C109	Relative Density (%):	44%
Test ID:	C124	Void Ratio:	0.654
Date of Test:	12/12/2014	Vertical Stress (kPa):	200
Test Performed:	Cyclic Shear	Loading Frequency (Hz):	0.33
Test Material:	Ottawa C109 Sand	Number of Cycles:	3
Sample Preparation:	Prepared Loose by using a funnel. Tamped 5x in 3 layers.	Cyclic Stress Ratio:	0.127
		Shear Modulus (kPa):	
		Damping (%):	
Prepared by:	J. Hubler	Shear Strain Single Amplitude (%)	
Checked by:	J. Hubler		

Additional Comments:

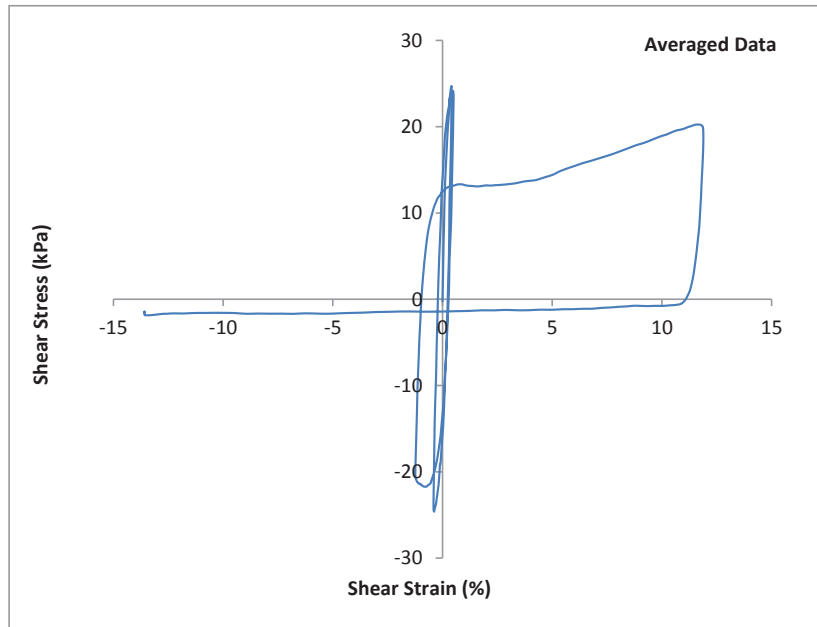
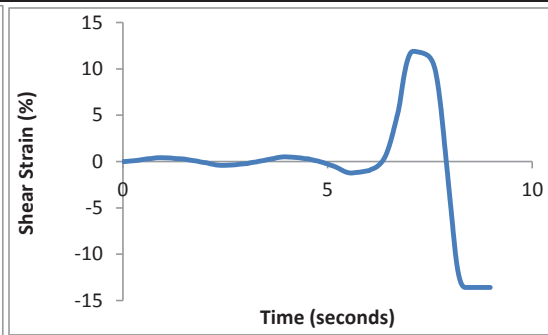
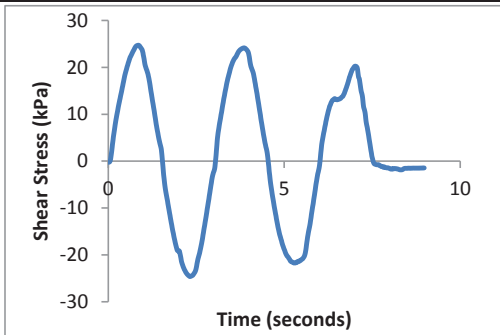

CSS Cyclic Shear Test Report

Geotechnical Engineering Laboratory



Cyclic Shear Test Summary

Device:	CSS	Density (kg/m³):	1602
Specimen ID:	C109	Relative Density (%):	44%
Test ID:	C124	Void Ratio:	0.654
Date of Test:	12/12/2014	Vertical Stress (kPa):	200
Test Performed:	Cyclic Shear	Loading Frequency (Hz):	0.33
Test Material:	Ottawa C109 Sand	Number of Cycles:	3
Sample Preparation:	Prepared Loose by using a funnel. Tamped 5x in 3 layers.	Cyclic Stress Ratio:	0.127
		Number of Cycles to Liq:	3
		Maximum ru:	0.99
Prepared by:	J. Hubler		
Checked by:	J. Hubler		

Additional Comments:

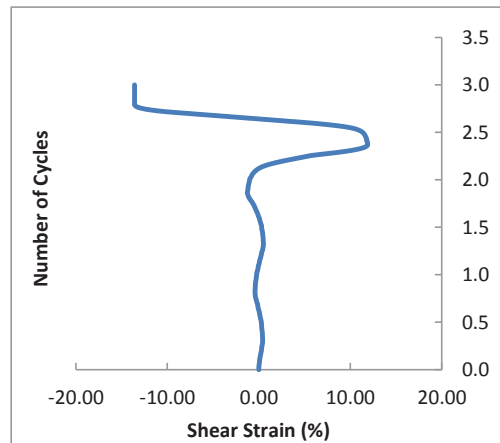
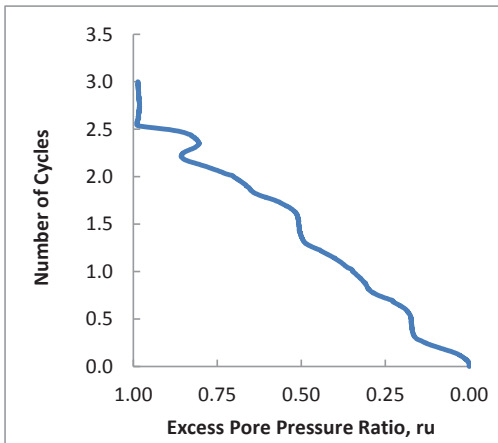
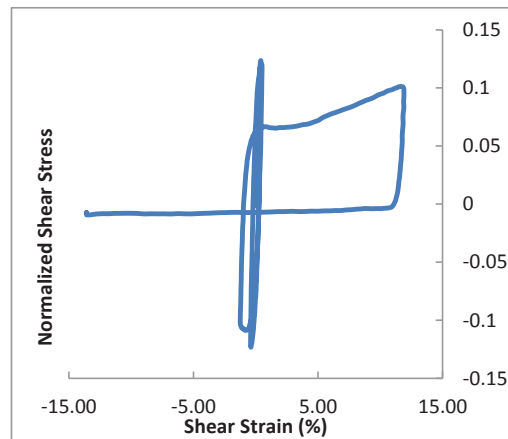
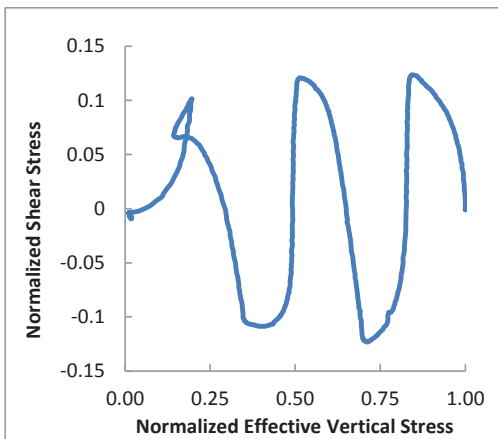

CSS Shear Wave Velocity Measurement Report



Geotechnical Engineering Laboratory

12/18/2013 Version 1.0

General Test Info and Sample Preparation			
Device:	CSS	Relative Density (%):	27%
Specimen ID:	C109	Void Ratio:	0.693
Test ID:	C124	Height (mm):	114.25
Date of Test:	12/12/2014	Soil-Only Specimen Diameter	307.5
Test Performed:	Cyclic Shear	Weight (kg):	13.277
Test Material:	Ottawa C109 Sand	Density (kg/m ³):	1564.8
Sample Preparation:	Prepared loosely using a funnel. Tamped several times to desired density.	Membrane Thickness (mm):	0.000
		Moisture Content (%):	0%
		Saturated (Y/N):	N
		Prepared by:	J. Hubler
		Checked by:	J. Hubler
Consolidation Stage		Shear Wave Velocity Measurement	
Vertical Stress (kPa):	200	Signal type	Sinusoidal
Time to Compression	9.7	Signal amplitude (Vpp)	4.5
Relative Density (%):	44%	Signal frequency (kHz)	5.0
Void Ratio:	0.654	Sensor spacing (mm)	107.71
Height (mm):	111.6	Average Vs (m/s)	259.2
Density (kg/m ³):	1602.0	Stdev. (m/s)	12.9
First rise		P+V average Vs (m/s)	
Initiation time (ms)	-0.00750	Stdev. (m/s)	15.8
Arrival time (ms)	0.42000	Wavelength (m)	0.052
Vs (m/s)	251.9	Spacing/wavelength	2.1
First peak		First valley	
Initiation time (ms)	0.04200	Initiation time (ms)	0.14200
Arrival time (ms)	0.47000	Arrival time (ms)	0.53500
Vs (m/s)	251.6	Vs (m/s)	274.1

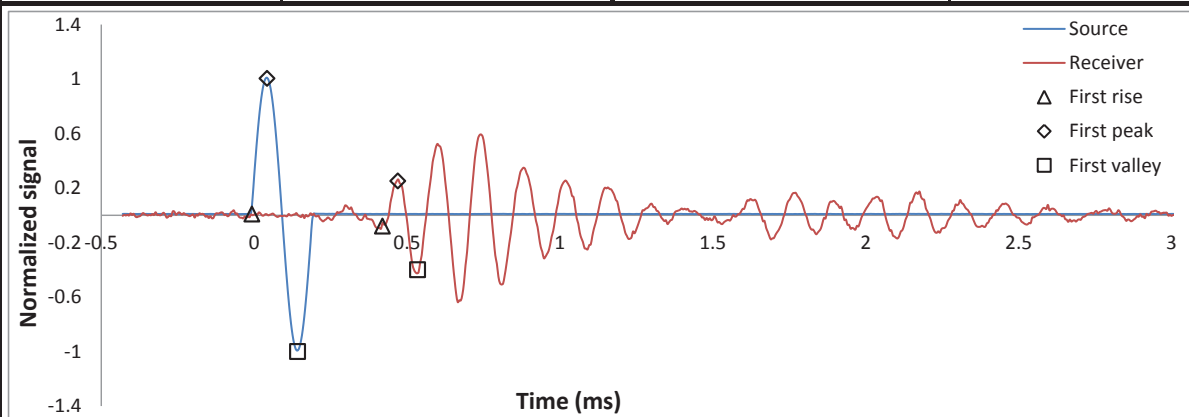

CSS Monotonic Shear Test Report

Geotechnical Engineering Laboratory



10/28/2013_Version 8.0

General Test Info and Sample Preparation

Device:	CSS	Relative Density (%):	-1%
Specimen ID:	PGL	Void Ratio:	0.775
Test ID:	M180	Height (mm):	121.3
Date of Test:	3/10/2015	Soil-Only Specimen Diameter (mm):	306.2
Test Performed:	Monotonic Shear	Weight (kg):	13.788
Test Material:	Pea Gravel	Density (kg/m³):	1543.8
Sample Preparation:	Prepared loose using shoveling method. Clay on top and bottom BE	Membrane Thickness (mm):	0.635
		Moisture Content (%):	0%
		Saturated (Y/N):	N
		Prepared by:	R. Thompson
		Checked by:	J. Hubler

Consolidation Stage

Vertical Stress (kPa):	400
Time to Compression (min):	51.5
Relative Density (%):	35%
Void Ratio:	0.702
Height (mm):	116.3
Diameter (mm):	306.2
Weight (kg):	13.788
Density (kg/m³):	1609.6

Shear Stage

Type of Test:	Constant Volume
Stress or Strain Controlled:	Strain
Shear Strain Rate (%/min):	0.28
Peak Shear Strength (kPa):	49.9

Comments

Silver Baseplate with cushion membrane

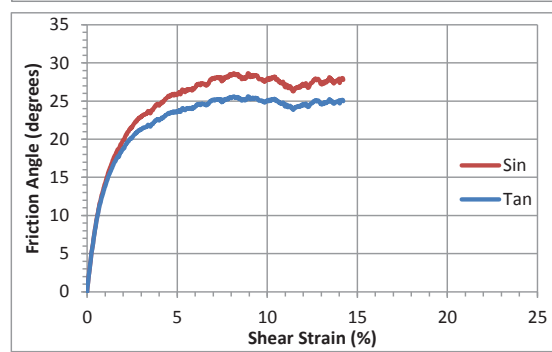
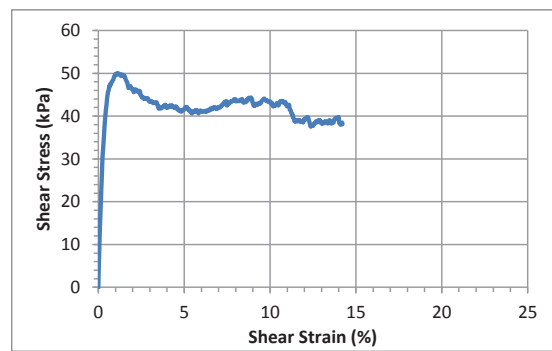
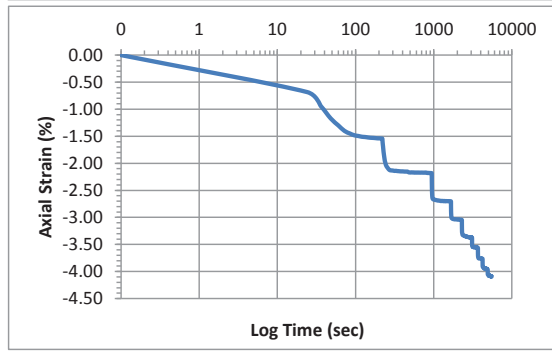
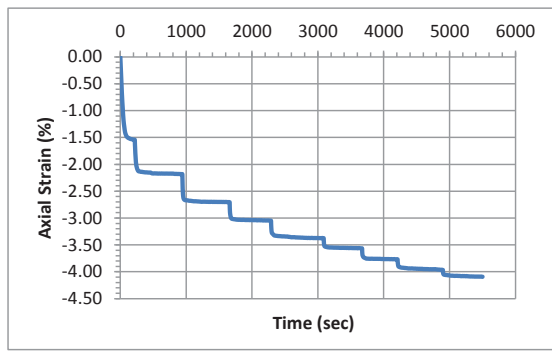

CSS Shear Wave Velocity Measurement Report

Geotechnical Engineering Laboratory



12/18/2013 Version 1.0

General Test Info and Sample Preparation

Device:	CSS	Relative Density (%):	5%
Specimen ID:	PGL	Void Ratio:	0.775
Test ID:	M180	Height (mm):	120.4
Date of Test:	3/10/2015	Specimen Diameter (mm):	306.2
Test Performed:	Monotonic Shear	Weight (kg):	13.788
Test Material:	Pea Gravel	Density (kg/m ³):	1554.39
Sample Preparation:	Prepared loose by shoveling method.	Membrane Thickness (mm):	0.635
		Moisture Content (%):	0%
		Saturated (Y/N):	N
		Prepared by:	J. Hubler
		Checked by:	J. Hubler

Consolidation Stage

Vertical Stress (kPa):	400
Time to Comp (min):	51.5
Relative Density (%):	35%
Void Ratio:	0.702
Height (mm):	116.3
Density (kg/m ³):	1609.67

Shear Wave Velocity Measurement

Signal type	Sinusoidal
Signal amplitude (Vpp)	4.5
Signal frequency (kHz)	5.0
Sensor spacing (mm)	108.68
Average Vs (m/s)	293.0
Stdev. (m/s)	8.1
P+V average Vs (m/s)	294.0
Stdev. (m/s)	11.2
Wavelength (m)	0.059
Spacing/wavelength	1.9

First rise

Initiation time (ms)	-0.00750
Arrival time (ms)	0.36600
Vs (m/s)	291.0

First peak

Initiation time (ms)	0.04000
Arrival time (ms)	0.42000
Vs (m/s)	286.0

First valley

Initiation time (ms)	0.15000
Arrival time (ms)	0.51000
Vs (m/s)	301.9

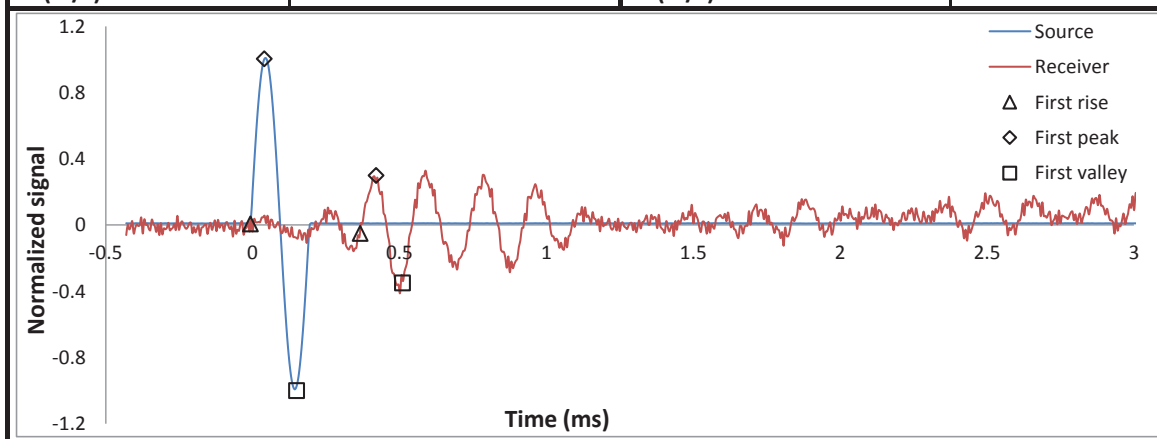

Accelerometer-Based Shear Wave Velocity Datasheet

Specimen ID: M180-PGL-400-4 high
 Test Material: PGL
 Date: 3/10/2015
 Test Performed by: J.Hubler
 Filename: M180-PGL-400-4 high

Vertical Stress: 400kPa
 Sensor Spacing: 0.11675 m
 V_s (rise) = 270 m/s

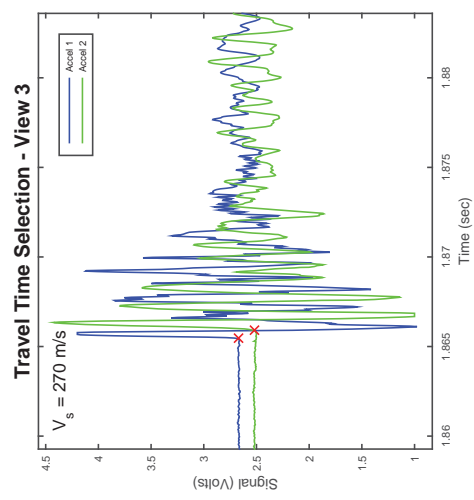
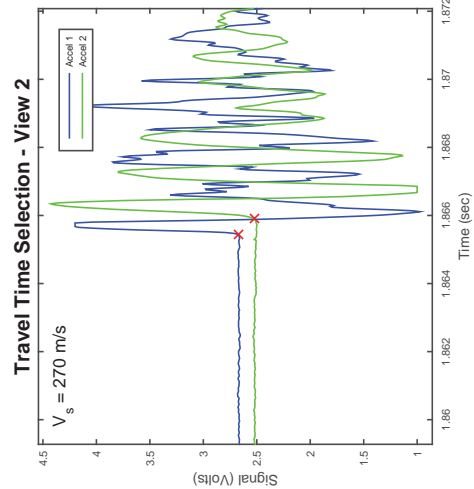
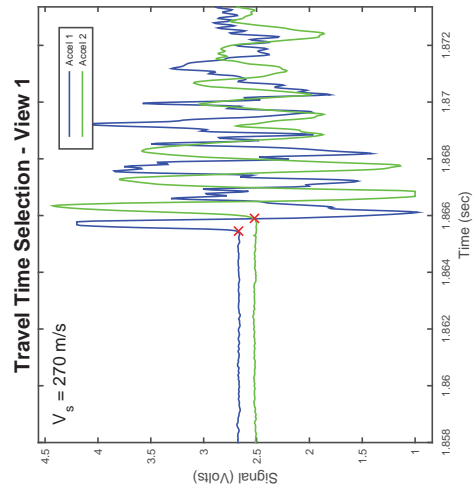
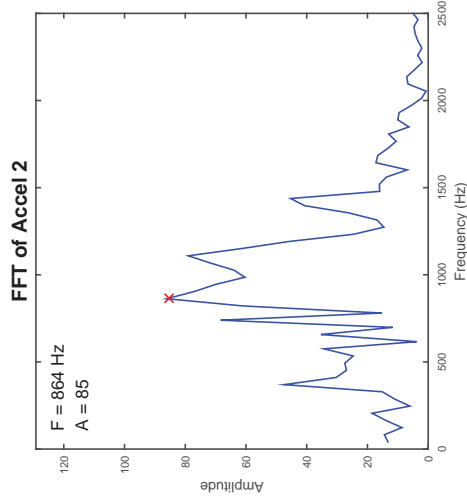
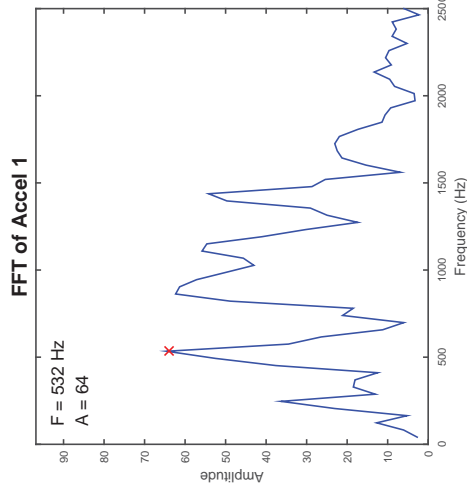
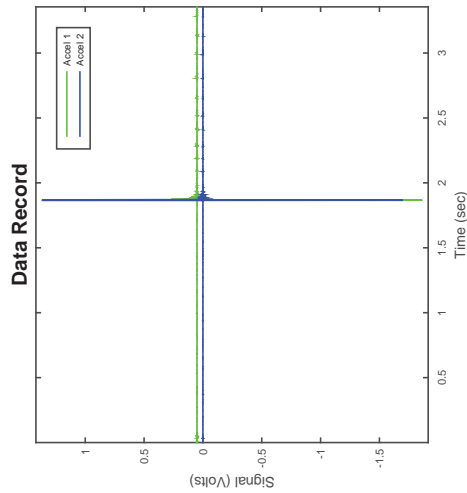

CSS Monotonic Shear Test Report

Geotechnical Engineering Laboratory



10/28/2013_Version 8.0

General Test Info and Sample Preparation

Device:	CSS	Relative Density (%):	1%
Specimen ID:	PGL	Void Ratio:	0.770
Test ID:	M194	Height (mm):	116.8
Date of Test:	4/21/2015	Soil-Only Specimen Diameter (mm):	306.23
Test Performed:	Monotonic Shear	Weight (kg):	13.317
Test Material:	Pea Gravel	Density (kg/m³):	1548.1
Sample Preparation:	Prepared loose using the shoveling method.	Membrane Thickness (mm):	0.635
		Moisture Content (%):	0%
		Saturated (Y/N):	N
		Prepared by:	R. Thompson
		Checked by:	J. Hubler

Consolidation Stage

Vertical Stress (kPa):	400
Time to Compression (min):	51.2
Relative Density (%):	39%
Void Ratio:	0.695
Height (mm):	111.8
Diameter (mm):	306.23
Weight (kg):	13.317
Density (kg/m³):	1616.6

Shear Stage

Type of Test:	Monotonic
Stress or Strain Controlled:	Strain
Shear Strain Rate (%/min):	0.29
Peak Shear Strength (kPa):	54.1

Comments

Staged consolidation for Vs measurements. Silver Baseplate used with cushion membrane. Test aborted at approximately 9% strain.

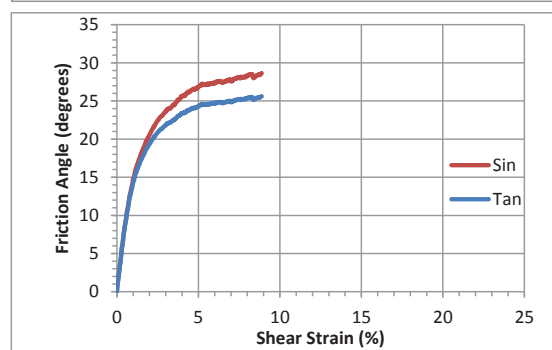
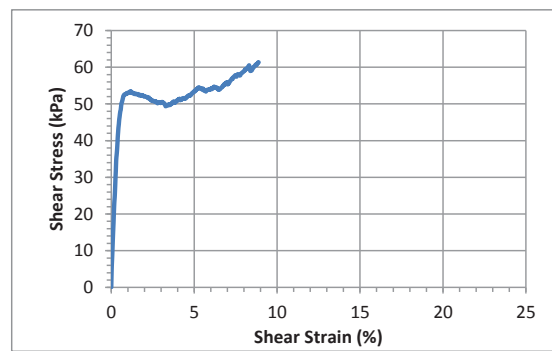
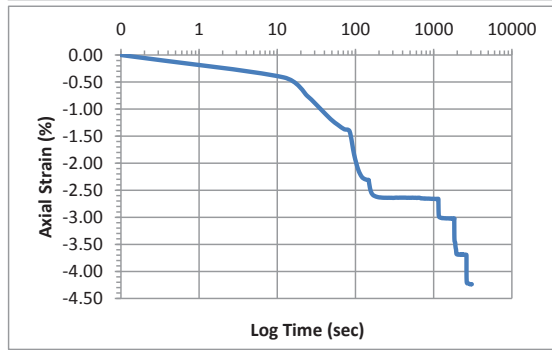
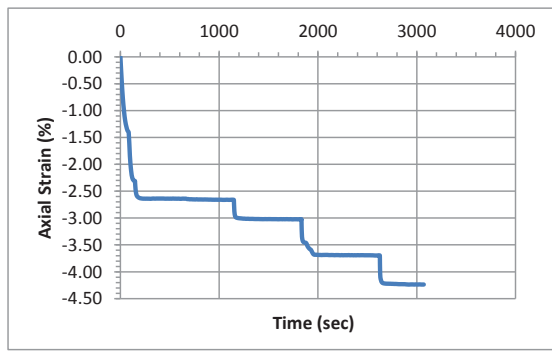

CSS Shear Wave Velocity Measurement Report



Geotechnical Engineering Laboratory

12/18/2013 Version 1.0

General Test Info and Sample Preparation

Device:	CSS	Relative Density (%):	1%
Specimen ID:	PGL	Void Ratio:	0.770
Test ID:	M194	Height (mm):	116.8
Date of Test:	4/21/2015	Soil-Only Specimen	306.2
Test Performed:	Vs Measurements	Weight (kg):	13.317
Test Material:	Pea Gravel	Density (kg/m ³):	1548.1
Sample Preparation:	Prepared loose using the shoveling method	Membrane Thickness (mm)	0.635
		Moisture Content (%):	0%
		Saturated (Y/N):	N
		Prepared by:	R. Thompson
		Checked by:	J. Hubler

Consolidation Stage

Vertical Stress (kPa):	400
Time to Compression	51.2
Relative Density (%):	39%
Void Ratio:	0.695
Height (mm):	111.8
Density (kg/m ³):	1616.6

Shear Wave Velocity Measurement

Signal type	Sinusoidal
Signal amplitude (Vpp)	4.5
Signal frequency (kHz)	3.0
Sensor spacing (mm)	104.23
Average Vs (m/s)	280.9
Stdev. (m/s)	14.7
P+V average Vs (m/s)	286.0
Stdev. (m/s)	16.6
Wavelength (m)	0.094
Spacing/wavelength	1.1

First rise

Initiation time (ms)	-0.02000
Arrival time (ms)	0.36500
Vs (m/s)	270.7

P+V average Vs (m/s)	286.0
Stdev. (m/s)	16.6
Wavelength (m)	0.094
Spacing/wavelength	1.1

First peak

Initiation time (ms)	0.07000
Arrival time (ms)	0.45000
Vs (m/s)	274.3

First valley

Initiation time (ms)	0.24000
Arrival time (ms)	0.59000
Vs (m/s)	297.8

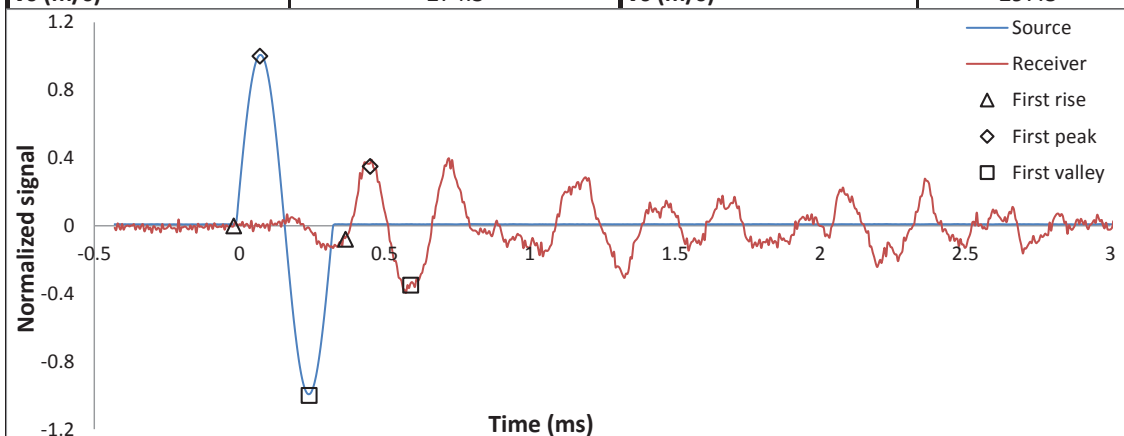

Accelerometer-Based Shear Wave Velocity Datasheet

Specimen ID: M194-PGL-400-1
 Test Material: PGL
 Date: 4/21/2015
 Test Performed by: J.Hubler
 Filename: M194-PGL-400-1

Vertical Stress: 400kPa
 Sensor Spacing: 0.11213 m
 V_s (rise) = 269 m/s

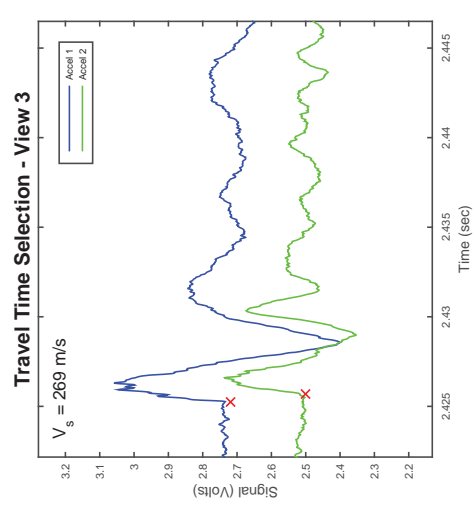
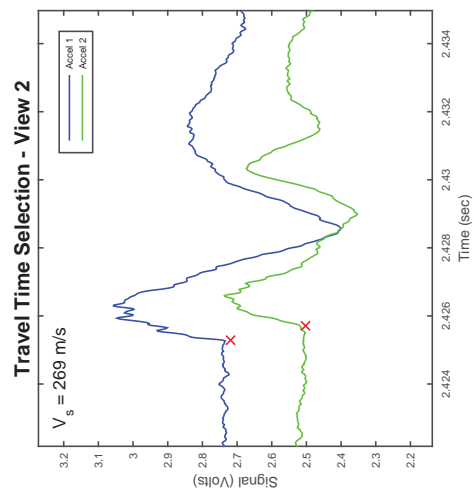
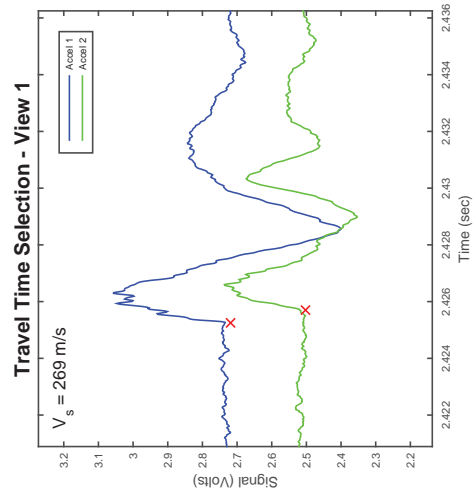
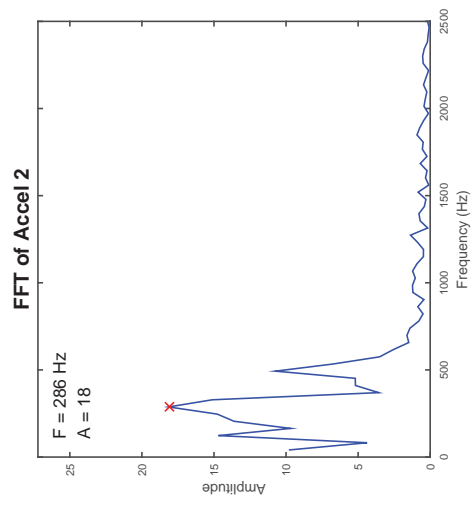
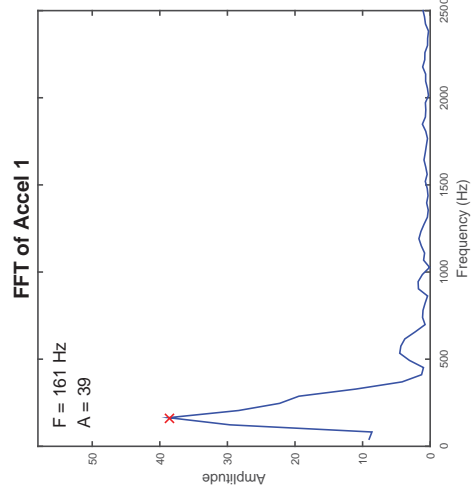
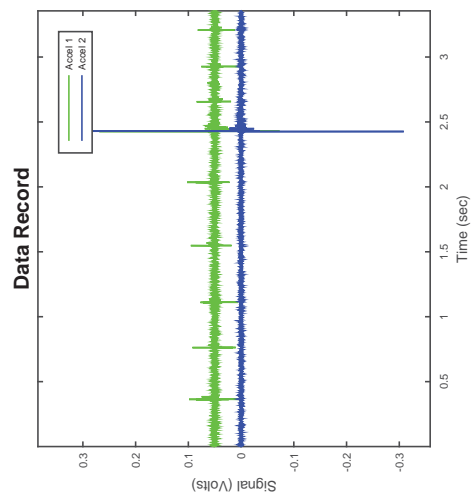

Accelerometer-Based Shear Wave Velocity Datasheet

Specimen ID: M194-PGL-400-2

Test Material: PGL

Date: 4/21/2015

Test Performed by: J.Hubler

Filename: M194-PGL-400-2

Vertical Stress: 400kPa

Sensor Spacing: 0.11213 m

V_s (rise) = 269 m/s

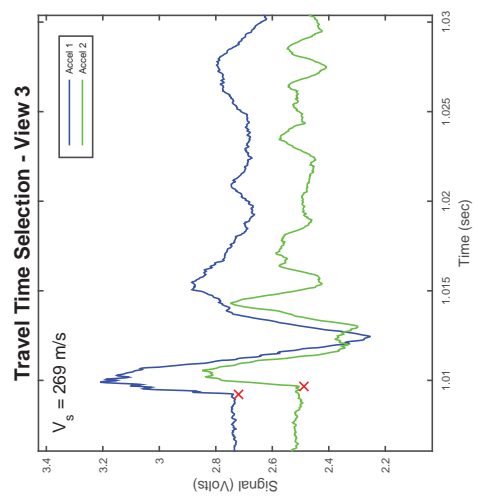
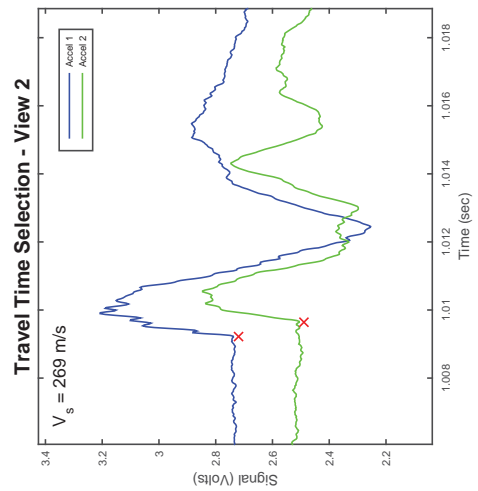
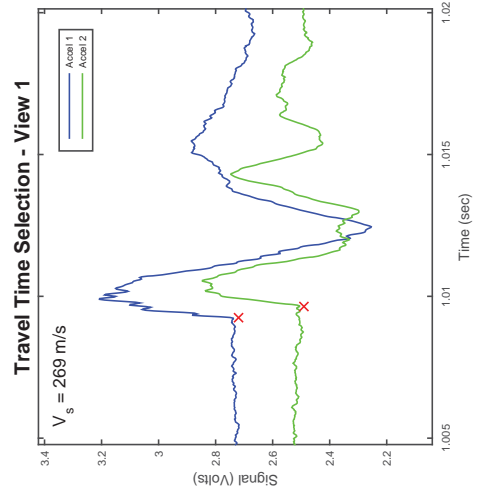
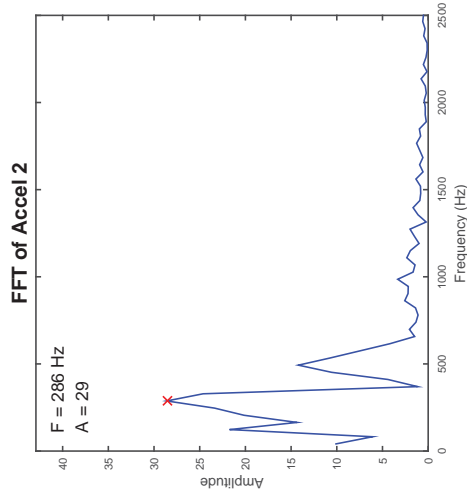
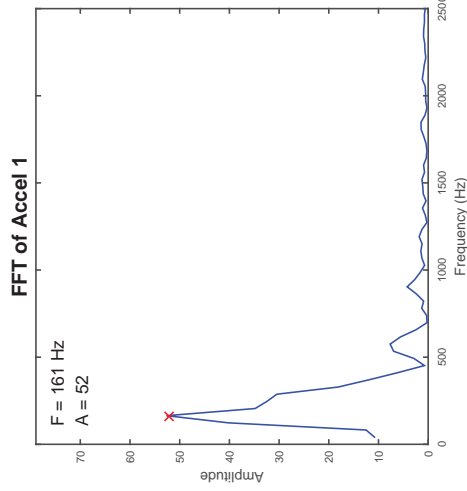
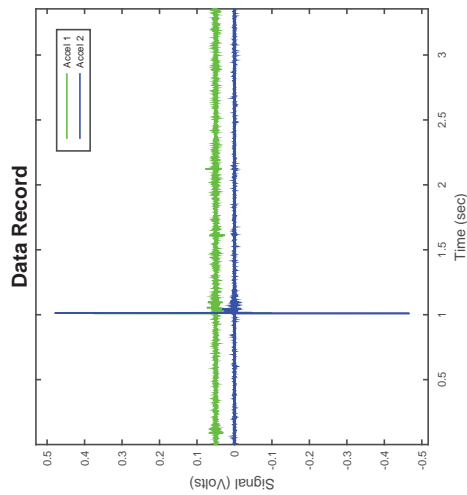

CSS Monotonic Shear Test Report

Geotechnical Engineering Laboratory



10/28/2013_Version 8.0

General Test Info and Sample Preparation

Device:	CSS	Relative Density (%):	-3%
Specimen ID:	PGL	Void Ratio:	0.778
Test ID:	M196	Height (mm):	116.0
Date of Test:	4/24/2015	Soil-Only Specimen Diameter (mm):	306.23
Test Performed:	Monotonic Shear	Weight (kg):	13.163
Test Material:	Pea Gravel	Density (kg/m³):	1540.7
Sample Preparation:	Prepared loose using the shoveling method.	Membrane Thickness (mm):	0.635
		Moisture Content (%):	0%
		Saturated (Y/N):	N
		Prepared by:	J. Hubler
		Checked by:	J. Hubler

Consolidation Stage

Vertical Stress (kPa):	400
Time to Compression (min):	42.5
Relative Density (%):	40%
Void Ratio:	0.692
Height (mm):	110.4
Diameter (mm):	306.23
Weight (kg):	13.163
Density (kg/m³):	1619.3

Shear Stage

Type of Test:	Constant Volume
Stress or Strain Controlled:	Strain
Shear Strain Rate (%/min):	0.30
Peak Shear Strength (kPa):	55.8

Comments

Staged consolidation for Vs measurements. Silver Baseplate used with cushion membrane.

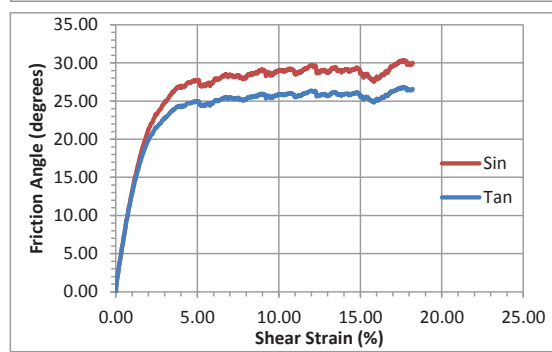
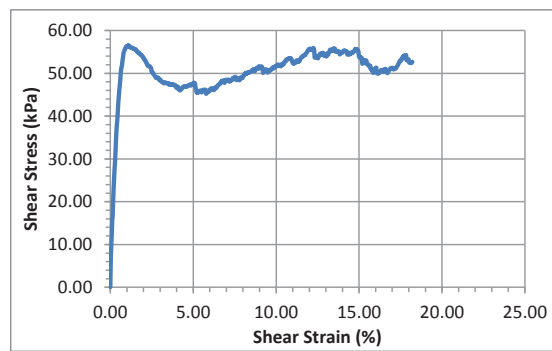
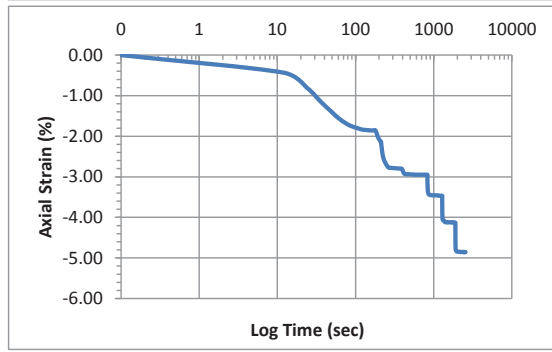
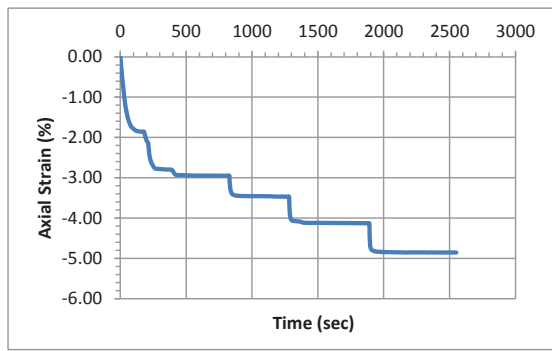

CSS Shear Wave Velocity Measurement Report



Geotechnical Engineering Laboratory

12/18/2013 Version 1.0

General Test Info and Sample Preparation

Device:	CSS	Relative Density (%):	-3%
Specimen ID:	PGL	Void Ratio:	0.778
Test ID:	M196	Height (mm):	116.0
Date of Test:	4/24/2015	Specimen Diameter (mm):	306.2
Test Performed:	Monotonic Shear	Weight (kg):	13.163
Test Material:	Pea Gravel	Density (kg/m ³):	1540.7
Sample Preparation:	Prepared loose using the shoveling method	Membrane Thickness (mm):	0.635
		Moisture Content (%):	0%
		Saturated (Y/N):	N
		Prepared by:	R. Thompson
		Checked by:	J. Hubler

Consolidation Stage

Vertical Stress (kPa):	400
Time to Comp (min):	42.5
Relative Density (%):	40%
Void Ratio:	0.692
Height (mm):	110.4
Density (kg/m ³):	1619.3

Shear Wave Velocity Measurement

Signal type	Sinusoidal
Signal amplitude (Vpp)	4.5
Signal frequency (kHz)	3.0
Sensor spacing (mm)	102.50
Average Vs (m/s)	290.5
Stdev. (m/s)	17.7
P+V average Vs (m/s)	297.3
Stdev. (m/s)	18.9
Wavelength (m)	0.097
Spacing/wavelength	1.1

First rise

Initiation time (ms)	-0.02000
Arrival time (ms)	0.35000
Vs (m/s)	277.0

First peak

Initiation time (ms)	0.06700
Arrival time (ms)	0.42800
Vs (m/s)	283.9

First valley

Initiation time (ms)	0.23000
Arrival time (ms)	0.56000
Vs (m/s)	310.6

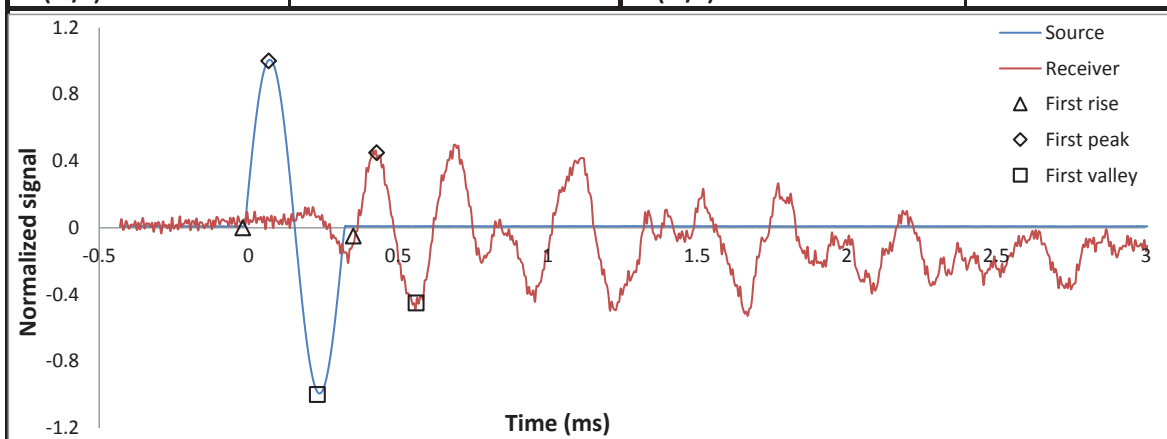

Accelerometer-Based Shear Wave Velocity Datasheet

Specimen ID: M196-PGL-400-1
 Test Material: PGL
 Date: 4/24/2015
 Test Performed by: J.Hubler
 Filename: M196-PGL-400-1

Vertical Stress: 400kPa
 Sensor Spacing: 0.1104 m
 V_s (rise) = 274 m/s

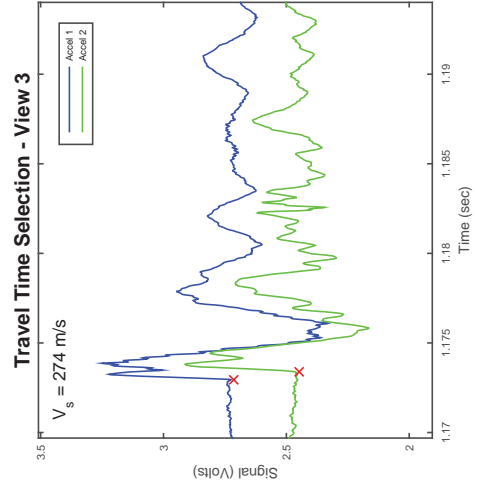
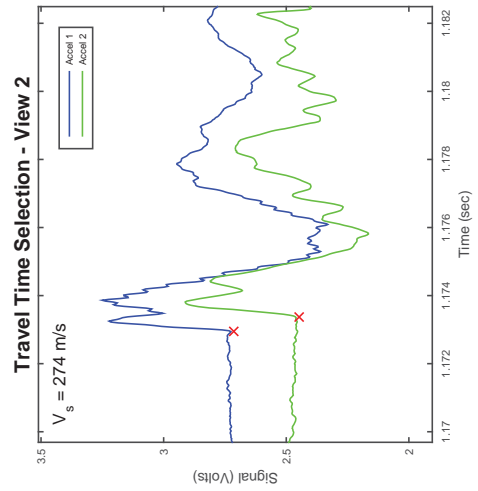
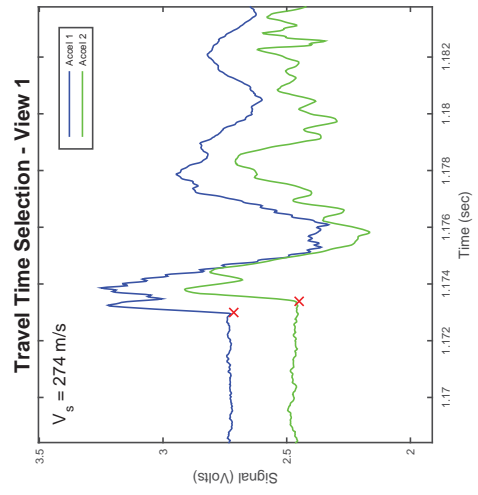
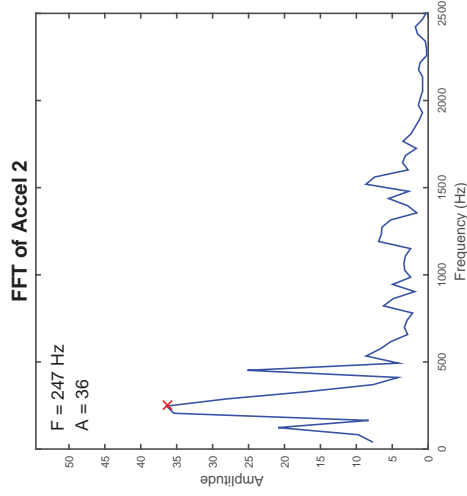
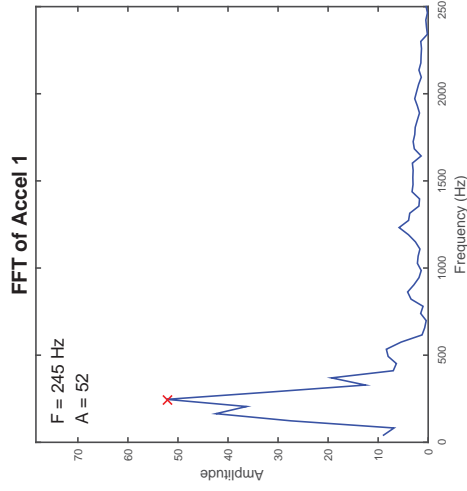
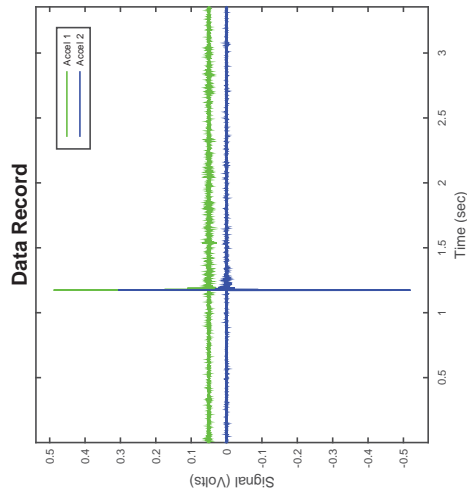

APPENDIX B

Test Data Sheets for Chapter 4

Data sheets (monotonic, cyclic, or post-cyclic shear and specimen V_S) corresponding to Tables 4.2 and 4.3 are provided in this appendix.

CSS Monotonic Shear Test Report

Geotechnical Engineering Laboratory



10/28/2013_Version 8.0

General Test Info and Sample Preparation

Device:	CSS	Relative Density (%):	25%
Specimen ID:	PGL	Void Ratio:	0.723
Test ID:	M193	Height (mm):	114.8
Date of Test:	4/13/2015	Soil-Only Specimen Diameter (mm):	306.2
Test Performed:	Monotonic Shear	Weight (kg):	13.443
Test Material:	Pea Gravel	Density (kg/m³):	1590.3
Sample Preparation:	Prepared loose using the shoveling method.	Membrane Thickness (mm):	0.635
		Moisture Content (%):	0%
		Saturated (Y/N):	N
		Prepared by:	R. Thompson
		Checked by:	J. Hubler

Consolidation Stage

Vertical Stress (kPa):	50
Time to Compression (min):	12.0
Relative Density (%):	50%
Void Ratio:	0.674
Height (mm):	111.5
Diameter (mm):	306.2
Weight (kg):	13.443
Density (kg/m³):	1637.2

Shear Stage

Type of Test:	Constant Volume
Stress or Strain Controlled:	Strain
Shear Strain Rate (%/min):	0.29
Peak Shear Strength (kPa):	4.5

Comments

Staged consolidation for Vs measurements. Silver Baseplate used with cushion membrane.

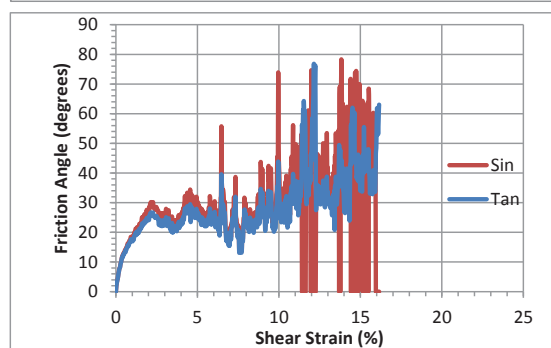
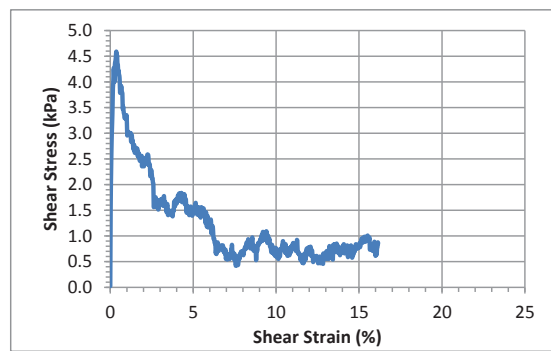
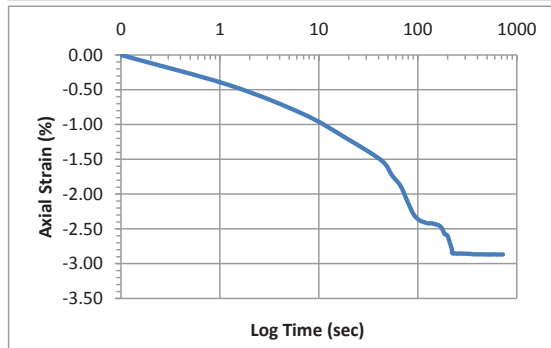
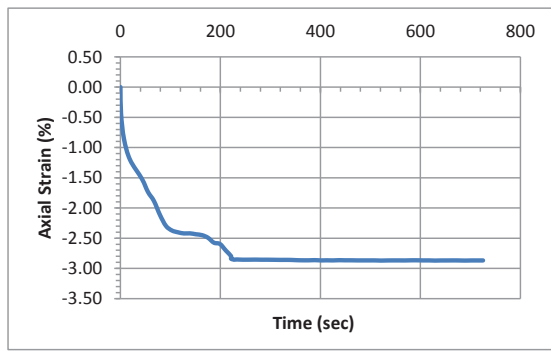

Accelerometer-Based Shear Wave Velocity Datasheet

Specimen ID: M193-PGL-50-1

Test Material: PGL

Date: 4/13/2015

Test Performed by: J.Hubler

Filename: M193-PGL-50-1

Vertical Stress: 50kPa

Sensor Spacing: 0.11176 m

V_s (rise) = 157 m/s

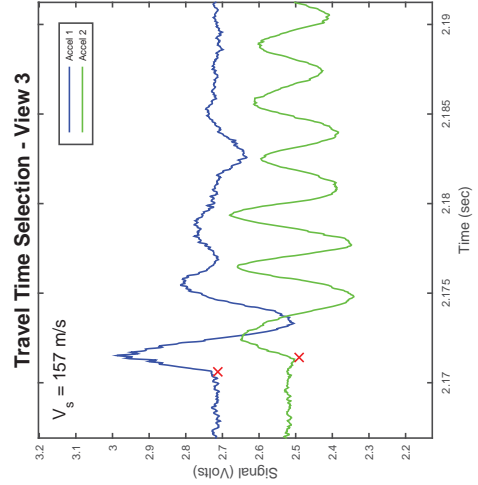
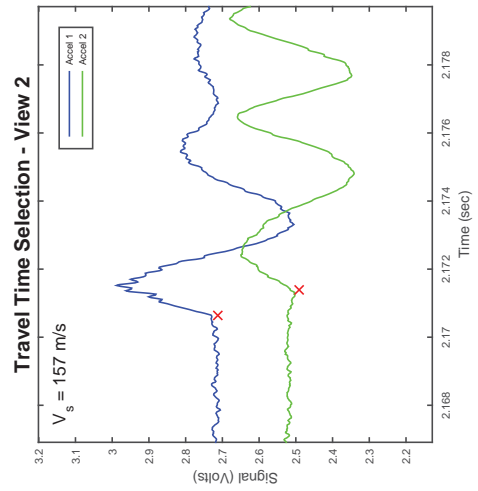
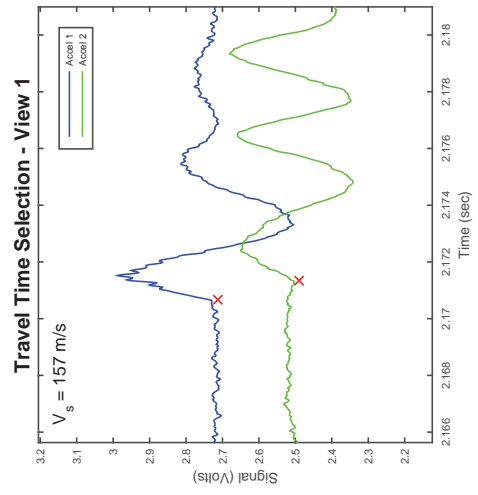
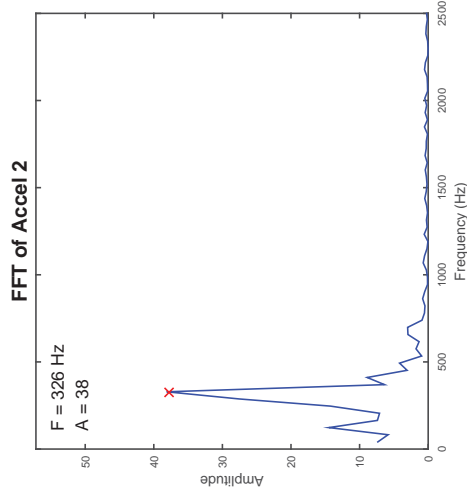
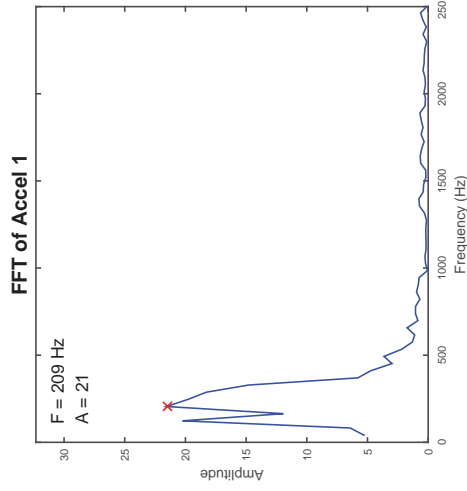
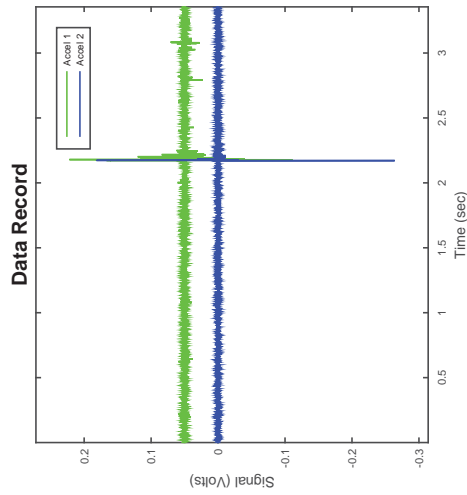

Accelerometer-Based Shear Wave Velocity Datasheet

Specimen ID: M193-PGL-50-3
 Test Material: PGL
 Date: 4/13/2015
 Test Performed by: J.Hubler
 Filename: M193-PGL-50-3

Vertical Stress: 50kPa
 Sensor Spacing: 0.11176 m
 V_s (rise) = 157 m/s

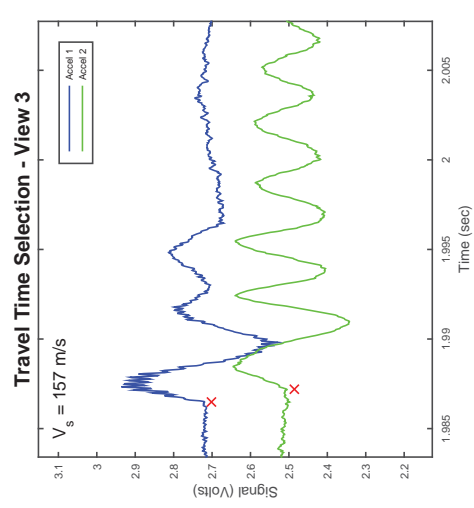
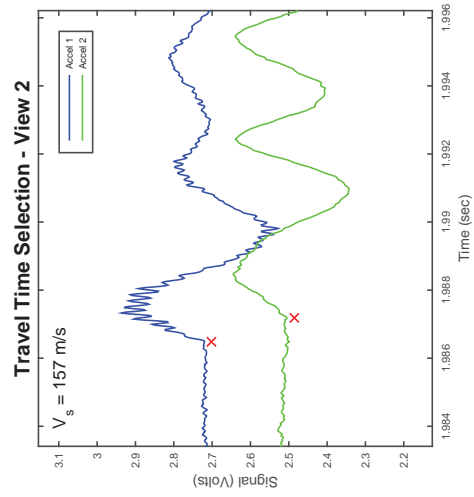
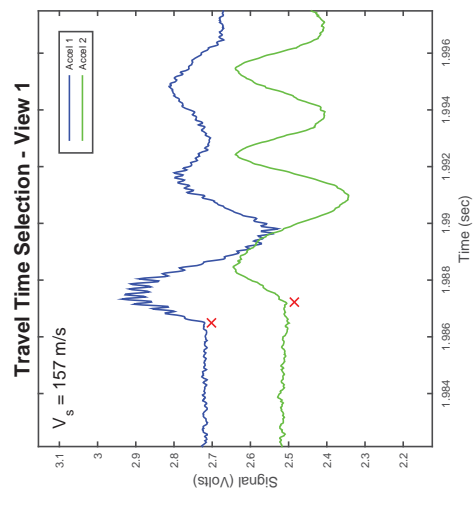
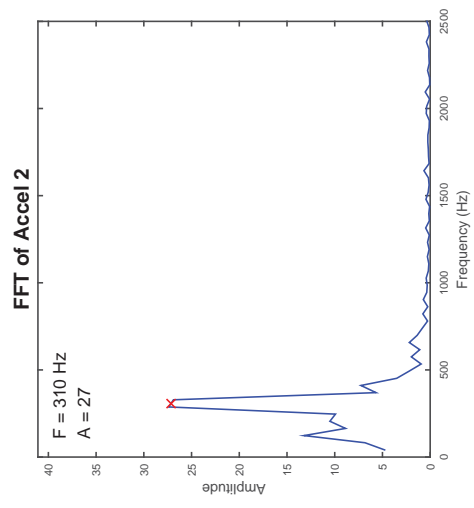
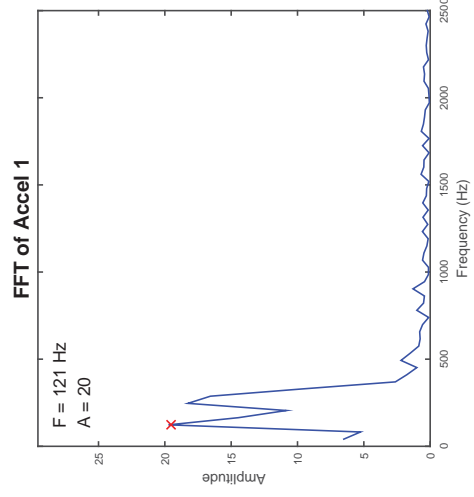
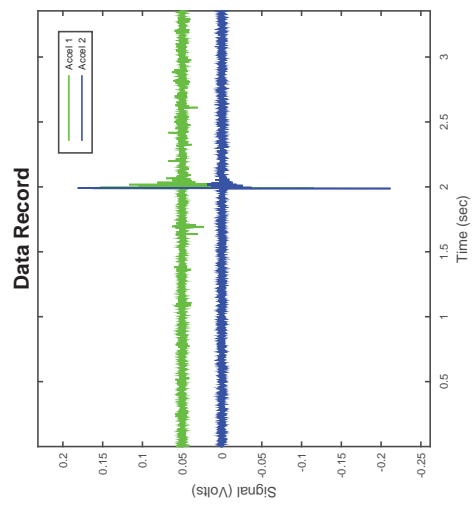

CSS Monotonic Shear Test Report

Geotechnical Engineering Laboratory



10/28/2013_Version 8.0

General Test Info and Sample Preparation

Device:	CSS	Relative Density (%):	17%
Specimen ID:	PGL	Void Ratio:	0.739
Test ID:	M191	Height (mm):	117.8
Date of Test:	4/8/2015	Soil-Only Specimen Diameter (mm):	306.2
Test Performed:	Monotonic Shear	Weight (kg):	13.678
Test Material:	Pea Gravel	Density (kg/m³):	1576.0
Sample Preparation:	Prepared loose using the shoveling method.	Membrane Thickness (mm):	0.635
		Moisture Content (%):	0%
		Saturated (Y/N):	N
		Prepared by:	R. Thompson
		Checked by:	J. Hubler

Consolidation Stage

Vertical Stress (kPa):	100
Time to Compression (min):	24.0
Relative Density (%):	44%
Void Ratio:	0.685
Height (mm):	114.2
Diameter (mm):	306.2
Weight (kg):	13.678
Density (kg/m³):	1626.0

Shear Stage

Type of Test:	Constant Volume
Stress or Strain Controlled:	Strain
Shear Strain Rate (%/min):	0.29
Peak Shear Strength (kPa):	11.5

Comments

Staged consolidation for Vs measurements. Silver Baseplate used with cushion membrane.

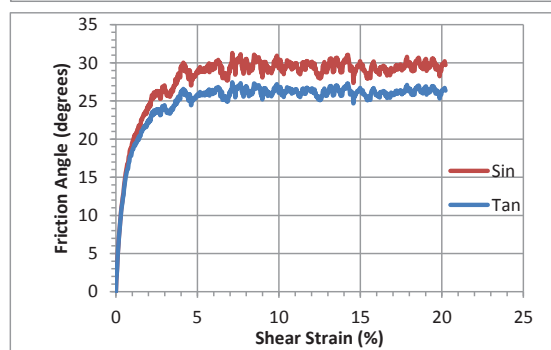
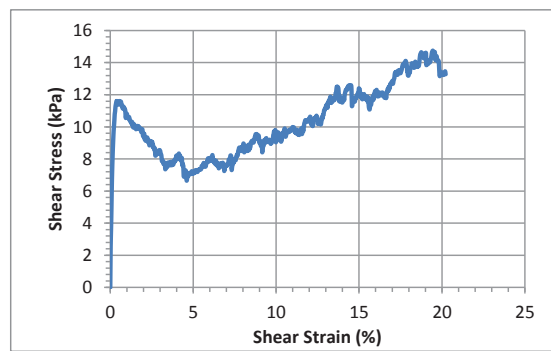
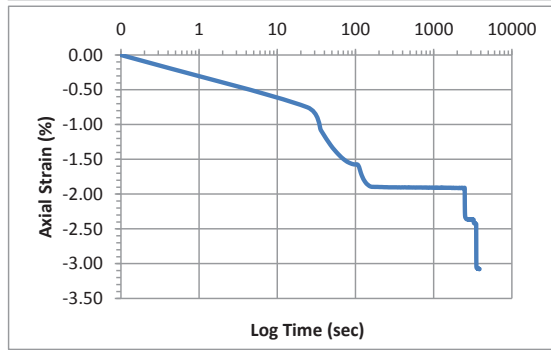
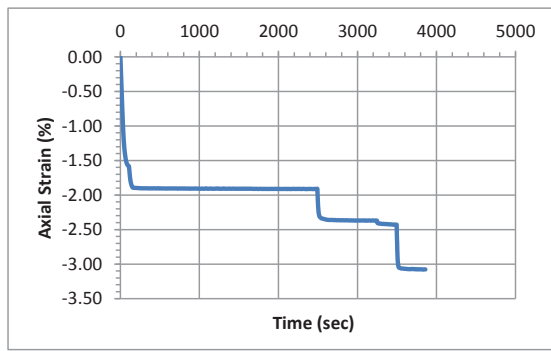

Accelerometer-Based Shear Wave Velocity Datasheet

Specimen ID: M191-PGL-100-1
Test Material: PGL
Date: 4/8/2015
Test Performed by: J.Hubler
Filename: M191-PGL-100-1

Vertical Stress: 100kPa
Sensor Spacing: 0.11466 m
 V_s (rise) = 193 m/s

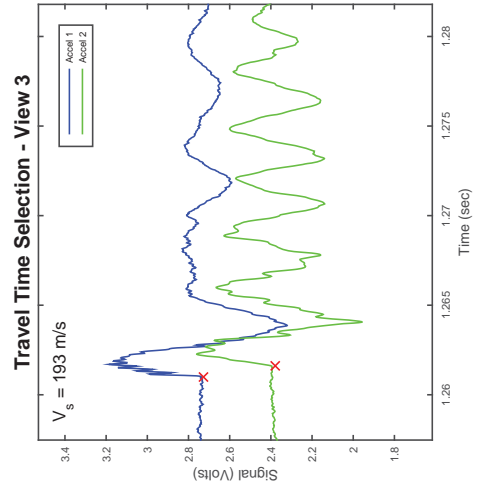
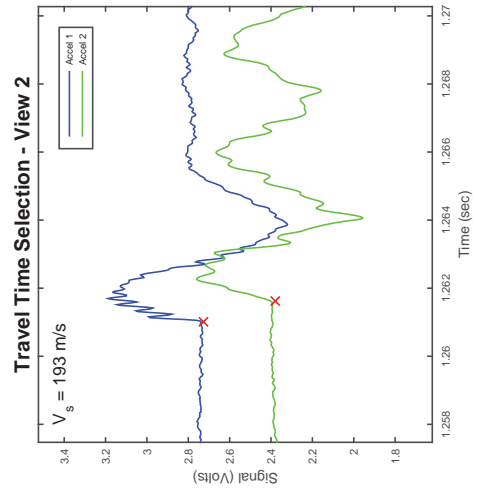
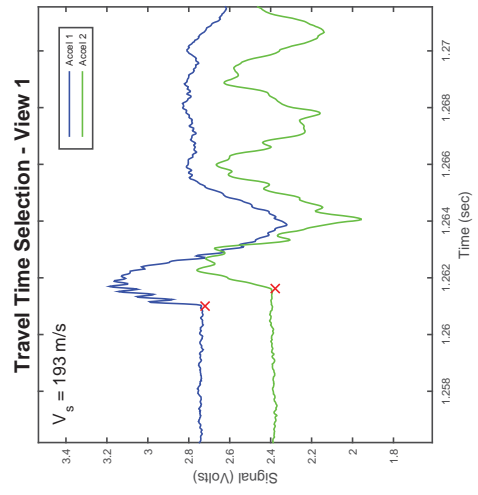
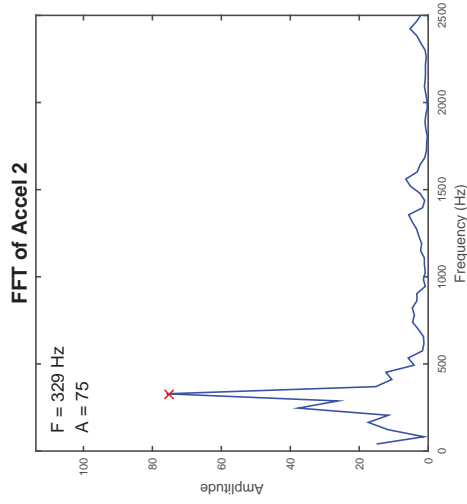
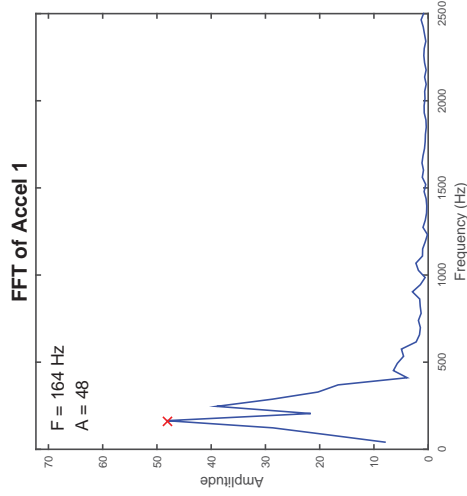
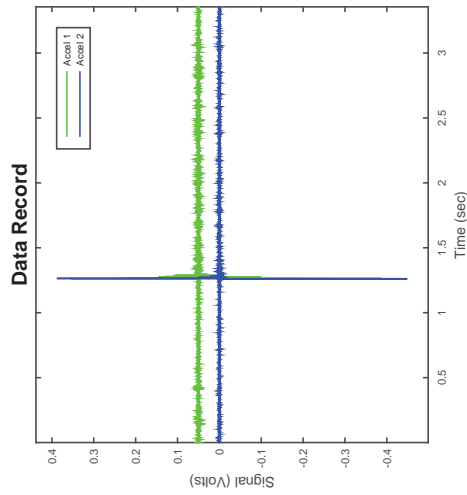

CSS Monotonic Shear Test Report

Geotechnical Engineering Laboratory



10/28/2013_Version 8.0

General Test Info and Sample Preparation

Device:	CSS	Relative Density (%):	26%
Specimen ID:	PGL	Void Ratio:	0.721
Test ID:	M184	Height (mm):	109.4
Date of Test:	3/22/2015	Soil-Only Specimen Diameter (mm):	306.2
Test Performed:	Monotonic Shear	Weight (kg):	12.830
Test Material:	Pea Gravel	Density (kg/m³):	1592.1
Sample Preparation:	Prepared loose using a shovel.	Membrane Thickness (mm):	0.635
		Moisture Content (%):	0%
		Saturated (Y/N):	N
		Prepared by:	J. Hubler
		Checked by:	J. Hubler

Consolidation Stage

Vertical Stress (kPa):	200
Compression Time (min):	29.3
Relative Density (%):	46%
Void Ratio:	0.681
Height (mm):	106.9
Diameter (mm):	306.2
Weight (kg):	12.830
Density (kg/m³):	1630.5

Shear Stage

Type of Test:	Constant Volume
Stress or Strain Controlled:	Strain
Shear Strain Rate (%/min):	0.31
Peak Shear Strength (kPa):	23.1

Comments

Silver Baseplate with cushion membrane

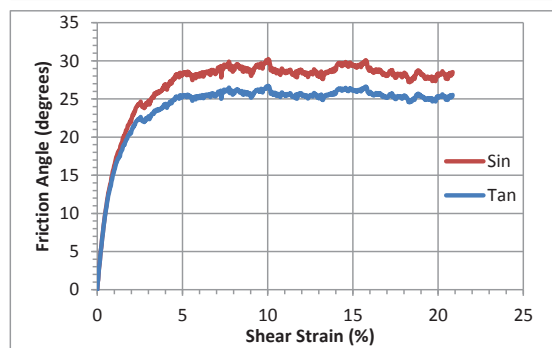
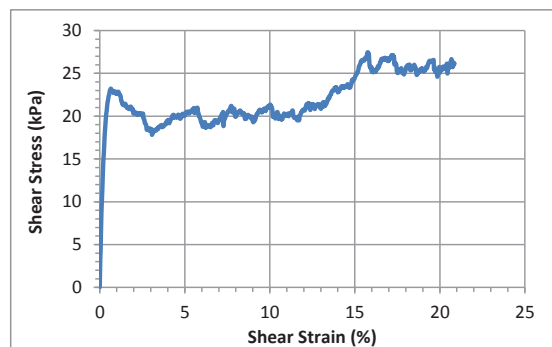
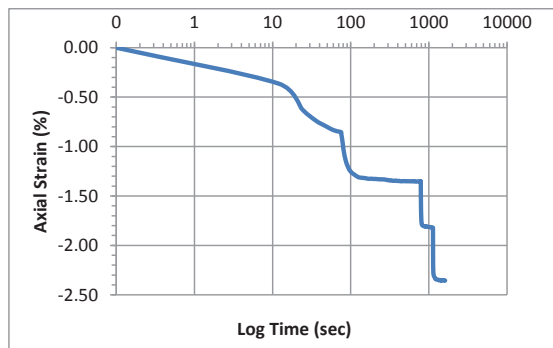
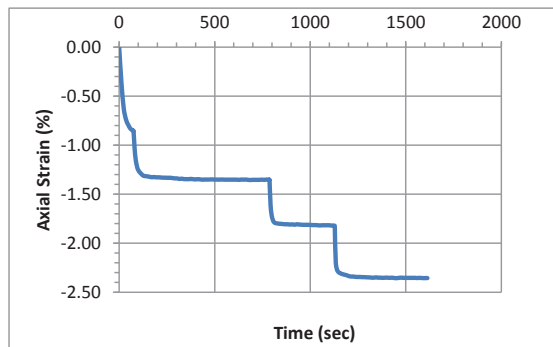

Accelerometer-Based Shear Wave Velocity Datasheet

Specimen ID: M184-PGL-200-2
 Test Material: PGL
 Date: 3/22/2015
 Test Performed by: J.Hubler
 Filename: M184-PGL-200-2

Vertical Stress: 200kPa
 Sensor Spacing: 0.1073 m
 V_s (rise) = 232 m/s

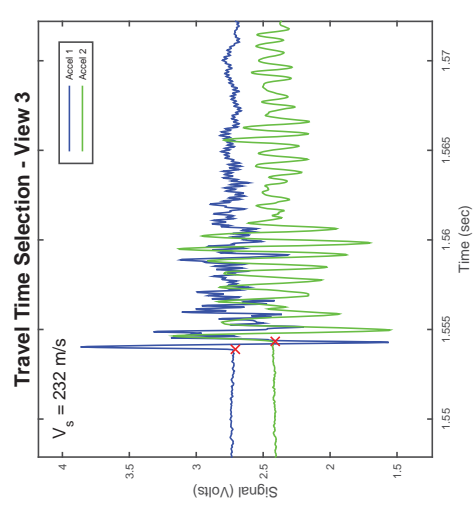
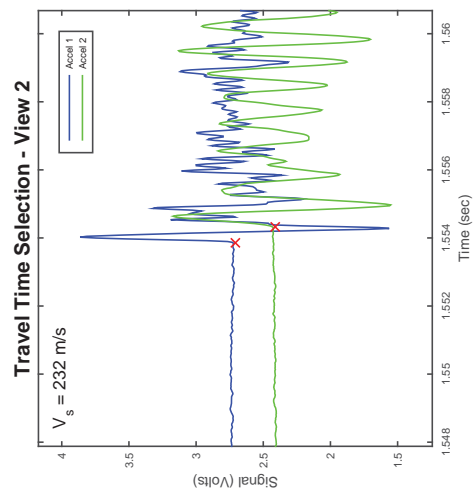
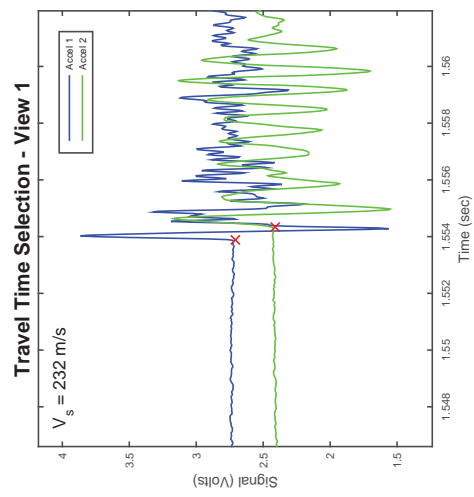
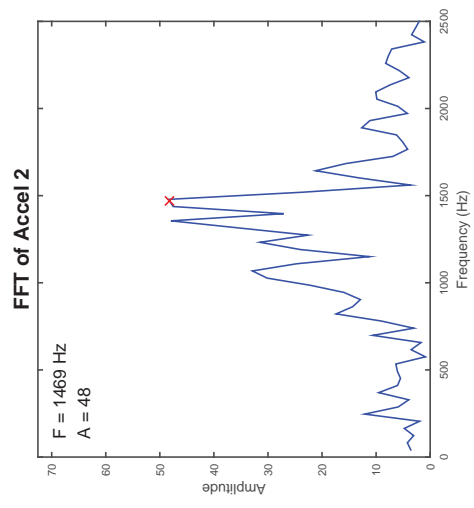
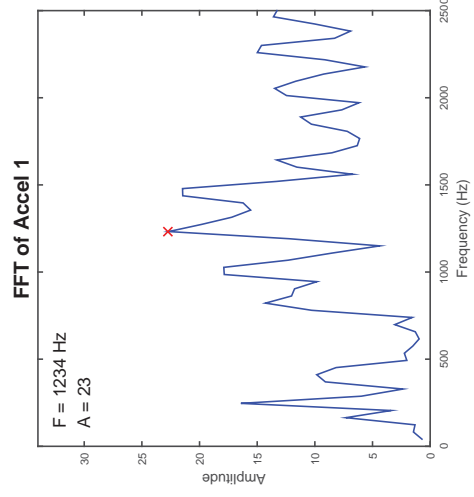
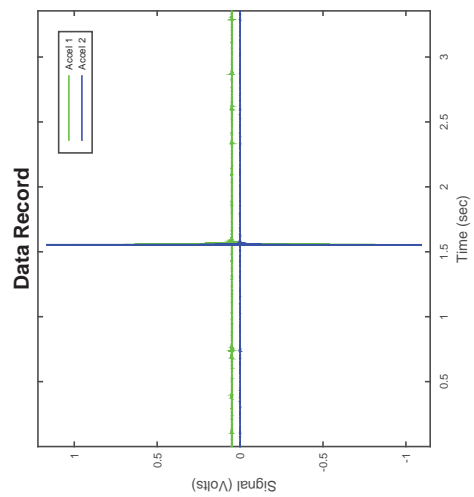

CSS Monotonic Shear Test Report

Geotechnical Engineering Laboratory



10/28/2013_Version 8.0

General Test Info and Sample Preparation

Device:	CSS	Relative Density (%):	8%
Specimen ID:	PGL	Void Ratio:	0.756
Test ID:	M171	Height (mm):	117.1
Date of Test:	1/12/2015	Soil-Only Specimen Diameter (mm):	306.2
Test Performed:	Monotonic Shear	Weight (kg):	13.45
Test Material:	Pea Gravel	Density (kg/m³):	1560.3
Sample Preparation:	Prepared loose using shoveling method.	Membrane Thickness (mm):	0.635
		Moisture Content (%):	0%
		Saturated (Y/N):	N
		Prepared by:	J.Hubler
		Checked by:	J. Hubler

Consolidation Stage

Vertical Stress (kPa):	400
Compression Time (min):	56.0
Relative Density (%):	46%
Void Ratio:	0.682
Height (mm):	112.1
Diameter (mm):	306.2
Weight (kg):	13.45
Density (kg/m³):	1629.7

Shear Stage

Type of Test:	Constant Volume
Stress or Strain Controlled:	Strain
Shear Strain Rate (%/min):	0.29
Peak Shear Strength (kPa):	51.1

Comments

Silver Baseplate with cushion membrane

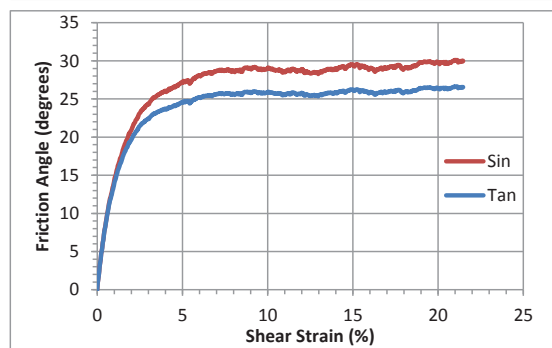
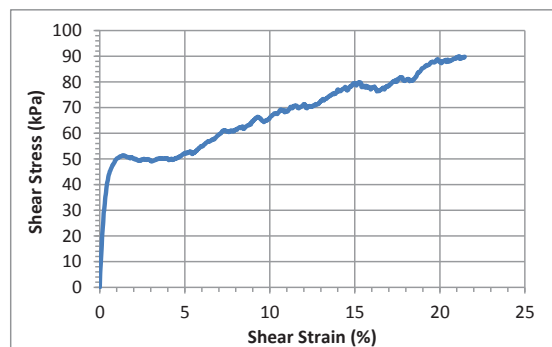
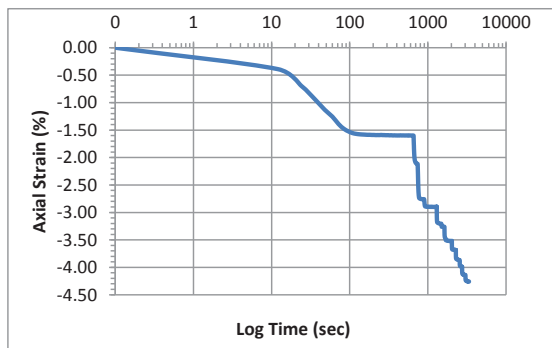
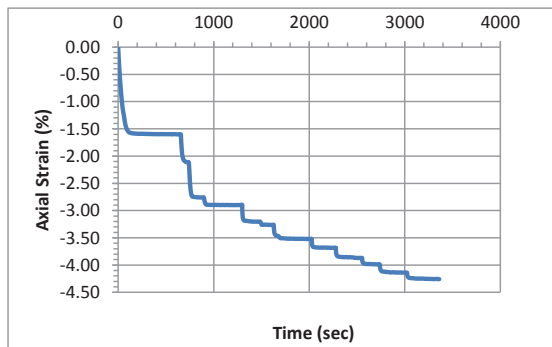

CSS Shear Wave Velocity Measurement Report

Geotechnical Engineering Laboratory



12/18/2013 Version 1.0

General Test Info and Sample Preparation

Device:	CSS	Relative Density (%):	8%
Specimen ID:	PGL	Void Ratio:	0.756
Test ID:	M171	Height (mm):	117.1
Date of Test:	1/12/2015	Specimen Diameter (mm):	306.2
Test Performed:	Monotonic Shear	Weight (kg):	13.45
Test Material:	Pea Gravel	Density (kg/m ³):	1559.79
Sample Preparation:	Prepared loose by shoveling method.	Membrane Thickness (mm):	0.635
		Moisture Content (%):	0%
		Saturated (Y/N):	N
		Prepared by:	J. Hubler
		Checked by:	J. Hubler

Consolidation Stage

Vertical Stress (kPa):	400
Time to Comp. (min):	56.0
Relative Density (%):	46%
Void Ratio:	0.682
Height (mm):	112.1
Density (kg/m ³):	1629.36

Shear Wave Velocity Measurement

Signal type	Sinusoidal
Signal amplitude (Vpp)	4.5
Signal frequency (kHz)	3.5
Sensor spacing (mm)	108.27
Average Vs (m/s)	276.5
Stdev. (m/s)	10.8
P+V average Vs (m/s)	278.5
Stdev. (m/s)	14.4
Wavelength (m)	0.079
Spacing/wavelength	1.4

First rise		First peak		First valley	
Initiation time (ms)	-0.00750	Initiation time (ms)	0.05650	Initiation time (ms)	0.20500
Arrival time (ms)	0.39000	Arrival time (ms)	0.46000	Arrival time (ms)	0.58000
Vs (m/s)	272.4	Vs (m/s)	268.3	Vs (m/s)	288.7

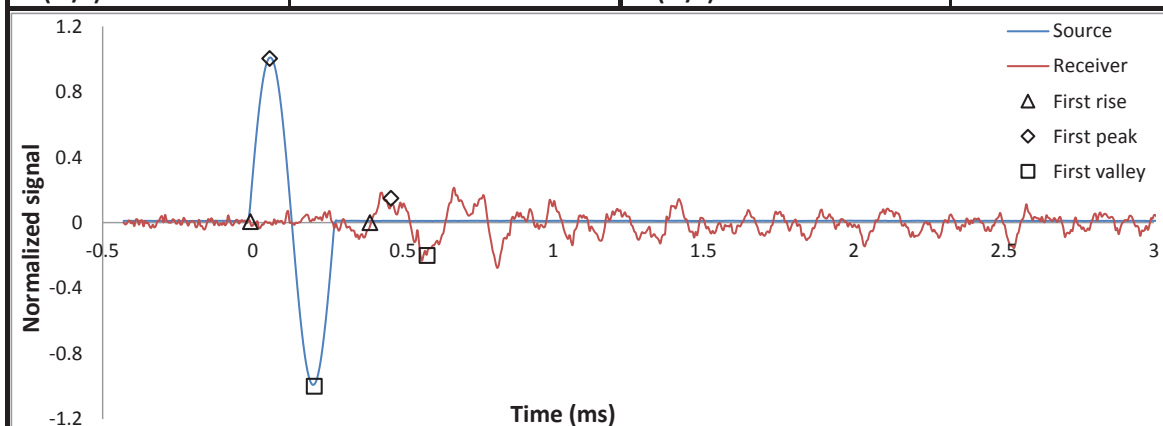

CSS Monotonic Shear Test Report

Geotechnical Engineering Laboratory



10/28/2013_Version 8.0

General Test Info and Sample Preparation

Device:	CSS	Relative Density (%):	71%
Specimen ID:	PGD	Void Ratio:	0.631
Test ID:	M192	Height (mm):	115.0
Date of Test:	4/13/2015	Soil-Only Specimen Diameter (mm):	306.2
Test Performed:	Monotonic Shear	Weight (kg):	14.223
Test Material:	Pea Gravel	Density (kg/m³):	1679.7
Sample Preparation:	Prepared dense by tamping 25x in 3 layers.	Membrane Thickness (mm):	0.635
		Moisture Content (%):	0%
		Saturated (Y/N):	N
		Prepared by:	R. Thompson
		Checked by:	J. Hubler

Consolidation Stage

Vertical Stress (kPa):	50
Time to Compression (min):	20.1
Relative Density (%):	90%
Void Ratio:	0.595
Height (mm):	112.4
Diameter (mm):	306.2
Weight (kg):	14.223
Density (kg/m³):	1718.3

Shear Stage

Type of Test:	Constant Volume
Stress or Strain Controlled:	Strain
Shear Strain Rate (%/min):	0.29
Peak Shear Strength (kPa):	5.9

Comments

Staged consolidation for Vs measurements. Silver Baseplate used with cushion membrane.

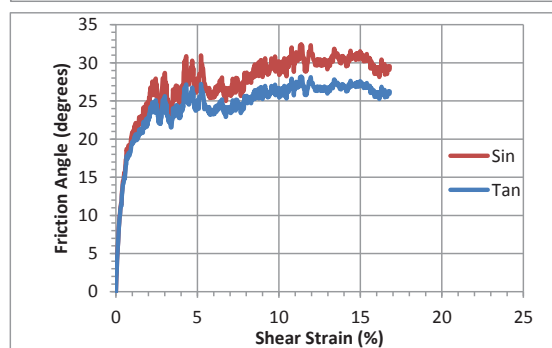
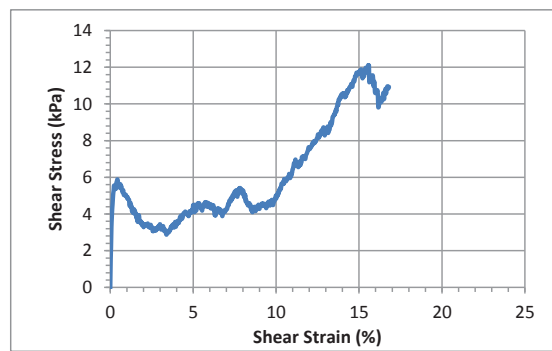
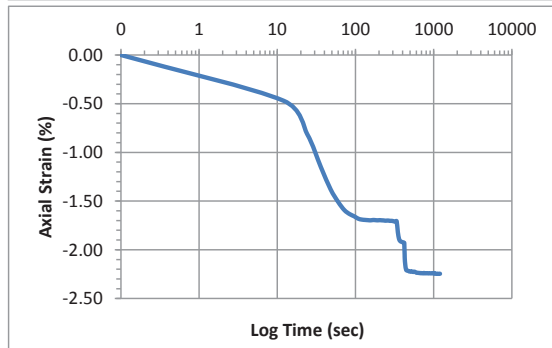
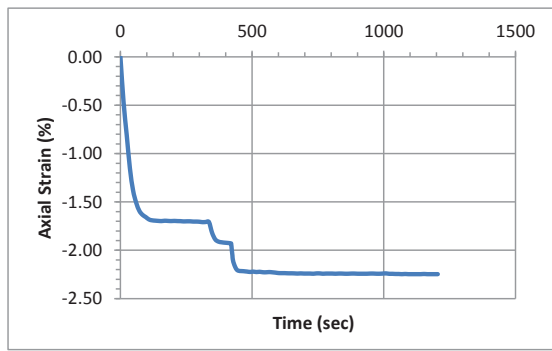

Accelerometer-Based Shear Wave Velocity Datasheet

Specimen ID: M192-PGD-50-1

Test Material: PGD

Date: 4/13/2015

Test Performed by: J.Hubler

Filename: M192-PGD-50-1

Vertical Stress: 50kPa

Sensor Spacing: 0.11267 m

V_s (rise) = 173 m/s

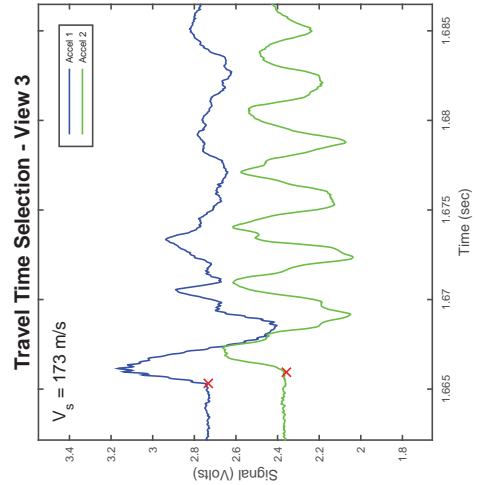
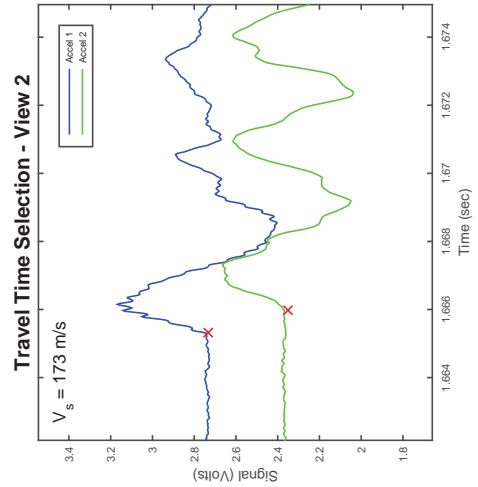
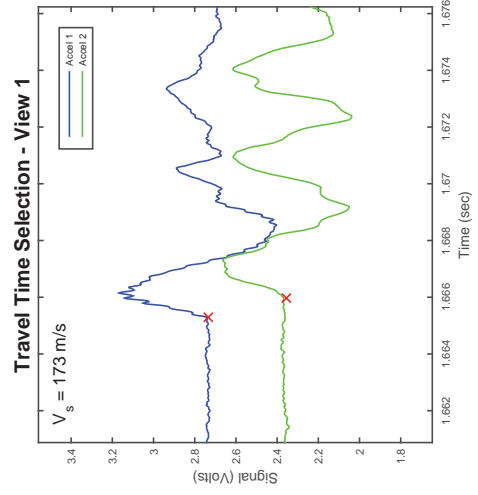
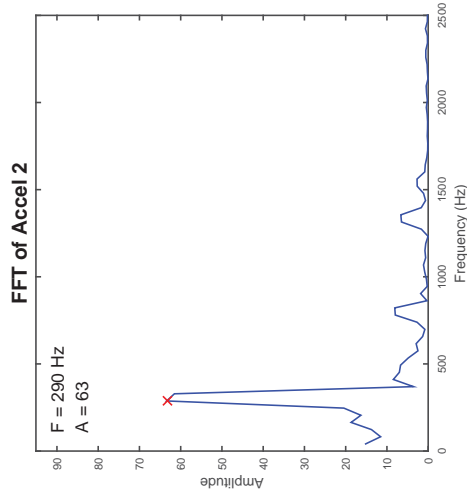
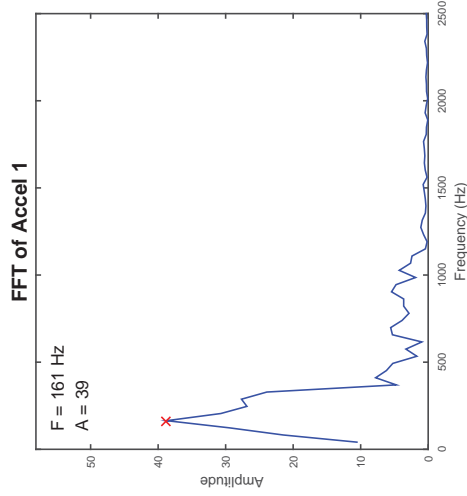
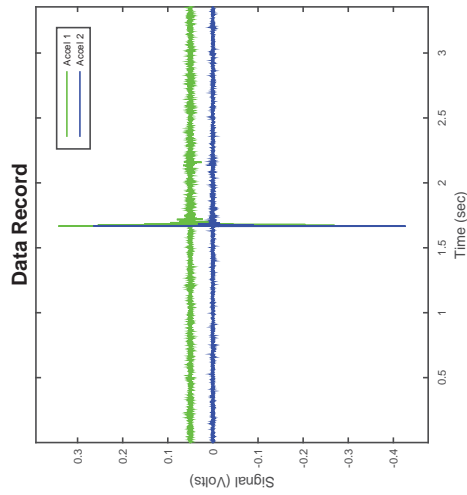

CSS Monotonic Shear Test Report

Geotechnical Engineering Laboratory



10/28/2013_Version 8.0

General Test Info and Sample Preparation

Device:	CSS	Relative Density (%):	75%
Specimen ID:	PGD	Void Ratio:	0.624
Test ID:	M205	Height (mm):	109.8
Date of Test:	6/9/2015	Soil-Only Specimen Diameter (mm):	306.23
Test Performed:	Monotonic Shear	Weight (kg):	13.651
Test Material:	Pea Gravel	Density (kg/m³):	1687.3
Sample Preparation:	Prepared dense by tamping 25x in 3 layers.	Membrane Thickness (mm):	0.635
		Moisture Content (%):	0%
		Saturated (Y/N):	N
		Prepared by:	A. Jackson
		Checked by:	J. Hubler

Consolidation Stage

Vertical Stress (kPa):	100
Time to Compression (min):	17.5
Relative Density (%):	91%
Void Ratio:	0.592
Height (mm):	107.7
Diameter (mm):	306.23
Weight (kg):	13.651
Density (kg/m³):	1721.5

Shear Stage

Type of Test:	Constant Volume
Stress or Strain Controlled:	Strain
Shear Strain Rate (%/min):	0.30
Peak Shear Strength (kPa):	13.3

Comments

Staged consolidation for Vs measurements. Silver Baseplate used with cushion membrane. Slid approximately 12/32" at the top by the end of the test (sliding evident at 25 minutes).

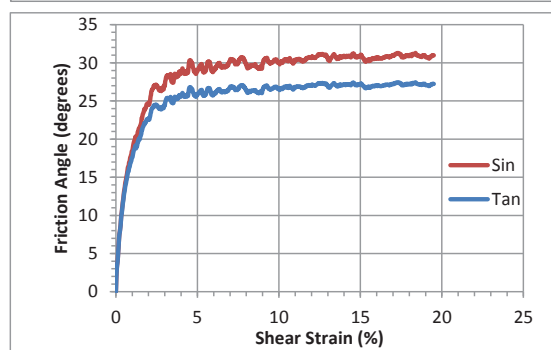
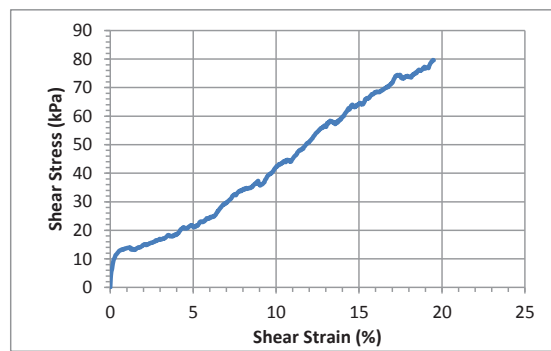
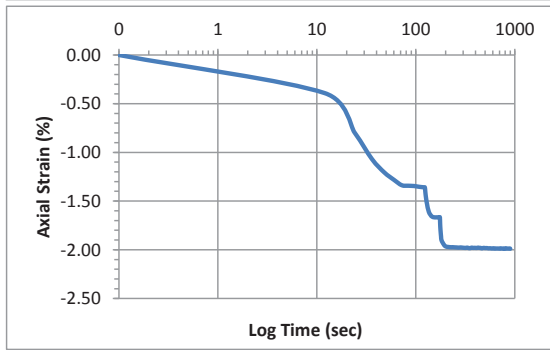
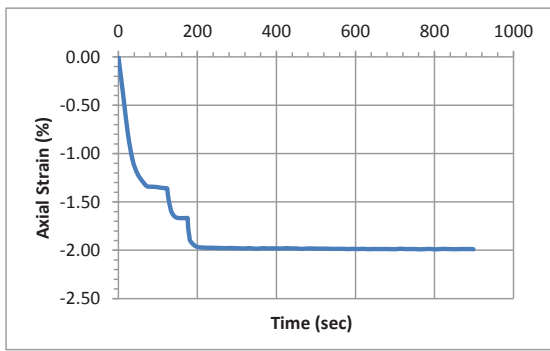

Accelerometer-Based Shear Wave Velocity Datasheet

Specimen ID: M205-PGD-100-1X

Test Material: PGD

Date: 6/9/2015

Test Performed by: J.Hubler

Filename: M205-PGD-100-1X

Vertical Stress: 100kPa

Sensor Spacing: 0.10762 m

V_s (rise) = 213 m/s

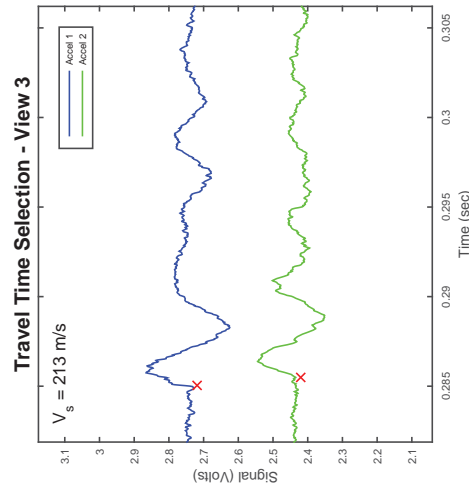
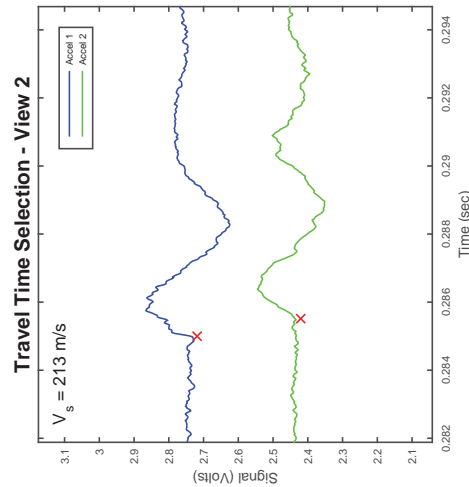
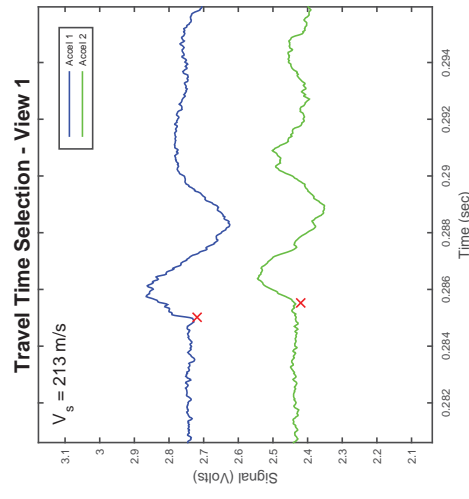
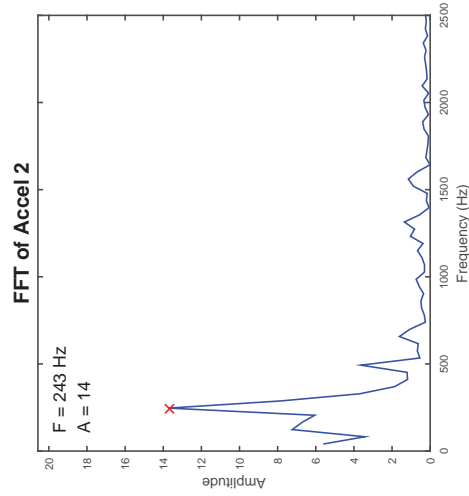
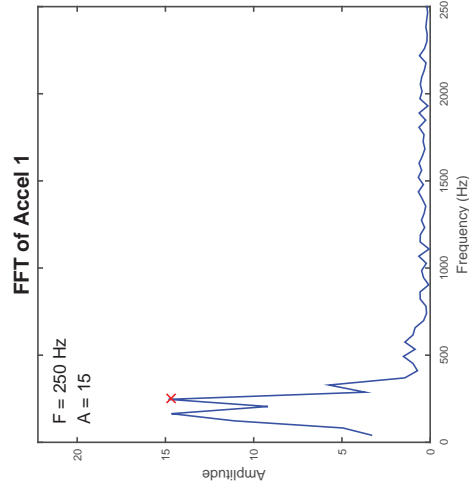
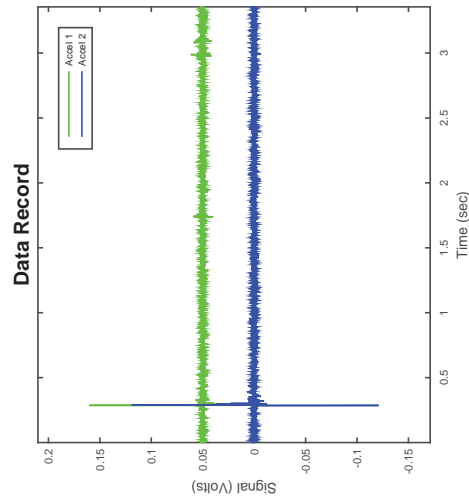

CSS Monotonic Shear Test Report

Geotechnical Engineering Laboratory



10/28/2013_Version 8.0

General Test Info and Sample Preparation

Device:	CSS	Relative Density (%):	72%
Specimen ID:	PGD	Void Ratio:	0.630
Test ID:	M206	Height (mm):	112.9
Date of Test:	6/10/2015	Soil-Only Specimen Diameter (mm):	306.23
Test Performed:	Monotonic Shear	Weight (kg):	13.973
Test Material:	Pea Gravel	Density (kg/m³):	1680.9
Sample Preparation:	Prepared dense by tamping 20x in 3 layers.	Membrane Thickness (mm):	0.635
		Moisture Content (%):	0%
		Saturated (Y/N):	N
		Prepared by:	A. Jackson
		Checked by:	J. Hubler

Consolidation Stage

Vertical Stress (kPa):	200
Time to Compression (min):	13.9
Relative Density (%):	88%
Void Ratio:	0.598
Height (mm):	110.6
Diameter (mm):	306.23
Weight (kg):	13.973
Density (kg/m³):	1715.1

Shear Stage

Type of Test:	Constant Volume
Stress or Strain Controlled:	Strain
Shear Strain Rate (%/min):	0.30
Peak Shear Strength (kPa):	25.9

Comments

Staged Consolidation for Vs measurement. Silver Baseplate used with cushion membrane.

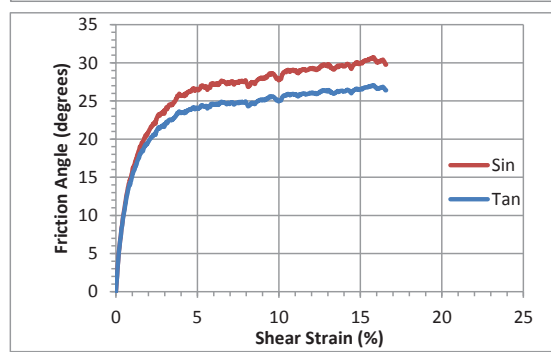
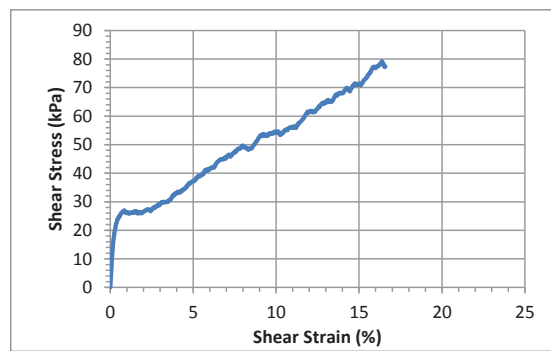
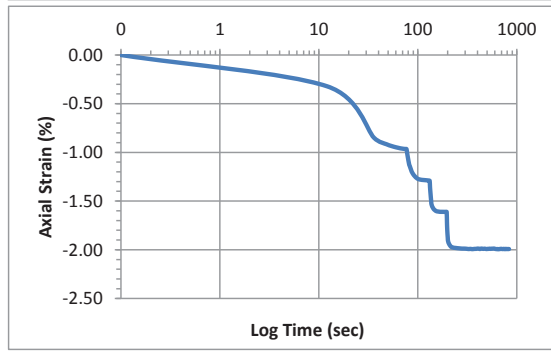
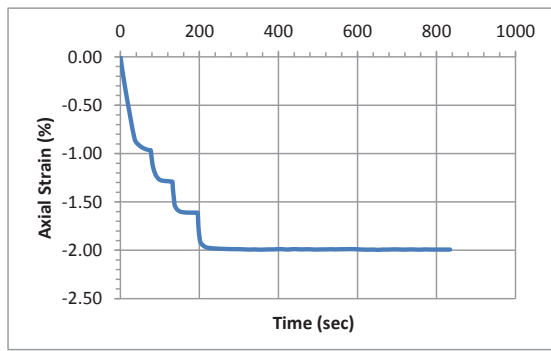

Accelerometer-Based Shear Wave Velocity Datasheet

Specimen ID: M206-PGD-200-1X

Test Material: PGD

Date: 6/10/2015

Test Performed by: J.Hubler

Filename: M206-PGD-200-1X

Vertical Stress: 200kPa

Sensor Spacing: 0.11057 m

V_s (rise) = 247 m/s

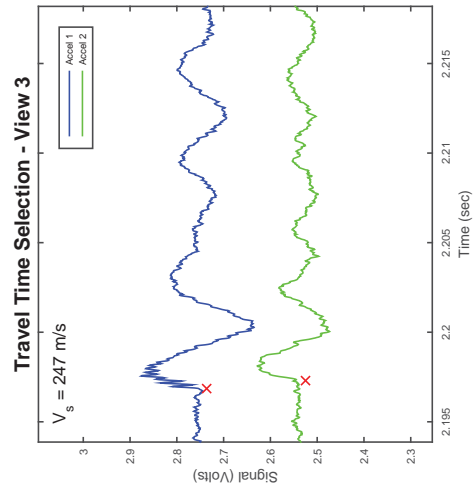
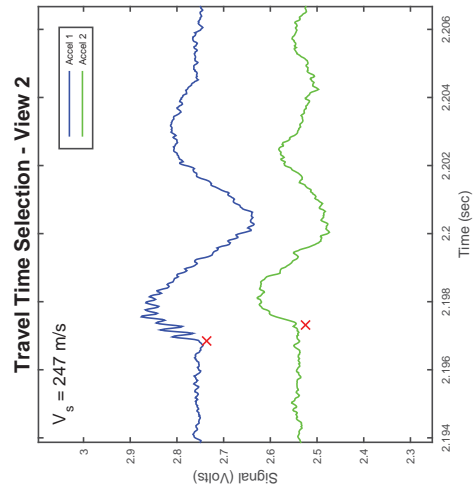
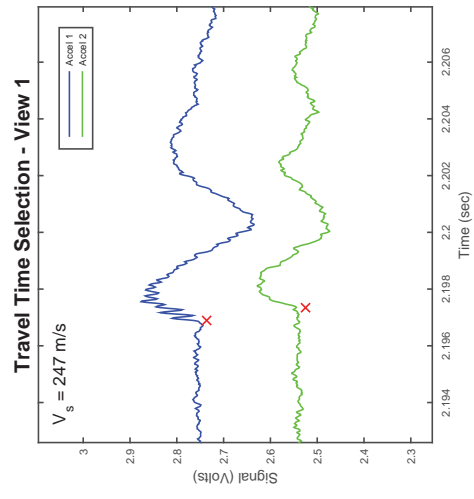
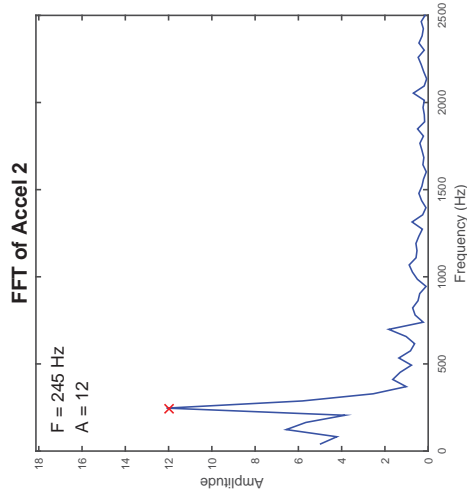
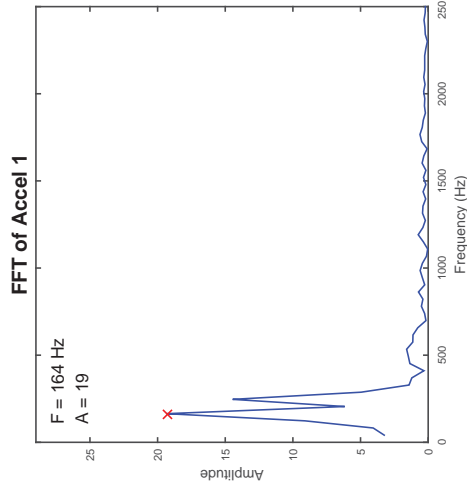
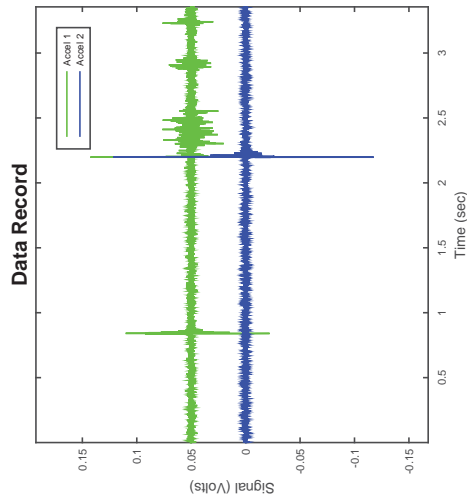

CSS Monotonic Shear Test Report

Geotechnical Engineering Laboratory



10/28/2013_Version 8.0

General Test Info and Sample Preparation

Device:	CSS	Relative Density (%):	64%
Specimen ID:	PGD	Void Ratio:	0.645
Test ID:	M201	Height (mm):	117.7
Date of Test:	6/3/2015	Soil-Only Specimen Diameter (mm):	306.23
Test Performed:	Monotonic Shear	Weight (kg):	14.435
Test Material:	Pea Gravel	Density (kg/m³):	1665.3
Sample Preparation:	Prepared dense by tamping 25x in 3 layers.	Membrane Thickness (mm):	0.635
		Moisture Content (%):	0%
		Saturated (Y/N):	N
		Prepared by:	J.Hubler
		Checked by:	J. Hubler

Consolidation Stage

Vertical Stress (kPa):	400
Time to Compression (min):	56.0
Relative Density (%):	90%
Void Ratio:	0.593
Height (mm):	114.0
Diameter (mm):	306.23
Weight (kg):	14.435
Density (kg/m³):	1719.7

Shear Stage

Type of Test:	Constant Volume
Stress or Strain Controlled:	Strain
Shear Strain Rate (%/min):	0.29
Peak Shear Strength (kPa):	68.0

Comments

Staged consolidation for Vs measurements. Silver Baseplate used with cushion membrane. Sliding of approximately 0.5" by the end of the test. Top two rings moved with topcap.

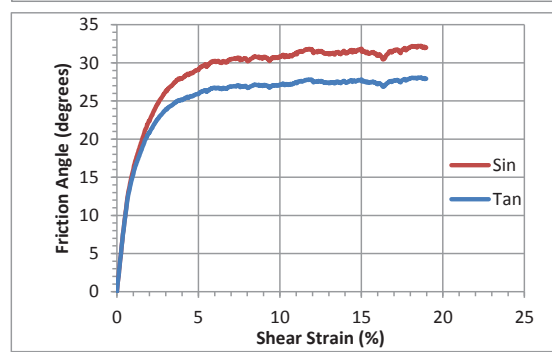
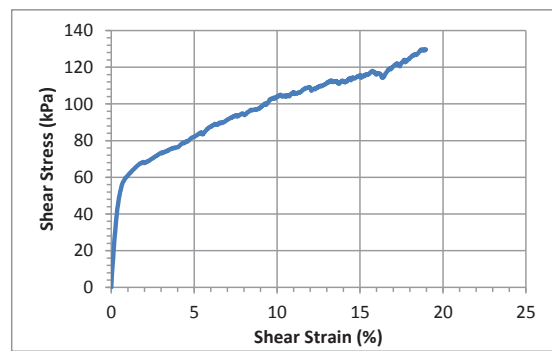
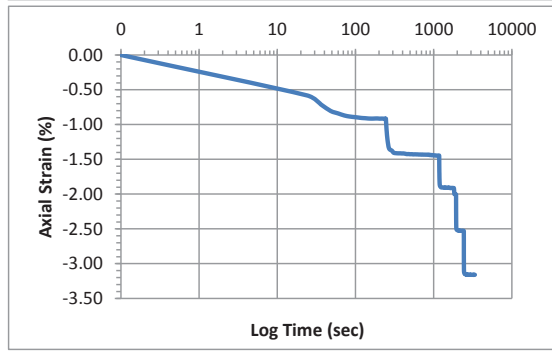
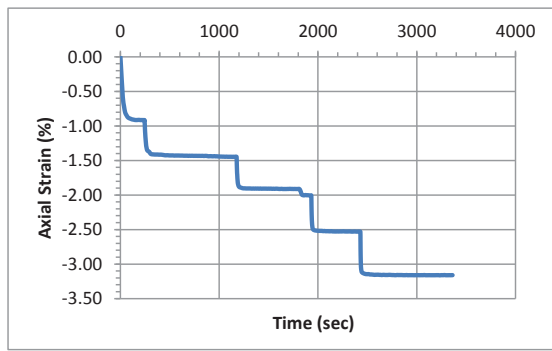

Accelerometer-Based Shear Wave Velocity Datasheet

Specimen ID: M201-PGD-400-2X

Test Material: PGD

Date: 6/3/2015

Test Performed by: J.Hubler

Filename: M201-PGD-400-2X

Vertical Stress: 400kPa

Sensor Spacing: 0.11397 m

V_s (rise) = 283 m/s

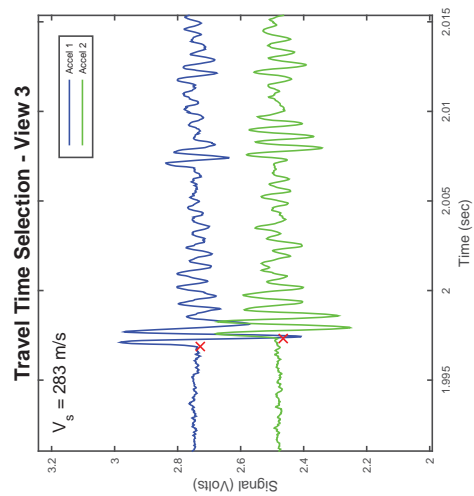
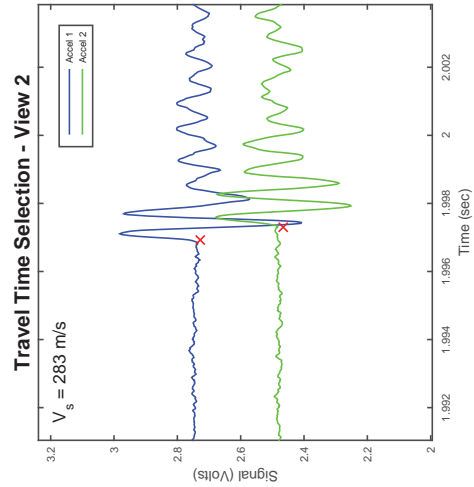
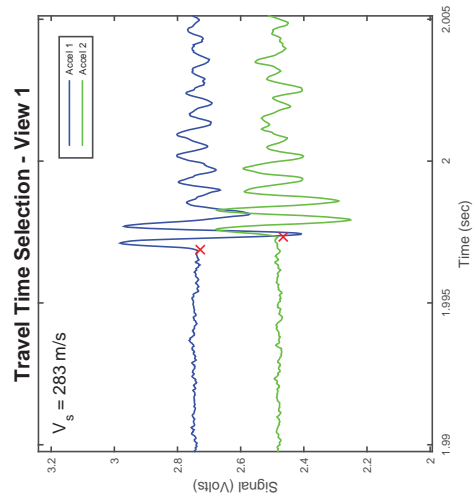
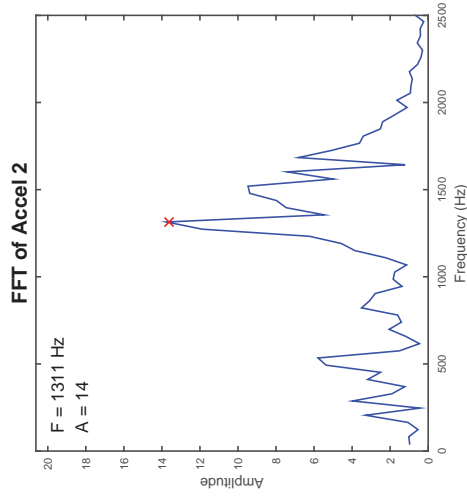
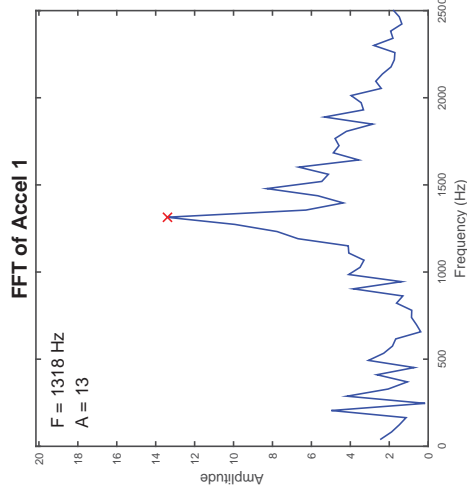
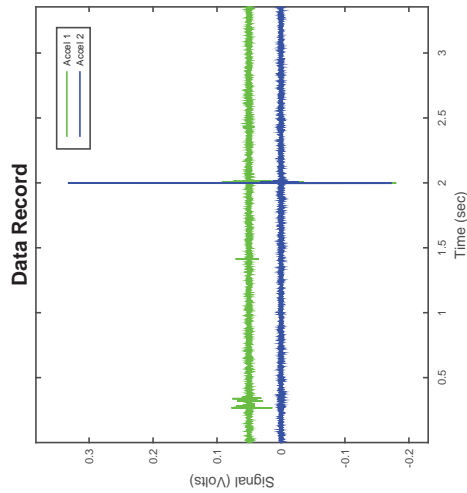

CSS Monotonic Shear Test Report

Geotechnical Engineering Laboratory



10/28/2013_Version 8.0

General Test Info and Sample Preparation

Device:	CSS	Relative Density (%):	37%
Specimen ID:	CLS5	Void Ratio:	0.895
Test ID:	M212	Height (mm):	110.5
Date of Test:	7/16/2015	Soil-Only Specimen Diameter (mm):	306.23
Test Performed:	Monotonic Shear	Weight (kg):	11.384
Test Material:	5mm Crushed Limestone	Density (kg/m ³):	1398.5
Sample Preparation:	Prepared loose using the shoveling method. To reach required density - rubber mallet hit baseplate 25x in 3 layers after shoveling.	Membrane Thickness (mm):	0.635
		Moisture Content (%):	0%
		Saturated (Y/N):	N
		Prepared by:	A. Jackson
		Checked by:	J. Hubler

Consolidation Stage

Vertical Stress (kPa):	50
Time to Compression (min):	26.7
Relative Density (%):	45%
Void Ratio:	0.857
Height (mm):	108.3
Diameter (mm):	306.23
Weight (kg):	11.384
Density (kg/m ³):	1427.4

Shear Stage

Type of Test:	Constant Volume
Stress or Strain Controlled:	Strain
Shear Strain Rate (%/min):	0.30
Peak Shear Strength (kPa):	7.9

Comments

Silver Baseplate used with cushion membrane.

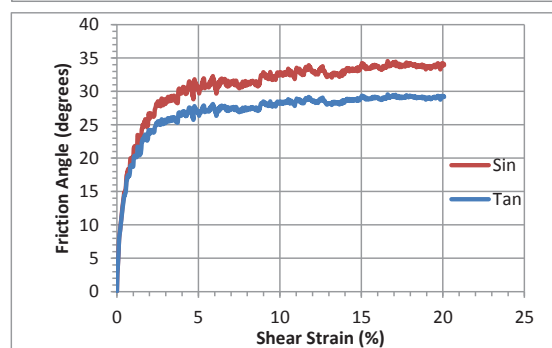
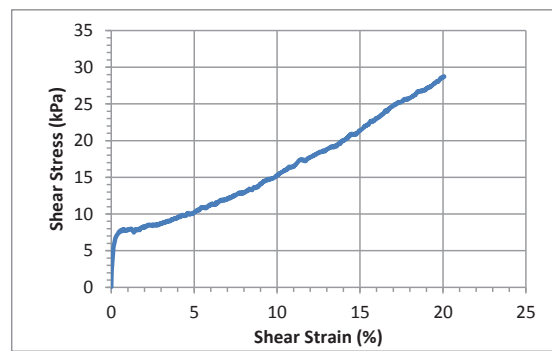
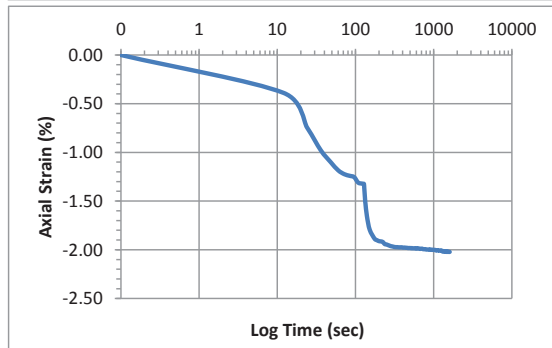
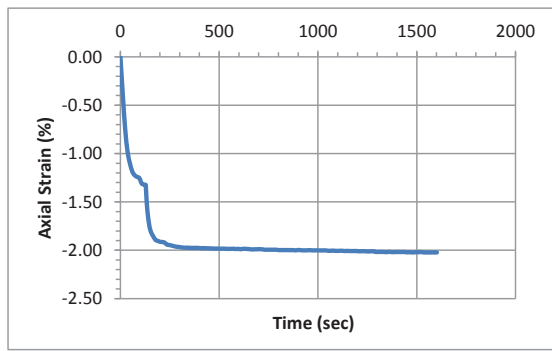

Accelerometer-Based Shear Wave Velocity Datasheet

Specimen ID: M212-FLS-50-1X

Test Material: FLS

Date: 7/16/2015

Test Performed by: J.Hubler

Filename: M212-FLS-50-1X

Vertical Stress: 50kPa

Sensor Spacing: 0.10824 m

V_s (rise) = 182 m/s

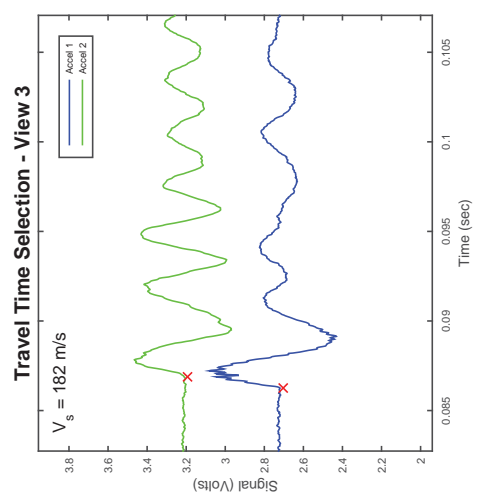
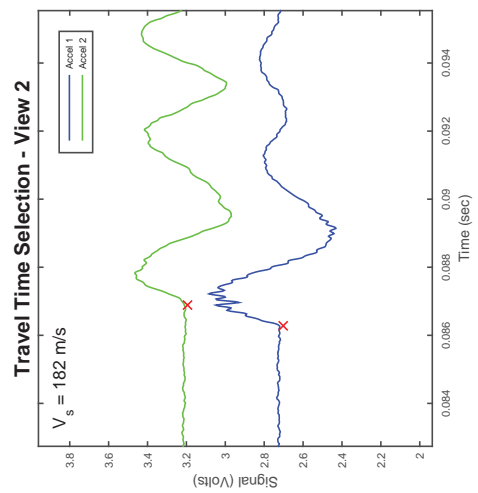
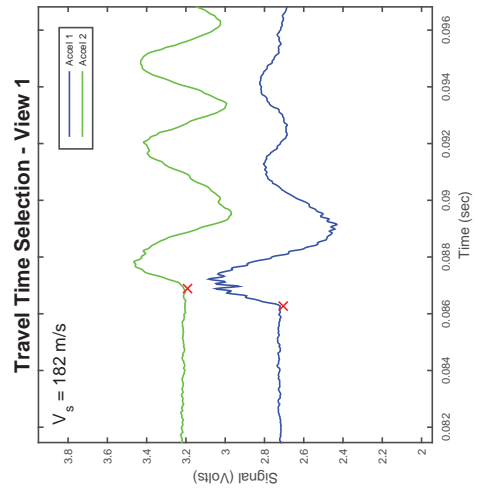
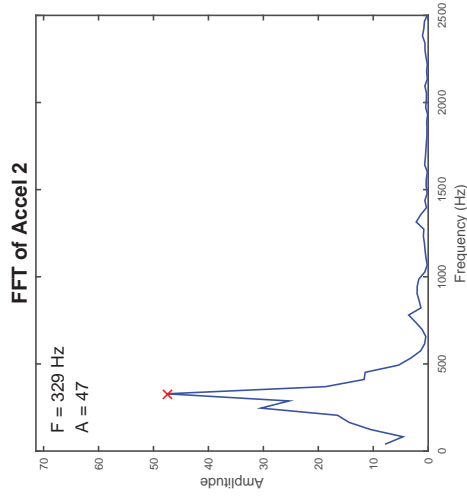
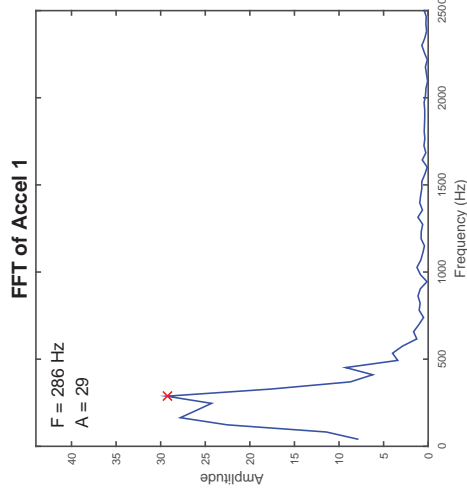
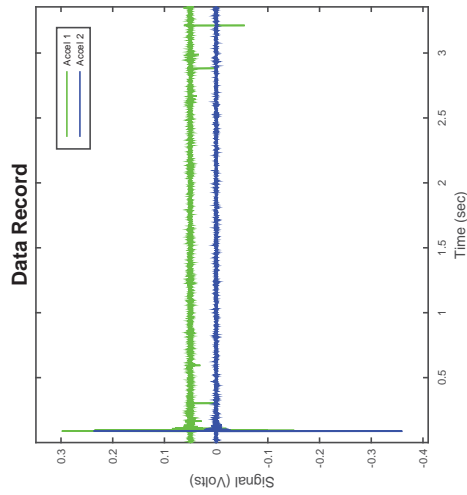

Accelerometer-Based Shear Wave Velocity Datasheet

Specimen ID: M212-FLS-50-2X
 Test Material: FLS
 Date: 7/16/2015
 Test Performed by: J.Hubler
 Filename: M212-FLS-50-2X

Vertical Stress: 50kPa
 Sensor Spacing: 0.10824 m
 V_s (rise) = 178 m/s

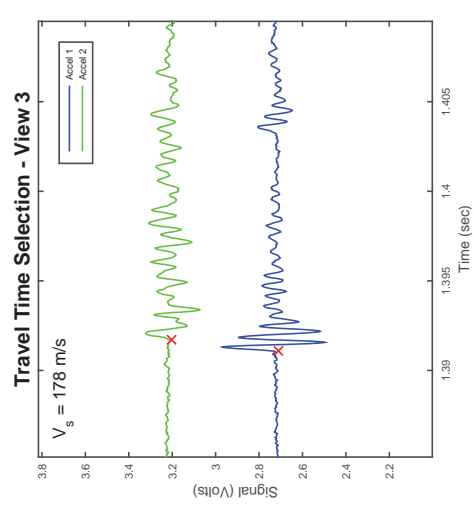
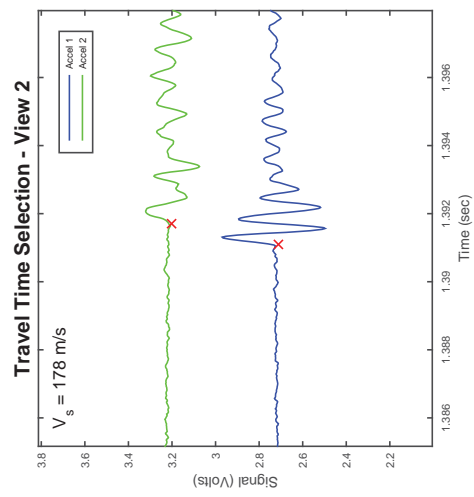
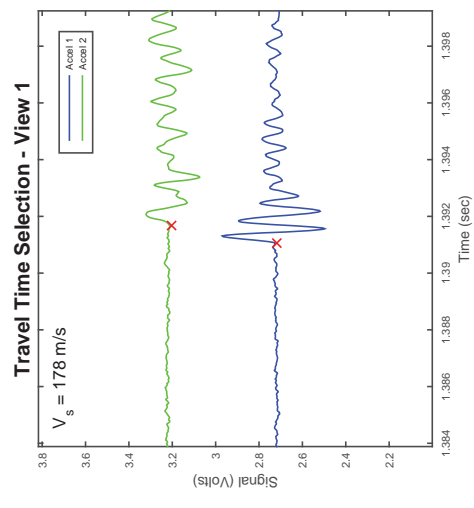
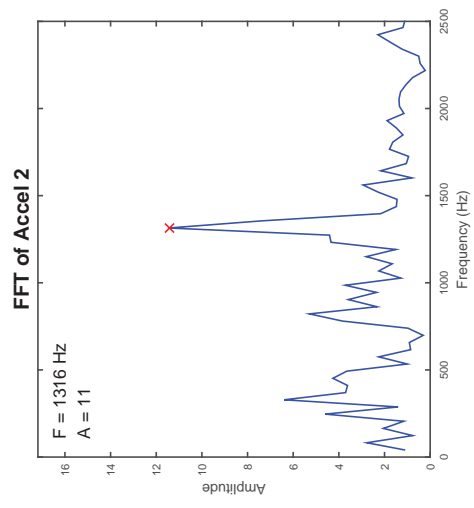
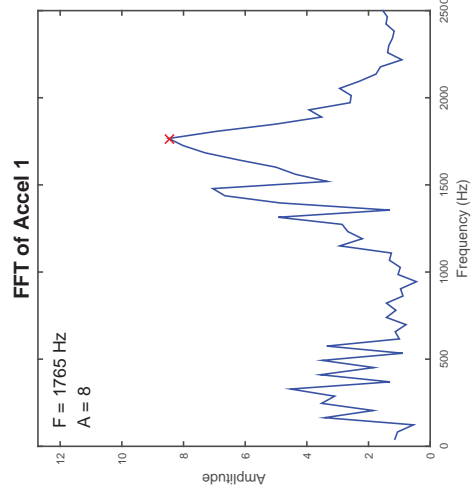
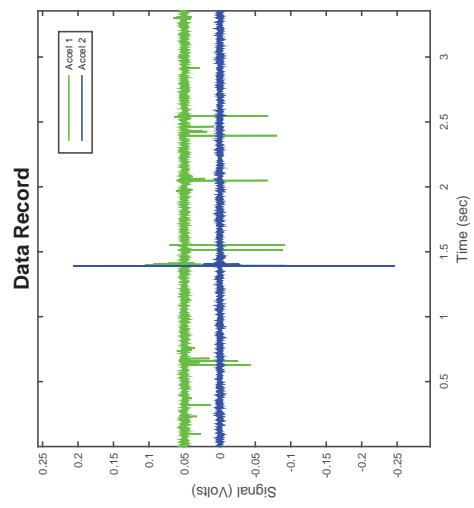

Accelerometer-Based Shear Wave Velocity Datasheet

Specimen ID: M212-FLS-50-3X
 Test Material: FLS
 Date: 7/16/2015
 Test Performed by: J.Hubler
 Filename: M212-FLS-50-3X

Vertical Stress: 50kPa
 Sensor Spacing: 0.10824 m
 V_s (rise) = 166 m/s

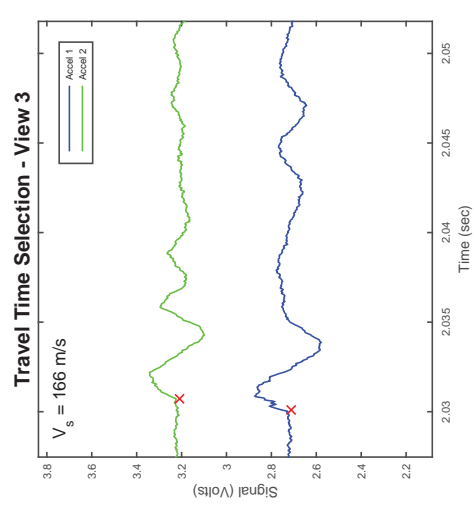
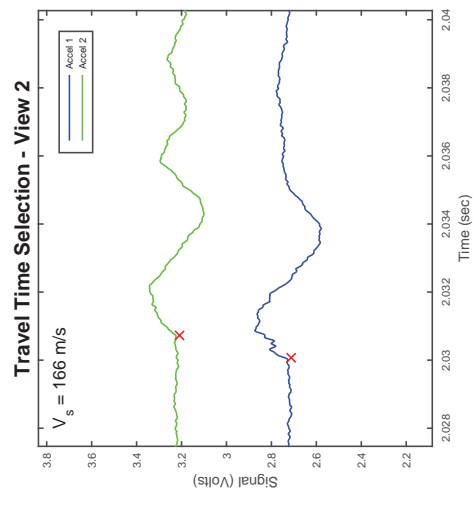
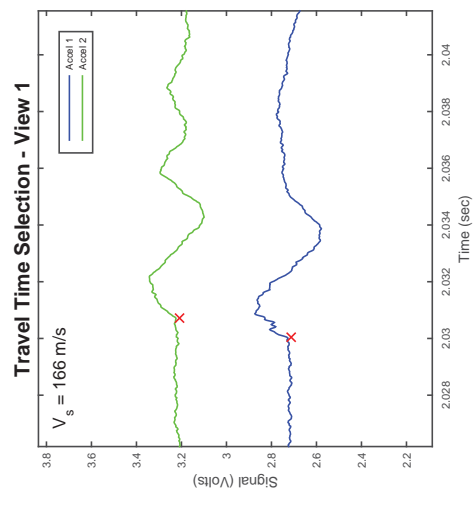
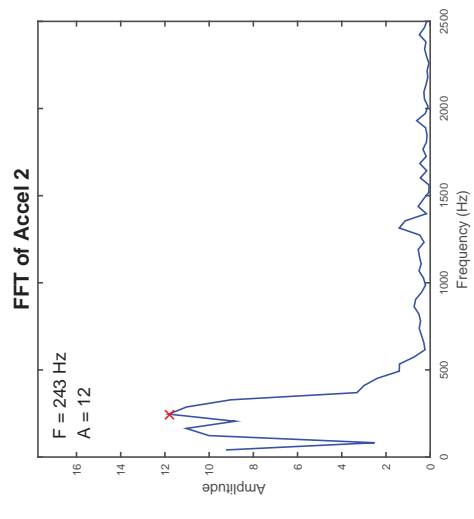
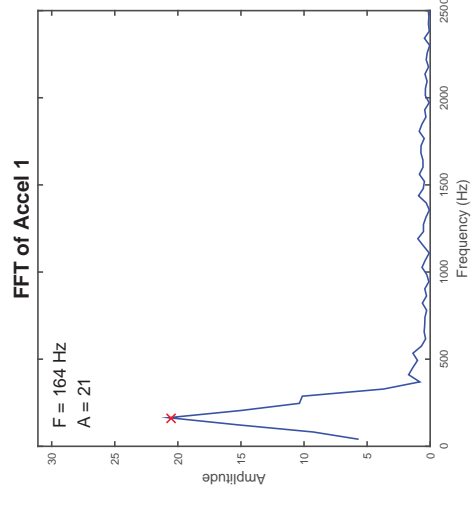
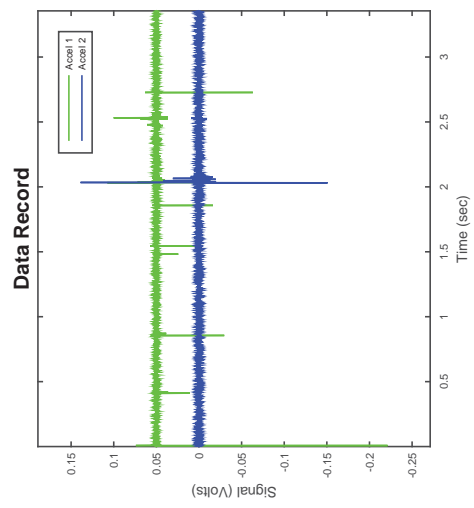

CSS Monotonic Shear Test Report

Geotechnical Engineering Laboratory



10/28/2013_Version 8.0

General Test Info and Sample Preparation

Device:	CSS	Relative Density (%):	33%
Specimen ID:	CLS5	Void Ratio:	0.915
Test ID:	M213	Height (mm):	112.3
Date of Test:	7/16/2015	Soil-Only Specimen Diameter (mm):	306.23
Test Performed:	Monotonic Shear	Weight (kg):	11.445
Test Material:	5mm Crushed Limestone	Density (kg/m ³):	1383.5
Sample Preparation:	Prepared loose using the shoveling method. To reach required density - rubber mallet hit baseplate 25x in 3 layers after shoveling.	Membrane Thickness (mm):	0.635
		Moisture Content (%):	0%
		Saturated (Y/N):	N
		Prepared by:	A. Jackson
		Checked by:	J. Hubler

Consolidation Stage

Vertical Stress (kPa):	100
Time to Compression (min):	17.4
Relative Density (%):	47%
Void Ratio:	0.849
Height (mm):	108.4
Diameter (mm):	306.23
Weight (kg):	11.445
Density (kg/m ³):	1433.2

Shear Stage

Type of Test:	Constant Volume
Stress or Strain Controlled:	Strain
Shear Strain Rate (%/min):	0.30
Peak Shear Strength (kPa):	14.9

Comments

Silver Baseplate used with cushion membrane.

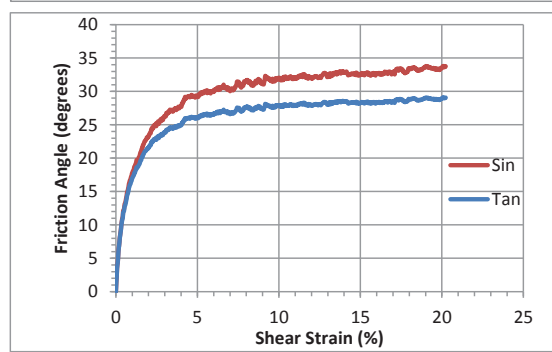
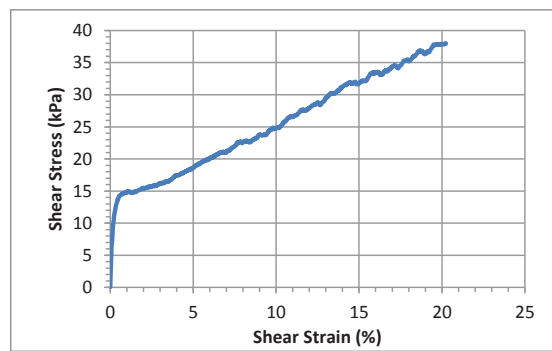
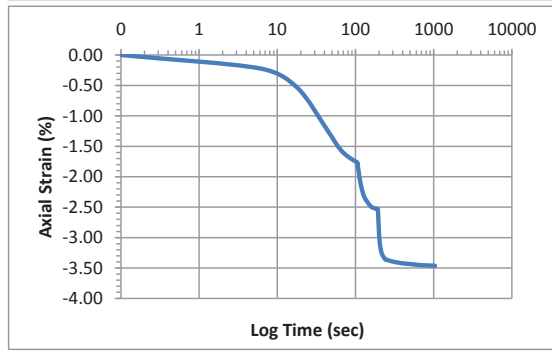
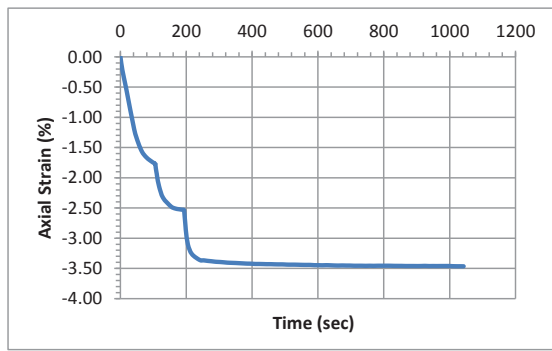

Accelerometer-Based Shear Wave Velocity Datasheet

Specimen ID: M213-FLS-100-1X
 Test Material: FLS
 Date: 7/16/2015
 Test Performed by: J.Hubler
 Filename: M213-FLS-100-1X

Vertical Stress: 100kPa
 Sensor Spacing: 0.10838 m
 V_s (rise) = 208 m/s

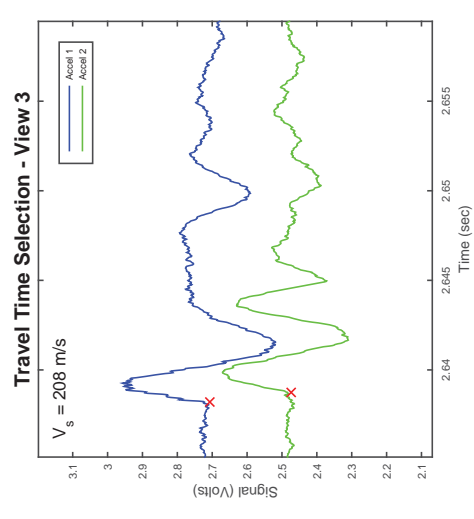
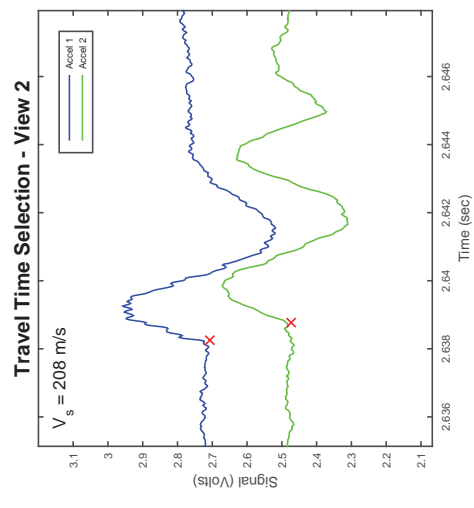
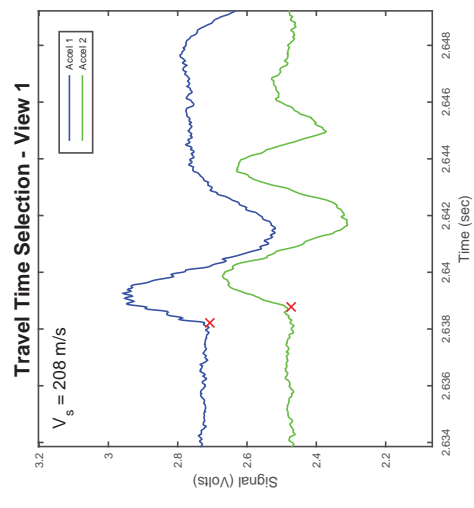
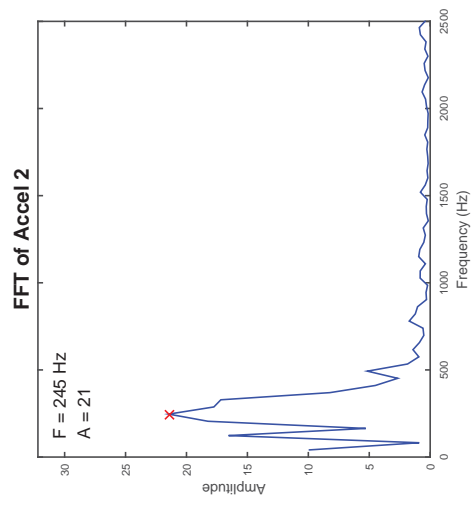
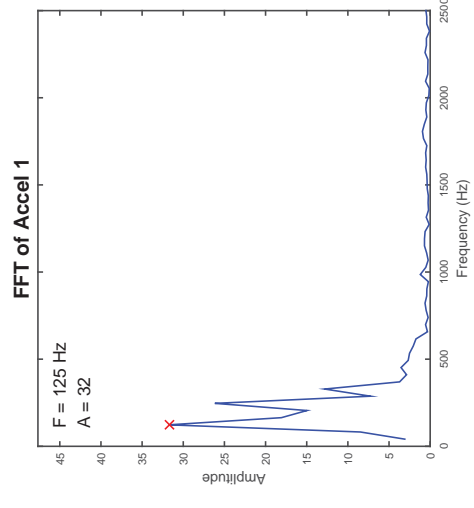
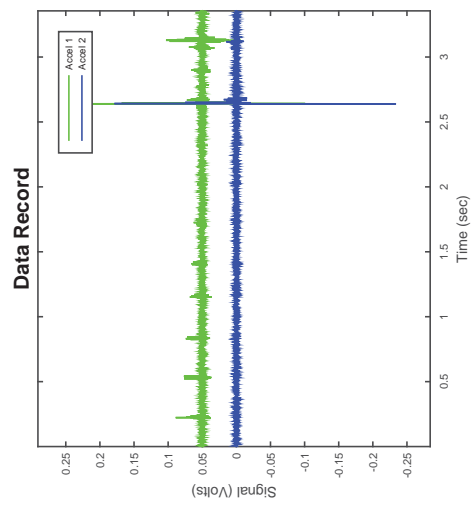

Accelerometer-Based Shear Wave Velocity Datasheet

Specimen ID: M213-FLS-100-2X
 Test Material: FLS
 Date: 7/16/2015
 Test Performed by: J.Hubler
 Filename: M213-FLS-100-2X

Vertical Stress: 100kPa
 Sensor Spacing: 0.10838 m
 V_s (rise) = 214 m/s

Data Record

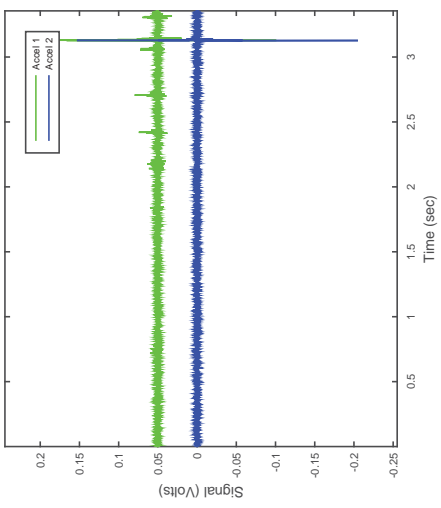

FFT of Accel 1

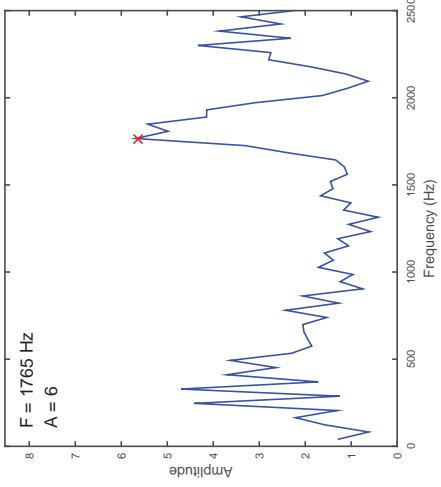

FFT of Accel 2

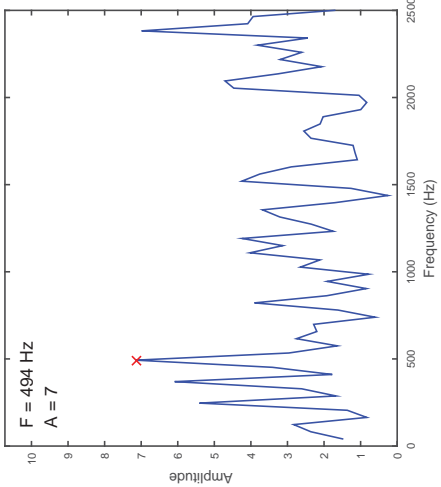

Travel Time Selection - View 1

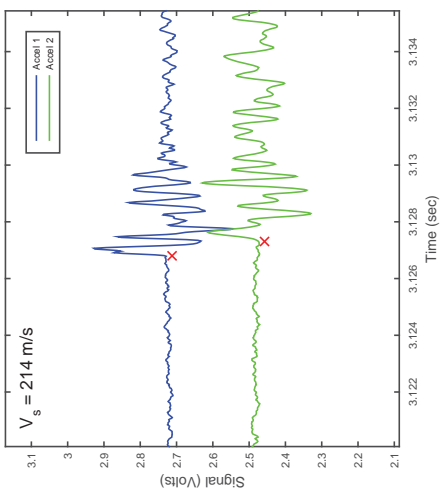

Travel Time Selection - View 2

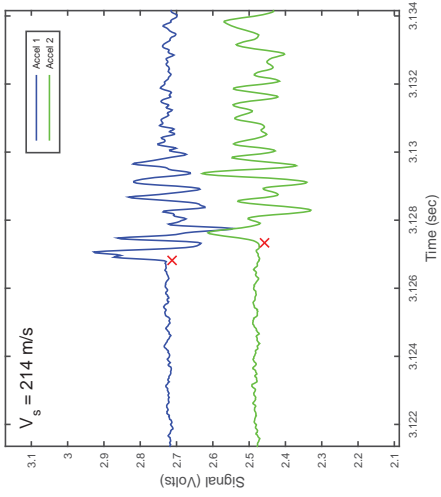

Travel Time Selection - View 3

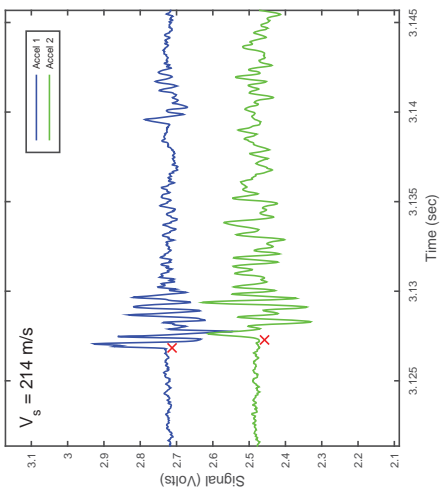

Accelerometer-Based Shear Wave Velocity Datasheet

Specimen ID: M213-FLS-100-3X
 Test Material: FLS
 Date: 7/16/2015
 Test Performed by: J.Hubler
 Filename: M213-FLS-100-3X

Vertical Stress: 100kPa
 Sensor Spacing: 0.10838 m
 V_s (rise) = 187 m/s

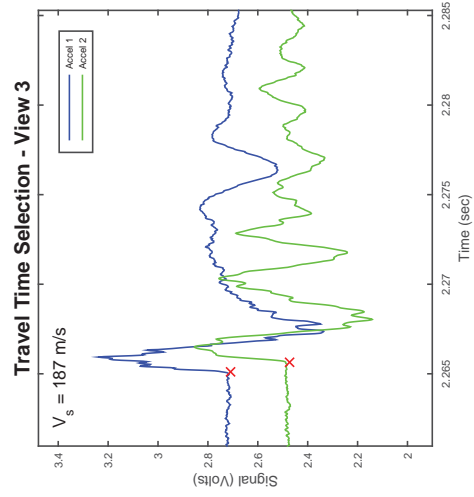
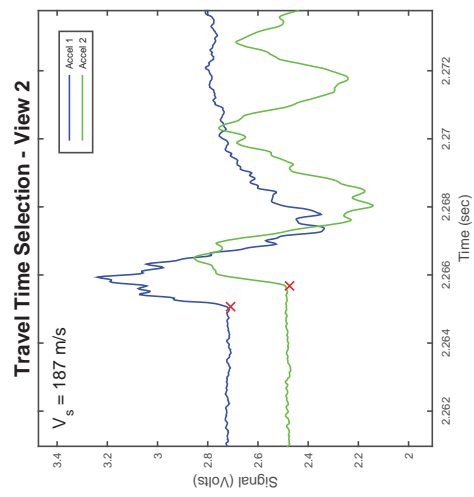
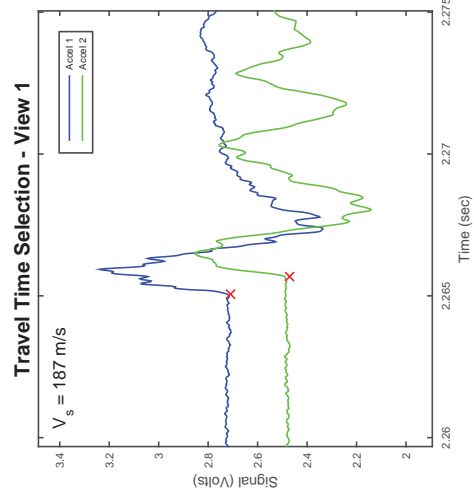
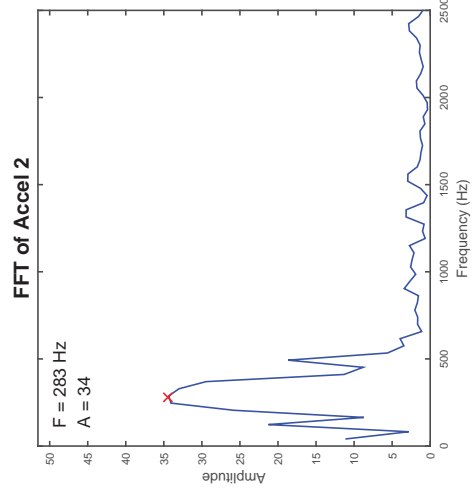
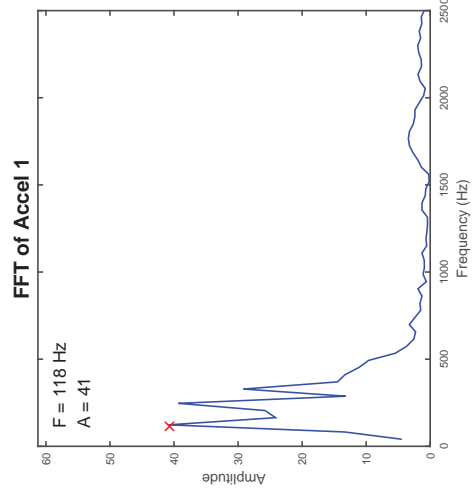
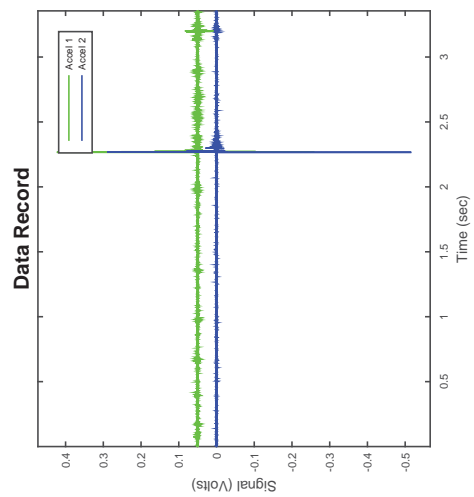

CSS Monotonic Shear Test Report

Geotechnical Engineering Laboratory



10/28/2013_Version 8.0

General Test Info and Sample Preparation

Device:	CSS	Relative Density (%):	16%
Specimen ID:	CLS5	Void Ratio:	1.000
Test ID:	M210	Height (mm):	112.1
Date of Test:	7/14/2015	Soil-Only Specimen Diameter (mm):	306.23
Test Performed:	Monotonic Shear	Weight (kg):	10.944
Test Material:	5mm Crushed Limestone	Density (kg/m³):	1325.1
Sample Preparation:	Prepared loose using the shoveling method.	Membrane Thickness (mm):	0.635
		Moisture Content (%):	0%
		Saturated (Y/N):	N
		Prepared by:	J.Hubler
		Checked by:	J. Hubler

Consolidation Stage

Vertical Stress (kPa):	200
Time to Compression (min):	33.7
Relative Density (%):	45%
Void Ratio:	0.858
Height (mm):	104.2
Diameter (mm):	306.23
Weight (kg):	10.944
Density (kg/m³):	1425.9

Shear Stage

Type of Test:	Constant Volume
Stress or Strain Controlled:	Strain
Shear Strain Rate (%/min):	0.32
Peak Shear Strength (kPa):	31.6

Comments

Silver Baseplate used with cushion membrane.

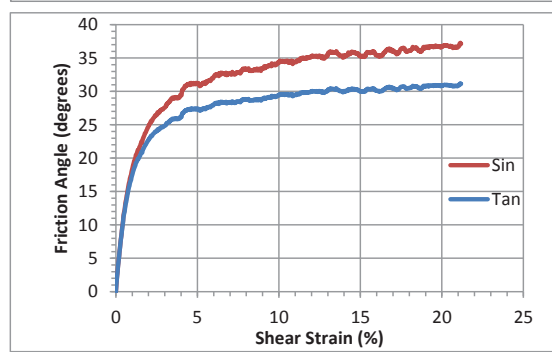
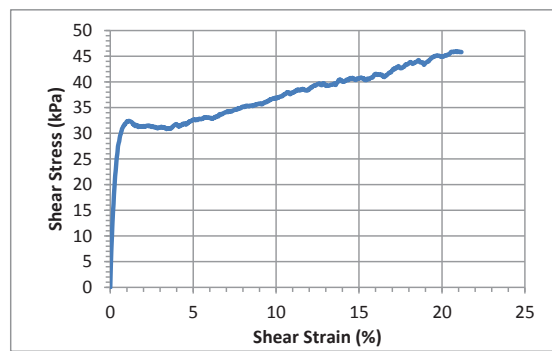
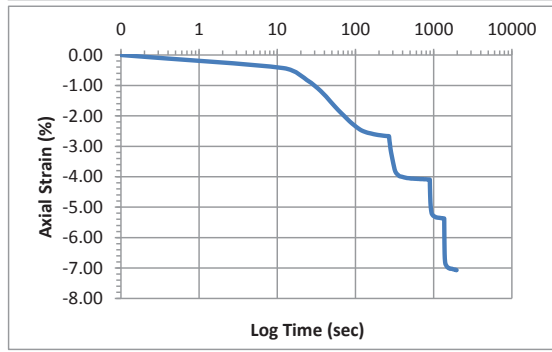
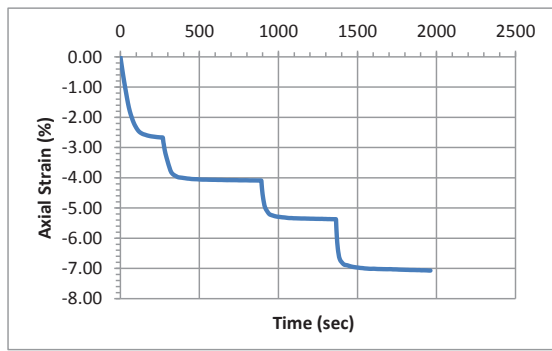

Accelerometer-Based Shear Wave Velocity Datasheet

Specimen ID: M210-FL-200-2X
 Test Material: FL
 Date: 7/14/2015
 Test Performed by: J.Hubler
 Filename: M210-FL-200-2X

Vertical Stress: 200kPa
 Sensor Spacing: 0.10416 m
 V_s (rise) = 250 m/s

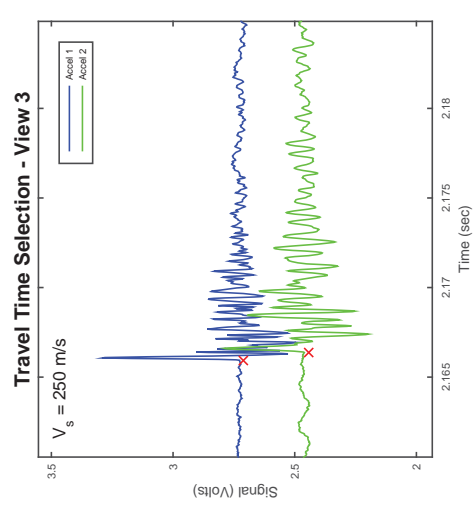
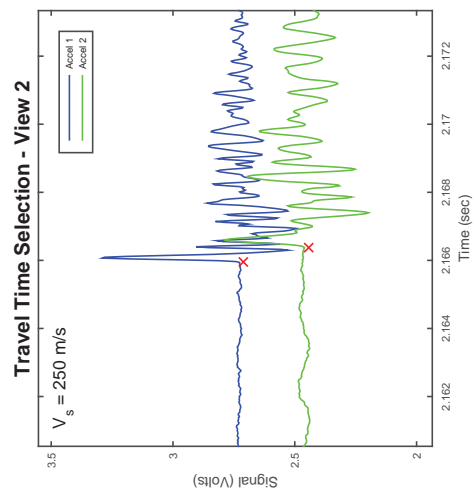
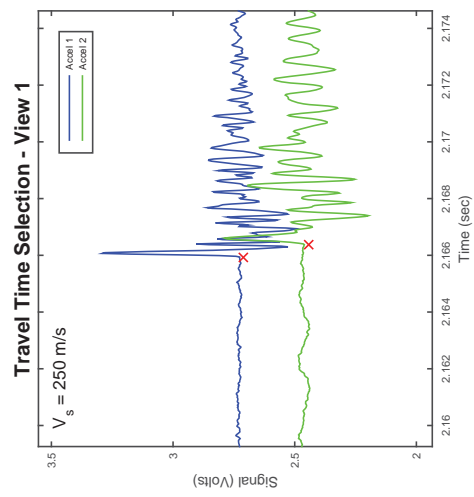
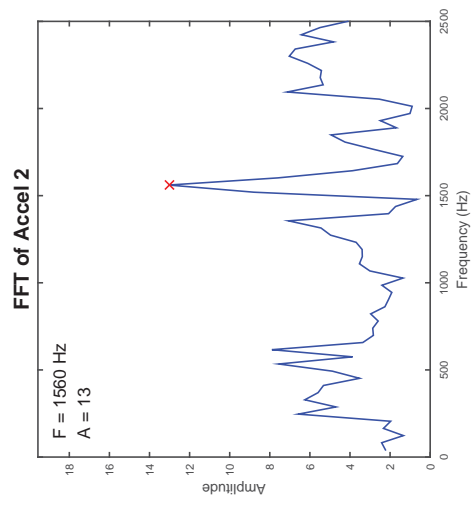
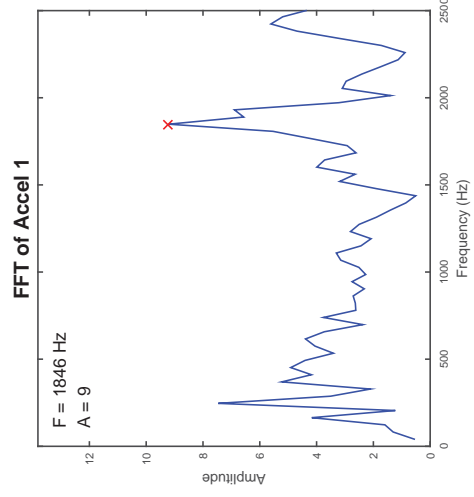
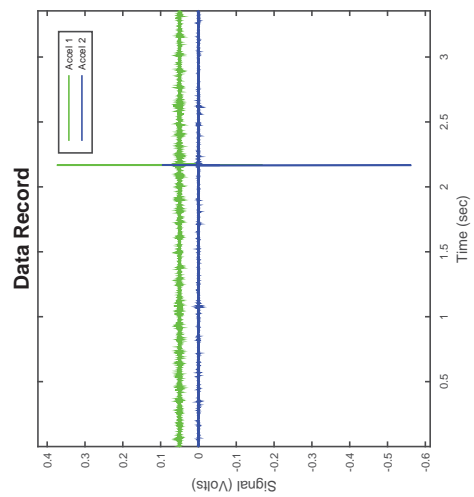

CSS Monotonic Shear Test Report

Geotechnical Engineering Laboratory



10/28/2013_Version 8.0

General Test Info and Sample Preparation

Device:	CSS	Relative Density (%):	19%
Specimen ID:	CLS5	Void Ratio:	0.984
Test ID:	M211	Height (mm):	112.3
Date of Test:	7/15/2015	Soil-Only Specimen Diameter (mm):	306.23
Test Performed:	Monotonic Shear	Weight (kg):	11.051
Test Material:	5mm Crushed Limestone	Density (kg/m³):	1336.0
Sample Preparation:	Prepared loose using the shoveling method.	Membrane Thickness (mm):	0.635
		Moisture Content (%):	0%
		Saturated (Y/N):	N
		Prepared by:	J.Hubler
		Checked by:	J. Hubler

Consolidation Stage

Vertical Stress (kPa):	400
Time to Compression (min):	18.4
Relative Density (%):	50%
Void Ratio:	0.834
Height (mm):	103.8
Diameter (mm):	306.23
Weight (kg):	11.051
Density (kg/m³):	1445.2

Shear Stage

Type of Test:	Constant Volume
Stress or Strain Controlled:	Strain
Shear Strain Rate (%/min):	0.32
Peak Shear Strength (kPa):	59.2

Comments

Silver Baseplate used with cushion membrane.

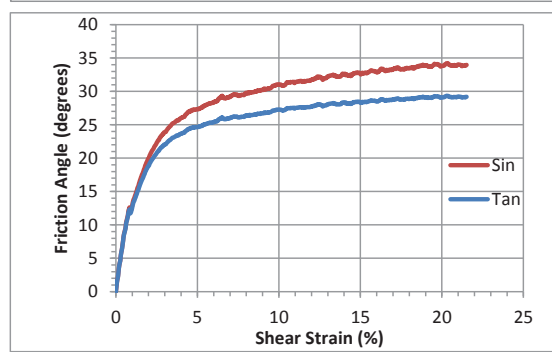
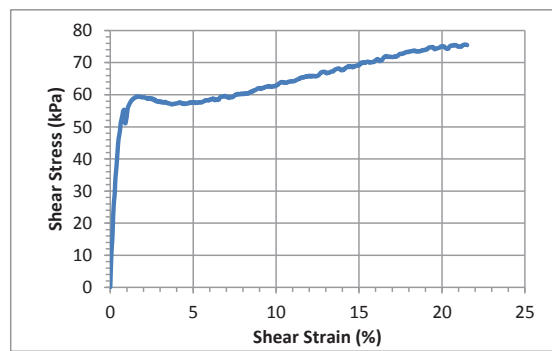
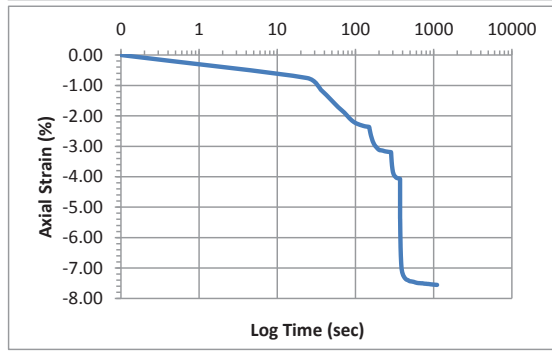
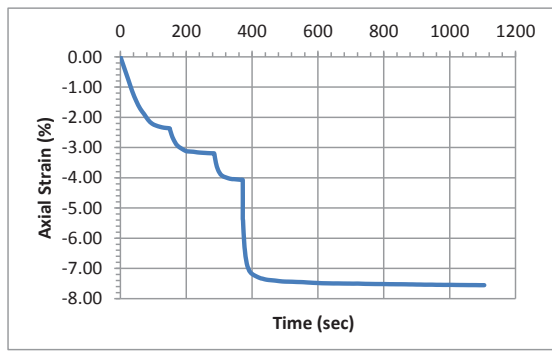

Accelerometer-Based Shear Wave Velocity Datasheet

Specimen ID: M211-FLS-400-1X
 Test Material: FLS
 Date: 7/15/2015
 Test Performed by: J.Hubler
 Filename: M211-FLS-400-1X

Vertical Stress: 400kPa
 Sensor Spacing: 0.10378 m
 V_s (rise) = 278 m/s

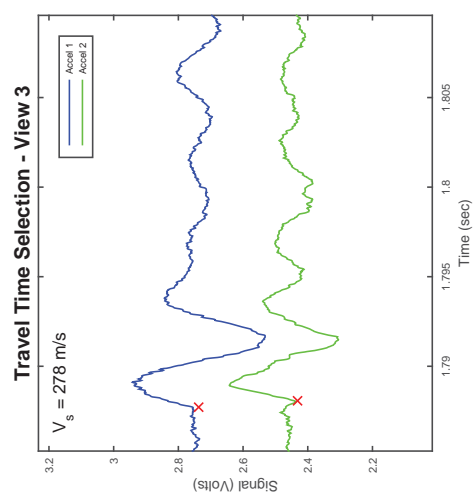
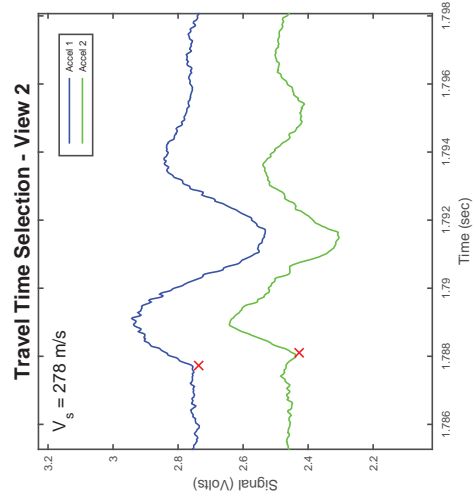
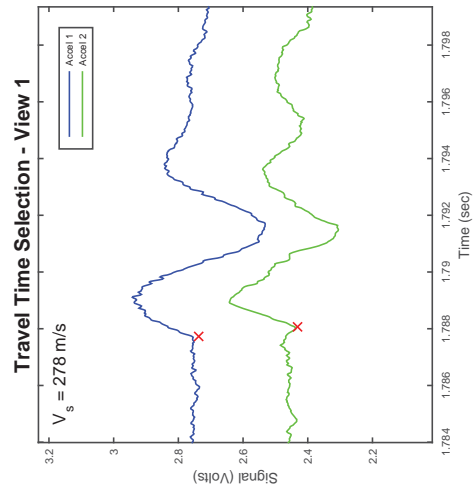
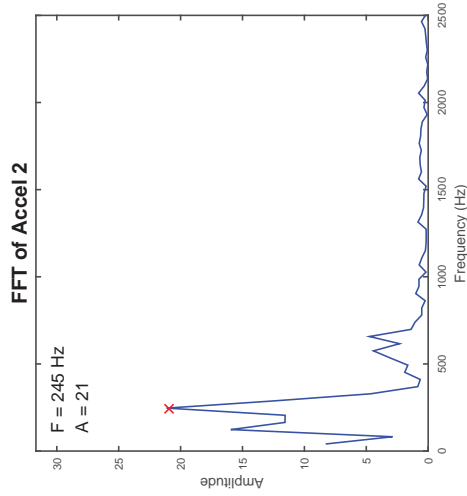
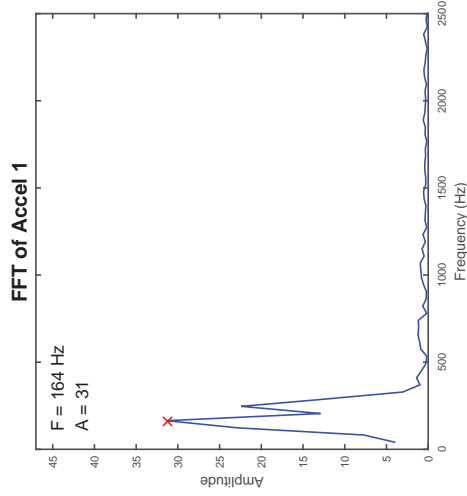
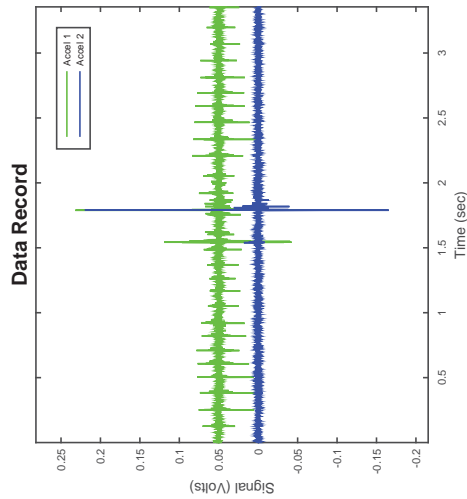

CSS Monotonic Shear Test Report

Geotechnical Engineering Laboratory



10/28/2013_Version 8.0

General Test Info and Sample Preparation

Device:	CSS	Relative Density (%):	80%
Specimen ID:	CLS5	Void Ratio:	0.689
Test ID:	M217	Height (mm):	104.2
Date of Test:	7/26/2015	Soil-Only Specimen Diameter (mm):	306.23
Test Performed:	Monotonic Shear	Weight (kg):	12.035
Test Material:	5mm Crushed Limestone	Density (kg/m ³):	1568.7
Sample Preparation:	Prepared dense by tamping 60x in 5 layers.	Membrane Thickness (mm):	0.635
		Moisture Content (%):	0%
		Saturated (Y/N):	N
		Prepared by:	J. Hubler
		Checked by:	J. Hubler

Consolidation Stage

Vertical Stress (kPa):	50
Time to Compression (min):	11.8
Relative Density (%):	90%
Void Ratio:	0.639
Height (mm):	101.0
Diameter (mm):	306.23
Weight (kg):	12.035
Density (kg/m ³):	1617.2

Shear Stage

Type of Test:	Constant Volume
Stress or Strain Controlled:	Strain
Shear Strain Rate (%/min):	0.32
Peak Shear Strength (kPa):	9.5

Comments

Silver Baseplate used with cushion membrane.

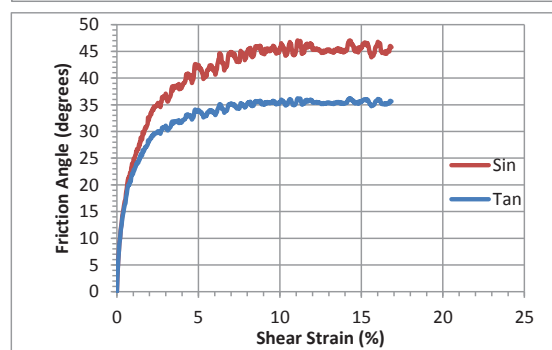
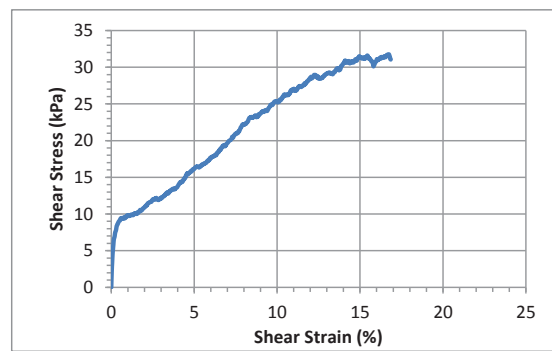
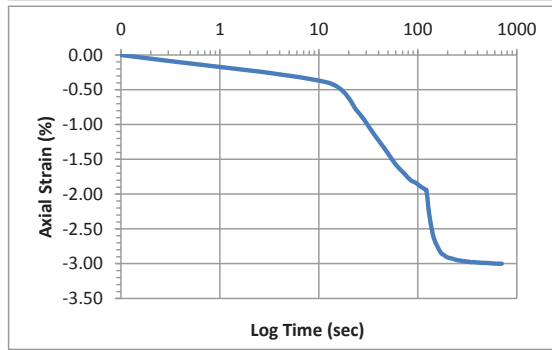
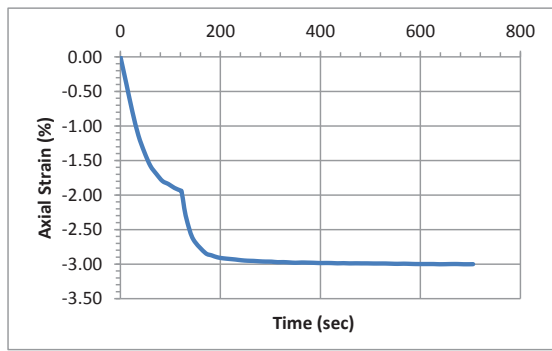

Accelerometer-Based Shear Wave Velocity Datasheet

Specimen ID: M217-FLS-50-1X
 Test Material: FLS
 Date: 7/26/2015
 Test Performed by: J.Hubler
 Filename: M217-FLS-50-1X

Vertical Stress: 50kPa
 Sensor Spacing: 0.101 m
 V_s (rise) = 201 m/s

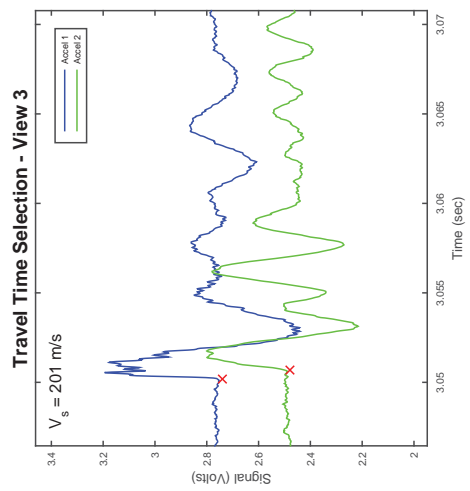
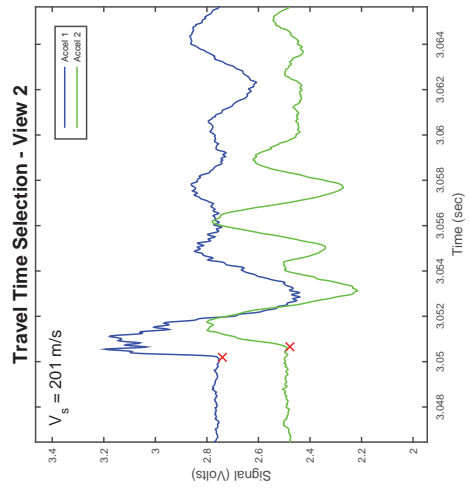
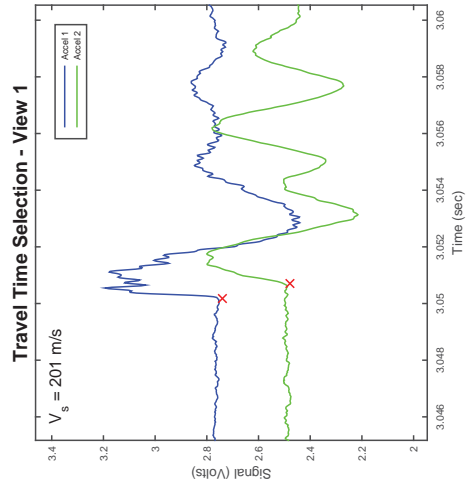
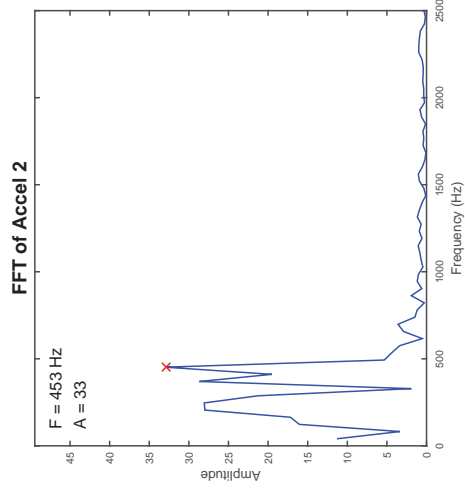
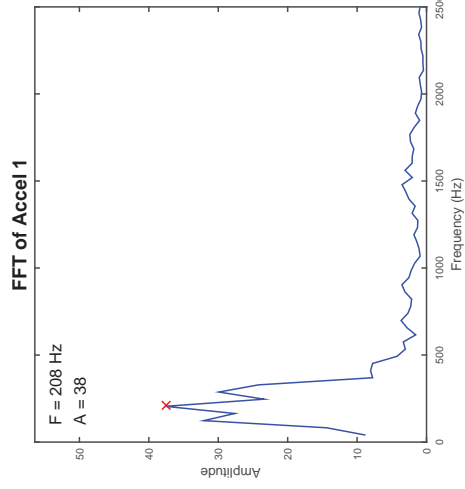
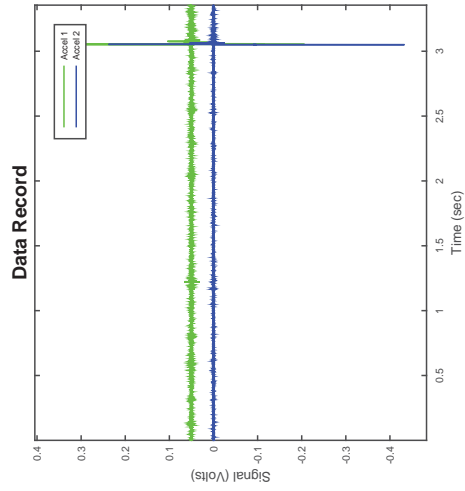

Accelerometer-Based Shear Wave Velocity Datasheet

Specimen ID: M217-FLS-50-2X
 Test Material: FLS
 Date: 7/26/2015
 Test Performed by: J.Hubler
 Filename: M217-FLS-50-2X

Vertical Stress: 50kPa
 Sensor Spacing: 0.101 m
 V_s (rise) = 197 m/s

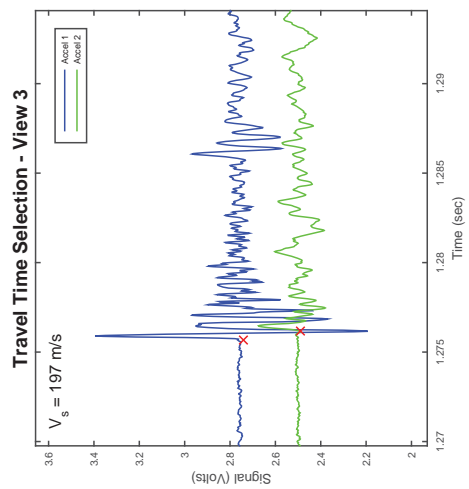
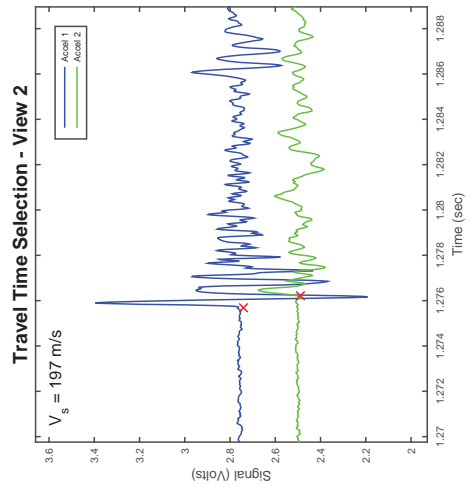
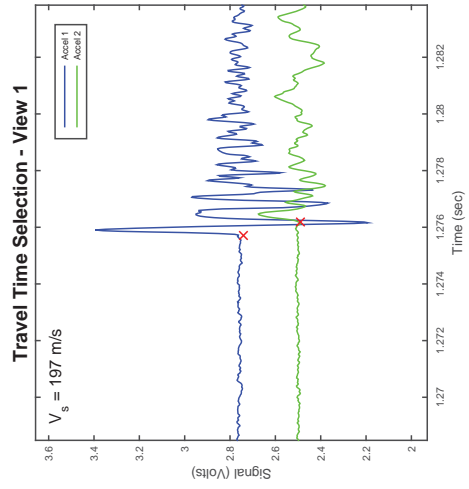
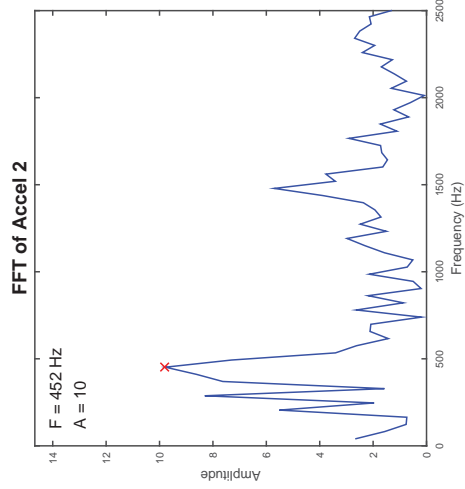
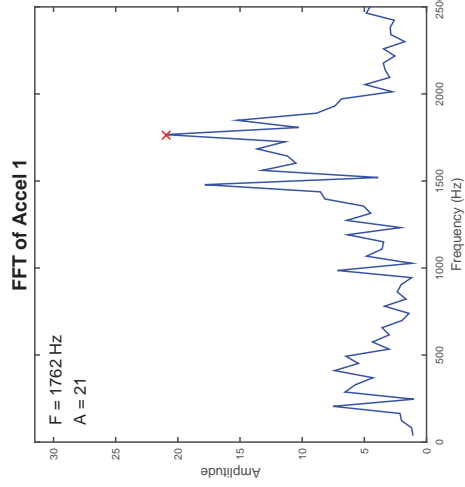
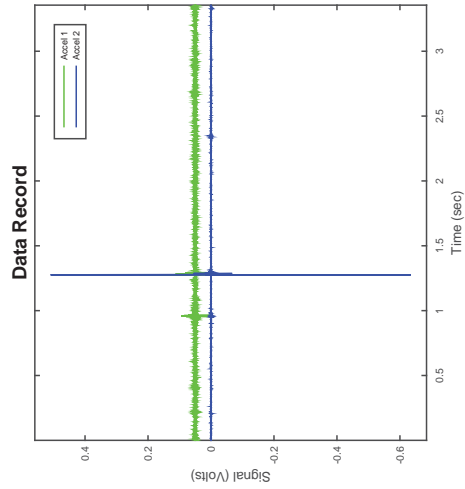

Accelerometer-Based Shear Wave Velocity Datasheet

Specimen ID: M217-FLS-50-3X
 Test Material: FLS
 Date: 7/26/2015
 Test Performed by: J.Hubler
 Filename: M217-FLS-50-3X

Vertical Stress: 50kPa
 Sensor Spacing: 0.101 m
 V_s (rise) = 189 m/s

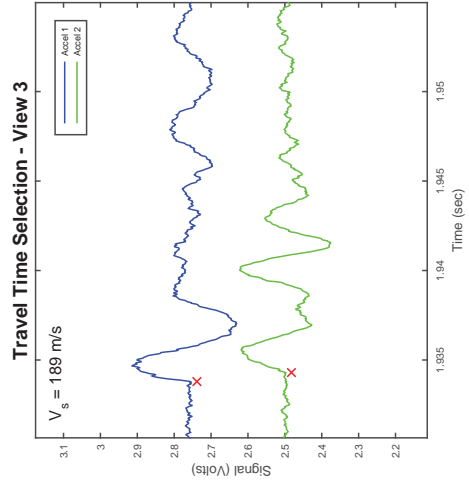
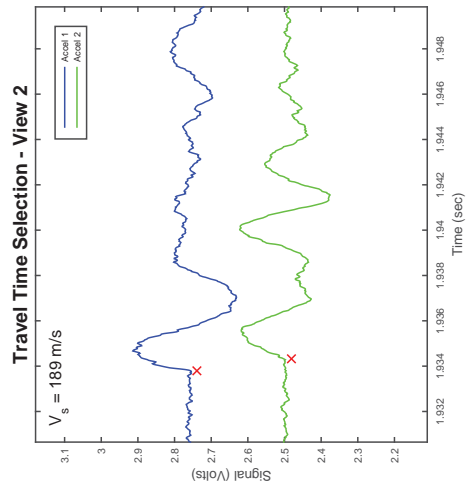
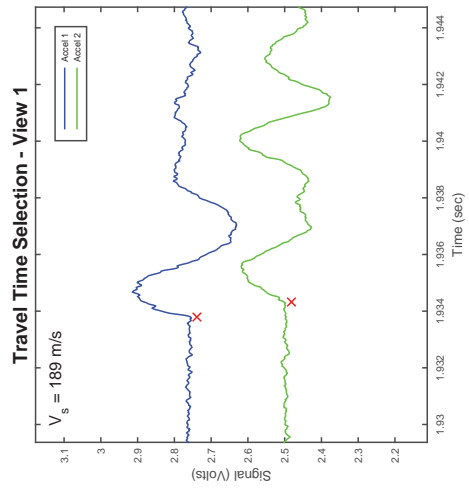
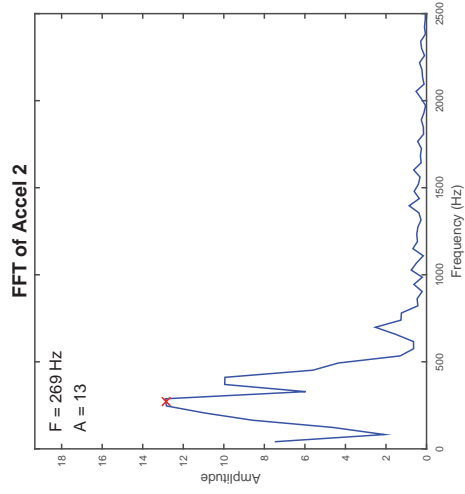
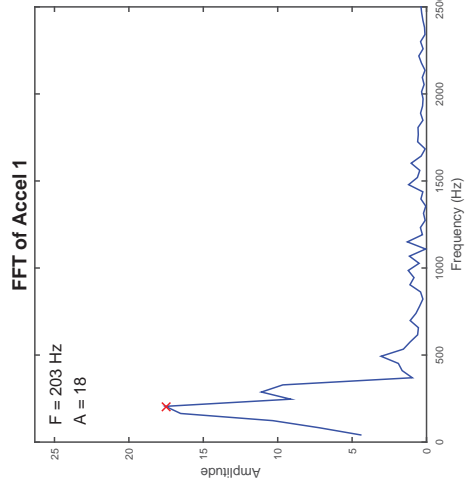
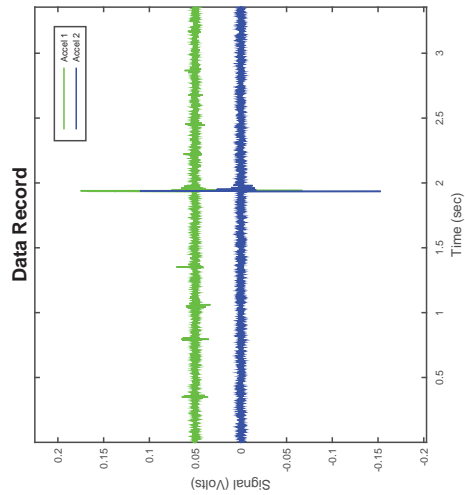

CSS Monotonic Shear Test Report

Geotechnical Engineering Laboratory



10/28/2013_Version 8.0

General Test Info and Sample Preparation

Device:	CSS	Relative Density (%):	75%
Specimen ID:	CLS5	Void Ratio:	0.709
Test ID:	M220	Height (mm):	109.5
Date of Test:	7/29/2015	Soil-Only Specimen Diameter (mm):	306.23
Test Performed:	Monotonic Shear	Weight (kg):	12.510
Test Material:	5mm Crushed Limestone	Density (kg/m³):	1550.6
Sample Preparation:	Prepared dense by tamping 50x in 5 layers.	Membrane Thickness (mm):	0.635
		Moisture Content (%):	0%
		Saturated (Y/N):	N
		Prepared by:	J. Hubler
		Checked by:	J. Hubler

Consolidation Stage

Vertical Stress (kPa):	100
Time to Compression (min):	13.2
Relative Density (%):	90%
Void Ratio:	0.637
Height (mm):	104.9
Diameter (mm):	306.23
Weight (kg):	12.510
Density (kg/m³):	1619.2

Shear Stage

Type of Test:	Constant Volume
Stress or Strain Controlled:	Strain
Shear Strain Rate (%/min):	0.31
Peak Shear Strength (kPa):	21.4

Comments

Silver Baseplate used with cushion membrane.

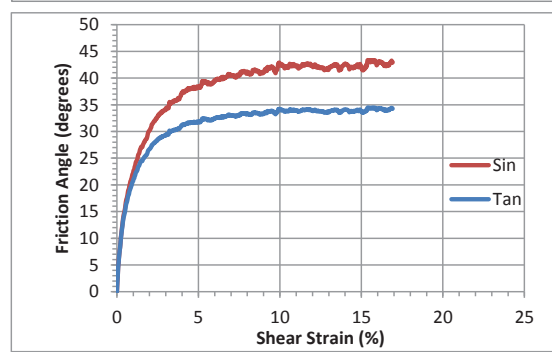
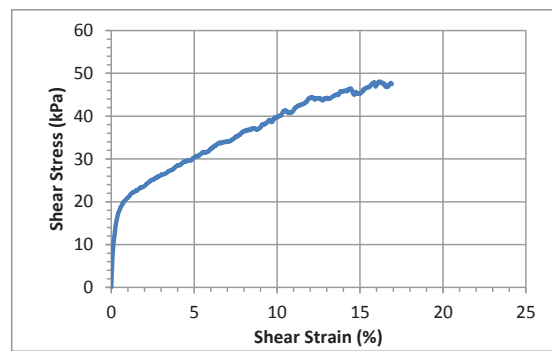
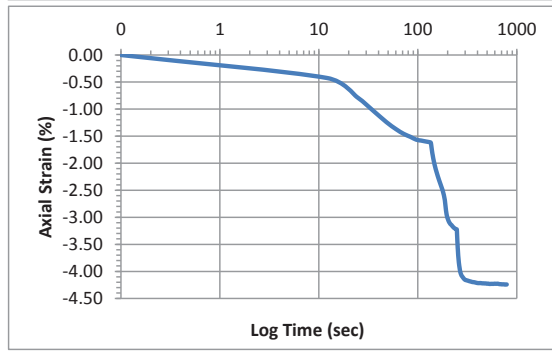
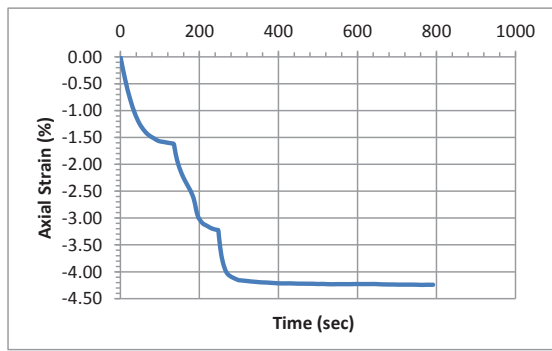

Accelerometer-Based Shear Wave Velocity Datasheet

Specimen ID: M220-FLS-100-2X
 Test Material: FLS
 Date: 7/29/2015
 Test Performed by: J.Hubler
 Filename: M220-FLS-100-2X

Vertical Stress: 100kPa
 Sensor Spacing: 0.10485 m
 V_s (rise) = 227 m/s

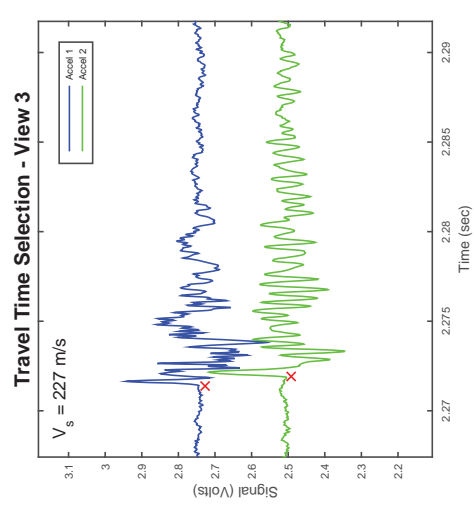
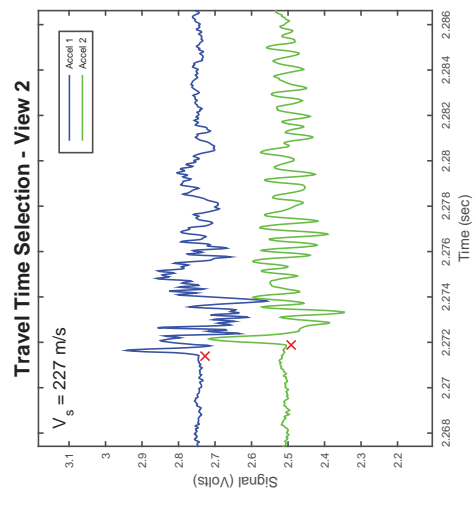
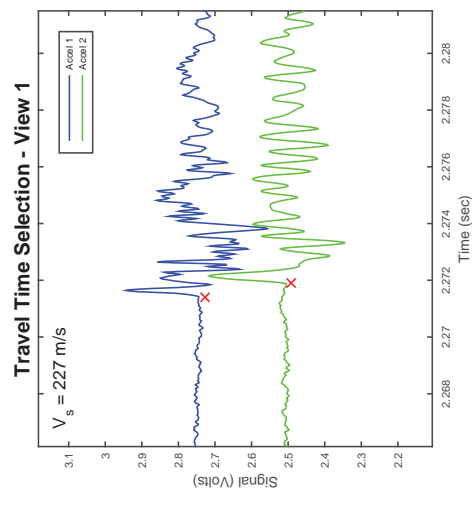
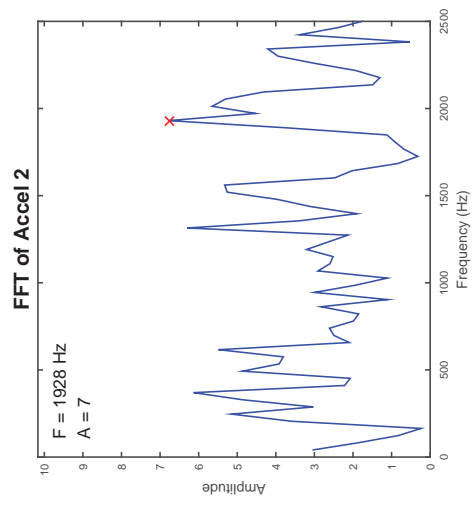
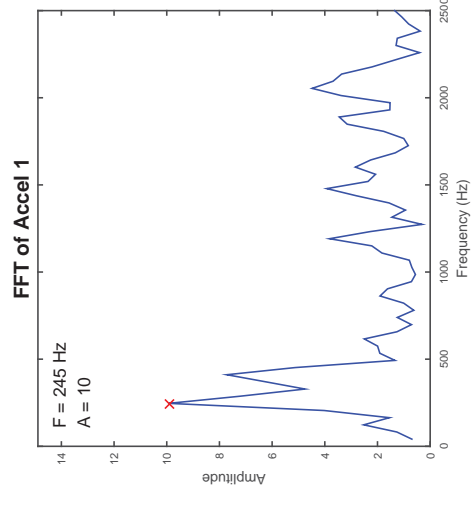
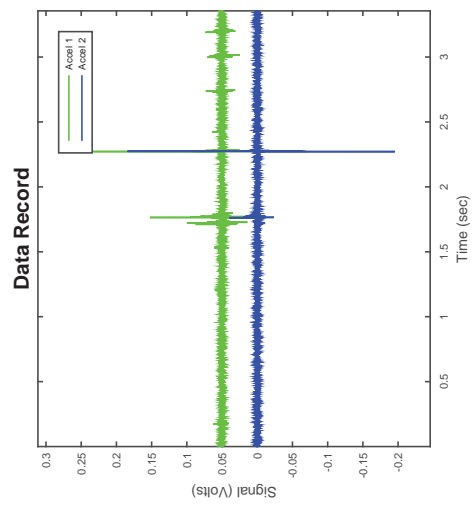

CSS Monotonic Shear Test Report

Geotechnical Engineering Laboratory



10/28/2013_Version 8.0

General Test Info and Sample Preparation

Device:	CSS	Relative Density (%):	66%
Specimen ID:	CLS5	Void Ratio:	0.759
Test ID:	M216	Height (mm):	110.7
Date of Test:	7/26/2015	Soil-Only Specimen Diameter (mm):	306.23
Test Performed:	Monotonic Shear	Weight (kg):	12.282
Test Material:	5mm Crushed Limestone	Density (kg/m ³):	1507.0
Sample Preparation:	Prepared dense by tamping 35x in 5 layers.	Membrane Thickness (mm):	0.635
		Moisture Content (%):	0%
		Saturated (Y/N):	N
		Prepared by:	J. Hubler
		Checked by:	J. Hubler

Consolidation Stage

Vertical Stress (kPa):	200
Time to Compression (min):	21.3
Relative Density (%):	87%
Void Ratio:	0.653
Height (mm):	104.0
Diameter (mm):	306.23
Weight (kg):	12.282
Density (kg/m ³):	1602.9

Shear Stage

Type of Test:	Constant Volume
Stress or Strain Controlled:	Strain
Shear Strain Rate (%/min):	0.32
Peak Shear Strength (kPa):	37.0

Comments

Silver Baseplate used with cushion membrane.

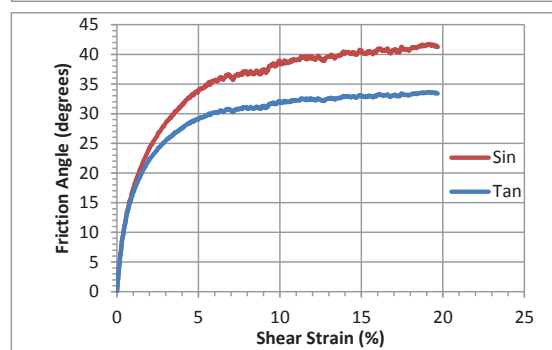
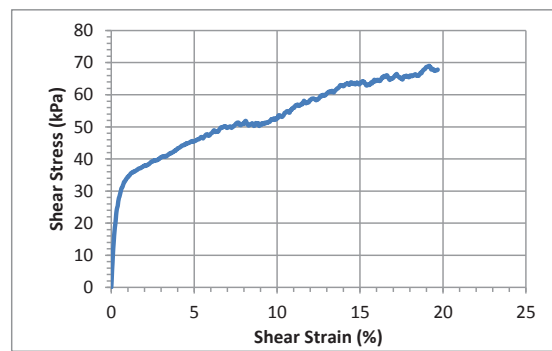
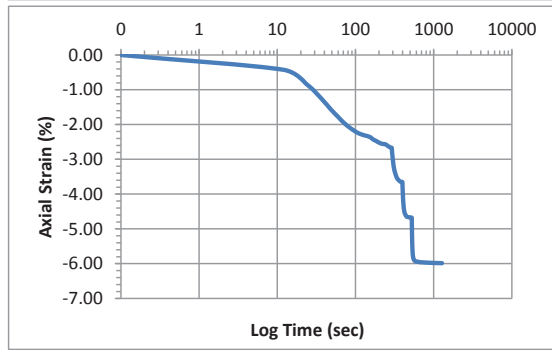
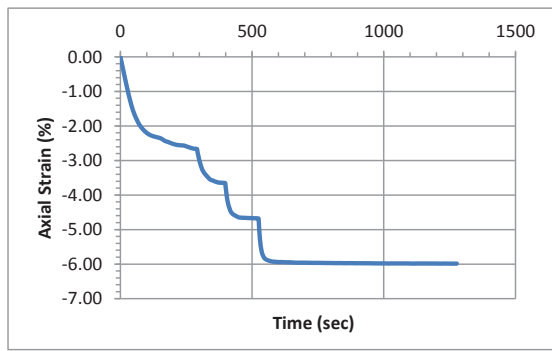

Accelerometer-Based Shear Wave Velocity Datasheet

Specimen ID: M216-FLS-200-1X
 Test Material: FLS
 Date: 7/26/2015
 Test Performed by: J.Hubler
 Filename: M216-FLS-200-1X

Vertical Stress: 200kPa
 Sensor Spacing: 0.10399 m
 V_s (rise) = 258 m/s

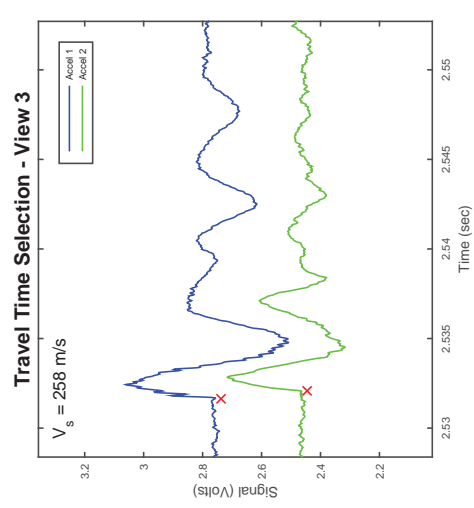
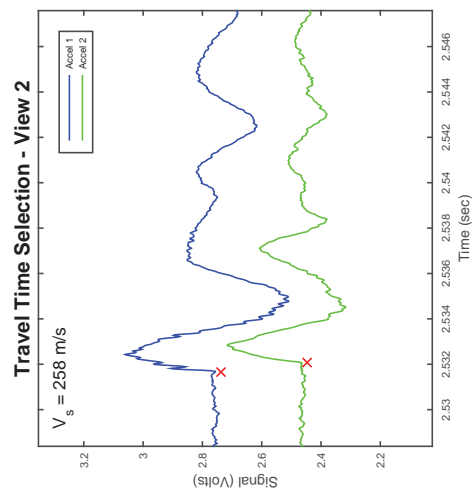
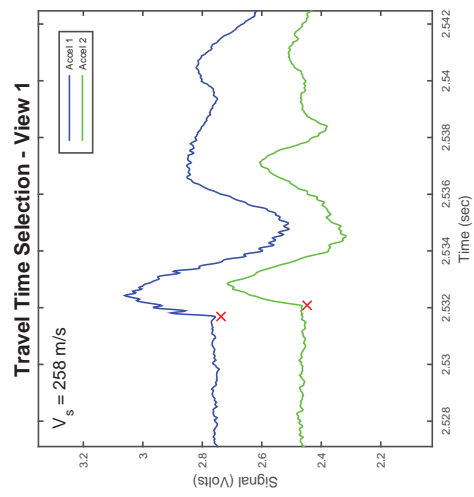
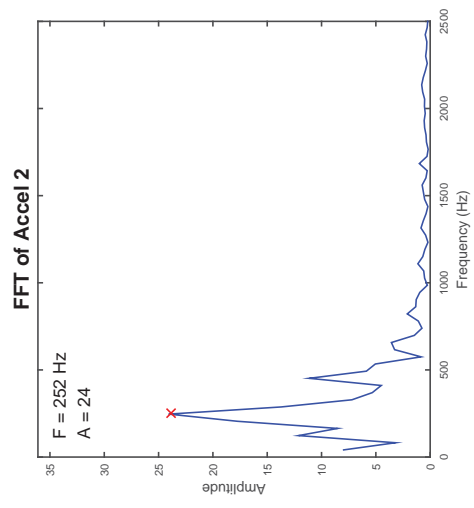
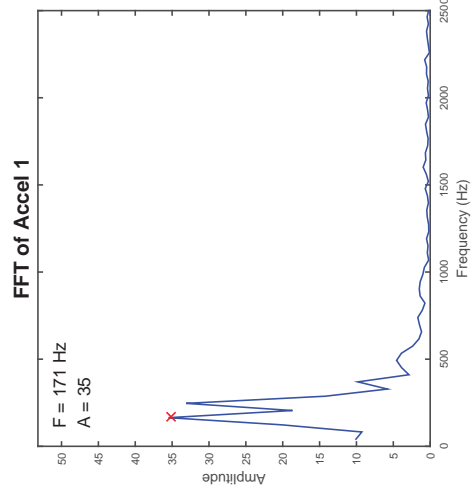
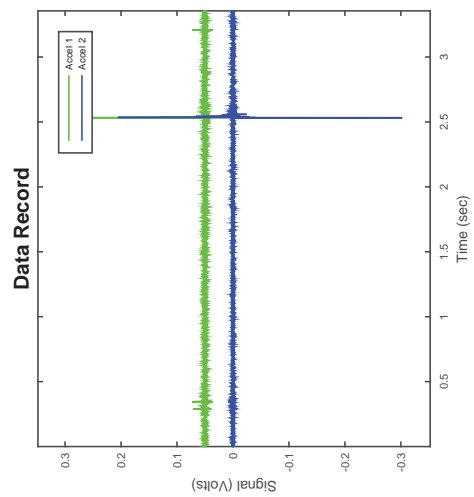

CSS Monotonic Shear Test Report

Geotechnical Engineering Laboratory



10/28/2013_Version 8.0

General Test Info and Sample Preparation

Device:	CSS	Relative Density (%):	66%
Specimen ID:	CLS5	Void Ratio:	0.757
Test ID:	M215	Height (mm):	106.4
Date of Test:	7/26/2015	Soil-Only Specimen Diameter (mm):	306.23
Test Performed:	Monotonic Shear	Weight (kg):	11.822
Test Material:	5mm Crushed Limestone	Density (kg/m³):	1508.7
Sample Preparation:	Prepared dense by tamping 30x in 5 layers.	Membrane Thickness (mm):	0.635
		Moisture Content (%):	0%
		Saturated (Y/N):	N
		Prepared by:	J.Hubler
		Checked by:	J. Hubler

Consolidation Stage

Vertical Stress (kPa):	400
Time to Compression (min):	24.8
Relative Density (%):	86%
Void Ratio:	0.658
Height (mm):	100.4
Diameter (mm):	306.23
Weight (kg):	11.822
Density (kg/m³):	1598.1

Shear Stage

Type of Test:	Constant Volume
Stress or Strain Controlled:	Strain
Shear Strain Rate (%/min):	0.32
Peak Shear Strength (kPa):	72.3

Comments

Silver Baseplate used with cushion membrane.

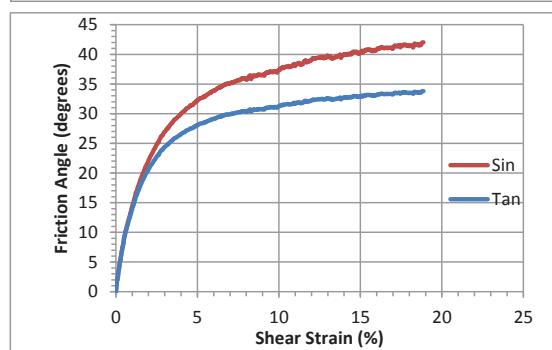
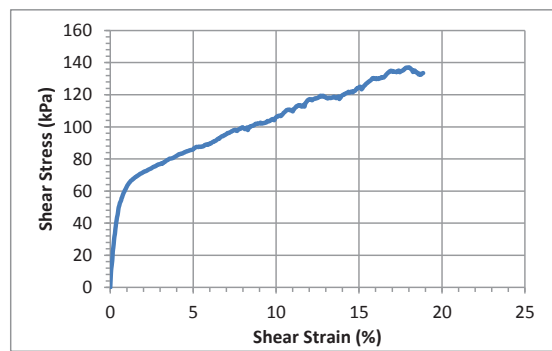
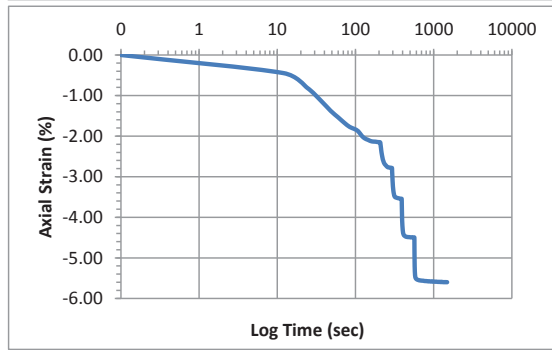
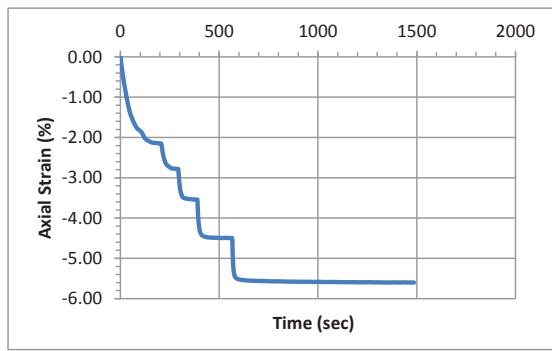

Accelerometer-Based Shear Wave Velocity Datasheet

Specimen ID: M215-FLS-400-2X
 Test Material: FLS
 Date: 7/25/2015
 Test Performed by: J.Hubler
 Filename: M215-FLS-400-2X

Vertical Stress: 400kPa
 Sensor Spacing: 0.10039 m
 V_s (rise) = 305 m/s

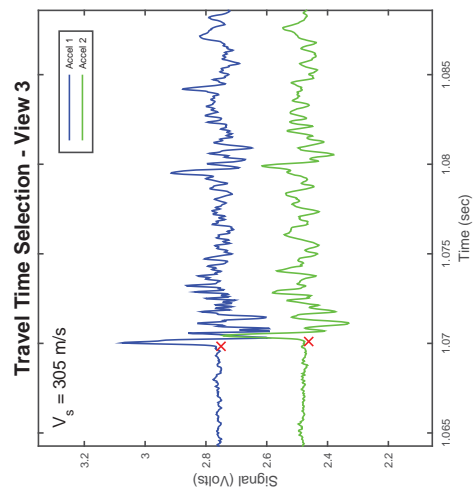
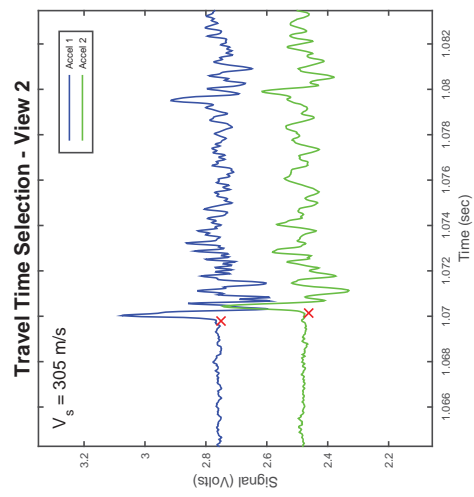
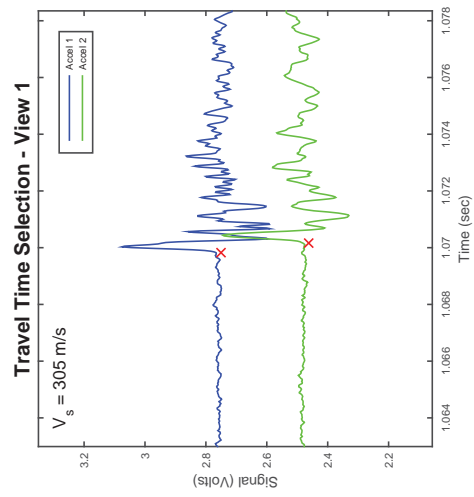
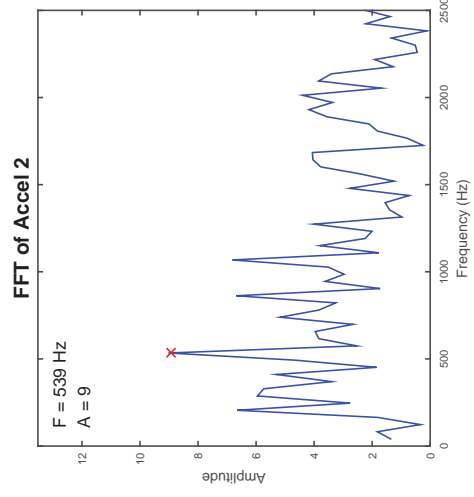
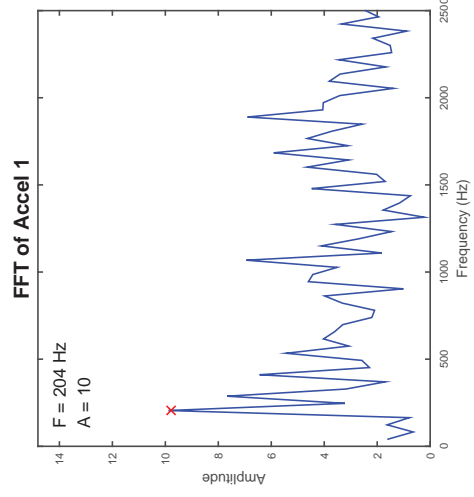
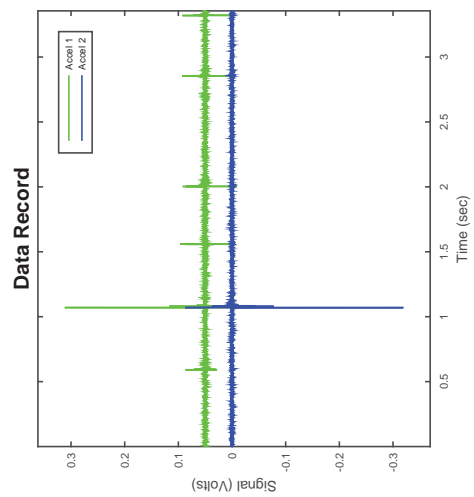

CSS Monotonic Shear Test Report

Geotechnical Engineering Laboratory



10/28/2013_Version 8.0

General Test Info and Sample Preparation

Device:	CSS	Relative Density (%):	32%
Specimen ID:	CLS8	Void Ratio:	0.813
Test ID:	M228	Height (mm):	111.5
Date of Test:	8/16/2015	Soil-Only Specimen Diameter (mm):	306.23
Test Performed:	Monotonic Shear	Weight (kg):	12.002
Test Material:	8mm Crushed Limestone	Density (kg/m ³):	1461.9
Sample Preparation:	Prepared loose using the shoveling method. Tamped 25x with a rubber mallet in 3 layers.	Membrane Thickness (mm):	0.635
		Moisture Content (%):	0%
		Saturated (Y/N):	N
		Prepared by:	J. Hubler
		Checked by:	J. Hubler

Consolidation Stage

Vertical Stress (kPa):	50
Time to Compression (min):	9.7
Relative Density (%):	49%
Void Ratio:	0.738
Height (mm):	106.9
Diameter (mm):	306.23
Weight (kg):	12.002
Density (kg/m ³):	1524.5

Shear Stage

Type of Test:	Constant Volume
Stress or Strain Controlled:	Strain
Shear Strain Rate (%/min):	0.31
Peak Shear Strength (kPa):	8.4

Comments

Silver Baseplate used with cushion membrane.

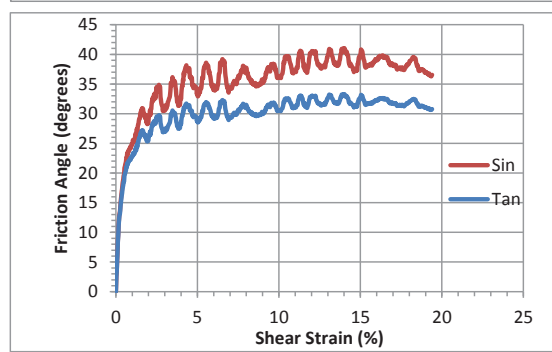
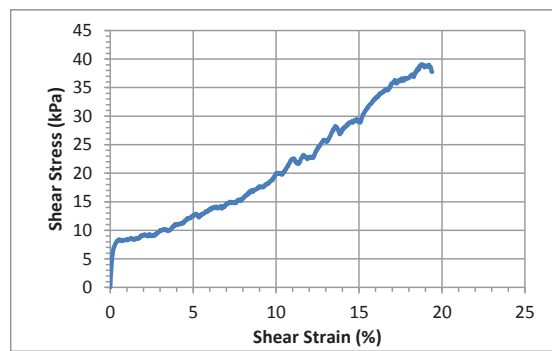
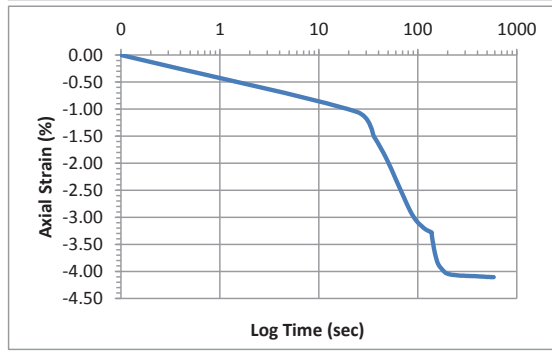
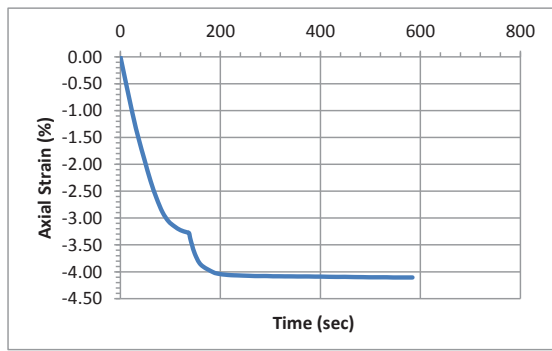

Accelerometer-Based Shear Wave Velocity Datasheet

Specimen ID: M228-LS-50-1X
 Test Material: LS
 Date: 8/16/2015
 Test Performed by: J. Hubler
 Filename: M228-LS-50-1X

Vertical Stress: 50kPa
 Sensor Spacing: 0.10685 m
 V_s (rise) = 186 m/s

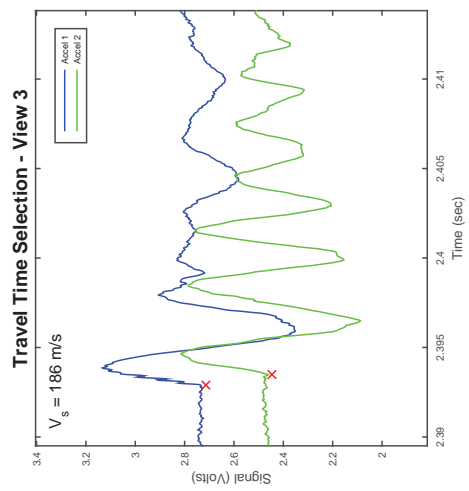
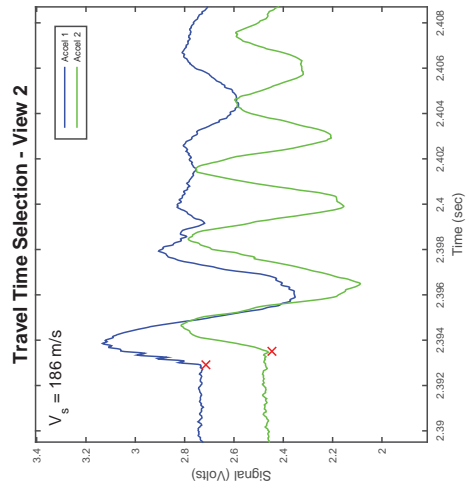
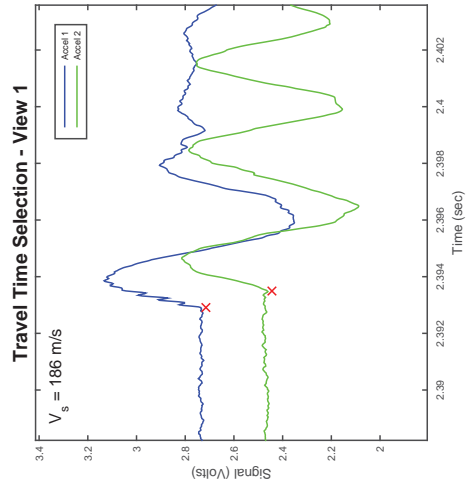
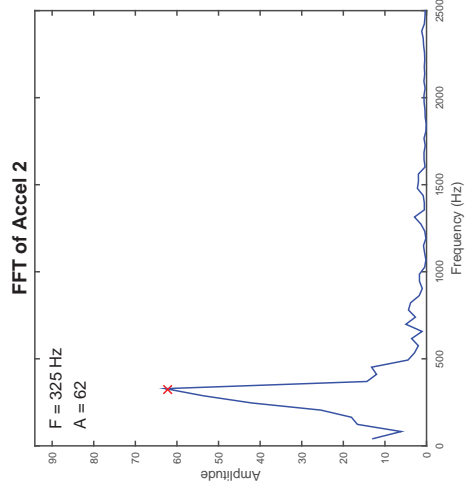
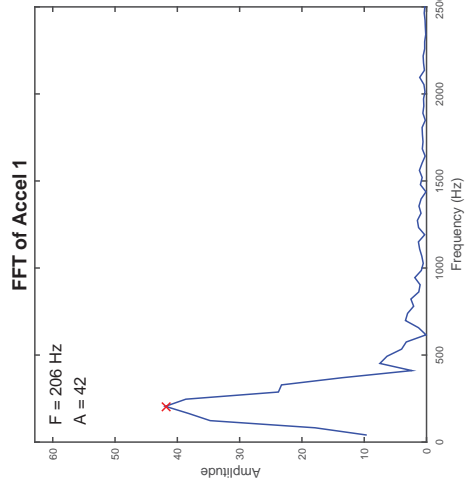
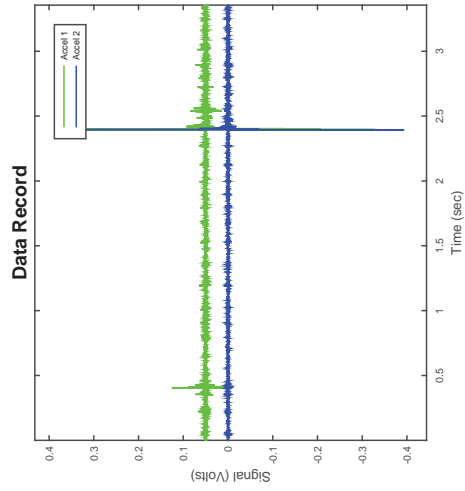

Accelerometer-Based Shear Wave Velocity Datasheet

Specimen ID: M228-LS-50-2X
 Test Material: LS
 Date: 8/16/2015
 Test Performed by: J. Hubler
 Filename: M228-LS-50-2X

Vertical Stress: 50kPa
 Sensor Spacing: 0.10685 m
 V_s (rise) = 179 m/s

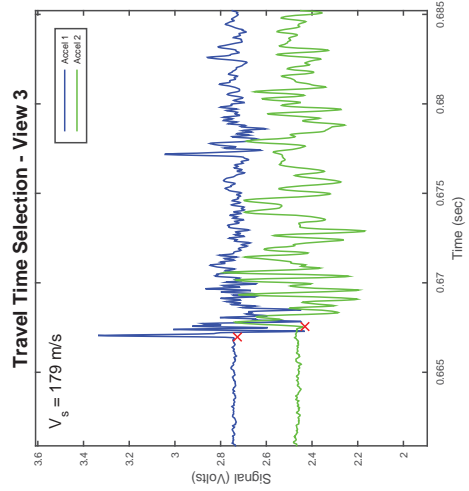
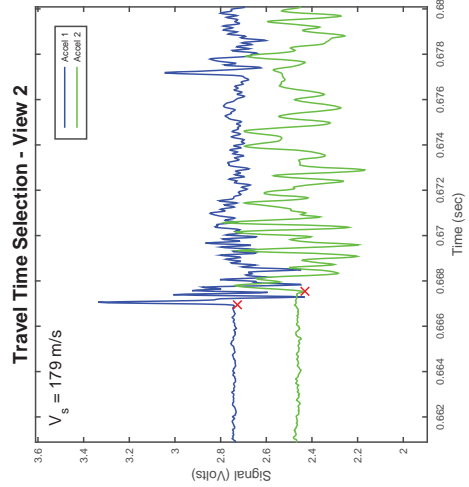
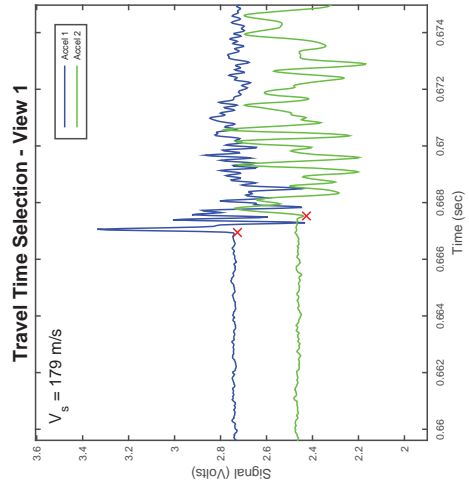
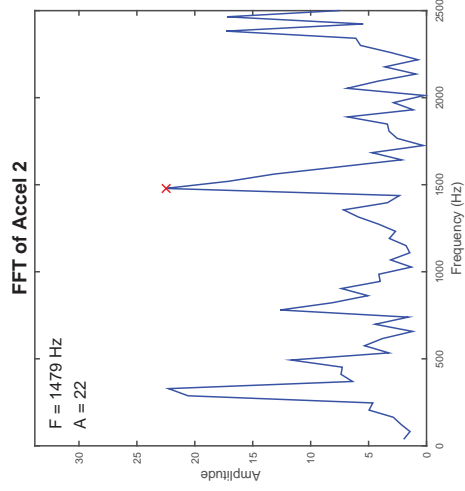
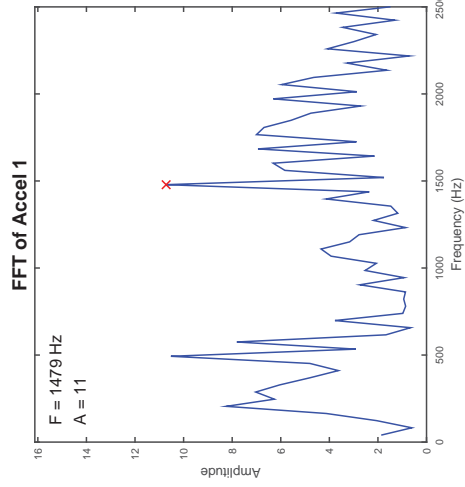
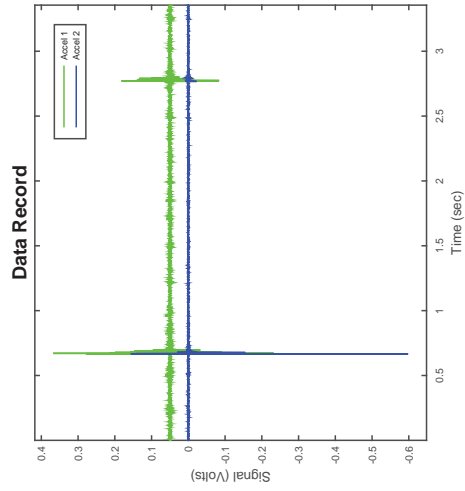

Accelerometer-Based Shear Wave Velocity Datasheet

Specimen ID: M228-LS-50-3X
 Test Material: LS
 Date: 8/16/2015
 Test Performed by: J.Hubler
 Filename: M228-LS-50-3X

Vertical Stress: 50kPa
 Sensor Spacing: 0.10685 m
 V_s (rise) = 176 m/s

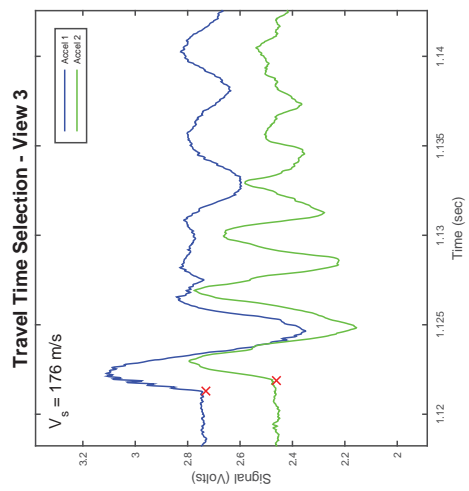
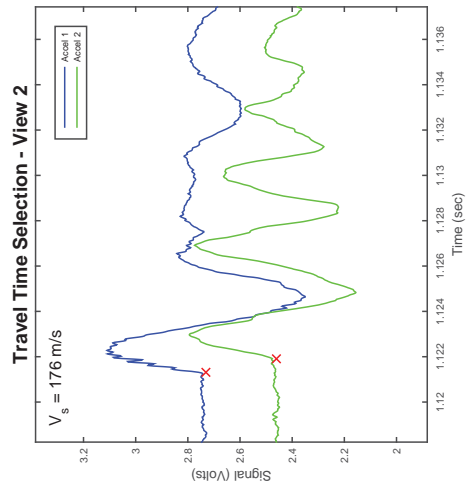
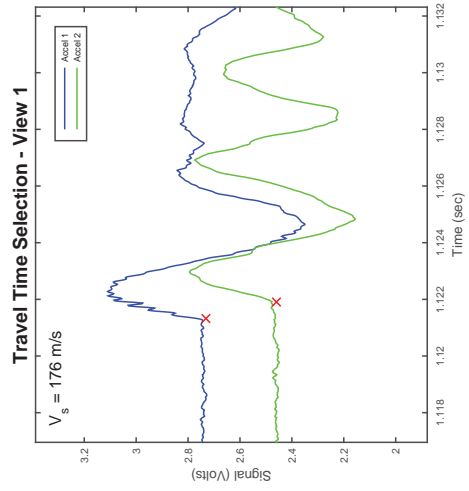
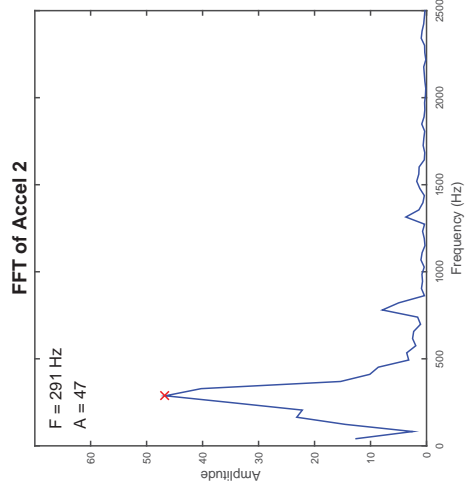
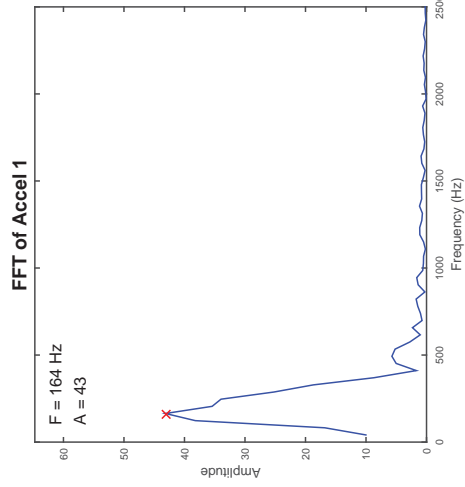
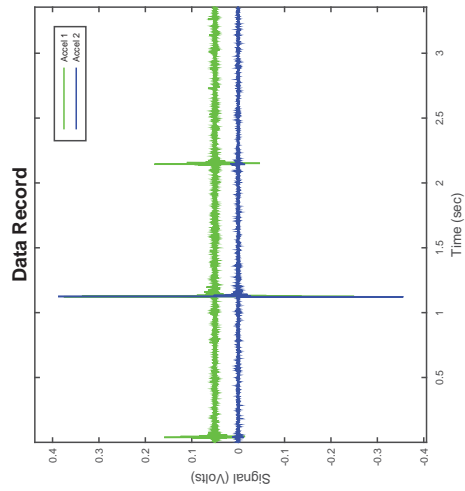

CSS Monotonic Shear Test Report

Geotechnical Engineering Laboratory



10/28/2013_Version 8.0

General Test Info and Sample Preparation

Device:	CSS	Relative Density (%):	28%
Specimen ID:	CLS8	Void Ratio:	0.831
Test ID:	M226	Height (mm):	113.2
Date of Test:	8/16/2015	Soil-Only Specimen Diameter (mm):	306.23
Test Performed:	Monotonic Shear	Weight (kg):	12.063
Test Material:	8mm Crushed Limestone	Density (kg/m³):	1447.5
Sample Preparation:	Prepared loose using the shoveling method. Tamped 25x with a rubber mallet in 3 layers.	Membrane Thickness (mm):	0.635
		Moisture Content (%):	0%
		Saturated (Y/N):	N
		Prepared by:	J. Hubler
		Checked by:	J. Hubler

Consolidation Stage

Vertical Stress (kPa):	100
Time to Compression (min):	14.7
Relative Density (%):	45%
Void Ratio:	0.756
Height (mm):	108.5
Diameter (mm):	306.23
Weight (kg):	12.063
Density (kg/m³):	1509.1

Shear Stage

Type of Test:	Constant Volume
Stress or Strain Controlled:	Strain
Shear Strain Rate (%/min):	0.30
Peak Shear Strength (kPa):	16.2

Comments

Silver Baseplate used with cushion membrane.

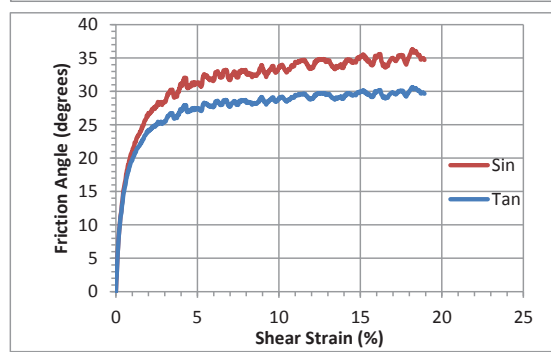
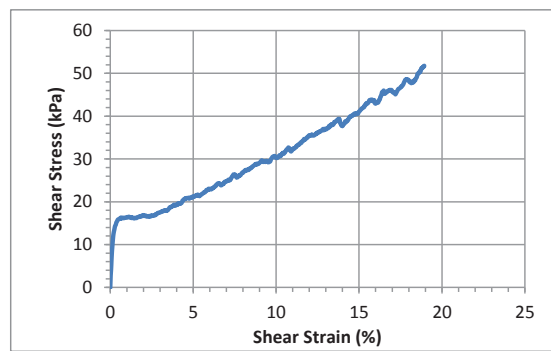
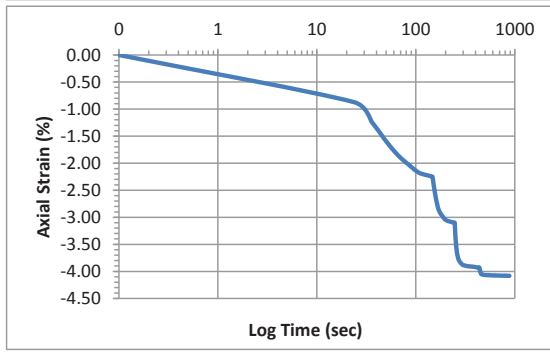
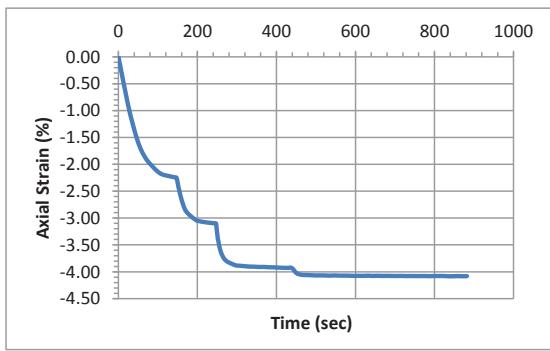

Accelerometer-Based Shear Wave Velocity Datasheet

Specimen ID: M226-LS-100-2X
 Test Material: LS
 Date: 8/16/2015
 Test Performed by: J.Hubler
 Filename: M226-LS-100-2X

Vertical Stress: 100kPa
 Sensor Spacing: 0.10849 m
 V_s (rise) = 212 m/s

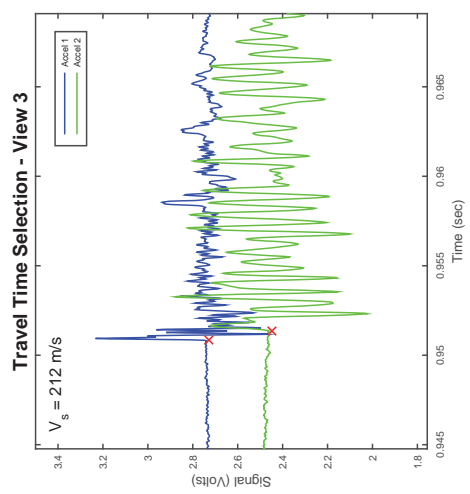
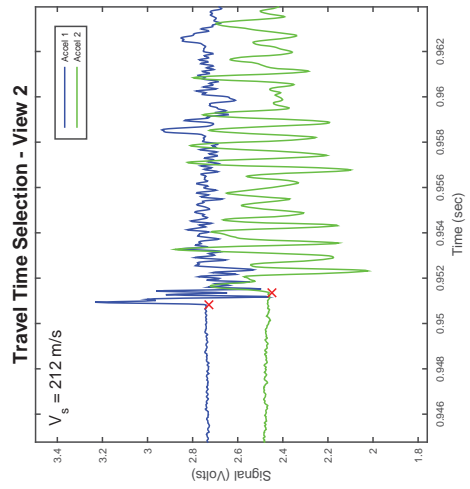
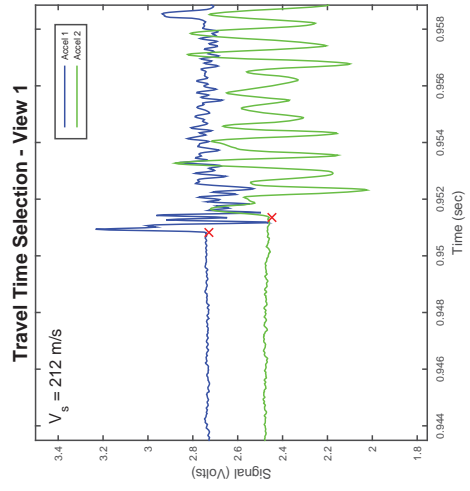
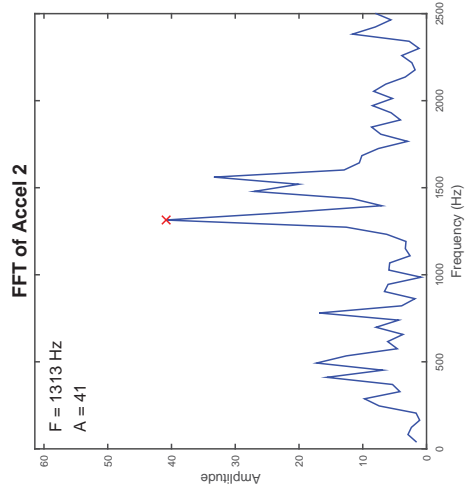
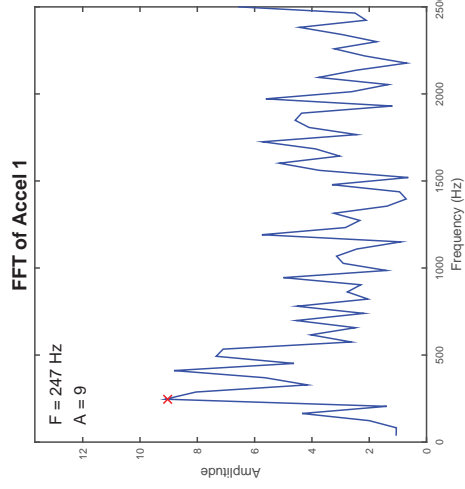
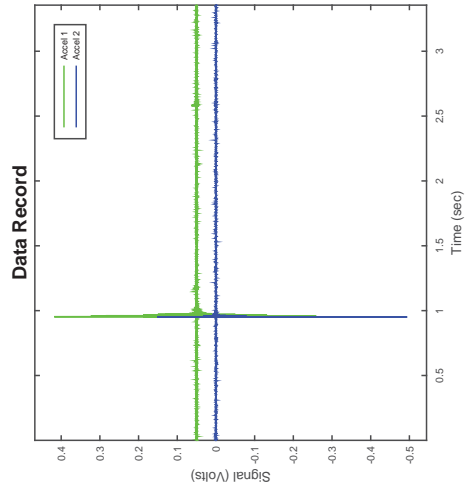

CSS Monotonic Shear Test Report

Geotechnical Engineering Laboratory



10/28/2013_Version 8.0

General Test Info and Sample Preparation

Device:	CSS	Relative Density (%):	25%
Specimen ID:	CLS8	Void Ratio:	0.842
Test ID:	M227	Height (mm):	115.9
Date of Test:	8/16/2015	Soil-Only Specimen Diameter (mm):	306.23
Test Performed:	Monotonic Shear	Weight (kg):	12.279
Test Material:	8mm Crushed Limestone	Density (kg/m³):	1438.8
Sample Preparation:	Prepared loose using the shoveling method. Tamped 25x with a rubber mallet in 3 layers.	Membrane Thickness (mm):	0.635
		Moisture Content (%):	0%
		Saturated (Y/N):	N
		Prepared by:	J. Hubler
		Checked by:	J. Hubler

Consolidation Stage

Shear Stage

Vertical Stress (kPa):	200	Type of Test:	Constant Volume
Time to Compression (min):	13.5	Stress or Strain Controlled:	Strain
Relative Density (%):	47%	Shear Strain Rate (%/min):	0.30
Void Ratio:	0.747	Peak Shear Strength (kPa):	30.3
Height (mm):	109.9	Comments Silver Baseplate used with cushion membrane.	
Diameter (mm):	306.23		
Weight (kg):	12.279		
Density (kg/m³):	1517.3		

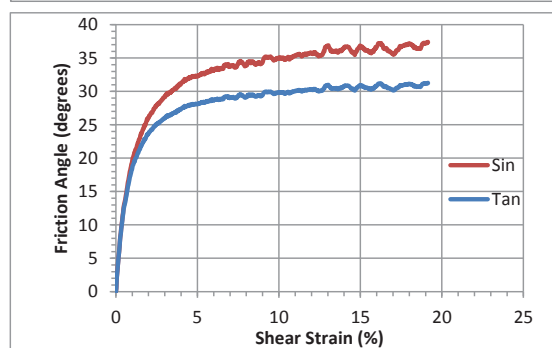
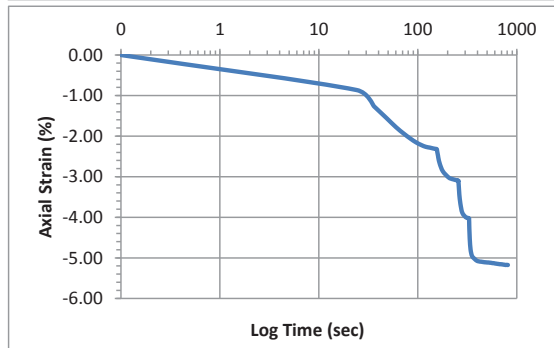
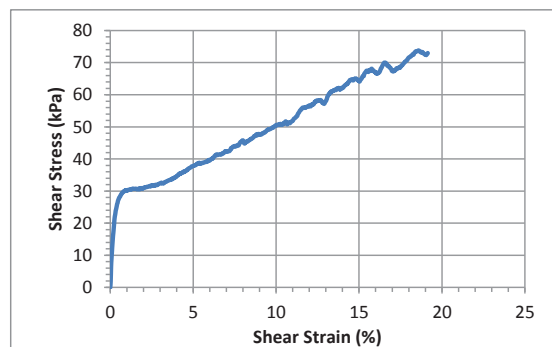
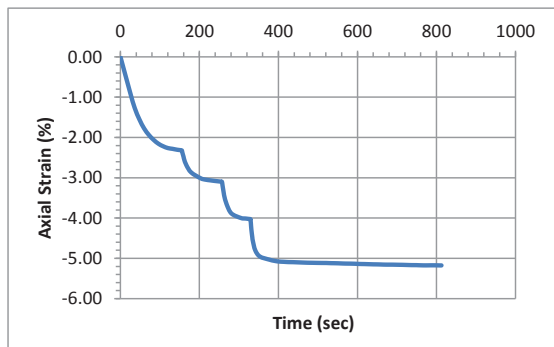

Accelerometer-Based Shear Wave Velocity Datasheet

Specimen ID: M227-LS-200-1X
 Test Material: LS
 Date: 8/16/2015
 Test Performed by: J. Hubler
 Filename: M227-LS-200-1X

Vertical Stress: 200kPa
 Sensor Spacing: 0.10983 m
 V_s (rise) = 250 m/s

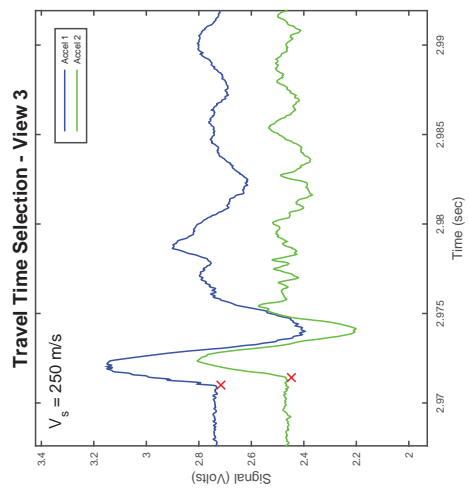
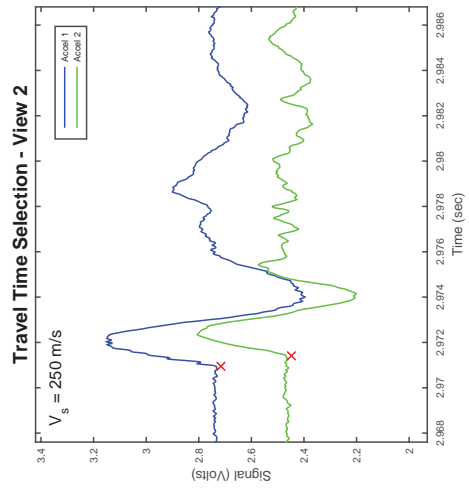
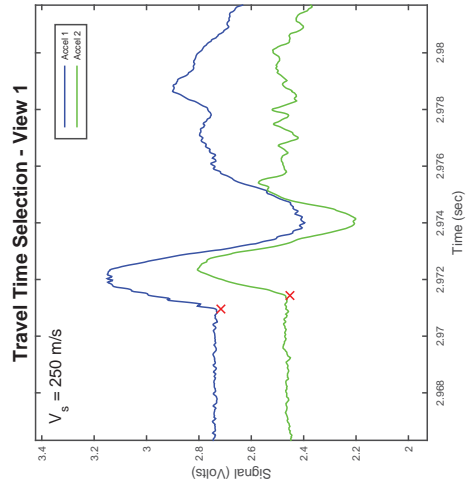
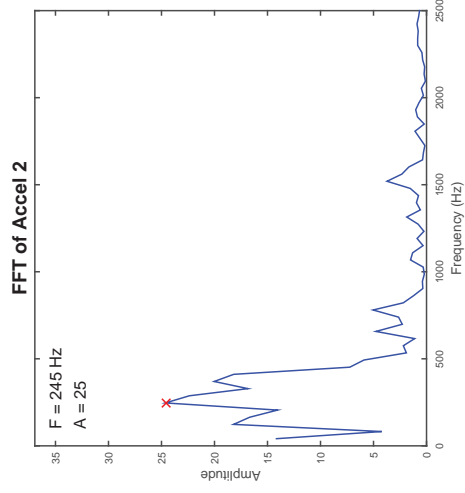
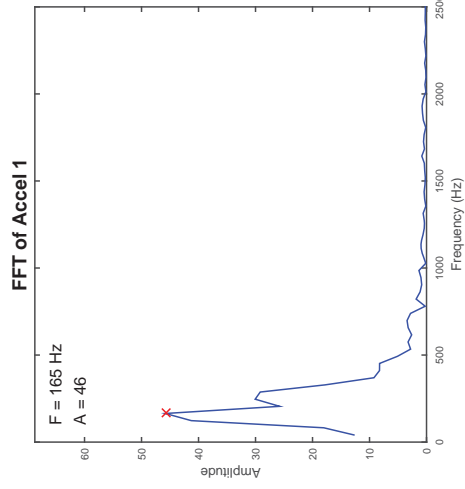
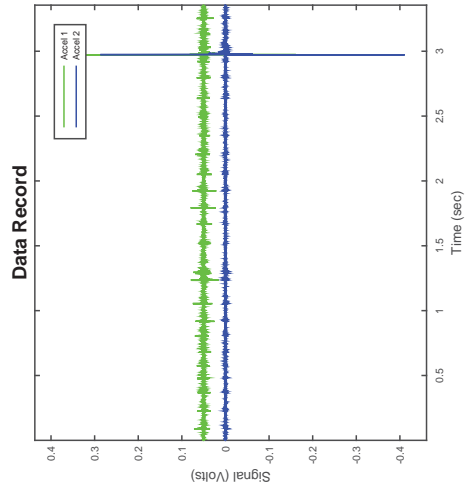

Accelerometer-Based Shear Wave Velocity Datasheet

Specimen ID: M227-LS-200-2X

Test Material: LS

Date: 8/16/2015

Test Performed by: J. Hubler

Filename: M227-LS-200-2X

Vertical Stress: 200kPa

Sensor Spacing: 0.10983 m

V_s (rise) = 262 m/s

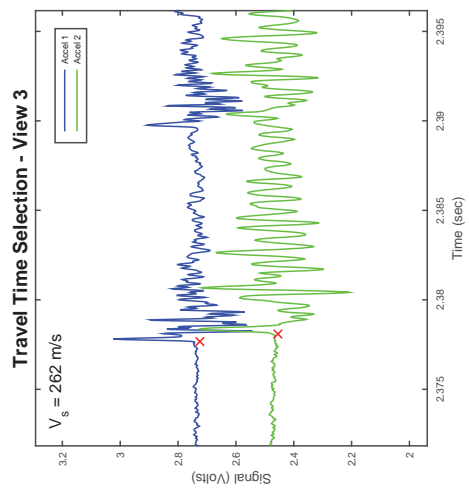
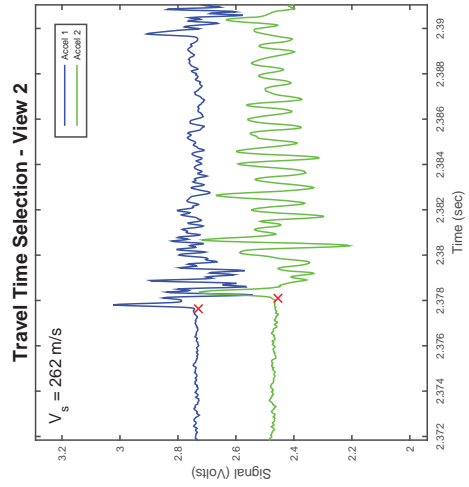
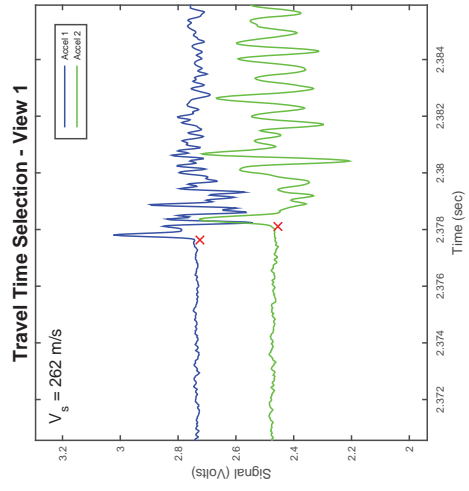
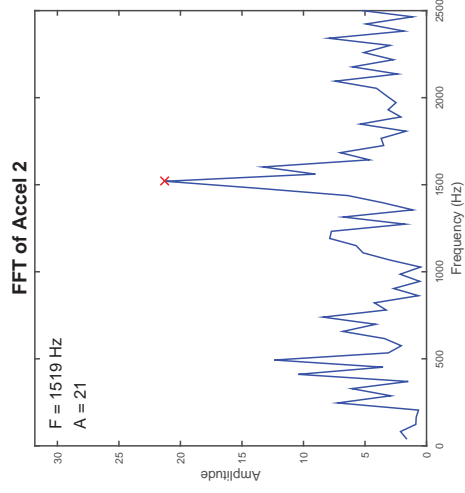
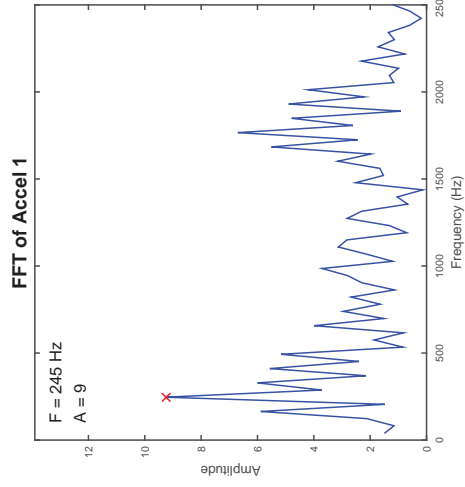
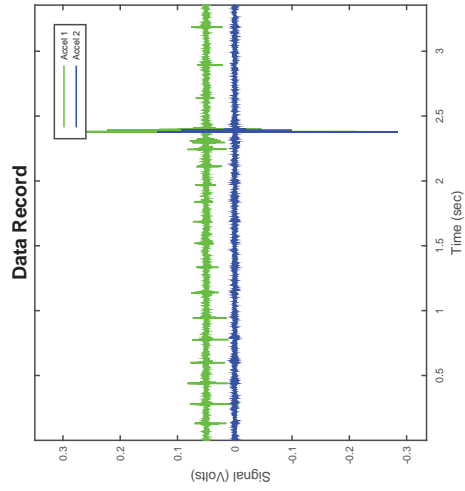

Accelerometer-Based Shear Wave Velocity Datasheet

Specimen ID: M227-LS-200-3X
 Test Material: LS
 Date: 8/16/2015
 Test Performed by: J. Hubler
 Filename: M227-LS-200-3X

Vertical Stress: 200kPa
 Sensor Spacing: 0.10983 m
 V_s (rise) = 244 m/s

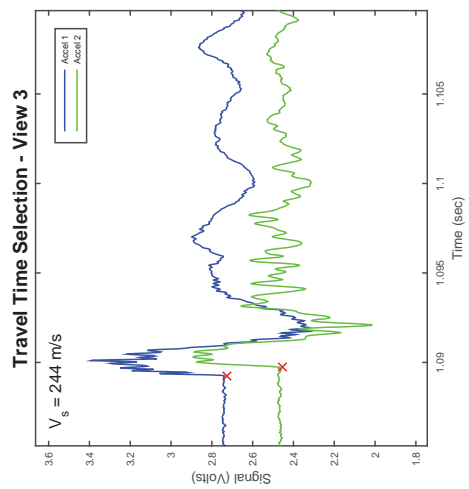
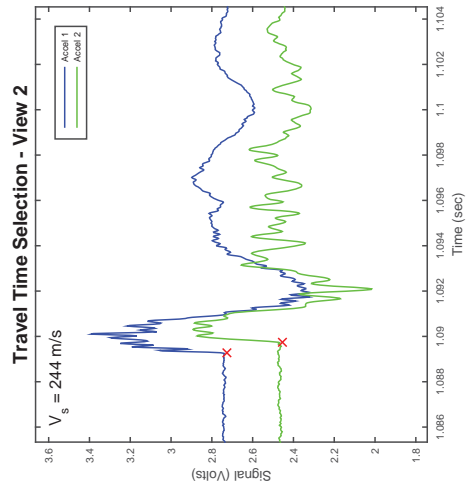
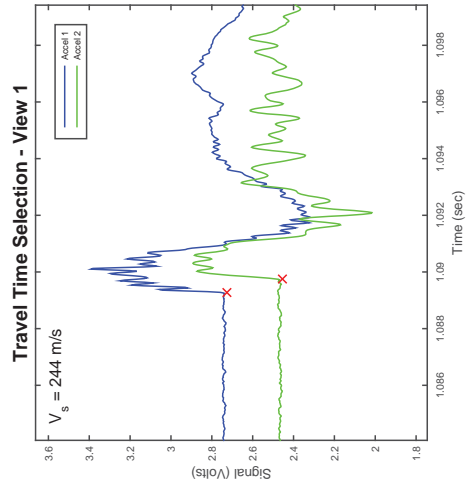
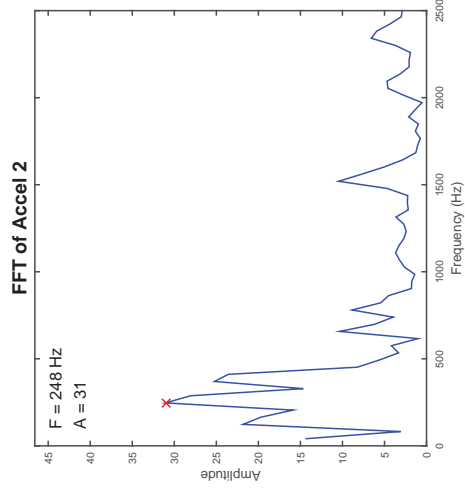
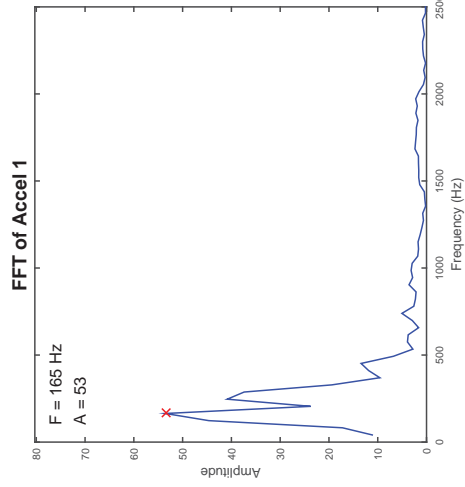
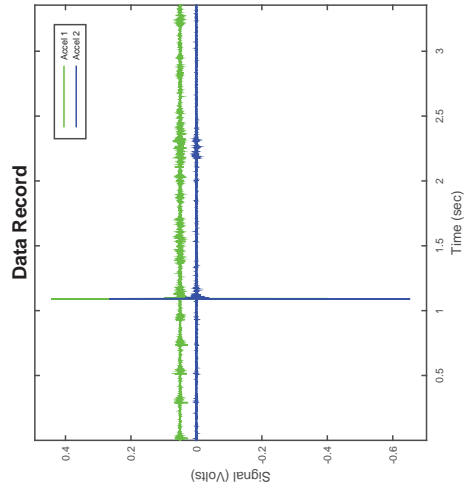

CSS Monotonic Shear Test Report

Geotechnical Engineering Laboratory



10/28/2013_Version 8.0

General Test Info and Sample Preparation

Device:	CSS	Relative Density (%):	19%
Specimen ID:	CLS8	Void Ratio:	0.870
Test ID:	M224	Height (mm):	111.6
Date of Test:	8/14/2015	Soil-Only Specimen Diameter (mm):	306.23
Test Performed:	Monotonic Shear	Weight (kg):	11.651
Test Material:	8mm Crushed Limestone	Density (kg/m³):	1416.9
Sample Preparation:	Prepared loose using the shoveling method.	Membrane Thickness (mm):	0.635
		Moisture Content (%):	0%
		Saturated (Y/N):	N
		Prepared by:	J. Hubler
		Checked by:	J. Hubler

Consolidation Stage

Vertical Stress (kPa):	400
Time to Compression (min):	14.8
Relative Density (%):	47%
Void Ratio:	0.748
Height (mm):	104.4
Diameter (mm):	306.23
Weight (kg):	11.651
Density (kg/m³):	1515.6

Shear Stage

Type of Test:	Constant Volume
Stress or Strain Controlled:	Strain
Shear Strain Rate (%/min):	0.31
Peak Shear Strength (kPa):	59.0

Comments

Silver Baseplate used with cushion membrane.

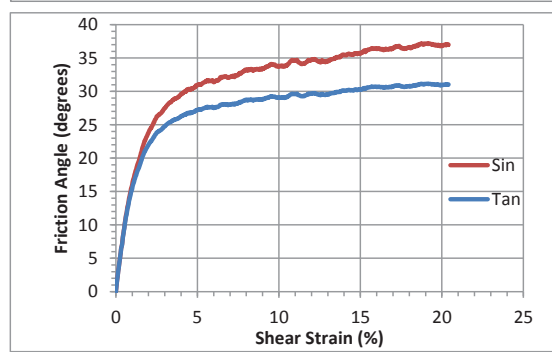
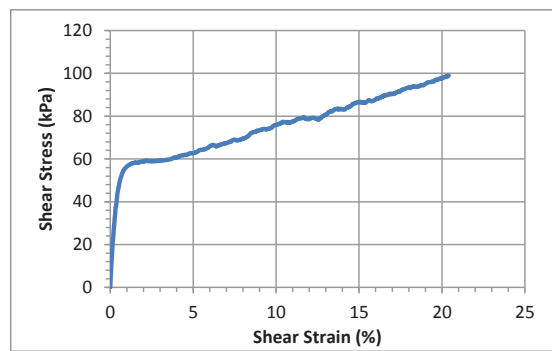
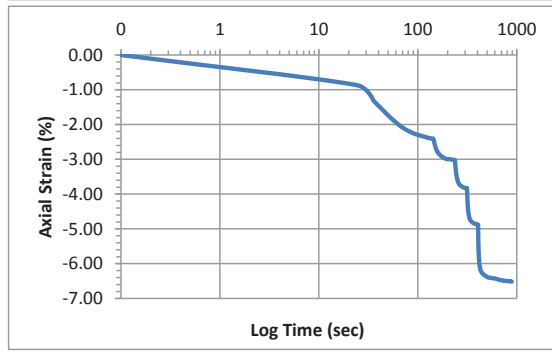
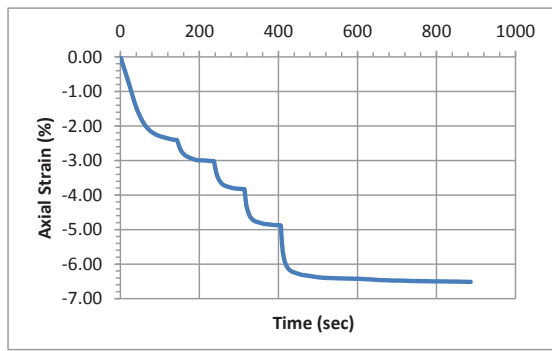

Accelerometer-Based Shear Wave Velocity Datasheet

Specimen ID: M224-LS-100-1X
 Test Material: LS
 Date: 8/16/2015
 Test Performed by: J. Hubler
 Filename: M224-LS-100-1X

Vertical Stress: 100kPa
 Sensor Spacing: 0.10433 m
 V_s (rise) = 293 m/s

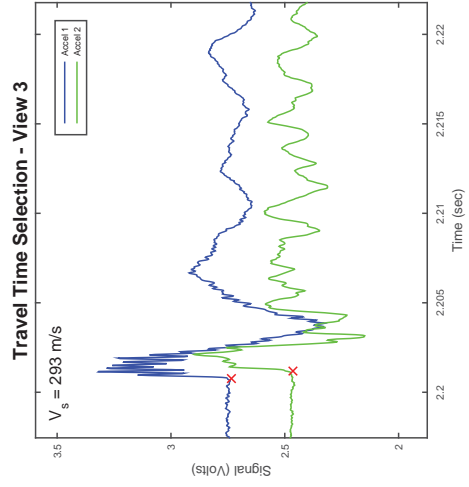
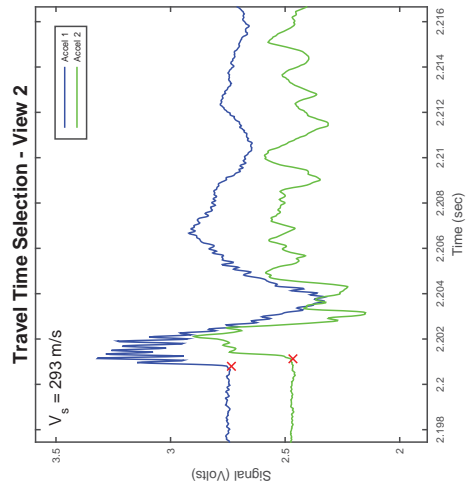
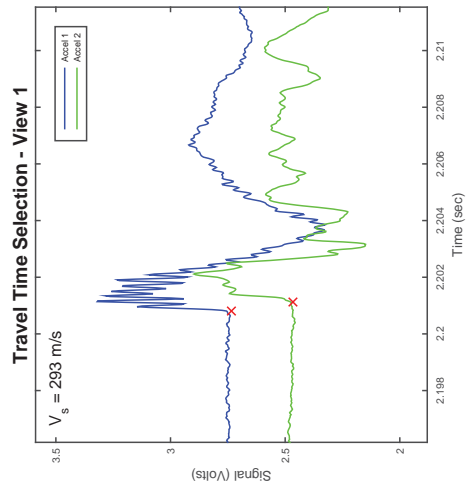
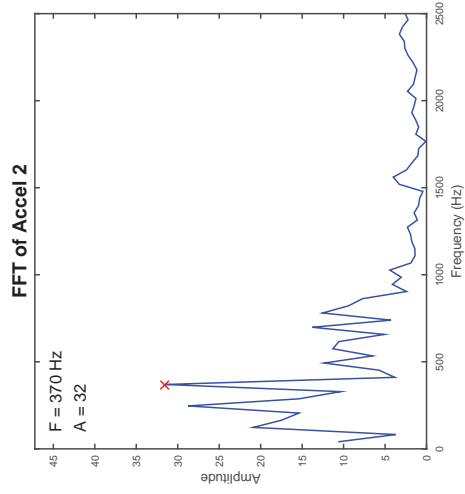
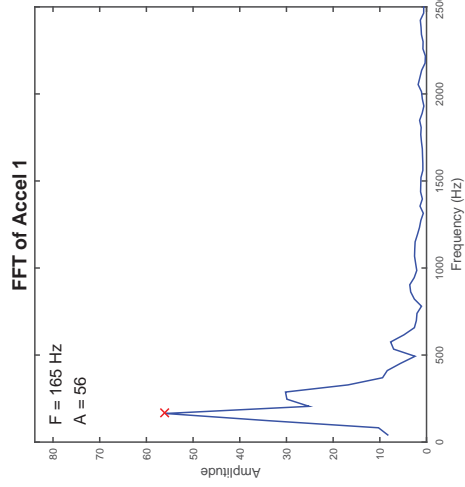
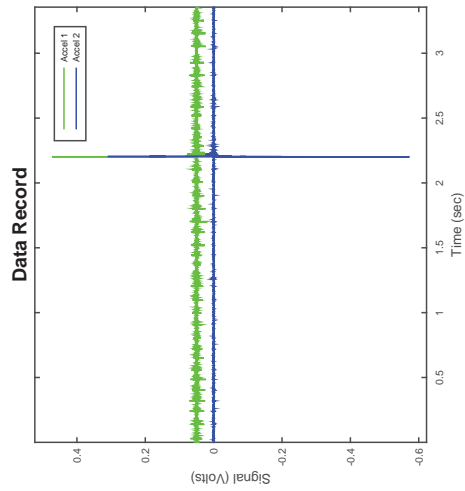

CSS Monotonic Shear Test Report

Geotechnical Engineering Laboratory



10/28/2013_Version 8.0

General Test Info and Sample Preparation

Device:	CSS	Relative Density (%):	75%
Specimen ID:	CLS8	Void Ratio:	0.622
Test ID:	M233	Height (mm):	114.1
Date of Test:	8/17/2015	Soil-Only Specimen Diameter (mm):	306.23
Test Performed:	Monotonic Shear	Weight (kg):	13.727
Test Material:	8mm Crushed Limestone	Density (kg/m ³):	1634.0
Sample Preparation:	Prepared dense by tamping 60x in 6 layers.	Membrane Thickness (mm):	0.635
		Moisture Content (%):	0%
		Saturated (Y/N):	N
		Prepared by:	J. Hubler
		Checked by:	J. Hubler

Consolidation Stage

Vertical Stress (kPa):	50
Time to Compression (min):	7.8
Relative Density (%):	87%
Void Ratio:	0.572
Height (mm):	110.6
Diameter (mm):	306.23
Weight (kg):	13.727
Density (kg/m ³):	1685.4

Shear Stage

Type of Test:	Constant Volume
Stress or Strain Controlled:	Strain
Shear Strain Rate (%/min):	0.30
Peak Shear Strength (kPa):	9.4

Comments

Silver Baseplate used with cushion membrane.

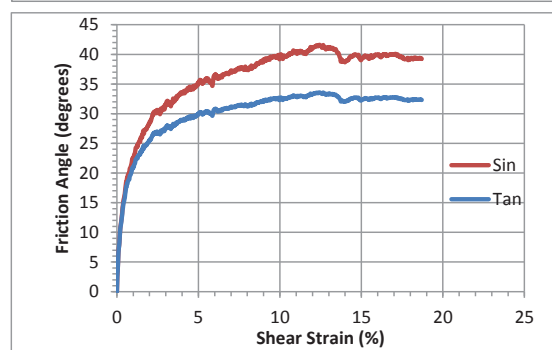
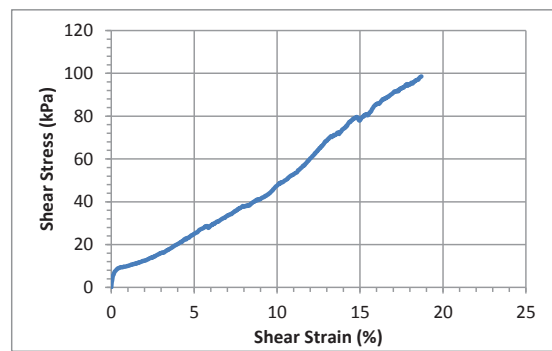
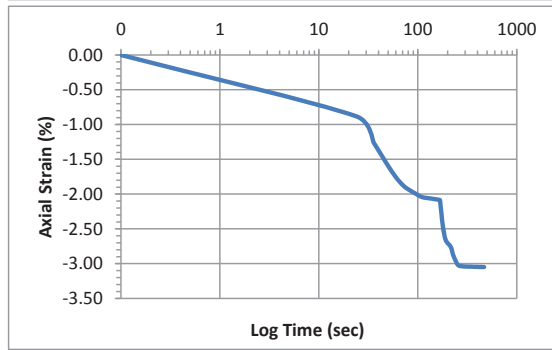
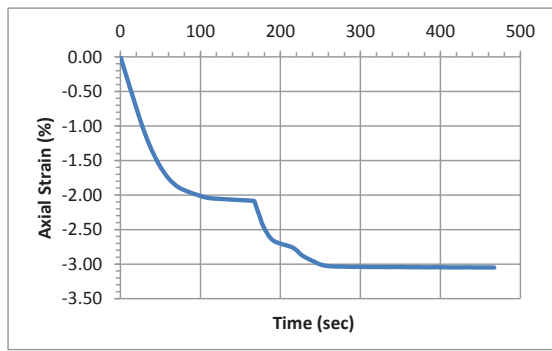

Accelerometer-Based Shear Wave Velocity Datasheet

Specimen ID: M233-LS-50-1X
 Test Material: LS
 Date: 8/17/2015
 Test Performed by: J. Hubler
 Filename: M233-LS-50-1X

Vertical Stress: 50kPa
 Sensor Spacing: 0.11054 m
 V_s (rise) = 189 m/s

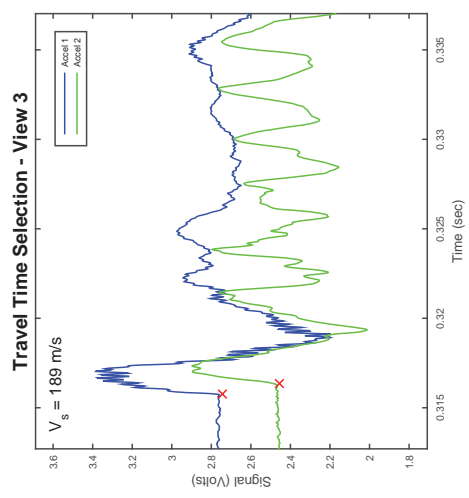
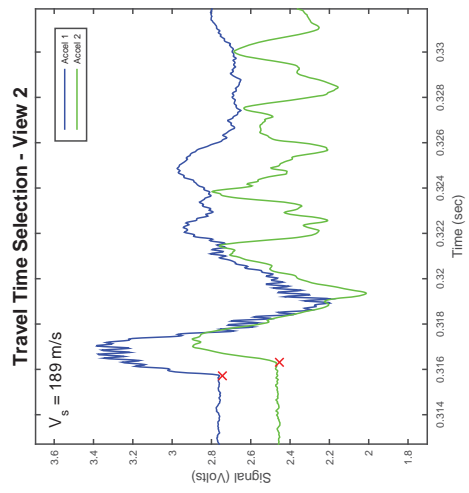
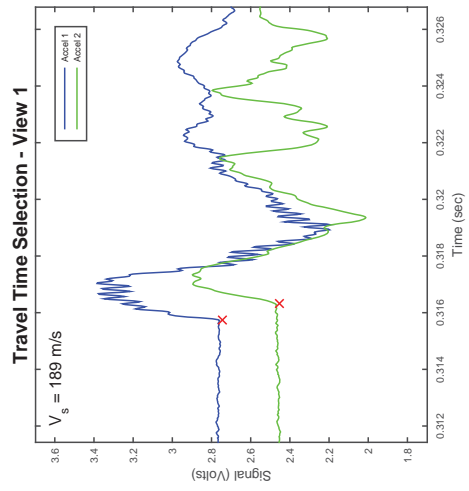
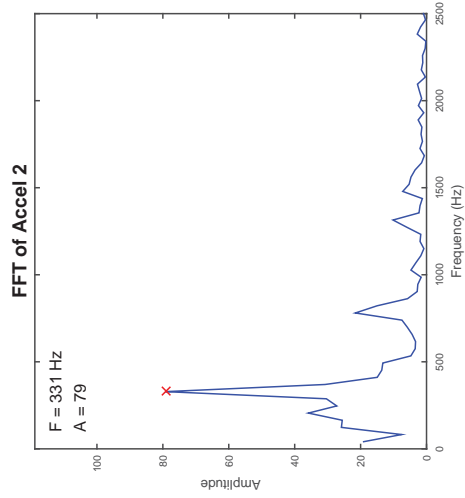
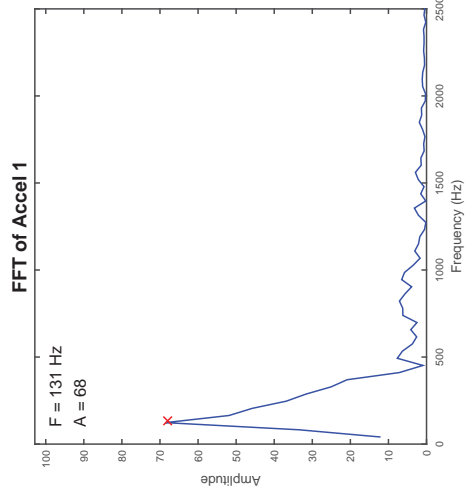
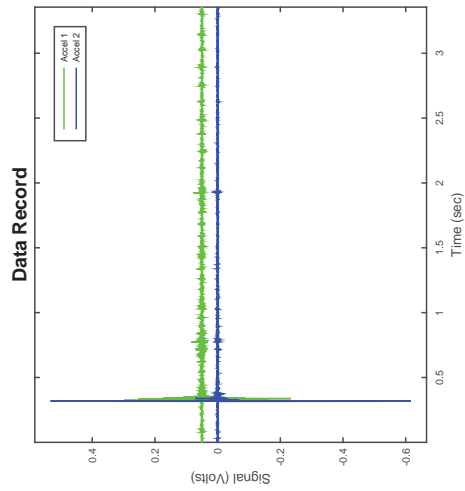

Accelerometer-Based Shear Wave Velocity Datasheet

Specimen ID: M233-LS-50-2X

Test Material: LS

Date: 8/17/2015

Test Performed by: J.Hubler

Filename: M233-LS-50-2X

Vertical Stress: 50kPa

Sensor Spacing: 0.11054 m

V_s (rise) = 192 m/s

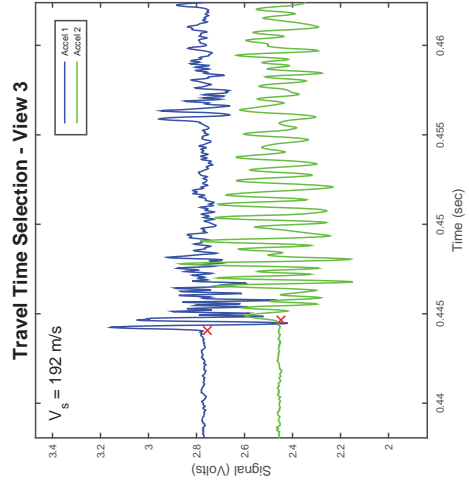
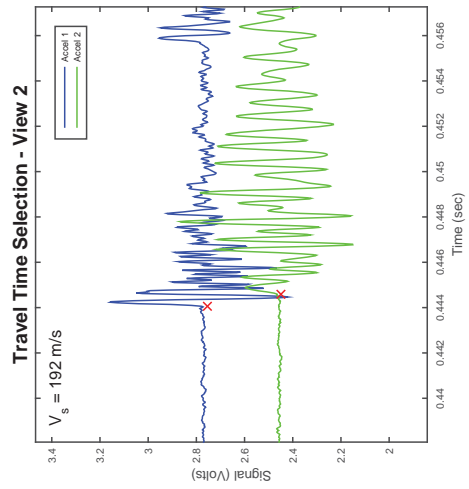
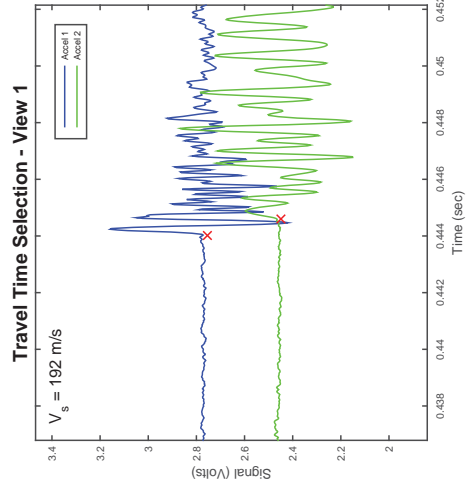
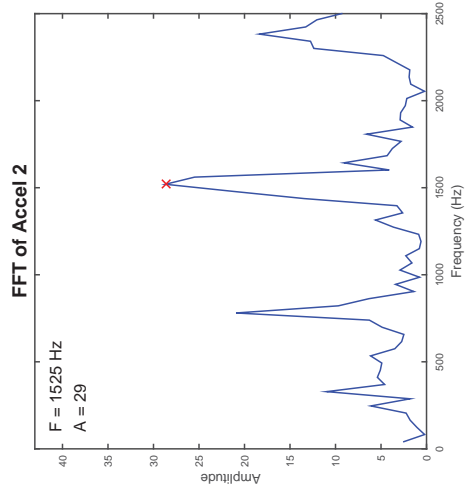
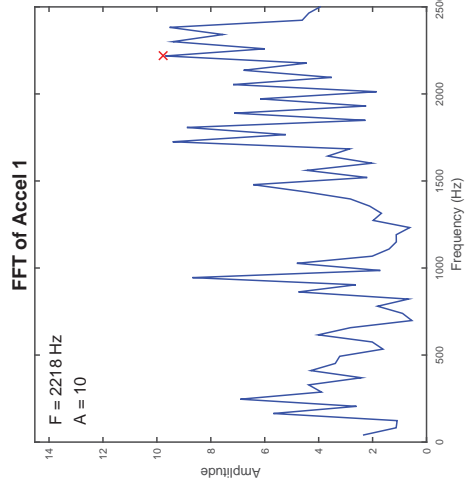
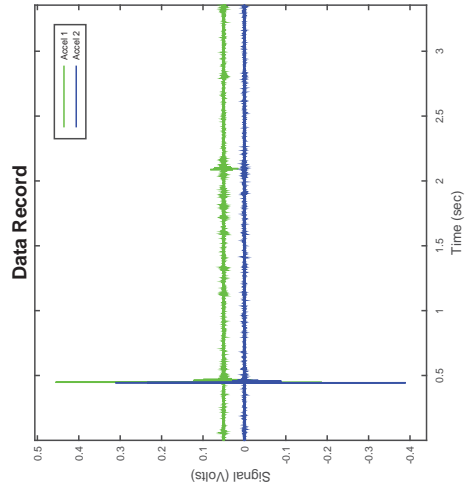

Accelerometer-Based Shear Wave Velocity Datasheet

Specimen ID: M233-LS-50-3X
 Test Material: LS
 Date: 8/17/2015
 Test Performed by: J. Hubler
 Filename: M233-LS-50-3X

Vertical Stress: 50kPa
 Sensor Spacing: 0.11054 m
 V_s (rise) = 192 m/s

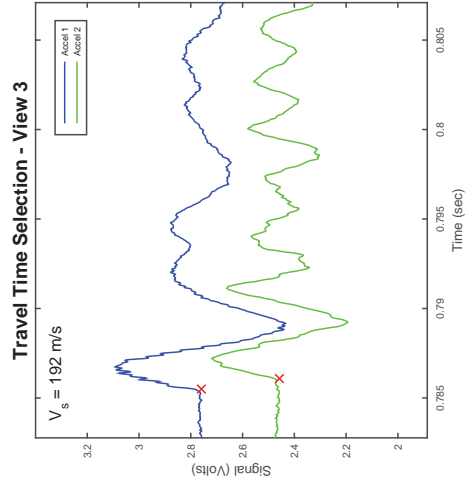
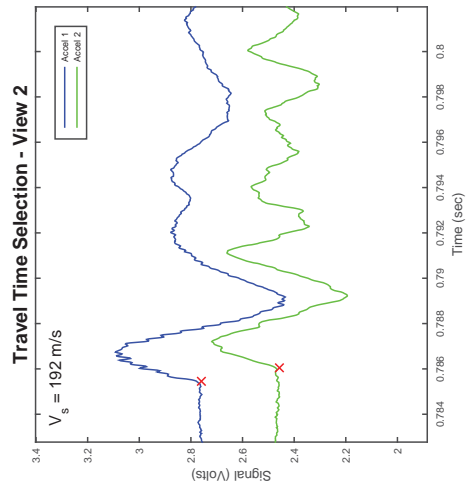
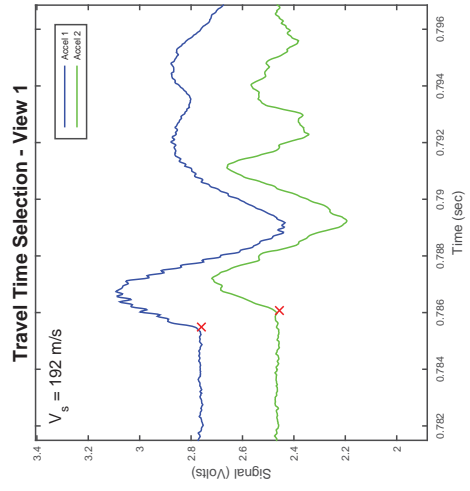
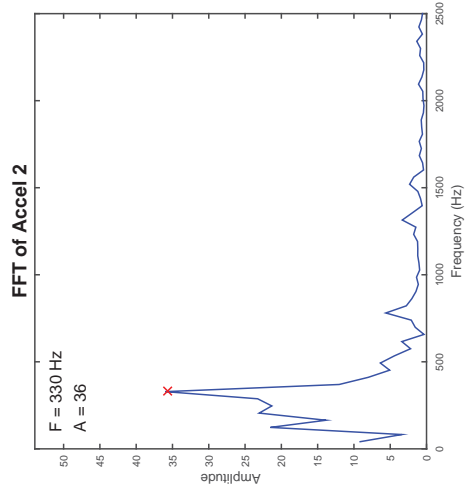
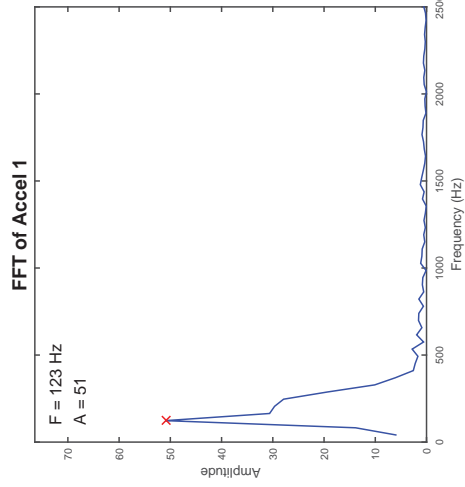
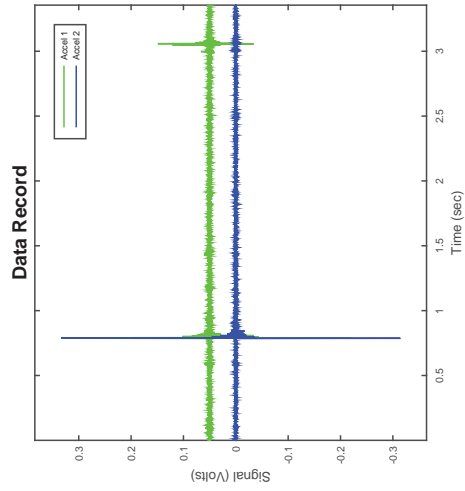

CSS Monotonic Shear Test Report

Geotechnical Engineering Laboratory



10/28/2013_Version 8.0

General Test Info and Sample Preparation

Device:	CSS	Relative Density (%):	77%
Specimen ID:	CLS8	Void Ratio:	0.614
Test ID:	M235	Height (mm):	115.1
Date of Test:	8/19/2015	Soil-Only Specimen Diameter (mm):	306.23
Test Performed:	Monotonic Shear	Weight (kg):	13.923
Test Material:	8mm Crushed Limestone	Density (kg/m³):	1642.1
Sample Preparation:	Prepared dense by tamping 60x in 5 layers.	Membrane Thickness (mm):	0.635
		Moisture Content (%):	0%
		Saturated (Y/N):	N
		Prepared by:	J.Hubler
		Checked by:	J. Hubler

Consolidation Stage

Vertical Stress (kPa):	100
Time to Compression (min):	6.9
Relative Density (%):	86%
Void Ratio:	0.575
Height (mm):	112.4
Diameter (mm):	306.23
Weight (kg):	13.923
Density (kg/m³):	1682.3

Shear Stage

Type of Test:	Constant Volume
Stress or Strain Controlled:	Strain
Shear Strain Rate (%/min):	0.29
Peak Shear Strength (kPa):	18.0

Comments

Silver Baseplate used with cushion membrane.

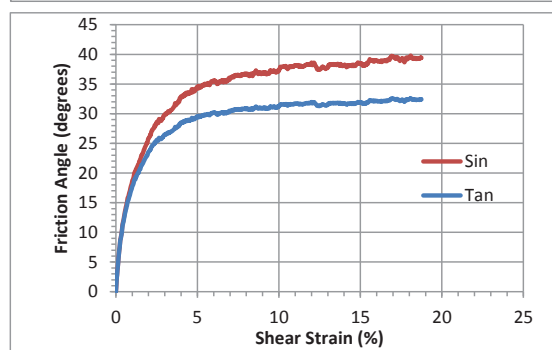
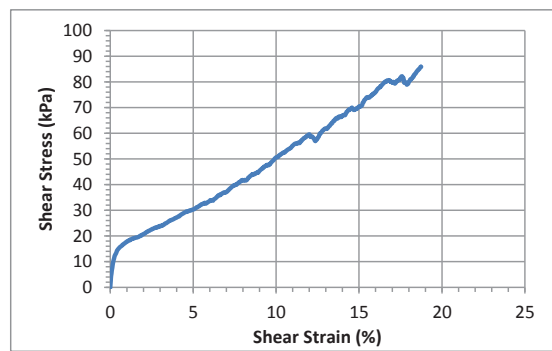
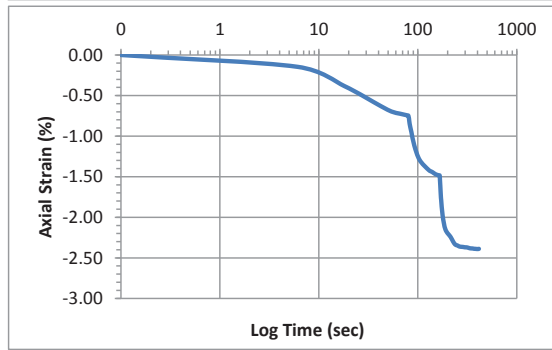
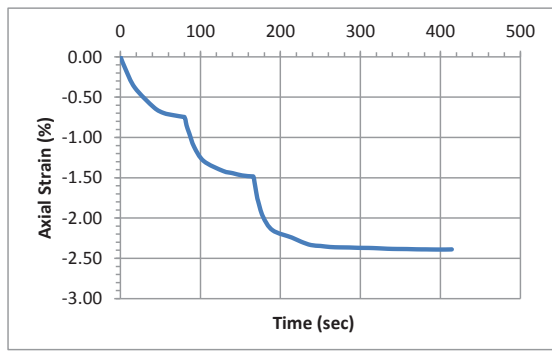

Accelerometer-Based Shear Wave Velocity Datasheet

Specimen ID: M235-LS-100-1X

Test Material: LS

Date: 8/19/2015

Test Performed by: J.Hubler

Filename: M235-LS-100-1X

Vertical Stress: 100kPa

Sensor Spacing: 0.11233 m

V_s (rise) = 216 m/s

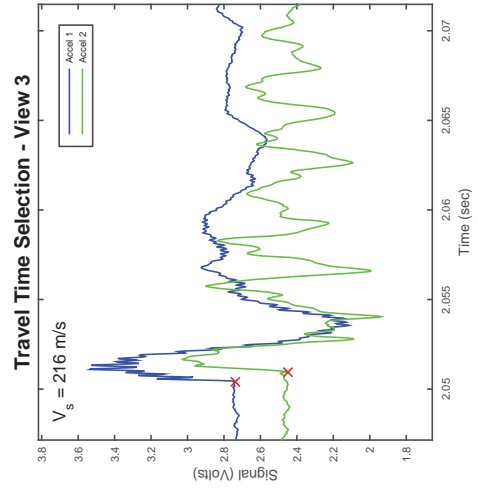
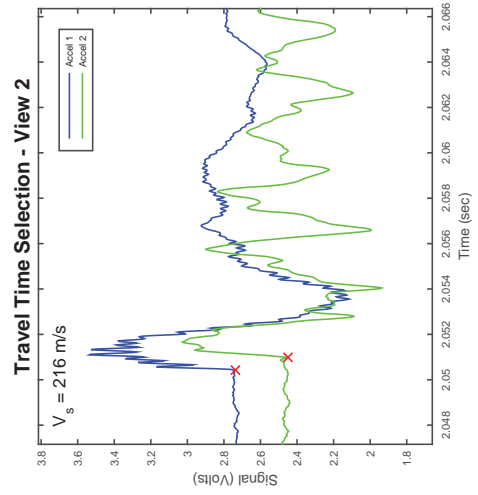
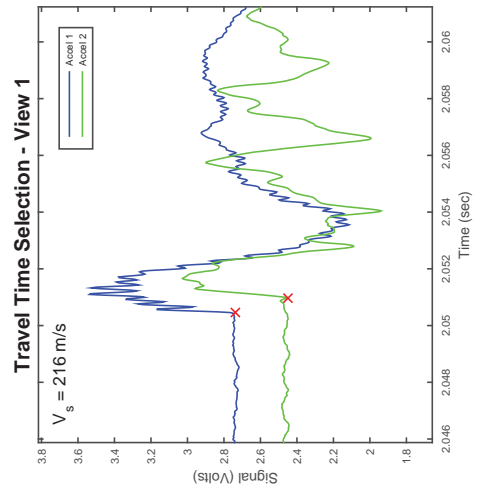
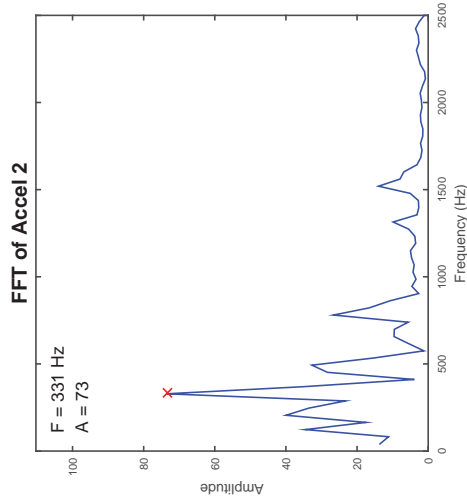
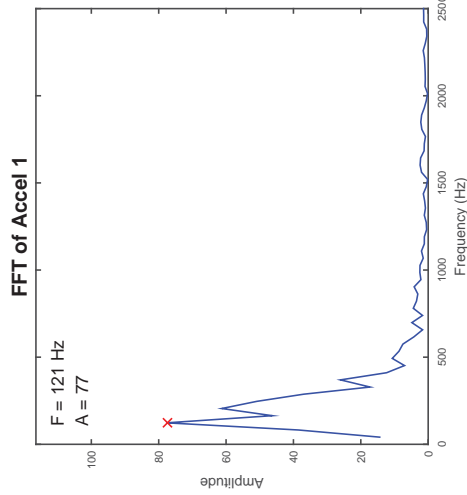
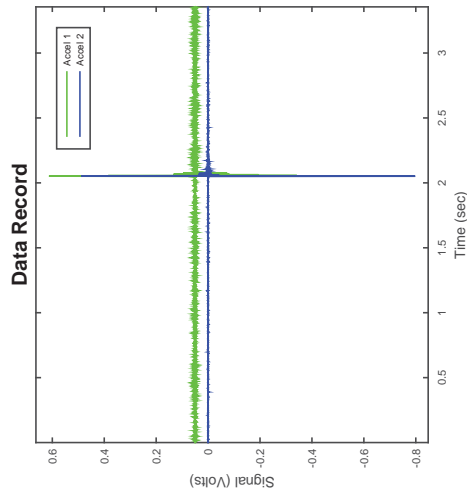

CSS Monotonic Shear Test Report

Geotechnical Engineering Laboratory



10/28/2013_Version 8.0

General Test Info and Sample Preparation

Device:	CSS	Relative Density (%):	66%
Specimen ID:	CLS8	Void Ratio:	0.661
Test ID:	M231	Height (mm):	112.3
Date of Test:	8/17/2015	Soil-Only Specimen Diameter (mm):	306.23
Test Performed:	Monotonic Shear	Weight (kg):	13.191
Test Material:	8 mm Crushed Limestone	Density (kg/m ³):	1595.1
Sample Preparation:	Prepared dense by tamping 50x in 5 layers.	Membrane Thickness (mm):	0.635
		Moisture Content (%):	0%
		Saturated (Y/N):	N
		Prepared by:	J. Hubler
		Checked by:	J. Hubler

Consolidation Stage

Vertical Stress (kPa):	200
Time to Compression (min):	13.8
Relative Density (%):	87%
Void Ratio:	0.569
Height (mm):	106.0
Diameter (mm):	306.23
Weight (kg):	13.191
Density (kg/m ³):	1689.2

Shear Stage

Type of Test:	Constant Volume
Stress or Strain Controlled:	Strain
Shear Strain Rate (%/min):	0.31
Peak Shear Strength (kPa):	31.5

Comments

Silver Baseplate used with cushion membrane.

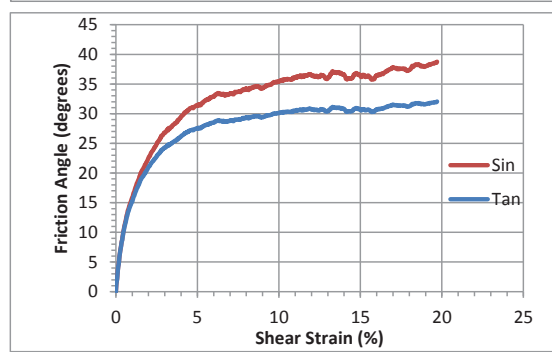
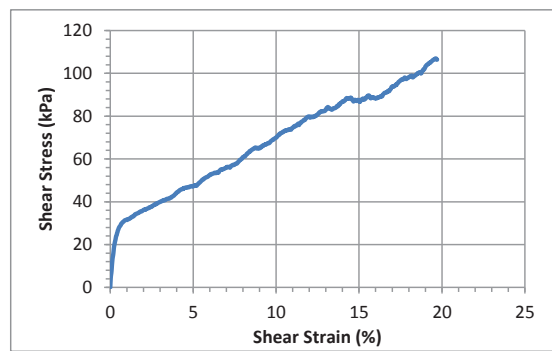
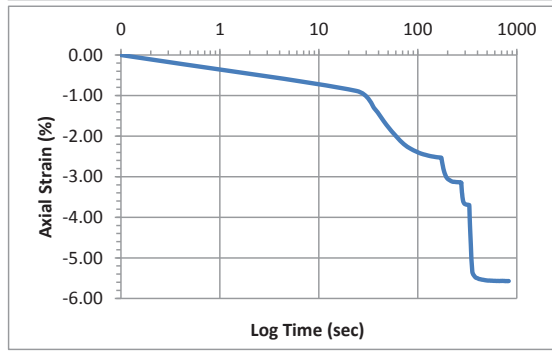
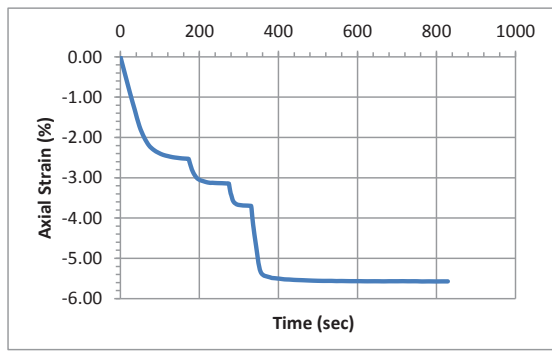

Accelerometer-Based Shear Wave Velocity Datasheet

Specimen ID: M231-LS-200-1X
 Test Material: LS
 Date: 8/17/2015
 Test Performed by: J.Hubler
 Filename: M231-LS-200-1X

Vertical Stress: 200kPa
 Sensor Spacing: 0.10598 m
 V_s (rise) = 266 m/s

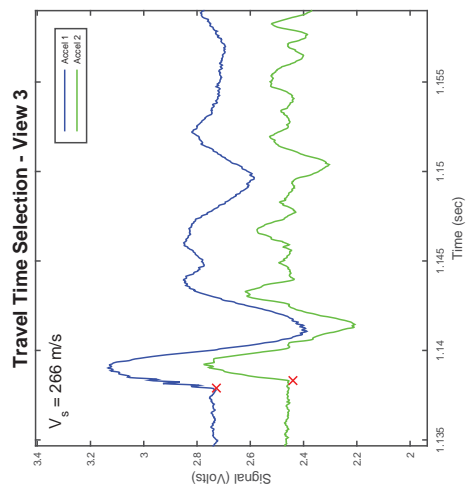
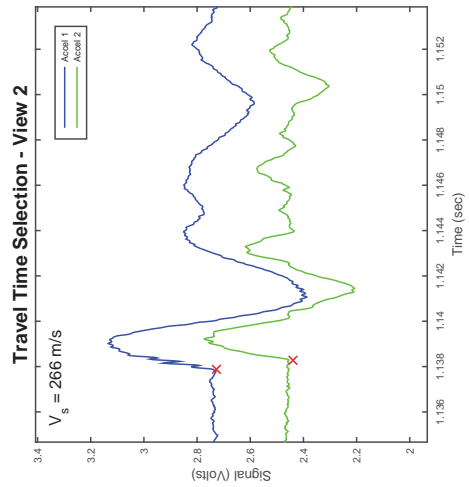
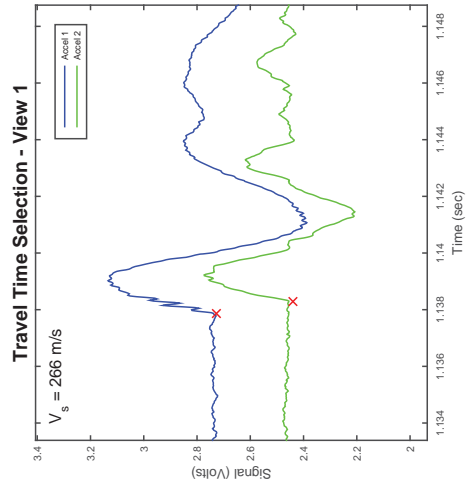
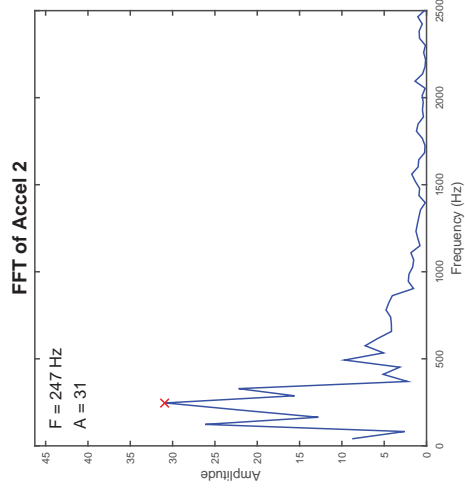
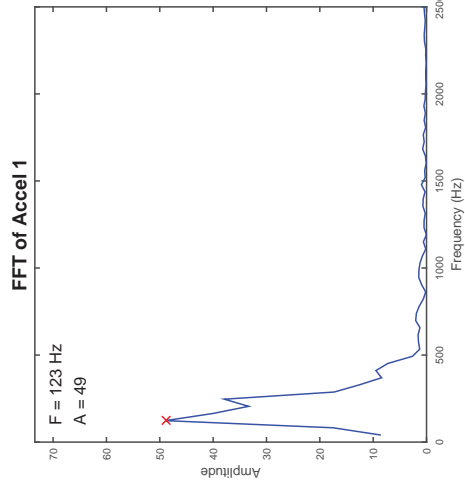
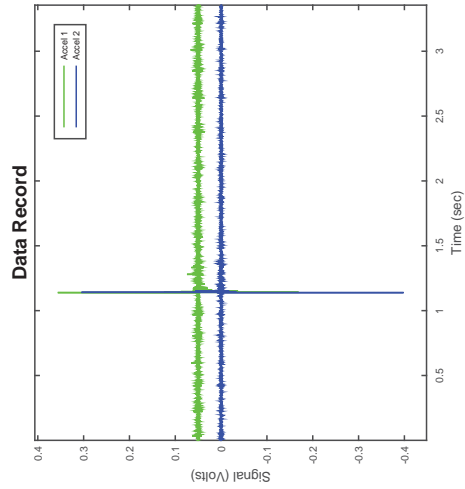

Accelerometer-Based Shear Wave Velocity Datasheet

Specimen ID: M231-LS-200-2X
Test Material: LS
Date: 8/17/2015
Test Performed by: J. Hubler
Filename: M231-LS-200-2X

Vertical Stress: 200kPa
Sensor Spacing: 0.10598 m
 V_s (rise) = 253 m/s

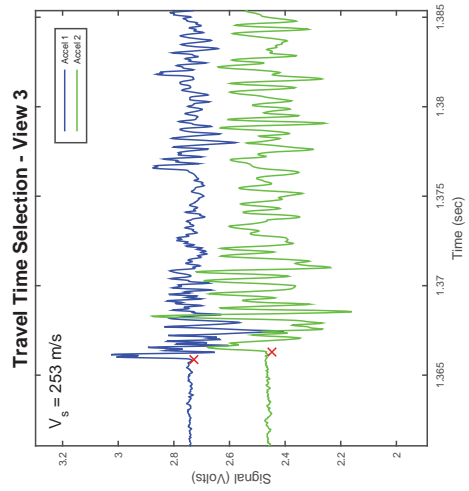
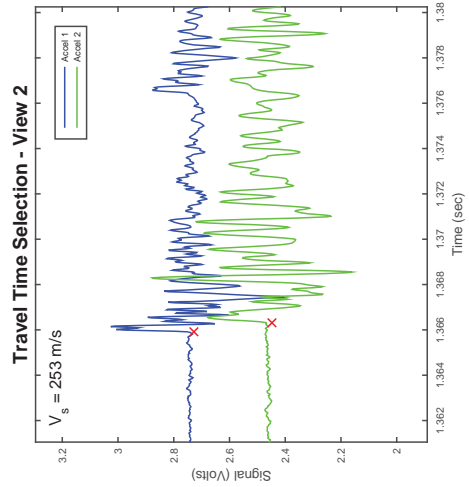
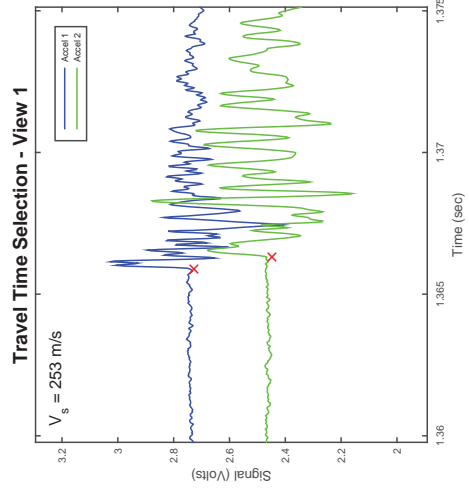
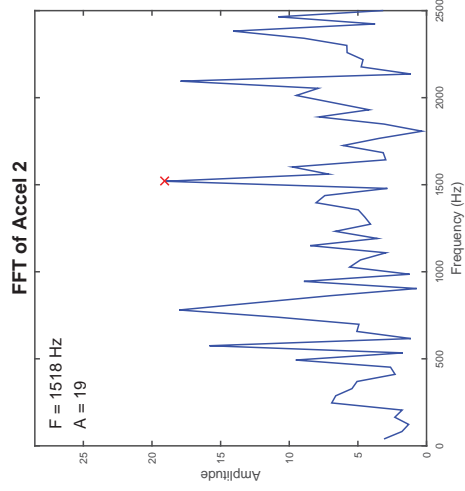
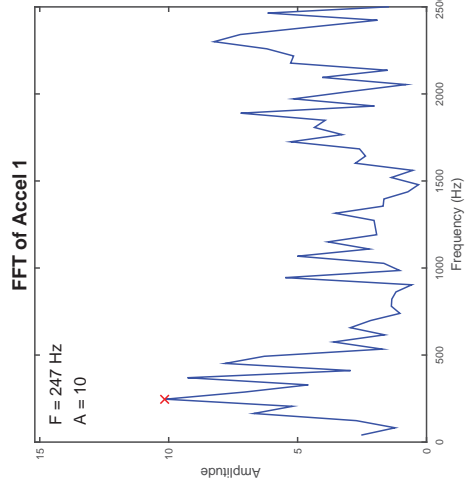
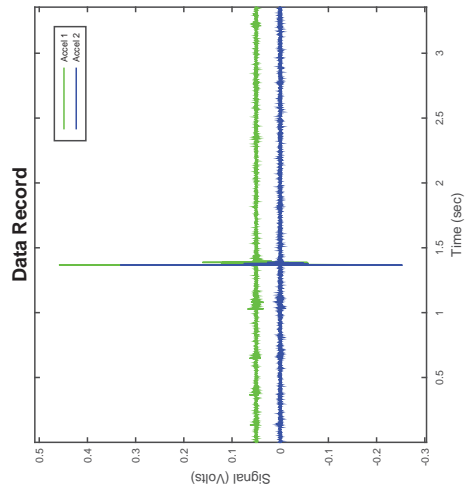

Accelerometer-Based Shear Wave Velocity Datasheet

Specimen ID: M231-LS-200-3X
 Test Material: LS
 Date: 8/17/2015
 Test Performed by: J.Hubler
 Filename: M231-LS-200-3X

Vertical Stress: 200kPa
 Sensor Spacing: 0.10598 m
 V_s (rise) = 253 m/s

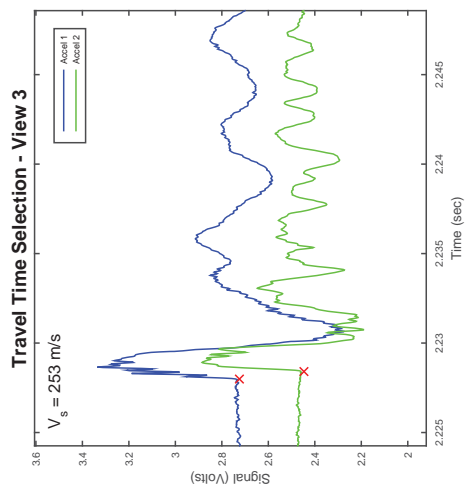
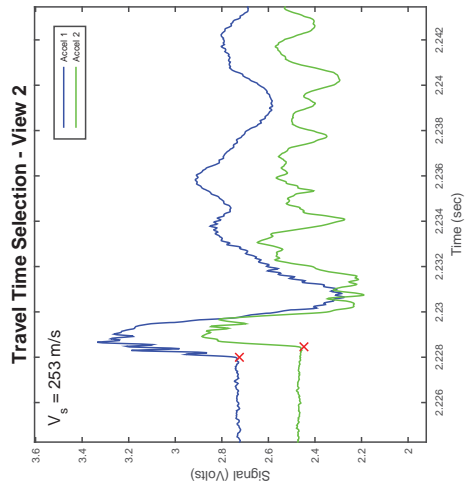
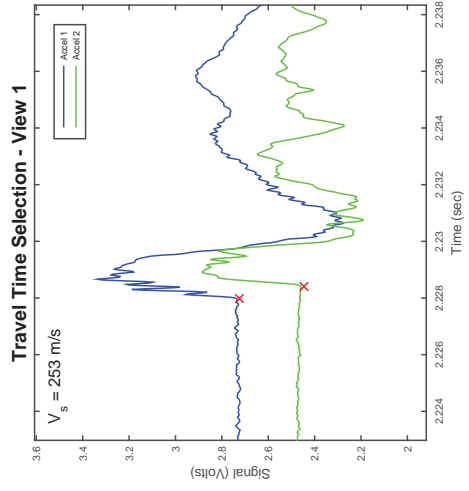
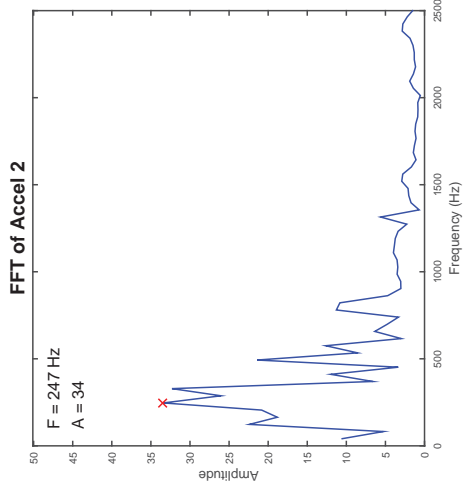
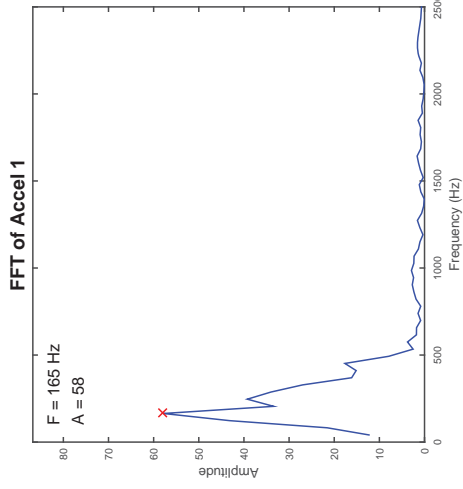
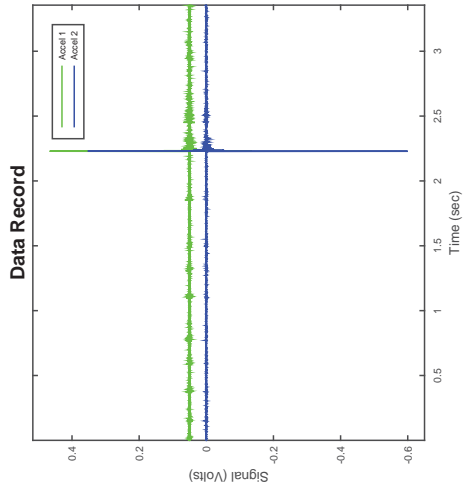

CSS Monotonic Shear Test Report

Geotechnical Engineering Laboratory



10/28/2013_Version 8.0

General Test Info and Sample Preparation

Device:	CSS	Relative Density (%):	63%
Specimen ID:	CLS8	Void Ratio:	0.676
Test ID:	M230	Height (mm):	112.9
Date of Test:	8/17/2015	Soil-Only Specimen Diameter (mm):	306.23
Test Performed:	Monotonic Shear	Weight (kg):	13.144
Test Material:	8mm Crushed Limestone	Density (kg/m³):	1581.3
Sample Preparation:	Prepared dense by tamping 50x in 5 layers.	Membrane Thickness (mm):	0.635
		Moisture Content (%):	0%
		Saturated (Y/N):	N
		Prepared by:	J. Hubler
		Checked by:	J. Hubler

Consolidation Stage

Vertical Stress (kPa):	400
Time to Compression (min):	12.4
Relative Density (%):	86%
Void Ratio:	0.574
Height (mm):	106.0
Diameter (mm):	306.23
Weight (kg):	13.144
Density (kg/m³):	1683.5

Shear Stage

Type of Test:	Constant Volume
Stress or Strain Controlled:	Strain
Shear Strain Rate (%/min):	0.31
Peak Shear Strength (kPa):	64.5

Comments

Silver Baseplate used with cushion membrane.

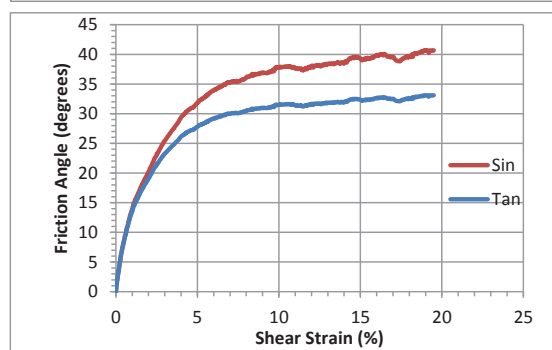
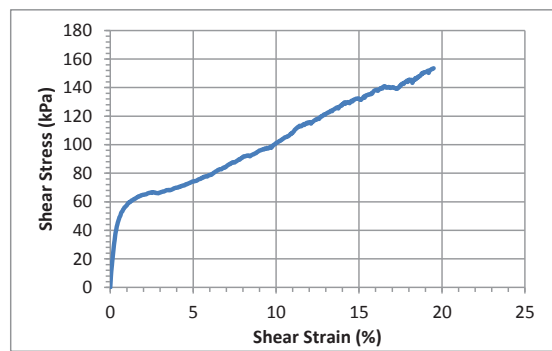
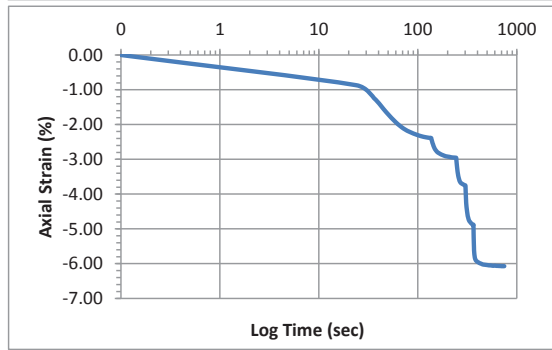
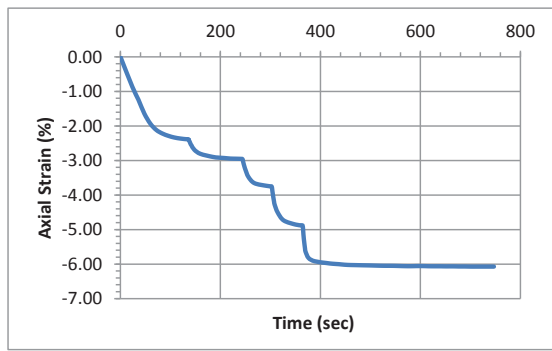

Accelerometer-Based Shear Wave Velocity Datasheet

Specimen ID: M230-LS-400-3X
 Test Material: LS
 Date: 9/17/2015
 Test Performed by: J. Hubler
 Filename: M230-LS-400-3X

Vertical Stress: 400kPa
 Sensor Spacing: 0.10966 m
 V_s (rise) = 308 m/s

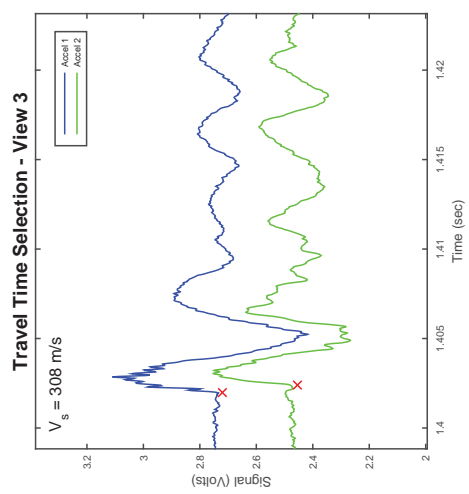
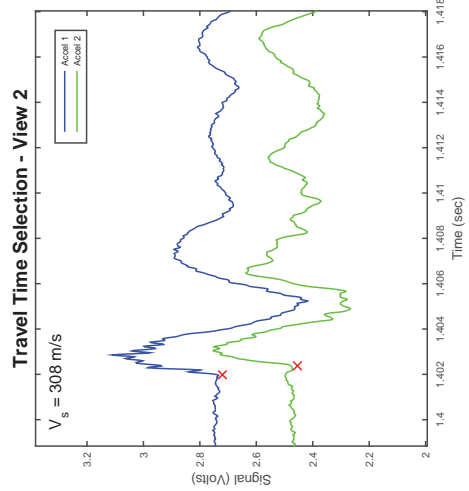
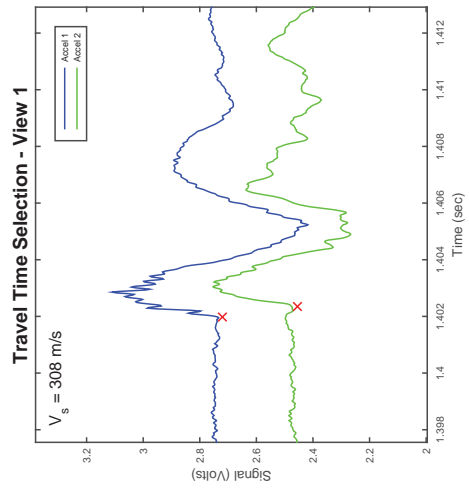
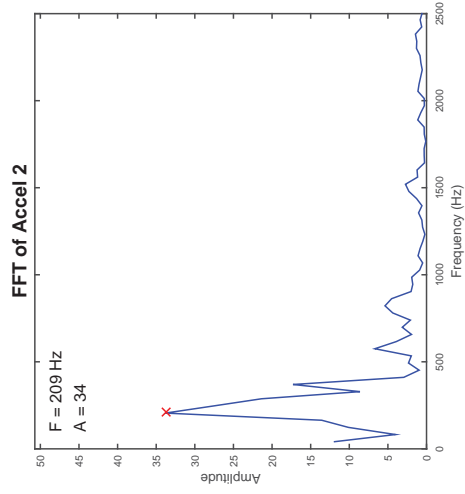
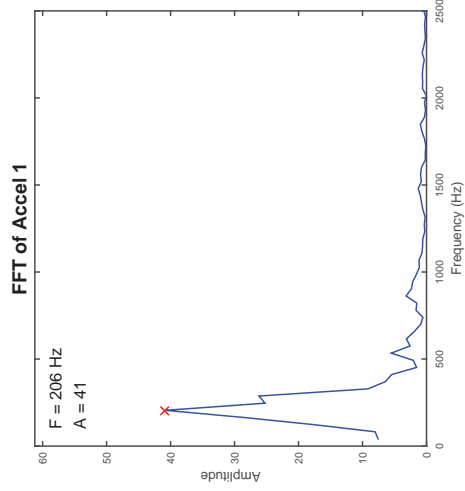
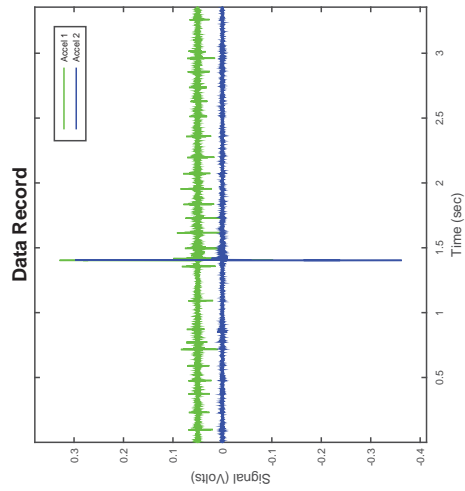

CSS Cyclic Shear Test Report

Geotechnical Engineering Laboratory



Cyclic Shear Test Summary

Device:	CSS	Density (kg/m³):	1631
Specimen ID:	PGL	Relative Density (%):	46%
Test ID:	C174	Void Ratio:	0.680
Date of Test:	6/15/2015	Vertical Stress (kPa):	50
Test Performed:	Cyclic Shear	Loading Frequency (Hz):	0.33
Test Material:	Pea Gravel	Number of Cycles:	5
Sample Preparation:	Prepared loose by shoveling	Cyclic Stress Ratio:	0.088
		Shear Modulus (kPa):	
		Damping (%):	
Prepared by:	A.Jackson	Shear Strain Single Amplitude (%)	
Checked by:	J.Hubler		

Additional Comments:

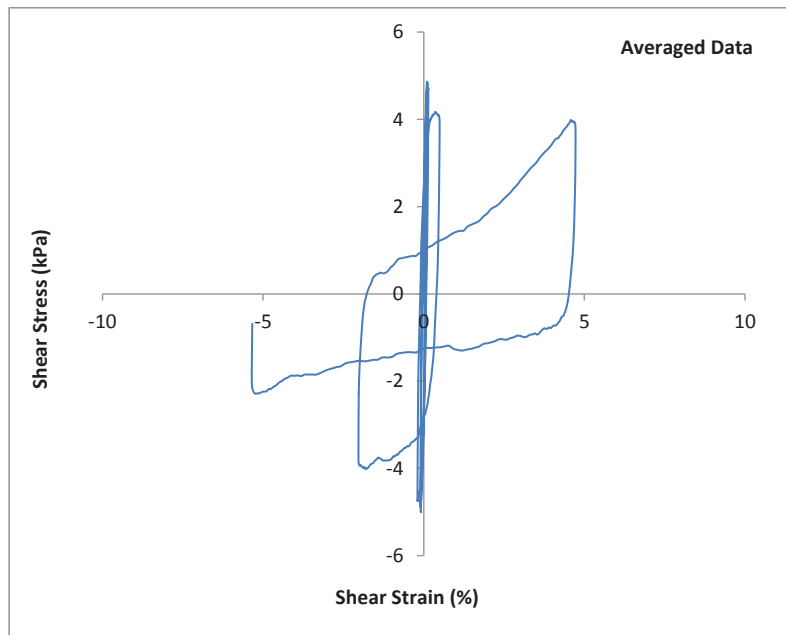
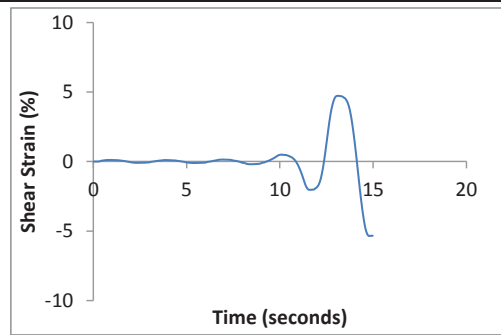
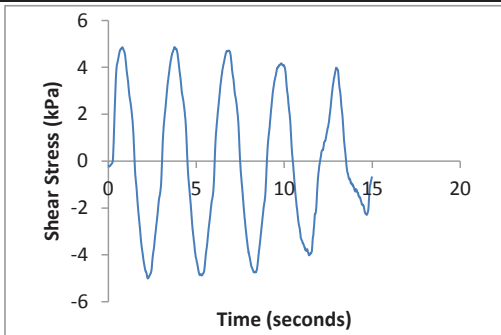

CSS Cyclic Shear Test Report

Geotechnical Engineering Laboratory



Cyclic Shear Test Summary

Device:	CSS	Density (kg/m³):	1631
Specimen ID:	PGL	Relative Density (%):	46%
Test ID:	C174	Void Ratio:	0.680
Date of Test:	6/15/2015	Vertical Stress (kPa):	50
Test Performed:	Cyclic Shear	Loading Frequency (Hz):	0.33
Test Material:	Pea Gravel	Number of Cycles:	5
Sample Preparation:	Prepared loose by shoveling	Cyclic Stress Ratio:	0.088
		Number of Cycles to Liq:	5
		Maximum ru:	0.98
Prepared by:	A.Jackson		
Checked by:	J.Hubler		

Additional Comments:

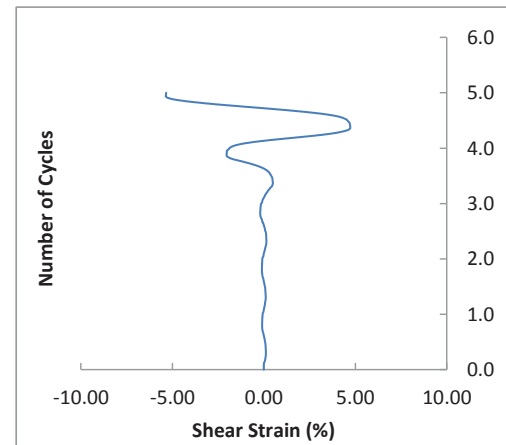
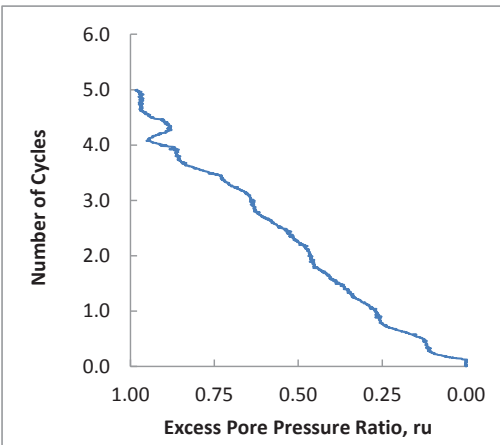
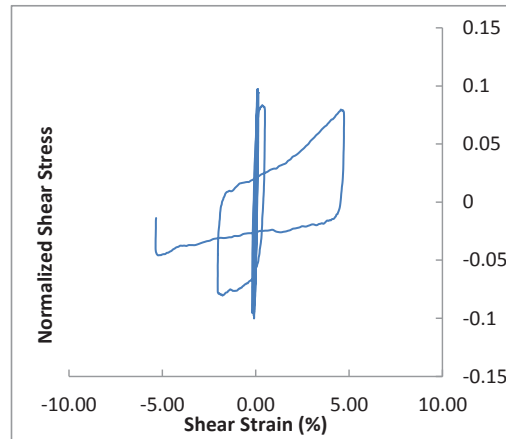
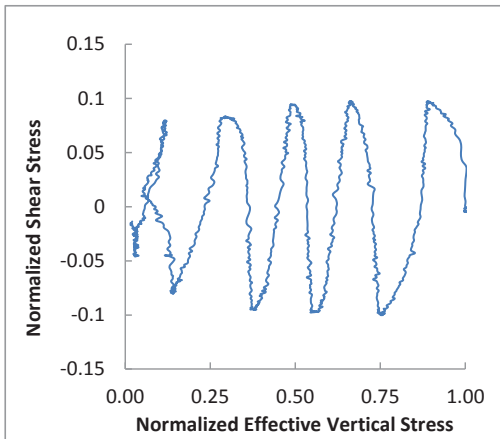

CSS Monotonic Shear Test Report

Geotechnical Engineering Laboratory



10/28/2013_Version 8.0

General Test Info and Sample Preparation

Device:	CSS	Relative Density (%):	28%
Specimen ID:	PGL	Void Ratio:	0.717
Test ID:	C174	Height (mm):	110.6
Date of Test:	6/15/2015	Soil-Only Specimen Diameter (mm):	306.23
Test Performed:	Post Cyclic Monotonic Shear	Weight (kg):	12.995
Test Material:	Pea Gravel	Density (kg/m ³):	1595.6
Sample Preparation:	Prepared loose by shoveling.	Membrane Thickness (mm):	0.635
		Moisture Content (%):	0%
		Saturated (Y/N):	N
		Prepared by:	A. Jackson
		Checked by:	J. Hubler

Consolidation Stage

Shear Stage

Vertical Stress (kPa):	50	Type of Test:	Constant Volume
Time to Compression (min):	13.1	Stress or Strain Controlled:	Strain
Relative Density (%):	46%	Shear Strain Rate (%/min):	0.30
Void Ratio:	0.680	Peak Shear Strength (kPa):	9.8
Height (mm):	108.2	Comments	
Diameter (mm):	306.23	Consolidation Data is for pre-liquefaction.	
Weight (kg):	12.995		
Density (kg/m ³):	1630.6		

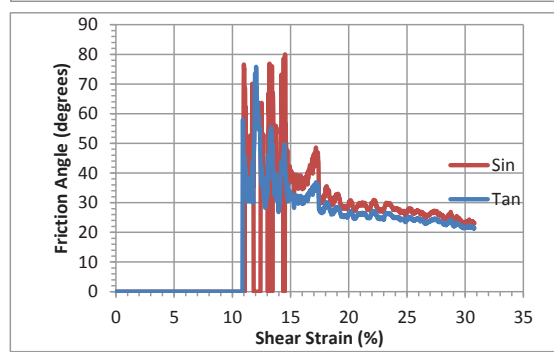
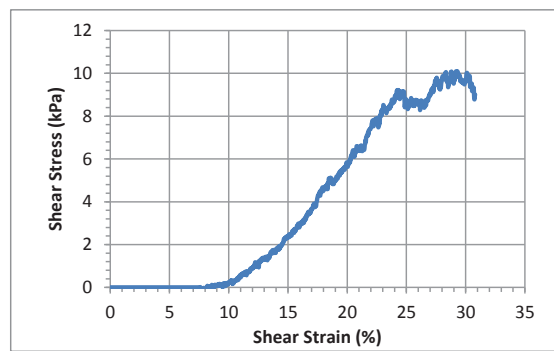
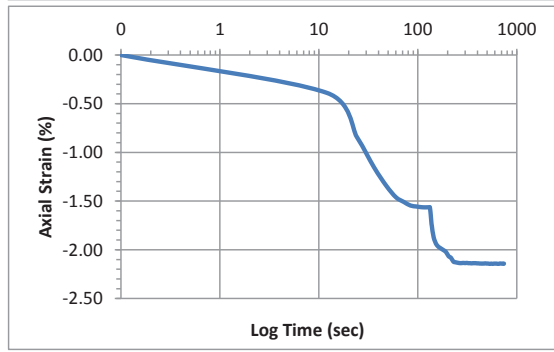
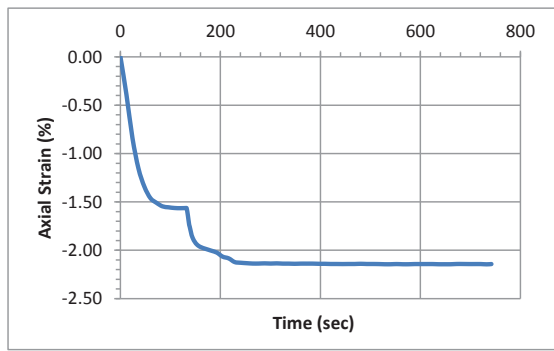

Accelerometer-Based Shear Wave Velocity Datasheet

Specimen ID: C174-PGL-50-1X
 Test Material: PGL
 Date: 6/15/2015
 Test Performed by: J.Hubler
 Filename: C174-PGL-50-1X

Vertical Stress: 50kPa
 Sensor Spacing: 0.10816 m
 V_s (rise) = 159 m/s

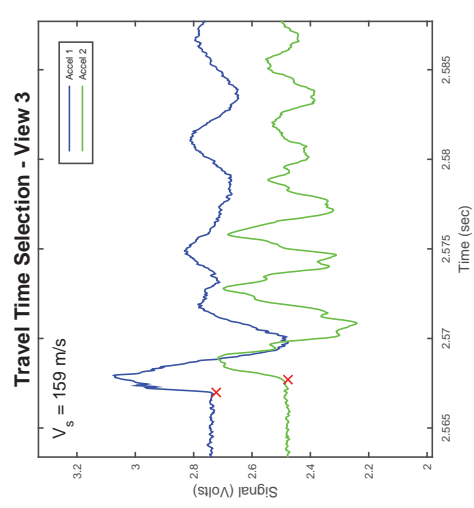
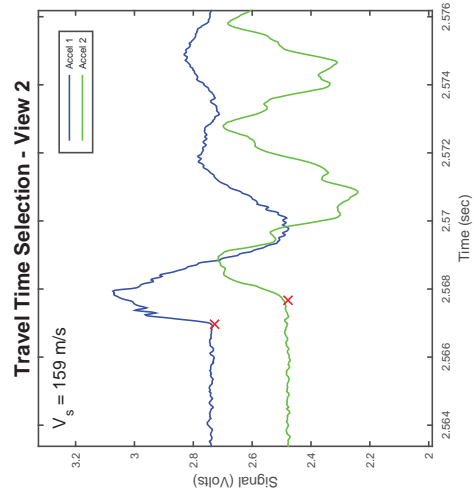
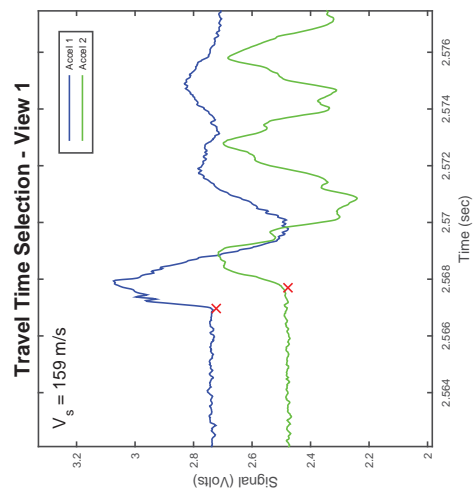
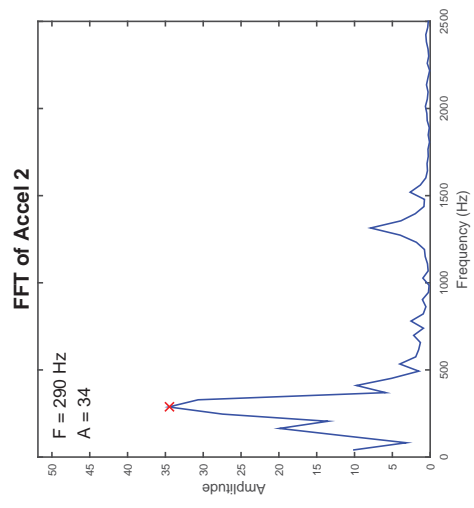
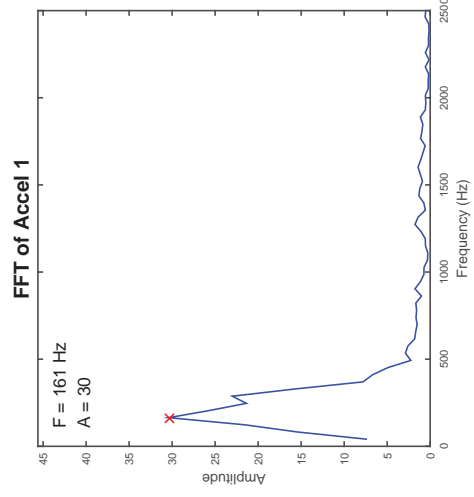
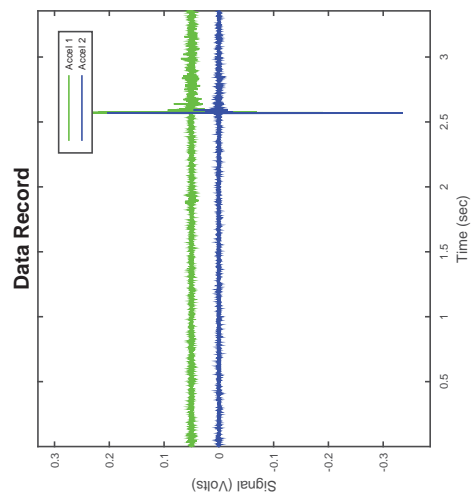

CSS Cyclic Shear Test Report

Geotechnical Engineering Laboratory



Cyclic Shear Test Summary

Device:	CSS	Density (kg/m³):	1627
Specimen ID:	PGL	Relative Density (%):	45%
Test ID:	C190	Void Ratio:	0.684
Date of Test:	7/13/2015	Vertical Stress (kPa):	100
Test Performed:	Cyclic	Loading Frequency (Hz):	0.33
Test Material:	Pea Gravel	Number of Cycles:	1
Sample Preparation:	Prepared loose specimen using shoveling method.	Cyclic Stress Ratio:	0.194
		Shear Modulus (kPa):	
		Damping (%):	
Prepared by:	Alesha Jackson	Shear Strain Single Amplitude (%)	
Checked by:	Jonathan Hubler		

Additional Comments:

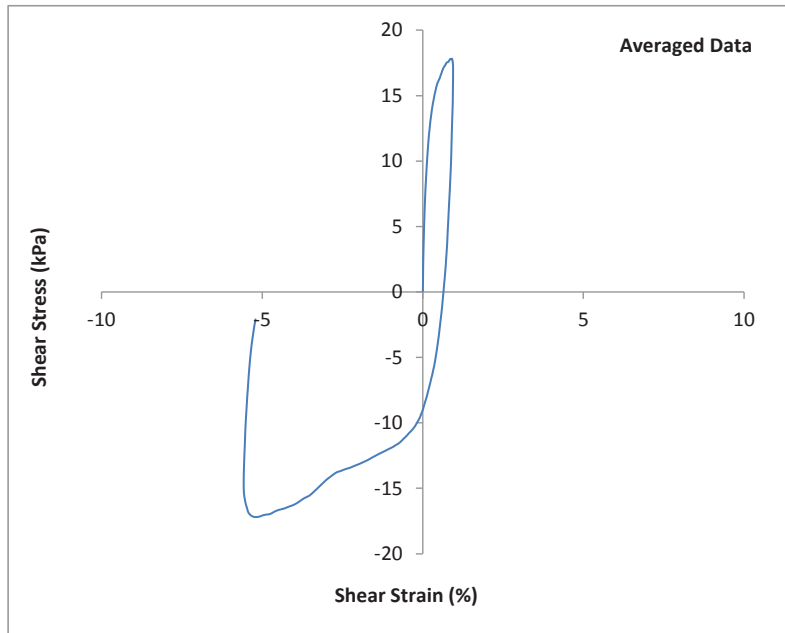
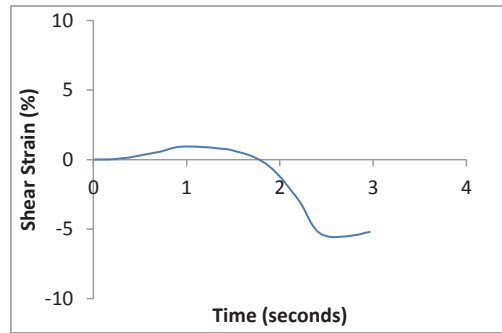
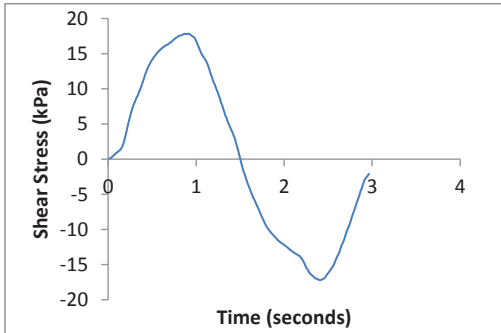

CSS Cyclic Shear Test Report

Geotechnical Engineering Laboratory



Cyclic Shear Test Summary

Device:	CSS	Density (kg/m³):	1627
Specimen ID:	PGL	Relative Density (%):	45%
Test ID:	C190	Void Ratio:	0.684
Date of Test:	7/13/2015	Vertical Stress (kPa):	100
Test Performed:	Cyclic	Loading Frequency (Hz):	0.33
Test Material:	Pea Gravel	Number of Cycles:	1
Sample Preparation:	Prepared loose specimen using shoveling method.	Cyclic Stress Ratio:	0.194
		Number of Cycles to Liq:	1
		Maximum ru:	0.82
Prepared by:	Alesha Jackson		
Checked by:	Jonathan Hubler		

Additional Comments:

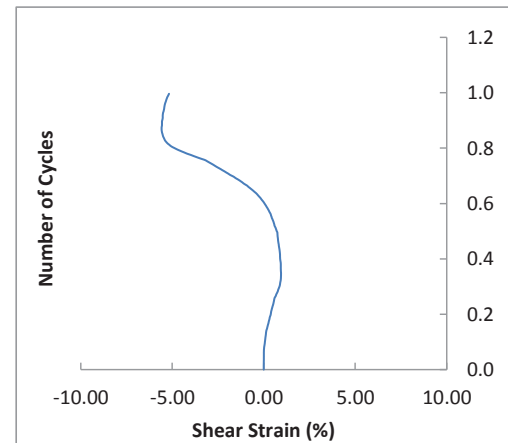
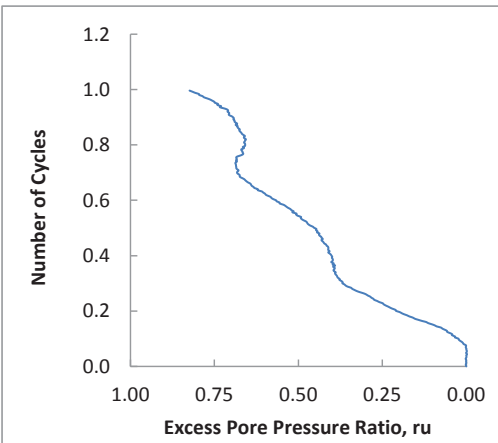
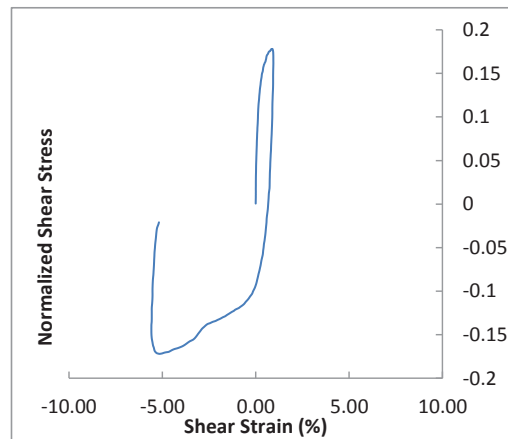
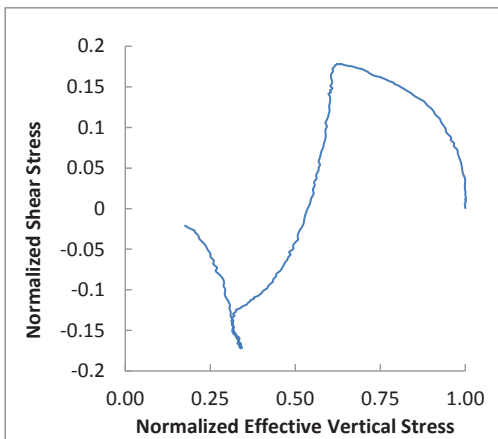

CSS Monotonic Shear Test Report

Geotechnical Engineering Laboratory



10/28/2013_Version 8.0

General Test Info and Sample Preparation

Device:	CSS	Relative Density (%):	-23%
Specimen ID:	PGL	Void Ratio:	0.817
Test ID:	C190	Height (mm):	111.6
Date of Test:	7/13/2015	Soil-Only Specimen Diameter (mm):	306.23
Test Performed:	Post Cyclic Monotonic Shear	Weight (kg):	12.395
Test Material:	Pea Gravel	Density (kg/m ³):	1507.6
Sample Preparation:	Prepared loose specimen using shoveling method.	Membrane Thickness (mm):	0.635
		Moisture Content (%):	0%
		Saturated (Y/N):	N
		Prepared by:	A. Jackson
		Checked by:	J. Hubler

Consolidation Stage

Vertical Stress (kPa):	100
Time to Compression (min):	22.1
Relative Density (%):	49%
Void Ratio:	0.676
Height (mm):	102.9
Diameter (mm):	306.23
Weight (kg):	12.395
Density (kg/m ³):	1635.1

Shear Stage

Type of Test:	Constant Volume
Stress or Strain Controlled:	Strain
Shear Strain Rate (%/min):	0.32
Peak Shear Strength (kPa):	9.0

Comments

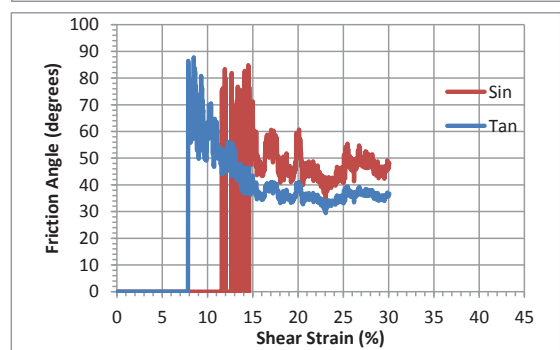
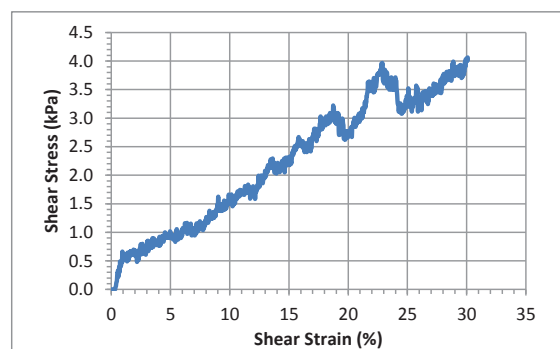
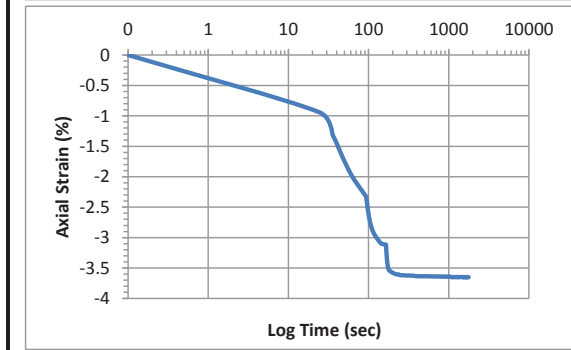
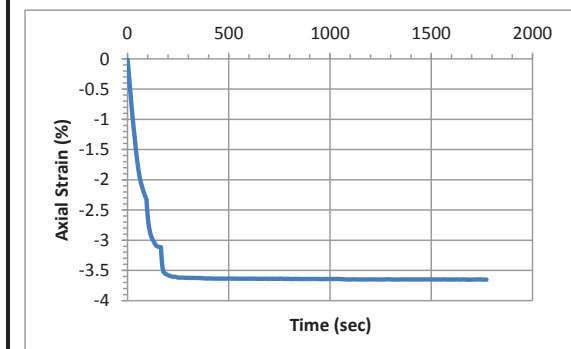

Accelerometer-Based Shear Wave Velocity Datasheet

Specimen ID: C190-PGL-100-2X
 Test Material: PGL
 Date: 7/13/2015
 Test Performed by: J.Hubler
 Filename: C190-PGL-100-2X

Vertical Stress: 100kPa
 Sensor Spacing: 0.10751 m
 V_s (rise) = 196 m/s

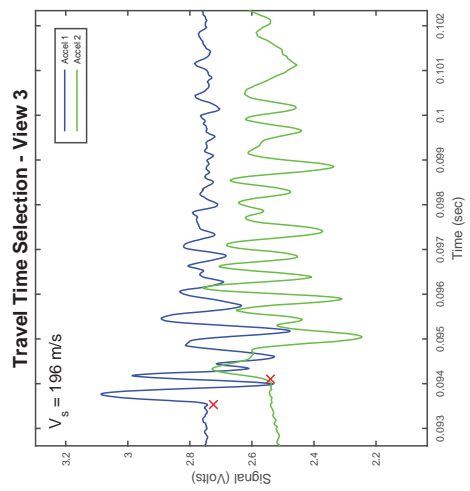
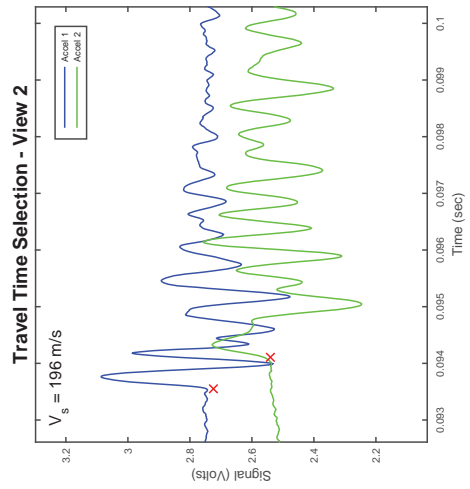
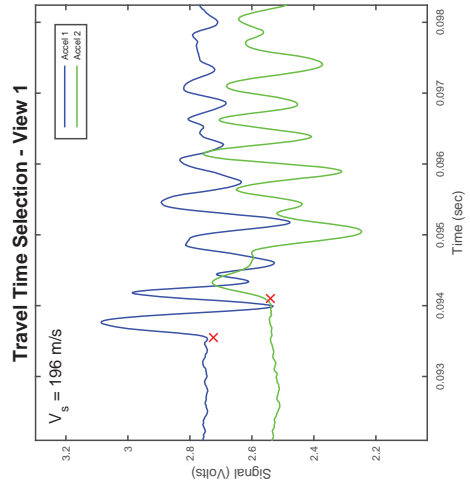
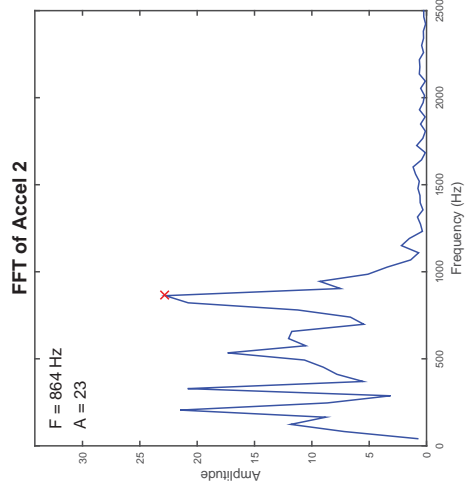
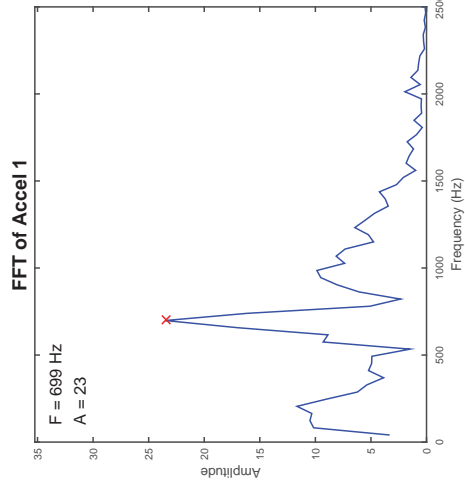
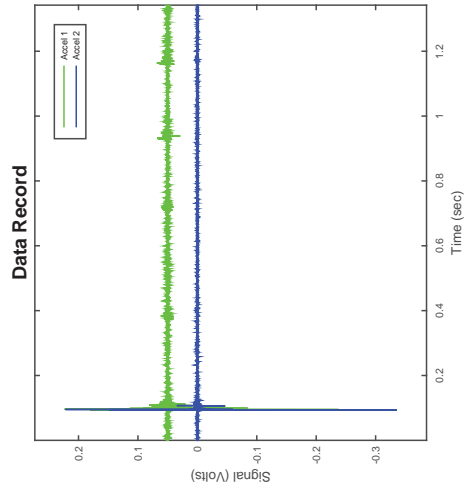

CSS Cyclic Shear Test Report

Geotechnical Engineering Laboratory



Cyclic Shear Test Summary

Device:	CSS	Density (kg/m³):	1631
Specimen ID:	PGL	Relative Density (%):	46%
Test ID:	C176	Void Ratio:	0.680
Date of Test:	6/18/2015	Vertical Stress (kPa):	200
Test Performed:	Cyclic Shear	Loading Frequency (Hz):	0.33
Test Material:	Pea Gravel	Number of Cycles:	6
Sample Preparation:	Prepared loose using the shoveling method.	Cyclic Stress Ratio:	0.097
		Shear Modulus (kPa):	
		Damping (%):	
Prepared by:	A.Jackson	Shear Strain Single Amplitude (%)	
Checked by:	J.Hubler		

Additional Comments:

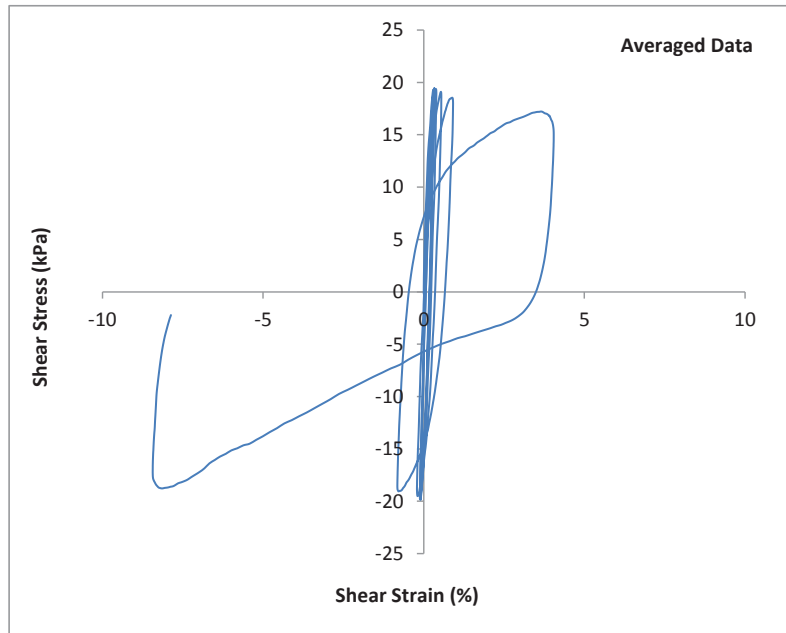
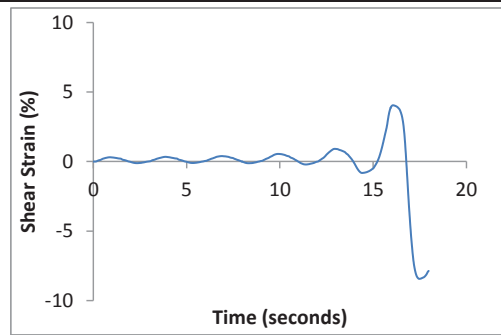
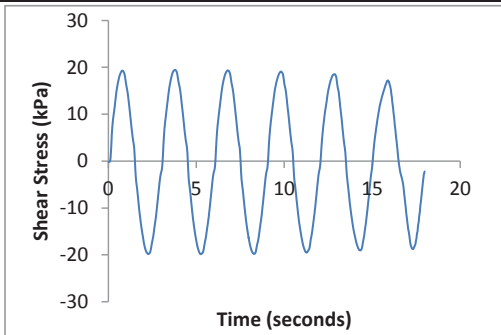

CSS Cyclic Shear Test Report

Geotechnical Engineering Laboratory



Cyclic Shear Test Summary

Device:	CSS	Density (kg/m³):	1631
Specimen ID:	PGL	Relative Density (%):	46%
Test ID:	C176	Void Ratio:	0.680
Date of Test:	6/18/2015	Vertical Stress (kPa):	200
Test Performed:	Cyclic Shear	Loading Frequency (Hz):	0.33
Test Material:	Pea Gravel	Number of Cycles:	6
Sample Preparation:	Prepared loose using the shoveling method.	Cyclic Stress Ratio:	0.097
		Number of Cycles to Liq:	6
		Maximum ru:	0.95
Prepared by:	A.Jackson		
Checked by:	J.Hubler		

Additional Comments:

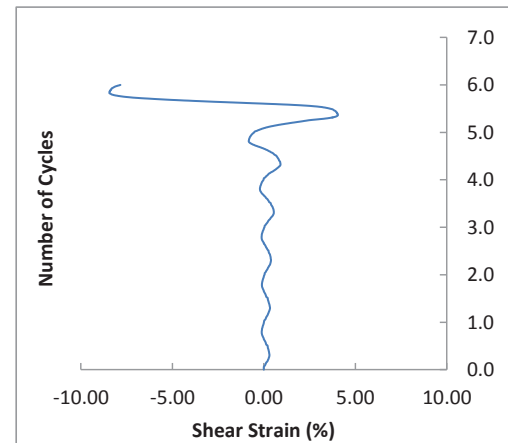
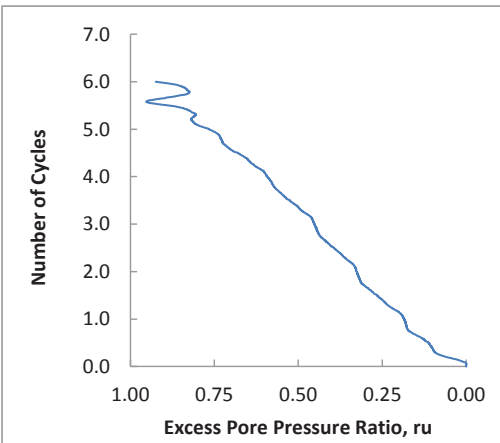
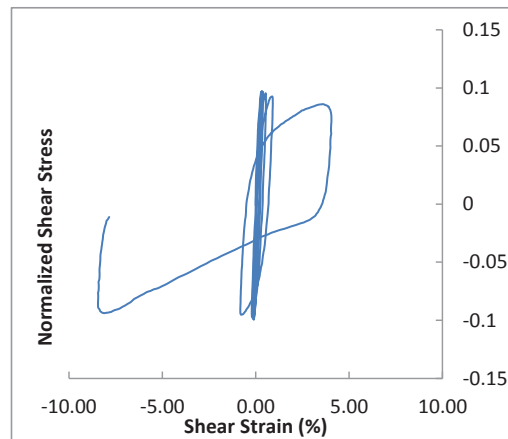
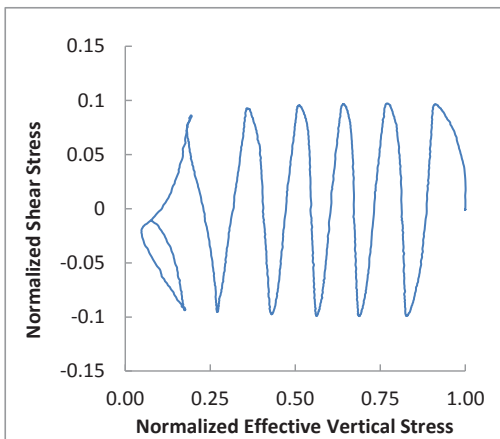

CSS Monotonic Shear Test Report

Geotechnical Engineering Laboratory



10/28/2013_Version 8.0

General Test Info and Sample Preparation

Device:	CSS	Relative Density (%):	13%
Specimen ID:	PGL	Void Ratio:	0.746
Test ID:	C176	Height (mm):	109.7
Date of Test:	6/18/2015	Soil-Only Specimen Diameter (mm):	306.23
Test Performed:	Post Cyclic Monotonic Shear	Weight (kg):	12.681
Test Material:	Pea Gravel	Density (kg/m ³):	1568.9
Sample Preparation:	Prepared loose using the shoveling method.	Membrane Thickness (mm):	0.635
		Moisture Content (%):	0%
		Saturated (Y/N):	N
		Prepared by:	A. Jackson
		Checked by:	J. Hubler

Consolidation Stage

Shear Stage

Vertical Stress (kPa):	200	Type of Test:	Constant Volume
Time to Compression (min):	20.5	Stress or Strain Controlled:	Strain
Relative Density (%):	46%	Shear Strain Rate (%/min):	0.31
Void Ratio:	0.680	Peak Shear Strength (kPa):	7.8
Height (mm):	105.6	Comments	
Diameter (mm):	306.23	Consolidation Data is for pre-liquefaction.	
Weight (kg):	12.681		
Density (kg/m ³):	1630.6		

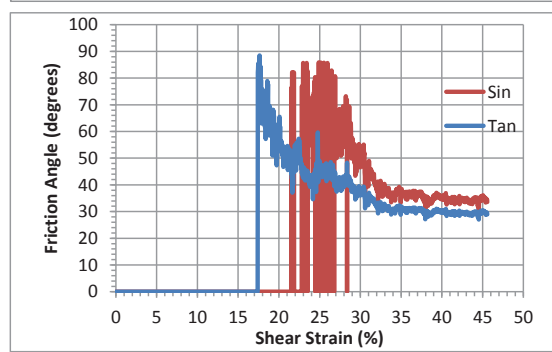
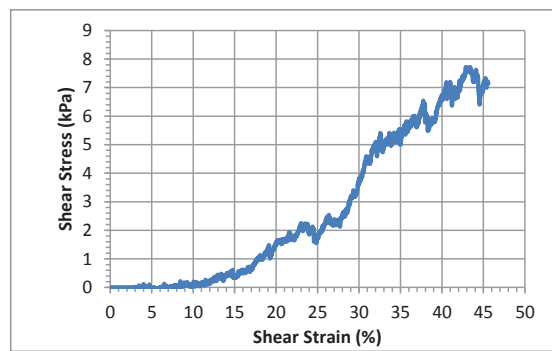
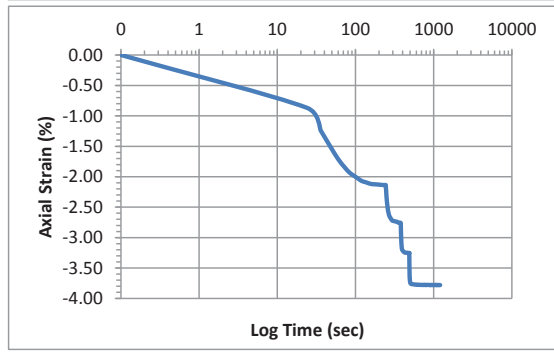
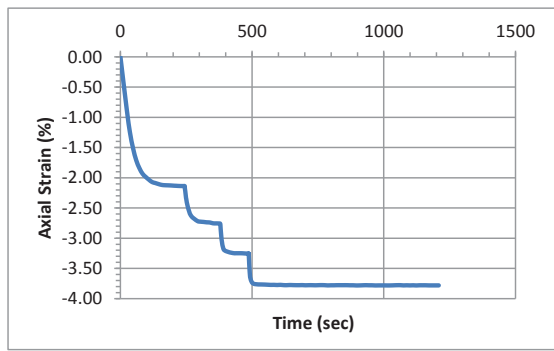

Accelerometer-Based Shear Wave Velocity Datasheet

Specimen ID: C176-PGL-200-1X
 Test Material: PGL
 Date: 6/18/2015
 Test Performed by: J.Hubler
 Filename: C176-PGL-200-1X

Vertical Stress: 200kPa
 Sensor Spacing: 0.10555 m
 V_s (rise) = 222 m/s

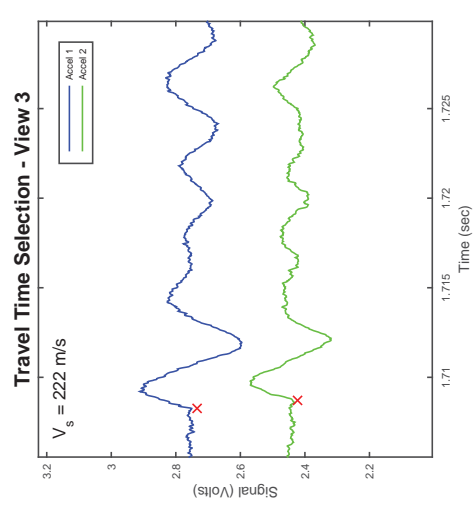
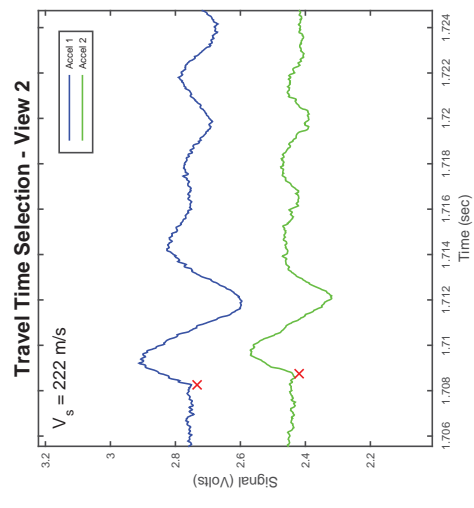
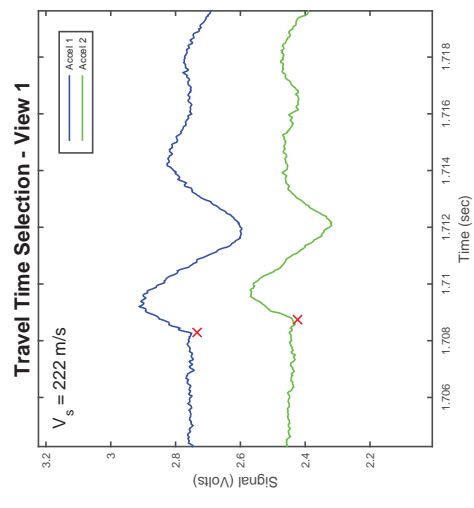
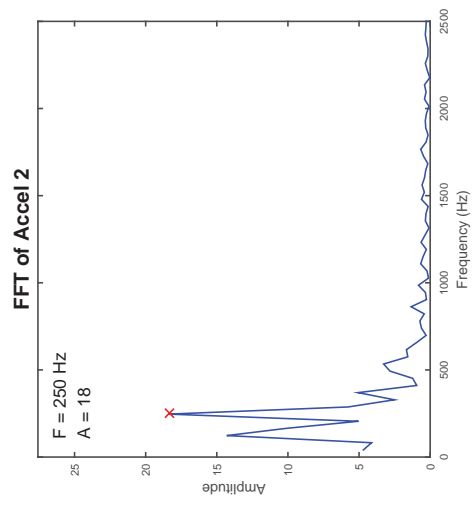
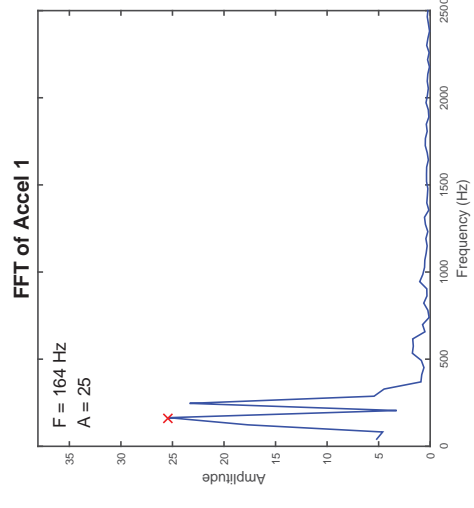
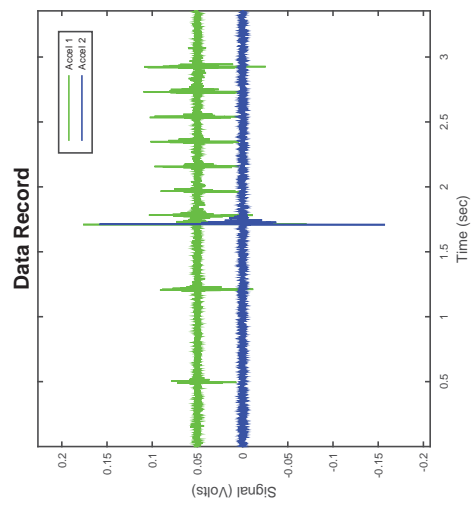

CSS Cyclic Shear Test Report

Geotechnical Engineering Laboratory



Cyclic Shear Test Summary

Device:	CSS	Density (kg/m³):	1625
Specimen ID:	PGL	Relative Density (%):	44%
Test ID:	C175	Void Ratio:	0.686
Date of Test:	6/16/2015	Vertical Stress (kPa):	400
Test Performed:	Cyclic Shear	Loading Frequency (Hz):	0.33
Test Material:	Pea Gravel	Number of Cycles:	9
Sample Preparation:	Prepared loose by shoveling	Cyclic Stress Ratio:	0.099
		Shear Modulus (kPa):	
		Damping (%):	
Prepared by:	A.Jackson	Shear Strain Single Amplitude (%)	
Checked by:	J.Hubler		

Additional Comments:

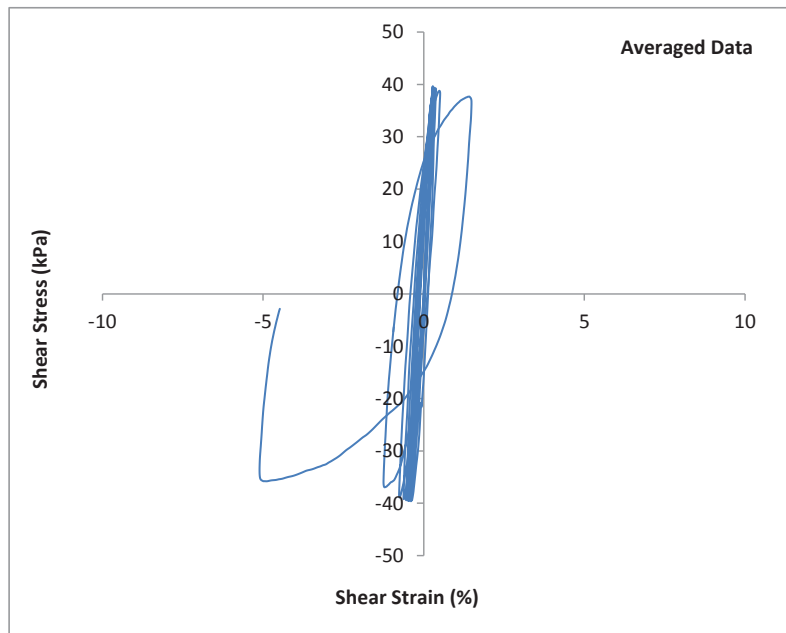
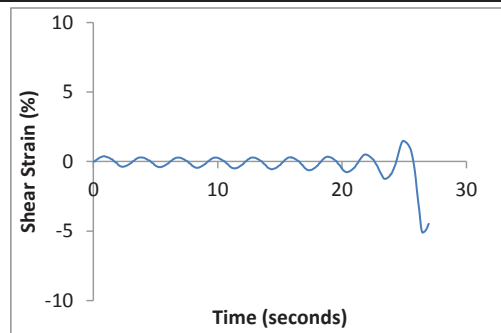
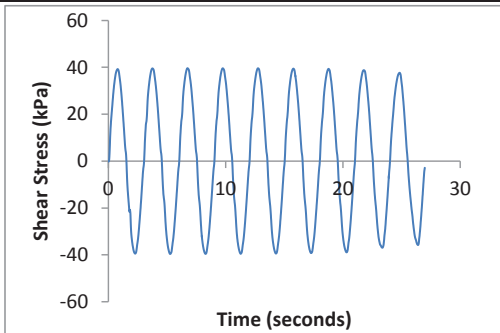

CSS Cyclic Shear Test Report

Geotechnical Engineering Laboratory



Cyclic Shear Test Summary

Device:	CSS	Density (kg/m³):	1625
Specimen ID:	PGL	Relative Density (%):	44%
Test ID:	C175	Void Ratio:	0.686
Date of Test:	6/16/2015	Vertical Stress (kPa):	400
Test Performed:	Cyclic Shear	Loading Frequency (Hz):	0.33
Test Material:	Pea Gravel	Number of Cycles:	9
Sample Preparation:	Prepared loose by shoveling	Cyclic Stress Ratio:	0.099
		Number of Cycles to Liq:	9
		Maximum ru:	0.89
Prepared by:	A.Jackson		
Checked by:	J.Hubler		

Additional Comments:

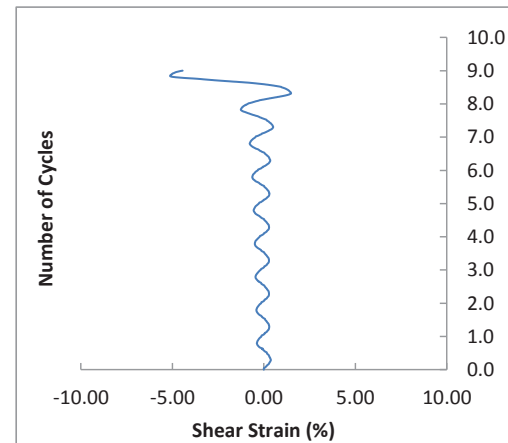
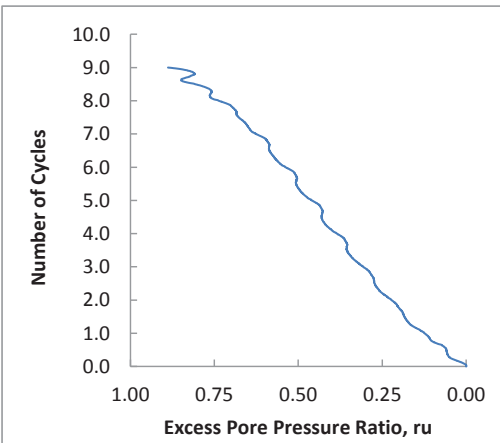
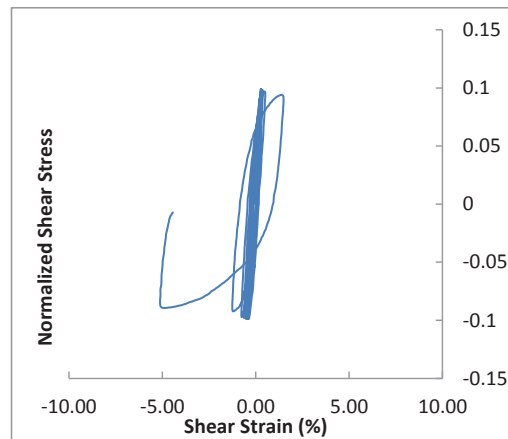
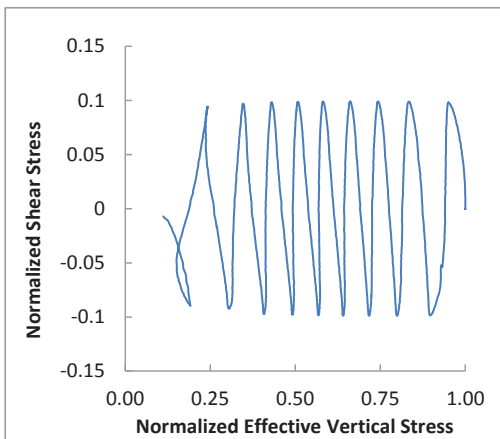

CSS Monotonic Shear Test Report

Geotechnical Engineering Laboratory



10/28/2013_Version 8.0

General Test Info and Sample Preparation

Device:	CSS	Relative Density (%):	7%
Specimen ID:	PGL	Void Ratio:	0.758
Test ID:	C175	Height (mm):	111.9
Date of Test:	6/16/2015	Soil-Only Specimen Diameter (mm):	306.23
Test Performed:	Post Cyclic Monotonic Shear	Weight (kg):	12.846
Test Material:	Pea Gravel	Density (kg/m³):	1558.6
Sample Preparation:	Prepared loose by shoveling and rodding lightly 3 times in 3 layers.	Membrane Thickness (mm):	0.635
		Moisture Content (%):	0%
		Saturated (Y/N):	N
		Prepared by:	A. Jackson
		Checked by:	J. Hubler

Consolidation Stage

Vertical Stress (kPa):	400
Time to Compression (min):	19.0
Relative Density (%):	44%
Void Ratio:	0.686
Height (mm):	107.3
Diameter (mm):	306.23
Weight (kg):	12.846
Density (kg/m³):	1625.4

Shear Stage

Type of Test:	Constant Volume
Stress or Strain Controlled:	Strain
Shear Strain Rate (%/min):	0.30
Peak Shear Strength (kPa):	11.0

Comments

Consolidation Data is for pre-liquefaction.

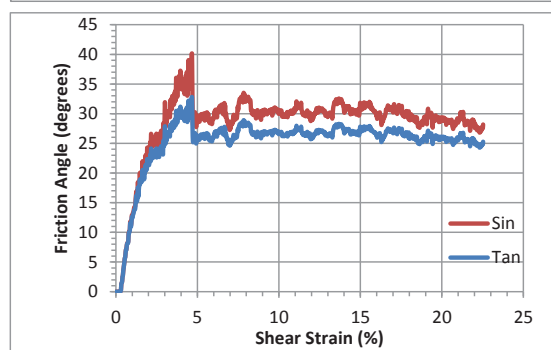
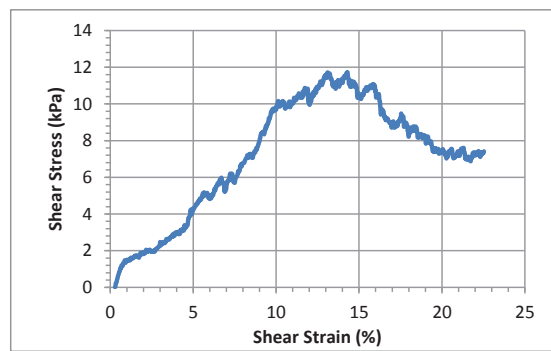
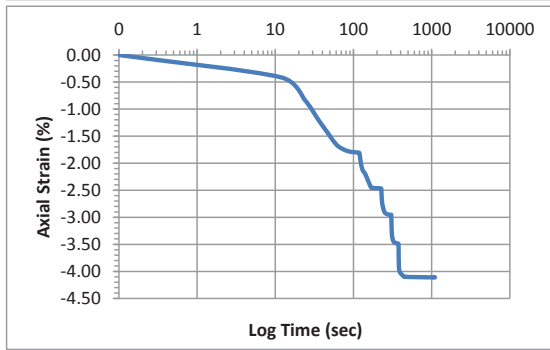
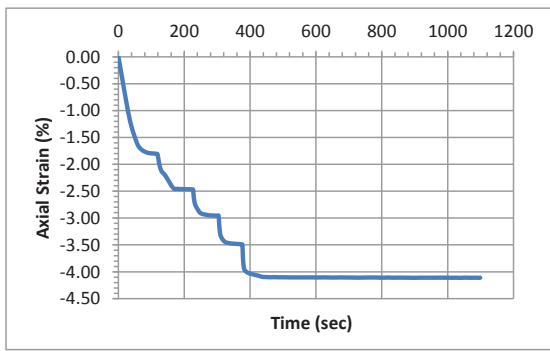

Accelerometer-Based Shear Wave Velocity Datasheet

Specimen ID: C175-PGL-400-2X

Test Material: PGL

Date: 6/16/2015

Test Performed by: J.Hubler

Filename: C175-PGL-400-2X

Vertical Stress: 400kPa

Sensor Spacing: 0.10726 m

V_s (rise) = 266 m/s

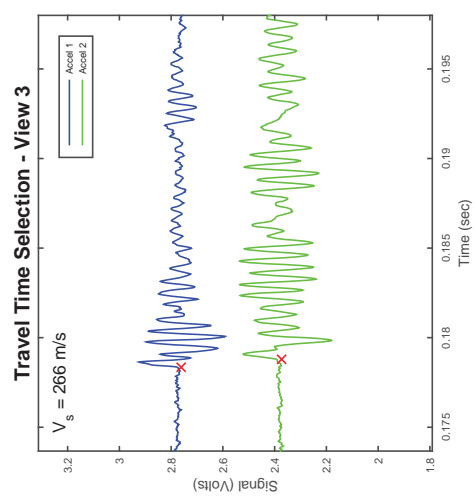
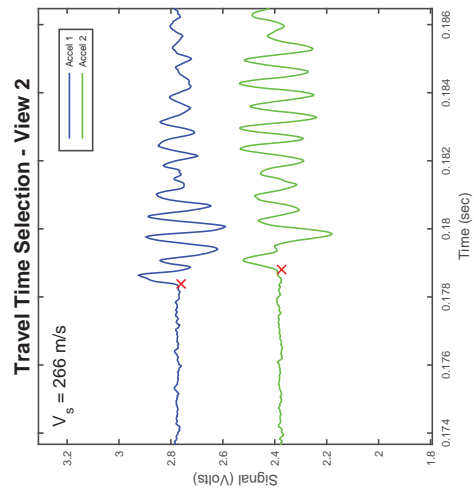
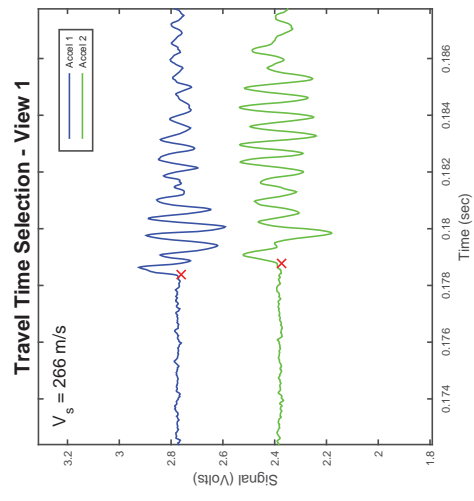
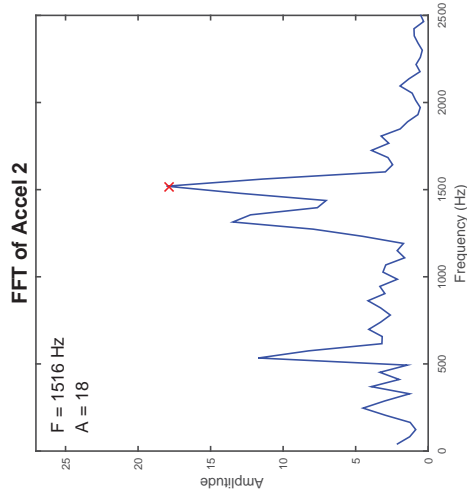
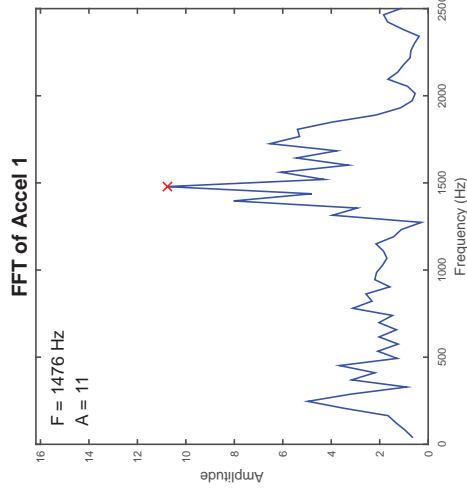
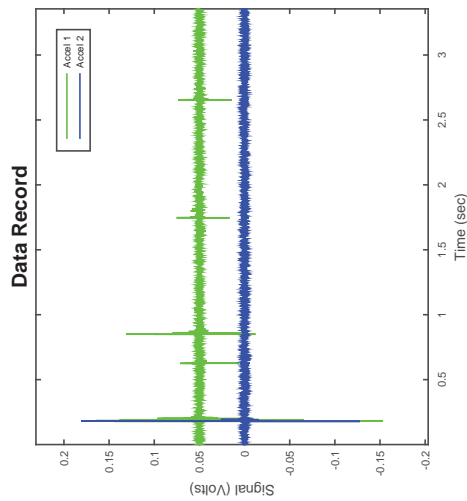

CSS Cyclic Shear Test Report

Geotechnical Engineering Laboratory



Cyclic Shear Test Summary

Device:	CSS	Density (kg/m³):	1725
Specimen ID:	PGD	Relative Density (%):	92%
Test ID:	C165	Void Ratio:	0.589
Date of Test:	6/10/2015	Vertical Stress (kPa):	50
Test Performed:	Cyclic Shear	Loading Frequency (Hz):	0.33
Test Material:	Pea Gravel	Number of Cycles:	11
Sample Preparation:	Prepared denser by tamping 25x in 3 layers.	Cyclic Stress Ratio:	0.088
		Shear Modulus (kPa):	
		Damping (%):	
Prepared by:	A. Jackson	Shear Strain Single Amplitude (%)	
Checked by:	J. Hubler		

Additional Comments:

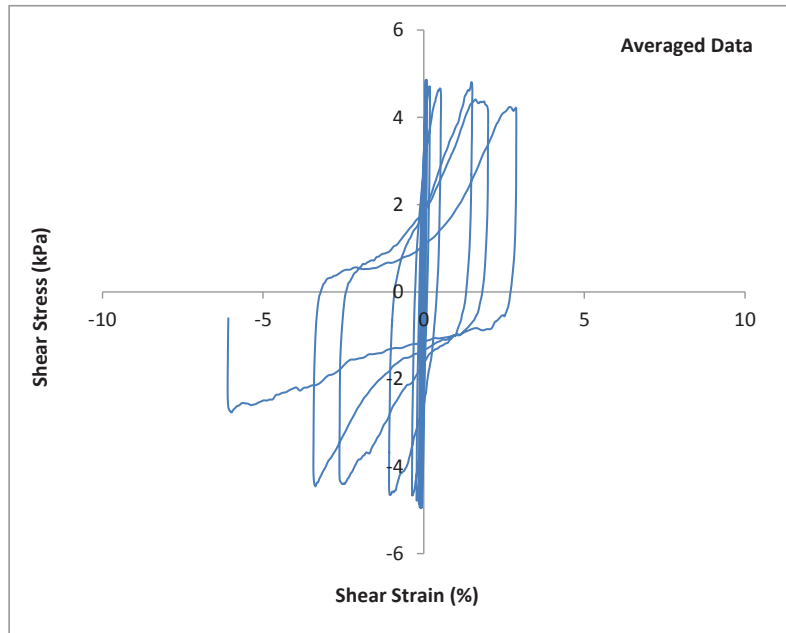
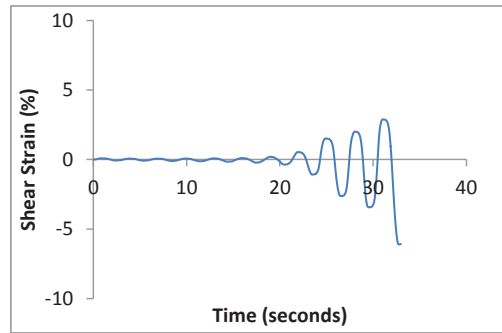
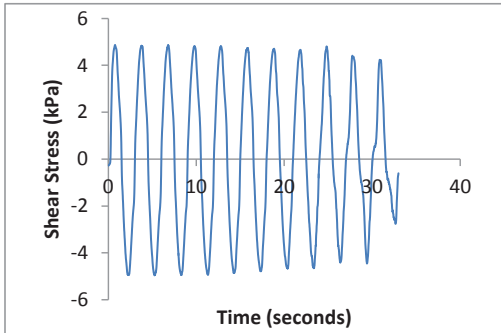

CSS Cyclic Shear Test Report

Geotechnical Engineering Laboratory



Cyclic Shear Test Summary

Device:	CSS	Density (kg/m³):	1725
Specimen ID:	PGD	Relative Density (%):	92%
Test ID:	C165	Void Ratio:	0.589
Date of Test:	6/10/2015	Vertical Stress (kPa):	50
Test Performed:	Cyclic Shear	Loading Frequency (Hz):	0.33
Test Material:	Pea Gravel	Number of Cycles:	11
Sample Preparation:	Prepared denser by tamping 25x in 3 layers.	Cyclic Stress Ratio:	0.088
		Number of Cycles to Liq:	11
		Maximum ru:	0.99
Prepared by:	A. Jackson		
Checked by:	J. Hubler		

Additional Comments:

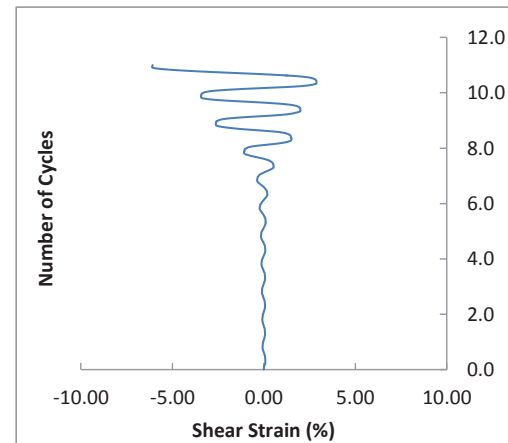
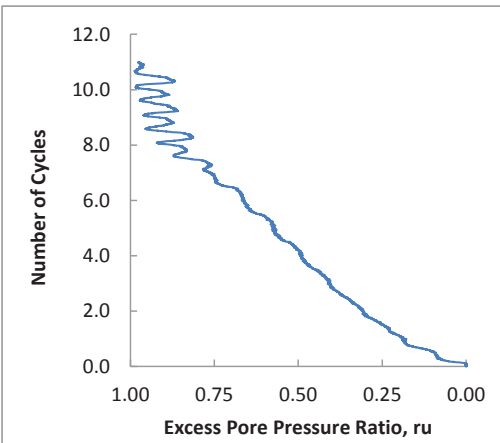
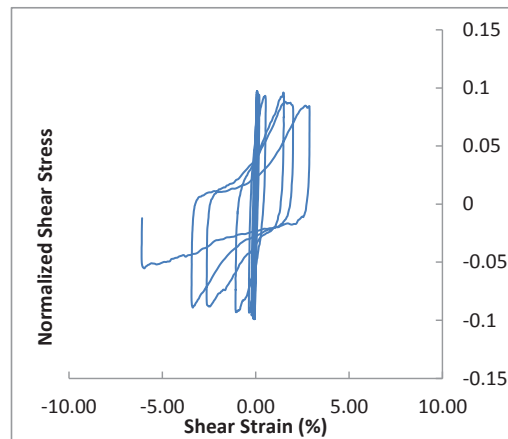
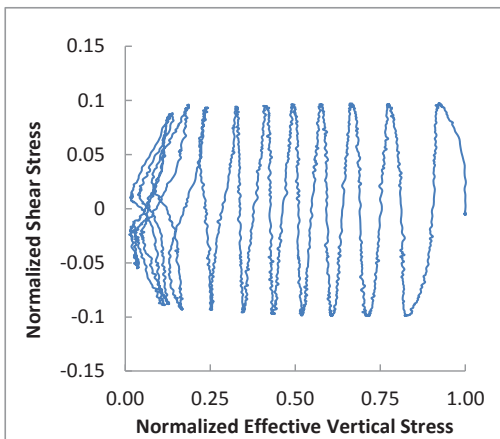

CSS Monotonic Shear Test Report

Geotechnical Engineering Laboratory



10/28/2013_Version 8.0

General Test Info and Sample Preparation

Device:	CSS	Relative Density (%):	85%
Specimen ID:	PGD	Void Ratio:	0.604
Test ID:	C165	Height (mm):	110.2
Date of Test:	6/10/2015	Soil-Only Specimen Diameter (mm):	306.23
Test Performed:	Post Cyclic Monotonic Shear	Weight (kg):	13.865
Test Material:	Pea Gravel	Density (kg/m³):	1708.4
Sample Preparation:	Prepared dense by tamping 25x in 3 layers.	Membrane Thickness (mm):	0.635
		Moisture Content (%):	0%
		Saturated (Y/N):	N
		Prepared by:	A. Jackson
		Checked by:	J. Hubler

Consolidation Stage

Vertical Stress (kPa):	50
Time to Compression (min):	16.4
Relative Density (%):	92%
Void Ratio:	0.589
Height (mm):	109.2
Diameter (mm):	306.23
Weight (kg):	13.865
Density (kg/m³):	1724.5

Shear Stage

Type of Test:	Constant Volume
Stress or Strain Controlled:	Strain
Shear Strain Rate (%/min):	0.30
Peak Shear Strength (kPa):	35.0

Comments

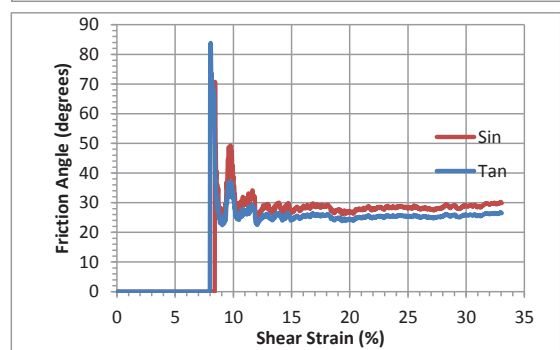
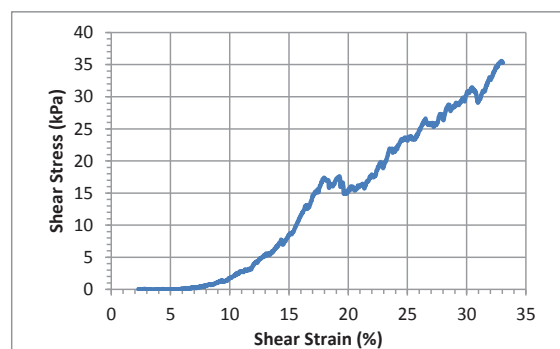
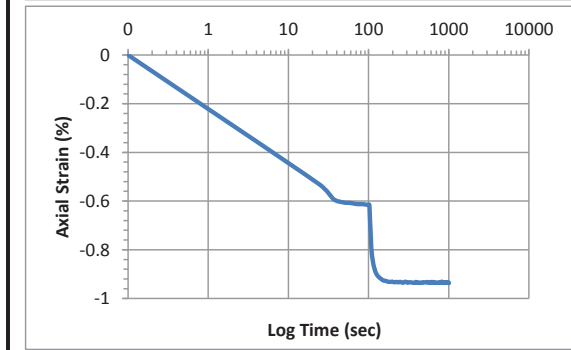
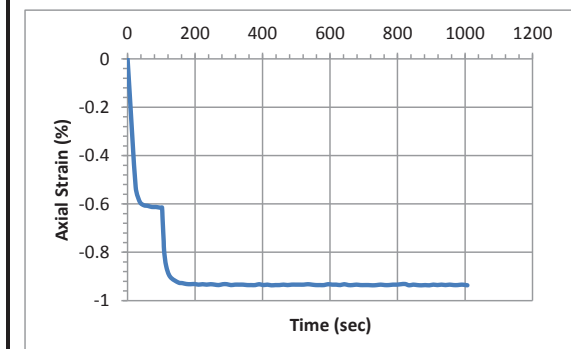

Accelerometer-Based Shear Wave Velocity Datasheet

Specimen ID: C165-PGD-50-1X

Test Material: PGD

Date: 6/10/2015

Test Performed by: J.Hubler

Filename: C165-PGD-50-1X

Vertical Stress: 50kPa

Sensor Spacing: 0.10912 m

V_s (rise) = 171 m/s

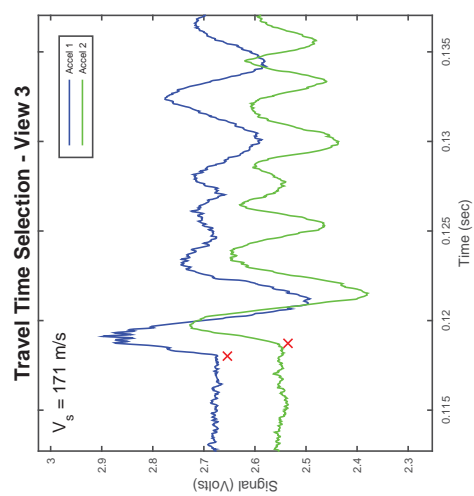
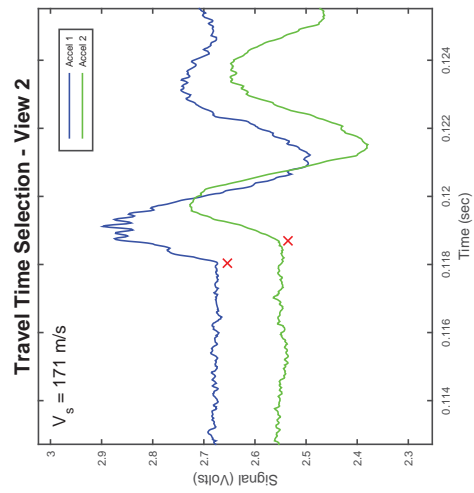
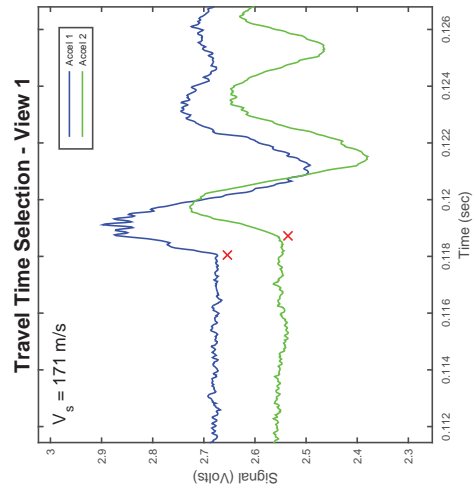
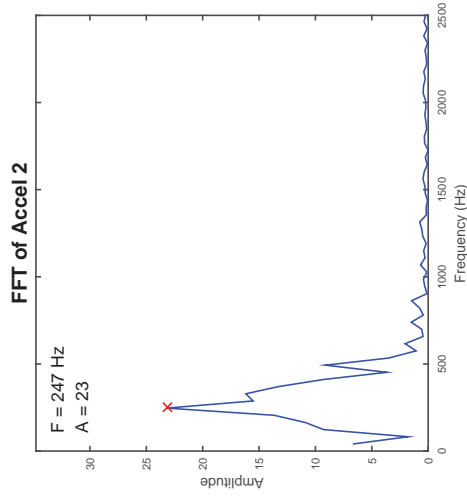
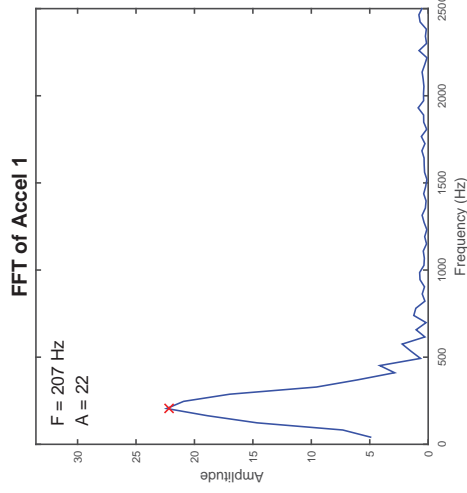
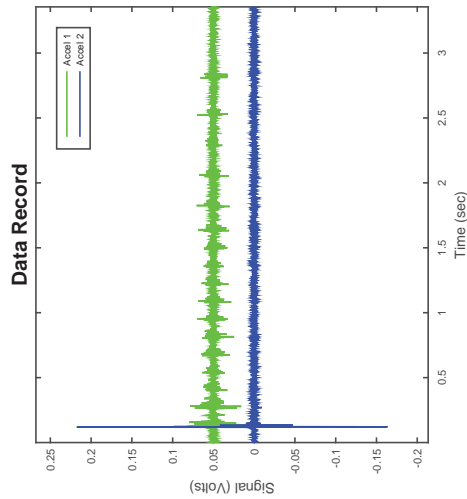

CSS Cyclic Shear Test Report

Geotechnical Engineering Laboratory



Cyclic Shear Test Summary

Device:	CSS	Density (kg/m³):	1725
Specimen ID:	PGD	Relative Density (%):	92%
Test ID:	C169	Void Ratio:	0.589
Date of Test:	6/12/2015	Vertical Stress (kPa):	100
Test Performed:	Cyclic Shear	Loading Frequency (Hz):	0.33
Test Material:	Pea Gravel	Number of Cycles:	8
Sample Preparation:	Prepared denser by tamping 25x in 3 layers.	Cyclic Stress Ratio:	0.094
		Shear Modulus (kPa):	
		Damping (%):	
Prepared by:	A. Jackson	Shear Strain Single Amplitude (%)	
Checked by:	J. Hubler		

Additional Comments:

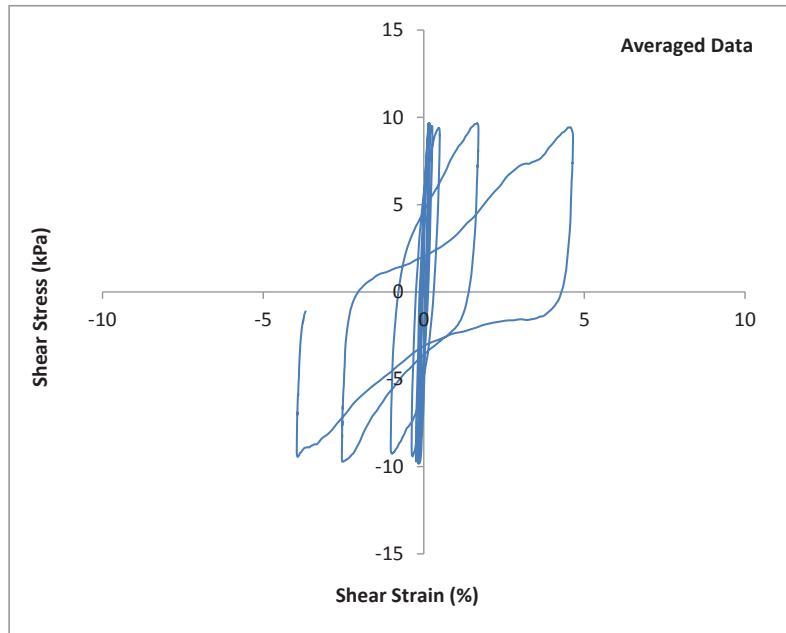
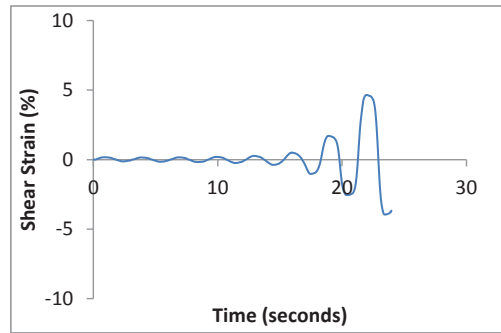
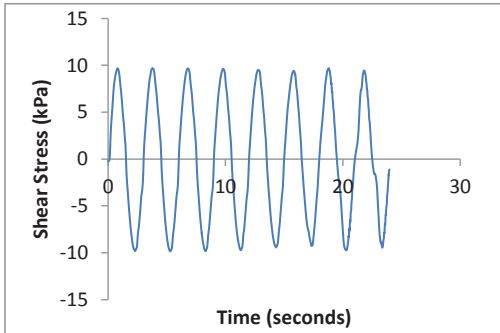

CSS Cyclic Shear Test Report

Geotechnical Engineering Laboratory



Cyclic Shear Test Summary

Device:	CSS	Density (kg/m³):	1725
Specimen ID:	PGD	Relative Density (%):	92%
Test ID:	C169	Void Ratio:	0.589
Date of Test:	6/12/2015	Vertical Stress (kPa):	100
Test Performed:	Cyclic Shear	Loading Frequency (Hz):	0.33
Test Material:	Pea Gravel	Number of Cycles:	8
Sample Preparation:	Prepared denser by tamping 25x in 3 layers.	Cyclic Stress Ratio:	0.094
		Number of Cycles to Liq:	8
		Maximum ru:	0.95
Prepared by:	A. Jackson		
Checked by:	J. Hubler		

Additional Comments:

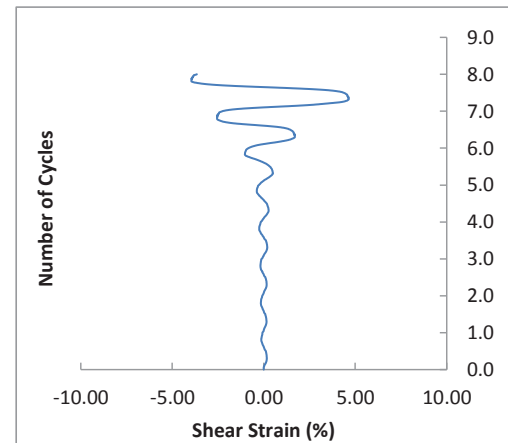
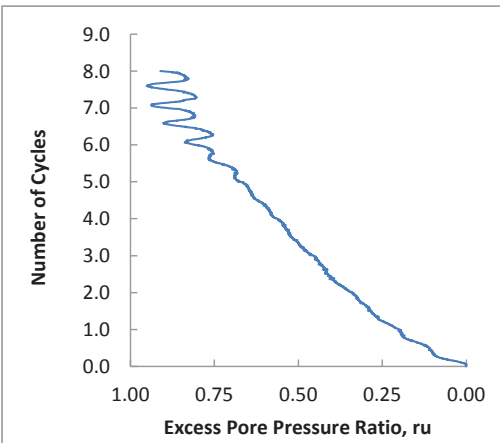
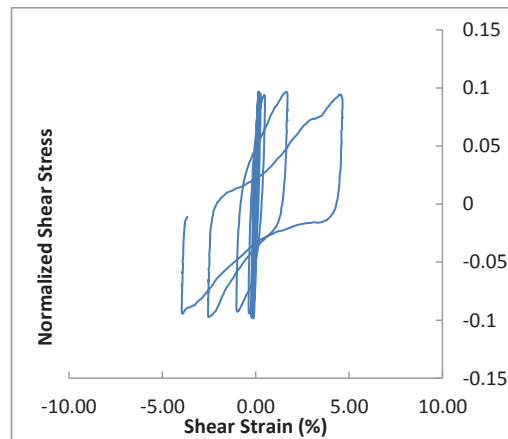
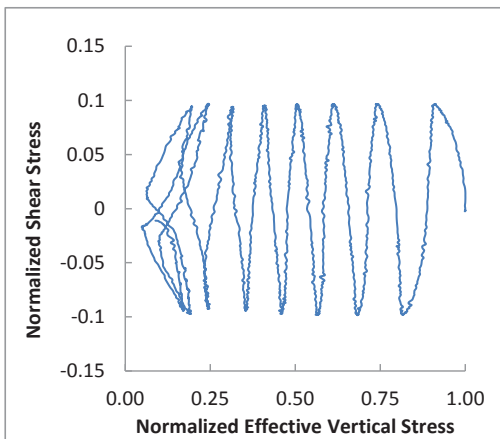

CSS Monotonic Shear Test Report

Geotechnical Engineering Laboratory



10/28/2013_Version 8.0

General Test Info and Sample Preparation

Device:	CSS	Relative Density (%):	78%
Specimen ID:	PGD	Void Ratio:	0.618
Test ID:	C169	Height (mm):	109.9
Date of Test:	6/12/2015	Soil-Only Specimen Diameter (mm):	306.23
Test Performed:	Post Cyclic Monotonic Shear	Weight (kg):	13.711
Test Material:	Pea Gravel	Density (kg/m³):	1693.6
Sample Preparation:	Prepared dense by tamping 25x in 3 layers.	Membrane Thickness (mm):	0.635
		Moisture Content (%):	0%
		Saturated (Y/N):	N
		Prepared by:	A. Jackson
		Checked by:	J. Hubler

Consolidation Stage

Vertical Stress (kPa):	100
Time to Compression (min):	14.0
Relative Density (%):	92%
Void Ratio:	0.589
Height (mm):	107.9
Diameter (mm):	306.23
Weight (kg):	13.711
Density (kg/m³):	1724.7

Shear Stage

Type of Test:	Constant Volume
Stress or Strain Controlled:	Strain
Shear Strain Rate (%/min):	0.30
Peak Shear Strength (kPa):	60.0

Comments

Consolidation Data is for pre-liquefaction.

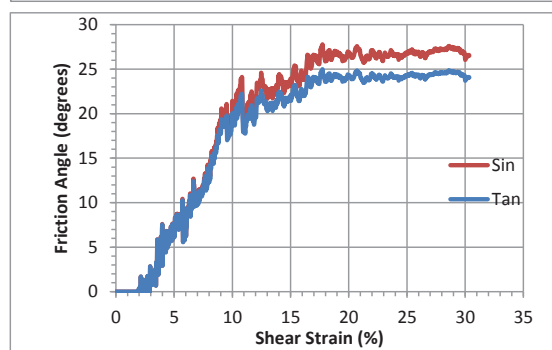
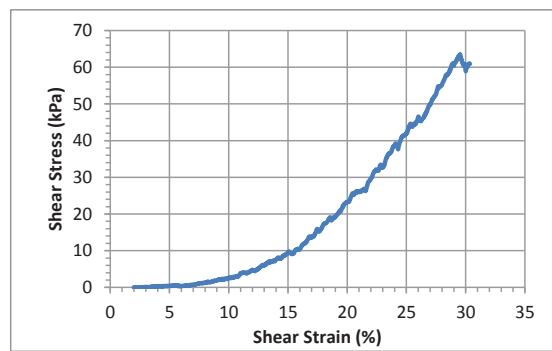
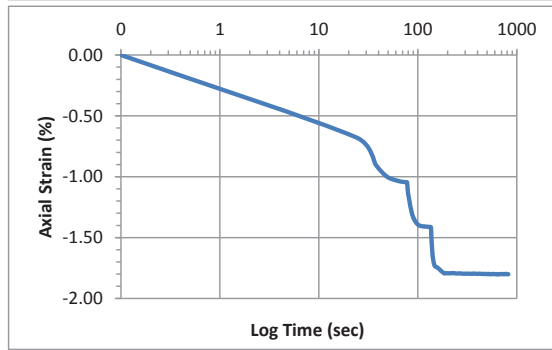
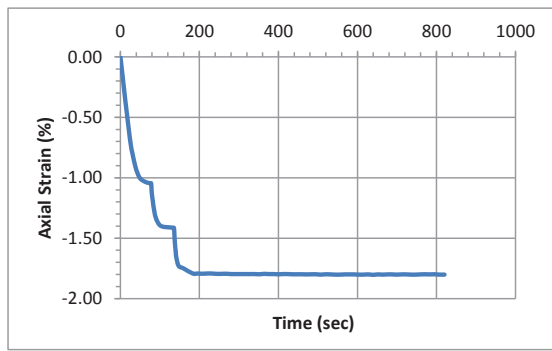

Accelerometer-Based Shear Wave Velocity Datasheet

Specimen ID: C169-PGD-100-1X

Test Material: PGD

Date: 6/12/2015

Test Performed by: J.Hubler

Filename: C169-PGD-100-1X

Vertical Stress: 100kPa

Sensor Spacing: 0.1079 m

V_s (rise) = 202 m/s

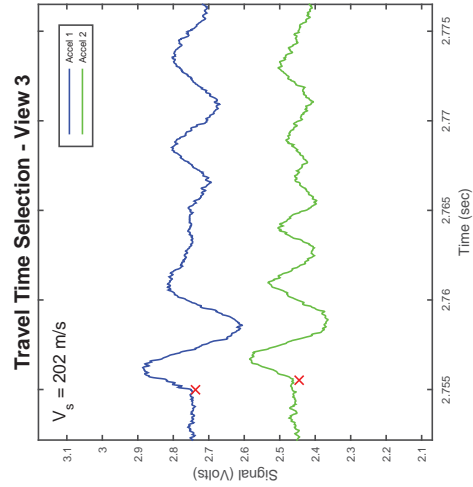
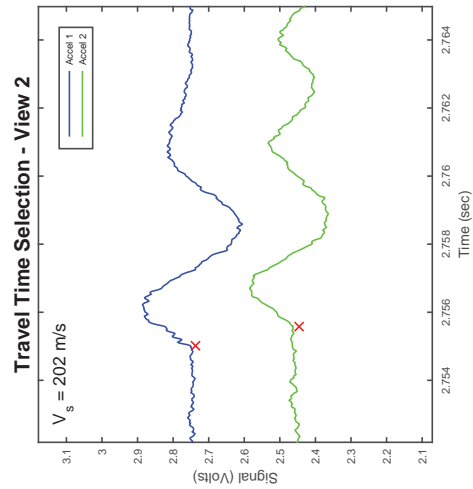
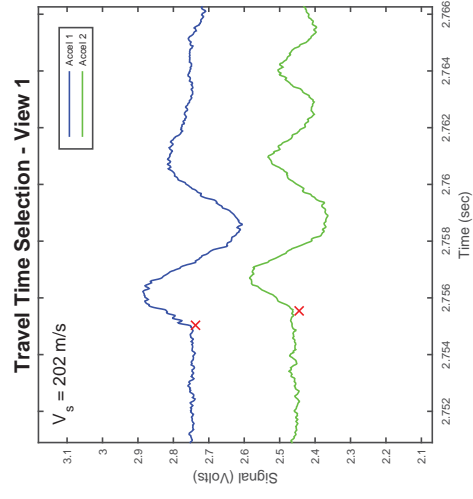
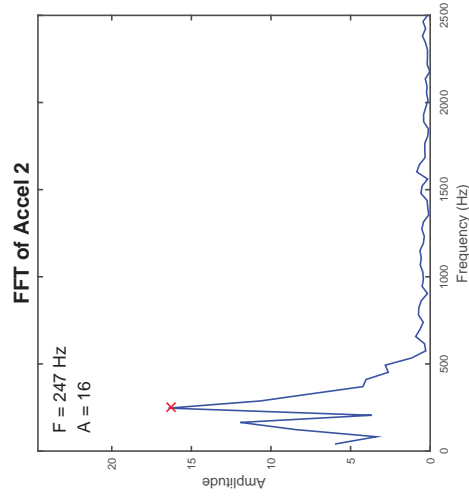
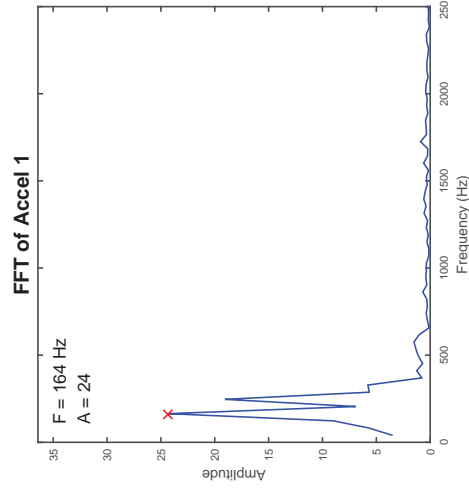
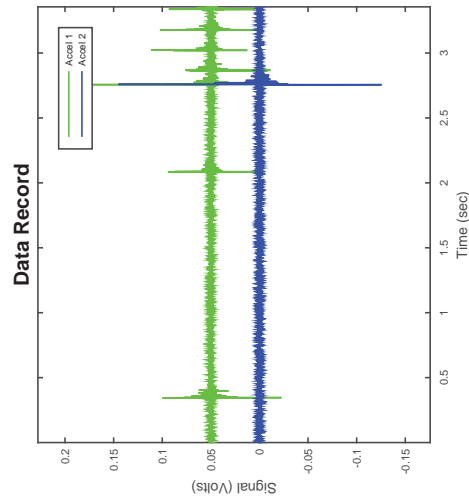

Accelerometer-Based Shear Wave Velocity Datasheet

Specimen ID: C169-PGD-100-2X

Test Material: PGD

Date: 6/12/2015

Test Performed by: J.Hubler

Filename: C169-PGD-100-2X

Vertical Stress: 100kPa

Sensor Spacing: 0.1079 m

V_s (rise) = 207 m/s

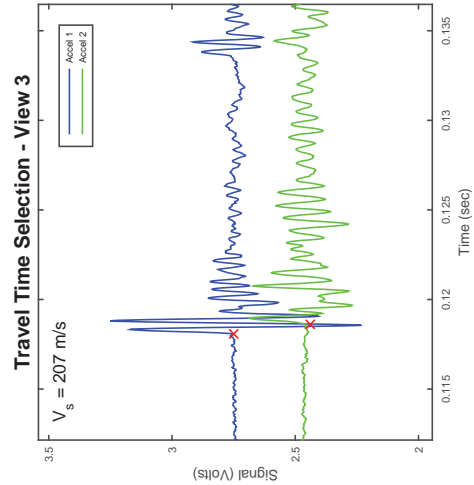
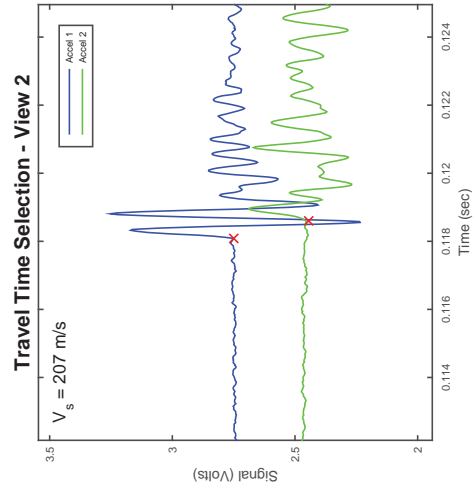
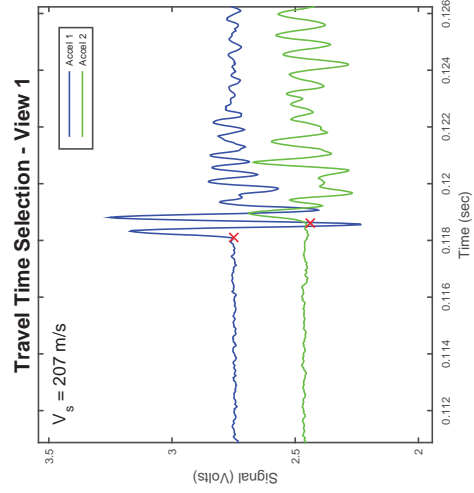
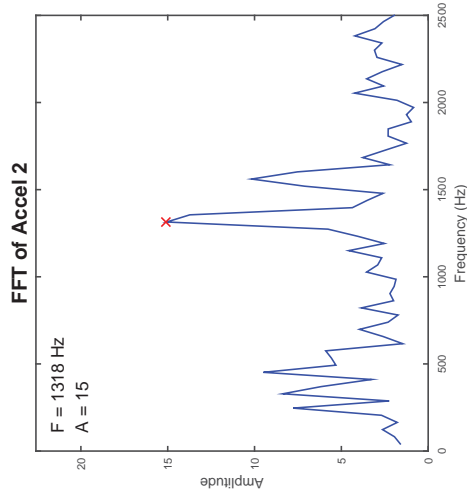
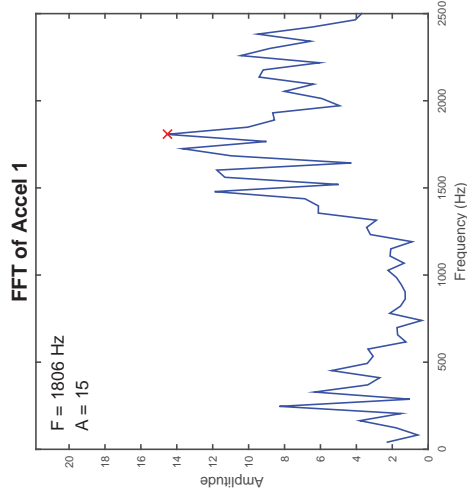
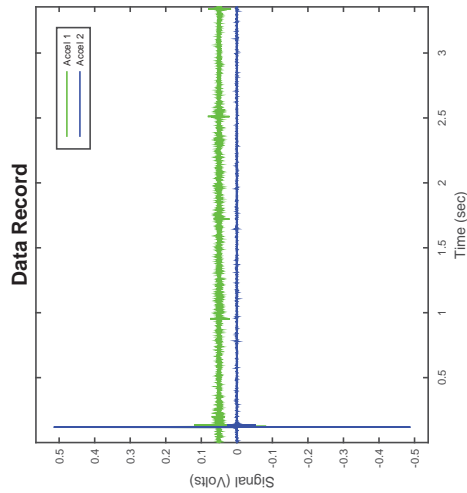

CSS Cyclic Shear Test Report

Geotechnical Engineering Laboratory



Cyclic Shear Test Summary

Device:	CSS	Density (kg/m³):	1717
Specimen ID:	PGD	Relative Density (%):	89%
Test ID:	C166	Void Ratio:	0.596
Date of Test:	6/10/2015	Vertical Stress (kPa):	200
Test Performed:	Cyclic Shear	Loading Frequency (Hz):	0.33
Test Material:	Pea Gravel	Number of Cycles:	11
Sample Preparation:	Prepared denser by tamping 25x in 3 layers.	Cyclic Stress Ratio:	0.097
		Shear Modulus (kPa):	
		Damping (%):	
Prepared by:	A. Jackson	Shear Strain Single Amplitude (%)	
Checked by:	J. Hubler		

Additional Comments:

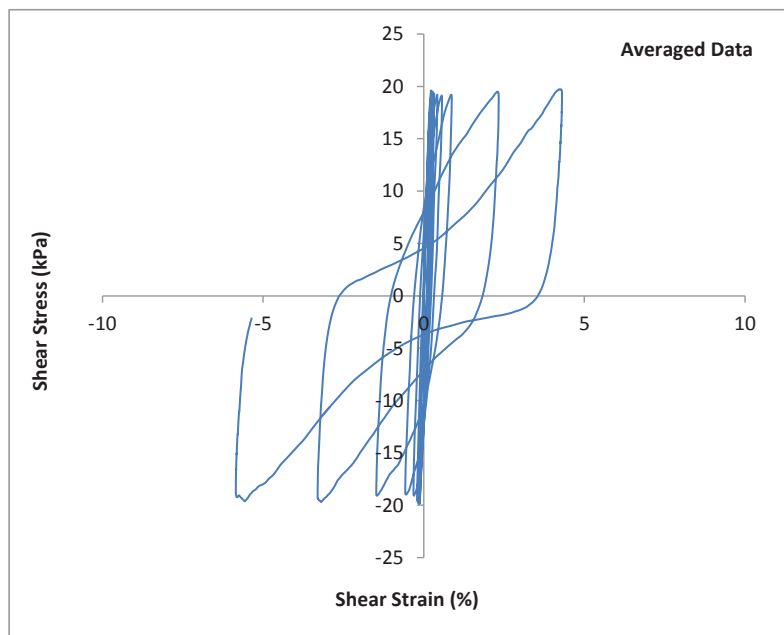
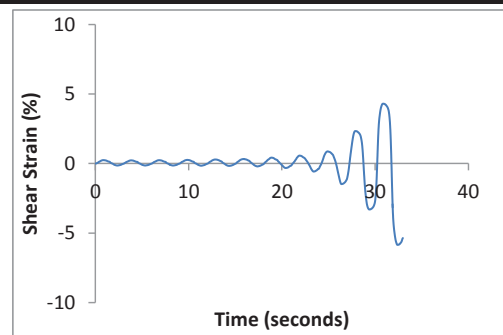
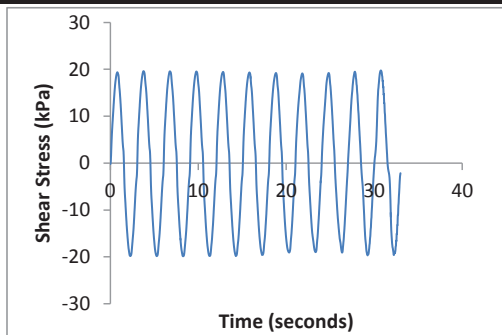

CSS Cyclic Shear Test Report

Geotechnical Engineering Laboratory



Cyclic Shear Test Summary

Device:	CSS	Density (kg/m³):	1717
Specimen ID:	PGD	Relative Density (%):	89%
Test ID:	C166	Void Ratio:	0.596
Date of Test:	6/10/2015	Vertical Stress (kPa):	200
Test Performed:	Cyclic Shear	Loading Frequency (Hz):	0.33
Test Material:	Pea Gravel	Number of Cycles:	11
Sample Preparation:	Prepared denser by tamping 25x in 3 layers.	Cyclic Stress Ratio:	0.097
		Number of Cycles to Liq:	11
		Maximum ru:	0.98
Prepared by:	A. Jackson		
Checked by:	J. Hubler		

Additional Comments:

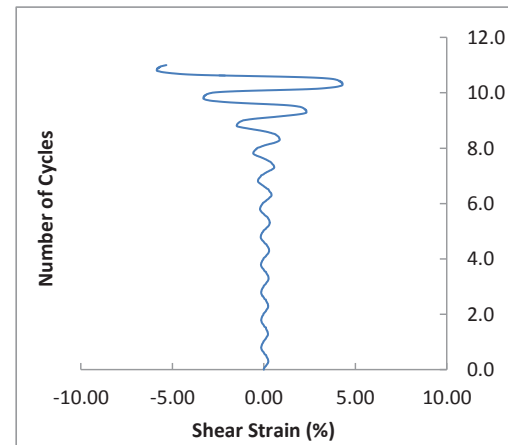
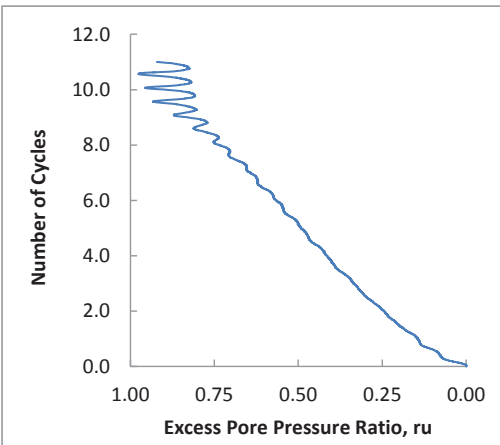
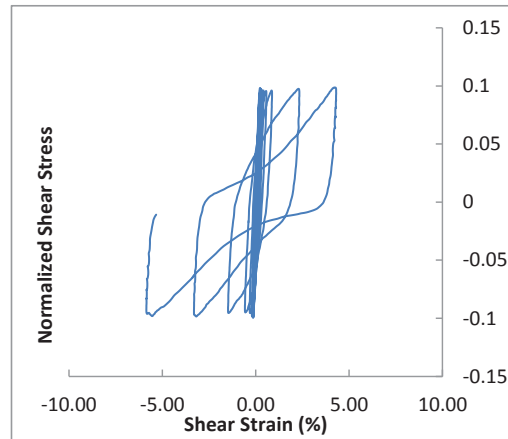
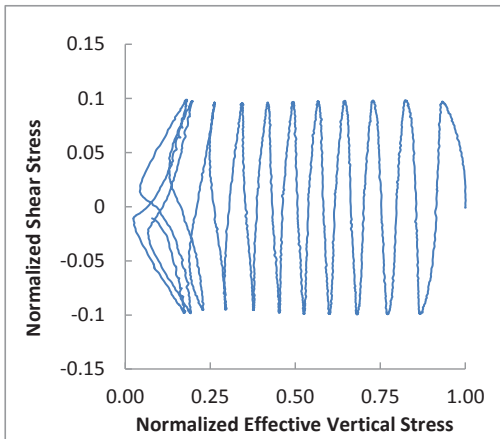

CSS Monotonic Shear Test Report

Geotechnical Engineering Laboratory



10/28/2013_Version 8.0

General Test Info and Sample Preparation

Device:	CSS	Relative Density (%):	66%
Specimen ID:	PGD	Void Ratio:	0.641
Test ID:	C166	Height (mm):	111.0
Date of Test:	6/10/2015	Soil-Only Specimen Diameter (mm):	306.23
Test Performed:	Post Cyclic Monotonic Shear	Weight (kg):	13.651
Test Material:	Pea Gravel	Density (kg/m³):	1669.5
Sample Preparation:	Prepared dense by tamping 25x in 3 layers.	Membrane Thickness (mm):	0.635
		Moisture Content (%):	0%
		Saturated (Y/N):	N
		Prepared by:	A. Jackson
		Checked by:	J. Hubler

Consolidation Stage

Vertical Stress (kPa):	200
Time to Compression (min):	14.3
Relative Density (%):	89%
Void Ratio:	0.596
Height (mm):	107.9
Diameter (mm):	306.23
Weight (kg):	13.651
Density (kg/m³):	1717.3

Shear Stage

Type of Test:	Constant Volume
Stress or Strain Controlled:	Strain
Shear Strain Rate (%/min):	0.30
Peak Shear Strength (kPa):	70.0

Comments

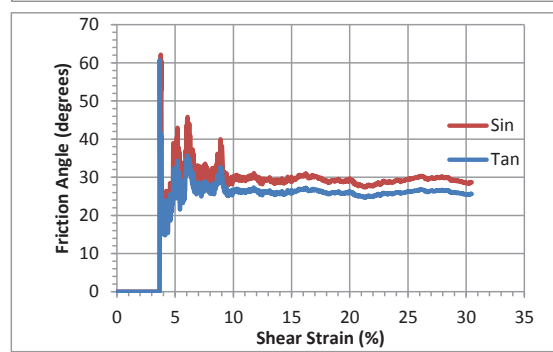
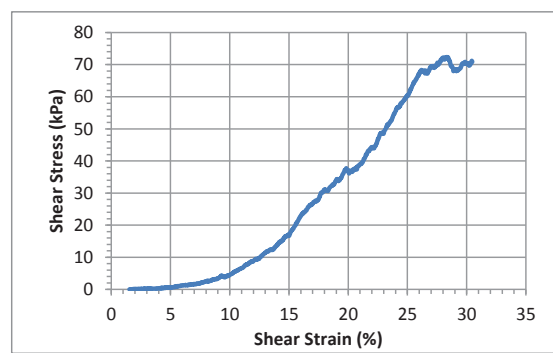
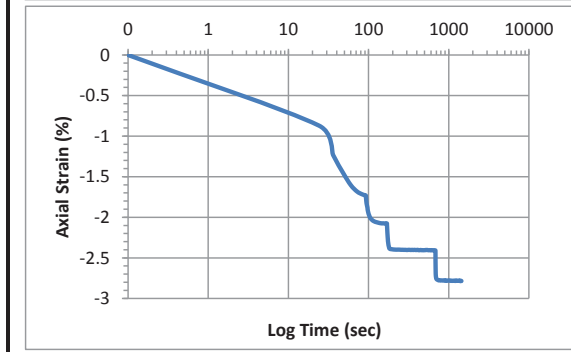
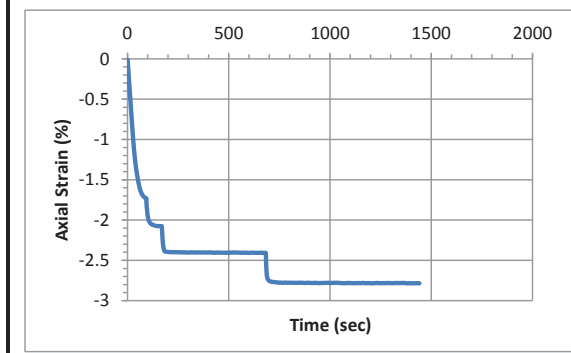

Accelerometer-Based Shear Wave Velocity Datasheet

Specimen ID: C166-PGD-200-1X
 Test Material: PGD
 Date: 6/10/2015
 Test Performed by: J.Hubler
 Filename: C166-PGD-200-1X

Vertical Stress: 200kPa
 Sensor Spacing: 0.10788 m
 V_s (rise) = 227 m/s

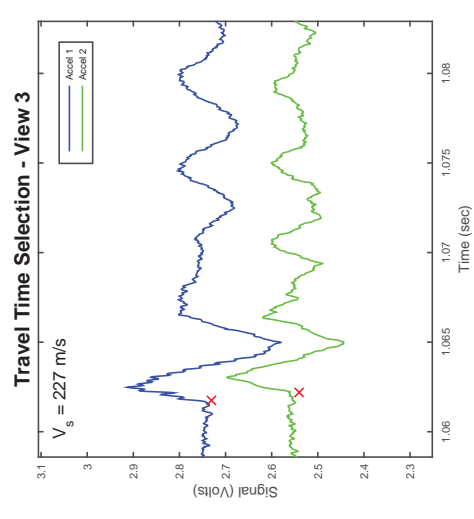
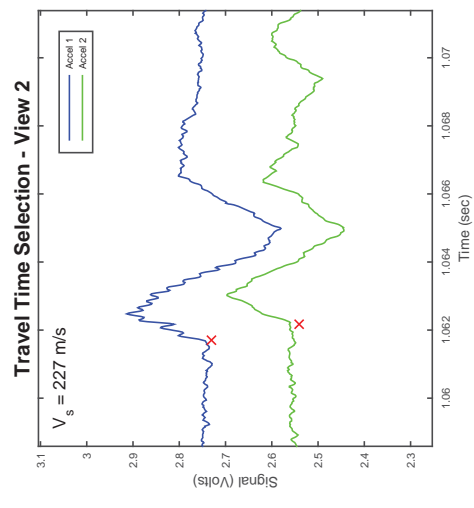
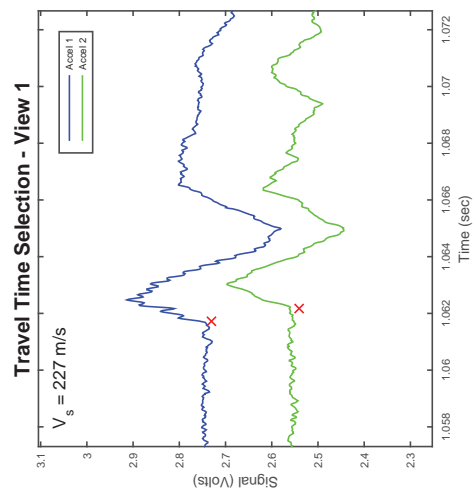
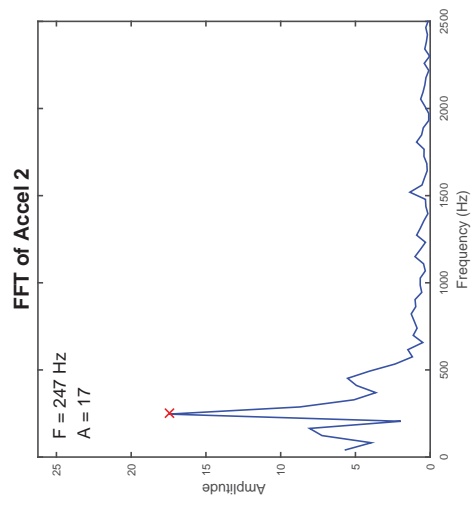
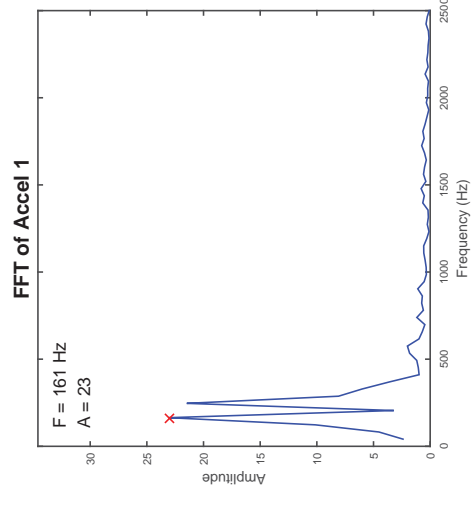
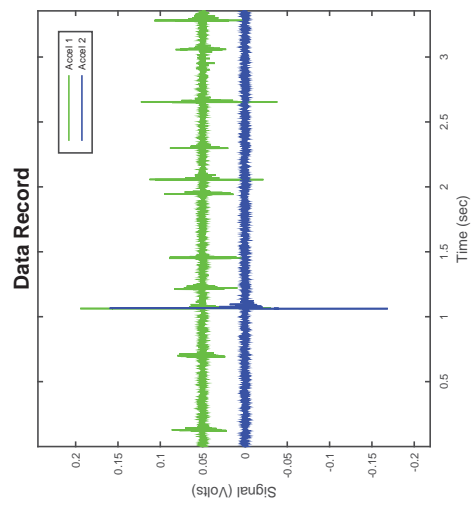

CSS Cyclic Shear Test Report

Geotechnical Engineering Laboratory



Cyclic Shear Test Summary

Device:	CSS	Density (kg/m³):	1723
Specimen ID:	PGD	Relative Density (%):	92%
Test ID:	C167	Void Ratio:	0.590
Date of Test:	6/11/2015	Vertical Stress (kPa):	400
Test Performed:	Cyclic Shear	Loading Frequency (Hz):	0.33
Test Material:	Pea Gravel	Number of Cycles:	38
Sample Preparation:	Prepared denser by tamping 20x in 3 layers.	Cyclic Stress Ratio:	0.099
		Shear Modulus (kPa):	
		Damping (%):	
Prepared by:	A. Jackson	Shear Strain Single Amplitude (%)	
Checked by:	J. Hubler		

Additional Comments:

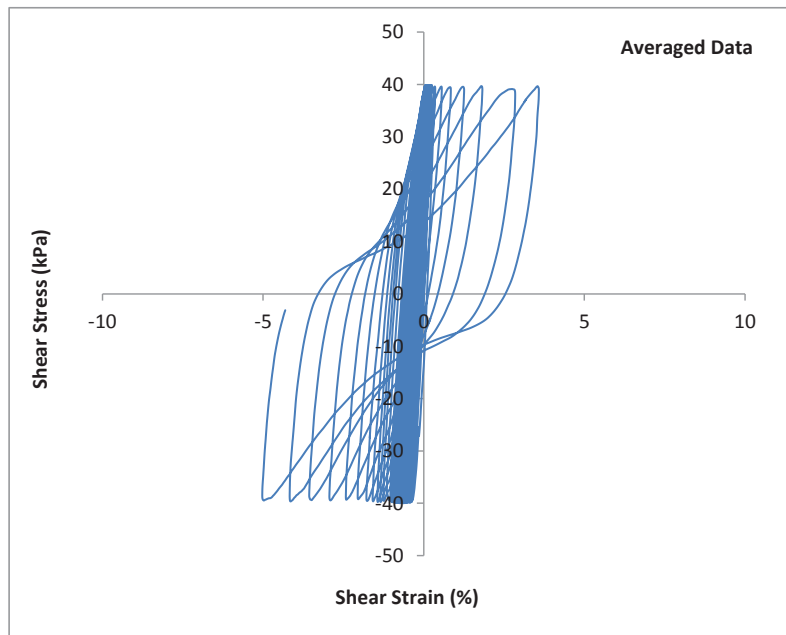
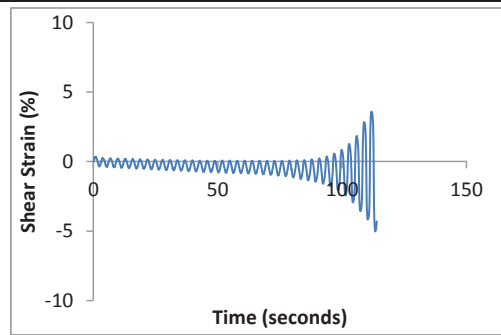
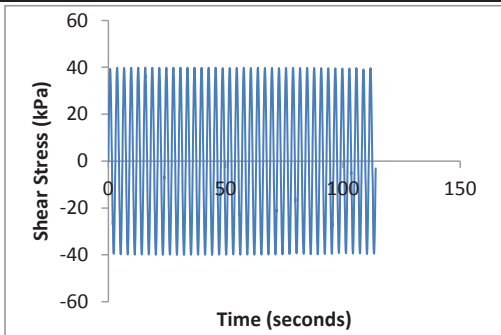

CSS Cyclic Shear Test Report

Geotechnical Engineering Laboratory



Cyclic Shear Test Summary

Device:	CSS	Density (kg/m³):	1723
Specimen ID:	PGD	Relative Density (%):	92%
Test ID:	C167	Void Ratio:	0.590
Date of Test:	6/11/2015	Vertical Stress (kPa):	400
Test Performed:	Cyclic Shear	Loading Frequency (Hz):	0.33
Test Material:	Pea Gravel	Number of Cycles:	38
Sample Preparation:	Prepared denser by tamping 20x in 3 layers.	Cyclic Stress Ratio:	0.099
		Number of Cycles to Liq:	37
		Maximum ru:	0.95
Prepared by:	A. Jackson		
Checked by:	J. Hubler		

Additional Comments:

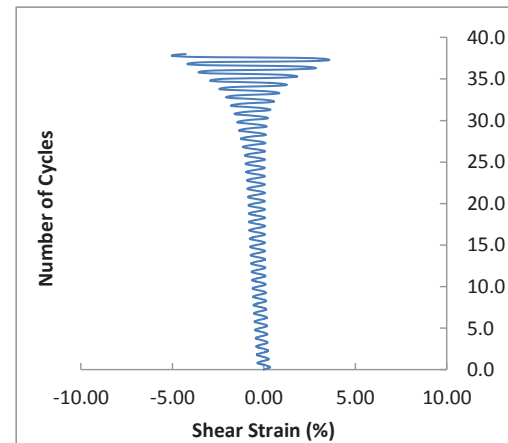
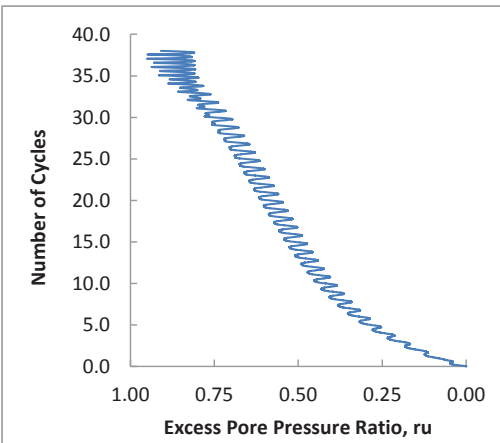
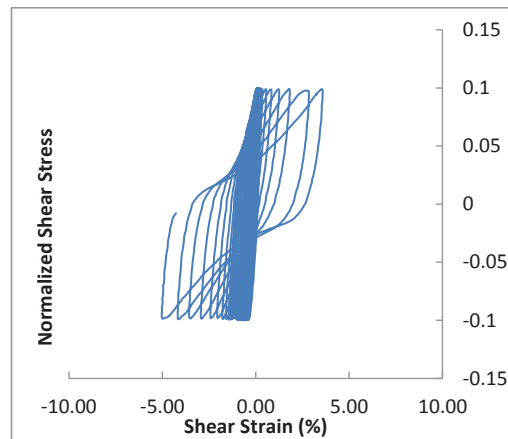
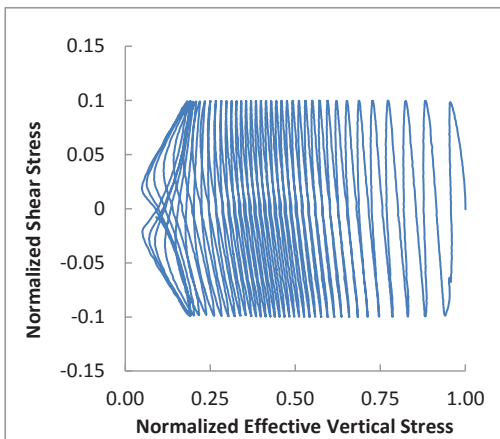

CSS Monotonic Shear Test Report

Geotechnical Engineering Laboratory



10/28/2013_Version 8.0

General Test Info and Sample Preparation

Device:	CSS	Relative Density (%):	63%
Specimen ID:	PGD	Void Ratio:	0.648
Test ID:	C167	Height (mm):	109.6
Date of Test:	6/11/2015	Soil-Only Specimen Diameter (mm):	306.23
Test Performed:	Post Cyclic Monotonic Shear	Weight (kg):	13.425
Test Material:	Pea Gravel	Density (kg/m ³):	1662.8
Sample Preparation:	Prepared dense by tamping 20x in 3 layers.	Membrane Thickness (mm):	0.635
		Moisture Content (%):	0%
		Saturated (Y/N):	N
		Prepared by:	A. Jackson
		Checked by:	J. Hubler

Consolidation Stage

Vertical Stress (kPa):	400
Time to Compression (min):	17.9
Relative Density (%):	92%
Void Ratio:	0.590
Height (mm):	105.8
Diameter (mm):	306.23
Weight (kg):	13.425
Density (kg/m ³):	1723.4

Shear Stage

Type of Test:	Constant Volume
Stress or Strain Controlled:	Strain
Shear Strain Rate (%/min):	0.31
Peak Shear Strength (kPa):	70.0

Comments

Consolidation Data is for pre-liquefaction.

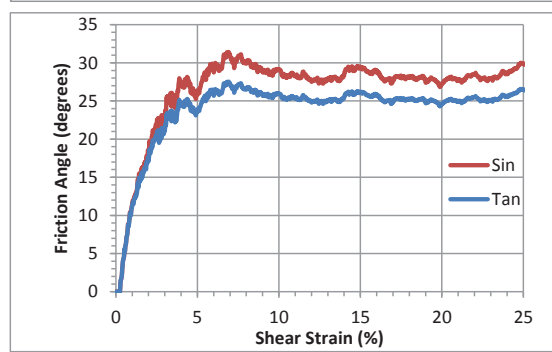
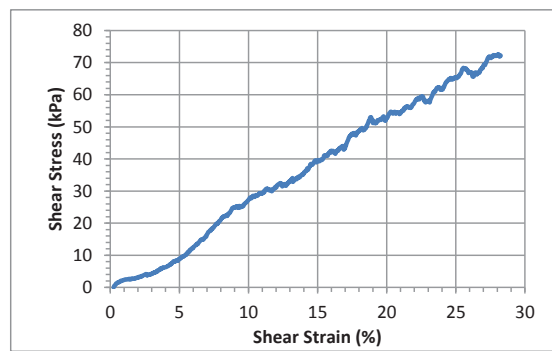
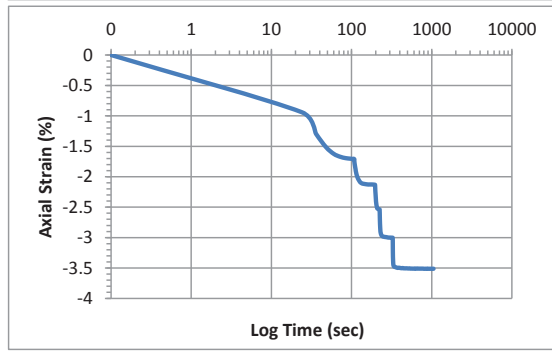
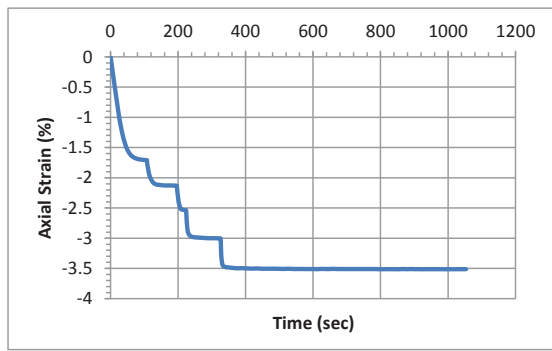

Accelerometer-Based Shear Wave Velocity Datasheet

Specimen ID: C167-PGD-400-2X
 Test Material: PGD
 Date: 6/11/2015
 Test Performed by: J.Hubler
 Filename: C167-PGD-400-2X

Vertical Stress: 400kPa
 Sensor Spacing: 0.10573 m
 V_s (rise) = 297 m/s

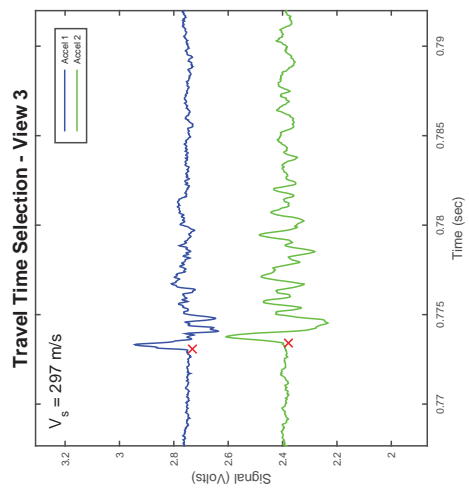
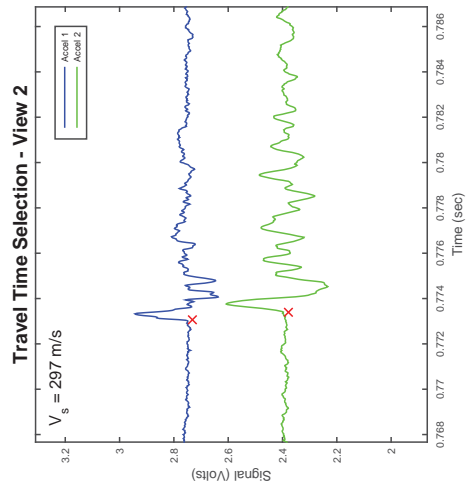
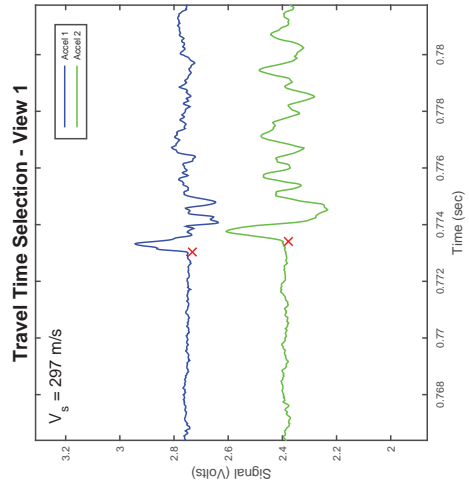
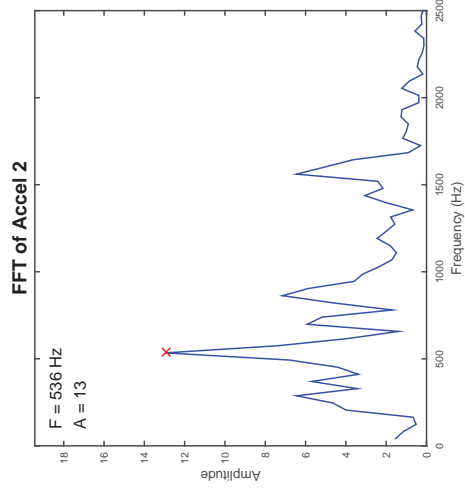
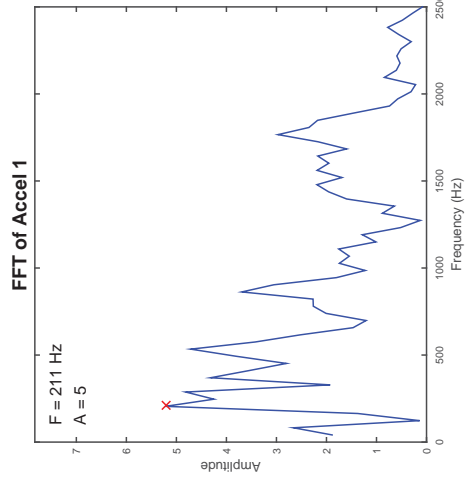
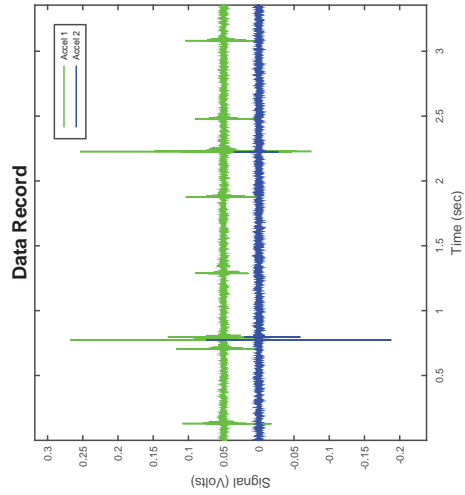

CSS Cyclic Shear Test Report

Geotechnical Engineering Laboratory



Cyclic Shear Test Summary

Device:	CSS	Density (kg/m³):	1625
Specimen ID:	PGL	Relative Density (%):	44%
Test ID:	C179	Void Ratio:	0.686
Date of Test:	6/22/2015	Vertical Stress (kPa):	100
Test Performed:	Cyclic Shear	Loading Frequency (Hz):	0.33
Test Material:	Pea Gravel	Number of Cycles:	6
Sample Preparation:	Prepared loose using the shoveling method.	Cyclic Stress Ratio:	0.094
		Shear Modulus (kPa):	
		Damping (%):	
Prepared by:	A.Jackson	Shear Strain Single Amplitude (%)	
Checked by:	J.Hubler		

Additional Comments:

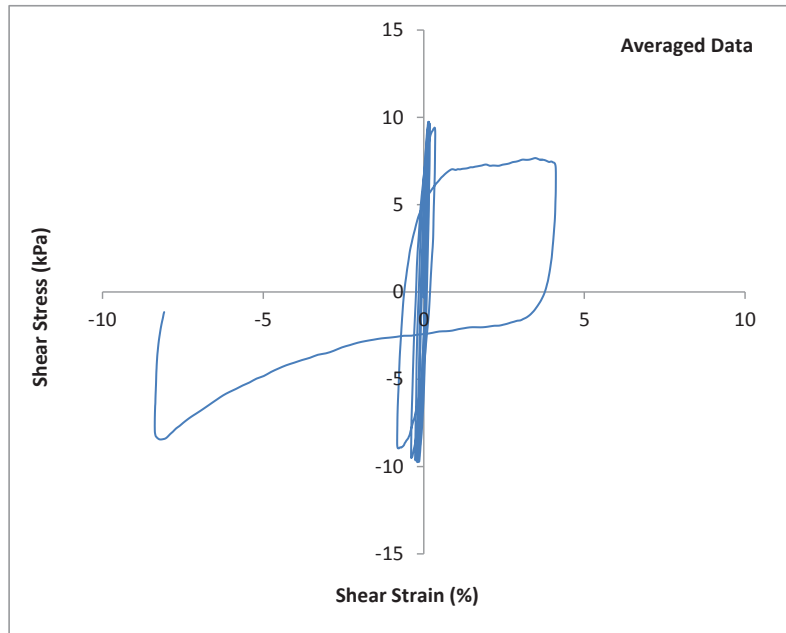
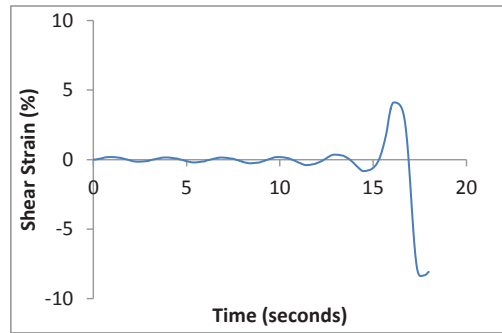
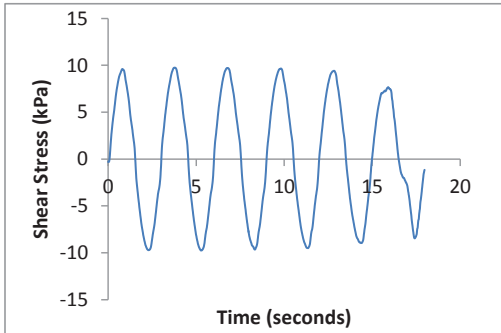

CSS Cyclic Shear Test Report

Geotechnical Engineering Laboratory



Cyclic Shear Test Summary

Device:	CSS	Density (kg/m³):	1625
Specimen ID:	PGL	Relative Density (%):	44%
Test ID:	C179	Void Ratio:	0.686
Date of Test:	6/22/2015	Vertical Stress (kPa):	100
Test Performed:	Cyclic Shear	Loading Frequency (Hz):	0.33
Test Material:	Pea Gravel	Number of Cycles:	6
Sample Preparation:	Prepared loose using the shoveling method.	Cyclic Stress Ratio:	0.094
		Number of Cycles to Liq:	6
		Maximum ru:	0.97
Prepared by:	A.Jackson		
Checked by:	J.Hubler		

Additional Comments:

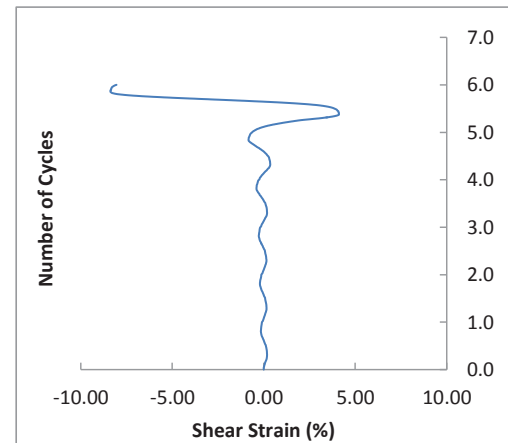
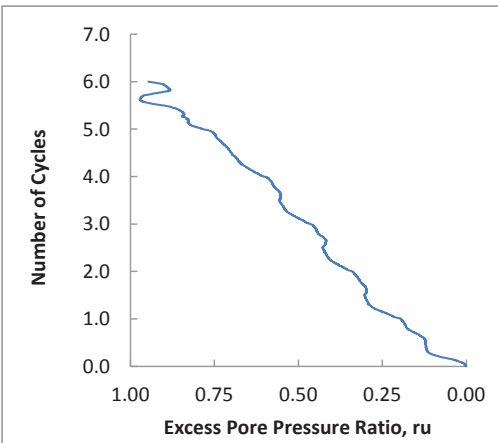
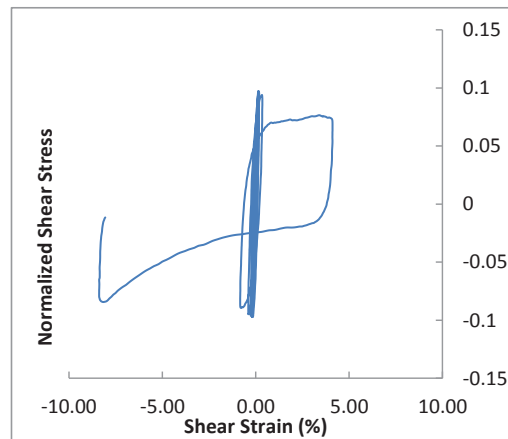
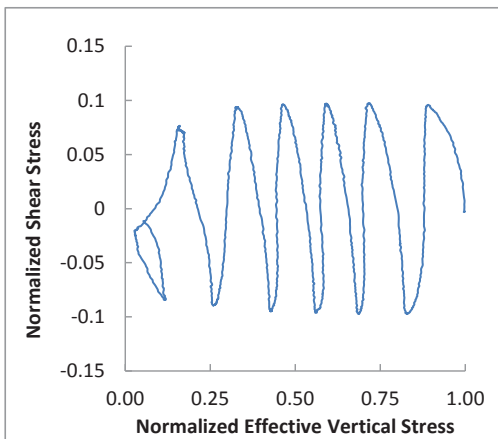

CSS Monotonic Shear Test Report

Geotechnical Engineering Laboratory



10/28/2013_Version 8.0

General Test Info and Sample Preparation

Device:	CSS	Relative Density (%):	13%
Specimen ID:	PGL	Void Ratio:	0.747
Test ID:	C179	Height (mm):	112.2
Date of Test:	6/22/2015	Soil-Only Specimen Diameter (mm):	306.23
Test Performed:	Post Cyclic Monotonic Shear	Weight (kg):	12.959
Test Material:	Pea Gravel	Density (kg/m³):	1568.6
Sample Preparation:	Prepared loose using the shoveling method.	Membrane Thickness (mm):	0.635
		Moisture Content (%):	0%
		Saturated (Y/N):	N
		Prepared by:	A. Jackson
		Checked by:	J. Hubler

Consolidation Stage

Vertical Stress (kPa):	100
Time to Compression (min):	14.2
Relative Density (%):	44%
Void Ratio:	0.686
Height (mm):	108.2
Diameter (mm):	306.23
Weight (kg):	12.959
Density (kg/m³):	1625.4

Shear Stage

Type of Test:	Constant Volume
Stress or Strain Controlled:	Strain
Shear Strain Rate (%/min):	0.30
Peak Shear Strength (kPa):	4.0

Comments

Consolidation Data is for pre-liquefaction.

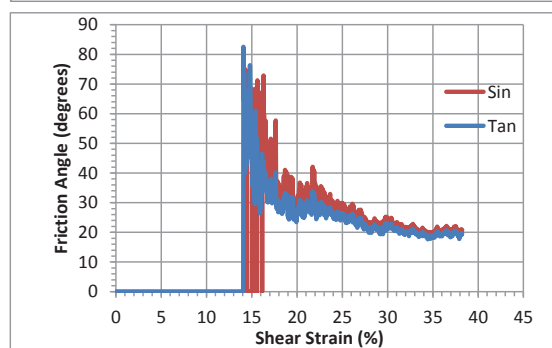
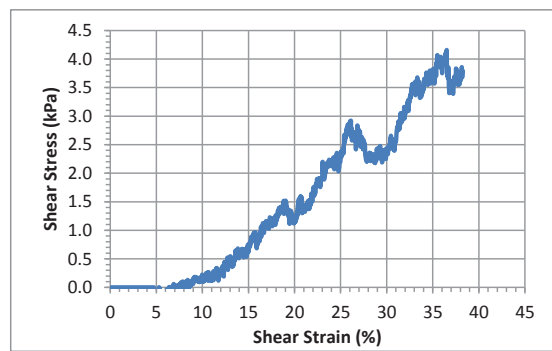
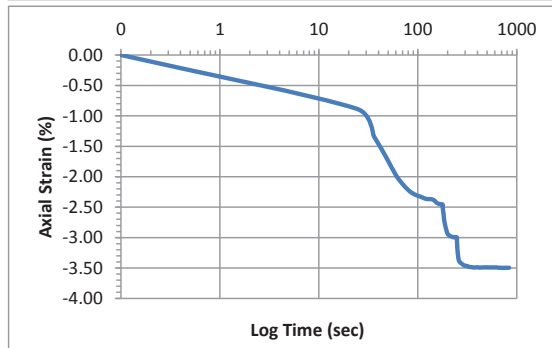
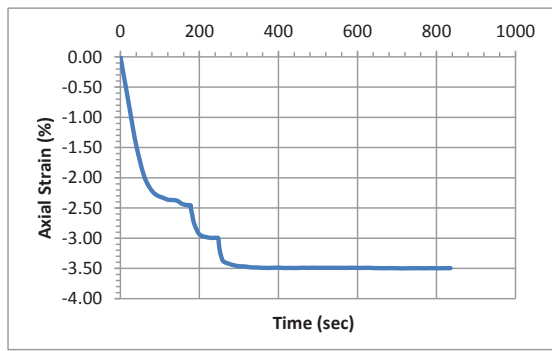

Accelerometer-Based Shear Wave Velocity Datasheet

Specimen ID: C179-PGL-100-1X
 Test Material: PGL
 Date: 6/22/2015
 Test Performed by: J.Hubler
 Filename: C179-PGL-100-1X

Vertical Stress: 100kPa
 Sensor Spacing: 0.1082 m
 V_s (rise) = 178 m/s

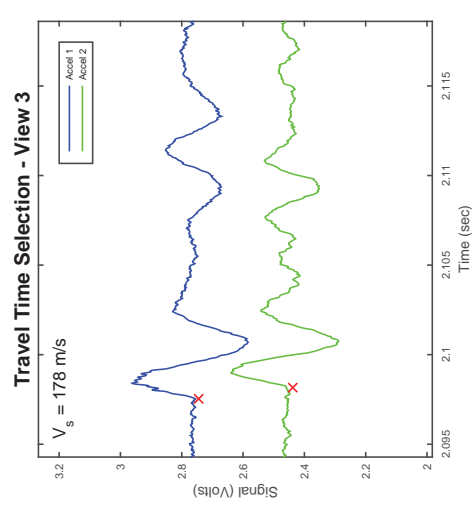
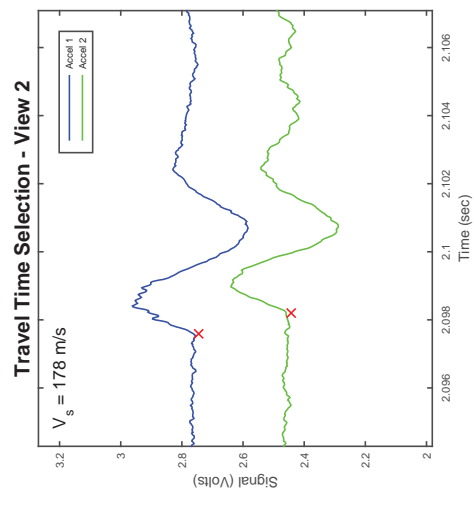
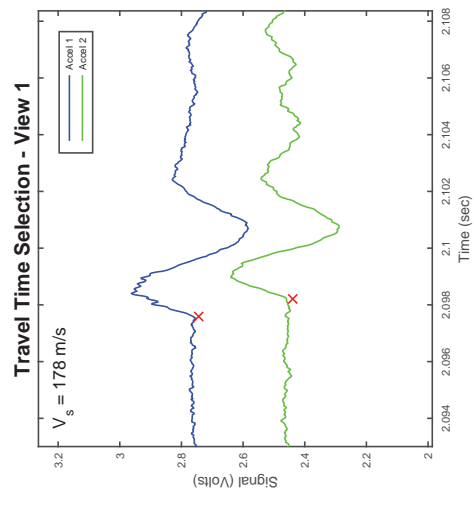
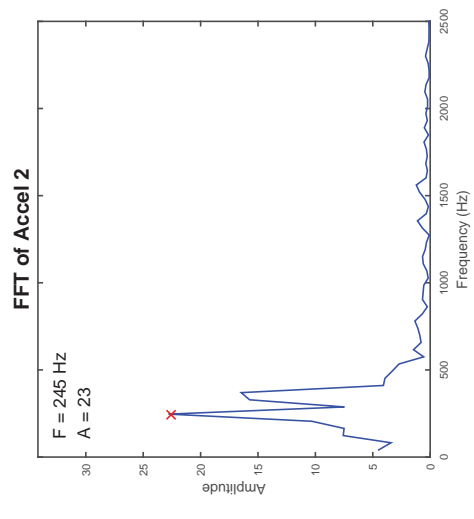
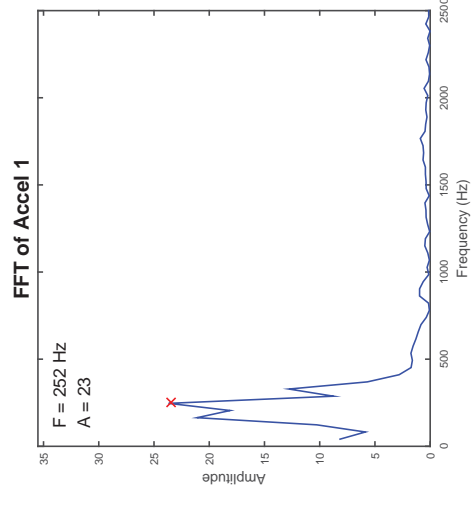
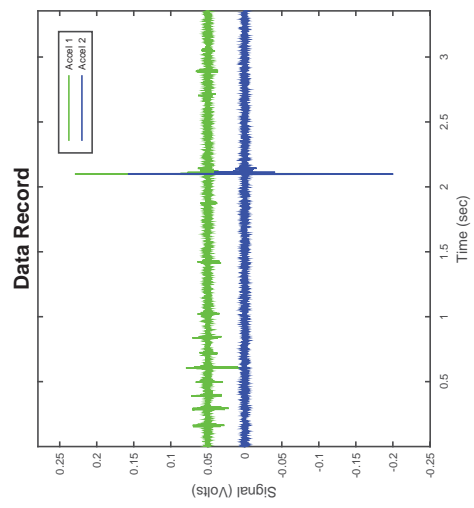

Accelerometer-Based Shear Wave Velocity Datasheet

Specimen ID: C179-PGL-100-2X
 Test Material: PGL
 Date: 6/22/2015
 Test Performed by: J.Hubler
 Filename: C179-PGL-100-2X

Vertical Stress: 100kPa
 Sensor Spacing: 0.1082 m
 V_s (rise) = 192 m/s

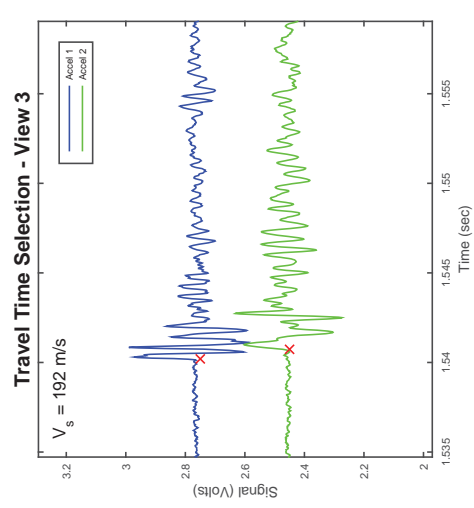
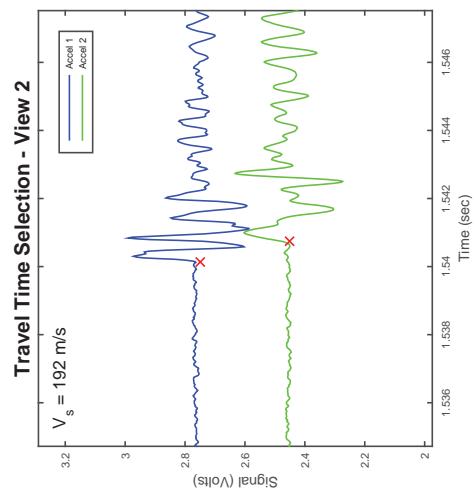
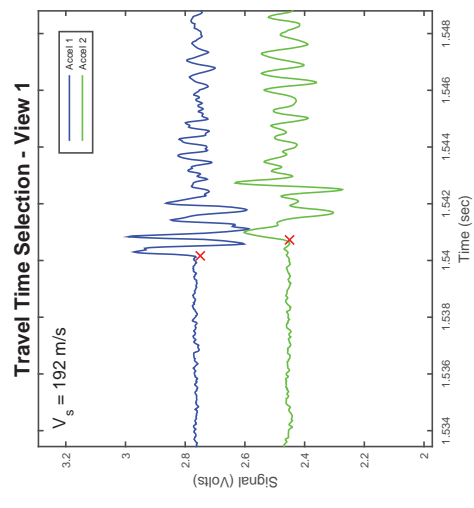
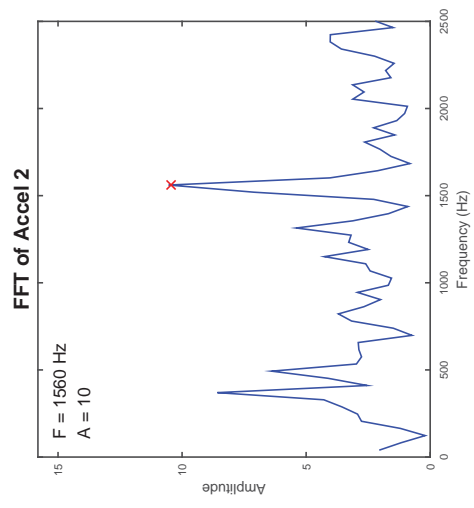
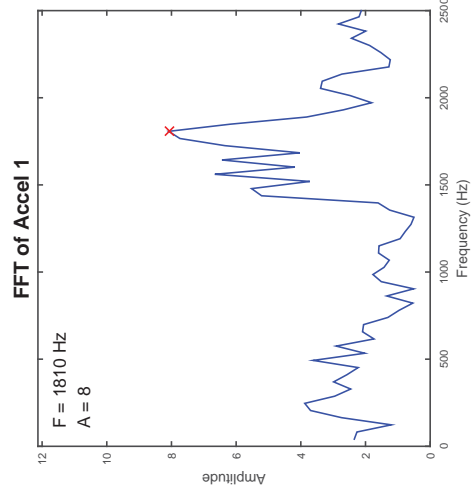
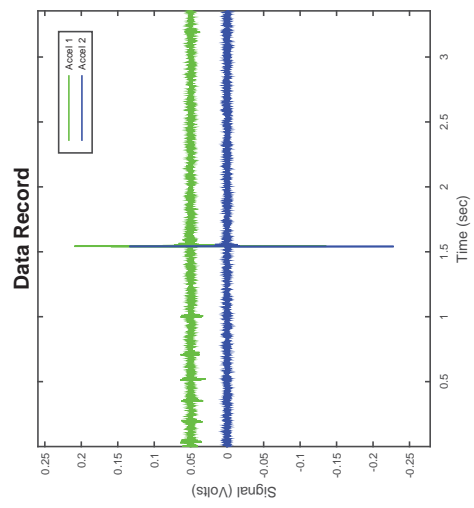

CSS Cyclic Shear Test Report

Geotechnical Engineering Laboratory



Cyclic Shear Test Summary

Device:	CSS	Density (kg/m³):	1713
Specimen ID:	PGD	Relative Density (%):	87%
Test ID:	C184	Void Ratio:	0.599
Date of Test:	6/30/2015	Vertical Stress (kPa):	100
Test Performed:	Cyclic Shear	Loading Frequency (Hz):	0.33
Test Material:	Pea Gravel	Number of Cycles:	276
Sample Preparation:	Prepared dense specimen with 25 tamps in 3 layers.	Cyclic Stress Ratio:	0.044
		Shear Modulus (kPa):	
		Damping (%):	
Prepared by:	A.Jackson	Shear Strain Single Amplitude (%)	
Checked by:	J.Hubler		

Additional Comments:

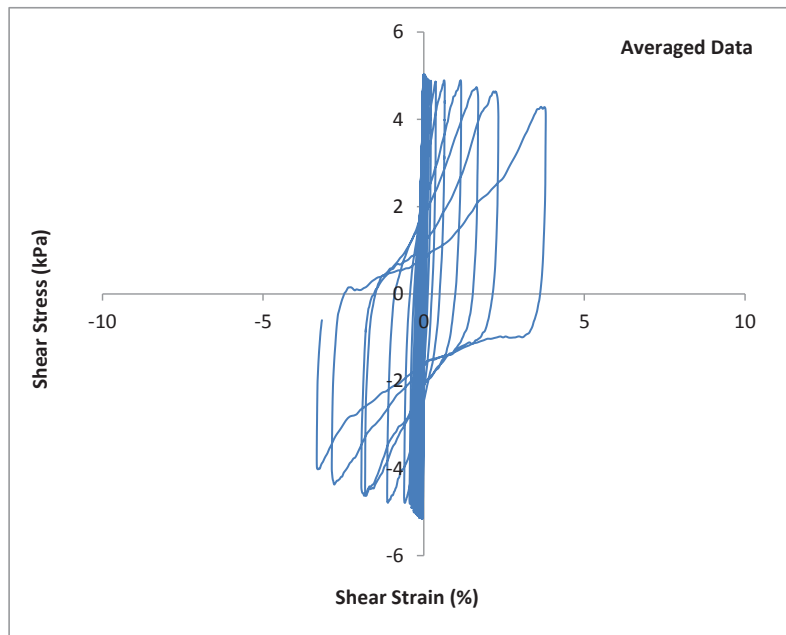
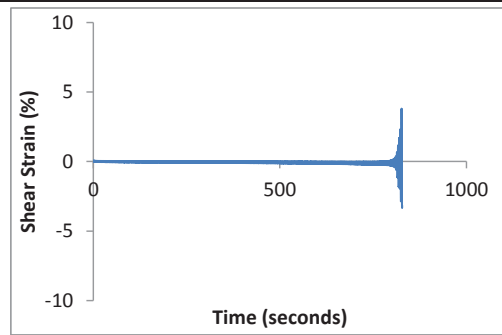
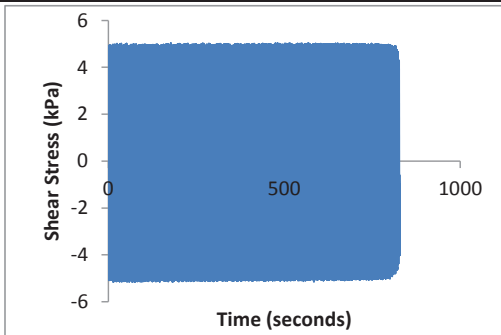

CSS Cyclic Shear Test Report

Geotechnical Engineering Laboratory



Cyclic Shear Test Summary

Device:	CSS	Density (kg/m³):	1713
Specimen ID:	PGD	Relative Density (%):	87%
Test ID:	C184	Void Ratio:	0.599
Date of Test:	6/30/2015	Vertical Stress (kPa):	100
Test Performed:	Cyclic Shear	Loading Frequency (Hz):	0.33
Test Material:	Pea Gravel	Number of Cycles:	276
Sample Preparation:	Prepared dense specimen with 25 tamps in 3 layers.	Cyclic Stress Ratio:	0.044
		Number of Cycles to Liq:	276
		Maximum ru:	0.99
Prepared by:	A.Jackson		
Checked by:	J.Hubler		

Additional Comments:

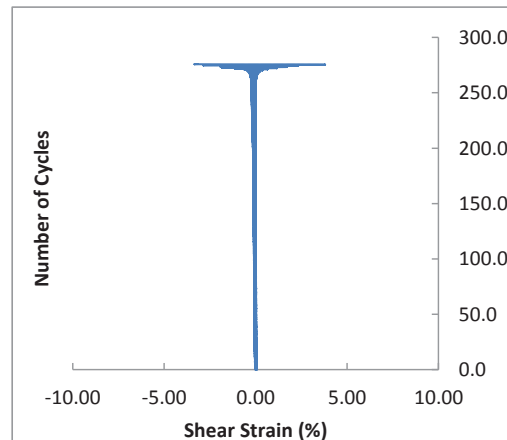
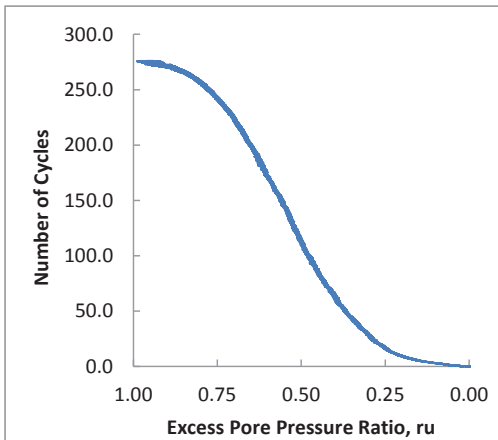
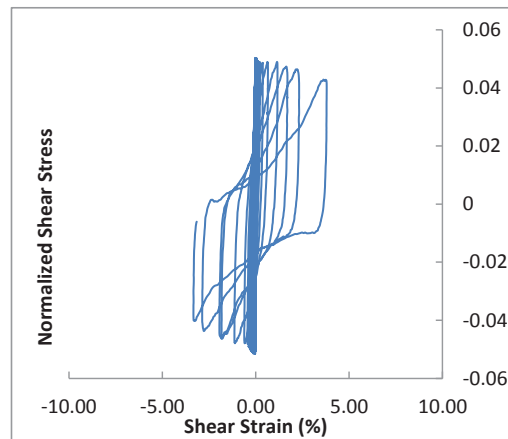
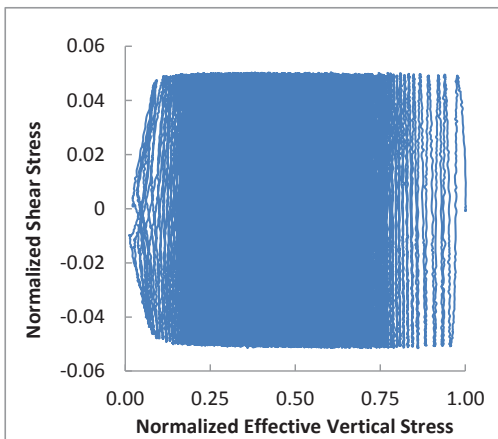

CSS Monotonic Shear Test Report

Geotechnical Engineering Laboratory



10/28/2013_Version 8.0

General Test Info and Sample Preparation

Device:	CSS	Relative Density (%):	74%
Specimen ID:	PGD	Void Ratio:	0.625
Test ID:	C184	Height (mm):	106.7
Date of Test:	6/30/2015	Soil-Only Specimen Diameter (mm):	306.23
Test Performed:	Post Cyclic Monotonic Shear	Weight (kg):	13.245
Test Material:	Pea Gravel	Density (kg/m³):	1686.1
Sample Preparation:	Prepared dense specimen with 25 tamps in 3 layers.	Membrane Thickness (mm):	0.635
		Moisture Content (%):	0%
		Saturated (Y/N):	N
		Prepared by:	A. Jackson
		Checked by:	J. Hubler

Consolidation Stage

Vertical Stress (kPa):	100
Time to Compression (min):	20.2
Relative Density (%):	87%
Void Ratio:	0.599
Height (mm):	105.0
Diameter (mm):	306.23
Weight (kg):	13.245
Density (kg/m³):	1713.5

Shear Stage

Type of Test:	Constant Volume
Stress or Strain Controlled:	Strain
Shear Strain Rate (%/min):	0.31
Peak Shear Strength (kPa):	22.8

Comments

Consolidation Data is for pre-liquefaction.

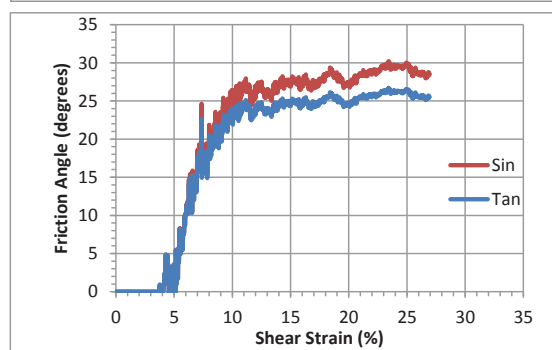
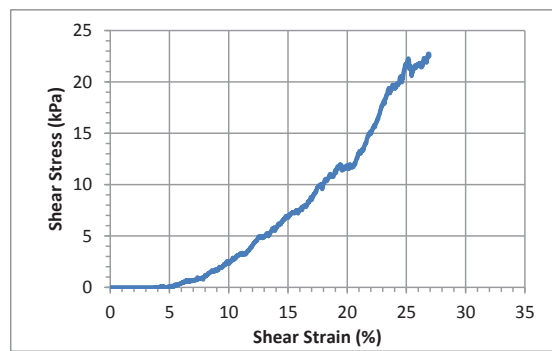
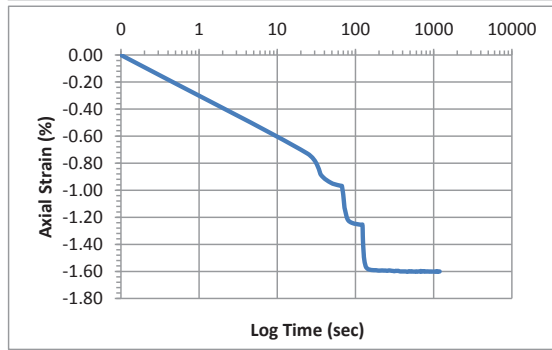
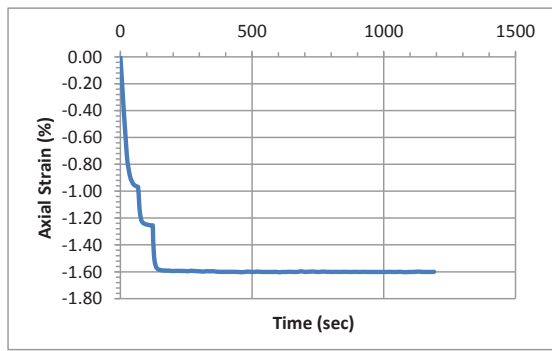

Accelerometer-Based Shear Wave Velocity Datasheet

Specimen ID: C184-PGD-100-1X
 Test Material: PGD
 Date: 6/30/2015
 Test Performed by: J.Hubler
 Filename: C184-PGD-100-1X

Vertical Stress: 100kPa
 Sensor Spacing: 0.10491 m
 V_s (rise) = 220 m/s

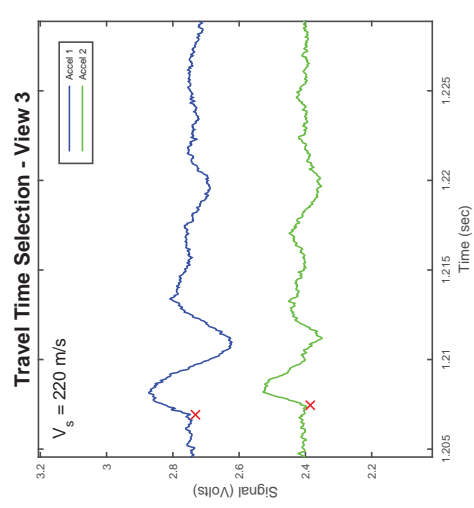
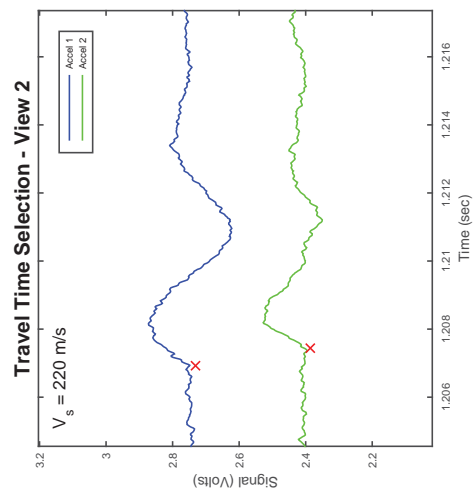
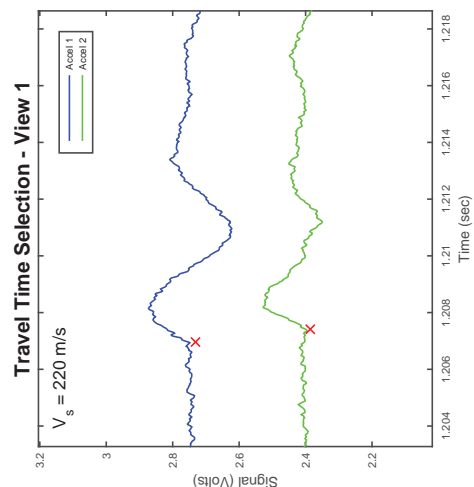
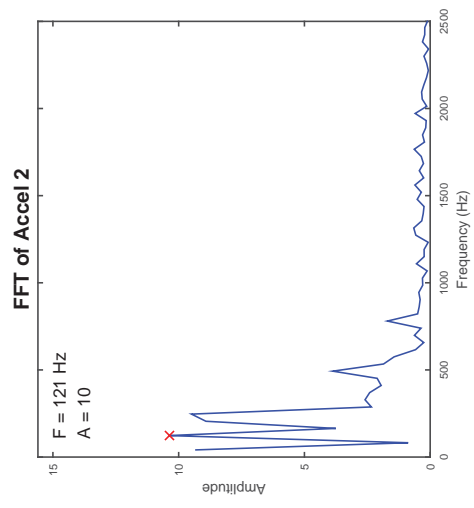
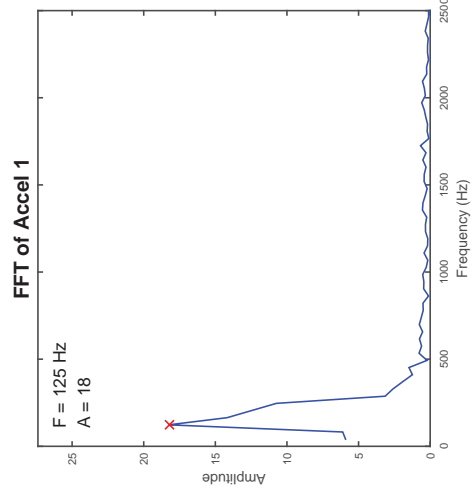
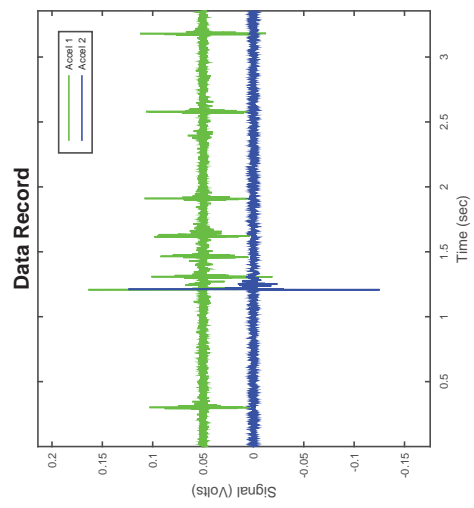

CSS Cyclic Shear Test Report

Geotechnical Engineering Laboratory



Cyclic Shear Test Summary

Device:	CSS	Density (kg/m³):	1711
Specimen ID:	PGD	Relative Density (%):	86%
Test ID:	C185	Void Ratio:	0.602
Date of Test:	6/30/2015	Vertical Stress (kPa):	100
Test Performed:	Cyclic Shear	Loading Frequency (Hz):	0.33
Test Material:	Pea Gravel	Number of Cycles:	8
Sample Preparation:	Prepared dense by tamping 25x in 3 layers.	Cyclic Stress Ratio:	0.144
		Shear Modulus (kPa):	
		Damping (%):	
Prepared by:	A.Jackson	Shear Strain Single Amplitude (%)	
Checked by:	J.Hubler		

Additional Comments:

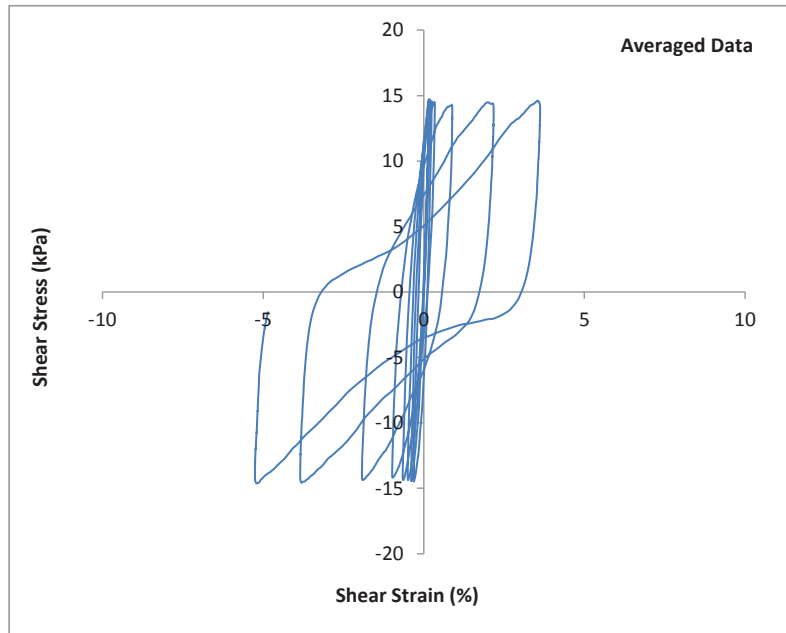
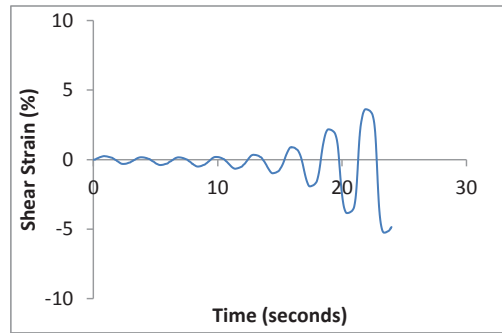
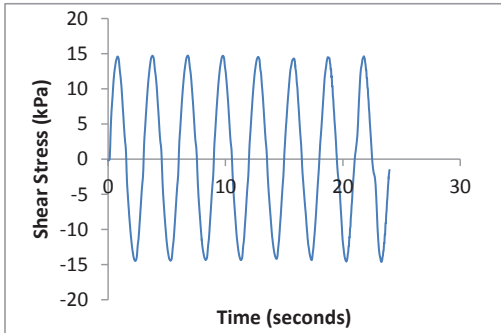

CSS Cyclic Shear Test Report

Geotechnical Engineering Laboratory



Cyclic Shear Test Summary

Device:	CSS	Density (kg/m³):	1711
Specimen ID:	PGD	Relative Density (%):	86%
Test ID:	C185	Void Ratio:	0.602
Date of Test:	6/30/2015	Vertical Stress (kPa):	100
Test Performed:	Cyclic Shear	Loading Frequency (Hz):	0.33
Test Material:	Pea Gravel	Number of Cycles:	8
Sample Preparation:	Prepared dense by tamping 25x in 3 layers.	Cyclic Stress Ratio:	0.144
		Number of Cycles to Liq:	8
		Maximum ru:	0.97
Prepared by:	A.Jackson		
Checked by:	J.Hubler		

Additional Comments:

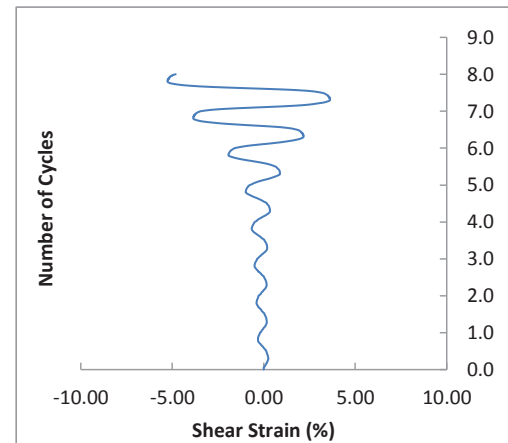
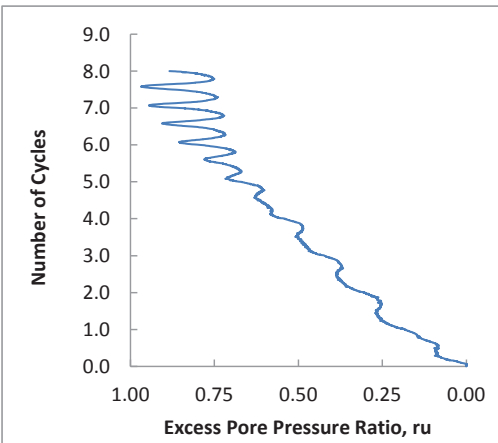
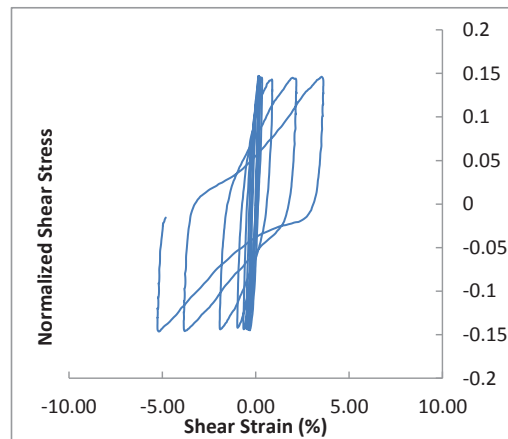
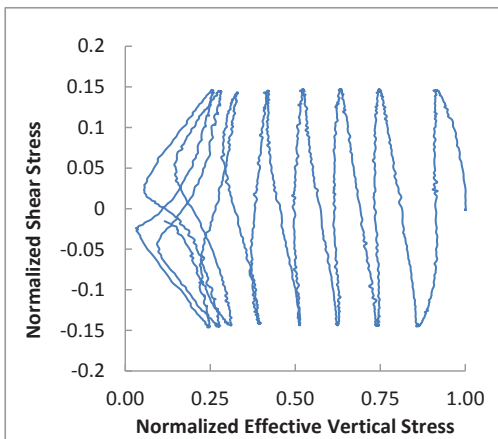

CSS Monotonic Shear Test Report

Geotechnical Engineering Laboratory



10/28/2013_Version 8.0

General Test Info and Sample Preparation

Device:	CSS	Relative Density (%):	66%
Specimen ID:	PGD	Void Ratio:	0.641
Test ID:	C185	Height (mm):	109.2
Date of Test:	6/30/2015	Soil-Only Specimen Diameter (mm):	306.23
Test Performed:	Post Cyclic Monotonic Shear	Weight (kg):	13.431
Test Material:	Pea Gravel	Density (kg/m³):	1670.1
Sample Preparation:	Prepared dense specimen with 25 tamps in 3 layers.	Membrane Thickness (mm):	0.635
		Moisture Content (%):	0%
		Saturated (Y/N):	N
		Prepared by:	A. Jackson
		Checked by:	J. Hubler

Consolidation Stage

Vertical Stress (kPa):	100
Time to Compression (min):	19.7
Relative Density (%):	86%
Void Ratio:	0.602
Height (mm):	106.6
Diameter (mm):	306.23
Weight (kg):	13.431
Density (kg/m³):	1710.5

Shear Stage

Type of Test:	Constant Volume
Stress or Strain Controlled:	Strain
Shear Strain Rate (%/min):	0.31
Peak Shear Strength (kPa):	60.0

Comments

Consolidation Data is for pre-liquefaction.

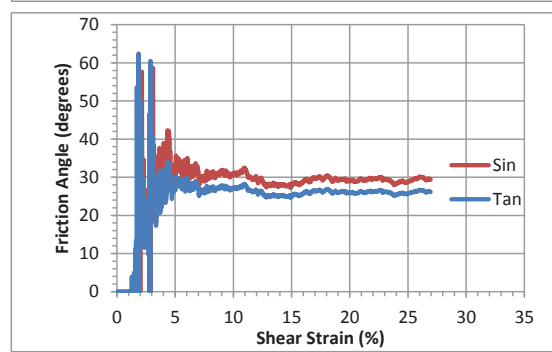
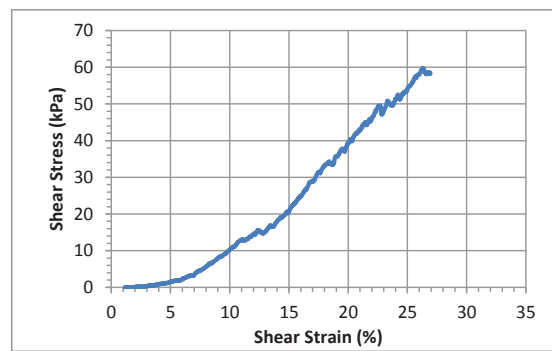
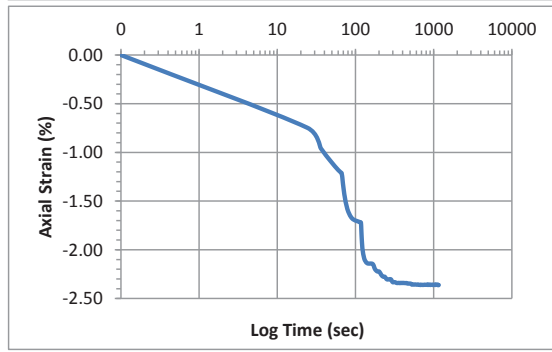
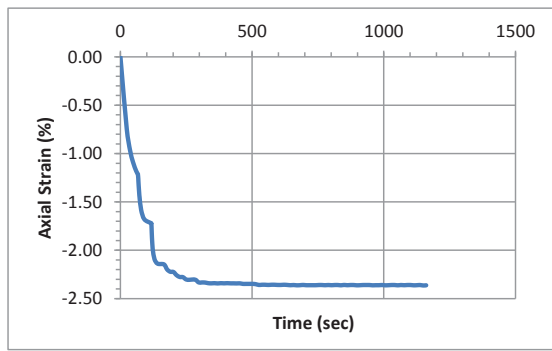

Accelerometer-Based Shear Wave Velocity Datasheet

Specimen ID: C185-PGD-100-2X
 Test Material: PGD
 Date: 6/30/2015
 Test Performed by: J.Hubler
 Filename: C185-PGD-100-2X

Vertical Stress: 100kPa
 Sensor Spacing: 0.10657 m
 V_s (rise) = 217 m/s

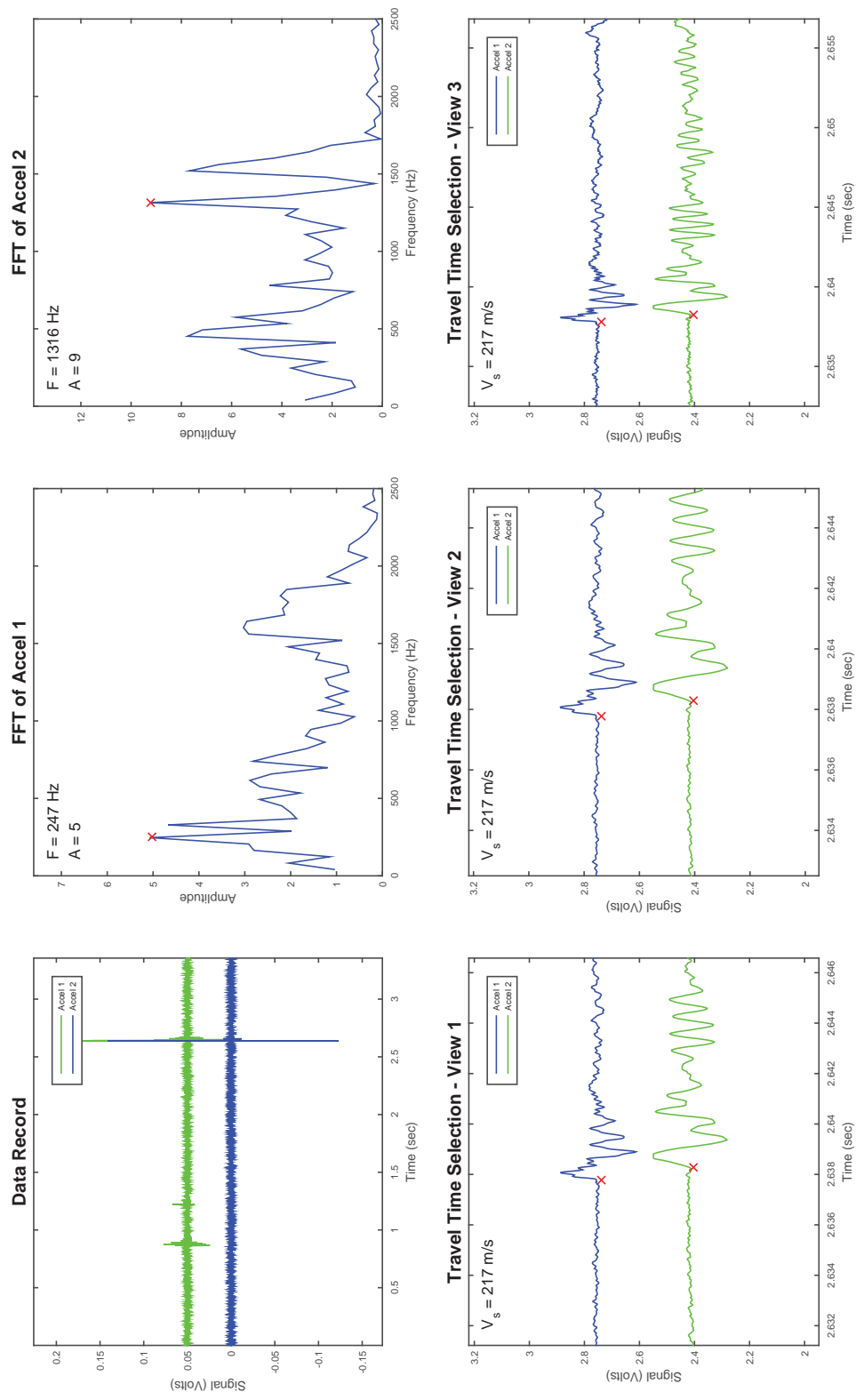

CSS Cyclic Shear Test Report

Geotechnical Engineering Laboratory



Cyclic Shear Test Summary

Device:	CSS	Density (kg/m³):	1630
Specimen ID:	PGL	Relative Density (%):	46%
Test ID:	C186	Void Ratio:	0.681
Date of Test:	7/1/2015	Vertical Stress (kPa):	100
Test Performed:	Cyclic Shear	Loading Frequency (Hz):	0.33
Test Material:	Pea Gravel	Number of Cycles:	240
Sample Preparation:	Prepared loose using the shoveling method.	Cyclic Stress Ratio:	0.044
		Shear Modulus (kPa):	
		Damping (%):	
Prepared by:	A.Jackson	Shear Strain Single Amplitude (%)	
Checked by:	J.Hubler		

Additional Comments:

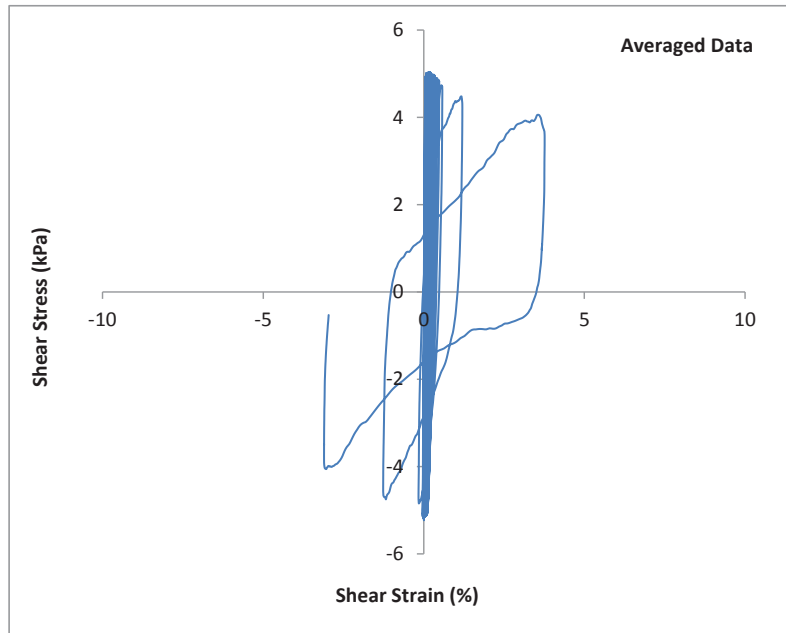
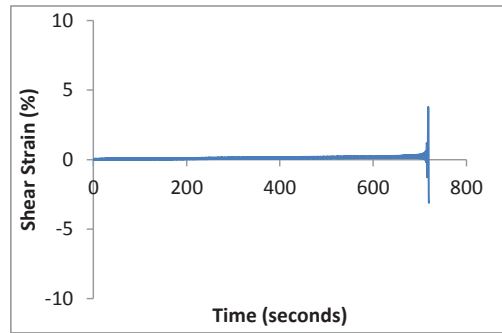
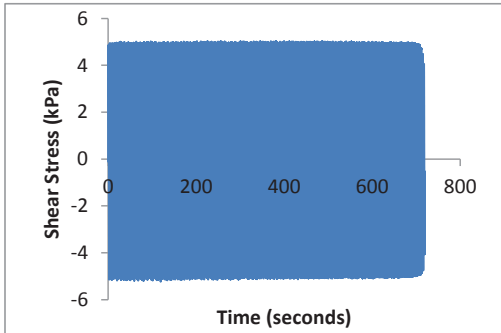

CSS Cyclic Shear Test Report

Geotechnical Engineering Laboratory



Cyclic Shear Test Summary

Device:	CSS	Density (kg/m³):	1630
Specimen ID:	PGL	Relative Density (%):	46%
Test ID:	C186	Void Ratio:	0.681
Date of Test:	7/1/2015	Vertical Stress (kPa):	100
Test Performed:	Cyclic Shear	Loading Frequency (Hz):	0.33
Test Material:	Pea Gravel	Number of Cycles:	240
Sample Preparation:	Prepared loose using the shoveling method.	Cyclic Stress Ratio:	0.044
		Number of Cycles to Liq:	240
		Maximum ru:	1.00
Prepared by:	A.Jackson		
Checked by:	J.Hubler		

Additional Comments:

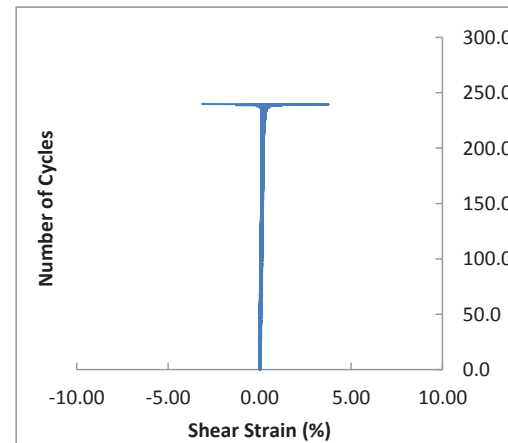
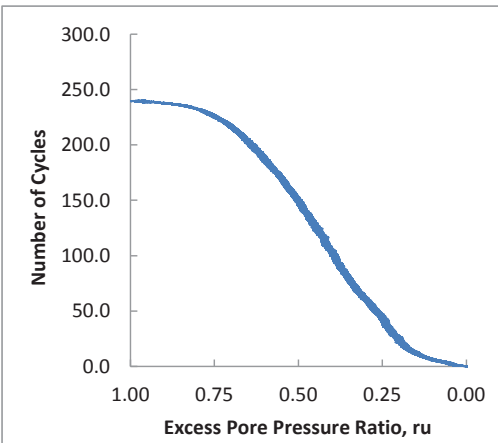
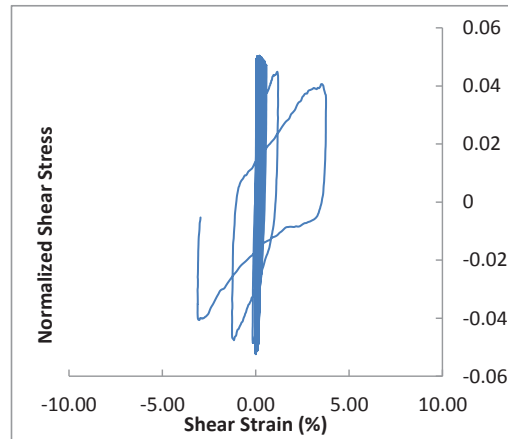
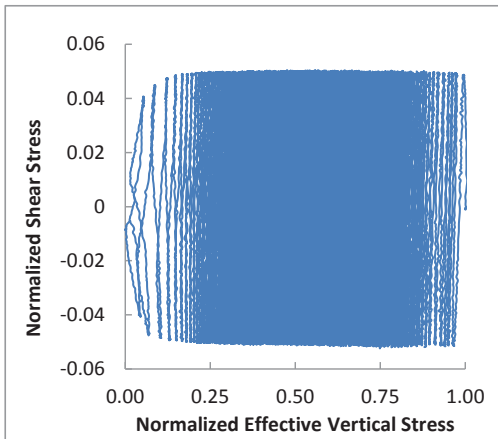

CSS Monotonic Shear Test Report

Geotechnical Engineering Laboratory



10/28/2013_Version 8.0

General Test Info and Sample Preparation

Device:	CSS	Relative Density (%):	1%
Specimen ID:	PGL	Void Ratio:	0.771
Test ID:	C186	Height (mm):	111.4
Date of Test:	7/1/2015	Soil-Only Specimen Diameter (mm):	306.23
Test Performed:	Post Cyclic Monotonic Shear	Weight (kg):	12.699
Test Material:	Pea Gravel	Density (kg/m³):	1547.2
Sample Preparation:	Prepared loose specimen using shoveling method	Membrane Thickness (mm):	0.635
		Moisture Content (%):	0%
		Saturated (Y/N):	N
		Prepared by:	A. Jackson
		Checked by:	J. Hubler

Consolidation Stage

Vertical Stress (kPa):	100
Time to Compression (min):	21.9
Relative Density (%):	46%
Void Ratio:	0.681
Height (mm):	105.8
Diameter (mm):	306.23
Weight (kg):	12.699
Density (kg/m³):	1629.7

Shear Stage

Type of Test:	Constant Volume
Stress or Strain Controlled:	Strain
Shear Strain Rate (%/min):	0.31
Peak Shear Strength (kPa):	6.0

Comments

Consolidation Data is for pre-liquefaction.

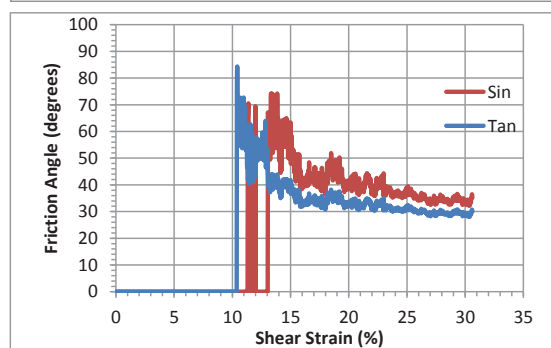
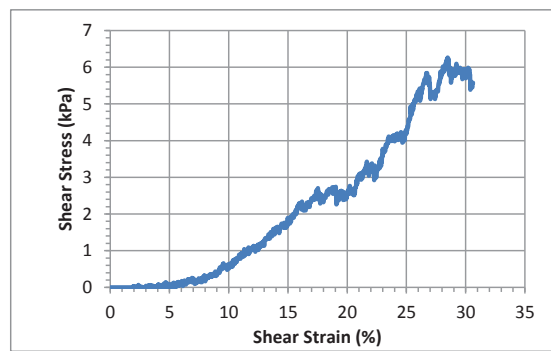
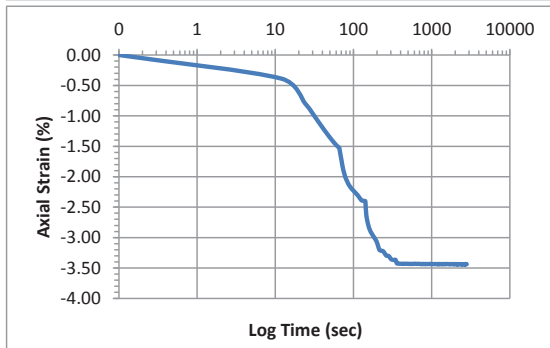
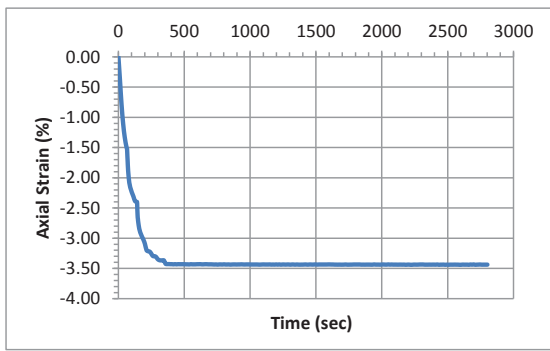

Accelerometer-Based Shear Wave Velocity Datasheet

Specimen ID: C186-PGL-100-1X

Test Material: PGL

Date: 7/1/2015

Test Performed by: J.Hubler

Filename: C186-PGL-100-1X

Vertical Stress: 100kPa

Sensor Spacing: 0.10576 m

V_s (rise) = 192 m/s

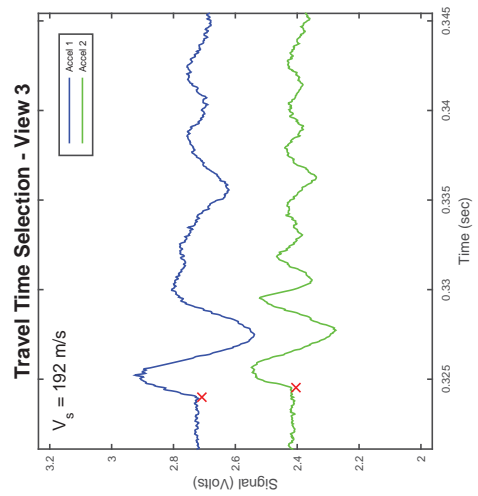
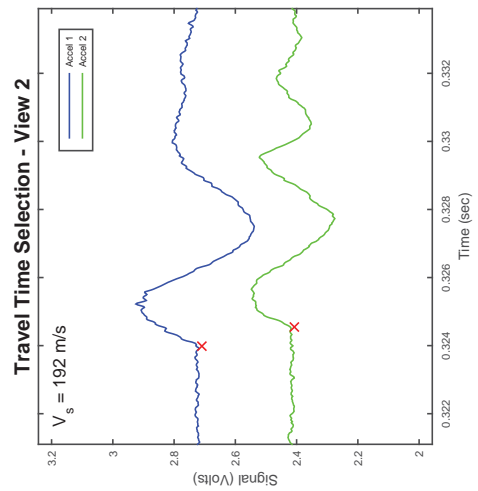
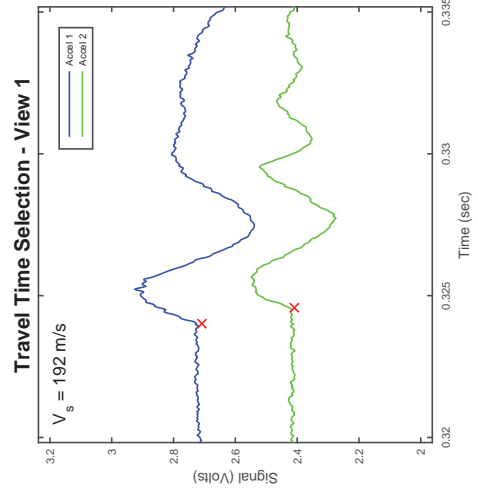
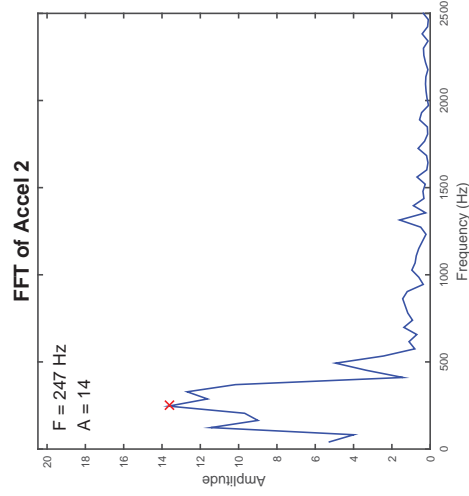
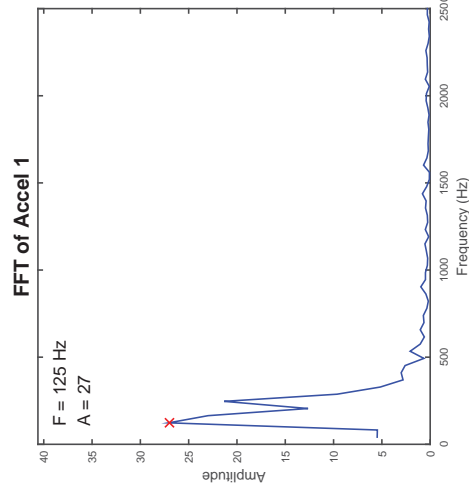
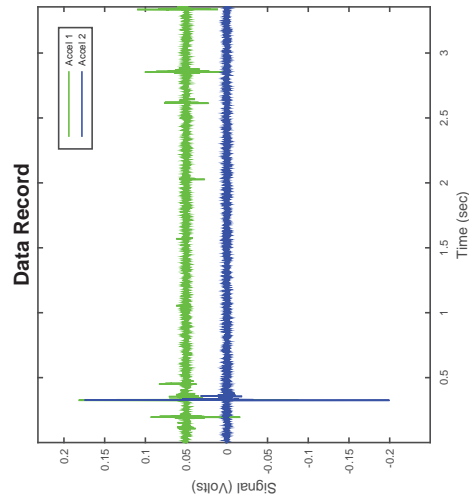

CSS Cyclic Shear Test Report

Geotechnical Engineering Laboratory



Cyclic Shear Test Summary

Device:	CSS	Density (kg/m³):	1631
Specimen ID:	PGL	Relative Density (%):	47%
Test ID:	C187	Void Ratio:	0.680
Date of Test:	7/1/2015	Vertical Stress (kPa):	100
Test Performed:	Cyclic Shear	Loading Frequency (Hz):	0.33
Test Material:	Pea Gravel	Number of Cycles:	6
Sample Preparation:	Prepared loose specimen using shoveling method.	Cyclic Stress Ratio:	0.144
		Shear Modulus (kPa):	
		Damping (%):	
Prepared by:	A.Jackson	Shear Strain Single Amplitude (%)	
Checked by:	J.Hubler		

Additional Comments:

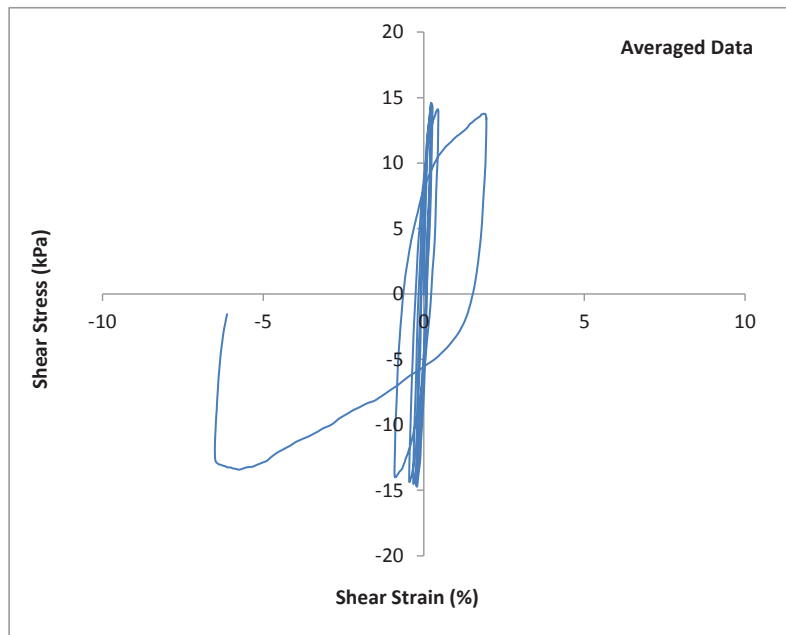
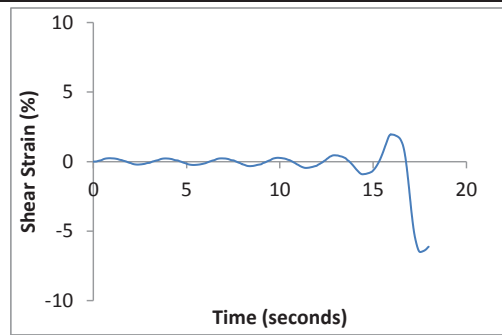
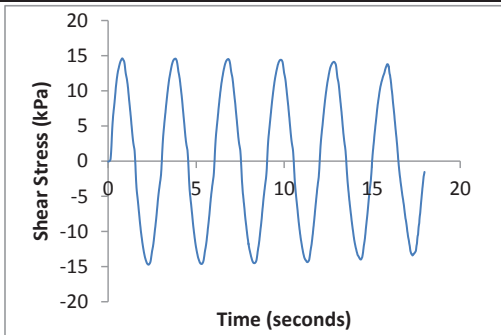

CSS Cyclic Shear Test Report

Geotechnical Engineering Laboratory



Cyclic Shear Test Summary

Device:	CSS	Density (kg/m³):	1631
Specimen ID:	PGL	Relative Density (%):	47%
Test ID:	C187	Void Ratio:	0.680
Date of Test:	7/1/2015	Vertical Stress (kPa):	100
Test Performed:	Cyclic Shear	Loading Frequency (Hz):	0.33
Test Material:	Pea Gravel	Number of Cycles:	6
Sample Preparation:	Prepared loose specimen using shoveling method.	Cyclic Stress Ratio:	0.144
		Number of Cycles to Liq:	6
		Maximum ru:	0.88
Prepared by:	A.Jackson		
Checked by:	J.Hubler		

Additional Comments:

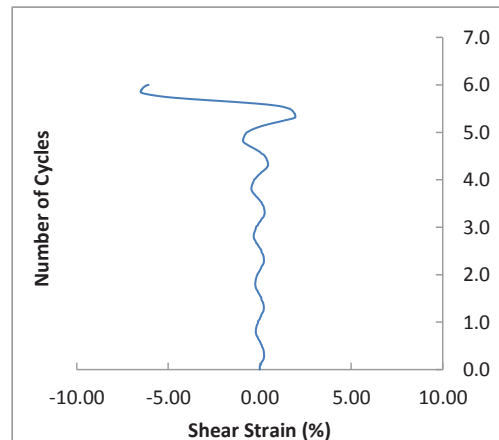
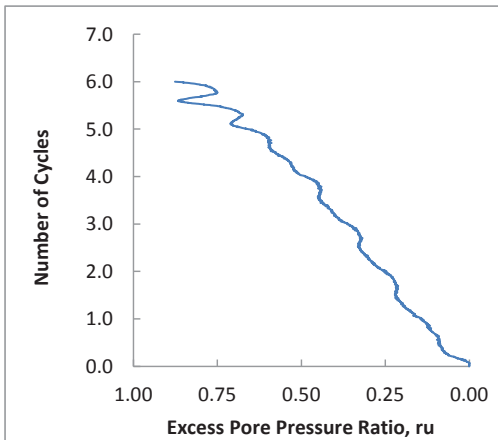
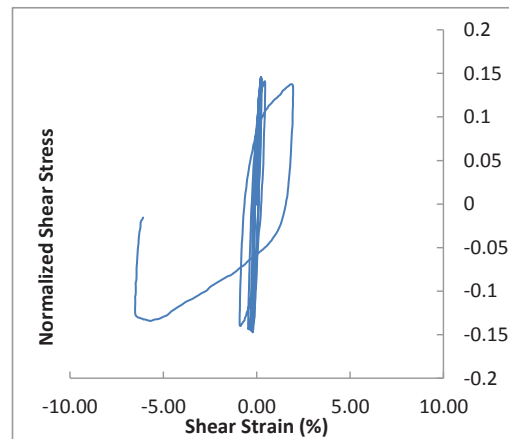
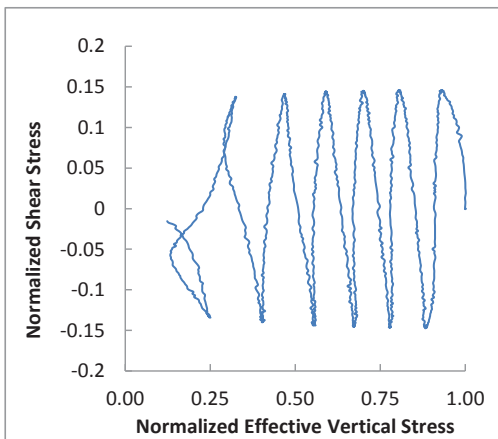

CSS Monotonic Shear Test Report

Geotechnical Engineering Laboratory



10/28/2013_Version 8.0

General Test Info and Sample Preparation

Device:	CSS	Relative Density (%):	4%
Specimen ID:	PGL	Void Ratio:	0.764
Test ID:	C187	Height (mm):	110.7
Date of Test:	7/1/2015	Soil-Only Specimen Diameter (mm):	306.23
Test Performed:	Post Cyclic Monotonic Shear	Weight (kg):	12.667
Test Material:	Pea Gravel	Density (kg/m³):	1553.6
Sample Preparation:	Prepaed loose using a shovel.	Membrane Thickness (mm):	0.635
		Moisture Content (%):	0%
		Saturated (Y/N):	N
		Prepared by:	A. Jackson
		Checked by:	J. Hubler

Consolidation Stage

Vertical Stress (kPa):	100
Time to Compression (min):	21.9
Relative Density (%):	47%
Void Ratio:	0.680
Height (mm):	105.4
Diameter (mm):	306.23
Weight (kg):	12.667
Density (kg/m³):	1631.1

Shear Stage

Type of Test:	Constant Volume
Stress or Strain Controlled:	Strain
Shear Strain Rate (%/min):	0.31
Peak Shear Strength (kPa):	11.0

Comments

Conosolidation Data is for pre-liquefaction.

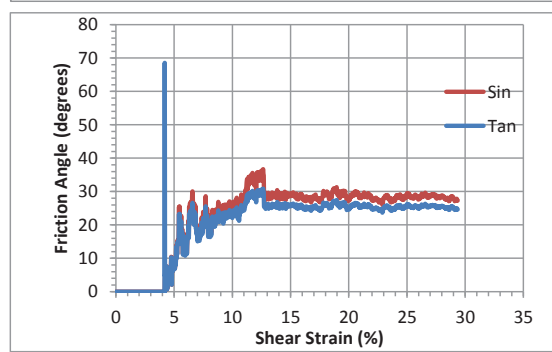
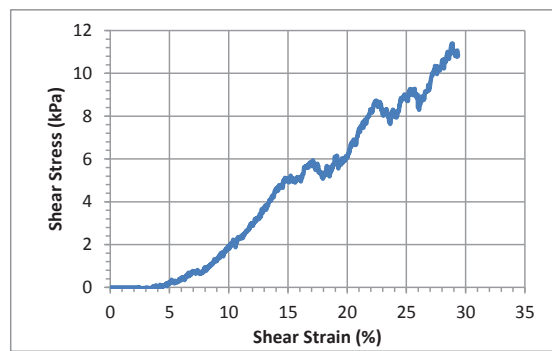
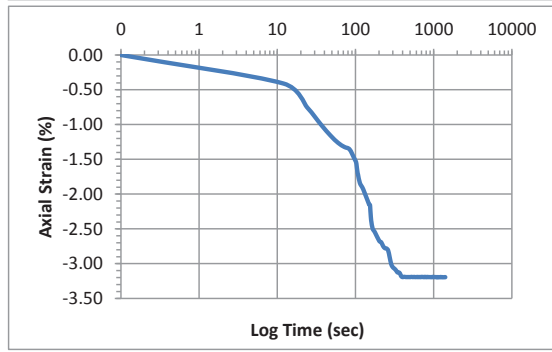
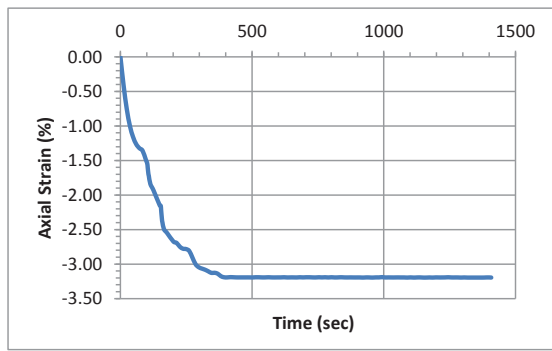

Accelerometer-Based Shear Wave Velocity Datasheet

Specimen ID: C187-PGL-100-1X

Test Material: PGL

Date: 7/1/2015

Test Performed by: J.Hubler

Filename: C187-PGL-100-1X

Vertical Stress: 100kPa

Sensor Spacing: 0.1054 m

V_s (rise) = 182 m/s

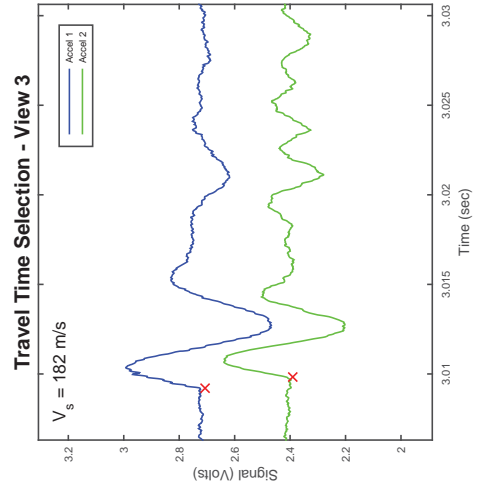
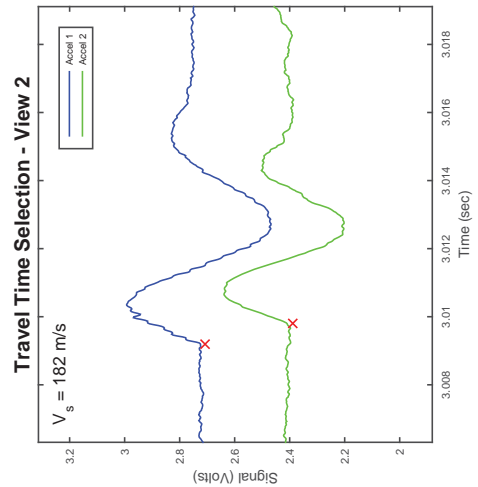
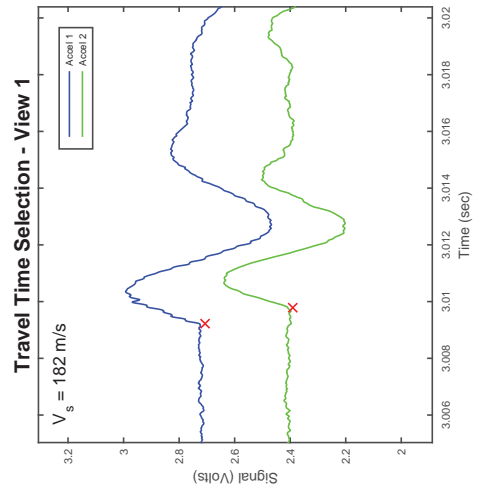
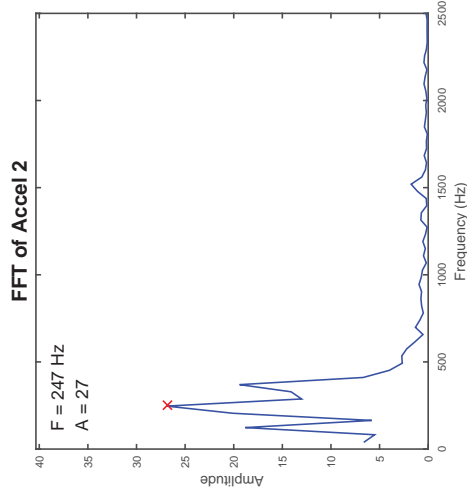
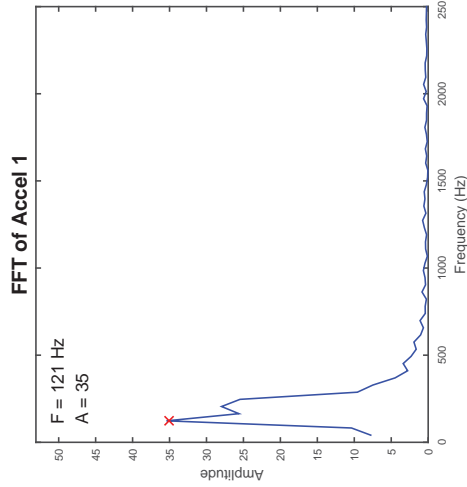
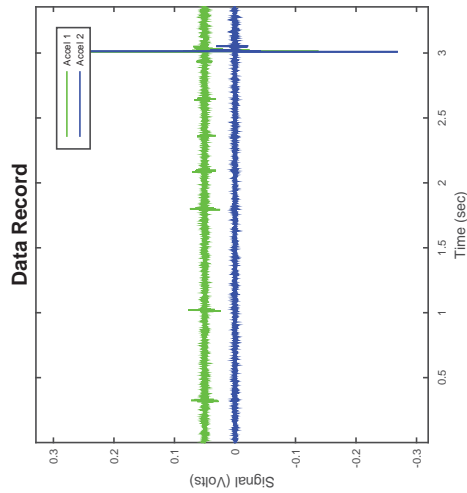

Accelerometer-Based Shear Wave Velocity Datasheet

Specimen ID: C187-PGL-100-2X
 Test Material: PGL
 Date: 7/1/2015
 Test Performed by: J.Hubler
 Filename: C187-PGL-100-2X

Vertical Stress: 100kPa
 Sensor Spacing: 0.1054 m
 V_s (rise) = 187 m/s

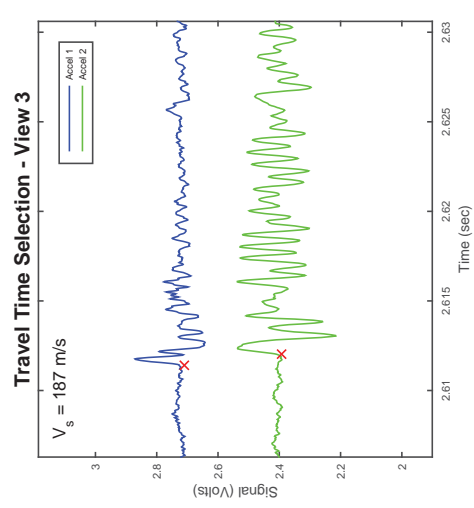
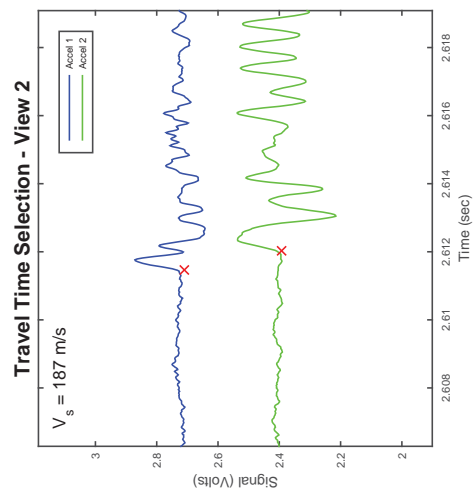
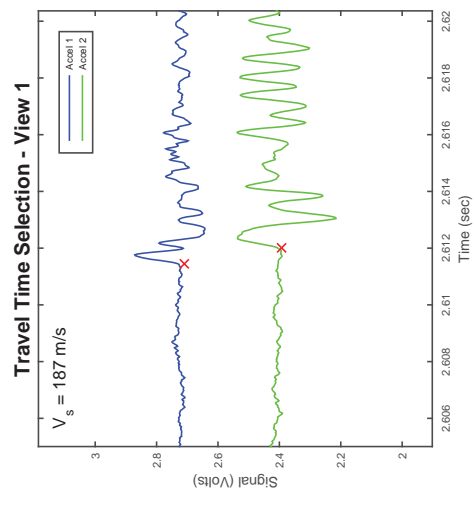
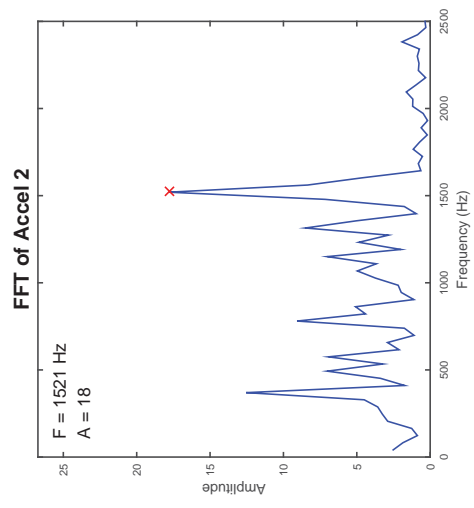
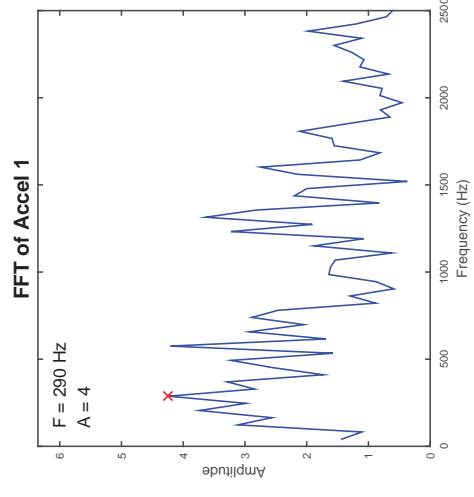
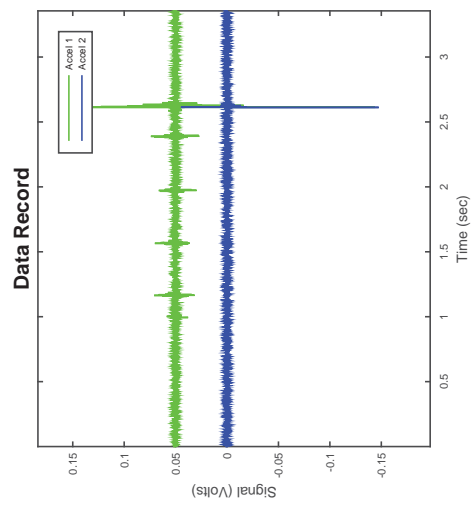

CSS Cyclic Shear Test Report

Geotechnical Engineering Laboratory



Cyclic Shear Test Summary

Device:	CSS	Density (kg/m³):	1724
Specimen ID:	PGD	Relative Density (%):	92%
Test ID:	C191	Void Ratio:	0.590
Date of Test:	7/13/2015	Vertical Stress (kPa):	100
Test Performed:	Cyclic	Loading Frequency (Hz):	0.33
Test Material:	Pea Gravel	Number of Cycles:	2
Sample Preparation:	Prepared dense specimen by tamping 25x at 3 layers.	Cyclic Stress Ratio:	0.194
		Shear Modulus (kPa):	
		Damping (%):	
Prepared by:	Alesha Jackson	Shear Strain Single Amplitude (%)	
Checked by:	Jonathan Hubler		

Additional Comments:

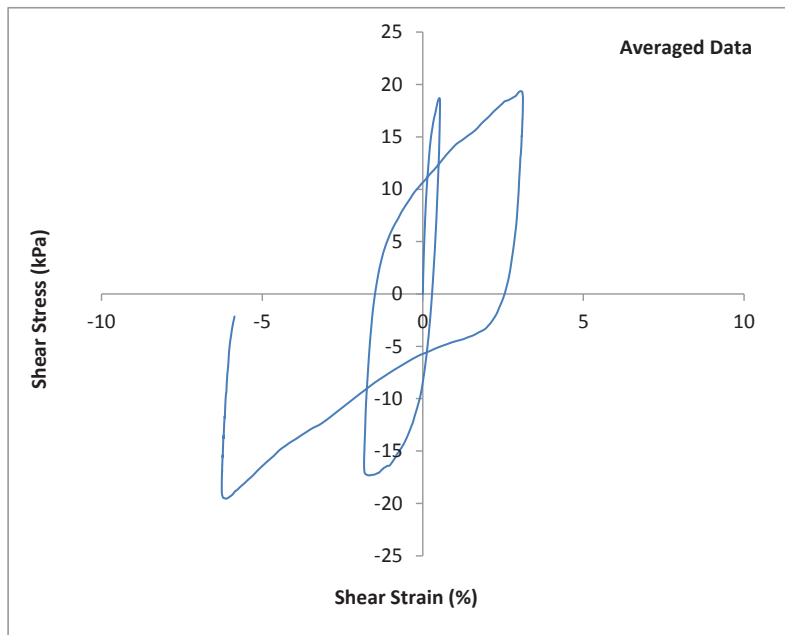
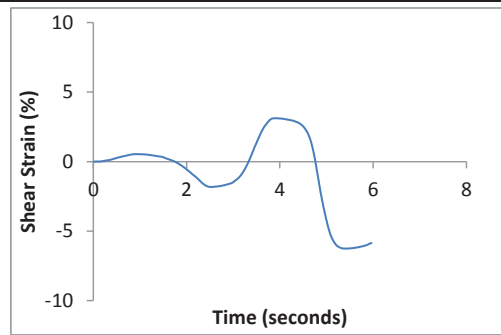
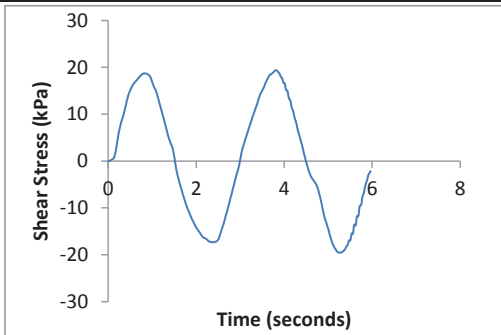

CSS Cyclic Shear Test Report

Geotechnical Engineering Laboratory



Cyclic Shear Test Summary

Device:	CSS	Density (kg/m³):	1724
Specimen ID:	PGD	Relative Density (%):	92%
Test ID:	C191	Void Ratio:	0.590
Date of Test:	7/13/2015	Vertical Stress (kPa):	100
Test Performed:	Cyclic	Loading Frequency (Hz):	0.33
Test Material:	Pea Gravel	Number of Cycles:	2
Sample Preparation:	Prepared dense specimen by tamping 25x at 3 layers.	Cyclic Stress Ratio:	0.194
		Number of Cycles to Liq:	2
		Maximum ru:	0.90
Prepared by:	Alesha Jackson		
Checked by:	Jonathan Hubler		

Additional Comments:

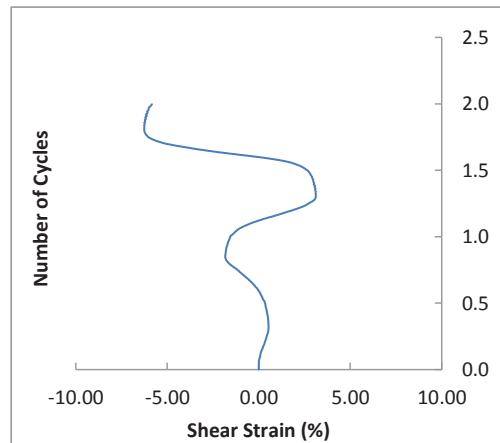
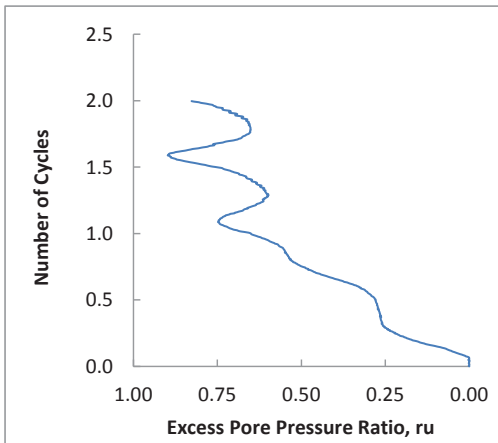
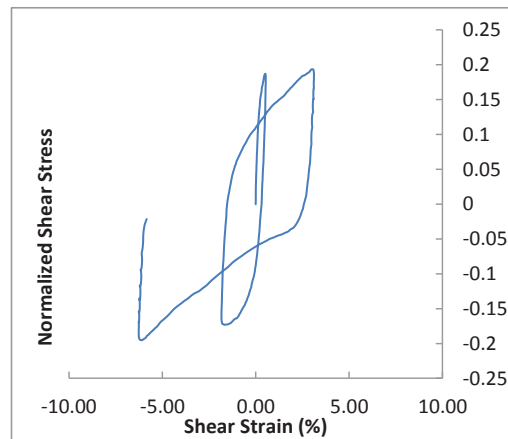
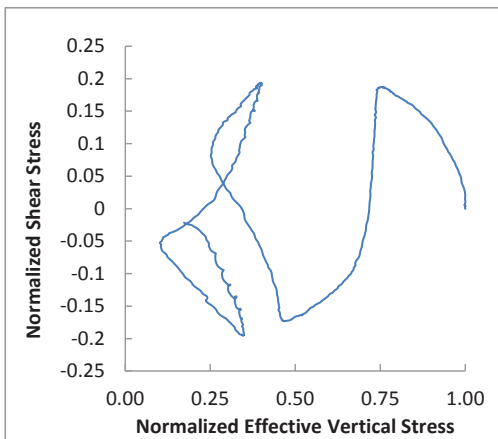

CSS Monotonic Shear Test Report

Geotechnical Engineering Laboratory



10/28/2013_Version 8.0

General Test Info and Sample Preparation

Device:	CSS	Relative Density (%):	79%
Specimen ID:	PGD	Void Ratio:	0.615
Test ID:	C191	Height (mm):	110.5
Date of Test:	7/13/2015	Soil-Only Specimen Diameter (mm):	306.23
Test Performed:	Post Cyclic Monotonic Shear	Weight (kg):	13.805
Test Material:	Pea Gravel	Density (kg/m³):	1696.2
Sample Preparation:	Prepared dense specimen by tamping 25x at 3 layers each	Membrane Thickness (mm):	0.635
		Moisture Content (%):	0%
		Saturated (Y/N):	N
		Prepared by:	A. Jackson
		Checked by:	J. Hubler

Consolidation Stage

Vertical Stress (kPa):	100
Time to Compression (min):	21.7
Relative Density (%):	92%
Void Ratio:	0.590
Height (mm):	108.7
Diameter (mm):	306.23
Weight (kg):	13.805
Density (kg/m³):	1723.7

Shear Stage

Type of Test:	Constant Volume
Stress or Strain Controlled:	Strain
Shear Strain Rate (%/min):	0.30
Peak Shear Strength (kPa):	26.0

Comments

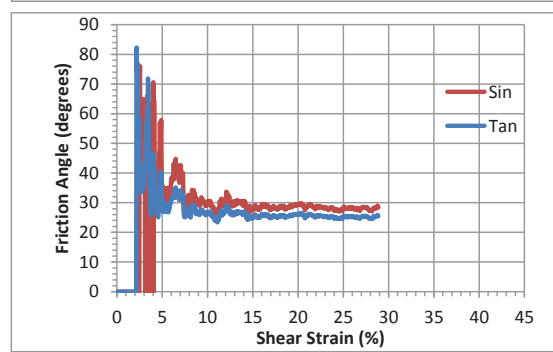
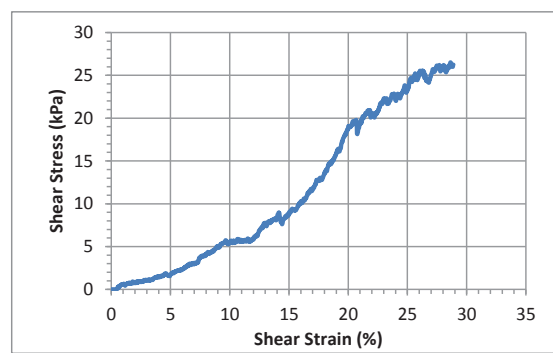
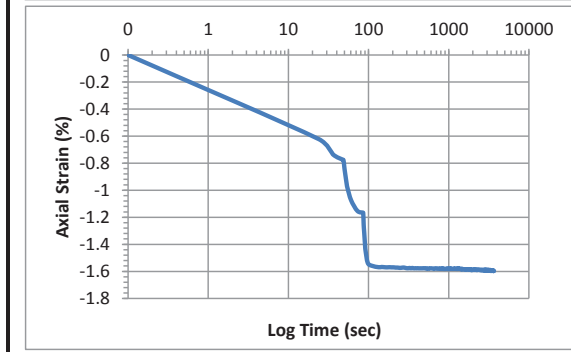
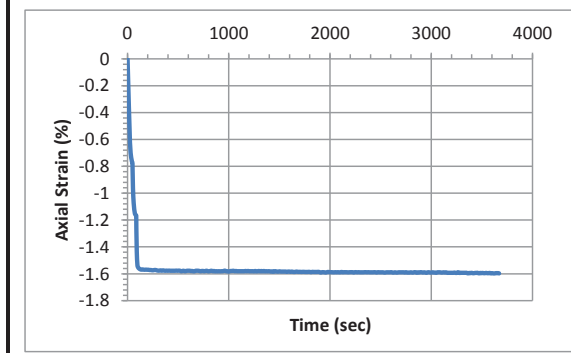

Accelerometer-Based Shear Wave Velocity Datasheet

Specimen ID: C191-PGD-100-2X
 Test Material: PGD
 Date: 7/13/2015
 Test Performed by: J.Hubler
 Filename: C191-PGD-100-2X

Vertical Stress: 100kPa
 Sensor Spacing: 0.10869 m
 V_s (rise) = 228 m/s

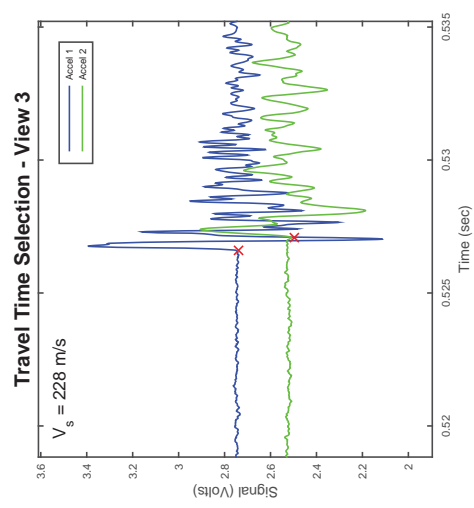
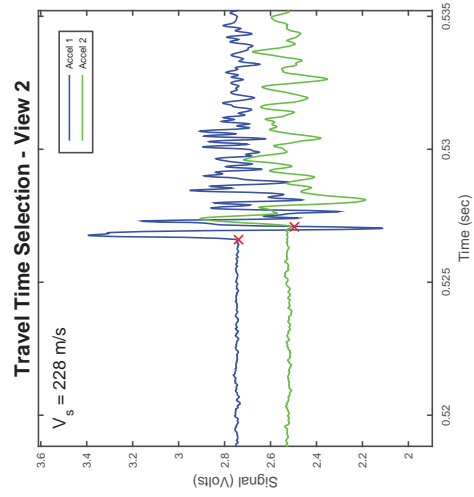
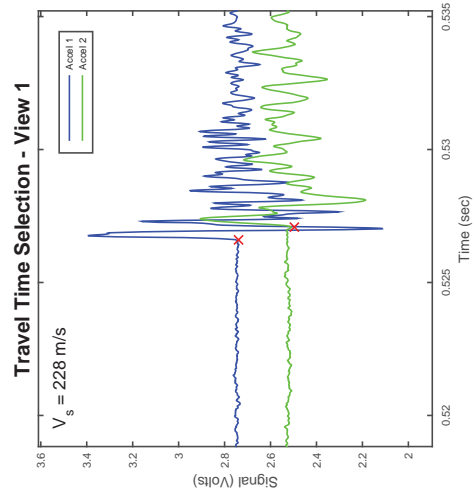
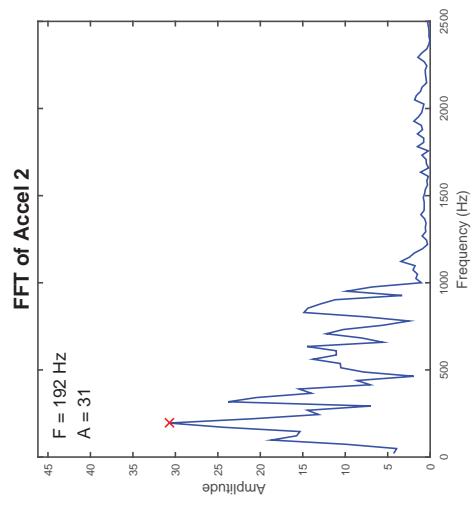
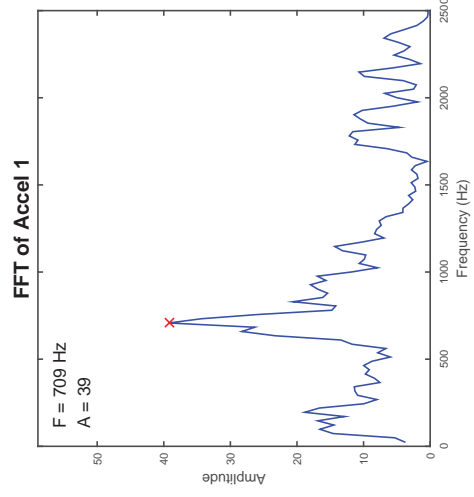
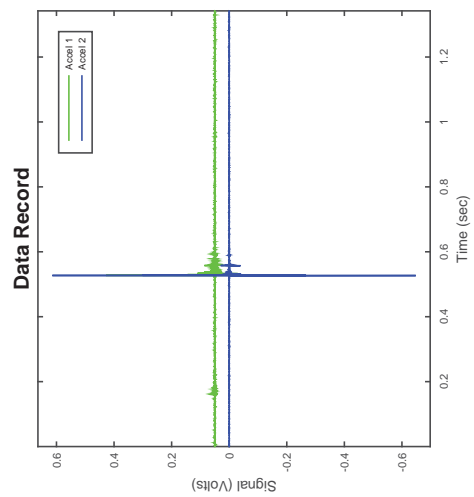

Accelerometer-Based Shear Wave Velocity Datasheet

Specimen ID: C191-PGD-100-3X

Test Material: PGD

Date: 7/13/2015

Test Performed by: J.Hubler

Filename: C191-PGD-100-3X

Vertical Stress: 100kPa

Sensor Spacing: 0.10869 m

V_s (rise) = 214 m/s

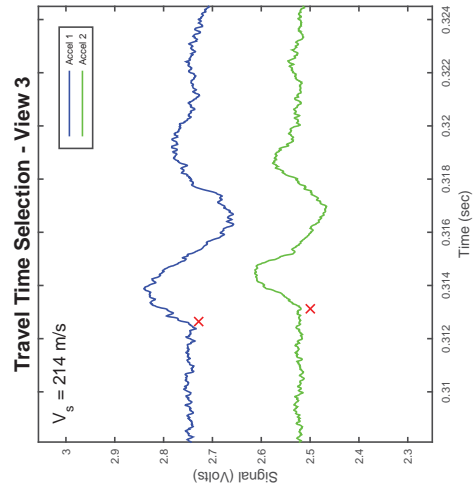
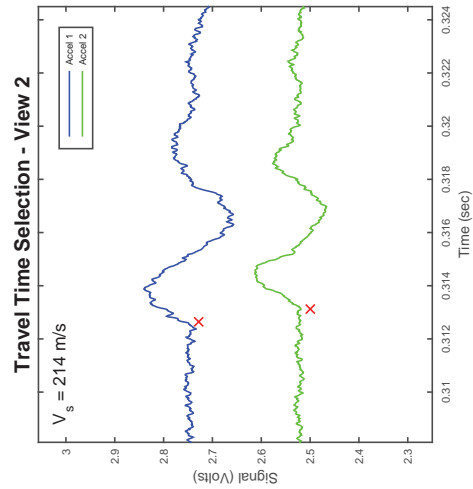
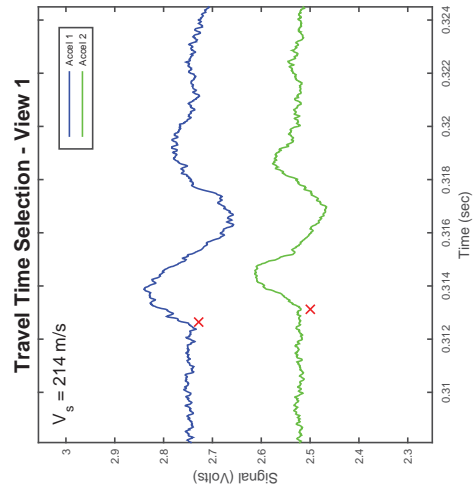
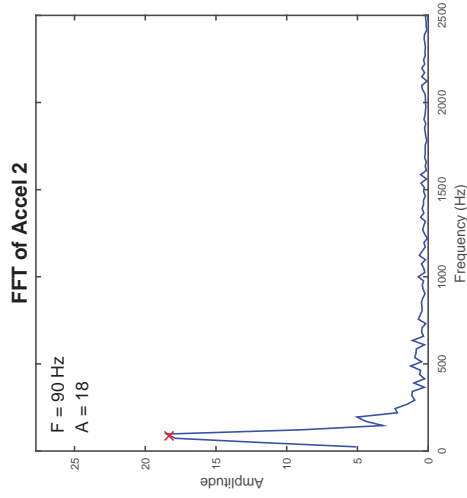
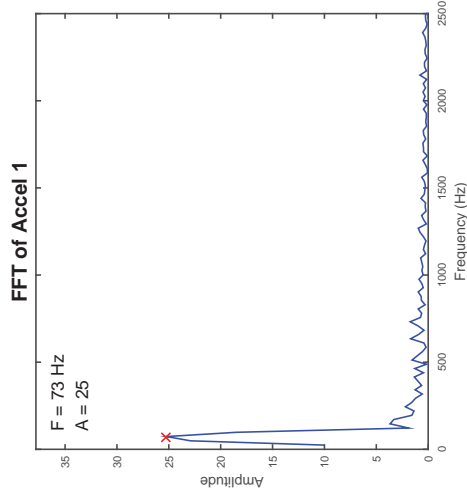
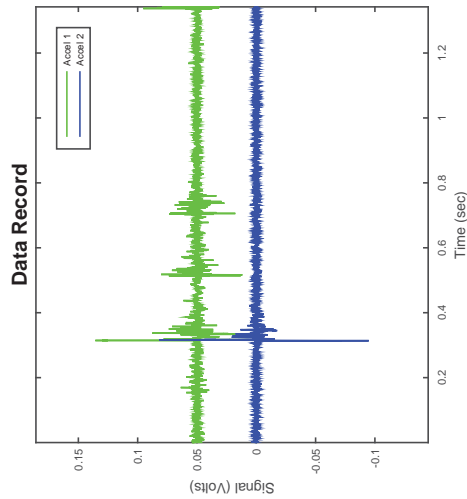

CSS Cyclic Shear Test Report

Geotechnical Engineering Laboratory



Cyclic Shear Test Summary

Device:	CSS	Density (kg/m³):	1437
Specimen ID:	CLS5	Relative Density (%):	48%
Test ID:	C192	Void Ratio:	0.844
Date of Test:	7/17/2015	Vertical Stress (kPa):	50
Test Performed:	Cyclic	Loading Frequency (Hz):	0.33
Test Material:	5mm Crushed Limestone	Number of Cycles:	47
Sample Preparation:	Prepared loose using shoveling method then hit base plate with rubber mallet 25x in 3 layers.	Cyclic Stress Ratio:	0.088
		Shear Modulus (kPa):	
		Damping (%):	
Prepared by:	A.Jackson	Shear Strain Single Amplitude (%):	
Checked by:	J.Hubler		

Additional Comments:

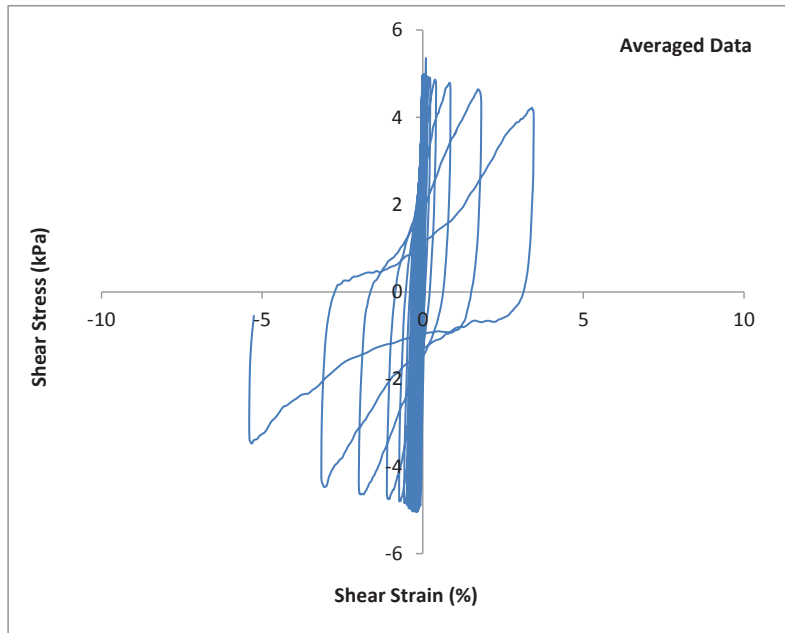
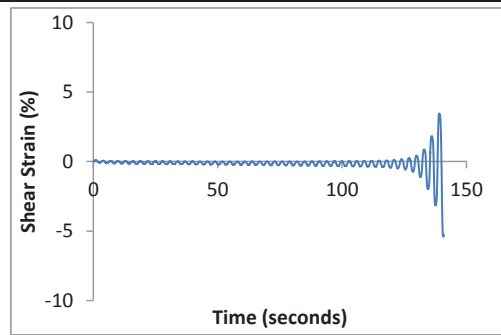
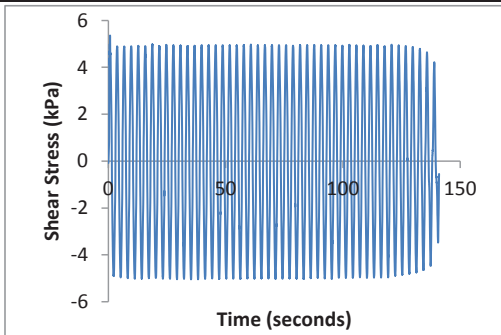

CSS Cyclic Shear Test Report

Geotechnical Engineering Laboratory



Cyclic Shear Test Summary

Device:	CSS	Density (kg/m³):	1437
Specimen ID:	CLS5	Relative Density (%):	48%
Test ID:	C192	Void Ratio:	0.844
Date of Test:	7/17/2015	Vertical Stress (kPa):	50
Test Performed:	Cyclic	Loading Frequency (Hz):	0.33
Test Material:	5mm Crushed Limestone	Number of Cycles:	47
Sample Preparation:	Prepared loose using shoveling method then hit base plate with rubber mallet 25x in 3 layers.	Cyclic Stress Ratio:	0.088
		Number of Cycles to Liq:	47
		Maximum ru:	1.05
Prepared by:	A.Jackson		
Checked by:	J.Hubler		

Additional Comments:

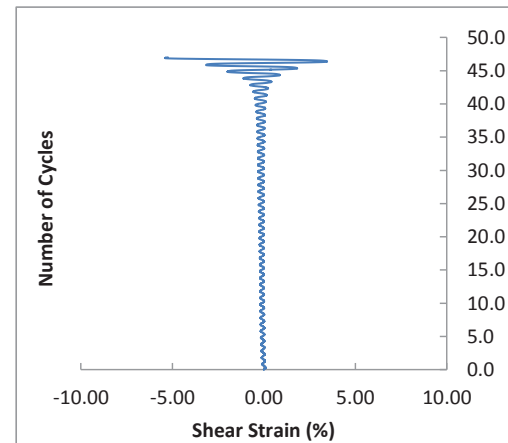
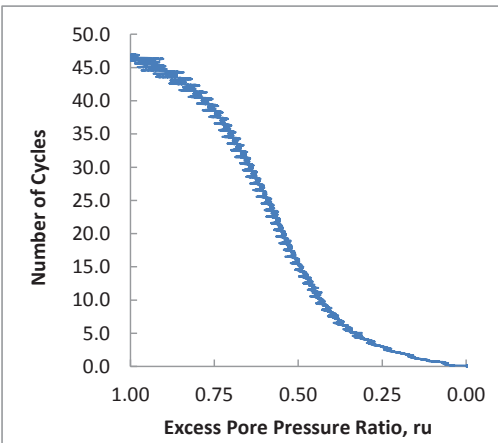
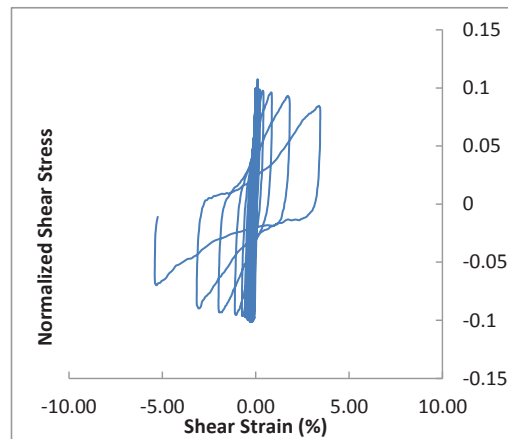
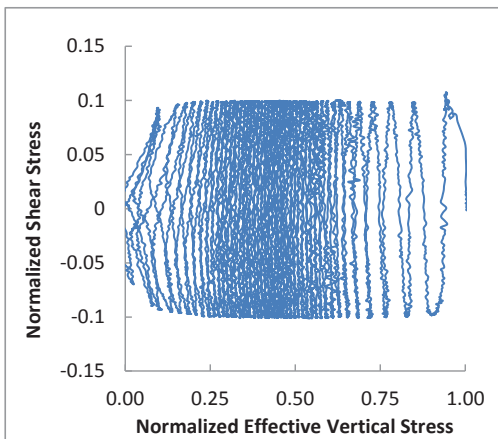

CSS Monotonic Shear Test Report

Geotechnical Engineering Laboratory



10/28/2013_Version 8.0

General Test Info and Sample Preparation

Device:	CSS	Relative Density (%):	37%
Specimen ID:	CLS5	Void Ratio:	0.895
Test ID:	C192	Height (mm):	109.7
Date of Test:	7/17/2015	Soil-Only Specimen Diameter (mm):	306.23
Test Performed:	Post-Cyclic Mono	Weight (kg):	11.295
Test Material:	5mm Crushed Limestone	Density (kg/m³):	1398.6
Sample Preparation:	Prepared loose using the shoveling method. To reach required density - rubber mallet hit baseplate 25x in 3 layers after shoveling.	Membrane Thickness (mm):	0.635
		Moisture Content (%):	0%
		Saturated (Y/N):	N
		Prepared by:	A. Jackson
		Checked by:	J. Hubler

Consolidation Stage

Vertical Stress (kPa):	50
Time to Compression (min):	13.0
Relative Density (%):	48%
Void Ratio:	0.844
Height (mm):	106.7
Diameter (mm):	306.23
Weight (kg):	11.295
Density (kg/m³):	1437.0

Shear Stage

Type of Test:	Constant Volume
Stress or Strain Controlled:	Strain
Shear Strain Rate (%/min):	0.31
Peak Shear Strength (kPa):	20.0

Comments

Silver Baseplate used with cushion membrane.

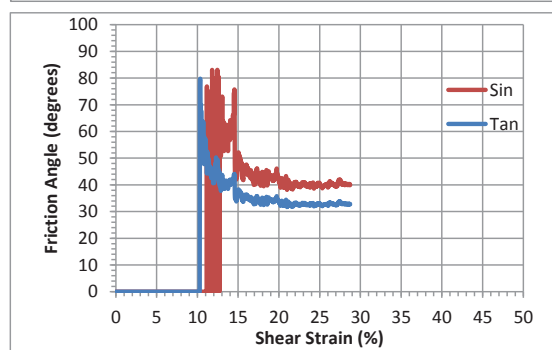
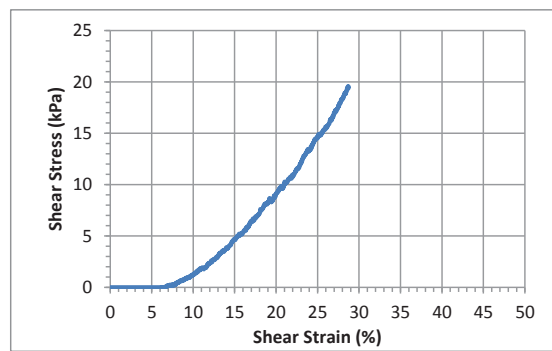
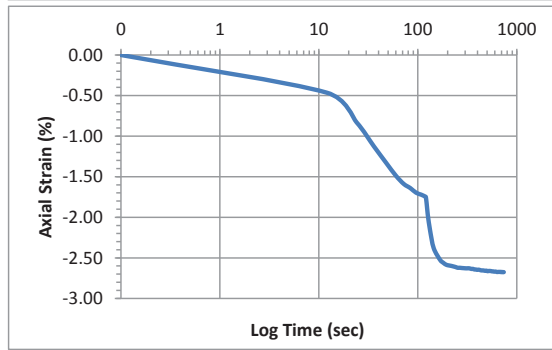
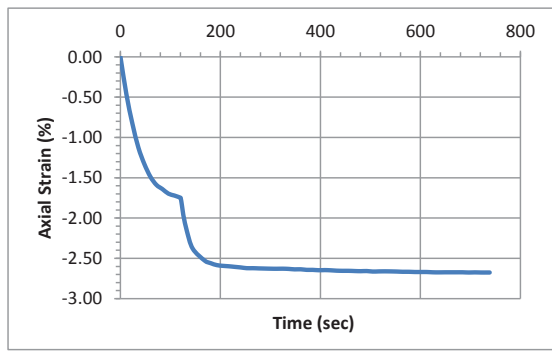

Accelerometer-Based Shear Wave Velocity Datasheet

Specimen ID: C192-FLS-50-1X
 Test Material: FLS
 Date: 7/17/2015
 Test Performed by: J.Hubler
 Filename: C192-FLS-50-1X

Vertical Stress: 50kPa
 Sensor Spacing: 0.10667 m
 V_s (rise) = 156 m/s

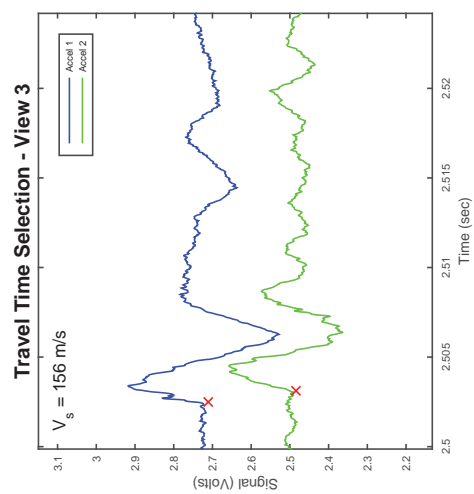
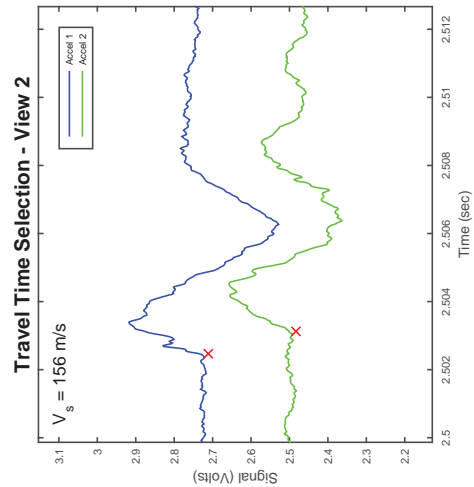
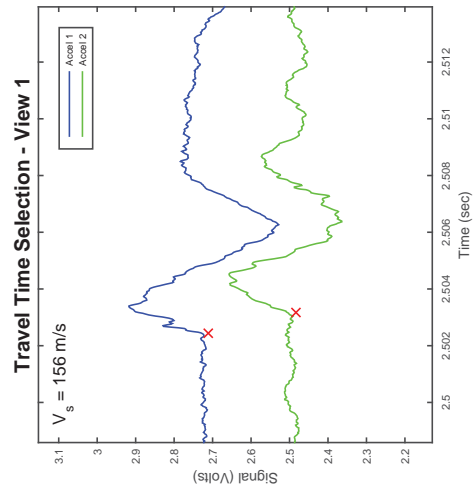
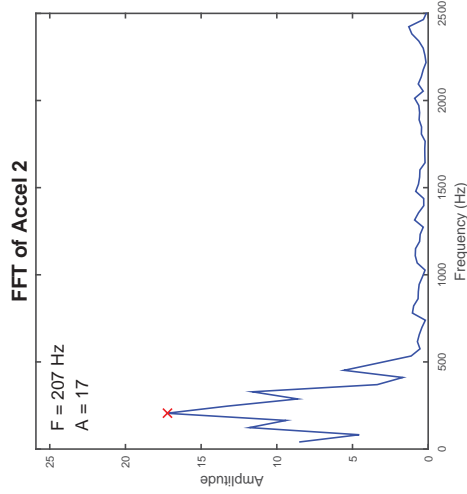
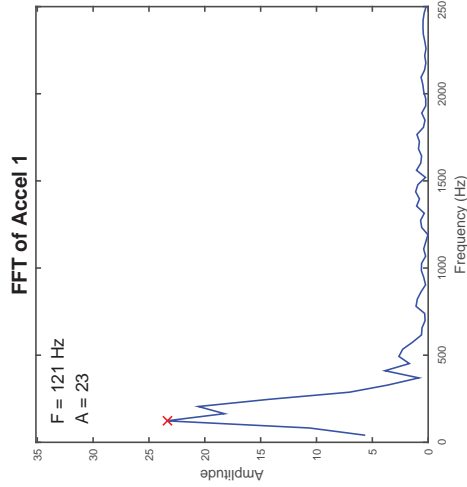
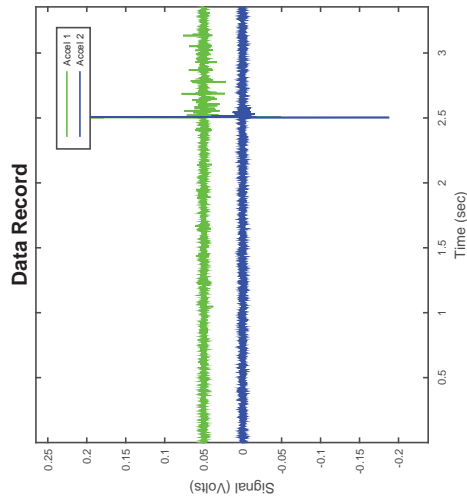

Accelerometer-Based Shear Wave Velocity Datasheet

Specimen ID: C192-FLS-50-3X
 Test Material: FLS
 Date: 7/17/2015
 Test Performed by: J.Hubler
 Filename: C192-FLS-50-3X

Vertical Stress: 50kPa
 Sensor Spacing: 0.10667 m
 V_s (rise) = 171 m/s

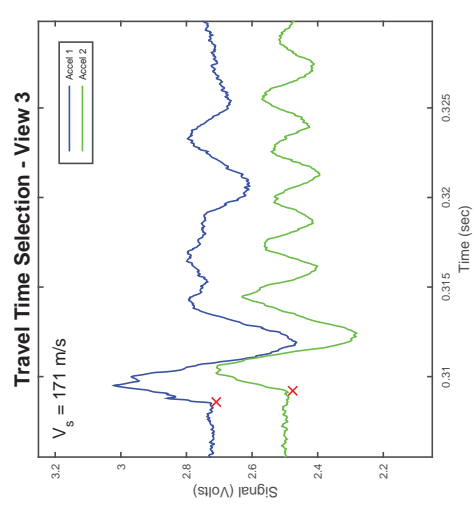
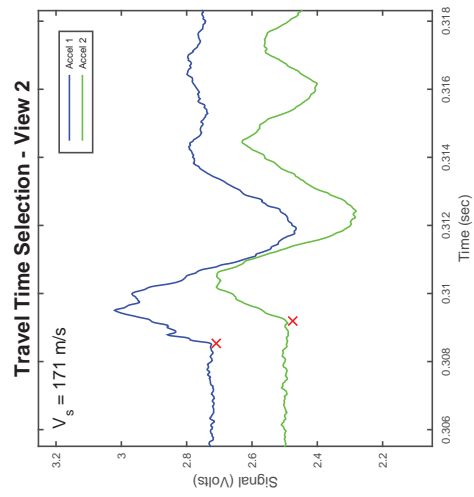
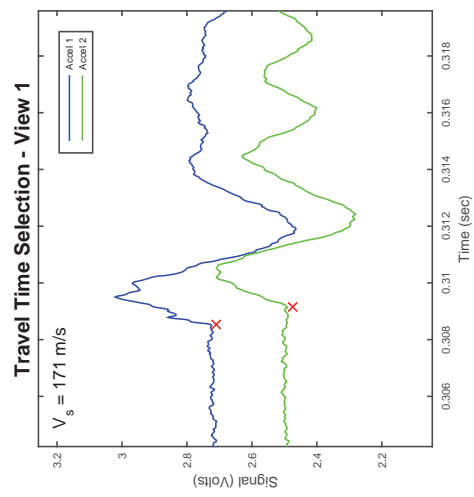
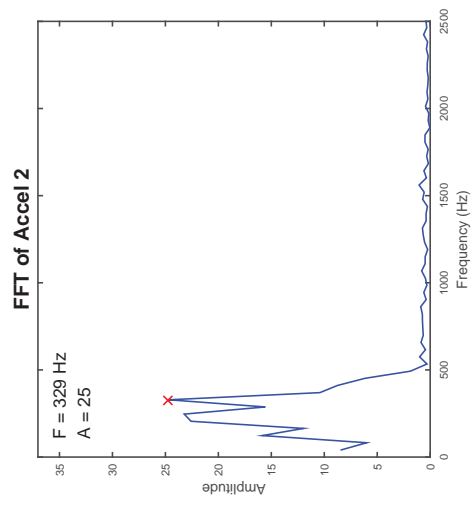
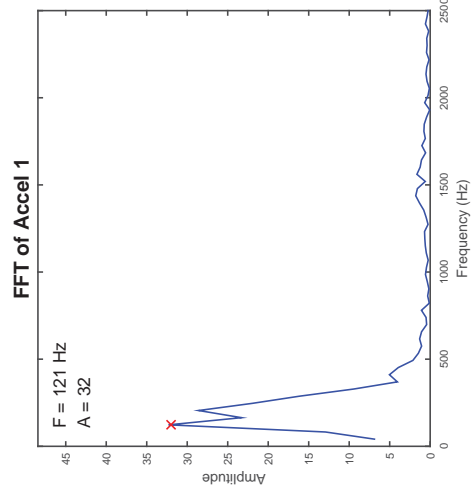
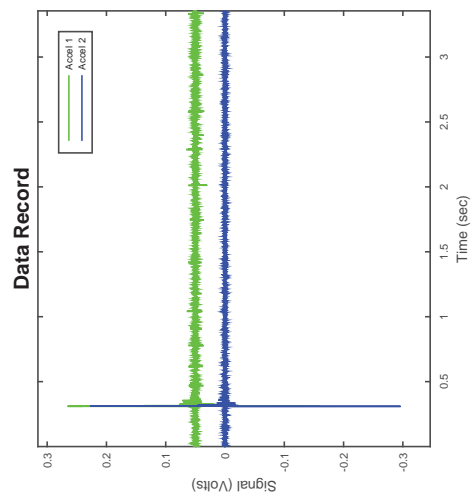

CSS Cyclic Shear Test Report

Geotechnical Engineering Laboratory



Cyclic Shear Test Summary

Device:	CSS	Density (kg/m³):	1423
Specimen ID:	CLS5	Relative Density (%):	44%
Test ID:	C195	Void Ratio:	0.863
Date of Test:	7/20/2015	Vertical Stress (kPa):	100
Test Performed:	Cyclic	Loading Frequency (Hz):	0.33
Test Material:	5mm Crushed Limestone	Number of Cycles:	45
Sample Preparation:	Prepared loose specimen using shoveling method then hitting base plate 25x at 3 layers with rubber mallet	Cyclic Stress Ratio:	0.094
		Shear Modulus (kPa):	
		Damping (%):	
Prepared by:	A. Jackson	Shear Strain Single Amplitude (%):	
Checked by:	J. Hubler		

Additional Comments:

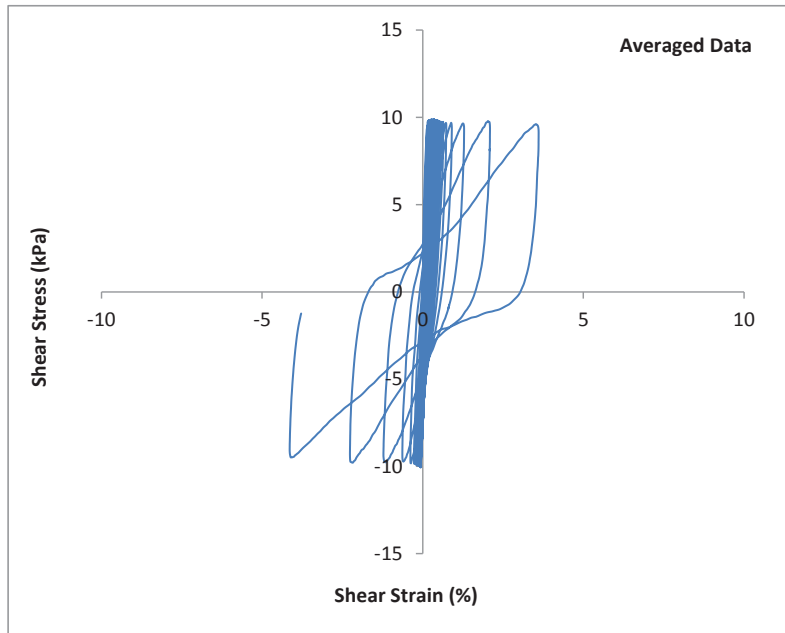
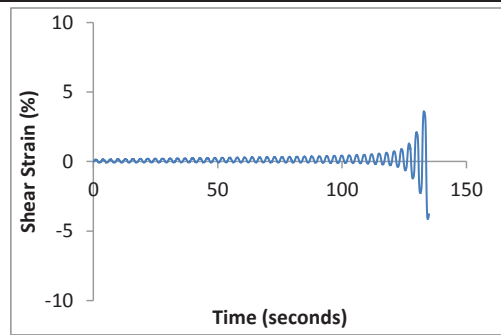
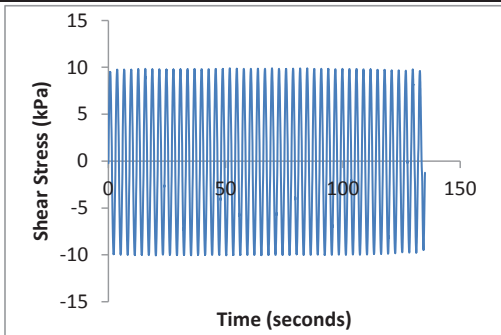

CSS Cyclic Shear Test Report

Geotechnical Engineering Laboratory



Cyclic Shear Test Summary

Device:	CSS	Density (kg/m³):	1423
Specimen ID:	CLS5	Relative Density (%):	44%
Test ID:	C195	Void Ratio:	0.863
Date of Test:	7/20/2015	Vertical Stress (kPa):	100
Test Performed:	Cyclic	Loading Frequency (Hz):	0.33
Test Material:	5mm Crushed Limestone	Number of Cycles:	45
Sample Preparation:	Prepared loose specimen using shoveling method then hitting base plate 25x at 3 layers with rubber mallet	Cyclic Stress Ratio:	0.094
		Number of Cycles to Liq:	45
		Maximum ru:	0.98
Prepared by:	A. Jackson		
Checked by:	J. Hubler		

Additional Comments:

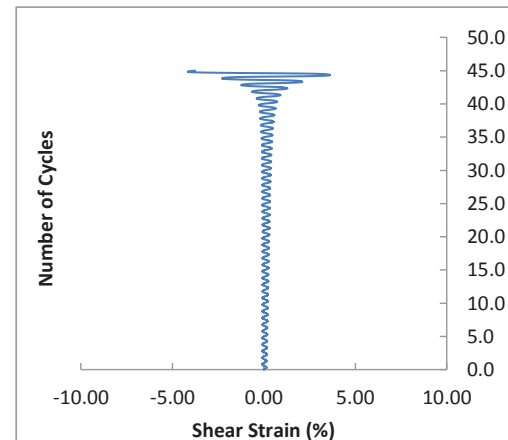
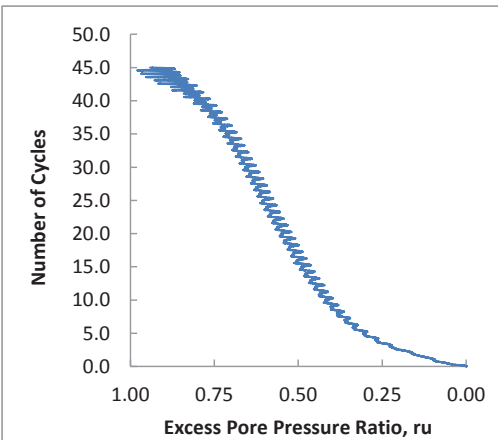
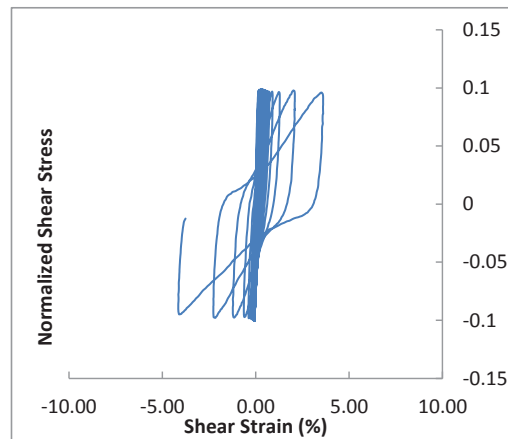
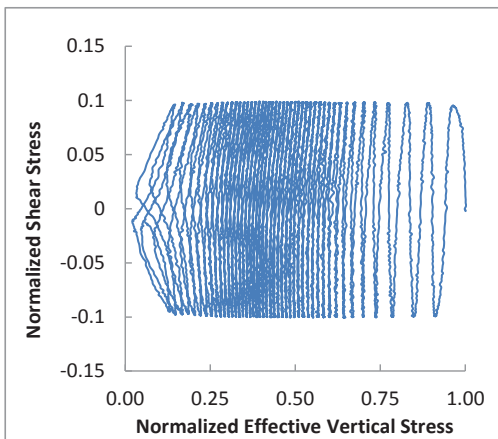

CSS Monotonic Shear Test Report

Geotechnical Engineering Laboratory



10/28/2013_Version 8.0

General Test Info and Sample Preparation

Device:	CSS	Relative Density (%):	32%
Specimen ID:	CLS5	Void Ratio:	0.921
Test ID:	C195	Height (mm):	109.5
Date of Test:	7/20/2015	Soil-Only Specimen Diameter (mm):	306.23
Test Performed:	Post Cyclic Monotonic Shear	Weight (kg):	11.128
Test Material:	5mm Crushed Limestone	Density (kg/m³):	1379.4
Sample Preparation:	Prepared loose specimen using shoveling method then hitting base plate 25x at 3 layers with rubber mallet	Membrane Thickness (mm):	0.635
		Moisture Content (%):	0%
		Saturated (Y/N):	N
		Prepared by:	A. Jackson
		Checked by:	J. Hubler

Consolidation Stage

Vertical Stress (kPa):	100
Time to Compression (min):	11.0
Relative Density (%):	44%
Void Ratio:	0.863
Height (mm):	106.2
Diameter (mm):	306.23
Weight (kg):	11.128
Density (kg/m³):	1422.5

Shear Stage

Type of Test:	Constant Volume
Stress or Strain Controlled:	Strain
Shear Strain Rate (%/min):	0.31
Peak Shear Strength (kPa):	38.2

Comments

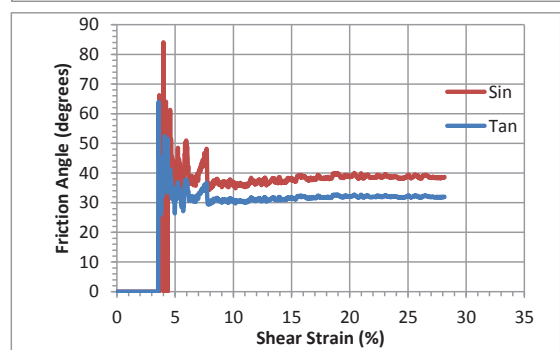
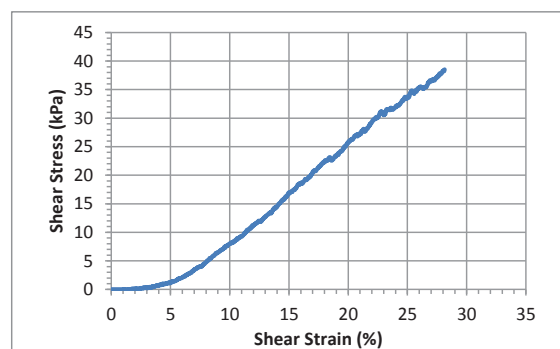
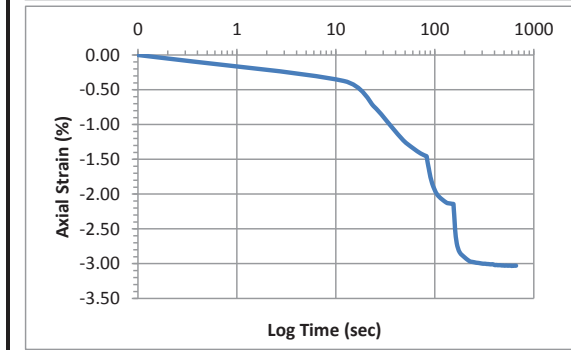
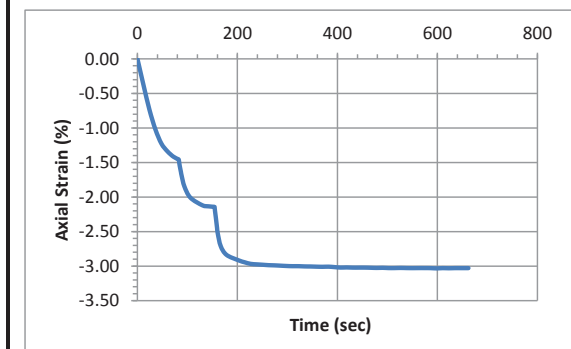

Accelerometer-Based Shear Wave Velocity Datasheet

Specimen ID: C195-FLS-100-1X
 Test Material: FLS
 Date: 7/20/2015
 Test Performed by: J.Hubler
 Filename: C195-FLS-100-1X

Vertical Stress: 100kPa
 Sensor Spacing: 0.10617 m
 V_s (rise) = 204 m/s

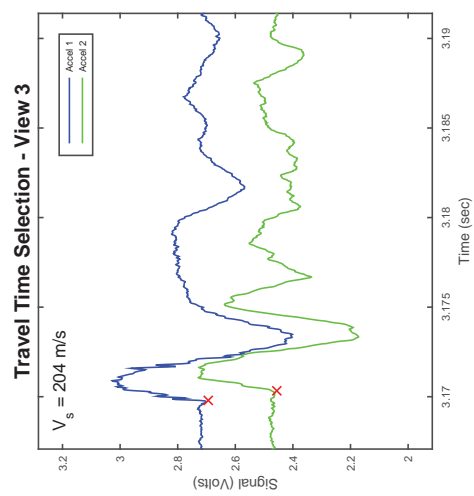
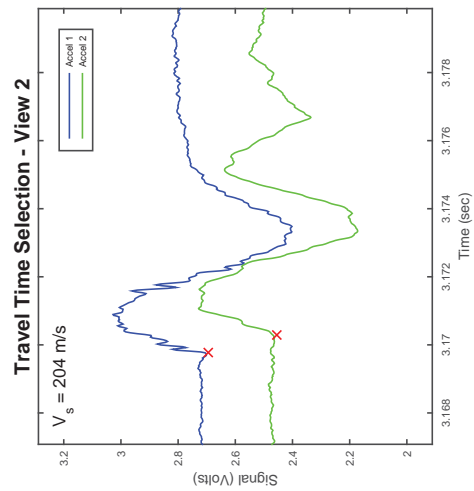
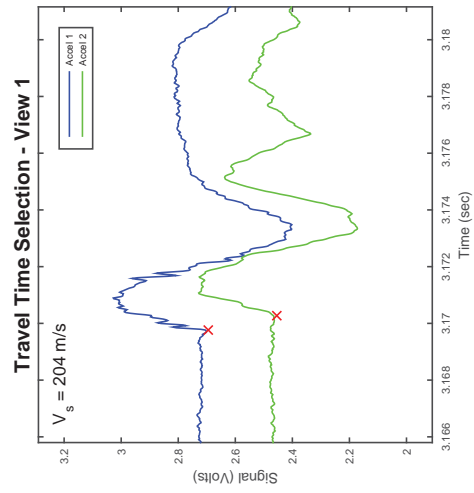
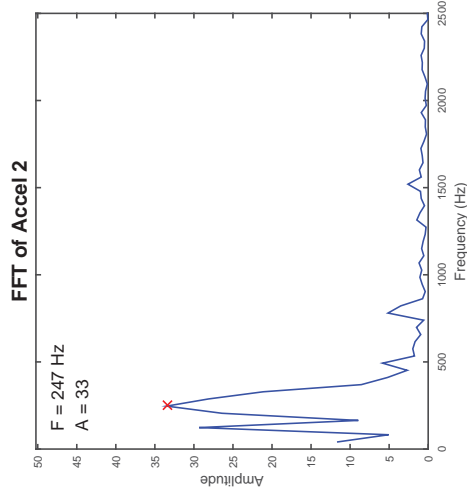
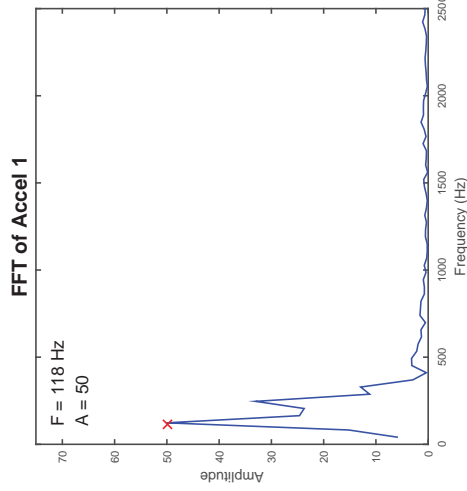
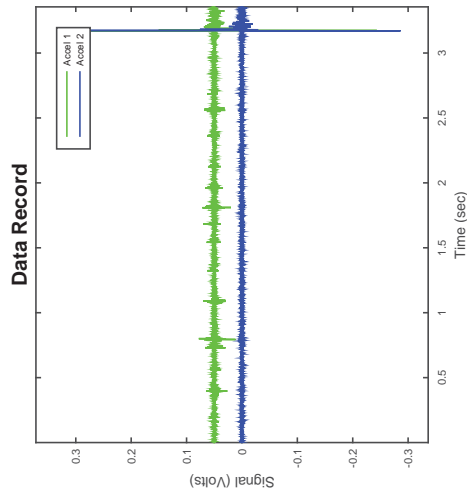

Accelerometer-Based Shear Wave Velocity Datasheet

Specimen ID: C195-FLS-100-2X
 Test Material: FLS
 Date: 7/20/2015
 Test Performed by: J.Hubler
 Filename: C195-FLS-100-2X

Vertical Stress: 100kPa
 Sensor Spacing: 0.10617 m
 V_s (rise) = 198 m/s

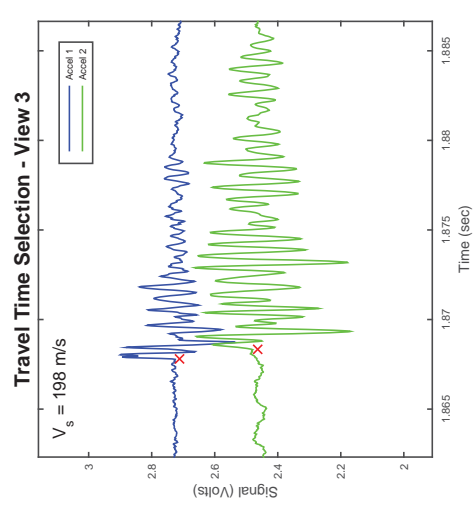
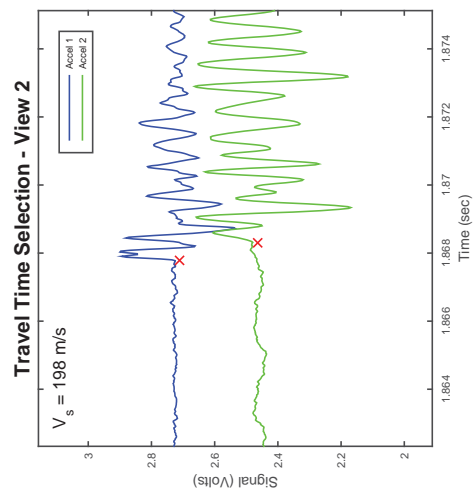
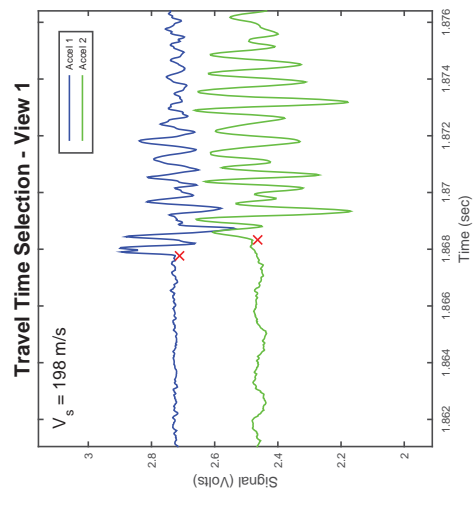
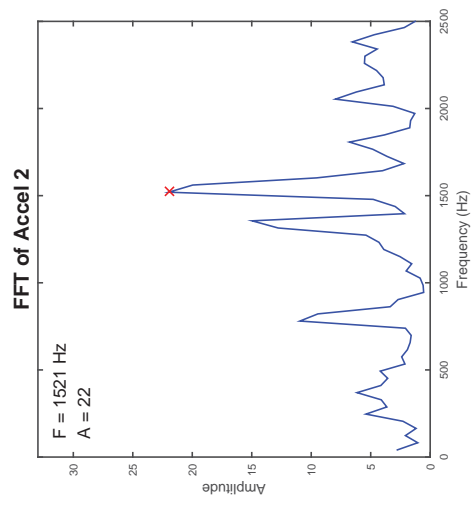
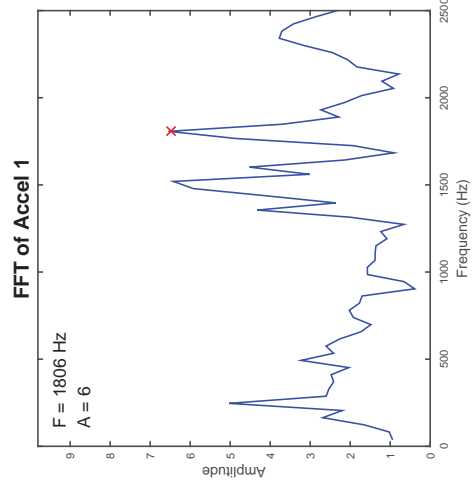
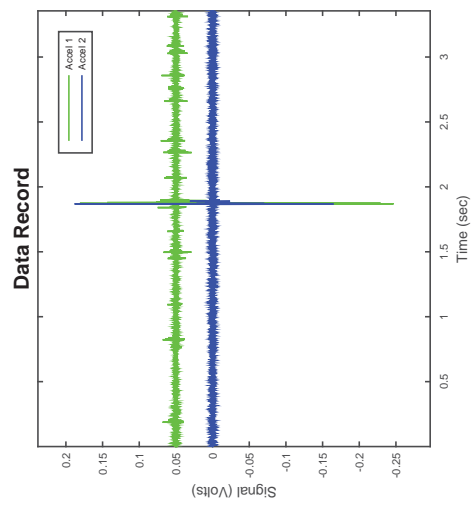

Accelerometer-Based Shear Wave Velocity Datasheet

Specimen ID: C195-FLS-100-3X
 Test Material: FLS
 Date: 7/20/2015
 Test Performed by: J.Hubler
 Filename: C195-FLS-100-3X

Vertical Stress: 100kPa
 Sensor Spacing: 0.10617 m
 V_s (rise) = 193 m/s

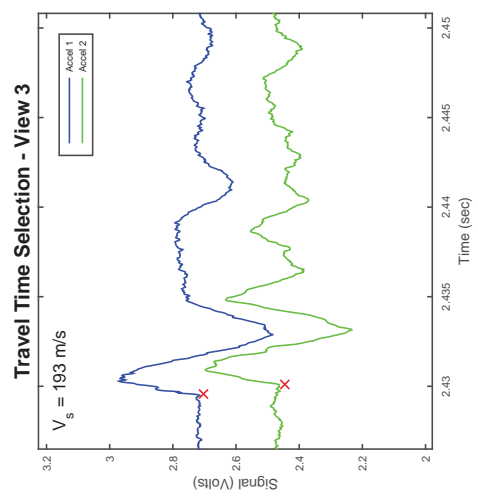
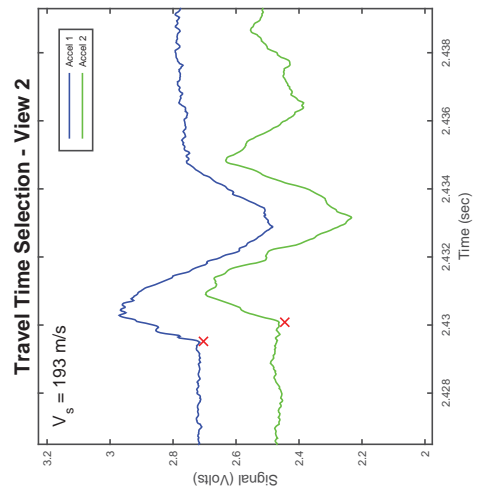
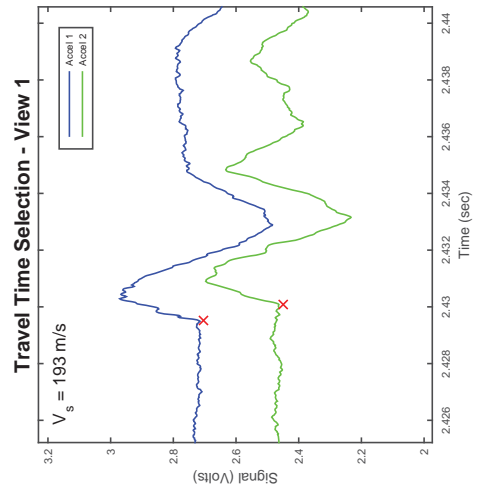
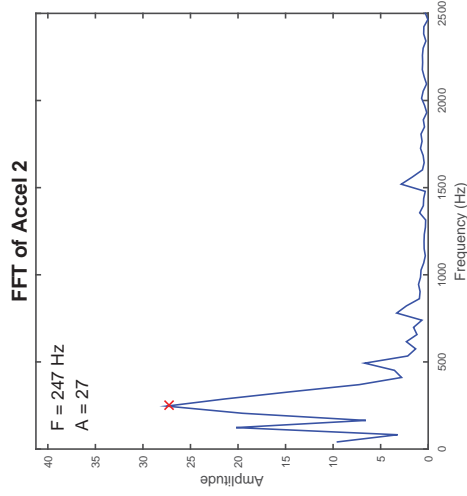
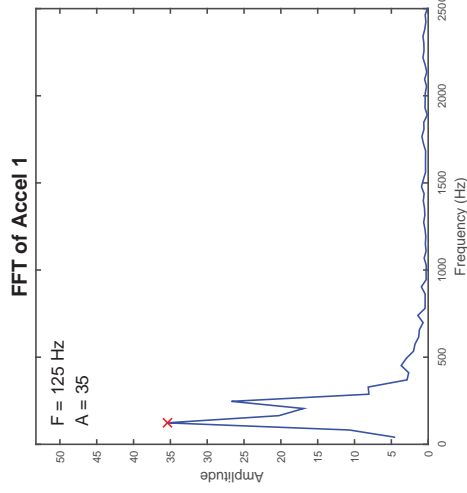
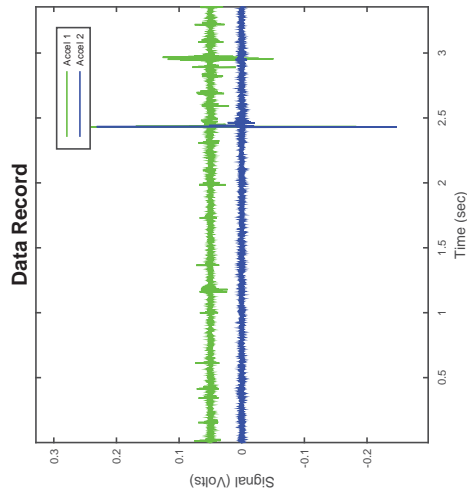

CSS Cyclic Shear Test Report

Geotechnical Engineering Laboratory



Cyclic Shear Test Summary

Device:	CSS	Density (kg/m³):	1428
Specimen ID:	CLS5	Relative Density (%):	45%
Test ID:	C194	Void Ratio:	0.856
Date of Test:	7/20/2015	Vertical Stress (kPa):	200
Test Performed:	Cyclic, Monotonic	Loading Frequency (Hz):	0.33
Test Material:	5mm Crushed Limestone	Number of Cycles:	35
Sample Preparation:	Prepared loose specimen using shoveling method then hitting base plate 25x at 3 layers using rubber mallet.	Cyclic Stress Ratio:	0.097
		Shear Modulus (kPa):	
		Damping (%):	
Prepared by:	A.Jackson	Shear Strain Single Amplitude (%):	
Checked by:	J.Hubler		

Additional Comments:

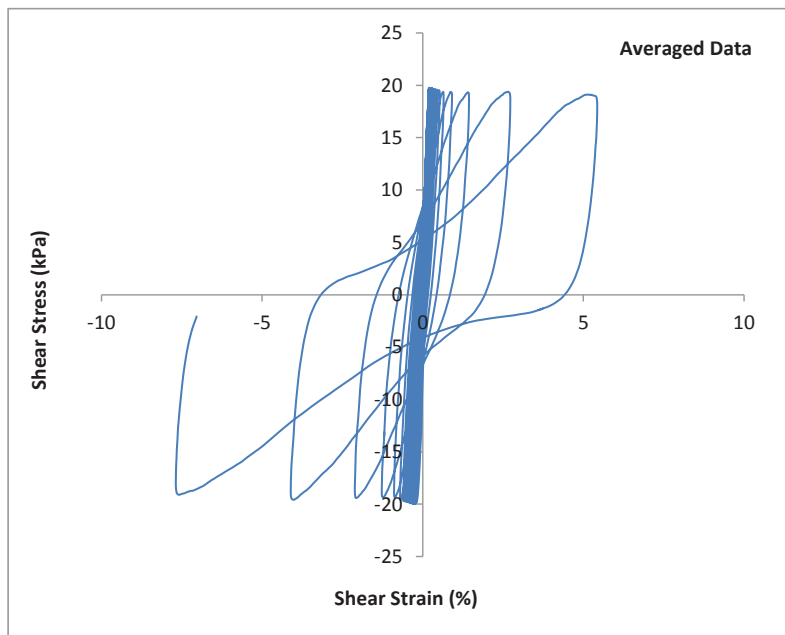
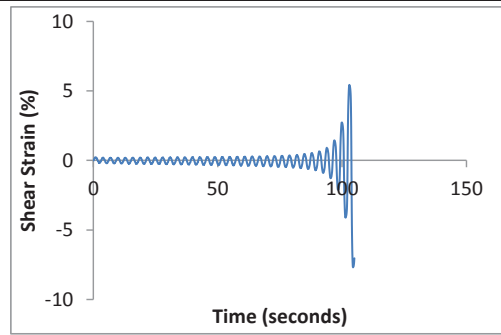
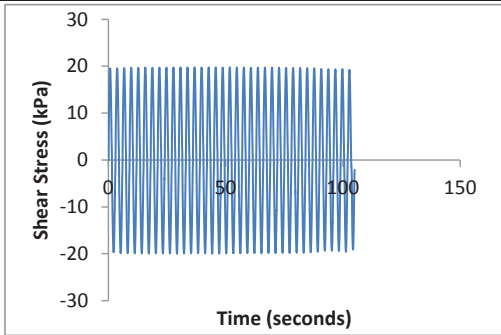

CSS Cyclic Shear Test Report

Geotechnical Engineering Laboratory



Cyclic Shear Test Summary

Device:	CSS	Density (kg/m³):	1428
Specimen ID:	CLS5	Relative Density (%):	45%
Test ID:	C194	Void Ratio:	0.856
Date of Test:	7/20/2015	Vertical Stress (kPa):	200
Test Performed:	Cyclic, Monotonic	Loading Frequency (Hz):	0.33
Test Material:	5mm Crushed Limestone	Number of Cycles:	35
Sample Preparation:	Prepared loose specimen using shoveling method then hitting base plate 25x at 3 layers using rubber mallet.	Cyclic Stress Ratio:	0.097
		Number of Cycles to Liq:	34
		Maximum ru:	0.98
Prepared by:	A.Jackson		
Checked by:	J.Hubler		

Additional Comments:

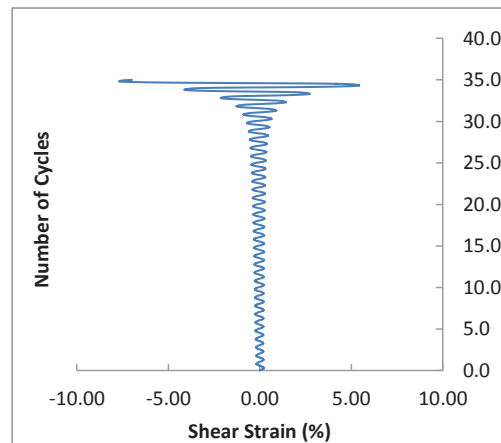
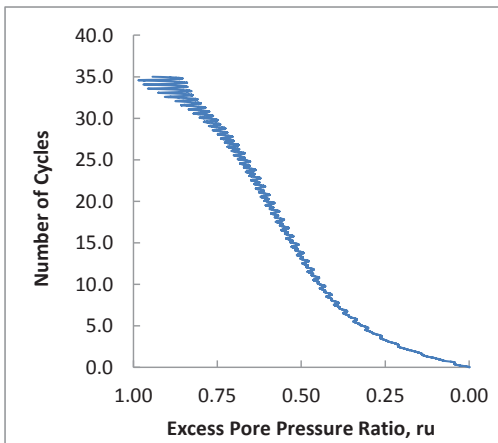
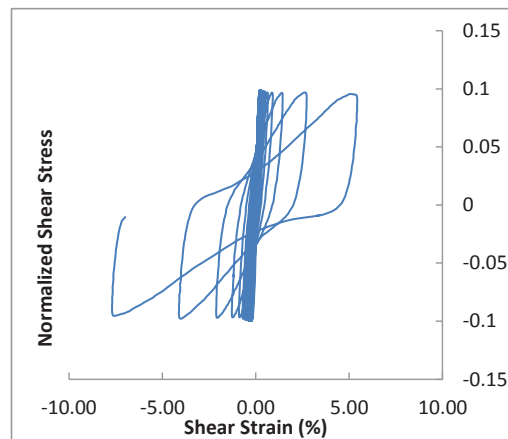
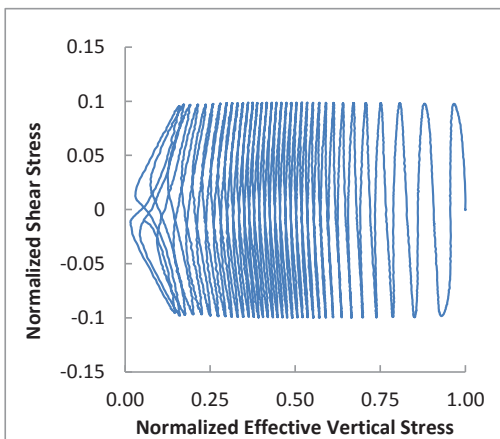

CSS Monotonic Shear Test Report

Geotechnical Engineering Laboratory



10/28/2013_Version 8.0

General Test Info and Sample Preparation

Device:	CSS	Relative Density (%):	27%
Specimen ID:	CLS5	Void Ratio:	0.946
Test ID:	C194	Height (mm):	109.5
Date of Test:	7/20/2015	Soil-Only Specimen Diameter (mm):	306.23
Test Performed:	Post Cyclic Monotonic Shear	Weight (kg):	10.975
Test Material:	5mm Crushed Limestone	Density (kg/m³):	1361.5
Sample Preparation:	Prepared loose specimen using shoveling method then hitting base plate 25x at 3 layers with rubber mallet.	Membrane Thickness (mm):	0.635
		Moisture Content (%):	0%
		Saturated (Y/N):	N
		Prepared by:	A.Jackson
		Checked by:	J. Hubler

Consolidation Stage

Vertical Stress (kPa):	200
Time to Compression (min):	14.3
Relative Density (%):	45%
Void Ratio:	0.856
Height (mm):	104.4
Diameter (mm):	0.31
Weight (kg):	10.975
Density (kg/m³):	1427.7

Shear Stage

Type of Test:	Constant Volume
Stress or Strain Controlled:	Strain
Shear Strain Rate (%/min):	0.31
Peak Shear Strength (kPa):	35.0

Comments

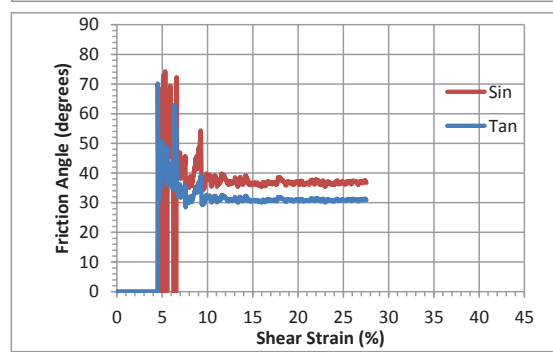
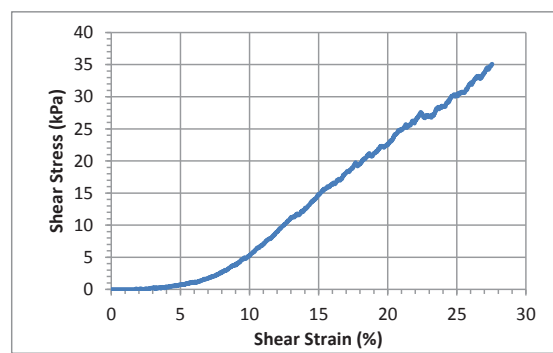
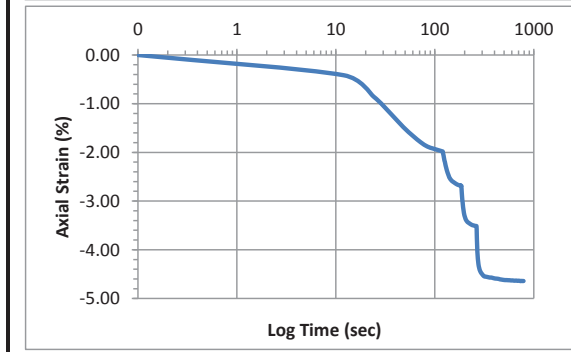
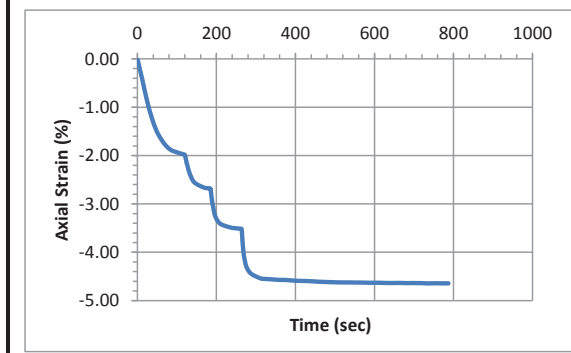

Accelerometer-Based Shear Wave Velocity Datasheet

Specimen ID: C194-FLS-200-1X
 Test Material: FLS
 Date: 7/20/2015
 Test Performed by: J.Hubler
 Filename: C194-FLS-200-1X

Vertical Stress: 200kPa
 Sensor Spacing: 0.10433 m
 V_s (rise) = 233 m/s

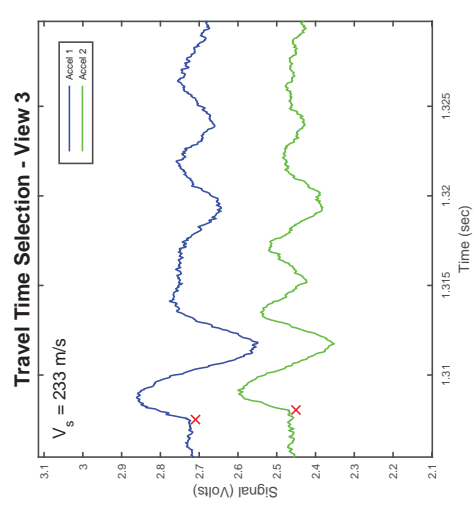
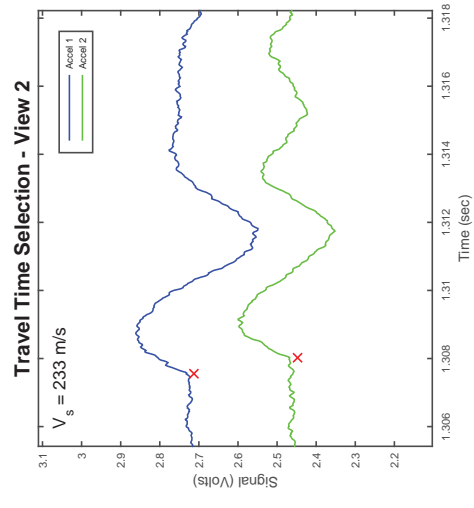
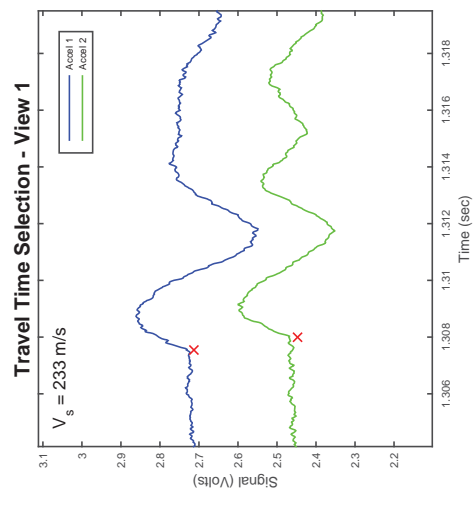
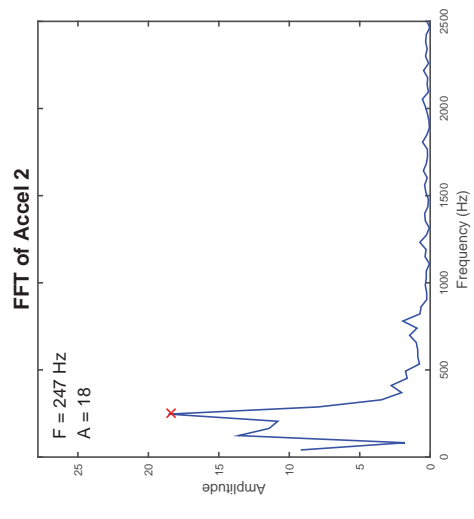
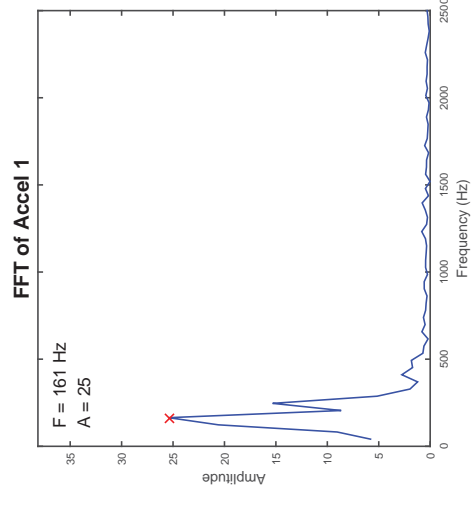
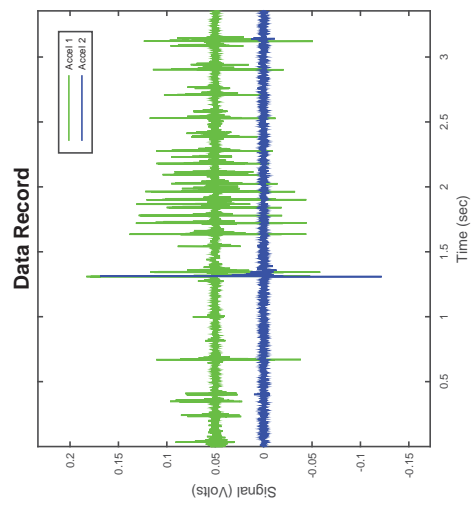

Accelerometer-Based Shear Wave Velocity Datasheet

Specimen ID: C194-FLS-200-2X
 Test Material: FLS
 Date: 7/20/2015
 Test Performed by: J.Hubler
 Filename: C194-FLS-200-2X

Vertical Stress: 200kPa
 Sensor Spacing: 0.10433 m
 V_s (rise) = 226 m/s

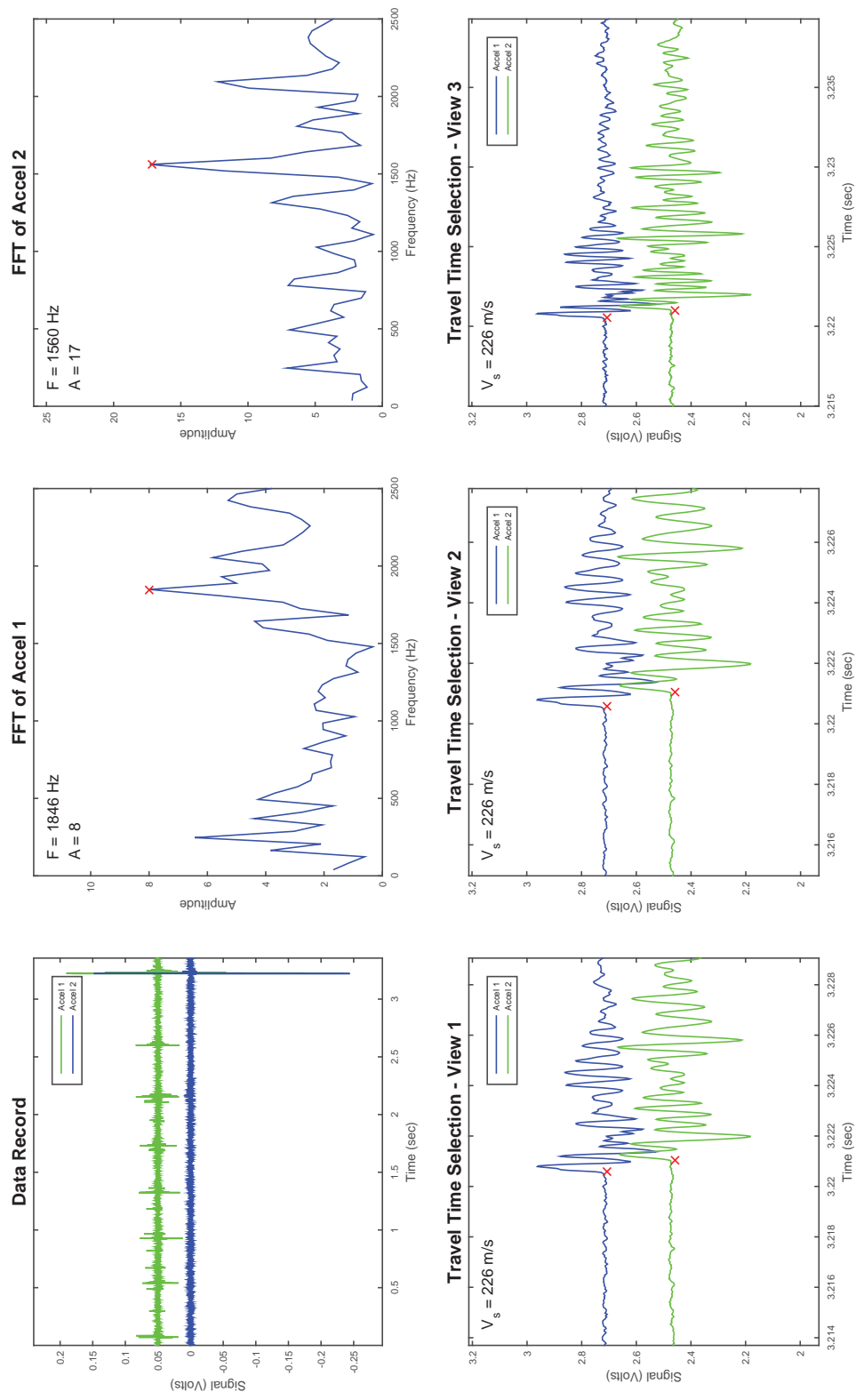

Accelerometer-Based Shear Wave Velocity Datasheet

Specimen ID: C194-FLS-200-3X
 Test Material: FLS
 Date: 7/20/2015
 Test Performed by: J.Hubler
 Filename: C194-FLS-200-3X

Vertical Stress: 200kPa
 Sensor Spacing: 0.10433 m
 V_s (rise) = 241 m/s

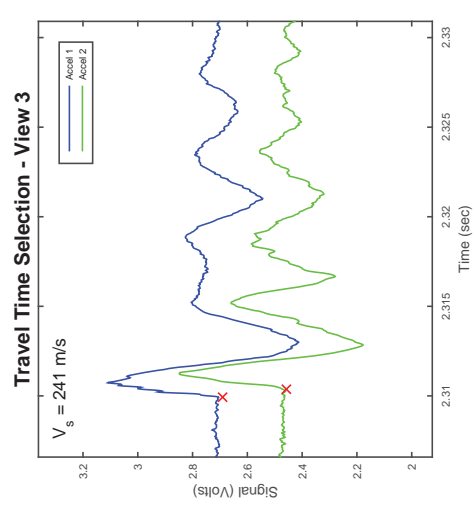
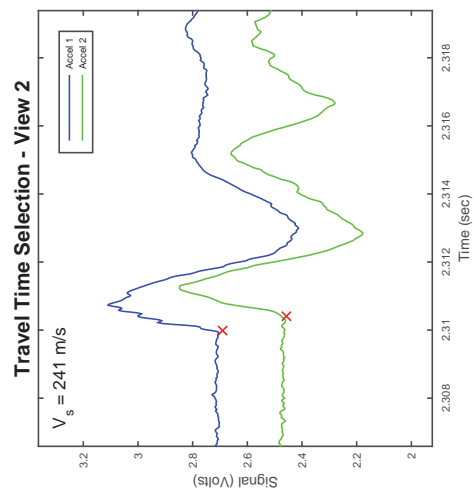
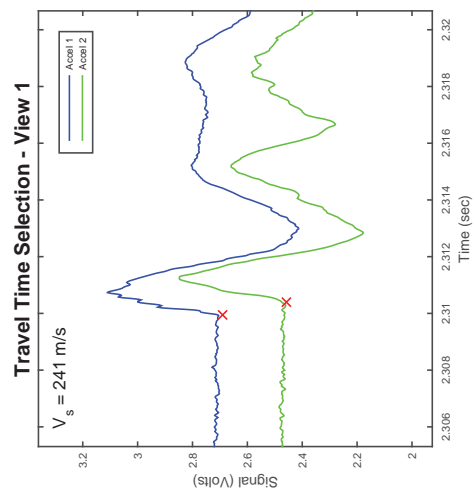
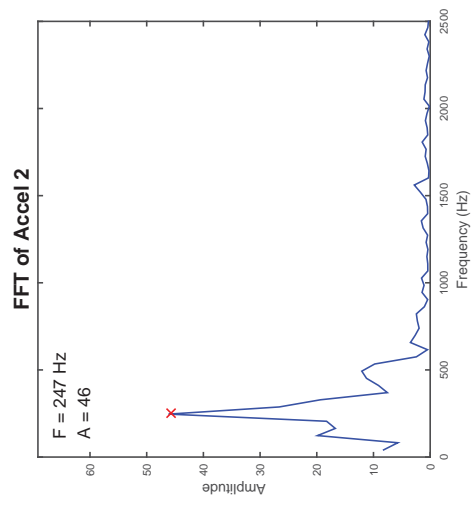
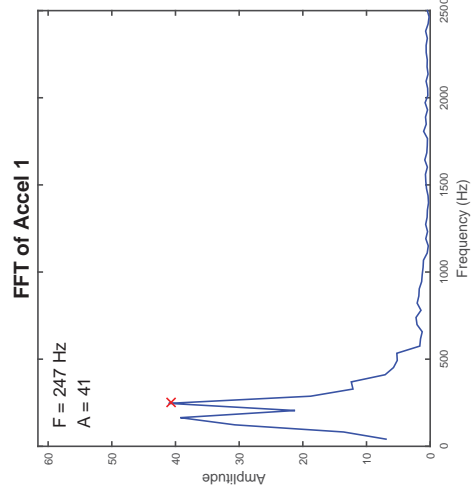
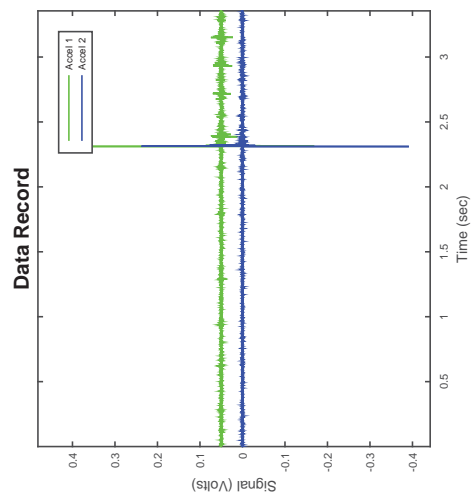

Accelerometer-Based Shear Wave Velocity Datasheet

Specimen ID: C194-FLS-200-4X
 Test Material: FLS
 Date: 7/20/2015
 Test Performed by: J.Hubler
 Filename: C194-FLS-200-4X

Vertical Stress: 200kPa
 Sensor Spacing: 0.10433 m
 V_s (rise) = 241 m/s

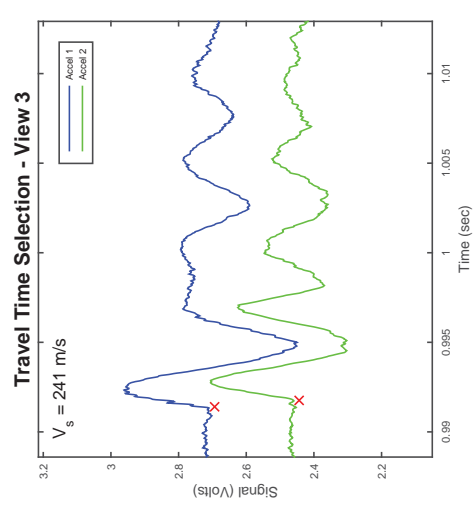
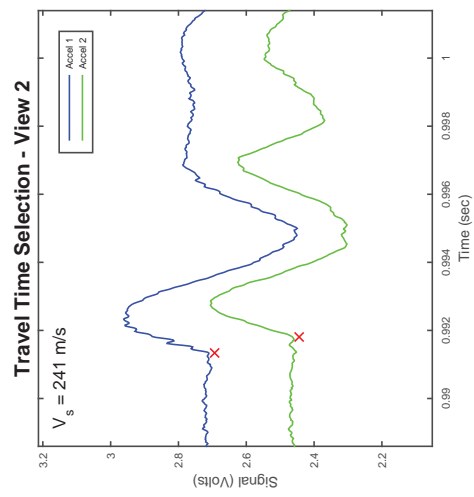
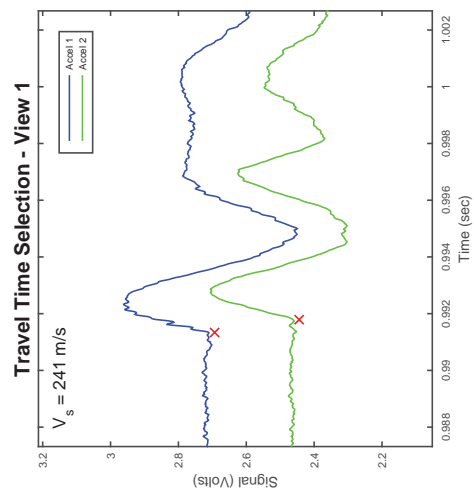
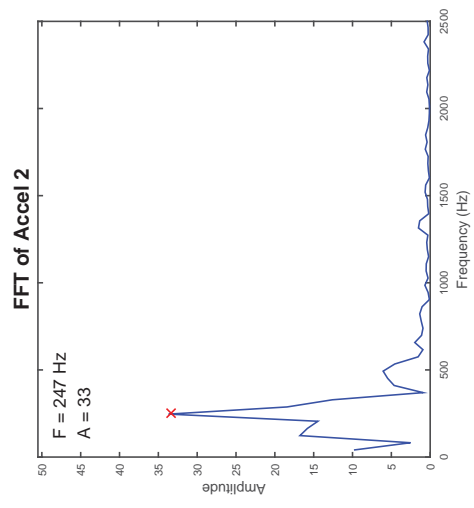
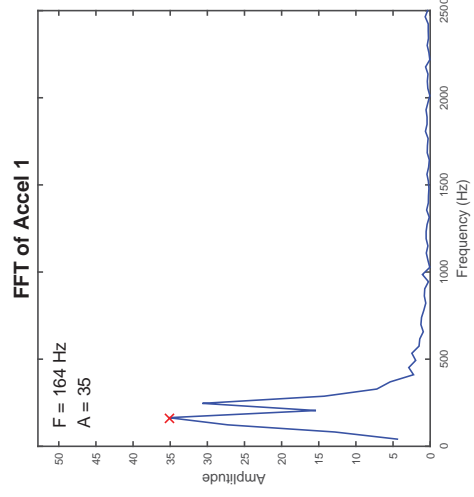
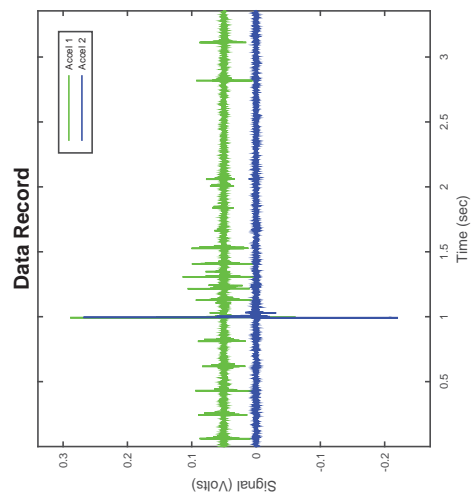

CSS Cyclic Shear Test Report

Geotechnical Engineering Laboratory



Cyclic Shear Test Summary

Device:	CSS	Density (kg/m³):	1442
Specimen ID:	CLS5	Relative Density (%):	49%
Test ID:	C193	Void Ratio:	0.838
Date of Test:	7/17/2015	Vertical Stress (kPa):	400
Test Performed:	Cyclic	Loading Frequency (Hz):	0.33
Test Material:	5mm Crushed Limestone	Number of Cycles:	30
Sample Preparation:	Prepared loose specimen using shoveling method then hit base plate with rubber mallet 25x in 3 layers.	Cyclic Stress Ratio:	0.099
		Shear Modulus (kPa):	
		Damping (%):	
Prepared by:	A.Jackson	Shear Strain Single Amplitude (%)	
Checked by:	J.Hubler		

Additional Comments:

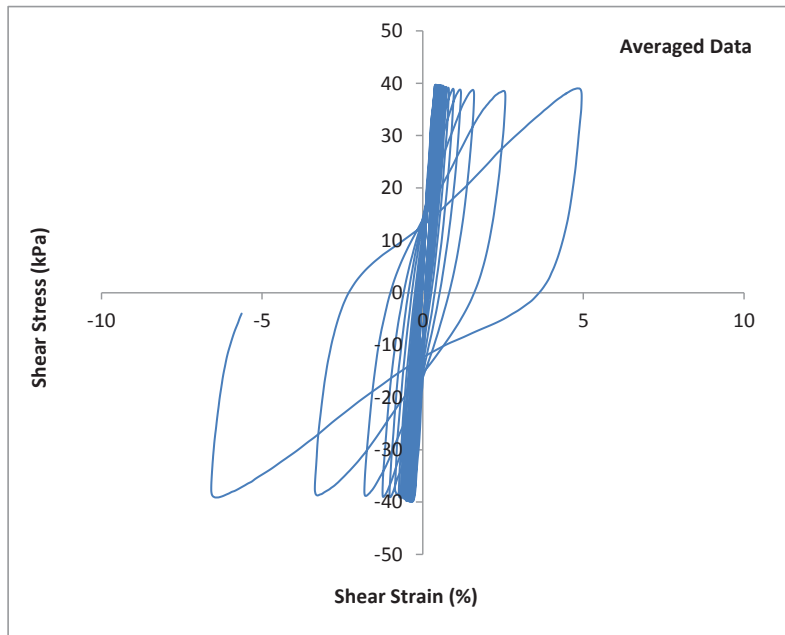
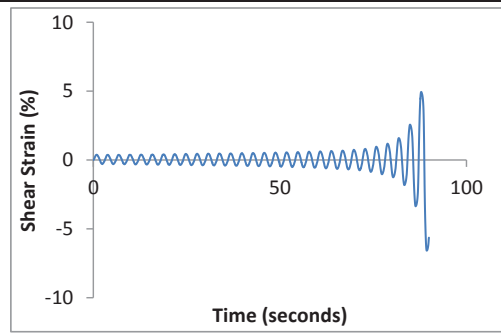
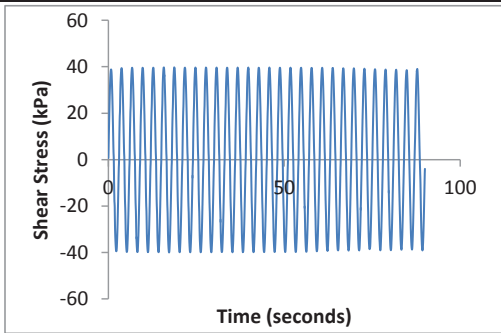

CSS Cyclic Shear Test Report

Geotechnical Engineering Laboratory



Cyclic Shear Test Summary

Device:	CSS	Density (kg/m³):	1442
Specimen ID:	CLS5	Relative Density (%):	49%
Test ID:	C193	Void Ratio:	0.838
Date of Test:	7/17/2015	Vertical Stress (kPa):	400
Test Performed:	Cyclic	Loading Frequency (Hz):	0.33
Test Material:	5mm Crushed Limestone	Number of Cycles:	30
Sample Preparation:	Prepared loose specimen using shoveling method then hit base plate with rubber mallet 25x in 3 layers.	Cyclic Stress Ratio:	0.099
		Number of Cycles to Liq:	30
		Maximum ru:	0.96
Prepared by:	A.Jackson		
Checked by:	J.Hubler		

Additional Comments:

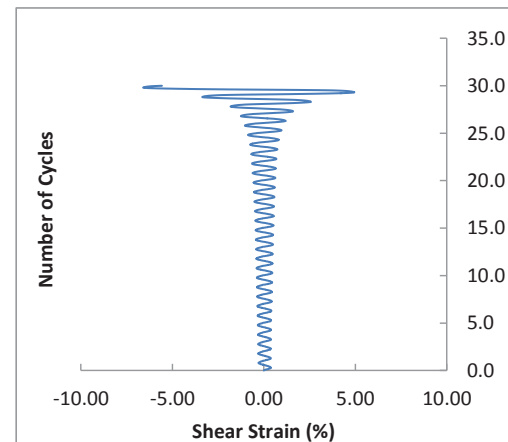
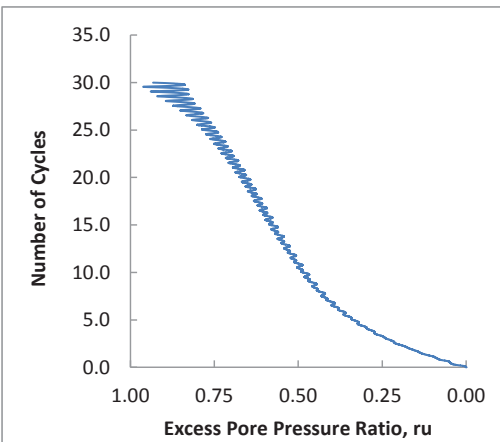
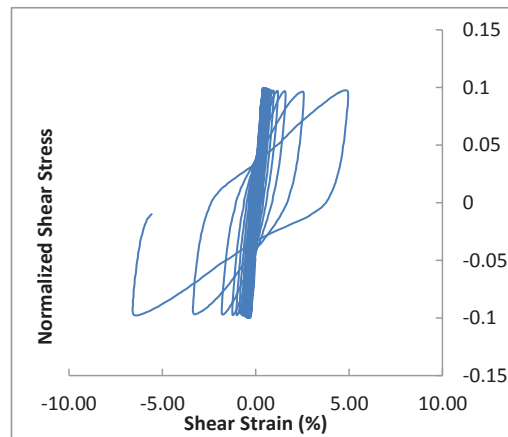
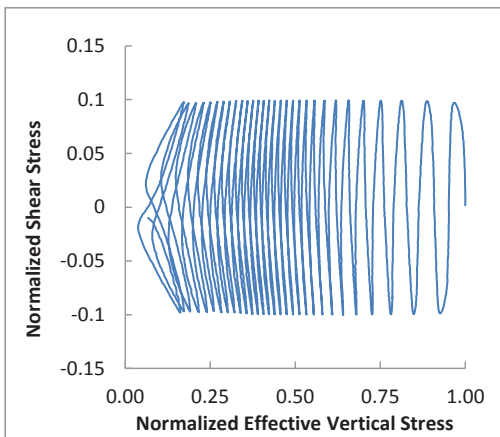

CSS Monotonic Shear Test Report

Geotechnical Engineering Laboratory



10/28/2013_Version 8.0

General Test Info and Sample Preparation

Device:	CSS	Relative Density (%):	30%
Specimen ID:	CLS5	Void Ratio:	0.931
Test ID:	C193	Height (mm):	111.0
Date of Test:	7/17/2015	Soil-Only Specimen Diameter (mm):	306.23
Test Performed:	Post-Cyclic Mono	Weight (kg):	11.218
Test Material:	5mm Crushed Limestone	Density (kg/m³):	1372.5
Sample Preparation:	Prepared loose using the shoveling method. To reach required density - rubber mallet hit baseplate 25x in 3 layers after shoveling.	Membrane Thickness (mm):	0.635
		Moisture Content (%):	0%
		Saturated (Y/N):	N
		Prepared by:	A. Jackson
		Checked by:	J. Hubler

Consolidation Stage

Vertical Stress (kPa):	400
Time to Compression (min):	16.9
Relative Density (%):	49%
Void Ratio:	0.838
Height (mm):	105.7
Diameter (mm):	306.23
Weight (kg):	11.218
Density (kg/m³):	1441.5

Shear Stage

Type of Test:	Constant Volume
Stress or Strain Controlled:	Strain
Shear Strain Rate (%/min):	0.31
Peak Shear Strength (kPa):	68.8

Comments

Silver Baseplate used with cushion membrane.

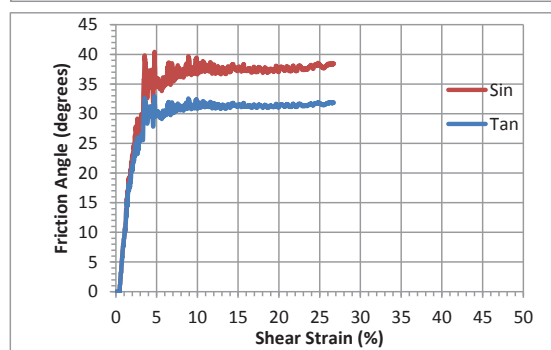
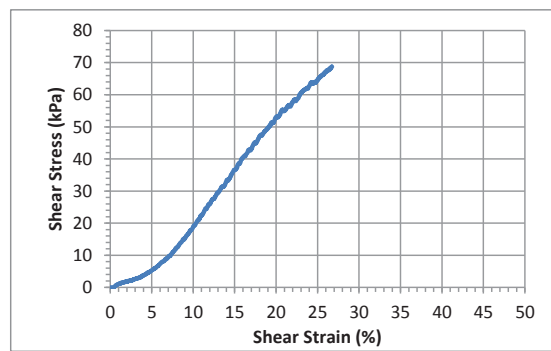
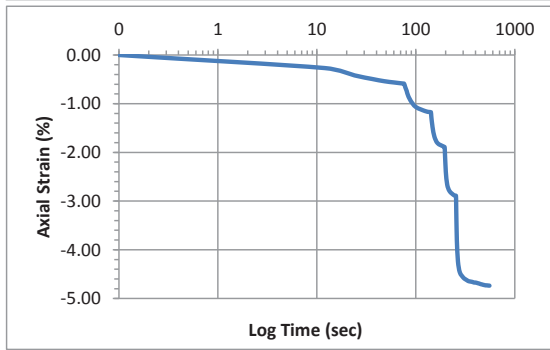
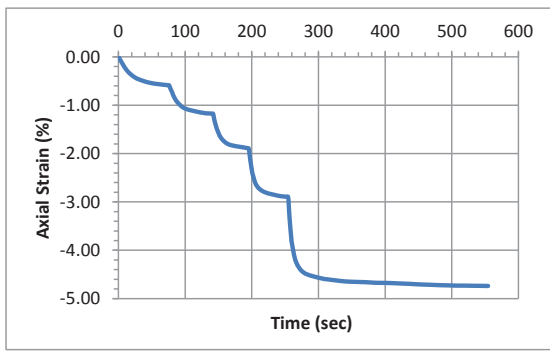

Accelerometer-Based Shear Wave Velocity Datasheet

Specimen ID: C193-FLS-400-1X
 Test Material: FLS
 Date: 7/17/2015
 Test Performed by: J.Hubler
 Filename: C193-FLS-400-1X

Vertical Stress: 400kPa
 Sensor Spacing: 0.10562 m
 V_s (rise) = 283 m/s

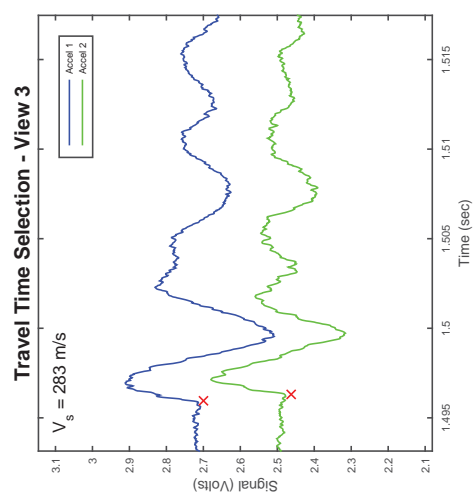
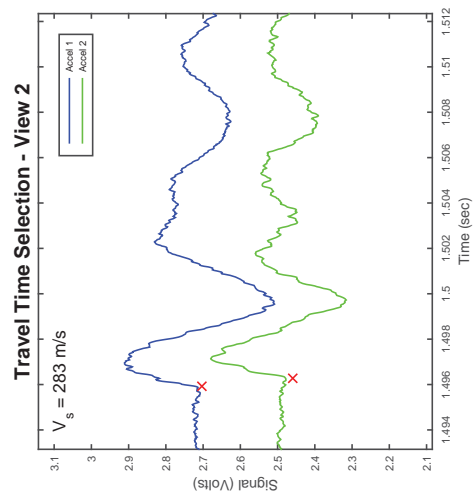
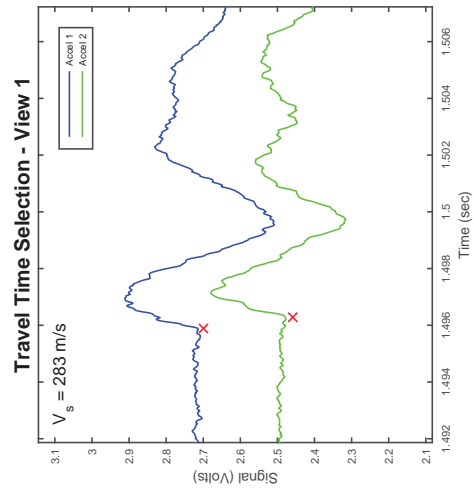
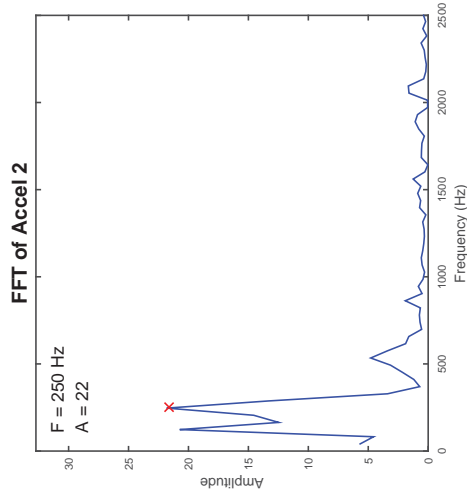
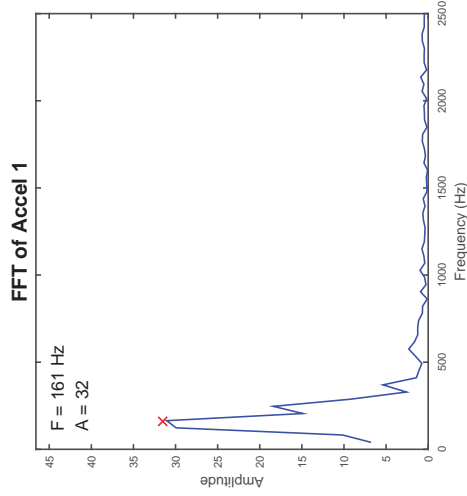
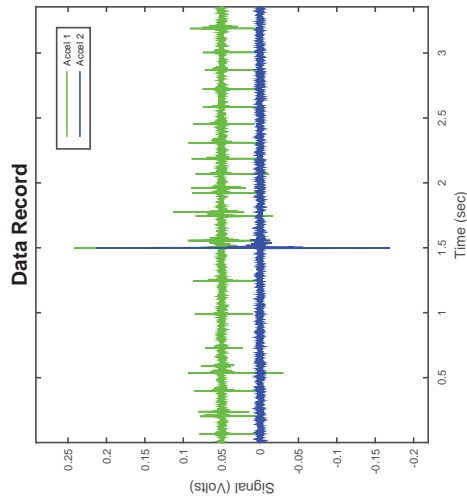

Accelerometer-Based Shear Wave Velocity Datasheet

Specimen ID: C193-FLS-400-2X
 Test Material: FLS
 Date: 7/17/2015
 Test Performed by: J.Hubler
 Filename: C193-FLS-400-2X

Vertical Stress: 400kPa
 Sensor Spacing: 0.10562 m
 V_s (rise) = 272 m/s

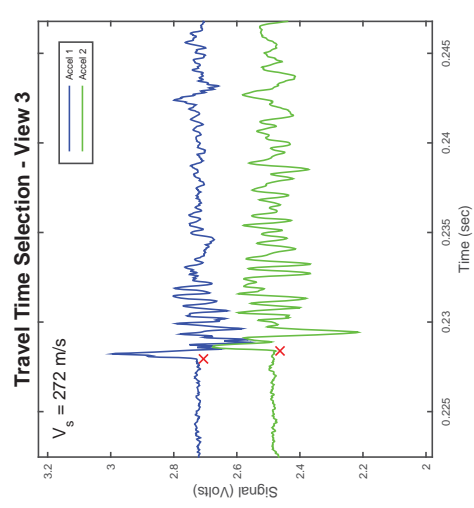
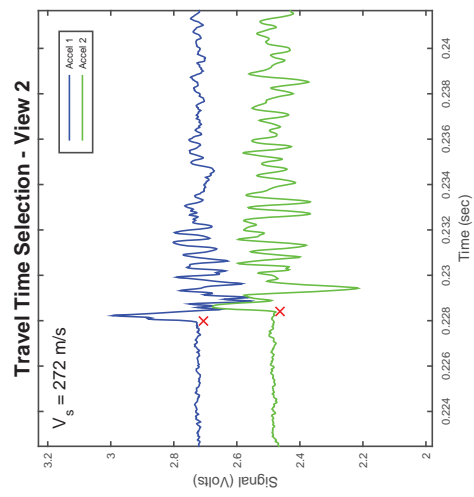
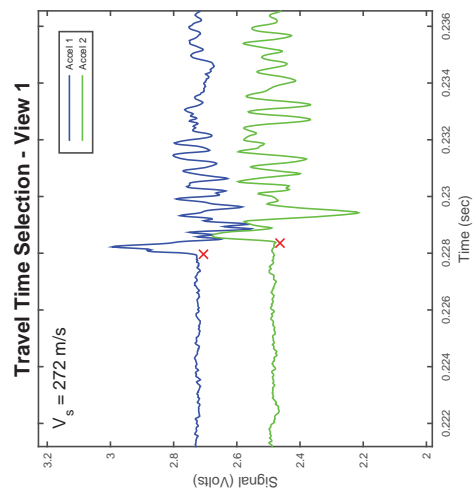
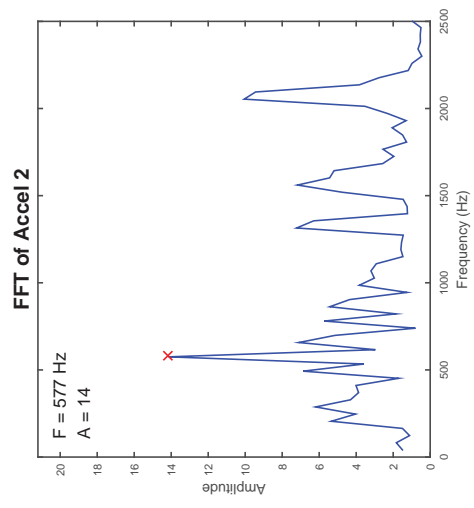
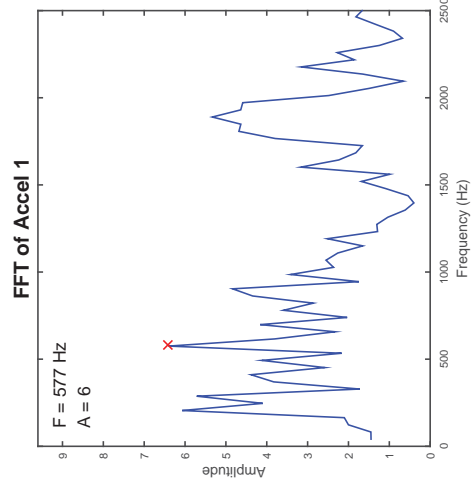
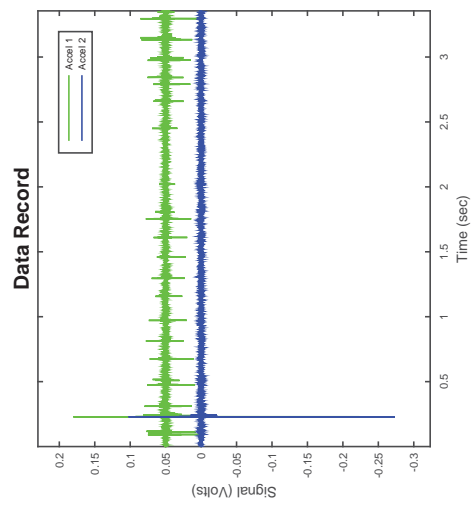

Accelerometer-Based Shear Wave Velocity Datasheet

Specimen ID: C193-FLS-400-3X
 Test Material: FLS
 Date: 7/17/2015
 Test Performed by: J.Hubler
 Filename: C193-FLS-400-3X

Vertical Stress: 400kPa
 Sensor Spacing: 0.10562 m
 V_s (rise) = 283 m/s

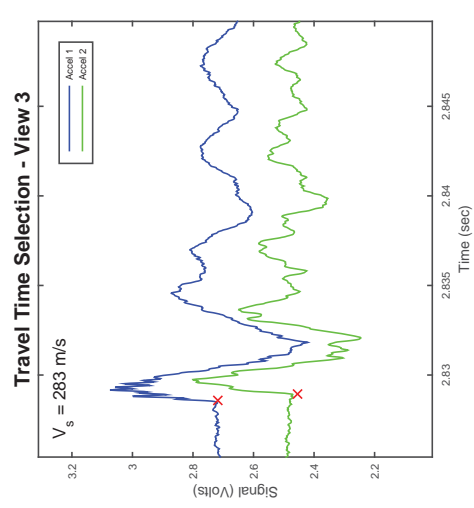
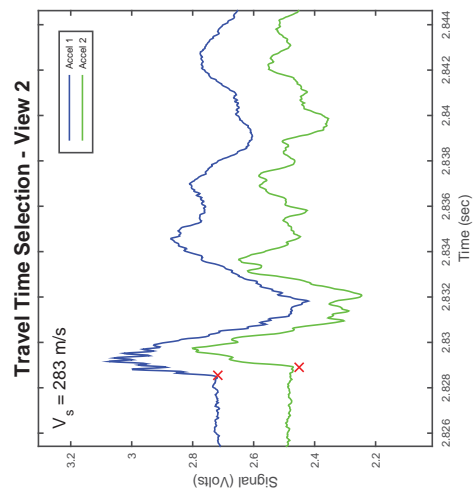
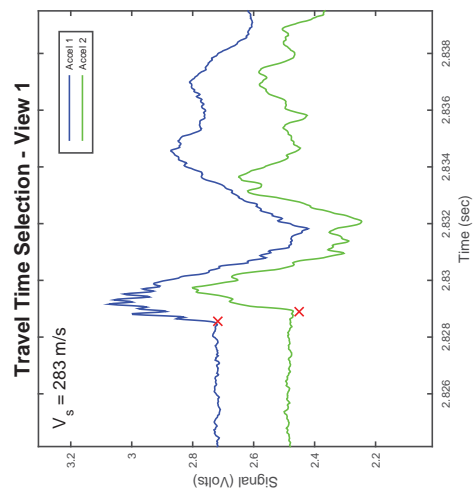
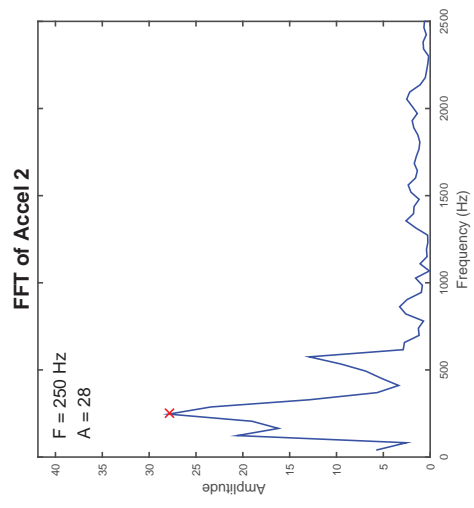
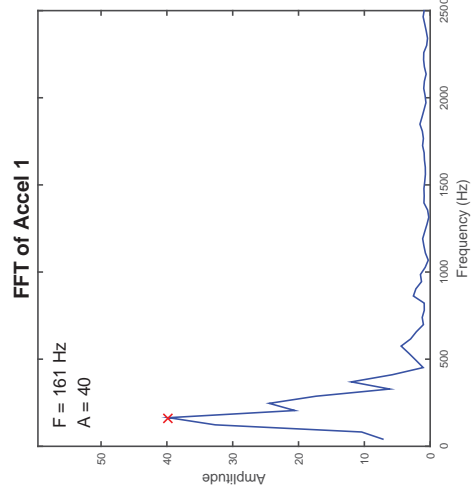
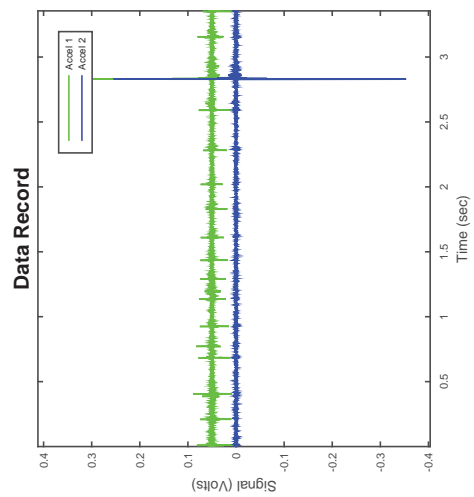

CSS Cyclic Shear Test Report

Geotechnical Engineering Laboratory



Cyclic Shear Test Summary

Device:	CSS	Density (kg/m³):	1614
Specimen ID:	CLS5	Relative Density (%):	89%
Test ID:	C199	Void Ratio:	0.642
Date of Test:	7/29/2015	Vertical Stress (kPa):	50
Test Performed:	Cyclic	Loading Frequency (Hz):	0.33
Test Material:	5mm Crushed Limestone	Number of Cycles:	200
Sample Preparation:	Prepared dense by tamping 60x in 5 layers.	Cyclic Stress Ratio:	0.088
		Shear Modulus (kPa):	
		Damping (%):	
Prepared by:	J. Hubler	Shear Strain Single Amplitude (%)	
Checked by:	J. Hubler		

Additional Comments:

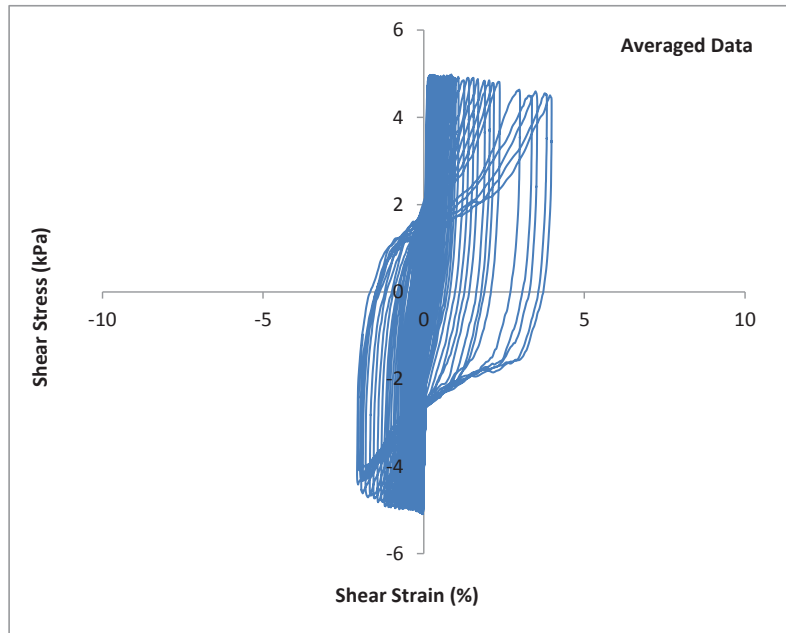
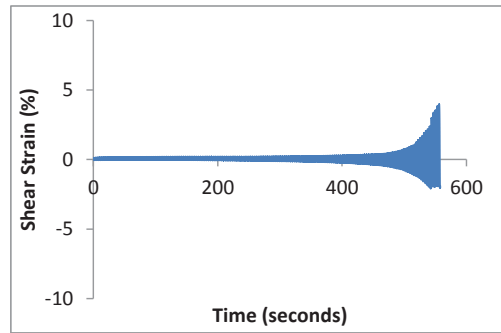
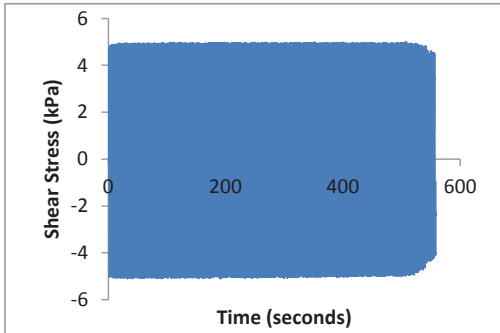

CSS Cyclic Shear Test Report

Geotechnical Engineering Laboratory



Cyclic Shear Test Summary

Device:	CSS	Density (kg/m³):	1614
Specimen ID:	CLS5	Relative Density (%):	89%
Test ID:	C199	Void Ratio:	0.642
Date of Test:	7/29/2015	Vertical Stress (kPa):	50
Test Performed:	Cyclic	Loading Frequency (Hz):	0.33
Test Material:	5mm Crushed Limestone	Number of Cycles:	200
Sample Preparation:	Prepared dense by tamping 60x in 5 layers.	Cyclic Stress Ratio:	0.088
		Number of Cycles to Liq:	185
		Maximum ru:	0.94
Prepared by:	J. Hubler		
Checked by:	J. Hubler		

Additional Comments:

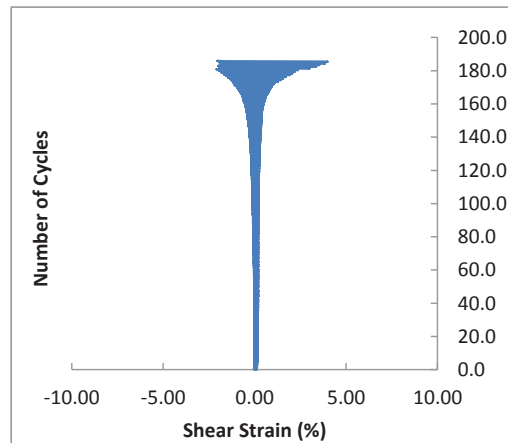
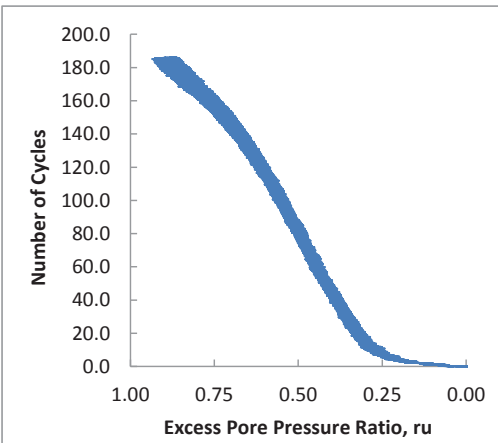
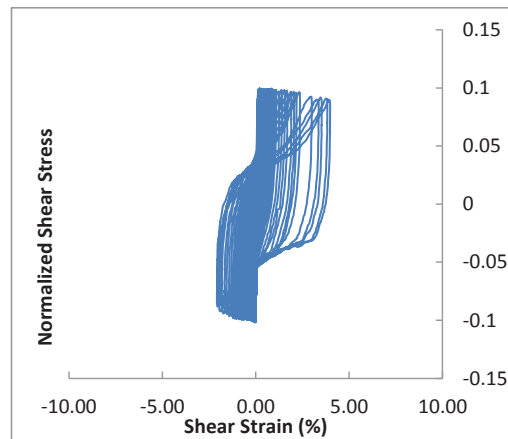
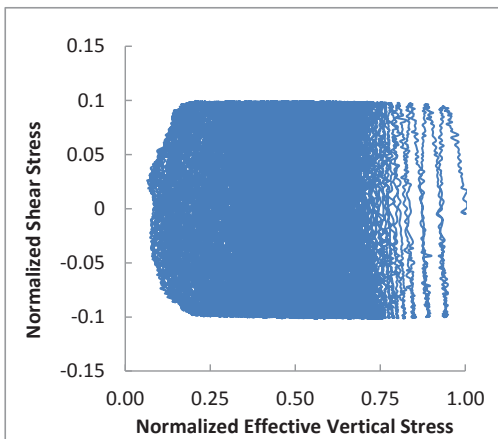

CSS Monotonic Shear Test Report

Geotechnical Engineering Laboratory



10/28/2013_Version 8.0

General Test Info and Sample Preparation

Device:	CSS	Relative Density (%):	79%
Specimen ID:	CLS5	Void Ratio:	0.691
Test ID:	C199	Height (mm):	104.1
Date of Test:	7/29/2015	Soil-Only Specimen Diameter (mm):	306.23
Test Performed:	Post Cyclic Monotonic Shear	Weight (kg):	12.017
Test Material:	5mm Crushed Limestone	Density (kg/m³):	1566.9
Sample Preparation:	Prepare dense by tamping 60x in 5 layers.	Membrane Thickness (mm):	0.001
		Moisture Content (%):	0%
		Saturated (Y/N):	N
		Prepared by:	J.Hubler
		Checked by:	J. Hubler

Consolidation Stage

Shear Stage

Vertical Stress (kPa):	50	Type of Test:	Constant Volume
Time to Compression (min):	11.4	Stress or Strain Controlled:	Strain
Relative Density (%):	89%	Shear Strain Rate (%/min):	0.32
Void Ratio:	0.642	Peak Shear Strength (kPa):	29.2
Height (mm):	101.1	Comments	
Diameter (mm):	306.23		
Weight (kg):	12.017		
Density (kg/m³):	1614.2		

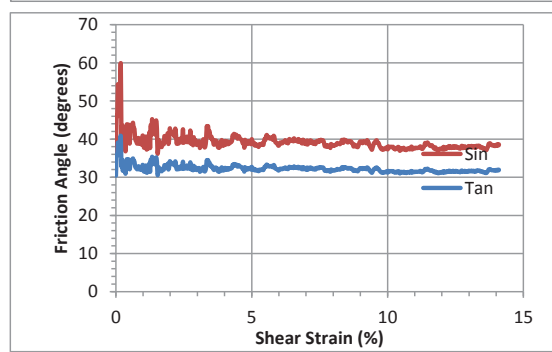
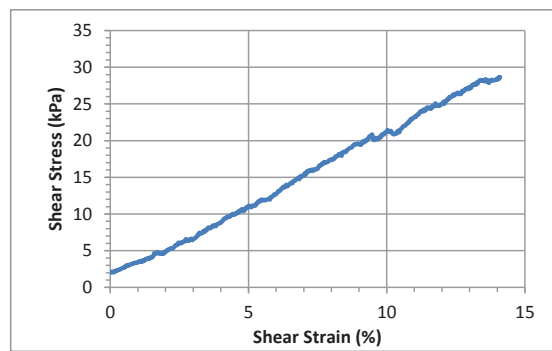
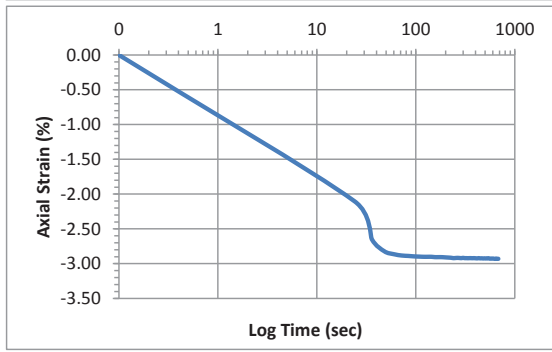
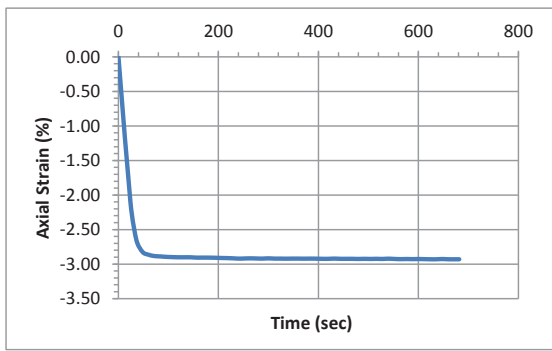

Accelerometer-Based Shear Wave Velocity Datasheet

Specimen ID: C199-FLS-50-1X
 Test Material: FLS
 Date: 7/29/2015
 Test Performed by: J. Hubler
 Filename: C199-FLS-50-1X

Vertical Stress: 50kPa
 Sensor Spacing: 0.10103 m
 V_s (rise) = 197 m/s

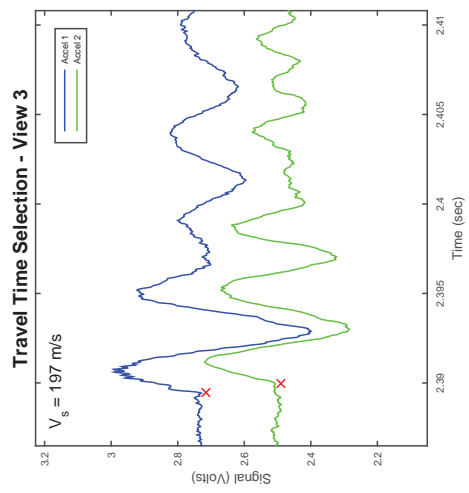
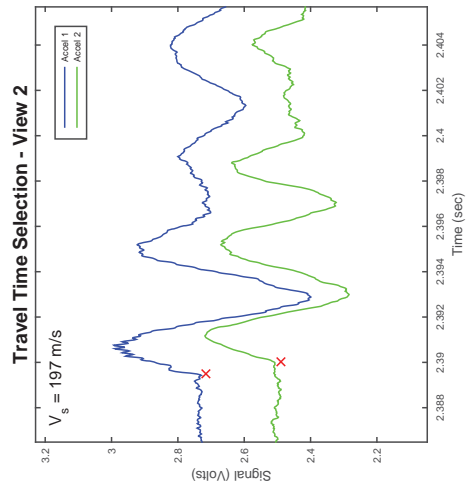
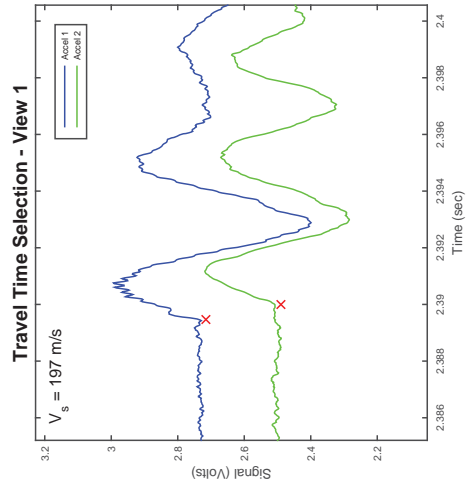
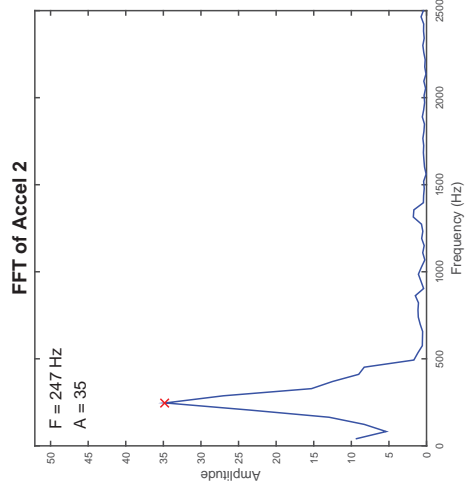
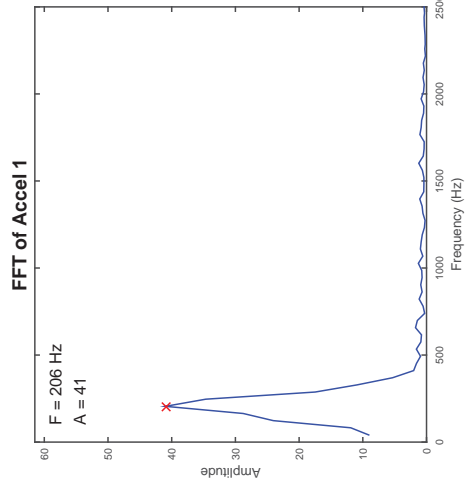
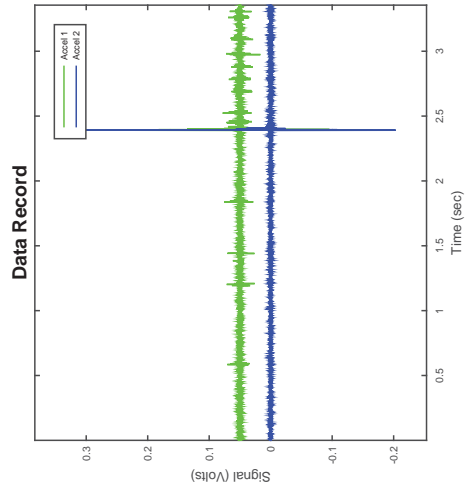

CSS Cyclic Shear Test Report

Geotechnical Engineering Laboratory



Cyclic Shear Test Summary

Device:	CSS	Density (kg/m³):	1601
Specimen ID:	CLS5	Relative Density (%):	87%
Test ID:	C209	Void Ratio:	0.655
Date of Test:	8/10/2015	Vertical Stress (kPa):	100
Test Performed:	Cyclic	Loading Frequency (Hz):	0.33
Test Material:	5mm Crushed Limestone	Number of Cycles:	163
Sample Preparation:	Prepared dense by tamping 50x in 5 layers.	Cyclic Stress Ratio:	0.094
		Shear Modulus (kPa):	
		Damping (%):	
Prepared by:	J. Hubler	Shear Strain Single Amplitude (%)	
Checked by:	J. Hubler		

Additional Comments:

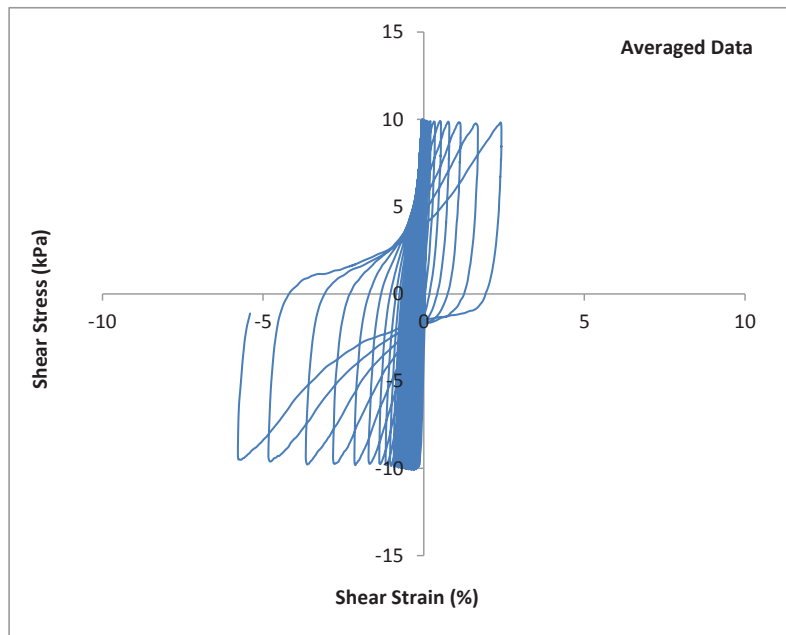
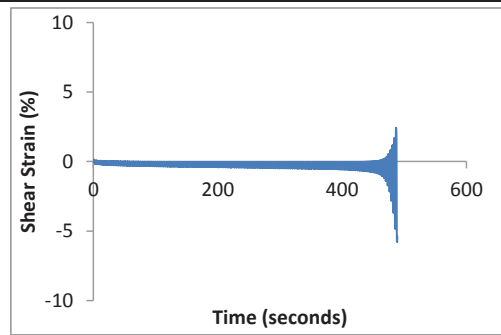
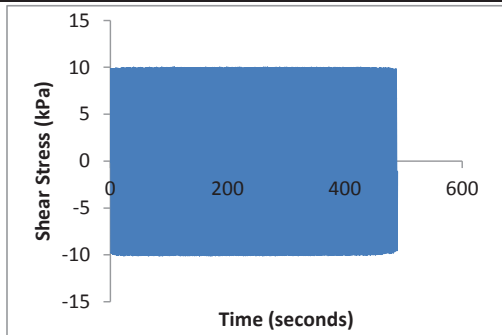

CSS Cyclic Shear Test Report

Geotechnical Engineering Laboratory



Cyclic Shear Test Summary

Device:	CSS	Density (kg/m³):	1601
Specimen ID:	CLS5	Relative Density (%):	87%
Test ID:	C209	Void Ratio:	0.655
Date of Test:	8/10/2015	Vertical Stress (kPa):	100
Test Performed:	Cyclic	Loading Frequency (Hz):	0.33
Test Material:	5mm Crushed Limestone	Number of Cycles:	163
Sample Preparation:	Prepared dense by tamping 50x in 5 layers.	Cyclic Stress Ratio:	0.094
		Number of Cycles to Liq:	162
		Maximum ru:	0.98
Prepared by:	J.Hubler		
Checked by:	J. Hubler		

Additional Comments:

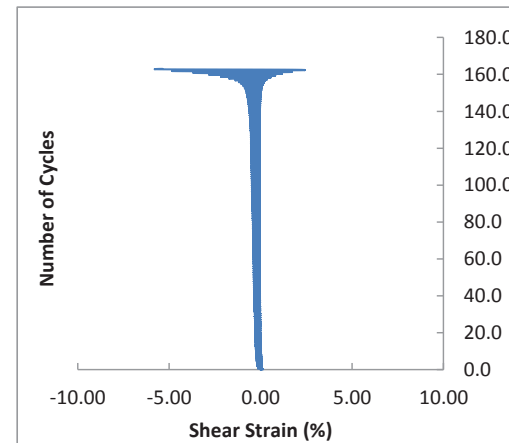
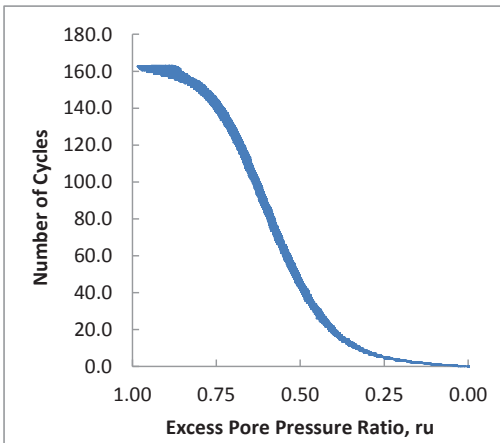
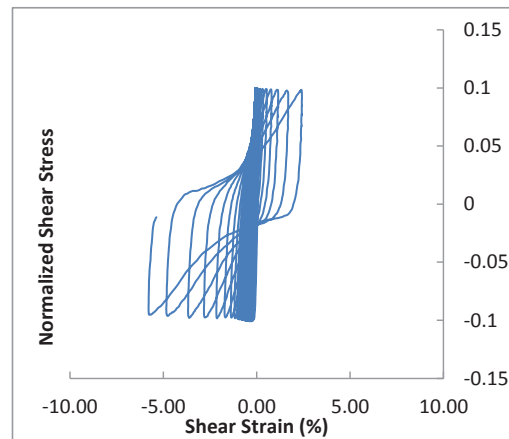
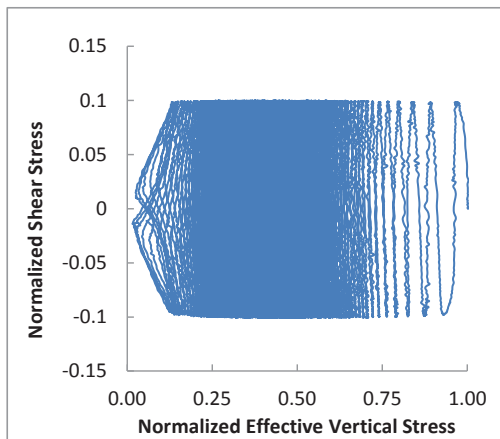

CSS Monotonic Shear Test Report

Geotechnical Engineering Laboratory



10/28/2013_Version 8.0

General Test Info and Sample Preparation

Device:	CSS	Relative Density (%):	68%
Specimen ID:	CLS5	Void Ratio:	0.744
Test ID:	C209	Height (mm):	109.5
Date of Test:	8/10/2015	Soil-Only Specimen Diameter (mm):	306.23
Test Performed:	Post Cyclic Monotonic Shear	Weight (kg):	12.258
Test Material:	5mm Crushed Limestone	Density (kg/m³):	1519.9
Sample Preparation:	Prepared dense by tamping 50x in 5 layers.	Membrane Thickness (mm):	0.635
		Moisture Content (%):	0%
		Saturated (Y/N):	N
		Prepared by:	J.Hubler
		Checked by:	J. Hubler

Consolidation Stage

Vertical Stress (kPa):	100
Time to Compression (min):	11.7
Relative Density (%):	87%
Void Ratio:	0.655
Height (mm):	104.0
Diameter (mm):	306.23
Weight (kg):	12.258
Density (kg/m³):	1600.9

Shear Stage

Type of Test:	Constant Volume
Stress or Strain Controlled:	Strain
Shear Strain Rate (%/min):	0.32
Peak Shear Strength (kPa):	34.0

Comments

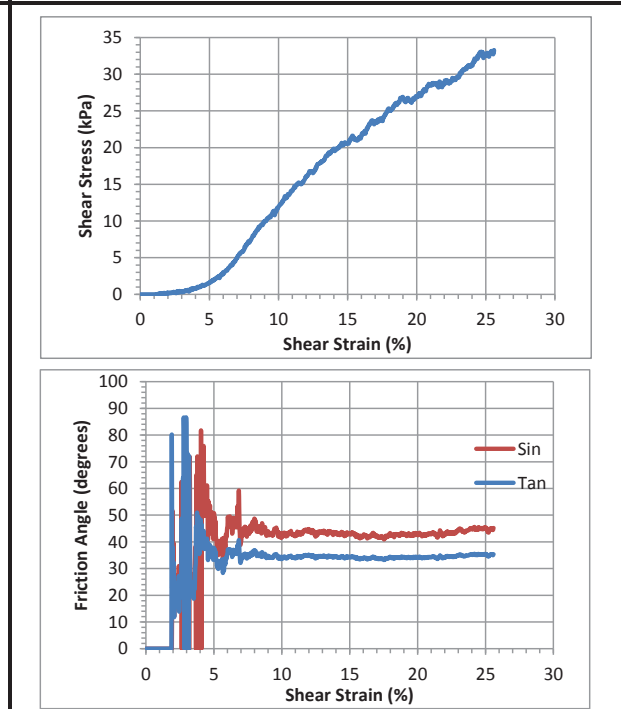
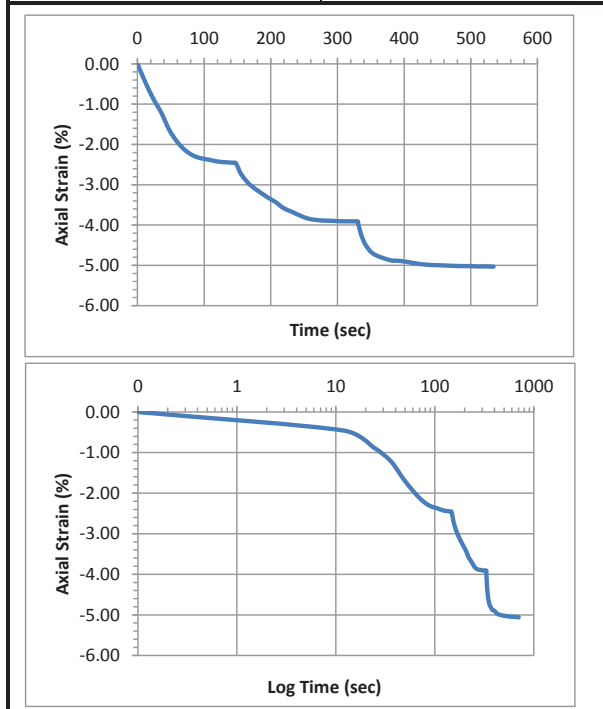

Accelerometer-Based Shear Wave Velocity Datasheet

Specimen ID: C209-FLS-100-1X
 Test Material: FLS
 Date: 8/10/215
 Test Performed by: J.Hubler
 Filename: C209-FLS-100-1X

Vertical Stress: 100kPa
 Sensor Spacing: 0.10392 m
 V_s (rise) = 233 m/s

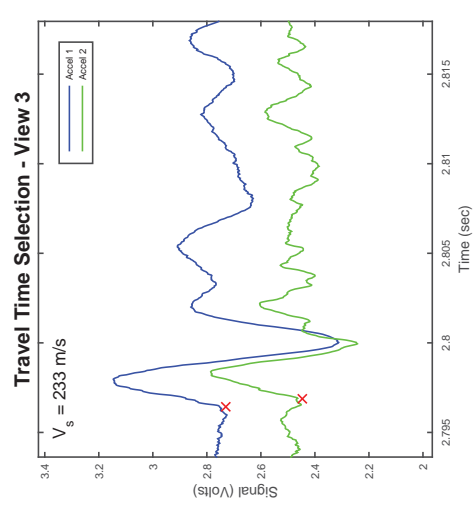
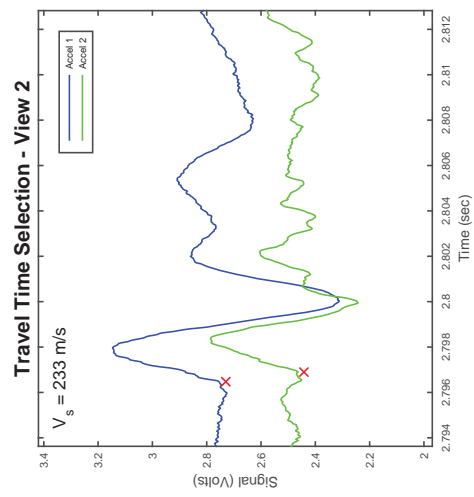
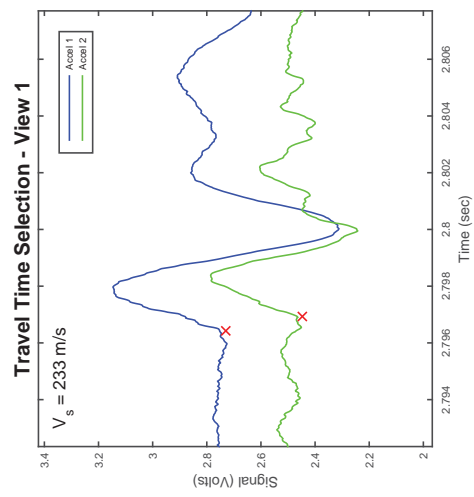
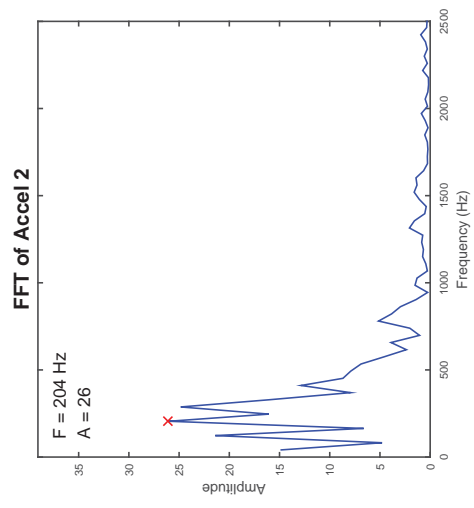
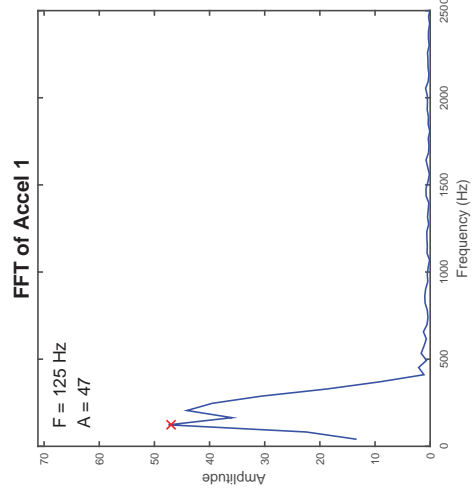
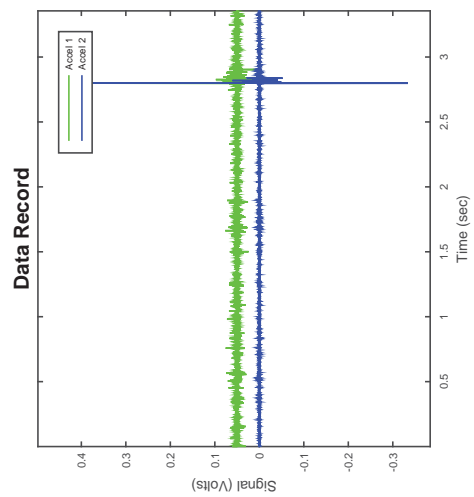

CSS Cyclic Shear Test Report

Geotechnical Engineering Laboratory



Cyclic Shear Test Summary

Device:	CSS	Density (kg/m³):	1603
Specimen ID:	CLS5	Relative Density (%):	87%
Test ID:	C198	Void Ratio:	0.654
Date of Test:	7/26/2015	Vertical Stress (kPa):	200
Test Performed:	Cyclic	Loading Frequency (Hz):	0.33
Test Material:	5mm Crushed Limestone	Number of Cycles:	94
Sample Preparation:	Prepared dense by tamping 35x in 5 layers.	Cyclic Stress Ratio:	0.097
		Shear Modulus (kPa):	
		Damping (%):	
Prepared by:	J. Hubler	Shear Strain Single Amplitude (%)	
Checked by:	J. Hubler		

Additional Comments:

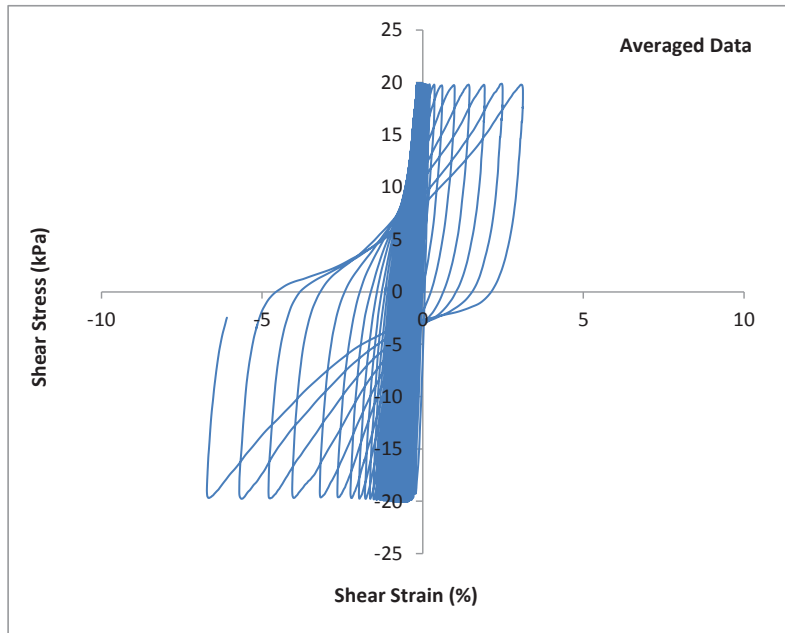
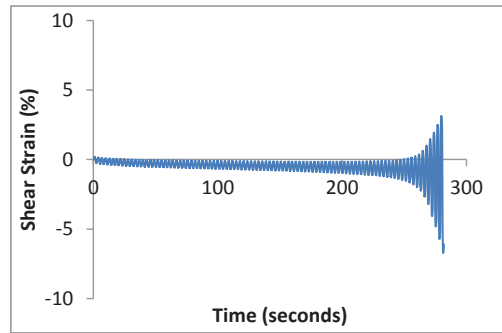
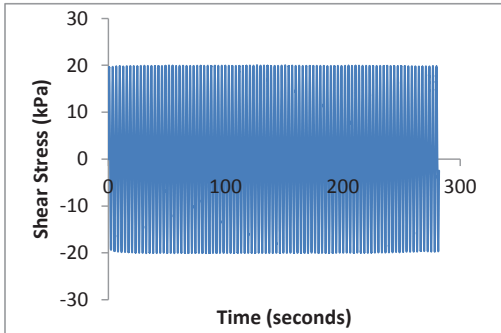

CSS Cyclic Shear Test Report

Geotechnical Engineering Laboratory



Cyclic Shear Test Summary

Device:	CSS	Density (kg/m³):	1603
Specimen ID:	CLS5	Relative Density (%):	87%
Test ID:	C198	Void Ratio:	0.654
Date of Test:	7/26/2015	Vertical Stress (kPa):	200
Test Performed:	Cyclic	Loading Frequency (Hz):	0.33
Test Material:	5mm Crushed Limestone	Number of Cycles:	94
Sample Preparation:	Prepared dense by tamping 35x in 5 layers.	Cyclic Stress Ratio:	0.097
		Number of Cycles to Liq:	91
		Maximum ru:	0.97
Prepared by:	J. Hubler		
Checked by:	J. Hubler		

Additional Comments:

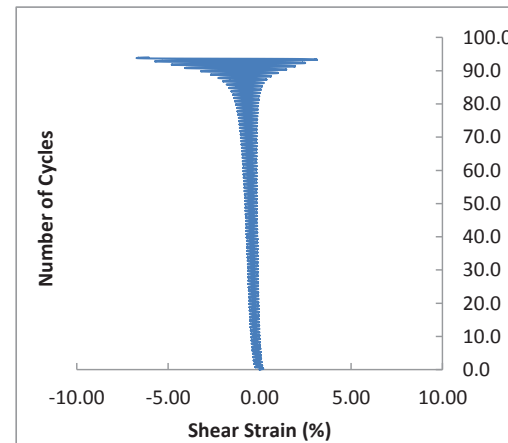
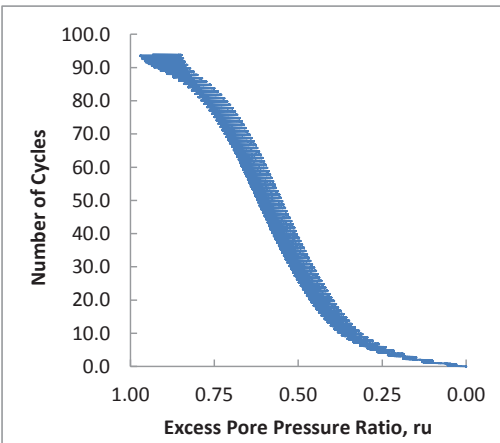
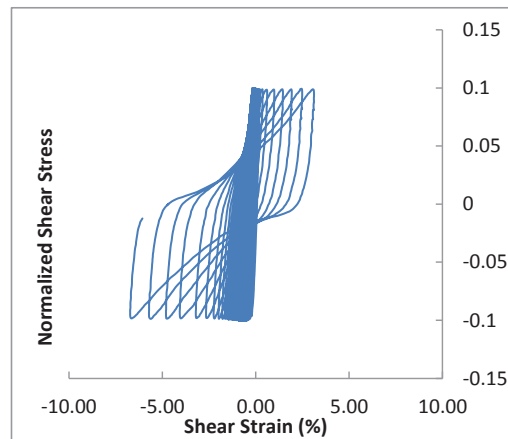
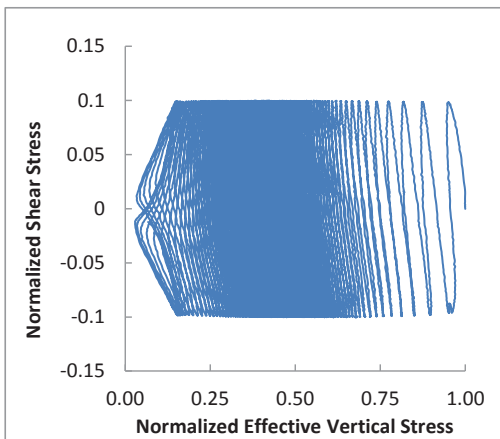

CSS Monotonic Shear Test Report

Geotechnical Engineering Laboratory



10/28/2013_Version 8.0

General Test Info and Sample Preparation

Device:	CSS	Relative Density (%):	82%
Specimen ID:	CLS5	Void Ratio:	0.676
Test ID:	C198	Height (mm):	102.3
Date of Test:	7/26/2015	Soil-Only Specimen Diameter (mm):	306.23
Test Performed:	Post Cyclic Monotonic Shear	Weight (kg):	11.921
Test Material:	5mm Crushed Limestone	Density (kg/m³):	1581.6
Sample Preparation:	Prepared dense by tamping 35x in 5 layers.	Membrane Thickness (mm):	0.001
		Moisture Content (%):	0%
		Saturated (Y/N):	N
		Prepared by:	J.Hubler
		Checked by:	J. Hubler

Consolidation Stage

Vertical Stress (kPa):	200
Time to Compression (min):	9.8
Relative Density (%):	87%
Void Ratio:	0.654
Height (mm):	101.0
Diameter (mm):	306.23
Weight (kg):	11.921
Density (kg/m³):	1602.6

Shear Stage

Type of Test:	Constant Volume
Stress or Strain Controlled:	Strain
Shear Strain Rate (%/min):	0.32
Peak Shear Strength (kPa):	78.8

Comments

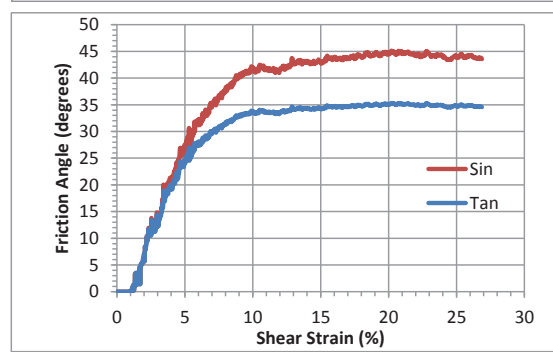
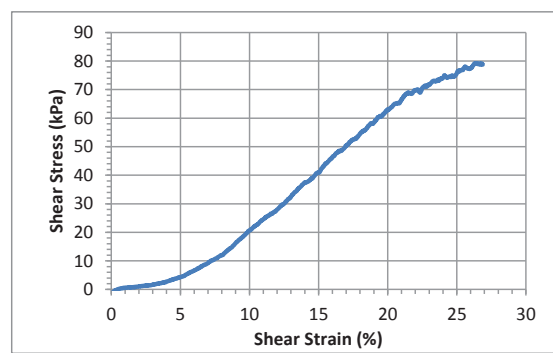
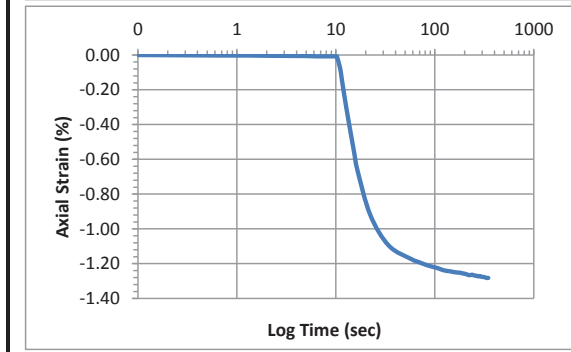
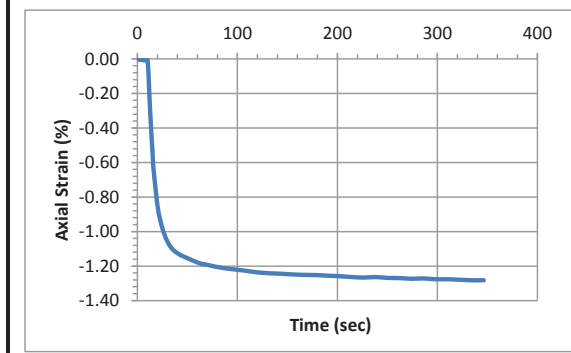

Accelerometer-Based Shear Wave Velocity Datasheet

Specimen ID: C198-FLS-200-1X
 Test Material: FLS
 Date: 7/26/2015
 Test Performed by: J.Hubler
 Filename: C198-FLS-200-1X

Vertical Stress: 200kPa
 Sensor Spacing: 0.10095 m
 V_s (rise) = 270 m/s

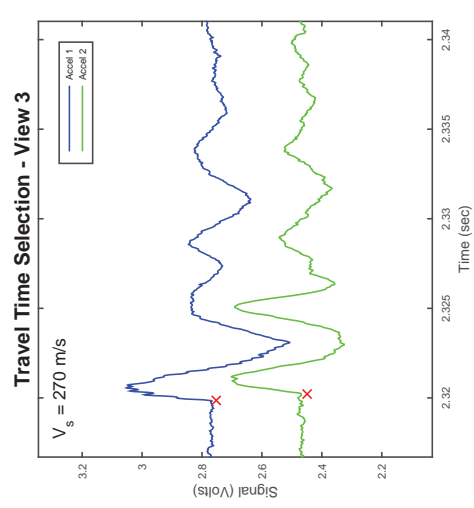
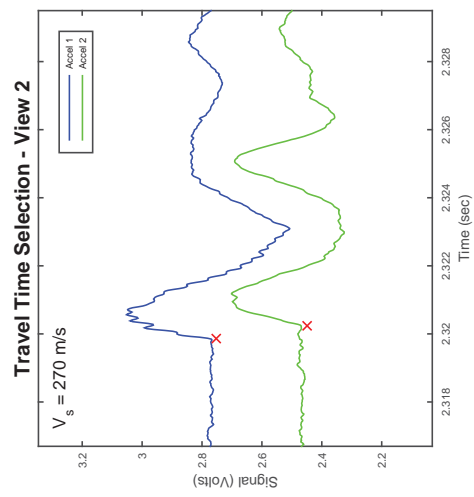
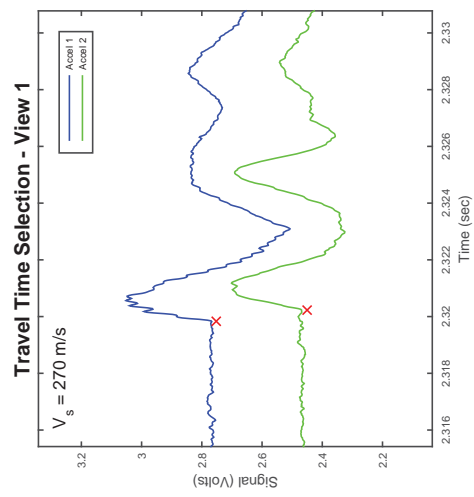
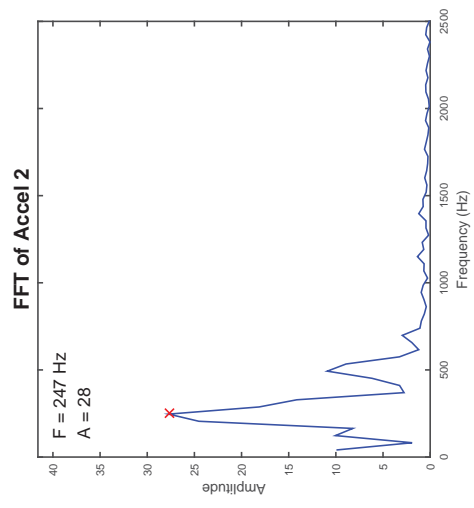
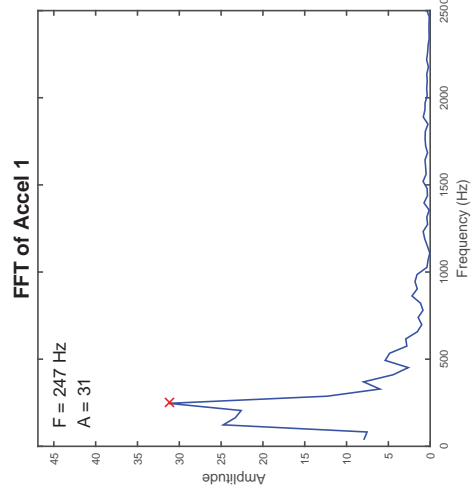
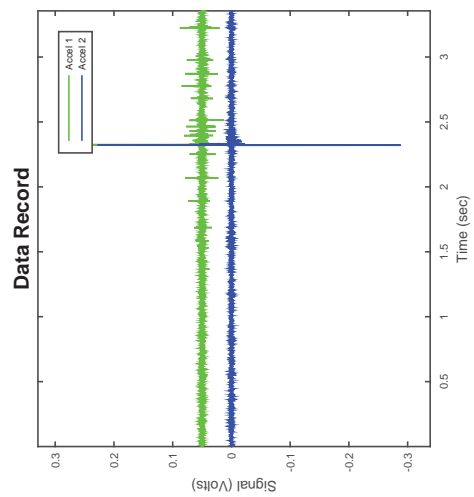

Accelerometer-Based Shear Wave Velocity Datasheet

Specimen ID: C198-FLS-200-2X

Test Material: FLS

Date: 7/26/2015

Test Performed by: J.Hubler

Filename: C198-FLS-200-2X

Vertical Stress: 200kPa

Sensor Spacing: 0.10095 m

V_s (rise) = 260 m/s

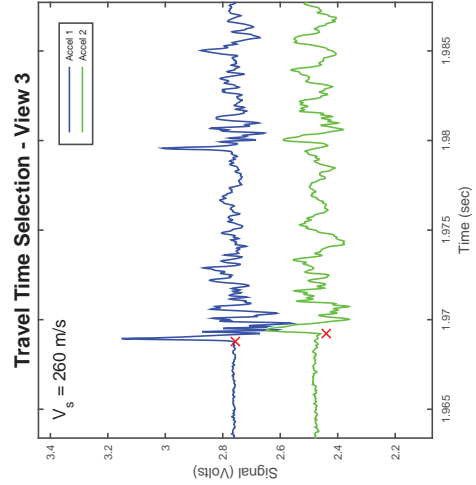
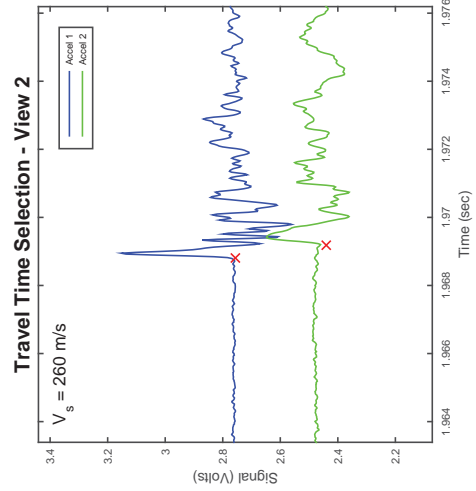
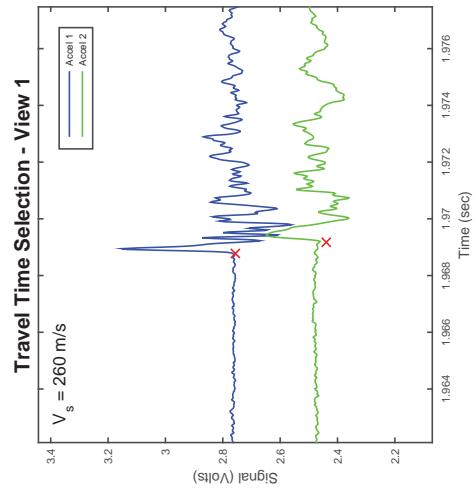
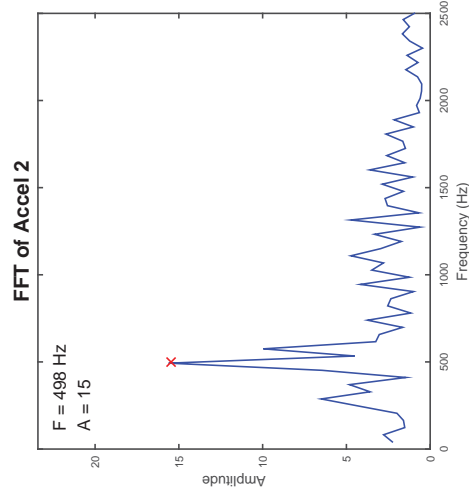
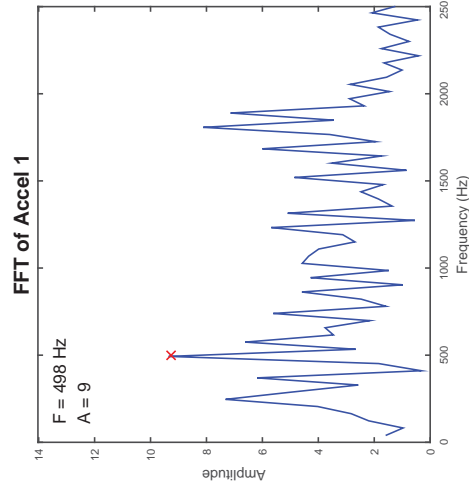
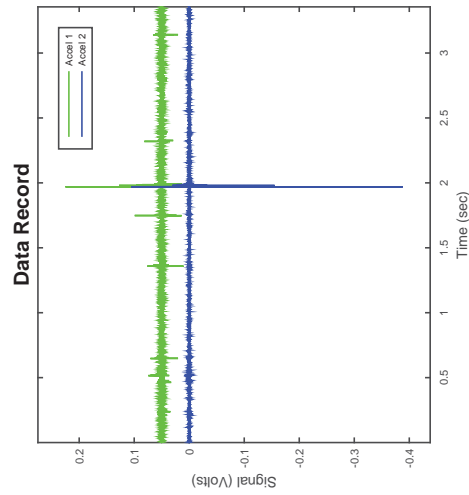

Accelerometer-Based Shear Wave Velocity Datasheet

Specimen ID: C198-FLS-200-3X
 Test Material: FLS
 Date: 7/26/2015
 Test Performed by: J.Hubler
 Filename: C198-FLS-200-3X

Vertical Stress: 200kPa
 Sensor Spacing: 0.10095 m
 V_s (rise) = 270 m/s

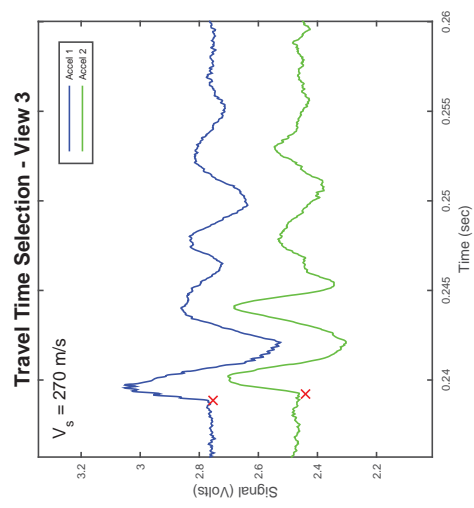
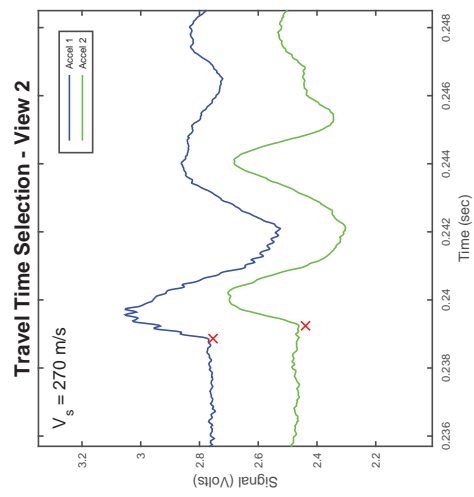
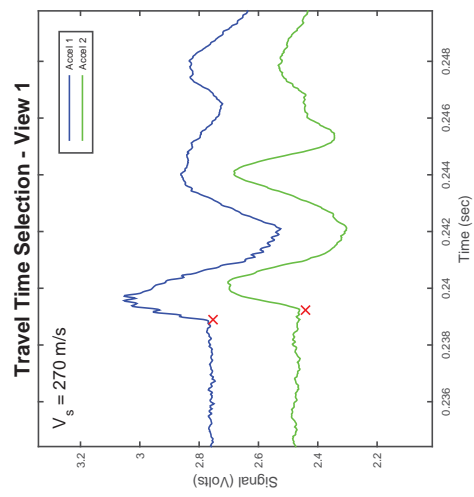
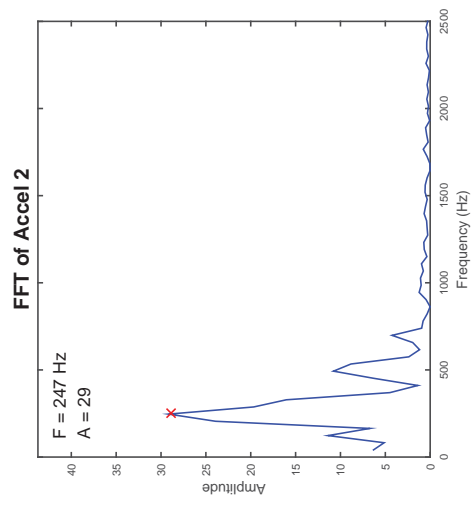
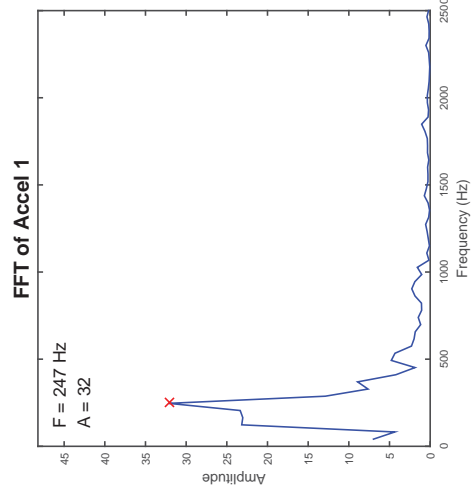
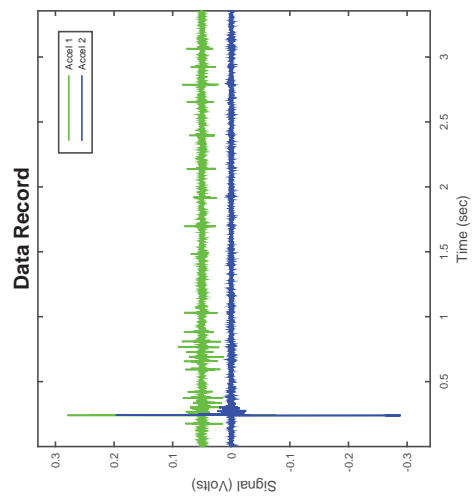

CSS Cyclic Shear Test Report

Geotechnical Engineering Laboratory



Cyclic Shear Test Summary

Device:	CSS	Density (kg/m³):	1618
Specimen ID:	CLS5	Relative Density (%):	90%
Test ID:	C201	Void Ratio:	0.637
Date of Test:	7/30/2015	Vertical Stress (kPa):	400
Test Performed:	Cyclic	Loading Frequency (Hz):	0.33
Test Material:	5mm Crushed Limestone	Number of Cycles:	90
Sample Preparation:	Prepared dense by tamping 30x in 5 layers.	Cyclic Stress Ratio:	0.099
		Shear Modulus (kPa):	
		Damping (%):	
Prepared by:	J. Hubler	Shear Strain Single Amplitude (%):	
Checked by:	J. Hubler		

Additional Comments:

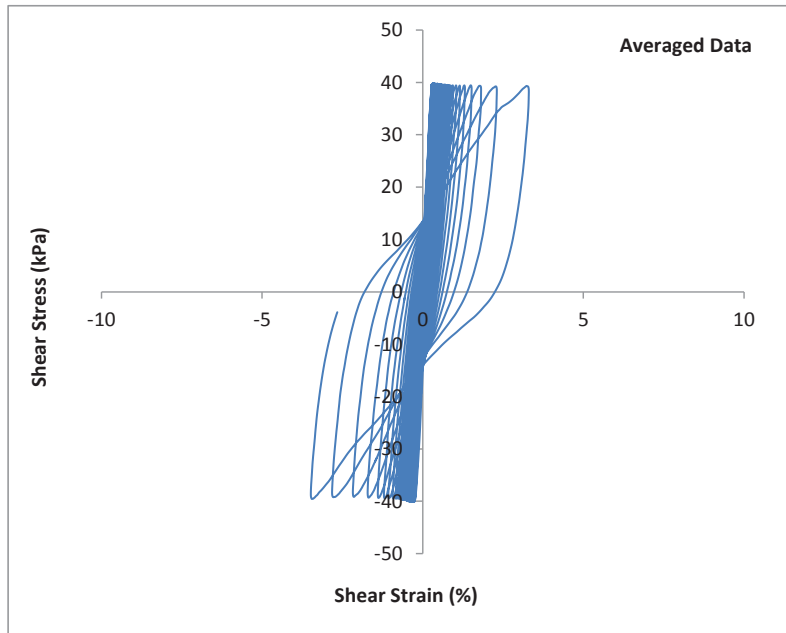
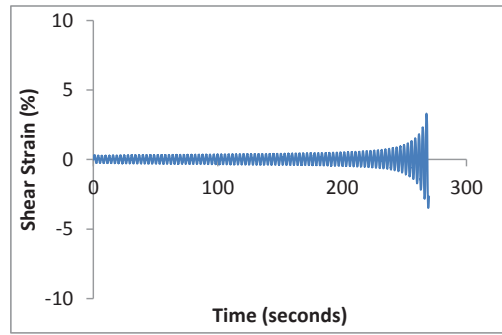
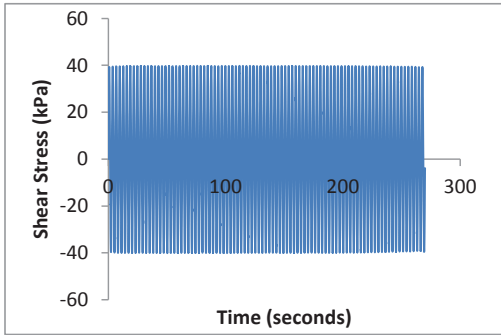

CSS Cyclic Shear Test Report

Geotechnical Engineering Laboratory



Cyclic Shear Test Summary

Device:	CSS	Density (kg/m³):	1618
Specimen ID:	CLS5	Relative Density (%):	90%
Test ID:	C201	Void Ratio:	0.637
Date of Test:	7/30/2015	Vertical Stress (kPa):	400
Test Performed:	Cyclic	Loading Frequency (Hz):	0.33
Test Material:	5mm Crushed Limestone	Number of Cycles:	90
Sample Preparation:	Prepared dense by tamping 30x in 5 layers.	Cyclic Stress Ratio:	0.099
		Number of Cycles to Liq:	90
		Maximum ru:	0.95
Prepared by:	J. Hubler		
Checked by:	J. Hubler		

Additional Comments:

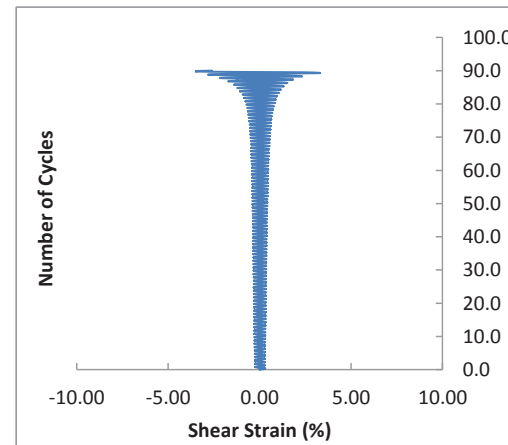
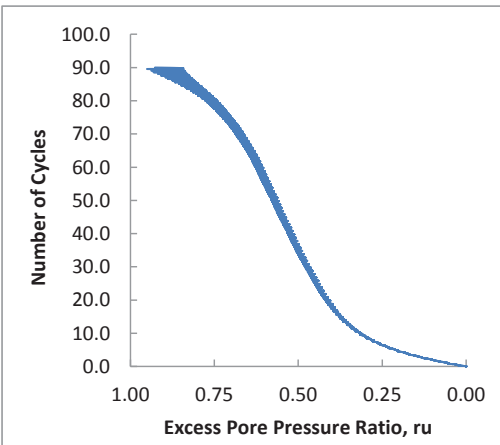
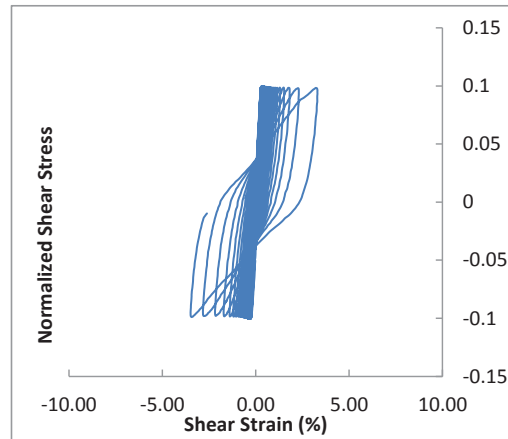
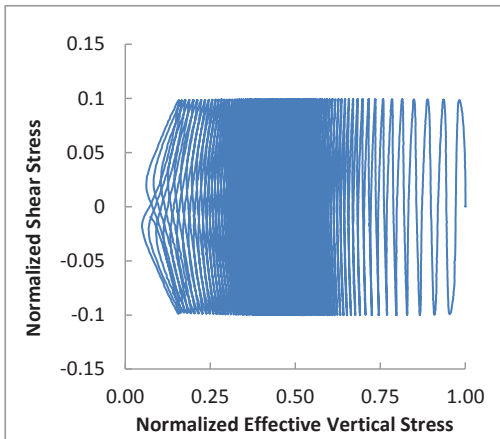

CSS Monotonic Shear Test Report

Geotechnical Engineering Laboratory



10/28/2013_Version 8.0

General Test Info and Sample Preparation

Device:	CSS	Relative Density (%):	68%
Specimen ID:	CLS5	Void Ratio:	0.744
Test ID:	C201	Height (mm):	109.9
Date of Test:	7/30/2015	Soil-Only Specimen Diameter (mm):	306.23
Test Performed:	Post Cyclic Monotonic Shear	Weight (kg):	12.303
Test Material:	5mm Crushed Limestone	Density (kg/m³):	1519.3
Sample Preparation:	Prepared dense by tamping 30x in 5 layers.	Membrane Thickness (mm):	0.001
		Moisture Content (%):	0%
		Saturated (Y/N):	N
		Prepared by:	J.Hubler
		Checked by:	J. Hubler

Consolidation Stage

Vertical Stress (kPa):	400
Time to Compression (min):	16.9
Relative Density (%):	90%
Void Ratio:	0.637
Height (mm):	103.2
Diameter (mm):	306.23
Weight (kg):	12.303
Density (kg/m³):	1618.4

Shear Stage

Type of Test:	Constant Volume
Stress or Strain Controlled:	Strain
Shear Strain Rate (%/min):	0.31
Peak Shear Strength (kPa):	92.8

Comments

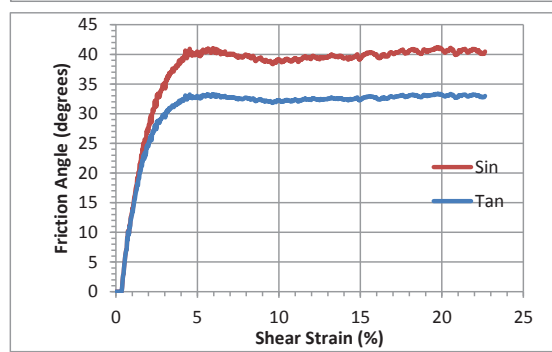
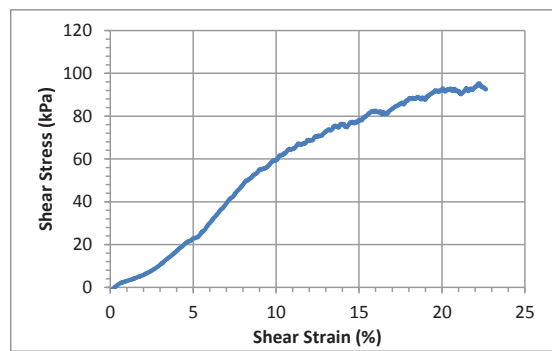
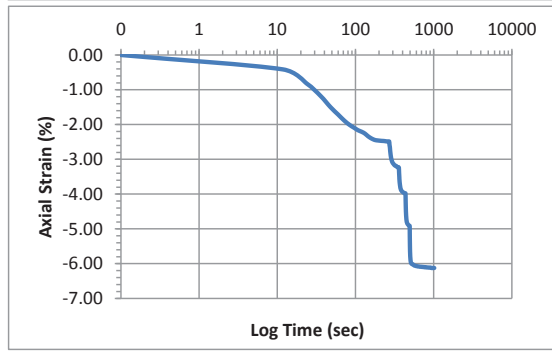
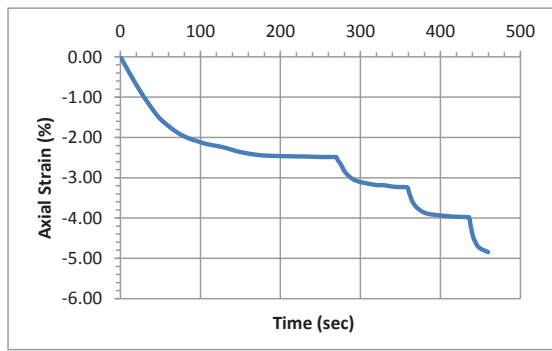

Accelerometer-Based Shear Wave Velocity Datasheet

Specimen ID: C201-FLS-400-1X
 Test Material: FLS
 Date: 7/30/2015
 Test Performed by: J.Hubler
 Filename: C201-FLS-400-1X

Vertical Stress: 400kPa
 Sensor Spacing: 0.10317 m
 V_s (rise) = 328 m/s

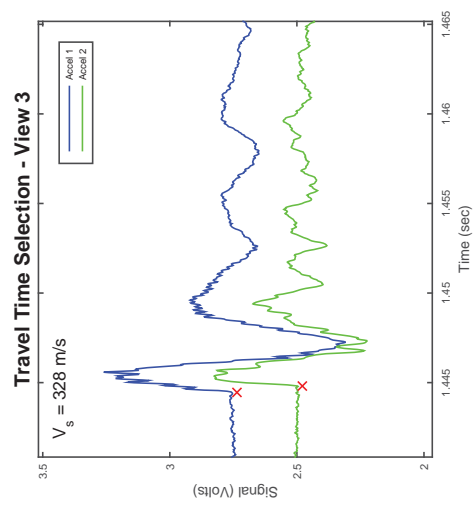
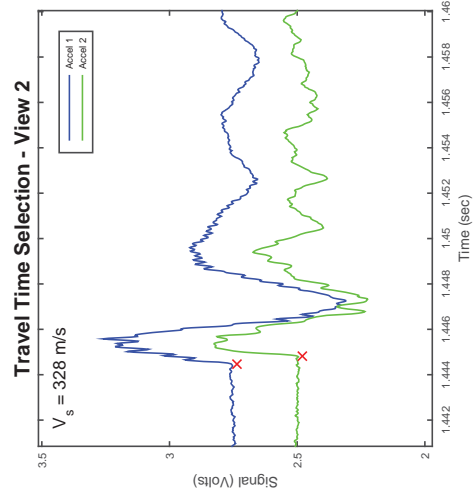
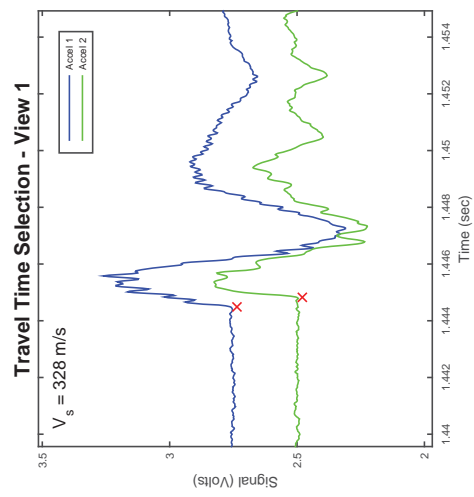
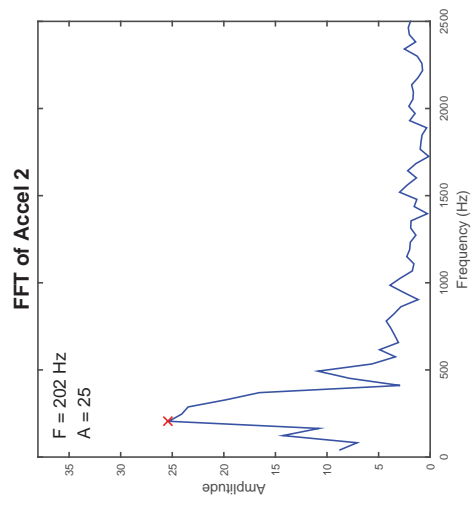
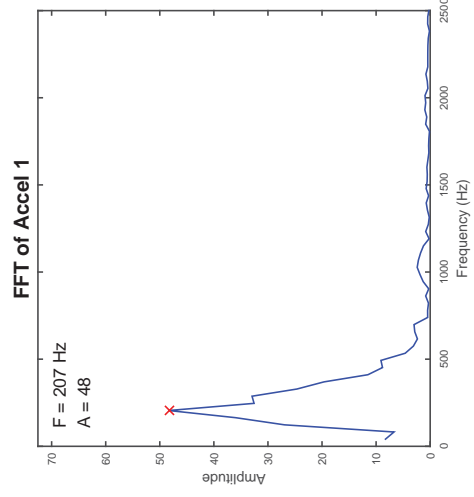
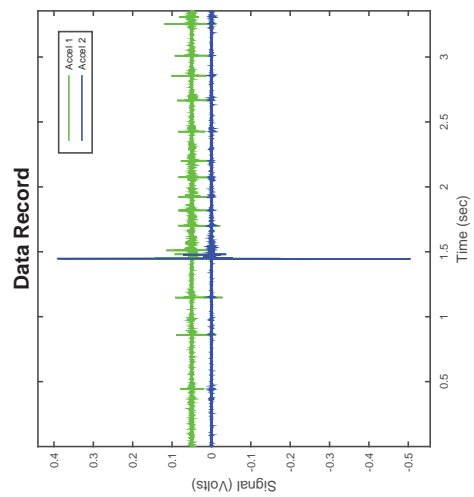

CSS Cyclic Shear Test Report

Geotechnical Engineering Laboratory



Cyclic Shear Test Summary

Device:	CSS	Density (kg/m³):	1417
Specimen ID:	CLS5	Relative Density (%):	42%
Test ID:	C196	Void Ratio:	0.870
Date of Test:	7/20/2015	Vertical Stress (kPa):	100
Test Performed:	Cyclic	Loading Frequency (Hz):	0.33
Test Material:	5mm Crushed Limestone	Number of Cycles:	7
Sample Preparation:	Prepared loose specimen using shoveling method then hit base plate 25x at 3 layers using rubber mallet	Cyclic Stress Ratio:	0.144
		Shear Modulus (kPa):	
		Damping (%):	
Prepared by:	A. Jackson	Shear Strain Single Amplitude (%)	
Checked by:	J. Hubler		

Additional Comments:

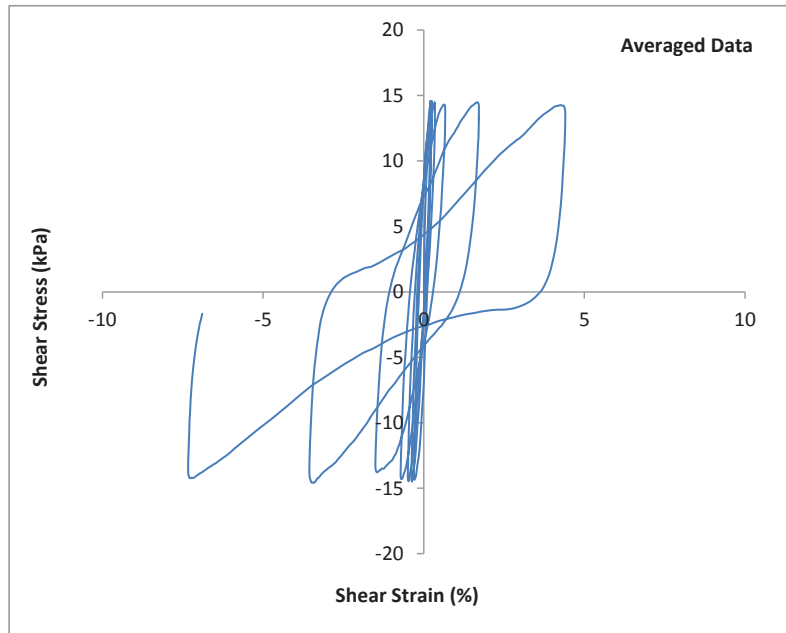
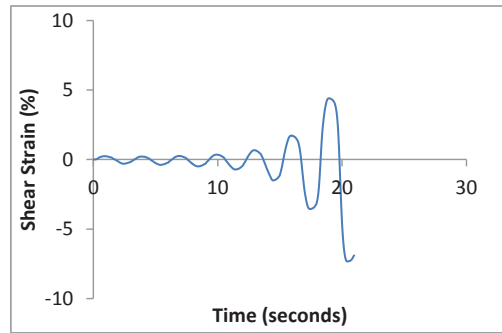
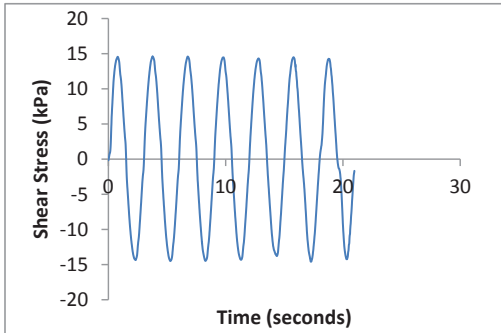

CSS Cyclic Shear Test Report

Geotechnical Engineering Laboratory



Cyclic Shear Test Summary

Device:	CSS	Density (kg/m³):	1417
Specimen ID:	CLS5	Relative Density (%):	42%
Test ID:	C196	Void Ratio:	0.870
Date of Test:	7/20/2015	Vertical Stress (kPa):	100
Test Performed:	Cyclic	Loading Frequency (Hz):	0.33
Test Material:	5mm Crushed Limestone	Number of Cycles:	7
Sample Preparation:	Prepared loose specimen using shoveling method then hit base plate 25x at 3 layers using rubber mallet	Cyclic Stress Ratio:	0.144
		Number of Cycles to Liq:	7
		Maximum ru:	0.97
Prepared by:	A. Jackson		
Checked by:	J. Hubler		

Additional Comments:

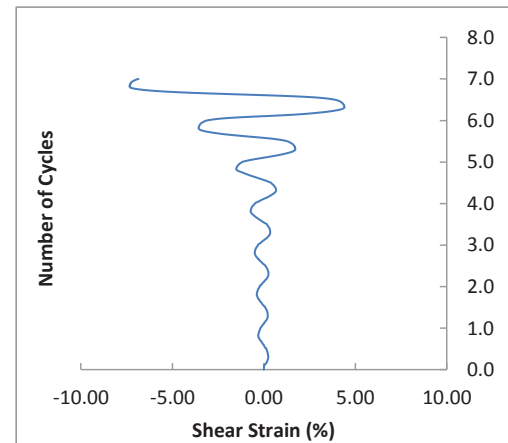
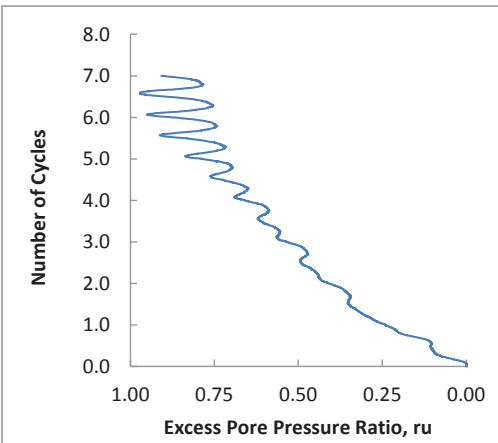
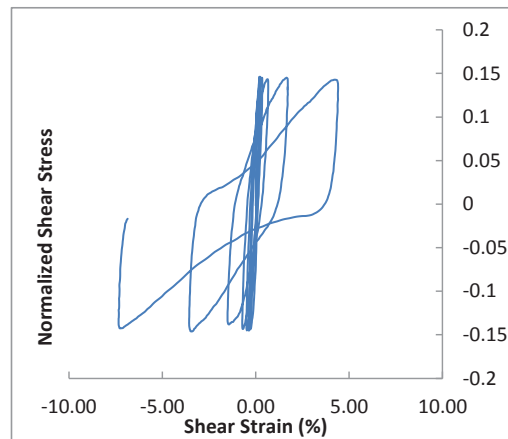
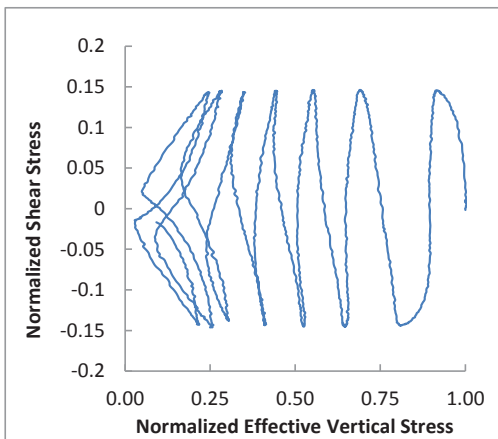

CSS Monotonic Shear Test Report

Geotechnical Engineering Laboratory



10/28/2013_Version 8.0

General Test Info and Sample Preparation

Device:	CSS	Relative Density (%):	42%
Specimen ID:	CLS5	Void Ratio:	0.872
Test ID:	C196	Height (mm):	108.9
Date of Test:	7/20/2015	Soil-Only Specimen Diameter (mm):	306.23
Test Performed:	Post Cyclic Monotonic Shear	Weight (kg):	11.358
Test Material:	5mm Crushed Limestone	Density (kg/m³):	1415.7
Sample Preparation:	Prepared loose specimen using shoveling method then hitting base plate 25x at 3 layers with rubber mallet	Membrane Thickness (mm):	0.635
		Moisture Content (%):	0%
		Saturated (Y/N):	N
		Prepared by:	A. Jackson
		Checked by:	J. Hubler

Consolidation Stage

Vertical Stress (kPa):	100
Time to Compression (min):	6.9
Relative Density (%):	42%
Void Ratio:	0.870
Height (mm):	108.8
Diameter (mm):	306.23
Weight (kg):	11.358
Density (kg/m³):	1417.0

Shear Stage

Type of Test:	Constant Volume
Stress or Strain Controlled:	Strain
Shear Strain Rate (%/min):	0.30
Peak Shear Strength (kPa):	34.0

Comments

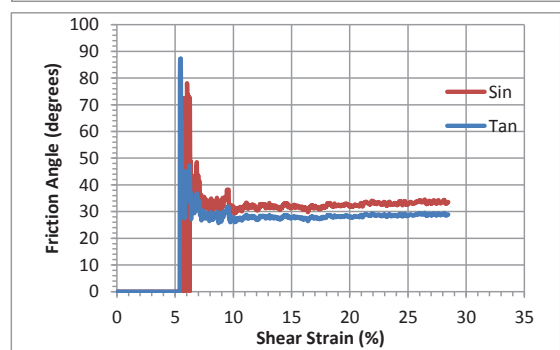
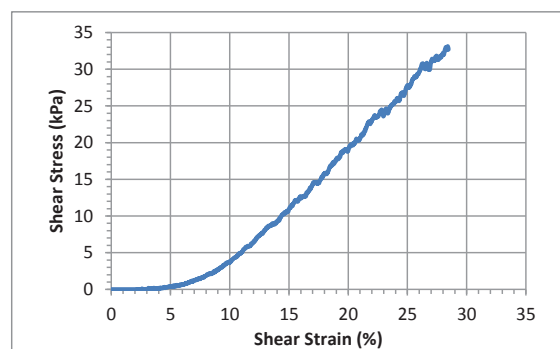
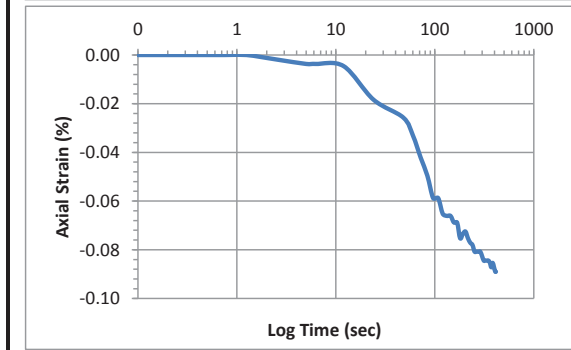
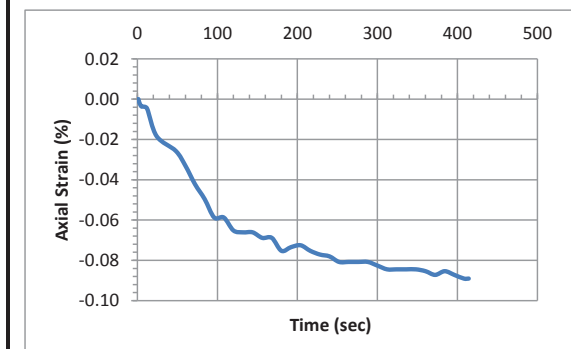

Accelerometer-Based Shear Wave Velocity Datasheet

Specimen ID: C196-FLS-100-1X
 Test Material: FLS
 Date: 7/20/2015
 Test Performed by: J.Hubler
 Filename: C196-FLS-100-1X

Vertical Stress: 100kPa
 Sensor Spacing: 0.10879 m
 V_s (rise) = 193 m/s

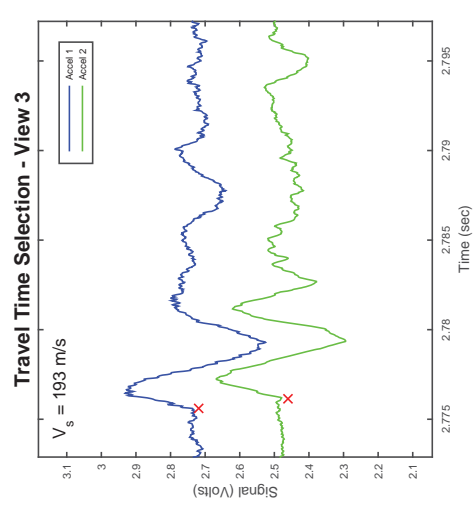
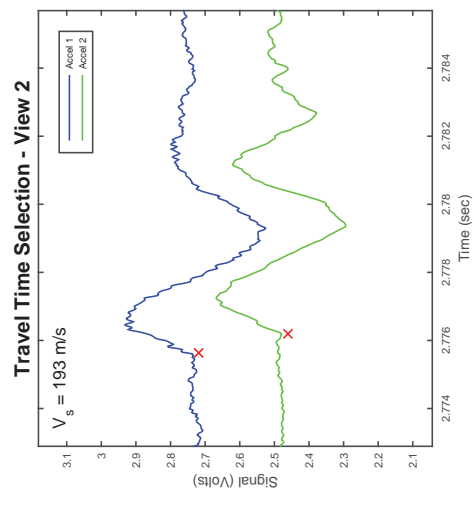
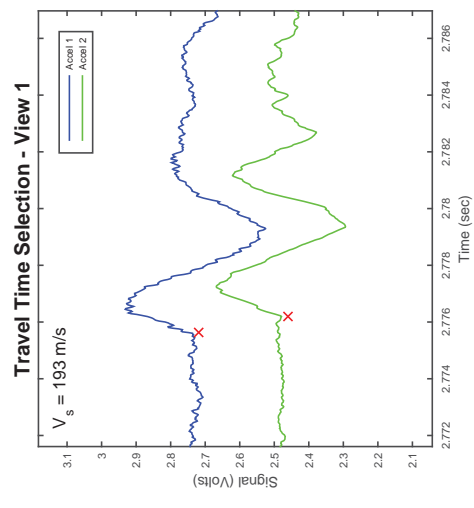
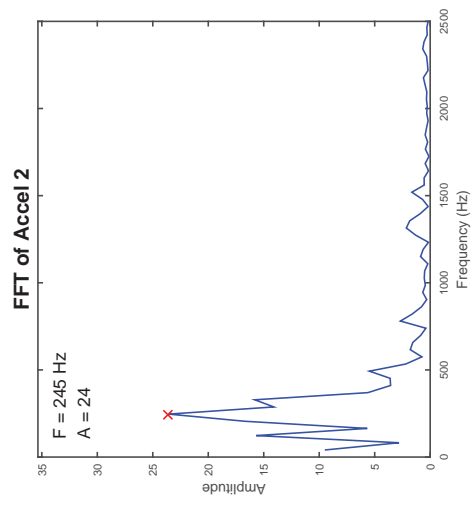
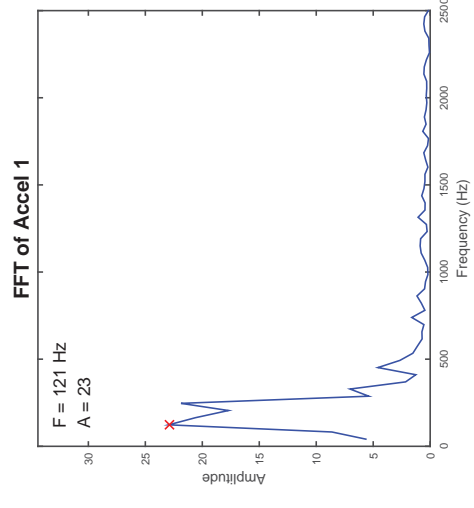
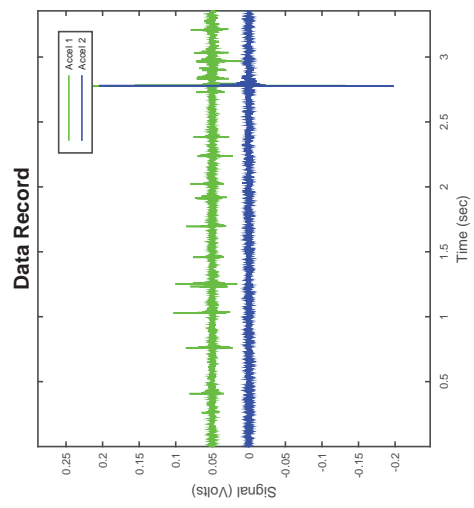

CSS Cyclic Shear Test Report

Geotechnical Engineering Laboratory



Cyclic Shear Test Summary

Device:	CSS	Density (kg/m³):	1414
Specimen ID:	CLS5	Relative Density (%):	42%
Test ID:	C197	Void Ratio:	0.875
Date of Test:	7/23/2015	Vertical Stress (kPa):	100
Test Performed:	Cyclic	Loading Frequency (Hz):	0.33
Test Material:	5mm Crushed Limestone	Number of Cycles:	1000
Sample Preparation:	Prepared loose specimen using shoveling method then hit base plate 25x at 3 layers using rubber mallet	Cyclic Stress Ratio:	0.094
		Shear Modulus (kPa):	
		Damping (%):	
Prepared by:	A.Jackson	Shear Strain Single Amplitude (%)	
Checked by:	J. Hubler		

Additional Comments:

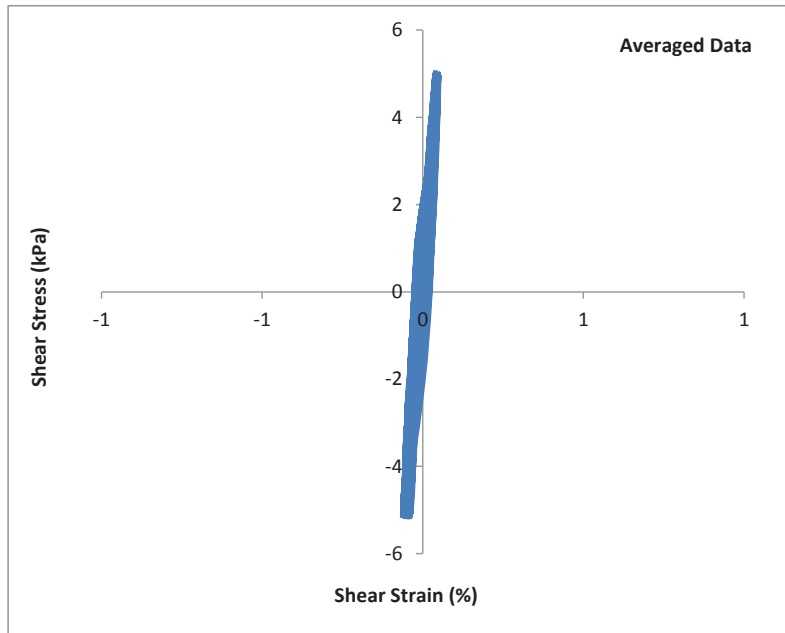
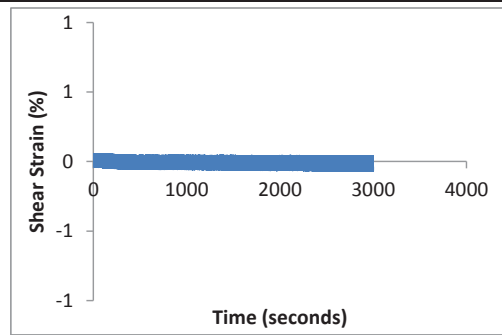
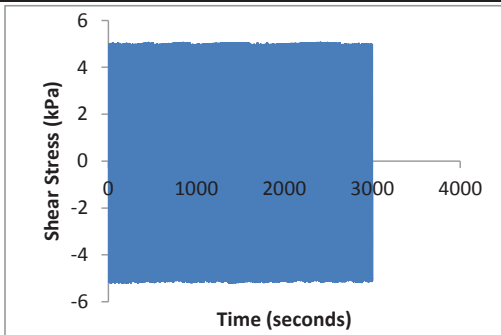

CSS Cyclic Shear Test Report

Geotechnical Engineering Laboratory



Cyclic Shear Test Summary

Device:	CSS	Density (kg/m³):	1414
Specimen ID:	CLS5	Relative Density (%):	42%
Test ID:	C197	Void Ratio:	0.875
Date of Test:	7/23/2015	Vertical Stress (kPa):	100
Test Performed:	Cyclic	Loading Frequency (Hz):	0.33
Test Material:	5mm Crushed Limestone	Number of Cycles:	1000
Sample Preparation:	Prepared loose specimen using shoveling method then hit base plate 25x at 3 layers using rubber mallet	Cyclic Stress Ratio:	0.094
		Number of Cycles to Liq:	
		Maximum ru:	0.35
Prepared by:	A.Jackson		
Checked by:	J. Hubler		

Additional Comments:

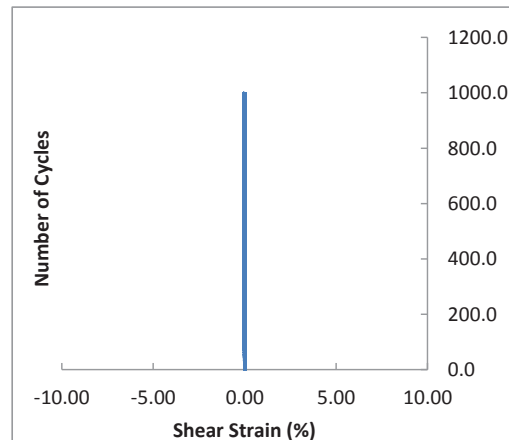
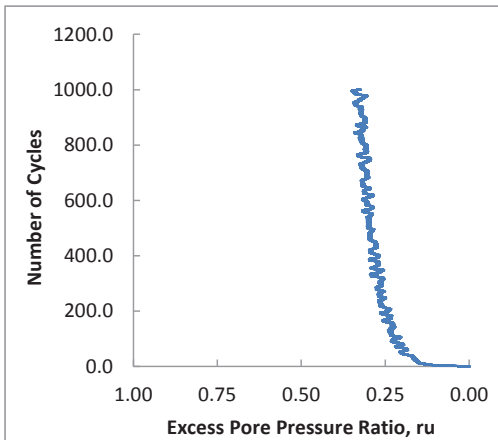
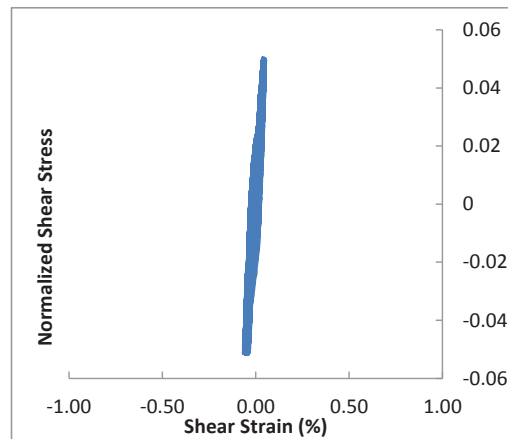
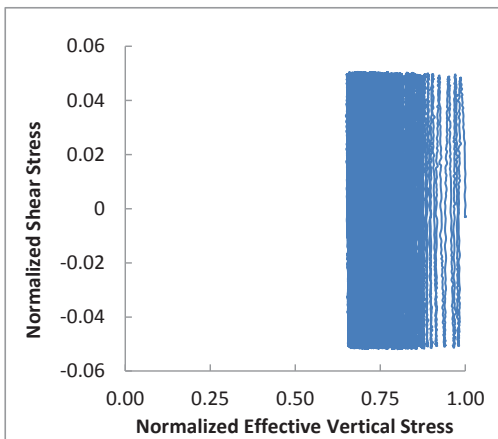

CSS Monotonic Shear Test Report

Geotechnical Engineering Laboratory



10/28/2013_Version 8.0

General Test Info and Sample Preparation

Device:	CSS	Relative Density (%):	29%
Specimen ID:	CLS5	Void Ratio:	0.933
Test ID:	C197	Height (mm):	110.2
Date of Test:	7/23/2015	Soil-Only Specimen Diameter (mm):	306.23
Test Performed:	Post Cyclic Monotonic Shear	Weight (kg):	11.128
Test Material:	5mm Crushed Limestone	Density (kg/m ³):	1370.8
Sample Preparation:	Prepared loose specimen using shoveling method then hitting base plate 25x at 3 layers with rubber mallet	Membrane Thickness (mm):	0.001
		Moisture Content (%):	0%
		Saturated (Y/N):	N
		Prepared by:	A. Jackson
		Checked by:	J. Hubler

Consolidation Stage

Vertical Stress (kPa):	100
Time to Compression (min):	16.0
Relative Density (%):	41%
Void Ratio:	0.875
Height (mm):	106.9
Diameter (mm):	306.23
Weight (kg):	11.128
Density (kg/m ³):	1413.6

Shear Stage

Type of Test:	Constant Volume
Stress or Strain Controlled:	Strain
Shear Strain Rate (%/min):	0.31
Peak Shear Strength (kPa):	44.0

Comments

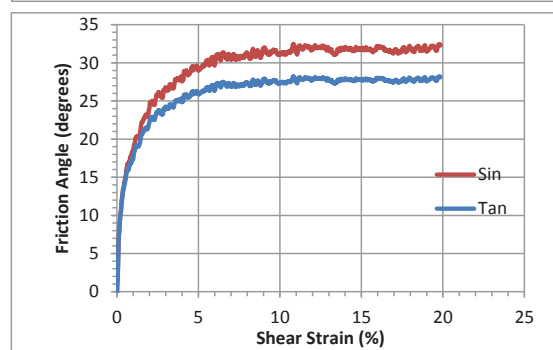
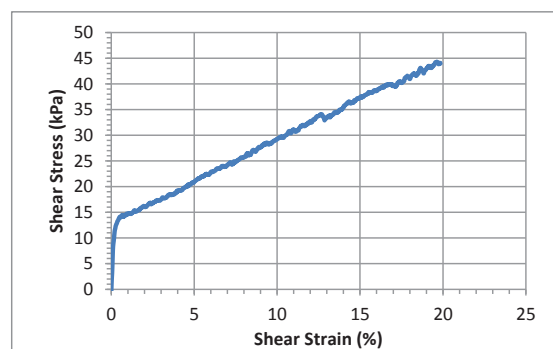
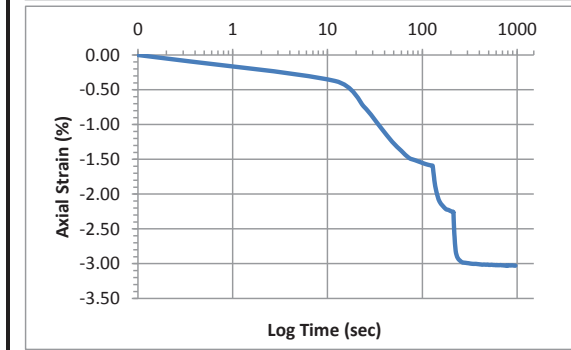
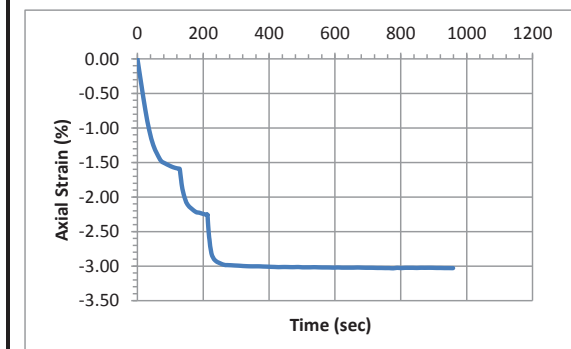

Accelerometer-Based Shear Wave Velocity Datasheet

Specimen ID: C197-FLS-100-2X
Test Material: FLS
Date: 7/23/2015
Test Performed by: J.Hubler
Filename: C197-FLS-100-2X

Vertical Stress: 100kPa
Sensor Spacing: 0.10684 m
 V_s (rise) = 205 m/s

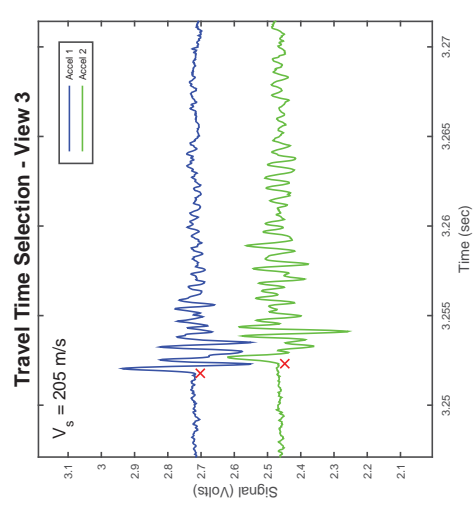
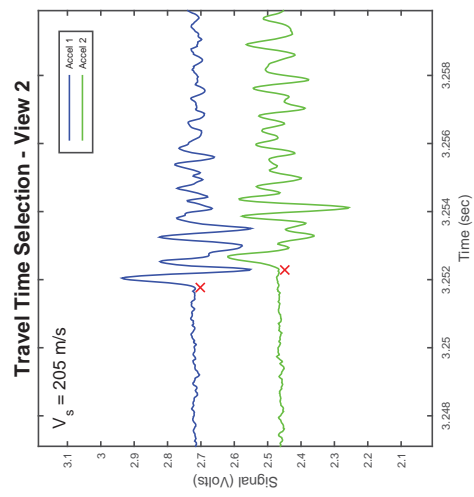
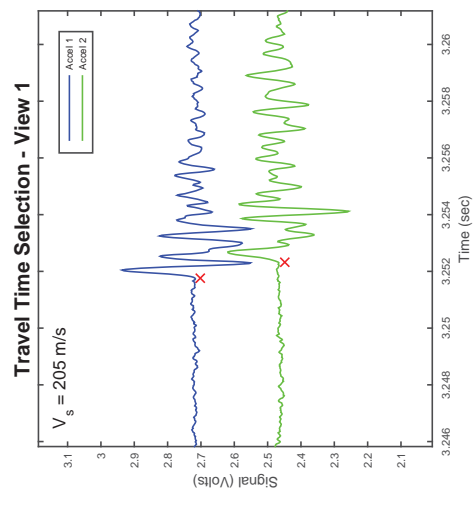
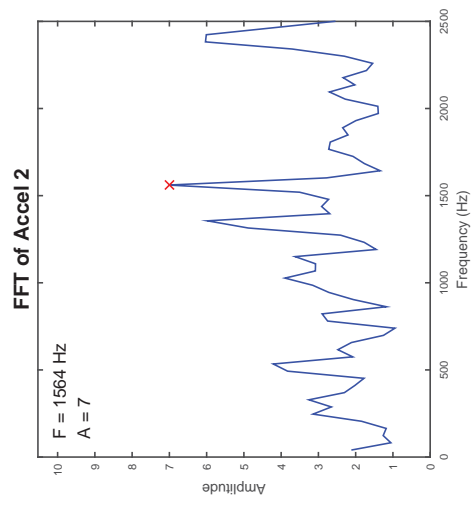
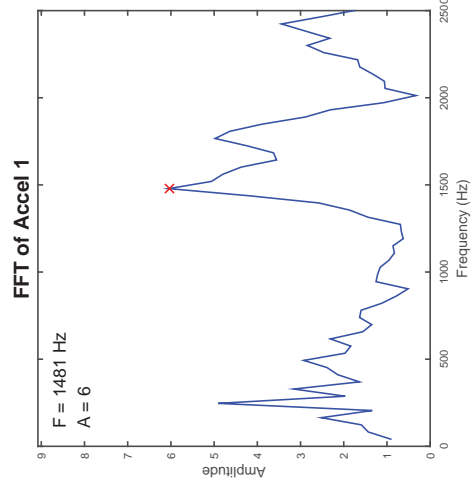
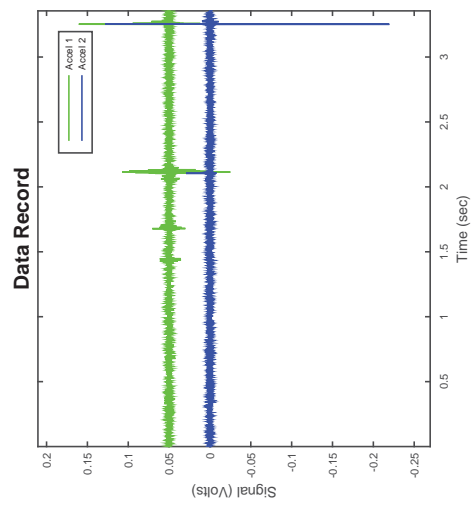

Accelerometer-Based Shear Wave Velocity Datasheet

Specimen ID: C197-FLS-100-3X

Test Material: FLS

Date: 7/23/2015

Test Performed by: J.Hubler

Filename: C197-FLS-100-3X

Vertical Stress: 100kPa

Sensor Spacing: 0.10684 m

V_s (rise) = 194 m/s

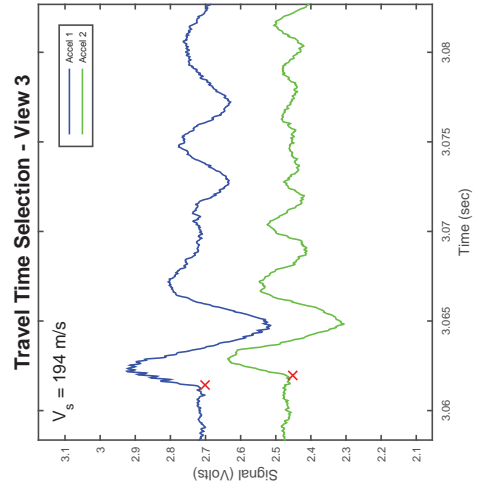
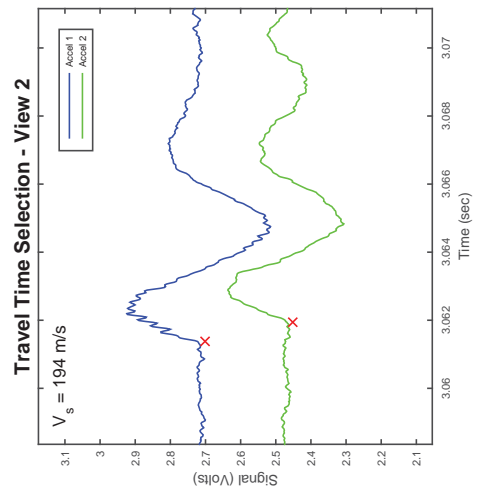
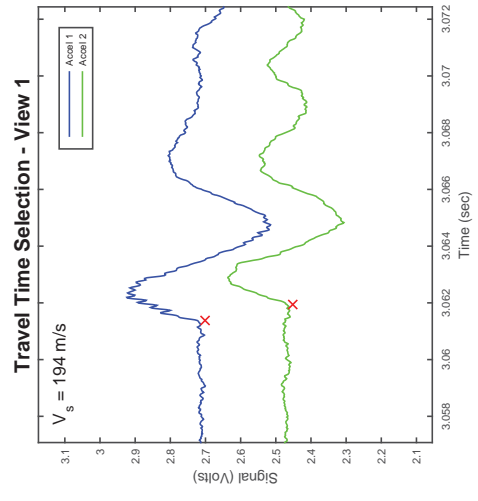
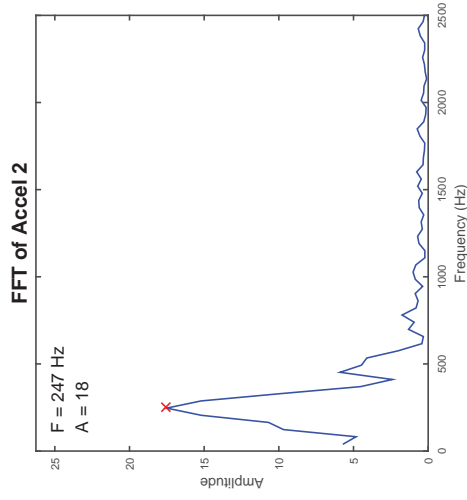
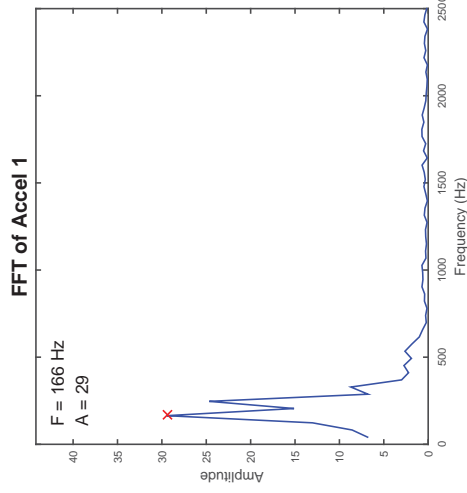
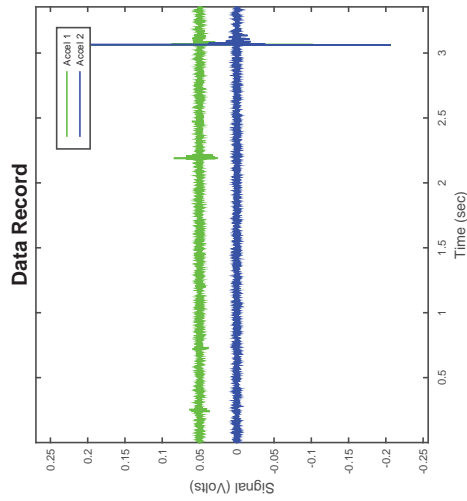

CSS Cyclic Shear Test Report

Geotechnical Engineering Laboratory



Cyclic Shear Test Summary

Device:	CSS	Density (kg/m³):	1599
Specimen ID:	CLS5	Relative Density (%):	86%
Test ID:	C213	Void Ratio:	0.657
Date of Test:	8/11/2015	Vertical Stress (kPa):	100
Test Performed:	Cyclic	Loading Frequency (Hz):	0.33
Test Material:	5mm Crushed Limestone	Number of Cycles:	9
Sample Preparation:	Prepared dense by tamping 50x in 5 layers.	Cyclic Stress Ratio:	0.144
		Shear Modulus (kPa):	
		Damping (%):	
Prepared by:	J. Hubler	Shear Strain Single Amplitude (%)	
Checked by:	J. Hubler		

Additional Comments:

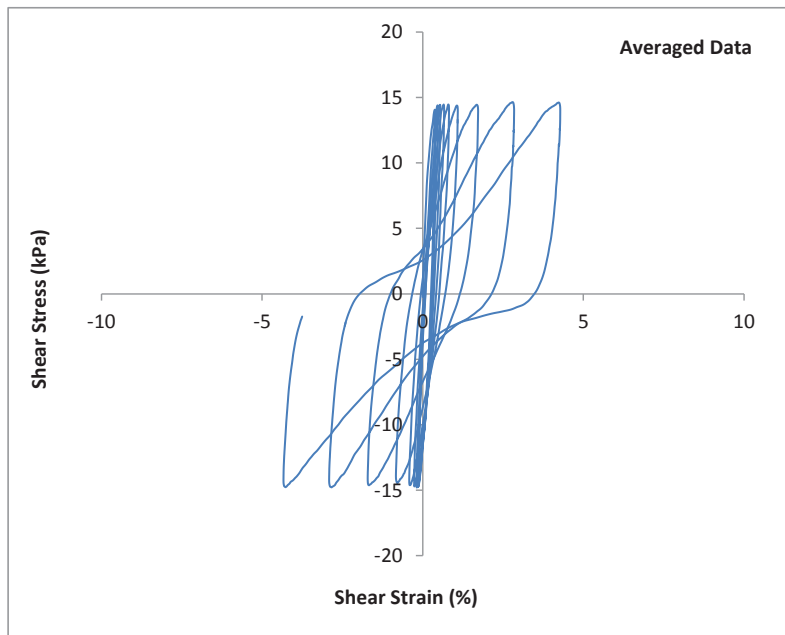
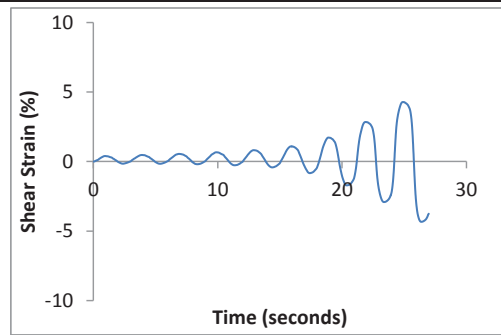
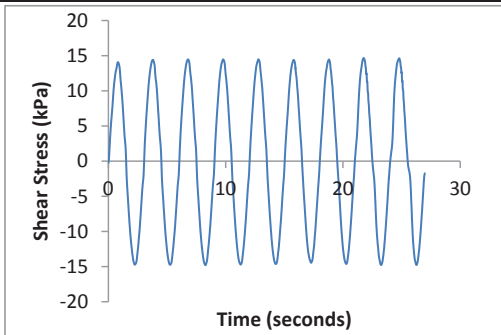

CSS Cyclic Shear Test Report

Geotechnical Engineering Laboratory



Cyclic Shear Test Summary

Device:	CSS	Density (kg/m³):	1599
Specimen ID:	CLS5	Relative Density (%):	86%
Test ID:	C213	Void Ratio:	0.657
Date of Test:	8/11/2015	Vertical Stress (kPa):	100
Test Performed:	Cyclic	Loading Frequency (Hz):	0.33
Test Material:	5mm Crushed Limestone	Number of Cycles:	9
Sample Preparation:	Prepared dense by tamping 50x in 5 layers.	Cyclic Stress Ratio:	0.144
		Number of Cycles to Liq:	9
		Maximum ru:	0.98
Prepared by:	J. Hubler		
Checked by:	J. Hubler		

Additional Comments:

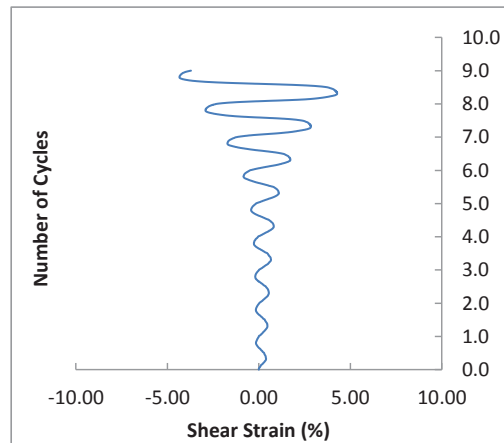
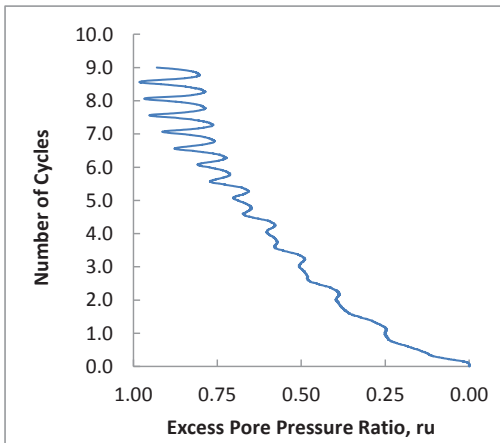
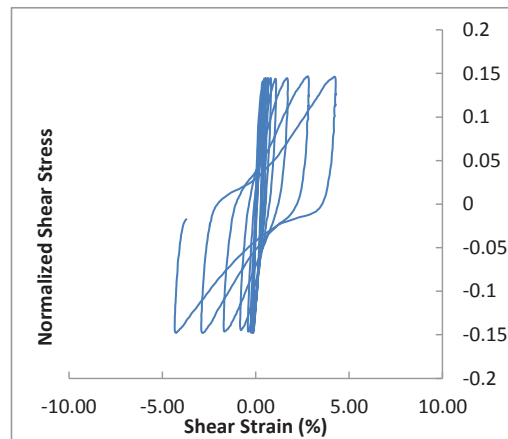
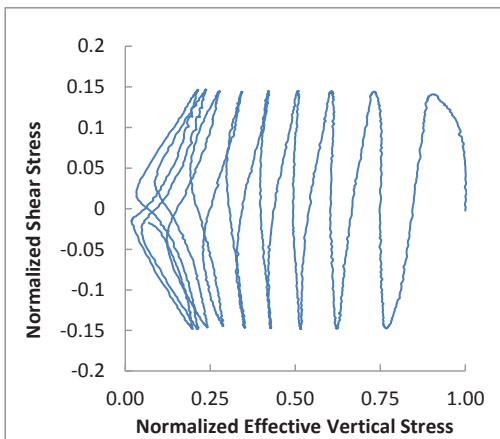

CSS Monotonic Shear Test Report

Geotechnical Engineering Laboratory



10/28/2013_Version 8.0

General Test Info and Sample Preparation

Device:	CSS	Relative Density (%):	75%
Specimen ID:	FLS	Void Ratio:	0.713
Test ID:	C213	Height (mm):	103.3
Date of Test:	8/11/2015	Soil-Only Specimen Diameter (mm):	306.23
Test Performed:	Post Cyclic Monotonic Shear	Weight (kg):	11.772
Test Material:	Fine Crushed Limestone	Density (kg/m ³):	1547.0
Sample Preparation:	Prepared dense by tamping 50x in 5 layers.	Membrane Thickness (mm):	0.635
		Moisture Content (%):	0%
		Saturated (Y/N):	N
		Prepared by:	J. Hubler
		Checked by:	J. Hubler

Consolidation Stage		Shear Stage	
Vertical Stress (kPa):	100	Type of Test:	Constant Volume
Time to Compression (min):	9.5	Stress or Strain Controlled:	Strain
Relative Density (%):	86%	Shear Strain Rate (%/min):	0.33
Void Ratio:	0.657	Peak Shear Strength (kPa):	55.0
Height (mm):	100.0	Comments	
Diameter (mm):	306.23		
Weight (kg):	11.772		
Density (kg/m ³):	1599.1		

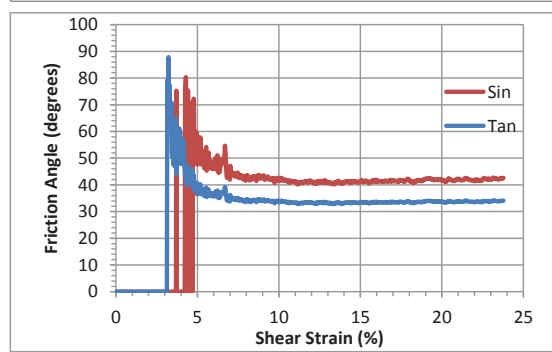
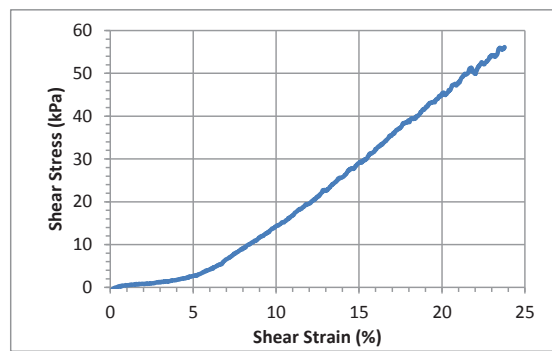
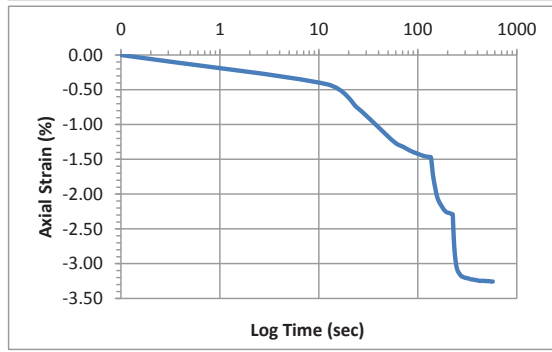
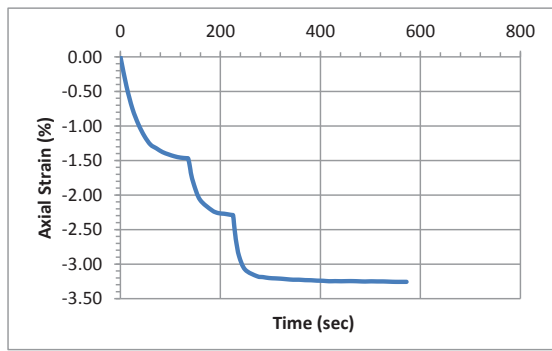

Accelerometer-Based Shear Wave Velocity Datasheet

Specimen ID: C213-FLS-100-1X
 Test Material: FLS
 Date: 8/11/2015
 Test Performed by: J.Hubler
 Filename: C213-FLS-100-1X

Vertical Stress: 100kPa
 Sensor Spacing: 0.099911 m
 V_s (rise) = 231 m/s

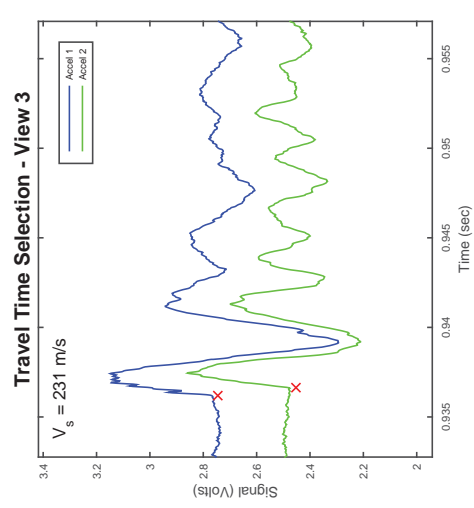
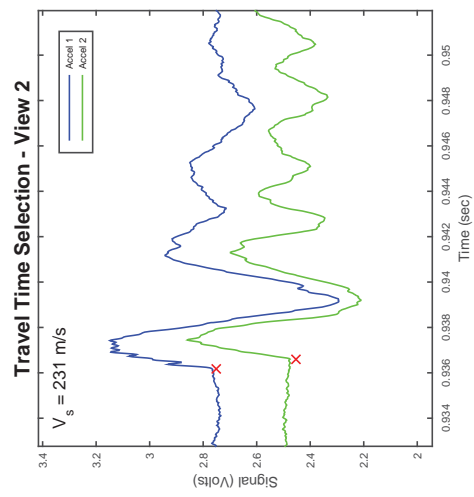
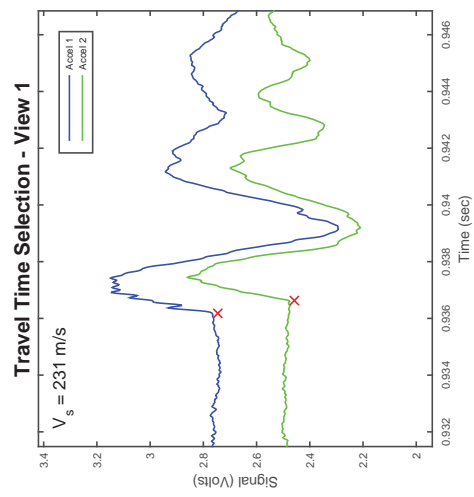
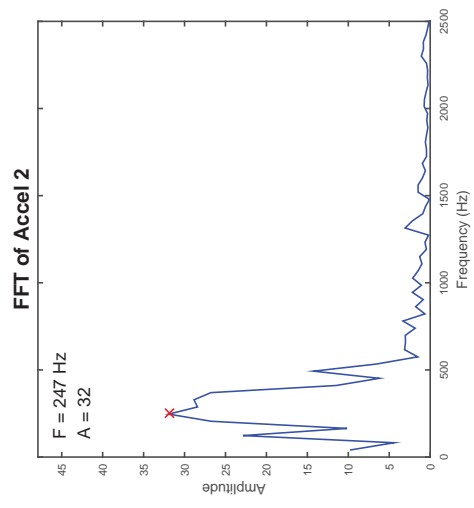
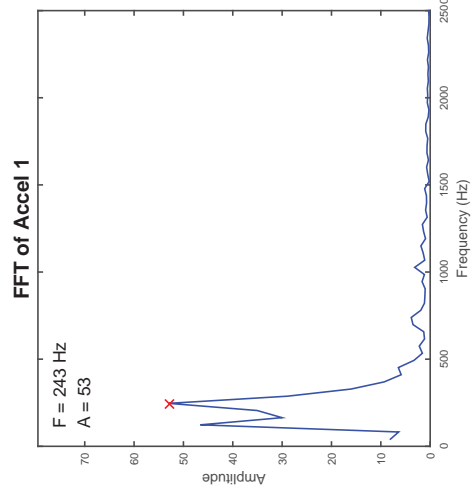
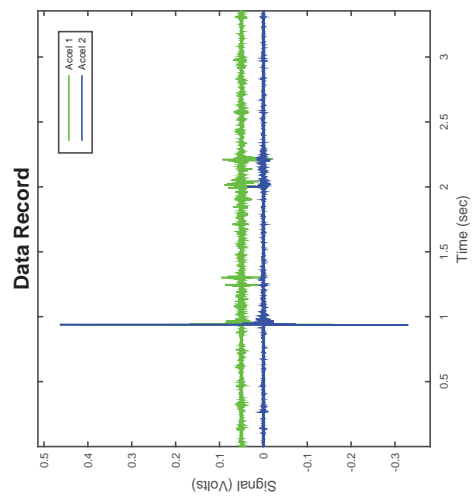

Accelerometer-Based Shear Wave Velocity Datasheet

Specimen ID: C213-FLS-100-2X

Test Material: FLS

Date: 8/11/2015

Test Performed by: J.Hubler

Filename: C213-FLS-100-2X

Vertical Stress: 100kPa

Sensor Spacing: 0.099911 m

V_s (rise) = 231 m/s

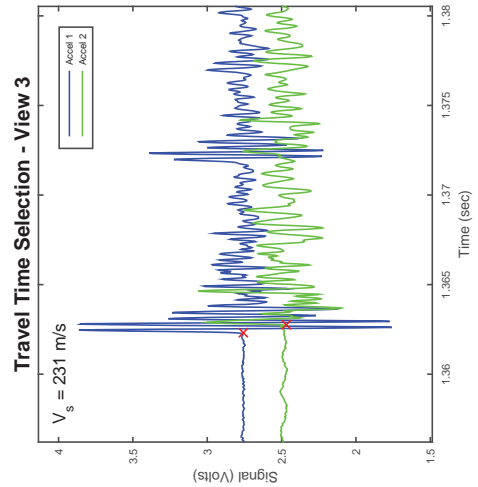
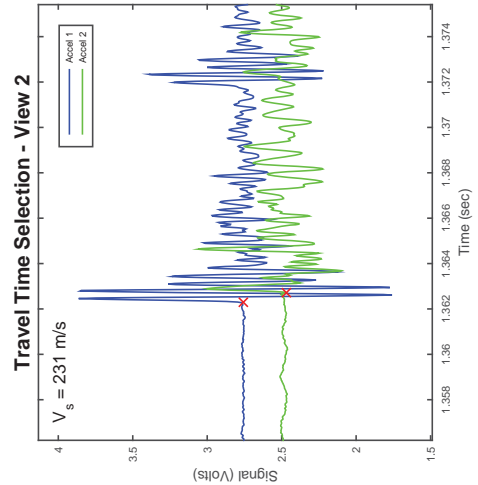
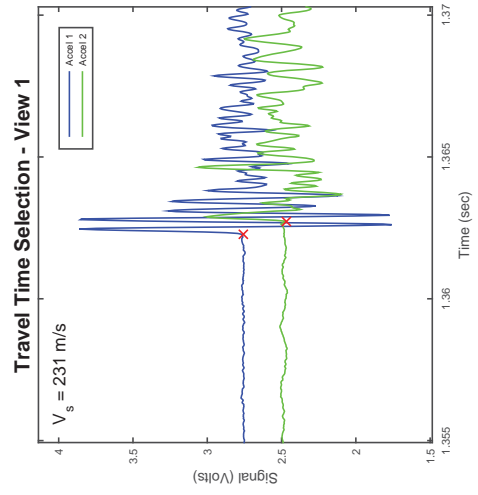
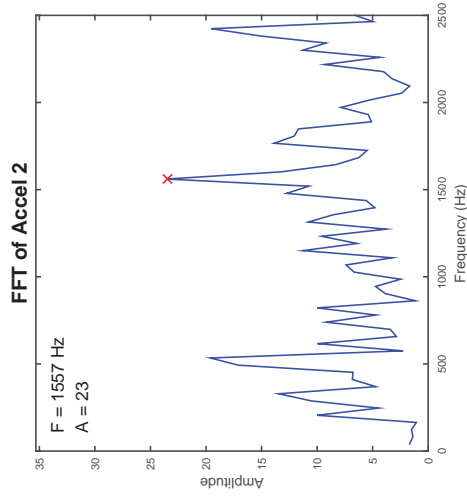
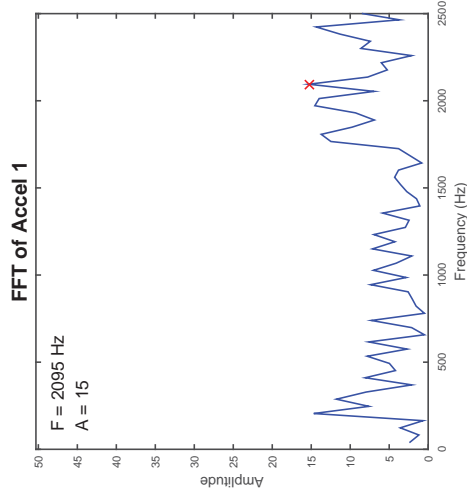
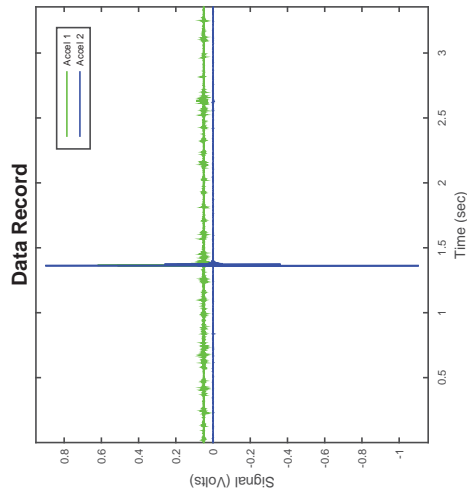

Accelerometer-Based Shear Wave Velocity Datasheet

Specimen ID: C213-FLS-100-3X
Test Material: FLS
Date: 8/11/2015
Test Performed by: J.Hubler
Filename: C213-FLS-100-3X

Vertical Stress: 100kPa
Sensor Spacing: 0.099911 m
 V_s (rise) = 224 m/s

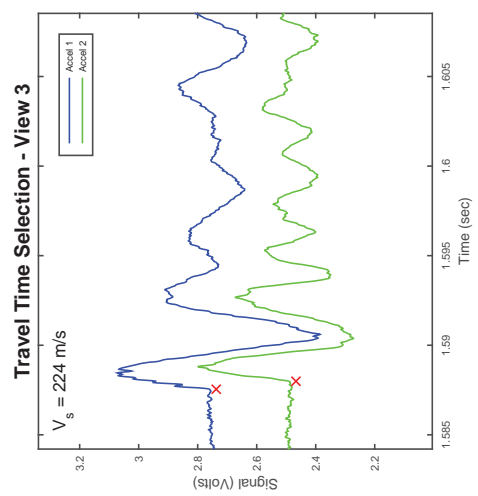
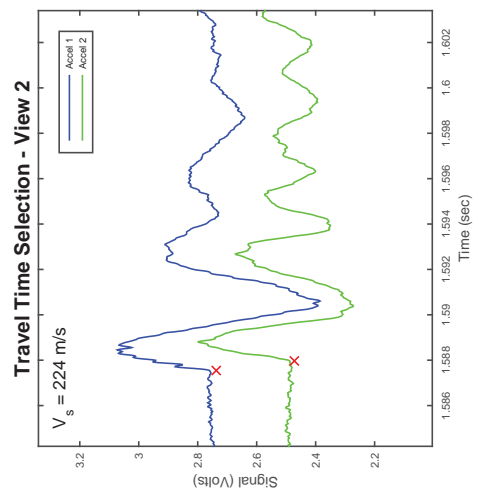
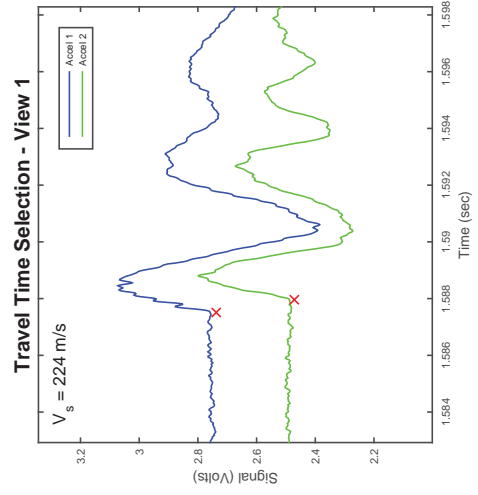
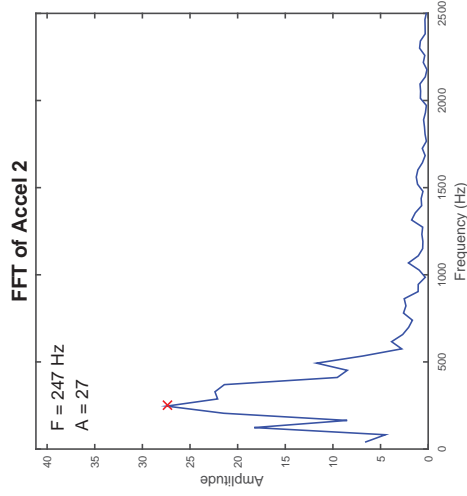
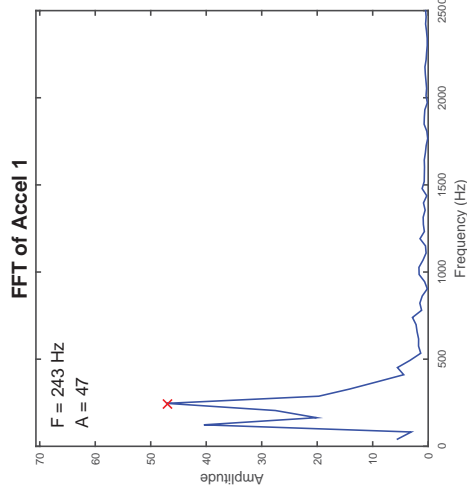
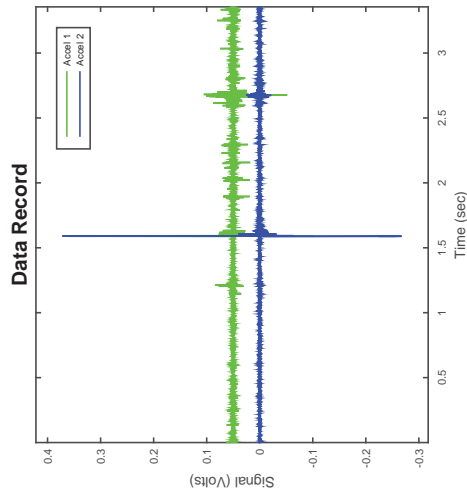

CSS Cyclic Shear Test Report

Geotechnical Engineering Laboratory



Cyclic Shear Test Summary

Device:	CSS	Density (kg/m³):	1515
Specimen ID:	CLS8	Relative Density (%):	46%
Test ID:	C215	Void Ratio:	0.749
Date of Test:	8/20/2015	Vertical Stress (kPa):	50
Test Performed:	Cyclic	Loading Frequency (Hz):	0.33
Test Material:	8mm Crushed Limestone	Number of Cycles:	13
Sample Preparation:	Prepared loose by shoveling and hitting baseplate with rubber mallet 15x.	Cyclic Stress Ratio:	0.088
		Shear Modulus (kPa):	
		Damping (%):	
Prepared by:	J. Hubler	Shear Strain Single Amplitude (%)	
Checked by:	J. Hubler		

Additional Comments:

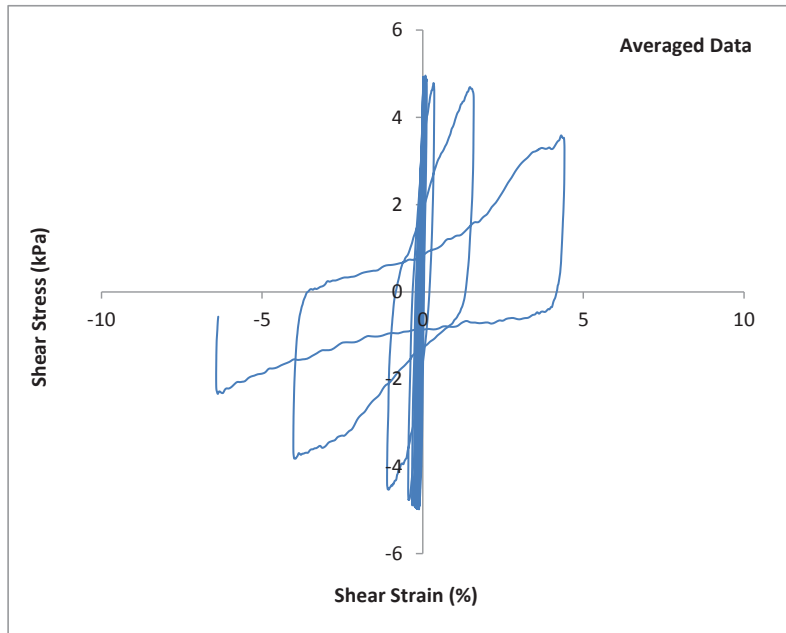
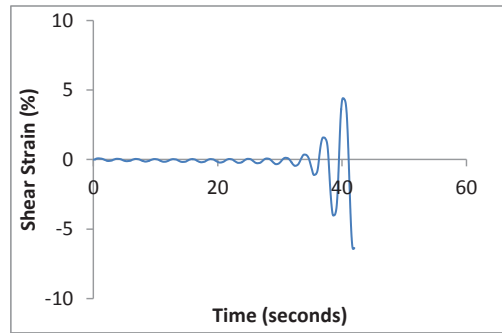
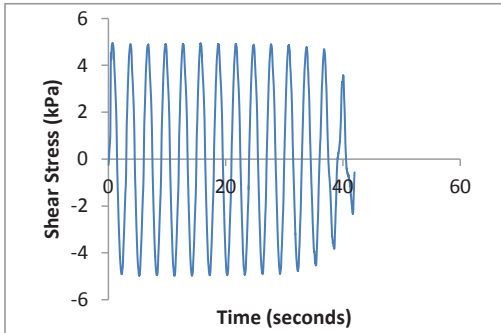

CSS Cyclic Shear Test Report

Geotechnical Engineering Laboratory



Cyclic Shear Test Summary

Device:	CSS	Density (kg/m³):	1515
Specimen ID:	CLS8	Relative Density (%):	46%
Test ID:	C215	Void Ratio:	0.749
Date of Test:	8/20/2015	Vertical Stress (kPa):	50
Test Performed:	Cyclic	Loading Frequency (Hz):	0.33
Test Material:	8mm Crushed Limestone	Number of Cycles:	14
Sample Preparation:	Prepared loose by shoveling and hitting baseplate with rubber mallet 15x.	Cyclic Stress Ratio:	0.088
		Number of Cycles to Liq:	13
		Maximum ru:	1.02
Prepared by:	J.Hubler		
Checked by:	J. Hubler		

Additional Comments:

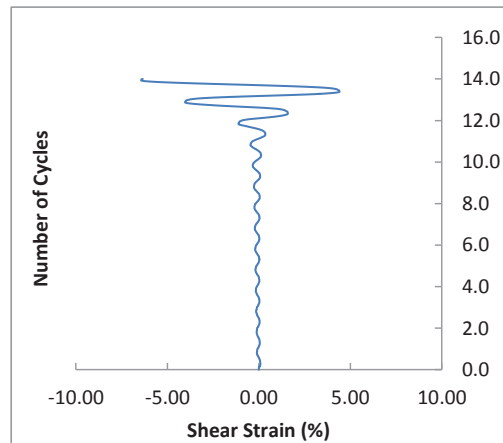
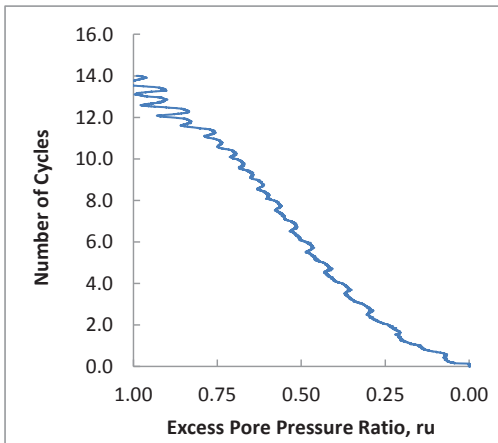
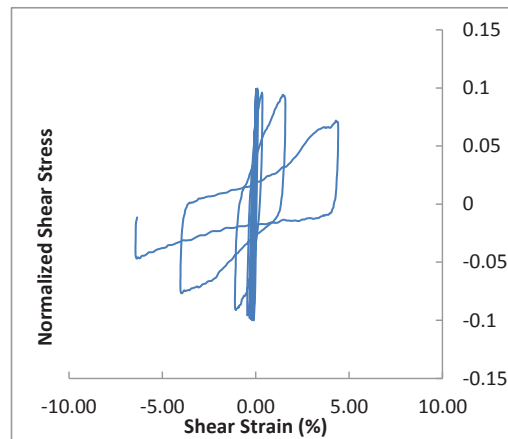
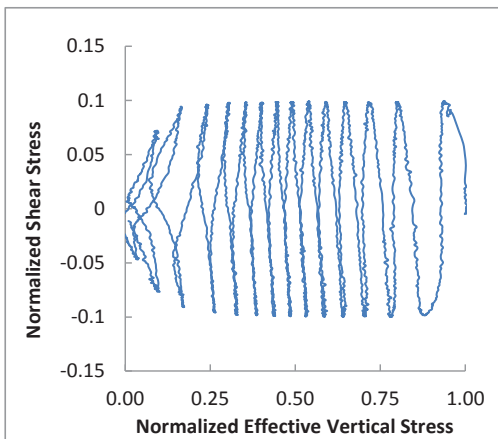

CSS Monotonic Shear Test Report

Geotechnical Engineering Laboratory



10/28/2013_Version 8.0

General Test Info and Sample Preparation

Device:	CSS	Relative Density (%):	37%
Specimen ID:	CLS8	Void Ratio:	0.790
Test ID:	C215	Height (mm):	113.2
Date of Test:	8/20/2015	Soil-Only Specimen Diameter (mm):	306.23
Test Performed:	Post Cyclic Monotonic Shear	Weight (kg):	12.344
Test Material:	8mm Crushed Limestone	Density (kg/m³):	1480.5
Sample Preparation:	Prepared loose by shoveling and hitting baseplate 15x in 3 layers with a rubber mallet.	Membrane Thickness (mm):	0.635
		Moisture Content (%):	0%
		Saturated (Y/N):	N
		Prepared by:	J. Hubler
		Checked by:	J. Hubler

Consolidation Stage

Vertical Stress (kPa):	50
Time to Compression (min):	6.9
Relative Density (%):	46%
Void Ratio:	0.749
Height (mm):	110.6
Diameter (mm):	306.23
Weight (kg):	12.344
Density (kg/m³):	1515.5

Shear Stage

Type of Test:	Constant Volume
Stress or Strain Controlled:	Strain
Shear Strain Rate (%/min):	0.30
Peak Shear Strength (kPa):	20.0

Comments

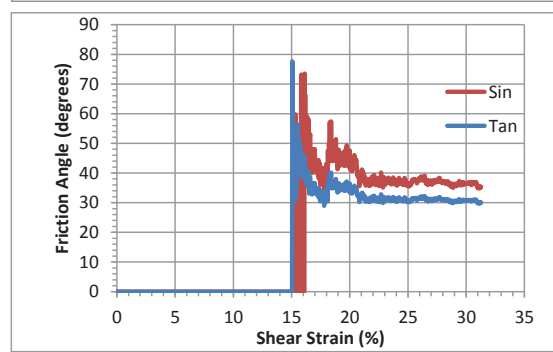
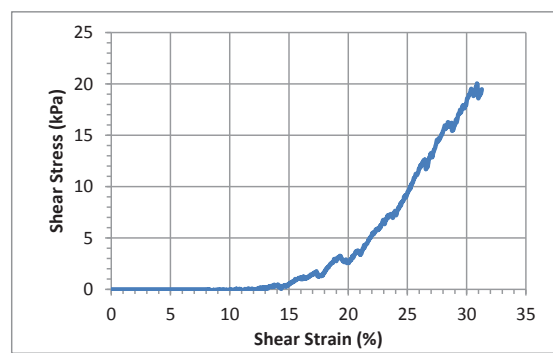
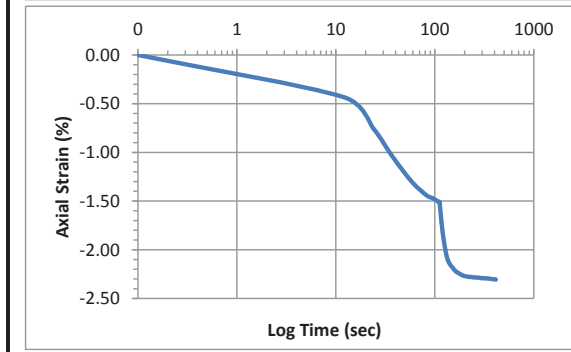
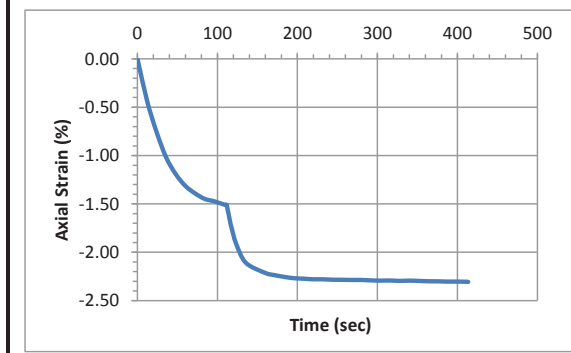

Accelerometer-Based Shear Wave Velocity Datasheet

Specimen ID: C215-50-LS-1X
 Test Material: 50
 Date: 8/20/2015
 Test Performed by: J.Hubler
 Filename: C215-50-LS-1X

Vertical Stress: LSkPa
 Sensor Spacing: 0.11055 m
 V_s (rise) = 173 m/s

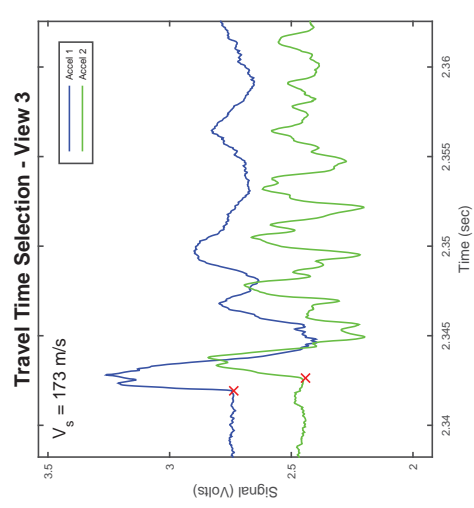
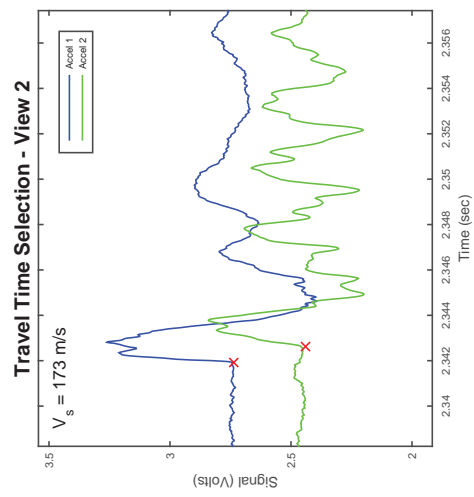
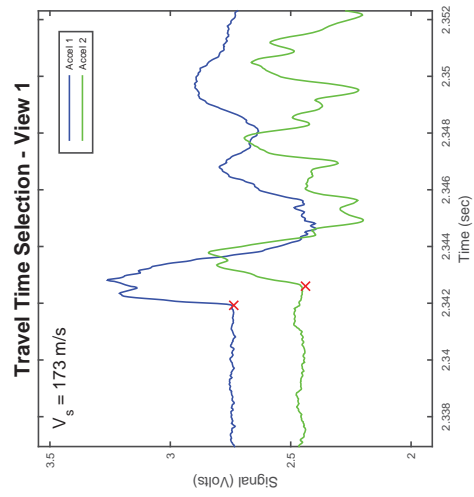
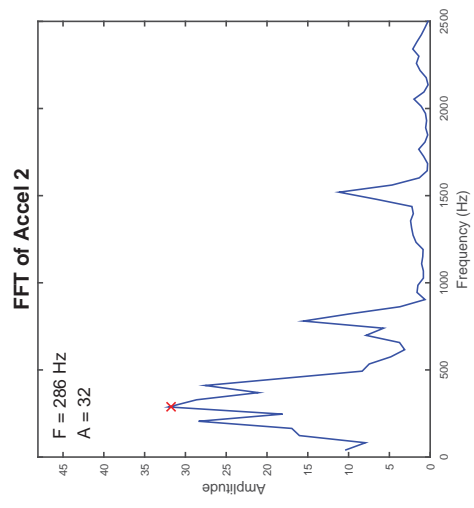
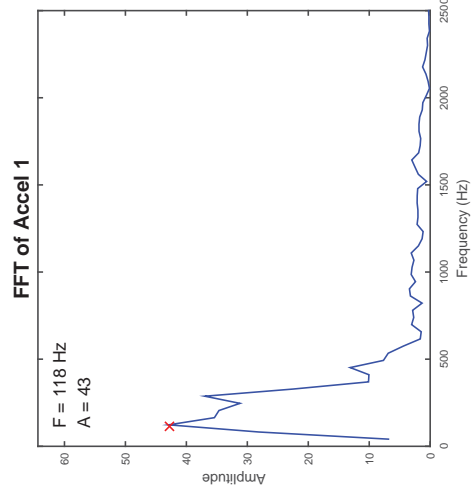
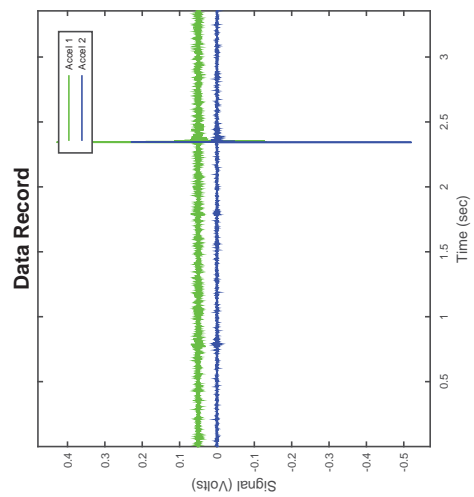

Accelerometer-Based Shear Wave Velocity Datasheet

Specimen ID: C215-50-LS-2X
 Test Material: 50
 Date: 8/20/2015
 Test Performed by: J.Hubler
 Filename: C215-50-LS-2X

Vertical Stress: LSkPa
 Sensor Spacing: 0.11055 m
 V_s (rise) = 182 m/s

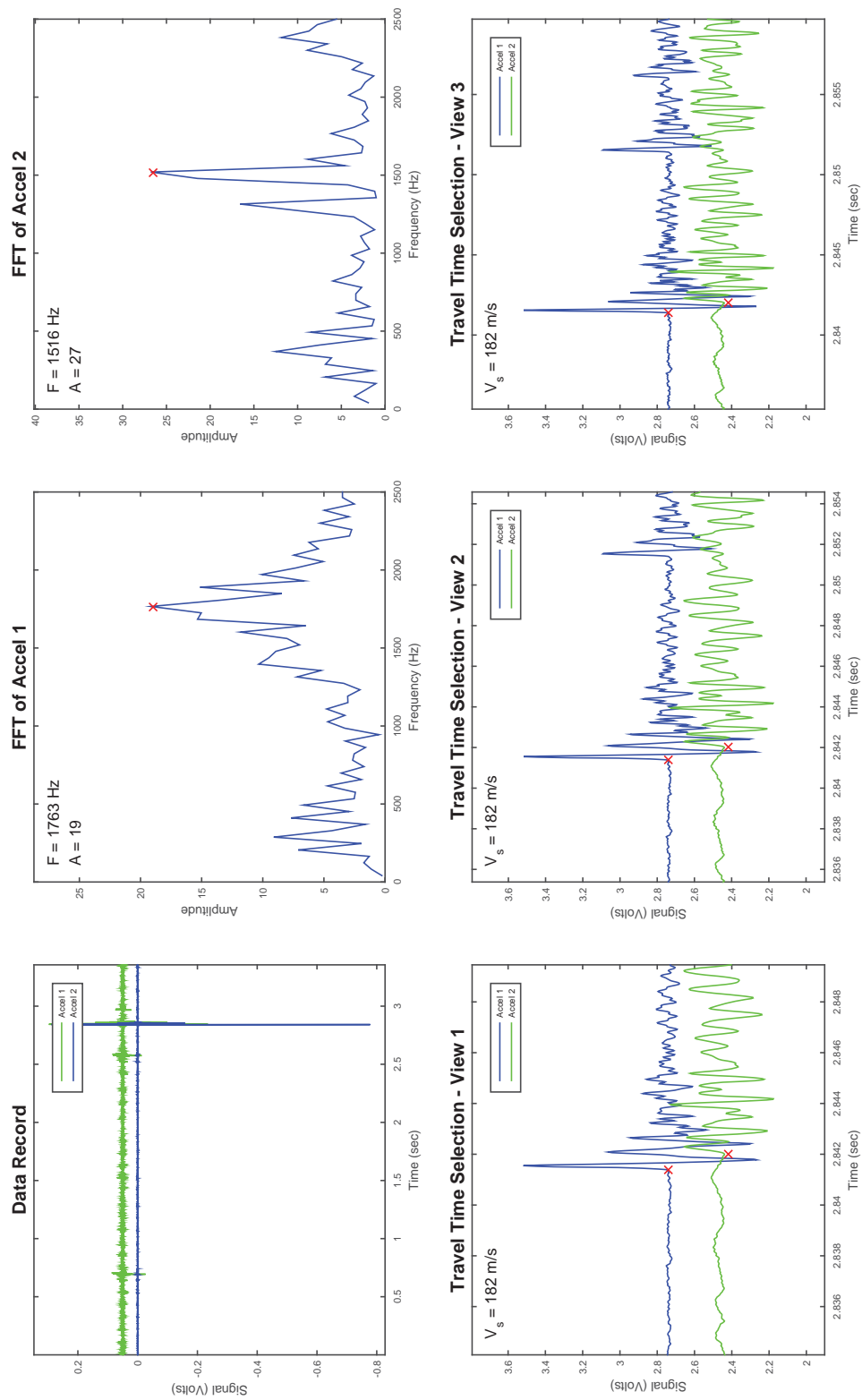

Accelerometer-Based Shear Wave Velocity Datasheet

Specimen ID: C215-50-LS-3X
 Test Material: 50
 Date: 8/20/2015
 Test Performed by: J.Hubler
 Filename: C215-50-LS-3X

Vertical Stress: LSkPa
 Sensor Spacing: 0.11055 m
 V_s (rise) = 173 m/s

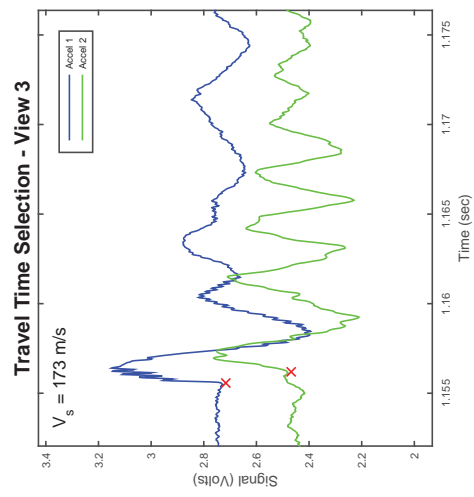
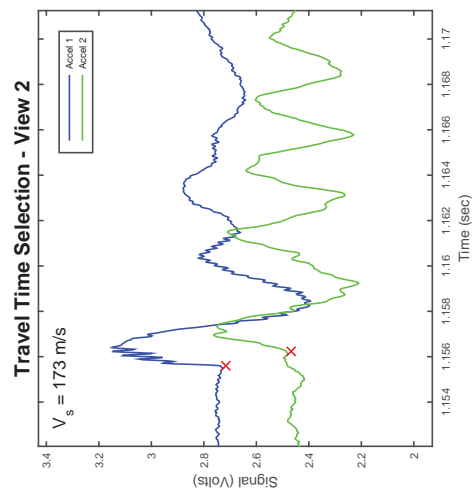
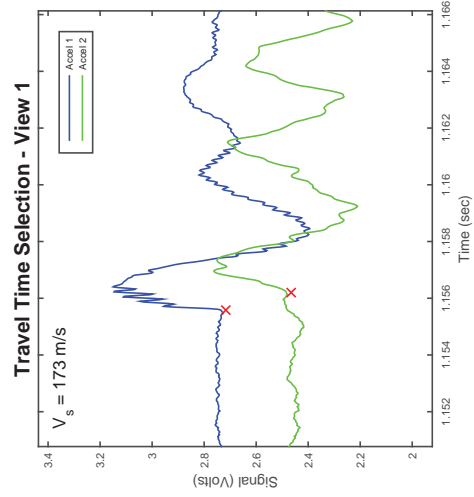
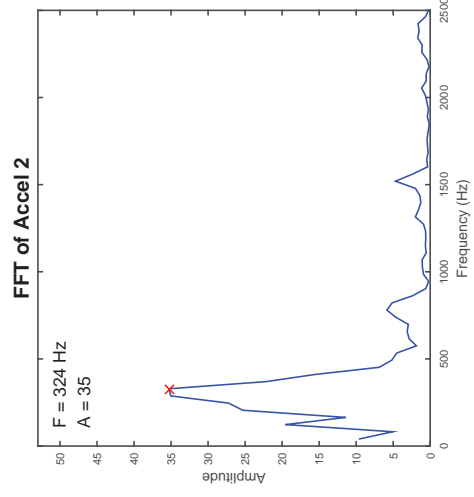
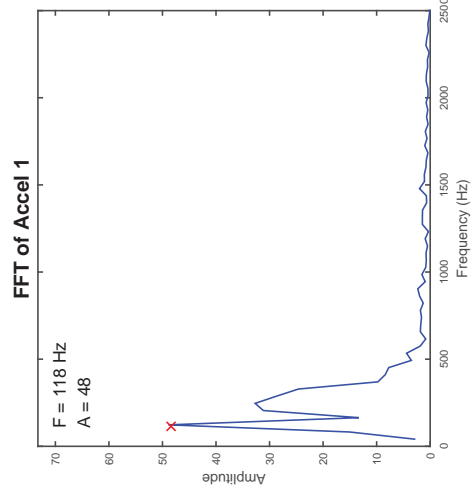
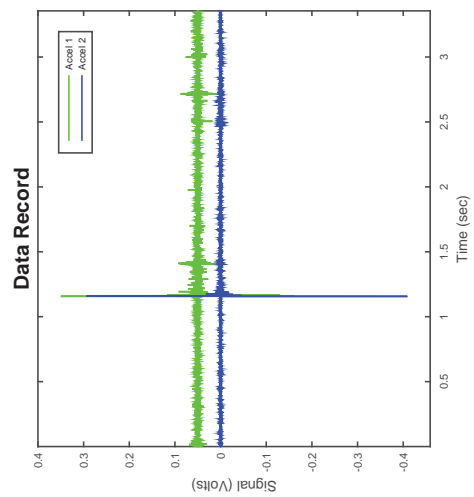

CSS Cyclic Shear Test Report

Geotechnical Engineering Laboratory



Cyclic Shear Test Summary

Device:	CSS	Density (kg/m³):	1510
Specimen ID:	CLS8	Relative Density (%):	45%
Test ID:	C217	Void Ratio:	0.755
Date of Test:	8/21/2015	Vertical Stress (kPa):	100
Test Performed:	Cyclic	Loading Frequency (Hz):	0.33
Test Material:	8mm Crushed Limestone	Number of Cycles:	25
Sample Preparation:	Prepared loose by shoveling and hitting baseplate with rubber mallet 15x.	Cyclic Stress Ratio:	0.094
		Shear Modulus (kPa):	
		Damping (%):	
Prepared by:	J. Hubler	Shear Strain Single Amplitude (%)	
Checked by:	J. Hubler		

Additional Comments:

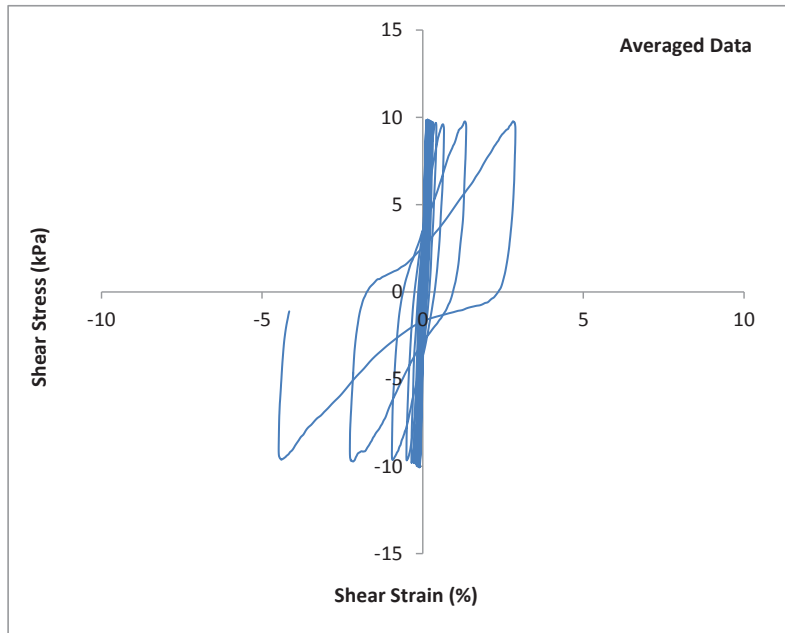
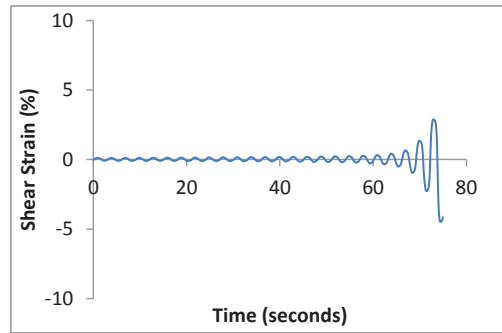
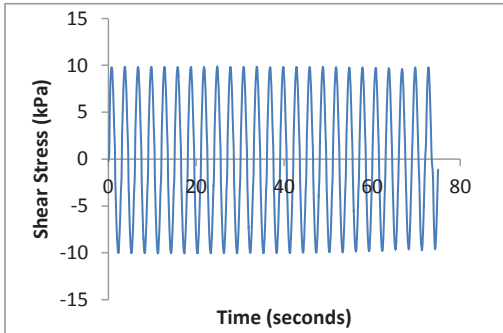

CSS Cyclic Shear Test Report

Geotechnical Engineering Laboratory



Cyclic Shear Test Summary

Device:	CSS	Density (kg/m³):	1510
Specimen ID:	CLS8	Relative Density (%):	45%
Test ID:	C217	Void Ratio:	0.755
Date of Test:	8/21/2015	Vertical Stress (kPa):	100
Test Performed:	Cyclic	Loading Frequency (Hz):	0.33
Test Material:	8mm Crushed Limestone	Number of Cycles:	25
Sample Preparation:	Prepared loose by shoveling and hitting baseplate with rubber mallet 15x.	Cyclic Stress Ratio:	0.094
		Number of Cycles to Liq:	25
		Maximum ru:	0.98
Prepared by:	J.Hubler		
Checked by:	J. Hubler		

Additional Comments:

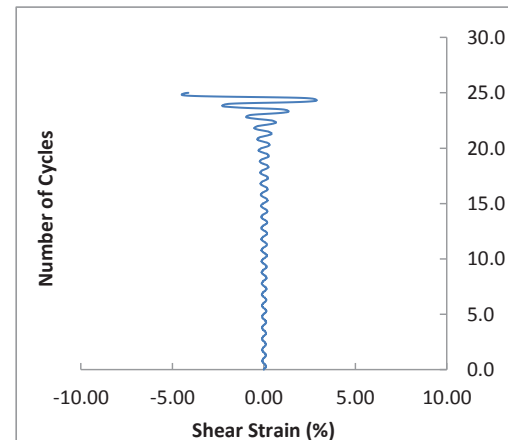
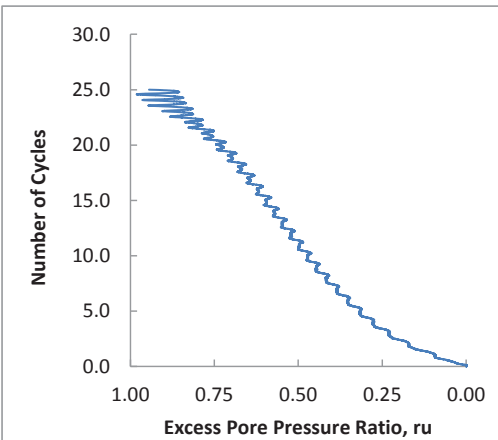
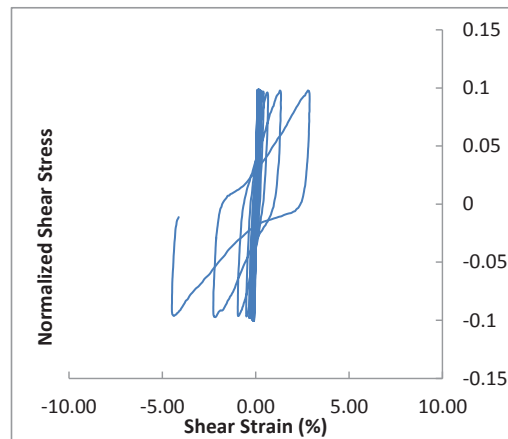
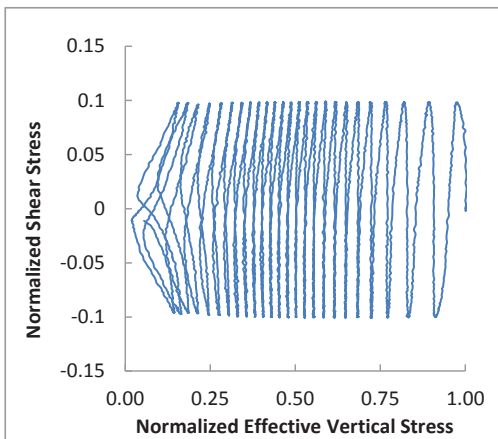

CSS Monotonic Shear Test Report



10/28/2013_Version 8.0

General Test Info and Sample Preparation

Device:	CSS	Relative Density (%):	31%
Specimen ID:	CLS8	Void Ratio:	0.817
Test ID:	C217	Height (mm):	112.6
Date of Test:	8/21/2015	Soil-Only Specimen Diameter (mm):	306.23
Test Performed:	Post Cyclic Monotonic Shear	Weight (kg):	12.096
Test Material:	8mm Crushed Limestone	Density (kg/m³):	1458.5
Sample Preparation:	Prepared loose by shoveling and hitting baseplate 15x in 3 layers with a rubber mallet.	Membrane Thickness (mm):	0.635
		Moisture Content (%):	0%
		Saturated (Y/N):	N
		Prepared by:	J.Hubler
		Checked by:	J. Hubler

Consolidation Stage

Vertical Stress (kPa):	100
Time to Compression (min):	11.9
Relative Density (%):	45%
Void Ratio:	0.755
Height (mm):	108.8
Diameter (mm):	306.23
Weight (kg):	12.096
Density (kg/m³):	1510.1

Shear Stage

Type of Test:	Constant Volume
Stress or Strain Controlled:	Strain
Shear Strain Rate (%/min):	0.30
Peak Shear Strength (kPa):	41.5

Comments

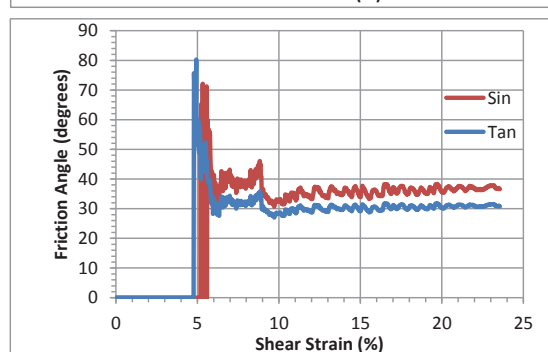
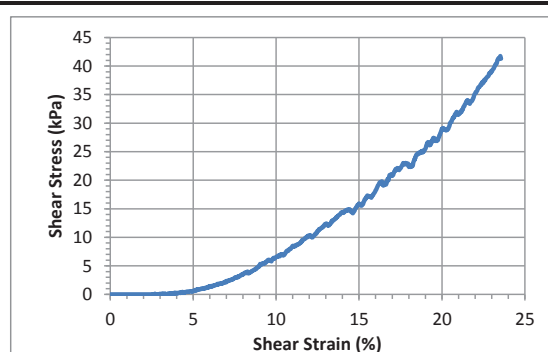
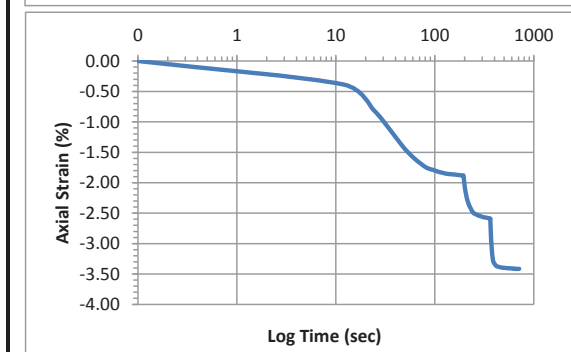
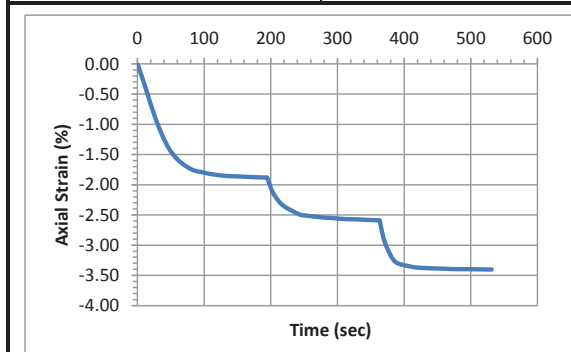

Accelerometer-Based Shear Wave Velocity Datasheet

Specimen ID: C217-LS-100-2X
 Test Material: LS
 Date: 8/21/2015
 Test Performed by: J.Hubler
 Filename: C217-LS-100-2X

Vertical Stress: 100kPa
 Sensor Spacing: 0.10871 m
 V_s (rise) = 198 m/s

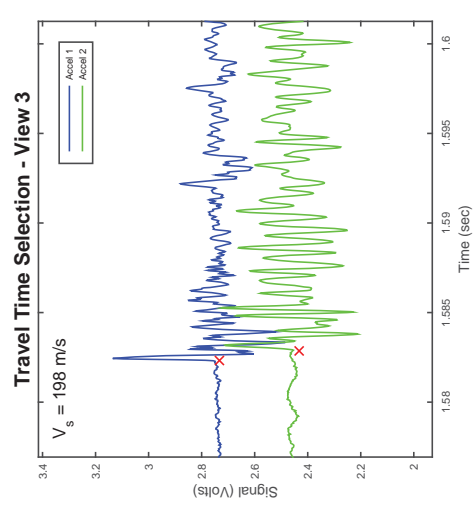
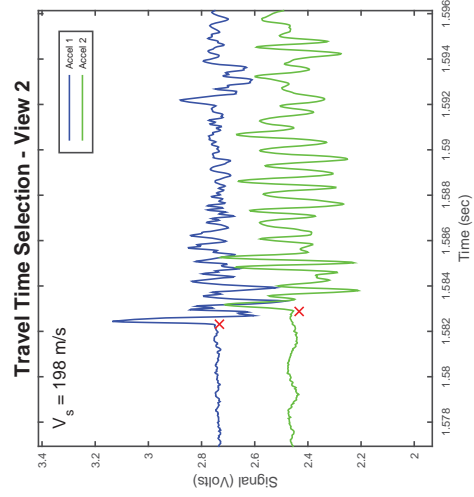
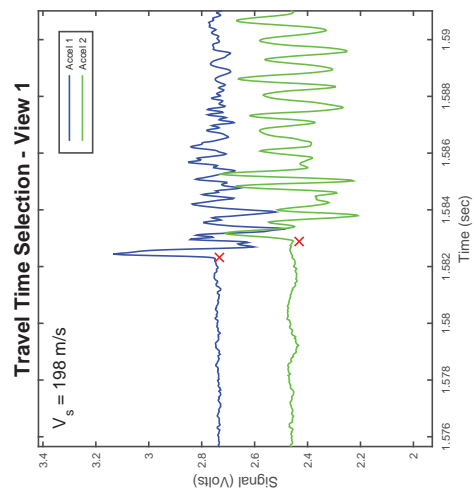
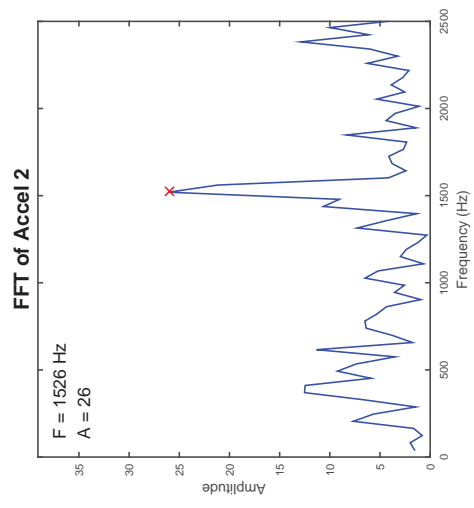
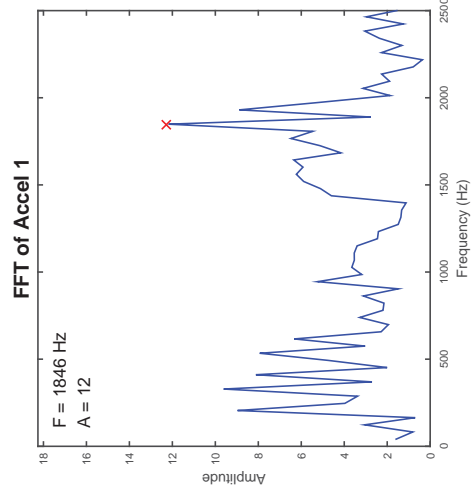
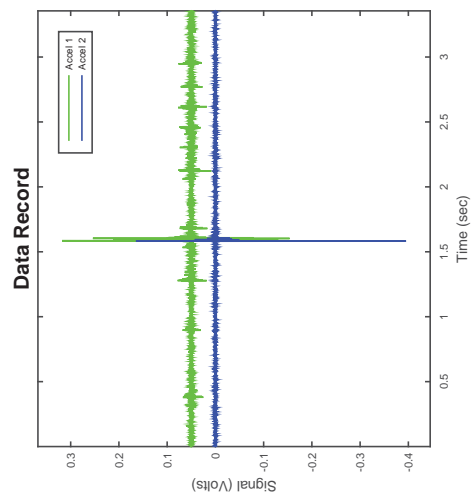

Accelerometer-Based Shear Wave Velocity Datasheet

Specimen ID: C217-LS-100-3X
 Test Material: LS
 Date: 8/21/2015
 Test Performed by: J.Hubler
 Filename: C217-LS-100-3X

Vertical Stress: 100kPa
 Sensor Spacing: 0.10871 m
 V_s (rise) = 209 m/s

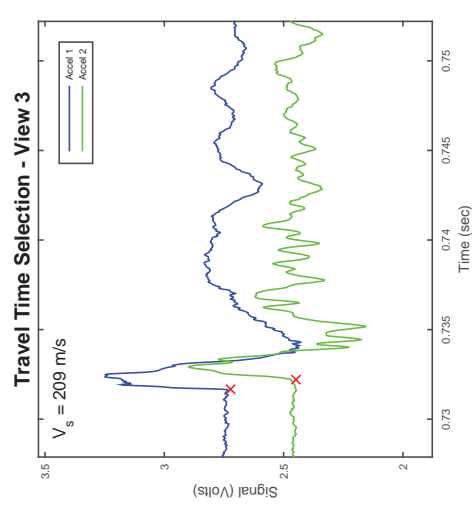
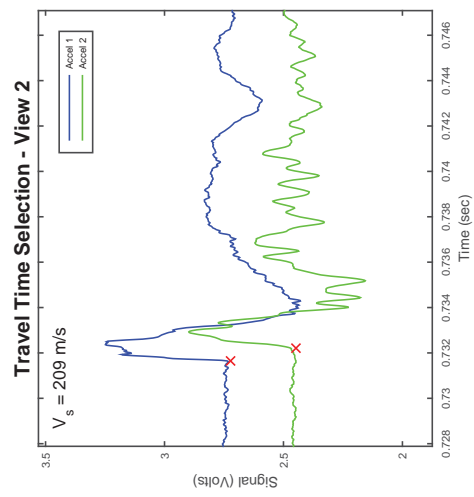
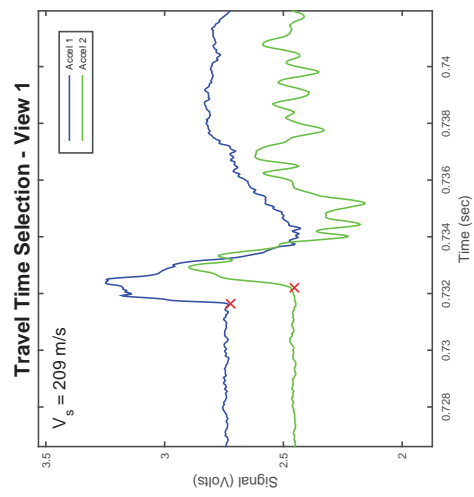
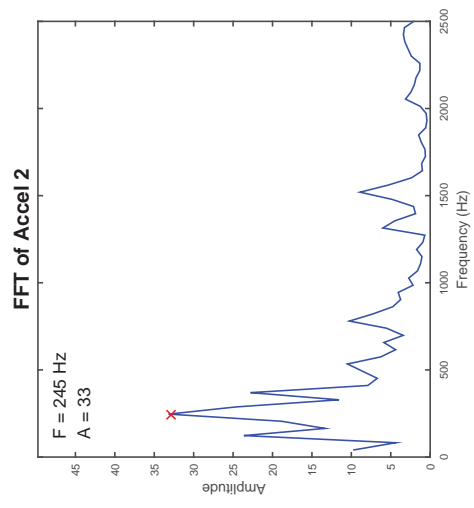
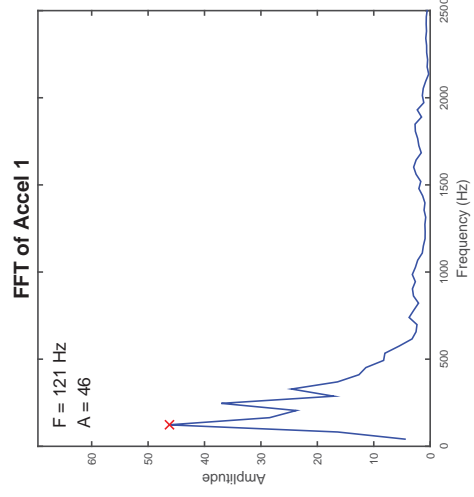
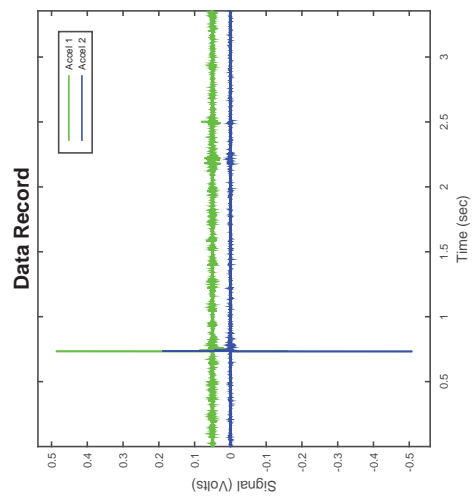

CSS Cyclic Shear Test Report

Geotechnical Engineering Laboratory



Cyclic Shear Test Summary

Device:	CSS	Density (kg/m³):	1522
Specimen ID:	CLS8	Relative Density (%):	48%
Test ID:	C214	Void Ratio:	0.741
Date of Test:	8/20/2015	Vertical Stress (kPa):	200
Test Performed:	Cyclic	Loading Frequency (Hz):	0.33
Test Material:	8mm Crushed Limestone	Number of Cycles:	24
Sample Preparation:	Prepared loose by shoveling and hitting baseplate with rubber mallet 15x.	Cyclic Stress Ratio:	0.097
		Shear Modulus (kPa):	
		Damping (%):	
Prepared by:	J. Hubler	Shear Strain Single Amplitude (%):	
Checked by:	J. Hubler		

Additional Comments:

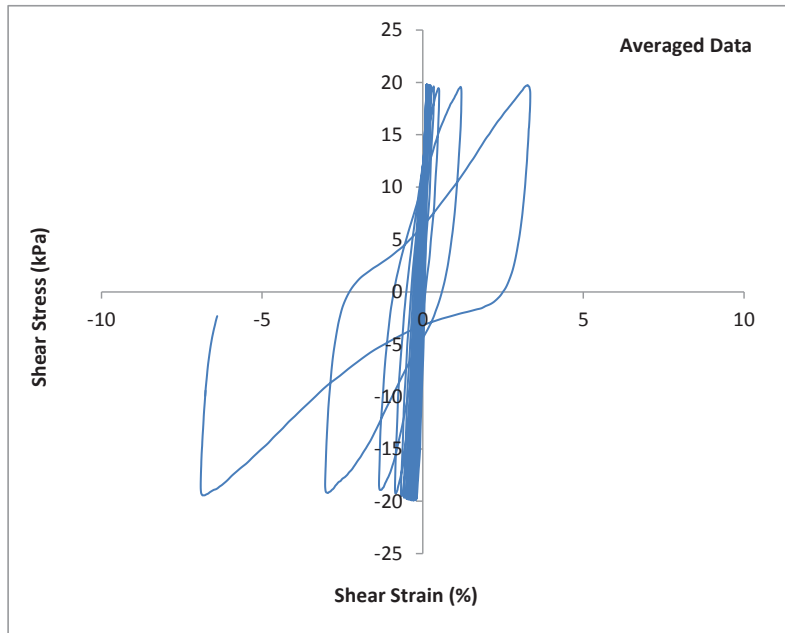
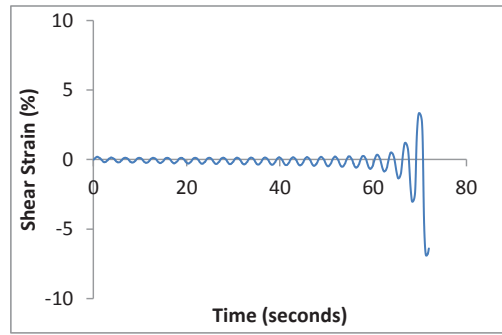
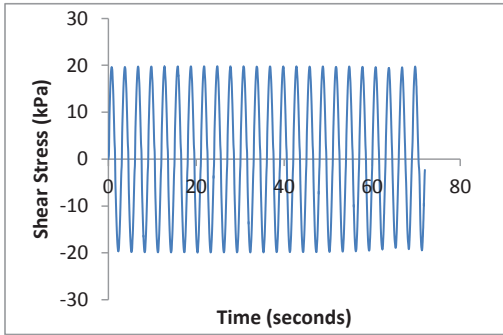

CSS Cyclic Shear Test Report

Geotechnical Engineering Laboratory



Cyclic Shear Test Summary

Device:	CSS	Density (kg/m³):	1522
Specimen ID:	CLS8	Relative Density (%):	48%
Test ID:	C214	Void Ratio:	0.741
Date of Test:	8/20/2015	Vertical Stress (kPa):	200
Test Performed:	Cyclic	Loading Frequency (Hz):	0.33
Test Material:	8mm Crushed Limestone	Number of Cycles:	24
Sample Preparation:	Prepared loose by shoveling and hitting baseplate with rubber mallet 15x.	Cyclic Stress Ratio:	0.097
		Number of Cycles to Liq:	24
		Maximum ru:	0.98
Prepared by:	J.Hubler		
Checked by:	J. Hubler		

Additional Comments:

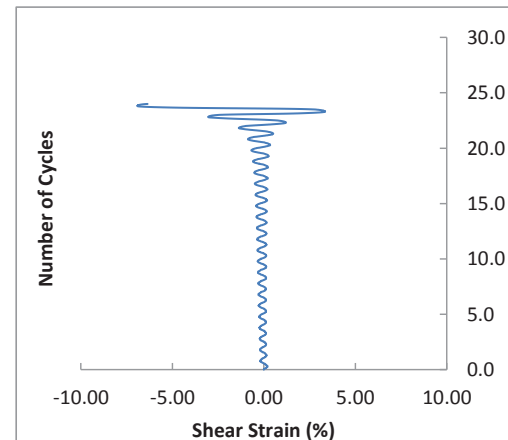
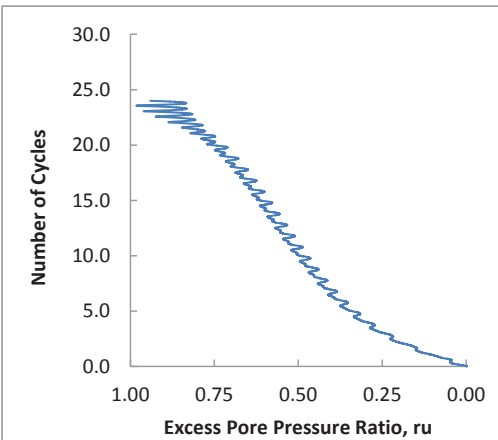
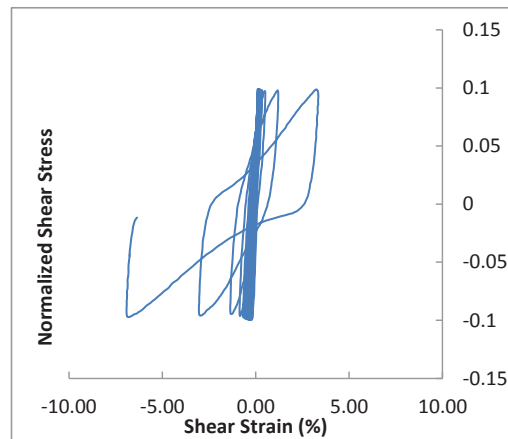
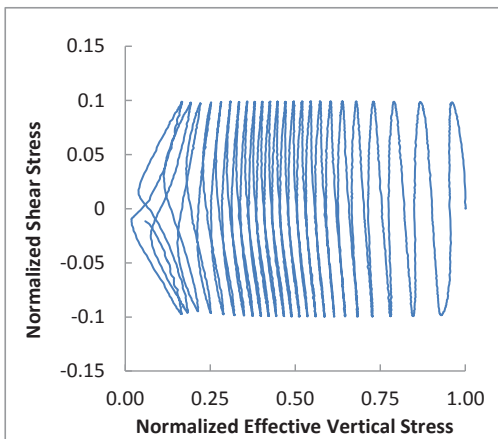

CSS Monotonic Shear Test Report

Geotechnical Engineering Laboratory



10/28/2013_Version 8.0

General Test Info and Sample Preparation

Device:	CSS	Relative Density (%):	31%
Specimen ID:	CLS8	Void Ratio:	0.816
Test ID:	C214	Height (mm):	113.7
Date of Test:	8/20/2015	Soil-Only Specimen Diameter (mm):	306.23
Test Performed:	Post Cyclic Monotonic Shear	Weight (kg):	12.215
Test Material:	8mm Crushed Limestone	Density (kg/m³):	1458.9
Sample Preparation:	Prepared loose by shoveling and hitting baseplate 15x in 3 layers with a rubber mallet.	Membrane Thickness (mm):	0.635
		Moisture Content (%):	0%
		Saturated (Y/N):	N
		Prepared by:	J. Hubler
		Checked by:	J. Hubler

Consolidation Stage

Vertical Stress (kPa):	200
Time to Compression (min):	10.0
Relative Density (%):	48%
Void Ratio:	0.741
Height (mm):	109.0
Diameter (mm):	306.23
Weight (kg):	12.215
Density (kg/m³):	1521.7

Shear Stage

Type of Test:	Constant Volume
Stress or Strain Controlled:	Strain
Shear Strain Rate (%/min):	0.30
Peak Shear Strength (kPa):	43.8

Comments

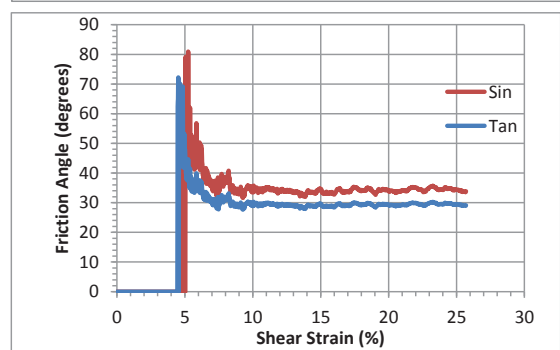
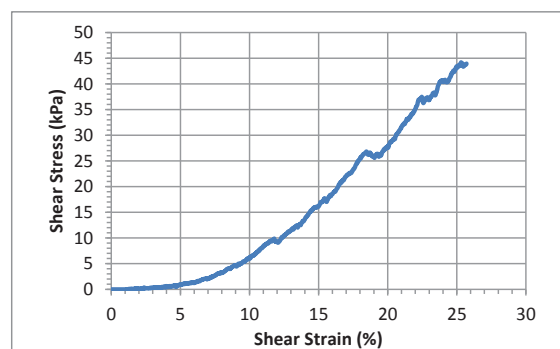
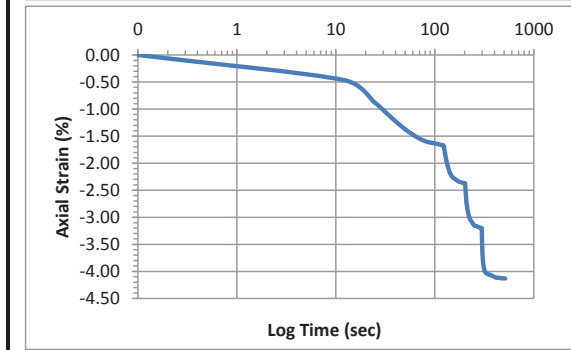
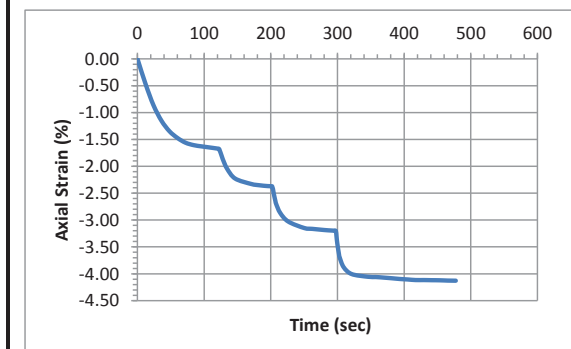

CSS Cyclic Shear Test Report

Geotechnical Engineering Laboratory



Cyclic Shear Test Summary

Device:	CSS	Density (kg/m³):	1525
Specimen ID:	CLS8	Relative Density (%):	49%
Test ID:	C216	Void Ratio:	0.738
Date of Test:	8/20/2015	Vertical Stress (kPa):	400
Test Performed:	Cyclic	Loading Frequency (Hz):	0.33
Test Material:	8mm Crushed Limestone	Number of Cycles:	33
Sample Preparation:	Prepared loose by shoveling and hitting baseplate with rubber mallet 15x.	Cyclic Stress Ratio:	0.099
		Shear Modulus (kPa):	
		Damping (%):	
Prepared by:	J. Hubler	Shear Strain Single Amplitude (%):	
Checked by:	J. Hubler		

Additional Comments:

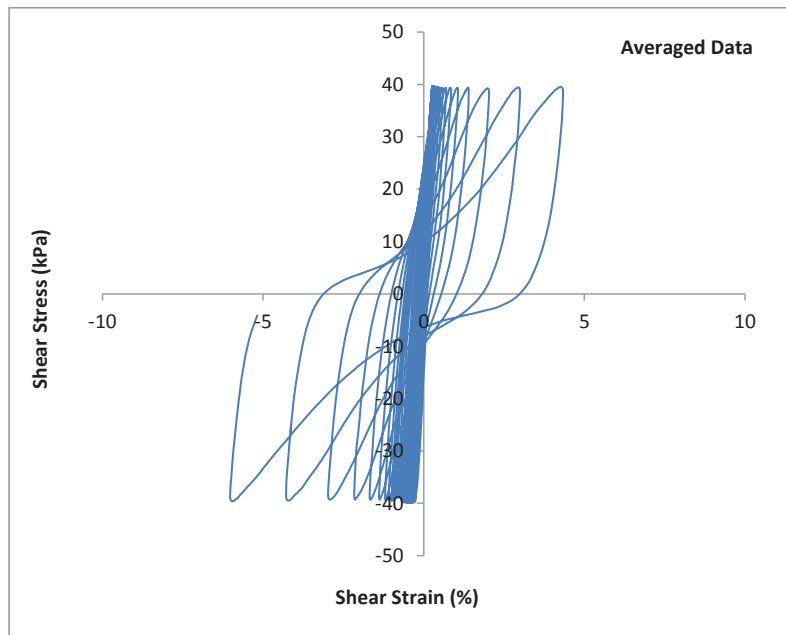
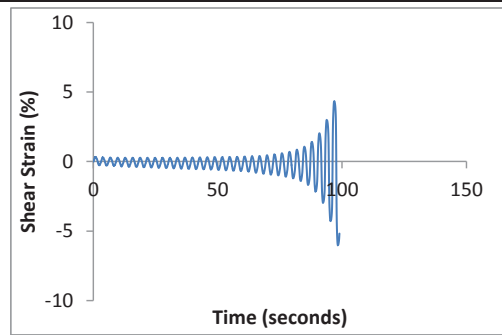
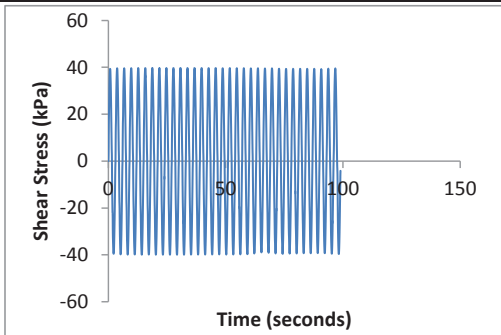

CSS Cyclic Shear Test Report

Geotechnical Engineering Laboratory



Cyclic Shear Test Summary

Device:	CSS	Density (kg/m³):	1525
Specimen ID:	CLS8	Relative Density (%):	49%
Test ID:	C216	Void Ratio:	0.738
Date of Test:	8/20/2015	Vertical Stress (kPa):	400
Test Performed:	Cyclic	Loading Frequency (Hz):	0.33
Test Material:	8mm Crushed Limestone	Number of Cycles:	33
Sample Preparation:	Prepared loose by shoveling and hitting baseplate with rubber mallet 15x.	Cyclic Stress Ratio:	0.099
		Number of Cycles to Liq:	32
		Maximum ru:	0.98
Prepared by:	J. Hubler		
Checked by:	J. Hubler		

Additional Comments:

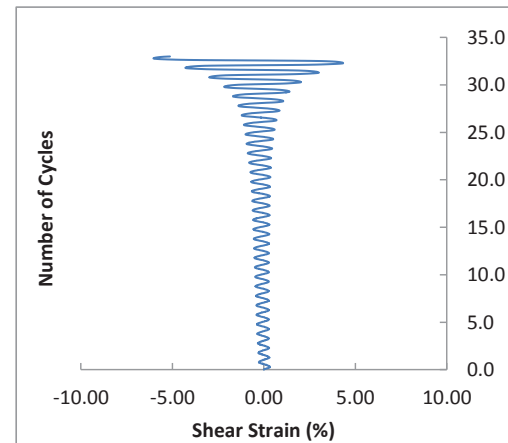
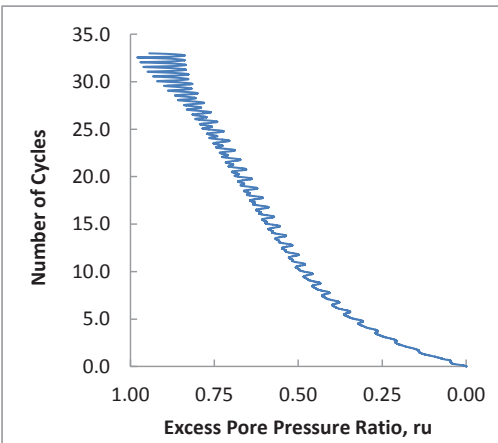
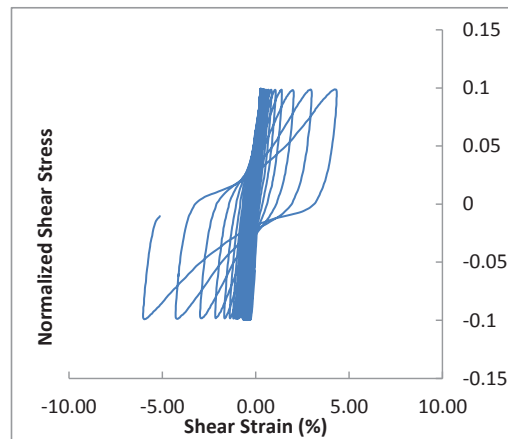
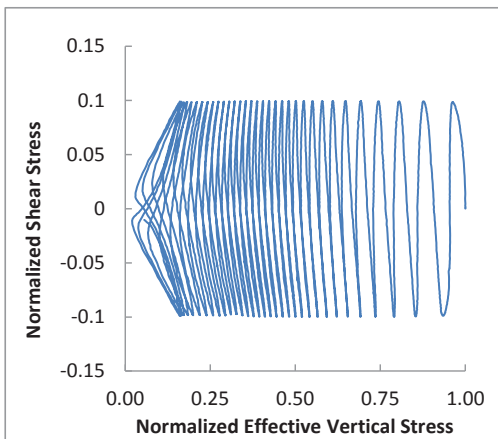

CSS Monotonic Shear Test Report

Geotechnical Engineering Laboratory



10/28/2013_Version 8.0

General Test Info and Sample Preparation

Device:	CSS	Relative Density (%):	26%
Specimen ID:	CLS8	Void Ratio:	0.840
Test ID:	C216	Height (mm):	111.6
Date of Test:	8/20/2015	Soil-Only Specimen Diameter (mm):	306.23
Test Performed:	Post Cyclic Monotonic Shear	Weight (kg):	11.833
Test Material:	8mm Crushed Limestone	Density (kg/m³):	1440.1
Sample Preparation:	Prepared loose by shoveling and hitting baseplate 15x in 3 layers with a rubber mallet.	Membrane Thickness (mm):	0.635
		Moisture Content (%):	0%
		Saturated (Y/N):	N
		Prepared by:	J. Hubler
		Checked by:	J. Hubler

Consolidation Stage

Vertical Stress (kPa):	400
Time to Compression (min):	10.9
Relative Density (%):	49%
Void Ratio:	0.738
Height (mm):	105.4
Diameter (mm):	306.23
Weight (kg):	11.833
Density (kg/m³):	1524.7

Shear Stage

Type of Test:	Constant Volume
Stress or Strain Controlled:	Strain
Shear Strain Rate (%/min):	0.31
Peak Shear Strength (kPa):	90.0

Comments

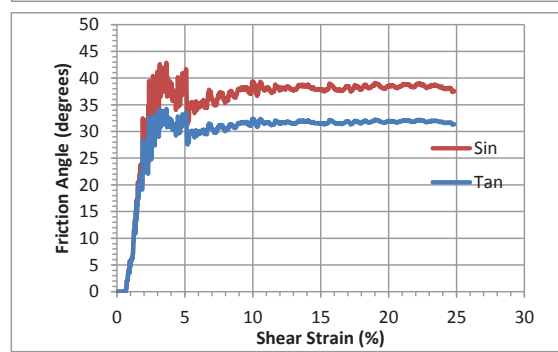
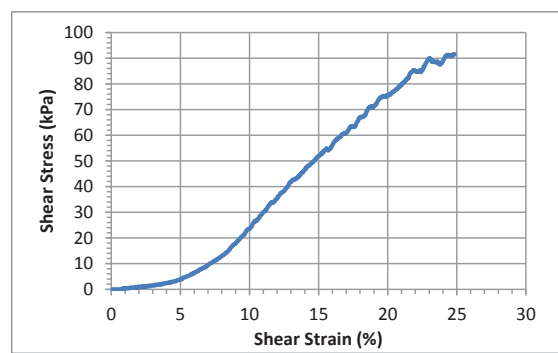
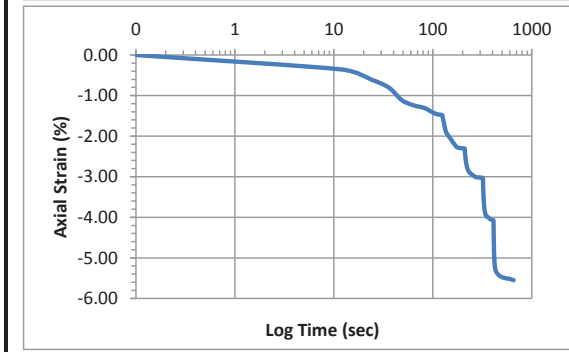
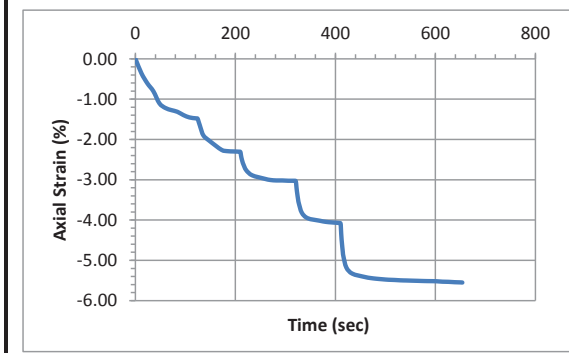

Accelerometer-Based Shear Wave Velocity Datasheet

Specimen ID: C216-LS-400-3X

Test Material: LS

Date: 8/20/2015

Test Performed by: J.Hubler

Filename: C216-LS-400-3X

Vertical Stress: 400kPa

Sensor Spacing: 0.10533 m

V_s (rise) = 296 m/s

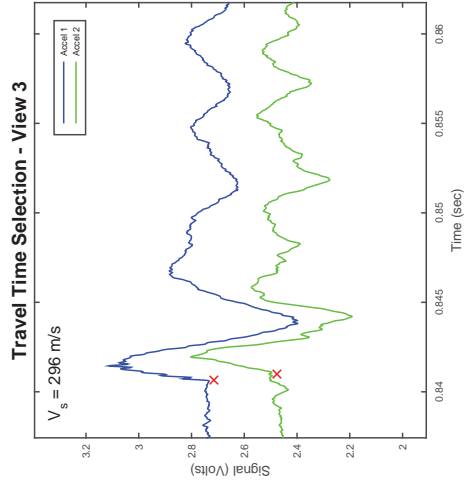
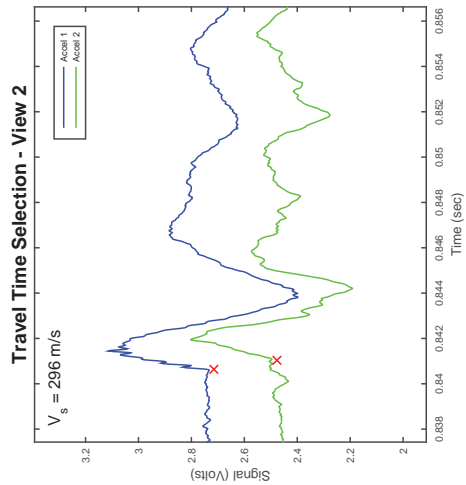
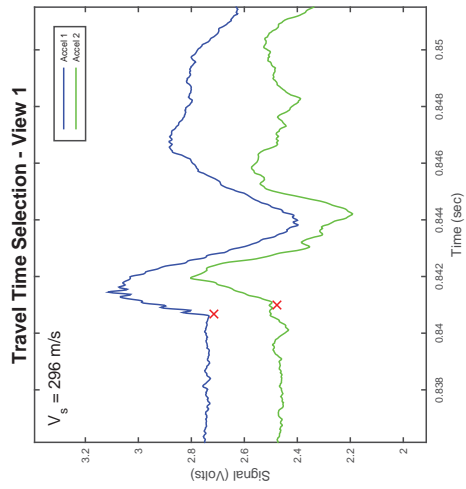
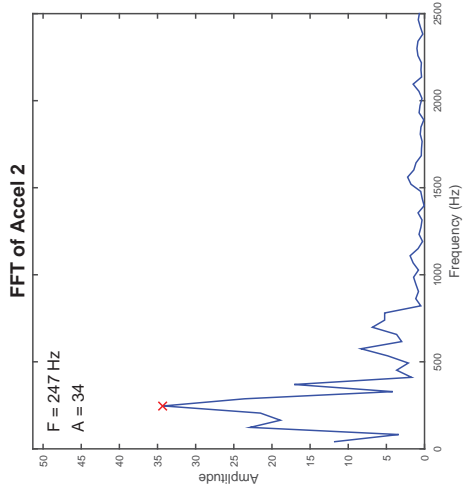
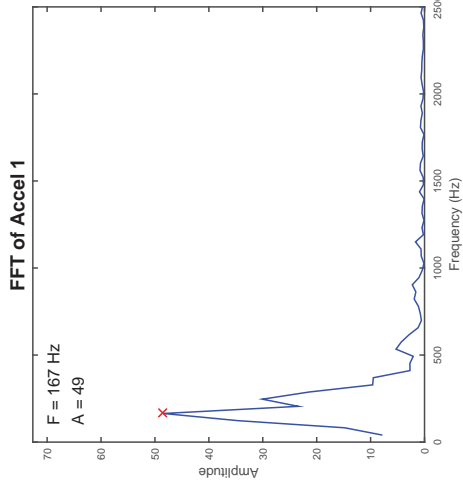
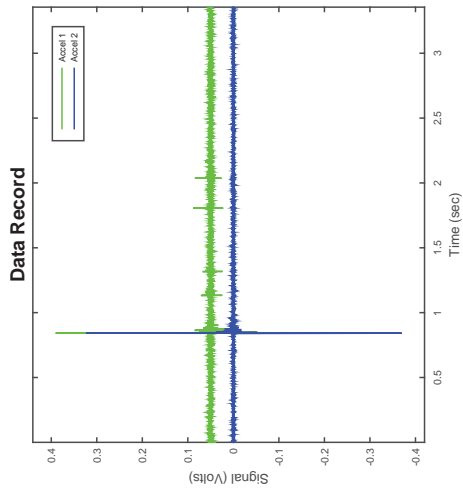

CSS Cyclic Shear Test Report

Geotechnical Engineering Laboratory



Cyclic Shear Test Summary

Device:	CSS	Density (kg/m³):	1695
Specimen ID:	CLS8	Relative Density (%):	89%
Test ID:	C225	Void Ratio:	0.563
Date of Test:	9/3/2015	Vertical Stress (kPa):	50
Test Performed:	Cyclic	Loading Frequency (Hz):	0.33
Test Material:	8mm Crushed Limestone	Number of Cycles:	48
Sample Preparation:	Tamped 60x in 6 layers	Cyclic Stress Ratio:	0.088
		Shear Modulus (kPa):	
		Damping (%):	
Prepared by:	J. Hubler	Shear Strain Single Amplitude (%)	
Checked by:	J. Hubler		

Additional Comments:

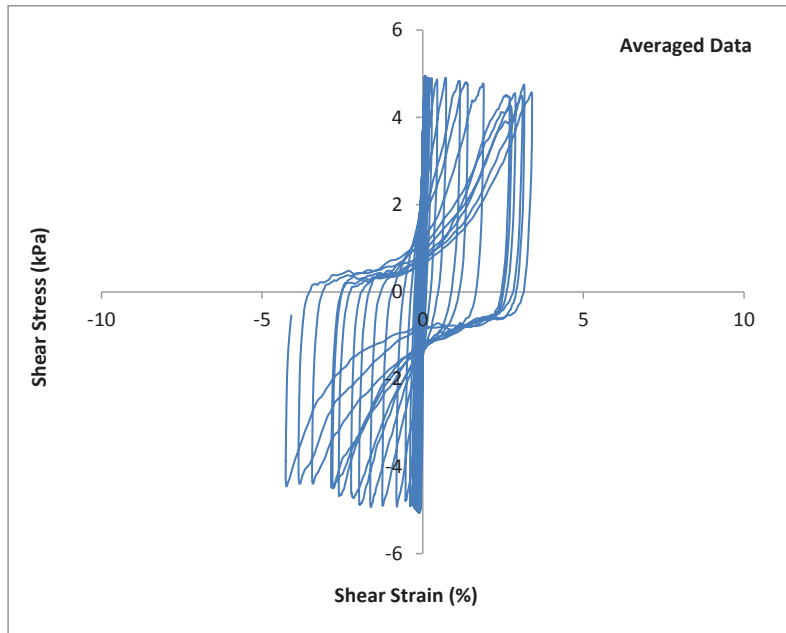
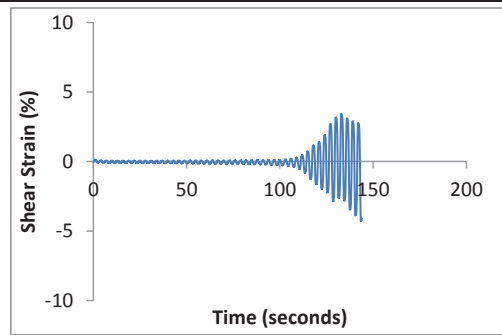
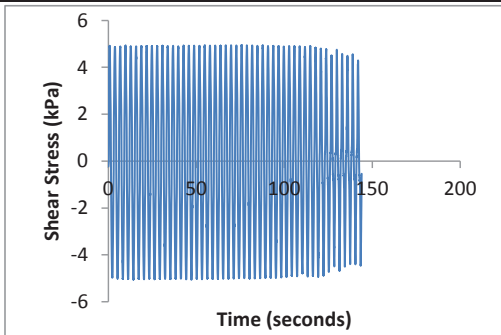

CSS Cyclic Shear Test Report

Geotechnical Engineering Laboratory



Cyclic Shear Test Summary

Device:	CSS	Density (kg/m³):	1695
Specimen ID:	CLS8	Relative Density (%):	89%
Test ID:	C225	Void Ratio:	0.563
Date of Test:	9/3/2015	Vertical Stress (kPa):	50
Test Performed:	Cyclic	Loading Frequency (Hz):	0.33
Test Material:	8mm Crushed Limestone	Number of Cycles:	48
Sample Preparation:	Tamped 60x in 6 layers	Cyclic Stress Ratio:	0.088
		Number of Cycles to Liq:	48
		Maximum ru:	1.02
Prepared by:	J. Hubler		
Checked by:	J. Hubler		

Additional Comments:

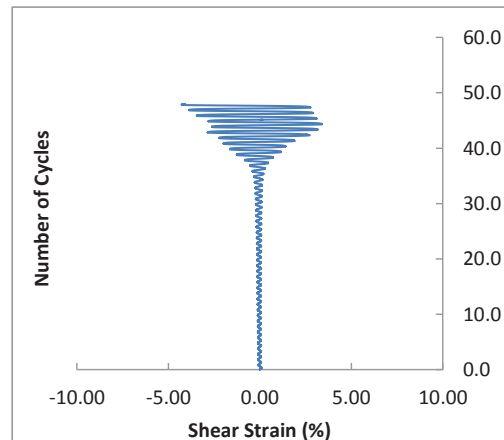
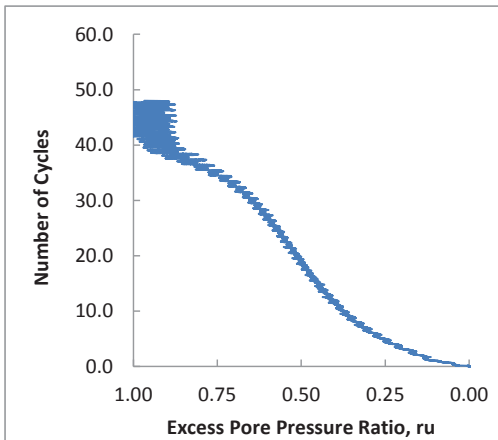
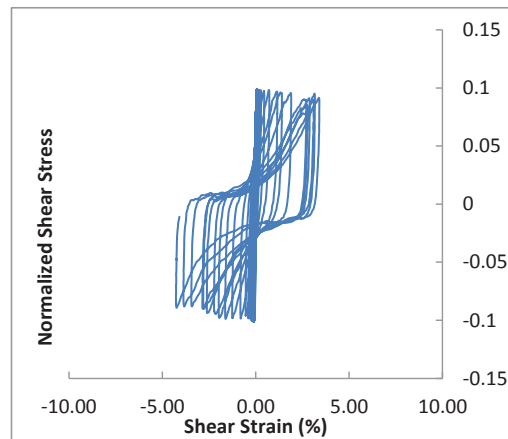
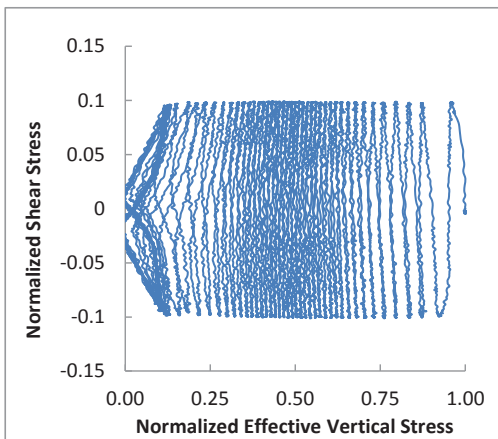

CSS Monotonic Shear Test Report

Geotechnical Engineering Laboratory



10/28/2013_Version 8.0

General Test Info and Sample Preparation

Device:	CSS	Relative Density (%):	79%
Specimen ID:	CLS8	Void Ratio:	0.605
Test ID:	C225	Height (mm):	116.3
Date of Test:	9/3/2015	Soil-Only Specimen Diameter (mm):	306.23
Test Performed:	Post Cyclic Monotonic Shear	Weight (kg):	14.140
Test Material:	8mm Crushed Limestone	Density (kg/m³):	1651.3
Sample Preparation:	Prepared dense by tamping 60x in 6 layers.	Membrane Thickness (mm):	0.635
		Moisture Content (%):	0%
		Saturated (Y/N):	N
		Prepared by:	J.Hubler
		Checked by:	J. Hubler

Consolidation Stage

Vertical Stress (kPa):	50
Time to Compression (min):	7.7
Relative Density (%):	89%
	0.563
Height (mm):	113.3
Diameter (mm):	306.23
Weight (kg):	14.140
Density (kg/m³):	1695.2

Shear Stage

Type of Test:	Constant Volume
Stress or Strain Controlled:	Strain
Shear Strain Rate (%/min):	0.29
Peak Shear Strength (kPa):	68.3

Comments

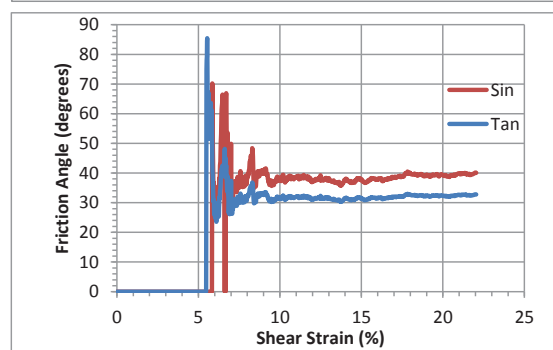
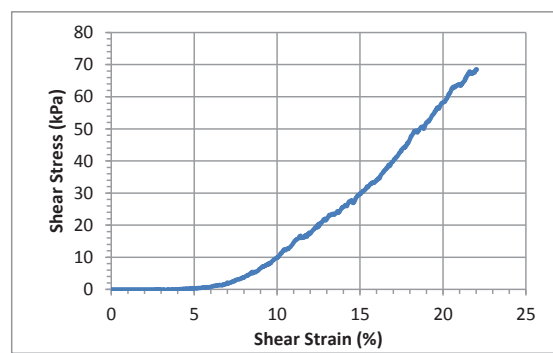
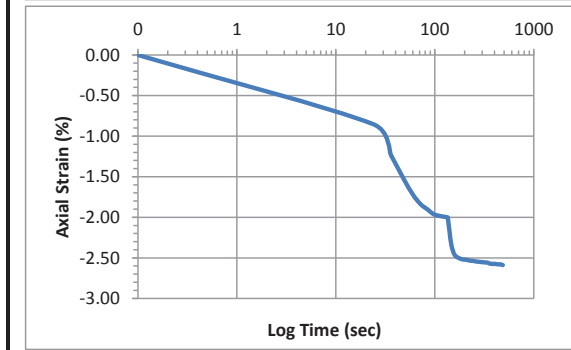
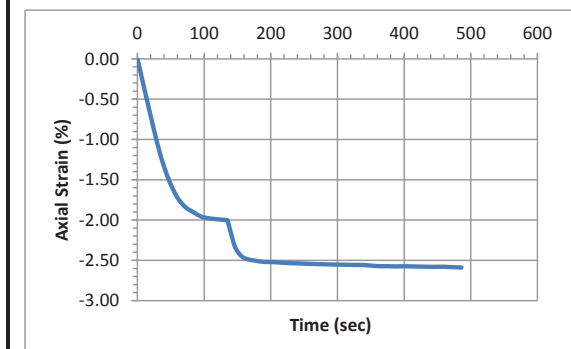

Accelerometer-Based Shear Wave Velocity Datasheet

Specimen ID: C225-LS-50-1X
 Test Material: LS
 Date: 9/3/2015
 Test Performed by: J.Hubler
 Filename: C225-LS-50-1X

Vertical Stress: 50kPa
 Sensor Spacing: 0.11321 m
 V_s (rise) = 196 m/s

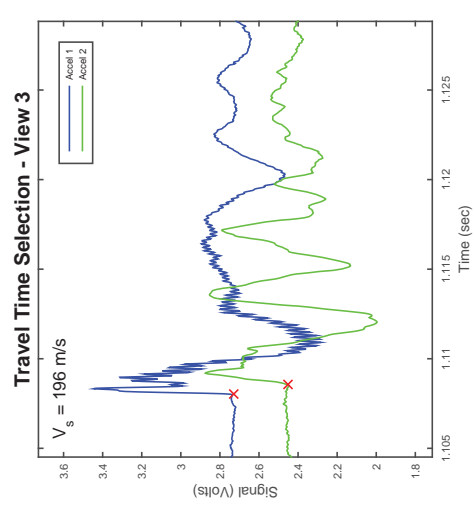
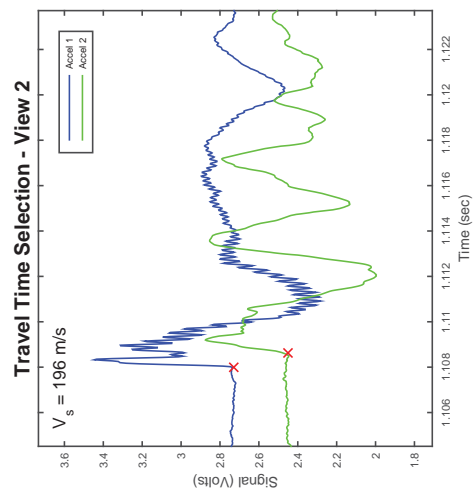
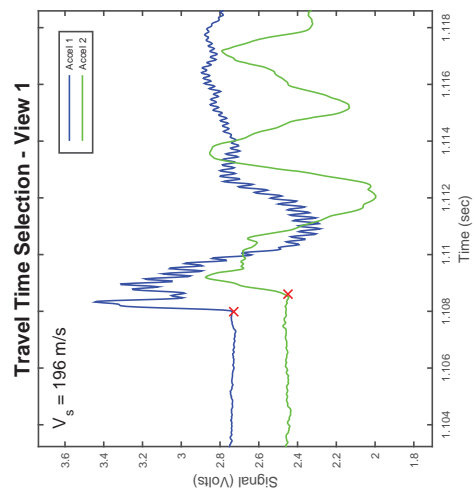
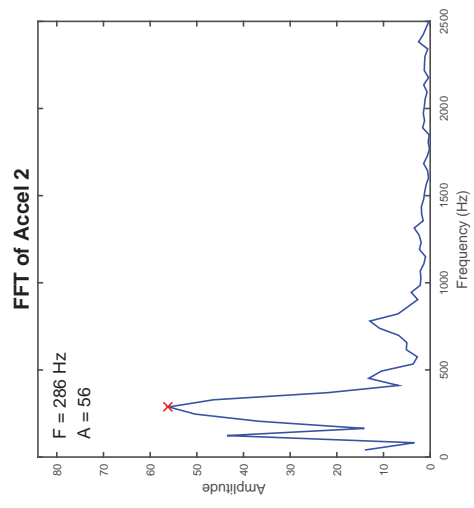
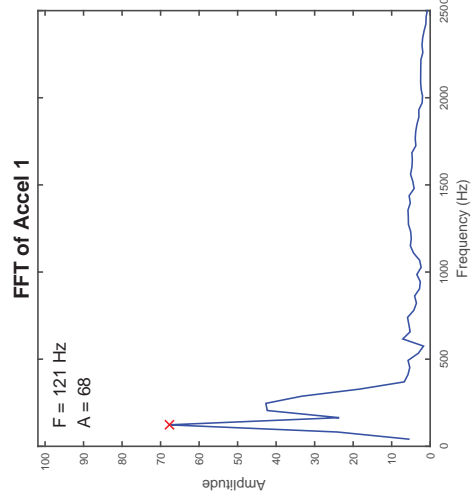
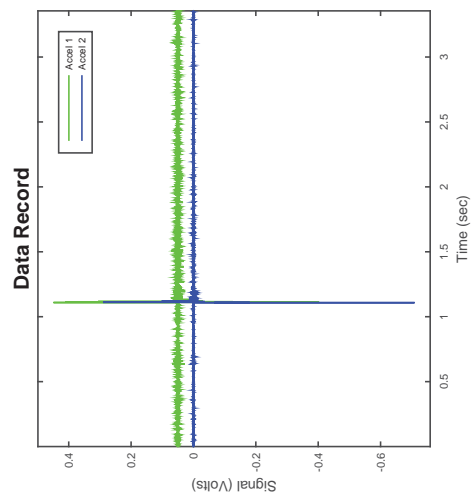

Accelerometer-Based Shear Wave Velocity Datasheet

Specimen ID: C225-LS-50-2X
 Test Material: LS
 Date: 9/3/2015
 Test Performed by: J.Hubler
 Filename: C225-LS-50-2X

Vertical Stress: 50kPa
 Sensor Spacing: 0.11321 m
 V_s (rise) = 201 m/s

Data Record

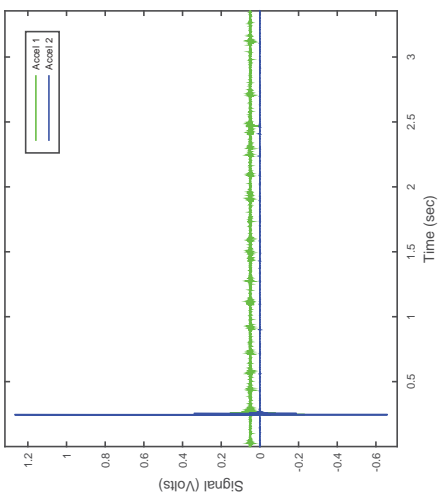

FFT of Accel 1

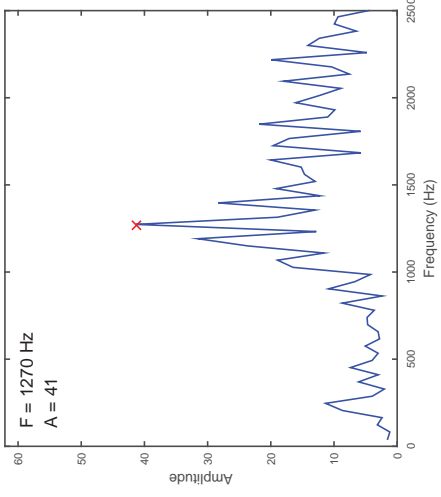

FFT of Accel 2

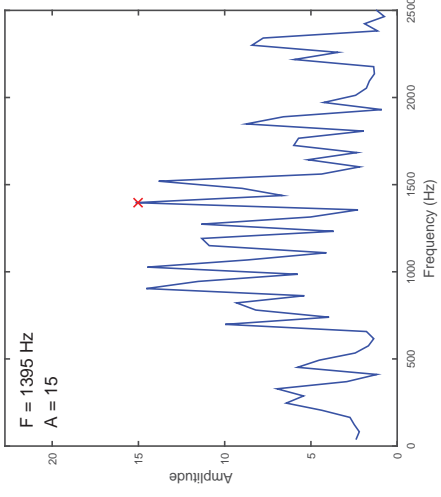

Travel Time Selection - View 1

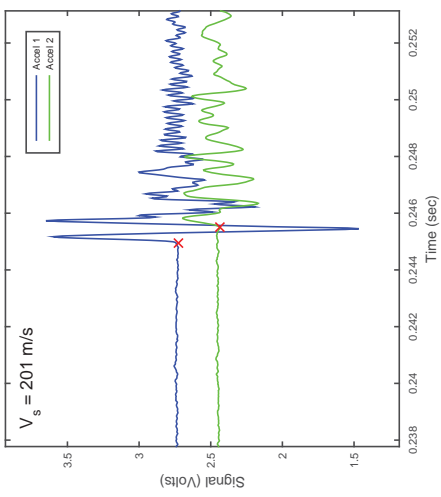

Travel Time Selection - View 2

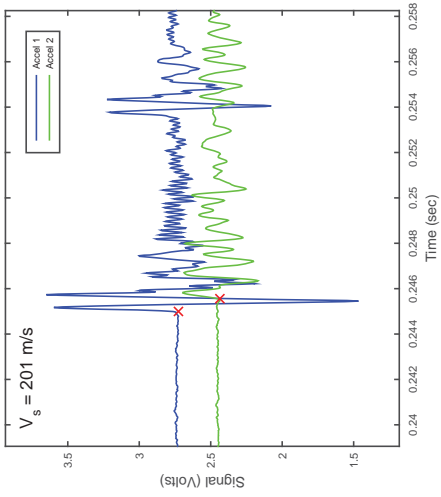

Travel Time Selection - View 3

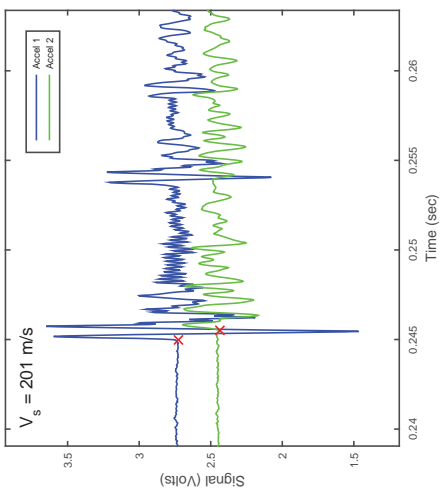

CSS Cyclic Shear Test Report

Geotechnical Engineering Laboratory



Cyclic Shear Test Summary

Device:	CSS	Density (kg/m³):	1676
Specimen ID:	CLS8	Relative Density (%):	85%
Test ID:	C230	Void Ratio:	0.581
Date of Test:	9/17/2015	Vertical Stress (kPa):	100
Test Performed:	Cyclic	Loading Frequency (Hz):	0.33
Test Material:	8mm Crushed Limestone	Number of Cycles:	58
Sample Preparation:	Tamped 60x in 6 layers	Cyclic Stress Ratio:	0.094
		Shear Modulus (kPa):	
		Damping (%):	
Prepared by:	J. Hubler	Shear Strain Single Amplitude (%)	
Checked by:	J. Hubler		

Additional Comments:

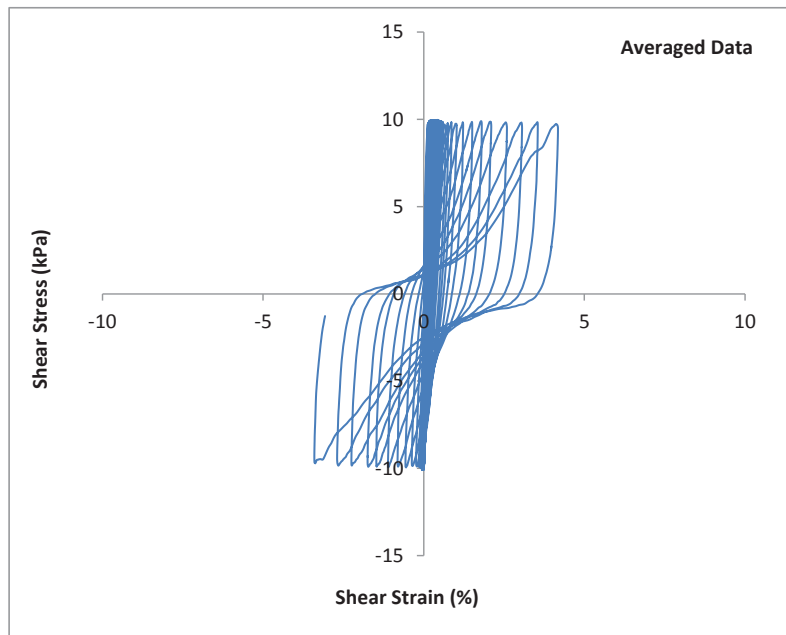
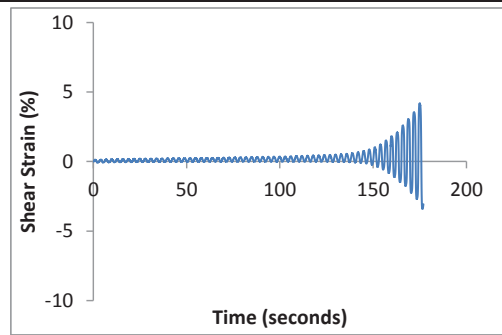
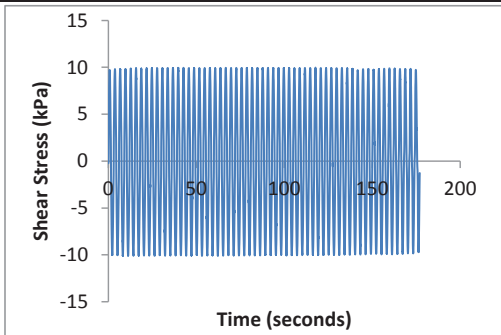

CSS Cyclic Shear Test Report

Geotechnical Engineering Laboratory



Cyclic Shear Test Summary

Device:	CSS	Density (kg/m³):	1676
Specimen ID:	CLS8	Relative Density (%):	85%
Test ID:	C230	Void Ratio:	0.581
Date of Test:	9/17/2015	Vertical Stress (kPa):	100
Test Performed:	Cyclic	Loading Frequency (Hz):	0.33
Test Material:	8mm Crushed Limestone	Number of Cycles:	58
Sample Preparation:	Tamped 60x in 6 layers	Cyclic Stress Ratio:	0.094
		Number of Cycles to Liq:	58
		Maximum ru:	1.00
Prepared by:	J. Hubler		
Checked by:	J. Hubler		

Additional Comments:

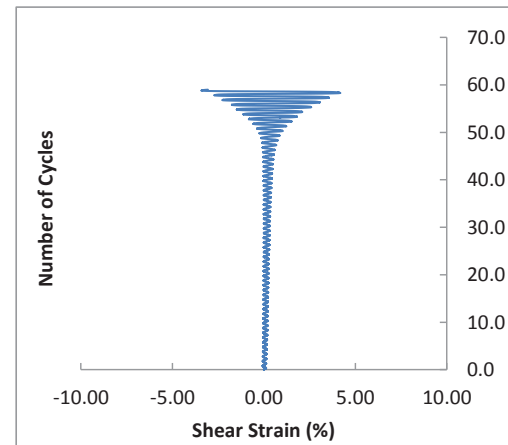
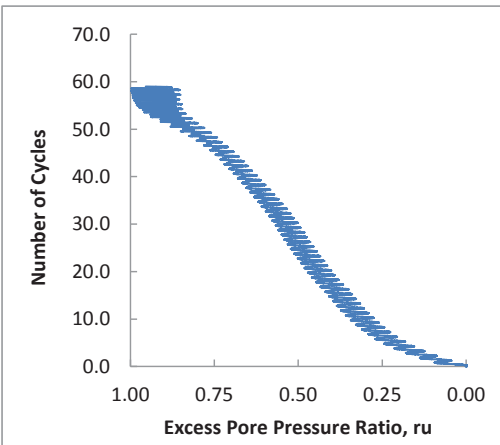
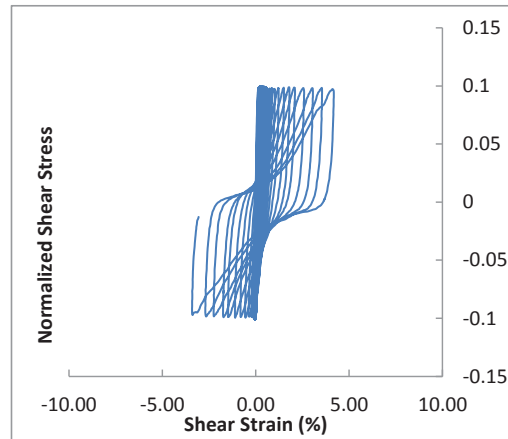
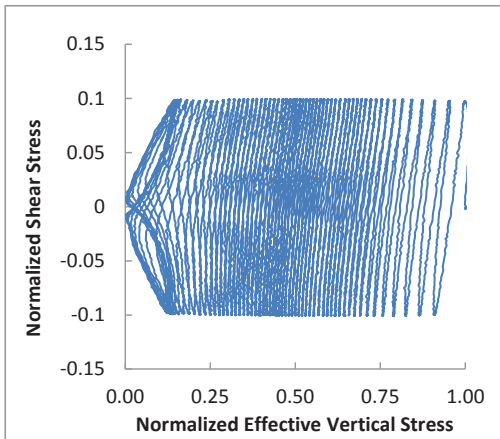

CSS Monotonic Shear Test Report

Geotechnical Engineering Laboratory



10/28/2013_Version 8.0

General Test Info and Sample Preparation

Device:	CSS	Relative Density (%):	74%
Specimen ID:	CLS8	Void Ratio:	0.627
Test ID:	C230	Height (mm):	113.1
Date of Test:	9/17/2015	Soil-Only Specimen Diameter (mm):	306.23
Test Performed:	Post Cyclic Monotonic Shear	Weight (kg):	13.565
Test Material:	8mm Crushed Limestone	Density (kg/m³):	1628.5
Sample Preparation:	Prepared dense by tamping 60x in 6 layers	Membrane Thickness (mm):	0.635
		Moisture Content (%):	0%
		Saturated (Y/N):	N
		Prepared by:	J.Hubler
		Checked by:	J. Hubler

Consolidation Stage

Vertical Stress (kPa):	100
Time to Compression (min):	11.5
Relative Density (%):	85%
	0.578
Height (mm):	109.7
Diameter (mm):	306.23
Weight (kg):	13.565
Density (kg/m³):	1678.9

Shear Stage

Type of Test:	Constant Volume
Stress or Strain Controlled:	Strain
Shear Strain Rate (%/min):	0.30
Peak Shear Strength (kPa):	74.0

Comments

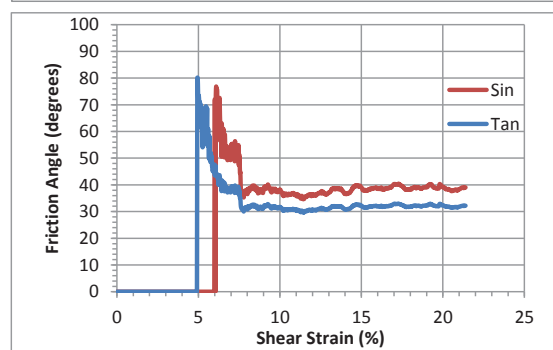
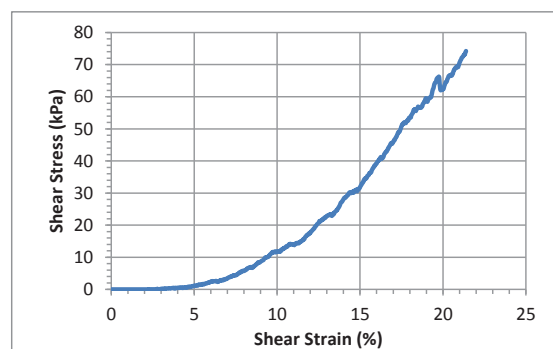
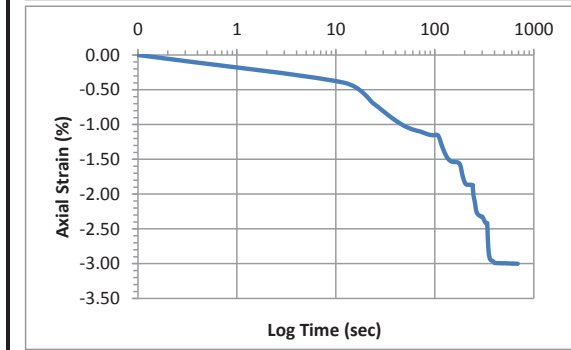
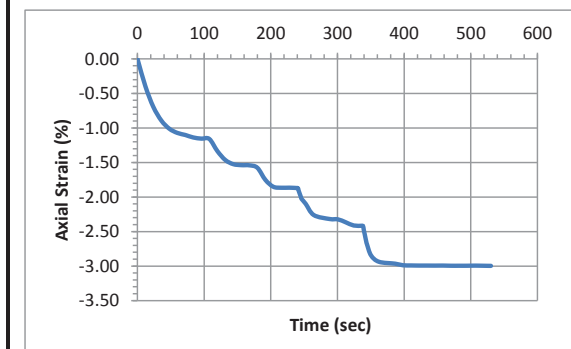

Accelerometer-Based Shear Wave Velocity Datasheet

Specimen ID: C230-LS-100-1X
 Test Material: LS
 Date: 9/17/2015
 Test Performed by: J.Hubler
 Filename: C230-LS-100-1X

Vertical Stress: 100kPa
 Sensor Spacing: 0.10966 m
 V_s (rise) = 223 m/s

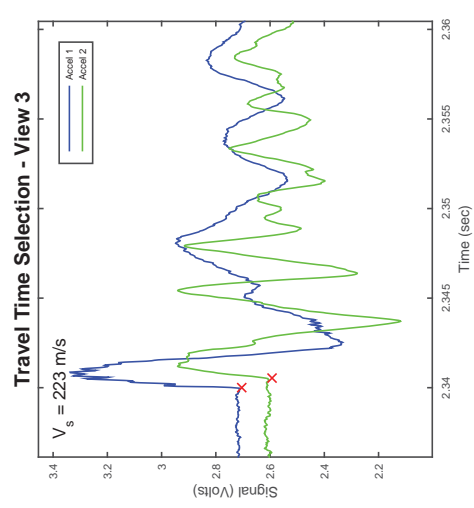
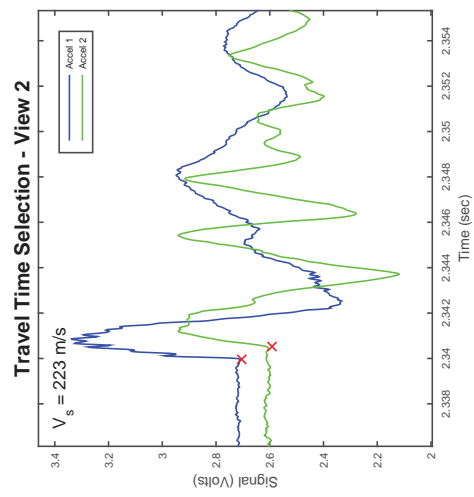
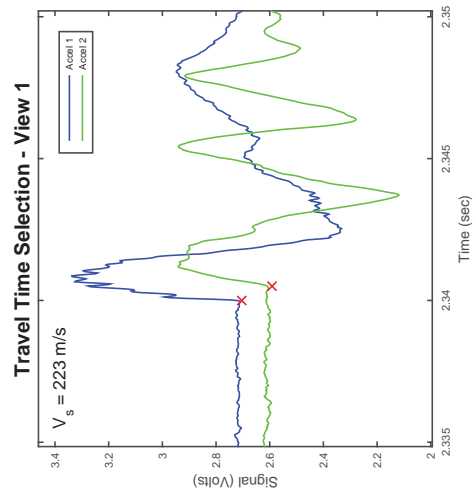
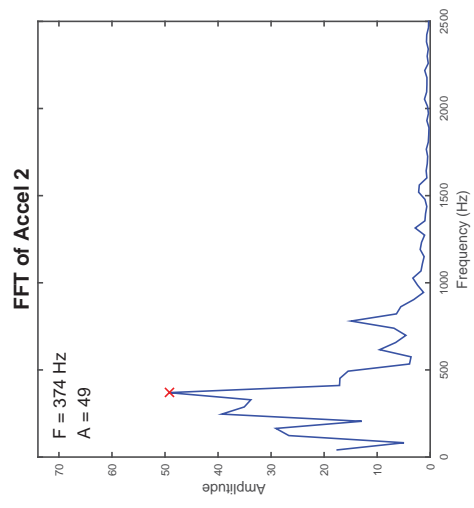
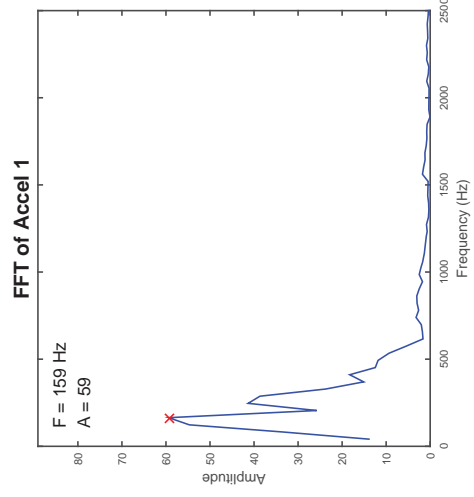
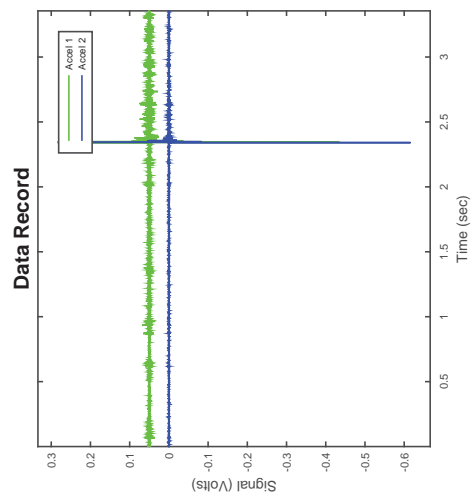

CSS Cyclic Shear Test Report

Geotechnical Engineering Laboratory



Cyclic Shear Test Summary

Device:	CSS	Density (kg/m³):	1691
Specimen ID:	CLS8	Relative Density (%):	88%
Test ID:	C224	Void Ratio:	0.567
Date of Test:	9/2/2015	Vertical Stress (kPa):	200
Test Performed:	Cyclic	Loading Frequency (Hz):	0.33
Test Material:	8mm Crushed Limestone	Number of Cycles:	45
Sample Preparation:	Tamped 55x in 6 layers.	Cyclic Stress Ratio:	0.094
		Shear Modulus (kPa):	
		Damping (%):	
Prepared by:	J. Hubler	Shear Strain Single Amplitude (%)	
Checked by:	J. Hubler		

Additional Comments:

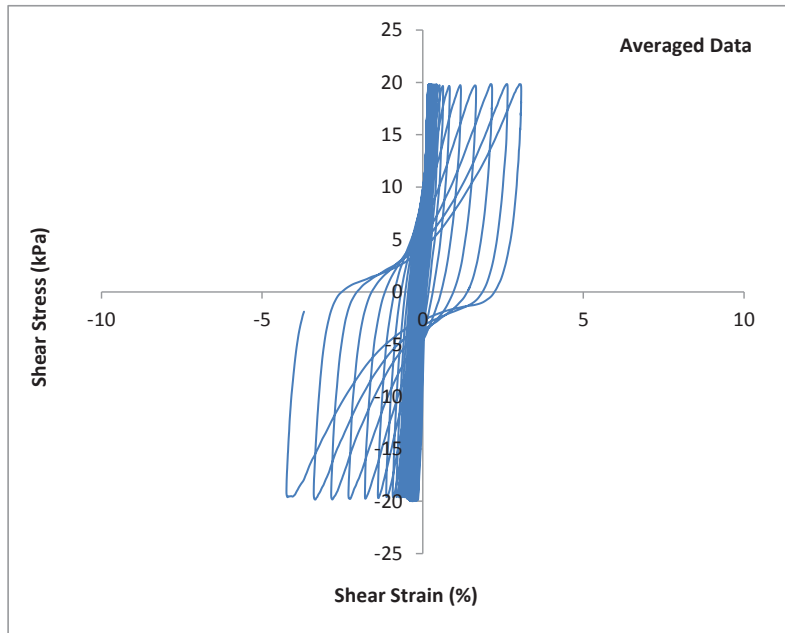
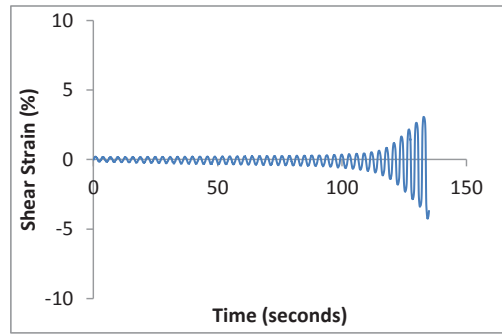
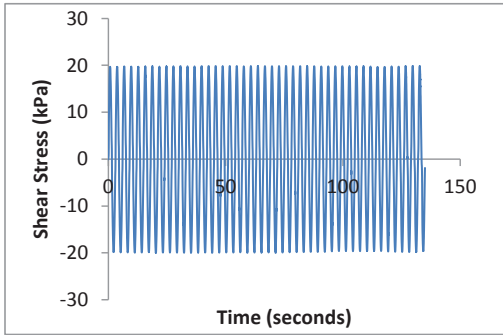

CSS Cyclic Shear Test Report

Geotechnical Engineering Laboratory



Cyclic Shear Test Summary

Device:	CSS	Density (kg/m ³):	1691
Specimen ID:	CLS8	Relative Density (%):	88%
Test ID:	C224	Void Ratio:	0.567
Date of Test:	9/2/2015	Vertical Stress (kPa):	200
Test Performed:	Cyclic	Loading Frequency (Hz):	0.33
Test Material:	8mm Crushed Limestone	Number of Cycles:	45
Sample Preparation:	Tamped 55x in 6 layers.	Cyclic Stress Ratio:	0.094
		Number of Cycles to Liq:	45
		Maximum ru:	0.98
Prepared by:	J. Hubler		
Checked by:	J. Hubler		

Additional Comments:

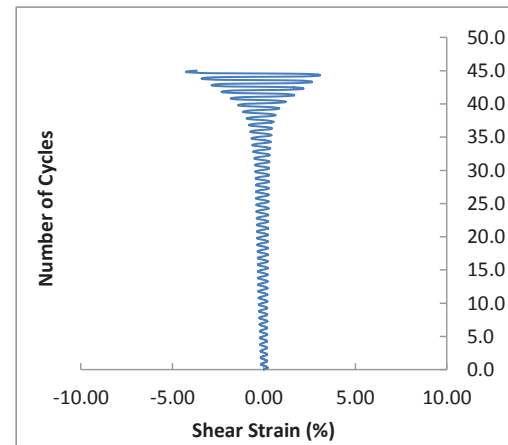
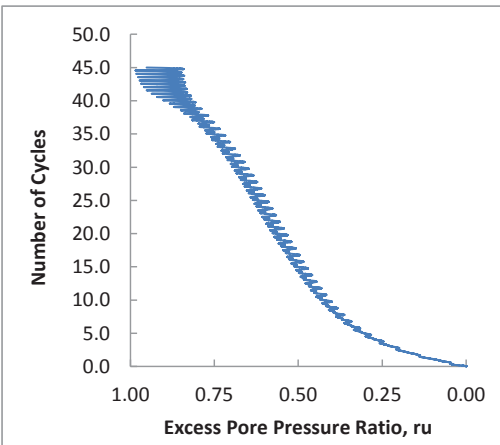
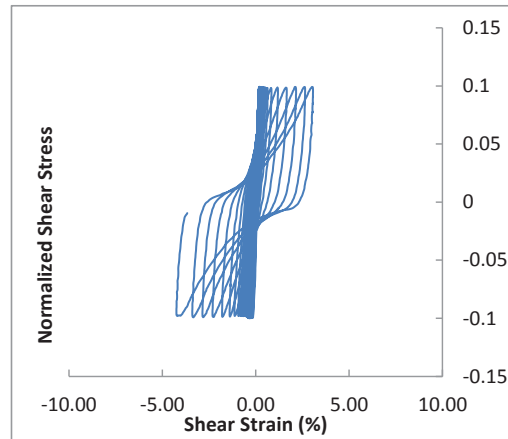
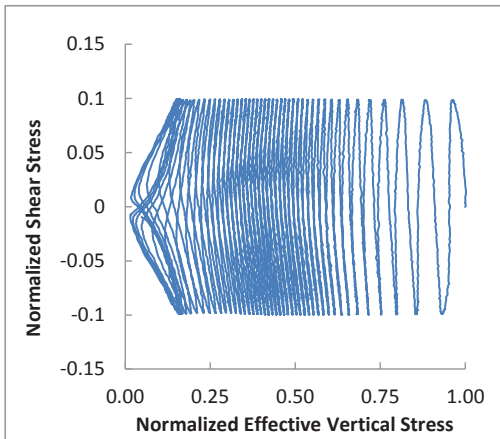

CSS Monotonic Shear Test Report



10/28/2013_Version 8.0

Geotechnical Engineering Laboratory

General Test Info and Sample Preparation

Device:	CSS	Relative Density (%):	77%
Specimen ID:	CLS8	Void Ratio:	0.616
Test ID:	C224	Height (mm):	113.8
Date of Test:	9/2/2015	Soil-Only Specimen Diameter (mm):	306.23
Test Performed:	Post Cyclic Monotonic Shear	Weight (kg):	13.748
Test Material:	8mm Crushed Limestone	Density (kg/m ³):	1640.2
Sample Preparation:	Prepared dense by tamping 55x in 6 layers	Membrane Thickness (mm):	0.635
		Moisture Content (%):	0%
		Saturated (Y/N):	N
		Prepared by:	J.Hubler
		Checked by:	J. Hubler

Consolidation Stage		Shear Stage	
Vertical Stress (kPa):	200	Type of Test:	Constant Volume
Time to Compression (min):	10.1	Stress or Strain Controlled:	Strain
Relative Density (%):	88%	Shear Strain Rate (%/min):	0.30
Void Ratio:	0.567	Peak Shear Strength (kPa):	102.4
Height (mm):	110.4	Comments	
Diameter (mm):	306.23		
Weight (kg):	13.748		
Density (kg/m ³):	1691.0		

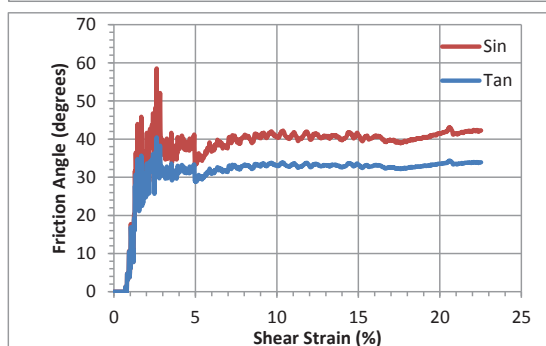
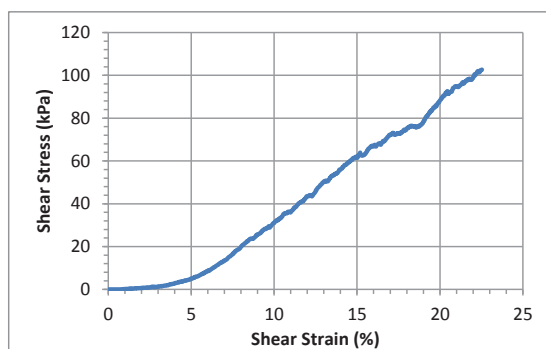
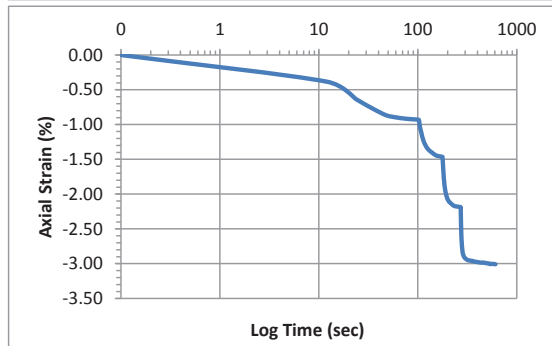
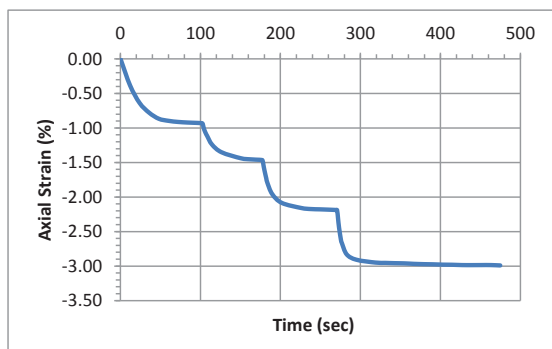

Accelerometer-Based Shear Wave Velocity Datasheet

Specimen ID: C224-LS-200-2X
 Test Material: LS
 Date: 9/2/2015
 Test Performed by: J.Hubler
 Filename: C224-LS-200-2X

Vertical Stress: 200kPa
 Sensor Spacing: 0.11034 m
 V_s (rise) = 274 m/s

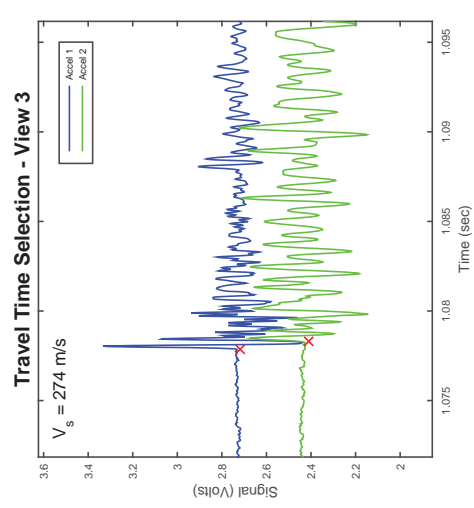
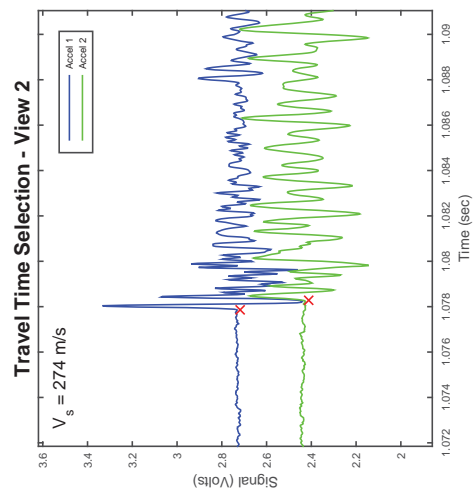
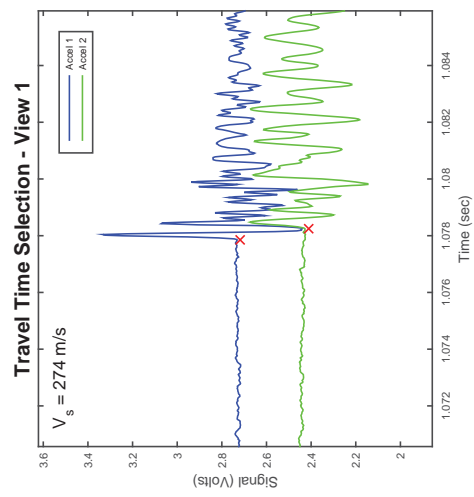
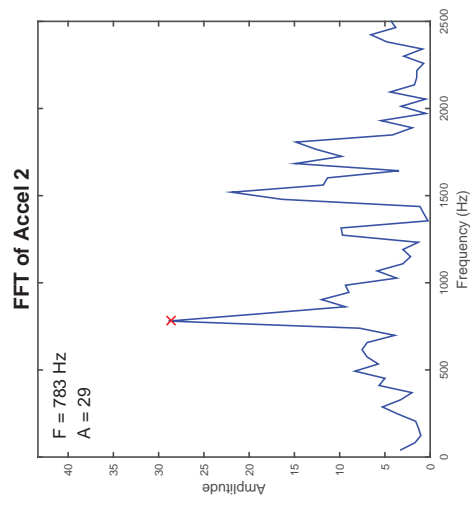
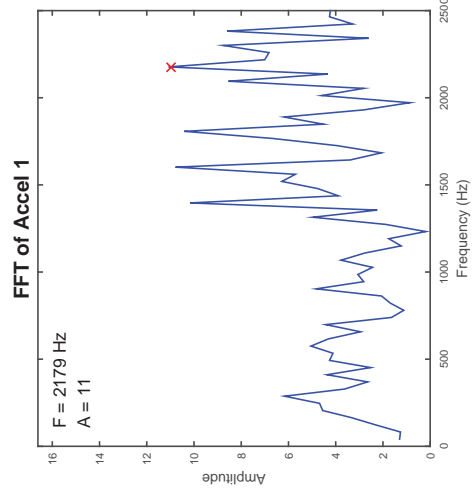
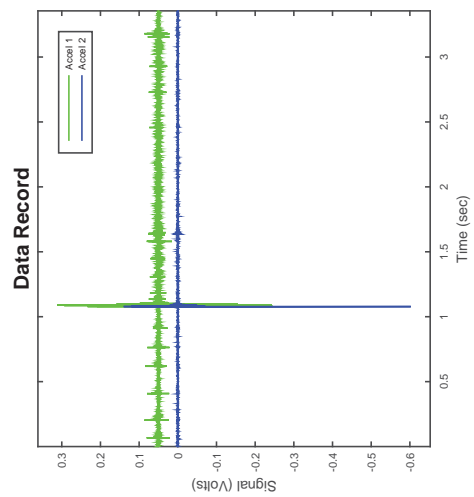

CSS Cyclic Shear Test Report

Geotechnical Engineering Laboratory



Cyclic Shear Test Summary

Device:	CSS	Density (kg/m³):	1680
Specimen ID:	CLS8	Relative Density (%):	85%
Test ID:	C222	Void Ratio:	0.577
Date of Test:	9/2/2015	Vertical Stress (kPa):	400
Test Performed:	Cyclic	Loading Frequency (Hz):	0.33
Test Material:	8mm Crushed Limestone	Number of Cycles:	75
Sample Preparation:	Tamped 55x in 6 layers.	Cyclic Stress Ratio:	0.099
		Shear Modulus (kPa):	
		Damping (%):	
Prepared by:	J. Hubler	Shear Strain Single Amplitude (%)	
Checked by:	J. Hubler		

Additional Comments:

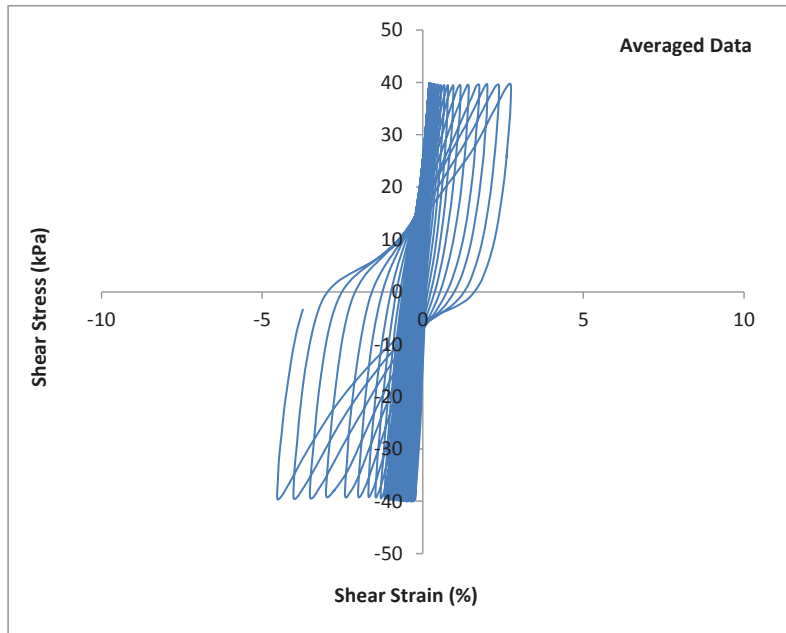
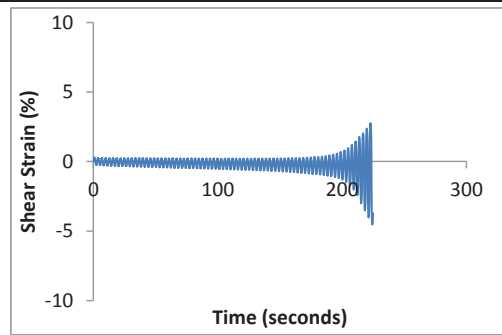
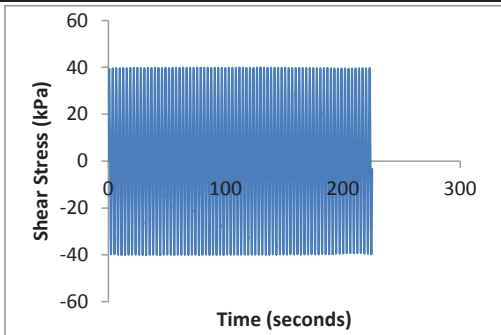

CSS Cyclic Shear Test Report

Geotechnical Engineering Laboratory



Cyclic Shear Test Summary

Device:	CSS	Density (kg/m³):	1680
Specimen ID:	CLS8	Relative Density (%):	85%
Test ID:	C222	Void Ratio:	0.577
Date of Test:	9/2/2015	Vertical Stress (kPa):	400
Test Performed:	Cyclic	Loading Frequency (Hz):	0.33
Test Material:	8mm Crushed Limestone	Number of Cycles:	75
Sample Preparation:	Tamped 55x in 6 layers.	Cyclic Stress Ratio:	0.099
		Number of Cycles to Liq:	74
		Maximum ru:	0.97
Prepared by:	J. Hubler		
Checked by:	J. Hubler		

Additional Comments:

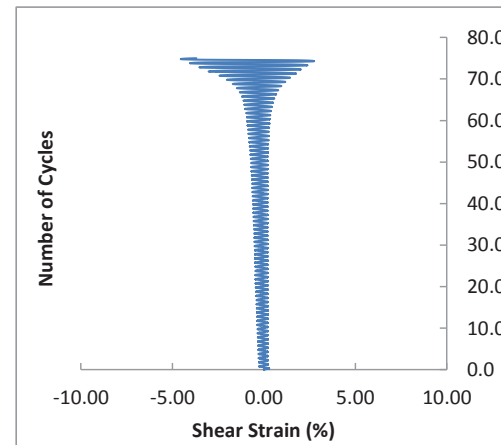
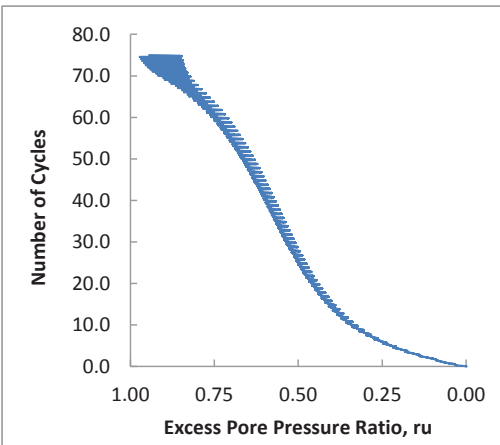
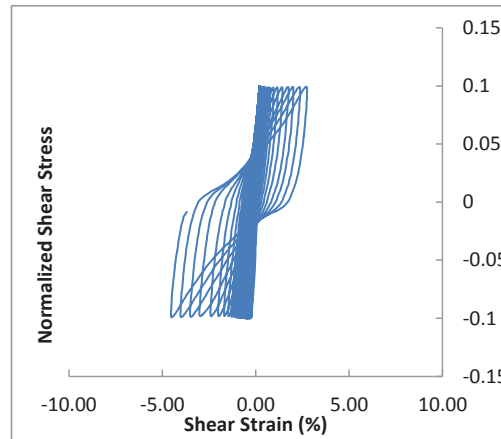
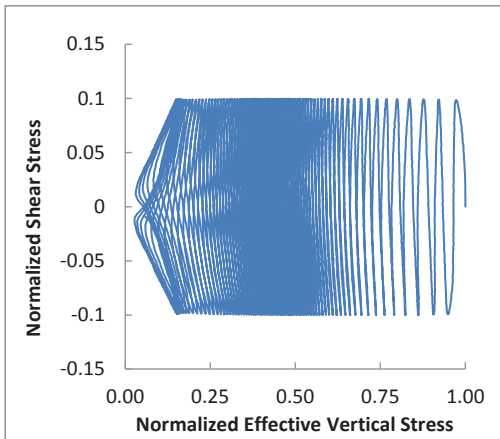

CSS Monotonic Shear Test Report

Geotechnical Engineering Laboratory



10/28/2013_Version 8.0

General Test Info and Sample Preparation

Device:	CSS	Relative Density (%):	71%
Specimen ID:	CLS8	Void Ratio:	0.642
Test ID:	C222	Height (mm):	113.3
Date of Test:	9/2/2015	Soil-Only Specimen Diameter (mm):	306.23
Test Performed:	Post Cyclic Monotonic Shear	Weight (kg):	13.467
Test Material:	8mm Crushed Limestone	Density (kg/m ³):	1614.2
Sample Preparation:	Prepared dense by tamping 55x in 6 layers.	Membrane Thickness (mm):	0.635
		Moisture Content (%):	0%
		Saturated (Y/N):	N
		Prepared by:	J. Hubler
		Checked by:	J. Hubler

Consolidation Stage

Vertical Stress (kPa):	400
Time to Compression (min):	13.4
Relative Density (%):	85%
Void Ratio:	0.577
Height (mm):	108.8
Diameter (mm):	306.23
Weight (kg):	13.467
Density (kg/m ³):	1680.2

Shear Stage

Type of Test:	Constant Volume
Stress or Strain Controlled:	Strain
Shear Strain Rate (%/min):	0.30
Peak Shear Strength (kPa):	143.5

Comments

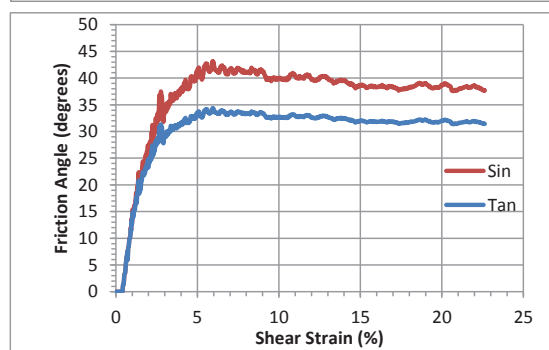
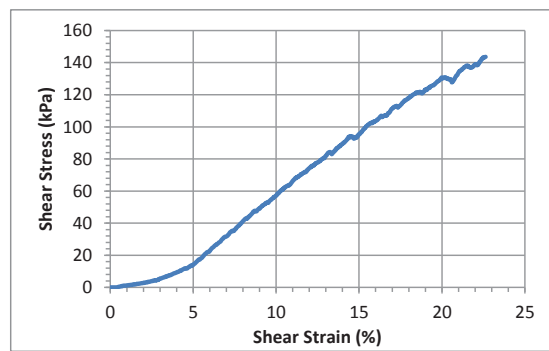
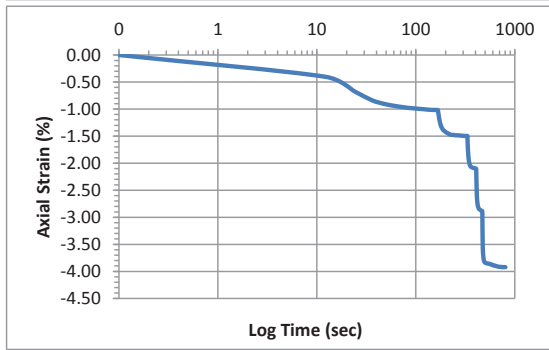
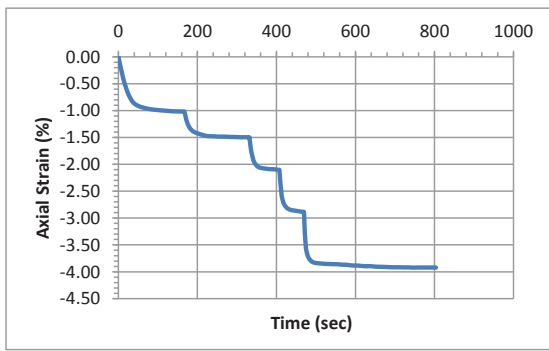

Accelerometer-Based Shear Wave Velocity Datasheet

Specimen ID: C222-LS-400-1X
 Test Material: LS
 Date: 9/2/2015
 Test Performed by: J.Hubler
 Filename: C222-LS-400-1X

Vertical Stress: 400kPa
 Sensor Spacing: 0.10878 m
 V_s (rise) = 316 m/s

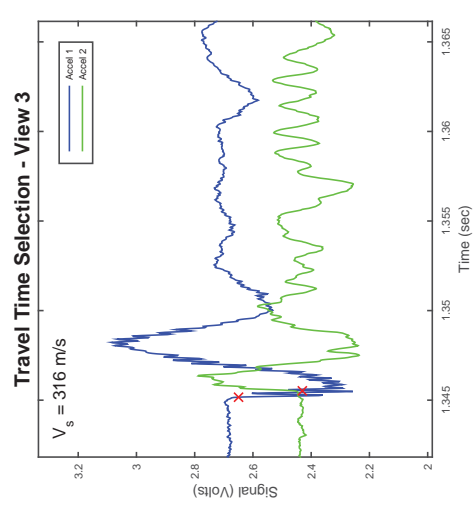
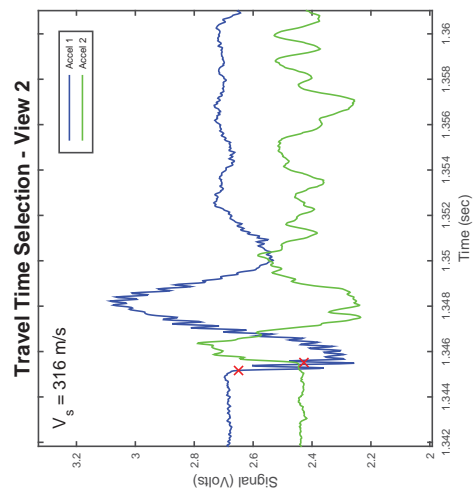
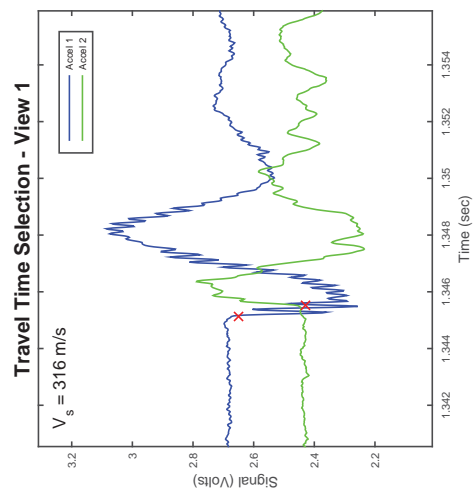
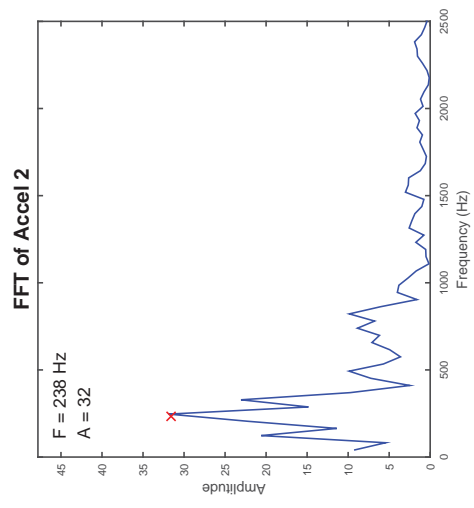
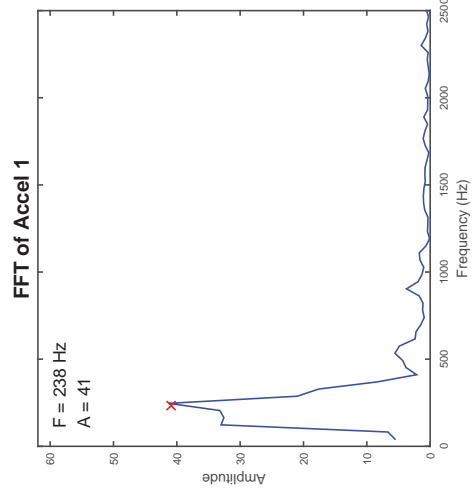
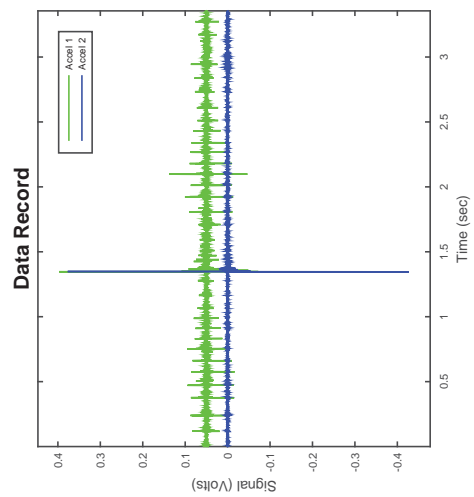

CSS Cyclic Shear Test Report

Geotechnical Engineering Laboratory



Cyclic Shear Test Summary

Device:	CSS	Density (kg/m³):	1516
Specimen ID:	CLS8	Relative Density (%):	47%
Test ID:	C218	Void Ratio:	0.747
Date of Test:	8/21/2015	Vertical Stress (kPa):	100
Test Performed:	Cyclic	Loading Frequency (Hz):	0.33
Test Material:	8mm Crushed Limestone	Number of Cycles:	500
Sample Preparation:	Prepared loose by shoveling and hitting baseplate with rubber mallet 15x.	Cyclic Stress Ratio:	0.044
		Shear Modulus (kPa):	
		Damping (%):	
Prepared by:	J. Hubler	Shear Strain Single Amplitude (%)	
Checked by:	J. Hubler		

Additional Comments:

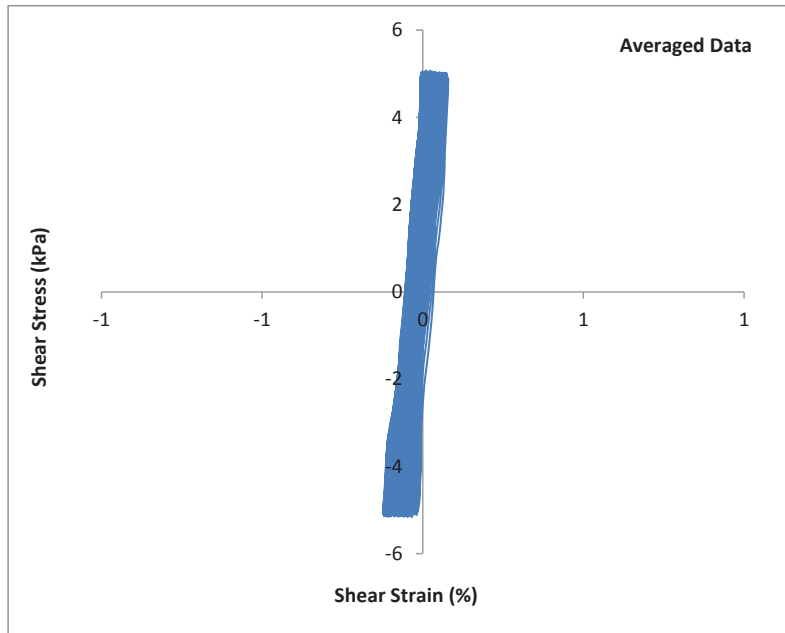
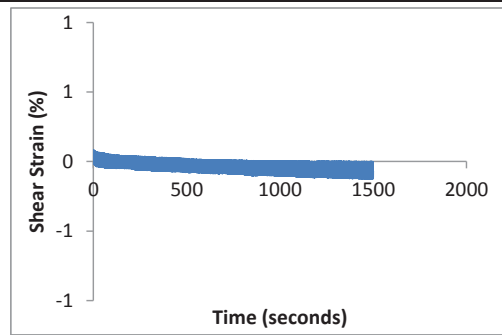
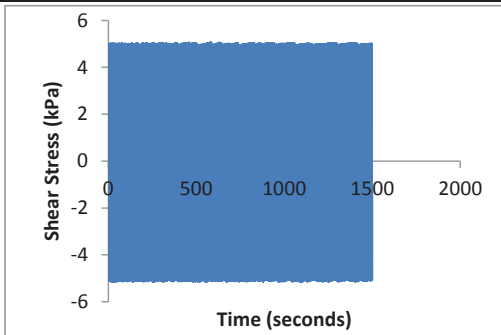

CSS Cyclic Shear Test Report

Geotechnical Engineering Laboratory



Cyclic Shear Test Summary

Device:	CSS	Density (kg/m³):	1516
Specimen ID:	CLS8	Relative Density (%):	47%
Test ID:	C218	Void Ratio:	0.747
Date of Test:	8/21/2015	Vertical Stress (kPa):	100
Test Performed:	Cyclic	Loading Frequency (Hz):	0.33
Test Material:	8mm Crushed Limestone	Number of Cycles:	500
Sample Preparation:	Prepared loose by shoveling and hitting baseplate with rubber mallet 15x.	Cyclic Stress Ratio:	0.044
		Number of Cycles to Liq:	N/A
		Maximum ru:	0.55
Prepared by:	J.Hubler		
Checked by:	J. Hubler		

Additional Comments:

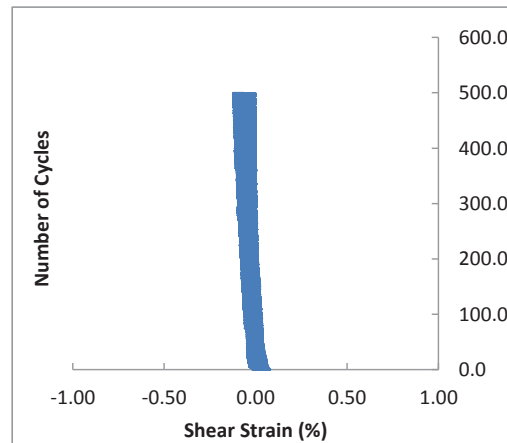
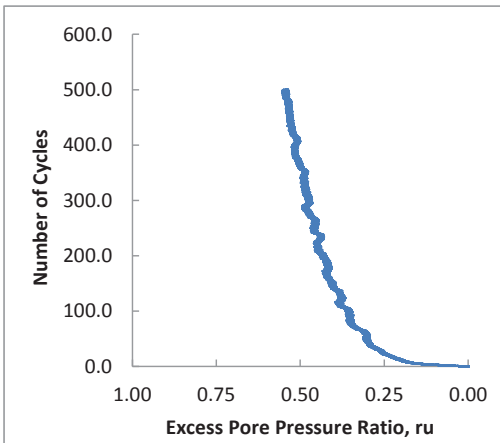
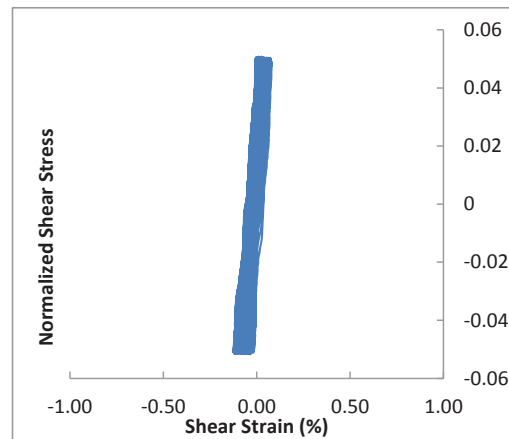
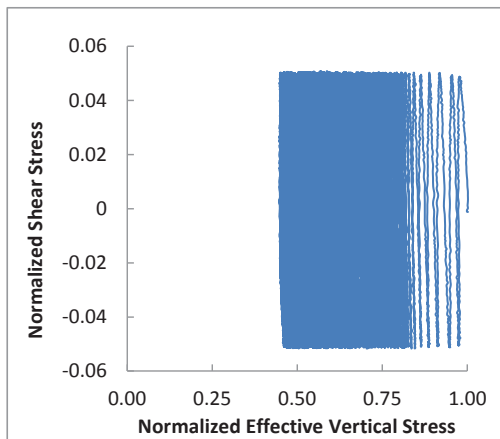

CSS Monotonic Shear Test Report

Geotechnical Engineering Laboratory



10/28/2013_Version 8.0

General Test Info and Sample Preparation

Device:	CSS	Relative Density (%):	33%
Specimen ID:	CLS8	Void Ratio:	0.809
Test ID:	C218	Height (mm):	112.2
Date of Test:	8/21/2015	Soil-Only Specimen Diameter (mm):	306.23
Test Performed:	Post Cyclic Monotonic Shear	Weight (kg):	12.107
Test Material:	8mm Crushed Limestone	Density (kg/m³):	1464.5
Sample Preparation:	Prepared loose by shoveling and hitting baseplate 15x in 3 layers with a rubber mallet.	Membrane Thickness (mm):	0.635
		Moisture Content (%):	0%
		Saturated (Y/N):	N
		Prepared by:	J. Hubler
		Checked by:	J. Hubler

Consolidation Stage		Shear Stage	
Vertical Stress (kPa):	100	Type of Test:	Constant Volume
Time to Compression (min):	7.2	Stress or Strain Controlled:	Strain
Relative Density (%):	47%	Shear Strain Rate (%/min):	0.30
Void Ratio:	0.747	Peak Shear Strength (kPa):	76.2
Height (mm):	108.4	Comments	
Diameter (mm):	306.23		
Weight (kg):	12.107		
Density (kg/m³):	1516.5		

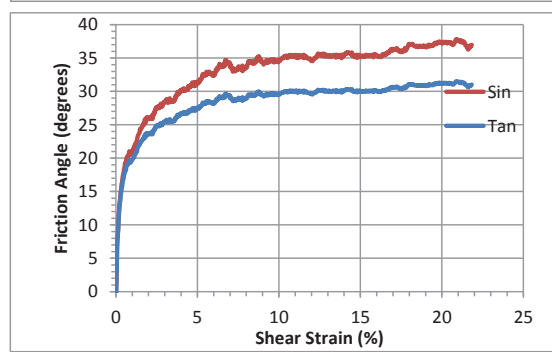
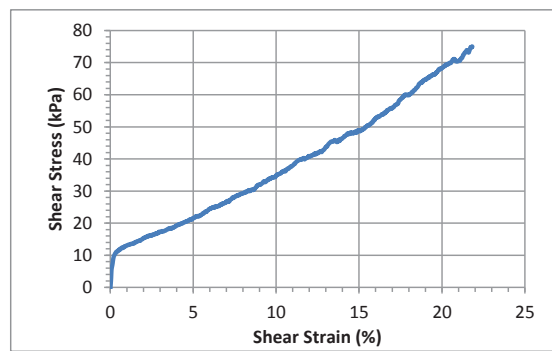
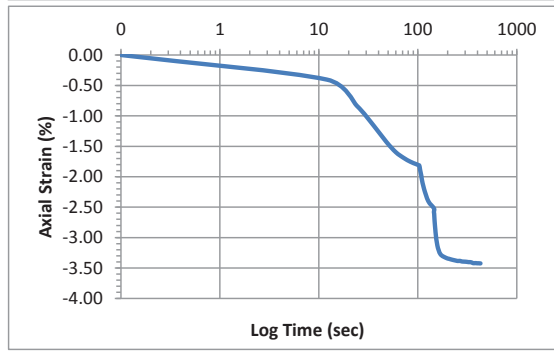
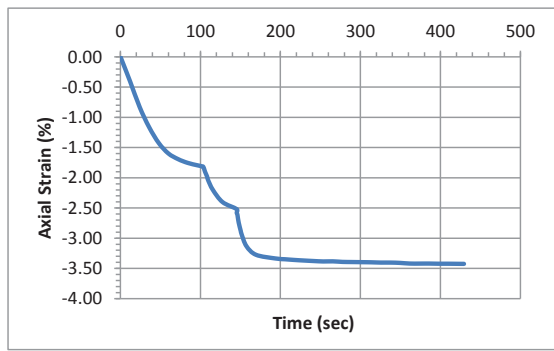

Accelerometer-Based Shear Wave Velocity Datasheet

Specimen ID: C218-LS-100-1X

Test Material: LS

Date: 8/21/2015

Test Performed by: J.Hubler

Filename: C218-LS-100-1X

Vertical Stress: 100kPa

Sensor Spacing: 0.10835 m

V_s (rise) = 197 m/s

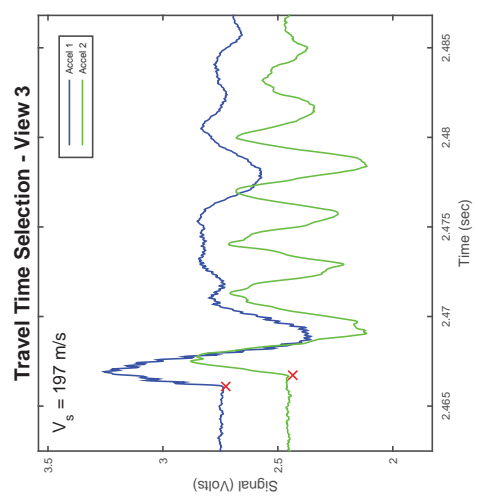
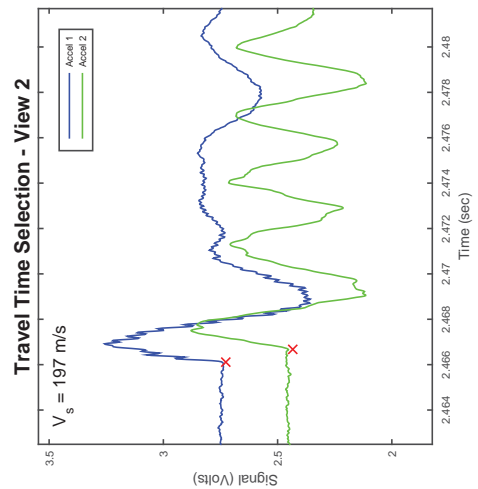
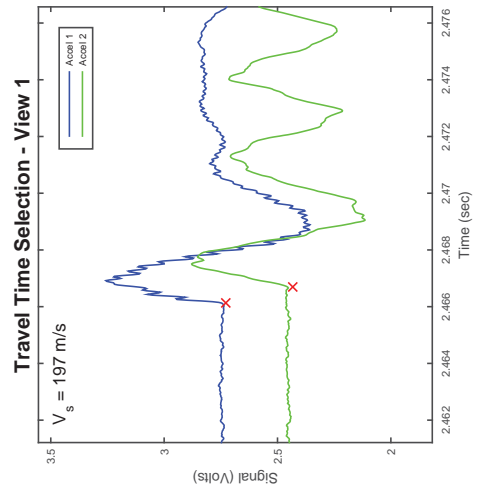
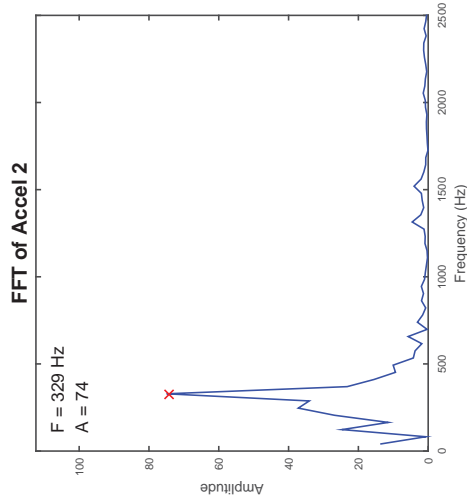
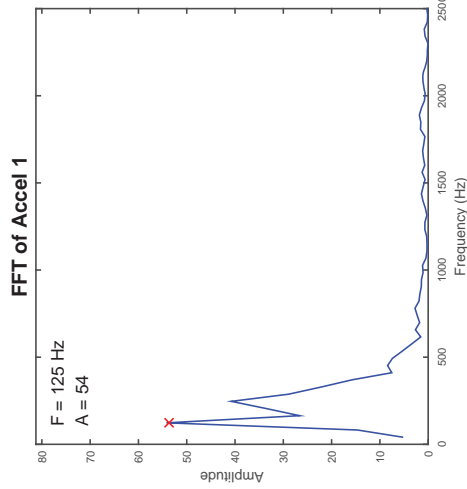
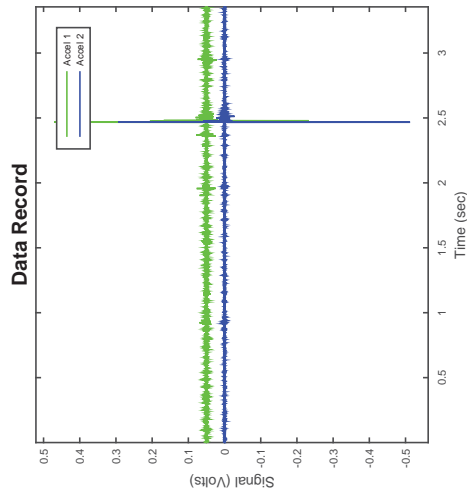

CSS Cyclic Shear Test Report

Geotechnical Engineering Laboratory



Cyclic Shear Test Summary

Device:	CSS	Density (kg/m³):	1513
Specimen ID:	CLS8	Relative Density (%):	46%
Test ID:	C219	Void Ratio:	0.751
Date of Test:	8/21/2015	Vertical Stress (kPa):	100
Test Performed:	Cyclic	Loading Frequency (Hz):	0.33
Test Material:	8mm Crushed Limestone	Number of Cycles:	5
Sample Preparation:	Prepared loose by shoveling and hitting baseplate with rubber mallet 15x.	Cyclic Stress Ratio:	0.144
		Shear Modulus (kPa):	
		Damping (%):	
Prepared by:	J. Hubler	Shear Strain Single Amplitude (%)	
Checked by:	J. Hubler		

Additional Comments:

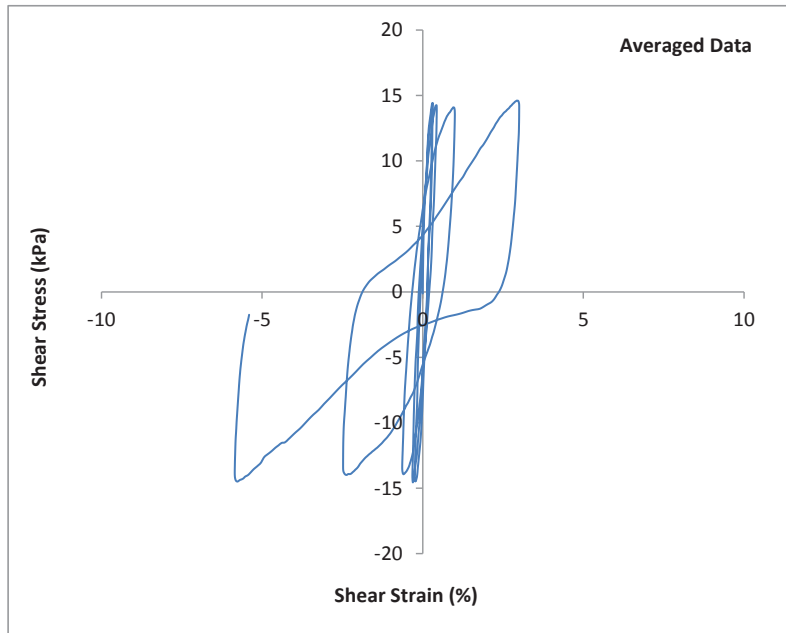
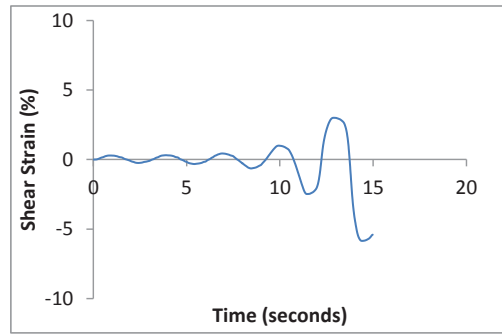
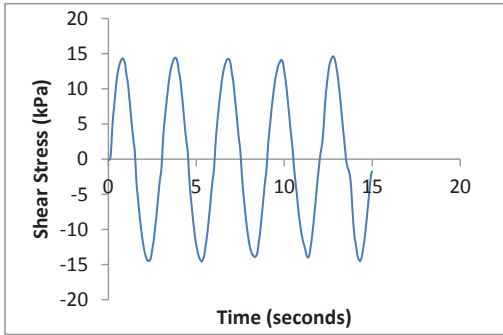

CSS Cyclic Shear Test Report

Geotechnical Engineering Laboratory



Cyclic Shear Test Summary

Device:	CSS	Density (kg/m³):	1513
Specimen ID:	CLS8	Relative Density (%):	46%
Test ID:	C219	Void Ratio:	0.751
Date of Test:	8/21/2015	Vertical Stress (kPa):	100
Test Performed:	Cyclic	Loading Frequency (Hz):	0.33
Test Material:	8mm Crushed Limestone	Number of Cycles:	5
Sample Preparation:	Prepared loose by shoveling and hitting baseplate with rubber mallet 15x.	Cyclic Stress Ratio:	0.144
		Number of Cycles to Liq:	5
		Maximum ru:	0.98
Prepared by:	J. Hubler		
Checked by:	J. Hubler		

Additional Comments:

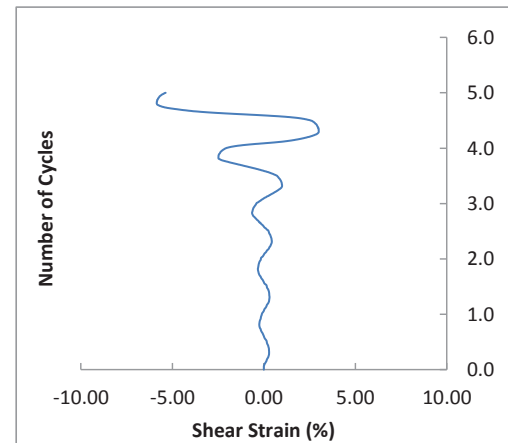
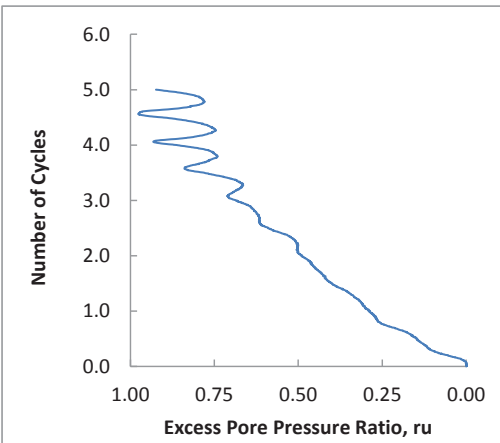
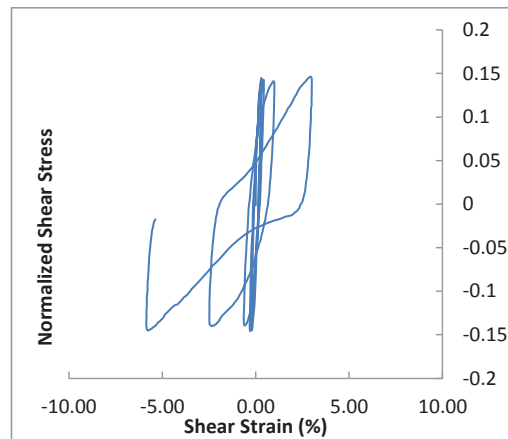
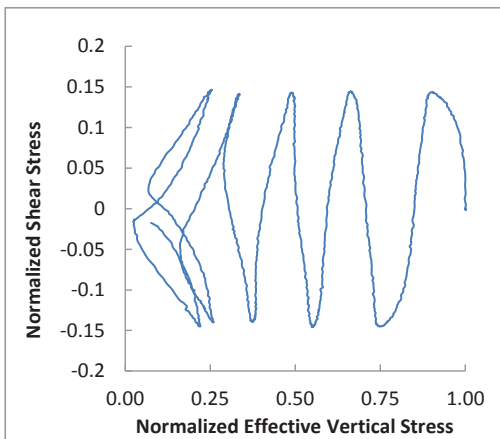

CSS Monotonic Shear Test Report



10/28/2013_Version 8.0

Geotechnical Engineering Laboratory

General Test Info and Sample Preparation

Device:	CSS	Relative Density (%):	32%
Specimen ID:	CLS8	Void Ratio:	0.810
Test ID:	C219	Height (mm):	113.3
Date of Test:	8/21/2015	Soil-Only Specimen Diameter (mm):	306.23
Test Performed:	Post Cyclic Monotonic Shear	Weight (kg):	12.216
Test Material:	8mm Crushed Limestone	Density (kg/m³):	1463.7
Sample Preparation:	Prepared loose by shoveling and hitting baseplate 15x in 3 layers with a rubber mallet.	Membrane Thickness (mm):	0.635
		Moisture Content (%):	0%
		Saturated (Y/N):	N
		Prepared by:	J. Hubler
		Checked by:	J. Hubler

Consolidation Stage		Shear Stage	
Vertical Stress (kPa):	100	Type of Test:	Constant Volume
Time to Compression (min):	9.4	Stress or Strain Controlled:	Strain
Relative Density (%):	46%	Shear Strain Rate (%/min):	0.30
Void Ratio:	0.751	Peak Shear Strength (kPa):	50.0
Height (mm):	109.6	Comments	
Diameter (mm):	306.23		
Weight (kg):	12.216		
Density (kg/m³):	1513.0		

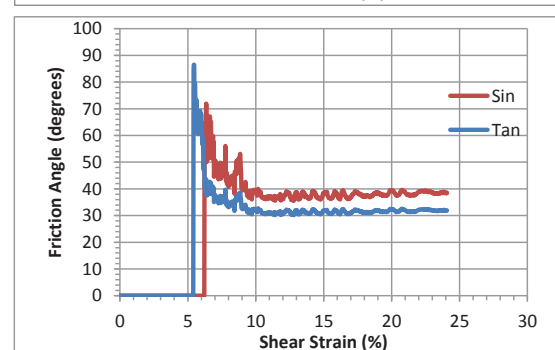
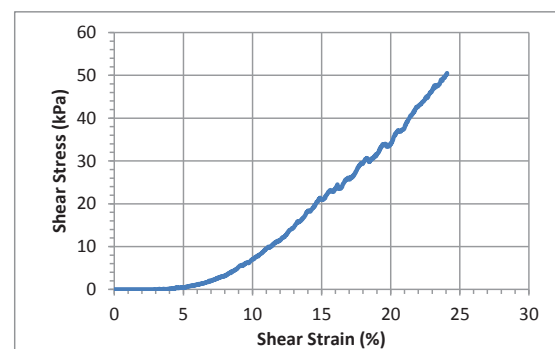
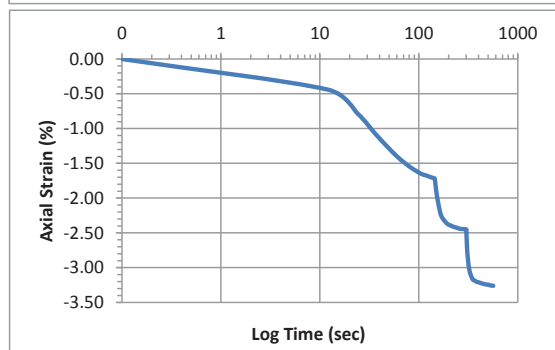
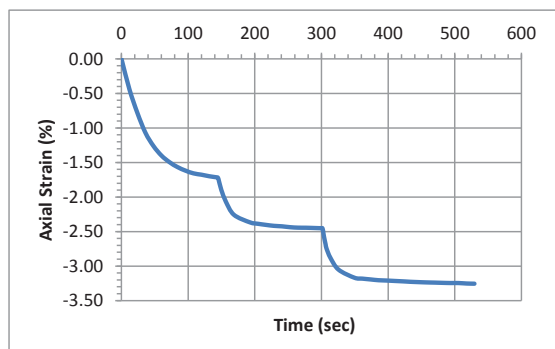

Accelerometer-Based Shear Wave Velocity Datasheet

Specimen ID: C219-LS-100-1X
 Test Material: LS
 Date: 8/21/2015
 Test Performed by: J.Hubler
 Filename: C219-LS-100-1X

Vertical Stress: 100kPa
 Sensor Spacing: 0.10958 m
 V_s (rise) = 211 m/s

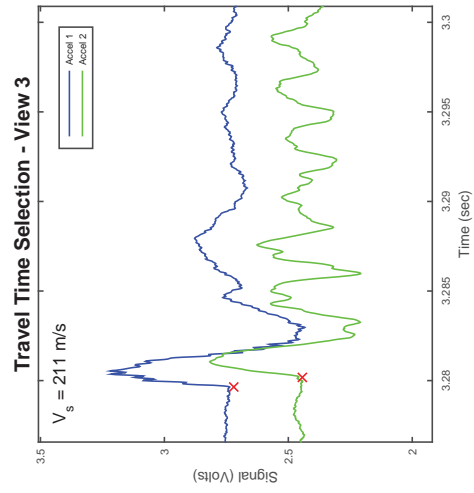
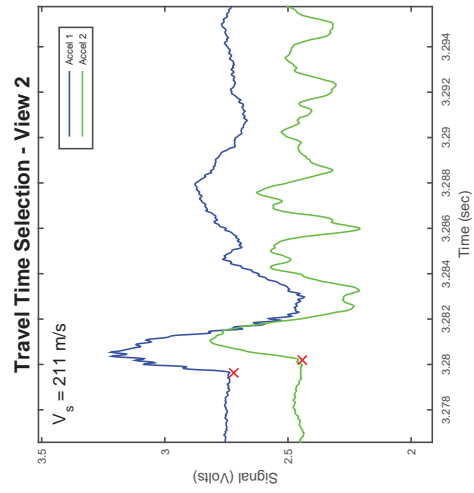
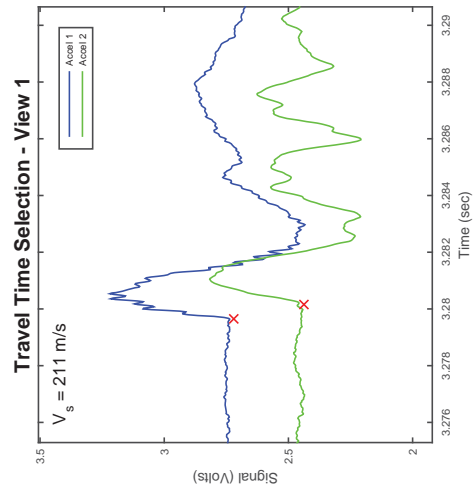
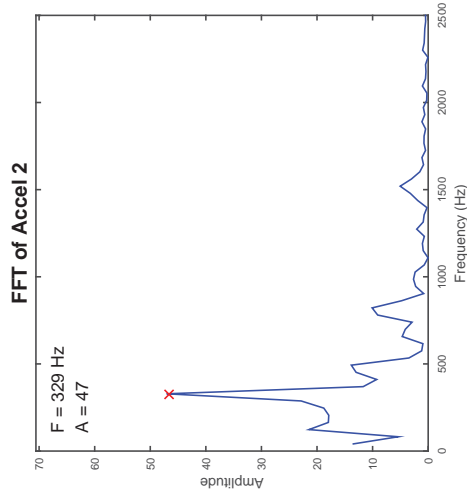
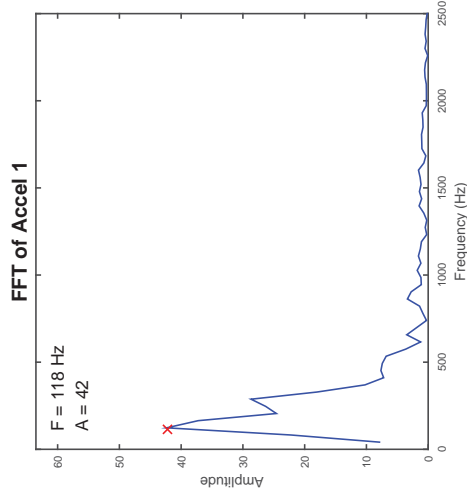
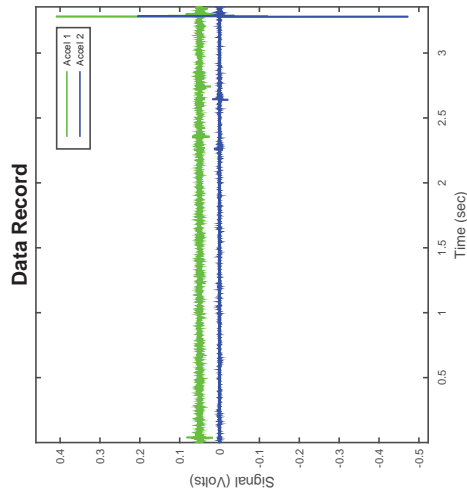

CSS Cyclic Shear Test Report

Geotechnical Engineering Laboratory



Cyclic Shear Test Summary

Device:	CSS	Density (kg/m³):	1678
Specimen ID:	CLS8	Relative Density (%):	85%
Test ID:	C226	Void Ratio:	0.580
Date of Test:	9/3/2015	Vertical Stress (kPa):	100
Test Performed:	Cyclic	Loading Frequency (Hz):	0.33
Test Material:	8mm Crushed Limestone	Number of Cycles:	170
Sample Preparation:	Tamped 60x in 6 layers	Cyclic Stress Ratio:	0.094
		Shear Modulus (kPa):	
		Damping (%):	
Prepared by:	J. Hubler	Shear Strain Single Amplitude (%)	
Checked by:	J. Hubler		

Additional Comments:

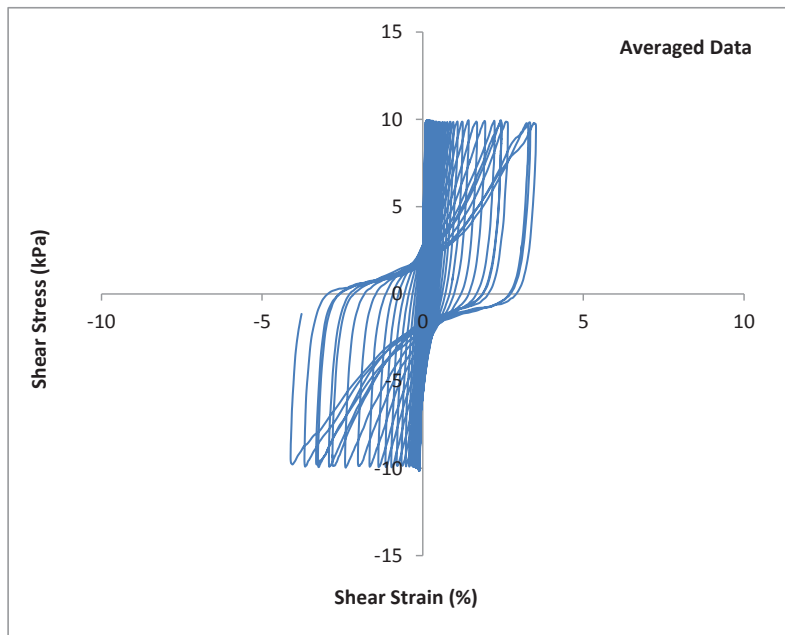
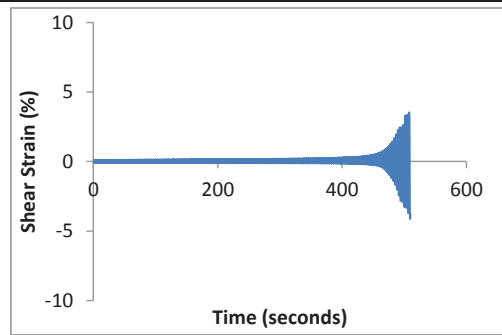
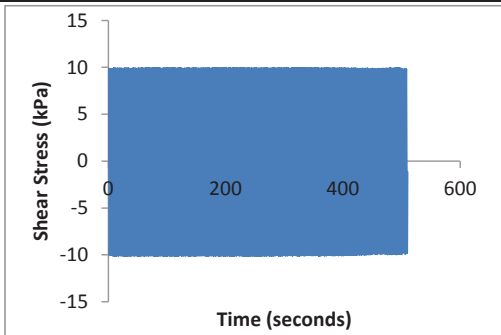

CSS Cyclic Shear Test Report

Geotechnical Engineering Laboratory



Cyclic Shear Test Summary

Device:	CSS	Density (kg/m ³):	1678
Specimen ID:	CLS8	Relative Density (%):	85%
Test ID:	C226	Void Ratio:	0.580
Date of Test:	9/3/2015	Vertical Stress (kPa):	100
Test Performed:	Cyclic	Loading Frequency (Hz):	0.33
Test Material:	8mm Crushed Limestone	Number of Cycles:	170
Sample Preparation:	Tamped 60x in 6 layers	Cyclic Stress Ratio:	0.094
		Number of Cycles to Liq:	170
		Maximum ru:	1.00
Prepared by:	J. Hubler		
Checked by:	J. Hubler		

Additional Comments:

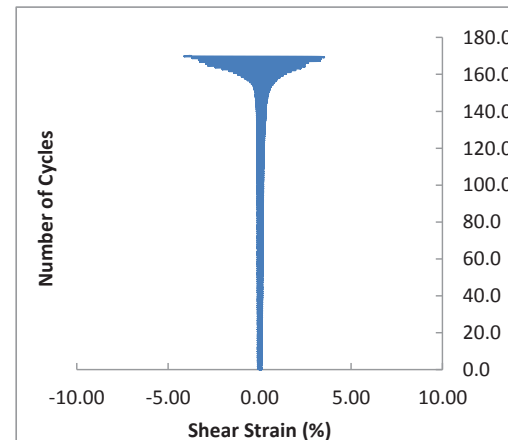
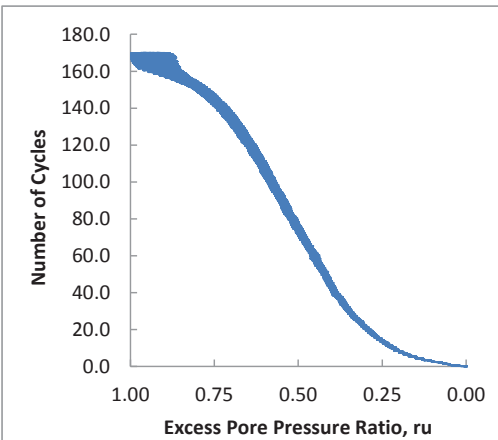
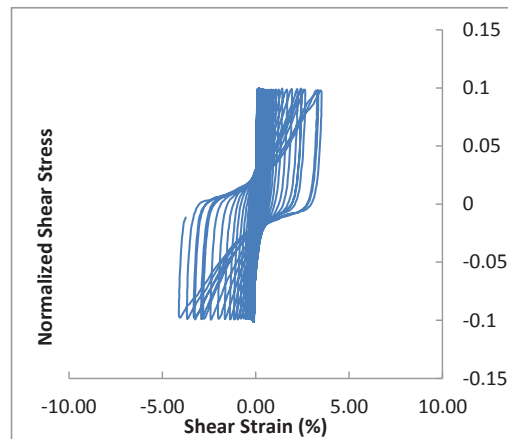
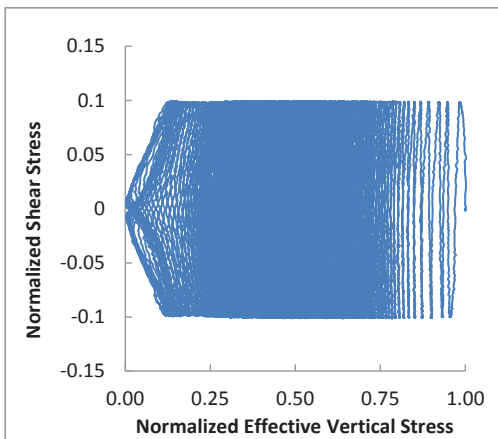

CSS Monotonic Shear Test Report

Geotechnical Engineering Laboratory



10/28/2013_Version 8.0

General Test Info and Sample Preparation

Device:	CSS	Relative Density (%):	67%
Specimen ID:	CLS8	Void Ratio:	0.658
Test ID:	C226	Height (mm):	115.5
Date of Test:	9/3/2015	Soil-Only Specimen Diameter (mm):	306.23
Test Performed:	Post Cyclic Monotonic Shear	Weight (kg):	13.599
Test Material:	8mm Crushed Limestone	Density (kg/m³):	1598.0
Sample Preparation:	Prepared dense by tamping 60x in 6 layers	Membrane Thickness (mm):	0.635
		Moisture Content (%):	0%
		Saturated (Y/N):	N
		Prepared by:	J.Hubler
		Checked by:	J. Hubler

Consolidation Stage

Vertical Stress (kPa):	100
Time to Compression (min):	8.3
Relative Density (%):	85%
	0.580
Height (mm):	110.1
Diameter (mm):	306.23
Weight (kg):	13.599
Density (kg/m³):	1677.6

Shear Stage

Type of Test:	Constant Volume
Stress or Strain Controlled:	Strain
Shear Strain Rate (%/min):	0.30
Peak Shear Strength (kPa):	90.4

Comments

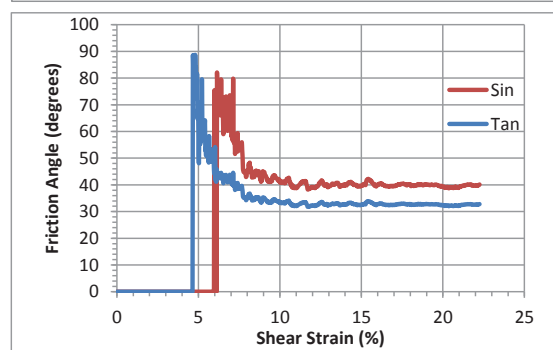
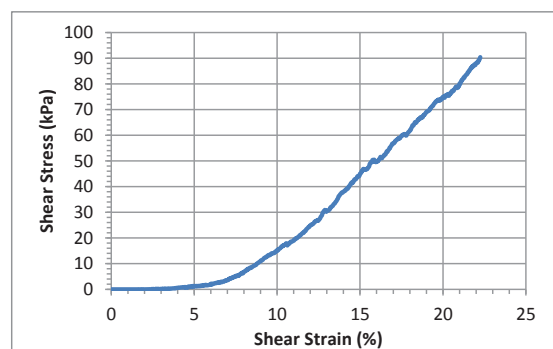
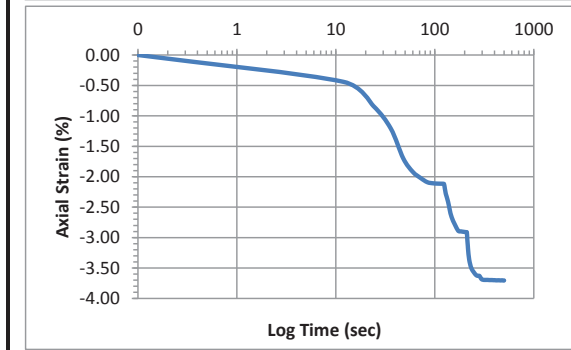
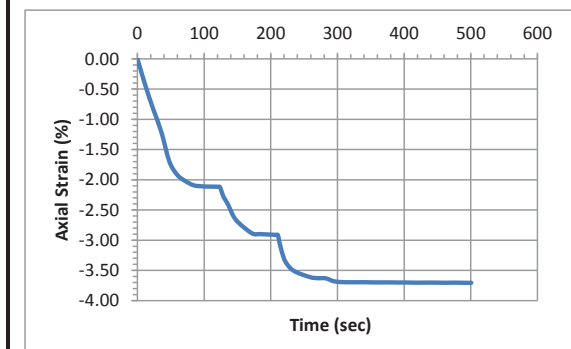

Accelerometer-Based Shear Wave Velocity Datasheet

Specimen ID: C226-LS-100-2X
 Test Material: LS
 Date: 9/3/2015
 Test Performed by: J.Hubler
 Filename: C226-LS-100-2X

Vertical Stress: 100kPa
 Sensor Spacing: 0.11002 m
 V_s (rise) = 238 m/s

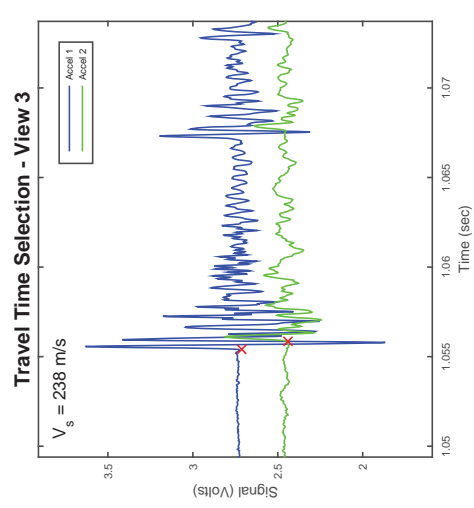
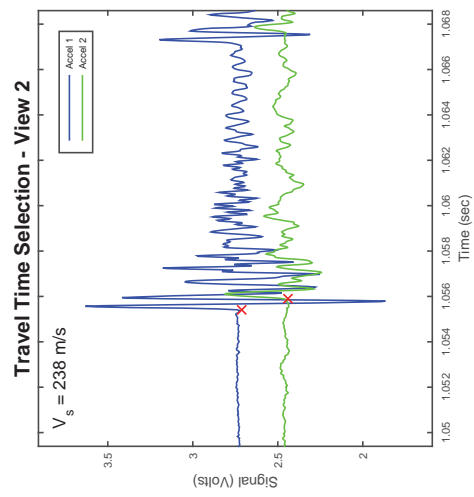
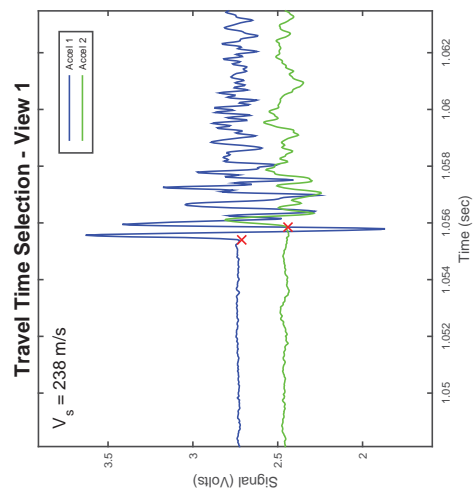
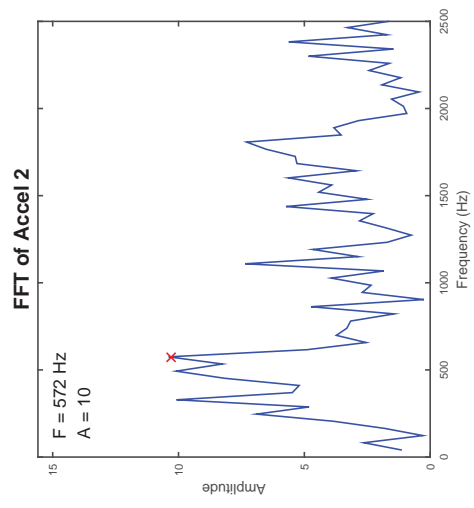
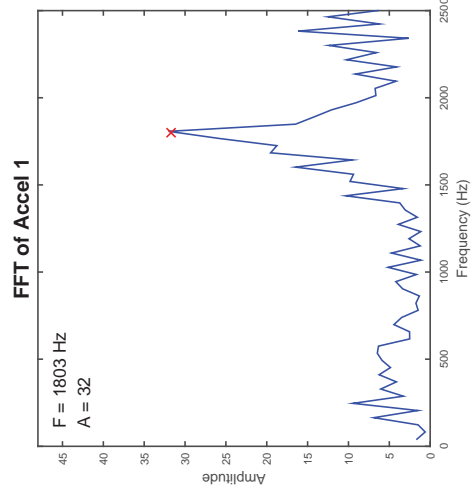
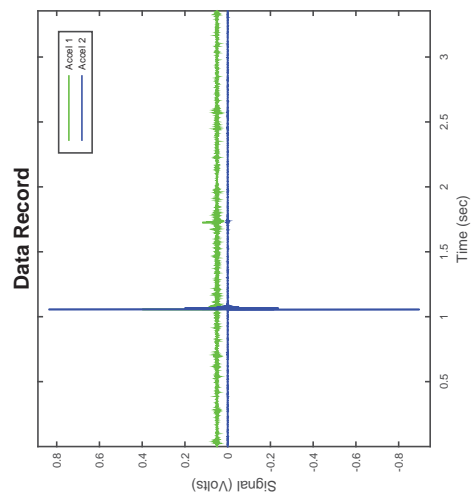

CSS Cyclic Shear Test Report

Geotechnical Engineering Laboratory



Cyclic Shear Test Summary

Device:	CSS	Density (kg/m³):	1677
Specimen ID:	CLS8	Relative Density (%):	85%
Test ID:	C227	Void Ratio:	0.581
Date of Test:	9/17/2015	Vertical Stress (kPa):	100
Test Performed:	Cyclic	Loading Frequency (Hz):	0.33
Test Material:	8mm Crushed Limestone	Number of Cycles:	7
Sample Preparation:	Tamped 60x in 6 layers	Cyclic Stress Ratio:	0.144
		Shear Modulus (kPa):	
		Damping (%):	
Prepared by:	J. Hubler	Shear Strain Single Amplitude (%)	
Checked by:	J. Hubler		

Additional Comments:

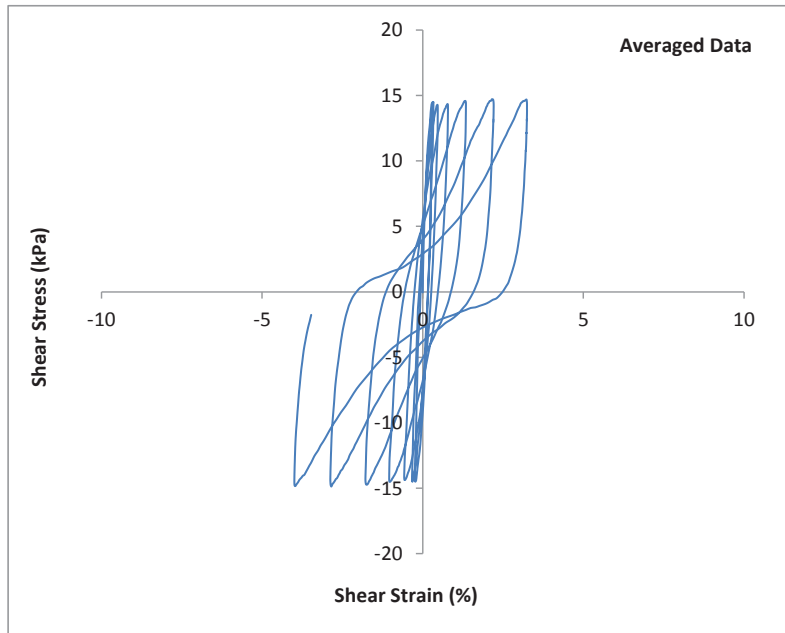
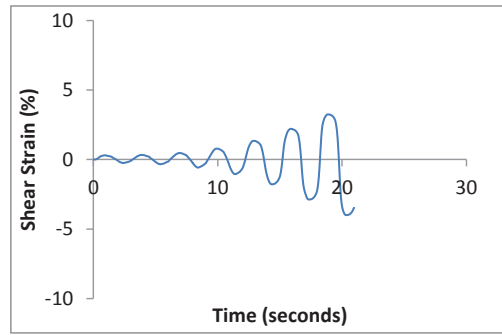
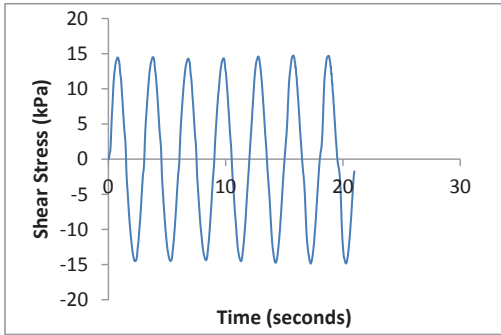

CSS Cyclic Shear Test Report

Geotechnical Engineering Laboratory



Cyclic Shear Test Summary

Device:	CSS	Density (kg/m³):	1677
Specimen ID:	CLS8	Relative Density (%):	85%
Test ID:	C227	Void Ratio:	0.581
Date of Test:	9/17/2015	Vertical Stress (kPa):	100
Test Performed:	Cyclic	Loading Frequency (Hz):	0.33
Test Material:	8mm Crushed Limestone	Number of Cycles:	7
Sample Preparation:	Tamped 60x in 6 layers	Cyclic Stress Ratio:	0.144
		Number of Cycles to Liq:	7
		Maximum ru:	0.98
Prepared by:	J. Hubler		
Checked by:	J. Hubler		

Additional Comments:

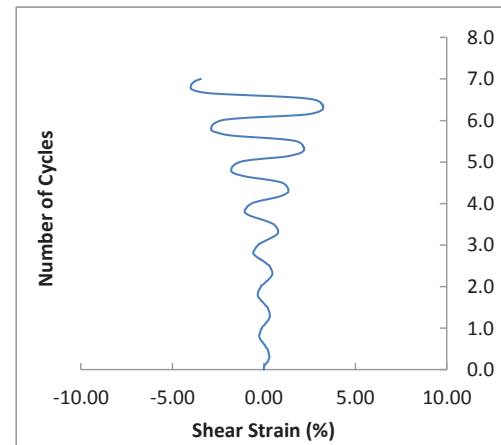
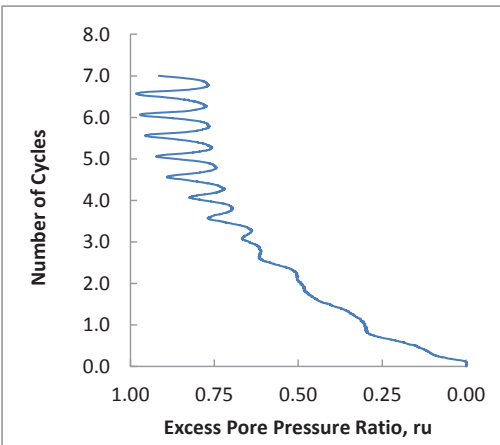
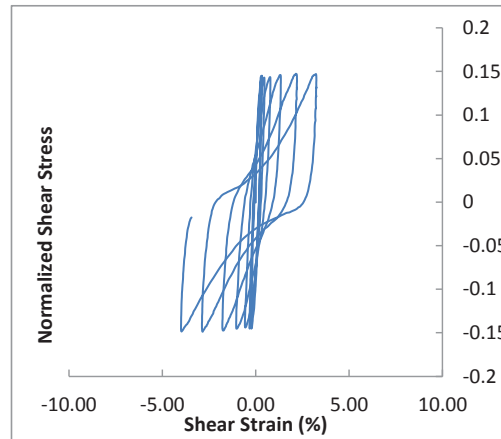
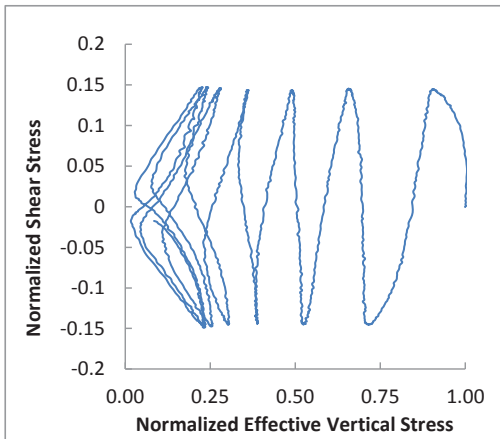

CSS Monotonic Shear Test Report

Geotechnical Engineering Laboratory



10/28/2013_Version 8.0

General Test Info and Sample Preparation

Device:	CSS	Relative Density (%):	75%
Specimen ID:	CLS8	Void Ratio:	0.624
Test ID:	C227	Height (mm):	114.4
Date of Test:	9/17/2015	Soil-Only Specimen Diameter (mm):	306.23
Test Performed:	Post Cyclic Monotonic Shear	Weight (kg):	13.750
Test Material:	8mm Crushed Limestone	Density (kg/m³):	1631.6
Sample Preparation:	Prepared dense by tamping 60x in 6 layers	Membrane Thickness (mm):	0.635
		Moisture Content (%):	0%
		Saturated (Y/N):	N
		Prepared by:	J.Hubler
		Checked by:	J. Hubler

Consolidation Stage

Vertical Stress (kPa):	100
Time to Compression (min):	10.7
Relative Density (%):	85%
	0.581
Height (mm):	111.3
Diameter (mm):	306.23
Weight (kg):	13.750
Density (kg/m³):	1676.6

Shear Stage

Type of Test:	Constant Volume
Stress or Strain Controlled:	Strain
Shear Strain Rate (%/min):	0.29
Peak Shear Strength (kPa):	83.7

Comments

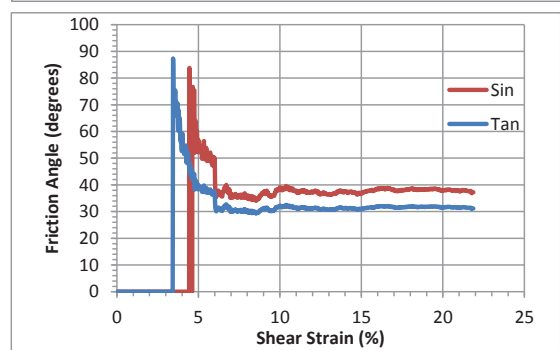
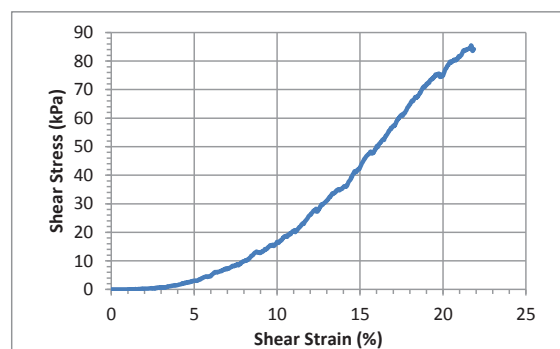
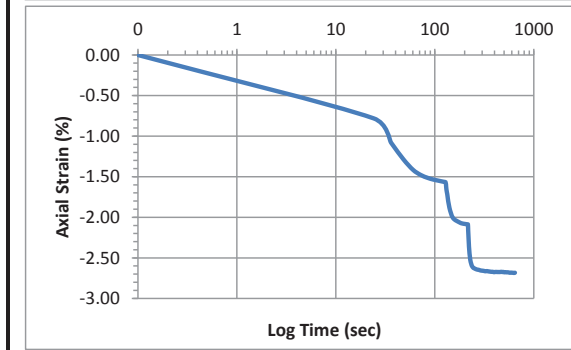
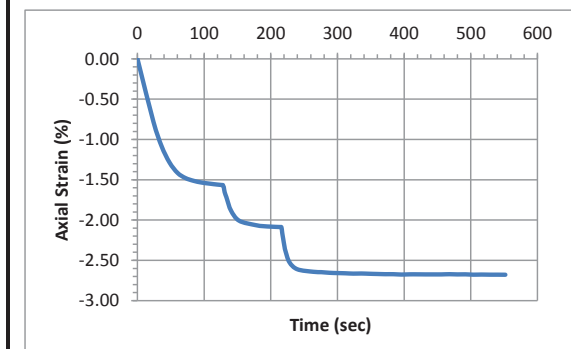

Accelerometer-Based Shear Wave Velocity Datasheet

Specimen ID: C227-LS-100-1X

Test Material: LS

Date: 9/17/2015

Test Performed by: J.Hubler

Filename: C227-LS-100-1X

Vertical Stress: 100kPa

Sensor Spacing: 0.1113 m

V_s (rise) = 220 m/s

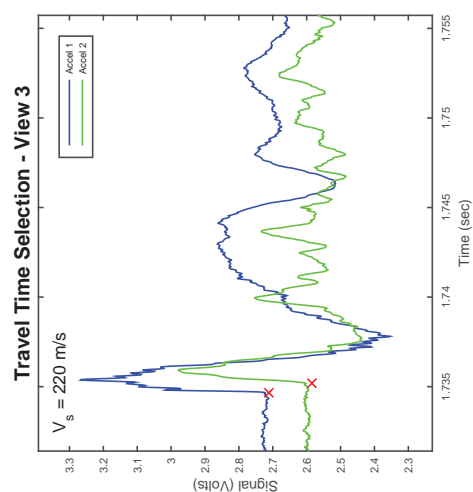
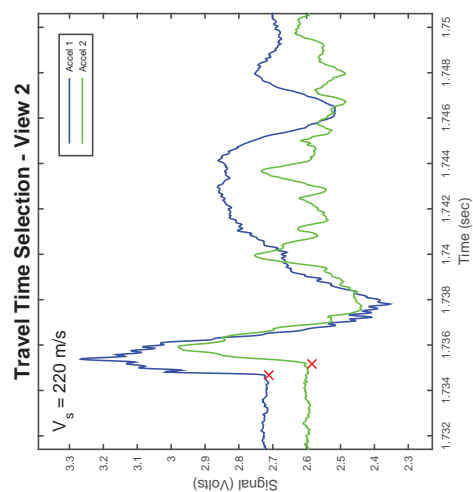
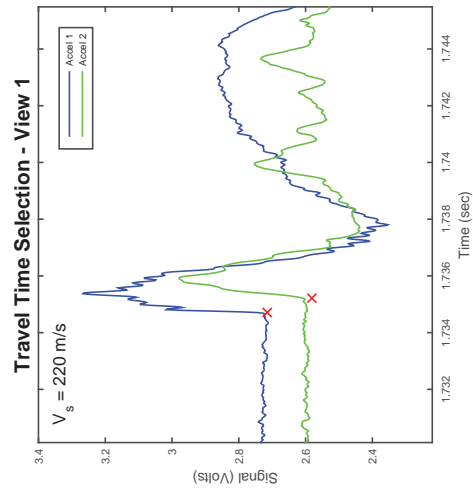
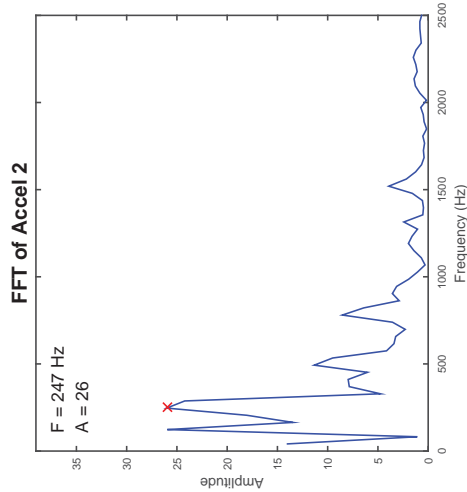
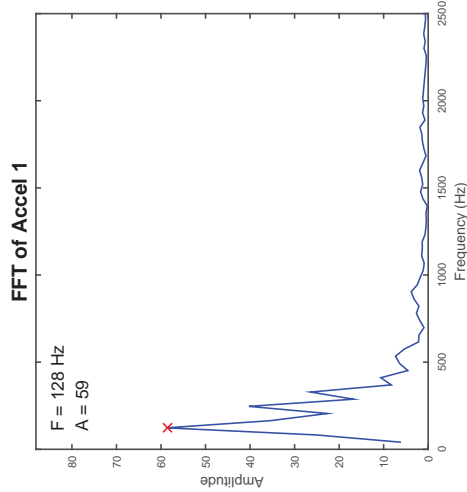
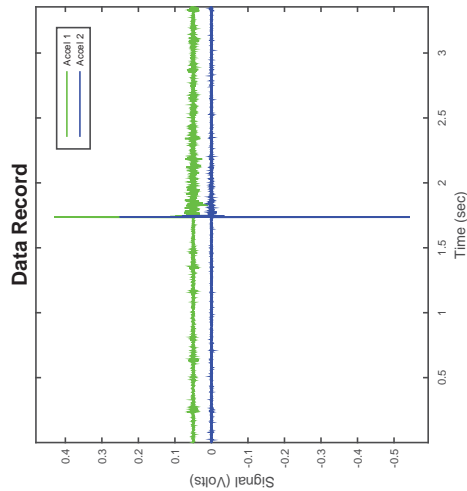

APPENDIX C

Test Data Sheets for Chapter 5

Data sheets (monotonic, cyclic, or post-cyclic shear and specimen V_S) corresponding to Tables 5.3, 5.4, 5.5, 5.6 are provided in this appendix. For tests where V_S was measured following liquefaction, V_S data sheets are labeled with an “XP” at the end of the filename.

CSS Monotonic Shear Test Report

Geotechnical Engineering Laboratory



10/28/2013_Version 8.0

General Test Info and Sample Preparation

Device:	CSS	Relative Density (%):	6%
Specimen ID:	C109	Void Ratio:	0.739
Test ID:	M301	Height (mm):	114.4
Date of Test:	3/30/2016	Soil-Only Specimen Diameter (mm):	306.23
Test Performed:	Monotonic Shear	Weight (kg):	12.832
Test Material:	Ottawa C109 Sand	Density (kg/m³):	1523.6
Sample Preparation:	Prepared using a funnel with zero drop height	Membrane Thickness (mm):	0.635
		Moisture Content (%):	5%
		Saturated (Y/N):	N
		Prepared by:	J. Hubler
		Checked by:	J. Hubler

Consolidation Stage

Vertical Stress (kPa):	100
Compression Time (min):	12.9
Relative Density (%):	44%
Void Ratio:	0.654
Height (mm):	108.8
Diameter (mm):	306.23
Weight (kg):	12.832
Density (kg/m³):	1601.9

Shear Stage

Type of Test:	Constant Volume
Stress or Strain Controlled:	Strain
Shear Strain Rate (%/min):	0.30
Peak Shear Strength (kPa):	14.0

Comments

Used Silver Baseplate

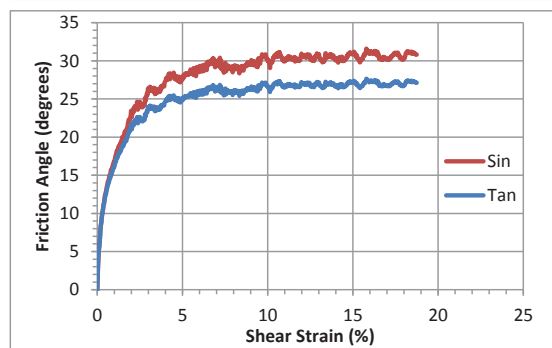
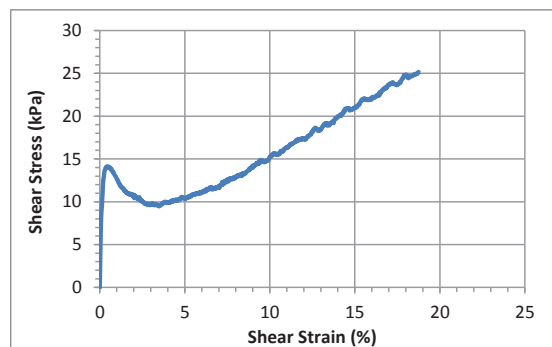
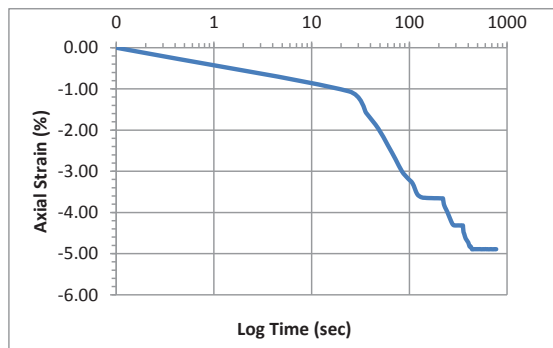
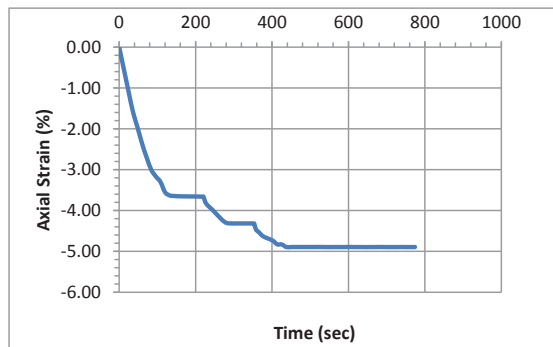

Accelerometer-Based Shear Wave Velocity Datasheet

Specimen ID: M301-C109-100-2X
 Test Material: C109
 Date: 4/1/2016
 Test Performed by: J.Hubler
 Filename: M301-C109-100-2X

Vertical Stress: 100kPa
 Sensor Spacing: 0.10848 m
 V_s (rise) = 192 m/s

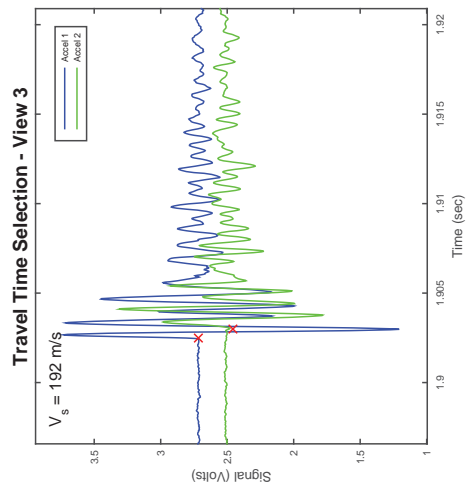
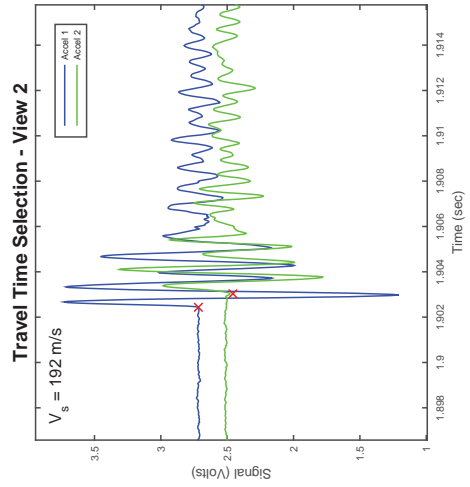
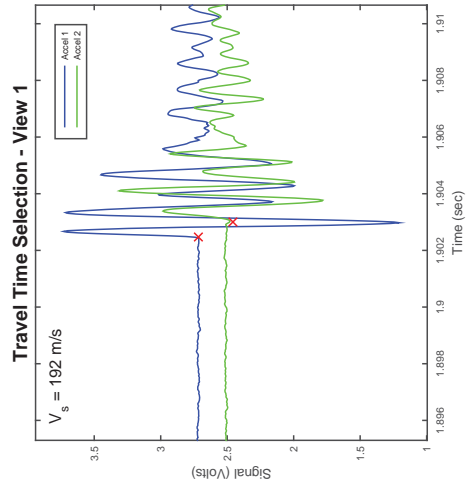
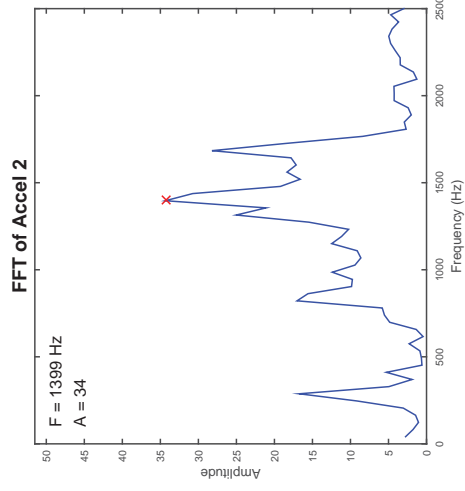
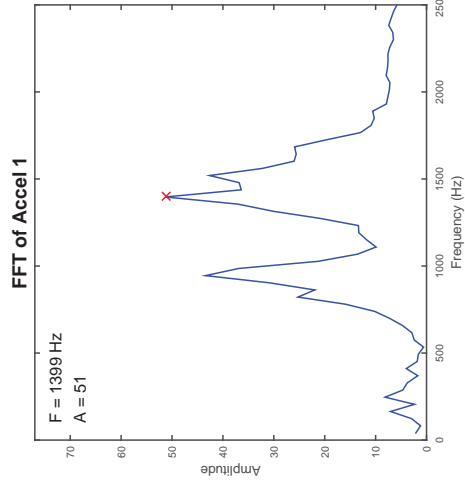
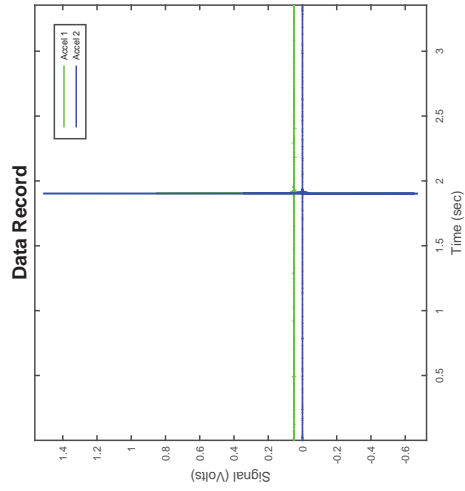

Accelerometer-Based Shear Wave Velocity Datasheet

Specimen ID: M301-C109-100-3X
 Test Material: C109
 Date: 4/1/2016
 Test Performed by: J.Hubler
 Filename: M301-C109-100-3X

Vertical Stress: 100kPa
 Sensor Spacing: 0.10848 m
 V_s (rise) = 189 m/s

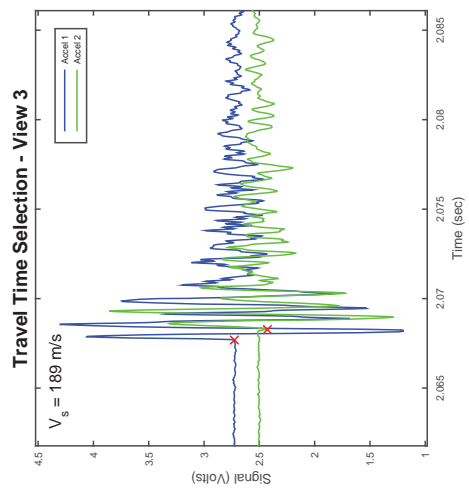
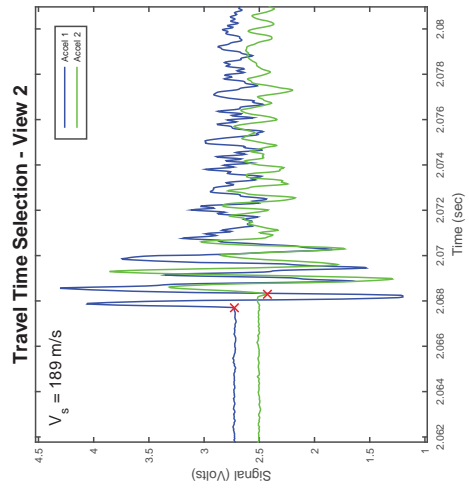
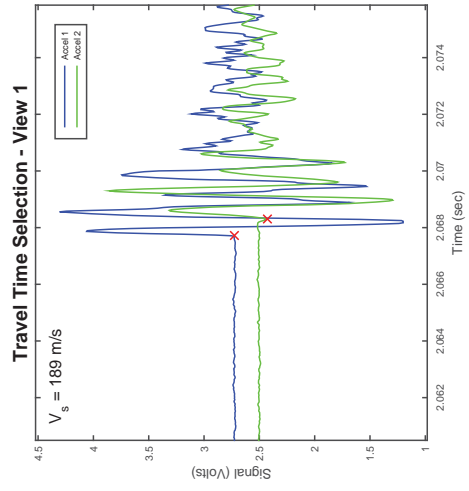
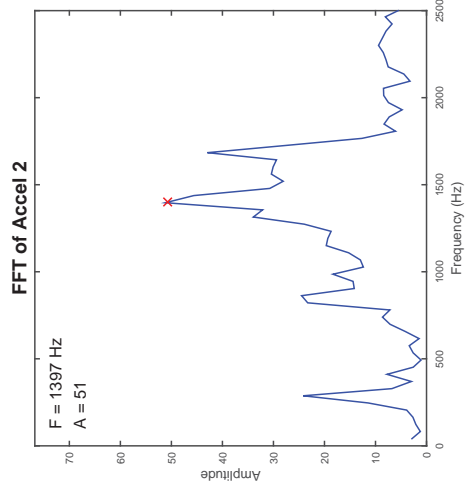
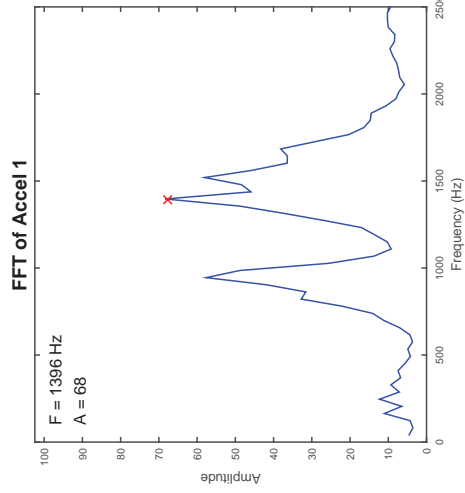
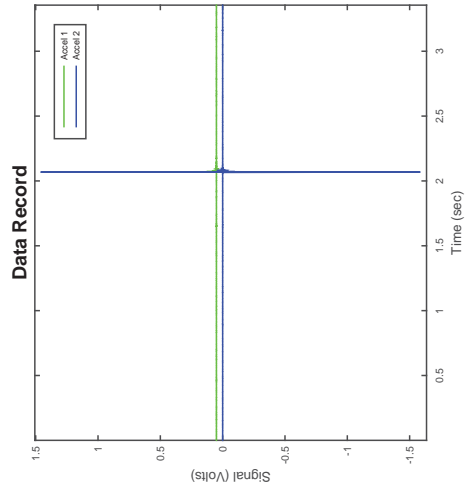

CSS Monotonic Shear Test Report

Geotechnical Engineering Laboratory



10/28/2013_Version 8.0

General Test Info and Sample Preparation

Device:	CSS	Relative Density (%):	14%
Specimen ID:	C109	Void Ratio:	0.721
Test ID:	M302	Height (mm):	115.0
Date of Test:	4/5/2016	Soil-Only Specimen Diameter (mm):	306.23
Test Performed:	Monotonic Shear	Weight (kg):	13.042
Test Material:	Ottawa C109 Sand	Density (kg/m³):	1540.0
Sample Preparation:	Dry deposition using funnel with zero drop height.	Membrane Thickness (mm):	0.635
		Moisture Content (%):	5%
		Saturated (Y/N):	N
		Prepared by:	J. Hubler
		Checked by:	J. Hubler

Consolidation Stage

Vertical Stress (kPa):	200
Compression Time (min):	8.7
Relative Density (%):	44%
Void Ratio:	0.655
Height (mm):	110.6
Diameter (mm):	306.23
Weight (kg):	13.042
Density (kg/m³):	1600.9

Shear Stage

Type of Test:	Constant Volume
Stress or Strain Controlled:	Strain
Shear Strain Rate (%/min):	0.30
Peak Shear Strength (kPa):	23.6

Comments

Used Silver Baseplate

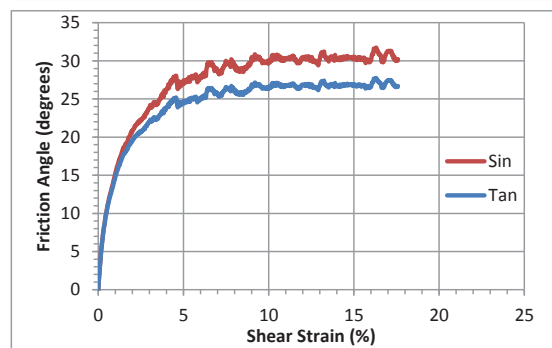
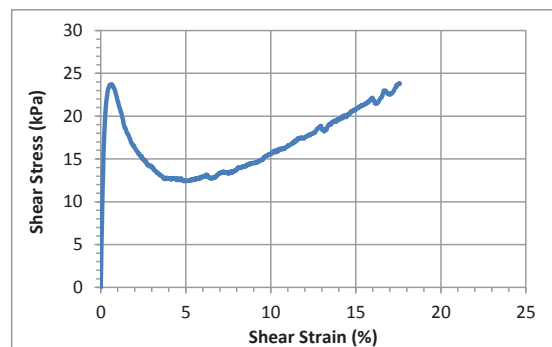
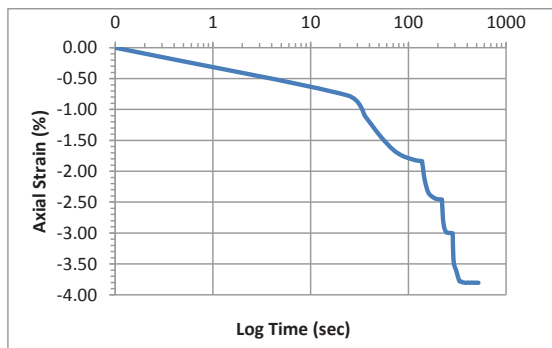
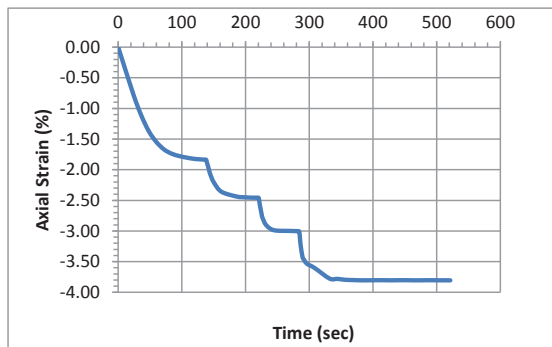

Accelerometer-Based Shear Wave Velocity Datasheet

Specimen ID: M302-C109-200-2X
 Test Material: C109
 Date: 4/5/2016
 Test Performed by: J.Hubler
 Filename: M302-C109-200-2X

Vertical Stress: 200kPa
 Sensor Spacing: 0.11033 m
 V_s (rise) = 229 m/s

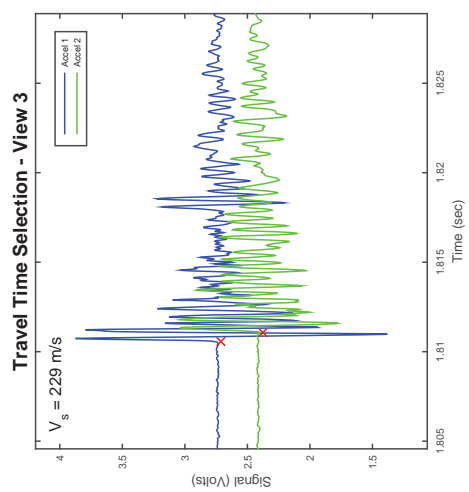
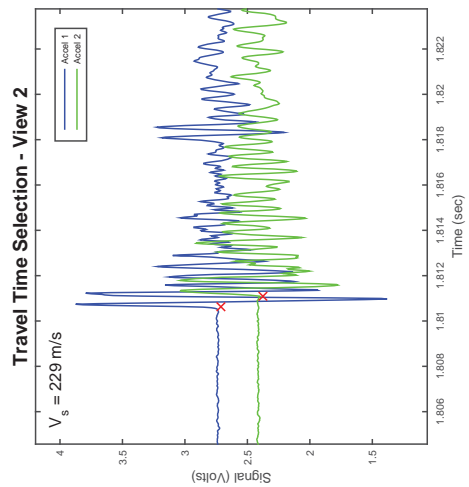
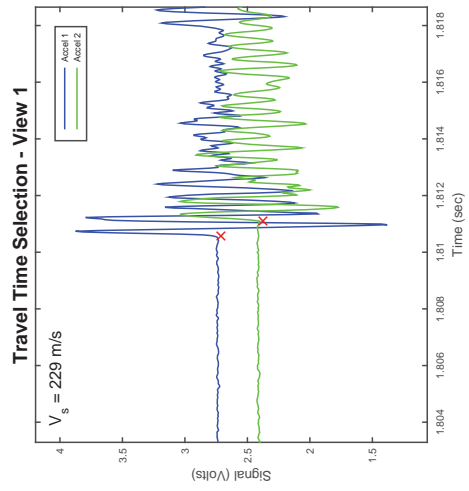
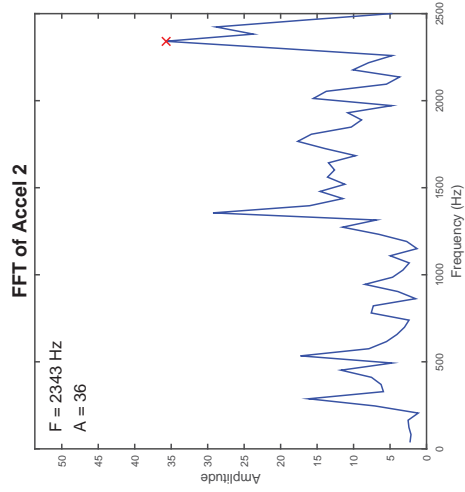
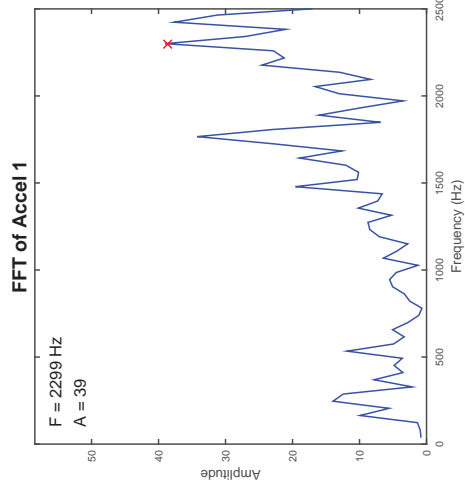
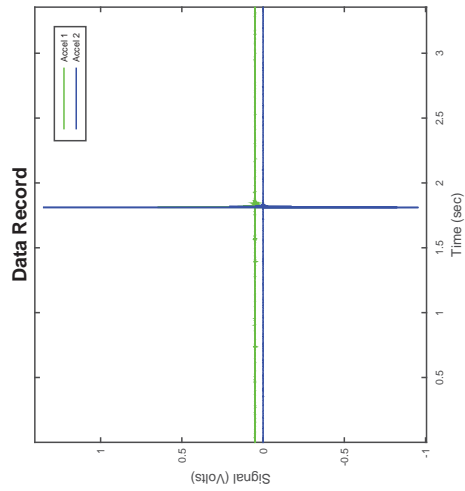

CSS Monotonic Shear Test Report

Geotechnical Engineering Laboratory



10/28/2013_Version 8.0

General Test Info and Sample Preparation

Device:	CSS	Relative Density (%):	13%
Specimen ID:	80C109_20PG	Void Ratio:	0.576
Test ID:	M262	Height (mm):	113.6
Date of Test:	12/1/2015	Soil-Only Specimen Diameter (mm):	307.50
Test Performed:	Monotonic Shear	Weight (kg):	14.190
Test Material:	C109 Ott Sand/Pea Gravel	Density (kg/m³):	1681.6
Sample Preparation:	Prepared loose by funneling sand with zero drop and placing gravel in 10 lifts.	Membrane Thickness (mm):	0.000
		Moisture Content (%):	0%
		Saturated (Y/N):	N
		Prepared by:	J.Hubler
		Checked by:	J. Hubler

Consolidation Stage		Shear Stage	
Vertical Stress (kPa):	100	Type of Test:	Constant Volume
Time to Compression (min):	10.8	Stress or Strain Controlled:	Strain
Relative Density (%):	44%	Shear Strain Rate (%/min):	0.30
Void Ratio:	0.536	Peak Shear Strength (kPa):	14.3
Height (mm):	109.9	Comments	
Diameter (mm):	307.50		
Weight (kg):	14.190		
Density (kg/m³):	1738.1		

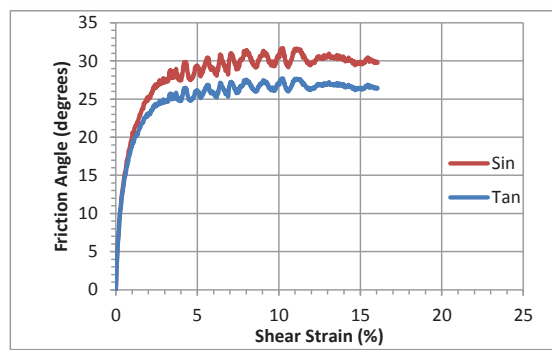
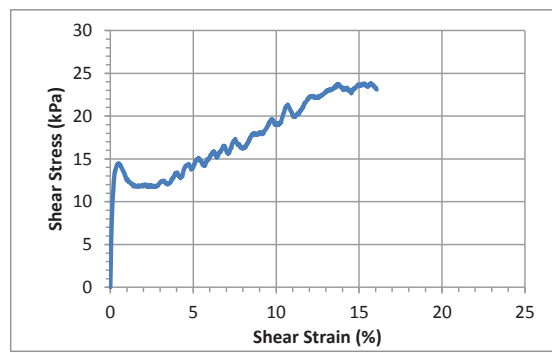
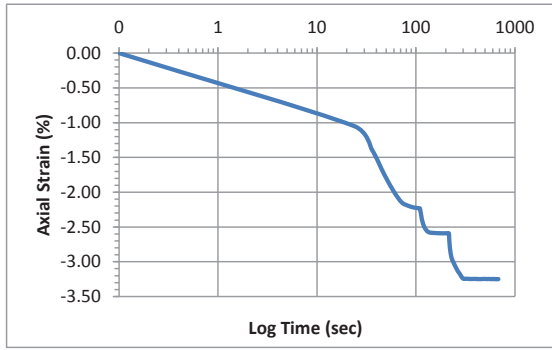
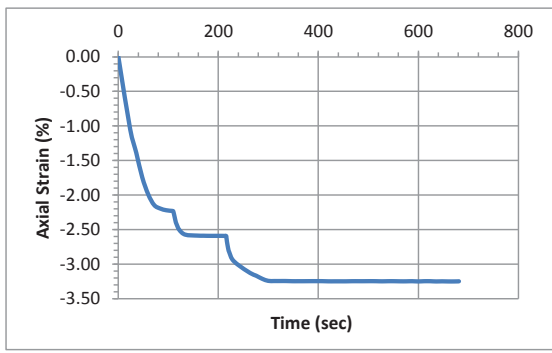

Accelerometer-Based Shear Wave Velocity Datasheet

Specimen ID: M262-C109PG-100-1X
 Test Material: C109PG
 Date: 12/1/2015
 Test Performed by: J. Hubler
 Filename: M262-C109PG-100-1X

Vertical Stress: 100kPa
 Sensor Spacing: 0.10966 m
 V_s (rise) = 198 m/s

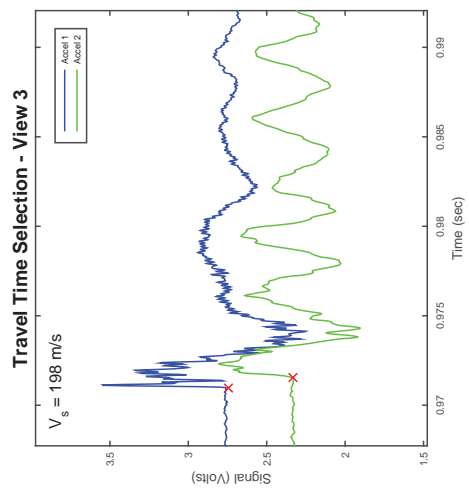
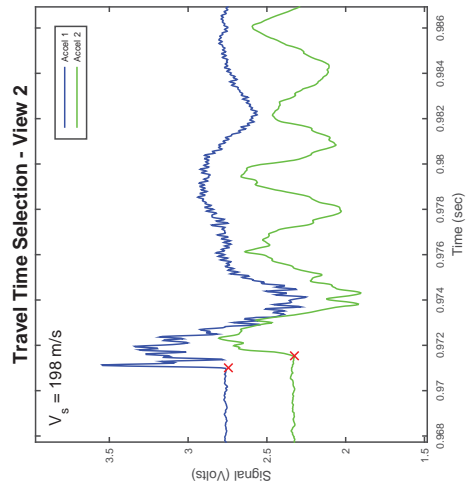
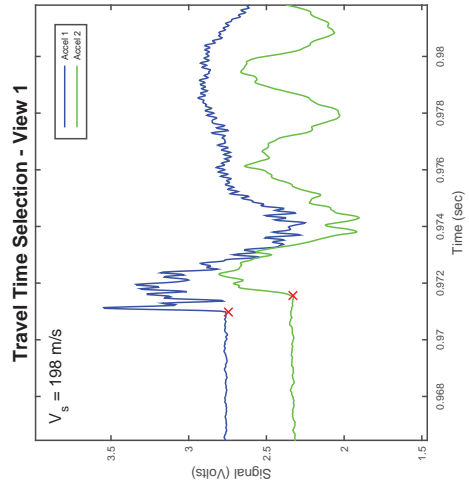
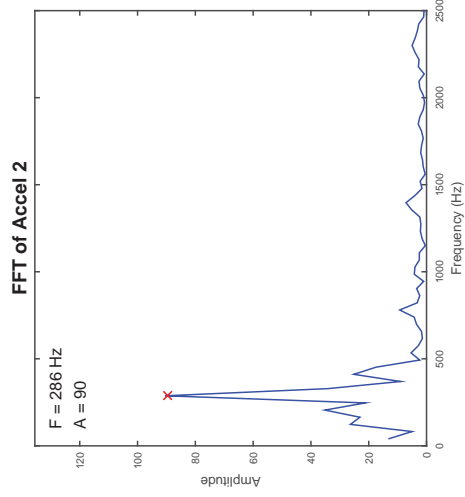
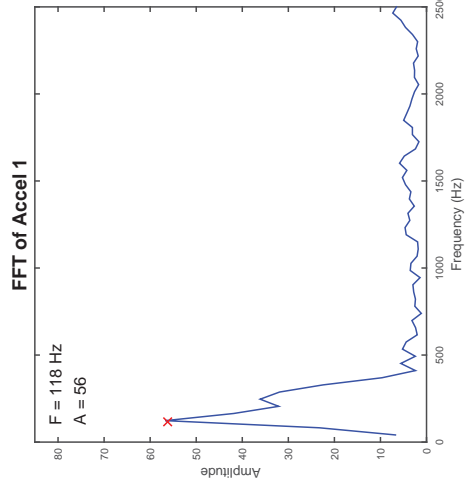
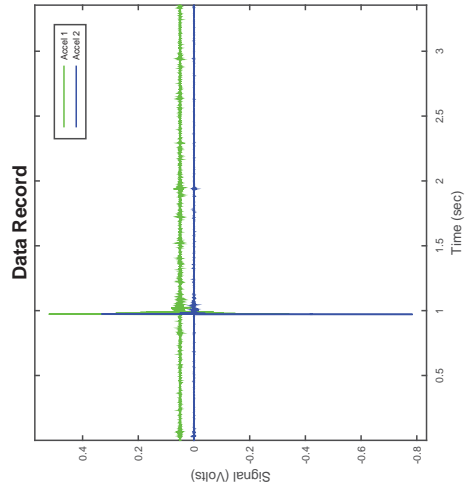

CSS Monotonic Shear Test Report

Geotechnical Engineering Laboratory



10/28/2013_Version 8.0

General Test Info and Sample Preparation

Device:	CSS	Relative Density (%):	18%
Specimen ID:	80C109_20PG	Void Ratio:	0.567
Test ID:	M275	Height (mm):	114.0
Date of Test:	1/25/2016	Soil-Only Specimen Diameter (mm):	307.50
Test Performed:	Monotonic Shear	Weight (kg):	14.320
Test Material:	C109 Ott Sand/Pea Gravel	Density (kg/m³):	1690.8
Sample Preparation:	Prepared loose using a funnel	Membrane Thickness (mm):	0.000
		Moisture Content (%):	0%
		Saturated (Y/N):	N
		Prepared by:	J.Hubler
		Checked by:	J. Hubler

Consolidation Stage

Shear Stage

Vertical Stress (kPa):	200	Type of Test:	Constant Volume
Time to Compression (min):	7.7	Stress or Strain Controlled:	Strain
Relative Density (%):	48%	Shear Strain Rate (%/min):	0.30
Void Ratio:	0.530	Peak Shear Strength (kPa):	25.7
Height (mm):	110.5	Comments	
Diameter (mm):	307.50		
Weight (kg):	14.320		
Density (kg/m³):	1745.0		

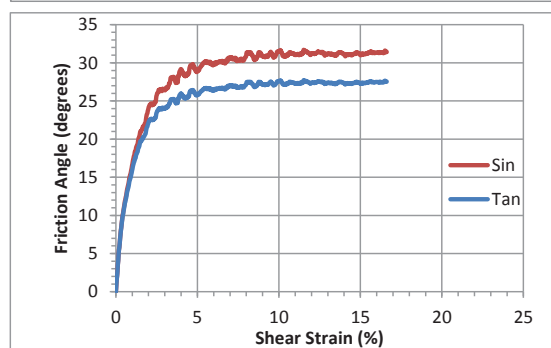
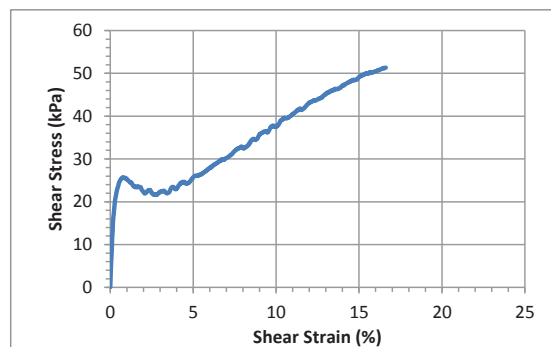
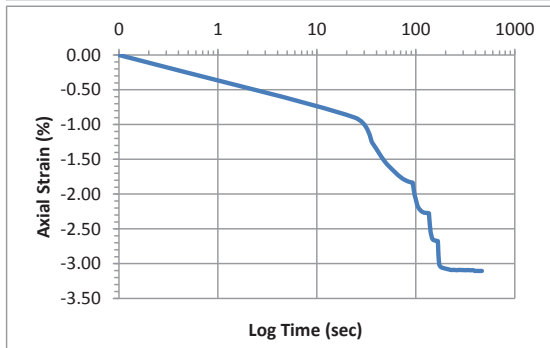
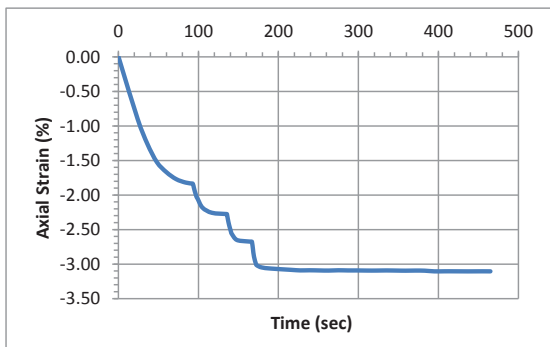

Accelerometer-Based Shear Wave Velocity Datasheet

Specimen ID: M275-PGC109-200-1X
 Test Material: PGC109
 Date: 1/25/2016
 Test Performed by: J.Hubler
 Filename: M275-PGC109-200-1X

Vertical Stress: 200kPa
 Sensor Spacing: 0.11019 m
 V_s (rise) = 239 m/s

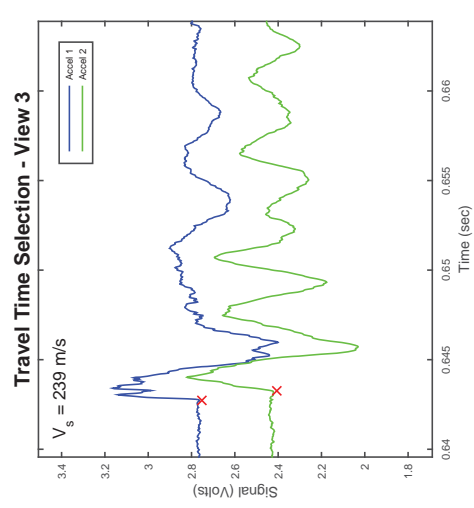
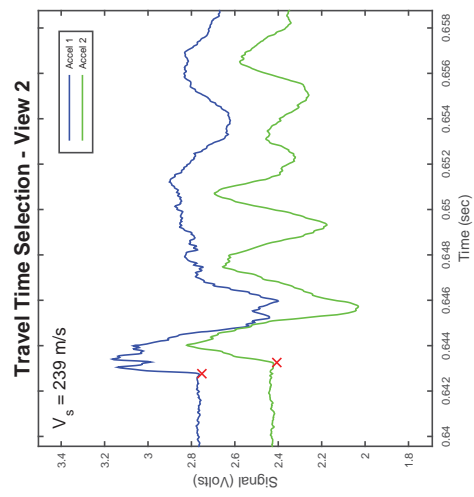
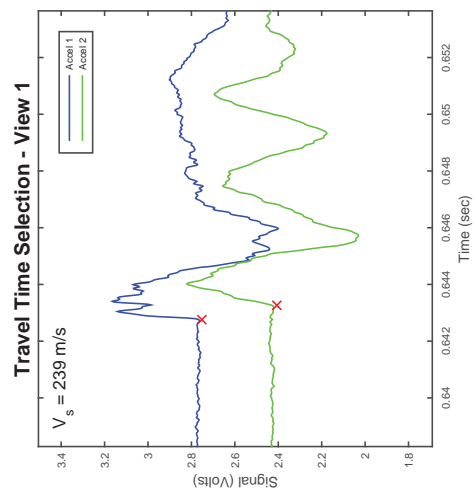
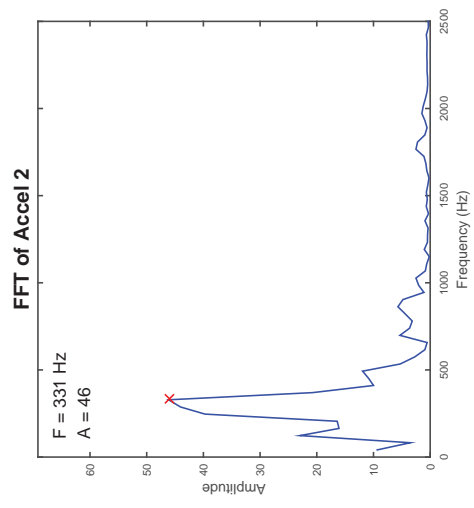
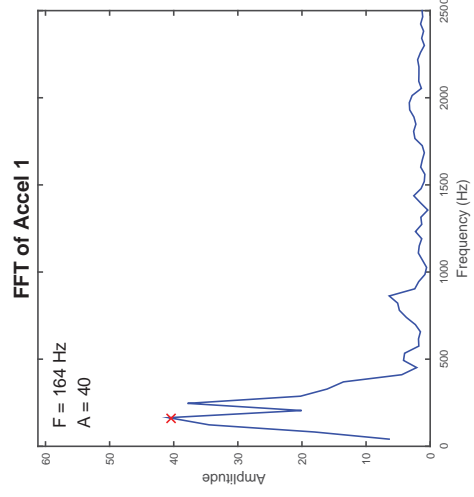
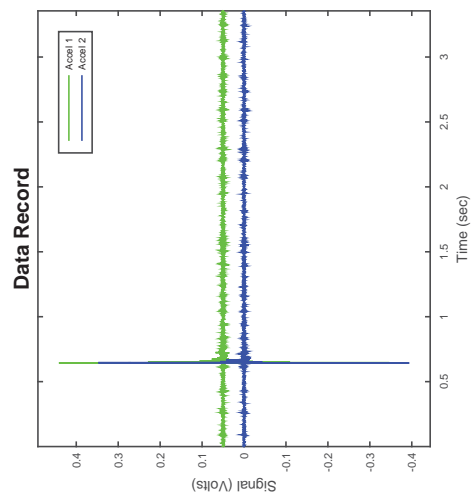

Accelerometer-Based Shear Wave Velocity Datasheet

Specimen ID: M275-PGC109-200-2X
 Test Material: PGC109
 Date: 1/25/2016
 Test Performed by: J.Hubler
 Filename: M275-PGC109-200-2X

Vertical Stress: 200kPa
 Sensor Spacing: 0.11019 m
 V_s (rise) = 239 m/s

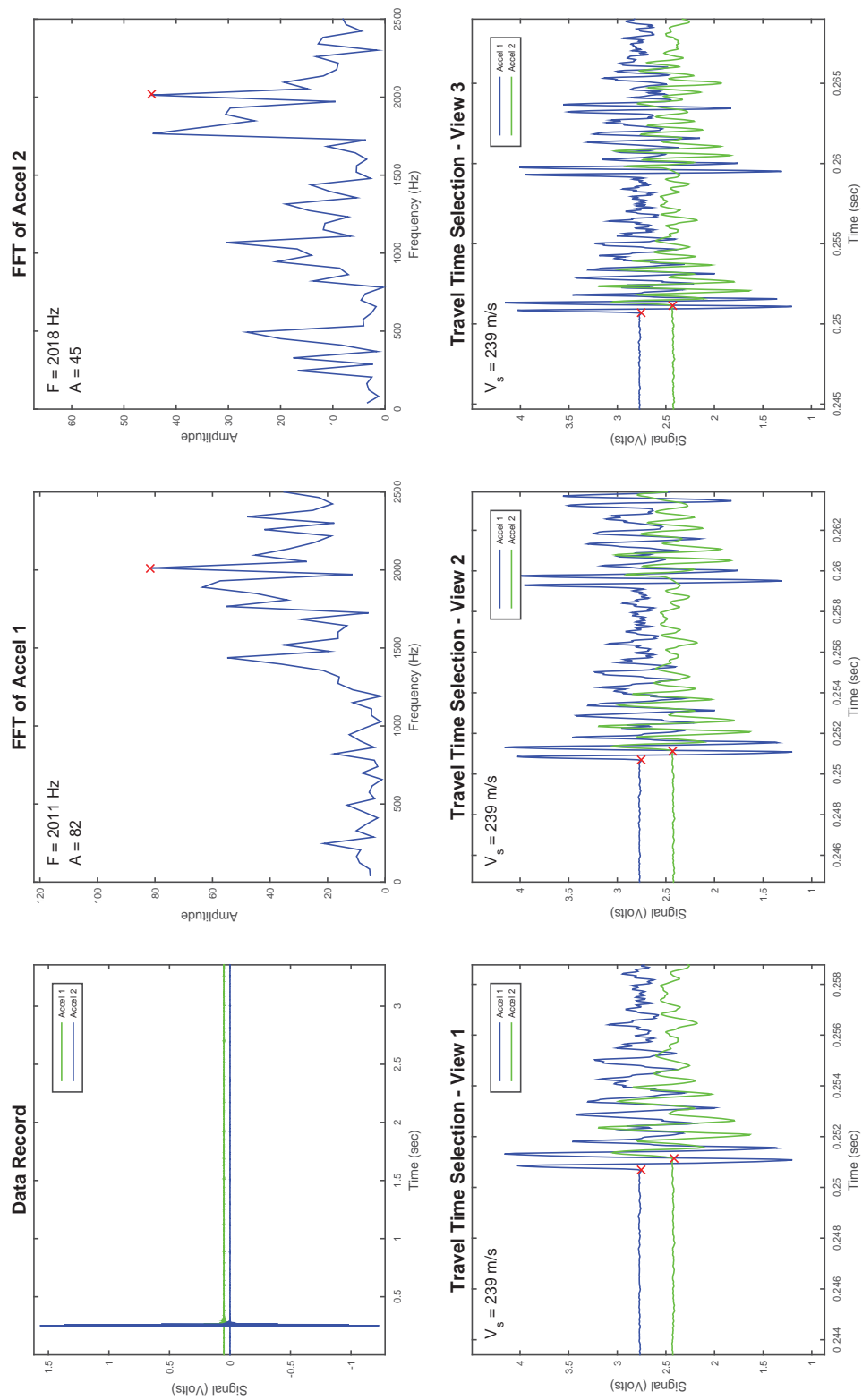

Accelerometer-Based Shear Wave Velocity Datasheet

Specimen ID: M275-PGC109-200-3X
 Test Material: PGC109
 Date: 1/25/2016
 Test Performed by: J.Hubler
 Filename: M275-PGC109-200-3X

Vertical Stress: 200kPa
 Sensor Spacing: 0.11019 m
 V_s (rise) = 231 m/s

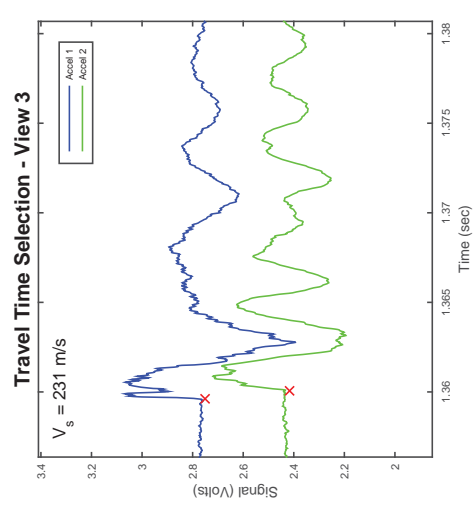
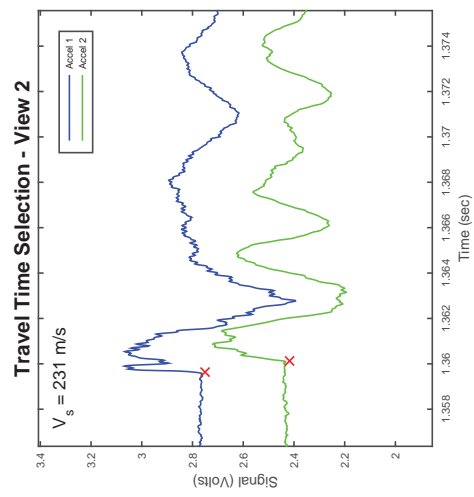
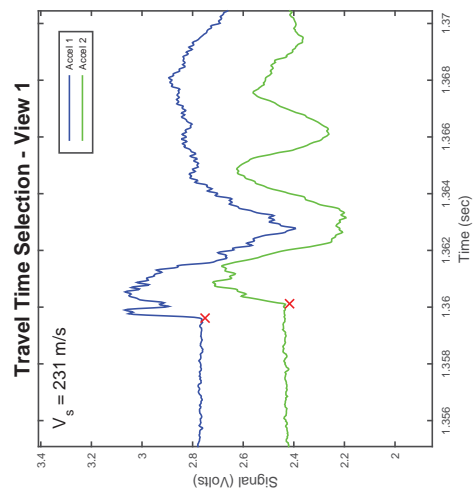
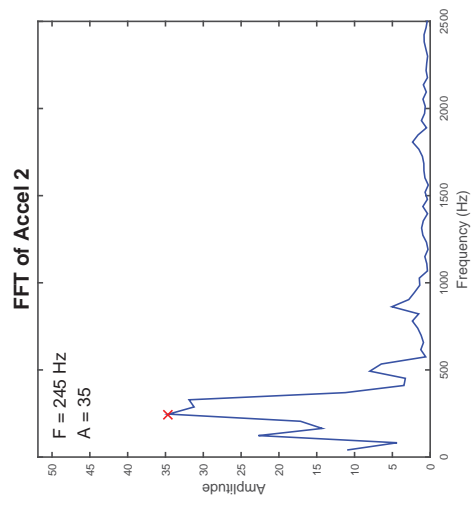
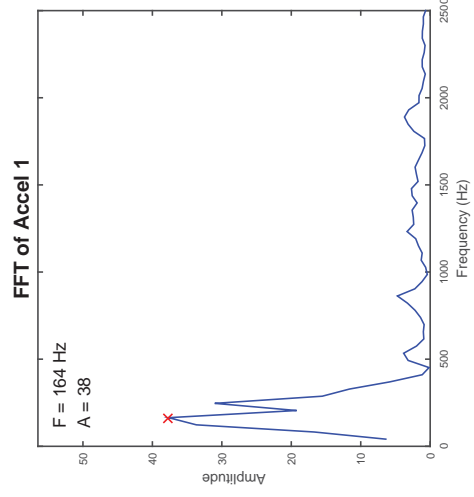
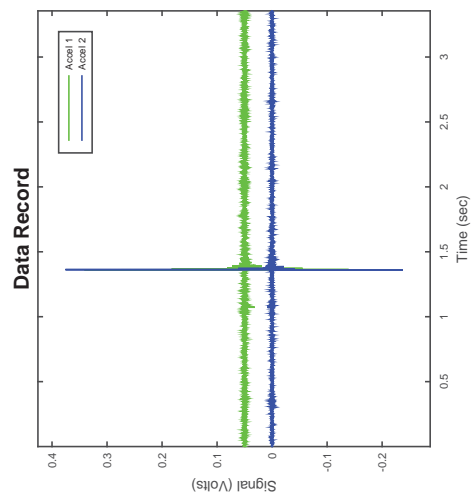

CSS Monotonic Shear Test Report

Geotechnical Engineering Laboratory



10/28/2013_Version 8.0

General Test Info and Sample Preparation

Device:	CSS	Relative Density (%):	18%
Specimen ID:	80C109_20PG	Void Ratio:	0.567
Test ID:	M277	Height (mm):	112.9
Date of Test:	1/25/2016	Soil-Only Specimen Diameter (mm):	307.50
Test Performed:	Monotonic Shear	Weight (kg):	14.183
Test Material:	C109 Ott Sand/Pea Gravel	Density (kg/m³):	1691.1
Sample Preparation:	Prepared loose using a funnel.	Membrane Thickness (mm):	0.000
		Moisture Content (%):	0%
		Saturated (Y/N):	N
		Prepared by:	J.Hubler
		Checked by:	J. Hubler

Consolidation Stage

Vertical Stress (kPa):	400
Time to Compression (min):	11.9
Relative Density (%):	45%
Void Ratio:	0.535
Height (mm):	109.8
Diameter (mm):	307.50
Weight (kg):	14.183
Density (kg/m³):	1739.2

Shear Stage

Type of Test:	Constant Volume
Stress or Strain Controlled:	Strain
Shear Strain Rate (%/min):	0.30
Peak Shear Strength (kPa):	50.8

Comments

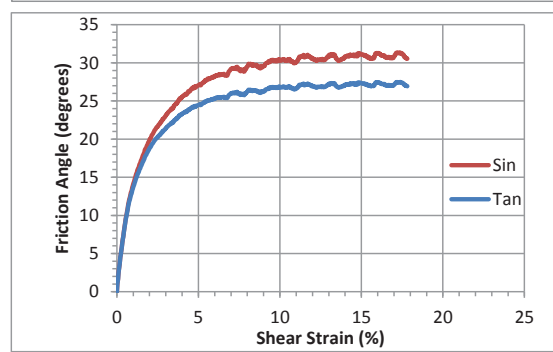
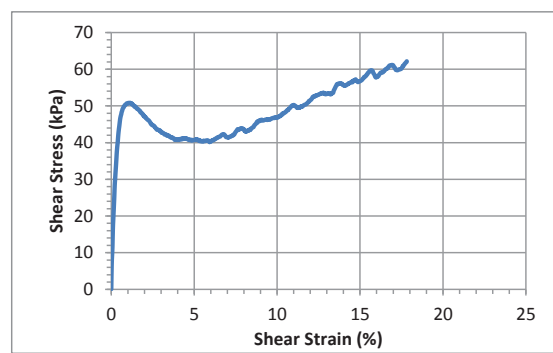
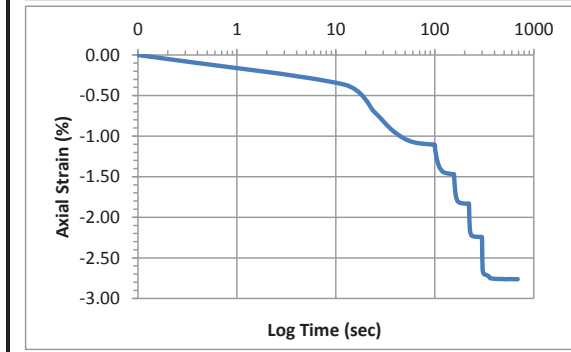
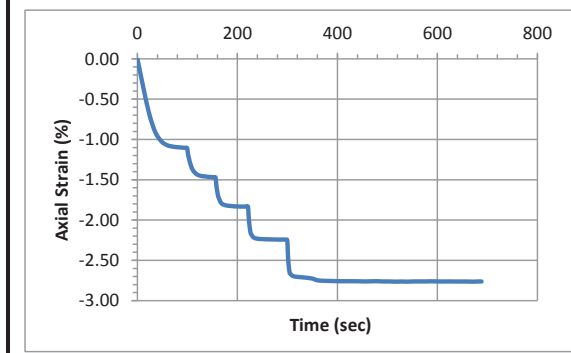

Accelerometer-Based Shear Wave Velocity Datasheet

Specimen ID: M277-PGC109-400-2X
 Test Material: PGC109
 Date: 1/25/2016
 Test Performed by: J.Hubler
 Filename: M277-PGC109-400-2X

Vertical Stress: 400kPa
 Sensor Spacing: 0.10948 m
 V_s (rise) = 282 m/s

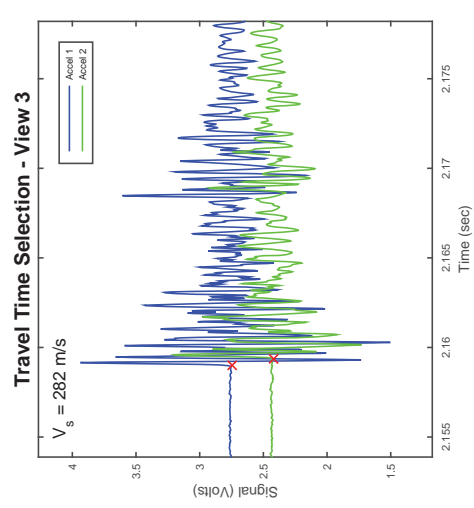
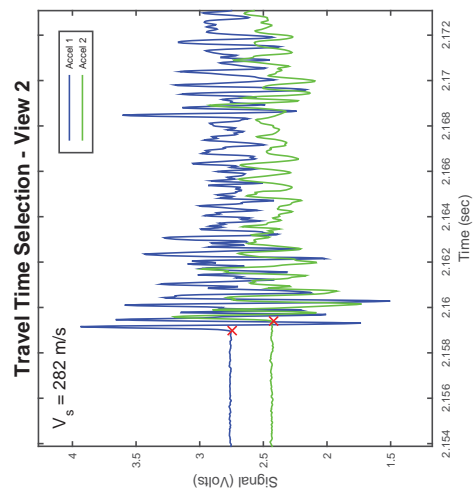
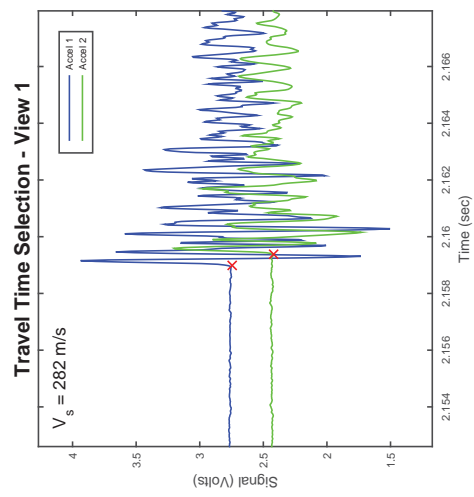
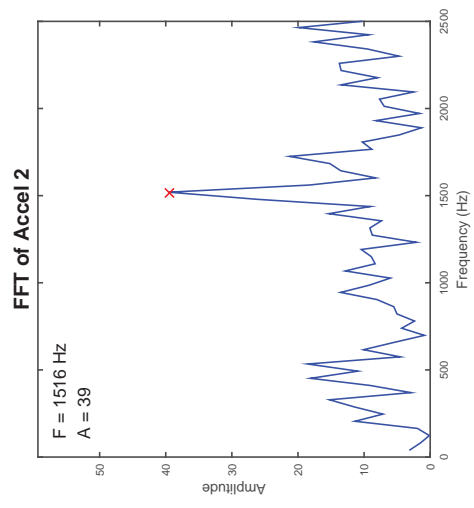
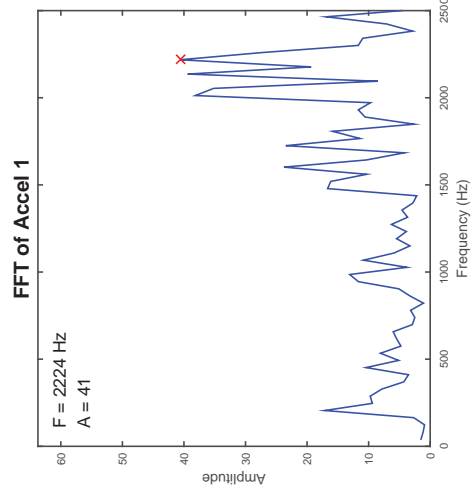
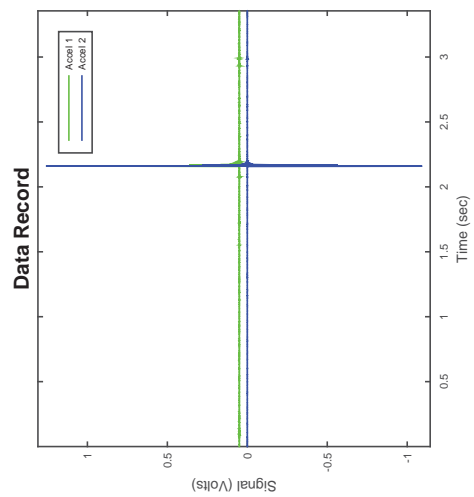

Accelerometer-Based Shear Wave Velocity Datasheet

Specimen ID: M277-PGC109-400-3X
 Test Material: PGC109
 Date: 1/25/2016
 Test Performed by: J.Hubler
 Filename: M277-PGC109-400-3X

Vertical Stress: 400kPa
 Sensor Spacing: 0.10948 m
 V_s (rise) = 272 m/s

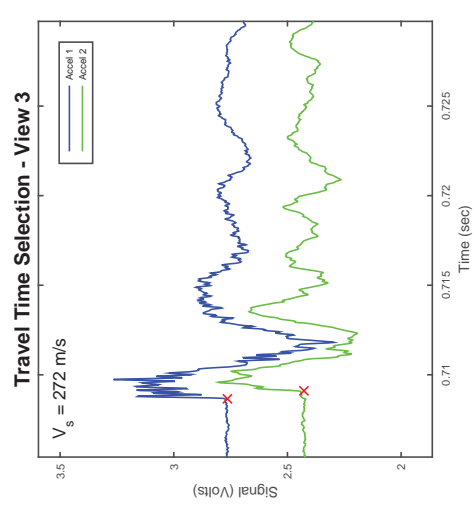
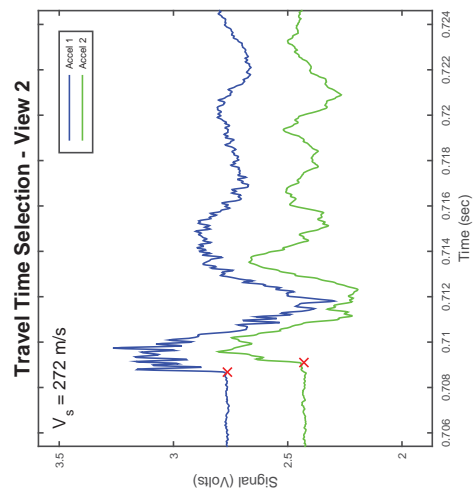
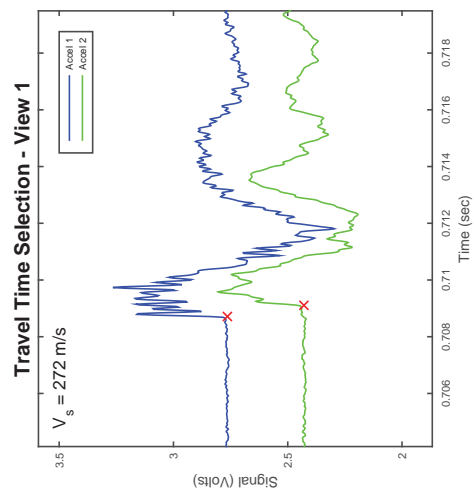
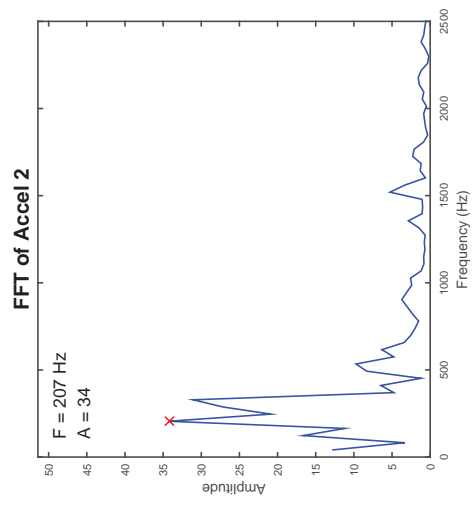
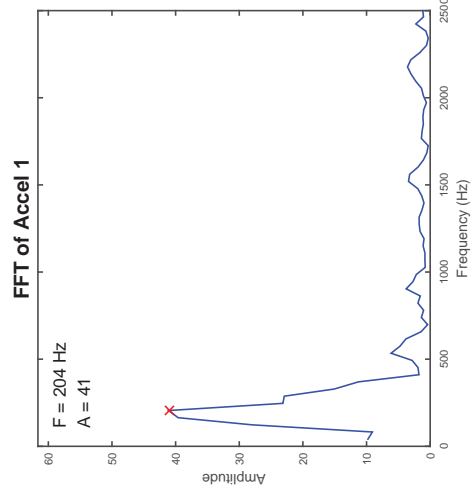
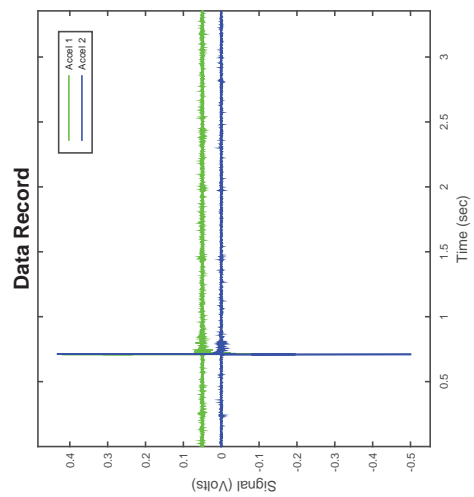

CSS Monotonic Shear Test Report



10/28/2013_Version 8.0

Geotechnical Engineering Laboratory

General Test Info and Sample Preparation

Device:	CSS	Relative Density (%):	5%
Specimen ID:	60C109_40PG	Void Ratio:	0.474
Test ID:	M268	Height (mm):	106.2
Date of Test:	1/14/2016	Soil-Only Specimen Diameter (mm):	307.50
Test Performed:	Monotonic Shear	Weight (kg):	14.400
Test Material:	C109 Ott Sand/Pea Gravel	Density (kg/m³):	1825.1
Sample Preparation:	Prepared by funneling sand/gravel mixture with zero drop height.	Membrane Thickness (mm):	0.000
		Moisture Content (%):	0%
		Saturated (Y/N):	N
		Prepared by:	J.Hubler
		Checked by:	J. Hubler

Consolidation Stage

Vertical Stress (kPa):	100
Time to Compression (min):	10.8
Relative Density (%):	47%
Void Ratio:	0.424
Height (mm):	102.6
Diameter (mm):	307.50
Weight (kg):	14.400
Density (kg/m³):	1889.1

Shear Stage

Type of Test:	Constant Volume
Stress or Strain Controlled:	Strain
Shear Strain Rate (%/min):	0.32
Peak Shear Strength (kPa):	13.6

Comments

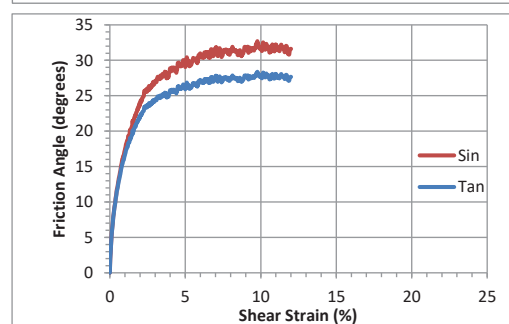
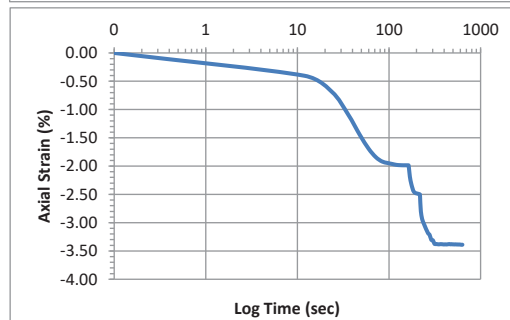
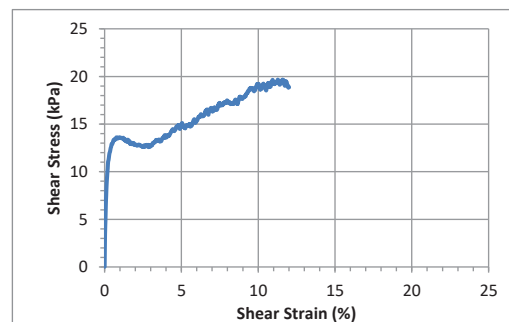
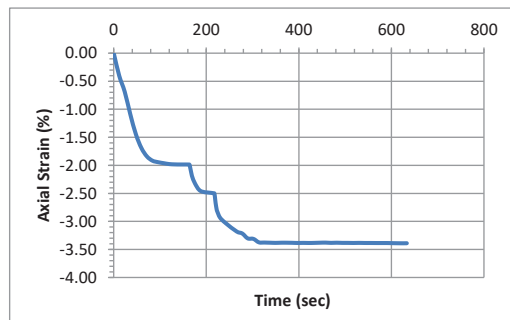

Accelerometer-Based Shear Wave Velocity Datasheet

Specimen ID: M268-PGC109-100-1X
 Test Material: PGC109
 Date: 4/19/2016
 Test Performed by: J.Hubler
 Filename: M268-PGC109-100-1X

Vertical Stress: 100kPa
 Sensor Spacing: 0.11026 m
 V_s (rise) = 199 m/s

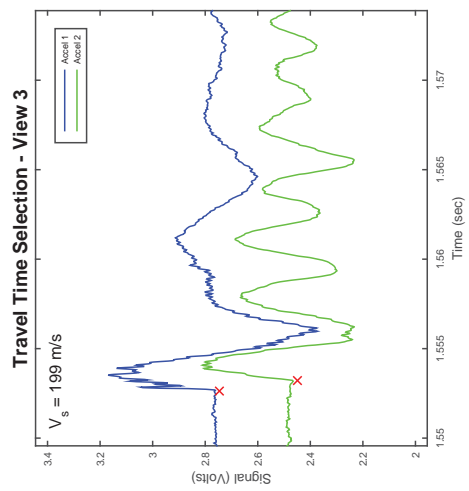
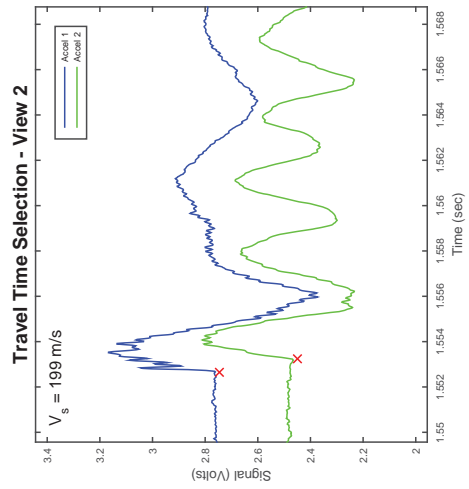
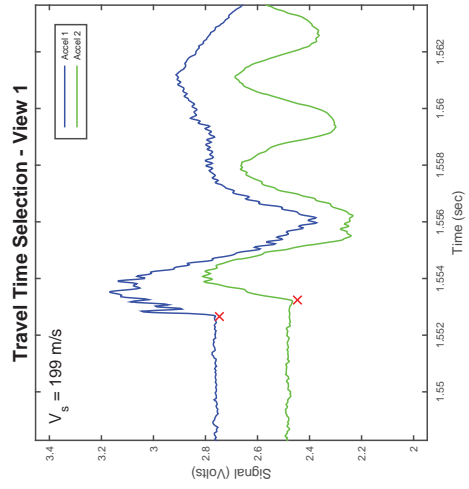
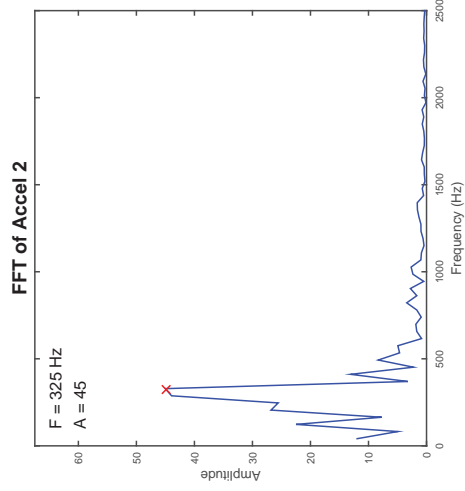
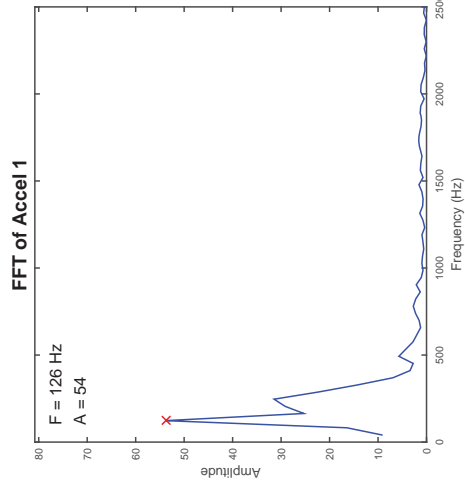
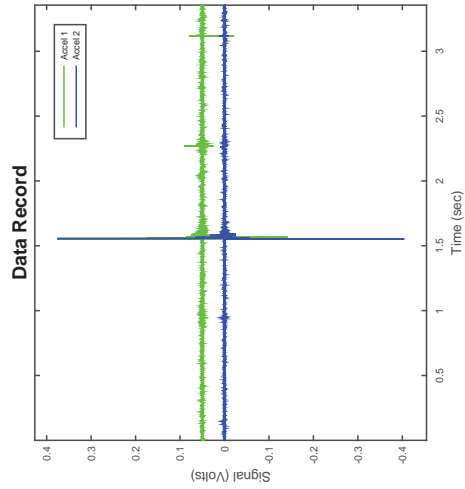

CSS Monotonic Shear Test Report



10/28/2013_Version 8.0

Geotechnical Engineering Laboratory

General Test Info and Sample Preparation

Device:	CSS	Relative Density (%):	13%
Specimen ID:	60C109_40PG	Void Ratio:	0.465
Test ID:	M281	Height (mm):	115.6
Date of Test:	1/27/2016	Soil-Only Specimen Diameter (mm):	307.50
Test Performed:	Monotonic Shear	Weight (kg):	15.769
Test Material:	C109 Ott Sand/Pea Gravel	Density (kg/m³):	1836.6
Sample Preparation:	Prepared by funneling sand/gravel mixture with zero drop height.	Membrane Thickness (mm):	0.000
		Moisture Content (%):	0%
		Saturated (Y/N):	N
		Prepared by:	J. Hubler
		Checked by:	J. Hubler

Consolidation Stage

Vertical Stress (kPa):	200
Time to Compression (min):	8.9
Relative Density (%):	46%
Void Ratio:	0.425
Height (mm):	112.5
Diameter (mm):	307.50
Weight (kg):	15.769
Density (kg/m³):	1887.9

Shear Stage

Type of Test:	Constant Volume
Stress or Strain Controlled:	Strain
Shear Strain Rate (%/min):	0.29
Peak Shear Strength (kPa):	25.2

Comments

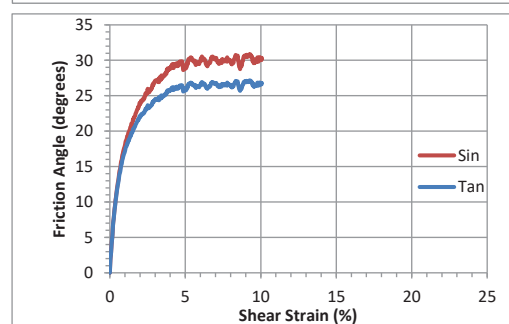
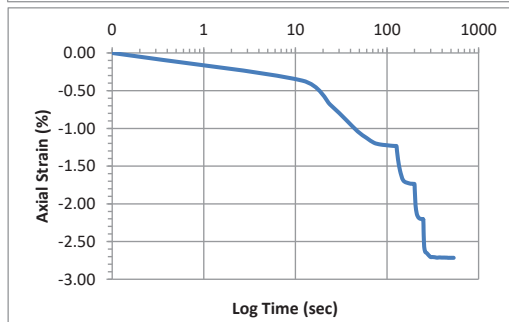
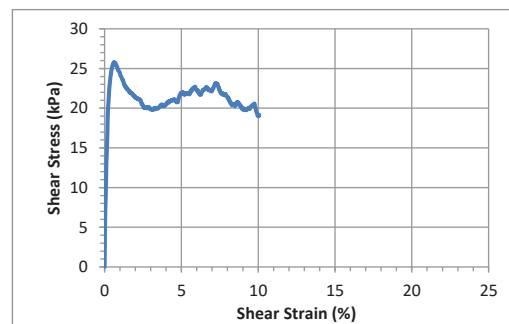
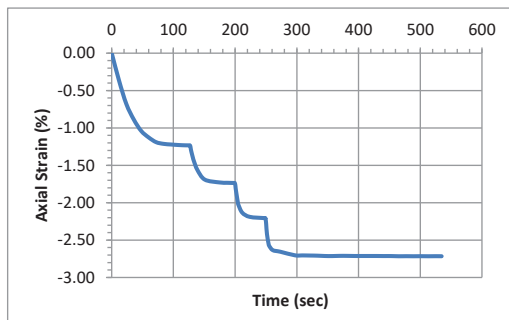

Accelerometer-Based Shear Wave Velocity Datasheet

Specimen ID: M281-PGC109-200-1X
 Test Material: PGC109
 Date: 1/27/2016
 Test Performed by: J.Hubler
 Filename: M281-PGC109-200-1X

Vertical Stress: 200kPa
 Sensor Spacing: 0.11219 m
 V_s (rise) = 236 m/s

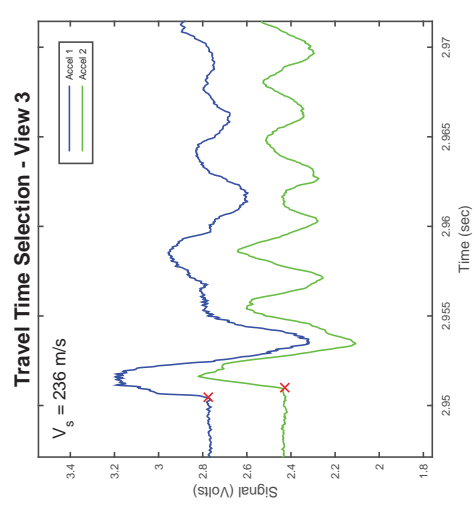
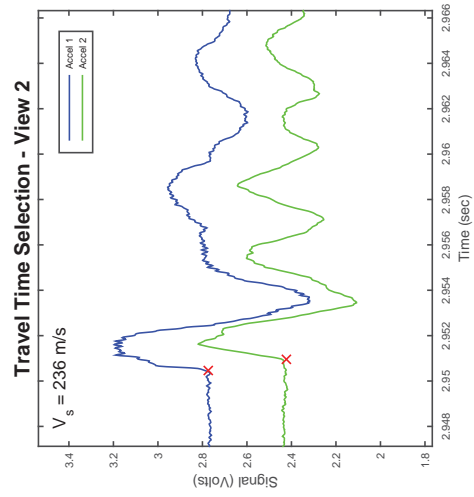
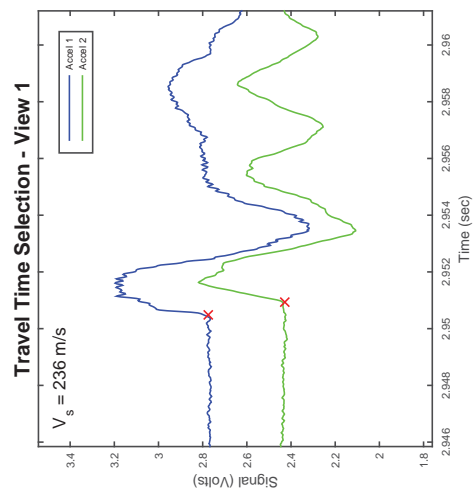
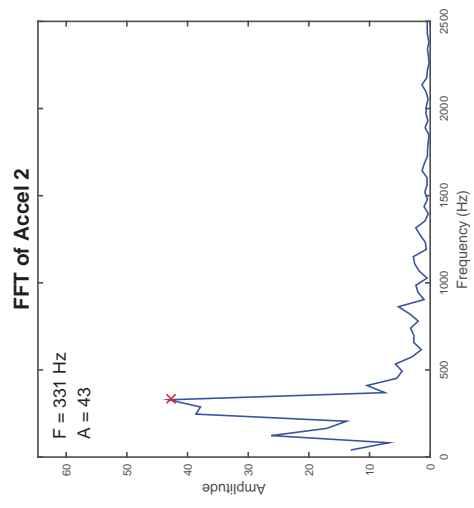
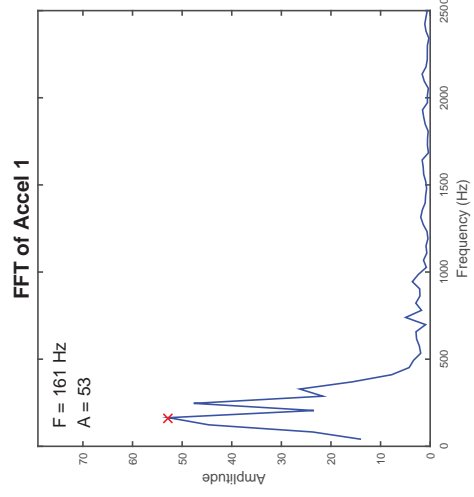
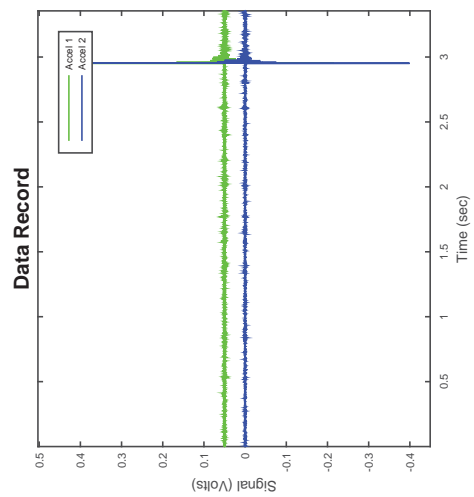

CSS Monotonic Shear Test Report



10/28/2013_Version 8.0

Geotechnical Engineering Laboratory

General Test Info and Sample Preparation

Device:	CSS	Relative Density (%):	1%
Specimen ID:	60C109_40PG	Void Ratio:	0.479
Test ID:	M280	Height (mm):	115.6
Date of Test:	1/26/2016	Soil-Only Specimen Diameter (mm):	307.50
Test Performed:	Monotonic Shear	Weight (kg):	15.622
Test Material:	C109 Ott Sand/Pea Gravel	Density (kg/m³):	1819.3
Sample Preparation:	Prepared by funneling sand/gravel mixture with zero drop height.	Membrane Thickness (mm):	0.000
		Moisture Content (%):	0%
		Saturated (Y/N):	N
		Prepared by:	J.Hubler
		Checked by:	J. Hubler

Consolidation Stage

Vertical Stress (kPa):	400
Time to Compression (min):	10.6
Relative Density (%):	47%
Void Ratio:	0.423
Height (mm):	111.3
Diameter (mm):	307.50
Weight (kg):	15.622
Density (kg/m³):	1890.0

Shear Stage

Type of Test:	Constant Volume
Stress or Strain Controlled:	Strain
Shear Strain Rate (%/min):	0.29
Peak Shear Strength (kPa):	48.6

Comments

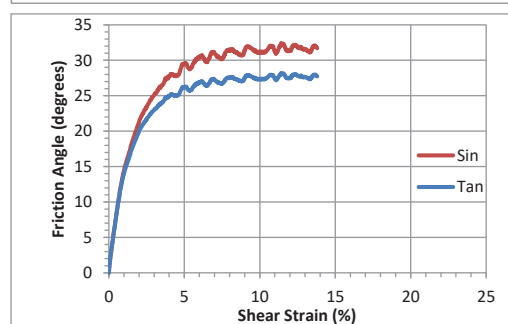
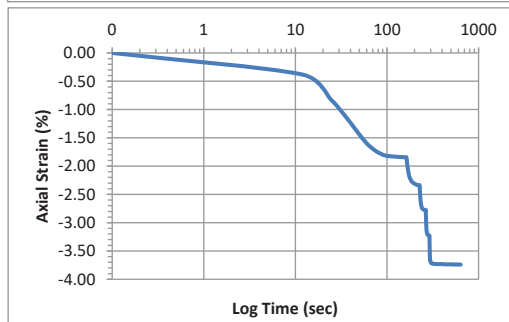
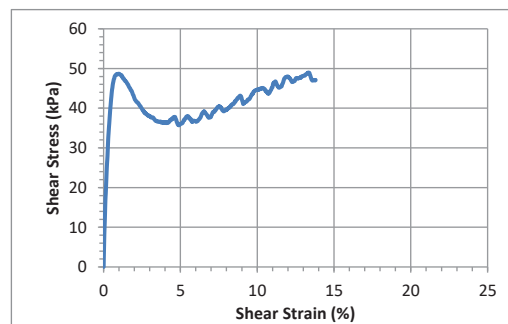
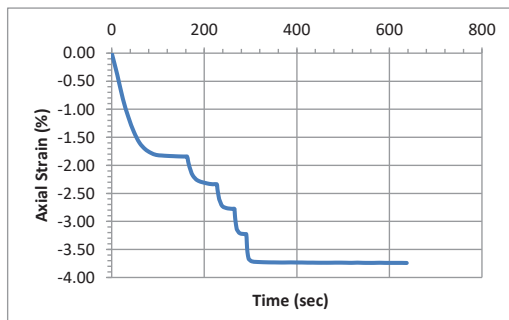

Accelerometer-Based Shear Wave Velocity Datasheet

Specimen ID: M280-PGC109-400-1X
 Test Material: PGC109
 Date: 1/26/2016
 Test Performed by: J.Hubler
 Filename: M280-PGC109-400-1X

Vertical Stress: 400kPa
 Sensor Spacing: 0.11102 m
 V_s (rise) = 266 m/s

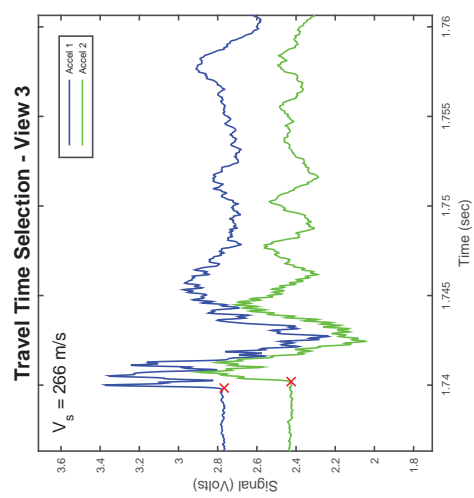
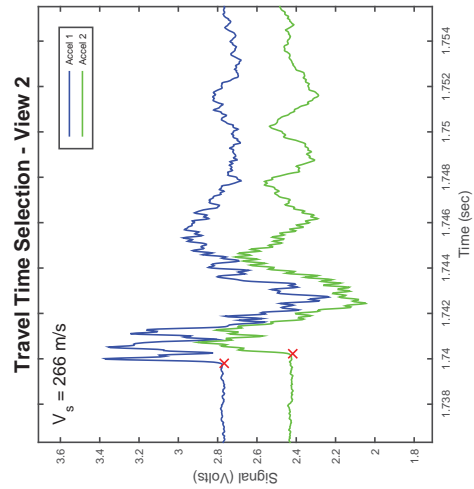
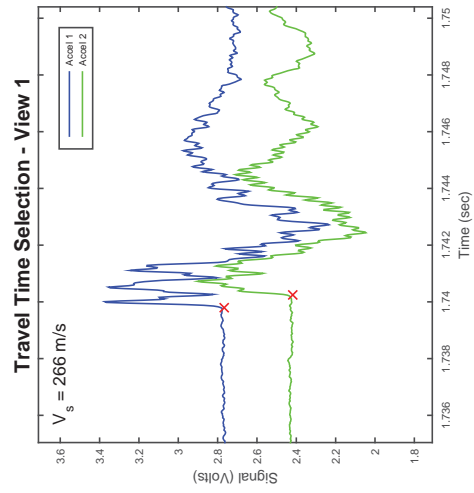
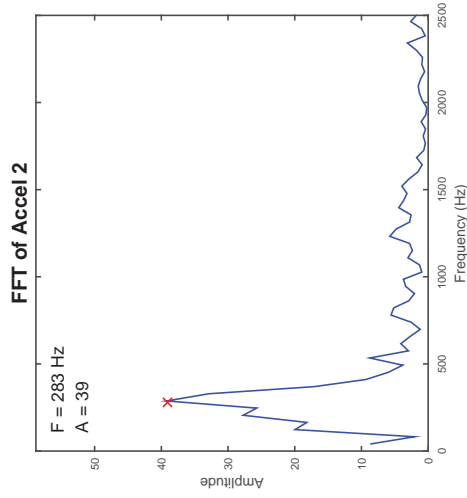
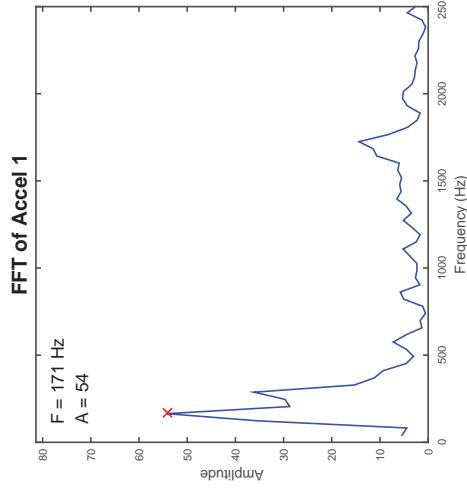
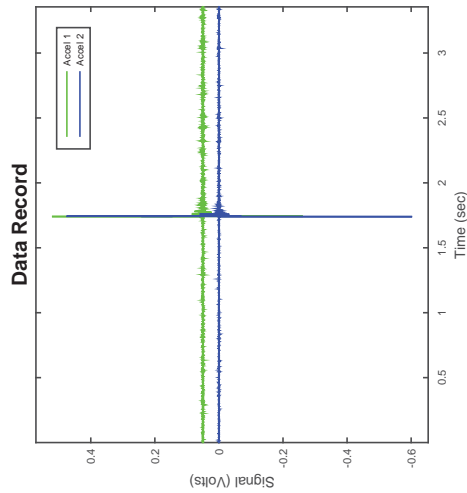

Accelerometer-Based Shear Wave Velocity Datasheet

Specimen ID: M280-PGC109-400-2X
 Test Material: PGC109
 Date: 1/26/2016
 Test Performed by: J.Hubler
 Filename: M280-PGC109-400-2X

Vertical Stress: 400kPa
 Sensor Spacing: 0.11102 m
 V_s (rise) = 276 m/s

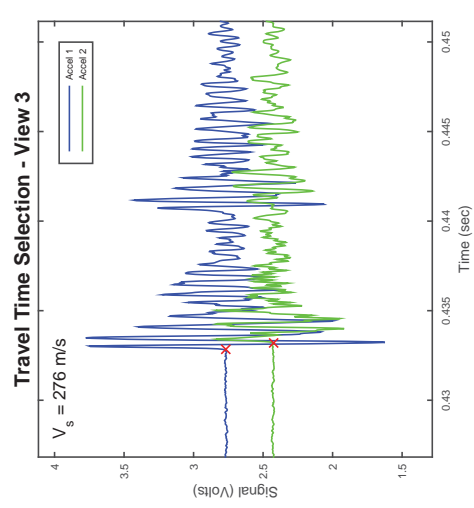
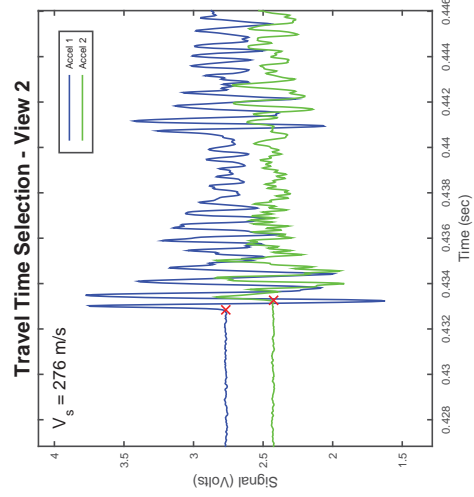
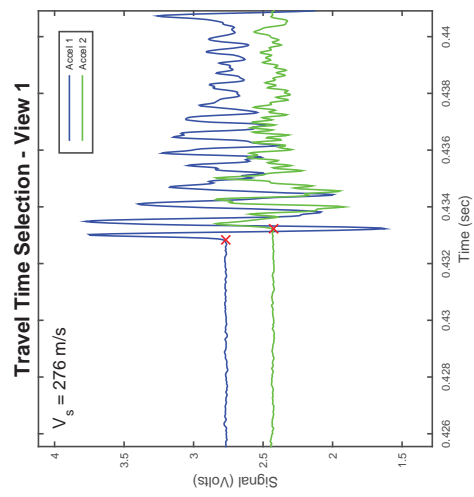
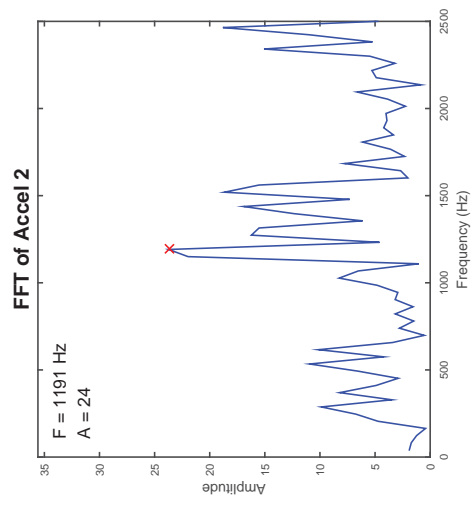
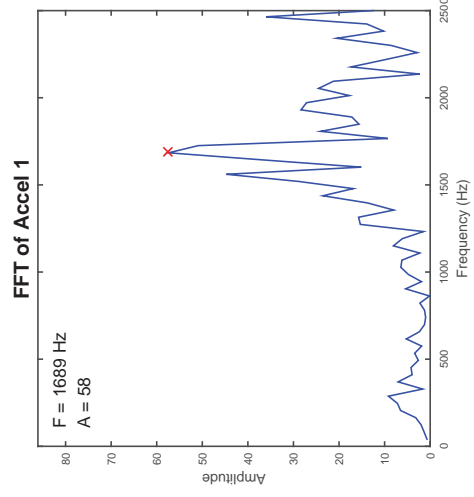
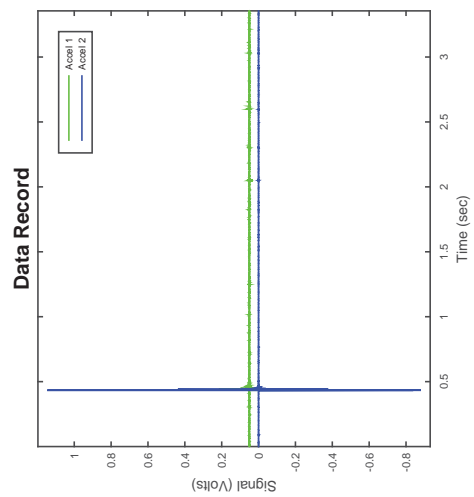

Accelerometer-Based Shear Wave Velocity Datasheet

Specimen ID: M280-PGC109-400-3X
 Test Material: PGC109
 Date: 1/26/2016
 Test Performed by: J.Hubler
 Filename: M280-PGC109-400-3X

Vertical Stress: 400kPa
 Sensor Spacing: 0.11102 m
 V_s (rise) = 276 m/s

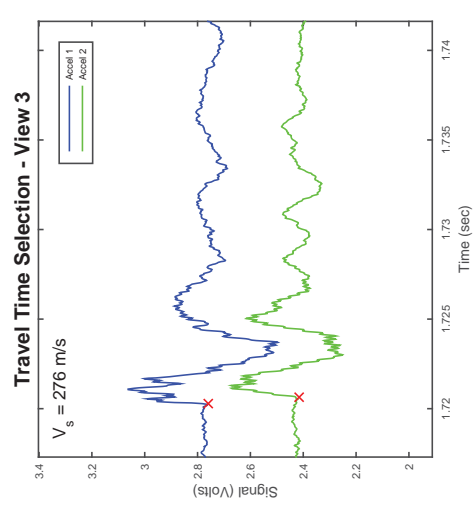
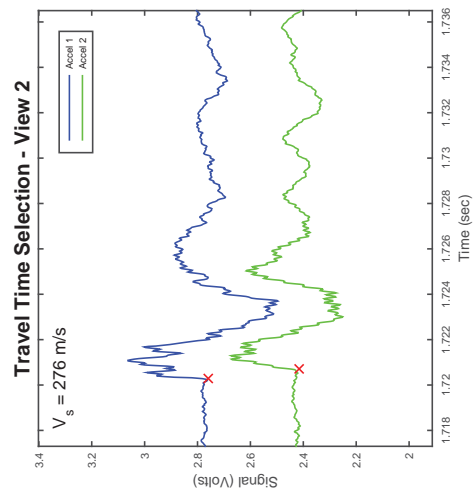
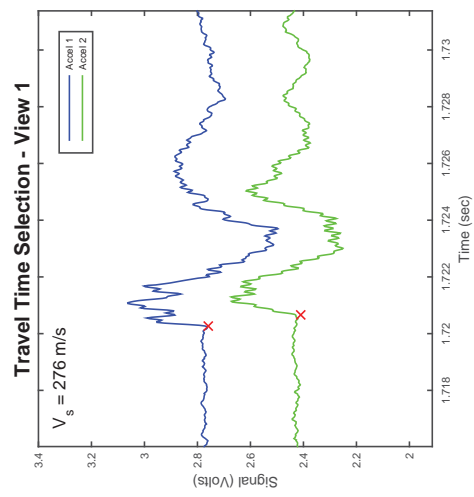
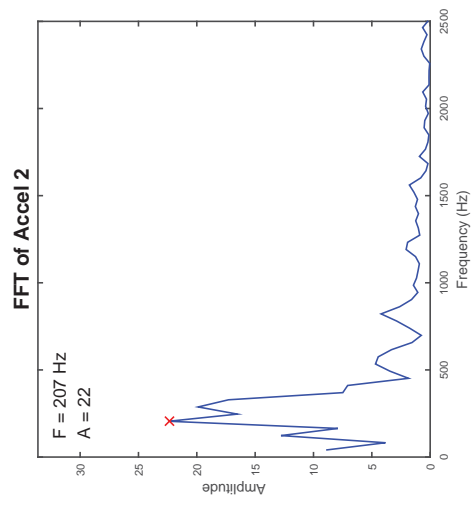
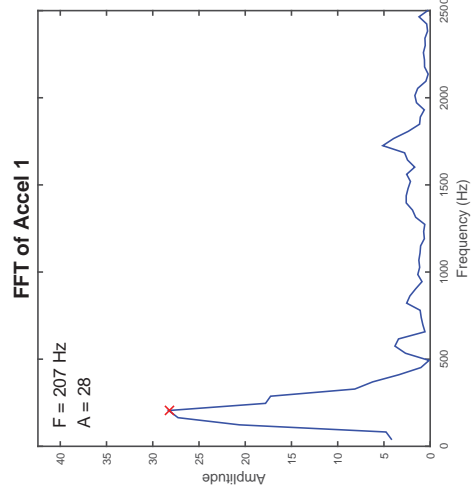
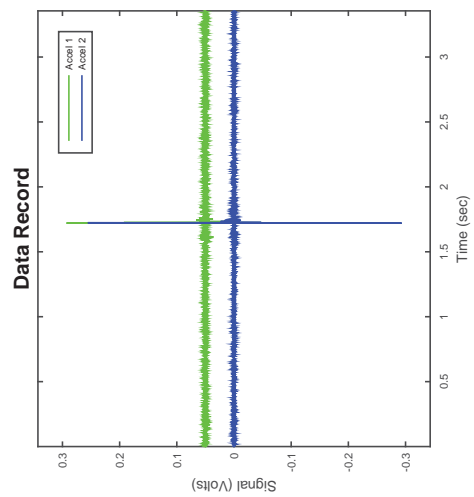

CSS Monotonic Shear Test Report



10/28/2013_Version 8.0

Geotechnical Engineering Laboratory

General Test Info and Sample Preparation

Device:	CSS	Relative Density (%):	7%
Specimen ID:	40C109_60PG	Void Ratio:	0.365
Test ID:	M296	Height (mm):	114.2
Date of Test:	2/11/2016	Soil-Only Specimen Diameter (mm):	306.20
Test Performed:	Monotonic Shear	Weight (kg):	16.574
Test Material:	C109 Ott Sand/Pea Gravel	Density (kg/m³):	1970.5
Sample Preparation:	Prepared by funneling sand/gravel mixture with zero drop height.	Membrane Thickness (mm):	0.635
		Moisture Content (%):	0%
		Saturated (Y/N):	N
		Prepared by:	J. Hubler
		Checked by:	J. Hubler

Consolidation Stage

Vertical Stress (kPa):	100
Time to Compression (min):	7.2
Relative Density (%):	44%
Void Ratio:	0.334
Height (mm):	111.1
Diameter (mm):	306.20
Weight (kg):	16.574
Density (kg/m³):	2025.0

Shear Stage

Type of Test:	Constant Volume
Stress or Strain Controlled:	Strain
Shear Strain Rate (%/min):	0.29
Peak Shear Strength (kPa):	18.3

Comments

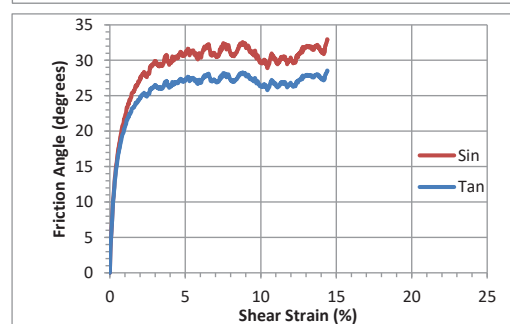
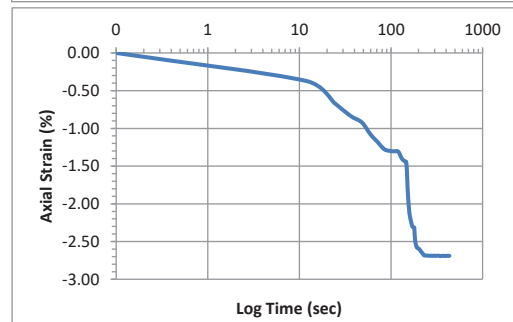
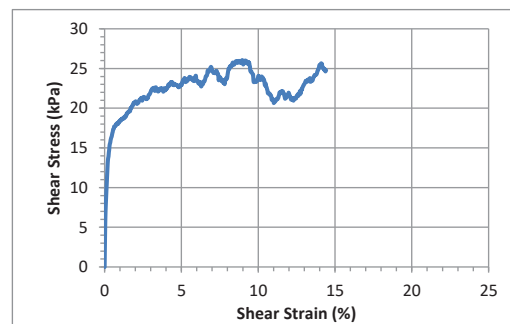
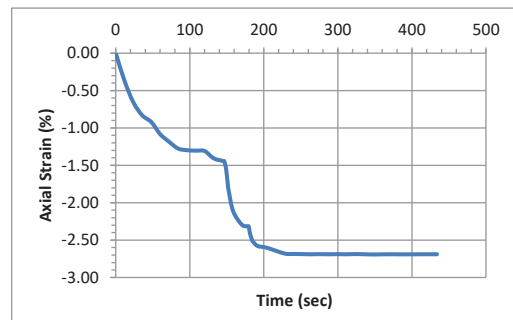

Accelerometer-Based Shear Wave Velocity Datasheet

Specimen ID: M296-PGC109-100-1X
 Test Material: PGC109
 Date: 2/11/2016
 Test Performed by: J.Hubler
 Filename: M296-PGC109-100-1X

Vertical Stress: 100kPa
 Sensor Spacing: 0.11087 m
 V_s (rise) = 202 m/s

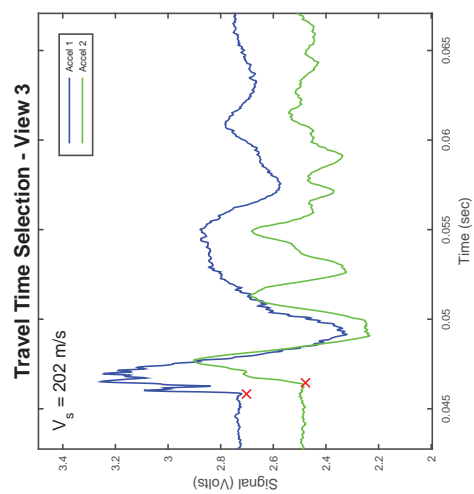
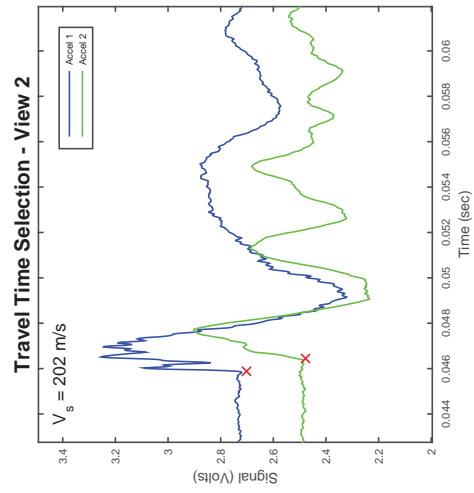
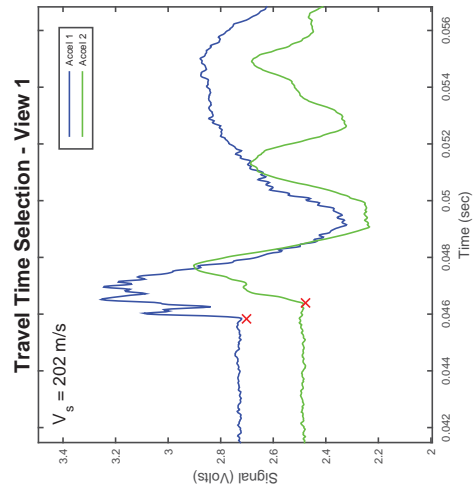
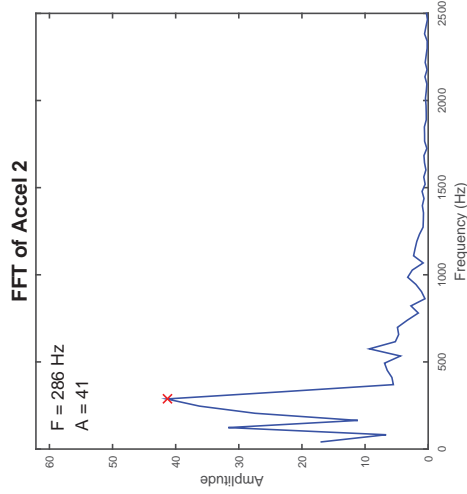
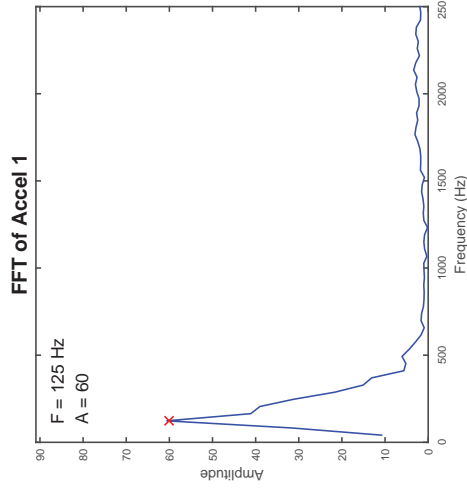
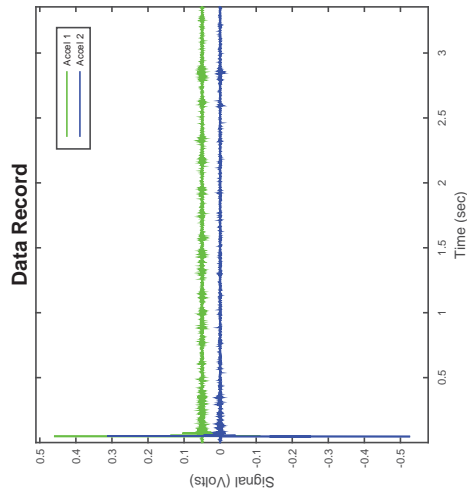

Accelerometer-Based Shear Wave Velocity Datasheet

Specimen ID: M296-PGC109-100-2X
 Test Material: PGC109
 Date: 2/11/2016
 Test Performed by: J.Hubler
 Filename: M296-PGC109-100-2X

Vertical Stress: 100kPa
 Sensor Spacing: 0.11087 m
 V_s (rise) = 202 m/s

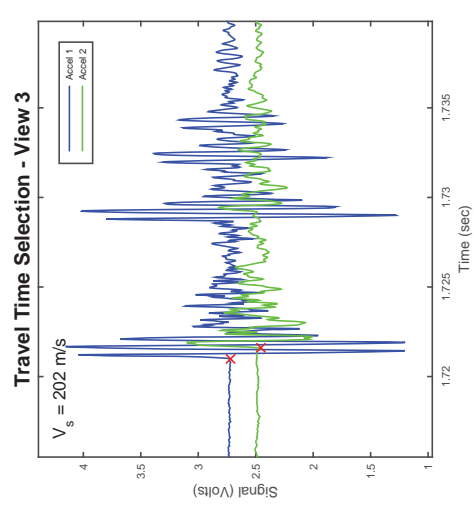
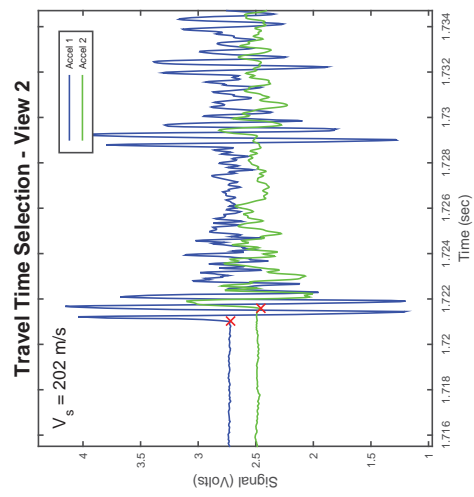
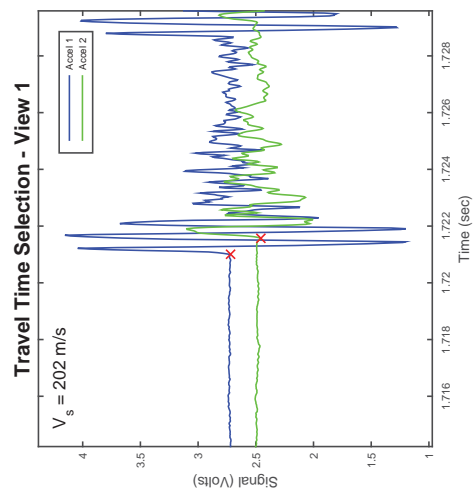
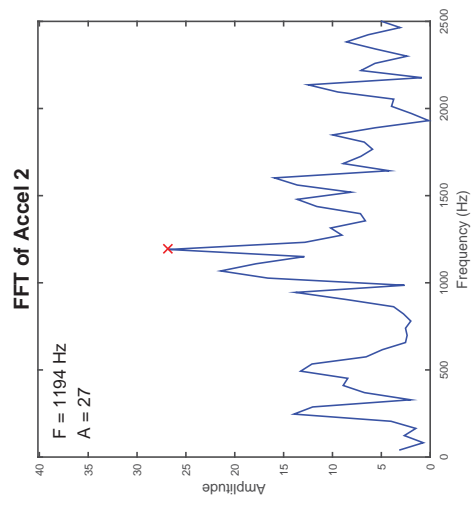
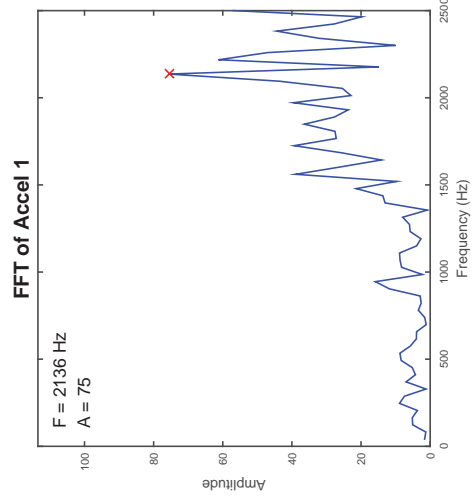
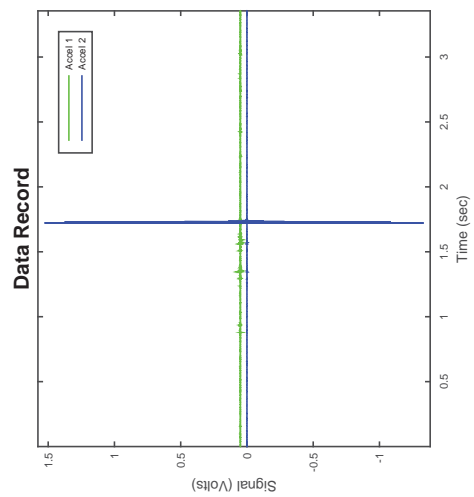

Accelerometer-Based Shear Wave Velocity Datasheet

Specimen ID: M296-PGC109-100-3X
 Test Material: PGC109
 Date: 2/11/2016
 Test Performed by: J.Hubler
 Filename: M296-PGC109-100-3X

Vertical Stress: 100kPa
 Sensor Spacing: 0.11087 m
 V_s (rise) = 207 m/s

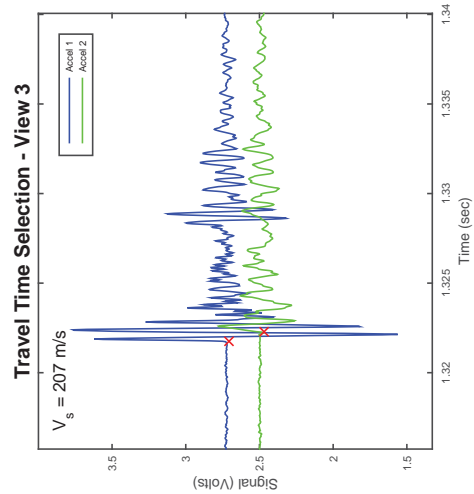
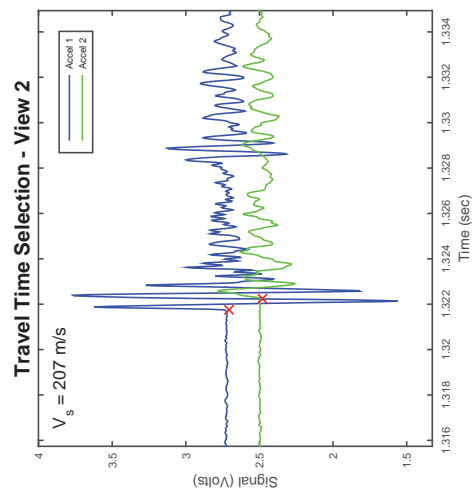
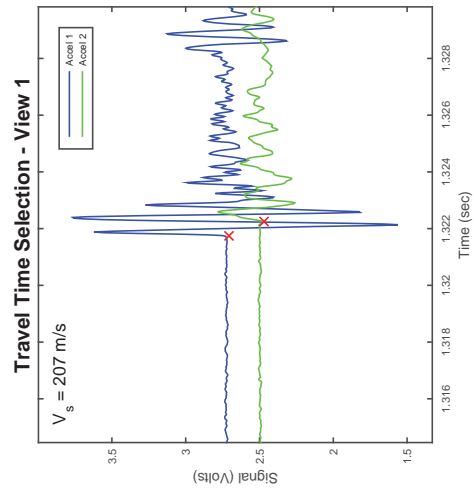
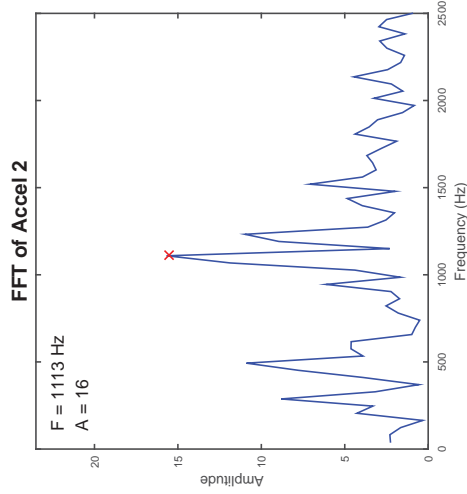
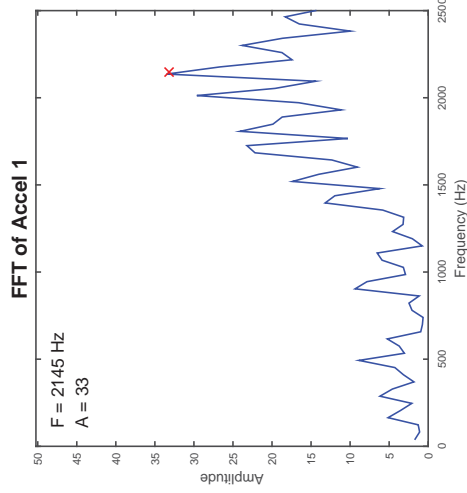
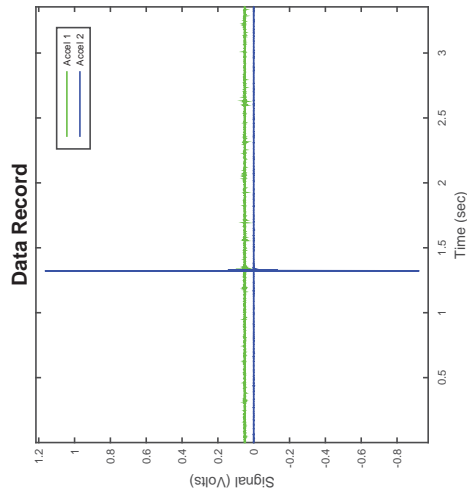

CSS Monotonic Shear Test Report



10/28/2013_Version 8.0

Geotechnical Engineering Laboratory

General Test Info and Sample Preparation

Device:	CSS	Relative Density (%):	0%
Specimen ID:	40C109_60PG	Void Ratio:	0.373
Test ID:	M295	Height (mm):	115.1
Date of Test:	2/9/2016	Soil-Only Specimen Diameter (mm):	306.20
Test Performed:	Monotonic Shear	Weight (kg):	16.615
Test Material:	C109 Ott Sand/Pea Gravel	Density (kg/m³):	1960.2
Sample Preparation:	Prepared by funneling sand/gravel mixture with zero drop height.	Membrane Thickness (mm):	0.635
		Moisture Content (%):	0%
		Saturated (Y/N):	N
		Prepared by:	J. Hubler
		Checked by:	J. Hubler

Consolidation Stage

Vertical Stress (kPa):	200
Time to Compression (min):	7.3
Relative Density (%):	44%
Void Ratio:	0.333
Height (mm):	111.4
Diameter (mm):	306.20
Weight (kg):	16.615
Density (kg/m³):	2025.7

Shear Stage

Type of Test:	Constant Volume
Stress or Strain Controlled:	Strain
Shear Strain Rate (%/min):	0.29
Peak Shear Strength (kPa):	33.0

Comments

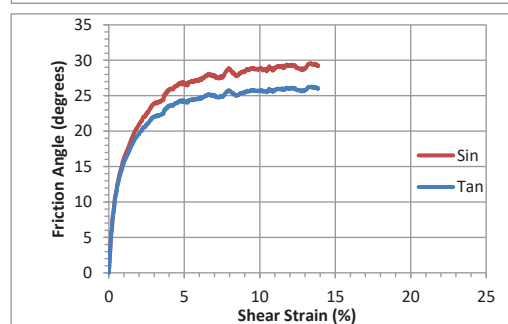
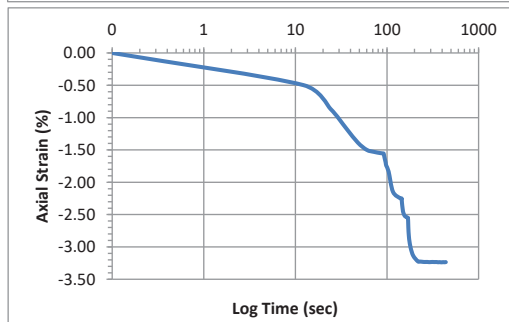
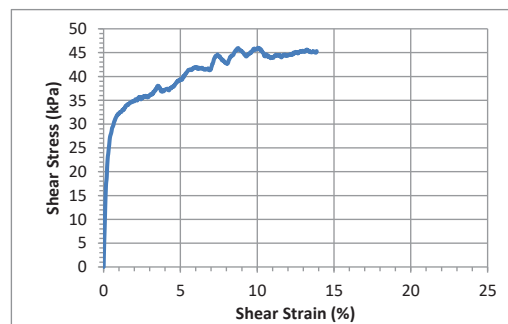
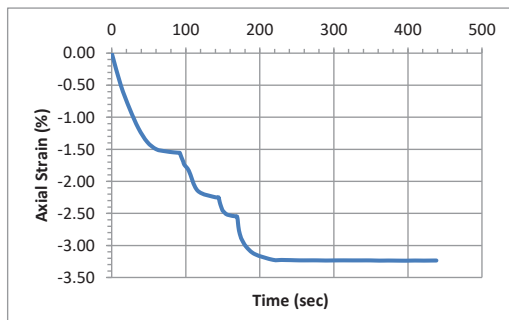

Accelerometer-Based Shear Wave Velocity Datasheet

Specimen ID: M295-PGC109-200-3X
 Test Material: PGC109
 Date: 2/10/2016
 Test Performed by: J.Hubler
 Filename: M295-PGC109-200-3X

Vertical Stress: 200kPa
 Sensor Spacing: 0.11111 m
 V_s (rise) = 241 m/s

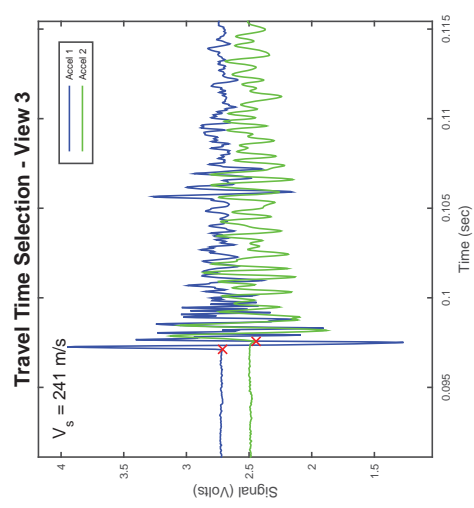
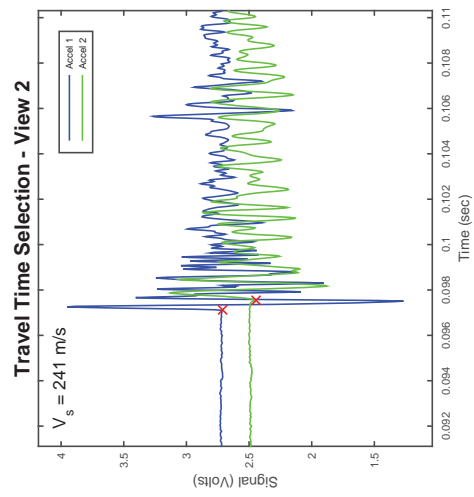
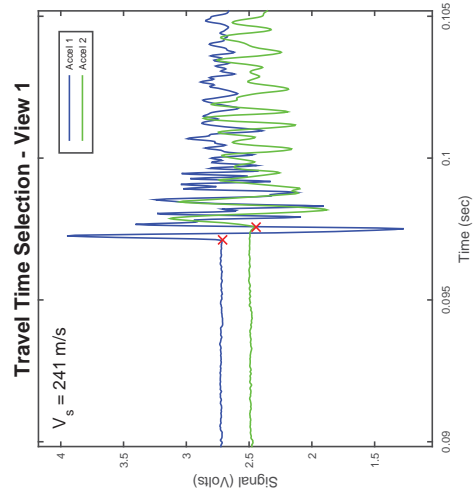
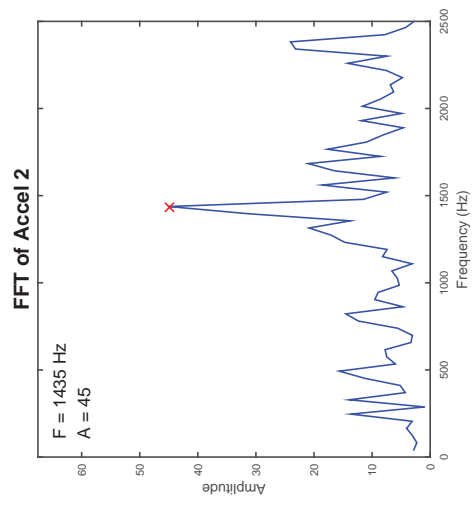
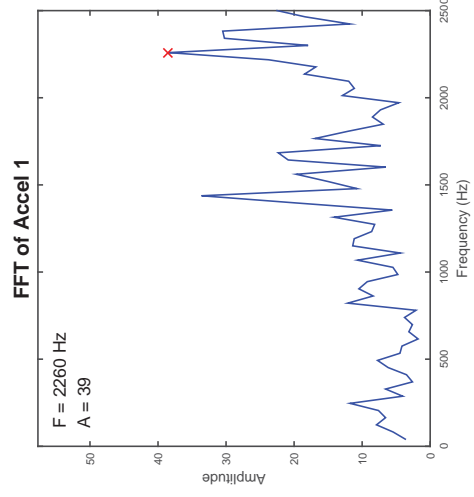
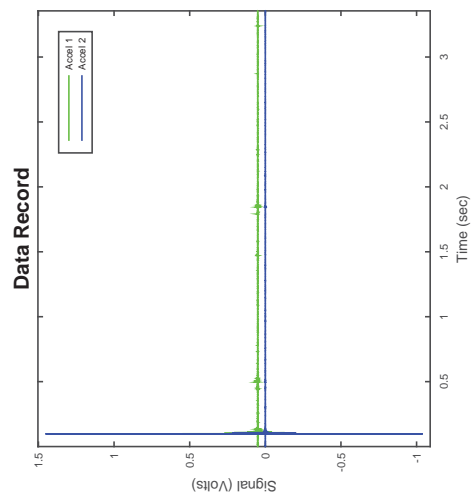

CSS Monotonic Shear Test Report



10/28/2013_Version 8.0

Geotechnical Engineering Laboratory

General Test Info and Sample Preparation

Device:	CSS	Relative Density (%):	-16%
Specimen ID:	40C109_60PG	Void Ratio:	0.389
Test ID:	M282	Height (mm):	114.1
Date of Test:	1/28/2016	Soil-Only Specimen Diameter (mm):	307.50
Test Performed:	Monotonic Shear	Weight (kg):	16.413
Test Material:	C109 Ott Sand/Pea Gravel	Density (kg/m³):	1936.8
Sample Preparation:	Prepared by funneling sand/gravel mixture with zero drop height.	Membrane Thickness (mm):	0.000
		Moisture Content (%):	0%
		Saturated (Y/N):	N
		Prepared by:	J.Hubler
		Checked by:	J. Hubler

Consolidation Stage

Vertical Stress (kPa):	400
Time to Compression (min):	13.2
Relative Density (%):	44%
Void Ratio:	0.333
Height (mm):	109.1
Diameter (mm):	307.50
Weight (kg):	16.413
Density (kg/m³):	2024.8

Shear Stage

Type of Test:	Constant Volume
Stress or Strain Controlled:	Strain
Shear Strain Rate (%/min):	0.30
Peak Shear Strength (kPa):	61.1

Comments

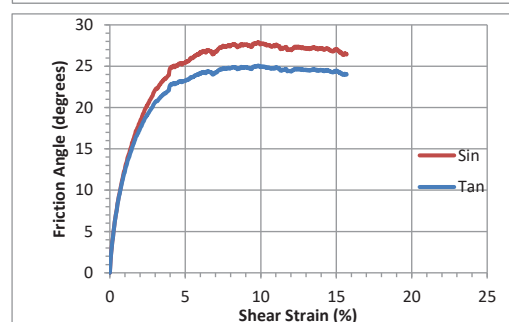
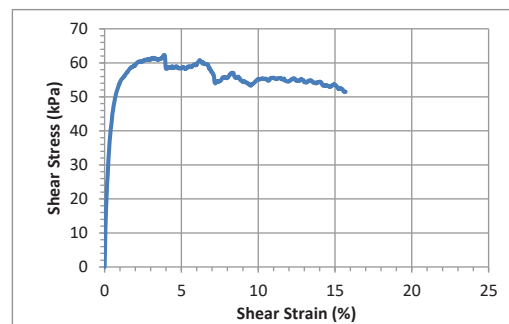
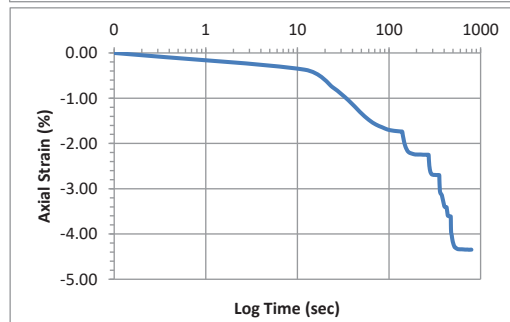
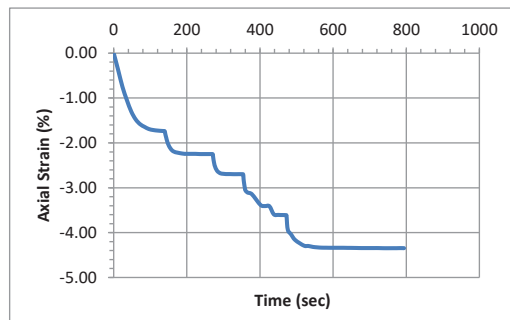

Accelerometer-Based Shear Wave Velocity Datasheet

Specimen ID: M282-PGC109-400-2X

Test Material: PGC109

Date: 1/28/2016

Test Performed by: J.Hubler

Filename: M282-PGC109-400-2X

Vertical Stress: 400kPa

Sensor Spacing: 0.10887 m

V_s (rise) = 281 m/s

Data Record

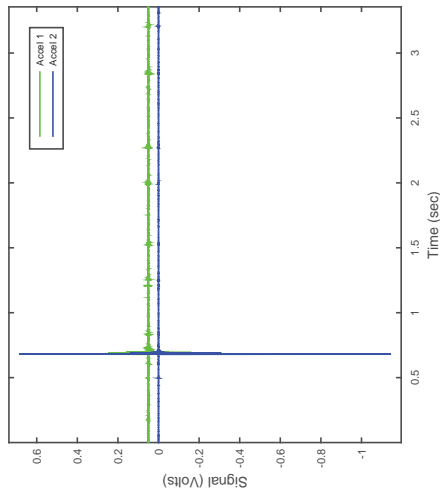

FFT of Accel 1

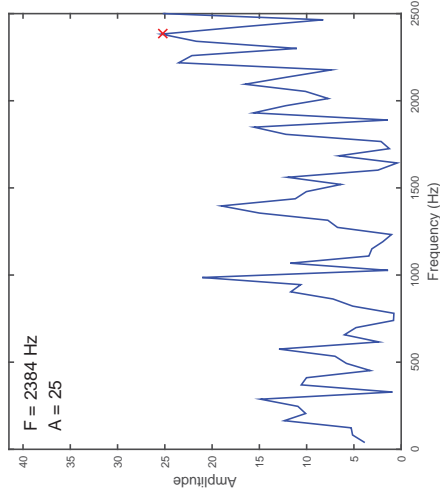

FFT of Accel 2

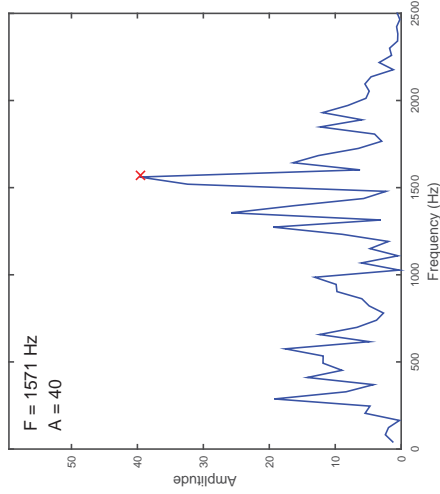

Travel Time Selection - View 1

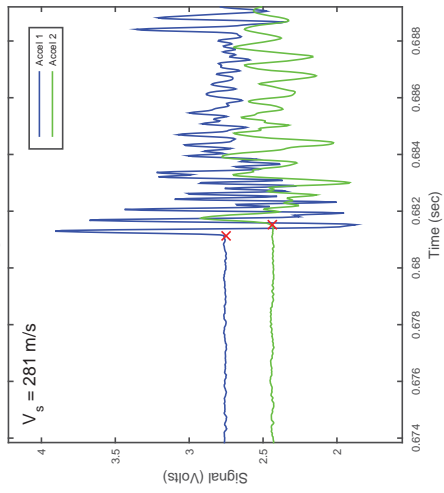

Travel Time Selection - View 2

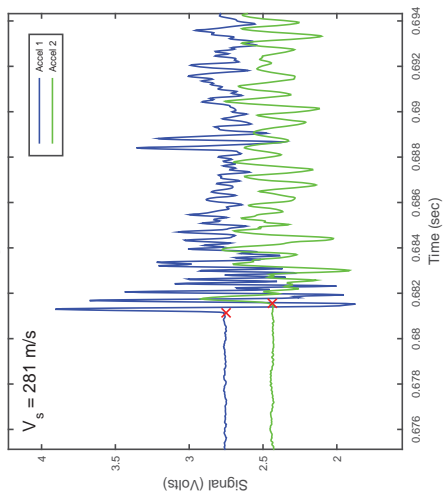

Travel Time Selection - View 3

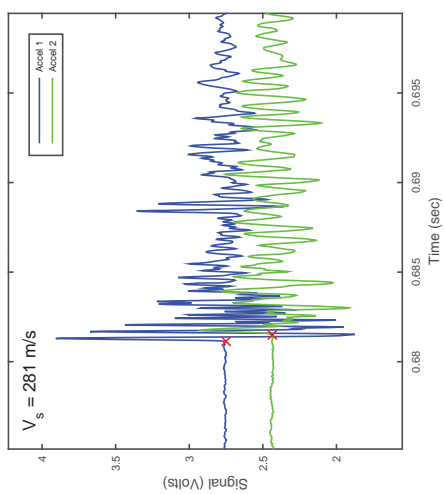

CSS Monotonic Shear Test Report

Geotechnical Engineering Laboratory



10/28/2013_Version 8.0

General Test Info and Sample Preparation

Device:	CSS	Relative Density (%):	59%
Specimen ID:	80C109_20PG	Void Ratio:	0.501
Test ID:	M329	Height (mm):	114.5
Date of Test:	10/24/2016	Soil-Only Specimen Diameter (mm):	307.50
Test Performed:	Monotonic Shear	Weight (kg):	14.888
Test Material:	C109 Ott Sand/Pea Gravel	Density (kg/m³):	1751.5
Sample Preparation:	Prepared dense by funelling and then tamping in 5 layers (25x)	Membrane Thickness (mm):	0.635
		Moisture Content (%):	0%
		Saturated (Y/N):	N
		Prepared by:	J. Hubler
		Checked by:	J. Hubler

Consolidation Stage

Vertical Stress (kPa):	100
Time to Compression (min):	6.1
Relative Density (%):	82%
Void Ratio:	0.475
Height (mm):	111.7
Diameter (mm):	307.50
Weight (kg):	14.888
Density (kg/m³):	1795.2

Shear Stage

Type of Test:	Constant Volume
Stress or Strain Controlled:	Strain
Shear Strain Rate (%/min):	0.29
Peak Shear Strength (kPa):	16.9

Comments

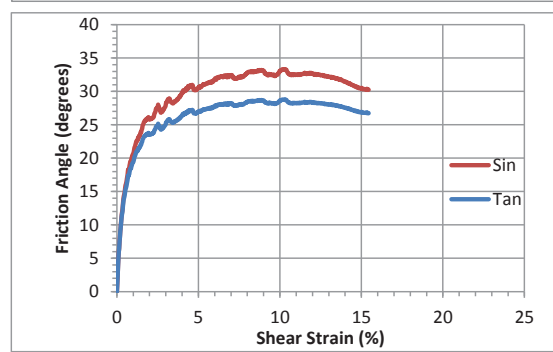
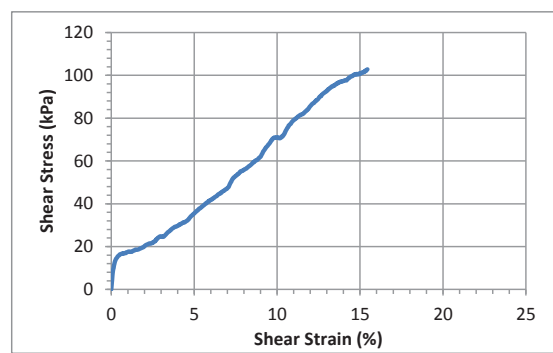
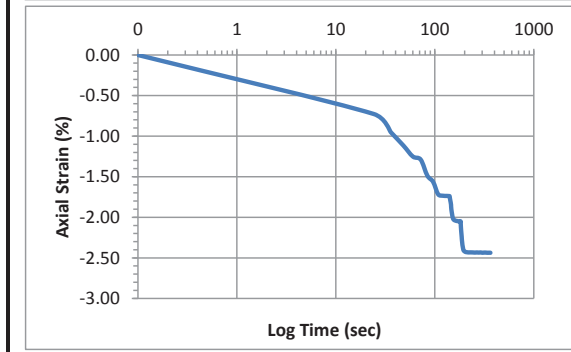
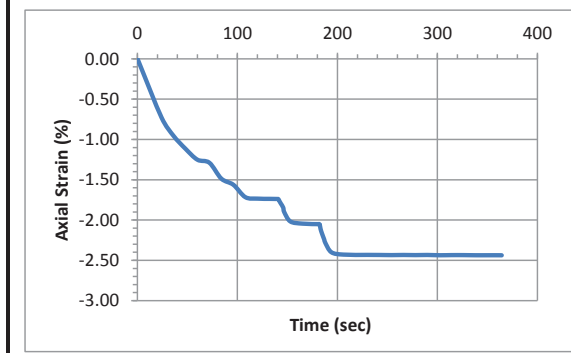

Accelerometer-Based Shear Wave Velocity Datasheet

Specimen ID: M329-80C10920PG-100-1X

Test Material: 80C10920PG

Date: 10/24/2016

Test Performed by: J.Hubler

Filename: M329-80C10920PG-100-1X

Vertical Stress: 100kPa

Sensor Spacing: 0.1114 m

V_s (rise) = 217 m/s

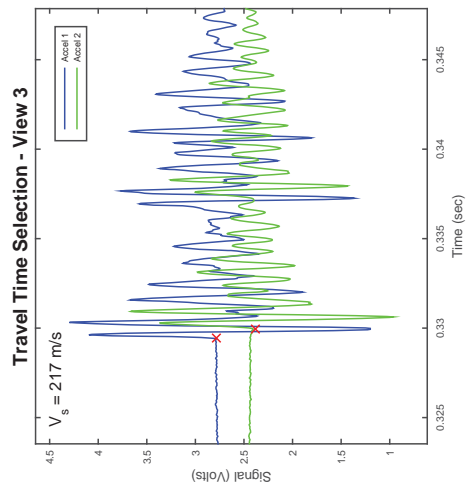
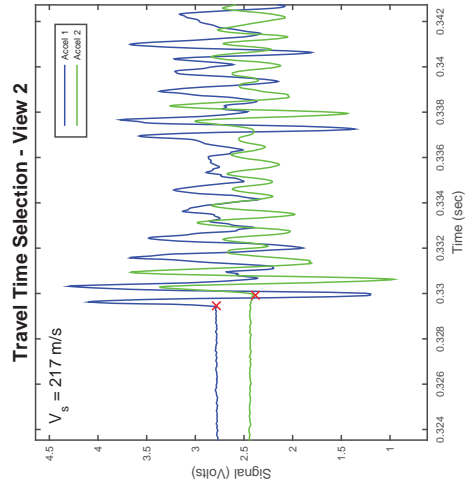
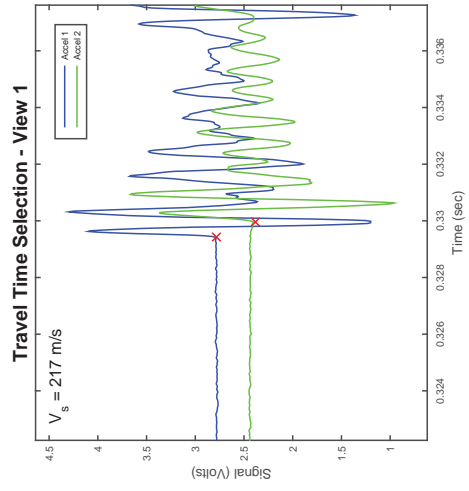
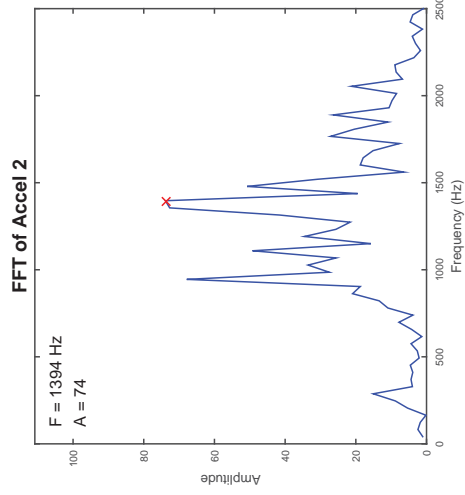
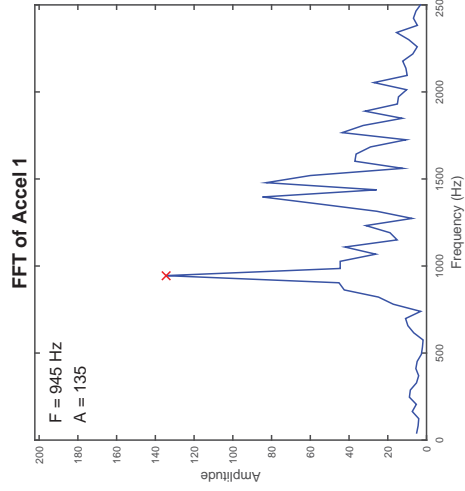
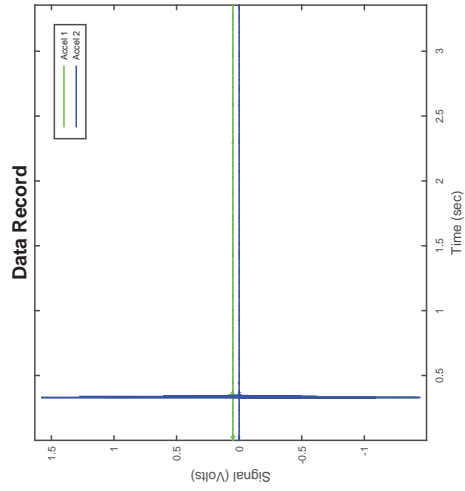

CSS Monotonic Shear Test Report

Geotechnical Engineering Laboratory



10/28/2013_Version 8.0

General Test Info and Sample Preparation

Device:	CSS	Relative Density (%):	44%
Specimen ID:	60C109_40PG	Void Ratio:	0.427
Test ID:	M330	Height (mm):	108.0
Date of Test:	10/24/2016	Soil-Only Specimen Diameter (mm):	307.50
Test Performed:	Monotonic Shear	Weight (kg):	15.000
Test Material:	C109 Ott Sand/Pea Gravel	Density (kg/m³):	1869.4
Sample Preparation:	Prepared dense by tamping in 5 layers (25x)	Membrane Thickness (mm):	0.635
		Moisture Content (%):	0%
		Saturated (Y/N):	N
		Prepared by:	J. Hubler
		Checked by:	J. Hubler

Consolidation Stage

Vertical Stress (kPa):	100
Time to Compression (min):	6.0
Relative Density (%):	82%
Void Ratio:	0.382
Height (mm):	104.6
Diameter (mm):	307.50
Weight (kg):	15.000
Density (kg/m³):	1930.9

Shear Stage

Type of Test:	Constant Volume
Stress or Strain Controlled:	Strain
Shear Strain Rate (%/min):	0.31
Peak Shear Strength (kPa):	25.2

Comments

Data good to 10% - appears to be sliding after that

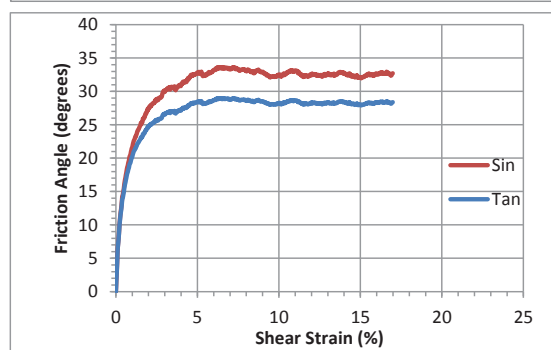
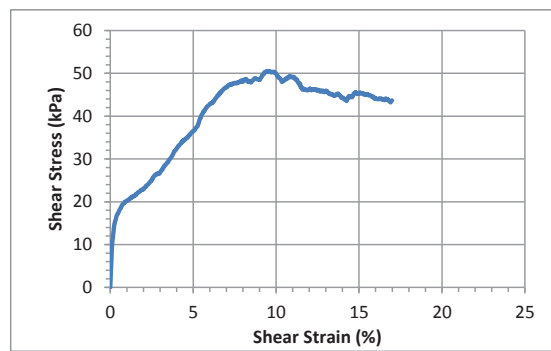
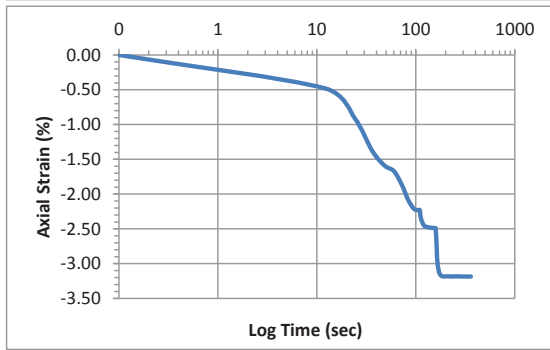
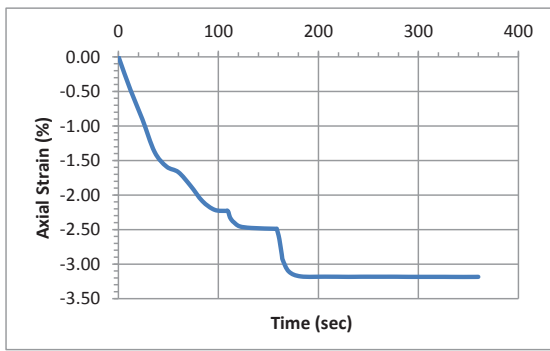

Accelerometer-Based Shear Wave Velocity Datasheet

Specimen ID: M330-60C10940PG-100-1X
 Test Material: 60C10940PG
 Date: 10/24/2016
 Test Performed by: J.Hubler
 Filename: M330-60C10940PG-100-1X

Vertical Stress: 100kPa
 Sensor Spacing: 0.10434 m
 V_s (rise) = 232 m/s

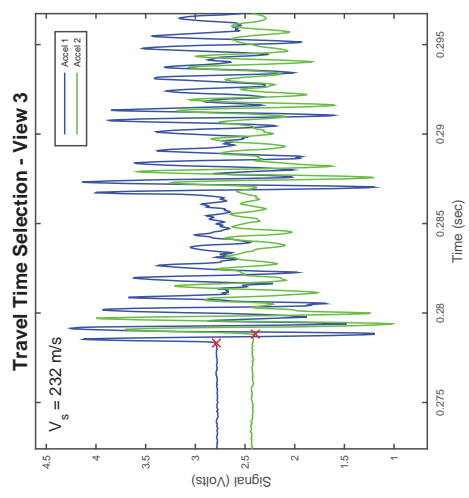
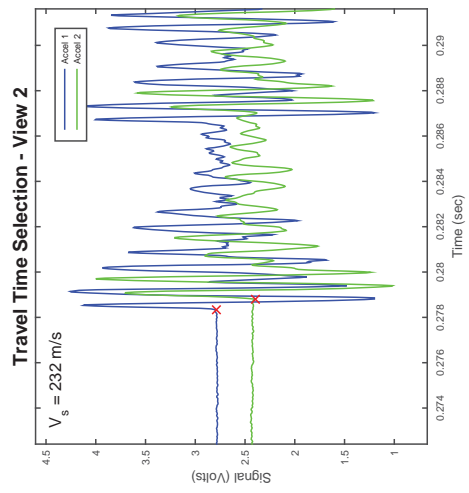
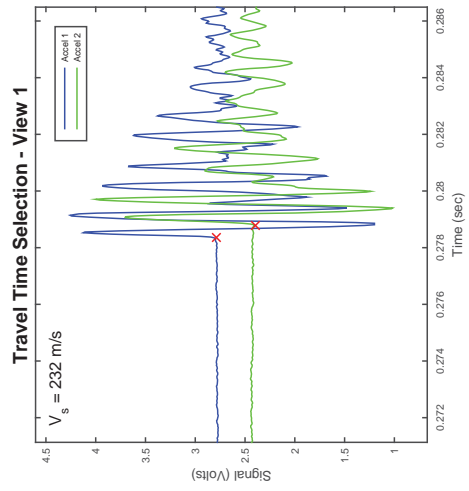
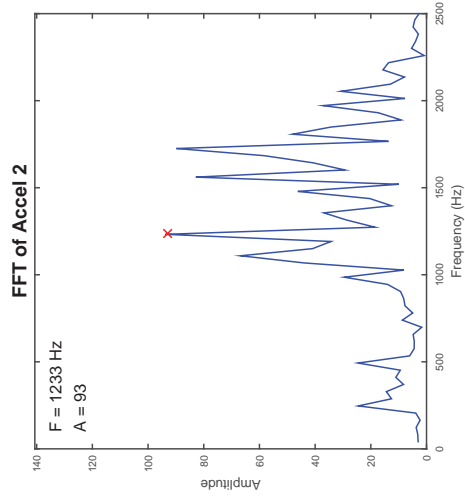
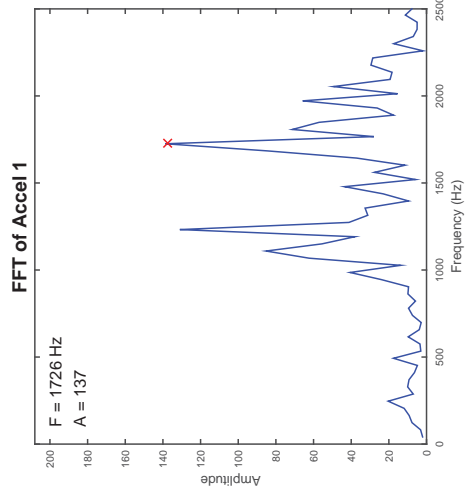
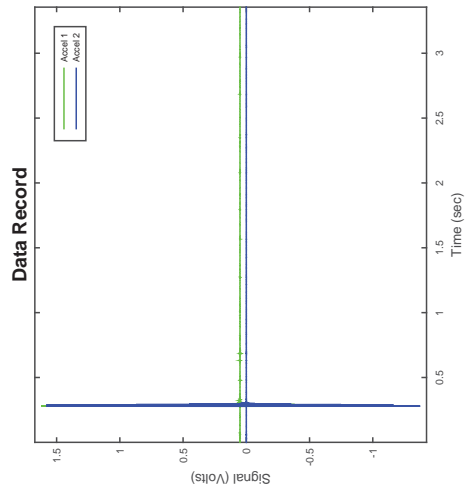

CSS Monotonic Shear Test Report

Geotechnical Engineering Laboratory



10/28/2013_Version 8.0

General Test Info and Sample Preparation

Device:	CSS	Relative Density (%):	3%
Specimen ID:	40C109_60PG	Void Ratio:	0.370
Test ID:	M331	Height (mm):	120.8
Date of Test:	10/26/2016	Soil-Only Specimen Diameter (mm):	307.50
Test Performed:	Monotonic Shear	Weight (kg):	17.477
Test Material:	C109 Ott Sand/Pea Gravel	Density (kg/m³):	1947.9
Sample Preparation:	Prepared dense by tamping in 5 layers (25x)	Membrane Thickness (mm):	0.635
		Moisture Content (%):	0%
		Saturated (Y/N):	N
		Prepared by:	J. Hubler
		Checked by:	J. Hubler

Consolidation Stage		Shear Stage	
Vertical Stress (kPa):	400	Type of Test:	Constant Volume
Time to Compression (min):	7.9	Stress or Strain Controlled:	Strain
Relative Density (%):	84%	Shear Strain Rate (%/min):	0.29
Void Ratio:	0.294	Peak Shear Strength (kPa):	21.2
Height (mm):	113.7	Comments	
Diameter (mm):	307.50		
Weight (kg):	17.477		
Density (kg/m³):	2069.8		

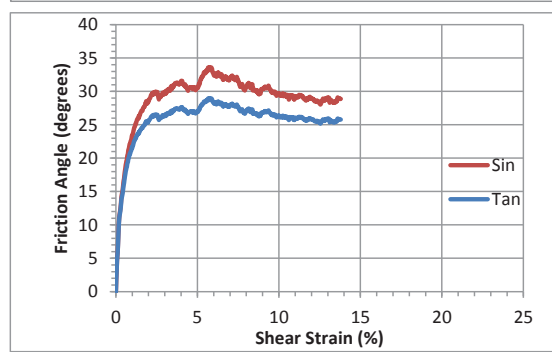
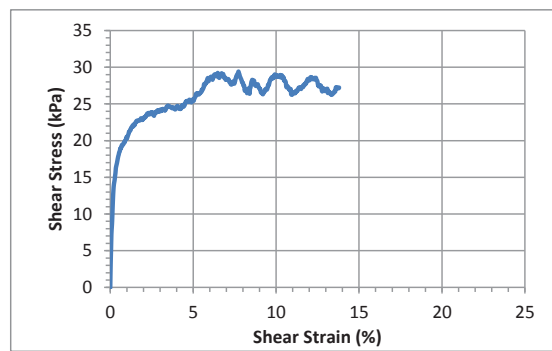
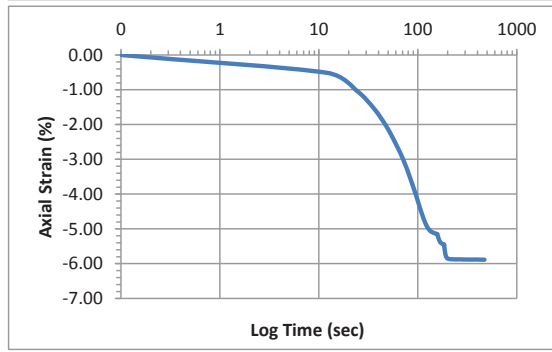
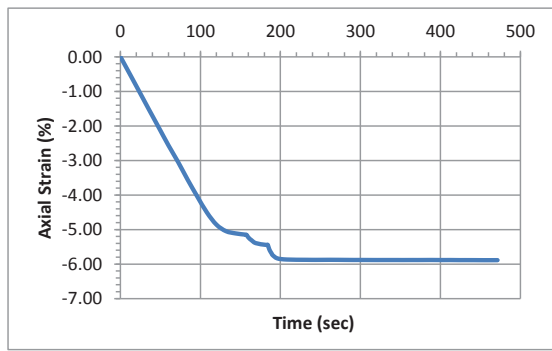

Accelerometer-Based Shear Wave Velocity Datasheet

Specimen ID: M331-40C10960PG-100-1X
 Test Material: 40C10960PG
 Date: 10/26/2016
 Test Performed by: J.Hubler
 Filename: M331-40C10960PG-100-1X

Vertical Stress: 100kPa
 Sensor Spacing: 0.11343 m
 V_s (rise) = 241 m/s

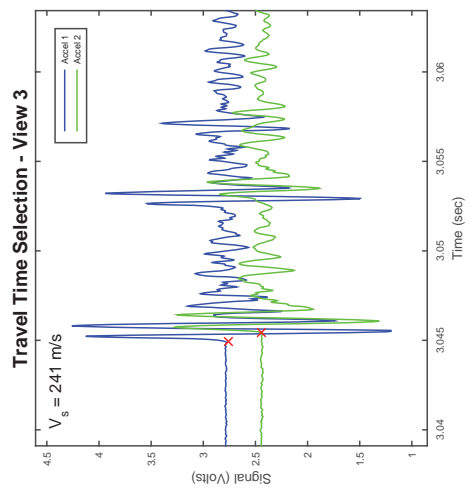
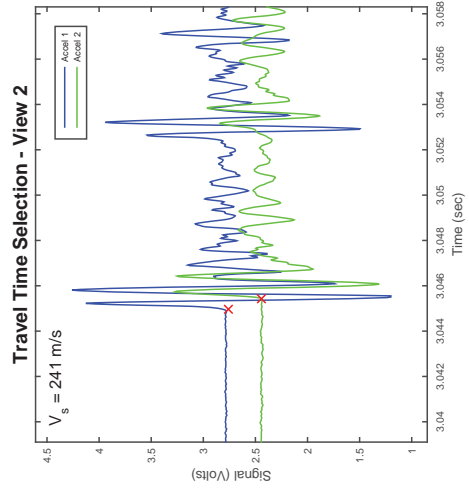
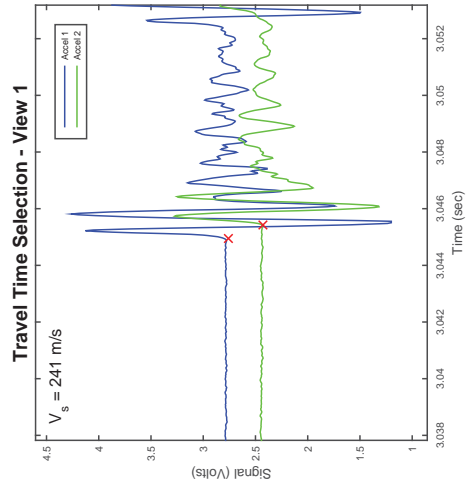
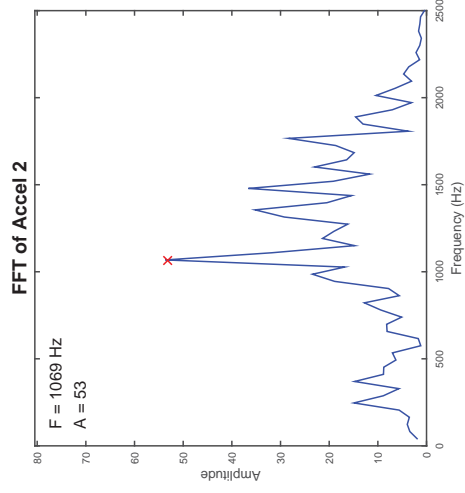
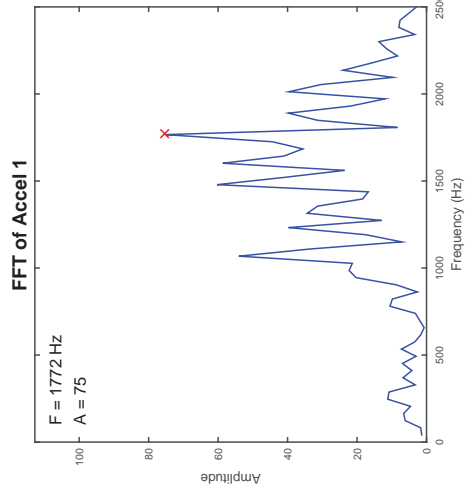
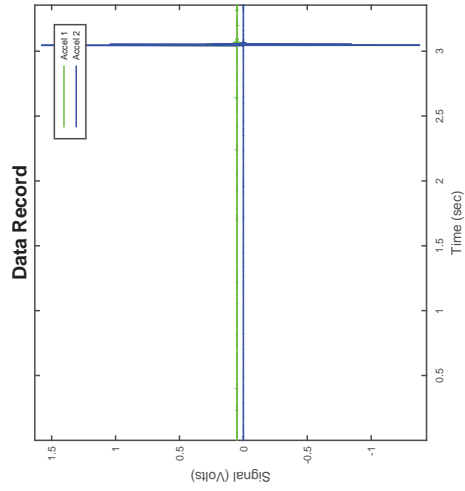

Accelerometer-Based Shear Wave Velocity Datasheet

Specimen ID: M331-40C10960PG-100-2X

Test Material: 40C10960PG

Date: 10/26/2016

Test Performed by: J.Hubler

Filename: M331-40C10960PG-100-2X

Vertical Stress: 100kPa

Sensor Spacing: 0.11343 m

V_s (rise) = 236 m/s

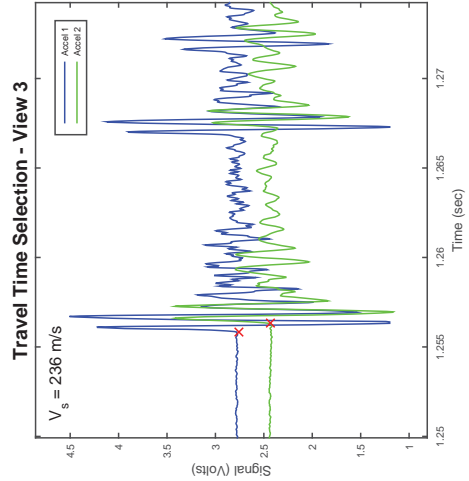
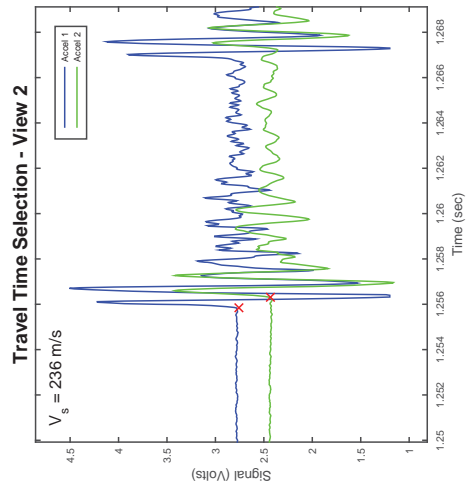
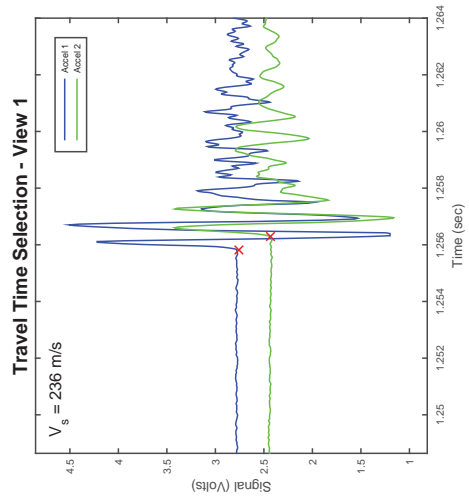
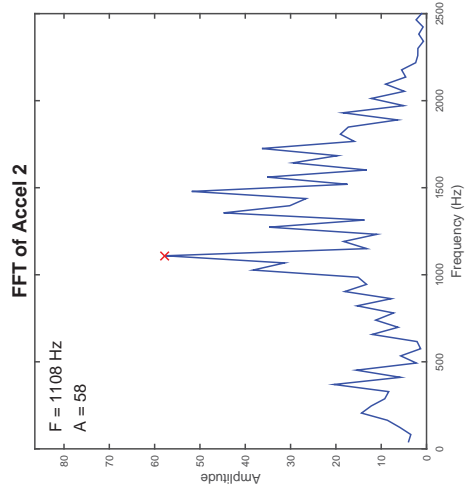
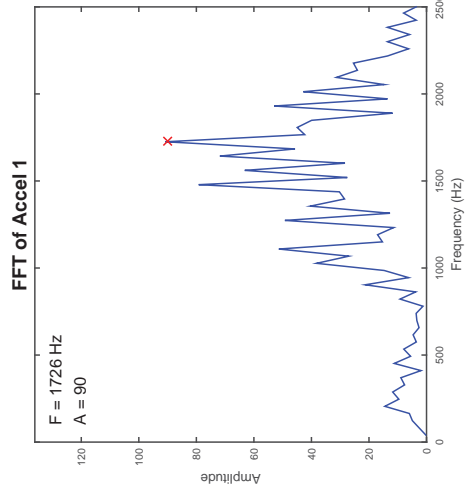
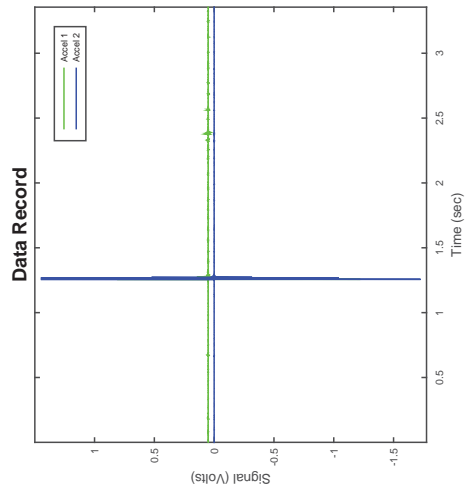

Accelerometer-Based Shear Wave Velocity Datasheet

Specimen ID: M331-40C10960PG-100-3X

Test Material: 40C10960PG

Date: 10/26/2016

Test Performed by: J.Hubler

Filename: M331-40C10960PG-100-3X

Vertical Stress: 100kPa

Sensor Spacing: 0.11343 m

V_s (rise) = 252 m/s

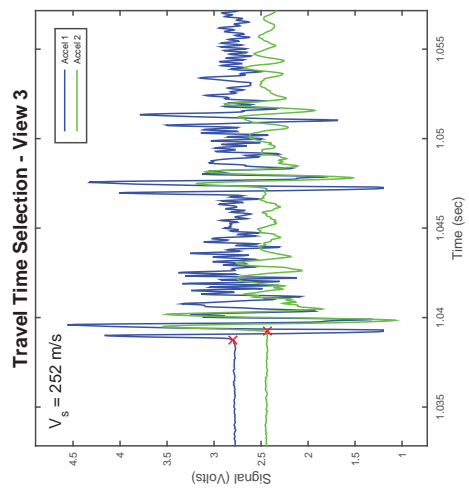
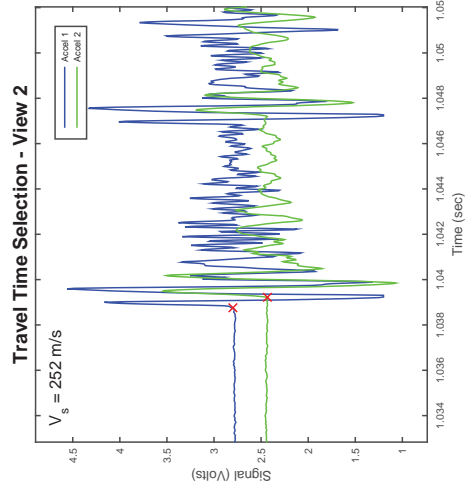
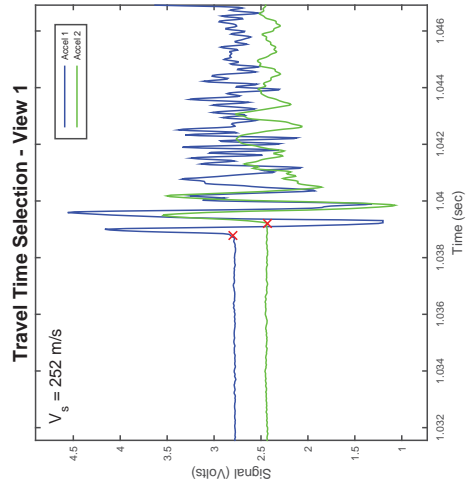
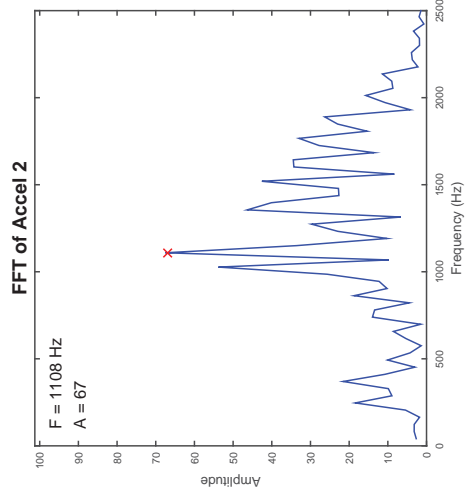
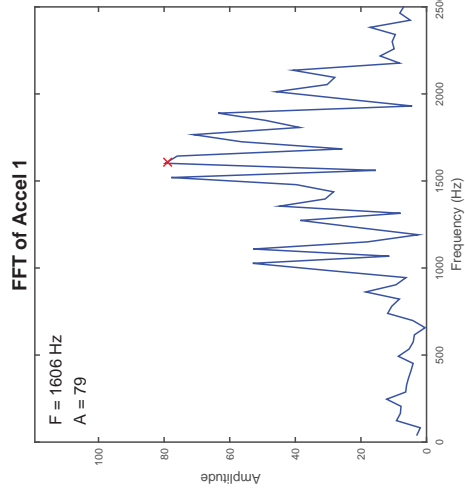
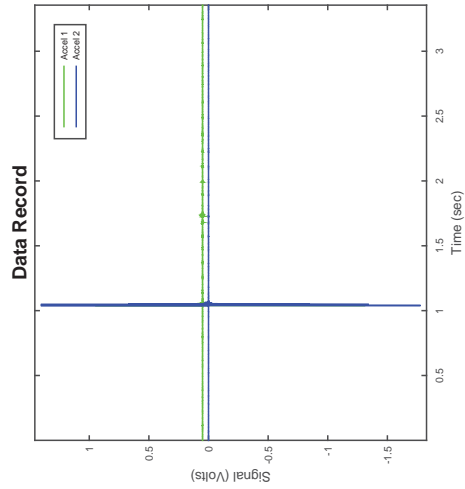

CSS Monotonic Shear Test Report

Geotechnical Engineering Laboratory



10/28/2013_Version 8.0

General Test Info and Sample Preparation

Device:	CSS	Relative Density (%):	24%
Specimen ID:	80C109_20LS	Void Ratio:	0.545
Test ID:	M305	Height (mm):	110.7
Date of Test:	4/6/2016	Soil-Only Specimen Diameter (mm):	306.20
Test Performed:	Monotonic Shear	Weight (kg):	13.985
Test Material:	C109 Ott Sand/Limestone	Density (kg/m³):	1715.3
Sample Preparation:	Prepared by funneling sand/gravel mixture with zero drop height.	Membrane Thickness (mm):	0.635
		Moisture Content (%):	0%
		Saturated (Y/N):	N
		Prepared by:	J.Hubler
		Checked by:	J. Hubler

Consolidation Stage

Shear Stage

Vertical Stress (kPa):	100	Type of Test:	Constant Volume
Time to Compression (min):	5.5	Stress or Strain Controlled:	Strain
Relative Density (%):	45%	Shear Strain Rate (%/min):	0.30
Void Ratio:	0.509	Peak Shear Strength (kPa):	11.8
Height (mm):	108.1	Comments	
Diameter (mm):	306.20		
Weight (kg):	13.985		
Density (kg/m³):	1756.9		

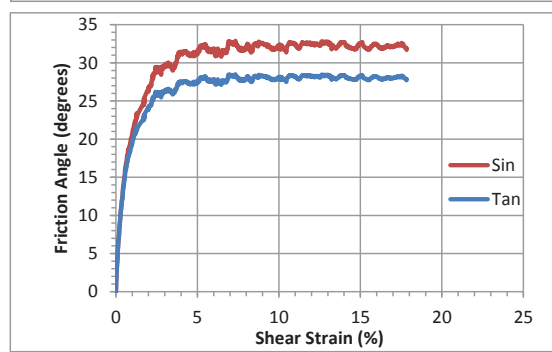
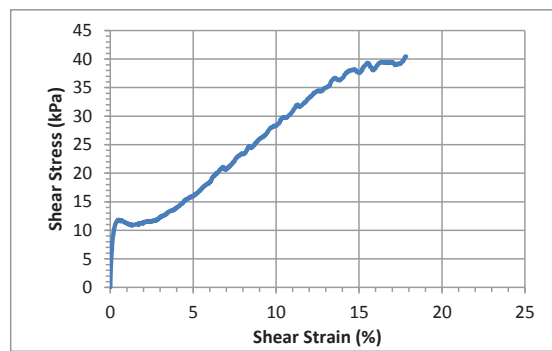
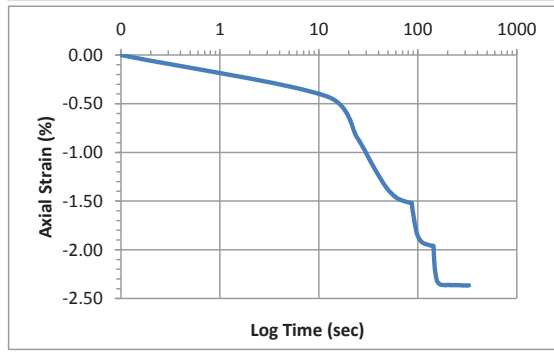
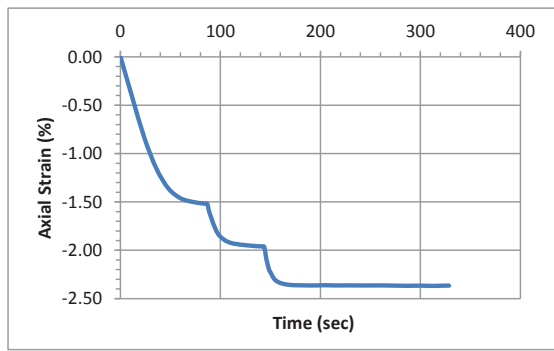

Accelerometer-Based Shear Wave Velocity Datasheet

Specimen ID: M305-LSC109-100-1X
 Test Material: LSC109
 Date: 4/6/2016
 Test Performed by: J.Hubler
 Filename: M305-LSC109-100-1X

Vertical Stress: 100kPa
 Sensor Spacing: 0.10802 m
 V_s (rise) = 207 m/s

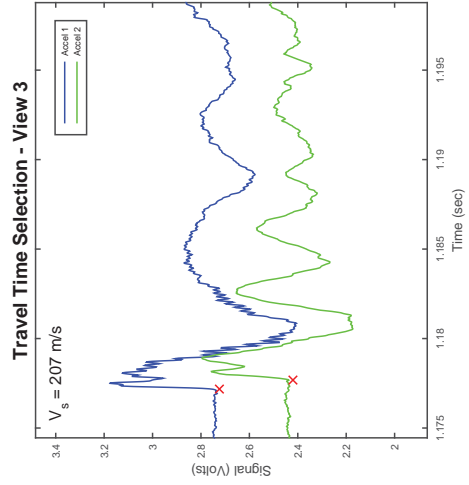
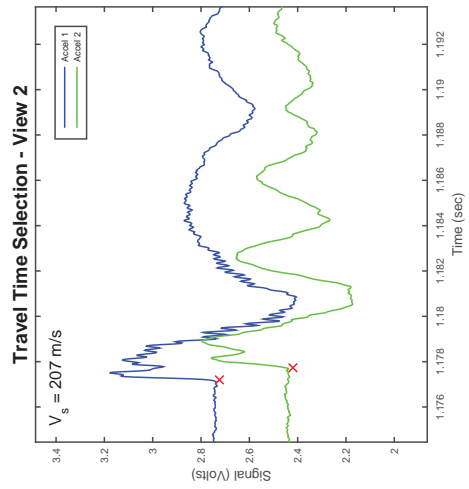
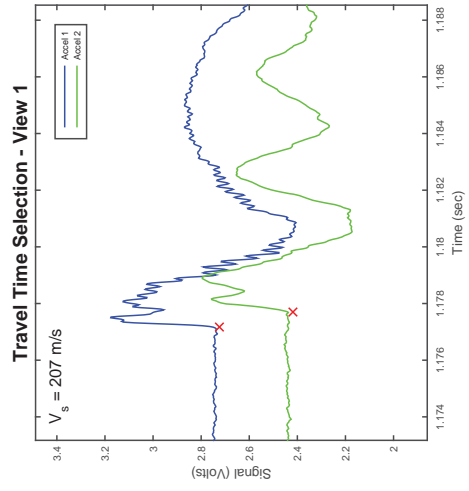
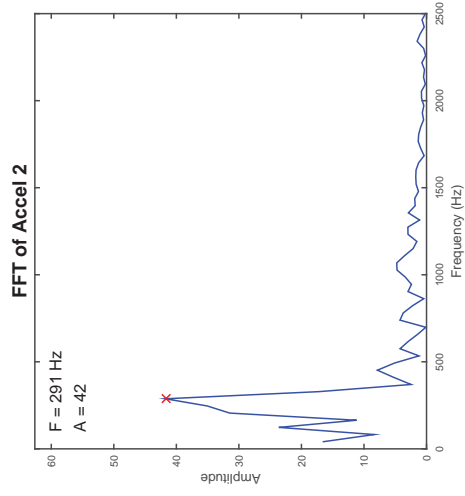
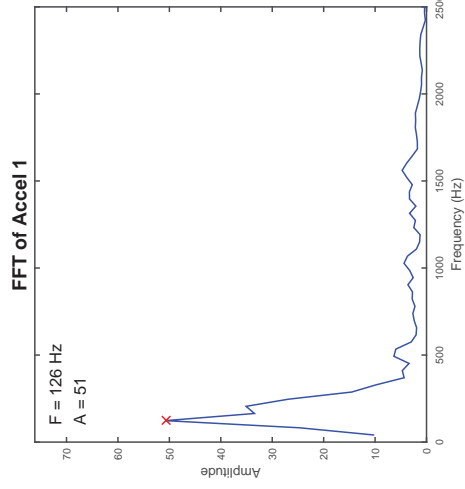
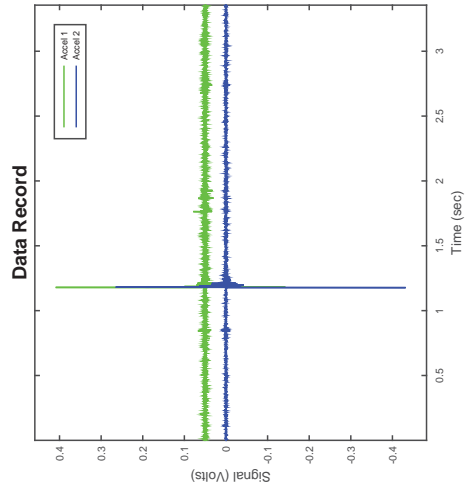

Accelerometer-Based Shear Wave Velocity Datasheet

Specimen ID: M305-LSC109-100-2X
 Test Material: LSC109
 Date: 4/6/2016
 Test Performed by: J. Hubler
 Filename: M305-LSC109-100-2X

Vertical Stress: 100kPa
 Sensor Spacing: 0.10802 m
 V_s (rise) = 215 m/s

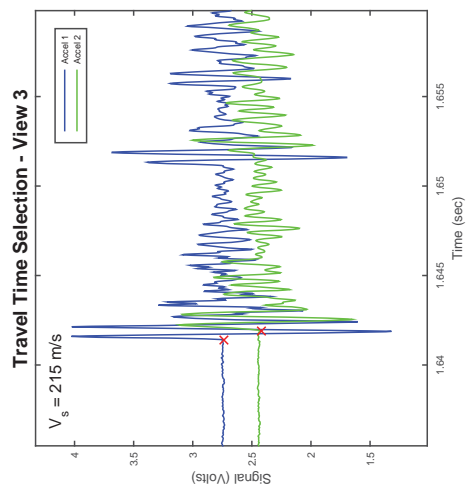
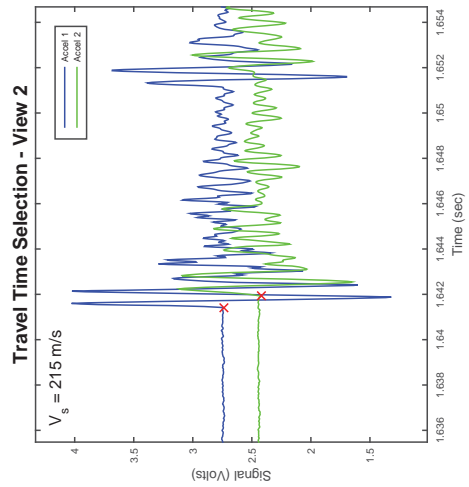
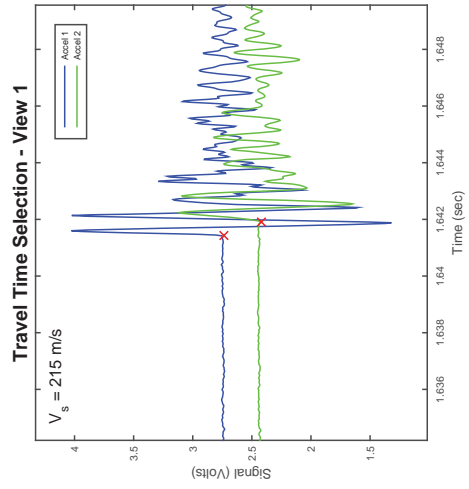
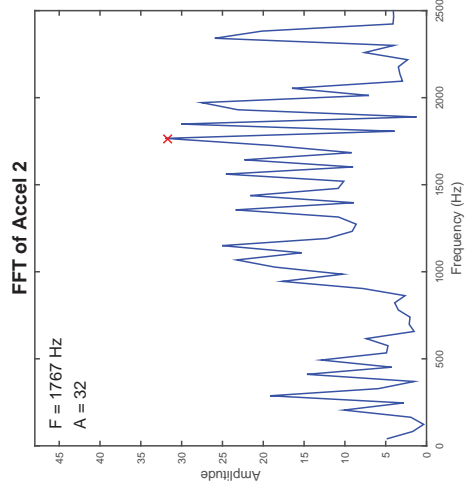
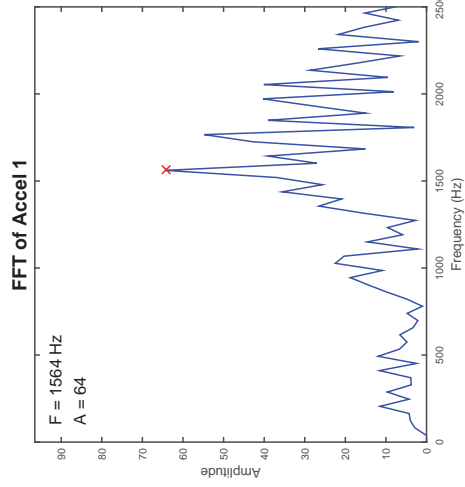
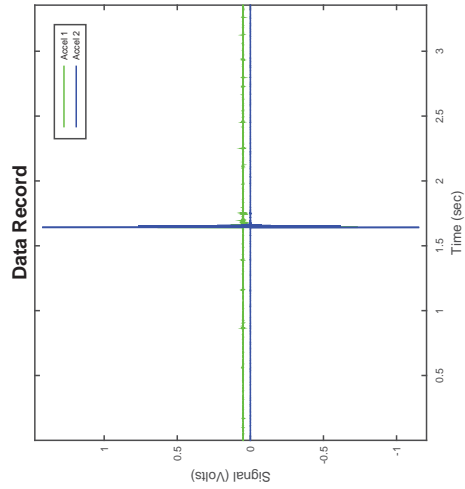

Accelerometer-Based Shear Wave Velocity Datasheet

Specimen ID: M305-LSC109-100-3X
 Test Material: LSC109
 Date: 4/6/2016
 Test Performed by: J. Hubler
 Filename: M305-LSC109-100-3X

Vertical Stress: 100kPa
 Sensor Spacing: 0.10802 m
 V_s (rise) = 203 m/s

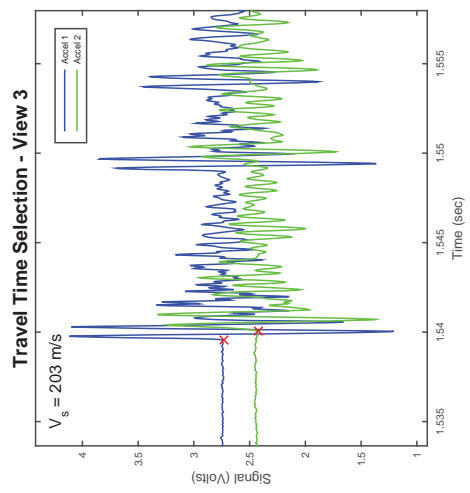
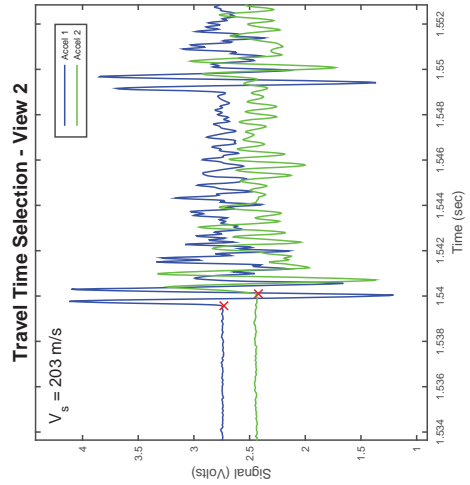
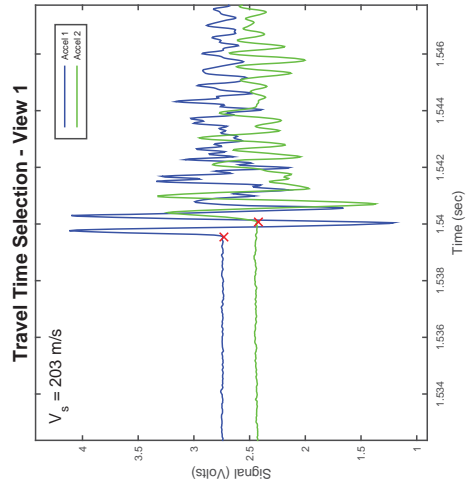
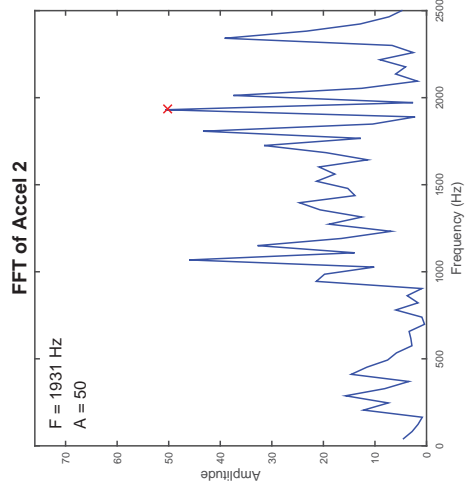
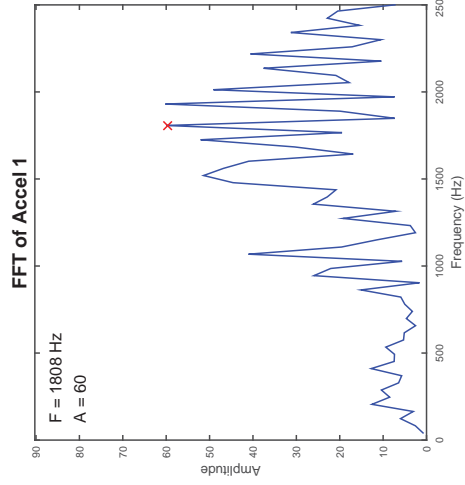
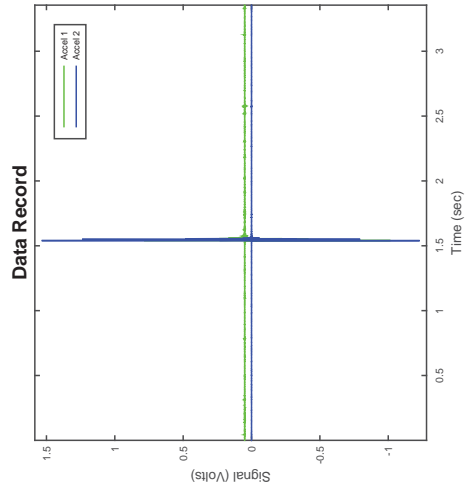

CSS Monotonic Shear Test Report

Geotechnical Engineering Laboratory



10/28/2013_Version 8.0

General Test Info and Sample Preparation

Device:	CSS	Relative Density (%):	20%
Specimen ID:	80C109_20LS	Void Ratio:	0.551
Test ID:	M308	Height (mm):	110.7
Date of Test:	4/8/2016	Soil-Only Specimen Diameter (mm):	306.20
Test Performed:	Monotonic Shear	Weight (kg):	13.930
Test Material:	C109 Ott Sand/Limestone	Density (kg/m³):	1708.4
Sample Preparation:	Prepared by funneling sand/gravel mixture with zero drop height.	Membrane Thickness (mm):	0.635
		Moisture Content (%):	0%
		Saturated (Y/N):	N
		Prepared by:	J. Hubler
		Checked by:	J. Hubler

Consolidation Stage

Shear Stage

Vertical Stress (kPa):	200	Type of Test:	Constant Volume
Time to Compression (min):	6.4	Stress or Strain Controlled:	Strain
Relative Density (%):	44%	Shear Strain Rate (%/min):	0.30
Void Ratio:	0.509	Peak Shear Strength (kPa):	26.2
Height (mm):	107.7	Comments	
Diameter (mm):	306.20		
Weight (kg):	13.930		
Density (kg/m³):	1756.0		

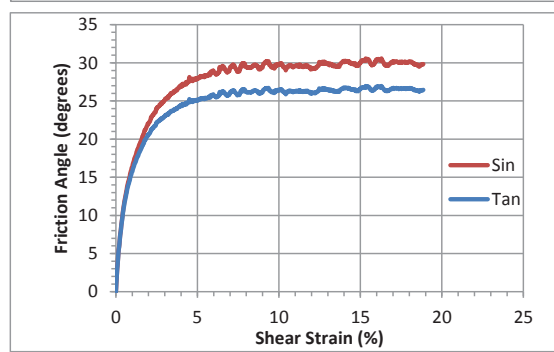
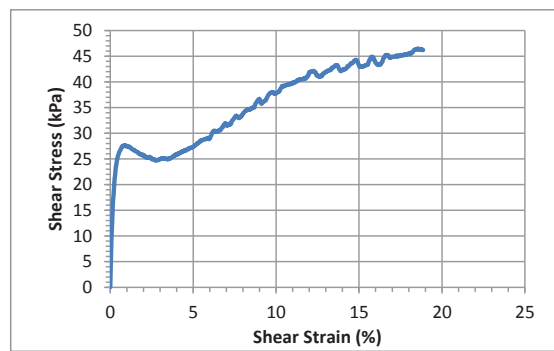
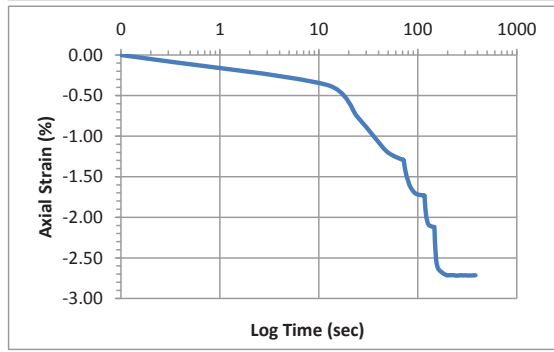
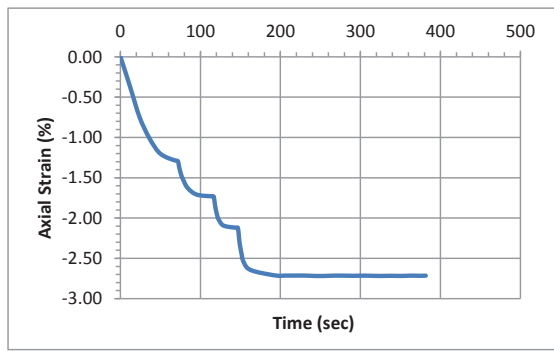

Accelerometer-Based Shear Wave Velocity Datasheet

Specimen ID: M308-LSC109-200-1X
 Test Material: LSC109
 Date: 4/11/2016
 Test Performed by: J. Hubler
 Filename: M308-LSC109-200-1X

Vertical Stress: 200kPa
 Sensor Spacing: 0.10765 m
 V_s (rise) = 245 m/s

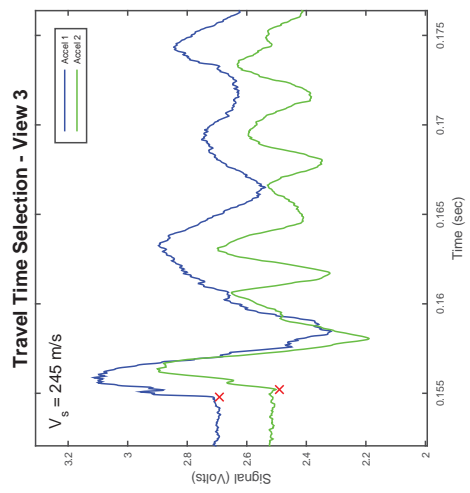
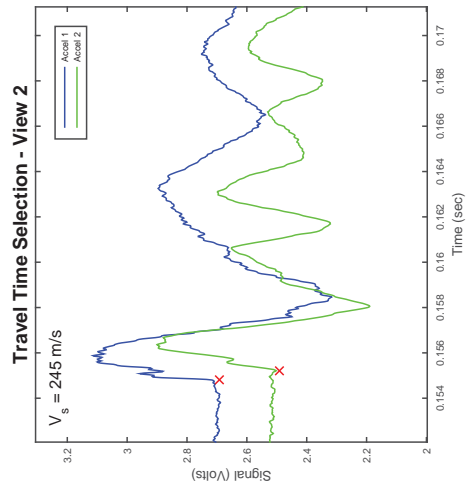
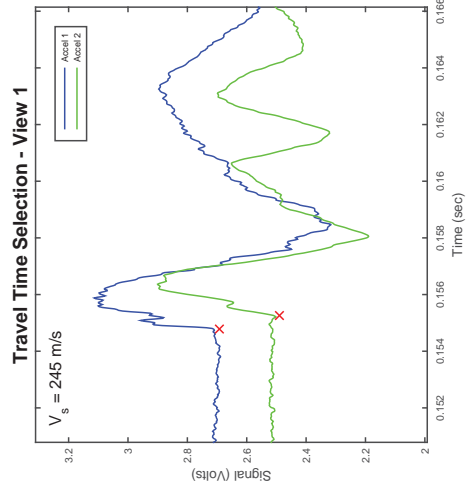
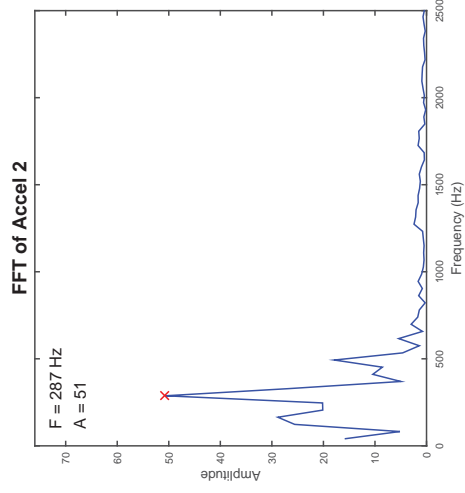
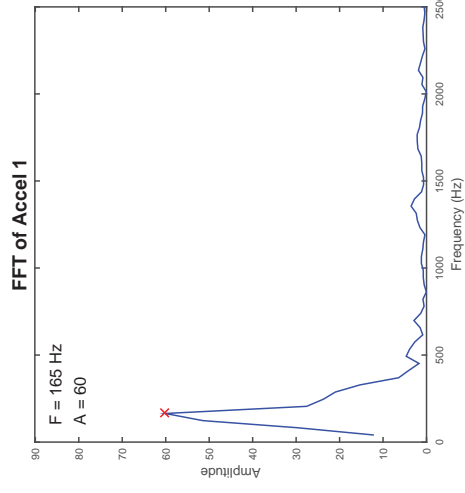
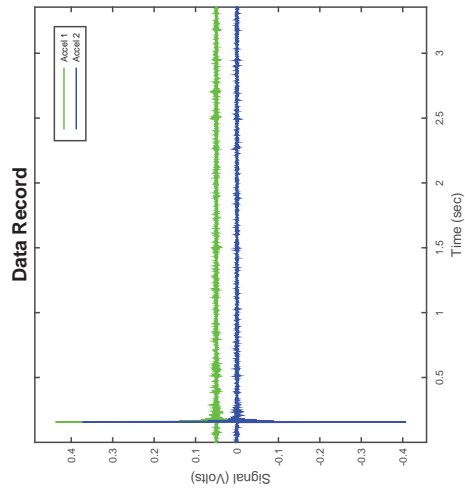

CSS Monotonic Shear Test Report

Geotechnical Engineering Laboratory



10/28/2013_Version 8.0

General Test Info and Sample Preparation

Device:	CSS	Relative Density (%):	10%
Specimen ID:	80C109_20LS	Void Ratio:	0.569
Test ID:	M307	Height (mm):	112.2
Date of Test:	4/8/2016	Soil-Only Specimen Diameter (mm):	306.20
Test Performed:	Monotonic Shear	Weight (kg):	13.957
Test Material:	C109 Ott Sand/Limestone	Density (kg/m³):	1689.8
Sample Preparation:	Prepared by funneling sand/gravel mixture with zero drop height.	Membrane Thickness (mm):	0.635
		Moisture Content (%):	0%
		Saturated (Y/N):	N
		Prepared by:	J.Hubler
		Checked by:	J. Hubler

Consolidation Stage

Vertical Stress (kPa):	400
Time to Compression (min):	8.0
Relative Density (%):	42%
Void Ratio:	0.514
Height (mm):	108.3
Diameter (mm):	306.20
Weight (kg):	13.957
Density (kg/m³):	1750.5

Shear Stage

Type of Test:	Constant Volume
Stress or Strain Controlled:	Strain
Shear Strain Rate (%/min):	0.30
Peak Shear Strength (kPa):	52.1

Comments

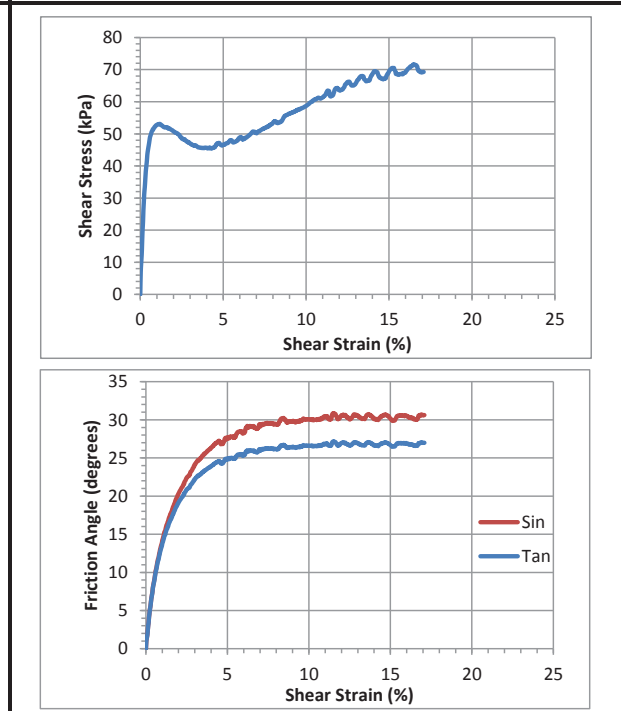
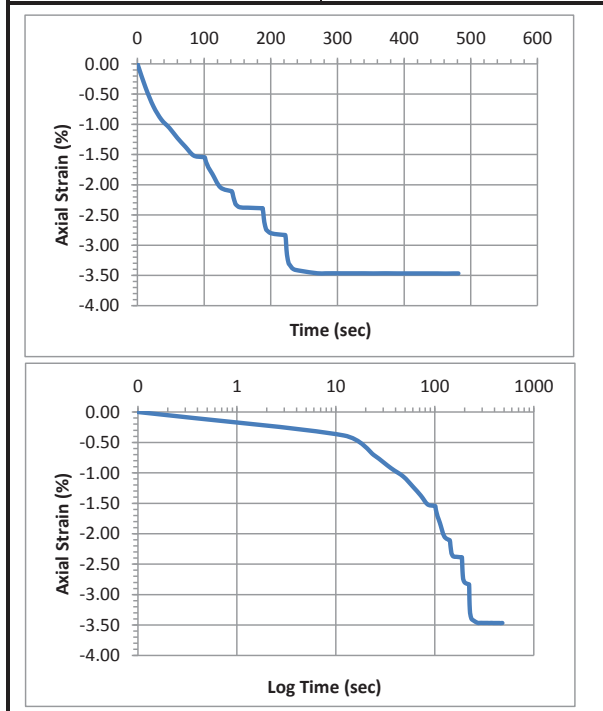

Accelerometer-Based Shear Wave Velocity Datasheet

Specimen ID: M307-LSC109-400-2X
 Test Material: LSC109
 Date: 4/8/2016
 Test Performed by: J. Hubler
 Filename: M307-LSC109-400-2X

Vertical Stress: 400kPa
 Sensor Spacing: 0.1082 m
 V_s (rise) = 287 m/s

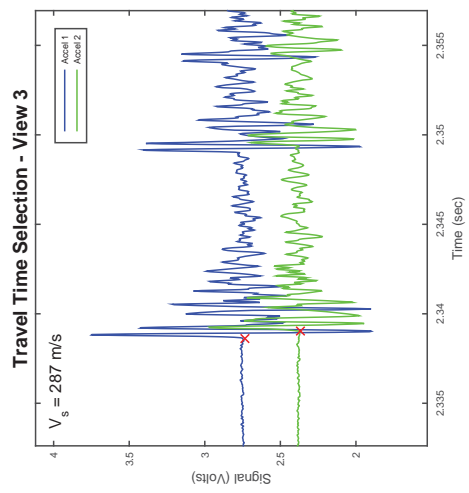
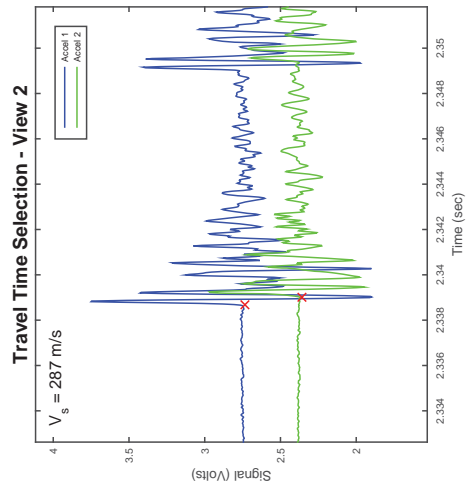
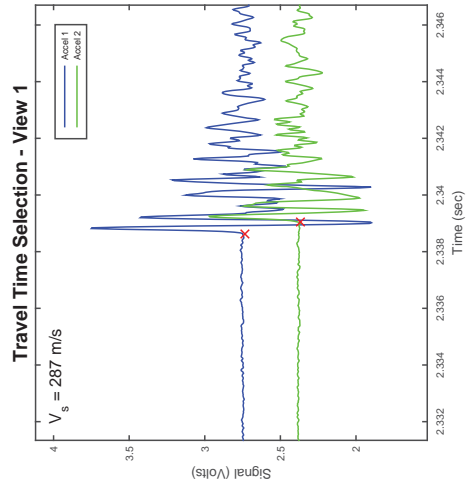
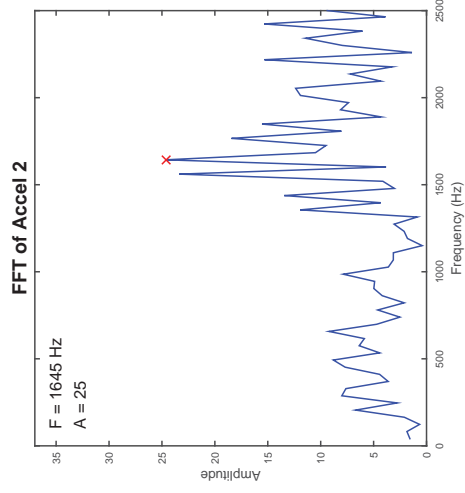
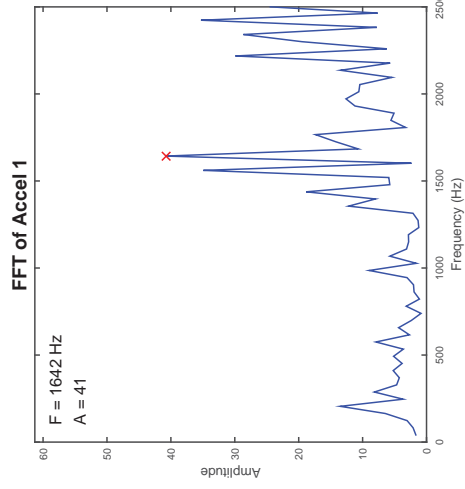
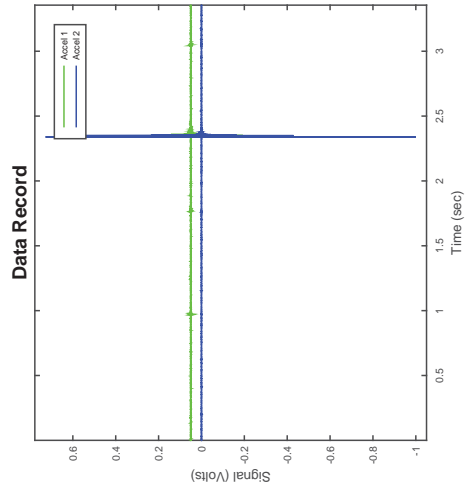

CSS Monotonic Shear Test Report

Geotechnical Engineering Laboratory



10/28/2013_Version 8.0

General Test Info and Sample Preparation

Device:	CSS	Relative Density (%):	26%
Specimen ID:	60C109_40LS	Void Ratio:	0.423
Test ID:	M313	Height (mm):	108.9
Date of Test:	4/13/2016	Soil-Only Specimen Diameter (mm):	306.20
Test Performed:	Monotonic Shear	Weight (kg):	14.933
Test Material:	C109 Ott Sand/Limestone	Density (kg/m³):	1862.9
Sample Preparation:	Prepared by funneling sand/gravel mixture with zero drop height.	Membrane Thickness (mm):	0.635
		Moisture Content (%):	0%
		Saturated (Y/N):	N
		Prepared by:	J. Hubler
		Checked by:	J. Hubler

Consolidation Stage

Vertical Stress (kPa):	100
Time to Compression (min):	6.5
Relative Density (%):	50%
Void Ratio:	0.394
Height (mm):	106.7
Diameter (mm):	306.20
Weight (kg):	14.933
Density (kg/m³):	1901.1

Shear Stage

Type of Test:	Constant Volume
Stress or Strain Controlled:	Strain
Shear Strain Rate (%/min):	0.31
Peak Shear Strength (kPa):	13.5

Comments

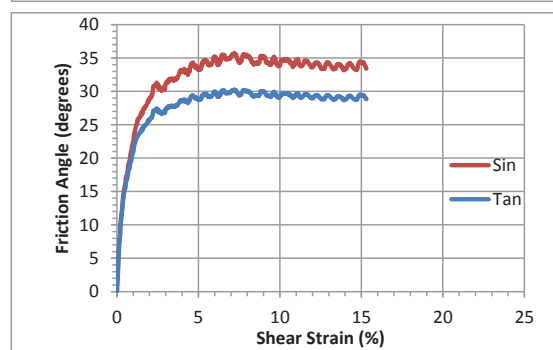
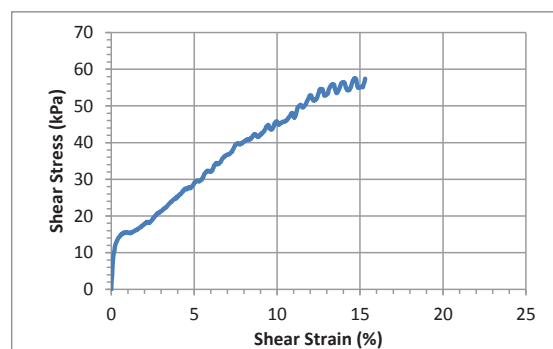
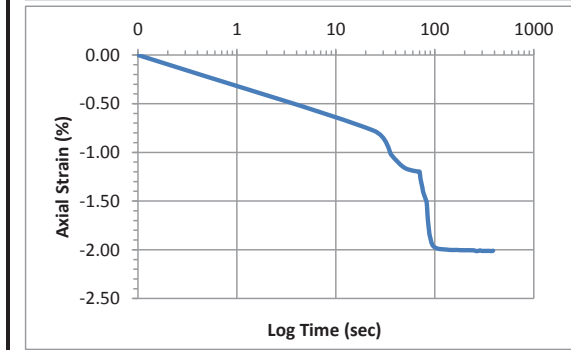
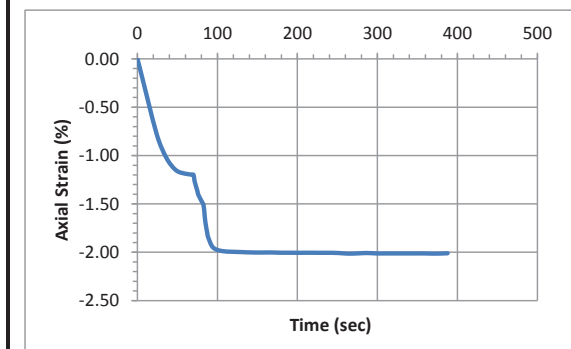

Accelerometer-Based Shear Wave Velocity Datasheet

Vertical Stress: 100kPa
 Sensor Spacing: 0.10659 m
 V_s (rise) = 224 m/s

Specimen ID: M313-LSC109-100-2X
 Test Material: LSC109
 Date: 4/13/2016
 Test Performed by: J.Hubler
 Filename: M313-LSC109-100-2X

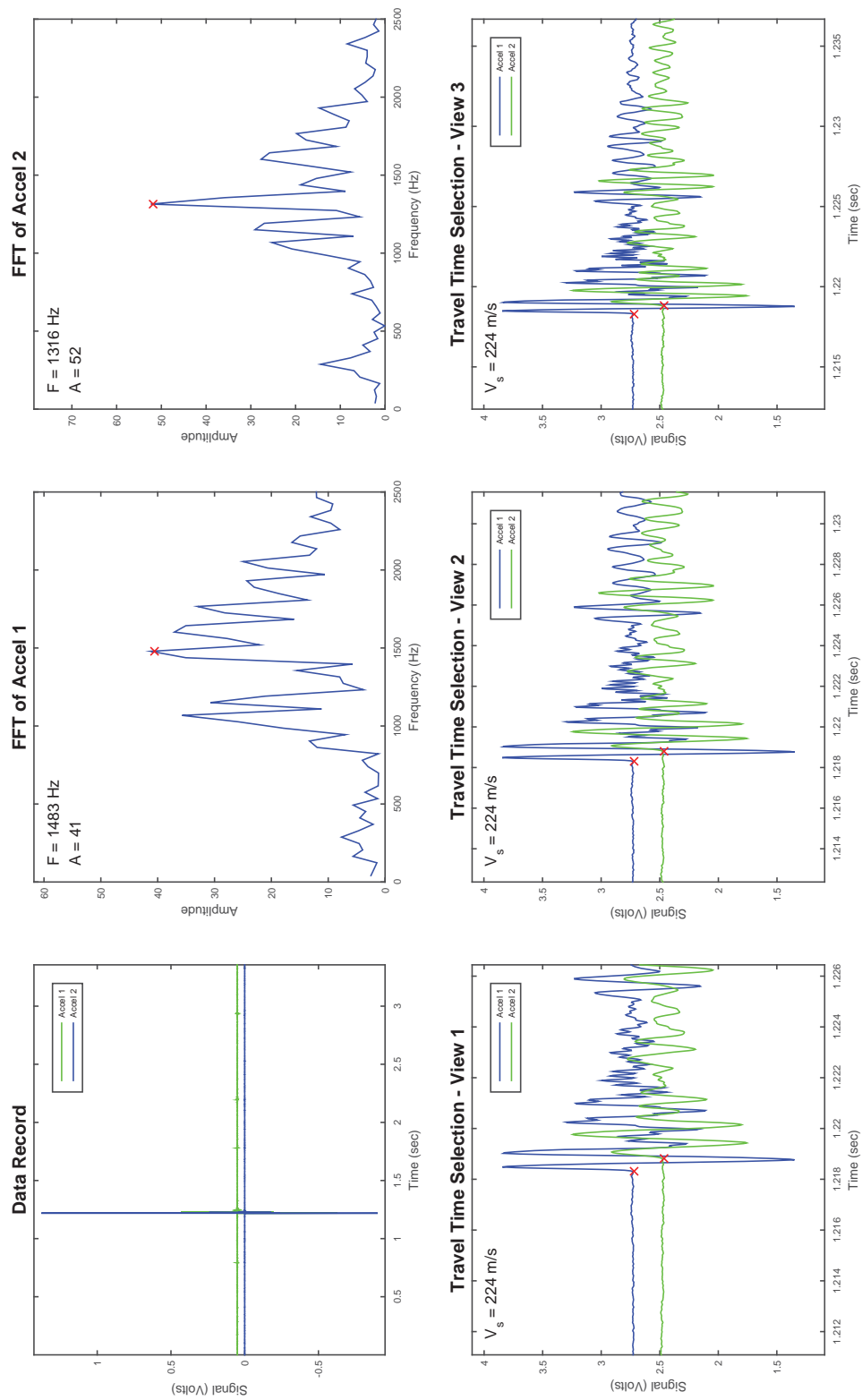

CSS Monotonic Shear Test Report

Geotechnical Engineering Laboratory



10/28/2013_Version 8.0

General Test Info and Sample Preparation

Device:	CSS	Relative Density (%):	28%
Specimen ID:	60C109_40LS	Void Ratio:	0.420
Test ID:	M310	Height (mm):	109.2
Date of Test:	4/13/2016	Soil-Only Specimen Diameter (mm):	306.20
Test Performed:	Monotonic Shear	Weight (kg):	15.000
Test Material:	C109 Ott Sand/Limestone	Density (kg/m³):	1866.0
Sample Preparation:	Prepared by funneling sand/gravel mixture with zero drop height.	Membrane Thickness (mm):	0.635
		Moisture Content (%):	0%
		Saturated (Y/N):	N
		Prepared by:	J. Hubler
		Checked by:	J. Hubler

Consolidation Stage

Shear Stage

Vertical Stress (kPa):	200	Type of Test:	Constant Volume
Time to Compression (min):	4.9	Stress or Strain Controlled:	Strain
Relative Density (%):	47%	Shear Strain Rate (%/min):	0.30
Void Ratio:	0.398	Peak Shear Strength (kPa):	18.3
Height (mm):	107.4	Comments	
Diameter (mm):	306.20		
Weight (kg):	15.000		
Density (kg/m³):	1895.9		

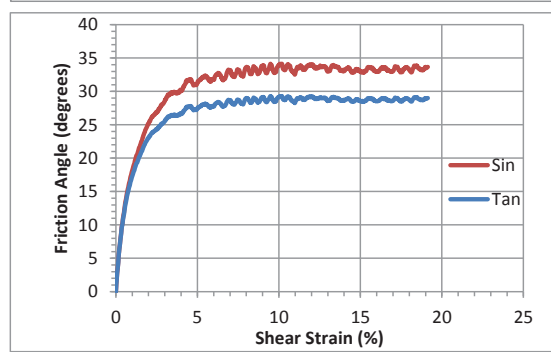
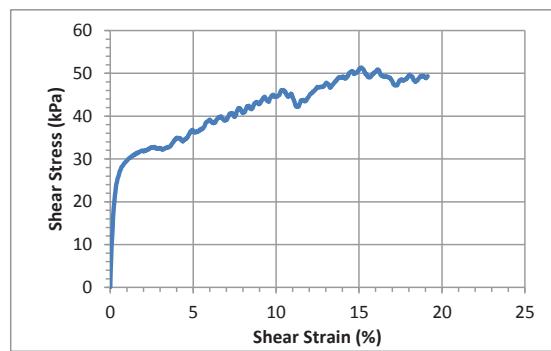
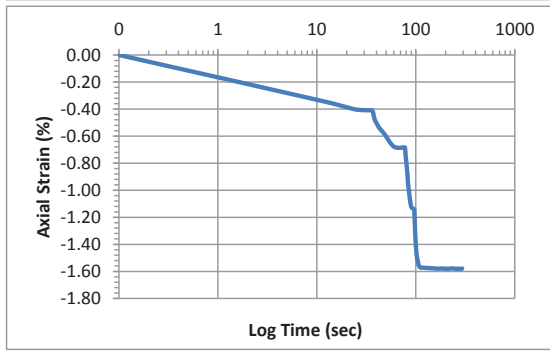
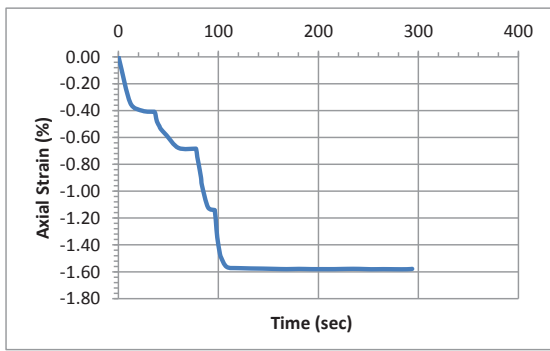

Accelerometer-Based Shear Wave Velocity Datasheet

Vertical Stress: 200kPa
 Sensor Spacing: 0.10736 m
 V_s (rise) = 267 m/s

Specimen ID: M310-LSC109-200-1X
 Test Material: LSC109
 Date: 4/13/2016
 Test Performed by: J.Hubler
 Filename: M310-LSC109-200-1X

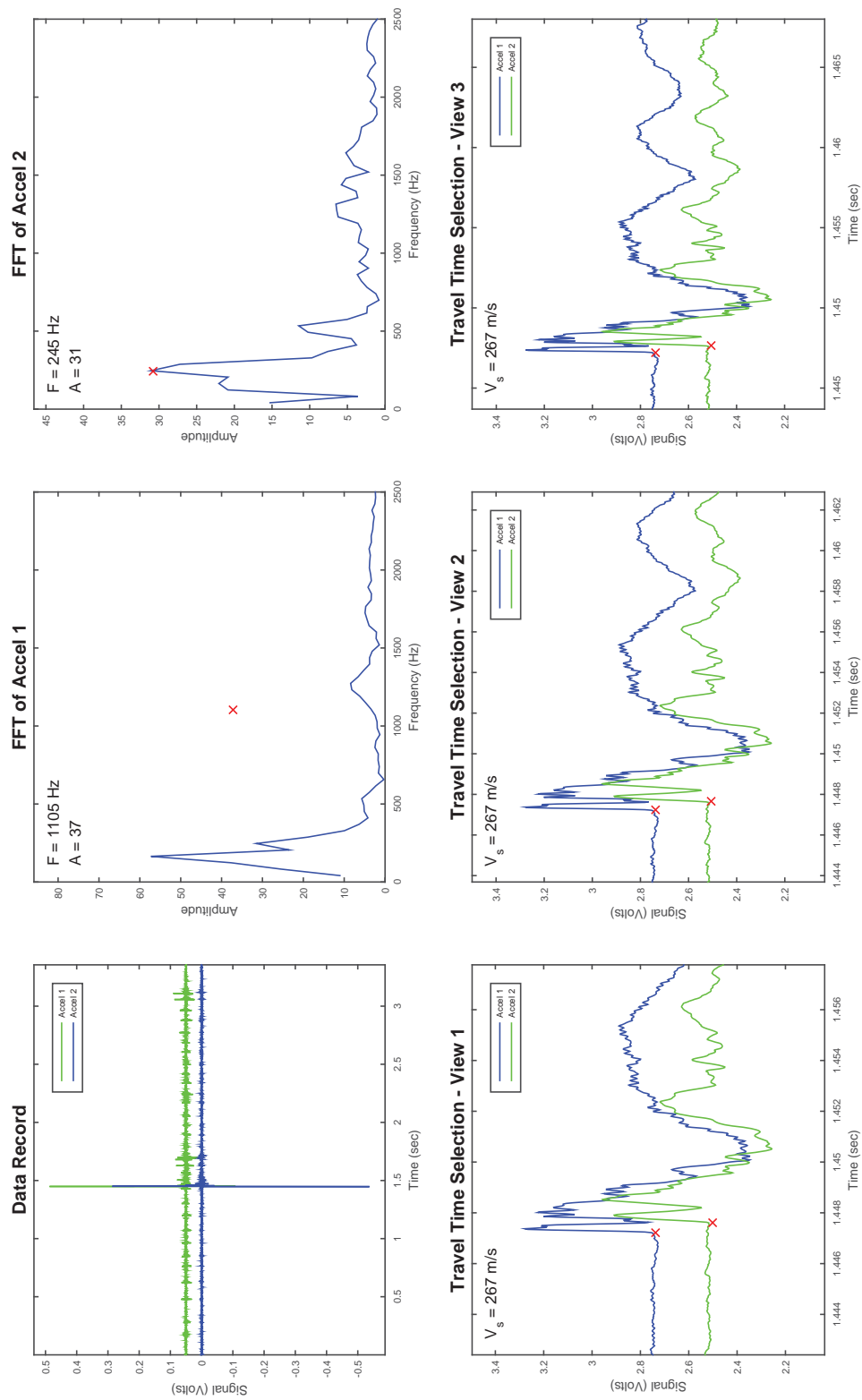

Accelerometer-Based Shear Wave Velocity Datasheet

Specimen ID: M310-LSC109-200-2X
 Test Material: LSC109
 Date: 4/13/2016
 Test Performed by: J.Hubler
 Filename: M310-LSC109-200-2X

Vertical Stress: 200kPa
 Sensor Spacing: 0.10736 m
 V_s (rise) = 277 m/s

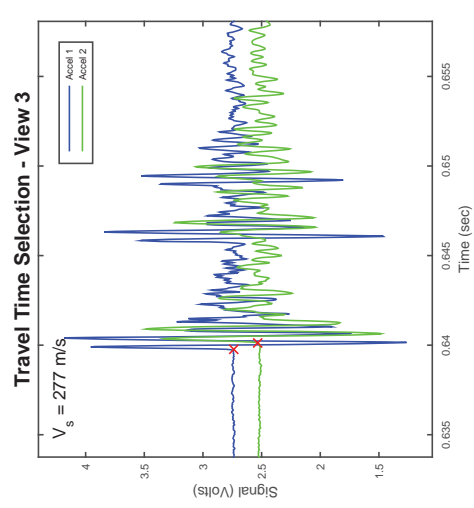
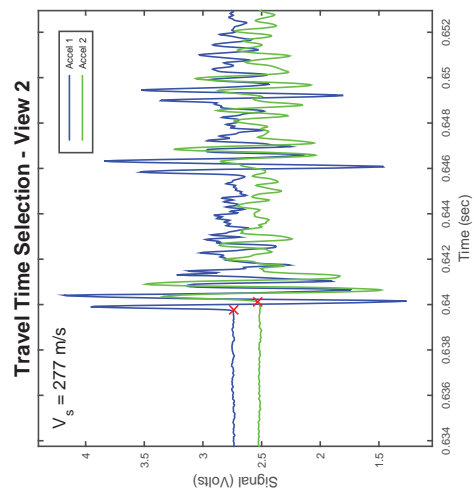
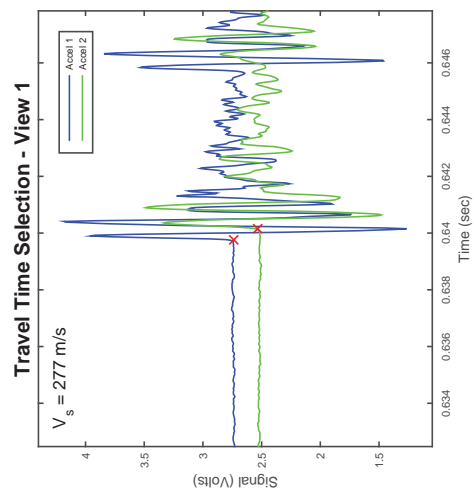
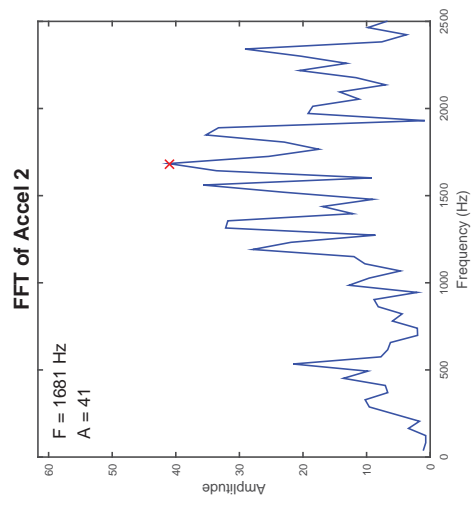
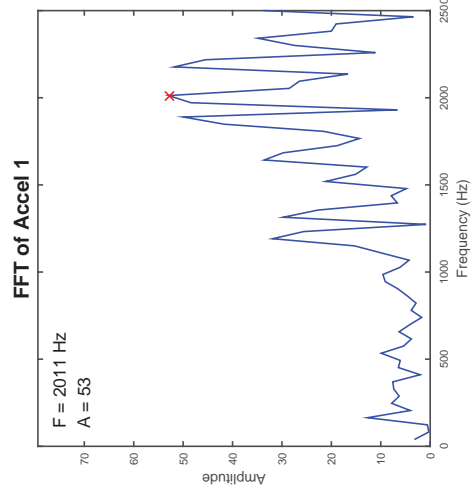
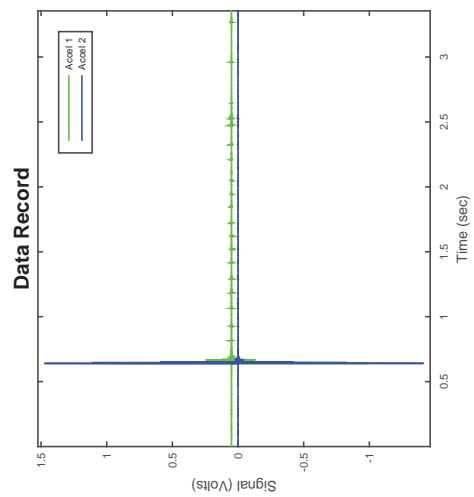

Accelerometer-Based Shear Wave Velocity Datasheet

Specimen ID: M310-LSC109-200-3X
 Test Material: LSC109
 Date: 4/13/2016
 Test Performed by: J.Hubler
 Filename: M310-LSC109-200-3X

Vertical Stress: 200kPa
 Sensor Spacing: 0.10736 m
 V_s (rise) = 277 m/s

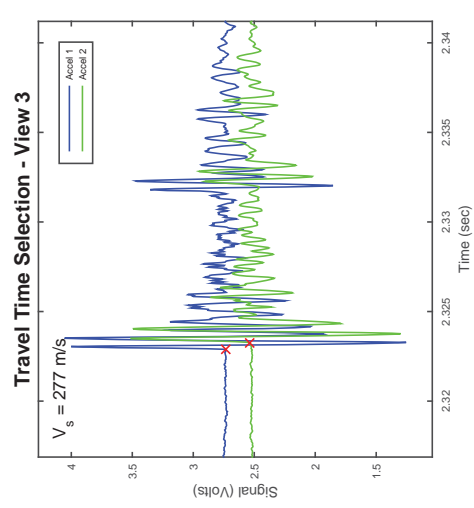
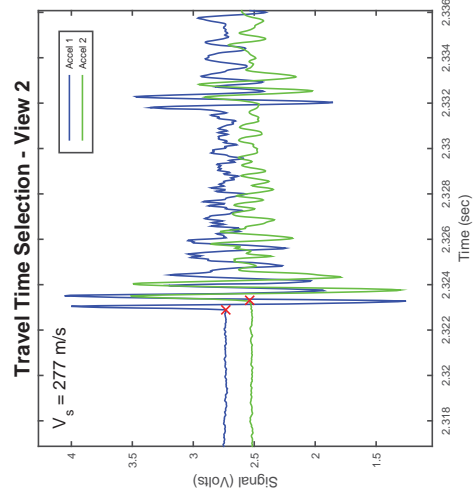
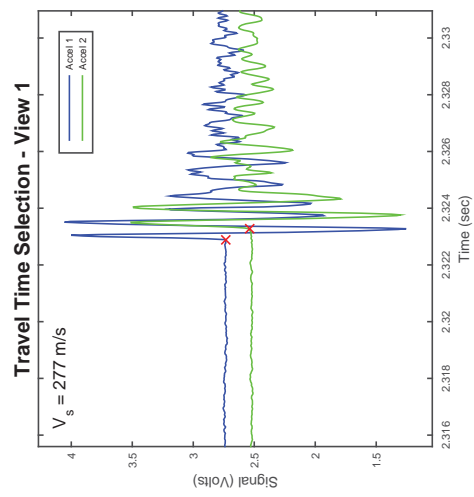
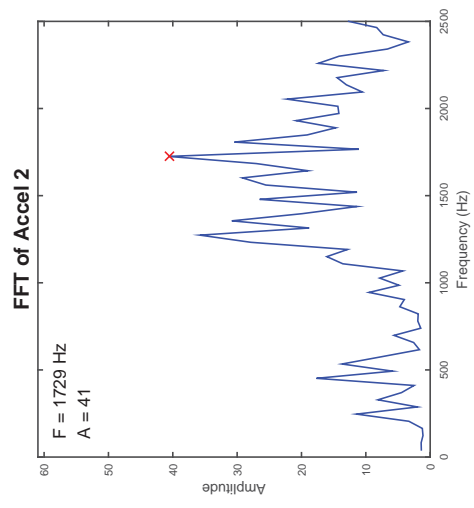
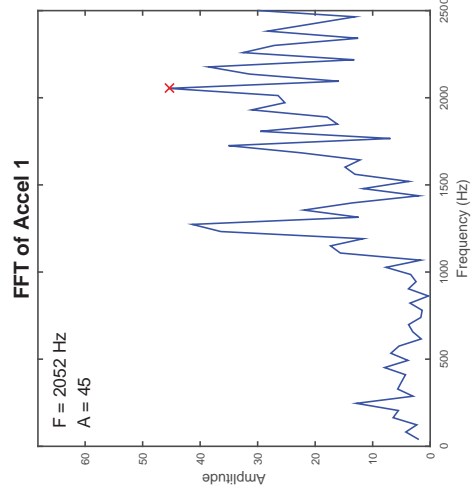
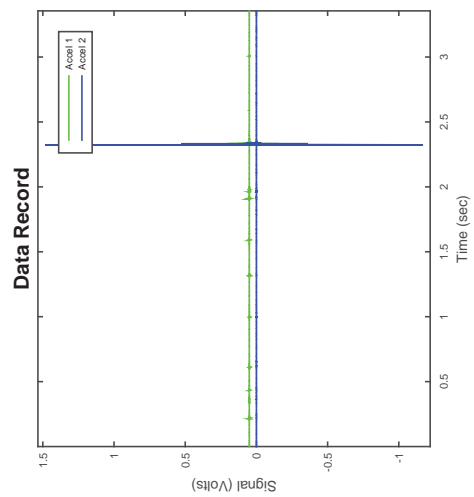

CSS Monotonic Shear Test Report

Geotechnical Engineering Laboratory



10/28/2013_Version 8.0

General Test Info and Sample Preparation

Device:	CSS	Relative Density (%):	15%
Specimen ID:	60C109_40LS	Void Ratio:	0.436
Test ID:	M314	Height (mm):	109.5
Date of Test:	4/17/2016	Soil-Only Specimen Diameter (mm):	306.20
Test Performed:	Monotonic Shear	Weight (kg):	14.881
Test Material:	C109 Ott Sand/Limestone	Density (kg/m³):	1845.8
Sample Preparation:	Prepared by funneling sand/gravel mixture with zero drop height.	Membrane Thickness (mm):	0.635
		Moisture Content (%):	0%
		Saturated (Y/N):	N
		Prepared by:	J. Hubler
		Checked by:	J. Hubler

Consolidation Stage

Vertical Stress (kPa):	400
Time to Compression (min):	5.4
Relative Density (%):	44%
Void Ratio:	0.402
Height (mm):	106.9
Diameter (mm):	306.20
Weight (kg):	14.881
Density (kg/m³):	1890.3

Shear Stage

Type of Test:	Constant Volume
Stress or Strain Controlled:	Strain
Shear Strain Rate (%/min):	0.30
Peak Shear Strength (kPa):	69.6

Comments

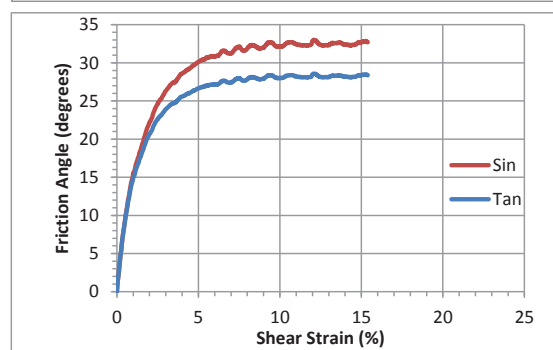
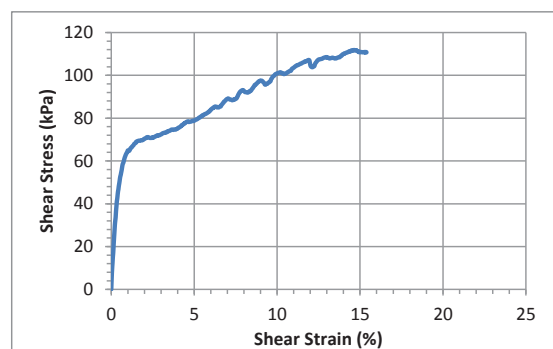
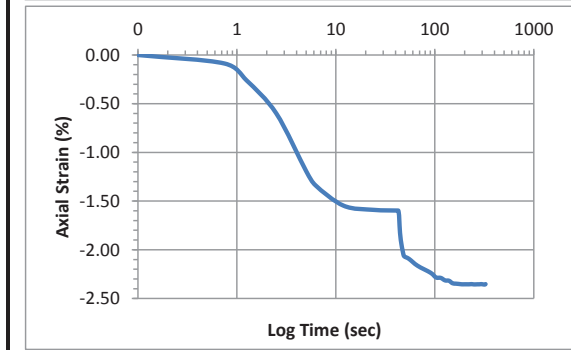
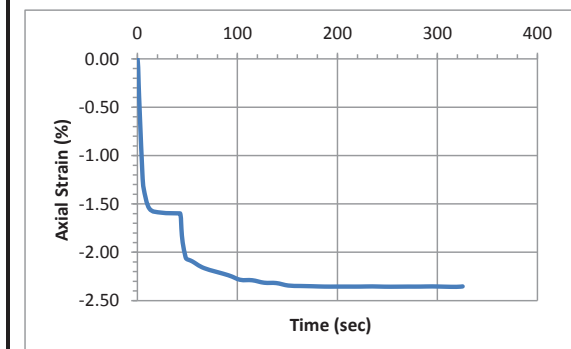

Accelerometer-Based Shear Wave Velocity Datasheet

Specimen ID: M314-LSC109-400-2X
 Test Material: LSC109
 Date: 4/17/2016
 Test Performed by: J.Hubler
 Filename: M314-LSC109-400-2X

Vertical Stress: 400kPa
 Sensor Spacing: 0.10683 m
 V_s (rise) = 311 m/s

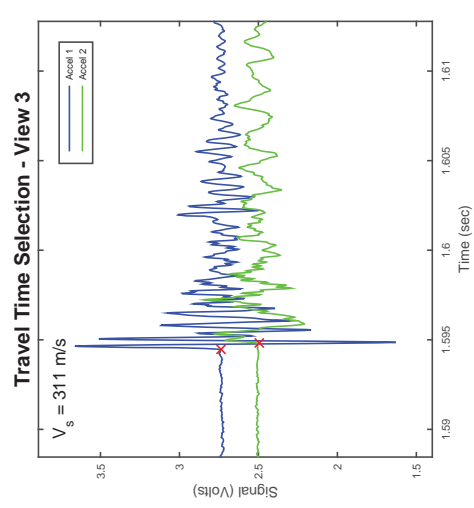
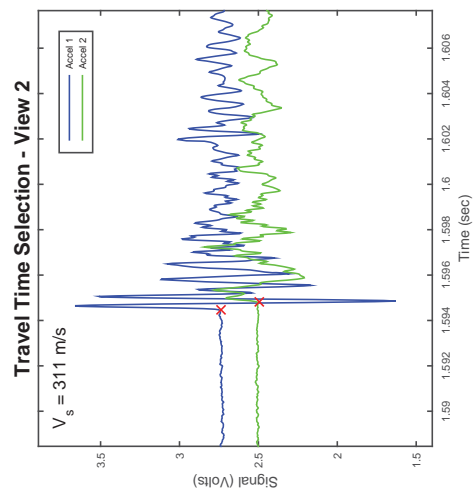
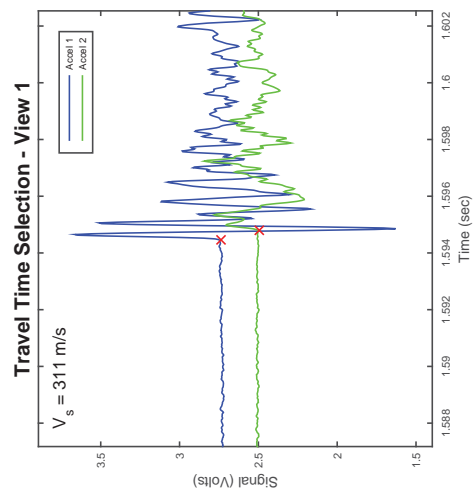
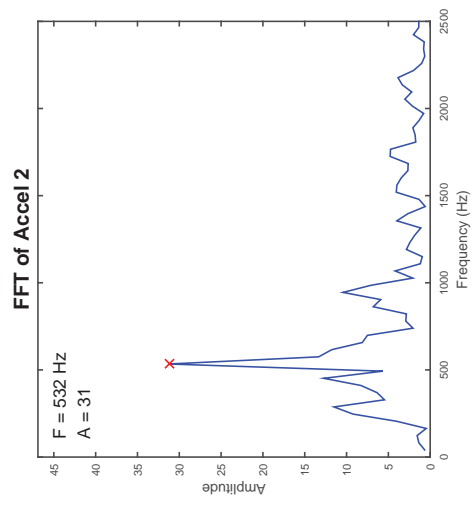
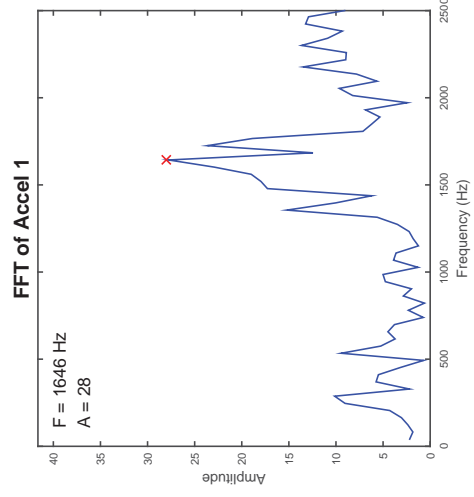
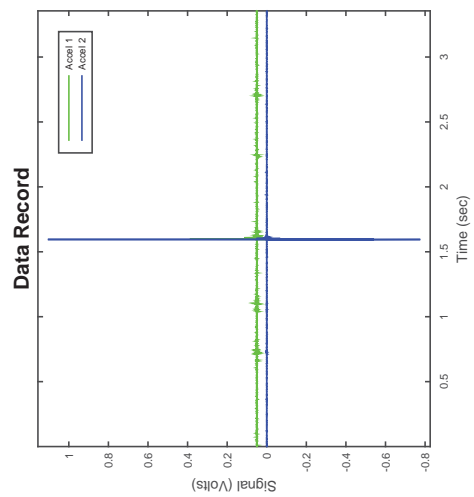

CSS Monotonic Shear Test Report

Geotechnical Engineering Laboratory



10/28/2013_Version 8.0

General Test Info and Sample Preparation

Device:	CSS	Relative Density (%):	9%
Specimen ID:	40C109_60LS	Void Ratio:	0.409
Test ID:	M316	Height (mm):	114.5
Date of Test:	4/19/2016	Soil-Only Specimen Diameter (mm):	306.20
Test Performed:	Monotonic Shear	Weight (kg):	15.861
Test Material:	C109 Ott Sand/Limestone	Density (kg/m³):	1880.8
Sample Preparation:	Prepared by funneling sand/gravel mixture with zero drop height.	Membrane Thickness (mm):	0.635
		Moisture Content (%):	0%
		Saturated (Y/N):	N
		Prepared by:	J. Hubler
		Checked by:	J. Hubler

Consolidation Stage

Vertical Stress (kPa):	100
Time to Compression (min):	6.9
Relative Density (%):	45%
Void Ratio:	0.371
Height (mm):	111.4
Diameter (mm):	306.20
Weight (kg):	15.861
Density (kg/m³):	1933.9

Shear Stage

Type of Test:	Constant Volume
Stress or Strain Controlled:	Strain
Shear Strain Rate (%/min):	0.29
Peak Shear Strength (kPa):	15.8

Comments

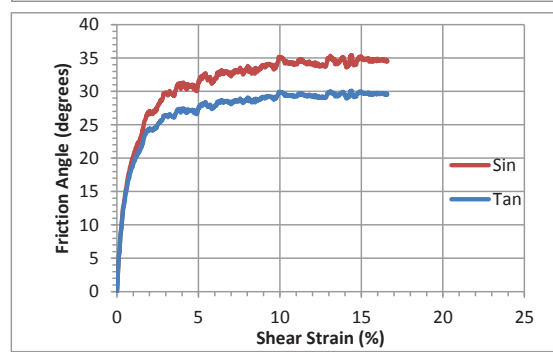
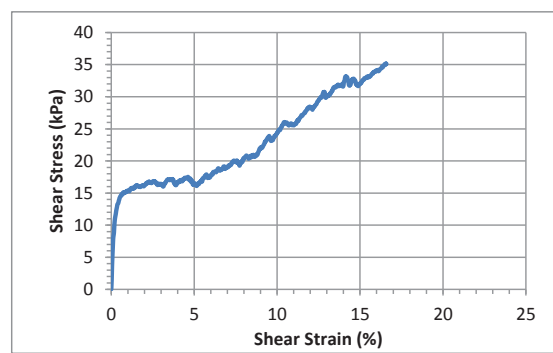
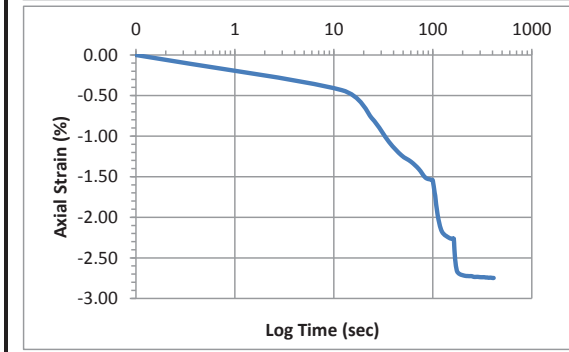
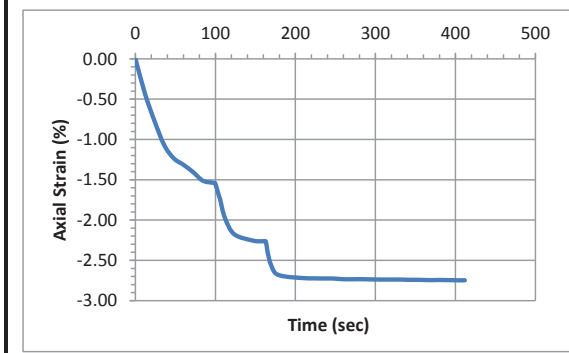

Accelerometer-Based Shear Wave Velocity Datasheet

Specimen ID: M316-LSC109-100-1X

Test Material: LSC109

Date: 4/19/2016

Test Performed by: J.Hubler

Filename: M316-LSC109-100-1X

Vertical Stress: 100kPa

Sensor Spacing: 0.1113 m

V_s (rise) = 203 m/s

Data Record

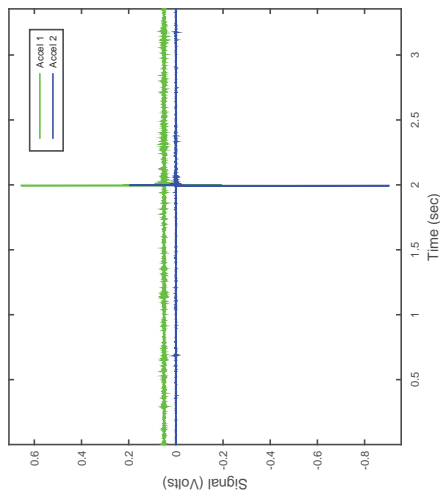

FFT of Accel 1

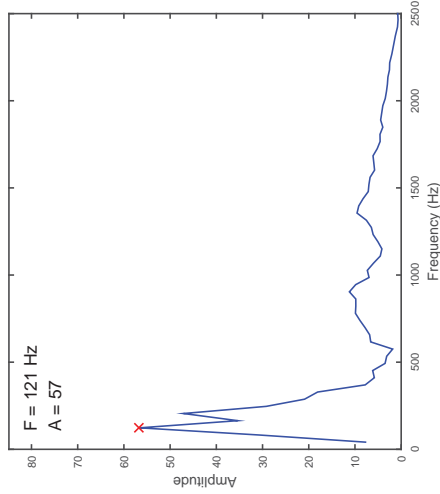

FFT of Accel 2

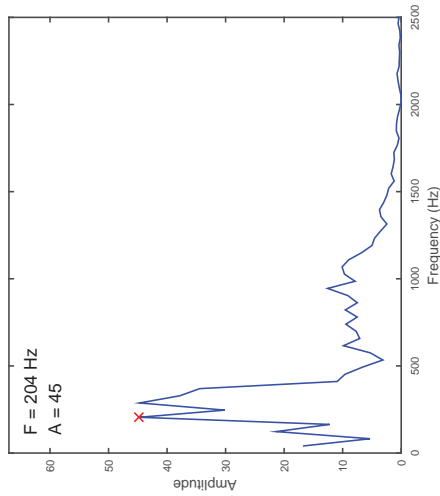

Travel Time Selection - View 1

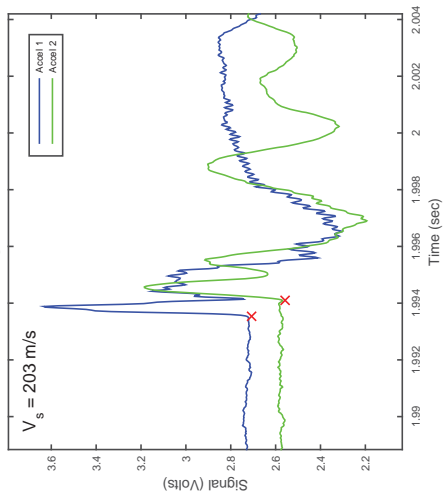

Travel Time Selection - View 2

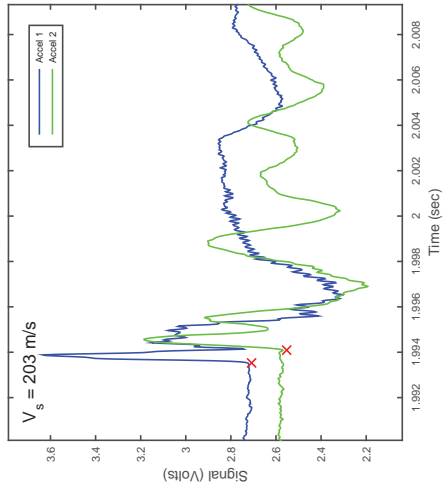

Travel Time Selection - View 3

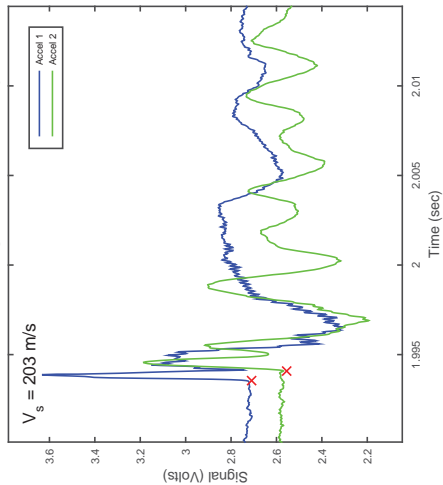

Accelerometer-Based Shear Wave Velocity Datasheet

Specimen ID: M316-LSC109-100-2X
 Test Material: LSC109
 Date: 4/19/2016
 Test Performed by: J.Hubler
 Filename: M316-LSC109-100-2X

Vertical Stress: 100kPa
 Sensor Spacing: 0.1113 m
 V_s (rise) = 192 m/s

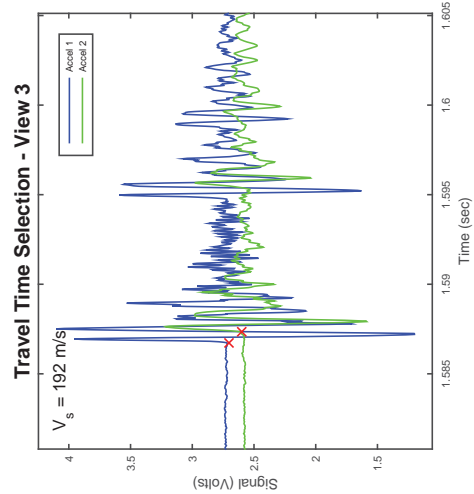
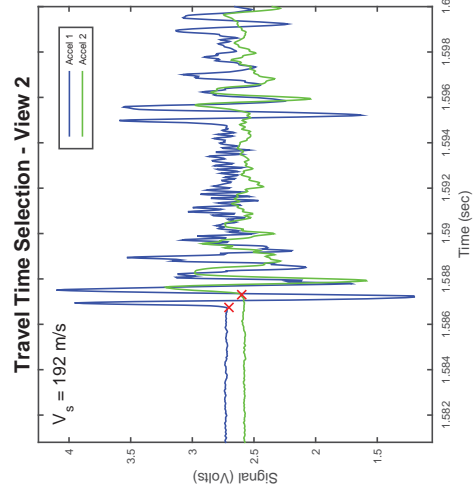
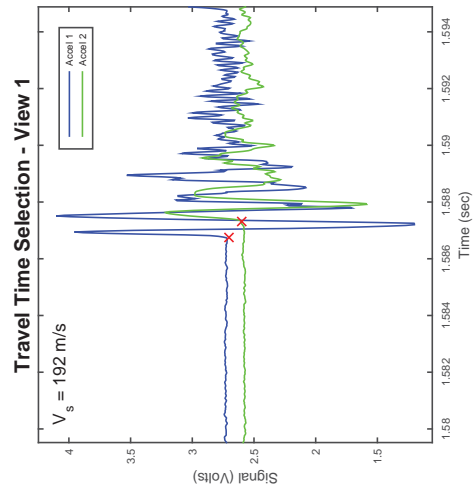
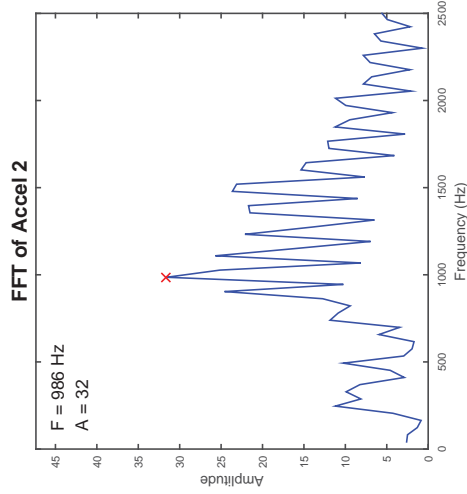
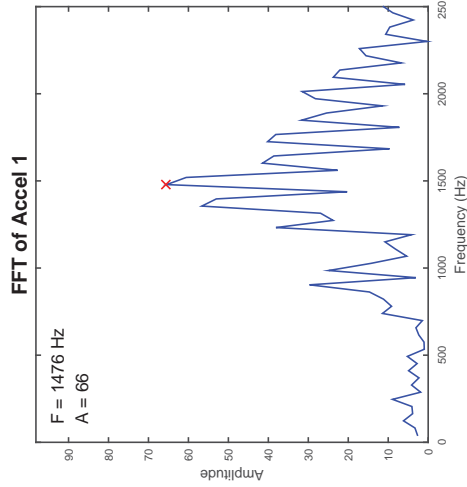
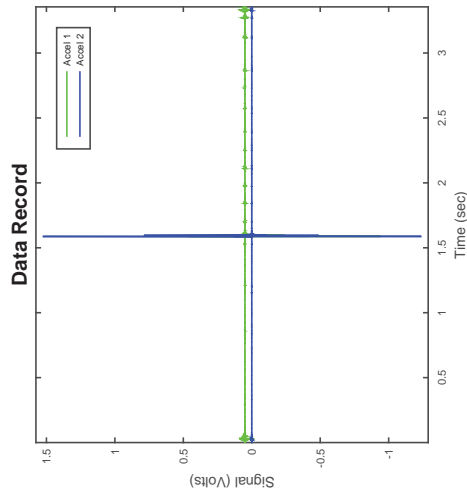

Accelerometer-Based Shear Wave Velocity Datasheet

Specimen ID: M316-LSC109-100-3X

Test Material: LSC109

Date: 4/19/2016

Test Performed by: J.Hubler

Filename: M316-LSC109-100-3X

Vertical Stress: 100kPa

Sensor Spacing: 0.1113 m

V_s (rise) = 208 m/s

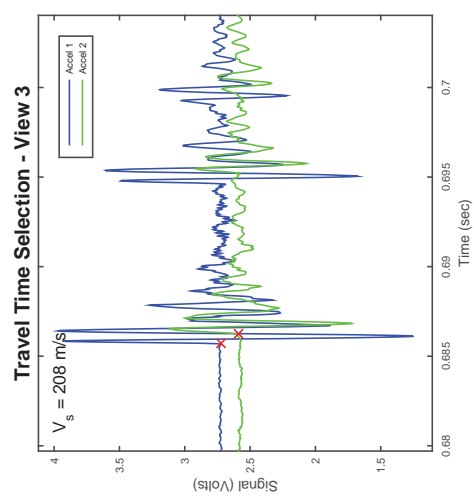
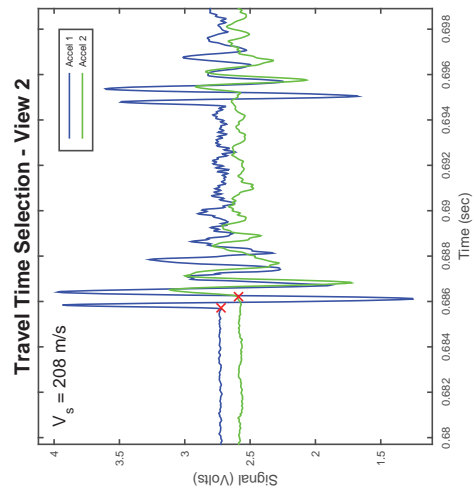
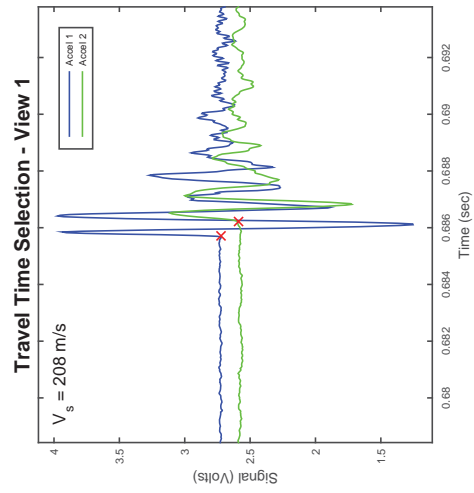
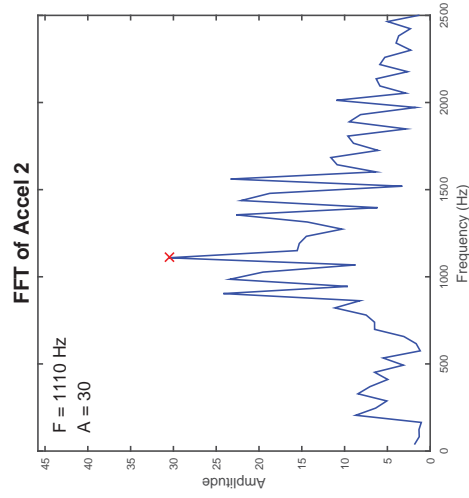
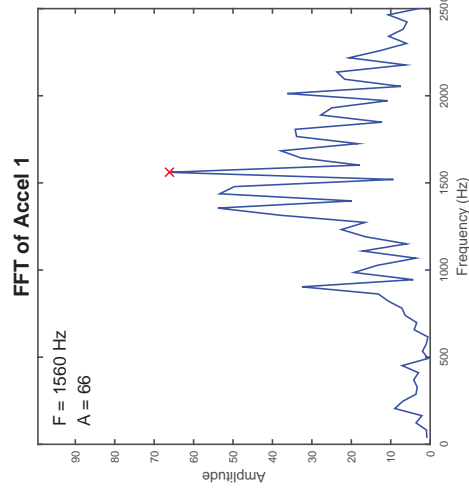
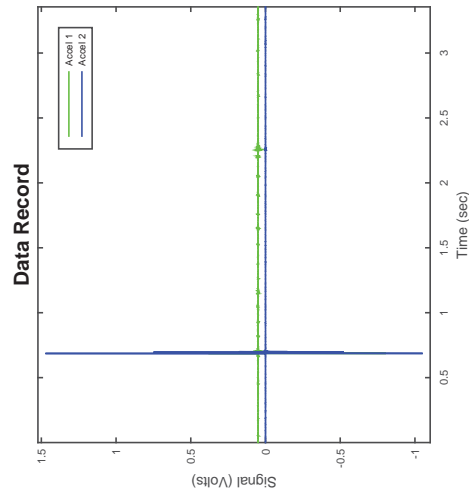

CSS Monotonic Shear Test Report

Geotechnical Engineering Laboratory



10/28/2013_Version 8.0

General Test Info and Sample Preparation

Device:	CSS	Relative Density (%):	10%
Specimen ID:	40C109_60LS	Void Ratio:	0.408
Test ID:	M318	Height (mm):	113.2
Date of Test:	4/20/2016	Soil-Only Specimen Diameter (mm):	306.20
Test Performed:	Monotonic Shear	Weight (kg):	15.691
Test Material:	C109 Ott Sand/Limestone	Density (kg/m³):	1883.0
Sample Preparation:	Prepared by funneling sand/gravel mixture with zero drop height.	Membrane Thickness (mm):	0.635
		Moisture Content (%):	0%
		Saturated (Y/N):	N
		Prepared by:	J.Hubler
		Checked by:	J. Hubler

Consolidation Stage

Vertical Stress (kPa):	200
Time to Compression (min):	7.3
Relative Density (%):	49%
Void Ratio:	0.366
Height (mm):	109.8
Diameter (mm):	306.20
Weight (kg):	15.691
Density (kg/m³):	1939.9

Shear Stage

Type of Test:	Constant Volume
Stress or Strain Controlled:	Strain
Shear Strain Rate (%/min):	0.30
Peak Shear Strength (kPa):	28.9

Comments

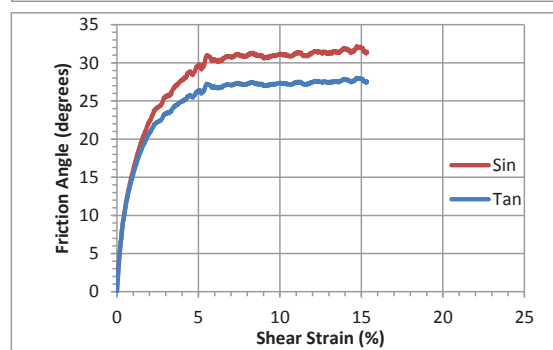
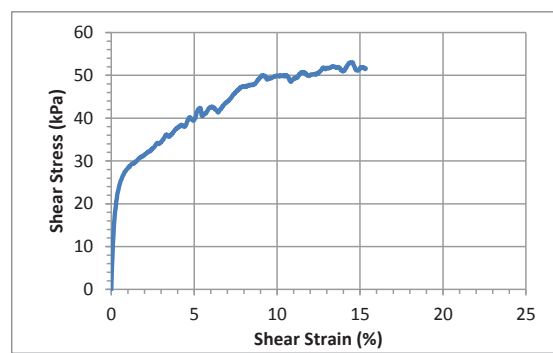
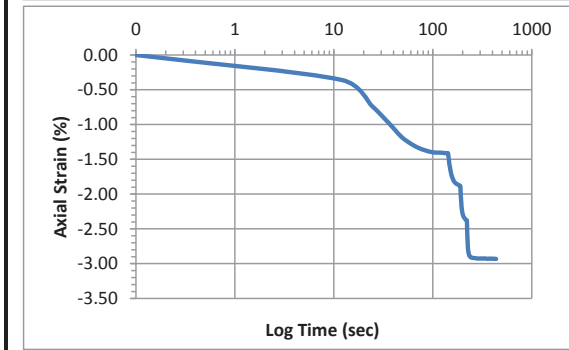
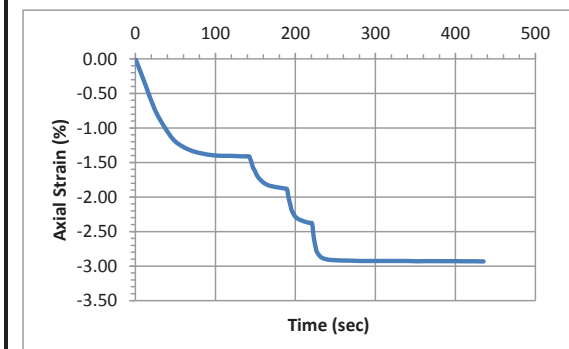

Accelerometer-Based Shear Wave Velocity Datasheet

Specimen ID: M318-LSC109-200-1X
 Test Material: LSC109
 Date: 4/20/2016
 Test Performed by: J.Hubler
 Filename: M318-LSC109-200-1X

Vertical Stress: 200kPa
 Sensor Spacing: 0.10977 m
 V_s (rise) = 224 m/s

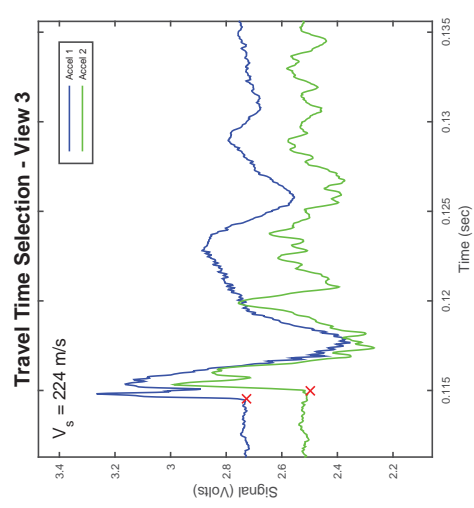
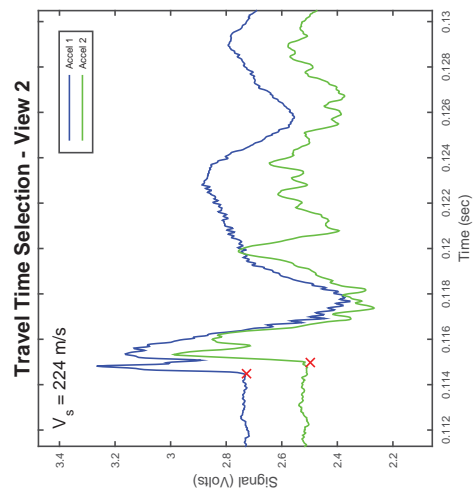
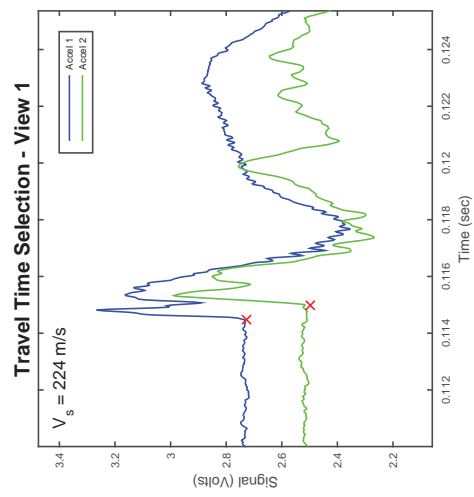
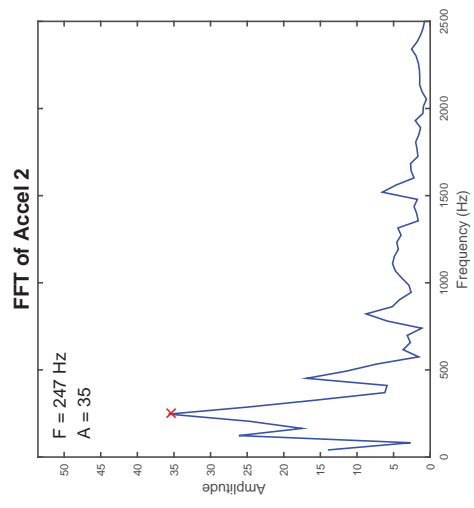
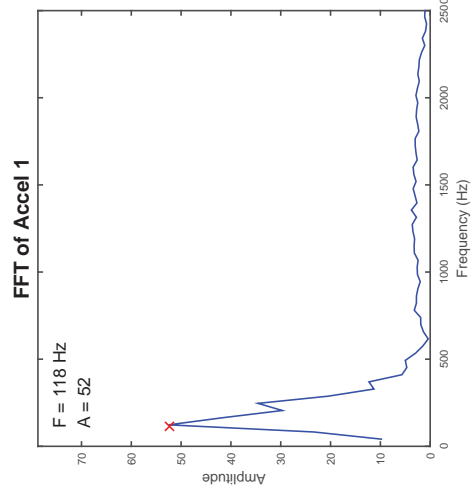
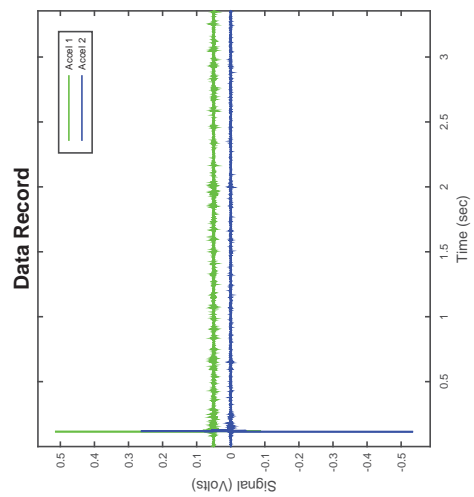

Accelerometer-Based Shear Wave Velocity Datasheet

Specimen ID: M318-LSC109-200-2X

Test Material: LSC109

Date: 4/20/2016

Test Performed by: J.Hubler

Filename: M318-LSC109-200-2X

Vertical Stress: 200kPa

Sensor Spacing: 0.10977 m

V_s (rise) = 246 m/s

Data Record

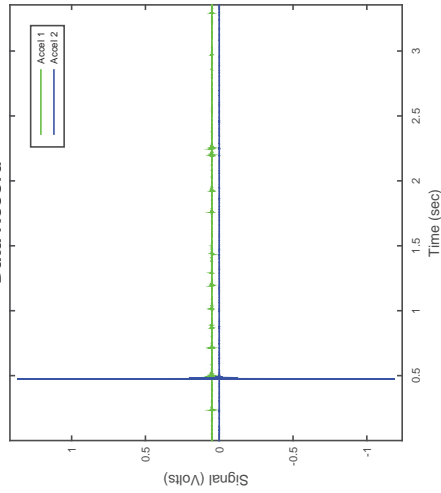

FFT of Accel 1

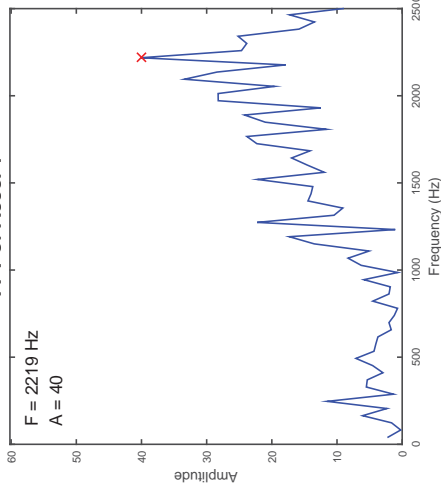

FFT of Accel 2

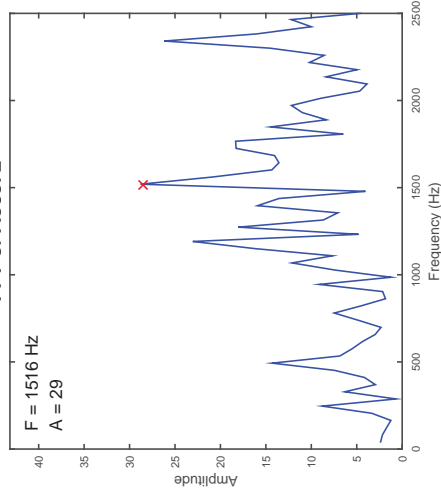

Travel Time Selection - View 1

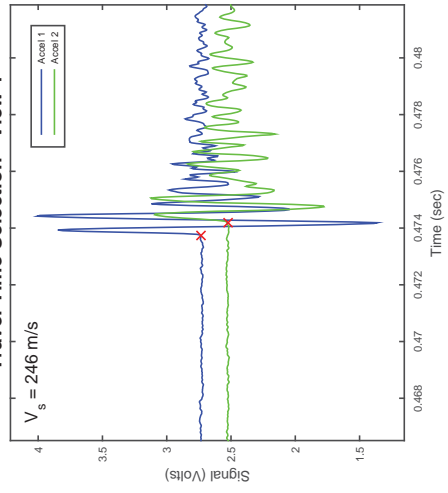

Travel Time Selection - View 2

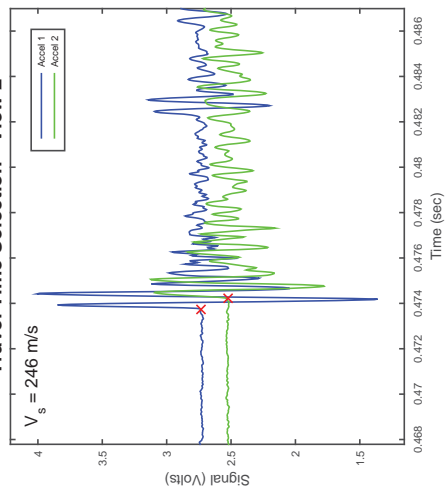

Travel Time Selection - View 3

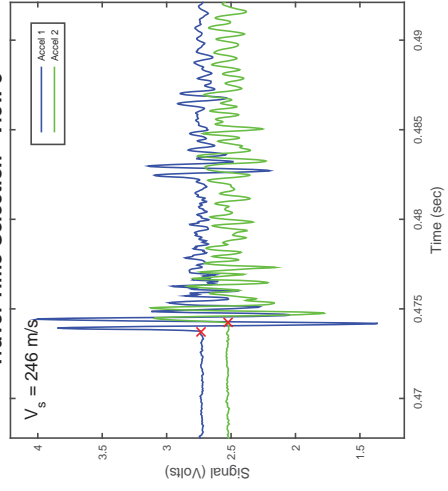

Accelerometer-Based Shear Wave Velocity Datasheet

Specimen ID: M318-LSC109-200-3X
 Test Material: LSC109
 Date: 4/20/2016
 Test Performed by: J.Hubler
 Filename: M318-LSC109-200-3X

Vertical Stress: 200kPa
 Sensor Spacing: 0.10977 m
 V_s (rise) = 238 m/s

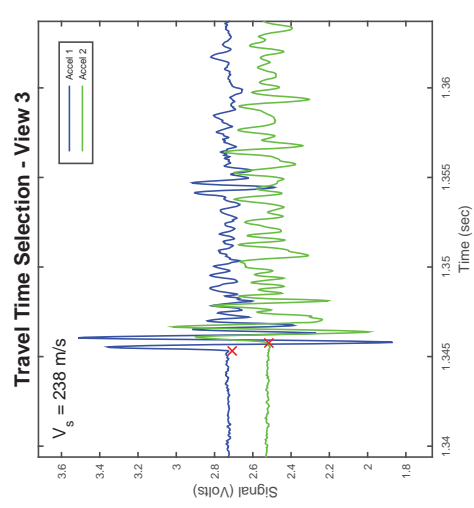
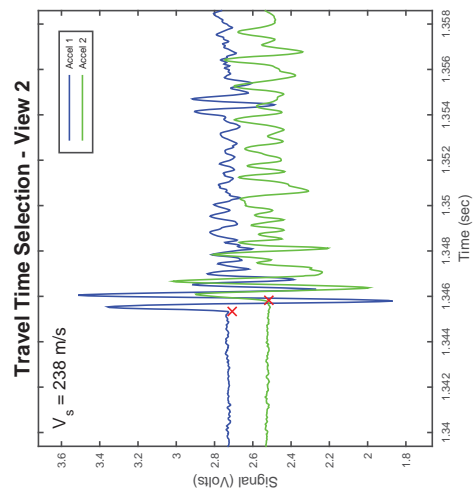
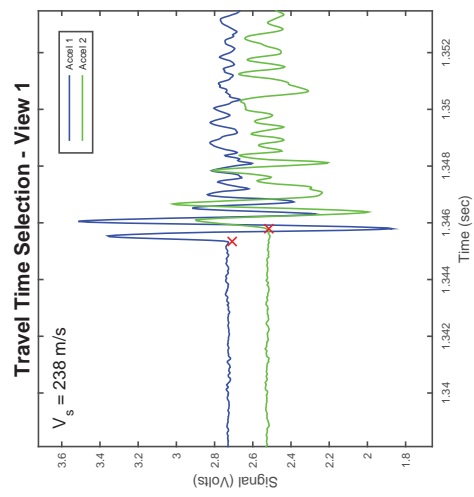
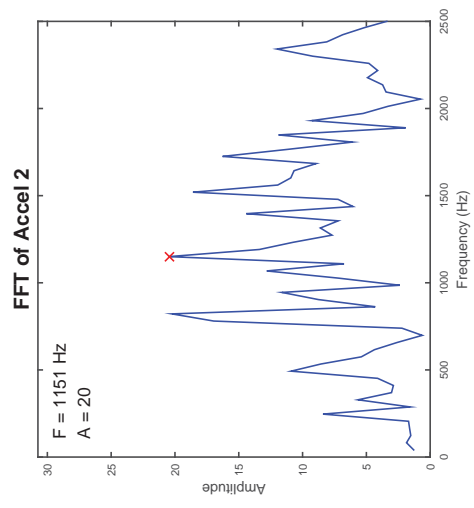
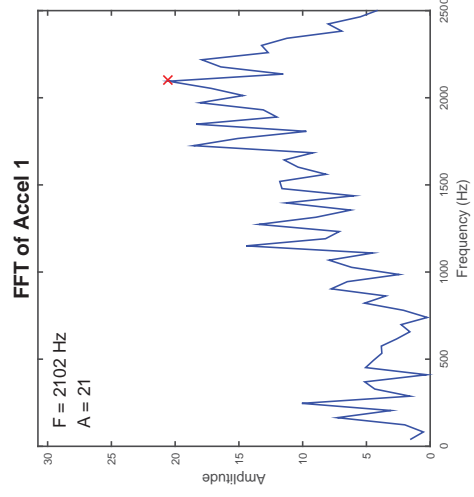
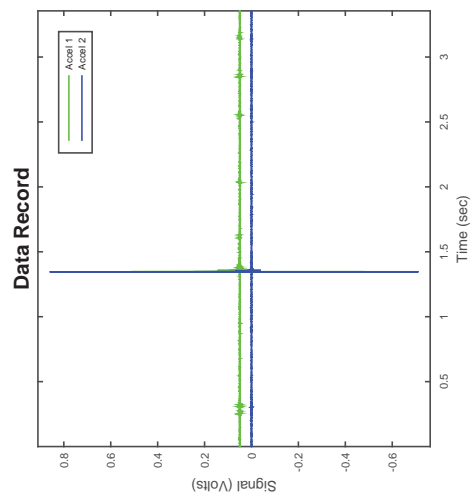

CSS Monotonic Shear Test Report

Geotechnical Engineering Laboratory



10/28/2013_Version 8.0

General Test Info and Sample Preparation

Device:	CSS	Relative Density (%):	5%
Specimen ID:	40C109_60LS	Void Ratio:	0.413
Test ID:	M315	Height (mm):	112.3
Date of Test:	4/18/2016	Soil-Only Specimen Diameter (mm):	306.20
Test Performed:	Monotonic Shear	Weight (kg):	15.503
Test Material:	C109 Ott Sand/Limestone	Density (kg/m³):	1875.4
Sample Preparation:	Prepared by funneling sand/gravel mixture with zero drop height.	Membrane Thickness (mm):	0.635
		Moisture Content (%):	0%
		Saturated (Y/N):	N
		Prepared by:	J.Hubler
		Checked by:	J. Hubler

Consolidation Stage

Shear Stage

Vertical Stress (kPa):	400	Type of Test:	Constant Volume
Time to Compression (min):	9.0	Stress or Strain Controlled:	Strain
Relative Density (%):	45%	Shear Strain Rate (%/min):	0.30
Void Ratio:	0.371	Peak Shear Strength (kPa):	59.0
Height (mm):	108.9	Comments	
Diameter (mm):	306.20		
Weight (kg):	15.503		
Density (kg/m³):	1933.8		

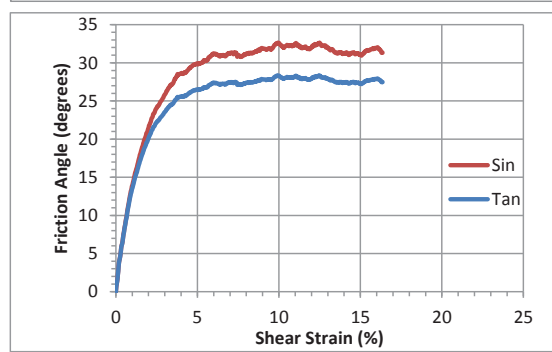
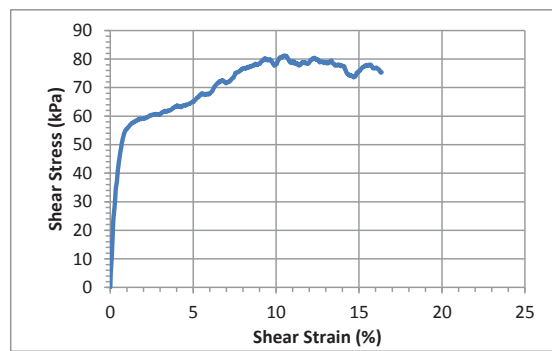
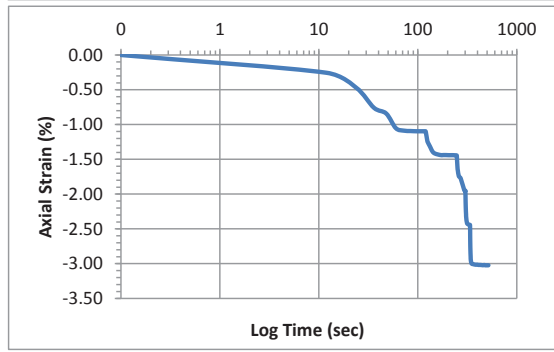
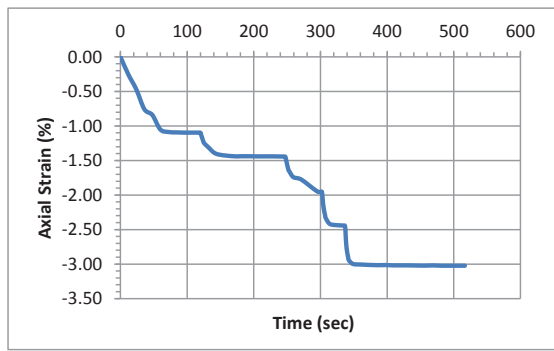

Accelerometer-Based Shear Wave Velocity Datasheet

Specimen ID: M315-LSC109-400-1X

Test Material: LSC109

Date: 4/18/2016

Test Performed by: J.Hubler

Filename: M315-LSC109-400-1X

Vertical Stress: 400kPa

Sensor Spacing: 0.10879 m

V_s (rise) = 280 m/s

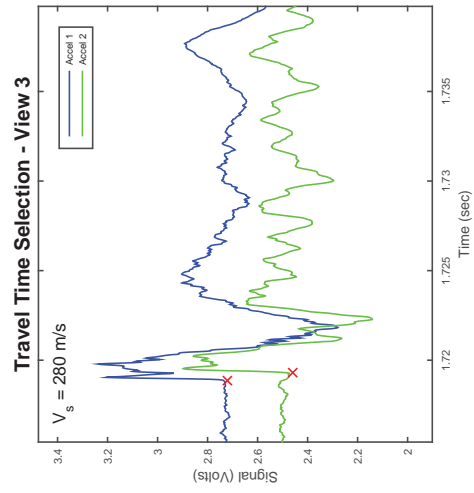
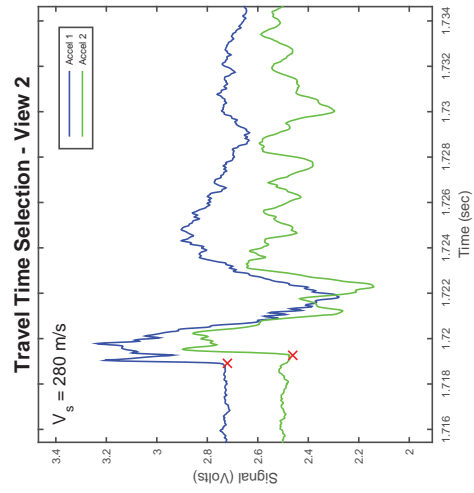
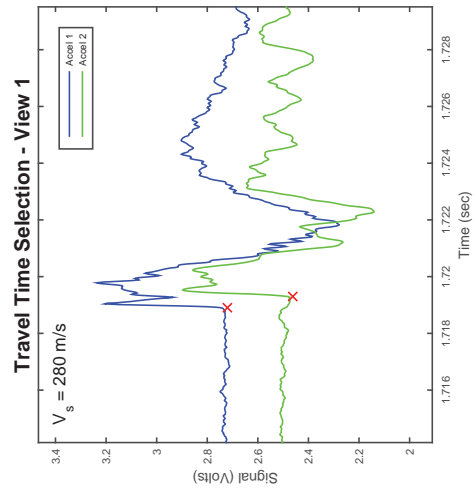
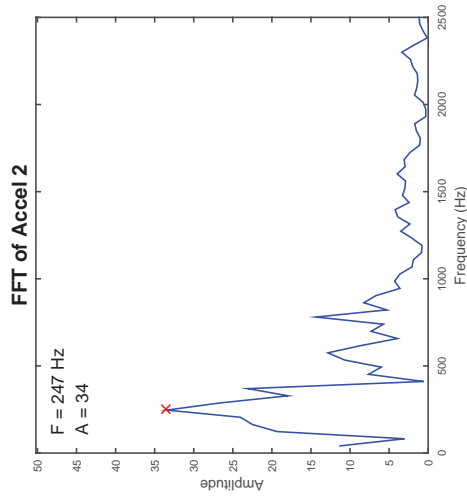
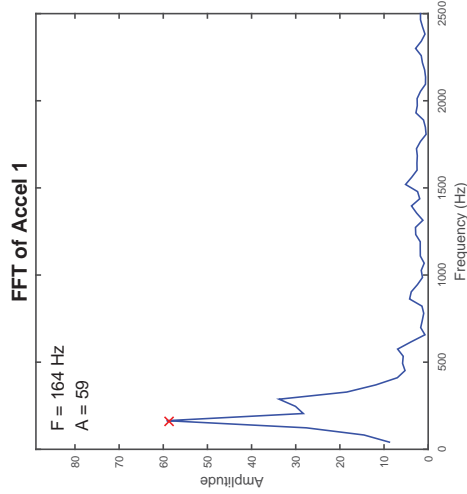
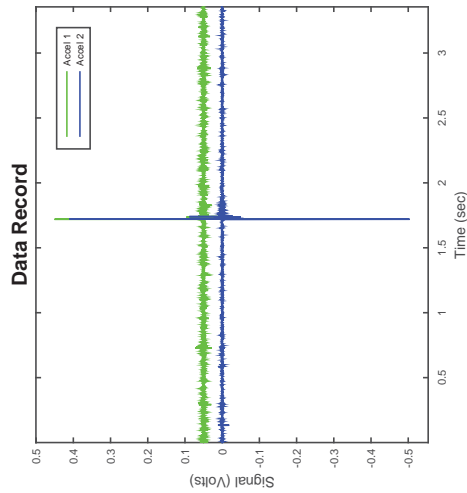

Accelerometer-Based Shear Wave Velocity Datasheet

Specimen ID: M315-LSC109-400-2X

Test Material: LSC109

Date: 4/18/2016

Test Performed by: J.Hubler

Filename: M315-LSC109-400-2X

Vertical Stress: 400kPa

Sensor Spacing: 0.10879 m

V_s (rise) = 280 m/s

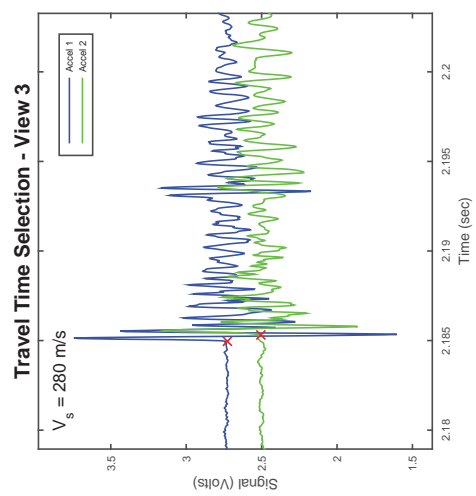
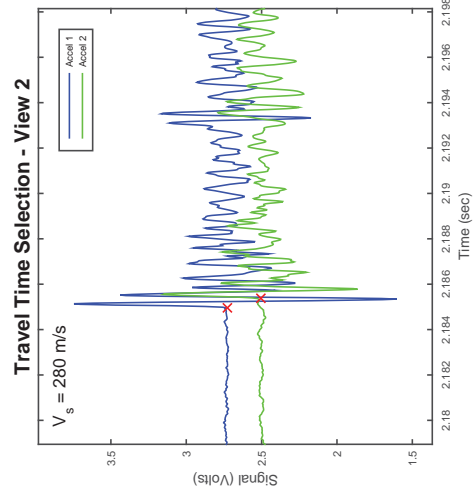
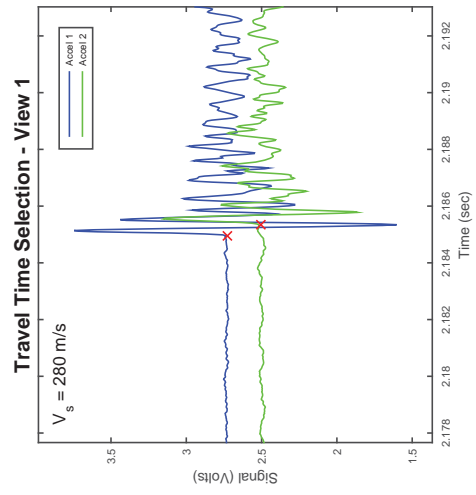
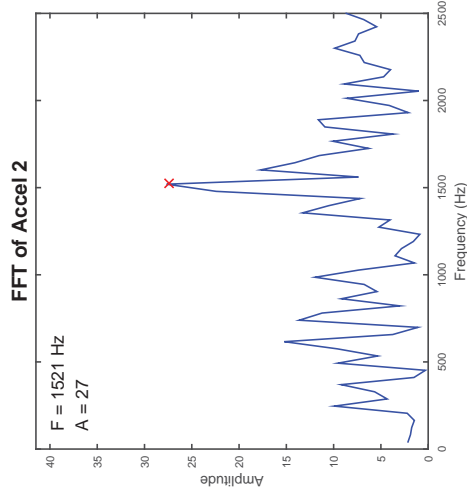
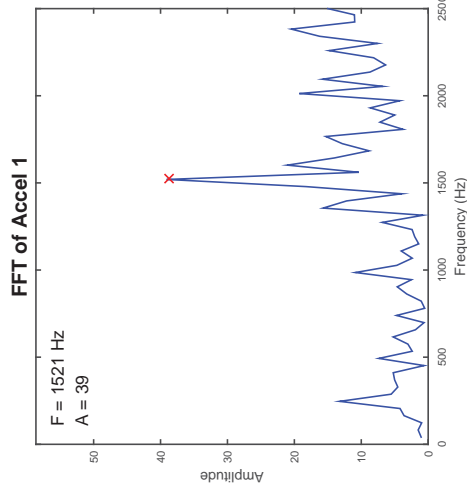
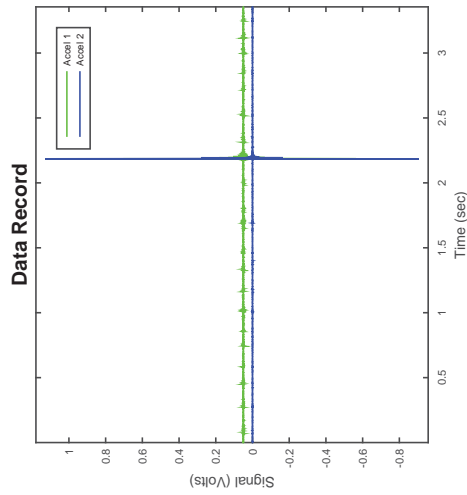

Accelerometer-Based Shear Wave Velocity Datasheet

Specimen ID: M315-LSC109-400-3X
 Test Material: LSC109
 Date: 4/18/2016
 Test Performed by: J.Hubler
 Filename: M315-LSC109-400-3X

Vertical Stress: 400kPa
 Sensor Spacing: 0.10879 m
 V_s (rise) = 291 m/s

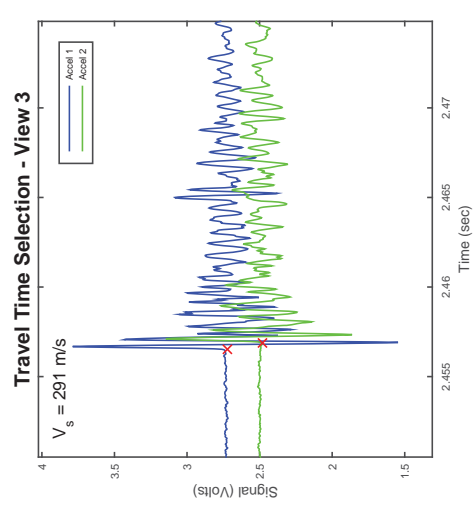
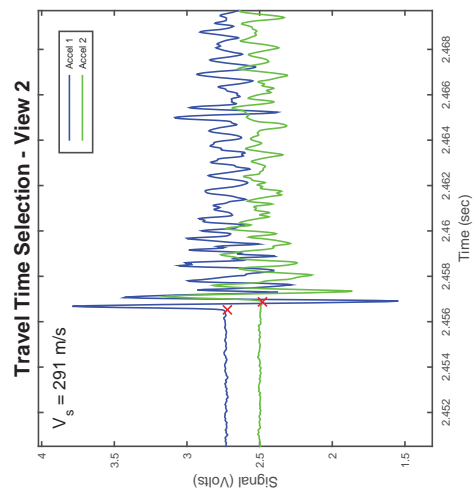
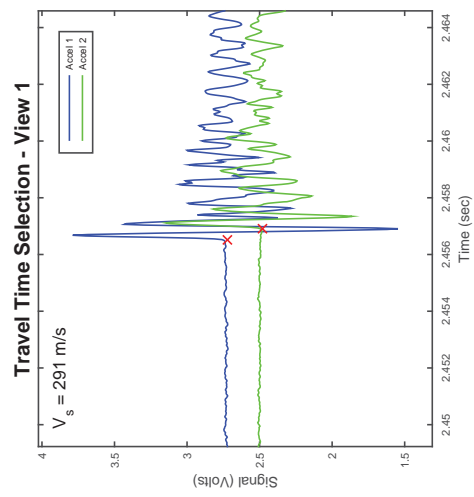
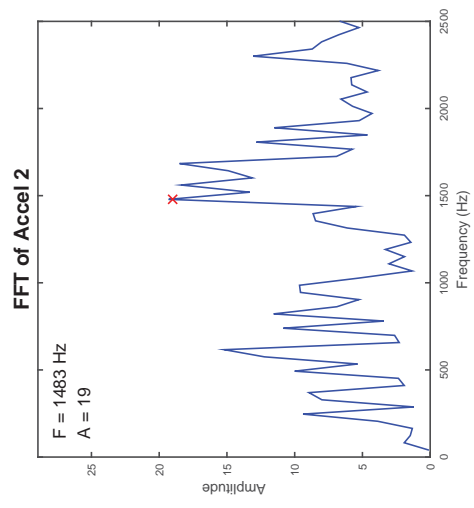
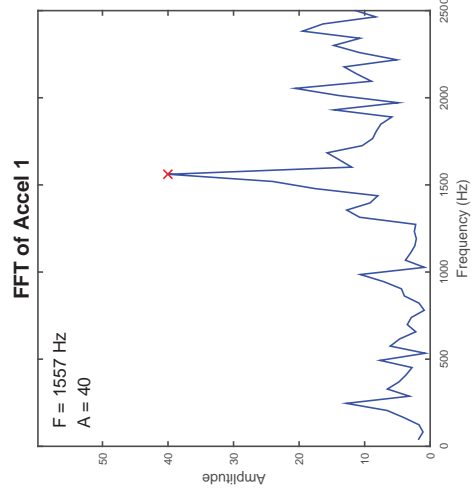
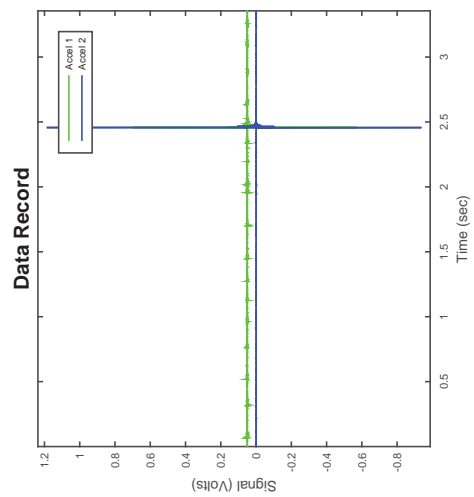

CSS Monotonic Shear Test Report

Geotechnical Engineering Laboratory



10/28/2013_Version 8.0

General Test Info and Sample Preparation

Device:	CSS	Relative Density (%):	69%
Specimen ID:	80C109_20LS	Void Ratio:	0.466
Test ID:	M333	Height (mm):	112.7
Date of Test:	10/26/2016	Soil-Only Specimen Diameter (mm):	306.20
Test Performed:	Monotonic Shear	Weight (kg):	14.996
Test Material:	C109 Ott Sand/Limestone	Density (kg/m³):	1807.6
Sample Preparation:	Prepared dense by tamping in 5 layers (40x)	Membrane Thickness (mm):	0.635
		Moisture Content (%):	0%
		Saturated (Y/N):	N
		Prepared by:	J. Hubler
		Checked by:	J. Hubler

Consolidation Stage

Vertical Stress (kPa):	100
Time to Compression (min):	7.2
Relative Density (%):	82%
Void Ratio:	0.444
Height (mm):	110.9
Diameter (mm):	306.20
Weight (kg):	14.996
Density (kg/m³):	1836.1

Shear Stage

Type of Test:	Constant Volume
Stress or Strain Controlled:	Strain
Shear Strain Rate (%/min):	0.29
Peak Shear Strength (kPa):	17.3

Comments

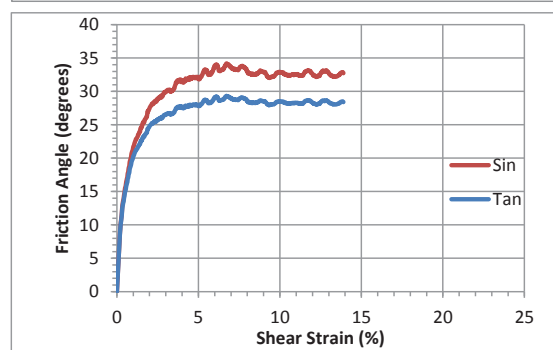
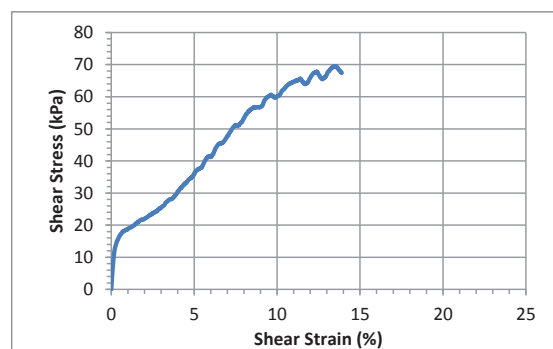
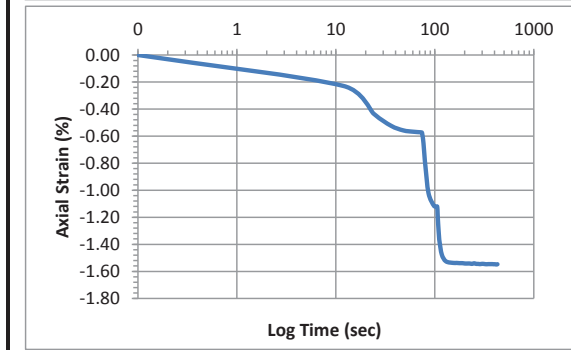
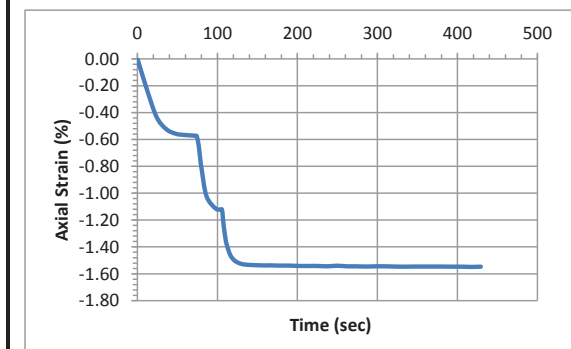

Accelerometer-Based Shear Wave Velocity Datasheet

Specimen ID: M333-80C10920LS-100-1X

Test Material: 80C10920LS

Date: 10/26/2016

Test Performed by: J.Hubler

Filename: M333-80C10920LS-100-1X

Vertical Stress: 100kPa

Sensor Spacing: 0.11065 m

V_s (rise) = 240 m/s

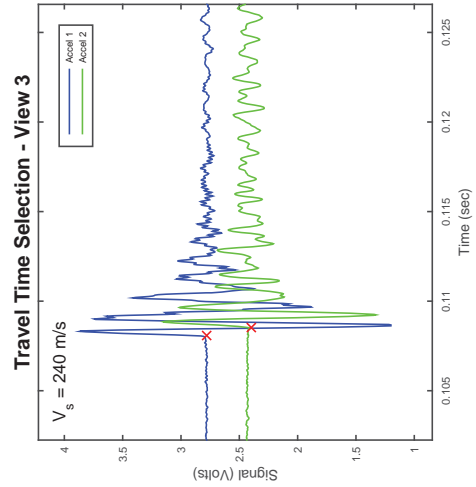
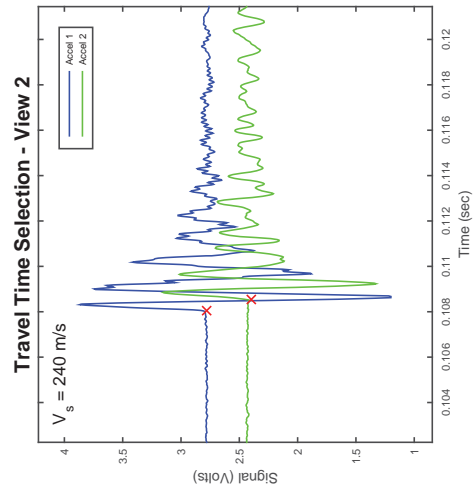
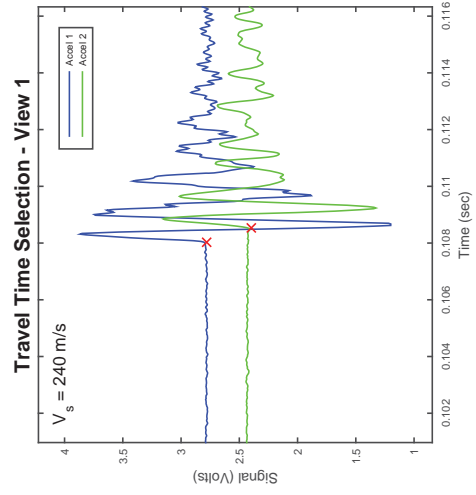
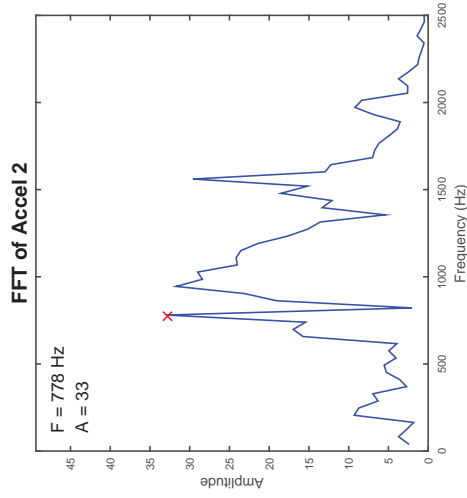
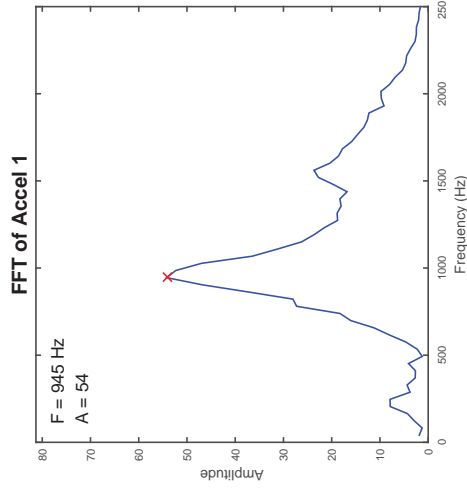
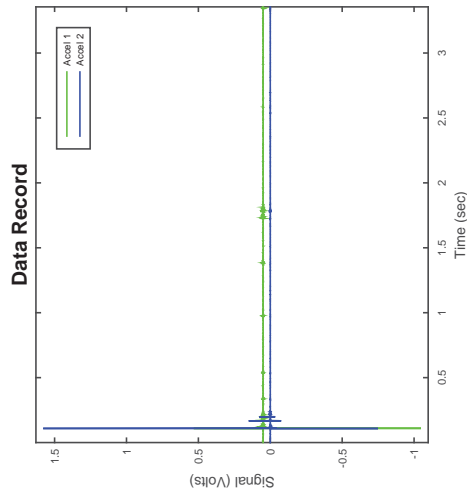

CSS Monotonic Shear Test Report



10/28/2013_Version 8.0

Geotechnical Engineering Laboratory

General Test Info and Sample Preparation

Device:	CSS	Relative Density (%):	62%
Specimen ID:	60C109_40LS	Void Ratio:	0.380
Test ID:	M320	Height (mm):	114.1
Date of Test:	10/4/2016	Soil-Only Specimen Diameter (mm):	306.20
Test Performed:	Monotonic Shear	Weight (kg):	16.145
Test Material:	C109 Ott Sand/Limestone	Density (kg/m³):	1920.9
Sample Preparation:	Prepared dense by tamping 35-55x in 5 layers	Membrane Thickness (mm):	0.635
		Moisture Content (%):	0%
		Saturated (Y/N):	N
		Prepared by:	J.Hubler
		Checked by:	J. Hubler

Consolidation Stage

Vertical Stress (kPa):	100
Time to Compression (min):	4.3
Relative Density (%):	92%
Void Ratio:	0.345
Height (mm):	111.2
Diameter (mm):	306.20
Weight (kg):	16.145
Density (kg/m³):	1970.9

Shear Stage

Type of Test:	Constant Volume
Stress or Strain Controlled:	Strain
Shear Strain Rate (%/min):	0.30
Peak Shear Strength (kPa):	

Comments

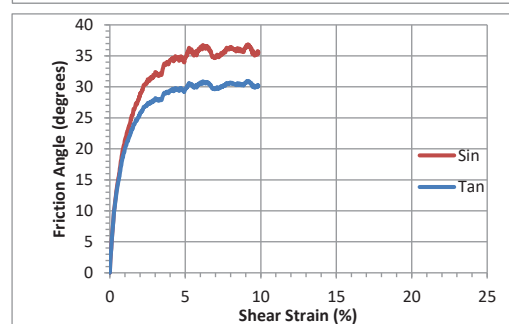
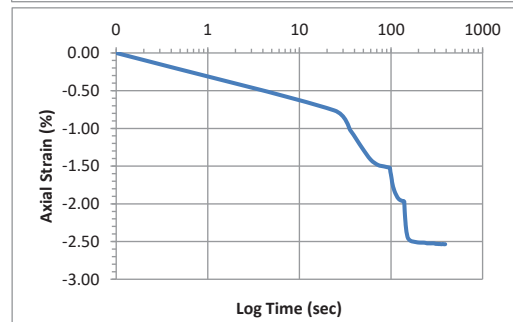
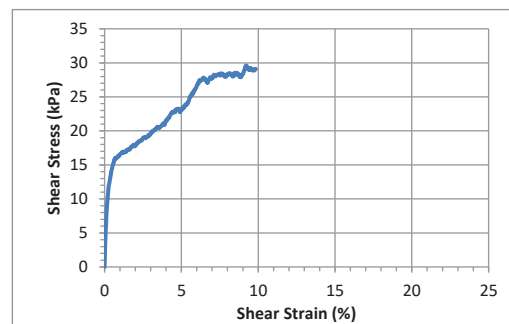
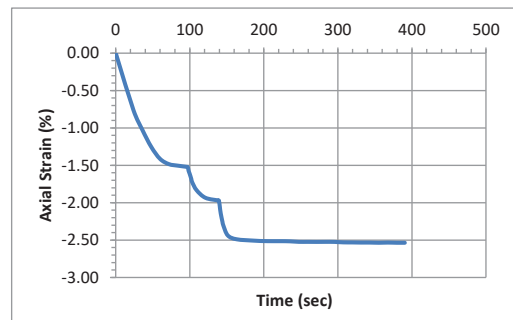

Accelerometer-Based Shear Wave Velocity Datasheet

Specimen ID: M320-40LS60C109-100-1X

Test Material: 40LS60C109

Date: 10/4/2016

Test Performed by: J.Hubler

Filename: M320-40LS60C109-100-1X

Vertical Stress: 100kPa

Sensor Spacing: 0.11093 m

V_s (rise) = 241 m/s

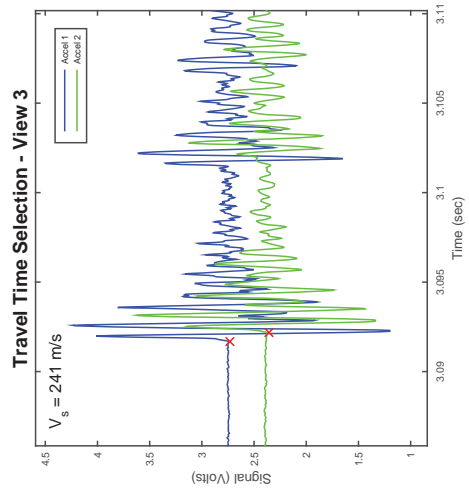
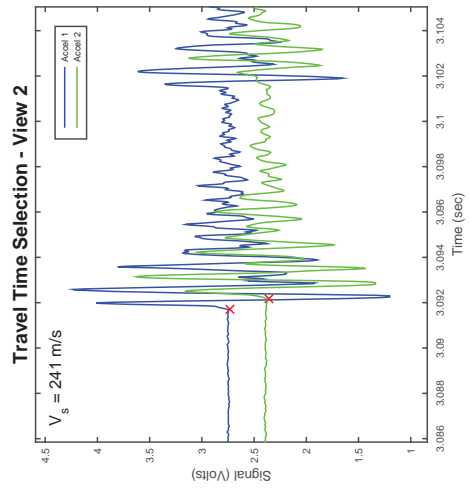
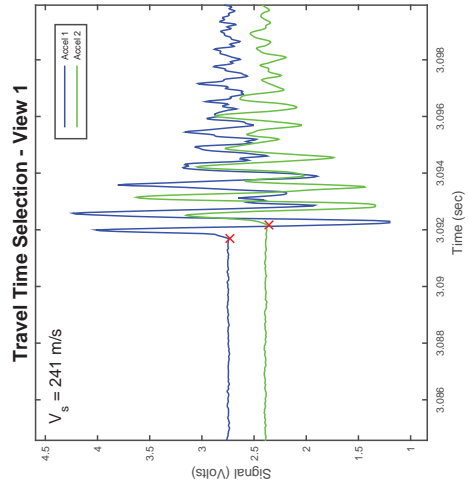
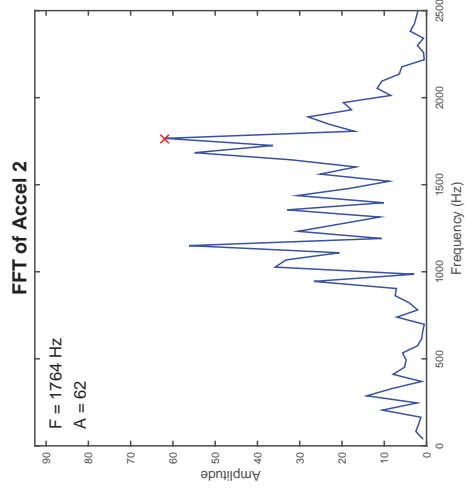
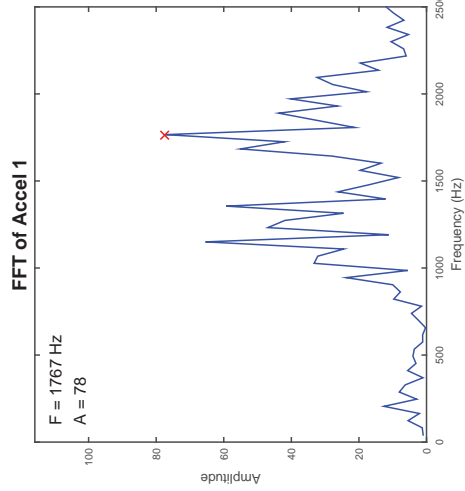
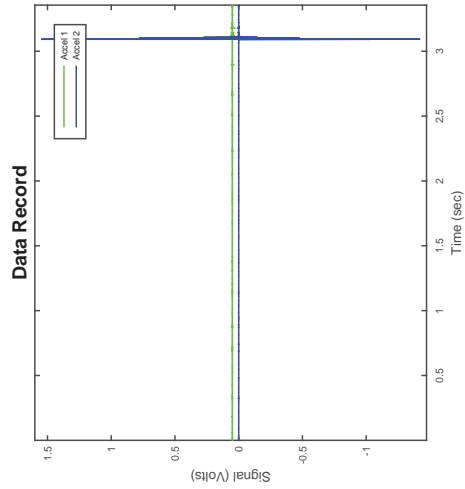

Accelerometer-Based Shear Wave Velocity Datasheet

Specimen ID: M320-40LS60C109-100-2X

Test Material: 40LS60C109

Date: 10/4/2016

Test Performed by: J. Hubler

Filename: M320-40LS60C109-100-2X

Vertical Stress: 100kPa

Sensor Spacing: 0.11093 m

V_s (rise) = 226 m/s

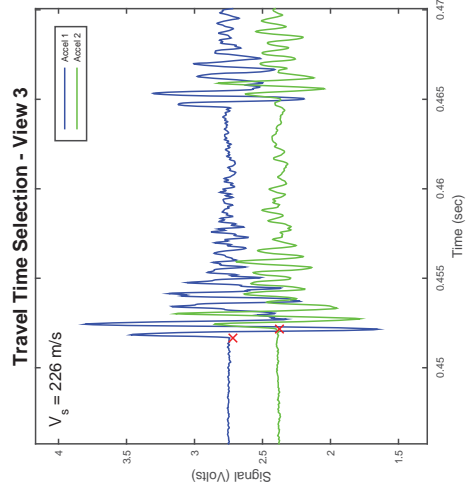
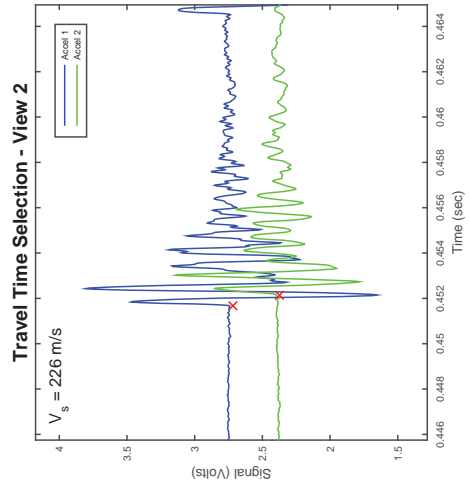
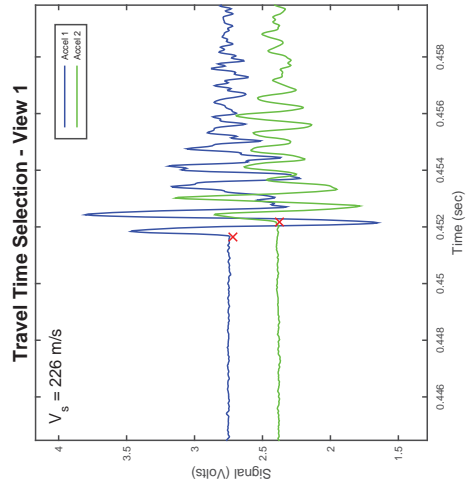
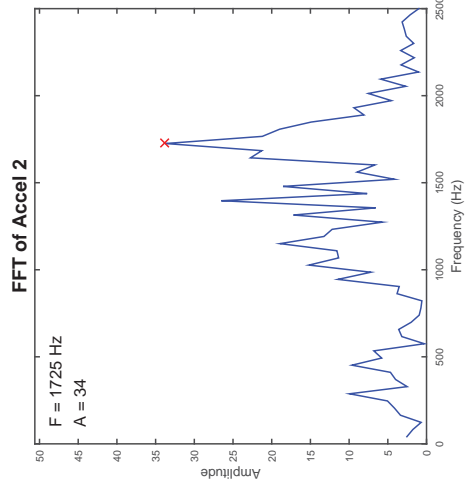
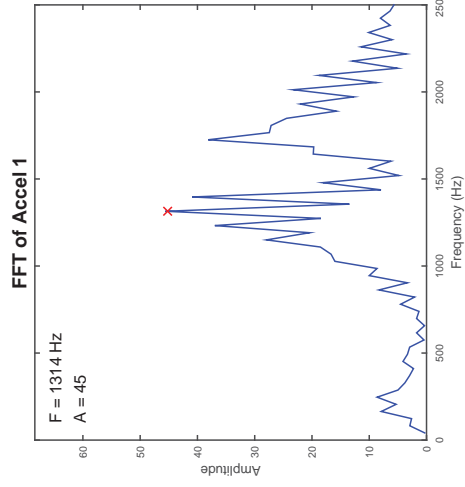
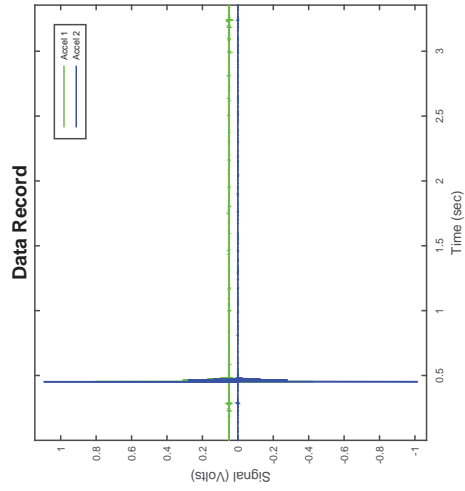

Accelerometer-Based Shear Wave Velocity Datasheet

Specimen ID: M320-40LS60C109-100-3X
 Test Material: 40LS60C109
 Date: 10/4/2016
 Test Performed by: J. Hubler
 Filename: M320-40LS60C109-100-3X

Vertical Stress: 100kPa
 Sensor Spacing: 0.11093 m
 V_s (rise) = 231 m/s

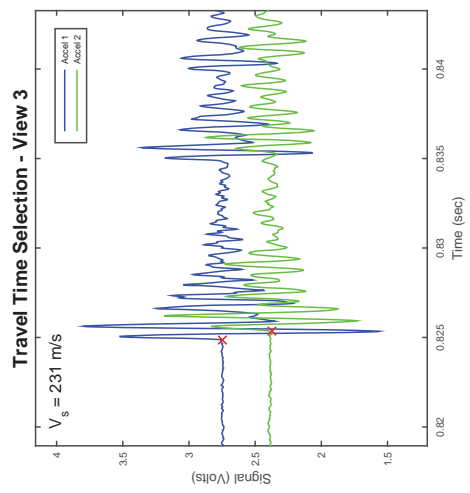
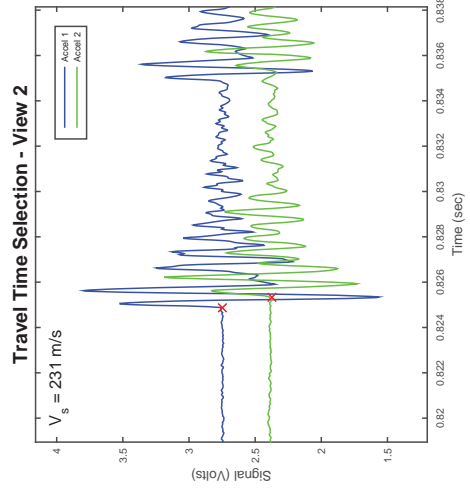
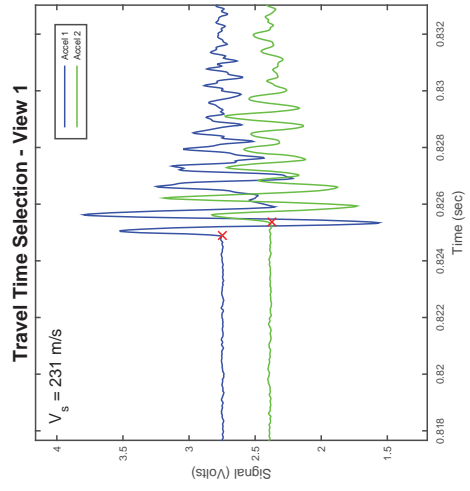
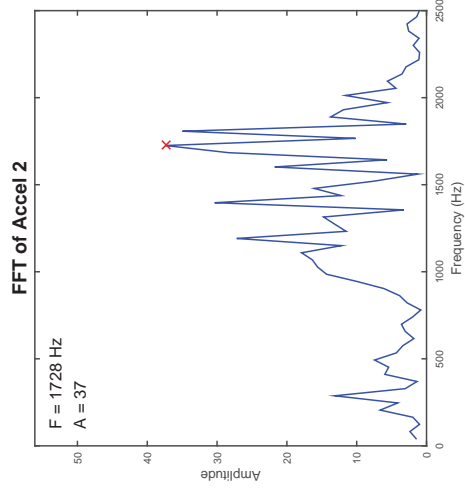
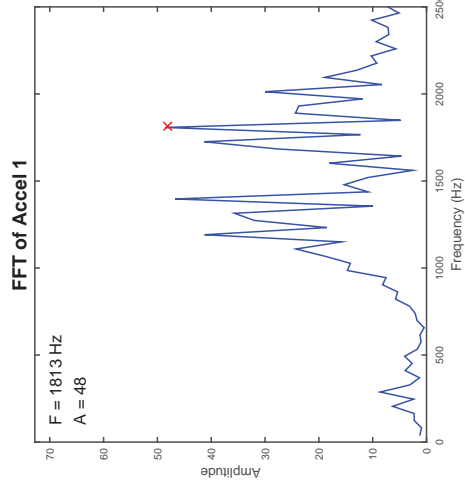
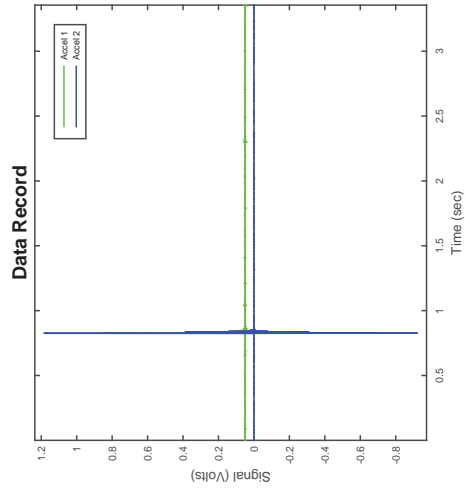

CSS Cyclic Shear Test Report

Geotechnical Engineering Laboratory



Cyclic Shear Test Summary

Device:	CSS	Density (kg/m³):	1613
Specimen ID:	C109	Relative Density (%):	49%
Test ID:	C257	Void Ratio:	0.643
Date of Test:	3/18/2016	Vertical Stress (kPa):	100
Test Performed:	Cyclic Shear	Loading Frequency (Hz):	0.33
Test Material:	C109 Sand	Number of Cycles:	219
Sample Preparation:	Prepared loose by the funneling method.	Cyclic Stress Ratio:	0.044
		Shear Modulus (kPa):	
		Damping (%):	
Prepared by:	A.Ventola	Shear Strain Single Amplitude (%)	
Checked by:	J.Hubler		

Additional Comments:

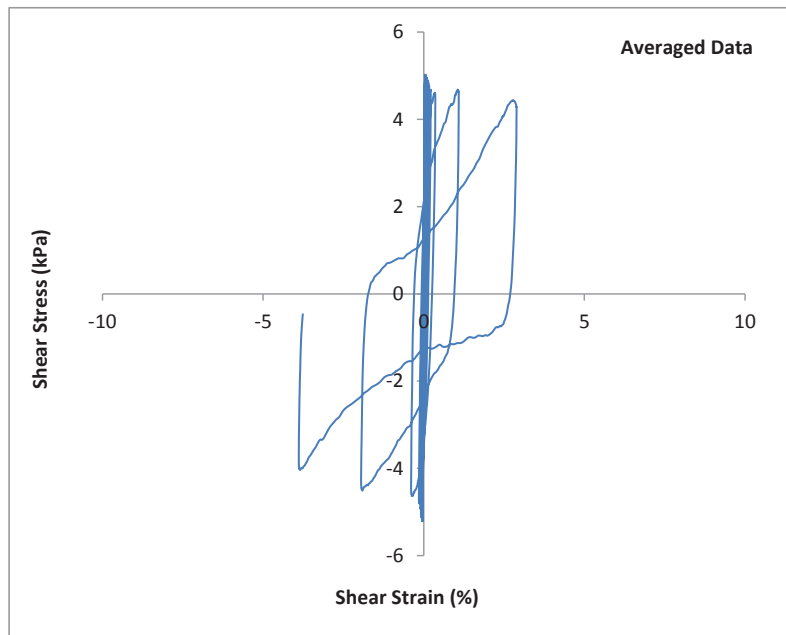
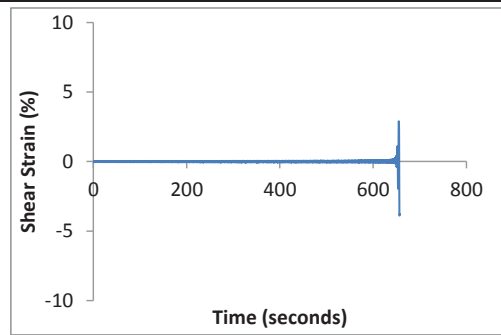
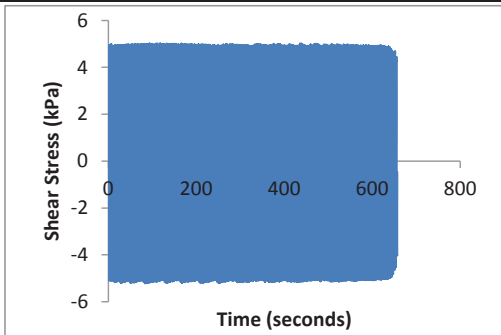

CSS Cyclic Shear Test Report

Geotechnical Engineering Laboratory



Cyclic Shear Test Summary

Device:	CSS	Density (kg/m ³):	1613
Specimen ID:	C109	Relative Density (%):	49%
Test ID:	C257	Void Ratio:	0.643
Date of Test:	3/18/2016	Vertical Stress (kPa):	100
Test Performed:	Cyclic Shear	Loading Frequency (Hz):	0.33
Test Material:	C109 Sand	Number of Cycles:	219
Sample Preparation:	Prepared loose by the funneling method.	Cyclic Stress Ratio:	0.044
		Number of Cycles to Liq:	219
		Maximum ru:	0.99
Prepared by:	A.Ventola		
Checked by:	J.Hubler		

Additional Comments:

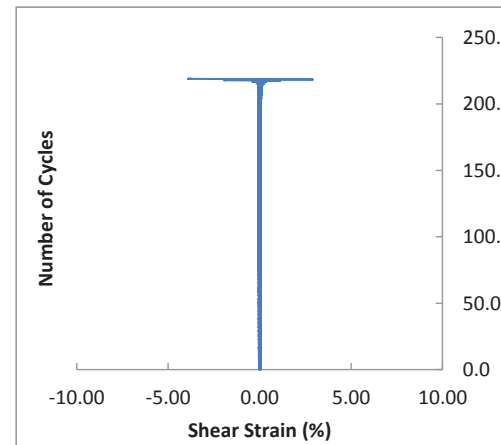
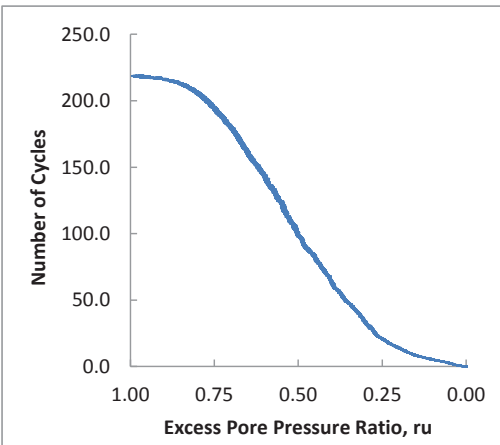
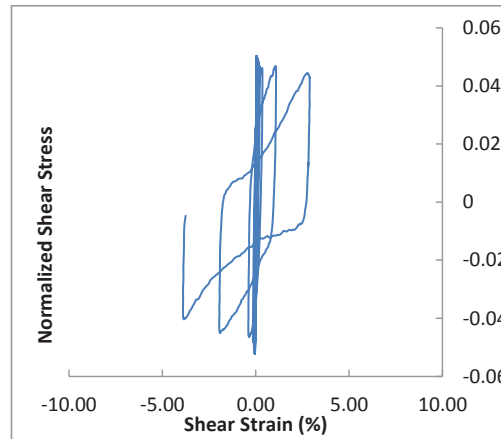
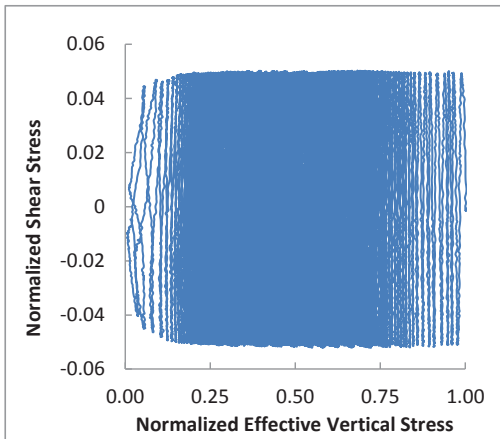

Accelerometer-Based Shear Wave Velocity Datasheet

Specimen ID: C257-C109-100-2X
 Test Material: C109
 Date: 3/18/2016
 Test Performed by: J.Hubler
 Filename: C257-C109-100-2X

Vertical Stress: 100kPa
 Sensor Spacing: 0.10826 m
 V_s (rise) = 188 m/s

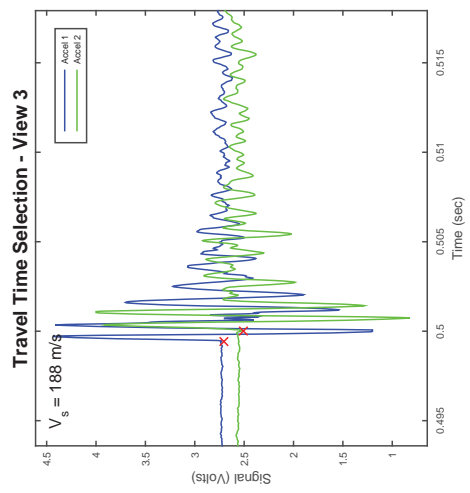
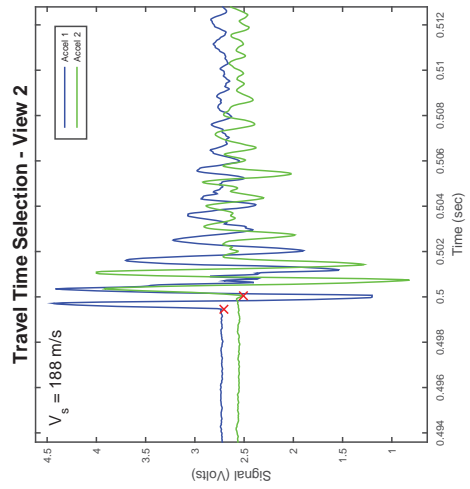
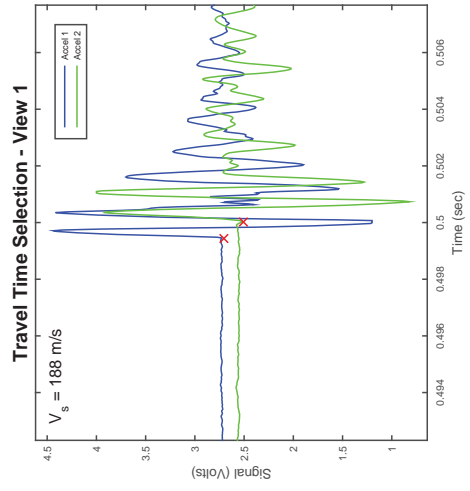
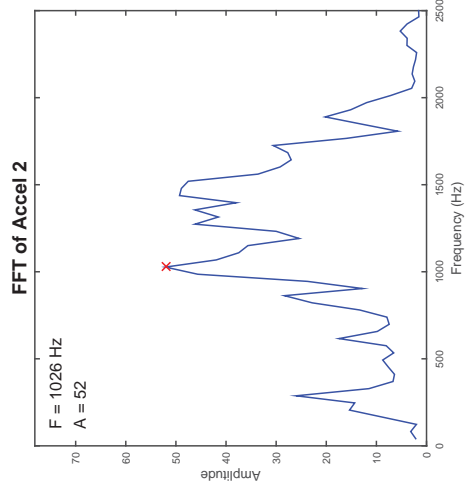
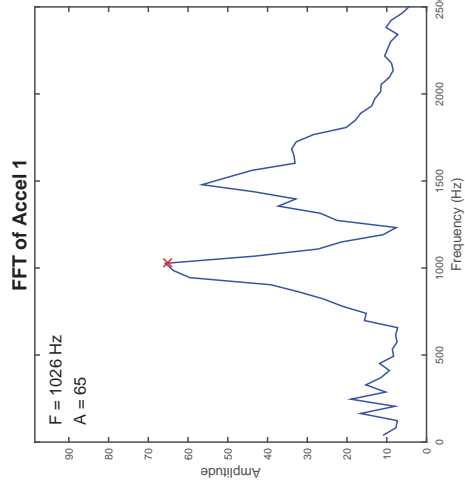
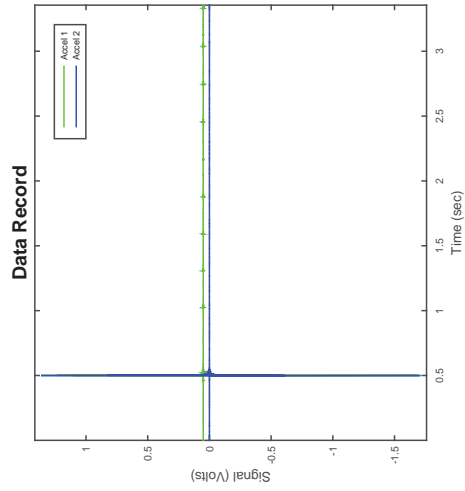

CSS Cyclic Shear Test Report

Geotechnical Engineering Laboratory



Cyclic Shear Test Summary

Device:	CSS	Density (kg/m³):	1609
Specimen ID:	C109	Relative Density (%):	47%
Test ID:	C258	Void Ratio:	0.646
Date of Test:	3/25/2016	Vertical Stress (kPa):	100
Test Performed:	Cyclic Shear	Loading Frequency (Hz):	0.3
Test Material:	C109 Sand	Number of Cycles:	6
Sample Preparation:	Prepared loose by the funneling method.	Cyclic Stress Ratio:	0.094
		Shear Modulus (kPa):	
		Damping (%):	
Prepared by:	A.Ventola	Shear Strain Single Amplitude (%):	
Checked by:	J.Hubler		

Additional Comments:

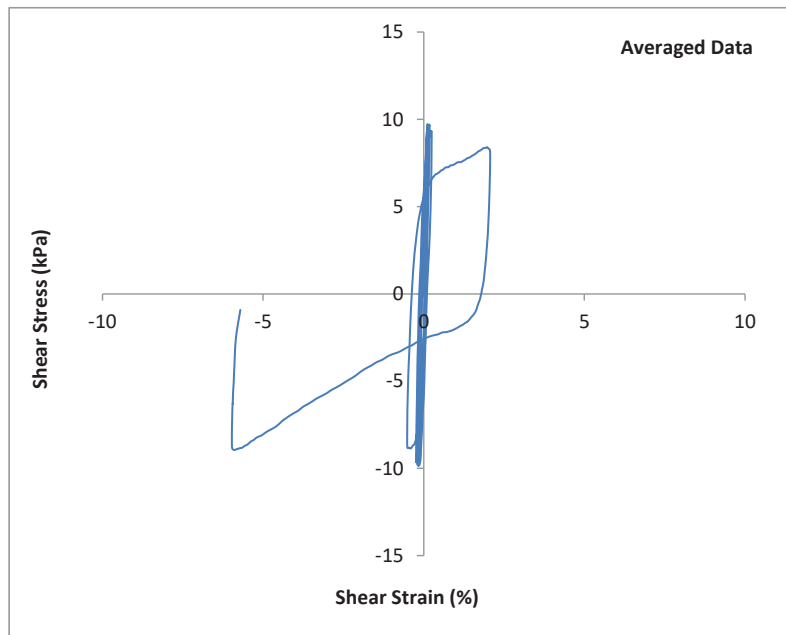
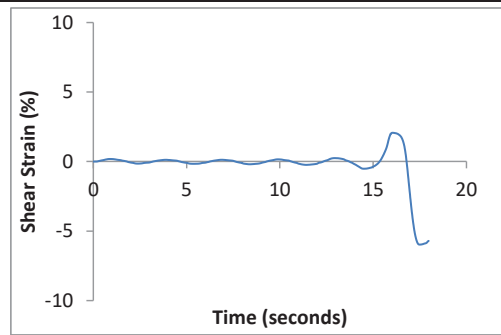
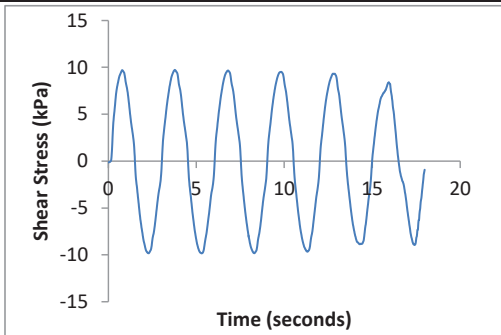

CSS Cyclic Shear Test Report

Geotechnical Engineering Laboratory



Cyclic Shear Test Summary

Device:	CSS	Density (kg/m ³):	1609
Specimen ID:	C109	Relative Density (%):	47%
Test ID:	C258	Void Ratio:	0.646
Date of Test:	3/25/2016	Vertical Stress (kPa):	100
Test Performed:	Cyclic Shear	Loading Frequency (Hz):	0.3
Test Material:	C109 Sand	Number of Cycles:	6
Sample Preparation:	Prepared loose by the funneling method.	Cyclic Stress Ratio:	0.094
		Number of Cycles to Liq:	6
		Maximum ru:	0.97
Prepared by:	A.Ventola		
Checked by:	J.Hubler		

Additional Comments:

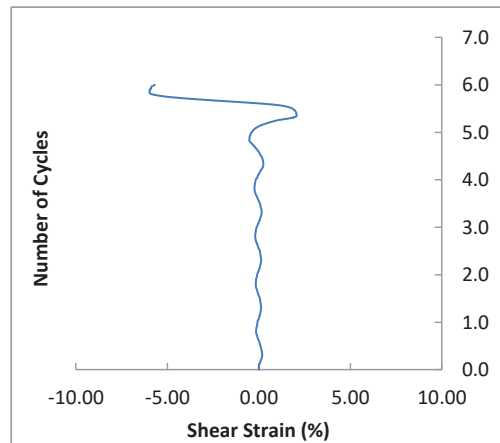
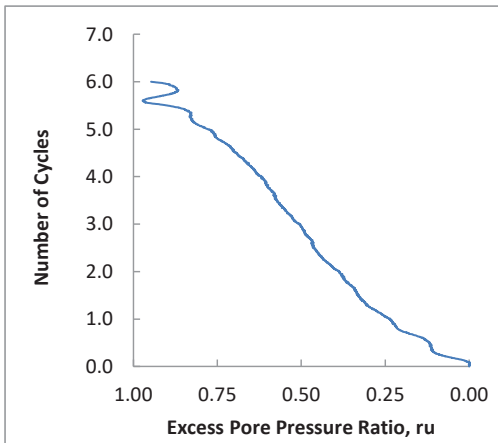
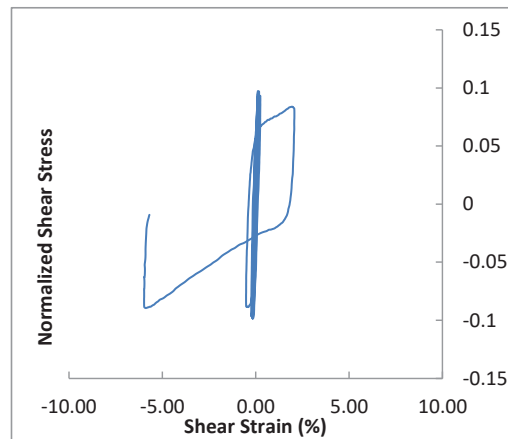
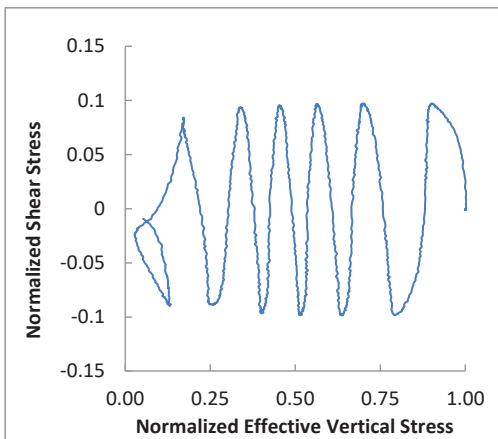

CSS Monotonic Shear Test Report

Geotechnical Engineering Laboratory



10/28/2013_Version 8.0

General Test Info and Sample Preparation

Device:	CSS	Relative Density (%):	31%
Specimen ID:	100C109	Void Ratio:	0.684
Test ID:	C258	Height (mm):	113.1
Date of Test:	3/25/2016	Soil-Only Specimen Diameter (mm):	306.23
Test Performed:	Post Cyclic Monotonic Shear	Weight (kg):	13.110
Test Material:	C109 Sand	Density (kg/m³):	1573.9
Sample Preparation:	Prepared loose by placing with a funnel and zero drop height.	Membrane Thickness (mm):	0.635
		Moisture Content (%):	0%
		Saturated (Y/N):	N
		Prepared by:	J.Hubler
		Checked by:	J. Hubler

Consolidation Stage

Vertical Stress (kPa):	100
Time to Compression (min):	8.8
Relative Density (%):	47%
Void Ratio:	0.646
Height (mm):	110.6
Diameter (mm):	306.23
Weight (kg):	13.110
Density (kg/m³):	1609.5

Shear Stage

Type of Test:	Constant Volume
Stress or Strain Controlled:	Strain
Shear Strain Rate (%/min):	0.30
Peak Shear Strength (kPa):	18.0

Comments

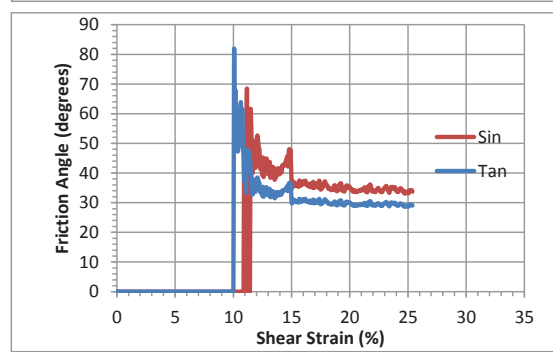
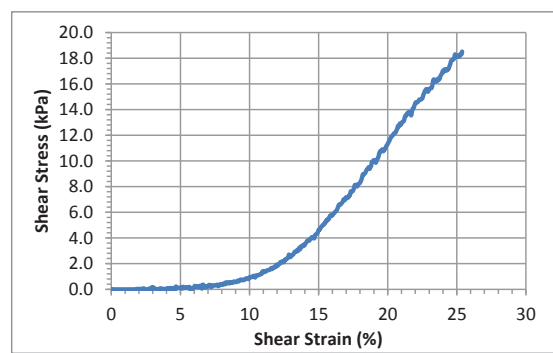
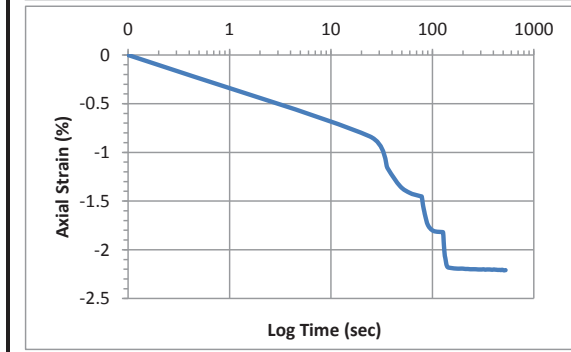
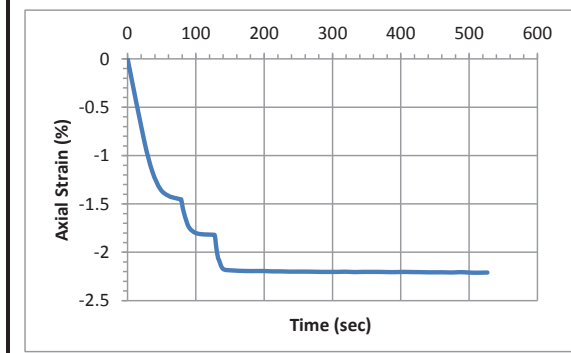

Accelerometer-Based Shear Wave Velocity Datasheet

Specimen ID: C258-C109-100-2X
 Test Material: C109
 Date: 3/25/2016
 Test Performed by: J.Hubler
 Filename: C258-C109-100-2X

Vertical Stress: 100kPa
 Sensor Spacing: 0.11032 m
 V_s (rise) = 192 m/s

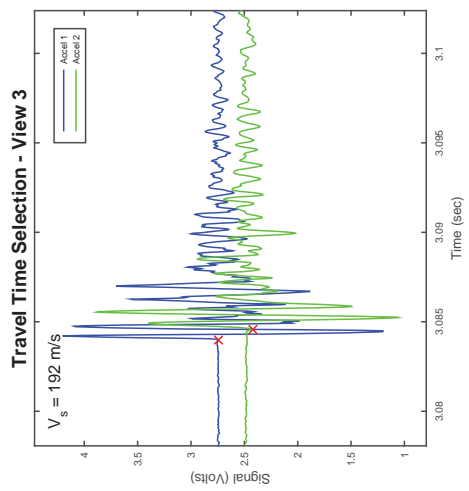
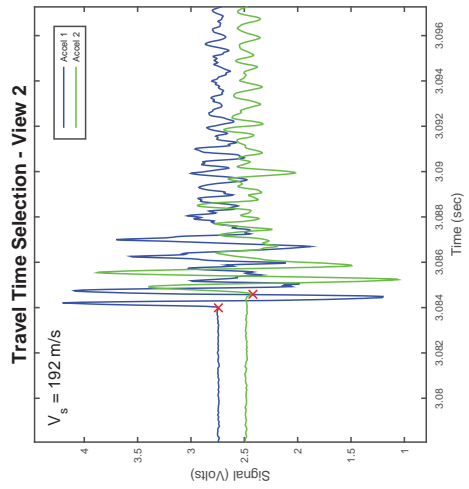
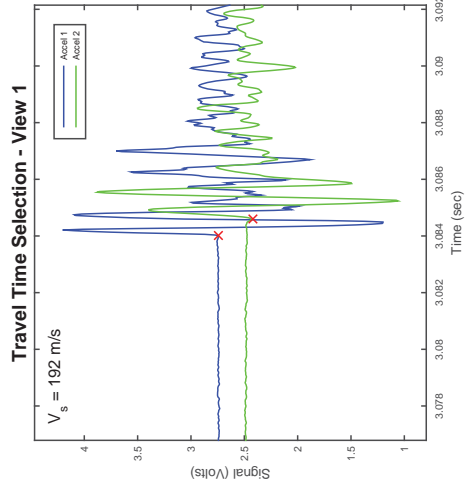
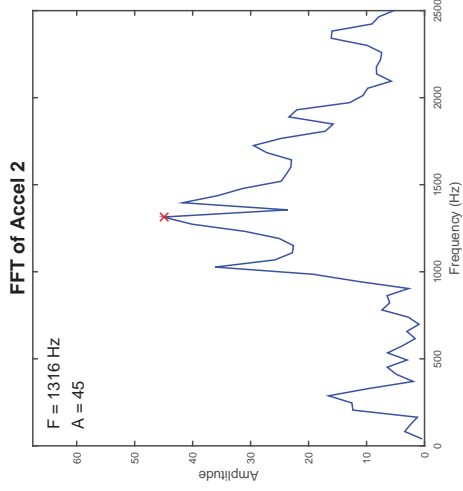
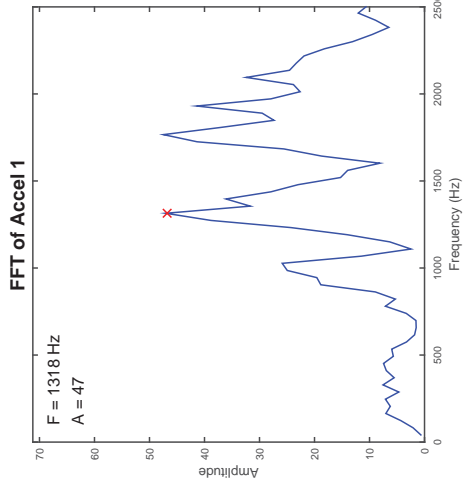
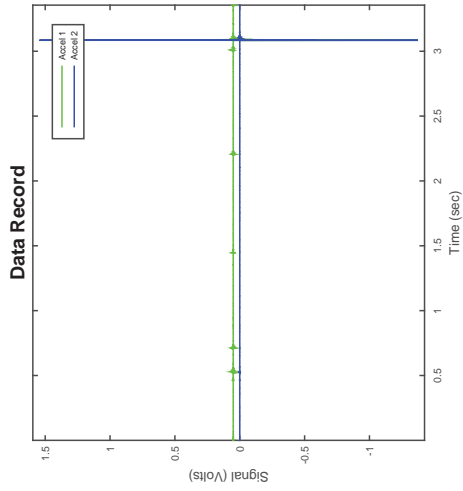

CSS Cyclic Shear Test Report

Geotechnical Engineering Laboratory



Cyclic Shear Test Summary

Device:	CSS	Density (kg/m³):	1616
Specimen ID:	C109	Relative Density (%):	50%
Test ID:	C256	Void Ratio:	0.640
Date of Test:	3/18/2016	Vertical Stress (kPa):	100
Test Performed:	Cyclic Shear	Loading Frequency (Hz):	0.3
Test Material:	C109 Sand	Number of Cycles:	2
Sample Preparation:	Prepared loose by the funneling method.	Cyclic Stress Ratio:	0.144
		Shear Modulus (kPa):	
		Damping (%):	
Prepared by:	A.Ventola	Shear Strain Single Amplitude (%)	
Checked by:	J.Hubler		

Additional Comments:

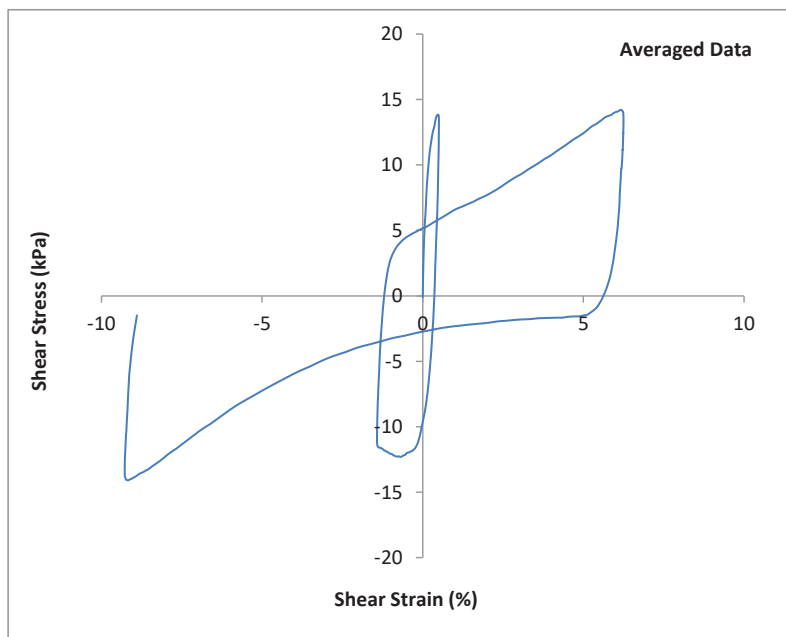
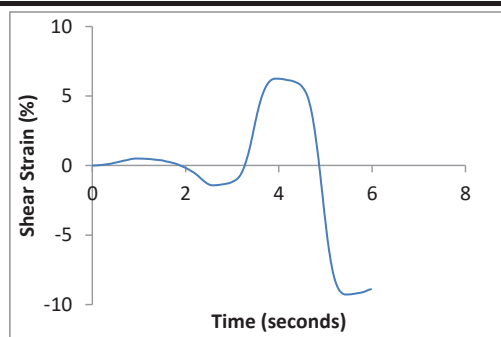
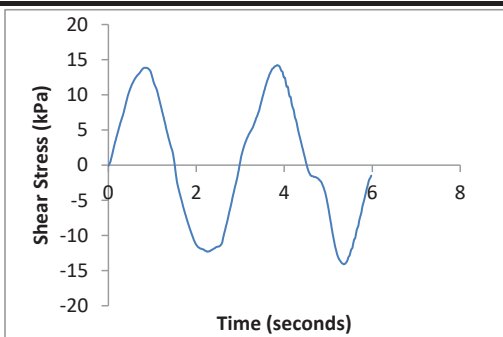

CSS Cyclic Shear Test Report

Geotechnical Engineering Laboratory



Cyclic Shear Test Summary

Device:	CSS	Density (kg/m³):	1616
Specimen ID:	C109	Relative Density (%):	50%
Test ID:	C256	Void Ratio:	0.640
Date of Test:	3/18/2016	Vertical Stress (kPa):	100
Test Performed:	Cyclic Shear	Loading Frequency (Hz):	0.3
Test Material:	C109 Sand	Number of Cycles:	2
Sample Preparation:	Prepared loose by the funneling method.	Cyclic Stress Ratio:	0.144
		Number of Cycles to Liq:	2
		Maximum ru:	0.97
Prepared by:	A.Ventola		
Checked by:	J.Hubler		

Additional Comments:

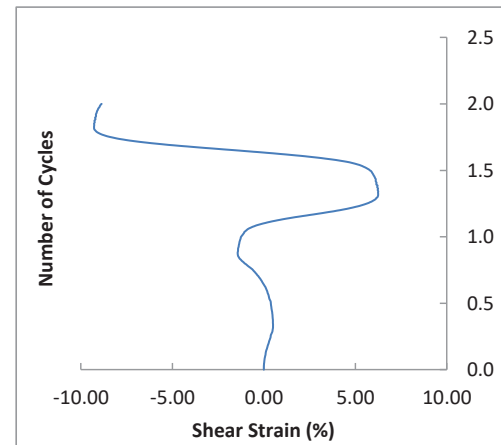
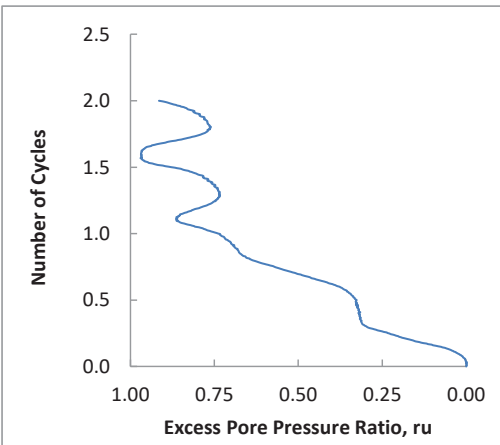
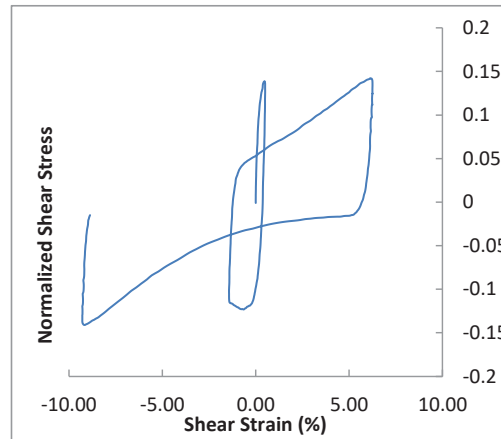
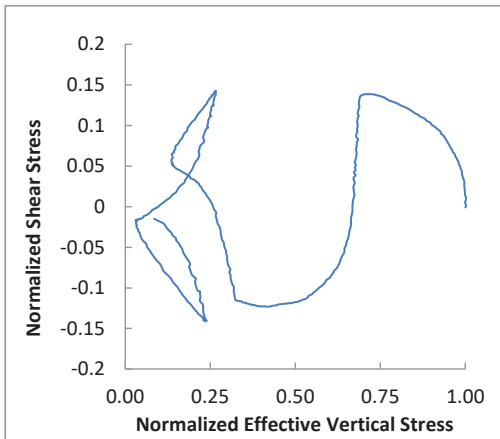

CSS Monotonic Shear Test Report

Geotechnical Engineering Laboratory



10/28/2013_Version 8.0

General Test Info and Sample Preparation

Device:	CSS	Relative Density (%):	50%
Specimen ID:	100C109	Void Ratio:	0.640
Test ID:	C256	Height (mm):	102.7
Date of Test:	3/18/2016	Soil-Only Specimen Diameter (mm):	306.23
Test Performed:	Post Cyclic Monotonic Shear	Weight (kg):	12.221
Test Material:	C109 Sand	Density (kg/m³):	1616.1
Sample Preparation:	Prepared loose by placing with a funnel and zero drop height.	Membrane Thickness (mm):	0.635
		Moisture Content (%):	0%
		Saturated (Y/N):	N
		Prepared by:	J.Hubler
		Checked by:	J. Hubler

Consolidation Stage

Shear Stage

Vertical Stress (kPa):	100	Type of Test:	Constant Volume
Time to Compression (min):	6.1	Stress or Strain Controlled:	Strain
Relative Density (%):	63%	Shear Strain Rate (%/min):	0.32
Void Ratio:	0.612	Peak Shear Strength (kPa):	78.0
Height (mm):	100.9	Comments Re-consolidated to 100 kPa after cyclic test at CSR = 0.144	
Diameter (mm):	306.23		
Weight (kg):	12.221		
Density (kg/m³):	1644.3		

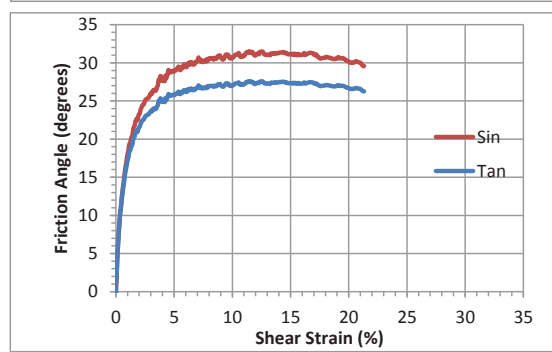
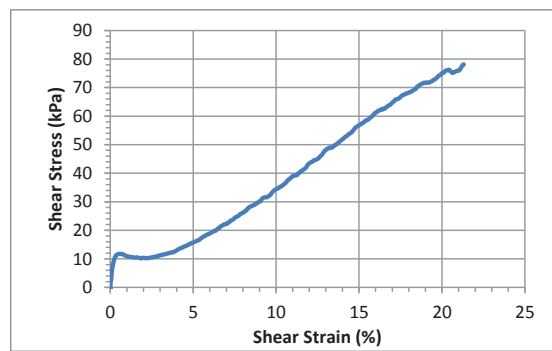
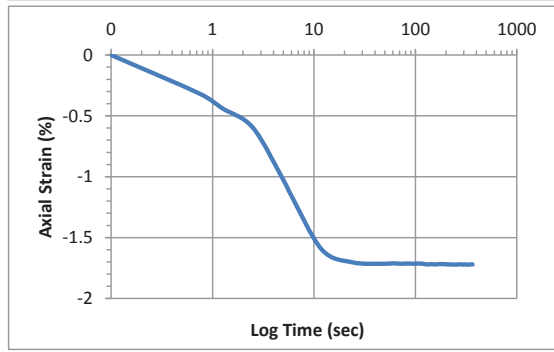
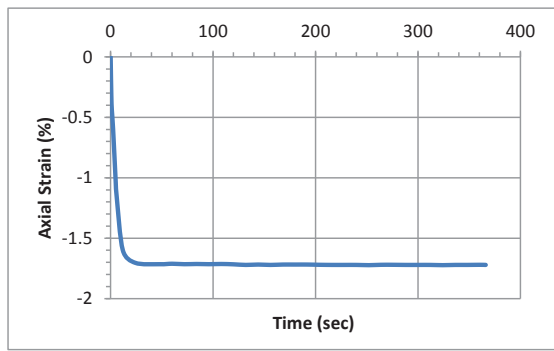

Accelerometer-Based Shear Wave Velocity Datasheet

Specimen ID: C256-C109-100-1X
 Test Material: C109
 Date: 3/18/2016
 Test Performed by: J.Hubler
 Filename: C256-C109-100-1X

Vertical Stress: 100kPa
 Sensor Spacing: 0.1024 m
 V_s (rise) = 192 m/s

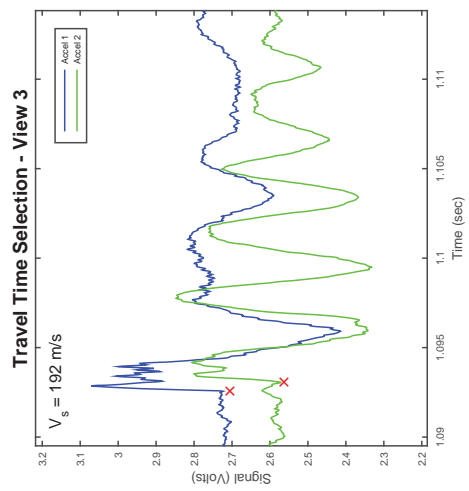
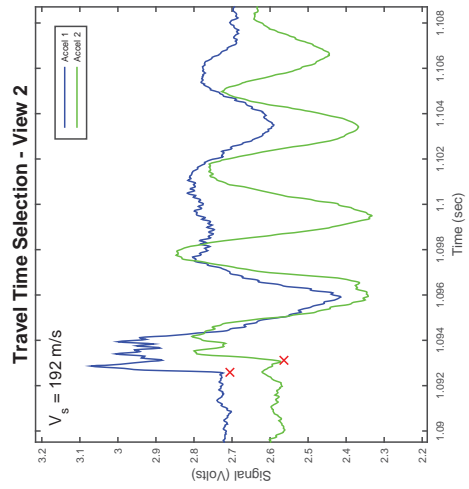
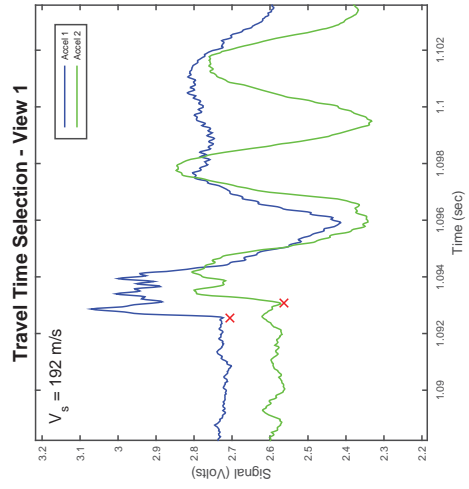
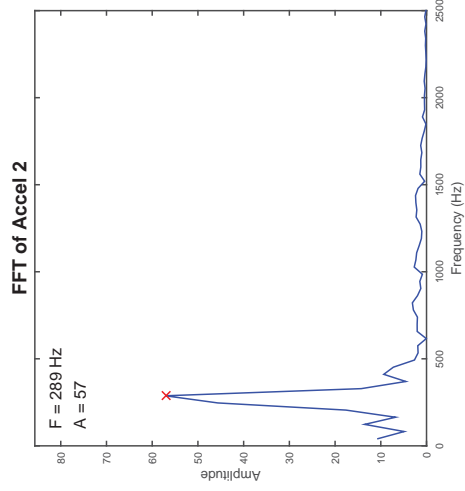
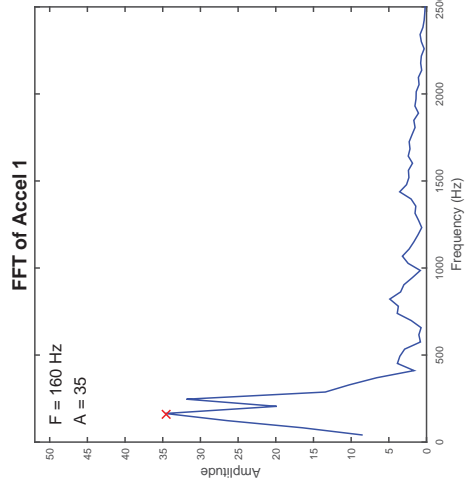
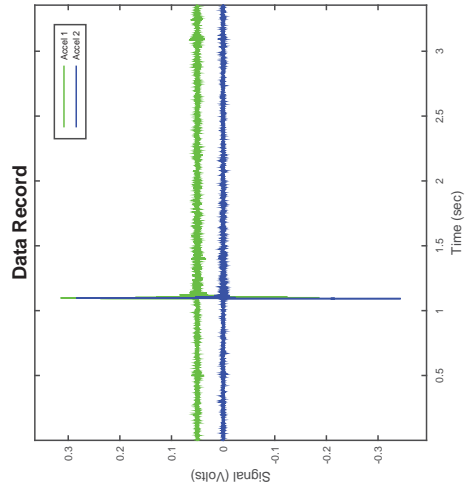

Accelerometer-Based Shear Wave Velocity Datasheet

Specimen ID: C256-C109-100-2X

Test Material: C109

Date: 3/18/2016

Test Performed by: J.Hubler

Filename: C256-C109-100-2X

Vertical Stress: 100kPa

Sensor Spacing: 0.1024 m

V_s (rise) = 204 m/s

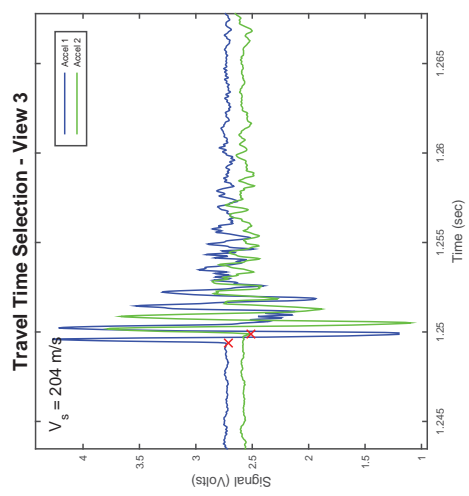
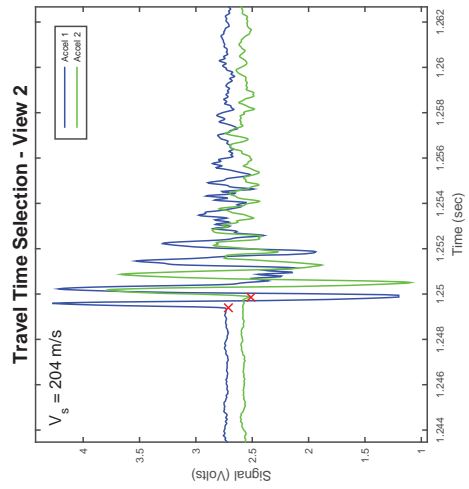
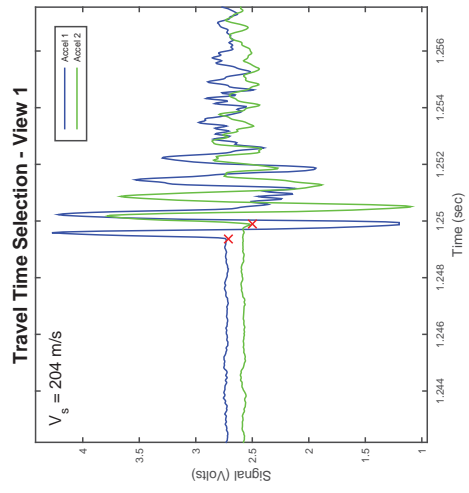
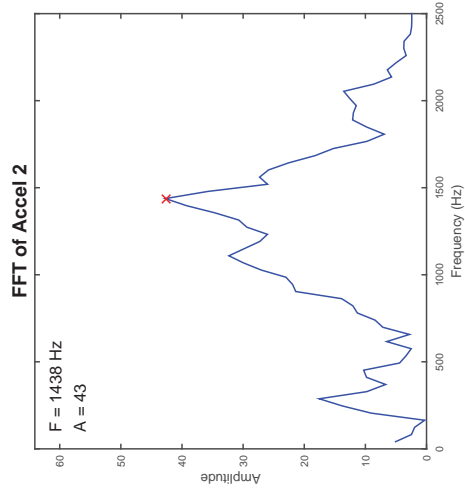
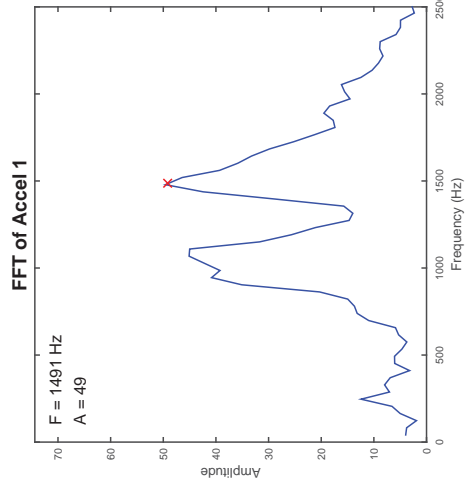
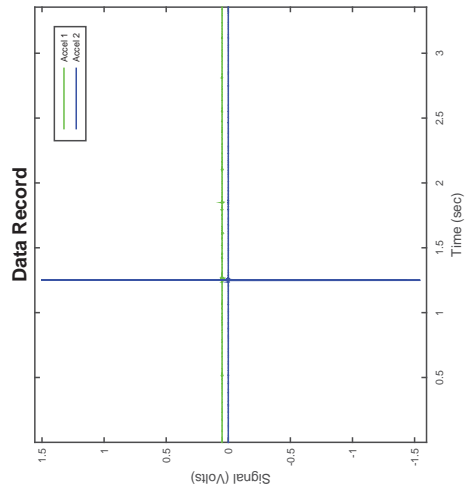

Accelerometer-Based Shear Wave Velocity Datasheet

Specimen ID: C256-C109-100-3X
 Test Material: C109
 Date: 3/18/2014
 Test Performed by: J.Hubler
 Filename: C256-C109-100-3X

Vertical Stress: 100kPa
 Sensor Spacing: 0.1024 m
 V_s (rise) = 200 m/s

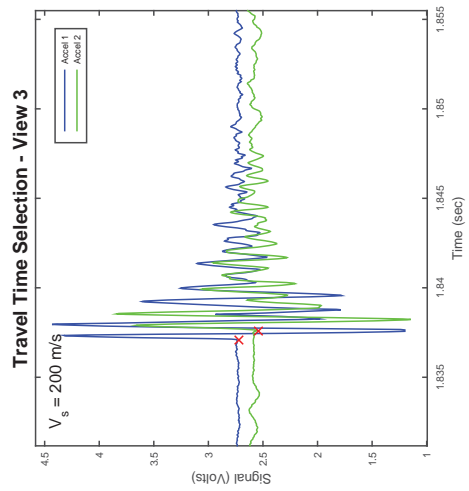
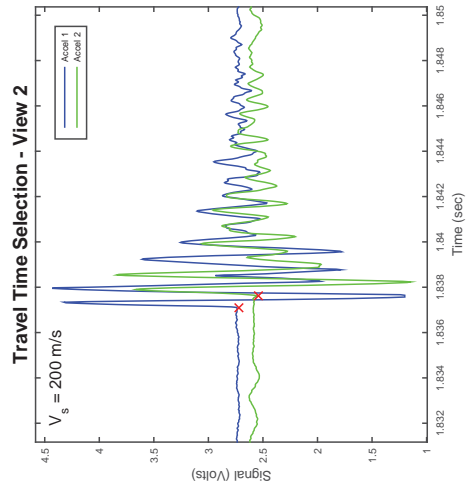
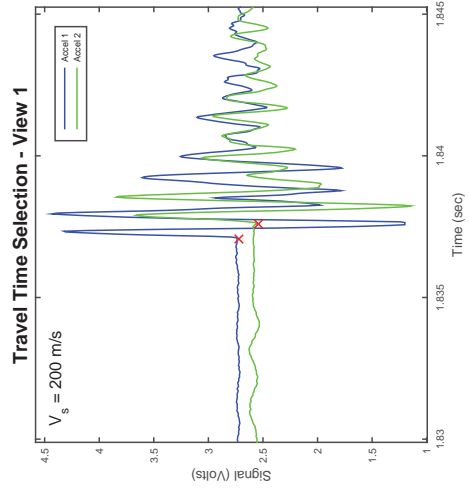
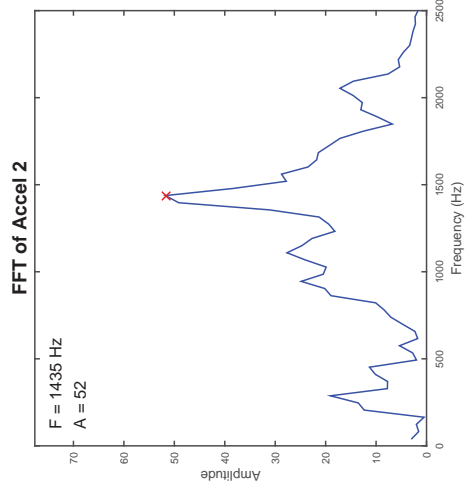
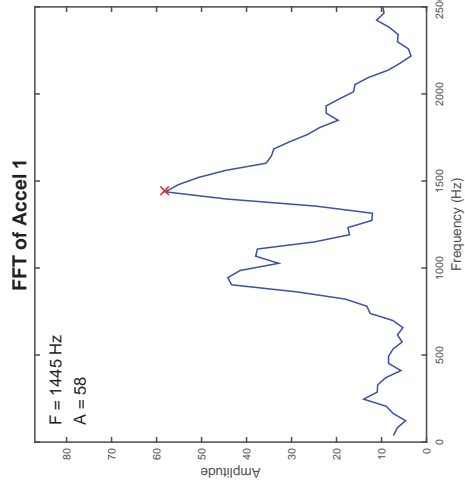
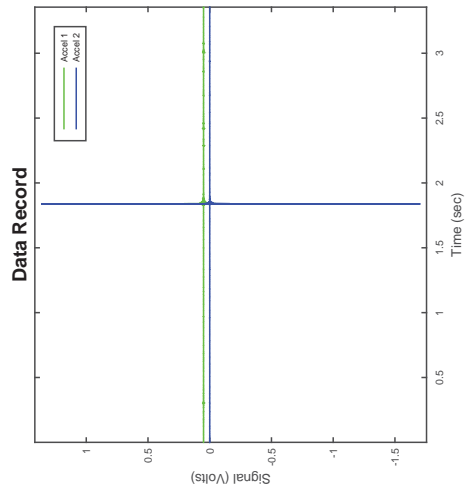

Accelerometer-Based Shear Wave Velocity Datasheet

Specimen ID: C256-C109-100-1XP
 Test Material: C109
 Date: 3/18/2016
 Test Performed by: J.Hubler
 Filename: C256-C109-100-1XP

Vertical Stress: 100kPa
 Sensor Spacing: 0.10063 m
 V_s (rise) = 193 m/s

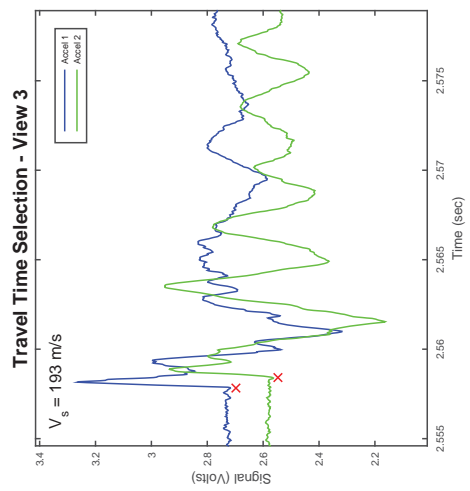
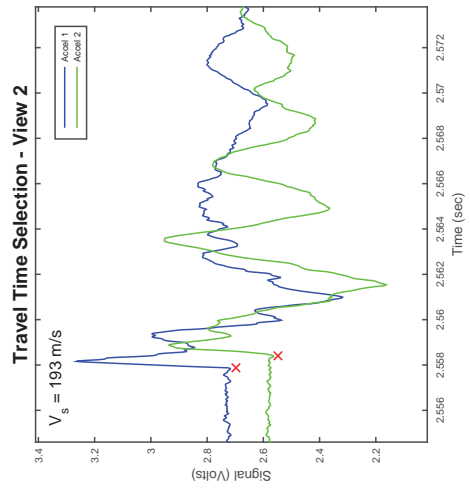
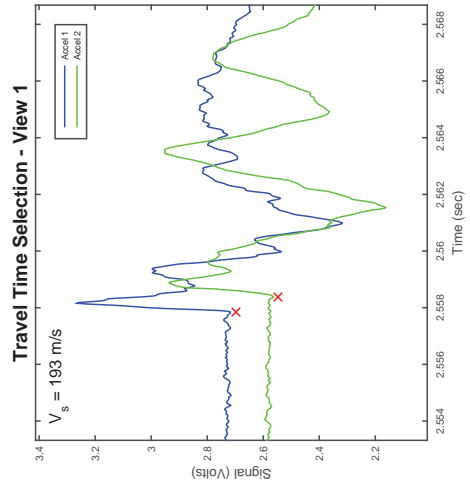
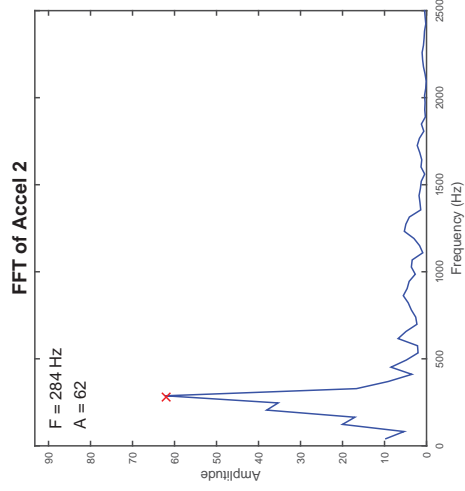
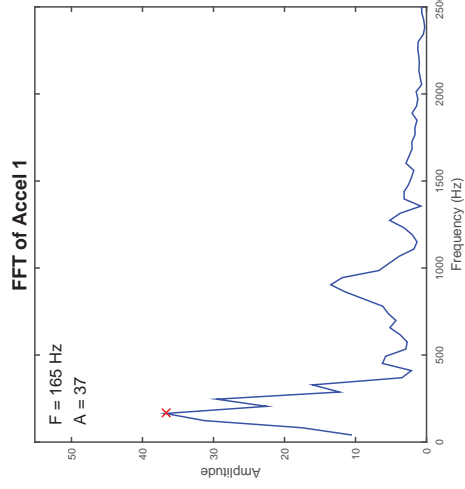
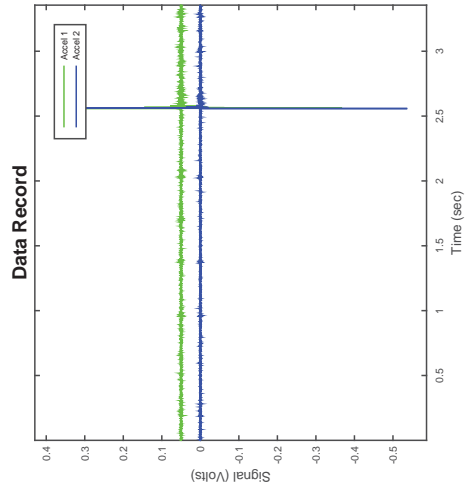

Accelerometer-Based Shear Wave Velocity Datasheet

Specimen ID: C256-C109-100-2XP

Test Material: C109

Date: 3/18/2016

Test Performed by: J.Hubler

Filename: C256-C109-100-2XP

Vertical Stress: 100kPa

Sensor Spacing: 0.10063 m

V_s (rise) = 175 m/s

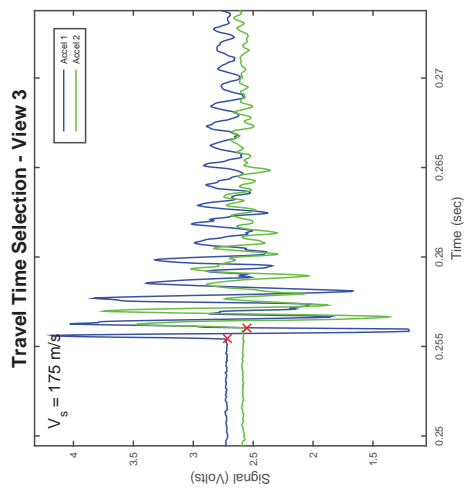
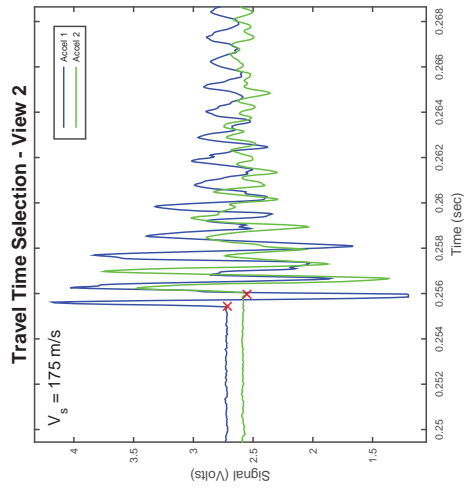
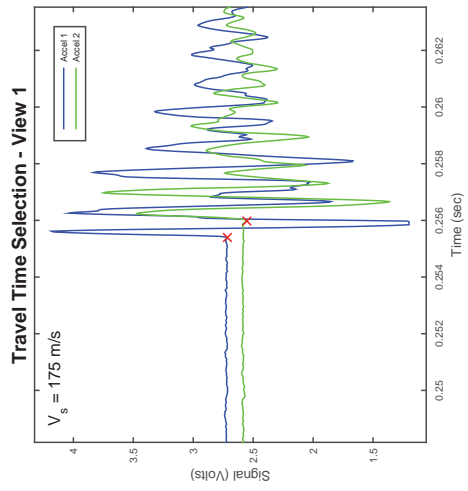
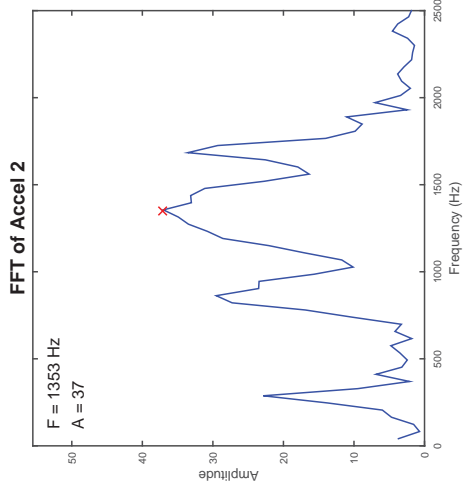
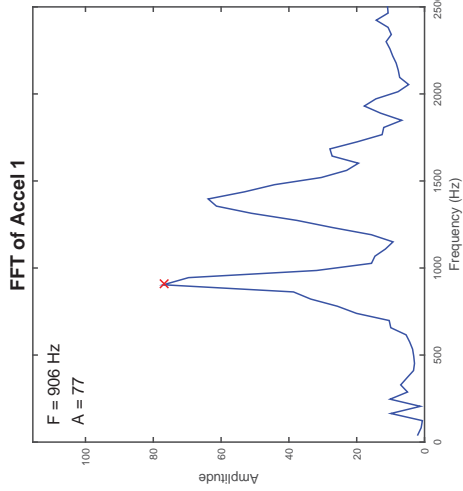
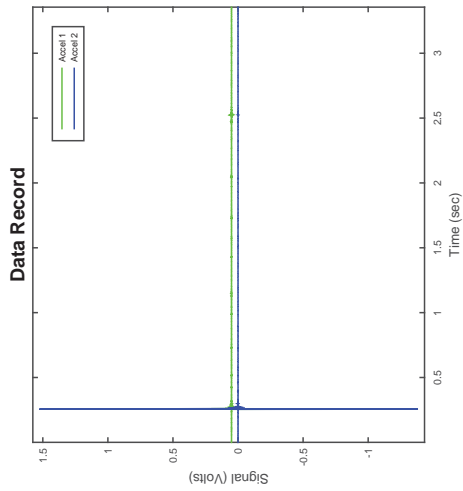

Accelerometer-Based Shear Wave Velocity Datasheet

Specimen ID: C256-C109-100-3XP

Test Material: C109

Date: 3/18/2016

Test Performed by: J.Hubler

Filename: C256-C109-100-3XP

Vertical Stress: 100kPa

Sensor Spacing: 0.10063 m

V_s (rise) = 182 m/s

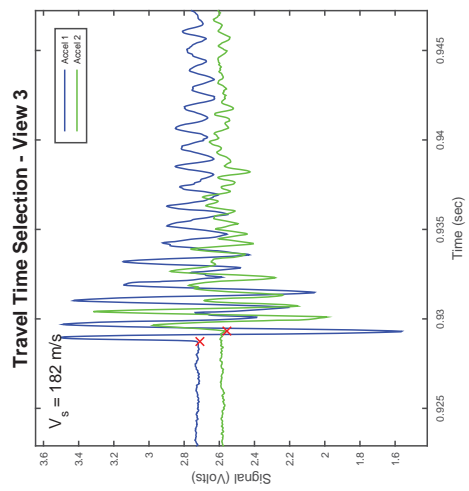
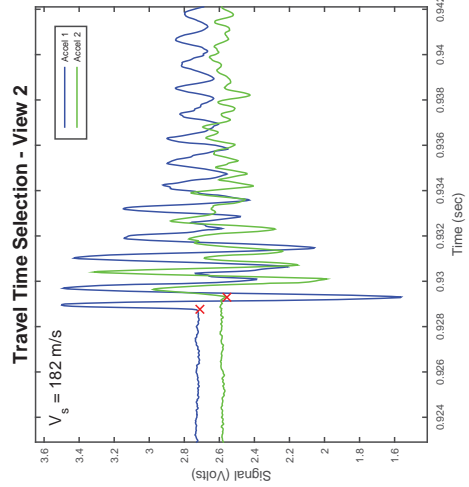
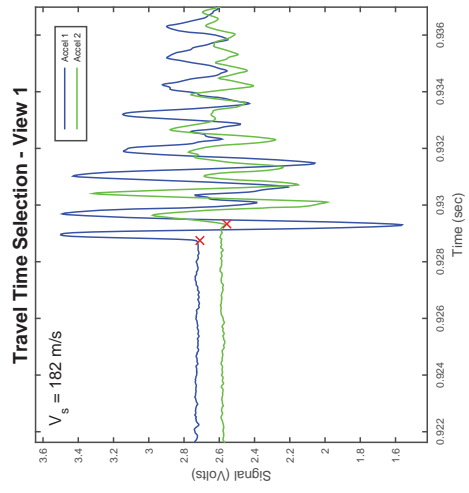
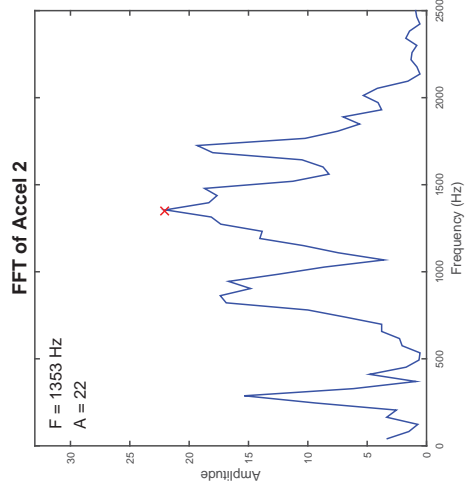
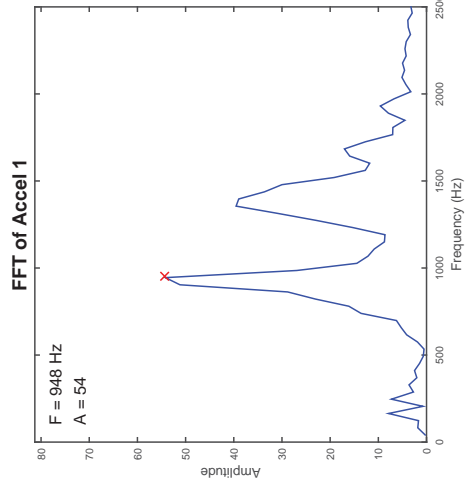
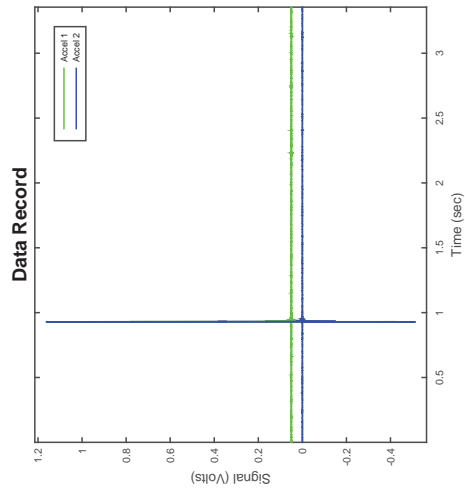

CSS Cyclic Shear Test Report

Geotechnical Engineering Laboratory



Cyclic Shear Test Summary

Device:	CSS	Density (kg/m³):	1707
Specimen ID:	C109	Relative Density (%):	90%
Test ID:	C280	Void Ratio:	0.552
Date of Test:	7/20/2016	Vertical Stress (kPa):	100
Test Performed:	Cyclic Shear	Loading Frequency (Hz):	0.33
Test Material:	C109 Sand	Number of Cycles:	2
Sample Preparation:	Prepared loose by the funneling method.	Cyclic Stress Ratio:	0.144
		Shear Modulus (kPa):	
		Damping (%):	
Prepared by:	J.Hubler	Shear Strain Single Amplitude (%)	
Checked by:	J.Hubler		

Additional Comments:

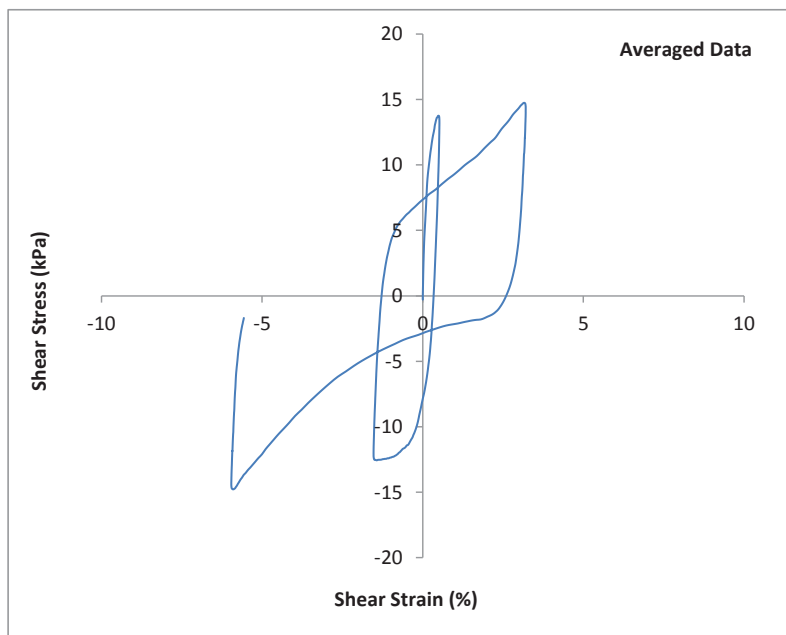
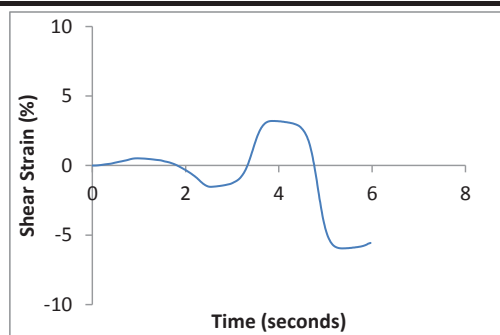
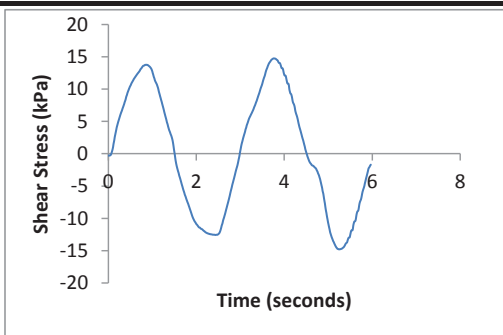

CSS Cyclic Shear Test Report

Geotechnical Engineering Laboratory



Cyclic Shear Test Summary

Device:	CSS	Density (kg/m³):	1707
Specimen ID:	C109	Relative Density (%):	90%
Test ID:	C280	Void Ratio:	0.552
Date of Test:	7/20/2016	Vertical Stress (kPa):	100
Test Performed:	Cyclic Shear	Loading Frequency (Hz):	0.33
Test Material:	C109 Sand	Number of Cycles:	2
Sample Preparation:	Prepared loose by the funneling method.	Cyclic Stress Ratio:	0.144
		Number of Cycles to Liq:	2
		Maximum ru:	0.96
Prepared by:	J.Hubler		
Checked by:	J.Hubler		

Additional Comments:

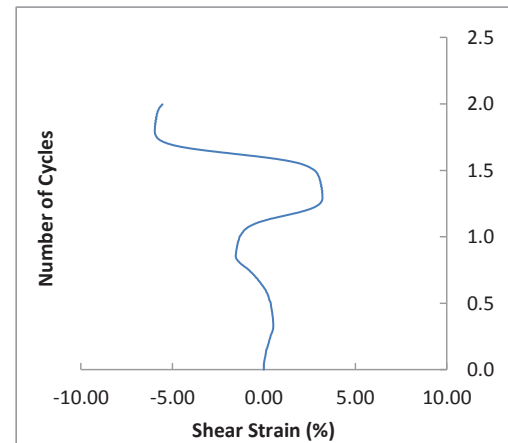
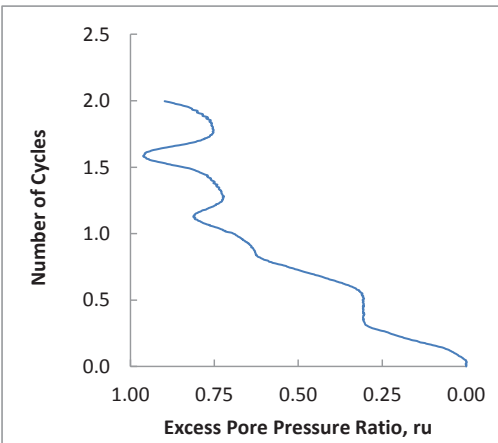
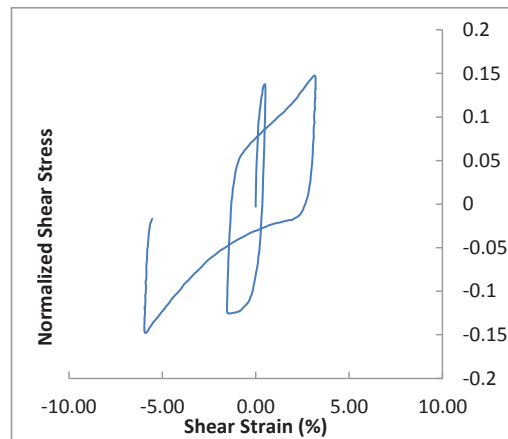
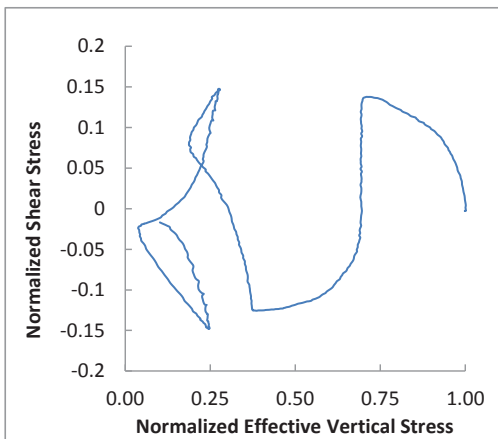

CSS Monotonic Shear Test Report

Geotechnical Engineering Laboratory



10/28/2013_Version 8.0

General Test Info and Sample Preparation

Device:	CSS	Relative Density (%):	90%
Specimen ID:	100C109	Void Ratio:	0.552
Test ID:	C280	Height (mm):	105.7
Date of Test:	7/20/2016	Soil-Only Specimen Diameter (mm):	306.23
Test Performed:	Post Cyclic Monotonic Shear	Weight (kg):	13.301
Test Material:	C109 Sand	Density (kg/m³):	1708.0
Sample Preparation:	Prepared loose by placing with a funnel and zero drop height.	Membrane Thickness (mm):	0.635
		Moisture Content (%):	0%
		Saturated (Y/N):	N
		Prepared by:	J.Hubler
		Checked by:	J. Hubler

Consolidation Stage

Vertical Stress (kPa):	100
Time to Compression (min):	3.1
Relative Density (%):	98%
Void Ratio:	0.534
Height (mm):	104.5
Diameter (mm):	306.23
Weight (kg):	13.301
Density (kg/m³):	1727.4

Shear Stage

Type of Test:	Constant Volume
Stress or Strain Controlled:	Strain
Shear Strain Rate (%/min):	0.31
Peak Shear Strength (kPa):	151.0

Comments

Re-consolidated to 100 kPa after cyclic test at CSR = 0.144

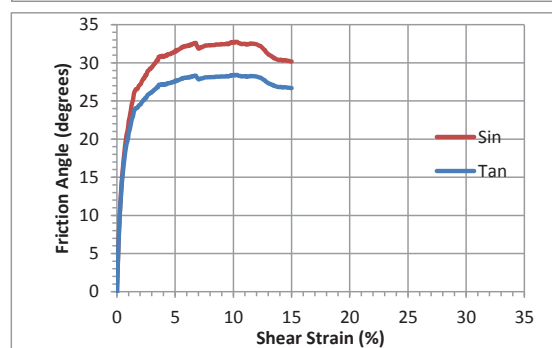
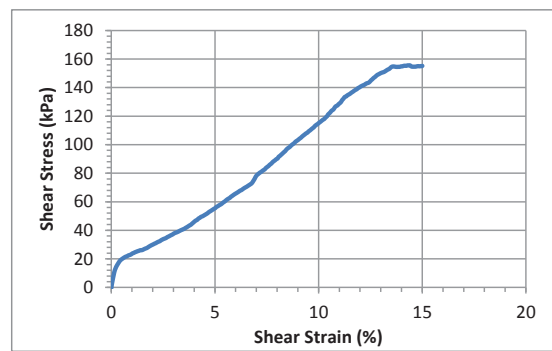
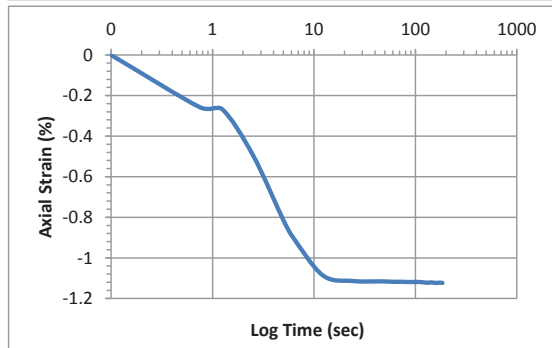
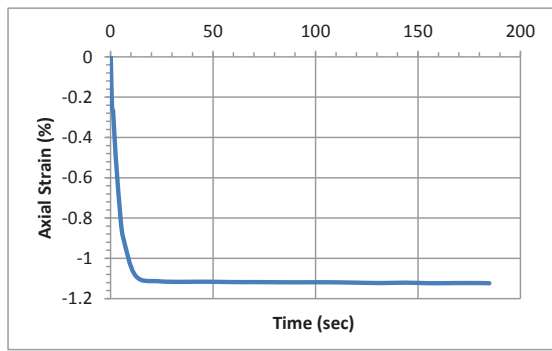

Accelerometer-Based Shear Wave Velocity Datasheet

Specimen ID: C280-C109-100-1X
 Test Material: C109
 Date: 7/20/2016
 Test Performed by: J.Hubler
 Filename: C280-C109-100-1X

Vertical Stress: 100kPa
 Sensor Spacing: 0.10545 m
 V_s (rise) = 210 m/s

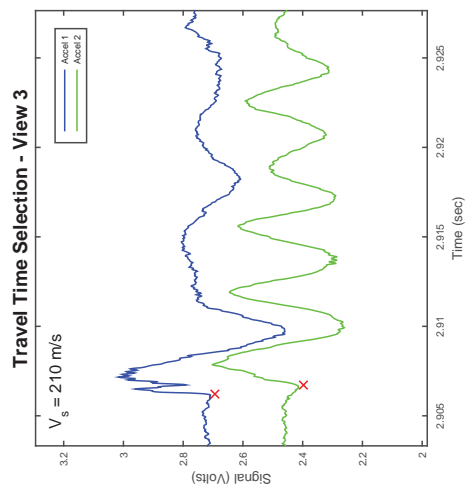
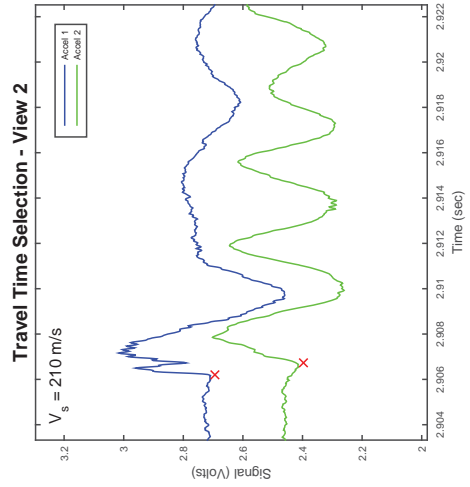
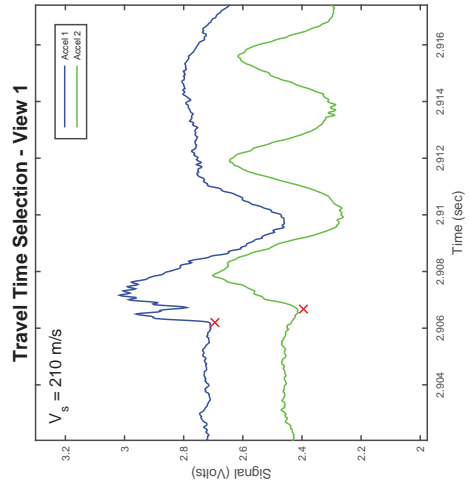
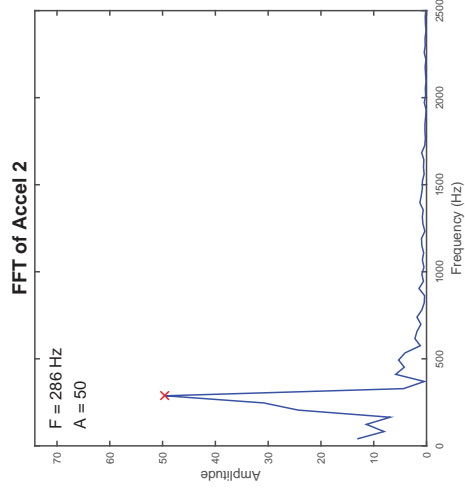
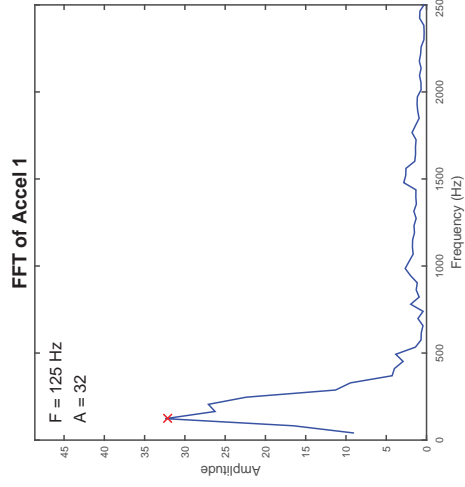
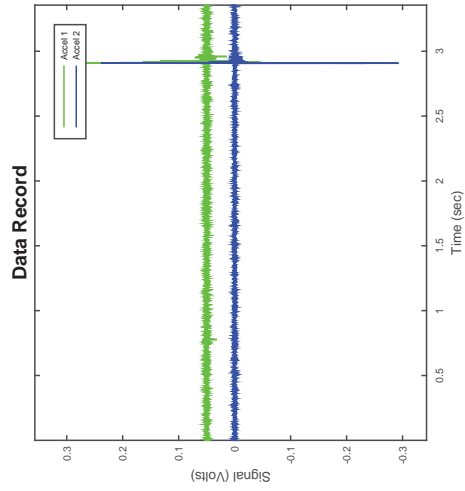

Accelerometer-Based Shear Wave Velocity Datasheet

Specimen ID: C280-C109-100-1XP
 Test Material: C109
 Date: 7/20/16
 Test Performed by: J.Hubler
 Filename: C280-C109-100-1XP

Vertical Stress: 100kPa
 Sensor Spacing: 0.10427 m
 V_s (rise) = 164 m/s

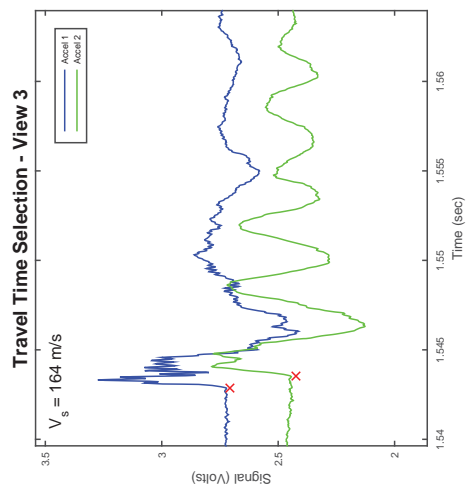
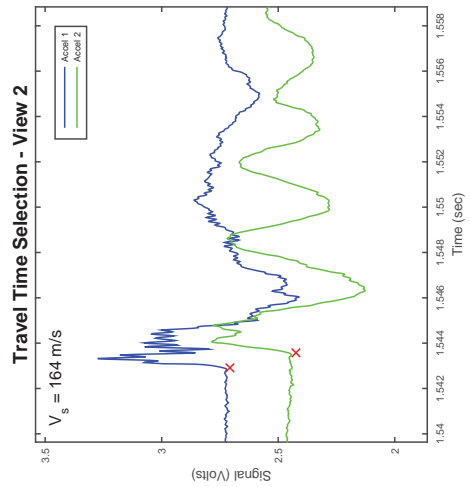
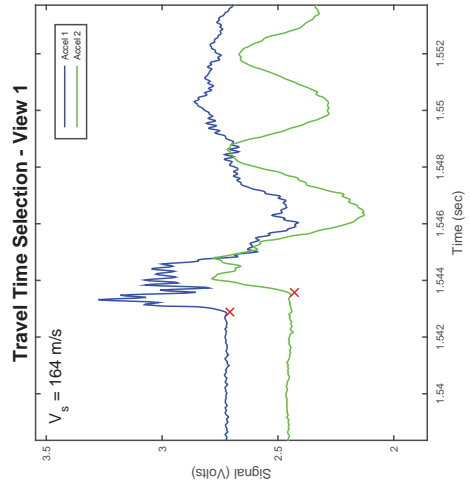
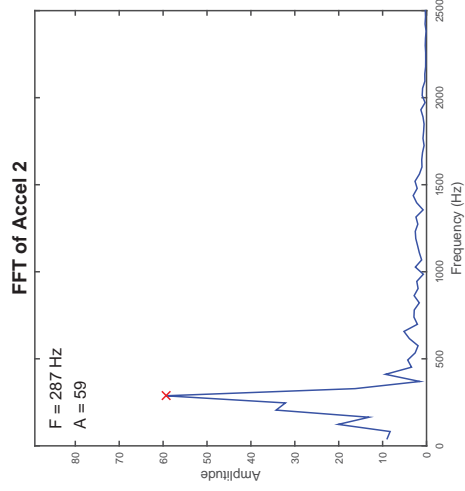
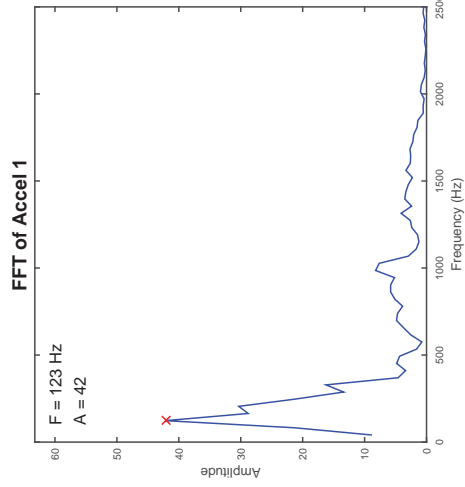
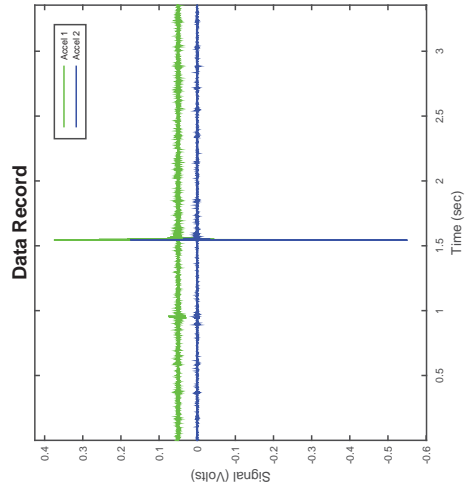

Accelerometer-Based Shear Wave Velocity Datasheet

Specimen ID: C280-C109-100-2XP
 Test Material: C109
 Date: 7/20/16
 Test Performed by: J.Hubler
 Filename: C280-C109-100-2XP

Vertical Stress: 100kPa
 Sensor Spacing: 0.10427 m
 V_s (rise) = 169 m/s

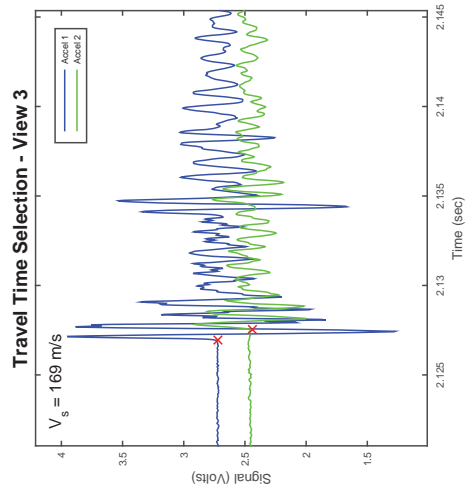
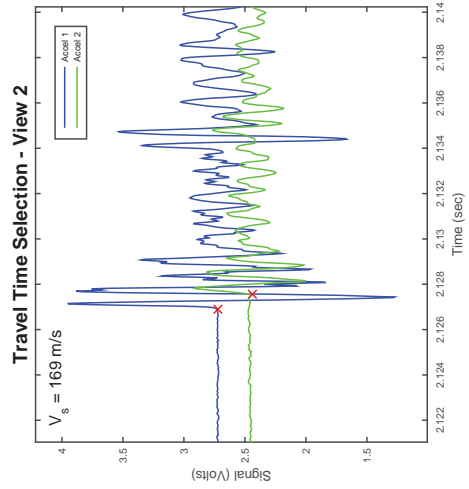
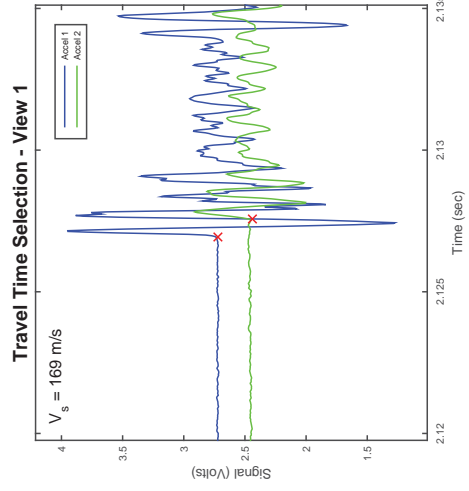
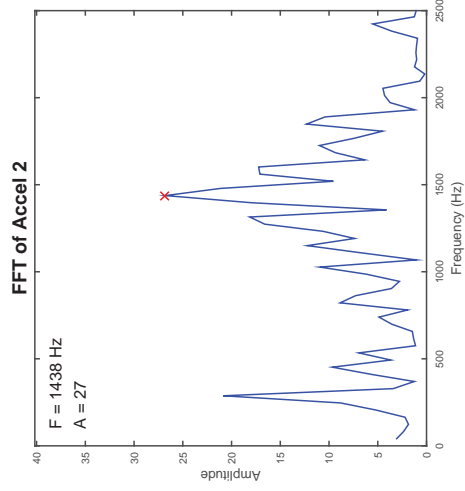
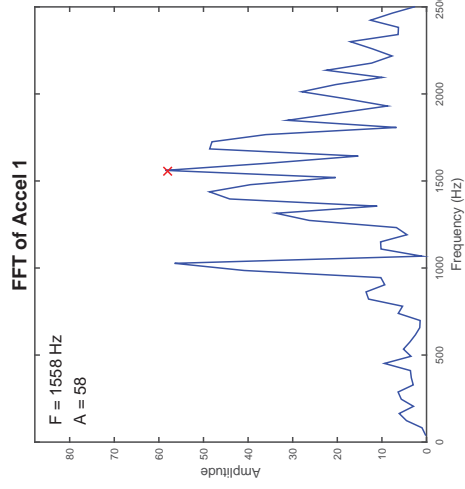
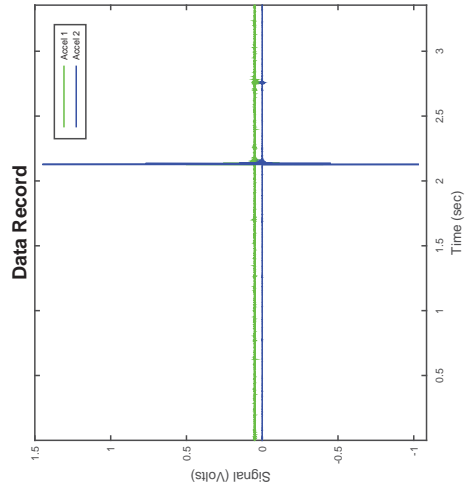

CSS Cyclic Shear Test Report

Geotechnical Engineering Laboratory



Cyclic Shear Test Summary

Device:	CSS	Density (kg/m³):	1612
Specimen ID:	C109	Relative Density (%):	49%
Test ID:	C274	Void Ratio:	0.644
Date of Test:	7/11/2016	Vertical Stress (kPa):	400
Test Performed:	Cyclic Shear	Loading Frequency (Hz):	0.33
Test Material:	C109 Sand	Number of Cycles:	6
Sample Preparation:	Prepared loose by the funnelling method.	Cyclic Stress Ratio:	0.099
		Shear Modulus (kPa):	
		Damping (%):	
Prepared by:	J.Hubler	Shear Strain Single Amplitude (%):	
Checked by:	J.Hubler		

Additional Comments:

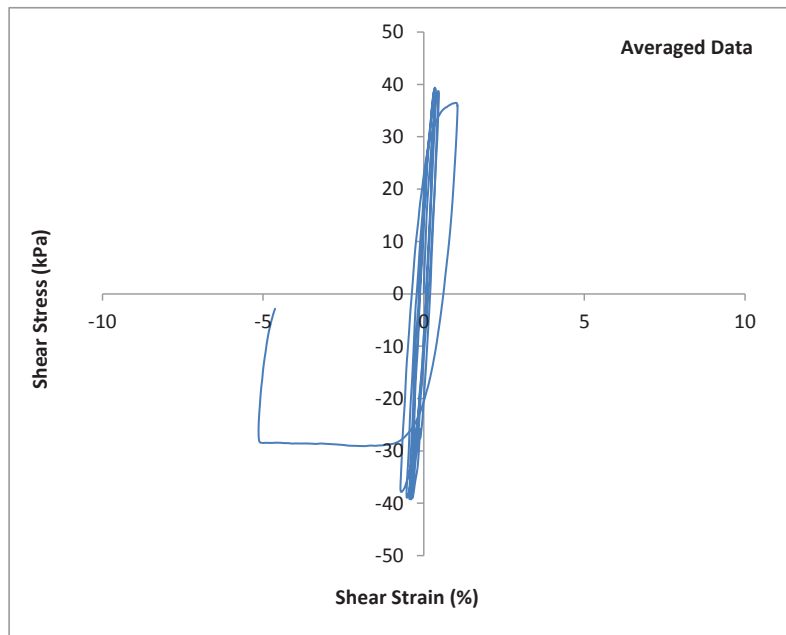
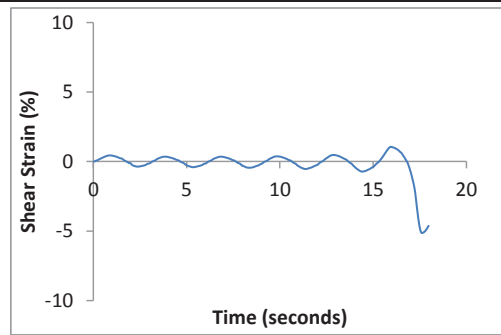
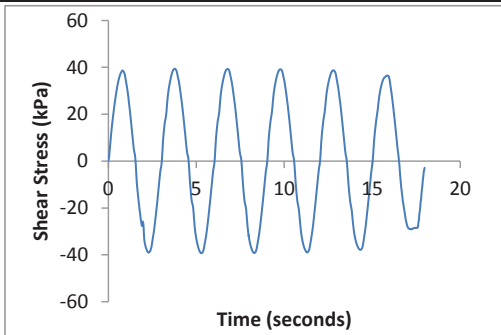

CSS Cyclic Shear Test Report

Geotechnical Engineering Laboratory



Cyclic Shear Test Summary

Device:	CSS	Density (kg/m³):	1612
Specimen ID:	C109	Relative Density (%):	49%
Test ID:	C274	Void Ratio:	0.644
Date of Test:	7/11/2016	Vertical Stress (kPa):	400
Test Performed:	Cyclic Shear	Loading Frequency (Hz):	0.33
Test Material:	C109 Sand	Number of Cycles:	6
Sample Preparation:	Prepared loose by the funneling method.	Cyclic Stress Ratio:	0.099
		Number of Cycles to Liq:	6
		Maximum ru:	0.90
Prepared by:	J.Hubler		
Checked by:	J.Hubler		

Additional Comments:

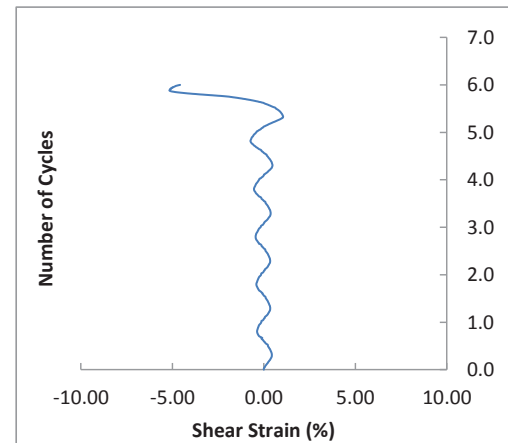
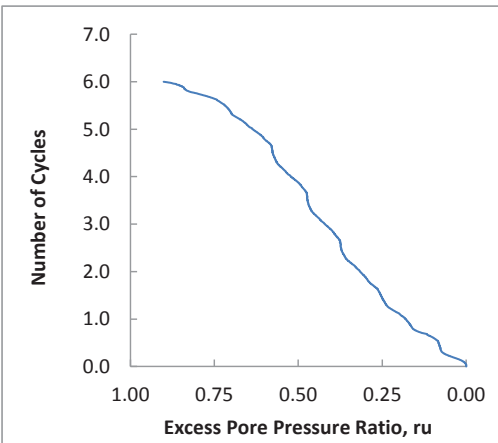
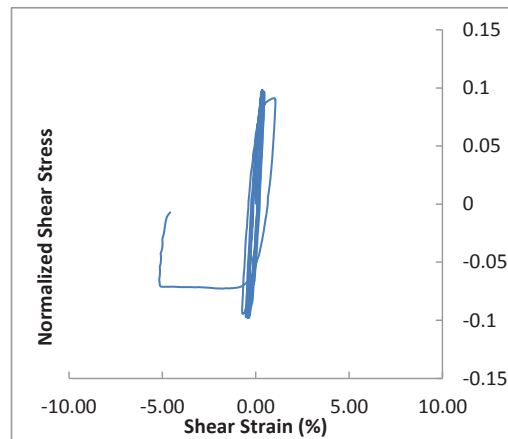
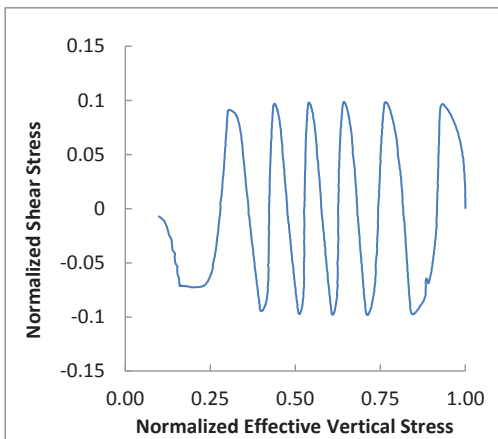

CSS Monotonic Shear Test Report



10/28/2013_Version 8.0

Geotechnical Engineering Laboratory

General Test Info and Sample Preparation

Device:	CSS	Relative Density (%):	15%
Specimen ID:	100C109	Void Ratio:	0.720
Test ID:	C274	Height (mm):	116.8
Date of Test:	7/11/2016	Soil-Only Specimen Diameter (mm):	306.23
Test Performed:	Post Cyclic Monotonic Shear	Weight (kg):	13.253
Test Material:	C109 Sand	Density (kg/m ³):	1541.0
Sample Preparation:	Prepared loose by placing with a funnel and zero drop height.	Membrane Thickness (mm):	0.635
		Moisture Content (%):	0%
		Saturated (Y/N):	N
		Prepared by:	J.Hubler
		Checked by:	J. Hubler

Consolidation Stage

Vertical Stress (kPa):	400
Time to Compression (min):	11.5
Relative Density (%):	49%
Void Ratio:	0.644
Height (mm):	111.6
Diameter (mm):	306.23
Weight (kg):	13.253
Density (kg/m ³):	1612.3

Shear Stage

Type of Test:	Constant Volume
Stress or Strain Controlled:	Strain
Shear Strain Rate (%/min):	0.29
Peak Shear Strength (kPa):	29.7

Comments

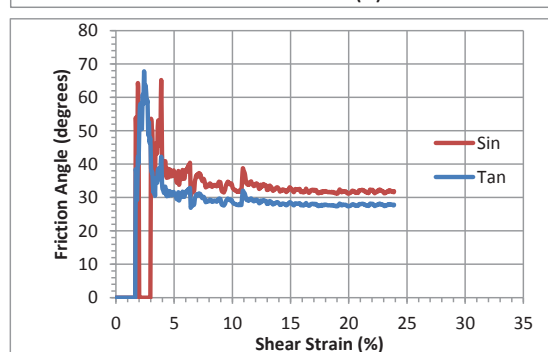
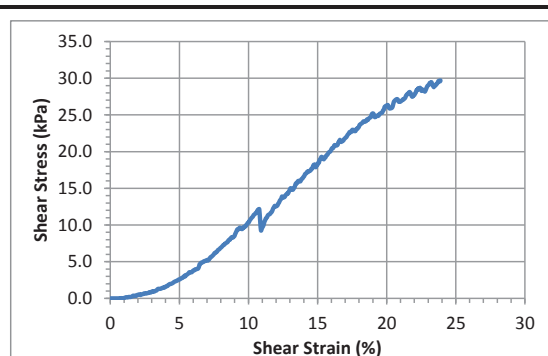
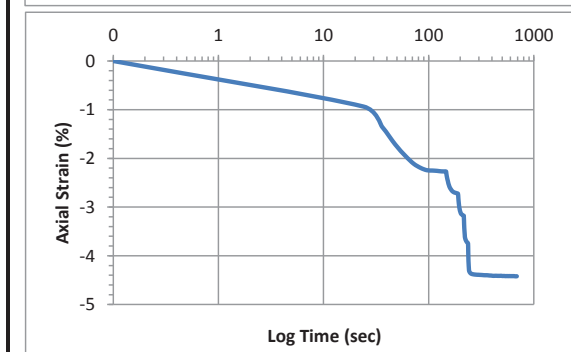
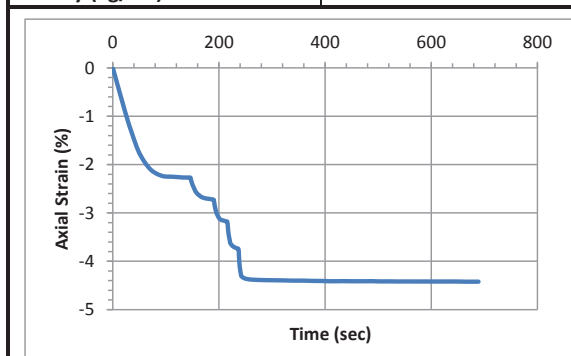

Accelerometer-Based Shear Wave Velocity Datasheet

Specimen ID: C274-C109-400-1X
 Test Material: C109
 Date: 7/11/16
 Test Performed by: J.Hubler
 Filename: C274-C109-400-1X

Vertical Stress: 400kPa
 Sensor Spacing: 0.11092 m
 V_s (rise) = 252 m/s

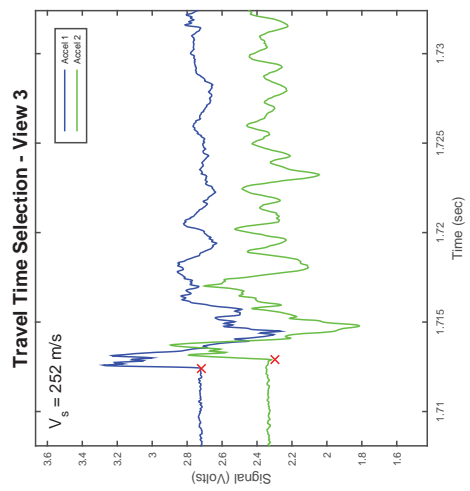
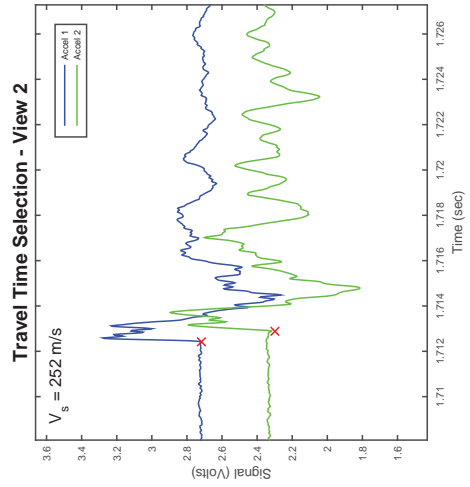
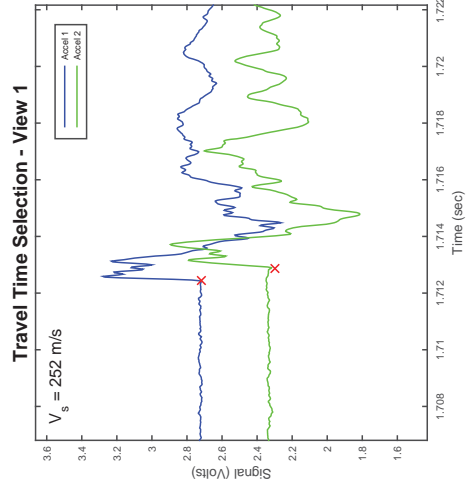
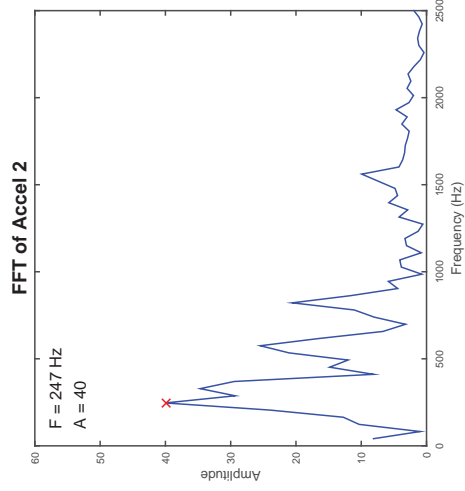
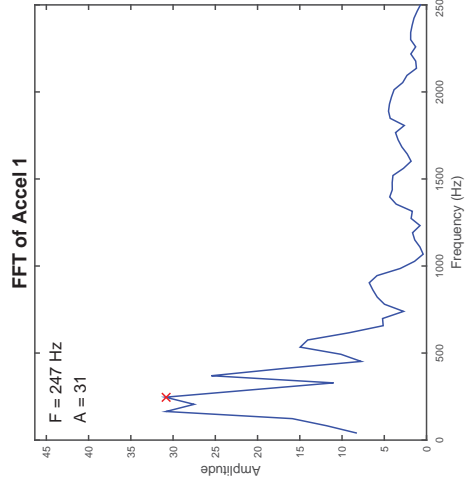
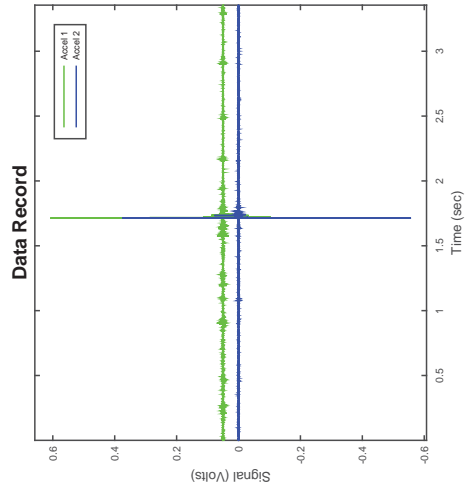

CSS Cyclic Shear Test Report

Geotechnical Engineering Laboratory



Cyclic Shear Test Summary

Device:	CSS	Density (kg/m³):	1696
Specimen ID:	C109	Relative Density (%):	85%
Test ID:	C279	Void Ratio:	0.563
Date of Test:	7/19/2016	Vertical Stress (kPa):	100
Test Performed:	Cyclic Shear	Loading Frequency (Hz):	0.33
Test Material:	C109 Sand	Number of Cycles:	181
Sample Preparation:	Prepared dense by tamping 20x in 5 layers	Cyclic Stress Ratio:	0.094
		Shear Modulus (kPa):	
		Damping (%):	
Prepared by:	J.Hubler	Shear Strain Single Amplitude (%)	
Checked by:	J.Hubler		

Additional Comments:

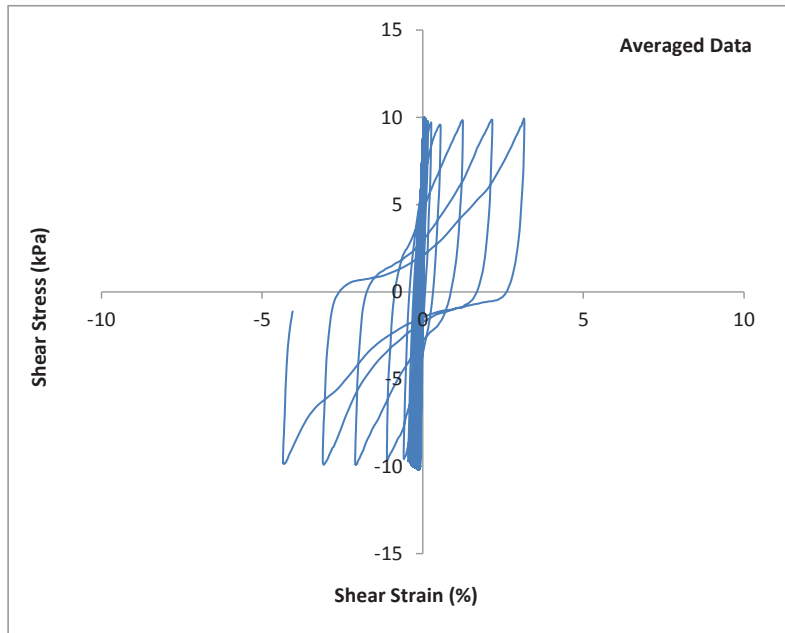
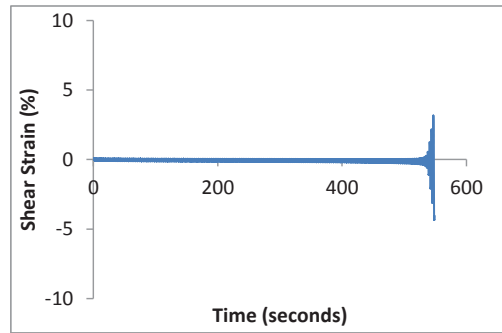
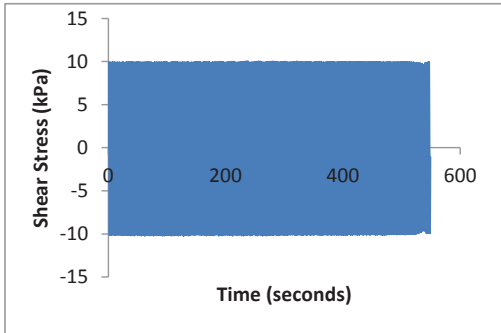

CSS Cyclic Shear Test Report

Geotechnical Engineering Laboratory



Cyclic Shear Test Summary

Device:	CSS	Density (kg/m³):	1696
Specimen ID:	C109	Relative Density (%):	85%
Test ID:	C279	Void Ratio:	0.563
Date of Test:	7/19/2016	Vertical Stress (kPa):	100
Test Performed:	Cyclic Shear	Loading Frequency (Hz):	0.33
Test Material:	C109 Sand	Number of Cycles:	181
Sample Preparation:	Prepared dense by tamping 20x in 5 layers	Cyclic Stress Ratio:	0.094
		Number of Cycles to Liq:	181
		Maximum ru:	0.98
Prepared by:	J.Hubler		
Checked by:	J.Hubler		

Additional Comments:

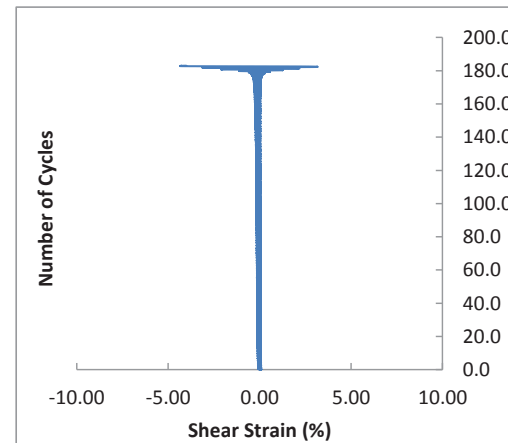
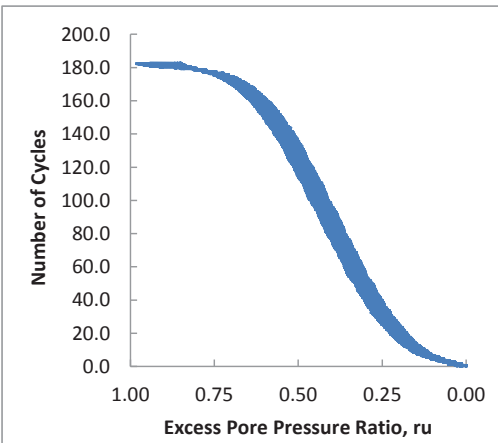
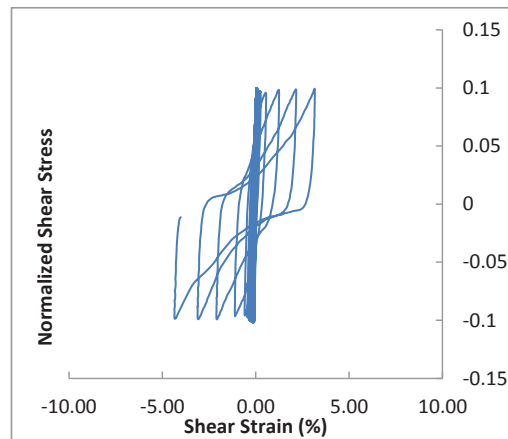
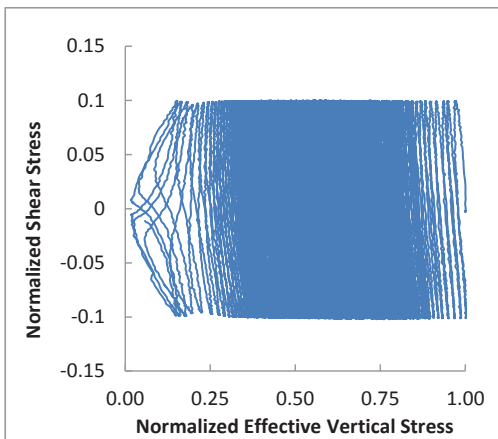

CSS Monotonic Shear Test Report

Geotechnical Engineering Laboratory



10/28/2013_Version 8.0

General Test Info and Sample Preparation

Device:	CSS	Relative Density (%):	34%
Specimen ID:	100C109	Void Ratio:	0.676
Test ID:	C279	Height (mm):	110.8
Date of Test:	7/19/2016	Soil-Only Specimen Diameter (mm):	306.23
Test Performed:	Post Cyclic Monotonic Shear	Weight (kg):	12.903
Test Material:	C109 Sand	Density (kg/m ³):	1581.0
Sample Preparation:	Prepared dense by tamping 20x in 5 layers.	Membrane Thickness (mm):	0.635
		Moisture Content (%):	0%
		Saturated (Y/N):	N
		Prepared by:	J.Hubler
		Checked by:	J. Hubler

Consolidation Stage

Vertical Stress (kPa):	100
Time to Compression (min):	10.1
Relative Density (%):	85%
Void Ratio:	0.563
Height (mm):	103.3
Diameter (mm):	306.23
Weight (kg):	12.903
Density (kg/m ³):	1695.5

Shear Stage

Type of Test:	Constant Volume
Stress or Strain Controlled:	Strain
Shear Strain Rate (%/min):	0.32
Peak Shear Strength (kPa):	30.5

Comments

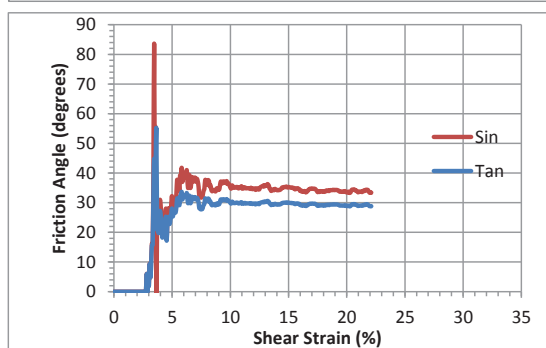
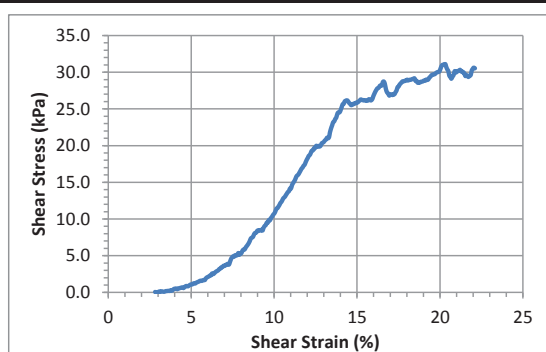
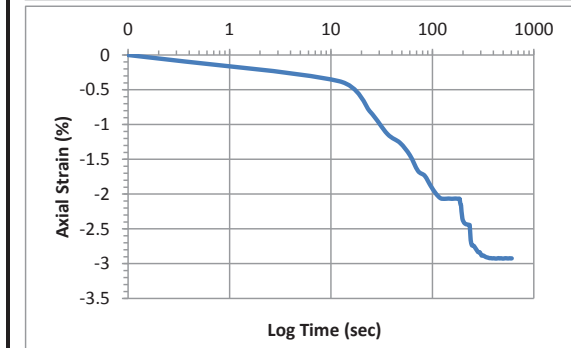
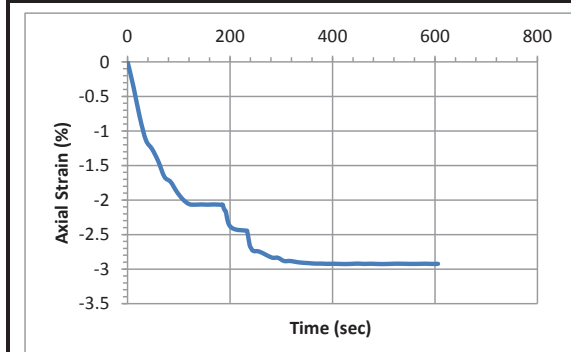

Accelerometer-Based Shear Wave Velocity Datasheet

Specimen ID: C279-C109-100-2X
 Test Material: C109
 Date: 7/19/2016
 Test Performed by: J.Hubler
 Filename: C279-C109-100-2X

Vertical Stress: 100kPa
 Sensor Spacing: 0.10301 m
 V_s (rise) = 210 m/s

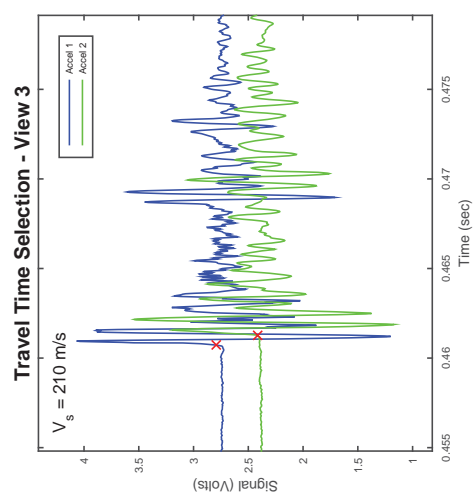
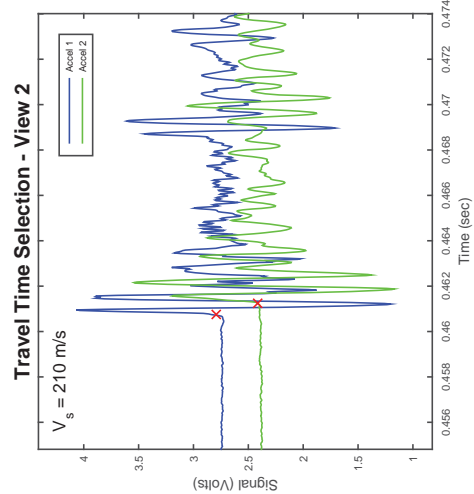
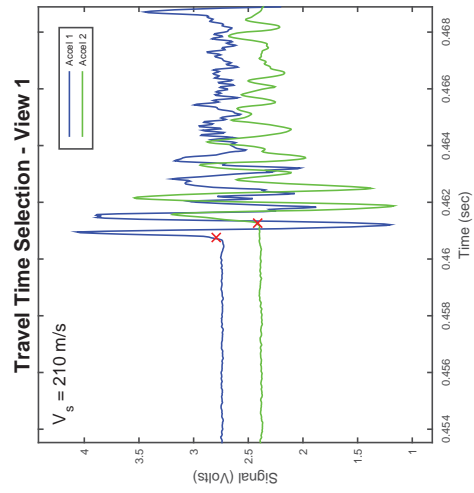
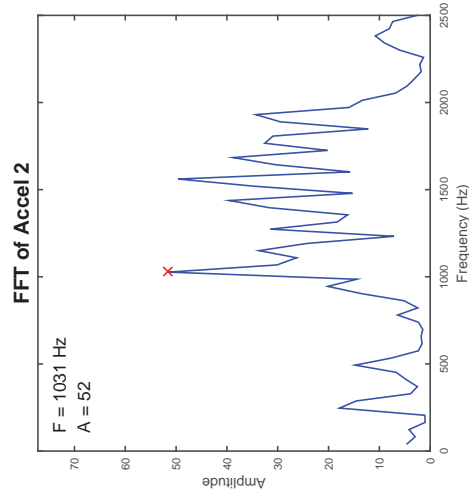
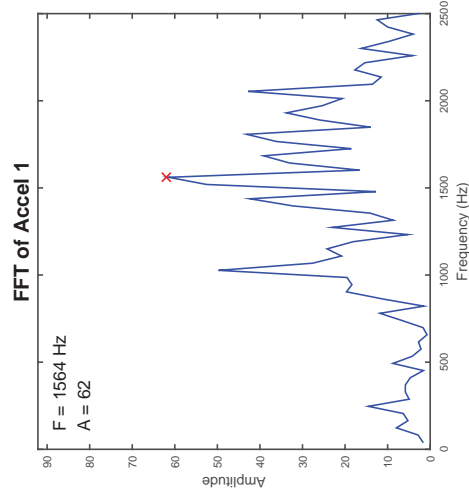
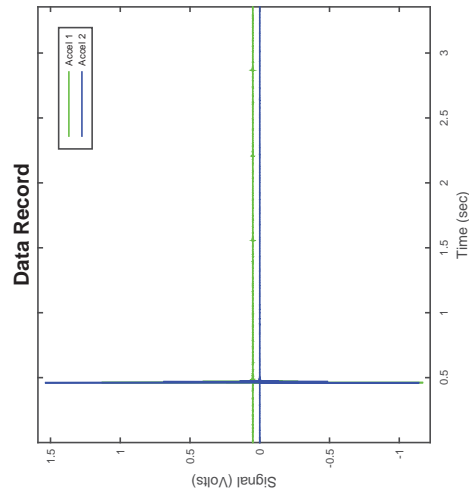

CSS Cyclic Shear Test Report

Geotechnical Engineering Laboratory



Cyclic Shear Test Summary

Device:	CSS	Density (kg/m³):	1815
Specimen ID:	80C109_20PG	Relative Density (%):	84%
Test ID:	C298	Void Ratio:	0.471
Date of Test:	10/26/2016	Vertical Stress (kPa):	100
Test Performed:	Cyclic Shear	Loading Frequency (Hz):	0.33
Test Material:	Ottawa Sand/Pea Gravel	Number of Cycles:	11
Sample Preparation:	Prepared dense by tamping in 5 layers (25x)	Cyclic Stress Ratio:	0.094
		Shear Modulus (kPa):	
		Damping (%):	
Prepared by:	J.Hubler	Shear Strain Single Amplitude (%)	
Checked by:	J.Hubler		

Additional Comments:

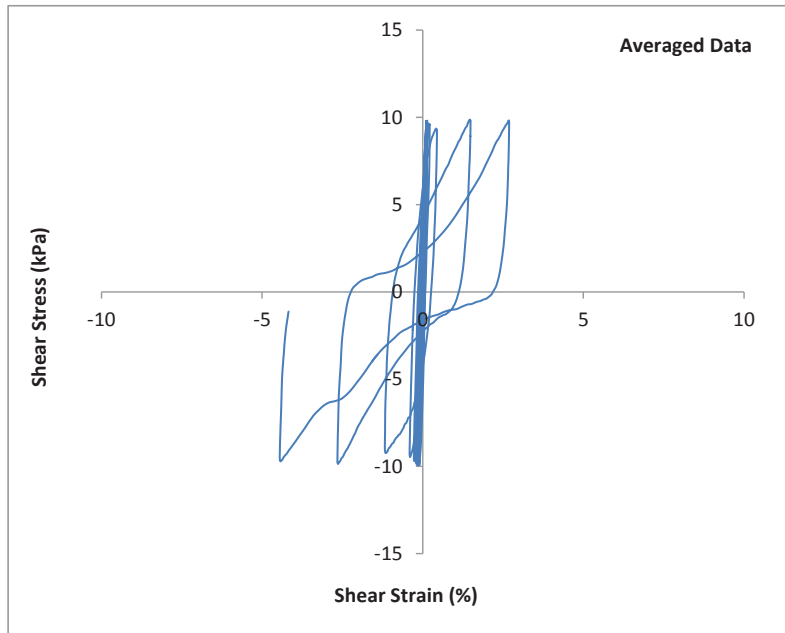
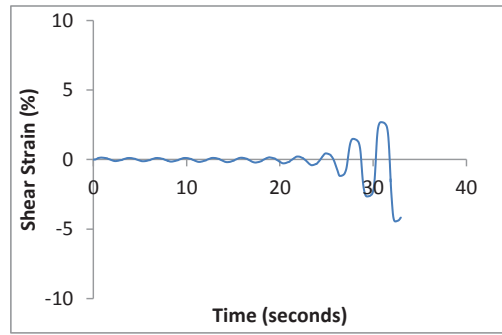
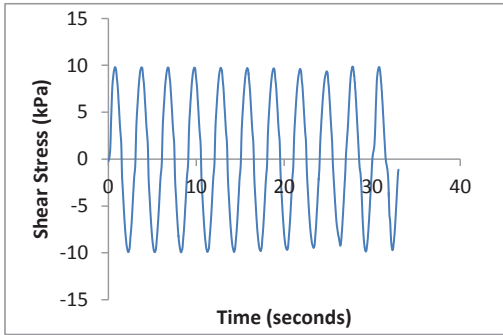

CSS Cyclic Shear Test Report

Geotechnical Engineering Laboratory



Cyclic Shear Test Summary

Device:	CSS	Density (kg/m³):	1815
Specimen ID:	80C109_20PG	Relative Density (%):	84%
Test ID:	C298	Void Ratio:	0.471
Date of Test:	10/26/2016	Vertical Stress (kPa):	100
Test Performed:	Cyclic Shear	Loading Frequency (Hz):	0.33
Test Material:	Ottawa Sand/Pea Gravel	Number of Cycles:	11
Sample Preparation:	Prepared dense by tamping in 5 layers (25x)	Cyclic Stress Ratio:	0.094
		Number of Cycles to Liq:	11
		Maximum ru:	0.99
Prepared by:	J.Hubler		
Checked by:	J.Hubler		

Additional Comments:

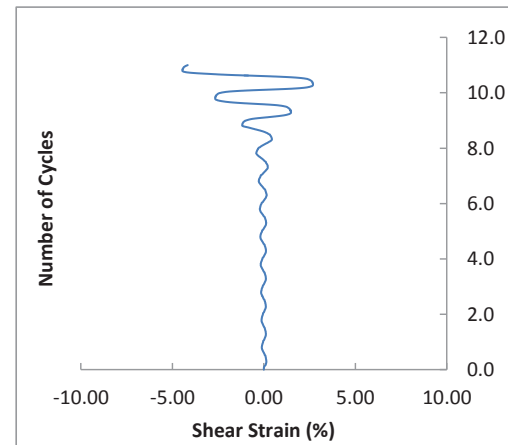
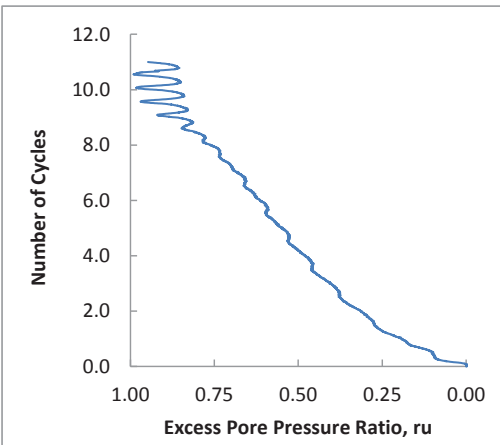
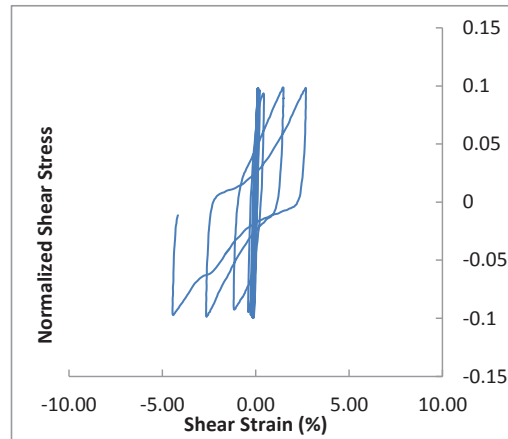
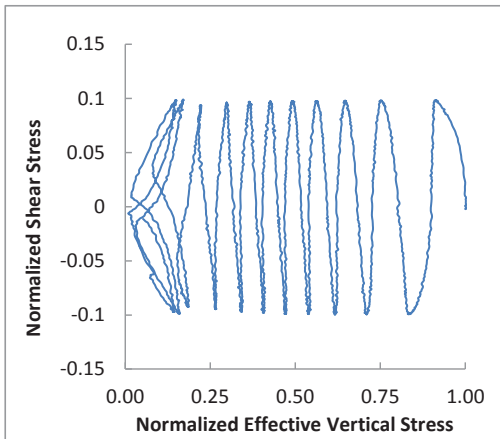

CSS Monotonic Shear Test Report

Geotechnical Engineering Laboratory



10/28/2013_Version 8.0

General Test Info and Sample Preparation

Device:	CSS	Relative Density (%):	73%
Specimen ID:	80C109_20PG	Void Ratio:	0.488
Test ID:	C298	Height (mm):	112.6
Date of Test:	10/26/2016	Soil-Only Specimen Diameter (mm):	306.23
Test Performed:	Post Cyclic Monotonic Shear	Weight (kg):	14.870
Test Material:	Ottawa Sand/Pea Gravel	Density (kg/m ³):	1793.8
Sample Preparation:	Prepared dense by tamping 25x in 5 layers.	Membrane Thickness (mm):	0.635
		Moisture Content (%):	0%
		Saturated (Y/N):	N
		Prepared by:	J.Hubler
		Checked by:	J. Hubler

Consolidation Stage

Vertical Stress (kPa):	100
Time to Compression (min):	7.4
Relative Density (%):	86%
Void Ratio:	0.468
Height (mm):	111.0
Diameter (mm):	306.23
Weight (kg):	14.870
Density (kg/m ³):	1818.5

Shear Stage

Type of Test:	Constant Volume
Stress or Strain Controlled:	Strain
Shear Strain Rate (%/min):	0.29
Peak Shear Strength (kPa):	32.4

Comments

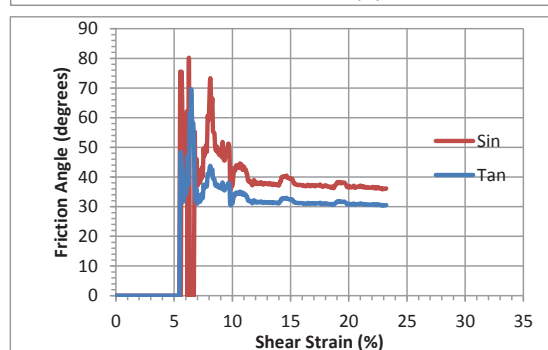
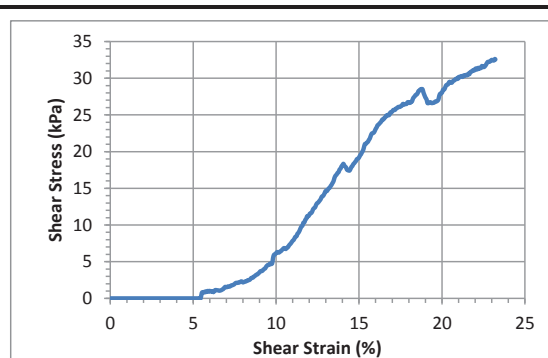
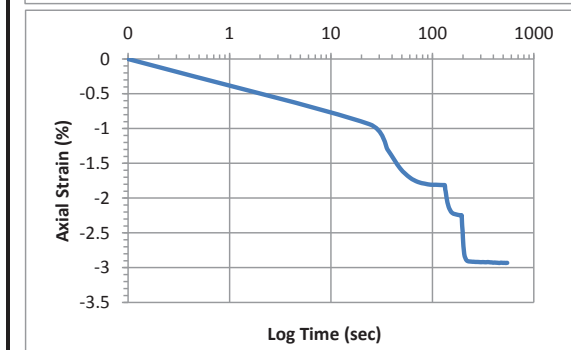
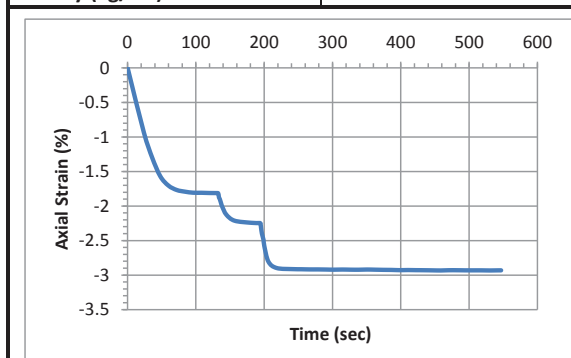

Accelerometer-Based Shear Wave Velocity Datasheet

Specimen ID: C298-80C10920PG-100-1X

Test Material: 80C10920PG

Date: 10/24/2016

Test Performed by: J.Hubler

Filename: C298-80C10920PG-100-1X

Vertical Stress: 100kPa

Sensor Spacing: 0.11074 m

V_s (rise) = 213 m/s

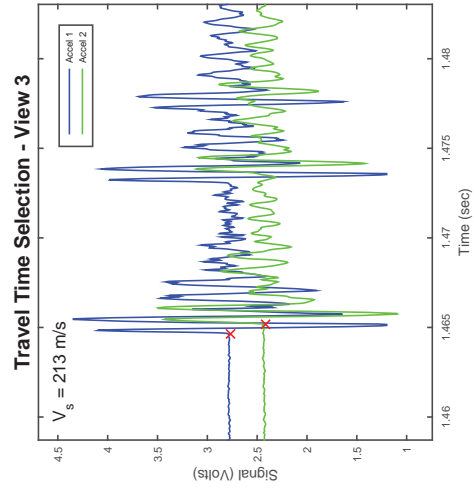
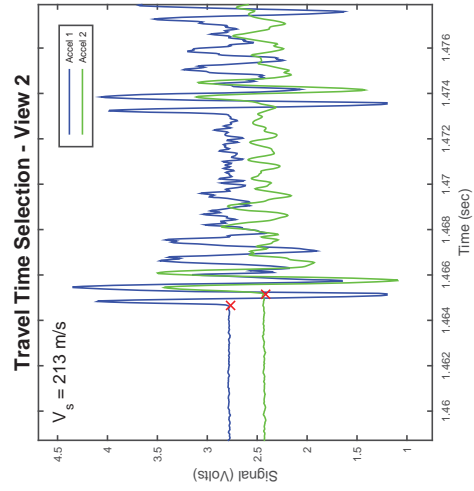
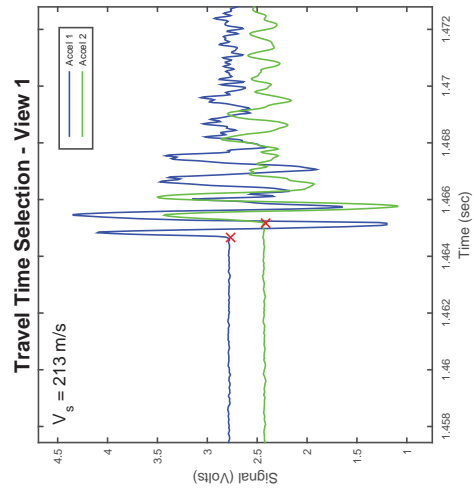
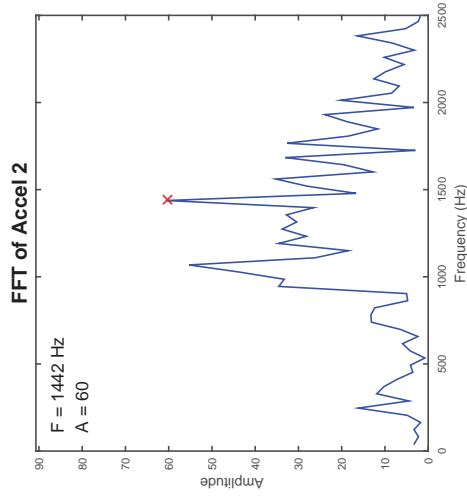
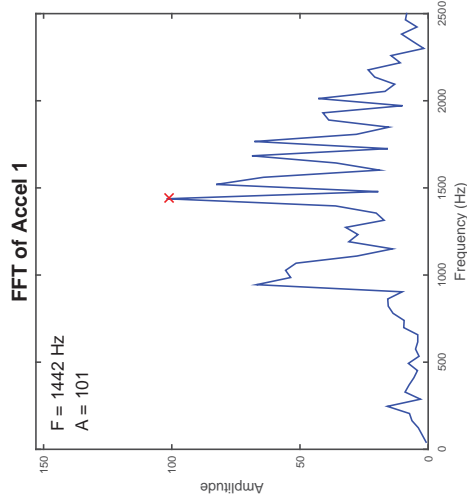
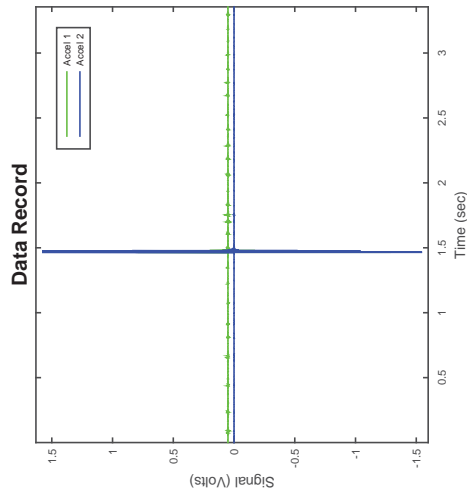

Accelerometer-Based Shear Wave Velocity Datasheet

Specimen ID: C298-80C10920PG-100-2X

Test Material: 80C10920PG

Date: 10/24/2016

Test Performed by: J.Hubler

Filename: C298-80C10920PG-100-2X

Vertical Stress: 100kPa

Sensor Spacing: 0.11074 m

V_s (rise) = 219 m/s

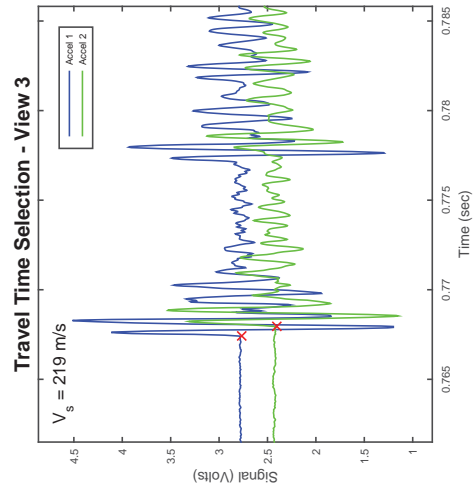
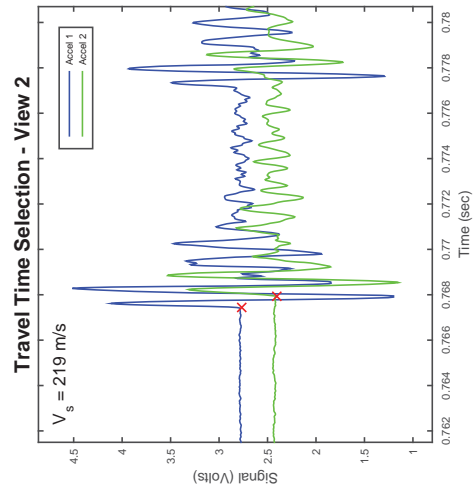
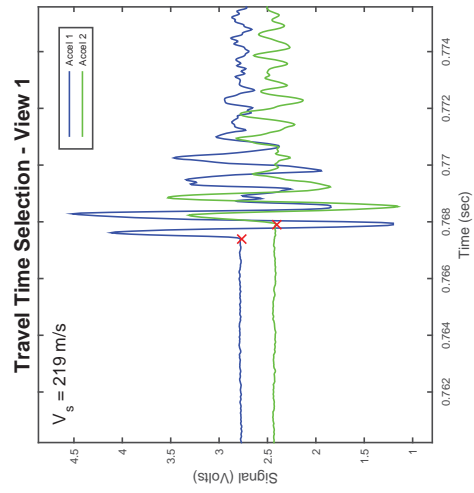
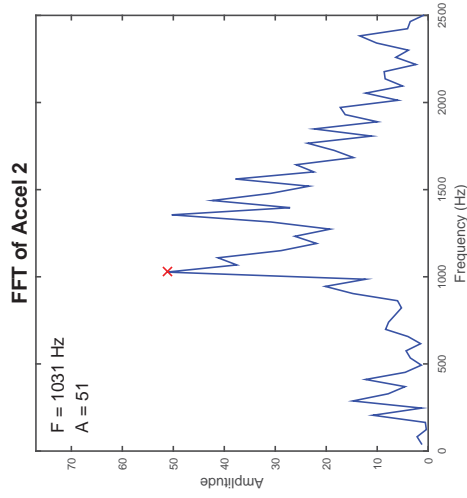
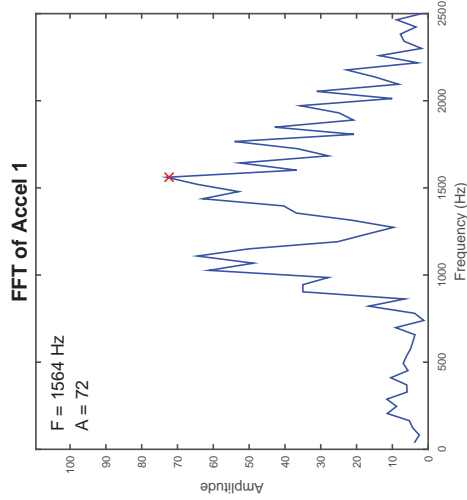
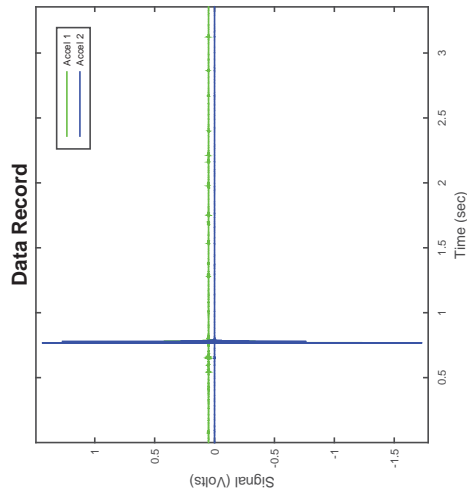

Accelerometer-Based Shear Wave Velocity Datasheet

Specimen ID: C298-80C10920PG-100-3X

Test Material: 80C10920PG

Date: 10/24/2016

Test Performed by: J.Hubler

Filename: C298-80C10920PG-100-3X

Vertical Stress: 100kPa

Sensor Spacing: 0.11074 m

V_s (rise) = 213 m/s

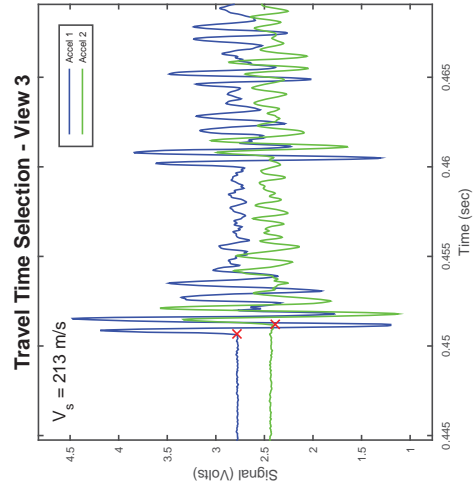
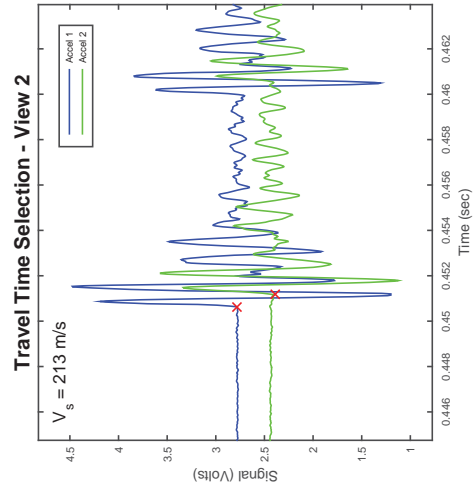
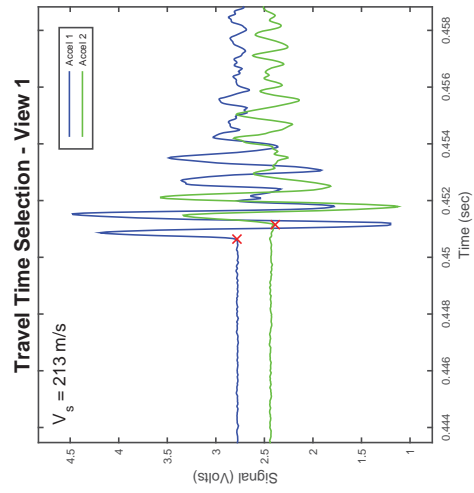
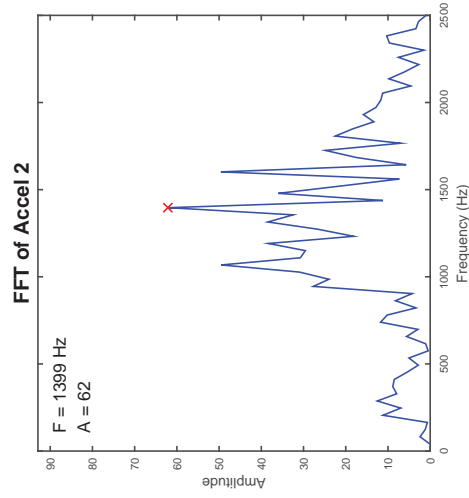
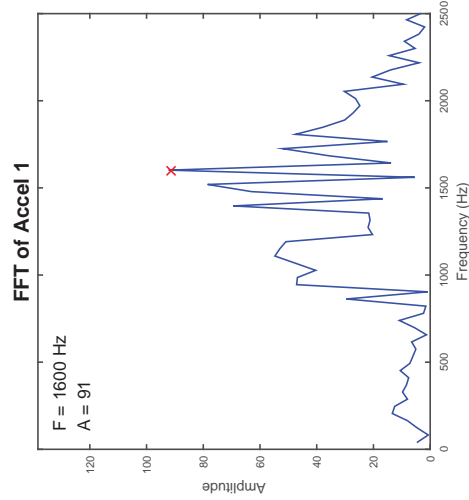
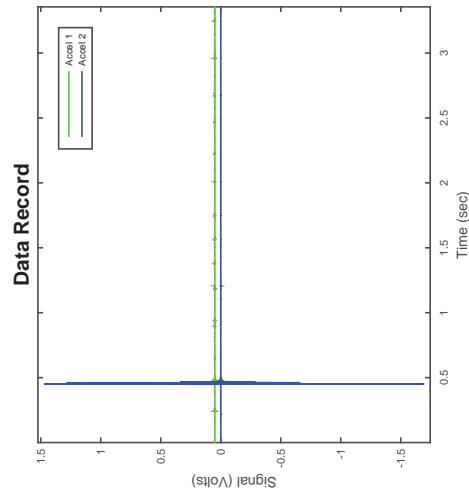

CSS Cyclic Shear Test Report

Geotechnical Engineering Laboratory



Cyclic Shear Test Summary

Device:	CSS	Density (kg/m³):	1738
Specimen ID:	80C109_20PG	Relative Density (%):	44%
Test ID:	C249	Void Ratio:	0.536
Date of Test:	2/29/2016	Vertical Stress (kPa):	100
Test Performed:	Cyclic Shear	Loading Frequency (Hz):	0.33
Test Material:	Ottawa Sand/Pea Gravel	Number of Cycles:	518
Sample Preparation:	Prepared Loose using a funnel with zero drop height.	Cyclic Stress Ratio:	0.044
		Shear Modulus (kPa):	
		Damping (%):	
Prepared by:	J.Hubler	Shear Strain Single Amplitude (%)	
Checked by:	J.Hubler		

Additional Comments:

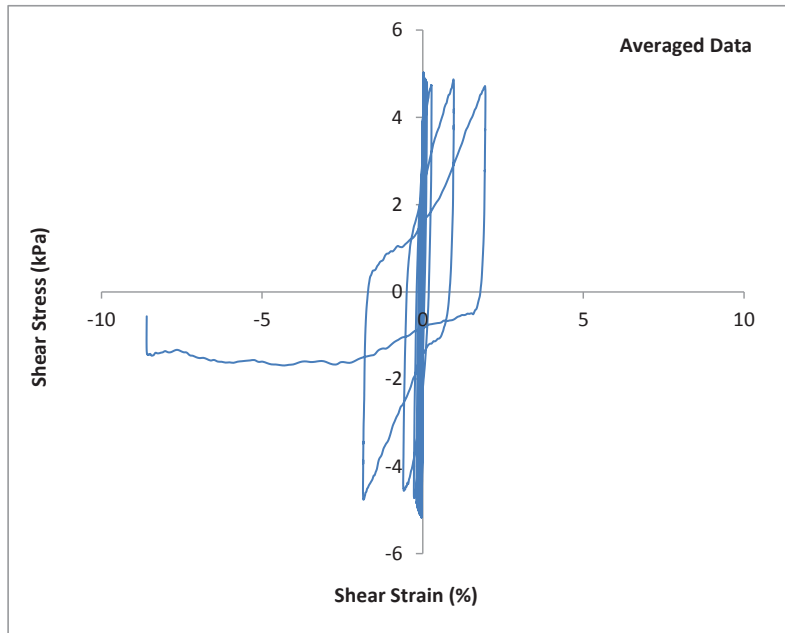
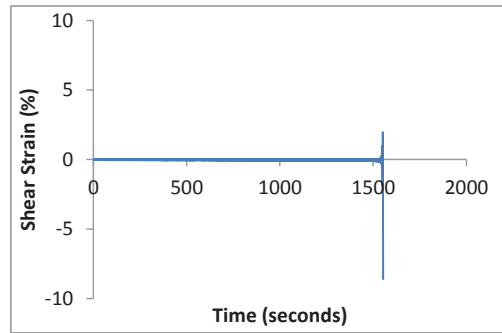
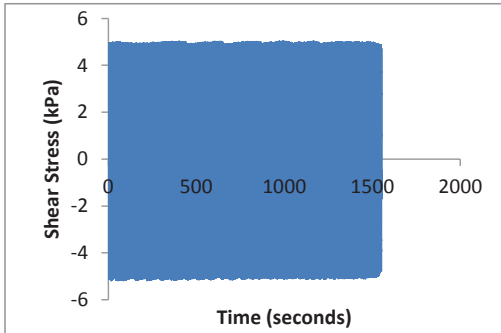

CSS Cyclic Shear Test Report

Geotechnical Engineering Laboratory



Cyclic Shear Test Summary

Device:	CSS	Density (kg/m³):	1738
Specimen ID:	80C109_20PG	Relative Density (%):	44%
Test ID:	C249	Void Ratio:	0.536
Date of Test:	2/29/2016	Vertical Stress (kPa):	100
Test Performed:	Cyclic Shear	Loading Frequency (Hz):	0.33
Test Material:	Ottawa Sand/Pea Gravel	Number of Cycles:	518
Sample Preparation:	Prepared Loose using a funnel with zero drop height.	Cyclic Stress Ratio:	0.044
		Number of Cycles to Liq:	518
		Maximum ru:	1.02
Prepared by:	J.Hubler		
Checked by:	J.Hubler		

Additional Comments:

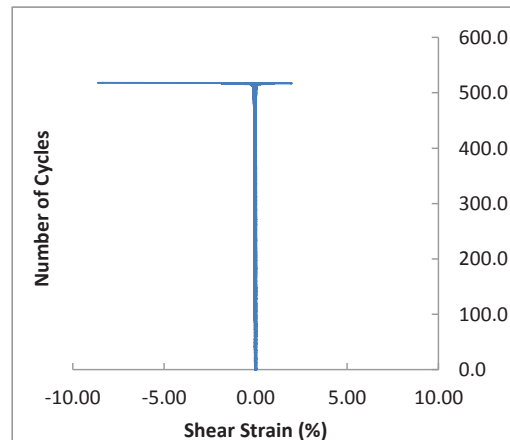
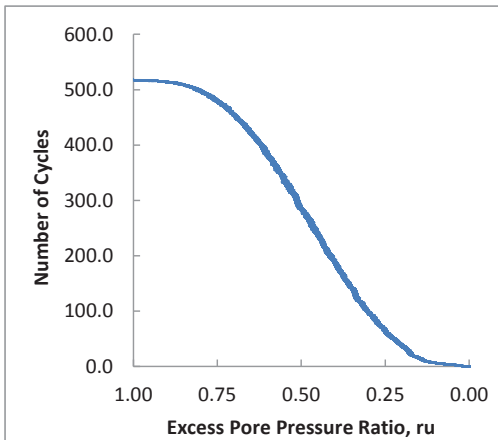
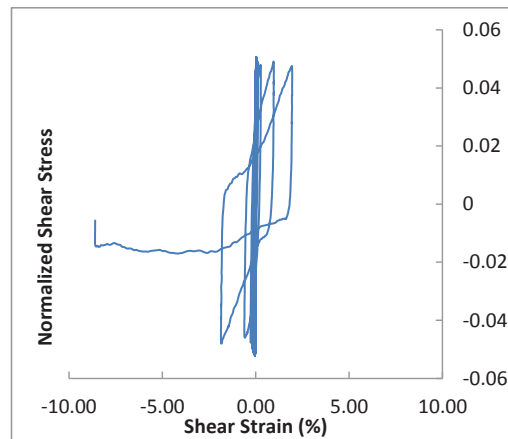
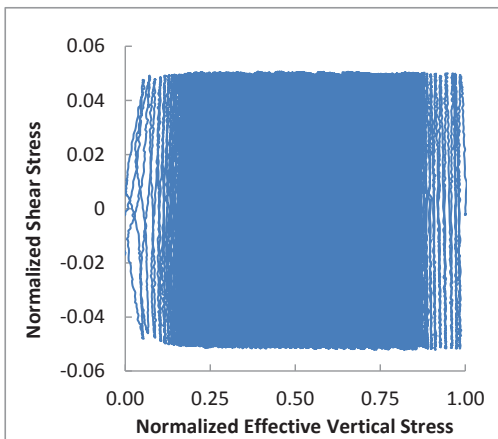

Accelerometer-Based Shear Wave Velocity Datasheet

Specimen ID: C249-PGC109-100-1X
 Test Material: PGC109
 Date: 2/29/2016
 Test Performed by: J.Hubler
 Filename: C249-PGC109-100-1X

Vertical Stress: 100kPa
 Sensor Spacing: 0.11022 m
 V_s (rise) = 212 m/s

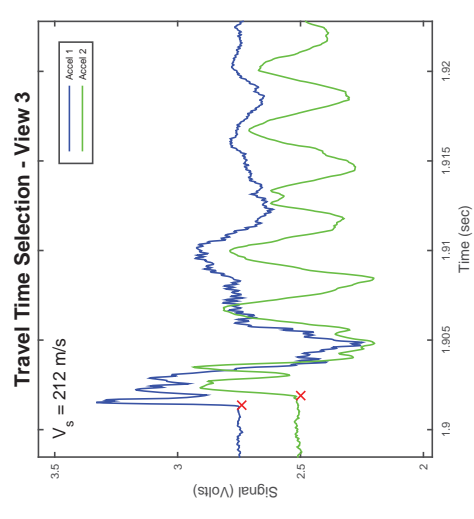
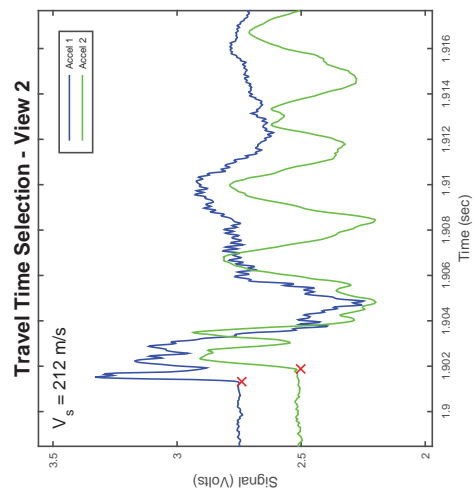
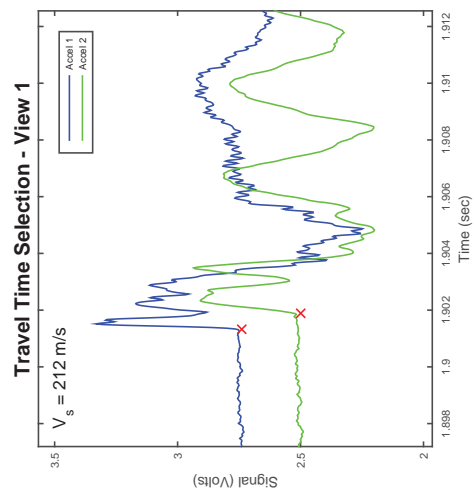
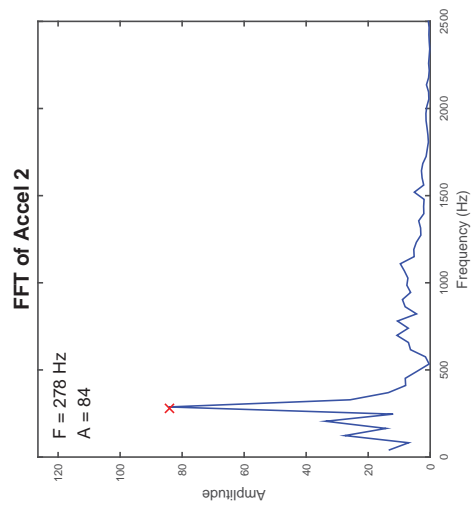
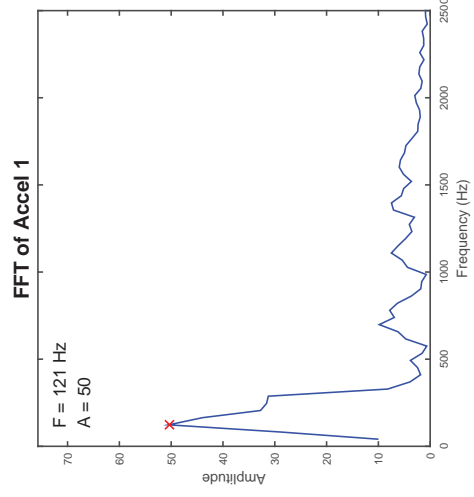
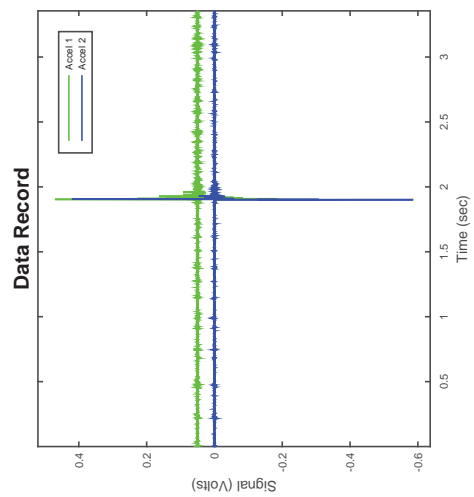

Accelerometer-Based Shear Wave Velocity Datasheet

Specimen ID: C249-PGC109-100-2X

Test Material: PGC109

Date: 2/29/2016

Test Performed by: J.Hubler

Filename: C249-PGC109-100-2X

Vertical Stress: 100kPa

Sensor Spacing: 0.11022 m

V_s (rise) = 206 m/s

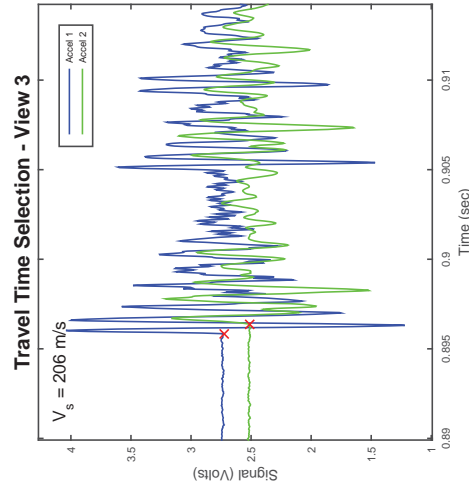
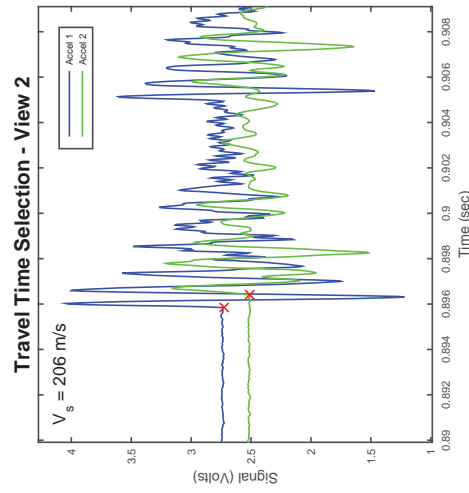
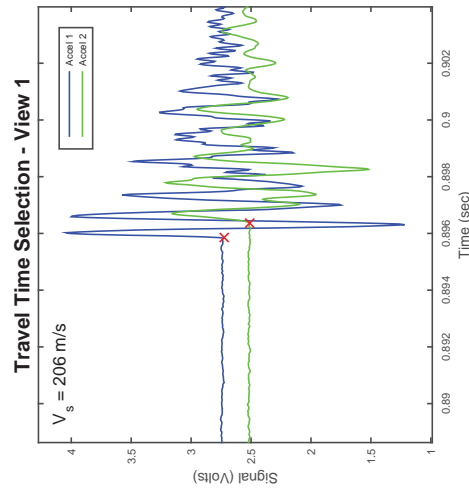
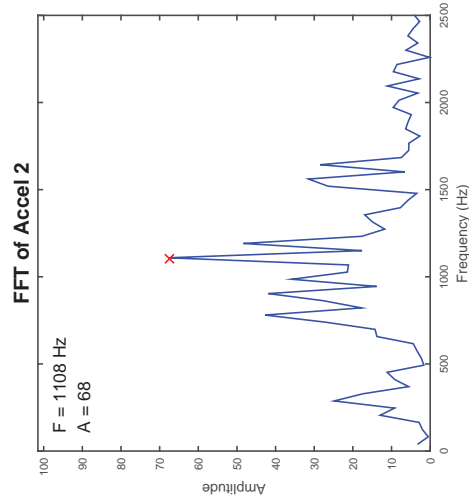
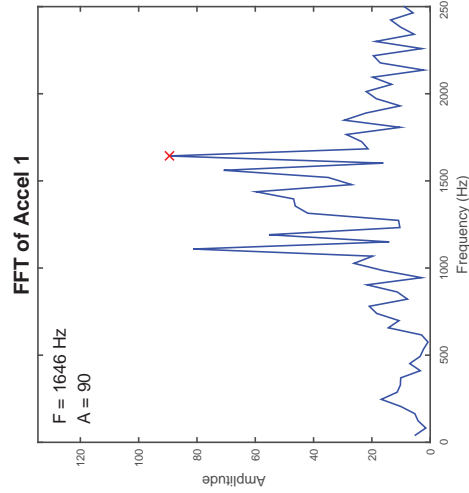
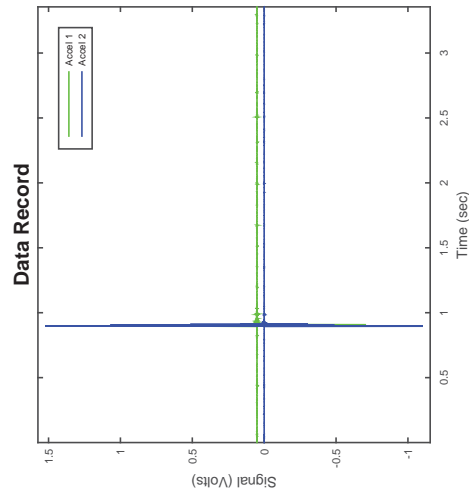

Accelerometer-Based Shear Wave Velocity Datasheet

Specimen ID: C249-PGC109-100-3X
 Test Material: PGC109
 Date: 2/29/2016
 Test Performed by: J.Hubler
 Filename: C249-PGC109-100-3X

Vertical Stress: 100kPa
 Sensor Spacing: 0.11021 m
 V_s (rise) = 206 m/s

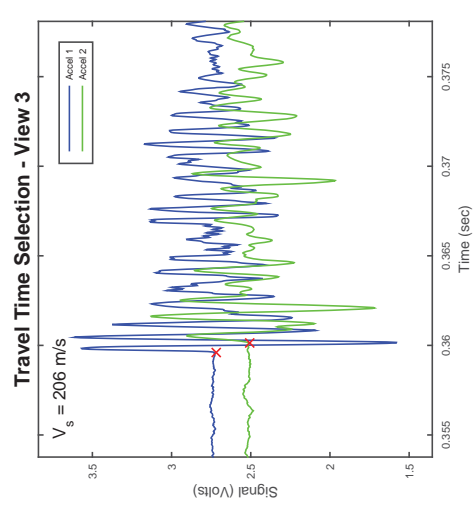
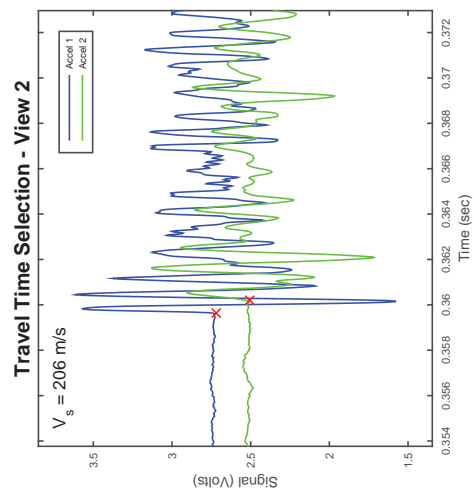
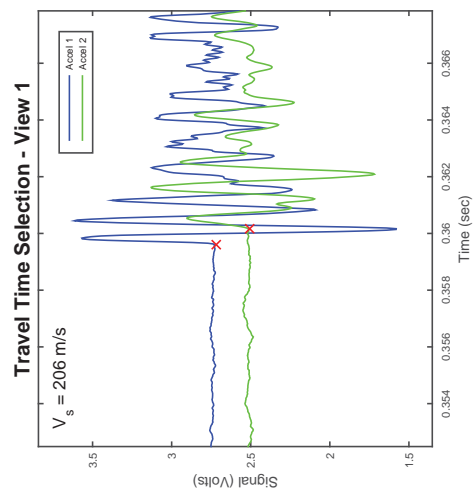
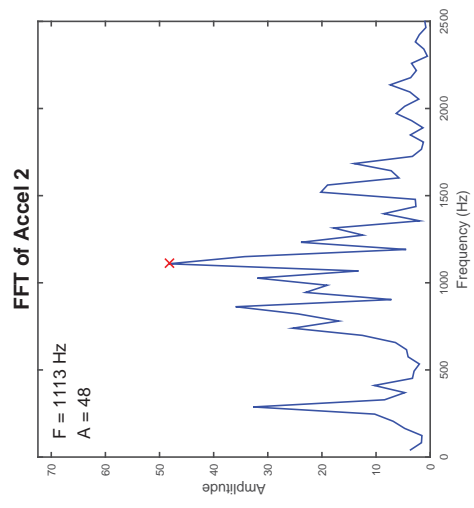
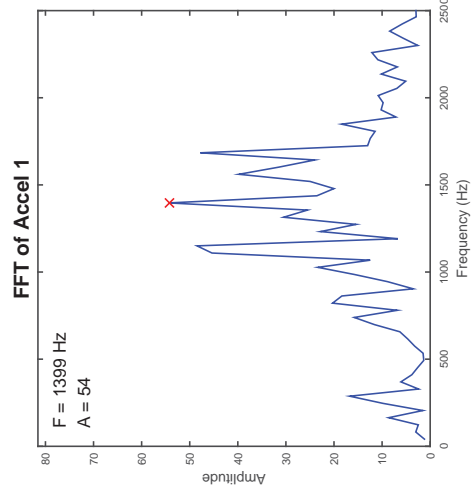
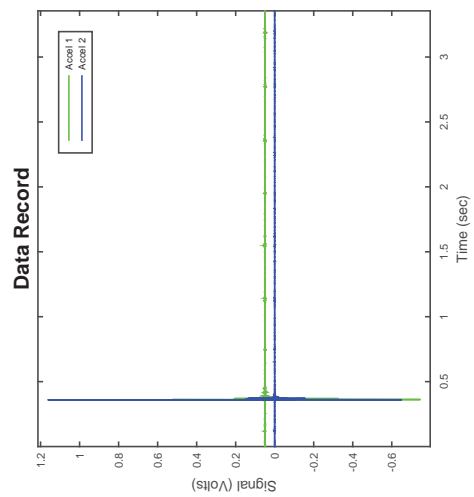

CSS Cyclic Shear Test Report

Geotechnical Engineering Laboratory



Cyclic Shear Test Summary

Device:	CSS	Density (kg/m³):	1750
Specimen ID:	80C109_20PG	Relative Density (%):	50%
Test ID:	C246	Void Ratio:	0.526
Date of Test:	2/25/2016	Vertical Stress (kPa):	100
Test Performed:	Cyclic Shear	Loading Frequency (Hz):	0.33
Test Material:	Ottawa Sand/Pea Gravel	Number of Cycles:	7
Sample Preparation:	Prepared Loose using a funnel with zero drop height.	Cyclic Stress Ratio:	0.094
		Shear Modulus (kPa):	
		Damping (%):	
Prepared by:	J.Hubler	Shear Strain Single Amplitude (%)	
Checked by:	J.Hubler		

Additional Comments:

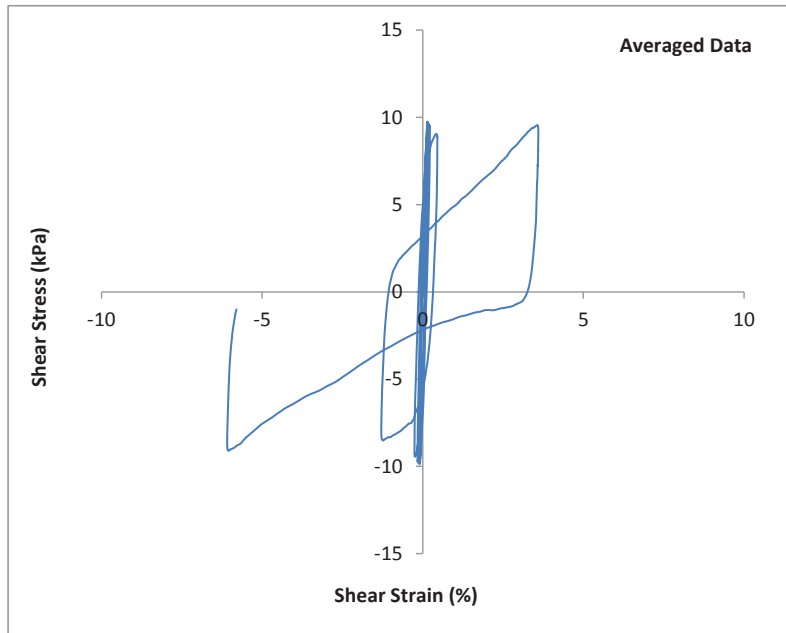
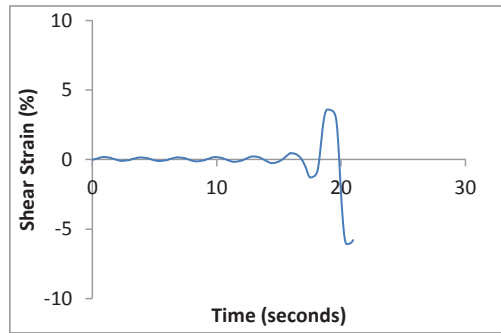
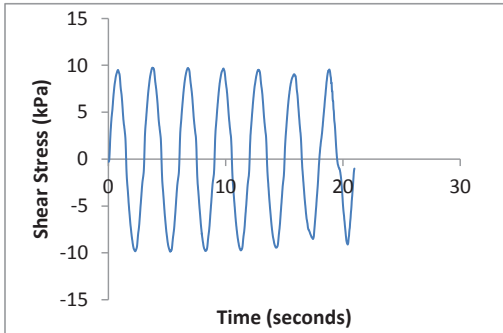

CSS Cyclic Shear Test Report

Geotechnical Engineering Laboratory



Cyclic Shear Test Summary

Device:	CSS	Density (kg/m³):	1750
Specimen ID:	80C109_20PG	Relative Density (%):	50%
Test ID:	C246	Void Ratio:	0.526
Date of Test:	2/25/2016	Vertical Stress (kPa):	100
Test Performed:	Cyclic Shear	Loading Frequency (Hz):	0.33
Test Material:	Ottawa Sand/Pea Gravel	Number of Cycles:	7
Sample Preparation:	Prepared Loose using a funnel with zero drop height.	Cyclic Stress Ratio:	0.094
		Number of Cycles to Liq:	7
		Maximum ru:	1.00
Prepared by:	J.Hubler		
Checked by:	J.Hubler		

Additional Comments:

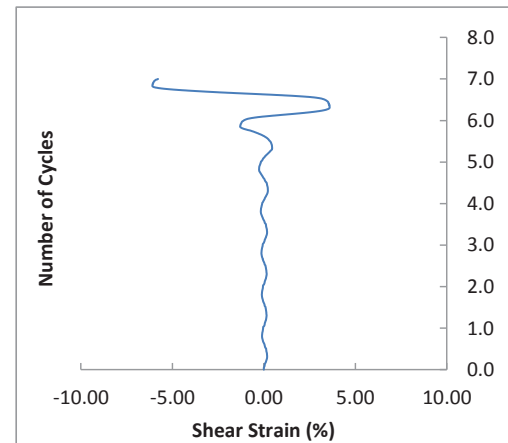
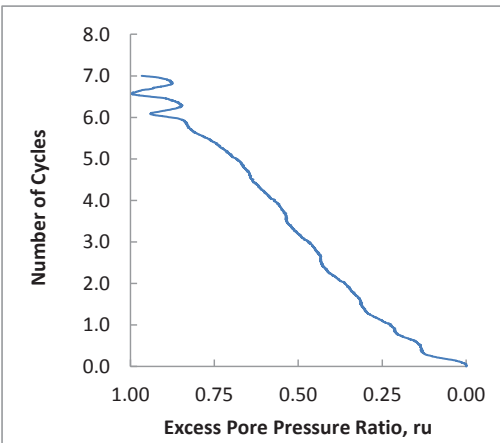
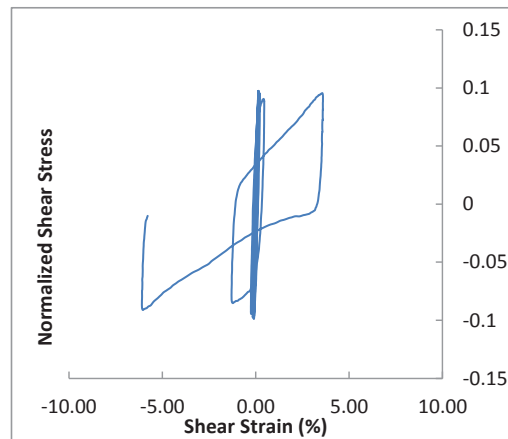
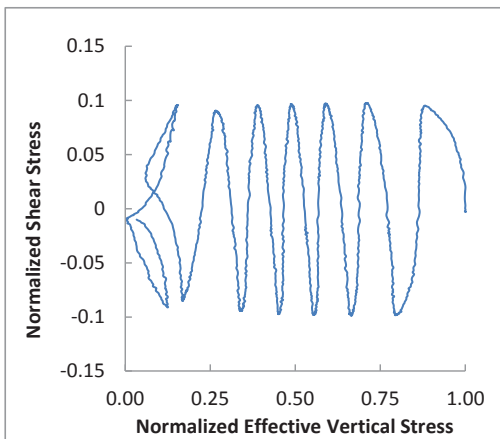

CSS Monotonic Shear Test Report

Geotechnical Engineering Laboratory



10/28/2013_Version 8.0

General Test Info and Sample Preparation

Device:	CSS	Relative Density (%):	26%
Specimen ID:	80C109_20PG	Void Ratio:	0.566
Test ID:	C246	Height (mm):	114.0
Date of Test:	2/25/2016	Soil-Only Specimen Diameter (mm):	306.23
Test Performed:	Post Cyclic Monotonic Shear	Weight (kg):	14.317
Test Material:	Ottawa Sand/Pea Gravel	Density (kg/m³):	1705.2
Sample Preparation:	Prepared loose by placing with a funnel and zero drop height.	Membrane Thickness (mm):	0.635
		Moisture Content (%):	0%
		Saturated (Y/N):	N
		Prepared by:	J.Hubler
		Checked by:	J. Hubler

Consolidation Stage

Vertical Stress (kPa):	100
Time to Compression (min):	7.5
Relative Density (%):	50%
Void Ratio:	0.526
Height (mm):	111.1
Diameter (mm):	306.23
Weight (kg):	14.317
Density (kg/m³):	1749.8

Shear Stage

Type of Test:	Constant Volume
Stress or Strain Controlled:	Strain
Shear Strain Rate (%/min):	0.29
Peak Shear Strength (kPa):	4.5

Comments

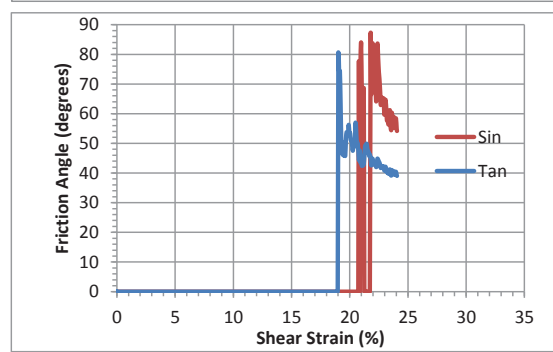
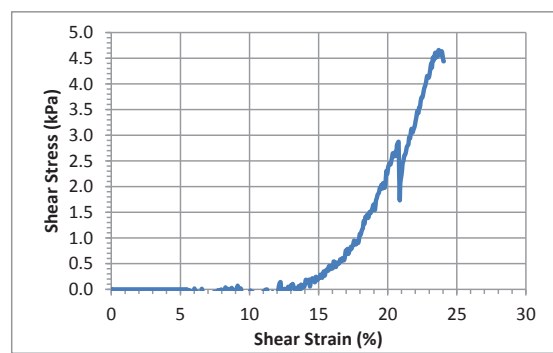
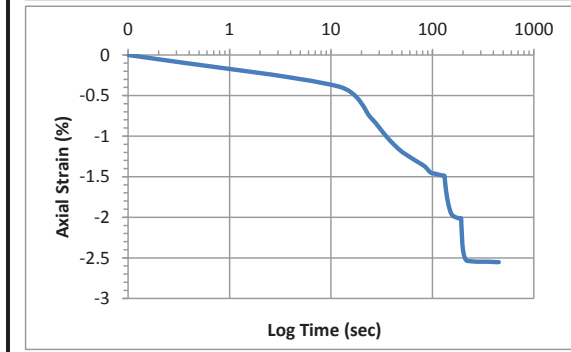
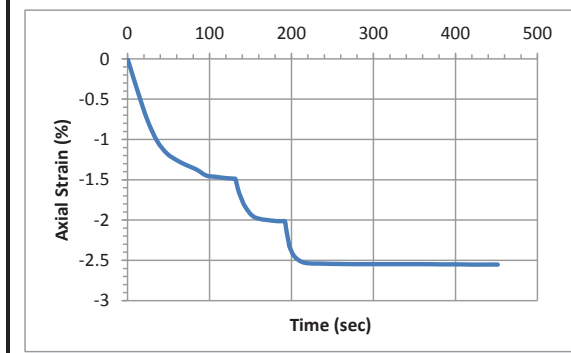

Accelerometer-Based Shear Wave Velocity Datasheet

Specimen ID: C246-PGC109-100-1X

Test Material: PGC109

Date: 2/25/2016

Test Performed by: J.Hubler

Filename: C246-PGC109-100-1X

Vertical Stress: 100kPa

Sensor Spacing: 0.11081 m

V_s (rise) = 196 m/s

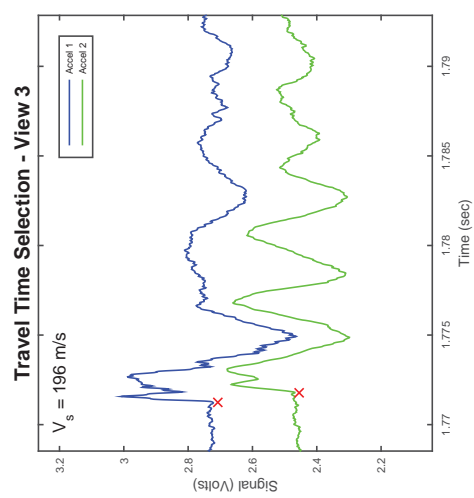
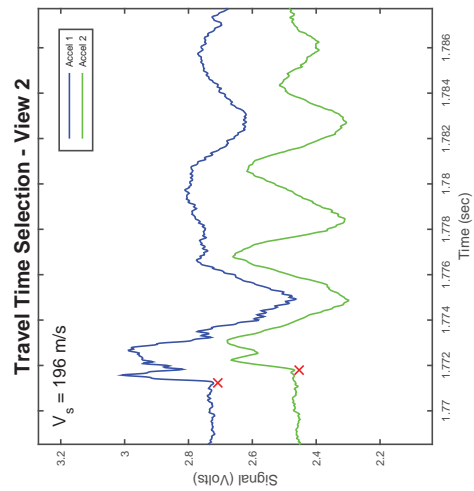
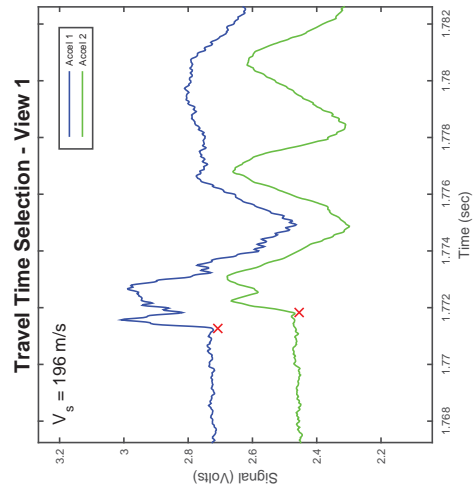
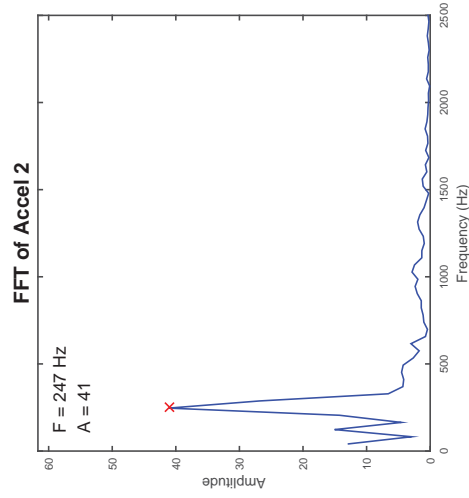
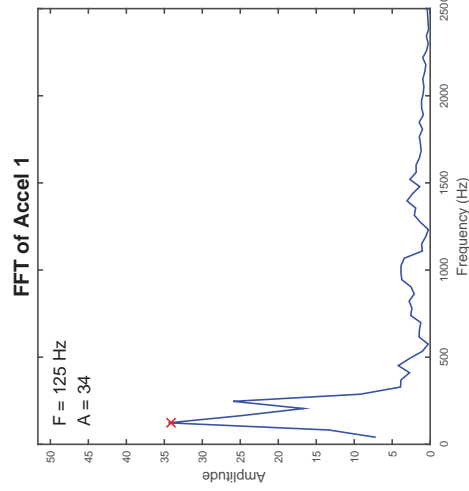
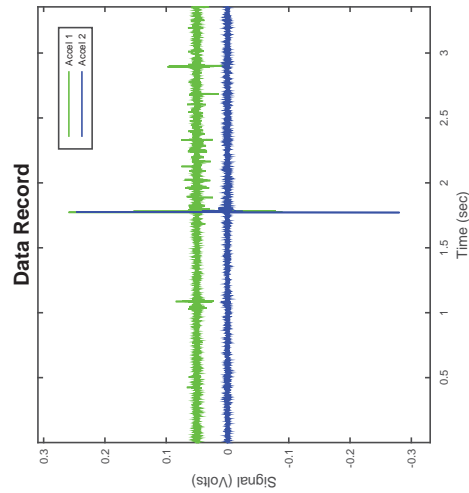

Accelerometer-Based Shear Wave Velocity Datasheet

Specimen ID: C246-PGC109-100-2X
 Test Material: PGC109
 Date: 2/25/2016
 Test Performed by: J.Hubler
 Filename: C246-PGC109-100-2X

Vertical Stress: 100kPa
 Sensor Spacing: 0.11081 m
 V_s (rise) = 207 m/s

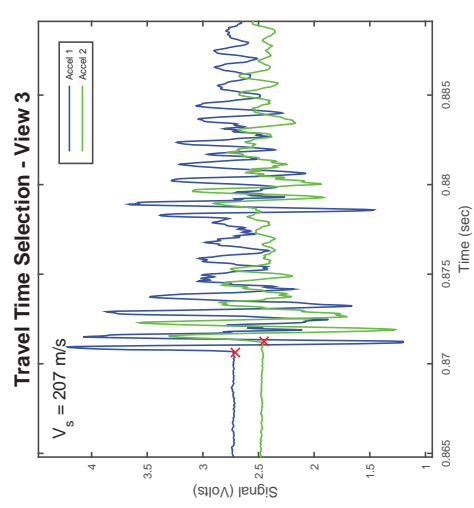
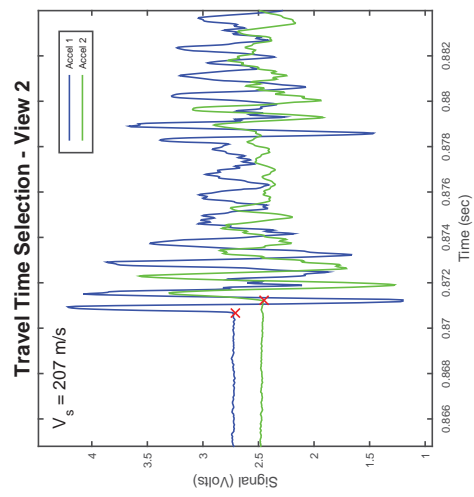
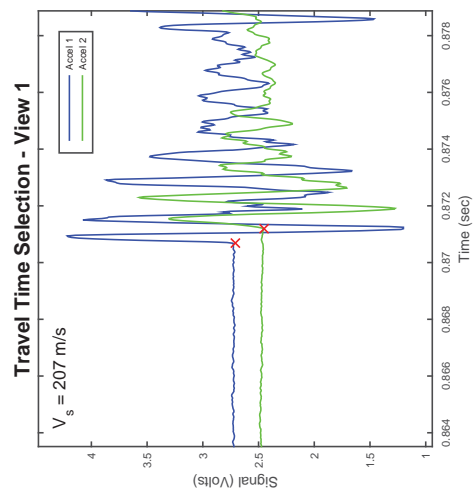
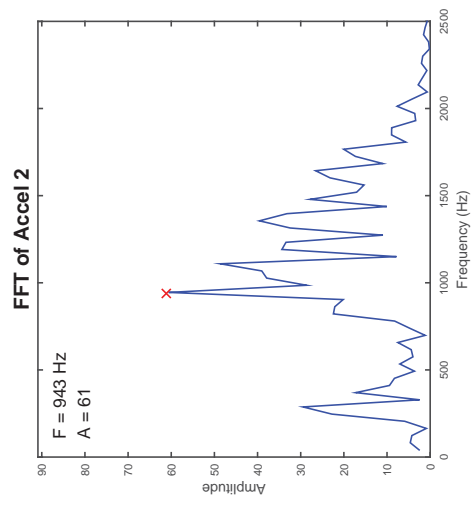
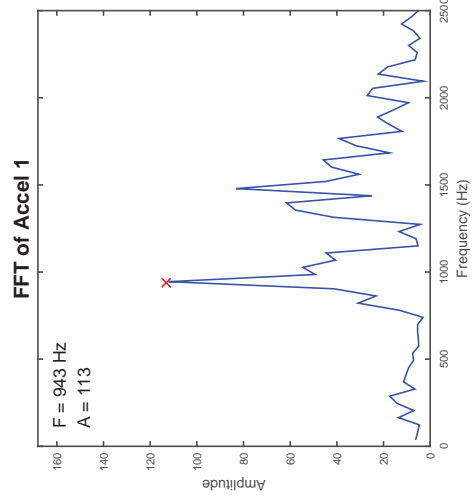
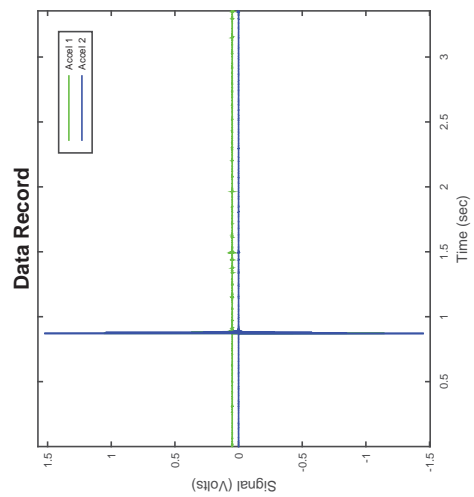

Accelerometer-Based Shear Wave Velocity Datasheet

Specimen ID: C246-PGC109-100-3X

Test Material: PGC109

Date: 2/25/2016

Test Performed by: J.Hubler

Filename: C246-PGC109-100-3X

Vertical Stress: 100kPa

Sensor Spacing: 0.11081 m

V_s (rise) = 213 m/s

Data Record

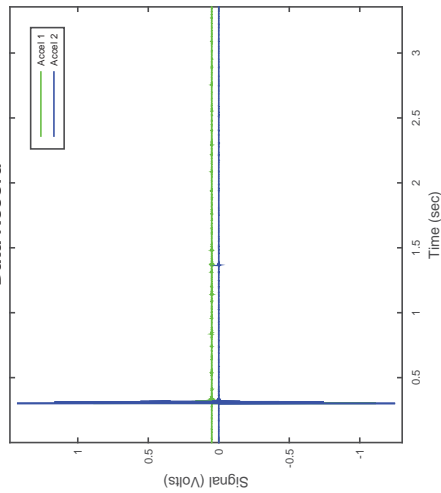

FFT of Accel 1

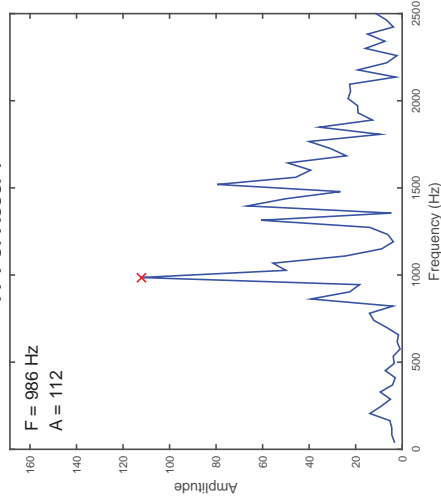

FFT of Accel 2

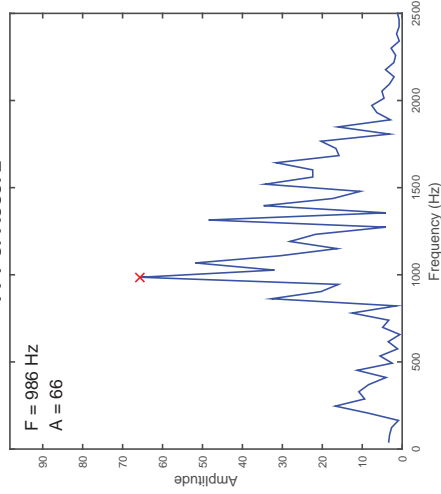

Travel Time Selection - View 1

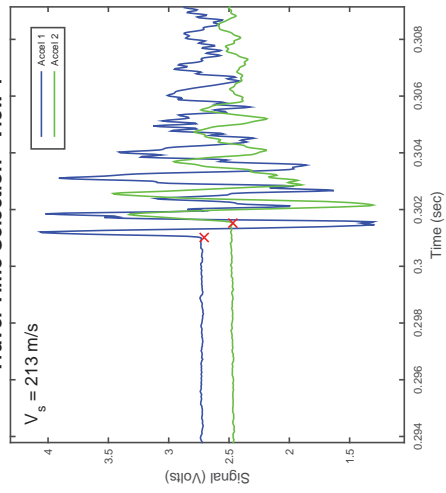

Travel Time Selection - View 2

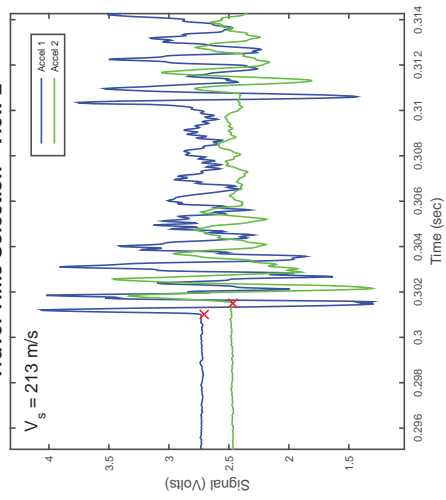

Travel Time Selection - View 3

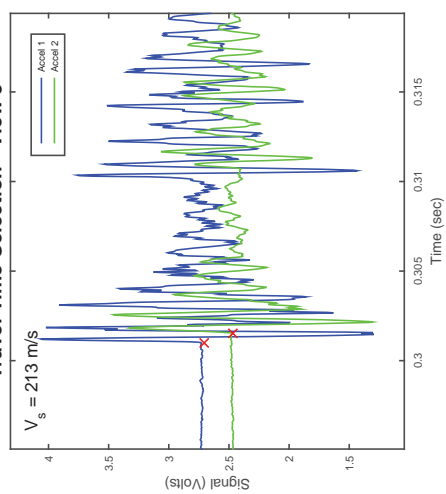

CSS Cyclic Shear Test Report

Geotechnical Engineering Laboratory



Cyclic Shear Test Summary

Device:	CSS	Density (kg/m³):	1738
Specimen ID:	80C109_20PG	Relative Density (%):	44%
Test ID:	C248	Void Ratio:	0.537
Date of Test:	2/29/2016	Vertical Stress (kPa):	100
Test Performed:	Cyclic Shear	Loading Frequency (Hz):	0.33
Test Material:	Ottawa Sand/Pea Gravel	Number of Cycles:	2
Sample Preparation:	Prepared Loose using a funnel with zero drop height.	Cyclic Stress Ratio:	0.144
		Shear Modulus (kPa):	
		Damping (%):	
Prepared by:	J.Hubler	Shear Strain Single Amplitude (%)	
Checked by:	J.Hubler		

Additional Comments:

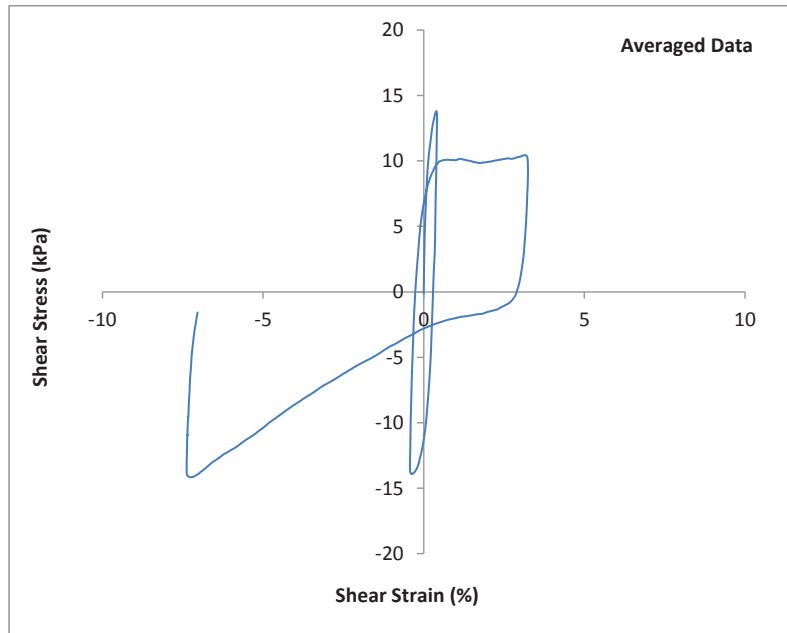
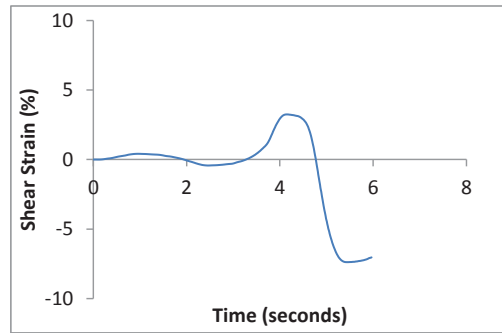
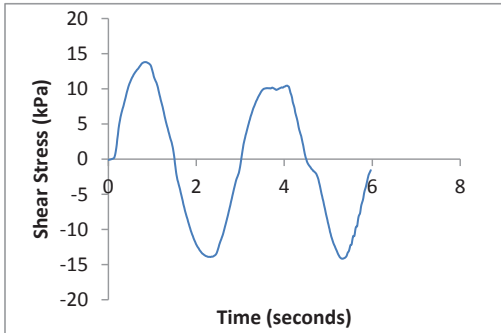

CSS Cyclic Shear Test Report

Geotechnical Engineering Laboratory



Cyclic Shear Test Summary

Device:	CSS	Density (kg/m³):	1738
Specimen ID:	80C109_20PG	Relative Density (%):	44%
Test ID:	C248	Void Ratio:	0.537
Date of Test:	2/29/2016	Vertical Stress (kPa):	100
Test Performed:	Cyclic Shear	Loading Frequency (Hz):	0.33
Test Material:	Ottawa Sand/Pea Gravel	Number of Cycles:	2
Sample Preparation:	Prepared Loose using a funnel with zero drop height.	Cyclic Stress Ratio:	0.144
		Number of Cycles to Liq:	2
		Maximum ru:	0.98
Prepared by:	J.Hubler		
Checked by:	J.Hubler		

Additional Comments:

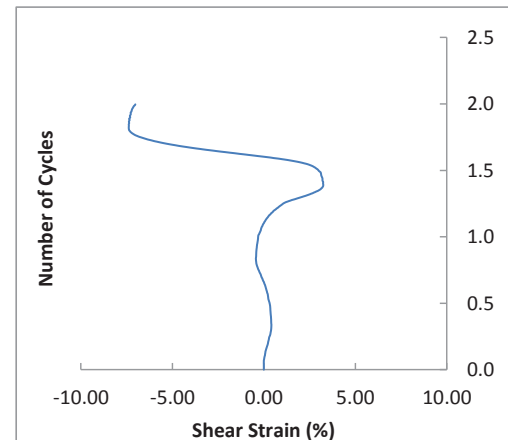
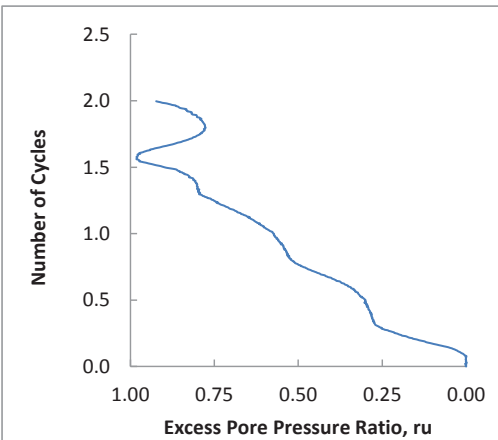
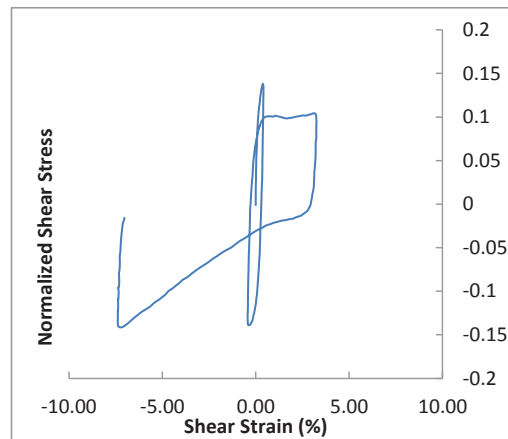
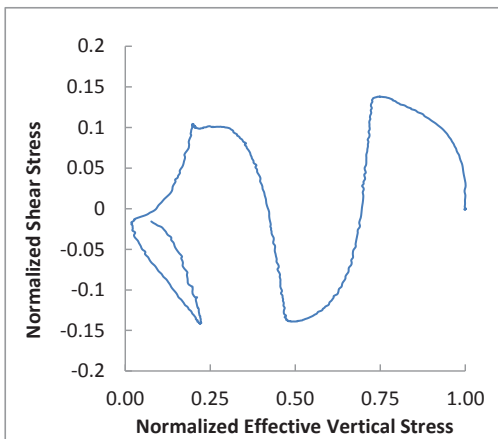

CSS Monotonic Shear Test Report

Geotechnical Engineering Laboratory



10/28/2013_Version 8.0

General Test Info and Sample Preparation

Device:	CSS	Relative Density (%):	44%
Specimen ID:	80C109_20PG	Void Ratio:	0.537
Test ID:	C248	Height (mm):	111.6
Date of Test:	2/29/2016	Soil-Only Specimen Diameter (mm):	306.23
Test Performed:	Post Cyclic Monotonic Shear	Weight (kg):	14.281
Test Material:	C109/Pea Gravel	Density (kg/m³):	1737.7
Sample Preparation:	Prepared loose by placing with a funnel and zero drop height.	Membrane Thickness (mm):	0.635
		Moisture Content (%):	0%
		Saturated (Y/N):	N
		Prepared by:	J.Hubler
		Checked by:	J. Hubler

Consolidation Stage

Shear Stage

Vertical Stress (kPa):	100	Type of Test:	Constant Volume
Time to Compression (min):	3.1	Stress or Strain Controlled:	Strain
Relative Density (%):	56%	Shear Strain Rate (%/min):	2.96
Void Ratio:	0.516	Peak Shear Strength (kPa):	55.7
Height (mm):	110.1	Comments	
Diameter (mm):	306.23	Re-consolidated to 100 kPa after cyclic test at CSR = 0.144	
Weight (kg):	14.281		
Density (kg/m³):	1760.9		

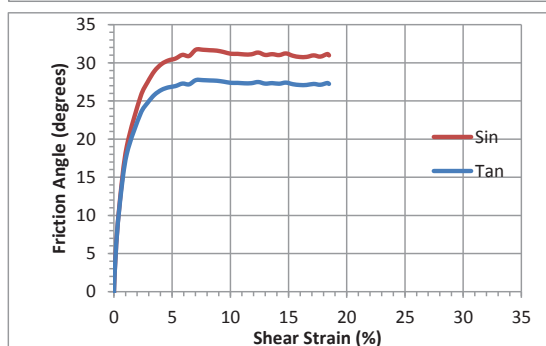
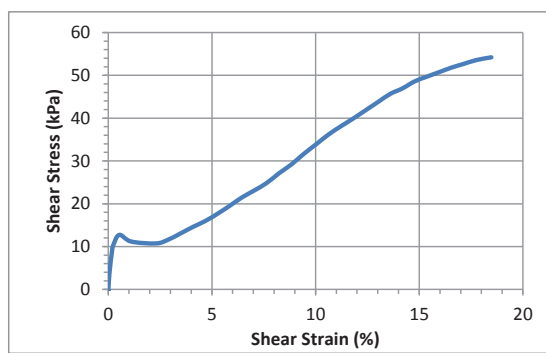
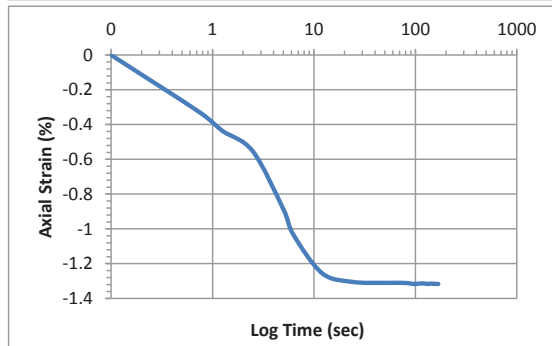
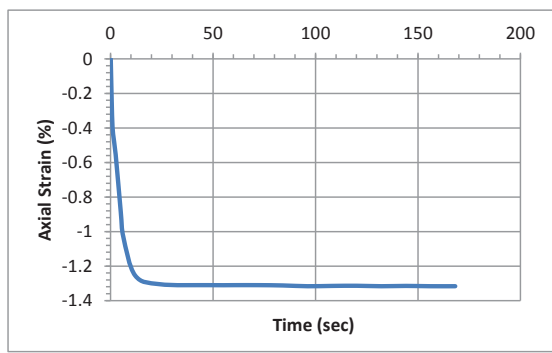

Accelerometer-Based Shear Wave Velocity Datasheet

Specimen ID: C248-PGC109-100-1X
 Test Material: PGC109
 Date: 2/29/2016
 Test Performed by: J.Hubler
 Filename: C248-PGC109-100-1X

Vertical Stress: 100kPa
 Sensor Spacing: 0.11131 m
 V_s (rise) = 203 m/s

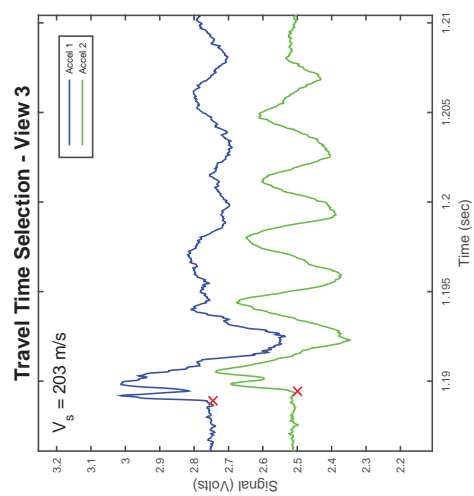
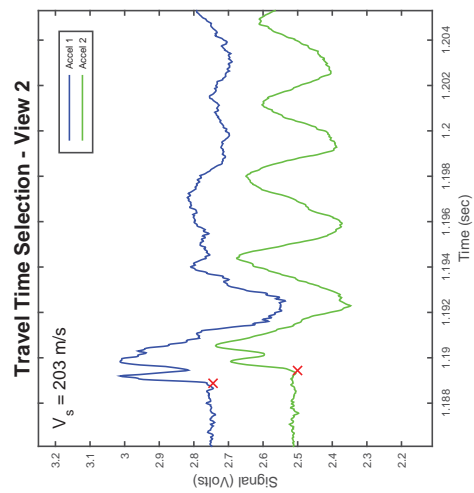
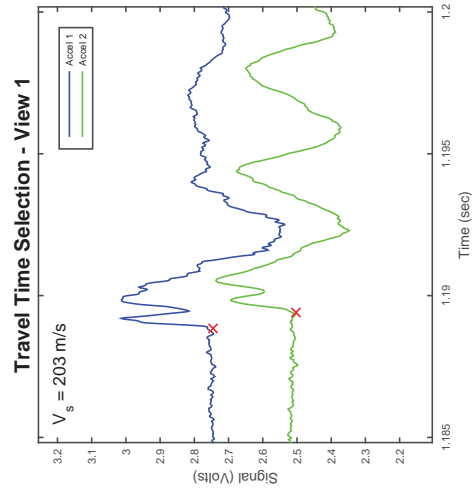
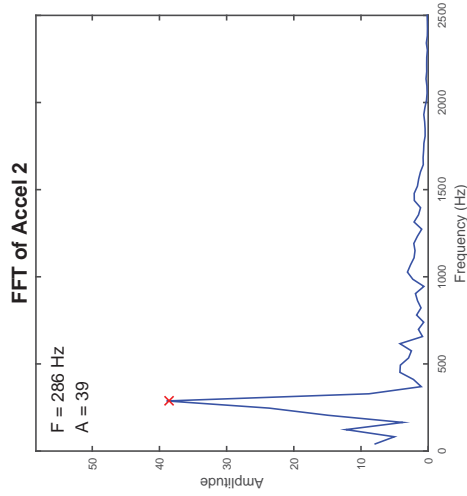
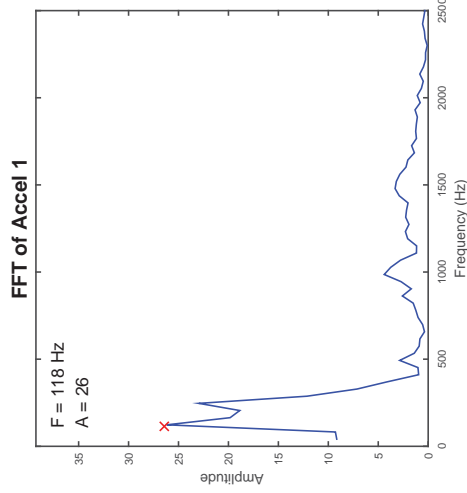
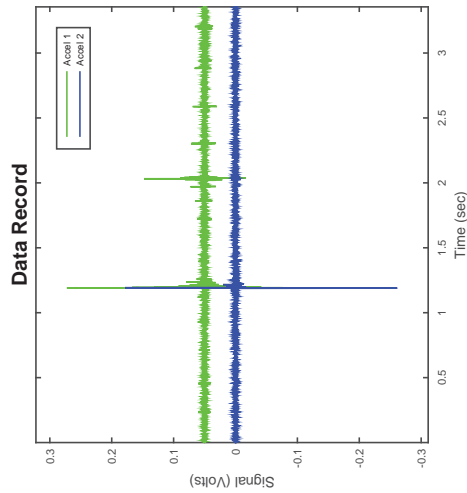

Accelerometer-Based Shear Wave Velocity Datasheet

Specimen ID: C248-PGC109-100-2X
 Test Material: PGC109
 Date: 2/29/2016
 Test Performed by: J.Hubler
 Filename: C248-PGC109-100-2X

Vertical Stress: 100kPa
 Sensor Spacing: 0.11131 m
 V_s (rise) = 208 m/s

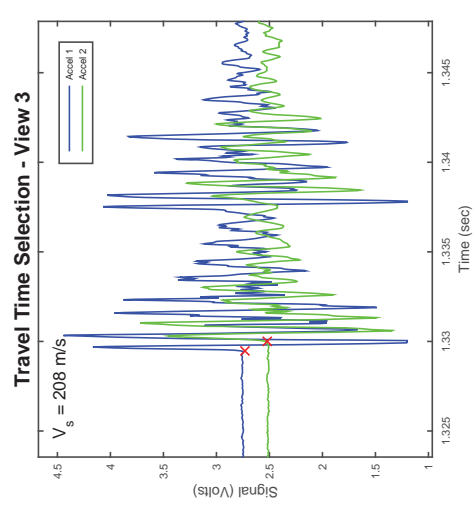
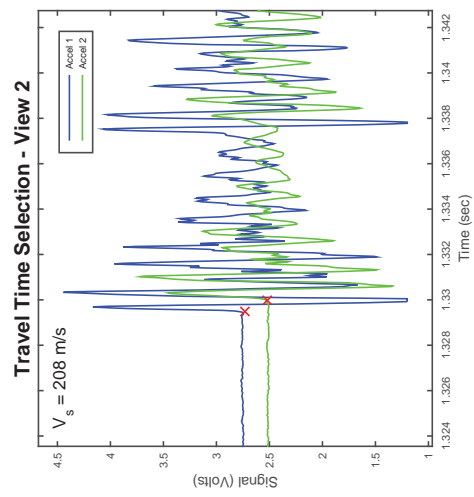
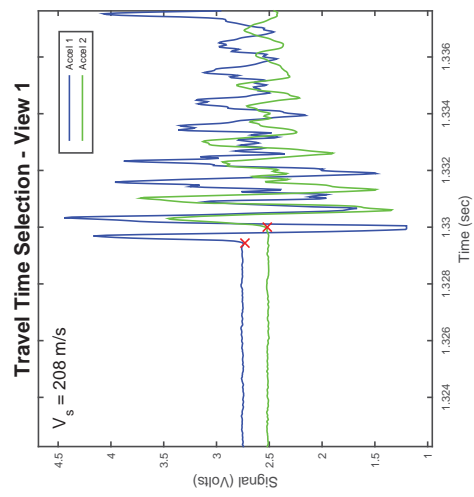
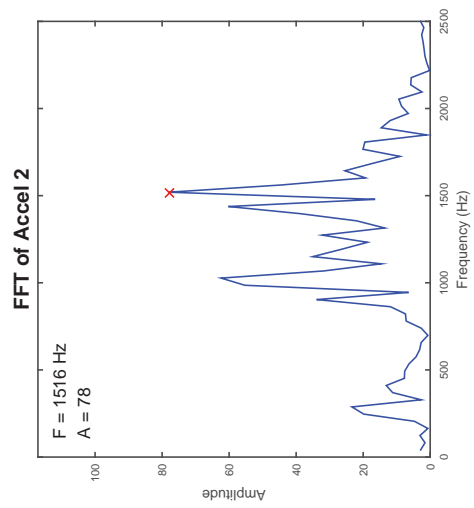
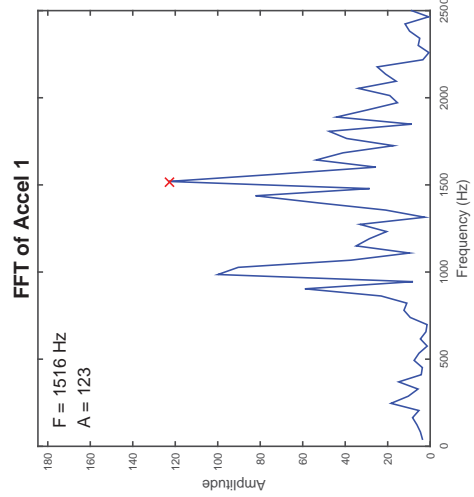
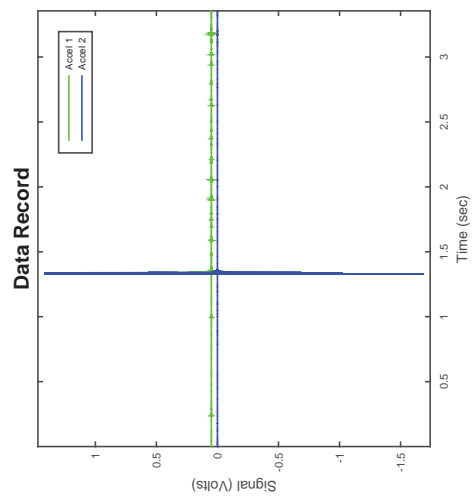

Accelerometer-Based Shear Wave Velocity Datasheet

Specimen ID: C248-PGC109-100-3X

Test Material: PGC109

Date: 2/29/2016

Test Performed by: J.Hubler

Filename: C248-PGC109-100-3X

Vertical Stress: 100kPa

Sensor Spacing: 0.11131 m

V_s (rise) = 208 m/s

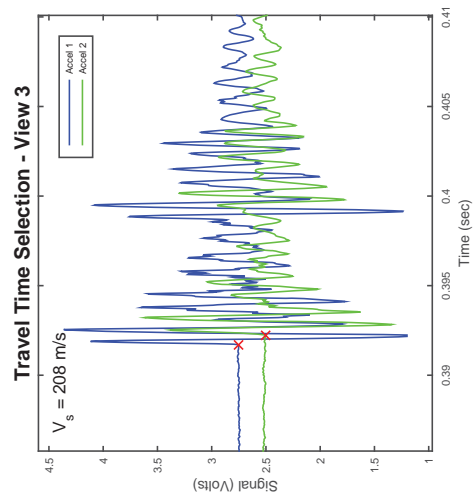
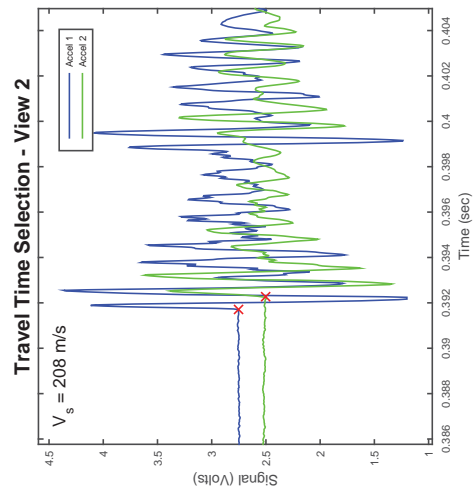
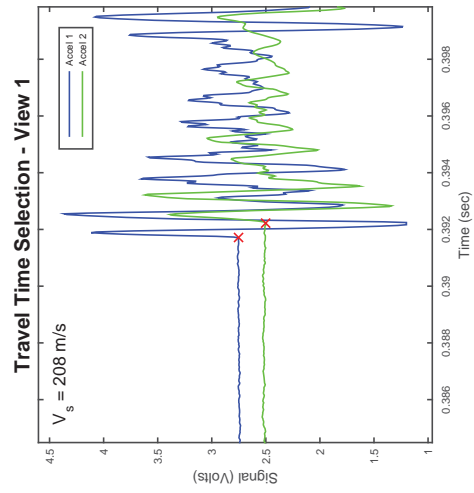
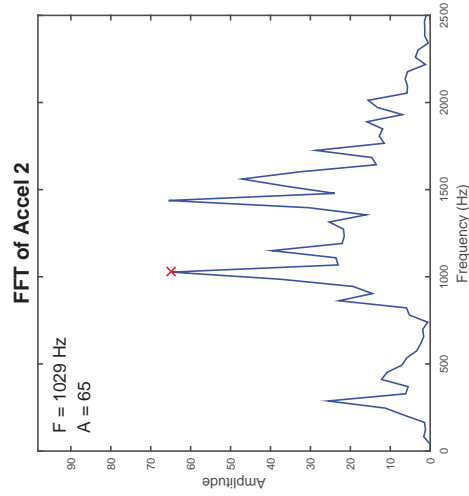
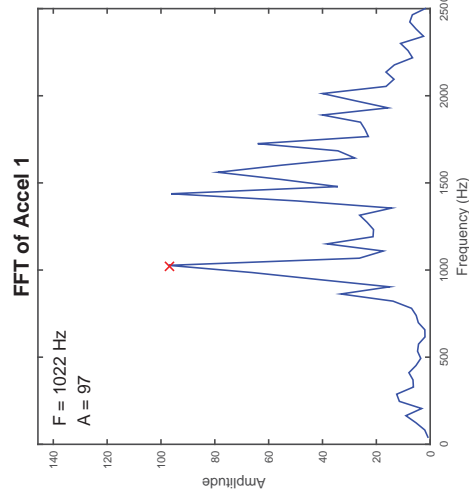
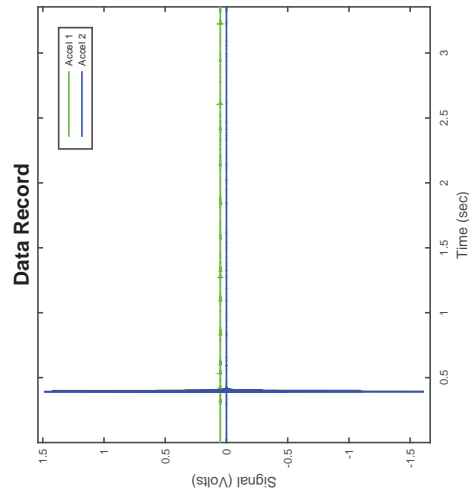

Accelerometer-Based Shear Wave Velocity Datasheet

Specimen ID: C248-PGC109-100-1XP
 Test Material: PGC109
 Date: 2/29/2016
 Test Performed by: J.Hubler
 Filename: C248-PGC109-100-1XP

Vertical Stress: 100kPa
 Sensor Spacing: 0.10984 m
 V_s (rise) = 192 m/s

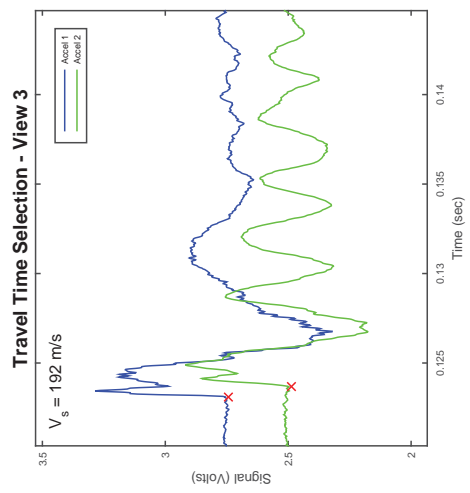
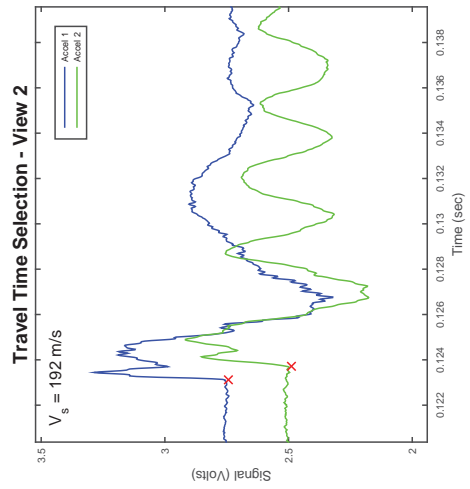
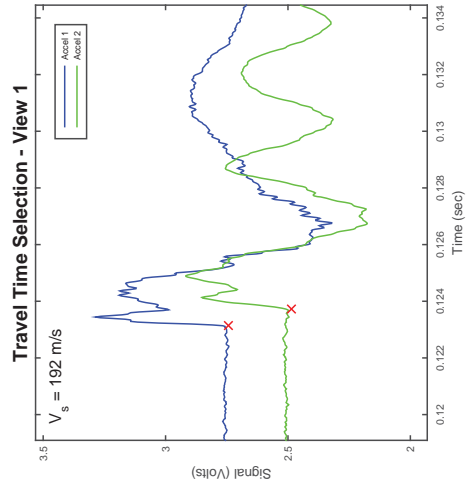
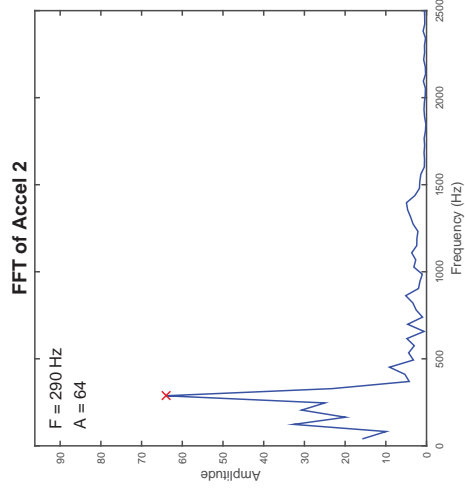
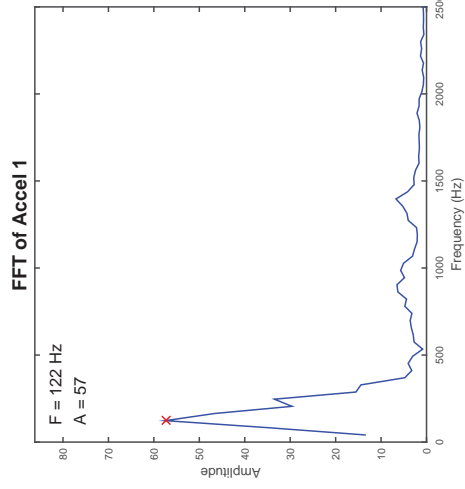
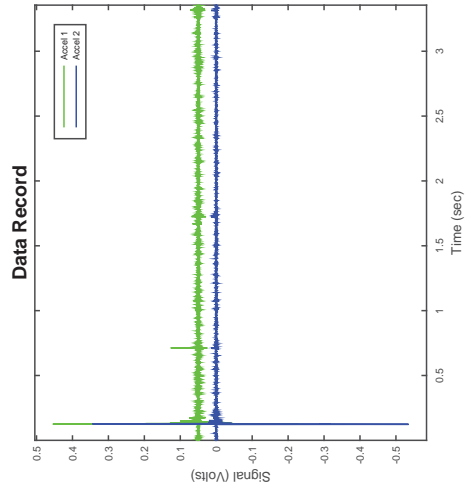

CSS Cyclic Shear Test Report

Geotechnical Engineering Laboratory



Cyclic Shear Test Summary

Device:	CSS	Density (kg/m³):	1890
Specimen ID:	60C109_40PG	Relative Density (%):	47%
Test ID:	C242	Void Ratio:	0.423
Date of Test:	2/17/2016	Vertical Stress (kPa):	100
Test Performed:	Cyclic Shear	Loading Frequency (Hz):	0.33
Test Material:	Ottawa Sand/Pea Gravel	Number of Cycles:	49
Sample Preparation:	Prepared Loose using a funnel with zero drop height.	Cyclic Stress Ratio:	0.044
		Shear Modulus (kPa):	
		Damping (%):	
Prepared by:	J.Hubler	Shear Strain Single Amplitude (%)	
Checked by:	J.Hubler		

Additional Comments:

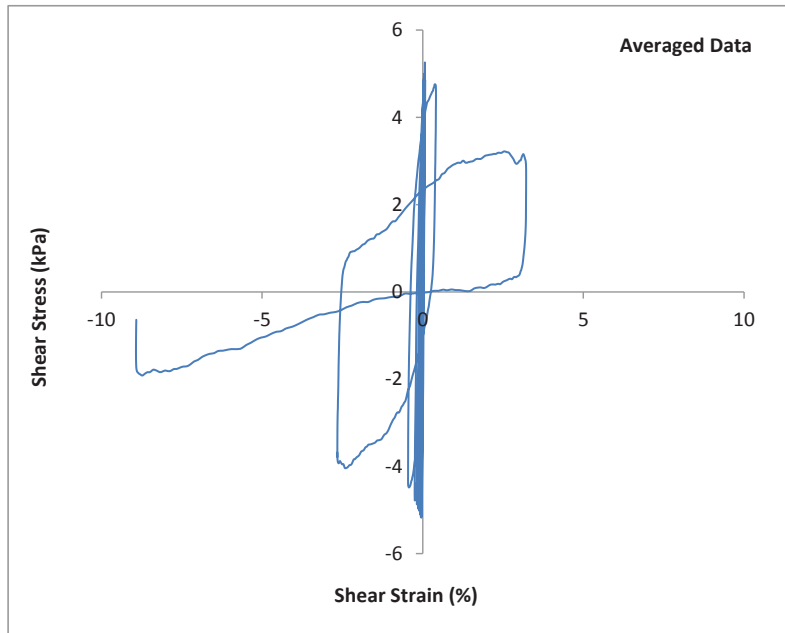
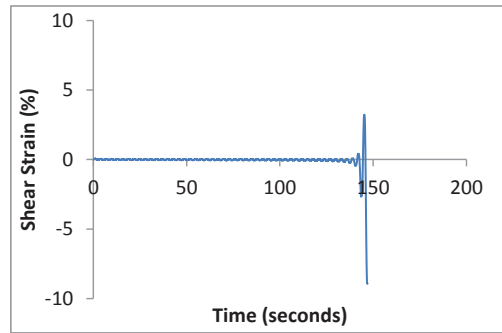
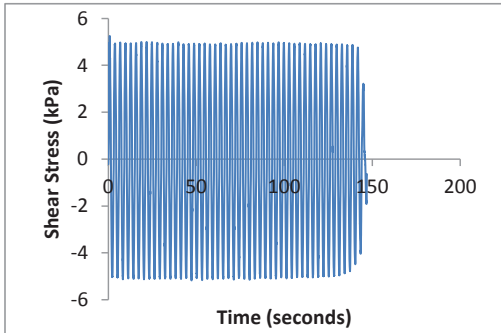

CSS Cyclic Shear Test Report

Geotechnical Engineering Laboratory



Cyclic Shear Test Summary

Device:	CSS	Density (kg/m³):	1890
Specimen ID:	60C109_40PG	Relative Density (%):	47%
Test ID:	C242	Void Ratio:	0.423
Date of Test:	2/17/2016	Vertical Stress (kPa):	100
Test Performed:	Cyclic Shear	Loading Frequency (Hz):	0.33
Test Material:	Ottawa Sand/Pea Gravel	Number of Cycles:	49
Sample Preparation:	Prepared Loose using a funnel with zero drop height.	Cyclic Stress Ratio:	0.044
		Number of Cycles to Liq:	49
		Maximum ru:	1.00
Prepared by:	J.Hubler		
Checked by:	J.Hubler		

Additional Comments:

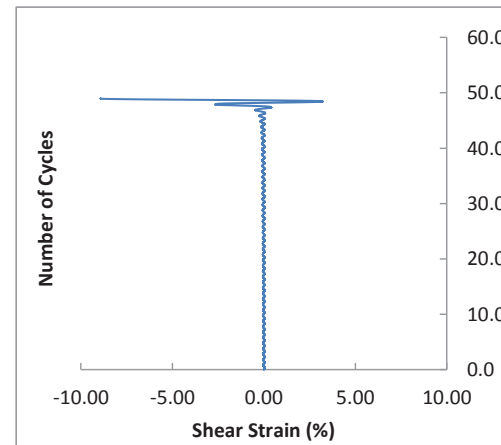
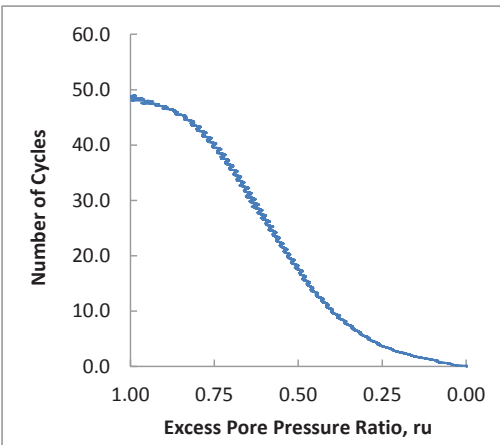
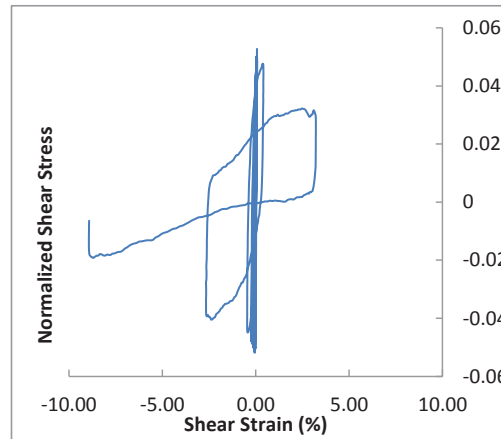
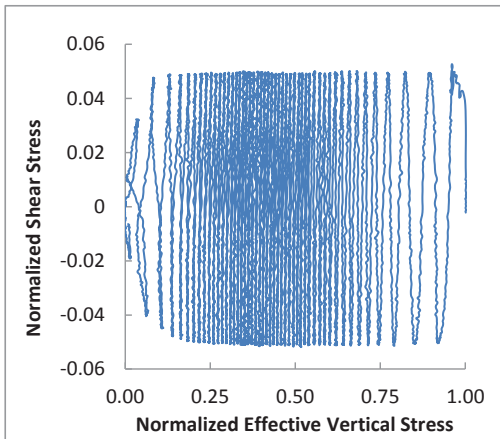

Accelerometer-Based Shear Wave Velocity Datasheet

Specimen ID: C242-PGC109-100-2X
 Test Material: PGC109
 Date: 2/17/2016
 Test Performed by: J.Hubler
 Filename: C242-PGC109-100-2X

Vertical Stress: 100kPa
 Sensor Spacing: 0.11588 m
 V_s (rise) = 205 m/s

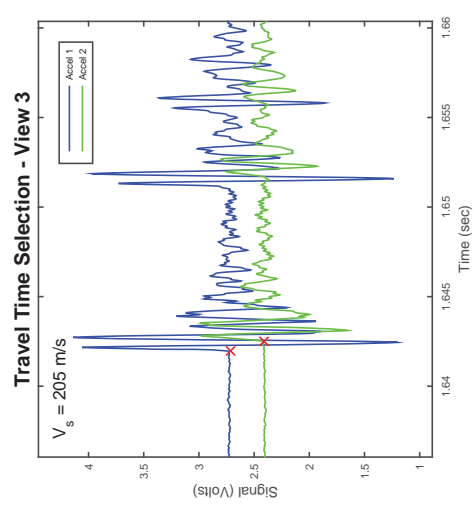
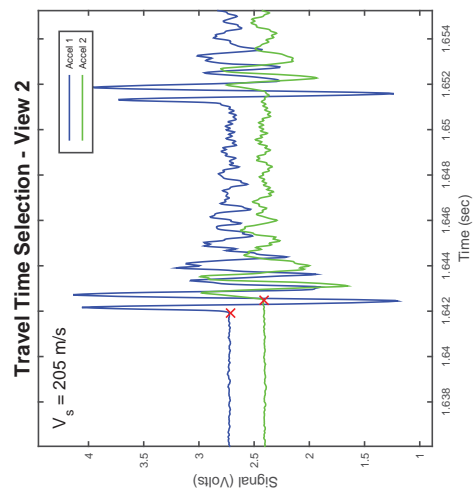
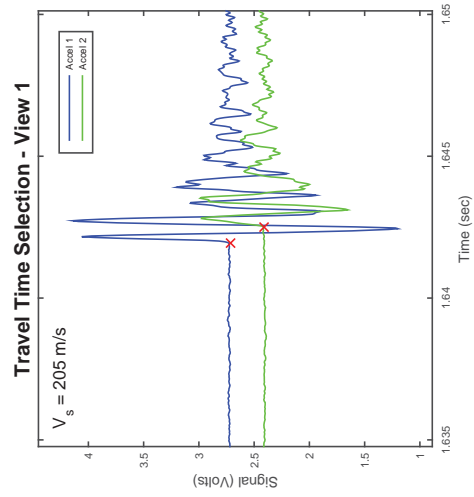
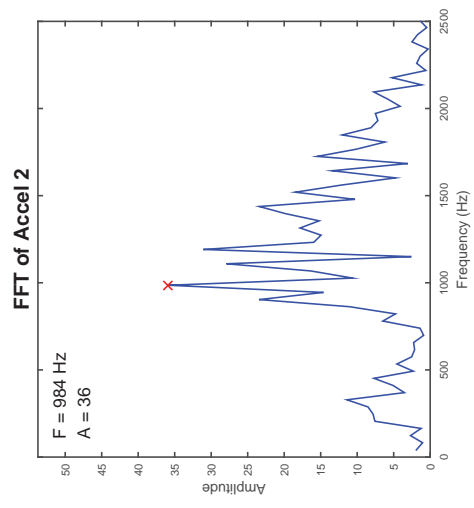
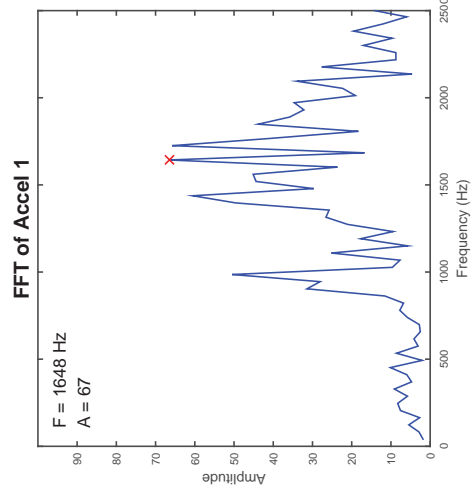
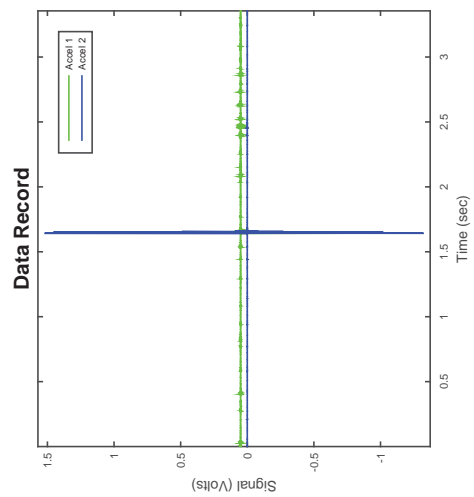

CSS Cyclic Shear Test Report

Geotechnical Engineering Laboratory



Cyclic Shear Test Summary

Device:	CSS	Density (kg/m³):	1885
Specimen ID:	60C109_40PG	Relative Density (%):	44%
Test ID:	C244	Void Ratio:	0.427
Date of Test:	2/22/2106	Vertical Stress (kPa):	100
Test Performed:	Cyclic Shear	Loading Frequency (Hz):	0.33
Test Material:	Ottawa Sand/Pea Gravel	Number of Cycles:	8
Sample Preparation:	Prepared Loose using a funnel with zero drop height.	Cyclic Stress Ratio:	0.094
		Shear Modulus (kPa):	
		Damping (%):	
Prepared by:	J.Hubler	Shear Strain Single Amplitude (%)	
Checked by:	J.Hubler		

Additional Comments:

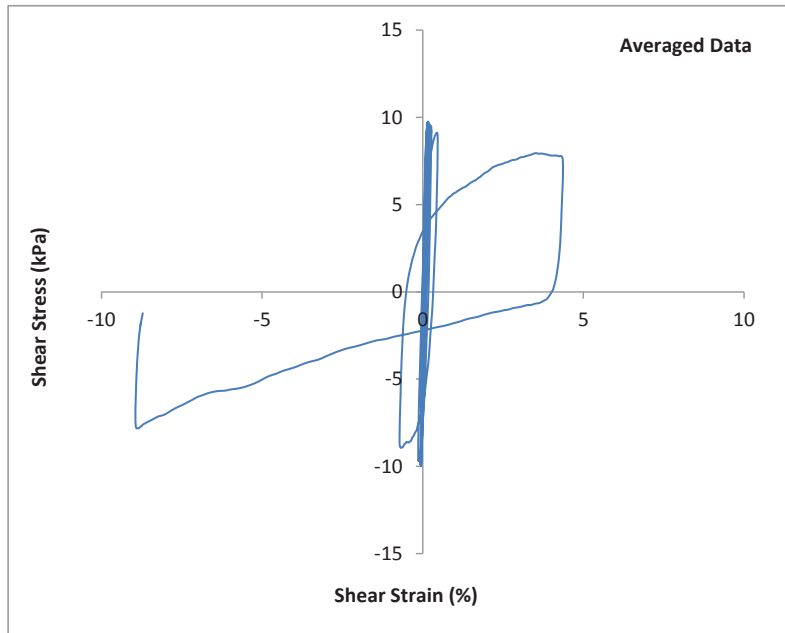
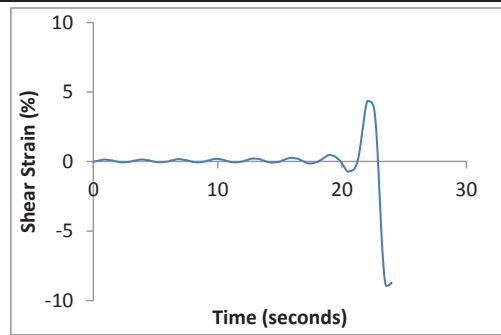
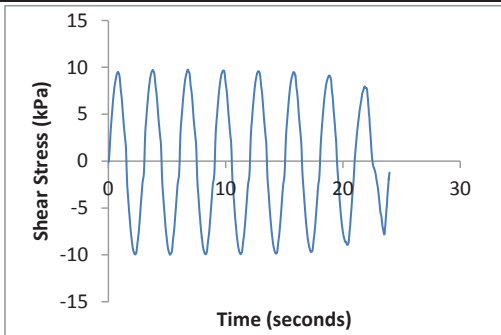

CSS Cyclic Shear Test Report

Geotechnical Engineering Laboratory



Cyclic Shear Test Summary

Device:	CSS	Density (kg/m³):	1885
Specimen ID:	60C109_40PG	Relative Density (%):	44%
Test ID:	C244	Void Ratio:	0.427
Date of Test:	2/22/2106	Vertical Stress (kPa):	100
Test Performed:	Cyclic Shear	Loading Frequency (Hz):	0.33
Test Material:	Ottawa Sand/Pea Gravel	Number of Cycles:	8
Sample Preparation:	Prepared Loose using a funnel with zero drop height.	Cyclic Stress Ratio:	0.094
		Number of Cycles to Liq:	8
		Maximum ru:	0.99
Prepared by:	J.Hubler		
Checked by:	J.Hubler		

Additional Comments:

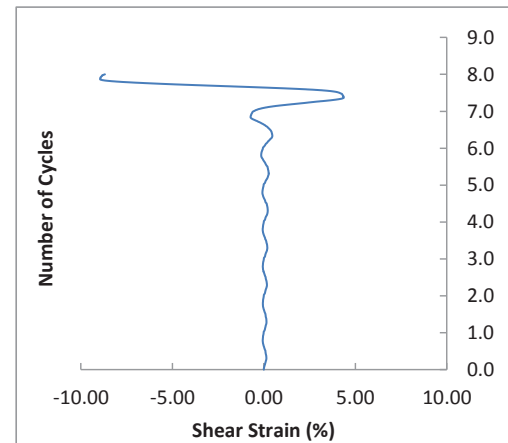
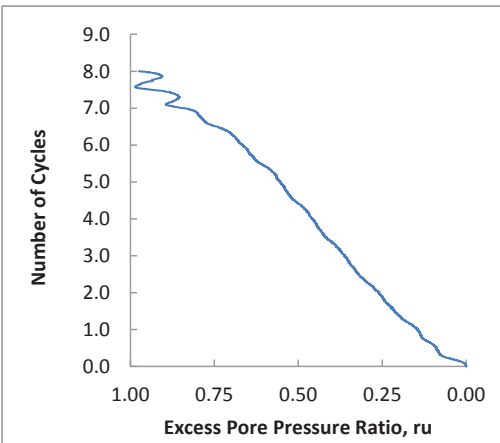
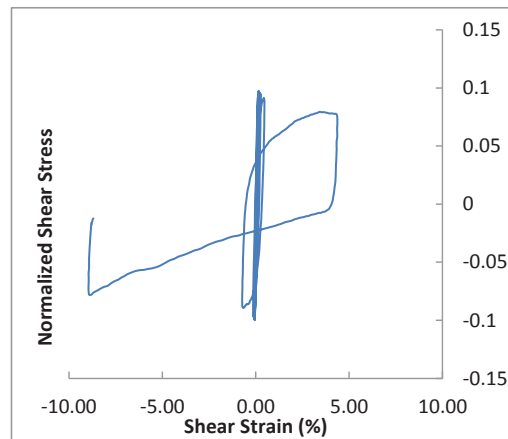
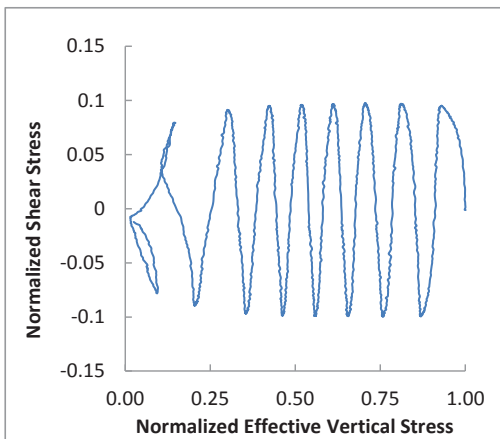

CSS Monotonic Shear Test Report

Geotechnical Engineering Laboratory



10/28/2013_Version 8.0

General Test Info and Sample Preparation

Device:	CSS	Relative Density (%):	9%
Specimen ID:	60C109_40PG	Void Ratio:	0.469
Test ID:	C244	Height (mm):	117.1
Date of Test:	2/22/2016	Soil-Only Specimen Diameter (mm):	306.23
Test Performed:	Post Cyclic Monotonic Shear	Weight (kg):	15.787
Test Material:	Ottawa Sand/Pea Gravel	Density (kg/m³):	1831.1
Sample Preparation:	Prepared loose by placing with a funnel and zero drop height.	Membrane Thickness (mm):	0.635
		Moisture Content (%):	0%
		Saturated (Y/N):	N
		Prepared by:	J.Hubler
		Checked by:	J. Hubler

Consolidation Stage

Vertical Stress (kPa):	100
Time to Compression (min):	6.8
Relative Density (%):	44%
Void Ratio:	0.427
Height (mm):	113.7
Diameter (mm):	306.23
Weight (kg):	15.787
Density (kg/m³):	1885.4

Shear Stage

Type of Test:	Constant Volume
Stress or Strain Controlled:	Strain
Shear Strain Rate (%/min):	0.29
Peak Shear Strength (kPa):	8.0

Comments

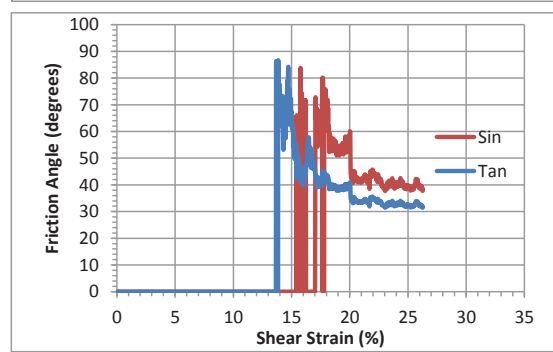
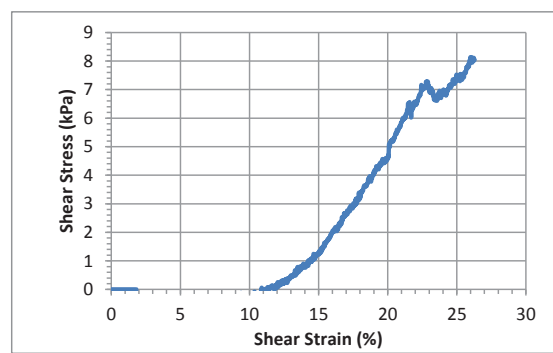
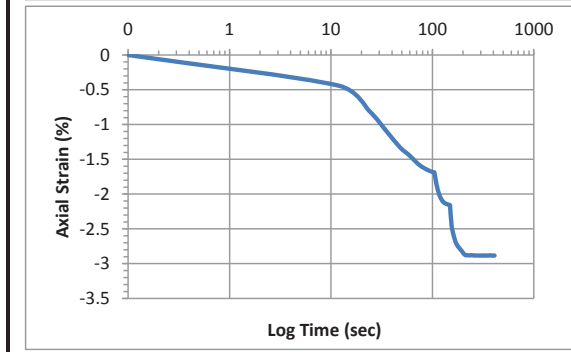
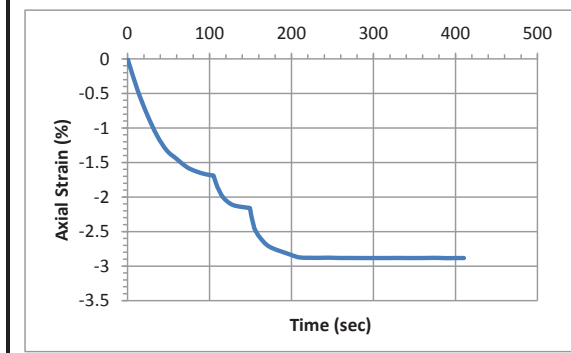

Accelerometer-Based Shear Wave Velocity Datasheet

Specimen ID: C244-PGC109-100-1X
 Test Material: PGC109
 Date: 2/22/2016
 Test Performed by: J. Hubler
 Filename: C244-PGC109-100-1X

Vertical Stress: 100kPa
 Sensor Spacing: 0.11341 m
 V_s (rise) = 217 m/s

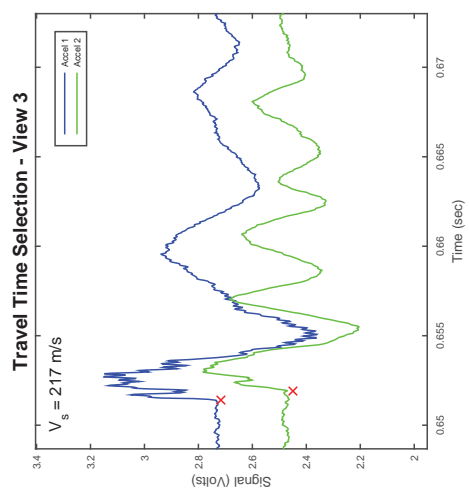
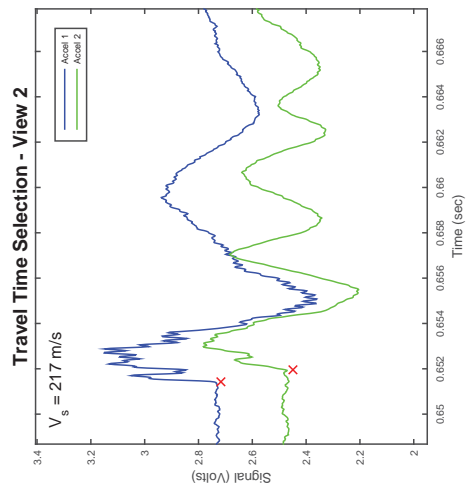
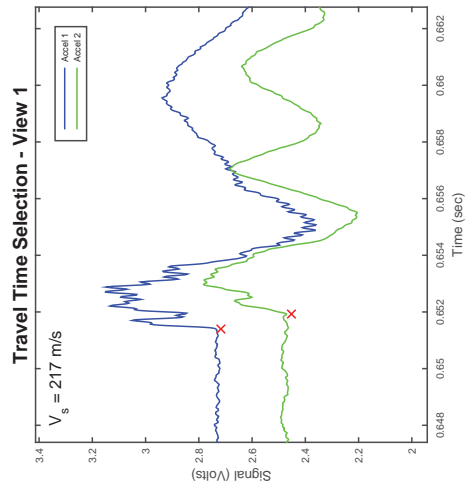
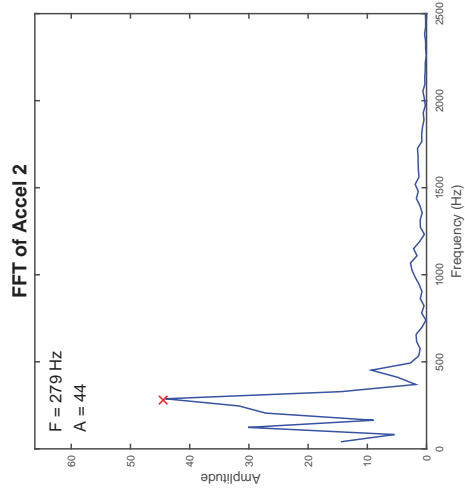
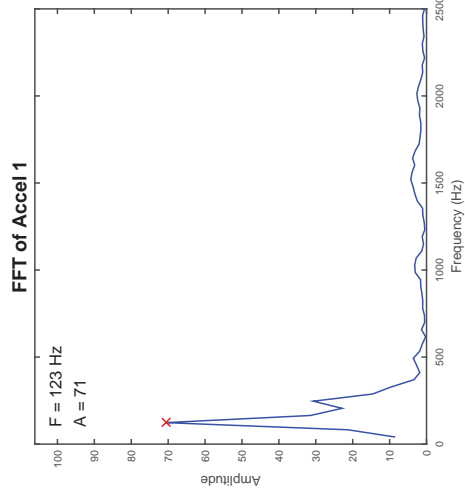
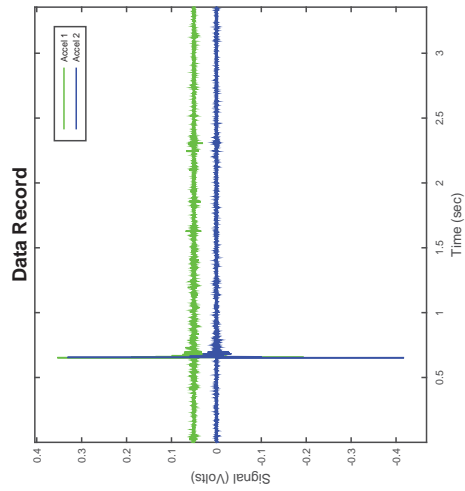

CSS Cyclic Shear Test Report

Geotechnical Engineering Laboratory



Cyclic Shear Test Summary

Device:	CSS	Density (kg/m³):	1891
Specimen ID:	60C109_40PG	Relative Density (%):	48%
Test ID:	C245	Void Ratio:	0.423
Date of Test:	2/25/2016	Vertical Stress (kPa):	100
Test Performed:	Cyclic Shear	Loading Frequency (Hz):	0.33
Test Material:	Ottawa Sand/Pea Gravel	Number of Cycles:	2
Sample Preparation:	Prepared Loose using a funnel with zero drop height.	Cyclic Stress Ratio:	0.144
		Shear Modulus (kPa):	
		Damping (%):	
Prepared by:	J.Hubler	Shear Strain Single Amplitude (%)	
Checked by:	J.Hubler		

Additional Comments:

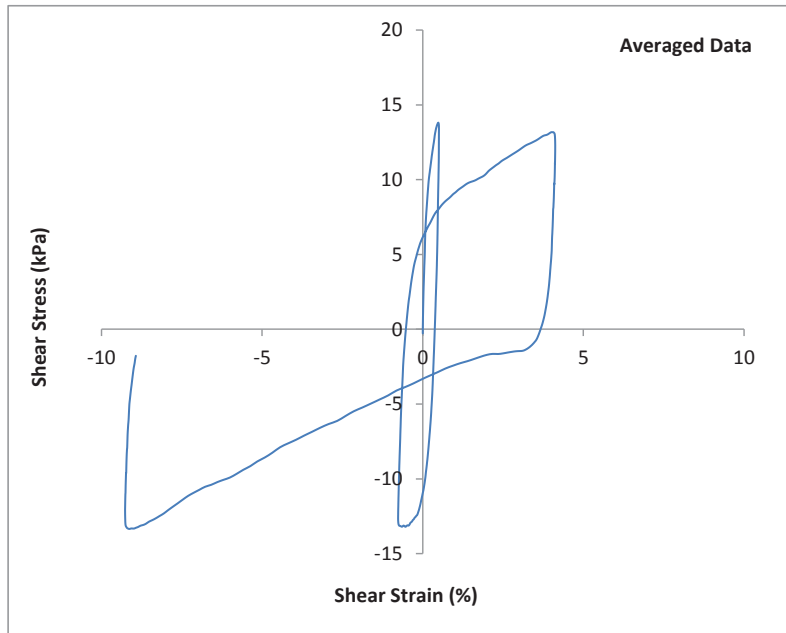
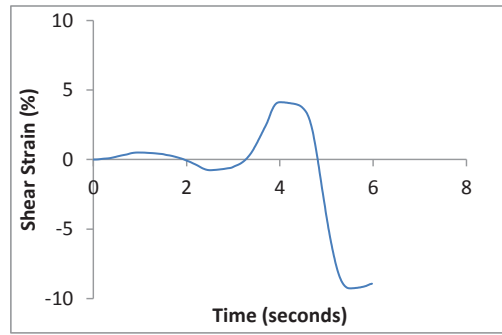
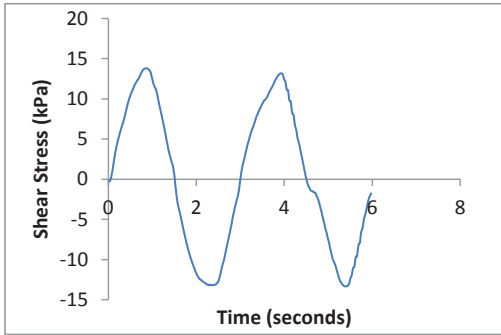

CSS Cyclic Shear Test Report

Geotechnical Engineering Laboratory



Cyclic Shear Test Summary

Device:	CSS	Density (kg/m³):	1891
Specimen ID:	60C109_40PG	Relative Density (%):	48%
Test ID:	C245	Void Ratio:	0.423
Date of Test:	2/25/2016	Vertical Stress (kPa):	100
Test Performed:	Cyclic Shear	Loading Frequency (Hz):	0.33
Test Material:	Ottawa Sand/Pea Gravel	Number of Cycles:	2
Sample Preparation:	Prepared Loose using a funnel with zero drop height.	Cyclic Stress Ratio:	0.144
		Number of Cycles to Liq:	2
		Maximum ru:	0.97
Prepared by:	J.Hubler		
Checked by:	J.Hubler		

Additional Comments:

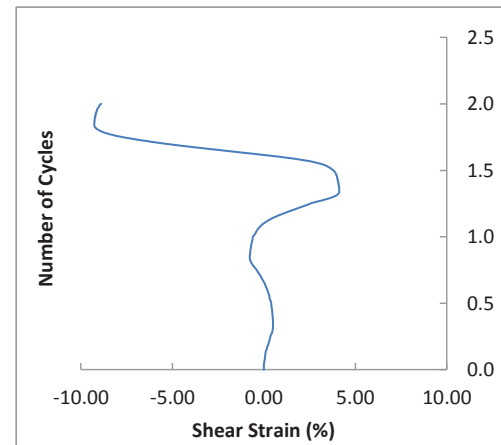
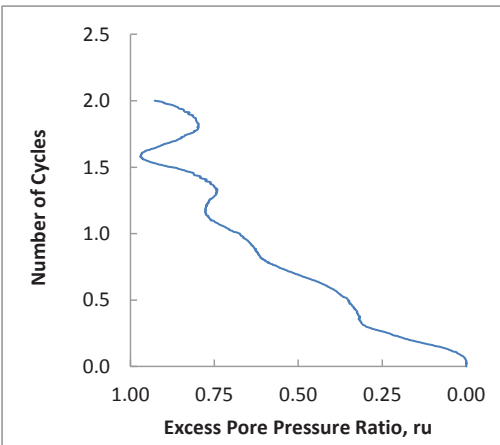
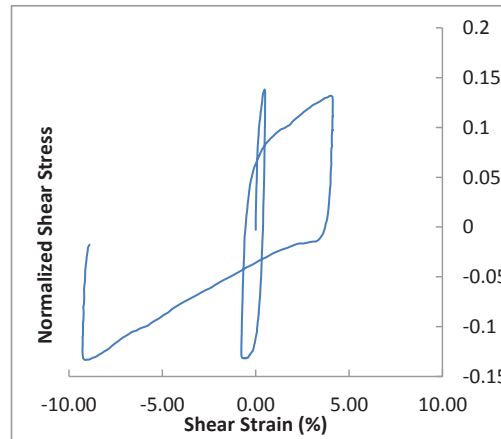
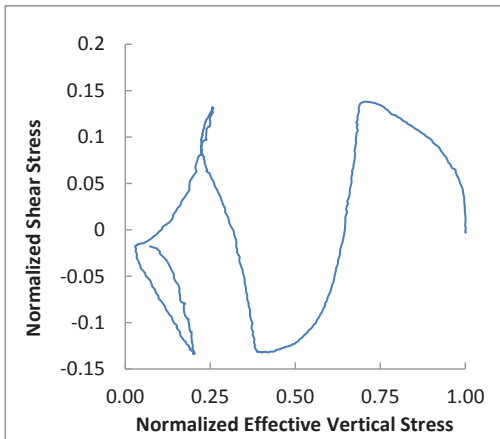

CSS Monotonic Shear Test Report

Geotechnical Engineering Laboratory



10/28/2013_Version 8.0

General Test Info and Sample Preparation

Device:	CSS	Relative Density (%):	48%
Specimen ID:	60C109_40PG	Void Ratio:	0.423
Test ID:	C245	Height (mm):	112.2
Date of Test:	2/24/2016	Soil-Only Specimen Diameter (mm):	306.23
Test Performed:	Post Cyclic Monotonic Shear	Weight (kg):	15.621
Test Material:	Pea Gravel	Density (kg/m³):	1890.9
Sample Preparation:	Prepared loose by placing with a funnel and zero drop height.	Membrane Thickness (mm):	0.635
		Moisture Content (%):	0%
		Saturated (Y/N):	N
		Prepared by:	J.Hubler
		Checked by:	J. Hubler

Consolidation Stage

Vertical Stress (kPa):	100
Time to Compression (min):	3.2
Relative Density (%):	62%
Void Ratio:	0.406
Height (mm):	110.8
Diameter (mm):	306.23
Weight (kg):	15.621
Density (kg/m³):	1913.9

Shear Stage

Type of Test:	Constant Volume
Stress or Strain Controlled:	Strain
Shear Strain Rate (%/min):	0.29
Peak Shear Strength (kPa):	55.7

Comments

Re-consolidated to 100 kPa after cyclic test at CSR = 0.144

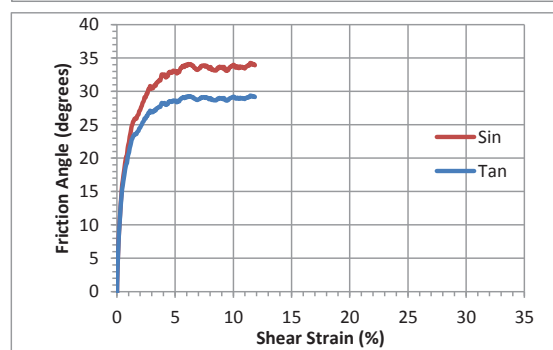
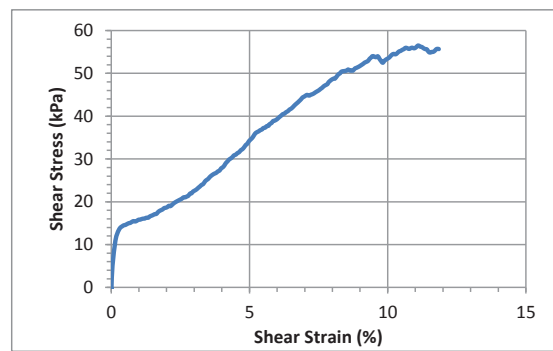
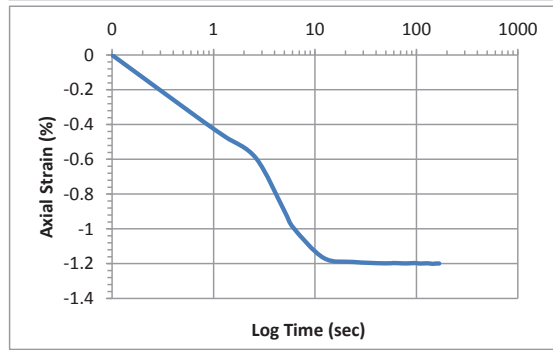
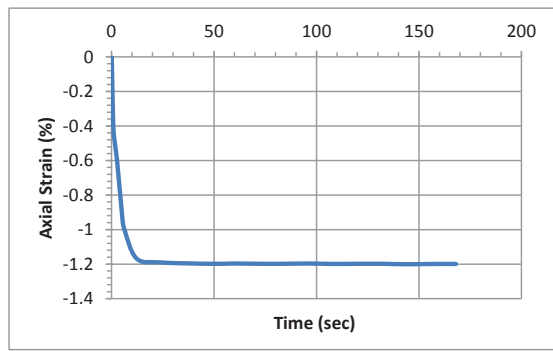

Accelerometer-Based Shear Wave Velocity Datasheet

Specimen ID: C245-PGC109-100-1X

Test Material: PGC109

Date: 2/24/2016

Test Performed by: J.Hubler

Filename: C245-PGC109-100-1X

Vertical Stress: 100kPa

Sensor Spacing: 0.11188 m

V_s (rise) = 209 m/s

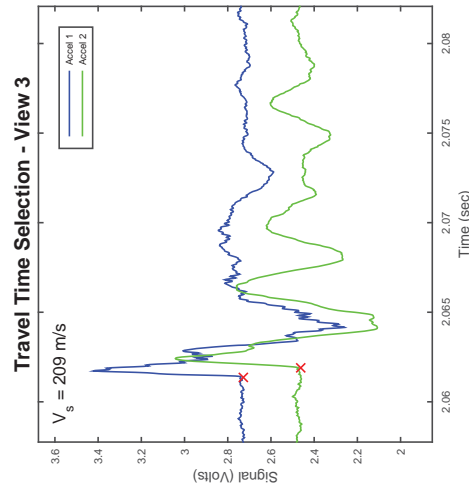
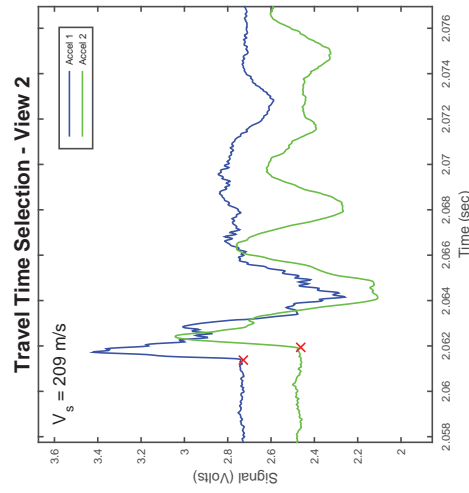
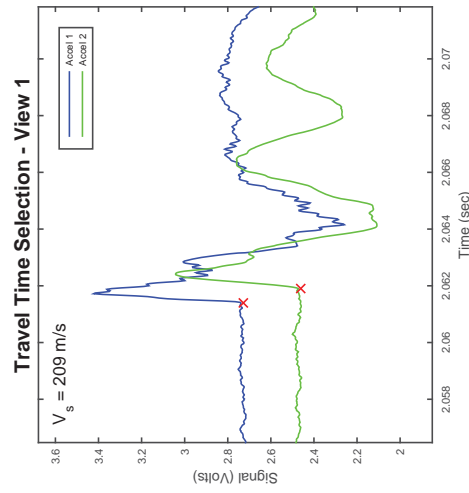
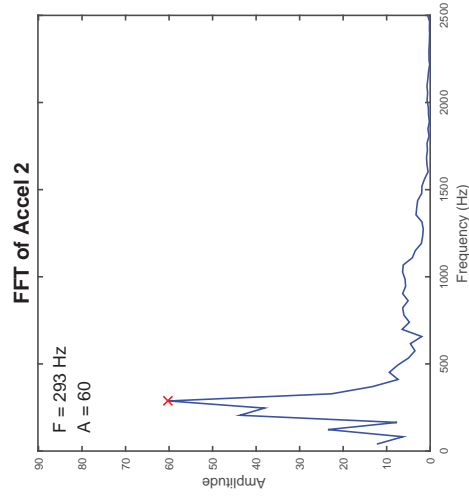
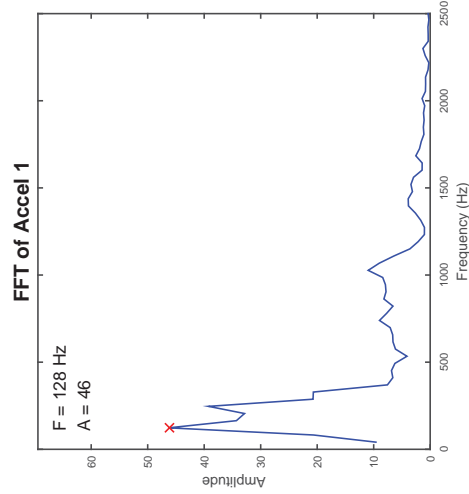
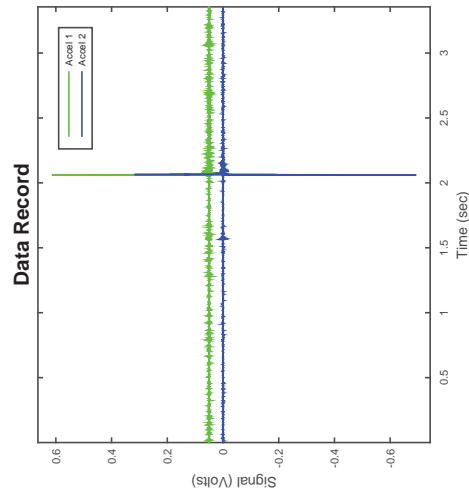

Accelerometer-Based Shear Wave Velocity Datasheet

Specimen ID: C245-PGC109-100-2X

Test Material: PGC109

Date: 2/24/2016

Test Performed by: J.Hubler

Filename: C245-PGC109-100-2X

Vertical Stress: 100kPa

Sensor Spacing: 0.11188 m

V_s (rise) = 198 m/s

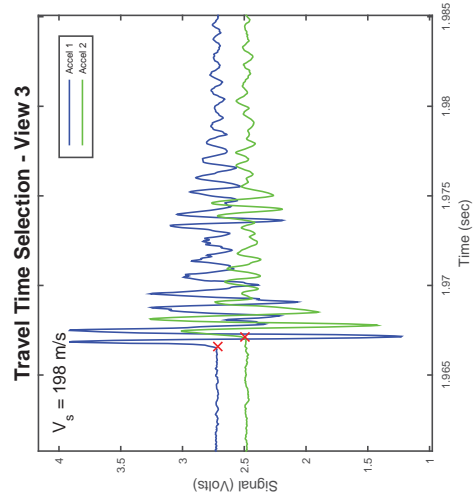
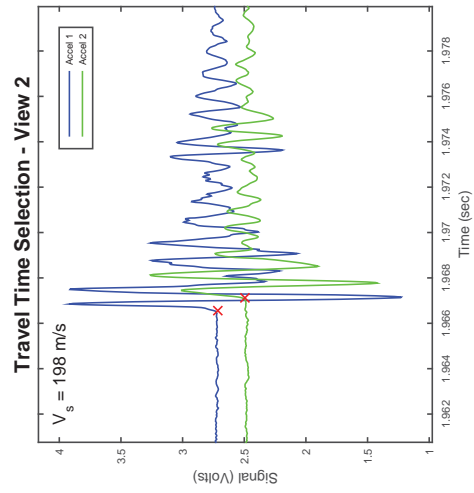
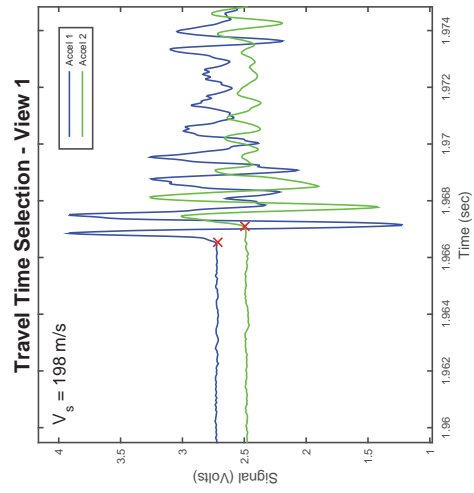
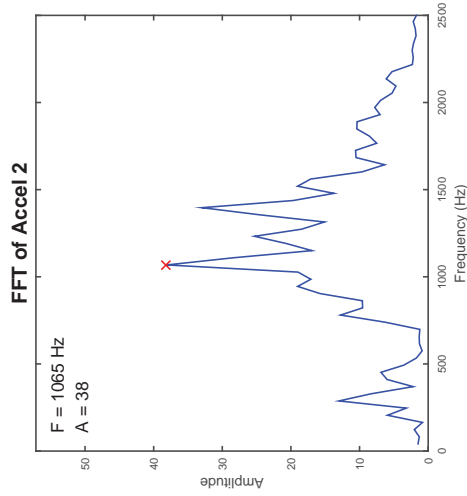
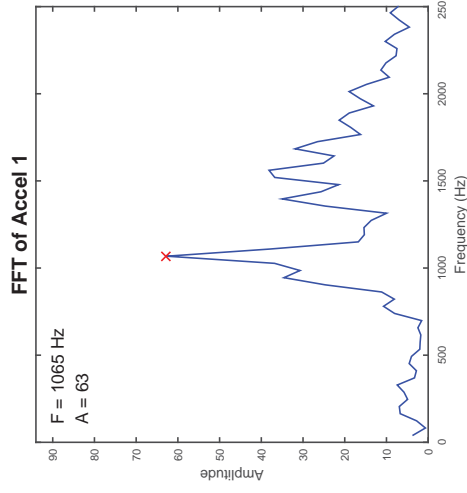
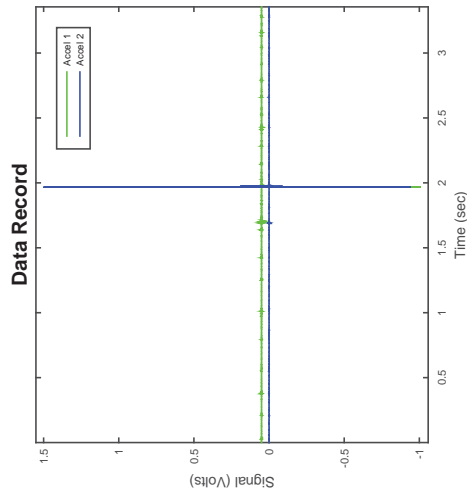

Accelerometer-Based Shear Wave Velocity Datasheet

Specimen ID: C245-PGC109-100-3X

Test Material: PGC109

Date: 2/24/2016

Test Performed by: J.Hubler

Filename: C245-PGC109-100-3X

Vertical Stress: 100kPa

Sensor Spacing: 0.11188 m

V_s (rise) = 209 m/s

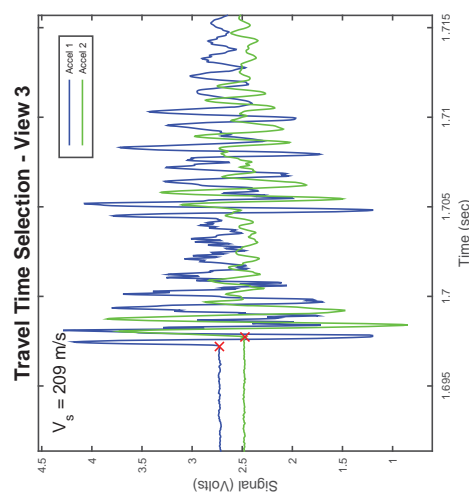
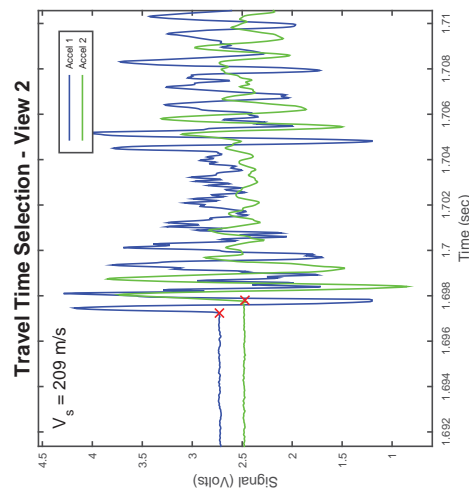
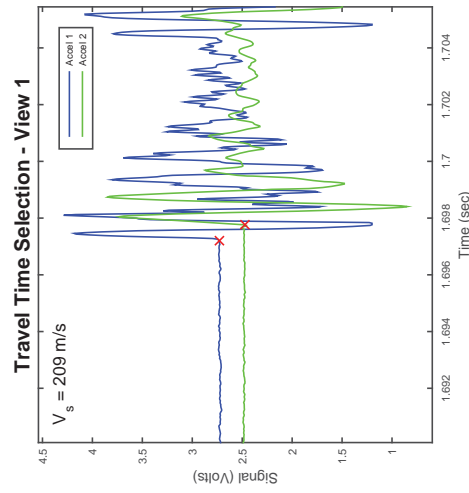
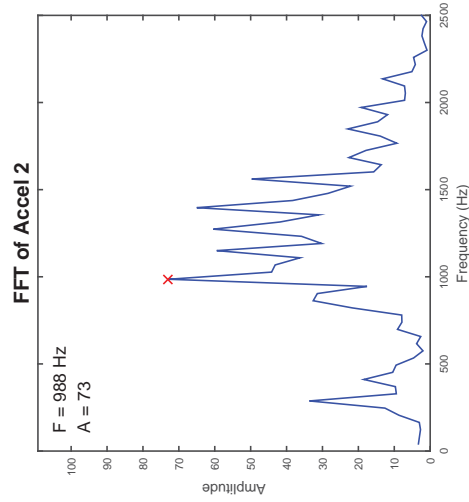
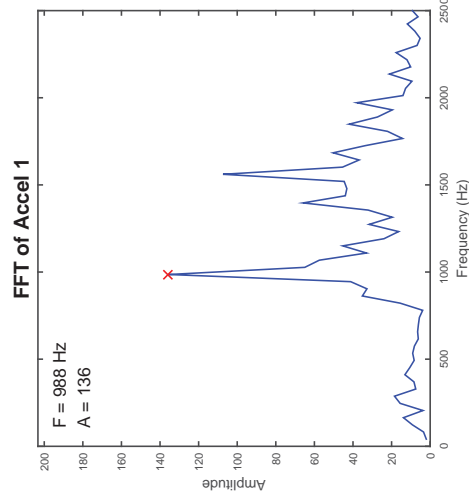
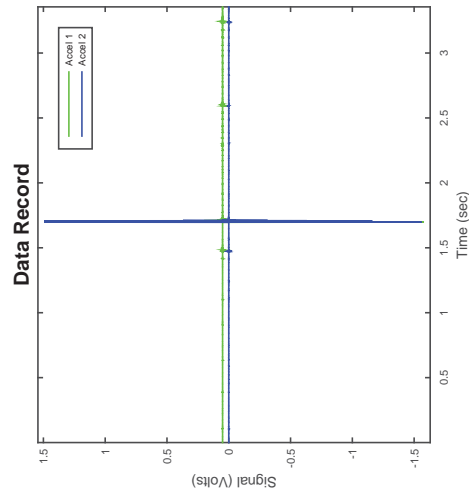

Accelerometer-Based Shear Wave Velocity Datasheet

Specimen ID: C245-PGC109-100-2XP
 Test Material: PGC109
 Date: 2/24/2016
 Test Performed by: J.Hubler
 Filename: C245-PGC109-100-2XP

Vertical Stress: 100kPa
 Sensor Spacing: 0.11054 m
 V_s (rise) = 221 m/s

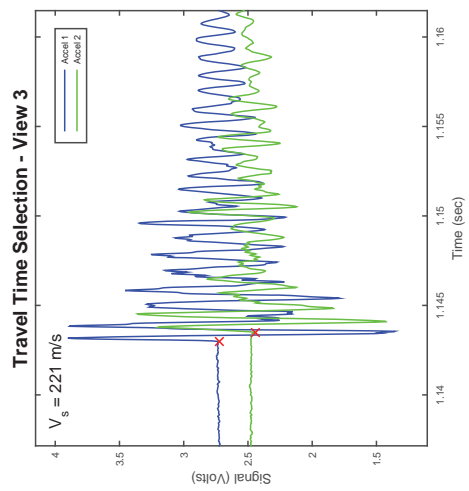
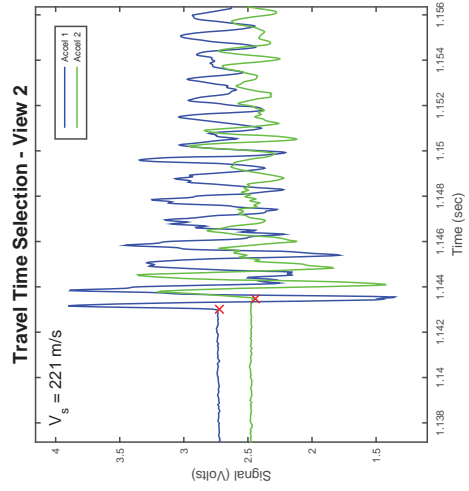
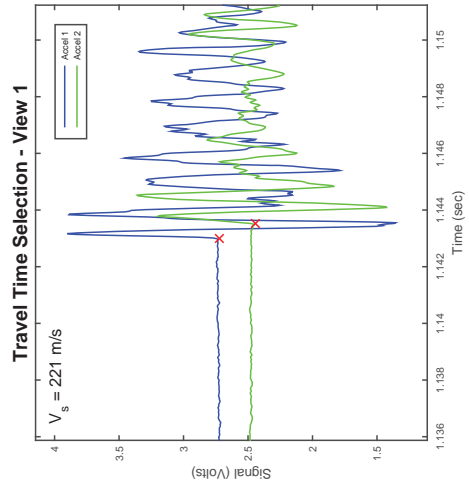
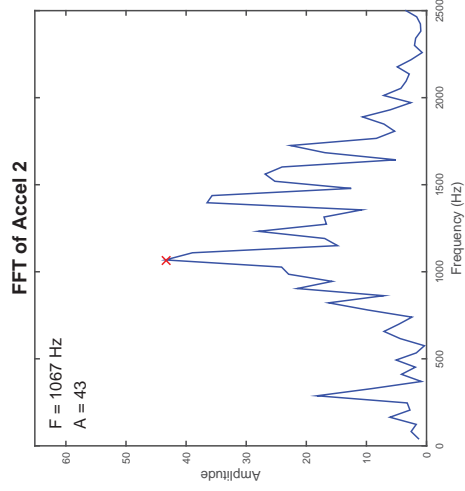
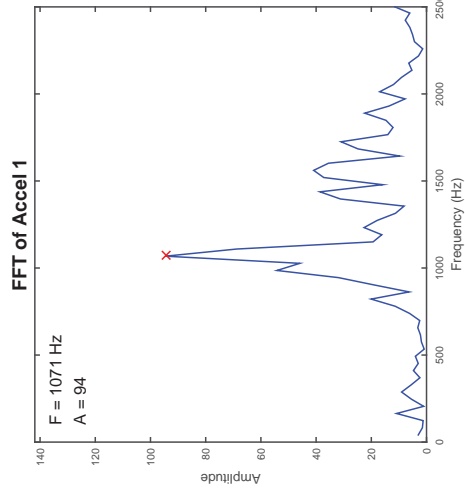
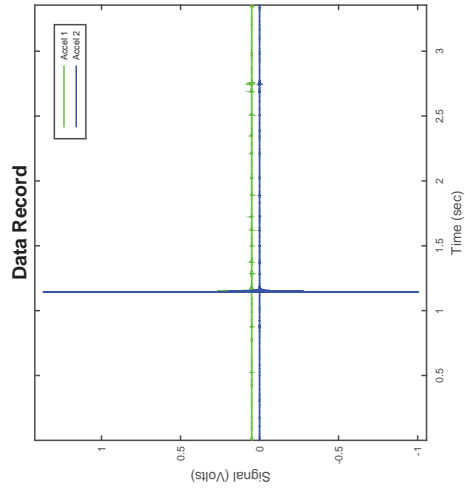

Accelerometer-Based Shear Wave Velocity Datasheet

Specimen ID: C245-PGC109-100-3XP
 Test Material: PGC109
 Date: 2/24/2016
 Test Performed by: J. Hubler
 Filename: C245-PGC109-100-3XP

Vertical Stress: 100kPa
 Sensor Spacing: 0.11054 m
 V_s (rise) = 209 m/s

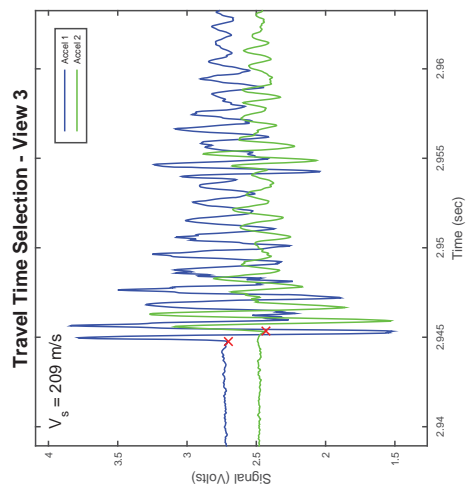
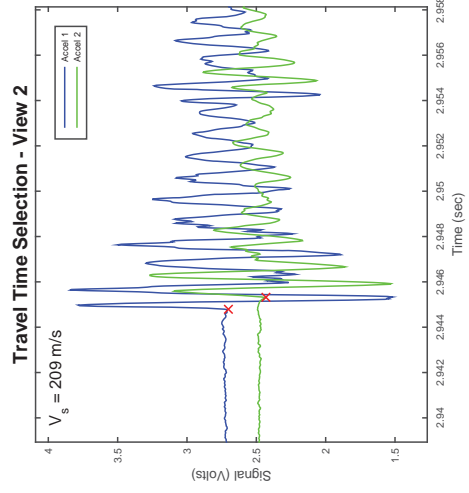
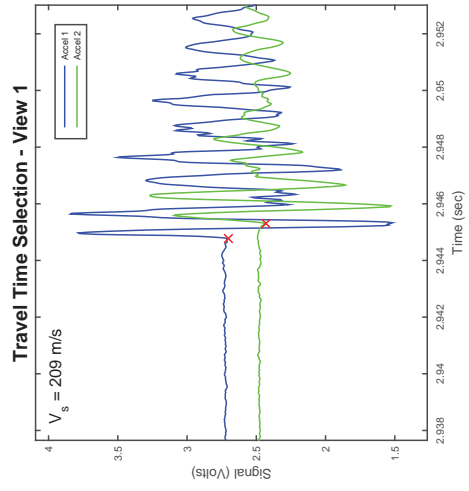
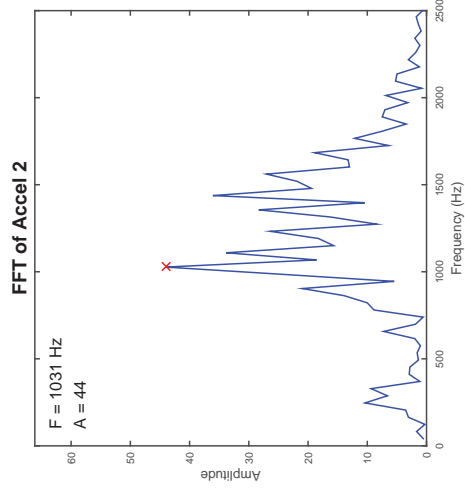
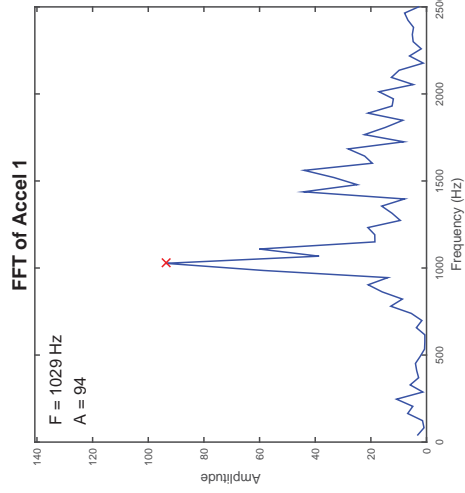
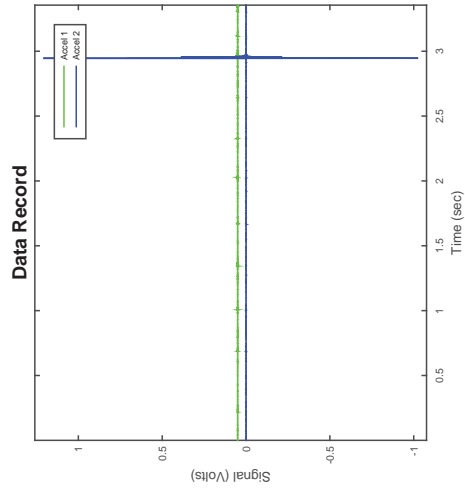

CSS Cyclic Shear Test Report

Geotechnical Engineering Laboratory



Cyclic Shear Test Summary

Device:	CSS	Density (kg/m³):	1952
Specimen ID:	60C109_40PG	Relative Density (%):	85%
Test ID:	C299	Void Ratio:	0.378
Date of Test:	10/26/2016	Vertical Stress (kPa):	100
Test Performed:	Cyclic Shear	Loading Frequency (Hz):	0.33
Test Material:	Ottawa Sand/Pea Gravel	Number of Cycles:	15
Sample Preparation:	Prepared dense by tamping in 5 layers (25x)	Cyclic Stress Ratio:	0.094
		Shear Modulus (kPa):	
		Damping (%):	
Prepared by:	J.Hubler	Shear Strain Single Amplitude (%)	
Checked by:	J.Hubler		

Additional Comments:

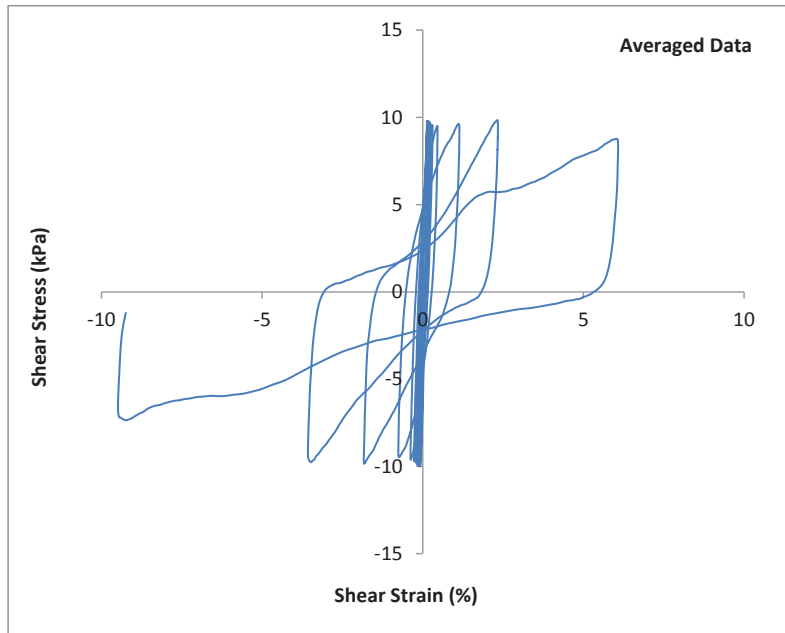
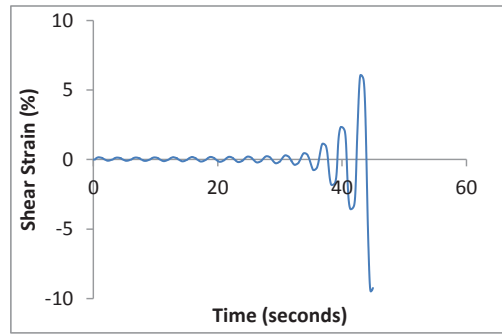
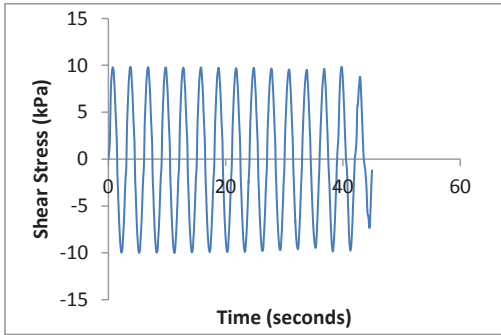

CSS Cyclic Shear Test Report

Geotechnical Engineering Laboratory



Cyclic Shear Test Summary

Device:	CSS	Density (kg/m³):	1952
Specimen ID:	60C109_40PG	Relative Density (%):	85%
Test ID:	C299	Void Ratio:	0.378
Date of Test:	10/26/2016	Vertical Stress (kPa):	100
Test Performed:	Cyclic Shear	Loading Frequency (Hz):	0.33
Test Material:	Ottawa Sand/Pea Gravel	Number of Cycles:	15
Sample Preparation:	Prepared dense by tamping in 5 layers (25x)	Cyclic Stress Ratio:	0.094
		Number of Cycles to Liq:	15
		Maximum ru:	0.99
Prepared by:	J.Hubler		
Checked by:	J.Hubler		

Additional Comments:

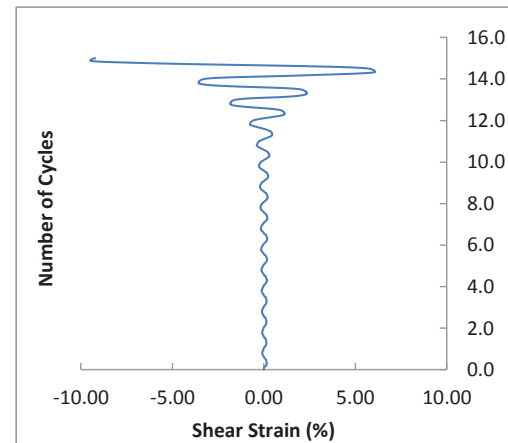
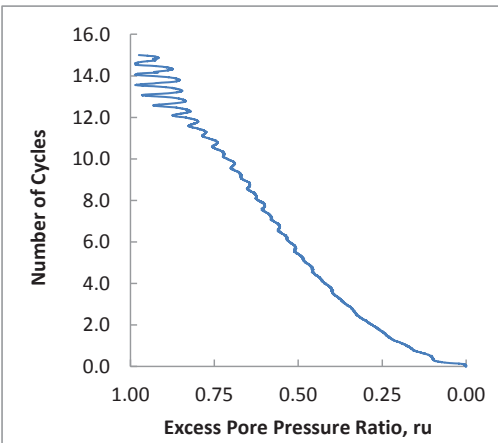
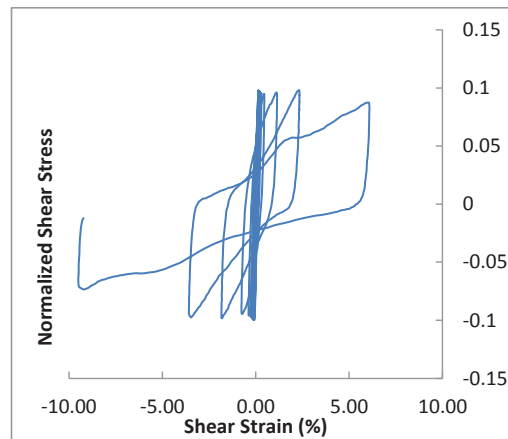
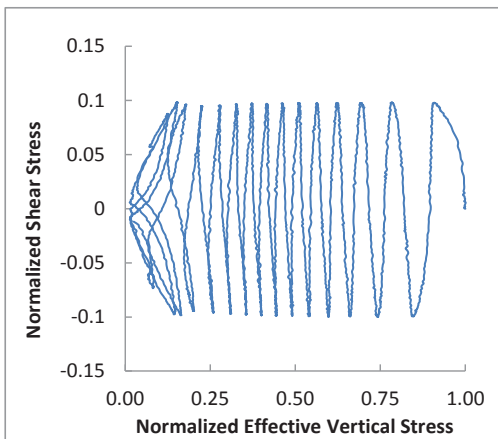

CSS Monotonic Shear Test Report

Geotechnical Engineering Laboratory



10/28/2013_Version 8.0

General Test Info and Sample Preparation

Device:	CSS	Relative Density (%):	39%
Specimen ID:	60C109_40PG	Void Ratio:	0.433
Test ID:	C299	Height (mm):	108.7
Date of Test:	10/26/2016	Soil-Only Specimen Diameter (mm):	306.23
Test Performed:	Post Cyclic Monotonic Shear	Weight (kg):	15.033
Test Material:	Ottawa Sand/Pea Gravel	Density (kg/m³):	1876.9
Sample Preparation:	Prepared dense by tamping 25x in 5 layers.	Membrane Thickness (mm):	0.635
		Moisture Content (%):	0%
		Saturated (Y/N):	N
		Prepared by:	J.Hubler
		Checked by:	J. Hubler

Consolidation Stage		Shear Stage	
Vertical Stress (kPa):	100	Type of Test:	Constant Volume
Time to Compression (min):	2.8	Stress or Strain Controlled:	Strain
Relative Density (%):	85%	Shear Strain Rate (%/min):	0.31
Void Ratio:	0.378	Peak Shear Strength (kPa):	5.2
Height (mm):	104.5	Comments	
Diameter (mm):	306.23		
Weight (kg):	15.033		
Density (kg/m³):	1952.3		

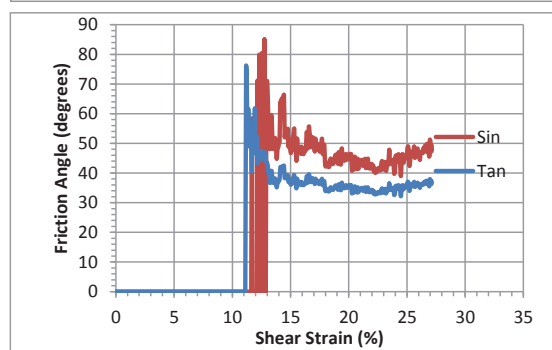
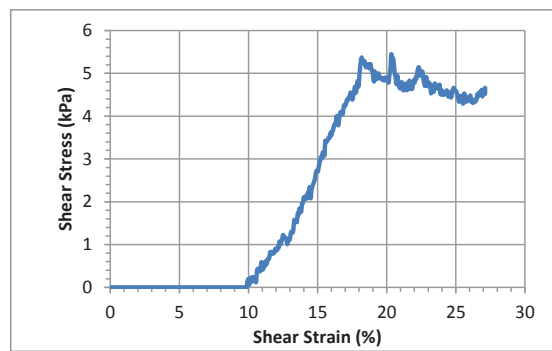
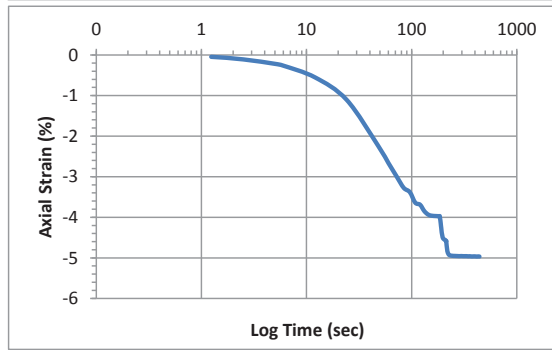
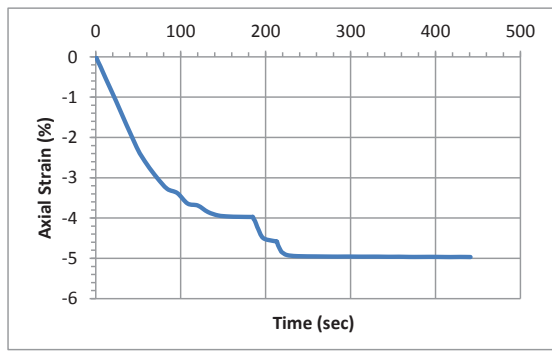

Accelerometer-Based Shear Wave Velocity Datasheet

Specimen ID: C299-60C10940PG-100-3X

Test Material: 60C10940PG

Date: 10/24/2016

Test Performed by: J.Hubler

Filename: C299-60C10940PG-100-3X

Vertical Stress: 100kPa

Sensor Spacing: 0.10427 m

V_s (rise) = 226 m/s

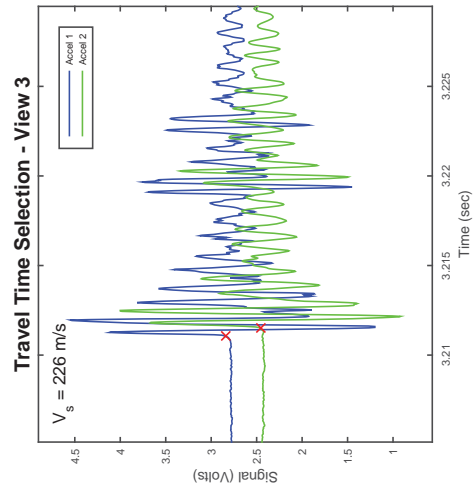
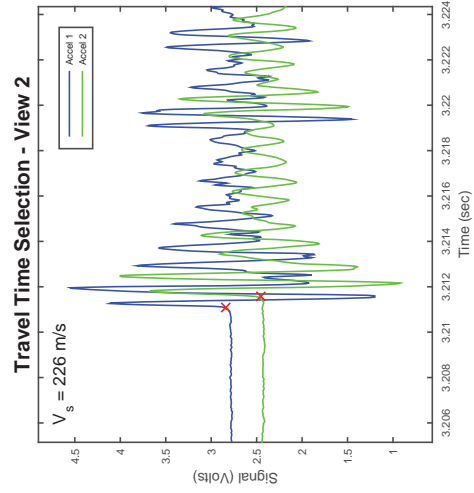
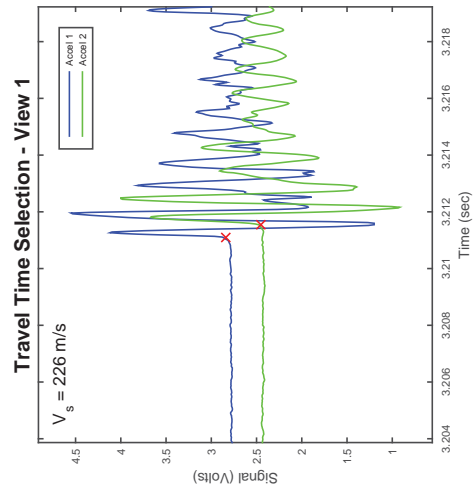
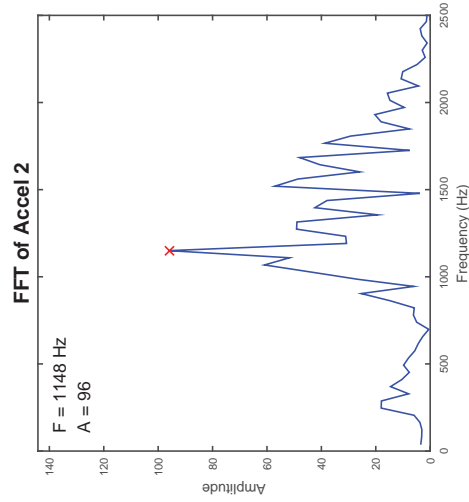
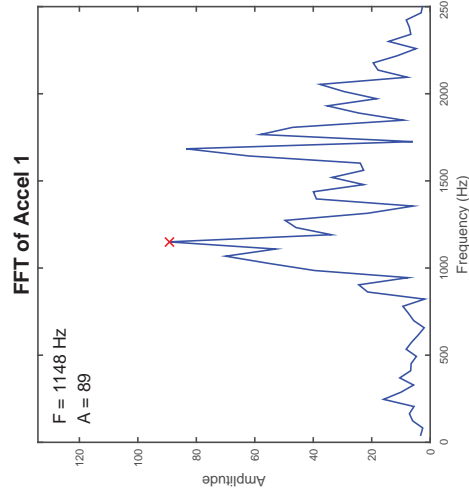
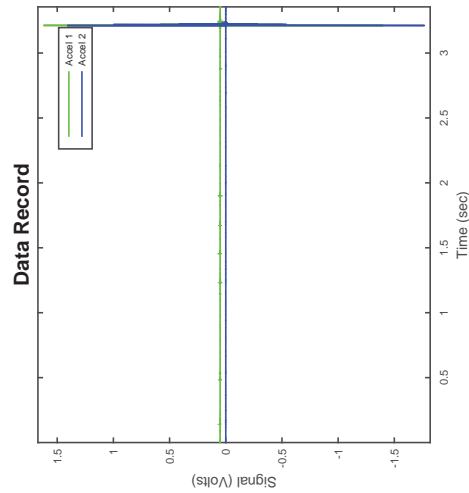

CSS Cyclic Shear Test Report

Geotechnical Engineering Laboratory



Cyclic Shear Test Summary

Device:	CSS	Density (kg/m³):	1890
Specimen ID:	60C109_40PG	Relative Density (%):	47%
Test ID:	C243	Void Ratio:	0.423
Date of Test:	2/17/2016	Vertical Stress (kPa):	400
Test Performed:	Cyclic Shear	Loading Frequency (Hz):	0.33
Test Material:	Ottawa Sand/Pea Gravel	Number of Cycles:	8
Sample Preparation:	Prepared Loose using a funnel with zero drop height.	Cyclic Stress Ratio:	0.099
		Shear Modulus (kPa):	
		Damping (%):	
Prepared by:	J.Hubler	Shear Strain Single Amplitude (%)	
Checked by:	J.Hubler		

Additional Comments:

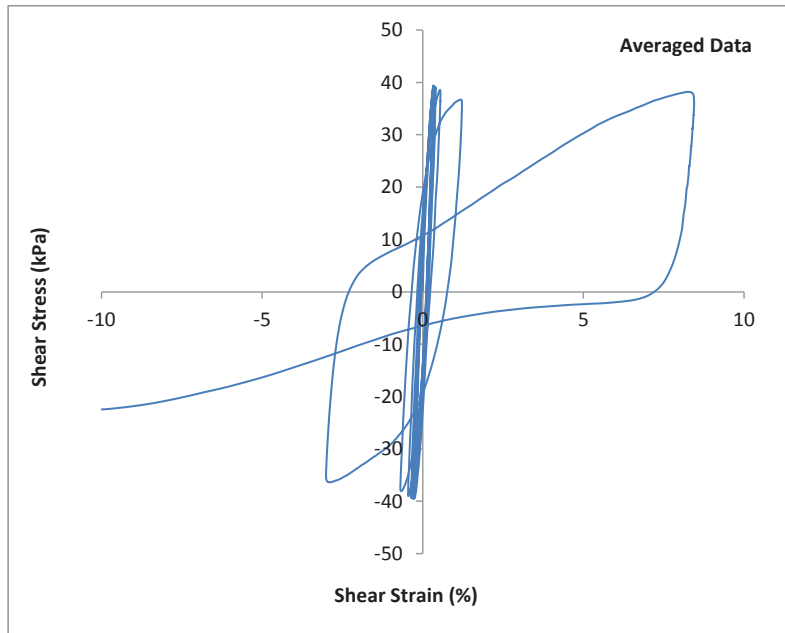
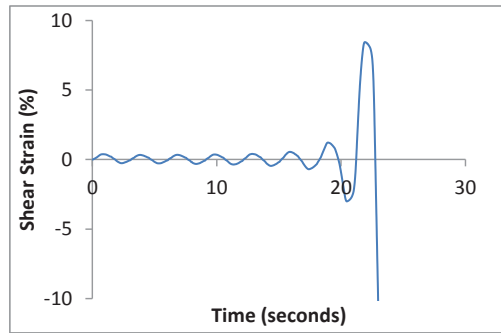
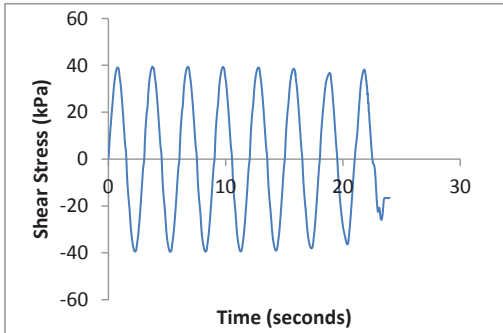

CSS Cyclic Shear Test Report

Geotechnical Engineering Laboratory



Cyclic Shear Test Summary

Device:	CSS	Density (kg/m³):	1890
Specimen ID:	60C109_40PG	Relative Density (%):	47%
Test ID:	C243	Void Ratio:	0.423
Date of Test:	2/17/2016	Vertical Stress (kPa):	400
Test Performed:	Cyclic Shear	Loading Frequency (Hz):	0.33
Test Material:	Ottawa Sand/Pea Gravel	Number of Cycles:	8
Sample Preparation:	Prepared Loose using a funnel with zero drop height.	Cyclic Stress Ratio:	0.099
		Number of Cycles to Liq:	8
		Maximum ru:	0.99
Prepared by:	J.Hubler		
Checked by:	J.Hubler		

Additional Comments:

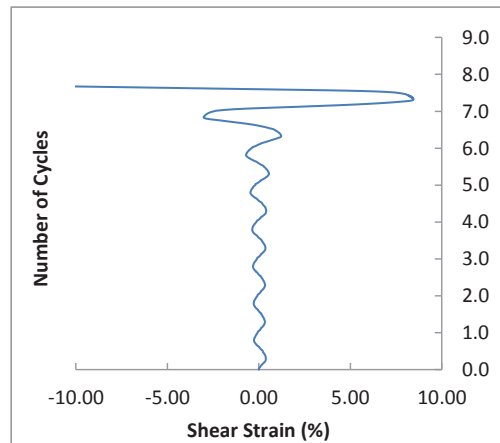
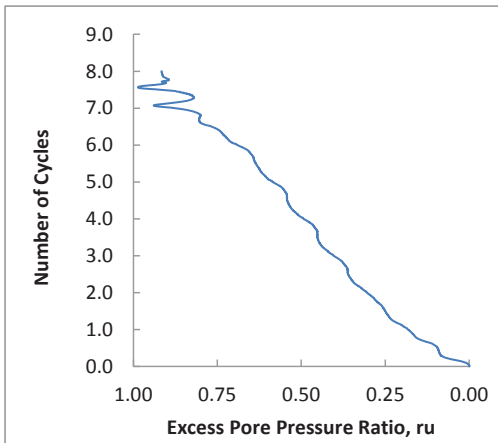
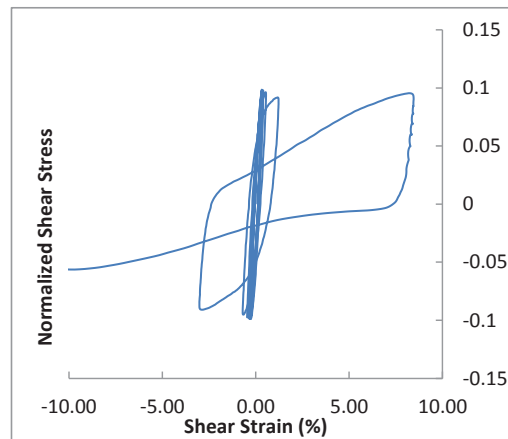
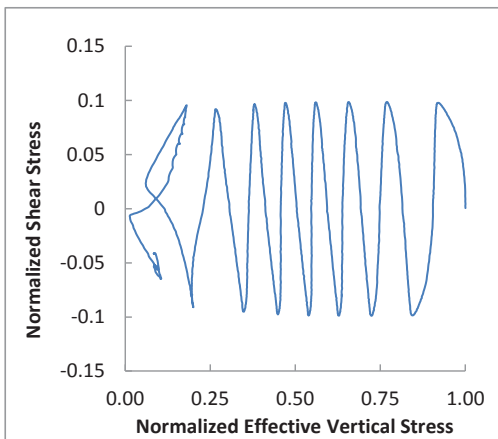

CSS Monotonic Shear Test Report



10/28/2013_Version 8.0

Geotechnical Engineering Laboratory

General Test Info and Sample Preparation

Device:	CSS	Relative Density (%):	6%
Specimen ID:	60C109_40PG	Void Ratio:	0.473
Test ID:	C243	Height (mm):	116.1
Date of Test:	2/17/2016	Soil-Only Specimen Diameter (mm):	306.23
Test Performed:	Post Cyclic Monotonic Shear	Weight (kg):	15.619
Test Material:	Ottawa Sand/Pea Gravel	Density (kg/m ³):	1826.5
Sample Preparation:	Prepared loose by placing with a funnel and zero drop height.	Membrane Thickness (mm):	0.635
		Moisture Content (%):	0%
		Saturated (Y/N):	N
		Prepared by:	J. Hubler
		Checked by:	J. Hubler

Consolidation Stage		Shear Stage	
Vertical Stress (kPa):	100	Type of Test:	Constant Volume
Time to Compression (min):	7.6	Stress or Strain Controlled:	Strain
Relative Density (%):	47%	Shear Strain Rate (%/min):	2.90
Void Ratio:	0.423	Peak Shear Strength (kPa):	14.0
Height (mm):	112.2	Comments	
Diameter (mm):	306.23		
Weight (kg):	15.619		
Density (kg/m ³):	1890.2		

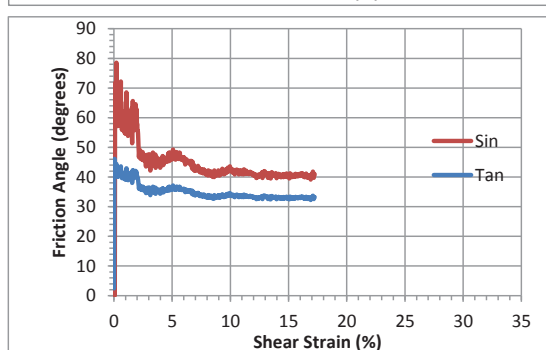
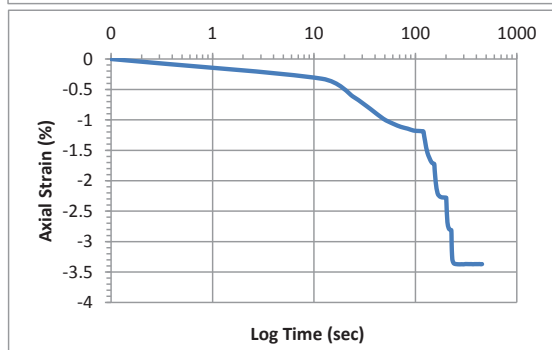
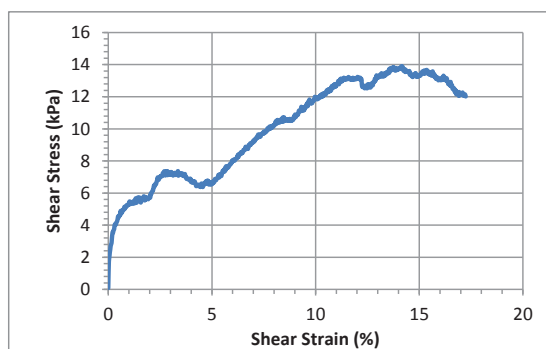
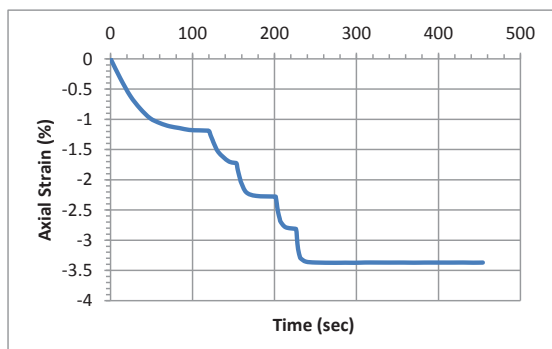

Accelerometer-Based Shear Wave Velocity Datasheet

Specimen ID: C243-PGC109-400-1X
 Test Material: PGC109
 Date: 2/17/2016
 Test Performed by: J.Hubler
 Filename: C243-PGC109-400-1X

Vertical Stress: 400kPa
 Sensor Spacing: 0.11191 m
 V_s (rise) = 278 m/s

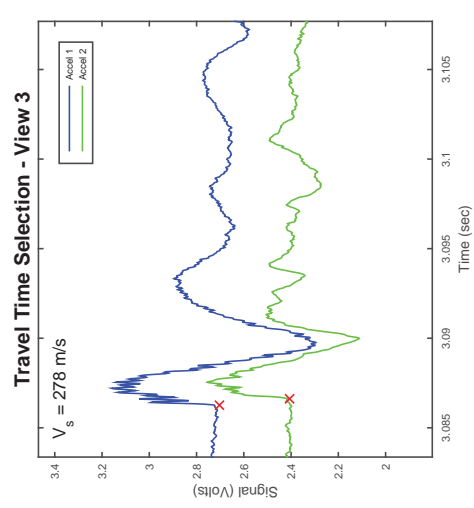
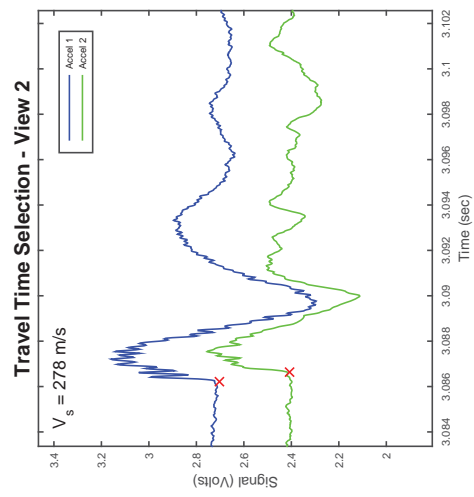
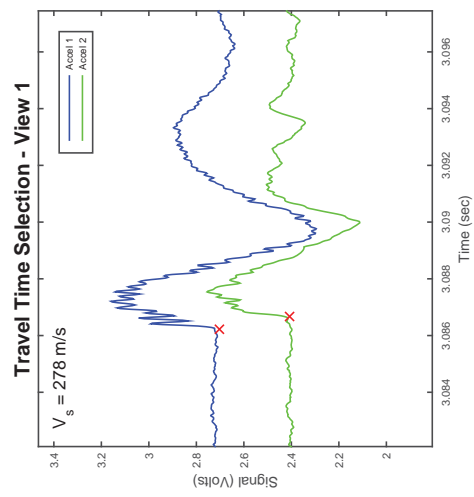
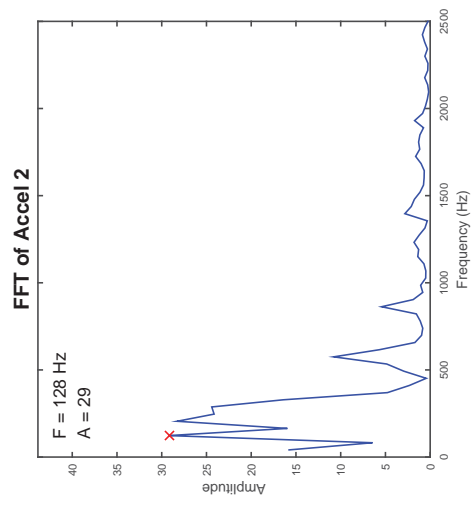
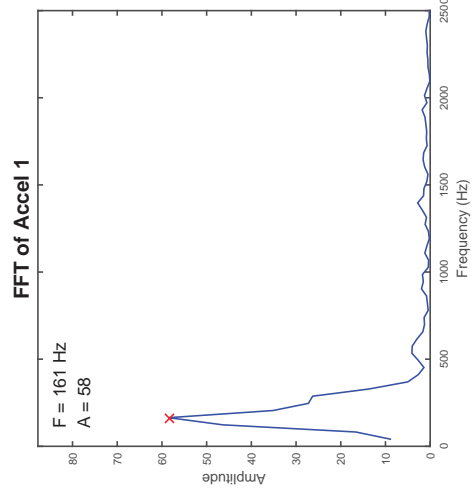
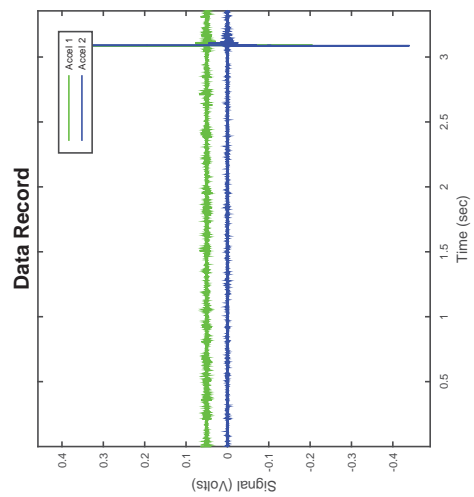

CSS Cyclic Shear Test Report

Geotechnical Engineering Laboratory



Cyclic Shear Test Summary

Device:	CSS	Density (kg/m³):	2035
Specimen ID:	40C109_60PG	Relative Density (%):	50%
Test ID:	C234	Void Ratio:	0.327
Date of Test:	2/10/2016	Vertical Stress (kPa):	100
Test Performed:	Cyclic Shear	Loading Frequency (Hz):	0.33
Test Material:	Ottawa Sand/Pea Gravel	Number of Cycles:	68
Sample Preparation:	Prepared Loose using a funnel with zero drop height.	Cyclic Stress Ratio:	0.044
		Shear Modulus (kPa):	
		Damping (%):	
Prepared by:	J.Hubler	Shear Strain Single Amplitude (%)	
Checked by:	J.Hubler		

Additional Comments:

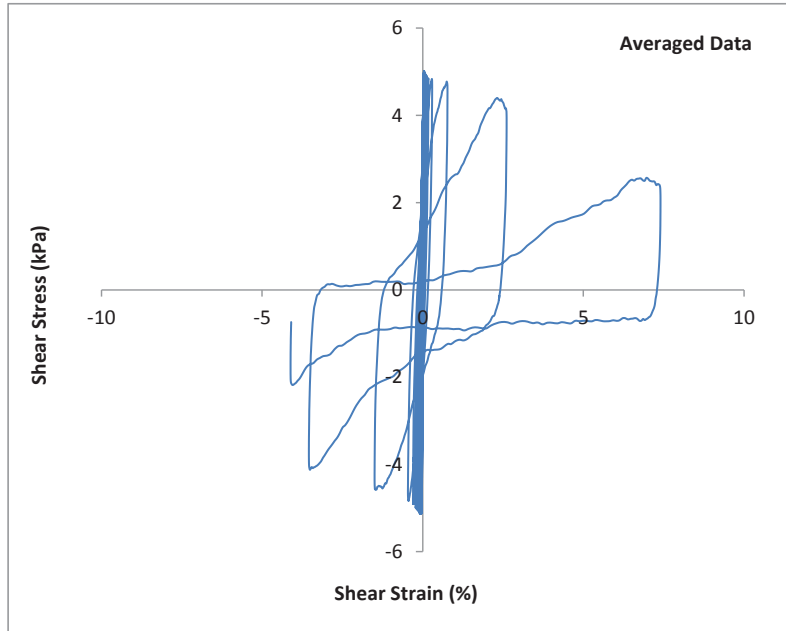
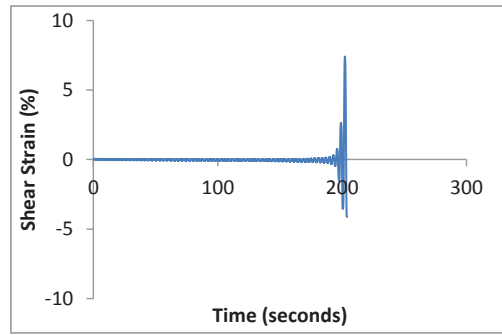
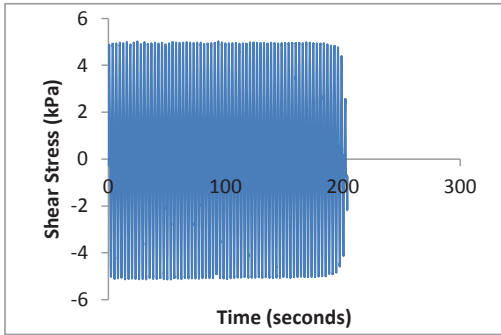

CSS Cyclic Shear Test Report

Geotechnical Engineering Laboratory



Cyclic Shear Test Summary

Device:	CSS	Density (kg/m³):	2035
Specimen ID:	40C109_60PG	Relative Density (%):	50%
Test ID:	C234	Void Ratio:	0.327
Date of Test:	2/10/2016	Vertical Stress (kPa):	100
Test Performed:	Cyclic Shear	Loading Frequency (Hz):	0.33
Test Material:	Ottawa Sand/Pea Gravel	Number of Cycles:	68
Sample Preparation:	Prepared Loose using a funnel with zero drop height.	Cyclic Stress Ratio:	0.044
		Number of Cycles to Liq:	68
		Maximum ru:	1.02
Prepared by:	J.Hubler		
Checked by:	J.Hubler		

Additional Comments:

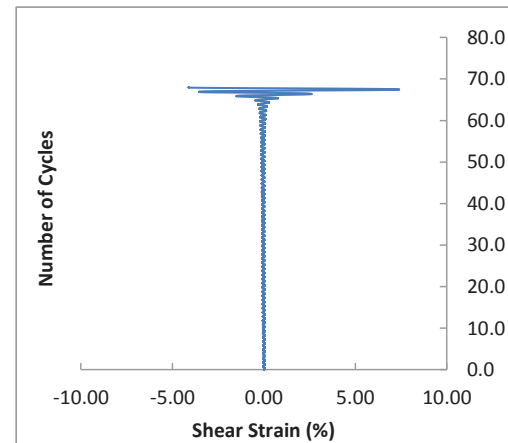
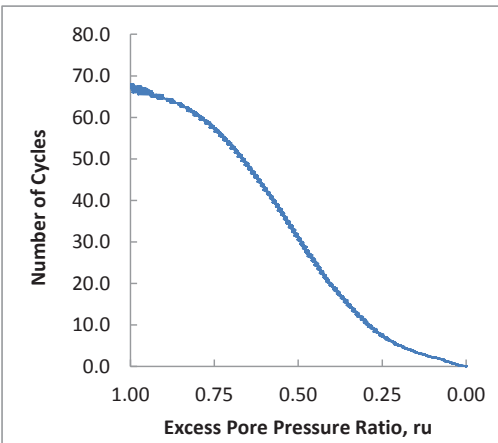
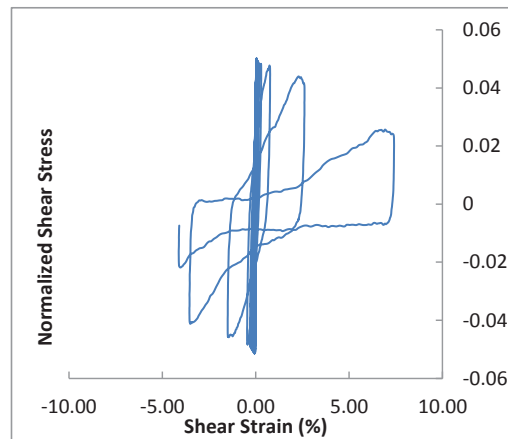
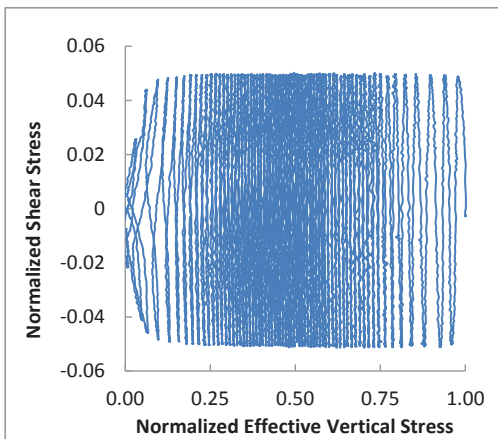

Accelerometer-Based Shear Wave Velocity Datasheet

Specimen ID: C234-PGC109-100-1X

Test Material: PGC109

Date: 2/10/2016

Test Performed by: J.Hubler

Filename: C234-PGC109-100-1X

Vertical Stress: 100kPa

Sensor Spacing: 0.11005 m

V_s (rise) = 206 m/s

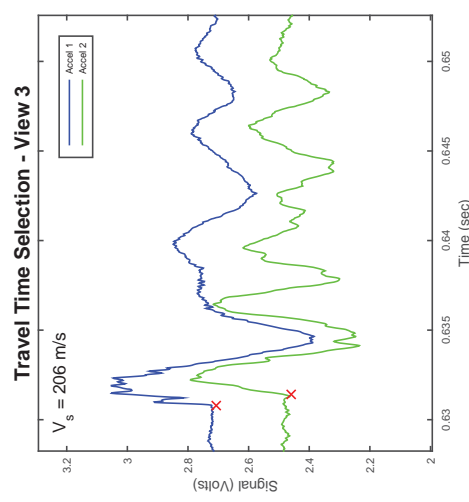
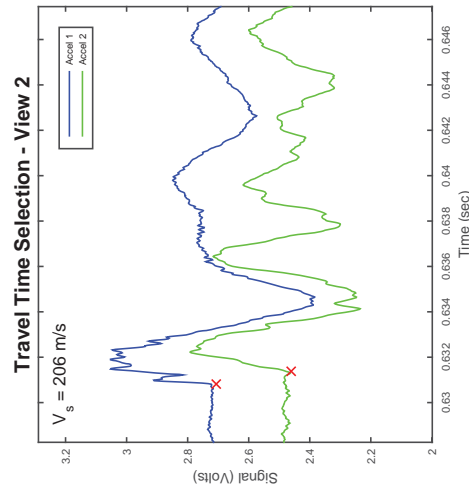
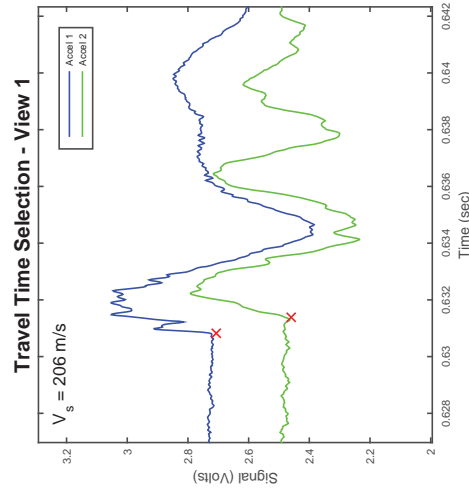
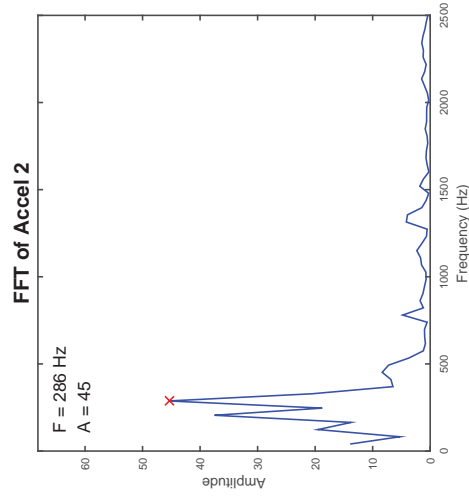
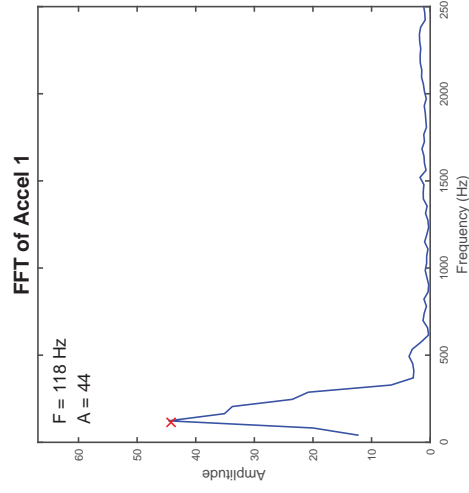
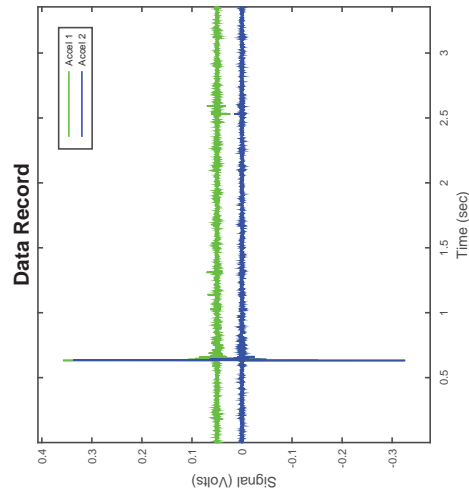

Accelerometer-Based Shear Wave Velocity Datasheet

Specimen ID: C234-PGC109-100-2X

Test Material: PGC109

Date: 2/10/2016

Test Performed by: J.Hubler

Filename: C234-PGC109-100-2X

Vertical Stress: 100kPa

Sensor Spacing: 0.11005 m

V_s (rise) = 212 m/s

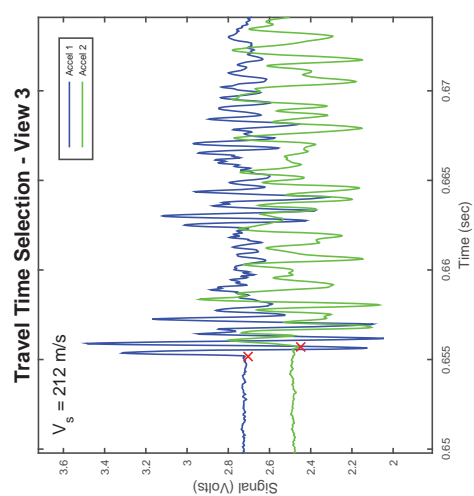
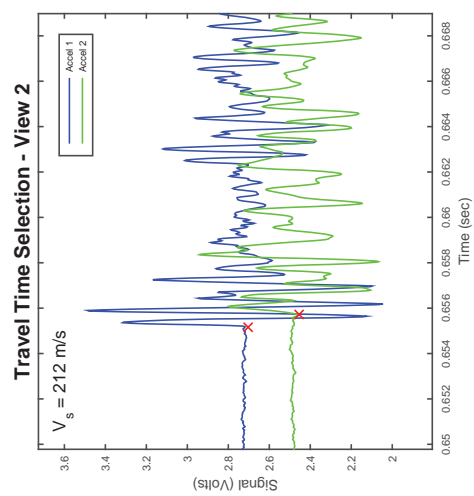
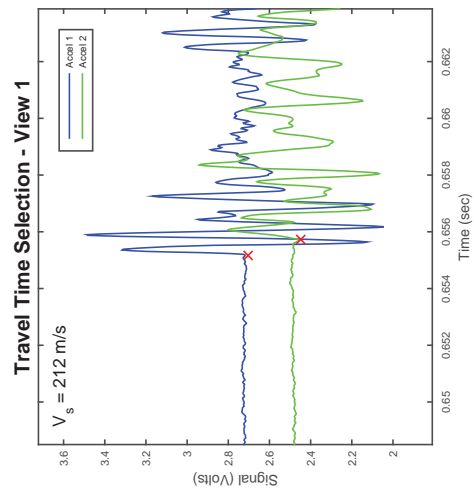
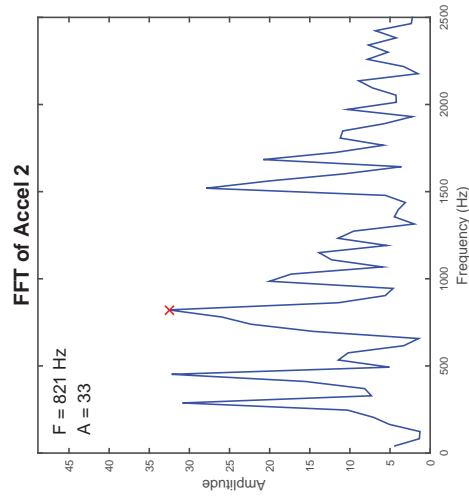
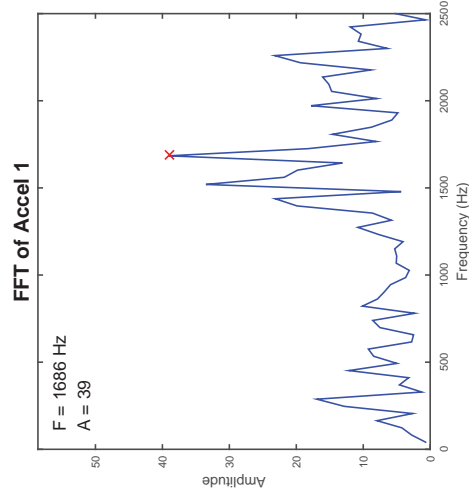
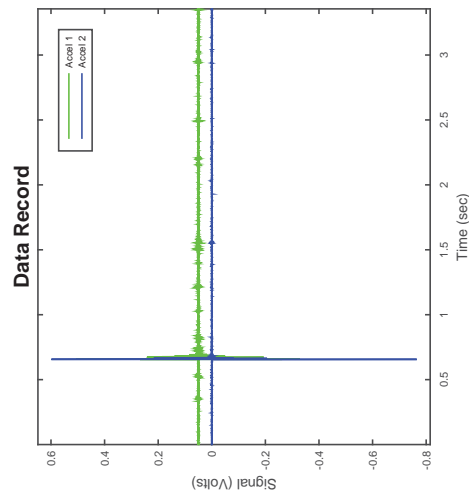

Accelerometer-Based Shear Wave Velocity Datasheet

Specimen ID: C234-PGC109-100-3X

Test Material: PGC109

Date: 2/10/2016

Test Performed by: J.Hubler

Filename: C234-PGC109-100-3X

Vertical Stress: 100kPa

Sensor Spacing: 0.11005 m

V_s (rise) = 206 m/s

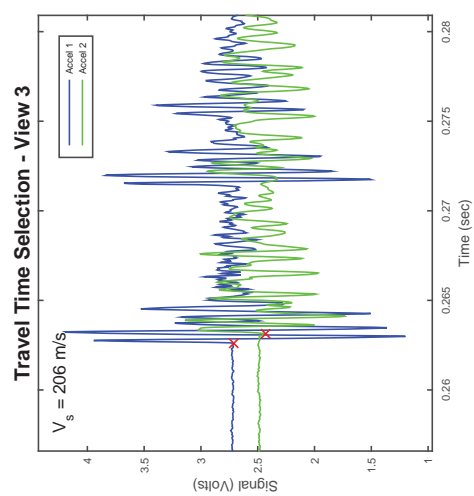
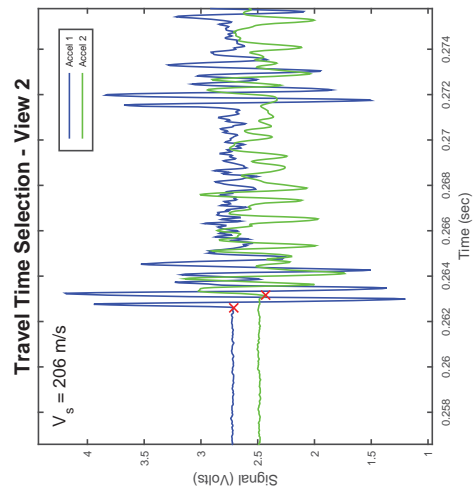
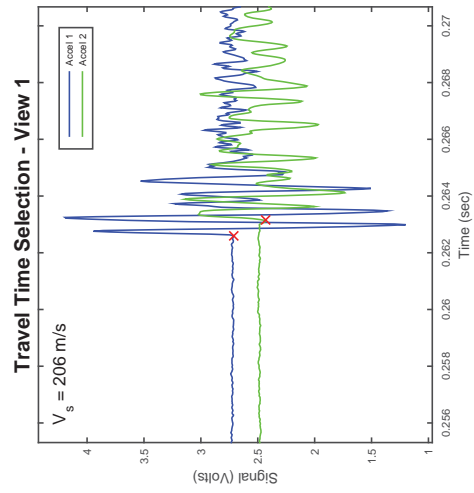
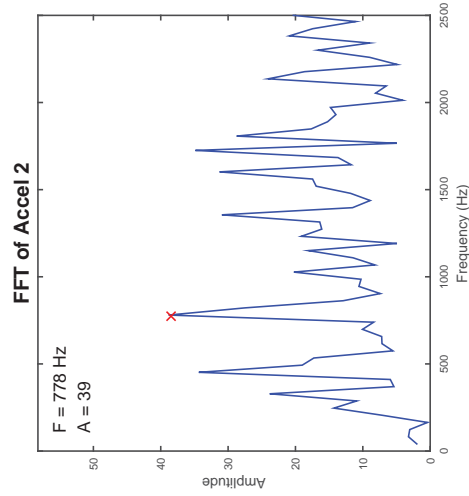
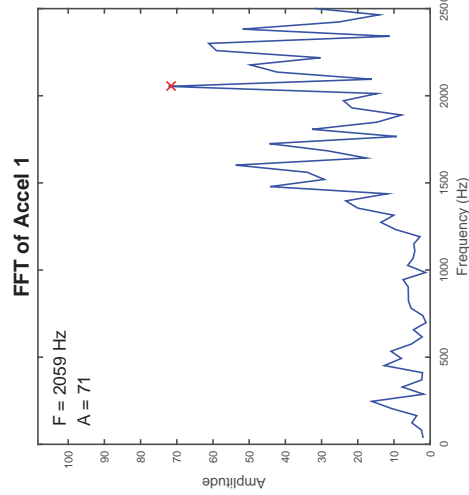
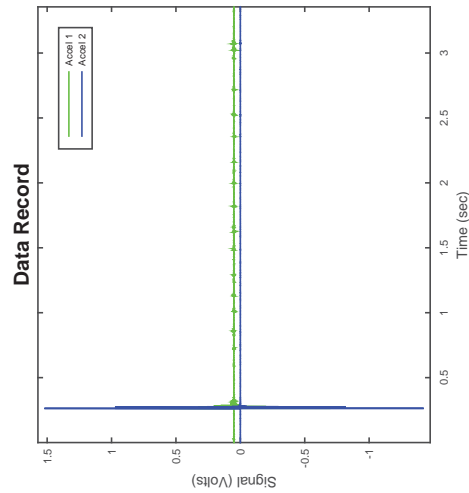

CSS Cyclic Shear Test Report

Geotechnical Engineering Laboratory



Cyclic Shear Test Summary

Device:	CSS	Density (kg/m³):	2025
Specimen ID:	40C109_60PG	Relative Density (%):	44%
Test ID:	C232	Void Ratio:	0.333
Date of Test:	2/9/2016	Vertical Stress (kPa):	100
Test Performed:	Cyclic Shear	Loading Frequency (Hz):	0.33
Test Material:	Ottawa Sand/Pea Gravel	Number of Cycles:	19
Sample Preparation:	Prepared Loose using a funnel with zero drop height.	Cyclic Stress Ratio:	0.094
		Shear Modulus (kPa):	
		Damping (%):	
Prepared by:	J.Hubler	Shear Strain Single Amplitude (%)	
Checked by:	J.Hubler		

Additional Comments:

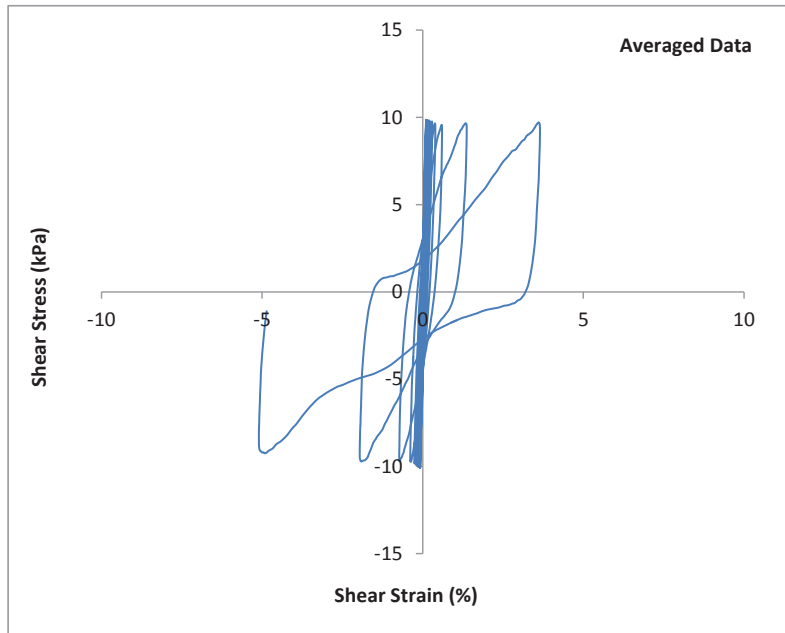
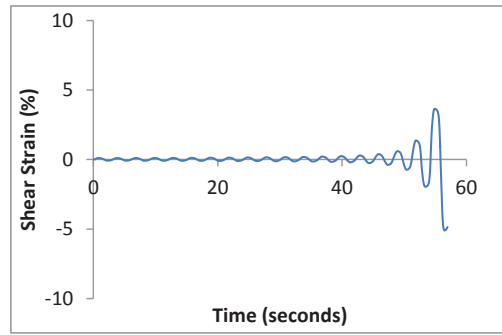
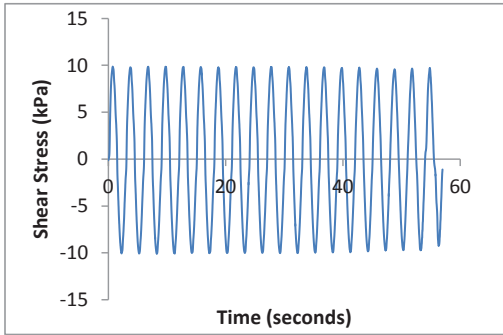

CSS Cyclic Shear Test Report

Geotechnical Engineering Laboratory



Cyclic Shear Test Summary

Device:	CSS	Density (kg/m³):	2025
Specimen ID:	40C109_60PG	Relative Density (%):	44%
Test ID:	C232	Void Ratio:	0.333
Date of Test:	2/9/2016	Vertical Stress (kPa):	100
Test Performed:	Cyclic Shear	Loading Frequency (Hz):	0.33
Test Material:	Ottawa Sand/Pea Gravel	Number of Cycles:	19
Sample Preparation:	Prepared Loose using a funnel with zero drop height.	Cyclic Stress Ratio:	0.094
		Number of Cycles to Liq:	19
		Maximum ru:	0.99
Prepared by:	J.Hubler		
Checked by:	J.Hubler		

Additional Comments:

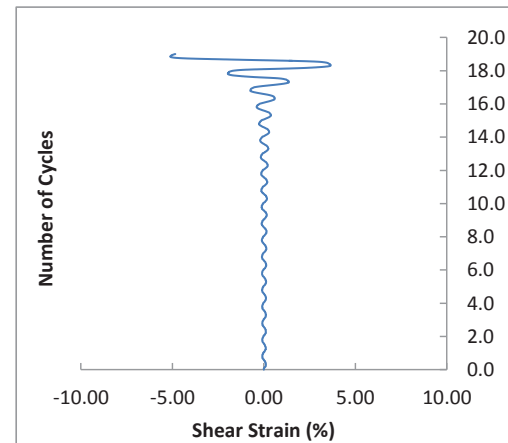
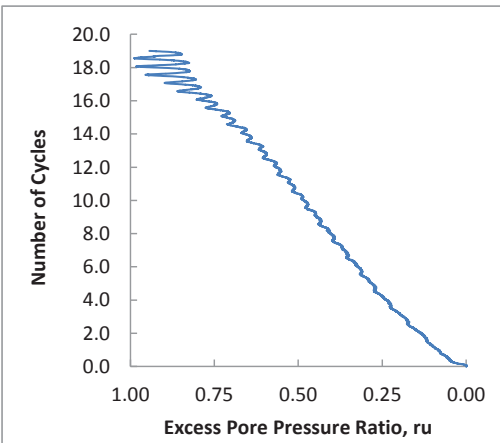
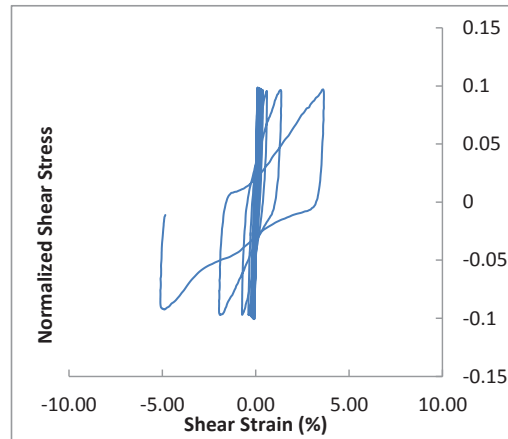
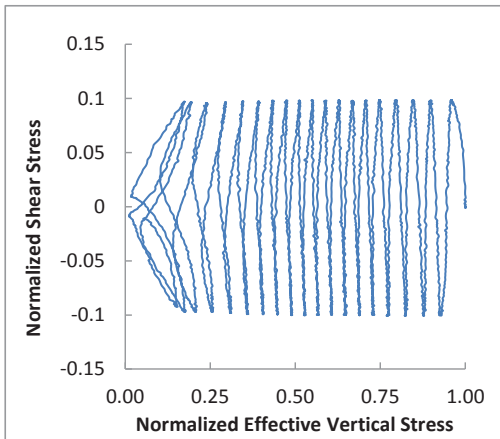

CSS Monotonic Shear Test Report

Geotechnical Engineering Laboratory



10/28/2013_Version 8.0

General Test Info and Sample Preparation

Device:	CSS	Relative Density (%):	7%
Specimen ID:	40C109_60PG	Void Ratio:	0.371
Test ID:	C232	Height (mm):	114.9
Date of Test:	2/9/2016	Soil-Only Specimen Diameter (mm):	307.50
Test Performed:	Post Cyclic Monotonic Shear	Weight (kg):	16.805
Test Material:	Ottawa Sand/Pea Gravel	Density (kg/m³):	1970.0
Sample Preparation:	Prepared loose by placing with a funnel and zero drop height.	Membrane Thickness (mm):	0.000
		Moisture Content (%):	0%
		Saturated (Y/N):	N
		Prepared by:	J. Hubler
		Checked by:	J. Hubler

Consolidation Stage

Vertical Stress (kPa):	100
Time to Compression (min):	8.4
Relative Density (%):	44%
Void Ratio:	0.333
Height (mm):	111.7
Diameter (mm):	307.50
Weight (kg):	16.805
Density (kg/m³):	2025.4

Shear Stage

Type of Test:	Constant Volume
Stress or Strain Controlled:	Strain
Shear Strain Rate (%/min):	0.29
Peak Shear Strength (kPa):	10.0

Comments

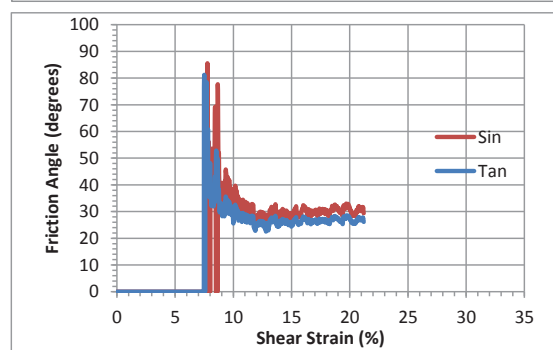
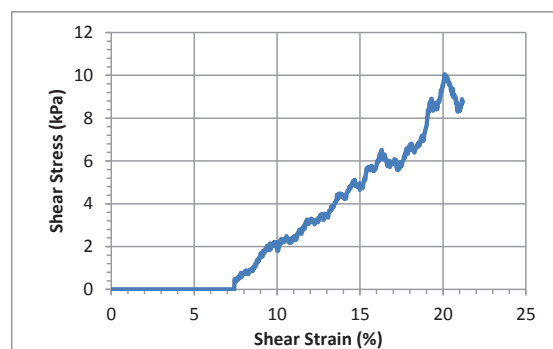
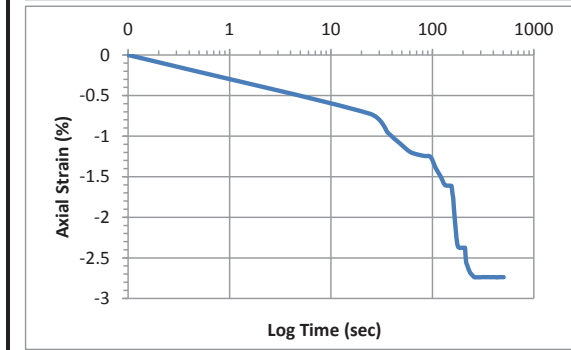
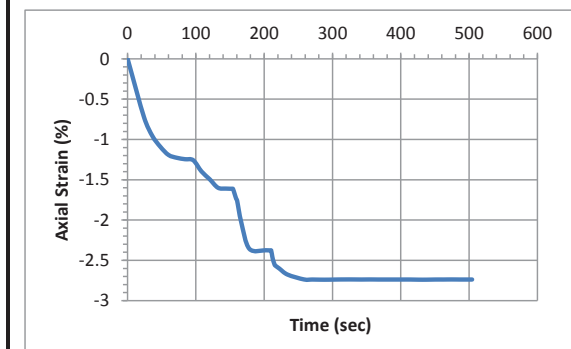

Accelerometer-Based Shear Wave Velocity Datasheet

Specimen ID: C232-PGC109-100-3X
 Test Material: PGC109
 Date: 2/9/2016
 Test Performed by: J. Hubler
 Filename: C232-PGC109-100-3X

Vertical Stress: 100kPa
 Sensor Spacing: 0.11145 m
 V_s (rise) = 201 m/s

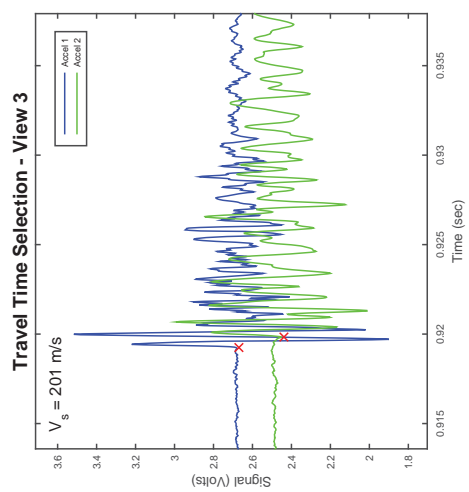
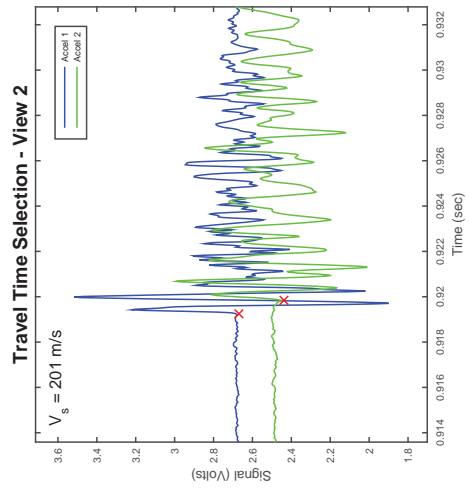
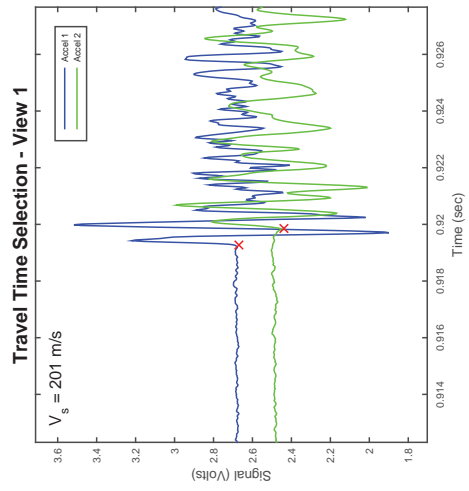
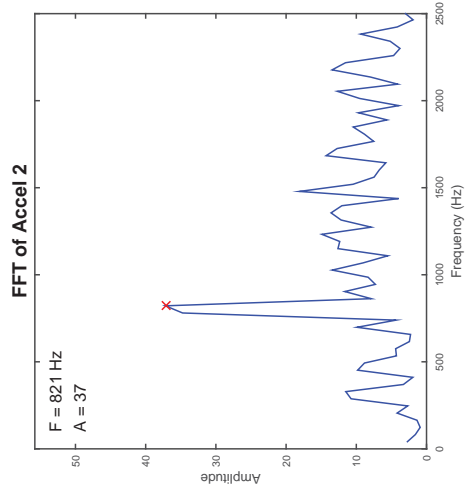
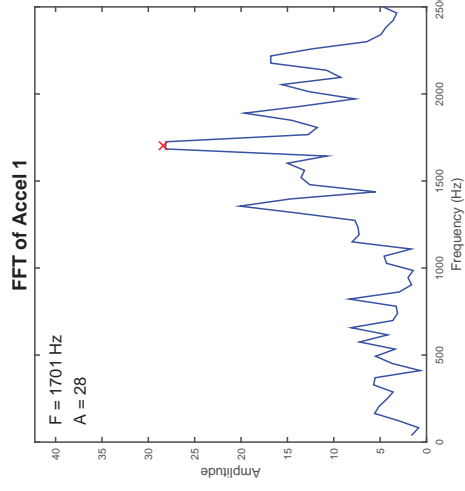
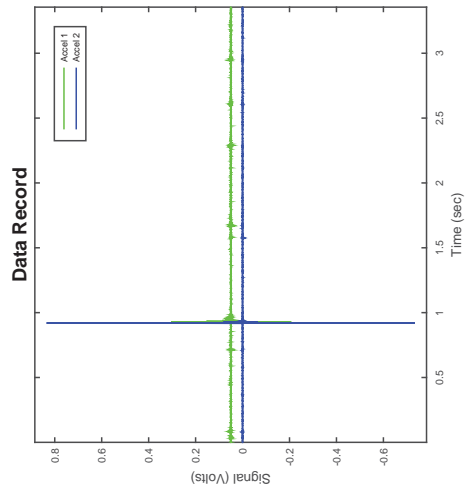

CSS Cyclic Shear Test Report

Geotechnical Engineering Laboratory



Cyclic Shear Test Summary

Device:	CSS	Density (kg/m³):	2025
Specimen ID:	40C109_60PG	Relative Density (%):	44%
Test ID:	C233	Void Ratio:	0.333
Date of Test:	2/10/2016	Vertical Stress (kPa):	100
Test Performed:	Cyclic Shear	Loading Frequency (Hz):	0.33
Test Material:	Ottawa Sand/Pea Gravel	Number of Cycles:	4
Sample Preparation:	Prepared Loose using a funnel with zero drop height.	Cyclic Stress Ratio:	0.144
		Shear Modulus (kPa):	
		Damping (%):	
Prepared by:	J.Hubler	Shear Strain Single Amplitude (%)	
Checked by:	J.Hubler		

Additional Comments:

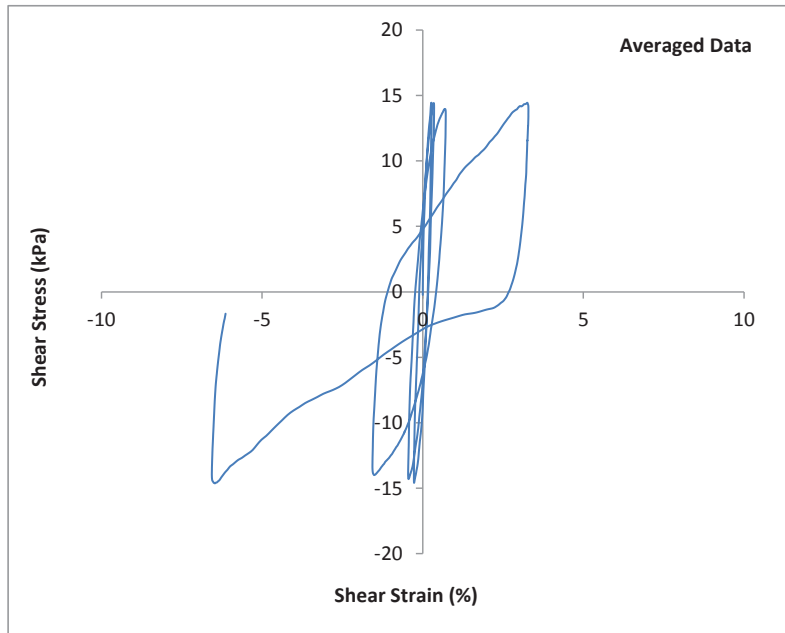
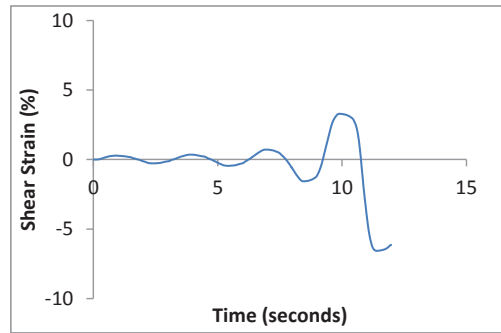
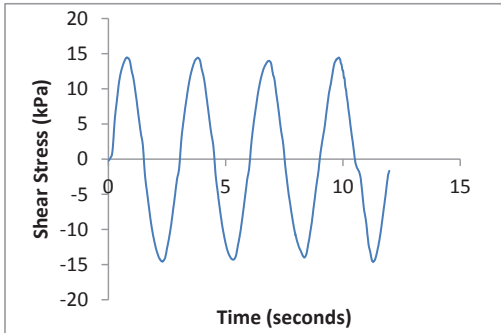

CSS Cyclic Shear Test Report

Geotechnical Engineering Laboratory



Cyclic Shear Test Summary

Device:	CSS	Density (kg/m³):	2025
Specimen ID:	40C109_60PG	Relative Density (%):	44%
Test ID:	C233	Void Ratio:	0.333
Date of Test:	2/10/2016	Vertical Stress (kPa):	100
Test Performed:	Cyclic Shear	Loading Frequency (Hz):	0.33
Test Material:	Ottawa Sand/Pea Gravel	Number of Cycles:	4
Sample Preparation:	Prepared Loose using a funnel with zero drop height.	Cyclic Stress Ratio:	0.144
		Number of Cycles to Liq:	4
		Maximum ru:	0.98
Prepared by:	J.Hubler		
Checked by:	J.Hubler		

Additional Comments:

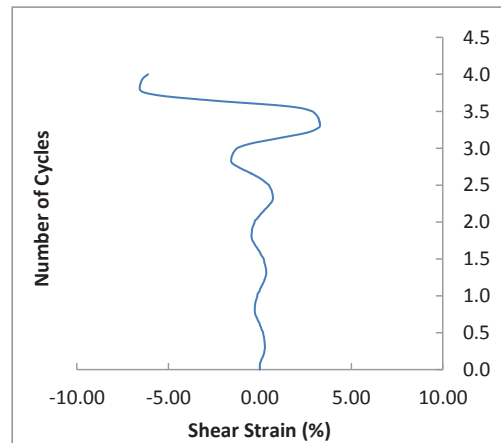
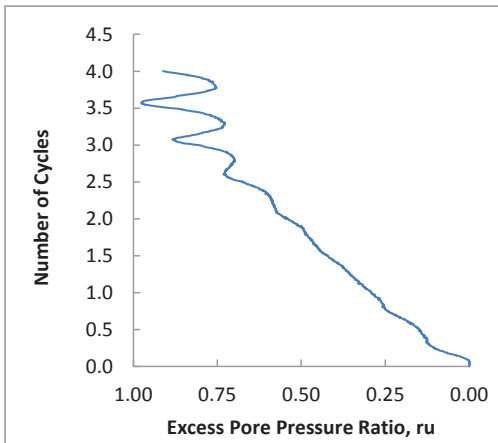
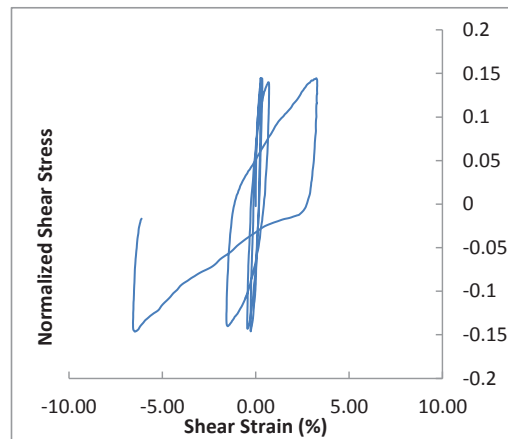
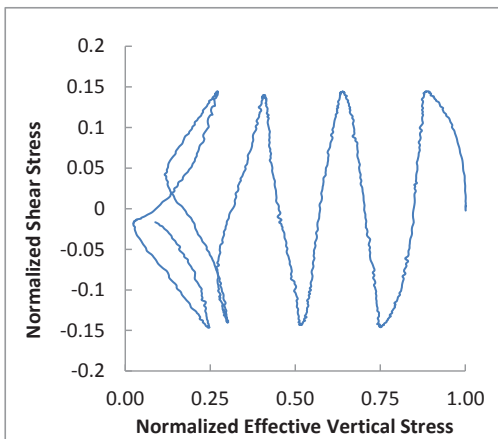

CSS Monotonic Shear Test Report

Geotechnical Engineering Laboratory



10/28/2013_Version 8.0

General Test Info and Sample Preparation

Device:	CSS	Relative Density (%):	47%
Specimen ID:	40C109_60PG	Void Ratio:	0.330
Test ID:	C233	Height (mm):	111.4
Date of Test:	2/10/2016	Soil-Only Specimen Diameter (mm):	307.50
Test Performed:	Post Cyclic Monotonic Shear	Weight (kg):	16.799
Test Material:	Ottawa Sand/Pea Gravel	Density (kg/m³):	2029.9
Sample Preparation:	Prepared loose by placing with a funnel and zero drop height.	Membrane Thickness (mm):	0.000
		Moisture Content (%):	0%
		Saturated (Y/N):	N
		Prepared by:	J. Hubler
		Checked by:	J. Hubler

Consolidation Stage

Vertical Stress (kPa):	100
Time to Compression (min):	4.3
Relative Density (%):	57%
Void Ratio:	0.321
Height (mm):	110.6
Diameter (mm):	307.50
Weight (kg):	16.799
Density (kg/m³):	2044.4

Shear Stage

Type of Test:	Constant Volume
Stress or Strain Controlled:	Strain
Shear Strain Rate (%/min):	0.29
Peak Shear Strength (kPa):	55.0

Comments

Reconsolidated to 100 kPa after cyclic test with CSR = 0.144

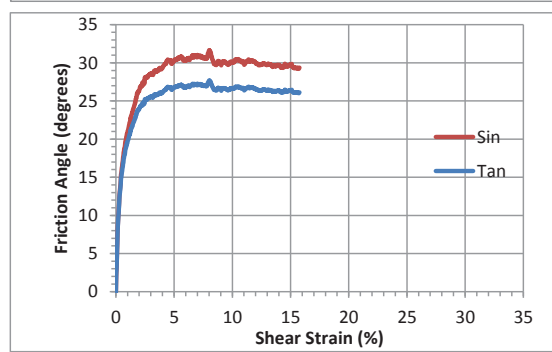
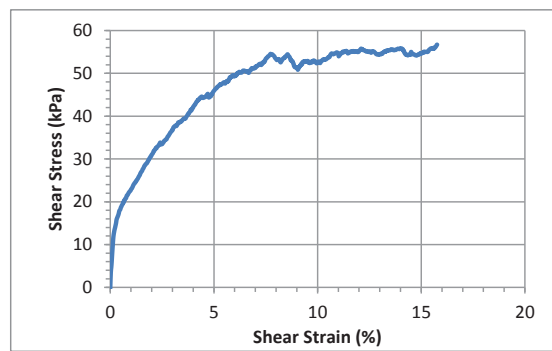
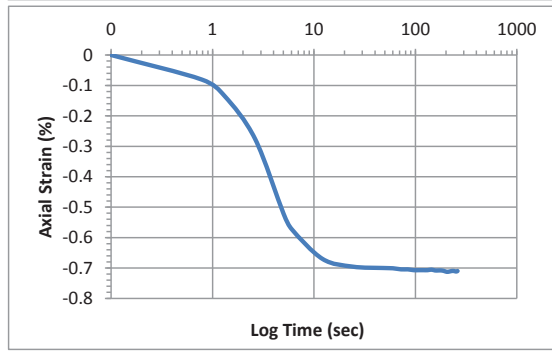
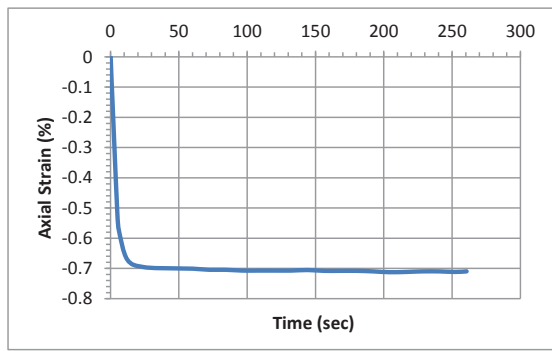

Accelerometer-Based Shear Wave Velocity Datasheet

Specimen ID: C233-PGC109-100-1X

Test Material: PGC109

Date: 2/10/2016

Test Performed by: J.Hubler

Filename: C233-PGC109-100-1X

Vertical Stress: 100kPa

Sensor Spacing: 0.11142 m

V_s (rise) = 203 m/s

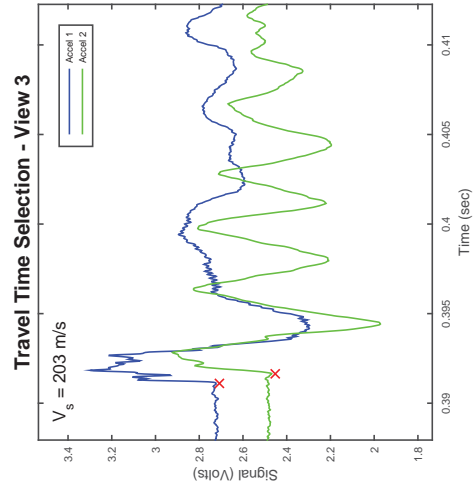
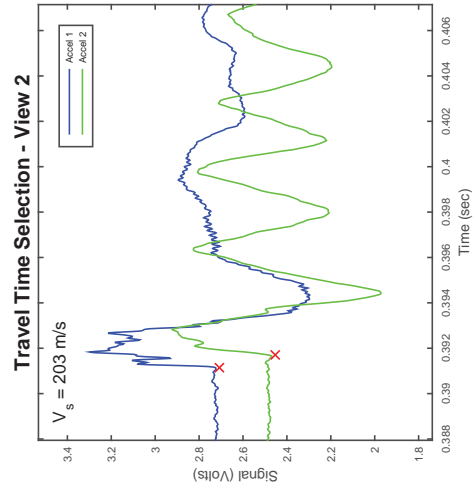
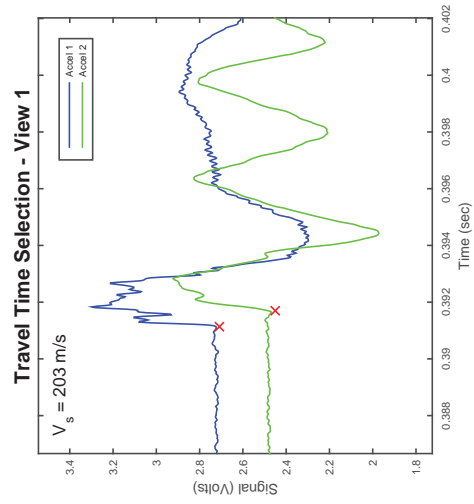
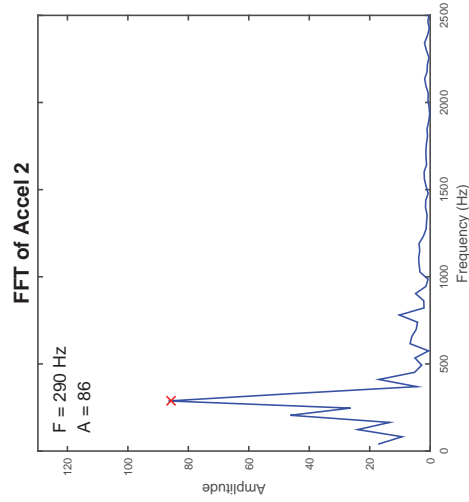
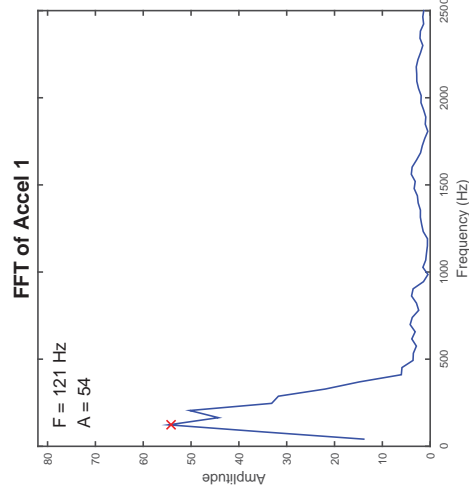
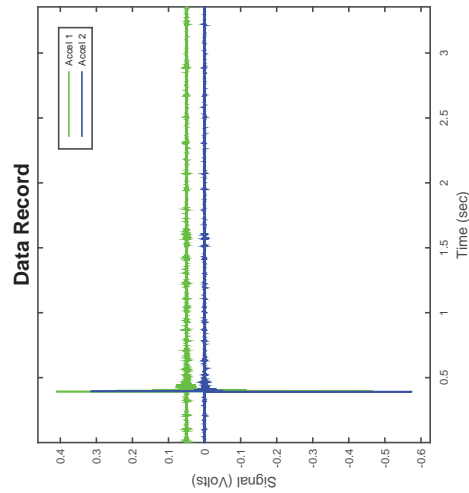

Accelerometer-Based Shear Wave Velocity Datasheet

Specimen ID: C233-PGC109-100-3XP
 Test Material: PGC109
 Date: 2/24/2016
 Test Performed by: J.Hubler
 Filename: C233-PGC109-100-3XP

Vertical Stress: 100kPa
 Sensor Spacing: 0.11037 m
 V_s (rise) = 201 m/s

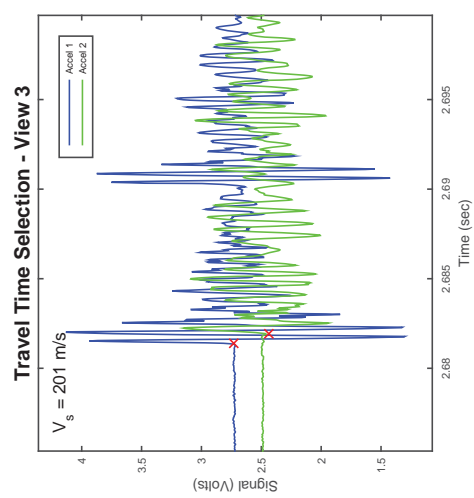
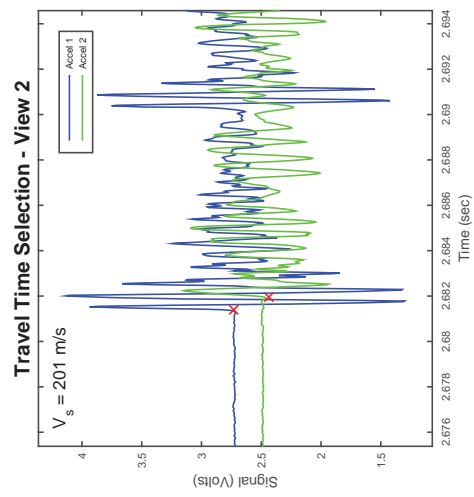
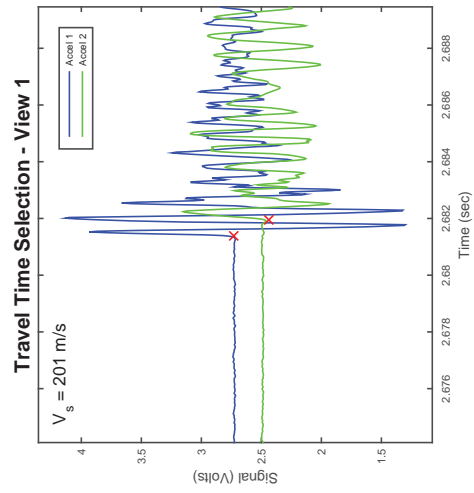
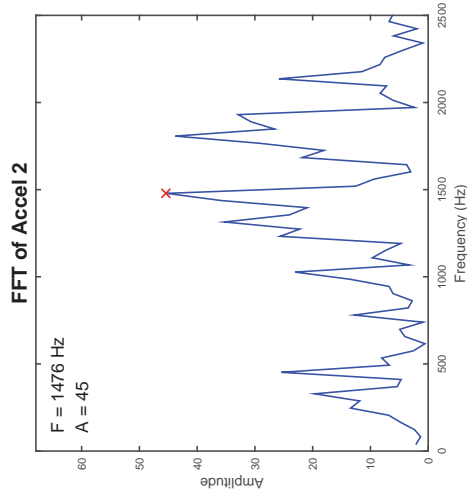
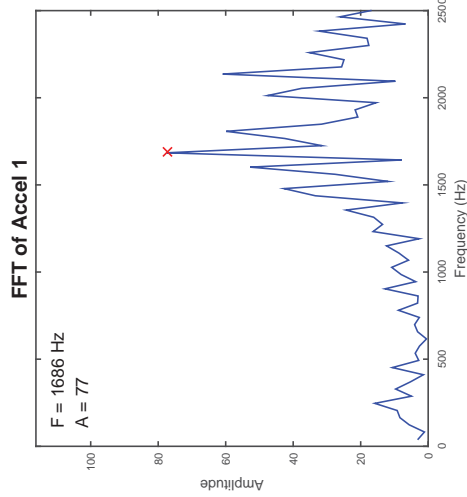
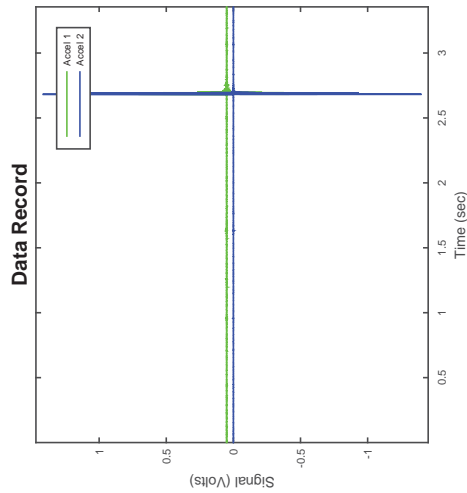

CSS Cyclic Shear Test Report

Geotechnical Engineering Laboratory



Cyclic Shear Test Summary

Device:	CSS	Density (kg/m³):	2103
Specimen ID:	40C109_60PG	Relative Density (%):	93%
Test ID:	C287	Void Ratio:	0.284
Date of Test:	8/17/2016	Vertical Stress (kPa):	100
Test Performed:	Cyclic Shear	Loading Frequency (Hz):	0.33
Test Material:	Ottawa Sand/Pea Gravel	Number of Cycles:	11
Sample Preparation:	Prepared Dense by tamping in 5 layers (25x)	Cyclic Stress Ratio:	0.094
		Shear Modulus (kPa):	
		Damping (%):	
Prepared by:	J.Hubler	Shear Strain Single Amplitude (%)	
Checked by:	J.Hubler		

Additional Comments:

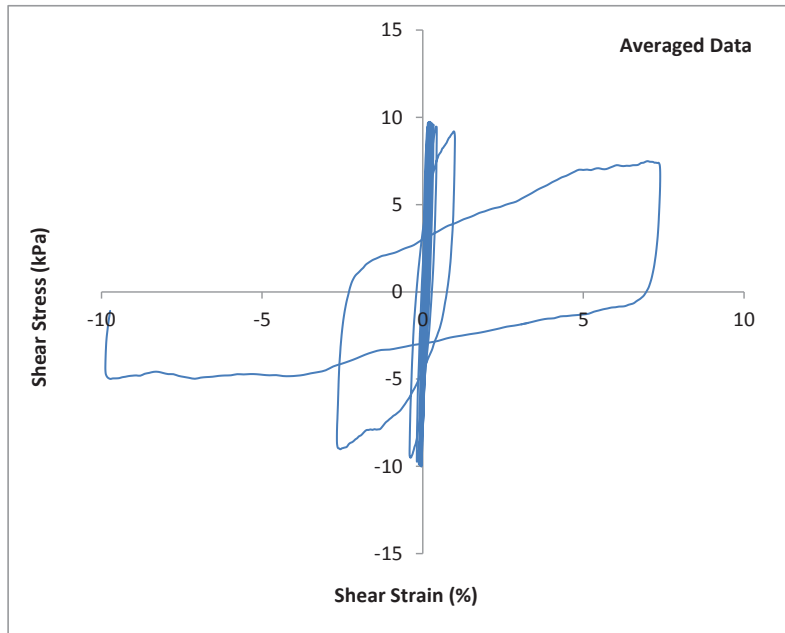
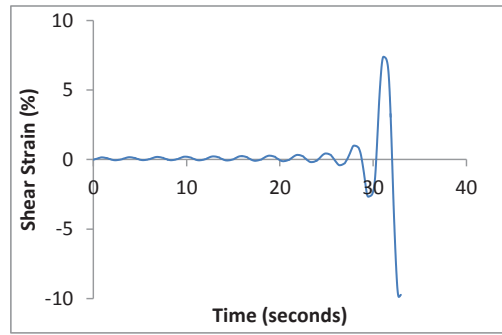
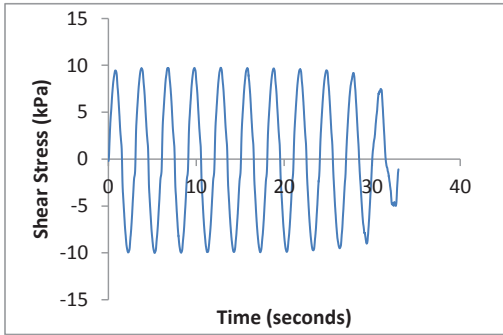

CSS Cyclic Shear Test Report

Geotechnical Engineering Laboratory



Cyclic Shear Test Summary

Device:	CSS	Density (kg/m³):	2103
Specimen ID:	40C109_60PG	Relative Density (%):	93%
Test ID:	C287	Void Ratio:	0.284
Date of Test:	8/17/2016	Vertical Stress (kPa):	100
Test Performed:	Cyclic Shear	Loading Frequency (Hz):	0.33
Test Material:	Ottawa Sand/Pea Gravel	Number of Cycles:	11
Sample Preparation:	Prepared Dense by tamping in 5 layers (25x)	Cyclic Stress Ratio:	0.094
		Number of Cycles to Liq:	11
		Maximum ru:	1.00
Prepared by:	J.Hubler		
Checked by:	J.Hubler		

Additional Comments:

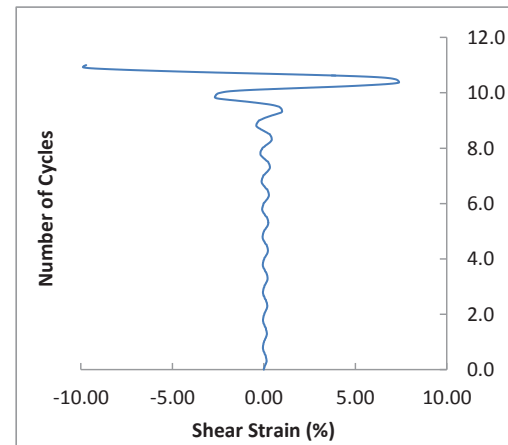
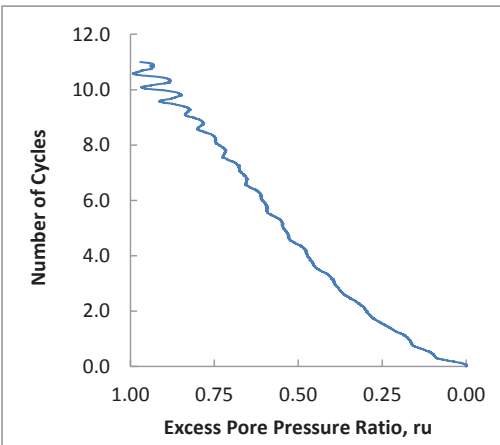
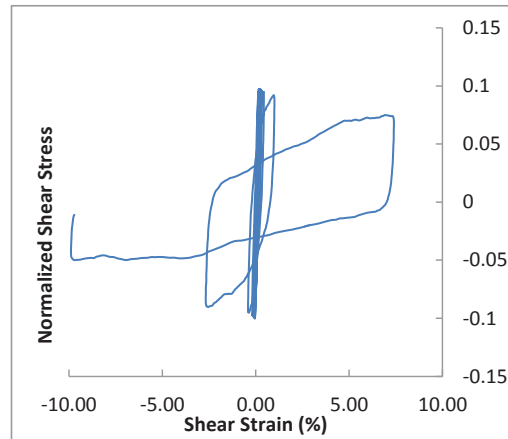
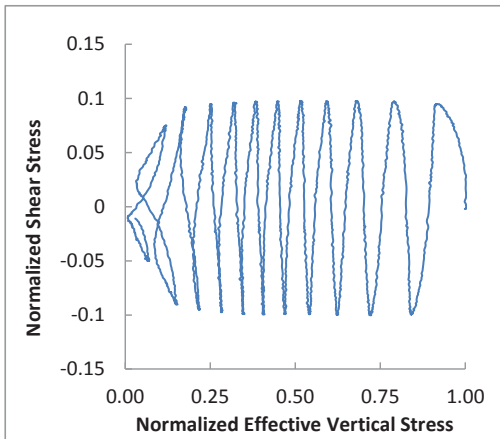

CSS Monotonic Shear Test Report

Geotechnical Engineering Laboratory



10/28/2013_Version 8.0

General Test Info and Sample Preparation

Device:	CSS	Relative Density (%):	68%
Specimen ID:	40C109_60PG	Void Ratio:	0.309
Test ID:	C287	Height (mm):	117.2
Date of Test:	8/17/2016	Soil-Only Specimen Diameter (mm):	306.23
Test Performed:	Post Cyclic Monotonic Shear	Weight (kg):	17.800
Test Material:	Ottawa Sand/Pea Gravel	Density (kg/m³):	2062.8
Sample Preparation:	Prepared dense by tamping in 5 layers (25x)	Membrane Thickness (mm):	0.635
		Moisture Content (%):	0%
		Saturated (Y/N):	N
		Prepared by:	J. Hubler
		Checked by:	J. Hubler

Consolidation Stage

Vertical Stress (kPa):	100
Time to Compression (min):	6.7
Relative Density (%):	93%
Void Ratio:	0.284
Height (mm):	114.9
Diameter (mm):	306.23
Weight (kg):	17.800
Density (kg/m³):	2102.6

Shear Stage

Type of Test:	Constant Volume
Stress or Strain Controlled:	Strain
Shear Strain Rate (%/min):	0.29
Peak Shear Strength (kPa):	1.2

Comments

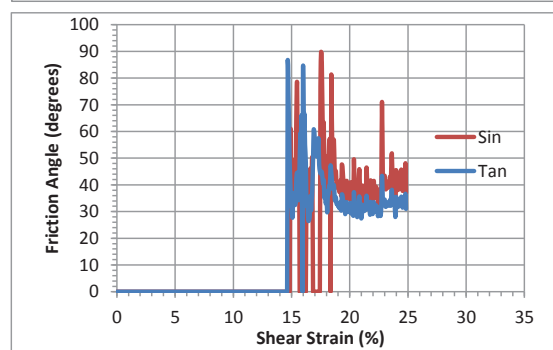
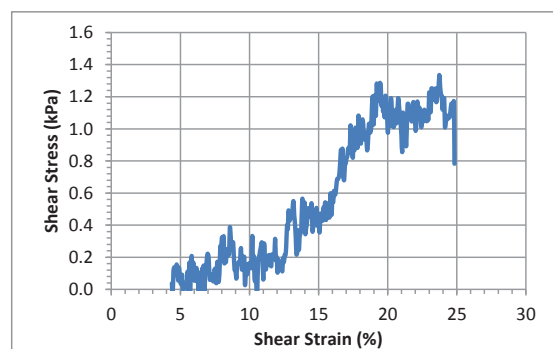
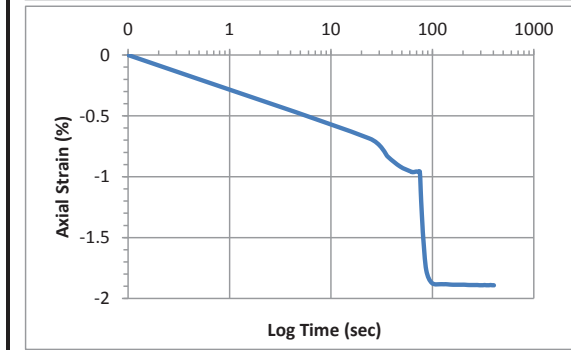
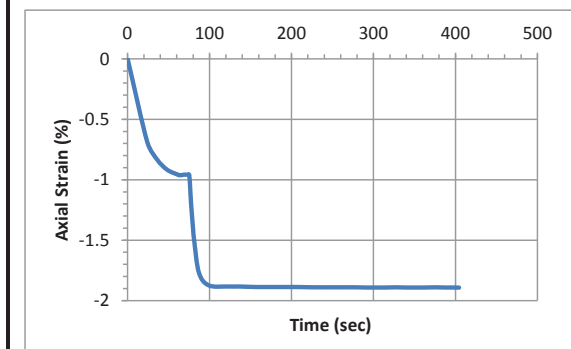

Accelerometer-Based Shear Wave Velocity Datasheet

Specimen ID: C287-60PG40C109-100-1X

Test Material: 60PG40C109

Date: 8/17/2016

Test Performed by: J. Hubler

Filename: C287-60PG40C109-100-1X

Vertical Stress: 100kPa

Sensor Spacing: 0.11422 m

V_s (rise) = 237 m/s

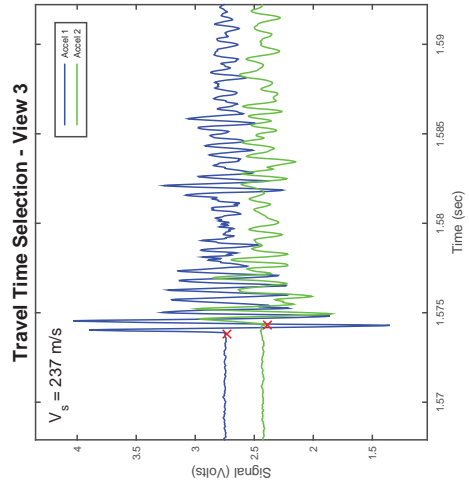
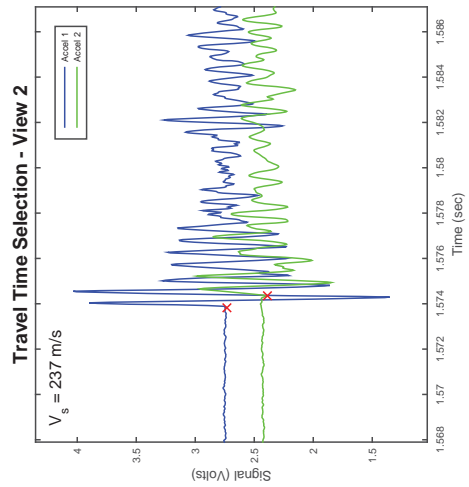
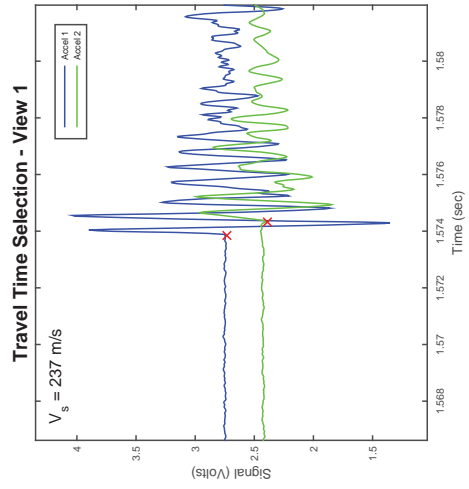
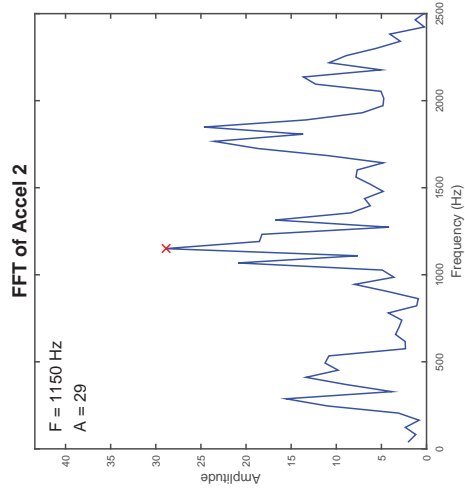
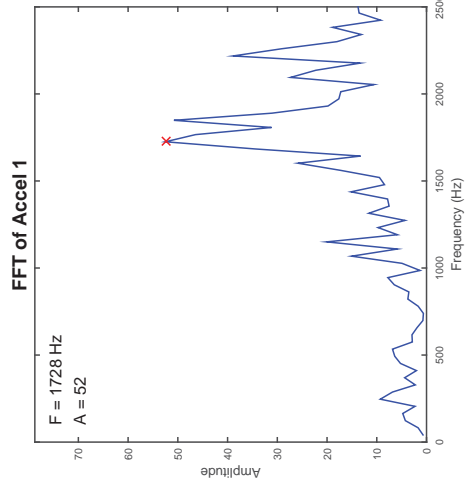
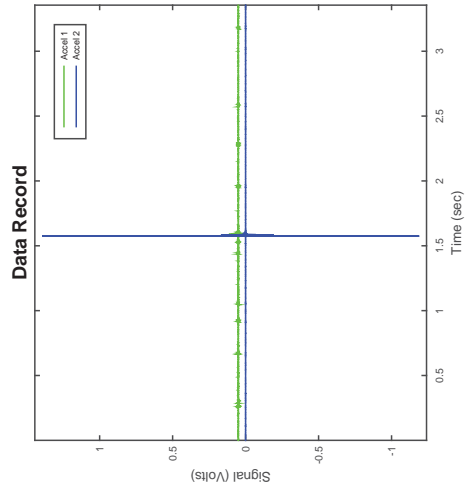

Accelerometer-Based Shear Wave Velocity Datasheet

Specimen ID: C287-60PG40C109-100-2X
 Test Material: 60PG40C109
 Date: 8/17/16
 Test Performed by: J.Hubler
 Filename: C287-60PG40C109-100-2X

Vertical Stress: 100kPa
 Sensor Spacing: 0.11422 m
 V_s (rise) = 228 m/s

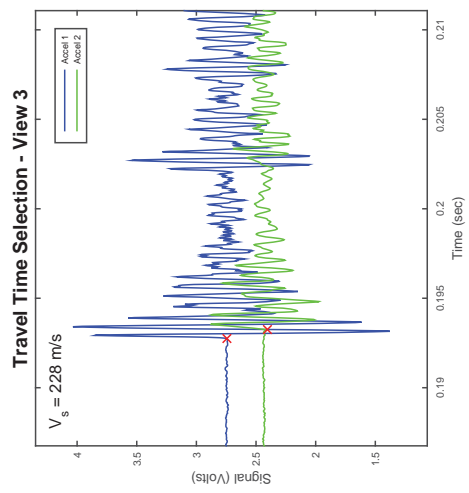
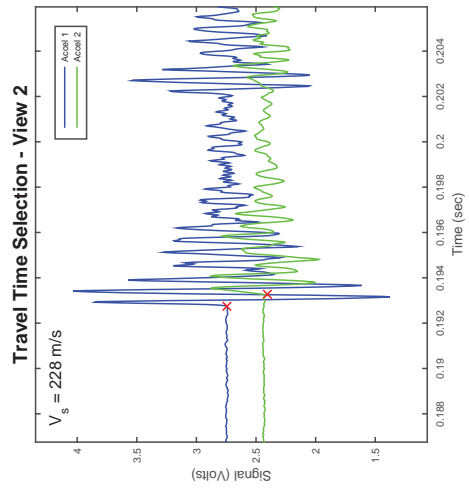
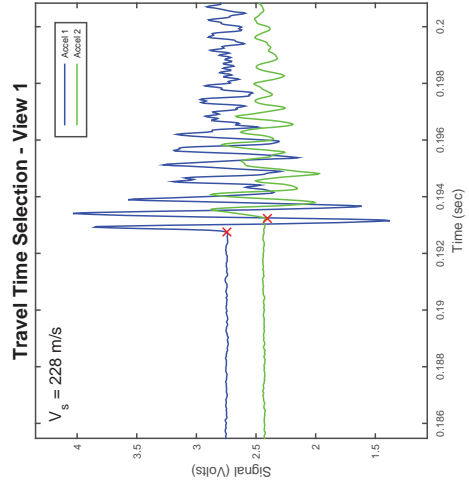
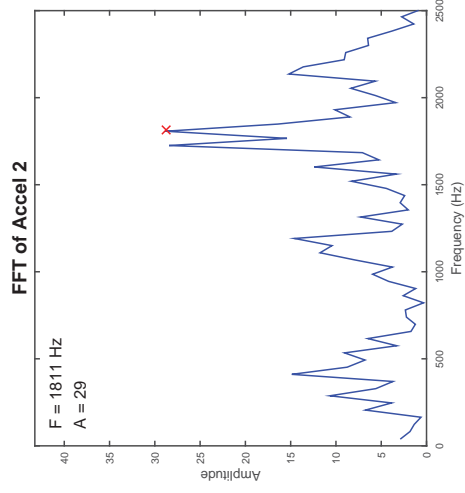
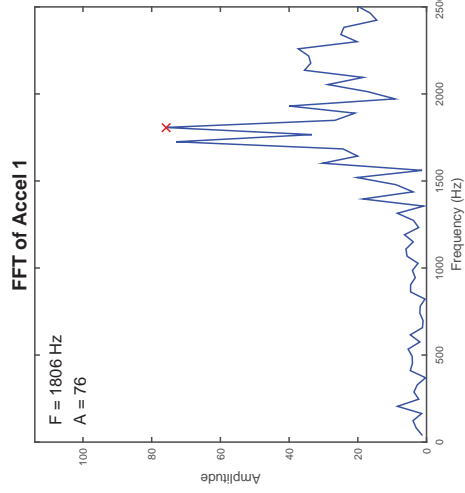
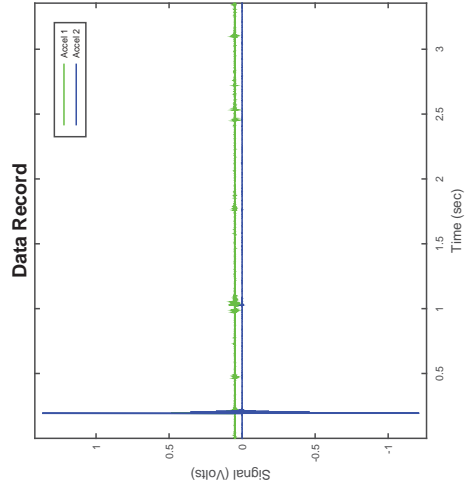

CSS Cyclic Shear Test Report

Geotechnical Engineering Laboratory



Cyclic Shear Test Summary

Device:	CSS	Density (kg/m³):	2025
Specimen ID:	40C109_60PG	Relative Density (%):	44%
Test ID:	C231	Void Ratio:	0.333
Date of Test:	2/9/2016	Vertical Stress (kPa):	200
Test Performed:	Cyclic Shear	Loading Frequency (Hz):	0.33
Test Material:	Ottawa Sand/Pea Gravel	Number of Cycles:	20
Sample Preparation:	Prepared Loose using a funnel with zero drop height.	Cyclic Stress Ratio:	0.097
		Shear Modulus (kPa):	
		Damping (%):	
Prepared by:	J.Hubler	Shear Strain Single Amplitude (%)	
Checked by:	J.Hubler		

Additional Comments:

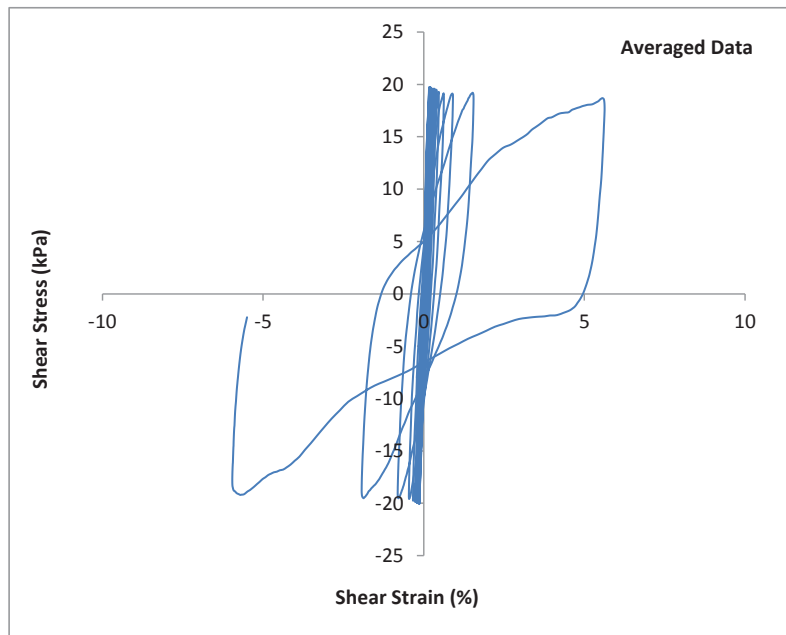
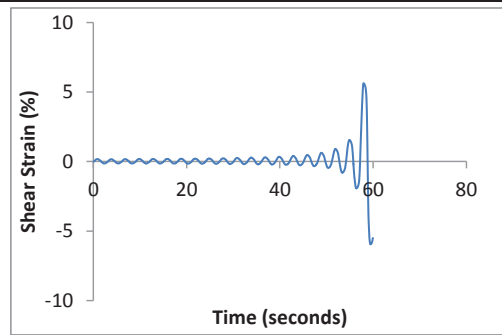
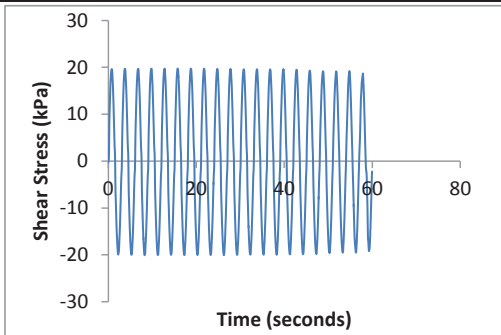

CSS Cyclic Shear Test Report

Geotechnical Engineering Laboratory



Cyclic Shear Test Summary

Device:	CSS	Density (kg/m³):	2025
Specimen ID:	40C109_60PG	Relative Density (%):	44%
Test ID:	C231	Void Ratio:	0.333
Date of Test:	2/9/2016	Vertical Stress (kPa):	200
Test Performed:	Cyclic Shear	Loading Frequency (Hz):	0.33
Test Material:	Ottawa Sand/Pea Gravel	Number of Cycles:	20
Sample Preparation:	Prepared Loose using a funnel with zero drop height.	Cyclic Stress Ratio:	0.097
		Number of Cycles to Liq:	20
		Maximum ru:	0.97
Prepared by:	J.Hubler		
Checked by:	J.Hubler		

Additional Comments:

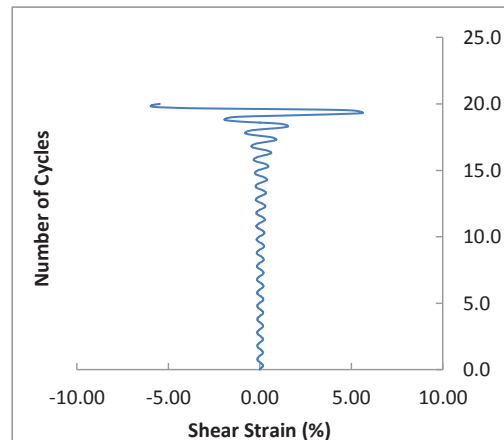
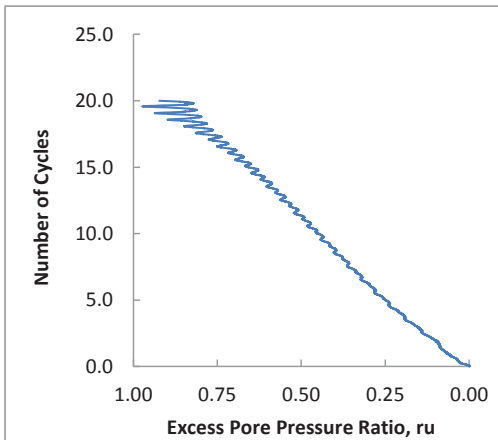
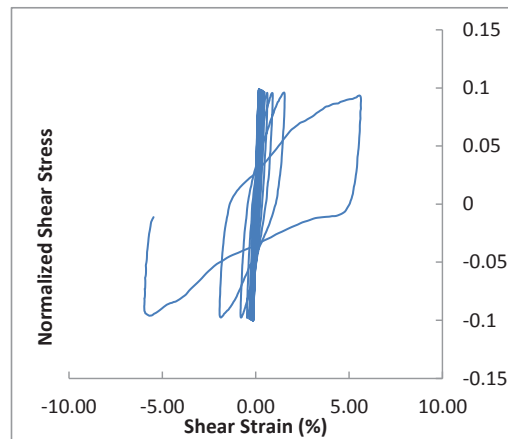
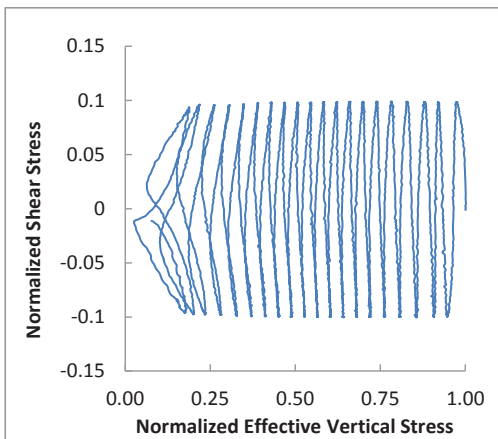

CSS Monotonic Shear Test Report

Geotechnical Engineering Laboratory



10/28/2013_Version 8.0

General Test Info and Sample Preparation

Device:	CSS	Relative Density (%):	5%
Specimen ID:	40C109_60PG	Void Ratio:	0.373
Test ID:	C231	Height (mm):	114.9
Date of Test:	2/9/2016	Soil-Only Specimen Diameter (mm):	307.50
Test Performed:	Post Cyclic Monotonic Shear	Weight (kg):	16.779
Test Material:	Ottawa Sand/Pea Gravel	Density (kg/m ³):	1967.0
Sample Preparation:	Prepared loose by placing with a funnel and zero drop height.	Membrane Thickness (mm):	0.000
		Moisture Content (%):	0%
		Saturated (Y/N):	N
		Prepared by:	J. Hubler
		Checked by:	J. Hubler

Consolidation Stage

Vertical Stress (kPa):	200
Time to Compression (min):	9.1
Relative Density (%):	44%
Void Ratio:	0.333
Height (mm):	111.6
Diameter (mm):	307.50
Weight (kg):	16.779
Density (kg/m ³):	2025.2

Shear Stage

Type of Test:	Constant Volume
Stress or Strain Controlled:	Strain
Shear Strain Rate (%/min):	0.29
Peak Shear Strength (kPa):	8.6

Comments

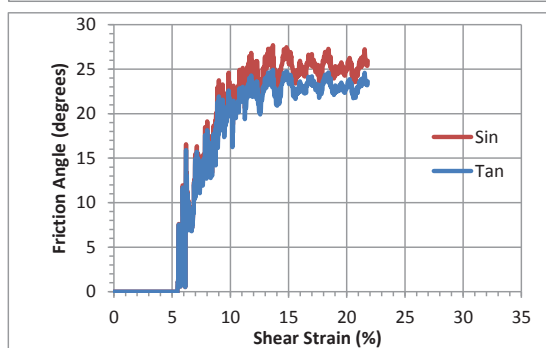
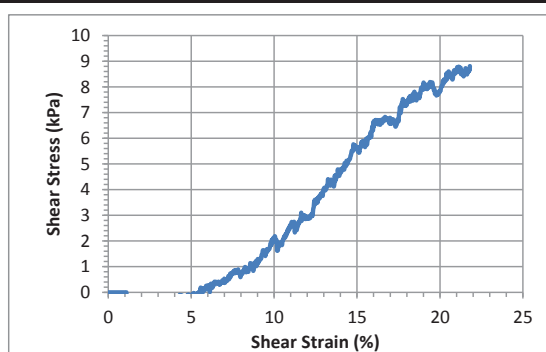
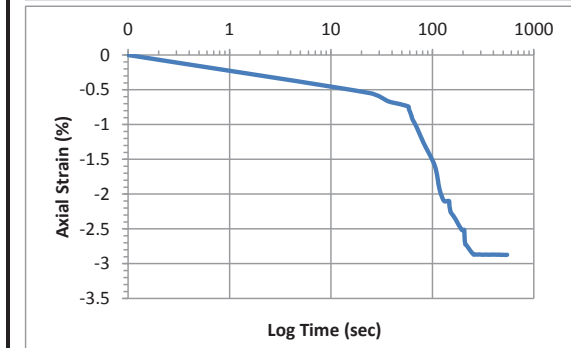
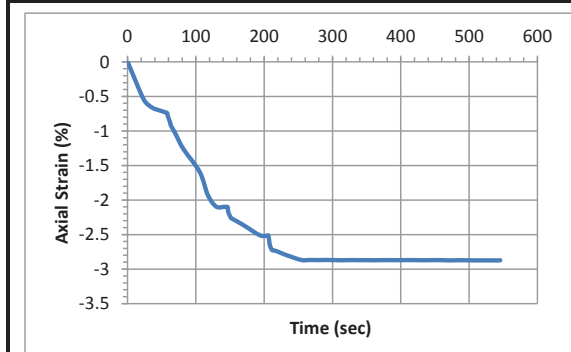

Accelerometer-Based Shear Wave Velocity Datasheet

Specimen ID: C231-PGC109-200-3X

Test Material: PGC109

Date: 2/9/2016

Test Performed by: J.Hubler

Filename: C231-PGC109-200-3X

Vertical Stress: 200kPa

Sensor Spacing: 0.11129 m

V_s (rise) = 234 m/s

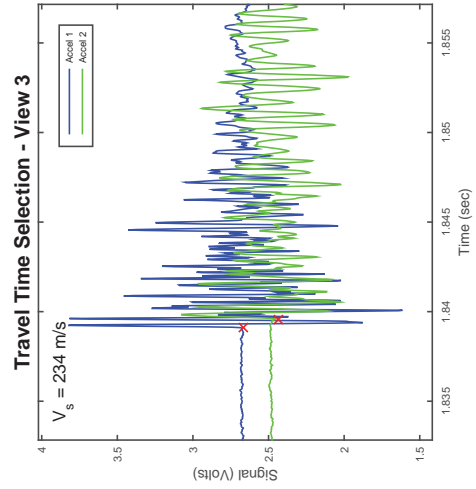
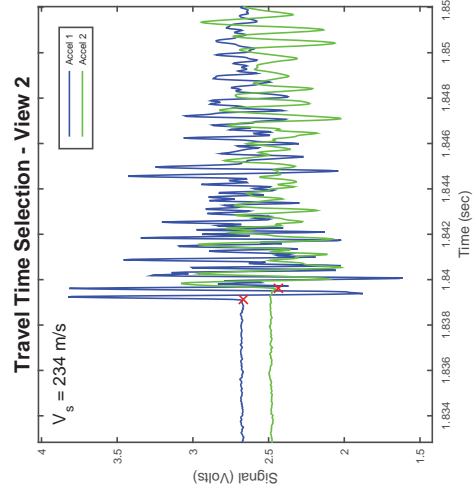
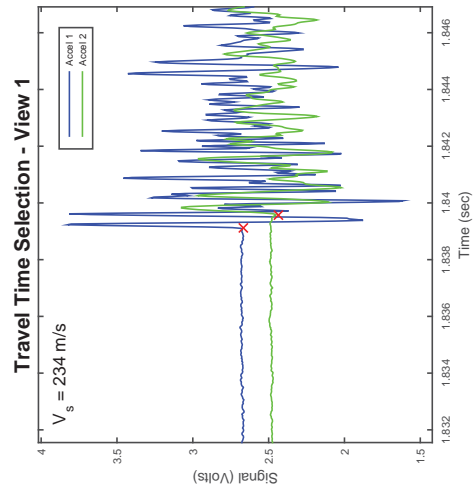
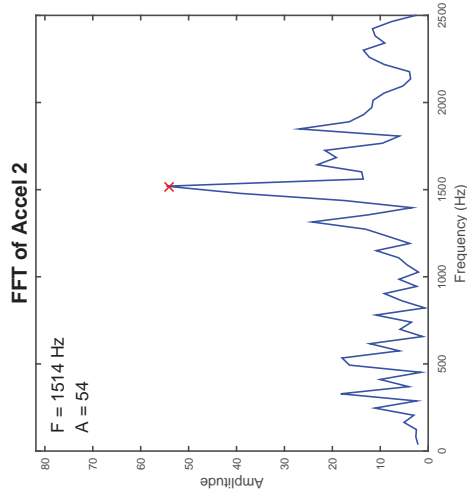
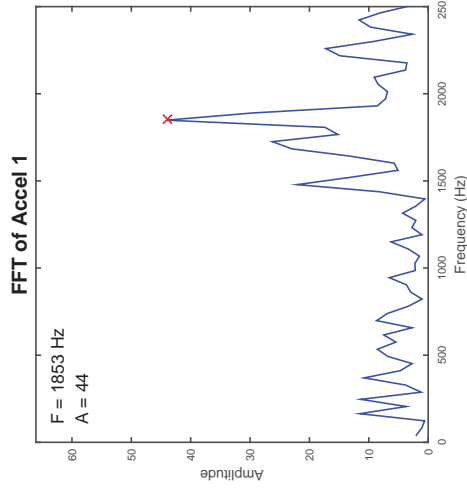
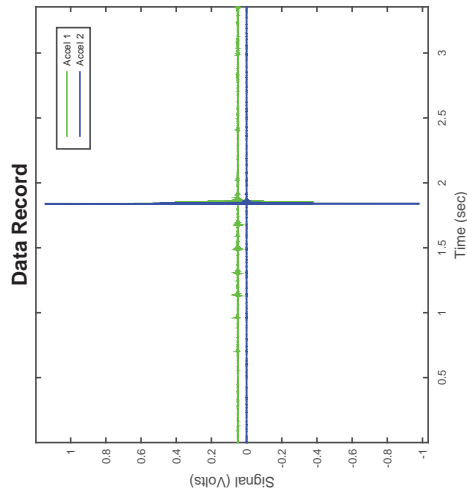

CSS Cyclic Shear Test Report

Geotechnical Engineering Laboratory



Cyclic Shear Test Summary

Device:	CSS	Density (kg/m³):	2025
Specimen ID:	40C109_60PG	Relative Density (%):	44%
Test ID:	C235	Void Ratio:	0.334
Date of Test:	2/10/2016	Vertical Stress (kPa):	400
Test Performed:	Cyclic Shear	Loading Frequency (Hz):	0.33
Test Material:	Ottawa Sand/Pea Gravel	Number of Cycles:	17
Sample Preparation:	Prepared Loose using a funnel with zero drop height.	Cyclic Stress Ratio:	0.099
		Shear Modulus (kPa):	
		Damping (%):	
Prepared by:	J.Hubler	Shear Strain Single Amplitude (%)	
Checked by:	J.Hubler		

Additional Comments:

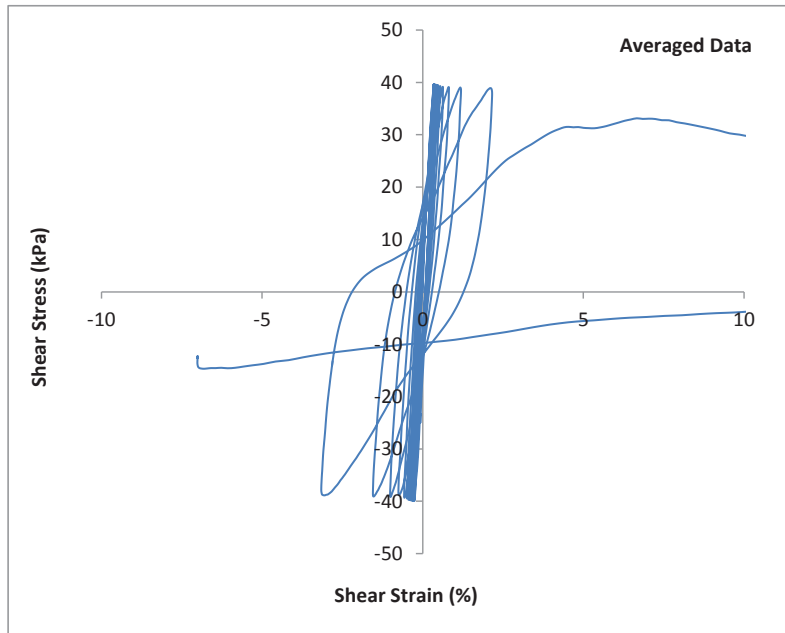
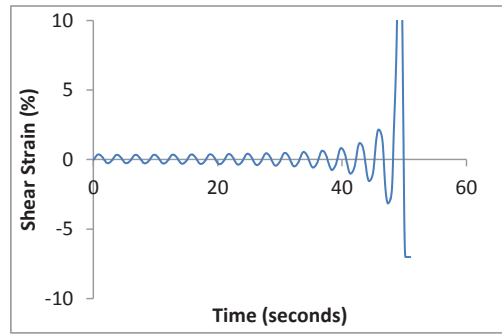
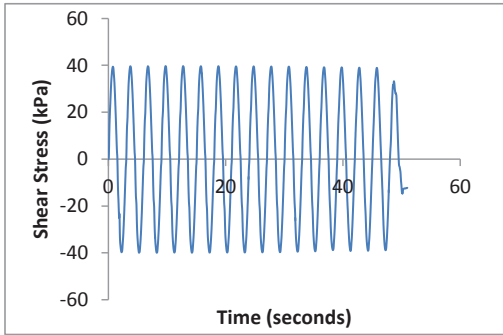

CSS Cyclic Shear Test Report

Geotechnical Engineering Laboratory



Cyclic Shear Test Summary

Device:	CSS	Density (kg/m³):	2025
Specimen ID:	40C109_60PG	Relative Density (%):	44%
Test ID:	C235	Void Ratio:	0.334
Date of Test:	2/10/2016	Vertical Stress (kPa):	400
Test Performed:	Cyclic Shear	Loading Frequency (Hz):	0.33
Test Material:	Ottawa Sand/Pea Gravel	Number of Cycles:	17
Sample Preparation:	Prepared Loose using a funnel with zero drop height.	Cyclic Stress Ratio:	0.099
		Number of Cycles to Liq:	17
		Maximum ru:	0.99
Prepared by:	J.Hubler		
Checked by:	J.Hubler		

Additional Comments:

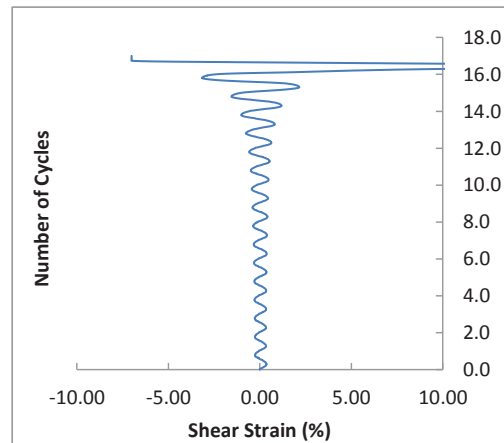
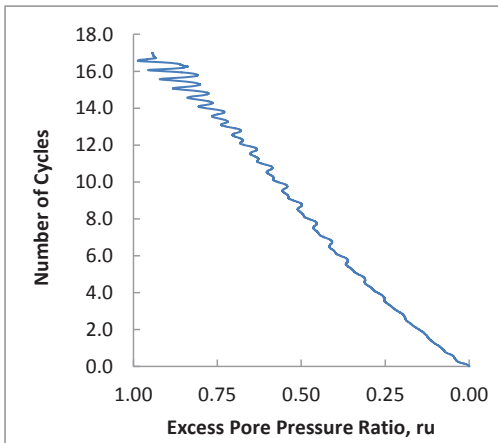
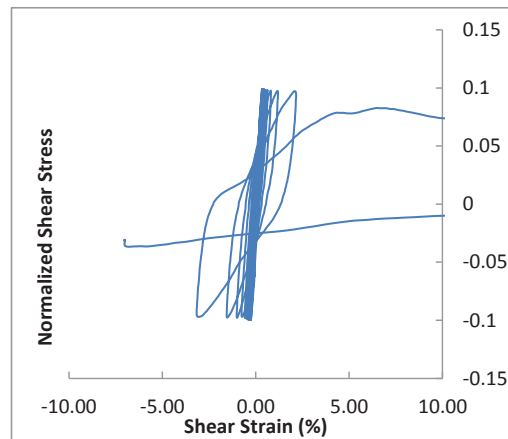
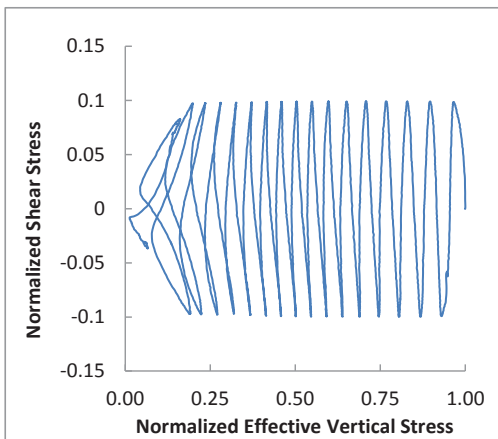

CSS Monotonic Shear Test Report

Geotechnical Engineering Laboratory



10/28/2013_Version 8.0

General Test Info and Sample Preparation

Device:	CSS	Relative Density (%):	-8%
Specimen ID:	40C109_60PG	Void Ratio:	0.386
Test ID:	C235	Height (mm):	114.5
Date of Test:	2/10/2016	Soil-Only Specimen Diameter (mm):	307.50
Test Performed:	Post Cyclic Monotonic Shear	Weight (kg):	16.564
Test Material:	Ottawa Sand/Pea Gravel	Density (kg/m³):	1948.6
Sample Preparation:	Prepared loose by placing with a funnel and zero drop height.	Membrane Thickness (mm):	0.000
		Moisture Content (%):	0%
		Saturated (Y/N):	N
		Prepared by:	J. Hubler
		Checked by:	J. Hubler

Consolidation Stage

Shear Stage

Vertical Stress (kPa):	400	Type of Test:	Constant Volume
Time to Compression (min):	7.2	Stress or Strain Controlled:	Strain
Relative Density (%):	44%	Shear Strain Rate (%/min):	0.30
Void Ratio:	0.334	Peak Shear Strength (kPa):	3.8
Height (mm):	110.2	Comments	
Diameter (mm):	307.50		
Weight (kg):	16.564		
Density (kg/m³):	2024.6		

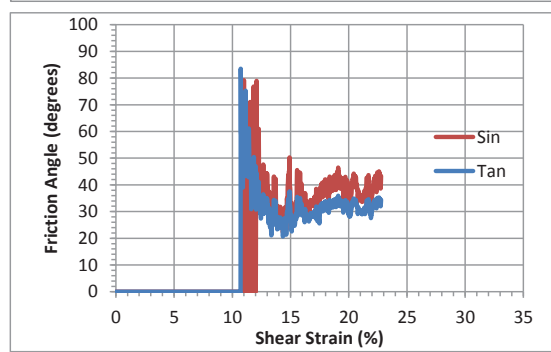
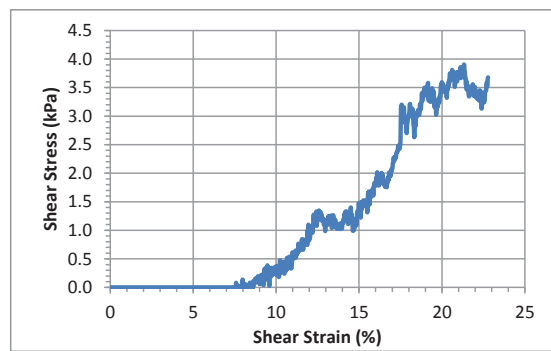
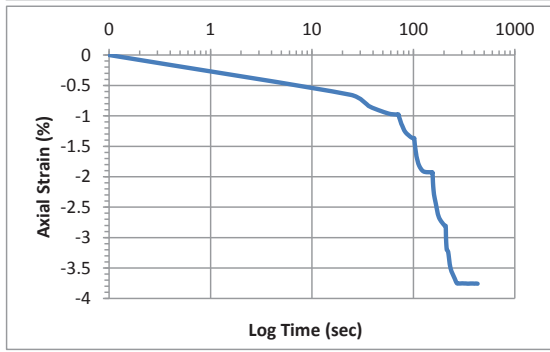
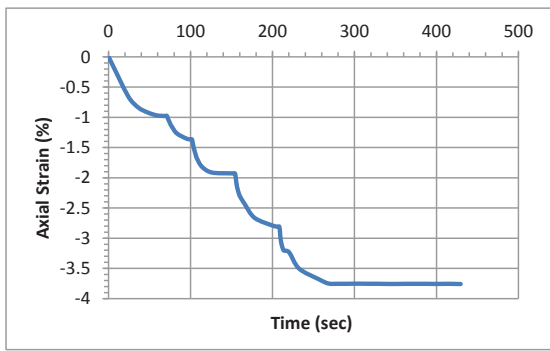

Accelerometer-Based Shear Wave Velocity Datasheet

Specimen ID: C235-PGC109-400-1X
 Test Material: PGC109
 Date: 2/10/2016
 Test Performed by: J.Hubler
 Filename: C235-PGC109-400-1X

Vertical Stress: 400kPa
 Sensor Spacing: 0.10989 m
 V_s (rise) = 231 m/s

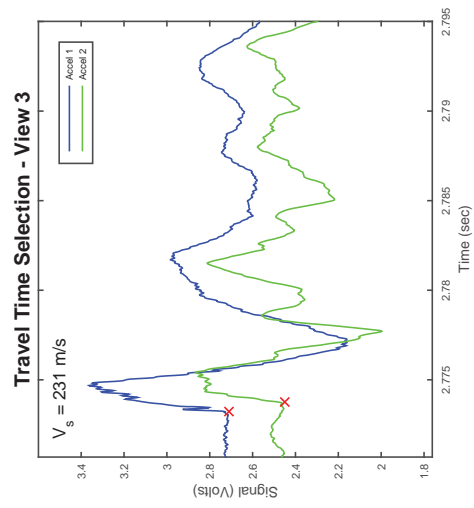
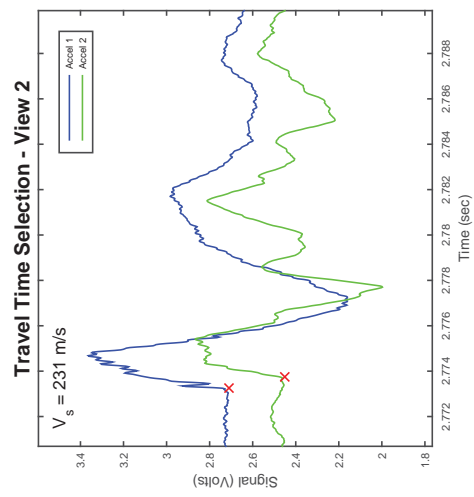
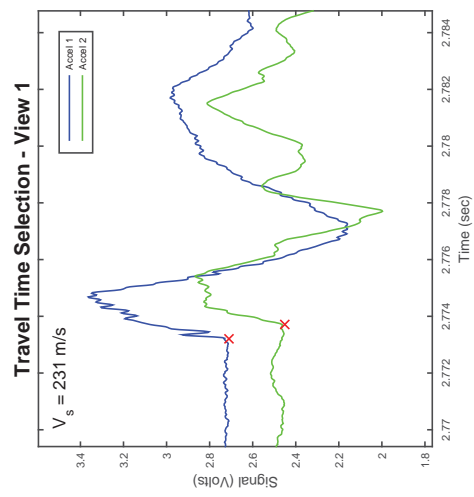
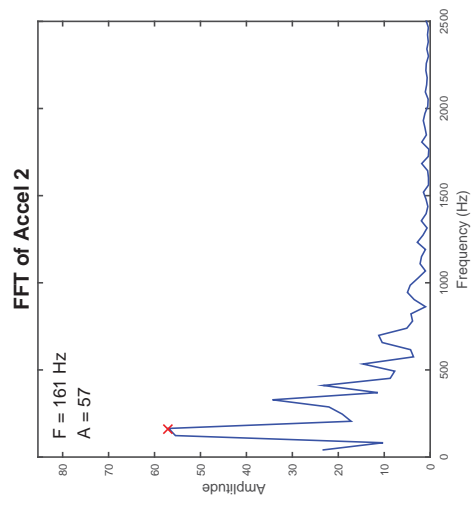
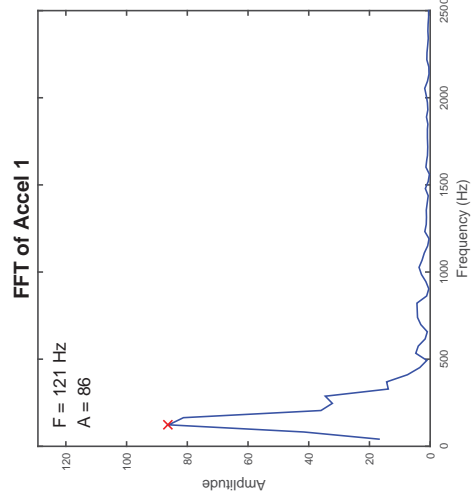
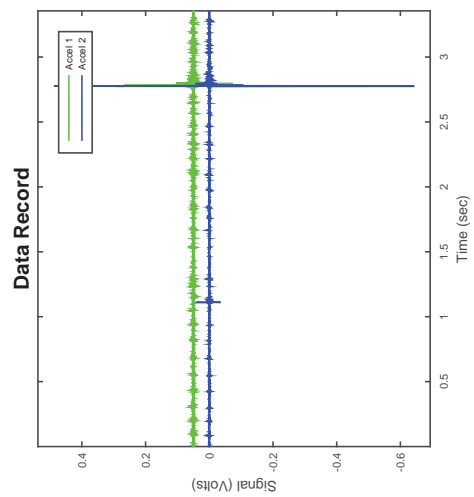

CSS Cyclic Shear Test Report

Geotechnical Engineering Laboratory



Cyclic Shear Test Summary

Device:	CSS	Density (kg/m³):	2101
Specimen ID:	40C109_60PG	Relative Density (%):	92%
Test ID:	C288	Void Ratio:	0.285
Date of Test:	8/17/2016	Vertical Stress (kPa):	100
Test Performed:	Cyclic Shear	Loading Frequency (Hz):	0.33
Test Material:	Ottawa Sand/Pea Gravel	Number of Cycles:	18
Sample Preparation:	Prepared Dense by tamping in 5 layers (25x)	Cyclic Stress Ratio:	0.144
		Shear Modulus (kPa):	
		Damping (%):	
Prepared by:	J.Hubler	Shear Strain Single Amplitude (%)	
Checked by:	J.Hubler		

Additional Comments:

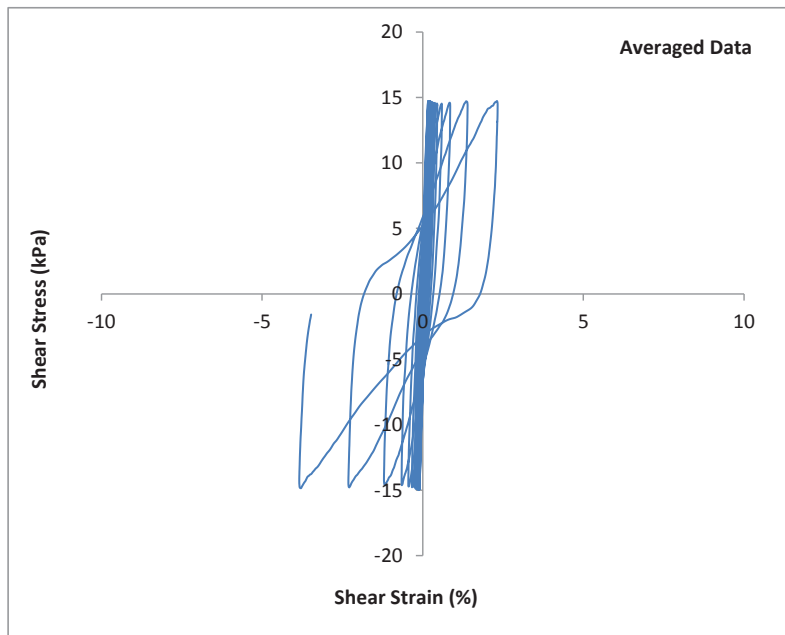
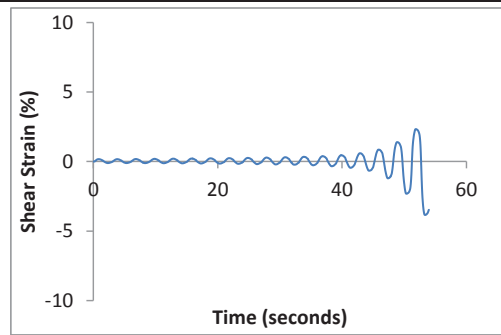
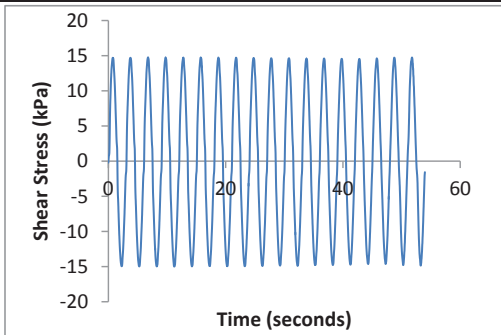

CSS Cyclic Shear Test Report

Geotechnical Engineering Laboratory



Cyclic Shear Test Summary

Device:	CSS	Density (kg/m³):	2101
Specimen ID:	40C109_60PG	Relative Density (%):	92%
Test ID:	C288	Void Ratio:	0.285
Date of Test:	8/17/2016	Vertical Stress (kPa):	100
Test Performed:	Cyclic Shear	Loading Frequency (Hz):	0.33
Test Material:	Ottawa Sand/Pea Gravel	Number of Cycles:	18
Sample Preparation:	Prepared Dense by tamping in 5 layers (25x)	Cyclic Stress Ratio:	0.144
		Number of Cycles to Liq:	18
		Maximum ru:	1.00
Prepared by:	J.Hubler		
Checked by:	J.Hubler		

Additional Comments:

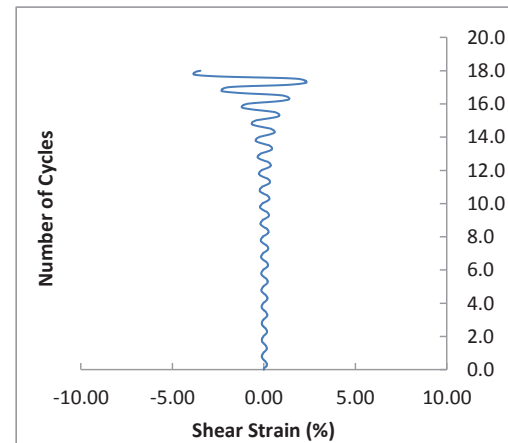
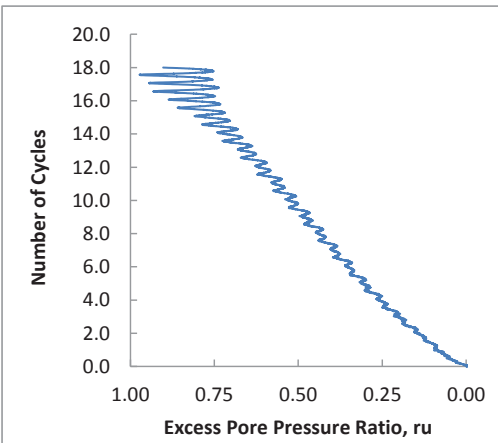
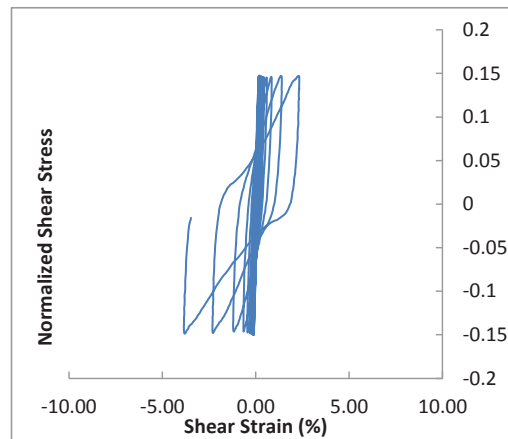
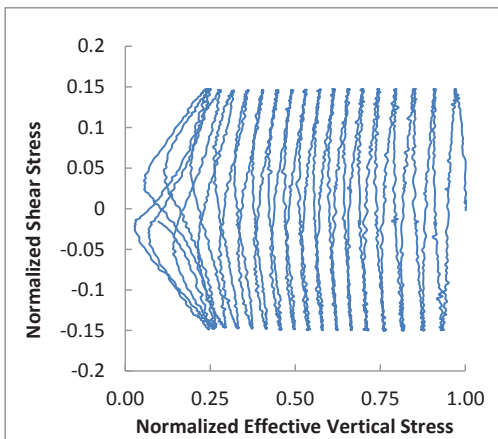

CSS Monotonic Shear Test Report

Geotechnical Engineering Laboratory



10/28/2013_Version 8.0

General Test Info and Sample Preparation

Device:	CSS	Relative Density (%):	92%
Specimen ID:	40C109_60PG	Void Ratio:	0.285
Test ID:	C288	Height (mm):	114.0
Date of Test:	8/17/2016	Soil-Only Specimen Diameter (mm):	306.23
Test Performed:	Post Cyclic Monotonic Shear	Weight (kg):	17.638
Test Material:	Ottawa Sand/Pea Gravel	Density (kg/m³):	2101.2
Sample Preparation:	Prepared dense by tamping in 5 layers (25x)	Membrane Thickness (mm):	0.635
		Moisture Content (%):	0%
		Saturated (Y/N):	N
		Prepared by:	J. Hubler
		Checked by:	J. Hubler

Consolidation Stage

Vertical Stress (kPa):	100
Time to Compression (min):	3.7
Relative Density (%):	100%
Void Ratio:	0.278
Height (mm):	113.3
Diameter (mm):	306.23
Weight (kg):	17.638
Density (kg/m³):	2113.4

Shear Stage

Type of Test:	Constant Volume
Stress or Strain Controlled:	Strain
Shear Strain Rate (%/min):	0.29
Peak Shear Strength (kPa):	88.6

Comments

Reconsolidated to 100 kPa after cyclic test with CSR = 0.144

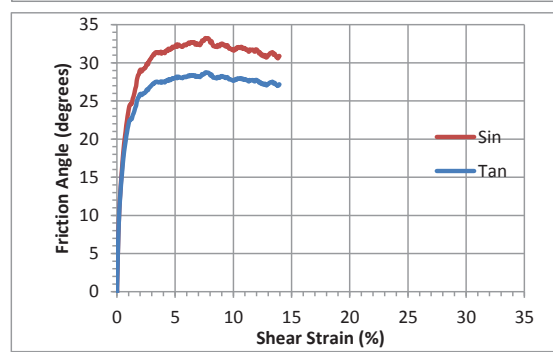
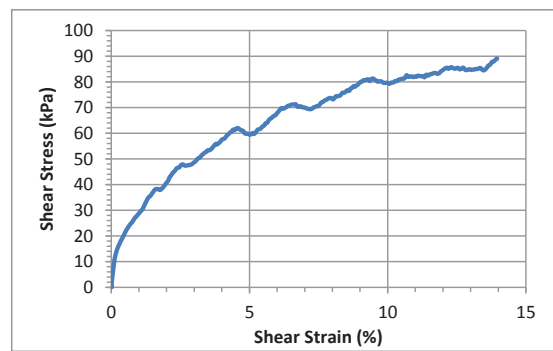
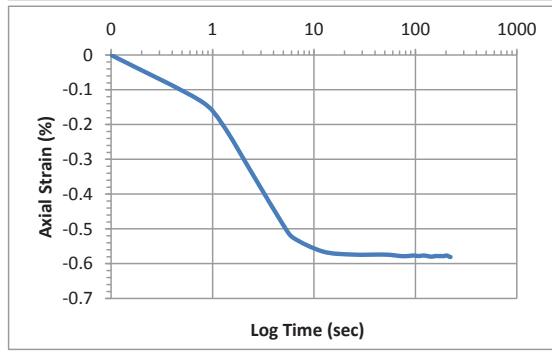
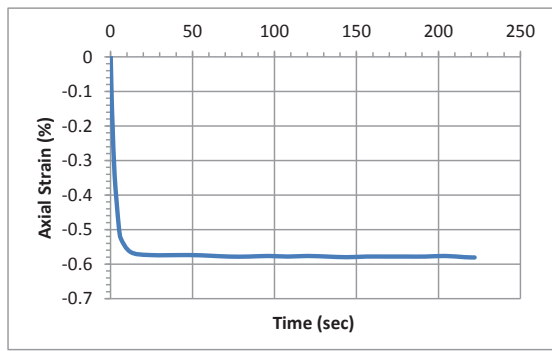

Accelerometer-Based Shear Wave Velocity Datasheet

Specimen ID: C288-60PG40C109-100-1X

Test Material: 60PG40C109

Date: 8/17/16

Test Performed by: J.Hubler

Filename: C288-60PG40C109-100-1X

Vertical Stress: 100kPa

Sensor Spacing: 0.11326 m

V_s (rise) = 226 m/s

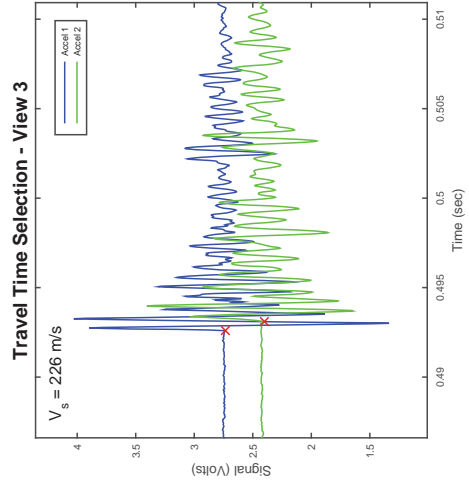
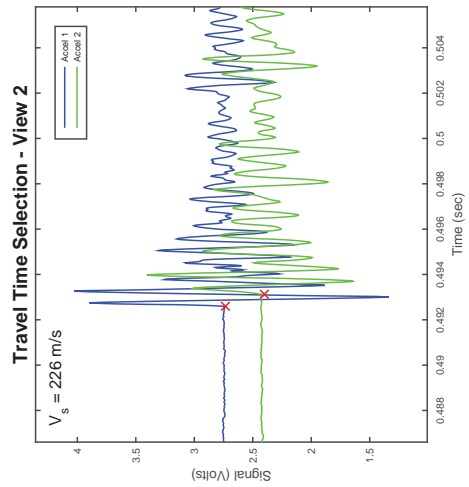
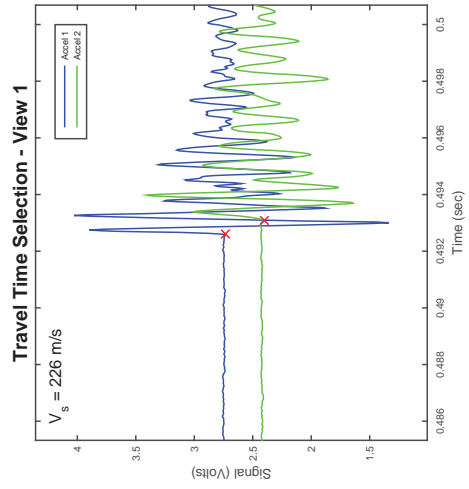
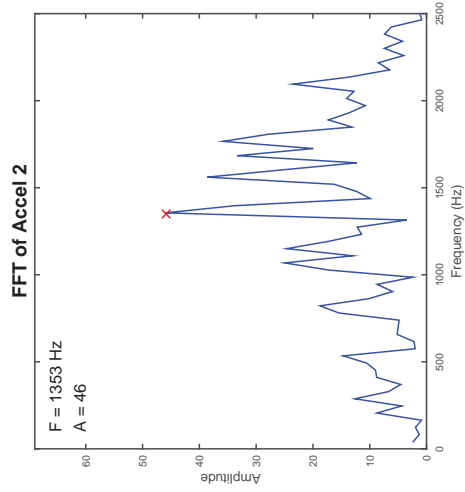
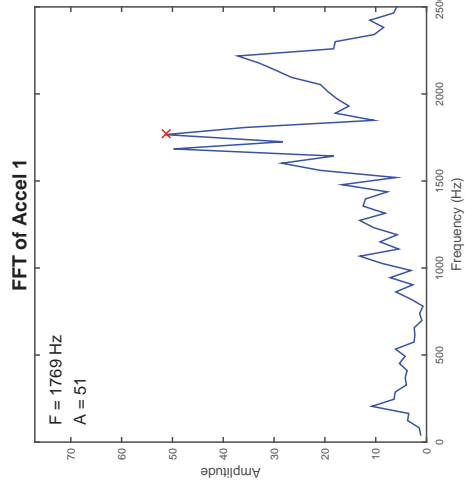
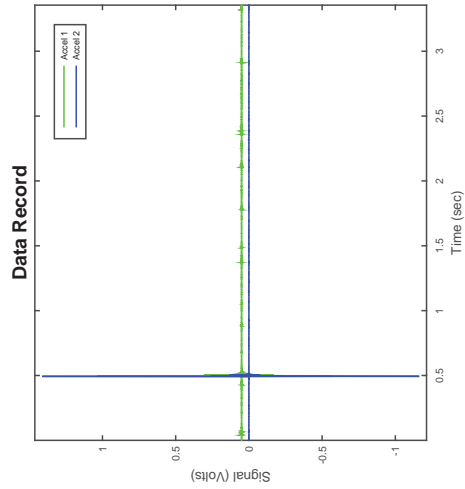

Accelerometer-Based Shear Wave Velocity Datasheet

Specimen ID: C288-60PG40C109-100-2XP

Test Material: 60PG40C109

Date: 8/17/16

Test Performed by: J.Hubler

Filename: C288-60PG40C109-100-2XP

Vertical Stress: 100kPa

Sensor Spacing: 0.1126 m

V_s (rise) = 203 m/s

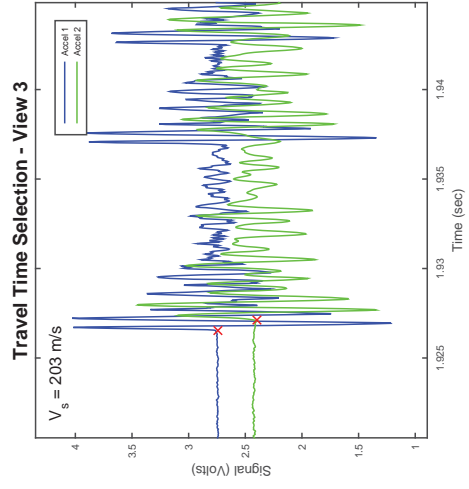
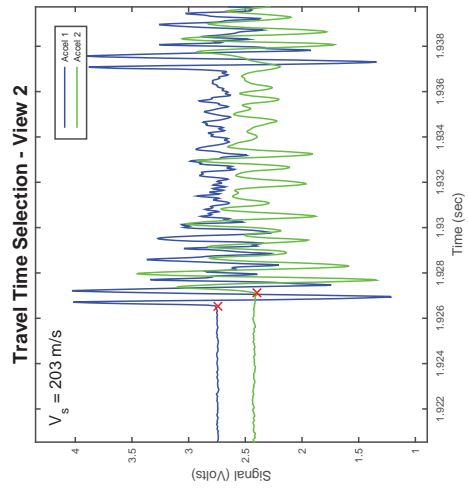
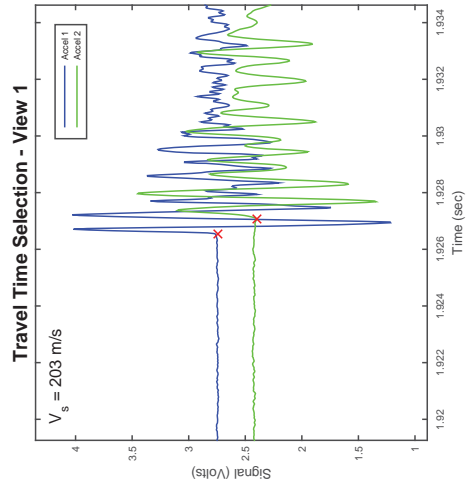
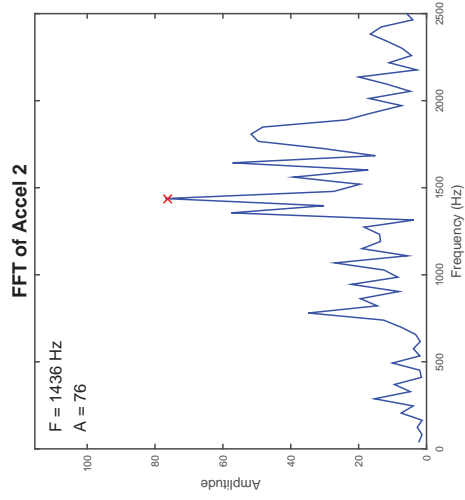
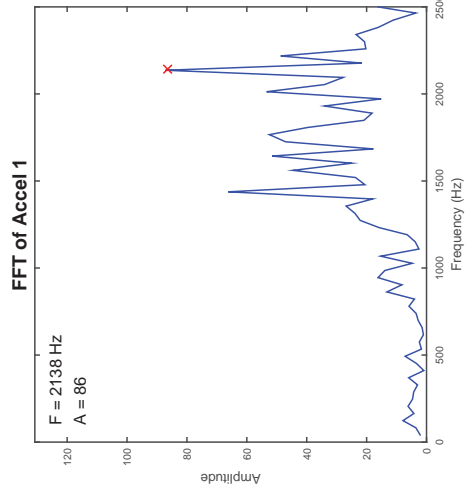
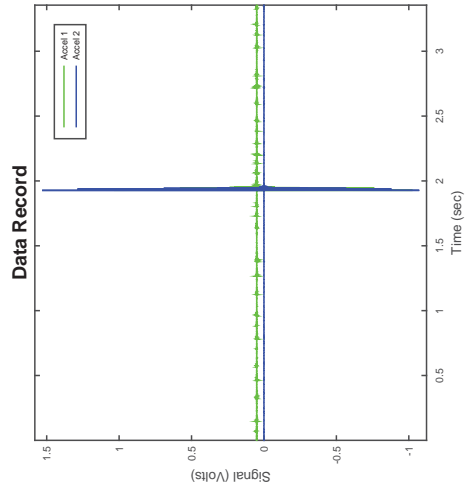

CSS Cyclic Shear Test Report

Geotechnical Engineering Laboratory



Cyclic Shear Test Summary

Device:	CSS	Density (kg/m³):	1638
Specimen ID:	PGL	Relative Density (%):	50%
Test ID:	C180	Void Ratio:	0.673
Date of Test:	6/22/2015	Vertical Stress (kPa):	100
Test Performed:	Cyclic Shear	Loading Frequency (Hz):	0.33
Test Material:	Pea Gravel	Number of Cycles:	4
Sample Preparation:	Prepared loose using the shoveling method.	Cyclic Stress Ratio:	0.094
		Shear Modulus (kPa):	
		Damping (%):	
Prepared by:	A.Jackson	Shear Strain Single Amplitude (%)	
Checked by:	J.Hubler		

Additional Comments:

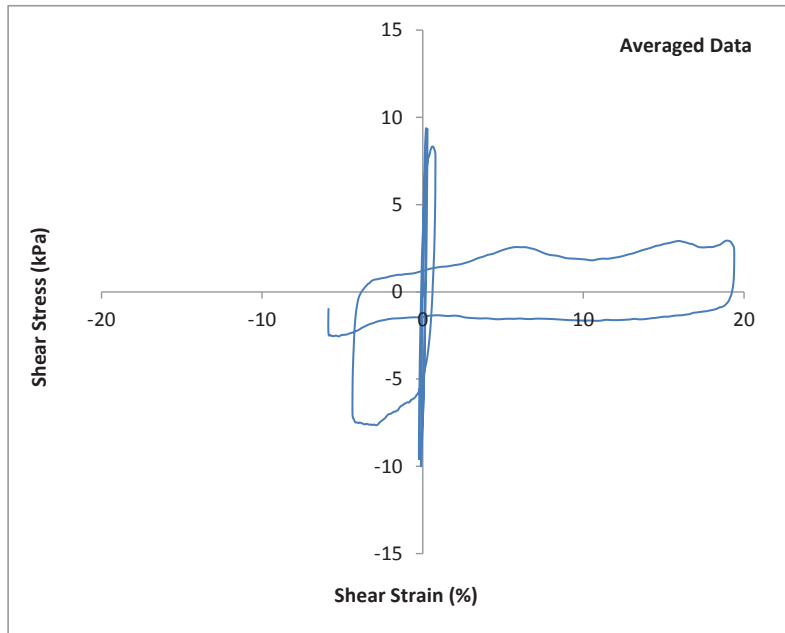
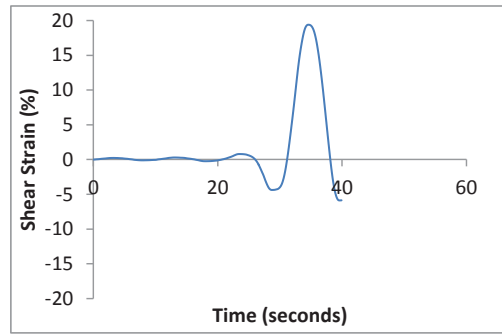
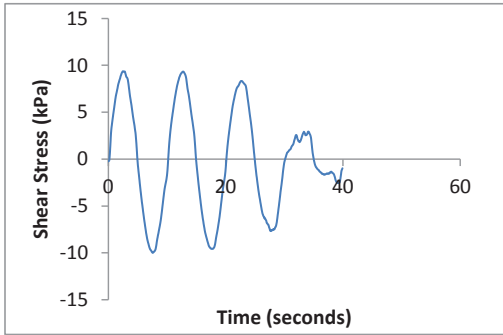

CSS Cyclic Shear Test Report

Geotechnical Engineering Laboratory



Cyclic Shear Test Summary

Device:	CSS	Density (kg/m³):	1638
Specimen ID:	PGL	Relative Density (%):	50%
Test ID:	C180	Void Ratio:	0.673
Date of Test:	6/22/2015	Vertical Stress (kPa):	100
Test Performed:	Cyclic Shear	Loading Frequency (Hz):	0.33
Test Material:	Pea Gravel	Number of Cycles:	4
Sample Preparation:	Prepared loose using the shoveling method.	Cyclic Stress Ratio:	0.094
		Number of Cycles to Liq:	4
		Maximum ru:	1.01
Prepared by:	A.Jackson		
Checked by:	J.Hubler		

Additional Comments:

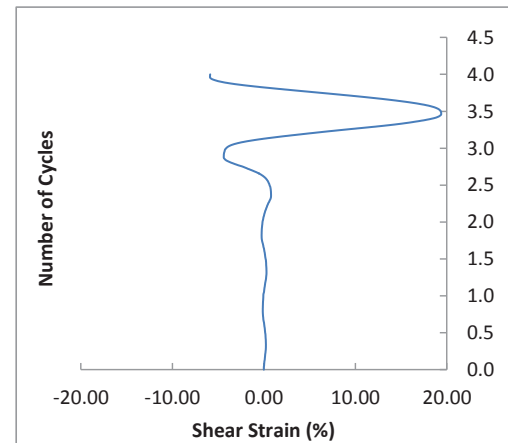
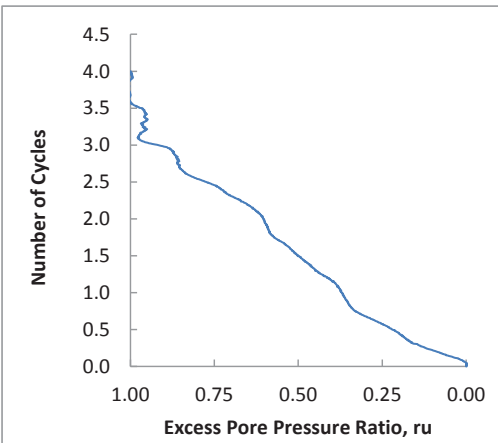
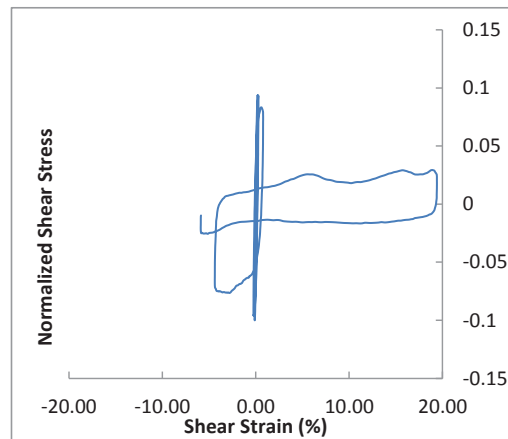
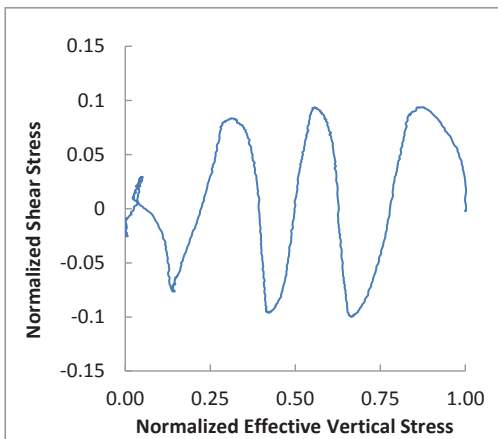

CSS Monotonic Shear Test Report

Geotechnical Engineering Laboratory



10/28/2013_Version 8.0

General Test Info and Sample Preparation

Device:	CSS	Relative Density (%):	50%
Specimen ID:	PGL	Void Ratio:	0.673
Test ID:	C180	Height (mm):	109.3
Date of Test:	6/22/2015	Soil-Only Specimen Diameter (mm):	306.23
Test Performed:	Post Cyclic Monotonic Shear	Weight (kg):	13.189
Test Material:	Pea Gravel	Density (kg/m ³):	1638.2
Sample Preparation:	Prepared loose using the shoveling method.	Membrane Thickness (mm):	0.635
		Moisture Content (%):	0%
		Saturated (Y/N):	N
		Prepared by:	A. Jackson
		Checked by:	J. Hubler

Consolidation Stage

Shear Stage

Vertical Stress (kPa):	100	Type of Test:	Constant Volume
Time to Compression (min):	4.1	Stress or Strain Controlled:	Strain
Relative Density (%):	64%	Shear Strain Rate (%/min):	0.31
Void Ratio:	0.646	Peak Shear Strength (kPa):	12.0
Height (mm):	107.6	Comments	
Diameter (mm):	306.23	Consolidation Data is for post-liquefaction reloading.	
Weight (kg):	13.189		
Density (kg/m ³):	1664.6		

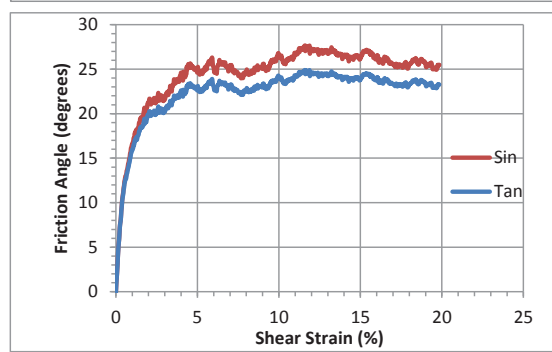
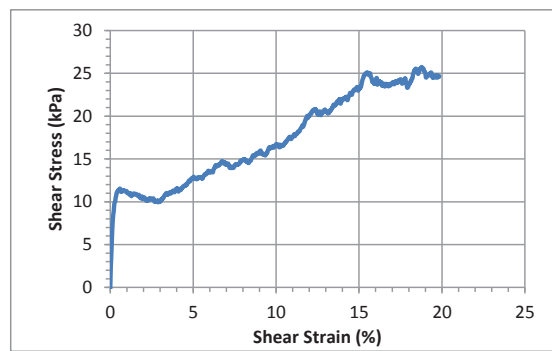
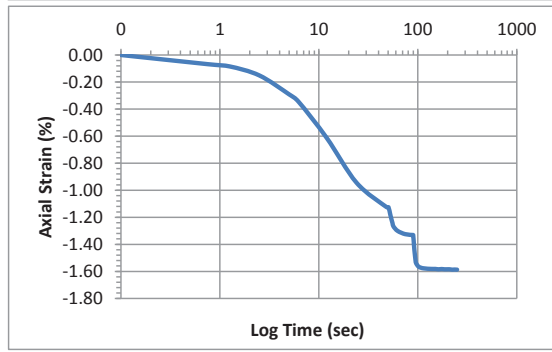
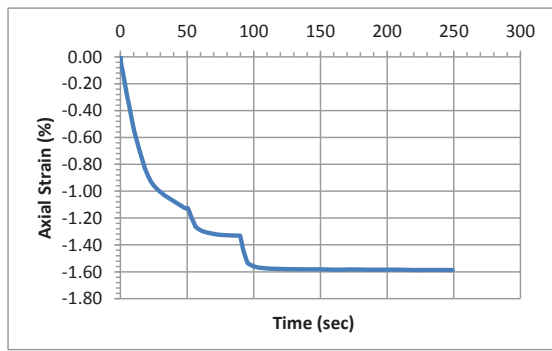

Accelerometer-Based Shear Wave Velocity Datasheet

Specimen ID: C180-PGL-100-1X
 Test Material: PGL
 Date: 6/22/2015
 Test Performed by: J.Hubler
 Filename: C180-PGL-100-1X

Vertical Stress: 100kPa
 Sensor Spacing: 0.10927 m
 V_s (rise) = 167 m/s

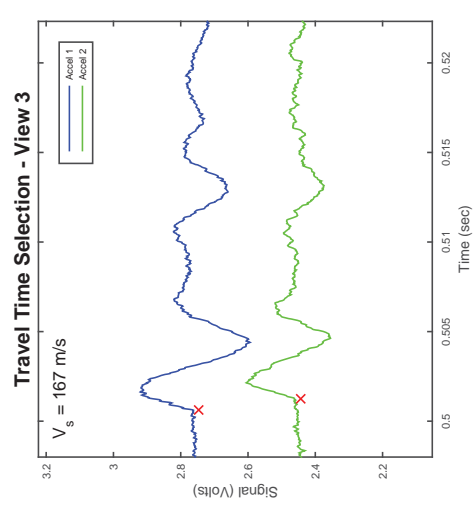
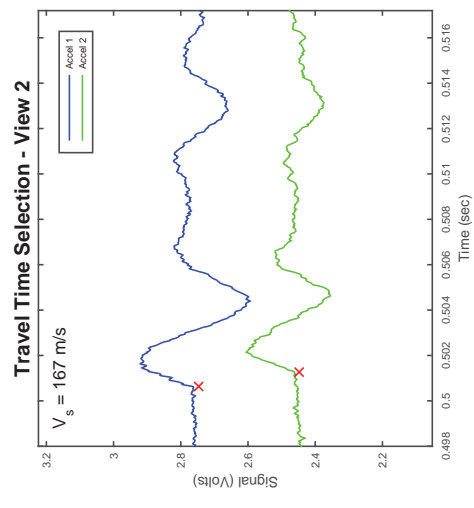
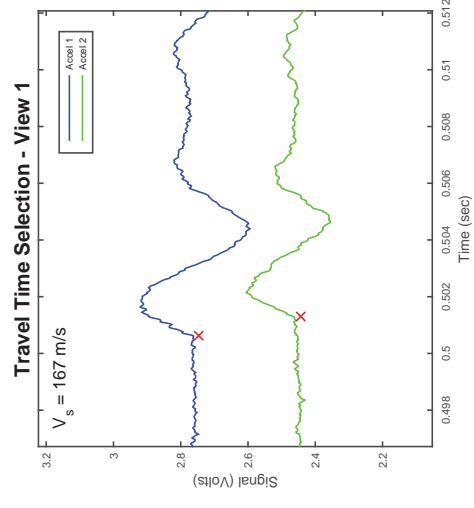
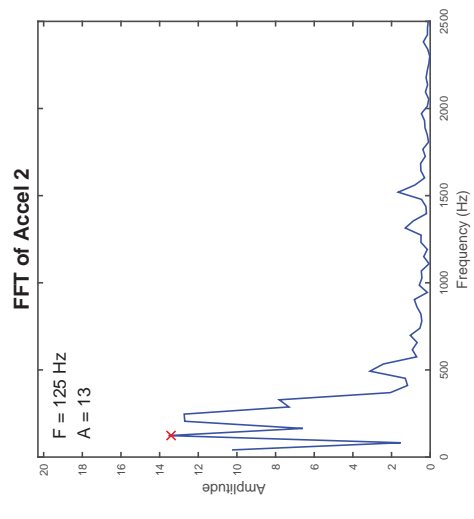
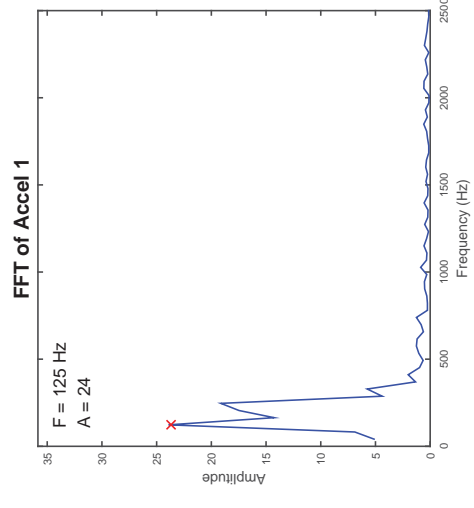
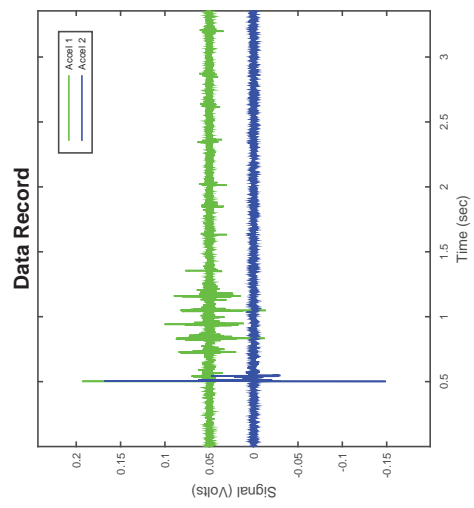

Accelerometer-Based Shear Wave Velocity Datasheet

Vertical Stress: 100kPa
 Sensor Spacing: 0.10927 m
 V_s (rise) = 180 m/s

Specimen ID: C180-PGL-100-2X
 Test Material: PGL
 Date: 6/22/2015
 Test Performed by: J.Hubler
 Filename: C180-PGL-100-2X

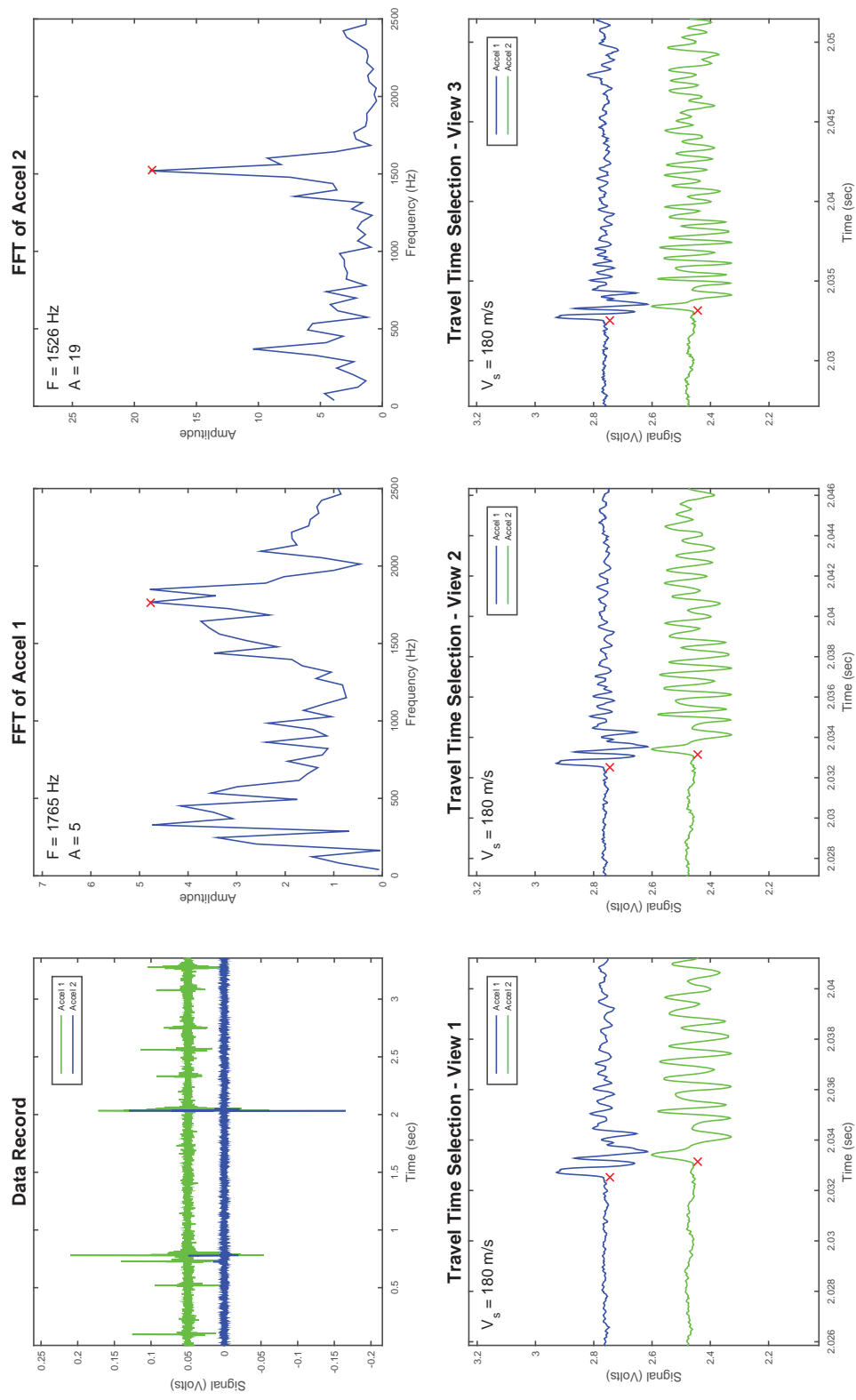

Accelerometer-Based Shear Wave Velocity Datasheet

Specimen ID: C180-PGL-100-3X

Test Material: PGL

Date: unknown

Test Performed by: J.Hubler

Filename: C180-PGL-100-3X

Vertical Stress: 100kPa

Sensor Spacing: 0.10927 m

V_s (rise) = 171 m/s

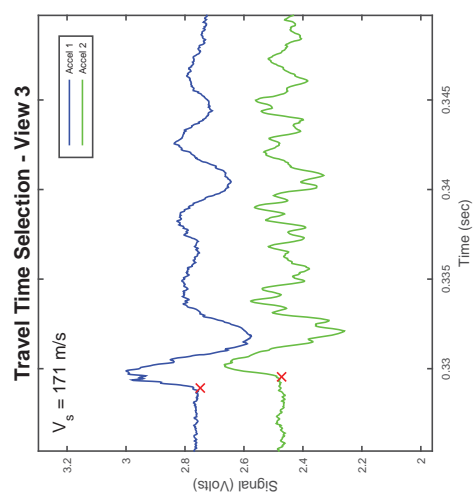
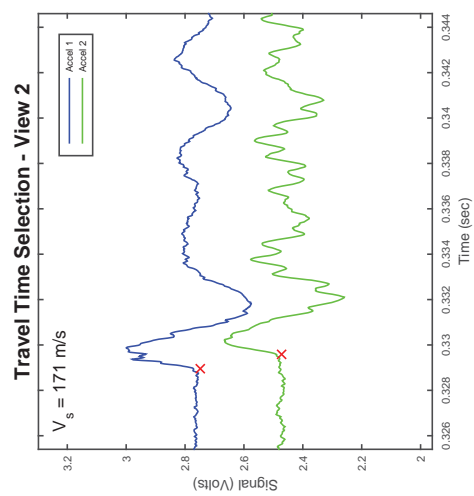
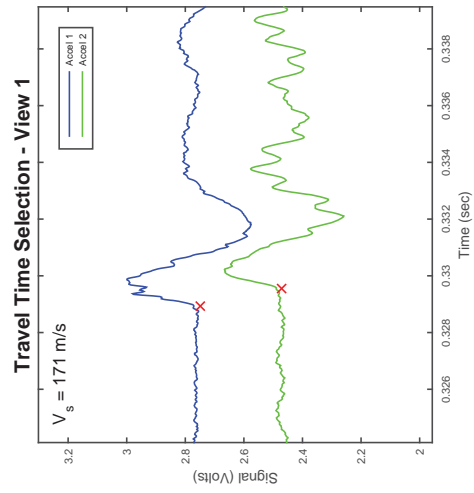
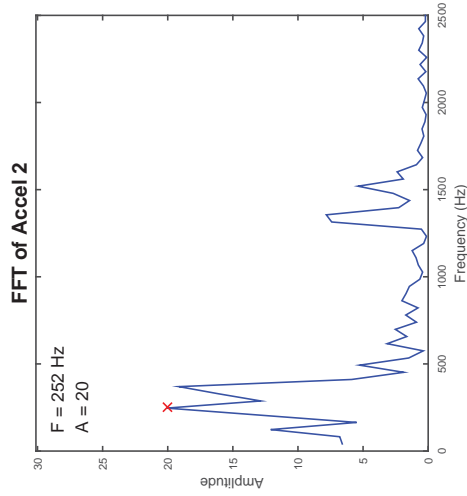
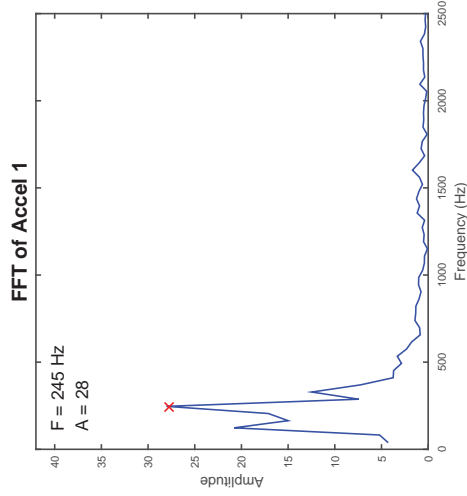
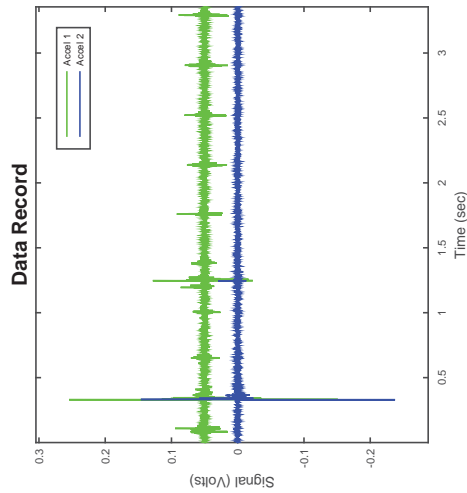

Accelerometer-Based Shear Wave Velocity Datasheet

Specimen ID: C180-PGL-100-4X
 Test Material: PGL
 Date: 6/22/2015
 Test Performed by: J.Hubler
 Filename: C180-PGL-100-4X

Vertical Stress: 100kPa
 Sensor Spacing: 0.10927 m
 V_s (rise) = 175 m/s

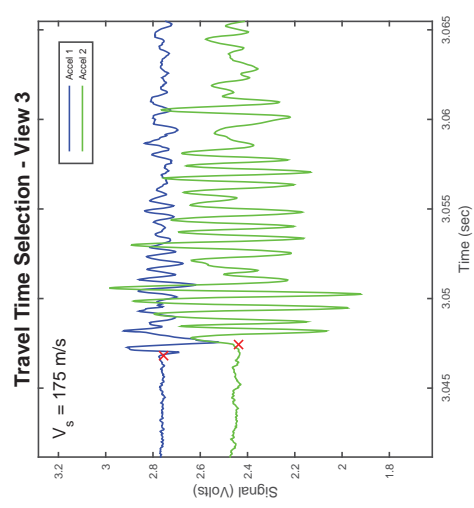
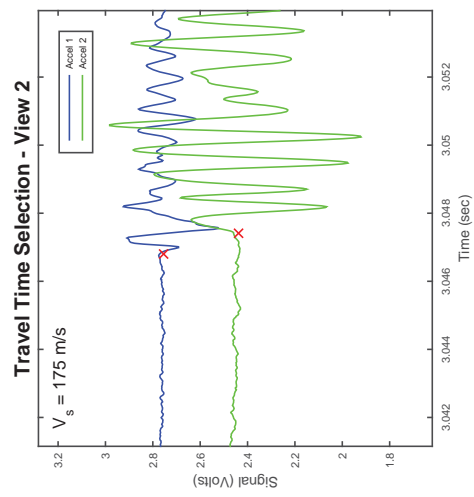
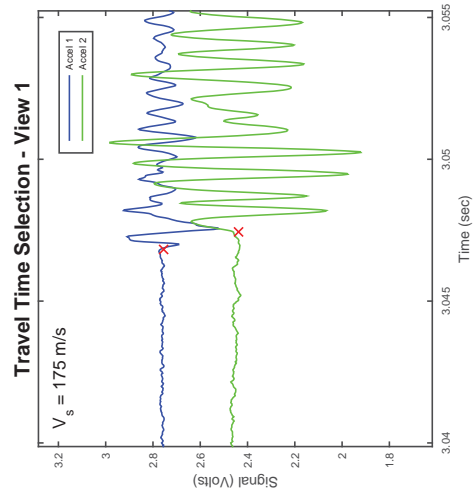
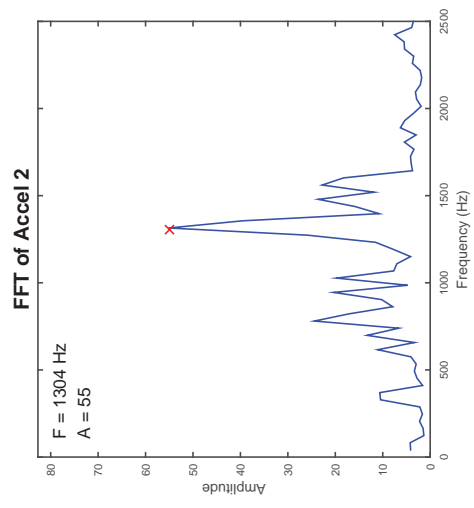
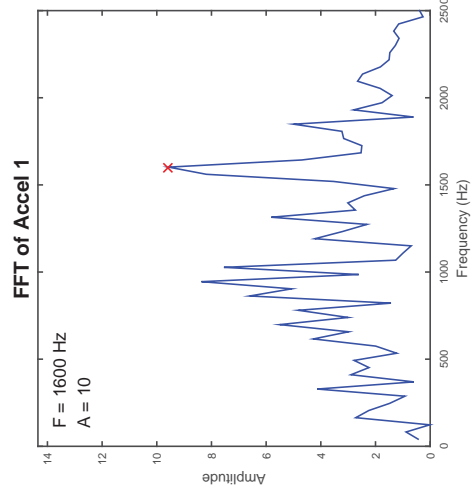
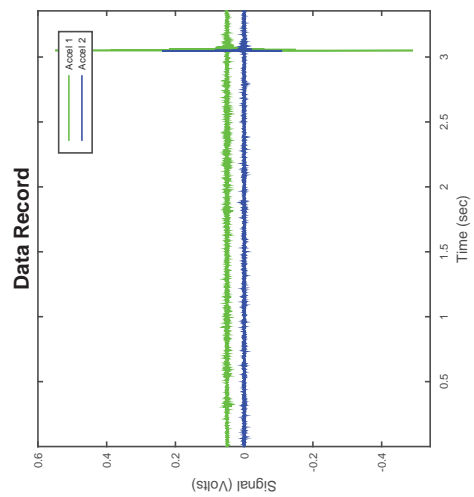

Accelerometer-Based Shear Wave Velocity Datasheet

Specimen ID: C180-PGL-100-3XP

Test Material: PGL

Date: 6/22/2015

Test Performed by: J.Hubler

Filename: C180-PGL-100-3XP

Vertical Stress: 100kPa

Sensor Spacing: 0.10753 m

V_s (rise) = 196 m/s

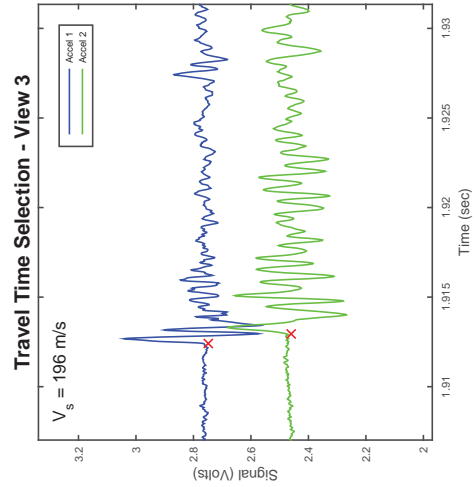
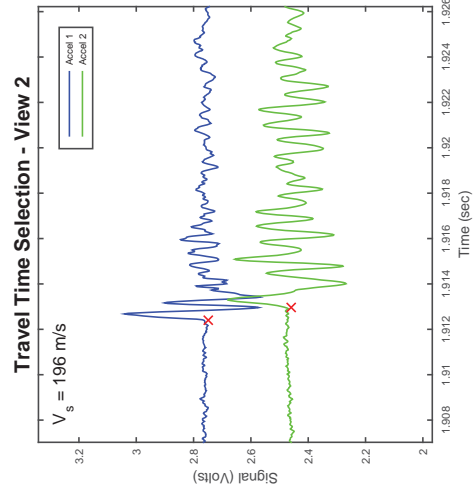
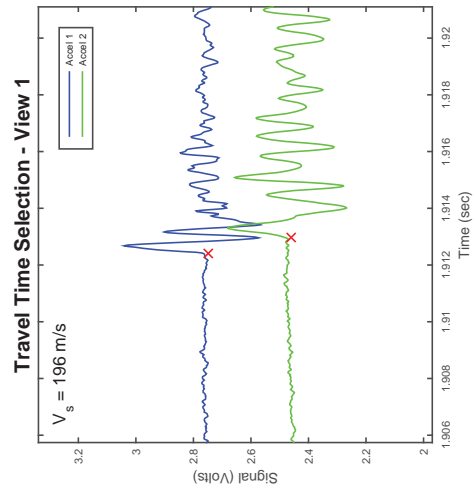
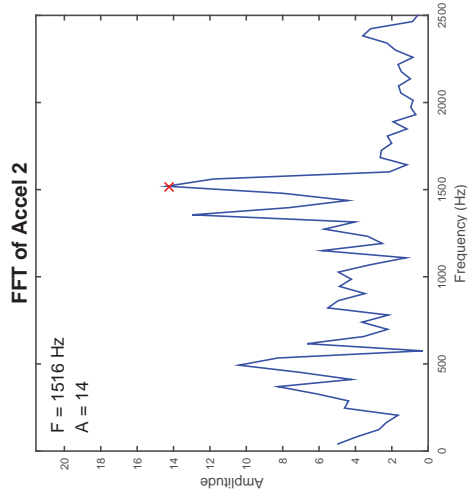
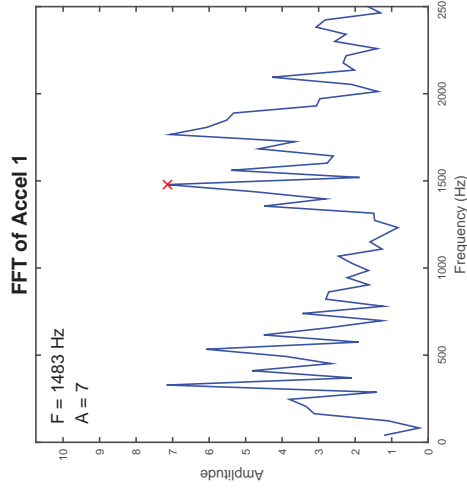
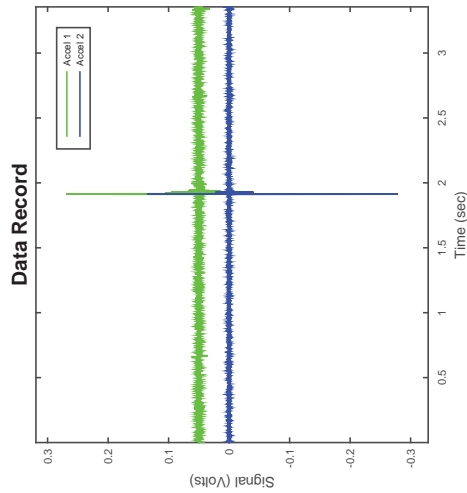

CSS Cyclic Shear Test Report

Geotechnical Engineering Laboratory



Cyclic Shear Test Summary

Device:	CSS	Density (kg/m³):	1702
Specimen ID:	PGD	Relative Density (%):	82%
Test ID:	C281	Void Ratio:	0.610
Date of Test:	8/16/2016	Vertical Stress (kPa):	100
Test Performed:	Cyclic Shear	Loading Frequency (Hz):	0.33
Test Material:	Pea Gravel	Number of Cycles:	8
Sample Preparation:	Prepared dense by tamping 25 times in 5 layers.	Cyclic Stress Ratio:	0.144
		Shear Modulus (kPa):	
		Damping (%):	
Prepared by:	J.Hubler	Shear Strain Single Amplitude (%)	
Checked by:	J.Hubler		

Additional Comments:

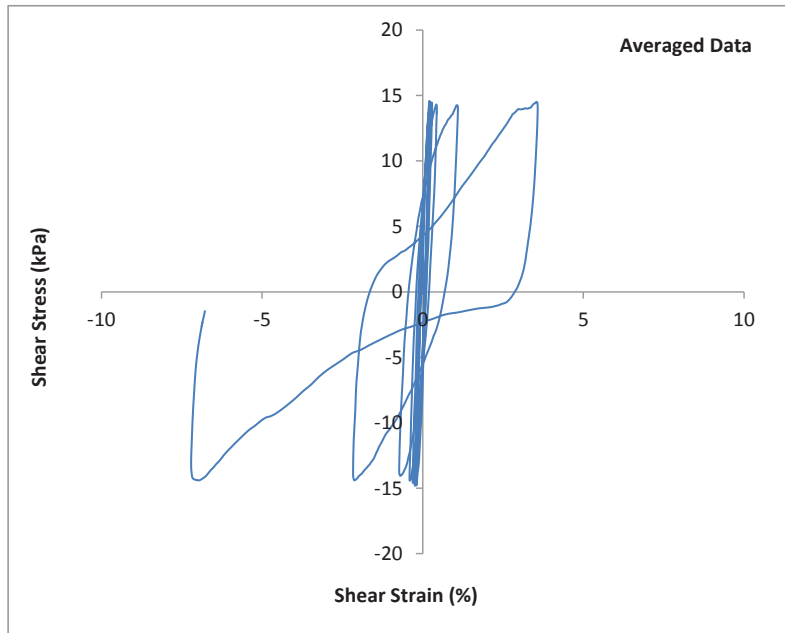
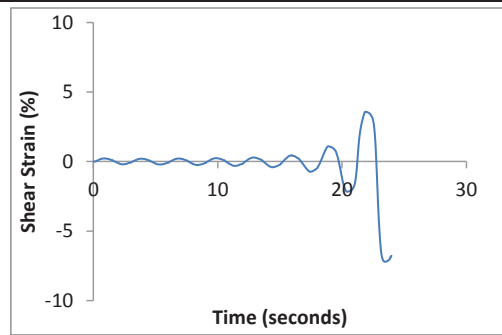
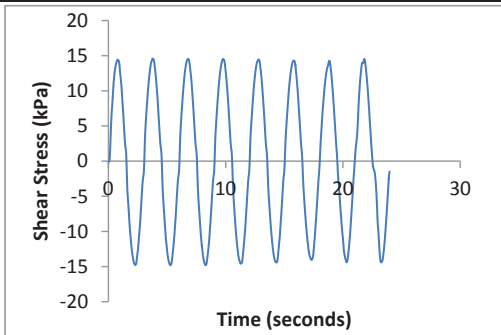

CSS Cyclic Shear Test Report

Geotechnical Engineering Laboratory



Cyclic Shear Test Summary

Device:	CSS	Density (kg/m³):	1702
Specimen ID:	PGD	Relative Density (%):	82%
Test ID:	C281	Void Ratio:	0.610
Date of Test:	8/16/2016	Vertical Stress (kPa):	100
Test Performed:	Cyclic Shear	Loading Frequency (Hz):	0.33
Test Material:	Pea Gravel	Number of Cycles:	8
Sample Preparation:	Prepared dense by tamping 25 times in 5 layers.	Cyclic Stress Ratio:	0.144
		Number of Cycles to Liq:	8
		Maximum ru:	0.97
Prepared by:	J.Hubler		
Checked by:	J.Hubler		

Additional Comments:

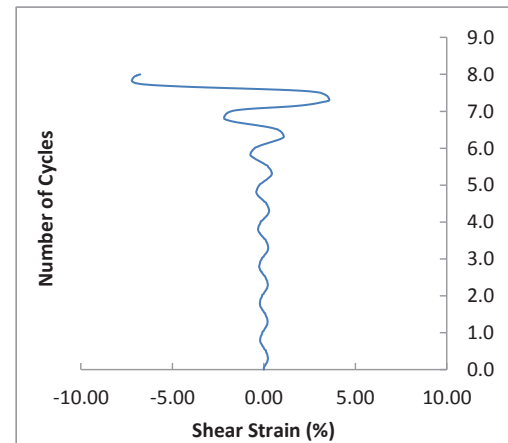
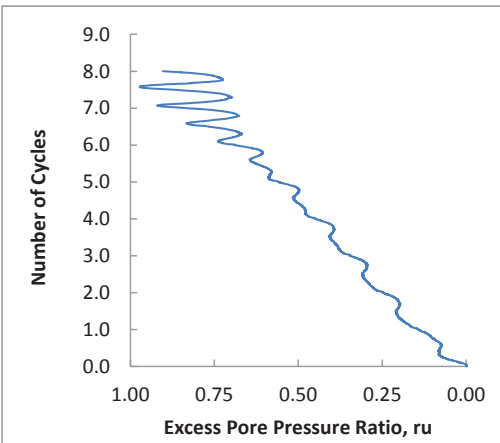
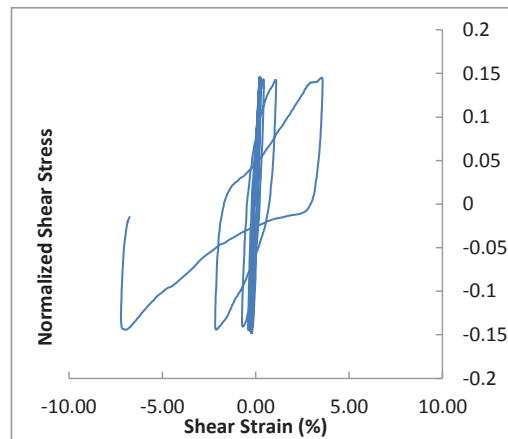
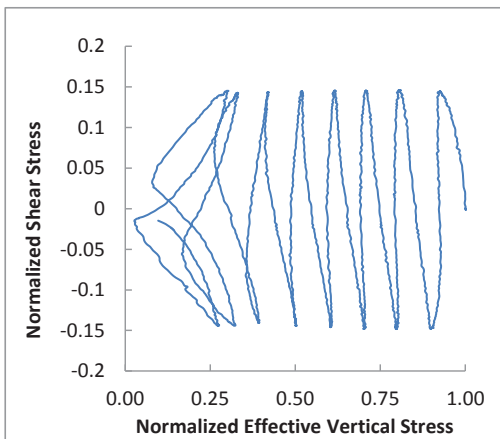

CSS Monotonic Shear Test Report

Geotechnical Engineering Laboratory



10/28/2013_Version 8.0

General Test Info and Sample Preparation

Device:	CSS	Relative Density (%):	82%
Specimen ID:	PGL	Void Ratio:	0.610
Test ID:	C281	Height (mm):	110.2
Date of Test:	9/5/2016	Soil-Only Specimen Diameter (mm):	306.23
Test Performed:	Post Cyclic Monotonic Shear	Weight (kg):	13.812
Test Material:	Pea Gravel	Density (kg/m³):	1701.9
Sample Preparation:	Prepared dense by tamping 25x in 5 layers.	Membrane Thickness (mm):	0.635
		Moisture Content (%):	0%
		Saturated (Y/N):	N
		Prepared by:	J. Hubler
		Checked by:	J. Hubler

Consolidation Stage

Vertical Stress (kPa):	100
Time to Compression (min):	3.0
Relative Density (%):	90%
Void Ratio:	0.594
Height (mm):	109.1
Diameter (mm):	306.23
Weight (kg):	13.812
Density (kg/m³):	1719.4

Shear Stage

Type of Test:	Constant Volume
Stress or Strain Controlled:	Strain
Shear Strain Rate (%/min):	0.30
Peak Shear Strength (kPa):	72.6

Comments

Consolidation Data is for post-liquefaction reloading.

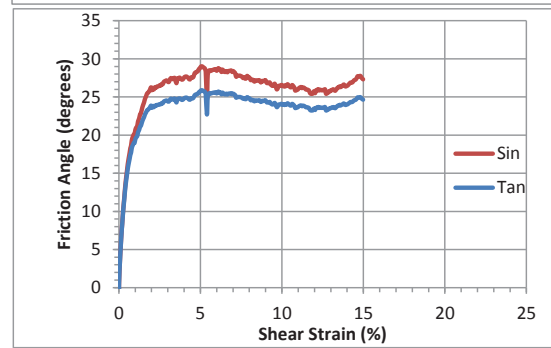
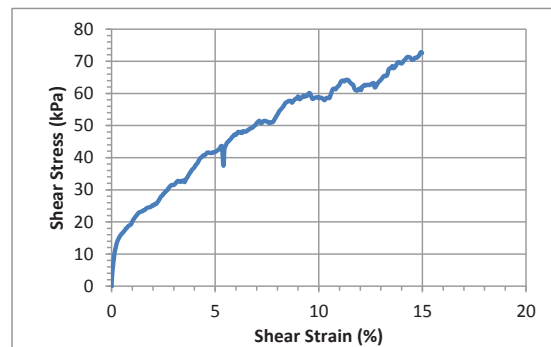
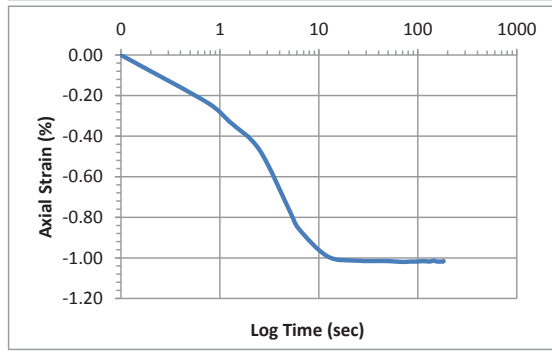
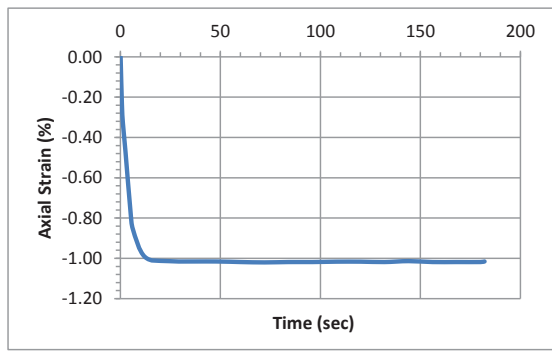

Accelerometer-Based Shear Wave Velocity Datasheet

Specimen ID: C281-100PG-100-3X
 Test Material: 100PG
 Date: 8/16/16
 Test Performed by: J. Hubler
 Filename: C281-100PG-100-3X

Vertical Stress: 100kPa
 Sensor Spacing: 0.1095 m
 V_s (rise) = 182 m/s

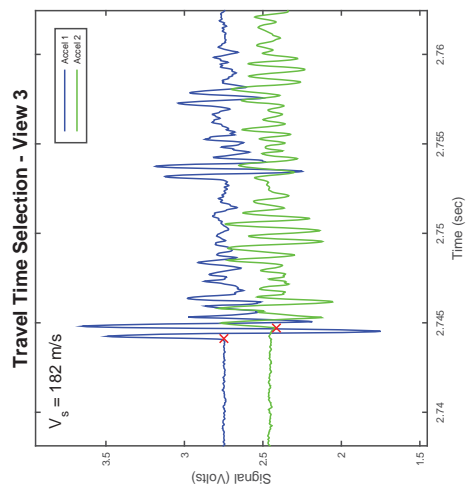
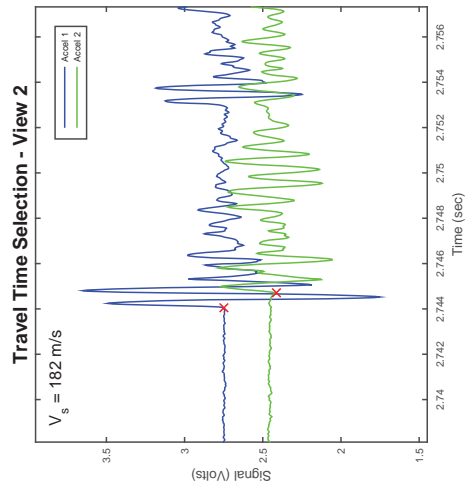
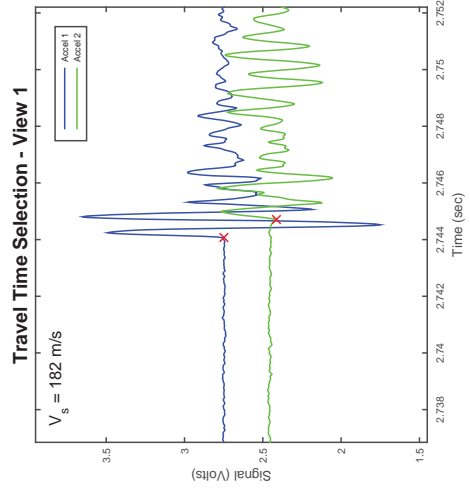
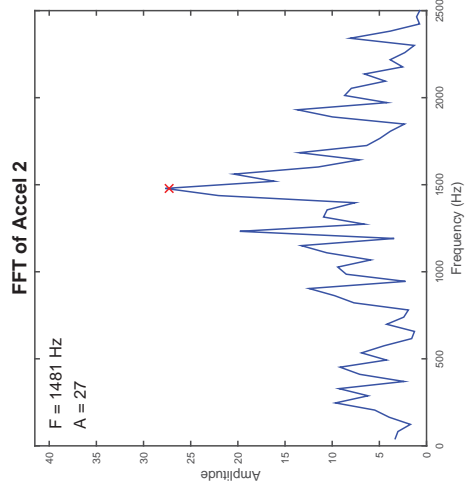
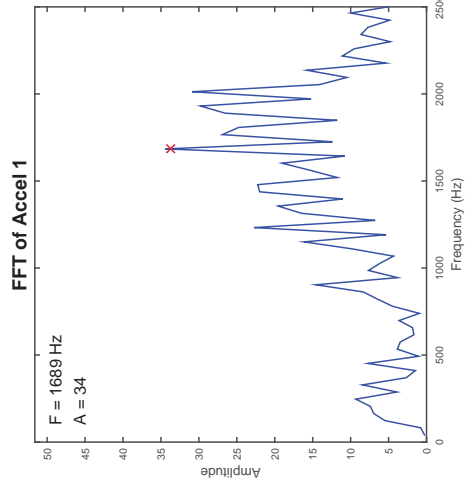
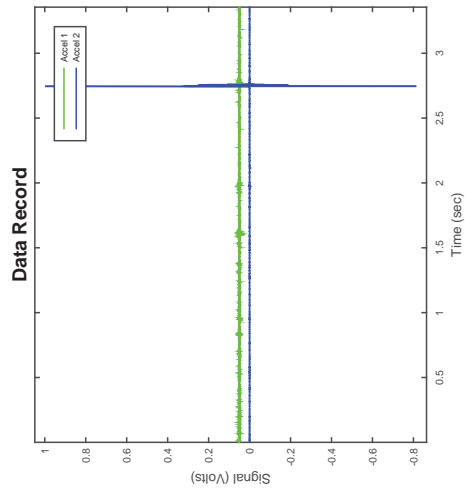

Accelerometer-Based Shear Wave Velocity Datasheet

Specimen ID: C281-100PG-100-3XP
 Test Material: 100PG
 Date: 8/16/16
 Test Performed by: J. Hubler
 Filename: C281-100PG-100-3XP

Vertical Stress: 100kPa
 Sensor Spacing: 0.10838 m
 V_s (rise) = 184 m/s

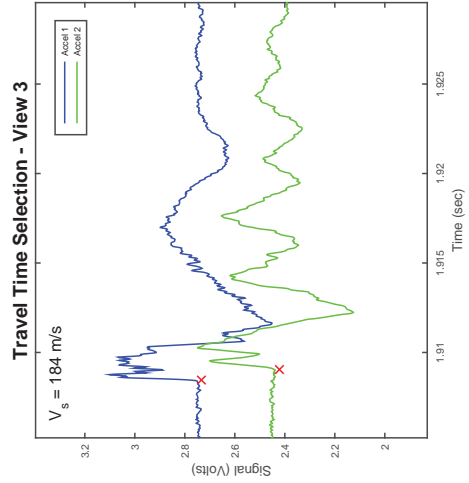
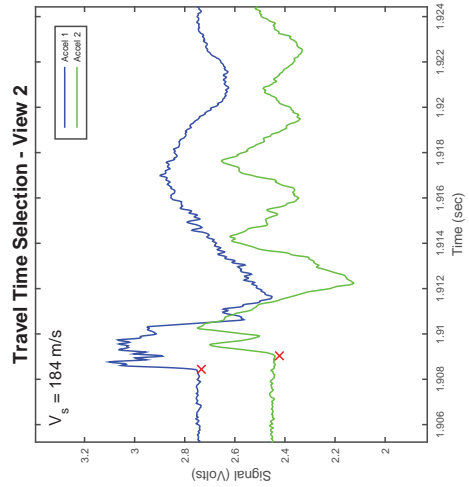
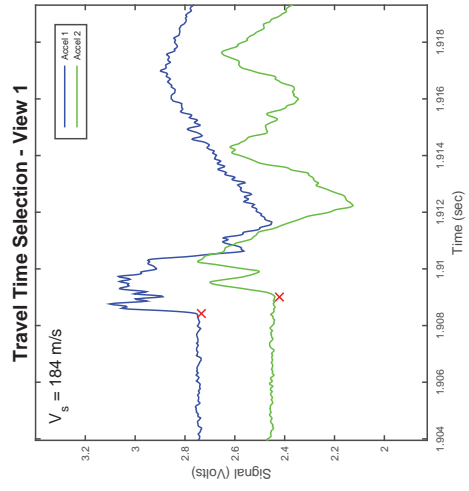
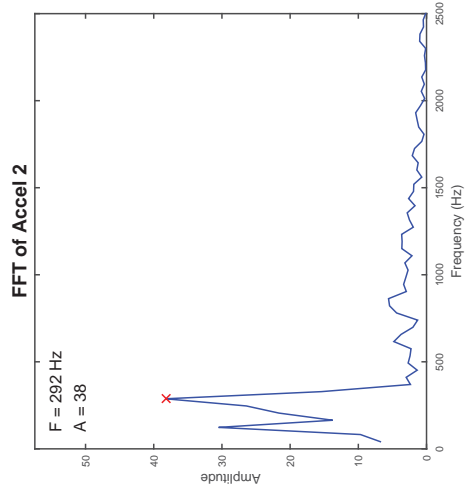
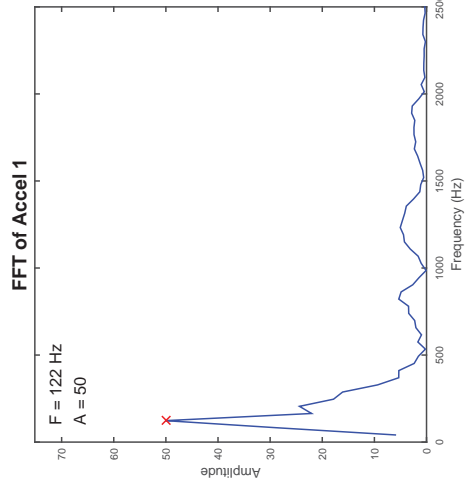
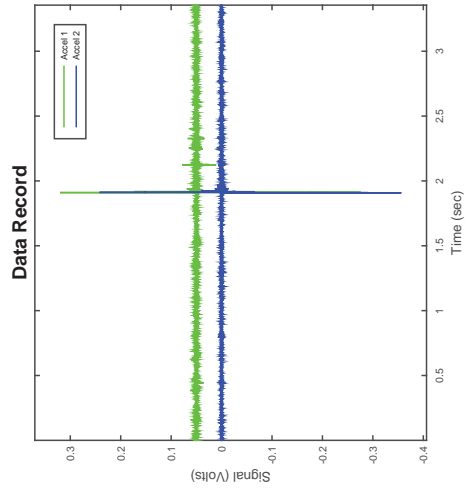

Accelerometer-Based Shear Wave Velocity Datasheet

Specimen ID: C281-100PG-100-4XP
 Test Material: 100PG
 Date: 8/16/16
 Test Performed by: J.Hubler
 Filename: C281-100PG-100-4XP

Vertical Stress: 100kPa
 Sensor Spacing: 0.10838 m
 V_s (rise) = 172 m/s

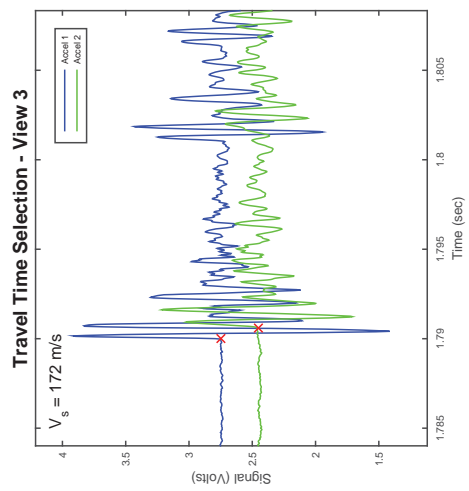
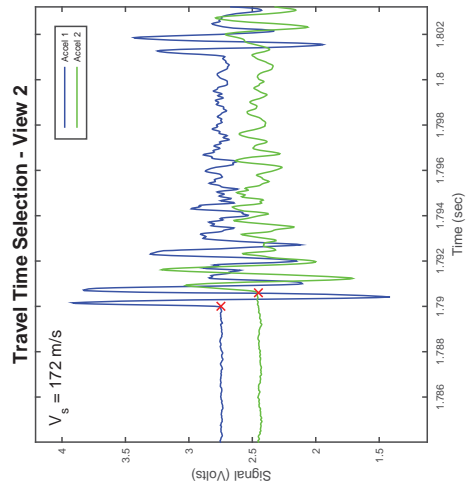
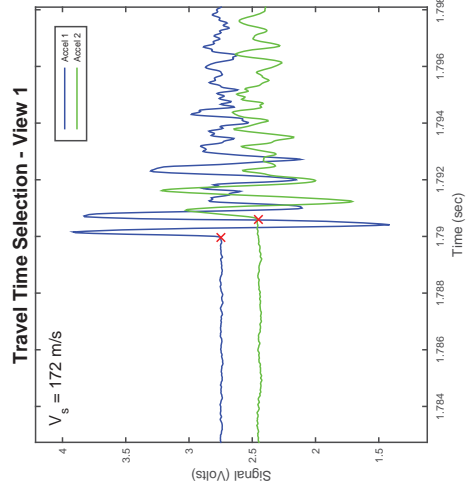
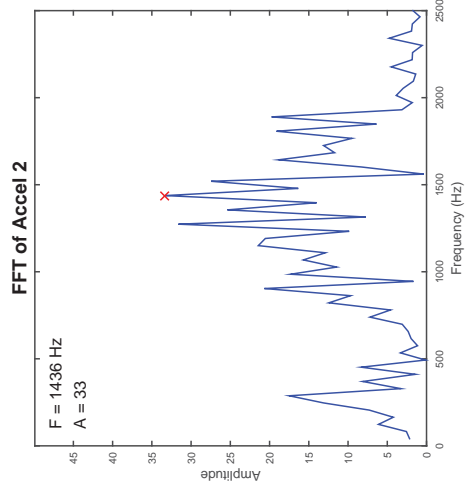
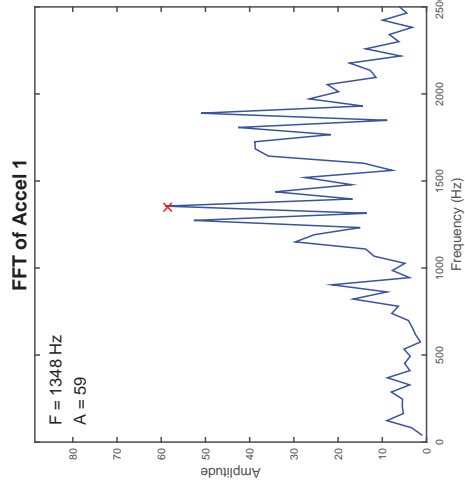
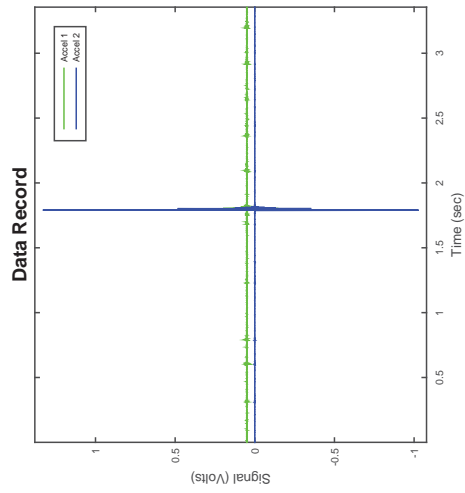

Accelerometer-Based Shear Wave Velocity Datasheet

Specimen ID: C281-100PG-100-5XP
 Test Material: 100PG
 Date: 8/16/16
 Test Performed by: J.Hubler
 Filename: C281-100PG-100-5XP

Vertical Stress: 100kPa
 Sensor Spacing: 0.10838 m
 V_s (rise) = 172 m/s

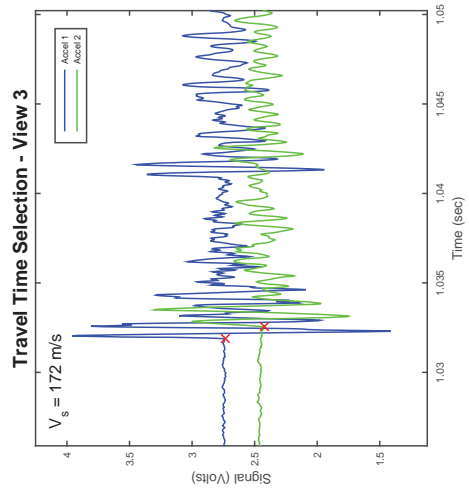
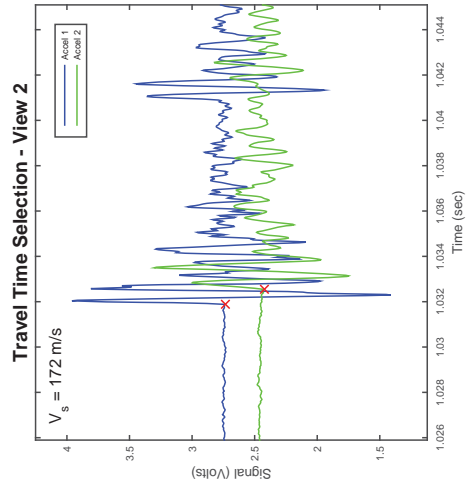
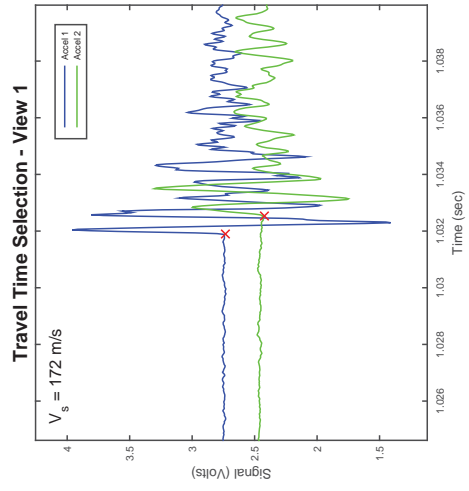
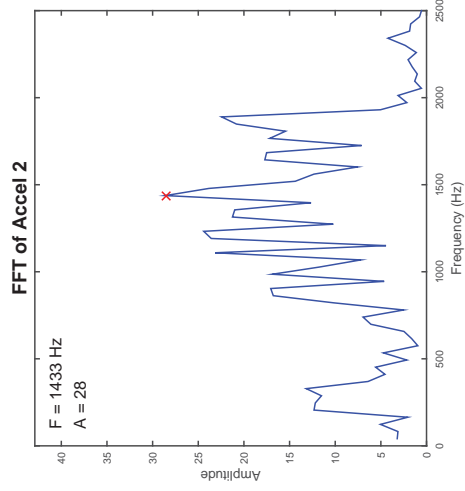
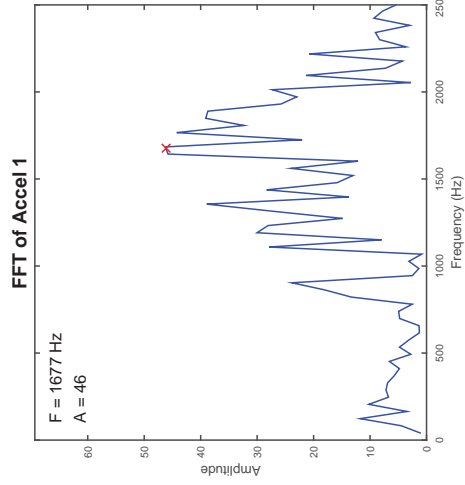
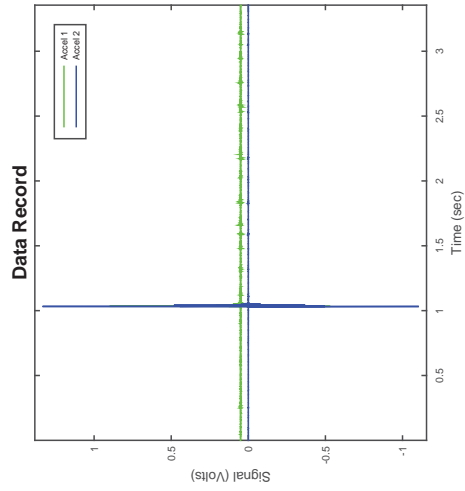

CSS Cyclic Shear Test Report

Geotechnical Engineering Laboratory



Cyclic Shear Test Summary

Device:	CSS	Density (kg/m³):	1759
Specimen ID:	80C109_20LS	Relative Density (%):	46%
Test ID:	C261	Void Ratio:	0.507
Date of Test:	4/11/2016	Vertical Stress (kPa):	100
Test Performed:	Cyclic Shear	Loading Frequency (Hz):	0.33
Test Material:	Ottawa Sand/LS	Number of Cycles:	6
Sample Preparation:	Prepared Loose using a funnel with zero drop height.	Cyclic Stress Ratio:	0.094
		Shear Modulus (kPa):	
		Damping (%):	
Prepared by:	J.Hubler	Shear Strain Single Amplitude (%)	
Checked by:	J.Hubler		

Additional Comments:

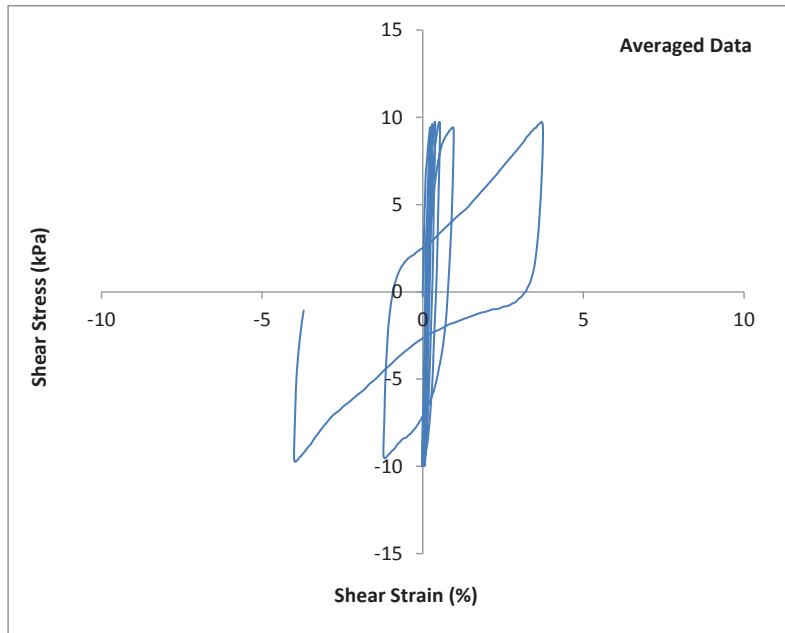
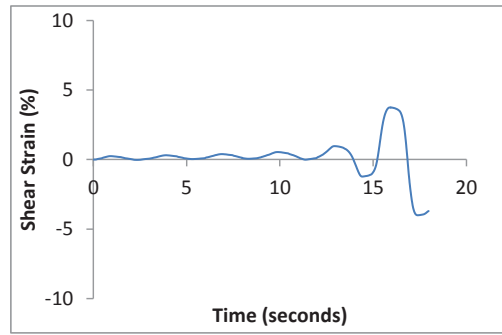
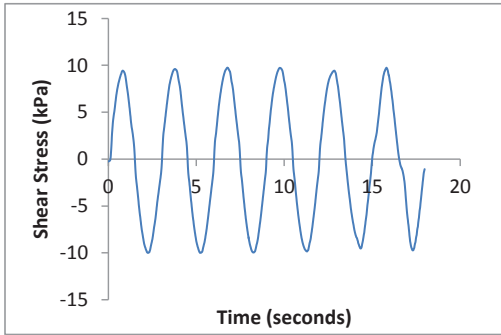

CSS Cyclic Shear Test Report

Geotechnical Engineering Laboratory



Cyclic Shear Test Summary

Device:	CSS	Density (kg/m³):	1759
Specimen ID:	80C109_20LS	Relative Density (%):	46%
Test ID:	C261	Void Ratio:	0.507
Date of Test:	4/11/2016	Vertical Stress (kPa):	100
Test Performed:	Cyclic Shear	Loading Frequency (Hz):	0.33
Test Material:	Ottawa Sand/LS	Number of Cycles:	6
Sample Preparation:	Prepared Loose using a funnel with zero drop height.	Cyclic Stress Ratio:	0.094
		Number of Cycles to Liq:	6
		Maximum ru:	0.99
Prepared by:	J.Hubler		
Checked by:	J.Hubler		

Additional Comments:

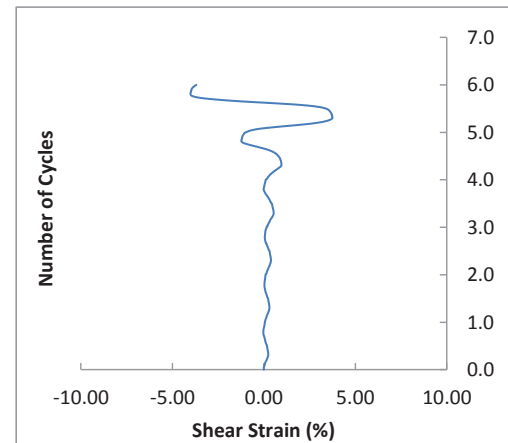
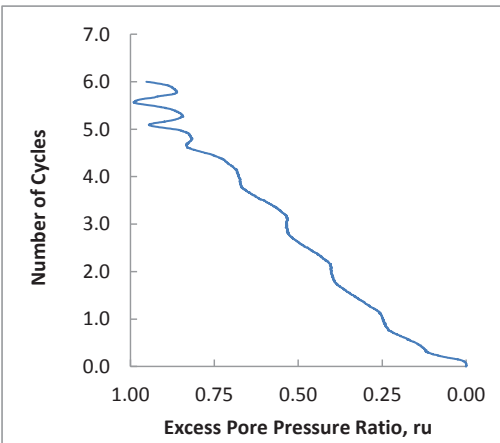
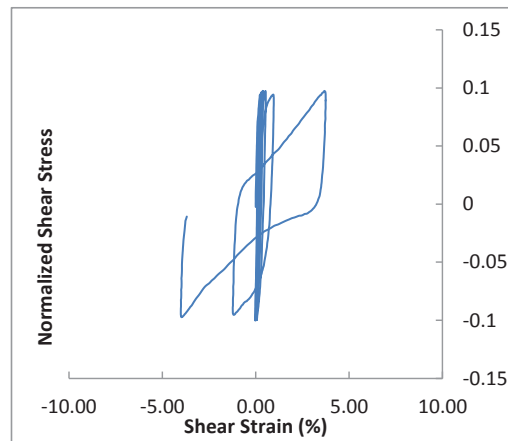
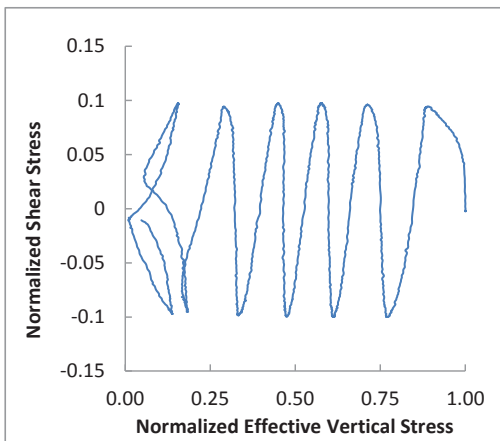

CSS Monotonic Shear Test Report

Geotechnical Engineering Laboratory



10/28/2013_Version 8.0

General Test Info and Sample Preparation

Device:	CSS	Relative Density (%):	28%
Specimen ID:	80C109_20LS	Void Ratio:	0.537
Test ID:	C261	Height (mm):	109.6
Date of Test:	4/11/2016	Soil-Only Specimen Diameter (mm):	306.23
Test Performed:	Post Cyclic Monotonic Shear	Weight (kg):	13.915
Test Material:	Ottawa Sand/Limestone	Density (kg/m³):	1723.9
Sample Preparation:	Prepared loose by placing with a funnel and zero drop height.	Membrane Thickness (mm):	0.635
		Moisture Content (%):	0%
		Saturated (Y/N):	N
		Prepared by:	J. Hubler
		Checked by:	J. Hubler

Consolidation Stage

Vertical Stress (kPa):	100
Time to Compression (min):	6.0
Relative Density (%):	46%
Void Ratio:	0.507
Height (mm):	107.4
Diameter (mm):	306.23
Weight (kg):	13.915
Density (kg/m³):	1758.9

Shear Stage

Type of Test:	Constant Volume
Stress or Strain Controlled:	Strain
Shear Strain Rate (%/min):	0.30
Peak Shear Strength (kPa):	20.0

Comments

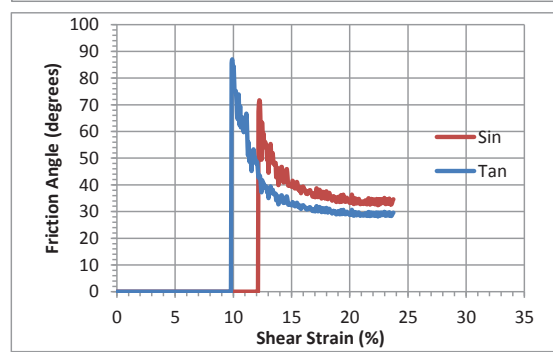
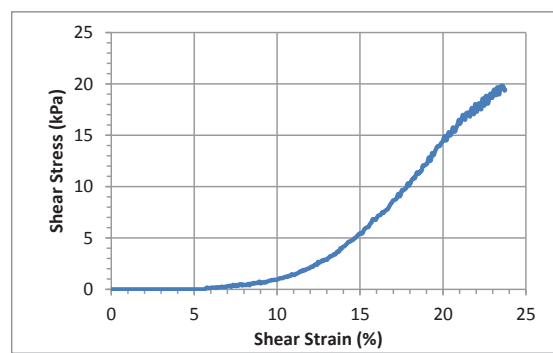
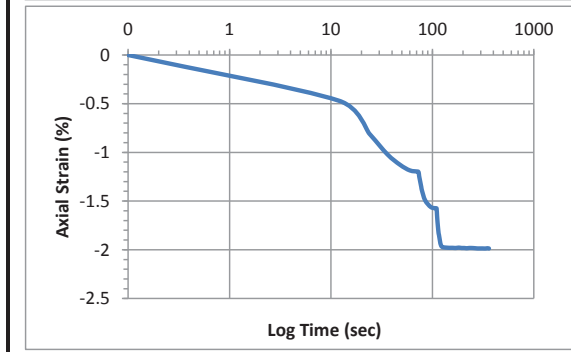
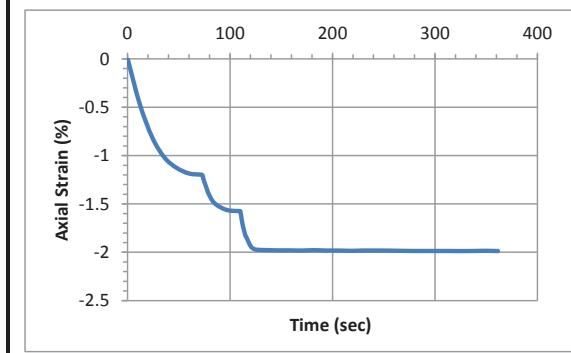

Accelerometer-Based Shear Wave Velocity Datasheet

Specimen ID: C261-LSC109-100-1X
 Test Material: LSC109
 Date: 4/11/2016
 Test Performed by: J.Hubler
 Filename: C261-LSC109-100-1X

Vertical Stress: 100kPa
 Sensor Spacing: 0.10734 m
 V_s (rise) = 197 m/s

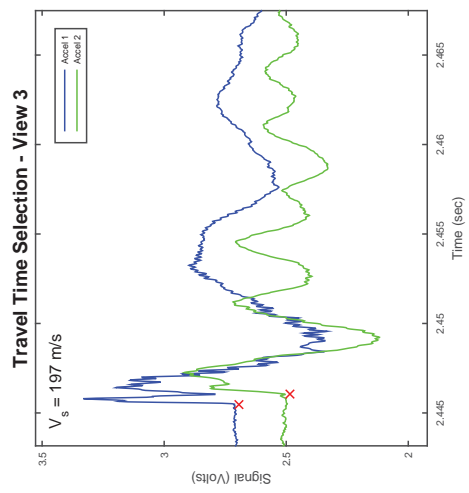
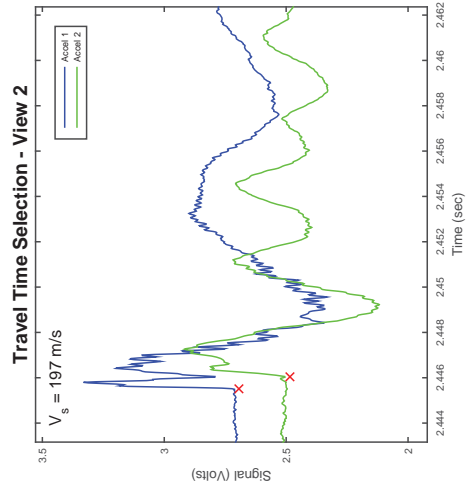
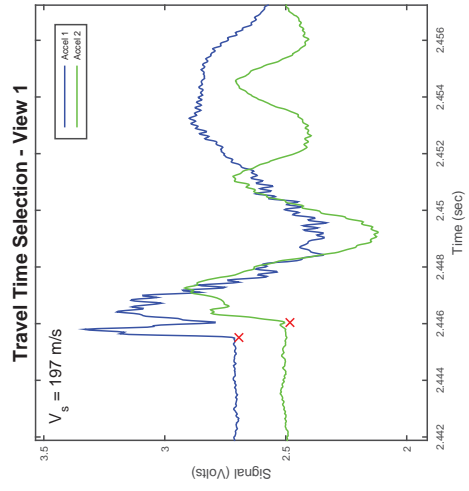
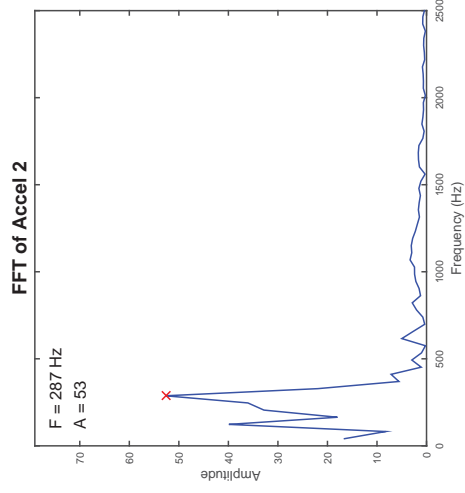
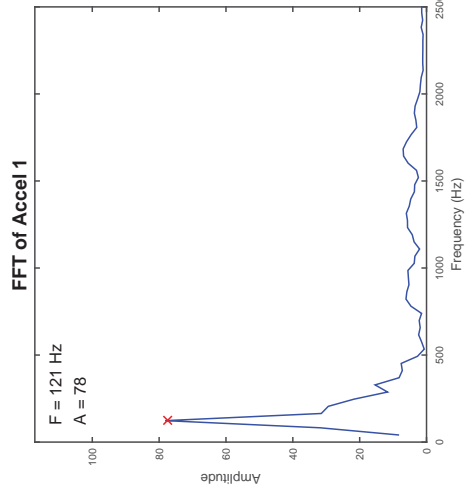
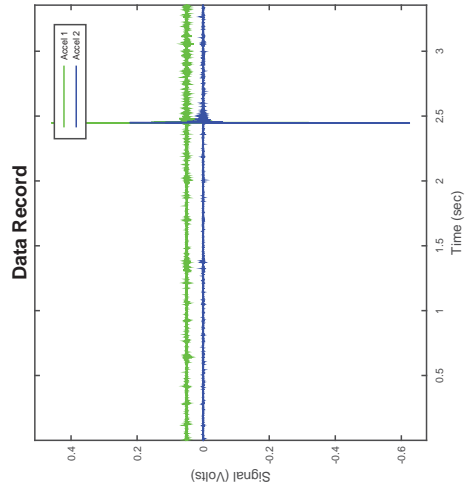

Accelerometer-Based Shear Wave Velocity Datasheet

Specimen ID: C261-LSC109-100-2X
 Test Material: LSC109
 Date: 4/11/2016
 Test Performed by: J.Hubler
 Filename: C261-LSC109-100-2X

Vertical Stress: 100kPa
 Sensor Spacing: 0.10734 m
 V_s (rise) = 183 m/s

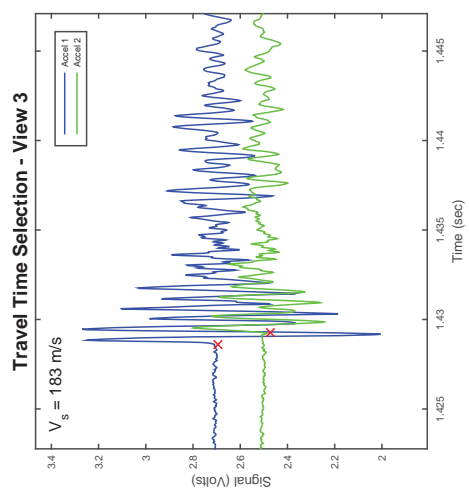
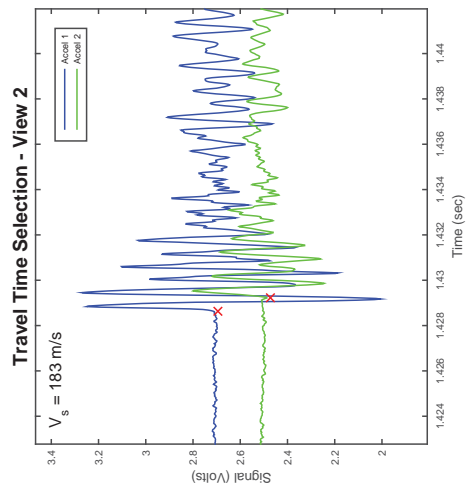
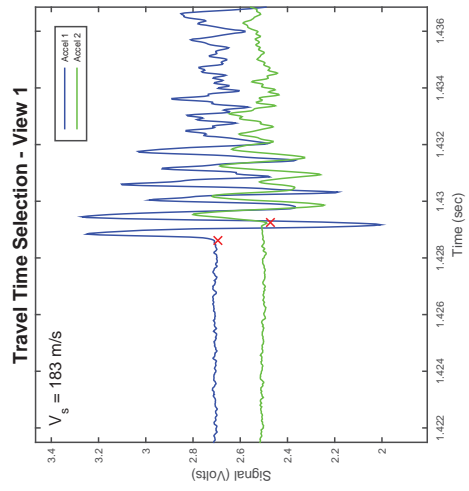
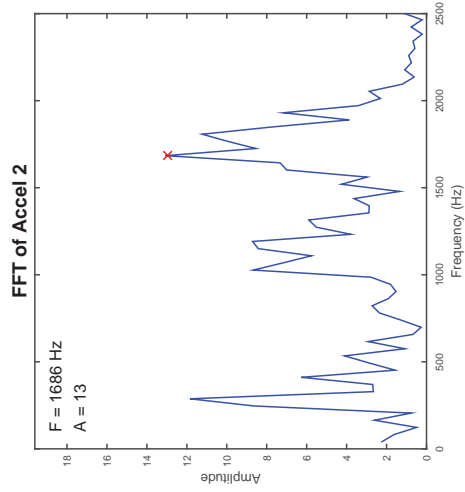
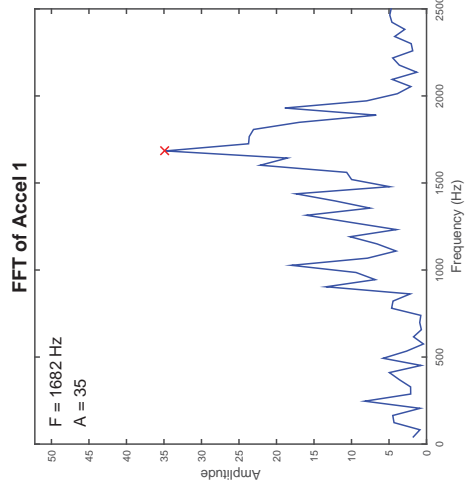
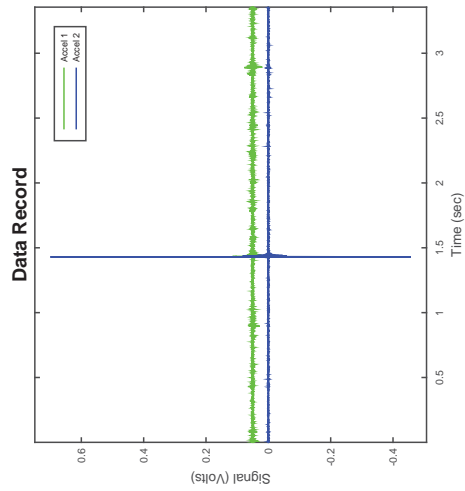

Accelerometer-Based Shear Wave Velocity Datasheet

Specimen ID: C261-LSC109-100-3X
 Test Material: LSC109
 Date: 4/11/2016
 Test Performed by: J. Hubler
 Filename: C261-LSC109-100-3X

Vertical Stress: 100kPa
 Sensor Spacing: 0.10734 m
 V_s (rise) = 183 m/s

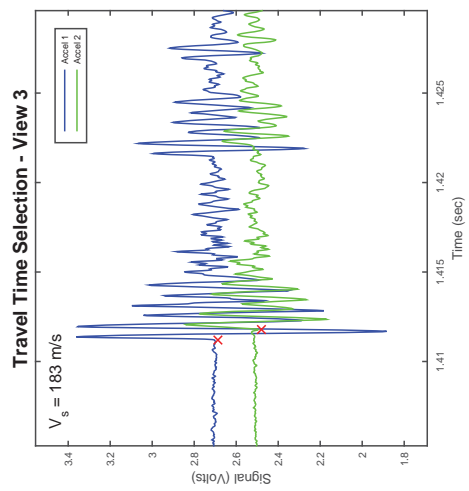
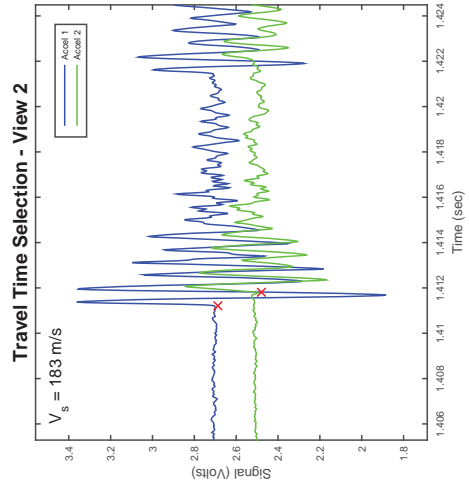
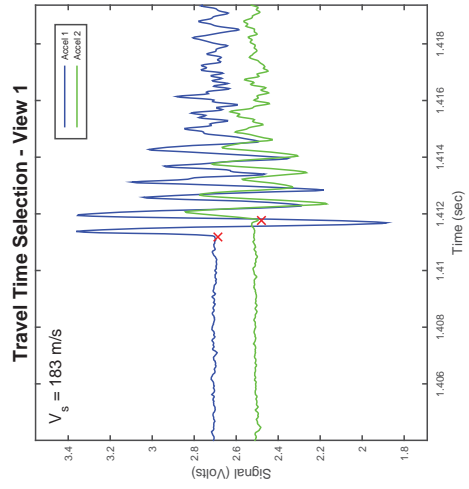
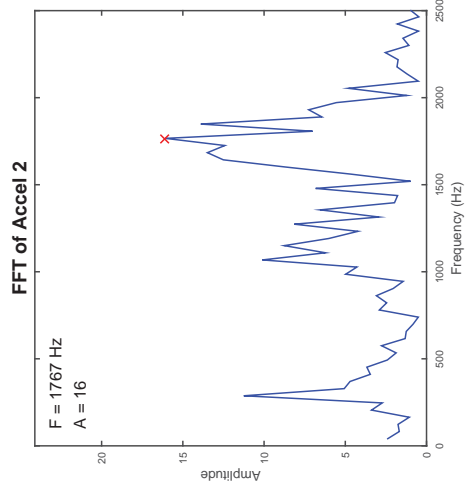
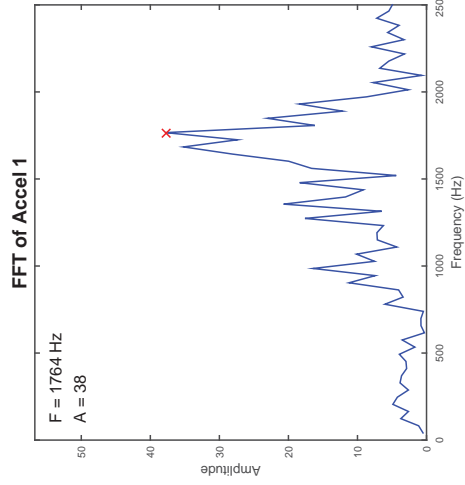
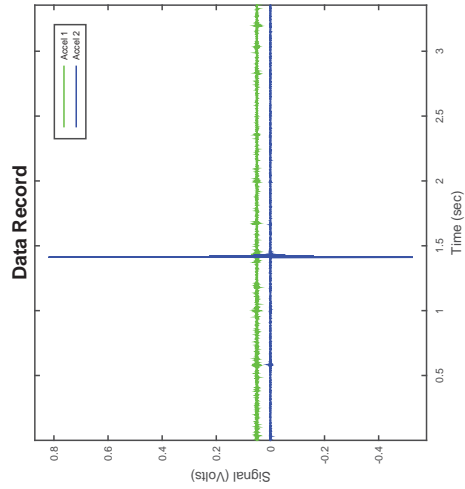

CSS Cyclic Shear Test Report

Geotechnical Engineering Laboratory



Cyclic Shear Test Summary

Device:	CSS	Density (kg/m³):	1755
Specimen ID:	80C109_20LS	Relative Density (%):	44%
Test ID:	C262	Void Ratio:	0.510
Date of Test:	4/11/2016	Vertical Stress (kPa):	100
Test Performed:	Cyclic Shear	Loading Frequency (Hz):	0.33
Test Material:	Ottawa Sand/LS	Number of Cycles:	4
Sample Preparation:	Prepared Loose using a funnel with zero drop height.	Cyclic Stress Ratio:	0.144
		Shear Modulus (kPa):	
		Damping (%):	
Prepared by:	J.Hubler	Shear Strain Single Amplitude (%)	
Checked by:	J.Hubler		

Additional Comments:

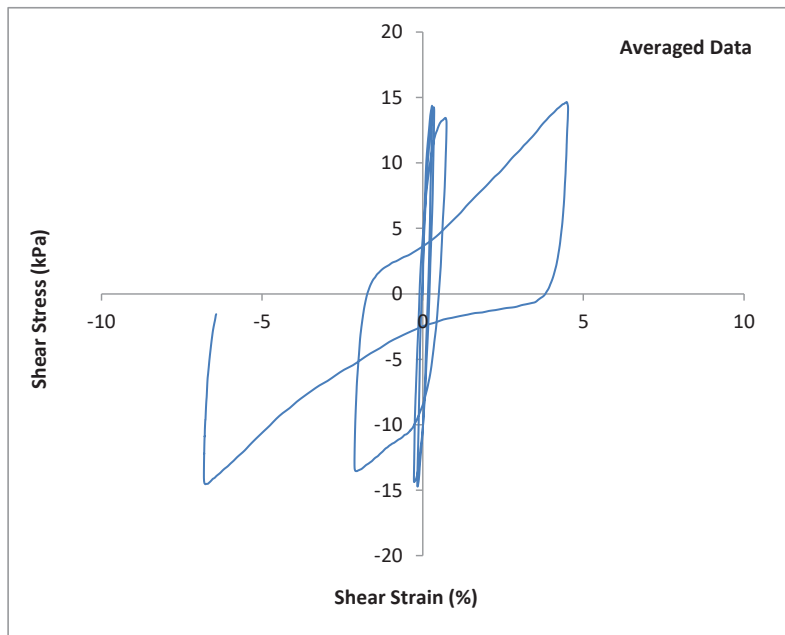
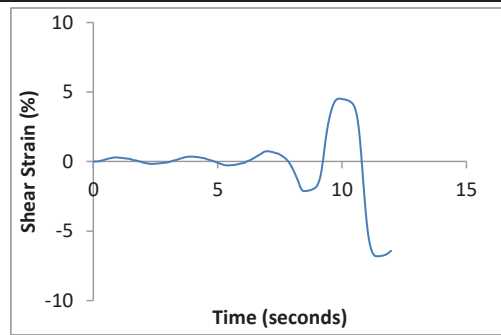
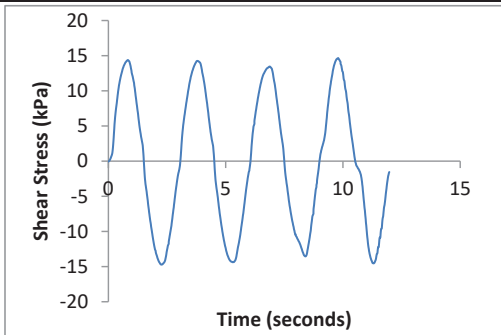

CSS Cyclic Shear Test Report

Geotechnical Engineering Laboratory



Cyclic Shear Test Summary

Device:	CSS	Density (kg/m³):	1755
Specimen ID:	80C109_20LS	Relative Density (%):	44%
Test ID:	C262	Void Ratio:	0.510
Date of Test:	4/11/2016	Vertical Stress (kPa):	100
Test Performed:	Cyclic Shear	Loading Frequency (Hz):	0.33
Test Material:	Ottawa Sand/LS	Number of Cycles:	4
Sample Preparation:	Prepared Loose using a funnel with zero drop height.	Cyclic Stress Ratio:	0.144
		Number of Cycles to Liq:	4
		Maximum ru:	0.99
Prepared by:	J.Hubler		
Checked by:	J.Hubler		

Additional Comments:

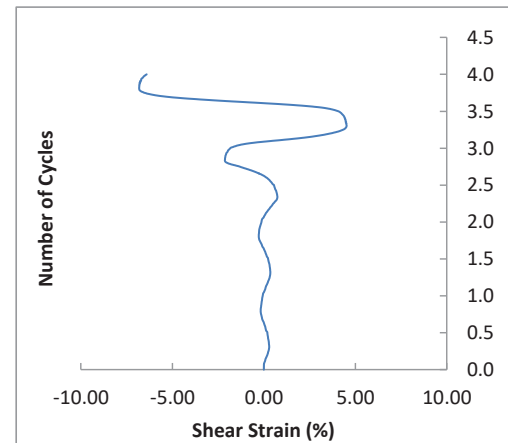
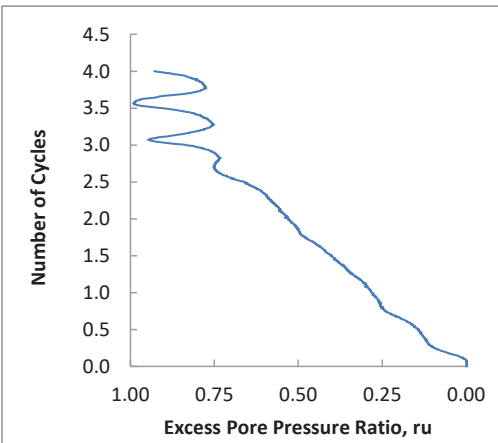
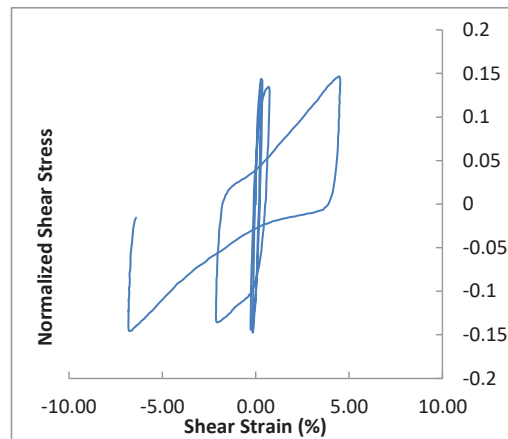
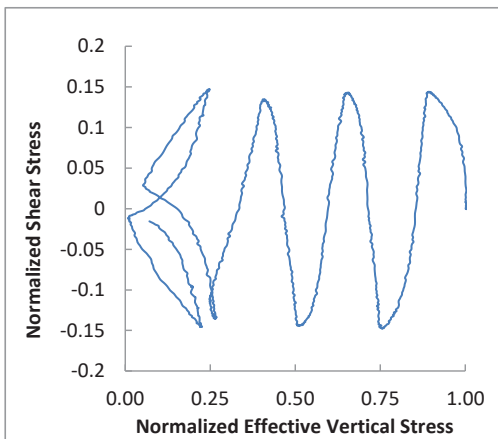

CSS Monotonic Shear Test Report

Geotechnical Engineering Laboratory



10/28/2013_Version 8.0

General Test Info and Sample Preparation

Device:	CSS	Relative Density (%):	44%
Specimen ID:	80C109_20LS	Void Ratio:	0.510
Test ID:	C262	Height (mm):	107.5
Date of Test:	4/11/2016	Soil-Only Specimen Diameter (mm):	306.23
Test Performed:	Post Cyclic Monotonic Shear	Weight (kg):	13.900
Test Material:	Ottawa Sand/Limestone	Density (kg/m³):	1754.9
Sample Preparation:	Prepared loose by placing with a funnel and zero drop height.	Membrane Thickness (mm):	0.635
		Moisture Content (%):	0%
		Saturated (Y/N):	N
		Prepared by:	J.Hubler
		Checked by:	J. Hubler

Consolidation Stage

Shear Stage

Vertical Stress (kPa):	100	Type of Test:	Constant Volume
Time to Compression (min):	1.4	Stress or Strain Controlled:	Strain
Relative Density (%):	55%	Shear Strain Rate (%/min):	0.31
Void Ratio:	0.491	Peak Shear Strength (kPa):	60.0
Height (mm):	106.2	Comments Post Cyclic Reconsol	
Diameter (mm):	306.23		
Weight (kg):	13.900		
Density (kg/m³):	1776.7		

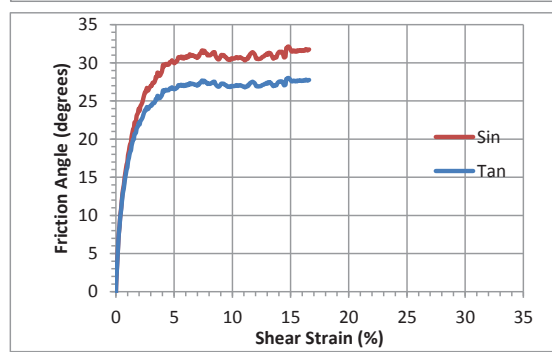
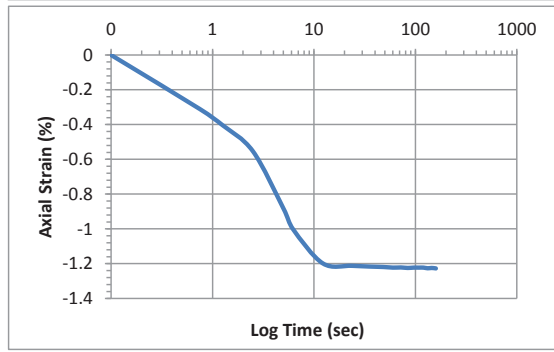
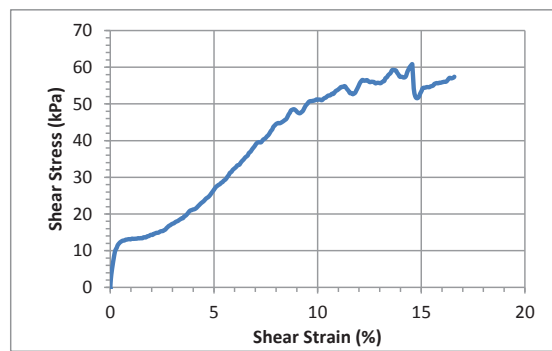
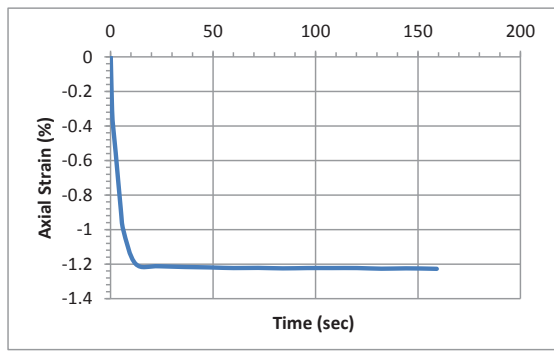

Accelerometer-Based Shear Wave Velocity Datasheet

Specimen ID: C262-LSC109-100-1X
 Test Material: LSC109
 Date: 4/11/2016
 Test Performed by: J.Hubler
 Filename: C262-LSC109-100-1X

Vertical Stress: 100kPa
 Sensor Spacing: 0.10746 m
 V_s (rise) = 194 m/s

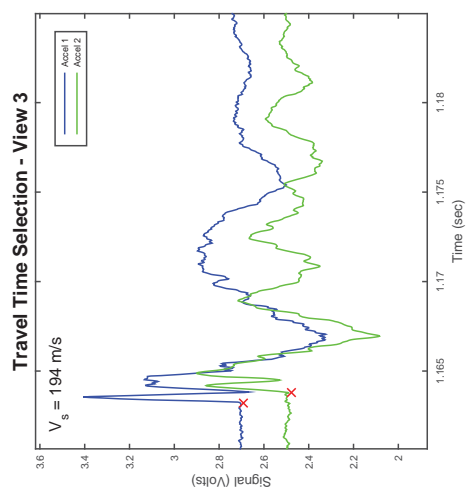
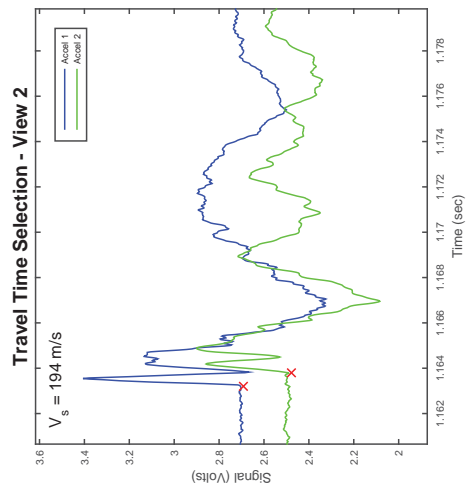
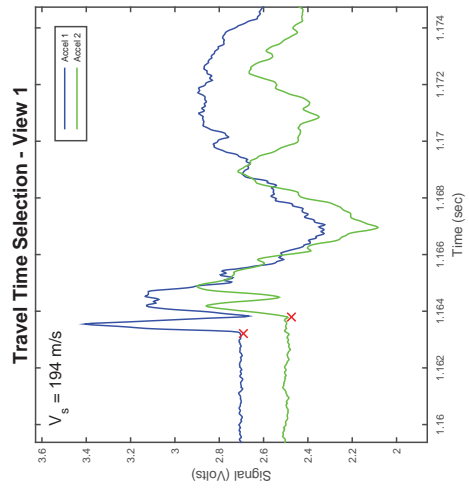
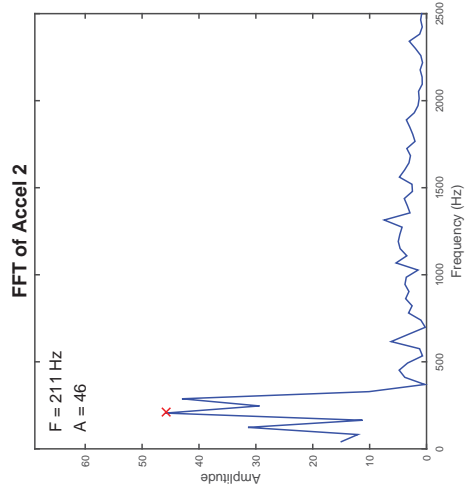
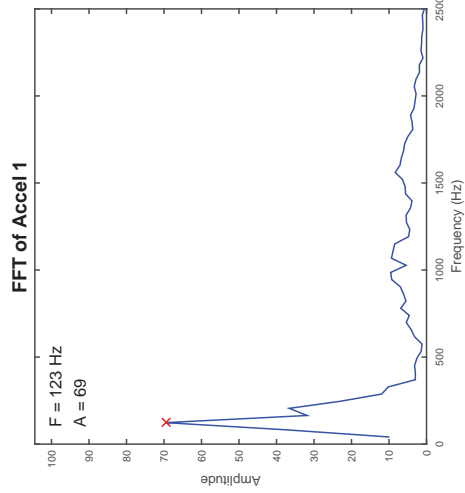
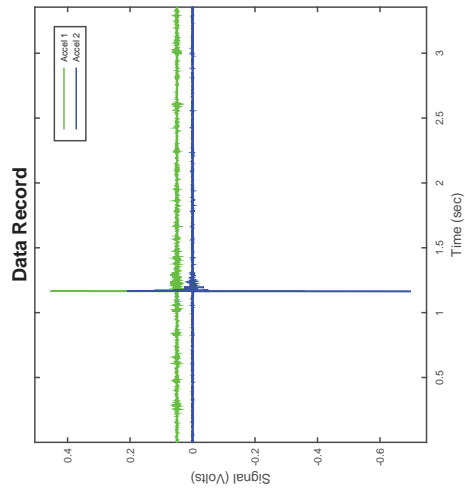

Accelerometer-Based Shear Wave Velocity Datasheet

Specimen ID: C262-LSC109-100-2X
 Test Material: LSC109
 Date: 4/11/2016
 Test Performed by: J.Hubler
 Filename: C262-LSC109-100-2X

Vertical Stress: 100kPa
 Sensor Spacing: 0.10746 m
 V_s (rise) = 184 m/s

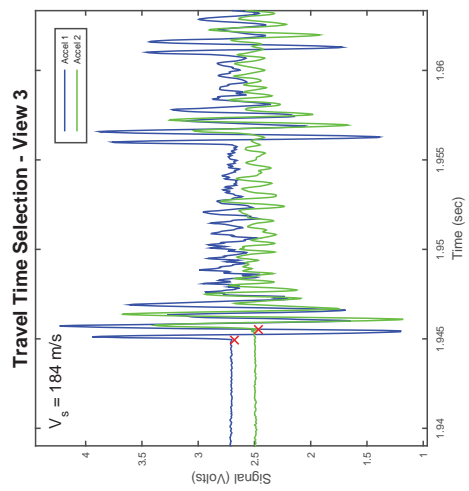
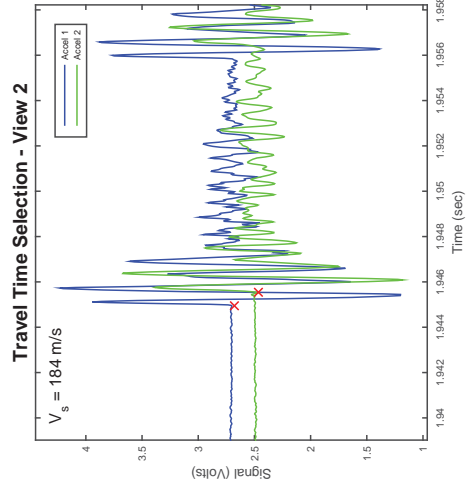
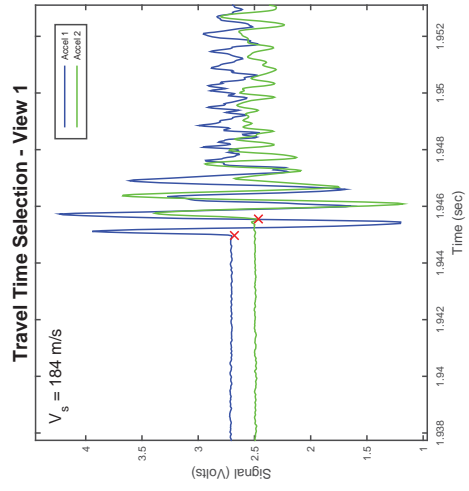
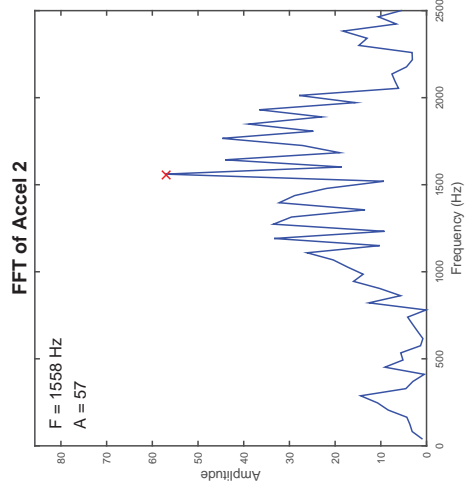
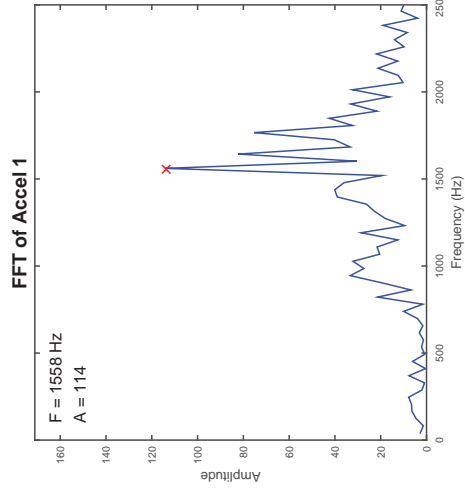
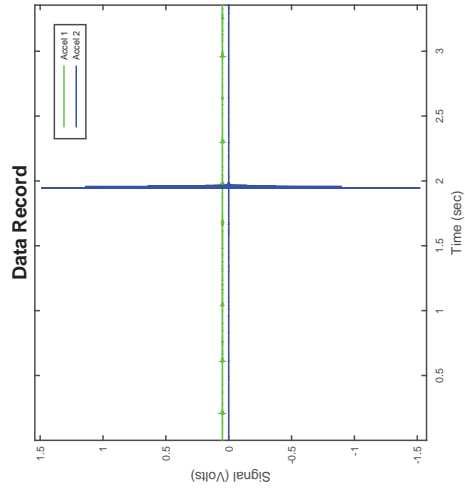

Accelerometer-Based Shear Wave Velocity Datasheet

Specimen ID: C262-LSC109-100-3X
 Test Material: LSC109
 Date: 4/11/2016
 Test Performed by: J.Hubler
 Filename: C262-LSC109-100-3X

Vertical Stress: 100kPa
 Sensor Spacing: 0.10746 m
 V_s (rise) = 190 m/s

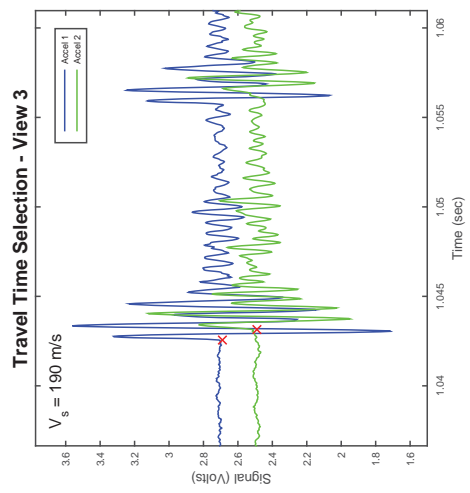
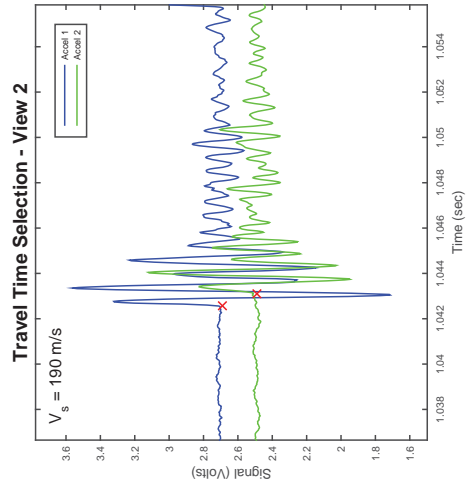
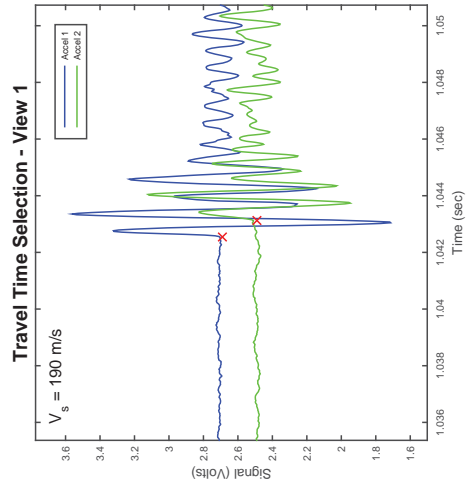
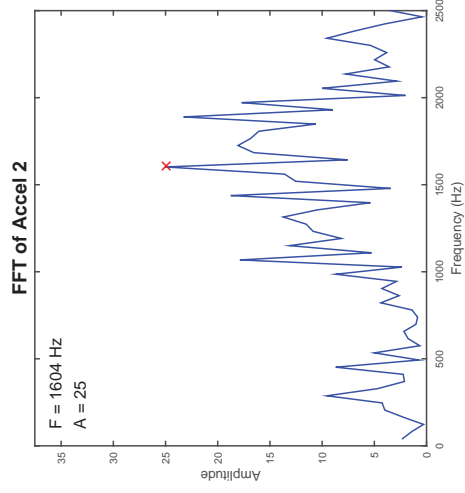
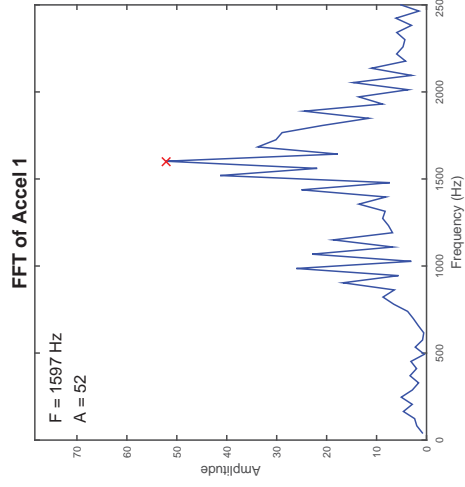
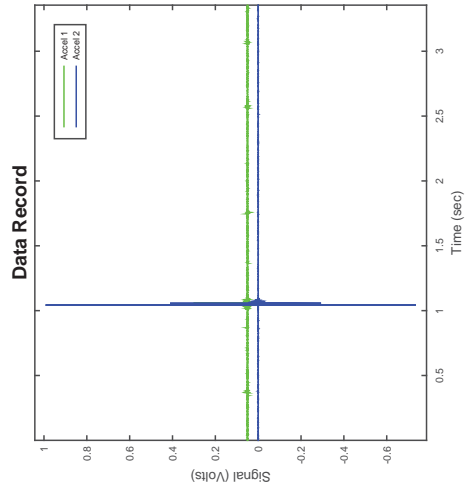

Accelerometer-Based Shear Wave Velocity Datasheet

Specimen ID: C262-LSC109-100-1XP
 Test Material: LSC109
 Date: 4/11/2016
 Test Performed by: J.Hubler
 Filename: C262-LSC109-100-1XP

Vertical Stress: 100kPa
 Sensor Spacing: 0.10614 m
 V_s (rise) = 178 m/s

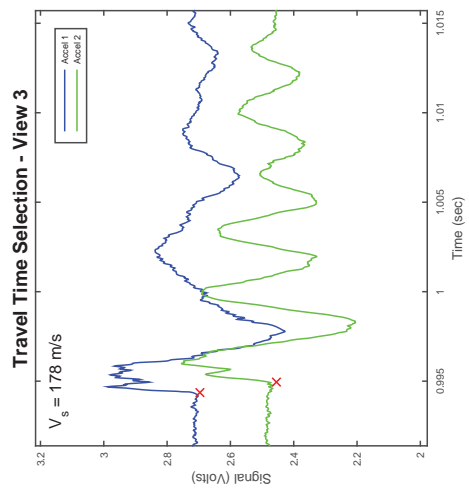
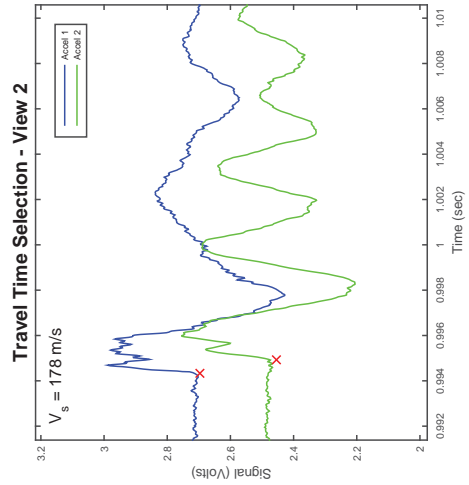
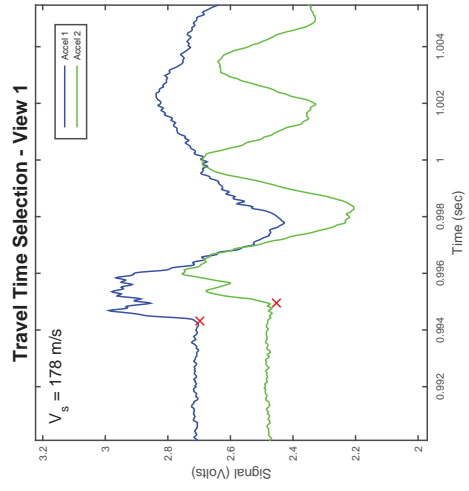
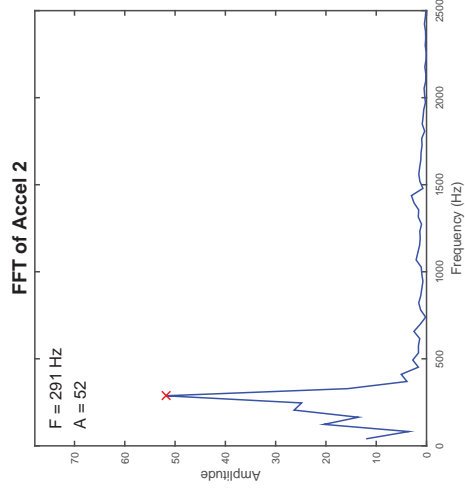
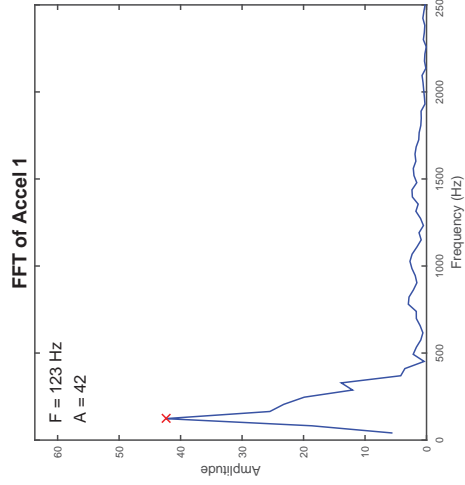
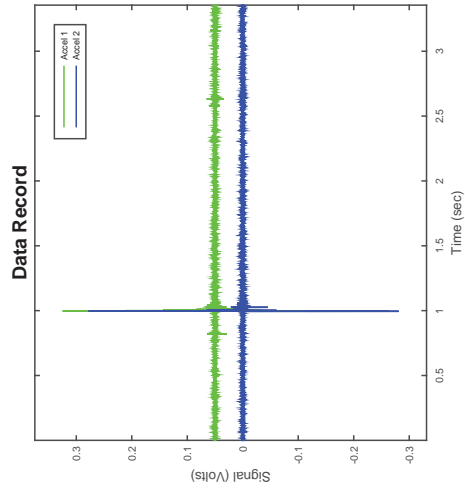

Accelerometer-Based Shear Wave Velocity Datasheet

Specimen ID: C262-LSC109-100-2XP
 Test Material: LSC109
 Date: 4/11/2016
 Test Performed by: J. Hubler
 Filename: C262-LSC109-100-2XP

Vertical Stress: 100kPa
 Sensor Spacing: 0.10614 m
 V_s (rise) = 169 m/s

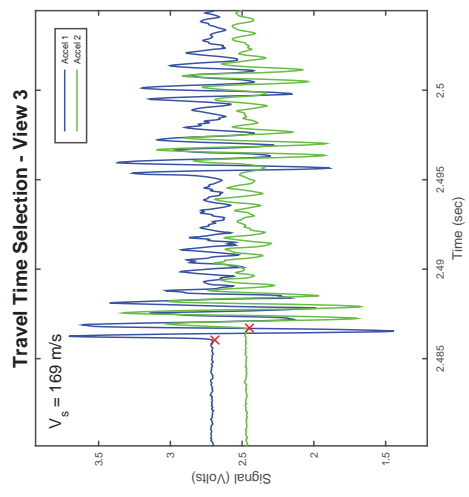
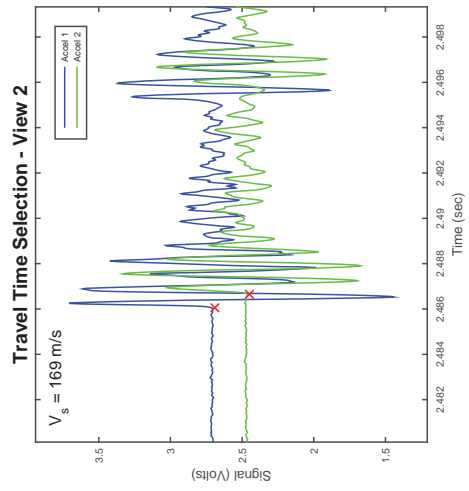
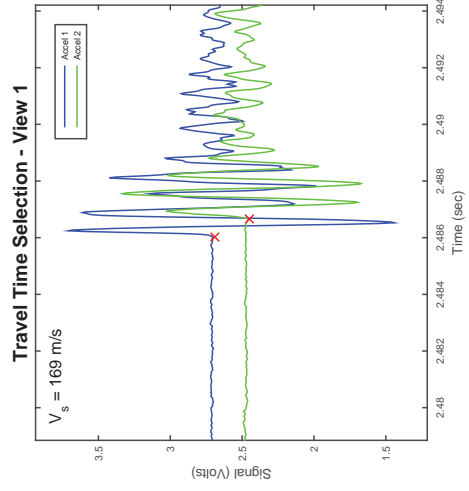
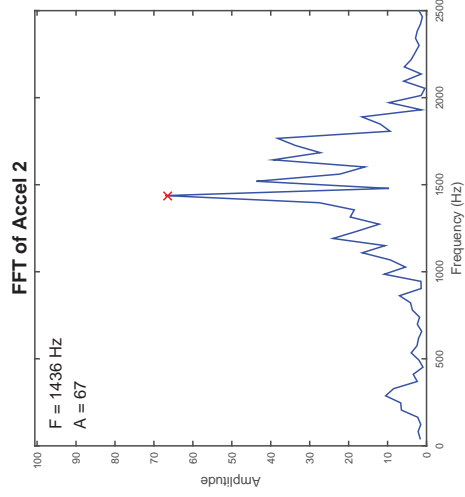
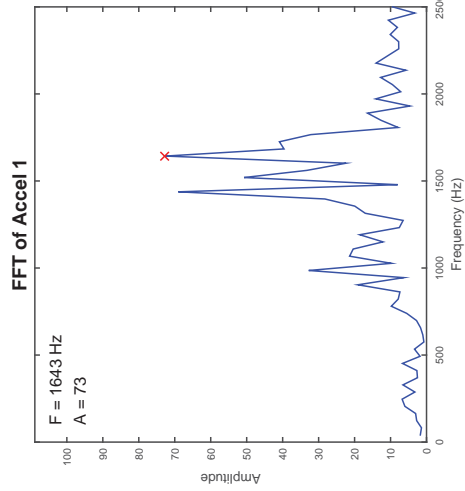
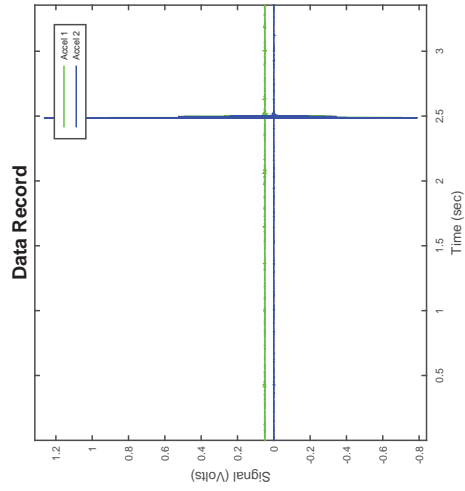

Accelerometer-Based Shear Wave Velocity Datasheet

Specimen ID: C262-LSC109-100-3XP
 Test Material: LSC109
 Date: 4/11/2016
 Test Performed by: J.Hubler
 Filename: C262-LSC109-100-3XP

Vertical Stress: 100kPa
 Sensor Spacing: 0.10614 m
 V_s (rise) = 181 m/s

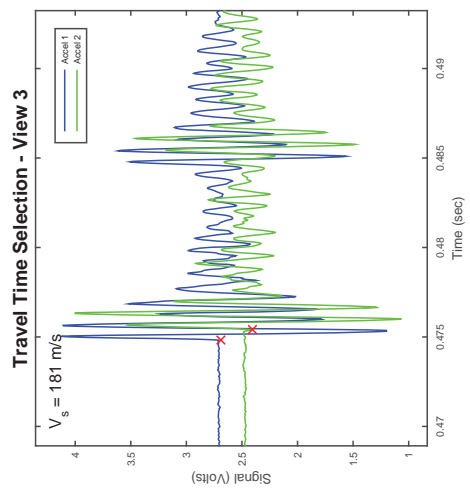
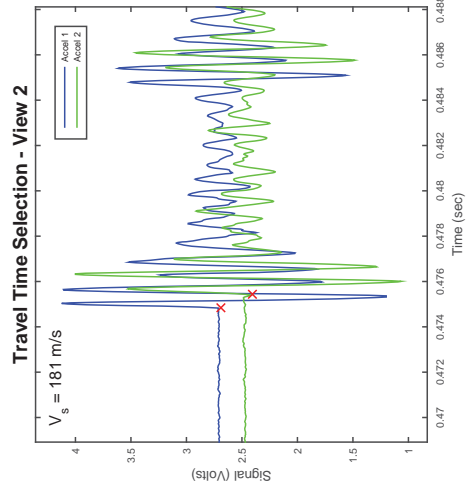
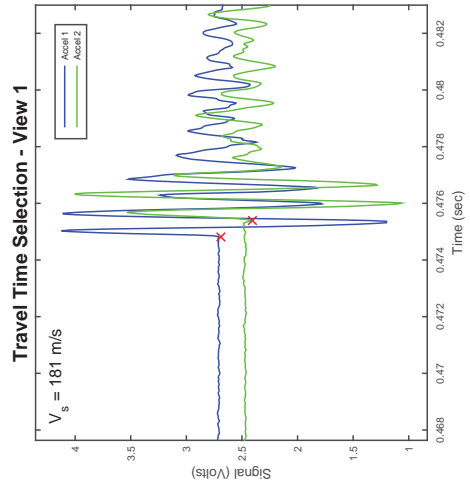
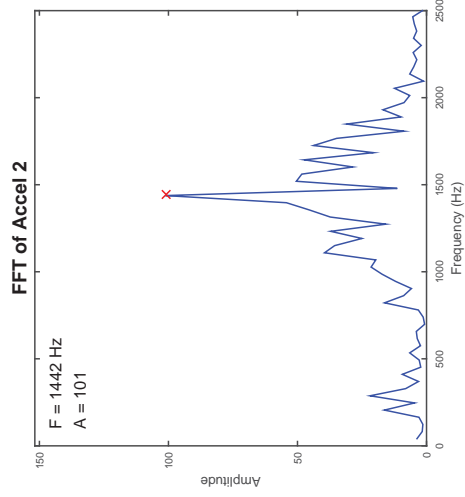
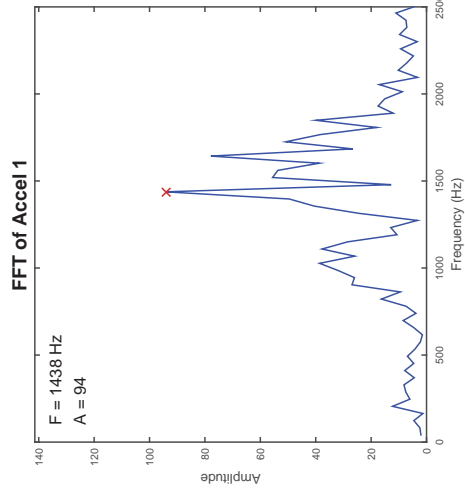
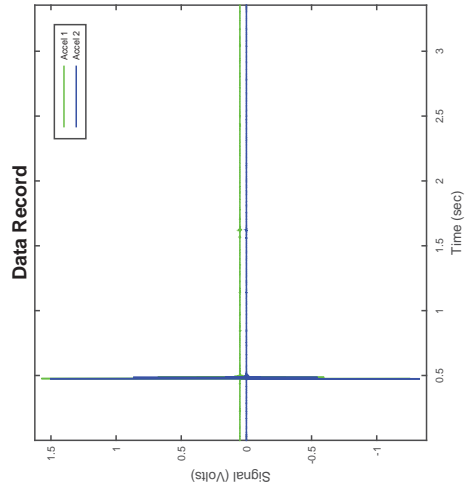

CSS Cyclic Shear Test Report

Geotechnical Engineering Laboratory



Cyclic Shear Test Summary

Device:	CSS	Density (kg/m³):	1759
Specimen ID:	80C109_20LS	Relative Density (%):	46%
Test ID:	C263	Void Ratio:	0.506
Date of Test:	4/12/2016	Vertical Stress (kPa):	100
Test Performed:	Cyclic Shear	Loading Frequency (Hz):	0.33
Test Material:	Ottawa Sand/LS	Number of Cycles:	84
Sample Preparation:	Prepared Loose using a funnel with zero drop height.	Cyclic Stress Ratio:	0.044
		Shear Modulus (kPa):	
		Damping (%):	
Prepared by:	J.Hubler	Shear Strain Single Amplitude (%)	
Checked by:	J.Hubler		

Additional Comments:

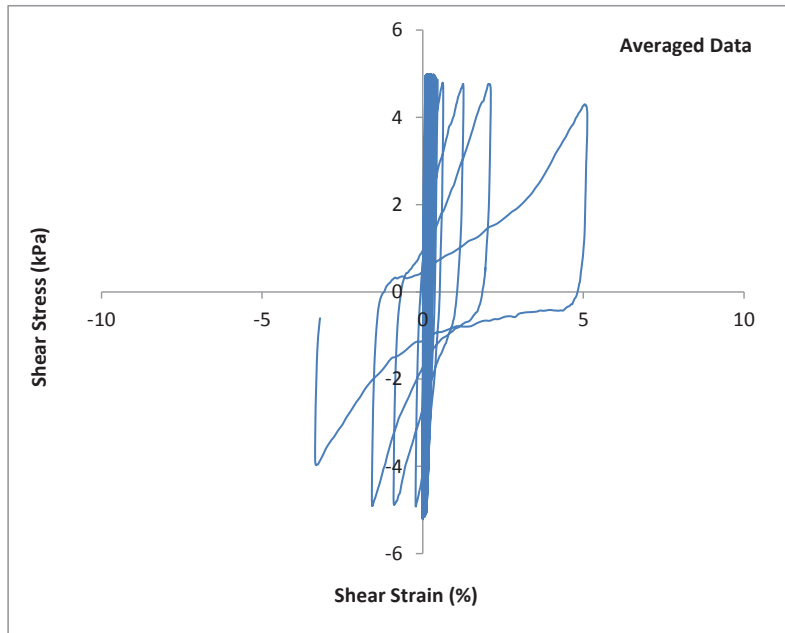
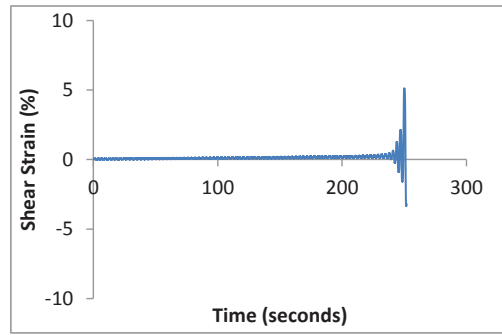
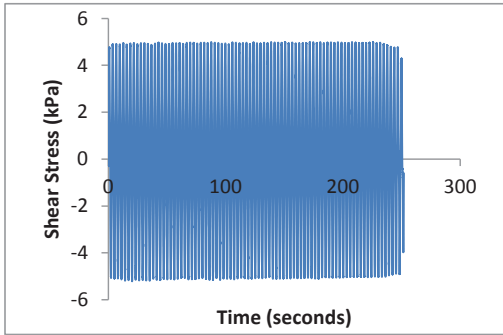

CSS Cyclic Shear Test Report

Geotechnical Engineering Laboratory



Cyclic Shear Test Summary

Device:	CSS	Density (kg/m³):	1759
Specimen ID:	80C109_20LS	Relative Density (%):	46%
Test ID:	C263	Void Ratio:	0.506
Date of Test:	4/12/2016	Vertical Stress (kPa):	100
Test Performed:	Cyclic Shear	Loading Frequency (Hz):	0.33
Test Material:	Ottawa Sand/LS	Number of Cycles:	84
Sample Preparation:	Prepared Loose using a funnel with zero drop height.	Cyclic Stress Ratio:	0.044
		Number of Cycles to Liq:	84
		Maximum ru:	1.01
Prepared by:	J.Hubler		
Checked by:	J.Hubler		

Additional Comments:

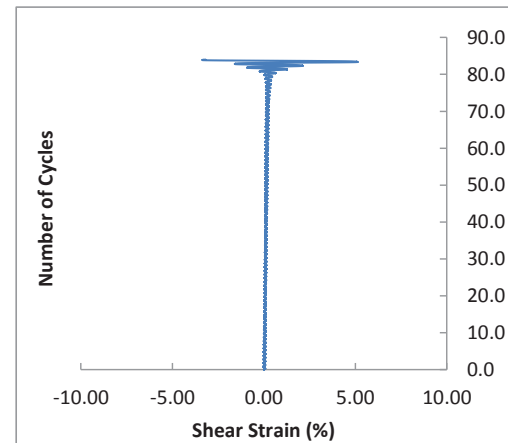
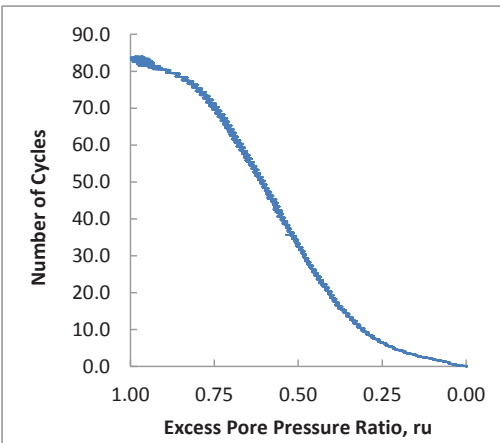
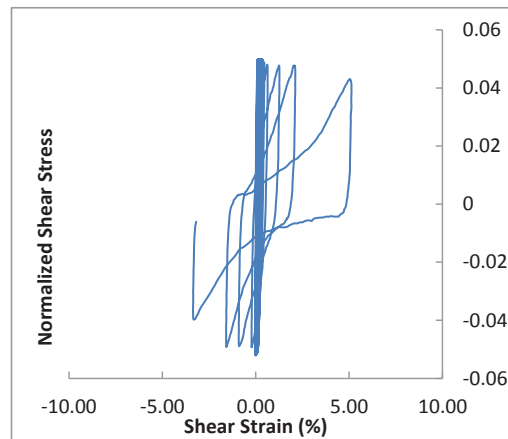
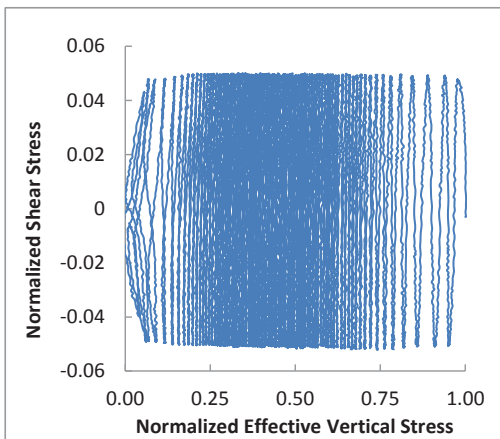

Accelerometer-Based Shear Wave Velocity Datasheet

Specimen ID: C263-LSC109-100-1X
 Test Material: LSC109
 Date: 4/12/2016
 Test Performed by: J.Hubler
 Filename: C263-LSC109-100-1X

Vertical Stress: 100kPa
 Sensor Spacing: 0.10711 m
 V_s (rise) = 183 m/s

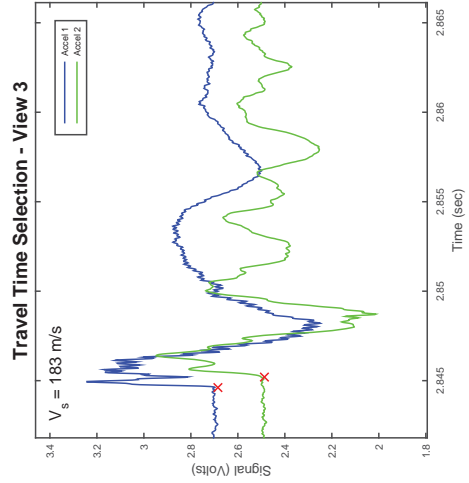
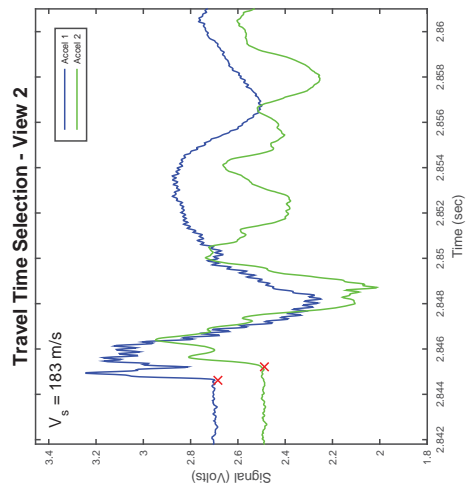
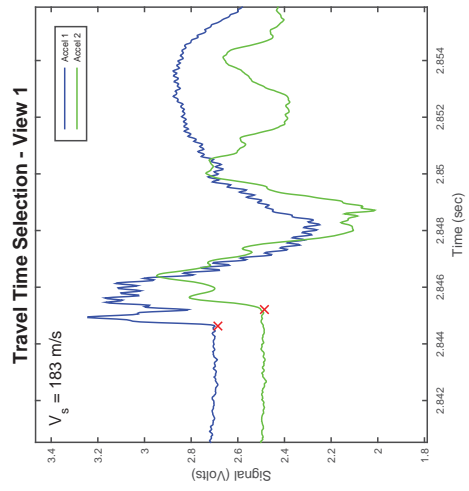
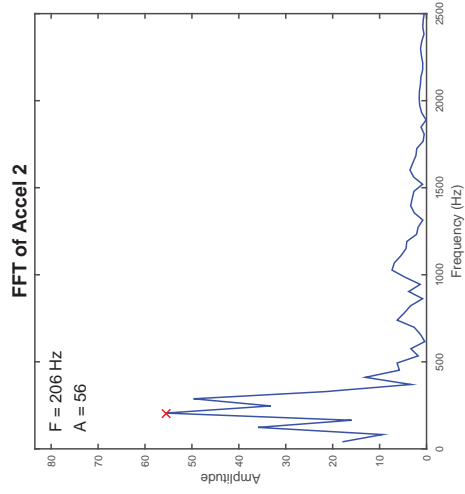
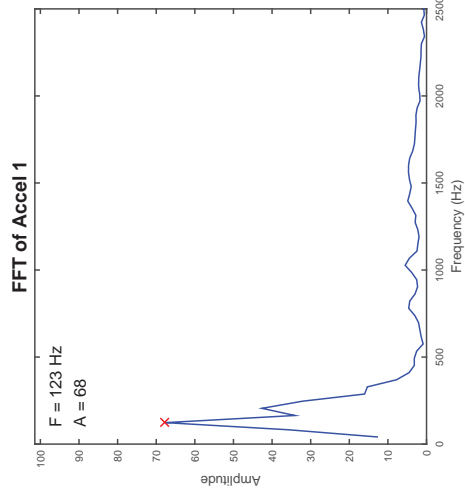
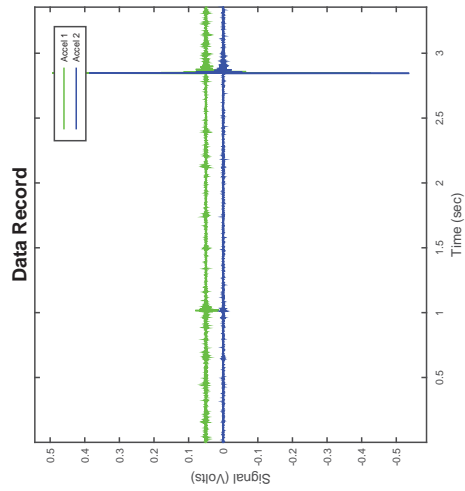

CSS Cyclic Shear Test Report

Geotechnical Engineering Laboratory



Cyclic Shear Test Summary

Device:	CSS	Density (kg/m³):	1852
Specimen ID:	80C109_20LS	Relative Density (%):	90%
Test ID:	C300	Void Ratio:	0.431
Date of Test:	10/26/2016	Vertical Stress (kPa):	100
Test Performed:	Cyclic Shear	Loading Frequency (Hz):	0.33
Test Material:	Ottawa Sand/LS	Number of Cycles:	12
Sample Preparation:	Prepared dense by tamping in 5 layers (30x)	Cyclic Stress Ratio:	0.094
		Shear Modulus (kPa):	
		Damping (%):	
Prepared by:	J.Hubler	Shear Strain Single Amplitude (%)	
Checked by:	J.Hubler		

Additional Comments:

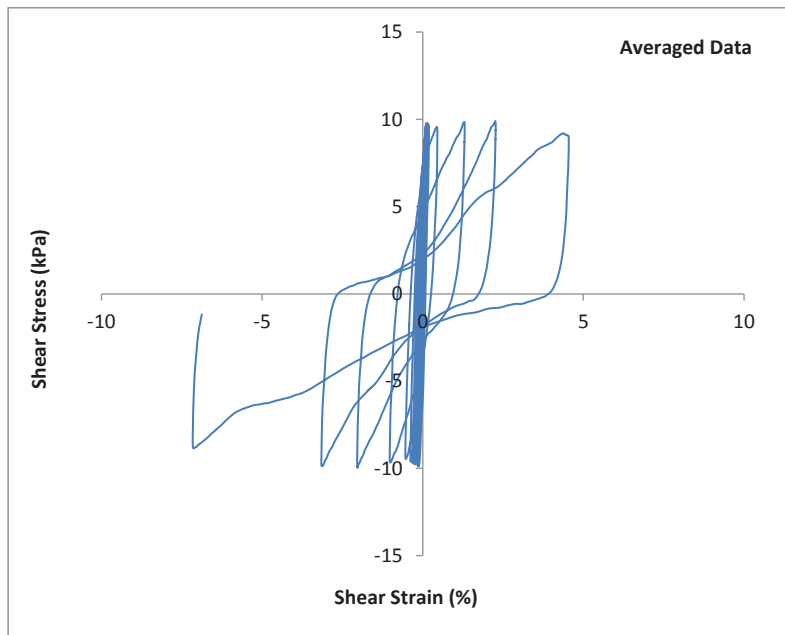
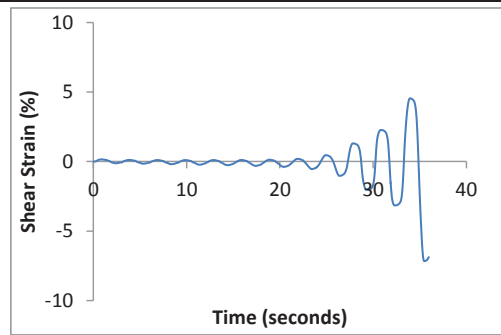
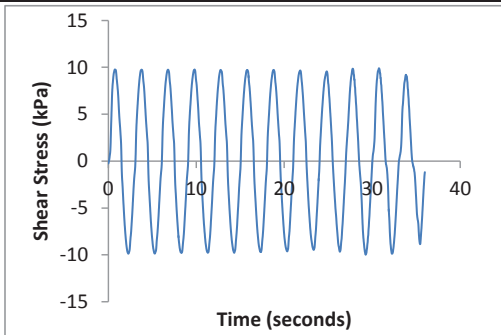

CSS Cyclic Shear Test Report

Geotechnical Engineering Laboratory



Cyclic Shear Test Summary

Device:	CSS	Density (kg/m³):	1852
Specimen ID:	80C109_20LS	Relative Density (%):	90%
Test ID:	C300	Void Ratio:	0.431
Date of Test:	10/26/2016	Vertical Stress (kPa):	100
Test Performed:	Cyclic Shear	Loading Frequency (Hz):	0.33
Test Material:	Ottawa Sand/LS	Number of Cycles:	12
Sample Preparation:	Prepared dense by tamping in 5 layers (30x)	Cyclic Stress Ratio:	0.094
		Number of Cycles to Liq:	12
		Maximum ru:	0.99
Prepared by:	J.Hubler		
Checked by:	J.Hubler		

Additional Comments:

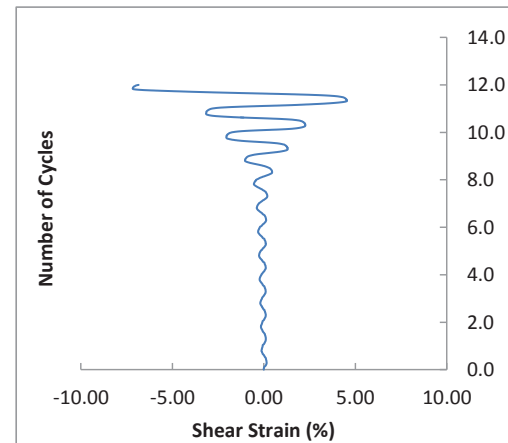
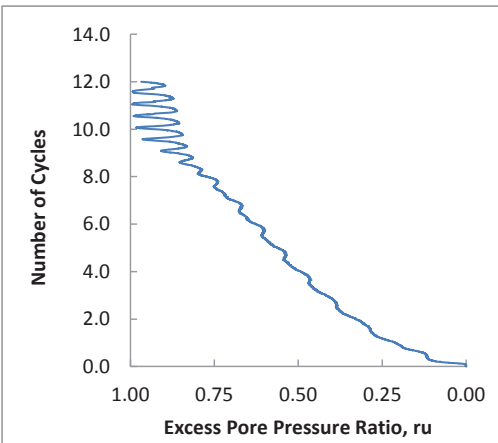
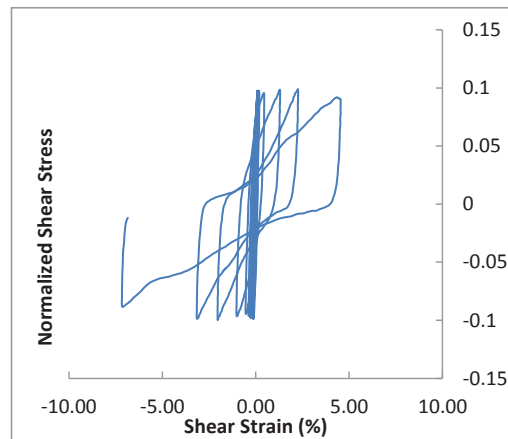
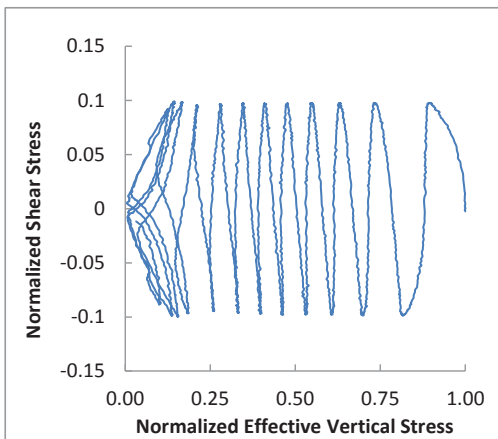

CSS Monotonic Shear Test Report

Geotechnical Engineering Laboratory



10/28/2013_Version 8.0

General Test Info and Sample Preparation

Device:	CSS	Relative Density (%):	72%
Specimen ID:	80C109_20LS	Void Ratio:	0.461
Test ID:	C300	Height (mm):	112.3
Date of Test:	10/26/2016	Soil-Only Specimen Diameter (mm):	306.23
Test Performed:	Post Cyclic Monotonic Shear	Weight (kg):	15.000
Test Material:	Ottawa Sand/Limestone	Density (kg/m³):	1813.8
Sample Preparation:	Prepared dense by tamping 30x in 5 layers.	Membrane Thickness (mm):	0.635
		Moisture Content (%):	0%
		Saturated (Y/N):	N
		Prepared by:	J.Hubler
		Checked by:	J. Hubler

Consolidation Stage

Vertical Stress (kPa):	100
Time to Compression (min):	1.4
Relative Density (%):	92%
Void Ratio:	0.428
Height (mm):	109.7
Diameter (mm):	306.23
Weight (kg):	15.000
Density (kg/m³):	1856.0

Shear Stage

Type of Test:	Constant Volume
Stress or Strain Controlled:	Strain
Shear Strain Rate (%/min):	0.30
Peak Shear Strength (kPa):	4.0

Comments

Post Cyclic Reconsol

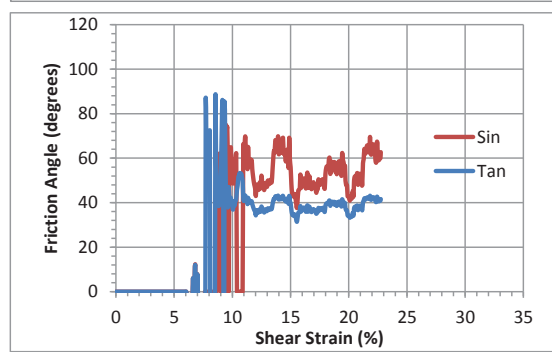
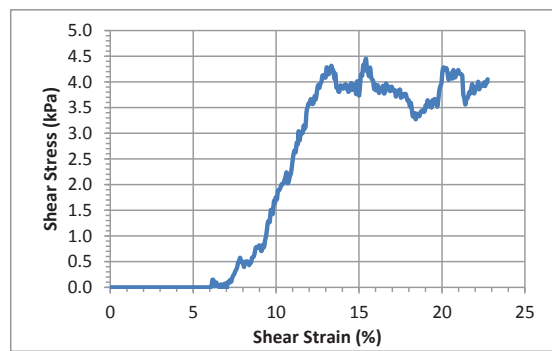
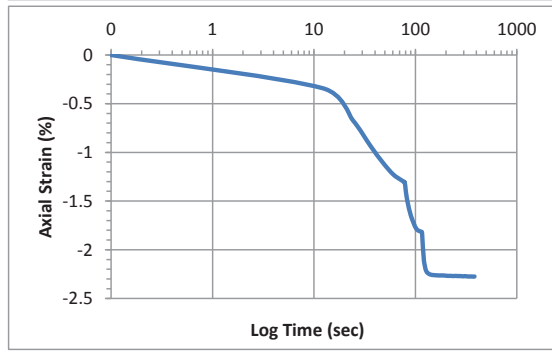
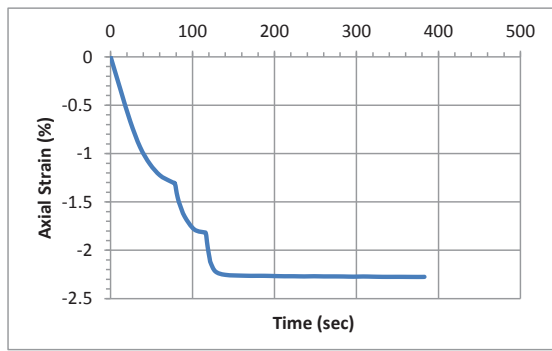

Accelerometer-Based Shear Wave Velocity Datasheet

Specimen ID: C300-80C10920LS-100-2X
 Test Material: 80C10920LS
 Date: 10/26/2016
 Test Performed by: J.Hubler
 Filename: C300-80C10920LS-100-2X

Vertical Stress: 100kPa
 Sensor Spacing: 0.10946 m
 V_s (rise) = 237 m/s

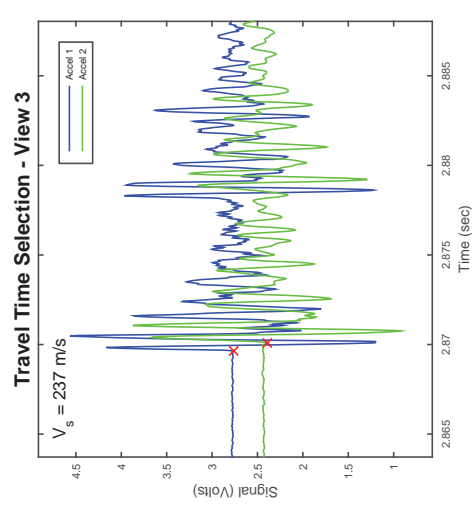
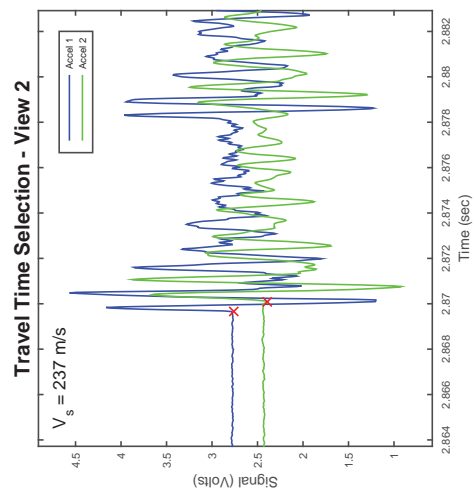
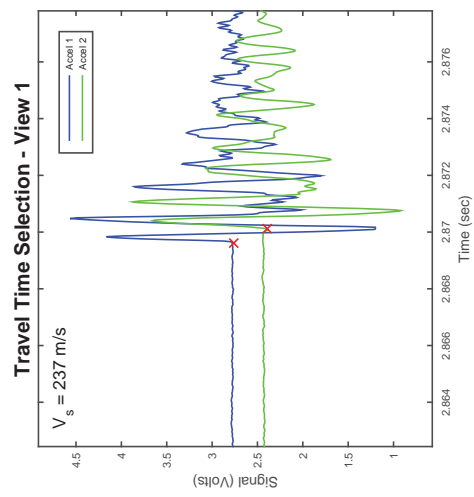
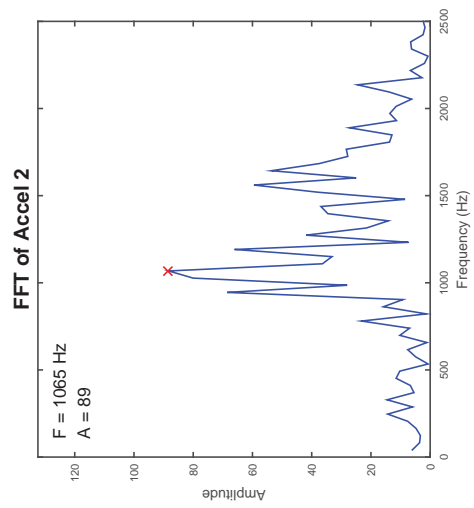
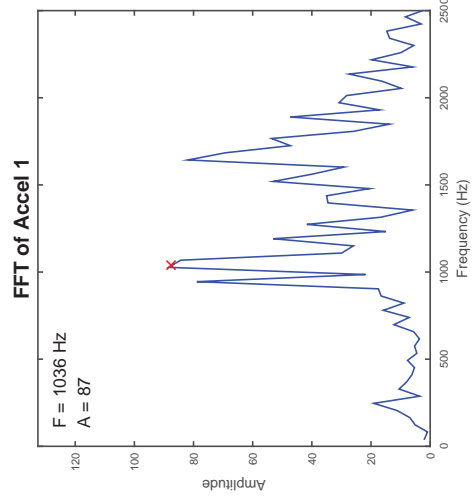
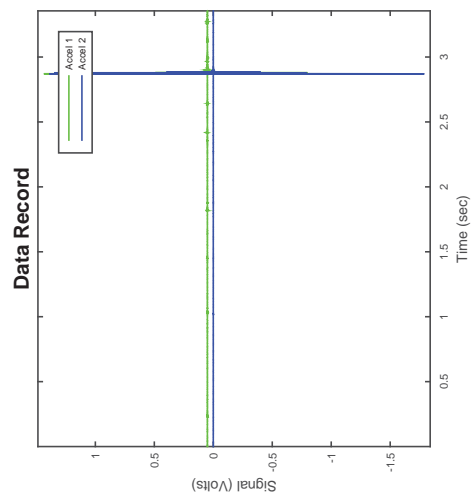

CSS Cyclic Shear Test Report

Geotechnical Engineering Laboratory



Cyclic Shear Test Summary

Device:	CSS	Density (kg/m³):	1890
Specimen ID:	80C109_20LS	Relative Density (%):	44%
Test ID:	C265	Void Ratio:	0.402
Date of Test:	4/11/2016	Vertical Stress (kPa):	100
Test Performed:	Cyclic Shear	Loading Frequency (Hz):	0.33
Test Material:	Ottawa Sand/LS	Number of Cycles:	36
Sample Preparation:	Prepared Loose using a funnel with zero drop height.	Cyclic Stress Ratio:	0.094
		Shear Modulus (kPa):	
		Damping (%):	
Prepared by:	J.Hubler	Shear Strain Single Amplitude (%)	
Checked by:	J.Hubler		

Additional Comments:

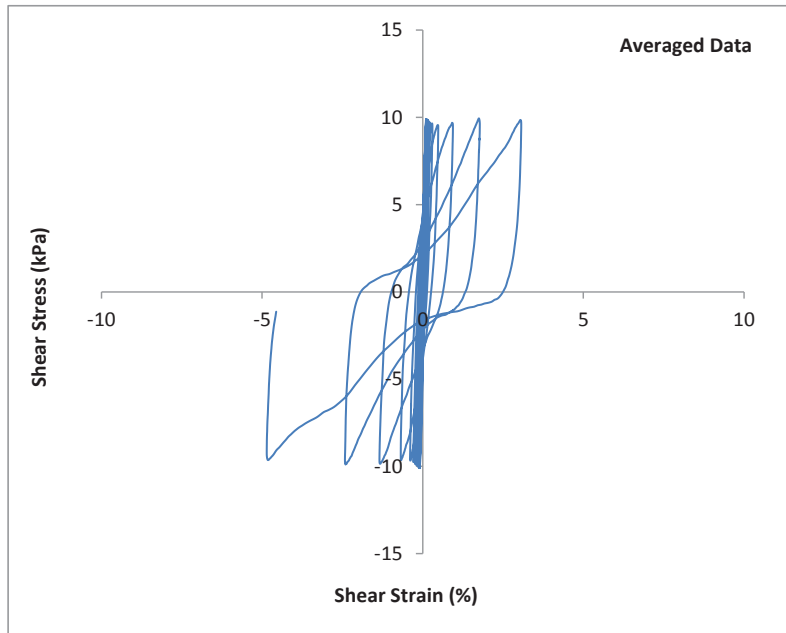
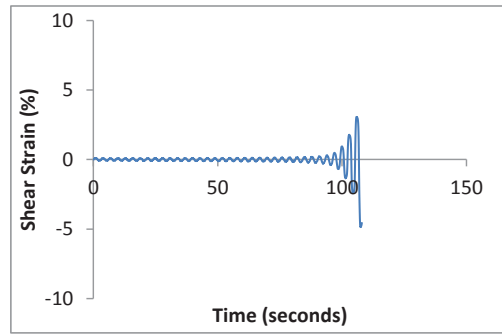
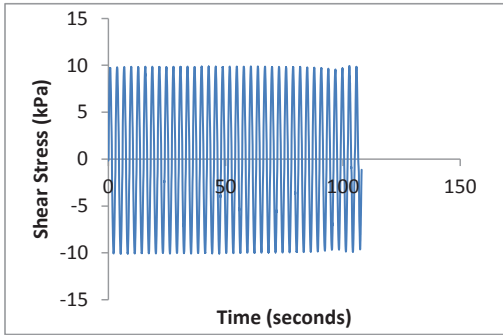

CSS Cyclic Shear Test Report

Geotechnical Engineering Laboratory



Cyclic Shear Test Summary

Device:	CSS	Density (kg/m³):	1890
Specimen ID:	80C109_20LS	Relative Density (%):	44%
Test ID:	C265	Void Ratio:	0.402
Date of Test:	4/11/2016	Vertical Stress (kPa):	100
Test Performed:	Cyclic Shear	Loading Frequency (Hz):	0.33
Test Material:	Ottawa Sand/LS	Number of Cycles:	36
Sample Preparation:	Prepared Loose using a funnel with zero drop height.	Cyclic Stress Ratio:	0.094
		Number of Cycles to Liq:	36
		Maximum ru:	0.99
Prepared by:	J.Hubler		
Checked by:	J.Hubler		

Additional Comments:

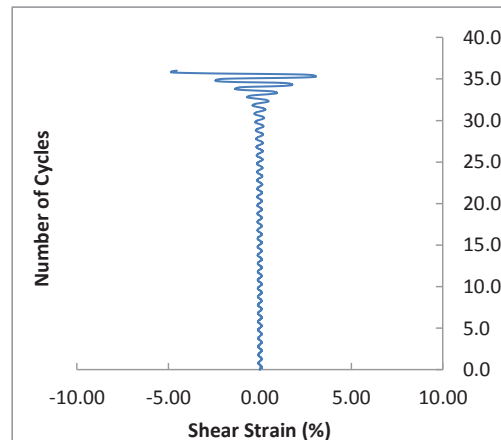
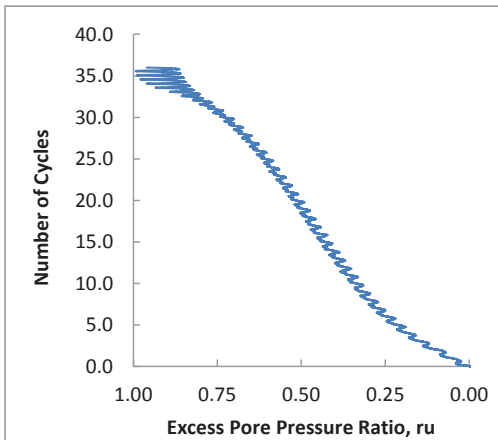
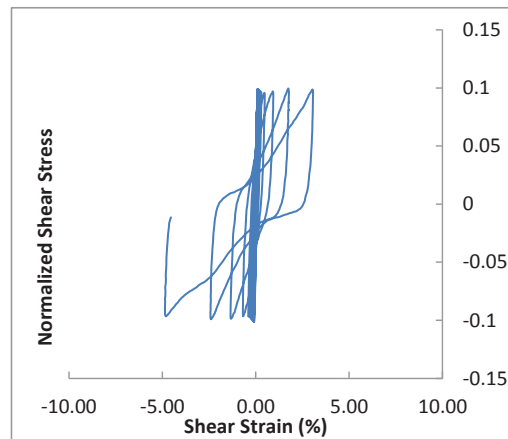
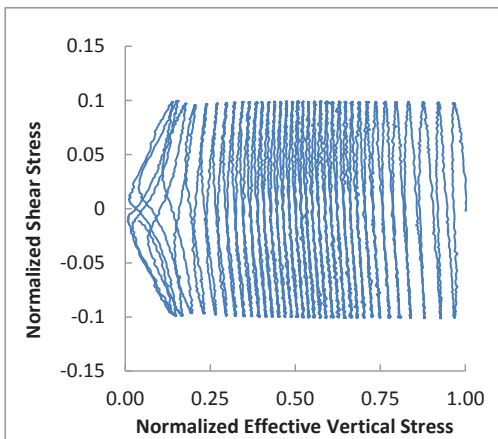

CSS Monotonic Shear Test Report

Geotechnical Engineering Laboratory



10/28/2013_Version 8.0

General Test Info and Sample Preparation

Device:	CSS	Relative Density (%):	12%
Specimen ID:	60C109_40LS	Void Ratio:	0.441
Test ID:	C265	Height (mm):	110.1
Date of Test:	4/11/2016	Soil-Only Specimen Diameter (mm):	306.23
Test Performed:	Post Cyclic Monotonic Shear	Weight (kg):	14.921
Test Material:	Ottawa Sand/Limestone	Density (kg/m³):	1839.4
Sample Preparation:	Prepared loose by placing with a funnel and zero drop height.	Membrane Thickness (mm):	0.635
		Moisture Content (%):	0%
		Saturated (Y/N):	N
		Prepared by:	J.Hubler
		Checked by:	J. Hubler

Consolidation Stage		Shear Stage	
Vertical Stress (kPa):	100	Type of Test:	Constant Volume
Time to Compression (min):	8.2	Stress or Strain Controlled:	Strain
Relative Density (%):	44%	Shear Strain Rate (%/min):	0.30
Void Ratio:	0.402	Peak Shear Strength (kPa):	17.3
Height (mm):	107.2	Comments	
Diameter (mm):	306.23		
Weight (kg):	14.921		
Density (kg/m³):	1889.9		

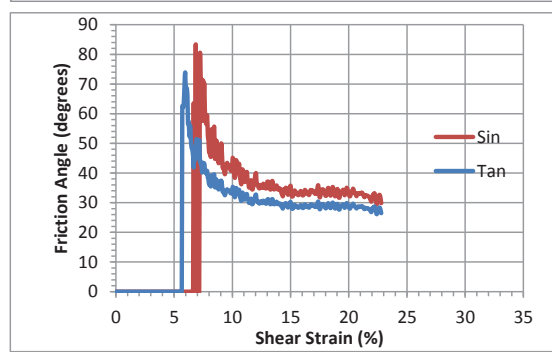
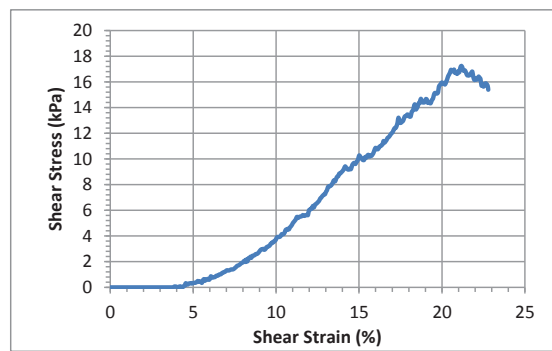
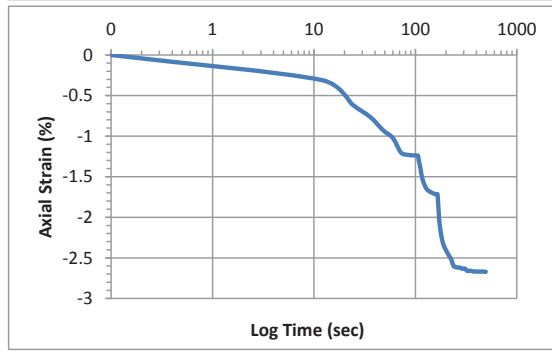
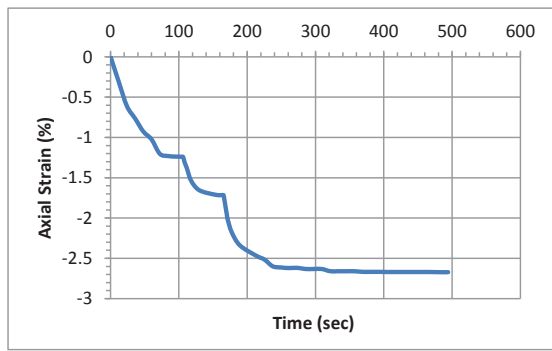

Accelerometer-Based Shear Wave Velocity Datasheet

Specimen ID: C265-LSC109-100-1X
 Test Material: LSC109
 Date: 4/15/2016
 Test Performed by: J.Hubler
 Filename: C265-LSC109-100-1X

Vertical Stress: 100kPa
 Sensor Spacing: 0.10712 m
 V_s (rise) = 218 m/s

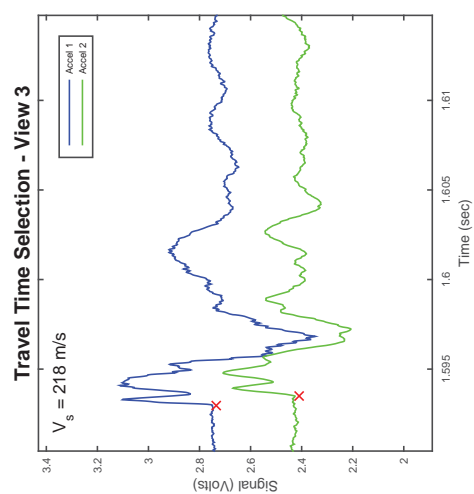
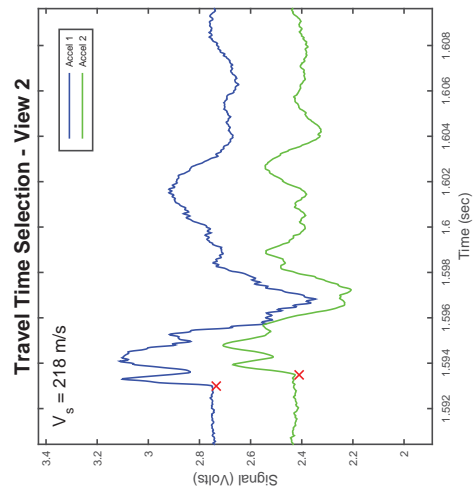
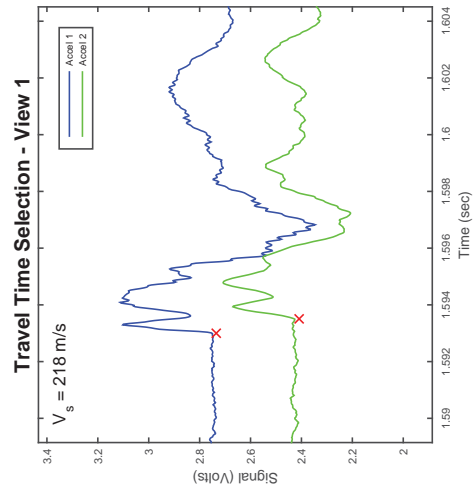
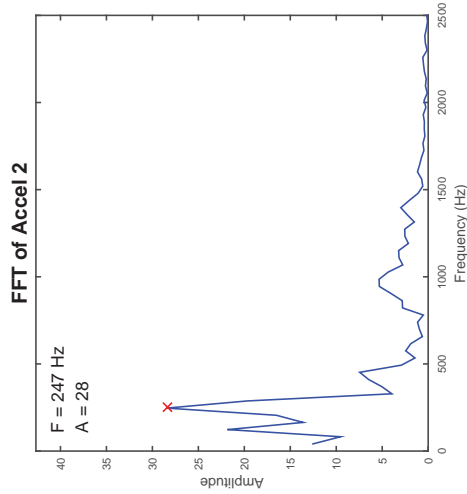
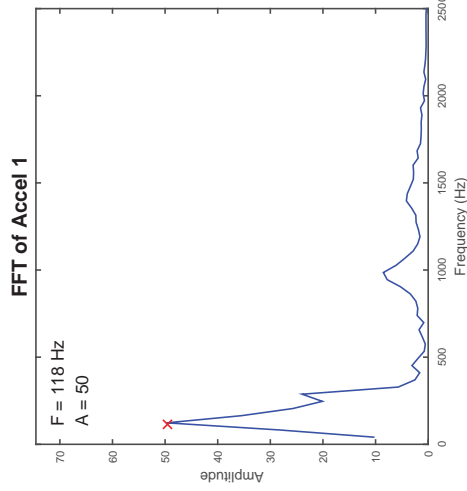
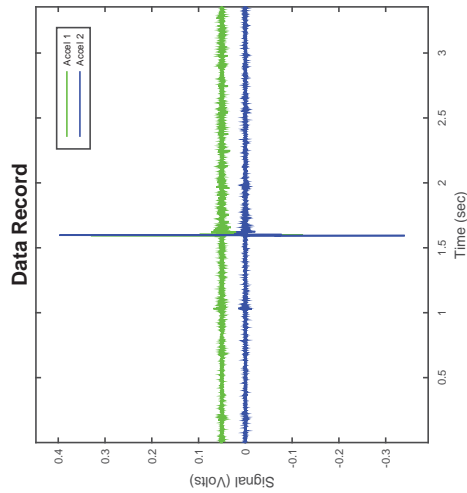

Accelerometer-Based Shear Wave Velocity Datasheet

Specimen ID: C265-LSC109-100-2X
 Test Material: LSC109
 Date: 4/15/2016
 Test Performed by: J.Hubler
 Filename: C265-LSC109-100-2X

Vertical Stress: 100kPa
 Sensor Spacing: 0.10712 m
 V_s (rise) = 232 m/s

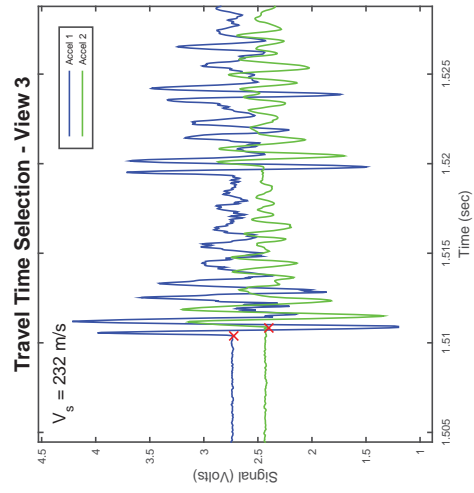
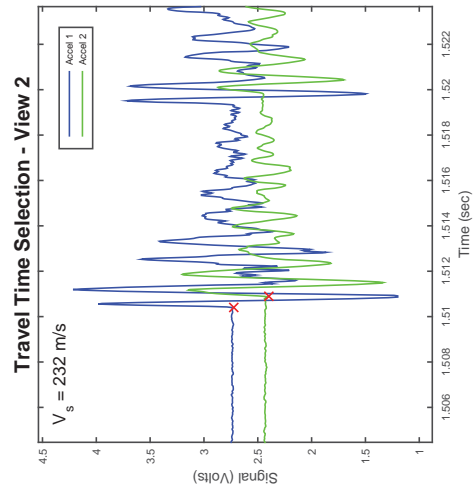
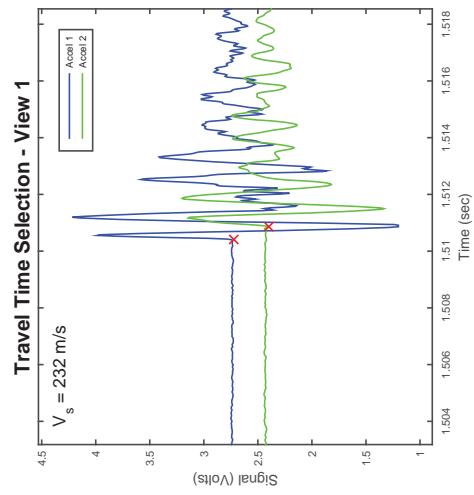
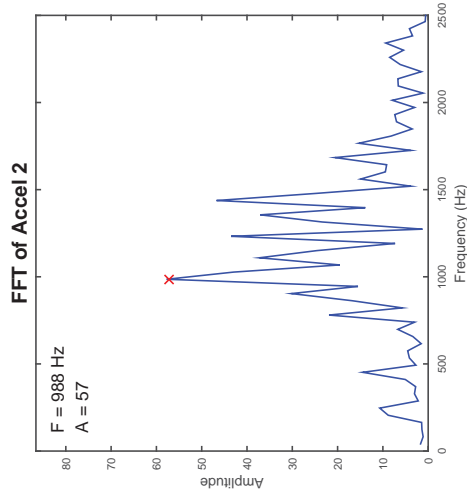
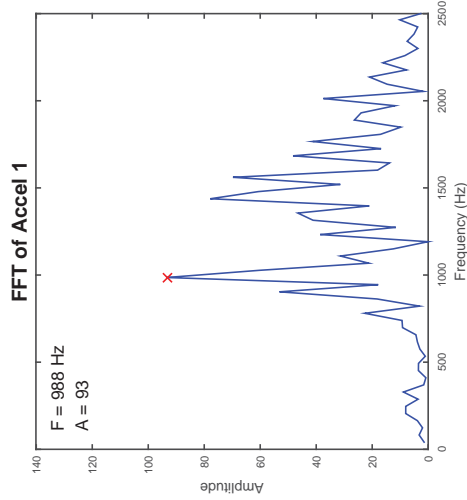
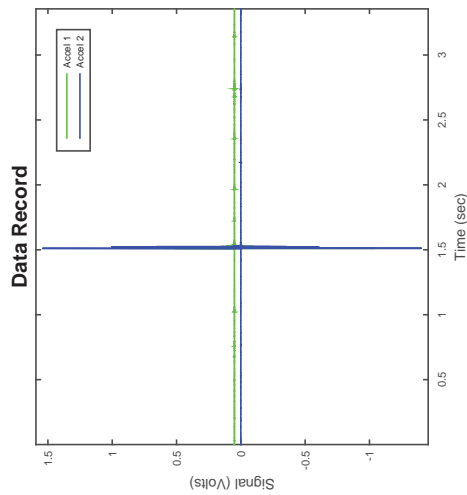

Accelerometer-Based Shear Wave Velocity Datasheet

Specimen ID: C265-LSC109-100-3X
 Test Material: LSC109
 Date: 4/15/2016
 Test Performed by: J.Hubler
 Filename: C265-LSC109-100-3X

Vertical Stress: 100kPa
 Sensor Spacing: 0.10712 m
 V_s (rise) = 240 m/s

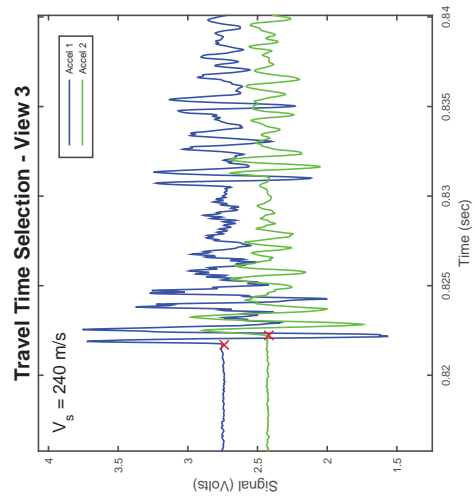
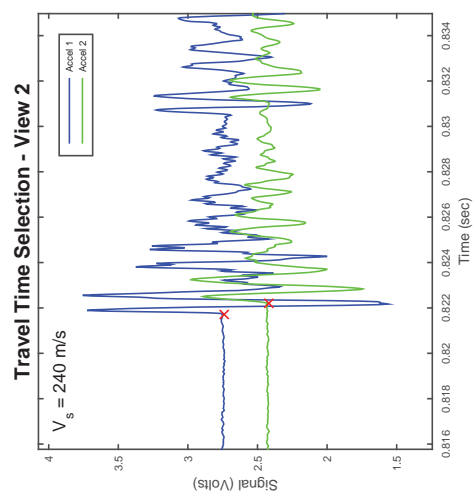
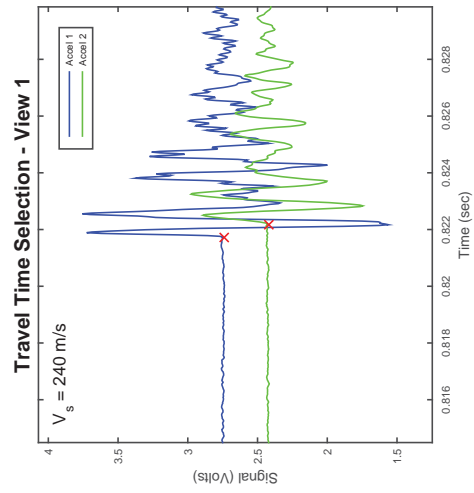
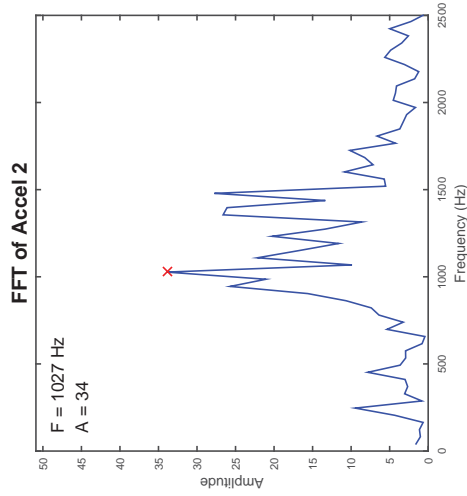
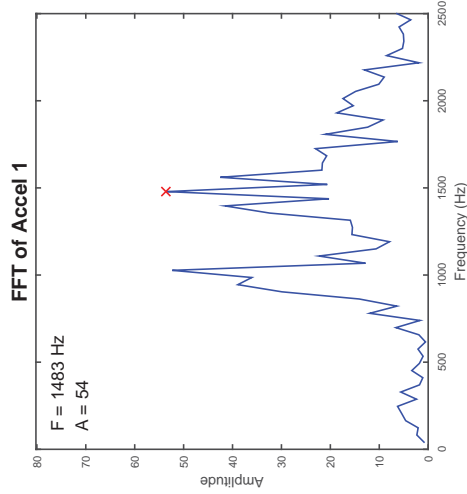
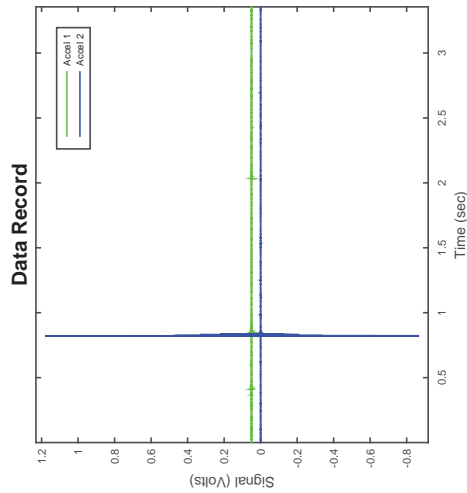

CSS Cyclic Shear Test Report

Geotechnical Engineering Laboratory



Cyclic Shear Test Summary

Device:	CSS	Density (kg/m³):	1892
Specimen ID:	60C109_40LS	Relative Density (%):	45%
Test ID:	C266	Void Ratio:	0.400
Date of Test:	4/15/2016	Vertical Stress (kPa):	100
Test Performed:	Cyclic Shear	Loading Frequency (Hz):	0.33
Test Material:	Ottawa Sand/LS	Number of Cycles:	4
Sample Preparation:	Prepared Loose using a funnel with zero drop height.	Cyclic Stress Ratio:	0.144
		Shear Modulus (kPa):	
		Damping (%):	
Prepared by:	J.Hubler	Shear Strain Single Amplitude (%)	
Checked by:	J.Hubler		

Additional Comments:

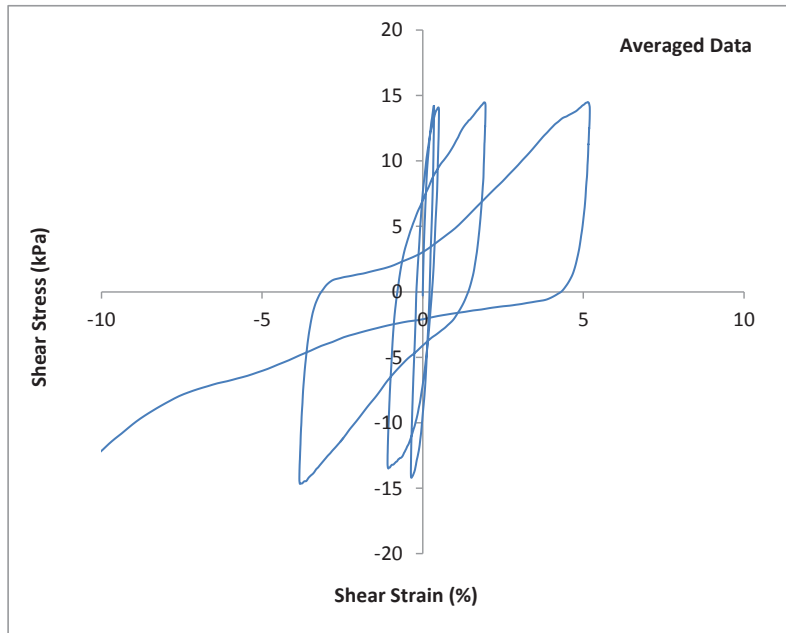
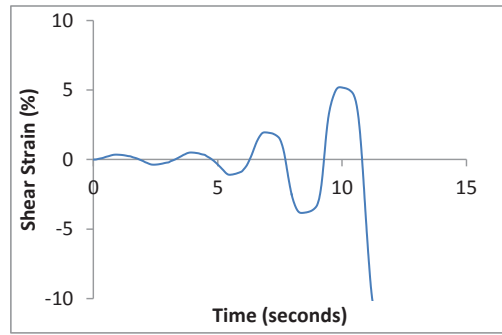
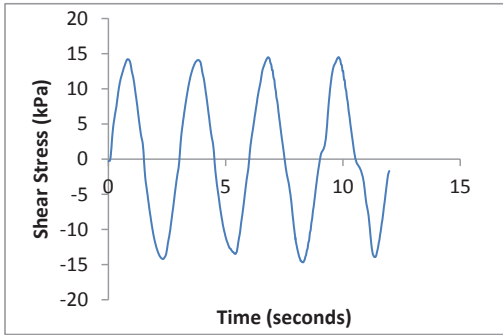

CSS Cyclic Shear Test Report

Geotechnical Engineering Laboratory



Cyclic Shear Test Summary

Device:	CSS	Density (kg/m³):	1892
Specimen ID:	60C109_40LS	Relative Density (%):	45%
Test ID:	C266	Void Ratio:	0.400
Date of Test:	4/15/2016	Vertical Stress (kPa):	100
Test Performed:	Cyclic Shear	Loading Frequency (Hz):	0.33
Test Material:	Ottawa Sand/LS	Number of Cycles:	4
Sample Preparation:	Prepared Loose using a funnel with zero drop height.	Cyclic Stress Ratio:	0.144
		Number of Cycles to Liq:	4
		Maximum ru:	0.99
Prepared by:	J.Hubler		
Checked by:	J.Hubler		

Additional Comments:

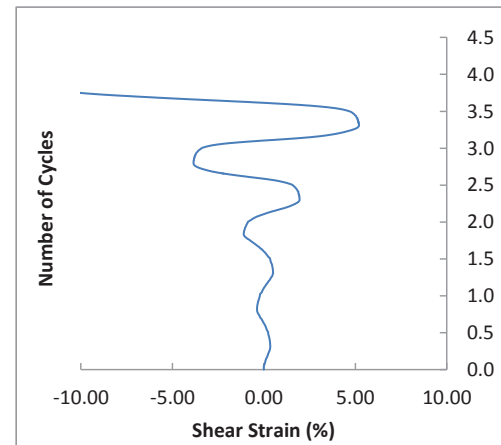
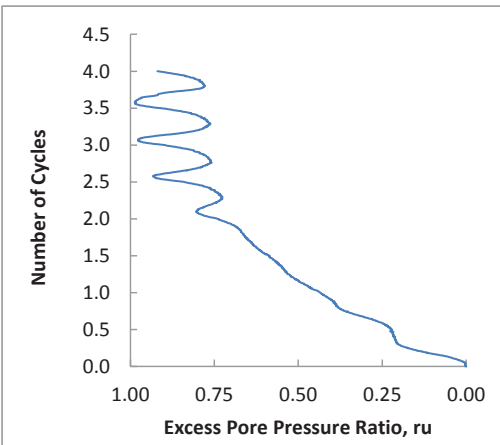
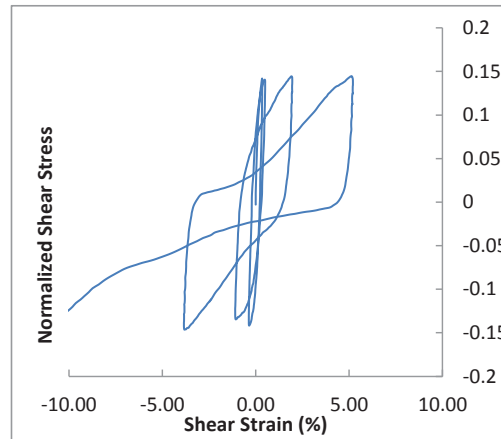
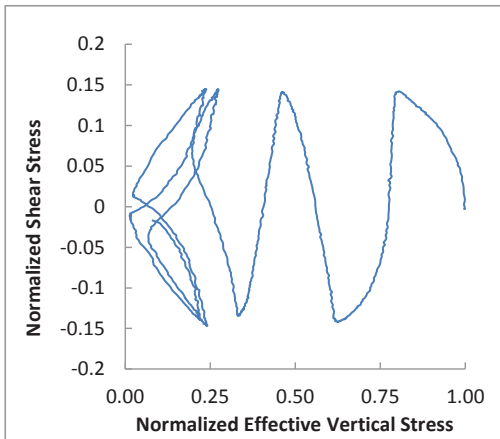

CSS Monotonic Shear Test Report

Geotechnical Engineering Laboratory



10/28/2013_Version 8.0

General Test Info and Sample Preparation

Device:	CSS	Relative Density (%):	45%
Specimen ID:	60C109_40LS	Void Ratio:	0.400
Test ID:	C266	Height (mm):	106.9
Date of Test:	4/15/2016	Soil-Only Specimen Diameter (mm):	306.23
Test Performed:	Post Cyclic Monotonic Shear	Weight (kg):	14.902
Test Material:	Ottawa Sand/Limestone	Density (kg/m³):	1892.3
Sample Preparation:	Prepared loose by placing with a funnel and zero drop height.	Membrane Thickness (mm):	0.635
		Moisture Content (%):	0%
		Saturated (Y/N):	N
		Prepared by:	J. Hubler
		Checked by:	J. Hubler

Consolidation Stage

Shear Stage

Vertical Stress (kPa):	100	Type of Test:	Constant Volume
Time to Compression (min):	1.4	Stress or Strain Controlled:	Strain
Relative Density (%):	59%	Shear Strain Rate (%/min):	0.31
Void Ratio:	0.384	Peak Shear Strength (kPa):	63.1
Height (mm):	105.6	Comments Post Cyclic Reconsol	
Diameter (mm):	306.23		
Weight (kg):	14.902		
Density (kg/m³):	1915.4		

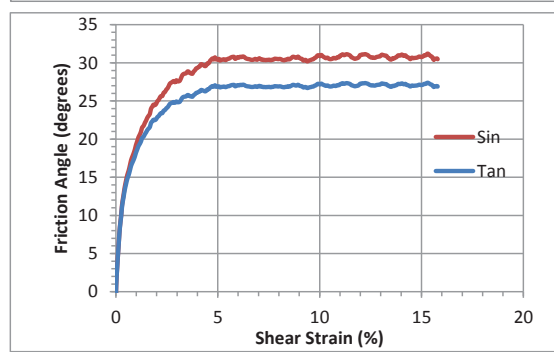
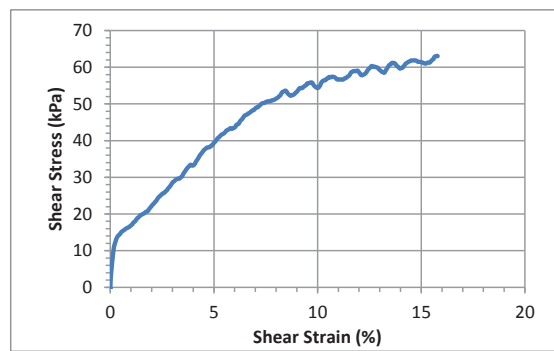
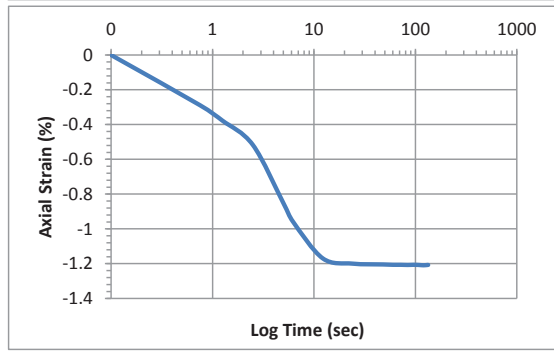
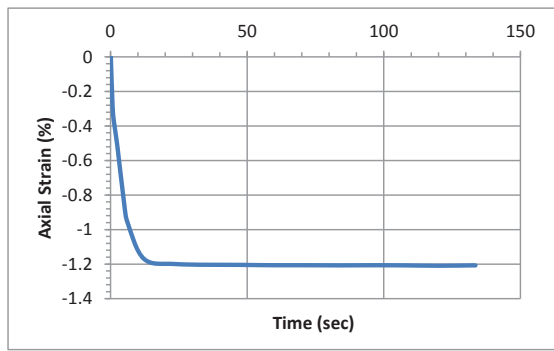

Accelerometer-Based Shear Wave Velocity Datasheet

Specimen ID: C266-LSC109-100-1X
 Test Material: LSC109
 Date: 4/15/2016
 Test Performed by: J.Hubler
 Filename: C266-LSC109-100-1X

Vertical Stress: 100kPa
 Sensor Spacing: 0.10685 m
 V_s (rise) = 224 m/s

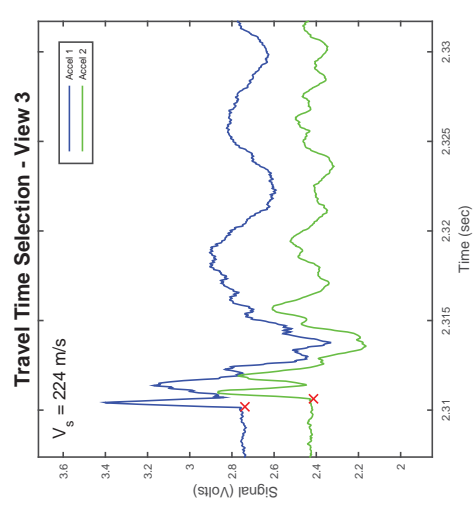
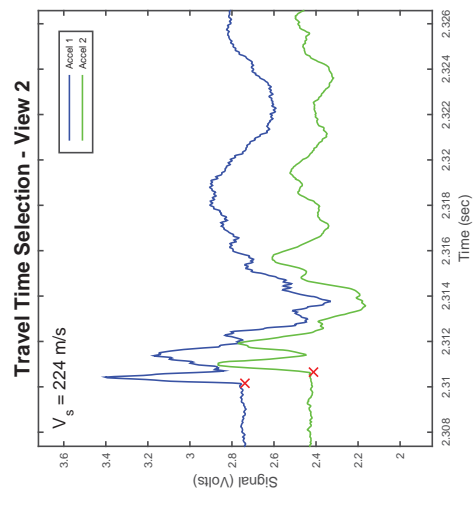
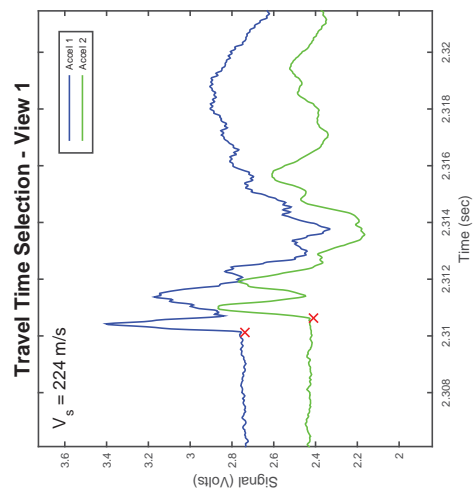
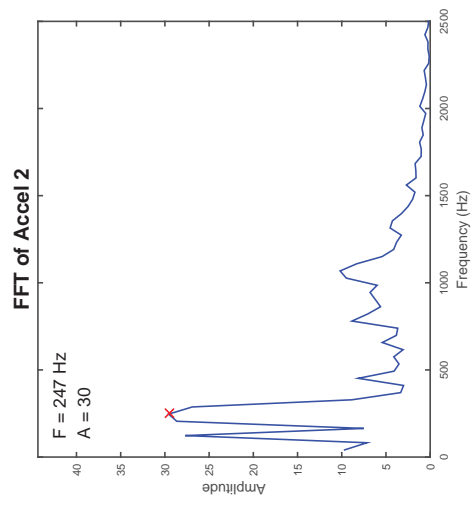
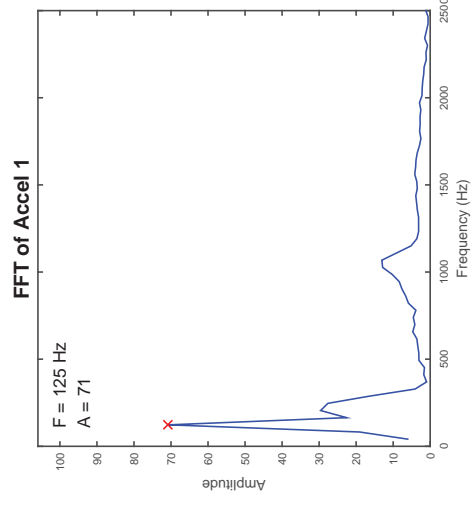
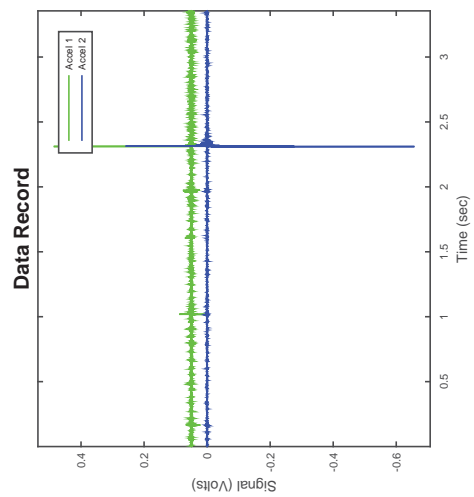

Accelerometer-Based Shear Wave Velocity Datasheet

Specimen ID: C266-LSC109-100-2X
 Test Material: LSC109
 Date: 4/15/2016
 Test Performed by: J.Hubler
 Filename: C266-LSC109-100-2X

Vertical Stress: 100kPa
 Sensor Spacing: 0.10685 m
 V_s (rise) = 232 m/s

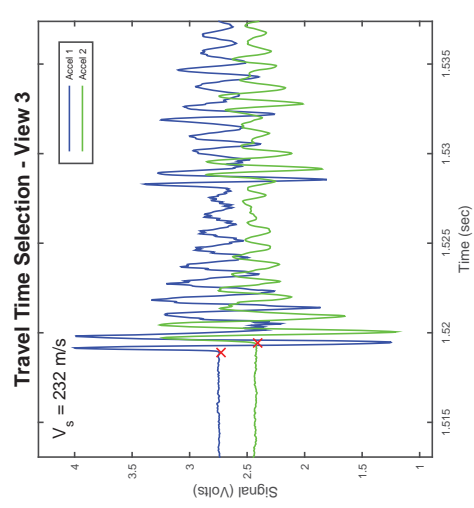
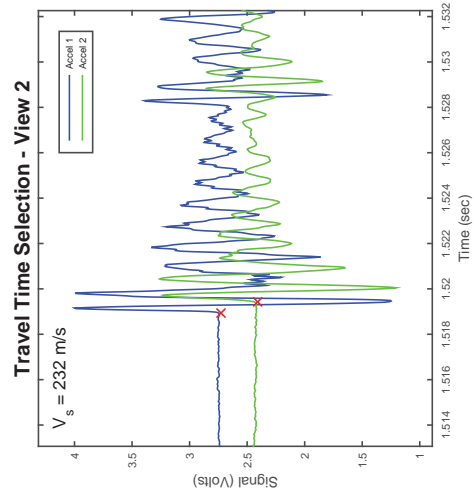
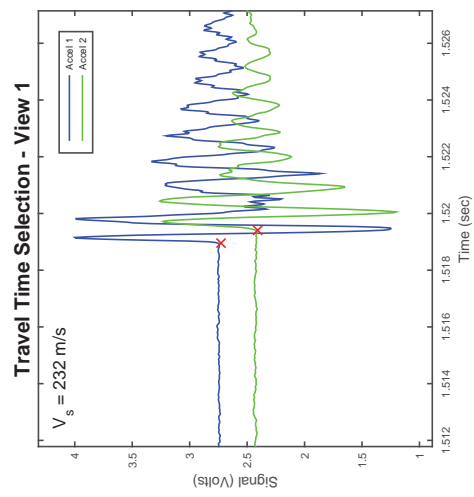
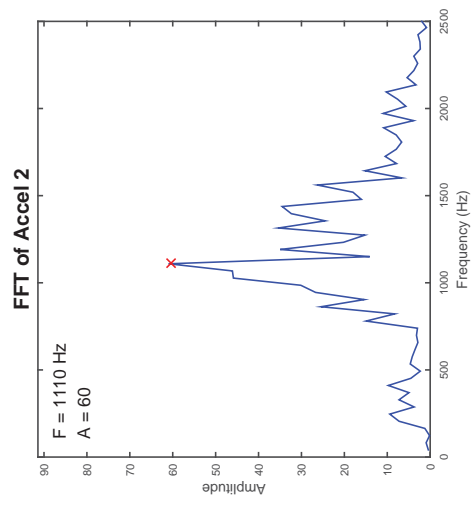
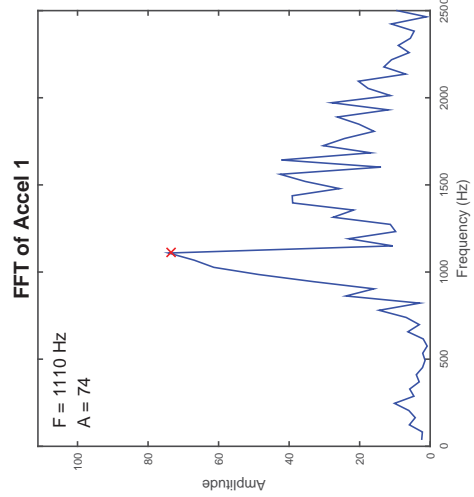
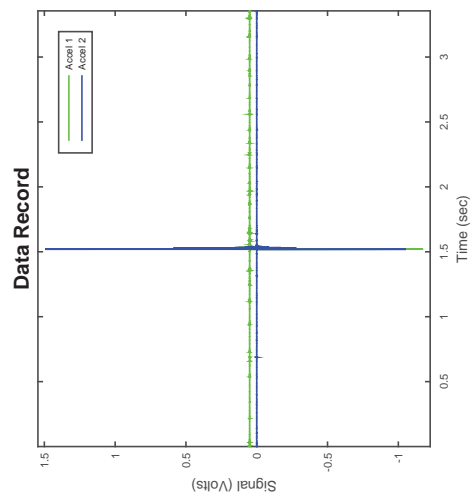

Accelerometer-Based Shear Wave Velocity Datasheet

Specimen ID: C266-LSC109-100-3X
 Test Material: LSC109
 Date: 4/15/2016
 Test Performed by: J.Hubler
 Filename: C266-LSC109-100-3X

Vertical Stress: 100kPa
 Sensor Spacing: 0.10685 m
 V_s (rise) = 232 m/s

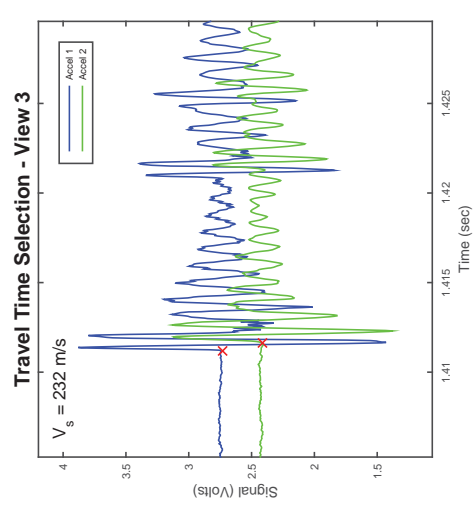
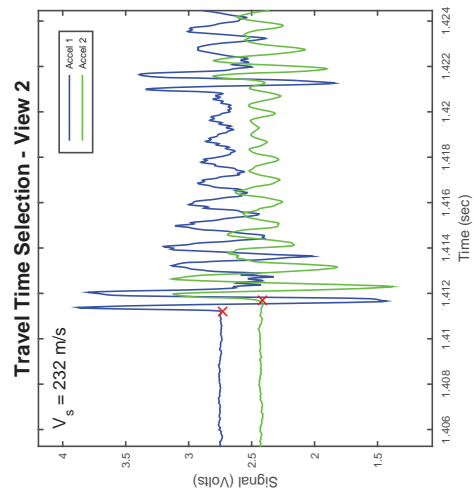
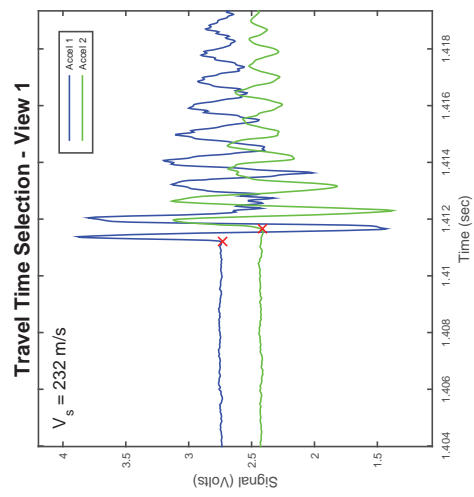
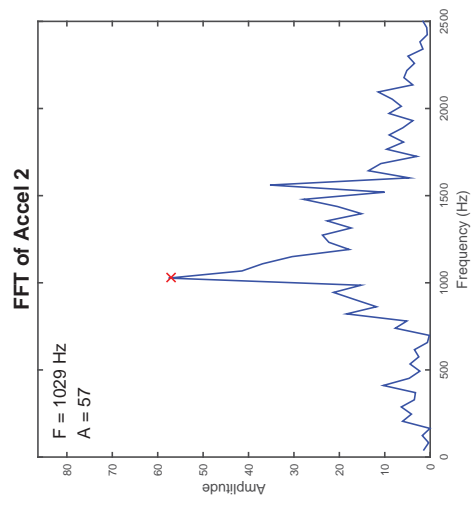
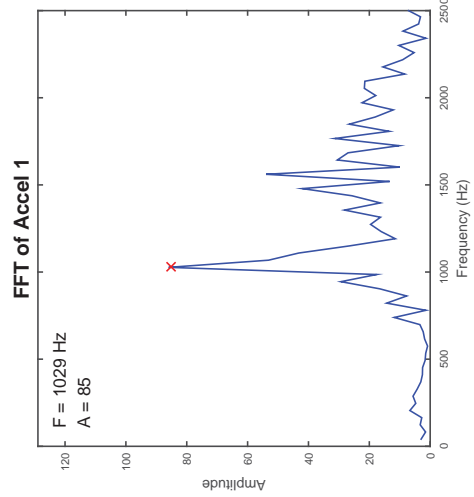
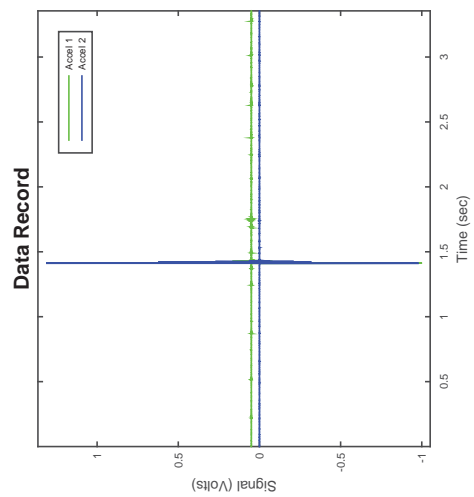

Accelerometer-Based Shear Wave Velocity Datasheet

Specimen ID: C266-LSC109-100-1XP

Test Material: LSC109

Date: 4/15/2016

Test Performed by: J.Hubler

Filename: C266-LSC109-100-1XP

Vertical Stress: 100kPa

Sensor Spacing: 0.10556 m

V_s (rise) = 222 m/s

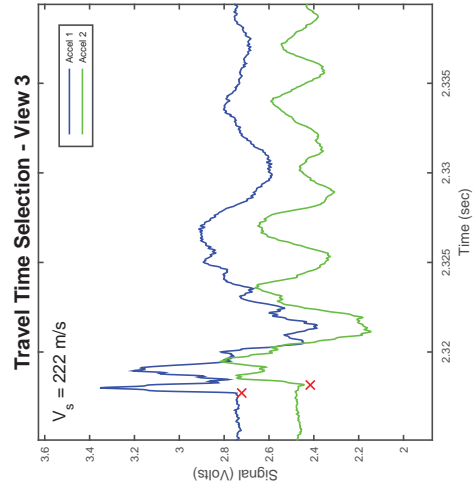
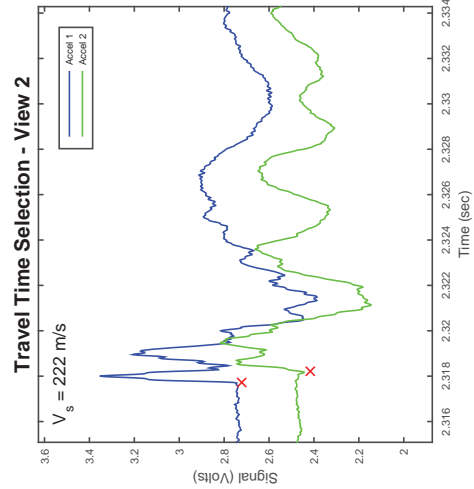
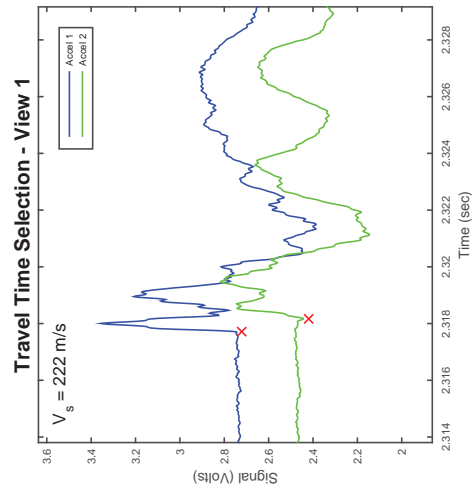
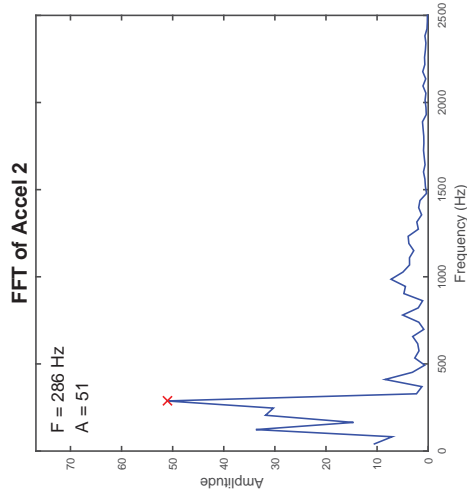
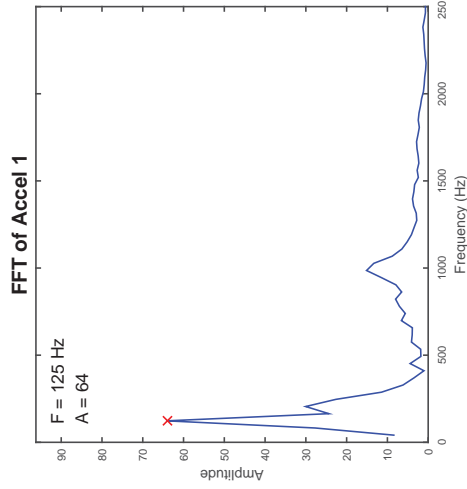
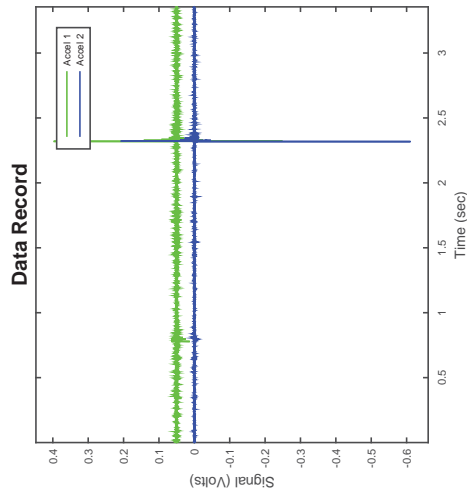

Accelerometer-Based Shear Wave Velocity Datasheet

Specimen ID: C266-LSC109-100-2XP

Test Material: LSC109

Date: 4/15/2016

Test Performed by: J.Hubler

Filename: C266-LSC109-100-2XP

Vertical Stress: 100kPa

Sensor Spacing: 0.10556 m

V_s (rise) = 203 m/s

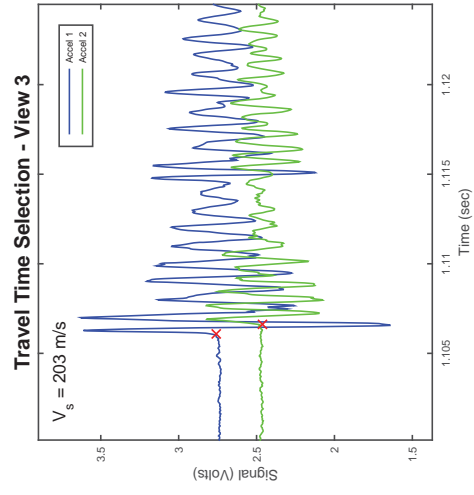
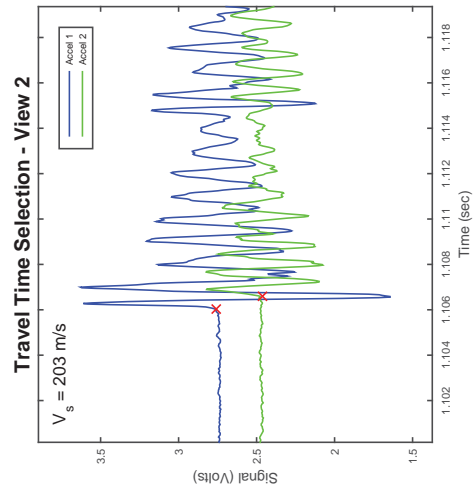
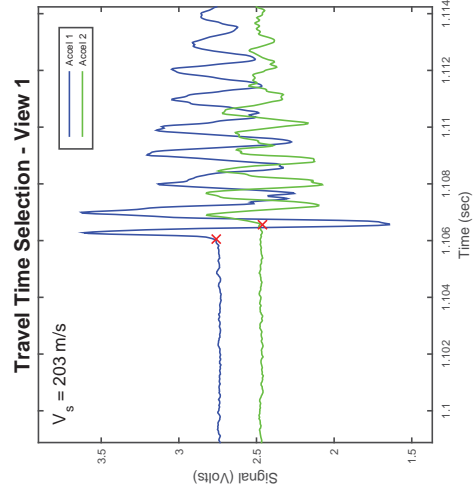
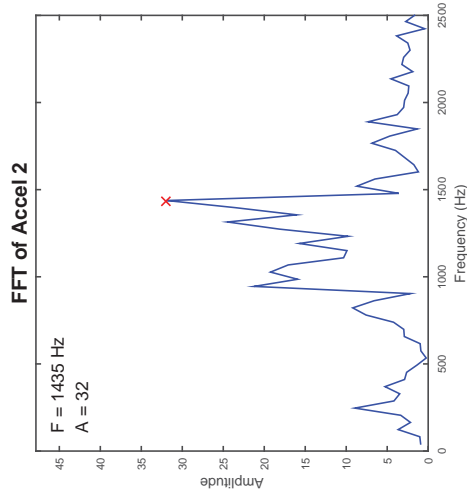
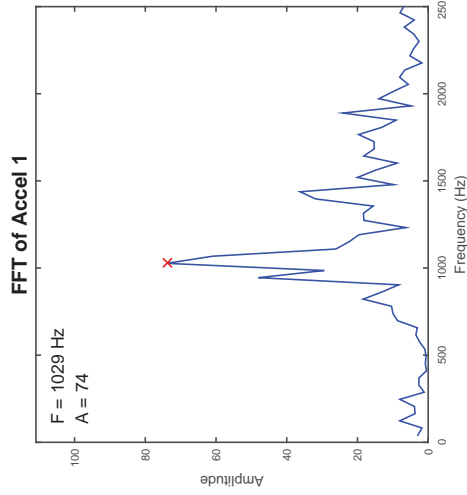
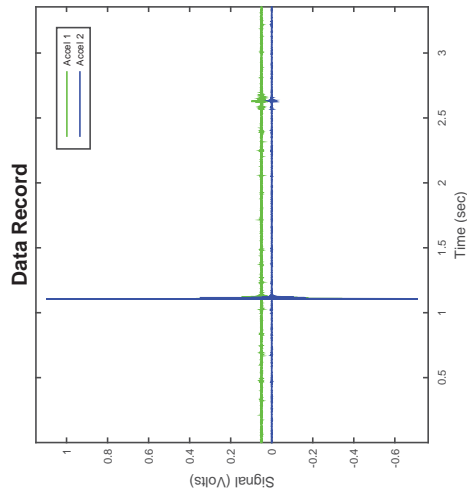

Accelerometer-Based Shear Wave Velocity Datasheet

Specimen ID: C266-LSC109-100-3XP

Test Material: LSC109

Date: 4/15/2016

Test Performed by: J.Hubler

Filename: C266-LSC109-100-3XP

Vertical Stress: 100kPa

Sensor Spacing: 0.10556 m

V_s (rise) = 209 m/s

Data Record

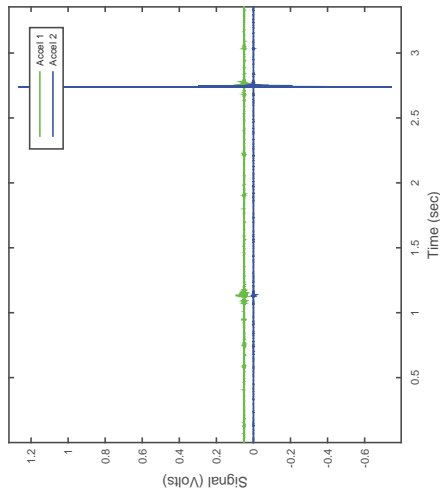

FFT of Accel 1

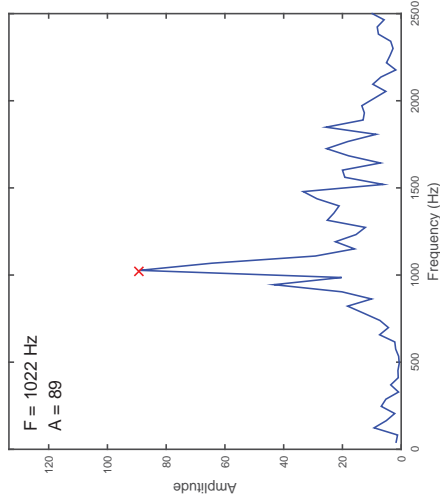

FFT of Accel 2

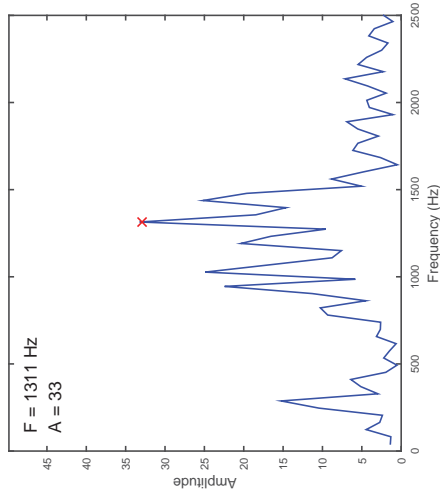

Travel Time Selection - View 1

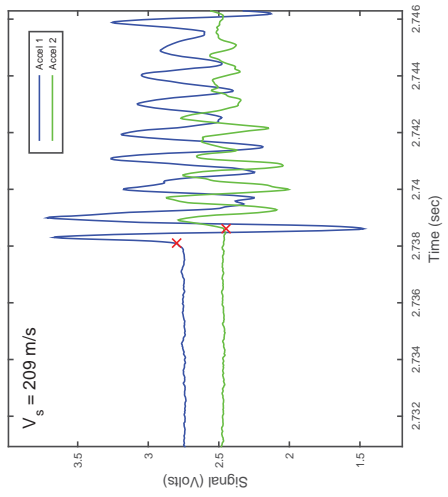

Travel Time Selection - View 2

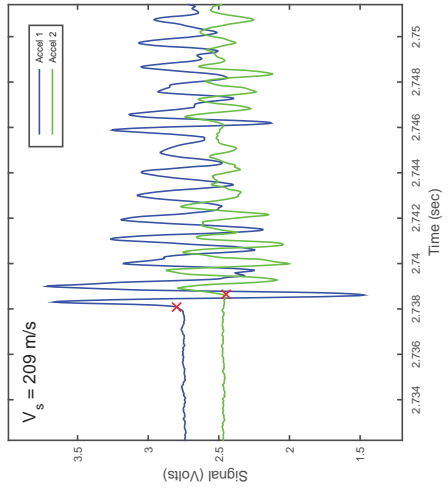

Travel Time Selection - View 3

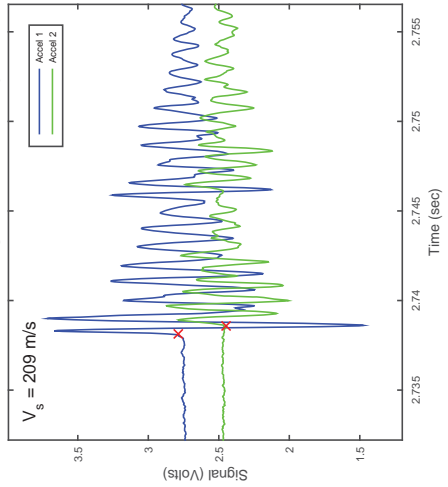

CSS Cyclic Shear Test Report

Geotechnical Engineering Laboratory



Cyclic Shear Test Summary

Device:	CSS	Density (kg/m³):	1899
Specimen ID:	60C109_40LS	Relative Density (%):	49%
Test ID:	C267	Void Ratio:	0.396
Date of Test:	4/15/2016	Vertical Stress (kPa):	100
Test Performed:	Cyclic Shear	Loading Frequency (Hz):	0.33
Test Material:	Ottawa Sand/LS	Number of Cycles:	87
Sample Preparation:	Prepared Loose using a funnel with zero drop height.	Cyclic Stress Ratio:	0.044
		Shear Modulus (kPa):	
		Damping (%):	
Prepared by:	J.Hubler	Shear Strain Single Amplitude (%)	
Checked by:	J.Hubler		

Additional Comments:

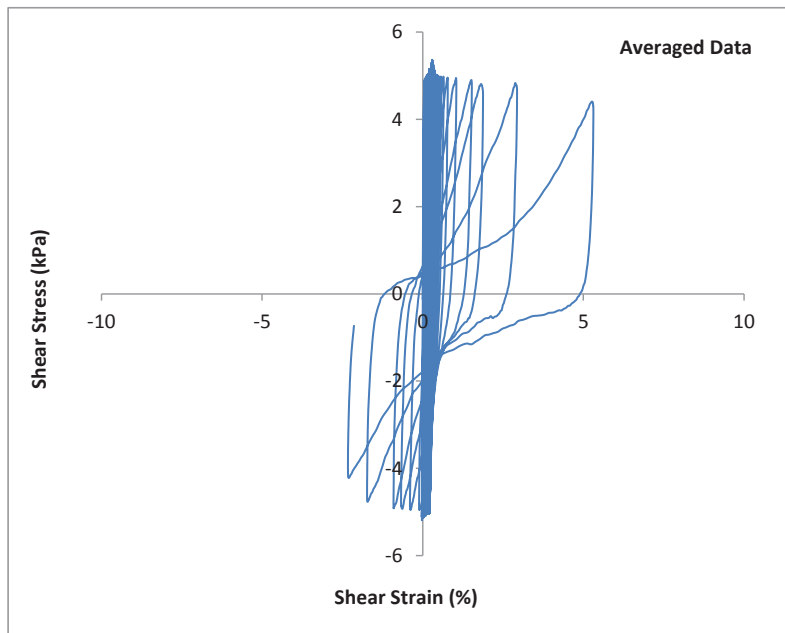
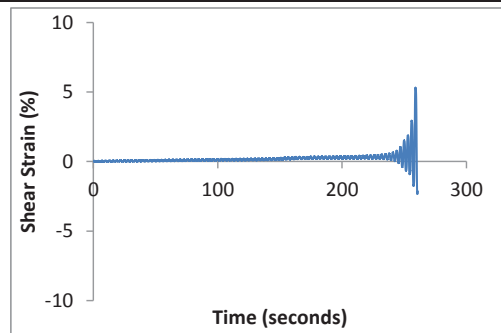
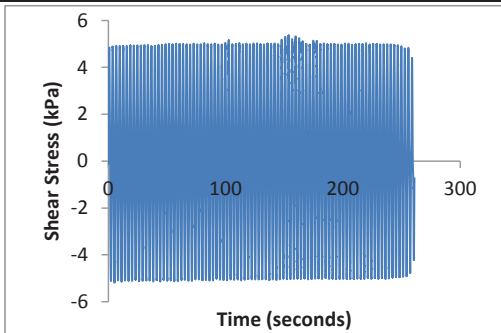

CSS Cyclic Shear Test Report

Geotechnical Engineering Laboratory



Cyclic Shear Test Summary

Device:	CSS	Density (kg/m³):	1899
Specimen ID:	60C109_40LS	Relative Density (%):	49%
Test ID:	C267	Void Ratio:	0.396
Date of Test:	4/15/2016	Vertical Stress (kPa):	100
Test Performed:	Cyclic Shear	Loading Frequency (Hz):	0.33
Test Material:	Ottawa Sand/LS	Number of Cycles:	87
Sample Preparation:	Prepared Loose using a funnel with zero drop height.	Cyclic Stress Ratio:	0.044
		Number of Cycles to Liq:	87
		Maximum ru:	1.01
Prepared by:	J.Hubler		
Checked by:	J.Hubler		

Additional Comments:

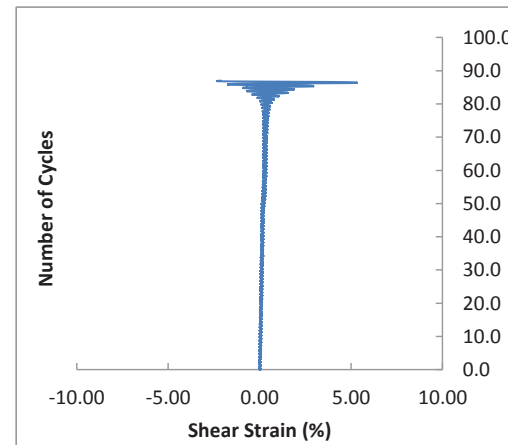
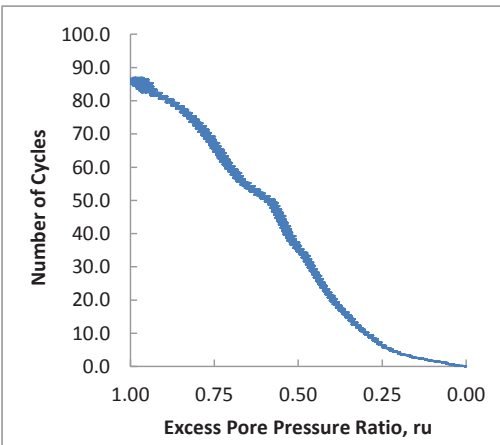
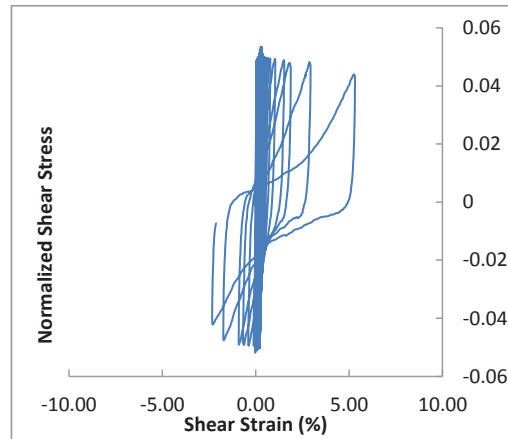
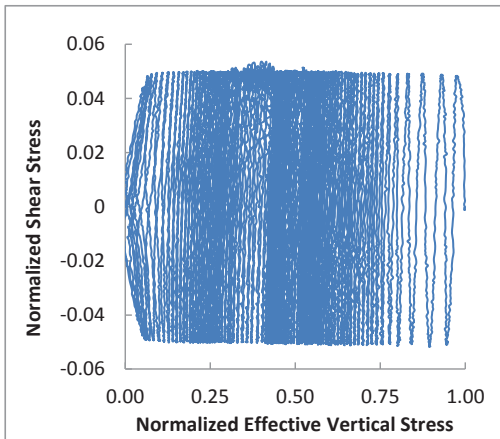

Accelerometer-Based Shear Wave Velocity Datasheet

Specimen ID: C267-LSC109-100-1X

Test Material: LSC109

Date: 4/15/2016

Test Performed by: J.Hubler

Filename: C267-LSC109-100-1X

Vertical Stress: 100kPa

Sensor Spacing: 0.10641 m

V_s (rise) = 205 m/s

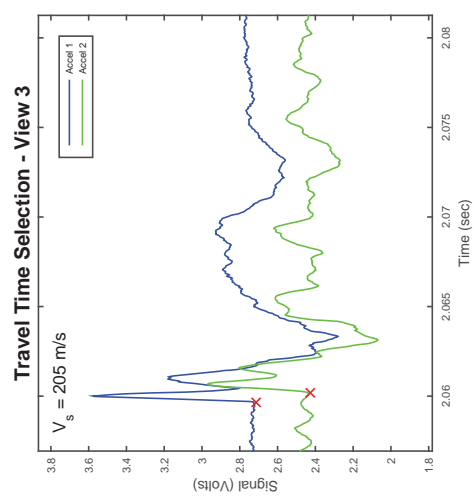
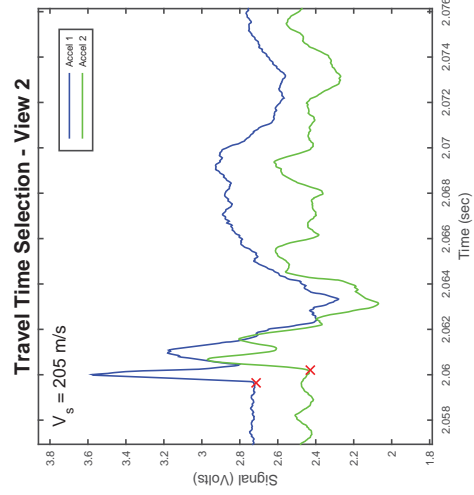
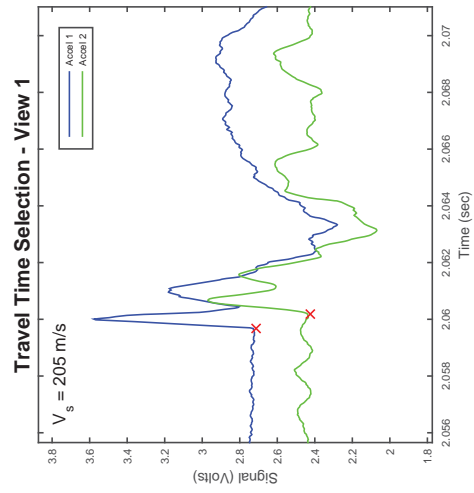
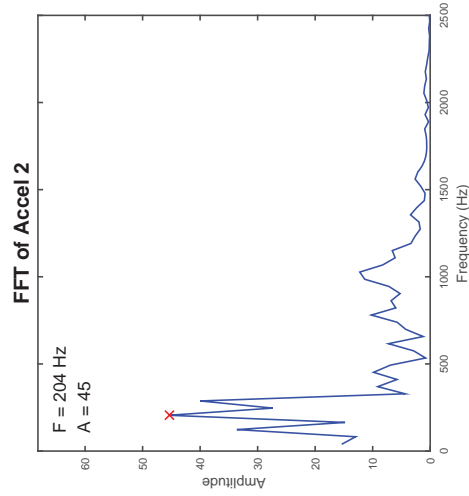
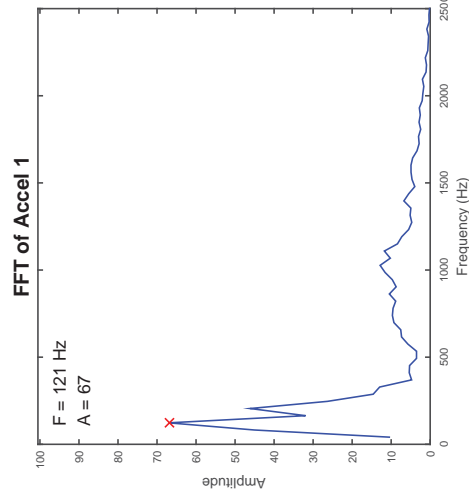
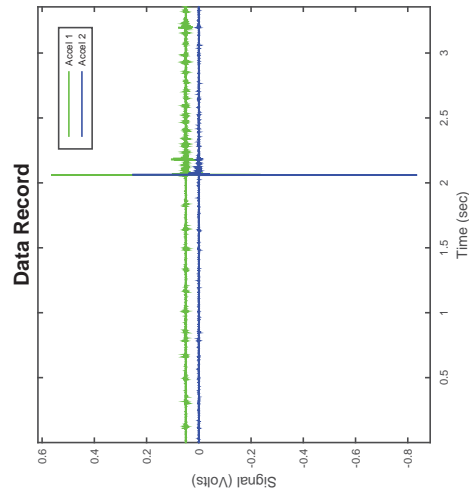

Accelerometer-Based Shear Wave Velocity Datasheet

Specimen ID: C267-LSC109-100-2X
 Test Material: LSC109
 Date: 4/15/2016
 Test Performed by: J.Hubler
 Filename: C267-LSC109-100-2X

Vertical Stress: 100kPa
 Sensor Spacing: 0.10641 m
 V_s (rise) = 205 m/s

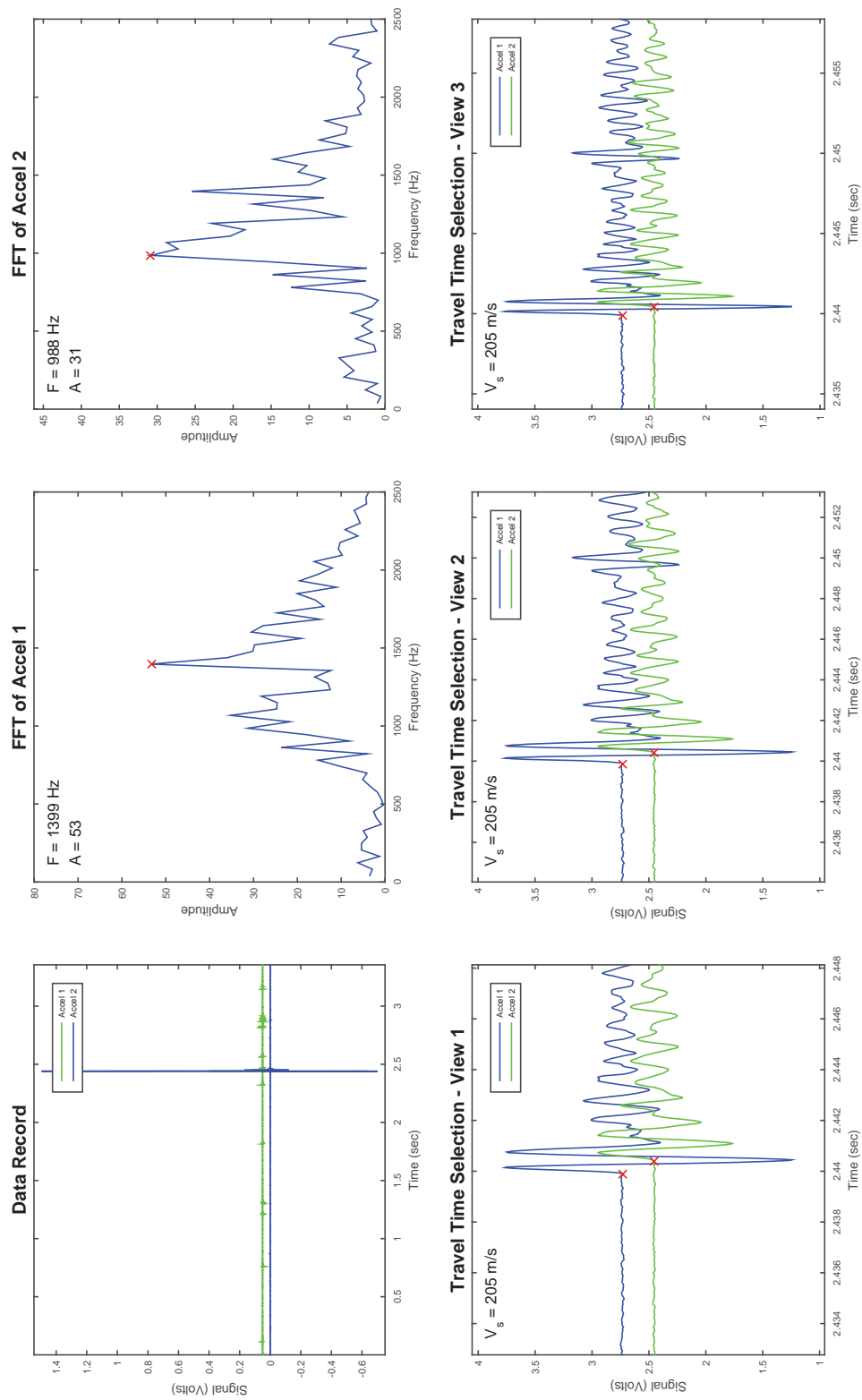

Accelerometer-Based Shear Wave Velocity Datasheet

Specimen ID: C267-LSC109-100-3X
 Test Material: LSC109
 Date: 4/16/2016
 Test Performed by: J.Hubler
 Filename: C267-LSC109-100-3X

Vertical Stress: 100kPa
 Sensor Spacing: 0.10641 m
 V_s (rise) = 210 m/s

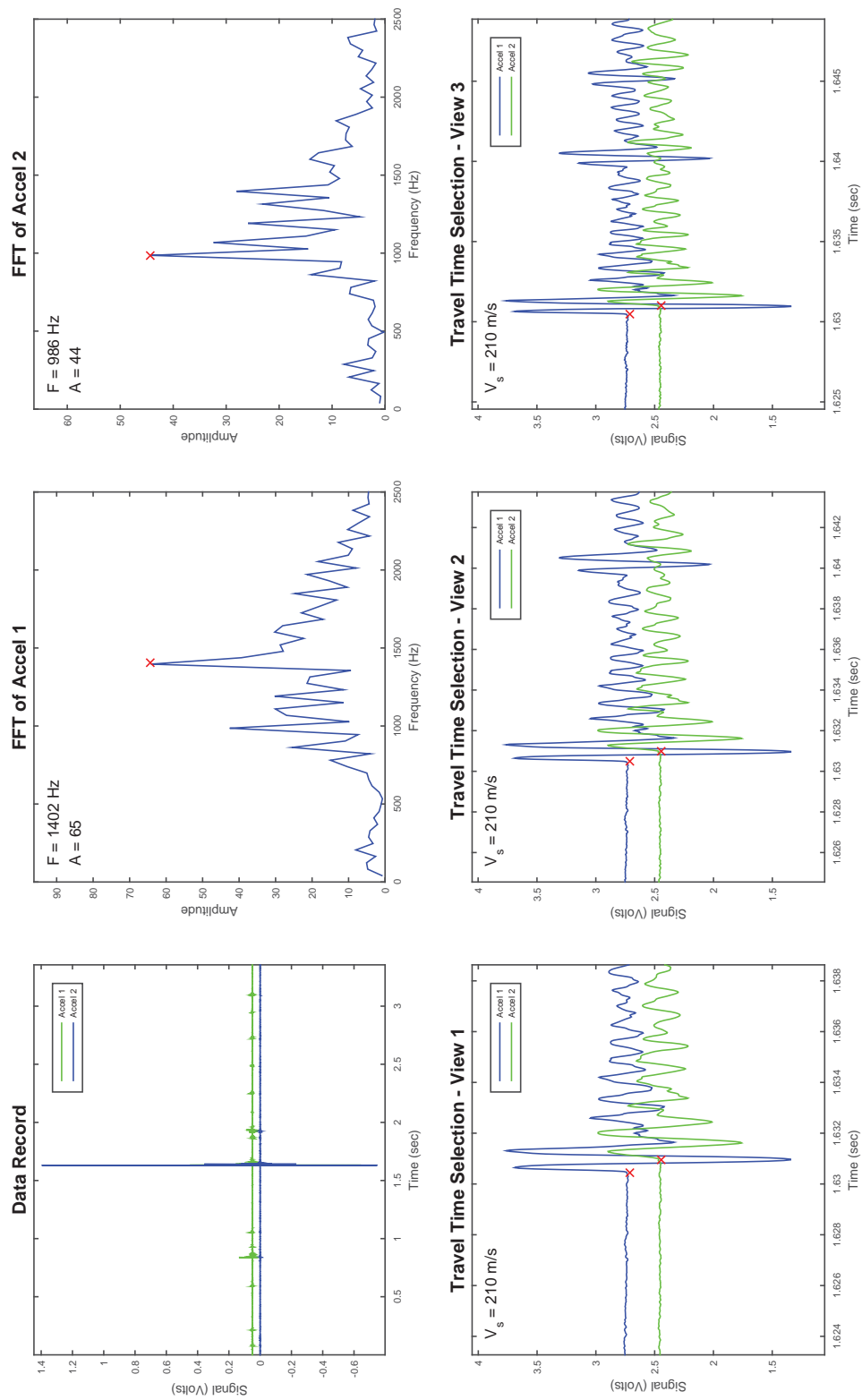

CSS Cyclic Shear Test Report

Geotechnical Engineering Laboratory



Cyclic Shear Test Summary

Device:	CSS	Density (kg/m³):	1967
Specimen ID:	60C109_40LS	Relative Density (%):	90%
Test ID:	C292	Void Ratio:	0.347
Date of Test:	8/18/2016	Vertical Stress (kPa):	100
Test Performed:	Cyclic Shear	Loading Frequency (Hz):	0.33
Test Material:	Ottawa Sand/LS	Number of Cycles:	11
Sample Preparation:	Prepared dense by tamping 45x in 5 layers	Cyclic Stress Ratio:	0.094
		Shear Modulus (kPa):	
		Damping (%):	
Prepared by:	J.Hubler	Shear Strain Single Amplitude (%)	
Checked by:	J.Hubler		

Additional Comments:

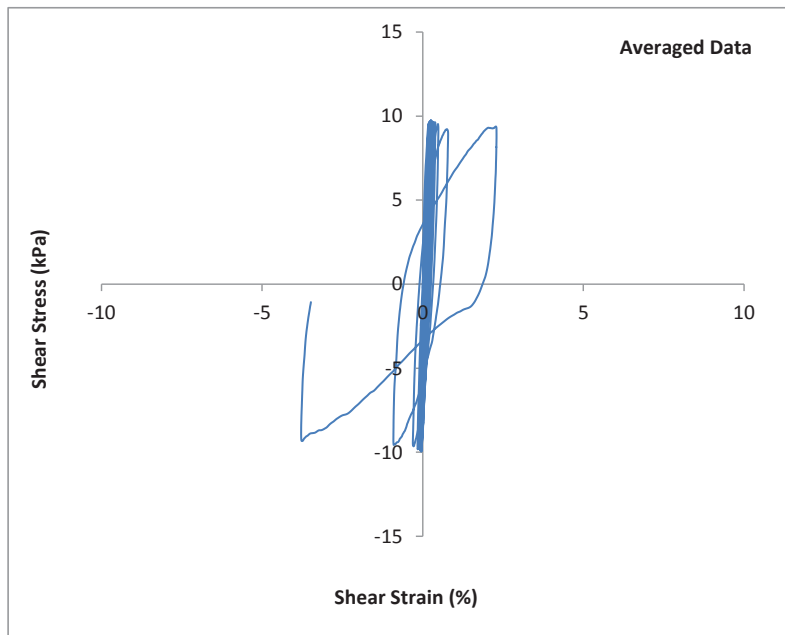
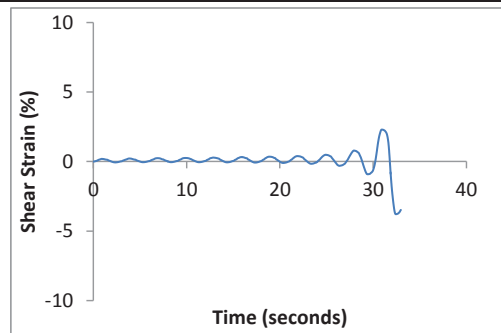
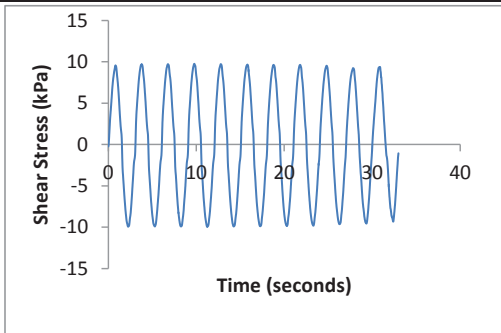

CSS Cyclic Shear Test Report

Geotechnical Engineering Laboratory



Cyclic Shear Test Summary

Device:	CSS	Density (kg/m³):	1967
Specimen ID:	60C109_40LS	Relative Density (%):	90%
Test ID:	C292	Void Ratio:	0.347
Date of Test:	8/18/2016	Vertical Stress (kPa):	100
Test Performed:	Cyclic Shear	Loading Frequency (Hz):	0.33
Test Material:	Ottawa Sand/LS	Number of Cycles:	11
Sample Preparation:	Prepared dense by tamping 45x in 5 layers	Cyclic Stress Ratio:	0.094
		Number of Cycles to Liq:	11
		Maximum ru:	0.96
Prepared by:	J.Hubler		
Checked by:	J.Hubler		

Additional Comments:

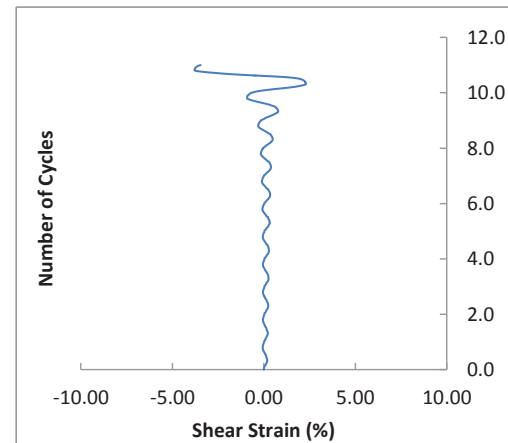
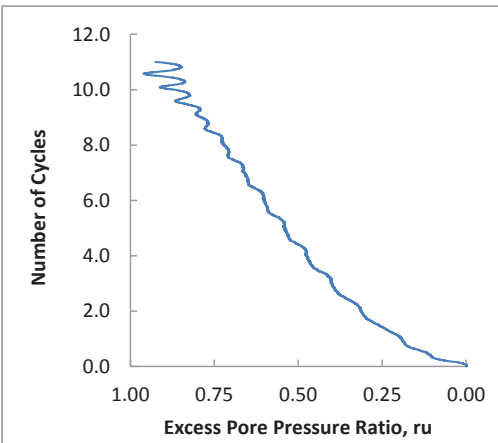
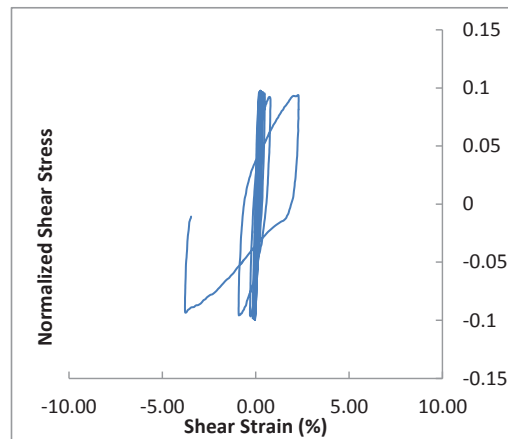
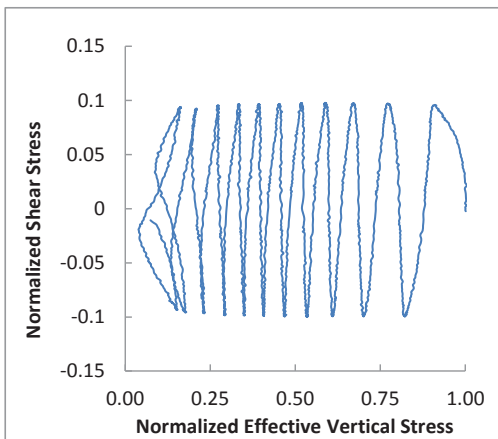

CSS Monotonic Shear Test Report

Geotechnical Engineering Laboratory



10/28/2013_Version 8.0

General Test Info and Sample Preparation

Device:	CSS	Relative Density (%):	69%
Specimen ID:	60C109_40LS	Void Ratio:	0.372
Test ID:	C292	Height (mm):	115.0
Date of Test:	8/18/2016	Soil-Only Specimen Diameter (mm):	306.23
Test Performed:	Post Cyclic Monotonic Shear	Weight (kg):	16.355
Test Material:	Ottawa Sand/Limestone	Density (kg/m³):	1931.5
Sample Preparation:	Prepared dense by tamping 45x in 5 layers.	Membrane Thickness (mm):	0.635
		Moisture Content (%):	0%
		Saturated (Y/N):	N
		Prepared by:	J.Hubler
		Checked by:	J. Hubler

Consolidation Stage		Shear Stage	
Vertical Stress (kPa):	100	Type of Test:	Constant Volume
Time to Compression (min):	6.1	Stress or Strain Controlled:	Strain
Relative Density (%):	90%	Shear Strain Rate (%/min):	0.29
Void Ratio:	0.347	Peak Shear Strength (kPa):	9.0
Height (mm):	112.9	Comments	
Diameter (mm):	306.23		
Weight (kg):	16.355		
Density (kg/m³):	1967.3		

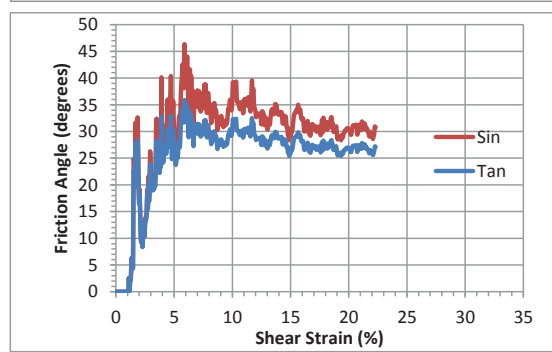
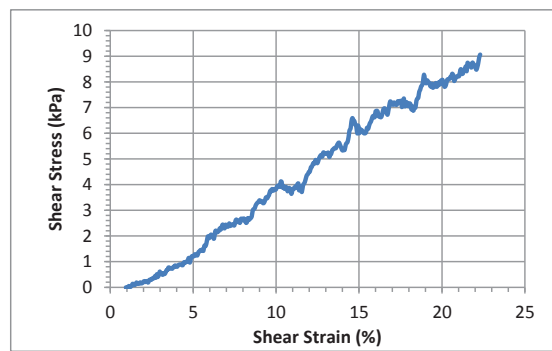
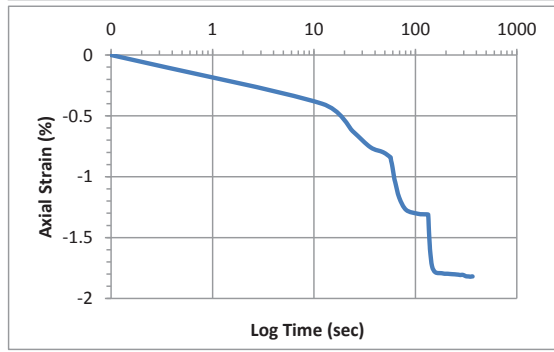
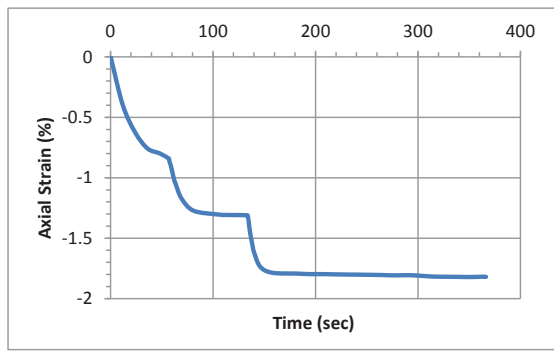

Accelerometer-Based Shear Wave Velocity Datasheet

Specimen ID: C290-40LS60C109-400-1X

Test Material: 40LS60C109

Date: 8/18/16

Test Performed by: J. Hubler

Filename: C290-40LS60C109-400-1X

Vertical Stress: 400kPa

Sensor Spacing: 0.10646 m

V_s (rise) = 290 m/s

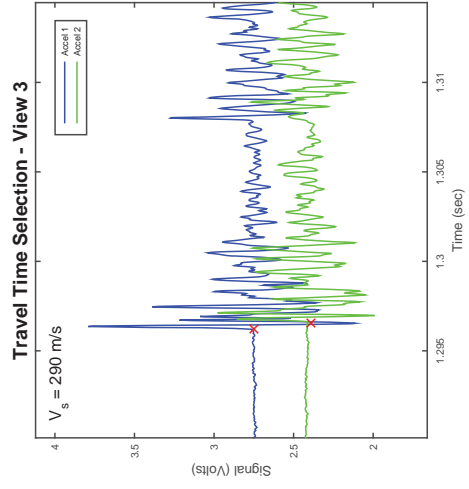
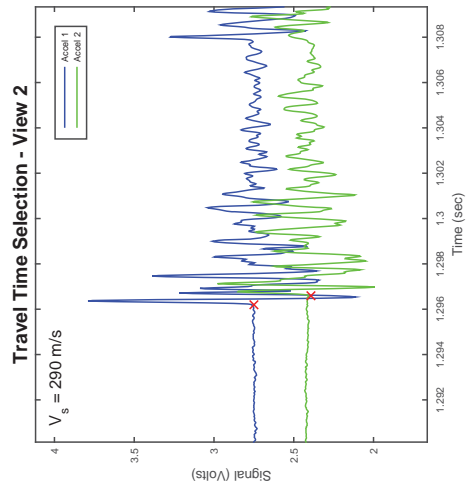
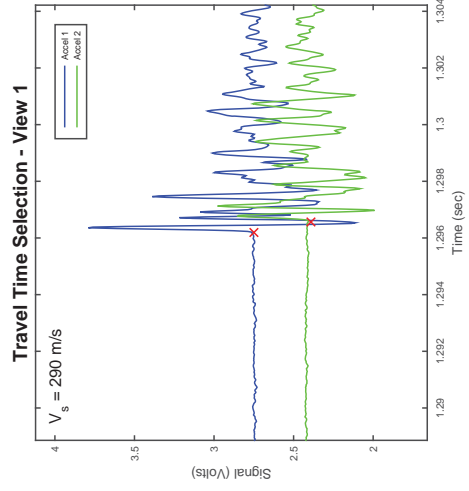
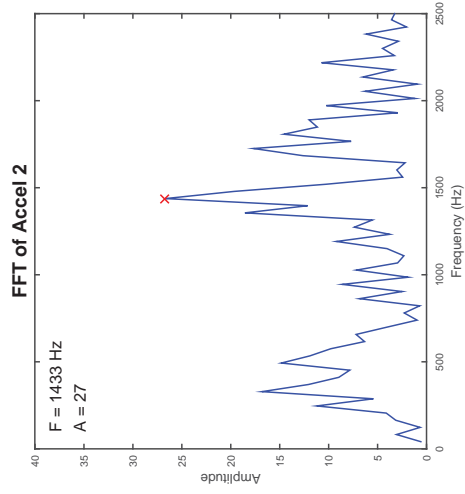
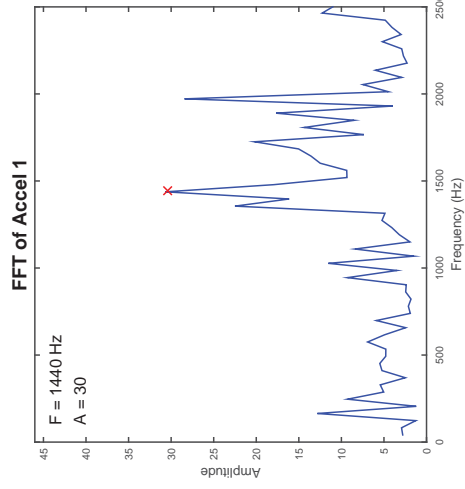
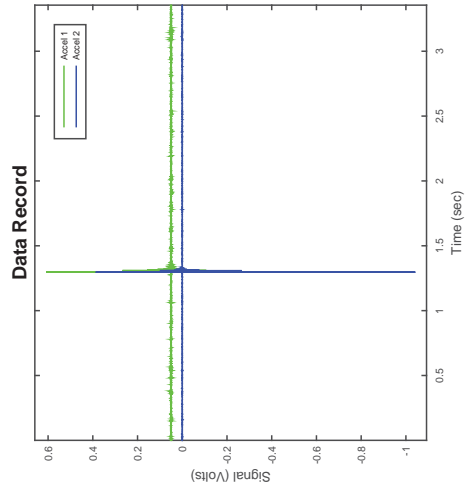

Accelerometer-Based Shear Wave Velocity Datasheet

Specimen ID: C290-40LS60C109-400-2X

Test Material: 40LS60C109

Date: 8/18/16

Test Performed by: J.Hubler

Filename: C290-40LS60C109-400-2X

Vertical Stress: 400kPa

Sensor Spacing: 0.10646 m

V_s (rise) = 282 m/s

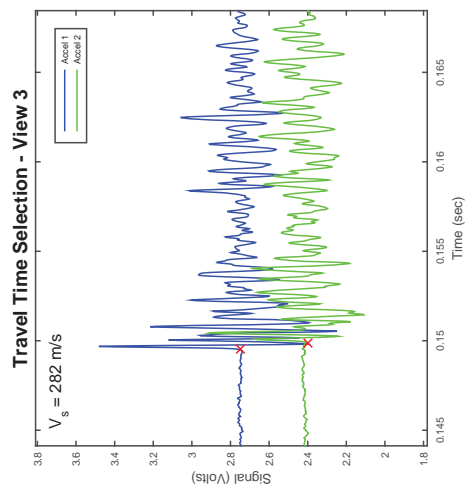
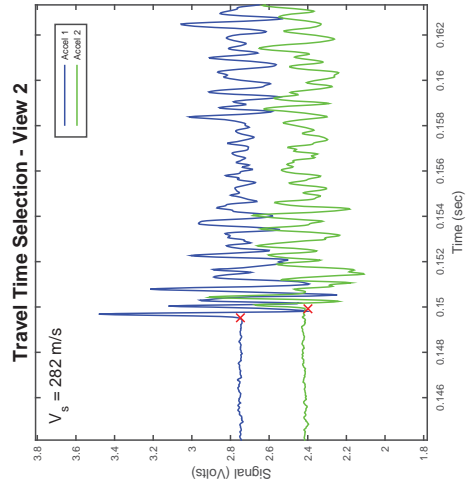
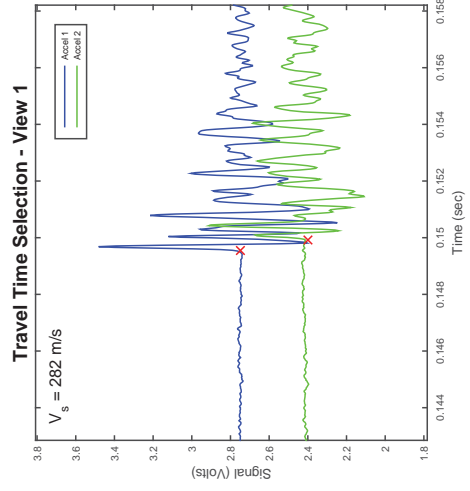
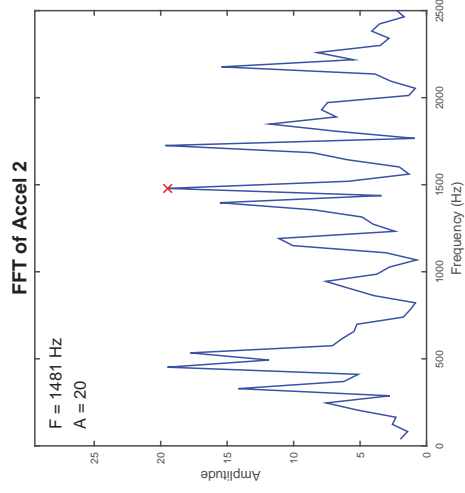
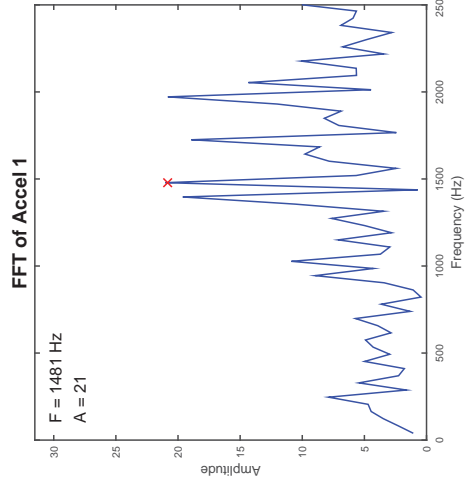
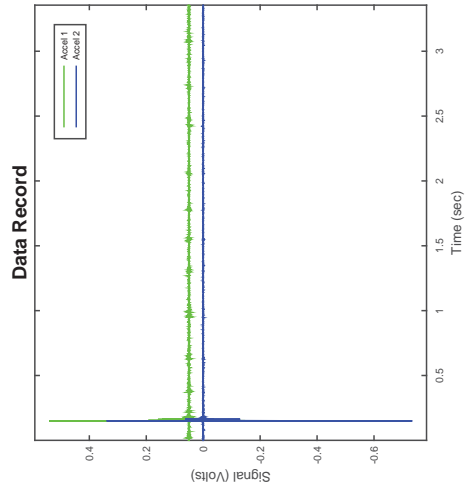

Accelerometer-Based Shear Wave Velocity Datasheet

Specimen ID: C290-40LS60C109-400-3X

Test Material: 40LS60C109

Date: 8/18/16

Test Performed by: J. Hubler

Filename: C290-40LS60C109-400-3X

Vertical Stress: 400kPa

Sensor Spacing: 0.10646 m

V_s (rise) = 299 m/s

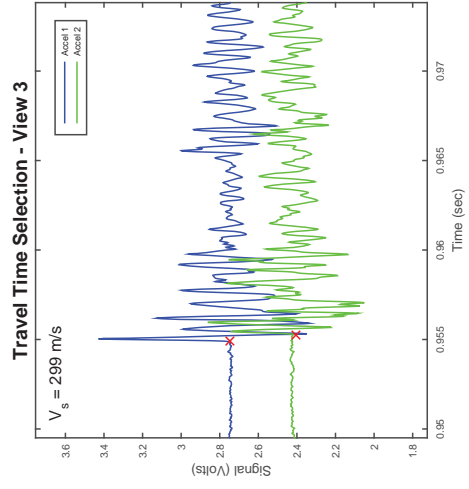
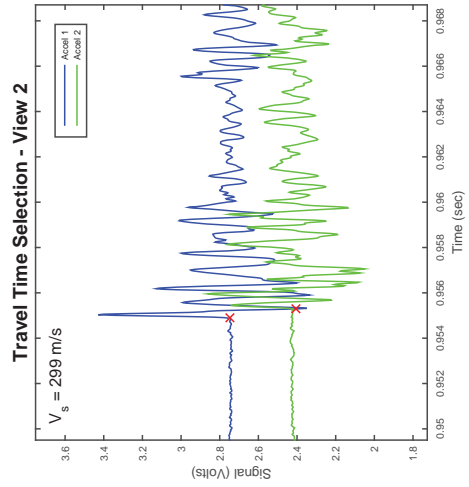
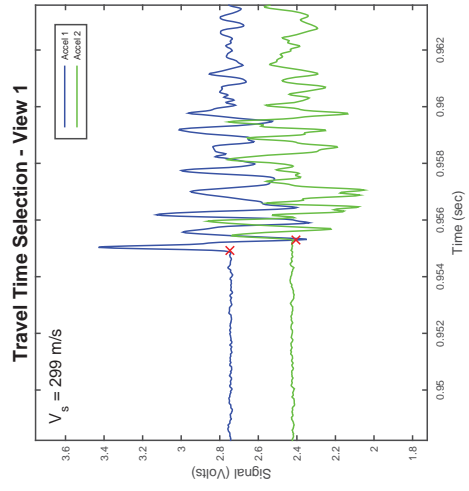
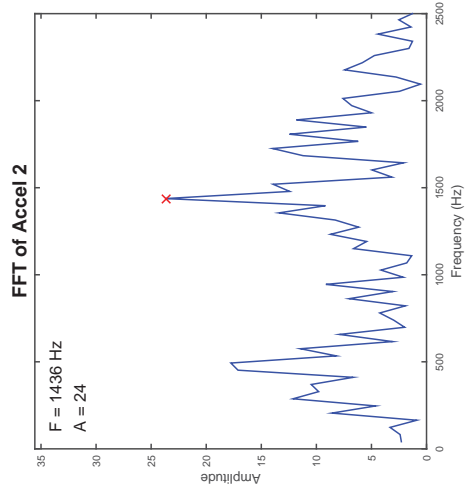
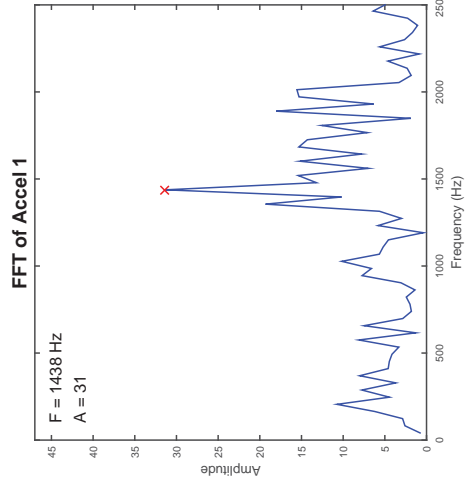
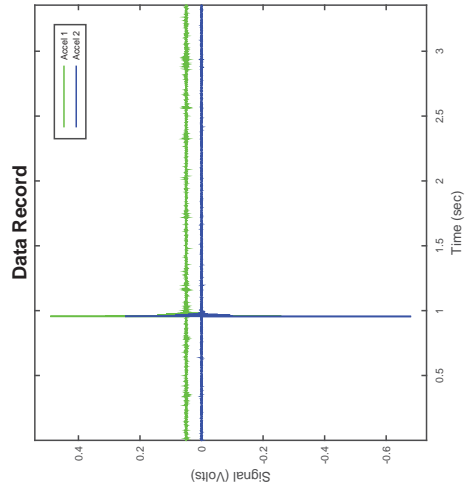

CSS Cyclic Shear Test Report

Geotechnical Engineering Laboratory



Cyclic Shear Test Summary

Device:	CSS	Density (kg/m³):	1963
Specimen ID:	60C109_40LS	Relative Density (%):	88%
Test ID:	C291	Void Ratio:	0.350
Date of Test:	8/18/2016	Vertical Stress (kPa):	100
Test Performed:	Cyclic Shear	Loading Frequency (Hz):	0.33
Test Material:	Ottawa Sand/LS	Number of Cycles:	6
Sample Preparation:	Prepared dense by tamping 45x in 5 layers.	Cyclic Stress Ratio:	0.144
		Shear Modulus (kPa):	
		Damping (%):	
Prepared by:	J.Hubler	Shear Strain Single Amplitude (%)	
Checked by:	J.Hubler		

Additional Comments:

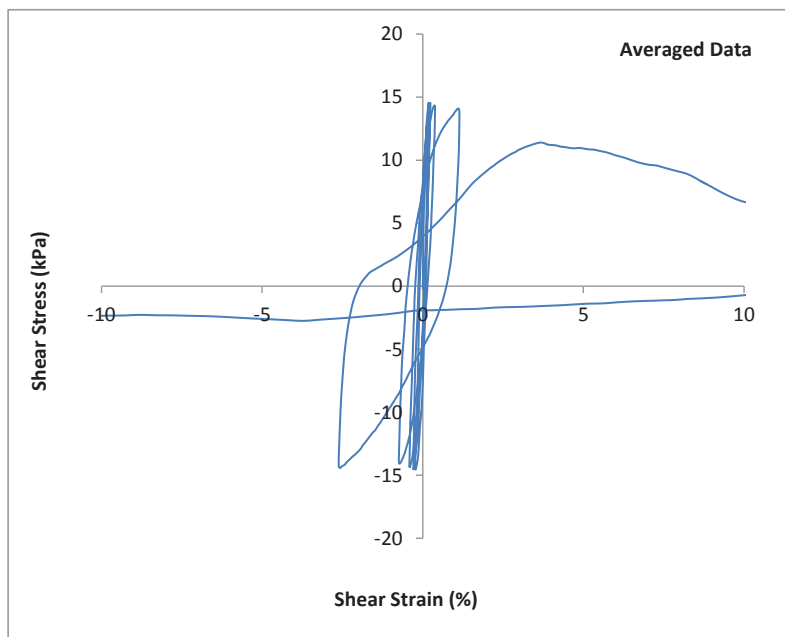
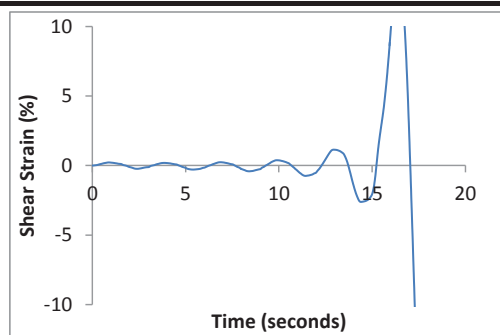
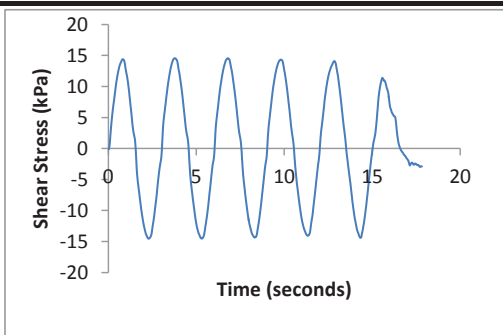

CSS Cyclic Shear Test Report

Geotechnical Engineering Laboratory



Cyclic Shear Test Summary

Device:	CSS	Density (kg/m³):	1963
Specimen ID:	60C109_40LS	Relative Density (%):	88%
Test ID:	C291	Void Ratio:	0.350
Date of Test:	8/18/2016	Vertical Stress (kPa):	100
Test Performed:	Cyclic Shear	Loading Frequency (Hz):	0.33
Test Material:	Ottawa Sand/LS	Number of Cycles:	6
Sample Preparation:	Prepared dense by tamping 45x in 5 layers.	Cyclic Stress Ratio:	0.144
		Number of Cycles to Liq:	6
		Maximum ru:	0.99
Prepared by:	J.Hubler		
Checked by:	J.Hubler		

Additional Comments:

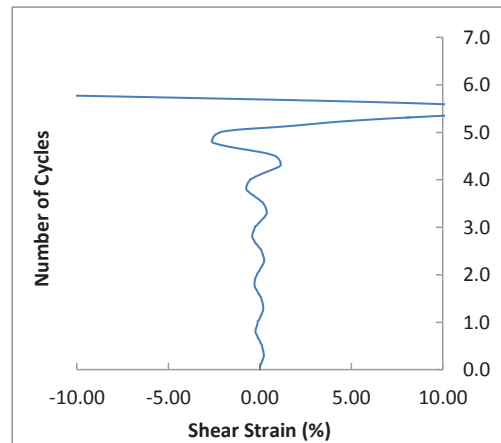
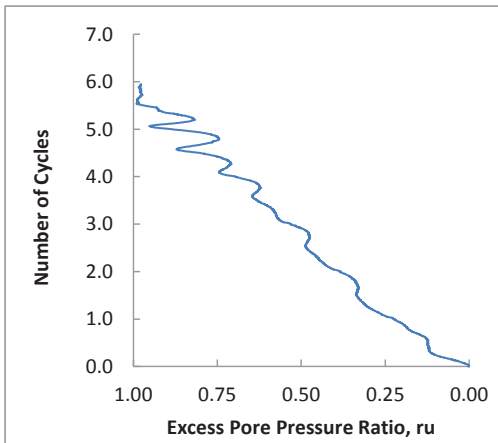
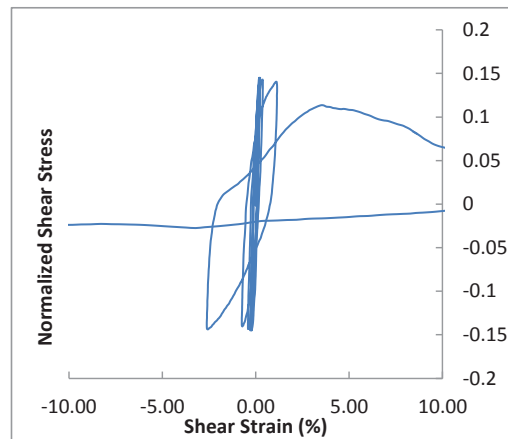
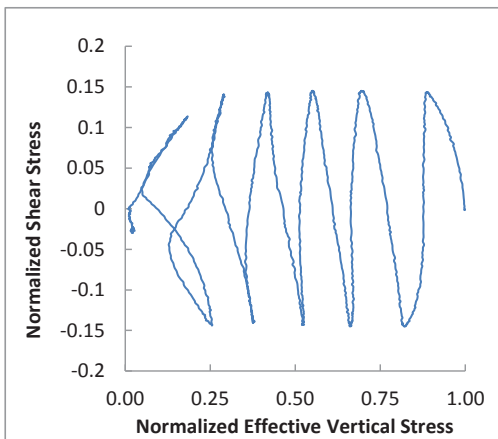

CSS Monotonic Shear Test Report

Geotechnical Engineering Laboratory



10/28/2013_Version 8.0

General Test Info and Sample Preparation

Device:	CSS	Relative Density (%):	88%
Specimen ID:	60C109_40LS	Void Ratio:	0.350
Test ID:	C291	Height (mm):	110.2
Date of Test:	8/18/2016	Soil-Only Specimen Diameter (mm):	306.23
Test Performed:	Post Cyclic Monotonic Shear	Weight (kg):	15.940
Test Material:	Ottawa Sand/Limestone	Density (kg/m³):	1963.2
Sample Preparation:	Prepared dense by tamping 45x in 5 layers.	Membrane Thickness (mm):	0.635
		Moisture Content (%):	0%
		Saturated (Y/N):	N
		Prepared by:	J.Hubler
		Checked by:	J. Hubler

Consolidation Stage

Shear Stage

Vertical Stress (kPa):	100	Type of Test:	Constant Volume
Time to Compression (min):	1.4	Stress or Strain Controlled:	Strain
Relative Density (%):	100%	Shear Strain Rate (%/min):	0.30
Void Ratio:	0.335	Peak Shear Strength (kPa):	23.3
Height (mm):	109.0	Comments Post Cyclic Reconsol	
Diameter (mm):	306.23		
Weight (kg):	15.940		
Density (kg/m³):	1984.7		

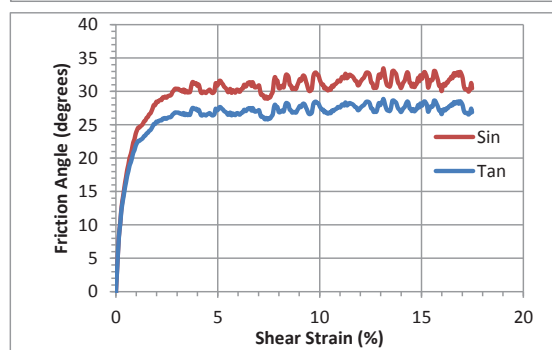
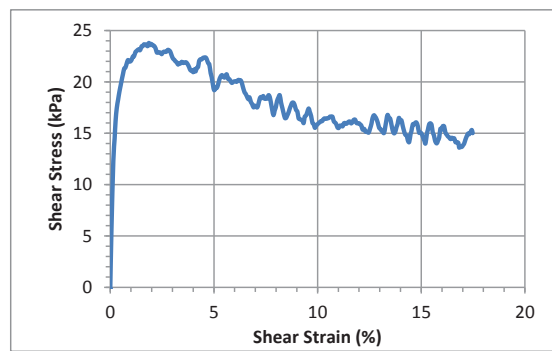
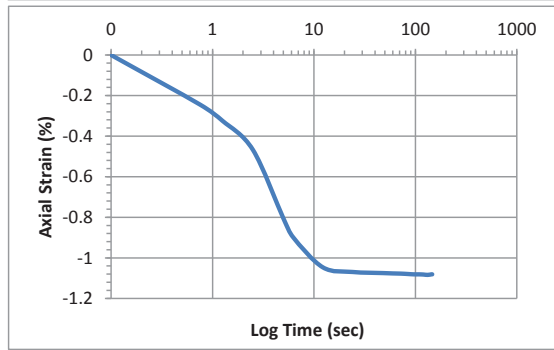
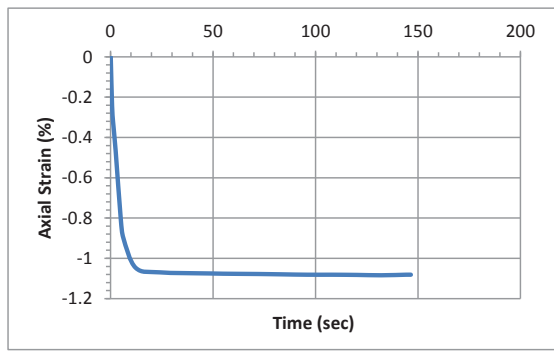

Accelerometer-Based Shear Wave Velocity Datasheet

Specimen ID: C291-40LS60C109-100-1X
 Test Material: 40LS60C109
 Date: 8/18/16
 Test Performed by: J.Hubler
 Filename: C291-40LS60C109-100-1X

Vertical Stress: 100kPa
 Sensor Spacing: 0.10992 m
 V_s (rise) = 234 m/s

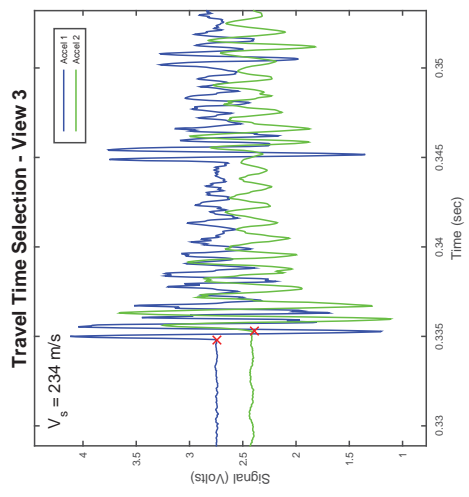
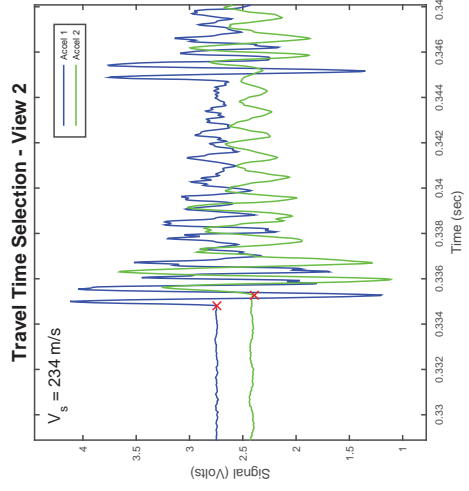
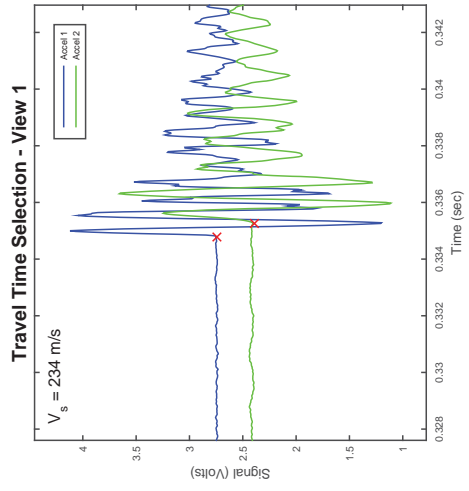
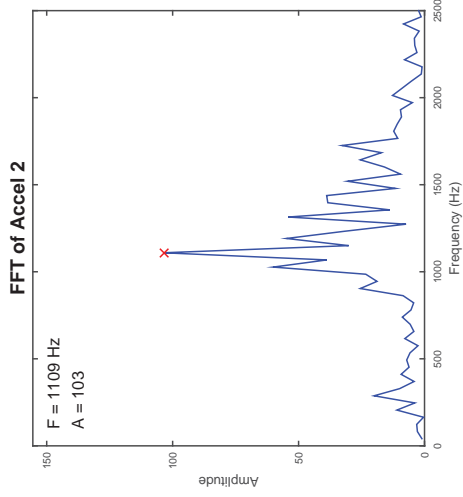
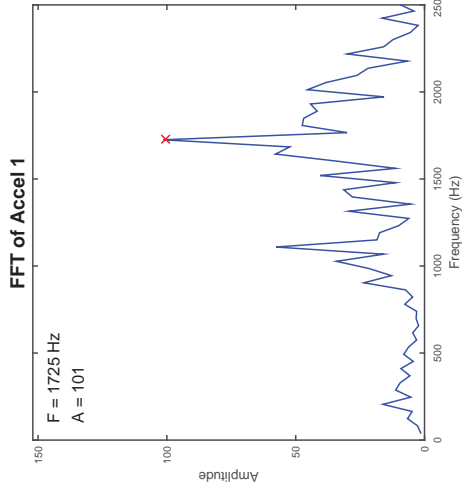
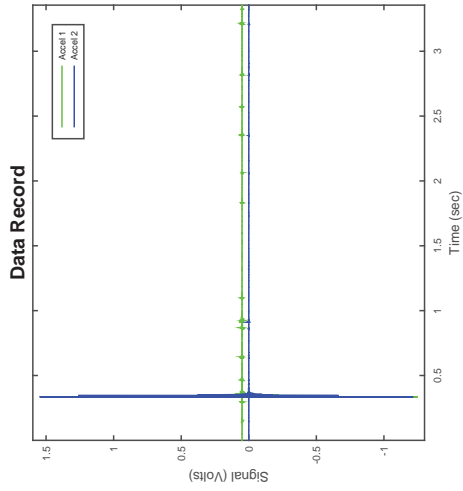

Accelerometer-Based Shear Wave Velocity Datasheet

Specimen ID: C291-40LS60C109-100-2X

Test Material: 40LS60C109

Date: 8/18/16

Test Performed by: J.Hubler

Filename: C291-40LS60C109-100-2X

Vertical Stress: 100kPa

Sensor Spacing: 0.10992 m

V_s (rise) = 239 m/s

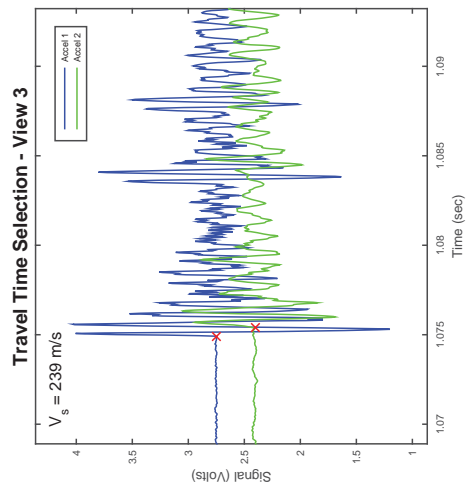
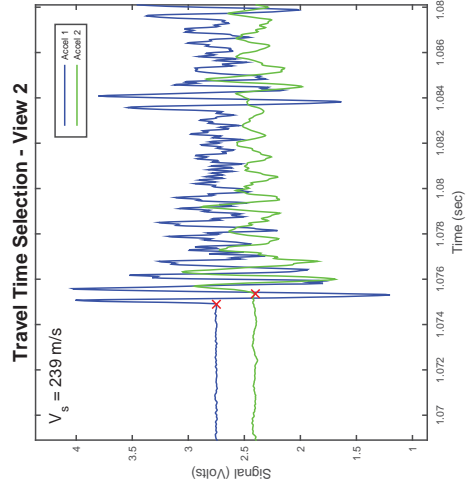
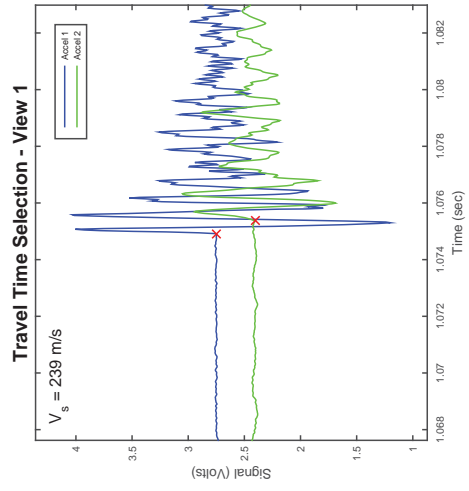
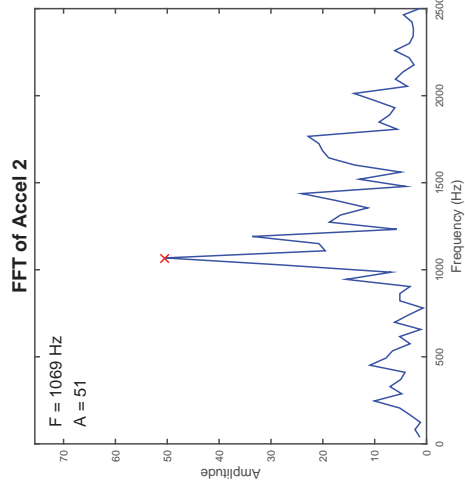
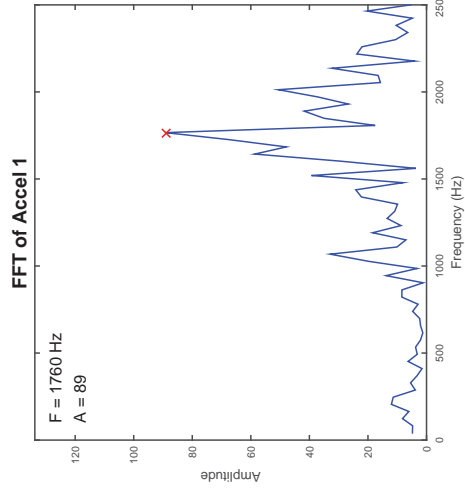
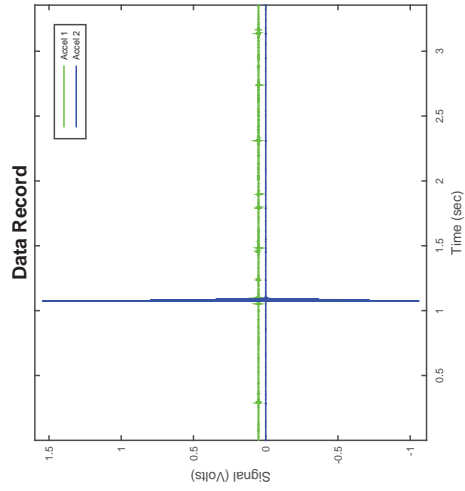

Accelerometer-Based Shear Wave Velocity Datasheet

Specimen ID: C291-40LS60C109-100-3X

Test Material: 40LS60C109

Date: 8/18/16

Test Performed by: J.Hubler

Filename: C291-40LS60C109-100-3X

Vertical Stress: 100kPa

Sensor Spacing: 0.10992 m

V_s (rise) = 234 m/s

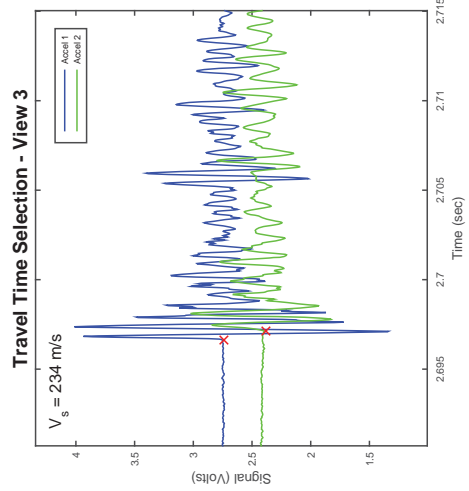
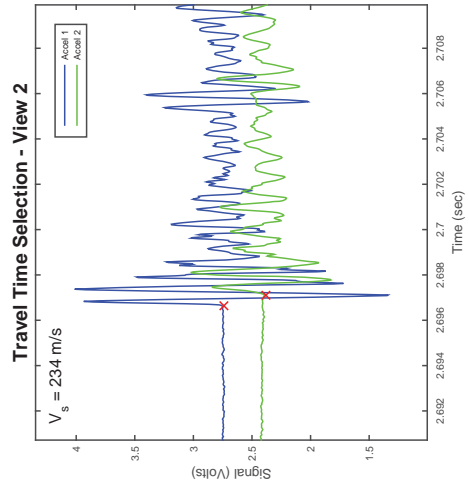
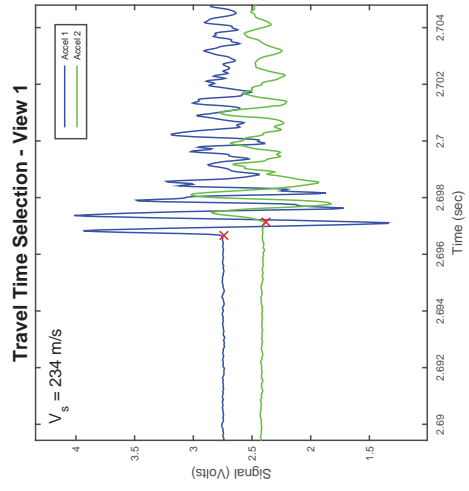
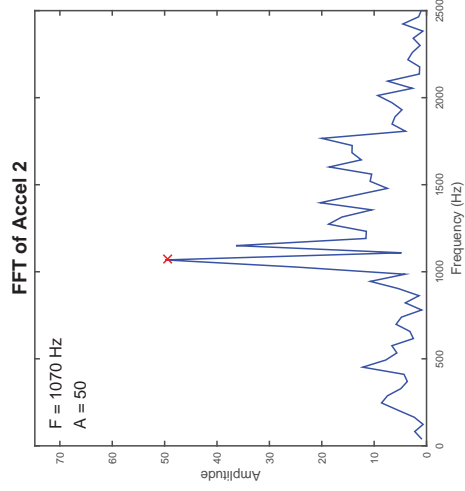
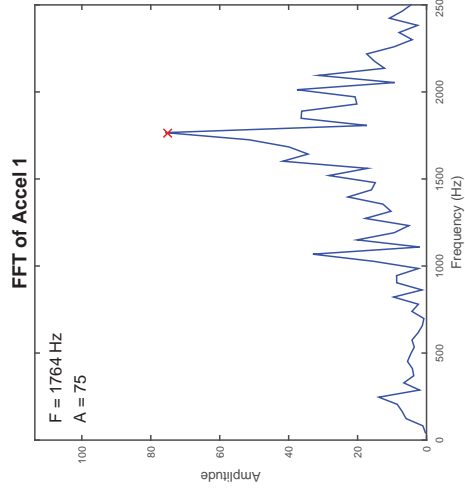
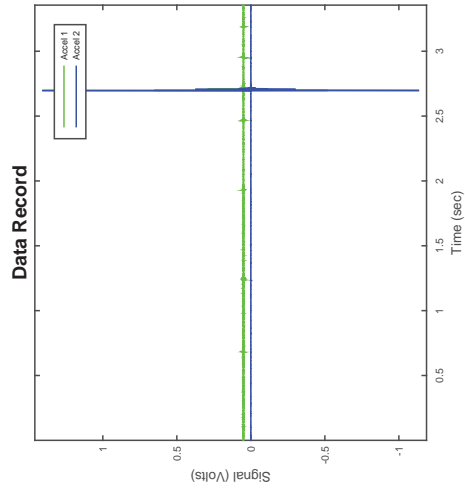

Accelerometer-Based Shear Wave Velocity Datasheet

Specimen ID: C291-40LS60C109-100-1XP

Test Material: 40LS60C109

Date: 8/18/16

Test Performed by: J.Hubler

Filename: C291-40LS60C109-100-1XP

Vertical Stress: 100kPa

Sensor Spacing: 0.10873 m

V_s (rise) = 193 m/s

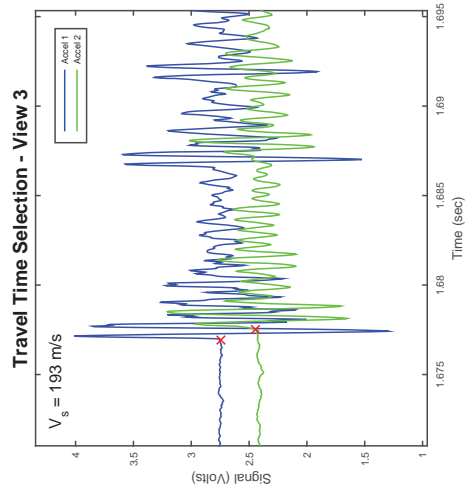
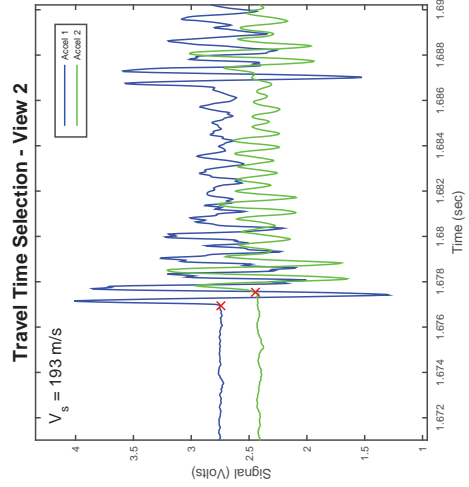
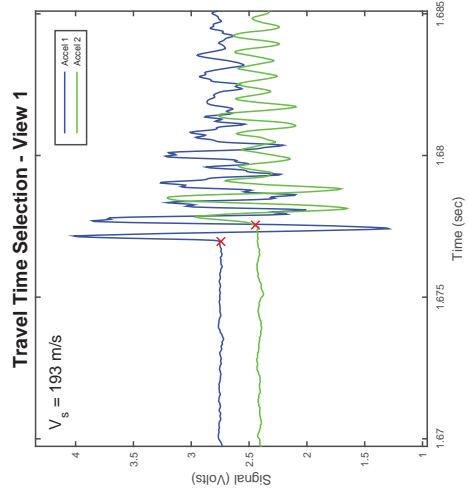
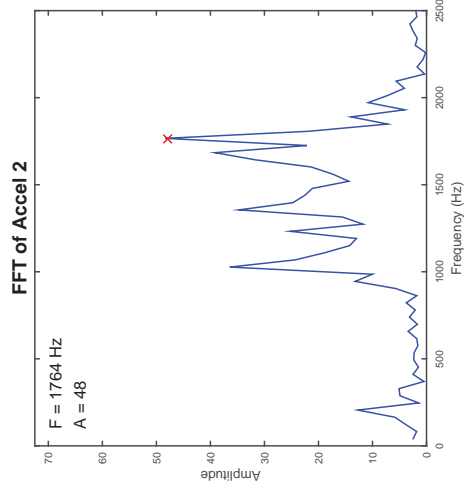
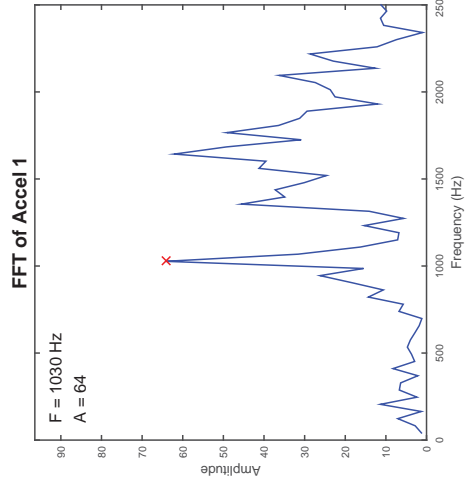
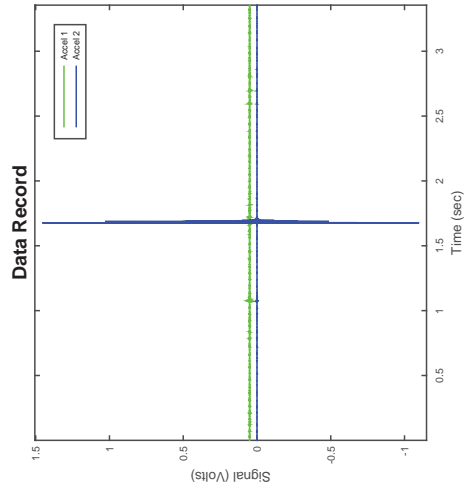

Accelerometer-Based Shear Wave Velocity Datasheet

Specimen ID: C291-40LS60C109-100-2XP

Test Material: 40LS60C109

Date: 8/18/16

Test Performed by: J.Hubler

Filename: C291-40LS60C109-100-2XP

Vertical Stress: 100kPa

Sensor Spacing: 0.10873 m

V_s (rise) = 200 m/s

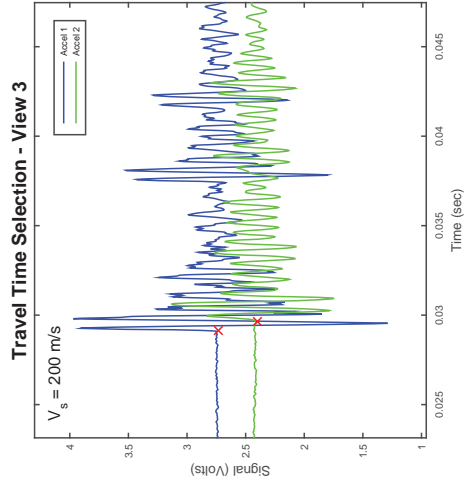
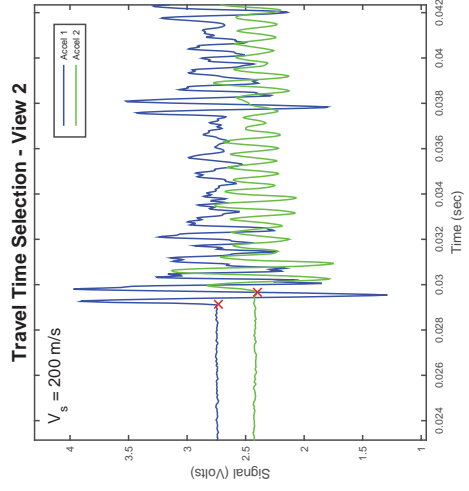
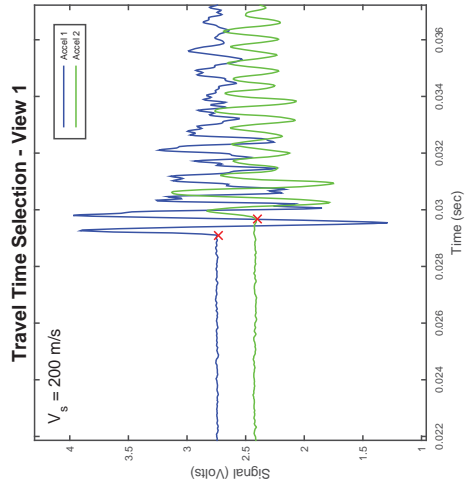
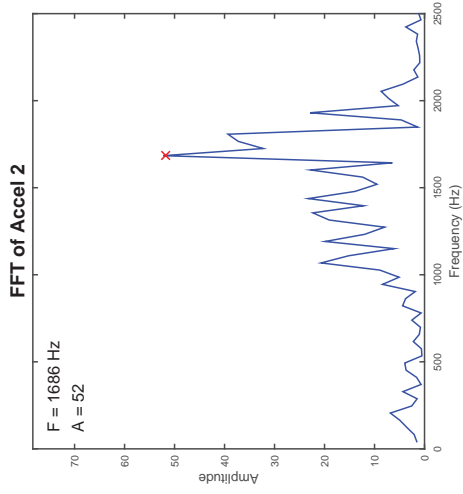
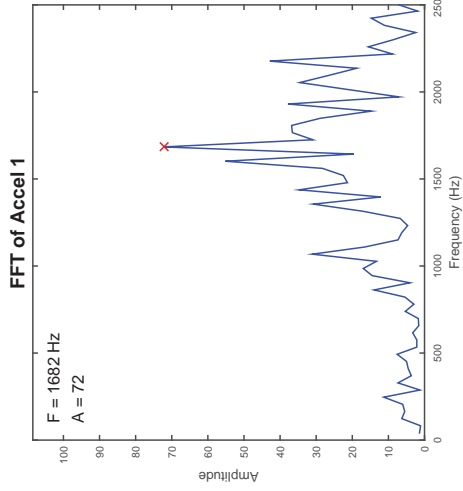
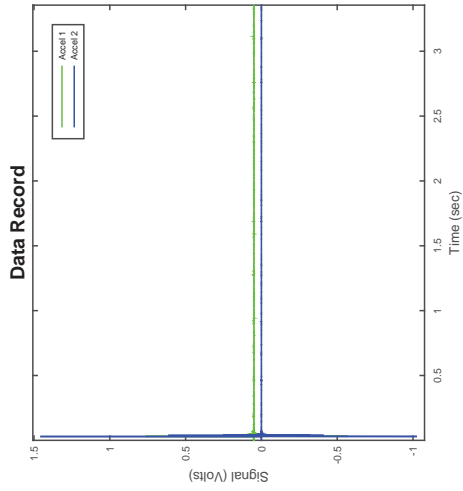

Accelerometer-Based Shear Wave Velocity Datasheet

Specimen ID: C291-40LS60C109-100-3XP

Test Material: 40LS60C109

Date: 8/18/16

Test Performed by: J.Hubler

Filename: C291-40LS60C109-100-3XP

Vertical Stress: 100kPa

Sensor Spacing: 0.10873 m

V_s (rise) = 193 m/s

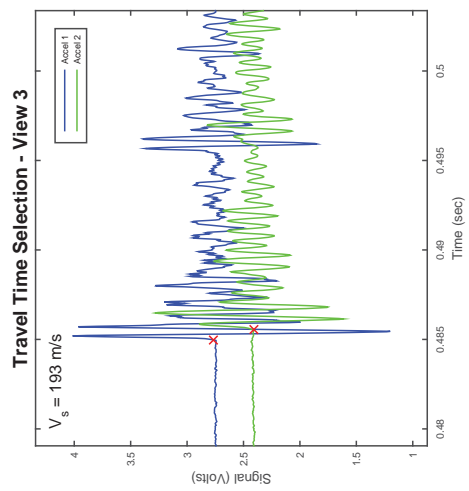
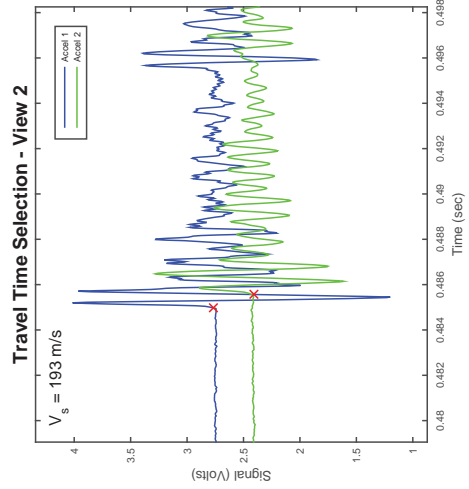
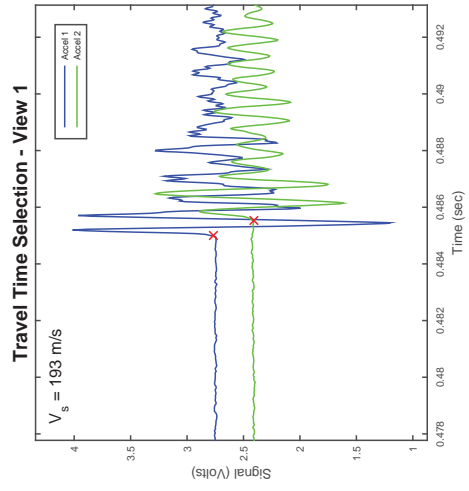
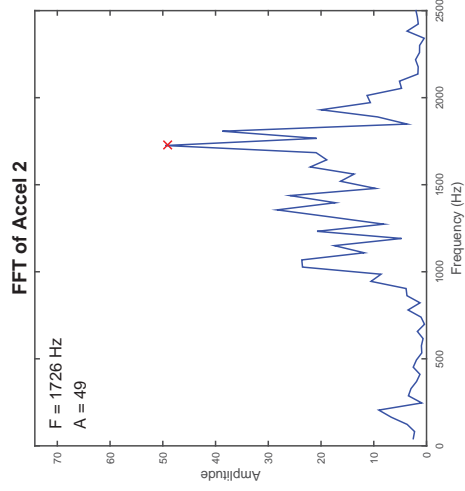
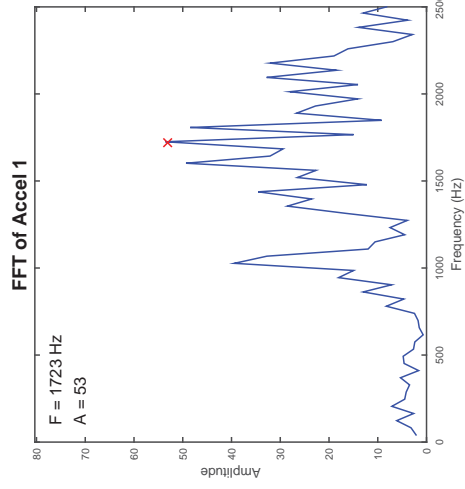
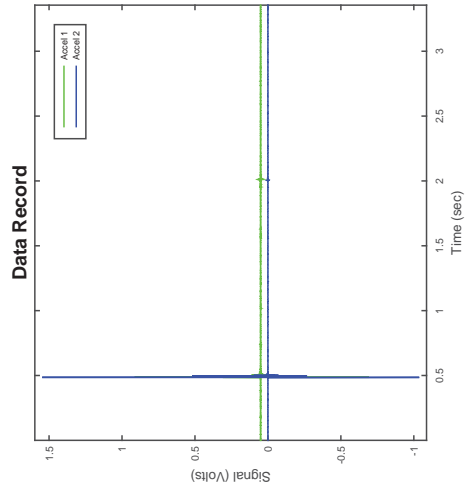

CSS Cyclic Shear Test Report

Geotechnical Engineering Laboratory



Cyclic Shear Test Summary

Device:	CSS	Density (kg/m³):	1939
Specimen ID:	40C109_60LS	Relative Density (%):	49%
Test ID:	C268	Void Ratio:	0.367
Date of Test:	4/19/2016	Vertical Stress (kPa):	100
Test Performed:	Cyclic Shear	Loading Frequency (Hz):	0.33
Test Material:	Ottawa Sand/LS	Number of Cycles:	8
Sample Preparation:	Prepared Loose using a funnel with zero drop height.	Cyclic Stress Ratio:	0.094
		Shear Modulus (kPa):	
		Damping (%):	
Prepared by:	J.Hubler	Shear Strain Single Amplitude (%)	
Checked by:	J.Hubler		

Additional Comments:

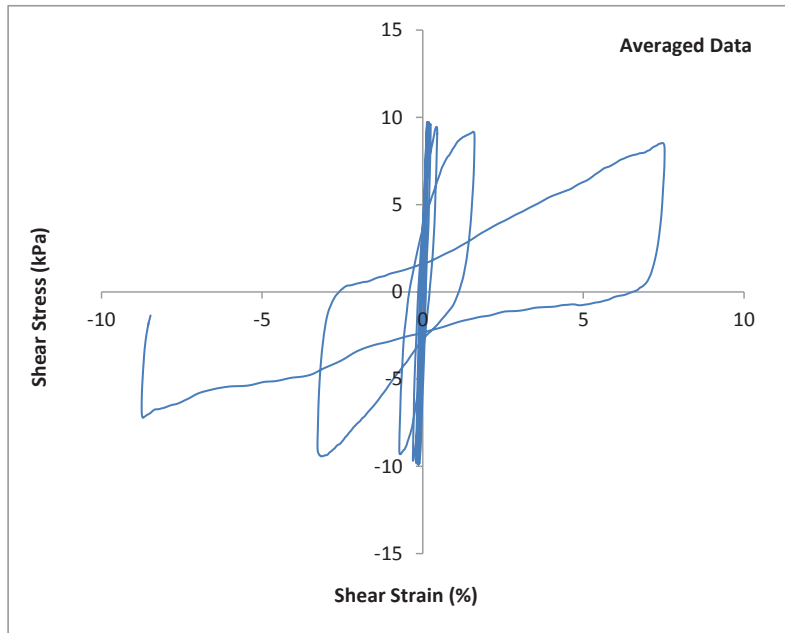
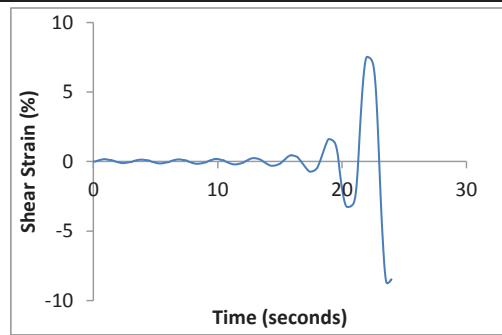
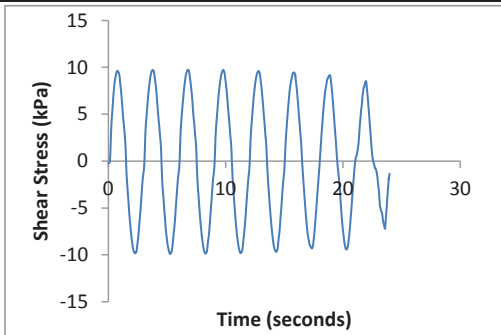

CSS Cyclic Shear Test Report

Geotechnical Engineering Laboratory



Cyclic Shear Test Summary

Device:	CSS	Density (kg/m³):	1939
Specimen ID:	40C109_60LS	Relative Density (%):	49%
Test ID:	C268	Void Ratio:	0.367
Date of Test:	4/19/2016	Vertical Stress (kPa):	100
Test Performed:	Cyclic Shear	Loading Frequency (Hz):	0.33
Test Material:	Ottawa Sand/LS	Number of Cycles:	8
Sample Preparation:	Prepared Loose using a funnel with zero drop height.	Cyclic Stress Ratio:	0.094
		Number of Cycles to Liq:	8
		Maximum ru:	1.00
Prepared by:	J.Hubler		
Checked by:	J.Hubler		

Additional Comments:

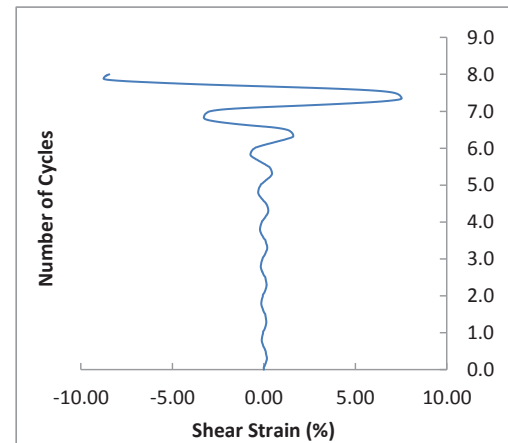
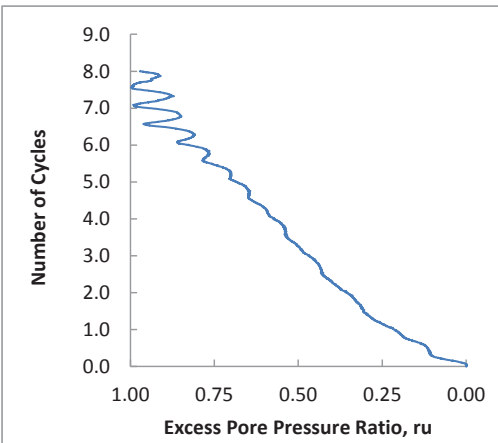
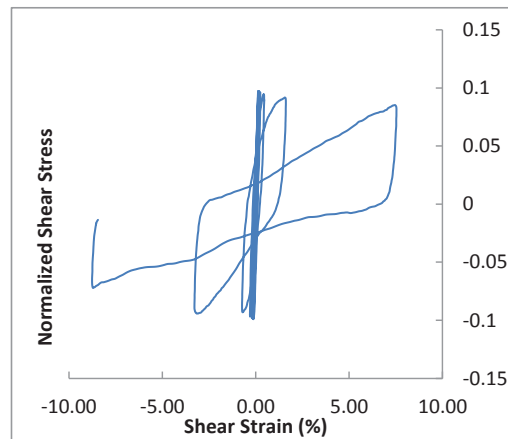
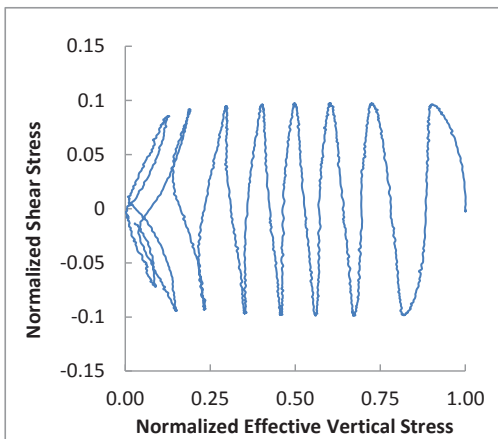

CSS Monotonic Shear Test Report

Geotechnical Engineering Laboratory



10/28/2013_Version 8.0

General Test Info and Sample Preparation

Device:	CSS	Relative Density (%):	49%
Specimen ID:	40C109_60LS	Void Ratio:	0.367
Test ID:	C268	Height (mm):	110.4
Date of Test:	4/19/2016	Soil-Only Specimen Diameter (mm):	306.23
Test Performed:	Post Cyclic Monotonic Shear	Weight (kg):	15.755
Test Material:	Ottawa Sand/Limestone	Density (kg/m³):	1938.5
Sample Preparation:	Prepared loose by placing with a funnel and zero drop height.	Membrane Thickness (mm):	0.635
		Moisture Content (%):	0%
		Saturated (Y/N):	N
		Prepared by:	J.Hubler
		Checked by:	J. Hubler

Consolidation Stage

Shear Stage

Vertical Stress (kPa):	100	Type of Test:	Constant Volume
Time to Compression (min):	2.8	Stress or Strain Controlled:	Strain
Relative Density (%):	49%	Shear Strain Rate (%/min):	0.30
Void Ratio:	0.367	Peak Shear Strength (kPa):	5.1
Height (mm):	110.3	Comments	
Diameter (mm):	306.23		
Weight (kg):	15.755		
Density (kg/m³):	1938.6		

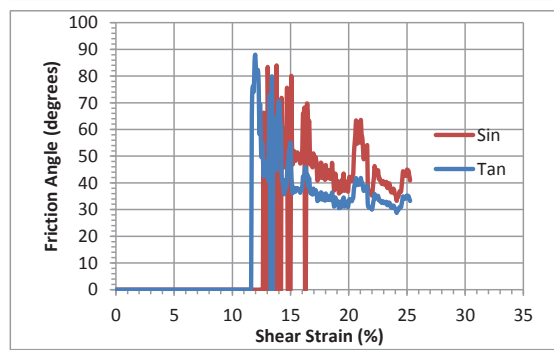
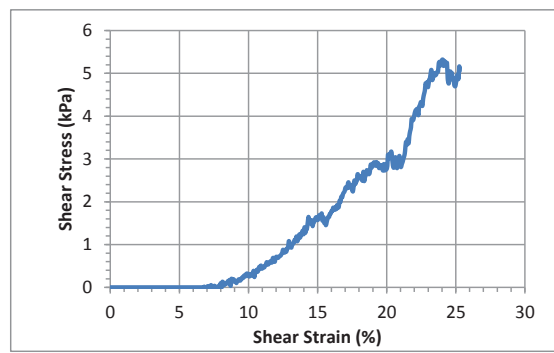
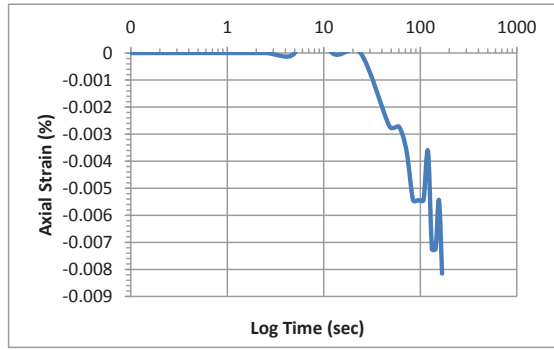
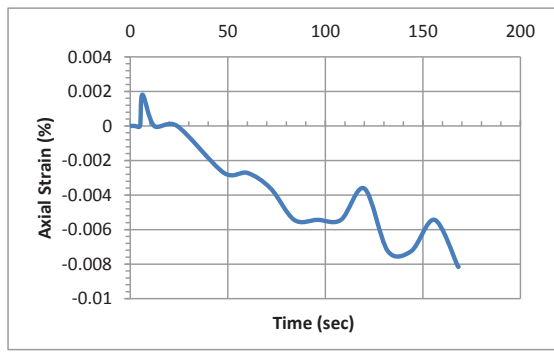

Accelerometer-Based Shear Wave Velocity Datasheet

Specimen ID: C268-LSC109-100-1X
 Test Material: LSC109
 Date: 4/19/2016
 Test Performed by: J.Hubler
 Filename: C268-LSC109-100-1X

Vertical Stress: 100kPa
 Sensor Spacing: 0.11026 m
 V_s (rise) = 201 m/s

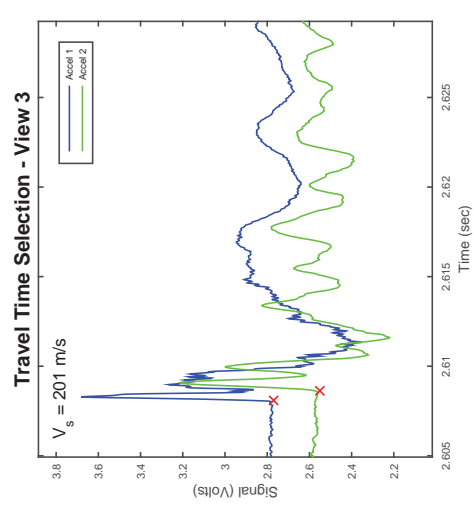
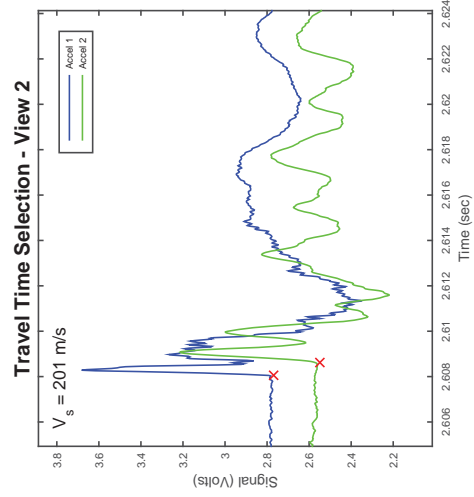
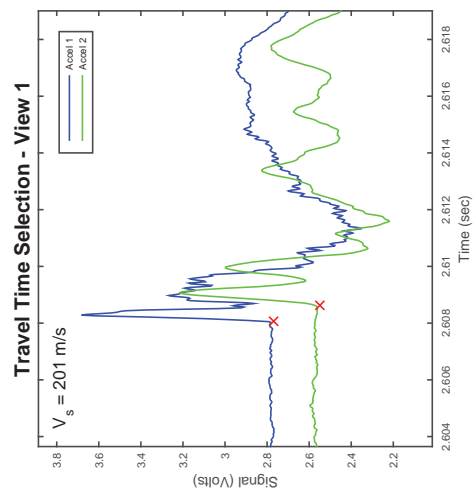
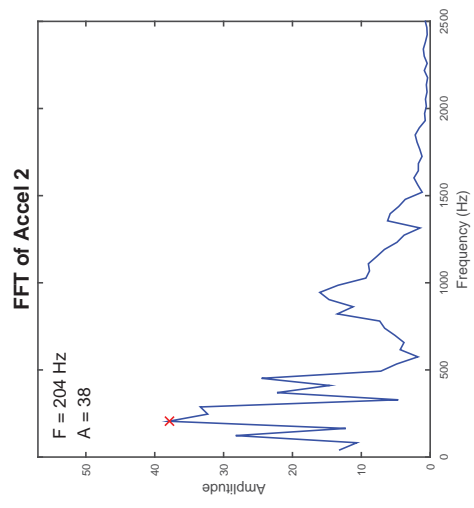
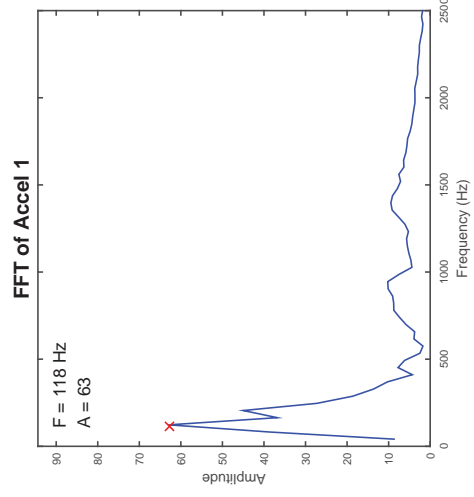
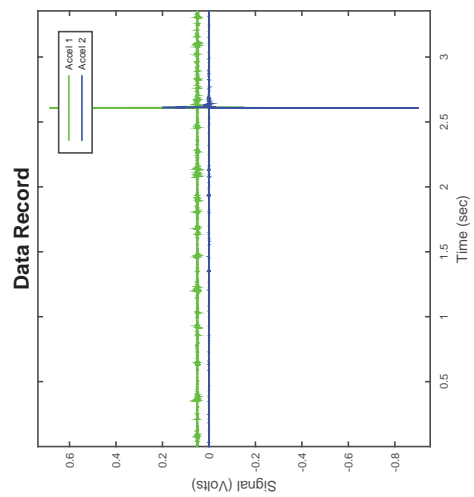

Accelerometer-Based Shear Wave Velocity Datasheet

Specimen ID: C268-LSC109-100-2X
 Test Material: LSC109
 Date: 4/19/2016
 Test Performed by: J.Hubler
 Filename: C268-LSC109-100-2X

Vertical Stress: 100kPa
 Sensor Spacing: 0.11026 m
 V_s (rise) = 195 m/s

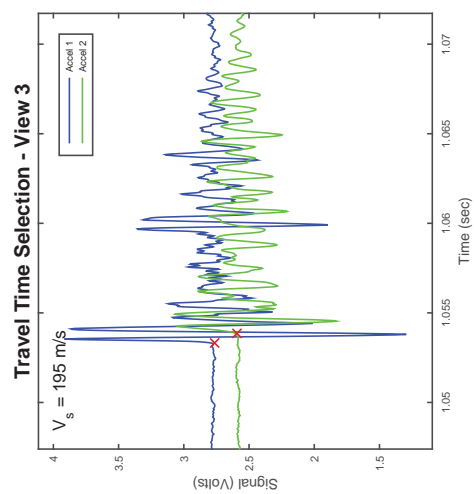
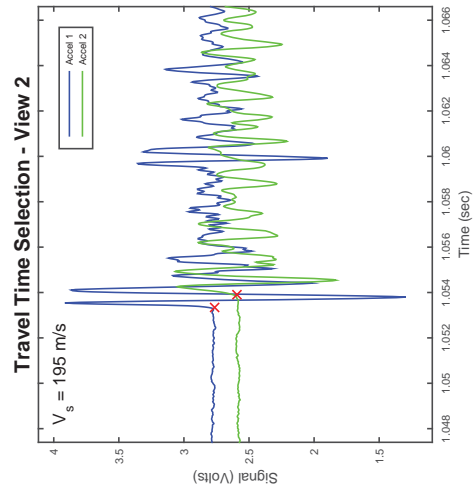
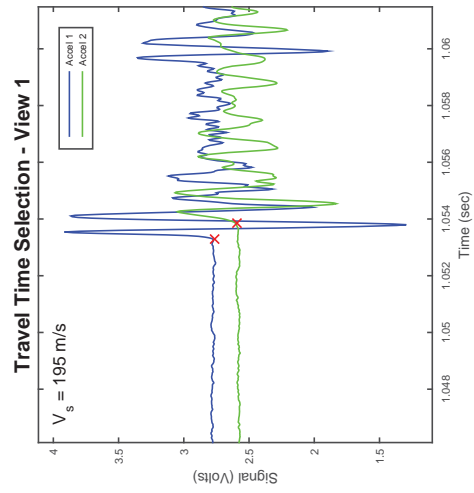
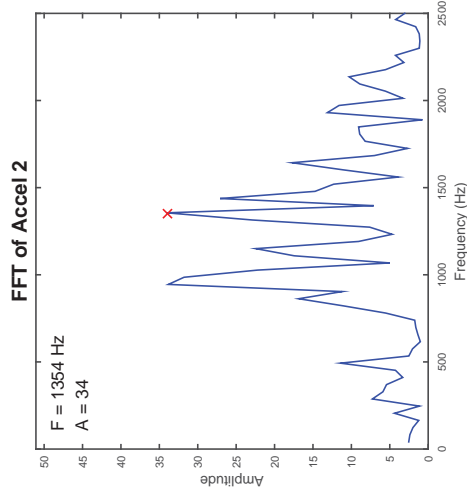
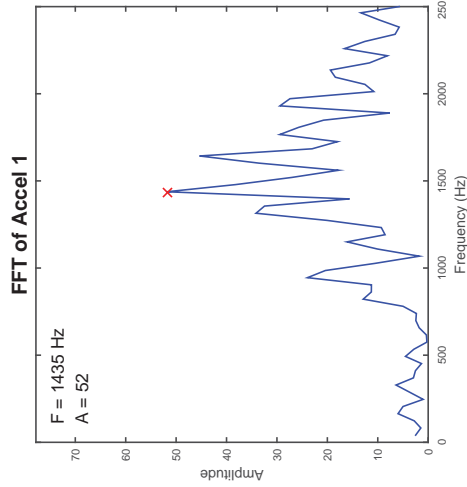
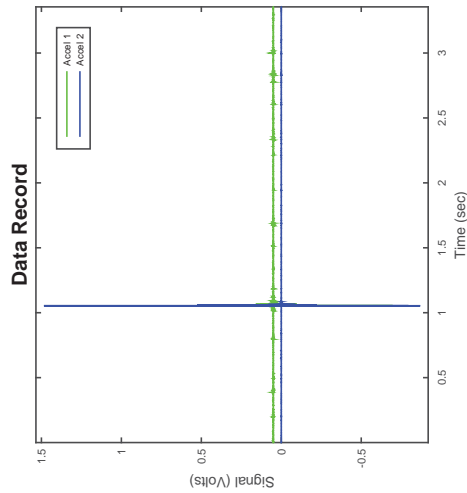

Accelerometer-Based Shear Wave Velocity Datasheet

Specimen ID: C268-LSC109-100-3X

Test Material: LSC109

Date: 4/19/2016

Test Performed by: J.Hubler

Filename: C268-LSC109-100-3X

Vertical Stress: 100kPa

Sensor Spacing: 0.11026 m

V_s (rise) = 201 m/s

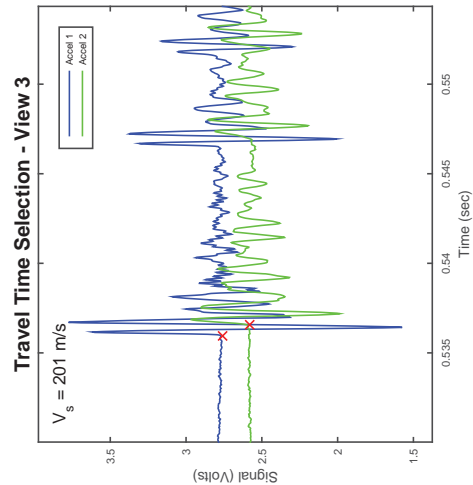
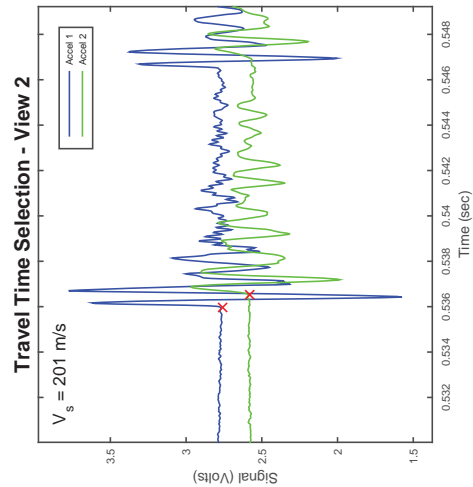
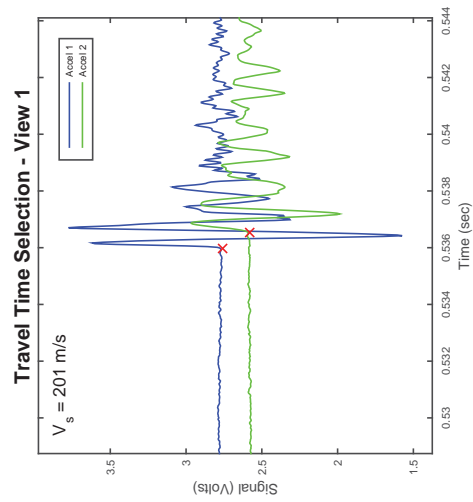
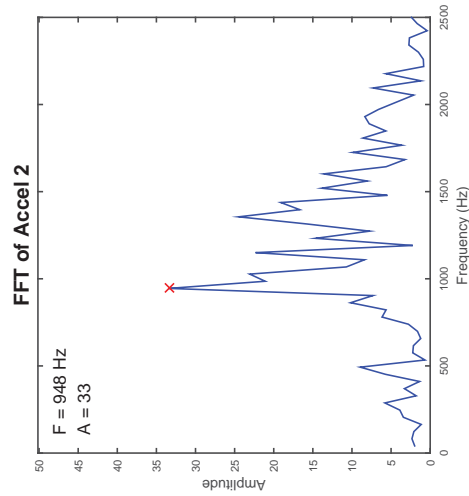
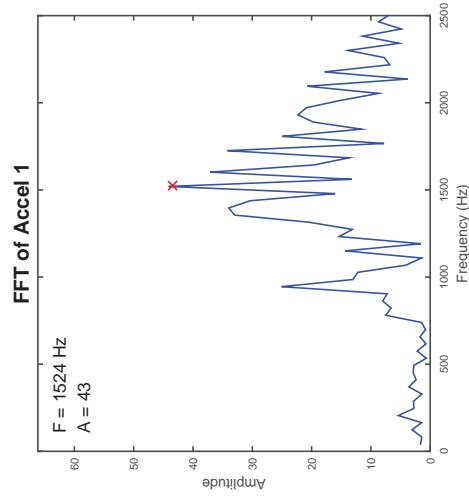
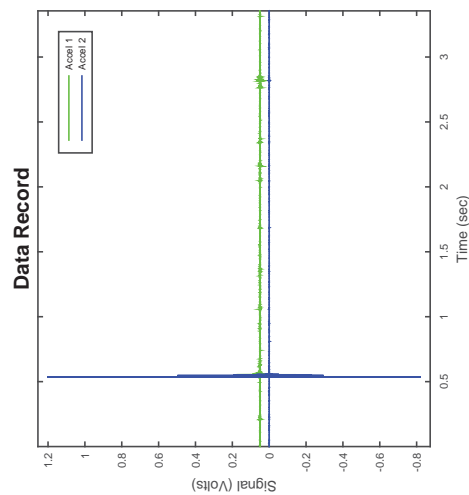

CSS Cyclic Shear Test Report

Geotechnical Engineering Laboratory



Cyclic Shear Test Summary

Device:	CSS	Density (kg/m³):	1931
Specimen ID:	40C109_60LS	Relative Density (%):	44%
Test ID:	C269	Void Ratio:	0.372
Date of Test:	4/20/2016	Vertical Stress (kPa):	100
Test Performed:	Cyclic Shear	Loading Frequency (Hz):	0.33
Test Material:	Ottawa Sand/LS	Number of Cycles:	4
Sample Preparation:	Prepared Loose using a funnel with zero drop height.	Cyclic Stress Ratio:	0.144
		Shear Modulus (kPa):	
		Damping (%):	
Prepared by:	J.Hubler	Shear Strain Single Amplitude (%)	
Checked by:	J.Hubler		

Additional Comments:

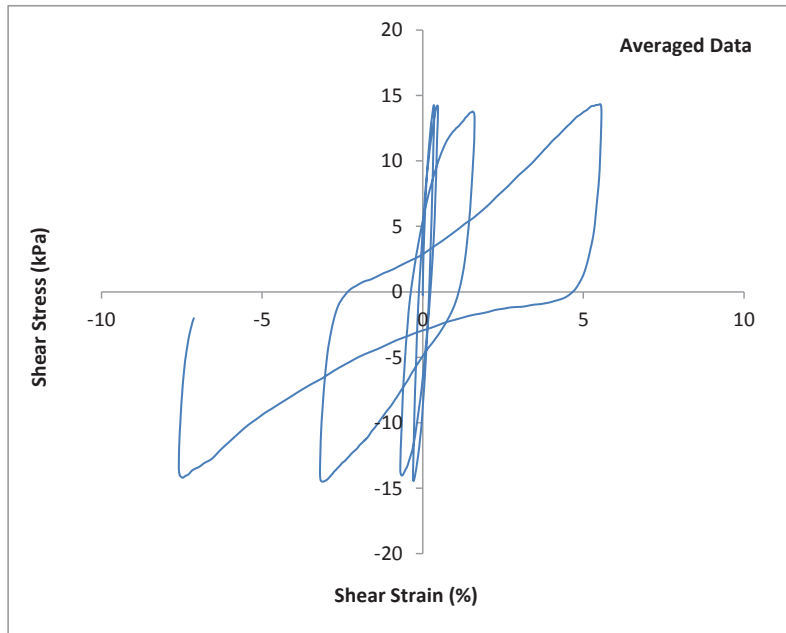
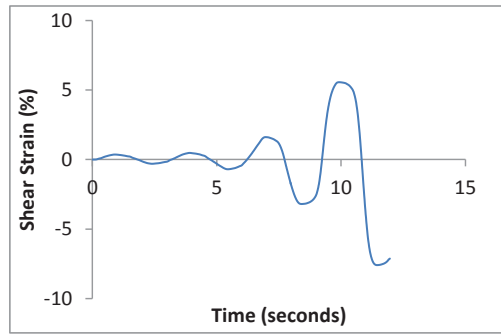
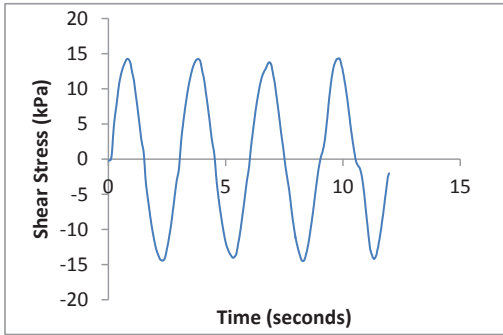

CSS Cyclic Shear Test Report

Geotechnical Engineering Laboratory



Cyclic Shear Test Summary

Device:	CSS	Density (kg/m³):	1931
Specimen ID:	40C109_60LS	Relative Density (%):	44%
Test ID:	C269	Void Ratio:	0.372
Date of Test:	4/20/2016	Vertical Stress (kPa):	100
Test Performed:	Cyclic Shear	Loading Frequency (Hz):	0.33
Test Material:	Ottawa Sand/LS	Number of Cycles:	4
Sample Preparation:	Prepared Loose using a funnel with zero drop height.	Cyclic Stress Ratio:	0.144
		Number of Cycles to Liq:	4
		Maximum ru:	0.99
Prepared by:	J.Hubler		
Checked by:	J.Hubler		

Additional Comments:

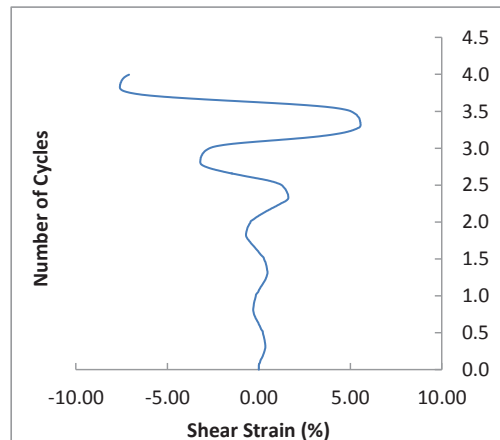
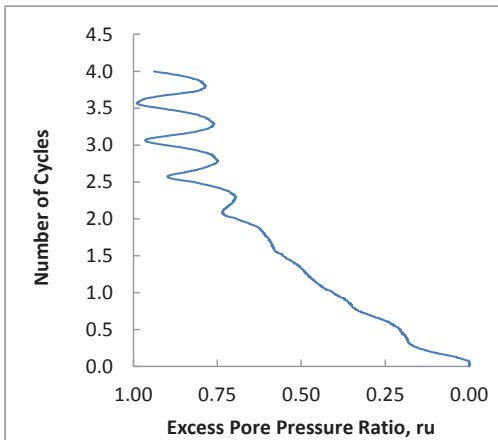
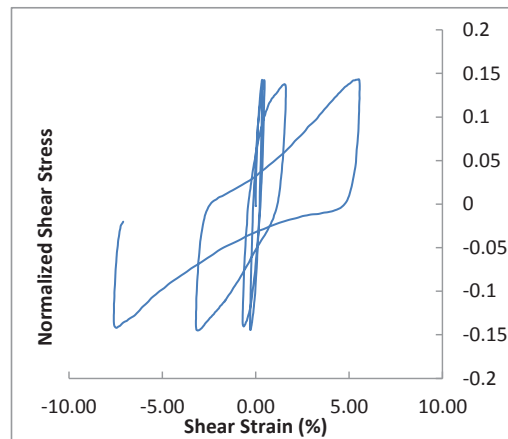
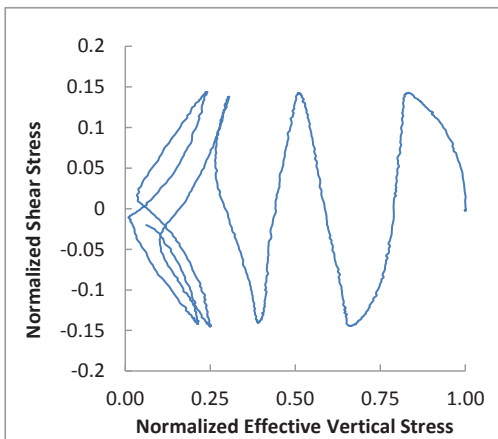

CSS Monotonic Shear Test Report

Geotechnical Engineering Laboratory



10/28/2013_Version 8.0

General Test Info and Sample Preparation

Device:	CSS	Relative Density (%):	44%
Specimen ID:	40C109_60LS	Void Ratio:	0.372
Test ID:	C269	Height (mm):	109.5
Date of Test:	4/20/2016	Soil-Only Specimen Diameter (mm):	306.23
Test Performed:	Post Cyclic Monotonic Shear	Weight (kg):	15.569
Test Material:	Ottawa Sand/Limestone	Density (kg/m³):	1930.9
Sample Preparation:	Prepared loose by placing with a funnel and zero drop height.	Membrane Thickness (mm):	0.635
		Moisture Content (%):	0%
		Saturated (Y/N):	N
		Prepared by:	J. Hubler
		Checked by:	J. Hubler

Consolidation Stage

Shear Stage

Vertical Stress (kPa):	100	Type of Test:	Constant Volume
Time to Compression (min):	1.4	Stress or Strain Controlled:	Strain
Relative Density (%):	60%	Shear Strain Rate (%/min):	0.30
Void Ratio:	0.355	Peak Shear Strength (kPa):	20.8
Height (mm):	108.0	Comments Post Cyclic Reconsol. Specimen slid after approximately 9% shear strain	
Diameter (mm):	306.23		
Weight (kg):	15.569		
Density (kg/m³):	1956.4		

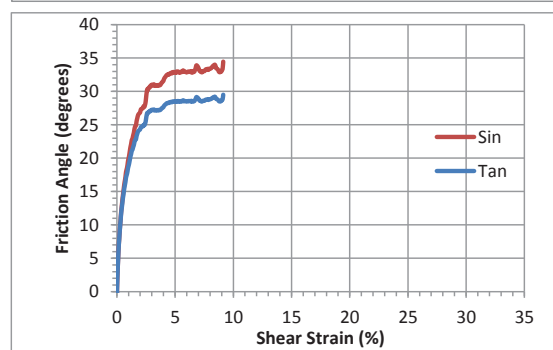
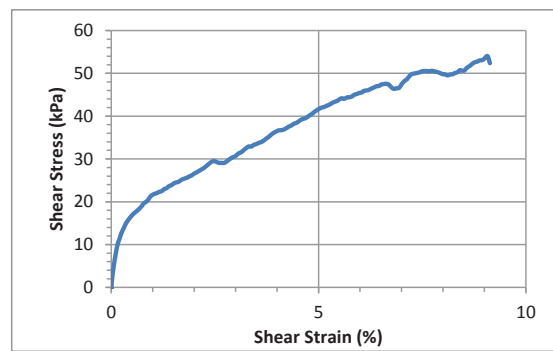
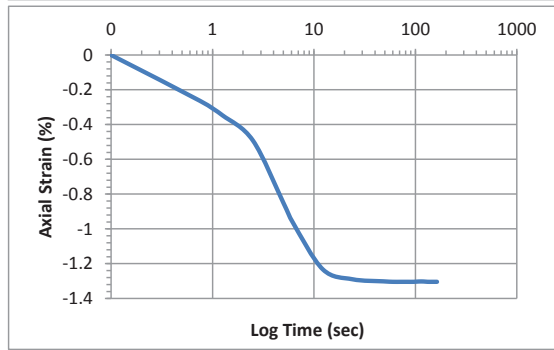
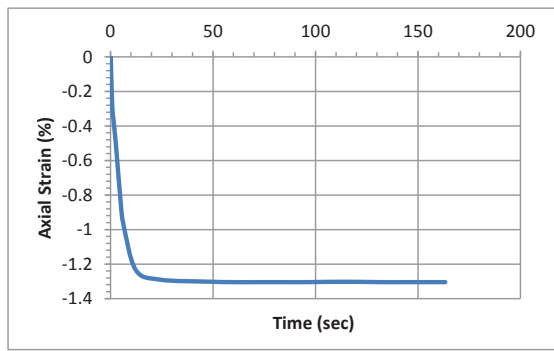

Accelerometer-Based Shear Wave Velocity Datasheet

Specimen ID: C269-LSC109-100-1X
 Test Material: LSC109
 Date: 4/20/2016
 Test Performed by: J.Hubler
 Filename: C269-LSC109-100-1X

Vertical Stress: 100kPa
 Sensor Spacing: 0.1094 m
 V_s (rise) = 199 m/s

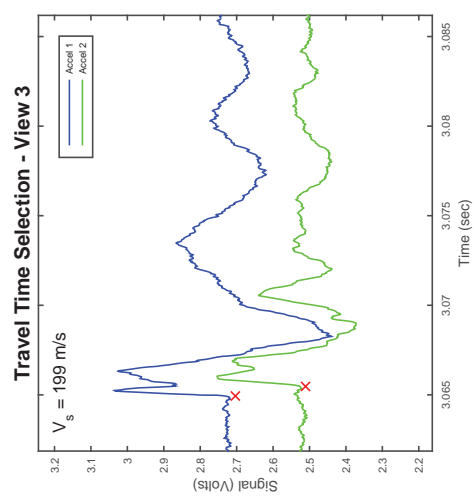
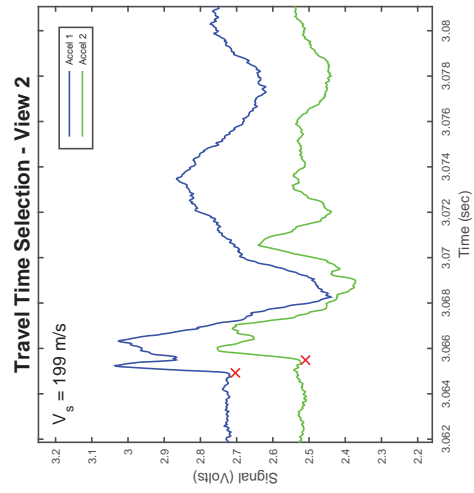
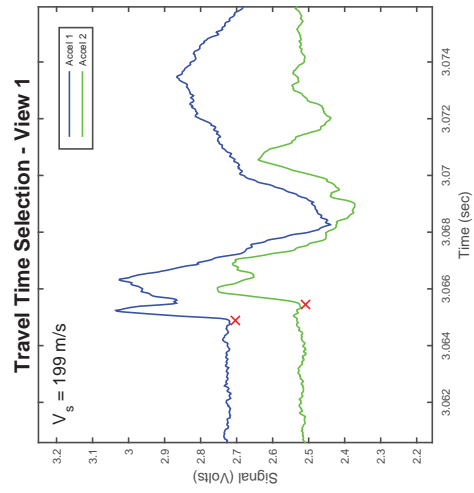
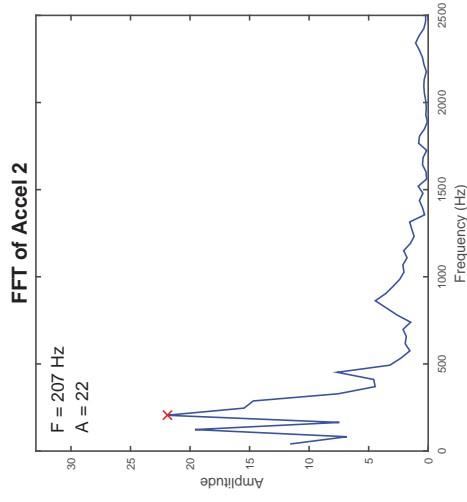
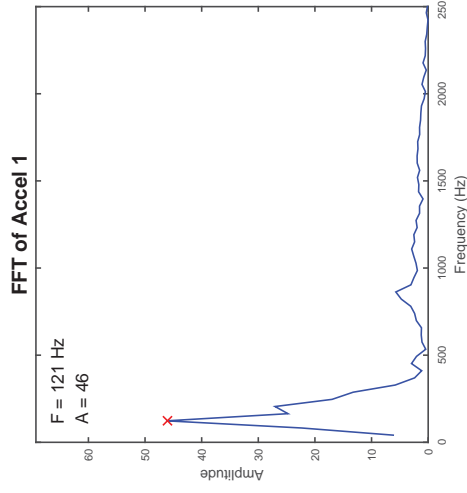
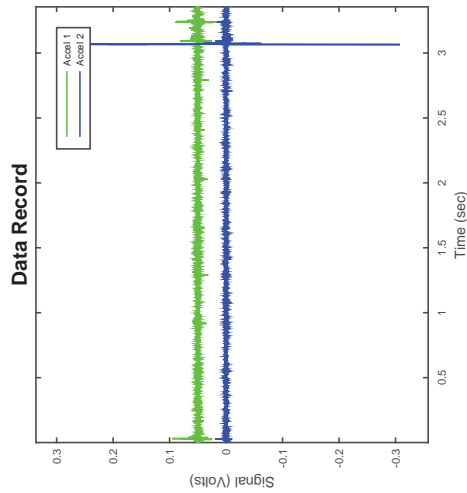

Accelerometer-Based Shear Wave Velocity Datasheet

Specimen ID: C269-LSC109-100-2X
 Test Material: LSC109
 Date: 4/20/2016
 Test Performed by: J.Hubler
 Filename: C269-LSC109-100-2X

Vertical Stress: 100kPa
 Sensor Spacing: 0.1094 m
 V_s (rise) = 210 m/s

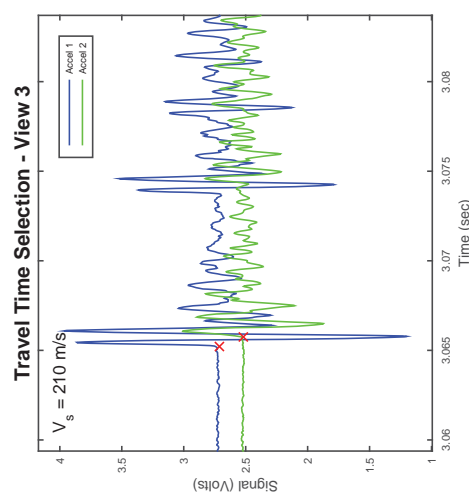
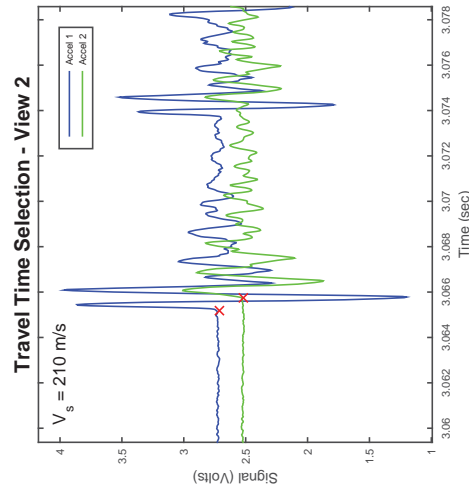
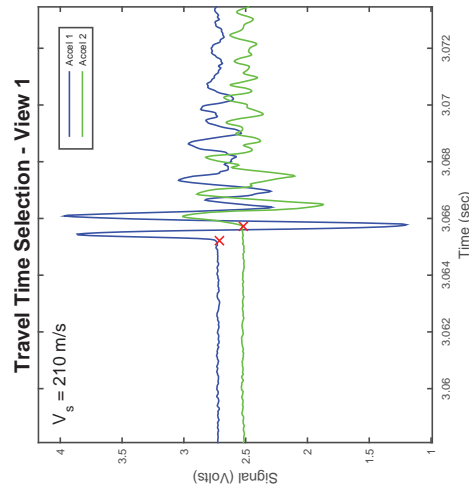
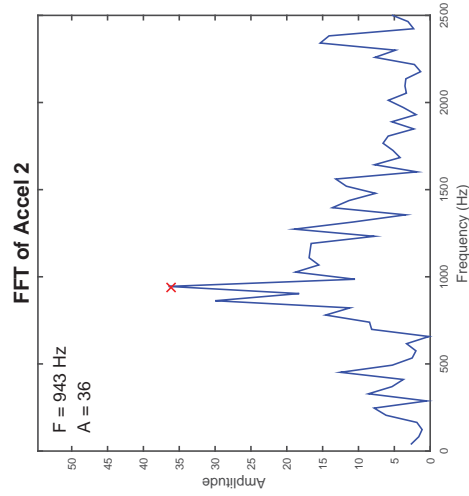
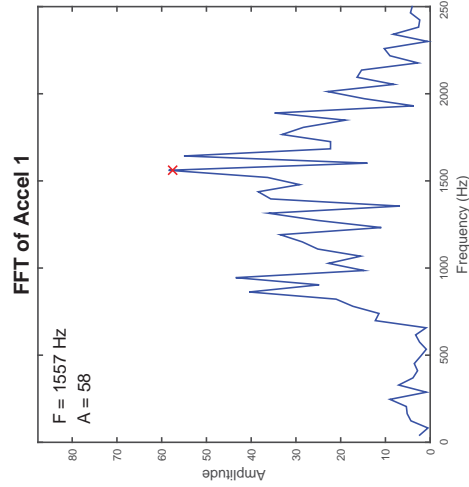
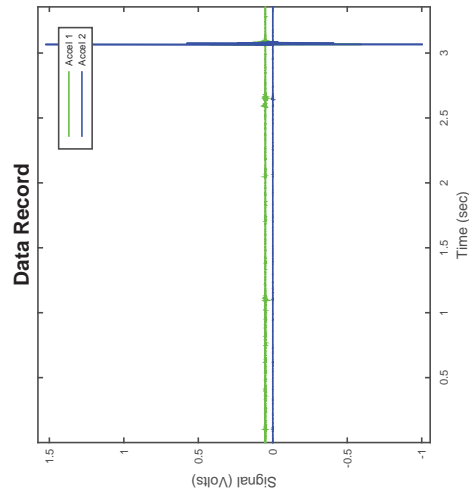

Accelerometer-Based Shear Wave Velocity Datasheet

Specimen ID: C269-LSC109-100-3X
 Test Material: LSC109
 Date: 4/20/2016
 Test Performed by: J.Hubler
 Filename: C269-LSC109-100-3X

Vertical Stress: 100kPa
 Sensor Spacing: 0.1094 m
 V_s (rise) = 210 m/s

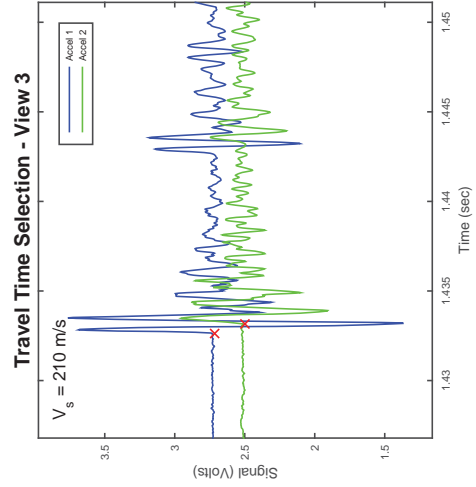
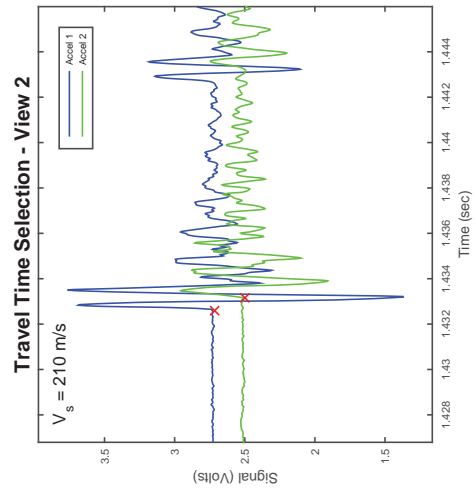
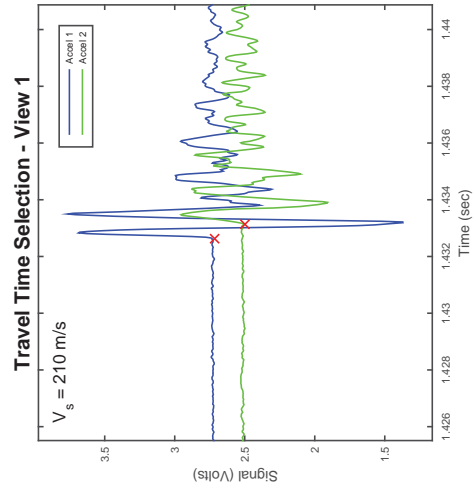
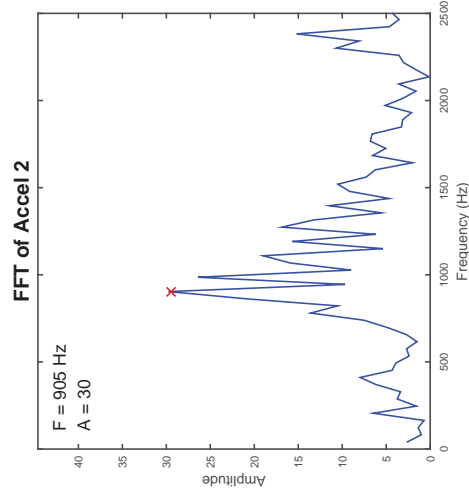
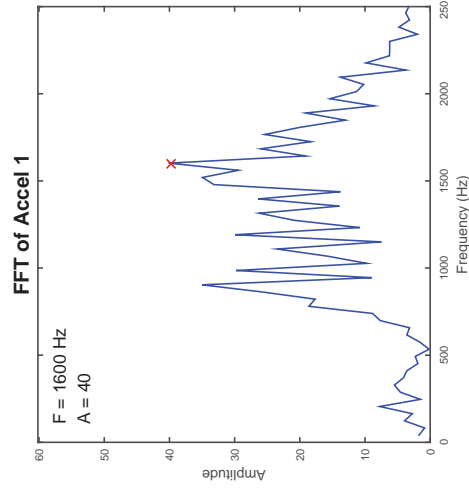
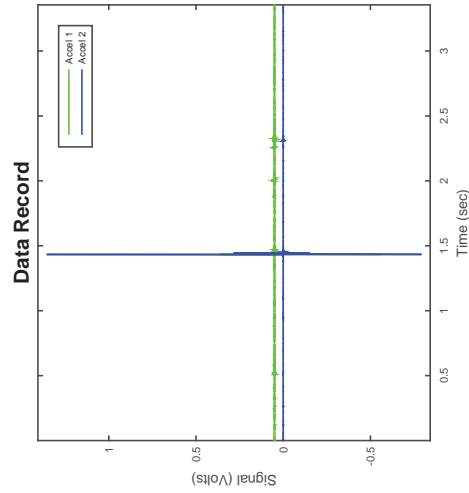

Accelerometer-Based Shear Wave Velocity Datasheet

Specimen ID: C269-LSC109-100-1XP
 Test Material: LSC109
 Date: 4/20/2016
 Test Performed by: J.Hubler
 Filename: C269-LSC109-100-1XP

Vertical Stress: 100kPa
 Sensor Spacing: 0.10797 m
 V_s (rise) = 196 m/s

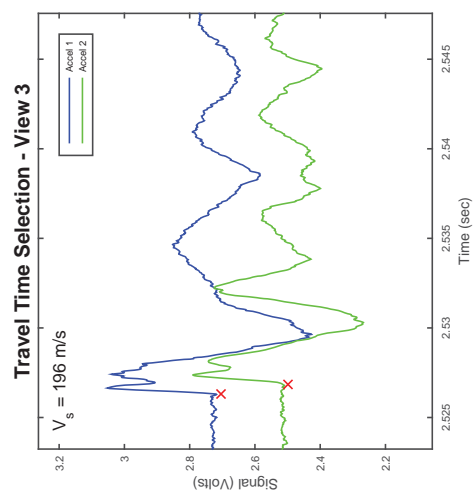
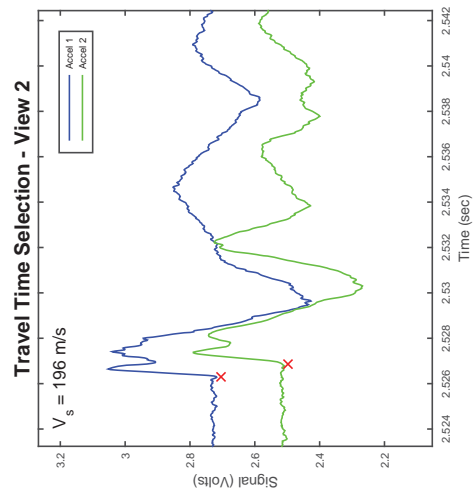
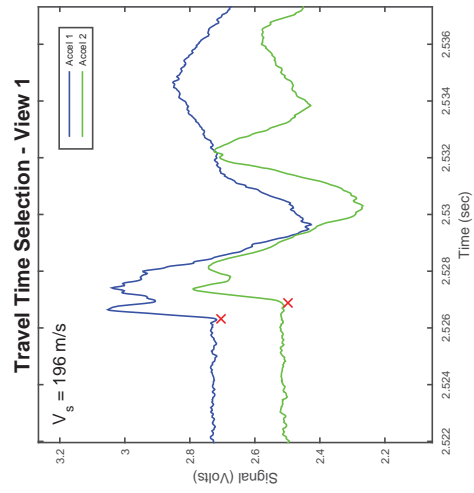
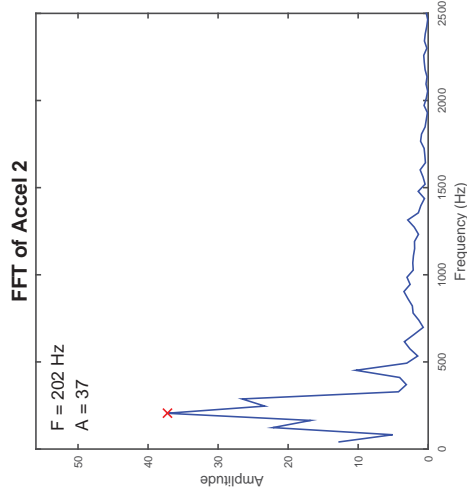
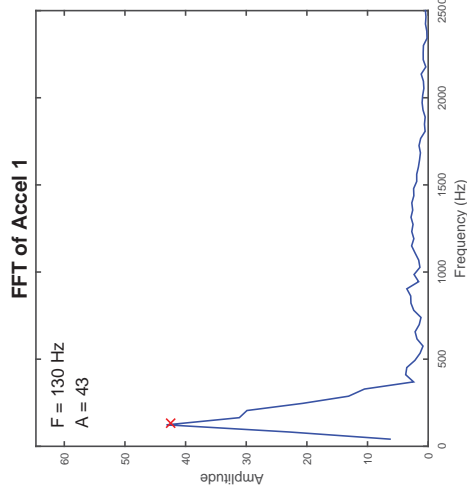
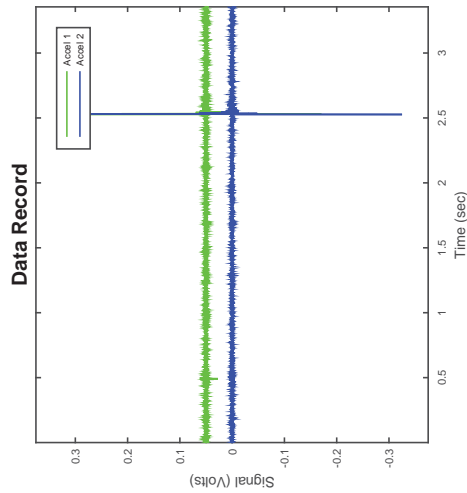

Accelerometer-Based Shear Wave Velocity Datasheet

Specimen ID: C269-LSC109-100-2XP

Test Material: LSC109

Date: 4/20/2016

Test Performed by: J.Hubler

Filename: C269-LSC109-100-2XP

Vertical Stress: 100kPa

Sensor Spacing: 0.10797 m

V_s (rise) = 208 m/s

Data Record

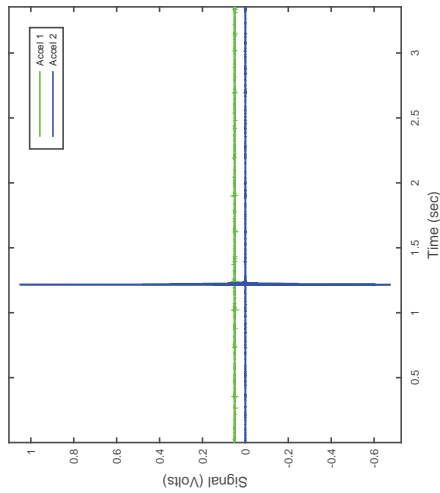

FFT of Accel 1

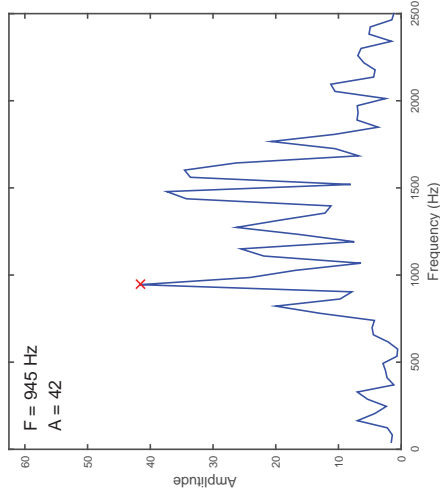

FFT of Accel 2

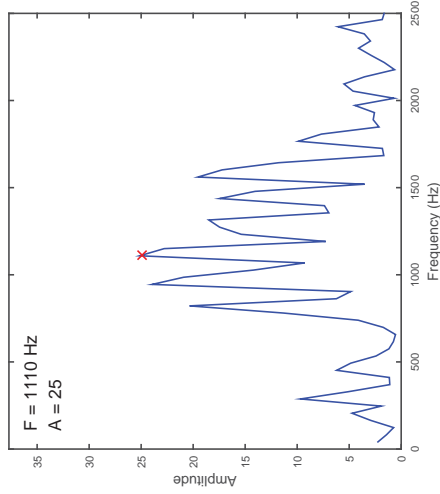

Travel Time Selection - View 1

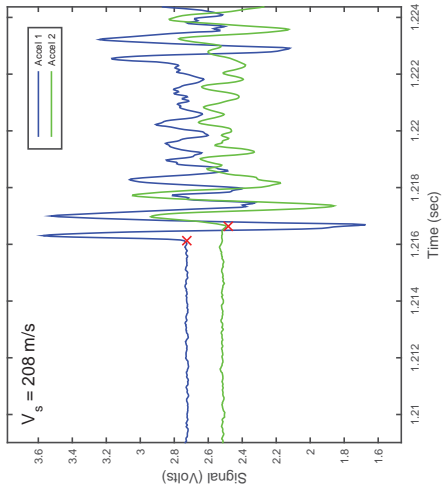

Travel Time Selection - View 2

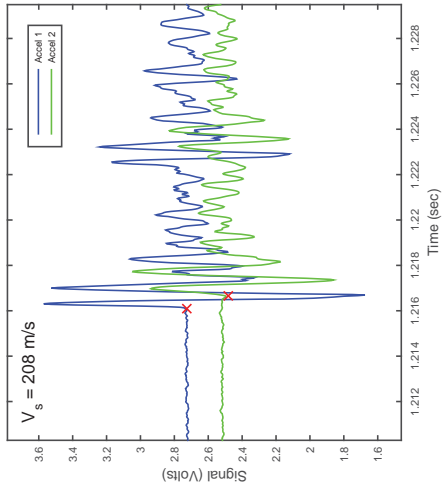

Travel Time Selection - View 3

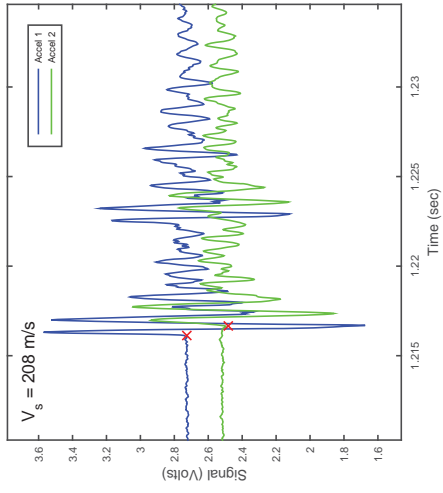

Accelerometer-Based Shear Wave Velocity Datasheet

Specimen ID: C269-LSC109-100-3XP

Test Material: LSC109

Date: 4/20/2016

Test Performed by: J.Hubler

Filename: C269-LSC109-100-3XP

Vertical Stress: 100kPa

Sensor Spacing: 0.10797 m

V_s (rise) = 202 m/s

Data Record

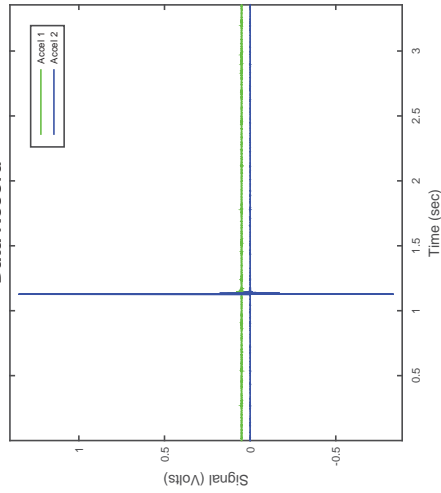

FFT of Accel 1

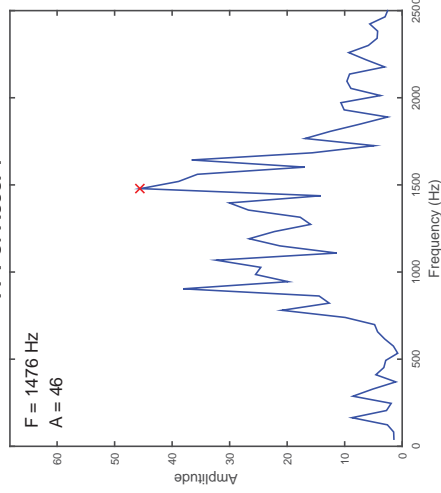

FFT of Accel 2

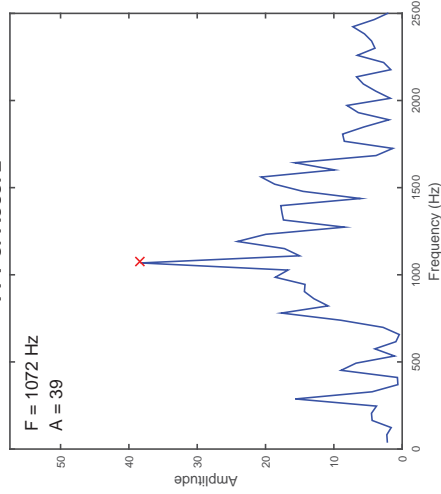

Travel Time Selection - View 1

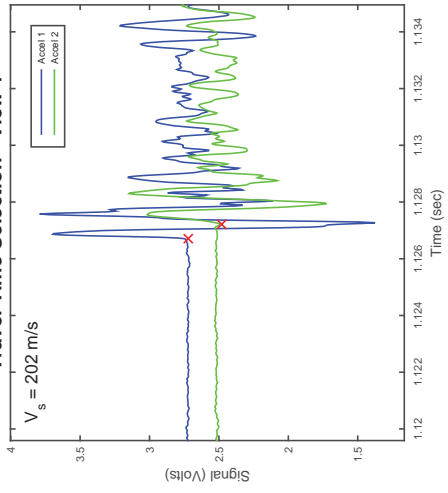

Travel Time Selection - View 2

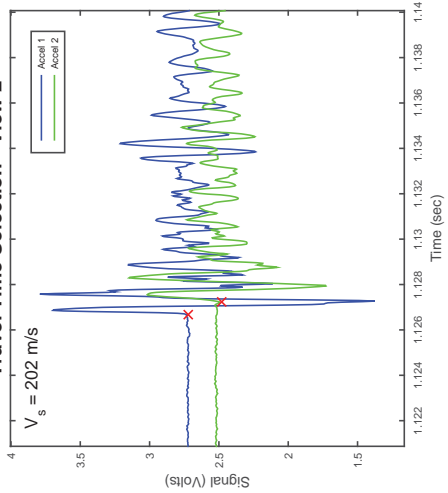

Travel Time Selection - View 3

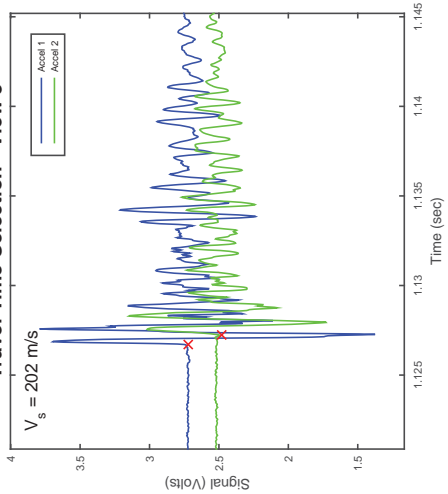

CSS Cyclic Shear Test Report

Geotechnical Engineering Laboratory



Cyclic Shear Test Summary

Device:	CSS	Density (kg/m³):	1936
Specimen ID:	40C109_60LS	Relative Density (%):	47%
Test ID:	C270	Void Ratio:	0.369
Date of Test:	4/21/2016	Vertical Stress (kPa):	100
Test Performed:	Cyclic Shear	Loading Frequency (Hz):	0.33
Test Material:	Ottawa Sand/LS	Number of Cycles:	146
Sample Preparation:	Prepared Loose using a funnel with zero drop height.	Cyclic Stress Ratio:	0.044
		Shear Modulus (kPa):	
		Damping (%):	
Prepared by:	J.Hubler	Shear Strain Single Amplitude (%)	
Checked by:	J.Hubler		

Additional Comments:

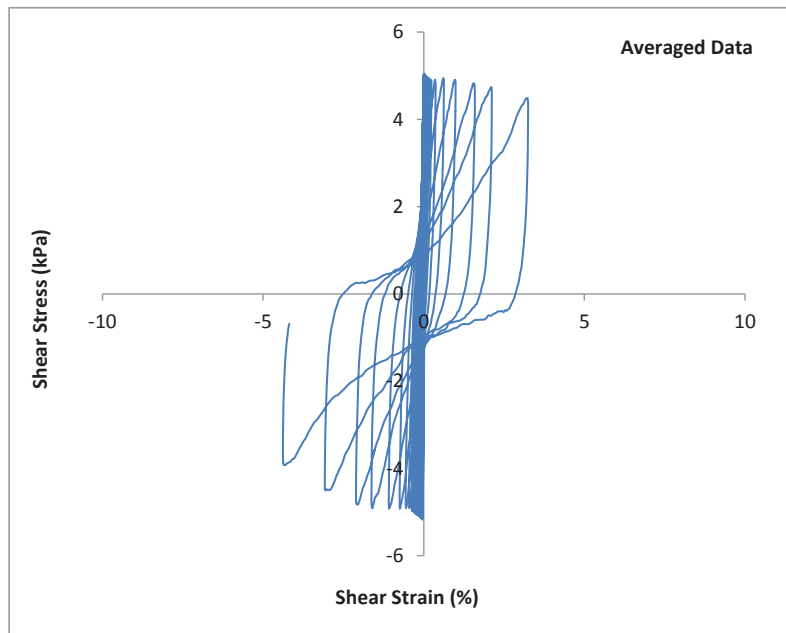
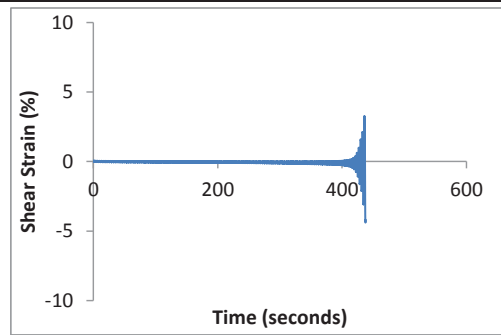
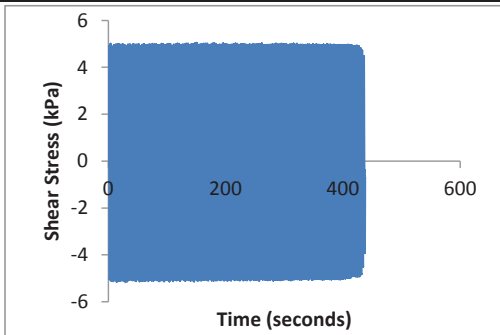

CSS Cyclic Shear Test Report

Geotechnical Engineering Laboratory



Cyclic Shear Test Summary

Device:	CSS	Density (kg/m³):	1936
Specimen ID:	40C109_60LS	Relative Density (%):	47%
Test ID:	C270	Void Ratio:	0.369
Date of Test:	4/21/2016	Vertical Stress (kPa):	100
Test Performed:	Cyclic Shear	Loading Frequency (Hz):	0.33
Test Material:	Ottawa Sand/LS	Number of Cycles:	146
Sample Preparation:	Prepared Loose using a funnel with zero drop height.	Cyclic Stress Ratio:	0.044
		Number of Cycles to Liq:	146
		Maximum ru:	1.01
Prepared by:	J.Hubler		
Checked by:	J.Hubler		

Additional Comments:

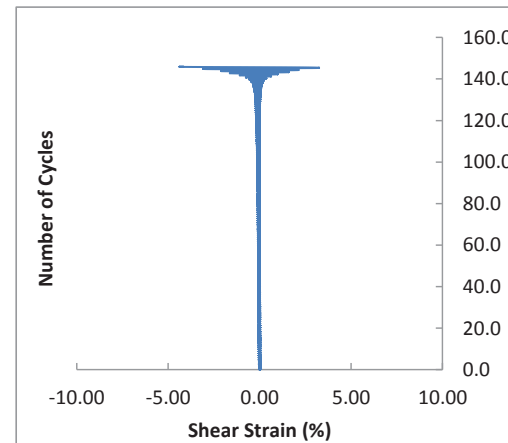
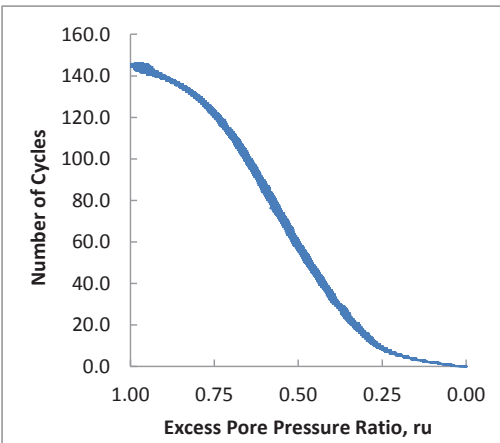
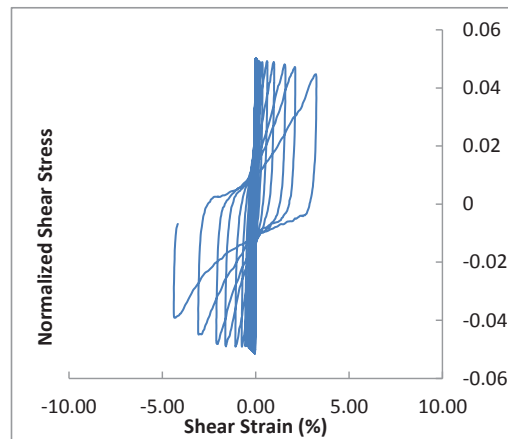
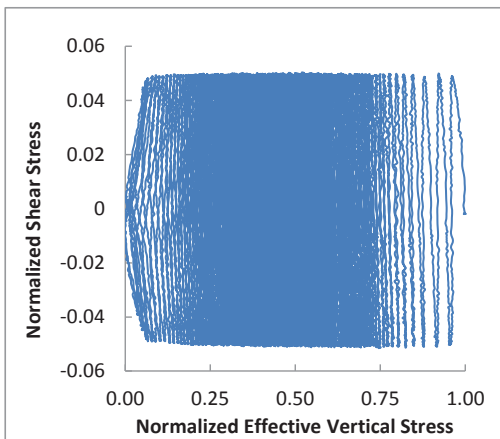

Accelerometer-Based Shear Wave Velocity Datasheet

Specimen ID: C270-LSC109-100-1X
 Test Material: LSC109
 Date: 4/21/2016
 Test Performed by: J.Hubler
 Filename: C270-LSC109-100-1X

Vertical Stress: 100kPa
 Sensor Spacing: 0.10977 m
 V_s (rise) = 205 m/s

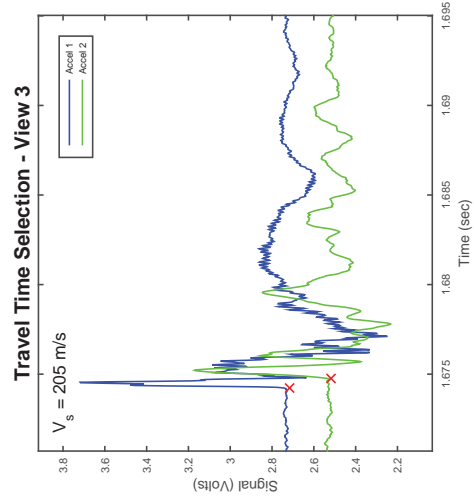
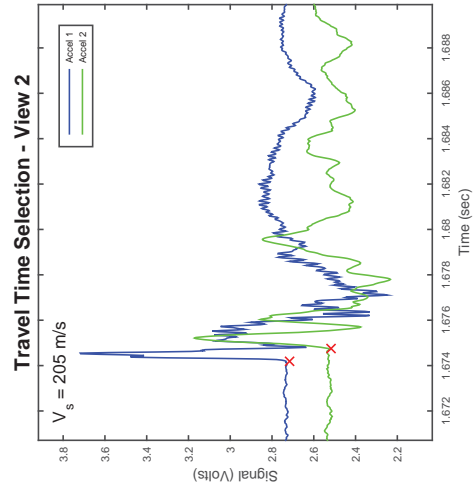
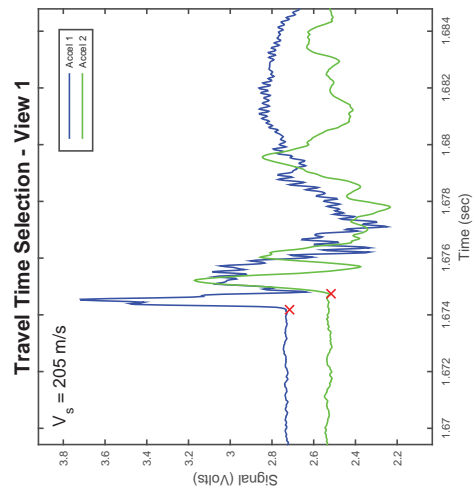
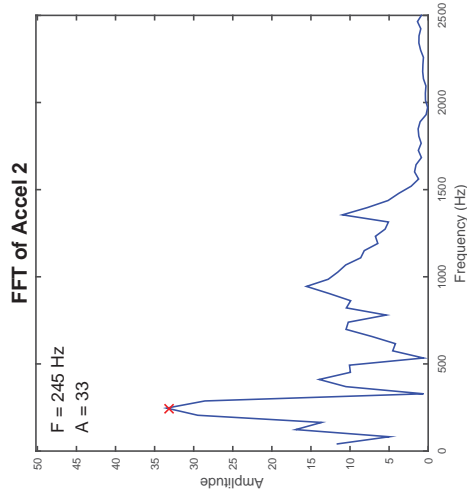
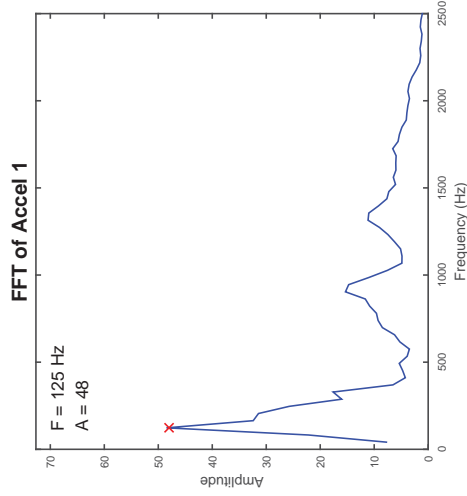
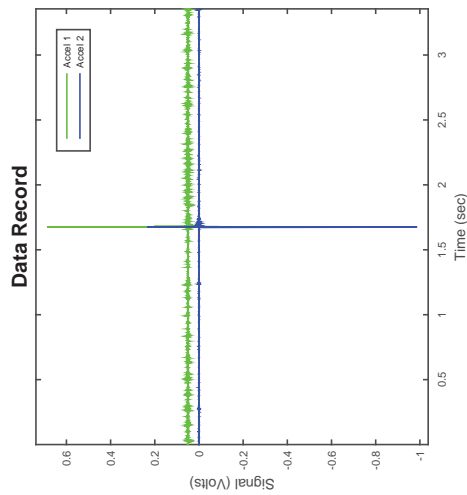

Accelerometer-Based Shear Wave Velocity Datasheet

Specimen ID: C270-LSC109-100-2X
 Test Material: LSC109
 Date: 4/21/2016
 Test Performed by: J.Hubler
 Filename: C270-LSC109-100-2X

Vertical Stress: 100kPa
 Sensor Spacing: 0.10977 m
 V_s (rise) = 200 m/s

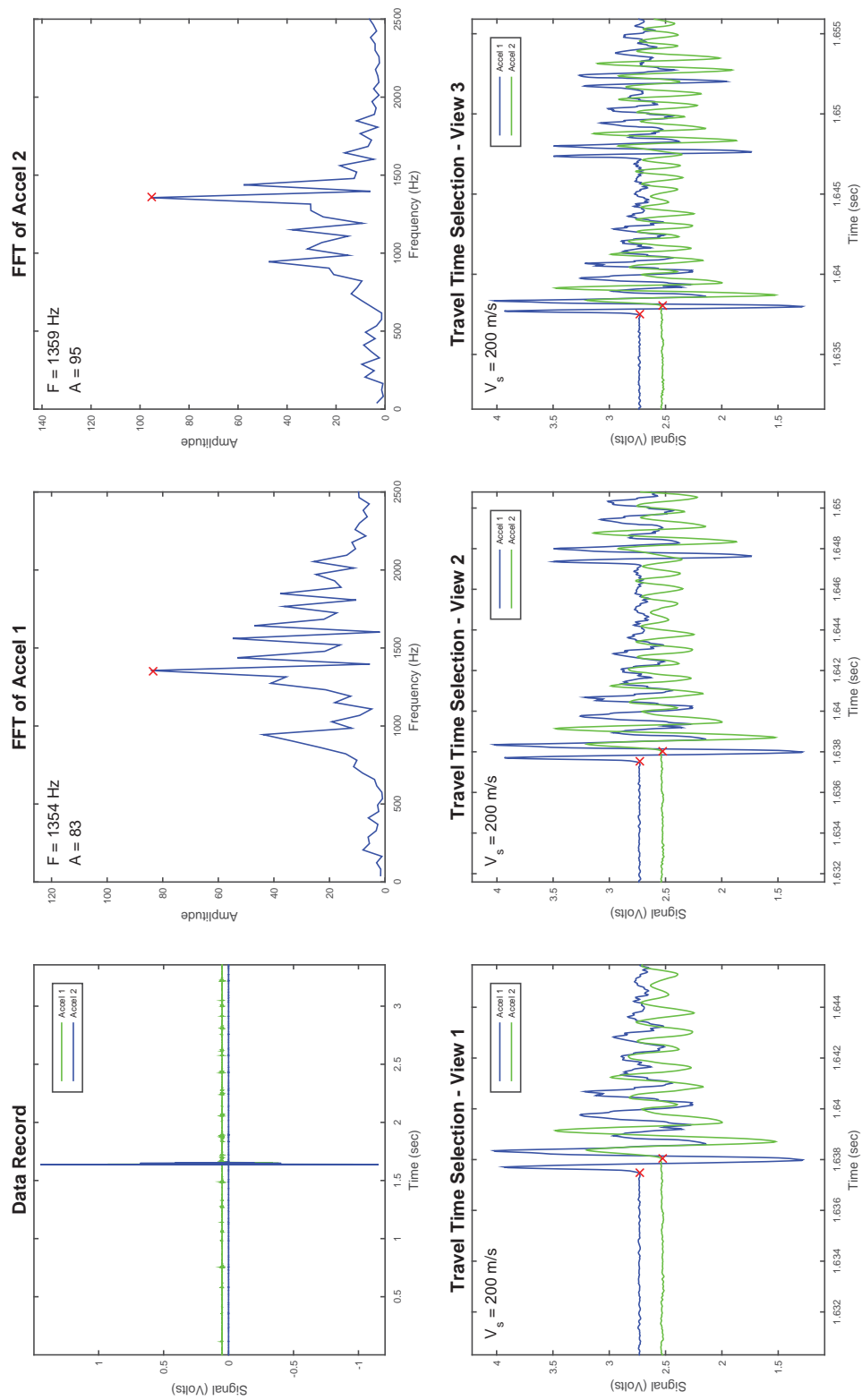

Accelerometer-Based Shear Wave Velocity Datasheet

Specimen ID: C270-LSC109-100-3X

Test Material: LSC109

Date: 4/21/2016

Test Performed by: J.Hubler

Filename: C270-LSC109-100-3X

Vertical Stress: 100kPa

Sensor Spacing: 0.10977 m

V_s (rise) = 205 m/s

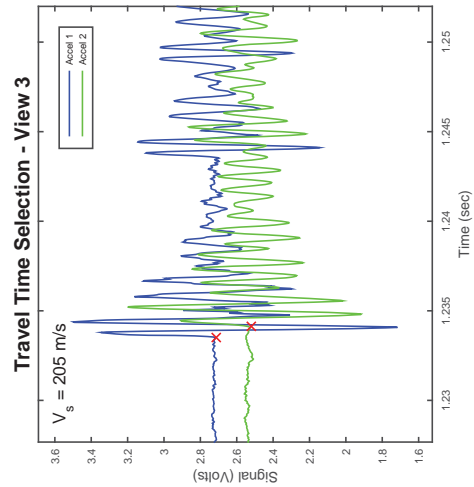
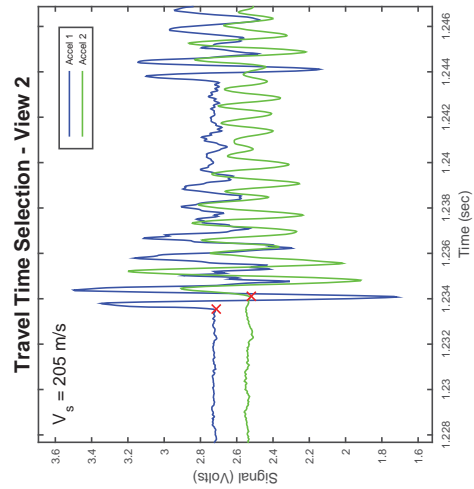
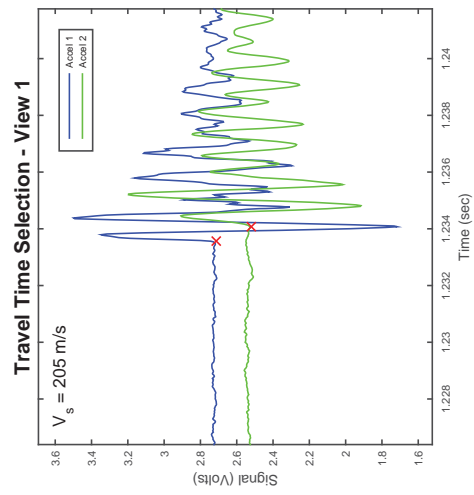
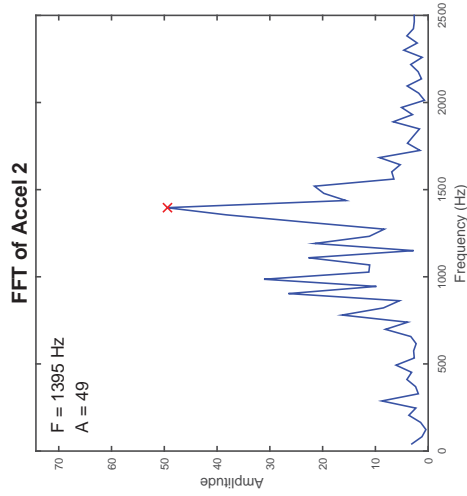
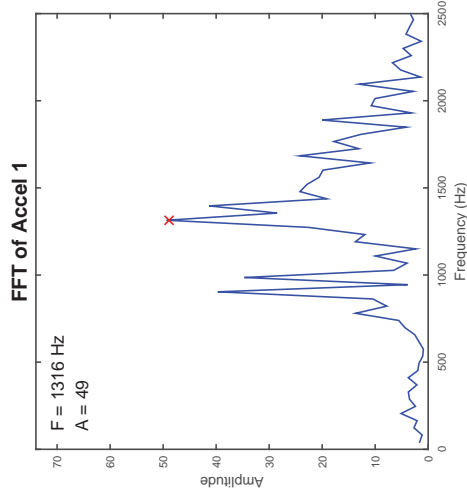
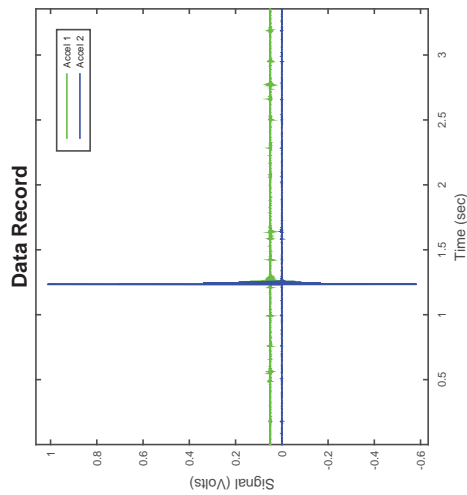

CSS Cyclic Shear Test Report

Geotechnical Engineering Laboratory



Cyclic Shear Test Summary

Device:	CSS	Density (kg/m³):	1505
Specimen ID:	LS	Relative Density (%):	44%
Test ID:	C272	Void Ratio:	0.761
Date of Test:	4/21/2015	Vertical Stress (kPa):	100
Test Performed:	Cyclic	Loading Frequency (Hz):	0.33
Test Material:	Limestone	Number of Cycles:	7
Sample Preparation:	Placed with shovel and then tamped with rubber mallet to desired density	Cyclic Stress Ratio:	0.144
		Shear Modulus (kPa):	
		Damping (%):	
Prepared by:	J. Hubler	Shear Strain Single Amplitude (%)	
Checked by:	J. Hubler		

Additional Comments:

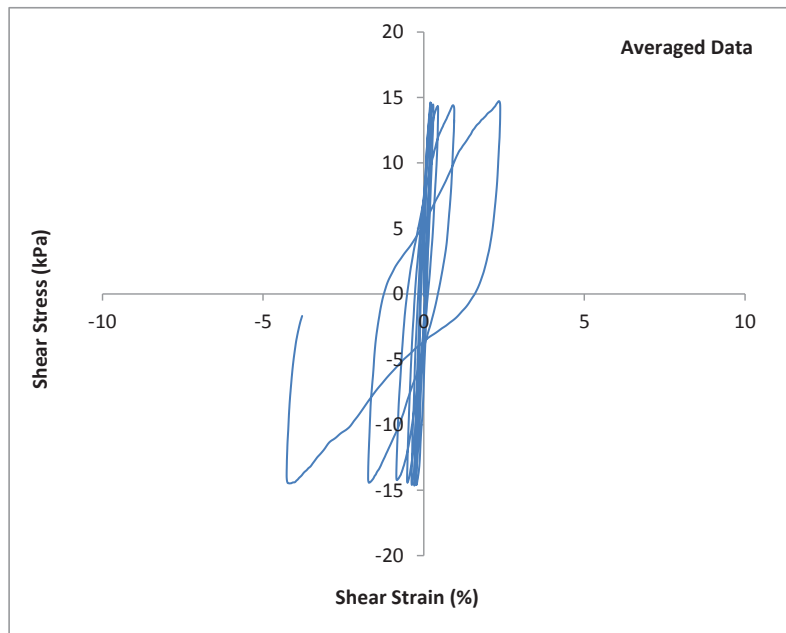
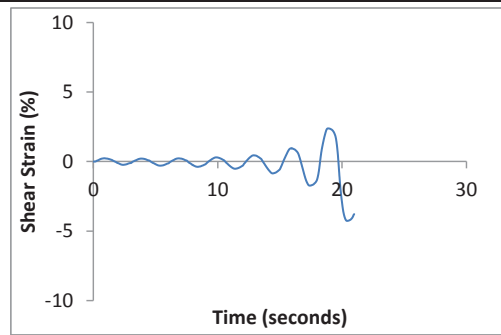
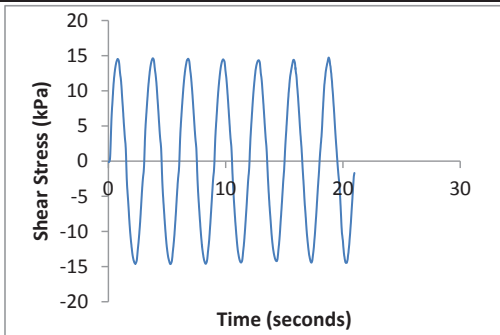

CSS Cyclic Shear Test Report

Geotechnical Engineering Laboratory



Cyclic Shear Test Summary

Device:	CSS	Density (kg/m³):	1505
Specimen ID:	LS	Relative Density (%):	44%
Test ID:	C272	Void Ratio:	0.761
Date of Test:	4/21/2015	Vertical Stress (kPa):	100
Test Performed:	Cyclic	Loading Frequency (Hz):	0.33
Test Material:	Limestone	Number of Cycles:	7
Sample Preparation:	Placed with shovel and then tamped with rubber mallet to desired density	Cyclic Stress Ratio:	0.144
		Number of Cycles to Liq:	7
		Maximum ru:	0.93
Prepared by:	J. Hubler		
Checked by:	J. Hubler		

Additional Comments:

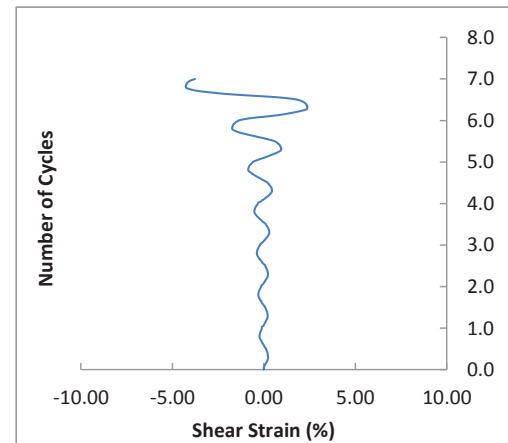
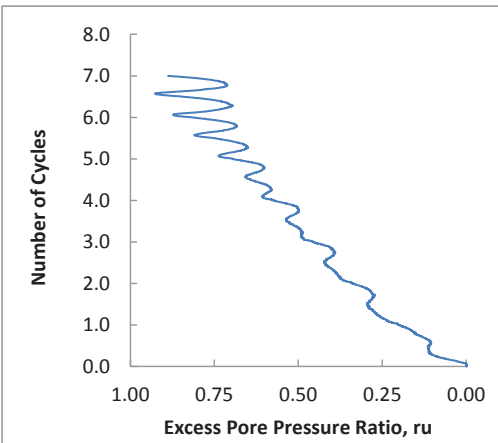
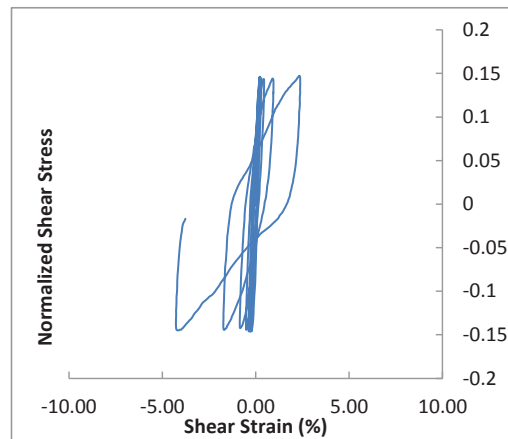
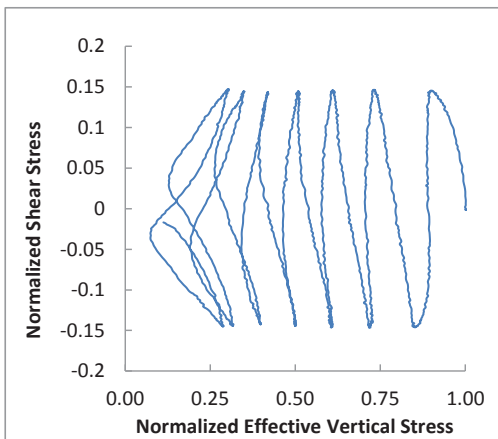

CSS Monotonic Shear Test Report

Geotechnical Engineering Laboratory



10/28/2013_Version 8.0

General Test Info and Sample Preparation

Device:	CSS	Relative Density (%):	44%
Specimen ID:	100LS	Void Ratio:	0.761
Test ID:	C272	Height (mm):	107.0
Date of Test:	4/21/2016	Soil-Only Specimen Diameter (mm):	306.23
Test Performed:	Post Cyclic Monotonic Shear	Weight (kg):	11.865
Test Material:	Limestone	Density (kg/m ³):	1505.0
Sample Preparation:	Prepared loose by placing with a funnel and zero drop height.	Membrane Thickness (mm):	0.635
		Moisture Content (%):	0%
		Saturated (Y/N):	N
		Prepared by:	J. Hubler
		Checked by:	J. Hubler

Consolidation Stage

Shear Stage

Vertical Stress (kPa):	100	Type of Test:	Constant Volume
Time to Compression (min):	1.4	Stress or Strain Controlled:	Strain
Relative Density (%):	48%	Shear Strain Rate (%/min):	0.31
Void Ratio:	0.743	Peak Shear Strength (kPa):	80.0
Height (mm):	106.0	Comments	
Diameter (mm):	306.23	Post Cyclic Reconsol. Slip at approximately 7.5% shear strain.	
Weight (kg):	11.865		
Density (kg/m ³):	1520.5		

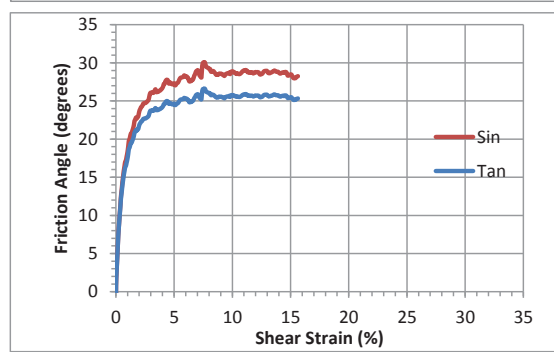
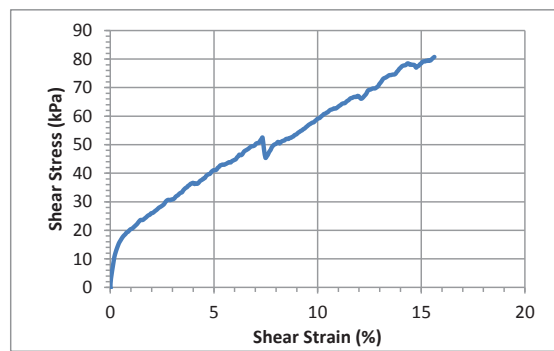
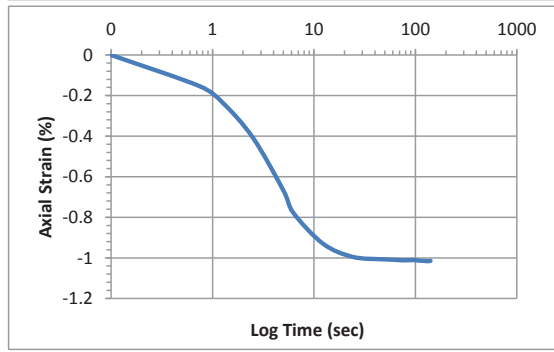
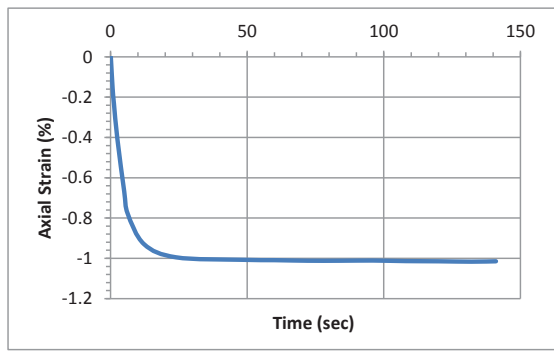

Accelerometer-Based Shear Wave Velocity Datasheet

Specimen ID: C272-LS-100-3X
 Test Material: LS
 Date: 4/21/2016
 Test Performed by: J.Hubler
 Filename: C272-LS-100-3X

Vertical Stress: 100kPa
 Sensor Spacing: 0.10696 m
 V_s (rise) = 200 m/s

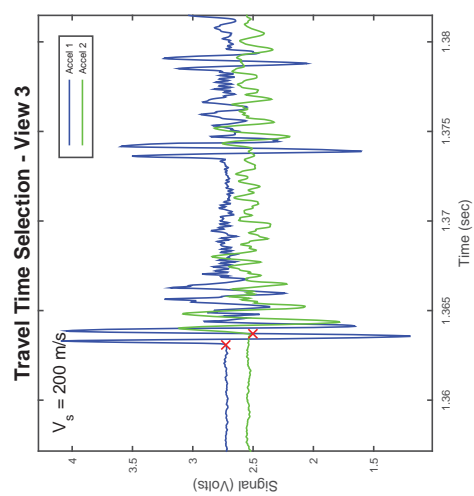
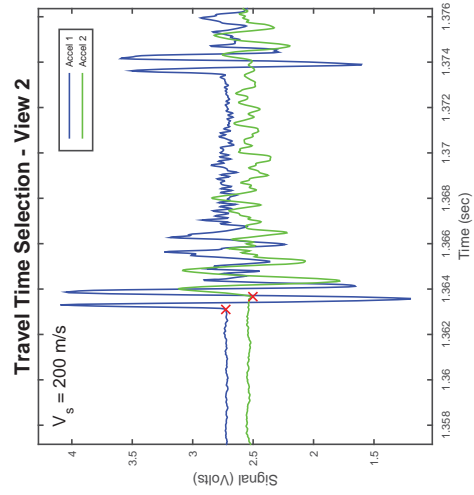
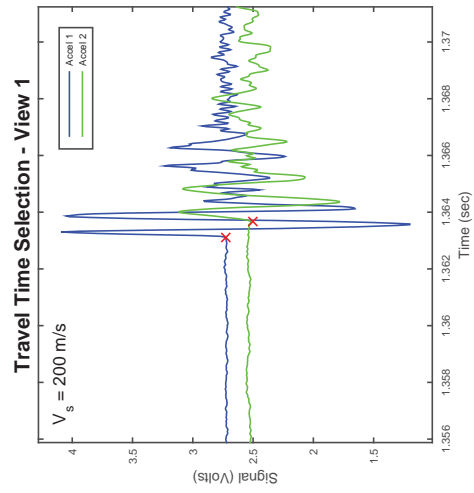
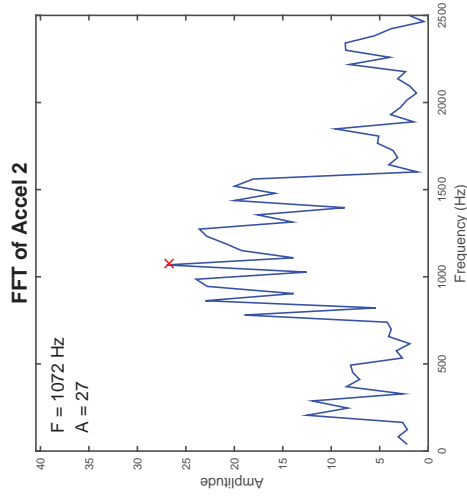
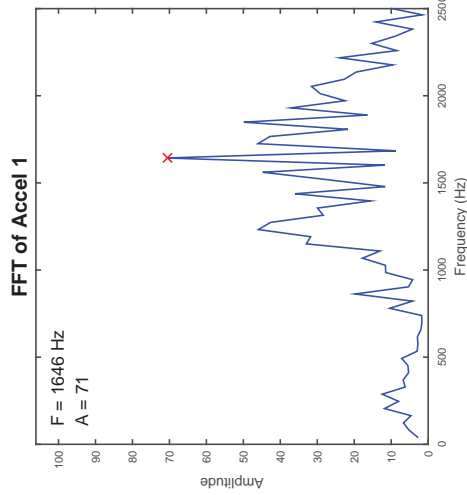
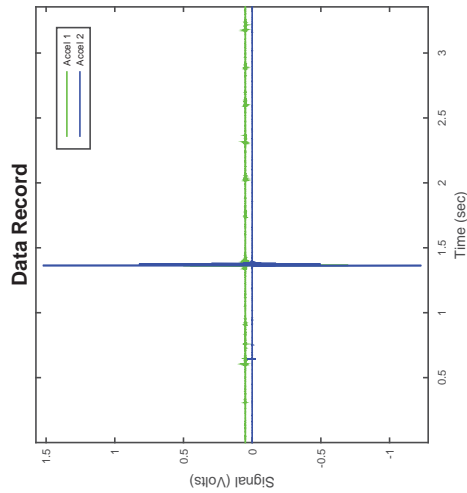

Accelerometer-Based Shear Wave Velocity Datasheet

Specimen ID: C272-LS-100-1XP
 Test Material: LS
 Date: 4/21/2016
 Test Performed by: J.Hubler
 Filename: C272-LS-100-1XP

Vertical Stress: 100kPa
 Sensor Spacing: 0.10587 m
 V_s (rise) = 183 m/s

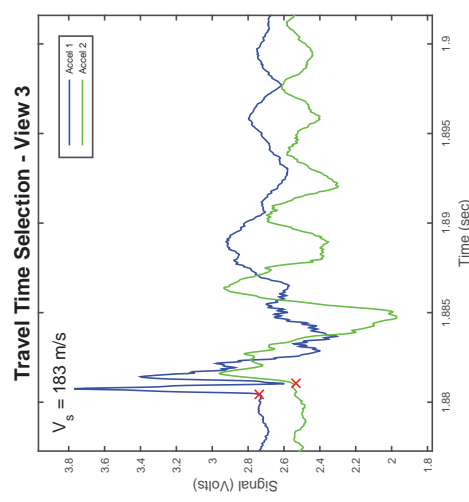
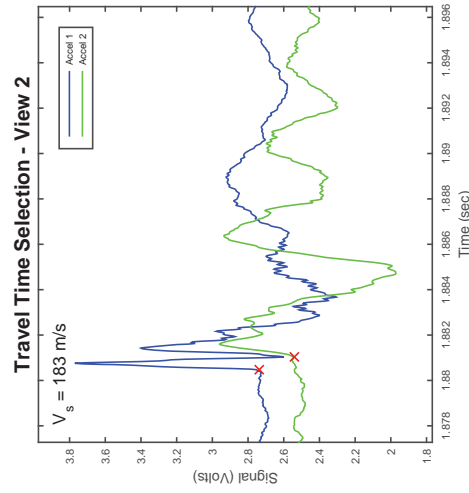
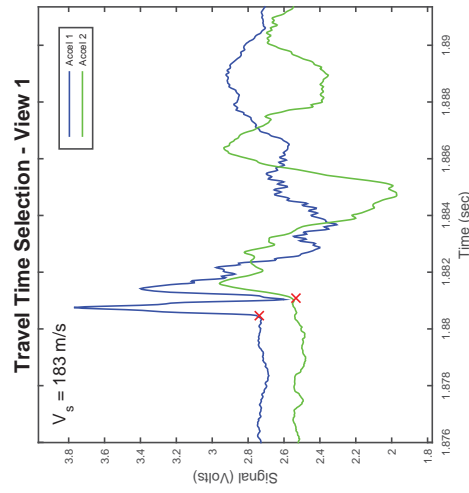
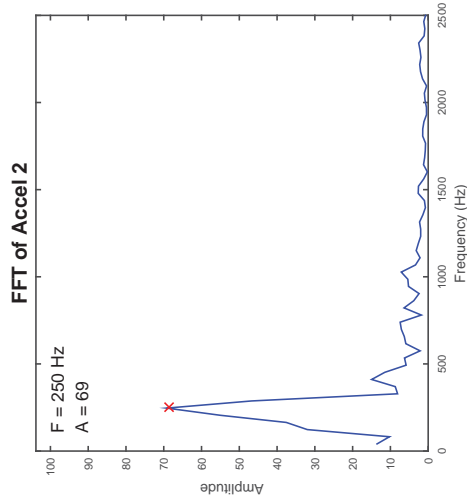
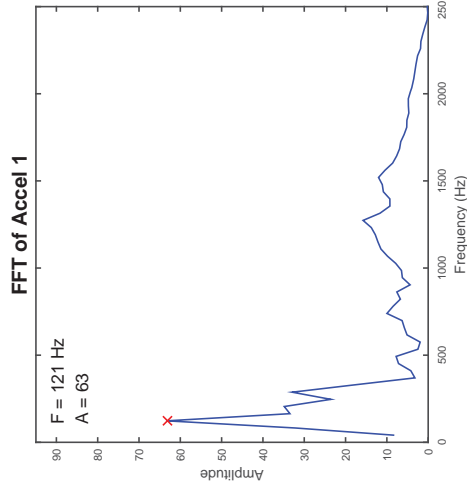
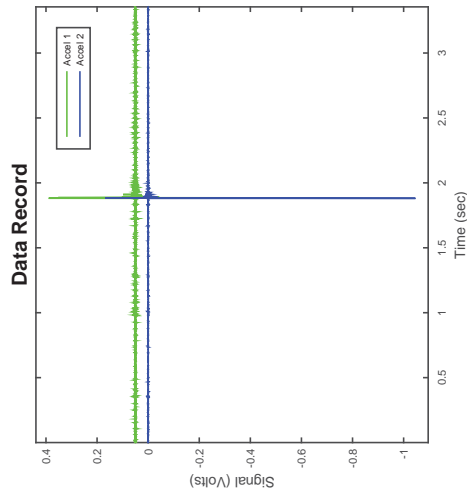

Accelerometer-Based Shear Wave Velocity Datasheet

Specimen ID: C272-LS-100-2XP

Test Material: LS

Date: 4/21/2016

Test Performed by: J.Hubler

Filename: C272-LS-100-2XP

Vertical Stress: 100kPa

Sensor Spacing: 0.10587 m

V_s (rise) = 198 m/s

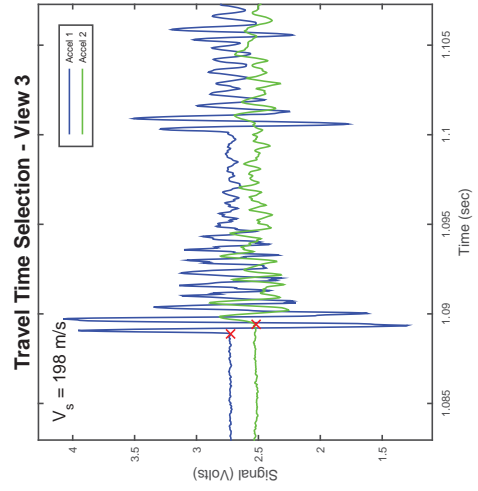
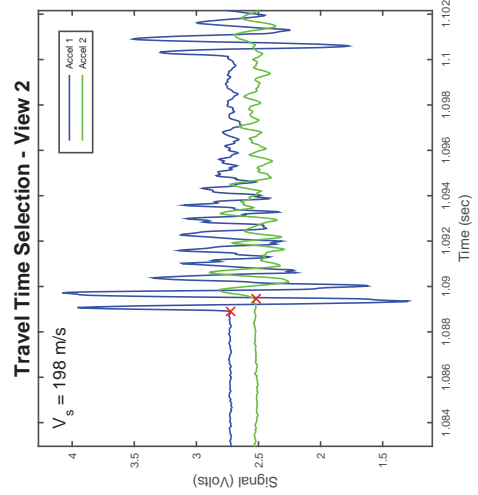
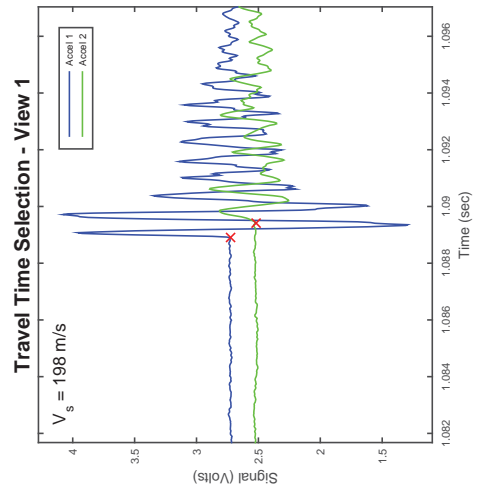
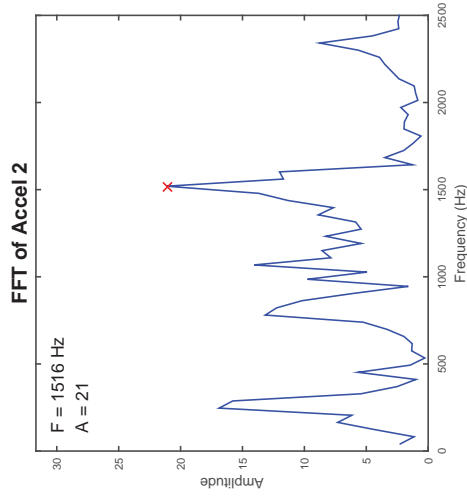
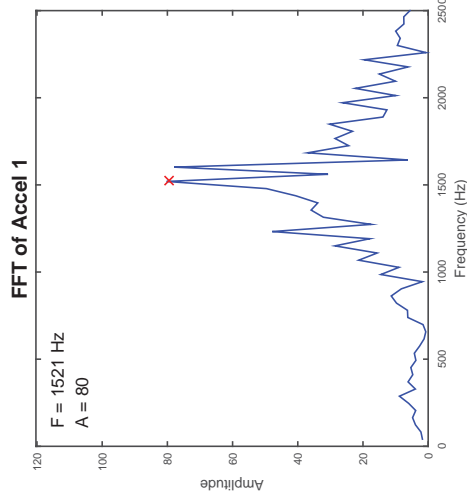
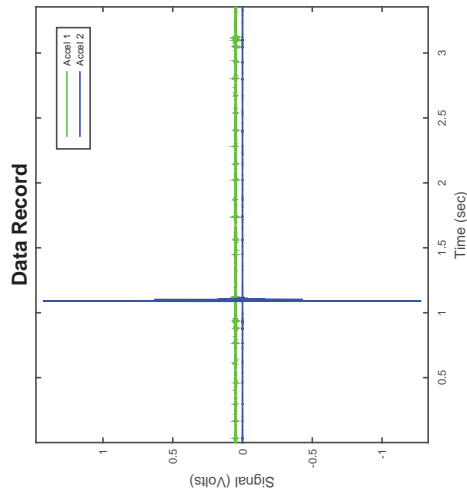

Accelerometer-Based Shear Wave Velocity Datasheet

Specimen ID: C272-LS-100-3XP

Test Material: LS

Date: 4/21/2016

Test Performed by: J.Hubler

Filename: C272-LS-100-3XP

Vertical Stress: 100kPa

Sensor Spacing: 0.10587 m

V_s (rise) = 183 m/s

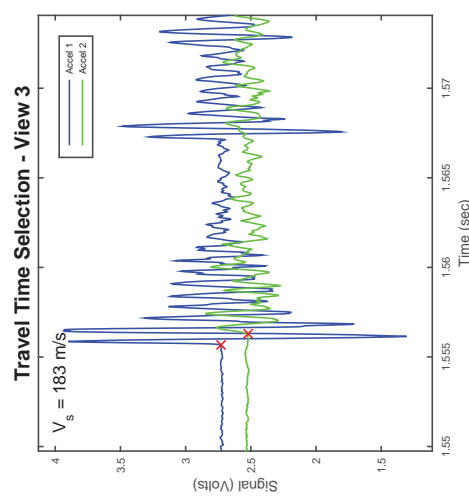
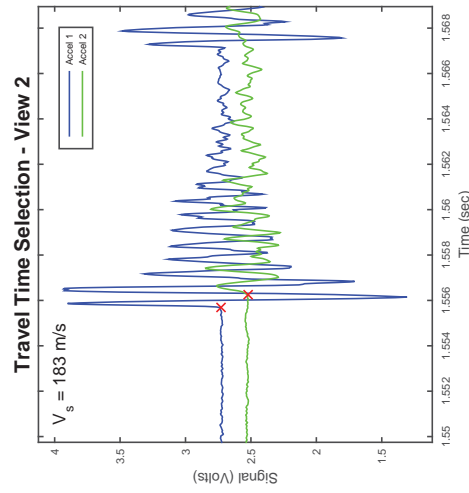
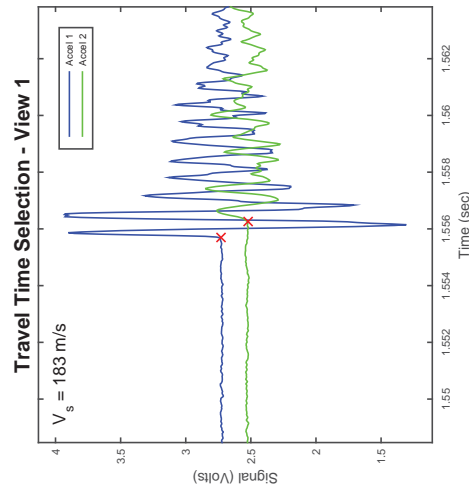
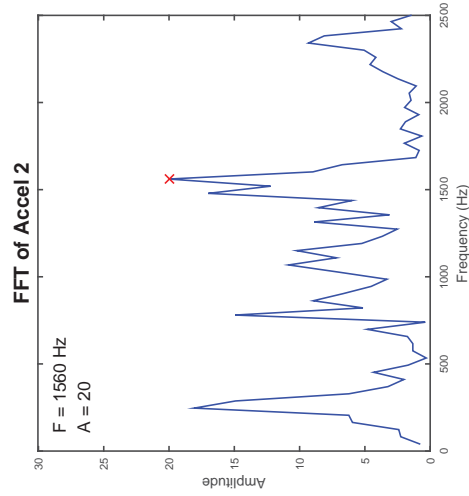
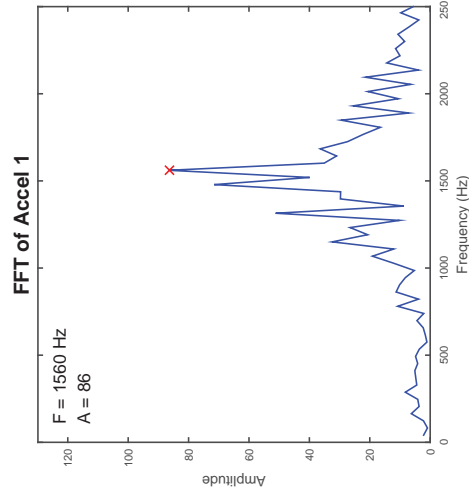
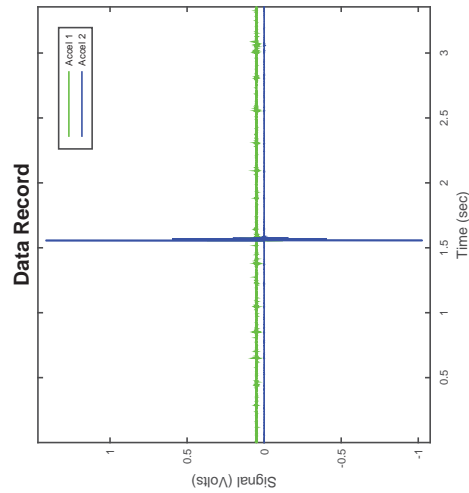

CSS Cyclic Shear Test Report

Geotechnical Engineering Laboratory



Cyclic Shear Test Summary

Device:	CSS	Density (kg/m³):	1660
Specimen ID:	LS	Relative Density (%):	81%
Test ID:	C283	Void Ratio:	0.597
Date of Test:	8/16/2016	Vertical Stress (kPa):	100
Test Performed:	Cyclic	Loading Frequency (Hz):	0.33
Test Material:	Limestone	Number of Cycles:	10
Sample Preparation:	Placed dense by tamping 60x in 5 layers.	Cyclic Stress Ratio:	0.144
		Shear Modulus (kPa):	
		Damping (%):	
Prepared by:	J. Hubler	Shear Strain Single Amplitude (%)	
Checked by:	J. Hubler		

Additional Comments:

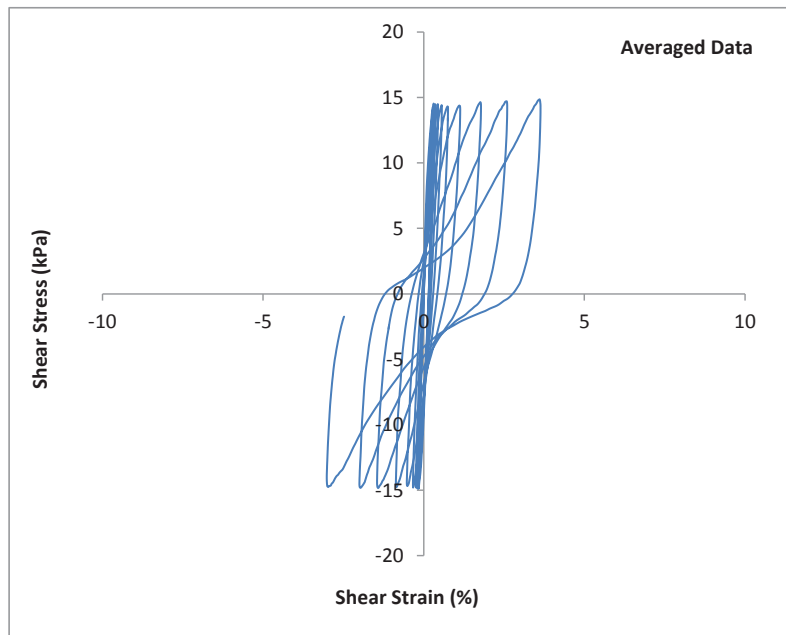
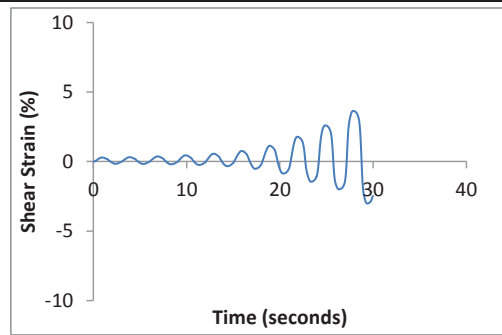
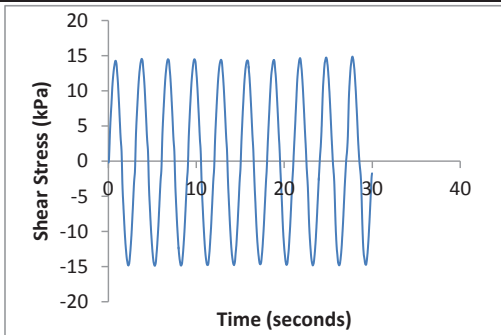

CSS Cyclic Shear Test Report

Geotechnical Engineering Laboratory



Cyclic Shear Test Summary

Device:	CSS	Density (kg/m³):	1660
Specimen ID:	LS	Relative Density (%):	81%
Test ID:	C283	Void Ratio:	0.597
Date of Test:	8/16/2016	Vertical Stress (kPa):	100
Test Performed:	Cyclic	Loading Frequency (Hz):	0.33
Test Material:	Limestone	Number of Cycles:	10
Sample Preparation:	Placed dense by tamping 60x in 5 layers.	Cyclic Stress Ratio:	0.144
		Number of Cycles to Liq:	10
		Maximum ru:	0.96
Prepared by:	J. Hubler		
Checked by:	J. Hubler		

Additional Comments:

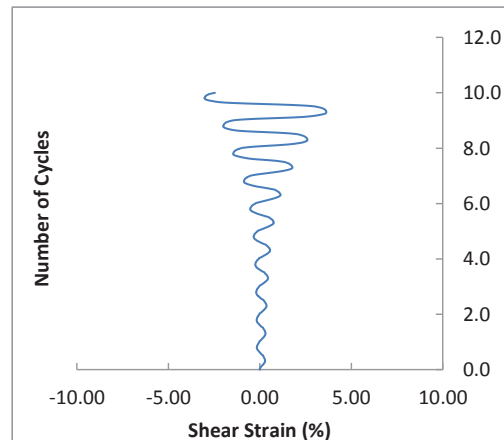
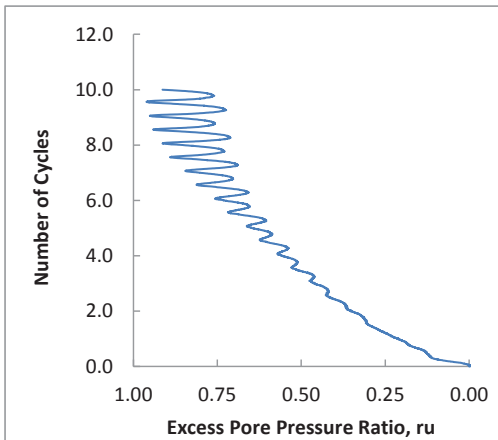
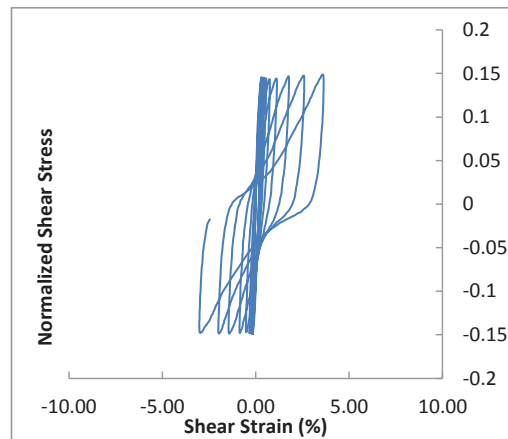
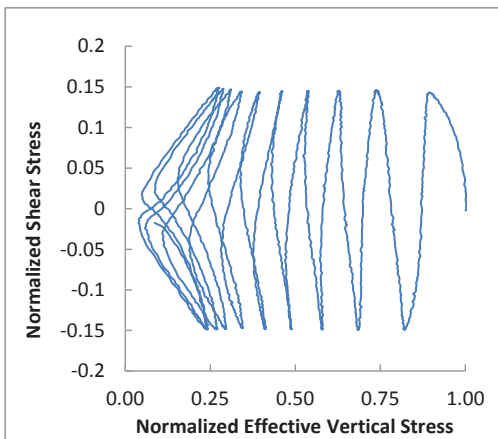

CSS Monotonic Shear Test Report

Geotechnical Engineering Laboratory



10/28/2013_Version 8.0

General Test Info and Sample Preparation

Device:	CSS	Relative Density (%):	81%
Specimen ID:	100LS	Void Ratio:	0.598
Test ID:	C283	Height (mm):	108.4
Date of Test:	8/16/2016	Soil-Only Specimen Diameter (mm):	306.23
Test Performed:	Post Cyclic Monotonic Shear	Weight (kg):	13.238
Test Material:	Limestone	Density (kg/m³):	1658.8
Sample Preparation:	Prepared dense by tamping 60x in 5 layers.	Membrane Thickness (mm):	0.635
		Moisture Content (%):	0%
		Saturated (Y/N):	N
		Prepared by:	J. Hubler
		Checked by:	J. Hubler

Consolidation Stage

Vertical Stress (kPa):	100
Time to Compression (min):	1.4
Relative Density (%):	85%
Void Ratio:	0.581
Height (mm):	107.2
Diameter (mm):	306.23
Weight (kg):	13.238
Density (kg/m³):	1675.9

Shear Stage

Type of Test:	Constant Volume
Stress or Strain Controlled:	Strain
Shear Strain Rate (%/min):	0.30
Peak Shear Strength (kPa):	102.0

Comments

Post Cyclic Reconsol

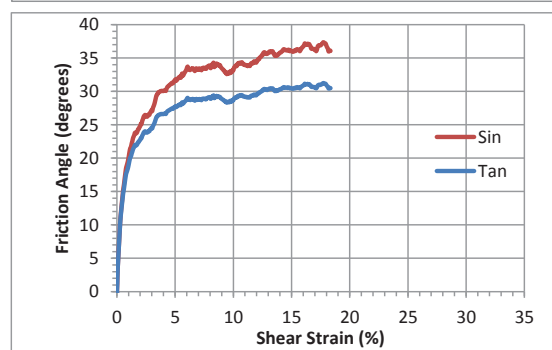
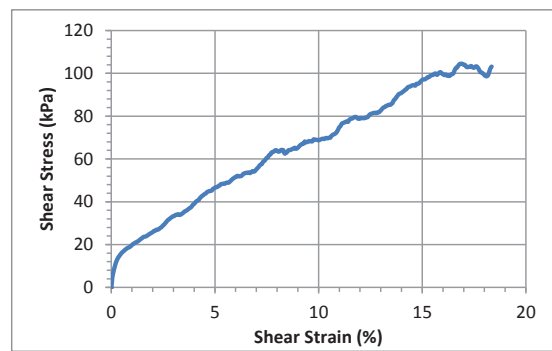
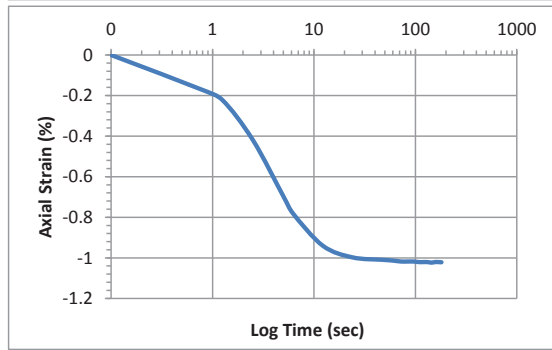
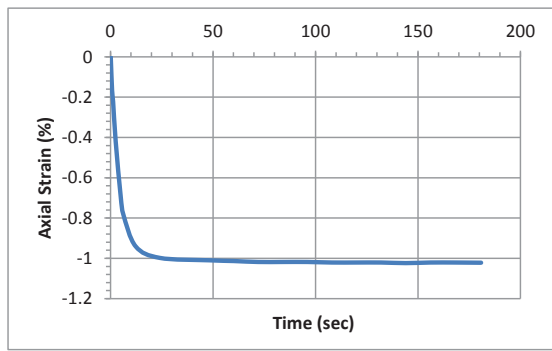

Accelerometer-Based Shear Wave Velocity Datasheet

Specimen ID: C283-100LS-100-1X
 Test Material: 100LS
 Date: 8/16/16
 Test Performed by: J.Hubler
 Filename: C283-100LS-100-1X

Vertical Stress: 100kPa
 Sensor Spacing: 0.10804 m
 V_s (rise) = 215 m/s

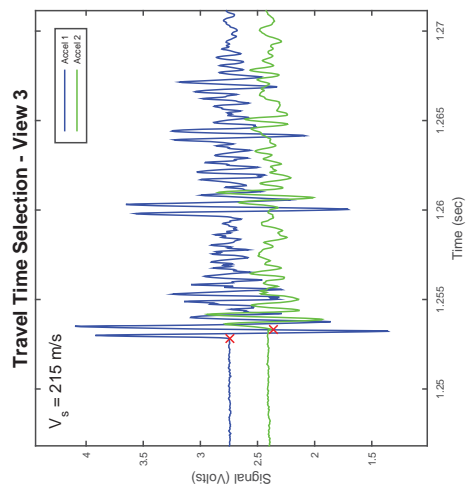
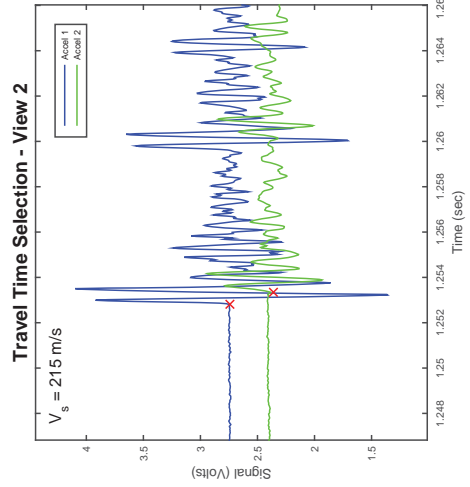
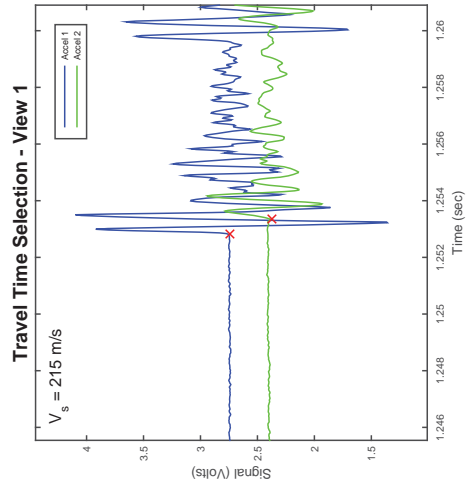
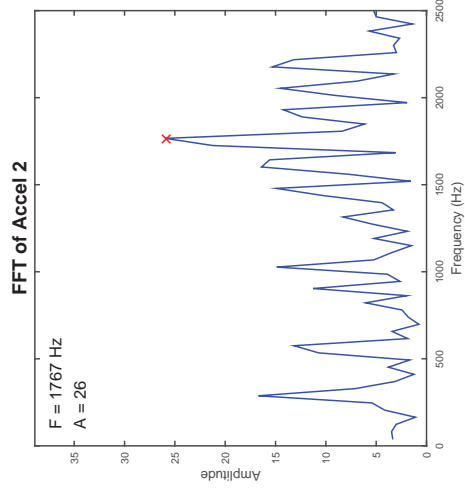
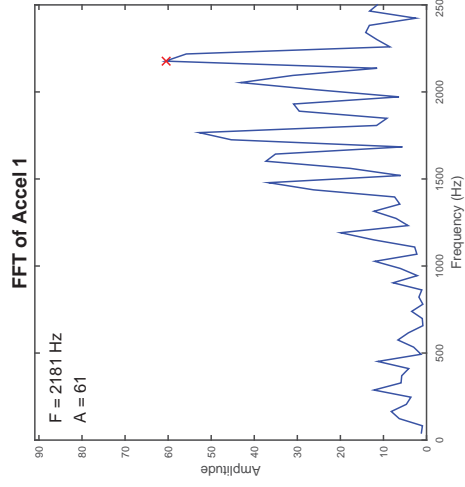
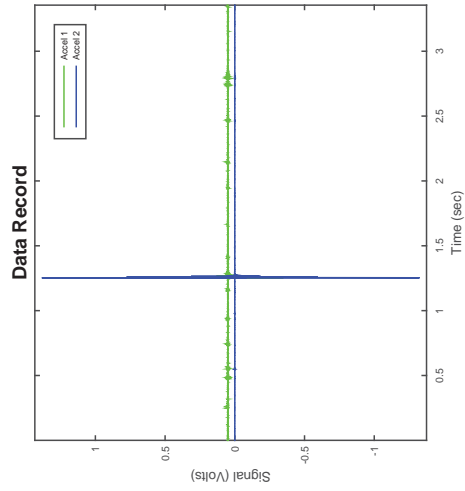

Accelerometer-Based Shear Wave Velocity Datasheet

Specimen ID: C283-100LS-100-3XP
Test Material: 100LS
Date: 8/16/16
Test Performed by: J. Hubler
Filename: C283-100LS-100-3XP

Vertical Stress: 100kPa
Sensor Spacing: 0.10693 m
 V_s (rise) = 205 m/s

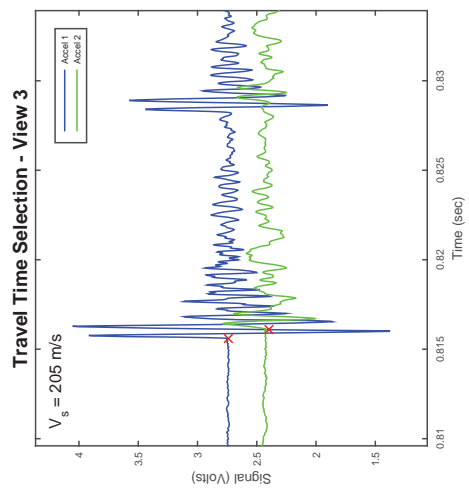
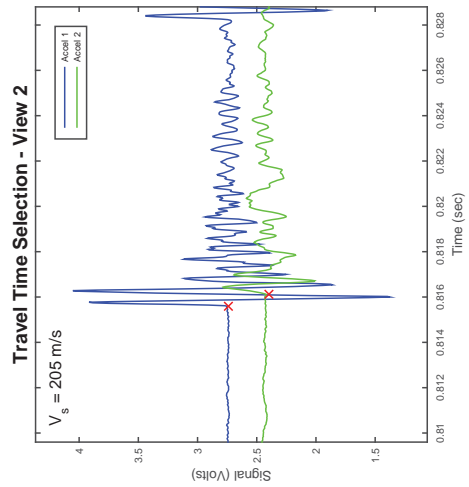
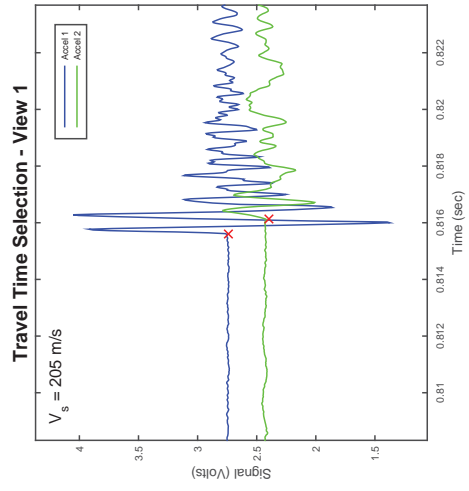
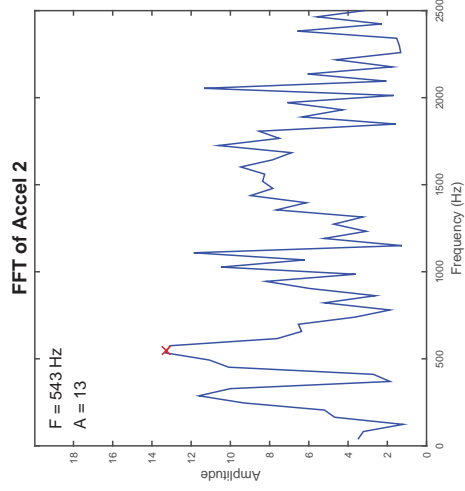
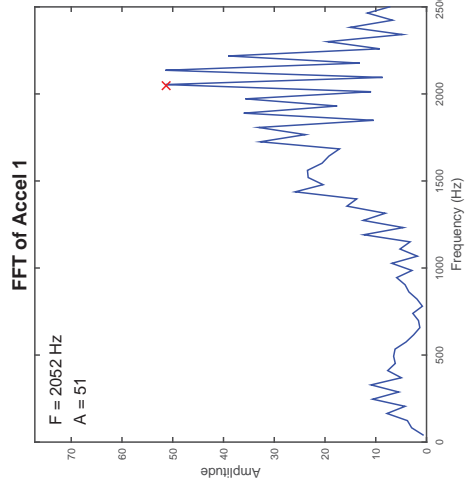
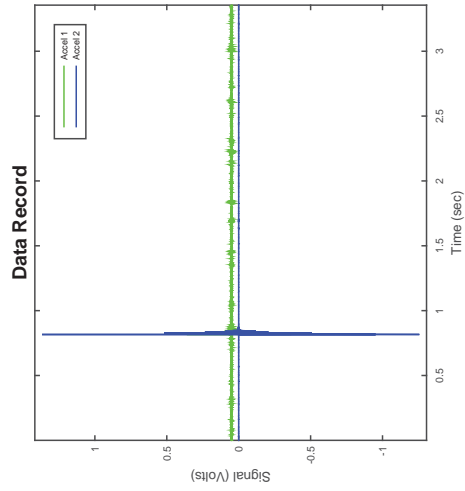

BIBLIOGRAPHY

BIBLIOGRAPHY

- AASHTO (2010), *Standard Method of Test for Correction for Coarse Particles in the Soil Compaction Test*, AASHTOT224, American Association of State Highway and Transportation Officials.
- Agarwal, T. K., and I. Ishibashi (1991), Multi-directional wave velocity by piezoelectric crystals, in *Recent Advances in Instrumentation, Data Acquisition and Testing in Soil Dynamics*:, pp. 102–117, ASCE.
- Airey, D., M. Budhu, and D. Wood (1985), Some aspects of the behaviour of soils in simple shear, in *Developments in soil mechanics and foundation engineering*, edited by P. Banerjee and R. Butterfield, pp. 185–213, Elsevier Applied Science Publishers.
- Aki, K. (1957), Space and time spectra of stationary stochastic waves, with spectral reference to microtremors, *Bull. Earthq. Res. Inst.*, 35, 415–456.
- Amer, M., W. Kovacs, and M. Aggour (1987), Cyclic simple shear size effects, *Journal of Geotechnical Engineering*, 113(7), 693–707.
- Amini, F., and A. Chakravarty (2003), Liquefaction testing of layered sand-gravel composites, *Geotechnical Testing Journal*, 27(1), 33–46.
- Anderson, W. F., and P. Fair (2008), Behavior of railroad ballast under monotonic and cyclic loading, *Journal of Geotechnical and Geoenvironmental Engineering*, 134(3), 316–327.
- Andrus, R., K. Stokoe, J. Bay, and T. Youd (1992), In situ V_S of gravelly soils which liquefied, in *Proceedings of the 10th World Conference on Earthquake Engineering*.
- Andrus, R. D., and K. H. Stokoe (2000), Liquefaction resistance of soils from shear-wave velocity, *Journal of Geotechnical and Geoenvironmental Engineering*, 126(11), 1015–1025.
- Andrus, R. D., K. H. Stokoe, and C. Hsein Juang (2004), Guide for shear-wave-based liquefaction potential evaluation, *Earthquake Spectra*, 20(2), 285–308.
- Ansell, P., and S. Brown (1978), A cyclic simple shear apparatus for dry granular materials, *Geotechnical Testing Journal*, 1(2), 82–92.
- Arroyo, M., D. Muir Wood, P. Greening, L. Medina, and J. Rio (2006), Effects of sample size on bender-based axial G_0 measurements, *Géotechnique*, 56(1), 39–52.

- Arulnathan, R., R. W. Boulanger, B. L. Kutter, and W. K. Sluis (2000), New tool for shear wave velocity measurements in model tests, *Geotechnical Testing Journal*, 23(4), 444–453.
- ASTM (2004), *Standard Test Methods for Particle-Size Distribution (Gradation) of Soils Using Sieve Analysis*, ASTM D6913-04, ASTM International.
- ASTM (2006), *Standard Test Methods for Minimum Index Density and Unit Weight of Soils and Calculation of Relative Density*, ASTM D4254-06, ASTM International.
- ASTM (2007), *Standard Test Method for Consolidated Undrained Direct Simple Shear Testing of Cohesive Soils*, ASTM D6528-07, ASTM International.
- ASTM (2012a), *Standard Test Method for Density, Relative Density (Specific Gravity), and Absorption of Coarse Aggregate*, ASTM C127-12, ASTM International.
- ASTM (2012b), *Standard Test Methods for Laboratory Compaction Characteristics of Soil Using Modified Effort*, ASTM D1557-12e1, ASTM International.
- ASTM (2012c), *Standard Test Methods for Laboratory Compaction Characteristics of Soil Using Standard Effort*, ASTM D698-12e2, ASTM International.
- Azzouz, A. S., A. M. Malek, and M. M. Baligh (1989), Cyclic behavior of clays in undrained simple shear, *Journal of Geotechnical Engineering*, 115(5), 637–657.
- Banerjee, N. G., C. K. Chan, and H. B. Seed (1979), *Cyclic behavior of dense coarse-grained materials in relation to the seismic stability of dams*, University of California.
- Bartake, P., A. Patel, and D. Singh (2008), Instrumentation for bender element testing of soils, *International Journal of Geotechnical Engineering*, 2(4), 395–405.
- Barton, N., and B. Kjaernsli (1981), Shear strength of rockfill, *Journal of Geotechnical and Geoenvironmental Engineering*, 107(ASCE 16374).
- Bates, C. (1989), Dynamic soil property measurements during triaxial testing, *Géotechnique*, 39(4).
- Baxter, C. D., A. S. Bradshaw, R. A. Green, and J.-H. Wang (2008), Correlation between cyclic resistance and shear-wave velocity for providence silts, *Journal of Geotechnical and Geoenvironmental Engineering*, 134(1), 37–46.
- Bergeson, K., C. Jahren, M. Wermager, and D. White (1998), Embankment quality: Phase I Report, *Tech. rep.*
- Berrill, J., V. Bienvenu, and M. Callaghan (1988), Liquefaction in the buller region in the 1929 and 1968 earthquakes, *Bulletin of the New Zealand National Society for Earthquake Engineering*, 21(3), 174–189.
- Bhatia, S. K. (1982), The verification of relationships for effective stress method to evaluate liquefaction potential of saturated sands, Ph.D. thesis, University of British Columbia.

- Bjerrum, L., and A. Landva (1966), Direct simple-shear tests on a norwegian quick clay, *Geotechnique*, 16(1), 1–20.
- Blewett, J., I. Blewett, and P. Woodward (1999), Measurement of shear-wave velocity using phase-sensitive detection techniques, *Canadian Geotechnical Journal*, 36(5), 934–939.
- Blewett, J., I. Blewett, and P. Woodward (2000), Phase and amplitude responses associated with the measurement of shear-wave velocity in sand by bender elements, *Canadian Geotechnical Journal*, 37(6), 1348–1357.
- Boulanger, R. W., C. K. Chan, H. B. Seed, R. B. Seed, and J. B. Sousa (1993), A low-compliance bi-directional cyclic simple shear apparatus, *Geotechnical Testing Journal*, 16(1), 36–45.
- Boylan, N., and M. Long (2008), Development of a direct simple shear apparatus for peat soils, *Geotechnical Testing Journal*, 32(2), 1–13.
- Brand, E. (1973), Some observations on the control of density by vibration, in *Evaluation of relative density and its role in geotechnical projects involving cohesionless soils*, ASTM International.
- Brignoli, E., M. Gotti, and K. H. Stokoe (1996), Measurement of shear waves in laboratory specimens by means of piezoelectric transducers, *Geotechnical Testing Journal*, 19(4), 384–397.
- Budhu, M. (1984), Nonuniformities imposed by simple shear apparatus, *Canadian Geotechnical Journal*, 21(1), 125–137.
- Budhu, M. (1988), Failure state of a sand in simple shear, *Canadian Geotechnical Journal*, 25(2), 395–400.
- Camacho-Tauta, J., G. Cascante, J. A. Santos, and A. Viana da Fonseca (2011), Measurements of shear wave velocity by resonant-column test, bender element test and miniature accelerometers, in *Proceedings of Pan-Am CGS geotechnical conference, Canada*, vol. 949, pp. 1–9.
- Cao, Z., T. L. Youd, and X. Yuan (2011), Gravelly soils that liquefied during 2008 wenchuan, china earthquake, $M_s = 8.0$, *Soil Dynamics and Earthquake Engineering*, 31(8), 1132–1143.
- Cao, Z., T. L. Youd, and X. Yuan (2013), Chinese dynamic penetration test for liquefaction evaluation in gravelly soils, *Journal of Geotechnical and Geoenvironmental Engineering*, 139(8), 1320–1333.
- Cetin, K. O., R. B. Seed, A. Der Kiureghian, K. Tokimatsu, L. F. Harder Jr, R. E. Kayen, and R. E. Moss (2004), Standard penetration test-based probabilistic and deterministic assessment of seismic soil liquefaction potential, *Journal of Geotechnical and Geoenvironmental Engineering*, 130(12), 1314–1340.

- Chang, W.-J., and M.-L. Hong (2008), Effects of clay content on liquefaction characteristics of gap-graded clayey sands, *Soils and Foundations*, 48(1), 101–114.
- Chang, W.-J., and T. Phantachang (2016), Effects of gravel content on shear resistance of gravelly soils, *Engineering Geology*, 207, 78–90.
- Chang, W.-J., C.-W. Chang, and J.-K. Zeng (2014), Liquefaction characteristics of gap-graded gravelly soils in k_0 condition, *Soil Dynamics and Earthquake Engineering*, 56, 74–85.
- Charles, J., and K. Watts (1980), The influence of confining pressure on the shear strength of compacted rockfill, *Geotechnique*, 30(4), 353–367.
- Chen, Y., H. Ke, and R.-p. Chen (2005), Correlation of shear wave velocity with liquefaction resistance based on laboratory tests, *Soil Dynamics and Earthquake Engineering*, 25(6), 461–469.
- Choi, C., P. Arduino, and M. D. Harney (2007), Development of a true triaxial apparatus for sands and gravels, *Geotechnical Testing Journal*, 31(1), 1–13.
- Cubrinovski, M., K. Ishihara, and T. Kijima (2001), Effects of liquefaction on seismic response of a storage tank on pile foundations, in *Proceedings of Fourth International Conference on Recent Advances in Geotechnical Earthquake Engineering and Soil Dynamics*.
- Dabeet, A., D. Wijewickreme, and P. Byrne (2015), Evaluation of stress strain non-uniformities in the laboratory direct simple shear test specimens using 3d discrete element analysis, *Geomechanics and Geoengineering*, 10(4), 249–260.
- De Alba, P., C. K. Chan, and H. B. Seed (1975), *Determination of soil liquefaction characteristics by large-scale laboratory tests*, Earthquake Engineering Research Center, University of California.
- De Josselin de Jong, G. (1988), Elasto-plastic version of the double sliding model in undrained simple shear tests, *Geotechnique*, 38(4), 533–555.
- DeGroot, D. J., C. C. Ladd, and J. T. Germaine (1992), *Direct simple shear testing of cohesive soils*, [Ralph M. Parsons Laboratory], Department of Civil Engineering, Massachusetts Institute of Technology.
- DeGroot, D. J., J. T. Germaine, and C. C. Ladd (1994), Effect of nonuniform stresses on measured dss stress-strain behavior, *Journal of Geotechnical Engineering*, 120(5), 892–912.
- DeJong, J., A. Sturm, and M. Ghafghazi (2016), Characterization of gravelly alluvium, *Soil Dynamics and Earthquake Engineering*, 91, 104–115.
- Den Haan, E., and M. Grognet (2014), A large direct simple shear device for the testing of peat at low stresses, *Géotechnique Letters*, 4(4), 283–288.

- Dobry, R., R. Ladd, F. Y. Yokel, R. M. Chung, and D. Powell (1982), *Prediction of pore water pressure buildup and liquefaction of sands during earthquakes by the cyclic strain method*, vol. 138, National Bureau of Standards Gaithersburg, MD.
- Dobry, R., W. Pierce, R. Dyvik, G. Thomas, and R. Ladd (1985), Pore pressure model for cyclic straining of sand, *Rensselaer Polytechnic Institute, Troy, New York*.
- Dobry, R., T. Abdoun, K. Stokoe, R. Moss, M. Hatton, and H. El Ganainy (2014), Liquefaction potential of recent fills versus natural sands located in high-seismicity regions using shear-wave velocity, *Journal of Geotechnical and Geoenvironmental Engineering*, 141(3), 04014,112.
- Doherty, J., and M. Fahey (2011), Three-dimensional finite element analysis of the direct simple shear test, *Computers and Geotechnics*, 38(7), 917–924.
- Donaghe, R. T., and V. Torrey III (1985), Strength and deformation properties of earth-rock mixtures., *Tech. rep.*, DTIC Document.
- Dounias, G. T., and D. M. Potts (1993), Numerical analysis of drained direct and simple shear tests, *Journal of Geotechnical Engineering*, 119(12), 1870–1891.
- Dyvik, R., and C. Madshus (1985), Lab measurements of g_{max} using bender elements, in *Advances in the Art of Testing Soils Under Cyclic Conditions*., pp. 186–196, ASCE.
- Dyvik, R., T. Berre, S. Lacasse, and B. Raadim (1987), Comparison of truly undrained and constant volume direct simple shear tests, *Geotechnique*, 37(1), 3–10.
- Evans, M. D., and H. B. Seed (1987), Undrained cyclic triaxial testing of gravels: the effect of membrane compliance, *University of California, Berkeley, EERC Report No. UCB/EERC-87-08*.
- Evans, M. D., and S. Zhou (1995), Liquefaction behavior of sand-gravel composites, *Journal of Geotechnical Engineering*, 121(3), 287–298.
- Evans, M. D., H. Bolton Seed, and R. B. Seed (1992), Membrane compliance and liquefaction of sluiced gravel specimens, *Journal of geotechnical engineering*, 118(6), 856–872.
- Fam, M., and C. Santamarina (1995), Study of geoprocesses with complementary mechanical and electromagnetic wave measurements in an oedometer, *Geotechnical Testing Journal*, 18(3), 307–314.
- Fear, C. E., and P. K. Robertson (1995), Estimating the undrained strength of sand: a theoretical framework, *Canadian Geotechnical Journal*, 32(5), 859–870.
- Finn, W. (1985), Aspects of constant volume cyclic simple shear, in *Advances in the Art of Testing Soils Under Cyclic Conditions*., pp. 74–98, ASCE.
- Finn, W. (1991), Assessment of liquefaction potential and post-liquefaction behavior of earth structures: Developments 1981-1991, in *International Conferences on Recent Advances in Geotechnical Earthquake Engineering and Soil Dynamics.2*.

- Fioravante, V., D. Giretti, M. Jamiolkowski, and G. Rocchi (2012), Triaxial tests on undisturbed gravelly soils from the sicilian shore of the messina strait, *Bulletin of Earthquake Engineering*, pp. 1–28.
- Flora, A., and S. Lirer (2013), Small strain shear modulus of undisturbed gravelly soils during undrained cyclic triaxial tests, *Geotechnical and Geological Engineering*, 31(4), 1107–1122.
- Flora, A., S. Lirer, and F. Silvestri (2012), Undrained cyclic resistance of undisturbed gravelly soils, *Soil Dynamics and Earthquake Engineering*, 43, 366–379.
- Fragaszy, R. J., and C. Sneider (1991), *Compaction Control of Granular Soils: Final Report, Research Project GC 8720, Task 08*, Washington State Department of Transportation, Planning, Research and Public Transportation Division.
- Fragaszy, R. J., W. Su, and F. H. Siddiqi (1990), Effects of oversize particles on the density of clean granular soils, *Geotechnical Testing Journal*, 13(2), 106–114.
- Franke, E., M. Kiekbusch, and B. Schuppener (1979), A new direct simple shear device, *Geotechnical Testing Journal*, 2(4), 190–199.
- Garga, V. K., and C. J. Madureira (1985), Compaction characteristics of river terrace gravel, *Journal of Geotechnical Engineering*, 111(8), 987–1007.
- Green, R., J. Mitchell, and C. Polito (2000), An energy-based excess pore pressure generation model for cohesionless soils, in *Proc.: Developments in Theoretical Geomechanics—The John Booker Memorial Symposium*, pp. 16–17, Sydney, New South Wales, Australia, Nov.
- Greening, P. D., and D. F. Nash (2004), Frequency domain determination of g_0 using bender elements, *Geotechnical Testing Journal*, 27(43), 288–294.
- Haeri, S. M., and M. R. Shakeri (2010), Effects of membrane compliance on pore water pressure generation in gravelly sands under cyclic loading, *Geotechnical Testing Journal*, 33(5), 1–10.
- Hamada, M. (2014), *Engineering for earthquake disaster mitigation*, 1–328 pp., Springer Series in Geomechanics and Geoengineering.
- Hara, T., H. Toyota, S. Takada, and K. Nakamura (2012), Liquefaction characteristic of intermediate soil including gravel, in *15th World Conference on Earthquake Engineering. Lisbon. Portugal*.
- Harder Jr., L. F. (1997), Application of the becker penetration test for evaluating the liquefaction potential of gravelly soils, in *NCEER Workshop on Evaluation of Liquefaction Resistance of Soils*.
- Harder Jr, L. F., and H. B. Seed (1986), Determination of penetration resistance for coarse-grained soils using the becker penetration test, *University of California, Berkeley, EERC Report No. UCB/EERC-86-06*.

- Hardin, B., and F. Richart (1963), Elastic wave velocities in granular soils, *Journal of the Soil Mechanics and Foundations Division, ASCE*, 89, 33–45.
- Hatanaka, M., Y. Suzuki, T. Kawasaki, and M. Endo (1988), Cyclic undrained shear properties of high quality undisturbed Tokyo gravel, *Soils and Foundations*, 28(4), 57–68.
- Hatanaka, M., A. Uchida, and J. Ohara (1997), Liquefaction characteristics of a gravelly fill liquefied during the 1995 Hyogo-Ken Nanbu earthquake, *Soils and Foundations*, 37(3), 107–115.
- Holtz, R. D., and W. D. Kovacs (1981), *An introduction to geotechnical engineering*, Monograph.
- Holtz, W., and H. J. Gibbs (1956), Triaxial shear tests on pervious gravelly soils, *Journal of the Soil Mechanics and Foundations Division*, 82(1), 1–22.
- Holtz, W. G., and C. A. Lowits (1957), *Compaction characteristics of gravelly soils*, US Department of the Interior, Bureau of Reclamation.
- Humphres, H. W. (1957), A method for controlling compaction of granular materials, *Highway Research Board Bulletin*, (159), 41–57.
- Hynes, M. E. (1988), *Pore pressure generation characteristics of gravel under undrained cyclic loading*, vol. 1, University of California, Berkeley.
- Idriss, I., and R. Boulanger (2006), Semi-empirical procedures for evaluating liquefaction potential during earthquakes, *Soil Dynamics and Earthquake Engineering*, 26(2), 115–130.
- Imai, T., and K. Tonouchi (1982), Correlation of N-value with S-wave velocity and shear modulus, in *Proceedings of the 2nd European symposium of penetration testing, Amsterdam*, pp. 57–72.
- Ishihara, K. (1985), Stability of natural deposits during earthquakes, in *Proceedings, 11th International Conference on Soil Mechanics and Foundation Engineering*, vol. 1, pp. 321–376.
- Ishihara, K., and M. Yoshimine (1992), Evaluation of settlements in sand deposits following liquefaction during earthquakes, *Soils and foundations*, 32(1), 173–188.
- Johnson (1965), Discussion of "research on vibratory maximum density test for cohesionless soils by pettibone and hardin", in *Compaction of Soils*, ASTM International.
- Jovičić, V., M. Coop, and M. Simić (1996), Objective criteria for determining g_{max} from bender element tests, *Geotechnique*, 46(2), 357–362.
- Kammerer, A., R. Seed, J. Wuz, M. Riemer, and J. Pestana (2004), Pore pressure development in liquefiable soils under bi-directional loading conditions, in *Proceedings of 11th International Conference on Soil Dynamics and Earthquake Engineering and the 3rd International Conference on Earthquake Geotechnical Engineering*, vol. 2, pp. 697–704.

- Kavazanjian Jr, E., N. Matasovic, and R. C. Bachus (1999), Large-diameter static and cyclic laboratory testing of municipal solid waste, in *Proceedings Sardinia - 7th International Waste Management and Landfill Symposium*, vol. 99, pp. 437–444.
- Kawaguchi, T., T. Mitachi, and S. Shibuya (2001), Evaluation of shear wave travel time in laboratory bender element test, in *Proceedings of the International conference on soil mechanics and geotechnical engineering*, vol. 1, pp. 155–158, AA Balkema Publishers.
- Kayen, R., R. Moss, E. Thompson, R. Seed, K. Cetin, A. D. Kiureghian, Y. Tanaka, and K. Tokimatsu (2013), Shear-wave velocity–based probabilistic and deterministic assessment of seismic soil liquefaction potential, *Journal of Geotechnical and Geoenvironmental Engineering*, 139(3), 407–419.
- Kishida, H. (1969), Characteristics of liquefied sands during Mino-Owari, Tohankai and Fukui earthquakes, *Soils and Foundations*, 9(1), 75–92.
- Kjellman, W. (1951), Testing the shear strength of clay in Sweden, *Geotechnique*, 2(3), 225–232.
- Koester, J. P., C. Daniel, and M. Anderson (2000), In situ investigation of liquefied gravels at Seward, Alaska, in *Innovations and Applications in Geotechnical Site Characterization*, pp. 33–48.
- Kokusho, T., and Y. Yoshida (1997), SPT N-value and S-wave velocity for gravelly soils with different grain size distribution, *Soils and Foundations*, 37(4), 105–113.
- Kokusho, T., Y. Tanaka, T. Kawai, K. Kudo, K. Suzuki, S. Tohda, and S. Abe (1995), Case study of rock debris avalanche gravel liquefied during 1993 Hokkaido-Nansei-Oki earthquake, *Soils and Foundations*, 35(3), 83–95.
- Kokusho, T., T. Hara, and R. Hiraoka (2004), Undrained shear strength of granular soils with different particle gradations, *Journal of Geotechnical and Geoenvironmental Engineering*, 130(6), 621–629.
- Kovacs, W. D., and E. Leo (1981), Cyclic simple shear of large scale sand samples: effects of diameter to height ratio, in *First International Conference on Recent Advances in Geotechnical Earthquake Engineering and Soil Dynamics*, University of Missouri–Rolla.
- Krumbein, W. C. (1941), Measurement and geological significance of shape and roundness of sedimentary particles, *Journal of Sedimentary Research*, 11(2).
- La Rochelle, P. (1981), Limitations of direct simple shear test devices, in *Laboratory Shear Strength of Soil*, ASTM International.
- Lade, P. V., C. Liggio, and J. A. Yamamuro (1998), Effects of non-plastic fines on minimum and maximum void ratios of sand, *Geotechnical Testing Journal*, 21(4), 336–347.

- Lee, J.-S., and J. C. Santamarina (2005), Bender elements: performance and signal interpretation, *Journal of Geotechnical and Geoenvironmental Engineering*, 131(9), 1063–1070.
- Lee, K. L., and A. Albaisa (1974), Earthquake induced settlements in saturated sands, *Journal of Geotechnical Engineering Division*, 100(GT4), 387–406.
- Leong, E. C., S. H. Yeo, and H. Rahardjo (2005), Measuring shear wave velocity using bender elements, *Geotechnical Testing Journal*, 28(5), 488–498.
- Leps, T. M. (1970), Review of shearing strength of rockfill, *Journal of Soil Mechanics & Foundations Div*, 96(4), 1159–1170.
- Liao, S. S., and R. V. Whitman (1986), *A catalog of liquefaction and non-liquefaction occurrences during earthquakes*, Department of Civil Engineering, MIT.
- Lin, S.-Y., P. S. Lin, H.-S. Luo, and C. H. Juang (2000), Shear modulus and damping ratio characteristics of gravelly deposits, *Canadian Geotechnical Journal*, 37(3), 638–651.
- Liu, H., D. Zou, and J. Liu (2014), Constitutive modeling of dense gravelly soils subjected to cyclic loading, *International Journal for Numerical and Analytical Methods in Geomechanics*, 38(14), 1503–1518.
- Marachi, N. (1969), Strength and deformation characteristics of rockfill materials, Ph.D. thesis, University of California, Berkeley.
- Marcuson, W. F. (1978), Definition of terms related to liquefaction, *Journal of the Geotechnical Engineering Division*, 104(9), 1197–1200.
- Marsal, R. J. (1967), Large-scale testing of rockfill materials, *Journal of the Soil Mechanics and Foundations Division*, 93(2), 27–43.
- Martin, G. R., W. L. Finn, and H. B. Seed (1975), Fundamentals of liquefaction under cyclic loading, *Journal of Geotechnical and Geoenvironmental Engineering*, 101(5).
- Matasovic, N., and E. Kavazanjian Jr (1998), Cyclic characterization of oii landfill solid waste, *Journal of Geotechnical and Geoenvironmental Engineering*, 124(3), 197–210.
- Matsuoka, H., and S. Liu (1998), Simplified direct box shear test on granular materials and its application to rockfill materials, *Soils and Foundations*, 38(4), 275–284.
- Matsuoka, H., S. Liu, D. Sun, and U. Nishikata (2001), Development of a new in-situ direct shear test, *Geotechnical Testing Journal*, 24(1), 92–102.
- Menq, F.-Y. (2003), Dynamic properties of sandy and gravelly soils, Ph.D. thesis, University of Texas, Austin.
- Miura, S., and S. Toki (1982), A sample preparation method and its effect on static and cyclic deformation-strength properties of sand, *Soils and Foundations*, 22(1), 61–77.

- Moroto, N., and T. Ishii (1990), Shear strength of uni-sized gravels under triaxial compression, *Soils and Foundations*, 30(2), 23–32.
- Moss, R., R. B. Seed, R. E. Kayen, J. P. Stewart, A. Der Kiureghian, and K. O. Cetin (2006), CPT-based probabilistic and deterministic assessment of in situ seismic soil liquefaction potential, *Journal of Geotechnical and Geoenvironmental Engineering*, 132(8), 1032–1051.
- Nikolaou, S., D. Zekkos, D. Assimaki, and R. Gilsanz (2014), *Earthquake Reconnaissance January 26th/February 2nd 2014 Cephalonia, Greece events, Version 1*, GEER/EERI/ATC.
- Nishio, S., and K. Tamaoki (1988), Measurement of shear wave velocities in diluvial gravel samples under triaxial conditions, *Soils and Foundations*, 28(2), 35–48.
- Ohm, H.-S., and R. D. Hryciw (2013), Translucent segregation table test for sand and gravel particle size distribution, *Geotechnical Testing Journal*, 36(4), 592–605.
- Okada, H., and K. Suto (2003), *The Microtremor Survey Method*, Society of Exploration Geophysicists.
- Özener, P. (2012), Estimation of residual shear strength ratios of liquefied soil deposits from shear wave velocity, *Earthquake Engineering and Engineering Vibration*, 11(4), 461.
- Papathanassiou, G., A. Ganas, and S. Valkaniotis (2016), Recurrent liquefaction-induced failures triggered by 2014 cephalonia, greece earthquakes: Spatial distribution and quantitative analysis of liquefaction potential, *Engineering Geology*, 200, 18–30.
- Park, C., R. Miller, N. Rydén, J. Xia, and J. Ivanov (2005), Combined use of active and passive surface waves, *Journal of Environmental & Engineering Geophysics*, 10(3), 323–334.
- Park, C. B., R. D. Miller, and J. Xia (1998), Imaging dispersion curves of surface waves on multi-channel record, in *SEG Technical Program Expanded Abstracts 1998*, pp. 1377–1380, Society of Exploration Geophysicists.
- Parsons, A. W., et al. (1992), *Compaction of soils and granular materials: a review of research performed at the Transport Research Laboratory.*, HMSO.
- Peacock, W. H., and H. B. Seed (1968), Sand liquefaction under cyclic loading simple shear conditions, *Journal of Soil Mechanics & Foundations Div*, 94(3), 689–708.
- Pelkey, S. A., A. J. Valsangkar, and A. Landva (2001), Shear displacement dependent strength of municipal solid waste and its major constituent, *Geotechnical Testing Journal*, 24(4), 381–390.
- Pennington, D. S., D. F. Nash, and M. L. Lings (2001), Horizontally mounted bender elements for measuring anisotropic shear moduli in triaxial clay specimens, *Geotechnical Testing Journal*, 24(2), 133–144.

- Polito, C. P., and J. R. Martin II (2001), Effects of nonplastic fines on the liquefaction resistance of sands, *Journal of Geotechnical and Geoenvironmental Engineering*, 127(5), 408–415.
- Polito, C. P., R. A. Green, and J. Lee (2008), Pore pressure generation models for sands and silty soils subjected to cyclic loading, *Journal of Geotechnical and Geoenvironmental Engineering*, 134(10), 1490–1500.
- Porcino, D., G. Caridi, and V. Ghionna (2008), Undrained monotonic and cyclic simple shear behaviour of carbonate sand, *Geotechnique*, 158(8), 635–644.
- Powers, M. C. (1953), A new roundness scale for sedimentary particles, *Journal of Sedimentary Research*, 23(2).
- Prevost, J.-H., and K. Høeg (1976), Reanalysis of simple shear soil testing, *Canadian Geotechnical Journal*, 13(4), 418–429.
- Qi, W., C. Guoxing, G. Hongmei, and J. Dandan (2015), Effect of plastic fines on liquefaction characteristics of gravelly soil, in *6th International Conference on Earthquake Geotechnical Engineering*.
- Rashidian, M. (1995), Undrained shearing behavior of gravelly sands and its relation with shear wave velocity, Ph.D. thesis, University of Tokyo.
- Robertson, P., S. Sasitharan, J. Cunning, and D. Segoo (1995), Shear-wave velocity to evaluate in-situ state of Ottawa sand, *Journal of Geotechnical Engineering*, 121(3), 262–273.
- Rollins, K. M., M. D. Evans, N. B. Diehl, and W. D. D. III (1998), Shear modulus and damping relationships for gravels, *Journal of Geotechnical and Geoenvironmental Engineering*, 124(5), 396–405.
- Roscoe, K. (1953), An apparatus for the application of simple shear to soil samples, in *Proceedings of the 3rd International Conference on Soil Mechanics and Foundation Engineering*, pp. 186–191.
- Roscoe, K., R. Bassett, and E. Cole (1967), Principal axes observed during simple shear of a sand, in *Proc. Geotech. Conf., Oslo*, vol. 1, pp. 231–237.
- Roscoe, K. H. (1970), The influence of strains in soil mechanics, *Geotechnique*, 20(2), 129–170.
- Sadrekarami, A., and S. Olson (2011), Critical state friction angle of sands, *Géotechnique*, 61(9), 771–783.
- Sahadewa, A. (2014), In-situ assessment of linear and nonlinear dynamic properties of municipal solid waste, Ph.D. thesis, University of Michigan.
- Sanin, M., and D. Wijewickreme (2006), Cyclic shear response of channel-fill fraser river delta silt, *Soil Dynamics and Earthquake Engineering*, 26(9), 854–869.

- Sawanguriya, A., E. Biringen, D. Fratta, P. Bosscher, and T. Edil (2006), Dimensionless limits for the collection and interpretation of wave propagation data in soils, in *GeoShanghai International Conference, Site and Geomaterial Characterization*, pp. 160–166.
- Seed, H., and W. H. Peacock (1968), Sand liquefaction under cyclic loading simple shear conditions, *Journal of Soil Mechanics & Foundations Div*, 94(3), 689–708.
- Seed, H., P. Martin, and J. Lysmer (1975), The generation and dissipation of pore water pressures during soil liquefaction. rep. no. ucb/eerc 75-26, *Earthq. Eng. Research Ctr., UC Berkely, CA*.
- Seed, R. B., and L. F. Harder (1990), Spt-based analysis of cyclic pore pressure generation and undrained residual strength, in *H. Bolton Seed Memorial Symposium Proceedings*, vol. 2, pp. 351–376.
- Seed, R. B., et al. (2003), Recent advances in soil liquefaction engineering: a unified and consistent framework, in *Proceedings of the 26th Annual ASCE Los Angeles Geotechnical Spring Seminar: Long Beach, CA*.
- Shaw, P., and S. F. Brown (1986), Cyclic simple shear testing of granular materials, *Geotechnical Testing Journal*, 9(4), 213–220.
- Silver, M. L., and H. B. Seed (1971), Deformation characteristics of sands under cyclic loading, *Journal of Soil Mechanics & Foundations Div*, 97(8), 1081–1098.
- Sivathayalan, S. (1994), *Static, cyclic and post liquefaction simple shear response of sands*, MS Thesis, University of British Columbia.
- Sivathayalan, S. (2000), Fabric, initial state and stress path effects on liquefaction susceptibility of sands, Ph.D. thesis, University of British Columbia.
- Sivathayalan, S., and A. M. Yazdi (2013), Influence of strain history on postliquefaction deformation characteristics of sands, *Journal of Geotechnical and Geoenvironmental Engineering*, 140(3), 04013,019.
- Skermer, N., and S. Hillis (1970), Gradation and shear characteristics of four cohesionless soils, *Canadian Geotechnical Journal*, 7(1), 62–68.
- Soga, K. (1998), Soil liquefaction effects observed in the kobe earthquakes of 1995, *Proceedings Of The Institution Of Civil Engineers-Geotechnical Engineering*, 131(1), 34–51.
- Spanovich (1965), Discussion of “Research on vibratory maximum density test for cohesionless soils by Pettibone and Hardin”, in *Compaction of Soils*, ASTM International.
- Stark, T. D., and G. Mesri (1992), Undrained shear strength of liquefied sands for stability analysis, *Journal of Geotechnical Engineering*, 118(11), 1727–1747.

- Strahler, A., A. W. Stuedlein, and P. W. Arduino (2015), Stress-strain response and dilatancy of sandy gravel in triaxial compression and plane strain, *Journal of Geotechnical and Geoenvironmental Engineering*, 142(4), 04015,098.
- Sun, Y., and Y. Xiao (2016), Fractional order model for granular soils under drained cyclic loading, *International Journal for Numerical and Analytical Methods in Geomechanics*.
- Suzuki, Y., S. Goto, M. Hatanaka, and K. Tokimatsu (1993), Correlation between strengths and penetration resistances for gravelly soils, *Soils and Foundations*, 33(1), 92–101.
- Theodoulidis, N., et al. (2016), The Cephalonia, Greece, January 26 (M6. 1) and February 3, 2014 (M6. 0) earthquakes: near-fault ground motion and effects on soil and structures, *Bulletin of Earthquake Engineering*, 14(1), 1–38.
- Thevanayagam, S. (1998), Effect of fines and confining stress on undrained shear strength of silty sands, *Journal of Geotechnical and Geoenvironmental Engineering*, 124(6), 479–491.
- Thomann, T., and R. Hryciw (1990), Laboratory measurement of small strain shear modulus under k_0 conditions, *Geotechnical Testing Journal*, 13(2), 97–105.
- Tokimatsu, K., and H. B. Seed (1987), Evaluation of settlements in sands due to earthquake shaking, *Journal of Geotechnical Engineering*, 113(8), 861–878.
- Tokimatsu, K., and Y. Yoshimi (1983), Empirical correlation of soil liquefaction based on SPT N-value and fines content, *Soils and Foundations*, 23(4), 56–74.
- Tokimatsu, K., T. Yamazaki, and Y. Yoshimi (1986), Soil liquefaction evaluations by elastic shear moduli, *Soils and Foundations*, 26(1), 25–35.
- Towhata, I., et al. (2014), Liquefaction in the kanto region during the 2011 off the pacific coast of tohoku earthquake, *Soils and Foundations*, 54(4), 859–873.
- USBR (1990), *Performing Laboratory Compaction of Soils - 5.5 lbm Rammer and 18-in Drop*, USBR 5500, Earth Manual, Part 2, Third Edition.
- Vaid, Y., and J. Chern (1985), Cyclic and monotonic undrained response of saturated sands, in *Advances in the Art of Testing Soils Under Cyclic Conditions*., pp. 120–147, ASCE.
- Vaid, Y., and S. Sivathayalan (1996), Static and cyclic liquefaction potential of fraser delta sand in simple shear and triaxial tests, *Canadian Geotechnical Journal*, 33(2), 281–289.
- Vaid, Y., and S. Sivathayalan (1997), Post liquefaction behaviour of saturated sand under simple shear loading, in *Proceedings of the International Conference on Soil Mechanics and Foundation Engineering, Society for Soil Mechanics and Foundation Engineering*, vol. 1, pp. 221–224, AA Balkema.
- Vaid, Y., and J. Thomas (1995), Liquefaction and postliquefaction behavior of sand, *Journal of Geotechnical Engineering*, 121(2), 163–173.

- Vaid, Y. P., and J.-C. Chern (1983), Effect of static shear on resistance to liquefaction, *Soils and Foundations*, 23(1), 47–60.
- Vaid, Y. P., J. C. Chern, and H. Tumi (1985), Confining pressure, grain angularity, and liquefaction, *Journal of Geotechnical Engineering*, 111(10), 1229–1235.
- Varadarajan, A., K. Sharma, K. Venkatachalam, and A. Gupta (2003), Testing and modeling two rockfill materials, *Journal of Geotechnical and Geoenvironmental Engineering*, 129(3), 206–218.
- Viggiani, G., and J. Atkinson (1995a), Interpretation of bender element tests, *Géotechnique*, 45(1), 149–154.
- Viggiani, G., and J. Atkinson (1995b), Stiffness of fine-grained soil at very small strains, *Géotechnique*, 45(2), 249–265.
- Vucetic, M. (1994), Cyclic threshold shear strains in soils, *Journal of Geotechnical engineering*, 120(12), 2208–2228.
- Vucetic, M., and R. Dobry (1988), Degradation of marine clays under cyclic loading, *Journal of Geotechnical Engineering*, 114(2), 133–149.
- Vucetic, M., and S. Lacasse (1982), Specimen size effect in simple shear test, *Journal of the Geotechnical Engineering Division*, 108(12), 1567–1585.
- Wair, B. R., J. T. DeJong, and T. Shantz (2012), Guidelines for estimation of shear wave velocity profiles, *PEER report*, 8, 95.
- Walsh, T. J., R. A. Combellick, and G. L. Black (1995), *Liquefaction features from a subduction zone earthquake: preserved examples from the 1964 Alaska earthquake*, 32, Washington State Department of Natural Resources, Division of Geology and Earth Resources.
- Wang, W. (1984), Earthquake damages to earth dams and levees in relation to soil liquefaction and weakness in soft clays, in *First International Conference on Case Histories in Geotechnical Engineering*.
- Wicaksono, R. I., Y. Tsutsumi, T. Sato, J. Koseki, and R. Kuwano (2008), Laboratory wave measurement on Toyoura sand and Hime gravel, *Bulletin of Earthquake Resistant Structure Research Center, University of Tokyo*, 41, 35–44.
- Wijewickreme, D., S. Sriskandakumar, and P. Byrne (2005), Cyclic loading response of loose air-pluviated Fraser River sand for validation of numerical models simulating centrifuge tests, *Canadian Geotechnical Journal*, 42(2), 550–561.
- Wong, T., H. Seed, and C. Chan (1974), Liquefaction of gravelly soils under cyclic loading conditions, university of california, *Earthquake Engineering Research Center, EERC Report*, (74-11).

- Wu, J., A. Kammerer, M. Riemer, R. Seed, and J. Pestana (2004), Laboratory study of liquefaction triggering criteria, in *13th World Conference on Earthquake Engineering, Vancouver, BC, Canada, Paper*, 2580.
- Xiao, Y., and H. Liu (2016), Elastoplastic constitutive model for rockfill materials considering particle breakage, *International Journal of Geomechanics*, 17(1), 04016,041.
- Xiao, Y., H. Liu, Y. Chen, and J. Jiang (2014a), Strength and deformation of rockfill material based on large-scale triaxial compression tests. i: Influences of density and pressure, *Journal of Geotechnical and Geoenvironmental Engineering*, 140(12), 04014,070.
- Xiao, Y., H. Liu, Y. Chen, and J. Jiang (2014b), Strength and deformation of rockfill material based on large-scale triaxial compression tests. ii: influence of particle breakage, *Journal of Geotechnical and Geoenvironmental Engineering*, 140(12), 04014,071.
- Xiao, Y., H. Liu, Y. Chen, and J. Jiang (2014c), Bounding surface plasticity model incorporating the state pressure index for rockfill materials, *Journal of Engineering Mechanics*, 140(11), 04014,087.
- Xiao, Y., H. Liu, C. S. Desai, Y. Sun, and H. Liu (2015a), Effect of intermediate principal-stress ratio on particle breakage of rockfill material, *Journal of Geotechnical and Geoenvironmental Engineering*, 142(4), 06015,017.
- Xiao, Y., H. Liu, X. Ding, Y. Chen, J. Jiang, and W. Zhang (2015b), Influence of particle breakage on critical state line of rockfill material, *International Journal of Geomechanics*, 16(1), 04015,031.
- Yang, J., L. Wei, and B. Dai (2015), State variables for silty sands: Global void ratio or skeleton void ratio?, *Soils and Foundations*, 55(1), 99–111.
- Yasuda, N., and N. Matsumoto (1994), Comparisons of deformation characteristics of rockfill materials using monotonic and cyclic loading laboratory tests and in situ tests, *Canadian geotechnical journal*, 31(2), 162–174.
- Yazdi, A. M. (2004), *Post-liquefaction Behaviour of Sands Under Simple Shear and Triaxial Loading Modes*, MS Thesis, Carleton University.
- Yegian, M., V. Ghahraman, and R. Harutiunyan (1994), Liquefaction and embankment failure case histories, 1988 Armenia earthquake, *Journal of geotechnical engineering*, 120(3), 581–596.
- Yi, F. (2010), Procedure to evaluate liquefaction-induced settlement based on shear wave velocity, in *Manuscript submitted to The 9th US ational and 10th Canadian Conference on Earthquake Engineering (9US/10CCEE), Toronto, Canada*.
- Yoshimine, M., H. Nishizaki, K. Amano, and Y. Hosono (2006), Flow deformation of liquefied sand under constant shear load and its application to analysis of flow slide of infinite slope, *Soil Dynamics and Earthquake Engineering*, 26(2), 253–264.

- Youd, T. (1973), Factors controlling maximum and minimum densities of sands, in *Evaluation of relative density and its role in geotechnical projects involving cohesionless soils*, ASTM International.
- Youd, T., E. Harp, D. Keefer, and R. Wilson (1985), The Borah Peak, Idaho Earthquake of October 28, 1983 Liquefaction, *Earthquake spectra*, 2(1), 71–89.
- Youd, T., et al. (2001), Liquefaction resistance of soils: summary report from the 1996 NCEER and 1998 NCEER/NSF workshops on evaluation of liquefaction resistance of soils, *Journal of Geotechnical and Geoenvironmental Engineering*, 127(10), 817–833.
- Youd, T. L., and S. N. Hoose (1978), *Historic ground failures in northern California triggered by earthquakes*, 1–177 pp., US Geological Survey Profession Paper 993, US Govt. Print. Off.
- Zekkos, D., and X. Fei (2016), Constant load and constant volume response of municipal solid waste in simple shear, *Waste Management*.
- Zhao, H., L. Zhang, and D. Chang (2012), Behavior of coarse widely graded soils under low confining pressures, *Journal of Geotechnical and Geoenvironmental Engineering*, 139(1), 35–48.