

**Cell Phone Ring Suppression and HUD Caller ID:
Effectiveness in Reducing Momentary
Driver Distraction Under Varying Workload Levels**

**Christopher Nowakowski
Dana Friedman
Paul Green**

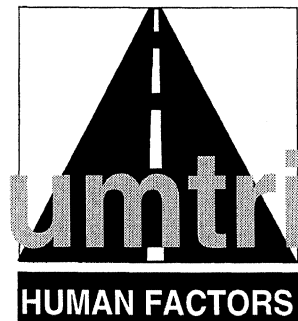

1. Report No. UMTRI-2000-29		2. Government Accession No.		3. Recipient's Catalog No.	
4. Title and Subtitle Cell Phone Ring Suppression and HUD Caller ID: Effectiveness in Reducing Momentary Driver Distraction Under Varying Workload Levels		5. Report Date October, 2001			
		6. Performing Organization Code account 378804			
7. Author(s) Christopher Nowakowski, Dana Friedman, and Paul Green		8. Performing Organization Report No. UMTRI-2001-29			
9. Performing Organization Name and Address The University of Michigan Transportation Research Institute (UMTRI) 2901 Baxter Rd, Ann Arbor, Michigan 48109-2150 USA		10. Work Unit no. (TRAIS)			
		11. Contract or Grant No.			
12. Sponsoring Agency Name and Address Nissan Research Center Nissan Motor Co., Ltd. 1 Natsushima-cho Yokosuka, 237-8523 Japan		13. Type of Report and Period Covered 1/2001 - 9/2001			
		14. Sponsoring Agency Code			
15. Supplementary Notes					
16. Abstract <p>Twenty-four drivers (12 ages 18-30, 12 ages 60-75) answered 4 implementations of hands-free cell phones while driving a simulator with 3 distinct caller ID locations: (1) a simulated cradle-mounted cell phone in the center console (a head-down implementation) with a typical auditory ring, (2) a central HUD location repeated both with and without a ring, and (3) an off-center (right) HUD location without a ring. For the center-console location, the buttons were located on the phone, but for the 2 HUD locations, the buttons were located on the steering wheel.</p> <p>Drivers answered the phone very quickly (mean 2.7 seconds), often on the first ring. In general, the phone was answered more quickly for HUD implementations (2.3 seconds) than for the head-down implementation (3.8 seconds). For just over 1/3 of the drivers, suppressing the ring actually decreased (sped up) their response times. Overall, the response time increased as the curvature of the road increased (2.3, 2.5 and 3.0 seconds for 0, 3, or 9 degrees of curvature), but the effects due to momentary workload (as measured by visual demand) were less consistent.</p> <p>There was little difference in driving performance between baseline driving (no incoming calls) and when the incoming calls used a HUD interface. However, for hands-free head-down interface, lane-keeping and speed-maintenance performance were degraded during incoming calls. While younger drivers showed little increase in line crossing rate (5.4 percent) using the head-down phone, the line crossing rate for older drivers was 25 percent, a value 2.5 times greater than during baseline driving. Thus, simply requiring the use of a hands-free phone (given the current implementations) will not eliminate the added crash risk while answering the phone.</p>					
17. Key Words ITS, human factors, ergonomics, driving, intelligent transportation systems, navigation, cell phones, usability, safety, telematics, HUD, head-up displays			18. Distribution Statement No restrictions. This document is available to the public through the National Technical Information Service, Springfield, Virginia 22161		
19. Security Classify. (of this report) (None)		20. Security Classify. (of this page) (None)		21. No. of pages 57	
				22. Price	



Cell Phone Ring Suppression and HUD Caller ID: Effectiveness in Reducing Momentary Driver Distraction Under Varying Workload Levels

UMTRI Technical Report 2000-29

Christopher Nowakowski, Dana Friedman & Paul Green

University of Michigan
Ann Arbor, Michigan, USA

1 Issues

1. Does the location of a caller ID display and phone buttons affect either the time to answer the phone or driving performance?
2. Does the presence or absence of an auditory ring (where the HUD caller ID indicated a call) affect either the time to answer the phone or driving performance?
3. Does increased driving workload affect either the time to answer the phone or driving performance?
4. What were the initial driver reactions to a HUD-based call timer?

2 Test Plan

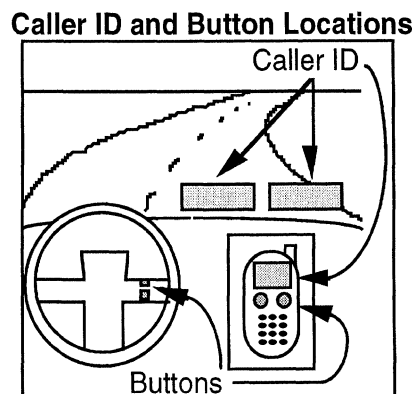
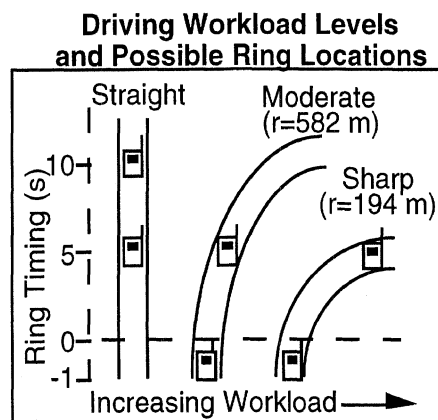

Test Participants

N=24	Female	Male
Older (60-75)	6	6
Younger (18-30)	6	6

3 Results and Conclusions

Issue 1: Effects of caller ID and button location

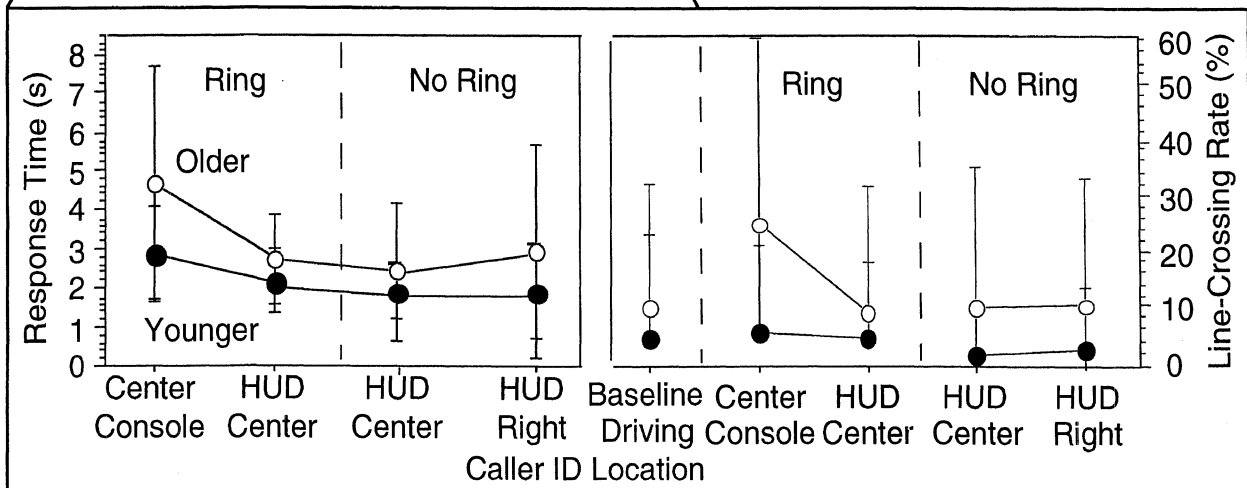

Issue 2: Effect of auditory ring

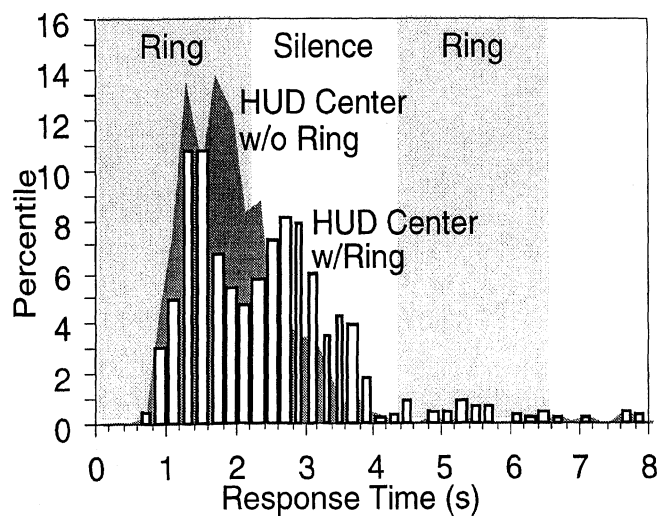

No. of Drivers	Ring/No Ring Difference
10/24	Response time unaffected
9/24	Response time slowed
5/24	No consistent RT trends

24/24	Driving performance unaffected by the ring
-------	--

Issue 3: Effect of driving workload

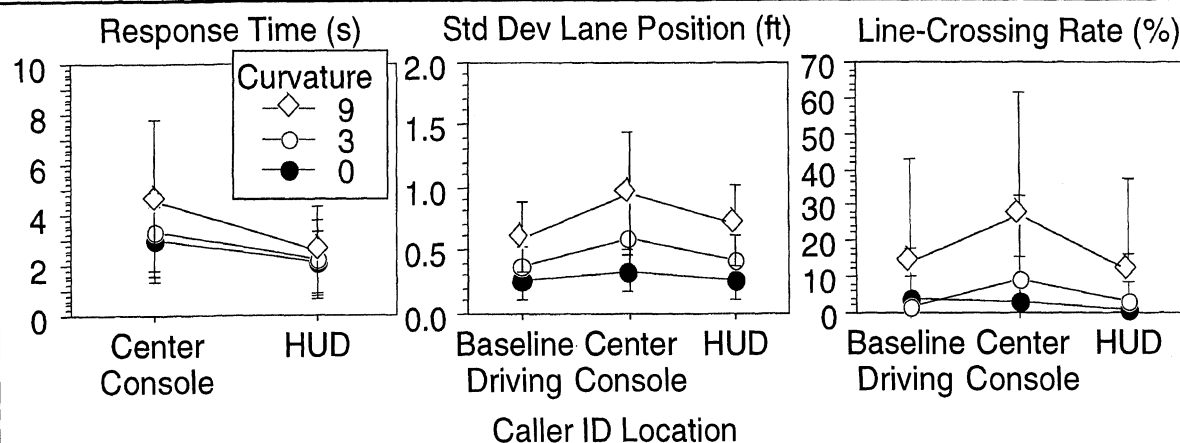

Issue 4: Driver reactions to call timer

- Seventy percent of drivers did not want to see the call timer.
- All drivers wanting the call timer also preferred the center HUD location.
- Many commented that they didn't notice the call timer in any of the locations.

4 Design Recommendations

Design Parameter	Recommendation
Caller ID Location	Use a central HUD location (e.g., within approximately 5 degrees down and 5 degrees right or left from center).
Button Locations	Use steering wheel buttons for "Talk" and "End."
Auditory Ring	Response time data suggests that the use of short auditory alerts (1 second or less) might be less distracting, but more research on other rings (including musical rings) is needed.
Call Timer	Preference data indicated that drivers did not want to see a call timer that was continuously updated on the HUD.

TABLE OF CONTENTS

INTRODUCTION	1
The Scope of Cell Phone Use While Driving.....	1
Public Concern Over Cell Phone Use While Driving.....	1
Prior Research on Cell Phone Use While Driving.....	2
Issues.....	2
TEST PLAN	5
Overview.....	5
Test Participants.....	5
Experimental Design.....	6
Test Materials and Equipment.....	6
Test Activities and Their Sequence.....	15
RESULTS	17
Overview.....	17
Caller ID and Button Location.....	17
Auditory Ring.....	20
Driving Workload.....	22
Hanging up the Phone.....	24
Subjective Evaluation.....	25
CONCLUSIONS	29
Discussion of the Issues.....	29
Design Recommendations.....	31
REFERENCES	33
Appendix A. Summary of the Relevant Cell Phone Literature.....	37
Appendix B. Participant Consent Form.....	41
Appendix C. Pretest Biographical Form.....	43
Appendix D. Posttest Survey Form.....	45
Appendix E. Payment Form.....	47
Appendix F. Analysis of Line-Crossing Incidents.....	49

INTRODUCTION

The Scope of Cell Phone Use While Driving

The use of cell phones or mobile phones has become increasingly common and some believe that wireless phones will eventually outnumber land-line phones. A recent study by the National Highway Traffic Safety Administration [NHTSA] (Utter, 2001) estimated that 54 percent of drivers usually have a wireless cell phone with them while driving. Of these drivers, 55 percent reported keeping their phone on for all or most of their trips, and 73 percent reported at least occasionally using their phone while driving. The study also went on to estimate that 3 percent of drivers or an average of one-half million passenger vehicles are actively engaged in a cell phone conversation at any given time during daylight hours.

Public Concern Over Cell Phone Use While Driving

Public concern over the safety implications of using a cell phone while driving has been widespread. A recent Insurance Research Council survey of U.S. households (2001) indicated that 91 percent of Americans believe that use of cellular phones while driving both distracts drivers and increases the likelihood of accidents. Similarly, a poll conducted as part of the NHTSA driver distraction internet forum (archived on the NHTSA research and development web site: <http://www-nrd.nhtsa.dot.gov/>) showed similarly strong public concerns about cell phone use while driving (Llaneras, 2000). For example, 75 percent of the 1,069 respondents said it was not safe to talk on a cell phone while driving. In terms of concerns, 28 percent said dialing was the biggest safety concern, 2 percent said answering, 36 percent said holding a conversation, and 34 percent said doing cell-phone related tasks such as writing down a phone number. When asked when they felt safe using a cell phone while driving, 7 percent said any time, 29 percent said when driving under light traffic conditions (on the open road), and 64 percent said never.

In other countries, public concern has lead to laws limiting the use of cell phones while driving. As an example, the use of cell phones while the vehicle is in motion is currently banned in Australia, Spain, Israel, Portugal, Italy, Brazil, Chile, Switzerland, Great Britain, Singapore, Taiwan, Sweden, Japan, and Austria. In the U.S., activists in favor of cell phone use regulation include Patti Pena who lost her daughter in a cell-phone related crash (<http://www.geocities.com/morganleepena/>), and Tom and Ray Magliozzi, the hosts of a popular radio program (Car Talk) on National Public Radio. These two prominent radio personalities have started a national campaign against cell phone use while driving called Drive Now Talk Later (<http://cartalk.cars.com/About/Drive-Now/>). Opposed to cell phone use regulation is the Cellular Telecommunications and Internet Association (<http://www.wow-com.com/>).

At this time, only one state in the U.S., New York, has passed any legislation to regulate or limit cell phone use while driving. The New York law goes into effect November 1, 2001, and bans the use of hand-held cell phones while driving (except during emergencies to call 911). The new law does not, however, include or limit the use of hands-free phones. In addition, several cities in the U.S. have restricted cell phone use while driving, and most state legislatures have considered or are currently

considering bills to limit cell phone use while driving. Current information on the status of legislation regarding telematics and mobile phone use while driving can be found in the transportation policy section on the National Conference of State Legislatures' web site (<http://www.ncsl.org/>).

Prior Research on Cell Phone Use While Driving

There have been a number of studies on cell phone use while driving, and the best summary to date is Goodman, Bents, Tijerina, Wierwille, Lerner, and Benel (1997). (See Appendix A for detailed summaries of the papers cited here.) Generally, the current research on cell phone use while driving can be categorized into 3 different research methods. First are the epidemiological and case studies such as Redelmeier and Tibshirani (1997) and Violanti and Marshall (1996). Both of these studies associate an increased crash risk for cell phone users, but Redelmeier and Tibshirani (1997) is most often cited for their finding that cellular phone use while driving increases the risk of a crash by a factor of 4.

A second common method asked drivers to carry on cell phone conversations or perform some other cognitive or memory tasks while driving (often with a handheld phone vs. a hands-free phone as a variable). Alm and Nilsson (1994, 1995) used this technique and measured both driving performance and braking reaction time to visual stimuli. They concluded that driving performance while using a cell phone only suffered under higher workloads. Parks and Hooijmeijer (1999) found similar results, but suggested that the reactions to unexpected events were only slowed near the beginning of the conversation and the performance decrement from using a cell phone was reduced with time.

The third method focused on dialing and other in-vehicle tasks (such as adjusting the radio) while driving. Among others, Stein, Parseghian, and Allen (1987), Brookhuis, de Vries, and de Waard (1991), and McKnight and McKnight (1993) have all shown detrimental effects such as increased lane variance and failure to respond to traffic events while drivers attempted to dial a phone. However, it is interesting to note that in the same studies, cell phone dialing tasks were reported to be no more distracting than some complex radio tasks.

Some (e.g., Hahn, Tetlock, and Burnett, 2000) have countered the increased risk of cell phone use while driving with the argument that the increased risk is acceptable because the economic benefits of calls made while driving outweigh the costs of injuries and deaths. Unfortunately, that analysis does not consider the distribution of benefits and losses. Additionally, none of these studies have examined more complex tasks such as instant text messaging/l-mode use, voice mail, or other tasks that potentially are visually, cognitively, or manually more demanding than current phones.

Issues

While much research has been devoted to dialing and talking on the phone, almost none has been devoted to the task of answering the phone. As reported earlier, only 2 percent of the respondents to the NHTSA driver distraction internet forum survey thought that answering the phone while driving was a safety concern. This becomes

even more unsettling given that prior to the restriction of cell phone use in Japan, crash data (January through November, 1999) showed that cell-phone induced crashes were most associated with receiving a call (1077), followed by dialing (504), followed by talking (350), followed by other tasks (487). (See Green, 2000 and 2001.)

The large number of crashes associated with receiving a call makes sense upon reflection. When a phone rings, many people are in the habit of answering it even if they are occupied with something else, such as an important face-to-face conversation. The immediacy of phone use can pose a significant risk to drivers since using a phone can add both visual and cognitive demands. The visual demand might entail finding the phone to pick it up, checking the caller ID of an incoming call, or confirming a number being dialed. Although the cognitive demands of conversations are more difficult to define, simply talking on the phone may distract drivers, reducing their situational awareness and causing them to miss life-threatening hazards.

Although there is evidence that cell phone use while driving increases risk, drivers bring cellular phones into their vehicles and use them because the phones provide an economic benefit. If drivers are going to continue to use phones while they drive, it may be in the vehicle manufacturer's interest to find ways to support phone use in a manner that minimizes distraction and crash risk. Table 1 suggests some possible design improvements to help minimize the risk associated with cell phone use while driving.

Table 1. Phone use problems and solutions.

Task	Problems	Solution
Receiving calls	Search for handset	Provide hands-free mounting
	Habit is to answer all calls	Provide caller ID to screen calls
	Strong association between a ringing phone and the urgency to answer it	Turn the ringer off
Dialing	Manual load of dialing call	Provide voice dialing
	Visual load to confirm number	Display dialed number on head-up display (HUD)
Talking	Calls are long and amount of distraction is proportional to call length	Reduce call length with timer display on HUD to remind the driver of the call length
	Driver is unaware of poor driving	Provide display of quality of driving, maybe warn drivers if driving is poor to discourage driving and talking

The purpose of the current experiment is to provide a preliminary driving simulator assessment of several hands-free design solutions with regard to the task of answering the phone while driving. Specifically, the following questions were examined:

1. Does the location of a caller ID display and the phone buttons (2 HUD locations vs. phone cradle) affect either the time to answer the phone or driving performance?
2. Does the presence or absence of a ring affect either the time to answer the phone or driving performance?
3. Does increased driving workload (visual demand) affect either the time to answer the phone or driving performance?
4. What were the initial driver reactions to a HUD-based call timer?

TEST PLAN

Overview

Participants drove a simulator on roads with straight sections and curves of 2 different radii while answering incoming cell phone calls. The calls were specifically timed to occur either during a curve or 1 second prior to entering a curve. Before answering the phone, the participants were asked to read the caller ID which was shown on either a head-up display or on a simulated cell phone located on the center console. Upon answering the phone, the participants greeted the caller by name and carried out a short (8-second) conversation. The response time to answer the phone, measures of driving performance, and subjective ratings were analyzed.

Test Participants

Twenty-four licensed drivers, who reported at least occasionally using a cell phone while driving, participated in this experiment, 12 younger (20 to 30 years old, mean of 23 years) and 12 older (60 to 75 years old, mean of 67 years). Within each age group there were 6 men and 6 women. Participants were recruited from the UMTRI participant database and through an advertisement placed in the local newspaper. All were paid \$40 for their participation.

Some of the characteristics reported by the participants are summarized in Table 2. The younger participants drove slightly less (10,000 annual miles) than the U.S. average for drivers aged 20-29 (15,000 annual miles). On the other hand, the older participants reported driving much more (17,000 annual miles) than the U.S. average for drivers age 60 plus (7,500 annual miles based on Hu and Young, 1999).

Eighteen (out of 24) of the test participants owned a cell phone. Fourteen of the participants who owned a phone reported using their phone while driving (6 older and 8 younger drivers). The remaining 4 participants with phones reported that they always stop the car to make a phone call and never answer a call while driving. In addition, two-thirds of the cell phone users reported using their phone on a daily or weekly basis and the rest use the phone for emergencies only.

Participants' vision was tested using a vision tester (Optec 2000, Stereo Optical Inc.) for far and near visual acuity. All but one had far visual acuity of 20/40 or better, as required by Michigan state law for driving (day and night). Six younger and 8 older participants had corrected vision (contacts or glasses).

Seven participants reported having experience driving the UMTRI simulator in previous studies and 2 had been exposed to a head-up display.

Table 2. Participant information summary.

	Younger			Older		
	Female	Male	Mean	Female	Male	Mean
Annual Mileage	6250	13,833	10,041	13,167	20,833	17,000
Previous Cell Phone Use (yrs)	2.3	1.9	2.1	6.3	4.8	5.55
Average Monthly Plan (min)	703	330	516	350	264	307
Average Calls per Day	2.8	2.5	2.7	0.8	0.5	0.7
Average Calls While Driving	1.9	0.7	1.3	0.3	0.3	0.3
Average Far Visual Acuity	19.3	18.5	18.9	25	32.2	28.6
Range of Far Visual Acuity	20/13- 20/35	20/13- 20/25	20/13- 20/35	20/18- 20/30	20/18- 20/50	20/18- 20/50
Average Near Visual Acuity	19.2	18.5	18.0	40.8	70	55.4
Range of Near Visual Acuity	20/13- 20/30	20/13- 20/22	20/13- 20/30	20/25- 20/70	20/40- 20/100	20/25- 20/100

Experimental Design

This study examined the effects of driving workload, caller ID location, and the presence or absence of an auditory ring on the response time to answering the phone. Driving workload was manipulated by both varying the radius of curvature and displaying the incoming call at various distances from the start of curve. Three locations for the caller ID were examined: (1) a conventional cell phone display on the right side of the center console (approximately 25 degrees down and 25 degrees right of center), (2) a head-up display (HUD) at 5.5 degrees down and 5 degrees right of center, and (3) a head-up display 5.5 degrees down and 15 degrees right of center. The more central HUD position was chosen for comparison with previous HUD studies, while the farther right position was chosen to more closely resemble several prototypes being developed by the sponsor.

The dependent variables in this study were the incoming call response time, the standard deviation lateral position, the line-crossing rate (for both edge and center lines), the standard deviation of speed, the amount of speed loss during a trial, and a subjective evaluation of the difficulty of each condition.

Test Materials and Equipment

Driving Simulator

This experiment was conducted using the UMTRI Driver Interface Research Simulator, a low-cost driving simulator based on a network of Macintosh computers (Olson and Green, 1997). The simulator (Figure 1) consists of an A-to-B pillar mockup of a car, a projection screen, a torque motor connected to the steering wheel, a sound system (to provide engine, drive train, tire, and wind noise), a sub-bass sound system (to provide vibration), a computer system to project images of an instrument panel, and other hardware. The projection screen, offering a horizontal field of view of 33 degrees and a vertical field of view of 23 degrees, was 6 m (20 ft) in front of the driver, effectively at optical infinity. The simulator collected driving data at 30 samples per second.

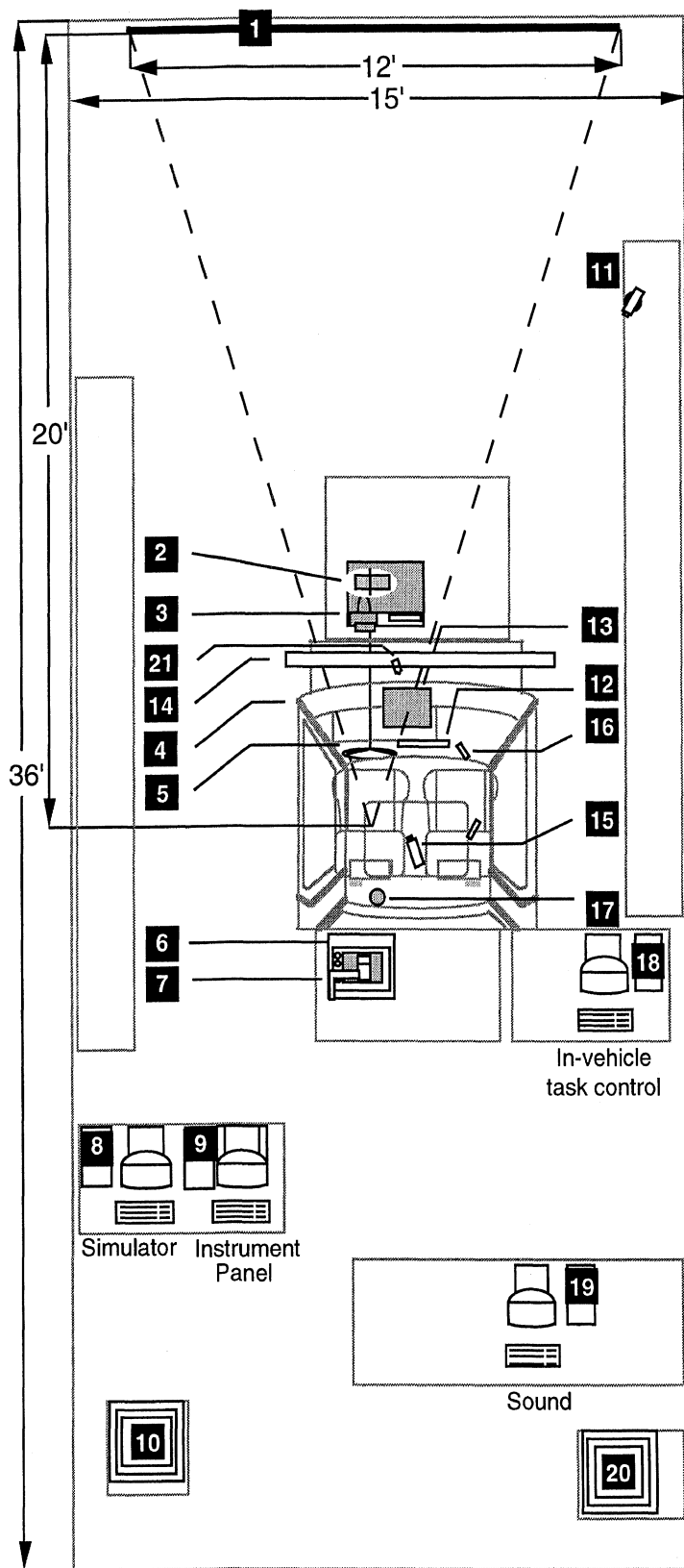

- 1** 8'X10' projection screen with 3M hi-white encapsulated reflective sheeting
- 2** PMI Motion Technologies ServoDisk DC motor (model 00-01602-002 type U16M4) with Copley Controls Corp. controller (model 413) and power supply (model 645)
- 3** Sharp color LCD projection system (model XG-E850U) for instrument panel
- 4** 1985 Chrysler Laser mockup with simulated hood
- 5** 3-spoke steering wheel with 2 push buttons center right
- 6** 3M overhead projector (model 9550)
- 7** Sharp computer projection panel (model QA-1650)
- 8** Power Macintosh 9500/200
- 9** Macintosh 7100/80AV
- 10** Video rack
- 11** Panasonic low level light camera (model WV-BP510) with TV zoom lens (WV LZ 81)
- 12** Touch-screen (Elotouch 1225L)
- 13** Mitsubishi 15" flat panel LCD monitors (model LXA520W)
- 14** 28.5" x 72" plexiglas screen
- 15** Panasonic low level light camera (model WV-BP550)
- 16** Sony speaker system (SR6-48)
- 17** Bass shaker
- 18** Power Macintosh 9500/120
- 19** Power Macintosh 9500/120
- 20** Audio rack
- 21** Panasonic Camera (model GP-k5152) suspended from the ceiling

Figure 1. Simulator layout.

Simulated Roads

The simulated roads combined with timing of the incoming calls were designed to impose multiple levels of momentary driving workload as the cell phone call arrived in the experiment. As shown in Figure 2 from Tsimhoni and Green (1999) (see also Wooldridge, Bauer, Green, and Fitzpatrick, 2000), the visual demand of driving varies both with the radius of curvature and the distance from the beginning of the curve. First, the visual demand increases linearly with the inverse of the curve radius (or as the curvature increases) for curves of 3, 6, 9, and 12 degrees of curvature. Second, the visual demand for each curve begins to rise starting at about 150 m from the start of the curve, peaks at the point of curvature, and levels off to a constant value 150 to 200 meters after the point of curvature.

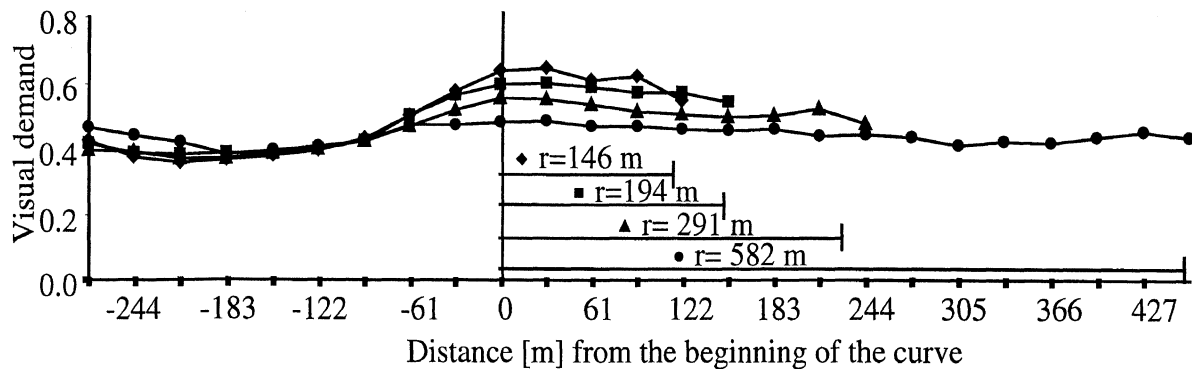

Figure 2. Visual demand as a function of curve radius and position.

In the current experiment, 3 types of road sections were driven: (1) straight sections, (2) moderate curves [3 degrees of curvature, 582 m radius], and (3) sharp curves [9 degrees of curvature, 194 m radius]. The curved sections were driven in both directions, right and left. Incoming calls occurred at 1 of 2 locations: (1) between 100 and 200 m or 5 to 10 seconds after the point of curvature (or point of tangent for straight sections) providing for a constant level of workload throughout the call or (2) 20 m or approximately 1 second before the point of curvature where the visual demand approaches its peak.

The simulated road was driven at a speed of 72.5 km/hr (45 mi/hr) without the aid of cruise control. At that speed, the driving simulator provided about 10 seconds of preview to the driver. Each curve used in the experiment measured at least 30 seconds in duration so that the driver would have at least 15 seconds to answer the phone and complete the conversation before the end of the curve was visible. The road also provided for at least 10 seconds of tangent (straight road) between curves. A road was approximately 16 minutes in length and consisted of 20 trials, as summarized by Table 3. To reduce expectation, the order of the conditions was randomized, and four additional curves without incoming calls were added to each road.

Table 3. Summary of the number of trials per road condition.

Incoming Call Timing (sec)	Road Section				Straight
	Moderate Curve		Sharp Curve		
	Left	Right	Left	Right	
-1	2	2	2	2	-
5	2	2	2	2	2
10	-	-	-	-	2

Both lanes of the two-lane road were 3.66 m (12 feet) wide. Traffic consisted of 4 vehicles: the participant's vehicle, a lead vehicle driving in the right lane, and 2 additional vehicles driving in the left lane (see Figure 3). The participant was instructed to drive in the right lane at a comfortable distance behind the lead vehicle, which maintained a constant speed of 72.5 km/hr (45 mi/hr). The left-lane lead vehicle drove next to the lead vehicle at a variable speed from 69 km/h to 75.5 km/h (43 mi/hr to 47 mi/hr). The trailing vehicle in the left lane was a police car 6 seconds behind the lead vehicle, and the drivers were instructed not to fall behind this vehicle. This particular traffic configuration was constructed to help keep the driver's priority focused on the driving task.

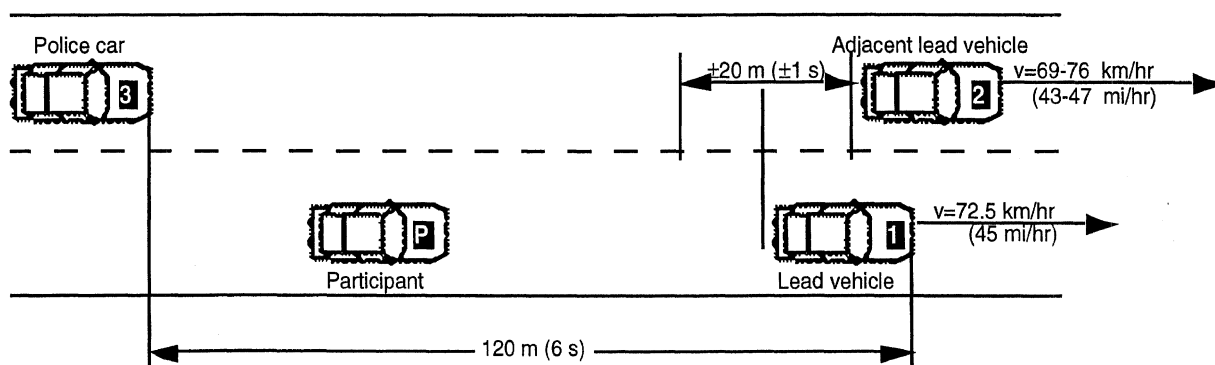

Figure 3. Typical traffic layout.

Four roads were required for the experiment (one for each of the 4 cell phone and caller ID locations). To ensure that each task was performed on a unique road of equal difficulty (preventing the drivers from memorizing the roads), the first road was used as a template and the remaining 3 roads were created by (1) inverting the degree of curvature and curve direction of each curve in the original road, (2) driving the original road backwards, and (3) driving the inversed road backwards. The road and caller ID location combination was then randomized across test participants.

Caller ID on the HUD

The simulated HUD consisted of an acrylic sheet (hung slightly in front of where the windshield would be) on which the images from a flat-panel LCD monitor were visible as reflections. As shown in Figure 4, the participants saw these reflections superimposed on the road scene. The images appeared at a focal distance of between 80 and 100 cm (31.5 and 38.4 inches) from the participant's eyes. The horizontal angle between the HUD locations was fixed for an average viewing distance of 90 cm (35.4 in). Thus, taller drivers saw the images between 0.5 and 1.5 degrees closer to center and shorter drivers saw the images between 0.5 and 1.5 degree farther from center. The vertical location of the HUD images were adjusted for seating height only enough to keep the image background on the road about 1 character height above the hood of the car.

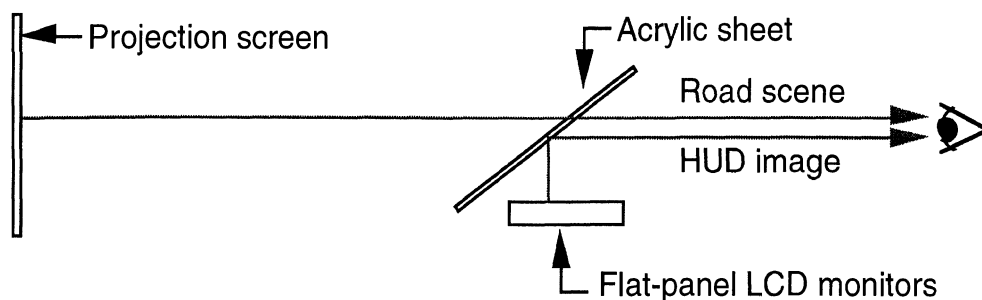

Figure 4. Diagram of the simulated HUD.

The HUD messages and graphics were displayed in monochrome green (RGB value of R=94, G=226, B=81). The caller ID for incoming calls typically displayed a cell phone icon, a first name, and a last initial as shown in Figure 5. After the call was answered, the caller ID disappeared and was replaced by the call timer which incremented every second. Calls were answered and ended using a pair of 1 cm x 1 cm pushbuttons mounted on the steering wheel that were labeled "Talk" and "End." Figure 6 shows the caller ID in both HUD locations, although only one location was used per test block.



Figure 5. Typical caller ID and call timer as displayed on the HUD.

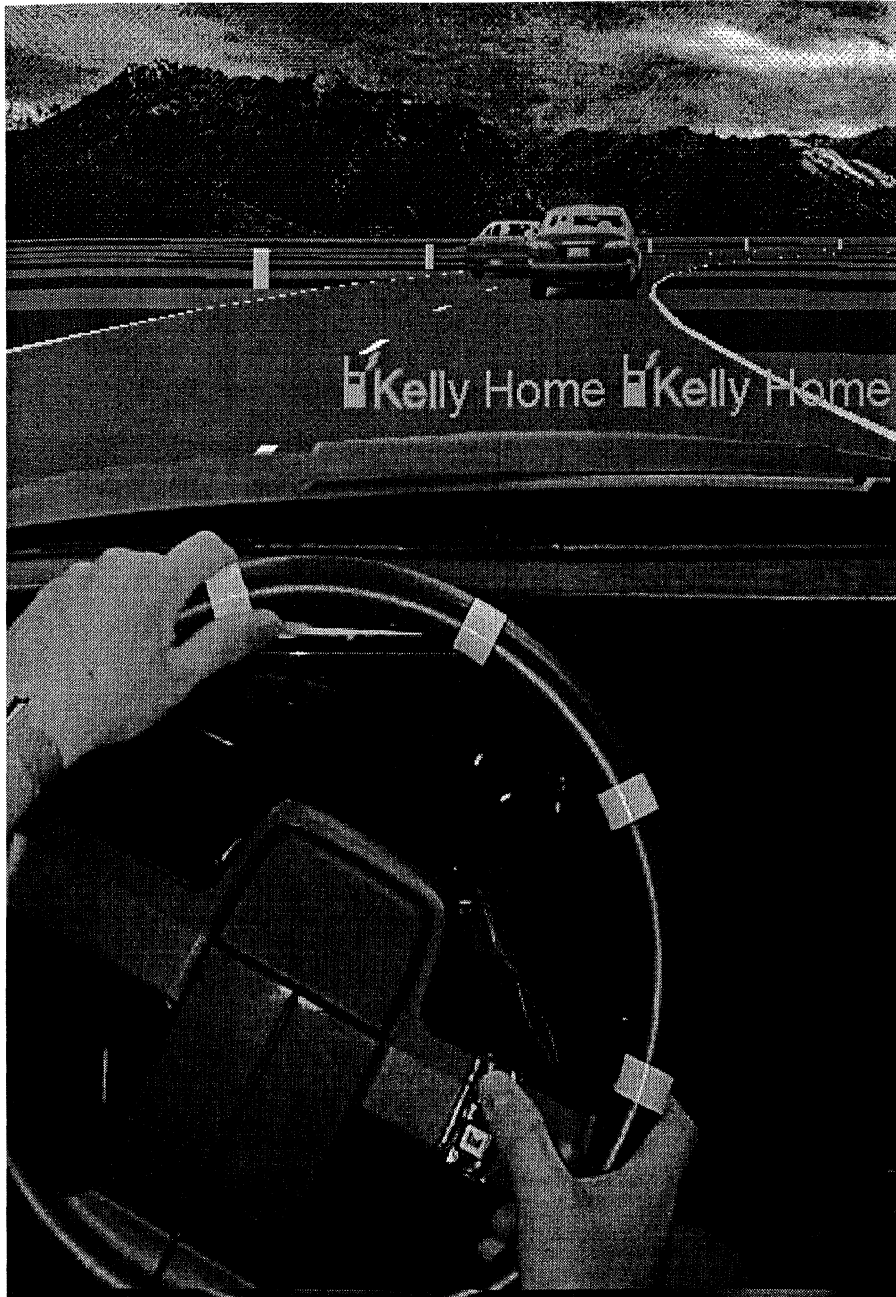

Figure 6. Cell phone buttons on the steering wheel (*HUD images enlarged by 50%*).

Caller ID on the Center Console Cell Phone

To obtain information on typical hands-free cell phone characteristics commonly sold in the U.S., Amazon.com's list of top 10 selling cell phone accessories was examined. Two types of phones were identified. First, some cell phones allow a microphone and ear piece to be connected so the driver does not need to hold the phone while talking and driving. Second, other phones, similar to the one shown in Figure 7, fit into a cradle which plugs into the vehicle's 12-volt outlet and utilize an additional speaker and microphone for hands-free use.

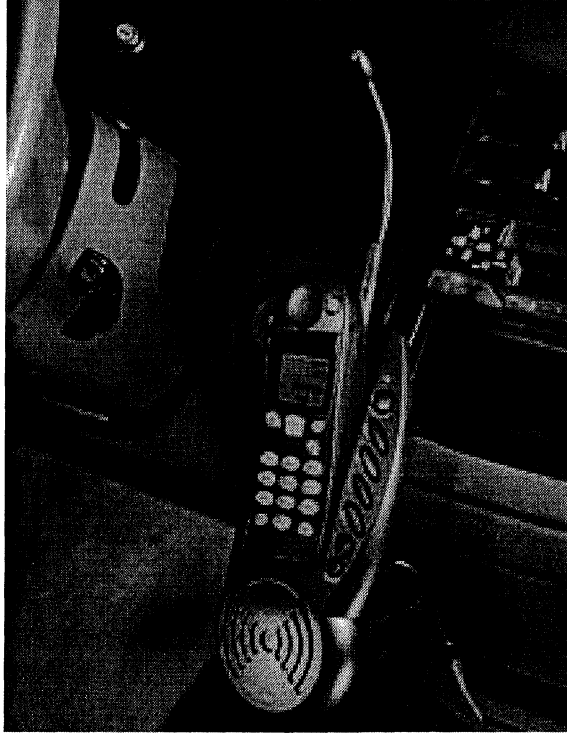

Figure 7. Typical cell phone cradle mounting.

Of these two cases, only the cradle mount was examined for a typical location. For the ear piece/microphone interface, no consistent location for the phone could be established though there are several options (e.g., on the seat, in a pocket) and most of them do not afford an immediate glance to the caller ID. Given the experiment's emphasis on caller ID use and the uncertain location of the phone, as well as uncertainties related to handling the phone, this configuration was not examined.

The simulated typical cell phone condition in this experiment used a touch screen (Elotouch 1225L) to display a life-sized cell phone image on the center console (as shown in Figure 8). The actual cell phone graphic as drawn on the touch screen measured 5 cm (2 inches) wide by 13.35 cm (5.25 inches) tall (not including the antenna), which was considered a reasonable size after surveying the dimensions of common cell phone models.

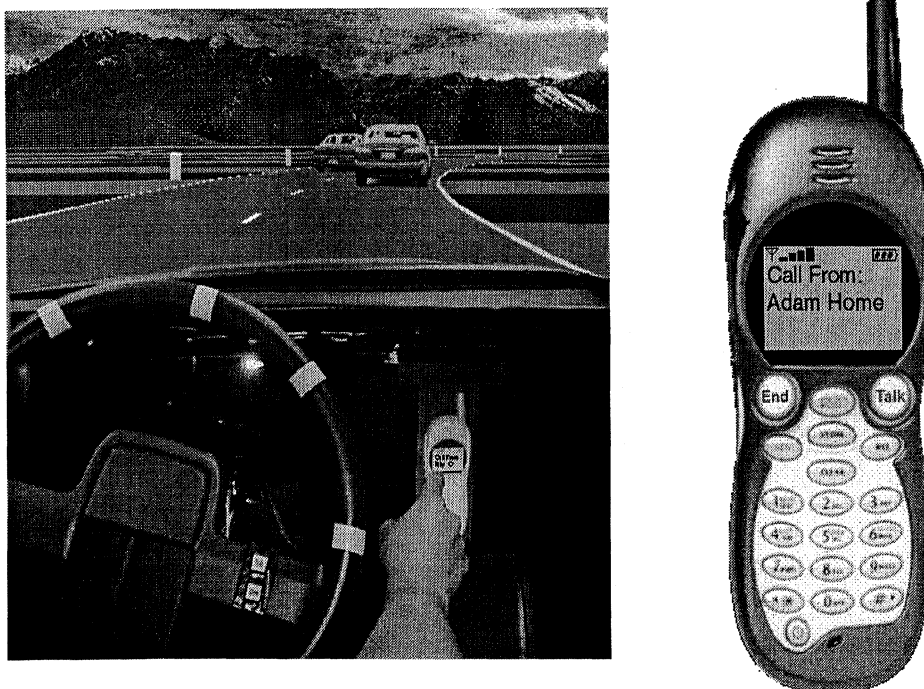

Figure 8. Center console cell phone image and location.

The cell phone image was displayed slightly higher in the driver's field of view than a typical cradle mount would allow for a mid-sized passenger car (based on the location of the 12-volt outlet). Although the reach to the touch screen may appear slightly farther given that a typical cradle would place a real cell phone 12.5 cm (5 inches) in front of the center console, the touch screen was still well within the comfortable reach of the drivers. Additionally, the phone image appeared at a focal distance of between 60 and 80 cm (24 and 32 inches) from the participant's eyes which compared reasonably well to the 76 cm (30 inches) average estimated viewing distance for a cradle mount used in a mid-sized passenger car.

Responses to incoming calls on the cell phone were made by pressing the buttons labeled "Talk" and "End" on the touch screen displaying the cell phone graphic. The target button graphics measured 1 cm in diameter (on screen), but to compensate for the inaccuracies and lack of tactile feedback inherent in using a touch screen, the actual target size was increased to 3 cm in diameter around each button.

Caller ID Text Size

Given the importance of being able to read the caller ID, care was taken to assure the text was legible. The legibility of text (both on a HUD and on an in-vehicle display) primarily depends upon 4 factors: (1) the character height, (2) the viewing distance (often combined with height as a visual angle specification), (3) the stroke width to stroke height ratio, and (4) the contrast between the character and the background.

For HUDs, Weintraub and Ensing (1992) and the military standards (MIL-D-81641 and MIL-M-18012B) recommend a minimum character height of 28 minutes of visual angle and a height ratio to stroke width ratio between 5:1 and 8:1. Nowakowski and Green

(1998) suggest a minimum visual angle of between 18 and 22 minutes for in-vehicle displays. The Helvetica font used for both the head-up display and the cell phone display had an average height to stroke width ratio of 6.75:1.

As shown in Table 4, the 38.5-minute text on the HUD far exceeded the recommended 28-minute minimum visual angle even at the maximum expected viewing distance. The simulated center console cell phone display was created to be equivalent in size to the largest cell phone displays currently on the market (3.4 cm wide by 2.4 cm high). For a typical 4-line display (with 12 characters per line), capital letters were 4 mm high. At the maximum expected viewing distance (seat adjusted all the way back and sitting up high), the 17.2-minute text was slightly smaller than the recommended 18-minute minimum visual angle. However, as the viewing range was expected to vary from a minimum of 60 cm to a maximum of 80 cm, the majority of drivers viewed the cell phone display at less than 75 cm where the display text size exceeded the 18-minute recommendation.

Table 4. Text size comparison between the HUD and the center-console cell phone.

Parameter	Center Console Cell Phone		Head-Up Display	
	Actual	Recommended	Actual	Recommended
Viewing distance (cm)	80.0	-	100.0	-
Character height (mm)	4.0	-	11.2	-
Visual angle (min)	17.2	18.0	38.5	28.0

Caller ID Name Selection

To assure that the gender of the names was readily understood, the names presented on the HUD and cell phone caller IDs were chosen from 300 popular names derived from <http://www.babynames.com>. The initial list was condensed using the criteria listed in Table 5, resulting in 128 remaining names.

Table 5. Criteria used to choose names for the caller ID.

Criteria	Examples	
	Accept	Reject
Length: Between 3 and 7 characters	Short: Rose, John Long: Eleanor, Vincent	Short: Ann, Lee Long: Elizabeth, Benjamin
Homophones: Similar pronunciations		Steven – Stephen
Ambiguous: Can be used for either sex		Pat, Chris, Robin
Popularity: Well known to young U.S. subjects	Carrie, Emily Mark, Jason	Gladys, Doris Eugene, Leroy
Repetitive start characters:		Aaron

To complete the caller ID, approximately 2/3 of names were followed by a random surname initial, and the remaining 1/3 of the names were followed by either "Home,"

“Cell,” or “Work” as distracter text. The distracters were added after an impromptu examination of several cell phone address books. This examination showed that often multiple entries for the same name were denoted by location (home, cell, or work), and given the limited number of characters available in the address book, multiple people with the same first name were distinguished by adding a single last initial.

Test Activities and Their Sequence

After a quick introduction to the study, the participants began by completing a consent form and a biographical form and then performed a vision test. (See Appendices B and C.) They were then seated in the driving simulator where they drove for about 9 minutes on a baseline road that consisted of straight sections, moderate curves, and sharp curves (0, 3, and 9 degrees of curvature, respectively). Baseline driving data was collected after 3 minutes of driving on this road. Next, 9 practice trials were given while the simulator was “parked” to teach the participants the scripted call dialogue and expose them to the various caller ID locations. Following this introduction, an 8-minute practice session was given which combined the driving and phone answering tasks.

Next, four test blocks were administered where each road was combined with a different caller ID location. The order in which the 4 blocks were run and the road used for each block was randomized over test participants. The phone answering task was performed in 4 blocks of 20 trials each (Table 6, activities 5 through 8). A sequence of events was duplicated for each trial. First, an incoming call was indicated by the presence of a caller ID (and an audible ring in blocks 4 and 5). The participant was asked to read the caller ID, press the talk button, and greet the caller with the scripted dialog (“Hello *<insert caller’s name>*. I can’t talk right now. Can I give you a call later?”) An automatic response (“OK, give me a call later then. Bye.”) prompted the participant to say goodbye and then press the end button, thus completing the trial. The location of the caller ID was fixed for the duration of each block. Additionally, the presence or absence of an audible phone ring was also constant for each block. A short break was given after the first test block or about half way through the experiment. After the driving portion of the experiment was completed, the participants were asked to complete a posttest survey and a payment form (see Appendices D and E).

Table 6. Experiment summary.

Activity Sequence	Caller ID Location	Ring	Duration (min)	Activity
1	-	-	10	Pretest forms
2	-	-	9	Baseline driving
3	All locations	on	8	Practice while parked
4	All locations	on	8	Practice while driving
5	Center console	on	18	Answer all calls
6	HUD 5.5 deg. right	on	18	Answer all calls
7	HUD 5.5 deg. right	off	18	Answer all calls
8	HUD 15.5 deg. right	off	18	Answer all calls
9	-	-	5	Posttest forms

RESULTS

Overview

The response time to an incoming call was measured from the moment the caller ID appeared until the moment the driver pressed the talk button on the cell phone to answer the call as shown in Figure 9. The overall mean incoming call response time was 2.68 seconds (standard deviation of 2.26 seconds), and the mean call duration (time spent talking on the phone) was 8.44 seconds (standard deviation of 1.96 seconds).

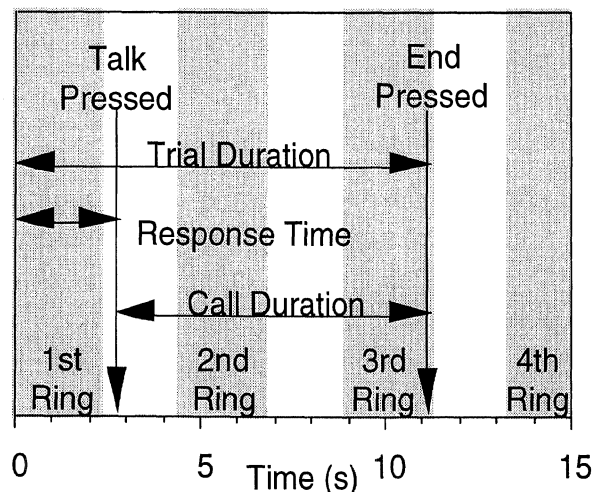

Figure 9. Response time definitions.

Driving performance data, lane position, speed, and headway were sampled at 30 Hz starting from the moment the phone rang until 2 seconds after the talk button was pressed (or for a minimum of 4 seconds to provide a stable estimate of the driving performance). The 2 seconds of sampling after the key press was added to capture any lane line crossings that may have occurred during or immediately after the key press. Although headway (the distance to lead vehicle) was recorded, the emphasis in the experiment was placed on maintaining 45 mi/hr and a comfortable following distance, not on maintaining a constant following distance.

Repeated measures ANOVAs with 2 between-subject factors (age and sex) and 4 within-subject factors (caller ID location, road curvature, curve direction, and call timing) were calculated for the incoming-call response time and for the various driving performance measures (such as the variability in lane position and speed during each trial). The ANOVAs were based on the mean of two repetitions of each condition, with missing and error trials omitted.

Caller ID and Button Location

Task Performance

The four combinations of caller ID display location (center console, HUD center, or HUD right), response button location (center console or steering wheel), and auditory

ring (present or absent) that were varied in the experiment were analyzed as a single factor with 4 levels in the repeated measures ANOVAs. For the incoming call response time, this factor was significant, $F(3,60) = 14.52, p < .001$. However, a post hoc Tukey-Kramer test revealed that only the response time for the center-console-mounted cell phone (mean 3.78 seconds, SD 2.44) was significantly different from the other conditions (see Figure 10). None of the 3 HUD-based cell phones had response times that were significantly different from each other (overall mean 2.32 seconds, SD 1.60).

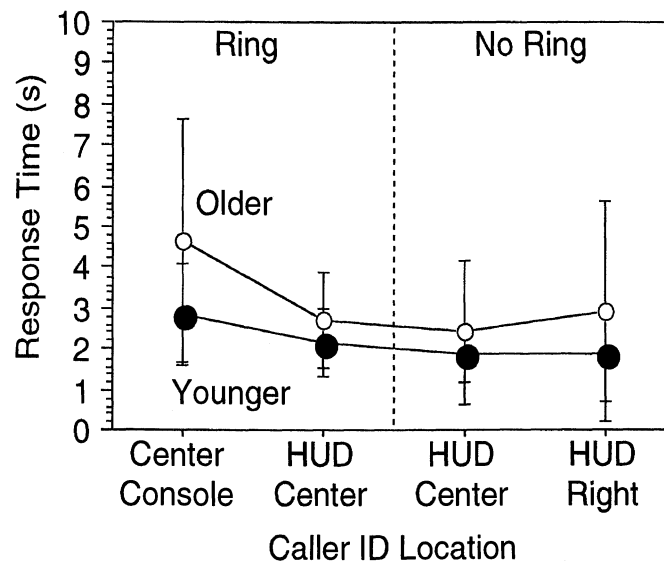

Figure 10. The effect of caller ID location and response button location.

Age was significant, $F(1,20) = 5.36, p = .03$, with the overall mean response time for older drivers being 0.94 seconds more than that of the younger drivers. Additionally, the age by caller ID location interaction was marginally significant, $F(3,60) = 2.41, p = 0.076$, with older drivers requiring 1.77 seconds more than younger drivers to answer the center-console-based cell phone. There was no effect on the response time based on the sex of the driver.

Driving Performance

The analysis of the response time indicated that the center console-mounted cell phone required more time to answer. However, longer response times do not necessarily indicate a decrease in driving safety as drivers can often trade off between task performance and driving performance (lane keeping and speed maintenance). Thus, 3 measures were used to assess driving performance: standard deviation of lane position, line-crossing incident rate, and speed loss during a trial. A line crossing was defined as the condition where the center of either the right or left tire touched the center of a lane marking at any point during a trial. (See Appendix F for more details on line crossings.) Speed loss was defined as the change in velocity between the start and end of a trial.

Significant main effects were found for both driver age and for the caller ID location for both lane keeping measures: (1) the standard deviation of lane position (age effect $F(1,20) = 16.37, p < .001$, and condition effect $F(4,80) = 30.14, p < .001$) and (2)

the line-crossing incident rate (age effect $F(1,20) = 7.23, p < .001$, and condition effect $F(4,80) = 11.12, p < .001$). However, as shown in Figure 11, the significant interaction between age and cell phone condition was more critical than the main effects in understanding the driving behavior (standard deviation of lane position $F(4,80) = 6.20, p < .001$, and line-crossing incident rate $F(4,80) = 6.52, p < .001$).

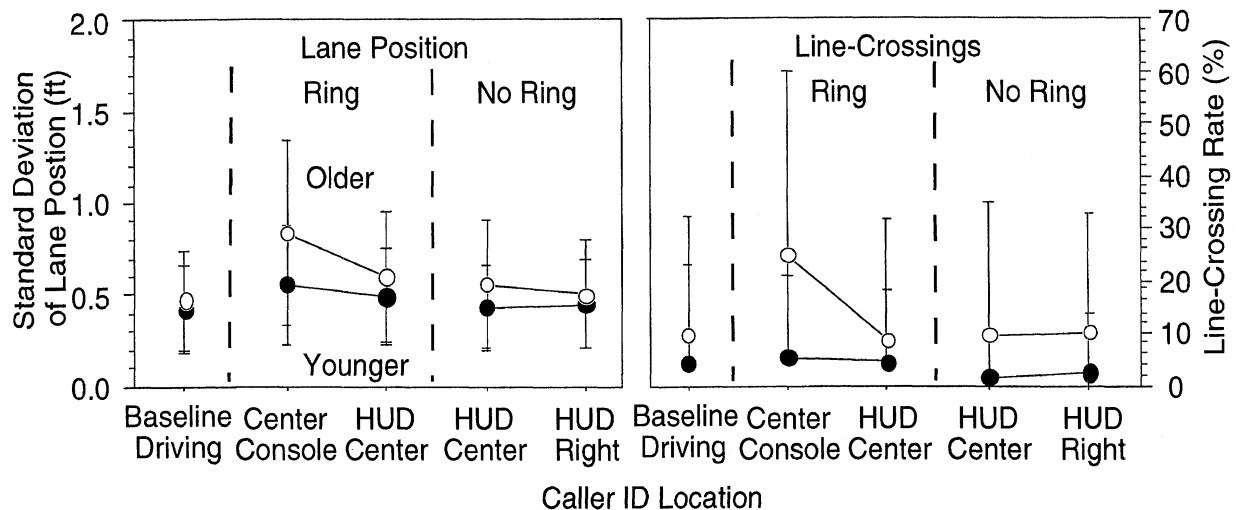

Figure 11. Lane keeping while answering the phone.

Overall, older drivers (mean standard deviation of lane position of 0.59 feet) were slightly more variable in keeping lane position than younger drivers (0.47 feet), and their driving resulted in a higher overall line-crossing rate (12.6 percent) than younger drivers (3.7 percent). Combined with the caller ID location, older drivers had significantly more difficulty keeping their lane position while answering the center-console-based cell phone. The mean standard deviation of lane position for older drivers increased from 0.47 feet during baseline driving to 0.83 feet while attempting to answer the center-console-based cell phone. Similarly, the line-crossing rate increased from 9.6 percent during baseline driving to 25 percent while answering the center-console-based cell phone. Remarkably, there was almost no difference among the 3 HUD-based cell phones and baseline driving condition for either the standard deviation of lane position (an increase from 0.47 to 0.55 feet) or the line-crossing rate (a decrease from 9.6 percent to 9.4 percent).

Younger drivers, on the other hand, showed little difference between the baseline driving and the cell phone conditions for either lane keeping measure. The standard deviation of lane position for younger drivers increased from 0.41 to 0.55 feet between the baseline driving and the center-console-based cell phone and averaged .46 feet for the HUD-based cell phones. Similarly, the line-crossing rate increased from 4.6 percent during the baseline driving to 5.4 percent while answering the center-console cell phone. However, the line-crossing rate actually decreased to a mean of 2.8 percent while answering the HUD-based cell phones.

Overall, speed loss occurred during 42.9 percent of the trials. Baseline driving alone yielded fewer trials with speed loss (mean of 37.1 percent), and the center-console-based cell phone yielded the most trials with speed loss (mean of 48.3 percent). An

analysis of the speed loss during trials also showed that the caller ID location was significant, $F(4,80) = 4.22, p = .003$. (See Figure 12.) Age was also significant, $F(1,20) = 4.16, p = .05$, with younger drivers showing no difference in speed loss between the baseline driving condition and the various cell phone conditions. Older drivers, on the other hand, showed an increase in mean speed loss from 3.6 ft/s (2.45 mi/hr) during baseline driving to 5.4 ft/s (3.68 mi/hr) while answering the center-console-based cell phone. The speed loss strategy also appeared to be more common for older women as evident by the significant age by sex interaction, $F(1,20) = 9.28, p = .006$, indicating that the mean speed loss for older women was 1.9 ft/s greater than that of older men.

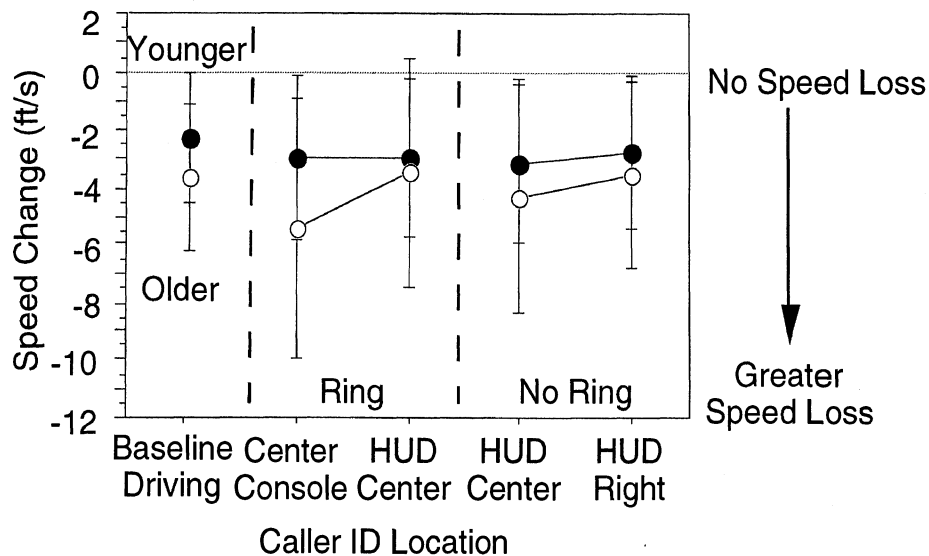

Figure 12. Speed loss while answering the phone.

Auditory Ring

Response Time Delay Caused by the Presence of the Ring

Although the post hoc Tukey-Kramer test failed to show a significant difference for the effect of an auditory ring on response time, the mean response time for the HUD-based cell phone with a ring (2.43 seconds) was 0.3 seconds slower than the time to answer the same HUD-based cell phone without the ring (2.13 seconds). Additionally, as shown in Figure 13, there was a disparity between the response time distributions for the comparable ring and no ring experimental conditions. The shape of the response time distribution for the ring condition and observations during the experiment suggested that the presence of an auditory ring influenced some subjects into postponing their response (pressing the "talk" button) until after the audible portion of the ring.

Figure 14 shows the effect of the ring on each subject. The first 10 test participants in this graph showed little to no influence due to the presence of the ring. These test participants responded to the calls as soon as possible, showing no difference in mean response time between the ring and no ring conditions. The next 9 test participants (11 through 19 in Figure 14) showed a very large ring effect. For these

drivers, when there was no ring, their mean response time was less than 2.3 seconds and a very low percentage of calls were answered after 2.3 seconds. However, when the ring was present, their mean response time increased to just greater than 2.3 seconds, and the percent of calls answered after the ring went silent (after 2.3 seconds) increased dramatically, suggesting that their responses were delayed until the ring had silenced.

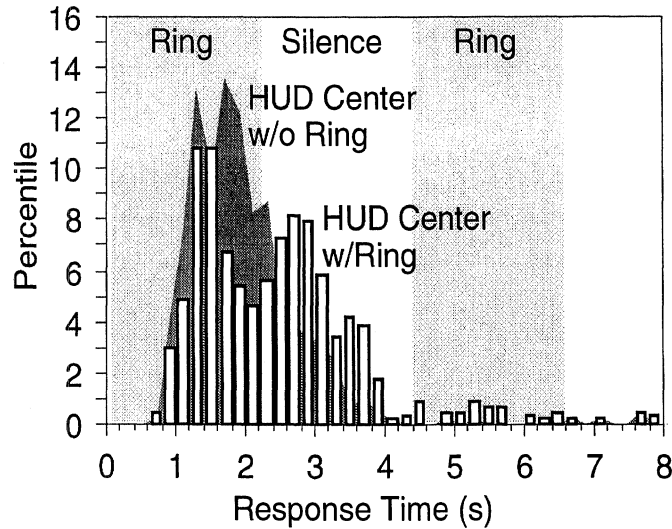

Figure 13. The effect of auditory ring on the distribution of response times.

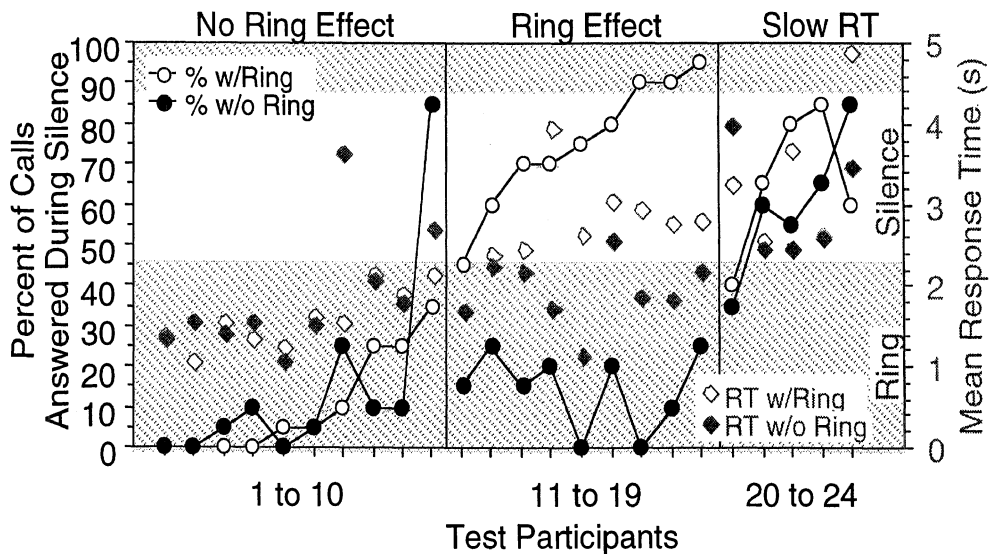

Figure 14. The effect of auditory ring by test participant.

The final group of 4 test participants (20 through 24 in Figure 14) could not be categorized. The mean response times for this group were greater than 2.3 seconds for both the ring and no ring conditions. Since the auditory portion of the ring was only 2.3 seconds in duration, it is unknown whether these drivers were influenced by the ring.

Response Time Delay Caused by the Absence of the Ring

While the presence of an auditory ring had a slight effect on some of the test participants' response times (though it was not found significant when looking at the mean response times), the absence of the auditory ring also produced a subtle effect on the distribution of response times. For the cell phone condition where the caller ID was in the center location on the HUD and a ring was provided, there were no response times recorded longer than 8 seconds. When the ring was not present (but the caller ID was still shown in the center HUD location), 8 trials (out of 480) were recorded with very long response times (between 8 and 21.1 seconds). When the ring was not present and the caller ID was shown on the farther right HUD location, the number of long trials increased to 13, and during 5 trials, the driver never saw the incoming call before it would have been routed to voicemail (23.84 seconds). All 5 of these trials occurred during left curves (where the driver was looking to the left while the caller ID appeared on the right HUD location). Thus, unsurprisingly, without an auditory alert, there exists a small probability that drivers will not see the incoming call on the HUD (likely increasing with the eccentricity of the HUD message location from the driver's point of attention).

Driving Workload

Road Curvature

Two factors, road curvature and the timing of the incoming call, were manipulated to provide different levels of driving workload during the experiment. Three different levels of curvature were explored: straight roads (0 degrees of curvature), moderate curves (3 degrees of curvature), and sharp curves (9 degrees of curvature). The main effect of road curvature was significant for the response time, $F(1,20) = 7.60$, $p = .01$, the standard deviation of lane position, $F(1,20) = 140.75$, $p < .001$, and the line-crossing rate, $F(1,20) = 43.52$, $p < .001$.

As the road curvature increased from 0 to 3 degrees of curvature, the mean response time increased from 2.31 to 2.53 seconds. Both the standard deviation of lane position and the line-crossing rate increased from 0.28 to 0.45 feet and from 2.1 to 4 percent, respectively. As the road curvature increased from 3 to 9 degrees of curvature, the mean response time increased from 2.53 to 3.02 seconds. Although the standard deviation of lane position only increased from 0.45 to 0.74 feet, the lane crossing rate nearly quadrupled from 4 to 15.3 percent, indicating that both task and driving performance suffered as the driving workload increased.

More interesting than the main effect for road curvature was the significant interaction between road curvature and caller ID location for the response time, $F(3,60) = 6.32$, $p < .001$, and the line-crossing rate, $F(4,80) = 2.99$, $p = .02$. As shown in Figure 15, the center-console cell phone resulted in disproportionately longer response times at higher driving workloads than the HUD-based cell phones. When using the HUD-based cell phones, the mean response time only increased by 11 percent from 2.26 to 2.50 seconds between 3 and 9 degree curves. However, when using the center-console-based cell phone, the mean response time increased by 37 percent from 3.35 to 4.59 seconds between 3 and 9 degree curves.

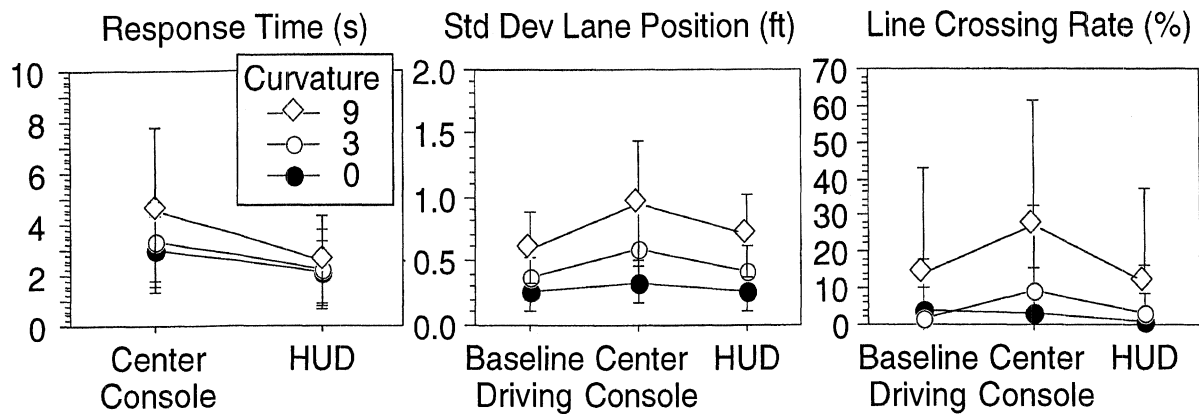

Figure 15. The effects of road curvature on task and driving performance.

Also shown in Figure 15, the line-crossing rate while using the HUD-based cell phone was nearly equivalent to the line-crossing rate for baseline driving for all degrees of curvature, averaging under 4 percent for 0 and 3 degree curves and between 12 and 14 percent for 9 degree curves. For the center-console-based cell phone, the line-crossing rate for 0 degree curves was 3.1 percent, which was equivalent to the baseline driving condition. However for 3 degree curves, the line-crossing rate increased to 9.1 percent, and for 9 degree curves, the line-crossing rate increased to 34.7 percent, both significantly higher than either the HUD-based cell phones or the baseline driving conditions.

The Timing of the Incoming Call

The incoming calls were timed to occur either 1 second before the start of a curve or 5 seconds after the start of a curve. For calls taken on straight sections of road, the incoming calls occurred either 5 or 10 seconds after the start of the straight section, but there was effectively no difference in task or driving performance for the call location on straight sections of road. Based on previous work, the peak visual demand while driving occurs just prior to entering a curve, and thus, the instantaneous driving workload should have been higher when the call occurred 1 second before the start of the curve. This suggests that a decrease in task or driving performance would be expected when the incoming call came 1 second before the curve; however, the results failed to show a clear trend of this nature.

The main effect of call timing was significant for the call response time, $F(1,20) = 6.20, p = .02$. The mean response time for calls taken during a curve was 0.17 seconds longer than the mean response time for calls taken just before the curve. Although this might seem contrary to what would be expected, there was also a significant interaction between the cell phone condition and the incoming call timing, $F(3,60) = 5.51, p = .002$. As shown in Figure 16, when there was no auditory ring, the response time to calls that came during the curve was greater than the response time to calls that came just before the curve. For the center HUD position, the response time increased from 2.02 seconds when the call came before the curve to 2.33 seconds when the call came during the curve. For the right HUD position, the response time increased from 2.21 seconds when the call came before the curve to 2.79 seconds when the call came during the curve. The increased response time

when the call came during a curve was likely due to an increase in HUD detection time, especially during left curves.

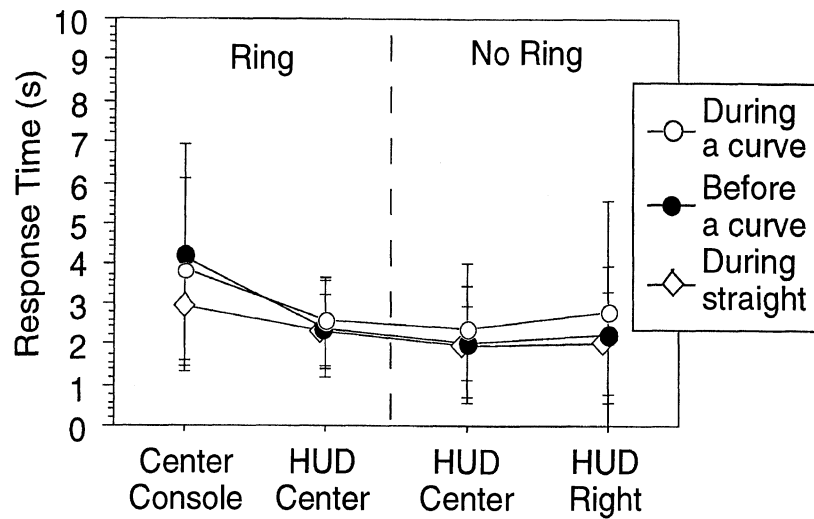

Figure 16. The effect of call timing on response time.

Interestingly, there was a slight reversal of the response time trend for the call timing when using the center-console-based cell phone. For this condition, the mean response time for calls taken just before the curve averaged 4.15 seconds, which was slightly higher than the 3.80 seconds for calls taken during a curve. However, there was little evidence from the driving data to indicate a decrease in driving performance due to the timing of the phone call. For the standard deviation of lane position, the main effect of call timing was significant, $F(1,20) = 18.39, p < .001$, indicating that the standard deviation of the lane position going into the curve (0.65 feet) was greater than the standard deviation of lane position while driving in a constant curve (0.53 feet). However, no significant effects were found for the line-crossing rate or in the interaction between lane keeping and cell phone condition.

Looking at speed loss as a driving performance measure, the main effect for call timing was significant, $F(1,20) = 4.33, p = .05$, and the interaction between call timing and cell phone condition was significant, $F(4,80) = 4.51, p = .002$. Both of these effects mimicked the response time results, indicating that speed loss occurred during more trials and in greater quantity during each trial when the call came while the driver was already in a curve. Overall, speed loss occurred on 36.5 percent of the trials when the calls came before a curve and 45.8 percent of the trials when the calls came during the curve. Additionally, the mean speed loss when the call came before the curve was only 2.7 ft/s while the mean speed loss when the call came during a curve was 4.4 ft/s. The interaction between call timing and cell phone condition simply indicated that during baseline driving, there was little difference between entering a curve (mean speed loss of 3.4 ft/s) and driving in a constant curve (mean speed loss of 3.1 ft/s).

Hanging up the Phone

Drivers were required to press a single button to end each call, located on a touch screen for the center console condition or on the steering wheel for the HUD conditions. While the overall line-crossing rate for baseline driving (near the

beginning of the curve) averaged 7.1 percent, the overall line-crossing rate while pressing the end button after the call averaged only 5.6 percent. The mean line-crossing rate for the center console condition was 5.8 percent, and the mean line-crossing rate for the HUD conditions was 5.5 percent, suggesting no difference due to the location of the buttons. There were slight effects on the line-crossing rate for age and road curvature. Younger drivers averaged 2.9 percent and older drivers averaged 8.4 percent. The line-crossing rate for straight roads was less than 1 percent and increased to 3.3 and 10.4 percent for 3 and 9 degree curves, respectively. No trends were evident in any of the other driving performance measures during the final button press.

Subjective Evaluation

Preferred Location of Caller ID

The participants were asked to rank, from best (1) to worst (3), their preference for location of the caller ID. All but two agreed that the caller ID should appear in the center HUD location. The next best location was the right HUD location, and finally the center console cell phone. Many participants commented that the caller ID on the center console was difficult to read, especially when compared to the closer proximity and larger font of the HUD-based caller ID.

Subjective Evaluation of Task Difficulty

Task difficulty, as measured by stressfulness, was ranked on an eight point scale (a 3-inch line graph that was divided into 8 equal segments) and then normalized for each participant. (Each test participant's responses were scaled such that the mean response for each participant was 0.) Figure 17 shows normalized stress comparisons for 5 different conditions: (1) baseline driving, (2) location of the caller ID, (3) answering a call with and without a ring, (4) workload increase marked by an increase in degree of curvature, and (5) timing of an incoming call on a curve. On average, participants felt that it was more stressful to answer a call when the caller ID was displayed on the center console. Many older drivers also commented that it was harder to read the caller ID in this location. The conditions without an audible ring were rated as more stressful than those with an audible ring. Most test participants commented that without the audible ring, they had no way of knowing how long the phone icon had been displayed before they saw it, and thus, they felt more stress when answering the call. Stress increased as the degree of curvature increased; straight sections were the least stressful, moderate curves were average, and sharp curves were the most stressful. In addition, there was a small effect produced by the variation in call timing, where participants felt that it was slightly more stressful to answer a call one second before the beginning of a curve. Age and gender effects were negligible.

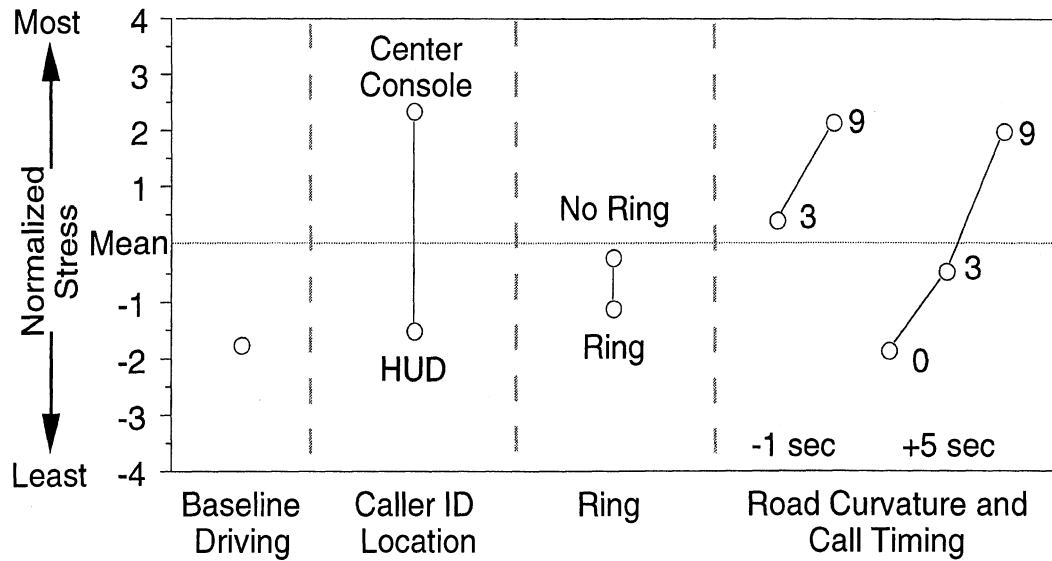

Figure 17. Normalized stress ratings.

Subjective Evaluation of Response Time

Response time and sense of urgency were also ranked on an eight-point scale and then normalized to reduce bias. Figure 18 (a and b) shows perceived response time and sense of urgency, respectively, for 2 conditions: (1) answering a call with and without a ring, and (2) location of the caller ID. Younger participants felt that their response times were faster when a ring accompanied the incoming call, while older participants felt there was no difference. When the caller ID was located on the HUD, both older and younger participants felt that their response times were faster. The sense of urgency to answer a call increased when a ring was present for older participants, but the presence or absence of a ring had no effect on the younger participants' sense of call urgency. Finally, the sense of urgency increased for both age groups when the caller ID was on the center console.

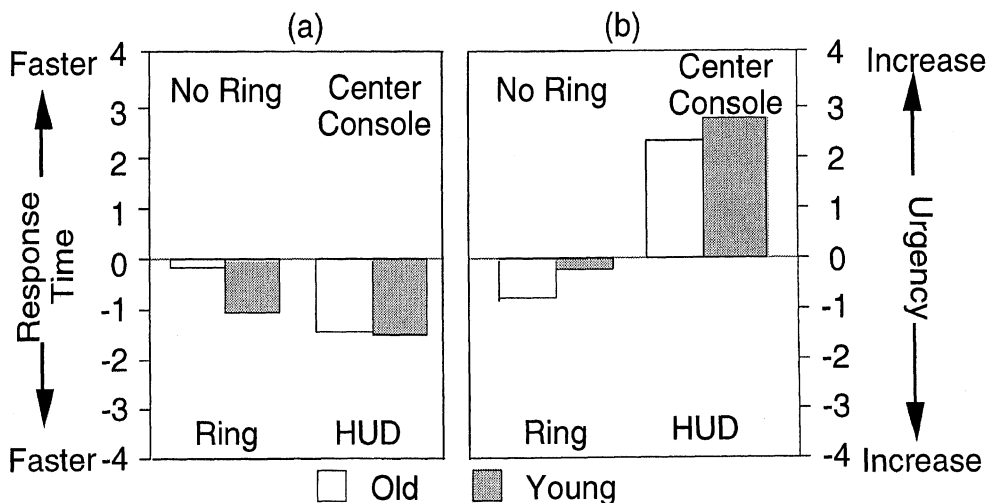

Figure 18. Perceived response time and urgency ratings.

Preferred Location of Call Timer

The participants were asked to rank, from most preferred (1) to least preferred (4), the location of the caller ID. Nearly 70 percent of the participants did not want to see the call timer at all. Of those who wanted to have a call timer, 100 percent preferred to see it in the center HUD location. Many participants commented that they didn't notice the call timer in either location until the end of the experiment. If the call timer was provided, 50 percent of the drivers would prefer it to increment at 1 second, 13 percent would prefer 1-minute updates, and 13 percent would prefer 5-minute updates.

CONCLUSIONS

Discussion of the Issues

1. *Does the location of a caller ID display and the phone buttons (2 HUD locations vs. phone cradle) affect either the time to answer the phone or driving performance?*

The current experiment examined 3 caller ID locations: (1) a head-down location (approximately 25 degrees down and 25 degrees right of center) simulating a hands-free phone on the center console, (2) a central HUD location approximately 5.5 degrees down and 5 degrees right of center, and (3) a HUD location approximately 5.5 degrees down and 15 degrees right of center. The location of the "talk" and "end" buttons was confounded with caller ID location. For the head-down, center-console cell phone, the buttons were located on the phone, and for the HUD locations, the buttons were located on the steering wheel.

This experiment builds upon prior UMTRI research on HUD use in motor vehicles. In a previous experiment (Tsimhoni, Watanabe, Green, and Friedman, 2000), the detection and reading time for various HUD locations was examined (including the central HUD location used in this experiment, 5.5 degrees down and 5 degrees right). The detection task in this previous experiment involved pressing a finger switch when a scrambled name appeared on the HUD. The mean detection time in this previous experiment for the 5-degrees-right location was approximately 0.7 seconds. During the reading task, a name appeared on the HUD and the participant had to press the appropriate finger switch after deciding whether it was male or female. The mean reading time for the 5-degrees-right location was approximately 1.3 seconds. In contrast, the mean time to read the caller ID and answer the phone in the current experiment when it appeared on the 5-degrees-right HUD location (without an auditory ring) was 2.1 seconds. However, it should be noted that the hand movements required to answer the phone were more complex than those required in the previous experiment.

Tsimhoni, Watanabe, Green, and Friedman (2000) also predicted an eccentricity effect for the reading task time. Using linear extrapolation, their results would predict a 16 percent increase in the reading time from 1.3 seconds for the central HUD location (5 degrees right of center) to 1.5 seconds for the far right HUD location (15 degrees right of center). The predicted eccentricity effect held true in the current experiment, with the mean response time increasing by 14 percent from 2.1 seconds for the central HUD location to 2.4 seconds for the right HUD location. Although it should be noted that the eccentricity effect was much greater for older drivers, but nearly non-existent for younger drivers.

This experiment compared answering a typical hands-free, head-down cell phone to a hands-free, HUD-based cell phone. The mean response time for the head-down, center-console location was 3.78 seconds, which was significantly greater than the response times for the 3 HUD-based locations (overall mean of 2.32 seconds). Additionally, the driving performance measures indicated that there was significantly more variability in lane keeping and significantly more line crossings while answering the head-down, center-console cell phone as compared to the HUD-based phones.

For older drivers, the line-crossing rate increased by a factor of almost 2.5 from 9.6 percent during driving alone to over 25 percent while answering the head-down cell phone. This suggests that the simple act of answering the phone added significantly to the risk of driving. Given that the head-down cell phone was modeled after a typical hands-free phone mounted in an optimal location for visibility and ease of use, this casts serious doubt on the notion that simply requiring drivers to use a hands-free kit will eliminate the risk of answering phone calls while driving.

Additionally, the head-down, hands-free phone that was tested was only one variant of the types of products available. Depending on the vehicle's size and the hands-free kit used, the mounting location of the phone may cause even more difficulty for drivers (requiring longer or more awkward reaches). Some hands-free kits may also require no mounting, in which case drivers may be required to search for the ringing phone and then place a small ear piece in their ear before answering the phone, which seems significantly more complex than the tested design. However, vehicle-integrated cell phone designs may hold some promise in helping to reduce the risk of cell-phone use while driving. In this study, the line-crossing rate was unaffected by the use of the HUD-based cell phone (with buttons on the steering wheel), suggesting that with proper human factors design and testing, safer alternative designs may be developed.

2. Does the presence or absence of a ring affect either the time to answer the phone or driving performance?

Although the auditory ring effect was not significant, the mean response time when the ring was present (2.43 seconds) was 14 percent slower than the mean response time when the ring was absent (2.13 seconds) for the center HUD location. Further analysis suggested that for at least 10 of the 24 drivers, the auditory ring had no effect on their individual mean response times. However, for at least 9 drivers, the presence of the auditory ring noticeably influenced their response times. For these drivers, their individual mean response times generally increased from less than 2.3 seconds without a ring to greater than 2.3 seconds with a ring. The presence of the auditory ring apparently delayed their responses until after the first ring pulse had silenced.

While the presence of an auditory ring may have delayed some drivers' responses, the absence of the ring also had subtle effects on the response times. It was thought that by removing the auditory ring, the drivers would feel less anxiety over answering the phone. However, without the ring, many drivers commented that they often felt increased stress because they did not know if they had detected the incoming call right away, and thus they felt the need to answer the phone more rapidly when the call was detected. This notion was supported in the increased number of long response times (over 8 seconds) and the increased number of missed calls, especially when using the farther right HUD location while driving in left curves. Interestingly, there was no effect on driving performance simply due to the presence or absence of an auditory ring.

3. Does increased driving workload (visual demand) affect either the time to answer the phone or driving performance?

Two factors, road curvature and the timing of the incoming call, were manipulated to provide different levels of driving workload during the experiment. The main effect of

road curvature was significant for the response time which increased from 2.31 to 2.53 to 3.02 seconds for 0, 3, and 9 degrees of curvature, respectively. Additionally, there was a significant interaction between the road curvature and the cell phone caller ID location, suggesting that answering the head-down, center-console cell phone while driving in the sharpest 9 degree curves produced extraordinarily long response times (mean of 4.59 seconds).

Road curvature and its interaction with the caller ID location were also found significant for several driving performance measures including the standard deviation of lane position and the line-crossing rate. While baseline driving on straight and moderate curves resulted in line-crossing rates of 4 percent or less, driving in sharp curves while answering the head-down, center-console cell phone resulted in line-crossing rates near 34.7 percent. However, driving while answering the HUD-based cell phones produced no decrease in driving performance.

Although it was expected that calls coming 1 second before the curve would cause higher momentary workload and thus take longer to respond to than calls coming 5 seconds after the start of a curve, the results indicated otherwise. In fact, responses to calls that came 5 seconds after the start of a curve averaged slightly longer when they appeared without an auditory ring since the driver's attention was already focused away from the HUD. No significant effects were found due to the call timing for the standard deviation of lane position or the line-crossing rate. However, speed loss while answering the phone was noted to be more prevalent during calls that came while the vehicle was already in the curve.

4. What were the initial driver reactions to a HUD-based call timer?

The majority of drivers, 70 percent, preferred not to see the call timer at all while driving. Of those who wanted to see the call timer on the HUD, all preferred that it be placed in the center HUD location. Even when the call timer was displayed on the HUD during the experiment, many participants commented that they did not notice the call timer or only noticed it at the end of the call.

Design Recommendations

This study looked at 4 design parameters of cell phones: caller ID location, button location, presence or absence of an auditory ring, and the use of a call timer. Based on the results of this study, several recommendations that may help to reduce the risk of answering cell phones while driving are listed in Table 7. To summarize, the recommended caller ID location (based on driver preference and performance) is the central HUD location (e.g., the 5.5 degrees down and 5 degrees right-of-center location that was used in this implementation). The use of steering wheel buttons for "talk" and "end" is also recommended, as there was no significant driving performance decrement when driving and answering calls with this configuration. In contrast, there was significantly more lane variability and line-crossing incidents when using the head-down caller ID combined with buttons on the phone (mounted on the center console). The use of a short auditory alert is recommended, as drivers expressed increased anxiety and occasionally missed calls when no auditory ring was present.

Finally, the use of a HUD-based call timer is not recommended based on the comments and reactions of the drivers in this study.

Table 7. In-vehicle cell phone design recommendations.

Design Parameters	Recommendations	Evidence
Caller ID Location -(center console) -(central HUD) -(right HUD)	-Use central HUD location (5.5 degrees down) (5 degrees right of center)	-Central HUD preferred by driver. -Central HUD yielded faster RTs.
Button Locations -(center console) -(steering wheel)	-Use steering wheel buttons	-No difference in driving performance was found between baseline (just driving) and the use of the steering wheel buttons (with the HUD caller ID), but driving was worse while answering the phone with the buttons (and caller ID) on the center console.
Auditory Ring -(on) -(off, HUD only)	-Use a short auditory alert (Alerts with an audible duration of 1 second or less are recommended, but more research is needed in this area, especially on using musical rings.)	-Drivers expressed increased anxiety without the ring. -Drivers occasionally missed calls without the ring. -However, nearly 1/3 of the drivers delayed answering the phone until the ring silenced.
Call Timer	-Do not use HUD call timer	-70% of drivers preferred not to see the call timer on the HUD during their call, but the calls in this study were short and the emphasis was on answering, not talking.

Perhaps the recommendation needing the most explanation is using a short auditory alert. One critical finding from this study was that the duration of the auditory ring influenced the response times of at least 1/3 of the drivers. These drivers were found to become “captured” by the ring, i.e., they delayed answering the call until the silence between the rings. Logically, it would seem that to avoid this “capture effect,” the auditory portion of the ring should be less than the fastest possible response time. As measured in this study, the quickest responses were around 1 second (using steering wheel mounted buttons), and thus, using an auditory alert which lasted 1 second or less should avoid unnecessarily delaying drivers’ responses. However, it should be noted that further research is needed to verify this finding and to examine the effects of musical rings were not examined in this experiment.

REFERENCES

- Alm, H. and Nilsson, L. (1994). Changes in driver behavior as a function of handsfree mobile telephones. *Accident Analysis and Prevention*, 26(4), 441-451.
- Alm, H. and Nilsson, L. (1995). The effects of a mobile telephone task on driver behavior in a car following situation. *Accident Analysis and Prevention*, 27(5), 707-715.
- Briem, V. and Hedman, L. (1995). Behavioral effects of mobile telephone use during simulated driving. *Ergonomics*, 38(12), 2536-2562.
- Brookhuis, K.A., de Vries, G., and de Waard, D. (1991). The effects of mobile telephoning on driving performance. *Accident Analysis and Prevention*, 23(4), 309-316.
- Goodman, M., Bents, F.D., Tijerina, L., Wierwille, W., Lerner, N., and Benel, D. (1997). *An investigation of the safety implications of wireless communication in vehicles* (Technical Report DOT HS 808 635). Washington, DC: U.S. Department of Transportation.
- Green, P. (2000). Crashes induced by driver information systems and what can be done to reduce them (SAE paper 2000-01-C008). *Convergence 2000 Conference Proceedings* (SAE publication P-360, pp. 26-36). Warrendale, PA: Society of Automotive Engineers.
- Green, P. (2001). *Safeguards for on-board wireless communications*. Paper presented at the second annual Plastics in Automotive Safety Conference, Troy, Michigan.
- Hahn, R.W., Tetlock, P.C., and Burnett, J.K. (2000). Regulating cellular phone use: Too little benefit for too much cost. *Regulation*, 23(3), 46-55.
- Hu, P. and Young, J. (1999). *Summary of travel trends 1995 nationwide personal transportation survey*. Washington, DC: U.S. Department of Transportation, Federal Highway Administration. [Online]. Available: http://www-cta.ornl.gov/npts/1995/Doc/trends_report.pdf
- Insurance Research Council. (2001, January 11). Americans believe cellular phones distract drivers, yet they use them anyway. [Online]. Available: <http://www.ircweb.org/news/PAM3CellPhones.htm> (See also Insurance Research Council. (2000, December). *Public Attitude Monitor 2000 Issue 3*. Malvern, PA: Insurance Research Council.)
- Llaneras, R. (2000). *NHTSA driver distraction internet forum: Summary and proceedings*. [Online]. Washington, DC: U.S. Department of Transportation, National Highway Safety Administration. Available: <http://www-nrd.nhtsa.dot.gov/pdf/nrd-13/FinalInternetForumReport.pdf>

- McKnight, A.J., & McKnight, A.S. (1993). The effect of cellular phone use upon driver attention. *Accident Analysis and Prevention*, 25(3), 259-265.
- Nowakowski, C. and Green, P. (1998). *Map design: An on-the-road evaluation of the factors affecting the time to read electronic navigation displays* (Technical Report UMTRI-98-4). Ann Arbor, MI: The University of Michigan Transportation Research Institute.
- Olson, A. and Green, P. (1997). *A description of the UMTRI driving simulator architecture and alternatives* (Technical Report UMTRI-97-15), Ann Arbor, MI: The University of Michigan Transportation Research Institute.
- Pachiandi, G., Morgillo, F., Pautie, A., Deleurence, P., & Giulhon, V. (1996, May 22-25). *Impact of the use of car phones on road safety*. Paper presented at International Conference on Traffic and Transport Psychology, Valencia, Spain.
- Parks, A. & Hooijmeijer, V. (1999). *The influence of the use of mobile phones on driver situation awareness*. [Online]. Paper presented online at the NHTSA Driver Distraction Internet Forum. Washington, DC: U.S. Department of Transportation, National Highway Safety Administration. Available: <http://www-nrd.nhtsa.dot.gov/departments/nrd-13/driver-distraction/PDF/2.PDF>
- Redelmeier, D. and Tibshirani, R. (1997). Association between cellular-telephone calls and motor vehicle collisions. *New England Journal of Medicine*, 336(7), 453-458.
- Stein, A., Parseghian, Z., and Allen, R. (1987, March). A simulator study of the safety implications of cellular mobile phone use (Paper No. 405). Hawthorne, CA: Systems Technology Inc. (See also Stein, A., Parseghian, Z., and Allen, R. (1987, September). A simulator study of the safety implications of cellular mobile phone use. *31st Annual Proceedings of the American Association for Automotive Medicine*, New Orleans, LA.)
- Tsimhoni, O., Watanabe, H., Green, P., and Friedman, D. (2000). *Display of short text messages on automotive HUDs: Effects of driving workload and message location* (UMTRI-2000-13). Ann Arbor, MI: University of Michigan Transportation Research Institute.
- Tsimhoni, O. and Green, P. (1999, August 22-25). *Visual Demand of Driving Curves Determined by Visual Occlusion*. Paper presented at the *Vision in Vehicles 8 Conference*, Boston, MA.
- Tsimhoni, O., Yoo, H., and Green, P. (1999). *Effects of workload and task complexity on driving and task performance for in-vehicle displays as assessed by visual occlusion* (Technical Report UMTRI-99-37). Ann Arbor, MI: University of Michigan Transportation Research Institute.

- U.S. Department of Defense. (1989). *Markings of aircrew displays, design and configuration of* (Military Standard MIL-M-18012B). Washington, DC: U.S. Department of Defense.
- U.S. Department of Defense. (1991). *Display, head-up, general specification for* (Military Standard MIL-D-81641). Washington, DC: U.S. Department of Defense.
- Utter, D. (2001). *Passenger vehicle driver cell phone use results from the fall 2000 national occupant protection use survey* (DOT HS 809 293). Washington, DC: U.S. Department of Transportation, National Highway Safety Administration.
- Violanti, J. M., & Marshall, J.R. (1996). Cellular phones and traffic accidents: an epidemiological approach. *Accident Analysis and Prevention, 28*, 265-270.
- Weintraub, D.J. and Ensing, M. (1992) *Human factors issues in head-up display design: The book of HUD* (SOAR 92-2). Wright-Patterson AFB, OH: U.S. Air Force, CSERIAC.
- Wooldridge, M., Bauer, K., Green, P., and Fitzpatrick, K. (2000). *Comparison of workload values obtained from test track, simulator, and on-road experiments*. Paper presented at the Transportation Research Board Annual Meeting, Washington, DC.

Appendix A. Summary of the Relevant Cell Phone Literature

Reference	Study Type & Participants	Method	Results
Alm, H., & Nilsson, L. (1994)	<ul style="list-style-type: none"> -Simulator study -20 males -20 females -Ages 26-61 -Mean age 32 	<p><u>Independent variables:</u></p> <ul style="list-style-type: none"> -Road (straight or curve) -Task (driving & talking) <p><u>Dependent measures:</u></p> <ul style="list-style-type: none"> -Memory span test score -Lane position & speed -Braking reaction time -NASA-TLX <p><u>Task description:</u> Answer the phone by pressing a button, then perform the Baddeley Working Memory Span Test while driving. When a visual stimulus appears, brake as fast as possible.</p>	<ul style="list-style-type: none"> -Drivers gave phone higher priority on straight roads; braking reaction time suffered -Priority given to driving on curved road; frustration increased and memory test scores decreased -Subjective workload increased due to phone use but not road difficulty
Alm H, & Nilsson L. (1995)	<ul style="list-style-type: none"> -Simulator study -30 males -10 females -Young (<60) -Old (>60) 	<p><u>Independent variables:</u></p> <ul style="list-style-type: none"> -Task (driving & talking) <p><u>Dependent measures:</u></p> <ul style="list-style-type: none"> -Memory span test score -Braking reaction time -Lane position -Headway <p><u>Task description:</u> Answer the phone and perform the Baddeley Working Memory Span Test. Brake as fast as possible when the lead vehicle brakes.</p>	<ul style="list-style-type: none"> -Drivers did not compensate for increased reaction time with increased headway while using the phone -Mental workload increased during phone task -Age effect for driving performance
Briem, V., & Hedman, L.R. (1995)	<ul style="list-style-type: none"> -Lab study -10 males -10 females -Ages 19-26 & 40-51 -Mean ages 21 & 45 	<p><u>Independent variables:</u></p> <ul style="list-style-type: none"> -Road (dry & wet) -Conversation (easy & hard) -Task (driving, obstacles, radio, & talking) <p><u>Dependent measures:</u></p> <ul style="list-style-type: none"> -Lane position & speed -Number of Collisions <p><u>Task description:</u> Perform pursuit tracking task while maintaining speed and avoiding obstacles. Tune the radio. Use the phone to converse or perform memory tests.</p>	<ul style="list-style-type: none"> -Both radio and phone affects driving performance; decreased most by radio, then hard conversation, then easy conversation -Speed deviation greatest during hard conversation, then radio, then easy conversation -Tasks had no effect on steering

Reference	Study Type & Participants	Method	Results
Brookhuis, K.A., de Vries, G., & de Waard, D. (1991)	-On road study -10 males -2 females -Ages 23-35, 35-50, & 50-65	<u>Independent variables:</u> -Phone (hand-held & hands-free) -Task (driving, talking) -Traffic (light, heavy, & city) <u>Dependent measures:</u> -Lane position & speed -Following distance -Steering wheel movement -Rearview mirror checking -Cardiac inter-beat intervals <u>Task description:</u> Drive and place calls, answer calls, and perform a paced serial addition task (memory + mental arithmetic).	-Phone use affected driving performance, especially in city traffic -Heart rate increased when using phone -Phone type affected steering; "violent" movements noted when dialing & increased movement noted when answering manually -hands-free phone recommended -Phone use did not lower attention to rearview mirror
McKnight, A. & McKnight, A. (1993)	Lab study & Simulator study -75 males -75 females -Ages 17-80	<u>Independent variables:</u> -Task (driving, radio, & talking) -Conversation (simple & complex) <u>Dependent measures:</u> -Response to traffic situations <u>Task description:</u> -Drive and respond to traffic situations (route changes, turning vehicles, construction) while using the phone to converse or perform arithmetic/memory tasks.	-Response to traffic suffered when distractions were present; radio and complex conversations were most (and equally) distracting -Age effect -Phone was as distracting (or less) than tuning the radio -Previous experience had no effect on performance
Pachiaudi, G. & Chapon, A. (1994)	-Simulator study -17 participants -Ages 18-35 & 45+	<u>Independent variables:</u> -Speed (slow & fast) <u>Dependent measures:</u> -Speed variation -Subjective questionnaires <u>Task description:</u> Drive and answer and talk on a hands-free phone.	-Phone tasks affected driving; speed increase & loss of speed control for half of participants -Performance may have been degraded by mental overload for one-third of participants

Reference	Study Type & Participants	Method	Results
Parks A. & Hooijmeijer, V. (1999)	-Simulator study -15 students -Ages 22-31	<u>Independent variables:</u> -Task (driving & talking) -Speed change (increase & decrease) <u>Dependent measures:</u> -Lane position & speed -Braking distance -Reaction time -Situation awareness <u>Task description:</u> Drive and use phone to answer questions. Respond to unexpected events by flashing lights or braking.	-Lane position not affected by phone use -Speed adjustment affected by phone use only when speed limit decreased -Reaction to events slowest when conversation first begins then decreases over time; reaction time greatest for event 1, then 2, then 3 -Situation awareness decreased for phone task; fewer correct answers
Stein, A., Parseghian, Z. & Allen, R. (1987)	-Simulator study -36 Males -36 Females -Ages 25-55+	<u>Independent variables:</u> -Task (dial, answer. and radio) -Road (straight, straight & obstacle, and curved) -Dial (manual, recall, voice) -Phone type (hand-held & hands-free) -Phone location (armrest & center console) <u>Dependent measures:</u> -Lane position & speed -Response time -Accidents <u>Task description:</u> Drive and observe highway signs (memorize information) while placing a call. Repeat memorized information.	-Driving performance worst when tuning radio, then dialing, then receiving a call -Phone location significant; decrease risk of crash by mounting phone on console rather than armrest -No advantage to hands-free phone -Voice & recall dialing less hazardous than manual and radio tuning -Age effect; old drivers more likely to crash when using phone or tuning radio
Redelmeier, D.A., & Tibshirani, R. J. (1997)	-Epidemiologic case-crossover study -699 drivers who have been involved in car crashes and own a cell phone	<u>Task Description:</u> Cell phone calls on the day of collision and the previous week were analyzed using billing records. Time of collision was estimated using statements made by subject, police & EMTs.	-Risk of collision is 4 times higher when using a cell phone -Relative risk increased for calls which occurred close to the time of collision -No safety advantage when using hands free

Reference	Study Type & Participants	Method	Results
Violanti, J. M. & Marshall, J. R. (1996)	<ul style="list-style-type: none"> -Epidemiologic case-control study -100 drivers involved in car crashes within the past 2 years -100 drivers not involved in car crashes 	<p><u>Independent variables:</u> -Subject (case & control)</p> <p><u>Dependent measures:</u> -Frequency of attention diverting behavior</p> <p><u>Task description:</u> Surveys containing demographic information & 18 driver inattention behaviors (e.g. drinking, smoking, phone use, talking to others, etc.) were completed by subjects. Accident information was obtained from DMV reports and cell phone information was obtained from monthly cell phone bills.</p>	<ul style="list-style-type: none"> -Use of cell phone combined with motor and cognitive activities are associated with increased traffic risk -Driving plus distracting behaviors (phone use, drinking, smoking) increases the risk of an accident -On average, phone users who were involved in a crash were younger and had less driving experience -Risk for a crash is 5.5 higher for those who talk on the phone for 50+ minutes per month

Appendix B. Participant Consent Form

**PARTICIPANT CONSENT FORM
Cellular Telephone Caller ID Study**

The use of cellular telephones while driving a vehicle has become a common practice in the United States. Carrying a cell phone in the car can be beneficial in case of an emergency or to report an accident. However, the act of answering the phone while driving can be distracting. The purpose of this study is to determine the least distracting way to indicate someone is calling you while you are driving.

During the experiment, you will be asked to drive the UMTRI Driving Simulator on 2-lane roads at 45 mph while following a lead vehicle. The roads will consist of a series of curved and straight sections. Practice driving the simulator and answering the phone will be provided.

The experiment will last for approximately 2 hours and will be divided into 15-minute test segments. Short breaks can be taken in between these segments whenever necessary. During the experiment, calls will appear on a caller ID on a simulated hands-free cell phone or on a head-up display, both while driving. When safe, answer the phone, greet the caller, and then hang up.

Some people experience motion discomfort in the simulator. If this occurs, please tell the experimenter immediately and he or she will stop the experiment. You can withdraw from the study at any time and for any reason. You will be paid regardless.

If you have any questions, please do not hesitate to ask the experimenter at any time.

Thank you for your participation.

It is OK to show segments of my test session in UMTRI presentations. (This is not required for participation in the study but is useful to have. Your name will not be mentioned.)

I agree _____ *I disagree* _____

I have reviewed and understand the information presented above. My participation in this study is entirely voluntary.

Subject Name (PRINTED)

Date

Subject Signature

Witness (experimenter)

Investigator: Paul Green 763-3795

Appendix C. Pretest Biographical Form

Pretest Biographical Form

**University of Michigan Transportation Research Institute
Human Factors Division**

Name: _____ Subject:

Age: _____ Gender: _____ Date:

Occupation/Major: _____

How many times have you driven the UMTRI simulator? _____

What is your primary vehicle (model and year)? _____

Annual Mileage: _____

Do you own a cell phone? Yes No
 If yes, how long have you used one? _____ Is it your primary phone? _____
 How many minutes is your monthly plan? _____
 Do you usually go... Over Under Neither (circle one) By how much? _____

How often do you use a cell phone?
 Daily Weekly Monthly Emergency Only

Approximately how many calls do you make or receive?
 _____ per day week month (circle one)

Have you ever used a cell phone while driving? Yes No
 If yes, how many times? _____ per day week month (circle one)
 Is it a hands-free or hand-held device? Hands-free Hand-held Unsure

How often do you: *Never* *Always*

a. Stop the car to make a call |-----|

b. Not answer the phone while driving |-----|

Have you ever had experience using a heads up display? Yes No
 If yes, please explain.

Experimenter Use Only

Far Vision (Landolt Rings)														Vision Corrected?	
1	2	3	4	5	6	7	8	9	10	11	12	13	14	Y	N
T	R	R	L	T	B	L	R	L	B	R	B	T	R		
20/200	/100	/70	/50	/40	/35	/30	/25	/22	/20	/18	/17	/15	/13		
Near Vision														which?	
1	2	3	4	5	6	7	8	9	10	11	12	13	14		
T	R	R	L	T	B	L	R	L	B	R	B	T	R		
20/200	/100	/70	/50	/40	/35	/30	/25	/22	/20	/18	/17	/15	/13		

Appendix D. Posttest Survey Form

Posttest Survey

Preferred Location of Caller ID

Rank the locations diagrammed below according to preference from best (1) to worst (3). If you think two locations were similar, you may give them both the same rank. Consider how easy it was to detect the message, to read it, and its impact on driving.

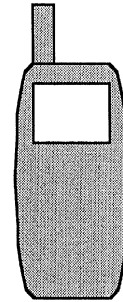
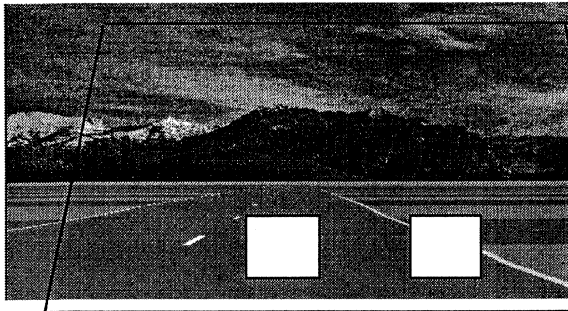

Difficulty

How *stressful* was it to drive the simulator:

a. Without answering calls

Least *Most*

How *stressful* was it to answer a call while driving on the following roads:

Least *Most*

a. Straight _____

b. Moderate Curve _____

c. Sharp Curve _____

d. Going into a Moderate Curve _____

e. Going into a Sharp Curve _____

How *stressful* was it to answer a call during the following conditions:

Least *Most*

a. With a ring _____

b. Without a ring _____

How *stressful* was it to read the caller ID when it was in the following locations:

Least *Most*

a. Cell phone _____

b. Heads up display _____

Response Time to Caller ID

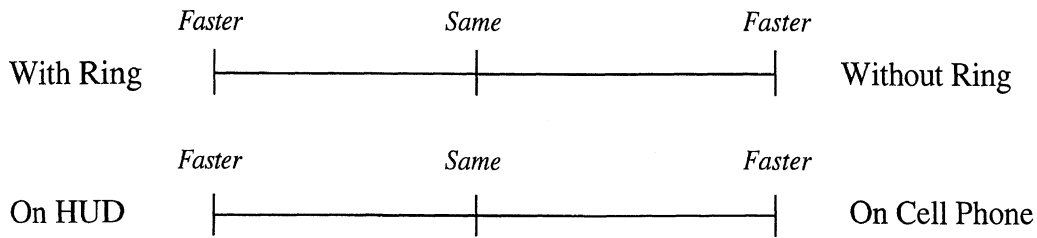

Sense of Urgency to Answer Phone

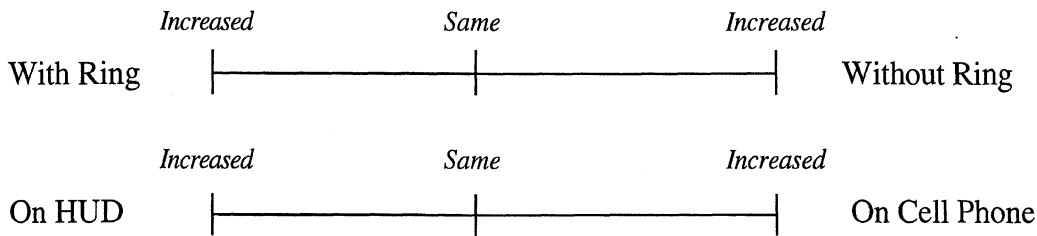

Call Timer

Sense of urgency to complete a call:

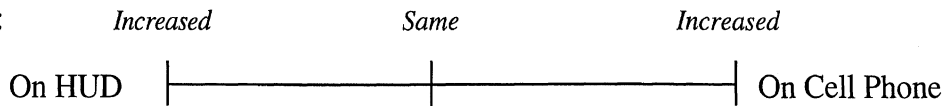

Where would you prefer to see a call timer? Rank the locations diagrammed below according to preference from most preferred (1) to least preferred (3). If two locations are similar, you may give them both the same rank.

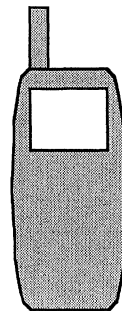
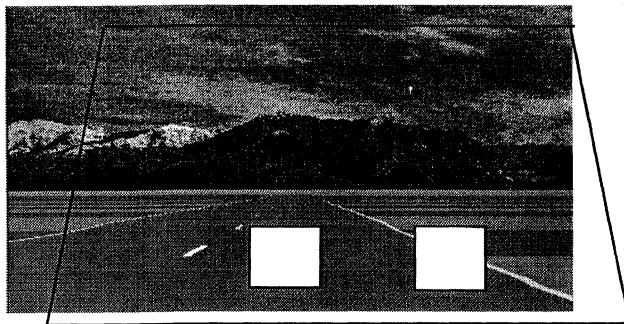

No Call Timer

If provided, how often should the call timer update? Once every...
 1 sec 5 sec 10 sec 30 sec 1 min 5 min 10 min 15 min (circle one)

Appendix E. Payment Form
THE UNIVERSITY OF MICHIGAN
SUBJECT FEE PAYMENT FORM
NON-EMPLOYEE

TO BE COMPLETED BY DEPARTMENT:

Date: _____
 University Department: UMTRI Human Factors
 Departmental Contact Person: Christopher Nowakowski
 Departmental Telephone Number: 763-2485
 Departmental Reference Number: 378804 Cash Receipt No. _____
 Study Name: Nissan – HUD III

Amount: \$ 40 Written Amount: Forty Dollars

I certify that the terms, restrictions, and qualifications set forth in this form's administration policy are met and that the payments are in compliance with all conditions imposed by the funding source.

Name Printed: Paul Green Authorized Signature: _____

Bus Unit	Account (6)	Fund (5)	Organization (6)	Program (5)	SubCl (5)	Bdgt Yr (4)	Project/Grant
UMICH	613100	25000	567015	10000	22000	2001	N002405

TO BE COMPLETED BY PARTICIPANT: (PLEASE PRINT)

 Volunteer's Name

 Social Security Number

 Street Address

 City, State, Zip

Are you a University of Michigan Employee? _____ Yes _____ No
 (If you answered "yes", you cannot use this form.)

I hereby acknowledge that I have received the above stated amount as full payment for my participation in the above described project.

 Volunteer's Signature

7.31.98 ET

Appendix F. Analysis of Line-Crossing Incidents

Overview

The simulated vehicle used in this experiment was modeled as a 6-foot wide vehicle traveling in a 12-foot wide lane. Throughout the experiment, the position of the center of the vehicle relative to the lane was recorded at 30 Hz. Both auditory and haptic feedback was provided when the driver crossed a lane line. Crossing the right lane line produced increased road noise (i.e., the sound of tires driving on gravel) and increased vibration on the steering wheel. Crossing the left lane line produced regular bumps each second (such as would be found from driving over raised reflectors). Crossing more than 3 feet into the left lane resulted in a subtle horn honk to alert the driver.

The 24 participants in the experiment completed 20 trials during the baseline condition (driving alone) and 80 trials while answering cell phone calls. On curved sections, the trials began either 1 second before or 5 seconds after the point of curvature, and on straight sections, the trials began either 5 or 10 seconds after the end of the last curve. The initial driving data for the baseline condition was collected from the start of the trial for 5 seconds, and for the cell phone answering tasks, the data collection started at the beginning of the trial and ended 2 seconds after the phone was answered (or for a minimum of 4 seconds).

A line-crossing incident was only recorded if the vehicle left the lane during a trial (as defined above). However, the duration of the incident often exceeded the length of a trial. The apex of the line crossing was defined as the point where the maximum lane position (outside of the lane) occurred. The duration of the line crossing was defined as the time spent out of the lane.

Line crossings occurred during 8 percent of the experimental trials. However, 4 out of 24 test participants had no line-crossings incidents recorded. There were 34 line-crossing incidents recorded during the baseline driving condition, and 164 crossings during the cell phone answering tasks. Additionally, 164 of the involved the left lane line, and the remaining 34 incidents involved the right lane line.

Line Crossings While Answering the Phone

During the cell phone answering tasks, it was expected that most line-crossing incidents would occur near the button press (as this was the time the driver's attention was most likely focused away from the road). Figure 19 shows the relationship between the start of line-crossing incidents and the button press. Line-crossing incidents began at a mean of 1.16 seconds before the button press, and nearly 75 percent of the line-crossing incidents occurred within ± 2 seconds of the button press.

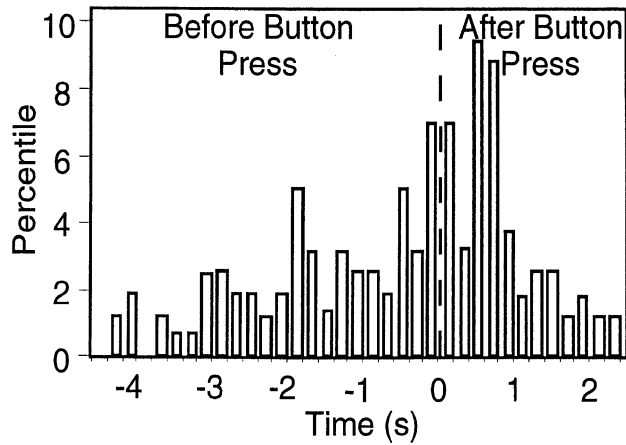

Figure 19. Line-crossing incidents relative to the button press.

A Description of Line-Crossing Incidents

In an attempt to describe line-crossing incidents, the apex and incident durations were calculated relative to the start of an incident. Figure 20 shows a histogram of the apex time and the location of the recovery (or incident duration) for line crossings during the baseline driving condition. If it can be assumed that drivers initiated a steering correction shortly after realizing that the vehicle was out of the lane, the apex of the line crossing would mark the moment the drivers realized they had left the lane. For baseline driving, the mean apex time was 0.89 seconds. Furthermore, 90 percent of drivers realized the line crossing within 2.2 seconds. The mean line-crossing duration (or recovery) was 1.82 seconds after the line crossing. Almost 20 percent of the line-crossing incidents were recovered within half of a second, and almost 85 percent of the incidents were recovered within 3.0 seconds.

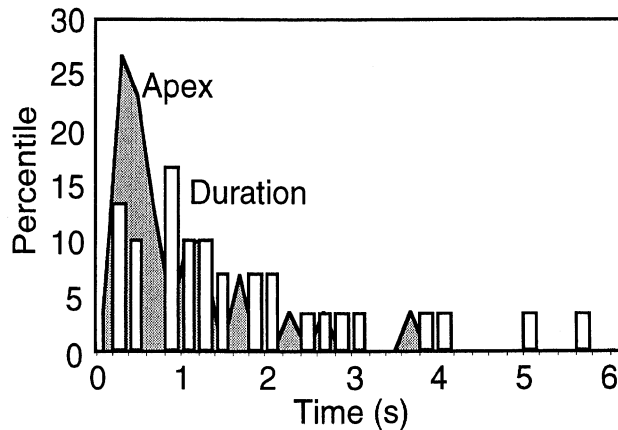

Figure 20. Line-crossing incidents during baseline driving.

While driving and answering the cell phone (Figure 21), the mean apex time for a line-crossing incident was 0.84 seconds, and 90 percent of the drivers realized their error after only 1.7 seconds. Similar to line crossing during the baseline driving condition, the mean line-crossing duration was 1.85 seconds. Almost 85 percent of the line-crossing incidents required at least 3.0 seconds to recover. However, unlike during the baseline driving, only about 10 percent of the incidents recovered within half of a second.

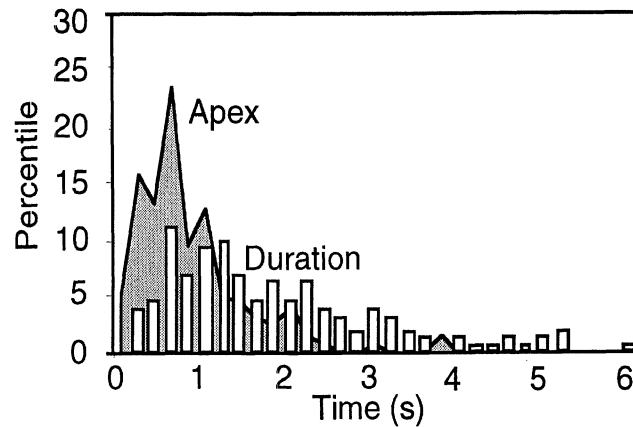

Figure 21. Line-crossing incidents while answering the phone.

