

# Final Design Report

## Postural Support Device for Children in Low-Income Families

ME 450 W21 Section 5 — Professor Skerlos  
Team 20

By: Jacob Applegate, Jack Campau, Kate Froling, Hana Grebovic, and Mai-Ly Tran  
Sponsored by: Bluelab Nicaragua

## **Executive Summary**

Alison (14) and Monica (9) are two young girls, suffering from poor posture due to stages 4 and 5 of cerebral palsy. They are in need of a postural and neck support device, which helps with spinal alignment and does not cause them pain. The problem of Alison and Monica's need for a postural support device that will help manage the side effects that occur with cerebral palsy has been defined. Their background, as well as the introduction to our project, stakeholders, and cerebral palsy have been explored. The stakeholders are listed and described, and the problem statement is defined around the three requests that the device should be adjustable, accessible, and affordable. An updated stakeholders engagement section has been added to represent communication through our design process. Available devices on the market were assessed and supported by our benchmarking for the design and concept exploration phase. The three requests were analyzed and used to produce the requirements and specifications of the device with the justification and evidence for each specification. The morphological chart separated each function of the device into subsystems, which specified the scope of our concept generation. Ideation techniques were utilized over multiple brainstorming sessions in order to ensure a large variety of ideas. The concept development phase of design focused heavily on 5 separate designs, which were evaluated using a pugh chart. Kate's overall design was selected as the leading concept, but we are still focusing on the finer details of certain subsystems (i.e. knee separation). Having developed a CAD model through DR3, specific design choices have been solidified for each subsystem. Engineering analysis consisting of force and moment analysis is detailed to justify the beginnings of project verification, and future plans for both verification and validation are outlined as well. The next steps for the project, as well as the project plan for how the team will proceed with solution development, are outlined. After finalizing the details of each subsystem, our team will complete the CAD and begin manufacturing. The overall project plan, status, and challenges are provided, where both past and future challenges have been defined. The biggest challenges upcoming are finalizing material selection, as well as creating a physical product while following COVID restrictions. Lastly, the feedback from the Design Review presentation is discussed, mainly leading us to focus more on the aesthetics of the device to make it look more child-friendly moving forward. Overall, the team is confident in its ability and current route to generate an effective solution to Alison and Monica's postural support problem.

## **Table of Contents**

<b>Problem Description and Background</b>	<b>1</b>
Stakeholders Discussion	1
Cerebral Palsy Background	3
Problem Statement and Scope	4
Benchmarking	4
<b>Requirements and Specifications</b>	<b>7</b>
Gathering Relevant Information	7
Defining Requirements and Specifications from Needs	7
<b>Determining Importance and Assessing Requirements</b>	<b>11</b>
<b>Concept Generation</b>	<b>11</b>
Morphological Chart	11
Further Brainstorming	12
Ideation Techniques	13
<b>Concept Development</b>	<b>14</b>
Jake's Concept	14
Kate's Concept	14
Jack's Concept	14
Hana's Concept	15
Mai-Ly's Concept	15
<b>Concept Evaluation and Selection</b>	<b>15</b>
<b>Current Solution CAD</b>	<b>18</b>
Lateral Supports	18
Frame and Base	19
Final Design	20
<b>Solution Development and Verification</b>	<b>21</b>
Engineering Analysis	22
Risk Assessment	24
<b>Detailed Design Solution</b>	<b>25</b>
Verification Plan	28
Validation Plan	29
<b>Discussion and Recommendations</b>	<b>30</b>
<b>Sustainable Design Assessment</b>	<b>33</b>
<b>Ethics and Professional Responsibility</b>	<b>33</b>

<b>Conclusion</b>	<b>33</b>
<b>Authors</b>	<b>34</b>
<b>Acknowledgments</b>	<b>35</b>
<b>References</b>	<b>36</b>
<b>Appendix A: Gantt Chart</b>	<b>38</b>
<b>Appendix B: Brainstorming and Ideation Sketches</b>	<b>40</b>
<b>Appendix C: Independent Concepts</b>	<b>45</b>
<b>Appendix D: Bill of Materials</b>	<b>48</b>
<b>Appendix E: Engineering Standards</b>	<b>49</b>
<b>Appendix F: Engineering Inclusivity</b>	<b>50</b>
<b>Appendix G: Environmental Context Assessment</b>	<b>51</b>
<b>Appendix H: Social Context Assessment</b>	<b>52</b>
<b>Appendix I: Ethical Decision Making</b>	<b>53</b>



## **Problem Description and Background**

This section includes a list and description of the project's stakeholders, some background information on cerebral palsy and the ways in which it affects people, and our problem statement with a description of the project's scope.

### **Stakeholders Discussion**

The main contact and project sponsor is team member Jacob Applegate on behalf of Bluelab Nicaragua. We will be working in parallel with Bluelab regarding their involvement in designing a postural support device for children with cerebral palsy in low-income families. We will be creating our design separately from theirs but will remain in contact with Bluelab Nicaragua as well as their connections, FNE International, Salud Para Todos Los Niños, and the two children, Alison and Monica.

Bluelab Nicaragua is a University of Michigan student organization focused on sustainable interdisciplinary design that aims to promote accessibility and equity for children with medical conditions. Company contact of Bluelab Nicaragua, FNE International, is a nonprofit organization operating in Central and South America for the advancement of housing, health, and education. FNE is connecting us with the community in León, Nicaragua, where we are focusing our efforts on two patients suffering from cerebral palsy (CP).

The two patients are Alison and Monica, both of which are in desperate need of corrective postural support devices to help them with their cerebral palsy. After speaking with their doctor and physical therapist, we were able to gather information regarding their current situations. Monica is a 9-year-old girl living with her mother, father, and younger brother in León. Her father works as a driver, so Monica's mother is left to be the sole caregiver most days, and when Monica needs to get to school, her mother has to carry her 1.5 km to the nearest bus stop because Monica is currently unable to walk on her own. Monica has relatively severe CP, ranking between 3 and 4 on the Gross Motor Function Classification System (GMFCS) [1] and with her lack of current support, her chair causes her pain, as during the day she simply rotates between her wheelchair and a generic chair in the family home.

Alison's current situation is quite dire, as she is a 14-year-old who suffers from level 5 CP on the GMFCS. Her father is not in the picture, and her mother works as a school teacher, so on a daily basis Alison's grandmother is left to be her caretaker, and with a bad back, her grandmother struggles with much of the lifting aspects of caregiving. Alison has suffered many side effects of poor posture that have been ingrained over the years due to a lack of support and postural correction, this has caused severe scoliosis, a currently dislocated hip, and plenty of bedsores. Alison also lacks the ability to communicate with her caretakers, which causes bathroom mistakes to be relatively commonplace (and a reason that our stakeholders desire the device to be non-absorbent). These two girls are the main focus of our project and we value them as our top priority and main stakeholders.

In order to get professional advice and opinions on our design, we will also be in contact with a partner of FNE called Salud Para Todos Los Niños, a group of doctors that will be able to give us some medically-based feedback. This will ensure that the device we create will be approved by experts to confirm that we will be properly helping Alison and Monica.

After a meeting with FNE, Salud Para Todos Los Niños, and leadership from Bluelab Nicaragua, the team received feedback regarding the position of the project as well as the requirements and specifications. We received great insight, the first of which was in a discussion of the knee separation for Alison and Monica. FNE wanted to ensure that our team put back and neck support at a higher emphasis than knee separation. They also wanted to inform us that the device needs to be waterproof, due to Alison not being able to communicate, this leads to a lot of bathroom messes, so ensuring non-absorbance is important. Stability is another aspect that our stakeholders liked in our specifications and they consistently reiterated the importance of making sure the device won't fall off the chair in rugged terrain, which is very common in Nicaragua. Local maintenance was another important factor that the stakeholders wanted us to keep in mind, as they wanted the caretakers to be able to work with the upkeep of the device in the country.

Further discussions with stakeholders occurred after our sketching phase of concept exploration. They were thrilled with the direction of the project as well as the process that the course has brought us through. Through probing of our design there were some concerns about the constriction of side supports with the use of multiple lateral "arms" of the device. There was a conversation over whether having more than one was necessary, and after deliberation, this was

something that we were happy to include in our design changes moving forward. Similarly, there was talk regarding the flat leg rest part of the device, with current flat supports resting below both of the girls' feet, it was decided that this would be something to address moving into a redesign. Overall, stakeholders were extremely excited about the path of our design and were very pleased to see how far the design has come in such a short amount of time.

### Cerebral Palsy Background

Cerebral palsy (CP) is a neurological disorder that comes up in the early life of a child and affects body movement and muscle coordination permanently [2]. It is caused by brain damage or irregularities within the brain while the child is developing that disrupt their ability to control movement and maintain posture and balance. CP is a disorder that affects people in an extremely wide range of severity, which can be seen in Figure 1 below.

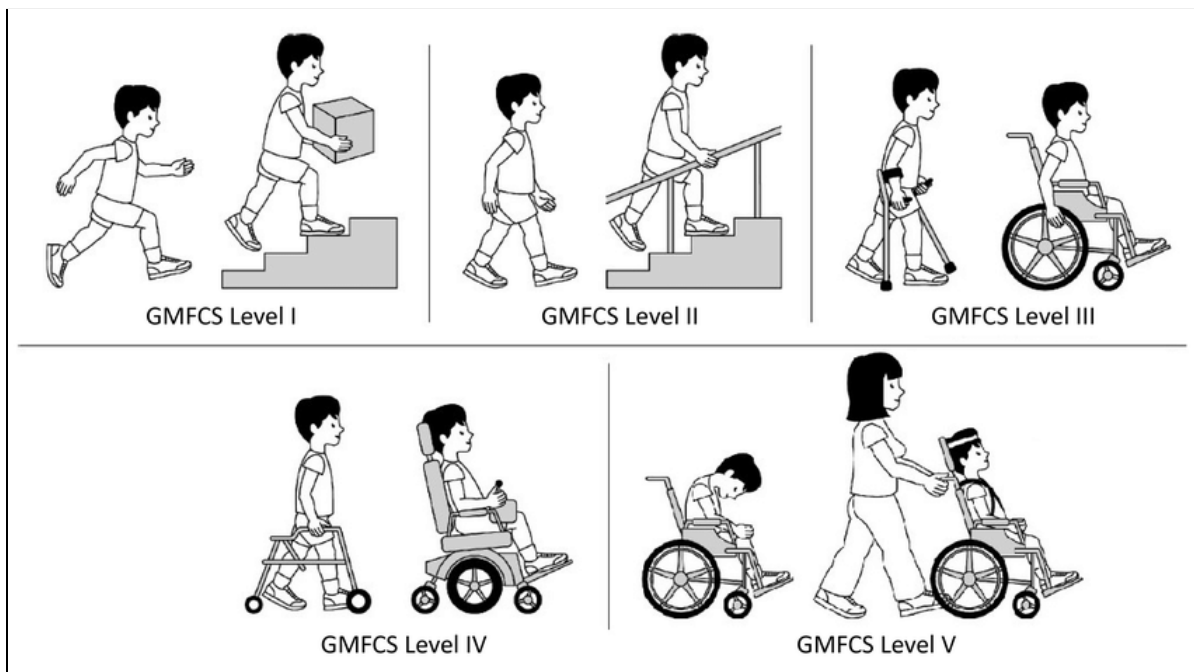

**Figure 1.** Gross Motor Function Classification System graphic [1]

In the lowest level of the GMFCS (level 1), children can complete almost all activities (walking, running, or climbing stairs) all with only a slight limitation to coordination and balance. In the highest level (level 5), self mobility is highly limited, even the head and neck need to be supported. This range, in turn, makes cerebral palsy a complex problem.

## **Problem Statement and Scope**

In order to properly define the scope of the project, a problem statement was developed and is written below:

Alison and Monica are in need of a low-cost, adjustable, and accessible seating device to provide them proper postural support by promoting alignment in their head, neck, spine, and legs, in order to prevent further side effects that result from improper posture over long periods of time due to cerebral palsy.

With the problem defined, the requests of the stakeholders could be addressed. The stakeholders for this project have three main requests regarding the postural support design. The first request is that the device needs to be adjustable. Not only are Alison and Monica currently at different heights, but we want our device to grow with them over time so that they can have the proper support for as long as possible. The next request is the device should be accessible. Since Alison is in level 5 of CP and Monica is in level 3-4, the two of them will have different needs based on the severity of their conditions. Stakeholders would like a device that can meet the needs of both of the girls, and in the future could hopefully be adapted in future iterations to fit the needs of any child with cerebral palsy who needs extra postural support. The third request is that the device needs to be affordable. The average take-home earnings per household in Nicaragua (when adjusted to USD) comes out to be just over \$18,000 annually [3]. This means that most households, including Monica and Alison's families, cannot afford the high prices of assistive postural devices, especially the more complex devices that are meant for patients with higher levels of cerebral palsy like Alison and Monica. Therefore, our stakeholders want a device that is affordable enough that it won't be a barrier for patients from lower-income households. These three requests (adjustable, accessible, and affordable) were further analyzed to determine the requirements and specifications of the design.

## **Benchmarking**

Prior to beginning any concept generation, developing a thorough view of solutions already on the market that could be inspiring to our ideation was an important step. Through knowledge of what others have already done, we can see what was done right, what was done wrong, and what could potentially be helpful in our needs case. Our approach to this method involved looking at the ideal solutions that perfectly customize seating support to a child but are way out of the price

range, current solutions that have interesting design aspects but are only a bit out of our project price range, and adjacent solutions that may offer some functionality that we desire in our device yet typically have no relation to cerebral palsy.

In terms of devices that are way out of our price range, it is very easy to find “ideal” solutions. For example, one of the devices we liked the most was the Quantum Q6 Edge Electric Powerchair, which can be found used on eBay for \$10,000 in some cases [12]. This wheelchair, while wildly out of the project budget, has adjustability aspects that our team found very interesting and helpful while keeping our current needs statement in mind. Having adjustability and support are exactly what Alison and Monica are in need of, so looking at important features such as the adjusting headrest is ideal. The headrest on this specific model can adjust and rotate on all axes through hydraulics within the chair. The chair also can adjust lateral support and tilt which help to align the user’s spine. The functionality of these chairs is great, but looking at their price and the amount of overkill they have in relation to our project scope, including their driving ability, we decided to take into consideration their features while ideating without letting it narrow our concept generation approach.

After carefully evaluating some of the more expensive approaches to seating support, our team wanted to recognize commonly used devices within the industry that were a little less far from our budget. While there were many to consider, the two that drove the most ideation were the Special Tomato Soft-Sitter and the Versa Form support device. These two devices incorporate clever designs and are commonplace in physical therapist offices in the United States. The Special Tomato Soft-Sitter is a seating device specifically designed for children with cerebral palsy. We noted that the device was very aesthetically pleasing, seemed to have great support through curvature, and harnesses that kept the child in the proper position, but we also noted that this device is extremely rigid and lacks adjustability in every aspect other than the harness. The Versa Form device is a positioning pillow filled with polystyrene beads that contain a nozzle for a specific vacuum to be able to remove the air and create a stiff device that remains in place. This is great for short periods of time where children at clinics and therapist offices need custom seating, as the caretaker can mold the bag while the child is sitting in it and then suction the air from the bag, leaving customized seating support for the child to sit through the appointment in. With that said, aspects of this solution that were concerning were that the device requires plenty

of tools to operate and cannot last in its position for long periods of time. Both of these devices (as well as others like the Bolster Chair and Sunbeam Infant Rocking Chair) had unique and creative approaches to cerebral palsy seating support which made for a great introduction to exploring concept ideation.

Though looking at devices within the industry is helpful, it is also important to evaluate concepts that could be relevant to our design yet are not necessarily used for children with cerebral palsy. Examples of this benchmarking include our research of car seat headrests. These devices are designed to maintain head positioning for young children and stay in place for extremely long periods of time. The technology used to create adjustability is a ratchet method in which the ‘wings’ of the headrest can be adjusted inwards towards the individual’s head. In their application, this allows for a child to rest their head as well as prevent whiplash from fast turns in the car. This could be very beneficial to our application because we could use a similar design to allow for our headrest to have adjustable support in a similar method for Alison and Monica. This particular design resonated through multiple designs in our concept generation as it served as great inspiration throughout our ideation. Another functional solution adjacent to cerebral palsy support was the race car harness. This 4-point harness is designed for race car drivers in order to prevent injury during high-speed crashes. It holds the user in place and prevents any undesired movement. This is extremely relevant to our project because of our needs for Alison and Monica, so utilizing this as a point of motivation in our ideation allowed us to add concepts to our solution exploration.

Moving into the functionality of our design, determining a method of adjustability for the different features became extremely necessary. There was extensive research regarding the different approaches our team could take when making the design adjustable. For example, four of the most influential options that inspired our ideation were a lead screw, crutches, a telescoping arm, and sail tracks as shown below in Figure 2.

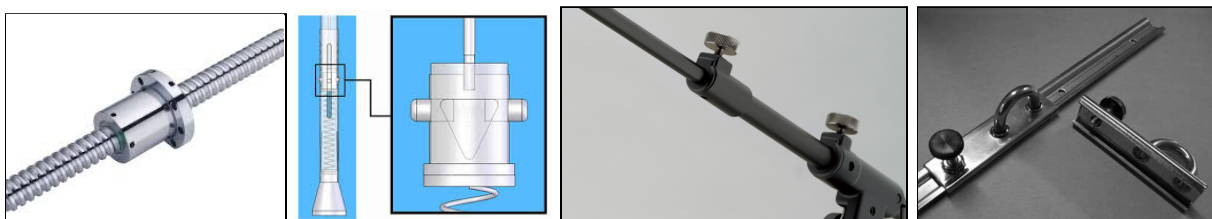

**Figure 2.** Pictured from left to right: lead screw, crutches, telescoping arm, sail track.

The lead screw intrigued us because of its ability to have continual adjustability along the axis of the screw with the use of a gear. Adjustability in crutches is something that we looked into as an option considering the ease of being able to click through different hole locations. Telescoping arms are a relatively common way for the extension to occur, these were greatly considered for their ease of both manufacturing and use. We also looked at some solutions in industries like sailing, where tracks for quickly adjustable clips exist to allow for fast changes of sturdy locations to attach ropes to. These are designed for ease of use and for strength, as they have to handle high winds and tension, which is why we decided to rely on these as our option moving forward for lateral support adjustability which will be discussed in future sections. There were many others, but these four methods were what most of our ideation regarding adjustability conversations surrounded.

## **Requirements and Specifications**

This section covers the process of translating stakeholder needs into requirements and defining each as a set of engineering specifications that can be tested during concept evaluation.

### **Gathering Relevant Information**

Before diving into the definition of the requirements and specifications necessary for the successful completion of the postural support device design, it was necessary to determine the base stakeholder needs and collect detailed research on any relevant topics. One of the first steps was to conduct stakeholder interviews, and Jacob took the lead on this. There were interviews conducted with Bluelab, as well as Alison and Monica's physical therapists and doctors, to determine the three main needs for a postural support device design: adjustability, accessibility, and affordability. These interviews also gave us access to pictures of Alison and Monica's current postural support devices, allowing us to observe how their different levels of cerebral palsy affected their movement and seating positions. Lastly, since this is to be a medical device, we researched the codes and regulations of similar medical devices in Nicaragua and found that there were not any laws restricting our design.

## Defining Requirements and Specifications from Needs

After determining the stakeholder needs, we came up with the following seven engineering requirements listed in Table 1 below. Each requirement is translated into engineering specifications for future product testing.

**Table 1.** Overview of Project Requirements and Specifications

Requirements	Specifications
Promotes Skeletal Alignment	<ul style="list-style-type: none"> <li>→ 90°-90°-90° seating position</li> <li>→ 0° to 90° neck support</li> <li>→ 0° to 60° spine support</li> <li>→ Knee supports can be adjusted from 0° hip abduction to 15° knee abduction</li> </ul>
Adjustable	<ul style="list-style-type: none"> <li>→ Fits 4' to 5' height range</li> <li>→ Adjustable parts do not move before/after being set by the user</li> <li>→ Less than 10" wide and 14" deep</li> </ul>
Durable	<ul style="list-style-type: none"> <li>→ Last a minimum of 5 years with daily usage</li> <li>→ Requires no more than 2 common tools to maintain</li> </ul>
Stable	<ul style="list-style-type: none"> <li>→ Support a vertical 150 lb force</li> <li>→ Moves less than 0.5" in any direction under 90 lbs</li> </ul>
Lightweight	<ul style="list-style-type: none"> <li>→ Less than 30 lbs.</li> </ul>
Comfortable	<ul style="list-style-type: none"> <li>→ 12 hours of use per day with little to no pain</li> <li>→ ≤ 3 on Comparative Pain Scale</li> </ul>
Low Cost	<ul style="list-style-type: none"> <li>→ Less than \$400</li> </ul>
Manufacturable	<ul style="list-style-type: none"> <li>→ Materials must be locally sourced and waterproof</li> </ul>
Easy to Maintain	<ul style="list-style-type: none"> <li>→ Requires no more than 2 common tools to maintain</li> </ul>

Firstly, “Promote Skeletal Alignment” addresses the main goal of the project, which is alleviating symptoms of Alison and Monica’s cerebral palsy. To translate this requirement into a set of specifications, we did research on proper seating posture and spine alignment. The 90°-90°-90° seating position, seen below in Figure 3, refers to the angle between one’s hips and



legs, thighs and shins, and shins and feet (ankles) [4]. Alison and Monica are not currently at this 90°-90°-90° ideal, so the main goal is that the device should be able to support them in their process of getting there. The other specifications listed below all similarly support the healthy alignment of their bodies in their neck, spine, and hips, supported by data from Physiopedia [5].

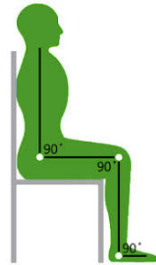

**Figure 3.** Visual representation of the 90°-90°-90° seating posture [4]

Next, to address the need for adjustability, two requirements were created: “Adjustable” and “Durable”. As adjustability requires a device that can accommodate users as they grow, the “Adjustable” requirement covers specifications that allow for a range of heights to be able to use the device. This height range is based on Alison and Monica’s current and projected sizes for the next few years, as are the width and depth measurements are given. It is also necessary for any adjustments such as bolts and screws on the device not to move after being set by the user or caretaker, as these girls may remain seated in their chairs up to this long. The “Durable” requirement relates to the adjustability need, since as Alison and Monica grow, the device should still be able to support them, and we decided on a five year period for lasting so that it could support the girls through puberty, where the biggest growth spurts generally occur [6]. Another durability factor was keeping the maintenance as easy as possible, which we quantified with requiring no more than 2 common tools to maintain.

To address the second major stakeholder need of accessibility, the requirements of “Stable”, “Lightweight”, and “Comfortable”. The first requirement allows both Alison and Monica with their different levels of cerebral palsy to safely use the device. The first specification was decided based on the girls’ average estimated weights at about 75 lbs. We took a safety factor of 2 to account for the girls’ growth and any other potential weight down on the postural device. For the second specification, we wanted to prevent as much slippage on the device, so we estimated the maximum amount of force the caretakers and girls could apply to the device.

For “Lightweight”, our main focus was addressing the different caretaking needs between Alison and Monica with their different levels of cerebral palsy. Since Monica’s mother is her main

caretaker, and Alison's grandmother is Alison's main caretaker, we needed the design to minimize the product's weight so that both women could comfortably handle the device to take care of the girls. The 30 lb value was determined through research where we found that if a woman is carrying a load at approximately elbow height, the load should not exceed 13kg, which is just about the 30 lb limit we set [7]. Since Alison's grandmother has back problems and may have more issues, we decreased the weight to 30 lb.

Finally, for the last accessibility need, this device should be "Comfortable" so that Alison and Monica can both use the device with no fear of bedsores and rashes due to low-quality materials of current devices and/or poor posture from the girls. Specification-wise, both girls stay in their chairs for an average of 12 hours a day, and so we decided on a 3 or less on the Comparative Pain Scale, where 3 is a tolerable pain, being a noticeable pain, but able to adapt to it [8].

The more obvious affordability need is covered by the "Low Cost" requirement. We decided on a budget of \$400 because we want families such as Alison and Monica's to be able to afford the device. Based on a study done on 242 Australian children with cerebral palsy, it was found that one could develop a cost average for assistive equipment based on the child's GMFCS level [9]. A level 1 child was found to spend typically close to \$780 USD, whereas children whose conditions put them within levels 4 and 5 were found to typically need upwards of \$3800 USD for their equipment. It is also important to note that this does not account for the repair or replacement of their equipment, so cost estimates are actually much higher. This is a major problem for families like Alison and Monica because while they don't have the funds to purchase the equipment, it is still extremely necessary for Alison and Monica to receive the support and assistance they need in order to improve their health and overall quality of life.

After speaking to the stakeholders and sharing our project progress with them, we also decided to add two new requirements: "Manufacturable" and "Easy to Maintain". The stakeholders were clear that any parts of our design should be able to be made locally in Nicaragua, both for cost and time, so we specified that any materials used should be locally sourced. As explained in Stakeholder Discussion, Alison also has issues communicating when she needs to use the restroom, so we specified that the device also is waterproof. "Easy to Maintain" was also added so that the device could last longer for the girls. Most households usually have a set of common

tools, so we set it as requiring a maximum of two tools for any adjustments or small fixes necessary to maintain the device.

### **Determining Importance and Assessing Requirements**

As a whole, the “Promotes Skeletal Alignment” was put at the highest relative importance. We also set “Adjustable”, “Low Cost”, and “Stable” as some of the more important requirements as well. The relative importance of the requirements and their engineering specifications were based on the main requests from our stakeholders. This was confirmed, as discussed above, through constant communication with our stakeholders and sponsors. The requirements and specifications were each checked for completeness, making sure that the requirements were all-encompassing, and that the engineering specifications were distinct and testable.

### **Concept Generation**

To begin with our concept generation, we had brainstorming sessions, both individually and as a group to come up with different solutions to parts of the design problem. This was the divergent thinking portion of our ideation process, in which we expanded outwards, thinking of multiple design solutions for our design problem.

### **Morphological Chart**

In Table 2 on the next page, one of our first steps in concept generation can be seen — the morphological chart. The 6 functions seen on the left-most column were derived from both our requirements and specifications, as well as a more recent discussion of our project goals with our stakeholders, as described in Stakeholder Discussion.

**Table 2.** Morphological chart with 6 functions and multiple feature ideas for each function

Functions				Features				
<b>Support Spine</b>	Back brace	lateral chair supports	straps (tensile support)	Springs	Elastic			
<b>Support Head/Neck</b>	Neck brace	lateral chair supports	straps (tensile support)					
<b>Able to separate knees</b>	Knee knob	Adjustable separators	Straps (tensile support)	Multiple lateral pieces (slowly add)	Crankable wedge	Malleable Metal		
<b>Relation to child (how does it attach)</b>	Directly to Child	Directly to chair	To the child and chair					
<b>Adjustable</b>	Straps	Velcro positioning	Notches (click into place)	Angle changing	Adding material	Stretches	malleable metal	
<b>Comfortable</b>	Cushioning	Gel	Memory foam	Leveled padding	Reclinability	Springs	Cloth or blanket	Bean bag

The morphological chart helped us begin to brainstorm different features for the design, with multiple ways of solving each given issue.

### Further Brainstorming

From here, we were able to continue our ideation through multiple Zoom meetings where we were able to bounce ideas off of each other and build on one another's ideas. Multiple sketches done during this period can be seen in Appendix B. The remainder of our ideas were collected in a shared Google Document, where we could all add in any of our ideas per design problem. Similarly to the morphological chart, we brainstormed ideas in 4 unique sections based on both Alison and Monica's needs for their bodies, listed here in order of importance: the head/neck, the spine, the legs, and the arms. Through group brainstorming, we were more inclined to think creatively and come up with more out-of-the-box ideas, such as seat padding supported by many small springs to encourage muscle use in the girls' backs while supporting their spinal alignment, or an exoskeleton covered in velcro to attach to a similarly velcro-covered wheelchair.

Not only did the morphological chart help us jumpstart our brainstorming process, but it also motivated us to take inspiration from the benchmarking research we had done throughout the semester to this point. A lot of what the benchmarking showed us was how adjustability highly improved the lives of the people who used certain products, as mentioned in the Benchmarking section previously. Many of our ideas were supported by this research into current solutions, as well as adjacent solutions to similar problems, such as the inclusion of a car seat-like headrest with side supports, materials that conform to the body like memory foam, or a velcro-in neck brace inspired design to support the neck.

### Ideation Techniques

Throughout this process, we incorporated concept generation strategies like the TRIZ Principles and Design Heuristics cards to expand on or improve any ideas we already had written down in our brainstorming sessions. Some examples are seen in Table 3 below.

**Table 3.** Examples of ideation techniques used in concept generation

TRIZ Principles	Design Heuristics
<b>Parameter Change:</b> modular adjustment supports for different bodily needs	<b>Slide:</b> adjustable portions of device similar to notches in a reclining pool chair
<b>Asymmetry:</b> thigh support at different heights to account for varying knee levels	<b>Visually distinguish functions:</b> different colored subsystems for ease of use
<b>Curvature:</b> malleable metal+foam to support knees	<b>Attach product to user:</b> support vest that attaches to user

The TRIZ principles allowed us to problem-solve creatively, finding benchmarked solutions or adjacent ideas and adapting them to our design solutions, such as “Curvature” inspiring us to take from current finger-splint use and adapt it to use as knee support for Alison and Monica. The Design Heuristics helped us to generate more ideas that were different from ones we had already come up with prior, leading to useful additions like “Visually distinguish functions” inspiring us to have different subsystems on our final design be colored very differently, both aiding in the ease of use and therefore accessibility of the product, and making the overall design look less imposing, as this is meant for use by Alison and Monica, two young children. Table 3 only shows a few examples of how we used these strategies to support our concept generation — we used more of them throughout our brainstorming sessions to build on current ideas or find new ways of solving the problem.

## **Concept Development**

After completing the concept generation portion of this design stage, we moved from divergent to convergent thinking in order to narrow down all of our brainstormed concepts for the subsystems into more overall concepts for the postural support device. Each team member utilized the morphological chart and unique design concepts from our divergent thinking ideation processes. The individual sketches can be seen in Appendix C. Each member's sketch description is shown below.

### **Jake's Concept**

This concept utilized a vest that would be harnessed to apply tensile force in all directions for the upper body of the child. This would be adjustable by straps allowing for continuous and constant adjustment in every direction. The headrest was inspired by the car seat headrest and adjustable by a ratchet method so that the device would be able to maintain control over the child's head. The knee separation was motivated by a finger splint. Combining malleable metal and foam to be able to roll and change in separation width and location.

### **Kate's Concept**

This concept is designed to have maximum adjustability for a child. To support the spine, a spinal bar with many notches is placed in the middle with a horizontal bar attached to it. The horizontal bar also has numerous notches to allow for the left and right support pads to be shifted anywhere on either side. A car seat-style headrest also attaches to the spinal bar and can be adjusted vertically along with it. The bottom of the device, where the child will sit, has an adjustable knee separation device to keep the child's knees from bowing in. It can be adjusted to slide along the chair to the left or right side, allowing the child to slowly correct their knee alignment.

### **Jack's Concept**

The concept is based on a car seat with a four-part harness to hold the user in the seat and prevent poor posture and slouching. Another system to support the design is two side pads that have ratchet hinges that will adjust the angle based on the needs of the user. The headrest is on a swivel that can adjust in height and angle, this would be another way to customize the seat to the user. The knee support system is a set of two independent pads that would wrap around the legs

and slide along a track that can lock into place in order to help the girls, specifically Alison, slowly get their knees in better alignment over time instead of a big adjustment in the beginning. Overall this concept was not selected for the final design because the spinal alignment system was not able to provide enough support to the girls.

### **Hana's Concept**

While conceptualizing, there was an idea to use a magnet attachment, which is embedded into the padding and can be laid on the chair. There is a vest the user puts on and velcro is stuck around the outside, thus being used to attach smaller magnets onto the user. These magnets can then be used to latch the user upright onto the chair. The neck support consists of an attachable padded device with clips and has a thin metal on the inside to adjust easily and wrap around the user's neck. The padded leg separators can expand or retract using a spring that is adjusted with a knob from the frontal part of the device. The device itself also attaches to any chair and is supported with belts and plastic clips.

### **Mai-Ly's Concept**

This concept was heavily inspired by current support wheelchairs on the market, where I drew a lot of ideas from. For spinal support, I had the foam pads on the sides, adjustable by a ratchet and attached through clamps to provide lateral support. A velcro-attached neck brace is included with straps to support the girls' heads, and foam pads attached to the chair by more velcro would keep legs elevated at different heights to accommodate different stages of cerebral palsy. Elastic bands similar to resistance bands commonly used in exercise are also included on the shins and feet area to encourage the girls to use their own muscles to slowly move their legs to the positions they should be in while still giving them the support they need. I had a more modular design in mind, where some parts like the foam pads around the legs could be used or not, as the girls have different needs due to their different levels of cerebral palsy.

### **Concept Evaluation and Selection**

To evaluate the designs that each member came up with, we created a Pugh chart. The functions that were identified for the Pugh chart were based on the requirements and specifications that were developed in Design Review 1. Each function was weighted on a 1-5 scale such that 5 was very important and 1 was not as important. We recognize that these values are incredibly

subjective, but we did our best to incorporate stakeholder feedback to rank what they asked for to be the highest. This Pugh chart can be seen below in Table 4.

**Table 4.** Pugh chart to evaluate each of the team members’ designs based on functions that were determined from the requirements and specifications for the project.

Functions	Weight	Designs				
		Jake	Kate	Jack	Hana	Mai-Ly
Spinal Alignment	5	0	0	0	-1	0
Knee Alignment	3	0	-1	1	1	-1
Neck/Head Support	5	0	0	0	1	1
Adjustable	4	0	1	0	-1	1
Durable	3	0	1	1	0	-1
Stable	4	0	-1	-1	0	0
Transferability	4	0	1	-1	0	-1
Comfortable	3	0	1	-1	-1	-1
Low Cost	4	0	1	1	-1	1
Manufacturability	2	0	1	1	0	1
<b>TOTAL</b>	<b>37</b>	<b>0</b>	<b>13</b>	<b>1</b>	<b>-8</b>	<b>2</b>

Spinal alignment, as well as head and neck support, were determined to be the most important functions to address in our design considering this is what two children with cerebral palsy need the most help with when it comes to addressing their posture. This was confirmed after speaking with our stakeholders, as they were adamant about the importance and relevance of these two functions to our project. The stakeholders also addressed our knee separation function and stated that although it should still be taken into consideration, it is less important and critical to design success than spinal alignment and head/neck support. Adjustability, stability, transferability, and low cost were deemed to be the essential functions but do not carry as much weight as the functions valued at 5 points. Stakeholders specifically identified these needs as necessary for the project to be successful in helping Alison and Monica. The remaining functions are listed at lower values because they are not crucial to the performance of the device



Each team members' design was ranked as better or worse than Jake's, whose design was set at 0 for each function. For designs that had the same functionality as Jake's, they were also scored as a 0. As can be seen in the Pugh chart, Kate's design ended up scoring the highest, so her design was chosen to modify. Her design scored lower than other team members' designs in a few categories such as knee alignment, neck/head support, and stability. We also thought there was room for improvement in spinal alignment.

This led us to develop the design in Figure 4, using Kate's design as the base. Improvements were made based on how well we thought that the design met the requirements and specifications listed prior, as well as the functions listed in the Pugh chart. To make changes in each subsystem, we took the ideas that we thought worked best from the other individual concepts and applied them where we could to the final design.

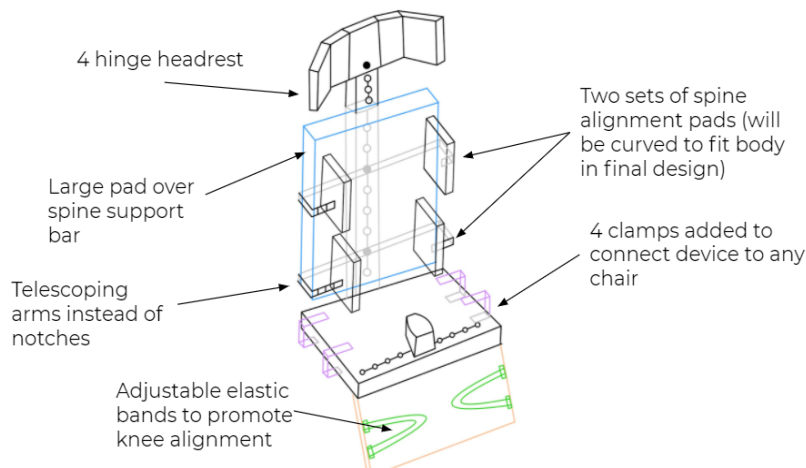

**Figure 4.** Modified design based on Kate's initial device sketch.

To improve the spinal alignment, we added another set of support pads and changed them to have telescoping arms to be better adjustable to the child. We also added a large pad to go over the spine bar for added comfort. To improve the stability of the device we added four clamps which allow for the base of the device to be securely clamped onto any chair. The headrest was modified to have more hinges so that it can bend in more directions around the child's head and neck, providing more comfortable support. Since the knee alignment of Kate's device was especially lacking, we added another piece that hinges off the seat of the chair. This piece can rest on the legs of a standard chair or can rest on the foot supports of a wheelchair. Adjustable elastic bands are placed on both sides to encourage the knees of the child to become separated.

The adjustability of these bands will ensure that the bands can be loosened or tightened to the child's current range of motion.

## CAD Design

The design from the end of Design Review 2 was taken to the project stakeholders who provided feedback that guided the next decisions in the project. This section will discuss the process of how this design was achieved and then cover an in-depth discussion of the design and its functions.

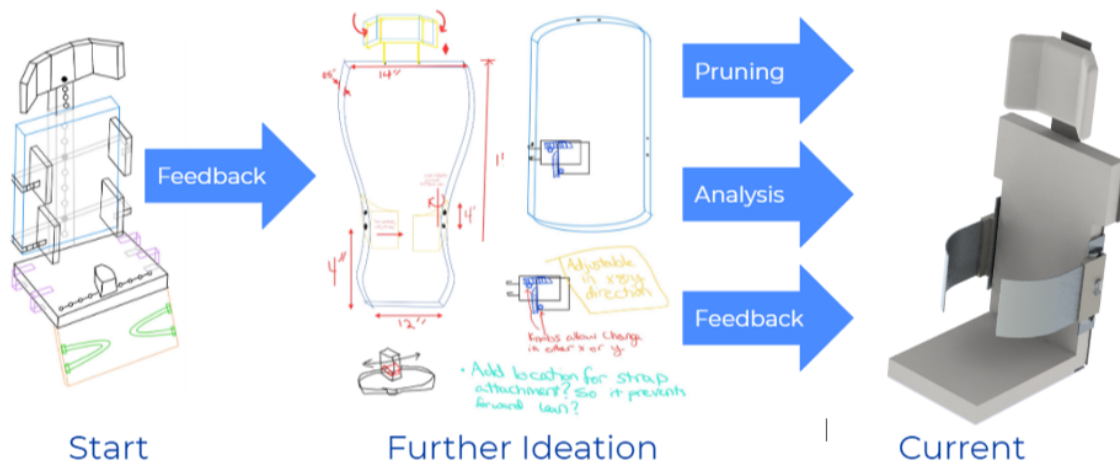

**Figure 5.** Graphic depicting the steps taken since Design Review 2 to arrive at the current design

On the left in Figure 5 above is the design from DR2. Feedback from stakeholders and the students was taken into consideration to draw up some changes that were brought back to our stakeholders. They recommended that the second set of lateral supports be removed and the structure be remodeled to no longer have the central bar that runs through the center of the back support. With their additional feedback, we began the process of fine-tuning the design and began conducting engineering analysis which led us to the final design.

## Lateral Supports

Going into a little further detail and looking at the side postural supports that are meant to promote proper skeletal alignment, we have decided on the setup shown below in Figure 6. The side supports will have a thin sheet of either plastic or aluminum sheet metal on the outside to

promote stability, and padding will be on the inside of the support to ensure that it is comfortable. The main premise is that there are two tracks on either side of the seat and there are two studs that hold the side supports in place that can be adjusted up to 6 inches as the children grow. The inspiration for the track and stud system came from the adjustability benchmarking that is discussed earlier in this paper.

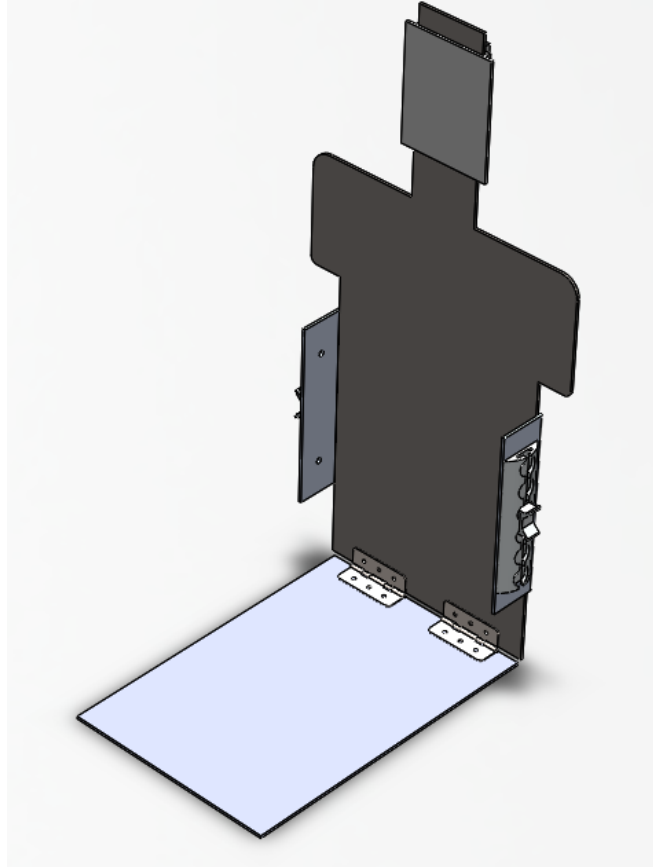

**Figure 6.** Isolated view of the lateral supports with the O-track, the studs, and the padding.

There is a button in the middle of the stud that can be pressed down to release the hold on the track and from there the piece can be adjusted. The pads can even be fully removed if needed. In terms of how the side supports will attach to the studs, we will make the side pieces with a custom cutout made from that will fit over the stud and then lock into place. The inner side of the support will have a hard plastic that runs along the side of the track to disperse force and provide stability to the support.

### **Frame and Base**

Taking a look at the overall frame in Figure 7 below, it can be seen that it is pretty simple in terms of custom parts, which should simplify the manufacturing process.

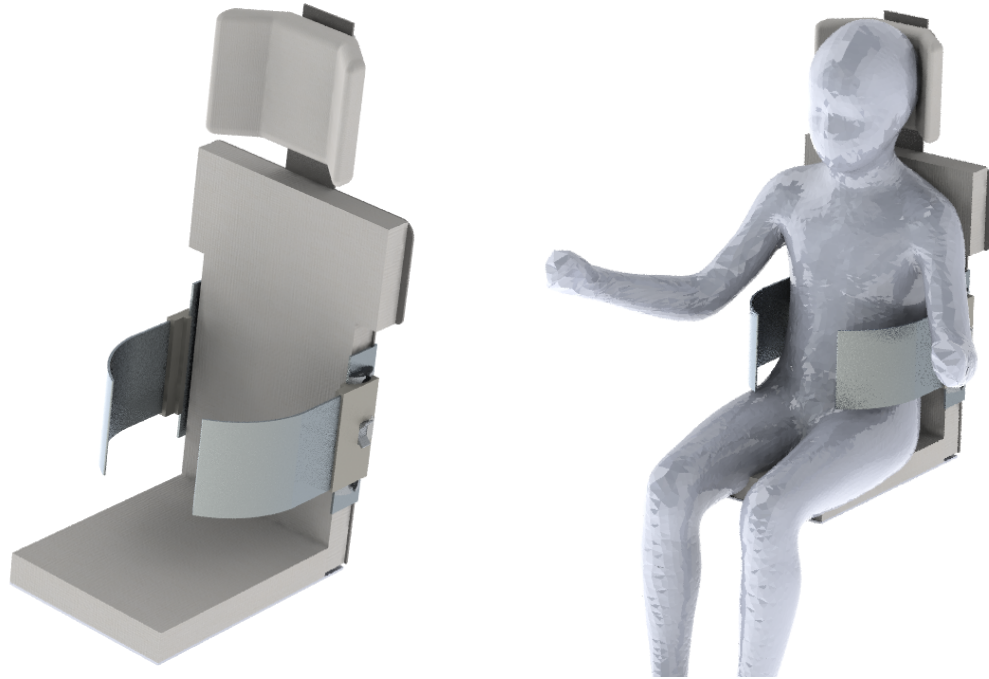

**Figure 7.** CAD Model of device frame

The dimensions of the seat are designed to fit within the size constraint of the girls' wheelchairs but will fit in any seat that is of equal or larger dimensions, which should be a wide range of seats since Monica's seat is 10' wide. The back piece will be cut out and light-weighted with the use of water jetting, which should be a low-cost process. The base will consist of a frame made of ½ inch aluminum tube stock. There is also a hinge at the base where the backing connects to the base which allows the seat to fold inward, which will aid in the transferability from one chair to another.

### **Complete Design**

The overall 3D rendering of the whole constructed piece with the waterproof padding added is shown below in Figure 8. The padding will be attached with velcro to the seat and backing and can be removed for easy cleaning as well as easy transferability. There will be a headrest that adjusts in the same fashion as the lateral supports with another custom 3D printed bracket. The device will be able to adjust in height as the children grow.



**Figure 8.** Fully constructed assembly of the postural support device. Two images depict the seat both with and without a human model.

On the right in Figure 8, there is a rendering of a person that is roughly the same height and weight as the girls to illustrate how they would fit into the seat. Not pictured in this rendering are the straps that will be used to secure the device to the external chair as well as the knee separator that will be attached near the front of the base and will keep the children's knees in the proper position to support skeletal alignment. The straps have connection points on the back and through the slotted holes in the base. The knee separator is not included at this point because the stakeholders have identified this subsystem as a lower priority but the system will be decided on in the near future.

### **Solution Development and Verification**

The static forces which impact the stability of our design will be analyzed in the following section, with a static analysis for each current subsystem of our device, including the vertical, horizontal, and headrest maximal applied forces. The verification and validation plans have been formed in order to prepare for the process of our design to undergo testing to assure it passes each requirement and specification specified by our stakeholders and our team. Lastly, any risks

the device may pose to the user have been identified and assessed to assure the device is equipped and the risks prevented.

### Engineering Analysis

Since our device is intended to be static, the main analyses that needed to be done were related to applied forces at different points. First, we looked at the seating portion of the chair in order to determine the minimum strength of the straps that connect the device to the wheelchair. The bottom of the device will be connected by two straps, with one towards the back and one towards the front to reduce the likelihood of it tipping. To analyze how it could tip, we calculated the moment when a 100-pound force is applied to the front end of the device. Both Alison and Monica weigh less than 100 pounds, and it is highly unlikely that all of their weight would be applied to just the end of the device at any time, but we used this value so that we would have a buffer in our calculations. The diagram and calculation of this analysis can be seen in Figure 9 below.

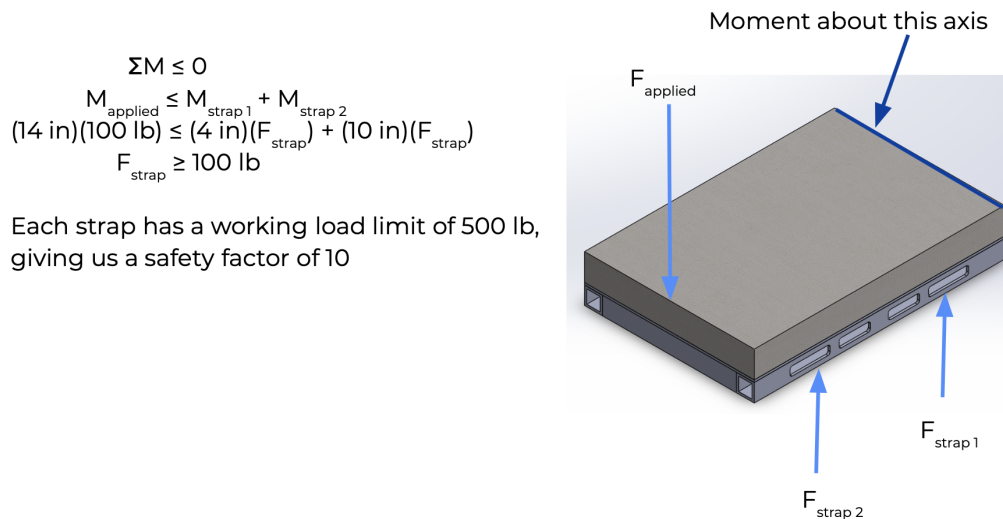

**Figure 9.** Diagram of the moment analysis on the bottom of the chair to determine minimum strap strength.

Since each of our straps have a working load limit of 500 pounds, they will be able to handle an applied force of 100 pounds at the front end such that the device does not tip along the back axis.

We did a very similar calculation for the back of the chair. The back of the chair also has two straps, one at the top and one at the bottom, and we applied a 100-pound force at the top of it to

determine the moment about the same axis. The diagram and calculation of this analysis can be seen below in Figure 10.

$$\begin{aligned} \Sigma M &\leq 0 \\ M_{\text{applied}} &\leq M_{\text{strap 1}} + M_{\text{strap 2}} \\ (19 \text{ in})(100 \text{ lb}) &\leq (4 \text{ in})(F_{\text{strap}}) + (18 \text{ in})(F_{\text{strap}}) \\ F_{\text{strap}} &\geq 86.4 \text{ lb} \end{aligned}$$

Each strap has a working load limit of 500 lb, giving us a safety factor of 10

Lateral supports have a working load limit of 1300 lbs so even if the child applies all 100 lbs of weight onto the farthest point of 9 in., it still won't break

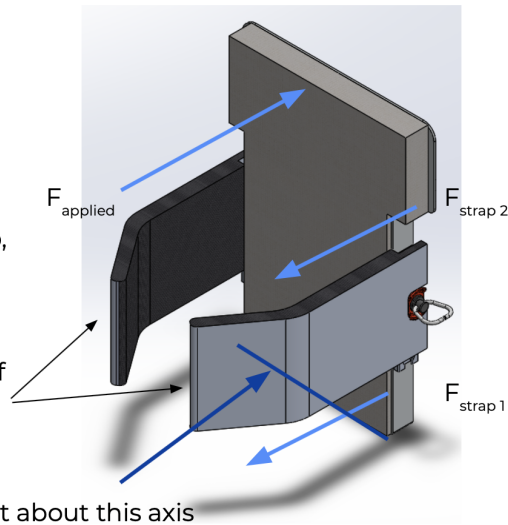

**Figure 10.** Diagram of the moment analysis on the back of the chair to determine minimum strap strength.

The lateral supports that we are interested in using for the device have a working load limit of 1,300 pounds, which we determined to be strong enough to support the child. This is because it will be able to handle a horizontal force of 100 pounds at the tip of the support, so it will easily handle the child sitting in it normally.

The last analysis that we did was on the headrest. Once again, we applied a 100-pound horizontal force, but this time it was at the top of the headrest. The aluminum rods that adjust the height of the headrest are designed to be a minimum of 2 inches deep in the chair when it is fully extended. The diagram of the loads on the headrest is shown in Figure 11 below.

$$\begin{aligned} \Sigma M &\leq 0 \\ M_{\text{applied}} &\leq M_{\text{backrest}} \\ (10 \text{ in})(100 \text{ lb}) &\leq (2 \text{ in})(F_{\text{backrest}}) \\ F_{\text{backrest}} &\geq 375 \text{ lb} \end{aligned}$$

$$\begin{aligned} \epsilon &= 1.15, \sigma = F/A = F/0.08 \text{ in}^2 \\ E &= \sigma/\epsilon \\ 10^7 \text{ psi} &= F/(0.08 \text{ in}^2)(1.15) \\ F &= 920000 \text{ lb} \end{aligned}$$

Aluminum can handle a force of 920,000 lbs which is significantly greater than 375 lb

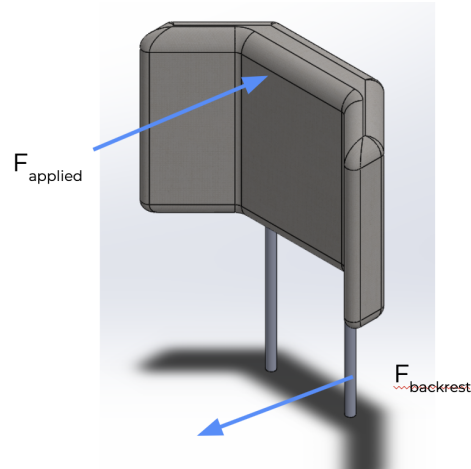

**Figure 11.** Diagram of the moment analysis on the headrest to determine the force that the aluminum is required to support.

To determine if the backrest would be able to support the necessary 375-pound force that was calculated from the moment analysis, we looked into the material properties of aluminum. As shown in Figure 11, we used the strain, Young's modulus, and the area of the aluminum rods to calculate the force that the rods would be able to support. Following the calculations, it is shown that the rods can easily handle the applied force of 100 pounds.

### Risk Assessment

In order to assure the device is completely safe for child use, we have assessed any risk associated with the device within Table 5 on the next page. The three greatest potential risks posed to the user are clip failure, sharp edges of the device base, and broken supports. These next three hazards hold the highest levels of impact upon the device and user.

Clip failure causes the user or device to detach from the chair, which may lead to the user falling out of the chair. Upon analysis, the clips were determined to withstand the load applied and the risk was then assessed within our prototype testing.

Due to the metal incorporated within our base, the risk of users hurting themselves on sharp edges poses a threat. To reduce this risk, the aluminum base has been changed to HDPE and any remaining metal parts will be sanded and burr-free.

In order to secure the connections between interfaces, an analysis was conducted to assure us that the supports are strong enough to endure forces from each of the children. Since a break in the



connection would be a crucial failure, the connections were assessed during our prototype testing and the device passed each test, validating our engineering analysis results.

In addition to these three risks, we have utilized waterproof testing and load-bearing testing to ensure neither water nor tipping will ruin the device or cause it to break in any way. The material encasing all-foam padding will be recycled nylon, making the device waterproof and eliminating risks of water absorption. Upon engineering analysis and prototype assembly, the risk of tipping was assessed and eliminated due to successful test results during prototype testing.

**Table 5:** Postural Support Device Risk Assessment

Risk/Hazard	Situation	Likelihood	Level of Impact	Performance	Necessary Action
Clip Failure	Clips fails and causes the device to detach from the chair	Unlikely	High	Disrupts the performance of the device	Engineering analysis and prototype testing with applied load to ensure clip success
Sharp Edges	User cuts and hurts herself on the sharp metal edges	Likely	High	No effect on the technical performance	Using a plastic base instead of metal, sanding any metal components
Broken Supports	Connection snaps between device interfaces	Unlikely	High	Disrupts the entire device	Engineering analysis, prototype testing, strong material within design
Water Absorption	The foam absorbs any liquid during use and ruins the material	Likely	Low	Affects the comfortability and easy to clean requirements	Nylon cover to slide over the device, such as the material used on boat seats
Tipping and Instability	The device cannot withstand load and tips over	Unlikely	Moderate	There is some technical impact during use	Performed engineering analysis and prototype load-bearing testing

### Detailed Design Solution

This section will showcase our final design and show the prototype that was created to show the proof of concept. The prototype unfortunately does not have the padding that was in the final CAD design, but the frame of the device was fully able to be built. Figures 12 through 14 show the photos from the entire build and the adjustable subsystems of the chair.



**Figure 12:** Two views of the full-frame prototype with brackets and adjustable straps.

Figure 12 above shows how the device is able to attach to a variety of different chairs. This ability to fit in many chairs satisfies the transferability requirement that was listed by stakeholders and will give the girls the ability to have more variety in their seating options while still receiving the proper support they need. The device may look small in the photos compared to the size of these chairs, but this is so that the device can fit within the confines of the girls' wheelchairs, the narrower of which has a 10-inch width.

Figure 13 on the next page shows the lateral supports that are meant to support the sides of the girls to help them sit up properly with the correct posture. As mentioned earlier, the pads are not shown in the photographs because we were not able to get them in time due to a misjudgment on the build schedule. Even though the pads are not there, the adjustability of the device was able to be tested by checking how well the O-track system was able to raise and lower the brackets.



**Figure 13:** Outer and inner view of lateral support bracket with the O-track adjustability system attached to the frame of the device.

Figure 14 below shows the adjustable straps that loop into the frame of the device and clip in the back of the seat, and an identical strap is attached to the base of the seat to make sure it stays fixed onto the chair and does not come undone unless it is taken off by a caretaker. This was an important feature that is mentioned in the requirements as well as the risk assessment portion of this report.

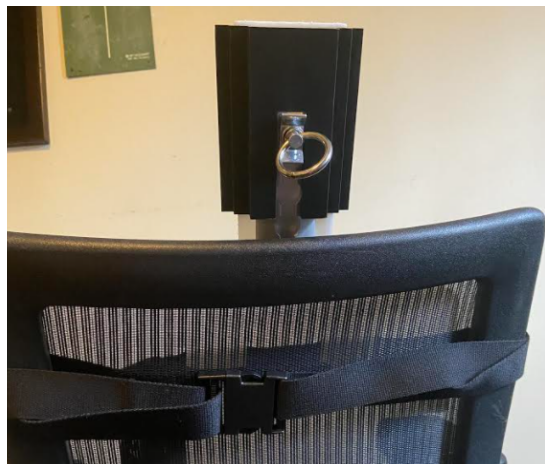



**Figure 14:** View of the back of the device, showing the O-track sliding headrest attachment as well as the buckle for the adjustable straps for attaching the device to chairs.

This image also displays the headrest adjustability system which uses the same O-track method as the lateral supports but has a different custom 3D printed bracket to mount it to the headrest.

### **Verification Plan**

To begin the steps to verification on our project, we checked back through our engineering specifications to see how they aligned with the stakeholder requirements given to us at the beginning of the project. After continual meetings with the stakeholders, they agreed with us that we are on track to meet that goal, so we have continued on to come up with verification plans for each of our requirements and specifications. Again, the requirements and specifications needing verification are all listed in Table 1 of the report.

The “Promote Skeletal Alignment” requirement will be verified through the CAD model, as the specifications noted specific angle values for us to conform to which can be measured through SolidWorks. For the “Adjustable” requirement, we will also use CAD, along with physical prototyping to further verify that we meet the specifications, especially with the “adjustable parts do not move before/after being set by the user” specification. “Durable” will be verified through physical prototyping as well so we can see how the materials and articulating parts work together. During the engineering analysis, the specifications for the “Stable” requirement were confirmed, and further verification will be conducted during prototype testing. The CAD model in SolidWorks will calculate a final weight estimate based on our chosen materials which will be used to verify the design requirement of “Lightweight”.

Manual pressure test	
A	 <p>Explain to the wheelchair user what you are going to do, and why it is important.</p>
B	 <p>Ask the wheelchair user to push up or lean forward to allow you to place your fingertips under their left or right seat bone (palm up). This is best done from behind the wheelchair by reaching under the back upholstery with one hand.</p>
C	 <p>Ask the wheelchair user to sit back down on your fingers. They should sit normally, face forward, and place their hands on their thighs. This will ensure that they sit in the same position each time you move to check another location. If your fingers are not in a good position to feel the pressure under the seat bone, then ask the user to push up again and reposition your fingers.</p>
D	<p>Identify the pressure under the first seat bone as either level 1, 2, or 3: <b>Level 1 = safe:</b> Fingertips can wriggle up and down 5 mm or more. <b>Level 2 = warning:</b> Fingertips cannot wriggle, but can easily slide out. <b>Level 3 = unsafe:</b> Fingertips are squeezed firmly. It is difficult to slide fingers out.</p>
E	<p>Repeat under the second seat bone.</p>

**Figure 12.** Steps explained for the Manual Pressure Test

The Manual Pressure Test, seen in Figure 12 above, will be used to test the cushioning on our device, along with the Comparative Pain Scale used in physical prototype testing to verify the “Comfortable” requirement. The finalized bill of materials with the prices for each part will verify our final costs to be under the \$400 limit for the “Low Cost” requirement, and since the “Manufacturable” requirement states that materials must all be locally sourced in Nicaragua and waterproof, checking in with the stakeholders about resources available and conducting waterproof testing of the materials will aid the verification process. Lastly, the adjustment points and methods will be precisely handled with our physical prototype to assure that no more than 2 common tools are necessary for the “Maintenance” requirement.

### Validation Plan

In terms of validation, we hope to check in with three main groups of people: our stakeholders, medical experts, and the girls, Alison and Monica. Our primary stakeholders (Bluelab, Salud Para Todos Los Niños, and FNE) will be contacted to see their thoughts on the design prior to prototyping. We also need to reach out to medical experts, such as the girls’ physical therapists, to gauge the success of our design decisions in alleviating the girls’ cerebral palsy symptoms. We

have found a contact who started an adaptive sports club with cerebral palsy that helps customize wheelchairs for others with cerebral palsy. Lastly, the most important group to check in with is Alison and Monica, as they are the people we are designing this device for. If we get the chance, we aim to send a physical prototype down to Nicaragua so we can see how Alison and Monica respond to our design.

## **Discussion and Recommendations**

Overall, this iteration of our design has many strengths and meets a majority of our requirements and specifications, but the device does have some weaknesses as well. This section will cover those strengths and weaknesses, and also discuss what should be done differently if this project were to be repeated. To judge success, we will be referring to the project specifications and requirements.

The first requirement is promoting skeletal alignment, and the specifications for this requirement include the 90-90-90 seating position, 0-90 neck support, and 0-60 spine support. We originally had another specification for the proper knee alignment but our stakeholders told us it was not necessary. For the most part, the 90-90-90 seating position is promoted, but this does require the device to be installed properly onto the seat. We were not able to test the 0-90 neck support because we did not have the padding for the headrest. Lastly, the specification for 0-60 spine support was found to be met.

The next requirement to discuss is adjustability and the specifications that accompany it. The specifications state that the seat should work for children in the 4-5 ft height range, the adjustable parts should not move once set in place by the user or caregiver, and the seat needs to be less than 10" wide and 14" deep so that it can fit in a wide variety of chairs. Based on the estimations of body proportions and the 6" of adjustability we have designed into the device for both the headrest and the lateral supports, we have determined that the specification is met. As for the specification of not moving once the piece is set, we did find that once the height is set on the lateral supports, there is about a quarter-inch of vertical movement that the pads can be shifted. This movement is a result of the O-track system and the tolerance of the stud that attaches to the track. Luckily, the bracket is not loose because of the design of the custom 3D printed bracket which keeps the piece in proper alignment.

The durability requirement has the specifications that the device should be able to last 5 years, and it should require no more than 2 tools to maintain. There is no way to confirm the 5-year lifespan at this current time but based on our choice of material, we believe that the device should be able to withstand wear and tear over a long period of time. The only point where there is any major concern would be the narrow point in the frame where the bracket for the headrest slides on. As for maintenance, we built the frame so that it can be maintained with a regular Phillips-head screwdriver and any common wrench, which means that this specification has been met.

The next requirement is stability, and the specifications for it are that it needs to support a vertical 150lb force, and it needs to move less than 0.5” in any direction with a force of 90 lbs. Our force analysis shows that the device will withstand these forces and therefore will be able to fully meet these specifications.

Weight is the next requirement that the stakeholders stressed the importance of because the device needs to be moved over long distances. The specification for this requirement is that the device must be under 30 lbs. We do not know the exact weight of the final product since we do not have our padding, but the weight of the frame by itself weighs 12.3 lbs, and we know that the frame weighs more than the foam padding we had planned to use. Therefore we can reasonably conclude that the device will meet this specification.

The next requirement is the comfortability of the device, and the specification is that the child can use the device and can use the seat for 12 hours a day and have no more than a 3 on the comparative pain scale. This specification was not able to be tested since we did not have the pads, and the device was designed for a child meaning it is too small for any of us to sit in the seat even if we did.

The low-cost requirement had a specification that the device cost no more than \$400. This specification was easily met. We were able to build the device for \$177, and we estimate that with the cost of padding, the device will still come out to around \$200.

The final requirement states that the device needs to be easily manufactured using materials that are accessible in Nicaragua. We were able to use materials that are easy to come by and will be accessible to those who would maintain the device. As for the manufacturing, the frame was cut out by using a laser cutter because of the convenience and the fact that we only needed to make one device. If the seat needed to be manufactured in a more accessible way, it is entirely possible that the pieces of the frame could be cut out with a number of electric saws, or if it needed to be mass-manufactured, the pieces could be injection molded.

## **Recommendations**

The first recommendation that we would have for the device would be to swap the hinge system at the base with one that can lock at the 90-degree angle instead of depending on the chair the child is going to be sitting in. This would make it so the device will always promote the 90-90-90 seating position. The next recommendation we would have is to replace the O-track with another system if the quarter-inch of height variance is deemed too much. We would also recommend reinforcing the base of the narrow portion of the frame where the headrest attaches so that it doesn't get worn down over time. This could be done in a number of ways, but we believe that using a thicker sheet of HDPE (such as 0.25" instead of 0.125") throughout the whole frame would help the stability of the whole device and would also help to increase the durability. Another option would be to only reinforce the neck portion using a sturdy material such as a lightweight metal like aluminum. We would also recommend purchasing and installing the padding for the seat in order to conduct the testing that we were unable to accomplish.

As for manufacturing, our recommendation is to potentially switch to a more easily accessible option in Nicaragua. Though the laser cutter worked impressively well, for this project to be as accessible as possible, the use of common and available machinery should be considered with great importance. This said, potentially switching from our HDPE, one could theoretically use the dimensions and part drawings to create the design with easily accessible plywood. Using a simple jigsaw, one could even quickly make design adjustments and form the design to meet the requirements of a specific chair. This would likely allow for the device to be more accessible and sustainable for local communities.



## **Sustainable Design Assessment**

The environmental context assessment of our postural support device has been provided within Appendix G, following by a social context assessment of the device within Appendix H. Upon reflection, our design has been determined sustainable based on the environmental, social, and cost assessment results.

## **Ethics and Professional Responsibility**

All ethical considerations and professional responsibility has been outlined within Appendix I. The ethical model context assessment has been taken into consideration while outlining the ethical considerations taken.

Our team has upheld ASME Code of Ethics and abided by The Michigan Engineering Honor Code throughout the entire design process.

## **Conclusion**

In summary, this paper identifies the problem of Alison and Monica's need for a postural support device that will help manage the side effects that occur with cerebral palsy. The stakeholders are identified and the problem statement is defined around the three requests that the device should be adjustable, accessible, and affordable. The three requests were analyzed and used to produce the requirements and specifications of the device which are all defined in Table 1. Our methods for concept exploration are outlined, and the final design concept is defined and justified through the use of various design strategies such as Design Heuristics and TRIZ. The CAD model for the device as well as the bill of materials for our parts and prices of the final design have been developed. The finer details of the design are under construction and the final CAD model will resemble a more natural figure that attracts the user to the device. The individual parts were acquired and we have assembled a prototype of our design, which has aided us during the verification and validation processes. Overall the project has been successful and effective with generating an effective final product that will help Alison and Monica with their posture.

## **Authors**

### **Jacob Applegate**

This will be my last undergraduate semester at the University of Michigan and I will be graduating in May with a degree in Mechanical Engineering and a minor in entrepreneurship through the College of Engineering Honors Program. I am a member of Bluelab Nicaragua which led me to propose and sponsor this project. Next year I will be pursuing my Master's degree in Systems Engineering and Design.

### **Jack Campau**

I am a senior in the last semester of my undergraduate degree in Mechanical Engineering with a minor in entrepreneurship. I am returning in the Fall to get a Master's degree in systems engineering and design. I am currently working at the Global Design Laboratory at the University of Michigan.

### **Kate Froling**

I am a senior graduating with an undergraduate degree in Mechanical Engineering and a minor in the environment at the end of the semester. I will be pursuing my graduate degree in Systems Engineering + Design through ISD next year.

### **Hana Grebovic**

As I am finishing my last semester at the University of Michigan, I will be acquiring a B.S.E. in Mechanical Engineering and a minor in Bosnian/Croatian/Serbian. My career following graduation will begin in Pontiac, MI. with the Amazon Operations team, while I further my education by pursuing an MBA.

### **Mai-Ly Tran**

I am a senior graduating at the end of this semester with an undergraduate Mechanical Engineering degree at the University of Michigan with the International Minor for Engineers. I am currently working at the Maize and Blue Cupboard, the food pantry on campus for UM students, faculty, and staff. After graduation, I am excited to be starting my career at Epic Systems as a Technical Solutions Engineer in Madison, WI.

## **Acknowledgments**

We are very grateful to have had the support of Bluelab Nicaragua for giving us this opportunity to contribute to the project that they started to help out Alison and Monica. Their support as one of our main stakeholders throughout the process has really helped us do the best job we can to create a design to help improve the girls' cerebral palsy.

Our team would like to thank our sponsors FNE, Salud Para Todos Los Niños, and Bluelab Nicaragua. Their involvement, feedback, and support throughout the project have made the design process very efficient and effective. Their faith in us to create this device is an honor, and working on such an influential project has been extremely rewarding.

We would also like to give a big thanks to Professor Steven Skerlos for his guidance and enthusiasm this semester. Every discussion we had in our weekly meetings was beneficial to keeping us on track not just in the class itself, but also the project as a whole. He always encouraged us to take one step further in our work, which helped us go a lot further in the design process and analysis.

## References

- [1] Alliance, C. (n.d.). Gross motor Function classification SYSTEM (GMFCS). Retrieved February 09, 2021, from <https://cerebralpalsy.org.au/our-research/about-cerebral-palsy/what-is-cerebral-palsy/severity-of-cerebral-palsy/gross-motor-function-classification-system/>
- [2] What is cerebral palsy? (2020, September 11). Retrieved February 09, 2021, from [https://www.cdc.gov/ncbddd/cp/facts.html#:~:text=Cerebral%20palsy%20\(CP\)%20is%20a,problems%20with%20using%20the%20muscles](https://www.cdc.gov/ncbddd/cp/facts.html#:~:text=Cerebral%20palsy%20(CP)%20is%20a,problems%20with%20using%20the%20muscles)
- [3] Nicaragua: 2020/21 average salary survey. (n.d.). Retrieved February 08, 2021, from [https://www.averagesalariesurvey.com/nicaragua#:~:text=NICARAGUA%20SALARY&text=Averag%20salary%20in%20Nicaragua%20is,is%20NIO%20190%2C984%20\(Gross\)](https://www.averagesalariesurvey.com/nicaragua#:~:text=NICARAGUA%20SALARY&text=Averag%20salary%20in%20Nicaragua%20is,is%20NIO%20190%2C984%20(Gross))
- [4] Sitting techniques: The 90° Rule: NorthEast spine and sports medicine. (2016, May 19). Retrieved February 09, 2021, from <https://www.northeastspineandsports.com/sitting-techniques-using-90o-rule/>
- [5] Positioning the child with cerebral palsy. (n.d.). Retrieved February 09, 2021, from [https://www.physio-pedia.com/Positioning\\_the\\_Child\\_with\\_Cerebral\\_Palsy](https://www.physio-pedia.com/Positioning_the_Child_with_Cerebral_Palsy)
- [6] Gavin, M. (Ed.). (2019, June). Growth and Your 13- TO 18-year-old (for parents) - NEMOURS KidsHealth. Retrieved February 09, 2021, from <https://kidshealth.org/en/parents/growth-13-to-18.html#:~:text=There's%20a%20very%20broad%20range,ages%20of%2010%20and%2014>
- [7] Burton, L. (2020, December 17). Do you know your manual handling weight limits? Retrieved February 09, 2021, from <https://www.highspeedtraining.co.uk/hub/manual-handling-weight-limits/>
- [8] Comparative pain scale. (2017, February 02). Retrieved February 09, 2021, from <https://www.chronicpainpartners.com/comparative-pain-scale/>
- [9] Novak I, Hines M, Goldsmith S, Barclay R. Clinical prognostic messages from a systematic review on cerebral palsy. *Pediatrics*. 2012 Nov;130(5):e1285-312. DOI: 10.1542/peds.2012-0924. Epub 2012 Oct 8. PMID: 23045562.
- [10] Mind Tools. (2020, March 05). SCAMPER: Improving products and services. Retrieved February 09, 2021, from [https://www.mindtools.com/pages/article/newCT\\_02.htm](https://www.mindtools.com/pages/article/newCT_02.htm)

[11] Mindtools. TRIZ: A Powerful Methodology for Creative Problem Solving. Retrieved February 09, 2021, from [www.mindtools.com/pages/article/newCT\\_92.htm](http://www.mindtools.com/pages/article/newCT_92.htm)

[12] “Quantum Q6 Edge Electric Powerchair.” *eBay*, [www.ebay.com/itm/Quantum-Q6-Edge-Electric-Powerchair/261755854587?\\_trkparms=aid%3D1110006%26algo%3DHOMESPLICE.SIM%26ao%3D1%26asc%3D231204%26meid%3D116d4728747840e7966ea7e621a10e2e%26pid%3D100010%26rk%3D12%26rkt%3D12%26sd%3D392987566074%26itm%3D261755854587%26pmt%3D0%26noa%3D1%26pg%3D2047675%26algv%3DDefaultOrganic%26brand%3DQuantum&\\_trksid=p2047675.c100010.m2109](http://www.ebay.com/itm/Quantum-Q6-Edge-Electric-Powerchair/261755854587?_trkparms=aid%3D1110006%26algo%3DHOMESPLICE.SIM%26ao%3D1%26asc%3D231204%26meid%3D116d4728747840e7966ea7e621a10e2e%26pid%3D100010%26rk%3D12%26rkt%3D12%26sd%3D392987566074%26itm%3D261755854587%26pmt%3D0%26noa%3D1%26pg%3D2047675%26algv%3DDefaultOrganic%26brand%3DQuantum&_trksid=p2047675.c100010.m2109).

[13] American Society of Mechanical Engineers. (2012). Code of Ethics of Engineers. <https://www.asme.org/wwwasmeorg/media/resourcefiles/aboutasme/get%20involved/advocacy/policy-publications/p-15-7-ethics.pdf>

[14] Michigan Engineering Honor Code Pamphlet. (2018). Retrieved from <http://elc.engin.umich.edu/wp-content/uploads/sites/19/2019/03/Honor-Code-Pamphlet-2018.pdf>

## Appendix A: Gantt Chart

<b>2 Concept Generation Phase (Design Review 2)</b>						
<b>2.1 Concept Exploration</b>						
2.12	Come up with plethora of solution options and unique concepts	All	2/8/21	2/15/21	8	100%
2.121	Use concept techniques such as SCAMPER, TRIZ, Design Heuristics, and general brainstorming	All	2/8/21	2/15/21	8	100%
2.122	Use morphological chart	All	2/9/21	2/19/21	11	100%
2.13	Use pruning methods to narrow down options	Kate, Hana	2/15/21	2/18/21	4	100%
2.14	Attempt to merge multiple ideas or concepts using best aspects of each	All	2/17/21	2/20/21	4	100%
2.15	Determine best concept/alpha design through evaluation/rapid prototyping	All	2/17/21	2/19/21	3	100%
2.151	Design a pugh chart	Jake	2/17/21	2/19/21	3	100%
2.152	Evaluate solutions in accordance to requirements and specifications	All	2/17/21	2/19/21	3	100%
<b>2.2 Utilize Feedback, Research, and Reflection</b>						
2.22	Re-evaluate all necessary information from stakeholders and research	Jake, Jack	2/18/21	2/19/21	2	100%
2.23	Iterate and reflect upon alpha design	All	2/18/21	2/19/21	2	100%
2.24	Complete mechanical analysis of top design options	Mai-Ly, Jake	2/19/21	2/22/21	4	100%
2.25	Speak with medical professionals (preferably with knowledge in cerebral palsy) regarding our design	Jake, Kate	2/19/21	2/22/21	4	100%
2.26	Assess design in accordance to sustainability and ethics	Jack	2/19/21	2/22/21	4	100%
2.27	Gather evidence to ensure that the top option is best and would fulfill requirements and specifications	Kate, Mai-Ly, Hana	2/22/21	2/22/21	1	100%
<b>2.3 Validate Project Plan For Future</b>						
2.31	Create Design Review 2 Presentation	All	2/20/21	2/23/21	4	100%
2.32	Write Design Report 2	All	2/22/21	2/25/21	4	100%
2.33	Teammate Assessments	All	2/18/21	2/26/21	9	100%
2.34	Design Report 3 Schedule/Gantt Adjustments	Jake, Hana, Mai-Ly	2/23/21	2/25/21	3	100%

Figure A-1: Design Review 1 Gantt Chart

<b>3 Solutions(Design Review 3)</b>						
<b>3.1 CAD Model Creation and Analysis</b>						
3.11	Fully planned design solution	All	2/23/21	3/8/21	14	100%
3.111	Create CAD model, manufacturing plan, engineering drawings, and any other necessary plans	Mai-Ly, Kate, Hana	3/8/21	3/16/21	9	100%
3.12	Analysis of design (Determine the success of our design based on calculatable values)	Jake, Jack	3/12/21	3/16/21	5	100%
3.13	Verify design success	All	3/15/21	3/15/21	1	100%
<b>3.2 Added Assessments and Tests</b>						
3.21	Address FNE/SPTLN/BLN	Kate	3/4/21	3/4/21	1	100%
3.22	Iterate and evaluate feedback from FNE/SPTLN/BLN	Jack	3/5/21	3/8/21	4	100%
3.23	Potential Prototype Testing	All	3/12/21	3/15/21	4	50%
3.24	Assess design in accordance to sustainability and ethics	Hana, Jake	3/12/21	3/15/21	4	100%
<b>3.3 Validate Project Plan For Future</b>						
3.31	Add any necessary adjustments to Gantt chart	Hana	2/24/21	3/16/21	21	100%
3.32	Create Design Review 3 Presentation	All	3/12/21	3/16/21	5	100%
3.33	Write Design Report 3	All	3/17/21	3/22/21	5	100%
3.34	Teammate Assessments	All	3/16/21	3/22/21	6	100%
3.35	Evaluate potentiality of sending device down to Alison and Monica for observation (likely after course ends)	All	3/19/21	3/22/21	4	25%

Figure A-2: Design Review 2 Gantt Chart

<b>4 Final Design Expo/Communication</b>						
<b>4.1 Technical Content Input</b>						
4.11	Show detailed mapping of our solution from start to finish	Jake, Jack	3/25/21	4/2/21	9	40%
4.12	Show how we utilized design process to develop solution for Alison and Monica	Hana, Kate	3/29/21	4/2/21	5	0%
4.13	Description of features and functions of solution	Mai-Ly	3/29/21	4/2/21	5	0%
4.131	Final design justification	Jack, Hana	3/31/21	4/5/21	6	0%
<b>4.2 Design Prototype/Verification</b>						
4.21	Evidence of appropriate design solution for the given problem	Kate	4/2/21	4/6/21	5	0%
4.22	Evidence of verification to requirements and specifications	Jake, Jack	4/5/21	4/8/21	4	0%
4.23	Begin preparation for design expo	All	4/8/21	4/20/21		0%
<b>4.3 Design Expo</b>						
4.31	Create final presentation	All	4/9/21	4/15/21	7	0%
4.32	Write final design expo report	All	4/13/21	4/19/21	7	0%
4.33	Supplemental appendix sections	Kate, Mai-Ly	4/16/21	4/20/21	5	50%
4.33	Final budget and expenses report	Jake, Hana	4/16/21	4/20/21	5	30%

**Figure A-3: Design Review 3 Gantt Chart**

## Appendix B: Brainstorming and Ideation Sketches

Idea 1: strapped/harness vest/wearable

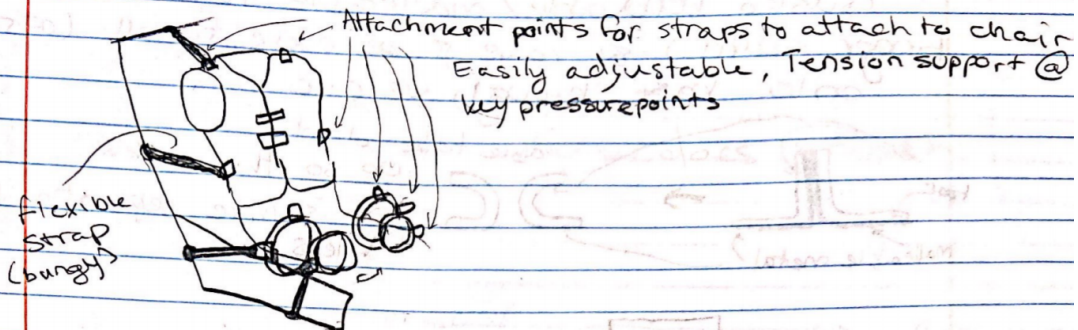

Idea 2: Spring support

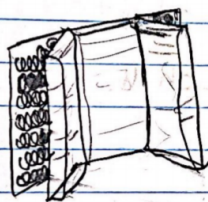

Would ideally promote proper posture while not forcing the child's position out of balance fully

Idea 3: Velcro-Exoskeleton

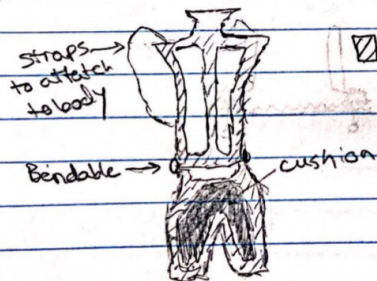

☑ = velcro

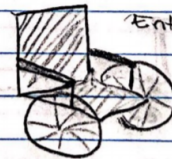

for position flexibility

Appendix B-1: Ideation sketches for spinal support



## Knee Separation

↳ using bendable/malleable metal (like my finger splint) & have it be able to roll (attached onto base through velcro

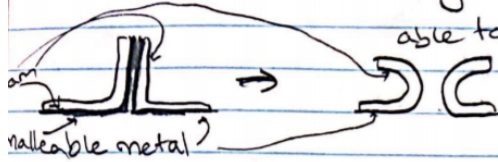

able to be rolled up so that it is more separation between knees



able to adjust horizontally so it can start at any point like for how Alison is far on the right side of the chair

Same can work for back!



able to roll up & be molded to the child.



Appendix B-2: Ideation sketches on knee support

- replaces chair ①
- attached to chair(s) ②
- attached to girls ③



- 3 separate parts to attach to different types of chairs
- belt to hold in place
  - snap-on parts
  - all easily moveable/adjustable using a notch/valve

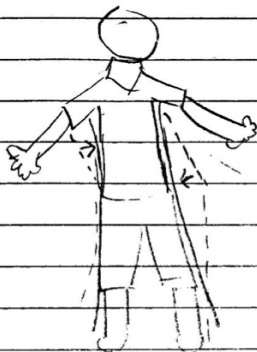

- while laying in bed
- memory foam interior?
- to comfort for sleep
- remote adjustable to alignment?
- what could actual design entail?

2 parts? / layers

all separate parts to serve purpose for each AWON MANILA

can be used in all chairs and laying down.

Appendix B-3: Ideation sketches on spinal support with ideation techniques

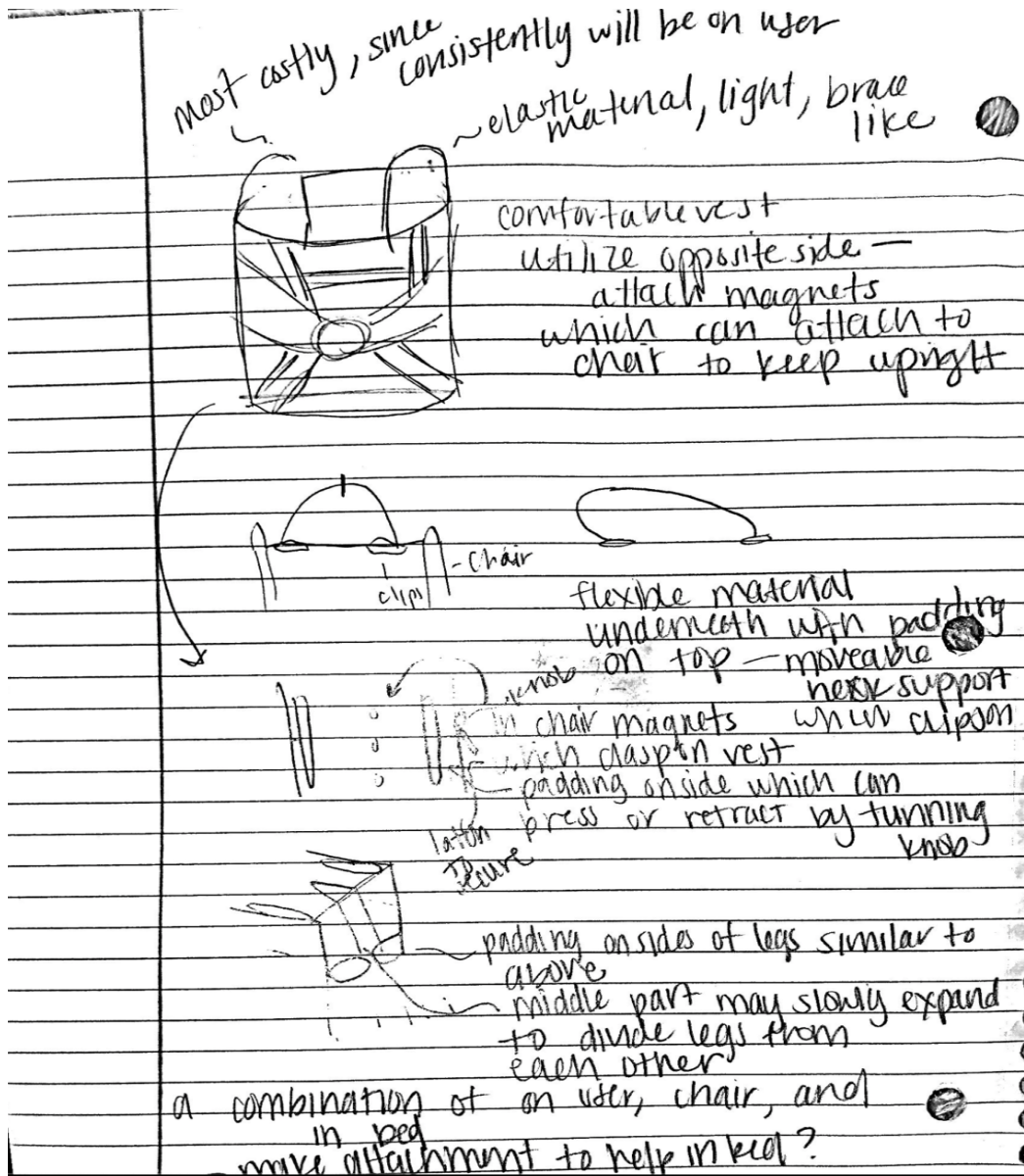

Appendix B-4: Ideation sketches on neck support

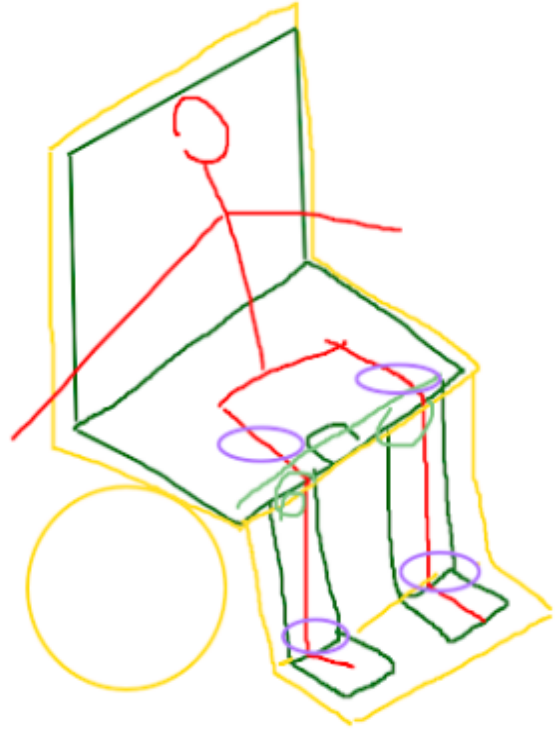
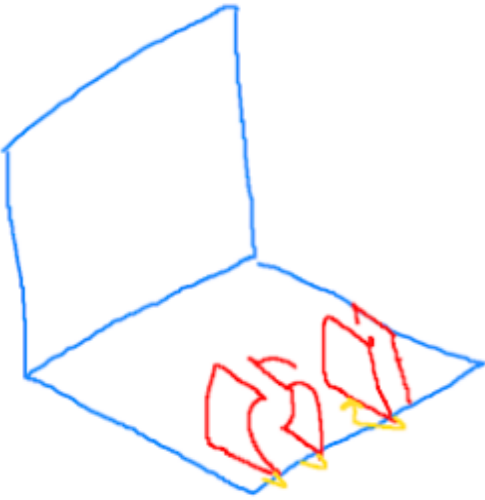

**Appendix B-3:** Ideation sketches over Zoom whiteboard for combining concepts

## Appendix C: Independent Concepts

Functions	Jake
Support spine	Vest that can attach to child with straps to different locations on the chair
Support head/neck	Ratchet pads that can be velcroed onto chair. "wings" are curved at bottom to better support head
Able to separate knees	Malleable metal + foam roll-up
Relation to child (how does it attach)	vest to child, rest to chair
Adjustable (everything should start from worst position to best)	through straps as well as ratchet and rolling
Comfortable	foam/comfy vest

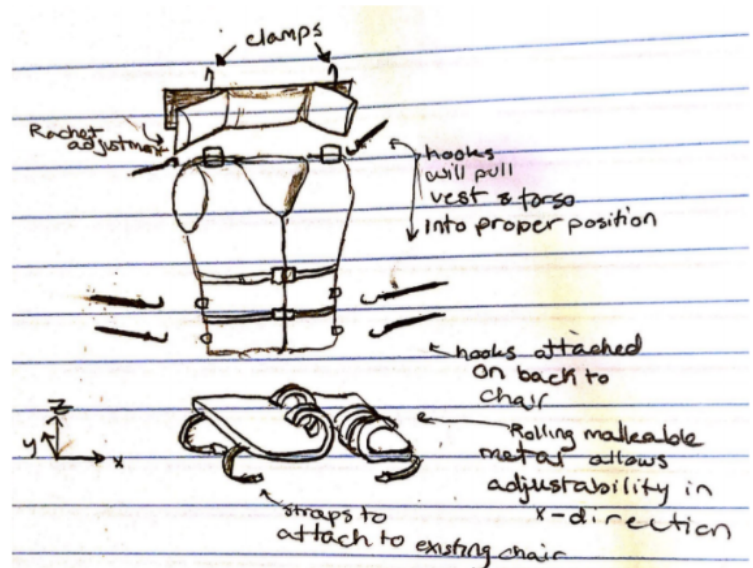

### Appendix C-1: Jake's Concept

Functions	Kate
Support spine	piece along ideal center spine with "branches" off of it that have side support. could lock in place at small intervals for adjustment
Support head/neck	carseat headrest style
Able to separate knees	adjustable width and depth oval shaped piece
Relation to child (how does it attach)	free standing but can sit in chair
Adjustable (everything should start from worst position to best)	small interval holes
Comfortable	3d printed or metal with foam cushioning on it

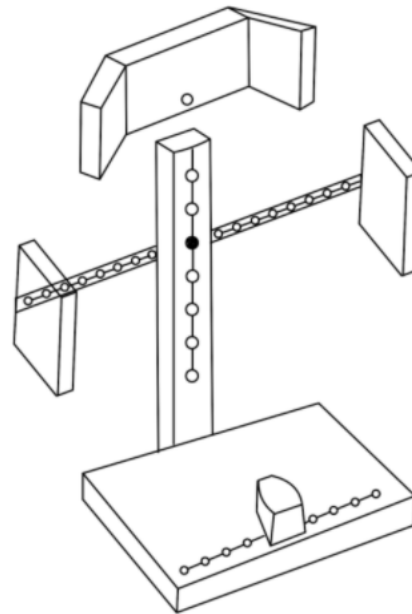

### Appendix C-2: Kate's Concept



Functions	Jack
Support spine	4 point harness to prevent slouching and side supports with ratcheting hinges to change the angles as needed
Support head/neck	Swiveling head rest with adjustable height
Able to separate knees	Sliding Track
Relation to child (how does it attach)	Clips onto chair with buckles on back of seat
Adjustable (everything should start from worst position to best)	Adjustable straps
Comfortable	foam cushioning

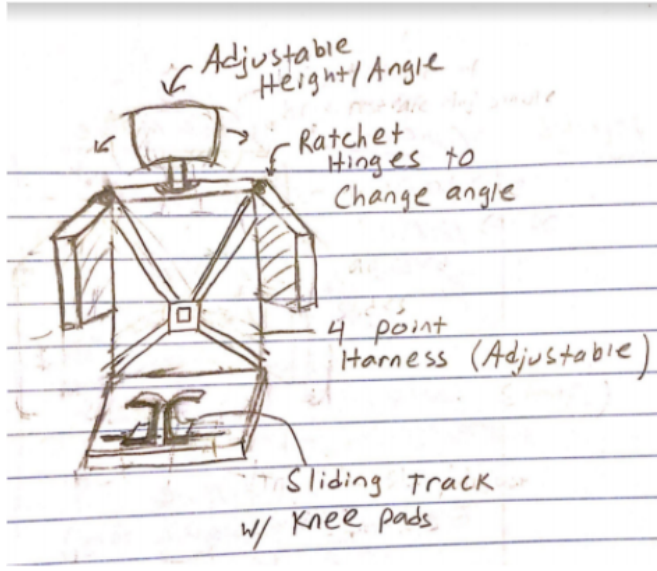

Appendix C-3: Jack's Concept

Functions	Hana
Support spine	Vest with magnets on the inside, where they can attach to the magnets implemented in or on the chair. The vest can be attached, tightened, released, using a belt.
Support head/neck	2 ideas: 1. Clamps to chair, padded material with inside metal that can bend easily to adjust to any head angle. 2. Attaches to vest, where it acts like a hat/stroller shade, so it can retract and be set up with just a pull.
Able to separate knees	clips on to chair and acts as a divider with a spring between which can be tightened or loosened with a knob.
Relation to child (how does it attach)	Vest is on the person but also can attach to chair, combines both
Adjustable (everything should start from worst position to best)	Extremely adjustable, the device either physically can be moved without tools, with a knob, or by moving the magnets on the chair
Comfortable	Memory foam pads to cushion legs and neck, firm but comfortable vest material

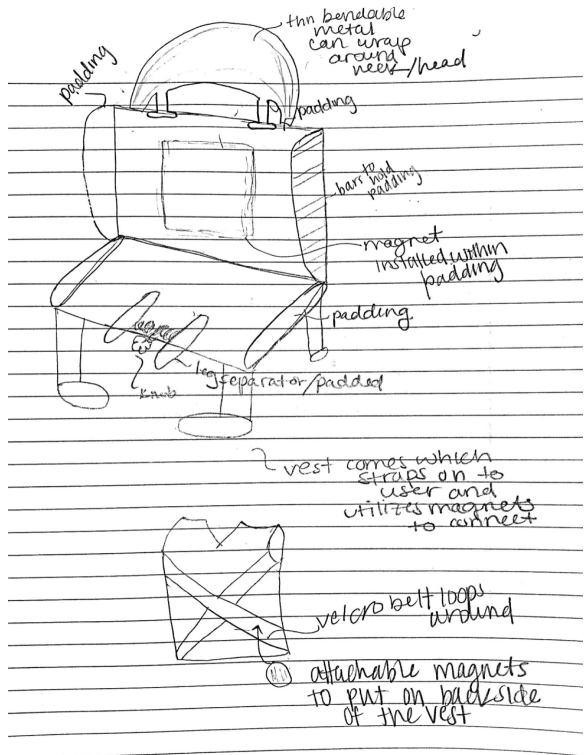

Appendix C-4: Hana's Concept

<b>Functions</b>	Mai-Ly
<b>Support spine</b>	Lateral support pads
<b>Support head/neck</b>	neck brace-like support
<b>Able to separate knees</b>	foam pads around the thighs to keep legs apart; adjustable pad inserts to go underneath thighs
<b>Relation to child (how does it attach)</b>	Attach to chair (velcro, straps, etc)
<b>Adjustable (everything should start from worst position to best)</b>	adjustable bands (similar to resistance bands for exercise) for shins and ankles
<b>Comfortable</b>	mostly firmer foam materials across the board

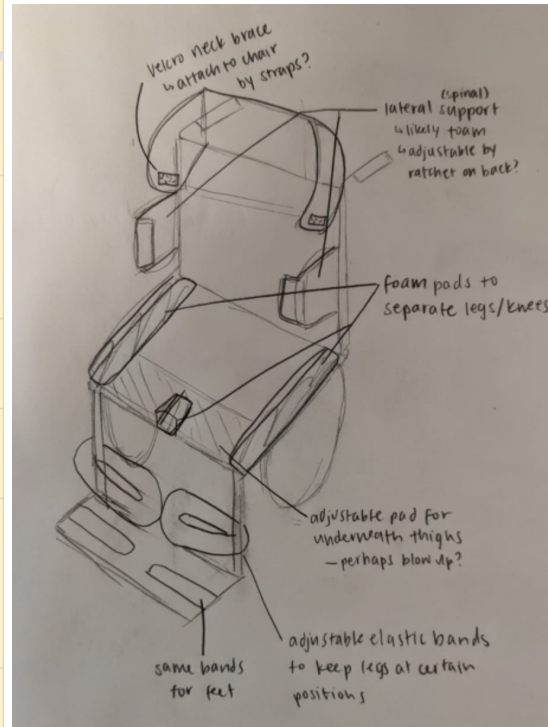

### Appendix C-5: Mai-Ly's Concept

## Appendix D: Bill of Materials

Part #	Part Title	Material	Dimension	Supplier	Quantity	Price	Total Cost
1	Back and Base Support Frame	1/8" Thick HDPE	24"x48"	Paragon Plastics	1	\$37.09	\$37.09
2	O-Track	Aluminum	12"x1"	Keeper	2	\$13.99	\$27.98
3	O-Track Single Stud	Aluminum, Steel Spring	1.5"x1"x1.5"	Keeper	3	\$3.99	\$11.97
4	L- Bracket	Aluminum	8"x.25"	Jack's Hardware	2	\$5.79	\$11.58
5	Side Pad	1/8" Thick Aluminum Sheet	13.5"x6"	Lowes	2	\$19.96	\$39.92
6	Hinge	1.5" wide 5" long	2.5"x 2.5"	Boat Outfitters	1	\$3.83	\$3.83
7	Straps w/ buckle	Nylon	2"x48"x 0.1"	Home Depot	4	\$8.97	\$35.88
8	3D printed Brackets	FDM	6"x1.5"x 5"		3	\$2	\$6
<b>FASTENERS</b>							
9	0.25" diameter Screws	Steel	.25"x.25"	Jack's Hardware	12	\$0.14	\$1.68
10	0.25" diameter Bolts	Steel	.25"x.25"	Jack's Hardware	10	\$0.16	\$1.60
						<b>Final Price</b>	<b>\$177.53</b>



## **Appendix E: Engineering Standards**

Our team did not incorporate engineering standards into the design development for our project. The engineering standards and those in Nicaragua are quite different and are significantly more lenient in Nicaragua. Our device, however, is quite simple and does not require complicated pieces of equipment to construct it that could pose any risk to the user. All pieces that are purchased to assemble the device are commercially available and are able to be machined to the proper sizes where needed. Because of this, we did not find the inclusion of engineering standards to be appropriate. Once the product is fully developed with foam padding and a waterproof cover, a larger consumer base may be achieved, thus leading to a need for engineering standards to be incorporated.

## **Appendix F: Engineering Inclusivity**

Our team's project was directed to help two Nicaraguan girls, Alison and Monica, with their postural support needs while also keeping a low budget. On the social identity wheel, they can be classified as disabled, having low socioeconomic status, and are from a developing country. Currently, they are given wheelchairs that have previously been used and aren't tailored to fit them or their needs. Our goal was to develop a product that would be affordable, adjustable, and accessible so that it would work for them.

Our team held the majority of the power in the development of this product, but we still received input from stakeholders that work with the girls. It was fairly clear that this was the case, but the input from stakeholders did also influence some of our design choices, such as when they told us what parts of the design should be prioritized. Many of our design ideas were developed in closed spaces when it was just the five of us communicating over Zoom. On a weekly basis, these design ideas would be shared with some of our stakeholders in invited spaces so that we could receive feedback on our progress. We also received feedback from Professor Skerlos and some of our classmates in invited spaces that encouraged us to become more creative with our ideas.

Our device currently costs \$168 without padding and is estimated to be around \$200 once padding and the protective covering are added. By developing a design that is significantly under our initial budget of \$400, we are confident that we created a much more affordable device for Alison and Monica, considering other postural support devices can cost well into the thousands range. We also designed it to have multiple points of adjustment so that it will be able to fit both girls as they grow and their support needs change.

To make our design process more inclusive we could have tried to directly reach out to Monica and Alison, although this could've been difficult due to the language barrier. Instead of communicating with them directly though, we could have tried to reach out to other children with cerebral palsy to understand their needs and see if we could translate their needs into Monica and Alison's.

## **Appendix G: Environmental Context Assessment**

The main portion of the device's base consists of an HDPE frame, aiding in the device's recyclability efforts and environmental impact. All upholstery foam padding will be encased with a recycled nylon cover, protecting the integrity of the material and preserving the device overall. The padding may also be reused for different purposes, and recycled nylon is used as an environmentally acceptable alternative to regular nylon.

The product has an expected life cycle of at least 5 years, which relieves the environment of any excess manufacturing and eases maintenance on the device. Metal connectors and clips provide a durable and long-lasting solution within our design. The entire 'skeleton' of our device is highly recyclable and eases environmental impact after replacements towards the end of its lifecycle. The resources needed to produce our design are all easily accessible in Nicaragua, which eases any transportation costs associated with the device.

Considering Alison and Monica are our current focus as the main users and stakeholders in our project design, the impact due to mass manufacturing and large factory pollution is nonexistent. However, if the device is to be improved on and released to a wider audience through Bluelab after we are finished, heavy impacts from mass manufacturing and the pollution and energy use that come with it must be considered. Overall, the product itself would be environmentally friendly upon mass production, due to the reusable and recyclable materials. The system makes significant progress towards resourcing long-lasting and environmentally friendly materials used within the device.

## **Appendix H: Social Context Assessment**

Considering the need we discovered not only for Alison and Monica but many other children worldwide who struggle with their posture due to cerebral palsy, for a more affordable but still long-lasting and comfortable device to support spinal alignment and other factors, we believe that the system we designed will be adopted in the market. At its current point in the design process, it does still need work, but we were closely partnered with Bluelab and other people related who will continue our work past the scope of this particular project. One of our main goals aside from improving posture was making this device as affordable as possible. With the possibility of more mass manufacturing of this product in the future, we believe costs can go down more and be sustainable in the low-resource market.

The solution we created was not made for profit, and there are no existing competing devices at this price in the market we are looking at (Nicaragua). Our seating device should therefore not have detrimental effects on the local economy, but rather hopefully assist it, as we designed the device to be manufactured locally with local materials. As discussed in our environmental cost assessment, many of the materials chosen for the device are also recycled and/or recyclable. This should aid in not adding significantly to the landfills in our target market.

The cost of ownership, as previously reported, should be around \$200, with costs of manufacturing being low because we are catering specifically to Alison and Monica. The highest costs for this device outside of materials and manufacturing will likely be the transport to Nicaragua but still keeps below our proposed \$400 budget, and much lower than the average costs of postural support devices that cost in the thousands. This, again, should not negatively affect the people who need it, as the benefits for this device within its lifecycle outweigh the costs.

## **Appendix I: Ethical Decision Making**

Prior to releasing the product for consumer use, engineers must uphold the responsibility of reporting accurate data and results, prioritizing the safety of the general public, and testing the product to ensure functionality and safety. Fundamental Principles of The American Society of Mechanical Engineers Code of Ethics and The Michigan Engineering Honor Code have been upheld for the entire duration of the design process including proper stakeholder engagement, data collection, analysis, and verification/validation of the device [13][14].

During the review of our initial problem description, the team encountered a dilemma when considering the users of our device. Although Monica and Alison are the inspiration for our design and our main stakeholders, our team decided that limiting the use of our device to only two people in need was unrealistic. Since we decided to expand our consumer network, we prioritized design focus on the head, neck, and spinal support of our users, to ensure the most reliable and efficient product. Taking into consideration the time restrictions of the project, we centered our focus on quality and strong foundations.

Major ethical considerations within our postural support design were the stability and durability of the device during use. While deliberating whether to create a prototype or virtual simulation to test and verify our requirements/specifications, we referenced the ASME Code of Ethics. The first fundamental canon of the ASME Code of Ethics states “Engineers shall hold paramount the safety, health, and welfare of the public in the performance of their professional duties.” To ensure proper testing could be performed, our team assembled a prototype of our product and physically tested the specifications of our device. A physical prototype increases stakeholder and team confidence in our product and ensures the stability, durability, and therefore safety of the device.