

# **ME450 WN23 Final Report**

**Team 16: Mechatronics System for ME240 Course Objectives**

**Bridget O'Connor, Lihan Lian, Haotian Xie, Ruitao Su**

**Section 004**

**04/24/2023**

**Sponsor: Jeffrey Koller, LEO Lecturer II, University of Michigan**

**Department of Mechanical Engineering**

**Alex Shorter, Assistant Professor, University of Michigan Department of  
Mechanical Engineering**

## Table of Contents

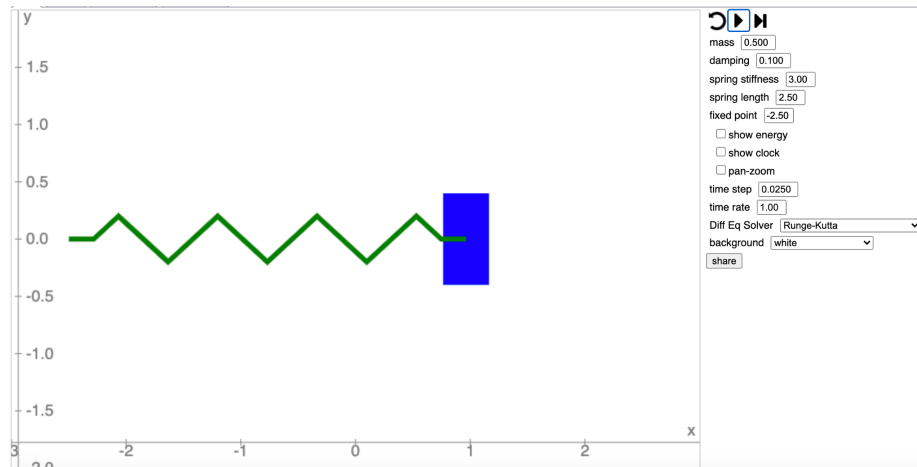
Introduction	pg. 3
Requirements and Engineering Specifications	pg.9
Concept Generation	pg.11
Concept Selection Process	pg.15
Concept Description	pg.19
Engineering Analysis	pg.21
Description of Verification and Validation Approach	pg.26
Discussion	pg.27
Reflection	pg.28
Recommendations	pg.29
Conclusion	pg.30
Acknowledgements	pg.32
Reference List	pg.32
Appendix	pg.33
Build Design Bill of Materials	pg.48
Manufacturing/ Fabrication Plan	pg.50

## Introduction

At the University of Michigan, ME240: Introduction to Dynamics and Vibrations is a core class for undergraduate mechanical engineering students. Topics such as particle kinetics, angular motion, and vibrations are introduced in this course and understanding them can be difficult, especially due to a lack of many physical models to demonstrate them. The course concepts are fundamental for later courses and in real-life applications. Researchers have studied the effects of experiential learning on students' learning and have proven that it is extremely beneficial in long-term learning. Experiential learning places an emphasis on experimentation and experience that students can use to help contextualize topics they have learned. Students can become more engaged in the classroom and connect theoretical behaviors and concepts to real-life applications. Professors currently have online simulations and simple models and have requested a model that incorporates sensors and encoders. We are tasked with creating a mechatronic system for use as a teaching aid and learning tool.

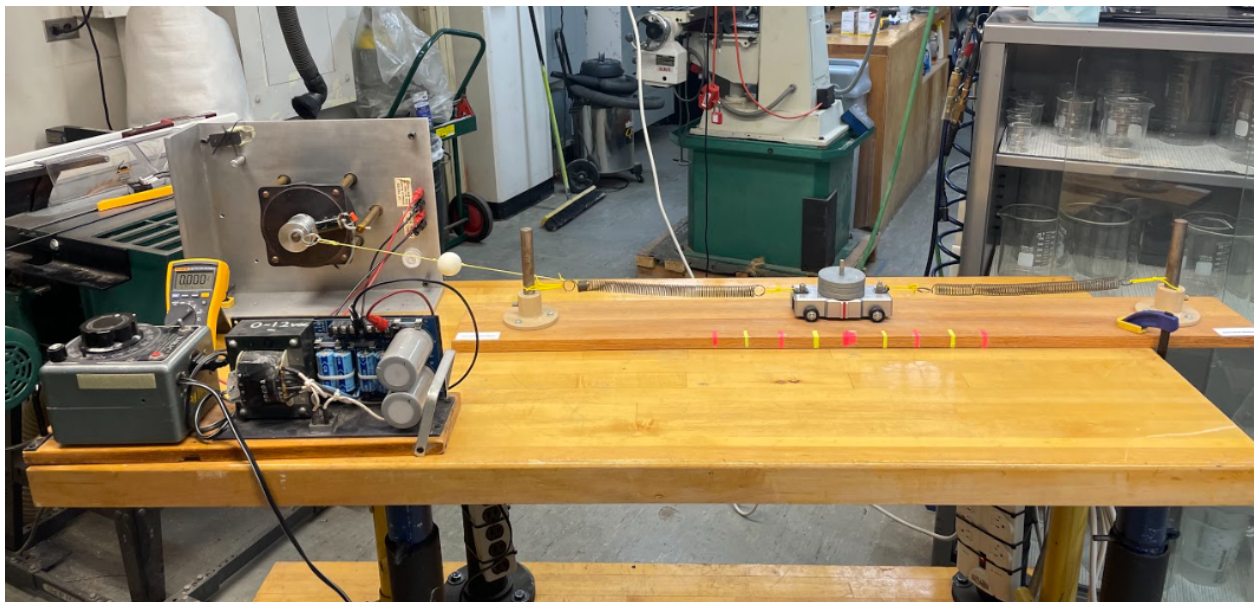
Traditional and inquiry-based learning pedagogy has been criticized for many of its drawbacks and inefficiencies in the literature. Khalaf and Zin stated the nature of memorization that characterized traditional learning, which is considered a drawback to the long-term practice of learning and limits the development of learners' background knowledge [6]. Experiential learning (EL) could be helpful for solving this problem and it was first introduced by John Dewey. Later, David Kolb further concretized this concept by proposing the Kolb's model whose overall concept is an EL cycle that has four major components: concrete experience, reflective observation, abstract conceptualization and active experimentation [7]. EL can help students to better grasp concepts, making sure students have the opportunity to be more creative, and teachers often observe improved attitudes toward learning [10]. In addition, EL experiences can help to complete students' preparation for their chosen careers which reinforce course content and theory [2]. Jamison et al. indicated that the most common experiential learning setting in multiple studies include collaborative learning, gamification, and project teams [5]. Gadola et al. stated that student competitions can play an important role in education: they promote interest and engagement of the students, as well as of the teachers [3]. Thus, we could consider designing our device to be used in parallel with laboratory activities or group projects.

In order to determine what current resources there were to demonstrate topics in ME240 we consulted with our sponsor, Professor Koller. Professor Koller has been a wonderful mentor and resource for us throughout the project in helping with designing and troubleshooting. He has given us great insight into how he teaches and devices he has used here at the University of Michigan and at Villanova University, where he previously taught. This past fall 2022 semester, Professor Koller, with the help of Professor Shorter, created a pendulum model to use in the classroom to model pendulum motion. The device had variable parameters, such as length and moment of inertia, and used sensors to measure positional data that students later used in homework problems. We expect to draw inspiration from this device to create our own this semester. In addition to Professor Koller's and Professor Shorter's pendulum model, there are online simulations that aid in student's learning. Software, such as MATLAB, enable professors to create visualizations of systems, such as a mass-spring damper system [8]. Figure 1 below shows an example of an online simulation of a mass-spring damper system where the user can vary different parameters to observe the resulting behavior.



**Figure 1.** Online simulation of a mass-spring damper system with variable parameters [8].

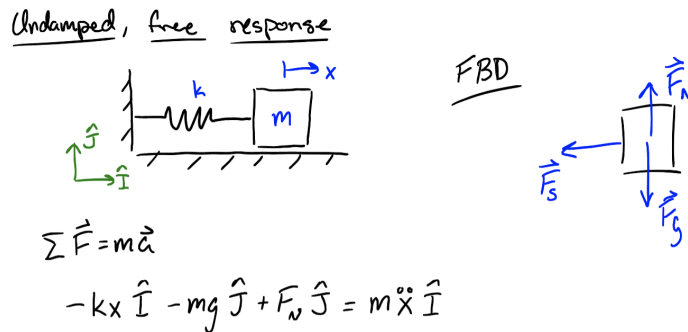
Additionally, we consulted with the Physics lecture demonstration laboratory and visited the lab in the beginning of the design phase. We saw how some of their devices worked, such as the device called “Driven Cart Between Two Springs”, which demonstrates resonance frequency. The device is shown below in **Figure 2** and consists of a cart between 2 springs, one of which is driven by a motor to impart a forcing frequency. We talked to the Physics lab staff and they expressed issues that the current device has, such as no data output and wanted friction from the wood base. The device inspired some of our initial designs and gave us insight into things that might cause problems in our designs, such as unwanted friction.



**Figure 2.** Driven Cart Between Two Springs Equipment in the Physics lecture demonstration laboratory [15]

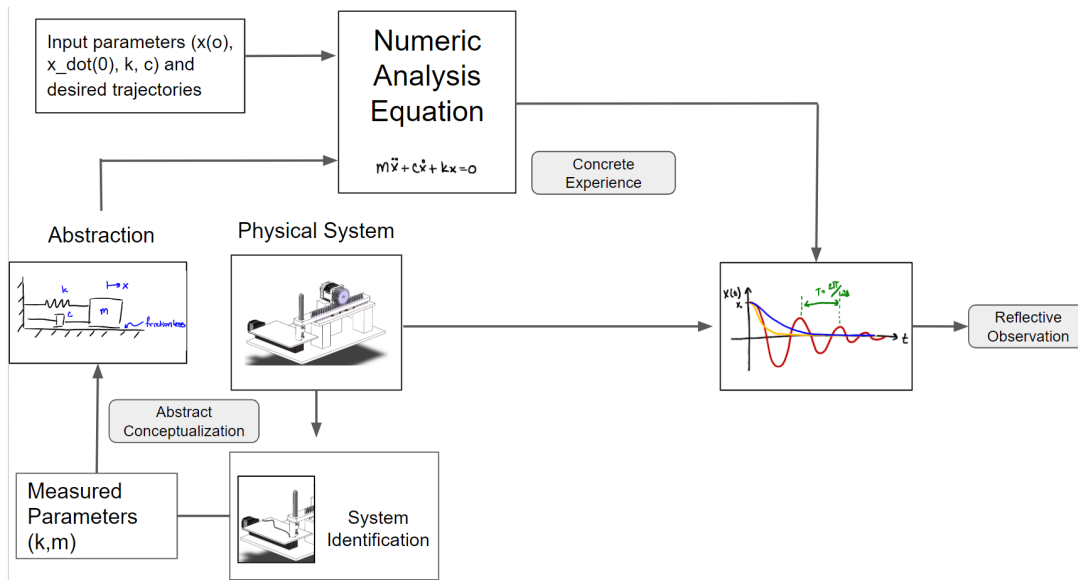
Professors often use ‘traditional’ teaching methods, such as verbal lectures with corresponding lecture notes, to convey topics to students. While this method may work well for some students, many students

often do not feel completely confident in their understanding with only ‘traditional’ methods, especially with more complex topics such as the ones taught in ME240. An example of lecture notes is shown below in **Figure 3** from Professor Koller’s ME240 lecture from 11/16/22 [9].

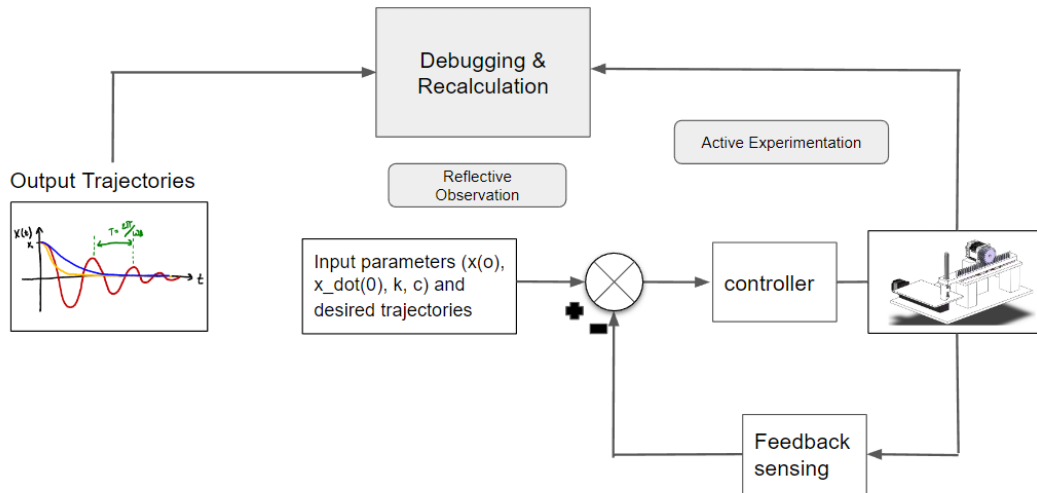


**Figure 3.** Professor Koller’s ME240 lecture notes from 11/16/22 [9] showing a mass-spring system, its associated free-body diagram, and kinematic equation.

Our main objective for this project is to help students learn and to give professors a physical system to demonstrate complex topics with. Our project will be successful if students feel our device helps them to connect the theoretical behaviors they learn in class to real-life systems that model those behaviors and that it helps them understand concepts further to allow for better application both inside and outside the classroom. In order to achieve this, our device will incorporate aspects of experiential learning. As shown in **Figure 4a** and **4b** below, we have created a flowchart that helps us design our device to fit into the experiential learning cycle.



**Figure 4a:** Flowchart indicating how our device corresponds to experiential learning



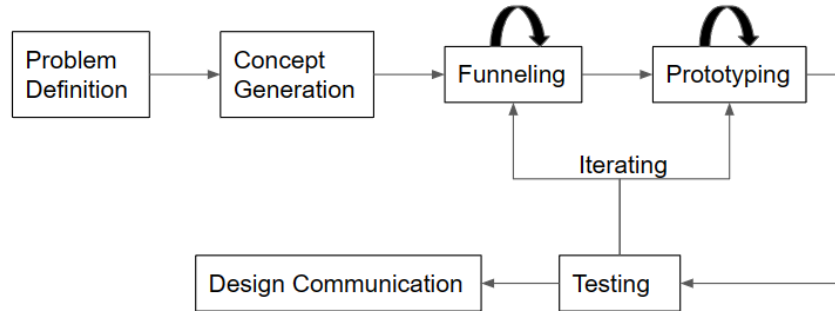
**Figure 4b:** Flowchart indicating how our device corresponds to experiential learning

**Figure 4a** shows an example using a mass-spring-damper system of how our device is used. Students will use the physical system to measure parameters, such as mass, spring stiffness, and damping coefficient, then use an abstracted system to perform numerical analysis and determine a predicted trajectory, thus giving them concrete experience. They can then take the measured parameter values and use an online simulator, such as shown in **Figure 1**, to track the theoretical trajectory. Lastly, students can compare the predicted trajectory to the theoretical trajectory and be able to make observations regarding similarities and differences between them and then determine what may cause these differences that arise. **Figure 4b** explores how motor control is implemented in the system to further incorporate experiential learning.

Thus far in our design process, we have been following a problem-oriented approach as shown in **Figure 5**. In a problem-oriented design process, multiple solutions are produced by thoroughly analyzing the problem. We have also incorporated aspects of an activities-based process as well as a stage-based process. By combining these design processes, we implement iteration into our process in each phase in an organized and structured manner [11]. While maintaining structured phases, the model allows for iteration within each phase, as well as between phases, to produce the best solutions possible which can be chosen from to continue onto manufacturing.

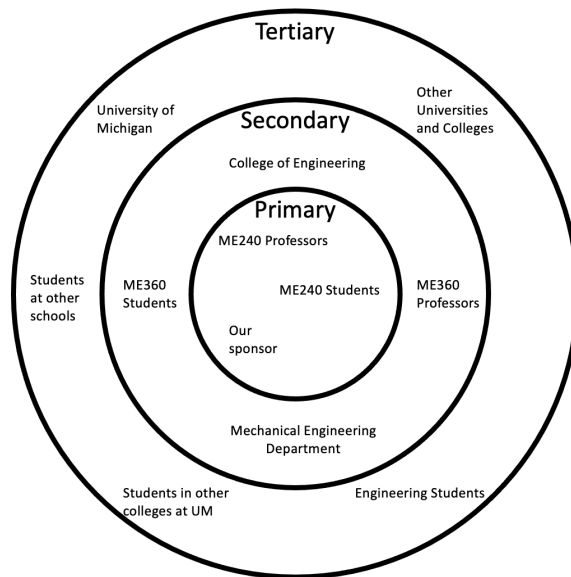
The problem has been well defined by consulting with our sponsor, Professor Koller, and our ME450 section lead, Professor Shorter. We have determined who the relevant stakeholders are, why our project is necessary to be completed, and what requirements and specifications must be met in order for our project to be successful. To progress in our project, we have created potential designs to model our chosen topic and iterated through them to determine which design best satisfies our requirements and specifications and is manufacturable. During the concept generation phase, we drew inspiration from existing designs that achieve what we hope to and from each other's designs. To learn more about existing designs, we researched solutions globally and, locally, reached out to the University of Michigan Physics Department as they have many devices that model vibration. The physics department allowed us to come into their lab to interact with some of their devices and consult with them on improvements that could be made and

what aspects of the design work well. After we have iterated through multiple possible solutions, we ranked the potential designs using a Pugh chart with respect to our requirements, specifications, and other relevant criteria, such as manufacturability. From this ranking, along with input from our sponsor, we chose a final design and have begun the process of optimizing the design. Once we have the final design complete and we have determined what components are needed, we will begin manufacturing and troubleshooting in order to meet our deadlines. We will continue to consult with our sponsor in order to maintain clear communication and ensure his requirements are met.



**Figure 5.** Problem-oriented design process diagram with iteration implanted.

There are several primary, secondary, and tertiary stakeholders in our project. They all have varying degrees of influence on and impact from our design. Below, **Figure 6** shows a stakeholder map and categorizes some of the primary, secondary, and tertiary stakeholders. In regards to our primary stakeholder, the sponsor, Professor Koller has extensive knowledge in ME240 and ME360 topics, has significant teaching experience, and can give us feedback on the tool we are creating to help students learn. Other ME240 professors can give us additional suggestions on how to improve the device from the perspective of teaching and ME240 students can give the advice from a student’s perspective so they can make an important contribution to the project.



**Figure 6.** Stakeholder map showing primary, secondary, and tertiary stakeholders. Stakeholders were

classified based on their level of influence on the design and the extent of impact the design would have on the individual or group.

ME240 professors and students fulfill multiple ecosystem roles in our stakeholder map, including resource providers, beneficiaries and customers, and affected or influential bystanders. We need to maintain clear communication to keep them up to date with our project, respect and implement their suggestions to the best of our abilities to satisfy their requirements throughout the process. Throughout the process, we were able to maintain communication with our sponsor, Professor Koller, in order to get his opinion on design or component decisions or obtain his help when needed.

Secondary stakeholders include ME360 students and professors as well as the College of Engineering and the Mechanical Engineering Department. ME360 professors and students play the role of affected or influential bystanders in the ecosystem. We expect the device will be able to be used in ME360 with minimal modifications, so ME360 students and professors stand to benefit from the device, but are not primary stakeholders as they have low influence on our design and since the use of the device in ME360 is something we expect to achieve but is not essential in the scope of our ME450 project. The College of Engineering and the Mechanical Engineering Department may benefit from our device if it is able to be adapted, if needed, and implemented in other ME courses or other engineering courses outside of the ME department, although they do not have significant influence on the design. Additionally, these stakeholders provide us with resources for designing and manufacturing.

Tertiary stakeholders consist of the University of Michigan, which plays the roles of resource providers and affected or influential bystanders, and other colleges, universities, and their students. The University of Michigan provides project funding, and engineering students, who may benefit from the device if it is implemented in their specific classrooms. Additionally, if our device is successful enough that other universities and other colleges at UM want to implement similar tools, those individuals and groups act as tertiary stakeholders since they have low influence and impact on our design. More information for primary and secondary stakeholders can be found in the stakeholder analysis attached in Appendix A. Students in the stakeholder map are further categorized with former, current and future in the analysis for a clearer scope.

The reason for our design to be created and implemented is to benefit students. The need for a teaching aid in ME240 comes from the complexity of topics that can cause students to become frustrated with the concepts. Through our design, we hope to benefit the community of mechanical engineering students at the University of Michigan without inflicting any societal harm to other groups. We do not anticipate our device causing societal harm as it will strictly demonstrate concepts from the ME240 course. Our sponsor, Professor Koller, wants the device to create a positive educational experience and impact on students. The most relevant impact our device will have is an educational impact given that it is a scientific and mathematical model not intended for mass production or use outside of ME240 in the scope of this project. We are the students creating the device that have not signed any legal documents regarding the transfer of intellectual property rights, so we own the intellectual property rights to the device.

As we have made progress in our project, we have gained a better understanding of our project and the implications it will have. Although we have technically been assigned the task of creating a mechatronic



system for use in ME240, we recognize we are really creating the physical aspect of a new way to learn ME240 at UM. Our goal is to create a physical system that demonstrates vibration and we classify our project as a success if we have a working prototype of the design at the ME450 Final Expo. However, students' learning has a larger scope than just a physical system and in order to successfully implement the device in ME240, we will need to consult with our sponsor, Professor Koller, and our ME450 section lead, Professor Shorter, as they are both professors of ME240. In collaboration with them, we will determine how the device we create and their teaching will work together to better the learning experience of students. In a larger scope than this semester of ME450, this project is successful if it does not inflict any social or environmental harm and provides a positive educational impact. As previously mentioned, we do not anticipate causing societal harm. In terms of environmental impact, we recognize the device we create by the end of the semester will likely be a prototype. Given prototypes are improved upon and then often discarded, we will be conscious of what materials we use to manufacture and outline plans to recycle or reuse components where applicable to limit our environmental impact.

### Requirements and Engineering Specifications

In order to determine the requirements and specifications for our project, we consulted with our sponsor, Professor Jeffrey Koller, as well as our ME450 section lead, Professor Alex Shorter. In a sponsor interview with Professor Koller, he wanted us to choose from topics including particle kinematics, rigid body dynamics, and vibrations; he agreed with us that these were some of the more complex topics in the course and that students could most benefit from a device that demonstrates one of these topics. In addition, he also wanted the designed device to potentially integrate with ME360 [4]. Therefore, we will need to come up with a solution so that we can help students with the transition from ME240 to ME360, and we will also take the "Criteria for Accrediting Engineering Programs, 2022 – 2023" into consideration when we are designing the device [1]. The requirements and specifications we determined and believe to be reasonable are listed below in Table 1. We also made a decision to our final design and in Figure 5 we illustrate how this device is going to be incorporated with experiential learning and the process from a concept abstracted from a real physical system to its demonstration through our mechatronic system.

**Table 1.** Summary of Requirements and Specifications for the project. The requirements were determined through engineering experience and consultation with our sponsor and our ME450 section lead. Specifications allow for our requirements to be measured to ensure they are satisfied.

Requirement	Specification	Weight
Portable size	Able to fit in an area smaller than 500mm x 500mm (~1.5ft x 1.5ft) Weigh less than 15 lbs or have wheels with a locking mechanism	3 - High Importance
Able to output data to track trajectories	Use at least one sensor or encoder to record the data; be able to use video tracking to create an experiential trajectory	3 - High Importance

Variable parameters	Able to change at least 2 parameters of the system, such as mass or spring stiffness	3 - High Importance
Affordable cost	Design and manufacture using less than \$500	2 - Mid Importance
Able to be used in ME360 with minimal modifications	Demonstrate a topic taught in both ME240 and ME360 Incorporate sensors and encoders	1 - Low Importance

In our sponsor meeting, Professor Koller had asked that we ensure our design was portable so that the device can be transported between classrooms easily. We specified that the device should be able to fit in an area of about 1.5ft by 1.5ft and weigh a maximum of 15 lbs to ensure easy transport. If we cannot design the device to be less than 15 lbs, we will add wheels that are able to be locked in place to aid in transportation and prevent unwanted dynamics into the system. This requirement is important to achieve since ME240 is taught in various locations and by various professors; if it cannot be easily transported it will not be utilized by as many students and professors. Professor Koller also asked that the device be able to record and output data to track trajectories as well as have variable parameters, such as spring stiffness or mass, depending on its design. Consequently, we aim to include at least one sensor or encoder to record data, such as position data, as well as be able to perform video analysis to track sample oscillations. Additionally, we will have two of the parameters of our device able to be varied. These requirements are important for various reasons. Being able to record data is extremely beneficial to help students connect concepts taught in class to real-life scenarios by using the data for in-class work and homework problems. The concepts are further reinforced when students are able to interact with the system to see how it responds to different conditions and inputs; they can first predict the behavior through analysis, then witness the behavior in-person with the device. Lastly, Professor Koller would ideally like the device to later have use in the ME360 course with minimal alterations. In order to achieve this, the device should demonstrate a topic that is covered in both ME240 and ME360 and incorporate sensors. This requirement is a benefit if we can achieve it but is not of utmost importance since our design is planned to be used in ME240 in the scope of our ME450 project [4].

In addition to the requirements given to us by Professor Koller, there are additional requirements dictated by the ME450 course and our own judgment. We have been allotted a budget of \$500 to use for the design and manufacture of our device. It is important for us to maintain this budget since we will not be given additional funds once the \$500 are spent and so that the design can be recreated if professors would like their own device without causing the University of Michigan or the College of Engineering significant financial strain.

The weighting of each requirement and specification was dictated by our own experience as engineers and verified by our sponsor, Professor Koller. We chose to rank on a scale of 1-3, with 1 being a requirement of low importance, 2 of mid importance, and 3 of high importance. As a team, we dictated the weights of each requirement. The most important requirements that received a weight of 3 were portable size, ability to output data, and variable parameters. Portability is important so that the device can be transferred easily

from one classroom to another in order to benefit the most students and ensure ease of handling for the professor. Data output was a feature Professor Koller expressed a large desire to have. While it is not a necessity for function, we hope to satisfy our sponsor's needs to the best of our ability and as a team decided the ability to output data would enhance our device's ability to connect theory to real-life application. Variable parameters was another feature that Professor Koller expressed an interest in and we felt this feature would also enhance our device. Variable parameters would allow students to view different behaviors due to these parameters that we felt would help them learn better. The requirement of an affordable cost was deemed to be of mid-importance. This is because in our initial exploration into materials for the design, we were able to stay within our budget and we were informed by our 450 supervisor that if additional funding was needed it would be available with proper justification. Additionally, Professor Koller would like our device to be used in ME360 with minimal modification, however, we were tasked with designing a device for ME240. While we hope to achieve this parameter, it is more important in the scope of the project to create a productive and successful ME240 aid.

Our requirements and specifications help us to be successful in creating a physical device to be used in the ME240 classroom by professors. However, this device alone will not be able to fully teach students and we will need to coordinate with professors to determine how the device will be used. **Figure 5** below shows how our physical system fits into the learning experience we are working to cultivate. Our concept of vibration creates the basis of this learning block. Numerical analysis and modeling can be used to allow students to predict behaviors, such as period and amplitude of oscillations or what type of damping is present. Our physical device incorporates mechatronics to enable the user, whether that be the professor or the student, to control the system and enhance data output abilities. The physical system behavior and output can be compared with the previous analysis done to establish connections between theory and real-life for students.

### **Concept Generation**

During the process of our concept generation, we used many techniques including divergent thinking, brainstorming, and planning an ideation session. We used divergent thinking techniques to generate multiple unique solutions to model this concept. Before we began any design generation, we first decided to model vibration. This was based on our meeting with Professor Koller where he agreed with the team that vibration was a difficult topic to understand that students would benefit from seeing in a physical demonstration and based on the fact that vibration was feasible to create a physical demonstration for, unlike some topics, such as particle kinetics. In the next phase of designing, each teammate generated 40 initial concepts that included sketches of design concepts, ways to visualize motion, or how to output data. **Figure 7** below shows some one team member's design sketches that she presented to her team during the initial design stages.

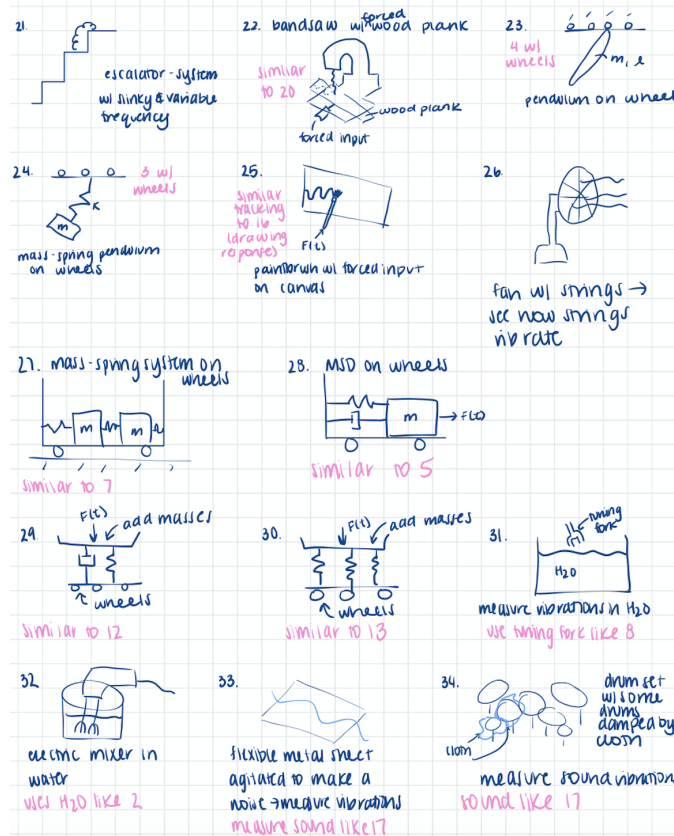


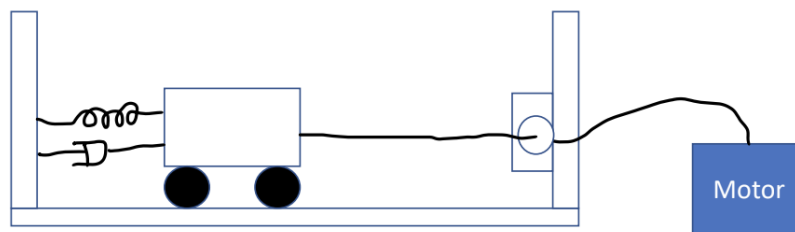
Figure 7. Initial concept generation sketches from one team member

After each team member came up with 40 design ideas for a total of 160 designs (shown in Appendix B), we held a brainstorming session and came up with a metrics table that is based on the requirements and specifications of the project, as shown below in **Table 2**. This table decomposes the project into different sub functions that need to be achieved, shown in the columns. The subfunctions include ways to create motion, to make the device portable, to vary parameters, to visualize the data, and to output data. We created a list of potential options for each sub function based on the initial list of 160 designs, so it could serve as inspiration for our brainstorming. We recognize this is not an extensive list of every possible option but, due to the limited time of this project, the list encapsulates ideas from each team member’s initial ideas. We did additional brainstorming together to see if anyone had additional ideas to add to the table. This table was used as a tool to create new ideas as team members could mix-and-match different elements to create a new idea based on previously established ones. A full list of generated concepts are provided in Appendix C; 5 designs will be explained in more detail within this section to convey different ideas the team had considered, as shown in **Figures 8** and **9**. All designs shown in Appendix C and elaborated on below were generated using different aspects of the columns in the metrics table.

Table 2. Metrics table used for concept generation

	Motions	Portability	Variable Parameters	Motion Visualization Strategy	Data output
1	Pendulum	Mount on a Cart	Mechatronic Control	Larger Moving Range	Encoder
2	Sheet Metal/String	Limit Size	Interchangeable Parts	Grab a Pen	Laser Sensor
3	Water on Top of Speaker	Foldable Device	Adjustable Parameters	Releasing Colored Gas	Video Analysis
4	Mass-Spring-Damper System	Wheels with Locking Mechanism		Releasing Colored Powder	
5	Mass-Spring System			Half-merged in Water	

The first design we will elaborate on is “Lihan 4”, which is a mass-spring-damper system that includes a motor to provide force input. It is worth noting that for clarity of our Pugh chart, shown in **Figure 10** in the following section, during the Design Review 2 presentation and to avoid confusion when differentiating similar concepts, designs were named using the group member who created the design and a number; “Lihan 4” indicates the design was created by Lihan and it was the fourth design he presented to the group. The mass-spring-damper model is a common system that is used in textbooks and classrooms for teaching vibrations concepts and a good beginner example for vibration analysis. The design is shown below in **Figure 8**.



**Figure 8.** Mass-spring-damper system, entitled “Lihan 4”, used as the base design for the Pugh chart

We later chose this design to be the basis of comparison when constructing our Pugh chart. The design functions with a motor that imparts a force on the cart. The force can be varied to be a step function, impulse, or harmonic frequency. By varying the spring and damper attached to the mass as well as varying the mass added to the cart, students would observe different behaviors such as over-damped, under-damped, and critically-damped vibration. In order for students to visualize the data, the design size is large enough to be seen in an average classroom; it will not be so large as to inhibit portability, however. This design did not include any method to output data.

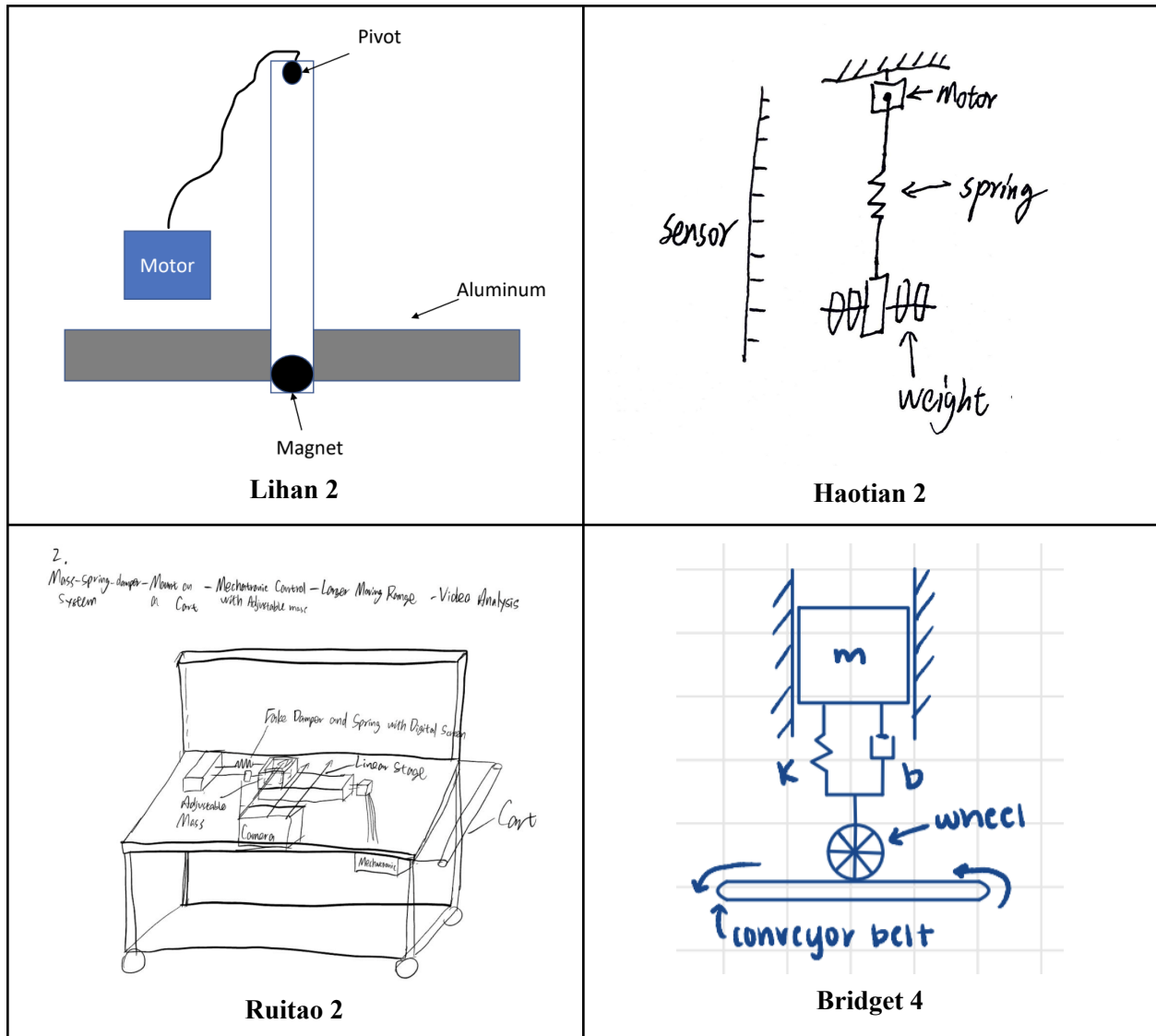


Figure 9. Examples various of concept designs generated by different team members

“Lihan 2” utilizes pendulum motion to demonstrate vibration and is inspired from the website [12]. In this design, damping is imparted using magnetic forces, as opposed to a physical damper, from an aluminum block and a magnet located on the end of the pendulum. The distance between the aluminum block and the magnet dictates the damping ratio. As the aluminum block is placed further or closer to the pendulum, the damping varies and the system is able to show conditions of under-damping, over-damping, and critical-damping by varying the distance between them. A motor on the top of the pendulum could be utilized to add forcing to the system. The device would be large enough for students to see the behavior but not very large that it would be cumbersome to transport. This design also does not include any method of data output.

“Haotian 2” uses a mass-spring system that moves vertically due to a force from the motor. The motor would impart a force on the spring, causing the mass to oscillate. The mass is able to be varied in order to produce different behaviors. Additionally, there is a sensor that would measure when the mass passes the

equilibrium point but would not be able to track positional data of the mass since the sensor is fixed to the wall.

“Ruitao 2” is a mass-spring-damper system that has a “virtual” spring and damper, dictated by the motor. This design varies from a typical mass-spring-damper system because it lacks a physical spring and damper and uses a microcontroller to dictate the spring constant and damping coefficient. This allows the parameters to be varied very easily because no extra parts need to be carried with the device and the user does not need to physically manipulate the device; they can simply plug in the desired values into the system and then allow it to run. Additionally, the system uses an encoder to output positional data of the mass as it oscillates horizontally on a linear stage. The linear stage is used to allow motion of the mass.

“Bridget 4” demonstrates a mass-spring-damper system in the form of a quarter car model. The device consists of a vertical mass-spring-damper on a wheel and is held upright using a well in the top of the foundation/base of the device. The wheel spins on a conveyor belt that is attached to an actuator. The actuator would move the conveyor belt vertically to impart an impulse, step, or harmonic input. Students would be able to see the model oscillate vertically in the well in response to the input. Additionally, there would be a sensor located on the bottom of the mass to record vertical positional data relative to the conveyor; when evaluating the response using this data, the fact the conveyor moves would need to be taken into consideration by the professor and the students.

**Concept Selection Process**

In order to determine which design would best help us to be successful this semester, we used a Pugh chart to compare all possible designs which is shown in **Figure 10**. The Pugh chart compares all designs shown in Appendix B that were generated from the metrics table.

	Weight	Lihan 4- MSD cart	Lihan 1	Lihan 2	Lihan 3	Haotian 1	Haotian 2
Portability	3	0	1	-1	-1	0	0
Data Output	3	0	-1	0	0	0	0
Variable Parameters	3	0	-1	-1	-1	0	0
Affordable Cost	2	0	1	1	1	0	0
Durability	1	0	0	0	0	0	0
Use in ME360 with Minimal Modification	1	0	-1	-1	-1	0	0
Ease of Maintenance	1	0	0	0	0	0	0
Manufacturability	2	0	0	0	0	0	0
Technical Feasibility	3	0	0	0	0	0	0
Creativity	2	0	0	0	0	0	0
Clear Visualization	2	0	0	1	1	0	0
Demonstrates Vibration	3	0	0	0	0	0	0
Weighted Total	-	0	-2	-4	-4	0	0

	Weight	Haotian 3	Ruitao 1	Ruitao 2	Bridget 1	Bridget 2	Bridget 3	Bridget 4
Portability	3	0	0	0	0	0	0	0
Data Output	3	-1	0	0	0	0	0	0
Variable Parameters	3	0	-1	0	0	-1	-1	0
Affordable Cost	2	0	0	-1	0	0	0	-1
Durability	1	0	0	0	0	0	0	0
Use in ME360 with Minimal Modification	1	0	0	0	0	-1	0	0
Ease of Maintenance	1	0	0	0	0	0	0	0
Manufacturability	2	0	0	0	0	0	0	-1
Technical Feasibility	3	0	0	0	0	0	0	0
Creativity	2	0	1	1	0	1	1	1
Clear Visualization	2	0	1	1	0	0	0	0
Demonstrates Vibration	3	0	0	0	0	0	0	0
Weighted Total	-	-3	1	2	0	-2	-1	-2

Figure 10. Pugh chart used to compare generated concepts for concept selection

We used a Pugh chart to select our final design, with Lihan’s fourth design - a mass-spring-damper system- as the base design to make comparisons with. We made several criteria based on the requirements and specifications and assigned the value of 1 to 3 based on their importance. A weight of 3 indicates a high importance, 2 indicates mid-importance, and 1 indicates low importance. A total of 13 concepts were compared using the Pugh chart to determine which best met the requirements and specifications. It is worth mentioning that many designs got negative scores on the Pugh chart; this can be attributed to the base design of the mass-spring-damper system being a good design that has been verified in the classroom as an effective way to teach vibration.

The top five scoring designs were Haotian 1, Haotian 2, Bridget 1, Ruitao 1, and Ruitao 2. Haotian 1, shown in **Figures 11**, The design consists of a cart on wheels between two springs and driven by a motor to demonstrate resonance frequency. This design was seen in the physics lab and this design was based on that concept. In this design, the weight of the car can be varied by adding mass to see how this would affect resonance frequency. This design was considered to be comparable to the base design in all categories. This is reasonable because the designs are extremely similar. However, this design lacked creativity and is only able to demonstrate resonance frequency and no other vibrational topics. Additionally, this design does not include damping, which other designs did, and outputted data using video analysis, which would be more difficult to use than a sensor or encoder. For these reasons, we did not pursue this as a final design concept.

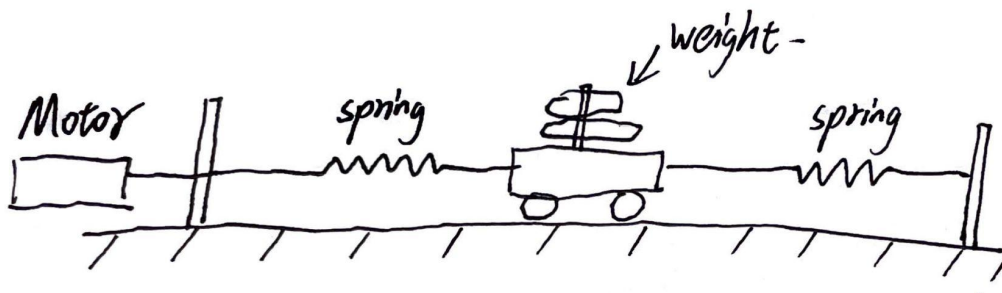
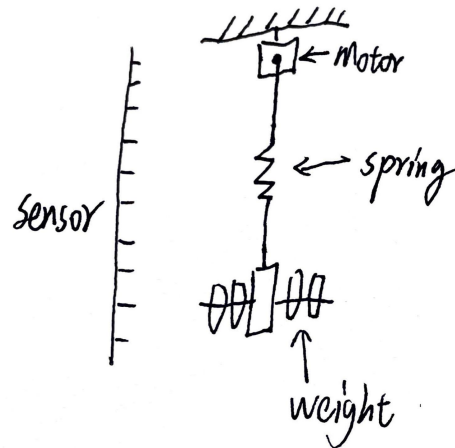


Figure 11. Haotian 1 design of a cart between two springs

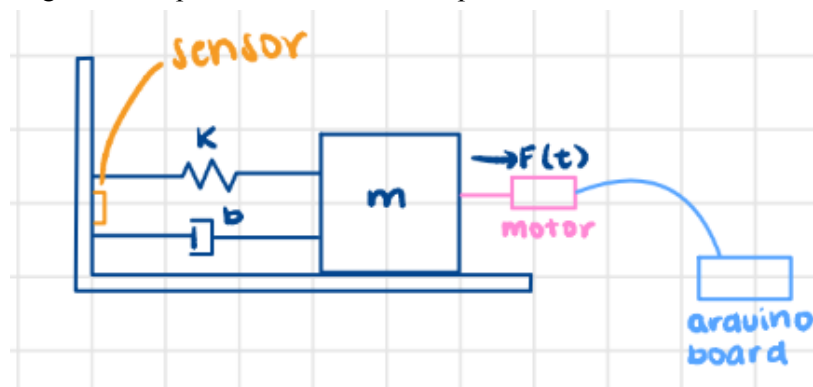


Haotian 2 is the design that uses a vertical mass-spring system as shown in **Figure 12**. This design gives the benefit of portability, variable parameters with adjustable mass, affordable cost, and ease of manufacturing. However, this design lacked creativity as it was also based on an existing design that the Physics Department uses in their lab [15]. Additionally, other designs conveyed the concept of vibration and outputted data more effectively than this design so this was not pursued as a final design.



**Figure 12.** Haotian 2 design of a vertical mass-spring system

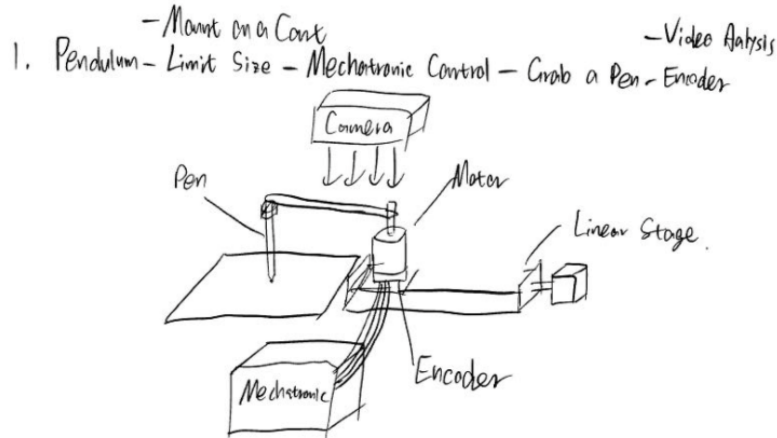
Bridget 1 is a mass-spring-damper system, shown in **Figure 13**, and is very similar to the base design. This design includes a variable mass, spring, and damper that can be adjusted to observe different behaviors. A motor is used to impart a force on the system such as an impulse, step, or harmonic input. Additionally, there is a sensor on the base structure to output positional data of the mass as it oscillates. This design has the same benefits as the base design, Lihan 4, with an added benefit of data output. While this design is a good demonstration of vibration, other designs offered the same/more benefits with more creativity so this design was not pursued as a final concept.



**Figure 13.** Bridget 1 design of a mass-spring-damper system

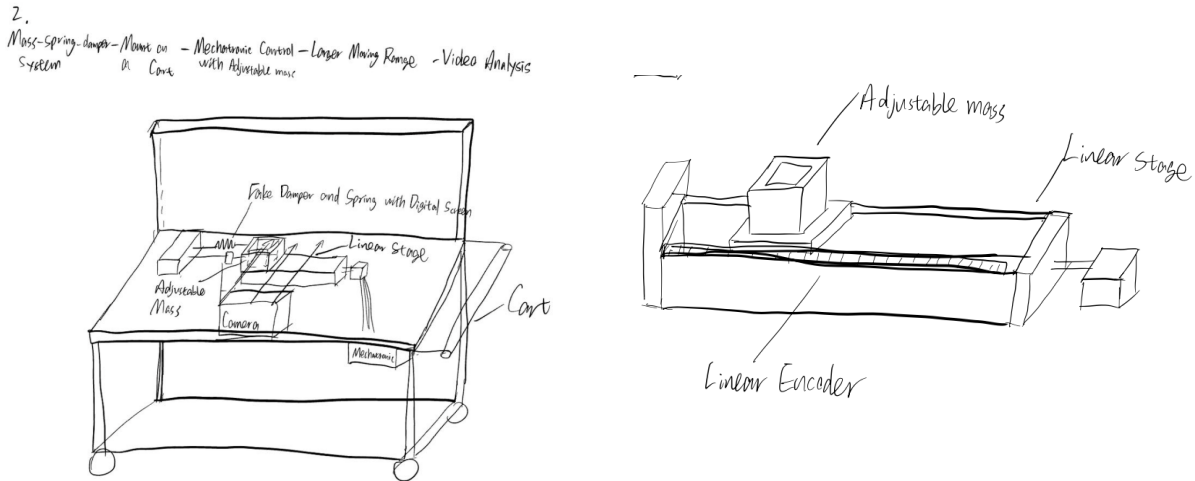
Ruitao 1 is a design that uses a motor to cause oscillations in a pendulum and is shown in **Figure 14**. This design is unique from other designs in that it uses a pen to draw out the motion of the pendulum to allow for better visualization of the behavior for students. To ensure the drawn response shows the behavior with respect to time, the motor and pendulum are on a linear stage so it will move backwards and the

drawn lines will not overlap. An encoder is used to provide data output and there is the option for video analysis with a camera. This design is creative with good visualization but lacks variable parameters. In addition, during our sponsor meeting where we shared our ideas, our sponsor shared concerns over using video analysis, as it is very complicated, and told us he preferred other designs that used linear motion instead of pendulum motion. For these reasons we did not choose this design as our final design.



**Figure 14.** Ruitao 1 design that uses a motor to create pendulum motion that is visualized with a pen.

Ruitao 2, shown in **Figure 15**, is a mass-spring-damper system that uses a “virtual” spring and damper instead of physical components. A microcontroller is used to do this and it allows for easily varied parameters because the user does not need to physically interchange parts to change the spring stiffness or damping coefficient, they can simply input the desired values into the controller. A linear stage and encoder are used to allow the block to oscillate and to output data. The initial design included a camera for video analysis, which was later disregarded due to the complexity in setting up video analysis correctly. This design was very creative in using a microcontroller to add “virtual” springs and damping that allowed for easily varied parameters. The design was made portable by placing it on a cart for easy transportation; to avoid unwanted dynamics during use, the device can easily be taken off the cart and placed on a table top. The design also allowed the motion to be clearly visualized by students. One disadvantage of this design is that, due to the number of parts and the price of many parts being slightly expensive, it is more expensive than other options. However, during initial exploration of component purchases, we do not anticipate challenges in staying under budget even with the additional and more expensive parts.



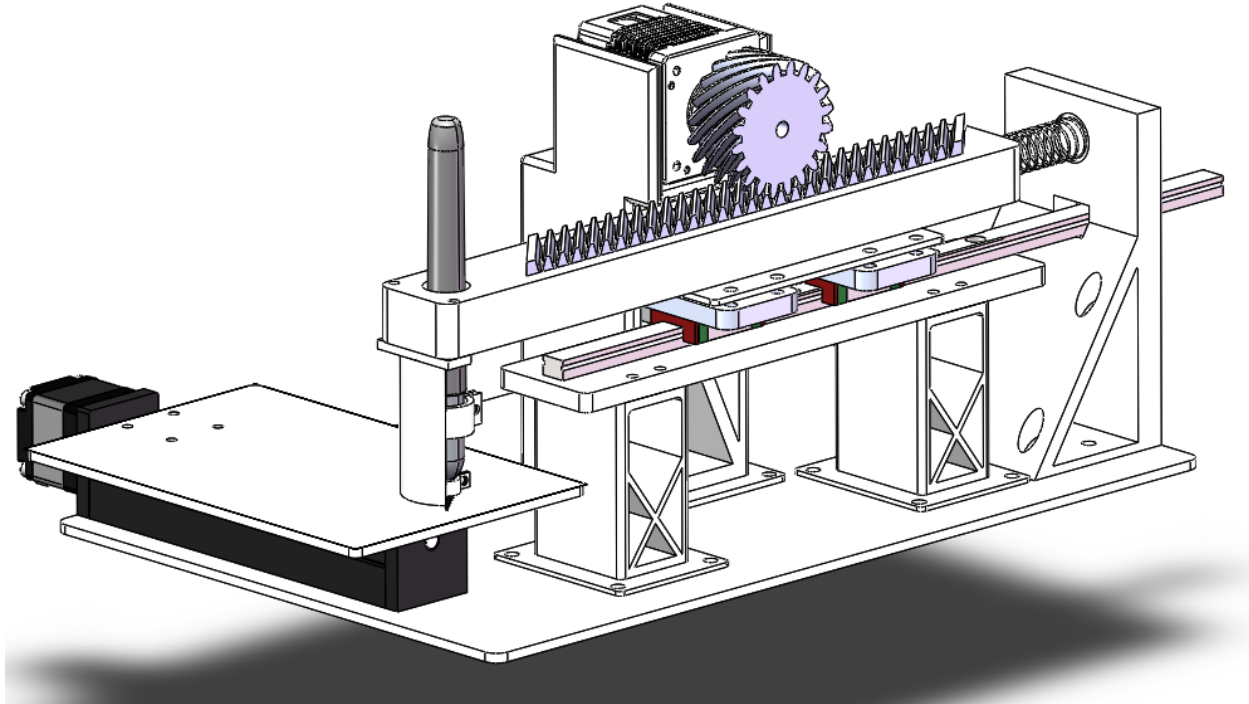
**Figure 15.** Ruitao 2 design that uses a “virtual” spring and damper to impart linear oscillations

In order to make a decision on our final design, we also proposed all of these ideas to our sponsor on February 14th. We value our sponsor’s feedback and wanted his opinions and preference on our designs; since we had many unique ideas, many ideas had similar scores from the Pugh chart and our sponsor’s opinion would verify that our highest scoring design was the best design in his view. We concluded that Ruitao’s second design should be chosen as our final “Alpha” design as our sponsor enjoyed the design and it had the highest score from the Pugh chart. It is worth noting that prior to our meeting with Professor Koller Ruitao’s second design had the second highest score, not the highest score. However, when speaking to Professor Koller he made the argument that Ruitao’s second design gave good visualization as it made linear motion. As a team, we agreed with this observation and adjusted the score accordingly (changing 0 to 1 for ‘Clear Visualization’), resulting in Ruitao 2 becoming the highest scoring design and the design we chose as our “Alpha” design.

### Concept Description

The “Alpha” design we have decided to pursue for our project is Ruitao’s second design, with slight modifications. The design can be seen below in **Figure 16**. As labeled in **Figure 16**, the linear stage simulating vibration with virtual damper and spring is controlled by an Arduino board. Vibration equations are implanted in the code, allowing the linear stage to make motions that simulate vibration accordingly. A user interface prompts for parameters input, including mass, damping coefficient, and spring factor, which allows the user to easily change the parameters for each iteration. Connected to the linear stage by the shaft, the pen holder drawing on the paper can record the vibration motion while the linear stage moving at constant speed can make the drawing have a time sequence. The paper will be placed on top of a metal plate mounted on the linear stage. The offset of the drawing from the center line can reflect the vibration amplitude. The pen holder clamps the pen with two ring designs tightened by screws and nuts. The shaft is simply mounted on the linear stage. The linear stage support elevating the linear stage is also attached with screws and nuts. In addition, a physical spring is attached for free response motion. It could be used to verify the result of the virtual system and also create interactions with students as students can get their hands on the device and see the motion. All of these parts can be

3D printed for easier manufacturing and lower cost. There are several details worth mentioning in the design. First, the pen holder is designed to hold the pen as close as possible to the tip in order to reduce the torque and pen deflection during the drawing process, which would make the drawing process smoother. Second, an encoder will be built in the linear stage to output positional data. Third, current work on the mechatronic side will only focus on implanting free response equations. The equations implanted can be adjusted and the motor control can be further modified for further use in other courses like ME 360 and ME 461. Analysis on equations implanted and the motor capability on the linear stage needs to be done, in order to select the proper motor for this device.



**Figure 16.** CAD model of final design with further modifications

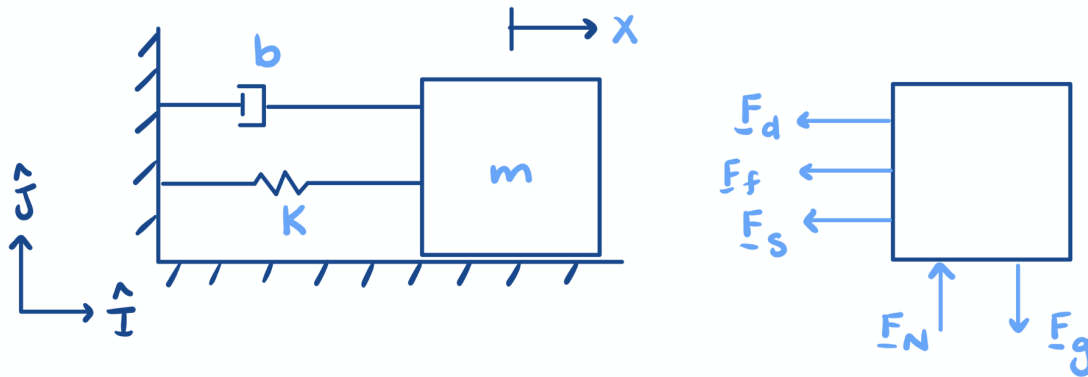
In order to finalize this design as our “alpha” design, we consulted with our sponsor to confirm our choice based on the Pugh chart. Our sponsor’s opinion did not heavily influence the final concept selection, as it was one of the highest scoring designs in the Pugh chart. However, we initially ranked this design’s ability to visualize the data as the same as the base mass-spring-damper design. Our sponsor helped us recognize that the design actually allowed for better visualization since the linear motion is clear and easy to understand for students. We agreed with his perspective and changed the design’s score for visualization from a 0 to a 1, resulting in it becoming the highest scoring design. The design selection process was objective since we made objective judgment at each step in the process. Nothing was “fudged” to satisfy the sponsor or section instructor in this design review, however, our sponsor did give us his perspective from an instructor’s point of view that caused us to reevaluate certain scores.

The selected concept is well-defined in the CAD model to be analyzed rigorously using engineering concepts since dimensions and materials are defined properly. We do expect some further iterations to fine-tune certain aspects of the design but will update the CAD model as necessary. The final design will

not be extremely difficult to manufacture. The mechanical design is straightforward so few challenges are expected for the mechanical aspect, although the pen holder design will need to be carefully analyzed in order to prevent breakage from occurring. We will create several possible solutions to hold the pen and analyze each to determine which is compatible and functional with the rest of the design. The mechatronic component will be more challenging and time consuming. Exploration needs to be done to implant the numerical equations of vibration, pick out parameters to be changed by the user, and make a user interface for input. Although it will be tedious and require lots of dedicated time and effort, the team is ready to put in the necessary work and it is promising to achieve the desired outcome within the time frame.

### Engineering Analysis

In order to determine the necessary parameters for our system, we did several analyses. In order to obtain a position function of the gear and pinion with respect to time, we modeled the system and produced an associated free-body diagram, shown in **Figure 17**. The forces acting on the system in the horizontal direction include friction, spring force, and a damping force. In the vertical direction, there is the force of gravity and the normal force.



**Figure 17:** Free body diagram of mass-spring damper system.

Using Newton's second law, **Equation 1** below, we were able to determine the normal force and obtain a second order differential equation of the mass, **Equation 2**.

$$F = m * a \quad (1)$$

$$x'' + 2\xi\omega_n x' + \omega_n^2 x = g\mu \quad (2)$$

In this equation,  $\xi$  is the damping ratio,  $\omega_n$  is the natural frequency,  $g$  is acceleration due to gravity, and  $\mu$  is the coefficient of friction. The values of  $\xi$  and  $\omega_n$  are shown below in **Equations 3** and **4**.

$$\xi = b/(2m\omega_n) \quad (3)$$

$$\omega_n = \sqrt{k/m} \quad (4)$$

Here,  $b$  is the damping coefficient,  $m$  is the mass, and  $k$  is the spring constant. The solution of **Equation 2**, using initial conditions of  $x(0)=x_0$  and  $x'(0)=v_0$ , is shown in **Equation 5** with relevant parameters defined in **Equations 6, 7, and 8**.

$$x(t) = e^{-\xi\omega_n t} (C_1 \cos(\omega_d t) + C_2 \sin(\omega_d t)) + g\mu \quad (5)$$

$$C_1 = x_0 - g\mu/\omega_n \quad (6)$$

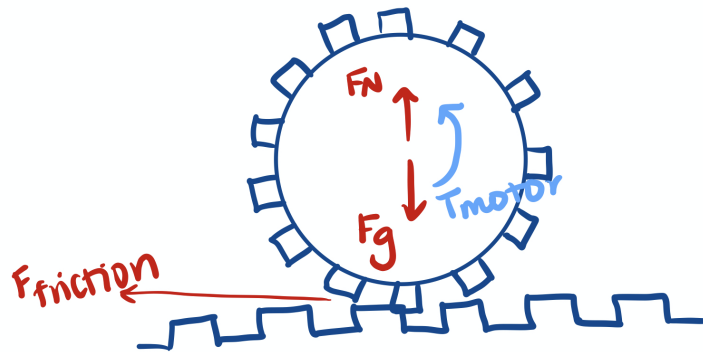
$$C_2 = v_0 + \xi g\mu/\omega_n \quad (7)$$

$$\omega_d = \omega_n \sqrt{1 - \xi} \quad (8)$$

Here,  $\omega_d$  is the damped natural frequency. Using this analysis, we can control the position of our motor in order to demonstrate the vibrational behavior of the system characterized by user input of  $k$ ,  $b$ , and  $m$ .

In order to determine which motor would be needed to move the gear and pinion, we did a friction-torque analysis. Since we want to model the vibrational response in real time, we knew the motor needed to have high speeds to achieve a real time demonstration and we did not anticipate the motor needing a high torque output since the system is relatively lightweight. Additionally, we concluded a DC motor would be the best type of motor for our application since the user can accurately control the motor speed [17].

Based on these parameters, we chose a preliminary motor to analyze and ensure it met our requirements. The motor chosen was the *Lin Engineering DC Motor Model No. BL17E19-01D-A-ED1000-B12X*. We first drew a free-body diagram of the gear and pinion, shown in **Figure 18**. We were able to simplify the free-body diagram and maintain accuracy due to the fact that the required torque is significantly lower than the torque the motor is able to provide. This is proven later.



**Figure 18:** Free-body diagram of gear and pinion, simplified.

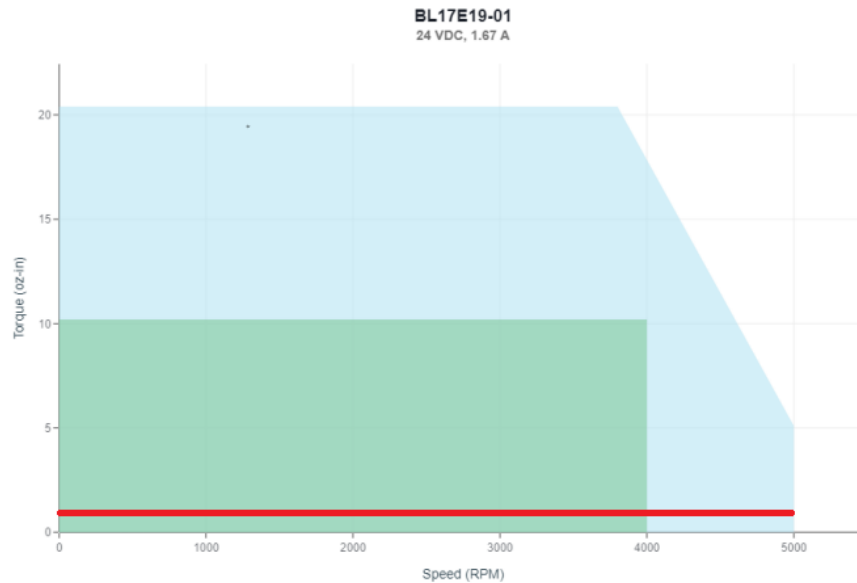
The friction arises from contact between the gear and pinion, both of which we plan to 3D print using Accura Xtreme White 200. However, information regarding the coefficient of friction for this material is unavailable. In order to estimate the coefficient, we did research regarding other plastic materials used for 3D printing and chose the largest value that was presented to us to ensure we would overestimate the friction instead of underestimate it. The coefficient of friction we used for calculations is 0.57 [18]. Using our final CAD model, we were able to gather the volume and radius of the gear, 22mm. Using the density of Accura Xtreme White 200 1.18 g/cm<sup>3</sup> [19], we were able to determine the mass in kilograms of our gear; the force of gravity resulting from this mass is equal to the normal force that is used to calculate frictional force. Using this information we determined the estimated frictional force and the torque that results from that force. This is shown in **Equations 9** and **10**.

$$F_{friction} = F_N \mu = (0.2719 \text{ kg})(0.57) = 0.155 \text{ N} \quad (9)$$

$$T_{friction} = F_{friction} r_{gear} = (0.155 N)(22 mm) = 3.41 Nmm \quad (10)$$

The total torque exerted on the system is the sum of the  $T_{friction}$  and the rotor inertia of the motor. The rotor inertia was obtained from the motor data sheet provided by the manufacturer, Lin Engineering. The data sheet also provided data regarding the maximum torque the motor can provide and the rated motor torque [20]. We compared the total torque to the rated motor torque since we want the system and motor to last as long as possible and requiring the motor to run at too great of a torque could shorten its life cycle. The total torque exerted on the system is 4.7 Nmm and the rated motor torque is 72.028 Nmm. The rated motor torque is approximately 15 times greater than the required torque of the system, verifying our simplified assumption and assuring this motor can supply the necessary torque to move our system and cause vibration.

According to the performance curve of our selected motor shown in **Figure 19**, we can reach 4000 RPM with our load. The maximum linear speed the motor can reach is shown in **Equation 11**.



**Figure 19:** Selected motor performance curve.

$$V_{linear\ max} = 2\pi r_{gear} = 2\pi(4000\ RPM)(22\ mm) = 922\ cm/s \quad (11)$$

The motor's mechanical time constant is 3 ms, which means that it takes 3 ms to reach 63.2% of the maximum speed. We triple the mechanical time constant to make sure the motor can reach more than 90% of its maximum speed. For one time period of the oscillation, the motor has to change its direction of motion twice and reach its maximum speed in the extreme condition. So the motor should experience 4 times to accelerate or decelerate the motor and the minimum time for one period is 36 ms. As the result of which, the maximum frequency the motor can reach is 27.7 Hz and it is shown in **Equation 12**.

$$f_{max} = 1 s / T_{min\ cycle\ time} = (1\ s) / (36\ ms) = 27.7\ Hz \quad (12)$$

Based on the analysis, the motor is able to test the oscillation with maximum speed 922 cm/s and maximum frequency 27.7 Hz. Since the plot base size is smaller than the length that the linear bearing stage can move driving by motor in one rotation, the rotate angle corresponding to the plot can be defined as **Equation 13**.

$$\theta = (\text{Amplitude})(360 \text{ degrees}) / (13.8 \text{ cm}) \quad (13)$$

In addition to our device being controlled by a motor, we hope to have a simplified spring model that users can physically touch and displace to create oscillations. To do this, we will attach a physical spring to our device where the pinion is; this will allow the pinion, which is on top of linear bearings, to oscillate back and forth without use of the motor. Our goal with this addition is to aid in the conceptualization of ideas by users physically displacing a system and watching it move and then having the opportunity to simulate the same response on the mechatronic system to be able to compare the two behaviors. We did the following analysis to determine the necessary spring stiffness to see oscillations in our system. First, we determined the mass that the spring would need to oscillate, which includes the mass of the pinion, the pen, and the pen holder. The mass of the pinion and the pen holder were determined by multiplying the volume of each piece, obtained from the CAD model, and the density of Accura Xtreme White 200 [19], shown below in **Equation 14**

$$m = V\rho \quad (14)$$

where  $m$  is the mass,  $V$  is the volume, and  $\rho$  is the density. The mass of the pinion is 102.522 grams and the mass of the pen holder is 8.082 grams. The mass of the sharpie we will use in our model is 9 grams [21]. The total mass to be moved is 119.604 grams which is equivalent to 1.172 N. To determine the necessary spring constant to move this mass, **Equation 15** was used.

$$k = F/x \quad (15) [22]$$

The length of the linear bearing track the pinion is located on is 300mm so we calculated the spring constant using a displacement of 100mm (0.100m) to allow for oscillations in both directions without the pinion falling off the bearings. It was determined that the spring constant needed to be at least 0.12 N/mm to successfully move the mass.

In order to determine the maximum parameter values that can be inputted into the system, we did an analysis on the electrical and mechanical components of the motor. From the electrical portion of the motor, we obtained the equation of motion shown in **Equation 16**.

$$V_s = iR + L\left(\frac{di}{dt}\right) + k_b \omega \quad (16) [23]$$

In this equation,  $i$  is the current,  $R$  is the resistance,  $L$  is the inductance,  $k_b$  is the back EMF constant, and  $\omega$  is the angular speed. Since the back EMF constant was not given in the motor data sheet, it was calculated using **Equation 17** below.

$$k_b = k_T * 0.74 \quad (17) [24]$$

Here,  $k_T$  is the torque constant, which was given from the data sheet. To analyze the mechanical components of the motor, the equation of motion shown in **Equation 18** was used.

$$I_e \left(\frac{d\omega}{dt}\right) = k_T i - c_T \omega \quad (18) [23]$$

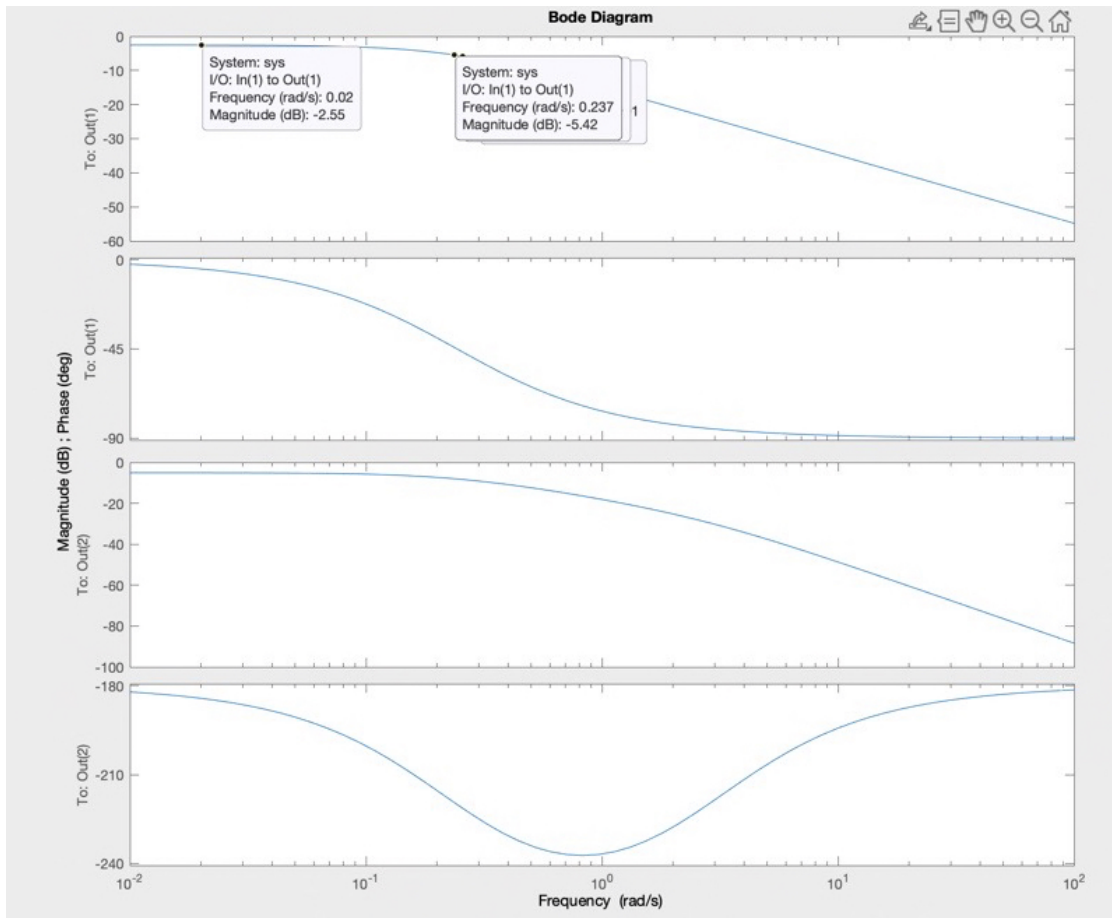
In this equation,  $I_e$  is the equivalent inertia of the motor and load,  $k_T$  is the torque constant,  $c_T$  is viscous damping, and  $\omega$  is the angular speed. It is worth noting that the load torque was not used in our analysis due to the negligible load torque of our system and the equivalent inertia was used in place of the load torque. The viscous damping was not given and was calculated using **Equation 19**.

$$c_T = k_T R \quad (19) [25]$$

Here,  $c_T$  is viscous damping,  $k_T$  is the torque constant, and  $R$  is the terminal resistance. Next, **Equation 16** and **18** were put in a state space representation and the Laplace transform was taken in order to determine



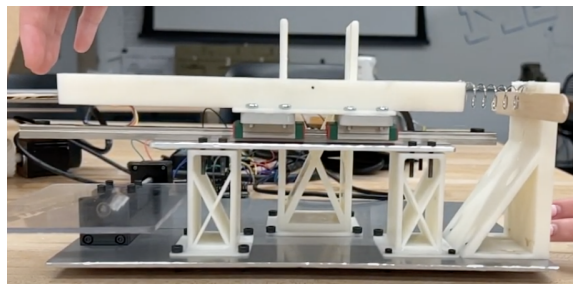
the transfer function. The transfer function was put into MATLAB to create a bode plot, as shown in **Figure 20**.



**Figure 20:** Bode plots created in MATLAB using the transfer function

The bode plots allowed us to determine the bandwidth of the motor, where the magnitude changes by  $-3.01$  dB, which dictates the maximum frequency the motor can operate at before the response is slowed or inaccurate. It was determined the bandwidth of the motor is about  $0.24$  Hz. This analysis was used to verify the requirement of variable parameters which is further explained in the following section.

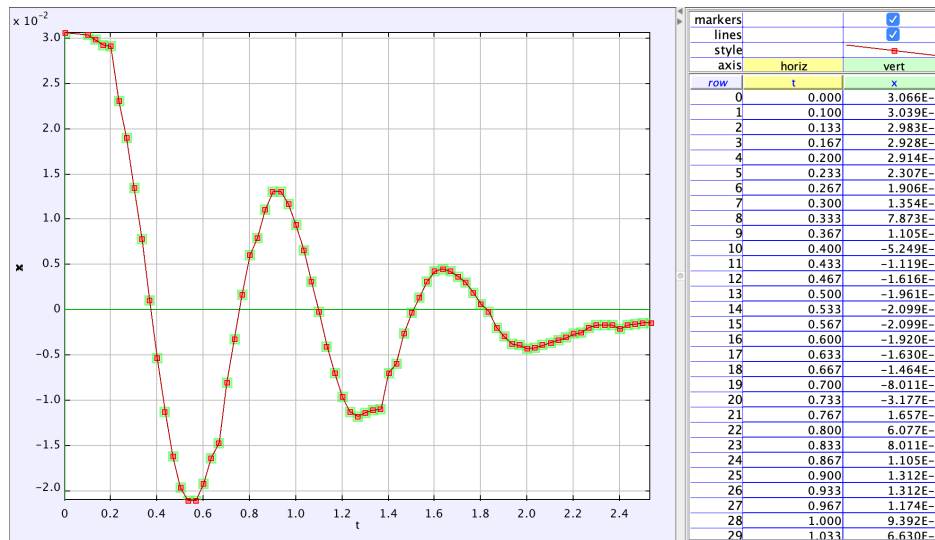
Lastly, we did a video analysis of the simple system using just the spring to oscillate the rack on the linear bearings. We attached the spring between the rack and the support, as shown in **Figure 21**.



**Figure 21:** Simple spring set up for the device

We then imposed an initial displacement by compressing the spring then allowed the rack to oscillate while we took a video to perform video analysis. Using an online software, we tracked the horizontal

displacement of the black dot on the rack, which we made using a sharpie. The trajectory that resulted from the video analysis is shown in **Figure 22**. It is worth noting that the video used in the video analysis was taken in slow motion due to the real time video being too fast to track frame by frame.



**Figure 22:** Trajectory of oscillations from video analysis

Using these results and knowing the mass of the rack and the stiffness of the spring, the damping that occurs from friction in the linear bearing can be determined. Then the trajectory of these 3 parameters can be inputted into an online simulation to create the ideal trajectory. The actual and ideal trajectories can be compared and error can be determined from the differences in the amplitudes of the trajectories to determine how accurate our model is. This is helpful when the device is actually being used for professors to warn students that a certain amount of error comes from the device itself.

### Description of Verification and Validation Approach

In order to verify our requirements and specifications are met by our final design, we identified verification plans for each specification. Our critical specifications are related to portability, data output, and variable parameters. For portability, the specification requires our design to be smaller than 500mm x 500mm or weigh less than 15 lbs. To verify this, we created a finalized CAD model prior to ordering any components, that included accurate components with respect to dimensions and materials. Using CAD functions, we were able to verify that our design was smaller than 500mm x 500mm so this specification is achieved. In order to ensure data is able to be outputted, we dictated the specification of our device using at least one sensor or encoder. The motor we have chosen, analyzed, and verified has a differential encoder incorporated into it so we created a verification plan to ensure this encoder functions properly. To do this, we plan to perform multiple trials on our device and compare the theoretical trajectory of the system to the trajectory recorded and outputted by the encoder and system. The specification will be satisfied if the actual data matches the theoretical data closely. We anticipate some minor differences between the theoretical and actual data since it is difficult to accurately model frictional forces of the system. The last critical specification is to be able to vary at least 2 parameters in the system. In order to verify this, we performed an analysis using the mechanical and electrical components of the motor, which is discussed in the previous section in **Figure 20**. In this analysis, we determine the maximum frequency the motor can operate at before the response is slowed down or inaccurate. This helps us to verify our requirement of variable parameters because given a mass, spring constant, and damping coefficient, we

can determine if the frequency required to simulate this trajectory in real time is above or below the bandwidth frequency. If the frequency is greater than the bandwidth frequency, the device can prompt the user to input a new set of parameters in order to ensure the response is correct and in real time. If the frequency is below the bandwidth frequency, the system is able to support the varied parameters.

The non-critical requirements and specifications include the budget and use in ME360. We want the cost of manufacturing of the device to be less than \$500, as dictated by our project description. This cost includes the cost of materials and any manufacturing costs. To verify this, we ensured that all the materials we needed to purchase totaled a cost of less than \$500. We wanted to maintain a cost of under \$500 so that if we needed to order additional or replacement parts later on we would have the necessary funds to obtain these. The specifications associated with the requirement of use in ME360 are to demonstrate a topic taught in both ME240 and ME360 and to incorporate sensors or encoders. We have already created a verification plan to ensure there are sensors and/or encoders in our system. To verify that the device demonstrates a topic of both ME240 and ME360, we will consult with our sponsor, Professor Koller, who is also a professor of ME360. We will coordinate with him to perform multiple trials on the device where we maintain the same parameter values (spring constant, damping coefficient, and mass) and instead vary the proportional, integral, and derivative gain values in order to practice motor control. In doing this, we can verify that ME360 students would be able to gain experience manipulating gain values to refine the system in regards to speed of response, overshoot, and settling time. Our trials with Professor Koller will allow him to give us feedback on how well our system can be used as a motor tuning training tool while still demonstrating vibration.

## **Discussion**

The essence of the problem that our device aims to solve is improving the learning experience for future MECHENG 240 students. By using a system thinking approach, we address not only what mechanical function that our device needs to achieve but also potential tradeoffs between different functions, manufacturing feasibility, and the end-users for our device. We had interviews with both our sponsor and stakeholders Professor Koller and Professor Shorter to ask their opinion and suggestions on our design and they did provide valuable feedback. However, if we had more time and resources to collect data, we would better define the problem by considering the implementation details into account. For instance, we could do more research on the data on sales, customer ratings, complaints and warranties on the product we need to purchase. This includes the linear stage and DC motor. We could also do more research on the code, standards and regulations of the products. This is because the performance of the device and the difficulty level of implementation highly depend on the quality of the components. Having a better understanding of the linear stage and motor can help us know more about the range of motion that the device can achieve, and this can also make it easier for us when implementing the Arduino code.

The strength of this design is that it can be incorporated into the mode of experiential learning, which many studies have proved can outperform the traditional way of teaching. Figure 4 shows how each step of using the device corresponds to the four components of experiential learning. For students who are interested in mechatronics systems, this device could also serve as a good introductory project which can allow them to have their first experience with Arduino and some other basic knowledge for mechatronics systems, which are also beneficial for MECHENG 350. However, there are two major weaknesses for our current device. The first one is that our motor is not functional due to the first motor purchased motor is

not compatible. Thus, the first step for future modification is going to be replacing it with a motor that can be connected to Arduino and provide enough power so that the device can move at a big frequency to show a wider range of vibration motion. Second major issue is the external factors that might affect the device performance. There are many components in this device and they all need to overcome the friction to have a smooth motion. For instance, if the friction between the contact surface on the linear stage and the tip of the pen is not taken into account, the output trajectory may not be ideal and students are not able to identify the type of vibration. Therefore, we need to tune some parameters to have a better control of the motion and benchmarking is needed for testing the performance.

There are also some risks for the usage of the device. The biggest risk is the product problem with the purchased linear stage. After implementing the Arduino code for controlling the linear stage, the temperature of the linear stage motor rises quickly and becomes too hot to touch. To solve this problem, we suggest replacing the current linear stage with another one that has better and safer performance. Since the components like base plate and some of the supports were manufactured at the machine shop, there were some sharp burrs at the edge and the holes, but we have addressed this problem by deburring components with the file. Another anticipated risk is controlling the motion of the motor. After executing the code to tell the motor the desired operation speed, the motor will have some error and time lag. Thus, control techniques need to be applied to the motor in order to make the motion precise and avoid damaging the device,

## **Reflection**

The primary goal of our project is to create a device that helps to create a positive learning experience for students. In the scope of this project, we primarily have a societal impact as our device will affect students and professors that are using the device; it is designed to aid professors in conveying material and aid students in learning by providing them with a physical system to observe. The impacts of our device beyond its societal impact are negligible. This device will not be mass-produced or implemented in a large number of classrooms in the foreseeable future, so the global, public health, and economic impacts are negligible. In order to determine the impact our device would have, we created a stakeholder map and did analysis to determine which individuals or groups would have impact on our design and be impacted by the end product. Throughout the semester, our perspective remained about the same since we knew our task was to create a device to help students learn. However, our perspective was shifted slightly from the device being a stand-alone tool to being an asset in an experiential learning block. This learning block would be designed by ME240 professors with our help to determine how to best incorporate our device into classroom learning. Using the learning block, professors could alter their teaching plans, if needed, to incorporate numerical analysis of a system, experimentation using the device, iteration, and reflection on how the physical device compared to the theoretical analysis.

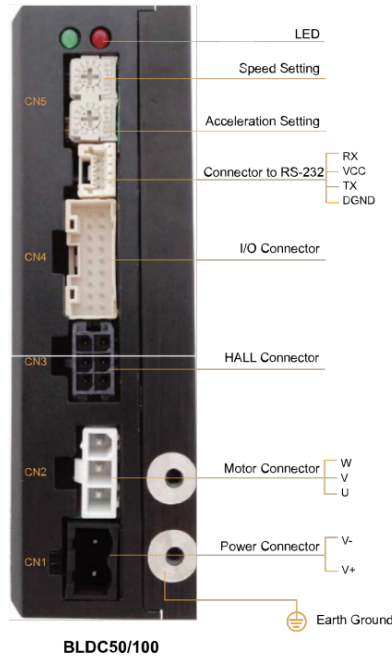
Throughout the design and manufacturing process, we used the different identities and experiences that each team member has to create as holistic a design as we could. We all shared educational experiences through the Mechanical Engineering curriculum at UM that allowed us to discuss tools that other courses have used that we thought were beneficial as well as methods we experienced that we did not think were beneficial and aimed to create a design to better the less helpful methods. In addition, our differences gave us a wide variety of designs and design components that introduced new ideas and creativity to our design. Our design process was also influenced by our sponsors' identities and viewpoints. Our sponsors helped us to refine our design using their experience and knowledge. Professor Koller is very

knowledgeable in controls, motors, and vibration and he helped us to adjust our design to be feasible using a motor, decide which motor to use, and gave us advice on how we could best implement PID control into our device. He also was able to give us a professor's perspective on what he felt students would benefit from that we combined with our perspective as students to ensure we were looking at the problem holistically. Professor Shorter was also able to give us a professor's point of view as well as keep us focused on the project task. It was easy for us to become invested in creating a unique and creative device and it was helpful that Professor Shorter would encourage us to think of how aspects of the design would benefit students and make conceptualization of topics easier. We greatly respect our sponsors' opinions regarding our design since they will be the professors using the device. Their suggestions helped us to adjust aspects of our design to maintain our creativity while making the device easier to use, manufacture, or understand for students. To balance the ideas that were available, we respected our sponsors' opinions and tried to incorporate them into our design so we could keep our ideas integrated in the design while optimizing it to function.

Throughout our design and manufacturing process, we ensured we upheld inclusive, equitable, and ethical decisions. We understand that some students are tactile learners and need more than a lecture to fully understand topics and we wanted to create a device that would allow students to physically engage with the concepts. This ensures every student is included in obtaining the best education possible, treated with equity, and is given the same opportunity to conceptualize topics as students that are satisfied with a lecture. In upholding inclusivity and equity we create a more ethical learning environment that ensures each student is given equal opportunity to learn without an increased struggle.

### **Recommendations**

Although we did not have time during the semester to implement mechatronic control in the system, we have determined the necessary steps to incorporate it. As shown in **Figure 23**, pins of the BLDC motor can be simply connected to CN2 and CN3 channels on the driver. While CN1 needs to be connected to the power supply. As the power supply used is only 24 V while the driver voltage range is 12-48 V. It should be safe to directly connect them together without a recommended regeneration clamp RC880. The connector to RS-232 is used to connect to the PC, which is not suitable for the project. And CN5 speed and acceleration setting only allows a fixed value at a time so it will be ignored as well. CN4 needs to be connected to the Arduino board for our motor control purpose.



**Figure 23: BLDC Motor Driver Layout**

As indicated in **Figure 24**, driver pin 1 and 2 corresponds to 5V and GND pins on Arduino boards. Pin 3 is for direction control. Driver pin 12 and pin 16 also need to be connected to pin VCC and GND on Arduino board as well for reference. Use pin 14 to input analog signals for speed and acceleration control purposes. Arduino does not have a built-in digital to analog converter, so the PWM signal output from Arduino is required. It can be achieved with the `analogWrite(pin, value)` function in the arduino code. The value here should be a continuous signal as it will be determined from the implemented vibration numerical equation. PID control should also be integrated in the code for precise motion control.

PIN NUM	SIGNAL TYPE	SIGNAL NAME		FUNCTION
		BASIC	GENERAL	BASIC
1	POWER SUPPLY	+5V USER		The drive provides users with up to 100mA +5V supply
2		GND		External control signal GND
18		INCOM		External opto-coupler power input (common anode or common cathode connection can dial to select)
3	INPUT	CW/CCW	X1	Clockwise/Counter Clockwise Select
5		STMD (STOP MODE)	X2	Stop mode choice input
7		EN/RE (Enable/Reset)	X3	Motor enable/disable. It can be used for alarm reset as well.
9		SPST (SPEED-SET)	X4	Internal/external speed-set choice
11		STOP	X5	The electromagnetic brake operation is selected when the motor is stopped.
13		M0	X6	For multi-speed operation, the M0, M1, M2 signals are used in combination.
15		M1	X7	
17		M2	X8	
12	ANALOG INPUT	Analog VCC	-	Using external speed potentiometer setting speed
14		Analog In	-	
16		Analog GND	-	

**Figure 24: BLDC Motor Driver Layout**

## Conclusion

We aim to create a mechatronic system as a beneficial learning tool and teaching aid for ME240. Studies show that students learn well from hands-on experiences and we would like to implement this in the ME240 classroom. Research has established that students benefit from hands-on learning where they can apply concepts and theories they have learned in class to physical systems.

There are various primary, secondary, and tertiary stakeholders such as ME240 students and professors, the Department of Mechanical Engineering, and the University of Michigan. Each of the stakeholders we have determined have varying degrees of influence on and impact from our design but we aim to benefit as many stakeholders as we can and minimize harm to all.

We have created a list of requirements and specifications based on our sponsor meeting with Professor Koller, speaking with our section lead Professor Shorter, the course objective of ME450, and our experiences as engineers. We expect our device will be able to translate a common in-class example of a topic of our choosing into a physical system that can record data to create visuals to help students better understand the course material.

The objective of our design is to demonstrate concepts of ME240; as shown in our problem analysis, this project will translate a theoretical concept into a physical system by examining the numerical analysis. In order to translate theory to a physical application, we will create a physical, mechatronic system that models the theory and creates graphs to demonstrate the concept to students. In order to create our device within the semester, we have created a detailed schedule to ensure our project is done efficiently and on time while producing quality work.

We began our concept generation with individually creating 40 ideas. These ideas included concept sketches, methods of outputting data, methods of visualizing data, and methods of ensuring the device is portable. From these ideas, we created a metrics table that identified the subfunctions of our device and then listed ways to satisfy them. The sub functions included portability, data visualization, data output, variable parameters, and motion. The metrics table was then used as inspiration to create new ideas by using different methods to satisfy each sub function and creating a new concept. Using the table, each team member created 2-4 detailed designs that were then presented to the group.

The next step was to select the concept(s) that best satisfies our requirements and specifications. To do this, we first did a “gut check” of the designs where we used our intuition and experience to eliminate designs that would not successfully achieve our goals or were not feasible to create. Then, we used a Pugh chart with requirements, specifications, and other vital aspects, such as ease of manufacturability, that were each given a weight. Aspects with high importance were given weight of 3, mid-importance was given a weight of 2, and aspects of low importance were given weight of 1. Next, we met with our sponsor and presented all of the ideas compared in the Pugh chart. From this meeting, we verified our final design, which had the highest score on the Pugh chart and our sponsor expressed approval of.

The “Alpha” design we chose is a variation on a mass-spring-damper system. The design is unique in that it does not have a physical spring or damper; it instead uses a microcontroller to dictate values of the spring stiffness and damping coefficient which allows for easily varied parameters. A linear stage allows

the mass to oscillate and the mass has a pen attached to the bottom to draw the response. The paper the pen draws on is on a linear stage perpendicular to the other to ensure the pen does not draw overlapping lines and the time sequence is shown.

We did several analyses and verifications in order to verify that components of our design would support the necessary motions. Analyses include the position equation of oscillations with respect to time, a torque analysis to ensure the motor was powerful enough for the required loads, and determining the bandwidth of the motor and therefore the maximum frequency using a state space model of the electrical and mechanical components of the motor. The analysis of motor bandwidth helped to verify the requirement of variable parameters and other requirements were verified using our CAD model and Bill of Materials.

Although we were not able to implement the mechatronic components of our design during the given time period, we have created plans of how to implement the motor and motor controller to cause oscillatory motion. With more time, we also would have liked to create two separate systems, one mechatronic and one simple using a spring so that they can be used simultaneously for comparison. We believe a future ME450 group would be able to take our design and iterate on it to include forced responses, since our current design can only model free responses.

### **Acknowledgements**

We would like to thank our sponsor, Professor Jeffrey Koller, and our section lead, Professor Alex Shorter, for their knowledge, advice, and support throughout the semester. Their help was integral to the success of our project and we are very grateful for their involvement. Professor Koller and Professor Shorter helped us to overcome obstacles throughout our design process and incorporate new ideas that allow students to engage more with the device and their learning.

### **Reference List**

[1] ABET

<https://www.abet.org/accreditation/accreditation-criteria/criteria-for-accrediting-engineering-programs-2022-2023/>

[2] Experiential Learning | Center for Innovative Teaching and Learning | Northern Illinois University. (n.d.). Northern Illinois University.

<https://www.niu.edu/citl/resources/guides/instructional-guide/experiential-learning.shtml#:~:text=Students%20learn%20through%20student%2D%20rather,real%20world%20problems%20and%20processes.>

[3] Gadola M, Chindamo D. Experiential learning in engineering education: The role of student design competitions and a case study. *International Journal of Mechanical Engineering Education*. 2019;47(1):3-22. doi:10.1177/0306419017749580

[4] Interview with Professor Jeffrey Koller

[5] Jamison, C. S. E., Fuher, J., Wang, A., & Huang-Saad, A. (2022). Experiential learning implementation in undergraduate engineering education: a systematic search and review. *European Journal of Engineering Education*, 1–24. <https://doi.org/10.1080/03043797.2022.2031895>

[6] Khalaf, B. K. (2018). Traditional and Inquiry-Based Learning Pedagogy: A Systematic Critical Review. *International Journal of Instruction*, 11(4), 545–564. <https://doi.org/10.12973/iji.2018.11434a>



- [7] Mcleod, S. (2017b, February 5). Kolb's Learning Styles and Experiential Learning Cycle. Simply Psychology. <https://www.simplypsychology.org/learning-kolb.html>
- [8] myPhysicsLab Single Spring. (n.d.). <https://www.myphysicslab.com/springs/single-spring-en.html>
- [9] Professor Koller's Fall 2022 ME240 Lecture 32 notes from 11/16/22
- [10] Why is experiential learning important? (n.d.). <https://www.easchooltours.com/blog/experiential-learning-learn-through-experience>
- [11] Wynn D., Clarkson J. (2005) Models of designing. In: Clarkson J., Eckert C. (eds) Design process improvement. Springer, London. [https://doi-org.proxy.lib.umich.edu/10.1007/978-1-84628-061-0\\_2](https://doi-org.proxy.lib.umich.edu/10.1007/978-1-84628-061-0_2)
- [12] M. (2019, April 19). 068 Oscillations: Critical Damping. xmDemo. <https://xmdemo.wordpress.com/2014/12/21/068-oscillations-critical-damping/>
- [13] UMDemoLab. (2022, May 11). 3A60.40 - Driven Oscillators - Resonance with a Ball and Spring [Video]. YouTube.
- [14] UMDemoLab. (2022a, May 11). 3A60.31 - Driven Pendulum. YouTube.
- [15] UMDemoLab. (2022, May 11). 3A60.24 - Driven Cart Between Two Springs
- [16] Xie, H. ME450 Learning Blocks, Concept Exploration, [https://drive.google.com/file/d/12tOjKlim8GuYscUirauM4ES6\\_ABRZr6Y/view?usp=sharing](https://drive.google.com/file/d/12tOjKlim8GuYscUirauM4ES6_ABRZr6Y/view?usp=sharing)
- [17] <https://www.parvalux.com/us/advantages-of-dc-motors/#:~:text=DC%20motors%20offer%20highly%20controllable,wide%20range%20of%20industry%20applications>.
- [18] Şirin, Ş., Aslan, E. and Akincioğlu, G. (2023), "Effects of 3D-printed PLA material with different filling densities on coefficient of friction performance", *Rapid Prototyping Journal*, Vol. 29 No. 1, pp. 157-165. <https://doi.org/10.1108/RPJ-03-2022-0081>
- [19] <https://www.3dsystems.com/sites/default/files/2020-11/3d-systems-accura-xtreme-white%20200-datasheet-us-a4-2020-09-17-a-print.pdf>
- [20] <https://www.linengineering.com/products/brushless-motors/standard-bl-dc-motors/bl17-series/bl17e19-01/BL17E19-01D-A-ED1000-B12X>
- [21] <https://www.intermediaarts.org/how-much-does-a-marker-weigh/>
- [22] [https://math.temple.edu/~dhill001/course/DE\\_SPRING\\_2016/Hookes%20Law%20for%20Springs.pdf](https://math.temple.edu/~dhill001/course/DE_SPRING_2016/Hookes%20Law%20for%20Springs.pdf)
- [23] Professor Koller Lecture Notes from 02/21/23
- [24] <https://www.bodine-electric.com/blog/bodine-gearmotor-constants/#:~:text=Voltage%20Constant%2C%20or%20Back%20EMF,units%20of%20Volts%2F1000%20rpm>.
- [25] <http://hades.mech.northwestern.edu/images/6/61/Asst7.pdf>

## Appendix

### Appendix A

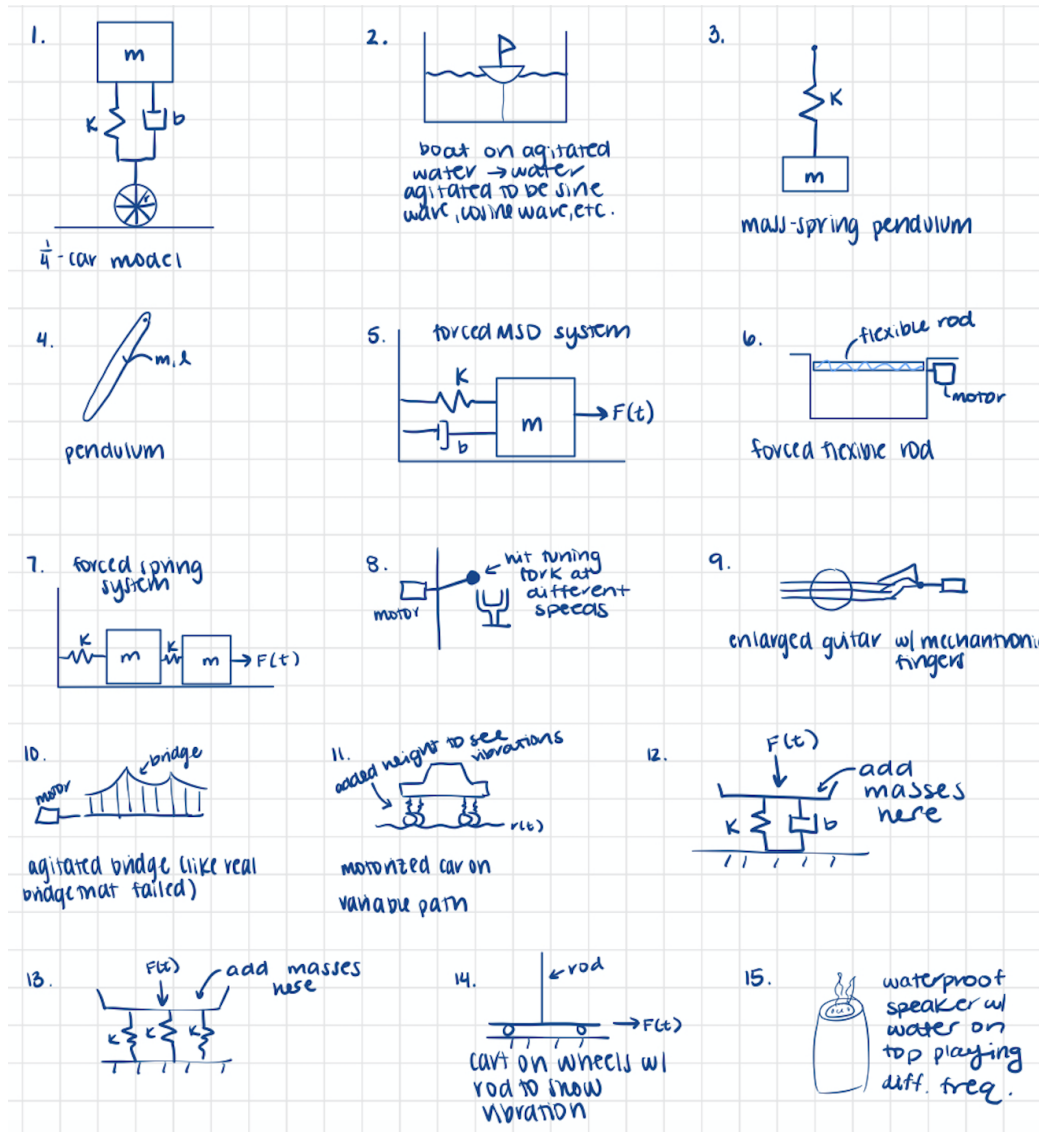
Appendix A shows a detailed stakeholder analysis that examines each stakeholder's impact, influence, opinions, and ability to block the project. Additional stakeholders not shown previously in the stakeholder map are included here for completeness. These stakeholders were not shown in detail previously to prevent overwhelming the reader and to maintain clarity.

Stakeholder	Impact	Influence	What is important to the stakeholder	How could the stakeholder contribute to the project	How could the stakeholder block the project	Strategy for engaging the stakeholder
Sponsor	High	High	Creating a functional and helpful device for use in the classroom - our sponsor is an ME240 professor	Has extensive knowledge in ME240 and ME360 topics; has experience teaching and can give us feedback on the tool we're creating to help students learn	Unsatisfied with the project progress or outcome and stop sponsoring	Clear communication often to keep them up to date with our project; respecting their suggestions and doing our best to implement them; ensure we are satisfying their requirements throughout the process
ME240 Professors	High	High	Use the device to better demonstrate lecture concepts for students	Suggestions on how to improve the device from the perspective of teaching	Refuse to implement the device in their classroom	Communicate through email and in-person meetings to give update and get feedback
Current ME240 Students	Low	High	N/A	Suggestions on how to improve the device from the perspective of learning	Not giving feedback	Sending questionnaires to have a sense of what topics need to be covered
Future ME240 Students	High	Low	Better learn lecture concept from the demonstration with the device	Suggestions on how to improve the device from the perspective of learning	Not giving feedback	Encourage them to help in any way we may need them to (i.e. a survey) by explaining it will help them later on
Former ME240 Students	Low	High	N/A	Help gain knowledge of what students felt was difficult in the class and feedback on potential system solutions	Not giving feedback	Use surveys to ask for their opinions on our proposed solutions
ME360 Professors	Medium	Medium	Use the device to better demonstrate lecture concepts for students	Suggestions on how to improve the device from the perspective of teaching	N/A	Communicate through email and in-person meetings to give update and get feedback
Current ME360 Students	Low	High	N/A	Suggestions on how to improve the device from the perspective of learning	Not giving feedback	N/A
Future ME360 Students	High	Low	Better learn lecture concept from the demonstration with the device	Suggestions on how to improve the device from the perspective of learning	Not giving feedback	N/A
Mechanical Engineering Department	Medium	Medium	Improve lecture qualities	Provide resources to support the project	Refuse to put the product in use	Communicate through email and report for project update and future plan
College of Engineering	Medium	Medium	Improve lecture qualities	Provide resources to support the project	Refuse to put the product in use	Communicate through email and report for project update and future plan


## Appendix B

Shown in Appendix B are the 160 concepts generated during the initial concept generation. All team members contributed 40 designs.

**Bridget:**




16.



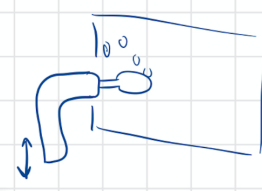
pendulum to draw graph

17.




symbol & measure vibrations

18.

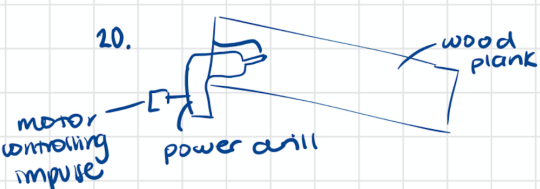


meragun impiting on gel

19. forced vibrating string




20.



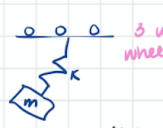
motor controlling impulse power drill wood plank

21.



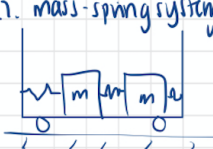
escalator-system w/ sinky & variable frequency

24.



mass-spring pendulum on wheels

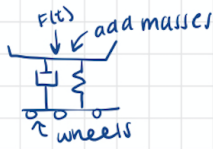
27.



mass-spring system on wheels

similar to 7


29.



add masses

similar to 12

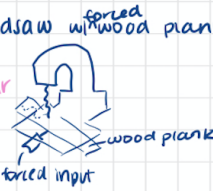
32.



electric mixer in water

use H2O like 2


22. bandsaw w/ forced wood plank



forced input

similar to 20

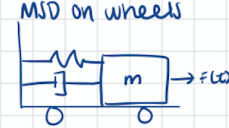
25.



paintbrush w/ forced input on canvas

similar tracking to 16 (drawing response)


28.



MSD on wheels

similar to 5

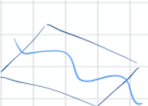
30.



add masses

similar to 13

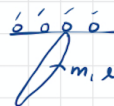
33.



flexible metal sheet agitated to make a noise -> measure vibrations

measure sound like 17


23.



pendulum on wheels

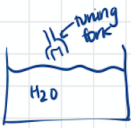
4 w/ wheels

26.



fan w/ strings -> see how strings vibrate

31.

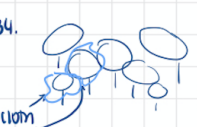


tuning fork

measure vibrations in H2O

use tuning fork like 8

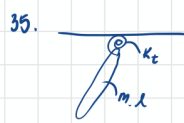
34.



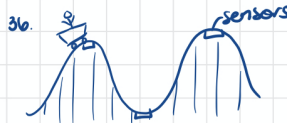
drum set w/ some drums damped by cloth

measure sound vibrations

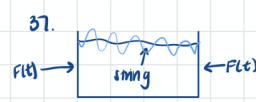
sound like 17



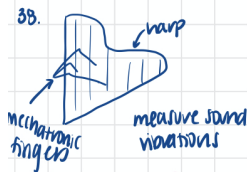
35. pendulum w/ torsional spring → similar to 4



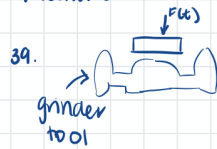
36. roller coaster model w/ force sensors at various locations



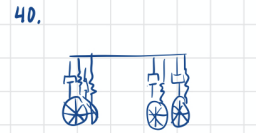
37. smng to show vibrations from forced input  
similar to 6



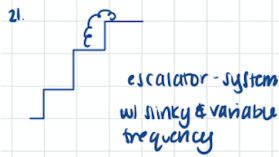
similar to 9



39. grinder tool  
forced input pressing a block/rod of material & seeing the shape of grinding



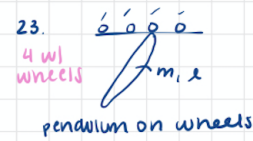
40. MSD on 4 wheels to create a car  
similar to 1 & 11



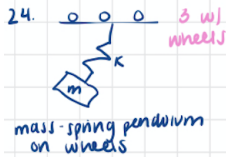
21. escalator-system w/ spring & variable frequency



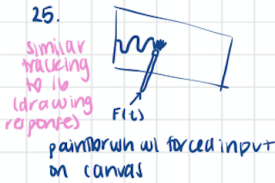
22. bandsaw w/ forced wood plank  
similar to 20



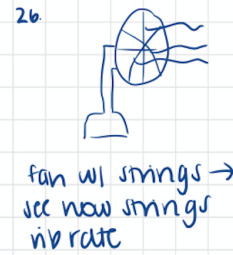
23. 4 w/ wheels  
pendulum on wheels



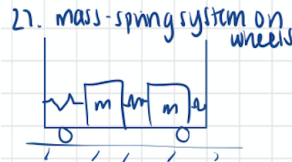
24. mass-spring pendulum on wheels  
3 w/ wheels



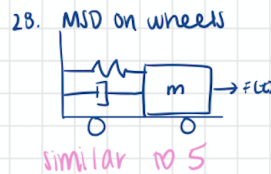
25. similar tracking to 16 (drawing responses)  
paintbrush w/ forced input on canvas



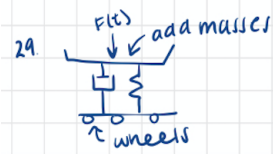
26. fan w/ strings → see how strings vibrate



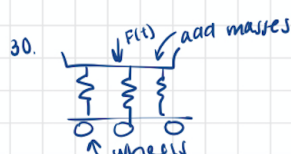
27. mass-spring system on wheels  
similar to 7



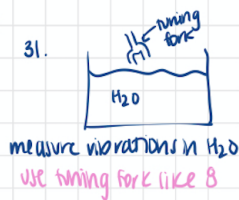
28. MSD on wheels  
similar to 5



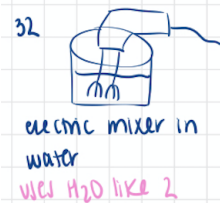
29. similar to 12



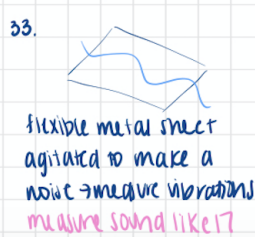
30. similar to 13



31. measure vibrations in \$H\_2O\$  
use tuning fork like 8



32. electric mixer in water  
w/ \$H\_2O\$ like 2



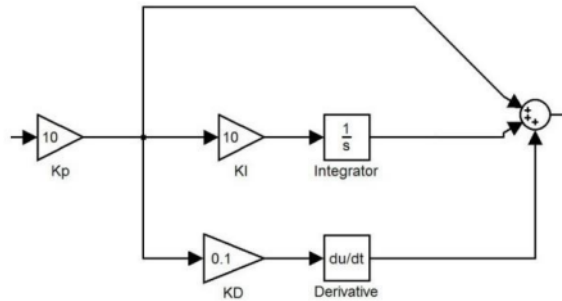
33. flexible metal sheet agitated to make a noise → measure vibrations  
measure sound like 17



34. drum set w/ some drums damped by cloth  
measure sound vibrations  
round like 17

**Lihan:**

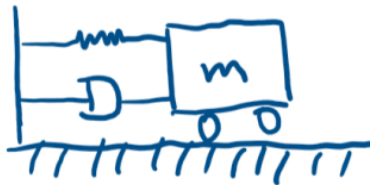
1. Using spring and damper mass system to show different type of vibration systems.
2. Use MATALB toolbox to simulate controller.



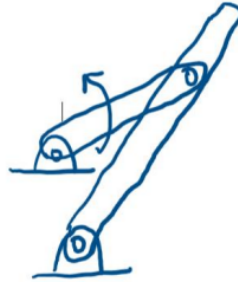
3. Use Arduino board and a mechanical arm to familiarize students with PID parameters.
4. Use simple mechanical device to demonstrate projectile motion.
5. Use magnetic, aluminum rod to act as a pendulum.
6. Simulate an inverted pendulum in MATLAB/PyBullet
7. Including a camera that can capture the instant position of moving object.
8. Use a string and weight to demonstrate harmonic motion.



9. A small cart connected with a damper and a spring.



10. Two bar that connected together and both have fixed pivot.



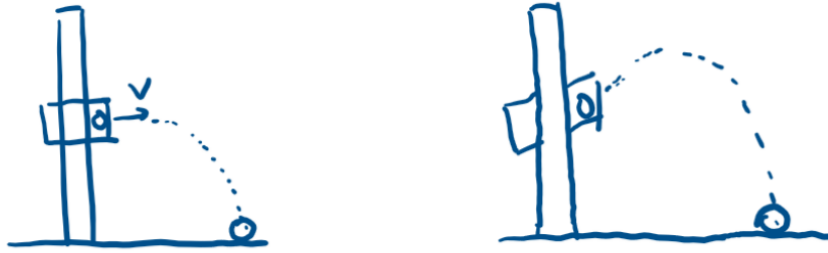
11. A slope which can have various coefficient of friction.
12. A rotational gyro to show the conservation of angular momentum.
13. Two carts connected with spring.
14. A sensor that can track the moving trajectory of the object.
15. Use Simulink to design a PID controller.
16. Include an encoder to the device.
17. Have a software tool to visualize the experiment result.
18. Include a motor to the device.
19. Having a oscilloscope to output the experiment result.
20. Having a GUI interface that student can experiment with.

1. Use rotational damper in a device instead of a common damper.
2. Include raspberry pi in the device
3. Use Arduino to have a PID controller that used to balance a ball.



4. An Arduino PID based motor controller.
5. Glasses with different shape that can be used for showing different harmonic frequency (through striking)
6. Building electric circuit that can be used with oscilloscope.
7. Use Arduino simulation software to visualize the result.
8. Use motion capture system to capture the motion of object.

- 9. A device with adjustable height and can throw ball with same effort.
- 10. A device that can adjust shooting angle that can throw ball with same effort.



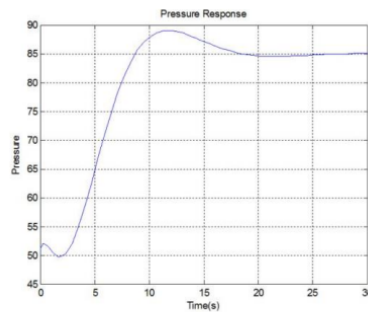
- 11. A slope that can change releasing angle of the ball.
- 12. A pulley system
- 13. A device that has change damping ratio to show the damping effect.
- 14. A device with force measurement sensor
- 15. Include instant velocity detection sensor in the device.
- 16. A mass system with damper and spring at different side



- 17. A pendulum that can attach mass at different length to show the radius effect in angular motion.
- 18. An assembly a fixed pivot, with a rod attached two mass at different end, to show the concept of momentum.



- 19. Include MATLAB or Simulink simulation plot.



- 20. A mechanical system contains multiple mass, string, and damper.

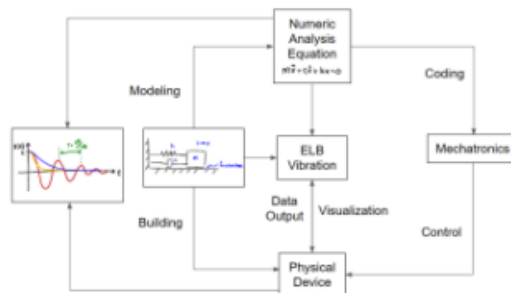


15. Releasing colored gas to visualize the motion
16. Half-merged in water to visualize the motion



17. Mount on a cart for portability
18. Make the device foldable
19. Make the device out of legos
20. Simply constrain the size of the device

1. Choose particle dynamics as the topic
2. Choose angular dynamics as the topic
3. Choose vibration as the topic
4. Mechatronic control for variable parameters



5. Changeable physical parts
6. Changeable mechanisms
7. Adjustable connecting location
8. Several settings that could demonstrate situations with different parameters
9. Motor with encoder for data output
10. Video with grids for later video analysis
11. Laser sensor for data output
12. Large moving range for better motion visualization
13. Grab a pen to visualize the motion



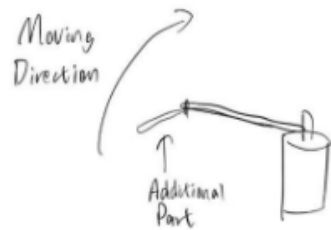
14. Pouring colored powders to visualize the motion

Starting point:

Large moving range for better motion visualization

Descriptive titles:

2. Attach an additional part making an even more obvious motion



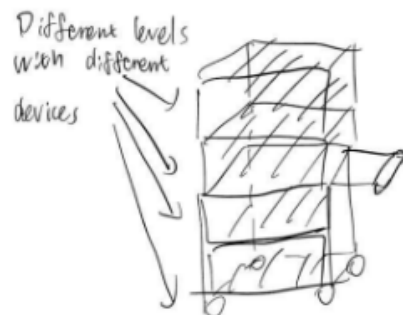
20. Change the geometry of the moving part to make the motion more obvious

Starting point:

Mount on a cart for portability

Descriptive titles:

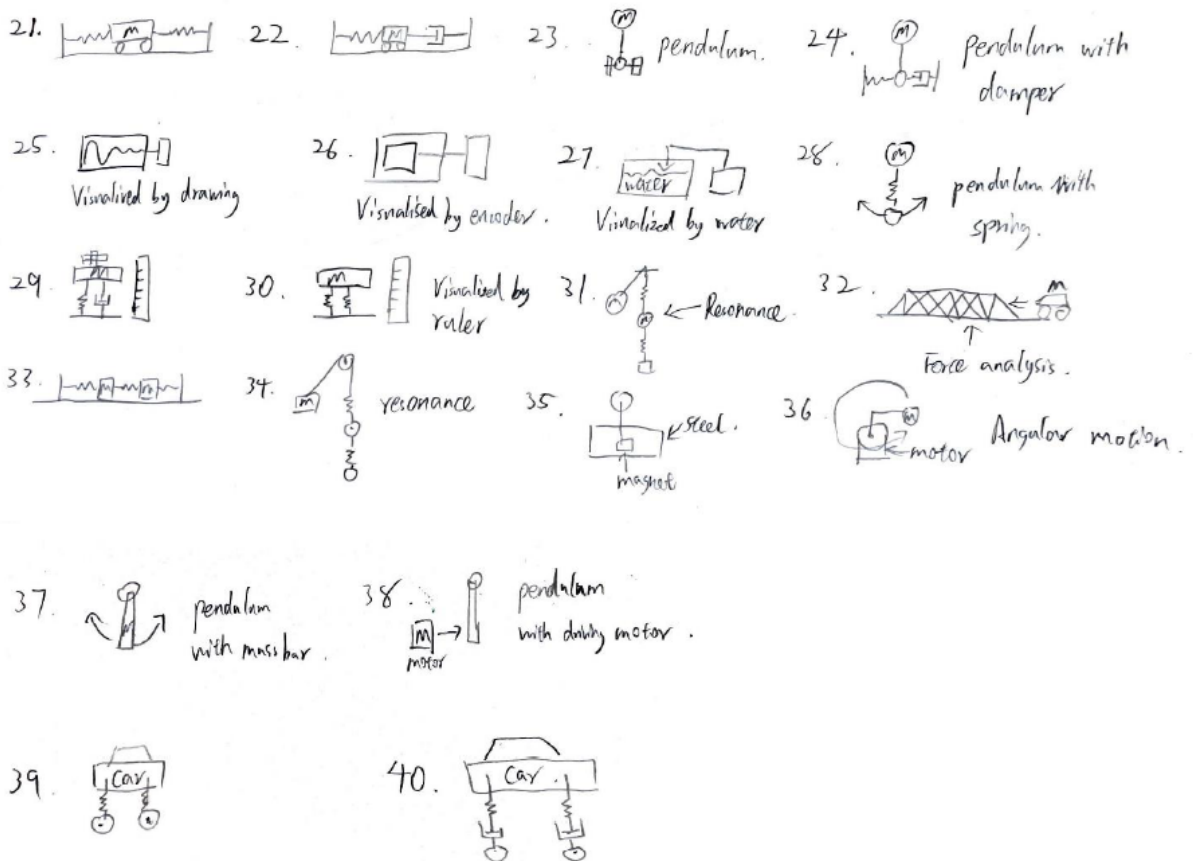
1. Add levels to the cart to utilize the vertical space
4. look for existing cart design for our need
8. Allow lecturers to mount different modules of devices on the cart for specific needs



27. Cover the cart in case of misalignment during the transportation

- (1) Rigid body dynamics<sup>←</sup>
- (2) Rigid body linear motion<sup>←</sup>
- (3) Rigid body angular motion<sup>←</sup>
- (4) Combination of linear and angular motion<sup>←</sup>
- (5) Motion with two rigid bodies<sup>←</sup>
- (6) Joint connection with two rigid bodies<sup>←</sup>
- (7) Vibration<sup>←</sup>
- (8) Use encoder to control the vibration<sup>←</sup>

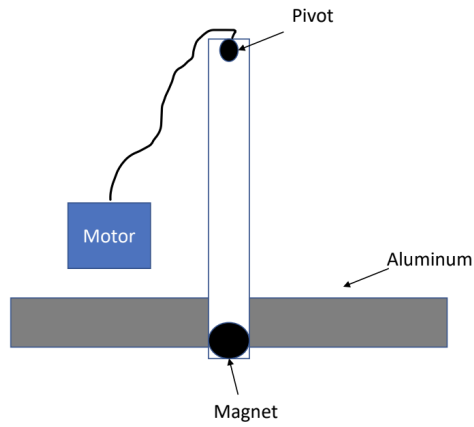
- (9) PID control<sup>←</sup>
- (10) Vibration without damping<sup>←</sup>
- (11) Forced damping<sup>←</sup>
- (12) Damping with friction<sup>←</sup>
- (13) Magnet damping<sup>←</sup>
- (14) Vibration with driven system<sup>←</sup>
- (15) Use a car to visualize the vibration<sup>←</sup>
- (16) Vibration with two springs<sup>←</sup>
- (17) Pendulums with magnet<sup>←</sup>
- (18) Pendulums with load<sup>←</sup>
- (19) Pendulums with motor (forced)<sup>←</sup>
- (20) Pendulums with encoder <sup>←</sup>



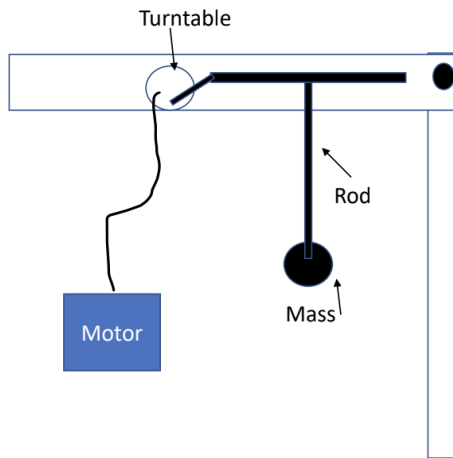
### Appendix C

In this section, there is a comprehensive list of all designs created using the metrics table. Each team member created 2-4 designs which are shown here. The designs are named based on who created them and the order in which they were presented. This was done so when the Pugh chart was presented during Design Review 2 it had better visibility and this naming convention helped differentiate between designs as some team members created very similar designs that could be confused had the names been based off its attributes.

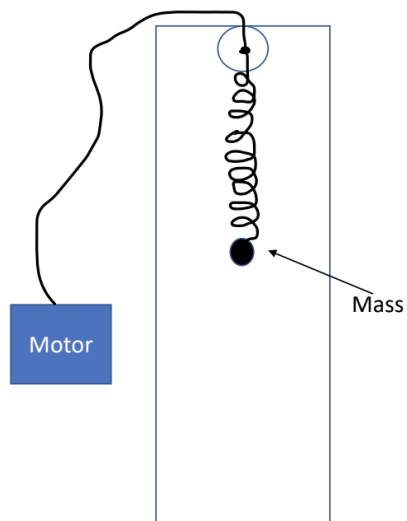
**Lihan 1:**



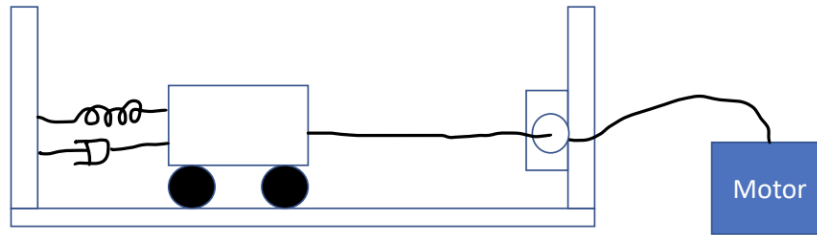
**Lihan 2**



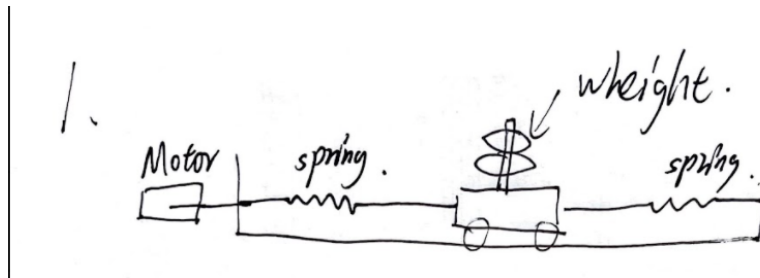
**Lihan 3**



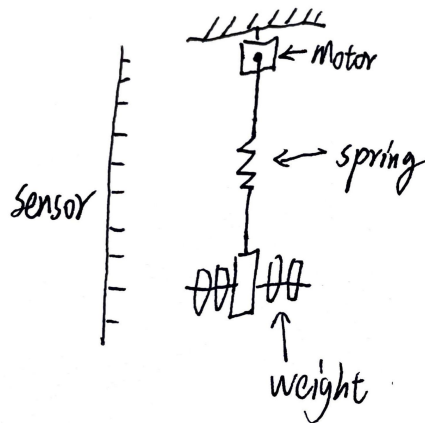
**Lihan 4 - base design for the Pugh chart**



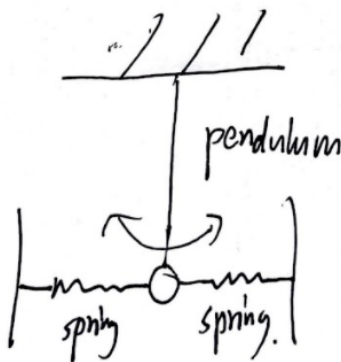
**Haotian 1**



**Haotian 2**

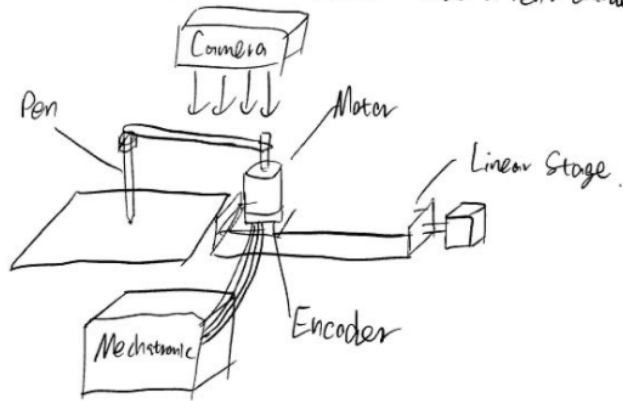


**Haotian 3**



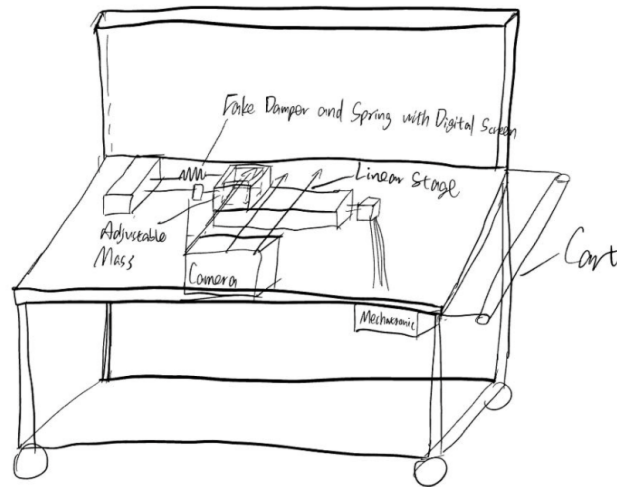
**Ruitao 1**

1. Pendulum - Limit Size - Mechatronic Control - Grab a Pen - Encoder - Video Analysis

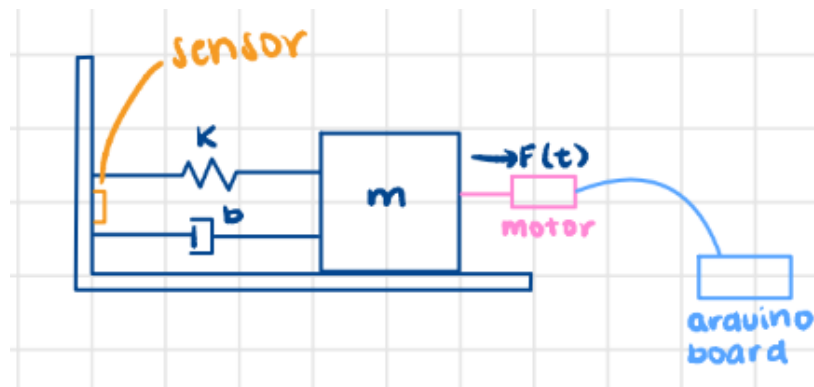


**Ruitao 2**

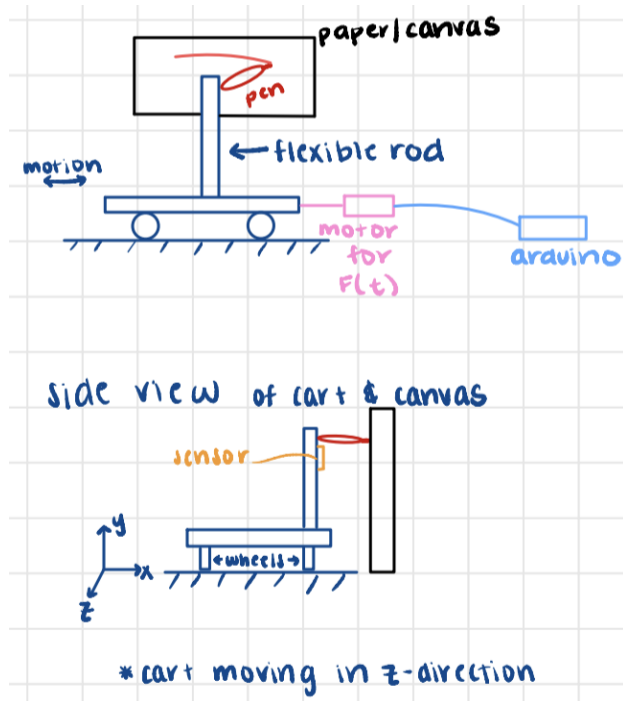
2. Mass-spring-damper - Mount on Cart - Mechatronic Control - Larger Moving Range - Video Analysis



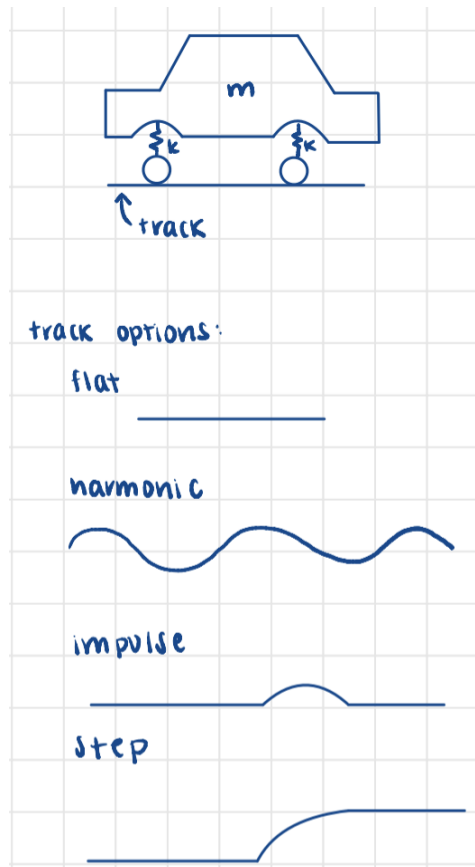
**Bridget 1**



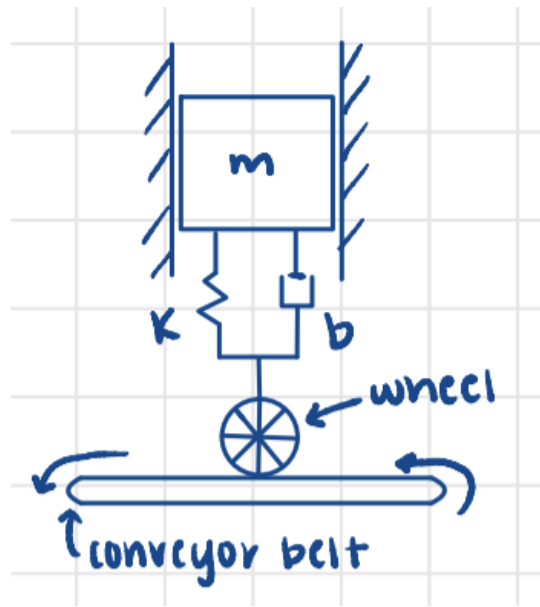
### Bridget 2



### Bridget 3



**Bridget 4**



**Build Design Bill of Materials**

Item	Quantity	Source	Catalog Number	Cost (\$)	Contact
6Ft Long USB-2.0 Cable Type-A to Type-B High Speed Cord for Audio Interface, Midi Keyboard, USB Microphone, Mixer, Speaker, Monitor, Instrument, Strobe Light System Laptop Mac PC Type A to Type B	1	Amazon	B01BIE98PO	9.99	<a href="https://www.amazon.com/go/contact-us?orderId">https://www.amazon.com/go/contact-us?orderId</a>
Arduino UNO REV3 [A000066]	1	Amazon	B008GRTSV6	28.5	<a href="https://www.amazon.com/go/contact-us?orderId">https://www.amazon.com/go/contact-us?orderId</a>
Linear Rail 50mm / 100mm / 150mm/ 200mm Linear Stage Actuator with Square Linear Rails Mini Slide Table + NEMA 11 Stepper Motor for DIY CNC Router Milling Machine (100mm)	1	Amazon	B07K7FQ245	67	<a href="https://www.amazon.com/go/contact-us?orderId">https://www.amazon.com/go/contact-us?orderId</a>
ALITOVE DC 24V 15A 360W Power Supply Universal Regulated Switching Transformer Adapter LED Driver 110V/220V AC Input for LED Strip CCTV	1	Amazon	B06XK2ZNNK	23.99	<a href="https://www.amazon.com/go/contact-us?orderId">https://www.amazon.com/go/contact-us?orderId</a>



Radio					
Bergen Industries Inc PS615143 3-Wire Appliance and Power Tool Cord, 6 ft, 14 AWG, 15A/125V AC, 1875w , Black	1	Amazon	B07BQ8MRKR	7.37	<a href="https://www.amazon.com/go/contact-us?orderId">https://www.amazon.com/go/contact-us?orderId</a>
0.5-4A 9-40V DC CNC Stepper Motor Driver 32 Micro-Step Resolutions Step Controller Module Board for Nema 8, 11, 14, 16, 17 Stepper Motor	1	Amazon	B07FXLRQ47	11.75	<a href="https://www.amazon.com/go/contact-us?orderId">https://www.amazon.com/go/contact-us?orderId</a>
DC Motor Driver, DROK L298 Dual H Bridge Motor Speed Controller DC 6.5V-27V 7A PWM Motor Regulator Board 12V 24V Electric Motor Control Module Industrial 160W with Optocoupler Isolation	1	Amazon	B06XGD5SCB	15.78	<a href="https://www.amazon.com/go/contact-us?orderId">https://www.amazon.com/go/contact-us?orderId</a>
6061 T6 Aluminium Metal Sheet 12 x 12 x 1/8 Inch Flat Plain Plate Panel Aluminum Sheet Plate Finely Polished and Deburred	1	Amazon	B08M63VD66	14.99	<a href="https://www.amazon.com/go/contact-us?orderId">https://www.amazon.com/go/contact-us?orderId</a>
SIMAX3D MGN12H 300mm Linear Rail Guide 2Carriages MGN12 Linear Slide 8mm for 3D Printer and CNC Machine Upgrade	1	Amazon	B08L21Q4TZ	27.99	<a href="https://www.amazon.com/go/contact-us?orderId">https://www.amazon.com/go/contact-us?orderId</a>
Art3d (2 Pack) 1/8" Thick Plexiglass Sheets - 12" x 12" PET Clear Acrylic Sheets for Art Design, Craft Projects, Signs, DIY in Home, Wedding, Festival,Party,Office	1	Amazon	B0BHQYLHQN	16.99	<a href="https://www.amazon.com/go/contact-us?orderId">https://www.amazon.com/go/contact-us?orderId</a>
BL17E19-01D-03RO BLDC Motor	1	Digi-Key	2090-BL17E19-01D-03RO-ND	136.04	Phone: 800-338-4105
METALLIXITY Compression Springs (1.2x15mm OD,30mm Free Length) 10Pcs, 304 Stainless Steel Extension Spring - for Shop Home Repairs, DIY Projects, Silver Tone	1	Amazon	B0B6HYBNK5	9.99	<a href="https://www.amazon.com/go/contact-us?orderId">https://www.amazon.com/go/contact-us?orderId</a>
METALLIXITY Compression Springs (1x16mm OD,40mm Free Length) 10Pcs, 304 Stainless Steel Extension Spring - for Shop Home Repairs, DIY Projects, Silver Tone	1	Amazon	B0B6HZYD7H	9.99	<a href="https://www.amazon.com/go/contact-us?orderId">https://www.amazon.com/go/contact-us?orderId</a>
BLDC50-BL17E19-01 BLDC Motor Driver+Controller	1	Digi-Key	2090-BLDC50-BL17E19-01-ND	186.65	Phone: 800-338-4105

### Manufacturing/ Fabrication Plan

Our device components are manufactured by three main methods; 3D printing, mill and water jet. The overview of the components is shown below. All of the supports, gear, rack and pen holder are manufactured by 3D printers. The paper platform is cut by water jet and the rest of the parts are manufactured by mill such as the base plate. The reason why we choose the 3D printing method is because 3D printing is the quickest way to make a prototype which meets our design. For the future product and improvements, we suggest using metals to increase the stability of the device.

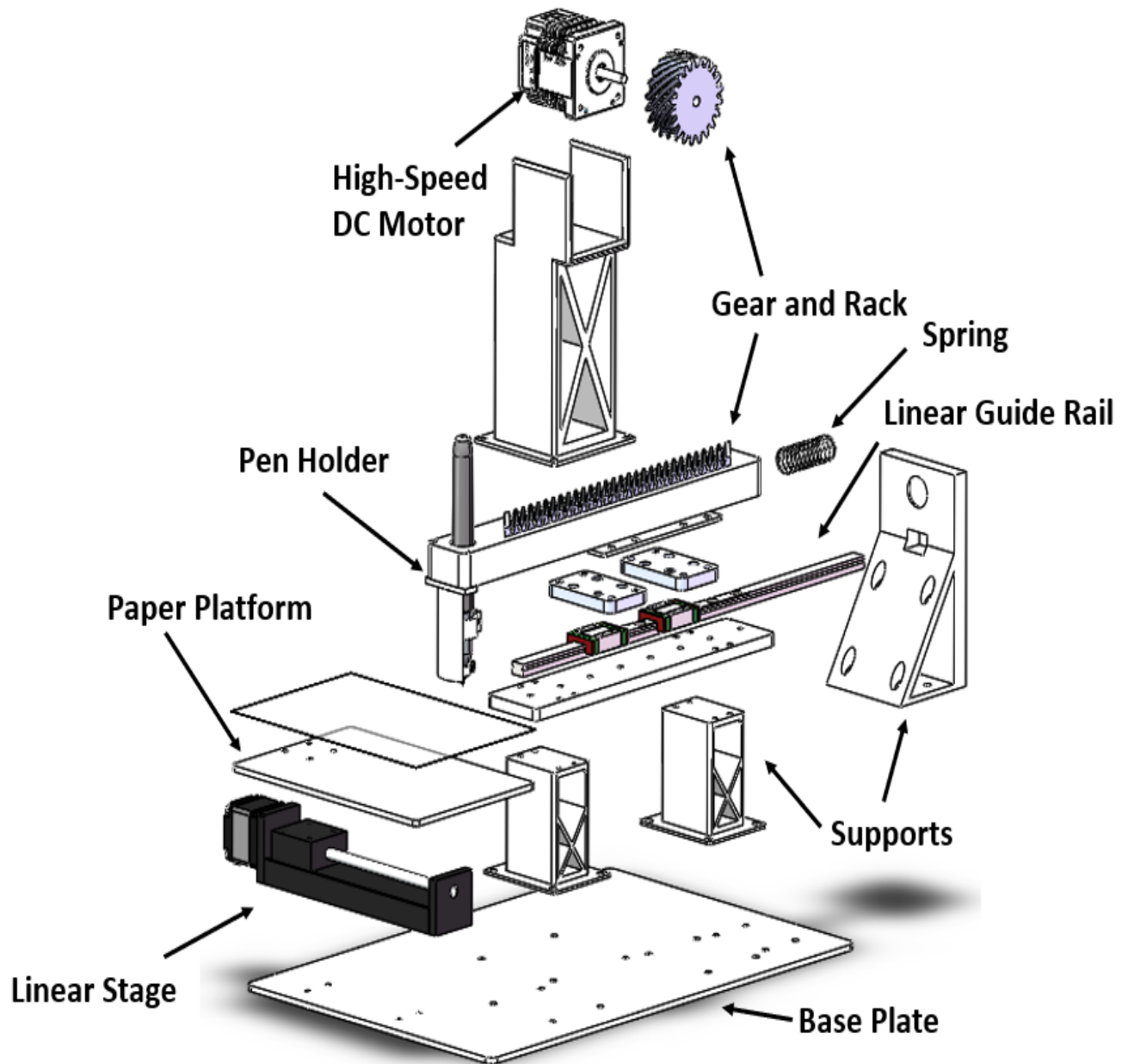


Figure 23: Overview of device components

When we assemble the device, we use M3 and M4 screws to fix the supports and linear stage on the aluminum base plate first. Then we set up the rack, pen holder and spring on the linear guide rail and put them on supports with the motor. Be Careful that when assembling the plate between the pen holder and linear guide rail, the eight M3 screws should be tightened at the same time to let the motion direction along the rail. After that we put the paper platform on the linear stage and adjust the distance between pen to paper on the paper platform to make sure that it can draw the vibration trajectory smoothly. According to this set up order, our device can be assembled with good performance and can be easily adjusted.