

ELECTROMAGNETIC SCATTERING FROM CERTAIN
RADIALLY INHOMOGENEOUS DIELECTRICS

by

Nicolaos Georgiou Alexopoulos

A dissertation submitted in partial fulfillment
of the requirements for the degree of
Doctor of Philosophy in
The University of Michigan
1968

Doctoral Committee:

Professor Chiao-Min Chu, Co-chairman
Doctor Piergiorgio L. E. Uslenghi, Co-Chairman
Professor Lamberto Cesari
Professor Dale M. Grimes
Professor Chen-To Tai
Doctor Vaughan H. Weston

RL-454 = RL-454

ELECTROMAGNETIC SCATTERING FROM CERTAIN
RADIALLY INHOMOGENEOUS DIELECTRICS

by

Nicolaos Georgiou Alexopoulos

Co-Chairmen: Chiao-Min Chu
Piergiorgio L. E. Uslenghi

In this research, the phenomenon of electromagnetic wave propagation through, and scattering from, radially inhomogeneous dielectrics is studied for very high frequencies. The dielectrics are considered lossless, radially inhomogeneous in the spherical coordinates system, and of the converging or of the diverging type. The lens problem is studied by the geometrical optics technique and the radar cross-section of perfectly conducting spheres coated with radially inhomogeneous dielectrics is investigated. By assuming a plane wave as the incident electromagnetic field, the contribution in the backscattering direction due to the reflected field and the creeping waves is determined by applying asymptotic theory. This necessitates the use of the WKB and/or Langer's method for the solution of the pertinent differential equations, depending on whether there exist transition points in the range for which the solutions are required. Also, the integrals of Scott (1949) are needed in order to determine the reflected portion of the field.

Such a study is interesting not only from the theoretical but also from the practical point of view, in that it lends itself useful to the understanding of radio wave propagation in radially inhomogeneous dielectrics and of the effect of coating perfectly conducting spheres with radially inhomogeneous media. It also has applications to problems of wave propagation in the ionosphere and around the earth.

To begin with, a general outline of the problem and the methods of solution is given. Then, a new class of radially inhomogeneous dielectrics is introduced and it is studied by the ray tracing technique. This new class of

radially inhomogeneous dielectrics is also treated as the coating of a perfectly conducting sphere and the monostatic cross-section is examined when the dielectric is of the converging or diverging kind. Finally another class of radially inhomogeneous media, previously discussed by Nomura and Takaku, is considered and its effect in reducing or enhancing the radar cross-section of a perfectly conducting sphere is determined.

ACKNOWLEDGEMENTS

The author is indebted to Dr. P.L.E. Uslenghi for suggesting the topic and for his guidance, to Professor C.M. Chu for his valuable discussions and suggestions, to Professor C.T. Tai for proposing the Nomura Takaku lens and his continuous encouragement, to the other members of his committee for their participation and useful comments during this research.

Acknowledgment is also due to Mrs. N. Asano and Mrs. P. Job for typing the manuscript, Mr. G. Antones for drawing the figures and Mr. P. Wilcox for performing the computer calculations.

Finally, the author wishes to thank the director of the Radiation Laboratory, Professor R.E. Hiatt, for his encouragement and assistance.

Part of the support for this research is due to Contract F19628-68-C-0071.

TABLE OF CONTENTS

	Page
ACKNOWLEDGMENTS	ii
LIST OF TABLES	iv
LIST OF ILLUSTRATIONS	v
CHAPTER ONE: GENERAL CONSIDERATIONS	1
1.1 Introduction	1
1.2 Scattering from Radially Inhomogeneous Media	5
1.3 Outline of Research	8
CHAPTER TWO: A NEW CLASS OF RADIALLY INHOMOGENEOUS MEDIA	22
2.1 Introduction	22
2.2 Solution for the Eigenfunctions when $\epsilon(\xi) = (1-\gamma)^2 / (\xi-\gamma)^2$	24
2.3 Geometrical Optics Approach for the New Class of Lenses	29
CHAPTER THREE: HIGH FREQUENCY BACKSCATTERING FROM A PERFECTLY CONDUCTING SPHERE COATED WITH THE NEW CLASS OF RADIALLY INHOMOGENEOUS DIELECTRICS	36
3.1 Introduction	36
3.2 The Asymptotic Solutions of $S_{\nu-1/2}(\xi)$ and $T_{\nu-1/2}(\xi)$	37
3.3 The Reflected Electric Field	41
3.4 Derivation of the Reflected Electric Field by Geometrical Optics	50
3.5 Scattering Cross-Section Computations	54
3.6 An Outline for the Creeping Wave Contribution in the Backscattering Direction	55
CHAPTER FOUR: HIGH FREQUENCY BACKSCATTERING FROM A PERFECTLY CONDUCTING SPHERE COATED WITH A DIELECTRIC WHOSE INDEX OF REFRACTION IS $N(\xi) = \xi^p$	69
4.1 Introduction	69
4.2 The Radial Eigenfunctions in their Asymptotic Form	70
4.3 The Reflected Electric Field	73
4.4 The Geometrical Optics Approach	80
4.5 Numerical Computations	83
4.6 The Creeping Wave Contribution	86
CHAPTER FIVE: CONCLUSIONS	94
BIBLIOGRAPHY	96

LIST OF TABLES

Table	Title	Page
4-1	Computations of σ_{N_1} for Various β and p	85

LIST OF ILLUSTRATIONS

Figure	Title	Page
1-1	Geometry of the Problem	4
1-2	Contour C in the Complex ν -plane	8
1-3	The Deformed Path in the Complex ν -plane	9
2-1	Case 1: $0 \leq \gamma < 1$	26
2-2	Case 2: $\gamma \geq 1$	27
2-3	Case 3: $\gamma \leq 0$, $\gamma \stackrel{\Delta}{=} -h$, $h \geq 0$	28
2-4	Ray Path through the Inhomogeneous Dielectric	30
2-5	Deviation Angle vs. Angle of Incidence	33
2-6	Deviation Angle vs. Angle of Incidence	34
2-7	Maximum Deviation Angle vs. h	35
3-1	The Geometry of the Problem ($c = a\gamma$)	40
3-2	Contours of Integration and Different Regions Considered in the Complex ν -plane	44
3-3	Paths of Incident and Reflected Rays when $0 < \gamma < 1$	52
3-4	σ_{N_1} vs. β , for $0 < \gamma < 1$	56
3-5	σ_{N_1} vs. β , for $1.1 \leq \gamma \leq 2.0$	57
3-6	D vs. ka for $\gamma = \beta/4$	58
3-7	D vs. ka for $\gamma = \beta/4$	59
3-8	D vs. ka for $\gamma = \beta/2$	60
3-9	D vs. ka for $\gamma = \beta/2$	61
3-10	D vs. ka for $\gamma = 3\beta/4$	62
3-11	D vs. ka for $\gamma = 3\beta/4$	63
3-12	D vs. ka for $\gamma = 0.99\beta$	64
3-13	D vs. ka for $\gamma = 0.99\beta$	65
4-1	Paths of Incident and Reflected Rays	81

ELECTROMAGNETIC SCATTERING FROM CERTAIN RADIALLY INHOMOGENEOUS DIELECTRICS

by

Nicolaos Georgiou Alexopoulos

ABSTRACT

In this research, the phenomenon of electromagnetic wave propagation through, and scattering from, radially inhomogeneous dielectrics is studied for very high frequencies. The dielectrics are considered lossless, radially inhomogeneous in the spherical coordinates system, and of the converging or of the diverging type. The lens problem is studied by the geometrical optics technique and the radar cross-section of perfectly conducting spheres coated with radially inhomogeneous dielectrics is investigated. By assuming a plane wave as the incident electromagnetic field, the contribution in the backscattering direction due to the reflected field and the creeping waves is determined by applying asymptotic theory. This necessitates the use of the WKB and/or Langer's method for the solution of the pertinent differential equations, depending on whether there exist transition points in the range for which the solutions are required. Also, the integrals of Scott (1949) are needed in order to determine the reflected portion of the field.

Such a study is interesting not only from the theoretical but also from the practical point of view, in that it lends itself useful to the understanding of radio wave propagation in radially inhomogeneous dielectrics and of the effect of coating perfectly conducting spheres with radially inhomogeneous media. It also has applications to problems of wave propagation in the ionosphere and around the earth.

To begin with, a general outline of the problem and the methods of solution is given. Then, a new class of radially inhomogeneous dielectrics is introduced and it is studied by the ray tracing technique. This new class of

radially inhomogeneous dielectrics is also treated as the coating of a perfectly conducting sphere and the monostatic cross-section is examined when the dielectric is of the converging or diverging kind. Finally another class of radially inhomogeneous media, previously discussed by Nomura and Takaku, is considered and its effect in reducing or enhancing the radar cross-section of a perfectly conducting sphere is determined.

TABLE OF CONTENTS

	Page
LIST OF TABLES	vi
LIST OF ILLUSTRATIONS	vii
CHAPTER ONE: GENERAL CONSIDERATIONS	1
1.1 Introduction	1
1.2 Scattering from Radially Inhomogeneous Media	5
1.3 Outline of Research	8
CHAPTER TWO: A NEW CLASS OF RADIALY INHOMOGENEOUS MEDIA	22
2.1 Introduction	22
2.2 Solution for the Eigenfunctions when $\epsilon(\xi) = (1-\gamma)^2 / (\xi-\gamma)^2$	24
2.3 Geometrical Optics Approach for the New Class of Lenses	29
CHAPTER THREE: HIGH FREQUENCY BACKSCATTERING FROM A PERFECTLY CONDUCTING SPHERE COATED WITH THE NEW CLASS OF RADIALY INHOMOGENEOUS DIELECTRICS	36
3.1 Introduction	36
3.2 The Asymptotic Solutions of $S_{\nu-1/2}(\xi)$ and $T_{\nu-1/2}(\xi)$	37
3.3 The Reflected Electric Field	41
3.4 Derivation of the Reflected Electric Field by Geometrical Optics	50
3.5 Scattering Cross-Section Computations	54
3.6 An Outline for the Creeping Wave Contribution in the Backscattering Direction	55
CHAPTER FOUR: HIGH FREQUENCY BACKSCATTERING FROM A PERFECTLY CONDUCTING SPHERE COATED WITH A DIELECTRIC WHOSE INDEX OF REFRACTION IS $N(\xi) = \xi^p$	69
4.1 Introduction	69
4.2 The Radial Eigenfunctions in their Asymptotic Form	70
4.3 The Reflected Electric Field	73
4.4 The Geometrical Optics Approach	80
4.5 Numerical Computations	83
4.6 The Creeping Wave Contribution	86
CHAPTER FIVE: CONCLUSIONS	94
BIBLIOGRAPHY	96

LIST OF TABLES

Table	Title	Page
4-1	Computations of σ_{N_1} for Various β and p	85

01263-3 T

LIST OF ILLUSTRATIONS

Figure	Title	Page
1-1	Geometry of the Problem	4
1-2	Contour C in the Complex ν -plane	8
1-3	The Deformed Path in the Complex ν -plane	9
2-1	Case 1: $0 \leq \gamma < 1$	26
2-2	Case 2: $\gamma \geq 1$	27
2-3	Case 3: $\gamma \leq 0, \gamma \stackrel{\Delta}{=} -h, h \geq 0$	28
2-4	Ray Path through the Inhomogeneous Dielectric	30
2-5	Deviation Angle vs. Angle of Incidence	33
2-6	Deviation Angle vs. Angle of Incidence	34
2-7	Maximum Deviation Angle vs. h	35
3-1	The Geometry of the Problem ($c = a\gamma$)	40
3-2	Contours of Integration and Different Regions Considered in the Complex ν -plane	44
3-3	Paths of Incident and Reflected Rays when $0 < \gamma < 1$	52
3-4	σ_{N_1} vs. β , for $0 < \gamma < 1$	56
3-5	σ_{N_1} vs. β , for $1.1 \leq \gamma \leq 2.0$	57
3-6	D vs. ka for $\gamma = \beta/4$	58
3-7	D vs. ka for $\gamma = \beta/4$	59
3-8	D vs. ka for $\gamma = \beta/2$	60
3-9	D vs. ka for $\gamma = \beta/2$	61
3-10	D vs. ka for $\gamma = 3\beta/4$	62
3-11	D vs. ka for $\gamma = 3\beta/4$	63
3-12	D vs. ka for $\gamma = 0.99\beta$	64
3-13	D vs. ka for $\gamma = 0.99\beta$	65
4-1	Paths of Incident and Reflected Rays	81

CHAPTER I
GENERAL CONSIDERATIONS

1.1 Introduction

The problem of electromagnetic scattering from radially inhomogeneous media has been considered in the past by many authors. On the subject there exist some books such as Brekhovskikh's (1960) and Wait's (1962) and numerous articles published in technical journals. The problem in its most general form was considered by Gutman (1965). Gutman assumed the electromagnetic properties of the medium to be inhomogeneous in the angular as well as the radial direction. He applied a modified form of the Hansen-Stratton vector wave-function method due to Kisun'ko in order to solve the vector wave equation and thus to determine a representation of the electromagnetic field in the medium. The solution which he obtained, however, is of a purely formal nature since it involves an infinite set of first order linear ordinary differential equations. Explicit results can be obtained if the inhomogeneity is only in the radial direction and it is with this case that this research is concerned. Marcuvitz (1951) gave a rather systematic treatment of the electromagnetic field representation in a medium whose index of refraction depends on the radius in the spherical coordinate system. Nomura and Takaku (1955) studied the radio wave propagation around the earth. They considered both the earth and the atmosphere radially stratified with the permittivity being given by $\epsilon\left(\frac{r}{a}\right) = \left(\frac{r}{a}\right)^{2p\kappa}$, $p < -1$, κ = index pertaining to the κ th layer of stratification. Tai (1958a) applied the vector wave-function method of Hansen and Stratton to obtain a complete representation of the electromagnetic field by superposing electric and magnetic types of waves each of which he expressed in terms of two vector wave functions. He then applied these general results to the particular case of a sphere whose index of refraction

$$N\left(\frac{r}{a}\right) = \left(2 - \frac{r^2}{a^2}\right)^{1/2}$$

is that of the Luneburg lens and obtained the complete representation of the electromagnetic field inside the sphere, as well as the scattered and total fields, when the excitation source is a dipole of moment p_x in the x-direction and located at $(r, \theta, \phi) = (b, \pi, 0)$ in the spherical coordinates system. Flammer (1958) gave asymptotic solutions for the case of the conical Luneburg lens. His approach is not complete in the sense of comparison with the method developed by Tai and also the solutions he obtained are not exact, but asymptotic. Other radially inhomogeneous media which have been studied are the Maxwell fish-eye by Tai (1958b) and a Gaussian type of inhomogeneity by Yeh and Kaprielian (1960). Arnush (1964) studied the case of scattering when the dielectric constant vanishes on a spherical surface by using a phase-shift analysis method. Fikioris (1965a) examined the behavior of a bi-conical antenna immersed in radially stratified media and performed detailed calculations for small-angle and wide-angle biconical antennas. Farone (1965) used the Rayleigh-Gans approximation to determine the scattering by a radially inhomogeneous sphere whose index of refraction is close to unity. Finally, Uslenghi (1967) extended Tai's method for media whose permeability is also radially inhomogeneous. He established general results for the presence of resonances and dips in the low-frequency backscattered cross section. Uslenghi (1968) also studied the high frequency backscattering problem from the inverse square power lens by applying asymptotic theory.

In this dissertation, the case of high frequency electromagnetic scattering from radially inhomogeneous media in the spherical coordinates system is considered. The relative magnetic permeability is taken to be unity and the excitation field is assumed to be a plane wave. Particular emphasis is placed upon the study of backscattering from perfectly conducting spheres coated with a radially inhomogeneous medium and on the computation of the monostatic scattering cross section. This study is of practical importance in that it lends itself useful to the understanding of electromagnetic wave propagation in dielectric lenses at microwave and optical frequencies, the propagation of radio waves around the earth, and the effect of coating perfectly conducting spheres with radially inhomogeneous dielectrics.

In assuming the incident field to be a plane wave, it is implied that the more general case of an arbitrary incident electromagnetic field can be simplified by decomposing it into the sum of plane monochromatic waves by Fourier analysis, and therefore the simplest case only is considered. In what follows, the rationalized MKSA system of units is used and the time dependence $e^{-i\omega t}$ is omitted. The following symbols are listed for convenience.

ω = angular frequency,

$k = \frac{2\pi}{\lambda} = \omega \sqrt{\epsilon_0 \mu_0}$ = wave number in vacuo,

ϵ_0 = electric permittivity (dielectric constant) in vacuo

μ_0 = magnetic permeability in vacuo,

$Z = Y^{-1} = \sqrt{\mu_0 / \epsilon_0}$ = intrinsic impedance of free space (= 120π ohm),

ϵ, μ = relative permittivity, permeability inside the inhomogeneous medium (functions of r),

$i = \sqrt{-1}$ = imaginary unit,

\underline{E} and \underline{H} = electric and magnetic field vectors,

x, y, z = rectangular Cartesian coordinates,

r, θ, ϕ = spherical polar coordinates.

Vectors will be underlined and unit vectors will be denoted by carets.

Maxwell's equations are recalled and in the notation considered they are

$$\nabla \times \underline{H} = -ikY \epsilon \underline{E}, \quad (1.1)$$

$$\nabla \times \underline{E} = ikZ \mu \underline{H},$$

with the constitutive relations

$$\begin{aligned} \nabla \cdot \epsilon \underline{E} &= 0 \\ \nabla \cdot \underline{H} &= 0, \end{aligned} \quad (1.2)$$

and $\epsilon = \mu = 1$ in the case of vacuum. The general geometry of the problem is shown in Fig. 1-1 with region I representing the scatterer and II the free space. The superscript i indicates the incident field while, later on, s indicates the scattered field.

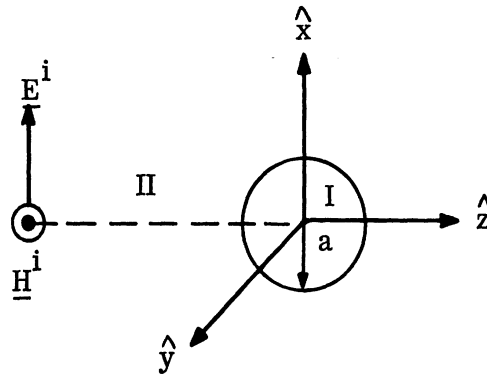

FIG. 1-1: GEOMETRY OF THE PROBLEM

The electric field of the incident plane wave is

$$\underline{E}^i = \hat{x} e^{ikz} \quad (1.3)$$

The scattered field is required to satisfy Sommerfeld's radiation condition at infinity throughout the free space region, specifically the condition

$$\lim_{r \rightarrow \infty} \left[\underline{r} \times (\nabla \times) + ikr \right] \begin{Bmatrix} \underline{E}^s \\ \underline{H}^s \end{Bmatrix} = 0 \quad (1.4)$$

must hold uniformly in \hat{r} . This is known as the Silver-Müller condition. Also, at the interface of regions I and II the appropriate boundary conditions, i.e. the continuity of the total tangential electric and magnetic fields, are applied for the determination of any constants pertinent to the solution of the problem. In order also are the following definitions in regard to the scattering cross-section of the body. The differential scattering cross-section or bistatic radar cross-section $\sigma(\theta, \phi)$ is given by

$$\sigma(\theta, \phi) = \lim_{r \rightarrow \infty} 4\pi r^2 \frac{|\underline{E}^s|^2}{|\underline{E}^i|^2} \quad (1.5)$$

01362-2 T

The total scattering cross-section is defined by the ratio of the time averaged total scattered power to the time averaged incident Poynting vector, and is related to the bistatic cross-section by

$$\sigma_{\text{total}} = \frac{1}{4\pi} \int_{\theta=0}^{\pi} \int_{\phi=0}^{2\pi} \sigma(\theta, \phi) \sin\theta d\theta d\phi. \quad (1.6)$$

Since the research herein is concerned primarily with backscattering, the definition of the monostatic radar cross-section is given for reference as

$$\sigma(\theta, \phi) \Big|_{\theta=\pi} = \lim_{r \rightarrow \infty} 4\pi r^2 \frac{\left| \frac{\underline{E}^s}{r} \right|^2}{\left| \frac{\underline{E}^i}{r} \right|^2} \Big|_{\theta=\pi}. \quad (1.7)$$

It is also mentioned here that the methods of solution to be applied are the geometrical optics method, exact solutions and asymptotic determination of formal solutions. The approach employed in each of these methods is well known (e.g. Uslenghi, 1967) and therefore detailed description is omitted.

1.2 Scattering From Radially Inhomogeneous Media

Assume a plane wave incident upon a radially inhomogeneous sphere of outer radius a whose index of refraction is $N(\xi)$ where $\xi = r/a$ (see Fig. 1-1). Applying the pertinent boundary conditions at $r=a$ and at $r=\infty$ the far zone ($r \rightarrow \infty$) bistatic scattered electric field produced by the incident field of Eq. (1.3) is given by the well known expression

$$\underline{E}^s \sim -i \frac{e^{ikr}}{kr} \sum_{n=1}^{\infty} \frac{2n+1}{n(n+1)} \left\{ \left[a_n^s \frac{P_n^1(\cos\theta)}{\sin\theta} + b_n^s \frac{dP_n^1}{d\theta} \right] \cos\phi \hat{\theta} - \left[a_n^s \frac{dP_n^1}{d\theta} + b_n^s \frac{P_n^1(\cos\theta)}{\sin\theta} \right] \sin\phi \hat{\phi} \right\}, \quad (1.8)$$

which in the backscattered direction becomes

Handwritten note: $\sigma_{\text{total}} = \sigma_{\text{back}} + \sigma_{\text{other}}$

$$\underline{E}^{b.s.} \sim -i \frac{e^{ikr}}{kr} \sum_{n=1}^{\infty} (-1)^n (n+1/2) \left[a_n^s - b_n^s \right] \quad (1.9)$$

These expressions are the Mie series for the radially inhomogeneous scatterer.

The scattering coefficients a_n^s and b_n^s are given in their general form by

$$a_n^s = - \frac{\psi_n'(ka) - M_n(ka) \psi_n(ka)}{\zeta_n^{(1)'}(ka) - M_n(ka) \zeta_n^{(1)}(ka)}, \quad b_n^s = - \frac{\psi_n'(ka) - \tilde{M}_n(ka) \psi_n(ka)}{\zeta_n^{(1)'}(ka) - \tilde{M}_n(ka) \zeta_n^{(1)}(ka)} \quad (1.10)$$

where

$$\psi_n(ka) = \sqrt{\frac{\pi ka}{2}} J_{n+1/2}(ka), \quad \zeta_n^{(1)}(ka) = \sqrt{\frac{\pi ka}{2}} H_{n+1/2}^{(1)}(ka)$$

and the primes indicate differentiation with respect to ka . The constants $M_n(ka)$ and $\tilde{M}_n(ka)$ are determined from the boundary conditions at $r=a$ and $r=0$, if the scatterer is a radially inhomogeneous sphere throughout the range $0 \leq r \leq a$, or by the boundary conditions at $r=a$ and $r=b$ if the scatterer is a perfectly conducting sphere of radius $r=b$ coated with a radially inhomogeneous medium of outer radius a . For these two cases, these constants are given respectively by

$$M_n(ka) = \frac{1}{ka} \frac{\partial}{\partial \xi} \ln S_n^{(1)}(\xi) \Big|_{\xi=1}, \quad \tilde{M}_n(ka) = \frac{1}{ka} \frac{\partial}{\partial \xi} \ln T_n^{(1)}(\xi) \Big|_{\xi=1} \quad (1.11)$$

and by

$$M_n(ka) = \frac{1}{ka} \frac{\partial}{\partial \xi} \ln C_n(\xi, \beta) \Big|_{\xi=1}, \quad \tilde{M}_n(ka) = \frac{1}{ka} \frac{\frac{\partial^2 \tilde{C}_n(\xi, \beta)}{\partial \xi \partial \beta}}{\frac{\partial \tilde{C}_n(\xi, \beta)}{\partial \beta}} \Big|_{\xi=1} \quad (1.12)$$

and they are true only if $\epsilon(1)=1$ which is the case in this research. The parameters involved in the previous expressions are defined as

$$\xi \equiv \frac{r}{a}, \quad \beta \equiv \frac{b}{a}, \quad (1.13)$$

$$C_n(\xi, \beta) = S_n^{(1)}(\xi) S_n^{(2)}(\beta) - S_n^{(1)}(\beta) S_n^{(2)}(\xi), \quad (1.14)$$

0129-27

and

$$\tilde{C}_n(\xi, \beta) = T_n^{(1)}(\xi) T_n^{(2)}(\beta) - T_n^{(1)}(\beta) T_n^{(2)}(\xi) \quad (1.15)$$

The functions $S_n^{(j)}(\xi)$, $T_n^{(j)}(\xi)$; $j=1, 2$, are any two linearly independent solutions of

$$\frac{d^2 S_n(\xi)}{d\xi^2} + (ka)^2 \left\langle \epsilon(\xi) - \frac{n(n+1)}{(ka)^2 \xi^2} \right\rangle S_n(\xi) = 0 \quad (1.16)$$

and

$$\frac{d^2 T_n(\xi)}{d\xi^2} - \left\langle \frac{d}{d\xi} \ln \epsilon(\xi) \right\rangle \frac{dT_n(\xi)}{d\xi} + (ka)^2 \left\langle \epsilon(\xi) - \frac{n(n+1)}{(ka)^2 \xi^2} \right\rangle T_n(\xi) = 0 \quad (1.17)$$

where $\epsilon(\xi) = N^2(\xi)$. The functions $S_n^{(1)}(\xi)$ and $T_n^{(1)}(\xi)$ which are used to determine $M_n(ka)$ and $\tilde{M}_n(ka)$ in (1.11) are required to be finite at $\xi = 0$.

The differential equations (1.16) and (1.17) arise as follows. Consider the vector wave equation

$$\left[\nabla^2 + k^2(\xi) \right] \underline{F} = 0 \quad (1.18)$$

with $k^2(\xi) = \omega^2 \mu \epsilon(\xi)$, $\underline{F} = \left\langle \frac{\underline{E}}{\underline{H}} \right\rangle$ inside the radially inhomogeneous medium.

The vector wave equation is reduced to the scalar wave equation

$$\left[\nabla^2 + k^2(\xi) \right] \psi^{(e)} = 0 \quad (1.19)$$

by defining, after Tai (1958a), vector wave-functions $M^{(m)} = \nabla \times (r \psi^{(m)})$ proportional to the electric field for magnetic type or transverse electric modes, and $M^{(e)} = \nabla \times (r \psi^{(e)})$ proportional to the magnetic field for electric type or transverse magnetic modes. Separation of variables in the spherical polar coordinates system yields (1.16) and (1.17) for the magnetic and electric type of waves correspondingly. Superposition of the two types of waves gives the complete representation of the electromagnetic field in the medium.

1.3 Outline of Research

The backscattered field given by (1.9) is amenable to numerical calculation for ka not too large. When $ka \gg 1$, Eq. (1.9) is extremely slowly convergent and it is necessary therefore, since this research is in regard with high frequency backscattering, to subject expression (1.9) to a Watson transformation. Thus the summation is firstly transformed to a line integral by applying Cauchy's residue theorem. The backscattered field is then given by

$$E^{b.s.} \sim \hat{x} \frac{e^{ikr}}{kr} \left\{ \frac{i}{2} (a_0^s - b_0^s) - \frac{1}{2} \int_C \frac{\nu d\nu}{\cos \pi \nu} \left[a_{\nu-1/2}^s - b_{\nu-1/2}^s \right] \right\}, \quad (1.20)$$

where $\nu = n + \frac{1}{2}$ and ν and ka are assumed complex with $0 < \text{Im}k \ll 1$. The path C in the complex ν -plane is shown in Fig. 1-2.

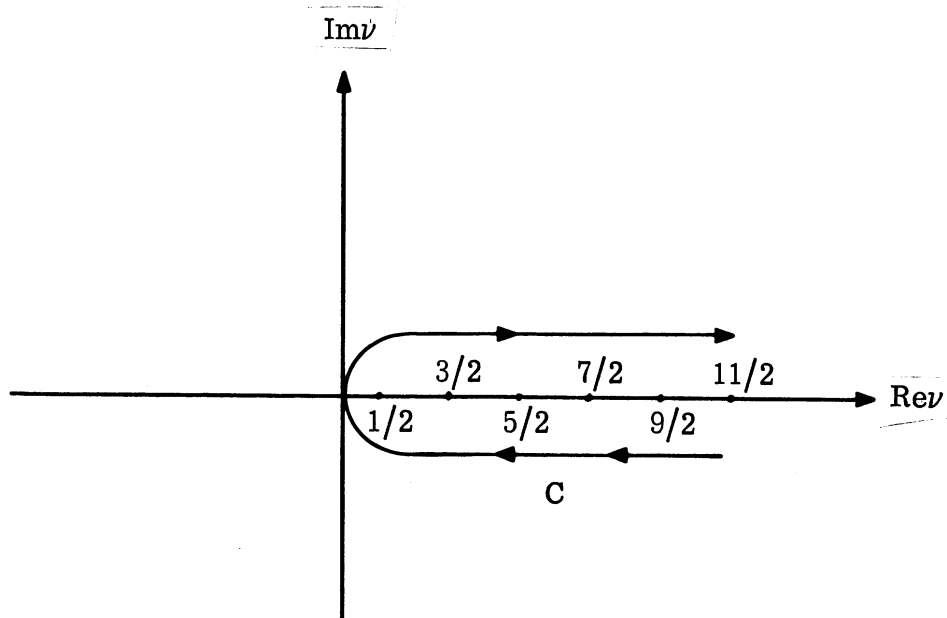

FIG. 1-2: CONTOUR C IN THE COMPLEX ν -PLANE

01-13-3-1

By observing that

$$a_{\nu-1/2}^s - b_{\nu-1/2}^s = i \frac{M_{\nu-1/2}(ka) - \tilde{M}_{\nu-1/2}(ka)}{\left(\xi_{\nu-1/2}^{(1)'}(ka) - M_{\nu-1/2}(ka) \xi_{\nu-1/2}^{(1)}(ka) \right) \left(\xi_{\nu-1/2}^{(1)'}(ka) - \tilde{M}_{\nu-1/2}(ka) \xi_{\nu-1/2}^{(1)}(ka) \right)}$$

the path C is deformed in such a manner that it accounts for the contribution of any poles of the integrand in the first quadrant of the complex ν -plane.

These poles occur at the zeros of

$$\xi_{\nu-1/2}^{(1)'}(ka) - M_{\nu-1/2}(ka) \xi_{\nu-1/2}^{(1)}(ka) = 0 \quad (1.21)$$

and

$$\xi_{\nu-1/2}^{(1)'}(ka) - \tilde{M}_{\nu-1/2}(ka) \xi_{\nu-1/2}^{(1)}(ka) = 0 \quad (1.22)$$

The new path is shown in Fig. 1-3.

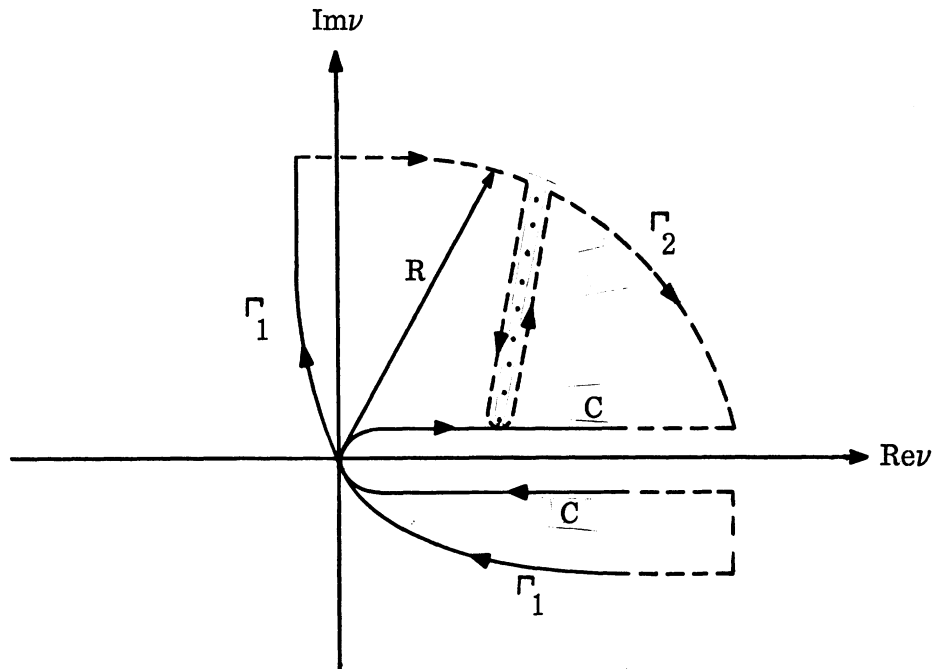

FIG. 1-3: THE DEFORMED PATH IN THE COMPLEX ν -PLANE

CP 101 2-1

Expression (1.20) can now be rewritten as

$$E_x^{b.s.} \sim \frac{e^{ikr}}{kr} \left\{ \frac{i}{2} (a_0^s - b_0^s) - \frac{1}{2} \int_{\Gamma_1} \frac{\nu}{\cos \pi \nu} a_{\nu-1/2}^s - b_{\nu-1/2}^s d\nu - \right. \\ \left. - \frac{1}{2} \int_{\Gamma_2} \frac{\nu}{\cos \pi \nu} a_{\nu-1/2}^s - b_{\nu-1/2}^s d\nu + 2\pi i \sum (\text{residues in 1}^{st} \text{ quadrant}) \right\} \quad (1.23)$$

Further computation of (1.23) is achieved through asymptotic analysis. The integral along Γ_1 together with the term $i/2 (a_0^s - b_0^s)$ gives the major contribution to the backscattered field. It physically corresponds to the reflected portion of the field. The integration over Γ_1 is performed by the saddle point method over the range $\nu = O(ka)^{1/2+\delta}$ with $\delta > 0$ but $\delta \ll 1$ and the major contribution arising near $\nu = 0$. In performing the integration one needs the appropriate Debye expansions for the spherical Bessel and Hankel functions in the proper regions of the complex ν -plane. The integrations are carried out with the aid of the formulas of Scott (1949) to $O((ka)^{-2})$. This implies that the radial eigenfunctions $S_{\nu-1/2}^{(j)}(\xi)$ and $T_{\nu-1/2}^{(j)}(\xi)$ need to be computed to $O((ka)^{-2})$. This can be achieved by either solving (1.16) and (1.17) exactly and then developing the asymptotic expansions valid in the regions of interest or by obtaining the asymptotic solutions directly from the differential equations. The latter is achieved by operating directly on the differential equations by the WKB method provided that the Stokes phenomenon is not present in the regions of interest. Otherwise, Langer's theory of transition points is to be used.

To obtain the pertinent asymptotic expansions for $S_{\nu-1/2}^{(j)}(\xi)$, $T_{\nu-1/2}^{(j)}(\xi)$, $j=1, 2$, equation (1.17) is put first in the normal form

$$\frac{d^2 U_{\nu-1/2}(\xi)}{d\xi^2} + (ka)^2 \left\{ \epsilon(\xi) - \frac{\nu-1/4}{\xi^2 (ka)^2} + \frac{1}{2\epsilon(\xi)(ka)^2} \frac{d^2 \epsilon(\xi)}{d\xi^2} - \frac{3}{4} \frac{1}{[\epsilon(\xi)]^2 (ka)^2} \left[\frac{d\epsilon(\xi)}{d\xi} \right]^2 \right\} U_{\nu-1/2}(\xi) = 0 \quad (1.24)$$

by setting

$$T_{\nu-1/2}(\xi) = \sqrt{\epsilon(\xi)} U_{\nu-1/2}(\xi) \quad (1.25)$$

By defining now

$$Q_{(i)}(\xi) = \begin{cases} \epsilon(\xi) - \frac{\nu-1/4}{\xi^2 (ka)^2} & ; i = 1 \\ \epsilon(\xi) - \frac{\nu-1/4}{\xi^2 (ka)^2} + \frac{1}{2\epsilon(\xi)(ka)^2} \frac{d^2 \epsilon(\xi)}{d\xi^2} - \frac{3}{4} \frac{1}{[\epsilon(\xi)]^2} \times \\ \times \frac{1}{(ka)^2} \left(\frac{d\epsilon(\xi)}{d\xi} \right)^2 & ; i = 2 \end{cases} \quad (1.26)$$

the asymptotic solutions for (1.16) and (1.24) are found directly by applying the WKB method provided that the $Q_{(i)}(\xi)$ have no zeros and that the following conditions hold

$$\frac{1}{8(ka)^2} \left| \frac{\frac{5}{4} \left(\frac{dQ_{(i)}(\xi)}{d\xi} \right)^2 - \frac{d^2 Q_{(i)}(\xi)}{d\xi^2} Q_{(i)}(\xi)}{[Q_{(i)}(\xi)]^3} \right| \ll \frac{1}{4ka} \left| \frac{\frac{dQ_{(i)}(\xi)}{d\xi}}{[Q_{(i)}(\xi)]^{3/2}} \right| \ll 1 \quad (1.27)$$

throughout $\beta \leq \xi \leq 1$. The solutions are

$$V_{(i)}^{(j)}(\xi) \sim [Q_{(i)}(\xi)]^{-1/4} \exp \left\{ \pm ika \int^{\xi} \sqrt{Q_{(i)}(\xi)} \right. \left. \left[1 + \frac{5}{4} \frac{dQ_{(i)}(\xi)}{d\xi} - \frac{d^2 Q_{(i)}(\xi)}{d\xi^2} Q_{(i)}(\xi) \right] d\xi \right\} \left\{ 1 + O[(ka)^{-2}] \right\} \quad (1.28)$$

with

$$V_{(i)}^{(j)}(\xi) = \begin{cases} S_{\nu-1/2}^{(j)}(\xi) ; & \text{if } i = 1 \\ U_{\nu-1/2}^{(j)}(\xi) ; & \text{if } i = 2 \end{cases} \quad (1.29)$$

$$T_{\nu-1/2}^{(j)}(\xi) = \sqrt{\epsilon(\xi)} V_{(2)}^{(j)}(\xi) . \quad (1.30)$$

It remains now to develop, with the aid of (1.28), the asymptotic expansions to $O[(ka)^{-2}]$ of $M_{\nu-1/2}(ka)$ and $\tilde{M}_{\nu-1/2}(ka)$. From the definitions of $C_{\nu-1/2}(ka)$ and $\tilde{C}_{\nu-1/2}(ka)$ and from Eq. (1.28) it is found that

$$C_{\nu-1/2}(\xi, \beta) = V_{(1)}^{(1)}(\xi) V_{(1)}^{(2)}(\beta) - V_{(1)}^{(1)}(\beta) V_{(1)}^{(2)}(\xi) \quad (1.31)$$

and asymptotically

$$C_{\nu-1/2}(\xi, \beta) \sim 2i [Q_{(1)}(\xi) Q_{(1)}(\beta)]^{-1/4} \sin [ika F_{(1)}(\xi, \beta)] \times \left[1 + O[(ka)^{-2}] \right] . \quad (1.32)$$

Likewise

$$\tilde{C}_{\nu-1/2}(\xi, \beta) = \sqrt{\epsilon(\xi)\epsilon(\beta)} \left[V_{(2)}^{(1)}(\xi) V_{(2)}^{(2)}(\beta) - V_{(2)}^{(1)}(\beta) V_{(2)}^{(2)}(\xi) \right] \quad (1.33)$$

and asymptotically

$$\begin{aligned} \tilde{C}_{\nu-1/2}(\xi, \beta) \sim 2i \sqrt{\epsilon(\xi)\epsilon(\beta)} \left[Q_{(2)}(\xi) Q_{(2)}(\beta) \right]^{-1/4} \sin \left[ika F_{(2)}(\xi, \beta) \right] \times \\ \times \left[1 + O \left[(ka)^{-2} \right] \right] \end{aligned} \quad (1.34)$$

with

$$F_{(i)}(\xi, \beta) = \int_{\beta}^{\xi} \sqrt{Q_{(i)}(\xi)} \left[1 + f_{(i)}(\xi) \right] d\xi \quad (1.35)$$

and

$$f_{(i)}(\xi) = \frac{\frac{5}{4} \frac{dQ_{(i)}(\xi)}{d\xi} - \frac{d^2 Q_{(i)}(\xi)}{d\xi^2} Q_{(i)}(\xi)}{8(ka)^2 \left[Q_{(i)}(\xi) \right]^3} \quad (1.36)$$

From the definitions of $M_{\nu-1/2}(ka)$ and $\tilde{M}_{\nu-1/2}(ka)$ in terms of $C_{\nu-1/2}(ka)$ and $\tilde{C}_{\nu-1/2}(ka)$ one obtains

$$\begin{aligned} M_{\nu-1/2}(ka) \sim \left\{ \frac{1}{ka} \frac{d}{d\xi} \ln \left[Q_{(1)}(\xi) \right]^{-1/4} + i \sqrt{Q_{(1)}(\xi)} \times \right. \\ \left. \times \cot \left[ika F_{(1)}(\xi, \beta) \right] \right\} \Bigg|_{\xi=1} \left[1 + O \left[(ka)^{-2} \right] \right] \end{aligned} \quad (1.37)$$

and

$$\begin{aligned} \tilde{M}_{\nu-1/2}(ka) \sim \left\{ \frac{1}{ka} \frac{d}{d\xi} \ln \left(\sqrt{\epsilon(\xi)} \left[Q_{(2)}(\xi) \right]^{-1/4} \right) + \right. \\ + \frac{1}{ka} \sqrt{\frac{Q_{(2)}(\xi)}{Q_{(2)}(\beta)}} \left[\frac{d}{d\beta} \ln \left(\sqrt{\epsilon(\beta)} \left[Q_{(2)}(\beta) \right]^{-1/4} \right) \right] \sec^2 \left[ika F_{(2)}(\xi, \beta) \right] - \\ \left. - i \sqrt{Q_{(2)}(\xi)} \tan \left[ika F_{(2)}(\xi, \beta) \right] \right\} \Bigg|_{\xi=1} \left[1 + O \left[(ka)^{-2} \right] \right] \end{aligned} \quad (1.38)$$

From expressions (1.37) and (1.38), the difference of the scattering coefficients follows:

01360-37

$$\begin{aligned}
& \frac{a^s \nu^{-1/2} - b^s \nu^{-1/2}}{\xi_{\nu-1/2}^{(1)'}(ka) - \left\{ i \sqrt{Q_{(1)}(\xi)} \cot(ika F_{(1)}(\xi, \beta)) + \frac{1}{ka} \frac{\partial}{\partial \xi} \ln [Q_{(1)}(\xi)]^{-1/4} \right\}} \times \\
& \quad - \frac{i}{ka} \left[\frac{\partial}{\partial \xi} \ln \left(\left(\frac{Q_{(1)}(\xi)}{Q_{(2)}(\xi)} \right)^{-1/4} [\epsilon(\xi)]^{-1/2} \right) \right] - \\
& \quad \times \xi_{\nu-1/2}^{(1)}(ka) \left[\xi_{\nu-1/2}^{(1)'}(ka) - \left\{ \frac{1}{ka} \frac{\partial}{\partial \xi} \ln \left(\sqrt{\epsilon(\xi)} [Q_{(2)}(\xi)]^{-1/4} \right) + \frac{Q_{(2)}(\xi)}{Q_{(2)}(\beta)} \left[\frac{\partial}{\partial \beta} \ln \left(\sqrt{\epsilon(\beta)} \right) \right. \right. \right. \\
& \quad \left. \left. \left. - \sqrt{\frac{Q_{(2)}(\xi)}{Q_{(2)}(\beta)}} \frac{\partial}{\partial \beta} \left(\ln \sqrt{\epsilon(\beta)} [Q_{(2)}(\beta)]^{-1/4} \right) \sec^2(ika F_{(2)}(\xi, \beta)) \right] \right\} \right] \times \\
& \quad \times \left[Q_{(2)}(\beta)^{-1/4} \right] \sec^2(ika F_{(2)}(\xi, \beta) - i \sqrt{Q_{(2)}(\xi)} \tan(ika F_{(2)}(\xi, \beta)) \left. \right] \xi_{\nu-1/2}^{(1)}(ka) \Big|_{\xi=1} \times \\
& \quad \times \left[1 + O[(ka)^{-2}] \right]. \tag{1.39}
\end{aligned}$$

and $(a_o^s - b_o^s)$ is obtained when $\nu = 1/2$. By substituting in (1.39) the appropriate Debye expansions for the spherical Bessel and Hankel functions in the proper regions of the complex ν -plane and by carrying out the algebra to $O[(ka)^{-2}]$, the reflected portion of the field is immediately obtained after the integration is carried out along Γ_1 with the aid of the integrals of Scott (1949). The advantage of this last result is that the final form of the integrand in (1.23) is determined for arbitrary $\epsilon(\xi)$ and one can, with direct substitution of the functional form of $\epsilon(\xi)$ in expression (1.39), carry out the algebra asymptotically and perform the integration without solving for the $V_{(i)}^{(j)}(\xi)$ eigenfunctions, in order to determine the reflected field.

The contribution of the integral along Γ_2 has been shown to be zero for the general case (Goodrich and Kazarinoff, 1963) as $R \rightarrow \infty$, and the verification for the particular cases considered here is therefore omitted.

01762-3-T

The summation over the residues in (1.23) gives the contribution in the backscattering direction due to creeping waves. In order to determine this contribution, asymptotic expansions are needed for the radial eigenfunctions which are valid for ν near ka . These asymptotic expansions are derived directly by the WKB method if $Q_{(i)}(\xi)$ has no zeros in the interval $\beta \leq \xi \leq 1$. In case there exists a single turning point at $\beta \leq \xi_0 \leq 1$, then Langer's method is used to solve the differential equations. By writing $\nu = mt + ka$ with $m = \left(\frac{ka}{2}\right)^{1/3}$, Langer's scheme gives, with the following definitions

$$\phi_{(i)}(\xi) = \sqrt{Q_{(i)}(\xi)} \quad (1.40)$$

$$\Phi_{(i)}(\xi) = \int_{\xi_0}^{\xi} \phi_{(i)}(\xi) d\xi \quad (1.41)$$

$$\Xi_{(i)}(\xi) = \Phi_{(i)}^{1/6}(\xi) \phi_{(i)}^{-1/2}(\xi) \quad (1.42)$$

$$\Lambda_{(i)}(\xi) = ka \phi_{(i)}(\xi) \quad (1.43)$$

and

$$u_{(i)}(\xi) = \int_{\xi_0}^{\xi} \Lambda_{(i)}(\xi) d\xi \quad (1.44)$$

the solutions

$$V_{(i)}^{(j)}(\xi) \sim \Xi_{(i)}(\xi) \left\{ ka \Phi_{(i)}(\xi) \right\}^{1/3} H_{1/3}^{(j)} \left(\Lambda_{(i)}(\xi) \right) \quad (1.45a)$$

or

$$V_{(i)}^{(j)}(\xi) \sim \frac{\left(\int_{\xi_0}^{\xi} \sqrt{Q_{(i)}(\xi)} d\xi \right)^{1/6}}{[Q_{(i)}(\xi)]^{1/4}} \left\{ ka \int_{\xi_0}^{\xi} \sqrt{Q_{(i)}(\xi)} d\xi \right\}^{1/3} \times \\ \times H_{1/3}^{(j)} \left(ka \int_{\xi_0}^{\xi} \sqrt{Q_{(i)}(\xi)} d\xi \right) \quad (1.45b)$$

with $i, j = 1, 2$.

01.62-3 T

If one now defines:

$$\xi_{(i)}(\xi) = \left(\frac{3}{2} \int_{\xi_0}^{\xi} \sqrt{Q_{(i)}(\xi)} d\xi \right)^{2/3} \quad (1.46)$$

and

$$u_{(i)}(\xi) = \frac{2}{3} \left[\chi_{(i)}(\xi) \right]^{-3/2} \quad (1.47)$$

it follows that

$$\chi_{(i)}(\xi) = (ka)^{2/3} \xi_{(i)}(\xi) \quad (1.48)$$

and the solutions can finally be written in the form

$$V_{(i)}^{(j)}(\xi) \sim \left(\frac{\xi_{(i)}(\xi)}{Q_{(i)}(\xi)} \right)^{1/4} w_{(j)} \left\{ (ka)^{2/3} \xi_{(i)}(\xi) \right\}, \quad j=1,2 \quad (1.49)$$

The $w_{(j)} \left\{ (ka)^{2/3} \xi_{(i)}(\xi) \right\}$ are Airy functions in Fock's notation and they are related to the Airy functions of Miller (1946) by

$$w_{(1)}^{(2)}(t) = \sqrt{\pi} \left[\text{Bi}(t) \pm i \text{Ai}(t) \right] \quad (1.50)$$

The creeping wave contribution to the backscattering direction now becomes

$$\left[E_x^{\text{b.s.}} \right]_{\text{cr.w.}} \sim \pi \frac{e^{ikr}}{kr} \left\{ \sum_{\nu=\nu_\ell} \frac{\nu}{\cos \pi \nu} \left(\xi_{\nu-1/2}^{(1)}(ka) \frac{\partial}{\partial \nu} \left[\xi_{\nu-1/2}^{(1)'}(ka) - \right. \right. \right. \\ \left. \left. \left. - M_{\nu-1/2}(ka) \xi_{\nu-1/2}^{(1)}(ka) \right] \right)^{-1} - \sum_{\nu=\tilde{\nu}_\ell} \frac{\nu}{\cos \pi \nu} \left(\xi_{\nu-1/2}^{(1)}(ka) \frac{\partial}{\partial \nu} \left[\xi_{\nu-1/2}^{(1)'}(ka) - \right. \right. \right. \\ \left. \left. \left. - \tilde{M}_{\nu-1/2}(ka) \xi_{\nu-1/2}^{(1)}(ka) \right] \right)^{-1} \right\} \quad (1.51)$$

with ν_ℓ and $\tilde{\nu}_\ell$ being respectively the roots of

$$\frac{\xi_{\nu^{-1/2}}^{(1)'}(ka)}{\xi_{\nu^{-1/2}}^{(1)}(ka)} = M_{\nu^{-1/2}}(ka) \quad (1.52)$$

and of

$$\frac{\xi_{\nu^{-1/2}}^{(1)'}(ka)}{\xi_{\nu^{-1/2}}^{(1)}(ka)} = \tilde{M}_{\nu^{-1/2}}(ka) \quad (1.53)$$

with $\text{Im} \nu_\ell > 0$, $\text{Im} \tilde{\nu}_\ell > 0$.

With the asymptotic forms

$$\xi_{\nu^{-1/2}}^{(1)}(ka) \sim -i m^{1/2} w_{(1)}(t) \quad (1.54)$$

$$\xi_{\nu^{-1/2}}^{(1)'}(ka) \sim i m^{-1/2} w'_{(1)}(t) \quad (1.55)$$

and the substitution $\nu = mt + ka$, the creeping wave contribution gives

$$\begin{aligned} \left[\mathbf{E}_x^{\text{b. s.}} \right]_{\text{cr. w.}} &\sim \frac{\pi}{m} \frac{e^{ikr}}{kr} \sum_{\ell} \left\{ \frac{\nu_\ell}{\cos \pi \nu_\ell} \left[w_{(1)}(t_\ell) \right]^{-2} \left[\frac{t_\ell}{m} \right]^2 + \right. \\ &+ \frac{1}{m} \left. \frac{\partial M(t)}{\partial t} \right|_{t=t_\ell} \left[M(t_\ell) \right]^{-2} - \frac{\tilde{\nu}_\ell}{\cos \pi \tilde{\nu}_\ell} \left[w_{(1)}(\tilde{t}_\ell) \right]^{-2} \left[\frac{\tilde{t}_\ell}{m} \right]^2 + \right. \\ &\left. + \frac{1}{m} \frac{\partial \tilde{M}(\tilde{t})}{\partial \tilde{t}} \right|_{\tilde{t}=\tilde{t}_\ell} \left[\tilde{M}(\tilde{t}_\ell) \right]^{-2} \right\} \quad (1.56) \end{aligned}$$

where the index ℓ scans the zeros of

$$\frac{w'_{(1)}(t_\ell)}{w_{(1)}(t_\ell)} = -m M(t_\ell), \text{ and } \frac{w'_{(1)}(\tilde{t}_\ell)}{w_{(1)}(\tilde{t}_\ell)} = -m \tilde{M}(\tilde{t}_\ell) \quad (1.57)$$

It remains to evaluate $M_{\nu^{-1/2}}(ka)$, $\tilde{M}_{\nu^{-1/2}}(ka)$ and then put them in the form $M(t_\ell)$ and $\tilde{M}(\tilde{t}_\ell)$ for the solution of equations (1.57) for the zeros t_ℓ and \tilde{t}_ℓ . The following explicit forms can be written down for $M_{\nu^{-1/2}}(ka)$ and $\tilde{M}_{\nu^{-1/2}}(ka)$ for the case where ν is near ka :

$$\begin{aligned}
 M_{\nu^{-1/2}}(ka) \sim & \frac{1}{4ka} \left\{ \frac{1}{\zeta_{(1)}(\xi)} \frac{\partial \zeta_{(1)}(\xi)}{\partial \xi} - \frac{1}{Q_{(1)}(\xi)} \frac{\partial Q_{(1)}(\xi)}{\partial \xi} \right\} \Bigg|_{\xi=1} + \\
 & + \frac{1}{(ka)^{1/3}} \frac{\partial \zeta_{(1)}(\xi)}{\partial \xi} \left\{ \frac{w'_{(1)} [(ka)^{2/3} \zeta_{(1)}(\xi)] w_{(2)} [(ka)^{2/3} \zeta_{(1)}(\beta)] - w_{(1)} [(ka)^{2/3} \zeta_{(1)}(\beta)] \times}{w_{(1)} [(ka)^{2/3} \zeta_{(1)}(\xi)] w_{(2)} [(ka)^{2/3} \zeta_{(1)}(\beta)] - w_{(1)} [(ka)^{2/3} \zeta_{(1)}(\beta)] \times} \right. \\
 & \times \left. \frac{w'_{(2)} [(ka)^{2/3} \zeta_{(1)}(\xi)]}{w_{(2)} [(ka)^{2/3} \zeta_{(1)}(\xi)]} \right\} \Bigg|_{\xi=1} \tag{1.58}
 \end{aligned}$$

and

01302-27

$$\begin{aligned}
\tilde{M}_{\nu-1/2}(ka) \sim & \left[\frac{1}{ka} \frac{\partial}{\partial \xi} \ln \sqrt{\epsilon(\xi)} + \frac{1}{4ka} \left\{ \frac{1}{\xi_{(2)}(\xi)} \frac{\partial \xi_{(2)}(\xi)}{\partial \xi} - \frac{1}{Q_{(2)}(\xi)} \frac{\partial Q_{(2)}(\xi)}{\partial \xi} \right\} + \right. \\
& + \frac{1}{(ka)^{1/3}} \frac{\partial \xi_{(2)}(\xi)}{\partial \xi} \left\{ \frac{w'_{(1)}[(ka)^{2/3} \xi_{(2)}(\xi)] w_{(2)}[(ka)^{2/3} \xi_{(2)}(\beta)] - w_{(1)}[(ka)^{2/3} \xi_{(2)}(\beta)] w'_{(2)}[(ka)^{2/3} \xi_{(2)}(\xi)]}{w_{(1)}[(ka)^{2/3} \xi_{(2)}(\xi)] w_{(2)}[(ka)^{2/3} \xi_{(2)}(\beta)] - w_{(1)}[(ka)^{2/3} \xi_{(2)}(\beta)] w'_{(2)}[(ka)^{2/3} \xi_{(2)}(\xi)]} \right. \\
& \times \frac{w'_{(2)}[(ka)^{2/3} \xi_{(2)}(\xi)]}{w_{(2)}[(ka)^{2/3} \xi_{(2)}(\beta)]} \left. \right\} - \frac{4(ka)^{1/3}}{\left[\frac{\partial}{\partial \beta} \ln \sqrt{\epsilon(\beta)} + (ka)^{2/3} \frac{\partial \xi_{(2)}(\beta)}{\partial \beta} \right]} \times \\
& \times \left\{ \frac{w_{(1)}[(ka)^{2/3} \xi_{(2)}(\xi)] w_{(2)}[(ka)^{2/3} \xi_{(2)}(\beta)] - w_{(1)}[(ka)^{2/3} \xi_{(2)}(\beta)] w_{(2)}[(ka)^{2/3} \xi_{(2)}(\xi)]}{w_{(1)}[(ka)^{2/3} \xi_{(2)}(\xi)] w_{(2)}[(ka)^{2/3} \xi_{(2)}(\beta)] - w_{(1)}[(ka)^{2/3} \xi_{(2)}(\beta)] w'_{(2)}[(ka)^{2/3} \xi_{(2)}(\xi)]} \right\}^{-2} \\
& \times \left(\frac{w_{(1)}[(ka)^{2/3} \xi_{(2)}(\xi)] w'_{(2)}[(ka)^{2/3} \xi_{(2)}(\beta)] - w'_{(1)}[(ka)^{2/3} \xi_{(2)}(\beta)] w_{(2)}[(ka)^{2/3} \xi_{(2)}(\xi)]}{w_{(1)}[(ka)^{2/3} \xi_{(2)}(\xi)] w_{(2)}[(ka)^{2/3} \xi_{(2)}(\beta)] - w_{(1)}[(ka)^{2/3} \xi_{(2)}(\beta)] w'_{(2)}[(ka)^{2/3} \xi_{(2)}(\xi)]} \right) \\
& \left. + \frac{1}{4} \left(\frac{\partial}{\partial \beta} \ln \xi_{(2)}(\beta) - \frac{\partial}{\partial \xi} \ln \xi_{(2)}(\xi) \right) \right] \Bigg|_{\xi=1}, \quad (1.59)
\end{aligned}$$

where to arrive at the forms (1.58) and (1.59) use has been made of the Wronskian

$$w'_{(1)}(t) w_{(2)}(t) - w_{(1)}(t) w'_{(2)}(t) = 2i \quad . \quad (1.60)$$

Primes above indicate differentiation with respect to the argument and it is assumed that

01/02/07

$$w_{(1)} (ka)^{2/3} \zeta_{(i)}(\xi) \cdot w_{(2)} (ka)^{2/3} \zeta_{(i)}(\beta) - w_{(1)} (ka)^{2/3} \zeta_{(i)}(\beta) \cdot w_{(2)} (ka)^{2/3} \zeta_{(i)}(\xi) \neq 0. \quad (1.61)$$

By substituting $\nu = mt + ka$ in (1.58) and (1.59), $M(t_\ell)$ and $\tilde{M}(\tilde{t}_\ell)$ can be simplified asymptotically and then equations (1.57) are solved numerically for the first few roots when t lies in the first quadrant. Finally for particular ka , expression (1.56) will give a numerical value for the creeping wave contribution in the backscattering direction.

From the theoretical expressions which will be obtained for the reflected electric field, the monostatic cross-section based on this reflected field will be derived and it will be computed for various thicknesses of the radially inhomogeneous coating as a function of ka , for two types of radially inhomogeneous dielectrics.

In Chapter Two, a new class of radially inhomogeneous dielectrics is discussed. The exact solutions for the radial eigenfunctions are derived and the geometrical optics technique is applied in order to determine the ray path of an incident ray through the medium in the optical limit ($ka \rightarrow \infty$). Detailed numerical computations of the deviation angle as a function of the angle of incidence and other pertinent parameters, are given. In Chapter Three, this new class of radially inhomogeneous dielectrics is considered as a coating of a perfectly conducting sphere. The detailed asymptotic computations for the derivation of the reflected electric field are presented, beginning with the application of the WKB method for the asymptotic determination of the radial eigenfunctions. The expression for the reflected electric field obtained by this method, is carried out to $O(ka)^{-2}$. As a means of comparison, the reflected field is also obtained by application of geometrical optics to $O(ka)^{-1}$. The results of the two methods are compared and the monostatic cross-section is computed for both cases with ka varying from $ka = 50$ to $ka = 1000$. Then the percentage error in considering only the geometrical optics solution is examined. Finally, in this chapter, the creeping wave study is outlined.

UPD 3-5

In Chapter Four, the Nomura-Takaku (1955) radial inhomogeneity is considered, as in Chapter Three with the exception that a more detailed study is carried out for the creeping wave contribution in the backscattering direction. This type of radial inhomogeneity has an index of refraction $N(\xi) = \xi^p$ (with $p > -1$, for reasons which will become apparent from the discussion of the exact solutions of the radial differential equations).

01362-3-1

CHAPTER II

A NEW CLASS OF RADially INHOMOGENEOUS MEDIA

2.1 Introduction

In the study of electromagnetic wave propagation in, as well as scattering from, radially inhomogeneous media, one of the difficulties is the determination of exact solutions for the eigenfunctions $S_n^{(j)}(\xi)$ and $T_n^{(j)}(\xi)$, and especially for the latter. Generally speaking, these eigenfunctions are expressed in their exact form in terms of hypergeometric and/or confluent hypergeometric functions, which are chosen to be finite at the origin. Although asymptotic solutions for the differential equations in the radial direction can always be found, by either applying the WKB method or Langer's uniform asymptotic theory under certain restrictions on the coefficients $Q_{(i)}(\xi)$, it is with the exact solutions that one has most of the difficulties. In this chapter, a particular technique is presented, which simplifies the problem of finding exact solutions for (1.16) and (1.17) considerably and which at the same time gives rise to a new class of radially inhomogeneous dielectrics.

If the differential equation (1.16) and the normal form of (1.17) are considered, it is seen that they reduce to one and the same differential equation if

$$Q_{(1)}(\xi) = Q_{(2)}(\xi) \quad , \quad (2.1)$$

which implies that one needs to solve only one equation, since in this case $T_n^{(j)}(\xi) = \sqrt{\epsilon(\xi)} S_n^{(j)}(\xi) = \sqrt{\epsilon(\xi)} U_n^{(j)}(\xi)$. Relation (2.1) is satisfied if and only if

$$\frac{1}{2\epsilon(\xi)} \frac{d^2 \epsilon(\xi)}{d\xi^2} - \frac{3}{4} \frac{1}{[\epsilon(\xi)]^2} \left(\frac{d\epsilon(\xi)}{d\xi} \right)^2 = 0 \quad , \quad (2.2)$$

which is rewritten as

$$\frac{d}{d\xi} \left[\frac{d}{d\xi} \ln \epsilon(\xi) \right] - \frac{1}{2 [\epsilon(\xi)]^2} \left(\frac{d\epsilon(\xi)}{d\xi} \right)^2 = 0 . \quad (2.3)$$

By substituting $w(\xi) = d/d\xi [\ln \epsilon(\xi)]$ in (2.3), the following Riccati differential equation is obtained in $w(\xi)$:

$$\frac{dw(\xi)}{d\xi} - \frac{1}{2} [w(\xi)]^2 = 0 . \quad (2.4)$$

If variables are separated in (2.4), then upon integration one obtains

$$\int d\xi = 2 \int \frac{dw}{w} \quad \text{or} \quad \xi = -\frac{2}{w} + \gamma , \quad (2.5)$$

where γ is an arbitrary constant. From the substitution $w(\xi) = d/d\xi [\ln \epsilon(\xi)]$ and (2.5), it follows that

$$w = \frac{2}{\gamma - \xi} = \frac{1}{\epsilon(\xi)} \frac{d\epsilon(\xi)}{d\xi} \quad (2.6)$$

which finally gives a solution for $\epsilon(\xi)$. This solution is

$$\epsilon(\xi) = \frac{A}{(\xi - \gamma)^2} \quad (2.7)$$

where A is another arbitrary constant. For the cases of interest in this research, i.e. for radially inhomogeneous media, the constant A is determined by choosing a continuous transition from free space to the inhomogeneous dielectric, i.e. $\epsilon(\xi) \Big|_{\xi=1} = 1$, which yields $A = (1 - \gamma)^2$, and

$$\epsilon(\xi) = \left(\frac{1 - \gamma}{\xi - \gamma} \right)^2 . \quad (2.8)$$

This type of functional dependence for the permittivity encompasses a large family of inhomogeneous media. Depending on the choice of γ , it lends itself to both converging and diverging types of dielectrics. Its most

valuable importance rests however in that it facilitates the theoretical study of the problem by reducing the two differential equations essentially to one.

2.2 Solution for the Eigenfunctions/when $\epsilon(\xi) = (1-\gamma)^2/(\xi-\gamma)^2$

In this section, the exact solutions for the radial eigenfunctions are determined when $\epsilon(\xi)$ is given by (2.8). The various possible applications with such a permittivity function are also discussed briefly.

By investigating the differential equation for the $S_n^{(j)}(\xi)$ eigenfunctions, when $\epsilon(\xi)$ is given by (2.8), it is found that it has three regular singular points at $\xi = 0$, $\xi = \gamma$ and $\xi = \infty$. This differential equation is easily reduced to a hypergeometric type with its Riemann P-symbol given by

$$S_n^{(j)}(\xi) = P \begin{pmatrix} 0 & \gamma & \infty \\ a' & b' & c' \\ a'' & b'' & c'' \end{pmatrix} \xi, \quad (2.9)$$

with a', a'' ; b', b'' ; and c', c'' being the exponents or solutions of the indicial equation at the singularity points 0 , γ and ∞ , respectively. In particular, these exponents are

$$a' = 1 + n, \quad a'' = -n, \quad (\text{at } \xi = 0), \quad (2.10)$$

$$b' = \frac{1 + \sqrt{1 - 4(ka)^2(1-\gamma)^2}}{2}, \quad b'' = \frac{1 - \sqrt{1 - 4(ka)^2(1-\gamma)^2}}{2}, \quad (\text{at } \xi = \gamma), \quad (2.11)$$

and

$$c' = \frac{-1 + \sqrt{1 - 4[(ka)^2(1-\gamma)^2 - n(n+1)]}}{2}, \quad c'' = \frac{-1 - \sqrt{1 - 4[(ka)^2(1-\gamma)^2 - n(n+1)]}}{2}, \quad (\text{at } \xi = \infty). \quad (2.12)$$

By reducing (2.9) to its canonical form, the result is

01202-2 T

$$S_n^{(j)}(\xi) = \xi^{n+1} (\xi-\gamma)^{\frac{1+\sqrt{1-4(ka)^2(1-\gamma)^2}}{2}} P \begin{pmatrix} 0 & 1 & \infty \\ 0 & 0 & \alpha_1 \\ 1-\alpha_3 & \alpha_3-\alpha_1-\alpha_2 & \alpha_2 \end{pmatrix} \xi/\gamma \quad (2.13)$$

where

$$\alpha_{1/2} = n+1 + \sqrt{\frac{1}{4} - (ka)^2(1-\gamma)^2} \pm \sqrt{(n+1/2)^2 - (ka)^2(1-\gamma)^2} \quad (2.14)$$

and

$$\alpha_3 = 2(n+1) \quad (2.15)$$

The functions represented by the canonical P-symbol are well known, and a solution is chosen which is finite at the origin. Then the radial eigenfunctions are given by

$$S_n^{(1)}(\xi) = \xi^{n+1} (\xi-\gamma)^{\frac{1+\sqrt{1-4(ka)^2(1-\gamma)^2}}{2}} {}_2F_1(\alpha_1, \alpha_2; 2(n+1); \xi/\gamma) \quad (2.16)$$

and

$$T_n^{(1)}(\xi) = \frac{1-\gamma}{\xi-\gamma} S_n^{(1)}(\xi) \quad (2.17)$$

A second solution $S_n^{(2)}(\xi)$, linearly independent from $S_n^{(1)}(\xi)$, is obtained by replacing ${}_2F_1$ in (2.16) with any other solution of the hypergeometric differential equation satisfied by ${}_2F_1$ which is linearly independent from ${}_2F_1$ itself.

Now $\epsilon(\xi)$ is investigated for various choices of γ .

Case 1 The constant γ is chosen so that $0 \leq \gamma < 1$. The dependence of $\epsilon(\xi)$ is plotted vs. ξ as shown in Fig. 2-1. It is seen that as ξ tends to γ , $\epsilon(\xi)$ approaches infinity (i.e. $\lim_{\xi \rightarrow \gamma} \epsilon(\xi) \rightarrow \infty$). This implies that the dielectric

012022 F

sphere acts as a penetrable barrier at $\xi = \gamma$ and therefore allows energy penetration for $\xi < \gamma$. When $\gamma = 0$ then $\epsilon(\xi) = 1/\xi^2$. This case corresponds to the inverse square power lens which has been studied by Uslenghi (1968).

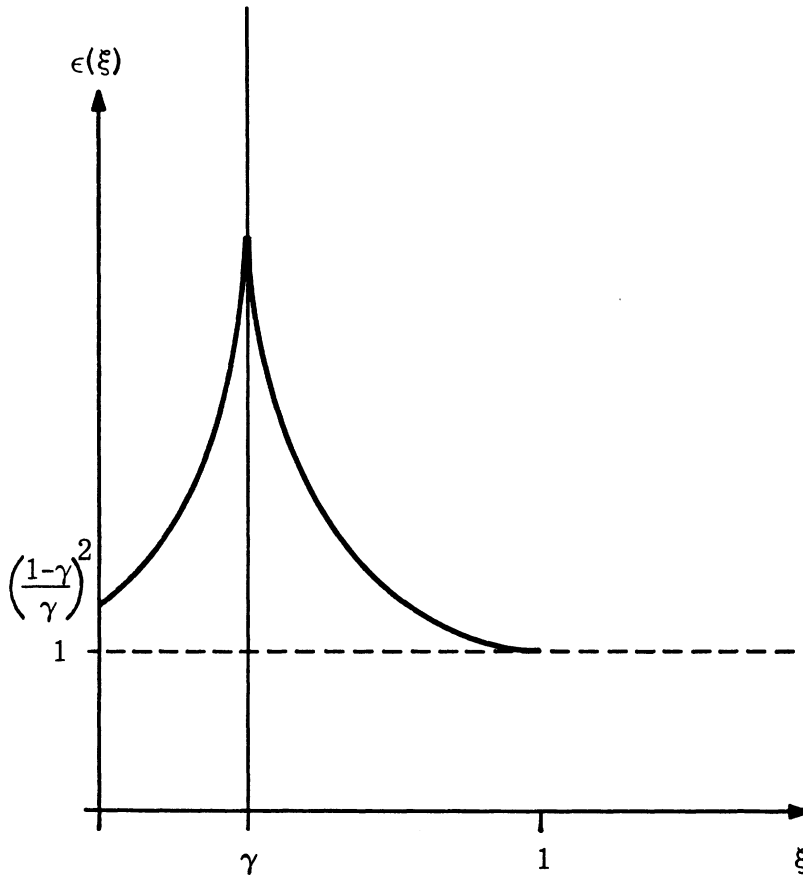

FIG. 2-1: Case 1: $0 \leq \gamma < 1$

Case 2 In this case $\gamma \geq 1$ (see Fig. 2-2) and $\epsilon(\xi) < 1$ for $0 \leq \xi \leq 1$. This case may be useful in studying diffraction of waves by plasma coated spheres or scattering from plasma clouds of spherical nature surrounded by an external medium with $\epsilon(\xi) > 1$.

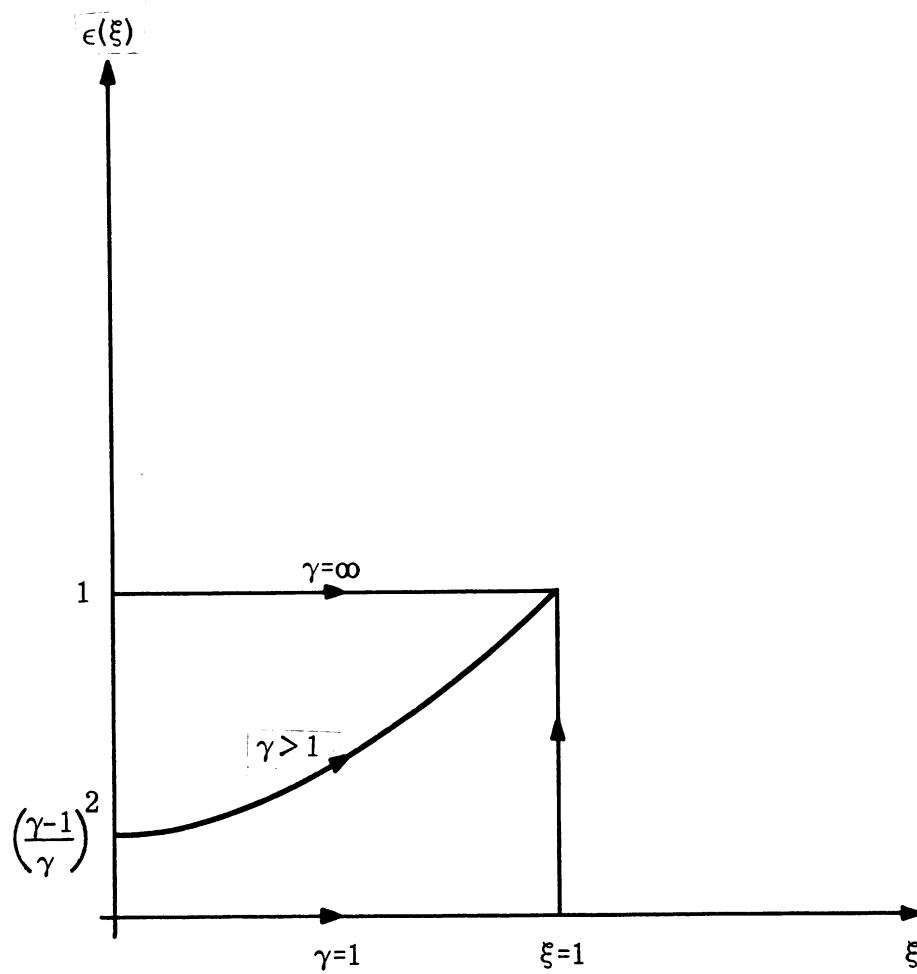

FIG. 2-2: Case 2: $\gamma \geq 1$

Case 3 Under this case ($\gamma \leq 0$, see Fig. 2-3) the lens has been studied from the point of view of geometrical optics in section 2.3.

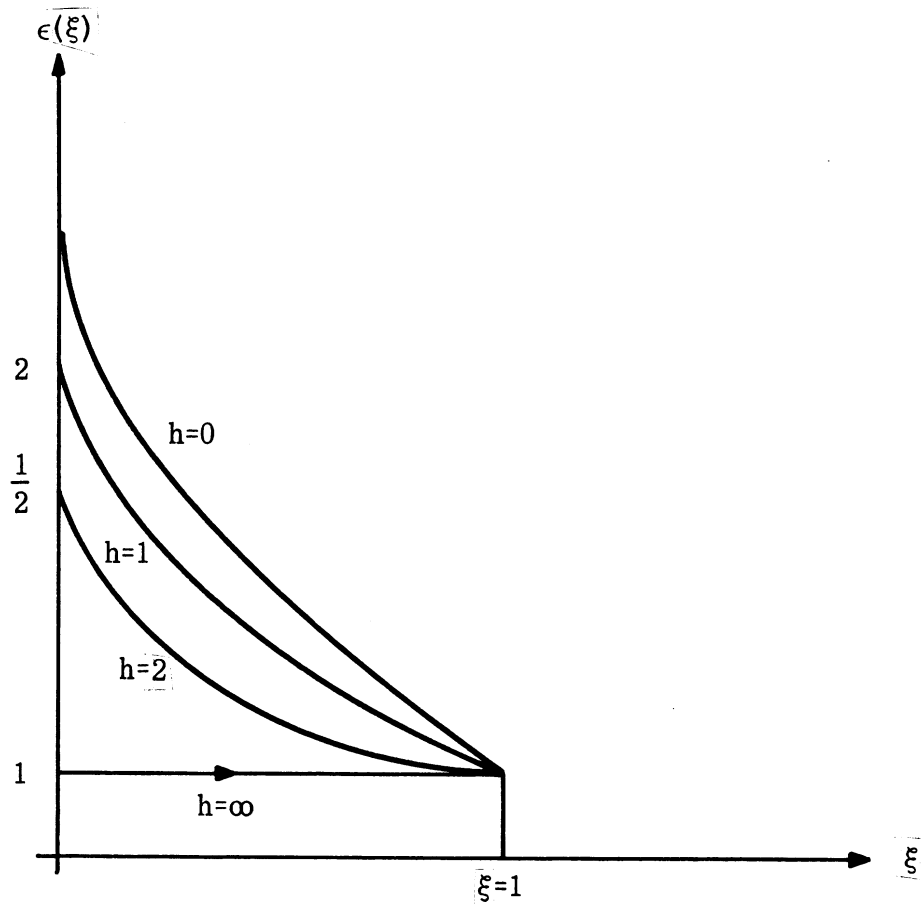

FIG. 2-3: Case 3: $\gamma \leq 0$, $\gamma \stackrel{\Delta}{=} -h$, $h \geq 0$

For a spherical lens of radius $r=a$ made of a radially inhomogeneous dielectric with

$$N(\xi) = \frac{1+h}{\xi+h}, \quad (0 \leq \xi \leq 1), \quad (2.18)$$

and $h \geq 0$, the exact backscattered field when the incident field is a plane wave is still given by expression (1.9) with

$$M_n(ka) = \frac{1}{ka} \left[\frac{\partial}{\partial \xi} \ln S_n^{(1)}(\xi) \right] \Big|_{\xi=1} \quad (2.19)$$

and

$$\tilde{M}_n(ka) = M_n(ka) - \frac{1}{ka(1+h)} \quad (2.20)$$

where $S_n^{(1)}(\xi)$ is given by (2.16) with $\gamma = -h$. It is observed here that $M_n(ka) - \tilde{M}_n(ka)$ is a known quantity and that it is independent of n .

This is of great advantage in the determination of the high-frequency backscattered field, because whenever $\epsilon(1)=1$ (as is usually the case for dielectric lenses), the leading terms in the high-frequency expansions of M_n and \tilde{M}_n are equal, and since $(M_n - \tilde{M}_n)$ appears in the numerator of all terms of the infinite series representing $\underline{E}^{\text{b.s.}}$, two terms are generally needed in the expansions of M and \tilde{M} to obtain the leading term in the expansion of $\underline{E}^{\text{b.s.}}$.

2.3 Geometrical Optics Approach for the New Class of Lenses

In this section it is assumed that the wavelength is infinitesimally small, i.e. $ka \rightarrow \infty$ for finite a . Under this condition, the electromagnetic wave propagation properties through the dielectric sphere are examined with the aid of optical ray theory. By considering Fig. 2-4, one traces any incident ray making an angle of incidence α at the surface of the dielectric sphere. The following parameters are also defined in Fig. 2-4:

$$\delta = \delta(\alpha, h) = \text{deviation angle}$$

$$\psi = \psi(\xi); \quad \psi(1) = \alpha$$

$$\psi(\xi_{\min}) = \pi/2$$

$$\rho = \rho(\xi)$$

and

$$\theta = 2\rho(\xi_{\min}) .$$

01/03/2008

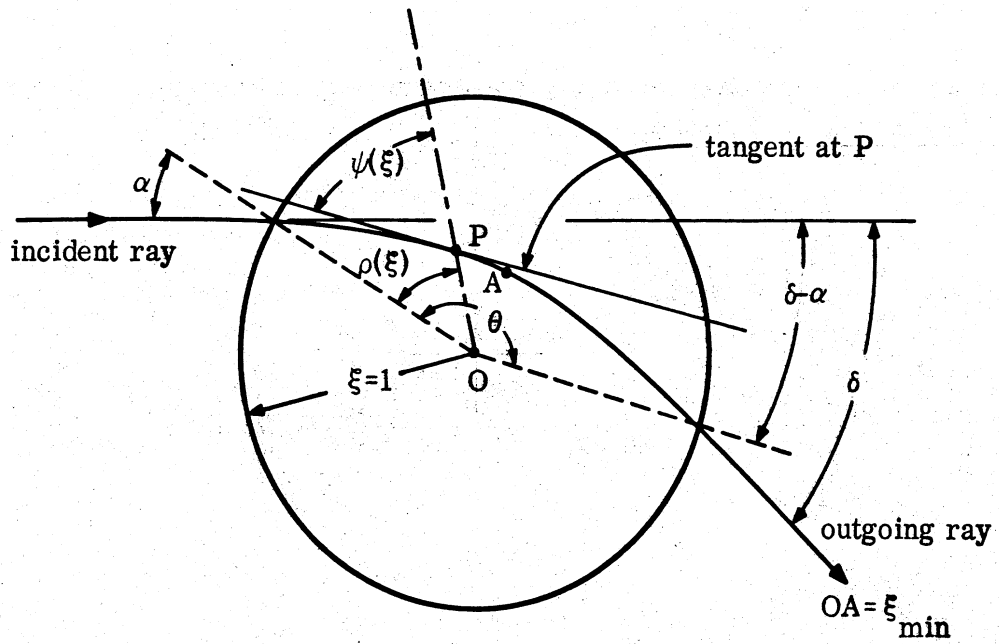

FIG. 2-4: RAY PATH THROUGH THE INHOMOGENEOUS DIELECTRIC:

01362-2-5

The generalized Snell law for the index of refraction is given by

$\xi N(\xi) \sin \psi = \text{constant}$. When $\xi=1$, $N(1)=1$ and $\psi=\alpha$. Then it follows that

$$N(\xi) = \frac{1+h}{\xi+h} = \frac{\sin \alpha}{\xi \sin \psi} \quad (2.21)$$

and when $\xi=\xi_{\min}$

$$N(\xi_{\min}) = \frac{1+h}{\xi_{\min}+h} = \frac{\sin \alpha}{\xi_{\min} \sin \pi/2} = \frac{\sin \alpha}{\xi_{\min}} \quad (2.22)$$

or

$$\xi_{\min} = \frac{h \sin \alpha}{1+h-\sin \alpha} \quad (2.23)$$

Therefore, $\xi_{\min} \neq 0$ unless $h=0$. If $h=0$, then agreement results with the inverse square power lens, where $\xi_{\min}=0$. In order to investigate how the refracted rays leave the lens, one considers the differential equation for the ray trajectory, which is

$$\frac{d\xi}{d\rho} = -\xi \cot \psi \quad (2.24)$$

Upon integrating (2.24) one obtains the following expression

$$\rho(\xi) = - \int_1^{\xi} \frac{d\xi}{\xi \cot \psi} \quad (2.25)$$

With the aid of (2.25) and the relations $\delta = \theta + 2\alpha - \pi$, $\theta = 2\rho(\xi_{\min})$ and

$$\cot \psi = \frac{\sqrt{\xi^2(1+h)^2 \csc^2 \alpha - (\xi+h)^2}}{\xi+h}, \quad \text{the deviation angle is given by}$$

$$\delta(\alpha, h) = 2\alpha - \pi - 2 \int_1^{\xi_{\min}} \frac{(\xi+h) d\xi}{\xi \sqrt{\xi^2(1+h)^2 \csc^2 \alpha - (\xi+h)^2}} \quad (2.26)$$

which upon completion of the integration yields

$$\delta(\alpha, h) = \frac{2 \sin \alpha}{\sqrt{(1+h)^2 - \sin^2 \alpha}} \log \left\{ \frac{h + \cos^2 \alpha + \cos \alpha \sqrt{(1+h)^2 - \sin^2 \alpha}}{h \sin \alpha} \right\}. \quad (2.27)$$

From the latter expression, the quantitative behavior of $\delta(\alpha, h)$ has been computed for different values of α and h . In Figs. 2-5 and 2-6, $\delta(\alpha, h)$ has been plotted vs. α . In these figures it is seen that δ increases from zero at $\alpha=0$ (with a slope $\left(\frac{d\delta}{d\alpha}\right)_{\alpha=0} = +\infty$) to a maximum value δ_{\max} , then it decreases toward zero, which is reached at $\alpha = \pi/2$ with a slope $\left(\frac{d\delta}{d\alpha}\right)_{\alpha=\pi/2} = -\frac{2}{h}$. Also the maximum deviation angle is shown as a function of h in Fig. 2-7. As h diminishes, δ_{\max} increases to infinity which indicates that the ray trajectory inside the lens follows a logarithmic spiral toward the origin in agreement with the inverse square power lens. On the other hand, as h increases indefinitely, the maximum deviation approaches zero in agreement with the fact that

$$\lim_{h \rightarrow \infty} N(\xi, h) = 1$$

i.e. the lens assimilates free space.

01202-3 T

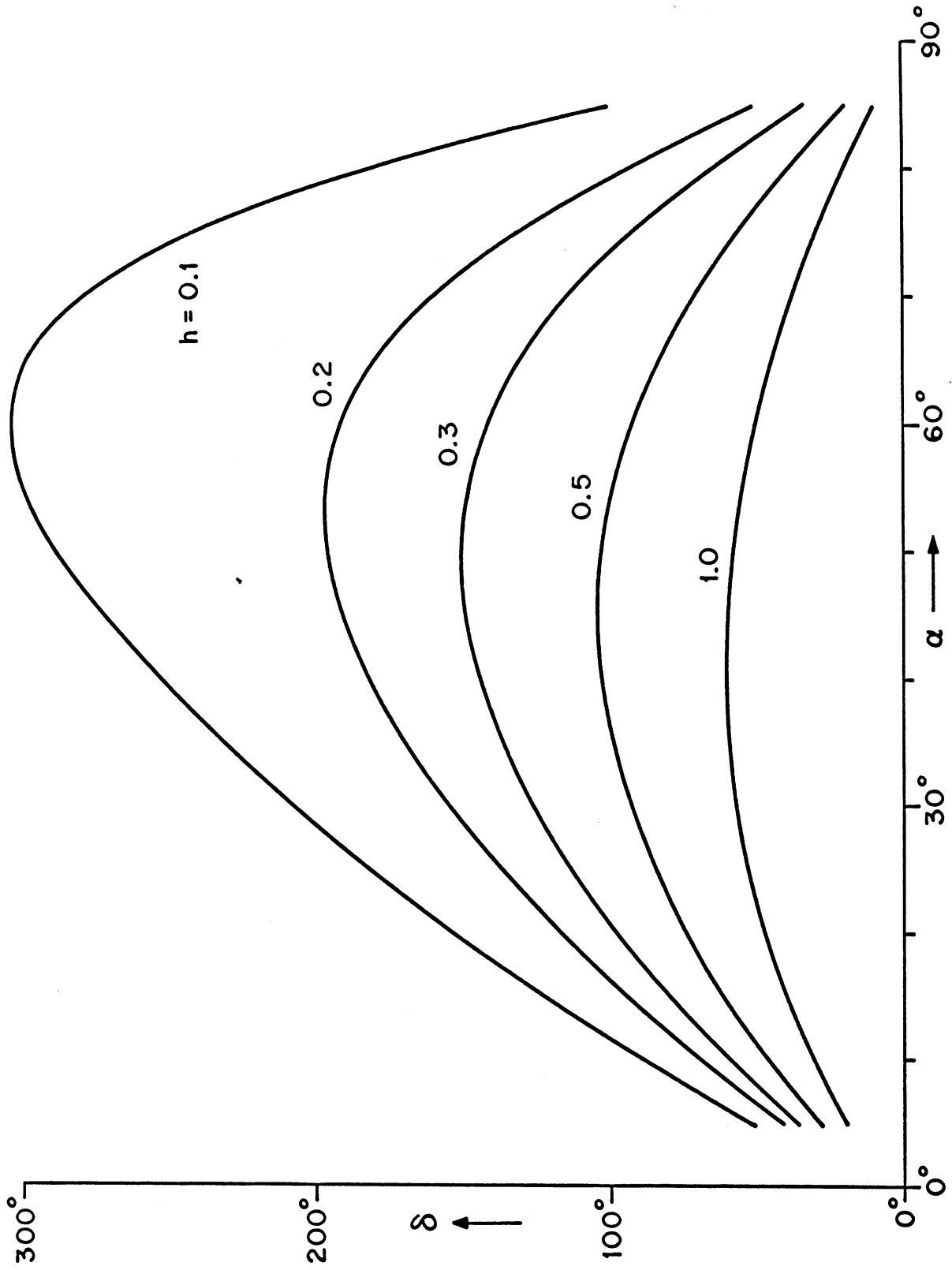

FIG. 2-5: DEVIATION ANGLE VS. ANGLE OF INCIDENCE

DIP-2-1

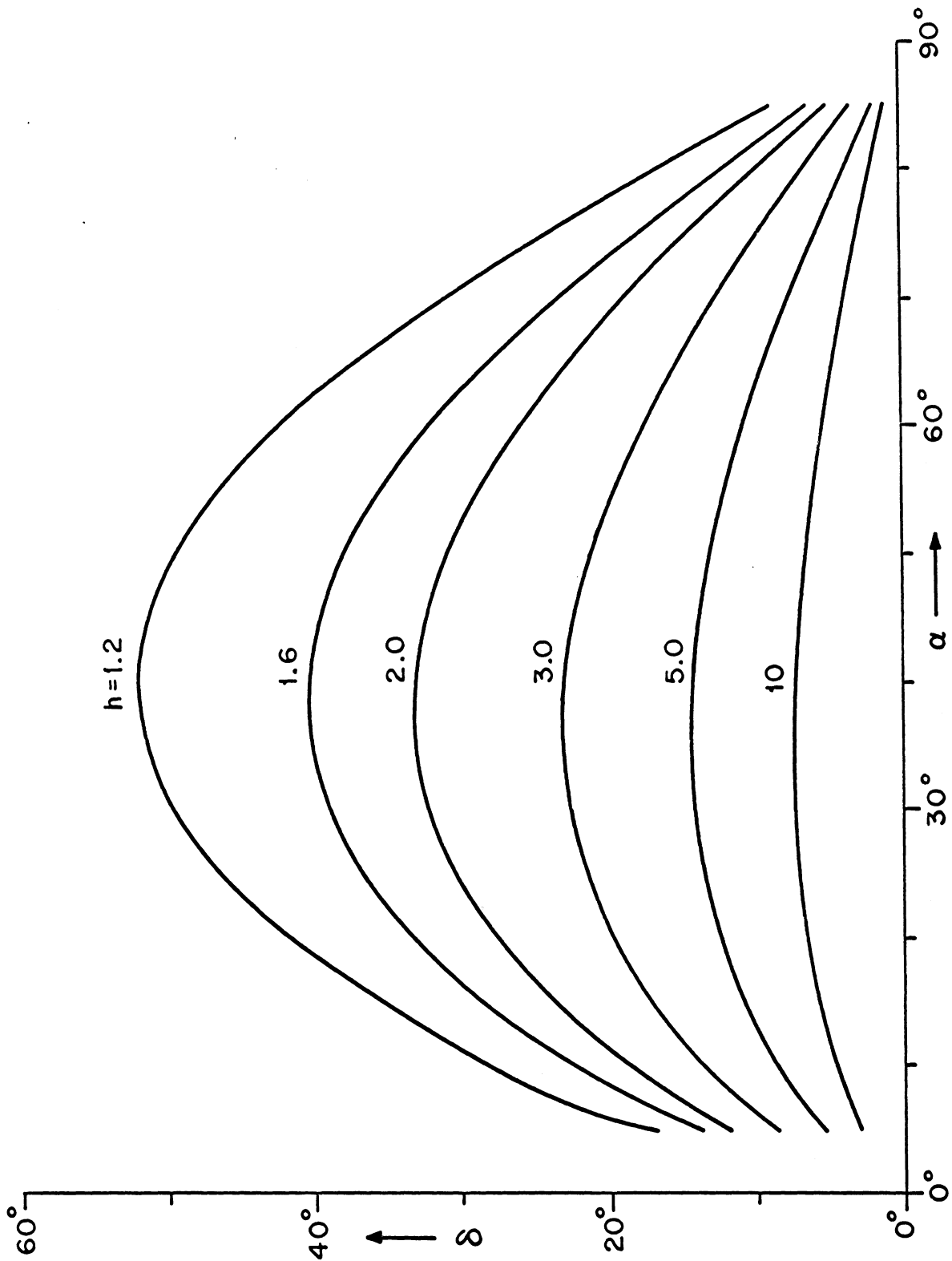

FIG. 2-6: DEVIATION ANGLE VS. ANGLE OF INCIDENCE

0302-117

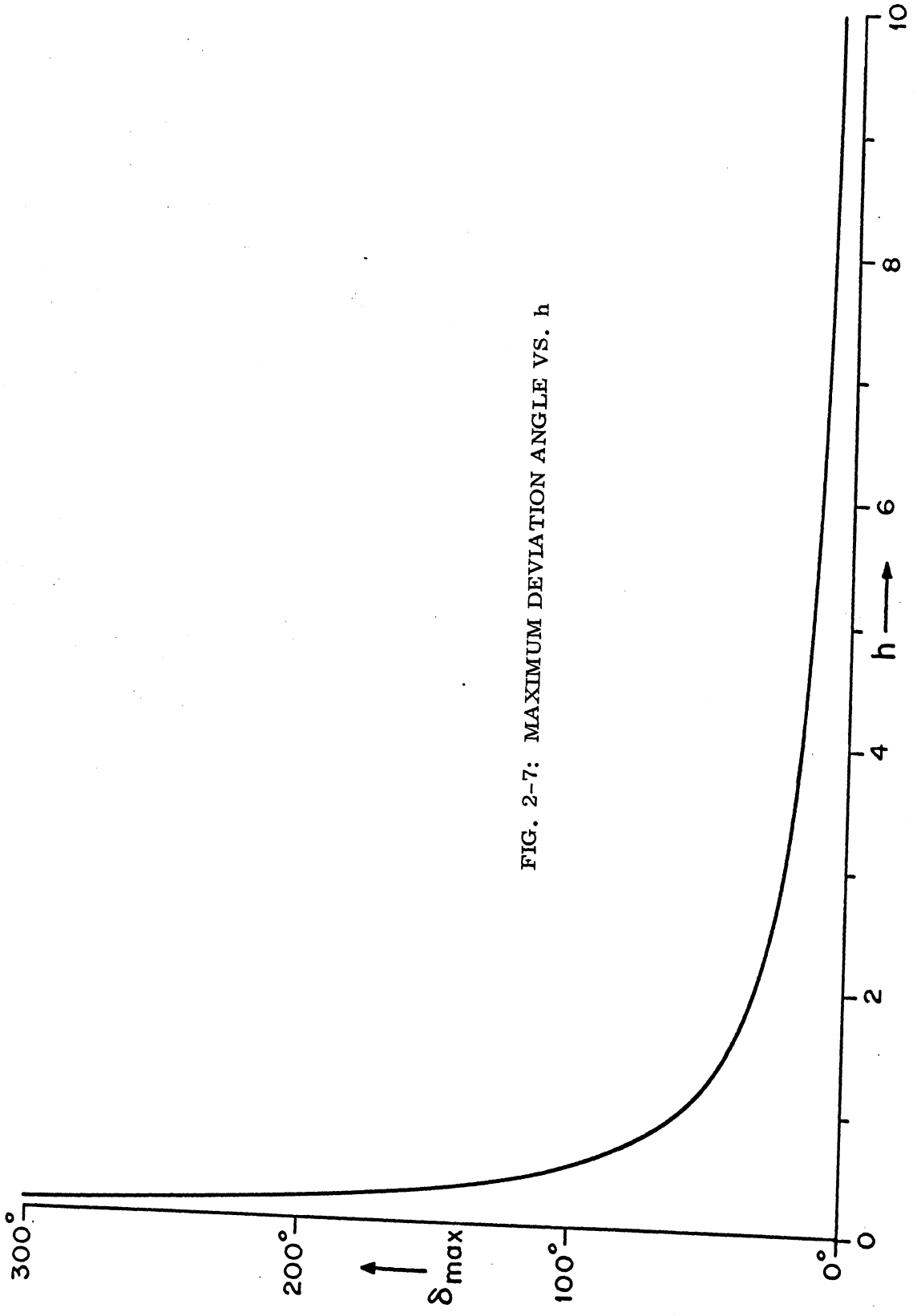

FIG. 2-7: MAXIMUM DEVIATION ANGLE VS. h

01303-2-T

CHAPTER III

HIGH FREQUENCY BACKSCATTERING FROM A PERFECTLY CONDUCTING SPHERE COATED WITH THE NEW CLASS OF RADIALLY INHOMOGENEOUS DIELECTRICS

3.1 Introduction

In this chapter, a theoretical study is carried out in order to determine the electric field in the backscattering direction, for high frequencies, when a plane wave is incident upon a perfectly conducting sphere, coated with the new class of radially inhomogeneous dielectrics. By high frequencies it is implied that $ka \gg 1$ or $\lambda \ll a$, where λ is the wavelength of the incident field. The analysis follows the discussion of section 1.3 in chapter one. The perfectly conducting sphere is of radius b and the outer radius of the coating is a . The electric field of the incident plane wave is given by (1.3) and the geometry of the problem is shown in Fig. 3-1. Following the development in chapter one, the Mie series (1.9) is transformed into a contour integral in the complex ν -plane, where $\nu = n + 1/2$. Then, the reflected portion of the electric field is determined asymptotically to $O[(ka)^{-2}]$. This is accomplished by solving for $S_{\nu-1/2}^{(j)}(\xi)$ and $T_{\nu-1/2}^{(j)}(\xi)$ with the WKB method for $\nu = O[(ka)^{1/2 + \delta}]$, then computing $a_{\nu-1/2}^s - b_{\nu-1/2}^s$ to $O[(ka)^{-2}]$ with the aid of the Debye expansions for $\xi_{\nu-1/2}^{(1)}(ka)$ and $\xi_{\nu-1/2}^{(1)'}(ka)$ in the proper regions of the complex ν -plane, and finally by performing a saddle point integration using the integrals of Scott (1949). It is recalled that the main contribution results near $\nu=0$ on the Γ_1 path of integration. The expression thus obtained for the electric field is then used to find the monostatic cross section, which is normalized to the monostatic cross section of a perfectly conducting sphere of radius b . This normalized relation is then used for numerical computations for $0.2 \leq \beta \leq 0.99$, $0.25\beta \leq \gamma \leq 0.99\beta$, $1.1 \leq \gamma \leq 2$ and $50 \leq ka \leq 1000$. The ray tracing

technique is also applied to determine the reflected electric field to $O[(ka)^{-1}]$. This is accomplished by considering the conservation of energy between incident and scattered fields in order to find the amplitude of the reflected field, and the eikonal relation in order to determine the phase. The result is then compared to the first term of the electric field obtained by the use of asymptotic theory. Finally, using this geometrical optics expression, the monostatic cross section normalized to that of a perfectly conducting sphere of radius b is computed, for the corresponding values of β and γ considered previously. From these numerical data, the monostatic cross section as determined by geometrical optics is plotted vs. β . Also, the percent error in using geometrical optics instead of the rigorous asymptotic theory to $O[(ka)^{-2}]$ to determine the cross section is plotted vs. ka for $50 \leq ka \leq 1000$.

The last section of this study is devoted to outlining the creeping wave contribution in the backscattering direction. The differential equations (1.13) and (1.24) are solved for ν near ka by applying Langer's uniform asymptotic theory, since in this case it is found that $Q_{(i)}(\xi)$ has a zero ξ_0 in $\beta \leq \xi \leq 1$.

3.2 The Asymptotic Solutions of $S_{\nu-1/2}^{(j)}(\xi)$ and $T_{\nu-1/2}^{(j)}(\xi)$.

The asymptotic solutions to $O[(ka)^{-2}]$ for the radial eigenfunctions $S_{\nu-1/2}^{(j)}(\xi)$ and $T_{\nu-1/2}^{(j)}(\xi)$ are obtained in this section, by applying the WKB method directly to Eqs. (1.16) and (1.24). Firstly, it is recalled that for this class of radially inhomogeneous dielectrics $S_{\nu-1/2}^{(j)}(\xi) = U_{\nu-1/2}^{(j)}(\xi)$ and therefore

$$Q(\xi) = Q_{(i)}(\xi) = \left(\frac{1-\gamma}{\xi-\gamma} \right)^2 - \frac{\nu^2 - 1/4}{(ka)^2 \xi^2} \quad (3.1)$$

for $i = 1, 2$. From (3.1) it is seen that $Q(\xi)$ has a zero at

$$\xi_0 = \frac{\gamma(1-\gamma) ka \sqrt{\nu^2 - 1/4} - \gamma(\nu^2 - 1/4)}{(1-\gamma)^2(ka)^2 - (\nu^2 - 1/4)} \quad (3.2)$$

which is almost zero. It follows, therefore, that if $\beta \leq \xi \leq 1$ such that $\beta > \xi_0$ the WKB method can be used. By restricting β to values greater than ξ_0 it is seen that conditions (1.27) are also satisfied, and this further justifies the use of the WKB method. The solutions which are obtained here are valid for $\nu \sim O[(ka)^{1/2 + \delta}]$ with $\delta > 0$ but $\delta \ll 1$. These solutions are given by

$$S_{\nu^{-1/2}}^{(j)}(\xi) = U_{\nu^{-1/2}}^{(j)}(\xi) = V_{(i)}^{(j)}(\xi) \quad (3.3a)$$

from (1.28) with $Q(\xi)$ as in (3.1) and

$$T_{\nu^{-1/2}}^{(j)}(\xi) = \left(\frac{1-\gamma}{\xi-\gamma} \right) S_{\nu^{-1/2}}^{(j)}(\xi) \quad (3.3b)$$

To obtain these solutions in their final form, one has to develop the asymptotic expansions. To this end, it is found with the aid of the binomial series expansions that

$$\begin{aligned} [Q(\xi)]^{-1/4} &= \sqrt{\frac{\xi-\gamma}{1-\gamma}} \exp \left\{ \frac{\nu^2}{4(ka)^2 \xi^2} \left(\frac{\xi-\gamma}{1-\gamma} \right)^2 \right\} \left[1 + \right. \\ &\left. + O[(ka)^{-2}] + O \left[\frac{\nu^4}{(ka)^4} \right] \right] \end{aligned} \quad (3.4)$$

and that

01/10/13 T

$$\begin{aligned}
& \exp \left\{ \pm ika \int_{\gamma}^{\xi} \sqrt{Q(\xi)} \left[1 + \frac{\frac{5}{4} \frac{dQ(\xi)}{d\xi} - \frac{d^2 Q(\xi)}{d\xi^2} Q(\xi)}{8(ka)^2 Q^3(\xi)} \right] d\xi \right\} \sim \\
& \sim \exp \left\{ \pm i \left(ka(1-\gamma) \ln(\xi-\gamma) - \frac{\nu^2}{2ka(1-\gamma)} \left[\ln \xi + \frac{\gamma}{\xi} \right] \right) \right\} \times \\
& \times \left[1 \mp \frac{i}{8ka(1-\gamma)} \left(\ln \left(1 - \frac{\gamma}{\xi} \right) - \frac{\gamma}{\xi} \right) \mp i \frac{\nu^4}{4(ka)^3(1-\gamma)^3} \left(\ln \xi + \right. \right. \\
& \left. \left. + 3 \frac{\gamma}{\xi} - 3 \frac{\gamma^2}{2\xi^2} + \frac{\gamma^3}{3\xi^3} \right) \right] \left(1 + O \left[\frac{\nu^2}{(ka)^3} \right] + O \left[\frac{\nu^4}{(ka)^4} \right] + \right. \\
& \left. + O \left[\frac{\nu^6}{(ka)^5} \right] + O \left[\frac{\nu^8}{(ka)^6} \right] \right) . \tag{3.5}
\end{aligned}$$

By combining (3.4) and (3.5) the solutions in their final form are

$$\begin{aligned}
S_{\nu^{-1/2}}^{(j)}(\xi) & \sim \sqrt{\frac{\xi-\gamma}{1-\gamma}} \exp \left\{ \pm i \left[ka(1-\gamma) \ln(\xi-\gamma) - \right. \right. \\
& \left. \left. - \frac{\nu^2}{2ka(1-\gamma)} \left(\ln \xi + \frac{\gamma}{\xi} \right) \right] \right\} \left(1 \mp \frac{i}{8ka(1-\gamma)} \left[\ln \left(1 - \frac{\gamma}{\xi} \right) - \right. \right. \\
& \left. \left. - \frac{\gamma}{\xi} \right] + \frac{\nu^2}{4(ka)^2(1-\gamma)^2} \left(1 - \frac{\gamma}{\xi} \right)^2 \mp \frac{i\nu^4}{8(ka)^3(1-\gamma)^3} \left[\ln \xi + \right. \right. \\
& \left. \left. + \frac{3\gamma}{\xi} - \frac{3\gamma^2}{2\xi^2} + \frac{\gamma^3}{3\xi^3} \right] \right) \left[1 + O[(ka)^{-2}] + \left[O \frac{\nu^2}{(ka)^3} \right] + \right. \\
& \left. + O \left[\frac{\nu^4}{(ka)^4} \right] + O \left[\frac{\nu^6}{(ka)^5} \right] + O \left[\frac{\nu^8}{(ka)^6} \right] \right] \tag{3.6}
\end{aligned}$$

and $T_{\nu^{-1/2}}^{(j)}(\xi)$ is given by (3.3b). These solutions are valid provided that $\xi \neq 0$, $\xi \neq \gamma$ and $|2ka(1-\gamma)| \gg 1$.

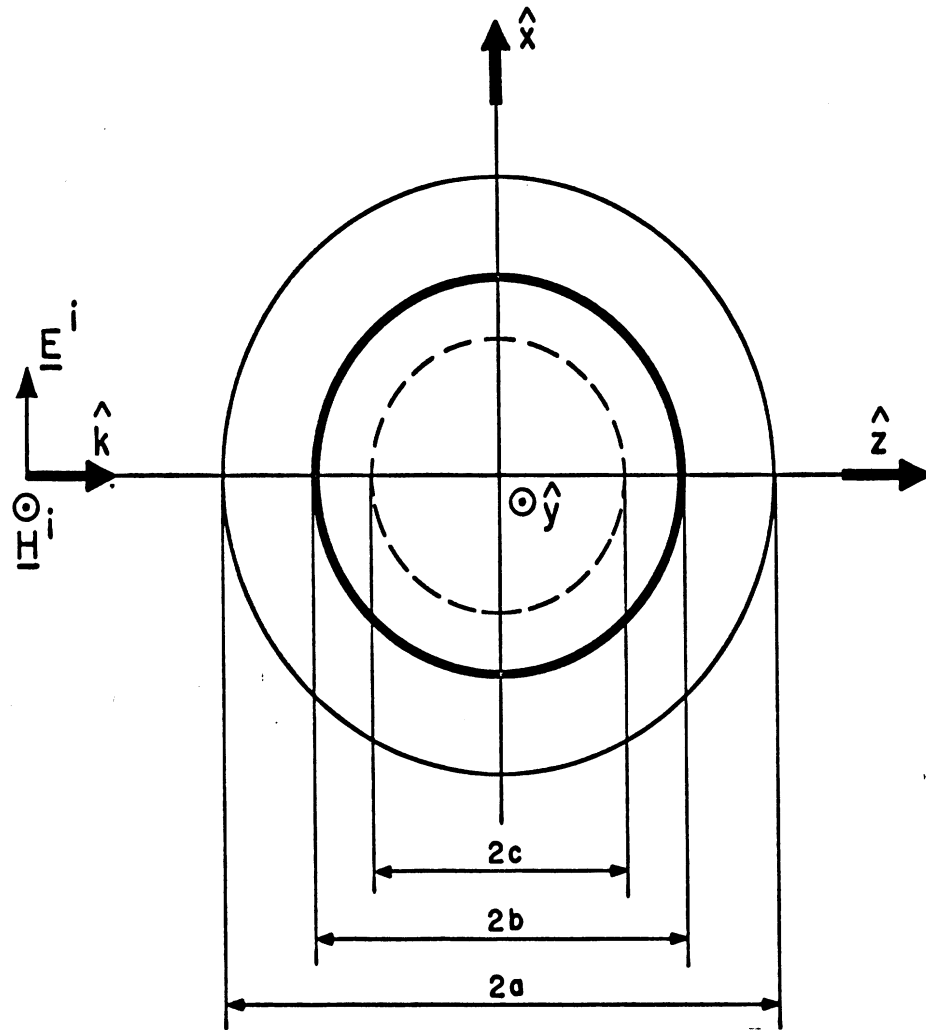

FIG. 3-1: THE GEOMETRY OF THE PROBLEM. ($c=a\gamma$)

01/03/87 T

3.3 The Reflected Electric Field

With the asymptotic forms of $S_{\nu-1/2}^{(j)}(\xi)$ and $T_{\nu-1/2}^{(j)}(\xi)$ one easily proceeds to determine the reflected electric field to $O[(ka)^{-2}]$. It is pertinent, that first of all the asymptotic expression for $a_{\nu-1/2}^s - b_{\nu-1/2}^s$ be derived. To this end, a step by step procedure is employed in determining these coefficients. Firstly, the definitions for $M_{\nu-1/2}(ka)$ and $\tilde{M}_{\nu-1/2}(ka)$ are recalled in terms of $C_{\nu-1/2}(\xi, \beta)$ and $\tilde{C}_{\nu-1/2}(\xi, \beta)$. In this case $\tilde{M}_{\nu-1/2}(ka)$ is simplified in the following form.

$$\tilde{M}_{\nu-1/2}(ka) = -\frac{1}{ka(1-\gamma)} + \frac{1}{ka} \left\{ \frac{\partial}{\partial \xi} \ln \left[C_{\nu-1/2}(\xi, \beta) - (\beta-\gamma) \frac{\partial C_{\nu-1/2}(\xi, \beta)}{\partial \beta} \right] \right\} \Bigg|_{\xi=1} \quad (3.7)$$

From (3.6):

$$C_{\nu-1/2}(\xi, \beta) \sim \frac{2i}{1-\gamma} \sqrt{(\xi-\gamma)(\beta-\gamma)} \exp \left\{ \frac{1}{4} \frac{\nu^2}{(ka)^2} \left(\left(\frac{\xi-\gamma}{1-\gamma} \right)^2 \frac{1}{\xi^2} + \right. \right. \\ \left. \left. + \left(\frac{\beta-\gamma}{1-\gamma} \right)^2 \frac{1}{\beta^2} \right) \right\} \sin g(\xi, \beta) \left[1 + O[(ka)^{-2}] + O\left[\frac{\nu^2}{(ka)^3}\right] + O\left[\frac{\nu^4}{(ka)^4}\right] + O\left[\frac{\nu^6}{(ka)^5}\right] + O\left[\frac{\nu^8}{(ka)^6}\right] \right]. \quad (3.8)$$

From this derivation for $C_{\nu-1/2}(\xi, \beta)$ one obtains:

$$M_{\nu-1/2}(ka) \sim \left(\frac{1}{2ka(1-\gamma)} + \frac{1}{ka} \left\{ \cot g(\xi, \beta) \frac{\partial g(\xi, \beta)}{\partial \xi} \right\} \Bigg|_{\xi=1} \right) \left(1 + \right. \\ \left. + O[(ka)^{-2}] + O\left[\frac{\nu^2}{(ka)^3}\right] + O\left[\frac{\nu^4}{(ka)^4}\right] + O\left[\frac{\nu^6}{(ka)^5}\right] + O\left[\frac{\nu^8}{(ka)^6}\right] \right) \quad (3.9)$$

and

CPV: 17

$$\begin{aligned} \tilde{M}_{\nu-1/2}(ka) \sim & \left\{ -\frac{1}{2ka(1-\gamma)} + \frac{1}{ka} \left(\cot g(\xi, \beta) \right) \frac{\partial g(\xi, \beta)}{\partial \xi} + \right. \\ & \left. + \frac{1}{ka} \left(\frac{(\beta-\gamma) \csc^2 g(\xi, \gamma) \frac{\partial g(\xi, \beta)}{\partial \beta} \frac{\partial g(\xi, \beta)}{\partial \beta}}{\frac{1}{2} - \frac{1}{4} \frac{\nu^2}{(ka)^2} - \frac{2\gamma(\beta-\gamma)^2}{\beta^2(1-\gamma)} - (\beta-\gamma) \cot g(\xi, \beta) \frac{\partial g(\xi, \beta)}{\partial \beta}} \right) \right\} \Bigg|_{\xi=1} \left[1 + \dots \right] \\ & + O[(ka)^{-2}] + O\left[\frac{\nu^2}{(ka)^3}\right] + O\left[\frac{\nu^4}{(ka)^4}\right] + O\left[\frac{\nu^6}{(ka)^5}\right] + O\left[\frac{\nu^8}{(ka)^6}\right] \end{aligned} \quad (3.10)$$

where

$$\begin{aligned} g(\xi, \beta) = & \left\{ ka(1-\gamma) - \frac{1}{8ka(1-\gamma)} \right\} \ln \left(\frac{\xi-\gamma}{\beta-\gamma} \right) - \frac{1}{2} \frac{\nu^2}{ka(1-\gamma)} \times \\ & \times \left\{ \ln \frac{\xi}{\beta} + \gamma \left(1 - \frac{1}{\beta} \right) \right\} - \frac{1}{8} \frac{\nu^4}{(ka)^3(1-\gamma)^3} \left[\ln \frac{\xi}{\beta} + 3\gamma \left(\frac{1}{\xi} - \frac{1}{\beta} \right) - \right. \\ & \left. - \frac{3}{2} \gamma^2 \left(\frac{1}{\xi^2} - \frac{1}{\beta^2} \right) + \frac{\gamma^3}{3} \left(\frac{1}{\xi^3} - \frac{1}{\beta^3} \right) \right] \end{aligned} \quad (3.11)$$

and henceforth $g(\xi, \beta) \Big|_{\xi=1} = g(1, \beta) = g$. (3.12)

By observing that

$$\frac{1}{ka} \frac{\partial g(\xi, \beta)}{\partial \xi} \Big|_{\xi=1} \sim 1 - \frac{1}{2} \frac{\nu^2}{(ka)^2} + O[(ka)^{-2}] + O\left[\frac{\nu^4}{(ka)^4}\right] \quad (3.13)$$

and by simplifying (3.10) after the term $(\beta-\gamma) \cot g(\xi, \beta) \frac{\partial g(\xi, \beta)}{\partial \beta}$ is factored out in the denominator, the following expressions are derived:

$$\begin{aligned} M_{\nu-1/2}(ka) \sim & \left(\frac{1}{2ka(1-\gamma)} + \left(1 - \frac{1}{2} \frac{\nu^2}{(ka)^2} \right) \cot g \right) \left[1 + O[(ka)^{-2}] + \dots \right] \\ & + O\left[\frac{\nu^2}{(ka)^3}\right] + O\left[\frac{\nu^4}{(ka)^4}\right] + O\left[\frac{\nu^6}{(ka)^5}\right] + O\left[\frac{\nu^8}{(ka)^6}\right] \end{aligned} \quad (3.14)$$

and

$$\tilde{M}_{\nu-1/2}(ka) \sim \left\{ -\frac{1}{2ka(1-\gamma)} + \frac{1}{2ka(1-\gamma)} \sec^2 g - \left(1 - \frac{1}{2} \frac{\nu^2}{(ka)^2}\right) \tan g \right\} \left(1 + O[(ka)^{-2}] + O\left[\frac{\nu^2}{(ka)^3}\right] + O\left[\frac{\nu^4}{(ka)^4}\right] + O\left[\frac{\nu^6}{(ka)^5}\right] + O\left[\frac{\nu^8}{(ka)^6}\right]\right). \quad (3.15)$$

It remains now to obtain the asymptotic expansions for the spherical Hankel function of the first kind and its derivative in the proper regions of the complex ν -plane. The regions in the complex ν -plane are shown in Fig. 3-2 (Watson, 1952). For the case of the reflected electric field the Debye asymptotic expansions are needed in region one. These expansions are

$$\xi_{\nu-1/2}^{(1)}(ka) \sim \sqrt{\frac{i}{\sinh \eta}} e^{\Omega - i\frac{\pi}{4}} \left\{1 - \frac{i}{4ka}\right\} \left[1 + O[(ka)^{-2}] + O\left[\frac{\nu^2}{(ka)^3}\right]\right] \quad (3.16)$$

and

$$\xi_{\nu-1/2}^{(1)'}(ka) \sim \sqrt{\frac{i}{\sinh \eta}} e^{\Omega - i\frac{\pi}{4}} \left\{i + \frac{1}{8ka} - \frac{i}{2} \frac{\nu^2}{(ka)^2}\right\} \left[1 + O[(ka)^{-2}] + O\left[\frac{\nu^2}{(ka)^3}\right]\right] \quad (3.17)$$

with the following relations being recalled

$$\nu = ka \cosh \eta, \quad \Omega = \nu (\tanh \eta - \eta), \quad (3.18)$$

the restriction

$$-\frac{\pi}{2} < \arg(-i \sinh \eta) < \frac{\pi}{2} \quad (3.19)$$

and the requirement that Γ_1 is sufficiently far from $\nu = ka$ in the fourth quadrant while it runs close to the imaginary ν -axis in the second quadrant. It is noted here that the notation has been changed somewhat from that of Watson (e.g. Watson uses γ instead of η) for convenience. If now the following asymptotic expressions are taken into account:

1952-3

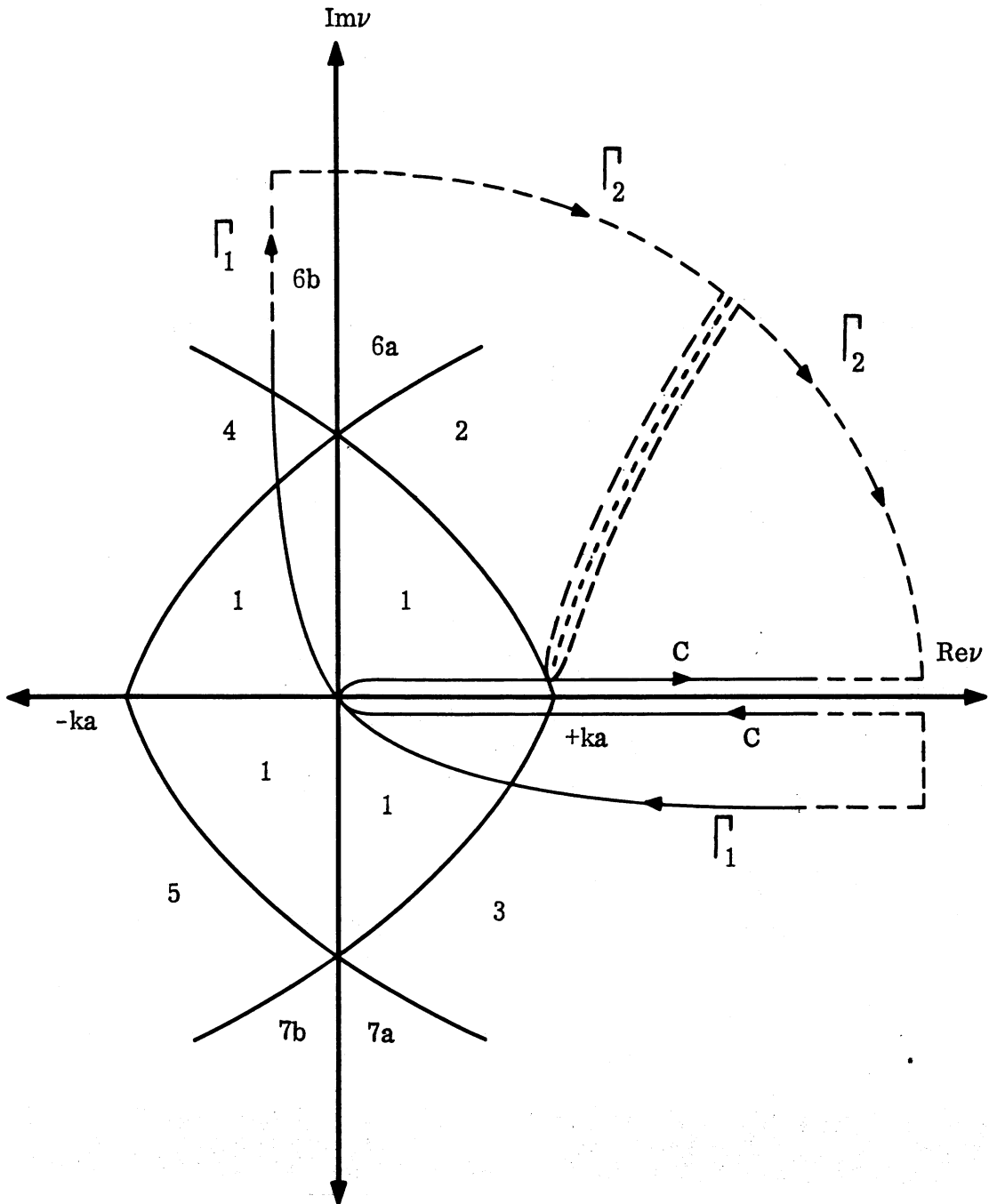

FIG. 3-2: CONTOURS OF INTEGRATION AND DIFFERENT REGIONS CONSIDERED IN THE COMPLEX ν -PLANE.

01343-3-T

$$e^{-2\Omega} \sim \exp \left\{ i\pi\nu - i\frac{\nu^2}{ka} - i2ka \right\} \left[1 - i\frac{\nu^4}{12(ka)^3} + O\left[\frac{\nu^6}{(ka)^5}\right] \right], \quad (3.20)$$

$$\sinh \eta \sim i \left\{ 1 - \frac{1}{2} \frac{\nu^2}{(ka)^2} \right\} \left[1 + O\left[\frac{\nu^4}{(ka)^4}\right] + O\left[\frac{\nu^6}{(ka)^6}\right] \right], \quad (3.21)$$

$$M_{\nu-1/2}(ka) - \tilde{M}_{\nu-1/2}(ka) \sim \left(\frac{1}{ka(1-\gamma)} + \left\{ 1 - \frac{1}{2} \frac{\nu^2}{(ka)^2} \right\} (2 \csc 2g) - \frac{1}{2ka(1-\gamma)} \right) \times \sec^2 g \left[1 + O[(ka)^{-2}] + O\left[\frac{\nu^2}{(ka)^3}\right] + O\left[\frac{\nu^4}{(ka)^4}\right] + O\left[\frac{\nu^6}{(ka)^5}\right] + O\left[\frac{\nu^8}{(ka)^6}\right] \right] \quad (3.22)$$

then together with (3.14, 15, 16 and 17) the difference of the scattering coefficients is found to be

$$a_{\nu-1/2}^s - b_{\nu-1/2}^s \sim \left(i \exp \left\{ i\pi\nu - \frac{\nu^2}{ka} - i2ka + i2g \right\} \left\{ 1 + \frac{i}{4ka} - \frac{i\nu^4}{12(ka)^3} - \frac{\tan g}{ka(1-\gamma)} \exp i2g \right\} - \frac{i \sin 2g}{2ka(1-\gamma)} \exp \left\{ i\pi\nu - \frac{\nu^2}{ka} - i2ka + i2g \right\} \right) \left[1 + O[(ka)^{-2}] + O\left[\frac{\nu^2}{(ka)^3}\right] + O\left[\frac{\nu^4}{(ka)^4}\right] + O\left[\frac{\nu^6}{(ka)^5}\right] + O\left[\frac{\nu^8}{(ka)^6}\right] \right]. \quad (3.23)$$

By substituting in (3.23) :

$$g = \epsilon_1 + \epsilon_2 \quad (3.24)$$

where

$$\epsilon_1 = \frac{1}{ka(1-\gamma)} \ln \left(\frac{1-\gamma}{\beta-\gamma} \right) + \frac{1}{2} \frac{\nu^2}{ka(1-\gamma)} \left\{ \ln \beta + \gamma \left(\frac{1}{\beta} - 1 \right) \right\}, \quad (3.25)$$

913-3-27

$$\begin{aligned} \epsilon_2 = & \frac{1}{8ka(1-\gamma)} \ln\left(\frac{\beta-\gamma}{1-\gamma}\right) + \frac{1}{8} \frac{\nu^4}{(ka)^3(1-\gamma)^3} \left[\ln\beta + 3\gamma\left(\frac{1}{\beta} - 1\right) + \right. \\ & \left. + \frac{3}{2}\gamma^2\left(\frac{1}{\beta^2} - 1\right) - \frac{\gamma^3}{3}\left(\frac{1}{\beta^3} - 1\right) \right], \end{aligned} \quad (3.26)$$

such that $\epsilon_2 \ll \epsilon_1$, then (3.23) is given in the following simpler form:

$$\begin{aligned} a_{\nu-1/2}^s - b_{\nu-1/2}^s \sim & \left(-i \exp\left[i\pi\nu - i\frac{\nu^2}{ka} - i2ka + i2\epsilon_1 \right] \left\{ 1 + \frac{i}{4ka} - i\frac{\nu^4}{12(ka)^3} + \right. \right. \\ & + \frac{i}{4ka(1-\gamma)} \ln\left(\frac{\beta-\gamma}{1-\gamma}\right) + \frac{i}{4} \frac{\nu^4}{(ka)^3(1-\gamma)^3} \left[\ln\beta + 3\gamma\left(\frac{1}{\beta} - 1\right) + \frac{3}{2}\gamma^2\left(\frac{1}{\beta^2} - 1\right) - \right. \\ & \left. \left. - \frac{\gamma^3}{3}\left(\frac{1}{\beta^3} - 1\right) \right] - \frac{(\tan\epsilon_1)[\exp(i2\epsilon_1)]}{ka(1-\gamma)} \right\} - \\ & - \frac{i}{2} \frac{(\sin 2\epsilon_1) \exp\left[i\pi\nu - i\frac{\nu^2}{ka} - i2ka + i2\epsilon_1 \right]}{ka(1-\gamma)} + \frac{i}{4ka(1-\gamma)} \sin 2\epsilon_1 \sec^2 \epsilon_1 \exp\left\{ i\pi\nu - \right. \\ & \left. - i\frac{\nu^2}{ka} - i2ka + i2\epsilon_1 \right\} \left[1 + O[(ka)^{-2}] + O\left[\frac{\nu^2}{(ka)^3}\right] + O\left[\frac{\nu^4}{(ka)^4}\right] + \right. \\ & \left. + O\left[\frac{\nu^6}{(ka)^5}\right] + O\left[\frac{\nu^8}{(ka)^6}\right] \right] \end{aligned} \quad (3.27)$$

If $\nu = 1/2$ in (3.27), then

$$\begin{aligned} a_o^s - b_o^s \sim & e^{-i2ka} \left[1 - (1-\gamma) \ln\left(\frac{1-\gamma}{\beta-\gamma}\right) \right] \left\{ 1 - \frac{i}{4ka} \right\} \left[1 + O[(ka)^{-2}] + \right. \\ & \left. + O\left[\frac{\nu^2}{(ka)^3}\right] + O\left[\frac{\nu^4}{(ka)^4}\right] + O\left[\frac{\nu^6}{(ka)^5}\right] + O\left[\frac{\nu^8}{(ka)^6}\right] \right] \quad \text{results.} \end{aligned} \quad (3.28)$$

01.02.15

If now one writes

$$\underline{E}_{\text{refl.}}^{\text{b.s.}} \sim \hat{x} \frac{e^{ikr}}{kr} \left\{ \frac{i}{2} \left(a_0^s - b_0^s \right) - \int_{\Gamma_1} \frac{\nu e^{-i\pi\nu}}{1 + e^{-i2\pi\nu}} \left[a_{\nu^{-1/2}}^s - b_{\nu^{-1/2}}^s \right] d\nu \right\}, \quad (3.29)$$

then by substituting (3.27) and (3.28) in (3.29) and by performing the integration along Γ_1 with the aid of the integrals of Scott (1949), the reflected electric field is obtained in an explicit but asymptotic form.

It is recalled that the integration along Γ_1 is a saddle point integration over the range $\nu = O[(ka)^{1/2+\delta}]$ with the major contribution arising for ν near zero. Scott (1949) evaluated such a class of integrals which in their general form are

$$E_{o,q} = \int_{-\infty}^{+\infty} \frac{e^{iy} e^{-\epsilon w^2}}{e^{iy} (1 + e^{-w})} w^{2q+1} dw \quad (3.30)$$

with $q = 0, 1, 2, 3, \dots$, $0 < y < \pi/2$. By performing the saddle point integration for $\nu \ll ka$ Scott found that the major contribution arises for ν near zero. Some of the integrals which he computed and which are of importance here are

$$E_{o,0} \sim \frac{1}{2\epsilon} - \frac{\pi^2}{6} + O(\epsilon^1) \quad (3.31)$$

$$E_{o,1} \sim \frac{1}{2\epsilon^2} + O(\epsilon^0) \quad (3.32)$$

and

$$E_{o,2} \sim \frac{1}{\epsilon^3} + O(\epsilon^0) \quad (3.33)$$

Scott used these integrals in order to determine the backscattered electric field from a perfectly conducting sphere, when the incident field is a plane

wave, for $ka \gg 1$. Throughout expressions (3.30) - (3.33), ϵ and w are given by

$$\epsilon = -\frac{i}{4\pi^2 ka}$$

and $w = i2\pi\nu$. In the problem considered here, expression (3.29) is reduced to several integrals of the type (3.30) by substituting the asymptotic expression for $a_{\nu^{-1/2}}^s - b_{\nu^{-1/2}}^s$ in (3.29) and by letting $w = i2\pi\nu$. In this case, in each occurring integral ϵ is a function of the β and γ parameters as well as of ka . A typical integral e.g. results if the first term of (3.27) is considered, i.e. the term $-i \exp \left\{ i\pi\nu - i(\nu^2/ka) - i2ka + i2\epsilon_1 \right\}$. The integral along Γ_1 in this case becomes:

$$\int_{\Gamma_1} \frac{\nu e^{-i\pi\nu}}{1 + e^{-i2\pi\nu}} \left[a_{\nu^{-1/2}}^s - b_{\nu^{-1/2}}^s \right] d\nu = \frac{i}{4\pi^2} e^{-i2ka \left[1 - (1-\gamma) \ln \left(\frac{1-\gamma}{\beta-\gamma} \right) \right]} \times$$

$$\times \int_{-2\pi\nu e^{iy}}^{+2\pi\nu e^{iy}} \frac{w e^{-\epsilon w^2}}{1 + e^{-w}} dw \sim \frac{1}{4\pi^2} e^{-i2ka \left[1 - (1-\gamma) \ln \left(\frac{1-\gamma}{\beta-\gamma} \right) \right]} \left\{ \frac{1}{2\epsilon} - \frac{\pi^2}{6} \right\} + O(\epsilon^1)$$

(3.34)

where for this particular integral, $\epsilon = -\frac{1}{4\pi^2 ka} \left[\frac{1 - \ln \beta - \gamma/\beta}{1-\gamma} \right]$ and

$\nu = (ka)^{1/2 + \epsilon}$. By proceeding in a similar manner, the following expression

is finally obtained for the reflected electric field:

01363 3-7

$$\begin{aligned}
\mathbf{E}_{\text{refl.}}^{\text{b.s.}} &\sim \hat{\mathbf{x}} \frac{e^{ikr}}{kr} \left(- \left[\frac{ka(1-\gamma)}{2(1-\ln\beta - \frac{\gamma}{\beta})} \right] \right) e^{-i2ka \left[1 - (1-\gamma) \ln \frac{1-\gamma}{\beta-\gamma} \right]} \mathbf{x} \\
&\times \left\{ 1 + \frac{i}{4ka(1-\gamma)} \left[\ln \frac{\beta-\gamma}{\beta(1-\gamma)} - \frac{\gamma}{\beta} - 1 - \frac{11}{3} \left(1 - \ln\beta - \frac{\gamma}{\beta} \right) \right] + \right. \\
&+ \frac{\frac{2}{3} + 4\gamma - \gamma^2 - 6\frac{\gamma}{\beta} + 3\frac{\gamma^2}{\beta} - \frac{2}{3}\frac{\gamma^3}{\beta} - 2\ln\beta}{\left(1 - \ln\beta - \frac{\gamma}{\beta} \right)^2} + \\
&+ \left(1 - \ln\beta - \frac{\gamma}{\beta} \right) \left\{ \frac{\exp \left[i2ka(1-\gamma) \ln \frac{1-\gamma}{\beta-\gamma} \right]}{1 + \gamma - 2 \left(\ln\beta + \frac{\gamma}{\beta} \right)} + \right. \\
&+ \left. \left. \frac{\exp \left[-i2ka(1-\gamma) \ln \frac{1-\gamma}{\beta-\gamma} \right]}{1-\gamma} \right\} \right\} + O[(ka)^{-2}] \quad (3.35)
\end{aligned}$$

The correctness of this expression is checked with the known result for the perfectly conducting sphere. It is thus observed that if $\beta=1$, i.e. if the thickness of the radially inhomogeneous coating is zero, then (3.35) reduces to

$$\mathbf{E}_{\text{refl.}}^{\text{b.s.}} \underset{b=a}{\sim} \hat{\mathbf{x}} \left(-\frac{a}{2r} \right) e^{ikr-i2ka} \left\{ 1 - \frac{i}{2ka} + O[(ka)^{-2}] \right\}, \quad (3.36)$$

which is the well known result for the reflected field by a perfectly conducting sphere. It is also observed in (3.35) that since $\text{Im}k \ll 1$ but positive, in the limit $\beta=\gamma$ the expression (3.35) reduces to

$$\mathbf{E}_{\text{refl.}}^{\text{b.s.}} \sim -\hat{\mathbf{x}} \frac{i}{8kr(1-\gamma)} e^{ikr-i2ka} \left\{ 1 + O[(ka)^{-1}] \right\} \quad (3.37)$$

which indicates that if $\beta=\gamma$ the reflected field contribution is very small.

3.4 Derivation of the Reflected Electric Field by Geometrical Optics.

Although the geometrical optics contribution can be determined from the first term of expression (3.35), it is of interest to derive this contribution by the ray tracing technique. Such a derivation gives not only a means of comparison with the results obtained by rigorous asymptotic theory, but also a physical insight into the problem.

In considering the geometrical optics solution for the reflected electric field, it is implied that $ka \rightarrow \infty$. Furthermore, the reflected electric field is polarized as the incident one, i.e. $E_x^{b.s.} = \hat{x} E_x^{b.s.}$, and it satisfies the vector wave equation. This vector wave equation easily reduces to

$$\left[\nabla_{\xi}^2 + (ka)^2 N^2(\xi) \right] E_x^{b.s.} = 0 \quad (3.38)$$

where

$$\nabla_{\xi} = \frac{d}{d\xi} \quad (3.39)$$

A solution is assumed for $E_x^{b.s.}$ in the form

$$E_x^{b.s.} \sim e^{ik\Theta(\xi) + i\pi} \sum_{l=0}^{\infty} \frac{E_l^{b.s.}}{(ik)^l} \quad (3.40)$$

whose leading term is

$$E_x^{b.s.} \sim E_0^{b.s.} e^{ik\Theta(\xi) + i\pi} \quad (3.41)$$

and which is the geometrical optics solution for the reflected electric field.

The amplitude $E_0^{b.s.}$ is easily determined from the principle of conservation of electromagnetic energy between the incident and scattered electromagnetic fields. This of course implies that the inhomogeneous dielectric is assumed to be lossless. The phase $\Theta(\xi)$ is determined from the eikonal equation

$$\left[\frac{1}{a} \nabla_{\xi} \Theta(\xi) \right]^2 = N(\xi)^2 \quad (3.42)$$

which follows from substituting (3.40) into (3.38), performing the differentiations and then equating terms in powers $1/k^2$ to zero.

In order to determine $E_o^{b.s.}$ explicitly, a tube of rays of cross-sectional area πd^2 is assumed incident upon the coated sphere in the $+z$ -direction. By considering the amplitude of the incident plane wave to be unity, the electromagnetic energy carried in the incident tube of rays is given by

$$\overline{\mathcal{E}}^{\text{incident}} = \frac{\pi d^2}{2Z} \quad (3.43)$$

On the other hand, the energy of the scattered field is

$$\overline{\mathcal{E}}^{\text{scattered}} = \frac{[E_o^{b.s.}]^2}{2Z} \int_0^{2\pi} \int_{\pi-2[\alpha+\rho]}^{\pi} dS \quad (3.44)$$

where \mathcal{E} = electromagnetic energy.

From the last two relations, it follows that

$$E_o^{b.s.} = \lim_{d \rightarrow 0} \sqrt{\frac{\pi d^2}{\int_0^{2\pi} \int_{\pi-2[\alpha+\rho]}^{\pi} dS}} \quad (3.45)$$

where dS is the element area in the spherical polar coordinates system. The limits of integration can be understood from Fig. 3-3. Upon completion of the integration, the denominator inside the radical of (3.45) is

$$\int_0^{2\pi} \int_{\pi-2[\alpha+\rho]}^{\pi} dS = 2\pi r^2 [1 - \cos[2(\alpha+\rho)]] \quad (3.46)$$

and therefore the magnitude $E_o^{b.s.}$ becomes

$$E_o^{b.s.} = \lim_{d \rightarrow 0} \frac{d}{2r \sin(\alpha+\rho)} \quad (3.47)$$

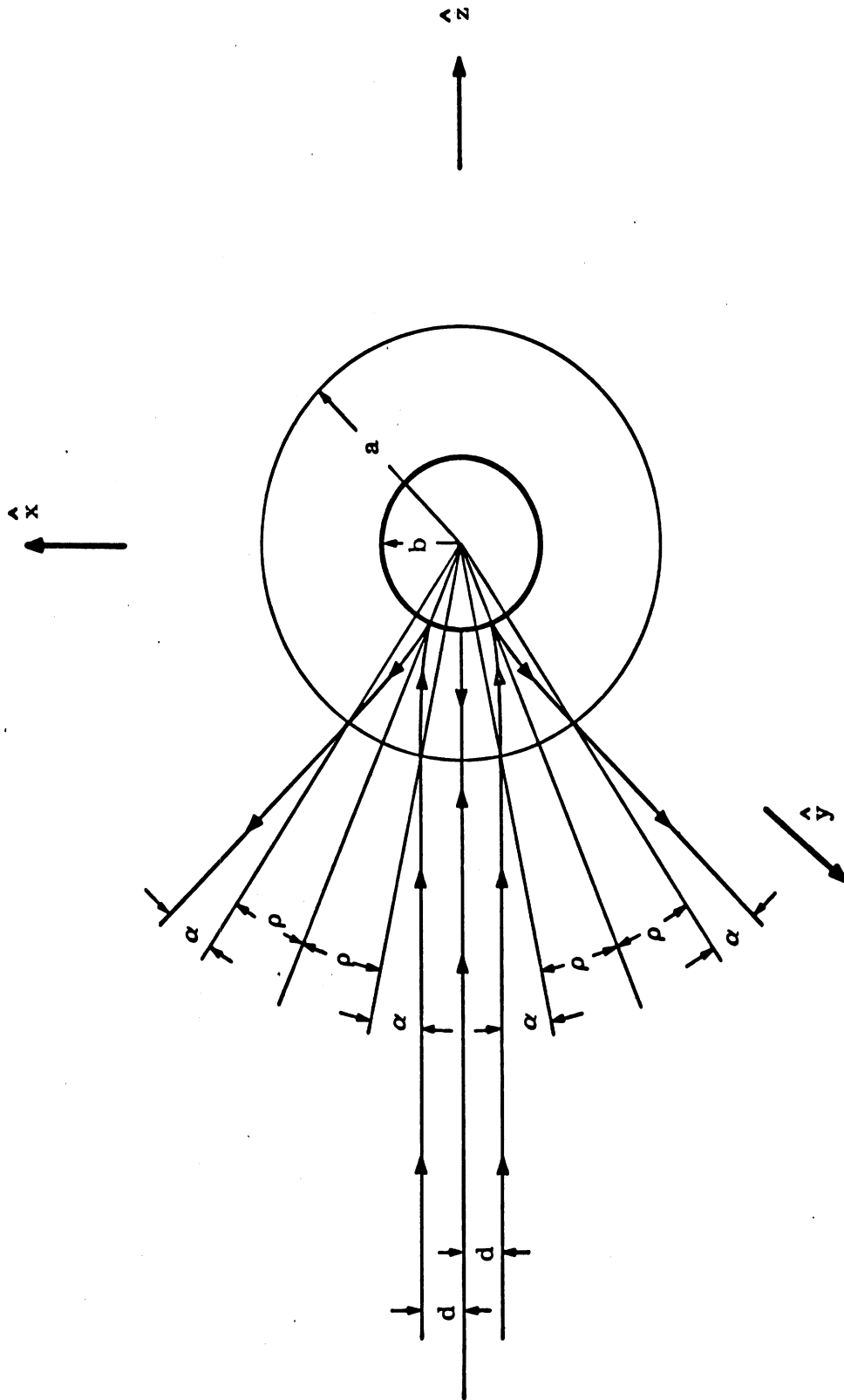

FIG. 3-3: PATHS OF INCIDENT AND REFLECTED RAYS WHEN $0 < \gamma < 1$.

01363-3-1

From the definition of $\rho(\xi)$ as given by (2.25), one obtains

$$\rho = \int_1^\beta d\rho(\xi) = -\sin\alpha \int_1^\beta \frac{(\xi-\gamma)d\xi}{\xi \sqrt{\xi^2(1-\gamma)^2 - (\xi-\gamma)^2 \sin^2 \alpha}} \quad (3.48)$$

By observing that $d = a \sin \alpha$, it easily follows that

$$E_o^{b.s.} = \lim_{\alpha \rightarrow 0} \left\{ \frac{a \sin \alpha}{2r \left[\sin \left(\alpha - \sin \alpha \int_1^\beta \frac{(\xi-\gamma) d\xi}{\xi \sqrt{\xi^2(1-\gamma)^2 - (\xi-\gamma)^2 \sin^2 \alpha}} \right) \right]} \right\} \quad (3.49)$$

and finally by carrying out the limit

$$E_o^{b.s.} = \frac{a}{2r} \left\{ \frac{1-\gamma}{1-\ell n \beta - \gamma/\beta} \right\} \quad (3.50)$$

results.

In determining the phase $\Theta(\xi)$, it is first mentioned that the factor of π in (3.40) is added in order that the 180° phase shift, from the total reflection of the incident rays at $r=b$, be taken into account. The explicit form of $\Theta(\xi)$ is evaluated from (3.42). By taking the origin ($\xi=0$) as the zero phase reference point, the solution of the first order linear differential equation

$$\frac{d\Theta(\xi)}{d\xi} = a \left(\frac{1-\gamma}{\xi-\gamma} \right) \quad (3.51)$$

is

$$\Theta(\xi) = a\xi - 2a \left[1 - (1-\gamma) \ell n \left(\frac{1-\gamma}{\beta-\gamma} \right) \right] \quad (3.52)$$

It follows then from (3.41) together with (3.50) and (3.52) that the reflected electric field is given by

$$E_x^{b.s.} \sim \hat{x} \frac{e^{ikr}}{kr} \frac{ka(1-\gamma)}{2 \left[1 - \ell n \beta - \frac{\gamma}{\beta} \right]} e^{-i2ka \left[1 - (1-\gamma) \ell n \left(\frac{1-\gamma}{\beta-\gamma} \right) \right]} \quad (3.53)$$

It is observed that this latter expression is in agreement with the first order term of (3.35).

3.5 Scattering Cross-Section Computations

It is of interest to perform numerical computations, so that the effect of the radially inhomogeneous coating in reducing or enhancing the monostatic cross-section of the perfectly conducting sphere of radius b , is determined. These computations are carried out for different values of β , γ , and ka . The cross-section of the perfectly conducting sphere of radius b is denoted by σ_b and it is normalized to σ_c , where σ_c is the cross section of this same perfectly conducting sphere coated with the new class of radially inhomogeneous dielectrics with outer radius a . The normalized cross-section $\sigma_N = \frac{\sigma_b}{\sigma_c}$ is determined for two cases. Under case one, σ_{N_1} is derived by considering the reflected electric field given by geometric optics. Under case two, σ_{N_2} is derived by using expression (3.35). The expressions for σ_{N_1} and σ_{N_2} are given respectively by

$$\sigma_{N_1} = \beta^2 \left\{ \frac{1 - \ell n \beta - \gamma/\beta}{1 - \gamma} \right\}^2 \quad (3.54)$$

and

$$\sigma_{N_2} = \beta^2 \left\{ 1 + \frac{1}{4\beta^2(ka)^2} \right\} \left(\frac{1 - \ell n \beta - \gamma/\beta}{1 - \gamma} \right)^2 \left\{ \left[1 + \frac{1 - \ell n \beta - \gamma/\beta}{4ka(1 - \gamma)} \sin \left[2ka(1 - \gamma) \ell n \left(\frac{1 - \gamma}{\beta - \gamma} \right) \right] \right. \right. \\ \left. \left. \times \left(\frac{1}{1 - \gamma} - \frac{1}{1 + \gamma - 2[\ell n \beta + \gamma/\beta]} \right) \right]^2 + \frac{1}{16(ka)^2(1 - \gamma)^2} \left[\ell n \left(\frac{\beta - \gamma}{\beta(1 - \gamma)} \right) - \frac{\gamma}{\beta} - 1 - \frac{11}{3} \left(1 - \ell n \beta - \frac{\gamma}{\beta} \right) + \right. \right. \\ \left. \left. + \frac{\frac{2}{3} + 4\gamma - \gamma^2 - 6\frac{\gamma}{\beta} + 3\left(\frac{\gamma}{\beta}\right)^2 - \frac{2}{3}\left(\frac{\gamma}{\beta}\right)^3 - 2\ell n \beta}{(1 - \ell n \beta - \gamma/\beta)^2} + (1 - \ell n \beta - \gamma/\beta) \cos \left[2ka(1 - \gamma) \ell n \left(\frac{1 - \gamma}{\beta - \gamma} \right) \right] \right. \right. \\ \left. \left. \times \left(\frac{1}{1 - \gamma} + \frac{1}{1 + \gamma - 2(\ell n \beta + \gamma/\beta)} \right) \right]^2 \right\}^{-1} \quad (3.55)$$

Along with σ_{N_1} and σ_{N_2} the relation $D = \frac{\sigma_{N_1} - \sigma_{N_2}}{\sigma_{N_2}} \times 100$ is computed for $0.2 \leq \beta \leq 0.99$, $50 \leq ka \leq 1000$ and various values of γ . The parameter D gives the percent error in using the geometrical optics approximation, in order to determine the cross-section, instead of (3.35). The most interesting numerical results are shown in Fig. 3-4 through Fig. 3-13. In Fig. 3-4 the parameter σ_{N_1} is plotted vs. β for $0 < \gamma < 1$. For this range of γ , the inhomogeneous dielectric is of the converging type and the coating enhances the cross-section of the perfectly conducting sphere as one would expect based on physical reasoning. On the other hand when $\gamma > 1$ the inhomogeneous dielectric is of the diverging type and as it would be expected the coating reduces the cross-section of the perfectly conducting sphere. In Fig. 3-5 one observes that this is the case and that for smaller β and γ very close to unity, the reduction of the cross-section is considerable. The percent error D is presented in the remaining figures vs. ka for various values of β and γ . It is deduced from these figures that the percent error is insignificant for ka as low as 50. The conclusion then is that the geometrical optics technique is indeed a powerful, very accurate and very simple tool in studying the cross sections of perfectly conducting spheres coated with radially inhomogeneous dielectrics. An exception to the above conclusion is the case $\gamma = 0.99\beta$. It is seen in the last two graphs that for this case, the error is as high as 74 percent when $ka = 50$. However, this should be expected if it is recalled that the radial eigenfunctions $S_{\nu-1/2}^{(j)}(\xi)$ and $T_{\nu-1/2}^{(j)}(\xi)$ as obtained by the WKB method are valid provided that $\xi \neq 0$ and $|2ka(1-\gamma)| \gg 1$. When $\gamma = 0.99\beta$ and $\beta = 0.98$ it clearly follows that this latter condition is violated and therefore the error for this case is explainable.

3.6 An Outline for the Creeping Wave Contribution in the Backscattering Direction

In this section, part of the analysis required in order to obtain the creeping wave contribution in the backscattering direction, in an explicit form, is presented.

01.2.13-7

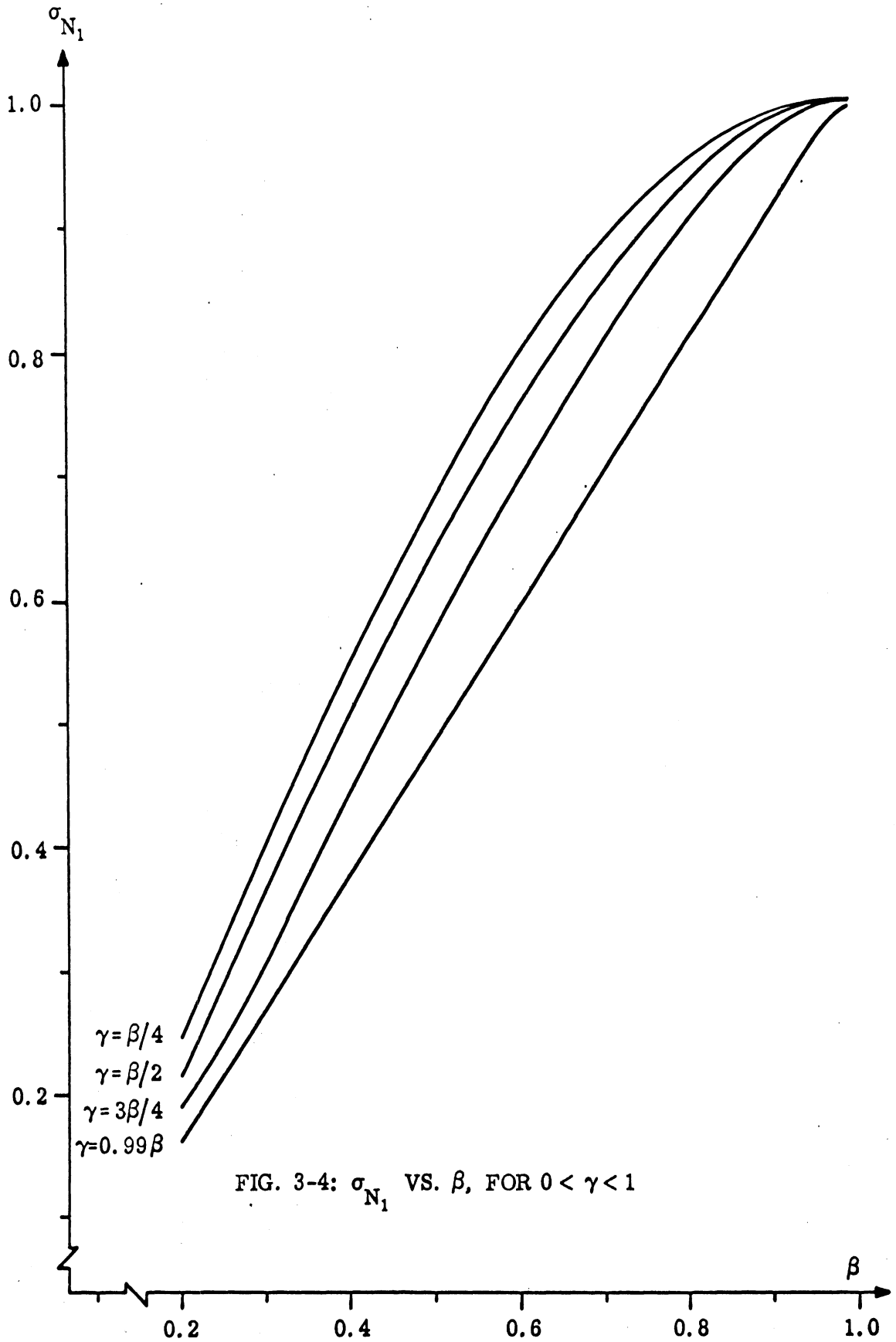

01363-2 T

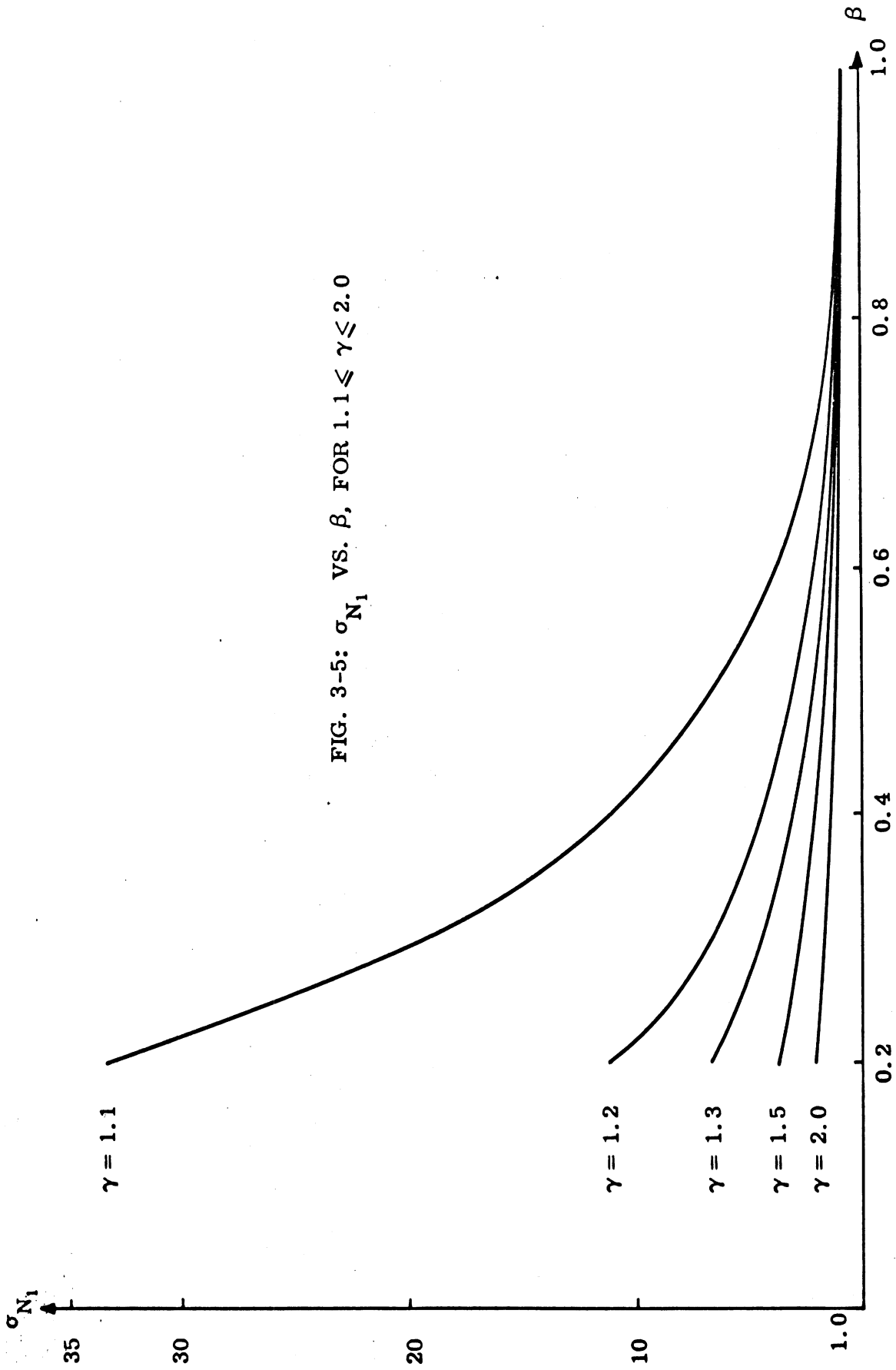

1-2-10

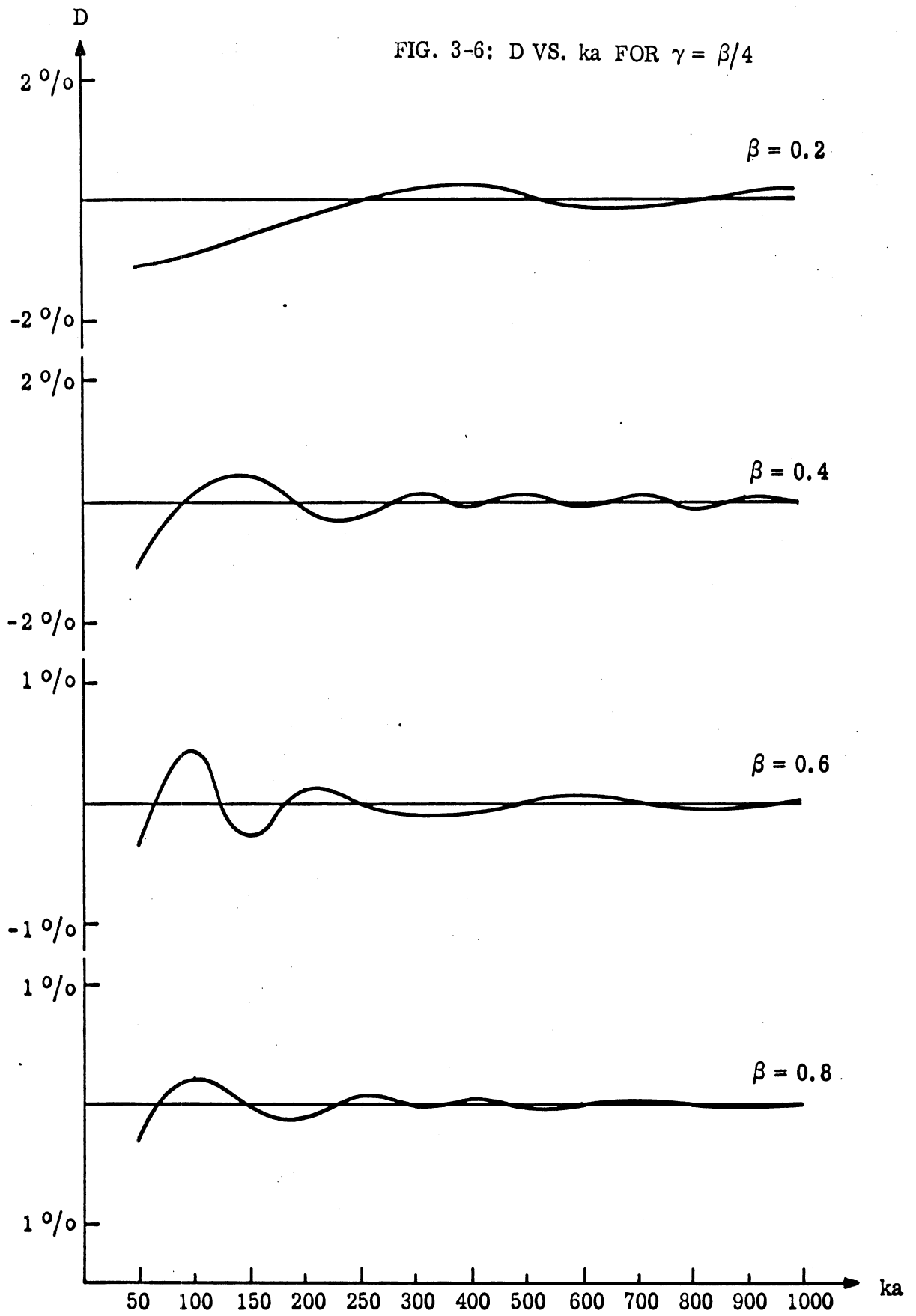

.01363-3-T

FIG. 3-7: D VS. ka FOR $\gamma = \beta/4$

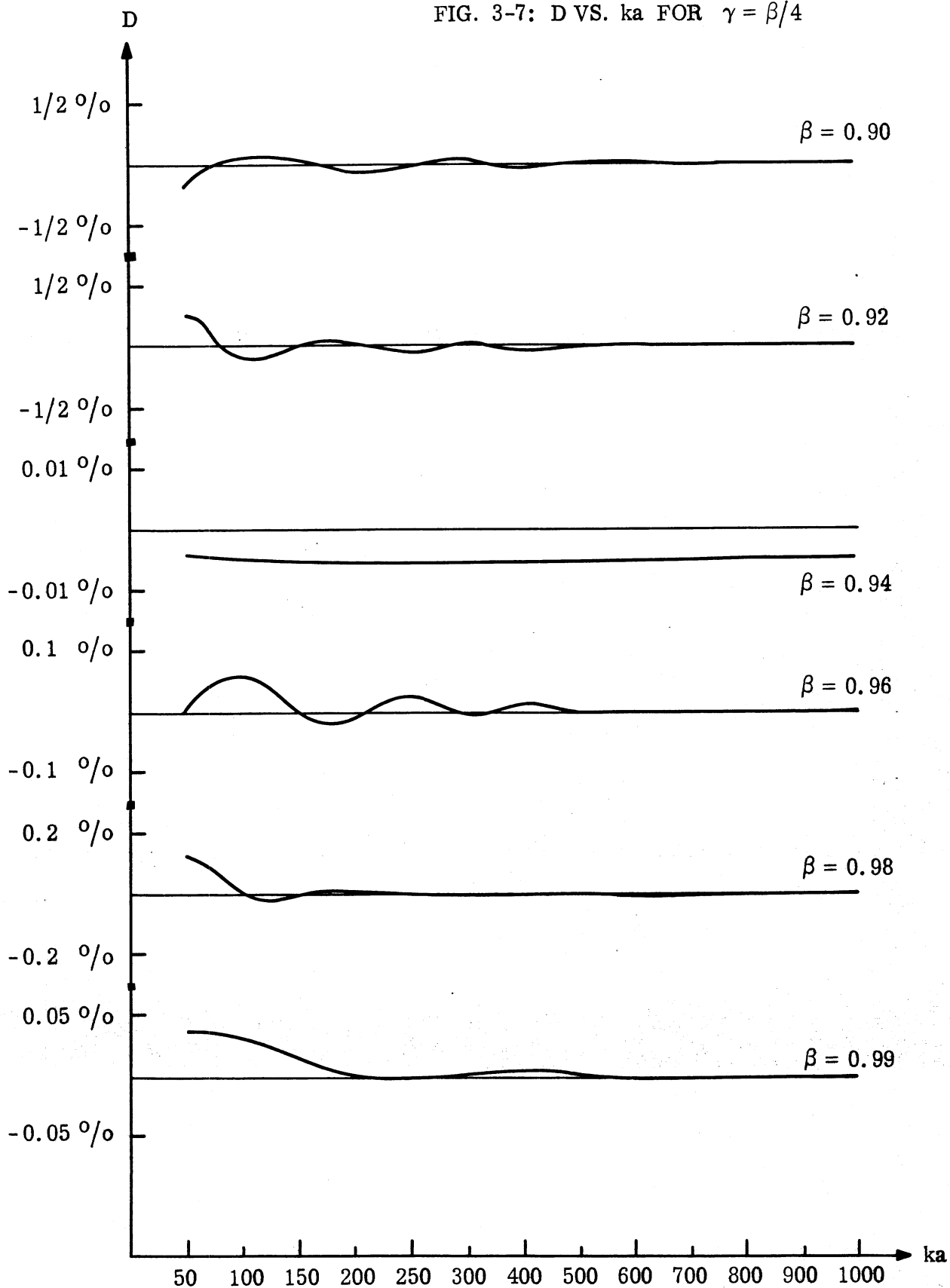

01302-2-7

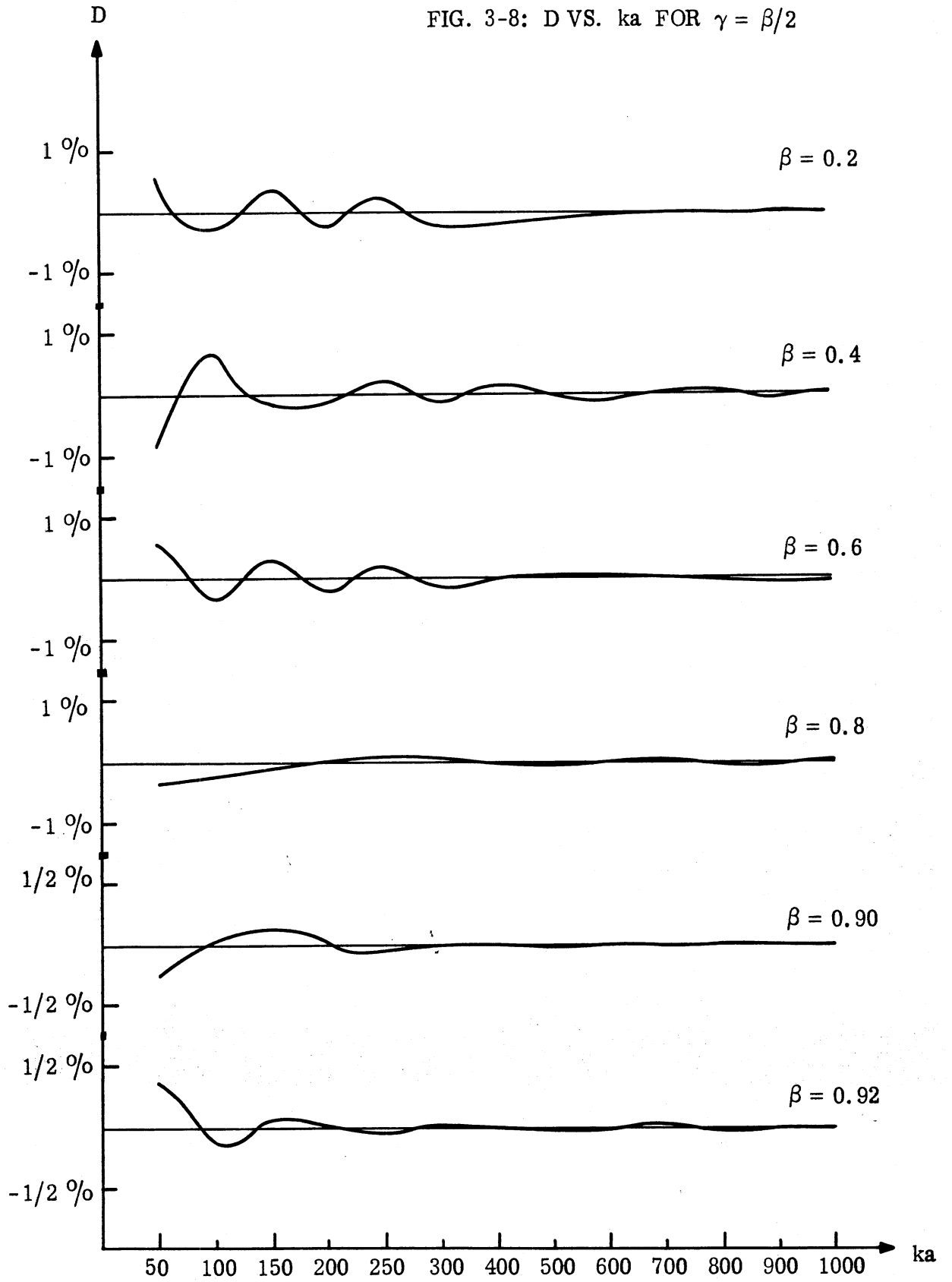
FIG. 3-8: D VS. ka FOR $\gamma = \beta/2$ 

01362-37

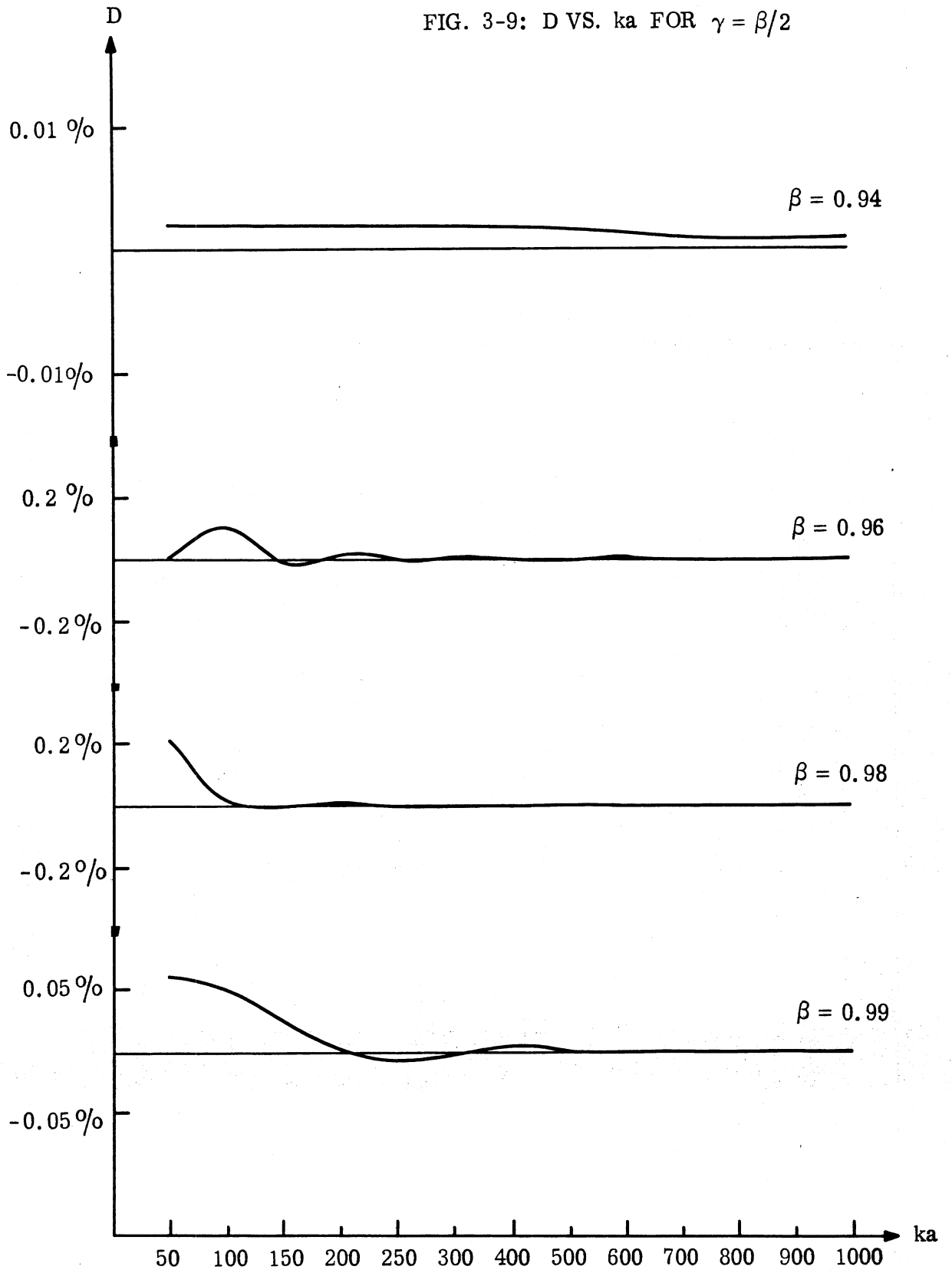

01263-2-T

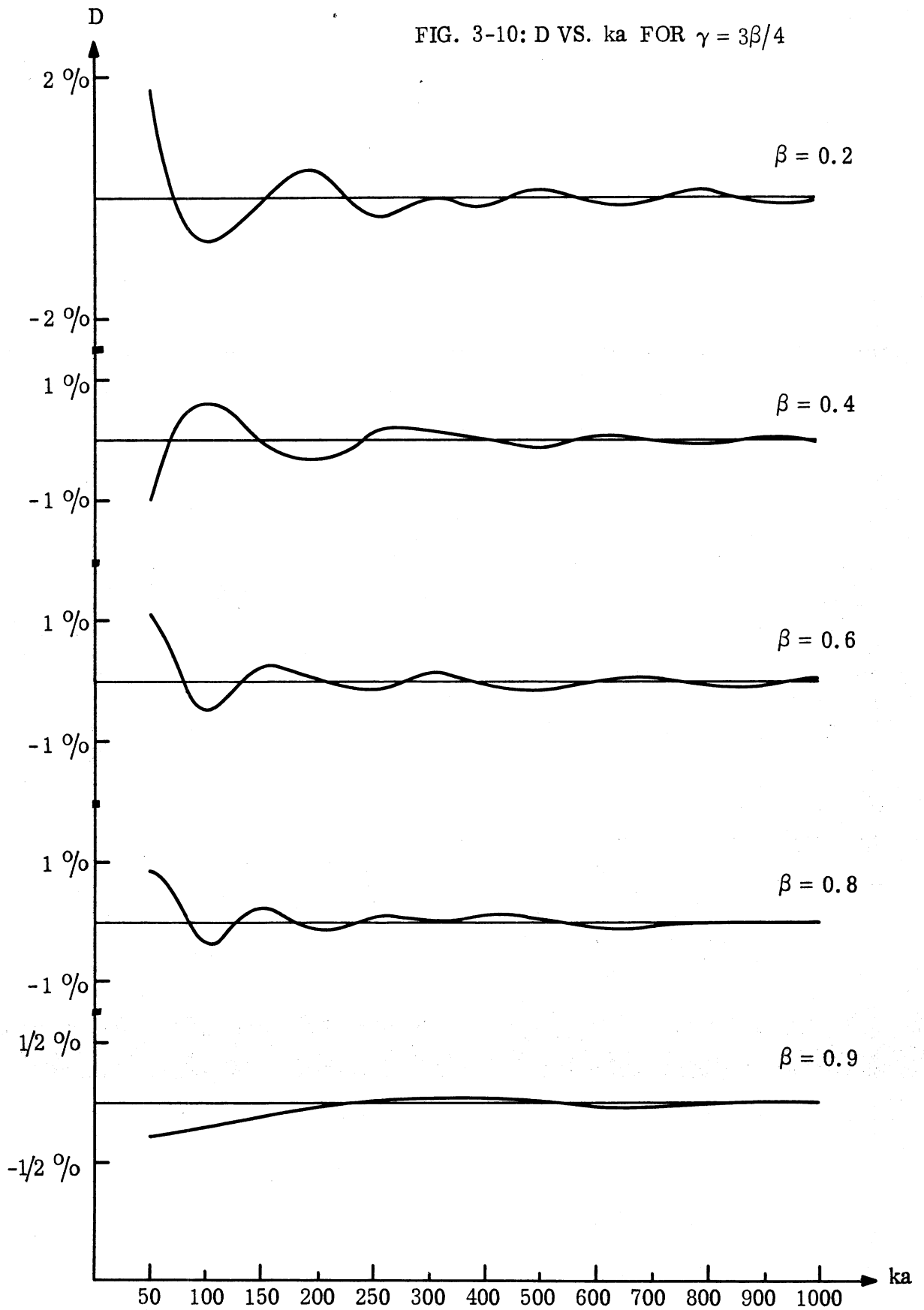

01363-3-T

FIG. 3-11: D VS. ka FOR $\gamma = 3\beta/4$

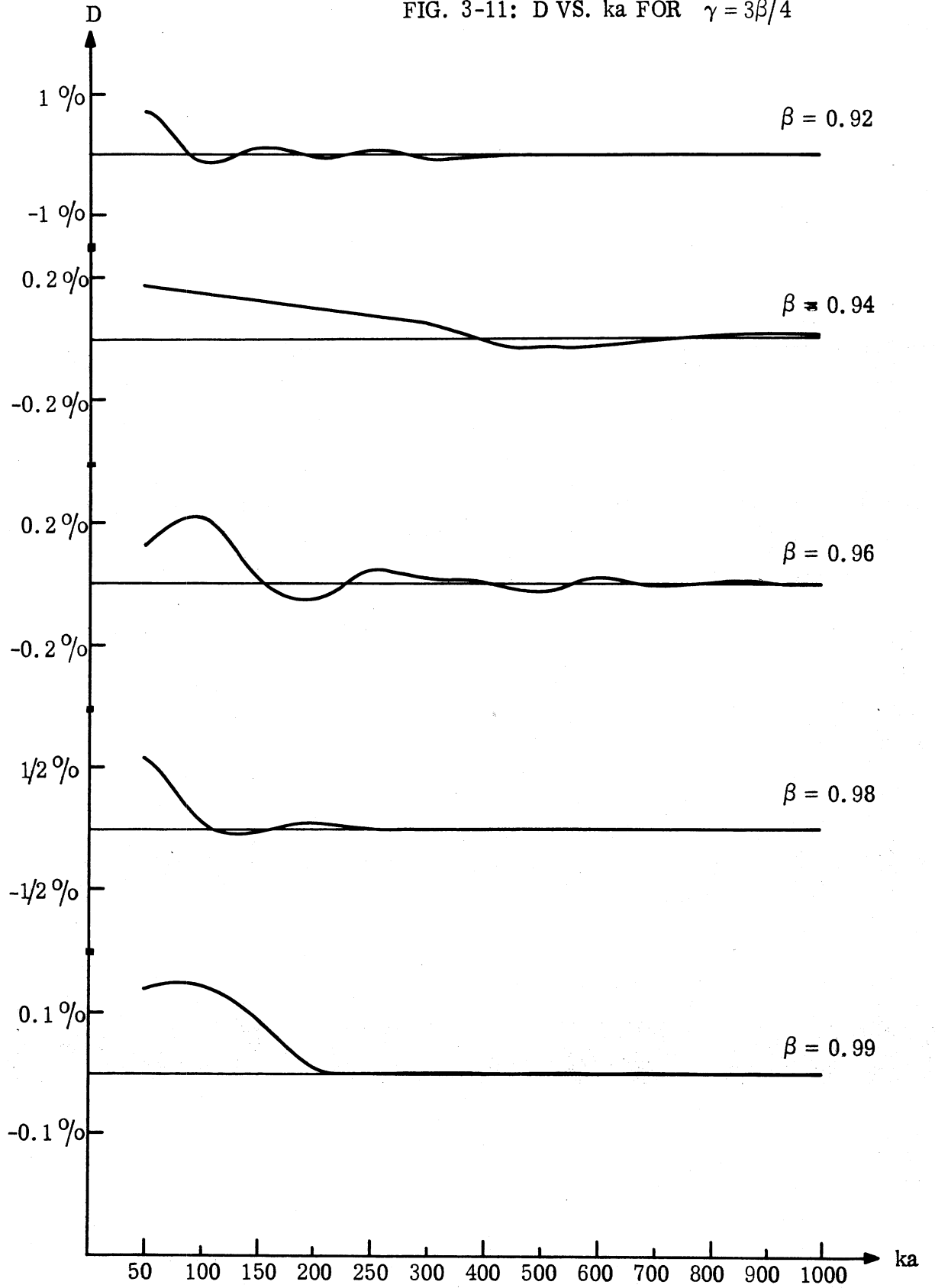

01062-3-T

FIG. 3-12: D VS. ka FOR $\gamma = 0.99\beta$

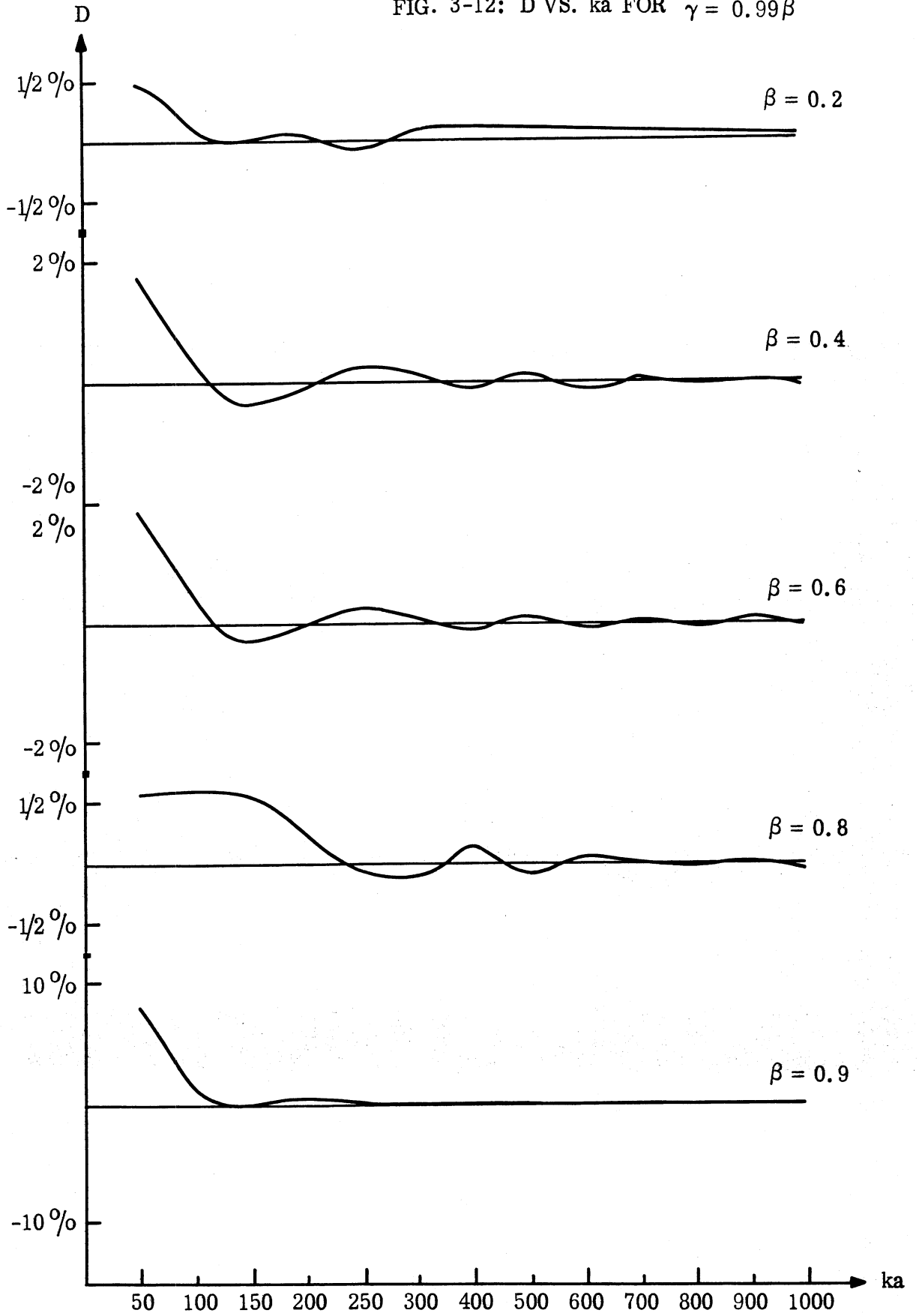

01262-3-T

FIG. 3-13: D VS. ka FOR $\gamma = 0.99 \beta$

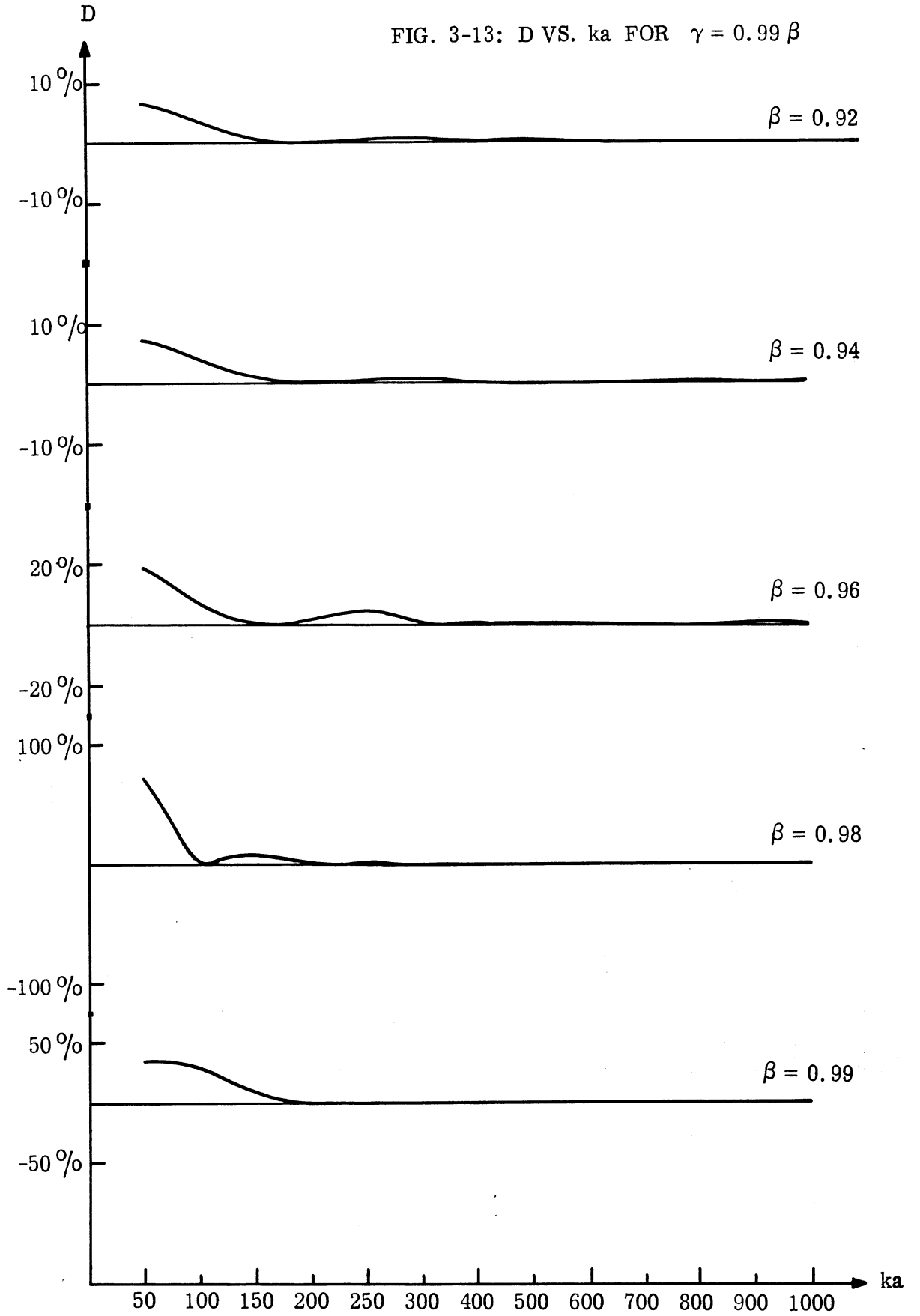

01003-5

The asymptotic expansions for the radial eigenfunctions $S_{\nu^{-1/2}}^{(j)}(\xi)$ and $T_{\nu^{-1/2}}^{(j)}(\xi)$, which are valid for ν near ka , are given in terms of the Airy functions in Fock's notation. These expansions must, more accurately, be valid for $\nu = ka + mt$, where $m = (ka/2)^{1/3}$ and t is of the order of unity. Since, in this research, interest is confined to the contribution of the first few creeping waves in the backscattering direction, particular attention is paid to those poles in the complex- ν plane which are located nearest the $\text{Re } \nu$ -axis. A parameter τ is, therefore, defined such that

$$\tau \equiv \frac{t}{m} \quad (3.56)$$

which implies that $|\tau| \ll 1$, and this latter condition corresponds to considering only the first few creeping waves in the $\theta = \pi$ direction.

With definition (3.56), the coefficient $Q(\xi)$ of the differential equation (1.16) becomes

$$Q(\xi) = \left(\frac{1-\gamma}{\xi-\gamma} \right)^2 - \frac{1}{\xi^2} - \frac{\tau + \frac{\tau^2}{4} - \frac{1}{4(ka)^2}}{\xi^2} \quad (3.57)$$

In order to examine whether the zeros of $Q(\xi)$ lie within $\beta \leq \xi \leq 1$ one first finds the zeros of

$$\left(\frac{1-\gamma}{\xi-\gamma} \right)^2 - \frac{1}{\xi^2} = 0 \quad (3.58)$$

which are at

$$\xi_{01} = 1 \quad (3.59)$$

and

$$\xi_{02} = \frac{\gamma}{2-\gamma} \quad (3.60)$$

It follows that since $\gamma < \beta$, ξ_{02} is outside $\beta \leq \xi \leq 1$ and therefore ξ_{01} is the only simple turning point in that range. By defining a parameter

$$T = \tau + \frac{\tau^2}{4} - \frac{1}{4(ka)^2},$$

01202-1 T

then since $\tau = O[(ka)^{-2/3}]$ and similarly $T = O[(ka)^{-2/3}]$, by a perturbation technique the simple turning point is found more accurately to lie at

$$\xi_0 = 1 - \left(\frac{1-\gamma}{2\gamma} \right) T + O(T^2) \quad (3.61)$$

Since $\tau^2 = O(T^2)$, then to the same order of approximation $T \sim \tau$ and

$$\xi_0 = 1 - \left(\frac{1-\gamma}{2\gamma} \right) \tau + O(\tau^2) \quad (3.62)$$

This turning point is within $\beta \leq \xi_0 \leq 1$ and therefore Langer's technique is now used to solve the differential equation. By writing the coefficient as

$$Q_0(\xi) = \left(\frac{1-\gamma}{\xi-\gamma} \right)^2 - \frac{1+\tau}{\xi^2}$$

the differential equation to be solved is

$$\frac{d^2}{d\xi^2} S_{\nu-1/2}^{(j)}(\xi) + (ka)^2 Q_0(\xi) S_{\nu-1/2}^{(j)}(\xi) = 0 \quad (3.63)$$

The solutions of (3.63) are given by

$$S_{\nu-1/2}^{(j)}(\xi) \sim \left(\frac{\xi_0(\xi)}{Q_0(\xi)} \right)^{1/4} w_{(j)} \left[(ka)^{2/3} \zeta(\xi) \right] \quad (3.64)$$

and

$$T_{\nu-1/2}^{(j)}(\xi) \sim \left(\frac{1-\gamma}{\xi-\gamma} \right) S_{\nu-1/2}^{(j)}(\xi), \quad j = 1, 2. \quad (3.65)$$

In the above relations

$$\xi_0(\xi) = \left(\frac{3}{2} \int_{\xi_0}^{\xi} \sqrt{Q_0(\xi)} d\xi \right)^{2/3}, \quad (3.66)$$

and therefore one calculates:

$$\begin{aligned}
& \int_{\xi_0}^{\xi} \sqrt{\left(\frac{1-\gamma}{\xi-\gamma}\right)^2 - \frac{1+\tau}{\xi^2}} d\xi = \sqrt{\gamma^2 - 2\gamma - \tau} \ln \left\{ \sqrt{\gamma^2 - 2\gamma - \tau} \right. \\
& \times \left. \sqrt{(\gamma^2 - 2\gamma - \tau) \xi^2 + 2\gamma(1+\tau)\xi - \gamma^2(1+\tau)} + (\gamma^2 - 2\gamma - \tau) \xi + \gamma(1+\tau) \right\} \Bigg|_{\xi_0}^{\xi} - i \sqrt{1+\tau} \times \\
& \times \ln \left\{ \frac{1}{\xi} \sqrt{-(1+\tau)} \sqrt{(\gamma^2 - 2\gamma - \tau) \xi^2 + 2\gamma(1+\tau)\xi - \gamma^2(1+\tau)} - \frac{\gamma}{\xi} (1+\tau) + (1+\tau) \right\} \Bigg|_{\xi_0}^{\xi} \\
& - (1-\gamma) \ln \left\{ \frac{1}{(1-\gamma)(\xi-\gamma)} \sqrt{(\gamma^2 - 2\gamma - \tau) \xi^2 + 2\gamma(1+\tau)\xi - \gamma^2(1+\tau)} + \frac{\gamma}{\xi-\gamma} + 1 \right\} \Bigg|_{\xi_0}^{\xi}.
\end{aligned} \tag{3.67}$$

In order to proceed in computing numerically (1.56) which gives the contribution of the creeping waves in the backscattering direction, equations (1.57) must be solved for the zeros t_ℓ and \tilde{t}_ℓ . This in turn necessitates simplification of $M_{\nu-1/2}(ka)$ and $\tilde{M}_{\nu-1/2}(ka)$ asymptotically in terms of τ or t/m^2 .

From relation (3.67), the asymptotic expansions to $O(\tau^{5/2})$ of

$$\int_{\xi_0}^1 \sqrt{Q_0(\xi)} d\xi \quad \text{and} \quad \int_{\xi_0}^{\beta} \sqrt{Q_0(\xi)} d\xi \quad \text{are obtained first. Then } \zeta(1),$$

$\zeta(\beta)$, $\frac{\partial \zeta(\xi)}{\partial \xi}$, $\frac{\partial \zeta(\beta)}{\partial \beta}$, etc., are computed, to give finally the asymptotic forms of $M(t)$ and $\tilde{M}(t)$. This work has not been included here due to the cumbersome expansions. The same technique, however, is carried out in Chapter Four for a simpler type of radial inhomogeneity, and the constants $M(t)$ and $\tilde{M}(t)$ are there given explicitly.

2/10/2 1-7

CHAPTER IV

HIGH FREQUENCY BACKSCATTERING FROM A PERFECTLY CONDUCTING SPHERE COATED WITH A DIELECTRIC WHOSE INDEX OF REFRACTION IS $N(\xi) = \xi^p$

4.1 Introduction

Nomura and Takaku (1955) considered an interesting class of radially inhomogeneous dielectrics in their study of radio wave propagation in an inhomogeneous atmosphere. They assumed the atmosphere to consist of stratified layers of radially inhomogeneous media. The index of refraction of the κ th layer was taken to be $N(\xi) = \xi^{p\kappa}$, with $p > -1$. This index of refraction represents a class of radially inhomogeneous dielectrics which are of the diverging type. The larger the exponent p , the greater is the divergence of the electromagnetic rays. Nomura and Takaku (1955) solved the wave equation and superposed the solutions of TE and TM modes in order to obtain a complete representation of the electromagnetic field. The following radial eigenfunctions were obtained for the corresponding TE and TM modes.

$$S_{\nu-1/2}^{(j)}(\xi) = \sqrt{\frac{\pi}{2\xi}} H_{\nu'}^{(j)}\left(\frac{ka\xi^{p+1}}{p+1}\right) \quad \text{for TE modes}$$

$$T_{\nu-1/2}^{(j)}(\xi) = ka\xi^p \sqrt{\frac{\pi}{2(2p+1)\xi}} H_{\nu''}^{(j)}\left(\frac{ka\xi^{p+1}}{p+1}\right) \quad \text{for TM modes}$$

with

$$\nu' = \frac{\nu}{p+1} \quad \text{and} \quad \nu'' = \frac{\sqrt{\nu^2 + p^2} + p}{p+1}$$

From these solutions, the restriction $p > -1$ becomes clear if one observes the argument of the Hankel functions. By assuming a dipole excitation source and by applying the Watson transformation the authors obtained a residue series, which represents the radio waves traveling around the earth. Nomura and Takaku also applied geometrical optics to trace the ray paths in the inhomogeneous atmosphere, and performed numerical computations by assuming different values of p for various environmental conditions.

In this chapter, the above mentioned radial inhomogeneity is considered as being the coating of a perfectly conducting sphere of radius b . The outer radius being taken as $r = a$, the normalized index of refraction is written as $N(\xi) = \xi^p$, $p > -1$. In the same manner as in Chapter Three, a plane wave is assumed incident on the coated sphere with its electric field given by (1.3). The backscattered electric field is put into an integral form by applying the Watson transform on the Mie series and the explicit asymptotic expression for the reflected electric field is obtained by integrating along the path Γ_1 (see Fig. 1-3) with the aid of Scott's integrals (Scott, 1949). The creeping wave contribution is given by the sum of the residue series as in (1.23). The monostatic cross section is finally obtained from the geometrical optics reflected electric field and it is computed for different thicknesses and different values of the exponent p .

4.2 The Radial Eigenfunctions in their Asymptotic Form

In solving the differential equations (1.13) and (1.14) exactly, one may encounter difficulties in developing their asymptotic expansions to $O[(ka)^{-2}]$. In this case the exact solutions are Hankel functions of complicated argument and index and their asymptotic forms may be derived from the well known Debye expansions of these functions. Nevertheless, it is easier to obtain these asymptotic expansions by applying the WKB method if possible. In order to apply the WKB method the normal forms (1.16) and (1.24) are considered in $S_{\nu^{-1/2}}^{(j)}(\xi)$ and $U_{\nu^{-1/2}}^{(j)}(\xi)$. From these differential equations, it is seen that

$$Q_{(1)}(\xi) = \xi^{2p} - \frac{\nu^2 - 1/4}{(ka)^2 \xi^2} \quad (4.1)$$

and

$$Q_{(2)}(\xi) = \xi^{2p} - \frac{\nu^2 - 1/4 + p(p+1)}{(ka)^2 \xi^2} \quad (4.2)$$

have zeros at

$$\xi_{10} = \left[\frac{\nu^2 - 1/4}{(ka)^2} \right] \frac{1}{2(p+1)} \quad (4.3)$$

and

$$\xi_{20} = \left[\frac{\nu^2 - 1/4 + p(p+1)}{(ka)^2} \right] \frac{1}{2(p+1)} \quad (4.4)$$

correspondingly. It follows that since $\nu = O[(ka)^{1/2+\delta}]$, with $\delta \ll 1$ and $\delta > 0$, then $\xi_{10} \ll 1$ and $\xi_{20} \ll 1$. For finite p , $\xi_{20} > \xi_{10}$ and therefore if $b > \xi_{20}$ then the WKB method can be used to obtain solutions of $S_{\nu^{-1/2}}^{(j)}(\xi)$ and $U_{\nu^{-1/2}}^{(j)}(\xi)$ which are valid throughout $b \leq \xi \leq 1$. It must be mentioned here that in this case the WKB method is applicable because conditions (1.27) are also satisfied for $b \leq \xi \leq 1$. By considering (1.28) valid over the range $\nu = O[(ka)^{1/2+\delta}]$, it remains to develop the asymptotic forms of $[Q_{(i)}^{(j)}(\xi)]^{-1/4}$ and perform the integration and carry the asymptotic algebra in the exponential term, in order to obtain the explicit asymptotic expressions for $S_{\nu^{-1/2}}^{(j)}(\xi)$ and $U_{\nu^{-1/2}}^{(j)}(\xi)$. In particular, for the functions $S_{\nu^{-1/2}}^{(j)}(\xi)$, by noting that

$$[Q_{(1)}^{(j)}(\xi)]^{-1/4} \sim \exp \left\{ \ln(\xi^{-p/2}) + \frac{1}{4} \frac{\nu^2}{(ka)^2} \frac{1}{\xi^{2(p+1)}} \right\} + O[(ka)^{-2}] + O \left[\frac{\nu^4}{(ka)^4} \right] \quad (4.5)$$

and

$$\begin{aligned} & \exp \left\{ \pm ika \int_{\xi}^1 \sqrt{Q_{(1)}^{(j)}(\xi)} \left[1 + \frac{\frac{5}{4} \frac{dQ_{(1)}^{(j)}(\xi)}{d\xi} - Q_{(1)}^{(j)}(\xi) \frac{dQ_{(1)}^{(j)}(\xi)}{d\xi}}{8(ka)^2 Q_{(1)}^3(\xi)} \right] d\xi \right\} \sim \\ & \sim \exp \left\{ \pm ika \frac{\xi^{p+1}}{p+1} \pm i \frac{\nu^2 - 1/4}{2ka} \frac{1}{(p+1)\xi^{p+1}} \pm \frac{\nu^4}{8(ka)^3} \left[\frac{1}{3(p+1)\xi^{3(p+1)}} \right] \mp \frac{5i}{48ka} \xi^{-3p} \pm \right. \\ & \left. \pm \frac{i}{4ka} \left[\frac{p(2p-1)}{p+1} \right] \xi^{-(p+1)} \right\} + O[(ka)^{-2}] + O \left[\frac{\nu^2}{(ka)^3} \right] + O \left[\frac{\nu^4}{(ka)^4} \right] + O \left[\frac{\nu^6}{(ka)^5} \right] + O \left[\frac{\nu^8}{(ka)^6} \right] \end{aligned} \quad (4.6)$$

the solutions

$$\begin{aligned}
 S_{\nu^{-1/2}}^{(j)}(\xi) \sim \xi^{-p/2} \exp \left\{ \pm ika \frac{\xi^{p+1}}{p+1} \pm i \frac{\nu^2 - 1/4}{2ka} \frac{1}{(p+1)\xi^{p+1}} \pm \frac{\nu^4}{8(ka)^3} \frac{i}{3(p+1)\xi^{3(p+1)}} \mp \right. \\
 \mp \frac{5i}{48ka} \frac{1}{\xi^{3p}} \pm \frac{i}{4ka} \frac{p(2p-1)}{p+1} \frac{1}{\xi^{p+1}} + \frac{1}{4} \frac{\nu^2}{(ka)^2} \frac{1}{\xi^{2(p+1)}} \left. \left(1 + O[(ka)^{-2}] + O\left[\frac{\nu^2}{(ka)^3}\right] + \right. \right. \\
 \left. \left. + O\left[\frac{\nu^4}{(ka)^4}\right] + O\left[\frac{\nu^6}{(ka)^5}\right] + O\left[\frac{\nu^8}{(ka)^6}\right] \right) \right) \quad (4.7)
 \end{aligned}$$

are derived, which are valid for $p > -1$ and $b > \xi_{20}$. The superscript j denotes

$$j = \begin{cases} 1, & \text{upper sign} \\ 2, & \text{lower sign} \end{cases} \quad (4.8)$$

By proceeding in a similar manner for the eigenfunctions $U_{\nu^{-1/2}}^{(j)}(\xi)$, it is found that with

$$[Q_{(2)}(\xi)]^{-1/4} \sim \xi^{-p/2} \left\{ 1 + \frac{1}{4} \frac{\nu^2}{(ka)^2 \xi^{2(p+1)}} \right\} \left(1 + O[(ka)^{-2}] + O\left[\frac{\nu^4}{(ka)^4}\right] \right), \quad (4.9)$$

$$\begin{aligned}
 \exp \left\{ \pm ika \int_{\xi}^{\xi} Q_{(2)}(\xi) d\xi \right\} \sim \exp \left\{ \pm ika \frac{\xi^{p+1}}{p+1} \pm i \frac{\nu^2}{2ka} \frac{1}{(p+1)\xi^{p+1}} \mp \right. \\
 \mp \frac{i}{8ka(p+1)\xi^{p+1}} \pm i \frac{p}{2ka} \frac{1}{\xi^{p+1}} \pm \frac{i}{24} \frac{\nu^4}{(ka)^3} \frac{1}{(p+1)\xi^{3(p+1)}} \left. \left(1 + O\left[\frac{\nu^2}{(ka)^3}\right] + \right. \right. \\
 \left. \left. + O\left[\frac{\nu^4}{(ka)^4}\right] + O\left[\frac{\nu^6}{(ka)^5}\right] + O\left[\frac{\nu^8}{(ka)^6}\right] \right) \right), \quad (4.10)
 \end{aligned}$$

and

$$\begin{aligned} & \pm ika \int_{\xi} \frac{\frac{5}{4} \frac{dQ_{(2)}(\xi)}{d\xi} - Q_{(2)}(\xi) \frac{d^2 Q_{(2)}(\xi)}{d\xi^2}}{8(ka)^2 [Q_{(2)}(\xi)]^{5/2}} d\xi \sim \left(\mp \frac{5}{48ka} \frac{1}{\xi^{3p}} \pm \right. \\ & \left. \pm \frac{p}{4ka} \left(\frac{2p-1}{p+1} \right) \frac{1}{\xi^{p+1}} \right) \left(1 + O[(ka)^{-2}] + O\left[\frac{\nu^2}{(ka)^3}\right] + O\left[\frac{\nu^4}{(ka)^4}\right] \right), \end{aligned} \quad (4.11)$$

the solutions

$$\begin{aligned} U_{\nu^{-1/2}}^{(j)}(\xi) & \sim \xi^{-p/2} \exp \left\{ \pm ika \frac{\xi^{p+1}}{p+1} \pm i \frac{\nu^2}{2ka} \frac{1}{(p+1)\xi^{p+1}} \mp \frac{i}{8ka(p+1)\xi^{p+1}} \pm \right. \\ & \left. \pm i \frac{p}{2ka} \frac{1}{\xi^{p+1}} \pm i \frac{\nu^4}{24(ka)^3} \frac{1}{(p+1)\xi^{3(p+1)}} \mp i \frac{5}{48ka} \frac{1}{\xi^{3p}} \pm i \frac{p}{4ka} \left(\frac{2p-1}{p+1} \right) \frac{1}{\xi^{p+1}} + \right. \\ & \left. + \frac{1}{4} \frac{\nu^2}{(ka)^2 \xi^{2(p+1)}} \right\} \left(1 + O[(ka)^{-2}] + O\left[\frac{\nu^2}{(ka)^3}\right] + O\left[\frac{\nu^4}{(ka)^4}\right] + O\left[\frac{\nu^6}{(ka)^5}\right] + O\left[\frac{\nu^8}{(ka)^6}\right] \right) \end{aligned} \quad (4.12)$$

result and they are valid for the same restrictions as $S_{\nu^{-1/2}}^{(j)}(\xi)$. From (4.12),

$$T_{\nu^{-1/2}}^{(j)}(\xi) = \xi^p U_{\nu^{-1/2}}^{(j)}(\xi) \quad (4.13)$$

is obtained. It is furthermore observed that

$$T_{\nu^{-1/2}}^{(j)}(\xi) = \xi^p \exp \left[\pm i \frac{p}{2ka\xi^{p+1}} \right] S_{\nu^{-1/2}}^{(j)}(\xi) \quad (4.14)$$

4.3 The Reflected Electric Field

In this section, the reflected portion of the backscattered electric field is derived. With the aid of the asymptotic expansions for the radial eigenfunctions the parameters $C_{\nu^{-1/2}}(\xi, \beta)$, $\tilde{C}_{\nu^{-1/2}}(\xi, \beta)$, $M_{\nu^{-1/2}}(ka)$ and $\tilde{M}_{\nu^{-1/2}}(ka)$ are computed. Then the difference of the scattering coefficients

01363-2-T

is found and finally by integrating along the path Γ_1 in the same manner as in Section 3.3 the reflected electric field is determined. From (4.7), (4.13) and the definitions of $C_{\nu^{-1/2}}(\xi, \beta)$ and $\tilde{C}_{\nu^{-1/2}}(\xi, \beta)$ one obtains:

$$C_{\nu^{-1/2}}(\xi, \beta) \sim 2i (\xi\beta)^{-p/2} \exp \left\{ \frac{1}{4} \frac{\nu^2}{(ka)^2} \left[\frac{1}{\xi^{2(p+1)}} + \frac{1}{\beta^{2(p+1)}} \right] \right\} \sin [g_{(1)}(\xi, \beta)] \left(1 + O[(ka)^{-2}] + O\left[\frac{\nu^2}{(ka)^3}\right] + O\left[\frac{\nu^4}{(ka)^4}\right] + O\left[\frac{\nu^6}{(ka)^5}\right] + O\left[\frac{\nu^8}{(ka)^6}\right] \right), \quad (4.15)$$

$$\tilde{C}_{\nu^{-1/2}}(\xi, \beta) \sim 2i (\xi\beta)^{p/2} \exp \left\{ \frac{1}{4} \frac{\nu^2}{(ka)^2} \left[\frac{1}{\xi^{2(p+1)}} + \frac{1}{\beta^{2(p+1)}} \right] \right\} \sin [g_{(2)}(\xi, \beta)] \left(1 + O[(ka)^{-2}] + O\left[\frac{\nu^2}{(ka)^3}\right] + O\left[\frac{\nu^4}{(ka)^4}\right] + O\left[\frac{\nu^6}{(ka)^5}\right] + O\left[\frac{\nu^8}{(ka)^6}\right] \right), \quad (4.16)$$

where

$$g_{(1)}(\xi, \beta) = \frac{ka}{p+1} \left(\xi^{p+1} - \beta^{p+1} \right) + \frac{\nu^2 - 1/4}{2ka} \frac{1}{p+1} \left(\frac{1}{\xi^{p+1}} - \frac{1}{\beta^{p+1}} \right) + \frac{\nu^4}{24(ka)^3} \frac{1}{p+1} \left(\frac{1}{\xi^{3(p+1)}} - \frac{1}{\beta^{3(p+1)}} \right) - \frac{5}{48ka} \left(\frac{1}{\xi^{3p}} - \frac{1}{\beta^{3p}} \right) + \frac{p(2p-1)}{4ka(p+1)} \left(\frac{1}{\xi^{p+1}} - \frac{1}{\beta^{p+1}} \right) \quad (4.17)$$

and

$$g_{(2)}(\xi, \beta) = g_{(1)}(\xi, \beta) + \frac{p}{2ka} \left(\frac{1}{\xi^{p+1}} - \frac{1}{\beta^{p+1}} \right) \quad (4.18)$$

From (4.15, 16, 17, 18):

$$M_{\nu^{-1/2}}(ka) \sim -\frac{p}{2ka} + \left(1 - \frac{1}{2} \frac{\nu^2}{(ka)^2}\right) \cot g_{(1)}(\xi, \beta) \Big|_{\xi=1} \left(1 + O[(ka)^{-2}]\right) + O\left[\frac{\nu^2}{(ka)^3}\right] + O\left[\frac{\nu^4}{(ka)^4}\right] + O\left[\frac{\nu^6}{(ka)^5}\right] + O\left[\frac{\nu^8}{(ka)^6}\right] \quad (4.19)$$

and

$$\tilde{M}_{\nu^{-1/2}}(ka) \sim \left[\frac{p}{2ka} - \left(1 - \frac{1}{2} \frac{\nu^2}{(ka)^2}\right) \tan g_{(2)}(\xi, \beta) - \frac{p}{2ka\beta^{p+1}} \left(1 + \tan^2 g_{(2)}(\xi, \beta)\right) \right] \Big|_{\xi=1} \times \left(1 + O[(ka)^{-2}]\right) + O\left[\frac{\nu^2}{(ka)^3}\right] + O\left[\frac{\nu^4}{(ka)^4}\right] + O\left[\frac{\nu^6}{(ka)^5}\right] + O\left[\frac{\nu^8}{(ka)^6}\right] \quad (4.20)$$

result, where the expansions

$$\frac{1}{ka} \frac{\partial g_{(1)}(\xi, \beta)}{\partial \xi} \Big|_{\xi=1} \sim 1 - \frac{1}{2} \frac{\nu^2}{(ka)^2} + O[(ka)^{-2}] + O\left[\frac{\nu^4}{(ka)^4}\right] \quad (4.21)$$

and

$$\frac{\partial g_{(1)}(\xi, \beta) / \partial \xi}{\partial g_{(1)}(\xi, \beta) / \partial \beta} \Big|_{\xi=1} \sim -\frac{1}{\beta^p} \left(1 - \frac{1}{2} \frac{\nu^2}{(ka)^2} \left[1 - \frac{1}{\beta^{2(p+1)}}\right]\right) + O[(ka)^{-2}] + O\left[\frac{\nu^4}{(ka)^4}\right] \quad (4.22)$$

have been used to arrive at (4.20) and (4.21).

By writing

$$g_{(1)} \equiv g_{(1)}(\xi, \beta) \Big|_{\xi=1}, \quad g_{(2)} \equiv g_{(2)}(\xi, \beta) \Big|_{\xi=1}, \quad (4.23)$$

$$g_{(2)} = g_{(1)} + \epsilon_3 = \epsilon_1 + \epsilon_2 + \epsilon_3, \quad (4.24)$$

with

$$\epsilon_1 = \frac{ka}{p+1} \left(1 - \beta^{p+1}\right) + \frac{\nu^2}{2ka} \frac{1}{p+1} \left(1 - \frac{1}{\beta^{p+1}}\right), \quad (4.25)$$

$$\begin{aligned} \epsilon_2 = & -\frac{1}{8ka} \frac{1}{p+1} \left(1 - \frac{1}{\beta^{p+1}}\right) + \frac{\nu^4}{24(ka)^3} \left(1 - \frac{1}{\beta^{3(p+1)}}\right) - \frac{5}{48ka} \left(1 - \frac{1}{\beta^{3p}}\right) + \\ & + \frac{p(2p-1)}{4ka(p+1)} \left(1 - \frac{1}{\beta^{p+1}}\right) , \end{aligned} \quad (4.26)$$

$$\epsilon_3 = \frac{p}{2ka} \left(1 - \frac{1}{\beta^{p+1}}\right) , \quad (4.27)$$

and by using the trigonometric approximations

$$\tan g_{(2)} \sim \tan \epsilon_1 + (\epsilon_2 + \epsilon_3) [1 + \tan^2 \epsilon_1] \quad (4.28)$$

and

$$\cot g_{(1)} \sim \cot \epsilon_1 - \epsilon_2 [1 + \cot^2 \epsilon_1] , \quad (4.29)$$

the following relationships are obtained:

$$\begin{aligned} M_{\nu^{-1/2}}(ka) - \tilde{M}_{\nu^{-1/2}}(ka) \sim & \left(-\frac{p}{ka} + \frac{2}{\sin 2\epsilon_1} \left\{ 1 - \frac{1}{2} \frac{\nu^2}{(ka)^2} - 2\epsilon_2 \cot 2\epsilon_1 + \right. \right. \\ & \left. \left. + \epsilon_3 \tan \epsilon_1 \right\} + \frac{p}{2ka\beta^{p+1}} [1 + \tan^2 \epsilon_1] \right) \left(1 + O[(ka)^{-2}] + O\left[\frac{\nu^2}{(ka)^3}\right] + O\left[\frac{\nu^4}{(ka)^4}\right] + \right. \\ & \left. + O\left[\frac{\nu^6}{(ka)^5}\right] + O\left[\frac{\nu^8}{(ka)^6}\right] \right) , \end{aligned} \quad (4.30)$$

$$\begin{aligned} M_{\nu^{-1/2}}(ka) + \tilde{M}_{\nu^{-1/2}}(ka) \sim & \left(\frac{2}{\sin 2\epsilon_1} \left\{ \cos 2\epsilon_1 - \frac{2\epsilon_2}{\sin 2\epsilon_1} - \frac{2\epsilon_3 \sin^2 \epsilon_1}{\sin 2\epsilon_1} \right\} \left(1 - \right. \right. \\ & \left. \left. - \frac{1}{2} \frac{\nu^2}{(ka)^2} \right) - \frac{p}{2ka\beta^{p+1}} (1 + \tan^2 \epsilon_1) \right) \left(1 + O[(ka)^{-2}] + O\left[\frac{\nu^2}{(ka)^3}\right] + O\left[\frac{\nu^4}{(ka)^4}\right] + \right. \\ & \left. + O\left[\frac{\nu^6}{(ka)^5}\right] + O\left[\frac{\nu^8}{(ka)^6}\right] \right) , \end{aligned} \quad (4.31)$$

and

$$\begin{aligned}
M_{\nu-1/2}(ka) \tilde{M}_{\nu-1/2}(ka) \sim & - \left(1 - \frac{\nu^2}{(ka)^2} \right) \left(1 + O[(ka)^{-2}] + O\left[\frac{\nu^2}{(ka)^3}\right] + O\left[\frac{\nu^4}{(ka)^4}\right] + \right. \\
& \left. + O\left[\frac{\nu^6}{(ka)^5}\right] + O\left[\frac{\nu^8}{(ka)^6}\right] \right) \quad (4.32)
\end{aligned}$$

With these expressions and the Debye asymptotic expansions for $\zeta_{\nu-1/2}^{(1)}(ka)$ and $\zeta_{\nu-1/2}^{(1)'}(ka)$ the asymptotic form for the difference of the scattering coefficients is found to be :

$$\begin{aligned}
a_{\nu-1/2}^s - b_{\nu-1/2}^s \sim & \left(-ie^{i\pi\nu - i\frac{\nu^2}{ka} - i2ka + i2\epsilon_1} \left\{ 1 + \frac{i}{4ka} - i\frac{\nu^4}{12(ka)^3} + 2i\epsilon_2 \right\} + \right. \\
& \left. + \frac{p}{4ka} e^{i\pi\nu - i\frac{\nu^2}{ka} + i4\epsilon_1 - i2ka} - \frac{p}{4ka} e^{i\pi\nu - i\frac{\nu^2}{ka} - i2ka} \right) \left(1 + O[(ka)^{-2}] + \right. \\
& \left. + O\left[\frac{\nu^2}{(ka)^3}\right] + O\left[\frac{\nu^4}{(ka)^4}\right] + O\left[\frac{\nu^6}{(ka)^5}\right] + O\left[\frac{\nu^8}{(ka)^6}\right] \right) \quad (4.33)
\end{aligned}$$

and when $\nu = \frac{1}{2}$,

$$\begin{aligned}
a_{\nu-1/2}^s - b_{\nu-1/2}^s \Big|_{\nu=\frac{1}{2}} & = a_o^s - b_o^s \sim e^{-i2ka \left[1 - \frac{1}{p+1} (1 - \beta^{p+1}) \right]} \left(1 - \frac{i}{4ka} \times \right. \\
& \left. \times \left[\frac{p+1}{\beta^{p+1}} \right] \right) \left(1 + O[(ka)^{-2}] + O\left[\frac{\nu^2}{(ka)^3}\right] + O\left[\frac{\nu^4}{(ka)^4}\right] + O\left[\frac{\nu^6}{(ka)^5}\right] + O\left[\frac{\nu^8}{(ka)^6}\right] \right) \quad (4.34)
\end{aligned}$$

results.

The reflected electric field is now given by

413625-3-T

$$\begin{aligned}
E_x^{b.s.} \sim & \frac{e^{ik \left[r - 2a \left(1 - \frac{1}{p+1} [1 - \beta^{p+1}] \right) \right]}}{kr} \left\{ \frac{i}{2} + i \int_{\Gamma_1} \frac{\nu \left[1 + \frac{i}{4} ka - i \frac{\nu^4}{12(ka)^3} + 2i\epsilon_2 \right]}{1 + e^{-i2\pi\nu}} \right. \\
& e^{-i \frac{\nu^2}{ka} \left[1 - \frac{1}{p+1} \left(1 - \frac{1}{\beta^{p+1}} \right) \right]} d\nu - \frac{p}{4ka} e^{i \frac{2ka}{p+1} [1 - \beta^{p+1}]} \int_{\Gamma_1} \frac{\nu e^{-i \frac{\nu^2}{ka} \left[1 - \frac{1}{p+1} \left(1 - \frac{1}{\beta^{p+1}} \right) \right]}}{1 + e^{-i2\pi\nu}} \\
& \left. \frac{-\frac{2}{p+1} \left(1 - \frac{1}{\beta^{p+1}} \right)}{e^{-i2\pi\nu}} d\nu + \frac{p}{4ka} e^{-i \frac{2ka}{p+1} [1 - \beta^{p+1}]} \int_{\Gamma_1} \frac{\nu e^{-i \frac{\nu^2}{ka} \left[1 - \frac{1}{p+1} \left(1 - \frac{1}{\beta^{p+1}} \right) \right]}}{1 + e^{-i2\pi\nu}} d\nu + O[(ka)^{-2}] \right\} \quad (4.35)
\end{aligned}$$

The contribution from each of these integrals is given with the aid of Scott's integrals (Scott, 1949) as follows:

$$\text{e.g. } \int_{\Gamma_1} \frac{\nu e^{-i \frac{\nu^2}{ka}}}{1 + e^{-i2\pi\nu}} d\nu = + \frac{1}{(2\pi i)^2} \int_{-2\pi v e^{iy}}^{2\pi v e^{iy}} \frac{w e^{-\epsilon w^2}}{1 + e^{-w}} dw \quad (4.36)$$

where $v = (ka)^{1/2+\epsilon}$, $\epsilon = -\frac{i}{4\pi ka}$, $w = i2\pi\nu$ and $0 < y < \pi/2$.

It is easily seen that the integral on the right hand side of (4.36) corresponds to $E_{0,0}$ of (3.31). Then

$$\int_{\Gamma_1} \frac{\nu e^{-i \frac{\nu^2}{ka}}}{1 + e^{-i2\pi\nu}} d\nu \sim \frac{-1}{(2\pi i)^2} \left[\frac{1}{2\epsilon} - \frac{\pi^2}{6} \right] + O(\epsilon^1), \quad (4.37)$$

or

$$\int_{\Gamma_1} \frac{\nu e^{-i \frac{\nu^2}{ka}}}{1+e^{-i2\pi\nu}} d\nu \sim i \frac{ka}{2} - \frac{1}{24} + O[(ka)^{-1}] \quad (4.38)$$

Another type of integral occurring in (4.35) is

$$\begin{aligned} & \frac{-i}{12(ka)^3} \int_{\Gamma_1} \frac{\nu^5 e^{-i \frac{\nu^2}{ka} \left[1 - \frac{1}{p+1} \left(1 - \frac{1}{\beta^{p+1}} \right) \right]}}{1+e^{-i2\pi\nu}} d\nu = - \frac{i}{12(ka)^3} \frac{1}{(2\pi i)^6} \times \\ & \times \int_{-2\pi ve^{iy}}^{2\pi ve^{iy}} \frac{w^5 e^{-\epsilon w^2}}{1+e^{-w}} dw \quad (4.39) \end{aligned}$$

The right hand side integral of (4.39) corresponds to the type (3.30) with $q=2$. Then from (3.33):

$$- \frac{i}{12(ka)^3} \frac{1}{(2\pi i)^6} \int_{-2\pi ve^{iy}}^{2\pi ve^{iy}} \frac{w^5 e^{-\epsilon w^2}}{1+e^{-w}} dw \sim + \frac{i}{12(ka)^3} \frac{1}{(2\pi i)^6} \left[\frac{1}{\epsilon^3} \right] + O(\epsilon^1) \quad (4.40)$$

$$\text{In this case } \epsilon = \frac{i}{(2\pi i)^2 ka} \left[1 - \frac{1}{p+1} \left(1 - \frac{1}{\beta^{p+1}} \right) \right] .$$

By proceeding in a similar manner, the saddle point method integrations are completed and the final result obtained for the reflected electric field is

$$\begin{aligned}
\hat{E}_{\text{refl.}}^{\text{b. s.}} \sim -\hat{x} \frac{e^{ikr}}{kr} \left[\frac{ka}{2} \left(1 - \frac{1}{p+1} \left[1 - \frac{1}{\beta^{p+1}} \right] \right)^{-1} \right] e^{-i2ka \left[1 - \frac{1}{p+1} \left[1 - \beta^{p+1} \right] \right]} \hat{x} \\
\times \left\{ 1 + \frac{i}{4ka} \left(\frac{11}{3} \frac{1}{p+1} \left(1 - \frac{1}{\beta^{p+1}} \right) - \frac{8}{3} + \frac{2}{3} \frac{1}{\left[1 - \frac{1}{p+1} \left(1 - \frac{1}{\beta^{p+1}} \right) \right]^2} \right) \right. \\
\times \left[1 - \frac{1 - \frac{1}{\beta^{3(p+1)}}}{p+1} \right] + 2 \left[\frac{p(2p-1)}{p+1} \left(1 - \frac{1}{\beta^{p+1}} \right) - \frac{5}{12} \left(1 - \frac{1}{\beta^{3p}} \right) - \frac{1}{2(p+1)} \right. \\
\times \left. \left. \left(1 - \frac{1}{\beta^{p+1}} \right) \right] + p \left[1 - \frac{1}{p+1} \left(1 - \frac{1}{\beta^{p+1}} \right) \right] \left[e^{-i \frac{2ka}{p+1} \left(1 - \beta^{p+1} \right)} - \right. \right. \\
\left. \left. - \frac{e^{i \frac{2ka}{p+1} \left(1 - \beta^{p+1} \right)}}{\left[1 - \frac{2}{p+1} \left(1 - \frac{1}{\beta^{p+1}} \right) \right]} \right] + O[(ka)^{-2}] \right\} . \quad (4.41)
\end{aligned}$$

This expression is valid for $p > -1$ and $\beta > \xi_{20}$. Furthermore it reduces to the result (3.36) for the perfectly conducting sphere when $\beta = 1$.

4.4 The Geometrical Optics Approach

The ray tracing technique, as it was shown in Chapter Three, is very useful not only because it is helpful in checking the results obtained by rigorous asymptotic theory to $O[(ka)^{-1}]$ but also because it clarifies to a good extent the physical phenomena which take place. In this section, the ray tracing technique is again applied to obtain the optical ray paths in the radially inhomogeneous coating and the reflected electric field to $O[(ka)^{-1}]$.

It is assumed that a tube of rays of diameter $2d$ is incident on the coated sphere. Upon incidence on the inhomogeneous medium the rays diverge away from the perfectly conducting sphere, as shown in Fig. 4-1. It is expected, therefore, that, based on physical reasoning, the coating will reduce the

0136-3-7

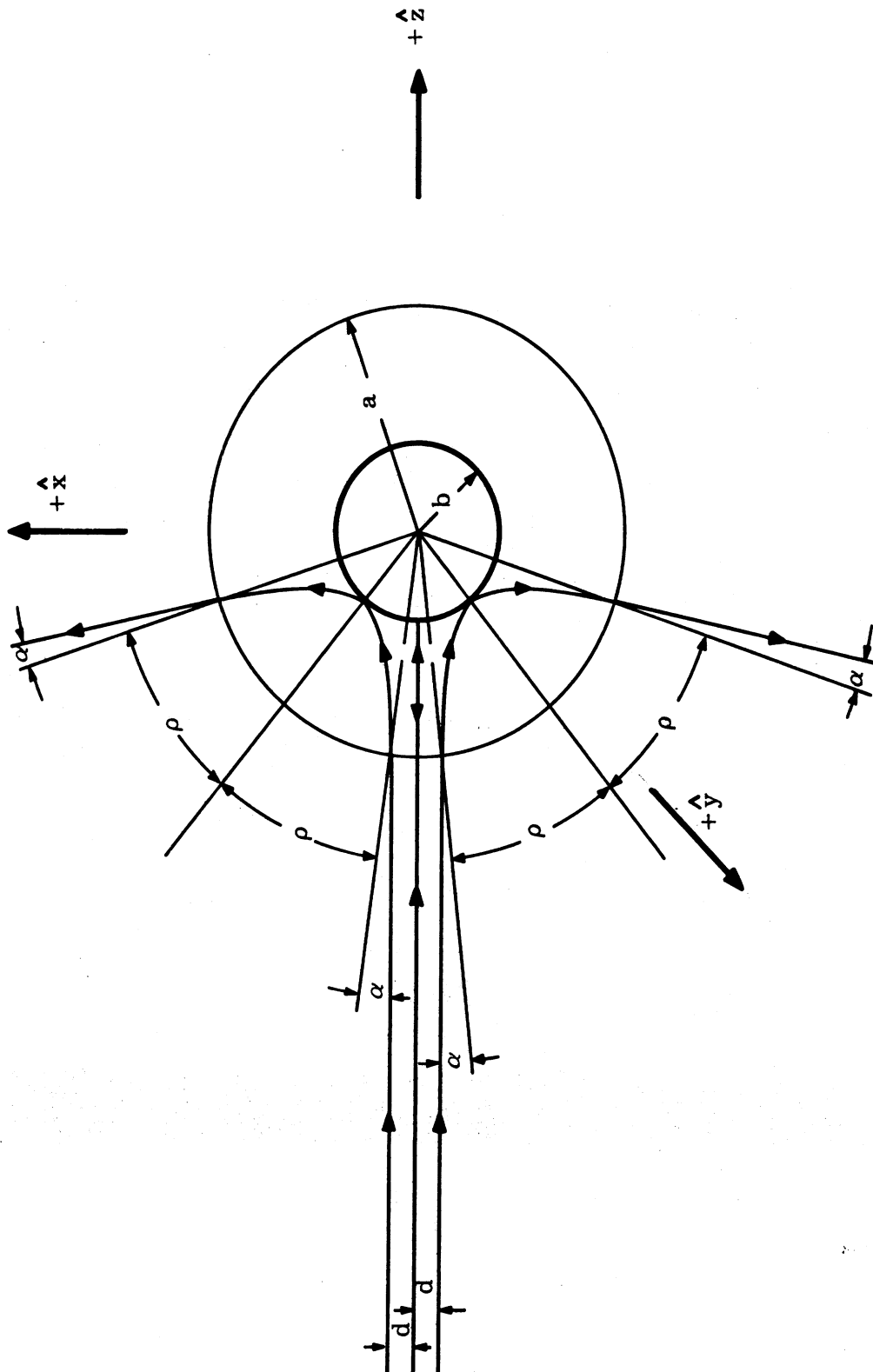

FIG. 4-1: PATHS OF INCIDENT AND REFLECTED RAYS

01363-2 r

monostatic cross-section of the perfectly conducting sphere. Indeed, it is shown in Section 4.5 that this is the case by computing numerically the monostatic cross-section.

The reflected electric field is now determined. By assuming that it is given by

$$E_x^{b.s.} \sim E_o^{b.s.} e^{ik\Theta(\xi) + i\pi} \quad (3.41)$$

for $ka \rightarrow \infty$ when a is finite, the amplitude is found first by applying the principle of conservation of energy between incident and scattered fields. The factor π in the exponent of (3.41) is due to the abrupt change of phase which occurs due to reflection of the incident ray at $r=b$. The relation for $E_o^{b.s.}$ is given by (3.45). In this case the angle ρ for an arbitrary incident ray is

$$\rho = \int_1^\beta \rho(\xi) d\xi = -\sin\alpha \int_1^\beta \frac{d\xi}{\xi \sqrt{\xi^{2(p+1)} - \sin^2\alpha}}, \quad (4.42)$$

or, by integrating

$$\rho = -\frac{1}{p+1} \left(\cos^{-1} \left[\frac{\sin\alpha}{\beta^{p+1}} \right] - \cos^{-1} [\sin\alpha] \right) \quad (4.43)$$

and it is shown in Fig. 4-1. From (3.45) and (4.43) one obtains

$$E_o^{b.s.} = \lim_{\alpha \rightarrow 0} \frac{a}{2r} \frac{\sin\alpha}{\sin \left\{ \alpha - \frac{1}{p+1} \left(\cos^{-1} \left[\frac{\sin\alpha}{\beta^{p+1}} \right] - \cos^{-1} [\sin\alpha] \right) \right\}} \quad (4.44)$$

By expanding the inverse cosine terms in a series form restricted to principal values (4.44) becomes:

01363-317

$$\begin{aligned}
E_o^{b.s.} &= \lim_{\alpha \rightarrow 0} \frac{a}{2r} \frac{\sin \alpha}{\sin \left\{ \alpha - \frac{1}{p+1} \alpha - \frac{\alpha}{\beta^{p+1}} + \frac{\alpha^3}{6} - \frac{\alpha^3}{6\beta^{3(p+1)}} + \dots \right\}} \\
&= \lim_{\alpha \rightarrow 0} \frac{a}{2r} \frac{\sin \alpha}{\sin \left\{ \alpha \left(1 - \frac{1}{p+1} \left[1 - \frac{1}{\beta^{p+1}} \right] + \frac{\alpha^2}{6} - \frac{\alpha^2}{6\beta^{3(p+1)}} + \dots \right) \right\}} \\
&= \frac{a}{2r} \frac{1}{\left[1 - \frac{1}{p+1} \left(1 - \frac{1}{\beta^{p+1}} \right) \right]} \quad . \quad (4.45)
\end{aligned}$$

In order to compute the phase $\Theta(\xi)$, the eikonal equation (3.40) is considered, which in this case gives the following differential equation:

$$\frac{d\Theta(\xi)}{d\xi} = a\xi^p \quad . \quad (4.46)$$

With the phase reference point being the origin, the solution of (4.46) is

$$\Theta(\xi) = a\xi - 2a \left[1 - \frac{1}{p+1} \left(1 - \beta^{p+1} \right) \right] \quad . \quad (4.47)$$

The reflected electric field is then given by

$$\vec{E}^{b.s.} \sim -\hat{x} \left(\frac{a}{2r} \right) e^{\frac{ikr - i2ka \left[1 - \frac{1}{p+1} \left(1 - \beta^{p+1} \right) \right]}{\left[1 - \frac{1}{p+1} \left(1 - \frac{1}{\beta^{p+1}} \right) \right]}} \quad (4.48)$$

and it agrees with the first order term of (4.41).

4.5 Numerical Computations

Based on the expression for the reflected electric field derived by geometrical optics, the monostatic cross-section of the coated sphere is found to be

$$\sigma_c = \frac{\pi a^2}{\left[1 - \frac{1}{p+1} \left(1 - \frac{1}{\beta^{p+1}}\right)\right]^2} \quad (4.49)$$

By proceeding as in Chapter Three, the cross-section of the perfectly conducting sphere σ_b is normalized to σ_c . Then computations are performed for $0.1 \leq \beta \leq 0.99$ and $p = 1, 2, 3, 4, 5$. The computed normalized expression is

$$\sigma_{N_1} = \frac{\sigma_b}{\sigma_c} = \beta^2 \left[1 - \frac{1}{p+1} \left(1 - \frac{1}{\beta^{p+1}}\right)\right]^2 \quad (4.50)$$

and the result is shown in a tabulated form in Table 4-1.

It is seen from Table 4-1 that the monostatic cross-section of the perfectly conducting sphere of radius b is reduced considerably, as the thickness of the radially inhomogeneous coating is increased (β decreases) and as the exponent p increases. The calculations of σ_{N_2} and D have been omitted for this case, since it is felt that the results of Section 3.5 give a rather general idea of the error involved in using geometrical optics down to $ka=50$ to compute the monostatic cross-section.

01363-3 T

TABLE 4-1: COMPUTATIONS OF σ_{N_1} FOR VARIOUS β AND p

β	$p = 1$	$p = 2$	$p = 3$	$p = 4$	$p = 5$
0.10	25.50252	1115.562	62537.64	4000331	277781.5 x 10 ¹⁵
0.20	6.760001	71.68446	985.9604	15665.03	271441.2
0.30	3.300279	15.23891	89.95126	621.5734	4738.555
0.40	2.102500	5.522501	17.69254	66.13759	275.8715
0.50	1.562500	2.777778	5.640625	12.96000	33.06250
0.60	1.284445	1.758080	2.583759	4.093380	6.987287
0.70	1.132704	1.315469	1.572172	1.940411	2.480574
0.80	1.050625	1.111267	1.184356	1.273019	1.381314
0.90	1.011142	1.023178	1.036193	1.050280	1.065543
0.91	1.008921	1.018474	1.028711	1.039690	1.051473
0.92	1.006969	1.014358	1.022228	1.030583	1.039470
0.93	1.005276	1.010831	1.016684	1.022851	1.029354
0.94	1.003833	1.007838	1.012022	1.016395	1.020967
0.95	1.002633	1.005363	1.008192	1.011126	1.014168
0.96	1.001667	1.003382	1.005147	1.006962	1.008830
0.97	1.000928	1.001876	1.002843	1.003832	1.004841
0.98	1.000408	1.000822	1.001242	1.001667	1.002098
0.99	1.000101	1.000203	1.000305	1.000408	1.000512

01362-27

4.6 The Creeping Wave Contribution

The contribution of the creeping waves to the backscattered electric field is studied in this section. In chapter one, it was mentioned that this contribution is given in terms of an infinite summation of residues in the first quadrant of the complex ν -plane, where the residues closest to the real ν -axis occur for ν near ka . The strongest contribution in the back-scattering direction comes from the residues nearest the real ν -axis. It is this case which is examined here. First it is recalled that the asymptotic expansions of $S_{\nu-1/2}^{(j)}(\xi)$ and $T_{\nu-1/2}^{(j)}(\xi)$ valid for ν near ka are required, so that $M_{\nu-1/2}(ka)$ and $\tilde{M}_{\nu-1/2}(ka)$ can be determined from their definitions in terms of $C_{\nu-1/2}(ka)$ and $\tilde{C}_{\nu-1/2}(ka)$. By considering the differential equations (1.16) and (1.17) with $Q_{(1)}(\xi)$ and $Q_{(2)}(\xi)$ given by (1.26), (4.1) and (4.2), it is readily seen that for

$\frac{p(p+1)}{(ka)^2 \xi^2} \ll 1$, or p finite and $(ka)^2 \xi^2 \gg 1$, one can define in approximation

$$Q(\xi) = Q_{(1)}(\xi) = Q_{(2)}(\xi) = \xi^{2p} - \frac{\nu^2}{(ka)^2 \xi^2} \quad (4.51)$$

By setting $\nu = ka + mt$, where $m = (ka/2)^{1/3}$, and by defining a parameter

$$\tau = t/m^2 \quad (4.52)$$

such that $|\tau| \ll 1$ for the first few creeping waves, it follows from (4.51) that

$$Q(\xi) = \xi^{2p} - \frac{\left(1 + \frac{\tau}{2}\right)^2}{\xi^2} \quad (4.53)$$

It is immediately seen that $Q(\xi)$ has a zero at

$$\xi_{\text{op}} = \left(1 + \frac{\tau}{2}\right)^{\frac{1}{p+1}}, \quad p > -1 \quad (4.54)$$

which is outside the interval $\beta \leq \xi \leq 1$ but nevertheless very close to it. Langer's theory is therefore used in order to obtain the solutions. These solutions are

$$S_{\nu-1/2}^{(j)}(\xi) = U_{\nu-1/2}^{(j)}(\xi) \sim \left(\frac{\zeta(\xi)}{Q(\xi)}\right)^{1/4} w_{(j)} \left[(ka)^{2/3} \zeta(\xi) \right] \quad (4.55)$$

$$\text{and } T_{\nu-1/2}^{(j)}(\xi) \sim \xi^p \left(\frac{\zeta(\xi)}{Q(\xi)}\right)^{1/4} w_{(j)} \left[(ka)^{2/3} \zeta(\xi) \right] \quad (4.56)$$

with $j = 1, 2$. Also

$$\zeta(\xi) = \left(\frac{3}{2} \int_{\xi_{\text{op}}}^{\xi} \sqrt{Q(\xi)} \, d\xi \right)^{2/3} \quad (4.57)$$

By following the outline in Chapter One, $M_{\nu-1/2}(ka)$ is still given by (1.58) with $\zeta_{(i)}(\xi) = \zeta(\xi)$, whereas $\tilde{M}_{\nu-1/2}(ka)$ in this case is:

$$\begin{aligned} \tilde{M}_{\nu-1/2}(ka) = & \frac{p}{ka} + M_{\nu-1/2}(ka) - \frac{4(ka)^{1/3} \frac{\partial \zeta(\xi)}{\partial \xi} \frac{\partial \zeta(\beta)}{\partial \beta} x}{\beta + \frac{1}{4} \left(\frac{1}{\zeta(\beta)} \frac{\partial \zeta(\beta)}{\partial \beta} - \frac{1}{Q(\beta)} \frac{\partial Q(\beta)}{\partial \beta} \right) +} \\ & \times \left(\frac{w_{(1)}[\omega(\xi)] w_{(2)}[\omega(\beta)] - w_{(1)}[\omega(\beta)] w_{(2)}[\omega(\xi)]}{w_{(1)}[\omega(\xi)] w_{(2)}[\omega(\beta)] - w_{(1)}[\omega(\beta)] w_{(2)}[\omega(\xi)]} \right)^{-2} \\ & + (ka)^{2/3} \frac{\partial \zeta(\beta)}{\partial \beta} \left[\frac{w_{(1)}[\omega(\xi)] w_{(2)}'[\omega(\beta)] - w_{(1)}'[\omega(\beta)] w_{(2)}[\omega(\xi)]}{w_{(1)}[\omega(\xi)] w_{(2)}[\omega(\beta)] - w_{(1)}[\omega(\beta)] w_{(2)}[\omega(\xi)]} \right] \Bigg|_{\xi=1} \end{aligned} \quad (4.58)$$

with

$$\omega(\xi) = (ka)^{2/3} \zeta(\xi), \quad \omega(\beta) = (ka)^{2/3} \zeta(\beta) \quad (4.59)$$

and it is assumed that $\beta \neq 1$ so that

$$w_{(1)} [\omega(1)] w_{(2)} [\omega(\beta)] - w_{(1)} [\omega(\beta)] w_{(2)} [\omega(1)] \neq 0 .$$

The asymptotic expansions $M(t)$ and $\tilde{M}(t)$ of (1.58) and (4.58) will be developed, so that

$$\frac{w'_{(1)}(t_\ell)}{w_{(1)}(t_\ell)} = -M(t_\ell) m$$

and

$$\frac{w'_{(1)}(\tilde{t}_\ell)}{w_{(1)}(\tilde{t}_\ell)} = -\tilde{M}(t_\ell) m$$

can be solved numerically with the aid of the asymptotic expansions and diagrams of Logan and Yee (1962), to yield the zeros t_ℓ and \tilde{t}_ℓ . To this end the following procedure is followed. Firstly the integral

$$\int_{\xi_{op}}^{\xi} \sqrt{Q(\xi)} d\xi \quad \text{is evaluated.}$$

One finds that

$$\int_{\xi_{op}}^{\xi} \sqrt{\xi^{2(p+1)} - \left(1 + \frac{\tau}{2}\right)^2} \frac{d\xi}{\xi} = \frac{\sqrt{\xi^{2(p+1)} - \left(1 + \frac{\tau}{2}\right)^2}}{p+1} - \frac{1 + \frac{\tau}{2}}{p+1} \sin^{-1} \left(\frac{\sqrt{\xi^{2(p+1)} - \left(1 + \frac{\tau}{2}\right)^2}}{\xi^{p+1}} \right) , \quad (4.60)$$

from which

$$\int_{\xi_{\text{op}}}^1 \sqrt{Q(\xi)} \, d\xi = \frac{\sqrt{-\tau \left(1 + \frac{\tau}{4}\right)}}{p+1} - \frac{1 + \frac{\tau}{2}}{p+1} \sin^{-1} \left(\frac{\sqrt{-\tau \left(1 + \frac{\tau}{2}\right)}}{\beta^{p+1}} \right) \quad (4.61)$$

results. The asymptotic expansion of (4.61) in τ yields

$$\int_{\xi_{\text{op}}}^1 \sqrt{Q(\xi)} \, d\xi \sim \frac{e^{i\frac{\pi}{2}} \tau^{3/2}}{3(p+1)} \left(1 - \frac{\tau}{40} + O[\tau^2] \right), \quad (4.62)$$

from which

$$\zeta(1) = \left[\frac{3}{2} \int_{\xi_{\text{op}}}^1 \sqrt{Q(\xi)} \, d\xi \right]^{2/3} \sim \frac{e^{i\frac{\pi}{3}} \tau}{[2(p+1)]^{2/3}} \left(1 - \frac{\tau}{60} + O[\tau^2] \right) \quad (4.63)$$

results. With the aid of (4.62) and (4.63) one has

$$\frac{1}{4ka} \left(\frac{1}{\zeta(\xi)} \frac{\partial \zeta(\xi)}{\partial \xi} - \frac{1}{\partial(\xi)} \frac{\partial Q(\xi)}{\partial \xi} \right) \Big|_{\xi=1} \sim \frac{1}{2ka} \left(1 - \frac{2}{5} [p+1] \right) + O[\tau^{5/2}] \quad (4.64)$$

and

$$\frac{\partial \zeta(\xi)}{\partial \xi} \Big|_{\xi=1} \sim e^{-i\frac{2\pi}{3}} [2(p+1)]^{1/3} \left(1 + \frac{2}{15} \tau - \frac{191}{28800} \tau^2 \right) + O[\tau^3] \quad (4.65)$$

Other computations pertinent to finding $M(t)$ and $\tilde{M}(t)$ are

$$\int_{\xi_{\text{op}}}^{\beta} \sqrt{Q(\xi)} \, d\xi = \frac{\sqrt{\beta^{2(p+1)} - \left(1 + \frac{\tau}{2}\right)^2}}{p+1} - \frac{1 + \frac{\tau}{2}}{p+1} \sin^{-1} \left(\frac{\sqrt{\beta^{2(p+1)} - \left(1 + \frac{\tau}{2}\right)^2}}{\beta^{p+1}} \right), \quad (4.66)$$

$$\int_{\xi_{op}}^{\beta} \sqrt{Q(\xi)} d\xi \sim \frac{e^{-i\frac{\pi}{2} [1-\beta^{2(p+1)}]^{3/2}}}{3(p+1)} \left[\alpha_0 + \alpha_1 \tau + \alpha_2 \tau^2 + O[\tau^3] \right] \quad (4.67)$$

with

$$\alpha_0 = \frac{1}{5} \left[8 - 3\beta^{2(p+1)} \right], \quad (4.68)$$

$$\alpha_1 = \frac{1}{10} \left[\frac{8 + 19\beta^{2(p+1)} - 12\beta^{4(p+1)}}{1 - \beta^{2(p+1)}} \right] \quad (4.69)$$

and

$$\alpha_2 = -\frac{3}{8} \frac{\beta^{2(p+1)}}{[1-\beta^{2(p+1)}]^2} \left[2 - 7\beta^{2(p+1)} + 4\beta^{4(p+1)} \right]. \quad (4.70)$$

Also

$$\xi(\beta) \sim \frac{e^{-i\frac{\pi}{3} [1-\beta^{2(p+1)}]}}{[2(p+1)]^{2/3}} \alpha_0^{2/3} \left(1 + \frac{2\alpha_1}{3\alpha_0} \tau + \left(\frac{2\alpha_2}{3\alpha_0} - \frac{1}{9} \frac{\alpha_1^2}{\alpha_0^2} \right) \tau^2 + O[\tau^3] \right), \quad (4.71)$$

$$\begin{aligned} \frac{\partial \xi(\beta)}{\partial \beta} \sim & \frac{e^{i\frac{2\pi}{3} [2(p+1)]^{1/3}}}{\beta \alpha_0^{1/3}} \left(1 + \left[\frac{1}{2 [1-\beta^{2(p+1)}]} - \frac{\alpha_1}{3\alpha_0} \right] \tau + \right. \\ & \left. + \left[\frac{2}{9} \frac{\alpha_1^2}{\alpha_0^2} - \frac{\alpha_1}{6\alpha_0 [1-\beta^{2(p+1)}]} - \frac{\alpha_2}{3\alpha_0} - \frac{\beta^{2(p+1)}}{8 [1-\beta^{2(p+1)}]^2} \right] \tau^2 + O[\tau^3] \right), \quad (4.72) \end{aligned}$$

and

$$\begin{aligned}
& \frac{1}{4ka} \left(\frac{1}{\xi(\beta)} \frac{\partial \xi(\beta)}{\partial \beta} - \frac{1}{Q(\beta)} \frac{\partial Q(\beta)}{\partial \beta} \right) \sim \frac{1}{2ka\beta [1-\beta^{2(p+1)}]} \left\{ 1 + p\beta^{2(p+1)} - \right. \\
& - \frac{p+1}{\alpha_0} + \left(\frac{p+1}{\alpha_0} \left[\frac{\alpha_1}{\alpha_0} - \frac{1}{2[1-\beta^{2(p+1)}]} \right] - \frac{(p+1)\beta^{2(p+1)}}{[1-\beta^{2(p+1)}]} \right) \tau + \\
& + \left(\frac{p+1}{\alpha_0} \left[\frac{\alpha_2}{\alpha_0} + \frac{\alpha_1}{2\alpha_0} \left(\frac{1}{1-\beta^{2(p+1)}} \right) - \frac{\alpha_1^2}{\alpha_0^2} + \frac{\beta^{2(p+1)}}{8[1-\beta^{2(p+1)]^2} \right] - \right. \\
& \left. - \frac{\beta^{2(p+1)}}{1-\beta^{2(p+1)}} - \frac{[3+\beta^{2(p+1)}][1+p\beta^{2(p+1)}]}{4[1-\beta^{2(p+1)}]^2} \right) \tau^2 + O[\tau^3] \left. \right\}, \quad (4.73)
\end{aligned}$$

all valid for $\alpha_0 \neq 0$.

By substituting (4.69) through (4.73) into (1.58) and (4.58), $M_{\nu-1/2}(ka)$ and $\tilde{M}_{\nu-1/2}(ka)$ are obtained asymptotically in τ . Then with $\tau = t/m^2$ and keeping terms to $O[m^{-4}]$:

$$M(t) \sim \frac{3-2p}{10ka} + C(t) \quad (4.74)$$

and

$$\tilde{M}(t) \sim \frac{3-2p}{10ka} + \tilde{C}(t) \quad (4.75)$$

result, where

$$\begin{aligned}
C(t) \sim & \frac{e^{-i\frac{2\pi}{3}} (p+1)^{1/3}}{m} \left(1 + \frac{2}{15} \frac{t}{m^2} + O[m^{-4}] \right) \left[\frac{w'_1[\omega(1)] w_2[\omega(\beta)] -}{w_1[\omega(1)] w_2[\omega(\beta)] -} \right. \\
& \left. \frac{-w_1[\omega(\beta)] w'_2[\omega(1)]}{-w_1[\omega(\beta)] w_2[\omega(1)]} \right], \quad (4.76)
\end{aligned}$$

and

$$\begin{aligned}
\tilde{C}(t) \sim & \frac{e^{-i\frac{2\pi}{3}(p+1)^{1/3}}}{m} \left(1 + \frac{2}{15} \frac{t}{m^2} + O[m^{-4}] \right) \left[\frac{w'_{(1)}[\omega(1)] w_{(2)}[\omega(\beta)]}{w_{(1)}[\omega(1)] w_{(2)}[\omega(\beta)]} - \right. \\
& \left. \frac{w_{(1)}[\omega(\beta)] w'_{(2)}[\omega(1)]}{w_{(1)}[\omega(\beta)] w_{(2)}[\omega(1)]} \right] - 4e^{-i\frac{2\pi}{3}(p+1)^{1/3}} \left(\frac{1}{m} + \frac{2}{15} \frac{t}{m^3} + O[m^{-4}] \right) \times \\
& \times \left(w_{(1)}[\omega(1)] w_{(2)}[\omega(\beta)] - w_{(1)}[\omega(\beta)] w_{(2)}[\omega(1)] \right)^{-1} \left(w_{(1)}[\omega(1)] w'_{(2)}[\omega(\beta)] - \right. \\
& \left. w'_{(1)}[\omega(\beta)] w_{(2)}[\omega(1)] \right)^{-1} + \frac{e^{-i\frac{4\pi}{3}}}{2m^3 \alpha_3} \left[1 + O(m^{-4}) \right] \left(w_{(1)}[\omega(1)] w'_{(2)}[\omega(\beta)] - \right. \\
& \left. w'_{(1)}[\omega(\beta)] w_{(2)}[\omega(1)] \right)^{-1} , \tag{4.77}
\end{aligned}$$

$$\text{where } \alpha_3 = 2\alpha_0^{1/3} \left[2p + \frac{1 + p\beta^{2(p+1)} - \frac{p+1}{\alpha_0}}{1 - \beta^{2(p+1)}} \right] . \tag{4.78}$$

With the expressions given by (4.76) and (4.77) the first few zeros t_ℓ and \tilde{t}_ℓ can be found approximately by solving the following equations numerically

$$\frac{w'_{(1)}(t_\ell)}{w_{(1)}(t_\ell)} = \frac{2p-3}{20m^2} - m C(t_\ell) \tag{4.79}$$

and

$$\frac{w'_{(1)}(\tilde{t}_\ell)}{w_{(1)}(\tilde{t}_\ell)} = \frac{2p-3}{20m^2} - m \tilde{C}(\tilde{t}_\ell) . \tag{4.80}$$

Then the approximate contribution in the backscattering direction due to the first few creeping waves is given by (1.56), where the explicit derivatives $\frac{\partial C(t)}{\partial t}$ and $\frac{\partial \tilde{C}(t)}{\partial t}$ can be determined from (4.76) and (4.77). It must finally be noted that in (4.76) and (4.77) the asymptotic expressions for $\omega(1)$ and $\omega(\beta)$ are given by

$$\omega(1) \sim \frac{e^{i\frac{\pi}{3}}}{(p+1)^{2/3}} \left\{ t - \frac{t^2}{60m^2} + O(m^{-4}) \right\} \quad (4.81)$$

and

$$\begin{aligned} \omega(\beta) \sim & \frac{e^{-i\frac{\pi}{3}}}{(p+1)^{2/3}} [1 - \beta^{2(p+1)}] \alpha_0^{2/3} \left\{ m^2 + \frac{2\alpha_1}{3\alpha_0} t + \right. \\ & \left. + \left(\frac{2\alpha_2}{3\alpha_0} - \frac{1}{9} \frac{\alpha_1^2}{\alpha_0^2} \right) \frac{t^2}{m^2} + O(m^{-4}) \right\} . \end{aligned} \quad (4.82)$$

For large b , it is to be expected that the creeping wave contribution is small compared to the reflected field contribution. Also it must be mentioned that by observing the coefficients α_1 , α_2 and α_3 , those values of β must be excluded for which the denominator of these coefficients becomes zero, i.e. $\beta \neq 1$ and $p \neq -1$.

CHAPTER V
CONCLUSIONS

In brief, it has been shown that the monostatic cross-section of perfectly conducting spheres is enhanced or reduced, when coated with radially inhomogeneous dielectrics, depending on whether the radially inhomogeneous dielectric is of the converging or diverging kind. It has been verified in the case of the Nomura and Takaku radial inhomogeneity that the greater the gradient of divergence of the coating, the greater the reduction of the radar cross-section of the perfectly conducting sphere. Furthermore, the new class of radially inhomogeneous dielectrics has been determined to be important in analytical studies for radar cross-sections, because it can present converging or diverging properties depending on the choice of the parameter γ , and because it reduces the two differential equations (1.16) and (1.17) essentially to one. When this new class of radially inhomogeneous media is considered as the coating of a perfectly conducting sphere, it has been found that when $0 < \gamma < 1$ it enhances the cross-section, whereas when $\gamma > 1$ it reduces it. However, it must be mentioned that the computations for σ_{N_1} when γ is very close to β , based on geometrical optics, are not very reliable since the condition $0 < \text{Im}k \ll 1$ is not taken into consideration. This is verified, if it is recalled that when $\gamma = \beta$ the rigorous asymptotic theory to $O[(ka)^{-2}]$ predicts a very large reduction of the cross-section, whereas the geometrical optics based computations for σ_{N_1} predict enhancement of the cross-section for $\gamma = 0.99\beta$. The introduced error in computing the radar cross-section by using the geometrical optics solution for the reflected electric field instead of the solution obtained by rigorous asymptotic theory to $O[(ka)^{-2}]$, has been found to be insignificantly small, except for the case where $\gamma = 0.99\beta$ and β near unity. In this latter case, the error is as large as 75 % due to the fact that the asymptotic solutions for the radial eigenfunctions are no longer valid since the condition $|2ka(1-\gamma)| \gg 1$ is violated.

Since this research has been confined to considering bodies whose radius is much larger than the wavelength of the incident electromagnetic field, particular emphasis has been placed upon the study of the reflected portion of the field. The creeping wave contribution is much smaller than the reflected field, since these waves radiate as they travel around the scatterer and since in actuality the dielectric coating presents some losses.

Other possible contributions to the backscattering direction, such as lateral or evanescent waves are not taken into account. These contributions are waves with algebraic or exponential decay, respectively, and they are expected to be much smaller than the reflected field. Such kind of contribution is given in terms of branch-cuts of $S_{\nu-1/2}^{(j)}(\xi)$ and $T_{\nu-1/2}^{(j)}(\xi)$ in the complex ν -plane; for example, it is seen from equation (2.14) that two branch points occur at $\nu = \pm ka(1-\gamma)$.

Finally, it must be mentioned that from the practical point of view the research in this dissertation has possible applications to the study of the monostatic cross-section of space vehicles during their re-entry flight in the atmosphere. In particular, the black-out phenomenon may possibly be explained by the formation of a plasma coating around the body, whose index of refraction behaves as a radially inhomogeneous dielectric of the diverging type.

BIBLIOGRAPHY

- Aden, A.L. and M. Kerker (1951) "Scattering of Electromagnetic Waves from Two Concentric Spheres," J. Appl. Phys. 22 (1242-1246).
- Arnush, D. (1964) "Electromagnetic Scattering from a Spherical Nonuniform Medium - Part 1: General Theory," IEEE Trans. AP-12 (86-90).
- Brekhovskikh, L.M. (1960) Waves in Layered Media (Academic Press, New York.)
- Farone, W.A. (1965) "Generalization of Rayleigh-Gans Scattering from Radially Inhomogeneous Spheres," J. Opt. Soc. Amer. 55 (737-738).
- Fikioris, John G. (1965a) "The Biconical Antenna in a Radially Stratified Medium," IEEE Trans. AP-13 (289-302).
- Fikioris, John G. (1965b) "Asymptotic Expansions of Solutions of Differential Equations," J. Math. Phys. 6 (1131-1148).
- Flammer, Carson (1958) "Electromagnetic Wave Propagation in a Medium with Variable Dielectric Constant $1 + \kappa r^{-1}$," Air Force Cambridge Research Center Report 63, AD 133624, January 1958.
- Fock, V. (1945) "Diffraction of Radio Waves around the Earth's Surface," J. Phys. USSR 9 (255-266).
-
- Friedman, B. (1951) "Propagation in a Non-homogeneous Atmosphere" in The Theory of Electromagnetic Waves (Interscience, New York);(317-350).
- Froman, N. and P.O. Froman (1965) JWKB Approximation - Contributions to the Theory (North-Holland Publishing Company, Amsterdam).
-
- Goodrich, R. F. and N. D. Kazarinoff (1963) "Scalar Diffraction by Prolate Spheroids whose Eccentricities are Almost One," Proc. Cambridge Philos. Soc. 59 (167-183).
- Gould, R.N. and R. Burman (1964) "Some Electromagnetic Wave Functions for Propagation in Stratified Media," J. Atm. Terr. Phys. 26 (335).
- Gutman, A.L. (1965) "Application of the Cross-Sections Method to the Solution of the Problem Concerning the Diffraction of an Electromagnetic Wave by an Inhomogeneous Sphere," Radio Engrg. and Electr. Phys. 10 (1363-1372); (translated from Radiotehn. i Elektron.).
-
- Langer, R. E. (1949) "The Asymptotic Solutions of Ordinary Linear Differential Equations of the Second Order, with Special Reference to a Turning Point," Amer. Math. Soc. Trans 67 (461-480).
- Logan, N.A. (1959) "General Research in Diffraction Theory," vols. 1 and 2, Lockheed Tech. Reps. LMSD-288087/8, Sunnyvale, California (DDC Documents AD 241228 and AD 243182).

Logan, N. A. and K. S. Yee (1962) "A Mathematical Model for Diffraction by Convex Surfaces," in Electromagnetic Waves, ed. R. E. Langer (University of Wisconsin Press, Madison, Wis.); (139-180).

Marcuvitz, N. (1951) "Field Representations in Spherically Stratified Regions," in The Theory of Electromagnetic Waves (Interscience, New York) (S263-S315); (reprinted by Dover Publ., New York).

Miller, J. C. P. (1946) The Airy Integral, Giving Tables of Solutions of the Differential Equation $y'' = xy$ (Cambridge University Press, Cambridge, England).

Nomura, Y. and K. Takaku (1955-I), (1956-II) "On the Propagation of the Electromagnetic Waves in an Inhomogeneous Atmosphere," Sci. Rep. RITU, B-(Elect. Comm.) 7 (107-148).

Scott, J. M. C. (1949) "An Asymptotic Series for the Radar Scattering Cross-Section of a Spherical Target," Atomic Energy Res. Est. Report T/M30.

Stratton, J. A. (1941) Electromagnetic Theory (McGraw-Hill, New York).

Tai, C. T. (1958a) "The Electromagnetic Theory of the Spherical Luneberg Lens," Appl. Sci. Res. B7 (113-130).

Tai, C. T. (1958b) "Maxwell Fish-eye Treated by Maxwell Equations," Nature 182 (1600-1601).

Tai, C. T. (1963) "Some Wave Functions and Potential Functions Pertaining to Spherically Stratified Media," J. Res. NBS 67D (199-202).

Uslenghi, P. L. E. (1964) "High-Frequency Scattering by a Coated Cylinder," Canad. J. Phys. 42 (2121-2128).

Uslenghi, P. L. E. (1965) "High Frequency Backscattering from a Coated Sphere," Alta Freq. 34 (785-788).

Uslenghi, P. L. E. (1966) "Scattering by Radially Inhomogeneous Cylinders," Alta Freq. 35 (911-912).

Uslenghi, P. L. E. (1967) "Electromagnetic Scattering from Radially Inhomogeneous Media," University of Michigan Radiation Laboratory Report 8658-1-T, NSF Grant GK-1408.

Uslenghi, P. L. E. (1968) "High Frequency Backscattering from the Inverse Square-Power Dielectric Lens," IEEE Trans. AP-16 (140-141).

Uslenghi, P. L. E. (1969) "Electromagnetic and Optical Behavior of Two Classes of Dielectric Lenses," accepted for publication in the April 1969 issue of IEEE Trans. G-AP.

Van der Waerden, B. L. (1950) "On the Method of Saddle Points," Appl. Sci. Res. B2 (33-45).

III

01102-3-T

- Wait, J.R. (1962) Electromagnetic Waves in Stratified Media (Macmillan, New York).
- Wait, J.R. (1963) "Electromagnetic Scattering from a Radially Inhomogeneous Sphere," Appl. Sci. Res. B10(441-450).
- Watson, G.N. (1918) "The Diffraction of Electric Waves by the Earth," Proc. Roy. Soc. London Ser. A 95 (83-99).
- Watson, G.N. (1952) A Treatise on the Theory of Bessel Functions (Cambridge University Press, Cambridge, England.)
- Weston, V.H. and R. Hemenger (1962) "High Frequency Scattering from a Coated Sphere," J. Res. NBS 66D(613-619).
- Yeh, C. and Z.A. Kaprielian (1960) "The Electromagnetic Theory of a Radially Stratified Medium," USCEC Report 84-202.