

## TELEVISION RECEPTION NEAR THE WIND TURBINE ON BLOCK ISLAND, RI

Dipak L. Sengupta and Thomas B.A. Senior  
Radiation Laboratory  
Department of Electrical and Computer Engineering  
The University of Michigan, Ann Arbor, MI 48109

## I. INTRODUCTION

A large horizontal axis wind turbine (WT) or windmill has recently been installed on Block Island, which is about 20 km off the southern coast of mainland Rhode Island and 25 km east-northeast of Mantauk Point, Long Island, New York. The experimental WT, designated as MOD-OA, is located on a knoll in New Meadow Hill Swamp in the eastern central portion of Block Island, as indicated on the map shown in Fig. 1. The island itself is 9.7 km long, and 5.6 km wide at its widest point. The population of Block Island is about 500 year round, but increases to 5000-10,000 during the summer months [1].

The present paper is concerned with the possible impact of the WT on the reception of the TV signals on Block Island. To ascertain and estimate the TV interference (TVI) caused by the WT, a number of tests were performed over a period of two weeks during the month of October 1979. Tests were conducted by receiving commercially available TV signals at selected sites in the vicinity of the windmill. The following sections describe these on-site tests, and discuss some selected results obtained and their implications. Detailed results are reported in [2].

## II. DESCRIPTION OF THE WT AND THE TEST SITES

A sketch of a MOD-OA series windmill similar to the one installed on Block Island is shown in Fig. 2. It is a large horizontal axis machine with a two-bladed propeller-type rotor and generator assembly mounted on a steel truss tower. The two aluminum blades are aerodynamically tapered with a fixed coning angle of  $7^\circ$ . The immediate vicinity of the WT site is shown in Fig. 3. There are no residences within 170 m of this site, and this is also the theoretical throw-distance in the event of the windmill blade failure [1].

The WT is integrated with the Block Island Power Company's power plant and supplies electricity to the existing utility network. It generates a maximum of 200 kw AC power in winds of 31 to 55 km per hour. Above 55 km per hour, the blades are feathered and braked to stop the machine. During periods of low wind (13-16 km per hour), the blades are also feathered and the machine is shut down. In operation, the windmill blades normally rotate at a speed ranging from 20-40 rpm depending on prevailing wind speed. It is appropriate to mention that the prevailing wind directions on Block Island are east and west.

Measurements were made at a number of test sites in the vicinity of the WT, as indicated in Fig. 3. At test site 1, located 0.24 km from the WT, it is planned to install the antenna assembly ('head end') of a cable TV (CATV) system for receiving the TV signals available on Block Island and subsequently cabling them to the local people. Since a knowledge of the WT-generated interference at this site is particularly important, a major portion of our

investigation was conducted here. Site 3 is about 0.37 km from the WT and is located such that forward region interference (to be described later) could be measured for some TV Channels. Two residential homes are located near the sites 4 and 6, distance of 0.37 and 0.4 km, respectively, from the WT. Some initial tests were also carried out at another home, marked site 7 in Fig. 3, located about 0.4 km from the WT.

### III. TV INTERFERENCE PHENOMENA

For a better appreciation of the various tests and results to be discussed later, a general discussion of the TV interference phenomena near a windmill is given in the present section. In our previous investigations, the interference to TV reception caused by large horizontal axis windmills has been identified and quantified by comprehensive theoretical and experimental studies [3,4]. It has been found that the rotating blades of a windmill act as a time-varying multipath source to produce pulse amplitude modulation of the total signal received in the vicinity of the machine. For a receiving antenna so located and oriented as to pick up the specular or forward scattering off the rotating blades, this extraneous modulation, if sufficiently strong, can distort the video portion of a TV signal reproduction. At a given distance from the WT, the interference increases with increasing frequency and is therefore worst on the upper UHF TV Channels; it also decreases with increasing distance from the windmill, but in the worst case (and with a non-directional receiving antenna) can still produce objectionable video distortion at distances up to a few kilometers [5]. For ambient or primary signals above the noise level of the TV receiver, there is in general no significant dependence on the receiver used, and no audio distortion has been observed.

Generally, the nature of the interference depends on the location of the receiver with respect to the WT, the state and orientation of the blades, and the direction of arrival of the primary signal. When the windmill blades are stationary, the scattered signal may appear on the TV screen as a ghost whose position, or separation from the main picture, depends on the difference between the time delays suffered by the primary and scattered signals. A rotation of the blades then causes the ghost to fluctuate, and if the ghost is sufficiently strong, the resulting interference can be quite objectionable. In such cases, the received picture displays a horizontal jitter in synchronism with the blade rotation. As the interference increases, the entire (fuzzy) picture shows a pulsed brightening, and still stronger interference can disrupt the TV receiver's vertical sync, producing picture break-up. This type of interference occurs when the interfering signal reaches the receiver primarily as a result of specular scattering off the broad faces of the blades, and is called backward region interference. In the forward scattering region when the WT is almost in line between the TV transmitter and the receiver, there may be little or no difference in the times of arrival of the primary and scattered signals at the receiver, and the video interference then appears as an intensity (or brightness) fluctuation of the picture in synchronism with the blade rotation. This type of interference is termed forward region interference. In both cases, the amount of interference depends on the strength of the scattered signal relative to the primary one, and this decreases with increasing distance from the WT. Since each blade of the MOD-OA machine contributes individually, the resulting interference occurs at twice the rotation frequency of the blades.

The backward region interference shows no significant dependence on the ambient signal strength and appears to be independent of the receiver if the

signal is well above the noise level of the receiver. Interference is observed only when a blade is positioned to direct the specularly reflected signal to the receiver. The azimuth and pitch angle of the blades are therefore key factors affecting the level of interference, and for any given transmitter and receiver locations, interference can occur only if the wind is such as to position the windmill appropriately. In the forward region, however, the interference does depend on the ambient signal strength, and a receiver located in a low signal level area is more vulnerable to this type of interference.

From laboratory simulation experiments [3,4] it has been established that the video distortion is still acceptable as long as the ratio of the scattered and primary field amplitudes at the receiver, i.e., the modulation index ( $m$ ) of the total received signal, is such that  $m < m_0 = 0.15$ . For  $m \geq m_0$  the resulting distortion is unacceptable. On the assumption that the WT blades are oriented to direct the maximum scattered signal to the receiver, the region where  $m \geq m_0$  is defined as the interference zone of the windmill [4,5]. That portion of the zone produced by specular reflection off the blades is approximately a cardioid centered at the WT with its maximum pointing towards the TV transmitter. There is also a narrow lobe directed away from the transmitter resulting from forward scattered off the blades.

A method has been developed [5] to calculate the interference zone of a given WT for any TV Channel. A typical TV interference zone of a MOD-OA WT, with omnidirectional receiving antenna, is sketched in Fig. 4 which indicates that the backward interference region is larger in area than the forward while the maximum interference distance  $r_1$  in the former is smaller than the distance  $r_2$  in the latter. For TV Channel 53,  $r_1 \approx 1$  km and  $r_2 \approx 2$  km with  $m_0 = 0.15$ . However, our recent investigations [6] indicate that forward interference distance should be reduced by at least a factor of two or more depending on the ambient level of the received signal. From these results it can be seen that the backward interference region of a WT is of primary concern. It should be mentioned that the shapes of the interference zones are independent of the TV Channel numbers but their size increases with increasing TV Channel number. Finally, the fact that a receiver is located within the interference zone does not necessarily mean that it will experience TVI during the entire viewing time. A method has been developed [7] to estimate the percent viewing time during which unacceptable video distortion may occur by taking into account the relevant statistical parameters, e.g., wind speed, direction, etc. For example, the probability of observing no significant interference on Channel 53 on Block Island at a distance of only 0.5 km northwest of the WT is about 0.9 [7].

#### IV. EXPERIMENTAL ARRANGEMENT AND DESCRIPTION OF MEASUREMENTS

The experimental set-up for performing the various tests is shown in Fig. 5 where only those components which are pertinent to the data collection have been included. With any given TV transmitter, a portion of the signal is scattered off the WT blades and this, together with the desired signal, was picked up by the receiving antenna and fed to a spectrum analyzer and a TV receiver.

The receiving antenna used was a commercially available receiving antenna designed to cover the entire band of TV frequencies. The input impedance of the antenna is about 150  $\Omega$  at the midband frequencies, and it has a nominal

gain (with respect to isotropic) of 7 dB and 4 dB in the VHF and UHF bands, respectively. The pattern of the antenna varies significantly over the TV Channel frequencies; however, the antenna maintains side-lobe levels (including back-lobe) of about -10 dB over the entire band.

The spectrum analyzer was tuned to the audio carrier frequency of the desired signal, and its vertical output was recorded on paper tape for later evaluation. This provided a recording of the total signal level received as a function of time, including any modulation produced by scattering from the windmill blades. The TV receiver used was a 1976 Zenith model 17GC45 which has been rated superior for its rejection of interference [8]. The received TV program was observed to see if there was any video distortion. There was also provision to record the observed interference on the TV screen if so desired; this was accomplished with a TV camera in conjunction with a video recorder, not shown in Fig. 5. The test instruments were powered from the commercially available 60 Hz power supply.

At a test site, the above set-up was used to conduct some or all of the following types of measurement:

(i) Field Strength: The strength of the available signal was measured by pointing the main beam of the receiving antenna towards the TV transmitter so that a maximum output was obtained from the spectrum analyzer which then yielded the field strength in dBm (dB above a milliwatt).

(ii) Antenna Response in Test Environment: For a given TV signal, the output of the spectrum analyzer was obtained as a function of the antenna beam pointing direction with the WT blades rotating and without. The results obtained from these measurements contained substantial information, and were used to judge the following: (a) the horizontal plane pattern of the antenna in the actual test environment, (b) the effect of the windmill and/or its blade rotation on the received signal and (c) an estimate of the amount of signal modulation caused by the blade rotation.

(iii) Static Scattering: With the blades locked in a desired position and the WT yawing in azimuth through 360°, the TV signal scattered by the windmill was measured with the antenna pointing at the WT. These measurements gave the maximum blade-scattered signal that could be received at a given site and for a given TV Channel.

(iv) TV Interference (TVI): The TVI measurements were conducted with the antenna beam positioned to receive the desired TV signal. With the windmill blades rotating, the spectrum analyzer output was recorded as a function of time, and, at the same time, the received picture on the TV screen was observed for video distortion.

As mentioned earlier, the signal scattered by a rotating blade combines with the direct signal to produce an amplitude modulated signal at the inputs to the spectrum analyzer and the TV receiver. Thus, as a function of time, the output of the spectrum analyzer varies above and below the ambient signal level, and it is conventional to quote the total variation ( $\Delta$ ) of the received signal amplitude in dB from which the amplitude modulation index ( $m$ ) can be obtained using the relationship  $\Delta = 20 \log_{10}(1+m/1-m)$ . Usually, a total signal variation greater than or equal to 2.6 dB ( $m > 0.15$ ) causes unacceptable video distortion for backward region interference [2,3]; however, it should be mentioned that barely visible but acceptable distortion may occur even for  $\Delta < \Delta_0 = 2.6$  dB. For forward region interference, the corresponding value of

$\Delta_{\circ}$  is larger, and can be as large as 6.5 dB ( $m \approx 0.35$ ) [7] for ambient signals of the order of -60 dBm or more, but smaller for weaker ambient signals.

During the TVI measurements, the observed picture distortion was video recorded whenever this was thought to be desirable.

In a few instances TVI measurements were also carried out by pointing the antenna beam at the rotating WT. This was done to simulate the worst possible situation of a directional antenna wrongly oriented and the interference in such cases was generally quite high.

(v) Threshold TVI: In addition to the experiments described in (iv), some measurements of the threshold (maximum acceptable) level of interference on a given TV Channel were performed as follows. With the blades rotating, data were collected in a manner similar to that described in (iv) but with the antenna oriented so that the maximum acceptable video distortion was observed on the TV screen. These results were obtained primarily for comparison with those of a previous study [3].

#### V. AVAILABLE TV SIGNALS

A number of commercial TV signals are available for reception on Block Island. The directions of arrival of these signals with respect to the WT are shown in Fig. 6 where we have also indicated the approximate distances to the transmitters and their locations. The circled numbers are the TV Channel numbers. Figures 3 and 6 can be used to determine whether a test site is in the backward or forward part of the WT zone for a given TV signal.

The field strengths of the available TV signals were measured at the test sites with the receiving antenna located 4.6 m above ground. Typical results obtained at site 1 are shown in Table 1, and in the cases where no

Table 1. Field Strengths of Available TV Signals at Site 1

TV Channel No.	Audio Carrier Frequency (MHz)	Distance of the Transmitter from WT (km)	Field Strength (dBm)
2	59.75	129	-84
3	65.75	105	--
4	71.75	129	-82
5	81.75	129	-86
6	87.75	156	-52
7	179.75	129	-81
8	185.75	105	-88
10	197.75	64	-66
12	209.75	64	-66
27	553.75	105	--
36	607.75	64	-90
38	619.75	129	--
53	709.75	56	-62
56	727.75	129	--

value is given the received field strength was too low (below the noise level of the spectrum analyzer) to allow meaningful reading to be obtained.

While some individual antennas can receive all nine VHF and five UHF TV Channels shown in Fig. 6, the results of Table 1 indicate that the reception quality is generally poor on Block Island [1]. In fact, the entire island is in either the fringe or deep shadow reception area for all of the available TV Channels [Note: with transmitting and receiving antenna heights of 300 m and 10 m, respectively, the distance to the radio horizon is about 73 km].

Because of the low field strengths on the island, the height of the receiving antenna used has a significant effect on the signal strength and, hence, on the quality of the received picture. The typical height of a TV antenna mounted on the roof of a home is 10 m, and this is much smaller than the height of the WT blades. The blades are therefore exposed to a stronger field than the home-owner's antenna, and this could lead to a WT-scattered field of the same order as the primary signal, resulting in unacceptable video distortion at that site. The possibility of this occurring was indicated by early theoretical calculations [1], and was the reason for the decision to install a CATV system to ensure interference-free TV reception on the island.

## VI. SELECTED RESULTS

The received field strengths on Channel 6 as functions of the antenna rotation, obtained with and without the WT blades rotating, are given in Figs. 7(a) and 7(b), respectively, where the effects of the WT blade rotation on the received signal are clearly evident. With the antenna beam pointing in the direction of the distant transmitter, the WT blade produces about 0.4 dB variation in the received signal, but with the beam directed towards the WT, a significantly larger variation of about 8 dB occurs. Similar results were obtained for TV Channels 10, 12 and 53.

The total received signal as a function of time with the antenna beam pointed in the direction of the TV Channel 6 transmitter and the WT blades rotating at 40 rpm is shown in Fig. 8. The modulation pulses due to the blade rotation occur at 0.75-sec. intervals, i.e., at half the rotation period of the blades. The total signal variation caused by these pulses is about 0.6 dB ( $m = 0.03$ ), and this produced a barely visible amount of video distortion of the received picture. Although this distortion was judged to be acceptable for ordinary viewing, it may not be acceptable for CATV transmission purposes.

Similar results obtained on Channel 6 but with the antenna beam pointed towards the operating WT are shown in Fig. 9 where the expanded time scale results are given so that the modulation waveform of the received signal may be judged. In this case it was found that the modulation produced by the blade rotation was quite strong and caused about 12 dB ( $m = 0.59$ ) total variation of the received signal (compare with Fig. 8). With such a large extraneous modulation, very strong (and naturally unacceptable!) video distortion of the received picture was observed. The results given in Figs. 8 and 9 are quite similar to those obtained in our previous studies reported elsewhere [3,4].

With the antenna beam pointed in the direction of the desired TV transmitter, signals received on Channels 10 and 53 contained insignificant amounts of modulation and, consequently no interference was observed in the received pictures for these Channels. However, when the antenna beam pointing direction was moved away from the desired transmitter by an appropriate amount,

observable TVI effects were obtained on the received pictures for these Channels. Figure 10 shows the results obtained at site 1 for Channel 10.

Since detectable TVI effects were observed on Channel 6, and since these effects were judged unacceptable for the proposed CATV system, further tests were conducted on Channel 6 to determine the specifications which the receiving antenna must have to make the interference insignificant. The results shown in Fig. 8 were obtained with the antenna oriented such that the direct and WT-scattered signals were received via the main-beam maximum and the back lobe of the antenna, respectively. By slightly rotating the antenna, it was possible to control the received strength of the scattered signal relative to the direct. In this manner, it was established that no TVI effects would be observed if the scattered signal is about 15 dB below the direct one. Based on this finding, it is argued that with a properly directed receiving antenna having a side and back lobe ratio of -15 dB or better, no TVI effects will be observed on Channel 6.

Site 3 was suitable for forward region interference measurements, i.e., the antenna received the direct and scattered signals from approximately the same direction (see Figs. 3 and 6). Typical results obtained at Channel 12 are shown in Fig. 11 where the occurrence of almost constant amplitude modulation pulses is indicative of the forward region type of interference. Although the modulation pulses are visible in Fig. 11, the pulse amplitude were not strong enough to produce any significant distortion of the TV picture.

Even with the antenna pointed towards the operating WT, no significant TVI effects were observed at site 4 for any TV Channel. Received TV Channel 53 signal vs. time is shown in Fig. 12 which indicates modulation pulses are of the order of 2 dB; at this site the receiver being located in the forward region of interference, no appreciable TVI effects were observed on the received picture.

During the initial part of our study, a home was selected near site 7 (see Fig. 3), about 0.4 km away from the WT. The owner was using a 'rabbit-ears' type of indoor antenna and, consequently, the received picture was very snowy, indicative of an extremely low signal level. It was observed that with the windmill blades rotating, video distortion due to the WT occurred on all of the available TV Channels, and that generally the interference synchronized with the vertical position of the blades.

At a home near site 4 and with our receiving antenna oriented to receive the desired signal, the total received signal as a function of time was recorded and the TV picture observed on the owner's RCA XL-100 set with TV Channels 6, 10, 12 and 36. We saw no detectable modulation pulses in the spectrum analyzer output; and no detectable distortion of the received pictures.

At a home near site 6 interference tests were conducted on Channels 30 and 53 using the homeowner's TV set model RCA XL-100 with an outdoor bow-tie type of UHF antenna. For both Channels the received signal strength was weak (-85 to -88 dBm). The signal variations of the spectrum analyzer output were about 3 dB, and these produced a fairly strong distortion of the received picture.

## VII. GENERAL DISCUSSION OF MEASUREMENTS AND RESULTS

Electromagnetic interference to television reception caused by the MOD-OA WT at Block Island has been studied by carrying out a number of on-site measurements at selected test sites and residential homes in the vicinity of the operating windmill. The commercial TV signals available on the island were used as the RF sources. The main findings from the measurements may be summarized as follows:

(i) Block Island is a poor reception area for all of the available TV signals. The ambient signals are weak, and the received picture is generally snowy and of poor quality.

(ii) Using a home-owner's "rabbit-ears" type of antenna, unacceptable interference has been observed on all TV Channels at a home located about 0.4 km from the WT.

With a moderately good receiving antenna having a front-to-back ratio of about 10 dB, unacceptable interference have been observed on Channel 6 at a site 0.24 km from the WT in the backward part of the interference zone. At this site it was also found that the observed interference could be made insignificant by using an antenna whose side and back lobes are  $\geq 15$  dB down; with this antenna no objectionable backward region interference would occur at distances  $> 0.24$  km.

At another home 0.37 km from the WT and located in the forward region of interference, unacceptable interference has been observed on Channels 30 and 53 when using the home-owner's "bow-type" outdoor UJF antenna.

(iii) Using an antenna having 10 dB front-to-back ratio and located 4.6 m above ground, unacceptable interference has been observed at the proposed CATV site located 0.24 km from the windmill. However, detailed measurements showed that the site would be acceptable for a CATV antenna installation provided the antenna system has side and back lobe levels which are at least 15 dB down. It is doubtful if any site closer to the WT would be acceptable, and it is preferable to have the site further away.

Overall, the above results are consistent with those of our previous studies [3,4].

## VIII. CONCLUSIONS

With a poor antenna (such as "rabbit ears") or a good directional antenna incorrectly oriented, the interference on some TV Channels could extend to 1 km and more from the WT. There are a number of homes located within 0.5 km of the WT and some as close as 0.2 km. Most are in the backward portion of the interference zone, but within 1 km of the WT there are many homes whose TV reception could be adversely affected.

Our measurements indicate that a properly oriented directional antenna having side and back lobes at least 15 dB down could provide interference-free reception at those homes 0.2 km or more from the WT that are in the backward region. At distances less than 0.2 it would be difficult, if not impossible, to avoid the interference even with the best antenna. In addition, there is also a handful of homes which are up to 0.5 km from the WT and in the forward region, and for these the TVI problem would not be corrected by the use of a good antenna.



In this sense, therefore, the installation of a CATV system is justified, particularly since the decision had to be made without benefit of the above results, and even prior to the pertinent results obtained from our earlier studies [3,4,5]. The present tests justify the provision of CATV service at all sites within about 1 km of the WT, but the data does not substantiate the need at distances greater than 1 km. At these greater distances, any TVI could be avoided by the correct use of even a moderately good antenna.

#### ACKNOWLEDGEMENTS

It is a pleasure to acknowledge the assistance of our colleagues in the performance of this study. We are particularly grateful to J. E. Ferris, who was responsible for the measurements; I. J. LaHaie and R. Ziemelis for their help with the data collection.

Completion of the interference tests on Block Island would not have been possible without the help of A. Birchenough of the NASA Lewis Research Center, and the excellent cooperation of F. Renz and H. Dupont of the Block Island Power Company.

This work was supported by the Wind Systems Branch, Division of Solar Technology, Department of Energy, under Contract No. E4-76-S-02-2846. A004.

#### REFERENCES

- [1] \_\_\_\_\_, "Wind Turbine Generator Systems, Block Island, Rhode Island," Final Environmental Impact Statement, DOE/EIS-0006, U.S. Department of Energy, Washington, D.C., July 1978.
- [2] D. L. Sengupta, T.B.A. Senior and J. E. Ferris, "Television Interference Tests on Block Island, RI," Technical Report No. 3 on Contract No. EY-76-S-02-2846.A004, Wind Systems Branch, Division of Solar Energy, Department of Energy, Washington, D.C., January 1980.
- [3] D. L. Sengupta and T.B.A. Senior, "Selectromagnetic Interference by Wind Turbine Generators," Final Report No. 2 on Contract No. EY-76-S-02-2846.A001, Wind Systems Branch, Division of Solar Energy, Department of Energy, Washington, D.C., March 1978.
- [4] D. L. Sengupta and T.B.A. Senior, "Electromagnetic Interference to Television Reception Caused by Horizontal Axis Windmills," Proc. IEEE, Vol. 67, No. 8, pp. 1133-1142, August 1979.
- [5] T.B.A. Senior and D. L. Sengupta "Wind Turbine Generator Siting and TV Reception Handbook," Technical Report No. 1 on Contract No. EY-26-S-02-2846.A001, Wind Systems Branch, Division of Solar Energy, Department of Energy, Washington, D.C., January 1978.
- [6] T.B.A. Senior and D. L. Sengupta, "Wind Turbine Generator Siting Handbook," Technical Report No. 2 on Contract No. EY-76-S-02-2846.A001, Wind Systems Branch, Department of Energy, Washington, D.C., December 1979.

- [7] D. L. Sengupta and T.B.A. Senior, "Wind Turbine Generator Interference to Electromagnetic Systems," Final Report on Contract No. EY-26-S-02-2846.A003, Wind Systems Branch, Division of Solar Technology, Department of Energy, Washington, D.C., August 1979.
- [8] Consumer Reports, Vol. 41, No. 1, pp. 22-26 (Consumers Union, Mount Vernon, N.Y.), 1976.

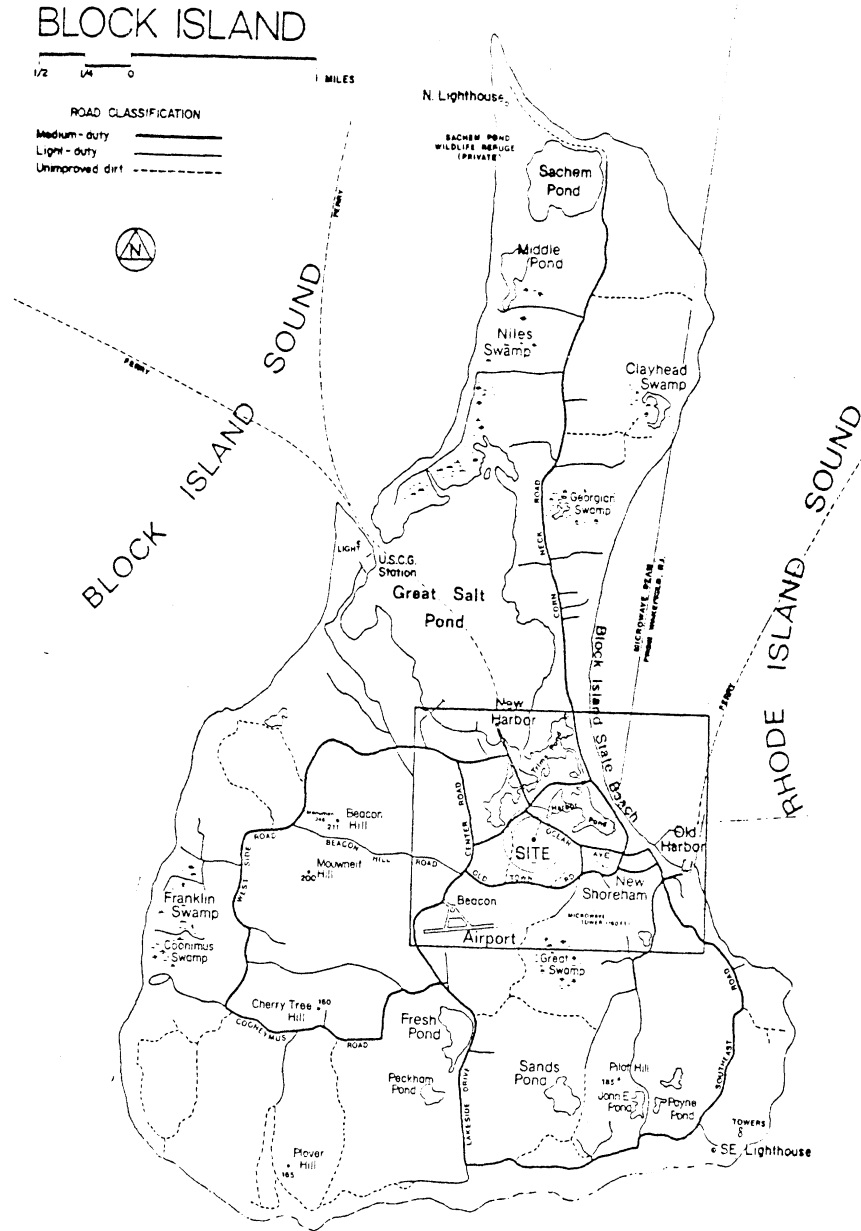

Figure 1. Map of Block Island.

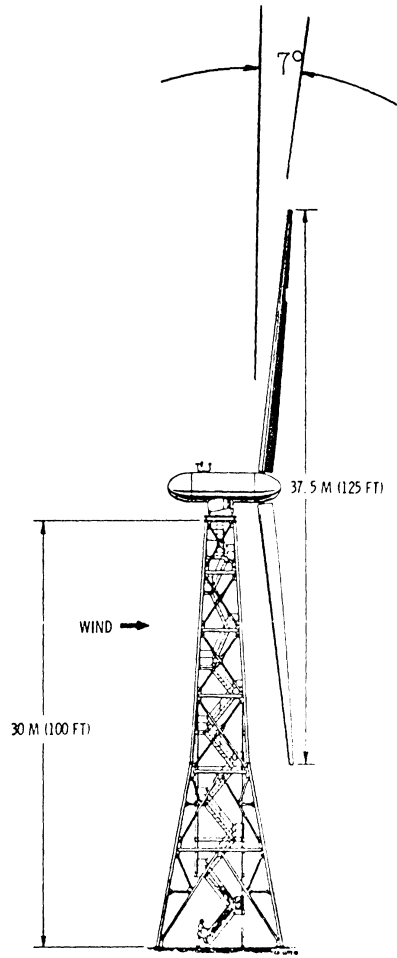

Figure 2. Sketch of a MOD-OA series wind turbine.

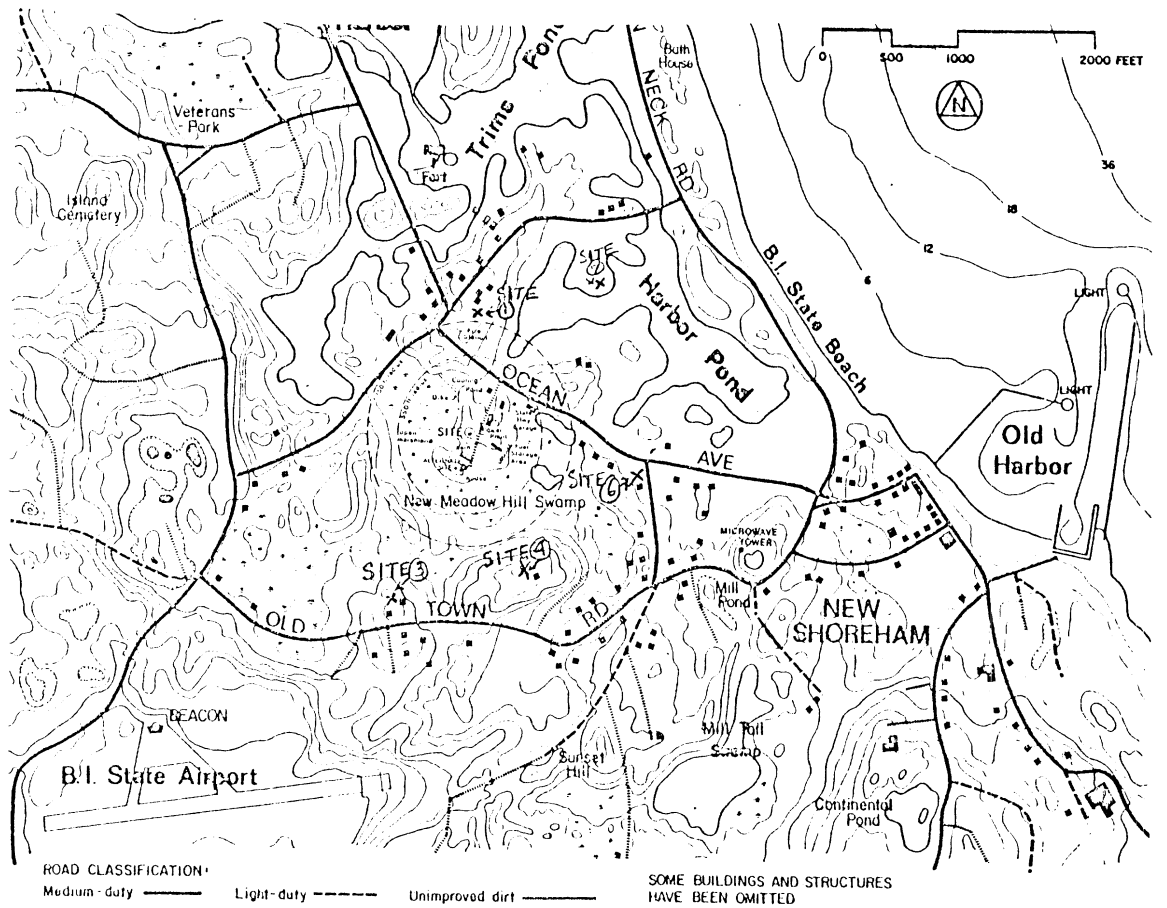

Figure 3. WT site vicinity map.

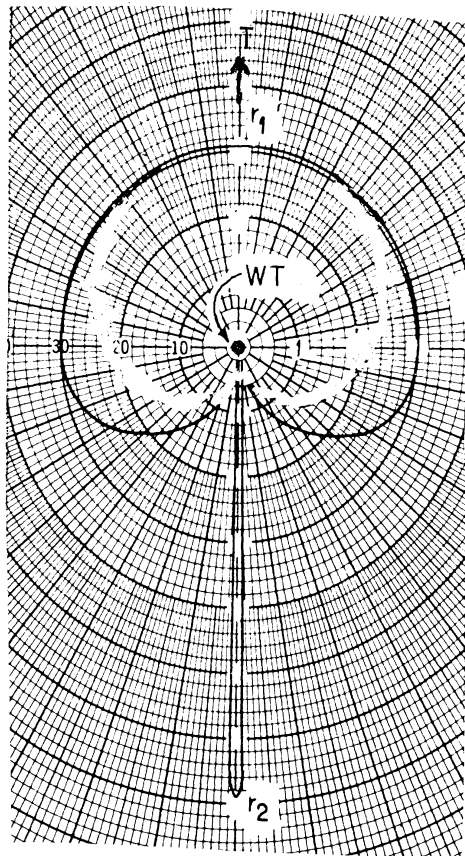

Figure 4. Calculated TV interference region of a MOD-OA WT for TV Channel 52. Transmitter-to-WT distance = 120 km; receiving antenna omnidirectional.

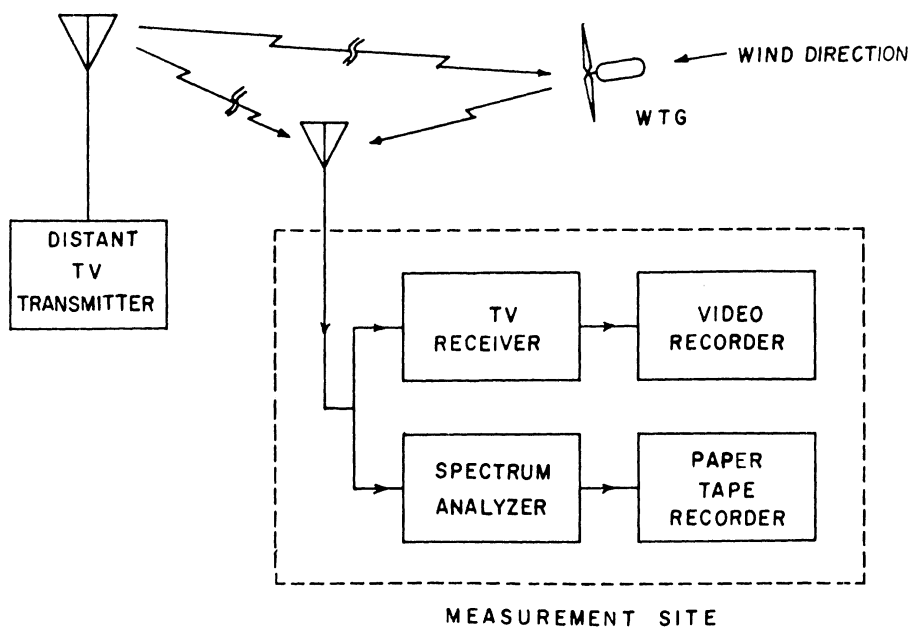

Figure 5. Schematic block diagram of a typical on-site measurement setup.

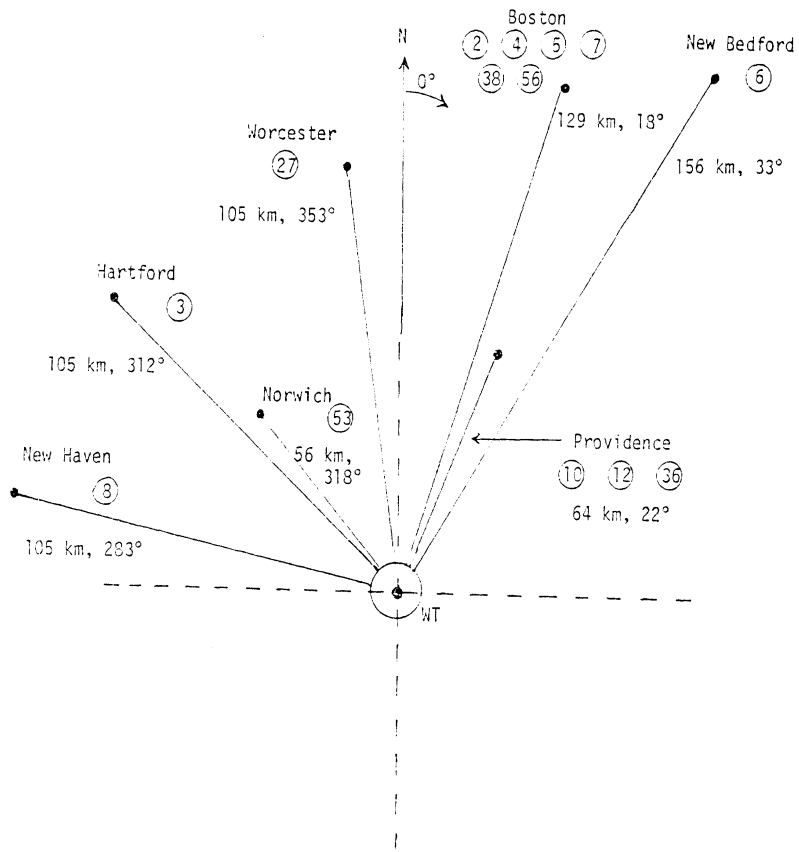

Figure 6. Location of the available TV signal transmitters with respect to the WT. Circled numbers indicate TV Channel numbers.

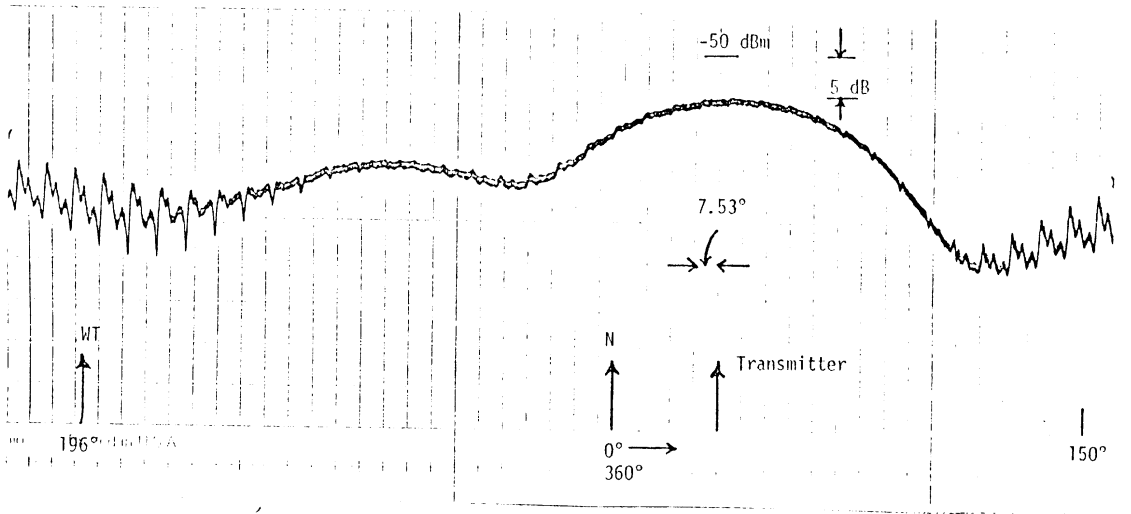

Figure 7(a). Strength of TV Channel 6 signal received at site 1 vs. antenna rotation angle in degrees (or time: 1 division = 1 second). Antenna height = 4.6 m; WT blades rotating.

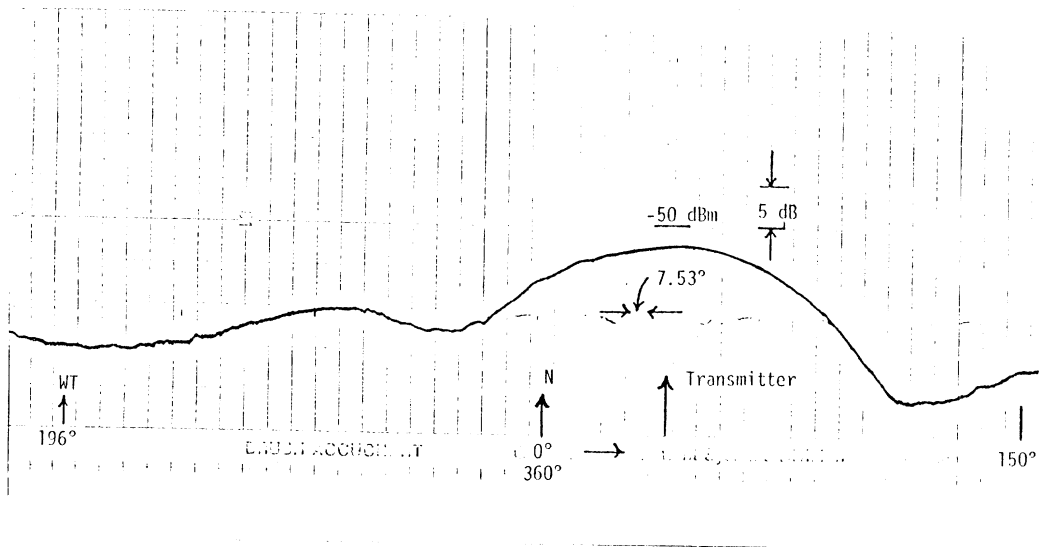

Figure 7(b). Strength of TV Channel 6 signal received at site 1 vs. antenna rotation angle in degrees (or time: 1 division = 1 second). Antenna height = 4.6 m; WT blades stationary.



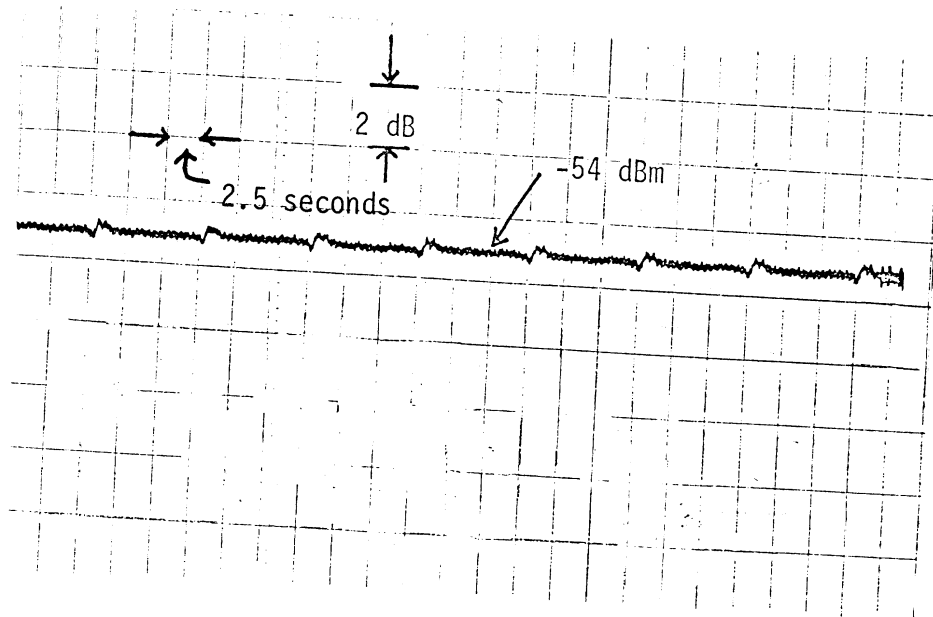

Figure 8. Channel 6 signal as a function of time received at site 1 with the antenna main beam pointed at the distant transmitter. Blade rotation frequency = 40 rpm; WT-to-receiver distance = 0.24 km.

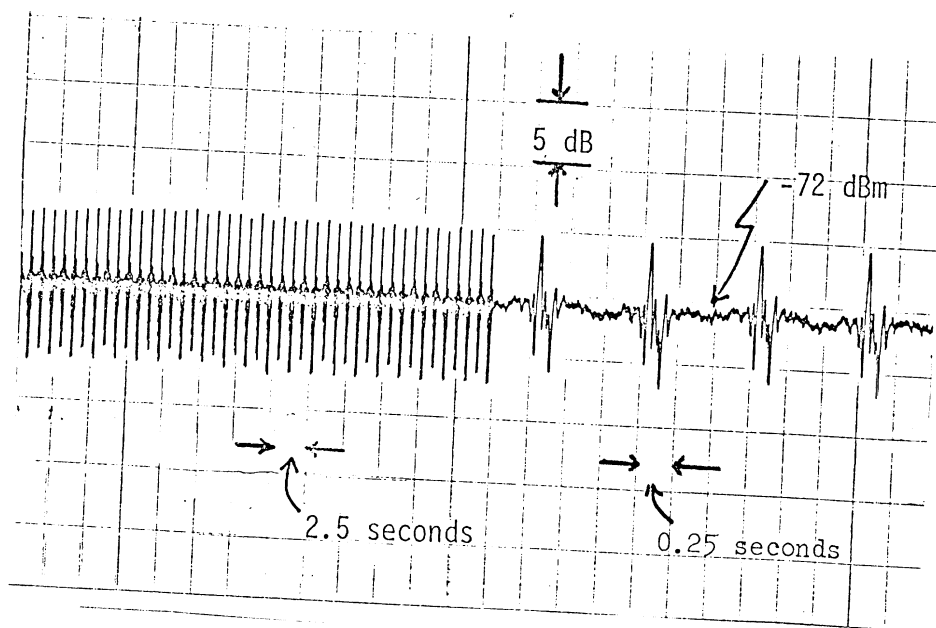

Figure 9. Channel 6 signal as a function of time received at site 1 with the antenna main beam pointed at the WT. Blade rotation frequency = 40 rpm; WT-to-receiver distance = 0.24 km.

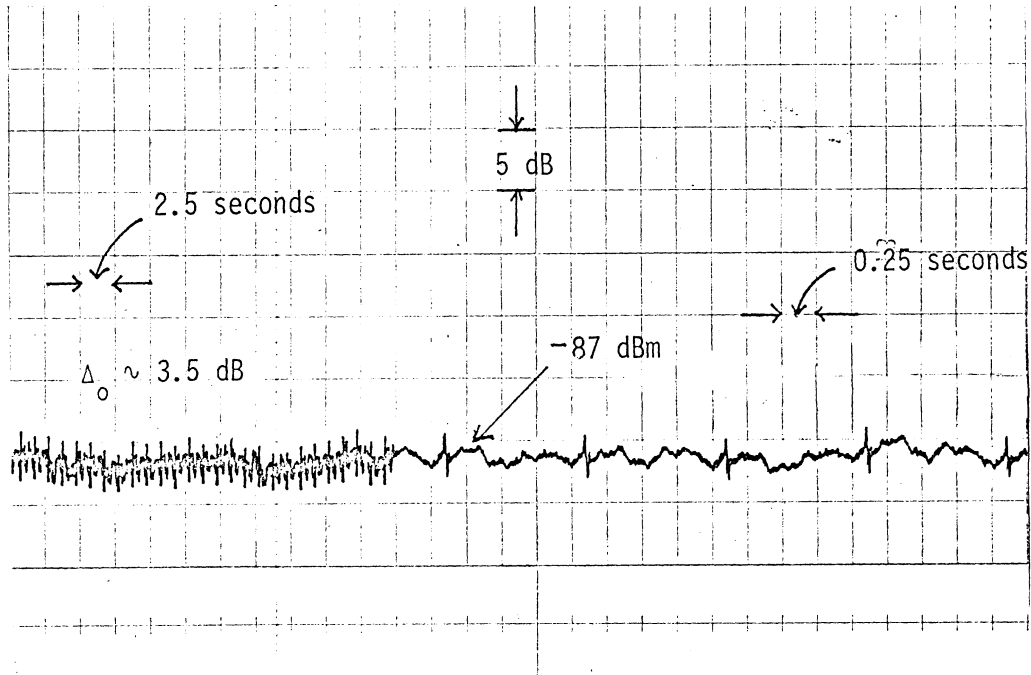

Figure 10. Received Channel 10 signal vs. time producing observable interference at site 1. Blade rotation frequency = 30 rpm; WT-to-receiver distance = 0.24 km.

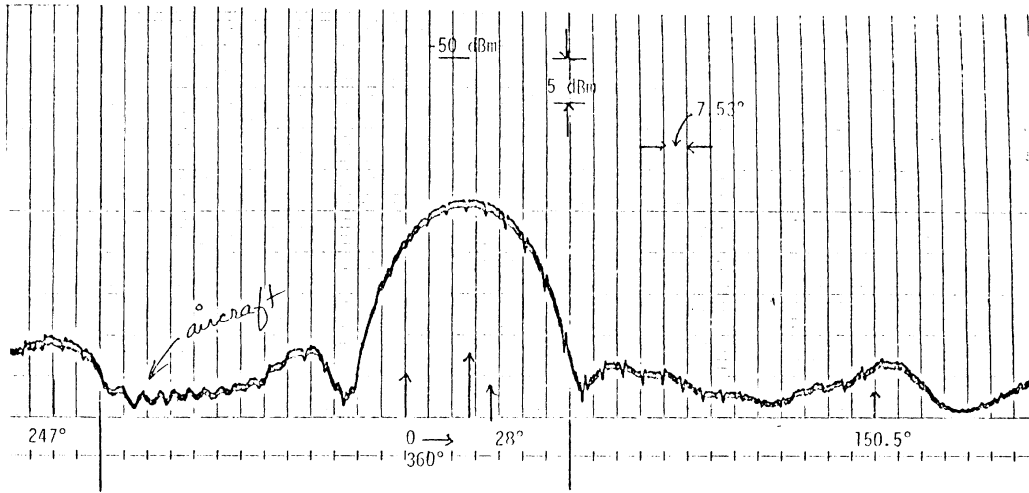

Figure 11. Strength of TV Channel 12 signal received at site 3 vs. antenna rotation angle (or time: 1 division = 1 second). Antenna height = 4.6 m; WT blades rotating.

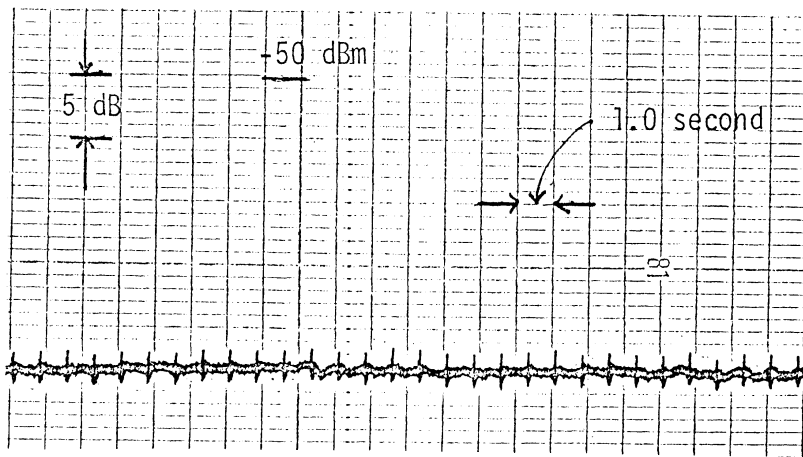

Figure 12. Received TV Channel 53 signal vs. time obtained at site 4 with the antenna pointing toward the WT. Blade rotation frequency ~ 30 rpm; WT-to-receiver distance = 0.37 km.