

UMTRI-83-25

COMPARATIVE STUDY OF VEHICLE ROLL STABILITY

Final Report

Contract No. FH-11-9577

Phase V

T.D. Gillespie

R.D. Ervin

May 1983

Technical Report Documentation Page

1. Report No.		2. Government Accession No.		3. Recipient's Catalog No.	
4. Title and Subtitle COMPARATIVE STUDY OF VEHICLE ROLL STABILITY				5. Report Date May 1983	
				6. Performing Organization Code	
7. Author(s) T.D. Gillespie and R.D. Ervin				8. Performing Organization Report No. UMTRI-83-25	
9. Performing Organization Name and Address The University of Michigan Transportation Research Institute 2901 Baxter Road Ann Arbor, Michigan 48109				10. Work Unit No.	
				11. Contract or Grant No. FH-11-9577 (Phase V)	
12. Sponsoring Agency Name and Address U.S. Department of Transportation Federal Highway Administration Washington, D.C. 20590				13. Type of Report and Period Covered Final 2/18/83-5/18/83	
				14. Sponsoring Agency Code	
15. Supplementary Notes					
<p>16. Abstract</p> <p>The roll stability levels of a broad range of motor vehicles were determined using computer simulation. The input data needed for these calculations were obtained from both direct measurements and from previously published information. The vehicles of interest covered the range from subcompact passenger cars through heavy-duty truck combinations.</p> <p>The results are discussed in the light of two issues, namely:</p> <ol style="list-style-type: none"> 1) the roll stability levels of step-van-type trucks used by the bakery industry relative to the stability levels of other vehicles and 2) the influence of width parameters on the roll stability of heavy truck combinations. 					
17. Key Words roll stability, passenger cars, light trucks, bakery trucks, heavy-duty trucks				18. Distribution Statement UNLIMITED	
19. Security Classif. (of this report) NONE		20. Security Classif. (of this page) NONE		21. No. of Pages 46	22. Price

TABLE OF CONTENTS

Chapter		
1	INTRODUCTION.	1
	1.1 Statement of the Problem	1
	1.2 Project Objectives	2
	1.3 Scope.	3
	1.4 Report Organization.	3
2	MECHANICS OF ROLLOVER	4
	2.1 Basics of Rollover	4
	2.2 Definition of the Rollover Threshold	6
	2.3 Suspension Compliance.	7
	2.4 Tire Compliance.	9
	2.5 Multiple Axles	9
	2.6 Tire/Suspension Lateral Compliance	11
	2.7 Simulation of Rollover	11
3	ANALYSIS AND FINDINGS	13
	3.1 Vehicle Parameter Data	13
	3.2 Results - Rollover Thresholds.	20
4	INTERPRETATION AND CONCLUSIONS.	27
	REFERENCES	34
	APPENDIX A - DESCRIPTION OF SIMULATED VEHICLES	35
	(PASSENGER CARS THROUGH STEP-VANS)	

ACKNOWLEDGEMENTS

The authors wish to acknowledge the individuals and organizations who cooperated in this project by providing access to typical vehicles for study. Specifically, we wish to thank:

- Mr. Ira Dorfman of the American Bakers Association for initiating contacts with the bakeries using such trucks
- Mr. Carl Vass of the American Bakeries Company, Taystee Division, Detroit, for loan of a delivery truck in the 10,000 lb GVW class
- Mr. Duane McLain of the ITT Continental Baking Company, Detroit, for loan of a delivery truck in the 15,000 lb GVW class.

CHAPTER 1

INTRODUCTION

This document constitutes a report to the U.S. Department of Transportation, Federal Highway Administration under Contract Number DOT-FH-11-9577. All work was performed by The University of Michigan Transportation Research Institute in the period of February through May 1983.

1.1 Statement of the Problem

The current trend in the trucking industry is one which strongly supports increased truck size and weight limits. Two recent developments are indicative of this trend. First, the Surface Transportation Assistance Act, which was signed by the President on January 6, 1983, contains provisions to permit 102-inch- (259-cm)-wide vehicles on highways having lane widths of 12 feet or more. Secondly, the Federal Highway Administration's Bureau of Motor Carrier Safety (BMCS), which enforces the Federal Motor Carrier Safety Regulations (FMCSR), was just recently petitioned by the bakery products industry to expand the exemptions provided in Section 391.62(a) of the FMCSR. The petitioner has requested that this exemption, which exempts vehicles of 10,000 pounds (4.5 m tons) or less from several regulatory requirements to be expanded to include vehicles up to 15,000 pounds (6.8 m tons).

Due to the trend of increased vehicle sizes and weights, the Federal Government has recognized the need to scientifically investigate the safety implications of the shift to larger vehicles. One such safety-related aspect that must be explored is vehicle roll instability.

Vehicle roll instability can be precipitated either from steering maneuvers on a smooth, level roadway, or from running off the road.

CHAPTER 1

INTRODUCTION

This document constitutes a report to the U.S. Department of Transportation, Federal Highway Administration under Contract Number DOT-FH-11-9577. All work was performed by The University of Michigan Transportation Research Institute in the period of February through May 1983.

1.1 Statement of the Problem

The current trend in the trucking industry is one which strongly supports increased truck size and weight limits. Two recent developments are indicative of this trend. First, the 1983 Department of Transportation Appropriations Act, which was signed by the President on December 20, 1982, contains provisions to permit 102-inch- (259-cm)-wide vehicles on designated highways. Secondly, the Federal Highway Administration's Bureau of Motor Carrier Safety (BMCS), which enforces the Federal Motor Carrier Safety Regulations (FMCSR), was just recently petitioned by the bakery products industry to expand the exemptions provided in Section 391.62(a) of the FMCSR. The petitioner has requested that this exemption, which exempts vehicles of 10,000 pounds (4.5 m tons) or less from several regulatory requirements to be expanded to include vehicles up to 15,000 pounds (6.8 m tons).

Due to the trend of increased vehicle sizes and weights, the Federal Government has recognized the need to scientifically investigate the safety implications of the shift to larger vehicles. One such safety-related aspect that must be explored is vehicle roll instability.

Vehicle roll instability can be precipitated either from steering maneuvers on a smooth, level roadway, or from running off the road.

The inherent susceptibility of a given vehicle to rollover can be described, in engineering terms, by a measure called the "rollover threshold" which is expressed in g's of lateral acceleration needed to initiate an unstable roll motion. A distinct relationship between the rollover threshold of tractor-semitrailers and the number of rollover accidents was established by Ervin, et al. [1] through a review of 1976-78 BMCS accident data. It has also been determined that some vehicle types are significantly more susceptible to rollover than others. There are many instances where typical passenger cars can successfully execute cornering maneuvers that several types of trucks and tractor-trailer combinations cannot. That is due, in part, to the high location of the center of gravity on typical loaded commercial vehicles.

This research program was directed toward predictions of the rollover threshold for various vehicle types, with special emphasis on bakery-delivery vehicles in the Gross Vehicle Weight Rating (GVWR) range of 10,000 to 15,000 pounds. This information will be of value to the BMCS in its consideration of the merits of the specific petition mentioned above, as well as in other matters.

Also, there is concern for the means by which the American trucking industry will implement the new allowance for 102-inch (259-cm) width vehicles on the Federal highway system. Since a primary safety aspect of the width change entails the question of roll stability, this study also addressed the roll stability of heavy-duty trucks as influenced by width variations. In addition, the examination of heavy-duty vehicles, together with light-duty vehicles, serves to bracket the roll stability properties of the overall vehicle population so that the stability level of the bakery delivery vehicles can be seen in perspective.

1.2 Project Objectives

The objectives of this project were to determine reasonable estimates of the rollover thresholds of various vehicles as a basis for comparing vehicles and predicting safety implications.

1.3 Scope

The project scope was limited to determination of the rollover thresholds, by means of computer simulation, for the following vehicles:

- 1) Passenger Sedan - One subcompact and one full-size sedan, both having a full load of passengers and luggage.
- 2) Passenger Van - Eight passengers with luggage.
- 3) Pickup Truck - Half-ton rated truck with 750 lbs (341 kg) payload centered 24 inches (61 cm) above the bed.
- 4) Step Van - Rated at 10,000 lbs (4.5 m tons) GVWR and loaded with typical bakery products to 10,000 lbs (4.5 m tons).
- 5) Step Van - Rated at 15,000 lbs (6.8 m tons) GVWR and loaded with typical bakery products to 15,000 lbs (6.8 m tons).
- 6) Straight Truck - Rated at 10,000 lbs (4.5 m tons) GVWR and loaded to 10,000 lbs (4.5 m tons) with a load centered 24 inches (61 cm) above the bed.
- 7) Tractor-Semitrailer - Three-axle power unit coupled to a two-axle, 45-ft (13.7 m) semitrailer—eight cases having differing width dimensions and loading conditions.
- 8) Double - Two-axle power unit coupled to two single-axle, 27-ft (8.2 m) semitrailers—three cases having differing width dimensions.

For those vehicle types for which rollover thresholds have been determined previously, the previous data are reported here. Specifically, the rollover thresholds for the combination vehicles (vehicles 7 and 8 above) have been obtained from previous work [2].

1.4 Report Organization

This report documents the work described above. Chapter 2 presents a description of the rollover process as background for the reader. Chapter 3 describes the vehicles analyzed and presents the rollover thresholds that were calculated. Chapter 4 contains the conclusions and recommendations from this work.

CHAPTER 2
MECHANICS OF ROLLOVER

The rollover of a motor vehicle involves a mechanical process that can be modeled with varying degrees of sophistication. The degree of sophistication necessary to accurately represent the rollover process with a specific vehicle depends to some extent on the vehicle type and its properties.

2.1 Basics of Rollover

The most fundamental model for vehicle rollover is the "quasi-static rigid body" model illustrated in Figure 1. Treating the vehicle as a rigid body, and summing moments about the outside wheels, the rollover threshold can be described by the ratio of the moments arising from lateral and gravitational forces. The gravitational force (i.e., the weight of the vehicle) always acts downward to hold the vehicle firmly against the ground. The lateral force, arising from the lateral acceleration due to cornering, acts at the center of mass above the ground, resulting in a moment on the vehicle that attempts to roll it over. As long as the resultant of the two forces falls inside of the outer wheels, the vehicle is stable in roll. However, when the lateral acceleration is large enough that the resultant force passes outside of the outer wheel, the net force on the vehicle will cause it to begin to roll. As roll angle builds up, the resisting moment produced by the vehicle's weight decreases because of the movement of its mass toward the outer wheels. The value of lateral acceleration needed to hold the vehicle at a given value of roll angle is illustrated in Figure 1b. Being a rigid body, no roll occurs until the lateral acceleration is increased to the level of " $T/2h$," at which point the inside wheels lift off the ground. Thereafter, with any increase of roll angle, less and

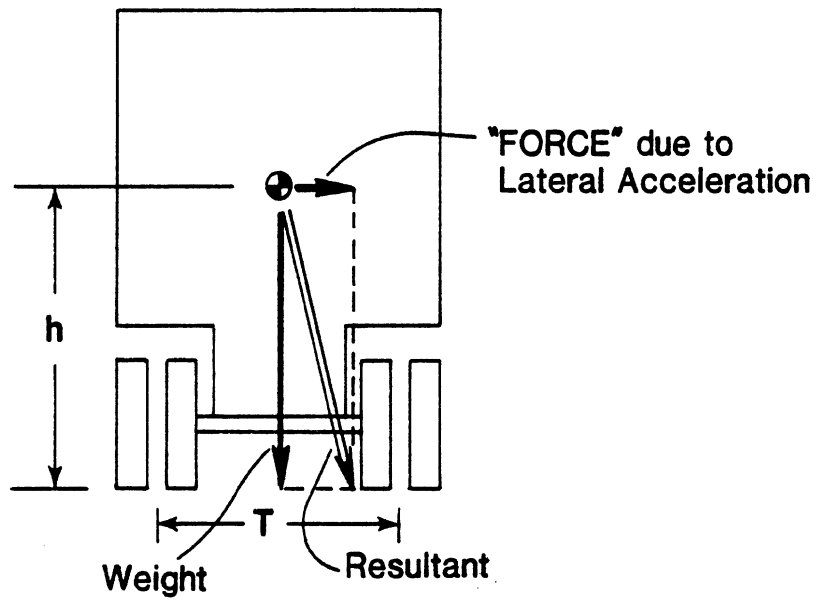

Figure 1a. "Rigid-body" rollover model.

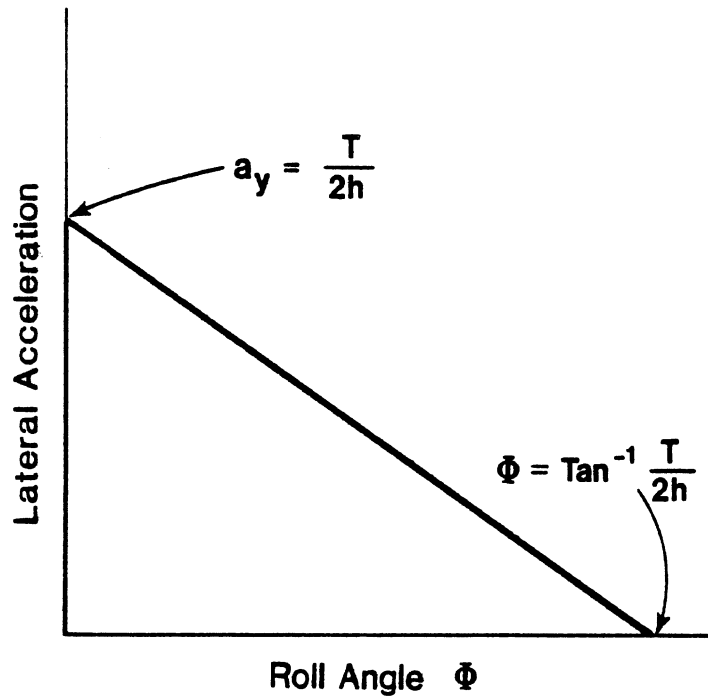

Figure 1b. Lateral acceleration versus roll angle for a rigid-body model.

less lateral acceleration is necessary to hold the vehicle in balance, up to the angle whose tangent is equal to " $T/2h$." At this point, the center of mass is exactly over the outside wheels, and the "necessary" level of lateral acceleration is zero. Beyond this point, rollover is only prevented by a negative lateral acceleration on the vehicle.

2.2 Definition of the Rollover Threshold

In this simple explanation of the rollover process, the lateral acceleration necessary to "balance" the vehicle in various roll positions has been described. Thus the plot in Figure 1b represents a "quasi-static" process. In actual maneuvering situations, rollover of the rigid vehicle would occur when the lateral acceleration builds up to the critical level, $T/2h$, that initiates rolling, beyond which the vehicle itself will accelerate in roll unless the lateral acceleration is decreased concurrently. Normally, the rollover threshold is defined by the peak value of lateral acceleration that is needed to bring the vehicle to the point of initiating roll instability, on the assumption that lateral acceleration levels do not change rapidly enough to prevent the roll process from proceeding to its conclusion. Certainly, once the vehicle has rolled past the critical angle ($\arctan T/2h$) it has passed the point of no return, and it is virtually impossible to prevent a completed rollover. With large vehicles having a high center of gravity, the critical angle is relatively small; thus, the vehicle quickly reaches the point of no return. This, in combination with the fact that large vehicles cannot be maneuvered quickly, makes it reasonable to consider this peak lateral acceleration value as the effective threshold level beyond which complete rollover will generally occur. For comparison purposes, the same criterion may be applied to smaller vehicles, such as passenger cars, although it is academically possible to recover from a rollover condition with the smaller vehicles (e.g., stunt drivers routinely drive passenger cars up on two wheels—literally at the critical angle).

2.3 Suspension Compliance

As the next step in developing a realistic understanding of the rollover process, it is necessary to consider the additional mechanisms that may exert a significant influence on the rollover limits of a vehicle. First among these is the influence of the vehicle body rolling on the suspension system. Figure 2 illustrates the roll process when roll compliance in the vehicle suspension is considered. Under the action of a lateral acceleration, the sprung mass rolls about the "roll center" of the suspension system. Although this motion is resisted by the roll stiffness of the suspension system(s), the lateral shift of the center of mass places it closer to the outside wheel, thus reducing the lever arm available for the gravitational force resisting rollover. The effect of suspension roll compliance is illustrated in the plot of Figure 2b. The plot of lateral acceleration versus roll angle is now modified, in that roll angle of the sprung mass increases with lateral acceleration, along a line determined by the roll stiffness of the suspension system(s). The rollover threshold occurs where this line intersects the rigid body roll line which, for this simple model, will be coincident with the point where the inside wheels lift off the ground. Thus, the rollover threshold with suspension compliance will always be less than that estimated for the rigid vehicle. The reduction will normally be in the range of 5 percent to 20 percent of the "rigid" model value, depending on the properties of the vehicle.

It is notable that the representation shown in Figure 2b assumes linear suspension properties, regardless of whether the springs are in compression or tension. In actuality, the linear assumption is often not accurate for rollover of certain vehicles. Especially in the case of heavy commercial vehicles, it has been noted that the springs often go through a region of free motion in the transition from compression to tension (i.e., there is a 1- or 2-inch (2.5 to 5 cm) gap between the pads contacted by the springs in the compression and tension directions). The effect of this gap, which has been termed "suspension lash," is to create an offset in the roll curve at the point where the springs convert to the tension mode, as shown in Figure 2b. At this point, the

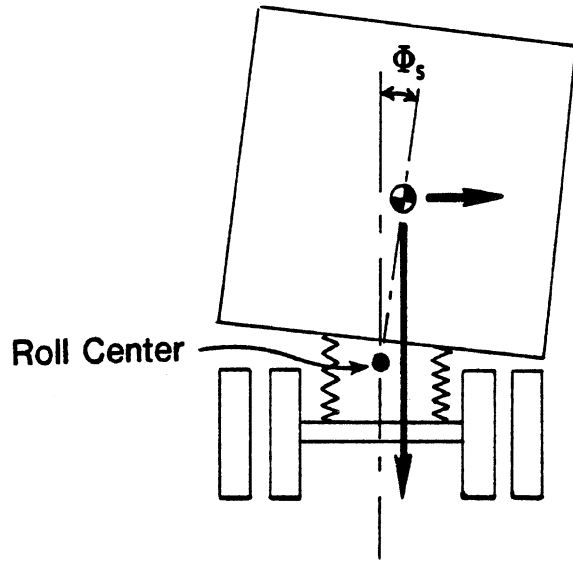

Figure 2a. Roll model for a vehicle with suspension compliance.

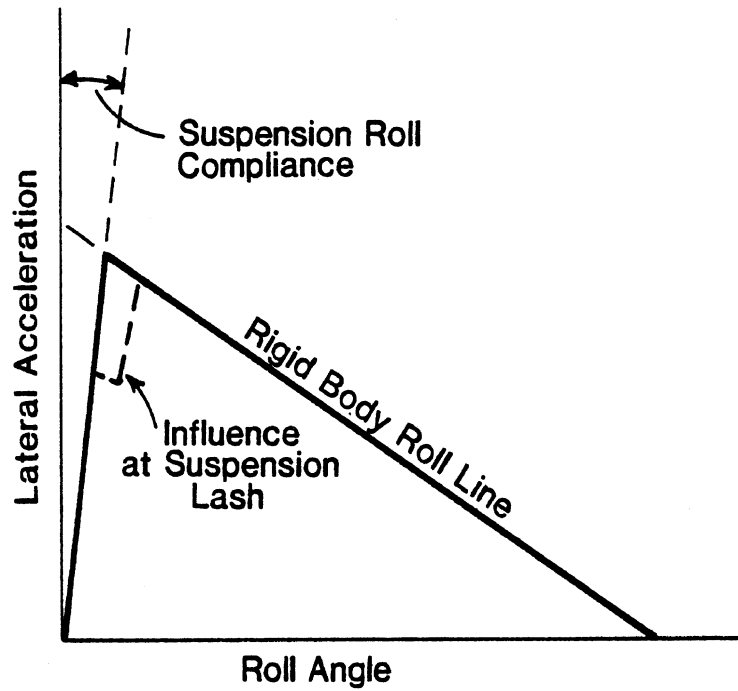

Figure 2b. Lateral acceleration versus roll angle for a vehicle with suspension compliance.

sprung mass goes through additional roll angle without significant change in the lateral acceleration, thus degrading the rollover threshold as evident in the Figure.

2.4 Tire Compliance

Pneumatic tires are not perfectly rigid, but act as springs allowing roll motion to occur just as does the suspension system. The tires, in effect, act as an additional roll compliance in series with the suspension system. Thus, tire compliance further reduces the effective stiffness during the initial phase of rolling. Taking tire compliance into account is equivalent to reducing the slope of the roll line that was shown in Figure 2b. Tire compliance normally yields a further reduction of rollover threshold by about 5 to 10 percent.

2.5 Multiple Axles

Thus far, rollover has been discussed as if the vehicle could be represented as a planar model (i.e., neglecting the fact that it has length, with the load distributed on a number of axles). The three-dimensional representation of a vehicle, however, is necessary when all axles do not have roll stiffness properties in proportion to the load carried by each. Recognition of this effect is especially important with combination vehicles where disproportionate roll stiffness properties, and torsional compliance of the vehicle chassis, come into play allowing one axle to lift its wheels while others are still on the ground. Extrapolating from the understanding of the planar model seen in Figure 2, Figure 3 shows the roll curve for a three-axle combination vehicle. The dashed lines represent the roll stiffness properties of the three separate axles resulting from the suspension and tire compliances of each. The total curve for the vehicle is that which is indicated by the solid line. Note that the curve exhibits a positive slope only while the tires on the tractor rear and trailer axles are on the ground. Thus, the rollover threshold is reached when the inside tires on both of these axles lift off. Even though the tires on the front axle remain on the ground for some additional roll angle, the

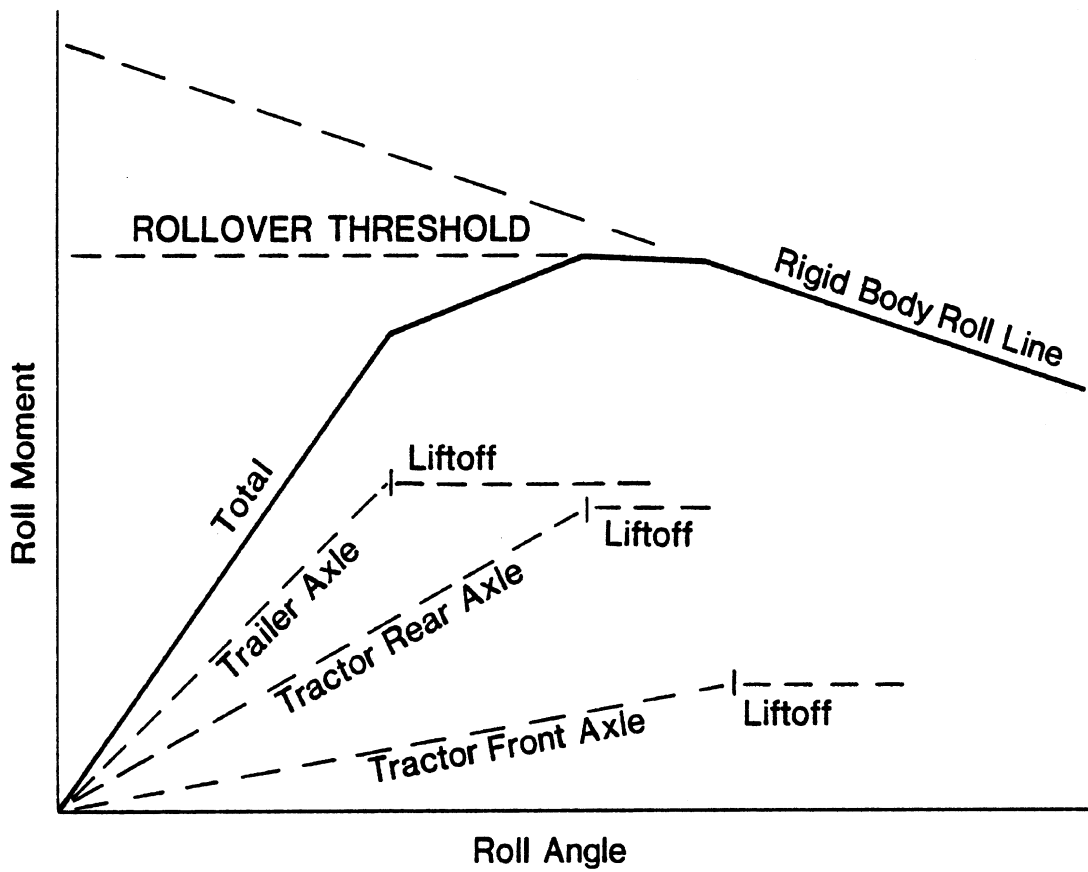

Figure 3. Roll moment versus angle for a three-axle tractor-semitrailer.

resisting moment arising from the front axle increases more slowly than the roll moment caused by the lateral shift of the center of mass. Thus, rollover begins while the front wheels are yet on the ground. As before, the rollover threshold is equivalent to the peak value of lateral acceleration observed on the curve.

2.6 Tire/Suspension Lateral Compliance

The last mechanisms that can be of some significance to rollover threshold are the lateral compliance properties of the tires and suspension systems. Rollover occurs only in the presence of substantial lateral forces imposed on the vehicle at the tires. If the effective contact point of the tire deflects sideways (toward the center of the vehicle), the effect is equivalent to additional lateral movement of the center of mass. Although lateral movement of the tire contact points might at first seem negligible, that is not always true. In the case of dual wheels, if the inner tire lifts from the ground, the rotation must occur about the outer tire, and the effective track of the vehicle is changed significantly. Similarly, the tires and suspension systems may deflect inward, reducing the effective track width. Lateral deflection tends to increase the downward slope of the rigid-body line. Counteracting this effect is the tendency for the center of the tire's vertical force reaction to move toward the outside of the tire tread, with an increase in the moment that resists rollover as the wheel cambers. If dual wheels are present, the effective contact point moves outward, as rolling proceeds, until only the outermost tire is involved in determining this point.

2.7 Simulation of Rollover

The calculation of rollover such as those shown in the figures are tedious when all the appropriate effects are taken into account. As an aid for determining rollover thresholds, computer simulation models have been prepared to actually perform the calculations. The simulation model used in this project is identified as the UMTRI "Static Rollover Model." Details of the program are described in Reference [3]. The

simulation model incorporates the various mechanisms described above, calculating the rollover threshold by incrementing the roll angle on a vehicle until the point of instability is reached. The calculations are "quasi-static" in nature, meaning that dynamic phenomena are not considered. In essence, the rollover threshold predicted by the simulation, and discussed in subsequent sections of this report, are representative of the rollover limits that would be experienced in steady-turning maneuvers (in contrast to transient maneuvers such as lane changes, etc.).

simulation model incorporates the various mechanisms described above, calculating the rollover threshold by incrementing the roll angle on a vehicle until the point of instability is reached. It should be recognized that the calculated thresholds are "quasi-static" in nature. That is, the absolute levels would be representative of the rollover limits that would be experienced in steady-turning maneuvers. This measure of vehicle performance with respect to rollover resistance does not include dynamic phenomena. Nevertheless, it appears to be the best fundamental measure of rollover resistance for comparing vehicles and has been closely correlated with the rollover accident experience of heavy-duty vehicles.

CHAPTER 3

ANALYSIS AND FINDINGS

The approach taken in this research was limited to examination of the rollover thresholds for step-van utility vehicles, and comparison to thresholds for other typical vehicles. To accomplish this, it was first necessary to determine the relevant properties of each vehicle as would affect the rollover behavior. The properties were then reduced to lists of input data needed to run the UMTRI Static Rollover Model, with which the rollover thresholds were calculated. This chapter of the report discusses the way in which parameter data were obtained for each vehicle, and presents the results of the calculations of rollover threshold.

3.1 Vehicle Parameter Data

In order to model the vehicles for rollover calculations, it was necessary to obtain data in the nature of:

- 1) Mass properties and locations - Sprung and unsprung mass values, c.g. heights for each mass, and fore/aft locations of the sprung masses
- 2) Suspension properties - Vertical spring rates, lateral spread between leaf springs, roll center heights, and auxiliary roll stiffnesses
- 3) Tire properties - Track width, tire vertical stiffnesses, dual wheel spacings, and tire radius.

The sources for the information in each case varied, some coming from data already available at the Institute, and others obtained by examination and testing of actual vehicles. The sources of information on each vehicle type are described below, with the actual parametric values listed in Appendix A.

3.1.1 Passenger Cars. The rollover thresholds for passenger cars provide a reference point for comparison of other vehicles. Data for two passenger sedans were obtained in this study. The vehicles were a 1970 Lincoln Continental and a 1979 Honda Civic. The Lincoln is typical of the larger luxury cars popular in the U.S. in the past. It has a common chassis design utilizing an independent front suspension, and a solid rear axle. Though representing the upper end of the range in terms of length, width, and weight, it is approximately equivalent to all other passenger cars in height (and hence vertical c.g. location). Data for the Lincoln with a four-passenger load were obtained from reference documents within the Institute. The Honda Civic is typical of the other extreme in passenger car size—being a subcompact. While such vehicles generally fit within the same overall height envelope as the larger cars, they are normally narrower in the body and track width. The other major distinction is the use of four-wheel independent suspension. Data for the Honda Civic were obtained from a parameter measurement task associated with the DOT/FHWA project in Reference [4]. The data included the sprung and unsprung mass values, their locations, suspension vertical rates and roll stiffnesses, and geometric properties such as track width and payload locations. Tire vertical stiffness was estimated from the following equation [5]:

$$K_t = 2.6P\sqrt{(SW)(D)} + 40 SW$$

where

- K_t = tire vertical stiffness (lb/in)
- P = inflation pressure (psi)
- SW = tire section width (in)
- D = tire diameter (in)

Data on the section width and diameter of the tires were obtained from the Tire and Rim Association Handbook.

The parameters for the Honda Civic were then adjusted for a 750-lb (341-kg) load (four passengers at 150 lb (68 kg) each plus 150 lb (68 kg) of luggage). Parametric data for the Lincoln and the Honda Civic are listed in Appendix A.

3.1.2 Passenger Van. Data for a 1979 Dodge van were obtained from the measurements made in the cited DOT project. The Dodge van is typical in height, width, length, and weight of those produced by all of the major manufacturers in the U.S. It has an independent front suspension, with a solid rear axle supporting a leaf spring rear suspension. As with the Honda, certain geometric properties were measured directly and the tire vertical stiffness values were calculated according to the above equation. Since the van was not outfitted as a passenger vehicle, the parameter values were adjusted to reflect the addition of two bench seats, eight passengers (1,200 lb (545 kg)), and 240 lb (109 kg) of luggage. Data for the Dodge van are listed in Appendix A.

3.1.3 Pickup Truck. Data for a 1979 Ford F-150 pickup truck were obtained from the DOT parameter measurements. This vehicle incorporated the Ford twin I-beam suspension, and a solid rear axle with leaf spring suspension. The vehicle had a conventional 8-ft (2.4-m) pickup bed mounted on the back. Geometric and tire properties were obtained as described above. Parameter values were adjusted to represent a 750-lb (341-kg) load whose c.g. was located 24 inches (61 cm) above the bed. Parameter data for this vehicle are listed in Appendix A.

3.1.4 10,000-lb GVW Step Van. Arrangements were made through the American Bakeries Company in the Detroit area to obtain a step-van utility vehicle for measurement of the needed properties. The authors visited one of the Company's local terminals to become familiar with typical bakery delivery vehicles, and the loading practices used. A utility van built on a 1977 Chevrolet chassis was selected as representative of the 10,000-lb (4.5 m-tons) GVW vehicles, and was loaned to the Institute for a period of three days. A photograph of the vehicle is shown in Figure 4. The vehicle has a 157-inch (399-cm) wheelbase with an independent front suspension, and the common rigid rear axle with leaf spring suspension. The rear axle utilizes dual wheels, although they do not extend to the full 96-inch (244-cm) width which is allowed

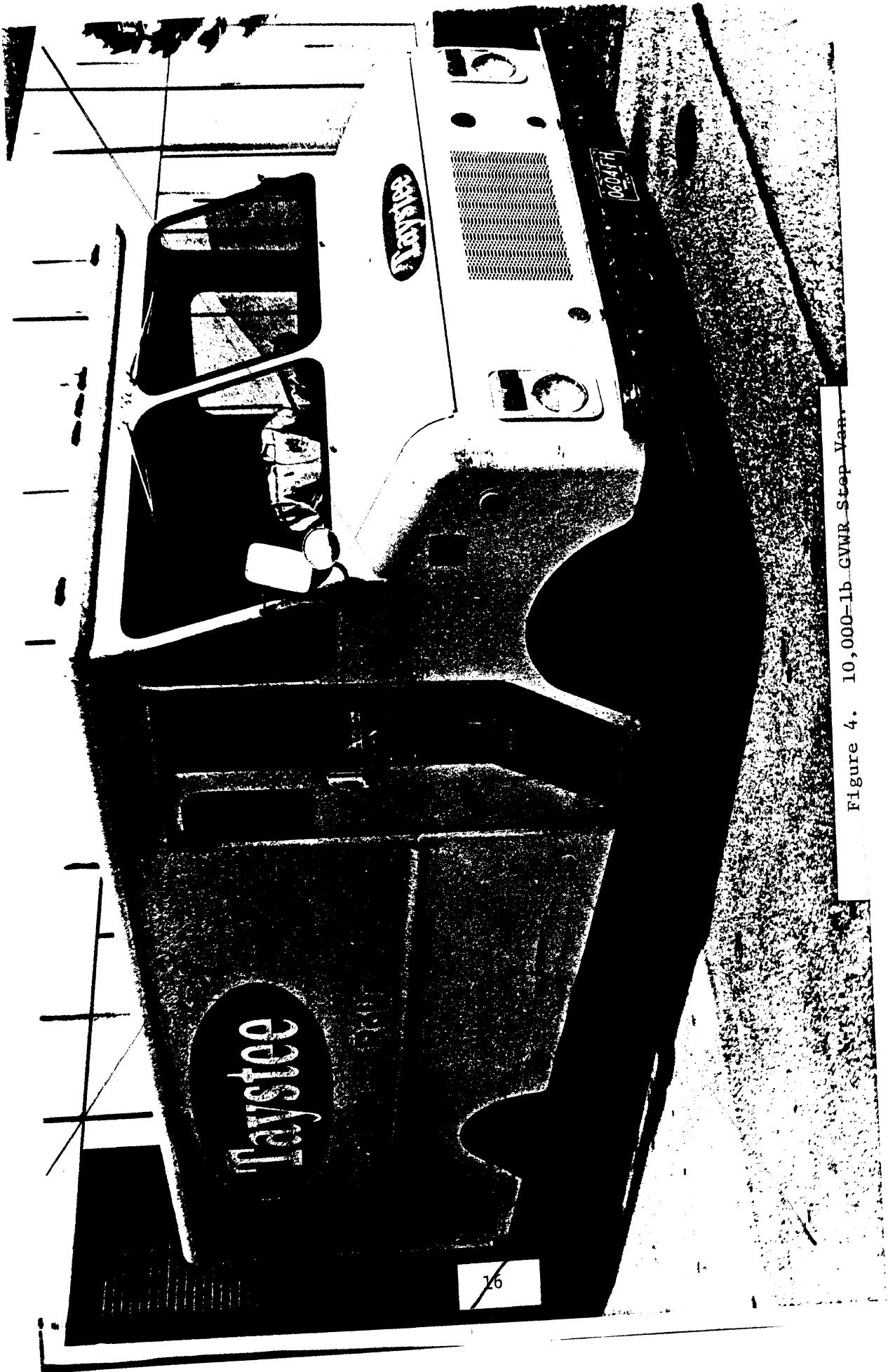

Figure 4. 10,000-lb GVWR Step-Van.

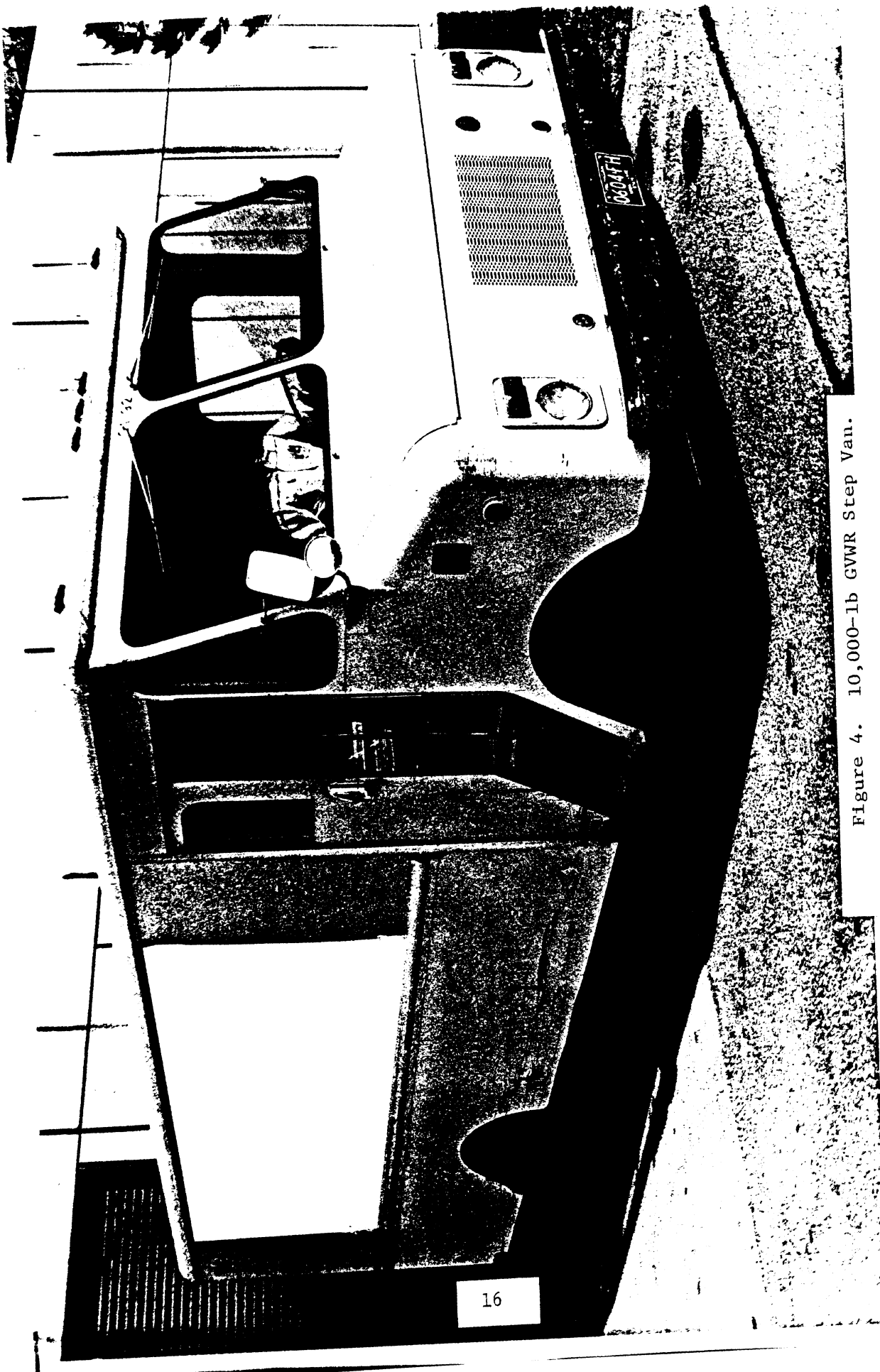

Figure 4. 10,000-lb GVWR Step Van.

for the vehicle. The vocational body is 96 inches (244 cm) in overall width, 70 inches (178 cm) from floor to ceiling, with a 14-foot (4.3-m) length of the load area and a capacity of 280 "trays" of bakery product. While at the Institute, the vehicle was weighed and its c.g. properties were measured on the UMTRI Pitch Plane Inertia Swing (see Figure 5). Concurrently, detailed measurements of the suspension and spring geometry were made, as a basis for calculating the required mechanical properties. Suspension vertical rates and auxiliary roll stiffnesses were calculated from detailed measurements of the spring sizes and their locations. The values obtained were compared against typical data available from the manufacturer in their "Body Builders Drawings and Supporting Data" handbook which is made available to final stage manufacturers. The load added to the vehicle was selected to bring the vehicle up to its 10,000-lb (4.5-m tons) rated load. The center of gravity of the simulated payload was placed at the height of the midpoint of the loading racks used for bakery goods. Parametric data describing this vehicle are listed in Appendix A.

3.1.5 15,000-lb GVW Step Van. Arrangements were made through the ITT Continental Baking Company in the Detroit area for loan of a step-van in the 15,000-lb (6.8-m tons) GVW class. A van built on a 1976 Ford chassis was obtained, as shown in the photograph of Figure 6. The listed GVW for the vehicle was 14,200 lb (6.4 m tons). The van body was essentially equivalent to that of the 10,000-lb (4.5-m tons) GVW vehicle in its interior dimensions, although its capacity was given as 338 "trays" of bakery product, and the chassis was larger and heavier. This vehicle incorporated a solid front axle with leaf spring suspension, typical of larger trucks. Likewise, the rear axle was solid, also with a leaf spring suspension and dual wheels. Parameters for this vehicle were obtained in the same manner as described for the 10,000-lb (4.5-m ton) GVW step-van, and are also listed in Appendix A. The load on the 15,000-lb (6.8-m ton) van was chosen to bring the vehicle to its rated load of 14,200 lb (6.4 m tons), with the payload c.g. height centered at the midpoint of the loading racks for bakery products.

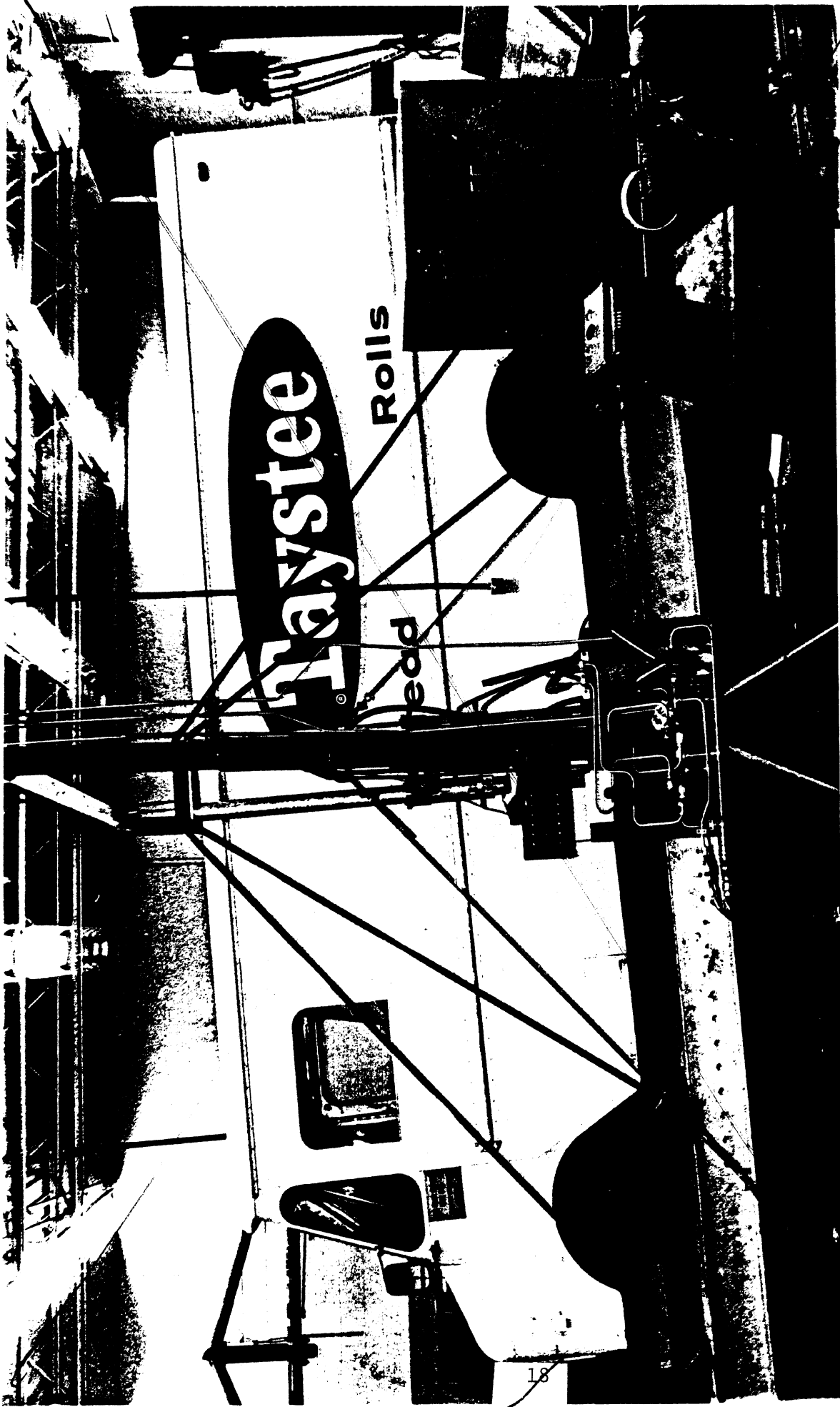

Figure 5. 10,000-lb GVWR Step Van on UMTRI Pitch Plane Inertia Swing

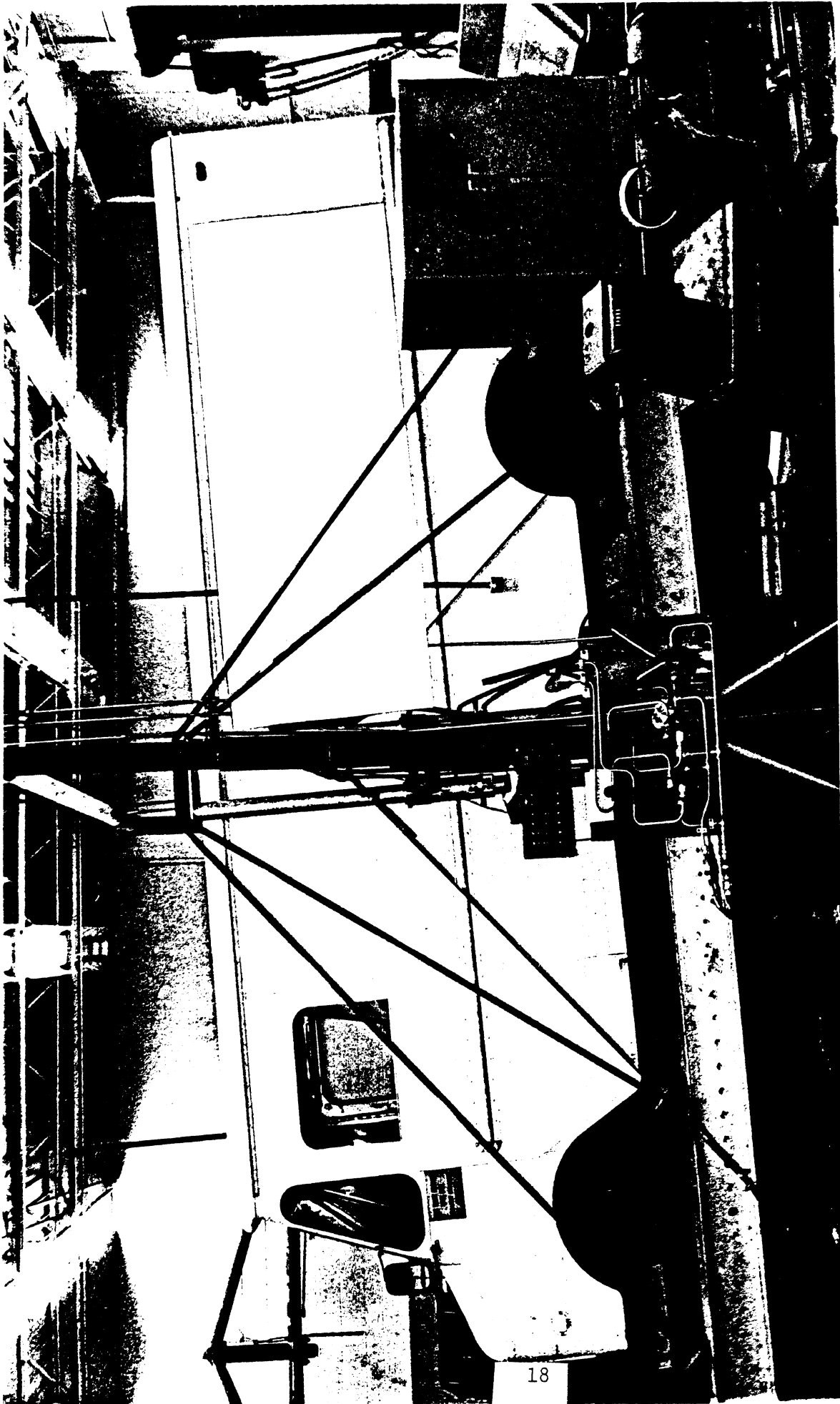

Figure 5. 10,000-lb GVWR Step Van on UMTRI Pitch Plane Inertia Swing

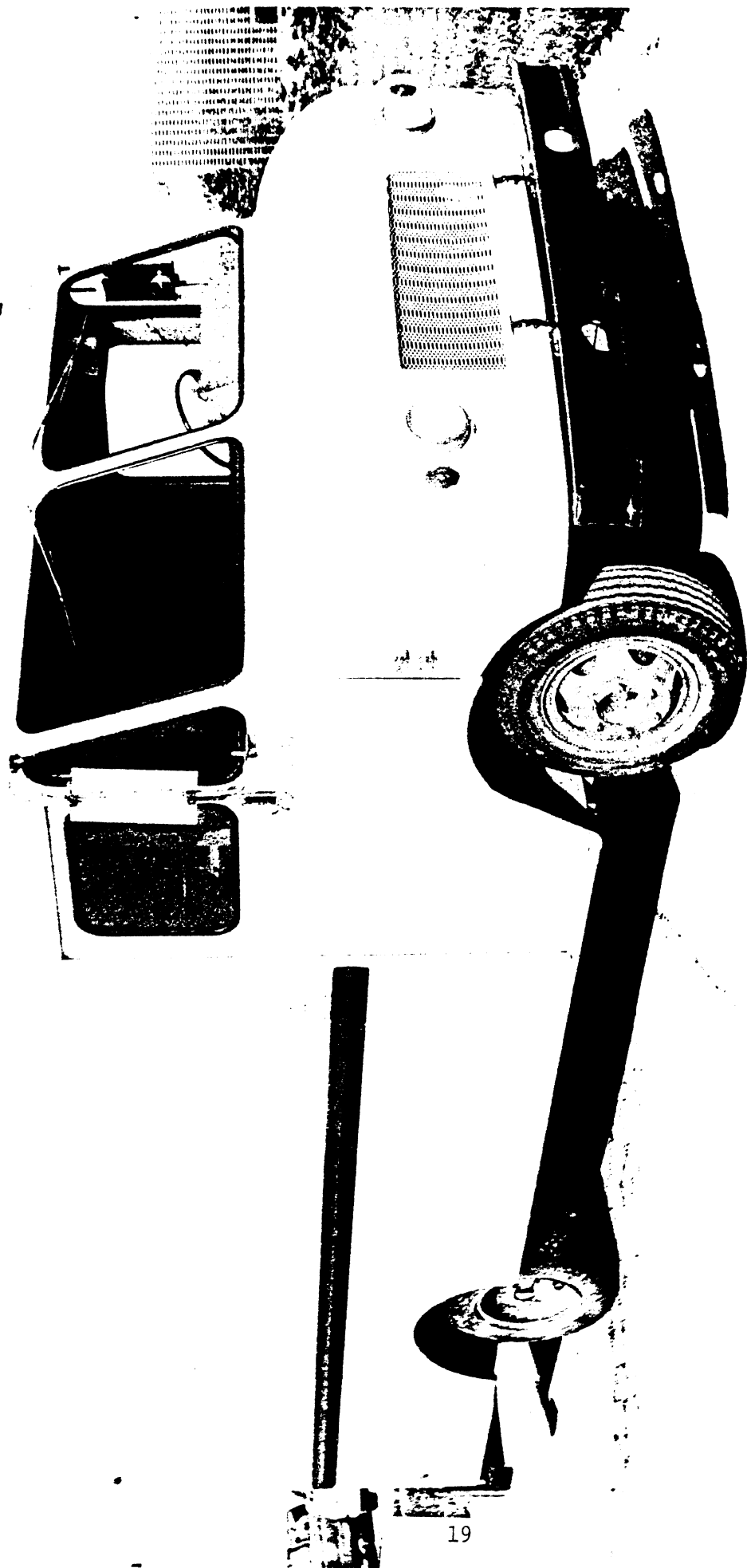

Figure 6. 15,000-lb GVWR Step Van

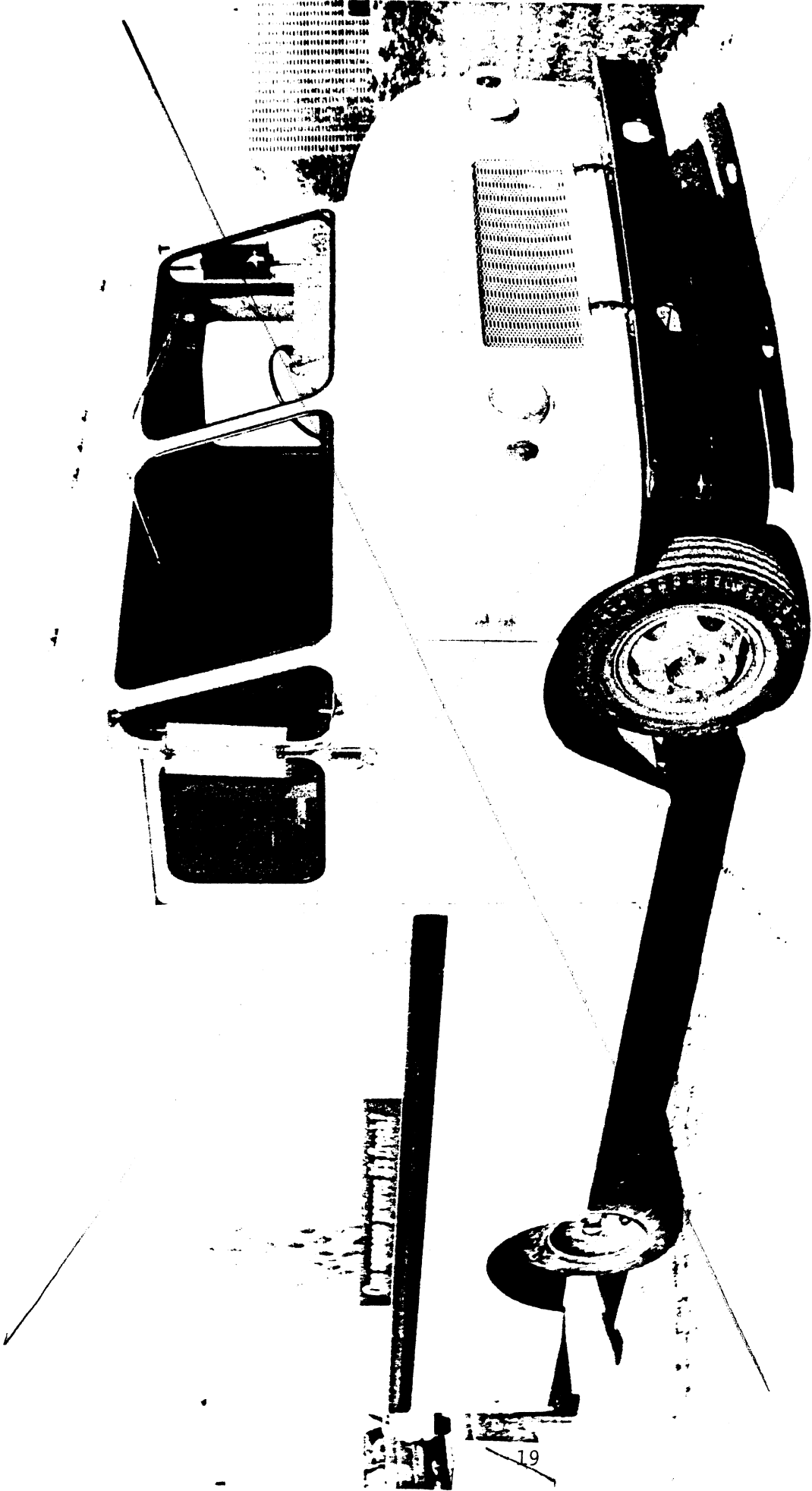

Figure 6. 15,000-lb GVWR Step Van

3.1.6 Straight Truck with 10,000-lb (4.5-m ton) GVWR. A 1975 Chevrolet straight truck in the Institute's vehicle pool was selected for this example. The truck has a 10,000-lb (4.5-m ton) GVW, and has a chassis essentially similar to that of the 10,000-lb (4.5-m ton) bakery van. The vehicle was weighed and geometric properties were measured. The c.g. values were estimated based on knowledge of comparable vehicles. A load was selected to bring the vehicle up to its full rating of 10,000 lb (4.5 m ton) and the load was positioned with its center 24 inches (61 cm) above the bed. Data for this vehicle are listed in Appendix A.

3.1.7 Heavy-Duty Truck Combination. Rollover thresholds for tractor-semitrailers and doubles combinations were specified as points of comparison for the bakery vehicles and as subjects for studying the implications of the 102-inch (259-cm) width allowance. The thresholds for these vehicles were determined in another FHWA research program entitled "Influence of Size and Weight Variables on the Stability and Control Properties of Heavy Trucks" [2]. The threshold values are simply quoted in this report, and the reader is directed to the cited reference for more details on their determination.

3.2 Results - Rollover Thresholds

The calculations from the Static Roll Model yield a great deal of information about the rollover process with each vehicle simulated. In this case, however, the only result of direct interest is the rollover threshold. The threshold is expressed in terms of lateral acceleration measured in units of g's (i.e., the fraction of the gravitational acceleration) at which rollover begins. As described in Chapter 2, the rollover threshold generally corresponds to the point at which most of the load-bearing wheels on one side of the vehicle lift off the ground. The results of the calculations of rollover threshold are summarized in Tables 1a and 1b, along with other summary information describing the vehicles.

Table 1a. Rollover Parameters for Selected Light-Duty Vehicles.

Model	Weight (lb)	C.G. Height (in) (Sprung Mass)	Track (in) Front	Track (in) Rear	Rollover Threshold
1979 Honda Civic with 750 lb passenger & luggage	2,449	22.93	52	51	1.01
1970 Lincoln Continental with four passengers	5,702	22.4	62	62	1.20
1979 Ford Pickup with 750 lb load centered 24" above bed	4,613	33.2	65.5	64.5	.90
1979 Dodge Van with 8 passengers and luggage	5,423	36.67	68.5	65	.85
Chevrolet Stake Truck with 4,120 lb load centered 24" above bed	10,000	48.26	66	64 w/dual wheels	.67
1977 Chevrolet Utility Van (bakery) with 2,760 lb product centered in van	10,000	48.75	65	63 w/dual wheels	.62
1976 Ford Utility Van (bakery) with 5180 lb product centered in van	14,200	52.5	76	67 w/dual wheels	.62

Table 1a. Rollover Parameters for Selected Light-Duty Vehicles.

Model	Weight (lb)	C.G. Height (in) (Sprung Mass)	Track (in) Front	Track (in) Rear	Rollover Threshold
1979 Honda Civic with 750 lb passenger & luggage	2,449	22.93	52	51	1.01
1970 Lincoln Continental with four passengers	5,702	22.4	62	62	1.20
1979 Ford Pickup with 750 lb load centered 24" above bed	4,613	33.2	65.5	64.5	.90
1979 Dodge Van with 8 passengers and luggage	5,423	36.67	68.5	65	.85
Chevrolet Stack Truck with 4,120 lb load centered 24" above bed	10,000	48.26	66	64 w/dual wheels	.67
1977 Chevrolet Utility Van (bakery) with 2,760 lb product centered in van	10,000	48.75	65	63 w/dual wheels	.62
1976 Ford Utility Van (bakery) with 5180 lb product centered in van	14,200	52.5	76	67 w/dual wheels	.62

Table 1b. Rollover Parameters for Selected Heavy-Duty Vehicles.

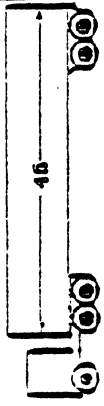
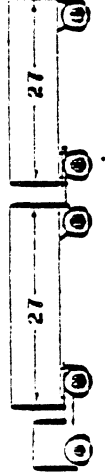
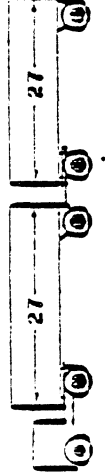
Case	Weight (lb)	Trailer Sprung Mass C.G. Hgt. (in)	Trailer Width Parameters (in)			Tractor Width (in)	Rollover Threshold (g's)
			W _B	W _S	W _T		
Medium Density Freight (~31 lb/ft ³) 	1	80,000	80.0	96	38	96	.348
	2	80,000	78.5	96	38	96	.358
	3	80,000	78.5	102	44	102	.379
	4	80,000	78.5	102	44	102	.412
Low Density Freight - Full Cube Load (~16.5 lb/ft ³) 	5	77,000	98.1	96	38	96	.244
	6	80,000	98.4	96	38	96	.238
	7	80,000	98.4	102	44	102	.261
	8	80,000	98.4	102	44	102	.281
Double Medium Density Freight (31 lb/ft ³) 	1	80,000	80.0	96	38	96	.376
	2	80,000	78.5	102	44	102	.404
	3	80,000	78.5	102	44	102	.441

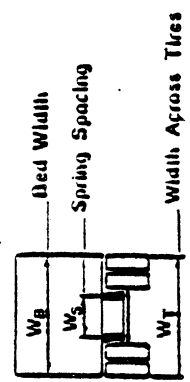

In general, the results indicate that passenger cars have the most favorable rollover thresholds, in the range of 1.0 to 1.2 g's of lateral acceleration necessary to produce rollover. Both the Honda Civic and the Lincoln Continental have nominally the same c.g. height, but the additional width of the Lincoln (seen in the front and rear track width of the wheels) yields a higher threshold value for that vehicle. Since the frictional coupling between the tire and the road typically limits the achievable lateral acceleration level on smooth pavement to 0.8 g or so, such vehicles cannot normally produce rollover on the roadway. Only under special circumstances, such as "tripping" on a curb or maneuvering on a cross-slope, would rollover be likely to occur.

The vehicle category which is ranked next in rollover threshold includes the light truck and van selections, with threshold levels in the range of 0.85 to 0.9 g's. Although the two selected vehicles were very similar in nominal size and width, the lower c.g. height represented on the pickup gives it a slightly higher value of rollover threshold than that seen on the van. Since, in these cases, the lateral acceleration required for rollover is much closer to that which can be achieved with tire/road frictional coupling, rollover would be expected to be more easily achieved on the highway.

The 10,000-lb (4.5-m ton) GVW stake truck and the two step-vans (bakery vehicles) fit into the same general range of rollover threshold, i.e., in the range of 0.6 to 0.7 g's. Note that the two utility vans examined are nominally identical in their rollover thresholds. Although the sprung mass on the larger 15,000-lb (6.8-m ton) van is higher (at 52.5 inches (133 cm)) than is that of the 10,000-lb (4.5-m ton) van (at 48.75 inches (124 cm)), the heavier vehicle is built on a chassis that provides a notably wider track at both the front and rear wheels. These two factors tend to compensate for one another, thus accounting for the same rollover threshold for the two vehicles. In general, the size and track of the chassis on light-to-medium trucks increases with the load rating, although there is no guarantee that vehicles in excess of 10,000 lb (4.5 m ton) will not be built on the narrower chassis, as was seen on

the 10,000-lb (4.5-m ton) GVW vehicle in this study. It may be anticipated that in such cases the rollover threshold will be decreased at least in proportion to the reduction of track width used. For example, the rollover threshold of the 15,000-lb (6.8-m ton) GVW vehicle would be expected to reduce from 0.62 to about 0.55 g if its track width were reduced to the values appearing on 10,000-lb (4.5-m ton) GVW chassis.

Moreover, these results pertaining to the stake truck and step-vans are of interest since vehicles having rollover thresholds in the range of 0.60 to 0.70 g can certainly be rolled over simply due to the impetus of tire traction forces on smooth pavement.

In Table 1b, the rollover threshold of selected heavy-duty vehicle cases are listed. These cases are generally intended to illustrate the various rollover threshold values which might attend differing implementations of a 102-inch (259-cm) width allowance. The tractor-semitrailer cases include two different loading scenarios. Cases 1 through 4 represent vehicles which are fully loaded with a medium density freight with which the vehicle reaches the 80,000-lb (36-m ton) gross weight limit. When the semitrailer is considered to be 96 inches (244 cm) wide, the composite sprung mass of the semitrailer, including the van body and the payload, is represented as having a c.g. height of 80 inches (203 cm). This c.g. location is thought to represent a large portion of the commercial trucking operations in the U.S. When the semitrailer body is widened to 102 inches (259 cm), the same freight assumes the lower c.g. height value of 78.5 inches (199 cm)

In cases 5 through 8, the vehicle is assumed to be loaded with a relatively low density freight such that the full cubic capacity of the trailer is utilized (less a 6-inch (15-cm) clearance space below the ceiling). The density of the freight is such that, in the 96-inch-(244-cm)-wide case, a gross weight of 77,000 lb (35 m tons) is attained. When the trailer is considered to be 102 inches (259 cm) wide, freight of this same density fills the container while yielding the maximum allowable gross weight condition of 80,000 lb (36 m tons). This loading scenario is seen as yielding the greatest c.g. height values which are attained

in normal trucking operations. As noted in Table 1b, the c.g. height of the composite sprung mass on the semitrailer in this case is slightly greater than 98 inches (249 cm). Note that this composite c.g. height is slightly higher in the 102-inch (259-cm) width cases due to the greater payload mass which, being carried at the elevated height, causes the center of gravity of the composite mass to rise.

The various cases represented in the table also are distinguished by the dimensions describing the nominal width of the load bed, W_B , spring spacing, W_S , and the width across the outside of the tires, W_T . Also, the tractor width is considered to have a dimension of either 96 or 102 inches (244 or 259 cm), with the tractor spring spacings extended accordingly. Cases involving the double represent the medium-density freight condition only and illustrate width variations on trailer (and dolly) hardware as well as on the tractor.

We see from the calculated values of rollover threshold that the heavy-duty vehicles show rollover thresholds which range from .24 to .44 g, for the cases considered here. Further, the extensions in width from 96 to 102 inches (244 to 259 cm) constitute means for substantial improvements in roll stability. We note that the improvement is sequential in the sense that widening the trailer axles and springs affords a certain increase in stability while widening the tractor axles affords an additional increase beyond that.

In the case of the double, we see significantly differing rollover thresholds on the first and second unit of the combination (that is, on the tractor-semitrailer and full trailer units, respectively). Note that it is worthwhile to distinguish between the roll stability of the two units since the pintle hook device which couples these two units together permits the front and rear trailers to roll independently of one another. A difference in the rollover thresholds of the two units is particularly pronounced in the widened-trailer case, No. 2, in which both the dolly and trailer axles were widened, thus making a greater improvement in the roll stability of the full trailer than in the tractor-semitrailer unit. With the widening of the tractor in Case 3, the roll stability of the

tractor-semitrailer is improved so as to slightly exceed that of the full trailer. As will be shown in the next chapter, improvement in the roll stability of heavy vehicles is thought to have strong implications for the likelihood of rollover accidents in service.

In using the above results, the reader should note that the reported values of rollover threshold are only estimates based on mathematical models. In general, these models have proved capable of predicting thresholds to within a few percent of that which was measured experimentally. However, errors of a larger magnitude can result from inaccuracies in specification of the input data. For the above calculations, those errors are expected to be well within 10 percent of the reported value for the rollover threshold. Thus, at worst, the limits for the two utility vans of interest would not be greater than .68 g nor less than 0.56 g, thus still placing their rollover thresholds below the pickup/van category and well above that of the heavy-duty vehicles. Because of the very limited sample size that was used in the study, no statements can be made as to the range of performance that can be expected from the populations of each of the respective categories of vehicles. The values reported are believed to be representative of typical vehicles, although there could exist certain vehicles which have significantly different performance limits.

CHAPTER 4

INTERPRETATIONS AND CONCLUSIONS

With regard to the issue of differing-style bakery trucks, it may be stated that

1) the expected rollover threshold for bakery trucks in the 10,000-lb (4.5-m ton) GVW class will be in the nominal range of 0.6 to 0.7 g's of lateral acceleration when loaded, and

2) the expected rollover threshold of bakery trucks in the 15,000-lb (6.8-m ton) GVW class will be in the same range if such vehicles are built on heavier chassis incorporating a track width near the 96-inch (244-cm) allowable limit. Thus, from a rollover standpoint, the two classes of bakery vehicles are seen as being equivalent, given the condition on track width stated above.

Inasmuch as the vehicles are being compared only on the basis of their rollover resistance, the key question is—What is the significance of rollover threshold to accident frequency, and hence safety?

For tractor-trailer vehicles, the rollover threshold has been found to relate closely to the frequency of rollover in single-vehicle accidents, as shown in Figure 7. This curve derived from accident data reported to the Bureau of Motor Carrier Safety (BMCS) of the U.S. Department of Transportation over the years 1976 through 1979. The figure shows that a remarkable correlation exists between the percent of rollovers occurring among single-vehicle accidents* (SVA) involving tractor-semitrailers and the rollover threshold of each vehicle. This plot represents some 9,000

*The accident data are plotted in this percentage fashion in order to express an accident rate-type of measure and also because rollover events are recorded in the BMCS data file only if they occur in single-vehicle accidents.

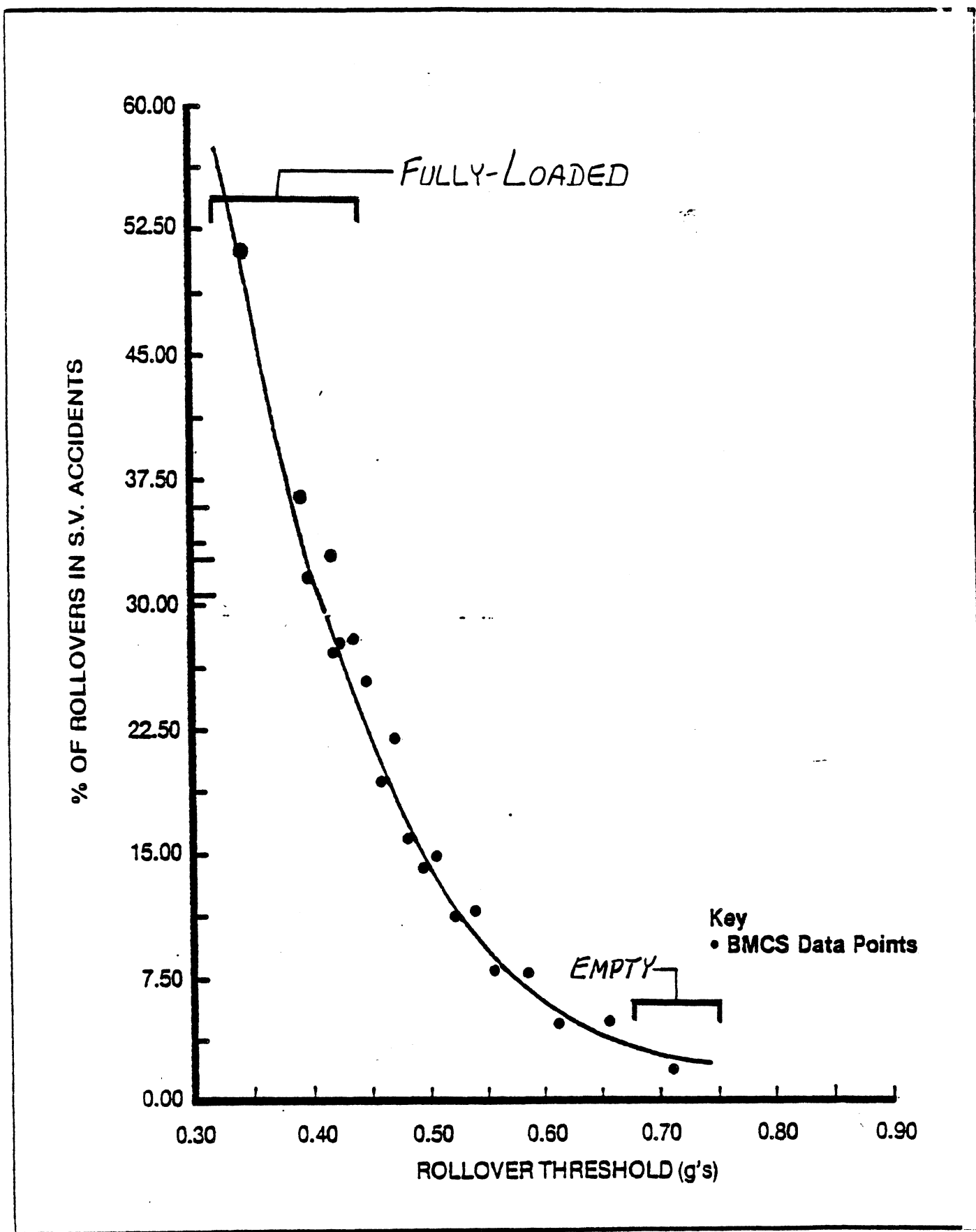

Figure 7. Percent of single-vehicle accidents in which rollover occurs on five-axle tractor/van-semitrailers as a function of the vehicle's inherent rollover threshold, in g's.

single-vehicle accidents involving three-axle tractors pulling two-axle, van-type semitrailers. Among these 9,000 accidents, more than 2,000 rollovers were recorded. These data were resolved into the illustrated format of Figure 7 with the aid of the computerized procedure for calculating the rollover threshold of such vehicle combinations, given the value of gross vehicle weight which is reported to BMCS with each accident. Knowing the gross vehicle weight, the analysis assumed that payload was placed in a fashion representing medium-density freight. Typical values for tire, spring, and geometric properties were then employed to calculate rollover thresholds for each increment of gross weight in the accident file.

From the figure, we see that the typical empty tractor-semitrailers experience rollover in approximately five percent of their SVA's. When such vehicles are loaded, on the other hand, the reduction in roll stability, due to the greater weight and higher c.g. location, causes an eight- to ninefold increase in the incidence of rollover. The figure clearly establishes that the rollover of tractor-semitrailers is highly sensitive to the vehicle's inherent rollover threshold in the 0.3 to 0.4 g range pertaining to typical, fully loaded units. The slope of the sensitivity in this range can be nominally evaluated at an approximate three percent change in rollovers/SVA per 0.01 g change in rollover threshold.

If these data were applicable to bakery vehicles (in the 0.6 to 0.7 g range), the figure suggests that the rollover frequency would be rather low and would not be strongly affected by minor variations in c.g. height or gross weight such as may prevail in the use of such vehicles. However, the applicability of this relationship to vehicles other than tractor-trailers is uncertain. Ideally, accident statistics related to rollover experience for vehicles in this subclass of 10,000 to 15,000 lbs (4.5 to 6.8 m tons) GVW step-vans would be used to judge the likely significance of rollover in accidents with these vehicles, but there are no such specialized accident data files available.

Looking to the rollover accident experience with passenger cars and light trucks does not show this relationship (as seen in Figure 7) to be applicable to vehicles other than tractor-trailers. The National Crash Severity Study (NCSS) [6,7] data on "tow-away" accidents of passenger

cars and light trucks shows much different rollover experiences. For passenger cars, rollover is experienced in 14.4 percent of the SVA's (4.4 percent of all reported accidents), and for light trucks in 31.5 percent of the SVA's (13.3 percent of all reported accidents). Much lower rates would be expected from the relationship in Figure 7, given the nominal rollover thresholds for these vehicles. In part, the disparity may derive from the differences in the cross-section of the accidents represented in the two types of accident files ("tow-away" accidents in the case of the NCSS files, versus a minimum "reporting threshold" of \$2,000 damage or an injury in the case of the BMCS file). The disparity may also reflect a difference between the fundamental driving skills (and attitudes) of the professional truck driver and the nonprofessional drivers of cars and light trucks. Further, vehicles reporting to the BMCS accident file are generally employed in interstate transportation and are predominantly operating on multi-lane and divided highways, while general passenger cars and light trucks incur the bulk of their mileage on lesser quality road systems. Nevertheless, the bottom line is that knowledge does not exist whereby one can draw specific inferences about the rollover accident rate to be expected with the step-side vans that have been studied here.

With regard to the width variations represented on the heavy tractor-semitrailers, the accident data shown in Figure 7 have direct applicability. Thus, an interpretation of the width-related items is offered below, by way of commentary on the rollover accident experience which may prevail in the U.S. as the new Federal provisions for 102-inch (259-cm) width become implemented. Figure 8 shows the improvements in percent rollovers per single-vehicle accident (SVA) accruing from the widening of trailer and tractor running gear from 96 to 102 inches (244 to 259 cm).

The figure suggests that the incidence of rollovers with tractor-semitrailers operating within the "medium-density freight" load scenario could be reduced by some 35 percent by adopting tractors and semitrailers which are fully widened to utilize a 102-inch (259-cm) width allowance. (Please note that the "35 percent" figure is obtained by observing that the "rollover/SVA" measure drops from the baseline value of 47 percent to 30 percent, thus incurring a net 35 percent drop from the rollover/SVA

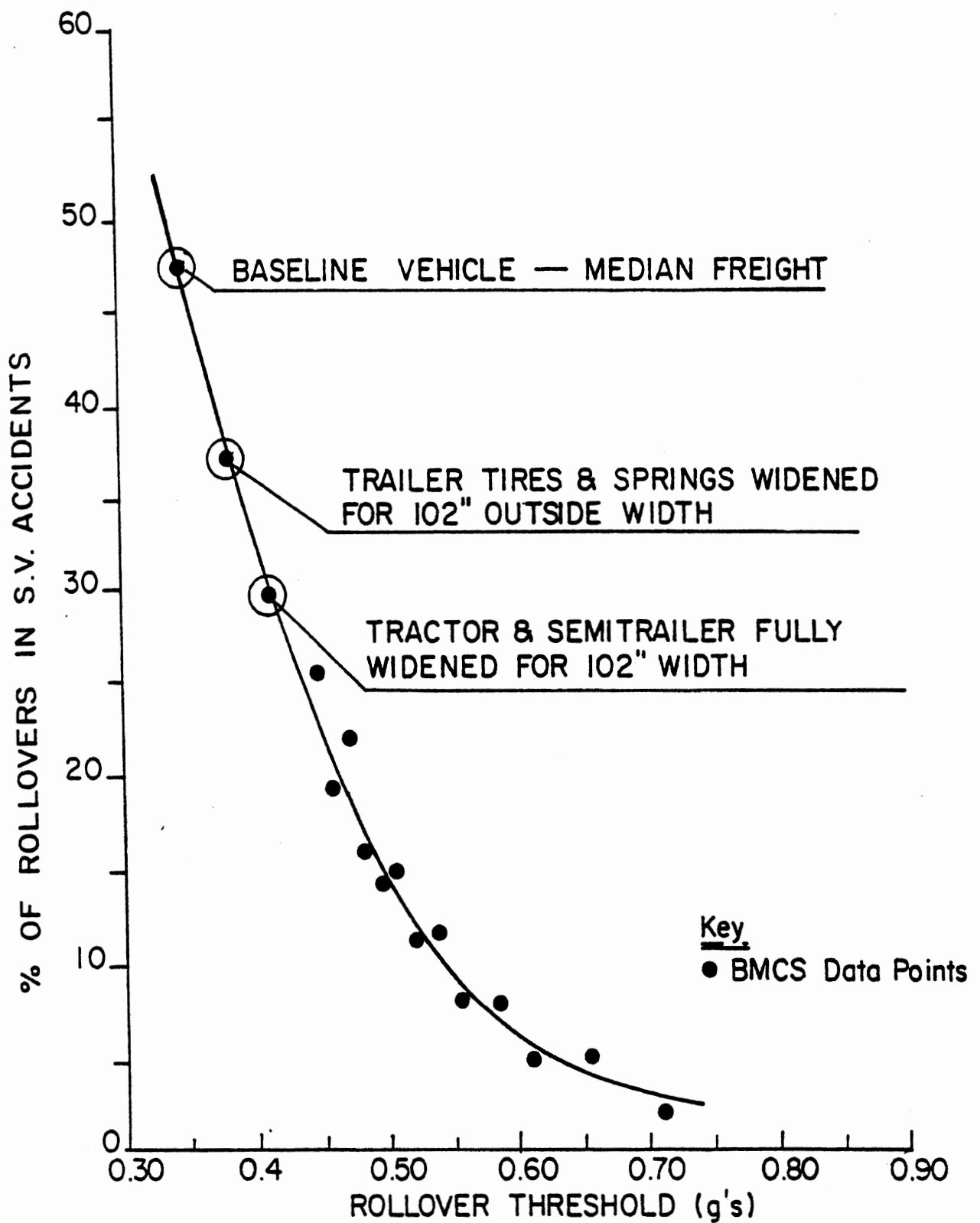

Figure 8. Overlay of Rollover Thresholds for Differing Width Parameters onto Curve Derived from Accident Data.

When only the semitrailer is "fully widened" (that is, with wider tire placement and spring spacing), the reduction in rollover accident rate for this vehicle category is predicted to be on the order of 20 percent.

In the context of these potential safety improvements, let us consider the implications of certain of the "shortcut" means of utilizing a liberalized width allowance. The tabulated results showed that widening the load bed alone, without also widening the tire track and spring spread dimensions, introduces a small and somewhat mixed effect upon roll stability. In general, the action of widening the bed, alone, can be looked upon simply as a "missed opportunity" to dramatically upgrade a vehicle's roll stability. Accordingly, it is clear that the approach which most benefits traffic safety is to assure that the increased width at the load bed be accompanied by appropriately widened tire and spring placements.

Notwithstanding the large benefit which widened tractors contribute to the roll stability of tractor-semitrailer combinations, it is recognized that extending tractor width involves a much more costly development process than is implied by widening trailers or dollies. Presumably, wider tractors would become available if a market develops following the liberalized width allowance. Those concerned with maximizing safety are well advised to promote such development. In the meantime, it should be noted that there are no known detrimental effects of coupling trailers having one width dimension to tractors having a narrower width.

The single most beneficial application of an increased width allowance is in the case of full trailers. It was seen in the results shown above that the rollover threshold of the full trailer of a conventional doubles configuration increases by 16.5 percent when the dolly and trailer axle hardware (tires and springs) is widened from 96 to 102 inches (244 to 259 cm). Since conventional doubles experience the majority of their rollover incidents as rear-trailer-only rollovers, the prospect for making large improvements in the roll stability of full trailers seems especially important to safety. When one considers that the inclusion of the wider axle hardware in the construction of new dollies and trailers is rather straightforward (especially in comparison to the widening of tractors),

value of the baseline case. This 35 percent reduction is then seen as indicating the approximate level of reduction in the total rate at which rollovers are produced per vehicle mile. Note, also, that, although these rollover data are derived from single-vehicle accident cases, they are useful for approximating total rollover involvement since some 80 percent of truck rollovers occur as single-vehicle events [1].)

When only the semitrailer is "fully widened" (that is, with wider tire placement and spring spacing), the reduction in rollover accident rate for this vehicle category is predicted to be on the order of 20 percent.

In the context of these potential safety improvements, let us consider the implications of certain of the "shortcut" means of utilizing a liberalized width allowance. The tabulated results showed that widening the load bed alone, without also widening the tire track and spring spread dimensions, introduces a small and somewhat fixed effect upon roll stability. In general, the action of widening the bed, alone, can be looked upon simply as a "missed opportunity" to dramatically upgrade a vehicle's roll stability. Accordingly, it is clear that the approach which most benefits traffic safety is to assure that the increased width at the load bed be accompanied by appropriately widened tire and spring placements.

Notwithstanding the large benefit which widened tractors contribute to the roll stability of tractor-semitrailer combinations, it is recognized that extending tractor width involves a much more costly development process than is implied by widening trailers or dollies. Presumably, wider tractors would become available if a market develops following the liberalized width allowance. Those concerned with maximizing safety are well advised to promote such development. In the meantime, it should be noted that there are no known detrimental effects of coupling trailers having one width dimension to tractors having a narrower width.

The single most beneficial application of an increased width allowance is in the case of full trailers. It was seen in the results shown above that the rollover threshold of the full trailer of a conventional doubles configuration increases by 16.5 percent when the dolly and trailer axle hardware (tires and springs) is widened from 96 to 102 inches (244

to 259 cm). Since conventional doubles experience the majority of their rollover incidents as rear-trailer-only rollovers, the prospect for making large improvements in the roll stability of full trailers seems especially important to safety. When one considers that the inclusion of the wider axle hardware in the construction of new dollies and trailers is rather straightforward (especially in comparison to the widening of tractors), the scenario by which a 102-inch (259-cm) width allowance would lead to much-improved roll stability for full trailers seems particularly achievable. No accident data are available which speak directly to the relationship between the rollover threshold of full trailers and their rollover accident involvement. Nevertheless, there is good reason to suspect that the rollover involvement of these vehicles would be sensitive to the rollover threshold property in approximately the same fashion as found for tractor-semitrailers. If this were so, we could expect that the 16.5 percent reduction in the rollover threshold of conventional (27-28-foot, 8.2-8.5-m) full trailers would serve to reduce the rollover involvement of doubles hauling full-weight, medium-density loads by some 30 percent.

the scenario by which a 102-inch (259-cm) width allowance would lead to much-improved roll stability for full trailers seems particularly achievable. No accident data are available which speak directly to the relationship between the rollover threshold of full trailers and their rollover accident involvement. Nevertheless, there is good reason to suspect that the rollover involvement of these vehicles would be sensitive to the rollover threshold property in approximately the same fashion as found for tractor-semitrailers. If this were so, we could expect that the 16.5 percent reduction in the rollover threshold of conventional (27-28-foot, 8.2-8.5-m) full trailers would serve to reduce the rollover involvement of doubles hauling full-weight, medium-density loads by some 30 percent.

REFERENCES

1. Ervin, R.D., Mallikarjunarao, C., and Gillespie, T.D. "Future Configuration of Tank Vehicles Hauling Flammable Liquids in Michigan." Final Report, Agreement #78-2230, Michigan Department of Transportation, Report #UM-HSRI-80-73, December 1980.
2. Ervin, R.D., et al. "Influence of Size and Weight Variables on the Stability and Control Properties of Heavy Trucks." Final Report, Contract FH-11-9577, Report No. UMTRI-83-10, March 1983.
3. Mallikarjunarao, C., Ervin, R.D., and Segel, L. "Roll Response of Articulated Motor Trucks During Steady-Turning Maneuvers." 1982 Winter Annual Meeting, Symposium on Computational Methods in Ground Transportation Vehicles, American Society of Mechanical Engineers, 1982.
4. "Evaluation of Barrier Limit Capacity for Different Classes of Vehicles and Impact Conditions." Subcontract #L300005 (Prime Contract #DTFH61-82-C-00051), University of Michigan Transportation Research Institute (in progress).
5. Cooper, D.H. "Radial Stiffness of the Pneumatic Tire." INSTN Rubber Industry, Transactions, Vol. 40, No. 1, February 1964, pp. T58-T70).
6. "NCSS for Passenger Cars, January 1977-March 1979." Leda Ricci, Editor, Report No. UM-HSRI-80-36, 1980.
7. "NCSS for Light Trucks and Vans, April 1978-March 1979." Leda Ricci, Editor, Report No. UM-HSRI-80-37, 1980.

APPENDIX A

DESCRIPTION OF SIMULATED VEHICLES
(PASSENGER CARS THROUGH STEP-VANS)

Vehicle: 1979 Honda Civic, 4 passengers plus 150 lb luggage

Front Axle Load:	1,374 lb	Rating:	N/A
Rear Axle Load:	1,075	Rating:	N/A
Total:	2,449	GVWR:	N/A
Sprung Mass:	2,219 lb	C.G. Height:	22.93 in
Front Unsprung:	130		10.75
Rear Unsprung:	100		10.75
Front Track:	52 in		
Tire Size:	155R12		
Vertical Stiffness:	1,310 lb/in		
Rear Track:	51 in		
Tire Size:	155R12		
Vertical Stiffness:	1,310 lb/in		
Dual Tire:	N/A		

Front Suspension Spacing: 52 in (IFS)

 Axle Roll Stiffness: 0

Force:	-900 lb	Deflection:	-4.75 in
	100		-3.75
	622		0
	800		1.25
	1275		2.25

Rear Suspension Spacing: 51 in (IRS)

 Axle Roll Stiffness: 0

Force:	-725 lb	Deflection:	-4.6 in
	100		-3.6
	488		0
	688		1.6
	1588		3.6

Vehicle: 1970 Lincoln Continental plus 4 passengers

Front Axle Load:	3,268 lb	Rating:	N/A
Rear Axle Load:	2,434	Rating:	N/A
Total:	5,702	GVWR:	N/A
Sprung Mass:	5,152 lb	C.G. Height:	22.4 in
Front Unsprung:	200		12.8
Rear Unsprung:	350		12.8
Front Track:	62 in		
Tire Size:	225R15		
Vertical Stiffness:	1,762 lb/in		
Rear Track:	62 in		
Tire Size:	225R15		
Vertical Stiffness:	1,762 lb/in		
Dual Tire:	N/A		

Front Suspension Spacing: 62 in (IFS)

Axle Roll Stiffness: 3,504 in-lb/deg

Force:	-2116 lb	Deflection:	-7 in
	804		-5
	1534		0
	2264		5
	3722		6

Rear Suspension Spacing: 45.2 in

Axle Roll Stiffness: 0

Force:	-2195 lb	Deflection:	-7 in
	465		-5
	1130		0
	1794		5
	3124		6

Vehicle: 1970 Lincoln Continental plus 4 passengers

Front Axle Load:	3,268 lb	Rating:	N/A
Rear Axle Load:	2,434	Rating:	N/A
Total:	5,702	GVWR:	N/A
Sprung Mass:	5,152 lb	C.G. Height:	22.4 in
Front Unsprung:	200		12.8
Rear Unsprung:	350		12.8
Front Track:	62 in		
Tire Size:	225R15		
Vertical Stiffness:	1,762 lb/in		
Rear Track:	62 in		
Tire Size:	225R15		
Vertical Stiffness:	1,762 lb/in		
Dual Tire:	N/A		
Front Suspension Spacing:	62 in (IFS)		
Axle Roll Stiffness:	3,504 in-lb/deg		
Force:	-2116 lb	Deflection:	-7 in
	804		-5
	1534		0
	2264		5
	3722		6
Rear Suspension Spacing:	22.6 in		
Axle Roll Stiffness:	0		
Force:	-2195 lb	Deflection:	-7 in
	465		-5
	1130		0
	1794		5
	3124		6

Vehicle: 1979 B-200 Dodge Van, 8 Passengers with 240 lb Luggage

Front Axle Load:	2,952 lb	Rating:	2,950 lb
Rear Axle Load:	2,471	Rating:	3,220
Total:	5,423	GVWR:	6,170
Sprung Mass:	4,729 lb	C.G. Height:	36.67 in
Front Unsprung:	294		14
Rear Unsprung:	400		14
Front Track:	68.5 in		
Tire Size:	7.00x15		
Vertical Stiffness:	2,290 lb/in		
Rear Track:	65 in		
Tire Size:	7.00x15		
Vertical Stiffness:	2,290 lb/in		
Dual Tire:	N/A		

Front Suspension Spacing: 68.5 in (IFS)

Axle Roll Stiffness:	0		
Force:	-500 lb	Deflection:	-5.5 in
	500		-3.5
	1000		-1.5
	1329		0
	1650		1.5
	2800		3.5

Rear Suspension Spacing: 49 in

Axle Roll Stiffness:	0		
Force:	-1000 lb	Deflection:	-5 in
	0		-4
	450		-2
	1035		0
	1725		2
	2600		4
	4000		6

Vehicle: 1979 Ford F-150 Pickup plus 750 lb Load @ 24" Above Bed

Front Axle Load:	2,297 lb	Rating:	3,300 lb
Rear Axle Load:	2,315	Rating:	3,750
Total:	4,612	GVWR:	6,150
Sprung Mass:	4,012 lb	C.G. Height:	33.2 in
Front Unsprung:	250		14
Rear Unsprung:	350		14
Front Track:	65.5 in		
Tire Size:	7.00x15		
Vertical Stiffness:	1,800 lb/in		
Rear Track:	64.5 in		
Tire Size:	7.00x15		
Vertical Stiffness:	1,800 lb/in		
Dual Tire:	N/A		

Front Suspension Spacing: 65.5 in (Twin I-Beam)

Axle Roll Stiffness: 0

Force:	-1000 lb	Deflection:	-8.5 in
	-100		-7.5
	1023		0
	1475		3
	2875		8

Rear Suspension Spacing: 44.75 in

Axle Roll Stiffness: 0

Force:	-2500 lb	Deflection:	-7.5 in
	0		-5
	983		0
	2183		4.5
	4383		7.0

Vehicle: 1979 Ford F-150 Pickup plus 750 lb Load @ 24" Above Bed

Front Axle Load:	2,297 lb	Rating:	3,300 lb
Rear Axle Load:	2,315	Rating:	3,750
Total:	4,612	GVWR:	6,150
Sprung Mass:	4,012 lb	C.G. Height:	33.2 in
Front Unsprung:	250		14
Rear Unsprung:	350		14
Front Track:	65.5 in		
Tire Size:	7.00x15		
Vertical Stiffness:	1,800 lb/in		
Rear Track:	64.5 in		
Tire Size:	7.00x15		
Vertical Stiffness:	1,800 lb/in		
Dual Tire:	N/A		

Front Suspension Spacing: 65.5 in (Twin I-Beam)

Axle Roll Stiffness: 0

Force:	-1000 lb	Deflection:	-8.5 in
	-100		-7.5
	1023		0
	1475		3
	2875		8

Rear Suspension Spacing: 22.375 in

Axle Roll Stiffness: 0

Force:	-2500 lb	Deflection:	-7.5 in
	0		-5
	983		0
	2183		4.5
	4383		7.0

Vehicle: 1975 Chevrolet Stake Truck plus 4120 lb load @24" Above Bed

Front Axle Load:	3,676 lb	Rating:	3,800 lb
Rear Axle Load:	6,324	Rating:	7,500
Total:	10,000	GVWR:	10,000
Sprung Mass:	8,500 lb	C.G. Height:	48.26 in
Front Unsprung:	500		15
Rear Unsprung:	1,000		15
Front Track:	66 in		
Tire Size:	7.50x16 (D)		
Vertical Stiffness:	2,900 lb/in		
Rear Track:	64 in		
Tire Size:	7.50x16 (D)		
Vertical Stiffness:	2,500 lb/in		
Dual Tire: (Spacing)	10"		

Front Suspension Spacing: 66 in (IFS)

Axle Roll Stiffness: 9,512 in-lb/deg

Force:	-2997 lb	Deflection:	-5 in
	1588		0
	6173		5

Rear Suspension Spacing: 40 in

Axle Roll Stiffness: 2,500 in-lb/deg

Force:	-1465 lb	Deflection:	-7.4 in
	850		-2.4
	1225		-1.6
	2662		0
	4600		0.67
	19127		5.67

Vehicle: 10,000 lb Bakery Truck (1977 Chev. Chassis) plus 2,739 lb Load @
28" Above Bed

Front Axle Load:	3,676 lb	Rating:	4,000 lb
Rear Axle Load:	6,324	Rating:	7,900
Total:	10,000	GVWR:	10,000
Sprung Mass:	8,500 lb	C.G. Height:	48.74 in
Front Unsprung:	500		15
Rear Unsprung:	1,000		15
Front Track:	65 in		
Tire Size:	7.50x16 (D)		
Vertical Stiffness:	2,900 lb/in		
Rear Track:	63 in		
Tire Size:	7.50x16 (D)		
Vertical Stiffness:	2,500 lb/in		
Dual Tire: (Spacing)	10"		

Front Suspension Spacing: 65 in (IFS)

Axle Roll Stiffness: 9,512 in-lb/deg

Force:	-2997 lb	Deflection:	-5 in
	1588		0
	6173		5

Rear Suspension Spacing: 40 in

Axle Roll Stiffness: 2500 in-lb/deg

Force:	-1465 lb	Deflection:	-7.4 in
	850		-2.4
	1225		-1.6
	2662		0
	4600		0.67
	19127		5.67

Vehicle: 10,000 lb Bakery Truck (1977 Chev. Chassis) plus 2,739 lb Load @ 28" Above Bed

Front Axle Load:	3,676 lb	Rating:	4,000 lb
Rear Axle Load:	6,324	Rating:	7,900
Total:	10,000	GVWR:	10,000
Sprung Mass:	8,500 lb	C.G. Height:	48.74 in
Front Unsprung:	500		15
Rear Unsprung:	1,000		15
Front Track:	65 in		
Tire Size:	7.50x16 (D)		
Vertical Stiffness:	2,900 lb/in		
Rear Track:	63 in		
Tire Size:	7.50x16 (D)		
Vertical Stiffness:	2,500 lb/in		
Dual Tire: (Spacing)	10"		

Front Suspension Spacing: 32.5 in (IFS)

Axle Roll Stiffness: 9,512 in-lb/deg

Force:	-2997 lb	Deflection:	-5 in
	1588		0
	6173		5

Rear Suspension Spacing:

Axle Roll Stiffness:

Force:	-1465 lb	Deflection:	-7.4 in
	850		-2.4
	1225		-1.6
	2662		0
	4600		0.67
	19127		5.67

Vehicle: 15,000 lb Bakery Truck (1976 Ford Chassis) plus 5,175 lb Load
@ 30.75" Above Bed

Front Axle Load:	5,180 lb	Rating:	5,180 lb
Rear Axle Load:	9,020	Rating:	9,080
Total:	14,200	GVWR:	14,200

Sprung Mass:	12,300 lb	C.G. Height:	52.54 in
Front Unsprung:	700		16.5
Rear Unsprung:	1,200		16.5

Front Track: 76 in
Tire Size: 7.00x18 (D)
Vertical Stiffness: 3,708 lb/in

Rear Track: 67 in
Tire Size: 7.00x18 (D)
Vertical Stiffness: 3,259 lb/in
Dual Tire:

Front Suspension Spacing: 32 in

Axle Roll Stiffness: 220 in-lb/deg

Force:	-1760 lb	Deflection:	-4 in
	2280		0
	6240		4
	26240		6

Rear Suspension Spacing: 40 in

Axle Roll Stiffness: 1,675 in-lb/deg

Force:	-5690 lb	Deflection:	-4 in
	3910		0
	13510		4
	61510		6