

1. Report No.	2. Government Accession No.	3. Recipient's Catalog No.	
4. Title and Subtitle Quantification of Thoracic Response and Injury: Tests Using Human Surrogate Subjects.		5. Report Date May 2, 1983	6. Performing Organization Code
		8. Performing Organization Report No. UMTRI-83-26	
7. Author(s) D. H. Robbins, R. J. Lehman, G. S. Nusholtz, J. W. Melvin, J. B. Benson		10. Work Unit No.	
9. Performing Organization Name and Address Transportation Research Institute Institute of Science and Technology University of Michigan Ann Arbor, Michigan 48109		11. Contract or Grant No. DOT-HS-4-00921	
		13. Type of Report and Period Covered Final July 1974-April 1983	
		14. Sponsoring Agency Code	
12. Sponsoring Agency Name and Address U.S. Department of Transportation National Highway Traffic Safety Administration Washington, D.C. 20590		15. Supplementary Notes	
16. Abstract The purpose of this report is to present methods and results of a series of twenty-three thorax impact tests using human surrogate subjects. After a discussion of the development of a thorax instrumentation package in Section 2, the test matrix and a description of each type of test are given in Section 3. Both frontal and lateral impact tests are included. Section 4 presents details of test protocol and methods. These are divided into surgery and impact sled laboratory components. An Appendix contains complete individual test reports including test description, transducer data, and injury data.			
17. Key Words Impact Test Thorax Injury Chest Injury Human Tolerance		18. Distribution Statement	
19. Security Classif.(of this report)	20. Security Classif.(of this page)	21. No. of Pages 211	22. Price

Report No. UMTRI-83-26

QUANTIFICATION OF THORACIC RESPONSE AND INJURY:
IMPACT TESTS USING HUMAN SURROGATE SUBJECTS.

FINAL REPORT. CONTRACT DOT-HS-4-00921

Prepared by:

D. H. Robbins, R. J. Lehman, G. S. Nusholtz,
J. W. Melvin, J. B. Benson
Transportation Research Institute
Institute of Science and Technology
University of Michigan
Ann Arbor, Michigan 48109

Prepared for:

U.S. Department of Transportation
National Highway Traffic Safety Administration
Washington, D.C. 20590

May 2, 1983

TABLE OF CONTENTS

	<u>Page</u>
List of Figures	ii
List of Tables	iii
Acknowledgements	iv
1.0 INTRODUCTION	1
2.0 THORACIC INSTRUMENTATION	3
3.0 TEST MATRIX AND DESCRIPTION OF EACH TEST TYPE	4
3.1 Test Facility	4
3.2 Geometry of Test Fixtures for Primate and Cadaver Tests	4
3.3 Test Matrix	8
3.4 Frontal Impact Sled Tests. Unpadded Columns.	8
3.5 Frontal Impact Sled Tests. Foam Padded Columns.. . . .	17
3.6 Frontal Impact Sled Tests. Airbag Padded Column.	17
3.7 Rigid Side Impact Tests..	17
4.0 TEST PROTOCOLS AND METHODS	20
4.1 Introduction.	20
4.2 Primate Handling and Instrumentation	20
4.2.1 Primate Acquisition	23
4.2.2 Preliminary Activities	23
4.2.3 Surgical Routines	24
4.2.4 Pre-Test Activities	24
4.2.5 Post-Test Activities.	24
4.3 Laboratory Procedures	25
APPENDIX: Individual Test Reports.	26

LIST OF FIGURES

	<u>Page</u>
1. EA Column Test Setup	5
2. Scaled Steering Wheel Schematic	7
3. HSRI Data Handling System	9
4. Body Measurement Form	13
5. Frontal Impact Sled Test Setup. Unpadded Column	14
6. Schematic of Scaled Energy Absorbing Column	15
7. Frontal Impact Sled Test Setup. Padded Column	16
8. Side Impact Test Setup. Rigid Door	18
9. Test Protocol (Anatomy)	21
10. Test Protocol (Sled Lab)	22

LIST OF TABLES

	<u>Page</u>
3.1 Summary of Tests with Primate Subjects	10
3.2 Summary of Primate Body Measures	11

ACKNOWLEDGEMENTS

The authors would like to acknowledge the timeless efforts of the laboratory crew and University of Michigan student Research Assistants who participated in the project. Of particular note are the laboratory and photography efforts of Marvin Dunlap and Jean Brindamour. We would also like to acknowledge the efforts of Dr. Richard L. Stalnaker who was on the staff during the experimental phase of the project. Finally, we would like to make a statement of appreciation of the patience shown by the Contract Technical Manager - Rolf Eppinger, and later, Richard Morgan.

1.0 INTRODUCTION

The purpose of this report is to present methods and results for a series of 23 tests using primate subjects. This is the second of a series of reports from a project addressing itself to the generation of fundamental knowledge to achieve four results:

1. Quantification of the impact response of the human thorax using human cadaver and laboratory animal¹ test subjects;

2. Definition of performance specifications which insure impact response fidelity between human and surrogate thoraxes;

3. Compilation of analytical functions which relate kinematic response of the thorax to the actual injuries which have been observed in the experimental portion of the project; and,

4. Development of a side impact device matching thoracic response corridors obtained during the project.

The present report is concerned primarily with the first of the four items listed above.

Section 2 will be devoted to a discussion of the thoracic instrumentation package, with particular emphasis on the differences between primate and human cadaver instrumentation.

Section 3 will present the test matrix and a description of each test type. Both frontal and side impact tests are included. Restraints include energy absorbing steering columns padded with foam or airbags.

Section 4 presents details of test protocol and methods. As with section 2, the emphasis will be on the differences between primate and human cadaver tests. Extensive reference will be made to a previous report, Quantification of Thoracic Response and Injury: the Gathering of Data, Final Report, Contract DOT-HS-4-00921, Highway Safety Research Institute, Ann Arbor, Michigan, August 1982.

¹Animals have been cared for and handled according to AALAC guidelines.

One appendix has been prepared containing individual test descriptors, autopsy results, analog data, and filtered digital data displays.

2.0 THORACIC INSTRUMENTATION

The instrumentation package was selected to reflect the procedures used for human cadaver subjects and was modified only enough to permit the attachment of transducers to living primates with minimum injury.

To this end, the following array of transducers was attached: four rib accelerometers, one spinal accelerometer complex, a vascular pressure transducer and a tracheal pressure transducer. The rib accelerometers were mounted in pairs on both sides of the chest. The lower accelerometers had their sensitive axes in the Posterior-Anterior direction (x-axis), and were attached to the ninth rib at its most lateral point. The upper accelerometers, attached to the fifth ribs, were oriented along the Y-axis, that is, Right-Left.

The spinal accelerometer complex was a biaxial mount attached over the spine at the sixth thoracic vertebra for most tests. The accelerometers attached to this mount were oriented along the Anterior-Posterior (X) and Superior-Inferior (Z) axis. A few of the later tests (76T004, 76T005, 78T102) used a triaxial mount on the spine. The side impact tests (76T004, 76T005) also included a pelvic triaxial mount.

The tracheal and vascular pressure transducers were inserted into the airway and the abdominal aorta (routed through the femoral artery), respectively, in manners similar to those used for human cadaver subjects.

The sternal accelerometers used in the human cadaver tests were not used (except for the first test on a cadaver primate) because it was believed that the cartilaginous nature of the primate sternum would be unable to provide adequate support for the mounts.

In some cases instrumentation failures prevented obtaining of useful information.

Section 4 describes the techniques of mounting transducers on the subjects. Section 5 and the Appendix detail the exact transducer array used for all subjects in the test series.

3.0 TEST MATRIX AND DESCRIPTION OF EACH TEST TYPE

3.1 Test Facility

The impact sled facility at HSRI was used for this test series. The sled moves on a 45-foot track into a pneumatic decelerator and has the capability of a 75 mph velocity change and a 75 G deceleration. The basic sled is a 975 lb test platform which is 6.5 ft². The various seating structures and other equipment associated with the tests were bolted directly to the sled or to a structure of steel channels which was then bolted to the sled. The impact sled is driven by a compressed-gas-powered ram, and is stopped by air-powered disk brakes. The sled operates on the principle of rebound, achieving the desired velocity change by reversing its direction during the impact with a pneumatic decelerator. The sled payload is 1,224 lbs. Equipment for acquiring and recording data includes high-speed cameras and a 65,000 watt lighting system. Accelerations, forces, and other physical quantities were transduced and recorded on magnetic tape. All controls were remotely operated, using safety-interlocked electronic sequences.

3.2 Geometry of Test Fixtures for Primate and Cadaver Tests

Figure 1 shows the geometry of the sled buck used for both human cadaver and primate tests. The dimensions are given in inches. The first number is for the cadaver and the second number, shown in parenthesis, is scaled to the baboon primate. Superimposed on the sled buck geometry is the full forward and full rearward geometry for a 1972 Maverick including the location of the steering column. The hardware is designed for the sled buck (seat midway in travel) as well as for the column, belt, or airbag arrangements. Scaling to the primate is based on a reduction to one-third. This number has been selected based on measurements of baboon chest width so that the collapsible column will "fit" the baboon chest breadth in approximately the same manner as the full-size column matches the human chest.

Shown in Figure 2 is the geometry of the steering wheel used for the primate tests. The rim is made from bent mild steel rod while the "dish" is made from steel sheet stock which can be padded for tests.

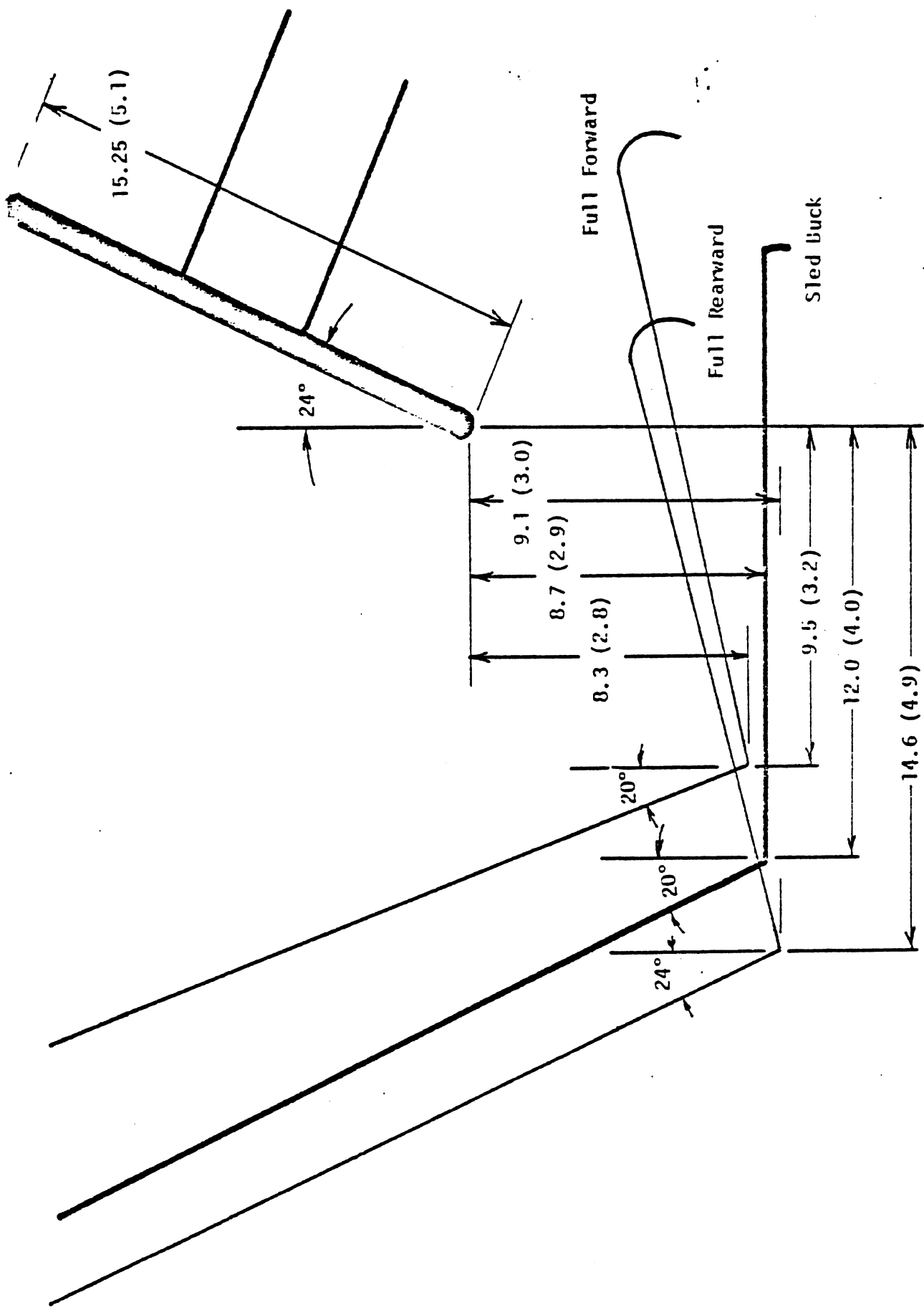

Figure 1. LA Column Test Setup

The column has been scaled to collapse at approximately 70 lbs. This was determined using the scaling formula

$$ESI \propto \log (fT^2/m(a)^{1/2})$$

where

ESI = Estimated Severity of Injury

f = force of impact

T = impact duration

m = mass of the animal

a = contact area

developed by Stalnaker and reported in "The Mechanisms of Injury in Blunt Abdominal Trauma," by M. L. Trollope, R. L. Stalnaker, J. H. McElhaney, and C. F. Frey, Journal of Trauma, Vol. 13, No. 11, pp. 962-970, 1973. The impact tests upon which this is based were blunt impacts to the lower half of the sternum, representing steering hub impact. The primary difference between these data and the planned experiments appears to be that the primate will impact the target rather than the impactor striking the primate. The assumptions were:

- ESI (estimated severity of injury) = 3
- m = 32 lb (the average weight of the subject baboons)
- a = 3.54 in² (hub area from Figure 2)
- T = 0.03 sec. (anticipated to be a typical duration based on past experience)

This result necessitated design of a column which collapsed at 70 lb. rather than 2000 lb., the load required to collapse the Maverick column. The rim for the Maverick steering wheel collapses at about 600 lb. This was scaled to 21 lb so that the primary load was applied to the baboon subject by the hub.

Figure 3 is a schematic of the overall data handling system used on the primate test series. Analog transducer data was digitized and

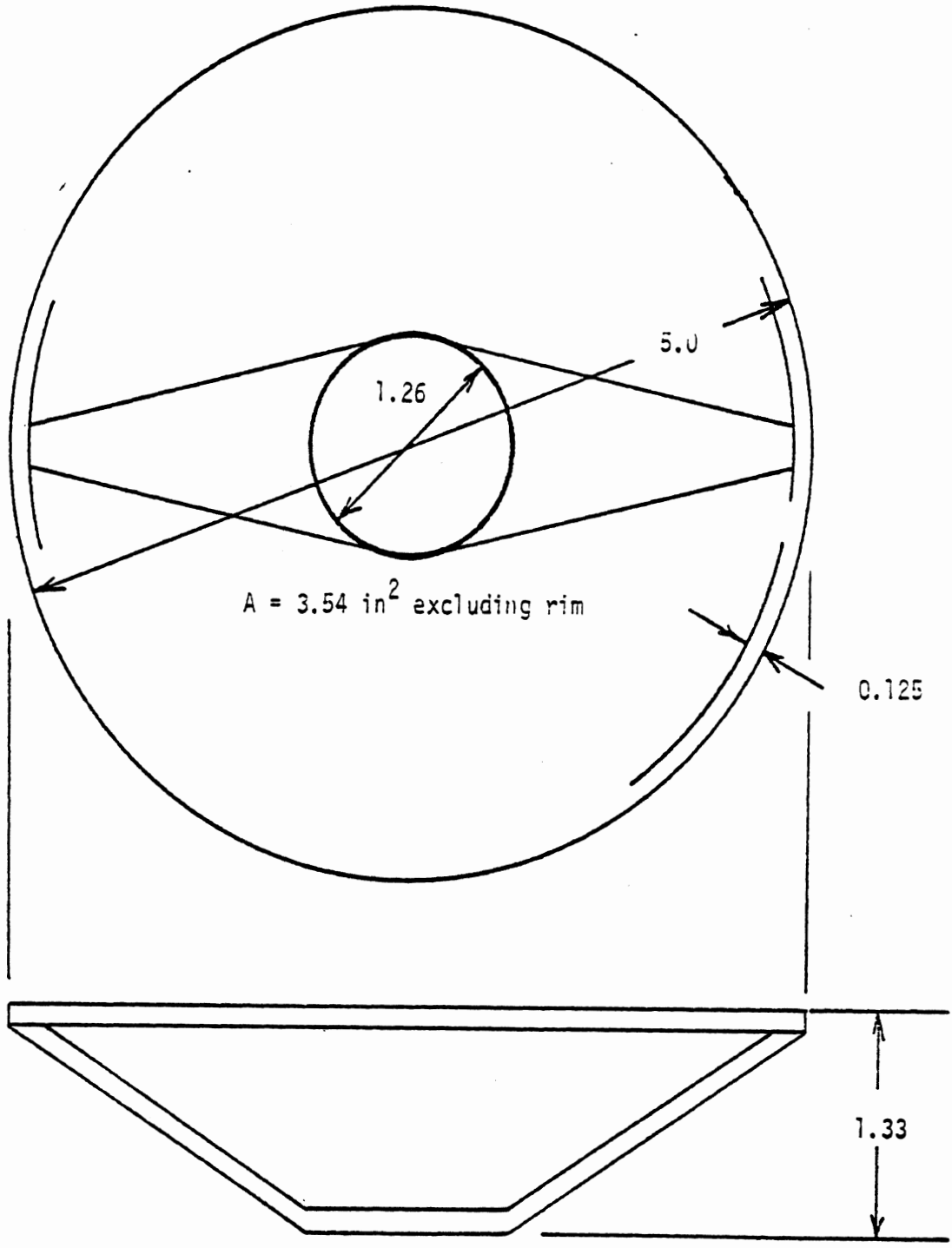

Figure 2 Scaled steering wheel schematic

filtered with output review possible at any stage. High speed photographic data were also available for analysis.

3.3 Test Matrix

Table 3.1 is a summary description of the tests conducted in the primate test series. The first column gives the test number. All tests are listed in chronological order. The test numbers with an "A" prefix were conducted between June and October 1975, while those beginning with a "76" or "78" were conducted in 1976 or 1978, respectively.

The second column gives the test velocity in miles per hour, while the third column gives the deceleration rate in G's. The fourth column lists the type of test which was conducted on each subject. All tests are frontal impacts unless otherwise noted (76T004, 76T005). All frontal impact tests were conducted using hardware similar to that used in the human cadaver tests but scaled down to primate proportions.

The fifth column contains the maximum AIS obtained from the thorax as determined during the autopsy. Higher or lower AIS numbers may have been obtained from other body regions such as head, abdomen, or extremities. Data on these injuries, if any, are included in the Appendix.

The last column lists the subject weight. Age and gender information are not given because the test population was entirely composed of juvenile males.

Table 3.2 is a summary of the body measurements taken on each subject prior to testing. The subject code used in Table 3.1 is also used here. Figure 4 is a copy of the form used to record the measurements and illustrates the actual points measured.

3.4 Frontal Impact Sled Tests. Unpadded Columns.

Figure 5 shows an oblique side view of the apparatus and positioning for the five tests using energy absorbing steering columns and lap belt restraints. The test seat, steering wheel, and column travel were scaled to primate proportions. Figure 6 is a drawing of the scaled columns and energy absorbing apparatus.

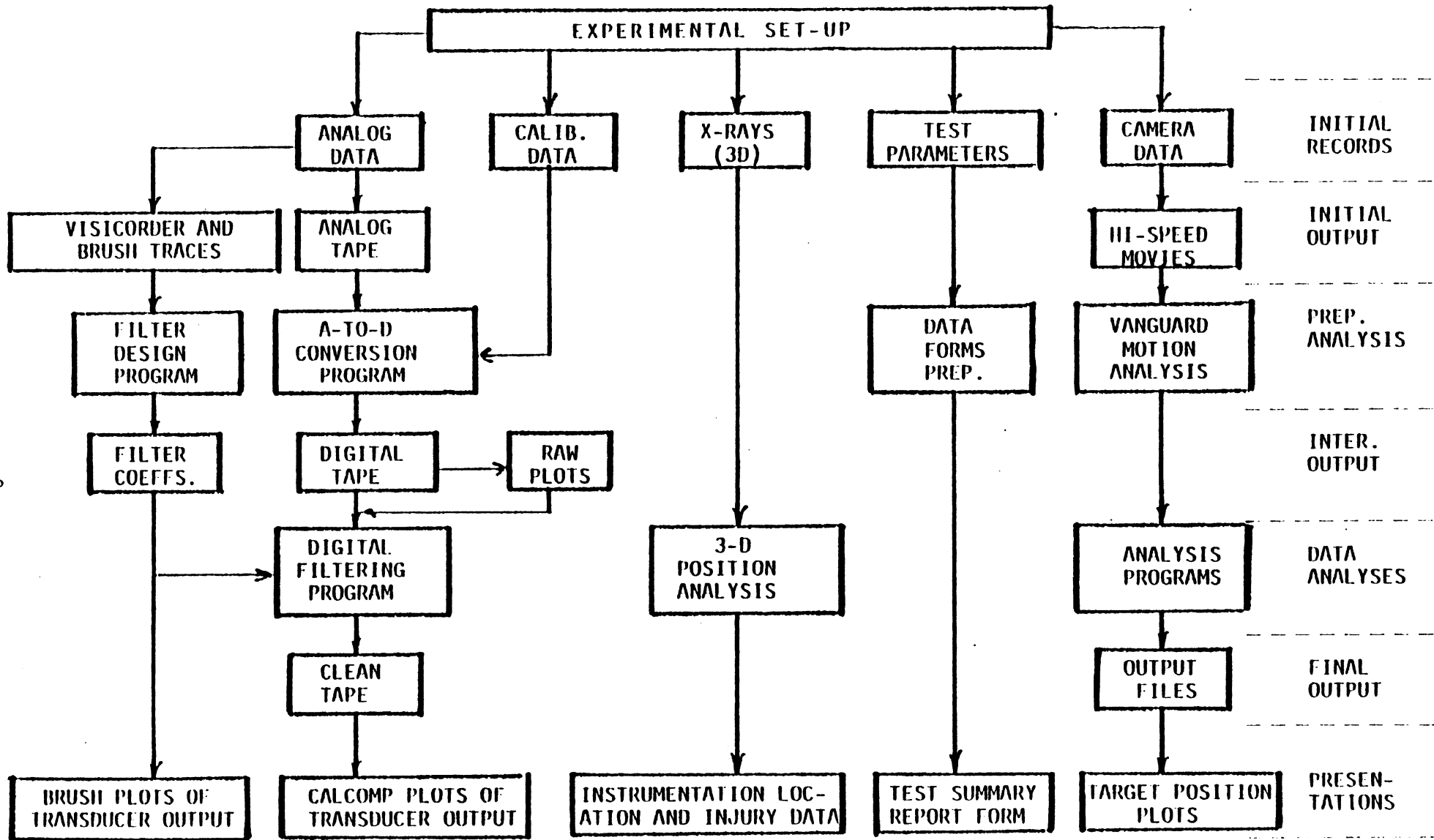

FIGURE 3. HSRI DATA HANDLING SYSTEM

TABLE 3.1 SUMMARY OF TESTS WITH PRIMATE SUBJECTS

TEST #	VELOCITY (mph)	ACCEL. (G's)	TEST TYPE	AIS	WEIGHT (Kg)
A-871*	24.0	10.0	Soft EA - column & lap belt	3	12.0
A-872	30.5	29.6	Soft EA - column & lap belt	4	12.0
A-873	30.1	30.4	Soft EA - column & lap belt	3	14.5
A-878*	30.1	30.0	Soft EA - column & lap belt	5	10.0
A-879	30.0	30.0	Stiff EA - column & lap belt	4	14.0
A-885	30.0	30.0	Stiff EA - column w/pad & lap belt	4	13.5
A-886	30.0	30.0	Stiff EA - column w/pad & lap belt	4-5	13.0
A-898*	30.0	30.0	Stiffest EA - column w/pad & lap belt	5	13.0
A-899	30.0	30.0	Stiffest EA - column w/pad & lap belt	4	11.0
A-904	21.2	15.0	Stiffest EA - column w/pad & lap belt	3	14.0
A-905	30.0	15.0	Stiffest EA - column w/pad & lap belt	4	13.9
A-906	21.2	30.0	Stiffest EA - column w/pad & lap belt	5	17.7
A-914	30.0	15.0	Stiffest EA - column w/airbag & lap belt	3	13.0
A-915	21.2	30.0	Stiffest EA - column w/airbag & lap belt	4	15.8
A-916	21.2	15.0	Stiffest EA - column w/airbag & alp belt	1	14.6
A-929	22.1	9.2	Stiff EA - column w/soft pad, lap belt	1	15.8
A-930*	21.9	9.6	Stiff EA - column w/soft pad, lap belt	3-4	16.0
A-931	21.2	10.0	Stiff EA - column w/soft pad, lap belt	2-3	17.0
A-932	21.9	14.9	Stiff EA - column w/airbag, lap belt	2-3	12.2
A-933*	21.4	14.9	Stiff EA - column w/airbag, lap belt	3-4	16.0
76T004	26.9	-	Lat. impact, rigid barrier	3	16.4
76T005	18.4	-	Lat. impact, rigid barrier	2	16.4
78T102	21.2	10.0	EA column w/Scott foam pad	1	14.8

* CADAVER PRIMATE SUBJECT

TABLE 3.2 SUMMARY OF PRIMATE BODY MEASURES

Test #	LENGTHS (INCHES)									
	(1) Buttock Crown	(2) Popliteal Height	(3) Top Head To Top Shoulder	(4) Acromial Height	(5) Shoulder To Elbow	(6) Buttock To Knee	(7) Heel To Toe	(8) Total Arm Reach	(9) Forearm To Hand	(10) Hand Length
A-871	-	-	-	-	-	-	-	-	-	-
A-872	23.0	6.0	6.5	18.0	8.5	10.0	7.5	24.0	13.8	5.25
A-873	27.0	5.0	8.0	20.5	10.5	11.5	8.5	27.5	15.0	6.0
A-878	23.0	6.5	5.5	19.0	9.0	10.0	7.0	19.5	13.0	5.0
A-879	25.0	5.5	5.5	20.0	9.0	12.0	7.5	26.0	14.8	5.5
A-885	25.0	7.0	7.0	19.0	10.0	11.0	8.3	23.0	15.7	5.0
A-886	23.5	8.5	5.0	20.0	10.0	10.0	7.8	22.0	14.0	5.0
A-898	25.0	5.0	4.8	19.8	9.5	9.5	7.0	24.0	13.5	5.0
A-899	73.5	5.8	6.8	18.3	9.8	10.0	8.0	25.0	13.5	4.5
A-904	26.0	7.3	7.5	19.3	9.8	9.0	7.3	25.0	13.8	5.0
A-905	25.0	9.0	6.0	19.5	9.5	10.0	7.5	25.0	14.0	5.0
A-906	26.3	6.3	5.0	22.3	10.5	11.5	8.0	27.5	16.0	5.3
A-914	25.0	8.0	5.0	21.5	10.0	10.5	7.3	24.5	14.5	4.5
A-915	26.5	8.0	6.0	20.5	10.5	10.5	7.5	26.5	15.3	5.3
A-916	26.0	10.8	5.8	19.0	9.5	10.5	8.0	21.8	14.8	5.5
A-929	26.0	9.0	6.0	20.5	10.0	11.0	8.0	25.0	15.0	6.0
A-930	27.0	10.0	6.0	21.0	10.5	10.0	8.0	26.0	15.0	5.3
A-931	24.0	6.0	4.3	20.3	9.8	11.0	7.8	21.5	14.5	5.0
A-932	23.5	6.0	5.5	19.0	9.0	11.0	7.3	25.5	13.8	5.0
A-033	26.8	4.6	6.0	21.0	10.0	12.3	8.0	25.0	15.3	5.8
76T004	27.0	6.5	6.0	21.0	10.5	11.8	8.0	27.0	15.5	5.5
76T005	27.0	8.5	6.25	21.5	10.25	11.5	7.5	27.0	15.0	5.5
78T102	23.0	-	6.0	20.3	9.8	11.8	8.2	26.9	15.7	6.0
(mean)	25.2	7.1	6.0	20.0	9.8	10.8	7.7	24.8	14.6	5.3
(std dev)	1.5	1.7	0.9	1.1	0.6	0.9	0.4	2.1	0.8	0.4

TABLE 3.2 (continued)

CIRCUMFERENCE (INCHES)

Test #	(11) Head	(12) Neck	(13) Shoulder	(14) Chest	(15) Waist (Hip)	(16) Biceps	(17) Wrist	(18) Thigh	(19) Calf	(20) Ankle
A-871	-	-	-	-	-	-	-	-	-	-
A-872	12.0	9.8	18.5	17.3	13.5	6.5	4.3	8.5	6.0	4.5
A-873	14.5	10.0	21.0	20.0	14.0	7.0	4.0	8.5	6.0	4.5
A-878	13.0	9.0	18.8	16.0	13.3	6.0	3.3	8.0	5.3	4.0
A-879	11.5	11.3	21.0	18.0	14.5	7.0	4.3	10.0	5.5	4.3
A-885	11.8	9.0	21.0	18.0	14.0	7.5	4.8	9.5	6.0	4.5
A-886	14.0	10.8	22.0	18.8	14.0	6.5	3.8	9.5	6.0	4.0
A-898	12.5	10.3	20.0	18.0	13.8	7.5	4.5	8.3	5.8	4.3
A-899	13.5	9.5	19.8	16.5	14.0	6.0	4.3	6.5	5.3	3.5
A-904	14.3	12.0	22.5	18.5	15.0	6.8	5.0	9.0	5.3	4.8
A-905	13.5	11.0	20.5	19.0	15.0	7.0	4.5	9.5	6.5	4.0
A-906	14.3	13.0	23.0	21.0	16.0	8.0	5.0	10.0	7.0	5.0
A-914	13.5	11.0	19.0	19.8	14.0	6.5	5.75	9.0	6.5	4.0
A-915	13.0	11.0	21.8	20.0	14.3	8.0	4.5	9.3	7.3	4.5
A-916	12.0	9.3	22.0	18.5	14.3	7.5	4.0	9.3	6.5	4.3
A-929	12.0	11.0	22.0	20.5	15.0	8.3	4.4	11.5	6.5	4.0
A-930	13.0	11.5	22.0	20.5	16.0	7.5	4.5	11.0	7.25	4.3
A-931	14.5	13.0	21.5	20.0	16.0	7.5	4.5	10.5	6.5	4.5
A-932	12.5	11.8	20.8	17.5	13.0	7.8	4.0	9.3	6.5	4.0
A-933	15.3	12.0	22.5	20.0	14.5	8.0	4.3	9.5	6.5	5.0
76T004	16.0	12.0	22.0	19.0	15.0	7.5	4.5	9.3	5.8	4.0
76T005	15.3	11.5	22.0	18.5	14.0	8.0	5.0	8.0	6.5	4.3
76T102	12.1	11.9	19.5	19.9	15.8	7.1	4.7	10.0	7.3	3.9
(mean)	13.3	11.0	21.1	18.9	14.5	7.3	4.5	9.2	6.3	4.3
(std dev)	1.3	1.2	1.4	1.4	1.0	0.7	0.5	1.1	0.6	0.4

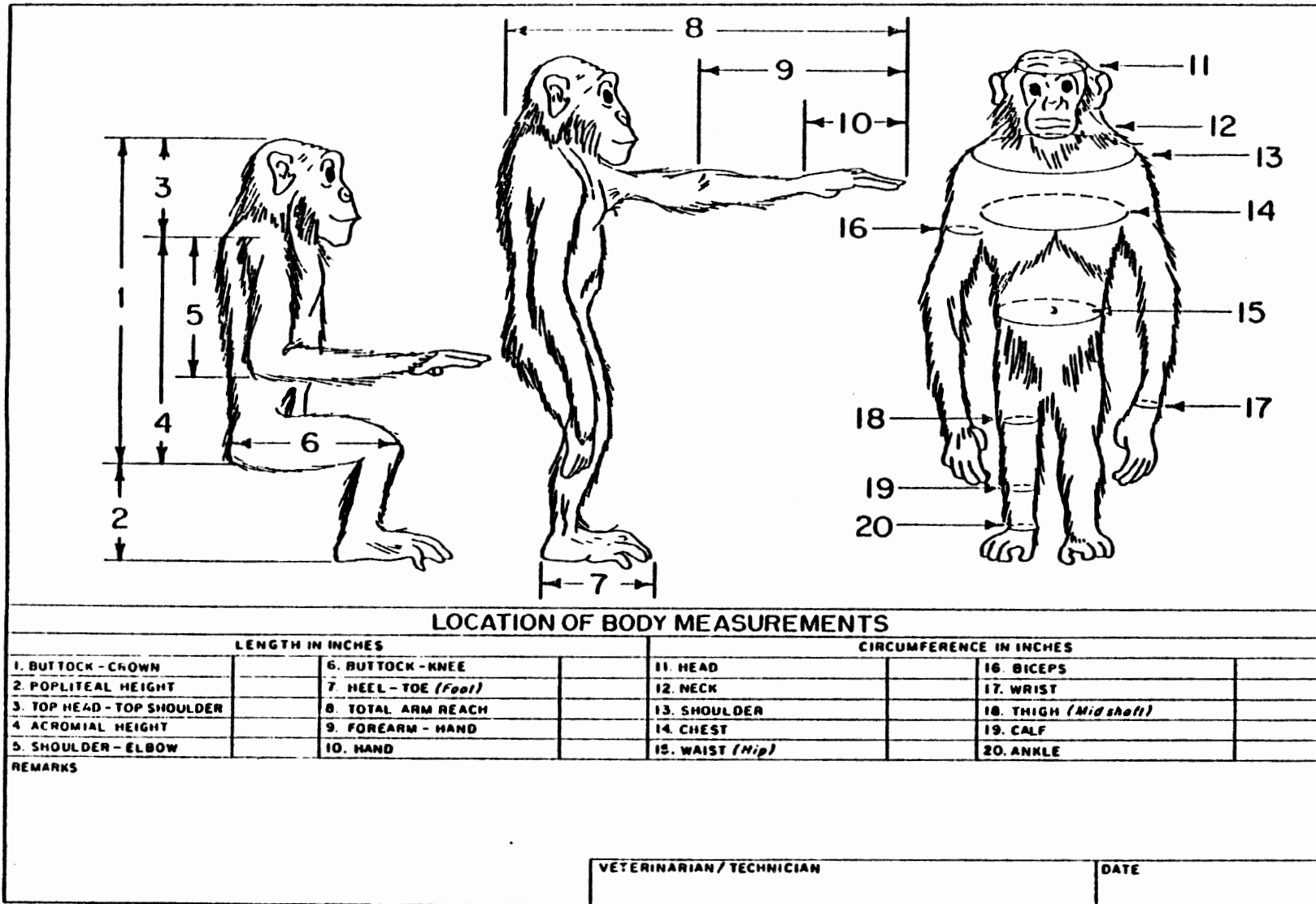

Figure 4. Body Measurement Form.

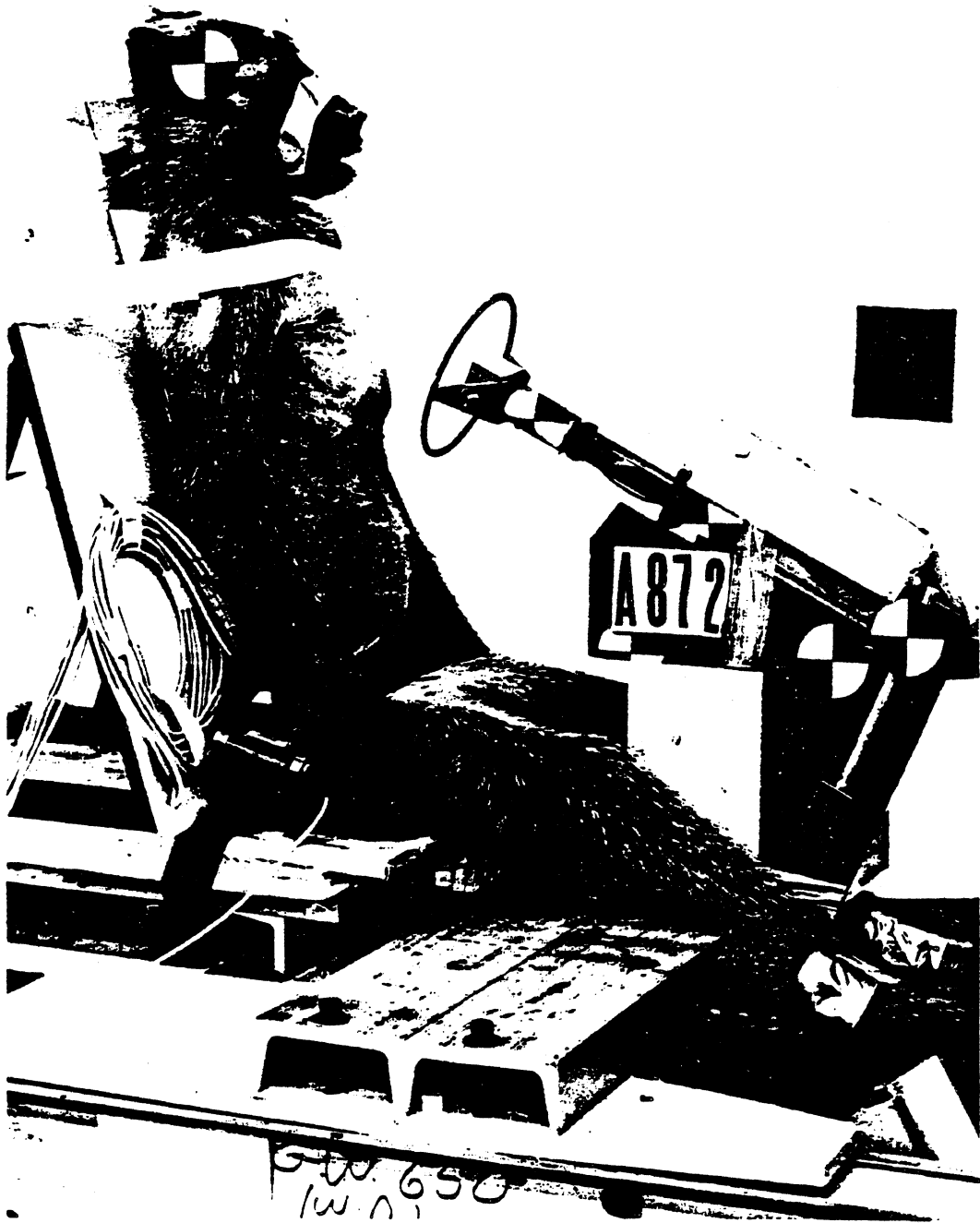

Figure 5. Frontal Impact Sled Test Setup. Unpadded Column.

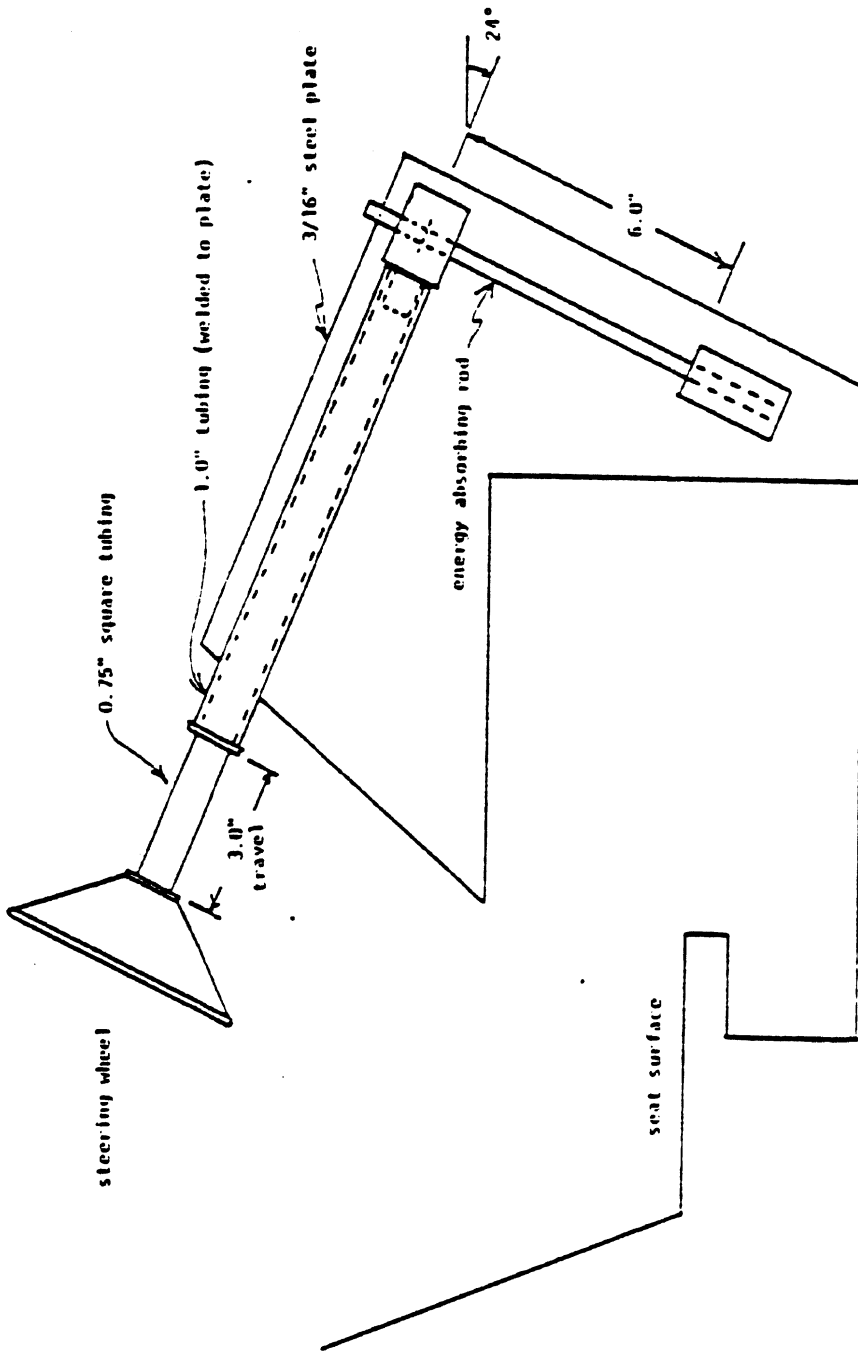

Figure 6. Schematic of Scaled Energy Absorbing Column.



Figure 7. Frontal Impact Sled Test Setup. Padded Column.

Three different stiffnesses of energy absorbing rod material were used in the front impact primate tests, labelled "soft", "stiff", and "stiffest", depending upon the level of force required to bend the rod.

3.5 Frontal Impact Sled Tests. Foam Padded Columns.

Figure 7 shows a perpendicular side view of a typical padded column frontal impact test. Note that the only major difference in apparatus and positioning between this test and the unpadded column test shown in Figure 5 is the presence of two inches of foam padding material placed over the steering column hub and filling the area within the riser.

A total of 12 tests were performed using various combinations of pad and column stiffness, velocity and deceleration.

3.6 Frontal Impact Sled Tests. Airbag Padded Column.

Five tests were performed using an energy absorbing steering column with a hub-mounted airbag. The test configuration was the same as that used in the padded column tests with the airbag replacing the foam pad. The airbag was inflated and sealed prior to the test, and was not intended to vent during impact. As before, a variety of column stiffnesses, velocities and decelerations were used in the airbag tests.

3.7 Rigid Side Impact Tests

Two side impact tests using primate subjects were performed in early 1976. Figure 8 shows the side view of a rigid barrier side impact primate test.

As can be seen, the apparatus used consists of a backboard mounted on the regular side impact sled buck used in the human cadaver tests and positioned so the primate can sit erect with his feet on the floor.

The sequence of actions which occur during a test is as follows. The sled buck is first brought up to speed. In order to accomplish this and maintain the proper initial position of the subject, a series of bolsters was placed on the right side of the subject. Next, the sled enters the deceleration phase. During this phase the sled is stopped and its motion reversed. The total change in velocity generated during

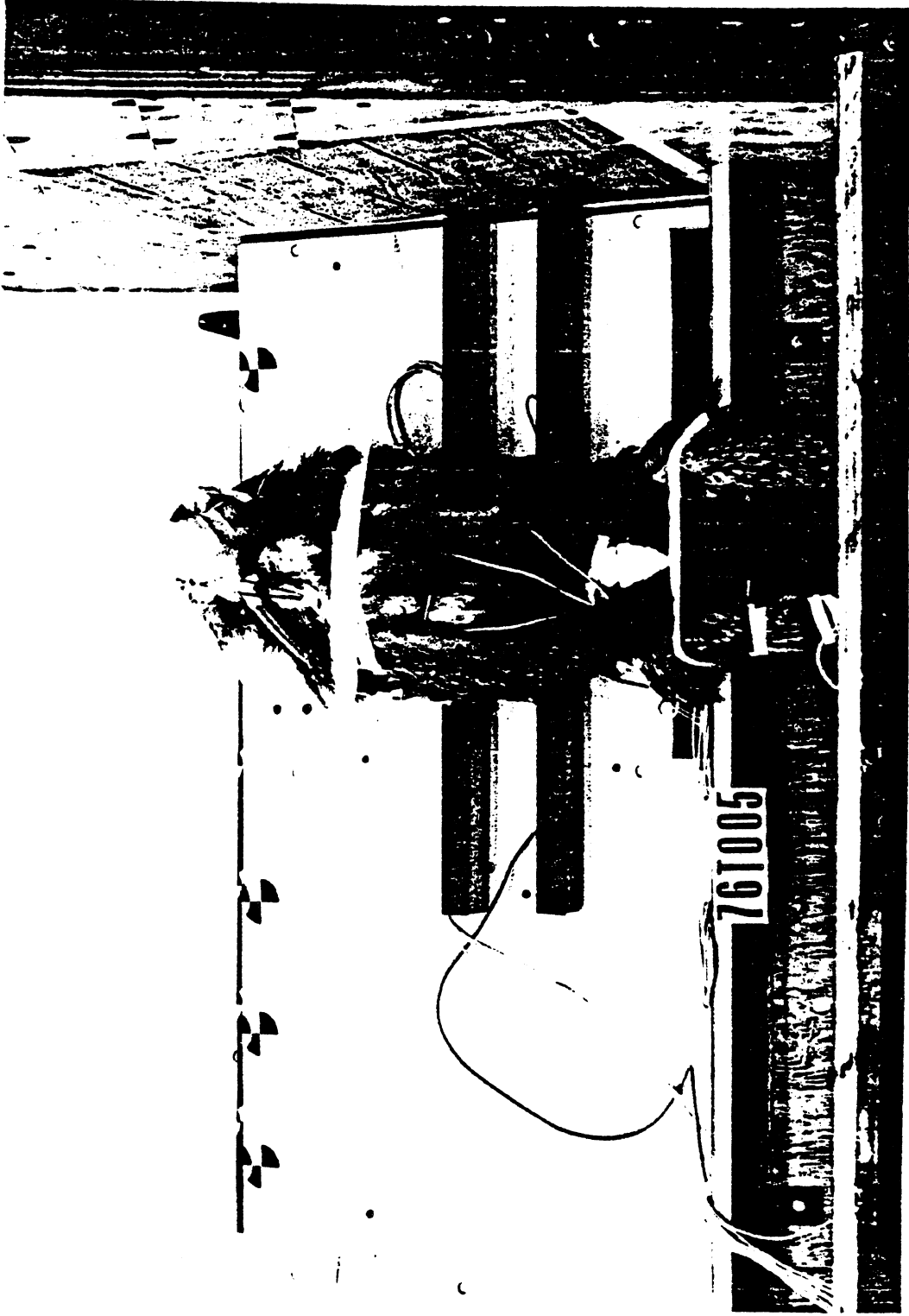

Figure 8. Side Impact Sled Test Setup. Rigid Door.

this phase represents the target velocity difference (ΔV) for the interaction between the subject and the side structures. While the sled motion is being reversed, the unrestrained subject begins to slide along the low friction seat surface building up a velocity relative to the sled about equal to the change in velocity generated by the deceleration. The distance between subject and door structures was selected to allow completion of sled deceleration before the interaction.

Note that for side sled tests the velocity noted in Table 3.1 is the closing velocity between the subject and the side structure.

4.0 TEST PROTOCOLS AND METHODS

4.1 Introduction

The test protocols and methods used in the primate test series were taken almost in their entirety from the protocols and methods developed for the human cadaver subjects. Rather than unnecessarily duplicate material previously reported, this section will refer to the earlier document (See page 1 for reference) for those cases.

As for the human cadaver tests, the protocols and methods can be divided conveniently into two areas: those dealing with the subject (the primate) and those involving the laboratory. The subject must be sedated, measured, instrumented and otherwise prepared for the test; tested, then removed from the test fixture and transferred from the sled laboratory to the anatomy laboratory for termination and autopsy.

In a parallel process, the laboratory must be prepared, the test fixture assembled, the data collection electronics and photographic cameras prepared and tested prior to the impact test. After the test, the lab must be cleaned and preliminary data analysis performed. Two distinct protocols were developed, one for each area. Figures 9 and 10 are samples of those protocols.

The discussion which follows in this section will be in two parts. It will elaborate the activities, methods, procedures, and hardware used in the primate test series.

4.2 Primate Handling and Instrumentation

The topic of primate handling and instrumentation can be divided into the following categories:

- Obtaining the primate
- Preliminary activities
- Surgical routines
- Pre-test activities
- Post-test activities
- Autopsy
- Disposal of the cadaver

Each of these will be discussed in turn.

TEST NO. _____ DATE _____ PROJECT DIRECTOR _____ PREPARED BY _____
 (ANATOMY)

BALBOM TEST SCHEDULE - THORACIC IMPACT PROJECT

ITEM	DETAILS	TEST #1 TIME	TEST #1 PERSONNEL	TEST #2 TIME	TEST #2 PERSONNEL
1. Initial Prep	Drugs (prep) Secure Baloom Shave (incl top of head) Insert drug catheter				
2. Initial Anthropometry					
3. Attach Rib Accelerometer Mounts	R ₅ (Normal) R & L. R ₉ (A-P) R & L.				
4. Insert Femoral Catheter					
5. Tracheal Tube					
6. Spinal Mount	Triax on T ₆				
7. Pelvic Mount	Triax on pelvic crests				
8. Move to Sled Lab					
9. Mount Accelerometers					
10. Set-up on Sled	Position, incl. blocking Targets Connect instruments Pad accelerometers on (left) barrier side				
11. Prep & Fire Sled (See Sled Lab Schedule)					
12. Post-Test Activities	Attend & terminate animal Clean & recycle sled Gather data & recycle instrumentation				
13. Autopsy					

Figure 9. Test Protocol (Anatomy).

BAHONN TEST SCHEMILE - THORACTIC IMPACT PROJECT (SLED LAB)

ITEM	DETAILS	TEST #1 TIME	TEST #1 PERSONNEL	TEST #2 TIME	TEST #2 PERSONNEL
a. Animal Arrives - Sled Lab					
b. Animal on Sled					
1. Calibration of Transducers					
2. Setup Photos & Check Cameras					
3. Prep & Fire Sled					
4. Disconnect Transducers					
5. Remove Animal from Sled					
6. Clean & Recycle	Clean & recycle sled Gather data & recycle instrumentation Unload & recycle cameras				

Figure 10. Test Protocol (Sled Lab).

4.2.1 Primate Acquisition

The primates were obtained through the Unit for Laboratory Animal Medicine of the University of Michigan School of Medicine. They were transported to the HSRI laboratory as needed and kept in a vivarium. The primates were fed and watered and their cages cleaned as necessary during the period between their arrival at HSRI and the test.

Great pains were taken at all times to minimize contact between Institute personnel and the primates to preclude the transmission of any disease in either direction. All persons working with the primates were required to wear full length lab coats and OSHA-approved masks. If contact was anticipated, gloves would be worn. All personnel who came in contact with the primates were required to undergo annual OSHA-approved physical examinations, which included tuberculin tests, as one requisite of their employment.

4.2.2 Preliminary Activities

The first task on the day of the test was to sedate the primate. This was accomplished by restraining the animal in an immobilizing cage. With the primate thus confined, it was possible to administer an initial anesthetic. A dose of Ketalar (20 mg/kg) was administered intramuscularly. Typically, the primate would be unconscious in less than two minutes. The animal was then removed from the cage and fitted with a venous catheter in either the right or left leg for further anesthetic injections. The level of anesthetization was maintained through the use of sodium pentobarbital in the following ways. An initial injection of 25 mg/kg of sodium pentobarbital was administered. The subject was then monitored for the duration of the experiment for breathing, heart rate, eye reflex and deep reflex as well as muscle tone and any spontaneous movements. Additional doses of sodium pentobarbital were administered as needed along with routine care (such as saline injections to maintain blood volume). The subject was maintained in an anesthetized state until the animal was killed after the impact test. The method of termination consisted of a lethal dose of sodium pentobarbital along with a bilateral pneumothorax.

4.2.3 Surgical Routines

After the drug catheter was inserted, the animal was shaved in the areas where transducers would be mounted. One series of body measures, similar to those taken for the human cadaver subjects, were recorded for each animal at this time.

Rib and spinal accelerometer mounts were attached to the body using stainless steel wires. A femoral catheter was inserted to provide a channel for a vascular pressure transducer. A tracheotomy was performed and the animal intubated to provide a channel for the airway transducer. The techniques used in attaching the mounts were essentially the same as the techniques used for the human cadaver subjects with the following differences:

1. the rib mounts were placed over the skin, not directly on the rib surface;
2. the spinal mount was placed over the spine, not bolted directly to the bone, and held in place by steel wires; and,
3. the tracheal tube was not plugged, so that the animal could continue to breath.

The transducers used were the same as those used in the human cadaver tests, as were the rib mounts and tubes. The spinal mount was a slightly modified version of the human cadaver spinal mount.

A final sanitary preparation completed the procedures.

4.2.4 Pre-test Activities

After the subject was moved from the surgical lab to the sled lab, the various transducers needed for the test were attached to the mounts and the animal was placed on the sled.

When the subject was in place, and phototargets had been applied, initial (setup) photographs were taken. Following this, the instrumentation was given a final check and the test was conducted.

4.2.5 Post-test Activities.

After impact, the subject was carefully removed from the sled and placed on a rolling table. Vital functions were checked to determine

whether the animal was still alive. The transducers were then removed and the subject transported to the anatomy laboratory. At this time the subject was killed with a dose of Dopram, Euthol or other humane toxic agent.

An autopsy was performed on each subject to determine the nature and the extent of injuries sustained as a result of the impact tests. (If the autopsy was not to be performed immediately, the primate cadaver was placed in cold storage until such time.) Particular attention was paid to the thorax; cervical, thoracic, and lumbar spines, and abdominal viscera. A thorough examination of each area was performed and any unusual injuries were noted and photographed. Examples of the autopsy recording forms can be found in the complete test data in the Appendix.

At the conclusion of the autopsy, the primate cadaver was sealed into a polyethylene bag and frozen. The remains were later given to other units of the University for other research purposes.

4.3 Laboratory Procedures

The routines of laboratory procedures were the same for the primates tests as for the human cadaver tests. This is detailed in the first report (See page 1 for reference) and will not be repeated here.

The only significant procedural change was in the final clean up. After a primate test, all exposed surfaces were cleaned with a bactericidal solution to prevent any possible disease transfer.

APPENDIX. INDIVIDUAL TEST REPORTS.

The following pages constitute a complete set of transducer and autopsy data for all primate tests performed during this project. The data are presented in the order in which the tests were performed.

At the time each test was performed, it was assigned a "test number." For the earliest tests (1975), this was a letter, "A" followed by a three digit number. The 1975 test series (both primate and human cadaver) for this project are in an unbroken series from A-867 through A-937. Later tests are numbered with a two-digit year identifier ("76", e.g.), a single letter ("T", for thorax tests), and a three digit number. All tests for this project subsequent to 1975 were numbered in sequence, irrespective of year.

The following data are supplied for each test:

- a. a Summary Test Report
- b. a Primate Injury Report
- c. detailed autopsy finding diagrams (as needed),
- d. plots of transducer channels made directly from the analog tape, interpreted and scaled ("Brush recordings"), and
- e. plots made from digitized, filtered and scaled transducer data along with interpretive information on the plots.

The test and autopsy summary sheets need no further elaboration. The autopsy diagrams were made on the basis of records, notes and drawings made at the time of the autopsy.

The Brush recordings were made shortly after the test was performed. The analog tape(s) containing the transducer data was played back at reduced speed, and the tape drive's output was fed directly into the Brush recorder. These data were then scaled, and values of important peaks recorded on the chart. They were then cut, assembled in a presentable form, and labelled with test numbers and channel name. An arrow, indicating direction of time flow, with a length equivalent to 100 msec, was drawn at the bottom of the page.

Computer-generated plots were prepared from the digitized, filtered and scaled transducer data. Each trace on these plots represents one transducer channel from one test. To the left of each trace is a scale from which the signal magnitude can be derived. The numeric value next to the bar is the number of units of signal magnitude per division on the bar. Also to the left of each trace is its channel number. Time scales in milliseconds and number of points are given at the bottom and top, respectively. The time origin is the arbitrary start-of-digitization, and bears no useful relationship to " t_0 " or the "start-of-test." The test number is given at the top of the right edge of the chart. This is usually suffixed with the number "-1" or "-2" indicating the analog tape drive used to record the raw data (1=Honeywell 7600, 2=CEC). These plots were prepared using the following data processing: a. electronic filtering to appropriately band limit the response and minimize aliasing in the A/D process; b. analog to digital conversion at a 100 Hz sampling rate; and, c. digital filtering with a finite impulse response filter having the following characteristics; pass band frequency = 100 Hz, stop band frequency = 189 Hz, pass band ripple = .045 dB, and stop band gain = -100dB.

Following the plots is a summary table, printed during the scaling/filtering portion of the analog-to-digital process. Among other information, this gives the test number and, for each channel digitized, the channel number, name of channel contents and units of measure. Scale factor (units/volt), signal frequency (approximately 1600 Hz for all), data of digitization and other general information are also given.

Summary Test Report

Thoracic Injury Project (Contract DOT-HS-4-00921) Highway Safety Research
Institute - The University of Michigan

Test No.: A-871

Test Date: June 10, 1975

Test Subject

Species - Baboon (cadaver)
Sex - Male
Weight - 12 kg.

Restraint System

Soft EA-column

Velocity

24.0 mph

Deceleration

10.0 G's

Injuries

Dislocation of 8th right rib at sternum.
Small laceration on right lung.
Fracture of sternum at site of sternal mounting screw.

AIS Number Estimate

3

THORACIC INJURY PROJECT

PRIMATE INJURY REPORT

Test Number A-871

Date 6-10-75

Anatomical Anomalies or Clinical Observations

1. Thoracic Skeleton
2. Heart
3. Lungs Minor bilateral hemopneumothorax -- probably surgically induced.
4. Other structures or systems

Injuries observed

1. External
2. Bony or Cartilaginous Structures
 Dislocation of R₈ right at sternum.
 Fracture of sternum at site of sternal mounting screw.
3. Heart and Vascular
4. Lungs 1 cm laceration right lung, lateral -- possibly surgically induced.
5. Other structures or systems

THORACIC IMPACT PROJECT

Test # 4-871

Date 6.10.75

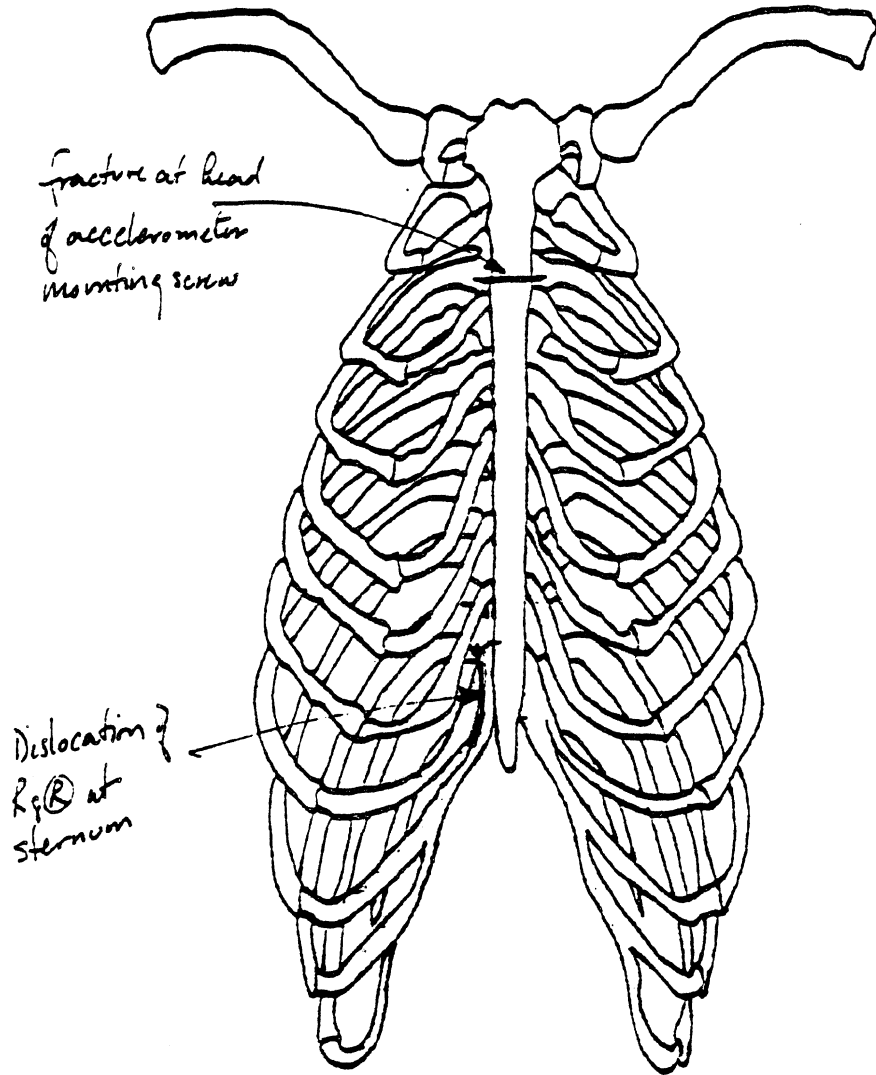

R

Papio

L

THORACIC IMPACT PROJECT

Test # 1-871

Date 6.10.75

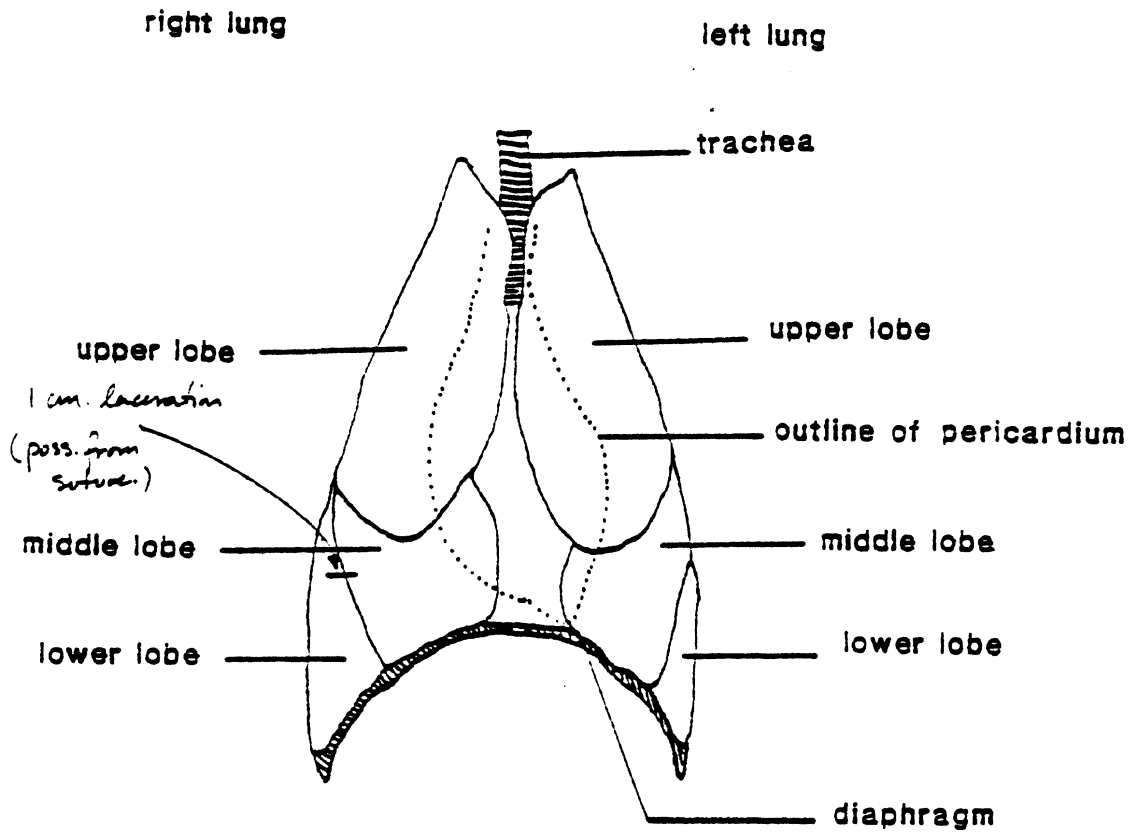

Papio

SLED DECELERATION PULSE

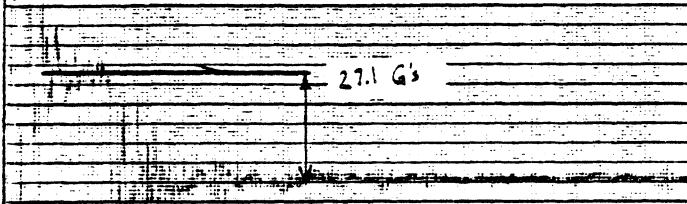

RIGHT RIB ACCELEROMETER

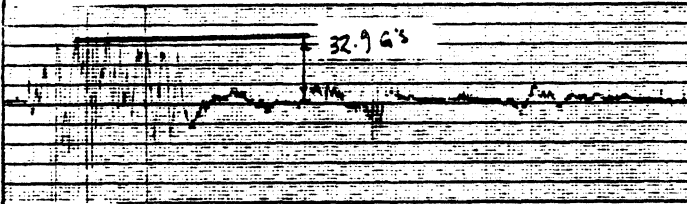

LEFT RIB ACCELEROMETER

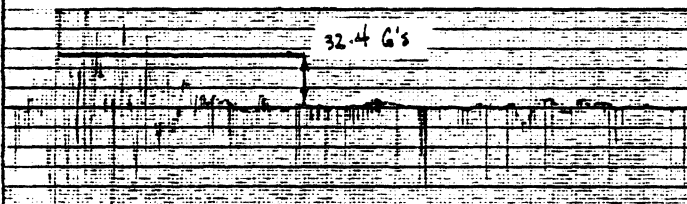

JACK ACCELEROMETER

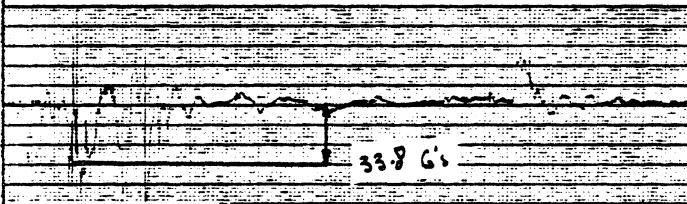

RIGHT LAP BELT LOAD

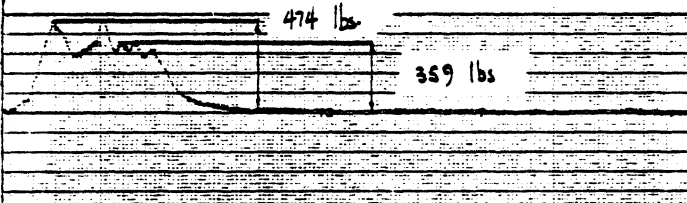

LEFT LAP BELT LOAD

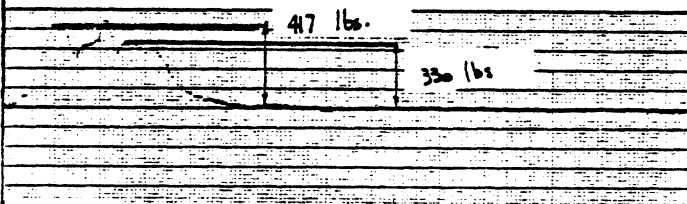

STEERING COLUMN LOAD

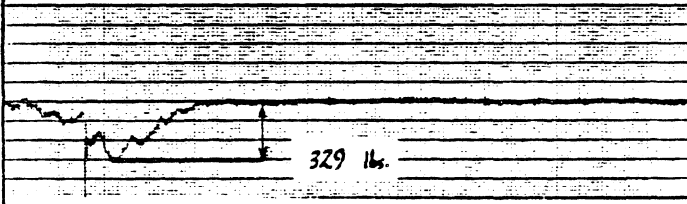

100 MSEC

10 MS
20 PTS

SEP 29, 1976 / 14:13:44

RUN ID: A-871-1:

< 1 > 4.E+00

< 2 > 6.E+00

< 3 > 1.E+01

< 4 > 5.E+00

< 7 > 4.E+01

< 8 > 4.E+01

< 9 > 3.E+01

< 10 > 3.E+01

10 MS
20 PTS

FILES: 1- 8, TAPE:THORAX

467 PTS @ 1600 HZ = 291.2 MS

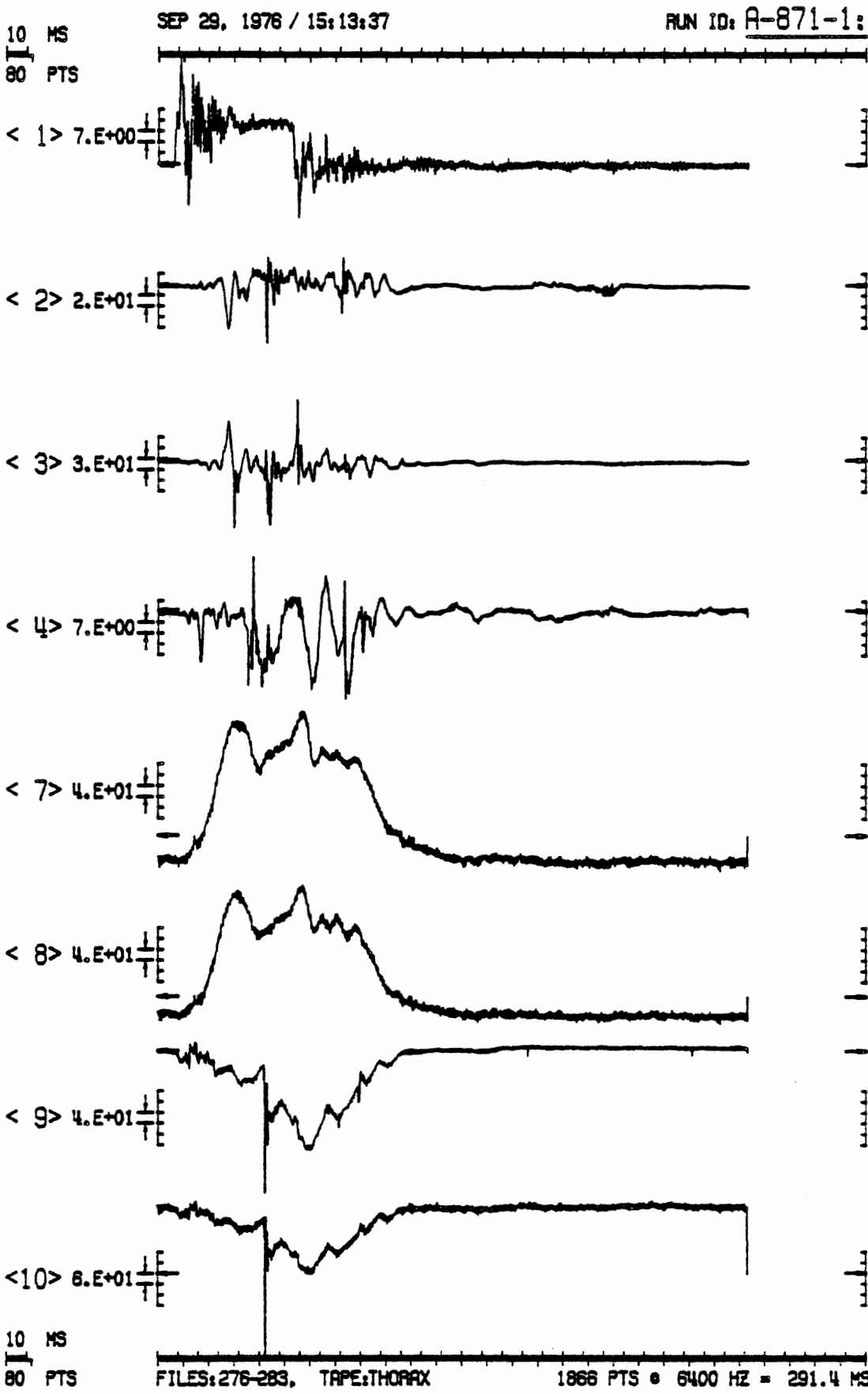

=====
RUN ID: A-871-11

ANALOG-TO-DIGITAL CONVERSION & DIGITAL FILTERING

=====
DATE: 20-SEP-76

PROJECT: THORACIC IMPACT PROJECT -- PRIMATE TEST SERIES

ANALOG TAPE: HSR1(136) EXPANDED 16:1, WAS A/D CONVERTED TO DIGITAL TAPE: T.I.P. DATE: 20-SEP-76
TEST SIGNALS: 1873 PTS/CH AT 6400.02 HZ. CAL SIGNALS: NOT DIGITIZED.

FILE	CH	CONTENT OF CHANNEL	UNITS/VOLT	UNITS	FILTER STAGES	FILTER CUTOFF	NO. PTS	SAMPLING HERTZ
1	11	SLED DECELERATION	20.00	G'S	4+1+3	100.0	467	1600.21
2	21	RIGHT RIB ACCELEROMETER	39.10	G'S	4+1+3	100.0	467	1600.21
3	31	LEFT RIB ACCELEROMETER	40.20	G'S	4+1+3	100.0	467	1600.21
4	41	BACK ACCELEROMETER	42.10	G'S	4+1+3	100.0	467	1600.21
5	71	RIGHT LAP BELT LOAD	1000.00	LBS.	4+1+3	100.0	467	1600.21
6	81	LEFT LAP BELT LOAD	1000.00	LBS.	4+1+3	100.0	467	1600.21
7	91	STEERING COLUMN LOAD (/10)	117.60	LBS.	4+1+3	100.0	467	1600.21
8	101	STEERING COLUMN LOAD	1176.00	LBS.	4+1+3	100.0	467	1600.21

11:
12:
13:
14:

Summary Test Report

Thoracic Injury Project (Contract DOT-HS-4-00921) Highway Safety Research
Institute - The University of Michigan

Test No.: A-872

Test Date: June 12, 1975

Test Subject

Species - baboon
Sex - male
Weight - 12 kg.

Restraint System

Soft EA column

Velocity

30.5 mph

Deceleration

29.6 G's

Injuries

Laceration almost through left lung.
Right lung bottom lobe bruised near vessels and bronchi.
Right ribs (6,7) broken, left (5,6,7).
Dent in cartilage at bottom of sternum
Small tear on surface of liver at adhesion.

AIS Number Estimate

4

THORACIC INJURY PROJECT

PRIMATE INJURY REPORT

Test Number A-872

Date 6-12-75

Anatomical Anomalies or Clinical Observations

1. Thoracic Skeleton
2. Heart
3. Lungs
4. Other structures or systems

Injuries observed

1. External none noted.
2. Bony or Cartilaginous Structures Fractures of R₇ right and R₅₋₇
left, lateral. Dents in cartilage of R₈₋₁₀ bilateral, near
junctions of R₉ and R₁₀.
3. Heart and Vascular none noted.
4. Lungs Laceration into left middle and lower lobes, almost through
lung. Right lower lobe bruised near vessels and bronchi.
5. Other structures or systems 2" laceration through capsule,
upper right lobe of liver. (Diaphragmatic adhesion tore loose
on impact.) Hemoperitoneum.

THORACIC IMPACT PROJECT

Test # A-872

Date 6.12.75

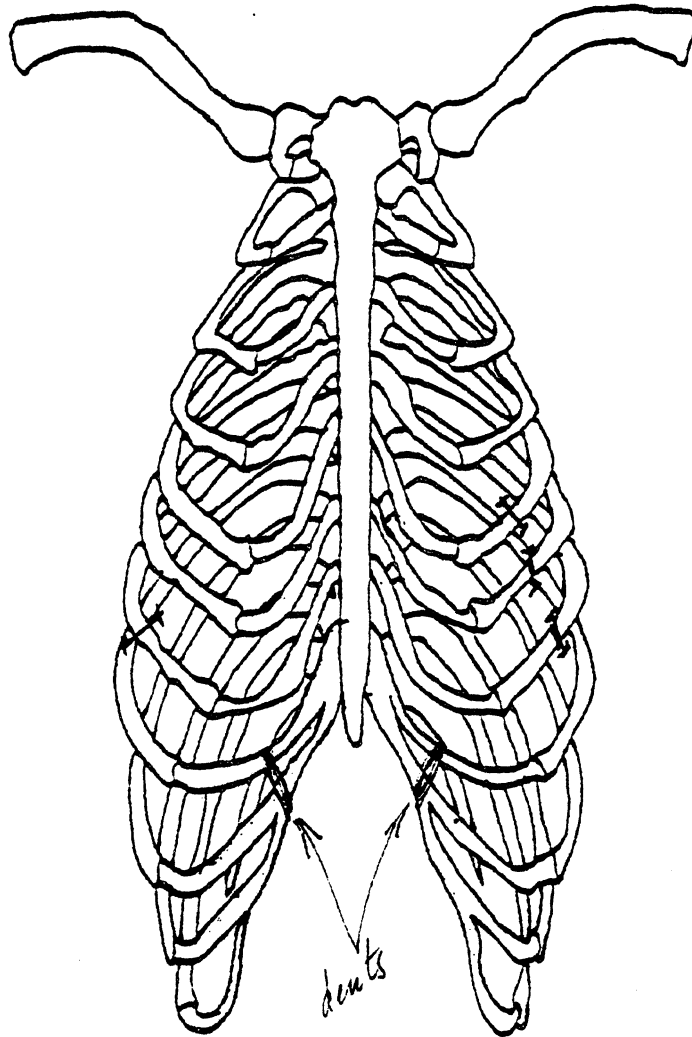

fractures:
R ②
R 5-7 ①

R

Papio

L

THORACIC IMPACT PROJECT

Test # 4-572

Date 6-12-75

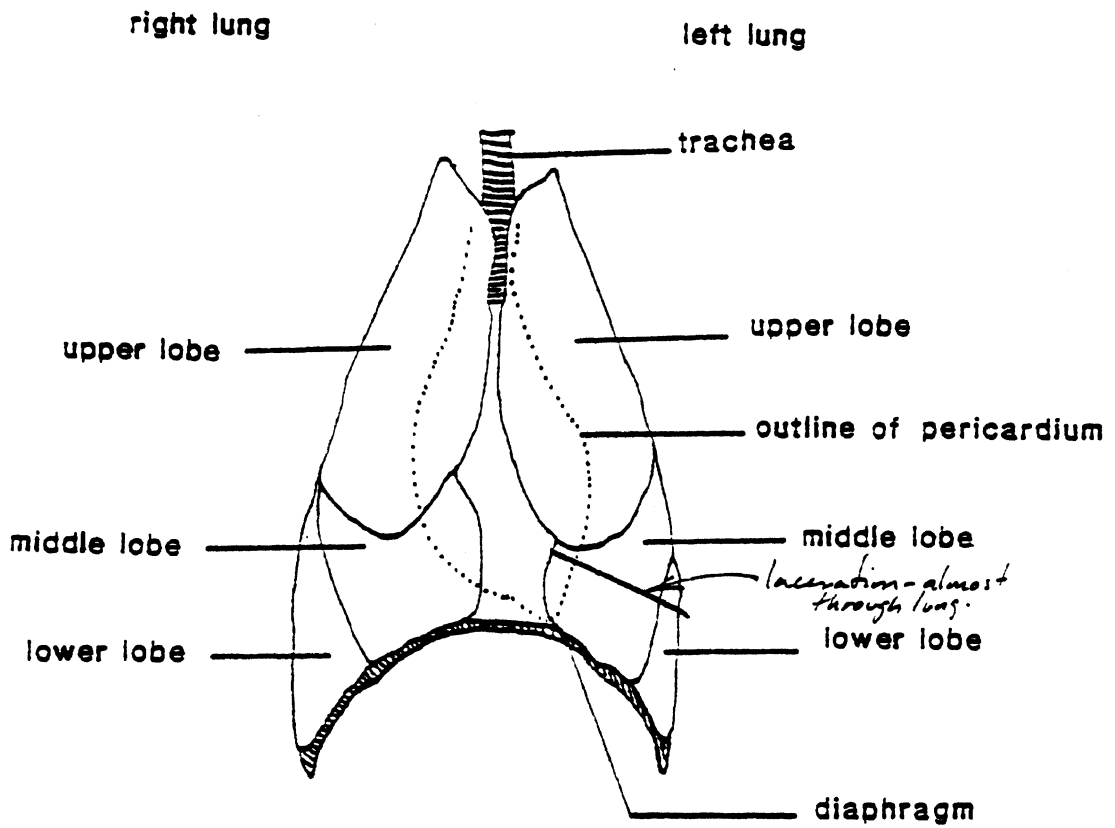

also: ② lower lobe
'crised near
vessels and bronchi

Papio

THORACIC IMPACT PROJECT

Test # A-872

Date 6.12.75

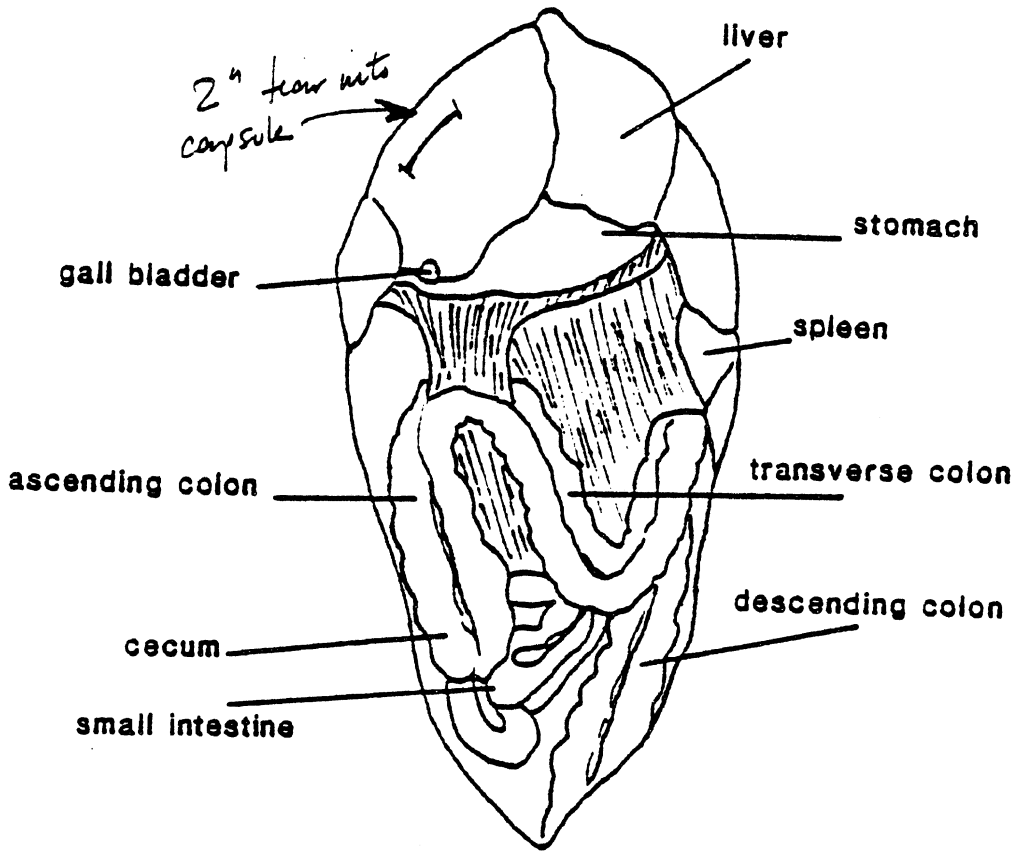

Papio

SLED DECELERATION PULSE

26.0 G's

RIGHT UPPER RIB
ACCELEROMETER

39.8 G's

RIGHT LOWER RIB
ACCELEROMETER

59.9 G's

30.0 G's

LEFT UPPER RIB
ACCELEROMETER

66.1 G's

25.3 G's

THORAX I-S ACCELEROMETER

75.8 G's

91.5 G's

RIGHT LAP BELT LOAD

282 lbs.

LEFT LAP BELT LOAD

296 lbs.

STEERING COLUMN LOAD

377 lbs.

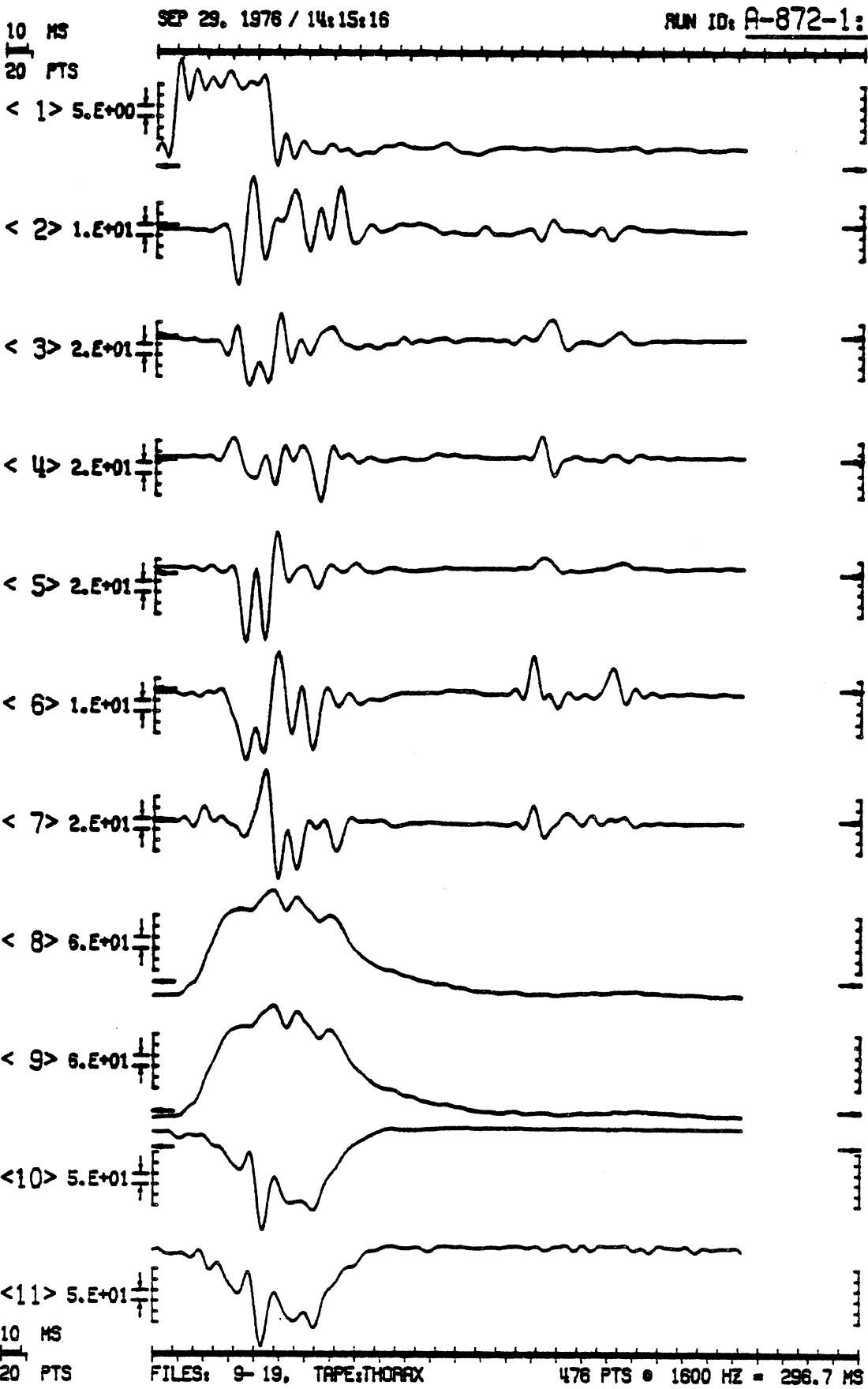

=====
 RUN ID: A-872-11
 =====

ANALOG-TO-DIGITAL CONVERSION & DIGITAL FILTERING
 =====

PROJECT: THORACIC IMPACT PROJECT - PRIMATE TEST SERIES

ANALOG TAPE: HSRI(136) EXPANDED 1611, WAS A/D CONVERTED TO DIGITAL TAPE: T.I.P. DATE: 20-SEP-76
 TEST SIGNALS: 1910 PTS/CH AT 6402.95 HZ. CAL SIGNALS: NOT DIGITIZED.

FILE	CH	CONTENT OF CHANNEL	UNITS/VOLT	UNITS	FILTER STAGES	FILTER CUTOFF	NO. PTS	SAMPLING HERTZ
9	11	SLED DECELERATION	20.00	G'S	4+1+3	100.0	476	1600.74
10	21	RIGHT UPPER RIB ACCELEROMETER	38.80	G'S	4+1+3	100.0	476	1600.74
11	31	RIGHT LOWER RIB ACCELEROMETER	48.20	G'S	4+1+3	100.0	476	1600.74
12	41	LEFT UPPER RIB ACCELEROMETER	41.00	G'S	4+1+3	100.0	476	1600.74
13	51	LEFT LOWER RIB ACCELEROMETER	56.20	G'S	4+1+3	100.0	476	1600.74
14	61	THORAX A-P ACCELEROMETER	44.90	G'S	4+1+3	100.0	476	1600.74
15	71	THORAX I-S ACCELEROMETER	46.80	G'S	4+1+3	100.0	476	1600.74
16	81	RIGHT LAP BELT LOAD	1000.00	LBS.	4+1+3	100.0	476	1600.74
17	91	LEFT LAP BELT LOAD	1000.00	LBS.	4+1+3	100.0	476	1600.74
18	101	STEERING COLUMN LOAD	117.60	LBS.	4+1+3	100.0	476	1600.74
19	111	STEERING COLUMN LOAD	1176.00	LBS.	4+1+3	100.0	476	1600.74

121
 131
 141

 FILTERED FILES: 9 - 19 DIGITAL TAPE: THORAX DATE: 28-SEP-76 RUN ID: A-872-11

Summary Test Report

Thoracic Injury Project (Contract DOT-HS-4-00921) Highway Safety Research
Institute - The University of Michigan

Test No.: A-873

Test Date: June 13, 1975

Test Subject

Species - baboon
Sex - Male
Weight - 14.5 kg.

Restraint System

Soft EA column and lap belt

Velocity

30.1 mph

Deceleration

30.4 G's

Injuries

Right clavicle dislocated at sternum.
Hemothorax and external longitudinal cut of left pectoral
muscle down to ribs 2, 3, 4 which were broken do to wheel
impact.

AIS Number Estimate

3

THORACIC INJURY PROJECT

PRIMATE INJURY REPORT

Test Number A-873

Date 6-13-75

Anatomical Anomalies or Clinical Observations

1. Thoracic Skeleton
2. Heart
3. Lungs
4. Other structures or systems

Injuries observed

1. External none noted.
2. Bony or Cartilaginous Structures Right clavicle dislocated at sternum. Fractures of R₂₋₄ left, lateral.
3. Heart and Vascular none noted.
4. Lungs Some small areas of hemorrhage, all less than 1 cm diameter. Hemothorax (4-5 cc free blood).
5. Other structures or systems Laceration of right pectoralis over site of fractures, through to bone.

THORACIC IMPACT PROJECT

Test # 4-813

Date _____

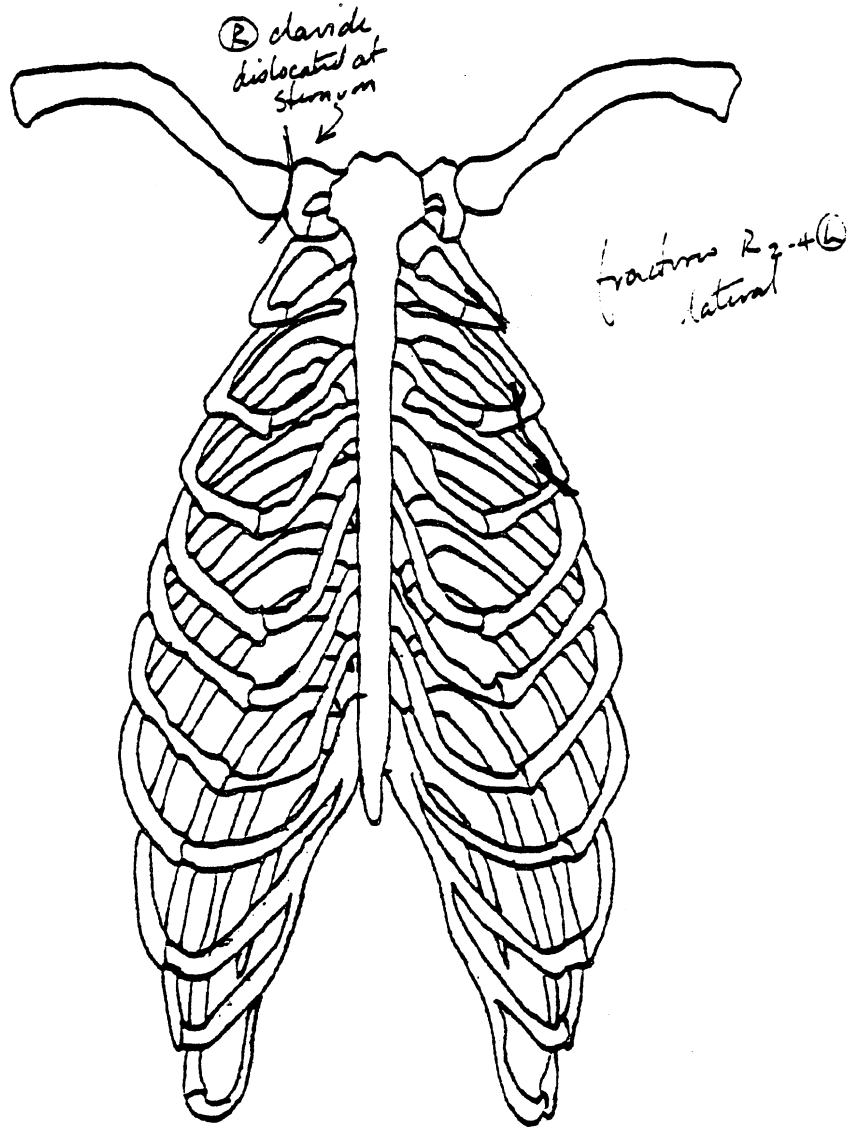

R

Papio

L

SLED DECELERATION PULSE

35.8 G's

RIGHT UPPER RIB
ACCELEROMETER

39.8 G's

RIGHT LOWER RIB
ACCELEROMETER

85.2 G's

36.6 G's

LEFT UPPER RIB
ACCELEROMETER

43.2 G's

56.1 G's

LEFT LOWER RIB
ACCELEROMETER

117.7 G's

77.6 G's

THORAX A-P ACCELEROMETER

48.5 G's

111.9 G's

THORAX I-S ACCELEROMETER

101.0 G's

124.8 G's

100 ISEC

TEST NO. A-873

RIGHT LAP BELT LOAD

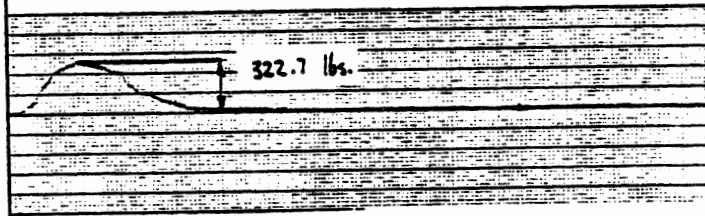

LEFT LAP BELT LOAD

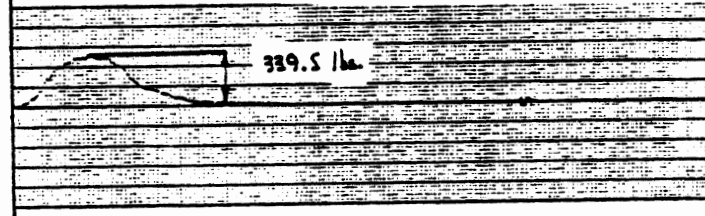

STEERING COLUMN LOAD

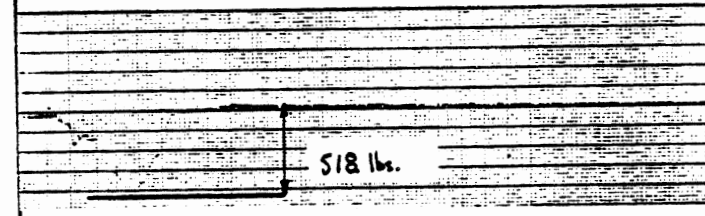

100 MSEC

SEP 29, 1976 / 14:16:26

RUN ID: A-873-1:

10 MS

20 PTS

< 1 > 5.E+00

< 2 > 1.E+01

< 3 > 8.E+00

< 4 > 4.E+00

< 5 > 8.E+00

< 6 > 2.E+01

< 7 > 2.E+01

< 8 > 6.E+01

< 9 > 6.E+01

< 10 > 6.E+01

< 11 > 6.E+01

10 MS

20 PTS

FILES: 20-30, TAPE:THORAX

480 PTS @ 1600 HZ = 299.2 MS

=====

RUN ID: A-873-11

=====

ANALOG-TO-DIGITAL CONVERSION & DIGITAL FILTERING

PROJECT: THORACIC IMPACT PROJECT -- PRIMATE TEST SERIES

ANALOG TAPE: HSRI(136) EXPANDED 1611, WAS A/D CONVERTED TO DIGITAL TAPE: T.I.P. DATE: 20-SEP-76

TEST SIGNALS: 1924 PTS/CH AT 6403.59 HZ. CAL SIGNALS: NOT DIGITIZED.

FILE	CH	CONTENT OF CHANNEL	UNITS/VOLT	UNITS	FILTER STAGES	FILTER CUTOFF	NO. PTS	SAMPLING HERTZ
20	11	SLED DECELERATION	20.00	G'S	4+1+3	100.9	480	1600.90
21	21	RIGHT UPPER RIB ACCELEROMETER	39.10	G'S	4+1+3	100.9	480	1600.90
22	31	RIGHT LOWER RIB ACCELEROMETER	-48.60	G'S	4+1+3	100.9	480	1600.90
23	41	LEFT UPPER RIB ACCELEROMETER	-41.80	G'S	4+1+3	100.9	480	1600.90
24	51	LEFT LOWER RIB ACCELEROMETER	-56.20	G'S	4+1+3	100.9	480	1600.90
25	61	THORAX A-P ACCELEROMETER	44.40	G'S	4+1+3	100.9	480	1600.90
26	71	THORAX I-S ACCELEROMETER	47.20	G'S	4+1+3	100.9	480	1600.90
27	81	RIGHT LAP BELT LOAD	1000.00	LBS.	4+1+3	100.9	480	1600.90
28	91	LEFT LAP BELT LOAD	1000.00	LBS.	4+1+3	100.9	480	1600.90
29	101	STEERING COLUMN LOAD	117.60	LBS.	4+1+3	100.9	480	1600.90
30	111	STEERING COLUMN LOAD	1176.00	LBS.	4+1+3	100.9	480	1600.90

120

130

140

FILTERED FILES: 20 * 30 DIGITAL TAPE: THORAX DATE: 20-SEP-76 RUN ID: A-873-11

Summary Test Report

Thoracic Injury Project (Contract DOT-HS-4-00921) Highway Safety Research
Institute - The University of Michigan

Test No.: A-878

Test Date: June 25, 1975

Test Subject

Species - baboon (cadaver)
Sex - Male
Weight - 10 kg.

Restraint System

Soft EA-column with lap belt

Velocity

30.1 mph

Deceleration

30.0 G;s

Injuries

Pericardial hematoma
Liver lacerations (2 subcapsular and 1 tear through
capsule approximately 2 cm. long)

AIS Number Estimate

5

THORACIC INJURY PROJECT

PRIMATE INJURY REPORT

Test Number A-878

Date 6-27-75

Anatomical Anomalies or Clinical Observations

1. Thoracic Skeleton
2. Heart
3. Lungs Left lung looks tubercular.
4. Other structures or systems Hemorrhage around transducer mounts on left ribs -- probably surgically induced.

Injuries observed

1. External none noted.
2. Bony or Cartilaginous Structures No fractures or dislocations.
3. Heart and Vascular Hematoma on pericardium.
4. Lungs
5. Other structures or systems Three liver lacerations -- two subcapsular, one torn through capsule (2 cm long). Minimal hemoperitoneum.

SLED DECELERATION PULSE

30.1 G's

RIGHT UPPER RIB
ACCELEROMETER

178.4 G's

97.7 G's

162.0 G's

RIGHT LOWER RIB
ACCELEROMETER

124.7 G's

LEFT UPPER RIB
ACCELEROMETER

208 G's

103.4 G's

173.5 G's

LEFT LOWER RIB
ACCELEROMETER

172.5 G's

THORAX A-P ACCELEROMETER

198.2 G's

84.9 G's

THORAX I-S ACCELEROMETER

79.9 G's

201. G's

78.7 G's

53

100 MSEC

TEST NO. A-878

RIGHT LAP BELT LOAD

246. lbs.

LEFT LAP BELT LOAD

234. lbs.

STEERING COLUMN LOAD

306. lbs

358. lbs

100 MSEC

SEP 29, 1976 / 14:17:17

RUN ID: A-878-1:

10 MS

20 PTS

< 1 > 5.E+00

< 2 > 3.E+01

< 3 > 2.E+01

< 4 > 1.E+01

< 5 > 2.E+01

< 6 > 2.E+01

< 7 > 3.E+01

< 8 > 5.E+01

< 9 > 5.E+01

< 10 > 4.E+00

< 11 > 9.E+02

10 MS

20 PTS

FILES: 31-41, TAPE:THORAX

412 PTS @ 1600 HZ = 256.7 MS

=====
 RUN ID: A-878-11
 =====

ANALOG-TO-DIGITAL CONVERSION & DIGITAL FILTERING

PROJECT: THORACIC IMPACT PROJECT -- PRIMATE TEST SERIES

ANALOG TAPE: MSKI(136) EXPANDED 1611, WAS A/D CONVERTED TO DIGITAL TAPE: T.I.P. DATE: 20-SEP-76

TEST SIGNALS: 1657 PTS/CH AT 6403.56 HZ. CAL SIGNALS: NOT DIGITIZED.

FILE NO	CH NO	CONTENT OF CHANNEL	UNITS/VOLT	UNITS	FILTER STAGES	FILTER CUTOFF	NO. PTS	SAMPLING HERTZ
31	1	SLED DECELERATION	20.00	G'S	4+1+3	100.0	412	1600.89
32	2	RIGHT UPPER RIB ACCELEROMETER	78.30	G'S	4+1+3	100.0	412	1600.89
33	3	RIGHT LOWER RIB ACCELEROMETER	-97.20	G'S	4+1+3	100.0	412	1600.89
34	4	LEFT UPPER RIB ACCELEROMETER	-83.60	G'S	4+1+3	100.0	412	1600.89
35	5	LEFT LOWER RIB ACCELEROMETER	-112.50	G'S	4+1+3	100.0	412	1600.89
36	6	THORAX A-P ACCELEROMETER	89.70	G'S	4+1+3	100.0	412	1600.89
37	7	THORAX I-S ACCELEROMETER	94.50	G'S	4+1+3	100.0	412	1600.89
38	8	RIGHT LAP BELT LOAD	1000.00	LBS.	4+1+3	100.0	412	1600.89
39	9	LEFT LAP BELT LOAD	1000.00	LBS.	4+1+3	100.0	412	1600.89
40	10	STEERING COLUMN LOAD	117.60	LBS.	4+1+3	100.0	412	1600.89
41	11	STEERING COLUMN LOAD	1176.00	LBS.	4+1+3	100.0	412	1600.89

121
 131
 140

Summary Test Report

Thoracic Injury Project (Contract DOT-HS-4-00921) Highway Safety Research
Institute - The University of Michigan

Test No.: A-879

Test Date: June 25, 1975

Test Subject

Species - Baboon
Sex - Male
Weight - 14 kg.

Restraint System

Stiffened EA column with lap belt

Velocity

30.0 mph

Deceleration

30.0 G's

Injuries

large, deep laceration, left upper anterior thorax
with extensive bruising.
perforation of left hemithorax between R₃ and R₄,
under surface laceration.
minor pericardial hemorrhage
gross hemorrhage - lungs with scattered petechiae;
hemopneumothorax

AIS Number Estimate

4

THORACIC INJURY PROJECT

PRIMATE INJURY REPORT

Test Number A-879

Date 6-25-75

Anatomical Anomalies or Clinical Observations

1. Thoracic Skeleton
2. Heart
3. Lungs
4. Other structures or systems

Injuries observed

1. External Large (6 X 1.5 cm), deep laceration (to bone) , left upper anterior thorax. Extensive bruising from steering wheel rim. Perforation of left hemithorax between R₃ and R₄, under surface laceration.
2. Bony or Cartilaginous Structures No rib fractures or dislocations noted. Contusions and hemorrhage medial rib cage and adjacent lung surface below laceration.
3. Heart and Vascular Pericardial hemorrhage without damage to underlying muscle.
4. Lungs Much hemorrhage. Petechiae spotted around both lungs. Hemothorax. Pneumothorax.
5. Other structures or systems Large laceration (noted above), through left pectoralis and into pectoralis abdominalis.

SLED DECELERATION PULSE

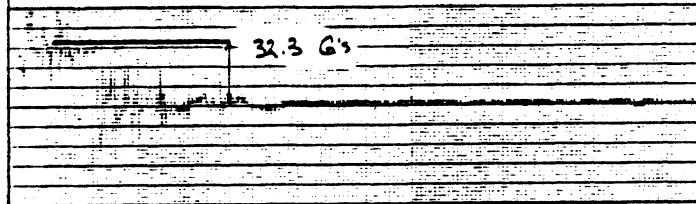

RIGHT UPPER RIB
ACCELEROMETER

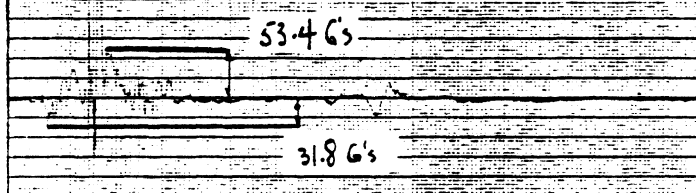

RIGHT LOWER RIB
ACCELEROMETER

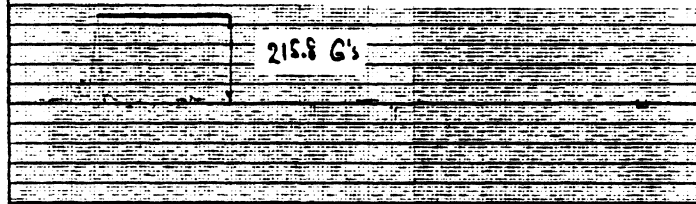

LEFT UPPER RIB
ACCELEROMETER

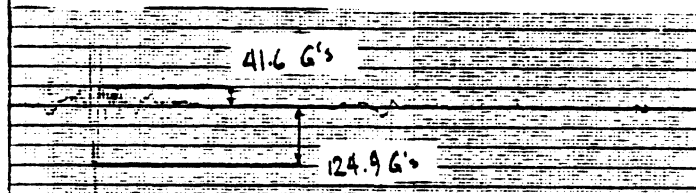

LEFT LOWER RIB
ACCELEROMETER

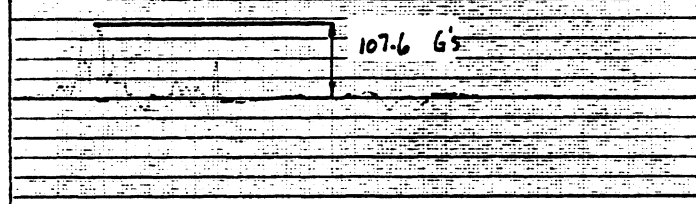

THORAX A-P ACCELEROMETER

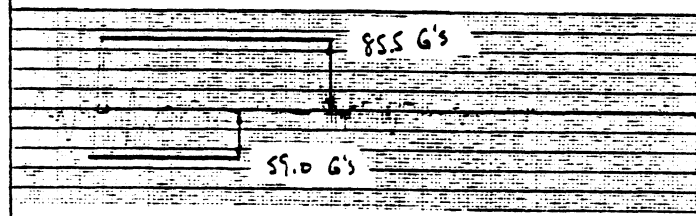

THORAX I-S ACCELEROMETER

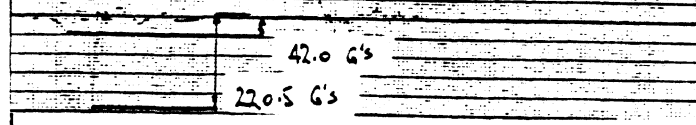

59

100 MSEC

TEST NO. A-879

RIGHT LAP BELT LOAD

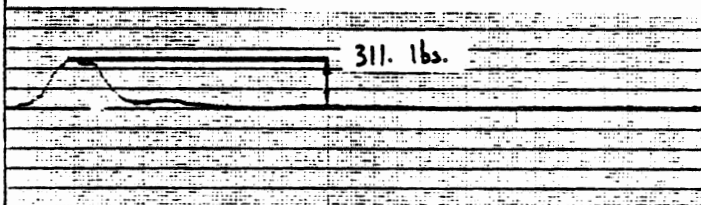

LEFT LAP BELT LOAD

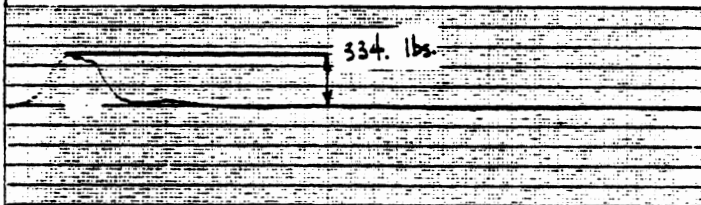

STEERING COLUMN LOAD

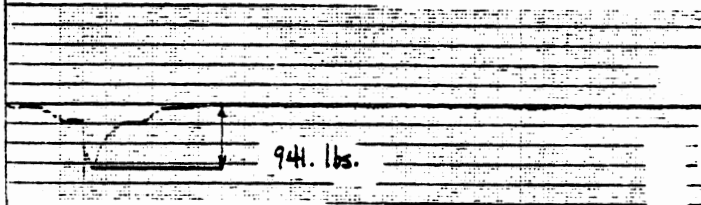

100 MSEC

SEP 29, 1976 / 14:18:03

RUN ID: A-879-1:

10 MS
20 PTS

< 1 > 5.E+00

< 2 > 2.E+01

< 3 > 2.E+01

< 4 > 2.E+01

< 5 > 2.E+01

< 6 > 2.E+01

< 7 > 2.E+01

< 8 > 6.E+01

< 9 > 7.E+01

< 10 > 9.E+00

< 11 > 9.E+02

10 MS
20 PTS

FILES: 42- 52, TAPE: THORAX

398 PTS • 1599 HZ = 248.2 MS

ESQ005

PLT N. 021

=====

ANALOG-TO-DIGITAL CONVERSION & DIGITAL FILTERING

RUN ID: A-879-11

=====

PROJECT: THORACIC IMPACT PROJECT -- PRIMATE TEST SERIES

ANALOG TAPE: HSKI(136) EXPANDED 1681, WAS A/D CONVERTED TO DIGITAL TAPE: T.I.P. DATE: 20-SEP-76

TEST SIGNALS: 1603 PTS/CH AT 6398.72 HZ. CAL SIGNALS: NOT DIGITIZED.

FILE	CH	CONTENT OF CHANNEL	UNITS/VOLY	UNITS	FILTER STAGES	FILTER CUTOFF	NO. PTS	SAMPLING HERTZ
42	11	SLED DECELERATION	20.00	G'S	4+1+3	100.0	398	1599.68
43	21	RIGHT UPPER RIB ACCELEROMETER	78.30	G'S	4+1+3	100.0	398	1599.68
44	31	RIGHT LOWER RIB ACCELEROMETER	-97.20	G'S	4+1+3	100.0	398	1599.68
45	41	LEFT UPPER RIB ACCELEROMETER	-83.60	G'S	4+1+3	100.0	398	1599.68
46	51	LEFT LOWER RIB ACCELEROMETER	-112.50	G'S	4+1+3	100.0	398	1599.68
47	61	THORAX A-P ACCELEROMETER	89.70	G'S	4+1+3	100.0	398	1599.68
48	71	THORAX I-S ACCELEROMETER	94.50	G'S	4+1+3	100.0	398	1599.68
49	81	RIGHT LAP BELT LOAD	1000.00	LBS.	4+1+3	100.0	398	1599.68
50	91	LEFT LAP BELT LOAD	1000.00	LBS.	4+1+3	100.0	398	1599.68
51	101	STEERING COLUMN LOAD	117.60	LBS.	4+1+3	100.0	398	1599.68
52	111	STEERING COLUMN LOAD	1176.00	LBS.	4+1+3	100.0	398	1599.68

121

131

141

Summary Test Report

Thoracic Injury Project (Contract DOT-HS-4-00921) Highway Safety Research
Institute - The University of Michigan

Test No.: A-885

Test Date: July 17, 1975

Test Subject

Species - baboon
Sex - Male
Weight - 13.5 kg.

Restraint System

Stiffened EA column with pad insert and lap belt

Velocity

30.0 mph

Deceleration

30.0 G's

Injuries

Hemorrhage and fractures 2nd rib (L and R) and 3rd rib (L).
Hemorrhage of pericardium at carotid juncture.

AIS Number Estimate

4

THORACIC INJURY PROJECT

PRIMATE INJURY REPORT

Test Number A-885

Date 7-17-75

Anatomical Anomalies or Clinical Observations

1. Thoracic Skeleton
2. Heart
3. Lungs
4. Other structures or systems

Injuries observed

1. External Subcutaneous hemorrhage over R₁ and R₂, left.
2. Bony or Cartilaginous Structures Fractures of R_{2, 3} left at costo-chondral junction. Incomplete fracture of R₂ right at costo-chondral junction.
3. Heart and Vascular Pericardial hemorrhage at carotid juncture.
Pneumopericardium.
4. Lungs
5. Other structures or systems Small subcutaneous hematoma on abdominal wall.

THORACIC IMPACT PROJECT

Test # A-FK5

Date 7.17.25

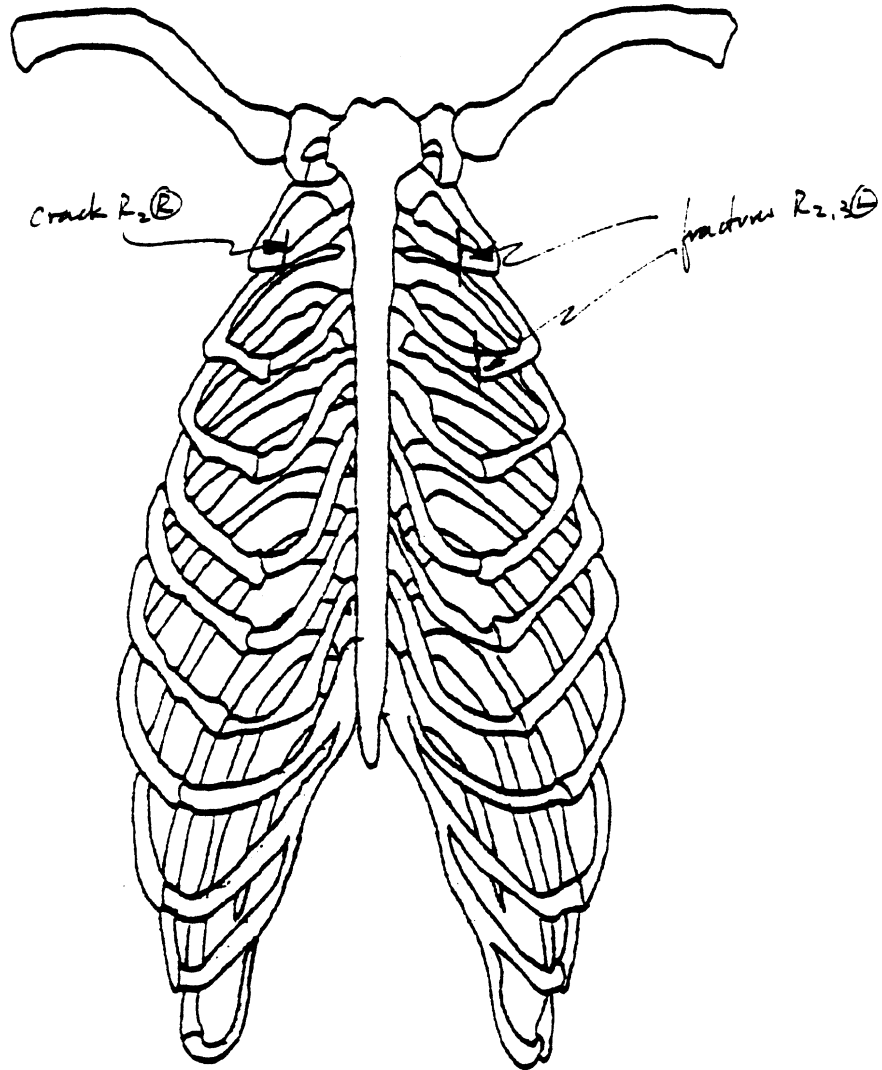

R

Papio

L

SLED DECELERATION PULSE

35.2 G's

RIGHT UPPER RIB
ACCELEROMETER

42.3 G's

37.1 G's

RIGHT LOWER RIB
ACCELEROMETER

109.7 G's

49.4 G's

LEFT UPPER RIB
ACCELEROMETER

26.0 G's

26.2 G's

LEFT LOWER RIB
ACCELEROMETER

136.2 G's

45.1 G's

THORAX A-P ACCELEROMETER

98.5 G's

THORAX I-S ACCELEROMETER

112.6 G's

131.4 G's

TEST A-885

RIGHT LAP BELT LOAD

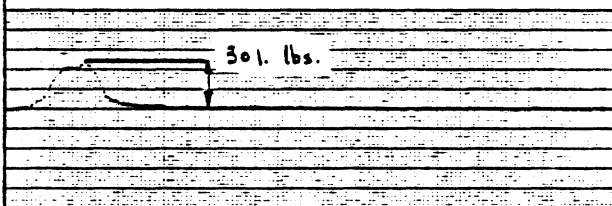

LEFT LAP BELT LOAD

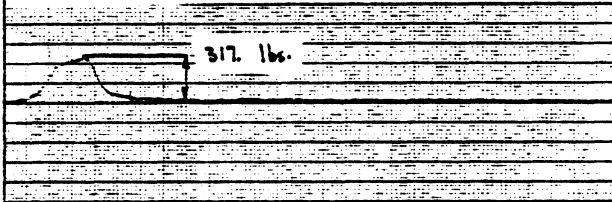

STEERING COLUMN LOAD

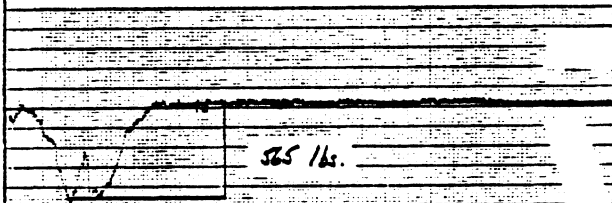

100 MSEC

SEP 29, 1978 / 14:18:59

RUN ID: A-885-1:

10 MS

20 PTS

< 1 > 5.E+00

< 2 > 9.E+00

< 3 > 2.E+01

< 4 > 9.E+00

< 5 > 2.E+01

< 6 > 1.E+01

< 7 > 3.E+01

< 8 > 6.E+01

< 9 > 6.E+01

< 10 > 6.E+01

< 11 > 6.E+01

10 MS

20 PTS

FILES: 53- 63, TAPE: THORAX

371 PTS @ 1500 HZ = 231.3 MS

=====

RUN ID: A-885-11

=====

ANALOG-TO-DIGITAL CONVERSION & DIGITAL FILTERING

PROJECT: THORACIC IMPACT PROJECT -- PRIMATE TEST SERIES

ANALOG TAPE: HSRI(136) EXPANDED 1611, WAS A/D CONVERTED TO DIGITAL TAPE: T.I.P. DATE: 20-SEP-76

TEST SIGNALS: 1496 PTS/CH AT 6399.14 HZ. CAL SIGNALS: NOT DIGITIZED.

FILE CH	CONTENT OF CHANNEL	UNITS/VOLT	UNITS	FILTER STAGES	FILTER CUTOFF	NO. PTS	SAMPLING HERTZ
53	11 SLED DECELERATION	20.00	G'S	4+1+ 3	100.0	371	1599.79
54	21 RIGHT UPPER RIB ACCELEROMETER	84.20	G'S	4+1+ 3	100.0	371	1599.79
55	31 RIGHT LOWER RIB ACCELEROMETER	-110.50	G'S	4+1+ 3	100.0	371	1599.79
56	41 LEFT UPPER RIB ACCELEROMETER	-84.30	G'S	4+1+ 3	100.0	371	1599.79
57	51 LEFT LOWER RIB ACCELEROMETER	-114.40	G'S	4+1+ 3	100.0	371	1599.79
58	61 THORAX A-P ACCELEROMETER	92.10	G'S	4+1+ 3	100.0	371	1599.79
59	71 THORAX I-S ACCELEROMETER	96.10	G'S	4+1+ 3	100.0	371	1599.79
60	81 RIGHT LAP BELT LOAD	1000.00	LBS.	4+1+ 3	100.0	371	1599.79
61	91 LEFT LAP BELT LOAD	1000.00	LBS.	4+1+ 3	100.0	371	1599.79
62	101 STEERING COLUMN LOAD	117.60	LBS.	4+1+ 3	100.0	371	1599.79
63	111 STEERING COLUMN LOAD	1176.00	LBS.	4+1+ 3	100.0	371	1599.79

121

131

141

FILTERED FILMS: 53 - 63 DIGITAL TAPE: THORAX DATE: 20-SEP-76 RUN ID: A-885-11

Summary Test Report

Thoracic Injury Project (Contract DOT-HS-4-00921) Highway Safety Research
Institute - The University of Michigan

Test No.: A-886

Test Date: July 18, 1975

Test Subject

Species - Baboon
Sex - Male
Weight - 13.0 kg.

Restraint System

Stiffened EA column with insert pad and lap belt

Velocity

30.0 mph

Deceleration

30.0 G's

Injuries

Some hemorrhage on surface of right lung.
Small torn spot on one of the pulmonary arteries.

AIS Number Estimate

4/5

THORACIC INJURY PROJECT

PRIMATE INJURY REPORT

Test Number A-886
7-18-75

Date _____

Anatomical Anomalies or Clinical Observations

1. Thoracic Skeleton
2. Heart
3. Lungs
4. Other structures or systems Bladder rupture secondary to
 urethral clamping.

Injuries observed

1. External none observed.
2. Bony or Cartilaginous Structures No rib or sternal fractures
 or dislocations.
3. Heart and Vascular none observed.
4. Lungs Petechiae at tip of left lung. Superficial hemorrhage
 on right lung. Small tear on one pulmonary artery.
5. Other structures or systems Hemorrhage on lower interior
 abdominal wall, the size and shape of seatbelt. Superficial
 bilateral posterior kidney contusions. Hemorrhage on lower
 abdominal mesentery.

SLED DECELERATION PULSE

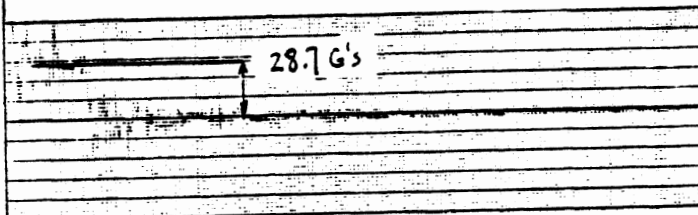

RIGHT UPPER RIB
ACCELEROMETER

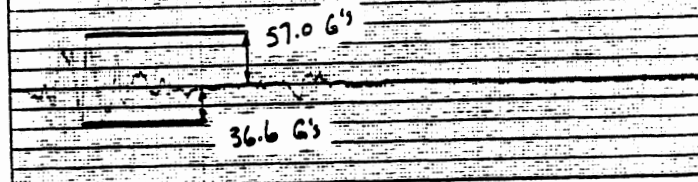

RIGHT LOWER RIB
ACCELEROMETER



LEFT UPPER RIB
ACCELEROMETER

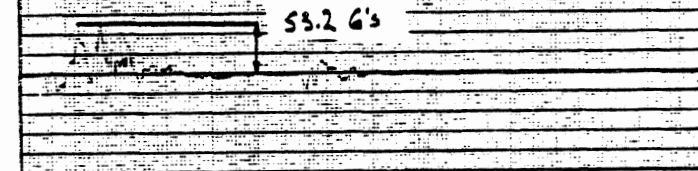

LEFT LOWER RIB
ACCELEROMETER

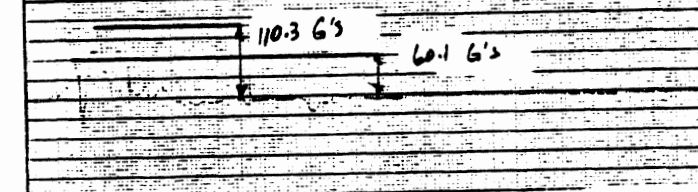

THORAX A-P ACCELEROMETER

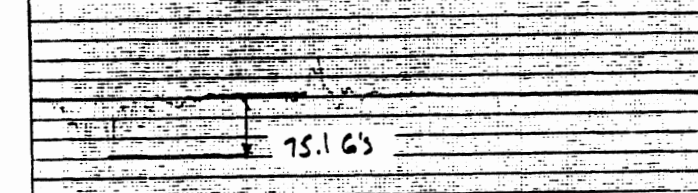

THORAX I-S ACCELEROMETER

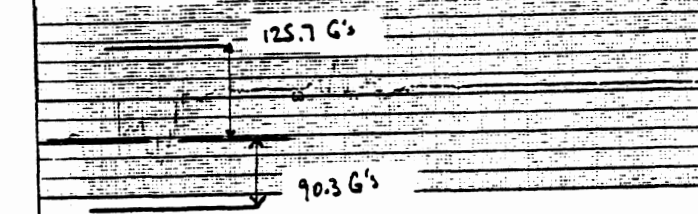

72

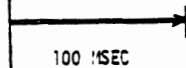

TEST NO. A-806

RIGHT LAP BELT LOAD

256 lbs.

LEFT LAP BELT LOAD

312 lbs.

STEERING COLUMN LOAD

588 lbs.

20

100 MSEC

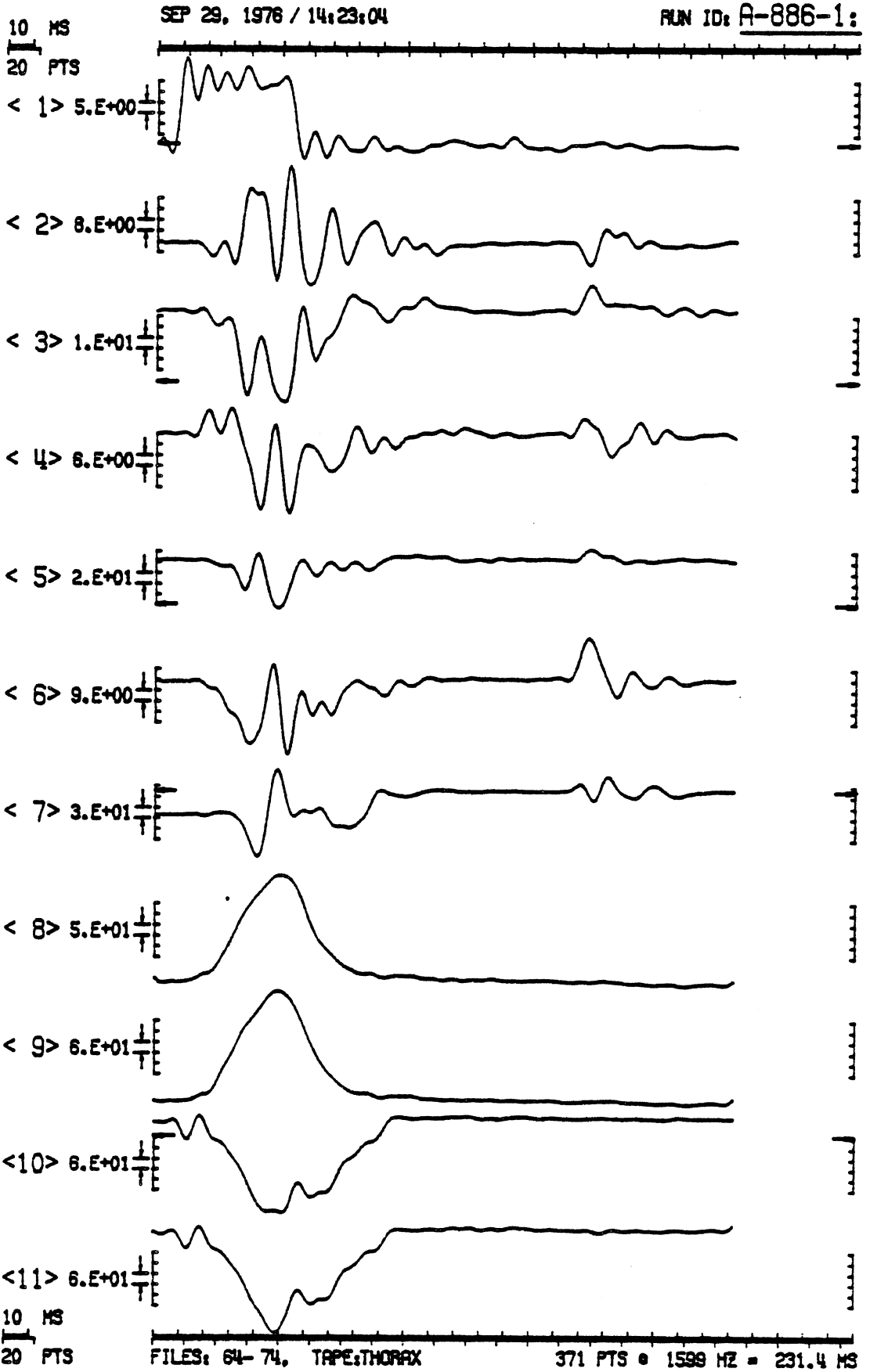

=====
 RUN ID: A-886-11
 =====

ANALOG-TO-DIGITAL CONVERSION & DIGITAL FILTERING

PROJECT: THORACIC IMPACT PROJECT - PRIMATE TEST SERIES

ANALOG TAPE: NSRI(136) EXPANDED 1611, WAS A/D CONVERTED TO DIGITAL TAPE: Y.I.P. DATE: 20-SEP-76
 TEST SIGNALS: 1498 PTS/CH AT 6396.41 HZ. CAL SIGNALS: NOT DIGITIZED.

FILE	CH	CONTENT OF CHANNEL	UNITS/VOLT	UNITS	FILTER STAGES	FILTER CUTOFF	NO. PT8	SAMPLING HERTZ
64	1	SLED DECELERATION	20.00	G'S	4+1+3	100.7	371	1599.10
65	2	RIGHT UPPER RIB ACCELEROMETER	84.20	G'S	4+1+3	100.7	371	1599.10
66	3	RIGHT LOWER RIB ACCELEROMETER	-125.30	G'S	4+1+3	100.7	371	1599.10
67	4	LEFT UPPER RIB ACCELEROMETER	-82.20	G'S	4+1+3	100.7	371	1599.10
68	5	LEFT LOWER RIB ACCELEROMETER	-113.40	G'S	4+1+3	100.7	371	1599.10
69	6	THORAX A-P ACCELEROMETER	90.50	G'S	4+1+3	100.7	371	1599.10
70	7	THORAX I-S ACCELEROMETER	94.50	G'S	4+1+3	100.7	371	1599.10
71	8	RIGHT LAP BELT LOAD	1000.00	LBS.	4+1+3	100.7	371	1599.10
72	9	LEFT LAP BELT LOAD	1000.00	LBS.	4+1+3	100.7	371	1599.10
73	10	STEERING COLUMN LOAD	117.60	LBS.	4+1+3	100.7	371	1599.10
74	11	STEERING COLUMN LOAD	1176.00	LBS.	4+1+3	100.7	371	1599.10

12:
 13:
 14:

 FILTERED FILES: 64 - 74 DIGITAL TAPE: THORAX DATE: 20-SEP-76 RUN ID: A-886-11

10 MS
20 PTS

SEP 29, 1976 / 14:58:54

RUN ID: A-886-2:

< 1 > 4.E+00

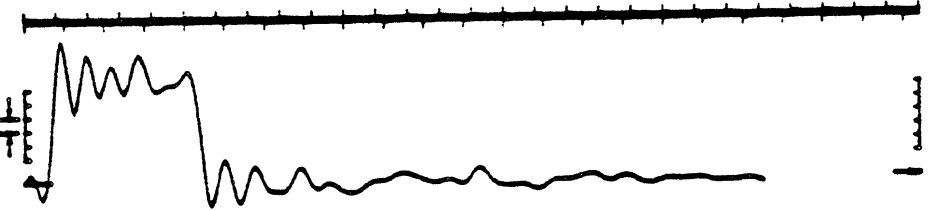

< 2 > 4.E+00

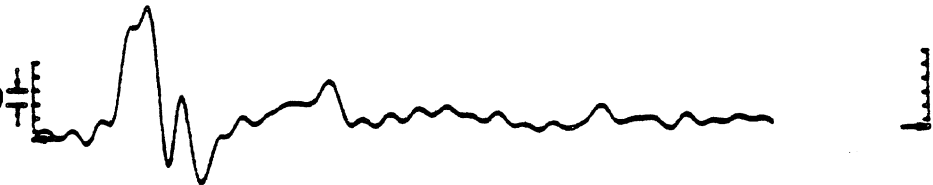

< 3 > 6.E+01

10 MS
20 PTS

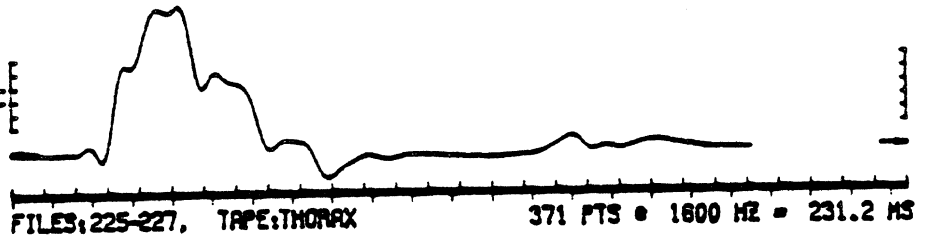

=====
 RUN ID: A-886-21
 =====

ANALOG-TO-DIGITAL CONVERSION & DIGITAL FILTERING
 PROJECT: THORACIC IMPACT PROJECT -- PRIMATE SERIES

ANALOG TAPE: HSRI(137) EXPANDED 16:1, WAS A/D CONVERTED TO DIGITAL TAPE: T,1,P. DATE: 20-SEP-76
 TEST SIGNALS: 1498 PTS/CH AT 6402.05 HZ. CAL SIGNALS: NOT DIGITIZED.

FILE	CH	CONTENT OF CHANNEL	UNITS/VOLT	UNITS	FILTER STAGES	FILTER CUTOFF	NO. PTS	SAMPLING HERTZ
225	1	SLED DECELERATION	20.00	G'S	4+1+3	100.0	371	1600.51
226	2	AIRWAY PRESSURE	290.00	MM-HG	4+1+3	100.0	371	1600.51
227	3	VASCULAR PRESSURE	145.60	MM-HG	4+1+3	100.0	371	1600.51

- 40
- 50
- 60
- 70
- 80
- 90
- 100
- 110
- 120
- 130
- 140

 FILTERED FILES: 225 - 227 DIGITAL TAPE: THORAX DATE: 28-SEP-76 RUN ID: A-886-21

Summary Test Report

Thoracic Injury Project (Contract DOT-HS-4-00921) Highway Safety Research
Institute - The University of Michigan

Test No.: A-898

Test Date: July 30, 1975

Test Subject

Species - Baboon (cadaver)
Sex - Male
Weight - 13 kg.

Restraint System

Stiffest column with insert pad and lap belt

Velocity

30.0 mph

Deceleration

30.0 G's

Injuries

Slight hemorrhage spots on heart.
Hemorrhage on pulmonary arteries - left side.
Bruises, one severe, on all lobes of left lung.
Minor bruises on right lung.

AIS Number Estimate

5

THORACIC INJURY PROJECT

PRIMATE INJURY REPORT

Test Number A-898

Date 7-31-75

Anatomical Anomalies or Clinical Observations

1. Thoracic Skeleton
2. Heart Possible heart worms.
3. Lungs
4. Other structures or systems Swollen lymph nodes.

Injuries observed

1. External none noted.
2. Bony or Cartilaginous Structures No fractures to ribs, sternum, spine.
3. Heart and Vascular Slight hemorrhage on arch and posterior heart. (7 spots total, 2 small on rear.) Hemorrhage on renal artery.
4. Lungs Extensive hemorrhage on left pulmonary arteries. Contusions on all lobes left lung -- severe on middle lobe. Very slight contusions on right lung.
5. Other structures or systems Minor discoloration on mesentery around small intestine.

THORACIC IMPACT PROJECT

Test # L-898

Date 7.31.75

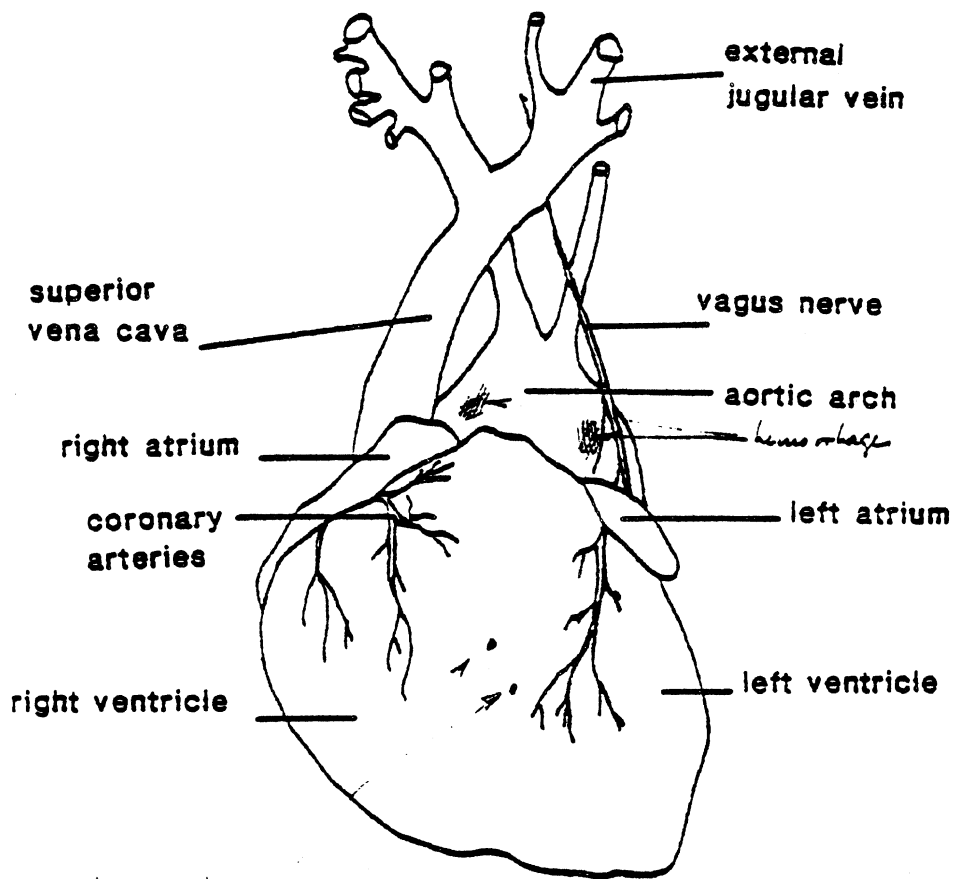

Approximate sites of hemorrhage on rear

hemorrhage on renal artery

Papio

SLED DECELERATION PULSE

27.3 G's

RIGHT LOWER RIB
ACCELEROMETER

73.8 G's

35.8 G's

33.9 G's

RIGHT UPPER RIB
ACCELEROMETER

107.8 G's

LEFT UPPER RIB
ACCELEROMETER

40.6 G's

LEFT LOWER RIB
ACCELEROMETER

108.5 G's

THORAX A-P ACCELEROMETER

60.8 G's

87.9 G's

THORAX I-S ACCELEROMETER

55.4 G's

90.2 G's

VASCULAR PRESSURE

495. mm Hg

233. mm Hg

TEST NO. A-898

RIGHT LAP BELT LOAD

285. lbs.

LEFT LAP BELT LOAD

325. lbs.

STEERING COLUMN LOAD

529. lbs.

100 msec

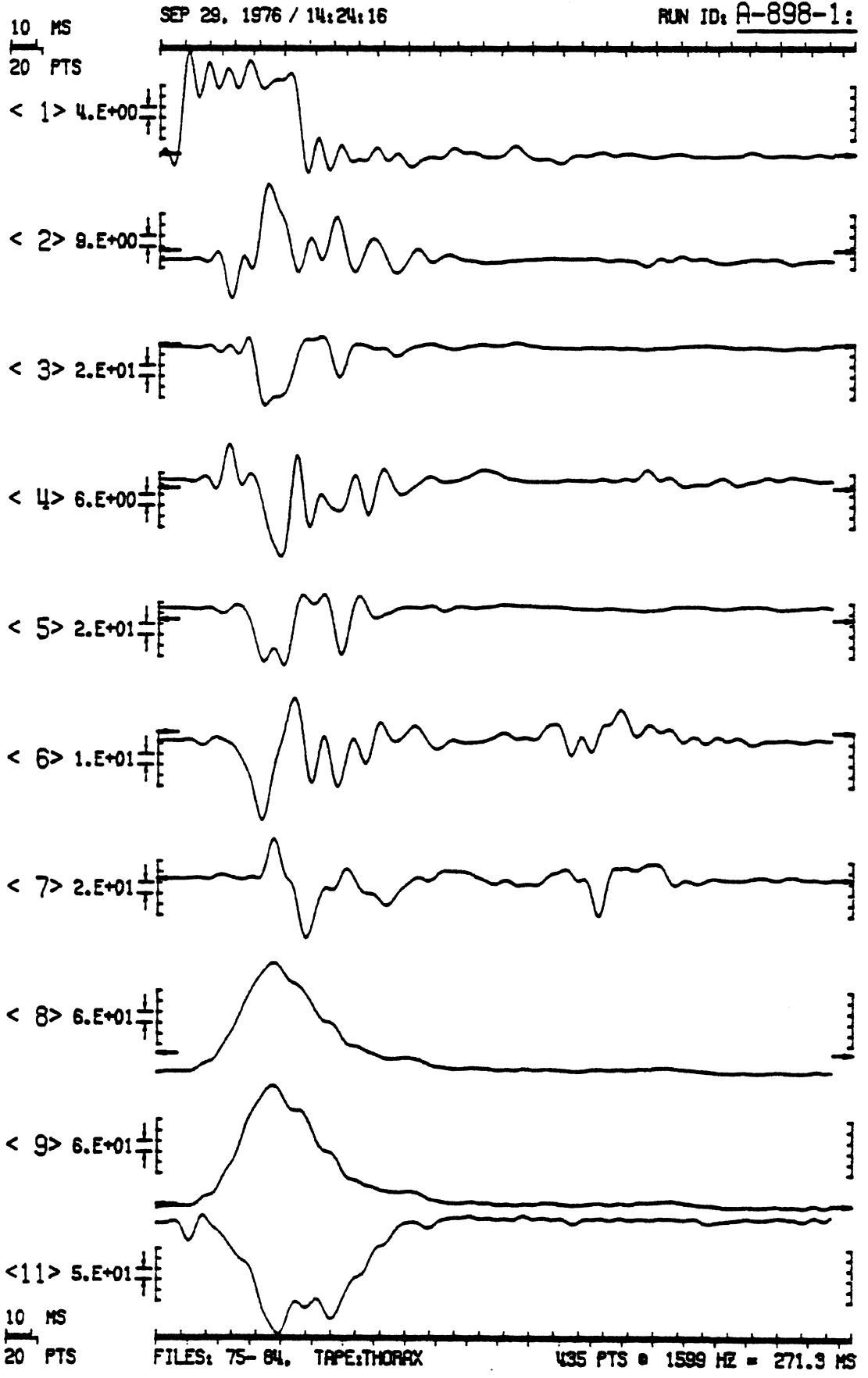

=====
 RUN ID: A-898-11
 =====

ANALOG-TO-DIGITAL CONVERSION & DIGITAL FILTERING

PROJECT: THORACIC IMPACT PROJECT -- PRIMATE TEST SERIES

ANALOG TAPE: MSRI(136) EXPANDED 1611, WAS A/D CONVERTED TO DIGITAL TAPE: T.I.P. DATE: 20-SEP-76
 TEST SIGNALS: 1744 PTS/CH AT 6397.95 KHZ. CAL SIGNALS: NOT DIGITIZED.

FILE	CH	CONTENT OF CHANNEL	UNITS/VOLT	UNITS	FILTER STAGES	FILTER CUTOFF	NO. PTS	SAMPLING HERTZ
75	11	SLED DECELERATION	20.00	G'S	4+1+3	100.0	435	1599.49
76	21	RIGHT UPPER RIB ACCELEROMETER	86.40	G'S	4+1+3	100.0	435	1599.49
77	31	RIGHT LOWER RIB ACCELEROMETER	-101.60	G'S	4+1+3	100.0	435	1599.49
78	41	LEFT UPPER RIB ACCELEROMETER	-82.90	G'S	4+1+3	100.0	435	1599.49
79	51	LEFT LOWER RIB ACCELEROMETER	-114.40	G'S	4+1+3	100.0	435	1599.49
80	61	THORAX AMP ACCELEROMETER	89.70	G'S	4+1+3	100.0	435	1599.49
81	71	THORAX I-S ACCELEROMETER	96.10	G'S	4+1+3	100.0	435	1599.49
82	81	RIGHT LAP BELT LOAD	1000.00	LBS.	4+1+3	100.0	435	1599.49
83	91	LEFT LAP BELT LOAD	1000.00	LBS.	4+1+3	100.0	435	1599.49
84	111	STIFERING COLUMN LOAD	1176.00	LBS.	4+1+3	100.0	435	1599.49

101
 121
 131
 141

 FILTERED FILES: 75 - 84 DIGITAL TAPE: THORAX DATE: 20-SEP-76 RUN ID: A-898-11

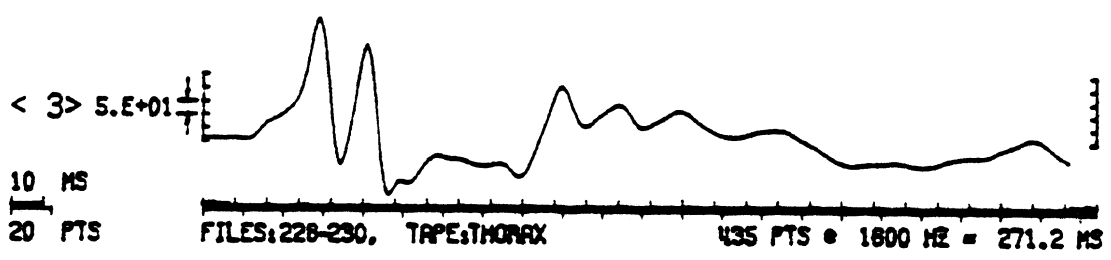
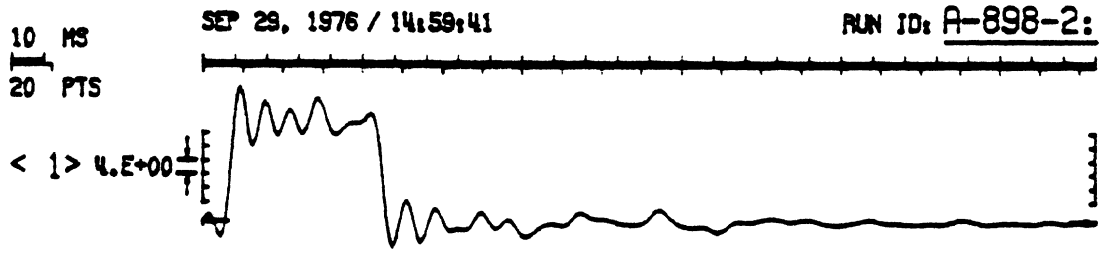

=====
RUN ID: A-898-21
=====

ANALOG TO DIGITAL CONVERSION & DIGITAL FILTERING

PROJECT: THORACIC IMPACT PROJECT - PRIMATE SERIES

ANALOG TAPE: MSRI(137) EXPANDED 1601, WAS A/D CONVERTED TO DIGITAL TAPE: T.I.P. DATE: 20-SEP-76

TEST SIGNALS: 1744 PTS/CH AT 6401.61 HZ. CAL SIGNALS: NOT DIGITIZED.

FILE	CH	CONTENT OF CHANNEL	UNITS/VOLT	UNITS	FILTER STAGES	FILTER CUTOFF	NO. PTS	SAMPLING HERTZ
228	10	SLED DECELERATION	20.00	G'S	4+1+	3 100.0	435 0	1600.40
229	20	AIRWAY PRESSURE	209.00	MM-HG	4+1+	3 100.0	435 0	1600.40
230	30	VASCULAR PRESSURE	145.60	MM-HG	4+1+	3 100.0	435 0	1600.40

40

86

50

60

70

80

90

100

110

120

130

140

FILTERED FILES: 228 - 230 DIGITAL TAPE: THORAX DATE: 20-SEP-76 RUN ID: A-898-21

Summary Test Report

Thoracic Injury Project (Contract DOT-HS-4-00921) Highway Safety Research
Institute - The University of Michigan

Test No.: A-899

Test Date: July 30, 1975

Test Subject

Species - Baboon
Sex - Male
Weight - 11 kg.

Restraint System

Stiffest EA column with pad insert and lap belt

Velocity

30.0 mph

Deceleration

30.0 G's

Injuries

Anatomical anomaly in location of inferior vena cava may be
related to hemorrhage therein.
Bruise on tip of left ventricle (<1 mm deep).
Small tear in membrane surrounding spleen.

AIS Number Estimate

4

SLED DECELERATION PULSE

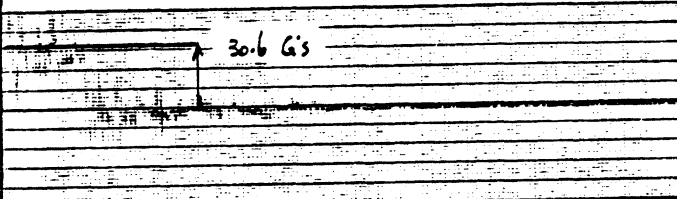

RIGHT UPPER RIB
ACCELEROMETER

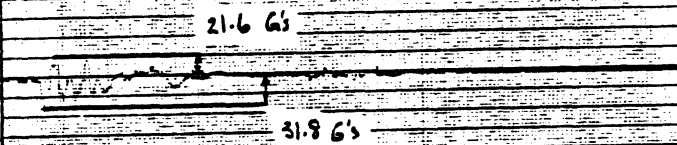

RIGHT LOWER RIB
ACCELEROMETER

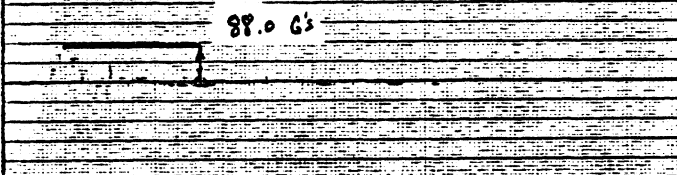

LEFT UPPER RIB
ACCELEROMETER

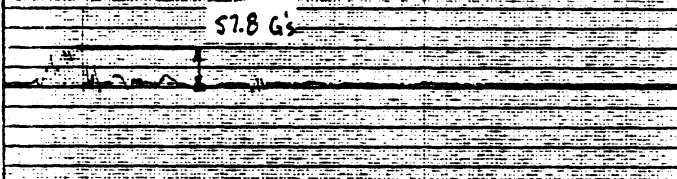

LEFT LOWER RIB
ACCELEROMETER

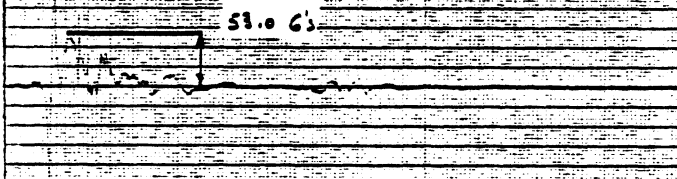

THORAX A-P ACCELEROMETER

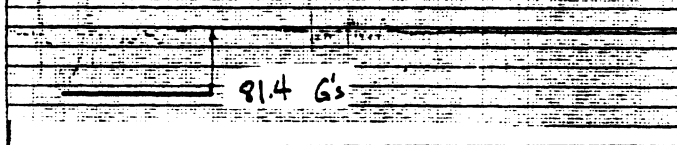

THORAX I-S ACCELEROMETER

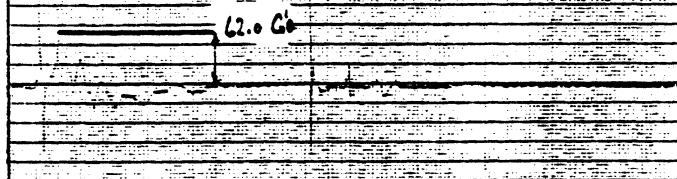

VASCULAR PRESSURE

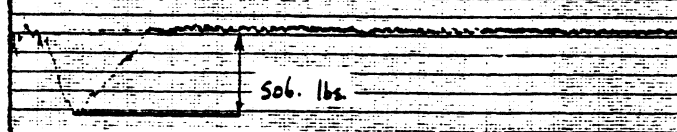

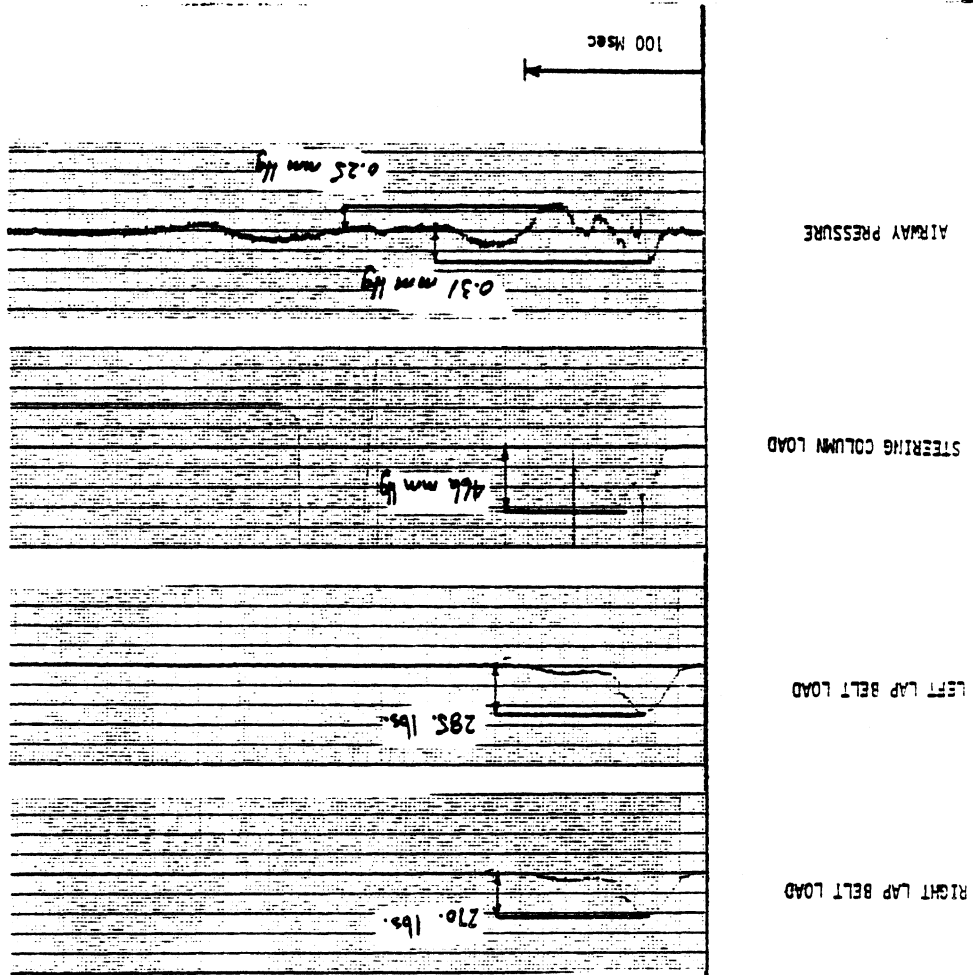

TEST A-899

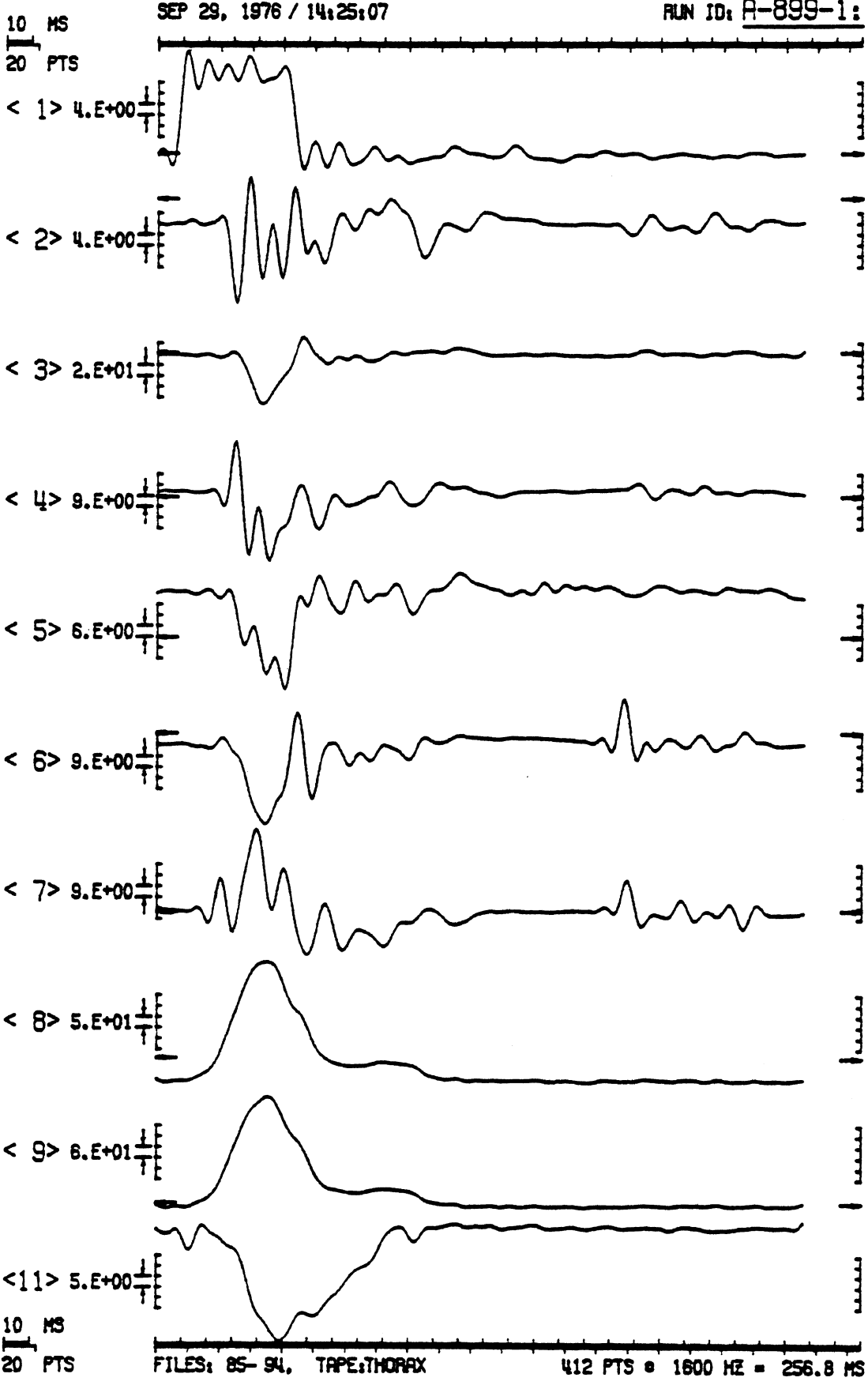

=====
 RUN ID: A-899-11

ANALOG-TO-DIGITAL CONVERSION & DIGITAL FILTERING

=====
 PROJECT: THORACIC IMPACT PROJECT -- PRIMATE TEST SERIES

ANALOG TAPE: HSHI(136) EXPANDED 1681, WAS A/D CONVERTED TO DIGITAL TAPE: Y.I.P. DATE: 20-SEP-76
 TEST SIGNALS: 1660 PTS/CH AT 6401.39 HZ. CAL SIGNALS: NOT DIGITIZED.

FILE CH	CONTENT OF CHANNEL	UNITS/VOLT	UNITS	FILTER STAGES	FILTER CUTOFF	NO. PTS	SAMPLING HERTZ
05	10 SLED DECELERATION	20.00	G'S	4+1+3	100.0	412	1600.35
06	20 RIGHT UPPER RIB ACCELEROMETER	86.40	G'S	4+1+3	100.0	412	1600.35
07	30 RIGHT LOWER RIB ACCELEROMETER	101.60	G'S	4+1+3	100.0	412	1600.35
08	40 LEFT UPPER RIB ACCELEROMETER	82.90	G'S	4+1+3	100.0	412	1600.35
089	50 LEFT LOWER RIB ACCELEROMETER	114.40	G'S	4+1+3	100.0	412	1600.35
90	60 THORAX A-P ACCELEROMETER	89.70	G'S	4+1+3	100.0	412	1600.35
91	70 THORAX I-S ACCELEROMETER	96.10	G'S	4+1+3	100.0	412	1600.35
92	80 RIGHT LAP BELT LOAD	1000.00	LBS.	4+1+3	100.0	412	1600.35
93	90 LEFT LAP BELT LOAD	1000.00	LBS.	4+1+3	100.0	412	1600.35
100							
94	110 STEERING COLUMN LOAD	117.60	LBS.	4+1+3	100.0	412	1600.35
120							
130							
140							

=====
 FILTERED FILES: 85 - 94 DIGITAL TAPE: THORAX DATE: 20-SEP-76 RUN ID: A-899-11
 =====

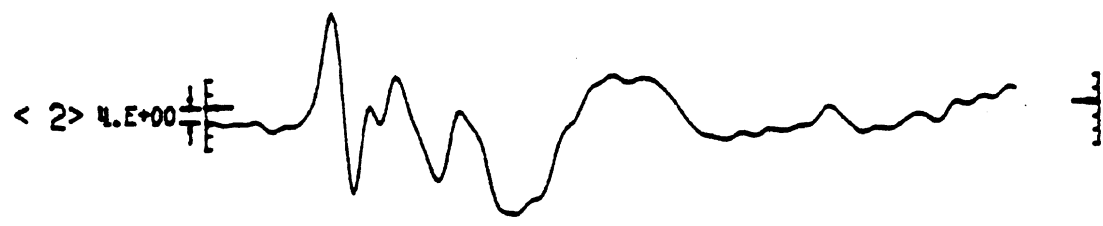
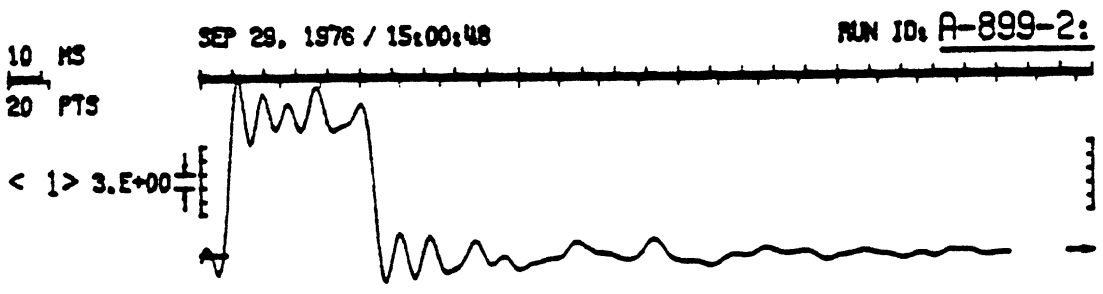

=====
 RUN ID: A-899-21

ANALOG-TO-DIGITAL CONVERSION & DIGITAL FILTERING
 =====

=====
 PROJECT: THORACIC IMPACT PROJECT -- PRIMATE SERIES

ANALOG TAPE: HSKI(137) EXPANDED 16:1, WAS A/D CONVERTED TO DIGITAL TAPE: T.I.P. DATE: 20-SEP-76
 TEST SIGNALS: 1659 PTS/CH AT 6400.93 HZ. CAL SIGNALS: NOT DIGITIZED.

FILE	CH	CONTENT OF CHANNEL	UNITS/VOLT	UNITS	FILTER STAGES	FILTER CUTOFF	NO. PTS	SAMPLING HERTZ
231	- 11	SLED DECELERATION	20.00	G'S	4+1+3	100.0	412	1600.23
232	- 21	AIRWAY PRESSURE	209.00	MM-HG	4+1+3	100.0	412	1600.23
233	- 31	VASCULAR PRESSURE	145.60	MM-HG	4+1+3	100.0	412	1600.23

41

51

61

71

81

91

101

111

121

131

141

=====
 FILTERED FILES: 231 - 233 DIGITAL TAPE: THORAX DATE: 20-SEP-76 RUN ID: A-899-21

Summary Test Report

Thoracic Injury Project (Contract DOT-HS-4-00921) Highway Safety Research
Institute - The University of Michigan

Test No.: A-904

Test Date: August 20, 1975

Test Subject

Species - baboon
Sex - Male
Weight - 14 kg.

Restraint System

Stiffest EA column with pad insert and lap belt

Velocity

21.2 mph

Deceleration

15.0 G's

Injuries

Small amount clotted blood at junction of left lung and fascia.
Hemorrhage throughout thalamus.
Minor Hemorrhage of pericardium.

AIS Number Estimate

3

THORACIC INJURY PROJECT

PRIMATE INJURY REPORT

Test Number A-904

Date 8-20-75

Anatomical Anomalies or Clinical Observations

1. Thoracic Skeleton
2. Heart
3. Lungs
4. Other structures or systems Absent right kidney.

Injuries observed

1. External Bruising at sites of accelerometer mounts on right ribs.
2. Bony or Cartilaginous Structures None observed.
3. Heart and Vascular Minor hemorrhage on pericardium.
4. Lungs Small amount of clotted blood at junction of left lung and fascia. No other injury observed.
5. Other structures or systems Small amount of fluid (not blood) in thoracic cavity. Hemorrhage throughout thalamus.

SLED DECELERATION PULSE

14.0 G's

RIGHT UPPER RIB
ACCELEROMETER

17.3 G's

RIGHT LOWER RIB
ACCELEROMETER

63.2 G's

LEFT UPPER RIB
ACCELEROMETER

41.5 G's

LEFT LOWER RIB
ACCELEROMETER

56.7 G's

THORAX P-A ACCELEROMETER

37.7 G's

THORAX I-S ACCELEROMETER

36.7 G's

23.8 G's

100 msec

RIGHT LAP BELT LOAD

325. lbs

LEFT LAP BELT LOAD

350. lbs

STEERING COLUMN LOAD

412. lbs

AIRBAG PRESSURE

25.1 mm Hg

VASCULAR PRESSURE

538. mm Hg

100 msec

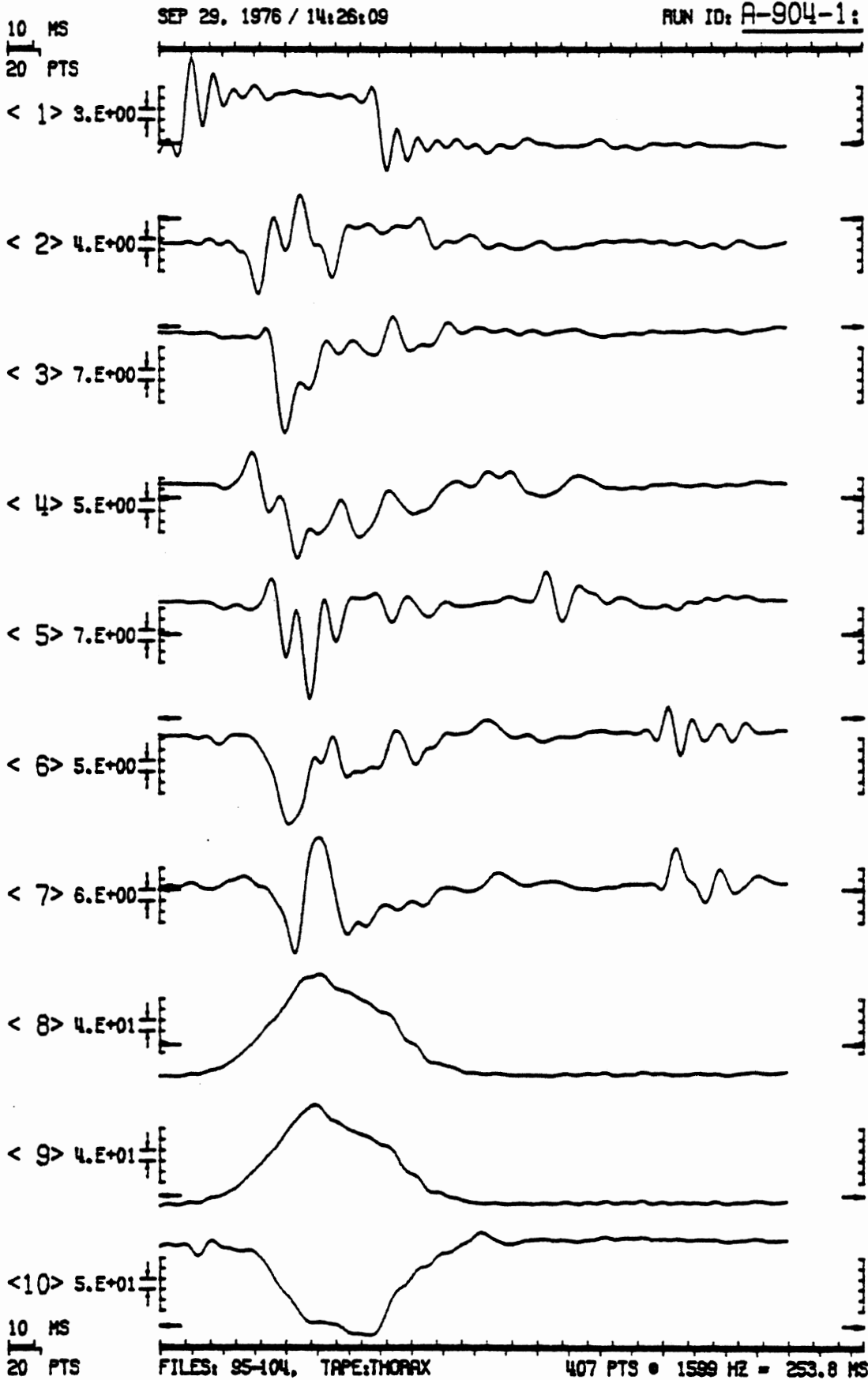

SEP 29, 1976 / 15:17:12

RUN ID: A-904-1:

10 MS

50 PTS

< 1 > 5.E+00

< 2 > 4.E+00

< 3 > 9.E+00

< 4 > 5.E+00

< 5 > 3.E+01

< 6 > 2.E+01

< 7 > 2.E+01

< 8 > 4.E+01

< 9 > 4.E+01

< 10 > 5.E+01

10 MS

50 PTS

FILES:370-379, TAPE:THORAX

1628 PTS @ 6398 HZ = 254.3 MS

=====

ANALOG-TO-DIGITAL CONVERSION & DIGITAL FILTERING

RUN ID: A-9004-11

=====

PROJECT: THORACIC IMPACT PROJECT -- PRIMATE TEST SERIES

ANALOG TAPE: HSRI(136) EXPANDED 1631, WAS A/D CONVERTED TO DIGITAL TAPE: T.I.P. DATE: 20-SEP-76

TEST SIGNALS: 1633 PTS/CH AT 6390.20 HZ. CAL SIGNALS: NOT DIGITIZED.

FILE	CH	CONTENT OF CHANNEL	UNITS/VOLT	UNITS	FILTER STAGES	FILTER CUTOFF	NO. PTS	SAMPLING HERTZ
95	18	SLED DECELERATION	20.00	G'S	4+1+3	100.0	407	1599.57
96	20	RIGHT UPPER RIB ACCELEROMETER	85.70	G'S	4+1+3	100.0	407	1599.57
97	30	RIGHT LOWER RIB ACCELEROMETER	97.20	G'S	4+1+3	100.0	407	1599.57
98	40	LEFT UPPER RIB ACCELEROMETER	82.90	G'S	4+1+3	100.0	407	1599.57
99	50	LEFT LOWER RIB ACCELEROMETER	113.40	G'S	4+1+3	100.0	407	1599.57
100	60	THORAX A-P ACCELEROMETER	79.30	G'S	4+1+3	100.0	407	1599.57
101	70	THORAX I-S ACCELEROMETER	95.30	G'S	4+1+3	100.0	407	1599.57
102	80	RIGHT LAP BELT LOAD	1000.00	LBS.	4+1+3	100.0	407	1599.57
103	90	LEFT LAP BELT LOAD	1000.00	LBS.	4+1+3	100.0	407	1599.57
104	100	STEERING COLUMN LOAD	1176.00	LBS.	4+1+3	100.0	407	1599.57

111

120

131

140

----- FILTERED FILES: 95 - 100 ----- DIGITAL TAPE: THORAX ----- DATE: 20-SEP-76 ----- RUN ID: A-9004-11 -----

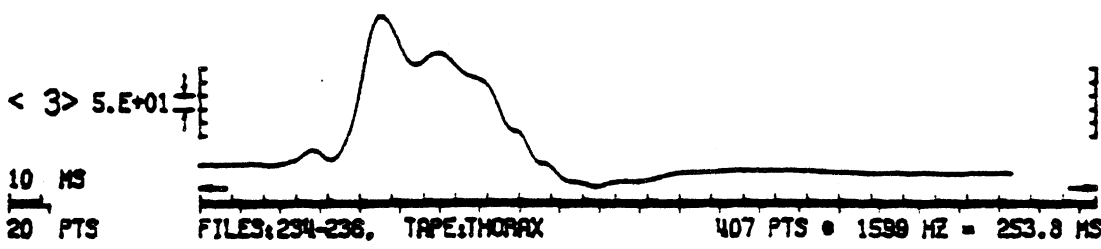
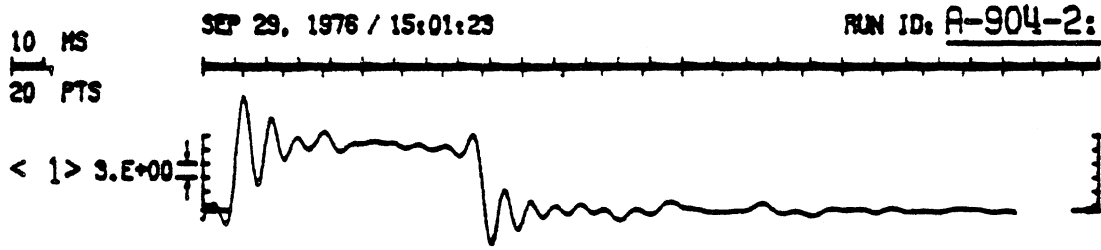

=====

RUN ID: A-9004-21

=====

ANALOG-TO-DIGITAL CONVERSION & DIGITAL FILTERING

PROJECT: THORACIC IMPACT PROJECT -- PRIMATE SERIES

ANALOG TAPE: HSRI(137) EXPANDED 1611, WAS A/D CONVERTED TO DIGITAL TAPE: T,I,P. DATE: 20-SEP-76

TEST SIGNALS: 1632 PTS/CH AT 6399.22 HZ. CAL SIGNALS: NOT DIGITIZED.

FILE	CH	CONTENT OF CHANNEL	UNITS/VOLT	UNITS	FILTER STAGES	FILTER CUTOFF	NO. PTS	SAMPLING HERTZ
234	11	SLED DECELERATION	20.00	G'S	4+1+3	100.0	407	1599.80
235	21	AIRWAY PRESSURE	209.00	MM-HG	4+1+3	100.0	407	1599.80
236	31	VASCULAR PRESSURE	145.60	MM-HG	4+1+3	100.0	407	1599.80

41

103

51

61

71

81

91

101

111

121

131

141

===== FILTERED FILES: 234 - 236 DIGITAL TAPE: THORAX DATE: 20-SEP-76 RUN ID: A-9004-21 =====

Summary Test Report

Thoracic Injury Project (Contract DOT-HS-4-00921) Highway Safety Research
Institute - The University of Michigan

Test No.: A-905

Test Date: August 21, 1975

Test Subject

Species - Baboon
Sex - Male
Weight - 13.9 kg.

Restraint System

Stiffest EA column with pad insert and lap belt.

Velocity

30.0 mph.

Deceleration

15.0 G's

Injuries

Laceration (1 cm) on middle lobe left lung.
Lesion on right atrium resulting in aneurism.
Hemorrhage on anterior side of pericardium.

AIS Number Estimate

4

THORACIC INJURY PROJECT

PRIMATE INJURY REPORT

Test Number A-905

Date 8-21-75

Anatomical Anomalies or Clinical Observations

1. Thoracic Skeleton
2. Heart
3. Lungs
4. Other structures or systems

Injuries observed

1. External None observed.
2. Bony or Cartilaginous Structures None observed.
3. Heart and Vascular Contusion of right atrium resulting in an aneurism. Hemorrhage on anterior pericardium.
4. Lungs Contusion on tip of lobe of right lung, 1 cm diameter.
5. Other structures or systems Small amount of free bile in abdomen. Slight hemorrhage on pancreatic subcapsule.

THORACIC IMPACT PROJECT

Test # A-905

Date 8.21.75

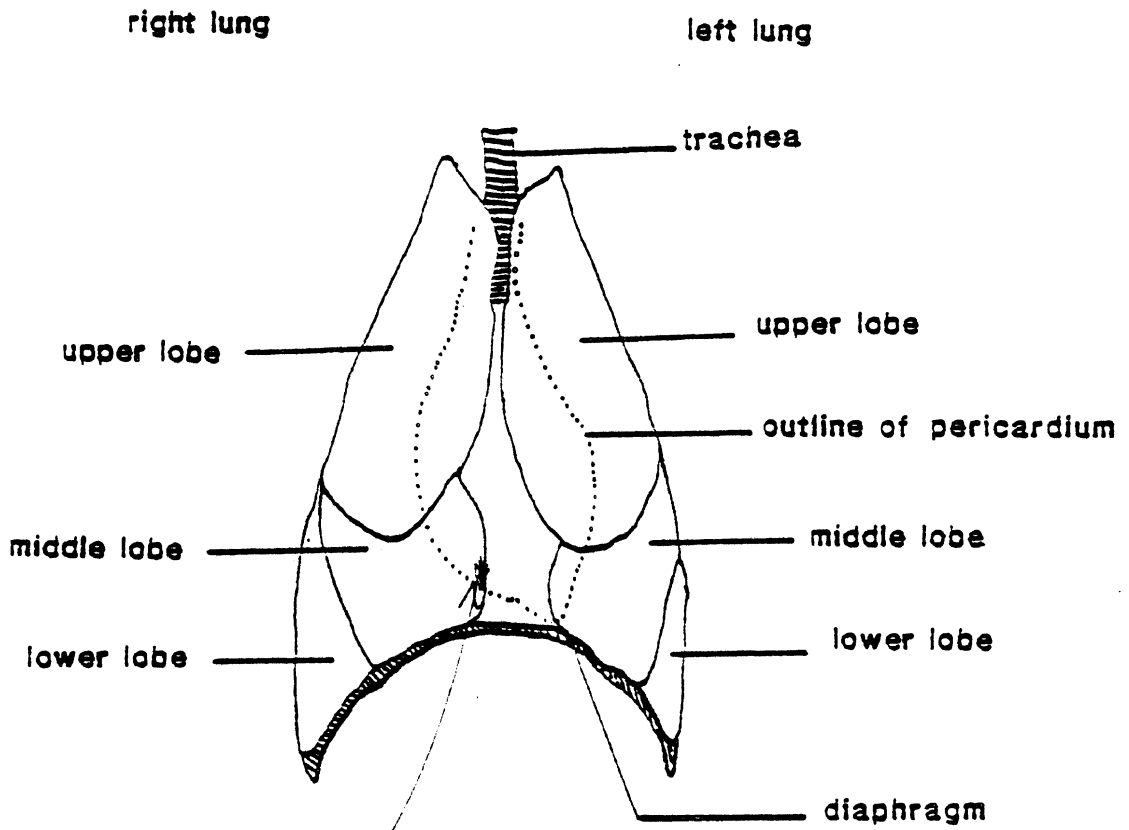

1 cm constriction

Papio

SLED DECELERATION PULSE

15.5 G's

RIGHT UPPER RIB
ACCELEROMETER

51.8 G's

RIGHT LOWER RIB
ACCELEROMETER

56.4 G's

LEFT UPPER RIB
ACCELEROMETER

56.5 G's

LEFT LOWER RIB
ACCELEROMETER

61.2 G's

THORAX P-A ACCELEROMETER

49.1 G's

THORAX I-S ACCELEROMETER

30.7 G's

21.3 G's

100 msec

RIGHT LAP BELT LOAD

340. lbs.

LEFT LAP BELT LOAD

325. lbs.

STEERING COLUMN LOAD

470. lbs.

AIRWAY PRESSURE

31.4 mm Hg

VASCULAR PRESSURE

422. mm Hg

100 msec

10 MS
20 PTS

SEP 29, 1976 / 14:26:40

RUN ID: A-905-1:

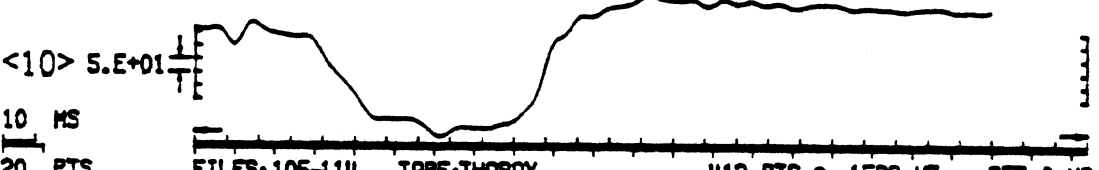
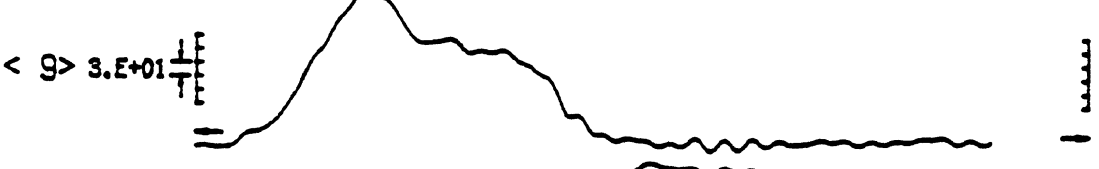
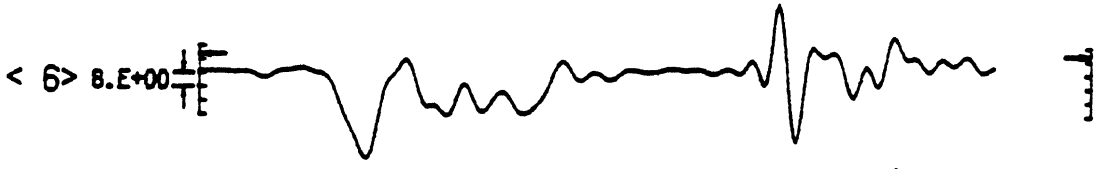

10 MS
20 PTS

FILES:105-114, TAPE:THORAX

412 PTS • 1599 HZ = 257.0 MS

=====
 RUN ID: A-905-11

ANALOG-TO-DIGITAL CONVERSION & DIGITAL FILTERING

=====
 PROJECT: THORACIC IMPACT PROJECT - PRIMATE TEST SERIES

ANALOG TAPE: HSRI(136) EXPANDED 1611, WAS A/D CONVERTED TO DIGITAL TAPE: T.I.P. DATE: 20-SEP-76
 TEST SIGNALS: 1651 PTS/CH AT 6397.83 HZ. CAL SIGNALS: NOT DIGITIZED.

FILE	CH	CONTENT OF CHANNEL	UNITS/VOLT	UNITS	FILTER STAGES	FILTER CUTOFF	NO. PTS	SAMPLING HERTZ
105	1	SLED DECELERATION	20.00	G'S	4+1+ 3	100.0	412	1599.46
106	2	RIGHT UPPER RIB ACCELEROMETER	06.40	G'S	4+1+ 3	100.0	412	1599.46
107	3	RIGHT LOWER RIB ACCELEROMETER	08.10	G'S	4+1+ 3	100.0	412	1599.46
108	4	LEFT UPPER RIB ACCELEROMETER	03.60	G'S	4+1+ 3	100.0	412	1599.46
109	5	LEFT LOWER RIB ACCELEROMETER	113.40	G'S	4+1+ 3	100.0	412	1599.46
110	6	THORAX A-P ACCELEROMETER	78.60	G'S	4+1+ 3	100.0	412	1599.46
111	7	THORAX I-S ACCELEROMETER	94.50	G'S	4+1+ 3	100.0	412	1599.46
112	8	RIGHT I-AP BELT LOAD	1000.00	LBS.	4+1+ 3	100.0	412	1599.46
113	9	LEFT LAP BELT LOAD	1000.00	LBS.	4+1+ 3	100.0	412	1599.46
114	10	STEERING COLUMN LOAD	1176.00	LBS.	4+1+ 3	100.0	412	1599.46

110
 120
 130
 140

=====
 FILTERED FILES: 105 - 114 DIGITAL TAPE: THORAX DATE: 20-SEP-76 RUN ID: A-905-11

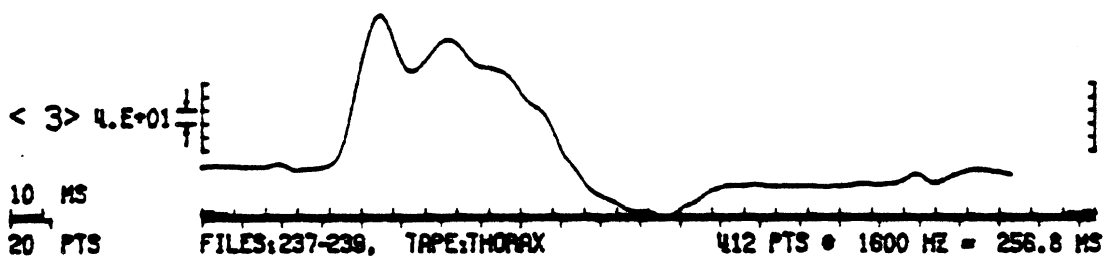
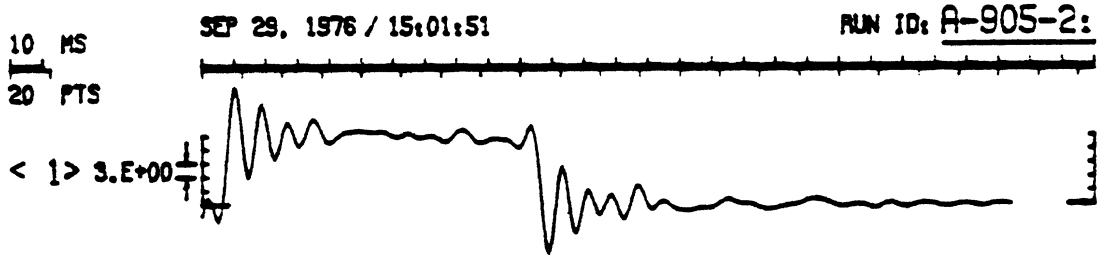

=====

RUN ID: A-905-21

ANALOG-TO-DIGITAL CONVERSION & DIGITAL FILTERING

=====

PROJECT: THORACIC IMPACT PROJECT - PRIMATE SERIES

ANALOG TAPE: HSK1(137) EXPANDED 1611, WAS A/D CONVERTED TO DIGITAL TAPE: T.I.P. DATE: 20-SEP-76

TEST SIGNALS: 1649 PTS/CH AT 6402.02 HZ. CAL SIGNALS: NOT DIGITIZED.

FILE	CH	CONTENT OF CHANNEL	UNITS/VOLT	UNITS	FILTER STAGES	FILTER CUTOFF	NO. PTS	SAMPLING HERTZ
237	1	SLED DECELERATION	20.00	G'S	4+1+	3 100.0	412	1600.50
238	2	AIRWAY PRESSURE	209.00	MM-HG	4+1+	3 100.0	412	1600.50
239	3	VASCULAR PRESSURE	291.00	MM-HG	4+1+	3 100.0	412	1600.50

41

51

61

71

81

91

101

111

121

131

141

FILTERED FILES: 237 - 239 DIGITAL TAPE: THORAX DATE: 28-SEP-76 RUN ID: A-905-21

Summary Test Report

Thoracic Injury Project (Contract DOT-HS-4-00921) Highway Safety Research
Institute - The University of Michigan

Test No.: A-906

Test Date: August 21, 1975

Test Subject

Species - baboon
Sex - male
Weight - 17.7 kg.

Restraint System

Stiffest EA column with pad insert and lap belt

Velocity

21.2 mph

Deceleration

30 G's

Injuries

Much hemorrhaging on 1st and 2nd lobes of left lung.
Hemorrhage of right lung at intersection of pulmonary
artery.
Bruising and laceration at several locations in heart and
neighboring vessels.

AIS Number Estimate

5

THORACIC INJURY PROJECT

PRIMATE INJURY REPORT

Test Number A-906

Date 8-21-75

Anatomical Anomalies or Clinical Observations

1. Thoracic Skeleton
2. Heart
3. Lungs
4. Other structures or systems Bit tongue on impact.

Injuries observed

1. External Bruising on anterior thorax and abdomen from contact with steering wheel. Very slight hemorrhage on surface of muscle tissue over sternum.
2. Bony or Cartilaginous Structures No fractures. Hemorrhage along medial surface of sternum.
3. Heart and Vascular Hemorrhage and clotted blood over entire pericardium. Contusions extending half way through the muscle of right ventricle at junction with left ventricle, anterior superior surface of right ventricle and posterior right *
4. Lungs Severe hemorrhage on left lung, upper lobes. Hemorrhage on right lung at junction of pulmonary arteries. Scattered petechiae in area under steering wheel impact site. Contusions and lacerations of both pulmonary arteries.
5. Other structures or systems Slight hemorrhage around left upper and right lower rib accelerometer mounts. Some free bile in peritoneum.

*

ventricle along line of coronary arteries.

SLED DECELERATION PULSE

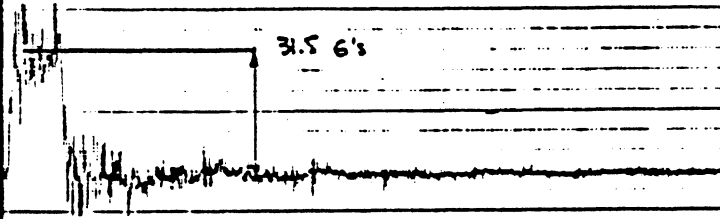

RIGHT UPPER RIB
ACCELEROMETER

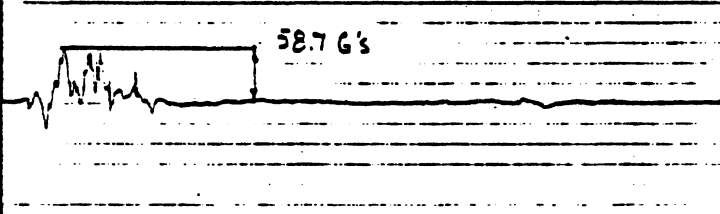

RIGHT LOWER RIB
ACCELEROMETER

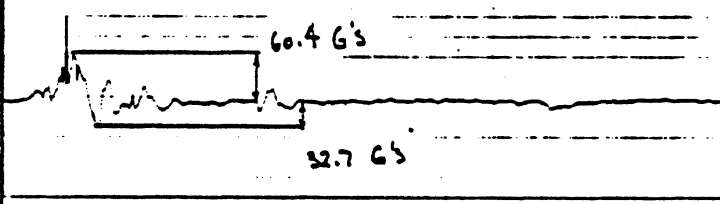

LEFT UPPER RIB
ACCELEROMETER

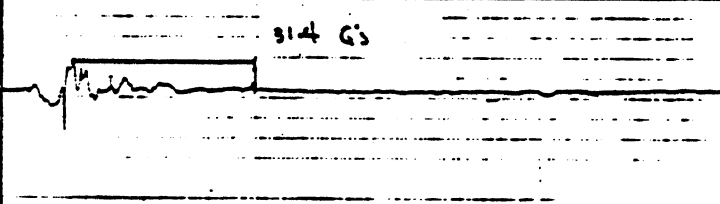

LEFT LOWER RIB
ACCELEROMETER

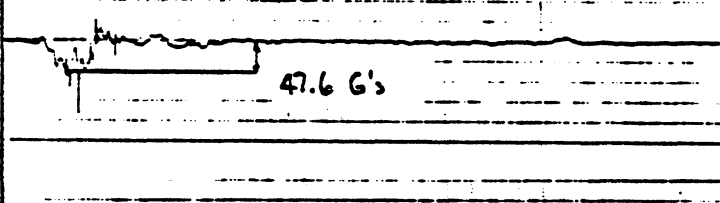

THORAX P-A ACCELEROMETER

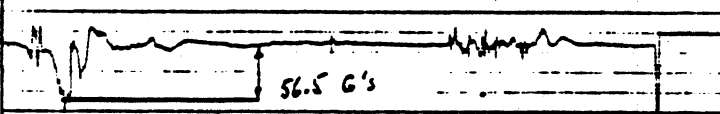

THORAX I-S ACCELEROMETER

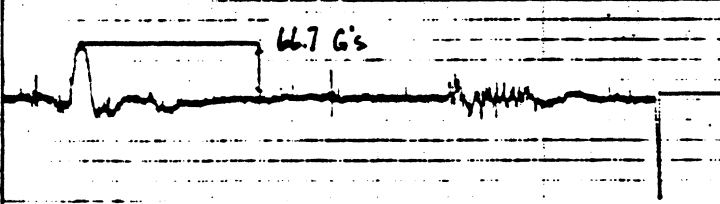

100 msec

TEST NO. A-906

RIGHT LAP BELT LOAD

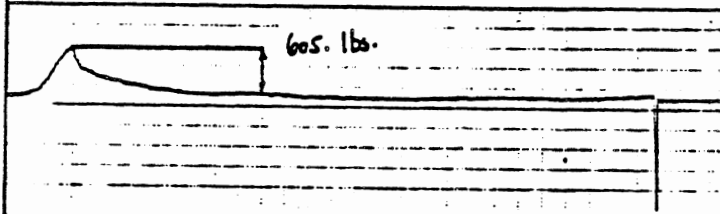

LEFT LAP BELT LOAD

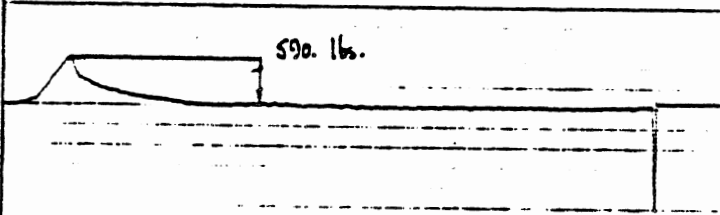

STEERING COLUMN LOAD

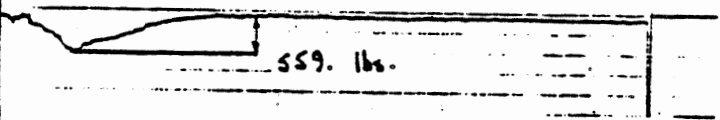

AIRWAY PRESSURE

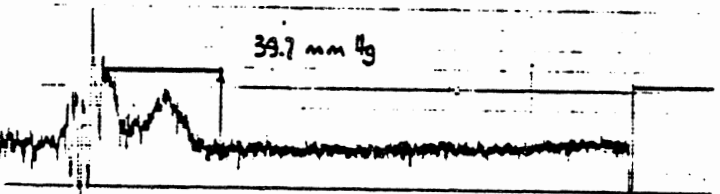

VASCULAR PRESSURE

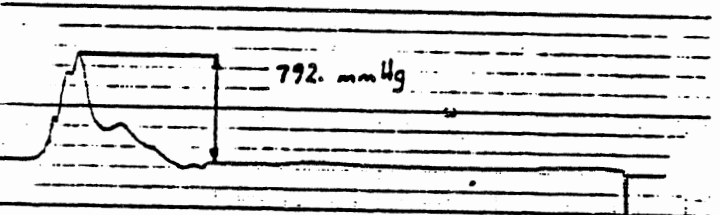

100 msec

SEP 29, 1976 / 14:27:05

RUN ID: A-906-1:

10 MS
20 PTS

< 1 > 4.E+00

< 2 > 6.E+00

< 3 > 7.E+00

< 4 > 4.E+00

< 5 > 5.E+00

< 6 > 7.E+00

< 7 > 1.E+01

< 8 > 6.E+01

< 9 > 5.E+01

< 10 > 5.E+01

10 MS
20 PTS

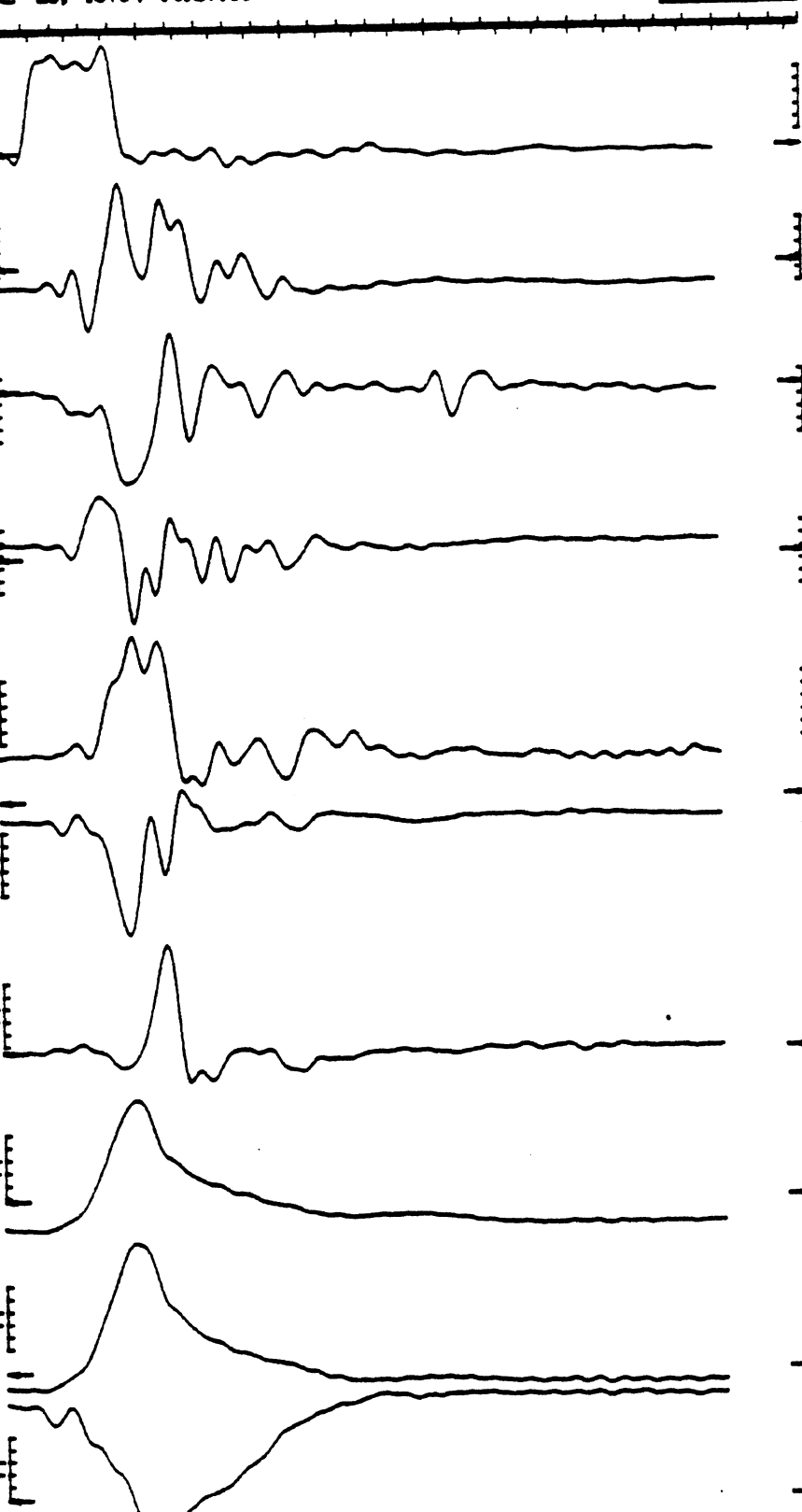

FILES:115-124. TAPE:THORAX

412 PTS • 1599 HZ = 257.0 MS

=====
 RUN ID: A-906-11

ANALOG-TO-DIGITAL CONVERSION & DIGITAL FILTERING

=====
 PROJECT: THORACIC IMPACT PROJECT -- PRIMATE TEST SERIES
 ANALOG TAPE: HSRI(136) EXPANDED 1681, WAS A/D CONVERTED TO DIGITAL TAPE: T.I.P. DATE: 20-SEP-76

TEST SIGNALS: 1661 PTS/CH AT 6396.61 HZ. CAL SIGNALS: NOT DIGITIZED.

FILE	CH	CONTENT OF CHANNEL	UNITS/VOLT	UNITS	FILTER STAGES	FILTER CUTOFF	NO. PTS	SAMPLING HERTZ
115	11	SIED DECELERATION	20.00	G'S	4+1+3	100.7	412	1599.15
116	21	RIGHT UPPER RIB ACCELEROMETER	85.70	G'S	4+1+3	100.7	412	1599.15
117	31	RIGHT LOWER RIB ACCELEROMETER	-100.70	G'S	4+1+3	100.7	412	1599.15
118	41	LEFT UPPER RIB ACCELEROMETER	-83.60	G'S	4+1+3	100.7	412	1599.15
119	51	LEFT LOWER RIB ACCELEROMETER	-119.10	G'S	4+1+3	100.7	412	1599.15
120	61	THORAX A-P ACCELEROMETER	80.70	G'S	4+1+3	100.7	412	1599.15
121	71	THORAX I-S ACCELEROMETER	95.30	G'S	4+1+3	100.7	412	1599.15
122	81	RIGHT LAP BELT LOAD	1000.00	LBS.	4+1+3	100.7	412	1599.15
123	91	LEFT LAP BELT LOAD	1000.00	LBS.	4+1+3	100.7	412	1599.15
124	101	STEERING COLUMN LOAD	1176.00	LBS.	4+1+3	100.7	412	1599.15

111
 121
 131
 141

=====
 FILTERED FILES: 115 - 124 DIGITAL TAPE: THORAX DATE: 28-SEP-76 RUN ID: A-906-11

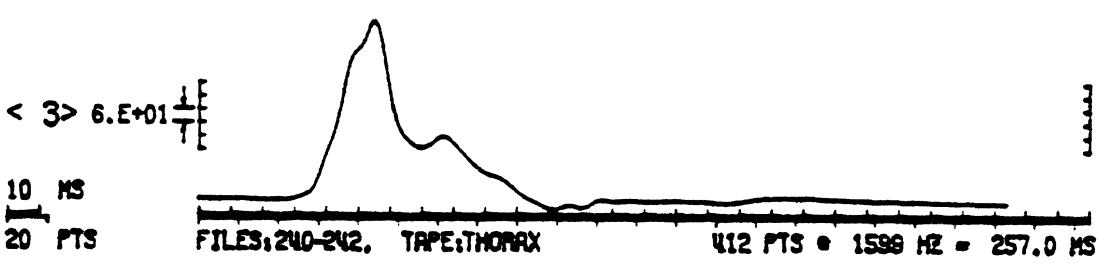
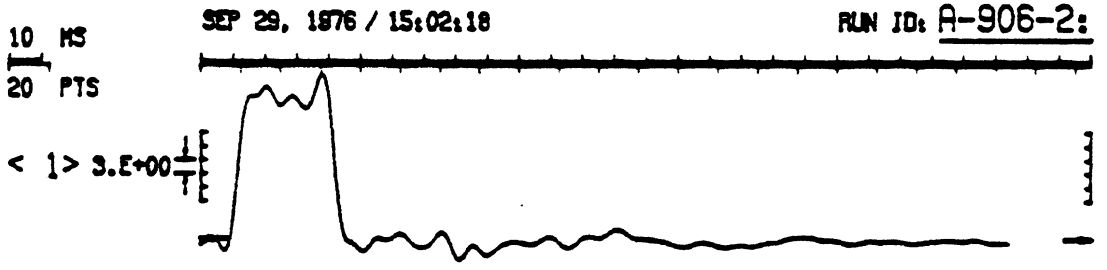

=====

RUN ID: A-906-21

=====

ANALOG-TO-DIGITAL CONVERSION & DIGITAL FILTERING

PROJECT: THORACIC IMPACT PROJECT - PRIMATE SERIES

ANALOG TAPE: NSRI(137) EXPANDED 1611, WAS A/D CONVERTED TO DIGITAL TAPE: T.I.P. DATE: 20-SEP-76

TEST SIGNALS: 1660 PTS/CH AT 6397.84 HZ. CAL SIGNALS: NOT DIGITIZED.

FILE	CH	CONTENT OF CHANNEL	UNITS/VOLT	UNITS	FILTER STAGES	FILTER CUTOFF	NO. PTS	SAMPLING HERTZ
240	10	SLED DECELERATION	20.00	G'S	4+1+3	100.0	412	1599.46
241	20	AIRWAY PRESSURE	209.00	MM-HG	4+1+3	100.0	412	1599.46
242	30	VASCULAR PRESSURE	291.00	MM-HG	4+1+3	100.0	412	1599.46

40

120

50

60

70

80

90

100

110

120

130

140

FILTERED FILFS: 240 - 242 DIGITAL TAPE: THORAX DATE: 20-SEP-76 RUN ID: A-906-21

Summary Test Report

Thoracic Injury Project (Contract DOT-HS-4-00921) Highway Safety Research
Institute - The University of Michigan

Test No.: A-914

Test Date: August 28, 1975

Test Subject

Species - baboon
Sex - Male
Weight - 13 kg.

Restraint System

Stiffest EA column with airbag insert and lap belt

Velocity

30.0 mph

Deceleration

15.0 G's

Injuries

Bruise and tear on anterior surface of pancreas

AIS Number Estimate

3

THORACIC INJURY PROJECT

PRIMATE INJURY REPORT

Test Number A-914

Date 8-28-75

Anatomical Anomalies or Clinical Observations

1. Thoracic Skeleton
2. Heart
3. Lungs
4. Other structures or systems Much free blood, external to pleura, due to laceration of third intercostal vein as a result of the attachment of spinal accelerometer mount.

Injuries observed

1. External None observed.
2. Bony or Cartilaginous Structures None observed.
3. Heart and Vascular None observed.
4. Lungs None observed.
5. Other structures or systems Contusions on anterior surface of pancreas. Several small contusions on pancreatic duct. Minor bruising on intestines under area of belt.

SEED DECELERATION PULSE

16.0 G's

RIGHT UPPER RIB ACCELEROMETER

72.8 G's

26.5 G's

RIGHT LOWER RIB ACCELEROMETER

78.4 G's

LEFT UPPER RIB ACCELEROMETER

39.7 G's

LEFT LOWER RIB ACCELEROMETER

53.9 G's

THORAX A-P ACCELEROMETER

55.6 G's

43.8 G's

THORAX I-S ACCELEROMETER

39.5 G's

28.2 G's

TEST # A-916

RIGHT LAP BELT LOAD

325. lbs.

LEFT LAP BELT LOAD

350. lbs

STEERING COLUMN LOAD

376. lbs.

VASCULAR PRESSURE

192.9 mm Hg

AIRBAG PRESSURE

92.4 psi

100 msec

124

10 MS
20 PTS

SEP 29, 1976 / 14:27:35

RUN ID: A-914-1:

< 1 > 3.E+00

< 2 > 6.E+00

< 3 > 7.E+00

< 4 > 6.E+00

< 5 > 6.E+00

< 6 > 8.E+00

< 7 > 7.E+00

< 8 > 3.E+01

< 9 > 3.E+01

< 10 > 4.E+01

10 MS
20 PTS

FILES: 125-134, TAPE: THORAX

407 PTS • 1600 HZ = 253.7 MS

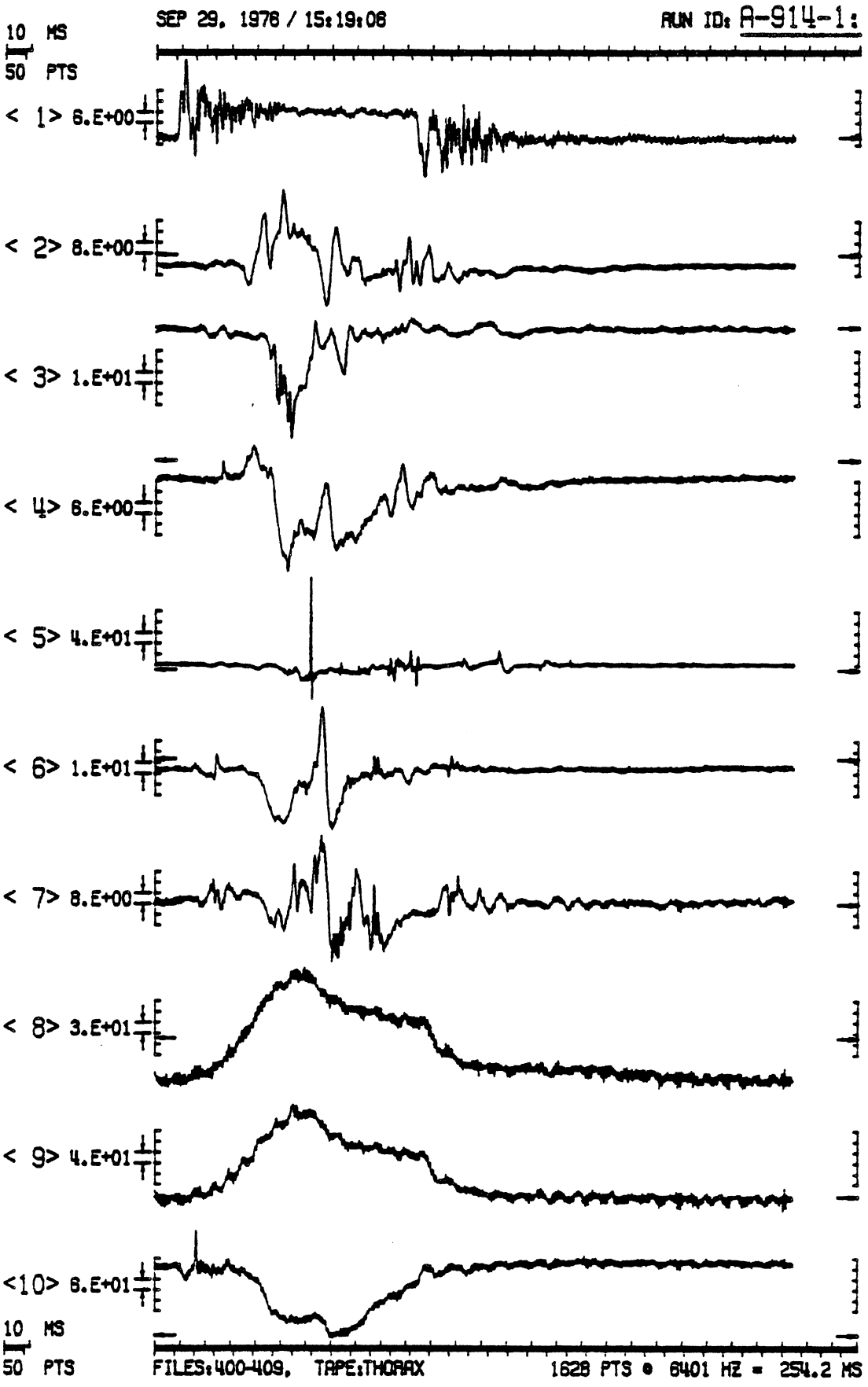

=====
 RUN ID: A-914-11
 =====

ANALOG-TO-DIGITAL CONVERSION & DIGITAL FILTERING

PROJECT: THORACIC IMPACT PROJECT - PRIMATE TEST SERIES

ANALOG TAPE: USRI(136) EXPANDED 1611, WAS A/D CONVERTED TO DIGITAL TAPE: T.I.P. DATE: 20-SEP-76
 TEST SIGNALS: 1640 PTS/CH AT 6401.25 HZ. CAL SIGNALS: NOT DIGITIZED.

FILE	CH	CONTENT OF CHANNEL	UNITS/VOLT	UNITS	FILTER STAGES	FILTER CUTOFF	NO. PTS	SAMPLING HERTZ
125	11	SLED DECELERATION	20.00	G'S	4+1+3	100.0	407	1600.31
126	20	RIGHT UPPER RIB ACCELEROMETER	85.70	G'S	4+1+3	100.0	407	1600.31
127	30	RIGHT LOWER RIB ACCELEROMETER	-98.00	G'S	4+1+3	100.0	407	1600.31
128	40	LEFT UPPER RIB ACCELEROMETER	-83.60	G'S	4+1+3	100.0	407	1600.31
129	50	LEFT LOWER RIB ACCELEROMETER	-113.40	G'S	4+1+3	100.0	407	1600.31
130	60	THORAX A-P ACCELEROMETER	79.30	G'S	4+1+3	100.0	407	1600.31
131	70	THORAX I-S ACCELEROMETER	95.30	G'S	4+1+3	100.0	407	1600.31
132	80	RIGHT LAP BELT LOAD	1000.00	LBS.	4+1+3	100.0	407	1600.31
133	90	LEFT LAP BELT LOAD	1000.00	LBS.	4+1+3	100.0	407	1600.31
134	100	STEERING COLUMN LOAD	1176.00	LBS.	4+1+3	100.0	407	1600.31

110
 120
 130
 140

 FILTERED FILES: 125 - 134 DIGITAL TAPE: THORAX DATE: 20-SEP-76 RUN ID: A-914-11

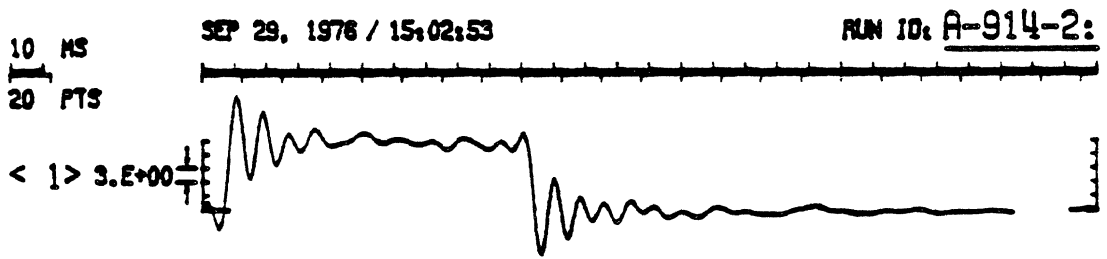

=====
RUN ID: A-914-21

ANALOG-TO-DIGITAL CONVERSION & DIGITAL FILTERING

=====
PROJECT: THORACIC IMPACT PROJECT -- PRIMATE SERIES

ANALOG TAPE: MSRI(137) EXPANDED 1611, WAS A/D CONVERTED TO DIGITAL TAPE: T.1.P. DATE: 20-SEP-76
TEST SIGNALS: 1638 PTS/CH AT 6401.09 HZ. CAL SIGNALS: NOT DIGITIZED.

FILE	CH	CONTENT OF CHANNEL	UNITS/VOLT	UNITS	FILTER STAGES	FILTER CUTOFF	NO. PTS	SAMPLING HERTZ
243	11	SLED DECELERATION	20.00	G'S	4+1+ 3	100.0	407	1600.27
244	21	AIRWAY PRESSURE	209.00	MM-HG	4+1+ 3	100.0	407	1600.27
245	31	VASCULAR PRESSURE	291.00	MM-HG	4+1+ 3	100.0	407	1600.27
246	41	AIRBAG PRESSURE	3620.00	MM-HG	4+1+ 3	100.0	407	1600.27

51
61
71
81
91
101
111
121
131
141

FILTERED FILES: 243 - 246 DIGITAL TAPE: THORAX DATE: 20-SEP-76 RUN ID: A-914-21

Summary Test Report

Thoracic Injury Project (Contract DOT-HS-4-00921) Highway Safety Research
Institute - The University of Michigan

Test No.: A-915

Test Date: August 29, 1975

Test Subject

Species - Baboon
Sex - Male
Weight - 15.8 kg.

Restraint System

Stiffest EA column with airbag insert and lap belt.

Velocity

21.2 mph

Deceleration

30.0 G's

Injuries

Spotty hemorrhage on both sides of pericardium
Bruise on left atrium
Bruise at junction of venacava and right atrium

AIS Number Estimate

4

THORACIC INJURY PROJECT

PRIMATE INJURY REPORT

Test Number A-915

Date 8-29-75

Anatomical Anomalies or Clinical Observations

1. Thoracic Skeleton
2. Heart
3. Lungs
4. Other structures or systems

Injuries observed

1. External Bruising in muscle tissue over sternum at R₅ and over R₆ left.
2. Bony or Cartilaginous Structures No fractures or dislocations observed.
3. Heart and Vascular Hemorrhage on pericardium (spotty), approximately 10 cm² total on right, less on left. Small bruise at junction of vena cava and right atrium. Bruise on left atrium, 1/3 through tissue.
4. Lungs None observed.
5. Other structures or systems Slight bruising of intestines under area of seat belt contact.

THORACIC IMPACT PROJECT

Test # 2-915

Date 8-29-75

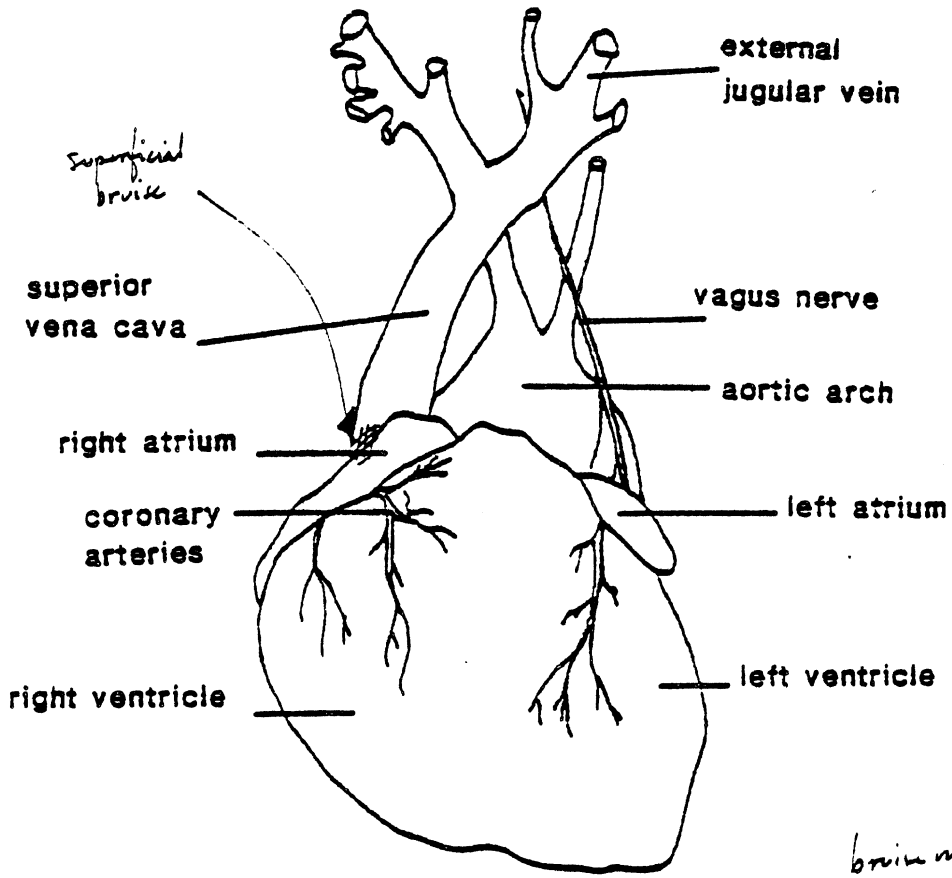

bruise in @atrium
1.5x2.0mm
1/3 through tissue.

Papio

SLID DECELERATION PULSE

30.6 G's

RIGHT UPPER RIB ACCELEROMETER

34.2 G's

RIGHT LOWER RIB ACCELEROMETER

64.3 G's

LFT UPPER RIB ACCELEROMETER

68.0 G's

LFT LOWER RIB ACCELEROMETER

59.5 G's

THORAX A-P ACCELEROMETER

80.2 G's

THORAX I-S ACCELEROMETER

22.0 G's

49.6 G's

100 msec

RIGHT LAP BELT LOAD

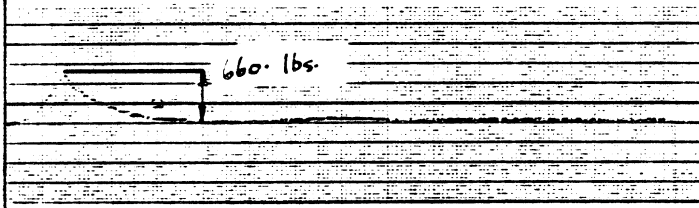

LEFT LAP BELT LOAD

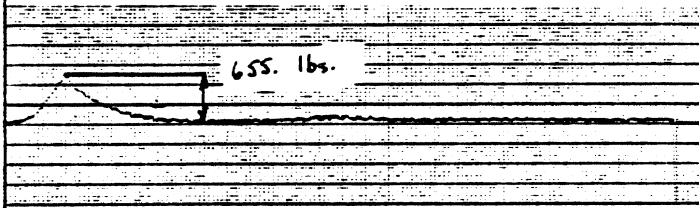

STEERING COLUMN LOAD

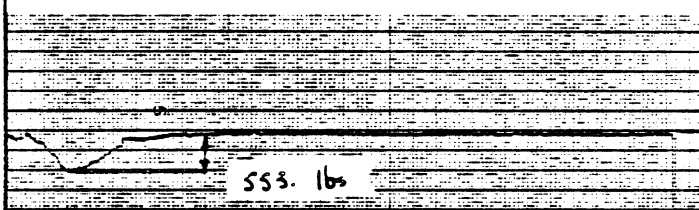

VASCULAR PRESSURE

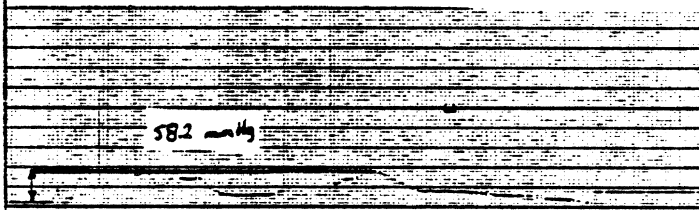

AIRBAG PRESSURE

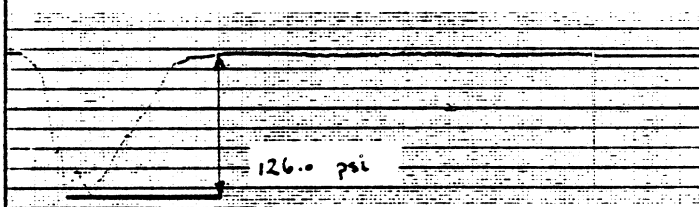

100 msec

10 MS
20 PTS

SEP 29, 1976 / 14:28:21

RUN ID: A-915-1:

< 1 > 4.E+00



< 2 > 5.E+00



< 3 > 7.E+00



< 4 > 6.E+00



< 5 > 7.E+00



< 6 > 8.E+00



< 7 > 2.E+01

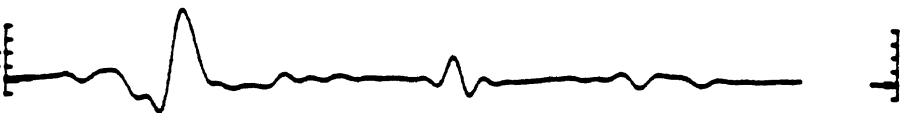

< 8 > 6.E+01



< 9 > 6.E+01



< 10 > 6.E+01



10 MS
20 PTS

FILES: 135-144, TAPE: THORAX

416 PTS • 1599 HZ = 259.5 MS

ANALOG-TO-DIGITAL CONVERSION & DIGITAL FILTERING

RUN ID: A-915-11

PROJECT: THORACIC IMPACT PROJECT -- PRIMATE TEST SERIES

ANALOG TAPE: HSHI(136) EXPANDED 1611, WAS A/D CONVERTED TO DIGITAL TAPE; T.I.P. DATE: 20-SEP-76

TEST SIGNALS: 1664 PTS/CH AT 6396.31 HZ. CAL SIGNALS: NOT DIGITIZED.

FILE	CH	CONTENT OF CHANNEL	UNITS/VOLT	UNITS	FILTER STAGES	FILTER CUTOFF	NO. PTS	SAMPLING HERTZ
135	1	SLED DECELERATION	20.00	G'S	4+1+ 3	100.7	416	1599.08
136	2	RIGHT UPPER RIB ACCELEROMETER	85.70	G'S	4+1+ 3	100.7	416	1599.08
137	3	RIGHT LOWER RIB ACCELEROMETER	-97.20	G'S	4+1+ 3	100.7	416	1599.08
138	4	LEFT UPPER RIB ACCELEROMETER	-82.90	G'S	4+1+ 3	100.7	416	1599.08
139	5	LEFT LOWER RIB ACCELEROMETER	-113.40	G'S	4+1+ 3	100.7	416	1599.08
136 140	6	THORAX A-P ACCELEROMETER	80.00	G'S	4+1+ 3	100.7	416	1599.08
141	7	THORAX I-S ACCELEROMETER	94.50	G'S	4+1+ 3	100.7	416	1599.08
142	8	RIGHT LAP BELT LOAD	1000.00	LBS.	4+1+ 3	100.7	416	1599.08
143	9	LEFT LAP BELT LOAD	1000.00	LBS.	4+1+ 3	100.7	416	1599.08
144	10	STEERING COLUMN LOAD	1176.00	LBS.	4+1+ 3	100.7	416	1599.08
	11							
	12							
	13							
	14							

FILTERED FILES: 135 - 144 DIGITAL TAPE: THORAX DATE: 28-SEP-76 RUN ID: A-915-11

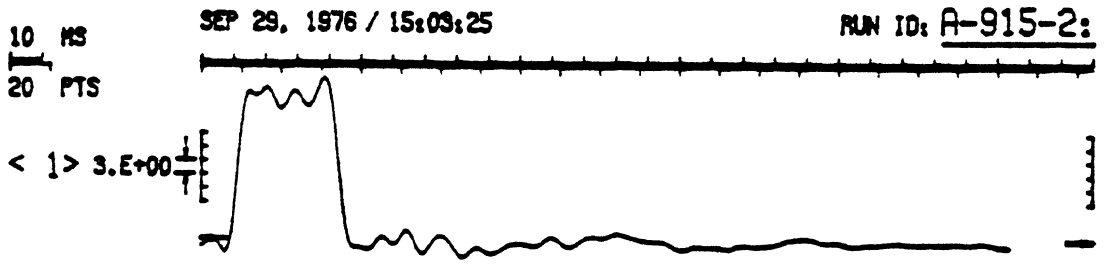

=====
RUN ID: A-915-21

ANALOG-TO-DIGITAL CONVERSION & DIGITAL FILTERING

=====

PROJECT: THORACIC IMPACT PROJECT - PRIMATE SERIES

ANALOG TAPE: HSHI(137) EXPANDED 1601, WAS A/D CONVERTED TO DIGITAL TAPE: T.I.P. DATE: 20-SEP-76

TEST SIGNALS: 1662 PTS/CH AT 6398.31 HZ. CAL SIGNALS: NOT DIGITIZED.

FILE	CH	CONTENT OF CHANNEL	UNITS/VOLT	UNITS	FILTER STAGES	FILTER CUTOFF	NO. PTS	SAMPLING HERTZ
247	11	SLED DECELERATION	20.00	G'S	4+1+3	100.0	412	1599.50
248	21	AIRWAY PRESSURE	209.00	MM-HG	4+1+3	100.0	412	1599.50
249	31	VASCULAR PRESSURE	291.00	MM-HG	4+1+3	100.0	412	1599.50
250	41	AIRBAG PRESSURE	3620.00	MM-HG	4+1+3	100.0	412	1599.50

138
51
61
71
81
91
101
111
121
131
141

=====
FILTERED FILES: 247 - 250 DIGITAL TAPE: THORAX DATE: 28-SEP-76 RUN ID: A-915-21

Summary Test Report

Thoracic Injury Project (Contract DOT-HS-4-00921) Highway Safety Research
Institute - The University of Michigan

Test No.: A-916

Test Date: August 29, 1975

Test Subject

Species - Baboon
Sex - Male
Weight - 14.6 kg.

Restraint System

Stiffest EA column with airbag insert and lap belt.

Velocity

21.2 mph

Deceleration

15.0 G's

Injuries

Minor injuries.

AIS Number Estimate

1

THORACIC INJURY PROJECT

PRIMATE INJURY REPORT

Test Number A-916

Date 8-29-75

Anatomical Anomalies or Clinical Observations

1. Thoracic Skeleton
2. Heart
3. Lungs
4. Other structures or systems Very minor hemorrhage at junction of spine and R₆ and R₇, due to puncture of 6th and 7th intercostal veins, as a result of the attachment of spinal accelerometer mount.

Injuries observed

1. External None observed.
2. Bony or Cartilaginous Structures No fractures or dislocations.
3. Heart and Vascular None observed.
4. Lungs Minor petechial spotting, right lung.
5. Other structures or systems Slight bruising of the intestines.

SLID DECELERATION PULSE

15.5 G's

RIGHT UPPER RIB ACCELEROMETER

40.66 G's

RIGHT LOWER RIB ACCELEROMETER

70.8 G's

LEFT UPPER RIB ACCELEROMETER

35.2 G's

LEFT LOWER RIB ACCELEROMETER

56.7 G's

THORAX A-P ACCELEROMETER

32.3 G's

46.3 G's

THORAX I-S ACCELEROMETER

26.0 G's

23.6 G's

100 msec

TEST # A-916

RIGHT LAP BELT LOAD

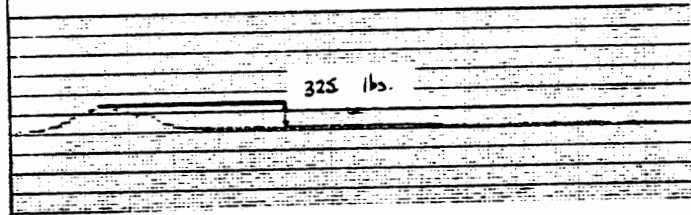

LEFT LAP BELT LOAD

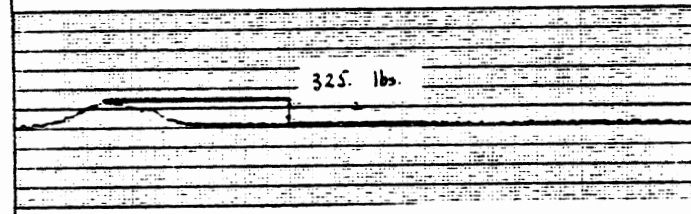

STEERING COLUMN LOAD

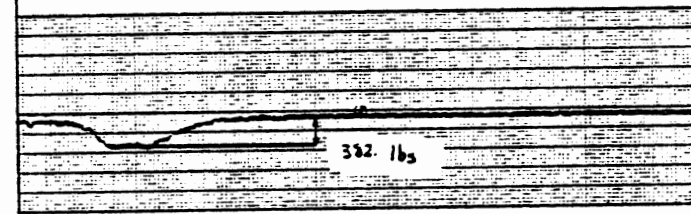

AIRBAG PRESSURE

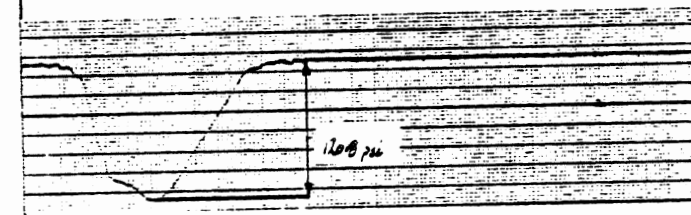

AIRWAY PRESSURE

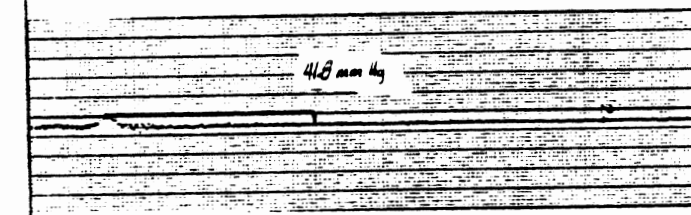

100 msec \rightarrow 142

10 MS
20 PTS
SEP 29, 1976 / 14:28:54
RUN ID: A-916-1:

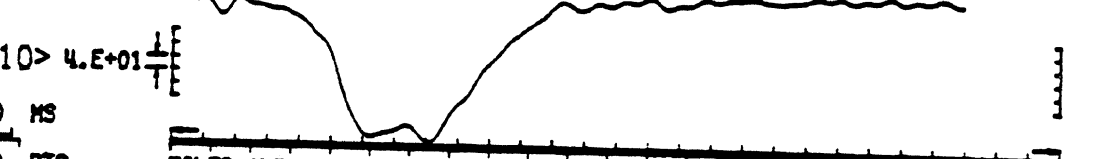
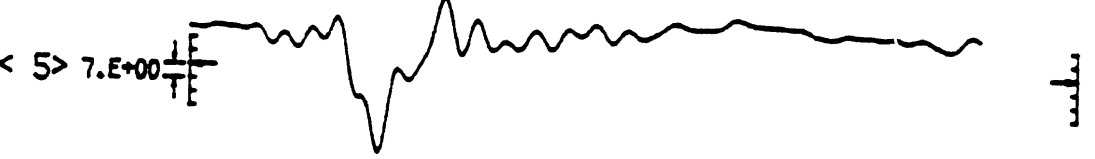

10 MS
20 PTS
FILES: 145-154, TAPE: THORAX
426 PTS • 1600 HZ = 265.5 MS

=====
 RUN ID: A-916-11
 =====

ANALOG-TO-DIGITAL CONVERSION & DIGITAL FILTERING
 =====

PROJECT: THORACIC IMPACT PROJECT -- PRIMATE TEST SERIES

ANALOG TAPE: HSRI(136) EXPANDED 1600, WAS A/D CONVERTED TO DIGITAL TAPE: T.I.P. DATE: 20-SEP-76

TEST SIGNALS: 1712 PTS/CH AT 64003.44 HZ. CAL SIGNALS: NOT DIGITIZED.

FILE	CH	CONTENT OF CHANNEL	UNITS/VOLT	UNITS	FILTER STAGES	FILTER CUTOFF	NO. PTS	SAMPLING HERTZ
145	11	SLED DECELERATION	20.00	G'S	4+1+3	100.0	426	1600.86
146	20	RIGHT UPPER RIB ACCELEROMETER	85.70	G'S	4+1+3	100.0	426	1600.86
147	30	RIGHT LOWER RIB ACCELEROMETER	-98.10	G'S	4+1+3	100.0	426	1600.86
148	40	LEFT UPPER RIB ACCELEROMETER	-82.90	G'S	4+1+3	100.0	426	1600.86
149	50	LEFT LOWER RIB ACCELEROMETER	-113.40	G'S	4+1+3	100.0	426	1600.86
150	60	THORAX A-P ACCELEROMETER	80.70	G'S	4+1+3	100.0	426	1600.86
151	70	THORAX I-S ACCELEROMETER	94.50	G'S	4+1+3	100.0	426	1600.86
152	80	RIGHT LAP BELT LOAD	1000.00	LBS.	4+1+3	100.0	426	1600.86
153	90	LEFT LAP BELT LOAD	1000.00	LBS.	4+1+3	100.0	425	1600.86
154	100	STEERING COLUMN LOAD	1176.00	LBS.	4+1+3	100.0	425	1600.86

- 111
- 120
- 130
- 140

SEP 29, 1976 / 15:04:25

RUN ID: A-916-2:

10 MS
20 PTS

< 1 > 2.E+00

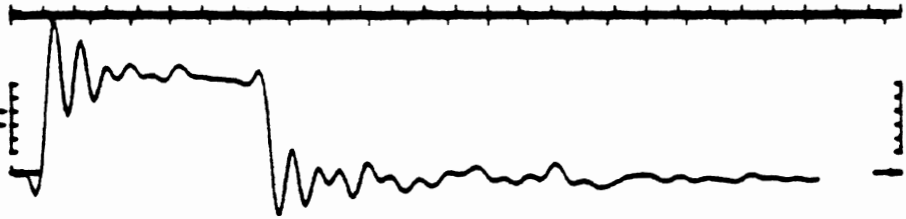

< 2 > 3.E+00



< 3 > 2.E+02

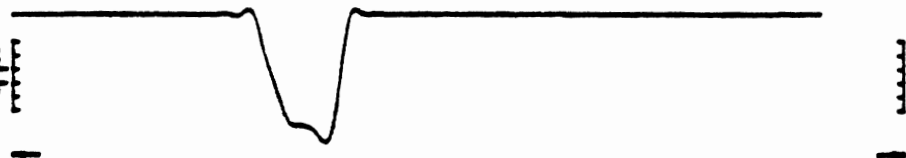

< 4 > 5.E+02

10 MS
20 PTS

FILES: 251-254, TAPE: THORAX

426 PTS @ 1600 HZ = 265.6 MS

=====

RUN ID: A-916-28

=====

ANALOG-TO-DIGITAL CONVERSION & DIGITAL FILTERING

PROJECT: THORACIC IMPACT PROJECT -- PRIMATE SERIES

ANALOG TAPE: HSRI(137) EXPANDED 16:1, WAS A/D CONVERTED TO DIGITAL TAPE: T.I.P. DATE: 20-SEP-76

TEST SIGNALS: 1709 PTS/CH AT 6400.75 HZ. CAL SIGNALS: NOT DIGITIZED.

FILE	CH	CONTENT OF CHANNEL	UNITS/VOLT	UNITS	FILTER STAGES	FILTER CUTOFF	NO. PTS	SAMPLING HERTZ
251	11	SLED DECELERATION	20.00	G'S	4+1+3	100.0	426 0	1600.19
252	21	AIRWAY PRESSURE	209.00	MM-HG	4+1+3	100.0	426 0	1600.19
253	31	VASCULAR PRESSURE	291.00	MM-HG	4+1+3	100.0	426 0	1600.19
254	41	AIRBAG PRESSURE	3620.00	MM-HG	4+1+3	100.0	426 0	1600.19

- 51
- 61
- 71
- 81
- 91
- 101
- 111
- 121
- 131
- 141

----- FILTERED FILES: 251 - 254 ----- DIGITAL TAPE: THORAX ----- DATE: 20-SEP-76 ----- RUN ID: A-916-28 -----

SUMMARY TEST REPORT

Thoracic Injury Project (Contract DOT-HS-4-00921) Highway Safety Research

Institute - The University of Michigan

Test No.: A-929

Test Date: October 23, 1975

Test Subject:

Species - Baboon

Sex - Male

Weight - 15.75 kg.

Restraint System

Stiff EA column with soft insert, lap belt

Velocity

22.1 mph

Deceleration

9.2 G's

Injuries

Insignificant lung hemorrhages

AIS Number Estimate

1

THORACIC INJURY PROJECT

PRIMATE INJURY REPORT

Test Number A-929

Date 10-23-75

Anatomical Anomalies or Clinical Observations

1. Thoracic Skeleton
2. Heart
3. Lungs
4. Other structures or systems

Injuries observed

1. External None observed.
2. Bony or Cartilaginous Structures No fractures or dislocations.
3. Heart and Vascular None observed.
4. Lungs Minute petechiae.
5. Other structures or systems No abdominal injuries observed.

149

100 msec

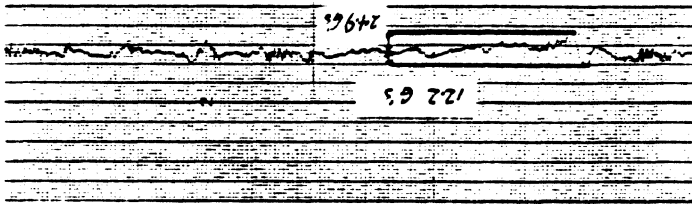
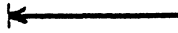

THORAX I-S ACCELEROMETER

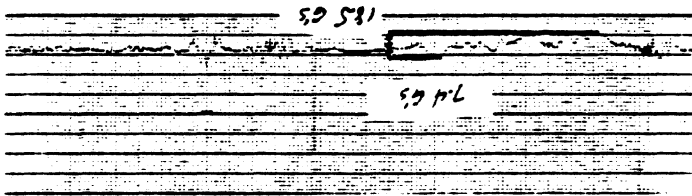

THORAX A-P ACCELEROMETER

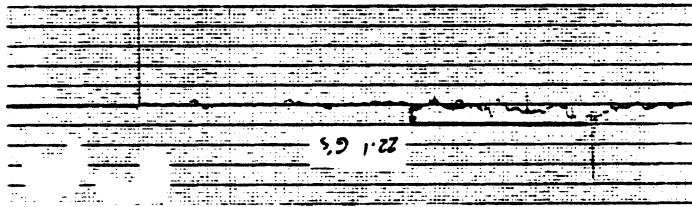

LEFT LOWER RIB ACCELEROMETER

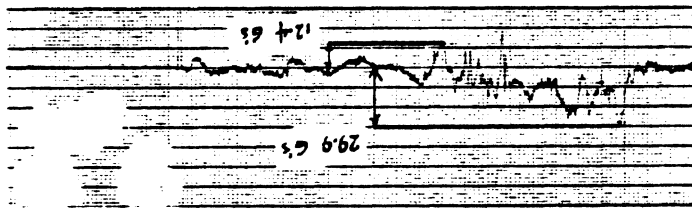

LEFT UPPER RIB ACCELEROMETER

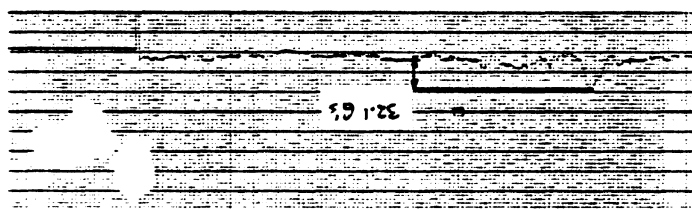

RIGHT LOWER RIB ACCELEROMETER

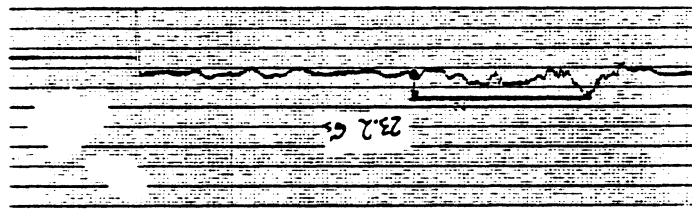

RIGHT UPPER RIB ACCELEROMETER

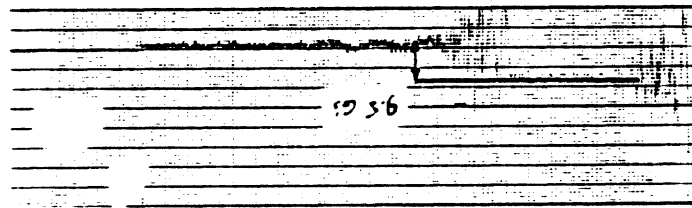

SPEED DECELERATION PULSE

TEST # A-929

RIGHT LAP BELT LOAD

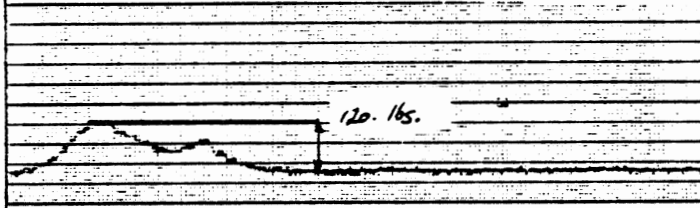

LEFT LAP BELT LOAD

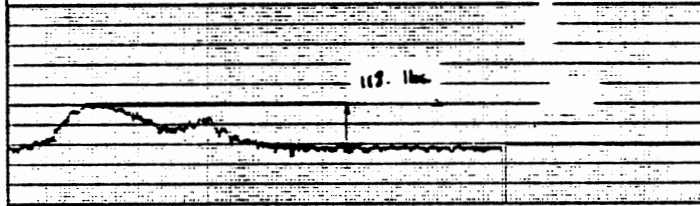

STEERING COLUMN LOAD

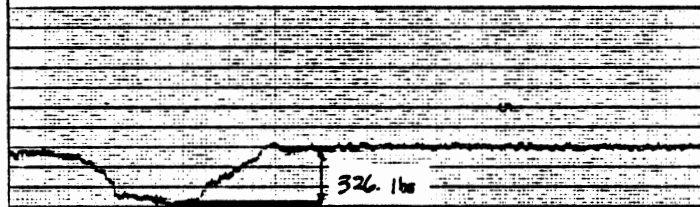

AIRWAY PRESSURE

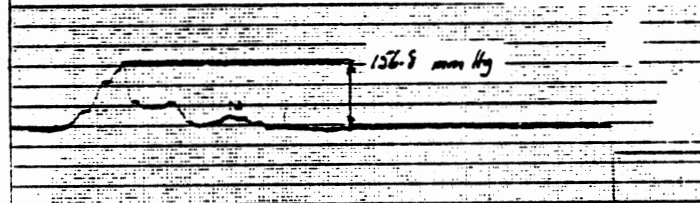

VASCULAR PRESSURE

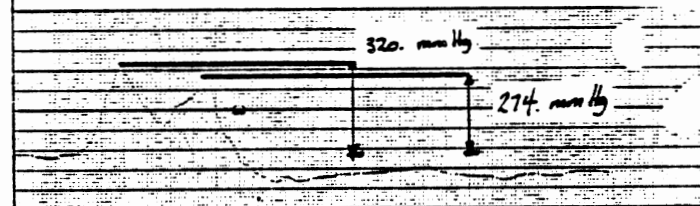

100 msec

150

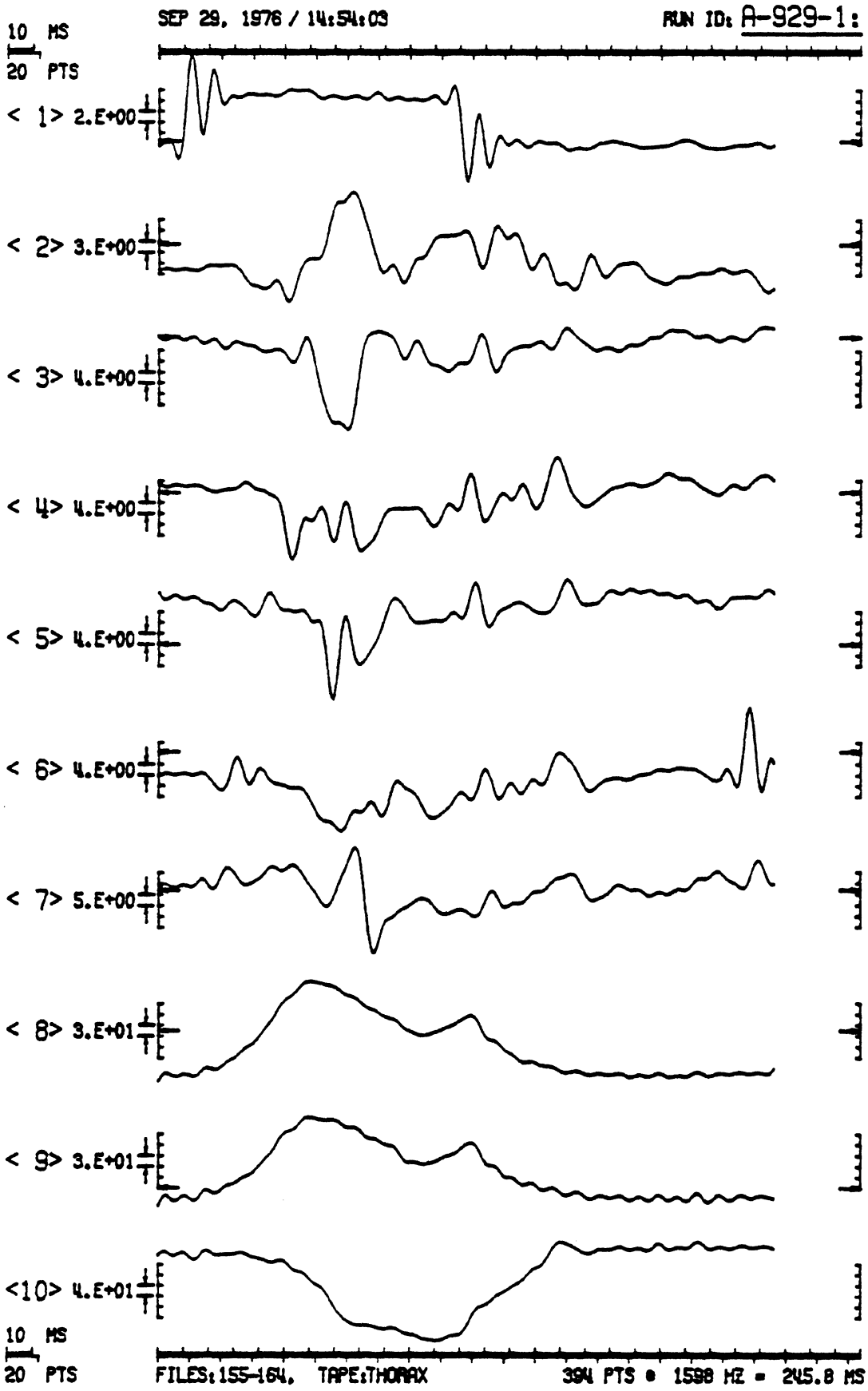

=====
 RUN ID: A-929-11
 =====

ANALOG-TO-DIGITAL CONVERSION & DIGITAL FILTERING

PROJECT: THORACIC IMPACT PROJECT -- PRIMATE TEST SERIES

ANALOG TAPE: HSKI(136) EXPANDED 1601, WAS A/D CONVERTED TO DIGITAL TAPE: T.I.P. DATE: 20-SEP-76

TEST SIGNALS: 1577 PTS/CH AT 6394.97 HZ. CAL SIGNALS: NOT DIGITIZED.

FILE CH	CONTENT OF CHANNEL	UNITS/VOLT	UNITS	FILTER STAGES	FILTER CUTOFF	NO. PTS	SAMPLING HERTZ
155	1: SLED DECELERATION	20.00	G'S	4+1+ 3	100.7	394	1598.74
156	2: RIGHT UPPER RIB ACCELEROMETER	80.00	G'S	4+1+ 3	100.7	394	1598.74
157	3: RIGHT LOWER RIB ACCELEROMETER	-85.70	G'S	4+1+ 3	100.7	394	1598.74
158	4: LEFT UPPER RIB ACCELEROMETER	-101.20	G'S	4+1+ 3	100.7	394	1598.74
159	5: LEFT LOWER RIB ACCELEROMETER	-98.00	G'S	4+1+ 3	100.7	394	1598.74
160	6: THORAX A-P ACCELEROMETER	82.20	G'S	4+1+ 3	100.7	394	1598.74
161	7: THORAX I-S ACCELEROMETER	90.50	G'S	4+1+ 3	100.7	394	1598.74
162	8: RIGHT LAP BELT LOAD	1000.00	LBS.	4+1+ 3	100.7	394	1598.74
163	9: LEFT LAP BELT LOAD	1000.00	LBS.	4+1+ 3	100.7	393	1598.74
164	10: STEERING COLUMN LOAD	1176.00	LBS.	4+1+ 3	100.7	393	1598.74

11:
 12:
 13:
 14:

=====
 FILTERED FILES: 155 - 164 DIGITAL TAPE: THORAX DATE: 20-SEP-76 RUN ID: A-929-11
 =====

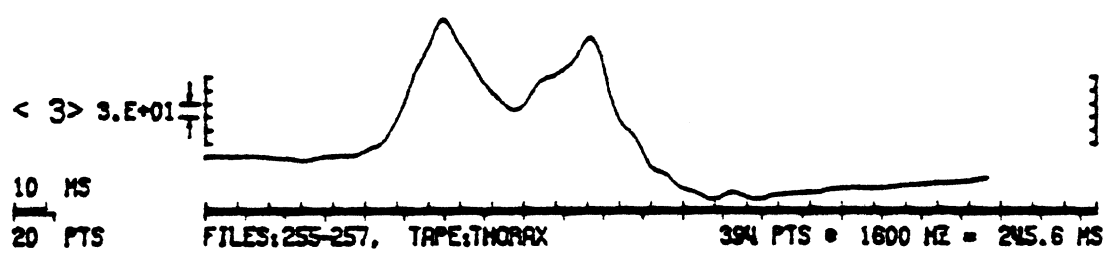
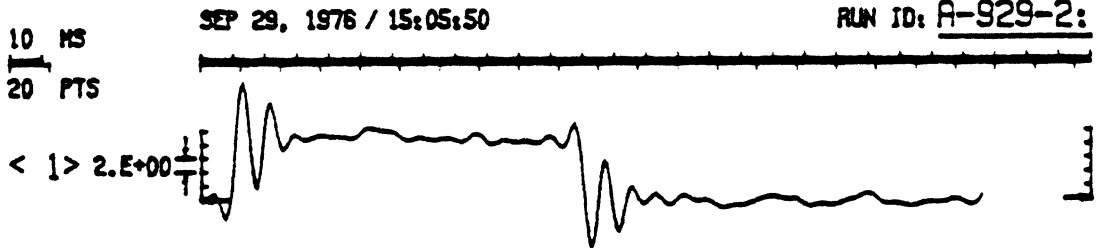

=====
 RUN ID: A-929-21
 =====

ANALOG-TO-DIGITAL CONVERSION & DIGITAL FILTERING

PROJECT: THORACIC IMPACT PROJECT -- PRIMATE SERIES

ANALOG TAPE: MSRI(137) EXPANDED 16:1, WAS A/D CONVERTED TO DIGITAL TAPE: T.I.P. DATE: 20-SEP-76

TEST SIGNALS: 1576 PTS/CH AT 6401.46 HZ. CAL SIGNALS: NOT DIGITIZED.

FILE	CH	CONTENT OF CHANNEL	UNITS/VOLT	UNITS	FILTER STAGES	FILTER CUTOFF	NO. PTS	SAMPLING HERTZ
255	10	SLIDED DECELERATION	20.00	G'S	4+1+3	100.0	394	1600.37
256	21	AIRWAY PRESSURE	209.00	MM-HG	4+1+3	100.0	394	1600.37
257	31	VASCULAR PRESSURE	145.60	MM-HG	4+1+3	100.0	394	1600.37

41

154

51

61

71

81

91

101

111

121

131

141

=====
 FILTERED FILES: 255 - 257 DIGITAL TAPE: THORAX DATE: 28-SEP-76 RUN ID: A-929-21
 =====

SUMMARY TEST REPORT

Thoracic Injury Project (Contract DOT-HS-4-00921) Highway Safety Research
Institute - The University of Michigan

Test No.: A-930

Test Date: October 23, 1975

Test Subject

Species - Baboon (cadaver)

Sex - Male

Weight - 16 kg

Restraint System

Stiff EA column with soft insert, lap belt

Velocity

21.9 mph

Deceleration

9.6 G's

Injuries

Slight hemorrhage - fascia surrounding ascending aorta

Slight lung hemorrhaging

Small bruise on lower anterior membrane portion of left kidney

Pancreas bruise

AIS Number Estimate

3/4

THORACIC INJURY PROJECT

PRIMATE INJURY REPORT

Test Number A-930

Date 10-23-75

Anatomical Anomalies or Clinical Observations

1. Thoracic Skeleton
2. Heart
3. Lungs
4. Other structures or systems Parasitic cysts in liver.

Injuries observed

1. External None observed.
2. Bony or Cartilaginous Structures No fractures or dislocations.
3. Heart and Vascular Slight hemorrhage in fascia surrounding
 ascending aorta.
4. Lungs Very slight petechiae.
5. Other structures or systems Small bruise on lower anterior
 membrane left kidney without damage to underlying tissue. Pancreas
 badly bruised. Slight bruising on viscera below duodenum.

TEST # A-930

SLED DECELERATION PULSE

9.5 G's

RIGHT UPPER RIB ACCELEROMETER

19.6 G's

RIGHT LOWER RIB ACCELEROMETER

24.8 G's

LEFT UPPER RIB ACCELEROMETER

29.3

LEFT LOWER RIB ACCELEROMETER

28.9 G's

THORAX A-P ACCELEROMETER

9.2 G's

20.1 G's

THORAX I-S ACCELEROMETER

13.5 G's

22.5 G's

100 msec

157

TEST # A-930

RIGHT LAP BELT LOAD

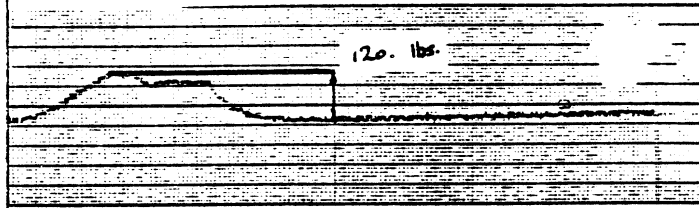

LEFT LAP BELT LOAD

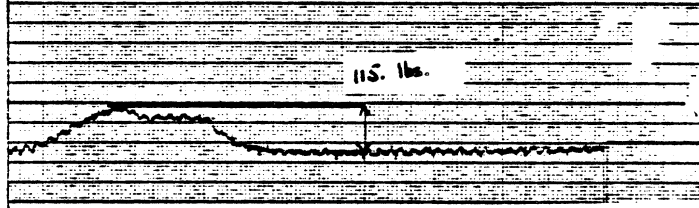

STEERING COLUMN LOAD

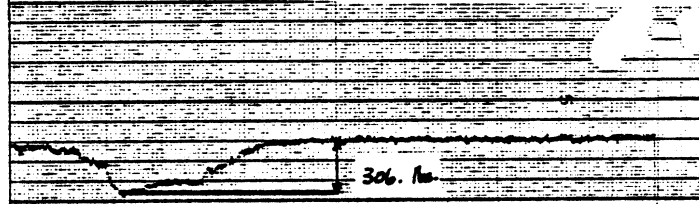

AIRWAY PRESSURE

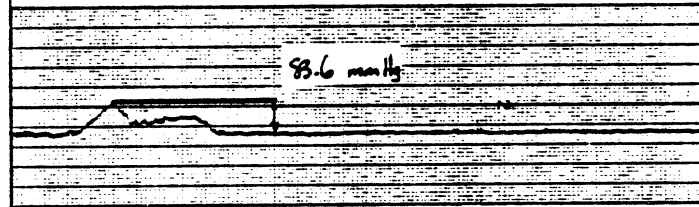

VASCULAR PRESSURE

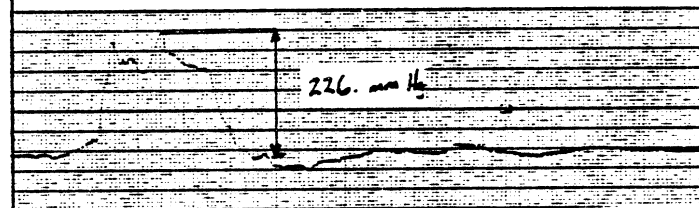

100 msec

SEP 29, 1976 / 14:54:37

RUN ID: A-930-1:

10 MS
20 PTS

< 1 > 2.E+00

< 2 > 3.E+00

< 3 > 4.E+00

< 4 > 3.E+00

< 5 > 3.E+00

< 6 > 4.E+00

< 7 > 5.E+00

< 8 > 3.E+01

< 9 > 2.E+01

< 10 > 3.E+01

10 MS
20 PTS

FILES:165-174, TAPE:THORAX

398 PTS • 1600 HZ = 248.1 MS

ANALOG-TO-DIGITAL CONVERSION & DIGITAL FILTERING

RUN ID: A-930-11

PROJECT: THORACIC IMPACT PROJECT - PRIMATE TEST SERIES

ANALOG TAPE: HSRI(136) EXPANDED 1611, WAS A/D CONVERTED TO DIGITAL TAPE: T.I.P. DATE: 20-SEP-76

TEST SIGNALS: 1594 PTS/CH AT 6400.16 HZ. CAL SIGNALS: NOT DIGITIZED.

FILE CH	CONTENT OF CHANNEL	UNITS/VOLT	UNITS	FILTER STAGES	FILTER CUTOFF	NO. PTS	SAMPLING HERTZ
165	11 SLED DECELERATION	20.00	G'S	4+1+3	100.8	398	1600.04
166	21 RIGHT UPPER RIB ACCELEROMETER	80.00	G'S	4+1+3	100.8	398	1600.04
167	31 RIGHT LOWER RIB ACCELEROMETER	85.70	G'S	4+1+3	100.8	398	1600.04
168	41 LEFT UPPER RIB ACCELEROMETER	103.00	G'S	4+1+3	100.8	398	1600.04
169	51 LEFT LOWER RIB ACCELEROMETER	96.40	G'S	4+1+3	100.8	398	1600.04
170	61 THORAX AMP ACCELEROMETER	83.60	G'S	4+1+3	100.8	398	1600.04
171	71 THORAX I-S ACCELEROMETER	89.70	G'S	4+1+3	100.8	398	1600.04
172	81 RIGHT LAP BELT LOAD	1000.00	LBS.	4+1+3	100.8	398	1600.04
173	91 LEFT LAP BELT LOAD	1000.00	LBS.	4+1+3	100.8	398	1600.04
174	101 STEERING COLUMN LOAD	1176.00	LBS.	4+1+3	100.8	398	1600.04

111

121

131

141

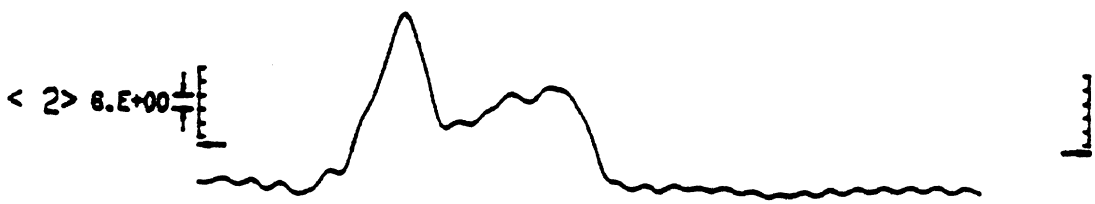
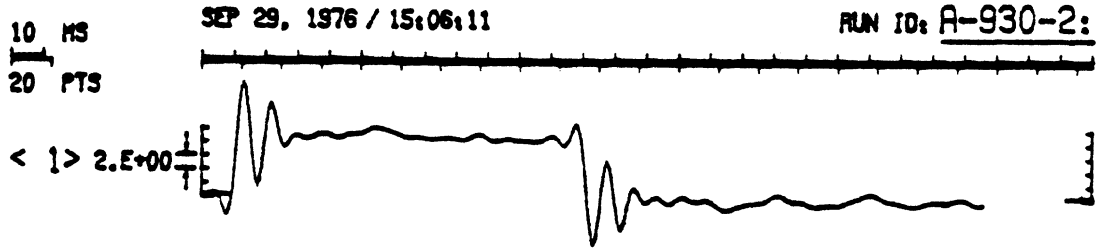

=====
 RUN ID: A-930-21

ANALOG-TO-DIGITAL CONVERSION & DIGITAL FILTERING
 =====

=====
 PROJECT: THORACIC IMPACT PROJECT - PRIMATE SERIES
 ANALOG TAPE: HSRI(137) EXPANDED 16:1, HAS A/D CONVERTED TO DIGITAL TAPE: T.I.P. DATE: 20-SEP-76

TEST SIGNALS: 1592 PTS/CH AT 6396.30 HZ. CAL SIGNALS: NOT DIGITIZED.

FILE	CH	CONTENT OF CHANNEL	UNITS/VOLT	UNITS	FILTER STAGES	FILTER CUTOFF	NO. PTS	SAMPLING HERTZ
258	1	SLED DECELERATION	20.00	G'S	4+1+	100.7	398	1599.08
259	2	AIRWAY PRESSURE	209.00	MM-HG	4+1+	100.7	398	1599.08
260	3	VASCULAR PRESSURE	145.60	MM-HG	4+1+	100.7	398	1599.08

40
 50
 60
 70
 80
 90
 100
 110
 120
 130
 140

=====
 FILTERED FILES: 258 - 260 DIGITAL TAPE: THORAX DATE: 28-SEP-76 RUN ID: A-930-21
 =====

SUMMARY TEST REPORT

Thoracic Injury Project (Contract DOT-HS-4-00921) Highway Safety Research
Institute - The University of Michigan

Test No.: A-931

Test Date: October 29, 1975

Test Subject

Species - Baboon

Sex - Male

Weight - 17 kg

Restraint System

Stiff EA column with soft insert, lap belt

Velocity

21.2 mph

Deceleration

10 G's

Injuries

Small hemorrhages at bottom of left lung, on the diaphragm
and on the membrane of the kidney

AIS Number Estimate

2/3

THORACIC INJURY PROJECT

PRIMATE INJURY REPORT

Test Number A-931

Date 10-29-75

Anatomical Anomalies or Clinical Observations

1. Thoracic Skeleton
2. Heart
3. Lungs
4. Other structures or systems Some superficial bruising due to
accelerometer mounts.

Injuries observed

1. External None observed.
2. Bony or Cartilaginous Structures No fractures or dislocations.
3. Heart and Vascular None observed.
4. Lungs Petechial hemorrhage base left lung.
5. Other structures or systems Small hemorrhages on diaphragm below
similar injuries on left lung. Slight bruise on capsule of left
kidney.

10 DECELERATION PULSE

9.6 Gs

17 UPPER RIB ACCELEROMETER

32.3

18 LOWER RIB ACCELEROMETER

29.1 Gs

19 PER RIB ACCELEROMETER

25.3 Gs

20 LOWER RIB ACCELEROMETER

31.6 Gs

21 CORAX A-P ACCELEROMETER

25.7 Gs

22 X 1-S ACCELEROMETER

10.0 Gs

16.3 Gs

100 msec

RIGHT LAP BELT LOAD

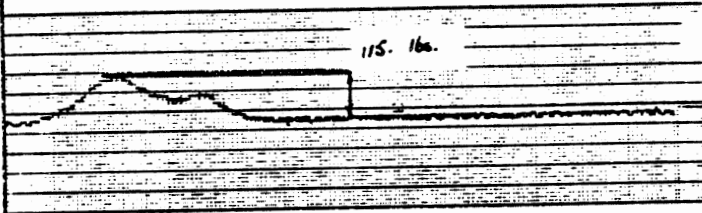

Division

LEFT LAP BELT LOAD

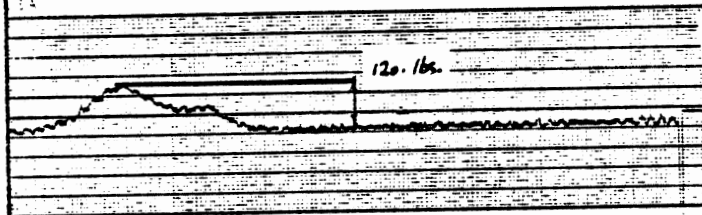

STEERING COLUMN LOAD

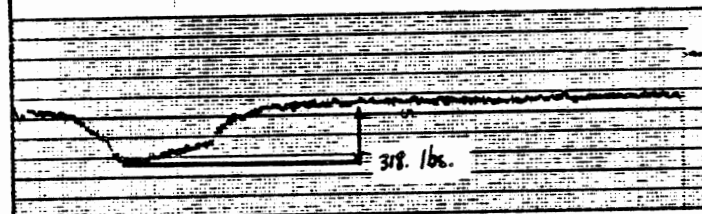

AIRWAY PRESSURE

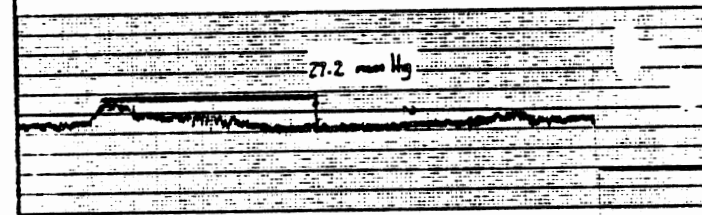

VASCULAR PRESSURE

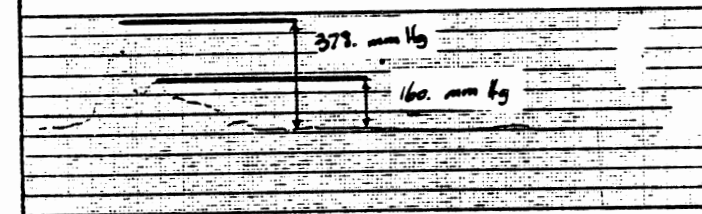

100 msec

10 MS
20 PTS

SEP 29, 1976 / 14:55:15

RUN ID: A-931-1:

< 1 > 2.E+00

< 2 > 4.E+00

< 3 > 4.E+00

< 4 > 3.E+00

< 5 > 3.E+00

< 6 > 3.E+00

< 7 > 3.E+00

< 8 > 2.E+01

< 9 > 3.E+01

< 10 > 3.E+01

10 MS
20 PTS

FILES: 175-184, TAPE: THORAX

403 PTS • 1599 HZ = 251.3 MS

=====
 RUN ID: A-931-11

ANALOG-TO-DIGITAL CONVERSION & DIGITAL FILTERING

=====
 PROJECT: THORACIC IMPACT PROJECT -- PRIMATE SERIES

ANALOG TAPE: HSRI(140) EXPANDED 1611, WAS A/D CONVERTED TO DIGITAL TAPE: T.I.P. DATE: 20-SEP-76
 TEST SIGNALS: 1620 PTS/CH AT 6399.21 HZ. CAL SIGNALS: NOT DIGITIZED.

FILE	CH	CONTENT OF CHANNEL	UNITS/VOLT	UNITS	FILTER STAGES	FILTER CUTOFF	NO. PTS	SAMPLING HERTZ
175	- 10	SLED DECELERATION	20.00	G'S	4+1+ 3	100.0	403	1599.80
176	- 20	RIGHT UPPER RIB ACCELEROMETER	80.70	G'S	4+1+ 3	100.0	403	1599.80
177	- 30	RIGHT LOWER RIB ACCELEROMETER	85.70	G'S	4+1+ 3	100.0	403	1599.80
178	- 40	LEFT UPPER RIB ACCELEROMETER	101.20	G'S	4+1+ 3	100.0	403	1599.80
179	- 50	LEFT LOWER RIB ACCELEROMETER	97.20	G'S	4+1+ 3	100.0	403	1599.80
180	- 60	THORAX A-P ACCELEROMETER	82.90	G'S	4+1+ 3	100.0	403	1599.80
181	- 70	THORAX I-S ACCELEROMETER	90.50	G'S	4+1+ 3	100.0	403	1599.80
182	- 80	RIGHT LAP BELT LOAD	1000.00	LBS.	4+1+ 3	100.0	403	1599.80
183	- 90	LEFT LAP BELT LOAD	1000.00	LBS.	4+1+ 3	100.0	403	1599.80
184	- 100	STEERING COLUMN LOAD	1176.00	LBS.	4+1+ 3	100.0	403	1599.80

110
 120
 130
 140

=====
 FILTERED FILES: 175 - 184 DIGITAL TAPE: THORAX DATE: 28-SEP-76 RUN ID: A-931-11
 =====

10 MS
20 PTS

SEP 29, 1976 / 15:06:35

RUN ID: A-931-2:

< 1 > 2.E+00

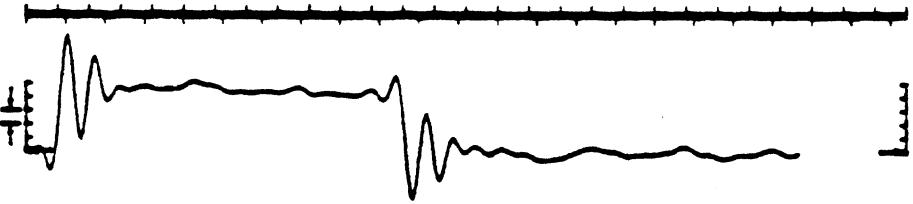

< 2 > 2.E+00



< 3 > 3.E+01

10 MS
20 PTS

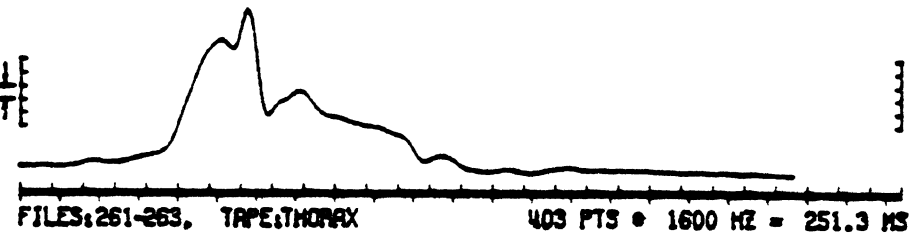

FILES:261-263, TAPE:THORAX

403 PTS • 1600 HZ = 251.3 MS

=====

ANALOG-TO-DIGITAL CONVERSION & DIGITAL FILTERING

RUN ID: A-931-21

=====

PROJECT: THORAX IMPACT PROJECT -- PRIMATE SERIES

ANALOG TAPE: HSRI(141) EXPANDED 1601, WAS A/D CONVERTED TO DIGITAL TAPE: T.I.P. DATE: 20-SEP-76

TEST SIGNALS: 1619 PTS/CH AT 6400.00 HZ. CAL SIGNALS: NOT DIGITIZED.

FILE	CH	CONTENT OF CHANNEL	UNITS/VOLT	UNITS	FILTER STAGES	FILTER CUTOFF	NO. PTS	SAMPLING HERTZ
261	1	SLED DECELERATION	20.00	G'S	4+1+3	100.0	403	1600.00
262	2	AIRWAY PRESSURE	209.00	MM-HG	4+1+3	100.0	403	1600.00
263	3	VASCULAR PRESSURE	145.60	MM-HG	4+1+3	100.0	403	1600.00

- 48
- 51
- 61
- 71
- 81
- 91
- 101
- 111
- 121
- 131
- 141

=====

FILTERED FILES: 261 - 263 DIGITAL TAPE: THORAX DATE: 28-SEP-76 RUN ID: A-931-21

SUMMARY TEST REPORT

Thoracic Injury Project (Contract DOT-HS-4-00921) Highway Safety Research
Institute - The University of Michigan

Test No: A-932

Test Date: October 30, 1975

Test Subject

Species - baboon

Sex - Male

Weight - 12.2 kg

Restraint System

Stiff EA column with airbag insert, lap belt

Velocity

21.9 mph

Deceleration

14.9 G's

Injuries

Slightest spotted hemorrhaging in lungs

Slight hemorrhaging on membrane at tip of spleen

AIS Number Estimate

2/3

THORACIC INJURY PROJECT

PRIMATE INJURY REPORT

Test Number A-932

Date 10-30-75

Anatomical Anomalies or Clinical Observations

1. Thoracic Skeleton
2. Heart
3. Lungs
4. Other structures or systems

Injuries observed

1. External None observed.
2. Bony or Cartilaginous Structures No fractures or dislocations.
3. Heart and Vascular None observed
4. Lungs Minor petechiae.
5. Other structures or systems Slight hemorrhage on capsule over
tip of spleen.

TEST # A-932

SLED DECELERATION PULSE

15.3 G's

RIGHT UPPER RIB ACCELEROMETER

26.1 G's

RIGHT LOWER RIB ACCELEROMETER

77.6 G's

34.1 G's

LEFT UPPER RIB ACCELEROMETER

28.8 G's

LEFT LOWER RIB ACCELEROMETER

47.6 G's

THORAX A-P ACCELEROMETER

23.2 G's

49.8 G's

THORAX I-S ACCELEROMETER

32.1 G's

34.9 G's

100 msec

173

RIGHT LAP BELT LOAD

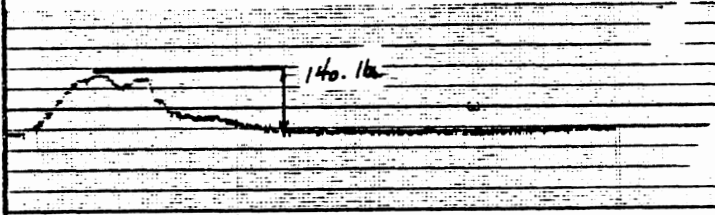

LEFT LAP BELT LOAD

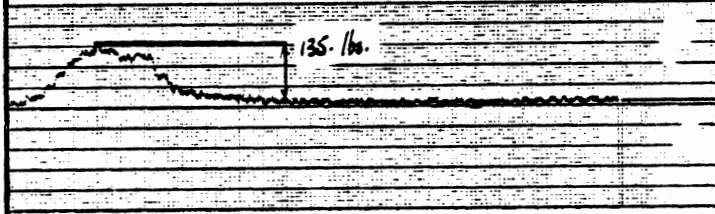

STEERING COLUMN LOAD

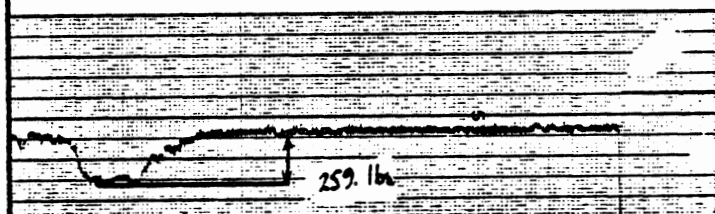

AIRWAY PRESSURE

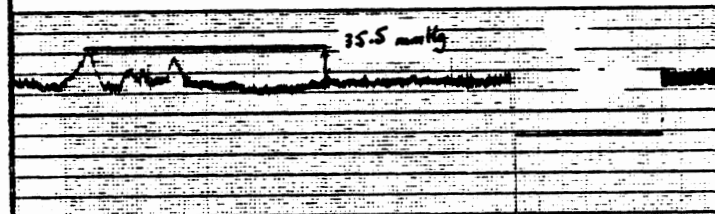

VASCULAR PRESSURE

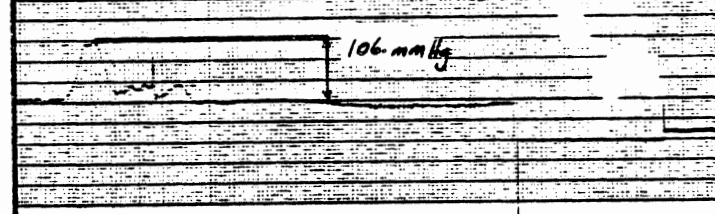

AIRBAG PRESSURE

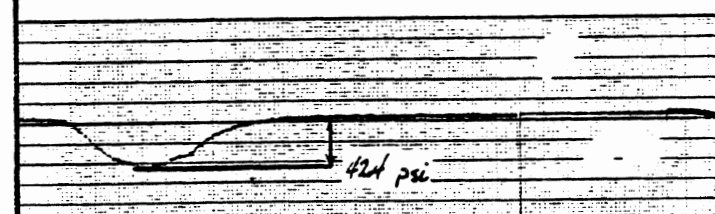

100 msec

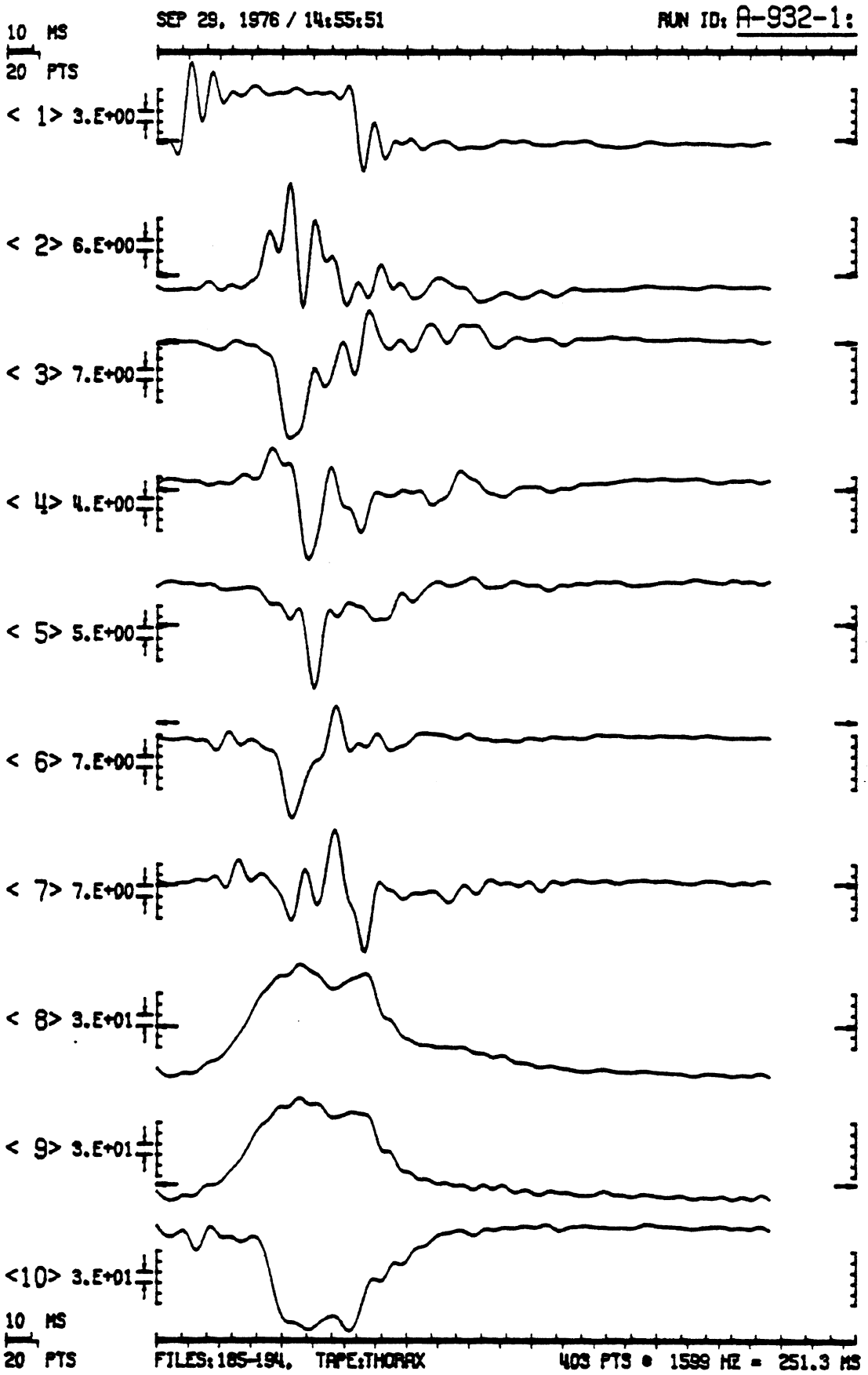

=====
RUN ID: A-932-11
=====

ANALOG-TO-DIGITAL CONVERSION & DIGITAL FILTERING

PROJECT: THORACIC IMPACT PROJECT - PRIMATE SERIES

ANALOG TAPE: HSRI(140) EXPANDED 16:1, WAS A/D CONVERTED TO DIGITAL TAPE: T.I.P. DATE: 20-SEP-76
TEST SIGNALS: 1616 PTS/CH AT 6396.58 HZ. CAL SIGNALS: NOT DIGITIZED.

FILE CH	CONTENT OF CHANNEL	UNITS/VOLT	UNITS	FILTER STAGES	FILTER CUTOFF	NO. PTS	SAMPLING HERTZ
185	11 SLED DECELERATION	20.00	G'S	4+1+3	100.0	403	1599.64
186	21 RIGHT UPPER RIB ACCELEROMETER	80.00	G'S	4+1+3	100.0	403	1599.64
187	31 RIGHT LOWER RIB ACCELEROMETER	-88.00	G'S	4+1+3	100.0	403	1599.64
188	41 LEFT UPPER RIB ACCELEROMETER	-102.00	G'S	4+1+3	100.0	403	1599.64
189	51 LEFT LOWER RIB ACCELEROMETER	-97.20	G'S	4+1+3	100.0	403	1599.64
190	61 THORAX A-P ACCELEROMETER	83.60	G'S	4+1+3	100.0	403	1599.64
191	71 THORAX I-R ACCELEROMETER	90.50	G'S	4+1+3	100.0	403	1599.64
192	81 RIGHT LAP BELT LOAD	1000.00	LBS.	4+1+3	100.0	403	1599.64
193	91 LEFT LAP BELT LOAD	1000.00	LBS.	4+1+3	100.0	403	1599.64
194	101 STEERING COLUMN LOAD	1176.00	LBS.	4+1+3	100.0	403	1599.64

111
121
131
141

FILTERED FILES: 185 - 194 DIGITAL TAPE: THORAX DATE: 20-SEP-76 RUN ID: A-932-11

10 MS
20 PTS

SEP 29, 1976 / 15:07:16

RUN ID: A-932-2:

< 1 > 3.E+00

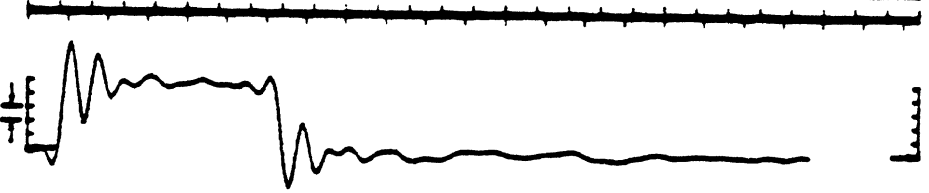

< 2 > 3.E+00

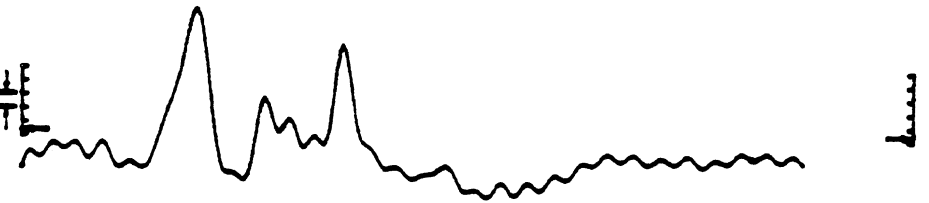

< 3 > 2.E+01

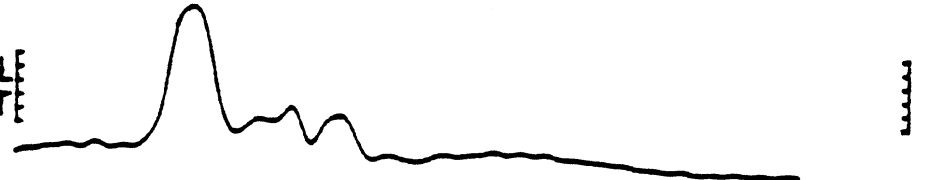

< 4 > 2.E+02

10 MS
20 PTS



FILES: 264-267, TAPE: THORAX

403 PTS • 1600 Hz = 251.2 MS

=====

ANALOG-TO-DIGITAL CONVERSION & DIGITAL FILTERING

RUN ID: A-932-21

=====

PROJECT: THORAX IMPACT PROJECT -- PRIMATE SERIES

ANALOG TAPE: MSRI(141) EXPANDED 1611, WAS A/D CONVERTED TO DIGITAL TAPE: T.I.P. DATE: 20-SEP-76

TEST SIGNALS: 1616 PTS/CM AT 6401.58 HZ. CAL SIGNALS: NOT DIGITIZED.

FILE	CH	CONTENT OF CHANNEL	UNITS/VOLT	UNITS	FILTER STAGES	FILTER CUTOFF	NO. PTS	SAMPLING HERTZ
264	11	SLED DECELERATION	20.00	G'S	4+1+3	100.0	403	1600.40
265	21	AIRWAY PRESSURE	209.00	MM-HG	4+1+3	100.0	403	1600.40
266	31	VASCULAR PRESSURE	291.00	MM-HG	4+1+3	100.0	403	1600.40
267	41	AIRBAG PRESSURE	3620.00	MM-HG	4+1+3	100.0	403	1600.40

178

SUMMARY TEST REPORT

Thoracic Injury Project (Contract DOT-HS-4-00921) Highway Safety Research
Institute - The University of Michigan

Test No.: A-933

Test Date: October 30, 1975

Test Subject

Species - Baboon (Cadaver)

Sex - Male

Weight - 16 kg

Restraint System

Stiff EA column with airbag insert, lap belt

Velocity

21.4 mph

Deceleration

14.9 G's

Injuries

Rib fracture - R4

Small hemorrhage on right lung

Small liver tear

Small mesentary tear near right kidney

AIS Number Estimate

3/4

THORACIC INJURY PROJECT

PRIMATE INJURY REPORT

Test Number A-933

Date 10-30-75

Anatomical Anomalies or Clinical Observations

1. Thoracic Skeleton
2. Heart
3. Lungs
4. Other structures or systems

Injuries observed

1. External None observed.
2. Bony or Cartilaginous Structures Fracture of R₄ right lateral.
3. Heart and Vascular None observed.
4. Lungs Small hemorrhage on lung.
5. Other structures or systems Slight laceration of liver with
clotted blood present. Slight mesentery tear near right kidney.

SLED DECELERATION PULSE



RIGHT UPPER RIB ACCELEROMETER

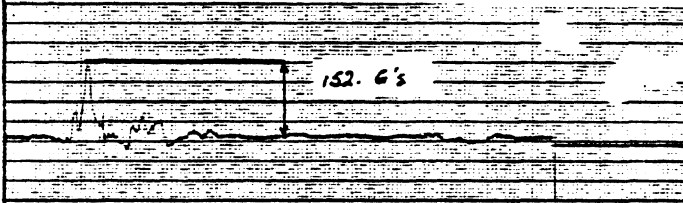

RIGHT LOWER RIB ACCELEROMETER

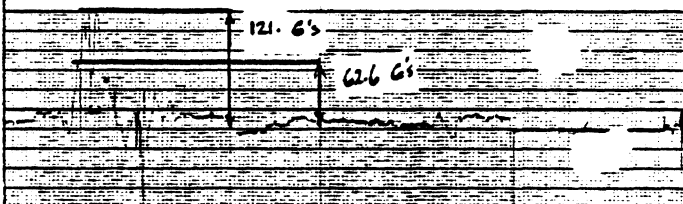

LEFT UPPER RIB ACCELEROMETER

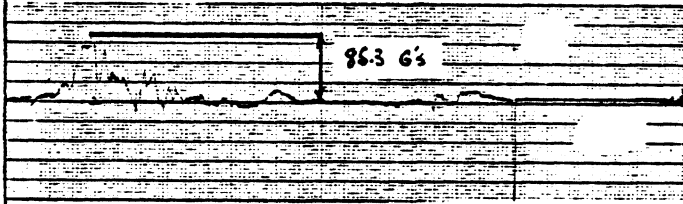

LEFT LOWER RIB ACCELEROMETER

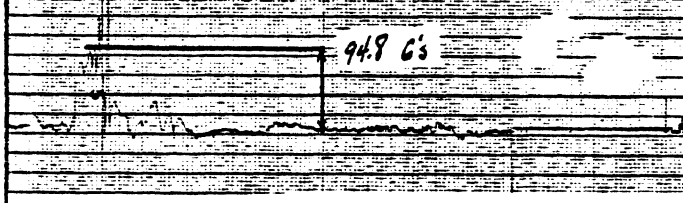

THORAX A-P ACCELEROMETER

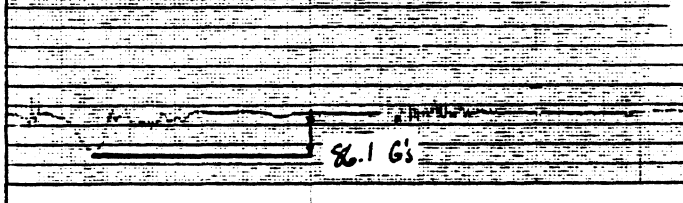

THORAX I-S ACCELEROMETER

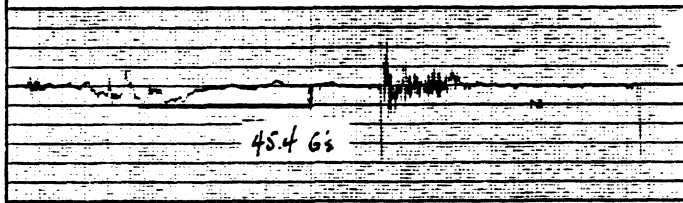

100 msec

RIGHT LAP BELT LOAD

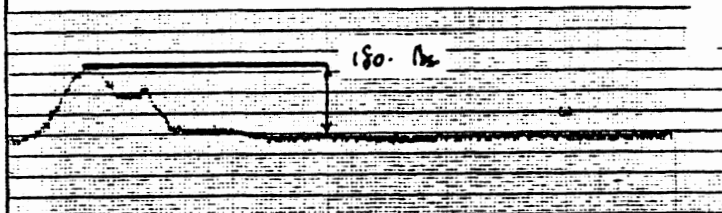

LEFT LAP BELT LOAD

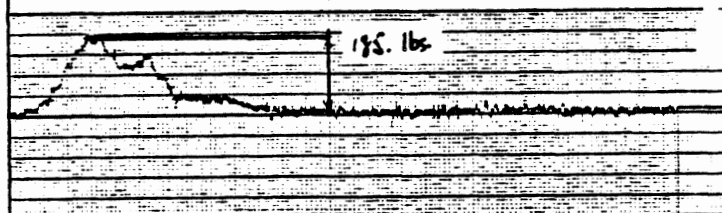

STEERING COLUMN LOAD

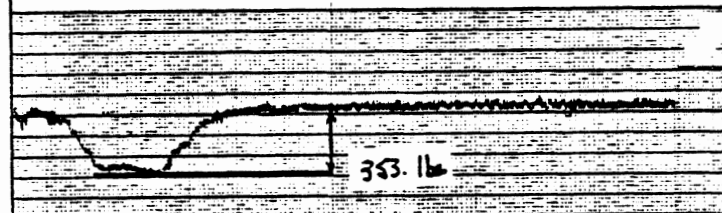

AIRWAY PRESSURE

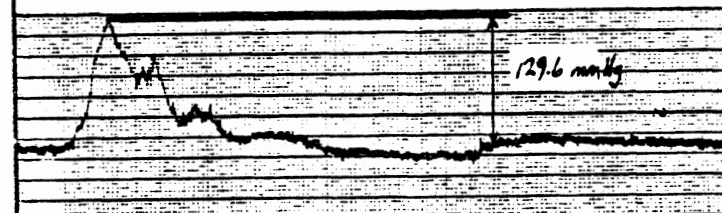

VASCULAR PRESSURE

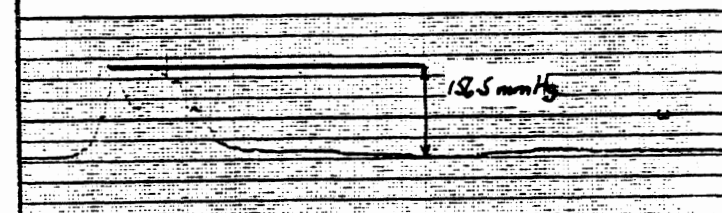

BRUSH ACCUCHART

AIRBAG PRESSURE

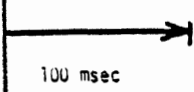
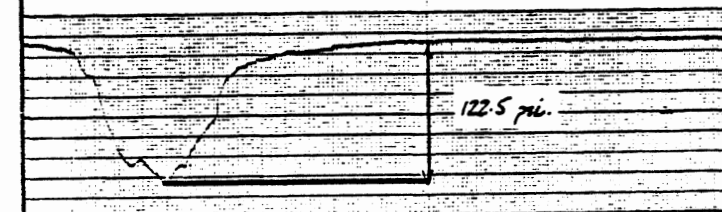

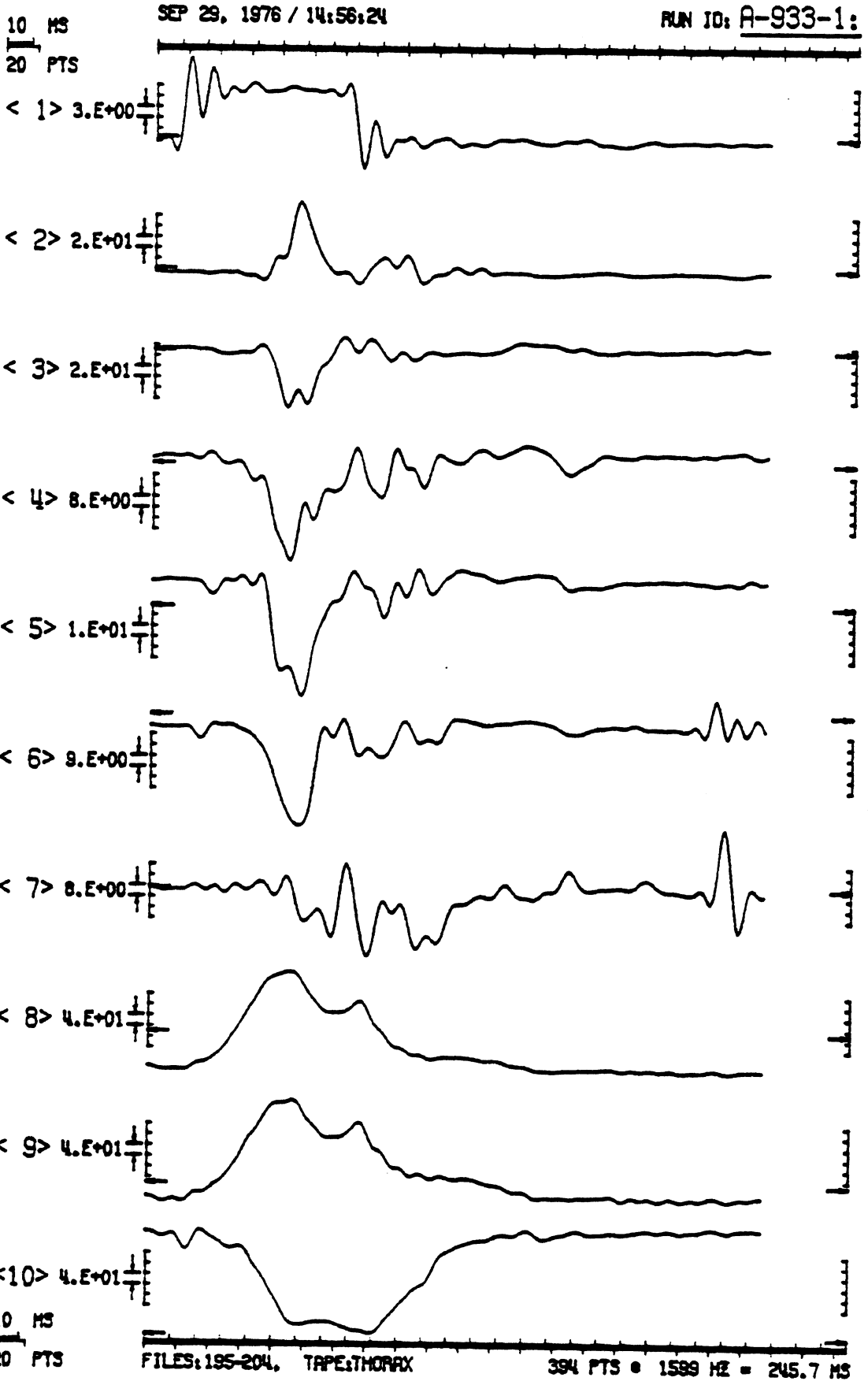

ANALOG-TO-DIGITAL CONVERSION & DIGITAL FILTERING

RUN ID: A-933-11

PROJECT: THORACIC IMPACT PROJECT - PRIMATE SERIES

ANALOG TAPE: HSRI(140) EXPANDED 1681, WAS A/D CONVERTED TO DIGITAL TAPE: T.I.P. DATE: 20-SEP-76

TEST SIGNALS: 1590 PTS/CH AT 6397.91 HZ. CAL SIGNALS: NOT DIGITIZED.

FILE	CH	CONTENT OF CHANNEL	UNITS/VOLT	UNITS	FILTER STAGES	FILTER CUTOFF	NO. PTS	SAMPLING HERTZ
195	1	SLED DECELERATION	20.00	G'S	4+1+3	100.0	394	1599.48
196	2	RIGHT UPPER RIB ACCELEROMETER	80.00	G'S	4+1+3	100.0	394	1599.48
197	3	RIGHT LOWER RIB ACCELEROMETER	-86.40	G'S	4+1+3	100.0	394	1599.48
198	4	LEFT UPPER RIB ACCELEROMETER	-100.30	G'S	4+1+3	100.0	394	1599.48
199	5	LEFT LOWER RIB ACCELEROMETER	-97.20	G'S	4+1+3	100.0	394	1599.48
200	6	THORAX A-P ACCELEROMETER	83.60	G'S	4+1+3	100.0	394	1599.48
201	7	THORAX I-S ACCELEROMETER	89.00	G'S	4+1+3	100.0	394	1599.48
202	8	RIGHT LAP BELT LOAD	1000.00	LBS.	4+1+3	100.0	394	1599.48
203	9	LEFT LAP BELT LOAD	1000.00	LBS.	4+1+3	100.0	393	1599.48
204	10	STEERING COLUMN LOAD	1176.00	LBS.	4+1+3	100.0	393	1599.48

111

121

131

141

FILTERED FILES: 195 - 204 DIGITAL TAPE: THORAX DATE: 20-SEP-76 RUN ID: A-933-11

SUMMARY TEST REPORT

Thoracic Injury Project (Contract DOT-HS-4-00921) Highway Safety Research
Institute - The University of Michigan

TEST NO.: 76T004

TEST DATE: March 10, 1976

TEST SUBJECT: Male baboon - 16.4 kg

RESTRAINT SYSTEM:

None: Lateral impact into rigid flat surface.

VELOCITY:

Closing velocity between subject and surface = 26.9 mph.

INJURIES:

Left hip bruise, 1 cm. in diameter.

Zygomatic arch fractured. Tip of parotid gland crushed.

Minor hemorrhage on pericardium (5 mm dia.).

Cartilage injury, transverse, between T10 and T11 as if the whole thing had been pulled loose. It was not disconnected or ruptured or was the spinal cord injured.

Pancreas - Extensive hemorrhaging.

Left kidney - Minor hemorrhage on capsule.

Small bruise on colon.

AIS NUMBER ESTIMATES:

Thorax - 3

Abdomen - 5

Head - 2

Pelvis - 1

THORACIC INJURY PROJECT

PRIMATE INJURY REPORT

Test Number 76T004

Date 3-10-76

Anatomical Anomalies or Clinical Observations

1. Thoracic Skeleton
2. Heart
3. Lungs
4. Other structures or systems

Injuries observed

1. External Contusion, left hip, 1 cm diameter, 2 mm deep into muscle.
2. Bony or Cartilaginous Structures Transverse fracture of spine between T₁₀ and T₁₁, without dislocation or cord damage. Multiple fractures of zygoma.
3. Heart and Vascular Minor (5 mm diameter) hemorrhage on pericardium.
4. Lungs None observed.
5. Other structures or systems Extensive hemorrhage of pancreas. Minor hemorrhage in capsule of left kidney. Slight bruising in colon.

THORACIC IMPACT PROJECT

Test # 767004

Date 3.4.76

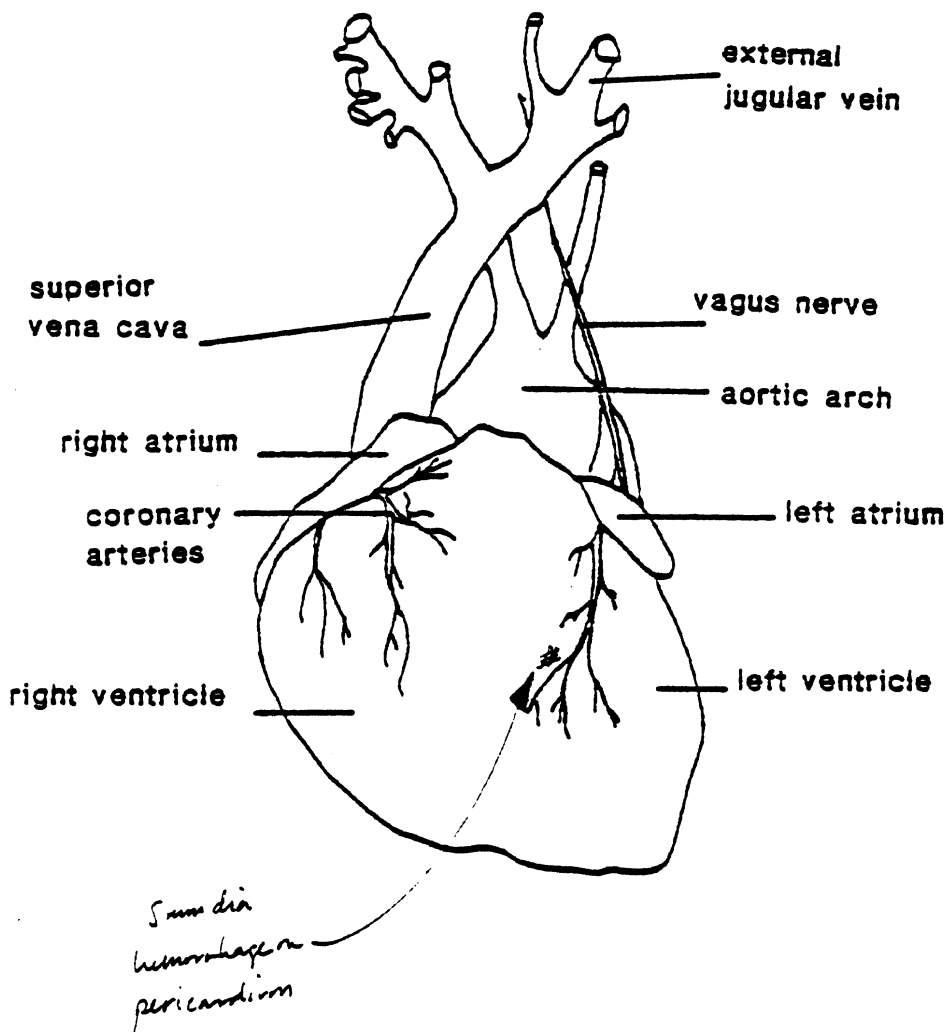

Papio

SLED DECELERATION PULSE

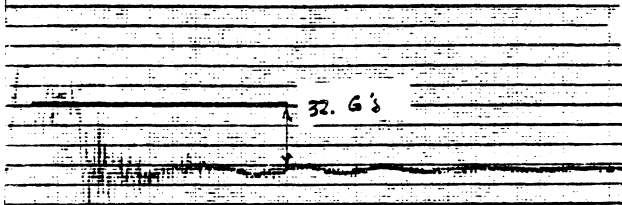

RIGHT UPPER RIB ACCELEROMETER

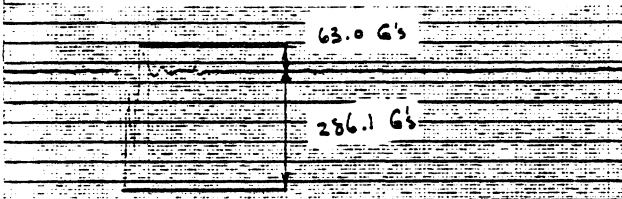

RIGHT LOWER RIB ACCELEROMETER

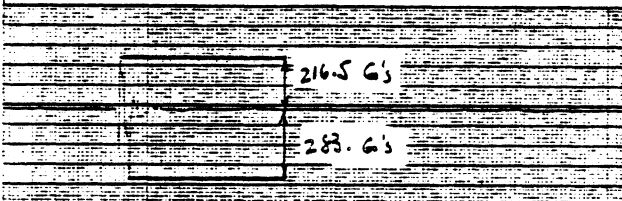

LEFT UPPER RIB ACCELEROMETER

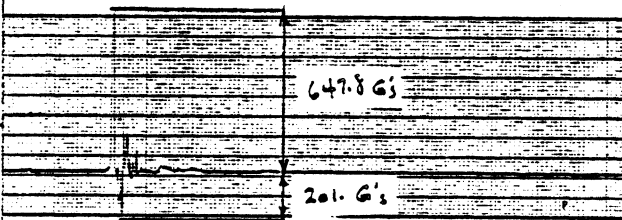

LEFT LOWER RIB ACCELEROMETER

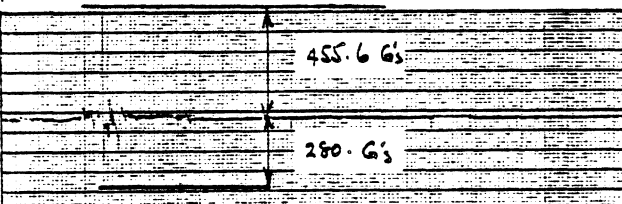

AIRWAY PRESSURE

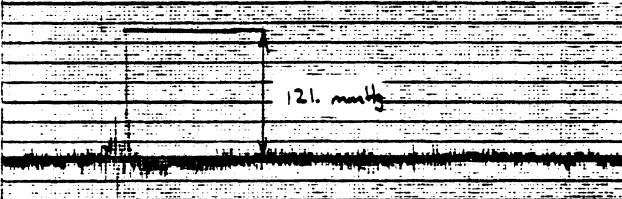

VASCULAR PRESSURE

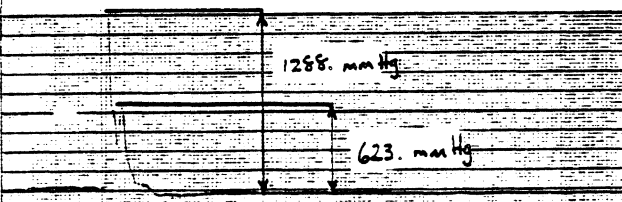

100 msec

TEST # 76 T 004

THORAX P-A ACCELEROMETER

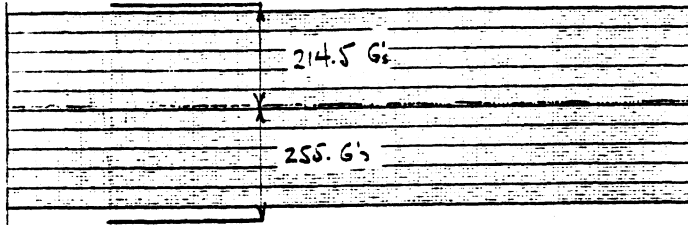

THORAX I-S ACCELEROMETER

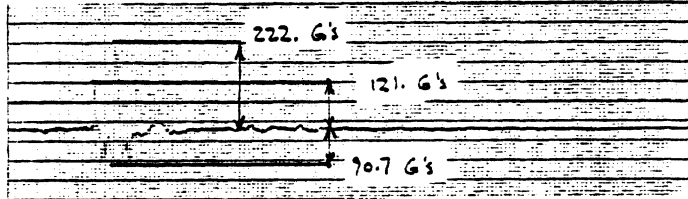

THORAX R-L ACCELEROMETER

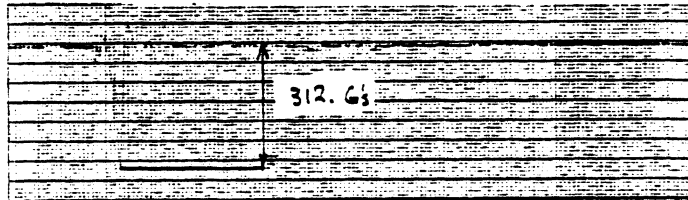

PELVIC P-A ACCELEROMETER

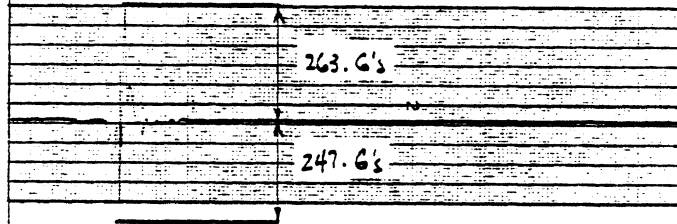

PELVIC I-S ACCELEROMETER

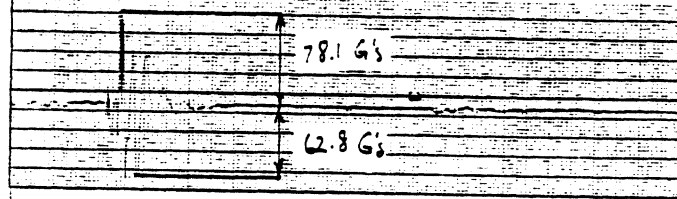

PELVIC R-L ACCELEROMETER

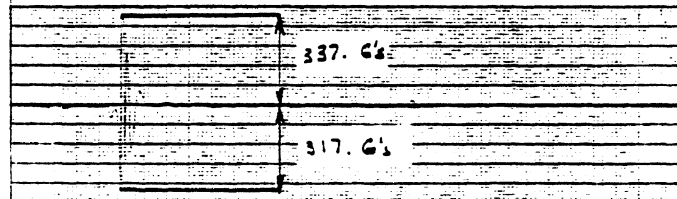

189

100 msec

SEP 29, 1976 / 14:57:07

RUN ID: 76T004-1:

10 MS
20 PTS

< 1 > 4.E+00

< 2 > 3.E+01

< 3 > 2.E+01

< 4 > 4.E+01

< 5 > 9.E+00

< 6 > 3.E+01

< 7 > 2.E+01

< 8 > 3.E+01

< 9 > 4.E+00

< 10 > 9.E+01

10 MS
20 PTS

FILES:205-214. TAPE:THORAX

398 PTS @ 1600 HZ = 248.1 MS

=====

RUN ID: 76T004-11

ANALOG-TO-DIGITAL CONVERSION & DIGITAL FILTERING

=====

PROJECT: THORACIC IMPACT PROJECT - PRIMATE SERIES

ANALOG TAPE: HSHI(140) EXPANDED 1611, WAS A/D CONVERTED TO DIGITAL TAPE: T.I.P. DATE: 20-SEP-76

TEST SIGNALS: 1604 PTS/CH AT 6400.32 HZ. CAL SIGNALS: NOT DIGITIZED.

FILE	CH	CONTENT OF CHANNEL	UNITS/VOLT	UNITS	FILTER STAGES	FILTER CUTOFF	NO. PTS	SAMPLING HERTZ
205	1	SLED DECELERATION	20.00	G'S	4+1+3	100.0	398	1600.00
206	2	RIGHT UPPER RIB ACCELEROMETER	97.00	G'S	4+1+3	100.0	398	1600.00
207	3	RIGHT LOWER RIB ACCELEROMETER	83.30	G'S	4+1+3	100.0	398	1600.00
208	4	LEFT UPPER RIB ACCELEROMETER	77.50	G'S	4+1+3	100.0	398	1600.00
209	5	LEFT LOWER RIB ACCELEROMETER	79.90	G'S	4+1+3	100.0	398	1600.00
210	6	THORAX P-A ACCELEROMETER	85.00	G'S	4+1+3	100.0	398	1600.00
211	7	THORAX I-S ACCELEROMETER	100.00	G'S	4+1+3	100.0	398	1600.00
212	8	THORAX R-L ACCELEROMETER	100.50	G'S	4+1+3	100.0	398	1600.00
213	9	AIRWAY PRESSURE	570.00	MM-HG	4+1+3	100.0	398	1600.00
214	10	VASCULAR PRESSURE	291.00	MM-HG	4+1+3	100.0	398	1600.00

111
120
131
141

=====

FILTERED FILES: 205 - 214 DIGITAL TAPE: THORAX

DATE: 20-SEP-76

RUN ID: 76T004-11

=====

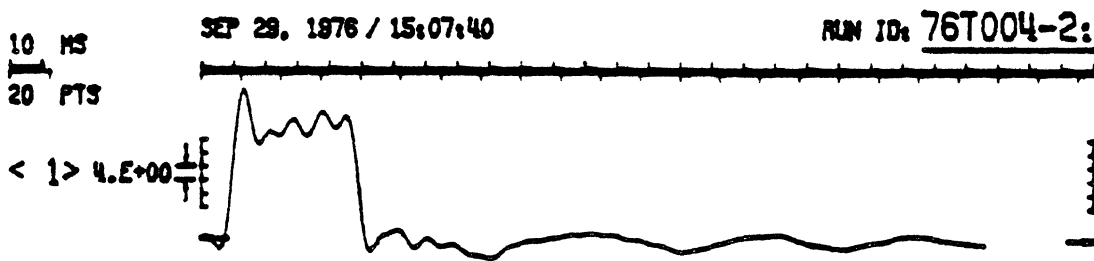

=====

RUN ID: 76T004-21

ANALOG-TO-DIGITAL CONVERSION & DIGITAL FILTERING

=====

PROJECT: THORAX IMPACT PROJECT - PRIMATE SERIES

ANALOG TAPE: HSRI(141) EXPANDED 1611, WAS A/D CONVERTED TO DIGITAL TAPE: T.I.P. DATE: 20-SEP-76

TEST SIGNALS: 1605 PTS/CH AT 6400.16 HZ. CAL SIGNALS: NOT DIGITIZED.

FILE	CH	CONTENT OF CHANNEL	UNITS/VOLT	UNITS	FILTER STAGES	FILTER CUTOFF	NO. PTS	SAMPLING HERTZ
268	1	SIED DECELERATION	20.00	G'S	4+1+3	100.8	398	1600.00
269	2	PELVIS P-A ACCELEROMETER	88.20	G'S	4+1+3	100.8	398	1600.00
270	3	PELVIS I-S ACCELEROMETER	-67.90	G'S	4+1+3	100.8	398	1600.00
271	4	PELVIS R-L ACCELEROMETER	73.30	G'S	4+1+3	100.8	398	1600.00

- 50
- 60
- 70
- 80
- 90
- 100
- 110
- 120
- 130
- 140

=====

FILTERED FILES: 268 - 271

DIGITAL TAPE: THORAX

DATE: 20-SEP-76

RUN ID: 76T004-21

SUMMARY TEST REPORT

Thoracic Injury Project (Contract DOT-HS-4-00921) Highway Safety Research
Institute - The University of Michigan

TEST NO.: 76T005

TEST DATE: March 18, 1976

TEST SUBJECT: Male baboon - 16.4 kg.

RESTRAINT SYSTEM:

None: Lateral impact into rigid flat surface.

VELOCITY:

Closing velocity between subject and surface = 18.4 mph.

INJURIES:

Left lung - Slight clotting where it tore loose from chest wall (2 cc clotting).

Left kidney - Small bruise.

Pancreas - Slight bruising. Duct intact.

AIS NUMBER ESTIMATES:

Thorax - 2

Abdomen - 3

THORACIC INJURY PROJECT

PRIMATE INJURY REPORT

Test Number 76T005

Date 3-18-76

Anatomical Anomalies or Clinical Observations

1. Thoracic Skeleton
2. Heart
3. Lungs
4. Other structures or systems

Injuries observed

1. External None observed.
2. Bony or Cartilaginous Structures No fractures or dislocations.
3. Heart and Vascular None observed.
4. Lungs Slight hemorrhage on surface of left lung (approximately 2 ml of clotted blood present) where it tore loose from chest wall.
5. Other structures or systems Small bruise left kidney. Minor contusion in pancreas. No other abdominal injuries observed.

SLED DECELERATION PULSE

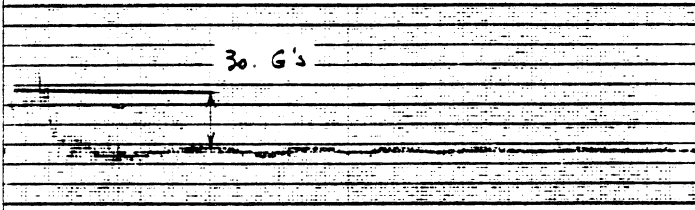

RIGHT UPPER RIB ACCELEROMETER

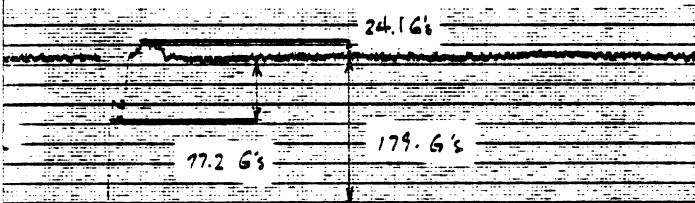

RIGHT LOWER RIB ACCELEROMETER

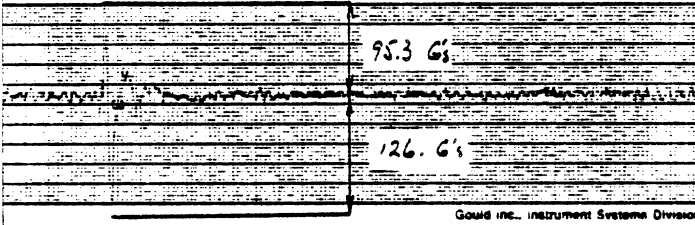

LEFT UPPER RIB ACCELEROMETER

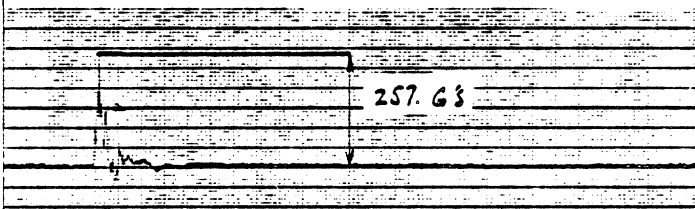

LEFT LOWER RIB ACCELEROMETER

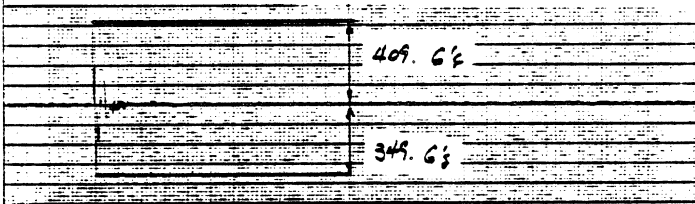

AIRWAY PRESSURE

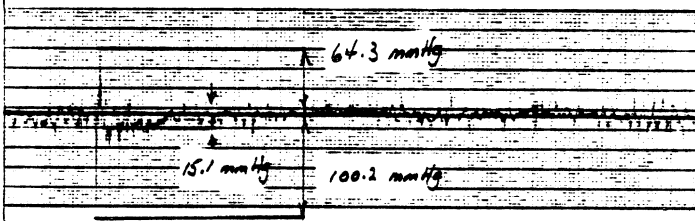

VASCULAR PRESSURE

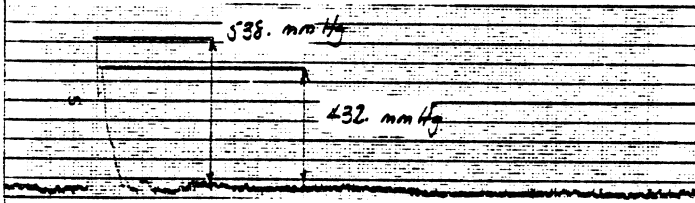

100 msec

THORAX P-A ACCELEROMETER

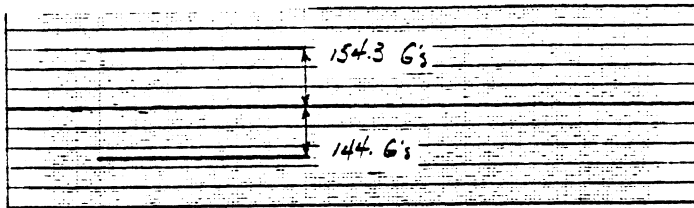

THORAX I-S ACCELEROMETER

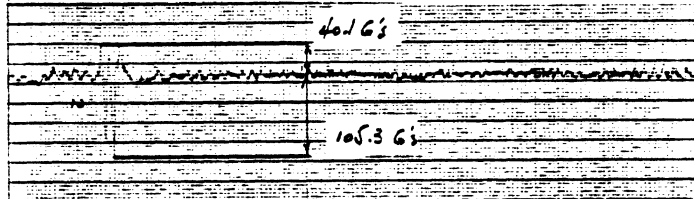

THORAX R-L ACCELEROMETER

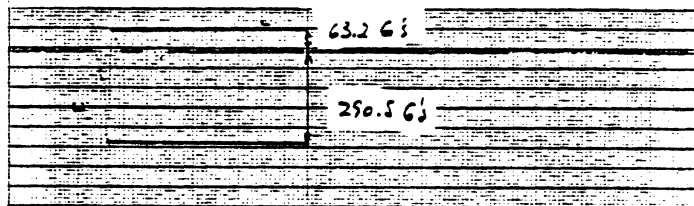

PELVIC P-A ACCELEROMETER

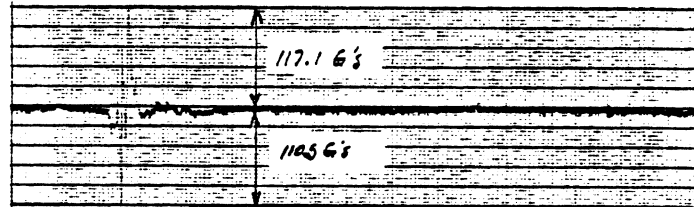

PELVIC I-S ACCELEROMETER

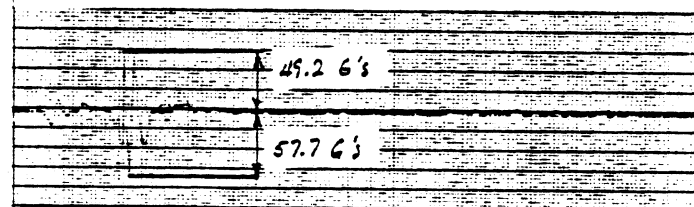

PELVIC R-L ACCELEROMETER

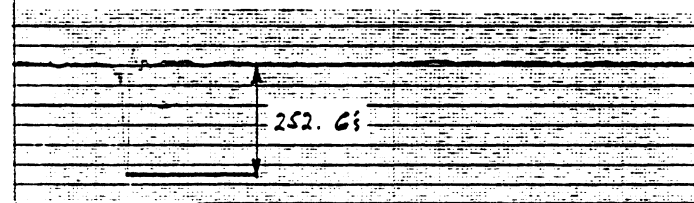

100 msec

10 MS
20 PTS

SEP 29, 1978 / 14:57:43

RUN ID: 76T005-1:

< 1 > 4.E+00



< 2 > 2.E+01

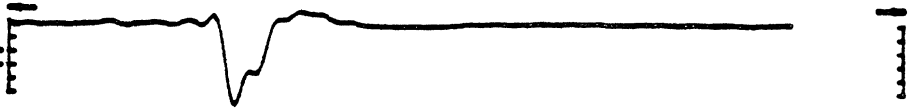

< 3 > 1.E+01



< 4 > 2.E+01

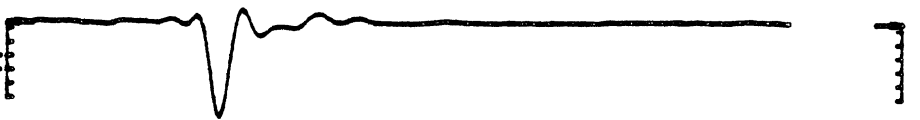

< 5 > 2.E+01



< 6 > 2.E+01



< 7 > 7.E+00

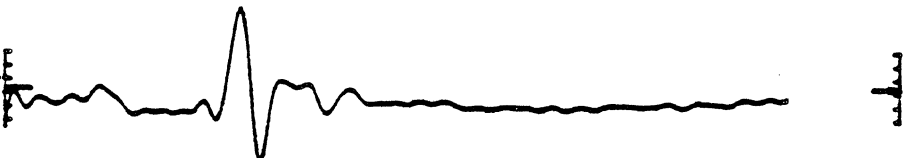

< 8 > 3.E+01

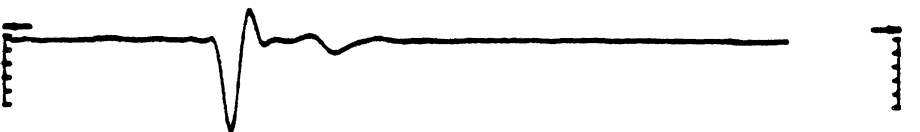

< 9 > 5.E+00

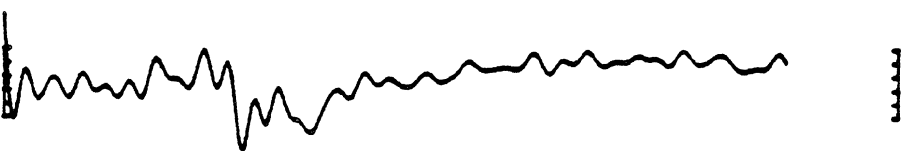

< 10 > 5.E+01



10 MS
20 PTS

FILES: 215-224, TAPE: THORAX

407 PTS @ 1600 HZ = 253.6 MS

=====
RUN ID: 76T005-11

ANALOG TO DIGITAL CONVERSION & DIGITAL FILTERING

=====
PROJECT: THORACIC IMPACT PROJECT -- PRIMATE SERIES

ANALOG TAPE: MSRI(140) EXPANDED 16:1, WAS A/D CONVERTED TO DIGITAL TAPE: T.I.P. DATE: 20-SEP-76
TEST SIGNALS: 1640 PTS/CH AT 6403.59 HZ. CAL SIGNALS: NOT DIGITIZED.

FILE	CH	CONTENT OF CHANNEL	UNITS/VOLT	UNITS	FILTER STAGES	FILTER CUTOFF	NO. PTS	SAMPLING HERTZ
215	- 11	SLED DECELERATION	20.00	G'S	4+1+ 3	100.9	407	1600.90
216	- 21	RIGHT UPPER RIB ACCELEROMETER	241.00	G'S	4+1+ 3	100.9	407	1600.90
217	- 31	RIGHT LOWER RIB ACCELEROMETER	-207.00	G'S	4+1+ 3	100.9	407	1600.90
218	- 41	LEFT UPPER RIB ACCELEROMETER	-186.70	G'S	4+1+ 3	100.9	407	1600.90
219	- 51	LEFT LOWER RIB ACCELEROMETER	-200.00	G'S	4+1+ 3	100.9	407	1600.90
220	- 61	THORAX P-A ACCELEROMETER	213.00	G'S	4+1+ 3	100.9	407	1600.90
221	- 71	THORAX I-S ACCELEROMETER	-251.00	G'S	4+1+ 3	100.9	407	1600.90
222	- 81	THORAX R-L ACCELEROMETER	253.00	G'S	4+1+ 3	100.9	407	1600.90
223	- 91	AIRWAY PRESSURE	570.00	MM-HG	4+1+ 3	100.9	407	1600.90
224	- 101	VASCULAR PRESSURE	720.00	MM-HG	4+1+ 3	100.9	407	1600.90

111
121
131
141

=====
FILTERED FILE: 215 - 224 DIGITAL TAPE: THORAX DATE: 28-SEP-76 RUN ID: 76T005-11

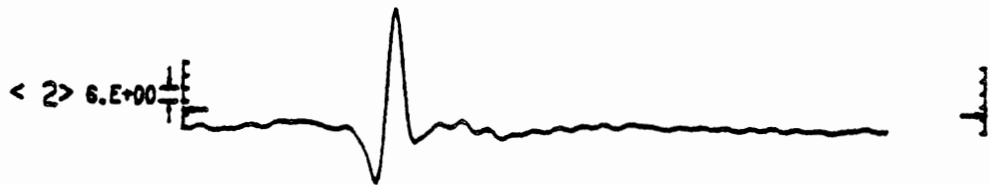
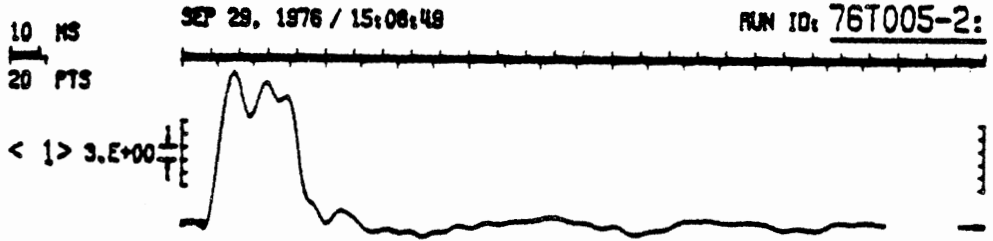

=====
 RUN ID: 76T005-21

ANALOG TO DIGITAL CONVERSION & DIGITAL FILTERING

=====
 PROJECT: THORAX IMPACT PROJECT - PRIMATE SERIES

ANALOG TAPE: HSRT(141) EXPANDED 1681, WAS A/D CONVERTED TO DIGITAL TAPE: T.I.P. DATE: 20-SEP-76
 TEST SIGNALS: 1639 PTS/CH AT 6399.84 HZ. CAL SIGNALS: NOT DIGITIZED.

FILE	CH	CONTENT OF CHANNEL	UNITS/VOLT	UNITS	FILTER STAGES	FILTER CUTOFF	NO. PTS	SAMPLING HERTZ
272	1	SLED DECELERATION	20.00	G'S	4+1+3	100.0	407	1599.96
273	2	PELVIS P-A ACCELEROMETER	221.00	G'S	4+1+3	100.0	407	1599.96
274	3	PELVIS I-S ACCELEROMETER	-169.70	G'S	4+1+3	100.0	407	1599.96
275	4	PELVIS R-L ACCFLEROMETER	183.10	G'S	4+1+3	100.0	407	1599.96

201
 51
 61
 71
 81
 91
 101
 111
 121
 131
 141

=====
 FILTERED FILES: 272 - 275 DIGITAL TAPE: THORAX DATE: 20-SEP-76 RUN ID: 76T005-21

Summary Test Report

Thoracic Injury Project (Contract DOT-HS-4-00921) Highway Safety
Research Institute - The University of Michigan

Test No.: 78T102

Test Date: February 2, 1978

Test Subject

Species - Baboon

Sex - Male

Weight - 14.8 kg

Restraint System

EA Column with Scott foam pad insert

Velocity

21.2 mph

Deceleration

10 g

Injuries

Minor bruises on right lung (1/8 cm.) as well as one such on left lung

AIS Number Estimate

1

THORACIC INJURY PROJECT

PRIMATE INJURY REPORT

Test Number 78T102

Date 2-2-78

Anatomical Anomalies or Clinical Observations

1. Thoracic Skeleton
2. Heart Scar tissue left lower septum.
3. Lungs
4. Other structures or systems Intramuscular hemorrhage over R₅
left; intradermal hemorrhage near R₉ left, both associated with
rib accelerometer mounts.

Injuries observed

1. External None observed.
2. Bony or Cartilaginous Structures No fractures or dislocations.
3. Heart and Vascular None observed.
4. Lungs Few small (2 mm diameter) bruises on right lung. one
small (2 mm diameter) bruise on left lung.
5. Other structures or systems No abdominal injuries observed.

SLED DECELERATION PULSE

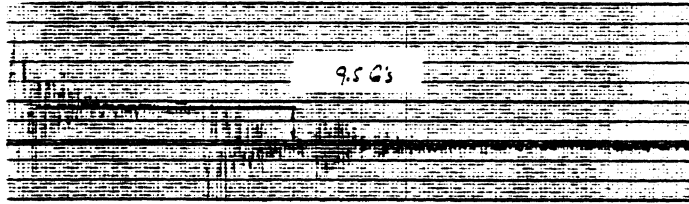

RIGHT UPPER RIB ACCELEROMETER

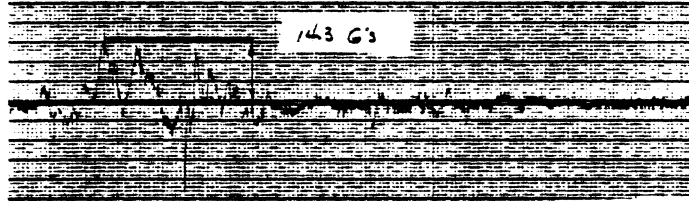

RIGHT LOWER RIB ACCELEROMETER

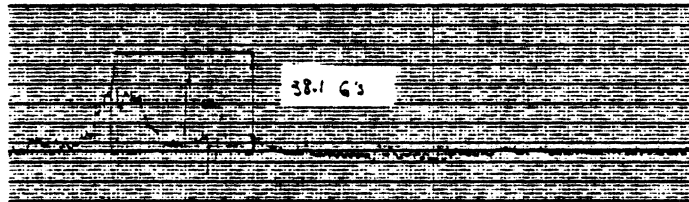

LEFT UPPER RIB ACCELEROMETER

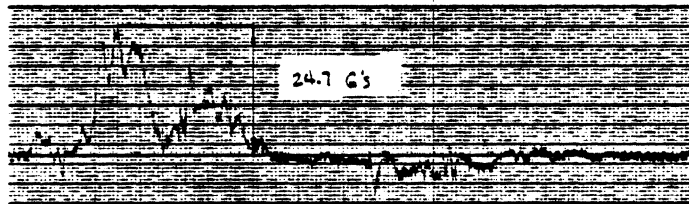

LEFT LOWER RIB ACCELEROMETER

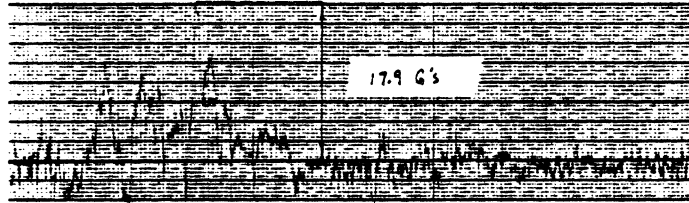

VASCULAR PRESSURE

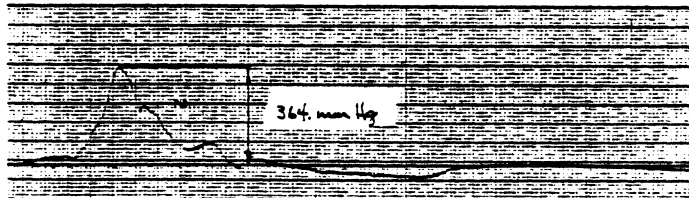

100 msec

THORAX P-A ACCELEROMETER

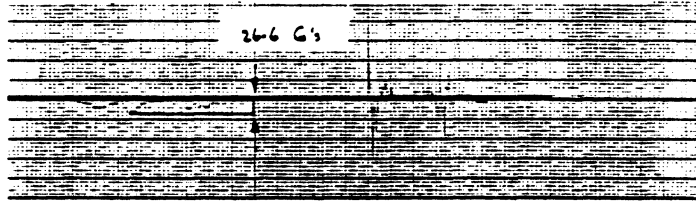

THORAX R-L ACCELEROMETER

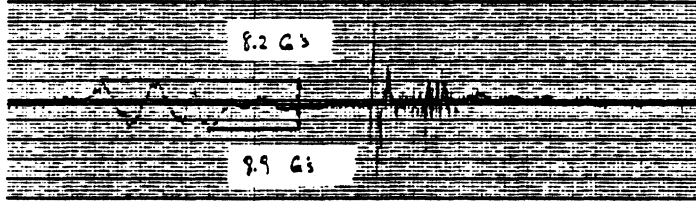

THORAX I-S ACCELEROMETER

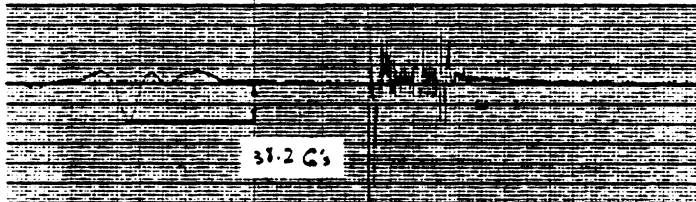

RIGHT LAP BELT LOAD

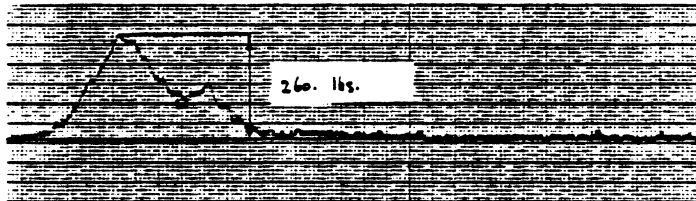

LEFT LAP BELT LOAD

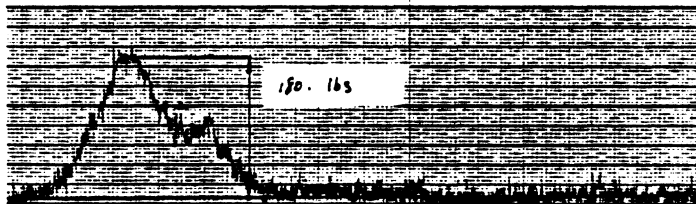

STEERING COLUMN LOAD

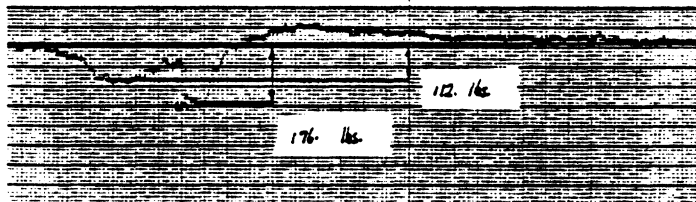

100 msec

ANALOG-TO-DIGITAL CONVERTER & DIGITAL FILTERING

FILE ID: 781102-1385

PROJECT: THORACIC IMPACT PROJECT -- PRIVATE FRONT SLED TEST

ANALOG TAPE: NSR1#148 EXPANDED 16:1, WAS A/D CONVERTED TO DIGITAL TAPE: US0452 DATE: 07-FEB-78

TEST SIGNALS: 2936 PTS/CH AT 6096.83 HZ. CAL SIGNALS: NOT DIGITIZED.

FILE CH	CONTENT OF CHANNEL	UNITS/VOLT	UNITS	FILTER STAGES	FILTER CUTOFF	NO. PTS	SAMPLING RATE
599 - 1:	SLED DECELERATION PULSE	20.00	G'S	4+1+3	102.3	732	1624.21
600 - 2:	RIGHT UPPER RIB ACCELEROMETER	84.00	G'S	4+1+3	102.3	732	1624.21
601 - 3:	RIGHT LOWER RIB ACCELEROMETER	-76.20	G'S	4+1+3	102.3	732	1624.21
602 - 4:	LEFT UPPER RIB ACCELEROMETER	-70.80	G'S	4+1+3	102.3	732	1624.21
603 - 5:	LEFT LOWER RIB ACCELEROMETER	-89.40	G'S	4+1+3	102.3	732	1624.21
604 - 6:	THORAX P-A ACCELEROMETER	66.40	G'S	4+1+3	102.3	732	1624.21
605 - 7:	THORAX R-L ACCELEROMETER	66.20	G'S	4+1+3	102.3	732	1624.21
606 - 8:	THORAX T-S ACCELEROMETER	-80.40	G'S	4+1+3	102.3	732	1624.21

9:

10:

11:

12:

13:

14:

=====

 RUN ID: 78112-2:RFS

 =====

ANALOG-TO-DIGITAL CONVERSION R DIGITAL FILTERING

PROJECT: THORACIC IMPACT PROJECT -- PRIMATE FRONT SLED TEST

ANALOG TAPE: MSK14149 EXPANDED 16:1, HAS A/D CONVERTED TO DIGITAL TAPE: HS0452 DATE: 07-FEB-79

TEST SIGNALS: 2434 PIS/CH AT 6475.02 HZ. CAL SIGNALS: NOT DIGITIZED.

FILE CH	CONTENT OF CHANNEL	UNITS/VOLT	UNITS	FILTER STAGFS	FILTER CUTOFF	AVG PIS	SAMPLING PERIZ
1:							
607 -	2: VASCULAR PRESSURE	145.50	MM-HG	4+1+ 3	102.0	608	1618.75
608 -	3: RIGHT LAP RELT LOAD	1000.00	LBS.	4+1+ 3	102.0	608	1618.75
609 -	4: LEFT LAP RELT LOAD	1000.00	LBS.	4+1+ 3	102.0	608	1618.75
610 -	5: STEERING COLUMN LOAD	1176.00	LBS.	4+1+ 3	102.0	608	1618.75

=====

 FILTERED FILES: 607 - 610 DIGITAL TAPE: JEFLEN DATE: 07-FEB-79 RUN ID: 78112-2:RFS

 =====

