

Spin Effects in High- P_{\perp}^2 Elastic Scattering¹

A. D. Krisch

Randall Laboratory of Physics, University of Michigan
 Ann Arbor, Michigan 48109-1120 USA

Recent experiments found large unexpected spin forces in high P_{\perp}^2 proton-proton elastic scattering by using a polarized proton target and sometimes a polarized proton beam. If both protons are unpolarized then one can only measure the differential elastic cross-section. If either the beam or the target is spin-polarized then one can measure the one-spin parameter A , which is called the analyzing power or the left-right asymmetry. If both the beam and the target are polarized then one can measure two spin quantities such as A_{nn} , the spin-spin correlation parameter. Recall that A_{nn} parametrizes the spin-spin force while A measures the spin-orbit force.

I will begin the discussion of spin effects in proton-proton scattering, by first reviewing unpolarized proton-proton scattering. Fig. 1 shows all high energy proton-proton elastic scattering data plotted against a scaled P_{\perp}^2 variable; the plot is about 14 years old¹. This variable removes most of the energy dependence which is sometimes called the shrinking of the diffraction peak. In the small P_{\perp}^2 diffraction peak the energy dependence is totally eliminated. The diffraction peak measures the outer size of the proton; Fourier transforming the $e^{-10P_{\perp}^2}$ slope gives an outer size of about 1 fermi. This agrees with the 1 fermi charge radius measured by Hofstadter in electron-proton scattering experiments. At medium P_{\perp}^2 there is some complex behavior which disappears above about 100 GeV. At high energy there is just a sharp dip at the end of the diffraction peak followed by a energy-independent large P_{\perp}^2 component. Presumably this large P_{\perp}^2 hard scattering component is the diffraction scattering due to the proton's constituents. By Fourier transforming the large P_{\perp}^2 slope of $e^{-1/3 P_{\perp}^2}$, one finds a size of about 1/3 of a fermi. This is the characteristic size that is seen when two constituents scatter; this 1/3 fermi probably contains both the constituents' intrinsic size and the range of their interaction.

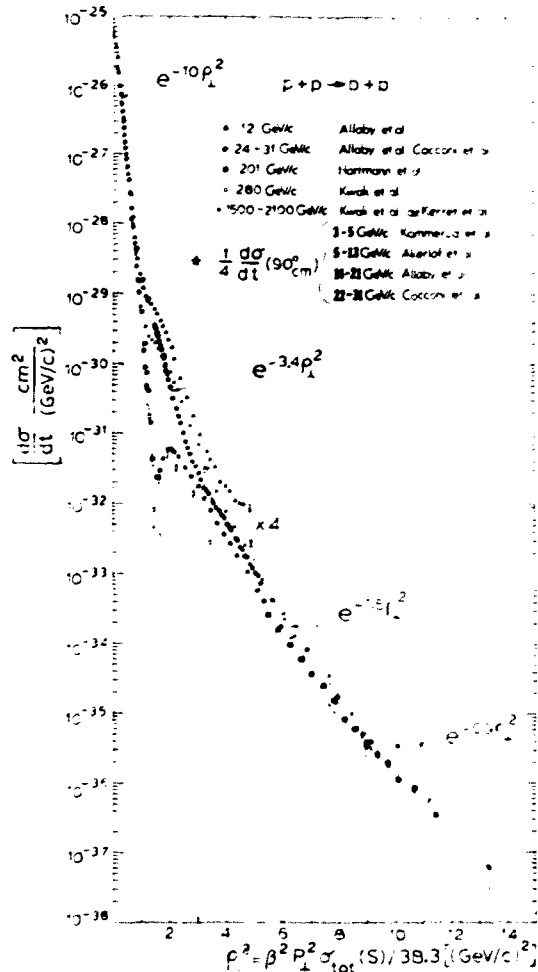

Fig. 1 Plot of unpolarized p-p elastic scattering against scaled P_{\perp}^2 .

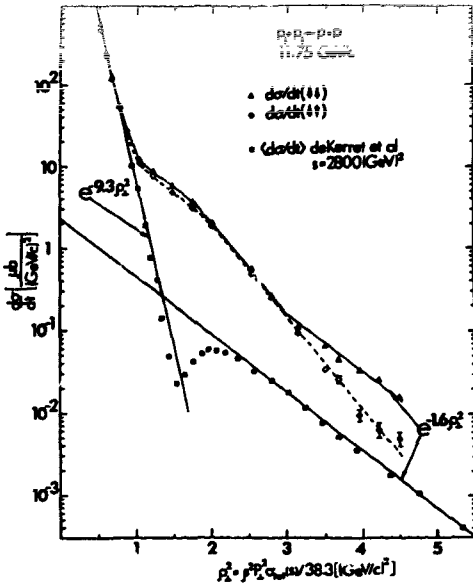

Fig. 2 Polarized and unpolarized p-p elastic scattering.

Now I will turn to spin physics. Fig. 2 shows the p-p elastic cross section again plotted against the scaled P_{\perp}^2 . The 2800 GeV² unpolarized data² from the CERN ISR was just shown in Fig. 1. The spin-polarized data is from our 12 GeV Argonne ZGS experiments³. What does this data show? In the small- P_{\perp}^2 diffraction peak, the protons apparently do not much care about their energy or their spin state; all the data points fall on top of each other. Thus in the diffraction peak the two protons just scatter off each other and the geometry of their 1 fermi outer size is dominant. There are also some low energy spin effects at medium- P_{\perp}^2 , but the whole medium- P_{\perp}^2 region disappears at high energy.

Therefore, I will concentrate on the large- P_{\perp}^2 hard-scattering region. Notice that the slope of the spin-parallel cross-section at 12 GeV is exactly the same as the slope at 2800 GeV². However, when the spins are antiparallel the behavior is very different; the cross-section just keeps dropping. This was a most surprising result when we first found it in 1977. In simple language: the

proton appear to have violent collisions only when they are spinning in the same direction; when they spin in opposite directions they seem to just pass through each other. The factor of four difference between the two spin cross-sections was totally unexpected. This large spin effect caused confusion for people who believed in Perturbative Quantum Chromodynamics, since it seems impossible to get large spin effects from PQCD alone.

Two of our most distinguished colleagues both made the same comment about this result after seminars in the Fall of 1977. Professor Bethe at Copenhagen and Professor Weiskopf at CERN both said approximately "It looks very interesting that you have such a large spin effect, but before you claim that it is a high- P_{\perp}^2 hard-scattering effect you should note that at your energy near 12 GeV the spin effect only gets large near 90°_{c.m.}. So perhaps it is not really a large- P_{\perp}^2 hard-scattering effect, but instead some particle identity effect which is only important near 90°_{c.m.}". One doesn't lightly dismiss the comments of two such eminent scientists; indeed there was apparently no way to answer their question theoretically. Therefore, we decided to instead answer it experimentally by doing an experiment⁴ where we held fixed the scattering angle at exactly 90°_{c.m.} and varied the incident energy. In Fig. 3 the ratio of the spin-parallel

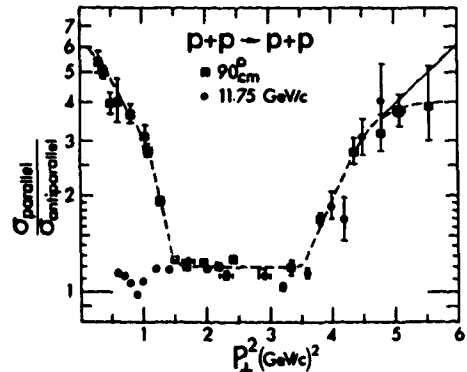

Fig. 3 Ratio of spin-parallel to spin-antiparallel p-p elastic cross-sections plotted against P_{\perp}^2 for fixed energy and fixed angle experiments.

to spin antiparallel cross-section is plotted against P_{\perp}^2 for both experiments. There are clearly differences at the low- P_{\perp}^2 points which correspond to energies below 1 GeV. But above 1.5 $(\text{GeV}/c)^2$, the two sets of data fall exactly on top of each other. This shows directly that this unexpected spin effect is a large- P_{\perp}^2 hard scattering effect. It is clearly not a 90_{cm}° effect, because the medium P_{\perp}^2 points where the spin effect is small are just as much at 90_{cm}° as the large- P_{\perp}^2 points where it is large.

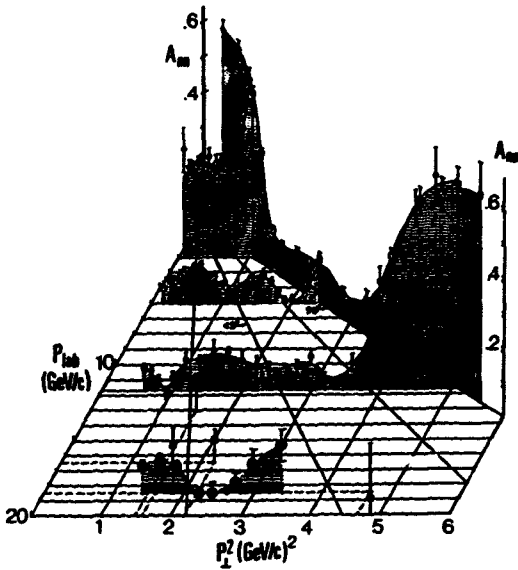

Fig. 4 Three dimensional plot of p-p elastic A_{nn} .

The high energy p-p elastic spin-spin data are compiled in the 3-dimensional Fig. 4. The spin-spin parameter A_{nn} is plotted against the incident momentum and against P_{\perp}^2 . Notice first the 90_{cm}° fixed angle data and the 12 GeV fixed energy data, which were both shown in Fig. 3. Also shown is a 6 GeV experiment by our group and a 3 GeV experiment by Yokosawa's group. Our recent 16.5 and 18.5 AGS data are also shown².

Notice that at each fixed energy there is a peaking near 90_{cm}° . The level to which it peaks changes but there is a peak near 90_{cm}° at each measured energy. While Bethe and Weiskopf were not completely correct in their

concerns about 90_{cm}° particle identity effects, perhaps they were partly correct. More generally Fig. 4 certainly does not support the belief that spin effects will disappear at higher energy and higher P_{\perp}^2 .

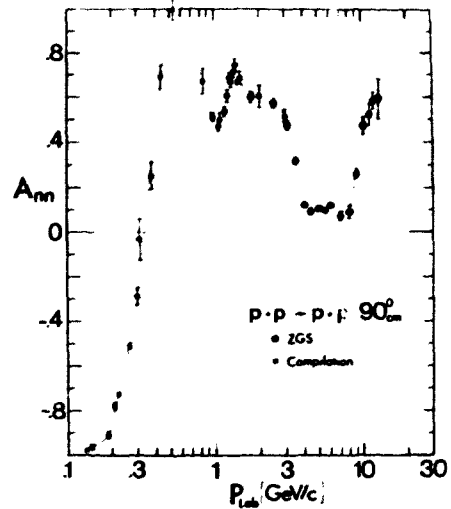

Fig. 5 A_{nn} plotted against P_{inc} for 90_{cm}° p-p scattering.

Since 90_{cm}° is clearly a special point for the p-p system, I prepared Fig. 5 which is a summary of the behavior of A_{nn} at 90_{cm}° . I believe this plot contains all 90_{cm}° data from the lowest energy to the highest energy. I obtained the lower energy data from a tabulation of Professor Haeblerli. The lowest momentum corresponds to about 10 MeV kinetic energy and the maximum is the same 12 GeV data shown in Figs. 3 and 4. What does Fig. 5 show about the behavior of spin-spin effects? At very low energy, A_{nn} must be -1 because of kinematics. Then A_{nn} rises very rapidly to $+1$. Next there is some structure in the "dibaryon" region; perhaps this structure is due to dibaryons or perhaps it is due to some threshold effect. After that A_{nn} drops rapidly near 3 GeV/c; it is then completely flat until about 8 GeV/c where A_{nn} again grows rapidly. Some theorists including Brodsky⁶ and Tyurin⁷ think that A_{nn} may oscillate at higher energy.

I will now turn to an experiment which used neither a polarized beam nor a polarized target, but is quite important to high energy spin physics. The experimenters measured¹⁰ the polarization of the inclusively produced lambdas, while scattering a high energy proton beam from either a proton target or a nuclear target such as Beryllium, or by colliding proton beams at the ISR. The measured lambda polarization is quite large as shown in Fig. 6. The dashed line corresponds to the rather extensive data at 400 GeV from Fermilab. The 400 GeV behavior is first compared with some 12 GeV data from KEK; notice that the 12 GeV data points fall on top of the 400 GeV curve. Next note that the ISR data at 2000 GeV behaves identically. Fig. 6 shows that there is an inclusive Λ polarization of about 20% which appears to be totally independent of energy from 12 GeV to 400 GeV to 2000 GeV. The belief that spin effects will disappear at higher energy is certainly not supported by this data.

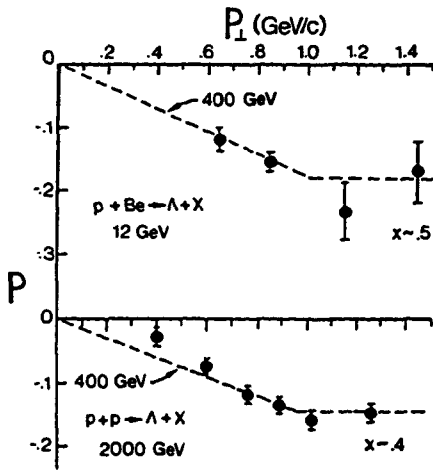

Fig. 6 Inclusive Λ polarization at different energies.

I will now discuss an experiment that we did almost by accident while developing the polarized proton beam at the Brookhaven AGS; we did this low priority experiment partly to test our polarized proton target and spectrometer. We did not expect large one-spin effects

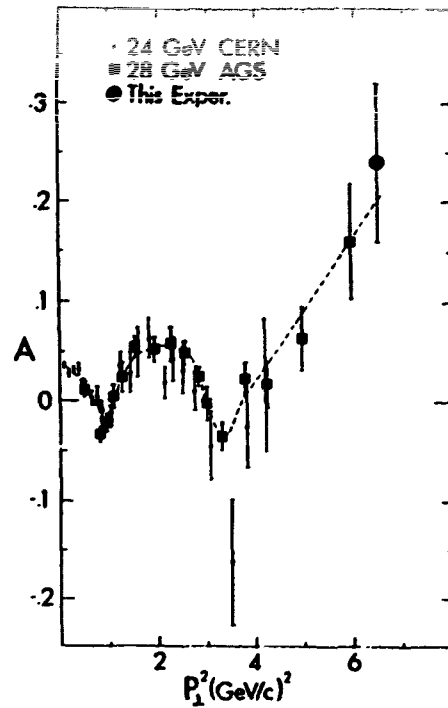

Fig. 7 Plot of A vs P_{\perp}^2 .

because most theorists thought that A would be zero. They said that while they might not understand the large two spin effects from the ZGS, they surely could understand one spin effects. PQCD predicted that A must be zero; furthermore, this prediction should become more reliable at higher energy and at larger P_{\perp}^2 . Using our then state of the art high intensity polarized target, we first confirmed some low to medium P_{\perp}^2 CERN/Oxford data at 24 GeV, as shown in Fig. 7. We next moved out to larger P_{\perp}^2 , where PQCD predictions should be better; we instead found¹¹ that A was moving rapidly away from the prediction of $A = 0$. This rather large spin effect apparently causes some problems for PQCD and perhaps for QCD in general. Some theorists believe that our energy and P_{\perp}^2 are too low to be of interest to PQCD; if true, this seems a fundamental weakness of PQCD.

This spin effect is larger than it may first appear. Notice that while A reaches only about 20%, the scattering to the left is about 50% more probable than the scattering to the right as shown on the σ_L/σ_R scale. This spin effect is actually even larger; notice that A is given by

$$A \equiv \frac{\sigma_{\uparrow\uparrow} - \sigma_{\uparrow\downarrow} + \sigma_{\downarrow\uparrow} - \sigma_{\downarrow\downarrow}}{\sigma_{\uparrow\uparrow} + \sigma_{\uparrow\downarrow} + \sigma_{\downarrow\uparrow} + \sigma_{\downarrow\downarrow}} = \frac{\sigma_{\uparrow\uparrow} - \sigma_{\downarrow\downarrow}}{\sigma_{\uparrow\uparrow} + \sigma_{\downarrow\downarrow} + \sigma_{\uparrow\downarrow} + \sigma_{\downarrow\uparrow}}$$

where the two arrows in σ_{ij} refer respectively to the beam and target polarizations. The second equality of the equation comes from rotational invariance of space which states that $\sigma_{\uparrow\downarrow}$ must be equal to $\sigma_{\downarrow\uparrow}$; this equality does not require parity or time reversal invariance. Thus there are only two σ_{ij} in the numerator, but four σ_{ij} in the denominator; the resulting ratio of 2 to 4 gives a simple theorem:

If $A_{\text{non}} = 0$, then the maximum value of A is not 100% but 50%.

Therefore, finding an A of more than 20% is really rather significant. To be more quantitative assume that there are no spin-spin effects so that A_{non} is zero. Then a result of $A = 20\%$ corresponds to a ratio of $\sigma_{\uparrow\uparrow} : \sigma_{\downarrow\downarrow} = 2.33$. This is certainly a large spin effect; indeed spin appears to be dominating the strong interaction at large P_{\perp}^2 .

Thus, there appeared to be large unexpected spin effects at high- P_{\perp}^2 . Most theorists thought that these spin effects should not exist; they could not explain them and offered no clear guidance about how to understand them. Being experimenters we tried to improve our understanding by extending the range of our parameters; we could go either to higher energy or to larger P_{\perp}^2 . Such extensions would certainly be consistent with the basic scientific principle of learning truth by exploring and observing nature. Unfortunately, we could not go to higher energy at the AGS; the maximum available energy was about 28 GeV.

After much discussion and thought we decided to make a much higher energy measurement of A in $p+p \rightarrow$

$p+p$ at the new UNK accelerator which is now being built at Protvino near Moscow. UNK should first operate in 1993 at 400 GeV and our NEPTUN A collaboration is approved to do the first experiment; UNK later will operate at 3 TeV. Perhaps some theoreticians may believe that 400 GeV and 3 TeV are still much too low to be interesting. However there will be no significantly higher energy proton-proton facilities operating on this planet until the end of the century.

I will now briefly describe this UNK experiment which is called NEPTUN A. The participants in NEPTUN A are:

O. V. Buyanov, V.V. Churakov, O.A. Guchov, V.N. Grishin, V.A. Kačanov, V.Yu. Khodyrev, Yu.M. Melnik, A.P. Meshanin, V.V. Mochalov, S.B. Nurshiev, D.I. Patalakha, A.F. Prudkoglyad, V.V. Rykalin, V.L. Solovianov, M.N. Ukhanov, A.N. Vasiliev, and A. E. Yakutin; **IHEP**.

V.V. Fimushkin, V.G. Luppov, M. Mertig, Yu.K. Pilipenko, V.V. Shutov; **JINR**.

V. A. Anferov, R. Baiod, J.A. Bywater, D.G. Crabb, D.A. Crandell, C.M. Chu, Ya.S. Derbenev, W.A. Kaufman, A.D. Krisch, A.M.T. Lin, D.C. Peasley, R.A. Phelps, R.S. Raymond, D.P. Stewart, J.A. Stewart, B.S. van Gulder, and V.K. Wong; **MICHIGAN**.

L.G. Ratner; **BNL**.

G.R. Court, D. Kleppner, A. Yu; **MIT**.

The UNK facility is shown in Fig. 8 with the construction status updated to about September 1990; the UNK tunnel is now about 95% finished. Our NEPTUN A experiment will be in the SS 3 cave, which is now being constructed 50 m below ground. This cave is in a nice wooded area; unfortunately, it is 11 km from the 70 GeV injector and the town of Protvino. Notice that 11 km is a rather long distance; one can no longer just walk across a room to check the experiment.

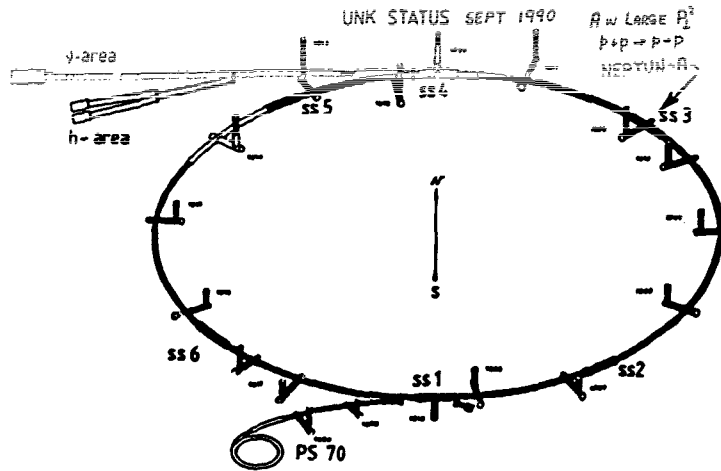

Fig. 8 Diagram of UNK showing the position of NEPTUN A.

A crucial component of this NEPTUN-A experiment is the polarized gas jet which produces spin-polarized atomic hydrogen by using a very high field magnet. We now have a Prototype Gas Jet working in Ann Arbor. It uses a 7.6 T magnet to trap the spin polarized hydrogen atoms in one spin state (the high-field seekers). Some 213 GHz microwaves then spin-flip the atoms, turning them into low-field-seekers which then emerge as an extracted beam. We use a sextupole to focus the beam. This Prototype Jet already has an intensity of well above 10^{16} atoms per sec. We are now building the Mark II

Polarized Gas Jet which we plan to install as an internal jet target in the UNK ring.

We will detect large- P_{\perp}^2 elastic and inclusive events using a 55 meter recoil spectrometer with focusing quadrupoles and bending magnets; it has a large solid angle and uses rather small scintillator hodoscopes and wire chambers. We plan to obtain a momentum resolution of about $\pm 0.1\%$ by using a 12° vertical bend. The spectrometer is shown in Fig. 9. We hope to obtain some 400 GeV NEPTUN-A data in about two years.

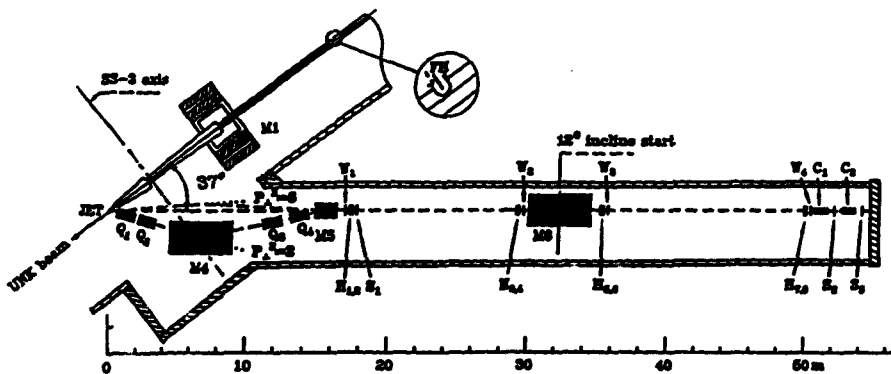

Fig. 9 The NEPTUN-A experiment: top view.

The other possibility for extending our high P_1^2 one spin measurements was to go to higher transverse momentum and higher precision. In summarizing a conference, my friend Willi Haebeli pointed out that our errors were fairly large at high P_1^2 . He said correctly that we had only a few points that were 2.5 to 3 standard deviations from the $\Lambda = 0$ prediction of PQCD. While it appeared rather unlikely, our non-zero Λ could be a statistical fluctuation. If it was a statistical fluctuation, a serious problem for PQCD would disappear.

We thus decided to build a new polarized proton target with a higher cooling power, so that we could use a higher beam intensity. Then we could study higher P_1^2 and obtain better precision. Recall that the polarization of particles with magnetic moment μ is given by

$$P = \tanh\left(\frac{\mu B}{kT}\right).$$

Because of the proton's small magnetic moment, this simple brute force technique gives a rather low polarization of only 1/3% at a magnetic field, B , of 2.5 T and a temperature, T , of 0.5 K. Fortunately, around 1958 Professors Jefferies and Abragam invented Dynamic Nuclear Polarization. They first noted that an electron's polarization at 2.5 T and 0.5 K is more than 99% because of its large μ ; they next proposed using 70 GHz microwaves to transfer this large electron polarization to nearby protons. DNP allows proton polarizations of up to 75% in a fairly intense beam. We had used such ^3He evaporation refrigerator targets at 0.5 K for many years to obtain the results shown in Figs. 2, 3, 4, and 7. Our best target had about 140 mW of cooling power. A few years ago, we designed a new target with a cooling power of about 1 W by evaporating ^4He at 1 K.

In using the rather complex Dynamic Nuclear Polarization technique we thought that if one doubles the temperature, one should also double the field to keep constant the quantity $\mu B/kT$. We hoped that this alcohol would keep the proton polarization fairly high.

We therefore obtained a new Oxford Instruments superconducting magnet which operates at 5 T with a good uniform field region. We built at Michigan a vertical ^3He cryostat; this was mostly designed by Geoff Court. We connected the cryostat to large Roots blower pumps which gave about 1 W of cooling at 1 K. The target material was radiation-doped ammonia. We used a 140 GHz microwave source of 20 W to transfer the electron polarization to the hydrogen protons. The new PPT is shown in Fig. 10; it worked unexpectedly well¹⁰. It not only gave the desired 1 W of cooling power; it also gave a totally unexpected 96% proton polarization.

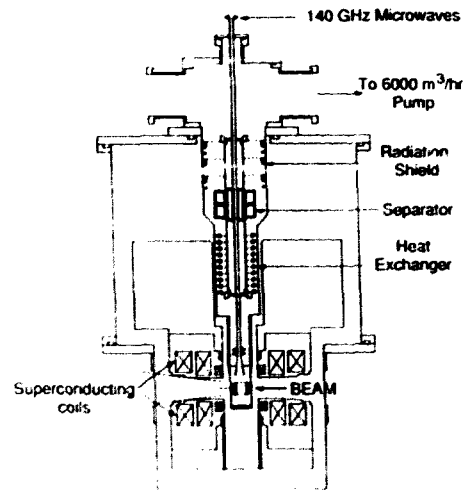

Fig. 10 The new 5 T at 1 K Polarized Proton Target.

However we got off to a bad start. We first tried a conventional alcohol material in the target; we thought that this alcohol would give higher polarization than ammonia, as in the old target. At the old conditions of 2.5 T at 0.5 K the alcohol gave a 75%–80% proton polarization while ammonia gave only 45%–50%. In the new 5 T at 1 K target the alcohol gave only about 10% polarization; this seemed to be a disaster. We were quite concerned about the expensive new 5 T target; perhaps some subtle property of DNP was making it fail. Then we put in ammonia and it worked beautifully.

With ammonia we obtained a maximum proton polarization of 96% in both spin states as shown in Fig. 11. During a 3 month AGS run with a beam intensity of over $2 \cdot 10^{11}$ protons per pulse on the target, the averaged polarization was about 85% including all of the spin reversals and difficulties. With our old 2.5 T at 0.5 K target, the polarization with ammonia would eventually reach about 50% but the rise time was quite slow. With the new target the polarization rose very quickly to 96% as shown. The new target is really a much better target: the polarization is about twice as large and it has about seven times the cooling power of the old target.

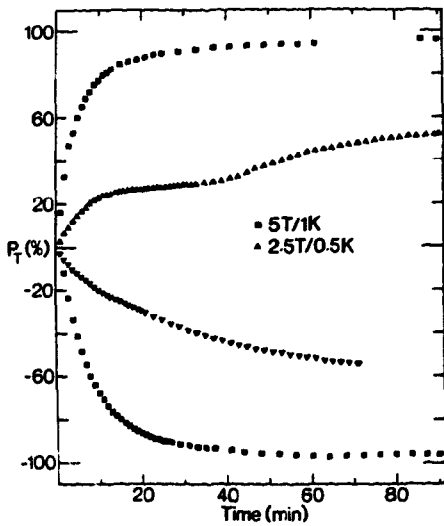

Fig. 11 Proton polarization plotted against microwave irradiation time.

We then installed this target in our spectrometer at the AGS as shown in Fig. 12. The spectrometer had bending magnets in both the forward arm and the recoil arm; both arms also contained scintillation counter hodoscopes. Because of the very high beam intensity our experiment was surrounded by three meters of concrete shielding; the total luminosity was well above $10^{15} \text{ sec}^{-1} \text{ cm}^{-2}$. We also installed two focusing quadrupoles in our spectrometer. These quadrupoles increased our event rate by a factor of almost 2; they also gave us some experience with spectrometer quadrupoles in preparation for our UNK experiment. The concrete shielding kept us from reaching larger P_{\perp}^2 ; we could not easily move the recoil arm to smaller angles or the forward arm to larger angles. To reach larger P_{\perp}^2 , we therefore installed a magnet which bent the incident beam by 3° to the left just before it hits the target. This 3° bend allowed us to reach somewhat larger P_{\perp}^2 where the recoil angle is smaller and the forward angle is larger; this bend was equivalent to rotating both spectrometer arms by 3° to the right. We also did careful background subtractions and other tests^{5,11} to insure that we had a clean elastic signal.

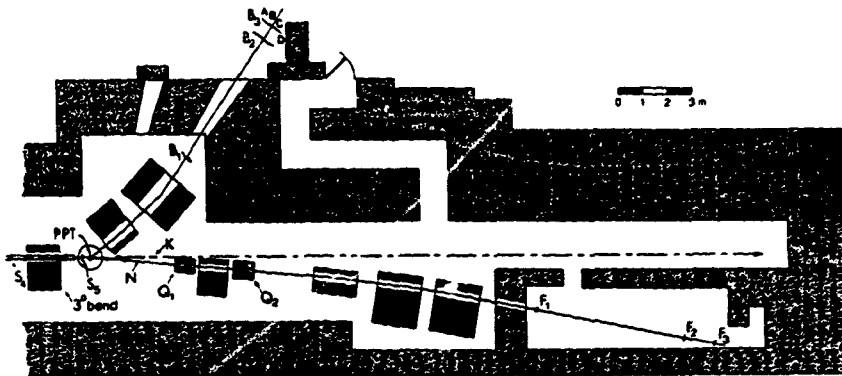

Fig. 12 The improved elastic spectrometer in the 24 GeV beam.

With the improvements, our experiment was much better than before. In fact, the data came in about 15 times faster which made an enormous difference. The new data¹¹ is plotted in Fig. 13 along with the earlier data⁹. Notice that the new data has finer bins; but even with these finer bins the errors are typically three times smaller than before. Our precise new 24 GeV data agree with the earlier 28 GeV data. The new data certainly confirm that, for p-p elastic scattering at high P_{\perp}^2 , the one spin analyzing power A is non zero and large.

It now seems most unlikely that the non zero A at high P_{\perp}^2 will disappear because it is a statistical fluctuation; several data points are six to eight standard deviation from zero. There now seems to be a clear disagreement with the PQCD prediction that $A = 0$. Perhaps the time has come when we should start to

look for either some new theory of strong interactions or some modification of Perturbative Quantum Chromodynamics which is able to more effectively deal with these large spin effects. More generally, this data suggests that the proton's spin may dominate the behavior of strong interactions at large P_{\perp}^2 .

References

1. This work was supported by a research grant from the U.S. Department of Energy.
2. A. D. Krisch, AIP Conf. Proc. **43**, 243 (1977); Phys. Rev. Lett. **11**, 247 (1963); Phys. Rev. Lett. **19**, 1149 (1967); Phys. Lett. **44B**, 71 (1973).
3. H. DeKerret et al., Phys. Lett. **62B**, 363 (1976); **68B**, 374 (1977).
4. D. G. Crabb et al., Phys. Rev. Lett. **41**, 1257 (1978); J. R. O'Fallon et al., Phys. Rev. Lett. **39**, 733 (1977).
5. E. A. Crosbie et al., Phys. Rev. **D23**, 600 (1981).
6. F. Z. Khadi et al., Phys. Rev. **D39**, 45 (1989).
7. S. J. Brodsky, C. E. Carlson, and H. J. Lipkin, Phys. Rev. **D20**, 2278 (1979).
8. S. M. Troshin and N. E. Tyurin, J. Phys. (Paris) **46**, Colloq. C2 235 (1985).
9. K. J. Heller, Proc. of the 7th International Symposium on High Energy Spin Physics, 1986, ed. L. D. Soloviev, Vol. 1, SI (Provincia, 1987).
10. P. R. Cameron et al., Phys. Rev. Rapid Comm. **D32**, 3070 (1985).
11. D. G. Crabb et al., Phys. Rev. Lett. **64**, 2627 (1990).
12. D. G. Crabb et al., Phys. Rev. Lett. **65**, 3244 (1990).

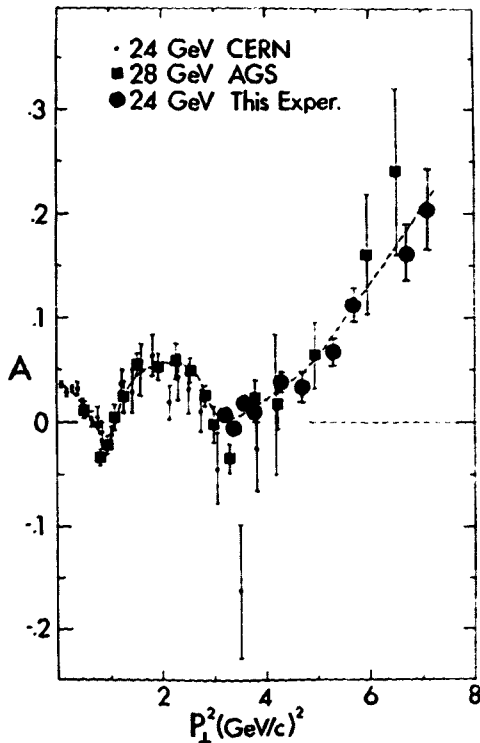

Fig. 13 Plot of A against P_{\perp}^2