



THE WILLIAM DAVIDSON INSTITUTE
AT THE UNIVERSITY OF MICHIGAN BUSINESS SCHOOL

***Labor Market Institutions and Restructuring: Evidence from
Regulated and Unregulated Labor Markets in Brazil***

By: Jasper Hoek

William Davidson Working Paper Number 484
July 2002

Preliminary and incomplete. Do not quote. Comments welcome.

**LABOR MARKET INSTITUTIONS AND RESTRUCTURING:
EVIDENCE FROM REGULATED AND UNREGULATED LABOR
MARKETS IN BRAZIL**

Jasper Hoek*
University of Michigan
Dept. of Economics and Population Studies Center
Ann Arbor, MI
jhoek@umich.edu

This draft: July 2002

Abstract: This paper compares patterns of hiring and separations in regulated and unregulated labor markets over the last two decades in Brazil, with an eye toward gauging the effects of employment protection on employment adjustment over the business cycle. Since the difference between the sectors is stark and well-defined, the consequences of employment protection on flows through the labor market are relatively easy to discern. Employment protection causes adjustment to demand fluctuations to come at the expense of the unemployed. A reduction in employment in the regulated labor market is achieved by lowering the rate at which the unemployed get jobs. In the unregulated market, the same reduction is achieved by raising the separation rate. In principle, the restructuring mechanisms of both sectors could be compatible with similar contributions to unemployment. In practice, contributions from the regulated sector are more persistent and erratic. The contribution of the unregulated sector is stable and countercyclical.

Keywords: Labor market institutions, incomplete contracts, informal sector, severance pay, business cycle fluctuations

JEL Classification Codes: J64, J65, E24

* Thanks to Francisco Ferreira, Stepan Jurajda, Gábor Kézdi, Matthew Kotchen, David Lam, Gerard Pfann, Kathy Terrell, and participants at the WDI-IZA 2002 conference on Labor Market Dynamics in Emerging Market Economies for comments and suggestions. Remaining errors are my own.

I. Introduction

In recent years, macroeconomic theorists have made great strides in clarifying the channels through which institutional constraints are thought to affect labor markets. One strand of this literature, attributable to Caballero and Hammour (1994, 1996a, 1996b, 1998, 2000), has its origins in a view of recessions as “cleansing” episodes and has evolved into a general theory of the macroeconomic consequences of transactional impediments in productive relationships. Caballero and Hammour have used this framework to examine the consequences of institutional constraints for patterns of creative destruction in steady state, over the business cycle, and during episodes of major restructuring. Another strand of the literature, associated with Mortensen and Pissarides (e.g., 1994, 1999) and Olivier Blanchard with various co-authors (e.g., Blanchard and Diamond 1992, Blanchard 2000, Blanchard and Portugal 2001) evolved out of the search-theoretic approach to labor markets and has incorporated an institutional focus in more recent incarnations.

The empirical work on this topic, however, lags behind, notwithstanding a rapidly expanding literature investigating patterns of job creation and destruction in a growing list of countries. There are good reasons for this. First, the theoretical work delivers its most salient predictions in terms of flows of workers and jobs between various states of the labor market – flows that are observed with notorious imprecision. Second, while institutional constraints are easily conceived of in theory, the concept is much harder to pin down empirically. Comparing labor flow patterns across institutional environments is therefore an inherently messy business, which has left a gulf between the theoretical and empirical research that has yet to be bridged.

This paper attempts to circumvent some of these difficulties by comparing two labor markets with extremely stark and well-defined institutional differences – regulated and unregulated labor markets in Brazil. Latin American labor markets are typically highly regulated, and Brazil is no exception. According to an index of job security costs calculated by Heckman and Pagés-Serra (2000), labor markets in Latin America are more regulated even than most European labor markets. On the other hand, almost half of Brazil's labor force works in the informal sector, free of any regulatory constraints. This paper makes use of a unique, two-decade, rotating panel of Brazilian households to compare labor reallocation in each sector over the business cycle.

One goal of this paper is to connect the empirical analysis more closely with theoretical work. To this end, the paper extends a simple bargaining model developed in Blanchard and Portugal (1998) and Blanchard (2000) (a static version of a model by Blanchard and Portugal, 2001) to illustrate the differential effect of demand shocks on labor market flows in regulated and unregulated markets. Job-specific costs have three effects in this model. They lower the wage that firms can pay, they increase the bargaining power of workers, and they lower the separation rate. In order to make the lower wage consistent with workers' increased demands, firms must lower the hiring rate. Furthermore, the lower the equilibrium level of the hiring rate, the more demand shocks are absorbed on the hiring margin.

The empirical analysis makes use of the steady state employment condition to develop a test of the extent to which a given employment change is achieved on the hiring and separation margins. This approach implicitly views restructuring as taking place on a continuum, on one side of which only the hiring rate adjusts and on the other side of

which only the separation rate adjusts. The regulatory environment and, more generally, the specificity of assets embedded in employment relationships, determine where on the continuum a labor market lies. This is a slightly different emphasis from much of the literature on labor market flows, which for the most part focuses on how inflows and outflows from jobs diverge to achieve a net change in employment. This paper takes flows into and out of jobs to be approximately equal at any point in time and focuses on adjustments to the hiring and separation *rates* over the business cycle. This is not to say that inflows and outflows do not diverge. Clearly they must if any change in employment is to occur. But empirically, the great majority of variation in inflows and outflows are “explained” by changes in hiring and separation rates, rather than deviations of hiring and separations from each other. Moreover, the exit rate from unemployment and the separation rate from jobs figure very prominently in theoretical work.

The results suggest that the regulated and unregulated labor markets lie on opposite ends of the restructuring continuum, that is, the unregulated labor market relies almost exclusively on the separation rate as an adjustment mechanism while the regulated labor market adjusts the hiring rate. Interestingly, separate regressions by 1-digit industry and by proxies for specific human capital do not change the basic result.

The paper then asks what effect the different restructuring mechanisms have had on the evolution of Brazilian unemployment. Although the equilibrium effects of institutional rigidity on unemployment are theoretically ambiguous, there are reasons to believe that institutions may affect the time it takes for a labor market to return to equilibrium after a shock, for example, because workers lose skills the longer they are unemployed or because firms discriminate against workers on the basis of the time they have spent in

unemployment. Hence, a given shock may have longer-lasting effects on unemployment. This argument is a major candidate in the quest to explain the evolution of European unemployment. I use a Markov process first to predict movements in unemployment, and then to isolate the contributions of the regulated and unregulated labor markets on changes in the unemployment rate. The results suggest that changes in unemployment attributable to the formal sector are more persistent and less cyclical than unemployment generated by the informal sector.

There are very few papers that have compared labor reallocation across institutional lines. The most recent and cleanest evidence comes from Blanchard and Portugal (2001) who compare job and worker flows in Portugal and the U.S. They find that flows through unemployment in Portugal are much lower than in the U.S., and they attribute the difference to employment protection laws. However, their paper looks only at long-run implications of employment protection. Several papers have looked at cyclical properties of job and worker flows, although few have compared patterns in different institutional environments. Davis and Haltiwanger (1992), find that job destruction is much more volatile than job creation over the U.S. business cycle. Caballero and Hammour (1994) fit a model to the same data and attribute this finding to convex adjustment costs of job creation. Firms smooth hiring across the business cycle, so employment adjustment has to occur on the job destruction margin. Using worker flows, Blanchard and Diamond (1990) also find that accessions are much less volatile than separations. Baldwin et al (1998) compare job creation and destruction in Canada and the United States and find that they are qualitatively similar, although job destruction is less volatile over the business cycle in Canada. Burda and Wyplosz (1994) cast doubt on the notion that European labor

markets have lower rates of restructuring than the U.S. They show that worker flows through unemployment in France, Germany, Spain, and the United Kingdom are similar to those observed in the United States, with both accessions and separations rising in recessions. In turn, Albæk and Sørensen (1998) cast some doubt on this finding. They use superior data to find that job destruction and creation in Denmark are roughly symmetric over the business cycle, while quits are strongly procyclical.

Brazil presents an interesting case for the study of job creation and destruction. The coexistence of fairly high job-specific costs to employers and extremely high rates of job turnover in the formal sector is something of a puzzle from the perspective of existing theory. Gonzaga (1998), Bivar, Gonzaga, and Pazello (2000), and Corseuil *et al* (2002) have all documented very high rates of job turnover using a variety of data sources and methodologies. Gonzaga (1998) argues that Brazil's labor laws perversely encourage high job turnover since workers who are fired are entitled not only to the balance of their personal "severance payment" account (which accumulates with a worker's tenure on a formal sector job), but, in the case of unjust dismissals, an additional payment of 40% over and above what has accumulated in this account, payable by the employer. In practice, many workers simply sign away their right to the 40% fee in order to gain access to their severance payment account, after which they may look for other work or continue at the same job without a formal contract. The existing studies have used primarily firm- or establishment-level data to document job reallocation patterns. By using household-level data, this paper is able to examine labor flow patterns in both the formal and informal sectors over a long period of time, but at the cost of distinguishing between job and worker flows.

The paper proceeds as follows. The next section provides a brief background of Brazil's macroeconomic experience since 1982. Section III presents the model and uses it to motivate the empirical approach. Section IV discusses the data. Section V presents the evidence on labor flows. Section VI presents the evidence on each sector's contribution to changes in unemployment, and Section VII concludes.

II. Background

The past two decades have been difficult for Latin American labor markets. Mexico's 1982 debt default drew the world's attention to the external vulnerability of most countries in the region and aggravated inflation. In Brazil's case, the debt crisis ushered in a decade of unsuccessful attempts at stabilizing inflation by means of “heterodox” stabilization plans, which attempted to subdue inflation directly through price controls. The first, and most successful, heterodox stabilization plan was the Cruzado plan in 1986, which provided a significant, though short-lived, stimulus to the economy; however, since it did not address the underlying excess demand problem, it inevitably failed as price controls became more difficult to enforce, sparking a bout of even higher inflation. The Cruzado plan was followed by five more stabilization attempts, each less successful than the last. The end result was a hyperinflation.

After spending the 1980s avoiding the inevitable, most Latin American countries came around to a policy view in the early 1990s that gave priority to macroeconomic stabilization and (less inevitably) trade liberalization. Brazil began liberalizing trade in 1990, eliminating export subsidies and reducing external tariffs from an average of 40 percent to 13 percent over four years. Successful stabilization did not come until the Real

Plan of 1994, which combined a nominal exchange rate anchor with cuts in government spending. For tradable goods industries, this was a double blow: trade liberalization put an end to the subsidies that firms in these industries had previously enjoyed and drastically lowered external tariffs, while stabilization required a period of extremely overvalued exchange rates. Thus, firms were suddenly forced to compete in world markets, and at a disastrously uncompetitive exchange rate. For the same reasons, and abstracting from the disabsorption that was supposed to occur to achieve external balance, stabilization and liberalization were also a tremendous boon to non-tradable goods industries, which suddenly faced cheaper import prices due to the greater purchasing power of their currencies and relaxed import restrictions.

These developments put enormous pressure on labor markets. Latin America started the 1990s with an excess demand for labor in the tradable goods sector. If there were no frictions in labor markets, wages in tradable goods industries would have fallen, inducing the excess labor to move to non-tradables until the resulting wage differential was eliminated. Adjustment on this scale would be onerous for even the most flexible of labor markets. Not surprisingly, therefore, unemployment and/or informal sector employment have increased in nearly all countries in the region. Brazil has experienced one of the largest movements of labor out of the manufacturing sector in Latin America. Despite the enormous outflow from manufacturing, however, unemployment has remained relatively contained (at least compared to other countries in the region). Although some of this apparent success is attributable to lower labor force participation, most of the labor flowing out of manufacturing has in fact been absorbed by the informal service sector, at least indirectly.

Figure 1 makes the point. Between 1986 and 1998, employment in formal-sector manufacturing jobs fell by more than half as a share of the labor force (Panel A). Most of the slack was taken up by the informal service sector, although unemployment (Panel B) also rose. The decline in formal manufacturing employment actually began well before the liberalization reforms were begun in the early 1990s. It appears that, in the Brazilian case, manufacturing really started to feel the pinch in the mid-1980s after the failure of the Cruzado Plan. A second point worth mentioning is that the transition of workers out of formal manufacturing jobs and into informal service sector jobs worked in reverse in the early days of the Cruzado Plan, as Brazil pulled out of the initial phase of the debt crisis. The share of employment in the informal service sector is thus almost the mirror image of the share in formal manufacturing employment.

III. A Simple Model

Incorporating specific investments into a flow model of the labor market is not an easy task because the hiring and firing decisions have to be made endogenous. This essentially requires some sort of heterogeneity across jobs, and the predictions of the model will be sensitive to how this heterogeneity is specified. Caballero and Hammour (1994, 1996a, 1998) get a lot of mileage out of introducing heterogeneity in a very simple way: exogenous technological progress makes newer jobs more productive than older ones. The advantage of their approach is that, since there is a continuum of job productivities at any given time, there is no ambiguity about which jobs should be scrapped in a downturn – the oldest jobs should go. Whether they do or not depends critically on the institutional environment. A more general form of job heterogeneity is introduced by Blanchard and

Portugal (2001), who follow in the tradition of Mortensen and Pissarides (1994, 1999). Job heterogeneity is modeled by introducing shocks to productivity randomly drawn from a productivity distribution. Shocks arrive at an exogenous rate determined by a Poisson process. A negative productivity shock has unclear implications for any given job, since the size of the shock is of critical importance. Some shocks may not be large enough to warrant a dissolution of the match between a firm and a worker, especially when firing costs are involved. This makes out-of-steady-state predictions difficult; however, since Blanchard and Portugal are interested in the steady state implications of employment protection, the model works well for their purpose.

In this section, I develop a simple empirical model of the labor market with irreversible costs of job creation, drawing on Blanchard (2000). The model glosses over many theoretical fine points, but it has the advantage that it captures the basic intuition of the more sophisticated models quite well, and it suggests a straightforward empirical test. I think of the economy as always being in steady state, that is, flows of workers into and out of employment are equal at all points in time. We are concerned with changes in steady state flows associated with changes in profitability. Clearly, inflows and outflows cannot always be equal if the economy is to accomplish any changes in employment. But these divergences are minor deviations from trends in the way flows relate to stocks at different points in the cycle. The empirical justification for this is that the time series patterns are quite similar whether we look at inflows or outflows from jobs. The theoretical justification is that it buys a lot of simplicity.

Consider a labor force of size one. At any given time, workers can be in one of three states: formal employment (m_f), informal employment (m_k), and unemployment (u). Thus,

$$m_f + m_k + u = 1$$

Formal and informal employment are distinguished by the level of job-specific investment. Employment in the formal sector requires an investment on the part of the employer. This is addressed in greater detail below.

Workers are constantly entering and leaving each sector, even in equilibrium. For each sector of employment i , let h_i denote the number of hires, and s_i the number of separations, where $i=f,k$. Hiring is determined by a standard Cobb-Douglas matching function, increasing in unemployment and vacancies, v_i :

$$h_i = u^\eta v_i^{1-\eta}$$

Workers can only be hired from the unemployment pool, and employed workers can only leave their sector for unemployment; there are no direct transitions between formal and informal employment. Labor is homogeneous, so that the chance of an unemployed worker entering employment in each sector is simply the number of hires relative to the unemployed. This is alternately referred to as the hiring rate or the exit rate from unemployment, denoted x_{ui} . Similarly, the chance of a vacancy getting filled, x_{vi} , is the number of hires relative to the stock of vacancies in each sector:

$$x_{ui} = \frac{h_i}{u} = \left(\frac{v_i}{u} \right)^\eta$$

$$x_{vi} = \frac{h_i}{v_i} = \left(\frac{v_i}{u} \right)^{-\eta}$$

The ratio v_i/u (or equivalently, $x_{ui} / x_{vi} = x_{ui}^2$) can be thought of as a measure of the tightness of labor market conditions in a given sector. A high number of vacancies relative to unemployed workers indicates that firms are having a relatively more difficult time filling vacancies than unemployed workers are having finding jobs. The parameter η

is a measure of firms' aversion to unfilled vacancies. When η is high, a given increase in vacancies relative to unemployed workers results in a greater increase in the hiring rate.

The probability that a worker leaves employment for unemployment (equivalently, the separation rate) is given by:

$$\lambda_i = \frac{s_i}{m_i}.$$

In steady state, the flow of workers into each sector must equal the flow out of that sector:

$$x_{ui} \times u = \lambda_i \times m_i$$

Solving for m_i yields:

$$m_i = (x_{ui} \times u) \left(\frac{1}{\lambda_i} \right). \quad (1)$$

Employment in a sector is equal to the inflow into that sector times the average duration of a job. Since all workers are assumed to have an equal chance of losing their job, the average job duration is equal to the inverse of the separation rate.

Changes in steady state

Changes in m_i can be achieved by changing the flow into employment or changing the average time an unemployed worker must wait to get a job, or any combination of the two. Taking the differential of the log of the steady state equation (1) yields:

$$d \ln m_i = d \ln x_{ui} + d \ln u - d \ln \lambda_i$$

We are interested in the effect of institutional constraints on the margin of adjustment. To fix ideas, it is useful to consider some extreme cases. Consider first a sector that operates entirely on the “destruction” margin. That is, to achieve a change in employment, this

sector increases only the separation rate, keeping constant the duration of an unemployment spell ending in a job in that sector. In this case,

$$d \ln x_{ui} = 0 \Rightarrow d \ln h_i - d \ln u = 0$$

In steady state, hiring and separations are equal, which implies that:

$$d \ln s_i = d \ln u \Rightarrow d \ln \lambda_i = d \ln u - d \ln m_i$$

If the hiring rate is constant, a negative shock to employment requires an increase in the separation rate equal in absolute magnitude to the proportional change in unemployment plus the proportional change in employment.

Now, consider the opposite case: a sector that operates entirely on the “creation” margin. A change in employment will be achieved by changing only the hiring rate, keeping the separation rate constant.

$$d \ln \lambda_i = 0 \Rightarrow d \ln s_i - d \ln m_i = 0$$

Again, the equality of hiring and separations implies that:

$$d \ln h_i = d \ln m_i \Rightarrow d \ln x_{ui} = d \ln m_i - d \ln u$$

Thus, if the separation rate is constant, a negative shock must be accommodated by a fall in the hiring rate. The change is of the same magnitude as the change in the separation rate if the hiring rate is held constant.

In between these extremes, a sector may adjust with any combination of changes in destruction and creation. We can capture this in the following way:

$$\begin{aligned} d \ln x_{ui} &= \beta(d \ln m_i - d \ln u) \\ d \ln \lambda_i &= -(1 - \beta)(d \ln m_i - d \ln u) \end{aligned} \tag{2}$$

Solving either of the equations in (2) for hiring and separations, we get:

$$d \ln h_i = d \ln s_i = \beta d \ln m_i + (1 - \beta) d \ln u \tag{3}$$

Thus, β measures the extent to which adjustment takes place on the creation margin. Mathematically, there is no reason why β should be confined to the interval $[0,1]$. For example, it is possible that a negative shock would increase unemployment duration by so much that the flow into unemployment could actually fall. Theoretically, however, it would be difficult to motivate such a reaction.

Institutional Rigidity

The formal sector differs from the informal sector in several respects. Workers with formal labor contracts accumulate funds in a personal account (*Fundo de Garantia por Tempo de Serviço*, or FGTS), which may be drawn upon when a worker is fired or upon retirement. Furthermore, if a worker is fired with unjust cause after more than three months of work, employers are required to pay a severance payment equal to 40% of the worker's FGTS balance. In addition, workers have recourse to the legal system for unjust dismissals, almost all formal sector jobs are unionized, and jobs are more likely to involve training costs and specific skills. Heckman and Pagés-Serra (2000) estimate that Brazil ranks above Austria, Belgium, France, and Germany in terms of costs associated with job security. However, Gonzaga (1998) has argued that these costs are at least partially reduced by direct negotiations between employers and employees. In the informal sector, the only institutional rigidities that might arise are through training or other specific human capital acquired on the job.¹

¹ There is likely to be an interaction between institutional constraints imposed by regulation and those induced by specific human capital. The existence of a regulatory constraint may facilitate investments in job-specific human capital that might otherwise not have occurred. Note also that it may be desirable to facilitate investment in job-specific skills.

Here, the institutional setting is modeled simply as a fixed cost, c , that must be paid by the employer to the worker if a match is terminated. We assume that some portion of this cost cannot be bonded away, so that the Coase theorem does not hold. Since separations are costly, the separation rate is decreasing in c :

$$\lambda_i = \lambda_i(c; \cdot) \quad \lambda_i' < 0$$

Furthermore, since all matches will eventually come to an end, the zero-profit condition ensures that the separation cost also lowers the wage that firms can pay. This is called the *feasible wage*. Among other things, the feasible wage is also affected by demand conditions, reflected in the price of output, p . Denoting derivatives by superscripts, we have:

$$w_i^f = \varphi_i(p, c; \cdot) \quad \varphi_i^p > 0, \varphi_i^c < 0$$

On the other hand, the rents associated with the employment relationship rise with the separation cost, since workers can walk away after firms have invested in the employment relationship. These rents must be bargained over, and the outcome of this bargaining is referred to as the *bargained wage*. For a given share of rents accruing to workers, the bargained wage rises with the separation cost. Furthermore, the share of the rents accruing to workers rises with the ease with which workers can find jobs relative to the ease with which firms can fill vacancies. Thus, for a given firing cost, the tighter is the labor market, the higher is the bargained wage:

$$w_i^b = \psi_i(x_{ui} / x_{vi}, c; \cdot) = \psi_i(x_{ui}^2, c; \cdot) \quad \psi_i^{x_{ui} / x_{vi}} > 0, \psi_i^c > 0$$

In equilibrium, the bargained wage equals the feasible wage. Figure 2A depicts the equilibrium wage and hiring rate in the formal and informal sectors. Equilibrium points in the formal and informal sectors are denoted E_f and E_k , respectively. The feasible wage

does not depend on the hiring rate; it is constant at a given wage level. However, the bargained wage increases exponentially with the hiring rate reflecting the fact that if workers could find jobs without delay wage demands would increase to infinity. The hiring rate therefore acts as a discipline device to moderate workers' wage demands. The separation cost reduces the equilibrium wage in the formal sector. But in order for the bargained wage to be consistent with this lower wage, workers must have a relatively harder time finding jobs there. Hence, job-specific costs reduce the wage and the flow of workers through jobs.

Figure 2B shows the effect of the separation cost on adjustment to a negative demand shock. The initial equilibrium points E_f and E_k from Figure 2A are depicted by the intersection of the solid lines for each sector. The formal sector starts at a much lower hiring rate than the informal sector because the feasible wage curve intersects the bargained wage curve at a lower point. A negative demand shock moves each of the feasible wage curves down by an equal amount, moving the equilibrium points to E'_f and E'_k . In the formal sector, the demand shock is absorbed by a much larger fall in the hiring rate compared to the informal sector. It follows that, for a given change in employment, the separation rate is relatively unaffected. The reverse is true of the informal sector. The shock is absorbed mostly in a higher separation rate.

Equation (3) suggests a natural empirical test of the model. The parameter β can be estimated by regressing hiring and separations in each sector on the stock of employment and unemployment over time by ordinary least squares (OLS). Since the model ignores adjustment dynamics, we account for them in reduced form by including lags of the dependent and independent variables on the right hand side:

$$\begin{aligned} A_i(L) \ln h_{it} &= \alpha_i + B_{i1}(L) \ln m_{it} + B_{i2}(L) \ln u_t + \varepsilon_{it} \\ C_i(L) \ln s_{it} &= \mu_i + D_{i1}(L) \ln m_{it} + D_{i2}(L) \ln u_t + v_{it} \end{aligned} \quad (4)$$

The coefficients of this error correction model (ECM) imply the following long-run elasticities of hiring and separations with respect to employment and unemployment:

$$\beta_{i1} = \frac{B_{i1}(1)}{A_i(1)}, \quad \beta_{i2} = \frac{B_{i2}(1)}{A_i(1)}, \quad \gamma_{i1} = \frac{D_{i1}(1)}{C_i(1)}, \quad \gamma_{i2} = \frac{D_{i2}(1)}{C_i(1)}$$

The model suggests that the informal sector is more likely to accomplish a given change in employment on the destruction margin, that is, by changing the separation rate. This implies that the elasticities of hiring and separations in the informal sector with respect to employment should be closer to zero and the elasticities with respect to unemployment closer to one. To the extent that gross adjustment costs are important in formal sector, the elasticities with respect to employment should be closer to one, and the unemployment elasticities closer to zero. Where on the interval each sector lies depends on the degree of specificity in employment relationships in each sector. In either case, to the extent that the assumptions of the model are valid, $\beta_{i1} + \beta_{i2}$ and $\gamma_{i1} + \gamma_{i2}$ are expected to sum to one. In the regressions below, we will compare specifications in which the parameters are restricted to sum to one with unrestricted specifications.

There are, of course, several caveats. The first is that the model does not address the distinction between quits and layoffs, and therefore neither does it address the distinction between job and worker flows. All separations are, in effect, layoffs due to job destruction, while hires are due to job creation. Roughly speaking, data on worker flows capture both job flows and flows of workers through a given set of jobs. Thus, if we observe a low flow of workers into unemployment, we cannot be sure whether job

destruction is low, whether workers and employers are happier with (or more prone to settle for) each other, or whether more workers are skipping unemployment altogether and switching directly to other jobs. There are probably good reasons to believe that each of these factors work in the direction of lowering flows through unemployment of formal sector workers. Employment protection laws make it more costly for firms to fire workers and more costly to experiment with new employees (who may one day have to be fired). Since firms are less disposed to hiring, currently employed workers are less likely to quit, especially if they do not have a new job lined up. Thus, one would expect lower rates of job creation and destruction, lower flows of workers through those jobs, and a higher fraction of job-to-job flows. To the extent that changes in employment are due to changes in the flow of workers through a given set of jobs, the OLS estimates may not be picking up the behavioral patterns predicted by the model.² Second, not all hiring comes from unemployment and not all separations spill workers into the unemployment pool. Thus, there are clearly important transitions that the model does not address. Third, flow data are notoriously subject to measurement error. Spurious transitions resulting from misreporting undoubtedly raise the observed level of transition rates above their actual level. To the extent that misreporting varies systematically with the labor market state of individuals, the coefficients may be biased, although it is not clear in which direction. Finally, there is a selection problem. Firms and workers are likely to sort themselves into the labor market most appropriate for their needs and skills. Thus, there are likely to be systematic differences in the characteristics of workers and jobs across sectors. We will deal with this modestly by running separate regressions by 1-digit industry and by

² In principle, it is possible to distinguish between worker and job flows, because there exist job flow data for Brazil. However, since these data are collected from establishments by the government, they only exist for the formal sector, and only for 1996-98 (Corseuil et al, 2002).

proxies for human capital. In general, however, it is not clear that it is economically meaningful to make a distinction between a labor market's institutional environment and the characteristics of workers and jobs that operate in it, unless the distribution of jobs and workers could plausibly be thought to be exogenous. However, we are interested in the effect of any form of institutional constraint on the operation of the labor market, whether these are imposed by labor market regulations or arise endogenously from other forms of specific capital.

IV. Data

The paper uses 18 years of the *Pesquisa Mensal de Emprego* (PME), the Brazilian Monthly Employment Survey. The PME has been administered by the Brazilian Statistical Agency (*Instituto Brasileiro de Geografia e Estatística*, or IBGE) in the six largest metropolitan areas of Brazil since 1980.³ Due to changes in the survey design, however, the data are only comparable across years beginning in February 1982. The survey is a rotating panel, similar in design to the United States' Current Population Survey. Households are interviewed once a month for four months, dropped from the survey for eight months, and then interviewed for four more months. The questionnaire is fairly typical: information is collected on labor force activity and demographic variables for every member of the household over the age of ten.

Crucially for our purposes, workers are asked whether they worked in a regulated or unregulated job. In Brazil, all workers have a "work card" which, when signed by an employer, gives them protection under the labor laws and covers them under the federal

³ The six metropolitan areas are São Paulo, Rio de Janeiro, Belo Horizonte, Porto Alegre, Salvador, and Recife. In the late 1990s, a seventh metropolitan area, Curitiba, was added.

Social Security system. Workers with a signed work card are considered to be in the regulated (or formal) sector. Employees whose work card is not signed and self-employed workers are considered to be in the unregulated (or informal) sector. The overhead costs associated with taking on employees with formal labor contracts are substantial in Brazil, typically around 70% of a worker's wage. The payroll tax alone exceeds 30% and is one of the highest in Latin America. Moreover, many workers prefer not to work with signed work cards since their take-home pay may be reduced.

Formal and informal jobs do not exist in independent spheres of the economy; on the contrary, many employers have both formal and informal employees at the same time, particularly in services and “traditional” manufacturing industries. A typical arrangement, especially among smaller firms, is to have a core of employees with formal contracts while contracts with less essential employees are handled informally. This system also works well in dealing with the regulatory authorities, who conduct their business in a characteristically Brazilian manner. Regulators more or less take into account that firms cannot afford to give all their employees formal contracts, while at the same time maintaining an external air of following the guidelines, checking the books, etc.

(Tokman, 1992) As a result, smaller firms tend to have a larger share of their employees working with informal contracts. On the other hand, workers in the large state-owned manufacturing firms are almost all unionized and operate mainly with formal contracts

Labor flows were constructed by matching individuals across consecutive months, and recording their labor force status in each month into one of the following categories: not in the labor force (N), unemployed (U), informal employment (K), and formal employment (F). There are 16 possible flows (NN, NU, NK, NF, UN, UU, UK, UF, KN,

KU, KK, KF, FN, FU, FK, FF). These monthly flows were then accumulated into quarters.

Figure 2 presents average labor flows for the period 1982 to 1998. The first three panels show the proportion of workers in employment (E), unemployment (U), and out of the labor force (N), as well as the monthly flows between these states. The circles represent labor market states, the arrows between them the corresponding flows. The numbers not in parentheses are proportions of the total population. Flows were also calculated as a proportion of the combined source and destination pools; these proportions are in parentheses. The first panel of Figure 1, labeled "Brazil", shows the relevant stocks and flows aggregated over the six metropolitan areas in which the Brazilian employment survey is administered. For purposes of comparison, the corresponding figure for the United States data is presented in the second panel, adapted from Blanchard and Diamond (1990). In the third panel, the pool of employed workers is divided into those with formal labor contracts (F) and those without (K).

Although a smaller fraction of the Brazilian population is employed, the ratio of the unemployed to the labor force (that is, the unemployment rate) is very similar in both countries, around 6%; however, flows between unemployment and employment as a proportion of the labor force are less than half as large in Brazil. For example, unemployment flows as a proportion of the labor force in São Paulo are roughly half those of the United States. On the other hand, flows between employment and out of the labor force are similar and flows between unemployment and out of the labor force are two to three times higher in the United States. Dividing the pool of employed workers

into those with formal and informal labor contracts reveals that flows through unemployment are much higher in the informal sector than in the formal sector.

V. Labor Flows

Figure 3 plots 3-quarter moving averages of the flow from unemployment to employment in each sector as a fraction of the stock of unemployed (Panel A) and employed (Panel B), respectively. Figure 4 does the same for the flow out of employment into unemployment. For each figure, the transitions of individuals between two successive interview months are summed, accumulated into quarters, and divided by the relevant stock of (unemployed or employed) individuals in that quarter who were matched across months.

The exit rate from unemployment into the formal sector, plotted in Figure 3A, is a strongly procyclical. It dips sharply in the immediate aftermath of the debt crisis in 1982, rising again during the Cruzado Plan in 1986 and then falls precipitously during the trade liberalization of the early 1990s. In sharp contrast, hiring as a fraction of formal-sector employment maintains a remarkably constant 1 percent over the entire period (Figure 3B). The reverse is true of the informal sector. Despite the enormous fluctuations in the macroeconomic environment during this period, the hiring rate in the informal sector remains relatively constant at around 23 percent, implying that an average unemployment spell ending in informal employment – whether in recession or recovery – lasts roughly four or five months. On the other hand, hiring as a fraction of employment in the informal sector is countercyclical. Taken together, Figures 3A and 3B suggest that adjustment in the formal and informal sectors could not be more different: to the extent that hiring

reflects steady state labor flows, the formal sector relies almost exclusively on the hiring rate while the informal sector relies almost exclusively on the separation rate as an adjustment mechanism.

A very similar pattern occurs in separations, plotted in Figure 4. The flow out of the informal sector covaries with unemployment, while the flow out of formal jobs covaries with formal sector employment. Note, however, that separations in the formal sector are considerably more volatile than hiring. Coincident with trade liberalization in the early 1990s, the outflow from formal jobs appears to be “pulled” slightly toward the informal line. Although the theoretical framework developed above is not equipped to explain this (due to the steady state assumption), the relative volatility of separations actually mimics a salient feature of the dynamic model of Caballero and Hammour (1996a, 1998). In their model, convex adjustment costs associated with job creation require too much adjustment to take place on the destruction margin, causing job creation and destruction to become decoupled. Thus, job destruction is too volatile, in spite of an inefficiently low level of turnover. In the absence of institutional constraints, job creation and destruction are highly correlated. This is, in fact, confirmed in the figures. The correlation between hiring and separations in the formal sector is only 0.68 compared to 0.98 in the informal sector.

Figure 5 further disaggregates hiring and separations into manufacturing and services employment, to see whether the differences in restructuring patterns are not picking up different shocks to which these sectors were exposed. Since much of the macroeconomic turmoil in Brazil during this period was external in nature (e.g., exchange rate appreciation, trade liberalization), a large component of the shocks were reallocative

rather than aggregate demand shocks. Disaggregating clearly has little effect, however. Hiring as a fraction of employment in the formal manufacturing sector and formal service sector both hover around one percent, although separations are considerably more volatile in manufacturing. In the informal sector, hiring and separations follow the same pattern in manufacturing and services; however, the level of turnover is clearly lower in the service sector and separations in manufacturing are, once again, more volatile. Lower turnover in the informal service sector is an interesting finding; it suggests that job-specific investments not mandated by law are higher in this sector. One reason for this may be that labor in formal services is generally less organized than labor in formal manufacturing. Due to the heavy presence of the state in the formal manufacturing sector, firms outside the state-controlled sector operate on the periphery. In contrast, the formal and informal service sectors are more integrated.

Table 1 reports estimates of equations (5). There are two dependent variables (hires and separations), two samples (formal and informal), and two specifications per sample (OLS and ECM). The top and bottom panels show the regressions for the formal and informal sectors, respectively. For each dependent variable, the table shows the estimates from the basic specification, in which hires and separations in a sector are regressed on the contemporaneous stock of unemployment and employment in that sector, as well as equilibrium elasticities implied by the coefficients of the ECM. Up to five lags of the dependent and independent variables were included. Furthermore, each equation is estimated twice: once unrestricted, and again restricting the coefficients to sum to one.⁴

⁴ Restricting the coefficients to sum to one implies, for example, that

$$\ln h_{it} = \beta_{i0} + \beta_{i1} \ln m_{it} + (1 - \beta_{i1}) \ln u_t + \varepsilon_{it}$$

for $i=f,k$. Subtracting $\ln u_t$ from both sides and collecting terms yields

Like the figures, the results in Table 1 suggest that very different restructuring mechanisms are at work in the formal and informal sectors. The formal sector adjusts primarily by adjusting the hiring rate. This shows up in the regressions as a large employment elasticity of hiring and separations. In contrast, the informal sector adjusts primarily by adjusting the separation rate, which shows up in a large *unemployment* elasticity. In the basic unrestricted specification, the elasticities of hiring and separations with respect to employment in the formal sector are 1.1 and 1.0, respectively. That compares to an informal sector elasticity with respect to employment of 0.11 for both hiring and separations. The corresponding elasticities with respect to unemployment are 0.23 and 0.15 in the formal sector and 0.91 and 0.93 in the informal sector. Although the coefficients sum close to one in the informal sample, the formal sector estimates overshoot the mark a bit. The null hypothesis that the sum of the coefficients in the basic specification equals one is rejected in the formal sector. Restricting the coefficients to equal one, the formal-sector employment elasticities become 0.92 for both hiring and separations, while the informal unemployment elasticities remain unchanged at 0.91 and 0.93.

Tables 2 and 3 present the same regressions from Table 1 estimated separately for manufacturing and services. The same basic result continues to hold, particularly with the ECM. The estimated employment elasticity in the basic, unrestricted specification for formal manufacturing are somewhat higher than for services: 1.24 for hires and 1.11 for separations for formal manufacturing, compared to 0.85 and 0.88 for formal services. The

$$\ln h_{it} - \ln u_{it} = \beta_{i0} + \beta_{i1}(\ln m_{it} - \ln u_{it}) + \varepsilon_{it}$$

Estimating this reparameterized version of the model yields the restricted coefficient, β_{i1} .

ECM suggests a minimal difference between the two. In the informal sector, the unemployment elasticities are 0.75 and 0.77 for manufacturing and 0.86 and 0.96 for services, suggesting a slightly more flexible labor market in the service sector.

Finally, Table 4 reports the results of estimating the constrained regressions separately by sex, education, and age categories. The idea is to separate out the effects of specificity related labor market regulations from specific human capital. The estimates are very similar for men and women, especially in the formal sector. Surprisingly, the hiring rate adjusts more for women than men in the informal sector. In both the formal and informal sector, the unemployment elasticity falls with education as expected; however, the difference across sectors is still large. For example, workers with less than a primary education in the formal sector have an unemployment elasticity of 0.39 and 0.30 for hiring and separations, compared to elasticities of 0.82 and 0.79 for the highly educated informal sector workers. The regulatory environment appears to account for the major differences between the formal and informal sector. Finally, the employment elasticity falls instead of rising with age in both sectors, contrary to expectations.

Summing up the results of this section, there are five salient points. First, flows through the formal sector vary primarily with formal sector employment. This suggests that job durations are stable, while the average duration of unemployment spells ending in formal sector jobs fluctuates enormously. Second, flows through the informal sector vary primarily with unemployment, suggesting that the duration of unemployment spells ending in informal jobs is fairly stable over the business cycle. It is job durations that vary. Third, separations are more volatile relative to hiring in the formal sector, indicating a decoupling of job creation and destruction. Fourth, the differences clearly lie along

institutional lines, not along “tradable”/“non-tradable” lines associated with transition. Finally, the informal sector does not simply soak up surplus labor during recessions (at least not via unemployment). Rather, recessions are associated with intense restructuring. In principle, the restructuring mechanisms of both sectors could be compatible with similar contributions to unemployment. This question is taken up in the next section.

VI. Changes in Unemployment

The restructuring patterns observed in the previous section are, in principle, consistent with similar equilibrium unemployment rates. There is a strong presumption in the literature, however, that suggests that institutions matter a great deal for the evolution of unemployment in response to shocks. The hypothesis is that, if a labor market responds to a negative shock by increasing the duration of unemployment rather than its incidence, and if the hazard of leaving unemployment is declining over the length of an unemployment spell, then a given shock will have longer lasting effects on unemployment. A declining exit hazard might result from workers losing skills the longer they are out of work, or because firms are more reluctant to hire the long-term unemployed. Whatever the reason, the return to equilibrium will be slower.

This paper cannot do justice to this argument since the data requires us to assume that the hazard of leaving any state of the labor force exhibits no duration dependence. Nevertheless, it is informative to isolate the contribution of each sector to the evolution of unemployment over time. This can be done by taking the assumptions of no duration dependence and steady state very seriously. In this case, the actual distribution of workers in the labor force at any point in time can be approximated by the steady-state

distribution implied by a Markov matrix of transition probabilities. Movements in the labor force can be simulated over time by calculating the implied steady state distribution of the sequence of Markov matrices in every period. If these simulations are reasonably accurate, we can then isolate movements in unemployment and employment attributable to various flows by varying only those flows in the sequence of matrices, holding the others constant at some base period.⁵

Dividing the labor force into three states (formal employment (f), informal employment (k), and unemployment (u)), the solution of the corresponding Markov system converges in steady state to the eigenvector associated with the eigenvalue of one.⁶ Normalizing this eigenvector so that its components sum to one yields the implied steady state distribution of the labor force:

$$\begin{pmatrix} f \\ k \\ u \end{pmatrix} = \begin{pmatrix} \Gamma(\lambda_{kf}\lambda_{uf} + \lambda_{ku}\lambda_{uf} + \lambda_{uk}\lambda_{kf}) \\ \Gamma(\lambda_{fk}\lambda_{uk} + \lambda_{fu}\lambda_{uk} + \lambda_{uf}\lambda_{fk}) \\ \Gamma(\lambda_{fu}\lambda_{ku} + \lambda_{fk}\lambda_{ku} + \lambda_{kf}\lambda_{fu}) \end{pmatrix}$$

where the λ_{ij} denote transition probabilities from state i to state j , and Γ is a function that normalizes each element to a share of the total labor force, $f+k+u$.

Panel A of Figure 6 shows the results of the simulation. Movements in the labor force are reasonably well approximated by a Markov process. The predicted share of formal employment is a few percentage points too high during the 1980s, and the predicted share of informal employment too low. But the predicted unemployment rate tracks the actual unemployment rate quite well.

⁵ This technique has been used by Pissarides (1986) and Abraham and Shimer (2001) in a different context.

⁶ By omitting the fourth state, out-of-the-labor-force (n), from the Markov process we have implicitly assumed that $\lambda_{in}=0$ and $\lambda_{ni}=1$, for $i=f,k,u$. When this condition fails to hold, as it clearly must, the implied steady-state employment distribution will be incorrect. However, the three-state Markov process omitting n still has considerably more predictive power than the unwieldy four-state Markov process including transitions through n .

In Panel B of Figure 6, the evolution of the predicted unemployment rate is decomposed into changes attributable to each of three sets of flows: flows between the formal sector and unemployment, flows between the informal sector and unemployment, and direct transitions between the formal and informal sectors. For example, changes in unemployment attributable to formal sector-unemployment flows are estimated by calculating the steady states implied by the sequence of Markov matrices holding λ_{fk} , λ_{kf} , λ_{uk} , and λ_{ku} constant at their average 1982 level.

Both the formal- and informal-unemployment flows contribute substantially to fluctuations in the unemployment rate. But the secular rise in unemployment in the wake of liberalization and stabilization during the 1990s appears to be purely a result of lower entry into the formal sector. Changes in unemployment due to the informal-unemployment flow exhibit no trend; they are merely countercyclical. Of course, this may be simply because the industries intensive in formal jobs were the ones exposed to the biggest shocks, and this was certainly the case.

To gauge the extent to which differences in shocks may be driving the results, it would be nice to perform the same exercise disaggregating the labor force further into the manufacturing and service sectors; however, predicting labor force movements using a Markov process becomes a rather unwieldy exercise when the population is split up into more than three sectors, and it quickly loses its predictive power. For this reason, I perform the exercise on subsets of the labor force. Specifically, I look separately at the manufacturing and service sectors, looking at movements in formal and informal employment shares within each, as well as unemployment.

The “labor force” shares predicted by the Markov process, plotted in Panel A of Figure 7 (for manufacturing) and Figure 8 (for services), are still fairly successful in tracking actual employment shares, though less so for the service sector than the manufacturing sector. Looking again at contributions to changes in unemployment, this time for manufacturing alone (Figure 7, Panel B), lower entry into formal manufacturing jobs is clearly the dominant factor behind the secular rise in unemployment in the 1990s; the informal sector adds only a mild countercyclical component to unemployment. Interestingly, rising direct transitions from the formal to the informal sector contributed steadily to rising unemployment. This suggests that the informal sector is actually responsible for a higher level of unemployment, despite a smaller contribution to changes in unemployment. Panel B of Figure 8 shows the contribution of service sector flows to the evolution of unemployment. Unemployment did not rise by nearly as much relative to the rising service sector; nevertheless, the same pattern continues to hold. Lower entry into the formal service sector caused unemployment to rise to a higher level in the 1990s, while the informal sector obeyed its countercyclical pattern.

VII. Conclusion

Employment protection lowers the flow of jobs and workers through the labor market. Job stability for the employed comes at the expense of the unemployed, who must wait longer to get jobs. The evidence from the Brazilian labor market suggests that employment protection also causes adjustment to demand fluctuations to come at the expense of the unemployed. A reduction in employment in the regulated labor market is achieved by lowering the rate at which the unemployed get jobs. In the unregulated

market, the same reduction is achieved by raising the separation rate. Recessions in an unregulated labor market are times of intense restructuring, but are otherwise no different from booms from the perspective of an unemployed worker. In contrast, recessions in a regulated labor market are times of hard luck for the unemployed.

Which is the more efficient adjustment mechanism depends on the productivity of the least productive workers with jobs compared to the productivity of the most productive unemployed workers. Caballero and Hammour (1996b) argue that, if the regulatory environment distorts efficient job creation incentives, a strong case can be made for job creation subsidies. These will not only offset the reductions in job creation with which this sector responds to negative demand shocks, but will also encourage scrapping of outmoded production units through pressure on wages. However, although the cyclical patterns documented in this paper are consistent with Caballero and Hammour, several pieces of evidence argue against this view. First, Gonzaga (1998) has linked high rates of job turnover observed in Brazil's formal sector to low job quality and has suggested that Brazil's labor laws actually encourage turnover at the expense of investments in specific human capital. As we have seen in this paper, however, turnover in the formal sector is still considerably lower than in the informal sector. Nevertheless, the evidence seems to indicate that turnover in Brazil is, if anything, already too high. Second, productivity in the formal manufacturing sector increased dramatically in the 1990s in Brazil, and throughout Latin America (Katz, 2000; Hay, 2001), so it is not obvious that the restructuring mechanisms observed in this paper for the formal sector hampered efficient adjustment in the wake of the liberalization and stabilization reforms. Such an assertion would require knowledge of the change in productivity that would have taken place had

the formal sector restructured without regulations. How to reconcile all of these facts is something of a puzzle, and suggests that the productivity consequences of employment protection remain an important topic for future research.

References

- Abraham, Katherine G. and Robert Shimer, "Changes in Unemployment Duration and Labor Force Attachment," NBER Working Paper No. W8352, October 2001.
- Albæk, Karsten and Bent E. Sørensen, "Worker Flows and Job Flows in Danish Manufacturing, 1980-91," *The Economic Journal*, 108, November 1998, 1750-71.
- Baldwin, John, Timothy Dunne, and John Haltiwanger, "A Comparison of Job Creation and Job Destruction in Canada and the United States," *Review of Economics and Statistics*, 80(3), August 1998, 347-56.
- Bivar, Wasmália, Gustavo Gonzaga and Toldo Pazello "Criação e Destruição de Postos de Trabalho por Tamanho de Empresa na Indústria Brasileira", *Pesquisa e Planejamento Econômico*, 30 (2), August 2000, 323-352.
- Blanchard, Olivier Jean. *The Economics of Unemployment: Shocks, Institutions, and Interactions*. Lionel Robbins Lectures, October, 2000.
- Blanchard, Olivier Jean and Peter Diamond, "The Cyclical Behavior of the Gross Flows of U.S. Worker Flows," *Brookings Papers on Economic Activity*, 0(2), 1990, 85-155.
- Blanchard, Olivier Jean and Peter Diamond, "The Flow Approach to Labor Markets," *American Economic Review*, 82(2), May 1992, 354-9.
- Blanchard, Olivier Jean and Pedro Portugal, "What Hides Behind an Unemployment Rate: Comparing Portuguese and U.S. Unemployment," NBER Working Paper No. 6636, July 1998.
- Blanchard, Olivier Jean and Pedro Portugal, "What Hides Behind an Unemployment Rate: Comparing Portuguese and U.S. Labor Markets," *American Economic Review*, 91(1), March 2001, 187-207.
- Burda, Michael and Charles Wyplosz, "Gross Worker and Job Flows in Europe," *European Economic Review*, 38(6), June 1994, 1287-1315.
- Caballero, Ricardo J. and Mohammad L. Hammour, "The Cleansing Effect of Recessions," *American Economic Review*, 84(5), December 1994, 1350-68.
- Caballero, Ricardo J. and Mohammad L. Hammour, "On the Timing and Efficiency of Creative Destruction," *Quarterly Journal of Economics*, 111(3), August 1996a, 805-52.
- Caballero, Ricardo J. and Mohammad L. Hammour, "On the Ills of Adjustment," *Journal of Development Economics*, 51(1), October 1996b, 161-92.

- Caballero Ricardo J. and Mohammad L. Hammour, "The Macroeconomics of Specificity," *Journal of Political Economy*, 106(4), August 1998, 724-67
- Caballero, Ricardo J. and Mohammad L. Hammour, "Creative Destruction and Development: Institutions, Crises, and Restructuring," mimeo., July, 2000.
- Corseuil, Carlos Henrique L., Eduardo P. Ribeiro, Daniel Santos, and Rodrigo Fernando Dias, "Job Creation and Destruction in Brazil," *Instituto de Pesquisa Econômica Aplicada Working Paper No. 855*, January 2002.
- Davis, Steven J. and John C. Haltiwanger, "Gross Job Creation, Gross Job Destruction, and Employment Reallocation," *Quarterly Journal of Economics*, 107(3), August 1992, 819-63.
- Gonzaga, Gustavo, "Rotatividade e Qualidade do Emprego no Brasil," *Revista de Economia Política*, 18(1), Jan.-March 1998, pages 120-40.
- Hay, Donald A. "The Post-1990 Brazilian Trade Liberalisation and the Performance of Large Manufacturing Firms: Productivity, Market Share and Profits," *Economic Journal*, 111(473), July 2001, pages 620-41.
- Heckman, James and Carmen Pagés-Serra, "The Cost of Job Security Regulation: Evidence from Latin American Labor Markets," *Economía*, 1(1), Fall 2000, 109-54.
- Katz, Jorge, "Structural Change and Labor Productivity Growth in Latin American Manufacturing Industries, 1970-96," *World Development*, 28(9), September 2000, 1583-96.
- Mortensen Dale T. and Christopher A. Pissarides, "Job Creation and Job Destruction in the Theory of Unemployment," *The Review of Economic Studies*, 61, July 1994, 397-415.
- Mortensen, Dale T. and Christopher A. Pissarides, "Job Reallocation and Employment Fluctuations," in M. Woodford and J.B. Taylor (eds.), *Handbook of Macroeconomics*, vol. 1, 1171-1227.
- Pissarides, Christopher, "Employment and Vacancies in Britain," *Economic Policy*, (3), 1986, 500-559.
- Tokman, Victor. *Beyond Regulation: The Informal Economy in Latin America*, Boulder: Lynne Rienner, 1992.

Table 1. Estimated Employment and Unemployment Elasticities of Flows Through Unemployment, Formal and Informal Sectors

Formal Sector									
	Dependent Variable (Flow): log UF				Dependent Variable (Flow): log FU				
	Unrestricted		Restricted		Unrestricted		Restricted		
	Steady-State ^a	ECM ^a	Steady-State ^a	ECM ^a	Steady-State ^a	ECM ^a	Steady-State ^a	ECM ^a	
log F	1.10 (0.08)	1.31	0.92 (0.07)	1.03	1.00 (0.06)	1.19	0.92 (0.05)	1.05	
log U	0.23 (0.07)	0.29	0.08 (0.07)	-0.03	0.15 (0.06)	0.09	0.08 (0.05)	-0.05	
Constant	-9.70 (1.28)		-4.52 (0.15)		-6.49 (1.01)		-4.28 (0.11)		
R ²	0.81	0.81	0.72	0.72	0.84		0.83		
SBC ^b	0.81	0.81	0.72	0.72	-3.82	-4.44		-4.35	
D-W	0.81	0.81	0.72	0.72	1.35	2.04		2.02	
Informal Sector									
	Dependent Variable (Flow): log UK				Dependent Variable (Flow): log KU				
	Unrestricted		Restricted		Unrestricted		Restricted		
	Steady-State ^a	ECM ^a	Steady-State ^a	ECM ^a	Steady-State ^a	ECM ^a	Steady-State ^a	ECM ^a	
log K	0.11 (0.05)	0.16	0.09 (0.03)	0.07	0.11 (0.07)	0.21	0.07 (0.05)	0.07	
log U	0.91 (0.03)	0.92	0.91 (0.03)	0.93	0.93 (0.05)	0.93	0.93 (0.05)	0.93	
Constant	-2.08 (0.61)		-1.68 (0.07)		-2.70 (0.92)		-1.93 (0.10)		
R ²	0.81		0.72		0.84		0.83		
SBC ^b	-5.32	-5.24		-5.28	-4.51	-4.51		-4.49	
D-W	1.47	2.01		2.02	1.73	2.05		2.04	

^aSteady-state regressions include only contemporaneous regressors. Error Correction Model (ECM) regressions include up to 5 lags of the dependent and independent variables. The results in the table reflect the implied long-run elasticities from these regressions.

^bSchwarz-Bayesian Criterion: $SBC = \ln(e'e)/n + (k/n) * \ln(n)$, where $e'e$ is the sum of squared residuals, n is the number of observations, and k is the number of parameters. F=formal sector, K=informal sector, U=unemployment, FU, UF, KU, UK denote flows between sectors. Restricted regressions are parameterized so that the coefficients add up to one.

Table 2. Estimated Employment and Unemployment Elasticities of Flows Through Unemployment, Formal and Informal Sectors

Formal Manufacturing									
	Dependent Variable (Flow): log UF				Dependent Variable (Flow): log FU				
	Unrestricted		Restricted		Unrestricted		Restricted		
	Steady-State ^a	ECM ^a	Steady-State ^a	ECM ^a	Steady-State ^a	ECM ^a	Steady-State ^a	ECM ^a	
log F	1.24 (0.07)	1.31	1.10 (0.07)	1.03	1.11 (0.05)	1.19	1.08 (0.05)	1.05	
log U	0.18 (0.09)	0.29	-0.10 (0.07)	-0.03	-0.01 (0.07)	0.09	-0.08 (0.05)	-0.05	
Constant	-10.98 (1.45)		-4.79 (0.08)		-5.93 (1.14)		-4.46 (0.06)		
R ²	0.81		0.72		0.84		0.83		
SBC ^b	-2.81	-3.16	-2.36	-2.90	-3.30	-3.75	-3.33	-3.75	
D-W	1.59	1.99	1.41	2.14	1.31	1.99	1.25	2.00	
Informal Manufacturing									
	Dependent Variable (Flow): log UK				Dependent Variable (Flow): log KU				
	Unrestricted		Restricted		Unrestricted		Restricted		
	Steady-State ^a	ECM ^a	Steady-State ^a	ECM ^a	Steady-State ^a	ECM ^a	Steady-State ^a	ECM ^a	
log K	0.36 (0.11)	0.16	0.27 (0.08)	0.07	0.25 (0.10)	0.21	0.23 (0.07)	0.07	
log U	0.75 (0.08)	0.92	0.73 (0.08)	0.93	0.77 (0.07)	0.93	0.77 (0.07)	0.93	
Constant	-4.89 (1.35)		-3.41 (0.04)		-4.09 (1.21)		-3.83 (0.04)		
R ²	0.81		0.72		0.84		0.83		
SBC ^b	-3.27	-3.47	-3.31	-3.50	-3.50	-3.49	-3.55	-3.52	
D-W	1.11	2.30	1.07	2.32	1.56	2.04	1.56	2.01	

^aSteady-state regressions include only contemporaneous regressors. Error Correction Model (ECM) regressions include up to 5 lags of the dependent and independent variables. The results in the table reflect the implied long-run elasticities from these regressions.

^bSchwarz-Bayesian Criterion: $SBC = \ln(e'e)/n + (k/n) * \ln(n)$, where $e'e$ is the sum of squared residuals, n is the number of observations, and k is the number of parameters. F=formal sector, K=informal sector, U=unemployment, FU, UF, KU, UK denote flows between sectors. Restricted regressions are parameterized so that the coefficients add up to one.

Table 3. Estimated Employment and Unemployment Elasticities of Flows Through Unemployment, Formal and Informal Sectors

Formal Services									
	Dependent Variable (Flow): log UF				Dependent Variable (Flow): log FU				
	Unrestricted		Restricted		Unrestricted		Restricted		
	Steady-State ^a	ECM ^a	Steady-State ^a	ECM ^a	Steady-State ^a	ECM ^a	Steady-State ^a	ECM ^a	
log F	0.85 (0.10)	1.13	0.79 (0.07)	0.86	0.88 (0.09)	1.00	0.83 (0.06)	0.99	
log U	0.23 (0.08)	0.20	0.21 (0.07)	0.14	0.18 (0.06)	0.02	0.17 (0.06)	0.01	
Constant	-5.89 (1.40)		-4.58 (0.11)		-5.40 (1.20)		-4.46 (0.09)		
R ²	0.81	0.81	0.72	0.72	0.84		0.83		
SBC ^b	0.81	0.81	0.72	0.72	-3.82	-4.44		-4.35	
D-W	0.81	0.81	0.72	0.72	1.35	2.04		2.02	
Informal Services									
	Dependent Variable (Flow): log UK				Dependent Variable (Flow): log KU				
	Unrestricted		Restricted		Unrestricted		Restricted		
	Steady-State ^a	ECM ^a	Steady-State ^a	ECM ^a	Steady-State ^a	ECM ^a	Steady-State ^a	ECM ^a	
log K	0.05 (0.06)	0.08	0.03 (0.04)	0.04	0.20 (0.08)	0.26	0.14 (0.06)	0.05	
log U	0.96 (0.04)	0.96	0.97 (0.04)	0.96	0.86 (0.06)	0.96	0.86 (0.06)	0.95	
Constant	-2.57 (0.70)		-2.41 (0.06)		-3.84 (0.95)		-2.85 (0.08)		
R ²	0.81		0.72		0.84		0.83		
SBC ^b	-5.32	-5.24		-5.28	-4.51	-4.51		-4.49	
D-W	1.47	2.01		2.02	1.73	2.05		2.04	

^aSteady-state regressions include only contemporaneous regressors. Error Correction Model (ECM) regressions include up to 5 lags of the dependent and independent variables. The results in the table reflect the implied long-run elasticities from these regressions.

^bSchwarz-Bayesian Criterion: $SBC = \ln(e'e)/n + (k/n) * \ln(n)$, where $e'e$ is the sum of squared residuals, n is the number of observations, and k is the number of parameters. F=formal sector, K=informal sector, U=unemployment, FU, UF, KU, UK denote flows between sectors. Restricted regressions are parameterized so that the coefficients add up to one.

Table 4. Regression Estimates of Labor Flows Through Unemployment on Source and Destination Stocks, by Sex, Education, and Age

	Formal Sector							
	Dep Var: log UF				Dep Var: log FU			
	log F		log U		log F		log U	
	Coeff.	S.E.	Coeff.	S.E.	Coeff.	S.E.	Coeff.	S.E.
Sex								
Men	1.10	(0.07)	0.22	(0.07)	0.99	(0.06)	0.16	(0.06)
Women	1.03	(0.10)	0.28	(0.08)	0.95	(0.08)	0.15	(0.06)
Education								
Less than primary	1.07	(0.07)	0.39	(0.08)	1.02	(0.07)	0.30	(0.08)
Primary	1.17	(0.08)	0.28	(0.09)	1.05	(0.07)	0.27	(0.08)
More than primary	1.05	(0.09)	0.15	(0.07)	0.94	(0.07)	0.08	(0.05)
Age								
10 to 29	1.08	(0.07)	0.22	(0.07)	1.05	(0.05)	0.04	(0.06)
30 to 44	0.94	(0.08)	0.26	(0.06)	0.85	(0.07)	0.26	(0.06)
45 and over	0.84	(0.14)	0.34	(0.07)	0.62	(0.13)	0.38	(0.07)
	Informal Sector							
	log UK				log KU			
	log K		log U		log K		log U	
	Coeff.	S.E.	Coeff.	S.E.	Coeff.	S.E.	Coeff.	S.E.
Sex								
Men	0.09	(0.05)	0.91	(0.03)	0.09	(0.08)	0.96	(0.05)
Women	0.22	(0.07)	0.91	(0.05)	0.27	(0.09)	0.82	(0.06)
Education								
Less than primary	0.06	(0.04)	0.96	(0.03)	0.05	(0.07)	0.94	(0.05)
Primary	0.03	(0.05)	0.94	(0.04)	-0.04	(0.09)	0.94	(0.06)
More than primary	0.15	(0.04)	0.82	(0.03)	0.30	(0.07)	0.79	(0.06)
Age								
10 to 29	0.30	(0.06)	0.81	(0.04)	0.25	(0.07)	0.82	(0.05)
30 to 44	0.06	(0.06)	0.98	(0.04)	-0.02	(0.10)	1.08	(0.06)
45 and over	-0.06	(0.08)	0.95	(0.04)	0.10	(0.11)	1.00	(0.05)

Significance levels: 1% (***), 5% (**), 10% (*)

F=formal sector, K=informal sector, U=unemployment, FU, UF, KU, UK denote flows between sectors

Figure 1. Labor Force Trends in Brazil, 1982-2000

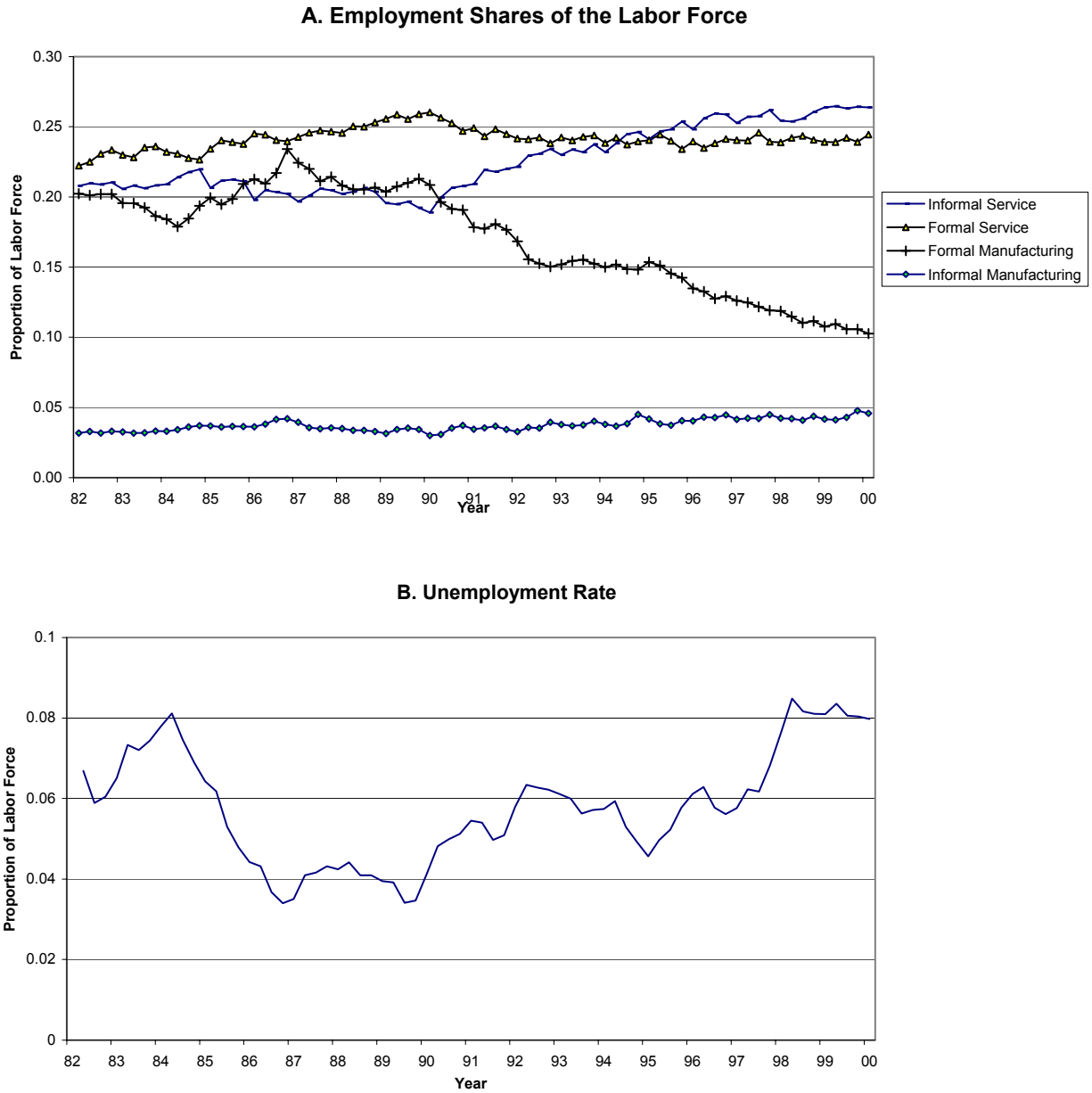

Source: PME

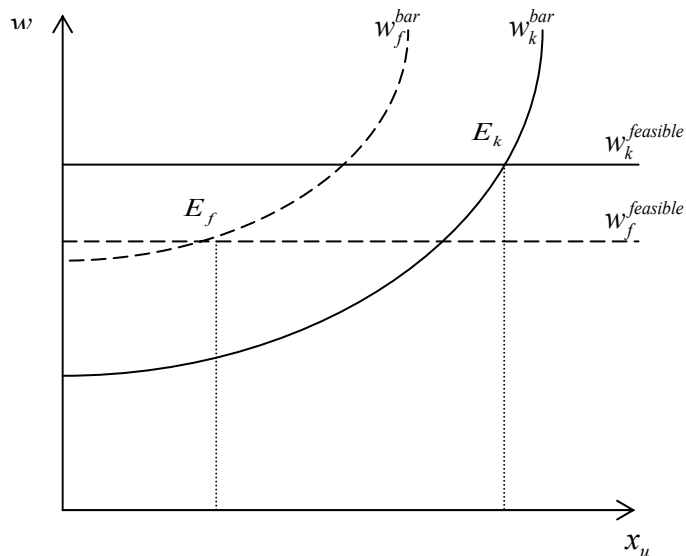

Figure 2A. The Effects of Job-Specific Costs on Labor Market Equilibrium

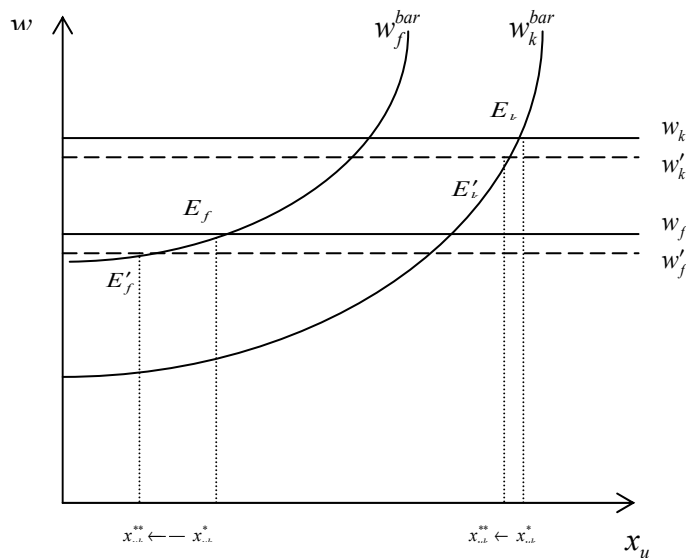
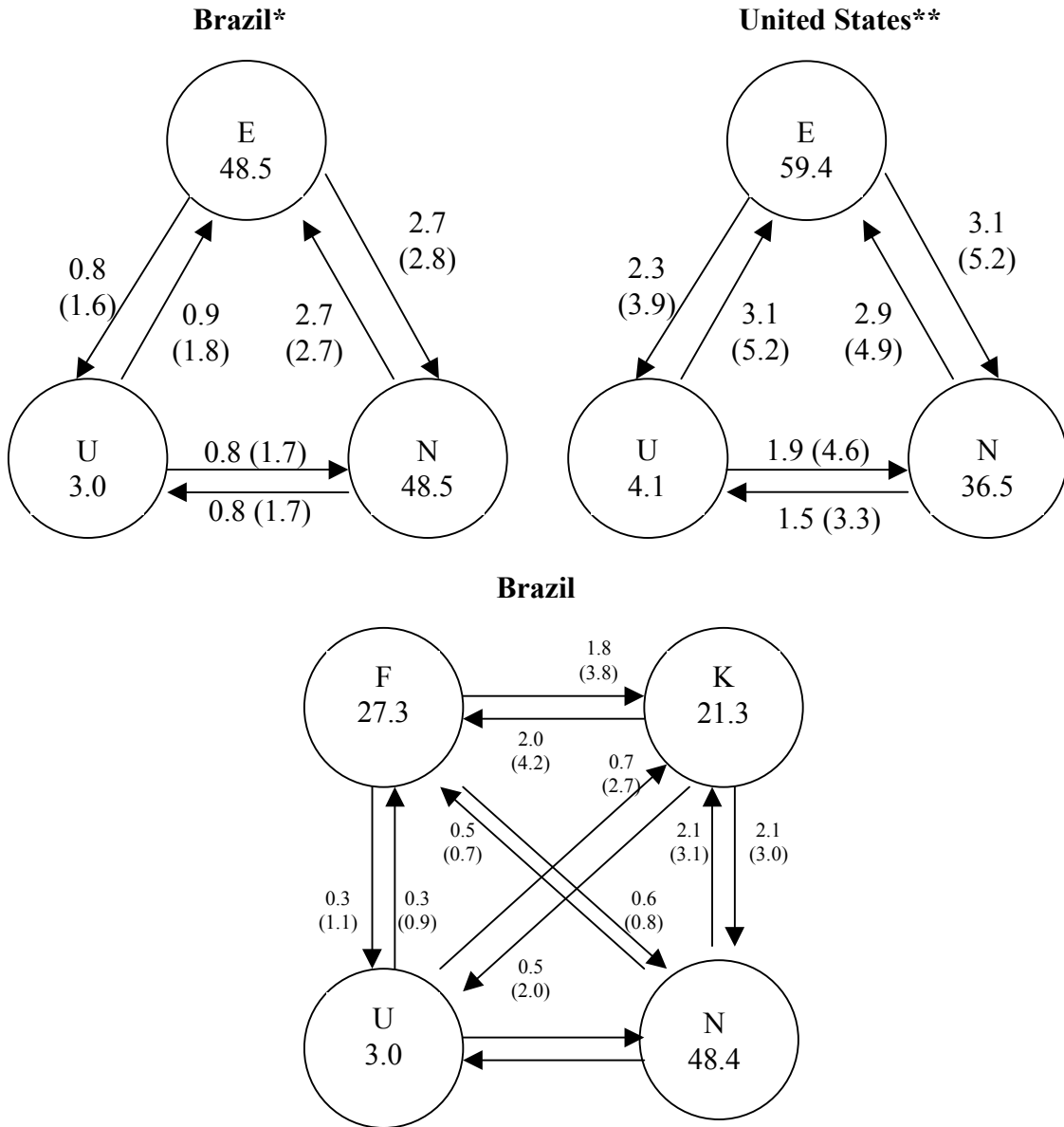

Figure 2B. The Effect of a Demand Shock on the Equilibrium Exit Rate

Figure 3. Average Stocks and Flows Between Labor Market States



Source: PME. Numbers not in parentheses are proportions of the total population. Numbers in parentheses are proportions of the source and destination pools.

*Based on data for six Brazilian cities: São Paulo, Rio de Janeiro, Salvador, Belo Horizonte, Porto Alegre, and Recife.

** Based on a figure in Blanchard and Diamond (1990).

Figure 4: Flows from unemployment to employment, formal and informal sectors, 3-quarter moving averages, Brazil, 1982-99

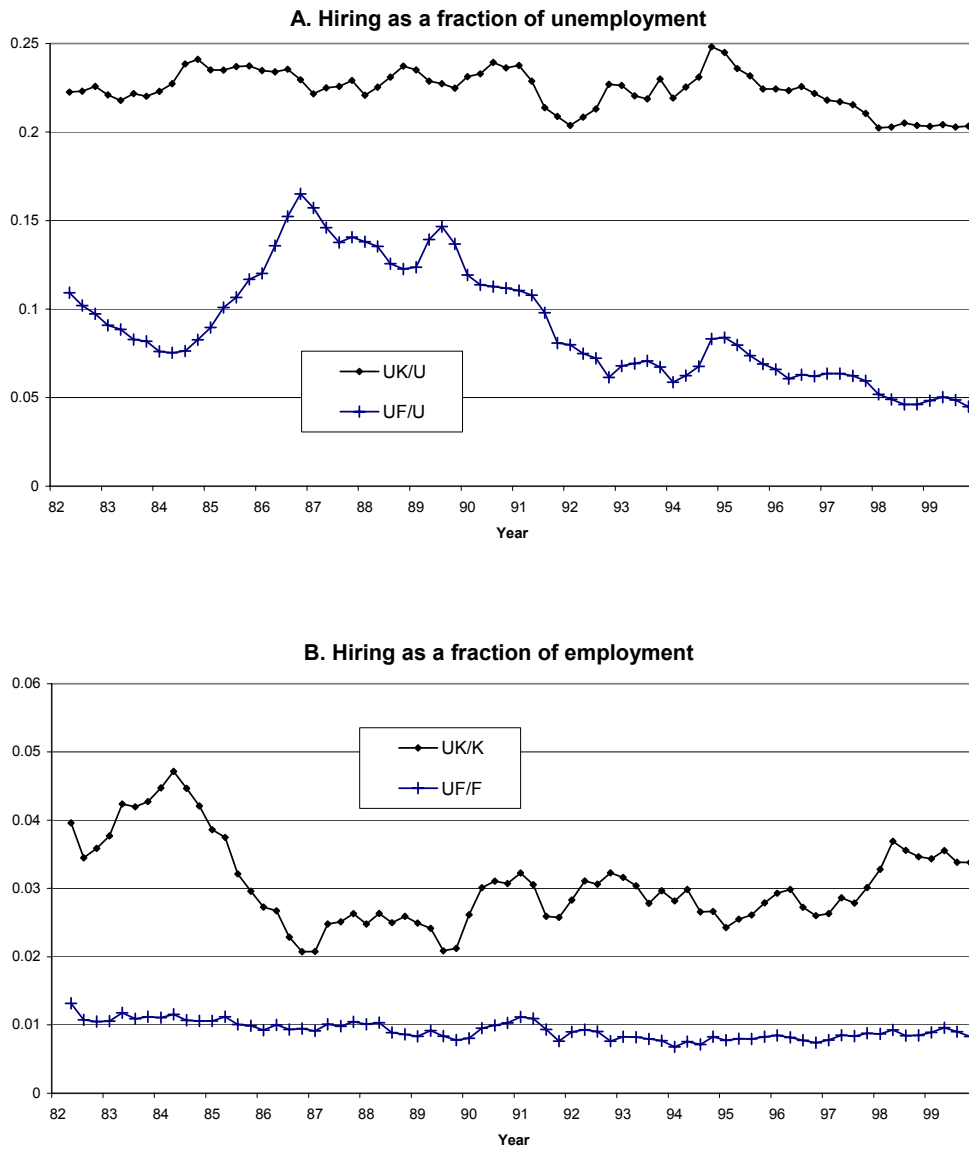

Figure 5: Flows from employment to unemployment, formal and informal sectors, 3-quarter moving averages, Brazil, 1982-99

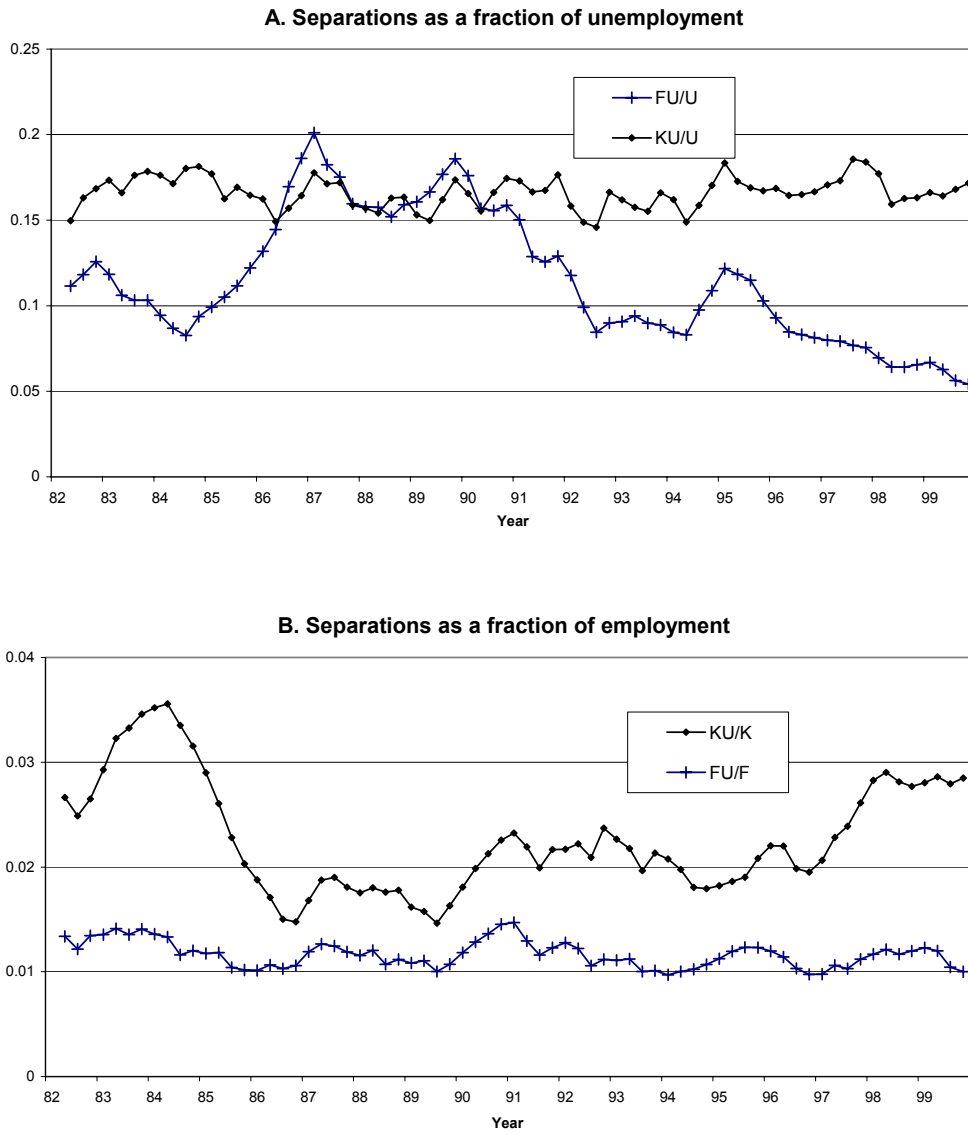
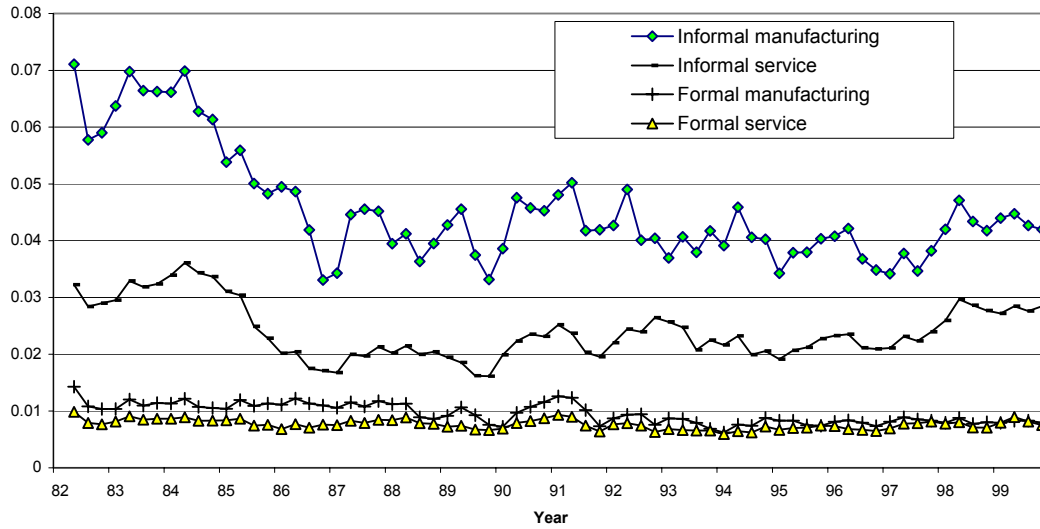

Figure 6. Hires and separations as a fraction of employment, by sector, 3-quarter moving averages, Brazil, 1982-99

A. Hiring as a fraction of employment



B. Separations as a fraction of employment

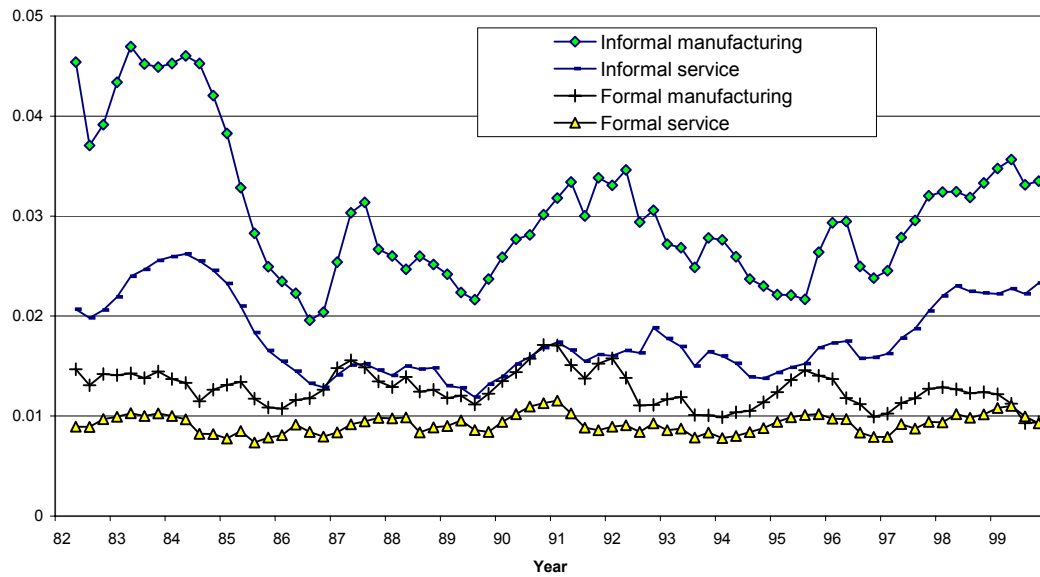
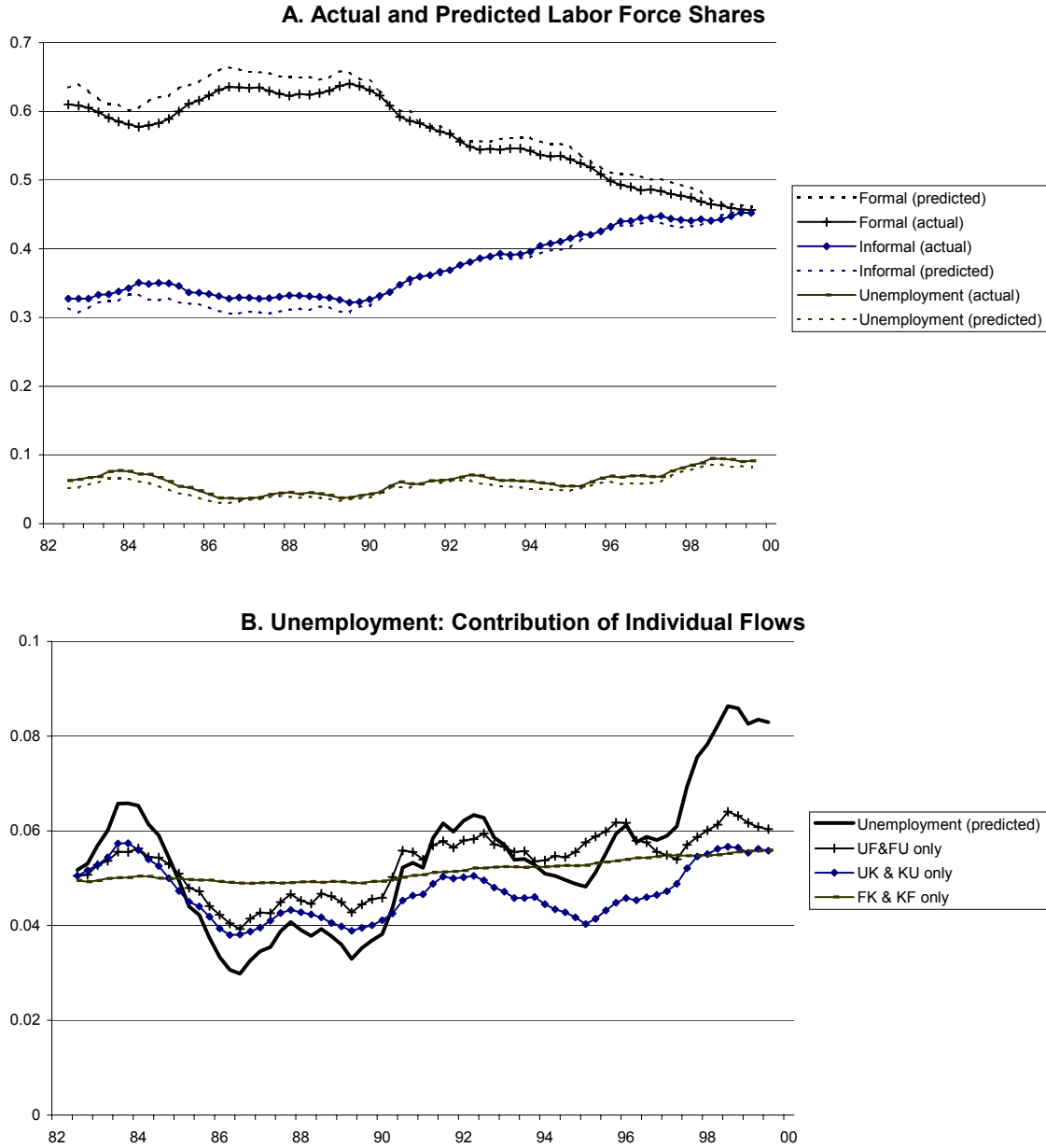
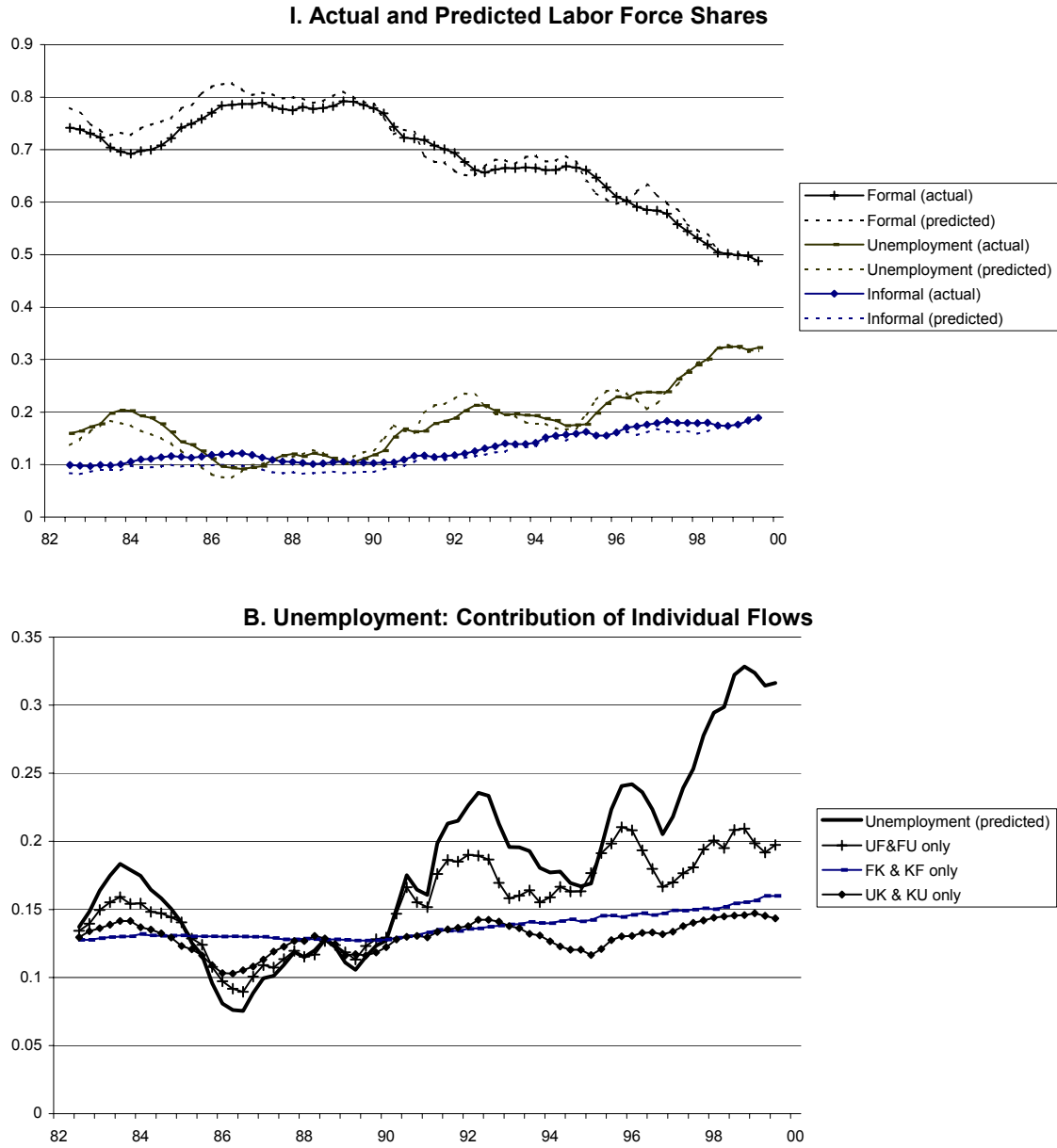

Figure 7. Counterfactual Changes in Unemployment, by Sector



F=formal employment, K=informal employment U=unemployment. Flows between states are indicated by UF, FU, UK, KU, etc. Predicted shares are those predicted by a Markov process. Counterfactual shares are calculated by holding all flows except those indicated constant at the 1982 level.

Figure 8. Counterfactual Changes in Unemployment by Type of Contract, Manufacturing Sector



F=formal employment, K=informal employment, U=unemployment. Flows between states are indicated by UF, FU, UK, KU, etc. Predicted shares are those predicted by a Markov process. Counterfactual shares are calculated by holding all flows except those indicated constant at the 1982 level.

Figure 9. Counterfactual Changes in Unemployment by Type of Contract, Service Sector

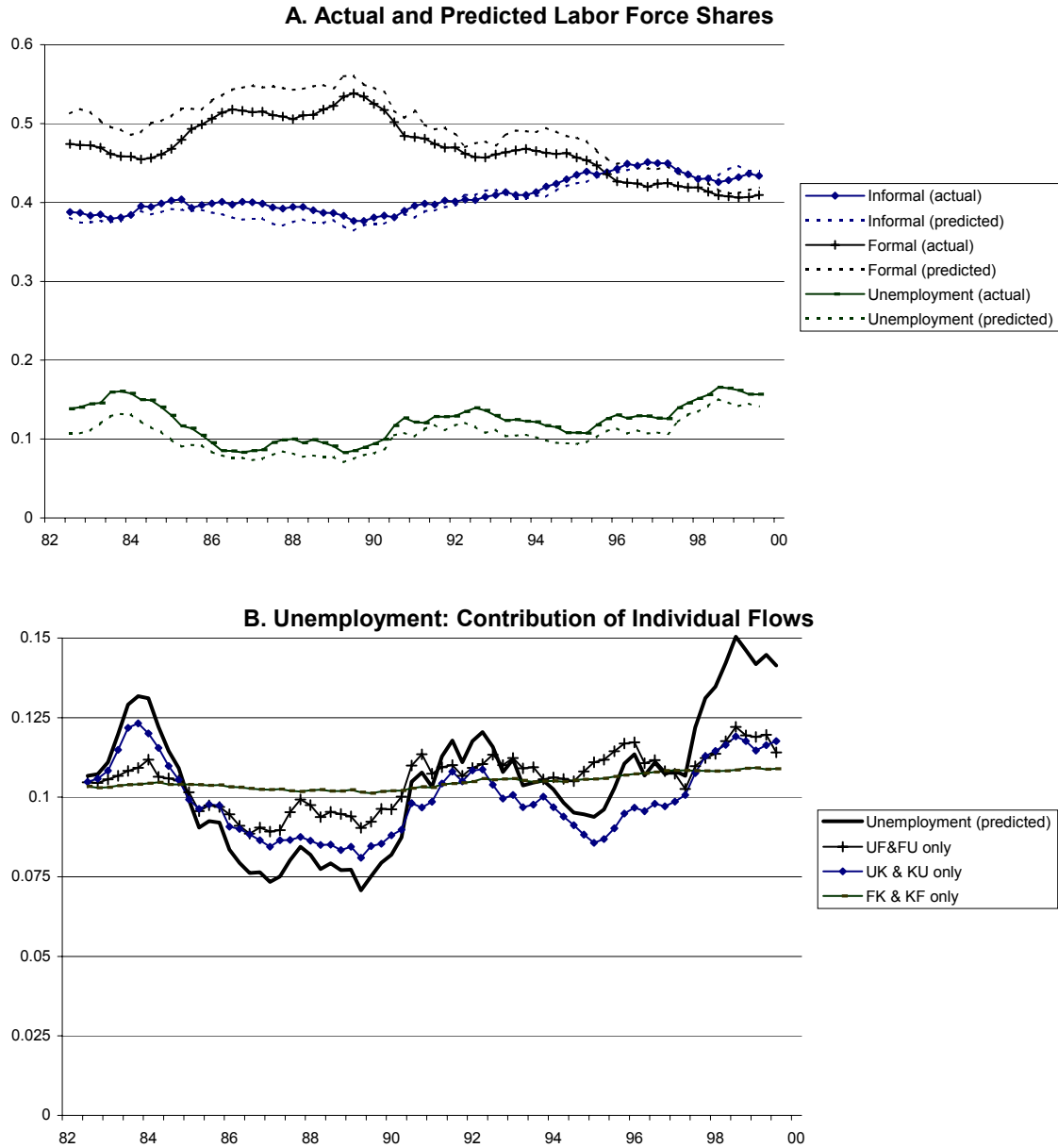

F=formal employment, K=informal employment U=unemployment. Flows between states are indicated by UF, FU, UK, KU, etc. Predicted shares are those predicted by a Markov process. Counterfactual shares are calculated by holding all flows except those indicated constant at the 1982 level.

DAVIDSON INSTITUTE WORKING PAPER SERIES - Most Recent Papers

The entire Working Paper Series may be downloaded free of charge at: www.wdi.bus.umich.edu

CURRENT AS OF 7/30/02

Publication	Authors	Date
No. 484: Labor Market Institutions and Restructuring: Evidence from Regulated and Unregulated Labor Markets in Brazil	Jasper Hoek	July 2002
No. 483: The Balassa-Samuelson effect in Central and Eastern Europe: Myth or reality?	Balázs Égert, Imed Drine, Kirsten Lommatzsch and Christophe Rault	July 2002
No. 482: Real Exchange Rates in Transition Economies	Boštjan Jazbec	July 2002
No. 481: Labor Force Participation Dynamics in the Romanian Labor Market	Alexandru Voicu	July 2002
No. 480: Equilibrium Real Exchange Rates in Central Europe's Transition Economies : Knocking on Heaven's Door	Balázs Égert	July 2002
No. 479: The Impact of Minimum Wages on Wage Inequality and Employment in the Formal and Informal Sector in Costa Rica	Fatma El-Hamidi and Katherine Terrell	Apr. 2001
No. 478: Beyond Oaxaca -Blinder: Accounting for Differences in Household Income Distributions	François Bourguignon, Francisco H. G. Ferreira and Phillippe G. Leite	Feb. 2002
No. 477: Participation Behavior of East German Women after German Unification	Holger Bonin and Rob Euwals	July 2002
No. 476: Duration and Risk of Unemployment in Argentina	Sebastian Galiani and Hugo A. Hopenhayn	Oct. 2001
No. 475: After, Before and During: Returns to Education in the Hungarian Transition	Nauro F. Campos and Dean Jolliffe	Apr. 2002
No. 474: The Locking-in Effect of Subsidized Jobs	Jan C. van Ours	June 2002
No. 473: How Reform Worked in China	Yingyi Qian	June 2002
No. 472: An Economic Perspective on Russia's Accession to the WTO	Robert M. Stern	June 2002
No. 471: The Effects of Ownership Forms and Concentration on Firm Performance after Large-Scale Privatization	Evzen Kocenda and Jan Svejnar	May 2002
No. 470: Growth in Transition: What We Know, What We Don't, and What We Should	Nauro F. Campos and Fabrizio Coricelli	Feb. 2002
No. 469: Barriers to Investment by Russian Firms: Property Protection or Credit Constraints?	Susan J. Linz	May 2002
No. 468: Job Satisfaction Among Russian Workers	Susan J. Linz	May 2002
No. 467: Assessing the Problem of Human Capital Mismatch in Transition Economies	Viliam Druska, Byeong ju Jeong, Michal Kejak, and Viatcheslav Vinogradov	Mar. 2002
No. 466: Motivating Russian Workers: Analysis of Age and Gender Differences	Susan J. Linz	Feb. 2002
No. 465: Virtual Reality: Barter and Restructuring in Russian Industry	Gary Krueger and Susan J. Linz	Apr. 2001
No. 464: Lending of Last Resort, Moral Hazard and Twin Crises: Lessons from the Bulgarian Financial Crisis 1996/1997	Michael Berlemann, Kalin Hristov and Nikolay Nenovsky	May 2002
No. 463: Deindustrialisation. Lessons from the Structural Outcomes of Post-Communist Transition	Tomasz Mickiewicz and Anna Zalewska	Jan. 2002
No. 462: Joint Liability Lending and the Rise and Fall of China's Township and Village Enterprises	Albert Park and Minggao Shen	July 2001
No. 461: A Refinancing Model of Decentralization with Empirical Evidence from China	Albert Park and Minggao Shen	Apr. 2002
No. 460: The Effects of Market Liberalization on the Relative Earnings of Chinese Women	Margaret Maurer-Fazio and James Hughes	Mar. 2002
No. 459: The Role of Education in Determining Labor Market Outcomes in Urban China's Transitional Labor Markets	Margaret Maurer-Fazio	Apr. 2002