

Visteon Low Cost Car Structural Center Pod

Senior Design and Manufacturing
Team 4

Braden Carroll
Ashley Kandt
John Taylor Leackfeldt
Stephanie Schnaith

Professor Yoram Koren
October 25, 2007

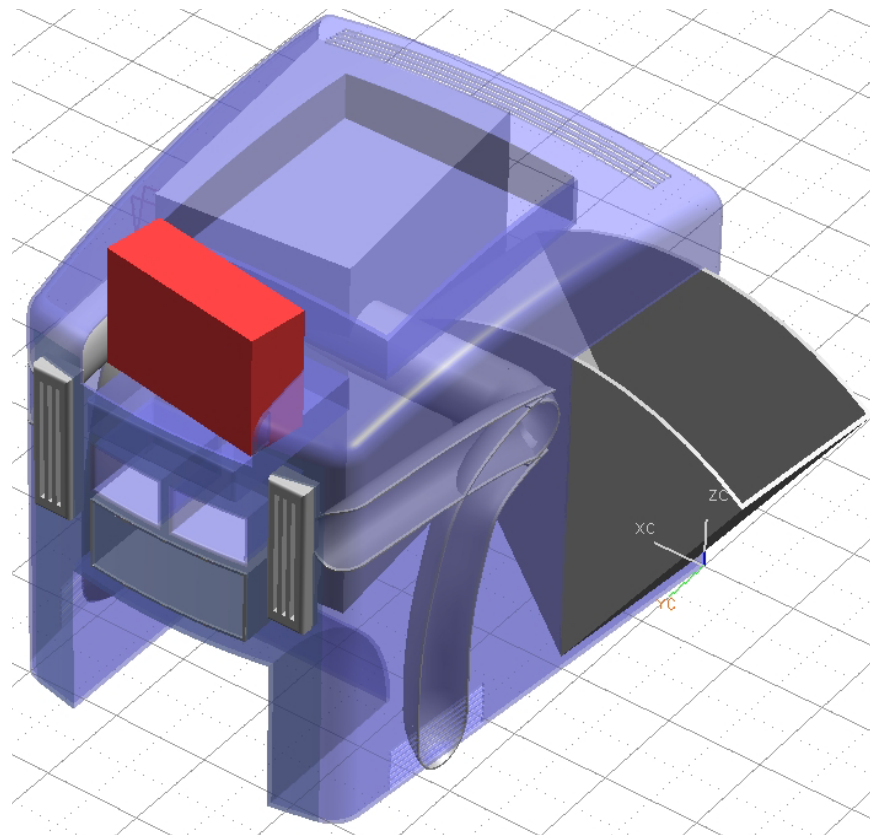

Abstract

The fastest growing market in the automotive industry is low cost cars , which Visteon has not yet entered. The low cost car market has large profit potentials, thus Visteon is looking for innovative designs in which to enter the market. For a fresh look, Visteon has asked us to design an innovative, low cost, scalable, environmentally friendly, and aesthetically pleasing center pod that has maximum storage space. Visteon has requested that we present two potential design concepts and develop one. This concept will include CAD drawings, a bill of materials, cost analysis, display boards depicting concept, and a prototype.

Table of Contents

List of Tables	iii
List of Figures	iii
1 Introduction.....	iv
1.1 Background - Low Cost Car Market.....	3
1.2 Low Cost Center Module.....	3
1.3 Motivation.....	3
1.3.1 Motivational Gap	3
1.4 Requirements - Final Outcome	5
2 Information Search.....	5
2.1 Benchmark Vehicles	5
2.2 Patents	10
2.2.1 Patent 1.....	10
2.2.2 Patent 2.....	10
2.3 Ergonomics, Aesthetics, Storage Needs	11
2.3.1 Ergonomics	11
2.3.2 Aesthetics.....	12
2.3.3 Storage Needs	12
2.4 Information Needed	12
3 Customer Requirements and Engineering Specifications.....	12
3.1 Customer Requirements.....	13
3.2 Engineering Requirements.....	13
3.3 Correlation of Customer Requirements and Engineering Requirements.....	13
3.3.1 Storage Space.....	13
3.3.2 Lighting.....	13
3.3.3 Durable.....	14
3.3.4 Aesthetically Pleasing.....	14
3.3.5 Environmentally Friendly	14
3.3.6 Low Cost.....	14
3.3.7 Scalable	15
3.3.8 Ergonomic.....	15
3.3.9 Innovative	15
3.3.10 Safe	15
3.3.11 Easily Cleaned	15
3.4 QFD Conclusion	17
4 Concept Generation	17
4.1 FAST Diagram.....	17
4.1.1 Blow Air.....	17
4.1.2 Support Structure	17
4.1.3 Display Information.....	18
4.1.4 Preserve Environment.....	18
4.1.5 Assure Durability	18
4.1.6 Assure Convenience.....	18
4.1.7 Please Senses	18
4.2 Morphological Chart.....	20
4.2.1 Blow Air.....	20

4.2.2 Support Structure	21
4.2.3 Display Information	22
4.2.4 Preserve Environment	22
4.2.5 Assure Durability	23
4.2.6 Assure Convenience	24
4.2.7 Please Senses	25
4.3 Concept Categories	29
4.3.1 Sided/Split Designs	29
4.3.2 Vent Designs	29
4.3.3 Storage Designs	30
4.3.4 Driver Interface Designs	31
4.3.5 Non-Sided/Sided Designs	32
5 Concept Evaluation and Selection	32
5.1 Designs	32
5.1.1 Design 1: Sided Design	33
5.1.2 Design 2: Non-Sided Design	34
5.1.2.1 Description	34
5.1.2.2 Background	34
5.1.2.3 Positive and Negatives	35
5.1.3 Design 3: Three Air Vent Design	36
5.2 Pugh Chart	38
6 Selected Concepts	39
6.1 Design Concept #3 Dimensions	39
6.2 Design Concept #3 Materials	40
6.2.1 Glassfibre Composites	40
6.2.2 ABS Plastic	41
6.2.3 Urethane	41
6.2.4 Support Structure Materials	42
6.3 Design Concept #3 Processes	42
6.3.1 Mold-In-Color	42
6.3.2 Injection Molding	42
6.3.3 Negative Thermoforming	42
6.3.4 Powder Slush Molding	42
6.3.5 Laminate Insert Molding	43
7 Engineering Analysis	43
7.1 Key Variables	43
7.1.1 Console/Center Pod	43
7.1.2 Driver Interface System	43
7.1.3 HVAC System	44
7.1.4 Support Structure	44
7.2 Qualitative Analysis	44
7.2.1 Design for Manufacturing and Assembly	44
7.2.2 Design for Environment	46
7.2.3 FMEA	48
7.3 Quantitative Analysis	53
7.3.1 Structural Analysis	54

7.3.2 HVAC Calculations	67
7.3.3 Thermal Expansion	73
8 Final Design	73
8.1 Description	73
8.2 Considerations.....	77
8.2.1 Condensation.....	77
8.3 Prototype	78
8.4 Bill of Materials	78
8.5 Engineering Specifications	79
9 Manufacturing and Testing Plan	79
9.1 “Mock-up” Prototype Manufacturing	79
9.2 Prototype Manufacturing	80
9.3 Mass Production Manufacturing.....	80
9.4 Testing.....	80
10 Discussion of Future Improvements	80
11 Conclusions.....	80
12 Acknowledgements.....	81
13 References.....	82
APPENDIX A: Open/Close Vent Design Concepts	83
APPENDIX B: Gantt Chart	84
Engineering Change Notice 1	85
Engineering Change Notice 2	85
Bios	86

List of Tables

Table 1: Cost Breakdown of the Low Cost Car Market.....	3
Table 2: Positive and Negatives of Center Pod Modules.....	5
Table 3: Engineering Specifications.....	16
Table 4: Structural testing specifications.....	53
Table 5: The velocities at each vent exit.....	65
Table 6: Bill of Materials.....	68
Table 7: Bill of Materials of the Production Model.....	78
Table 8: Engineering Change Notice 1: Structural Testing Specifications.....	86

List of Figures

Figure 1: Emerging Market Volume/Growth.....	4
Figure 2: BRIC Low Cost Car Market Growth.....	4
Figure 3: Motor-Vehicle Modular Dash Board Patent #6,464,281.....	10
Figure 4: Dashboard Patent #6,129,406.....	11
Figure 5: The Quality Function Development Diagram of the LCC Center Pod Module.....	16
Figure 6: FAST Diagram.....	19
Figure 7: Morphological Chart.....	26
Figure 8: Side Storage.....	29
Figure 9: Split Design.....	29
Figure 10: Fake Seam.....	29
Figure 11: Vent Concepts.....	30

Figure 12: Vents for Window/Driver/Feet.....	30
Figure 13: Side Storage.....	30
Figure 14: Front Base.....	30
Figure 15: Top Storage.....	30
Figure 16: Analog Embedded DI.....	31
Figure 17: Digital Swivel DI.....	31
Figure 18: Non-Sided.....	32
Figure 19: Sided.....	32
Figure 20: Design #1: Side Design.....	34
Figure 21: Design #2: Non-Sided Design.....	35
Figure 22: Design #3: Three Air Vent Design.....	37
Figure 23: Pugh Chart.....	38
Figure 24: Center Pod Main Outer Dimensions.....	39
Figure 25: Dimensions of HVAC.....	40
Figure 26: Mazda6 Dash Mounted Gauge Pod with ABS Plastic.....	41
Figure 27: Polyurethane Color and Grain Variability.....	41
Figure 28: This information has been removed for confidentiality reasons.....	42
Figure 29: This information has been removed for confidentiality reasons.....	43
Figure 30: Design for Injection Molding Criteria.....	45
Figure 31: Center Pod Shell with Perspective Draw Lines.....	46
Figure 32: FMEA for Body.....	48
Figure 33: FMEA for Vents	49
Figure 34: FMEA for Air Ducts.....	51
Figure 35: FMEA for HVAC Controls.....	52
Figure 36: FMEA for Side Storage.....	52
Figure 37: FMEA for Driver Interface.....	53
Figure 38: Distributed Load Applied on Noted Front Face.....	55
Figure 39: Front Face Mesh and Constraints.....	56
Figure 40: Deflection of Front Face at 44.5N.....	57
Figure 41: Stress on the Front Face Under 1000N Load	58
Figure 42: Distributed Load Applied on Noted Top Face.....	59
Figure 43: Top Face Mesh and Constraints.....	60
Figure 44: Deflection of the Top Surface under a 133N Load	61
Figure 45: Stress on Top Face Under a 1000N Load.....	62
Figure 46: Distributed Load Applied on Noted Side Face.....	63
Figure 47: Top Face Mesh and Constraints	64
Figure 48: Deflection of Side Under a 89N Load.....	65
Figure 49: Stress on Side Face Under a 310N Load.....	66
Figure 50: Duct Work Schematic	67
Figure 51: Final Design	74
Figure 52: Duct System and HVAC	75
Figure 53: Dimensions on the Front View.....	75
Figure 54: Dimensions of the Right Side view	76
Figure 55: Dimensions of the Top view	76
Figure 56: Final Design with Key Dimension	77

1 Introduction

This information has been removed for confidentiality reasons.

1.1 Background - Low Cost Car Market

This information has been removed for confidentiality reasons.

Table 1: Cost Breakdown of the Low Cost Car Market

Ultra Low Cost Car (ULCC)	< \$2500
Very Low Cost Car (VLCC)	\$2500 - \$3500
Low Cost Car (LCC)	\$3500 - \$7000

1.2 Low Cost Center Module

This information has been removed for confidentiality reasons.

1.3 Motivation

This information has been removed for confidentiality reasons.

1.3.1 Motivational Gap

This information has been removed for confidentiality reasons.

Figure 1: Emerging Market Volume/Growth

This information has been removed for confidentiality reasons.

Figure 2: BRIC Low Cost Car Market Growth

This information has been removed for confidentiality reasons.

1.4 Requirements - Final Outcome

By the end of the semester, a design will be developed that meets at least a 50% manufacturing feasibility level on component packaging, innovative storage, and unique interior lighting. The final design will be modeled with CAD level concept drawings. It has also been requested that a high level bill of materials, cost analysis, display boards, and a prototype be completed.



2 Information Search

This information has been removed for confidentiality reasons.

2.1 Benchmark Vehicles

After researching the different vehicles, it was enlightening to determine the type of function and look that should be obtained and overcome at the same prices. The different vehicles that have been researched and used as benchmarks are shown below in Table 2.

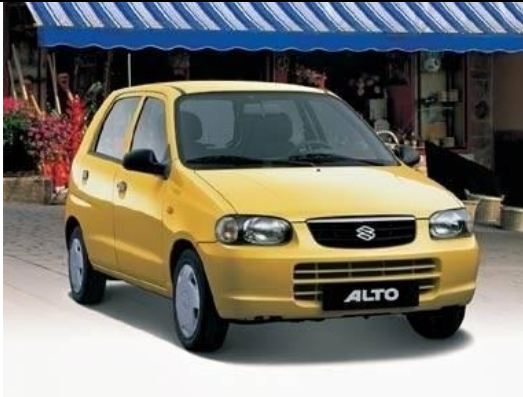
Table 2: Positive and Negatives of Center Pod Modules

Maruti Suzuki Alto (\$3,800)	
<p><u>Pros</u> – The price of the vehicle is extremely low and lends itself to people who would otherwise be on a motorcycle. This vehicle increases their capacity of carrying people, groceries, and things. The Alto contains many luxuries of a car outside of the low cost car market including a locally fitted AM/FM (88-108 Full range) radio cassette with 2 speakers, electronic multi trip meter, and an air conditioner/heater.</p>	<p><u>Cons</u> – The interior lacks aesthetics. The center pod is simply a rectangle with all the units stacked with little storage available. There is minimal storage compared to other vehicles in its class.</p>
	

Chevrolet Spark
(\$4,250)

Pros – This low cost vehicle was able to increase passenger space, while making an aesthetically pleasing center pod module. The silver accent gives the center pod a sporty look, and the circular vents are aesthetically pleasing according to the art department. The center pod maintains an overall symmetrical look, which is also pleasing to the eye. The centered driver interface is ergonomically friendly, allowing a driver to not have to look down to see their speedometer or look through their steering wheel. The rounded corners on the center pod module soften the look and make it more pleasing to view.

Cons – The Chevrolet Spark’s center pod module appears to lack much useful storage space. Although the center pod looks good, an important aspect to the low cost vehicles in the BRIC market is that they can transport a lot of material. Overall, the center pod has been designed well, but it simply needs more innovative storage space.



Maruti 800

(\$4,500)

<http://www.amwltd.com/maruti/pdf/800.pdf>

Pros –The interior has a dual color scheme, which enhances its aesthetics. There is extra storage space by creating space above the glove box and center air vents. They have been able to maintain four air vents across the dashboard to increase the climate comfort within the vehicle.

Cons – The interior has low quality upholstery, and the car interior is dark and bland. The unit appears to have its components placed randomly with no organization, which is not aesthetically pleasing. There is a lot of storage space, but because the shelves are open, items could fall. The price of this unit is low, but the quality of the interiors suffered greatly on account of cost.



**Renault Logan
(\$6,560-\$7,870)**

Pros – The Logan was able to meet the cost requirements of the low-cost car market. There were 248,000 Logans sold last year with an estimated production boost of 900,000 to 1 million units by 2009. The interior, which is shown below, appears to have been designed non-sided; meaning it the center pod module would work for a right-sided or left-sided drive. They have four vents across the front and defrost units closer to the windshield. It is interesting to see that they were able to have a detached driver interface and still maintain a low cost car selling price.

Cons – In the upgraded form of the Renault Logan, the cost superseded the low-cost car market ideal cost limit. The interior, which is shown below, is very bland with minimal aesthetics. It looks as though they tried to add storage above the glove box, but due to all the pot holes in the India's roads, it would be hard to use that storage space.



Suzuki Swift
(\$18,000)

Pros – The Suzuki Swift is aesthetically pleasing with the sporty look. The vehicle has a digital interface in its center pod module and a symmetric look, which would allow it to be non-sided. The accents of silver increase the look of the car by introducing contrast.

Cons – Although the interior has an overall aesthetically pleasing look, the specific units within the center pod module lack innovation. The vents are far from aesthetically pleasing, and they could use some silver accents or a better overall shape. The radio screen appears to be floating in the middle of the center pod, and the driver interface is not in an ergonomically friendly position.



After completing research on what has already been done, it was interesting to research different vehicles in the pipeline. Toyota has been doing research on the market demands of the different countries, and has decided that it might not be possible to create one basic model for all the countries and meet each market need. As of now, they continue to try to develop a basic model for all countries that will allow them to build on it to meet the needs of different countries.

2.2 Patents

A patent search was completed to ensure that we do not “re-invent the wheel” and to help gather ideas and inspire thought of new designs. It is also important to make sure we do not infringe on any current patents.

2.2.1 Patent 1

A similar idea is shown in Fig. 3, Pg.10, the Motor-Vehicle Modular Dash Board Patent #6,464,281. The patent shows a module design which allows for the dashboard to be customized for numerous different applications. The positive behind this design is that it enables one basic platform upon which many different designs arise, which may lower the manufacturing costs overall. This is a great idea for the BRIC market because as Toyota is researching, maybe not all markets of different countries can be met by one low cost vehicle design. Additionally it may increase the ease of assembly. The negative of using a design along these lines is that it may cost more for individual vehicles based on the materials that would need to be used to implement this design and make it self-supporting.

Figure 3: Motor-Vehicle Modular Dash Board Patent #6,464,281

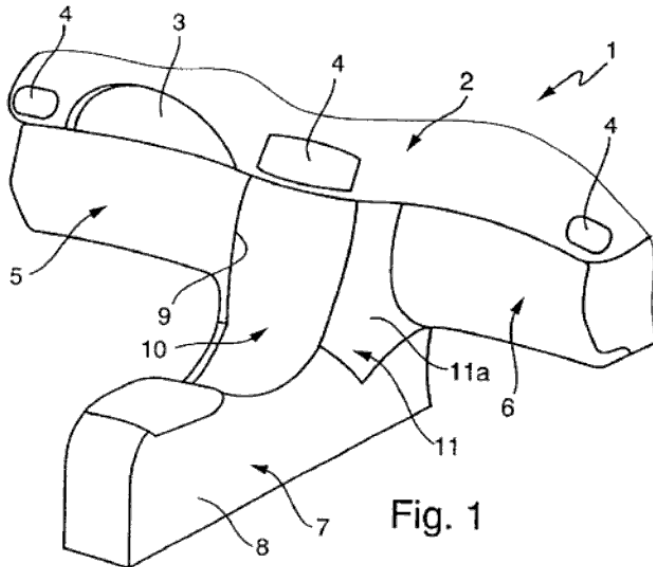

2.2.2 Patent 2

This information has been removed for confidentiality reasons.

Figure 4: Dashboard Patent #6,129,406

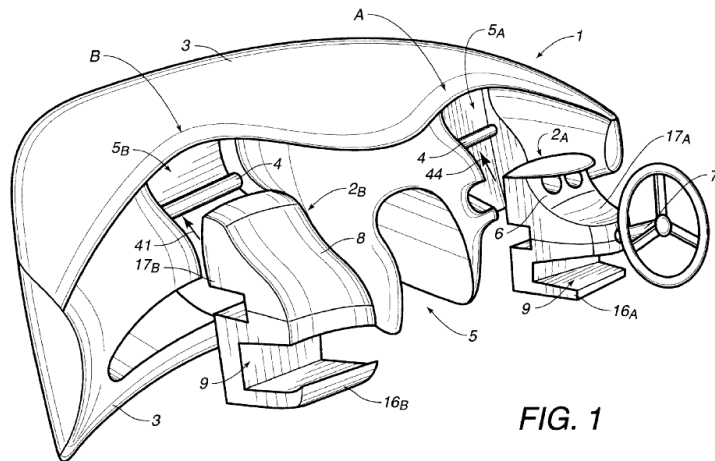

2.3 Ergonomics, Aesthetics, Storage Needs

In order to actually design the center pod module, ergonomics, aesthetics, and items to be carried must be studied. The correct placement of the components within the center pod module will be dictated by the ergonomics. The way to shape and color the center pod will be dictated by aesthetics guidelines, and market research will determine the type of storage the center pod module should have available.

2.3.1 Ergonomics

The ergonomics behind the placement of the components is based on the primary visual area (PVA), the stimulus-response compatibility, and display relatedness or sequence of use.

2.3.1.1 PVA

The PVA is the region of forward view as the head and eyes look straight forward. It is the best ergonomic practice to place the most frequently used instrument at the top and center part of the driver's view, so they do not have to take their eyes far from the road. Likewise, it is the next best practice to place the next most frequently used applications adjacent to the PVA. In the design of the center pod module, that would be the Driver Interface.

2.3.1.2 Stimulus-response Compatibility

Stimulus-response compatibility dictates that displays should be close to their associated controls and clutter avoidance, which dictates that ideally there should be a minimum visual angle between all pairs of display. In the center pod module, it would be ideal if the controls of all the different components were aligned in an orderly fashion opposed to a spread out scattered look.

2.3.1.3 Display Relatedness

Display relatedness of sequence of use states that related displays and those pairs that are often used in sequence should be close together. During the placement of our

components will have to understand common motion trends of the normal driver to better assess this ergonomic concern.

2.3.2 Aesthetics

This information has been removed for confidentiality reasons.

2.3.3 Storage Needs

In the countries of the BRIC market, many possible items may be carried and stored in the low cost cars. Specifically, there must be available generic storage spaces that would accommodate cell phones, umbrellas, articles of clothing, articles that will block the sun, groceries, purses, or any other item the user carries.

2.4 Information Needed

This information has been removed for confidentiality reasons.

3 Customer Requirements and Engineering Specifications

This information has been removed for confidentiality reasons.

3.1 Customer Requirements

Looking at the competition that already exists in Brazil, Russia, India, and China, and the market data, it was evident that automotive companies will want a low cost interior that maximizes storage space because the market calls for the ability to transport goods with their vehicles. It is important that the interior be durable and easily cleaned. If the interiors could be designed so that one basic design would work for all three tiers of the car market due to modularity, the cost of manufacturing could be decreased. Additionally, a lighting scheme of LEDs is a focus of the aesthetically pleasing requirement of the customer. Lastly, it is important to the driver of the vehicle that the center pod module be ergonomic and safe to use. All of the customer requirements listed above are shown in the QFD in Fig.5, Pg.16.

3.2 Engineering Requirements

The engineering specifications were determined from benchmarking of current cars as well as other constraints. The engineering specifications require that the material used must be environmentally friendly. Additionally, the design must maintain a certain size, weight, storage space, personal space, reach distance, number of configurations, number of LED lights, number of vents, and cost. The numbers associated with each characteristic of the center pod module are shown in Table 3, Pg.16.

3.3 Correlation of Customer Requirements and Engineering Requirements

3.3.1 Storage Space

The storage space is required to house items such as umbrellas, clothing, cell phones, and food. The engineering specifications that correlate with storage are size, weight personal space, number of configurations, and cost. As the size of the module increases, the storage space can increase. As the storage increases, the weight of the center pod increases. As the personal space increases, the storage space decreases. As the number of configurations change, the storage space will change due to adding and subtracting components. As the storage increases, the cost increases due to the increased material needed for the increased surface area.

3.3.2 Lighting

As a way to see the components within the center pod module at night and simply as a way to make the center pod aesthetically pleasing, a customer requirement was lighting. An efficient and cheap way to accomplish lighting is through the use of LEDs. A strong relation is found between lighting and the number of lights because as the number of lights increase, the lighting increases. Additionally as the configuration changes, the lighting may change, resulting in a low rating correlation between the number of configurations and lighting. Lastly, as the lighting is implemented in the center pod module, the cost of the center pod will increase.

3.3.3 Durable

It is important that the center pod be durable under pot-hole road conditions. The engineering specification that has the most prominent direct correlation is material density. The higher the density is, the more durable the material. Cost and weight have weaker correlations, but as the durability increases, so does the weight. The more durable the material, the more costly they become.

3.3.4 Aesthetically Pleasing

The customer wants a functional center pod module, but they also want it to look good. The most direct correlation of this customer requirement and an engineering specification is the number of lights. Lights can dramatically change the look of an interior, thus if the number of lights is increased, and more items are illuminated, the more aesthetically pleasing the center pod module becomes. Additionally, there is a weak correlation between aesthetically pleasing and personal space, cost, and number of vents. The personal space is related to aesthetics because it is more pleasing to the senses to sit somewhere spacious. The cost is related to aesthetics customer because as colors are added or different materials, the cost increases. Lastly, the number of vents is related because symmetry is more pleasing to the eye than not; therefore, an even number of vents would probably be more aesthetically pleasing than an odd number depending on the design.

3.3.5 Environmentally Friendly

This information has been removed for confidentiality reasons.

3.3.6 Low Cost

Low cost is related to many engineering specifications. It correlates to material density, size, number of configurations, number of lights, number of vents, and cost. As a material becomes more ideal with yielding a strong material that is light weight, the cost increases. As the size increases, the cost increases, thus they have a positive correlation. As the number of configurations increase, the cost may decrease due to one design working for many different vehicles. As the number of lights, number of vents, and cost increase, so does the cost of the vehicle.

3.3.7 Scalable

If a customer would want a scalable vehicle, then the engineering requirements that would have to be taken into consideration are size, weight, number of configurations, number of vents, and cost. For a center pod to have the ability to be scaled up with more options, the basic model must be large enough to accommodate and house additional components. As the unit is scaled, the weight of the unit will be increased, and also as the size is increased to allow for a scalable unit, the weight of the unit increases. For a basic model to be scalable there must be a number of configurations that yield increased functionality and luxury as a customer pays more. Something being taken into consideration is increasing the number of vents as a model is scaled for increased HVAC performance. Lastly, making a model scalable will correlate to cost because as the unit becomes bigger to accommodate the scalable features, the cost will rise.

3.3.8 Ergonomic

It is a customer requirement that it must be ergonomic, and ergonomics relates to reach distance and size. As the size increases, the reach distance decreases, and the ergonomics will have an ideal reach distance.

3.3.9 Innovative

To make the unit competitive, it must be innovative, and the innovation of the unit correlates to size, personal space, storage space, and number of configurations. In the design process, we will be trying to maximize personal space, storage space, and number of configurations while minimizing size.

3.3.10 Safe

Anytime people are involved, there is the concept of safety. It is important that safety requirements be met within the countries that the center pods will be sold. Safety is directly correlated to the material density, size, reach distance, and cost.

3.3.11 Easily Cleaned

In order to design a center pod that is easily cleaned the storage space must be designed so that all surfaces can be cleaned with a cleaning mechanism. Additionally, every configuration must be easily cleaned, so the number of configurations is also important.

Figure 5: The Quality Function Development Diagram of the Low Cost Car Center Pod Module

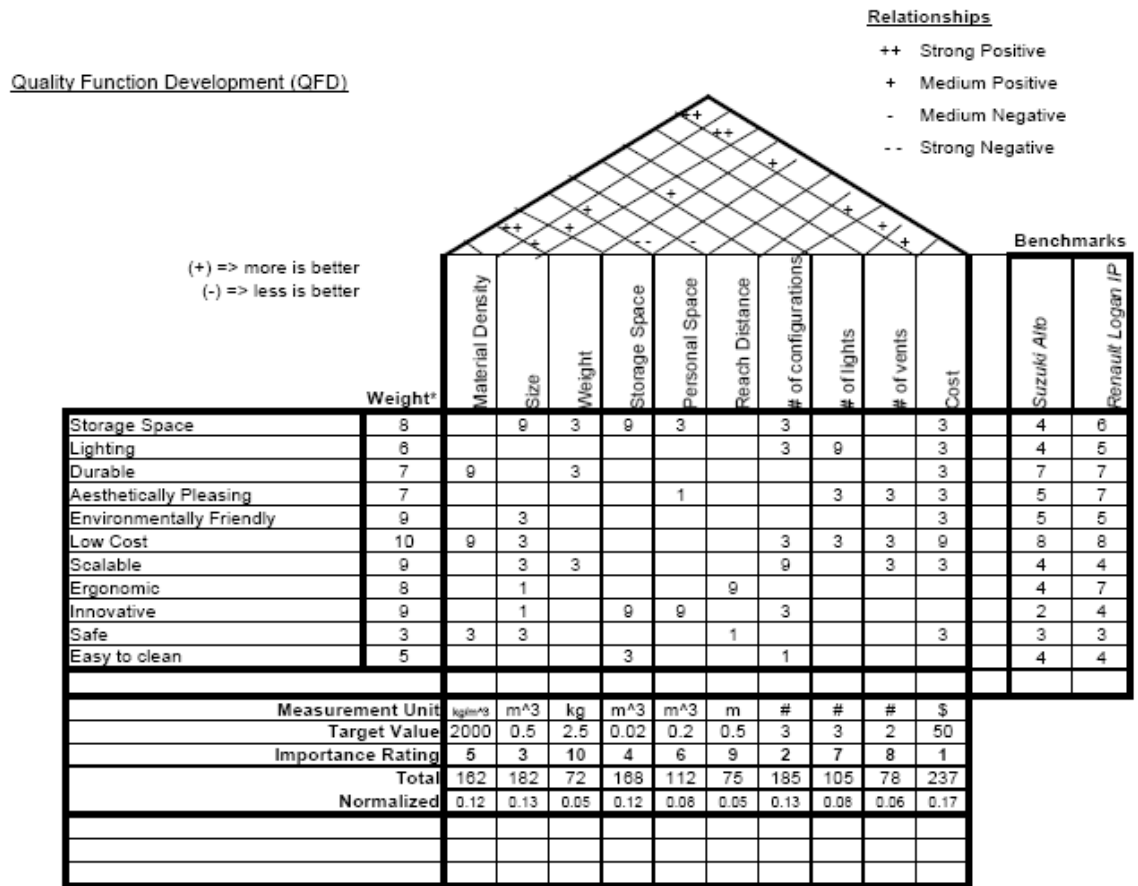

Key:
 9 => Strong Relationship
 3 => Medium Relationship
 1 => Small Relationship
 (blank) => Not Related

*Weights are figured on a scale of 1 to 10
 (ten being most important)

Table 3: Engineering Specifications

Cost	50 (\$)
Number of Configurations	3 (#)
Size	0.05 (m ³)
Material Density	20 (kg/m ³)
Number of Lights	3 (#)
Storage Space	0.02 (m ³)
Number of Vents	2 (#)
Reach Distance	0.5 (m)
Weight	2.5 (kg)
Personal Space	0.2 (m ³)

3.4 QFD Conclusion

After all customer requirements were correctly weighted with the engineering specifications, it was determined that the cost was the most important engineering specification with number of configurations at the second most important, and size was third. As we continue in the design process, we will keep referring back to this QFD to ensure that we have kept on track with our customer and engineering requirements.

4 Concept Generation

The concept generation process started with the creation of a Functional Analysis Systems Technique (FAST) diagram to identify the important functions of our center module. A morphological chart was generated to show engineering solutions to each necessary function, which ranged from possible to obviously infeasible. The most important functions were then investigated further.

4.1 FAST Diagram

To begin brainstorming design ideas for the inner console, we first looked at the Quality Function Development Diagram (QFD), which included the customer requirements and engineering specifications. Keeping these requirements in mind, a FAST diagram was created to identify and define the functions for the low cost car center module, as seen in Fig. 6, Pg. 19. The main task function of the FAST diagram is providing function to the driver for a low cost car, which can be broken down into the components which follow.

4.1.1 Blow Air

An essential function of an automotive interior is climate control, which can be broken into four major sub functions. The HVAC system, which drives airflow and provides heating and cooling, must be housed and secured inside the main body of the module. The HVAC system must also be controlled with a user input. An orifice through which air travels must be a shape that best promotes strong flow. Finally, a system of innovative vents must be designed in order to provide directionality to flow.

4.1.2 Support Structure

In order for any other system contained in the center module to be functional, the center pod module must contain a structure to support all necessary components. This structure has the two very important sub functions. First, it must provide stability to the system during everyday road driving and in crash situations. Also, it must be able to maintain shape against lateral and torsion forces applied while driving. Lastly, the module must be able to withstand the forces imposed by the user.

4.1.3 Display Information

An important component of the center module is the driver interface display (DI), which contains some combination of the speedometer, tachometer, odometer, and fuel gauge. In order to promote safety and ergonomics, the DI must be positioned in a location that does not require excessive head turning. Steps also must be taken to reduce glare on the gauge faces to provide visibility in all lighting conditions.

4.1.4 Preserve Environment

This information has been removed for confidentiality reasons.

4.1.5 Assure Durability

Despite low cost, we want our center module design to maintain durability through the wear and tear of everyday use. In order to accomplish this, we will design our concepts for maximum possible lifetime. Another important sub function of durability is the minimization of vibrations, which will prevent fatigue failure due to repeated use.

4.1.6 Assure Convenience

Customer convenience is an essential main function of our design, as it directly influences customer satisfaction and sales. Important sub functions which affect convenience are driver reach, convenient component placement, and storage. In order to ensure that there is an appropriate driver reach, an ergonomic standard for an average reach will be utilized in design of the center pod. The component placement will be determined using the ergonomic principles stated in the Information Search. Lastly, the storage will be designed to carry items like umbrellas, articles of clothing, items to protect people from the sun, and cell phones.

4.1.7 Please Senses

Pleasing the senses of our customers is very important. By combining all components into an aesthetically pleasing package with innovative lighting, we can separate ourselves from the existing competition in BRIC nations. Hidden storage will add functionality while creating a cleaner, less cluttered design. Finally, an ergonomic design will contribute to driver comfort, as well as both the long and short term safety of our customers.

Figure 6: FAST Diagram

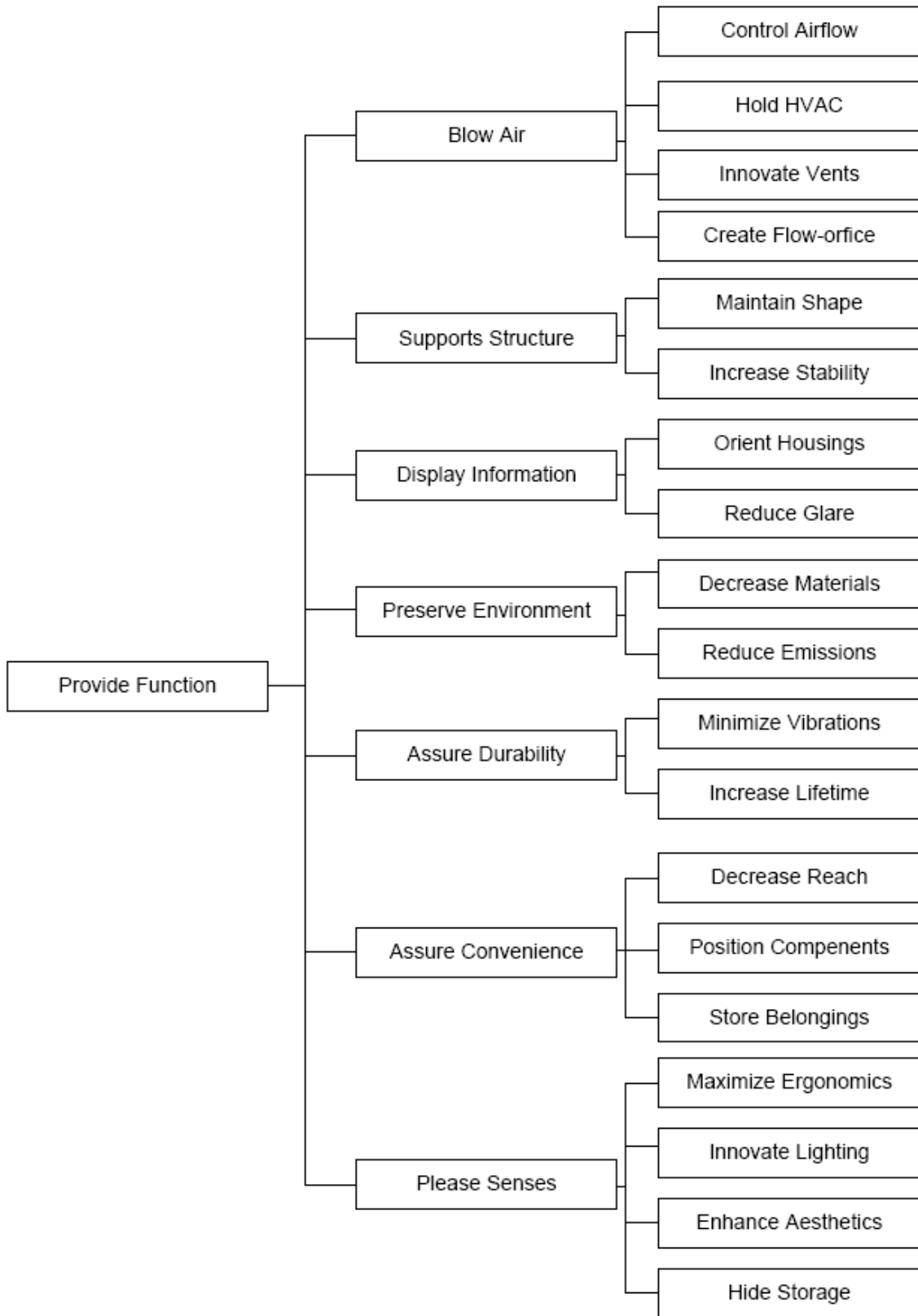

4.2 Morphological Chart

Once the main and sub functions of the center module were identified in the FAST diagram, we created a morphological chart, seen in Fig. 7, Pg. 26, to map the various concepts for each component of our design. By arranging all facets of our design in one chart, decisions can be made to narrow our scope down to three concepts.

4.2.1 Blow Air

The blow air function incorporates all the components of the HVAC system. This includes a way of controlling the airflow, housing the HVAC unit, creating innovative vents and flow orifices.

4.2.1.1 Control Airflow

An essential component of the climate control system is the control panel. According to our market research, two different methods currently exist for control of the HVAC. In an effort to not reinvent the wheel, we have decided to choose between these methods. The first is an inline interface with a linear knob which controls the HVAC. While easy to use and functional, it is not space effective or visually appealing. The second available method is a circular knob, which is both aesthetically pleasing and space effective. However, the gauge on a circular knob is harder to read at a quick glance, which could cause issues in safety and ergonomics.

4.2.1.2 House HVAC

It is a design requirement that the HVAC climate control system be housed within the center module. The location of the HVAC within our design is not specified by the engineering constraints, which allows us to shift the system to minimize wasted space. Specifically, we have narrowed HVAC placement to three main concepts: left justified, centered, and right justified. By justifying to the left side of the module, space is freed for possible use as a storage drawer in left-side drive automobiles. Also, justifying to the right creates usable space on the left for right-side drive automobiles. The downside to justifying the HVAC to either side of the center module is that it constrains our design to use in either left or right-side drive, depending on placement. Centered design allows for use in either drive setup, but creates wasted space inside the center module that is not large enough for storage.

4.2.1.3 Innovate Vents

Vents are a vital part of the climate control system, affecting both flow rate and dispersal throughout the interior of the car. We have designed several innovative vent concepts to improve functionality and reduce cost. Slider vents can direct air either out into the cockpit or up at the windshield by use of a sliding piece of plastic which opens a hole at either the bottom or top of a track. These vents are cheap, functional, and aesthetically pleasing, but may cause issues with dispersal of air, as they do not add directionality to flow. Turrets can provide air flow both to the cockpit and windshield by rotating around a center axis. While they provide good directionality, they are not aesthetically pleasing. Flip vents work much like slider vents, but redirect air by flipping a piece of plastic to block flow to either the cockpit or windshield. They are innovative and functional, but could prove too costly for our design. A three vent zone design would provide airflow to driver, windshield, and floor. It gives the fullest coverage of any of our designs, but will come at a higher cost as well. Our final design concept is a single large vent that provides flow to cockpit and windshield at a low cost, but is not aesthetically pleasing.

4.2.1.4 Create Orifice

Between the HVAC system and the vents, we need to design a duct system that effectively transmits air for steady flow. Our current conceptual designs include ducts that are circular, oval, square, and rectangular. In order to select the best working design, flow analysis will need to be completed.

4.2.2 Support Structure

The support structure is needed to allow us to maintain shape and increase the stability.

4.2.2.1 Maintain Shape

An essential function of our center module is maintenance of shape in everyday driving. In order to accomplish this, we created three designs: a built in plastic substructure, a thicker walled module, and a design that uses aesthetic metal for increased rigidity. All three will accomplish the task. In order to decide upon the best design, further investigations of strength and cost needs to be done.

4.2.2.2 Increase Stability

In order to increase stability against lateral and torsion forces, we have created four conceptual structural designs. The first two involve the creation of a metal substructure which will support the module from the inside through a series of either parallel or cross bars. As previously seen above, our third design uses a thicker layer of plastic to improve stability and strength. Finally, the use of a lightweight and aesthetic metal would vastly improve strength, but at the expense of possible additional cost. As with the maintaining of shape above, we will need to examine the relationship between improved stability, cost and space consumption in order to decide on a concept for our final design.

4.2.3 Display Information

To display necessary driver information we need to orient the driver interface housing properly and reduce the glare.

4.2.3.1 Orient Housing

Placement of the DI is critical for both safety and ergonomics of our design. We decided on three possible locations. A top mounted DI would exist directly in the driver's line of sight, while also freeing up space on the face of the module. A front mounted DI is more aesthetically pleasing and allows for top storage as well, but takes up space on the front of the module that could be used for storage and other components. Either of these designs could be biased to either side in a one-sided drive vehicle to improve ergonomics, but cannot be used very well in both-side drive automobiles. A swivel mount, however, can be rotated to support drive on either side, but is not aesthetically pleasing and may obstruct vision depending on height of the driver.

4.2.3.2 Reduce Glare

Once the DI is properly oriented on the center module, steps must be taken to reduce glare on the glass face of the gauges. This can be accomplished in two different ways. An embedded DI can be set back into the face of the center module, shading the gauges from the sun. This method will reduce glare in an easy and cost effective way and will also reduce wasted space within our design. However, it can only be used for front embedded designs, which decreases our options for top and swivel mounted concepts. A second method is the use of a hood which shades the face of the DI from glare. This design is harder to accomplish and takes more material, but is aesthetically pleasing and can be used in all three DI placements. In order to decide which method is the best to move forward with, aesthetics will need to be weighed against functionality to pick the best design.

4.2.4 Preserve Environment

Decreasing materials and reducing emissions are an important way to preserve the environment.

4.2.4.1 Decrease Materials

In our morphological chart, we highlighted two main ways of decreasing the materials in our design. The first is to produce a center module with the thinnest possible walls. However, many of the methods we discussed earlier for structural support involve adding material. A good balance must be met in order for our concept to be successful. Also, by maximizing storage space, we reduce the total amount of material used by utilizing wasted space.

4.2.4.2 Reduce Emissions

The easier way to help keep our design green is through reduced emissions in manufacturing, which can be accomplished by choosing green manufacturing methods and materials whose production is not harmful to the environment. Also, by using recyclable materials, we can help preserve the environment after the car is eventually scrapped. The biggest downside to reducing emissions is the added cost associated with green manufacturing processes and materials.

4.2.5 Assure Durability

In order to maintain a high quality, durability is very important. To ensure our product is durable we must minimize vibrations and increase the part lifetime.

4.2.5.1 Minimize Vibrations

Minimizing vibration of the center module in everyday driving situations is essential to durability and long life. Our first concept design adds springs to the body of the module in order to dampen vibration, much like an automobile suspension. Choosing the right spring stiffness will be important to the success of this concept, as the wrong spring could increase vibrations. A similar, yet easier and cheaper, way to accomplish this task would be through rubber washers which would attach the module to ground. Rubber is far cheaper than metal. Our final two concepts involve material choice. By choosing a material with higher mass, vibrations would have less effect on the module. This concept would also increase strength, which will have a positive effect on stability and maintenance of shape. On the other hand, a higher density material will likely cost more and added mass may negatively affect our goal for low net weight. Finally, a softer material could be used to decrease vibrations. This could reduce both cost and weight, but will detract from stability, lifetime, and maintenance of shape.

4.2.5.2 Increase Lifetime

Long lifetime is an important function of our design, as it directly impacts customer satisfaction for our product. We decided upon three concepts for increasing the lifetime of our center module. More material, while a hindrance to cost and weight constraints, will increase strength and time to fatigue failure. A bigger module will also accomplish this task, but will be difficult to design within our size limit. A harder material, though an excellent way to increase lifetime, would cause more vibrations, higher cost, and would be a detriment to safety in collisions.

4.2.6 Assure Convenience

To please the user we need to assure convenience by decreasing reach distance, properly placing components, and storing belongings effectively.

4.2.6.1 Decrease Reach

Decreasing the reach distance to frequently utilized components is an important function that affects both convenience and ergonomics. By shifting important components, such as HVAC controls, to the left towards the driver, more function can be placed within natural reach. Therefore, long awkward motions reaching for controls outside normal reach will be avoided. Additionally, it is good ergonomic practice to place frequently used components close to user to minimize time that they use to navigate their center pod interface. However, shifting important components to the left constrains the car to use only in left-side drive countries.

4.2.6.2 Place Components

Placement of components also effects ergonomics and reach distance. We placed 5 different arrangements of components in our morphological chart, some of which make appearances in different forms in our final concepts, as seen later in this report. According to good ergonomic practice, it is ideal to keep components that require user input to be in or adjacent to their primary visual area. As it is stated in the information search, the primary visual area the user can see as they look forward and drive. Placing the driver interface at the top of the center pod module is ergonomically correct because it places it adjacent to the primary visual area. Likewise, based on frequency of use, the other components will be places as close to the primary visual area as possible. Within the center pod module, it is also important to follow the display relatedness principle of ergonomics. Display relatedness of sequence of use states that related displays and those pairs that are often used in sequence should be close together. This principle will be investigated as the components are placed.

4.2.6.3 Store Belongings

This information has been removed for confidentiality reasons.

4.2.7 Please Senses

Pleasing senses will allow us to sell the product. By maximizing ergonomics, using lighting, enhancing the aesthetics, and hiding the storage we can please the users senses.

4.2.7.1 Maximize Ergonomics

Ergonomic design involves many factors which are integral to our design and is covered in many of our other sub functions. However, the most important ergonomic decisions we discussed are highlighted here. First, by biasing the DI toward the driver we can place important information adjacent to the primary visual area of the driver. This is important for the short term safety by decreasing risk of accidents. In order to decrease driver reach distance, we discussed shifting all important control panels to the left side of the car. This would cause more function to exist within the driver's range of motion. Unfortunately, similar to a justified HVAC system, a biased DI design and left-shifted control panels would cause our center module to be constrained to a one-sided design. Finally, driver comfort can be increased by placing more storage within the driver's range of motion.

4.2.7.2 Innovate Lighting

This information has been removed for confidentiality reasons.

















4.2.7.3 Enhance Aesthetics



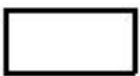
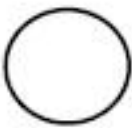







While adding little functionality to our design, aesthetics is what could set our module apart from current designs that exist in the market. Rounded edges and symmetry are paramount in an aesthetic design. However, aesthetic designs often come at the expense of ergonomics and reach distance by shifting important instrument panels to the center and away from the driver. Another way to increase aesthetics is in color selection and material choice. While color selection has little bearing on other functions, material choice can have great impact on structure and cost. Specific materials will be discussed at greater length later in this report.



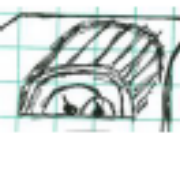



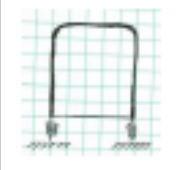











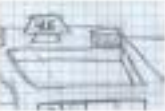

4.2.7.4 Hide Storage

While maximizing storage is more important to the functionality of our design than aesthetics, hidden storage can cause a cleaner and less cluttered appearance in an automotive interior. The best way to hide storage that we have discussed is in the side drawer design discussed above. Another way to hide storage is to create functional space that can be used to place belongings, but is aesthetically pleasing when not in use. Two methods we created are a well proportioned top storage bin and a compartment in the front base of the module.

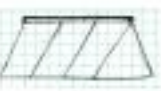
Figure 7: Morphological Chart

		Concept 1	Concept 2	Concept 3	Concept 4	Concept 5
Blow Air	Control Airflow	 Linear	 Circular			
	House HVAC	 Left Justified	 Centered	 Right Justified		
	Innovate Vents	 Slider	 Turret	 Multi-vent Design	 Flip	 Large Center
	Create Orifice	 Square	 Rectangle	 Circle	 Oval	
Support Structure	Maintain Shape	 Substructure	Aesthetic Metal	 More Material		
	Increase Stability	 Cross Bars	 Parallel Bars	 More Material	Aesthetic Metal	

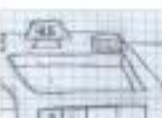
Display Information	Orient Housings	 Top Mounted	 Top Swivel	 Front Mounted		
	Reduce Glare	 Set In DI	 Hood			
Preserve Environment	Decrease Materials	 Thin Walls	 More Storage			
	Reduce Emissions	 Recyclable	Green Manufacturing Processes			
Assure Durability	Minimize Vibrations	 Springs	 Rubber Washers	Increase Mass of Materials	Softer Materials	
	Increase Lifetime	 More Material	Bigger Module	Harder Materials		

Assure Convenience	Decrease Reach		Important Components Close to Driver			
	Place Components					
	Store Belongings					
Please Senses	Max Ergonomics					
	Innovate Lighting				Lit Storage	
	Enhance Aesthetics	Rounded Edges	Aesthetic Color Scheme	Aesthetic Materials		
	Hide Storage					
		Horizontal	Vertical	Top	Large Front	Side Drawer
		Biased DI	Left Side Panels	Accesable Storage		
		Strip Lighting	Spot Lighting	Lit DI		
		Side Drawer	Top Storage	Front Base		

4.3 Concept Categories

Many concepts were generated and sketched out as preliminary ideas. Some designs had great qualities while others proved to be infeasible. The numerous designs created are classified below. By classifying the concepts we were then able to go into more detail for individual areas of the console.

4.3.1 Sided/Split Designs

These design concepts consisted of moving the HVAC to one side to allow for a “sided” design. By moving the HVAC, we have opened space on one side of the console for extra storage. Maximizing storage space was an important customer requirement, especially creating innovative ways to store different items. A side storage that opens and closes, as seen in Fig. 8 below, would be a great addition to keep the passengers safe from flying belongings. The split design incorporates the HVAC being attached to one wall of the console. This wall would support the HVAC entirely. The rest of the console could then snap fit onto the wall, as seen in Fig. 9 below. There would be a fake seam along the edge that does not have the HVAC supported on it to provide symmetry and aesthetics. This can be seen in Fig. 10 below. The main downside to this design is that only one wall is supporting the HVAC thus stronger materials will be needed to support the other wall, which could increase cost.

Figure 8: Side Storage

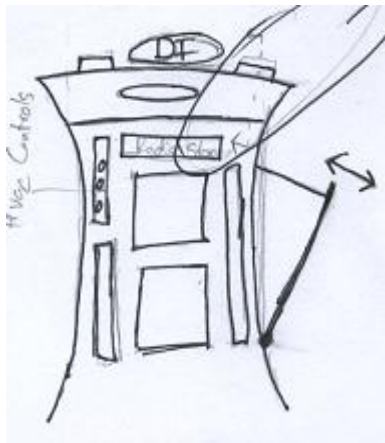

Figure 9: Split Design

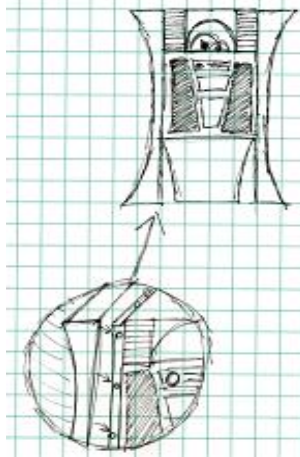
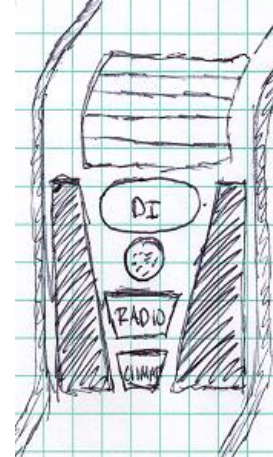

Figure 10: Fake Seam



4.3.2 Vent Designs

One engineering specification was the number of vents. There are many different ways to circulate air throughout the car. In order to maintain a low cost, many of the designs had vents at the top of the console that could provide defrost and occupant air. Another possible way to reduce cost would be to include one large vent as opposed to two vents. These ideas can be seen in Fig. 11, Pg. 30. Having floor vents is also an important feature to many users. Therefore we created a design seen in Fig. 12, Pg. 30 that provides this aspect as another option. There are creative vent covering designs for the function of directing air flow. These include slider designs, flip vents, and turrets. These designs can be seen in Appendix A.

Figure 11: Vent Concepts

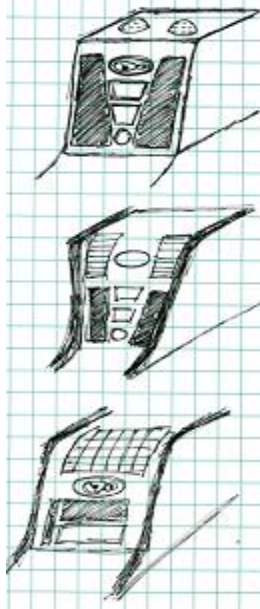
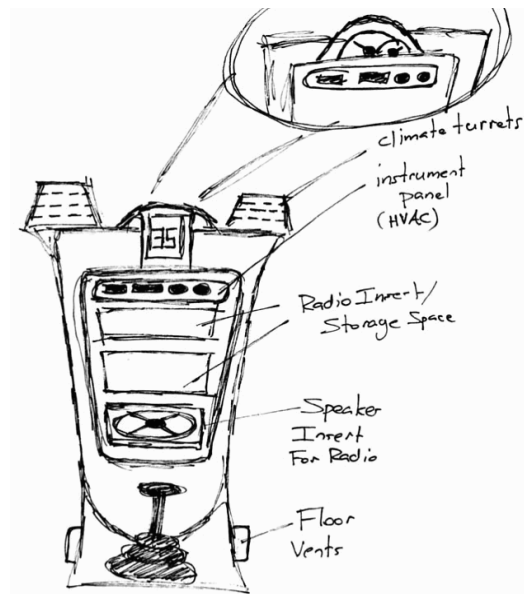

Figure 12: Vents for Window/Driver/Feet



4.3.3 Storage Designs

Another important customer requirement is the maximization of storage. There are a variety of different types of storage. First, if the HVAC is left or right justified, free space is available on the passenger side of the console for hidden storage with the covering of a door, as seen in Fig. 13 below. This can be moved by a variety of ways, including a hinge or a slider. Another important storage feature is the front base area, seen in Fig. 14 below. This is a huge advantage because it offers a large storage space area for big items such as hats, scarves, purses, etc. Lastly, a storage design could be incorporated on top of the console, seen in Fig. 15 below. This allows for items to be stored conveniently.

Figure 13: Side Storage

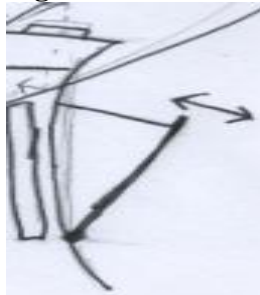
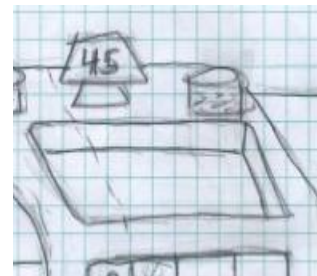

Figure 14: Front Base



Figure 15: Top Storage



4.3.4 Driver Interface Designs

This information has been removed for confidentiality reasons.

Figure 16: Analog Embedded DI

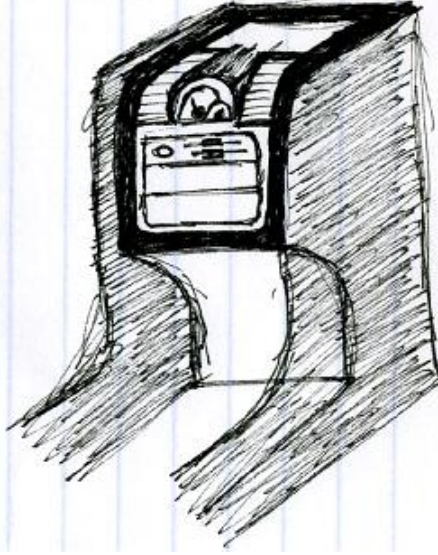
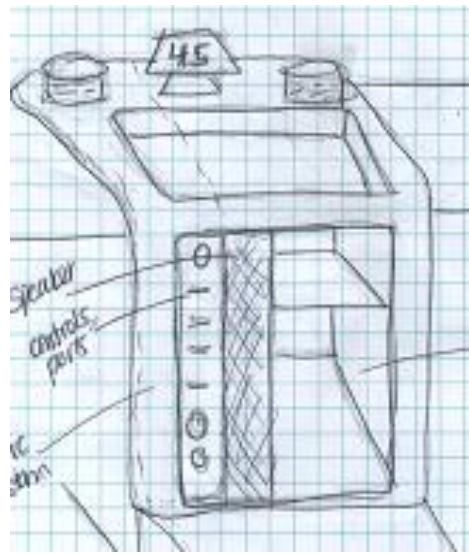

Figure 17: Digital Swivel DI



4.3.5 Non-Sided/Sided Designs

A non-sided design is one that allows for a driver on either the left or right side to use the console with ease. A sided design defines the side the driver would be on, limiting the available market. To increase marketability, making the console non-sided would be a benefit. However, it could make certain ideas impossible as well as increase the price. A sided design allows the control panel to be closer to the driver for easier use resulting in increased safety for the decreased time of interacting with the center console. Below are two different designs, non-sided, Fig. 18, and sided, Fig. 19, shown below. The non-sided design allows for a horizontal control panel, horizontal storage, and either an embedded or swivel DI. The sided design allows for a vertical control panel, vertical storage, hidden side storage, and an embedded DI.

Figure 18: Non-Sided

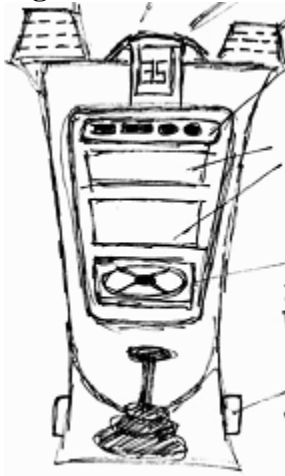
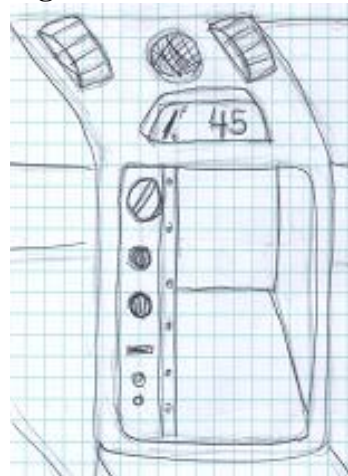

Figure 19: Sided



5 Concept Evaluation and Selection

We created a variety of design concepts for many of the different functions that the center pod needs to incorporate. By comparing and contrasting our ideas, we were able to eliminate infeasible concepts while determining which ideas provided the best possible performance for each function. After combining the best concepts for each function into several designs, we narrowed down to the three best choices. These three designs are discussed in the following sections.

5.1 Designs

Utilizing the FAST diagram, morphological chart, and Pugh chart, we were able to narrow our design choices to three, which are discussed below.

5.1.1 Design 1: Sided Design

5.1.1.1 Description

In this first design, seen in Fig. 20, Pg. 34, the most important feature is that the HVAC system enclosed within the console is left justified, incorporating a split design where the module will snap-fit to one seam and have a mock seam on the other side for an aesthetic look. This opens up the right side to be used for a storage bin, making this design a left side drive only. For air flow, round turrets with a circular flow orifice were chosen because of their ability to both blow air on the occupants and defrost the window. Another feature of this design is the vertical HVAC control panel for easy access by the driver. This design incorporates an embedded driver interface that is front mounted and includes a hood. By embedding the DI, top storage becomes available. Another large bin is located at the bottom of the center module in an effort to further maximize storage.

5.1.1.2 Background

There were many reasons for choosing some of the high-level concepts to accomplish functions in this design. We chose to justify the HVAC to the left side of the center module, as it allows us to reduce wasted space by incorporating an innovative storage drawer into the right side. The turret vents were chosen due to their minimal parts and low cost manufacturability. An embedded DI was chosen over the top mounted and swivel concepts because it would reduce cost and increase manufacturability. With the HVAC left justified we are able to incorporate the side storage, and top storage.

5.1.1.3 Positives and Negatives

The positives of this design include a hidden storage on the side enables the user to store items without worrying about them falling out. There is also innovate storage on top which enables easy access. The control panel location is excellent for left-side drivers because it minimizes reach distance. The embedded driver interface is an effective way to minimize parts needed yielding a reduction in cost. This console maintains a symmetric look to be aesthetically pleasing to the users as well as maximizing storage area. The open area at the bottom is a great location for hats, umbrellas, scarves, purses etc. that many of the occupants of the market we are targeting would store.

Although there are many positive aspects of this design, it also has a few downfalls. First, if we need to accommodate either left or right side drivers, this placement would not be ideal. Therefore, the market is limited. A downside to this driver interface is that it will be biased to one side, therefore not easily accessible for drivers on the opposite side. The negative to the turret air vents is that they obstruct the driver's view and are not aesthetically pleasing. Also, only having two vents means that there is a lack of air flow to the occupants.

Figure 20: Design #1: Side Design

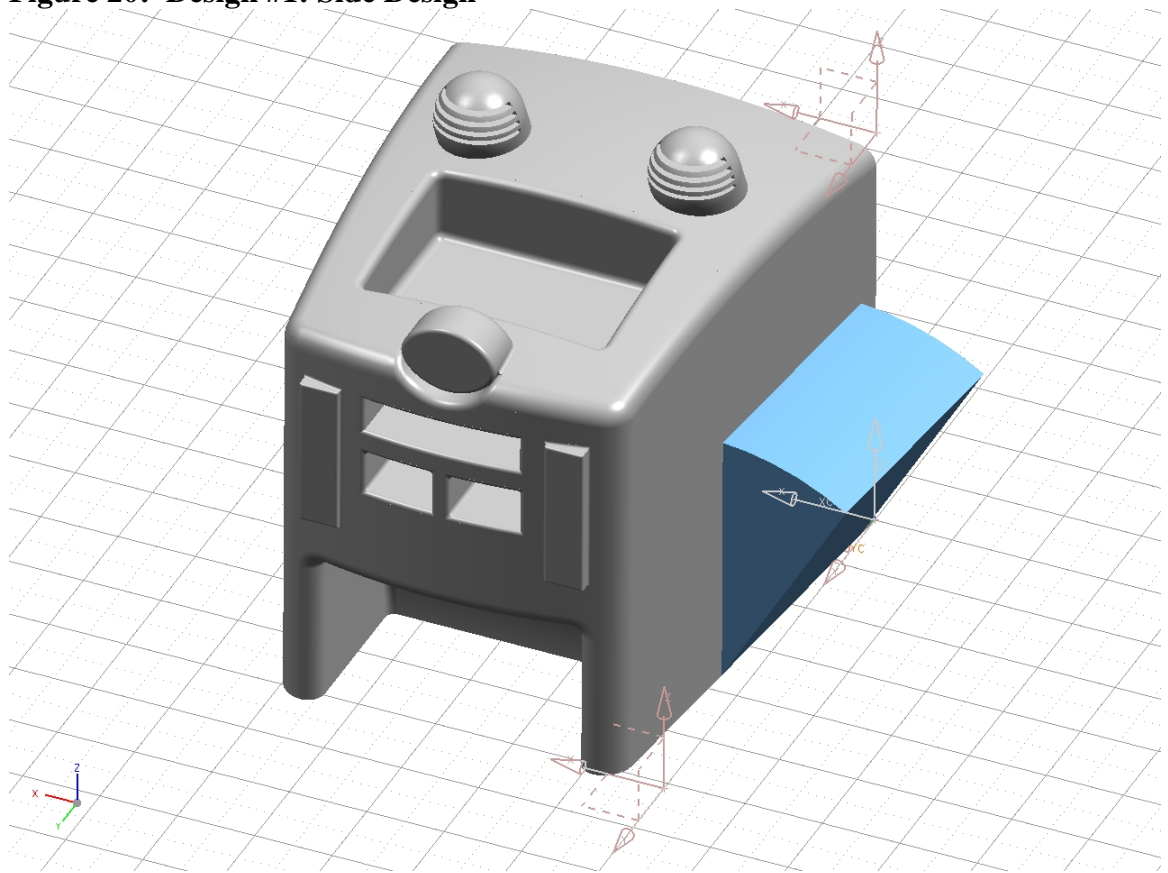

5.1.2 Design 2: Non-Sided Design

5.1.2.1 Description

In this second design, seen in Fig. 21, Pg. 35, we have created a non-sided concept by using a centered HVAC system. A swivel DI design allows use by drivers on both sides and contains a hood to reduce glare in both positions. For air flow, slider vents were built-in with a rectangular flow orifice. A large amount of frontal storage is incorporated with a symmetrical look so that the same storage is available if the driver is on either side. A horizontal HVAC control panel is included and located in the center of the console.

5.1.2.2 Background

In order to create a module that accommodated drivers on both sides, concepts were chosen with centered designs. Therefore, a centered HVAC was chosen which affected where the control panel would be located. The slider vents were chosen due to the fact that they minimize parts and therefore will reduce cost while still blowing air on the user and defrosting the window. A swivel driver interface surpassed the embedded DI due to the fact that the swivel could be turned to face drivers on either side.

5.1.2.3 Positive and Negatives

There are many positives to this design. First of all, this non-sided design enables it to be sold to an expanded market beyond BRIC nations. Second of all, a swivel driver interface allows drivers to position their gauges in a manner that is most convenient for them and is available for use in both left and right side drive automobiles. The third positive aspect is that the air vents are slider vents which reduce parts and allow for both defrosting and blowing air on the occupants. Additionally, this design incorporates a horizontal control panel which is a positive because it allows for drivers on either side to easily use it. Lastly, there are many compartments in the front, allowing the user to store a variety of different sized objects.

With every design, there are negative aspects. In this design the swivel DI is not aesthetically pleasing and could obstruct driver line of sight. Also, there is a lack of air flow to the occupants because of the single vent design. Lastly, due to the fact that the HVAC is centered in the center pod, side storage is not possible.

Figure 21: Design #2: Non-Sided Design

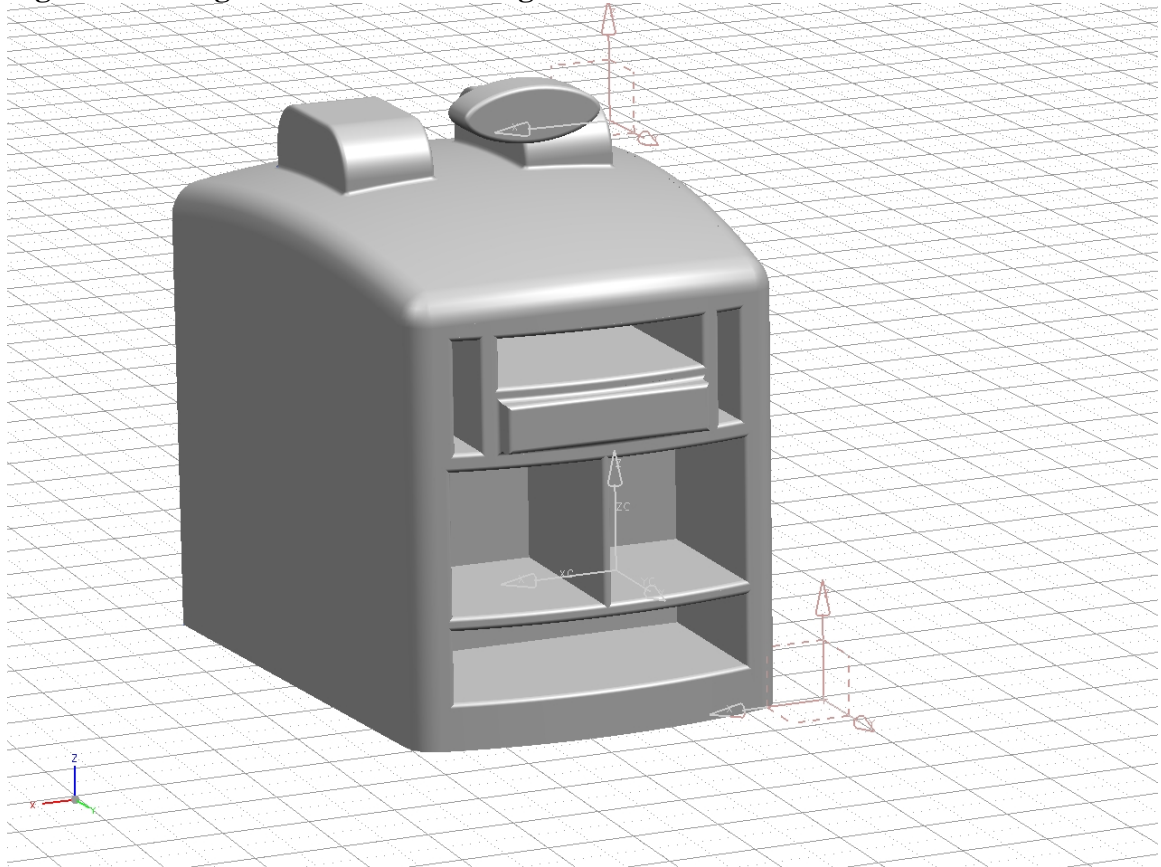

5.1.3 Design 3: Three Air Vent Design

5.1.3.1 Description

This information has been removed for confidentiality reasons.

5.1.3.2 Background

There were many reasons for choosing some of the high-level concepts to accomplish functions in this third design. For this design, the best concept is the multi-vent design, which allows for more balanced airflow throughout the vehicle interior. This is a vast improvement over other designs, which only allowed airflow on the user or the windshield. The left-justified HVAC was chosen because it enables side storage, therefore eliminating wasted space inside the console. In addition to this side drawer design, top and front storage were also included. In the display information section, an embedded DI was chosen over the top mounted and swivel DI because a built in design is cheaper, easier to manufacture and more aesthetically pleasing. Also, because this console would be for left-side drivers only, a swivel DI would be useless since it only needs to point in one direction.

5.1.3.3 Positives and Negatives

This design incorporates a multi-vent system which is great for controlling air flow to the occupant. This design incorporates an embedded analog DI with the stereo included which has numerous benefits. The benefits of this DI are that it reduces materials, costs, and also allows for more storage. The embedded DI is also aesthetically pleasing and ergonomically friendly. However, an embedded DI decreases the market because it is biased to one side. There is also a lot of storage maintaining that important customer requirement. The open area at the bottom is a great location for hats, umbrellas, scarves, etc. that many of the occupants of the market would store. The storage at the top allows for different items such as coins, phones, iPods, etc. to be stored within reach. Lastly, the HVAC will be left justified to allow for hidden storage on the right side.

This information has been removed for confidentiality reasons.

Figure 22: Design #3: Three Air Vent Design

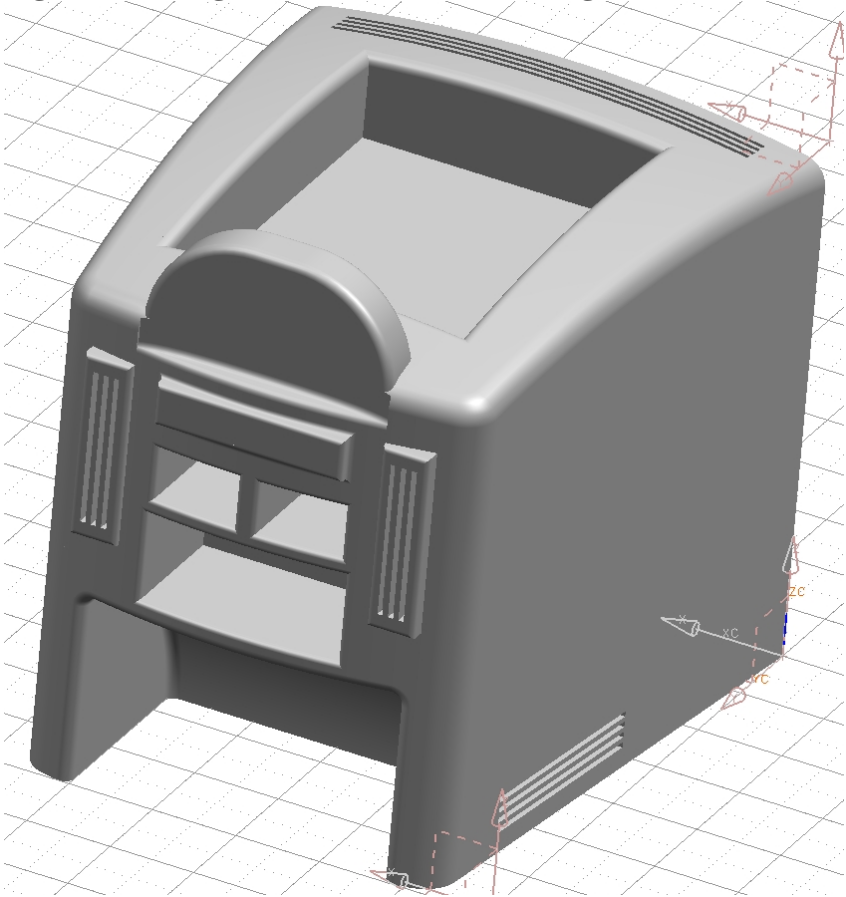

5.2 Pugh Chart

In order to pick a final design, a Pugh Chart was created, as seen in Fig. 23 below. It helped evaluate the design concepts by listing the customer requirements and judging each requirement in terms of the individual criteria, which enabled a more objective selection process. For each design, each customer requirement is rated on a scale of 1 to 3, 1 being below average, 2 being average, and 3 being above average on how well the concept incorporates the requirement. By using the ratings from the QFD for each criterion, the designs were weighted and those weights were added together to obtain a total which was normalized to give us a percentage score. The design concept that yielded the highest percent was the best design and therefore our selected concept.

As seen in Fig. 23, below, design concept #3 best accomplished the customer requirements with the highest percent of 37%. Design concept #2 came in second with 33% while design concept #1 came in last place with 30%. Therefore design concept #3 was our top chose.

Figure 23: Pugh Chart

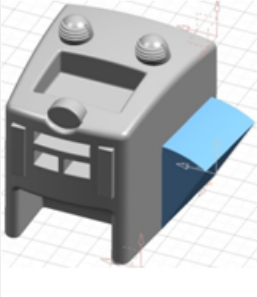
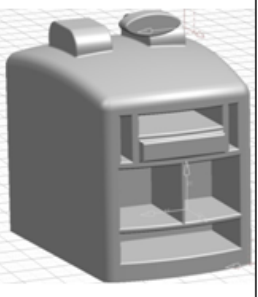
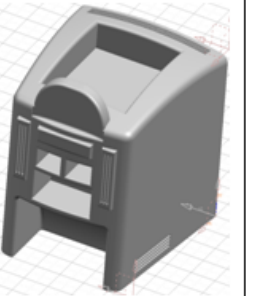
		Design 1		Design 2		Design 3	
							
	Weight	Rating	Weighted Rating	Rating	Weighted Rating	Rating	Weighted Rating
Storage Space	8	3	24	2	16	2	16
Lighting	6	2	12	2	12	2	12
Durable	7	3	21	2	14	3	21
Aesthetically Pleasing	7	2	14	1	7	3	21
Environmentally Friendly	9	2	18	2	18	2	18
Low Cost	10	1	10	2	20	3	30
Scalable	9	2	18	3	27	1	9
Ergonomic	8	2	16	1	8	3	24
Innovative	9	3	27	2	18	3	27
Safe	3	2	6	2	6	2	6
Easy to clean	5	2	10	3	15	2	10
Total			176		161		194
Normalized			0.33		0.30		0.37
Rank			3		2		1

6 Selected Concepts

This information has been removed for confidentiality reasons.

Since design #3 has three air vents, there is an importance in choosing the correct flow orifice as well as the correct locations to maximize air flow. One idea is to incorporate a piping system around the edges of the console, providing a symmetric and therefore still being aesthetically pleasing. This piping system could also allow us to better support the console by choosing materials like metals or PVC. The exact material and structure can't be completely decided until all the engineering analysis has been completed.

In the following sections we discuss the approximate dimensions of our console, the possible materials to be used, as well as the possible processes to manufacture our center pod.

6.1 Design Concept #3 Dimensions

This information has been removed for confidentiality reasons.

Figure 24: Center Pod Main Outer Dimensions

This information has been removed for confidentiality reasons.

Figure 25: Dimensions of HVAC

This information has been removed for confidentiality reasons.

6.2 Design Concept #3 Materials

The type of material chosen for the center pod is very important. It needs to be environmentally friendly as well as low cost. The materials chosen need to be aesthetically pleasing as well as be durable and support the unit. Described below are different materials that could be used with the advantages and disadvantages of each. Once the pros and cons of each are weighed out and a force analysis completed, an appropriate material can be chosen.

6.2.1 Glassfibre Composites

A glassfibre composite consists of an epoxy and matting mixed with each other. Matting is a woven material made from a synthetic material. This creates a wet material which can be shaped in a variety of ways and then once dried it's ready to be used. A great advantage is that it's cheap to produce, easy to work with, durable and very strong. However, a few disadvantages are that the quality is not always great, it cannot be used to create thin flush fitting items, and it is not environmentally friendly.

6.2.2 ABS Plastic

ABS Plastic is a material found in a variety of objects. Some advantages are that it is flexible, durable, light and cheap to manufacture therefore a cost effective product. It is very rigid and consequently more prone to wear and tear therefore minimizing lifetime. ABS Plastic is best used for small or thin objects, while if used for larger objects it can crack easily. An example can be seen in Fig. 26, below.

Figure 26: Mazda6 Dash Mounted Gauge Pod with ABS Plastic



6.2.3 Urethane

Urethane is widely used in the car industry and mostly used to create body panels. The advantages are that it is strong, impact resistant, rust resistant, durable, and light weight. One specific type of Urethane used is liquid polyurethane which is injected after painting in the open and grained molded. This is done to obtain a constant thickness in the finished skin. It offers a high-quality surface, is environmentally friendly, has color variability, and has a constant thickness. The polyurethane skin can be seen in Fig. 27. The main disadvantage is that the cost of the material and creation can get expensive.

Figure 27: Polyurethane Color and Grain Variability



6.2.4 Support Structure Materials

The most popular types of structure materials would probably be a type of metal. This is because metals and metal alloys possess high structural strength per unit mass. However, some metals can be vulnerable to fatigue damage through repeated use or from sudden stress failure when too much load occurs. Another type of structural material could be PVC, which is a widely used thermoplastic polymer. PVC is cheap and easy to assemble, however it is not environmentally friendly. One more type of material that is a possibility is bamboo. When treated, bamboo forms a very hard wood which is both light and durable but bamboo can get pretty expensive.

6.3 Design Concept #3 Processes

Different manufacturing processes need to be considered along with the material selection in our design. These processes need to be efficient while being low cost and environmentally friendly. Described below are different processes with the advantages and disadvantages of each. Once the pros and cons of each are weighed out and a force analysis is completed, an appropriate manufacturing process can be chosen.

6.3.1 Mold-In-Color

This information has been removed for confidentiality reasons.

Figure 28:

This information has been removed for confidentiality reasons.

6.3.2 Injection Molding

Injection molding is one of the most common processes to manufacture parts of an automobile. It's typically the lowest cost process for panels, however, the most common used thermoplastic material, polystyrene, lacks the strength and durability that other materials have.

6.3.3 Negative Thermoforming

Negative thermoforming is done by heating the thermoplastic olefin skin which is then drawn into a nickel tool. The skin can then be shaped to fit the instrument panel and attached. This process offers soft surfaces, excellent craftsmanship, design flexibility, low weight, and ten year durability. It is more cost effective than other processes but is not the most efficient way to save money.

6.3.4 Powder Slush Molding

Powder Slush Molding is a process in which a resin powder is introduced to a mold which is then heated. Once cooled, it can be removed from the mold and placed in the car. The materials usually used are polyvinyl chloride (PVC) or thermoplastic polyurethane (TPU). It offers soft surfaces, great grain quality and touch perception, and

it's exceptionally durable. The disadvantage to this process is that it is very expensive. An example of the Power Slush Molding can be seen in Fig. 29.

Figure 29:

This information has been removed for confidentiality reasons.

6.3.5 Laminate Insert Molding

Laminate Insert Molding is a method for molding a plastic part where you insert molding a plastic substrate against the film laminate. The main advantage of this process is that it is 100 percent recyclable which means it's environmentally friendly. It also is very durable and has excellent craftsmanship. The disadvantage is that it is not very cost effective.

7 Engineering Analysis

7.1 Key Variables

The key variables such as dimensions, tolerances, material choices and specifications are described below for each component of our center pod.

7.1.1 Console/Center Pod

This information has been removed for confidentiality reasons.

7.1.2 Driver Interface System

This information has been removed for confidentiality reasons.

7.1.3 HVAC System

This information has been removed for confidentiality reasons.

7.1.4 Support Structure

This information has been removed for confidentiality reasons.

7.2 Qualitative Analysis

To determine if the center pod module we created would be a good product we applied three different types of analysis: Design for Manufacturing and Assembly, Design for Environment, and Failure Modes and Effects Analysis.

7.2.1 Design for Manufacturing and Assembly

Design for Manufacturability (DFM) is making sure that your design is easy to manufacture. Design for Assembly (DFA) is done to ensure that the assembly of your design is quick and simple. Both DFM and DFA reduce manufacturing time and cost.

7.2.1.1 Reduce Parts

This information has been removed for confidentiality reasons.

7.2.1.2 Design Parts to be Multi-Functional

This information has been removed for confidentiality reasons.

7.2.1.3 Design for Ease of Fabrication

This information has been removed for confidentiality reasons.

Figure 30: Design for Injection Molding Criteria

This information has been removed for confidentiality reasons.

Figure 31: Center Pod Shell with Perspective Draw Lines

This information has been removed for confidentiality reasons.

7.2.1.4 Minimize Assembly Directions

This information has been removed for confidentiality reasons.

7.2.1.5 Minimize Handling

This information has been removed for confidentiality reasons.

7.2.2 Design for Environment

Design for Environment (DFE) is implemented as a way to decrease the products impact on the environment. There are guidelines that aid the designer in viewing the impact of their design as a whole life cycle. These guidelines include: materials and extraction; production; transport, distribution and packaging; use; end of life, design for disassembly and design for recycling.

7.2.2.1 Materials and Extraction

Materials and Extraction includes many guidelines to apply to the design for a variety of reasons. First, we must make sure to avoid use of hazardous, toxic and other environmentally unfriendly materials, which, in the future, will decrease harmful emissions during production. Therefore, we have only used the environmentally friendly polypropylene for the center pod and for the support structure. For example, we decided to not use PVC due to the fact that it is very harmful to the atmosphere when manufactured. Avoiding materials with high energy content decreases the energy used in production, therefore materials such as aluminum for the support structure has been eliminated. It is important to use materials that are renewable and recyclable. Polypropylene is recyclable. Another important guideline is to create a product that reduces material. By incorporating lots of storage space and one console unit, we have eliminated extra parts and materials. Lastly, it's beneficial to minimize the number of materials used. Therefore the console and support structure will be made of the same material. This reduces the number of materials, and it makes the design easier to recycle.

7.2.2.2 Production

In this area, we want to minimize and recycle residues and waste from the production processes to decrease the amount of wasted raw material. Therefore by using injection molding, only the material needed will be used, and the dies will be re-usable so they do not waste more material. Minimizing the use of energy intensive process steps decreases the amount of energy used by the production process. We accomplish this by choosing a material with a relatively low molding temperature. Lastly, by having good construction, service, and fast repair we can minimize losses in the production facilities.

7.2.2.3 Transport, Distribution, Packaging

This information has been removed for confidentiality reasons.

7.2.2.4 Use

This guideline focuses specifically on minimizing the amount of consumables used, optimizing lifetime of product, and designing for easier maintenance and repair. First, the center pod design does minimize consumables used because there are only permanent components; nothing needs to be replaced in a daily/monthly/or yearly manner. To optimize the lifetime, the product needs to be reliable and durable. The center pod module is made of polypropylene (40% talc) which has yield strength of 29 MPa. This means it is very strong and will not crack or break under given static and deflection loads, making it durable. Lastly, designing for easier maintenance and repair will increase the lifetime of the center pod module. A benefit of the center pod being scalable means that there are areas to add other components such as an iPod hookup, etc. Therefore, it's easier to repair because if an item breaks, it's easy to replace it quickly without having to take apart the entire center pod. Enabling upgradability pro-longs the lifetime.

7.2.2.5 End of life, Design for Disassembly and Design for Recycling

In this section, it is important that the product is able to be re-used, re-manufactured, and/or refurbished. This can be done by extending the lifetime of the center pod module so that it decreases the need for new products allowing it to be re-used. By creating the center pod to be scalable or upgradeable, we have made one item for three different priced cars so that one design could be re-used by three different parts of the market.

This information has been removed for confidentiality reasons.

Another important guideline in this section is the importance of being able to recycle parts of the center pod as well as the materials after it has been produced. Polypropylene is easily recyclable by regrinding. By using polypropylene we are also avoiding the painting process which emits many toxins.

7.2.3 FMEA

The first step in finalizing our design is to identify the potential failure modes for each major subsystem of our center module by use of Failure Mode and Effects Analysis (FMEA). In the following sections, each separate subsystem and its potential failure modes are analyzed in detail along with recommended actions.

7.2.3.1 Body

The main body of the center module has six possible failure modes identified in the FMEA chart located seen in Fig. 32, Pg. 49. The most severe failures are material yield, fracture, fatigue failure, and thermal fatigue. The potential effects of these failure modes are loss of ability to house components, maintain structure, and protect customer safety. Material yield is caused by force applied to the body which is greater than the yield strength of the material. If a material is chosen which has yield strength less than stresses seen from the applied force, the body will most certainly fail. This is the most serious threat to customer safety and system function. Fracture can be caused by automobile collision or excessive force applied by customer. Fatigue failure is caused by crack propagation due to cyclical forces applied during ordinary driving conditions. Thermal fatigue occurs as a result of cyclical expansion and relaxation of material due to fluctuations in temperature of both the ambient and the HVAC system. The solution to all four of these major potential failure modes lay in material selection. A high strength material with resistance to both thermal and cyclical loading fatigue failure must be identified and used in the manufacturing of our design.

Two less severe, but important failure modes are scratching and wear of material surface, which have an adverse effect on aesthetics and may cause minor loss of functionality. They are caused by repeated contact with foreign objects and internal automobile components. By selecting a material finish which is wear and scratch resistant, both these failure modes can be greatly reduced.

Figure 32: FMEA for Body

Part Number & Functions	Potential Failure Mode	Potential Effects of Failure	Severity (S)	Potential Causes / Mechanisms of Failure	Occurrence (O)	Current Design Controls / Tests	Detection (D)	Recommended Actions	RPN	New S	New O	New D	New RPN	
Body (Support Structure, Assure Durability, Assure Convenience, Please Senses)	Material Yield	Loss of ability to house components, maintain structure, and protect customer safety	10	Force applied to body greater than yield strength of material	10	Strength of materials studies	3	Choose material whose yield strength can hold up to typical applied force	300	10	1	2	20	
	Fracture		10	Automobile collision	2	Fracture analysis studies	1	Design structure and choose material with highest possible strength for low cost	20	10	2	1	20	
				Excessive force applied by customer	4		3		10	1	3	30		
	Fatigue Failure		7	Cyclical forces applied during regular driving conditions	5	Fatigue Failure Studies	5	Choose material with highest resistance to fatigue failure	175	7	2	5	70	
				Crack propagation	5		5		175	7	3	3	63	
	Thermal Fatigue		9	Changes in temperature due to climate control system	4	Fatigue Failure Studies	8	Choose material with melting/freezing point outside the range of possible HVAC temperatures	288	9	2	8	144	
				Changes in temperature due to environment	3		8	Choose material with melting/freezing point outside the range of possible environment temperatures	216	9	1	8	72	
	Scratching		Less pleasing to senses and possible minor loss of functionality	3	Repeated contact with other components	9	Create prototype out of polypropelene and perform endurance tests	3	Reduce contact between components	81	3	6	3	54
					Contact with foreign articles (i.e. stored belongings)	9		3	Choose body finish that is most resistant to scratching for low cost	81	3	6	3	54
	Wear		3	Chipped material finish due to general use	7		3	Choose body finish that is most resistant to wear for low cost	63	3	5	3	45	

7.2.3.2 Vents

There are five main failure modes of the vent subsystem of our center module, the most severe of which are cracking, fatigue failure, and thermal expansion and relaxation. All failures are shown in Fig. 33, Pg. 50. All three of these may cause minor climate control system failure through loss of airflow directionality. Depending on the extent of the failure, there may also be some loss of aesthetics. Cracking is caused by excessive applied force by the customer to the vent. Fatigue failure occurs as a result of formation of small cracks over time due to repeated use of the vent in everyday conditions. Thermal expansion and relaxation due to temperature change may cause cracking due to strain of the vent against the body housing. Over long periods of time, it may even lead to thermal fatigue failure. The best solution to all three of these failure modes is to select vent materials with the highest strength and fatigue resistance available at a relatively low cost.

Scratching and wear are potential failure modes as they were for the body subsystem and there is a similar solution for vents in choice of strong, hard material finishes.

Figure 33: FMEA for Vents

Part Number & Functions	Potential Failure Mode	Potential Effects of Failure	Severity (S)	Potential Causes / Mechanisms of Failure	Occurrence (O)	Current Design Controls / Tests	Detection (D)	Recommended Actions	RPN	New S	New O	New D	New RPN
Vents	Cracking	Vents cannot direct air effectively. Possible loss of aesthetics depending on excess of failure.	7	Excessive force applied by customer	4	Manufacture a prototype and perform tests for all potential failure modes	4	Choose material that is resistant to cracking	112	7	2	4	56
	Fatigue		7	Cyclical forces due to repeated use by customer	3		5	Choose material with highest resistance to fatigue failure	105	7	1	5	35
			3	Crack propagation	3		5	105	7	1	5	35	
	Thermal Expansion / Relaxation	7	Changes in temperature due to climate control system	2	6		Choose material with melting/freezing point outside the range of possible HVAC and environmental temperatures	84	7	1	6	42	
	Scratching	Loss of aesthetics and possible some functionality.	3	Chip or abrasion to finish due to rough use	9		2	Choose body finish that is most resistant to scratching for low cost	54	3	5	2	30
	Wear		3	Loss of finish due to use	9		2	Choose body finish that is most resistant to wear for low cost	54	3	5	2	30

7.2.3.3 Air Ducts

Air ducts are a vital subsystem of the center module’s climate control. Examination of failures in the air duct system can be seen in Fig. 34, below. Condensation occurs as a result of temperature difference between the airflow in the ducts and the ambient. This may lead to loss of functionality in electrical and mechanical systems throughout the module in the form of corrosion and short circuits. Condensation on the module face will cause a decrease in aesthetic appeal and customer satisfaction. The solution to this problem will be discussed later in this report. Thermal expansion and reaction is caused by rapid changes in temperature of the material due to the HVAC system and can eventually lead to thermal fatigue failure. This may cause loss of functionality of the system and a potential safety hazard to the customer due to inability to defrost the windshield. Material selection is the best way to deter thermal fatigue. Finally, leaking may occur as a result insufficient seal between duct components. Through the use of gaskets and snap fit seals, leaking can be stopped and system functionality can be assured.

Figure 34: FMEA for Air Ducts

Part Number & Functions	Potential Failure Mode	Potential Effects of Failure	Severity (S)	Potential Causes / Mechanisms	Occurrence (O)	Current Design Controls /	Detection (D)	Recommended Actions	RPN	New S	New O	New D	New RPN
Air Ducts (Blow Air, Assure Durability)	Condensation	Negative impact on aesthetics and condensed water could impact functionality of	7	Difference in temperature between flowing air and environment	8	Create prototype duct system out of polypropelene and run thermal tests	4	Choose material with melting/freezing point outside the range of possible HVAC and environmental temperatures	224	7	1	4	28
	Thermal Expansion / Relaxation	Negative impact on functionality of system. Possible safety concerns due to loss of defrost.	7	Material Properties	6		8		336	3	3	8	72
				Change in temperature due to climate control system	6		8		336	3	3	8	72
	Thermal Fatigue	Minor to complete loss of airflow out of vents depending on excess of leak.	7	Cyclical temperature change causes failure	4		8		224	7	2	8	112
				Rapid change in temperature due to climate control system	4		8		224	7	2	8	112
	Leaking	Minor to complete loss of airflow out of vents depending on excess of leak.	7	Crack in duct system due to collision	2		2		28	7	1	2	14
				Crack propagation in duct system	4		8		224	7	2	8	112
				Insufficient seal between components	4		8		224	7	2	8	112

7.2.3.4 HVAC Controls

The HVAC controls have several potential failure modes which must be taken into consideration in our final design. These failure modes are shown in Fig. 35 below. Wear, loosening, and de-lamination, of components are all effects of general use over time and may cause loss of climate control system functionality and aesthetics depending on the extent of the failure. All three afflictions can be solved by balancing quality with cost and choosing the best possible components. Fatigue failure is the most serious of these potential failure modes and will most certainly cause inability of HVAC system control. By choosing components with guaranteed lifetime that exceeds that of the car, we can avoid this failure mode.

Figure 35: FMEA for HVAC Controls

Part Number & Functions	Potential Failure Mode	Potential Effects of Failure	Severity (S)	Potential Causes / Mechanisms of Failure	Occurrence (O)	Current Design Controls / Tests	Detection (D)	Recommended Actions	RPN	New S	New O	New D	New RPN
HVAC Controls (Blow Air, Assure Durability, Assure Convenience, Please Senses)	Wear	Negative impact on aesthetics and functionality of the system depending on excess of wear.	3	General use	9	Manufacture a prototype and perform tests for all potential failure modes	2	Choose body finish that is most resistant to wear for low cost	54	3	5	2	30
	Loosening		4	General use	6		2	Choose components that are less prone to loosening	48	4	3	2	24
	Delamination		3	Chipping of gauge / knob	5		2	Choose material finish with high	30	3	3	2	18
	Fatigue		7	Failure of component due to repeated use	6		5	Choose matial with highest resistance to fatigue failure	210	7	3	5	105

7.2.3.5 Side Storage

The side storage compartment will be made of the same material as the body of the center module, and thus will also have two similar failure modes, shown in Fig. 36, below. Fracture is caused by excessive force applied by the user and fatigue failure occurs due to cyclic loading from general use. Though not critical to system function or customer safety, broken storage can cause customer dissatisfaction and must be a serious concern.

Figure 36: FMEA for Side Storage

Part Number & Functions	Potential Failure Mode	Potential Effects of Failure	Severity (S)	Potential Causes / Mechanisms of Failure	Occurrence (O)	Current Design Controls / Tests	Detection (D)	Recommended Actions	RPN	New S	New O	New D	New RPN
Side Storage (Assure Convenience, Assure Durability, Please Senses)	Fracture	Storage bin may not close or open, may fall out unexpectedly	4	Excessive force applied by customer	4	Manufacture a prototype and perform tests for all potential failure modes	7	Design structure and choose material with highest possible strength for low cost	112	6	2	7	84
	Fatigue Failure		4	Crack Propagation	5		8	Choose matial with highest resistance to fatigue failure	160	6	3	8	144
			4	Failure due to force applied during general use	3		7	84	6	2	7	84	

7.2.3.6 Driver Interface

The driver interface is a vital component of the center module as it provides important driver safety information. Intermittent to complete failure of the system causes a great threat to driver welfare and must be avoided at all cost, these failures are shown below in Fig. 37. Loose connections in the electrical system and inferior component selection both lead to intermittent system operation and can both be solved through selecting the best quality parts available for reasonable cost. Electrical short can be caused by condensation from the climate control system, so the DI will have to exist in a section of the module which is sealed away from the HVAC and ducts.

Figure 37: FMEA for Driver Interface

Part Number & Functions	Potential Failure Mode	Potential Effects of Failure	Severity (S)	Potential Causes / Mechanisms of Failure	Occurrence (O)	Current Design Controls / Tests	Detection (D)	Recommended Actions	RPN	New S	New O	New D	New RPN
DI (Display Information, Assure Durability, Assure Convenience, Please Senses)	Intermittent System Operation	Intermittent to complete failure of system. Great threat to driver safety.	8	Loose Connections in Electrical System	4	Manufacture a prototype and perform tests for all potential failure modes	9	Design components for minimum electrical connections	288	8	2	9	144
				Inferior Component Selection	3		8	Pick the best components available for low cost	192	8	2	8	128
	Electrical Short		8	Condensation from Climate Control System	4		9	Seal components off from main body of system	288	8	2	9	144

7.3 Quantitative Analysis

The quantitative analysis includes all of our mathematical and computer results. Numerous finite element analysis (FEA) simulations were completed for all structural components of the center pod using the program ANSYS 11.0. This is done to prove that our center pod can withstand specific applied loads to resist specified deflections and yield conditions. Engineering calculations were also done to determine the air flow through the ducts. There must be air flow through all the vents and similar air flows through associated cross car vents (i.e. both left and right floor vents) in order for the product to be deemed successful and sold in the market. Lastly, the thermal expansion analysis was completed to show its negligible effects on the unit.

7.3.1 Structural Analysis

We completed numerous FEA simulations of our structure using the program ANSYS 11.0. Using this program, we imported our geometry, created a mesh, and assigned the material properties to the model. Our geometry was created in Unigraphics 5.0 and was a solid structure 3mm thick. The structure includes the center pod shell and ducting. The mesh consisted of 4 node tetrahedron elements with a maximum size of 4mm. Once this was completed, we were able to designate supports at attachment locations and specify loads to each face. From the output, we reviewed the deflection and stress diagrams for each test. The testing specifications are outlined in Table 4 below. Note Engineering Change Notice 1, Pg 86. Two tests were completed on each face. The first test was the application of a specified load to determine if the deflection was under a predetermined value. The second test entailed applying a static load to each face and comparing the max stress to yield stress of the material to prove it would not plastically deform.

Table 4: Structural testing specifications

This information has been removed for confidentiality reasons.

7.3.1.1 Material

The chosen material to test in the ANSYS 11.0 program is Polypropylene (40% talc). This was determined using the Ashby software CES. This material was chosen because of its stiffness (modulus of elasticity), its strength (yield strength) and its cost. This material is also commonly used in low cost applications of center pod modules in vehicles.

7.3.1.2 Front Face

This information has been removed for confidentiality reasons.

Figure 38: Distributed Load Applied on Noted Front Face

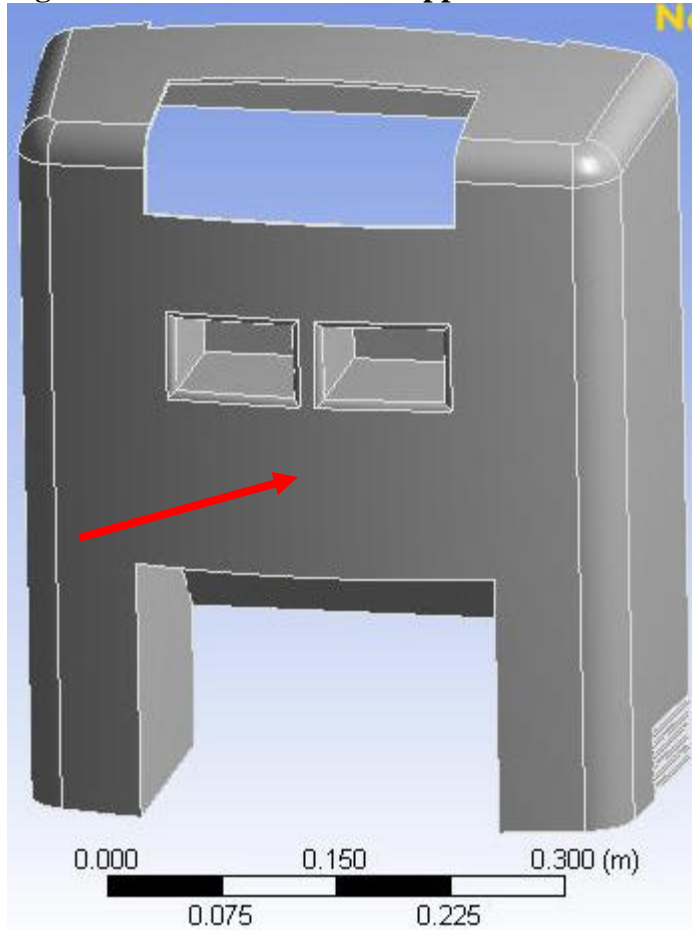

Figure 39: Front Face Mesh and Constraints

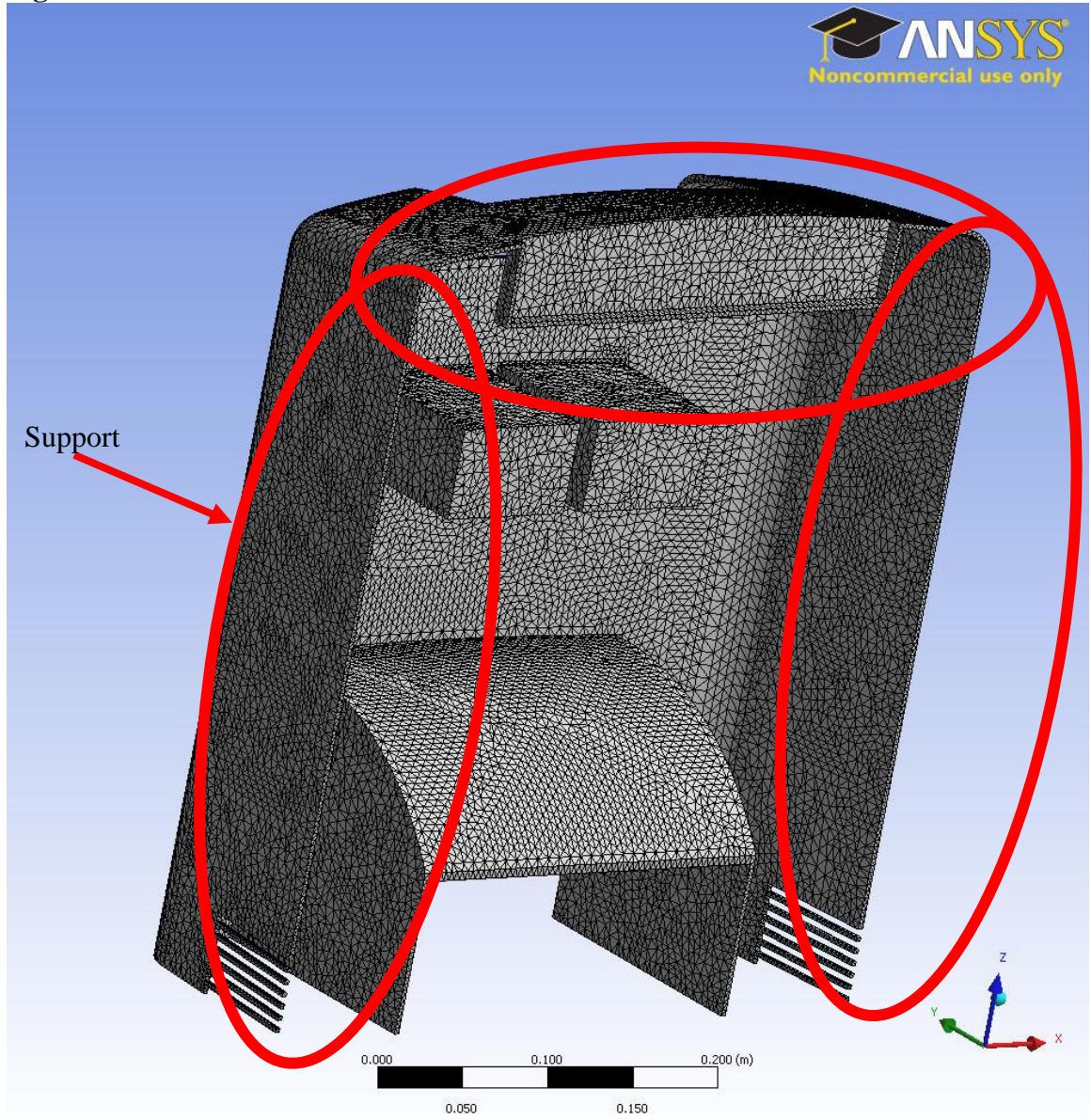
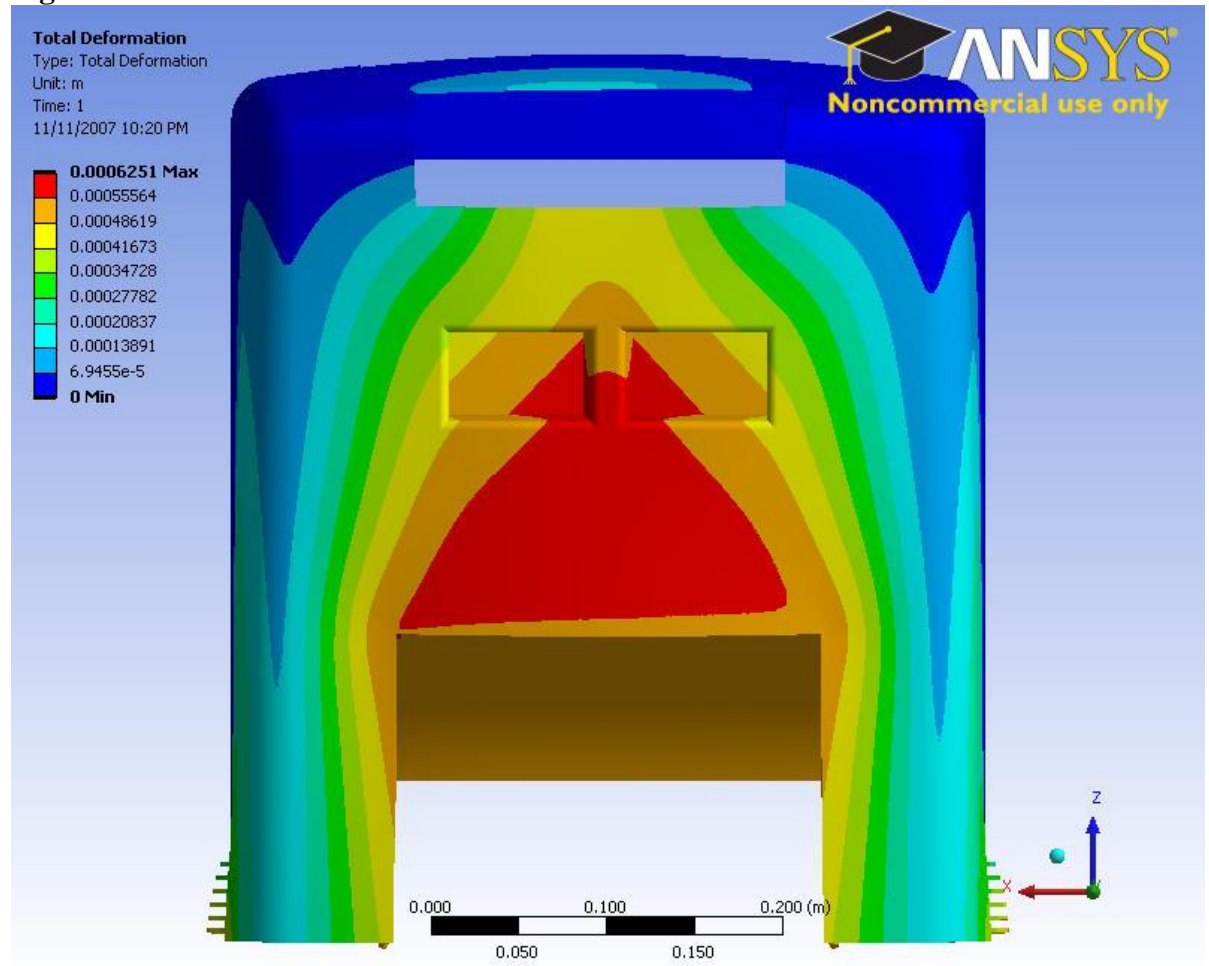
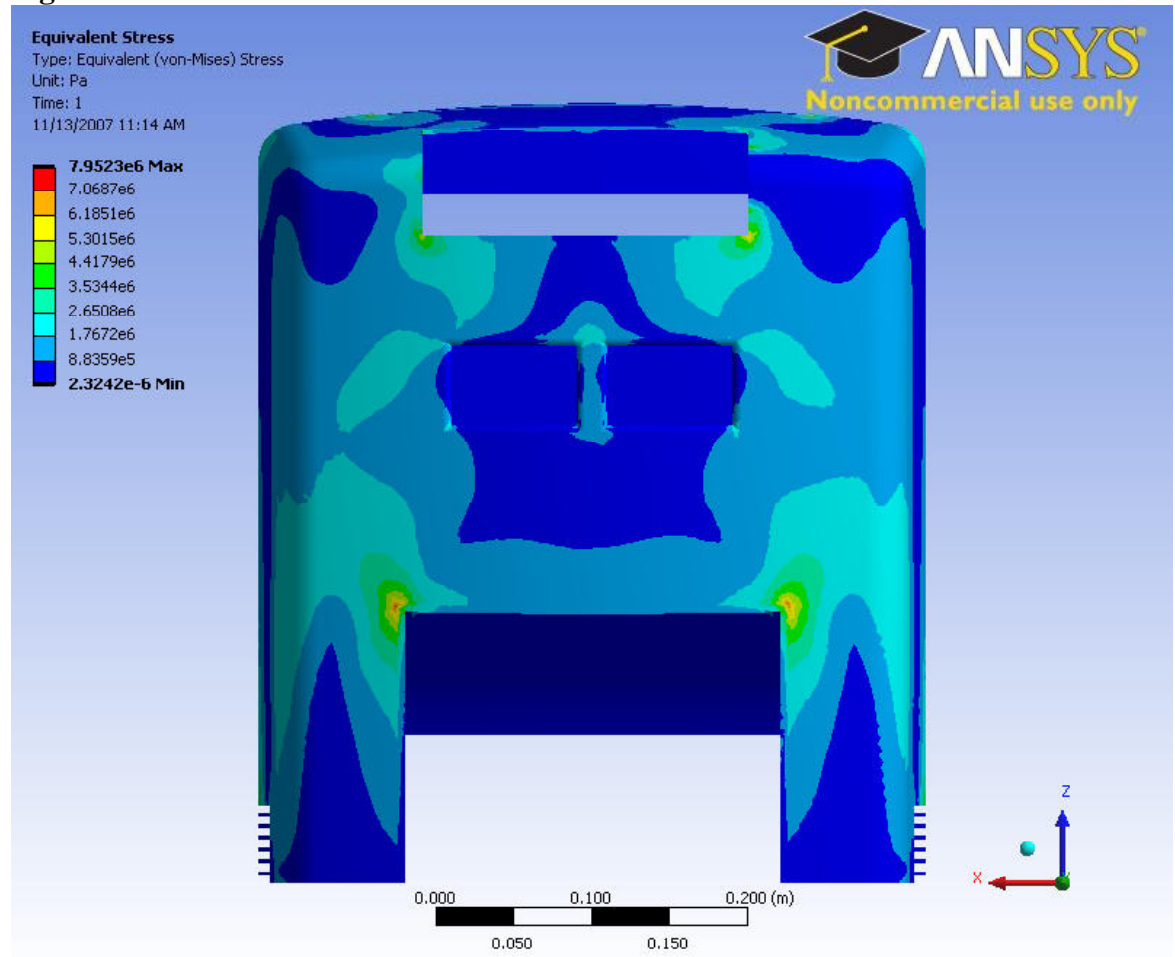

Figure 40: Deflection of Front Face at 44.5N



This information has been removed for confidentiality reasons.

Figure 41: Stress on the Front Face Under 1000N Load



7.3.1.3 Top Face

This information has been removed for confidentiality reasons.

Figure 42: Distributed Load Applied on Noted Top Face

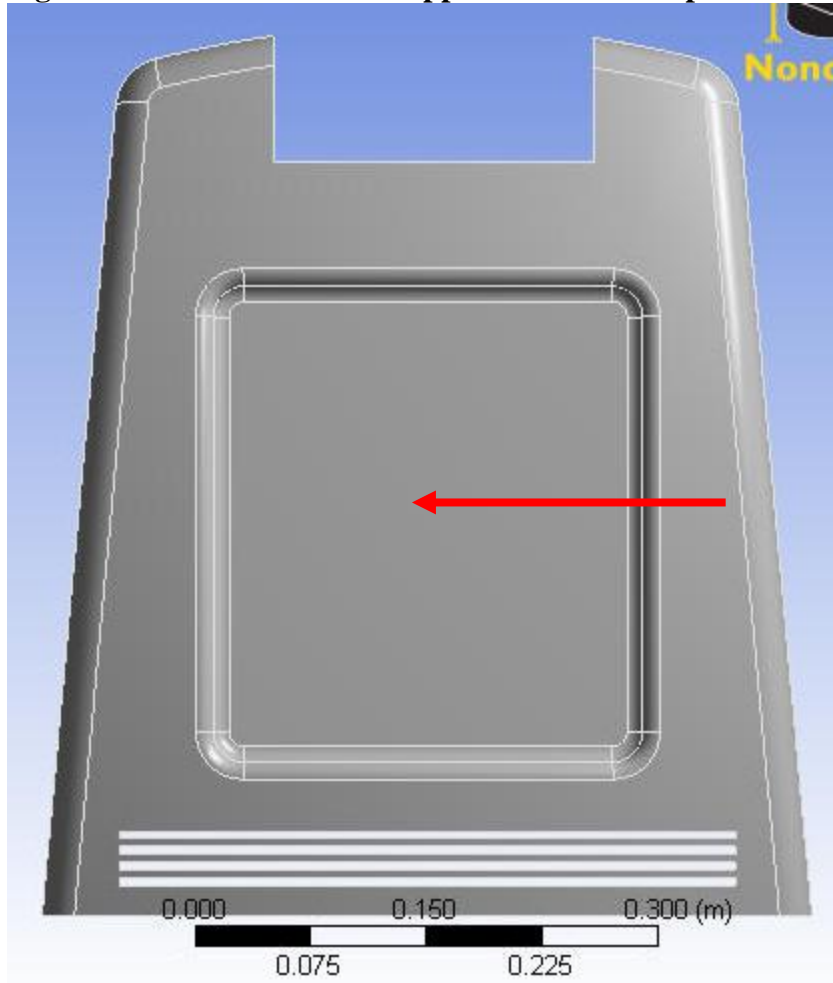

Figure 43: Top Face Mesh and Constraints

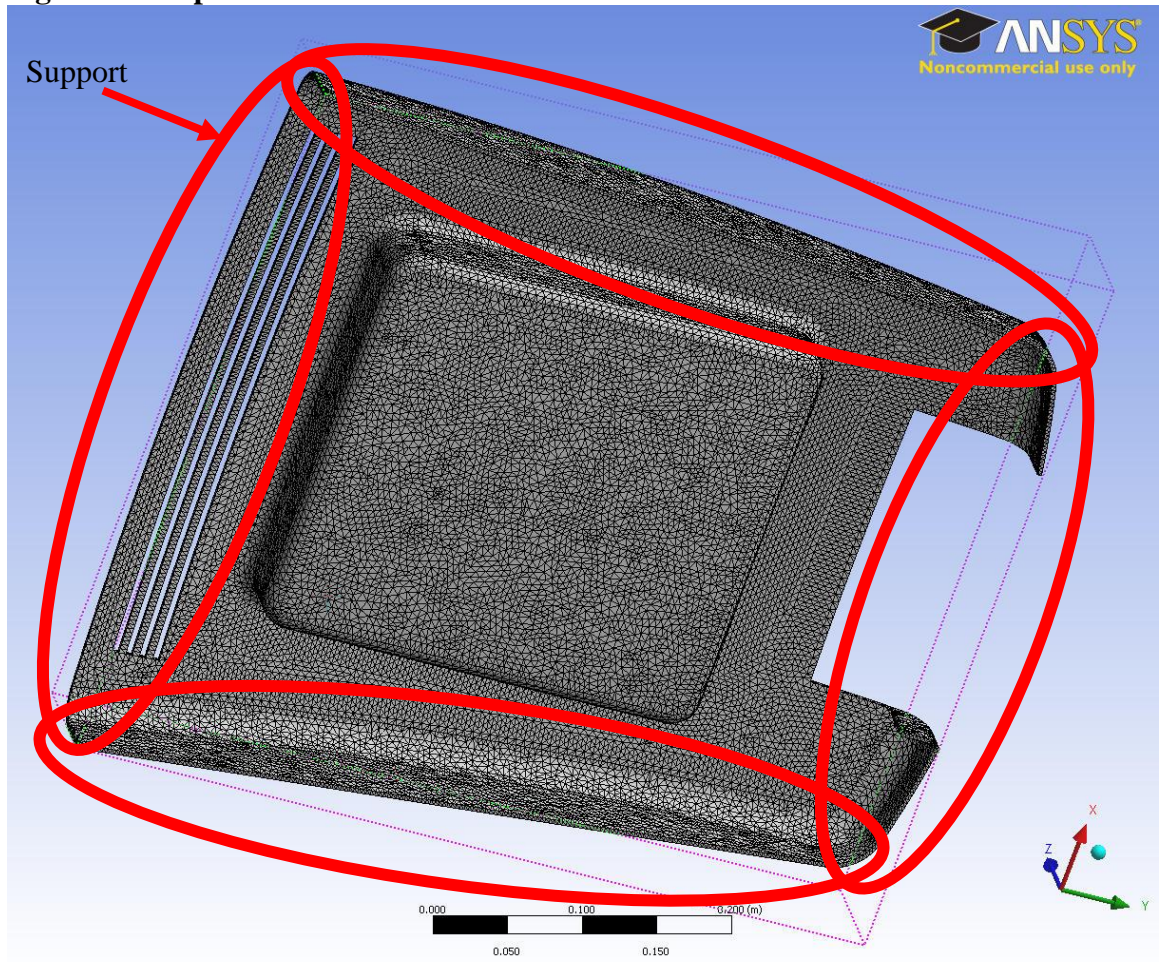
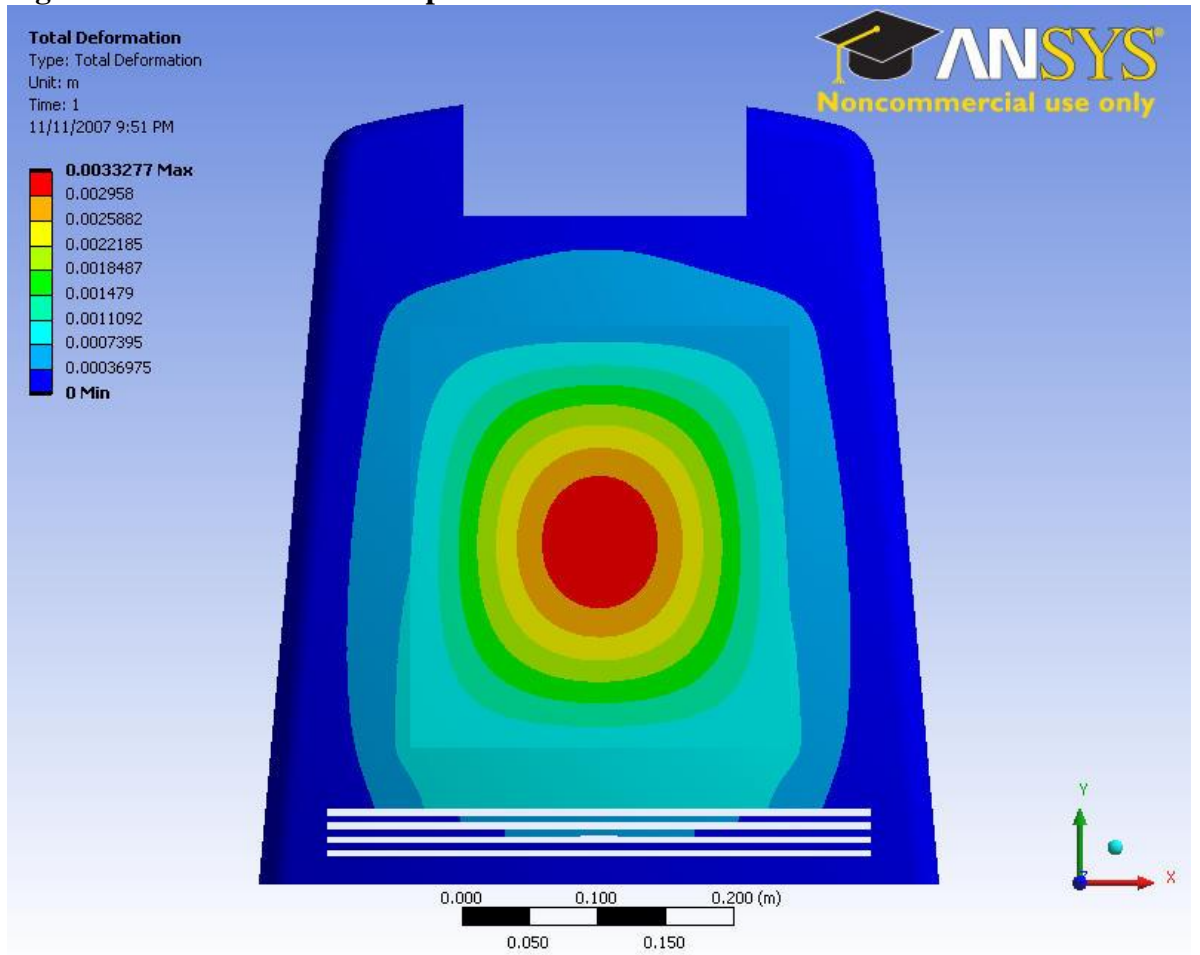
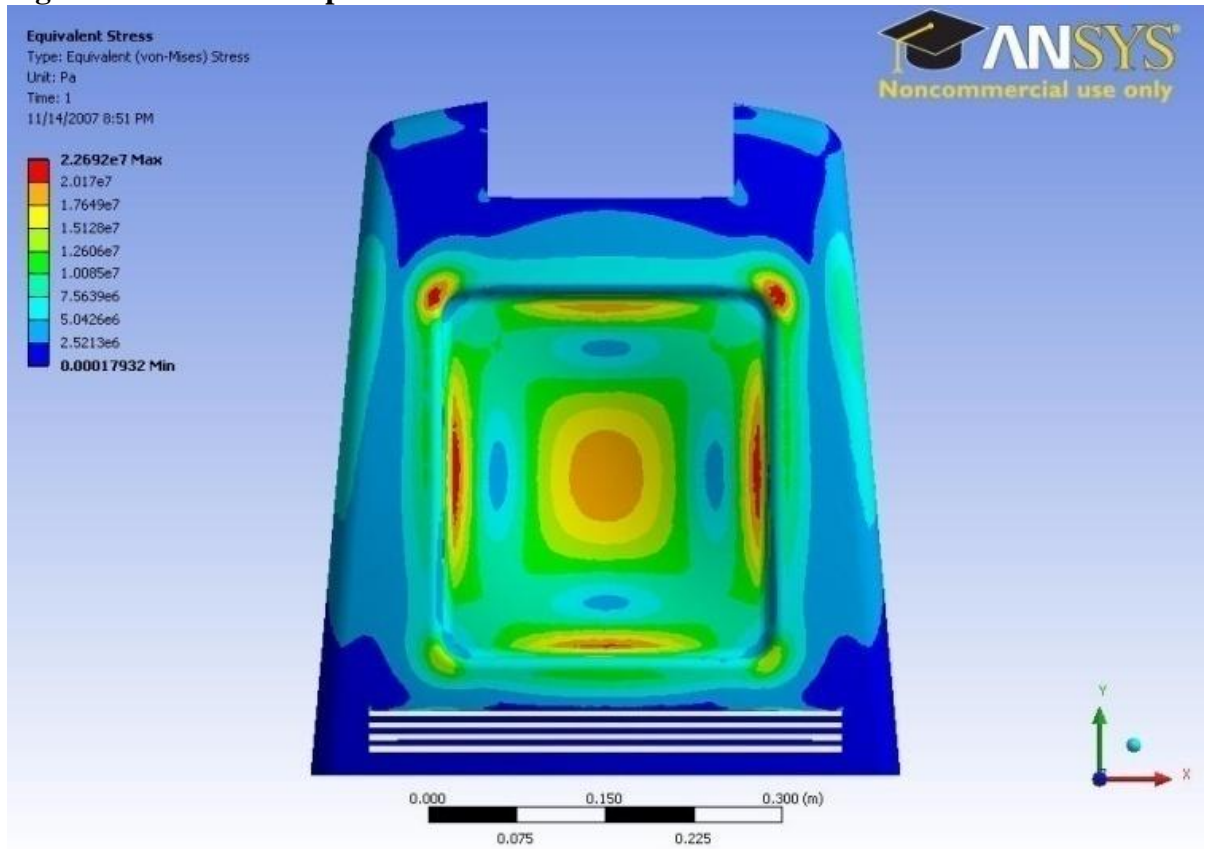

Figure 44: Deflection of the Top Surface under a 133N Load



This information has been removed for confidentiality reasons.

Figure 45: Stress on Top Face Under a 1000N Load



7.3.1.4 Side Face

This information has been removed for confidentiality reasons.

Figure 46: Distributed Load Applied on Noted Side Face

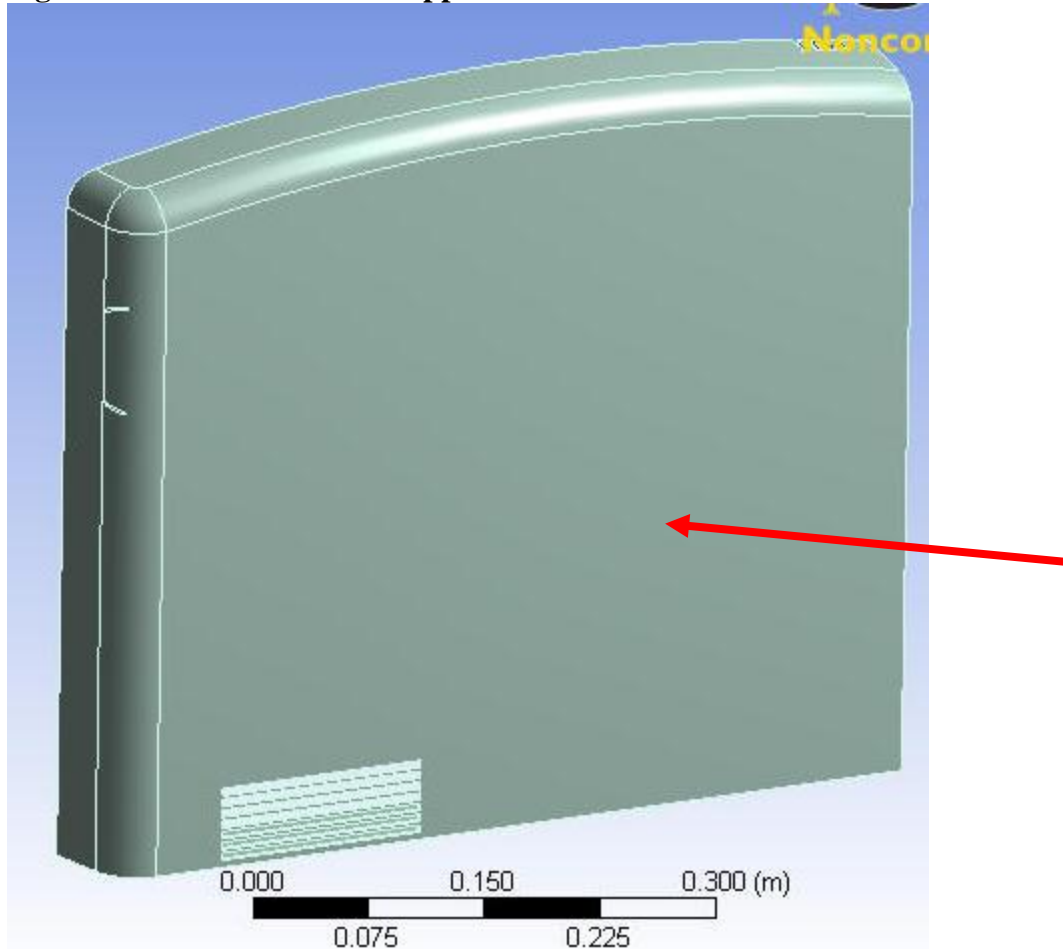

Figure 47: Top Face Mesh and Constraints

This information has been removed for confidentiality reasons.

Figure 48: Deflection of Side Under a 89N Load

This information has been removed for confidentiality reasons.

This information has been removed for confidentiality reasons.

Figure 49: Stress on Side Face Under a 310N Load

This information has been removed for confidentiality reasons.

7.3.1.5 Conclusions from FEA

This information has been removed for confidentiality reasons.

7.3.2 HVAC Calculations

This information has been removed for confidentiality reasons.

7.3.2.1 Piping Schematic

To better clarify the following calculations, below is a schematic with the duct work in the right places with the number of elbows to each vent shown.

Figure 50: Duct Work Schematic

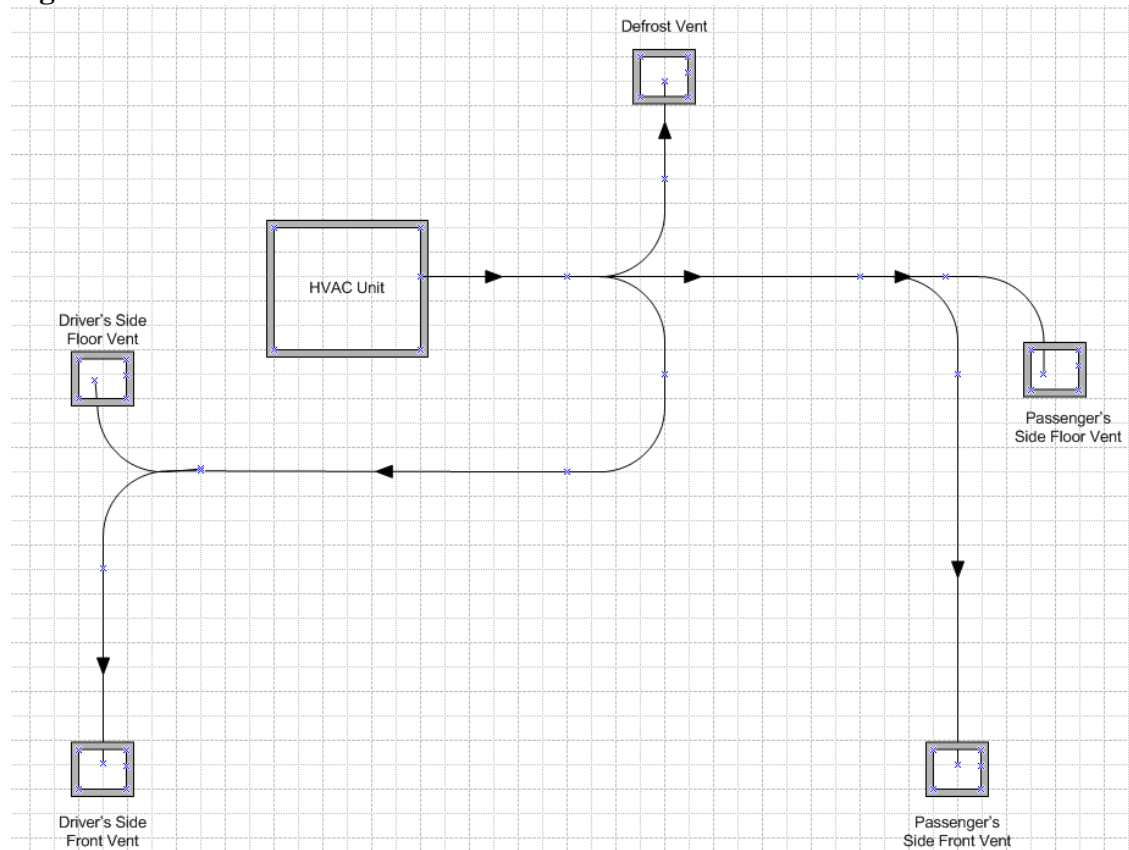

7.3.2.2 Initial Velocity

To begin the heating, ventilation, and air conditioning (HVAC) calculations, the velocity was calculated from the volumetric flow rate coming out of the HVAC to the total cross sectional area that diverges to all the pipes. The total cross sectional area is shown in Eq. 1, Pg. 68.

This information has been removed for confidentiality reasons.

Eq. 1

In Eq.2, below, the velocity at the exit of the HVAC is calculated using the volumetric flow rate, \dot{V} , where A is the area of the cross section and V is the velocity of the air.

This information has been removed for confidentiality reasons.

Eq. 2

With the initial velocity calculated coming from the HVAC system, the details of air flows from specific vents within the console can be analyzed. In order to deliver air to all the vents, a duct system was designed on paper. The rest of the calculations shown below were completed to ensure that every vent receives air, and that the cross car vents received similar air flows.

7.3.2.3 Governing Equation – Extended Bernoulli Equation

The equation shown below, Eq. 3, is the extended Bernoulli equation, where P_1 is the pressure at the exit of the HVAC, P_2 is the pressure at the exit of a vent, γ is the gravity multiplied by density, ρ is the density, g is the gravity, V_1 is the velocity at the exit of the HVAC, and V_2 is the velocity at the exit of a vent, z_1 is the height at the exit of the HVAC, and z_2 is the height at the exit of the vent, and h_L is the pressure loss. This generic equation was utilized to determine the pressure at the exit of the HVAC and the velocity at the exit of all the vents, V_2 .

$$\frac{P_1}{\gamma} + \frac{V_1^2}{2g} + z_1 = \frac{P_2}{\gamma} + \frac{V_2^2}{2g} + z_2 + h_L$$

Eq. 3

$$\gamma = \rho g = 1.169 * 9.81 = 11.4679 \frac{kg^2}{m^2 s^2}$$

7.3.2.4 Pressure Loss Equation

The pressure loss equation, Eq. 4, below, used to calculate the pressure drops in the system is shown below where K_L is the loss coefficient, V stands for velocity, and g stands for gravity.

$$h_L = \frac{K_L V^2}{2g}$$

Eq. 4

With the equations explained above, the equations for the air flow coming from each vent were defined, with the required initial pressure and final velocity as unknowns.

7.3.2.5 Driver's Side Register Governing Equation

The equation for air flow from the driver's front vent, Eq.5, shown below, is defined below where P is the pressure at the exit of the HVAC, and V_{LR} is the velocity at the exit of the driver's front vent. The pressure loss incorporated losses from the three turns in the piping scheme from the HVAC to the actual vent.

This information has been removed for confidentiality reasons. **Eq. 5**

7.3.2.6 Passenger's Side Register Governing Equation

The equation for air flow from the HVAC to the passenger's front vent is shown in Eq. 6, seen below, where P is the pressure at the exit of the HVAC, and V_{RR} is the velocity at the exit of the passenger's front vent. It incorporates pressure loss due to one turn in the piping scheme from the HVAC to the actual vent.

This information has been removed for confidentiality reasons. **Eq. 6**

7.3.2.7 Driver's Side Floor Vent Governing Equation

The equation that represents the air flow from the HVAC to the driver's side floor vent is shown in Eq.7, below, where P is the pressure at the exit of the HVAC, and V_{LF} is the velocity at the exit of the driver's floor vent. It incorporates three turns in the pressure loss equation.

This information has been removed for confidentiality reasons. **Eq. 7**

7.3.2.8 Passenger's Side Floor Vent Governing Equation

The equation that represents the air flow from the HVAC to the passenger's side floor vent is Eq. 8, below, where P is the pressure at the exit of the HVAC, and V_{RF} is the velocity at the exit of the passenger's floor vent. The pressure loss incorporates one turn in the piping scheme.

This information has been removed for confidentiality reasons.

Eq. 8

7.3.2.9 Defrost Vent Governing Equation

Lastly, the equation that represents the air flow from the HVAC to the defrost vent is shown in Eq. 9, seen below, where P is the pressure at the exit of the HVAC, and V_D is the velocity at the exit of the defrost vent. It incorporates 1 turn into the pressure loss equation.

This information has been removed for confidentiality reasons. **Eq. 9**

7.3.2.10 Conservation of Mass

In order to solve these equations, one more equation must be defined because there are 6 unknowns and 5 equations. The last equation needed to solve the problem is the conservation of mass equation, Eq. 10, shown below, where \dot{m}_{LR} is the mass flow rate at the driver's front vent, \dot{m}_{RR} is the mass flow rate at the passenger's front vent, \dot{m}_{LF} is the mass flow rate at the driver's floor vent, \dot{m}_{RF} is the mass flow rate at the passenger's floor vent, and \dot{m}_D is the mass flow rate at the exit of the defrost vent.

This information has been removed for confidentiality reasons. **Eq. 10**

The conservation of mass equation, Eq.10, Pg.63, can be simplified to a the equation below by dividing the conservation of mass equation by density, assuming the density of air remains constant throughout the whole duct system. In the equation below, Eq.11, V_{tot} is the velocity exiting the HVAC, A_{tot} is the total area of all the ducts cross sectional area, A_{LR} is the cross sectional area of the driver's front vent, A_{RR} is the cross sectional area of the passenger's front vent, A_{LF} is the cross sectional area of the driver's floor vent, A_{RF} is the cross sectional area of the passenger's floor vent, A_D is the cross sectional area of the defrost vent.

This information has been removed for confidentiality reasons. **Eq.11**

7.3.2.11 Nonlinear System of Equations

Once all the equations were defined for each vent and the conservation of mass equation was defined, there were six nonlinear equations and six unknowns. All the equations shown below, Eq.12, were placed in Maple so that a numerical answer for the pressure and all the exit velocities could be obtained using a numerical nonlinear systems of equations solver.

1. *Mass*

$$0.085056 = V_{LR} A_{LR} + V_{RR} A_{RR} + V_{LF} A_{LF} + V_{RF} A_{RF} + V_D A_D$$

2. *Left Register*

$$\frac{P}{11.4679} + \frac{3.46939^2}{2 * 9.81} = \frac{101}{11.4679} + \frac{V_{LR}^2}{2 * 9.81} + \frac{0.3 * 3.46939^2}{2 * (9.81)} + \frac{0.3 * V_{LR}^2}{2 * (9.81)} + \frac{0.3 * V_{LR}^2}{2 * (9.81)}$$

3. *Right Register*

$$\frac{P}{11.4679} + \frac{3.46939^2}{2 * 9.81} = \frac{101}{11.4679} + \frac{V_{RR}^2}{2 * 9.81} + \frac{0.3 * V_{RR}^2}{2 * (9.81)}$$

4. *Left Floor*

$$\frac{P}{11.4679} + \frac{3.46939^2}{2 * 9.81} + 0.4 = \frac{101}{11.4679} + \frac{V_{LF}^2}{2 * 9.81} + \frac{0.3 * 3.46939^2}{2 * (9.81)} + \frac{0.3 * V_{LF}^2}{2 * (9.81)} + \frac{0.3 * V_{LF}^2}{2 * (9.81)}$$

5. *Right Floor*

$$\frac{P}{11.4679} + \frac{3.46939^2}{2 * 9.81} + 0.4 = \frac{101}{11.4679} + \frac{V_{RF}^2}{2 * 9.81} + \frac{0.3 * V_{RF}^2}{2 * (9.81)}$$

6. *Defrost*

$$\frac{P}{11.4679} + \frac{3.46939^2}{2 * 9.81} = \frac{101}{11.4679} + \frac{V_D^2}{2 * 9.81} + \frac{0.2 * V_D^2}{2 * (9.81)}$$

Eq.12

7.3.2.12 Final Results of Air Flow

This information has been removed for confidentiality reasons.

Table 5: The velocities at each vent exit

This information has been removed for confidentiality reasons.

7.3.2.13 Conclusions of HVAC Analysis

From the HVAC engineering analysis, it has been determined that the duct system that we designed will work in such a way that all vents will receive similar air flows, and the HVAC is sized.

7.3.3 Thermal Expansion

Thermal expansion of the sides of the center pod had to be considered for maximum temperature differentials in India. After having completed research, it was found that India can get as hot as 120 degrees Fahrenheit; therefore, we made a conservative calculation of temperature changes ranging from 70 degrees Fahrenheit to 150 degrees Fahrenheit. With this change in temperature, the equation below, Eq. 13, was used to calculate the resulting change in length. In Eq.13, L stands for length; ΔL stands for change in length; ΔT stands for change in temperature; and α represents the thermal expansion coefficient. Considering this change in temperature, the change in length resulting from the change in temperature is about 0.5 millimeters. This is a small enough change in length that the design and materials is proven functionally stable.

$$\begin{aligned} \text{Thermal Expansion} &= \alpha = \frac{1}{L} * \left(\frac{\Delta L}{\Delta T} \right) \\ \frac{22.7 \mu\text{strain}}{^{\circ}\text{C}} &= \frac{1}{0.5} * \frac{\Delta L}{65 - 21} \\ \Delta L &= 0.000499 \text{ m} \end{aligned}$$

Eq.13

8 Final Design

The final design was completed by using all of the quantitative analysis and qualitative analysis results. Below is a description of the final design as well as important considerations to be made before prototyping.

8.1 Description

This information has been removed for confidentiality reasons.

Figure 51: Final Design

This information has been removed for confidentiality reasons.

Figure 52: Duct System and HVAC

This information has been removed for confidentiality reasons.

Figure 53: Dimensions on the Front View

This information has been removed for confidentiality reasons.

Figure 54: Dimensions of the Right Side view

This information has been removed for confidentiality reasons.

Figure 55: Dimensions of the Top view

This information has been removed for confidentiality reasons.

Figure 56: Final Design with Key Dimension

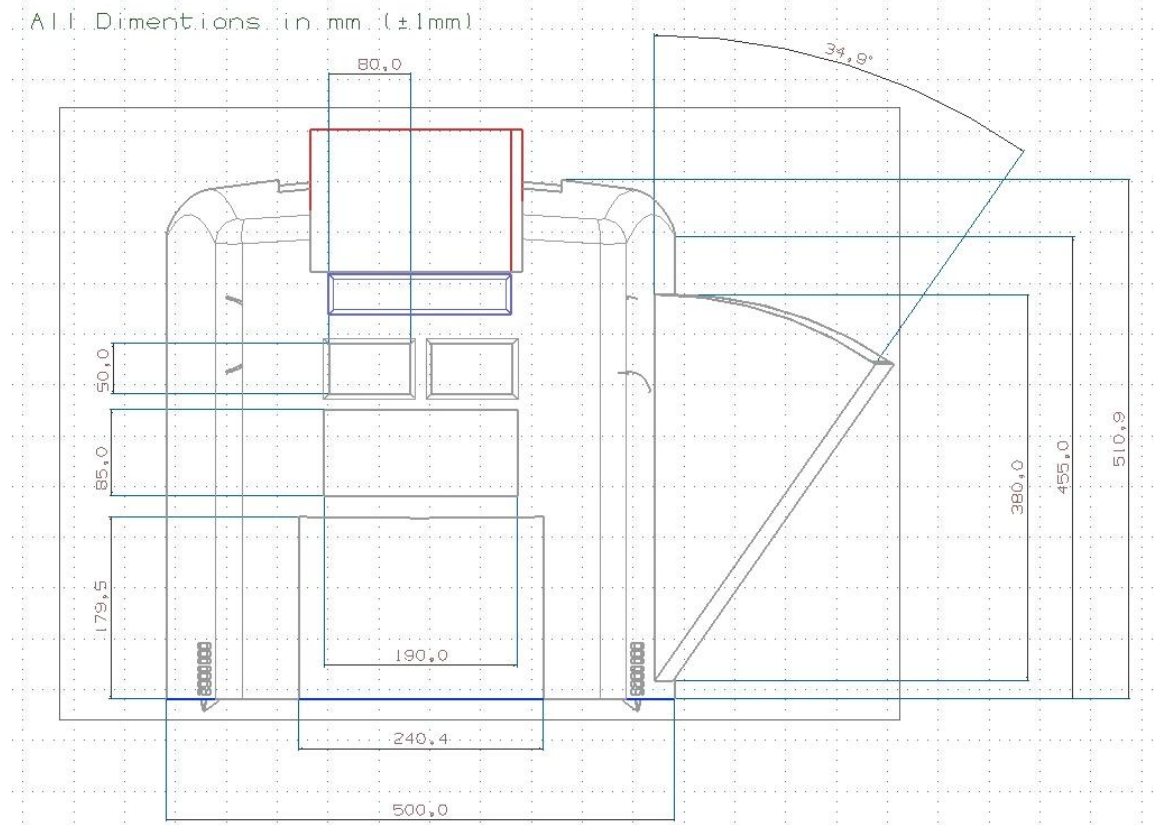

8.2 Considerations

The final design is complete except for the possible addition of lights. If LED's are used they must be incorporated before the prototype is manufactured. LED's will be used as long as they are cheap and functional. They would be placed in spaces where lighting would be important especially at night. This includes the storage spaces and near the controls.

8.2.1 Condensation

This information has been removed for confidentiality reasons.

8.3 Prototype

This information has been removed for confidentiality reasons.

Table 6: Bill of Materials of the Prototype

This information has been removed for confidentiality reasons.

8.4 Bill of Materials

This information has been removed for confidentiality reasons.

Table 7: Bill of Materials of the Production Model

This information has been removed for confidentiality reasons.

8.5 Engineering Specifications

This information has been removed for confidentiality reasons.

9 Manufacturing and Testing Plan

It is important that the right manufacturing process is chosen to create the prototype. Due to budget and time constraints, a “mock-up” prototype will be produced, which is described below. However, if we had the time and money, a prototype made out of the correct material and manufacturing process would be made. Once a final prototype is made of polypropylene using rapid prototyping methods, tests need to be run to make sure it will meet the load specifications.

9.1 “Mock-up” Prototype Manufacturing

This information has been removed for confidentiality reasons.

to show the type of control used. Lastly, our team added LED's to represent the lighting of the storage compartments as it may look in the actual vehicle. Our team manufactured the center pod housing in-house.

9.2 Prototype Manufacturing

The specifics that went into manufacturing our prototype follow. The prototype housing was manufactured by using the engineering drawings of our model to get accurate dimensions followed by the use of an exact-o knife to cut out the outer housing. By cutting close parallel slits in the foam core, a gradual bend can be formed to represent the rounded edges of the housing. Then each storage compartment was created, including the side and top storage, and they were bonded to the housing using hot glue. A box for a DI was created along with a hood to reduce glare on the driver interface. The floor and defrost vents were made by making slits in the housing. The front registers were made circular to allow for movement of the vent along with fins to allow direction of the air flow out of the vent. LED's were added at the end to add light into each of the storage compartments to allow for better viewing of the items inside.

9.3 Mass Production Manufacturing

This information has been removed for confidentiality reasons.

9.4 Testing

Before the center pod can be sold in the BRIC market, a few tests need to be completed. The tests need to be done in order to prove that the prototype indeed satisfies the engineering specifications and will withstand the typical loads applied during use. First, the center pod needs to not deflect more than what was specified. Therefore loads will be applied to the prototype in test cells and the deflection measured. As long as the maximum deflection is less than the given constraint, the prototype passes and can be sold. We will measure the load when yielding begins to make sure our center pod doesn't fail. Also, we will determine the fatigue life by applying a load repeatedly until it fails. We will determine the thermal expansion by measuring the component before heating it, then heat it up measure it, then cool it and measure it. Keep repeating this process until the thermal expansion is determined.

10 Discussion of Future Improvements

This information has been removed for confidentiality reasons.

11 Conclusions

This information has been removed for confidentiality reasons.

12 Acknowledgements

This information has been removed for confidentiality reasons.

13 References

Sponsor:

Gary W. Ismet, Manager, Advanced Cross Systems – Interiors
Visteon Corporation
One Village Center Drive
Van Buren Township, MI 48111
734-710-5698

Dauvergne, Jean. 2000. Dashboard. U.S. Patent 6,129,406, filed May 14, 1998, and issued Oct. 10, 2000.

Volkman, Tilo, Zipperle, Ralf. 2002. Motor-vehicle modular dashboard. U.S. Patent 6,464,281, filed Mar. 19, 2001, and issued Oct. 15, 2002.

<http://images.google.com/imgres?imgurl=http://www.amwltd.com/maruti/images/zen4.jpg&imgrefurl=http://www.amwltd.com/maruti/html/about.htm&h=175&w=350&sz=22&hl=en&start=8&tbnid=1DWA649fmwkAM:&tbnh=60&tbnw=120&prev=/images%3Fq%3DMaruti%2B800%26gbv%3D2%26ndsp%3D21%26svnum%3D10%26hl%3Den%26sa%3DN>

Eureka Technology Partners, 2007, *Suzuki Maruti*, viewed 20 October 2007, <<http://www.amwltd.com/maruti/html/about.htm>>.

Liquid Automotive, 2007, United Kingdom, viewed 20 October 2007, <<http://www.liquidautomotive.com/guide/>>.

APPENDIX A: Open/Close Vent Design Concepts

Figure 45: Flip Vents

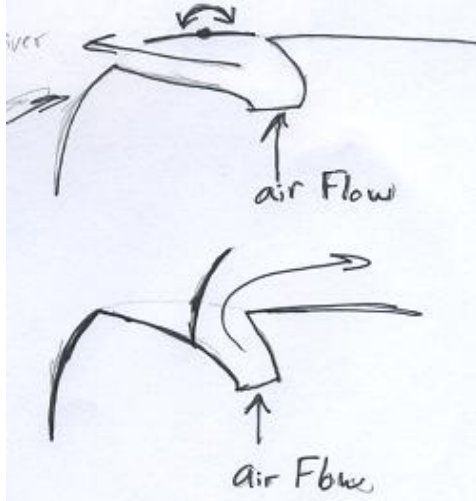

Figure 46: Slider Vents

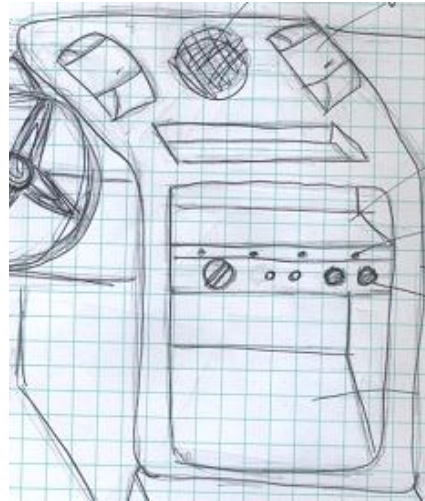
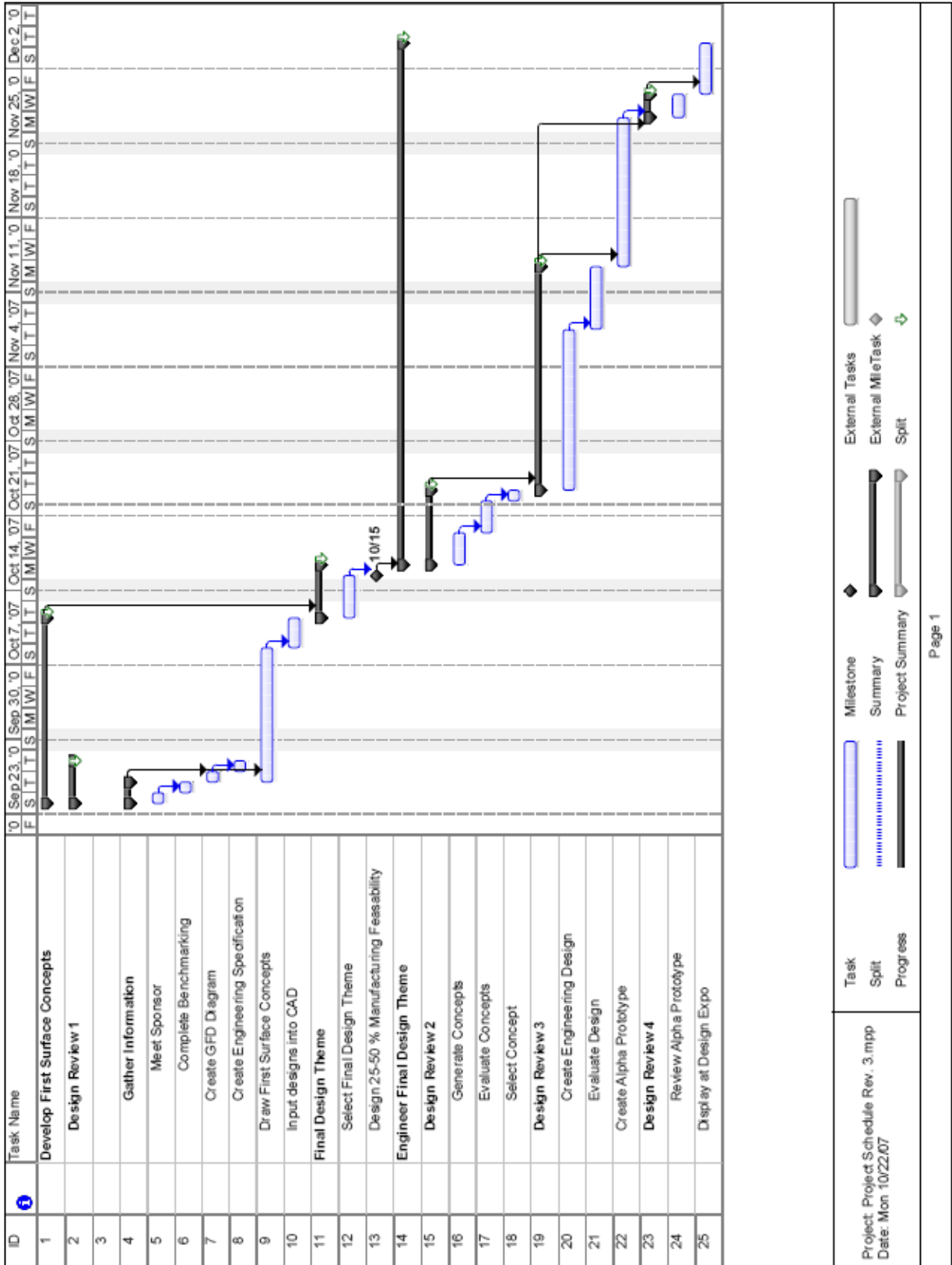

Figure 47: Angled Turret

Figure 48: Conical Turret

This information has been removed for confidentiality reasons.

APPENDIX B: Gantt Chart



Engineering Change Notice 1

This information has been removed for confidentiality reasons.

Table 8: Engineering Change Notice 1: Structural Testing Specifications

This information has been removed for confidentiality reasons.

Engineering Change Notice 2

This information has been removed for confidentiality reasons.

Bios

I am Ashley Kandt, and I was born and raised in Farmington Hills, Michigan. I am one of four children. I have an identical twin sister, Amanda, who is a senior in industrial operations engineering at the University of Michigan. My older sister, Kelly Myczka, received her nursing degree and Masters in nursing management from the University of Michigan. Lastly, I have an older brother, David, who is a mechanical engineer at Yazki, and is currently pursuing his Masters in Business Administration from the University of Michigan, Dearborn. My father is an electrical engineer by degree, and my mother received her undergraduate degree in psychology.

My passion in engineering started as a young child because I was exposed to a lot of it through my dad and brother. As I have entered into internships, my passion developed specifically into mechanical engineering because I realized that I have the ability to make devices and processes to make a difference. I have worked at Eli Lilly and Company for the past two summers, and I will continue to return there because I am passionate about knowing that at the end of the day, the product that I am manufacturing is saving someone's life. My future plan is to get my masters in mechanical engineering through the SGUS program, and then start full-time at Eli Lilly and Company in Indianapolis.

Beyond schooling and careers, I really enjoy running, playing lacrosse, spending time with friends, and visiting Indianapolis.



I am Stephanie Schnaith, but have always gone by the nickname Stevie. I was born in Columbus, Ohio and although I'm from the Buckeye State, I love Michigan and everything it offers. I have a younger sister who is attending Miami studying political science, and a brother who's a junior in high school. My mother is a professor at a private college called Otterbein. My father is a chemical engineer at Ashland Chemical Co. and had a great influence on me becoming an engineer.

I chose mechanical engineering because I have always been interested in the design aspect. I enjoy seeing a project through, from the design stage until the final product. I have had many internship experiences including my latest, CC Technologies, a pipeline consulting firm, where I applied knowledge I learned from my classes to real life. I analyzed pipe defects as well as interpreted data to determine when a problem might occur in a pipeline. All the real-world applications and hands on experience have shown me that I picked the right major. My future plan is to graduate in December of 2008, backpack through Europe, obtain a full-time job, and possibly go back to school to get my MBA.

When I'm not busy with school and applying for jobs, I like to play IM sports, read, hang out with friends, go to football games, watch movies, and take road trips. I also love to travel and have been to Alaska, Israel, Egypt, Costa Rica, and Spain, and plan on taking many more trips!!



My name is Braden Carroll. I grew up in Flushing, Michigan about an hour north of Ann Arbor. I've lived my entire life in Michigan and love the crazy weather and the four seasons. I enjoy wakeboarding, swimming, inter-tube water polo, and snowboarding. Most people reference me for constantly working on my MacBook Pro. I'm a convert from Windows to Mac OS X.

I always knew I wanted to be a mechanical engineer. Even as a child I love to build things and take things apart. In the early days of my adventures what I built was fairly simple and what I took apart never went back together. As time progressed I began building more complex widgets and trying to take things apart, fix the problem, and then return to a working condition. From all this I knew mechanical engineering was for me. As much as I like crunching numbers and making CAD drawings my real love lies in being hands on and making something tangible.

I currently and apply to the SGUS program in Mechanical Engineering. I've planned on participating in this since I was a freshman and am excited to do so. Over the summer I will be working at Eli Lilly and Company for the second time as a summer intern.



I am John Taylor Leackfeldt, but have always been called Taylor by my friends and family. I am from Rochester, NY, and have lived there my entire life, save for my time at the University of Michigan. I have a sister named Paige, who is a freshman in interior design at Purdue University. My mother was a nurse for 16 years and now volunteers for various organizations. My father is a Global Capital Manager for Ferro Corporation and has a degree in Ceramic Engineering from Alfred University.

My father's interests in cars and machines had a great impact on my choice of Mechanical Engineering. From a young age, I was avidly interested in taking things apart to find out how they work. My interest in design and manufacturing comes directly from early experiences working on helping to restore my father's 1955 Chevy Impala, a project that I feel has a great impact on my work here in ME 450. This past summer, I was an intern at a Johnson & Johnson research facility called Ortho-Clinical Diagnostics, where I was part of a design team for two subsystems of a prototype blood analyzer for hospital use. I plan to graduate in May 2008.

Outside of class, I am involved in several student groups. I am the Vice President of Operations for Alpha Phi Omega, a 300 person coeducational community service organization. In my job, I am the chapter parliamentarian in charge of adherence to both chapter and national bylaws, and am also in charge of keeping accurate records of all meetings and scheduling facilities for events. Projects I have worked on with APO include coordinating volunteers for the American Red Cross for Blood Battle drives, building houses for Habitat for Humanity, and cooking for the homeless at local Ann Arbor shelters. Outside of APO, I am involved in K-Grams, where I go to Gompers Elementary in Detroit at least once a month to help teachers with in-class projects. In my free time I enjoy watching football, snowboarding, and playing guitar in my rock band, Jefferson Road.

