

GAS POROSITY IN COPPER ALLOYS

I. ALUMINUM BRONZE

Yasuhiro Matsubara<sup>1</sup>, P.K. Trojan<sup>2</sup>,  
Shigeru Suga<sup>3</sup> and R.A. Flinn<sup>4</sup>

(1,3) Visiting Scholar, University of Michigan

(2,4) Professor of Metallurgical Engineering, University  
of Michigan



## ABSTRACT

Despite advances in the basic understanding of gases in metals, severe problems still exist in avoiding gas porosity in production castings of copper alloys. The present program has for its general objectives the development of a simple test for rating the gas content of the melt, the correlation of gas level in the melt with gas porosity in the casting and the role of mold materials in contributing to gas porosity. This first report is limited to aluminum bronze 954(9C).

A modification of the reduced pressure test for aluminum alloys has been developed. In this procedure, a small sample of liquid is placed in a test chamber and the time for evacuating the chamber is carefully controlled with respect to the stage of solidification of the sample. A rating of the gas level in the melt can be determined by finding the reduced chamber pressure which just produces a gas bubble in the surface of the test melt. This pressure was correlated with gassing procedure using wet clay discs, type of melting furnace, holding time after gassing, and purging with nitrogen.

The effects of mold variables such as section thickness, directional solidification, mold material, and moisture content were also evaluated.



## INTRODUCTION

The problem of porosity due to gas in copper alloy castings is still a major difficulty for the producer. In these days of costly product liability cases, the foundryman can no longer count on using a "controlled" amount of gas to produce good external surfaces, particularly near critically stressed sections. Instead, castings which are free of porosity due to gas or shrinkage are being required. There is a real need therefore for the following:

- 1) A simple test to indicate the gas level in molten metal while it is in the furnace where corrective action can be taken.

- 2) Determination of the effect of casting conditions (gating, mold material, mold design) upon the final gas content of the metal as it solidifies.

- 3) Determination of the effect of gas porosity and its distribution upon mechanical properties.

- 4) Development and evaluation of methods for reducing the gas content to acceptable levels.

This report describes the initial phase of this research (August-December 1971) supported by the International Copper Research Association with the technical support of the Brass and Bronze Research Committee of AFS. In this portion of the work it was decided to begin the effort with an investigation of Alloy 954(9C) which is important in many highly stressed castings in which elimination of gas porosity is essential. The emphasis of the experiments was on:

- 1) Development of a test for evaluation of the level of gas in the melt.

- 2) Variables affecting gas level in the melt.

- 3) Effect of gas level in the melt and of mold variables such as water content of sand on the porosity of castings.

available non-ferrous melt quality tests over a number of years<sup>(4)</sup> and summarized the available tests as follows:

- (a) Density determination of cast sample.
- (b) Direct measurement of hydrogen content.
- (c) Reduced pressure solidification test.
- (d) Appearance of sample cast in sand or metal mold.

The investigations indicated that (a) was too time consuming, (b) the Ramsley Telegas test equipment<sup>(5)</sup> was quite delicate and required further development, and that (d) was unreliable and rather subjective. The reduced pressure test (Straube-Pfeiffer) which has long been used for aluminum alloys did not work with copper alloys except in some cases with aluminum bronze.<sup>(6)</sup> For other copper alloys, gas indications were only obtained when large quantities of tin (30-35%) were added.<sup>(7)</sup> The gross change in composition and alteration of temperature of the sample have worked against the adoption of this modification of the test.

From advanced work in aluminum alloys on the reduced pressure test for aluminum, Sharov<sup>(8)</sup> and Neil<sup>(9)</sup> showed that the reduced pressure required for gas evolution can be basically related to the gas content of the melt. Burr<sup>(10)</sup> has discussed the observation of bubble formation at the surface of the test specimen during pressure reduction for aluminum alloys as a way of estimating gas content. Therefore if a satisfactory test procedure can be developed for copper alloys, it appears that it can be related to basic gas solubility data.

3) Data on effects of casting variables on gassing. Baker<sup>(11)</sup> has summarized a good deal of the data in this field. Pell-Walpole<sup>(12)</sup> showed that gas could be introduced into 10% tin bronze by pouring the liquid through basins containing different sand mixtures. He quotes the early work of Lepp<sup>(13)</sup> regarding the greater susceptibility of high phosphorus gun metal to gassing from the mold and the observation that molds with high water content (8-9%) give less susceptibility to gas pickup because of the chilling action. Pell-Walpole describes experiments showing that on the contrary the gas pickup increases with water content and also that a thoroughly dried clay bonded mold gives less gas than an oil bonded core sand mold.

#### GENERAL PROCEDURES

Two melting furnaces were used in the investigation to represent current commercial practice. A small gas fired furnace using a No. 10 clay graphite crucible of 25 lb capacity and a larger lift coil 3000 cycle induction furnace were used with a No. 50 clay graphite crucible, usually with 60 lb charges.

After discussion with the AFS Research Committee, it was decided to begin with Alloy 954(9C) aluminum bronze. Typical commercial ingot was used of the following analyses:

	Cu	Al	Fe
Lot 1	85.40	10.75	3.65
Lot 2	86.05	10.25	3.29

In general, remelted material was used for pilot tests of procedure and all ingot charges for critical tests but no difference in behavior was encountered. No machining scrap was used, only

cleaned gates, risers and test castings.

Molds were made of greensand, dry sand, and coresand of the following compositions:

Green Sand

140 mesh washed New Jersey Silica  
15% silica flour  
4% western bentonite  
0.75% dextrin  
4-8% moisture (variable)

Core Sand

80 mesh washed New Jersey silica  
1.5% western bentonite  
1% corn flour  
0.75% dextrin  
3% water  
2.5% core oil

Dry sand molds were rammed of the greensand mixture with 4% moisture and then dried overnight in a gas fired oven. Thermocouples placed in the mold showed the mold temperature to vary during drying within a cross-section from 335-340°F. The molds were removed from the oven approximately 1/2 hour before pouring. This procedure minimized moisture pickup from the atmosphere.

Other molds and chills were machined from electrode quality graphite.

Specialized procedures will be discussed separately in the sections to follow.



## PROCEDURE AND DISCUSSION

Since the work progressed in three stages the specialized procedures and results will be discussed together as follows:

- (1) Development of test equipment.
- (2) Evaluation of effect of melt variables on gas content.
- (3) Effects of mold variables, combined melt-mold effects.

### 1 - Development of test equipment

The equipment in its present stage of development is shown in Figures 1 and 2 and contains a number of modifications of the well known Straube-Pfeiffer test. A dip sample of the melt is taken by crucible and placed in the graphite crucible seat. A rapid response 28 ga. chromel alumel thermocouple is positioned quickly by a jig at 1/4 radius and the tip is approximately 2-1/2 cm beneath the surface (1-1/2 cm from the bottom). The lid, with an "O" ring seal and pyrex observation window, is placed on top of the chamber. The temperature recorder is observed and 15 seconds after the start of solidification (as shown by the recorder graph) the valve to the vacuum tank (an evacuated oxygen tank) is opened. The pressure in the system equalizes at approximately 45 mm in less than 11 seconds as shown by the pressure gage. Other chamber pressures can be rapidly attained if desired by regulation of the valve-tank combination.

The surface of the melt is observed through the window and it is noted whether a bubble forms on the melt surface and whether it breaks. When solidification is complete the tank valve is shut and the exhaust valve of the chamber is opened. The tank

is then connected to the vacuum pump through a bypass valve and reevacuated to 1 mm Hg (1 Torr) in preparation for the next test. Provision is made for sampling the gas in the chambers.

In the development of the test a number of variables were evaluated:

Crucible material. In most of the work to date the typical laboratory procelain crucibles used in quantitative chemical analysis have been employed. To avoid cracking these are preheated in a nearby resistance heated furnace at 900°C (1650°F). Electrode quality graphite, clay graphite, high purity alumina, and iron have also been evaluated. Samples of melts containing gas and solidified in different crucibles are shown in Figure 3. If a graphite seat is not used, the gas escapes through holes which form at the sides of the casting and therefore a good rise in the surface is not obtained. This effect is shown in the sample solidified in clay-graphite.

The porcelain crucible (52 mm dia. No. 2) gave the most consistent results although further development work with the iron crucible is in progress. There was no particular advantage in using high purity alumina and the cost is five times as great as porcelain. With care the porcelain crucibles can be used three to four times while the iron crucibles can be used only once. There is a possibility of contamination of the melt by iron oxide and the melt sticks to the crucible.

Figure 4 shows the effect of seat material. Melts solidified in porcelain crucibles placed in a seat of insulating

brick show holes in the side while the graphite seat gives smooth continuous sidewalls.

The effect of time of application of reduced pressure is shown by Figure 5. This modification of the conventional test is essential for obtaining the data discussed later. If the reduced pressure is applied too early as at (A), the melt is degassed while completely liquid and no holes are obtained later. The escape of gas can be observed but no measure of gas content can be made. On the other hand if the valve to the vacuum tank is opened at 15 sec. after solidification begins (C), a gassy casting is obtained. Naturally if the melt is allowed to solidify before application of reduced pressure (D), the test fails.

Effect of value of reduced pressure. From basic theory we know that a bubble may form at the surface of a melt when the gas content of the melt provides a partial pressure greater than the pressure in the atmosphere over the melt. For example under equilibrium conditions a hydrogen content of  $2.6 \text{ cm}^3/100\text{g}$  metal in an 8% Al-Cu alloy at  $2012^\circ\text{F}$  will produce a bubble when the pressure over the melt is less than 1 atmosphere (760 Torr). Let us suppose the dissolved gas is only half this value or  $1.3 \text{ cm}^3/100\text{g}$  metal. If we evacuate the chamber we find from Sieverts Law that the pressure at which a bubble could form is about:

$$\begin{aligned} p_{\text{H}_2} &= 112[\% \text{ H}]^2 \\ &= 190 \text{ mm} \end{aligned}$$

Note that this is not a linear relation between pressure and % H and that for the constant used (112) the % H is expressed in terms of cc/100g metal instead of the unwieldy value of wt %

which is very small. In other words the pressure for bubble formation is an index of the gas content of the melt.

Determination of gas pressure of the melt. As mentioned in the description of equipment it is possible to establish rapidly a pressure higher than 45 mm above the crucible by the control valves and the pressure in the tank. If several samples are taken in sequence and solidified under different pressures an index of the gas pressure in the melt can be obtained as shown in Figure 6. If the chamber pressure is well below the gas pressure in the melt, bubbles form rapidly and break through the surface. If the pressure in the chamber is above the gas pressure in the melt, no bubbles form and a shrinkage cavity develops. If the pressure in the chamber is just below the gas pressure in the melt, the surface will rise slightly due to bubble formation but the bubble will not break through. The precision of the measurement is quite good; in the example shown (Fig. 6) a well defined bubble formed at 106 mm, broke at 97 mm, and barely causes a surface rise at 112 mm. The reproducibility is equal to this precision. It is important however to watch the solidification to see if the bubble breaks, and not be wholly dependent upon the bubble appearance after solidification.

Before progressing to the next section it should be emphasized that the equipment shown is probably more elaborate than will be needed for general foundry use. In the development of the test and in evaluation of the variables to be discussed, it was considered important to provide for measurement at a higher

degree of precision than may be needed in control equipment.

It should be added that under the test conditions given, the expression "gas pressure of the melt" does not apply precisely to the gas pressure of the melt in the furnace for two reasons. First, the sample temperature is lower and secondly, the small amount of solidification at the side of the crucible will concentrate the gas in the remaining liquid. However, the chamber pressure which just produces a bubble can be measured accurately and provides a useful quantitative rating of the gas level. In work which is planned, the absolute measurement of gas levels of the melt will be obtained with a mass spectrometer and correlated with the simple pressure test.

## 2 - Evaluation of effect of melt variables on gas content

In this section we will discuss the deliberate introduction of gas in the melt by using moist clay discs, the effect of holding time in the furnace after gassing, the effect of melt temperature on the level of gassing, and preliminary data on degassing with nitrogen.

Introduction of gas in the melt. In order to investigate the effects of different gas levels on castings and evaluate remedies, it was necessary to find a way to attain different gas levels. While, in these alloys, the principal gas is probably hydrogen the possible role of a small amount of oxygen cannot be ignored.<sup>(1)</sup> It seemed best therefore to gas the melts by reaction with water vapor rather than hydrogen. After testing a number of methods, the use of wet clay additions to the surface of the melt was tried as recommended by R. A. Colton. In final

form, the clay is added as 0.2 lb discs, 2-1/2 in. diameter with 15% H<sub>2</sub>O. The correlation of the number of discs added with the gas content of the melt is surprisingly good as shown in Figures 7a and 7b. The discs were added according to the following schedules:

For induction furnace melts

No. 50 Clay Graphite Crucible,  
melt dimensions 4-1/2" deep, 8" dia., 60 lb

- 5 clay discs - added at same time, 2 minute exposure
- 10 clay discs - added at same time, 4 minute exposure
- 20 clay discs - 10 added at same time, 4 min. exposure,  
removed, 10 new added, 4 min. exposure
- 30 clay discs - 10 added, 4 min., removed  
10 added, 4 min., removed  
10 added, 4 min., removed

Power left on to maintain melt temperature.

For gas furnace melts

No. 10 Clay Graphite Crucible,  
melt dimensions 4" deep, 4-1/2" dia., 20 lb

- 2 clay discs - added at same time, 3 min. exposure
- 5 clay discs - 3 added for 3 min. exposure, then  
removed and 2 added for 3 min.
- 10 clay discs - 3 added for 3 min., removed  
3 added for 3 min., removed  
2 added for 3 min., removed  
2 added for 3 min., removed
- 15 clay discs - 3 added for 3 min., repeat 5 times
- 20 clay discs - added in groups of 3 for 3 min. exposures,  
finally 2.

The basis for these exposure times was to allow the discs to stay in contact with the melt until dried throughout.

It should not be inferred from these data that the metal in the gas furnace picks up gas faster than in the induction furnace. When the data are plotted to take into account the smaller amount of metal in the gas furnace, the results are comparable, Figure 7b.

Effect of holding time in the melt upon gas content. After removal of the last of the clay discs, samples were taken to rate the gas pressure of the melt as a function of holding time, Figure 8. In the case of the gas furnace, the gas escaped from the melt with holding time until a plateau was reached at about 105 mm. This probably indicates that at this time the input of gas from the furnace atmosphere balanced the evolution of gas from the melt. In contrast, the gas content in the induction furnace decreased to below 45 mm, the present lower level of pressure of the equipment. The relative humidity of the laboratory atmosphere was quite low at this time of the year (15-20%, 70°F) corresponding to a partial pressure of approximately 4 mm H<sub>2</sub>O under equilibrium conditions.

The combined effect of melting first in the induction furnace and transferring to the gas furnace was investigated next. A melt was degassed with nitrogen in the induction furnace and the melt gas pressure was below 45 mm, Figure 9. The melt was transferred to the gas furnace and held at 2230-2260°F for 140 minutes. The gas content increased as a function of time, levelling out at 105 mm. This checks the reversibility of the gas furnace data of Figure 8.

Effect of temperature on gas pressure of the melt. The usual test temperature for the experiments was controlled in the

range 2230-2260°F which is an average casting temperature for alloy 954. However, to investigate the effect of changing melt temperature on gas pickup, several experiments were conducted, Figure 10.

When an all ingot charge was melted in the gas furnace and tested immediately, the gas pressure of the melt rose from 60 mm at 2150 to 140 mm at 2340°F. Other results using clay discs are also given in the figure.

Effect of nitrogen purging. In future work the quantitative relationships for nitrogen purging will be determined. The work to date has confirmed expectations that the melt gas pressure in gassy melts can be reduced by purging. In the case of the induction furnace the melt was gassed with 30 clay discs and after 20 minutes of treatment with oil pumped nitrogen the melt gas pressure was reduced below the standard test pressure of 45 mm. With a gas furnace melt which was gassed to a melt gas pressure of 103 mm, purging with nitrogen for 25 minutes reduced the melt gas pressure somewhat but it was still above 45 mm. Apparently the induction furnace melt was degassed to a lower level from these early tests.

### 3 - Effects of gas pressure of the melt and of mold variables upon porosity in castings

In this section the correlation of melt gas pressure and mold material with gas porosity in actual test castings is described. First, the casting designs, then the effects of gas content of the metal, of water content of the sand and finally the variation in directional solidification will be considered.



Test castings. The different designs are shown in Figure 11. The gas test plate is a modification of an Abex Corp. design by Schaefer and Mott. The metal enters through two gates, passes through a heavy dirt trap into a notched plate casting. A large vent is present at the far end to avoid mechanically trapped gas. This design is representative of a light section casting with no strong thermal gradients.

The rectangular plate design is new and poured in 1/4, 1/2, 1 and 2 inch sections. The novel feature is the optional use of one, three, or four side chills made of graphite. Comparison of chilled<sup>and</sup>/unchilled castings is profitable as shown later.

The diamond shaped graphite casting was designed to trap any gas by rapid solidification from all sides. The metal enters through a small gate at the parting line which is frozen off quickly by the relatively massive graphite sides. This casting shows the effect of rapid freezing from the sidewalls and is intended to localize the gas porosity even in longer freezing range alloys.

Effect of the gas content of the melt. The correlation of casting porosity with a high gas content melt is shown both by the gas plate and the rectangular plate castings, Figures 12 and 13. In the case of the gas plate (Fig. 12), the mold material was green sand with 4% moisture. Six clay discs were added to the induction melted metal and one gas plate was poured. The gas free gas plate casting was obtained from the same melt by purging the metal 5 minutes with dry nitrogen before pouring.

The rectangular castings show the effect of gas in producing plates with excellent surface appearance but the internal porosity is evident from the X-rays. It is interesting that the worst porosity is shown by the heaviest section, the 2 inch section. It is especially important to note that despite the directional solidification the gas is badly trapped.

The correlation of porosity, the crucible test, and density is shown in Figure 14. In one case the melt was gassed with 30 discs and chilled from 4 sides. The figure shows severe porosity in both the crucible test and the casting. The melt degassed with nitrogen shows shrinkage and no gas.

Effect of mold material. In Figure 15 gas test plates were poured in different molds. Although all three test castings show some gas porosity, the amount of gas is least in the dry sand and most in the green sand with 6% moisture. The metal had been melted in the gas furnace and 10 clay discs added just before pouring. The presence of gas in the castings was therefore to be anticipated.

In the test shown in Figure 16 the effects of moisture in the sand and of core sand are shown. The best casting is of thoroughly dried green sand rather than baked core sand. This indicates that the hydrocarbons of the core sand can contribute to porosity, as found by Pell-Walpole for tin bronze. The variation in density with the gas in the melt, the mold material and section size agrees with the radiographs and is shown in Figure 17.

Effects of directional solidification. In addition to the castings already discussed a comparison of different freezing patterns is shown in Figures 18 and 19. In Figure 18 the effects of freezing from one side compared to three sides is evident. For comparison the radiograph from Figure 16d is reproduced (chilled one side) in order to see the advantage of using three chills to accentuate the presence of gas when gassy metal is poured into 6% moisture green sand molds. These data can also be treated quantitatively by comparing the densities in Figure 17.

In Figure 19, the entrapment of gas in one case and of shrinkage in another is shown for the diamond shaped graphite mold cavities. Even though the gating system and lack of risering would never allow for a completely sound casting, the high solidification rate encountered may find greater use for the alloys with a broad freezing range which are to be studied in the future.

### Conclusions

As mentioned earlier this is a progress report and further work involving evaluation of other alloys, molding materials, mechanical properties and degassing methods is planned. The results to date indicate the following conclusions for aluminum bronze (954):

(1) The reduced pressure test described permits the rating of the gas pressure of the melt with good precision.

(2) The gas level of the melt is related to the atmosphere above the melt. Under the conditions of low humidity prevailing during the tests the gas level of the melt reached a lower value

upon holding in an induction furnace compared to a gas furnace.

(3) The gas content of the melt reached higher values the higher the metal temperature.

(4) As expected, the gas content of the melt decreased on degassing with nitrogen and quantitative evaluation of the effect is now possible.

(5) Correlation of the gas content of the melt with gas porosity in three designs of test castings was obtained.

(6) The water content of the sand adds to the porosity of the casting. Severe gas porosity was encountered with 6 and 8% H<sub>2</sub>O in the sand tested.

(7) Directional solidification produced by side chilling does not eliminate gas porosity.

#### Acknowledgment

We wish to thank Dr. L. McDonald Schetky for his counsel and the International Copper Research Association for financial support of the project. We are also grateful for the contribution of alloys by R. Lavin and Sons.

The Research Committee of the A.F.S. contributed a number of helpful suggestions as mentioned in the report and we wish to acknowledge their support over the years.



## REFERENCES

- (1) Phillips, A.J., "The Separation of Gases from Molten Metals,"  
Trans. AIME 171, 17-46 (1947).
- (2) Bever, M. and Floe, C.F., Trans. AIME 166, 128 (1946).
- (3) Röntgen, P. and Möller, F., "The Solubility of Gases in Copper  
and Aluminum," Metallwirtschaft, Vol. 13, pp 81-83, 99-101 (1934).
- (4) Comm. T.S. 45, Brit. Fdyman. Tech. Council, pp 91-100 (1958).  
Final report March 1960, pp 120-128.
- (5) Ransley, C.E., British Patent 684865.
- (6) Hudson, F., Brit. Foundryman, 453 (1958).
- (7) Atterton, D.V., Brit. Foundryman, 455 (1958).
- (8) Sharov, M.V. and Gudchenko, A.P., "A Study of the Interaction  
of Hydrogen with Light Alloys during the Melting Process,"  
Metallurgicheskie Osnovy Lit'ya Legkikh Splarov,  
Oborongiz, Moscow, 306 (1957).
- (9) Neil, D.J. and Burr, A.C., Trans. A.F.S., Vol. 69, pp 272-276  
(1961).
- (10) Burr, A.C. and Neil, D.J., Société Française de Metallurgie  
1958 preprint 28.
- (11) Baker, W.A., Non-Ferrous Foundry Metallurgy, Ed. A.J. Murphy,  
McGraw-Hill Book Co., N.Y., pp 355-365 (1954).
- (12) Pell-Walpole, W.T., Fdy. Trade Jnl., Jan.-Feb. 1946, 87-241.
- (13) Lepp, H., Mezinárodní Sjezd Slavarensky Praha (Int. Fdy.  
Conf. Prague, 1933, 95-118.



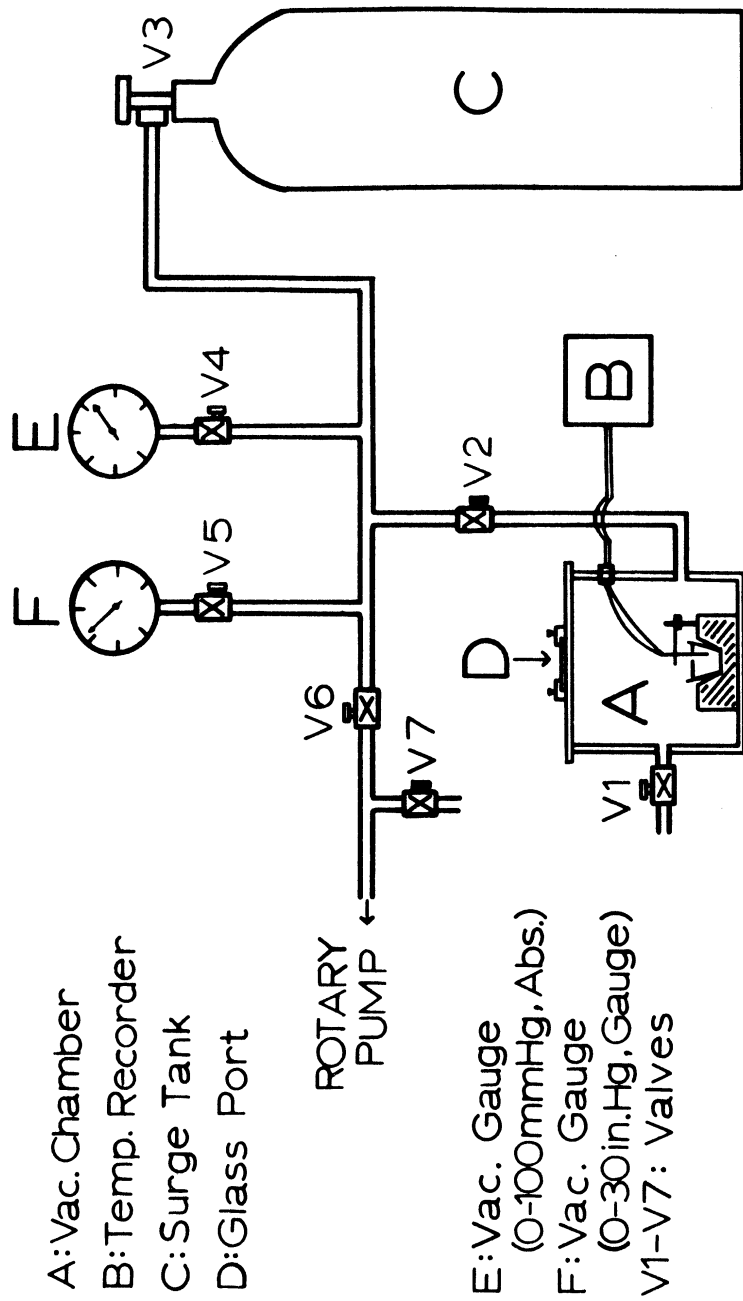

Figure 1. Schematic diagram of the reduced pressure test equipment.



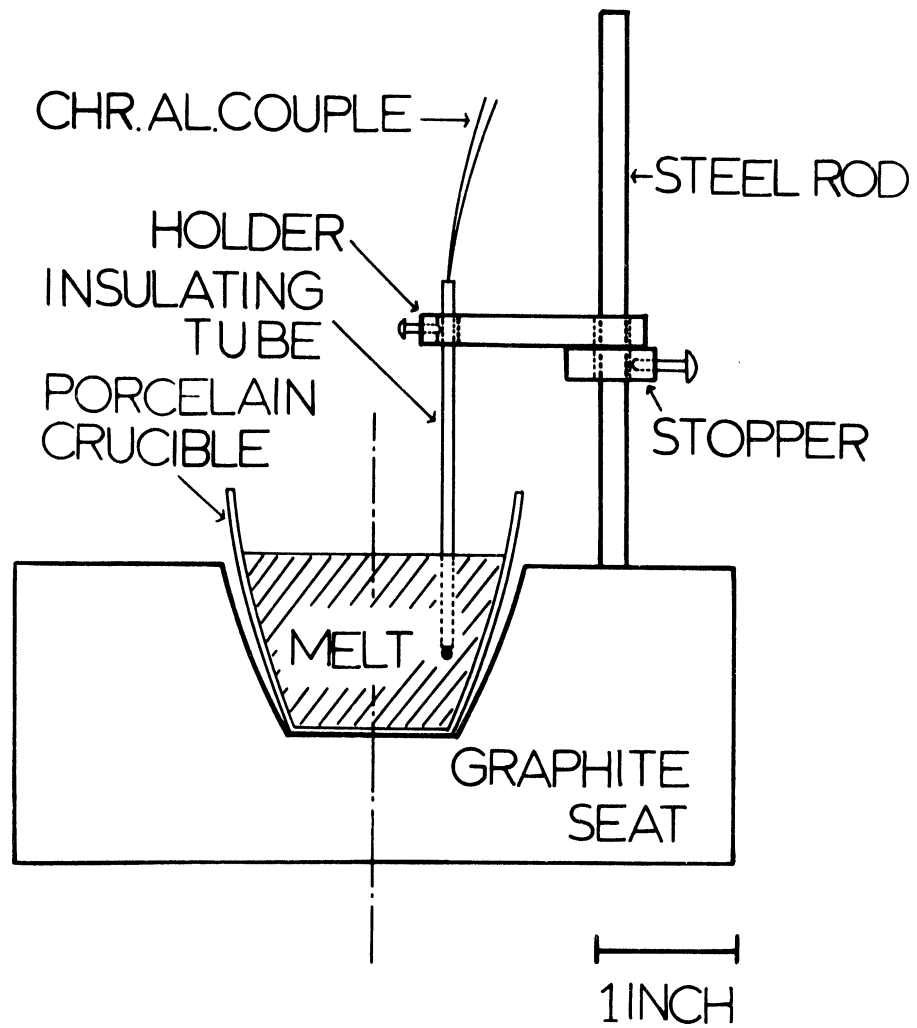

Figure 2. Cross sectional detail of the reduced pressure test assembly.

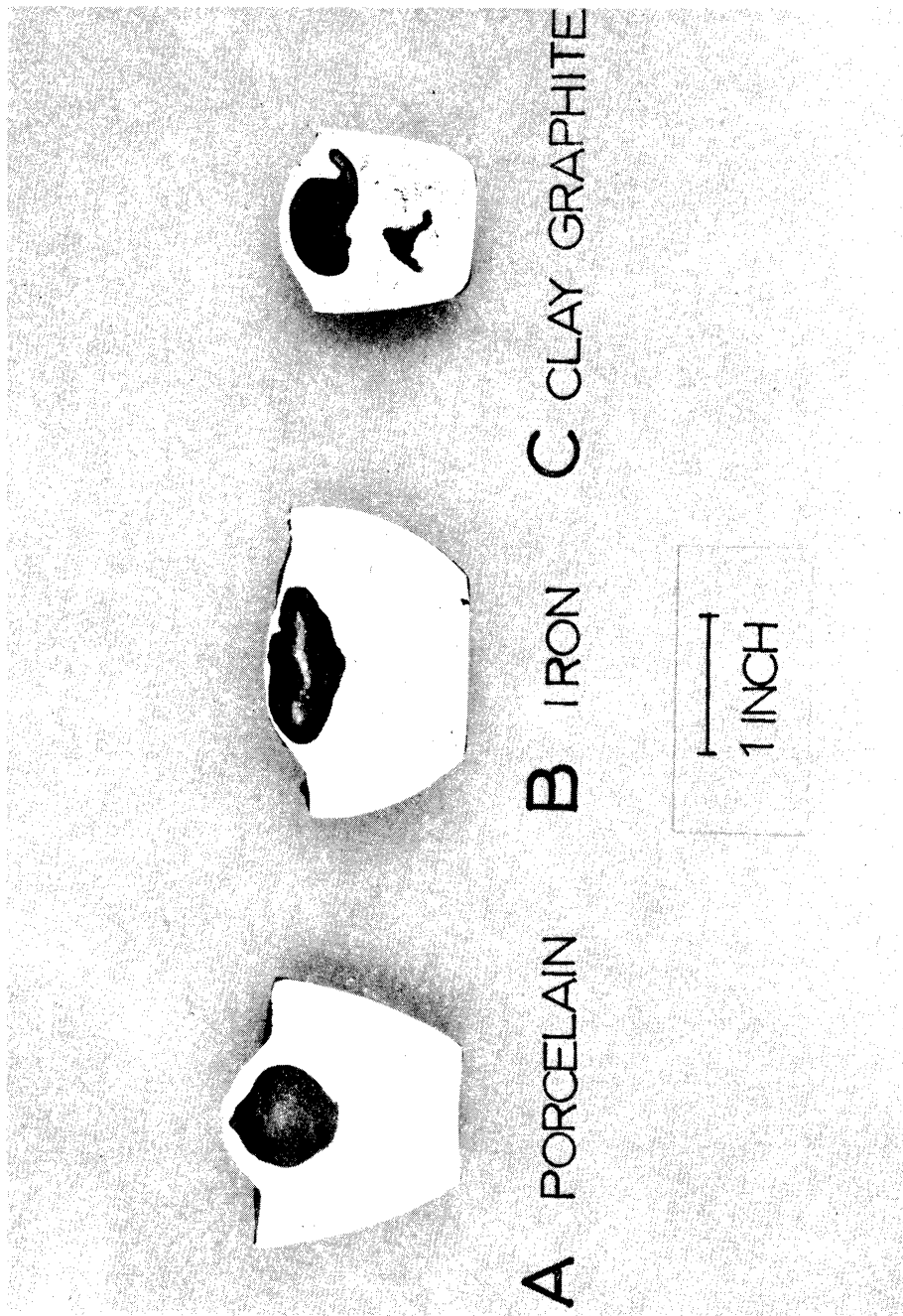

Figure 3. Sections of reduced pressure test samples of a gassy melt of alloy 954(9C) solidified in different crucibles. A and B were with a graphite crucible seat while C had an insulating brick crucible seat.

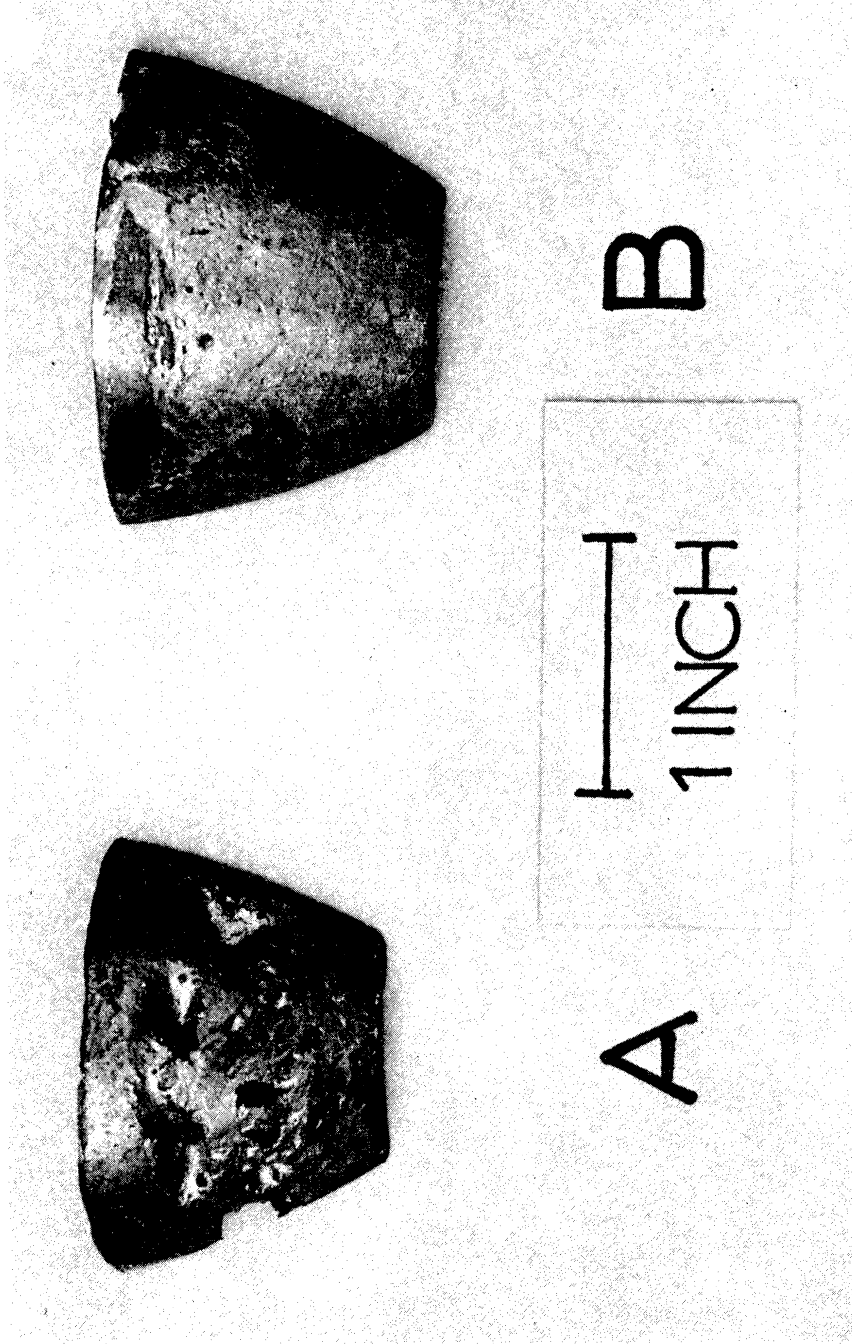

Figure 4. Effect of seat material on surface appearance of reduced pressure test samples. A - insulating brick seat and B - graphite seat. Crucible material was porcelain.

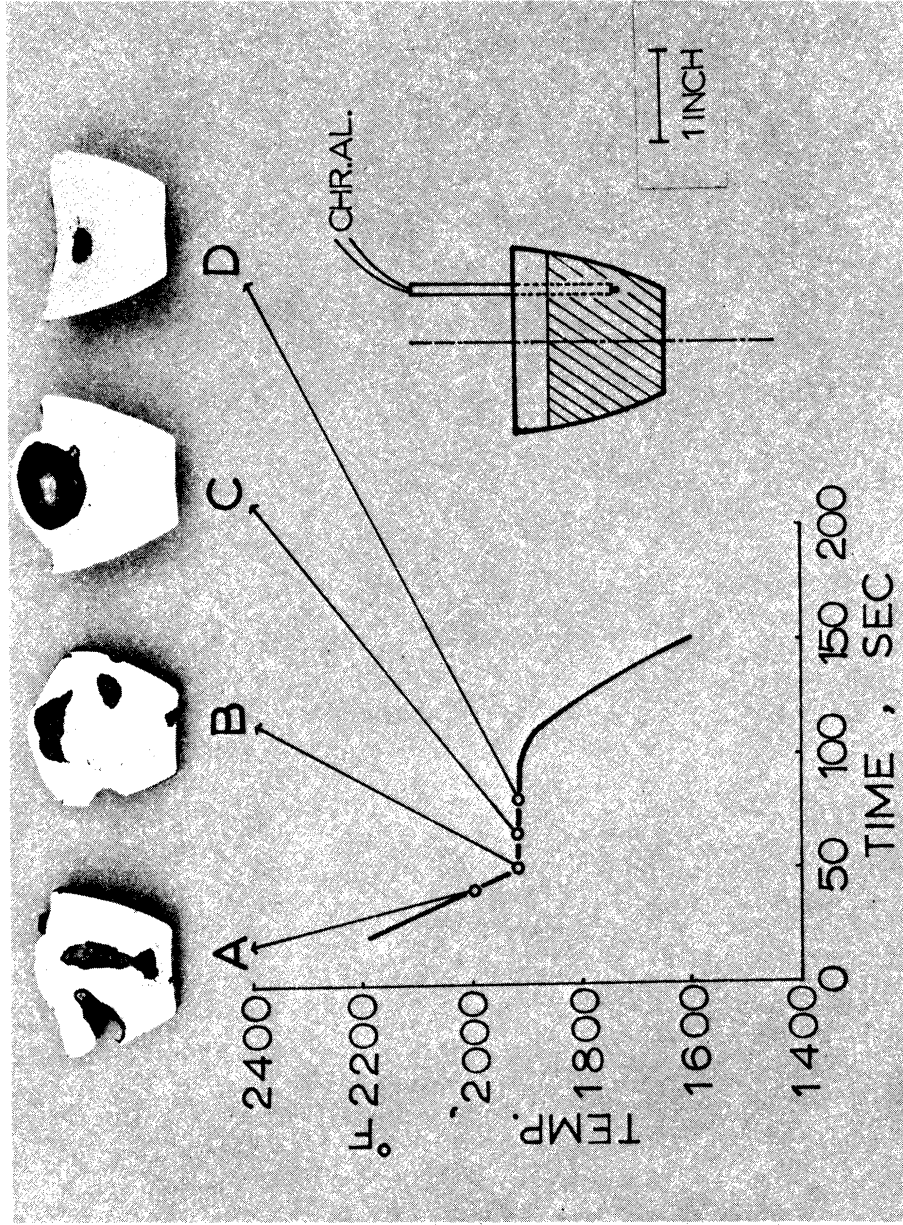

Figure 5. Relationship between temperature and time of application of reduced pressure. Optimum sensitivity to the presence of gas (largest bubble) is obtained approximately 15 sec. after solidification begins.

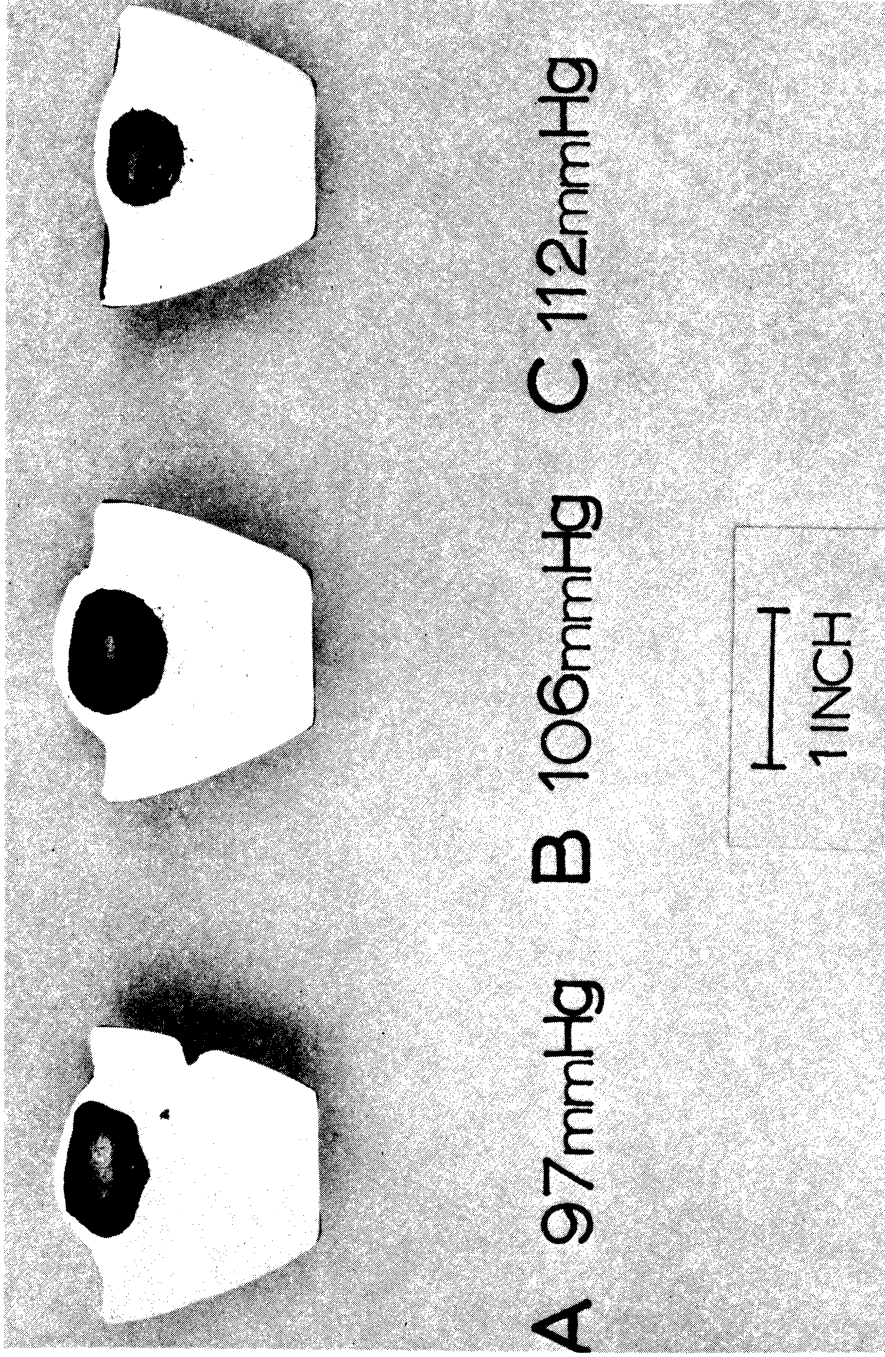

Figure 6. Effect of pressure above the sample on the appearance of the surface bubble. A critical value of pressure (B) allows maximum bubble rise without breaking. A porcelain crucible was used in a graphite seat.

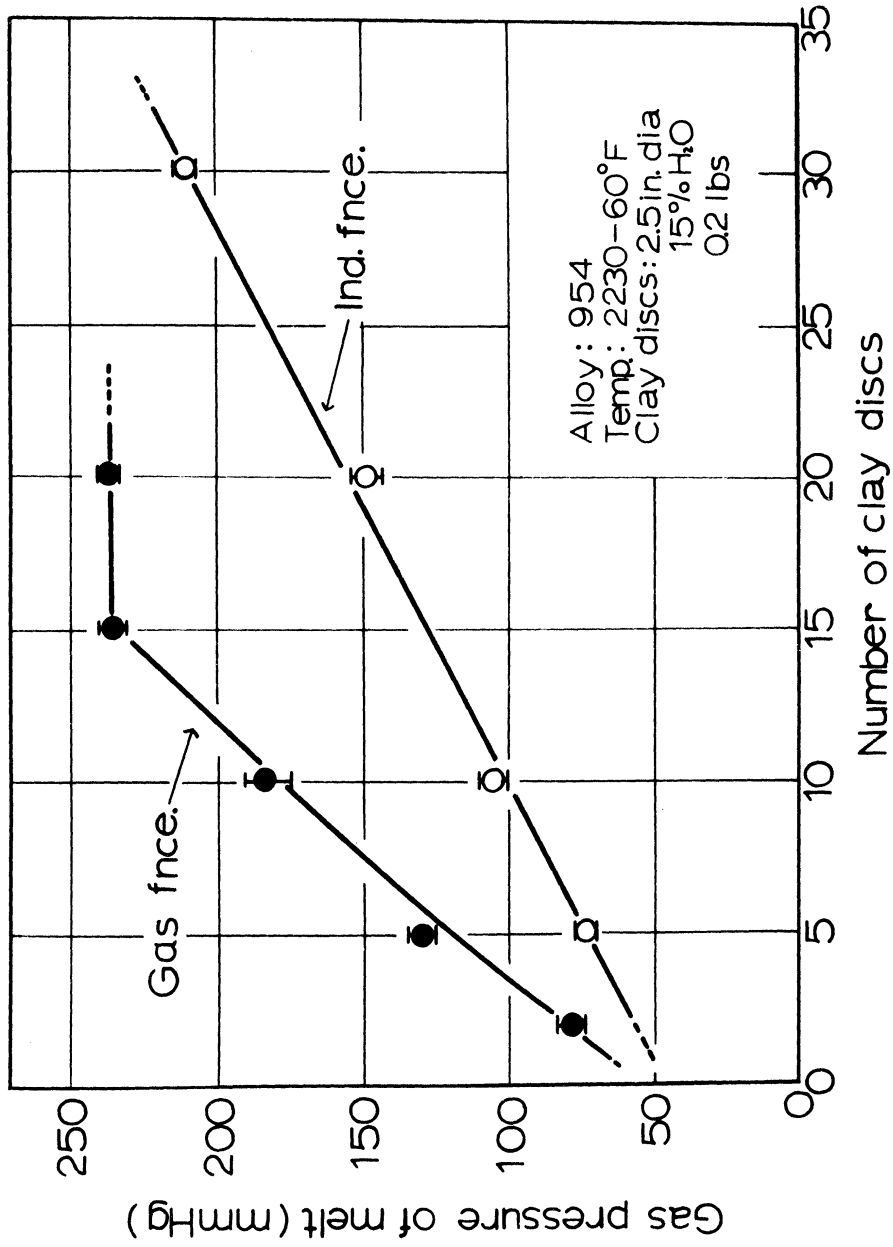

Figure 7a. Effect of number of wet clay discs on the pressure of gas in the melt for two different melting furnaces.

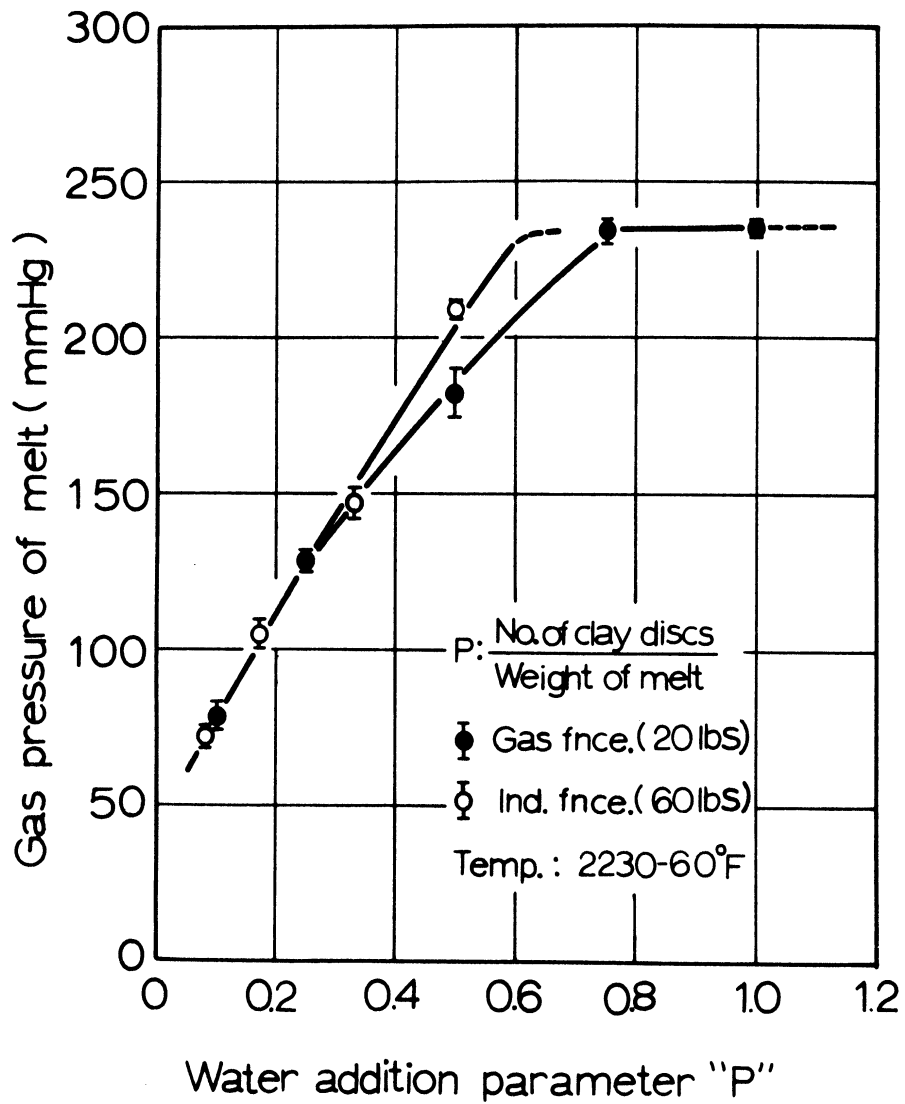

Figure 7b. Comparison of gas and induction furnace melts using a common parameter to account for different melt weights and number of wet clay discs.

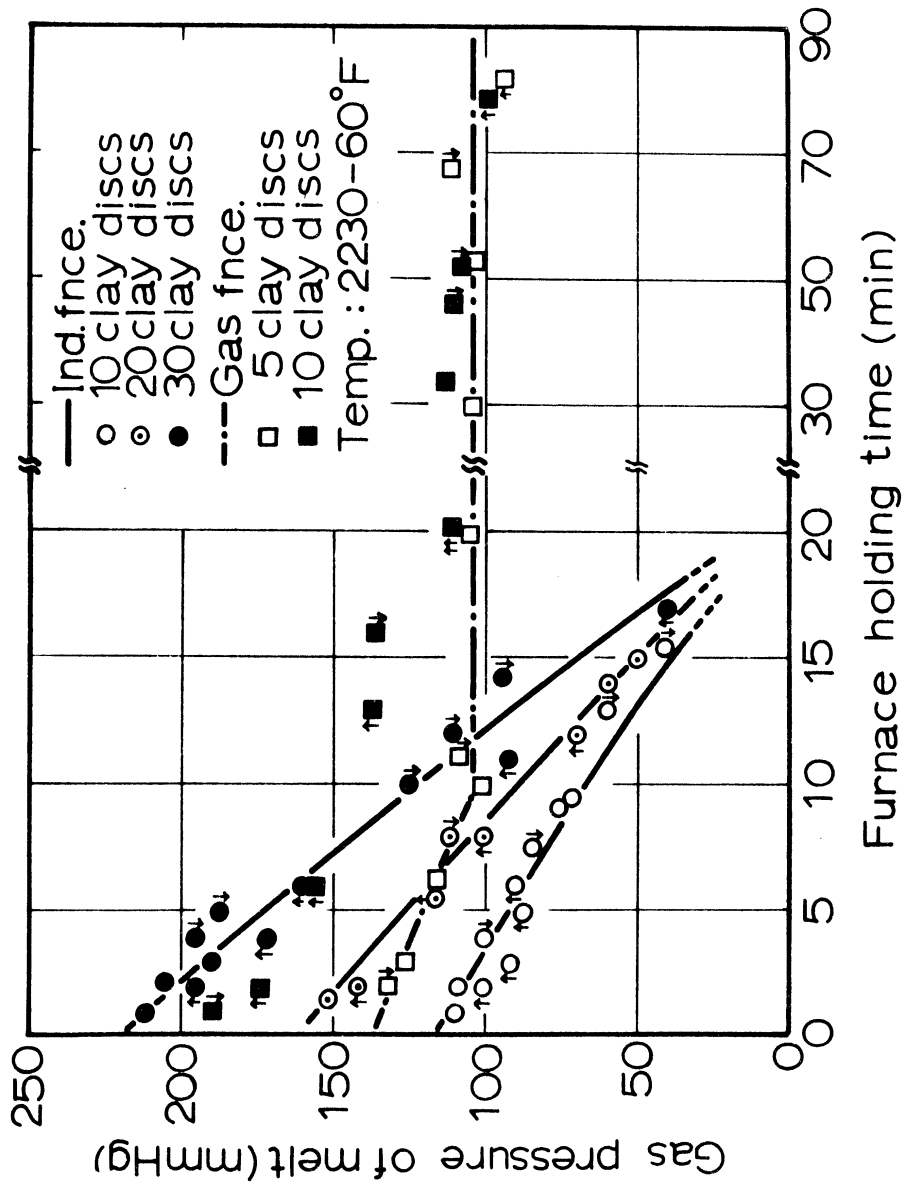

Figure 8. Effect of furnace type and holding time in the furnace on the retention of gas.



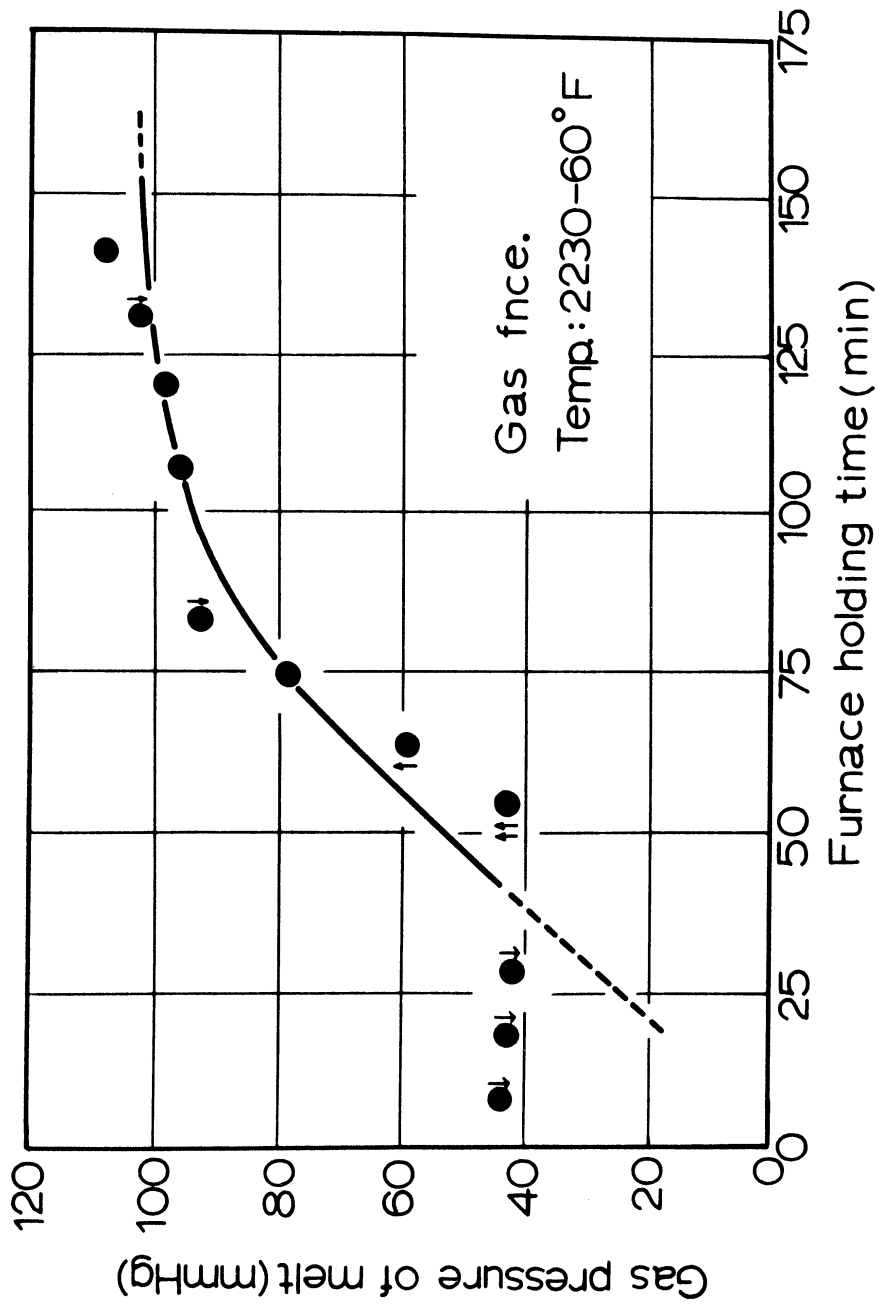

Figure 9. Gas reabsorption by holding in a gas fired furnace. The metal had been nitrogen purged in an induction furnace (zero time).

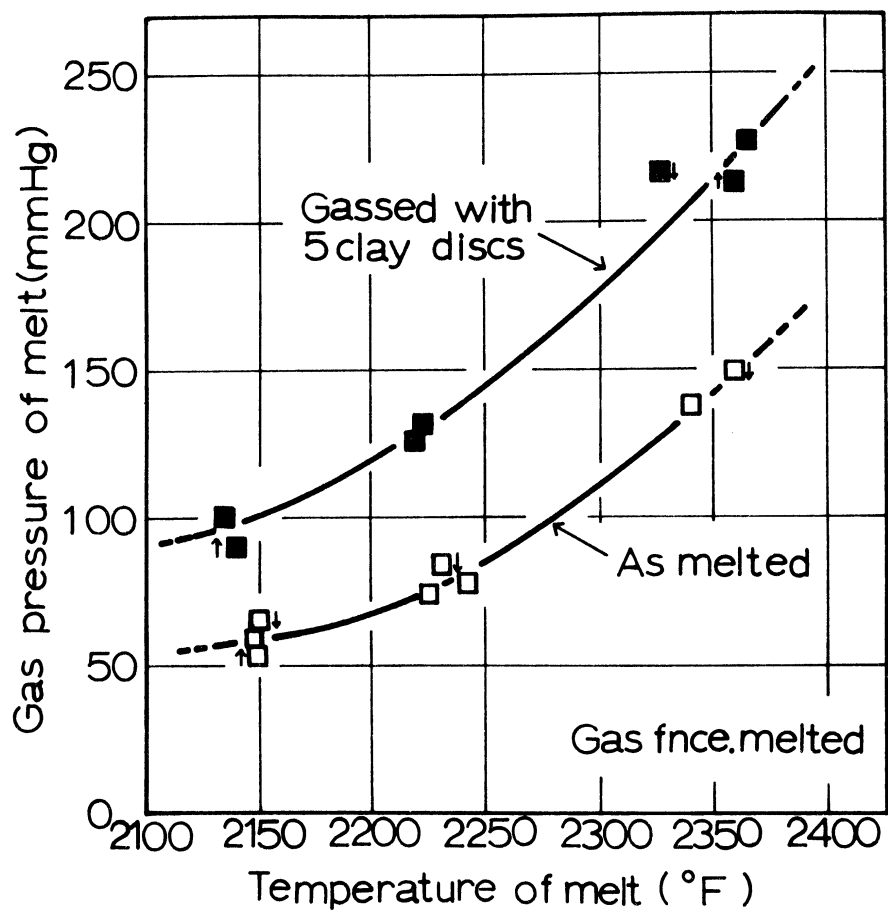

Figure 10. Effect of melt temperature on gas pressure of the melt for as melted and gassy metal. (The metal was melted in the gas furnace.)

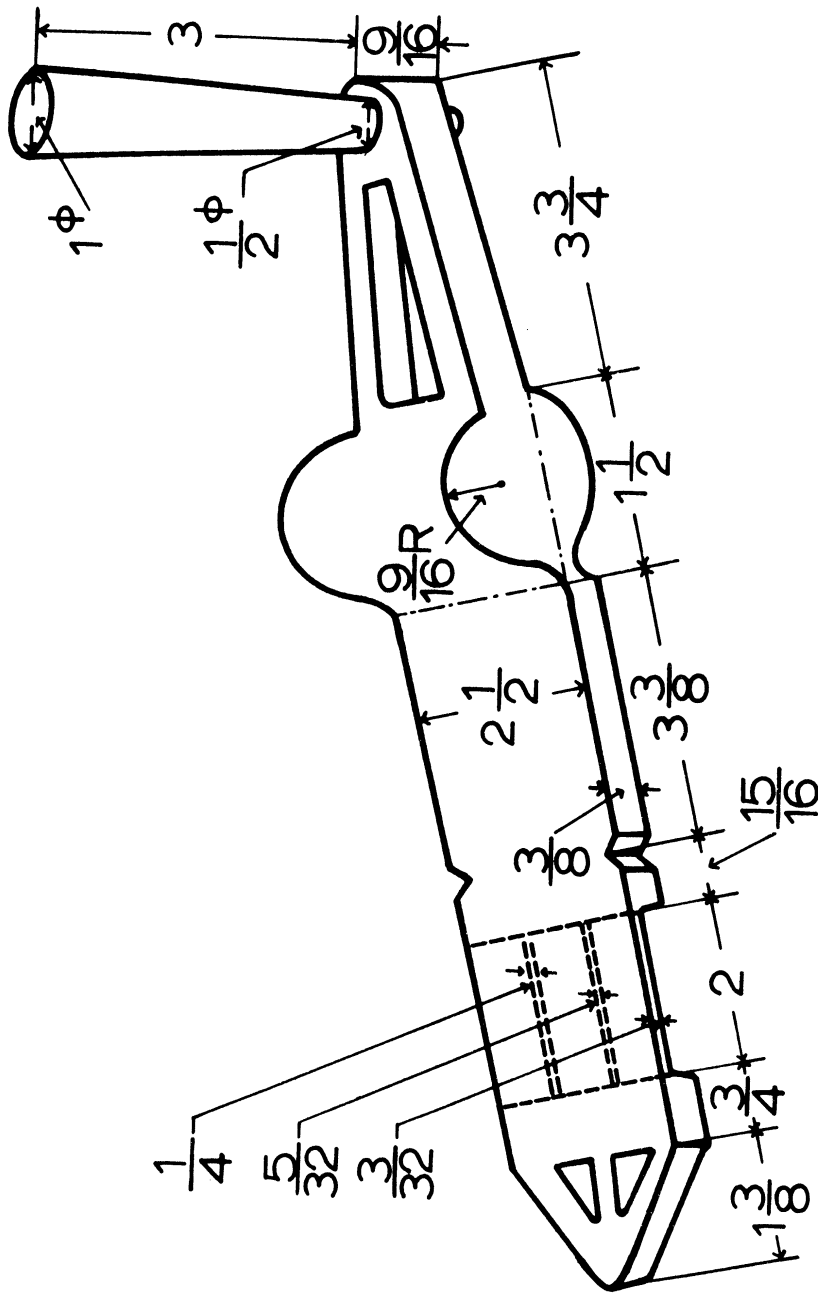

Figure 11a. Sketch of the gas plate casting as modified from an Abex design.  
 (All dimensions are in inches.)

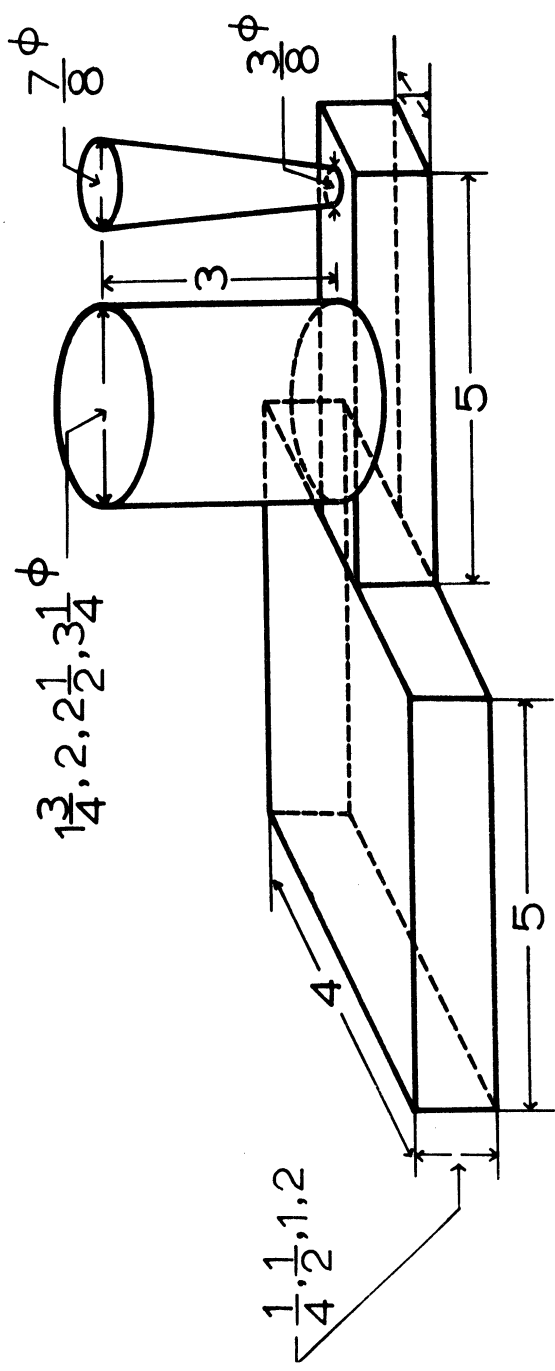

Figure 11b. Sketch of the rectangular gas plate castings. The thicknesses were varied from  $\frac{1}{4}$  to 2 in. One, three, and four end or side chills were used. With four side chills, the ingate was kept open by an insulating sleeve. (All dimensions are in inches.)

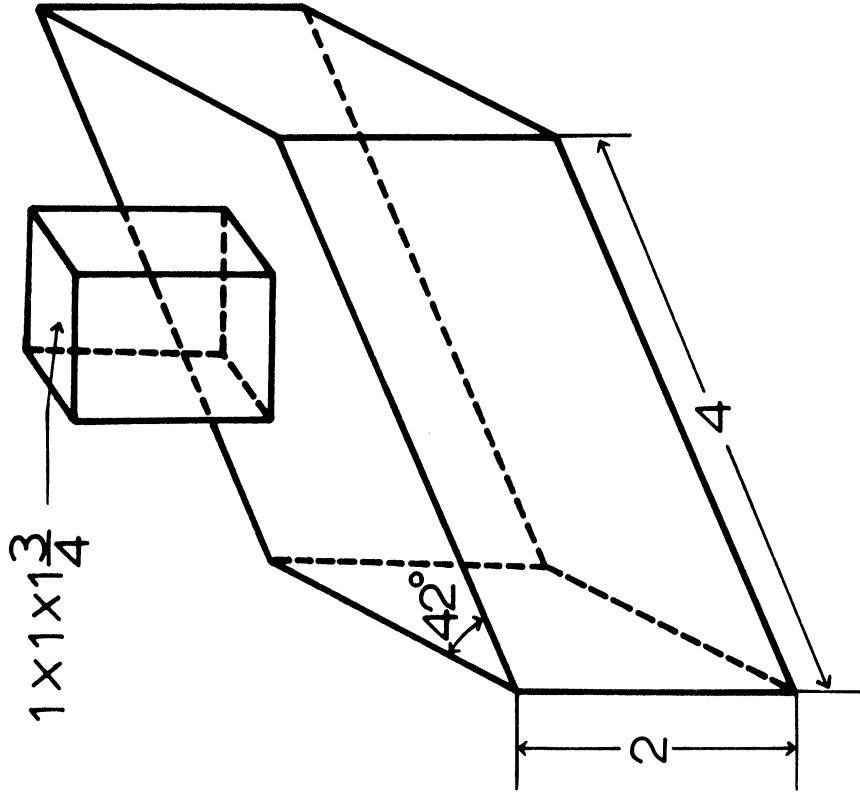

Figure 11c. Sketch of the diamond shaped casting made in a split graphite mold. A core sand pouring cup was placed on top of the dual purpose gate-sprue. (All dimensions are in inches.)

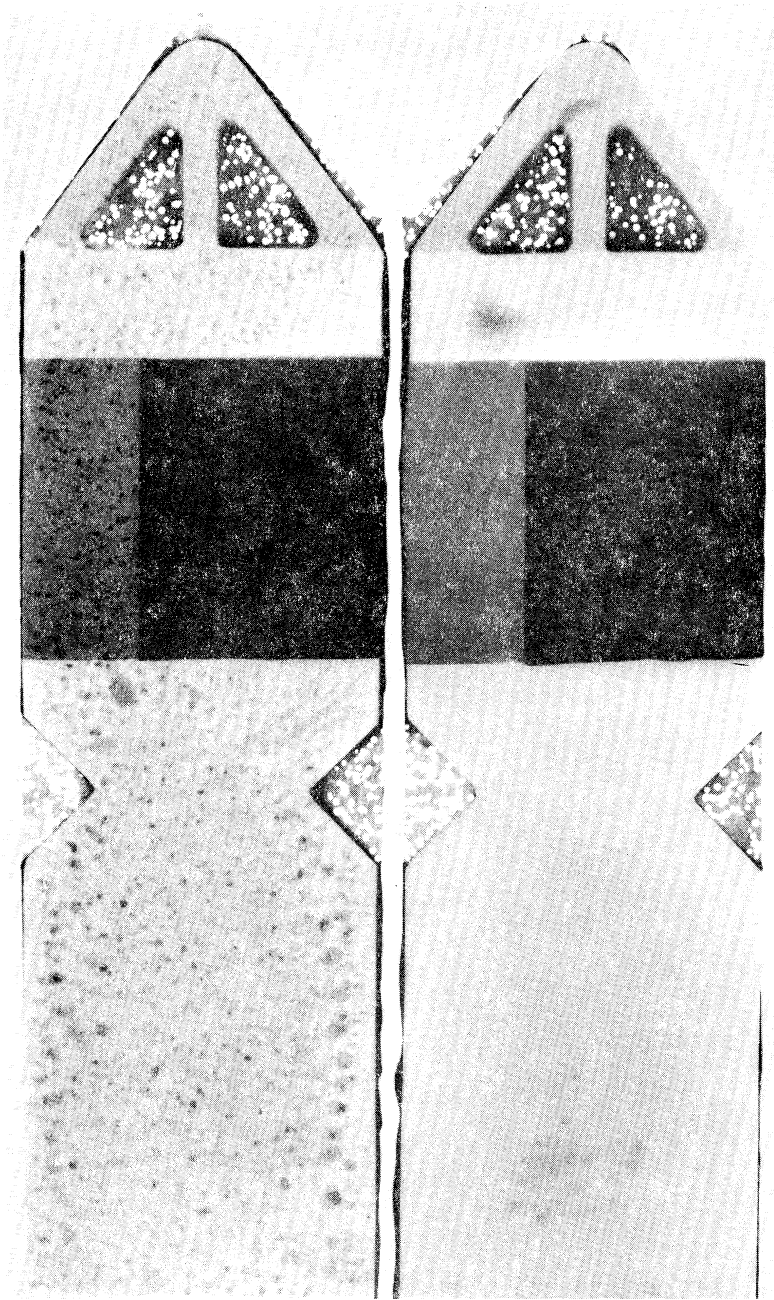

Figure 12. Radiographs of gas test plate poured from metal treated with 6 clay discs (left) and purged 5 minutes with dry nitrogen (right). Metal was induction melted and poured into 4% moisture green sand molds.

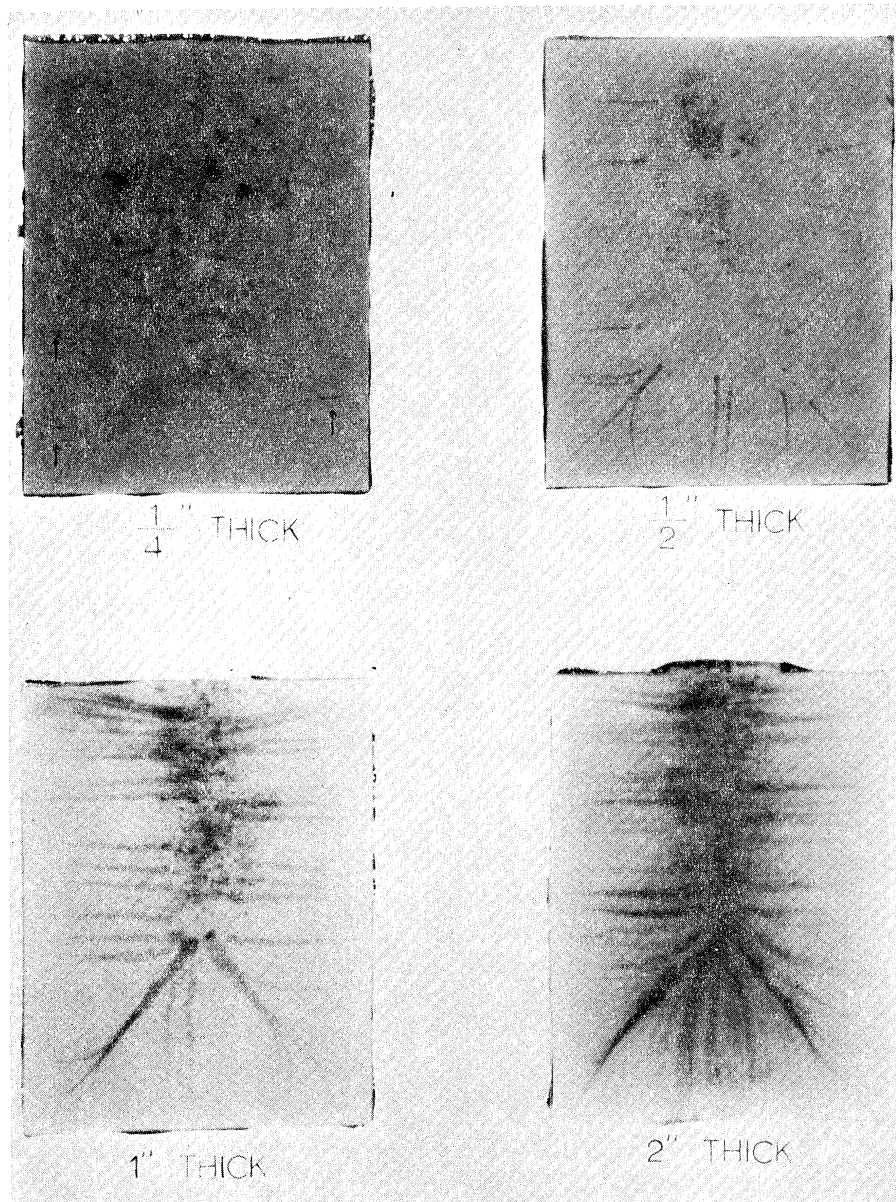

Figure 13. Radiographs of variable thickness rectangular plate castings chilled on 3 sides. The gassy metal from the induction furnace was poured into dry sand molds. (Arrows in the  $\frac{1}{4}$ " section show the position of gas porosity.)

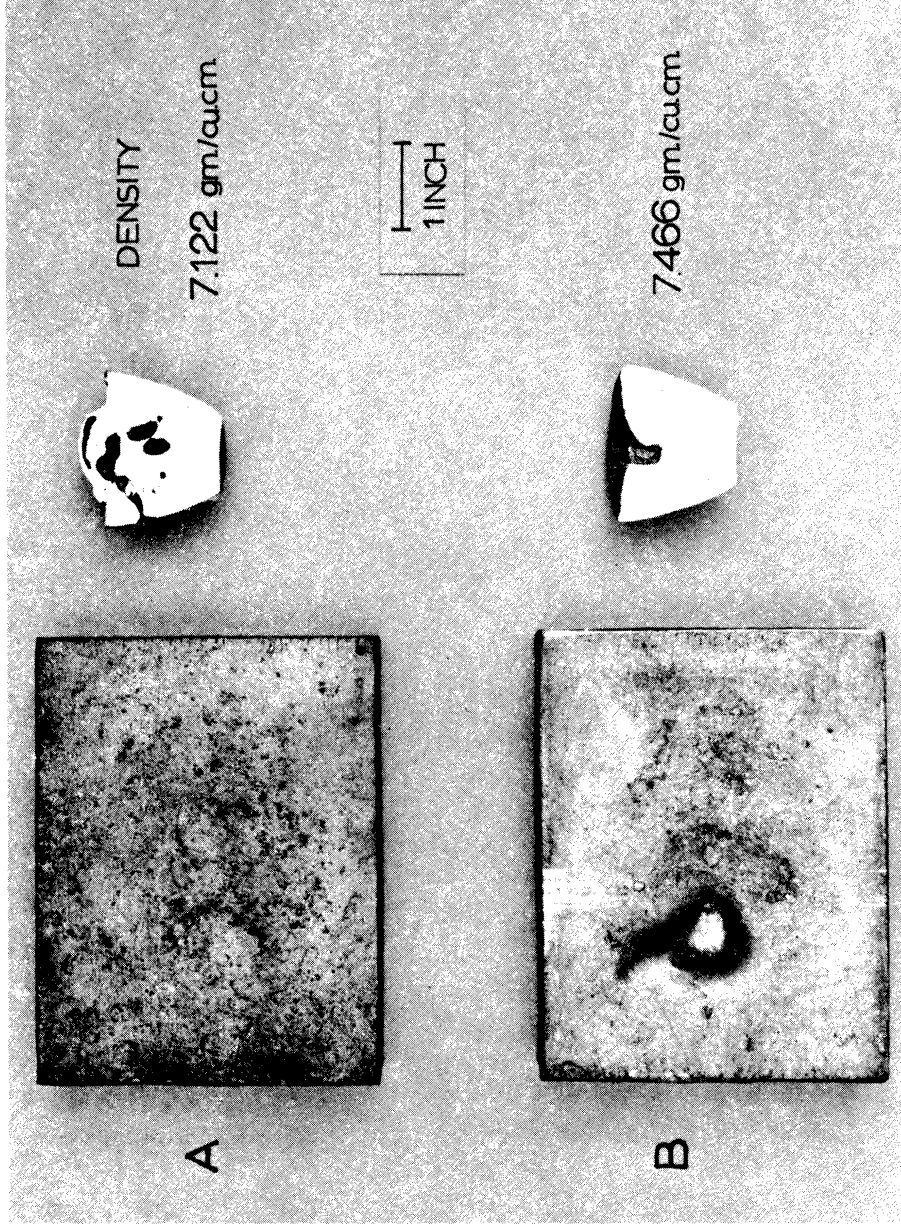

Figure 14. Comparison of 1" thick rectangular castings, crucible test, and density for gassy metal (A-30 clay discs) and degassed metal (B-purge 10 min. with nitrogen). Induction melted metal poured into 6% moisture green sand molds chilled on four sides.



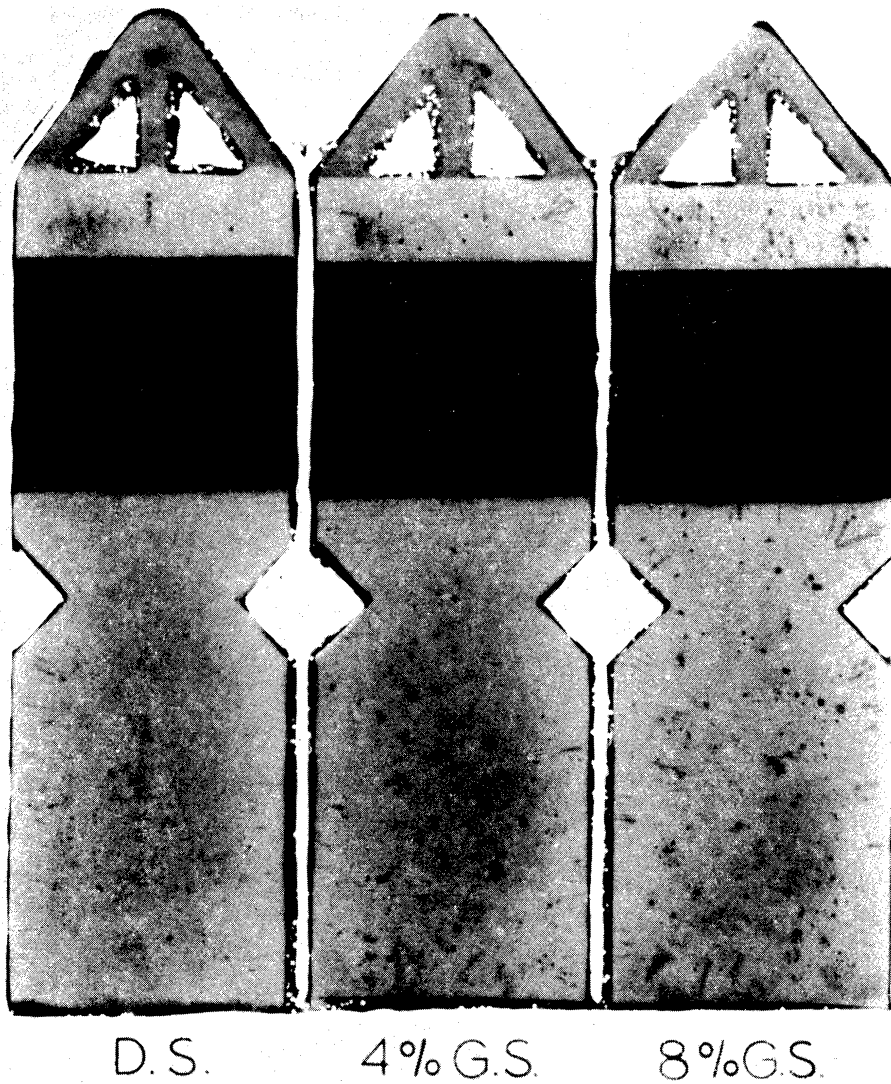

Figure 15. Radiographs of gas plate casting showing effect of dry sand and 4% and 8% moisture in green sand on the gas porosity. Metal was gassed with 10 clay discs in the gas furnace.

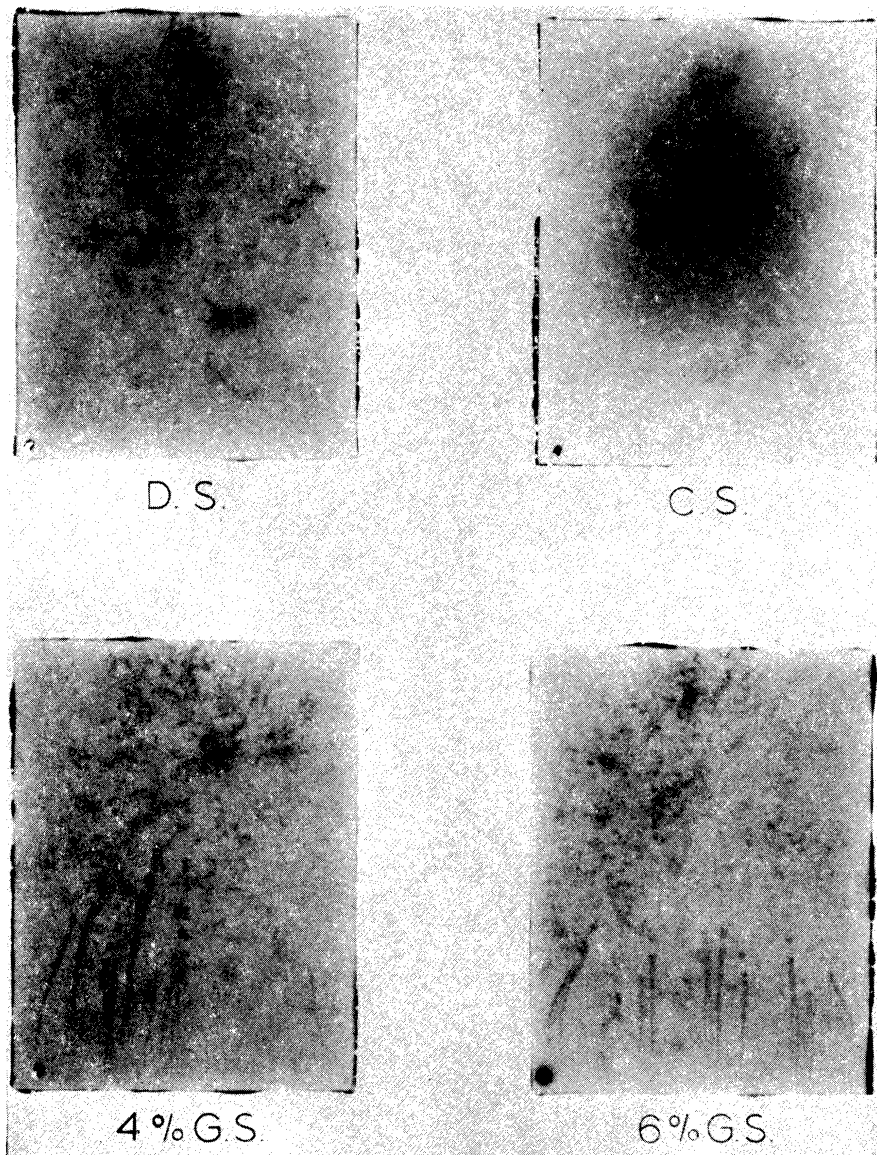

Figure 16. Effect of moisture in green sand compared with dry sand (D.S.) and core sand (C.S.). 1" thick rectangular plate castings chilled on one side were poured from metal gassed with 5 clay discs in the induction furnace.

Figure 17. Density Measurement of Castings (Induction Furnace Melts)

Heat No.	Treatment	Chill	Mold				Radiograph Fig. No.
			D.S.	C.S.	4% G.S.	6% G.S.	
44	Gassed with 30 clay discs	4 sides	7.407	7.280	7.181	7.122	
45	Degassed with N <sub>2</sub> (10 min.)	4 sides	7.466	7.463	7.474	7.466	
46	Gassed with 5 clay discs	1 side 3 sides	7.342	7.358	7.350	7.321 7.280	16, 18
50	Gassed with 20 clay discs	3 sides ( ) thickness	7.306 (1/4") 7.515 (1/2") 7.161 (1") 7.151 (2")				13
28 29	Gassed with 10 clay discs	none 1 side 4 sides			7.403 7.400 7.363		7.043 <5.971 7.241 *

\* Radiographs not shown.

D.S. = dry sand; C.S. = core sand; G.S. = green sand

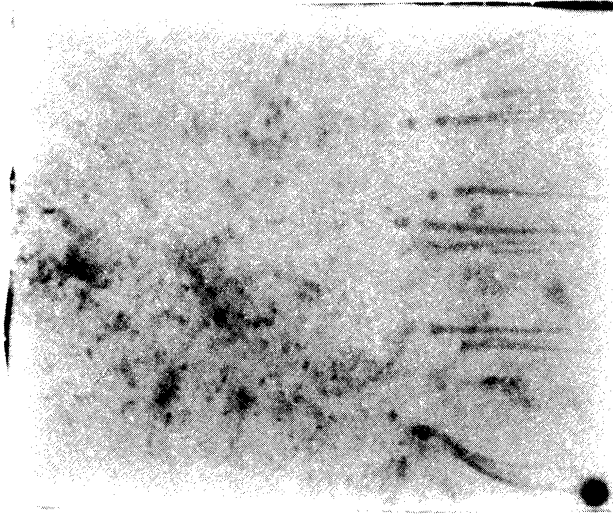

6% G.S.

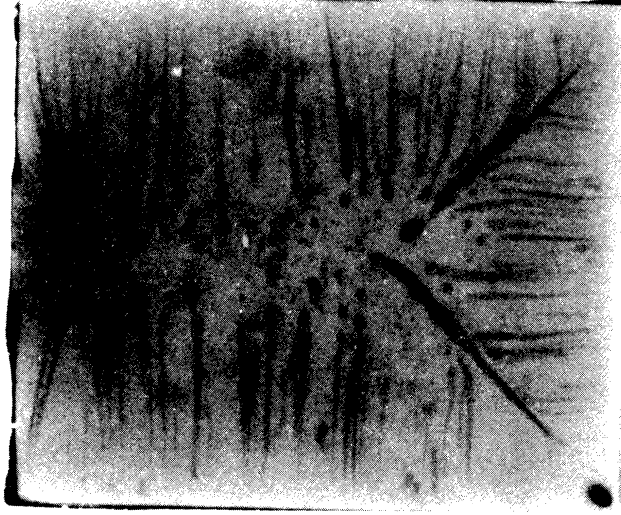

6% G.S.

Figure 18. Effect of directional solidification on gas porosity in 1" thick plates. The use of 1 end chill (left) does not show as much gas porosity as the presence of 3 chills (right) in the green sand molds. (Metal was gassed with 5 clay discs in the induction furnace.)

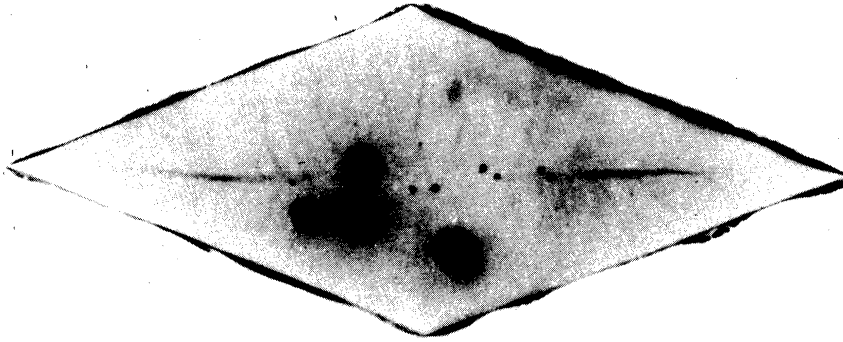
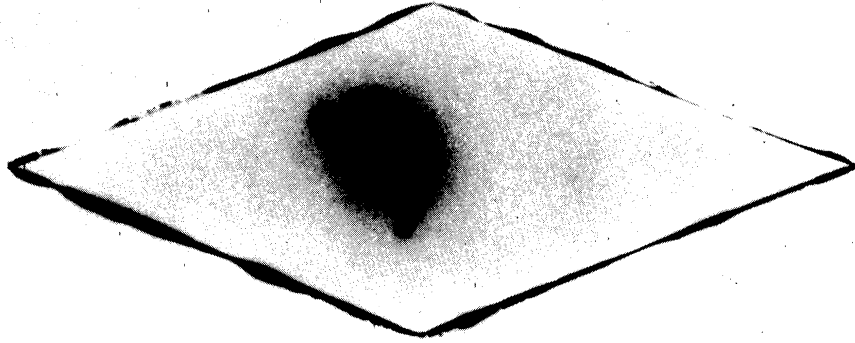

Figure 19. Appearance of the diamond shaped casting poured in a graphite mold from gassy metal (left-30 clay discs) and degassed metal (right-10 min. purge with nitrogen). Metal induction melted.



UNIVERSITY OF MICHIGAN



3 9015 03483 7602