

ENGINEERING RESEARCH INSTITUTE
THE UNIVERSITY OF MICHIGAN
ANN ARBOR

Progress Report

AN EVALUATION OF CERTAIN STEELS AS MACHINED IN A
SINGLE-SPINDLE, AUTOMATIC SCREW MACHINE

R. E. McKee
J. C. Mazur

Department of Production Engineering

Project 1197

BETHLEHEM STEEL COMPANY
BETHLEHEM, PENNSYLVANIA

April 1956

SUMMARY

Based on pieces per hour (cutting time) or feed rate in inches per minute, the following general relations have been established for the various steels:

1. The C1018 (Pb) material is 75% of the standard C1117 steel in turning, forming, and drilling operations under the conditions of cut found satisfactory on the single-spindle, automatic screw machine.
2. The C1045 (Pb) material is 120% of the C1045 standard in the turning, forming, and drilling tests.
3. The A4140 (Pb) steel is 120% of the A4140 standard in the turning, forming, and drilling operations.
4. Using an A8620 standard as a 100% value, the A8620 (Pb) steel is rated at 122%.

AN EVALUATION OF C1117, C1018 Pb, C1045, C1045 Pb,
A4140, A4140 Pb, A8620, AND A8620 Pb STEELS
AS MACHINED IN A BROWN AND SHARPE, NO. 2G,
SINGLE-SPINDLE, AUTOMATIC SCREW MACHINE

This study was made to obtain comparisons of the performance of certain types of leaded and standard steels. The operating conditions of the automatic screw machine and the geometry of the cutting tools were varied to obtain an acceptable performance on each of the materials.

OPERATING CONDITIONS

Machine.—The Brown and Sharpe No. 2G single-spindle, automatic screw machine was used for the entire test program.

Cutting Fluid.—A Standard Oil Co. "Stanoil No. 31" at 310 S.S.U. (100°F)—an equivalent to an SAE No. 20—was mixed 9 parts to 1 part of Stuart's Thred-Kut oil, a sulfur-base material, used as an E.P. lubricant.

Steels.—(See Table I)

Cutting Tools.—

1. Turning.—The turning tools—used in a knee-type tool holder—were Allegheny-Ludlum No. DBL-2 of 5% Mo, 4% Cr, 2% Va, and 6% W, representing a standard M-2, high-speed steel material. The standard tool signature was 8° back rake, 15° side rake, 6° end relief, 6° side relief, 6° end-cutting edge angle, 0° side-cutting edge angle, and 1/32 inch nose radius. This signature, which was used on all of the tests that are reported for direct comparisons, was adopted after some variations of nose radii were tried on the C1117 material.

2. Forming.—The form tools were held in a 7° tangential-type tool holder in the machine, after preparation by grinding a signature of 18° back rake and 0° side rake. The tool material was Firth Sterling, "Circle-C," T-5-B grade of 18% W, 4% Cr, 2% Va, and 8% Co, representing a T-2 type of high-speed steel with a cobalt additive.

3. Drilling.—The 2-flute, standard screw-machine drills were of moly-

TABLE I
(Bliss and Laughlin Specifications)

AISI Grade	Condition	Heat No.	C	M	P	S	Si	Cr	Ni	Mo	Pb
C1117	3/4" CFS	48438	.17	1.13	.020	.13	.02				.15-.35
C1018	3/4" CFS	24838	.19	.80	.010	.020					.15-.35
C1045	3/4" CFS	806587	.47	.75	.013	.032	.17				
C1045	3/4" CFS	826753	.47	.79	.015	.030	.21				
C1045	3/4" CFS	24445	.49	.80	.013	.029	.19				.15-.35
A4140	7/8" CFS (anneal)	34360	.40	.83	.015	.023	.24	.95		.20	
A4140	7/8" CFS (anneal)	4285	.39	.89	.017	.029	.32	1.07		.18	.15-.35
A8620	1" CFS	116583	.22	.83	.014	.020	.31	.58	.59	.21	
A8620	1" CFS	24919	.18	.77	.023	.022	.26	.49	.56	.22	.15-.35

Brinell Hardness Ranges
(as measured at the University)

C1117	156-166	A4140	202-217
C1018 Pb	153-163	A4140 Pb	217-229
C1045	217-223	A8620	217-248
C1045 Pb	248-255	A8620 Pb	197-207

high-speed steel and finished with an oxide treatment. They were ground to a 135° point angle and 11° relief angle. Drill diameter varied in relation to the size of the work piece to maintain a proper relationship of cutting speed.

4. Cut-off.—The cut-off tools were of a high-speed-steel type and ground periodically to maintain sharp cutting edges. No data were kept on this operation, except for observations of metal pickup on certain materials.

TEST METHOD

Figure 1 is a view of the Brown and Sharpe automatic screw machine used in the evaluation of the materials included in this report. It was selected for this study after due consideration was given to the ease of setup, available speed ranges and cycle times, and dimensional stability.

The shape and size of parts are shown in Fig. 2. The diameters of the part varied in some of the materials because of the original condition of finished-bar size as produced at the mill. The shape of the part remained constant for the tests on all materials.

A simple operational layout is shown in Fig. 3 with a listing of the sequence of machining cuts as follows:

1. In feed.
2. Partial cut-off.
3. First drill - $1/2$ length of part.
4. Form cut.
5. Knee-turn.
6. Second drill - $1/2$ length of part + cut-off.
7. Finish cut-off.

The standard test procedure consisted of (1) proper grinding and setting of all tools, (2) establishing correct conditions of cut, and (3) machining of parts with collections and inspections of three consecutive pieces at intervals of 25 throughout the life of all tools. Inspection of tools with a pocket comparator occurred at intervals of 100 pieces and a final inspection of all tools in a toolmaker's microscope, to insure greater accuracy, was made at the termination of the test.

TEST CRITERION

The basic criterion used in defining the performance of various steels was the surface quality produced by the turning and forming cuts. Additional observations were made on dimensional variation resulting from tool wear in the drilling operations.

The lengths of tests were defined by visual inspections of the parts and measurements of surface finish with a micrometrical profilometer. In most cases the observed failure points on the parts were similar to variations shown by the measurements taken from the profilometer.

The variations in (1) built-up edge on the cutting tool (particularly in the case of forming tools), (2) effects of tool-flank wear on the shoulder produced in a turning cut, (3) burnish on the machined surface, and (4) tearing of the machined surface are not measurable with a profilometer and required close examination to determine levels of change in results. In several cases, extended runs of 2000 pieces were required to produce an adequate sample size for observed changes in conditions of surface quality. In these cases the profilometer showed satisfactory surface quality on the form-cut surfaces for the entire test, even though visual inspection indicated an earlier change in the machined surface.

In most cases the form tools lasted for a larger number of pieces than either the turning or drilling tools. When observed failure was indicated on a turning or drilling tool prior to that of the form tool, the former was immediately replaced with a newly ground cutting edge to reproduce the results during the extended life of the latter.

TEST RESULTS

Figures 4 through 11, Turning Tests.— Figure 4 shows the results obtained from single-point turning tests with a knee tool holder on the material AISI-C1117 steel. The upper curve represents the average values of microinches, rms, for each 100th piece, including the measurement of the 25th on each side. In other words, the value at 400 pieces represents the average of three readings each, in microinches, rms, on numbers 375, 400, and 425. The range of readings is 80 to 105 microinches with a value of 100 microinches average at the visual failure point of 950 pieces.

The middle curve shows the ranges of minimum to maximum surface roughness for every 25 pieces, obtained by recording three readings each on three consecutive pieces at each interval. In other words, the values shown for piece number 25 are the maximum and minimum obtained from three readings each on parts number 24, 25, and 26. The visual failure point, obtained by close examination of the work pieces, was established at 950 pieces for this material, even though 2000 pieces were produced in the test to insure sufficient wear on the cutting tool. It may be noted that the limits of minimum to maximum appear to be more widely separated in the latter part of the run.

The lower curve represents the averages of two measurements of the turned diameter by using a supermicrometer on every 25th piece to illustrate the accuracy of the dimension produced by the turning tool and indicate possi-

ble effects of tool wear. Even though this curve shows only slight variation in the diameter of the work piece, it does not reveal the character of the surface roughness obtained by visual inspection and used for the definition of failure.

Figure 5 shows the results of tests on C1018 Pb steel, as turned with a single-point tool. A total of 2000 pieces were produced in this test with the form tool—representing the use of three turning tools—Runs I, II, and III. Runs I and II show completed tests with visual failure defined at 600 and 675 pieces, respectively. Visual failure in these tests corresponded closely to changes in the range of surface finish as measured by the profilometer.

The upper curves show a distinct similarity of results from the average values of surface roughness obtained on the three tests. The character of dimension, as shown by the lower curves, changed perceptibly after the failure of the turning tools defined by surface-roughness ranges on the middle curves.

Figure 6 shows the surface-finish averages in the upper curves and the ranges of surface roughness in the lower curves for C1045 (standard) steel. Observed failures at 500 pieces on both runs (I and II) appear to coincide with the changes in the characteristics of the curves for the surface-roughness range.

Dimensional variation is omitted from Fig. 6 because these tests were made at the start of the program, at which time the tools were removed from the machine for inspection at the end of each 100 pieces. Any variation shown under this procedure could represent tool-setting error as well as tool wear.

Figure 7 shows visual failures on the turned surfaces of C1045 Pb steel at 425 pieces on each of the two runs. The curves on each of surface-roughness range and surface-roughness averages are very similar in general characteristics.

The entire test, to obtain failure of the form tool, covered 1200 pieces and showed a reasonable duplication of results from the turning tools.

The results of turning tests on A4140 steel (standard) are indicated on Fig. 8 with visual failure shown at 600 pieces in the lower-left curve. This failure occurs just ahead of the noticeable change in erratic performance of the turning tool subsequent to producing reasonable surface quality. The dimensional-variation curve is somewhat erratic in this figure as the result of excessive peripheral wear on the cutting tool between 200 and 400 pieces. The 0.012-inch flank wear was sufficient to change the diameter of the work piece by 0.0024 inch prior to the 400th piece. The peak of 0.7572 inch at the

75th piece cannot be satisfactorily explained; however, it was observed that the outside diameter of this particular piece was 0.0006 inch out-of-round, a condition that might result from any of several possible variables, but not prevalent in the majority of the other tests.

Figure 9 shows the results of turning tests on the A4140 Pb steel. A total of 600 parts were made in this run, but a visual inspection of the surface revealed a turn failure at 400 pieces. This is indicated on the curve of surface-roughness range. The curve of average surface roughness, in the upper left of the graph, shows a comparatively steep rise in roughness values to the failure point. In conjunction with this observation, it may be noted that the tool inspections, made at every 100 pieces with a pocket comparator, revealed a rather rapid wear rate on the turn tool when compared with the results for the A4140 standard steel. For example, a measurement at 400 pieces showed approximately 0.002-inch flank wear of the tool under the conditions used for the standard steel. However, the turn tool used in the test of the A4140 Pb material had a flank wear of approximately 0.020 inch at the same interval in the test. The plot of the dimensional variations indicates that this excessive wear apparently had little, if any, effect on the turned diameter.

The results of the tests on the AISI-A8620 steels are shown in Figs. 10 and 11. A visual inspection of the turned surfaces revealed a turn-tool failure at 450 pieces in the test of the standard A8620 steel, as indicated in Fig. 10. The visual failure point appears to coincide quite favorably with the failure point as predicted by the profilometer readings. This is shown by the rather sharp break upward in the curve of average surface roughness at 400 pieces, and the increase in the surface-roughness range as noted in the lower-left curve. The effect on the turned diameter seems to be more pronounced in this test than it was in most of the others. The curve on the right in Fig. 10 shows an erratic behavior. It is difficult to account for the excessive variation in the diameters of the 25th and the 50th pieces, but two factors were noted which could account for at least some of the nonuniformity of results. First, the tool inspections, every 100 pieces, showed a very rapid initial rate of flank wear on the turn tool. For example, of the 0.030-inch wear which was measured at 400 pieces, 0.025 inch or approximately 80% was noted at the 200-piece inspection. In other words, a 100% increase in the number of pieces, from 200 to 400, resulted in only a 20% increase in flank wear. In contrast, the wear at 100 pieces was 0.015 inch, and a 100% increase in the number of pieces, from 100 to 200, resulted in a 67% increase in flank wear. Second, the nonuniformity in variation of Brinell hardness values of the steel, particularly along the lengths of a few of the cold-finished bars, was observed. This variation was first noted when it was observed that chip formation changed rather drastically for short periods, at various points in the test. Subsequent hardness readings revealed a spread from 217 to 248 Brinell.

Figure 11 shows the results of the tests on the A8620 Pb steel.

Visual failure of the tool occurred at 550 pieces. Two turn tools were used during this test, while the form tool produced 1150 pieces, although only one turn tool was used to failure. The second tool showed good reproducibility of results over the range of 400 pieces. It may be noted that visual failure occurred just prior to a rather wide dispersion in measured values of the turn diameter.

Figures 12 through 19, Forming Tests.—Figures 12 through 19 represent the results of surface-finish measurements obtained from the straight-edge, tangential forming tool used on the different materials. The procedure used in measuring the surface roughness was exactly the same as used in the turning tests. In each figure the lower curve represents the surface-roughness range, while the upper curve represents average values as obtained for each 100 pieces. No dimensional measurements were made on the formed diameter.

The results of the forming operation on the C1117 steel are shown in Fig. 12. Two thousand parts were produced with one form tool in this test, but the observed failure occurred at 1500 pieces. There does not appear to be any correlation between the visual failure and the profilometer readings of the surface roughness in microinches, rms. As a matter of fact, the pattern of surface-roughness range did not change appreciably over the entire test, the level of surface-roughness readings being practically the same at the end of the run as in the beginning. The erratic appearance of the lower curve in Fig. 12 may be due to an unstable built-up edge condition brought about by the excessive speed. Flank wear on the form tool was comparatively light, however, with a maximum of 0.0031 inch at the end of the 2000 pieces.

The test on the C1018 Pb steel, the results of which are shown in Fig. 13, was also carried on through 2000 pieces to assure a valid test for this material. The lower curve, representing the surface-roughness range, exhibits a slight trend upward, as the average surface roughness rises from a value of 85 microinches at the beginning of the test to a value of 150 microinches, rms, at the end of the test. Visual inspection of the surface revealed a form-tool failure at 1650 pieces, although the high and low values of the surface finish became more widely separated and the curve more erratic after the 1000th piece was produced. The rate of wear of the form tool was more severe in the case of the C1018 Pb steel than in that of the C1117. On the latter material the tool wear was fairly uniform along the flank with a maximum of 0.0031 inch. The C1018 Pb steel, however, caused several localized wear areas on the tool which extended to a maximum of 0.0072 inch in width. The average wear was 0.0049 inch, an increase of more than 50% over the results found in the C1117 steel for the same number of pieces, even though the feed rate was lower in the case of the leaded material.

In observing the results of the surface-roughness ranges from the forming tests on C1045 standard steel as shown in Fig. 14, it is noted that there is a considerable amount of variation in the level of surface finish in

microinches, rms, as measured by the profilometer, particularly during the first 600 pieces. Close scrutiny of the formed surface, however, could not reveal any definite or permanent change in appearance until approximately 1025 pieces. This value represents the number of pieces produced prior to failure and occurs in a region of rather wide ranges between the high and low readings of surface finish in microinches, rms, the average reading being 195. This value is higher than the reading at the visual failure point in the test of the C1045 Pb steel, the results of which are shown in Fig. 15. Visual failure occurred at 850 pieces in this test, but the average profilometer reading of the 850th piece was only 165 microinches. Actually, it was a little more difficult to judge the visual failure point on the C1045 Pb steel than it was in any of the other tests. There appeared to be a range between 750 and 1000 pieces in which the surface finish was somewhat unstable, and yet not sufficiently changed to classify failure.

The curves of average surface roughness in Figs. 14 and 15 show similar trends. In each case the surface-finish values go up more rapidly during the first few hundred pieces than in the latter part of the test run. Even the form-tool wear pattern was similar, at least to the point of failure. Both tools had approximately 0.003-inch flank wear after 400 pieces. This 0.003-inch wear remained constant to the end of the run in the test on the C1045 standard material. Moreover, on the C1045 Pb steel, the wear did not change until just past the visual failure point of 850 pieces, when it began to increase again, to reach a maximum value of 0.007 inch at the end of 1200 pieces.

The results plotted in Fig. 16 represent the values obtained from the form-tool tests on the A4140 standard steel. Both curves, representing surface-finish values, show a rather rapid change of the surface in terms of microinch values. Many tests were made on this material, as can be noted from Table II, but the conditions reported in Fig. 16 proved to be the most representative. The form-tool performance appeared to be quite sensitive to operating conditions, particularly to speed. The visual failure at 775 pieces corresponds to a profilometer reading of 155 microinches. The extension of this test beyond the visual failure produced a greater dispersion of roughness values.

The results of the form-tool operation on the A4140 Pb steel are shown in Fig. 17. The average surface-roughness values range from 145 microinches, rms, at the first piece to 165 microinches at the end of 600 pieces. Visual failure occurred at 500 pieces. There was a difference of from 35-40 microinches between the high and the low values of surface finish throughout the entire run, indicating a rather unstable condition that might be attributed to operating speed.

Figures 18 and 19 represent the results of the tests on the A8620 standard and the A8620 Pb steels, respectively. The form tool produced an

erratic finish on the standard steel, as compared to the more satisfactory results on the leaded steel. This is shown by the more stable condition of roughness measurements on the latter. Visual surface failure of the leaded steel occurred at 1000 pieces, coincident with the change shown by the profilometer values. The average surface roughness of the leaded steel was 165 microinches at failure. Only 550 pieces of the standard A8620 steel were produced before failure was reached, and this gave a profilometer reading of approximately 175 microinches. When the form tools were measured for wear at the end of each run, it was found that the tool used on the leaded material was in much better condition than that used on the standard, even though the latter tool had produced only 60% as many parts. Lower cutting speeds were not tried on the A8620 standard steel because the next lower speeds on the machine represented too great a decrease in this factor.

Figures 20 through 27, Drilling Tests.—The above figures show the dimensional variations in the holes produced in every 25th piece by each of two drills—drill No. 1, which cut to a depth of 1/2 inch or 1/2 the length of the part, and drill No. 2 which cut the remaining 1/2-inch length of hole, plus 1/16 inch for cut-off. The holes were drilled with oxide-coated, high-speed-steel, standard screw-machine drills, ground to a 135° point angle and 11° relief angle.

Figure 20 shows the variations in diameter of the holes produced in the C1117 steel. Several methods of measuring the diameters were tried, and the adopted method proved to be most satisfactory. In the method used, the drilled diameters were sorted by classes of 0.001-inch intervals rather than by direct measurement. The specimens were first placed in a group without regard to proper sequence or position in the particular test run. A telescoping gage was then used to find the maximum hole diameter to the nearest 0.001 inch. Once the maximum diameter was established, the telescoping gage setting was decreased by steps of 0.001 inch, and the instrument was used as a plug gage between each step to determine which holes were large enough to accept the set dimension. The acceptable pieces were removed from the rest of the samples and kept as a separate group. This procedure was repeated until all pieces were in their respective classes. The specimens were then identified and the results plotted as in Fig. 20. As an example, it is noted in Fig. 20 that under the results for drill No. 2, the largest recorded diameter is 0.449 inch. This value represents the largest gage setting which was accepted by any of the holes and identifies a class of diameters falling between 0.449 and 0.450 inch. Only one specimen fell into this class. However, when the gage dimension was reduced to 0.448 inch, seven additional holes permitted entry and thus made up a class of diameters between 0.448 and 0.449 inch.

This method of recording the results gives acceptable accuracy, is fairly rapid, and permits measurements near the center of the piece where any "bell-mouth" effect is minimized and where burrs cannot interfere with proper measurement. Interpretation of these results, however, is, at best, only a

matter of judgment. The visual method of predicting the failure point of the drills was very unsuccessful, as it was practically impossible to distinguish any definite changes in surface appearance within even a wide range of pieces. Likewise, drill wear could not be used exclusively as a failure criterion because of the nature of the test procedure. Accurate wear measurements were taken only at the end of a test run, or whenever a change of drills was made during the run. Therefore, in view of these facts, the possible drill failure points are predicted primarily from the results of the diameter variations. Notes taken during the test runs helped to substantiate some of the predictions.

The drilling tests on the AISI-C1117 steel showed a possible failure at 800 pieces in Run I of both drills, as indicated in Fig. 20. It may be noted that the variation in the diameter produced by drill No. 2 was extremely erratic beyond the predicted failure point. This drill was removed at 1300 pieces, and a tool inspection revealed only 0.0028-inch average wear on the flanks. However, one corner was found to have extensive damage. This corner damage was first noted at the 900-piece inspection with the pocket comparator. The drills in Runs II and III showed corner breakdown even after drilling only 400 and 300 pieces, respectively.

The failure point of drill No. 1 was predicted on the basis of a general change in slope of the curve, there being an upward trend beyond 800 pieces. However, when the drill was inspected, after being replaced at 1700 pieces, it showed only 0.0021-inch flank wear with only minor damage at the corners.

Figure 21, representing the drilling results on the C1018 Pb material shows possible failure between 700 and 900 pieces for drill No. 1, Run I, and 550 pieces for drill No. 2, Run II. Three drills were used on each drilling operation to complete a total of 2000 pieces, but only the runs indicated above produced enough holes to give some indication of drill failure. Corner damage seemed to be the critical factor. Run II, of drill No. 1, showed little corner damage to the drill at the end of 700 pieces. However, the drill which produced 900 pieces in Run I had very severe corner wear. Thus the failure point for the first drilling operation was assumed to be between 700 and 900 pieces. The possible failure in drill No. 2 occurs at a point where the hole diameter becomes noticeably unstable. The wear on the drills was considerably higher in the C1018 Pb steel than it was in the C1117 material—as much as 90% higher for approximately the same number of parts.

The drilling results on the C1045-series steels are shown in Figs. 22 and 23. These results indicate possible failures at 700 pieces for both drills on the standard steel, and at 400 pieces for both drills on the leaded steel. Drill-wear data were more complete on this series of tests because all tools were removed from the machine every 100 pieces and inspected under the toolmaker's microscope. These data revealed that, initially, wear progressed

very rapidly, and similarly, on both materials. For example, drill No. 1 in Fig. 22 showed 0.0104-inch wear at the end of 1200 pieces, but 0.0062 inch of this wear occurred during the production of the first 100 parts. In other words, in the case of the C1045 standard steel, approximately 60% of the total drill wear occurred during 8.3% of the total production. Beyond 100 pieces, the drill wear on the leaded material proceeded much more rapidly than it did on the standard steel. When the drills used on the C1045 Pb steel were inspected at the end of 600 pieces, they showed almost as much wear as was found at the end of 1200 pieces on the drills used in the test of the standard material.

Figure 24 shows the results of the drilling tests on the A4140 standard steel. Only one set of drills was used for each drilling operation throughout the entire run of 880 pieces in this test, although failure was predicted at 800 pieces for each of the two drills. These failure points occur just prior to rather sharp deviations in the drilled diameters. The drills themselves, however, did not show any extensive damage or wear which might substantiate the fact that failure actually had taken place. The cutting edges were sound and there was practically no rounding of the corners in either drill.

The drilling tests on the A4140 Pb steel, the results of which are shown in Fig. 25, indicated a failure at 550 pieces for each drill. As in the case of the standard material, these failures were predicted on the basis of the breaks in the curves representing a plot of drilled diameter vs number of pieces. However, inspection of the drills at the end of this run, 600 pieces, revealed that considerable damage had occurred. The cutting edges on both drills were badly chipped. In addition, cratering on the faces was far advanced and extended to the cutting edge in several places, particularly near the periphery.

Figures 26 and 27 represent the results of the drilling tests on the AISI-A8620-series steels. No failure points are reported in the test because the results are rather inconclusive. Judging purely on the basis of slight variations in level of hole-diameter measurements, or on the basis of a change in the general slope of the curves, it would appear that the drills failed at approximately 400 pieces on the standard material and at 500 pieces on the leaded steel. However, there is no other evidence to substantiate these values. When the drills were inspected after each run, it was found that one drill was badly damaged while the other drill was relatively sound. For example, of the drills used in the test of the standard steel, drill No. 2 had very severe damage at the corners, whereas drill No. 1 was undamaged except for wear on the flank. In the test on the leaded steel, it was drill No. 1 that had extremely severe wear at the corners.

There were several factors which may have contributed to the variation in results. First, in the case of the standard steel, there was an ex-

cessive variation in Brinell hardness of the material. Second, it may be noted that the drilled holes measured as much as 0.015 inch over the drill diameter. This may have been due to either unequal cutting edges or poor drill alignment. Either or both of these factors could have contributed to the reasons for the breakdown at the periphery of the drills.

The drill flank wear in the test of the standard material varied from 0.0057 inch to 0.0067 inch at 700 pieces. The wear measurements on the drills used in the test of the A8620 Pb steel, however, gave values of only 0.0034 inch to 0.0036 inch at the end of 1150 pieces, at a 20% increase in speed. The feed rate was practically the same in each case. In the tests of all the other materials, the drills on the leaded material always showed the greatest wear. It may be noted, however, that the Brinell hardness of the leaded steel was much lower than the hardness of the standard A8620 material.

Table II, All Conditions of Test.—This table lists all test conditions—machine speeds, operation cycle times, velocities, feeds, tool signatures—which were tried on each material during the search for satisfactory performance. The columns headed by an asterisk (*) represent the conditions which gave the most satisfactory results on each material. These results have been used in the evaluation of the different steels in this report.

The manipulating factors in each set of conditions were velocity, feed, and, occasionally tool signature. In many instances only one of the factors was changed, and in some cases all of the factors were varied in an attempt to better the surface finish, increase tool life, or both. Comments on the results of each test are given very briefly in the remarks column of the table.

It may be noted that in the case of the AISI-A4140 standard and leaded steels, the satisfactory performance, as marked by the asterisk, occurred prior to further test runs which were made under different conditions. An attempt was always made to get the best possible results, and the results of the tests on the A4140 steels did not appear to be entirely satisfactory. Therefore, conditions were changed and other test runs were made in an effort to improve existing values of surface finish and tool life. No set of conditions was found, however, which gave better performance than those indicated by the asterisk.

Table III, Summary of Recommended Conditions of Operation.—This table summarizes the results of the conditions marked with an asterisk in Table II and represents the most satisfactory performance for each material. For purposes of comparison, the steels have been grouped as follows: C1117 and C1018 Pb; C1045(std) and C1045 Pb; A4140(std) and A4140 Pb; and A8620(std) and A8620 Pb. The steels are compared on a basis of production rate, in terms of pieces per hour of cutting time, and on the basis of estimated tool life, in terms of number of pieces to failure.

TABLE II
ALL CONDITIONS OF TEST

Material	Test	Spindle Speed, rpm		Velocity, fpm		Cycle Time, sec/pc		Feed, in./rev		Form Tool	Turn Tool	Drill		Total Pieces	Remarks
		Form	Turn	Form	Turn	Form	Turn	1 1/2" point angle	11° relief angle						
C1117	1	740	145	85	82.5	.00058	.0074	.0042	18,0,7,7,15,15,0	"	8,15,6,6,0,1/32	7/16" diam	200	Excessive tearing by turn tool. Surface very unsatisfactory. Feed rates were halved in an attempt to eliminate this problem. Turned surface much improved. Turned surface better but not satisfactory. Turn tool regrind to 1/32" nose radius for next set under same conditions.	
	2	740	145	85	165	.00029	.0037	.0021	"	"	"	"	30	Turning results much better, but feed values on other tools too low. Conditions in test 1 to be repeated with 1/32" nose-radius turn tool.	
	3	740	145	85	165	.00029	.0037	.0021	"	"	8,15,6,6,0,1/32	"	500	Results fair on all tools except turn. New cam made to decrease turn feed rate by 1/2.	
	4	740	145	85	82.5	.00058	.0074	.0042	"	"	"	"	100	Conditions same as in test 4, but with new cam. Results fair, but erratic. Not wholly satisfactory.	
	5	740	145	85	82.5	.00058	.0036	.0042	"	"	"	"	500	Slight decrease in feed rates gave satisfactory performance.	
	* 6	740	145	85	90	.00054	.0033	.0039	18,0,7,7,15,15,0 with 22° chamfer	"	"	"	"	2000	Excessive wear of turn tool. Surface finish erratic and not satisfactory.
C1018 Pb	1	740	145	85	82.5	.00058	.0036	.0042	18,0,7,7,15,15,0	"	8,15,6,6,0,1/32	7/16" diam	100	Tearing of metal on specimen is still too great for satisfactory condition.	
	2	640	125	73	90	.00062	.0038	.0045	"	"	"	"	125	Reduced feeds gave better performance, but some tearing still evident. Form tool showed signs of failing at sharp corner of cutting edge. Conditions of test 3 repeated in test 4, with 22° chamfer ground on the form tool to help eliminate heat concentration on the corner of the cutting edge.	
	3	640	125	73	120	.00046	.0028	.0034	"	"	"	"	100	Speed increased to eliminate tearing. Results better than in previous run, but still not fully satisfactory. Too erratic.	
	4	640	125	73	120	.00046	.0028	.0034	18,0,7,7,15,15,0 with 22° chamfer	"	"	"	100	Speed too high. All tools showed signs of chipping along cutting edge at end of run.	
	5	740	145	85	105	.00046	.0028	.0034	"	"	"	"	1500	Surface-finish results good. However, turn tool showed signs of nose failure at 500 pieces.	
	6	815	160	95.5	97.5	.00045	.0028	.0033	"	"	"	"	800	Turn-tool side-rake angle increased to 20°. Results unsatisfactory to visual inspection of surface in both tests 8 and 9.	
	7	740	145	85	90	.00054	.0033	.0039	"	"	8,20,6,6,0,1/32	"	300	Conditions same as in test 5—best previous run—but with feed rates decreased 12.5%. Proved to give satisfactory performance.	
	8	740	145	85	90	.00054	.0033	.0039	"	"	"	"	25	Rapid wear of turn tool. Drills show chipped cutting edges.	
	9	740	145	85	135	.00056	.0022	.0026	"	"	"	"	25	Formed finish poor and very erratic. Speed thought to be too high.	
	*10	740	145	85	120	.00040	.0025	.0030	"	"	8,15,6,6,0,1/32	"	2000	Results fair. Formed surface still a little erratic but visual inspection indicates a satisfactory condition.	
C1045 (std)	1	505	99	58	120	.00059	.0036	.0043	18,0,7,7,15,15,0 with 22° chamfer	"	8,15,6,6,0,1/32	7/16" diam	200	Rapid wear on all tools. Formed finish very erratic.	
	* 2	400	78.5	46	180	.00050	.0030	.0036	"	"	"	"	1200	Lower speed and lighter feeds gave fair results. Same condition as in test 2 of C1045 (std) but formed and turned surfaces much better.	
C1045 Pb	1	505	99	58	120	.00059	.0036	.0043	18,0,7,7,15,15,0 with 22° chamfer	"	8,15,6,6,0,1/32	7/16" diam	100	Original conditions of test 1 tried with 20% lower feeds. Gave acceptable performance.	
	2	400	78.5	46	180	.00050	.0030	.0036	"	"	"	"	600		
* 3	505	99	58	150	.00047	.0029	.0034	"	"	"	"	1200			

*Evaluation of steel based on the results of these test conditions.

TABLE II (Concluded)

Material	Test	Spindle Speed, fpm	Velocity, fpm		Cycle Time, sec/pc	Feed, in./rev		Tool Signatures		Total Pieces	Remarks	
			Form and Turn	Drill		Form	Turn	Form Tool	Turn Tool			Drill
A4140 (std)	1	400	78.5	46	180	.00050	.0036	18,0,7,7,15,15,0 with 22° chamfer	8,15,6,6,6,0,1/32	7/16" diam	750	7/8" bar stock was turned to 3/4" OD with carbide tools. Test 1 was discontinued because rough turning had a very negative effect on form-tool and turn-tool life. Very unsatisfactory condition.
	* 2	400	92	52	180	.00050	.0036	"	"	1/2" diam	880	Rough turn eliminated. Original bar diameter used as reference, and drills changed to maintain correct ratio. Results fair.
	3	505	116	66	150	.00047	.0029	"	"	"	450	Rapid tool wear. Formed surface burnished and torn at approximately 325 pieces.
	4	505	116	66	150	.00047	.0029	10,0,7,7,15,15,0 with 22° chamfer	8,10,6,6,6,0,1/32	"	50	Lower tool-rake angles tried to help improve conditions. Poor form-tool finish. Speed appeared to be too high.
	5	445	102	58	165	.00048	.0030	"	"	"	60	Form finish still poor. Decided to try original tool-rake angles on form tool to note any possible effects of tool signature.
	6	445	102	58	165	.00048	.0030	18,0,7,7,15,15,0 with 22° chamfer	8,10,6,6,6,0,1/32	"	30	Finish better, but not satisfactory. Slower speed to be tried.
	7	400	92	52	180	.00050	.0036	10,0,7,7,15,15,0 with 22° chamfer	"	"	200	Form surface finish still not satisfactory with lower tool rakes. Not as good as results of test 2.
	8	400	92	52	180	.00050	.0036	18,0,7,7,15,15,0 with 22° chamfer	"	"	200	Original rake angles. Duplication of test 2. Results fair but hoped to find a better set of conditions.
	9	400	92	52	240	.00058	.0022	"	8,15,6,6,6,0,1/32	"	175	Extremes of feed rates tried in tests 9 and 10. Results unsatisfactory. Surface showed signs of burnish in test 9 while rapid tool wear and poor surface finish resulted from high feeds in test 10.
	10	400	92	52	120	.00076	.004	"	"	"	150	Results fair, but visual inspection showed a generally poorer finish than in test 2.
	A4140 Pb	1	505	116	66	150	.00047	.0029	18,0,7,7,15,15,0 with 22° chamfer	8,15,6,6,6,0,1/32	1/2" diam	300
* 2		475	109	62	150	.00050	.0031	"	"	"	600	Drop in speed proved to be effective, even though feed rate increased. Surface finish more stable.
3		445	102	59	165	.00049	.0030	"	"	"	500	Lower speed tried to improve on results of test 2. Formed surface not as stable, but turned surface better than in test 2.
A8620 (std)	1	400	105	60.5	150	.00059	.0043	18,0,7,7,15,15,0 with 22° chamfer	8,15,6,6,6,0,1/32	37/64" diam	200	Extremely rapid wear on turn and form tools. Formed surface finish unstable and erratic. Conditions very unsatisfactory.
	* 2	375	98	57	165	.00058	.0035	"	"	"	700	Formed finish still erratic and unstable at lower speed. Visual inspection shows more consistent surface appearance than revealed in test 1. Next available speed in this range is too slow for practical consideration.
A8620 Pb	* 1	450	118	68	135	.00059	.0043	18,0,7,7,15,15,0	8,15,6,6,6,0,1/32	37/64" diam	1150	Results were judged to be satisfactory, so no other conditions were tried on this material.

TABLE III

SUMMARY OF RECOMMENDED CONDITIONS OF OPERATION

Material	C1117	C1018 Pb	C1045	C1045 Pb	A4140	A4140 Pb	A8620	A8620 Pb
Spindle Speed, rpm	740	740	400	505	400	475	375	450
Velocity, fpm								
Drills	85	85	46	58	52	62	57	68
Form-Turn	145	145	78.5	99	92	109	98	118
Cycle Time, sec/pc	90	120	180	150	180	150	165	135
Pc/hr	40	30	20	24	20	24	21.8	26.5
Pc/hr Cutting Time								
Form Tool	424	318	212	255	212	255	231	283
Turn Tool	388	291	194	233	194	233	212	259
Drill No. 1	344	258	172	206	172	206	188	229
Drill No. 2	306	229	153	183	153	183	167	204
% Std	100	75	100	120	100	120	100	122
Estimated Tool Life								
Number of Pieces								
Form Tool	1500	1650	1025	850	775	500	550	1000
% Std	100	110	100	83	100	64.5	100	182
Turn Tool	950	600	500	425	600	400	450	550
% Std	100	63	100	85	100	66.7	100	122
*Drill No. 1	800	900	700	400	800	550	**	**
% Std	100	112	100	57	100	69	**	**
*Drill No. 2	800	550	700	400	800	550	**	**
% Std	100	69	100	57	100	69	**	**

*The number of pieces defining drill failure was determined arbitrarily from data showing values of hole diameter vs number of pieces—Figs. 20 through 27.

**Drill failure could not be definitely established in the A8620 steels.

The term "Pieces per Hour of Cutting Time" is a function of the spindle speed in rpm, feed in inches per revolution, and the length of cut in inches. It represents the number of pieces which could be cut in one hour if a tool were cutting continuously for that time. For any given operation—turn, drill, form—if cam lengths and cam throws are taken into account, the formula for pieces per hour of cutting time reduces to a constant divided by the cycle time in seconds per piece. The number of pieces to failure was defined by visual inspection of the turned and formed surfaces, and by changes in drilled hole diameters.

It may be noted that a comparison was made on the performance of each tool—form tool, turn tool, and drills—and that the standard material was always used as a base for the comparison. In other words, the performance on the leaded steel is always expressed as a percentage of the results on the standard material. For example, on the basis of production rate, the form tool on the C1117 material, used as the standard, was cutting at a rate of 424 pieces per cutting hour. The form tool on the C1018 Pb steel had a production rate of 318 pieces per cutting hour, or 75% of the standard. [This value of 75% could likewise be derived by taking a ratio of the actual number of pieces of the leaded material produced per hour (30) to the actual number of pieces of standard material produced per hour (40). An inverse ratio of the cycle times would also give the same result.] Visual inspection revealed that failure took place at 1500 pieces of the standard material and at 1650 pieces—110% of standard—of the leaded steel. Thus, satisfactory performance on the leaded steel could be achieved with a production rate of only 75% of standard although this production rate produced 110% as many parts before failure occurred. A single figure which might relate production rate and number of pieces to failure could be derived by obtaining the product of the above values. When this is done, the value of 82.5% of standard could represent a general rating for the forming operation on the C1018 Pb material. The other operations and the other materials may be compared in the same manner.

It should be emphasized that the values reported in Table III are based on actual values and do not take any other factors into account—factors such as Brinell hardness numbers of the steels. Table I shows, for example, that the C1045 Pb steel had an average Brinell hardness approximately 30 points higher than the standard material. The hardness results for the A8620 steels show that the leaded steel, in this case, was approximately 30 points lower in hardness value than the standard material. The variation in hardness could be great enough to affect the results of these comparisons.

CONCLUSIONS

Using the results of the recommended conditions of operation and assuming that the standard steel is rated at 100%, the following conclusions may be drawn for each group of materials:

C1018 Pb vs C1117

1. On the basis of production rate for best performance, the leaded material is rated at 75% of the standard steel.
2. In terms of tool life, or number of pieces to failure, the leaded steel is rated at:
 - a. 40% of standard in the forming operation
 - b. 63% of standard in the turning operation
 - c. 90% (average) of standard in the drilling operation.
3. Form-tool and turn-tool wear were greater on the leaded material, the wear rate being much more rapid in the later stages of the test run.
4. The Brinell hardness ranges of the leaded and the standard steels were 153-163 and 156-166, respectively.

C1045 Pb vs C1045 (std)

1. In terms of production rate for best performance, the leaded steel rates at 120% of the standard material.
2. On the basis of tool life, the leaded steel is rated at:
 - a. 83% of standard in the forming operation
 - b. 85% of standard in the turning operation
 - c. 57% of standard in the drilling operation.
3. The wear on the form and turn tools was more severe on the leaded steel.
4. The Brinell hardness ranges were 248-255 and 217-223 for the leaded and the standard steels, respectively.

A4140 Pb vs A4140 (std)

1. The leaded steel performed at a production rate of 120% of standard.

2. The number of pieces to failure was:
 - a. 64.5% of standard in the forming operation
 - b. 66.7% of standard in the turning operation
 - c. 69% of standard in the drilling operation.

3. Wear was much more severe on the tools used in the test of the leaded material.

4. The Brinell hardness numbers of the leaded and standard steels were 217-229 and 202-217, respectively.

A8620 Pb vs A8620 (std)

1. Satisfactory conditions were achieved on the leaded steel with a production rate of 122% of standard.

2. At the above production rate the number of pieces produced before failure was:

- a. 182% of standard in the forming operation
- b. 122% of standard in the turning operation.

No conclusions could be reached on drill performance.

3. The rate of tool wear on the leaded steel was much less severe than the rate of wear on the standard material.

4. The Brinell hardness ranged from 197-207 on the leaded material and from 217-248 on the standard steel.

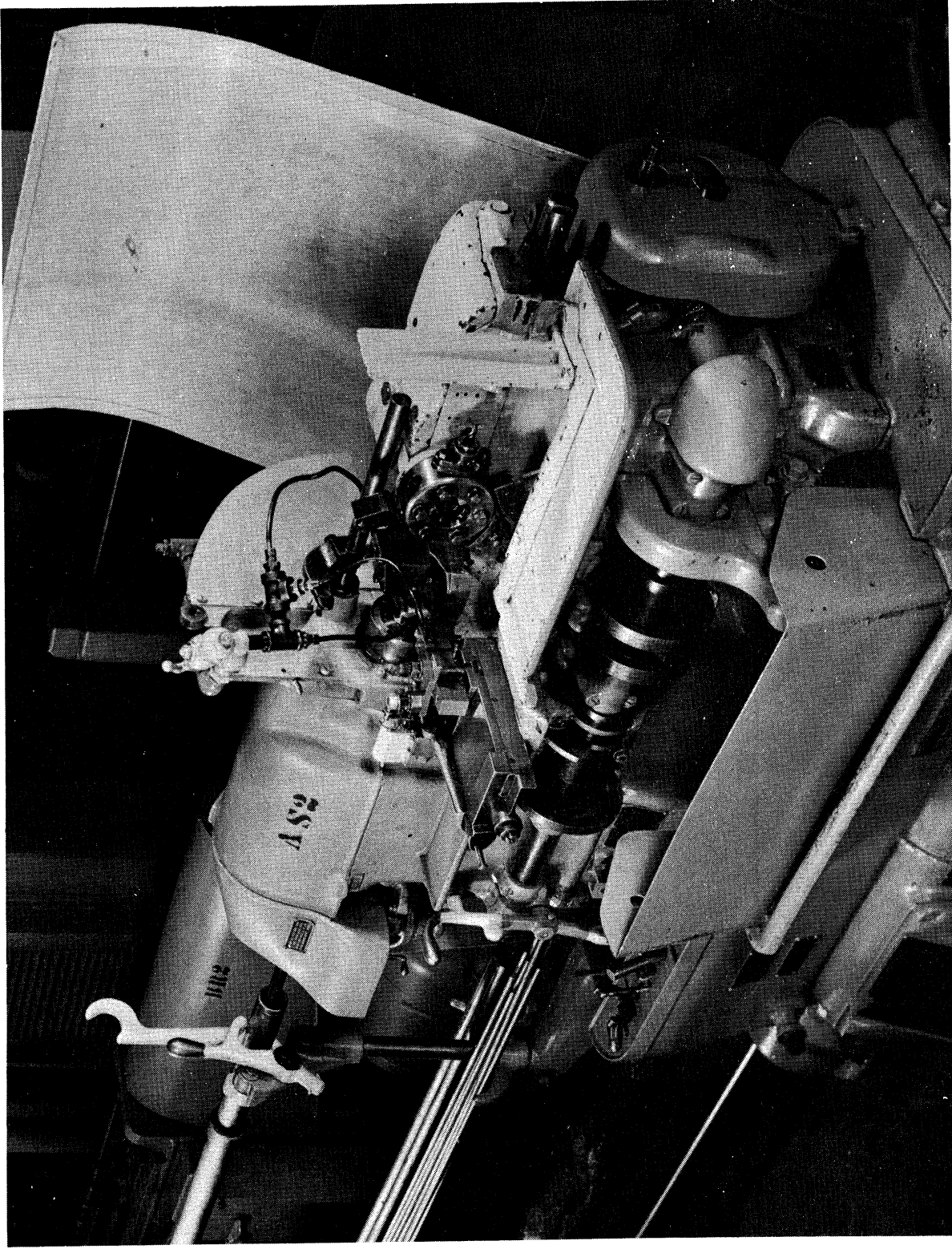
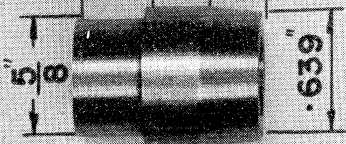

Fig. 1. View of the Brown and Sharpe automatic screw machine.

$\frac{3}{4}$ " BAR STOCK



MATERIAL:
C 1018 Pb
C 1117
C 1045

$\frac{7}{8}$ " BAR STOCK

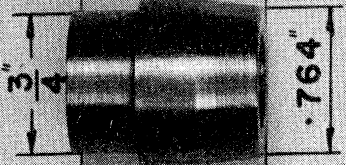

MATERIAL:
A 4140
A 4140 Pb

1" BAR STOCK

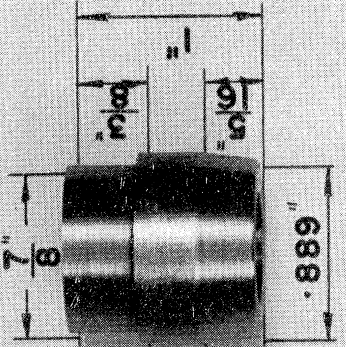

MATERIAL:
A 8620
A 8620 Pb

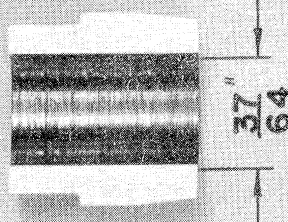
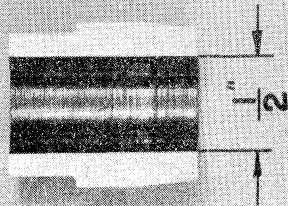
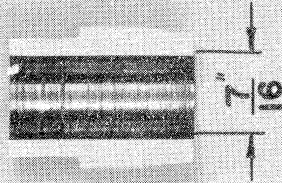

Fig. 2. Examples of machined parts.

STEEL BUSHING

THE BETHLEHEM STEEL CO.
PROJECT 1197-1

OPERATIONS:

- 1 ST CUTOFF
- 1 ST DRILL
- FORM (OVERLAP)
- OD TURN
- 2 ND DRILL
- 2 ND CUTOFF

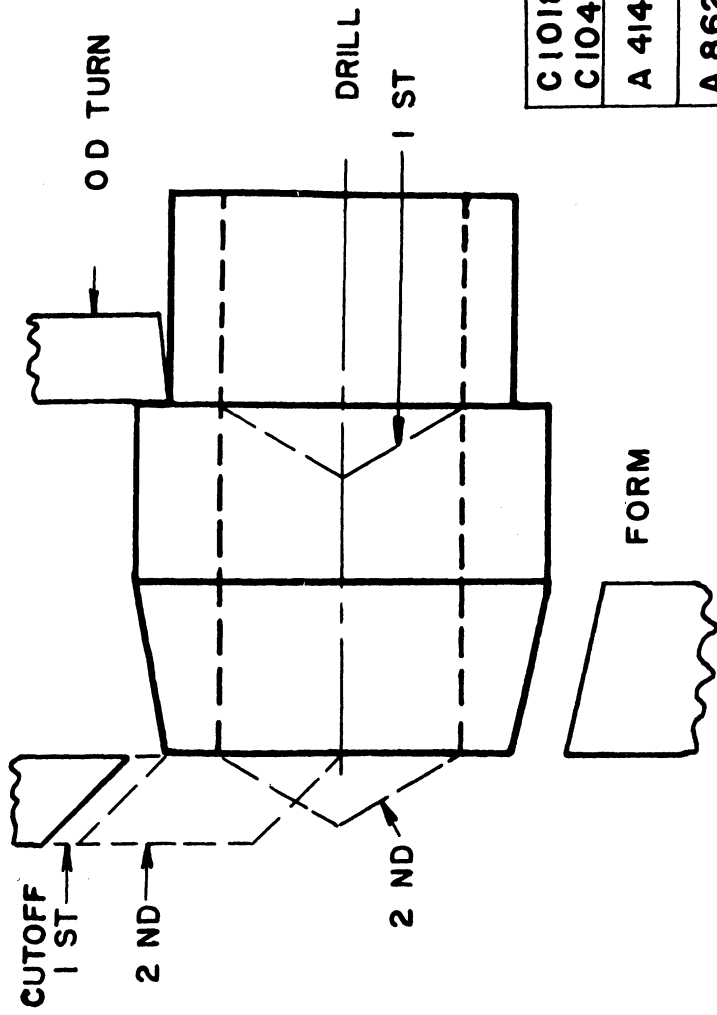

	A	B	C	D
C 1018	$\frac{7}{16}$	$\frac{3}{4}$	$\frac{5}{8}$.639
C 1045	$\frac{1}{2}$	$\frac{7}{8}$	$\frac{3}{4}$.764
A 4140	$\frac{37}{64}$	1	$\frac{7}{8}$.889

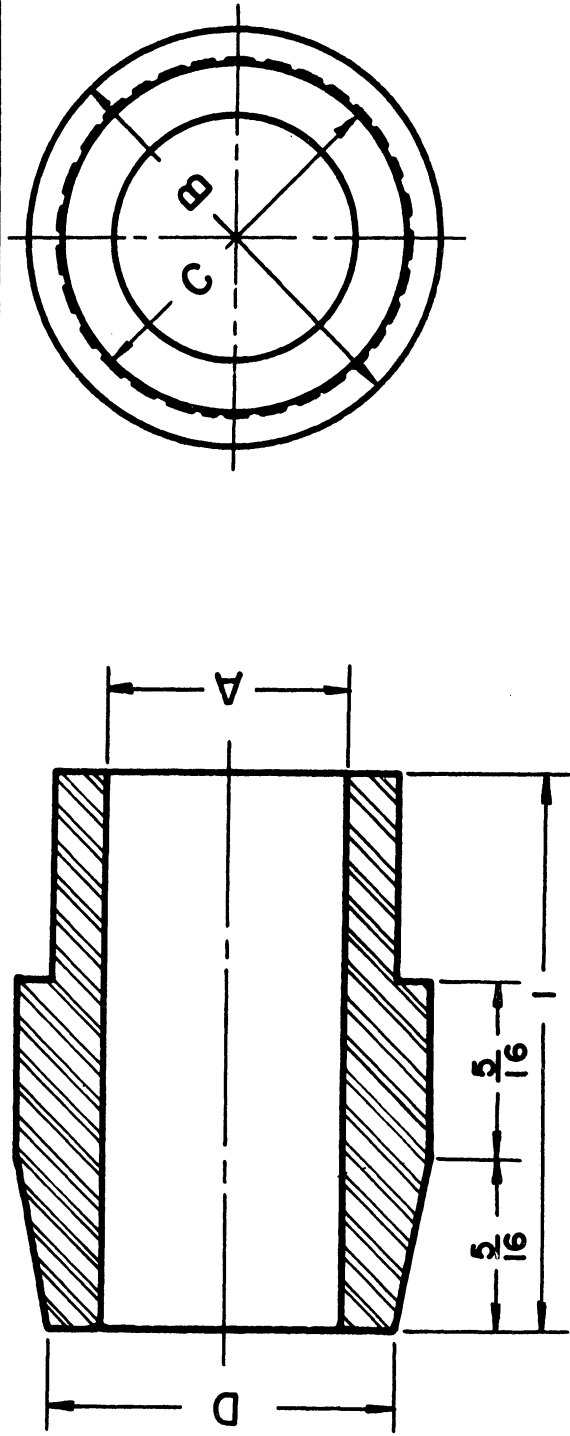

Fig. 3. Specification size and operational sequence.

Project No. 1197-1
The Bethlehem Steel Company
Surface Finish and Dimensional Stability vs No. of Pcs.

SURFACE FINISH
MICROINCHES - RMS

Machine: B and S, 267, Single Spindle Automatic
Speed: 740 RPM, 145 FPM
Feed: .0035 IPR
Parts per hour: 40
Cutting Fluid: 1-9 Iners-Kut and Oil
Material Cut: AISI 10117
Tool Material: M2-U HSS
Tool Type: Knave Turn
Tool Signature: 8, 13, 6, 6, 6, 10, 1/32

VISUAL FAILURE

SURFACE ROUGHNESS RANGE

VARIATION OF DIMENSION

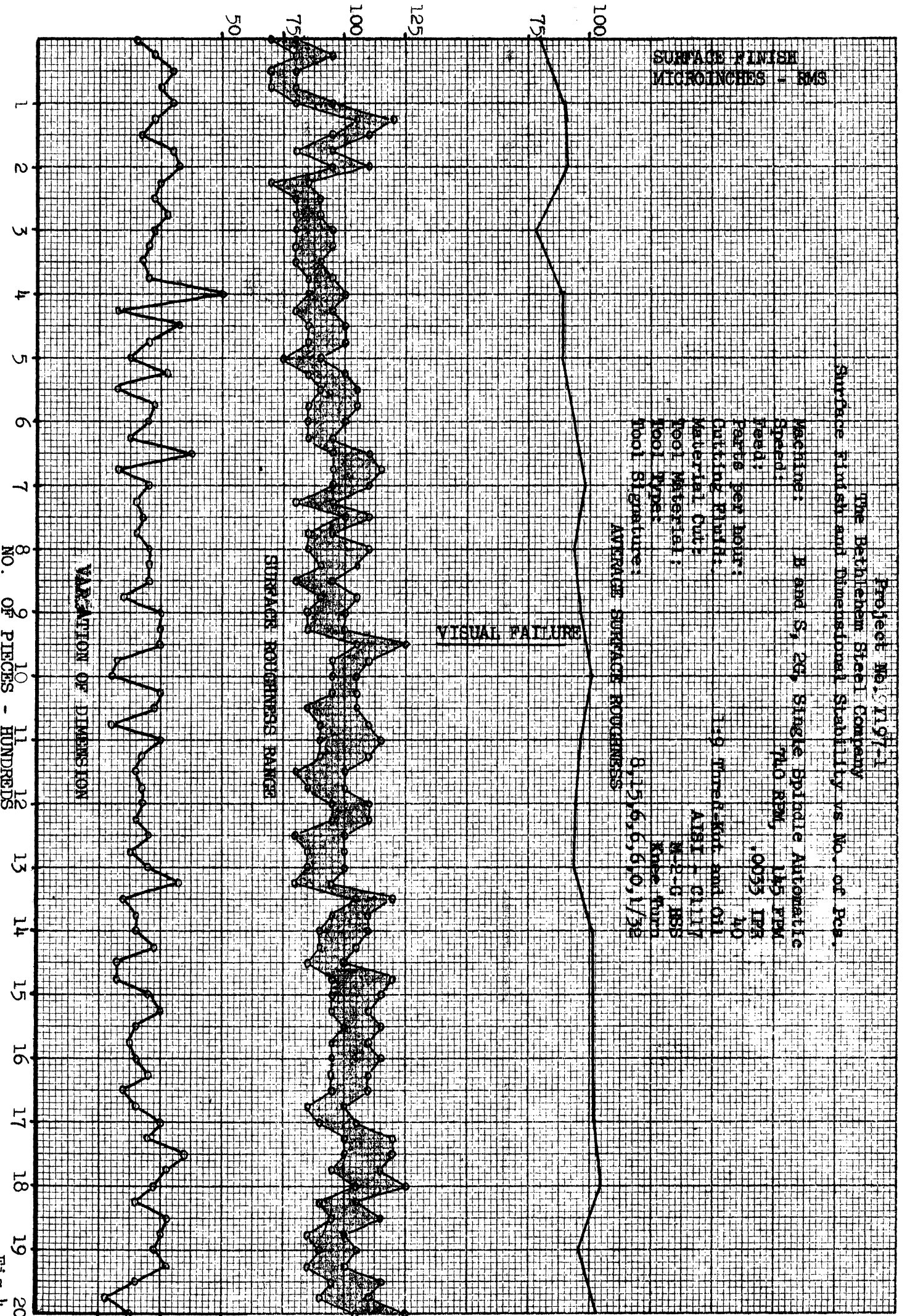

TURNED DIAM. - in.

.628
.627
.626

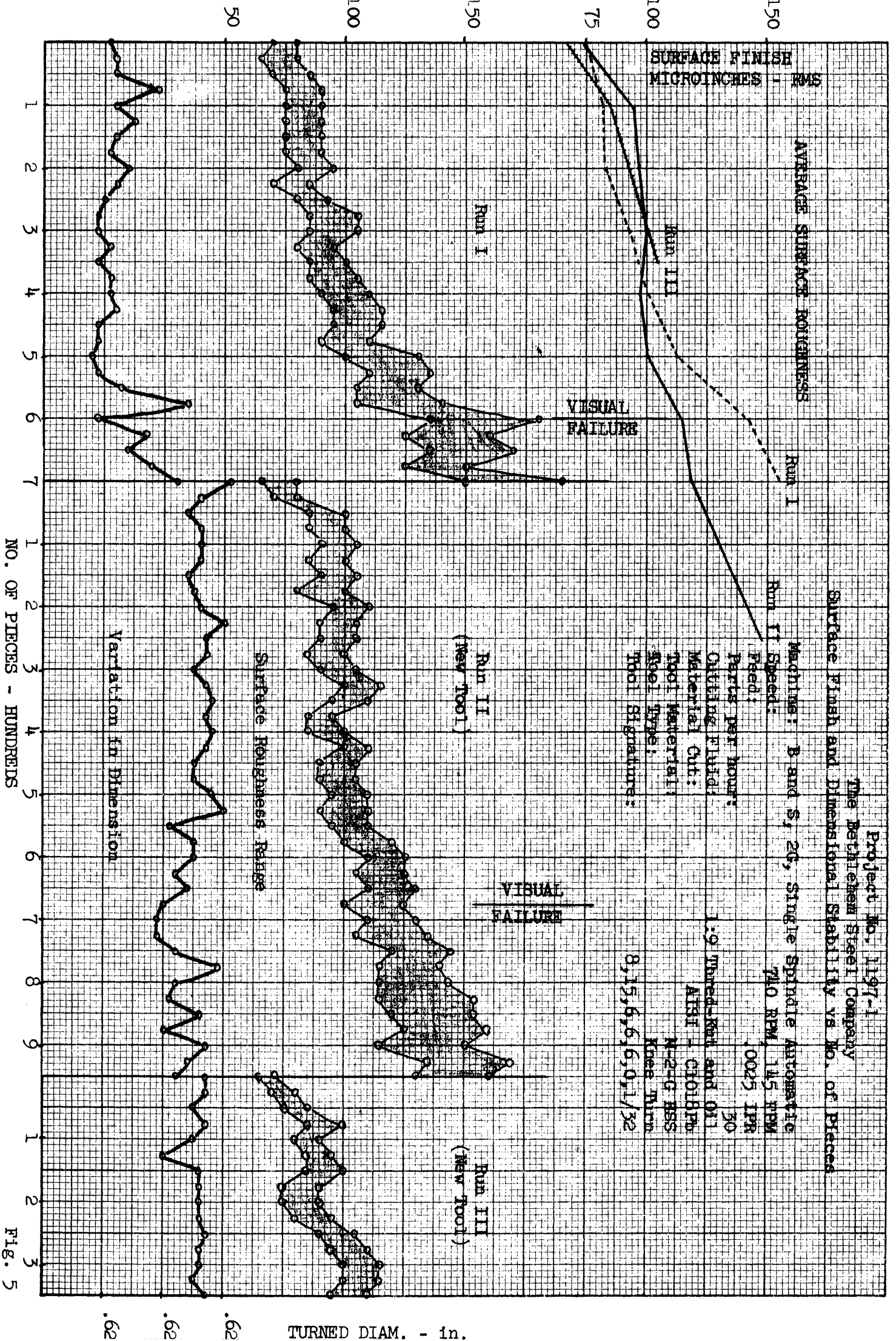
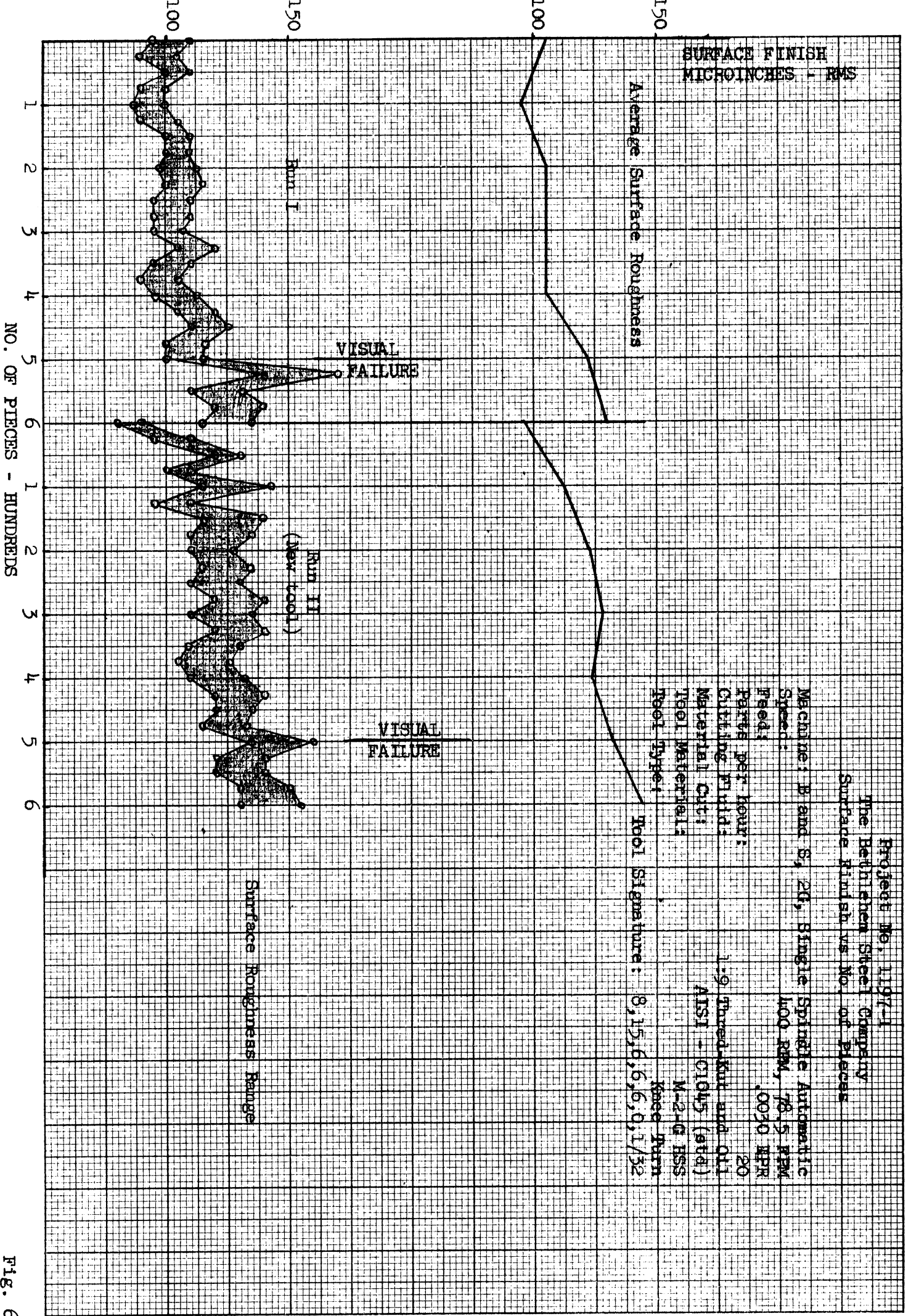

Fig. 5



Project No. 1197-1
 The Bethlehem Steel Company
 Surface Finish vs No. of Pieces

Machine: B and S, 20, Single Spindle Automatic
 Speed: 400 RPM, 78.5 RPM
 Feed: .0090 IPR
 Parts per hour: 20
 Cutting Fluids: 1.9 Thred-Kut and Oil
 Material Cut: AISI - C1045 (std)
 Tool Material: M-2-G HSS
 Tool Type: Knee Turn
 Tool Signature: 8, 15, 6, 6, 6, 0, 1/32

Fig. 6

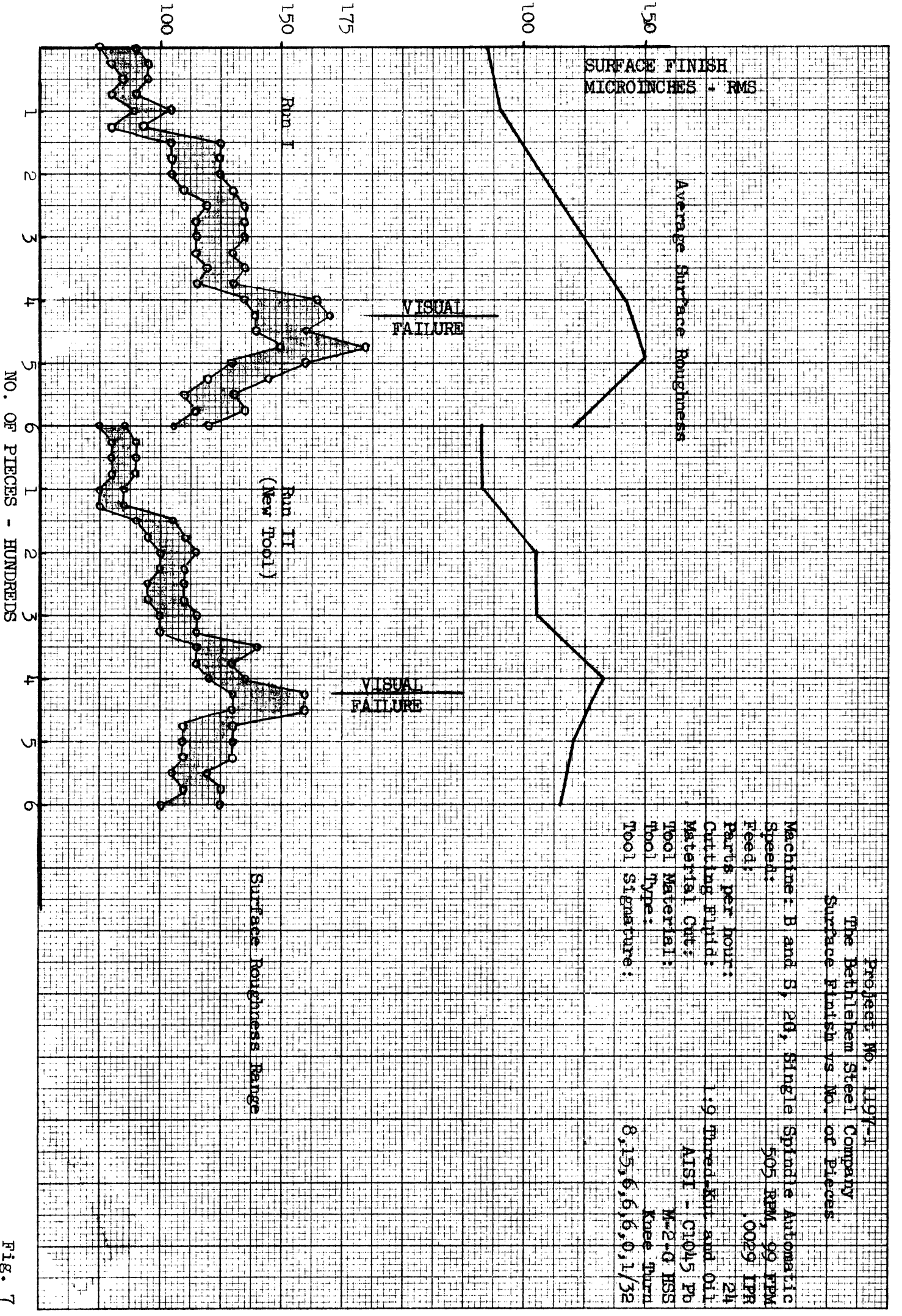

Fig. 7

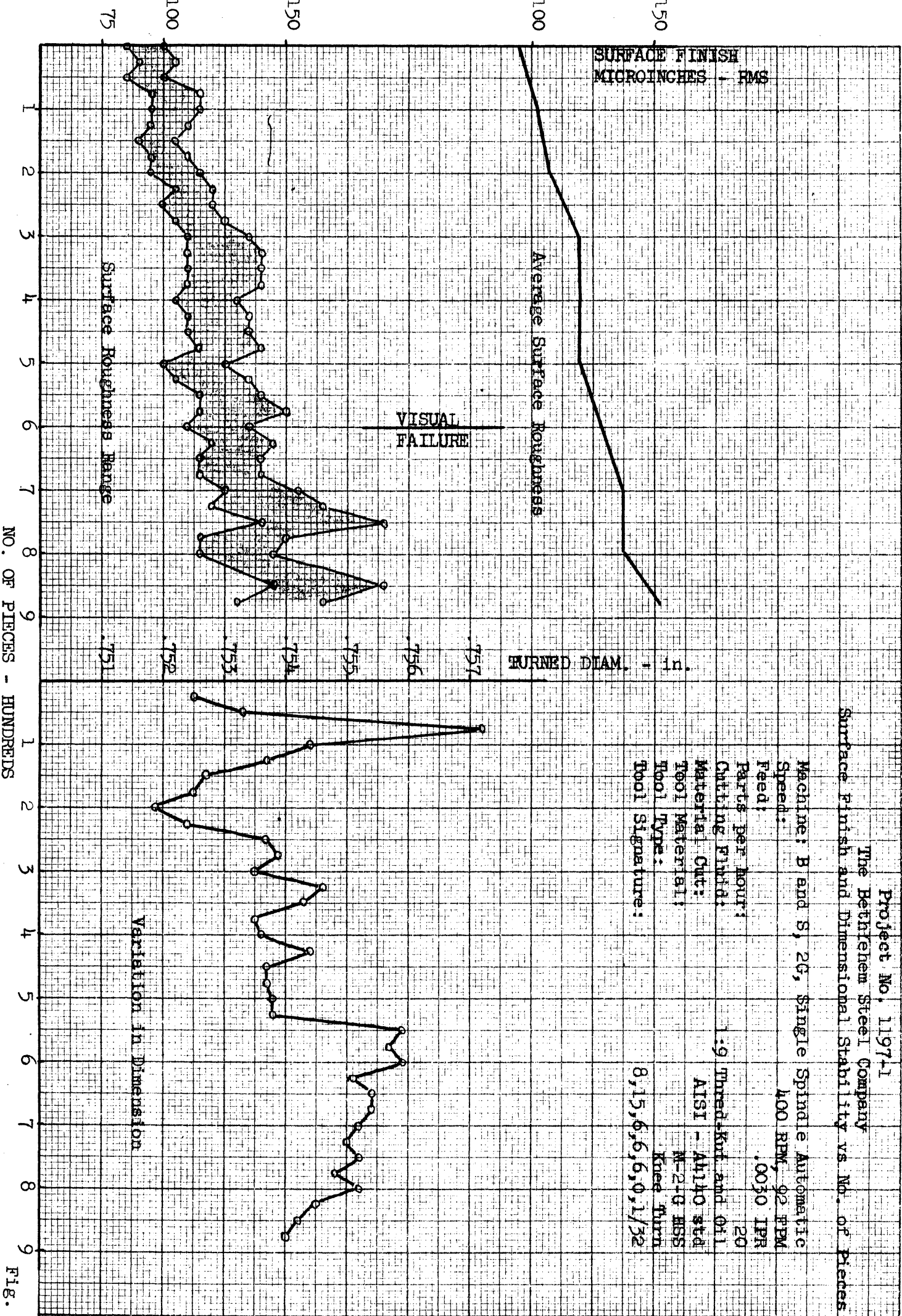

Fig. 8

SURFACE FINISH
MICROINCHES - RMS

Average Surface Roughness

VISUAL FAILURE

TURNED DIAM. - in.

Project No. 119711
The Bethlehem Steel Company
Surface Finish and Dimensional Stability vs No. of Pieces

Machine: B and S, 20, Single Spindle Automatic
Speed: 475 RPM, 109 RPM
Feed: .0031 IPR
Parts per hour: 24
Cutting Fluid: 1:9 Thred-Kut and Oil
Material Cut: AISI - A4140 F4
Tool Material: M-2-G HSS
Tool Type: Knee Turn
Tool Signature: 8, 15, 6, 6, 6, 0, 1, 1/32

Variation in Dimension

Run II
(New Tool)

Run I

Run II
(New Tool)

Run I

.754
.753
.752
.751
.750
.749

NO. OF PIECES - HUNDREDS

Fig. 9

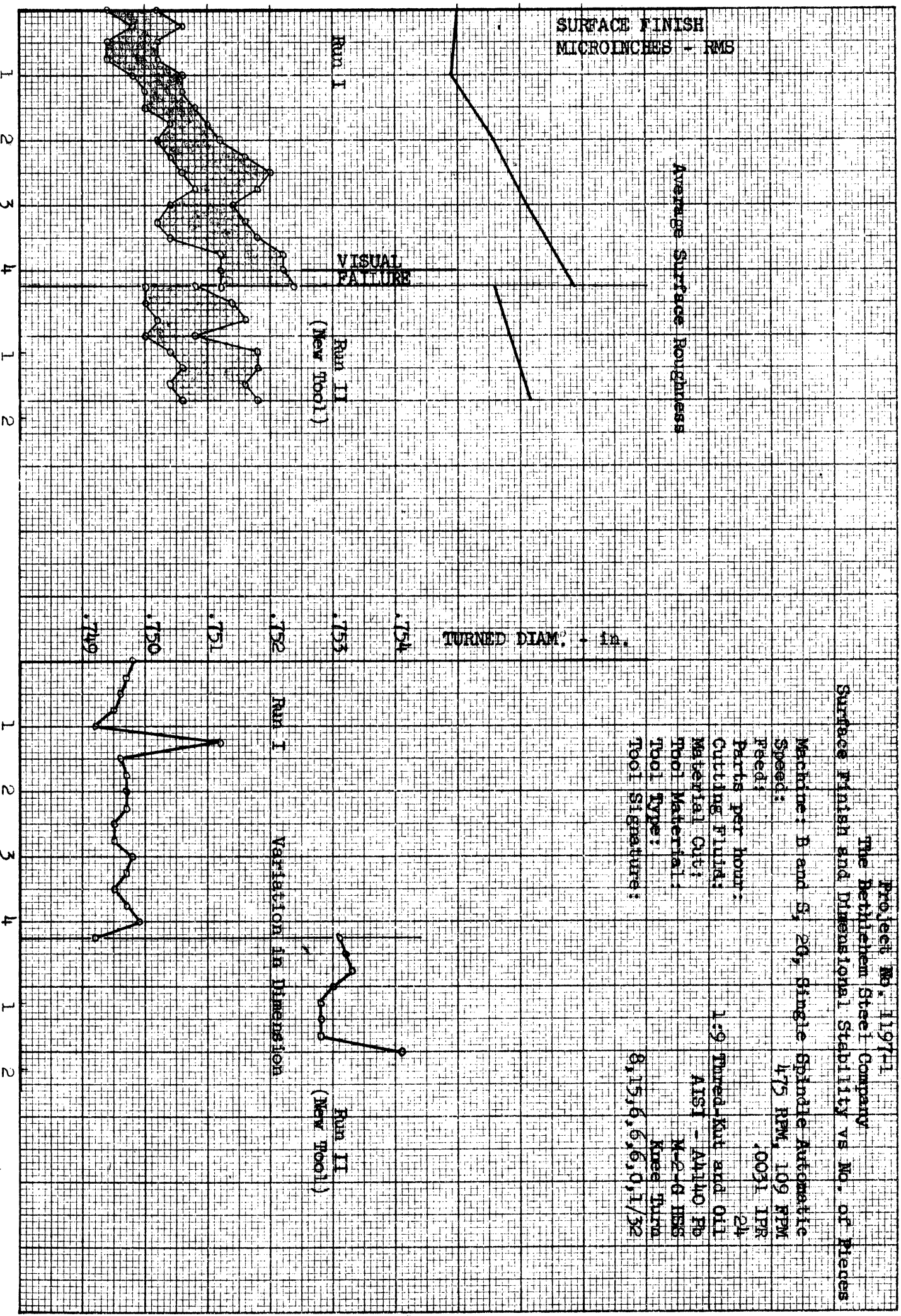

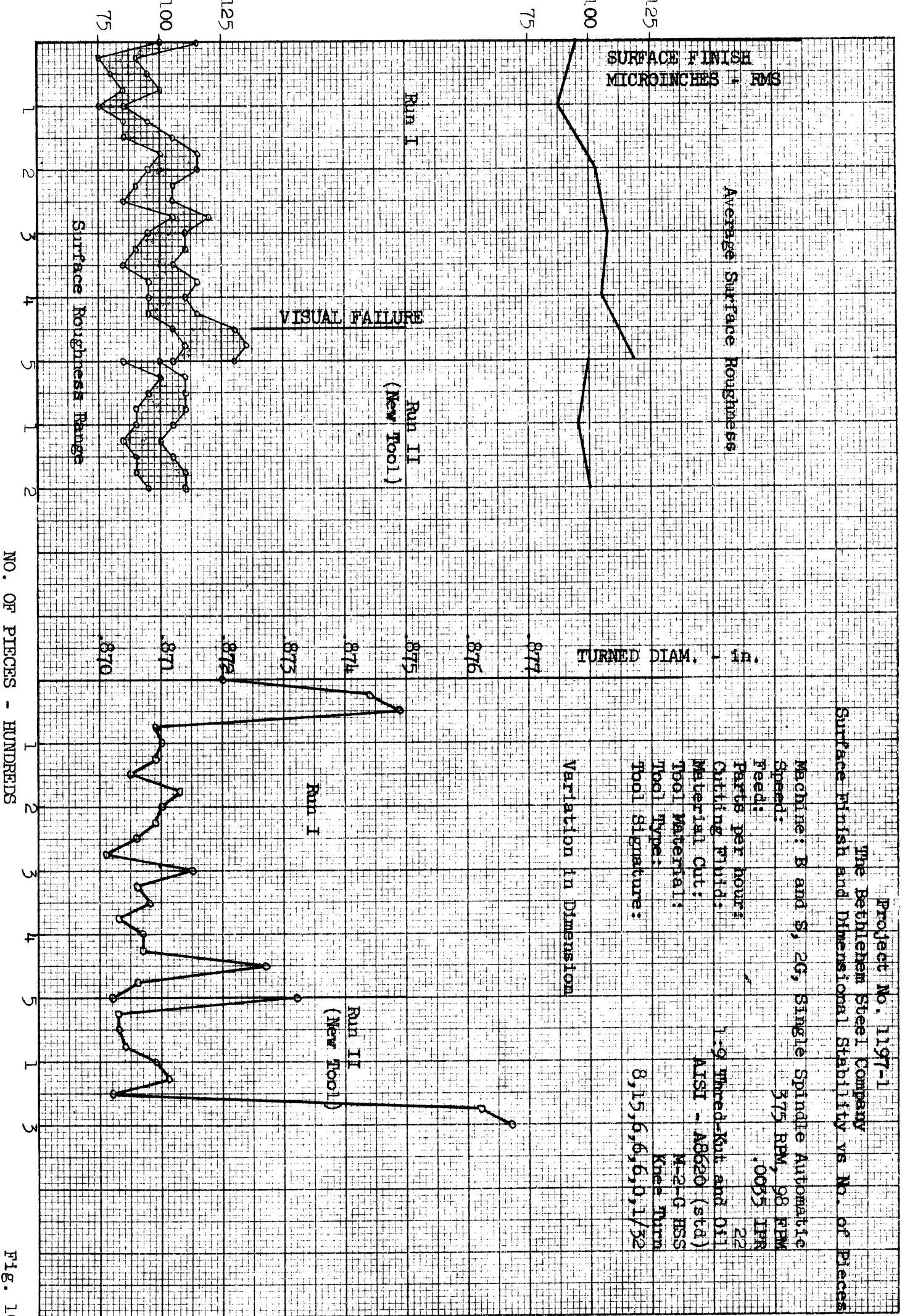

Fig. 10

Project No. 119711
 The Bethlehem Steel Company
 Surface Finish and Dimensional Stability vs No. of Pieces

Machine: B and S, 2G, Single Spindle Automatic
 Speed: 450 RPM, 118 FPM
 Feed: .0036 IPM
 Parts per hour: 26.7
 Cutting Fluid: 1:9 Tanned-Kut and Oil
 Material Cut: AISI - A8620 Dr
 Tool Material: M-2-C HSS
 Tool Type: Knee Turn
 Tool Signature: 8,15,6,6,0,1/32

SURFACE FINISH
 MICROINCHES - RMS

Average Surface Roughness

VISUAL
 FAILURE

Run I

Run II
 (New Tool)

Variation in Dimension

Run II
 (New Tool)

Run I

Surface Roughness Range

NO. OF PIECES - HUNDREDS

TURNED DIAM. - in.

.872
 .873
 .874
 .875
 .876
 .877

Fig. 11

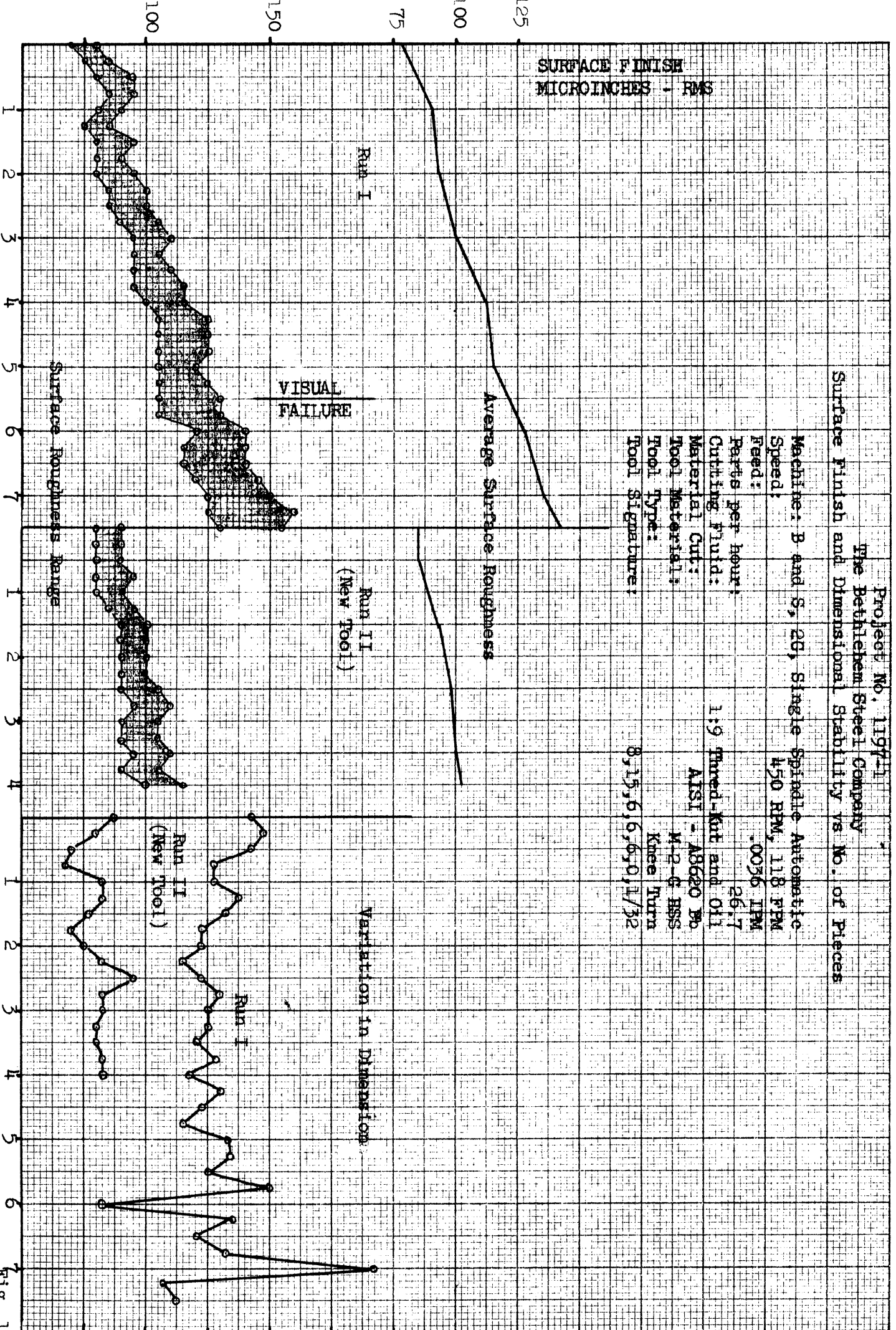

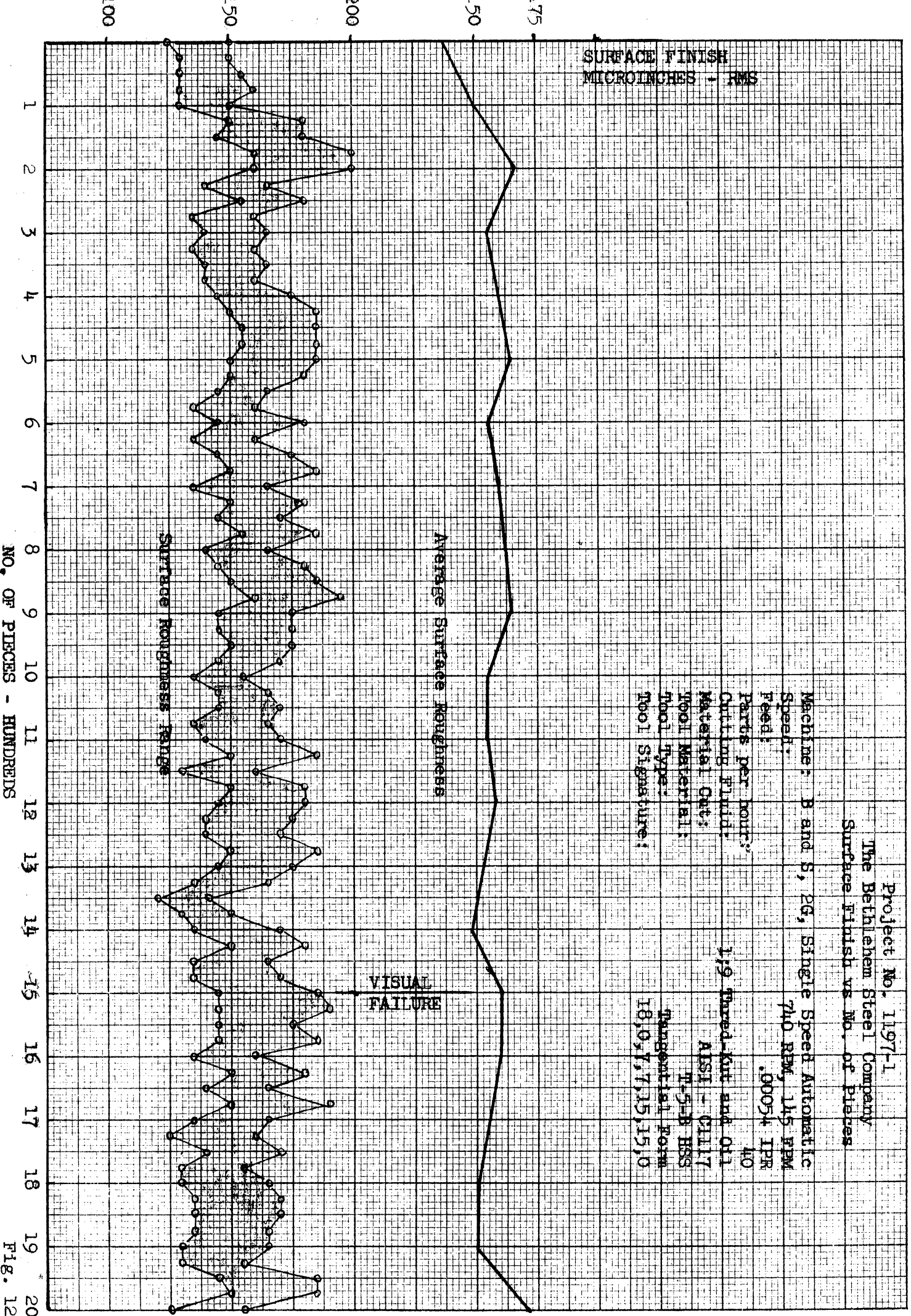

Project No. 1197-1
 The Bethlehem Steel Company
 Surface Finish vs No. of Pieces

Machine: B and S, PG, Single Speed Automatic
 Speed: 740 RPM, 145 FPM
 Feed: .00054 IPR
 Parts per hour: 40
 Cutting Fluid: 1/9 Thru-cut and Oil
 Material Cut: AISI - C1117
 Tool Material: T-5-B HSS
 Tool Type: Tangential form
 Tool Signature: 18,0,7,7,15,15,0

Fig. 12

**SURFACE FINISH
MICROINCHES - RMS**

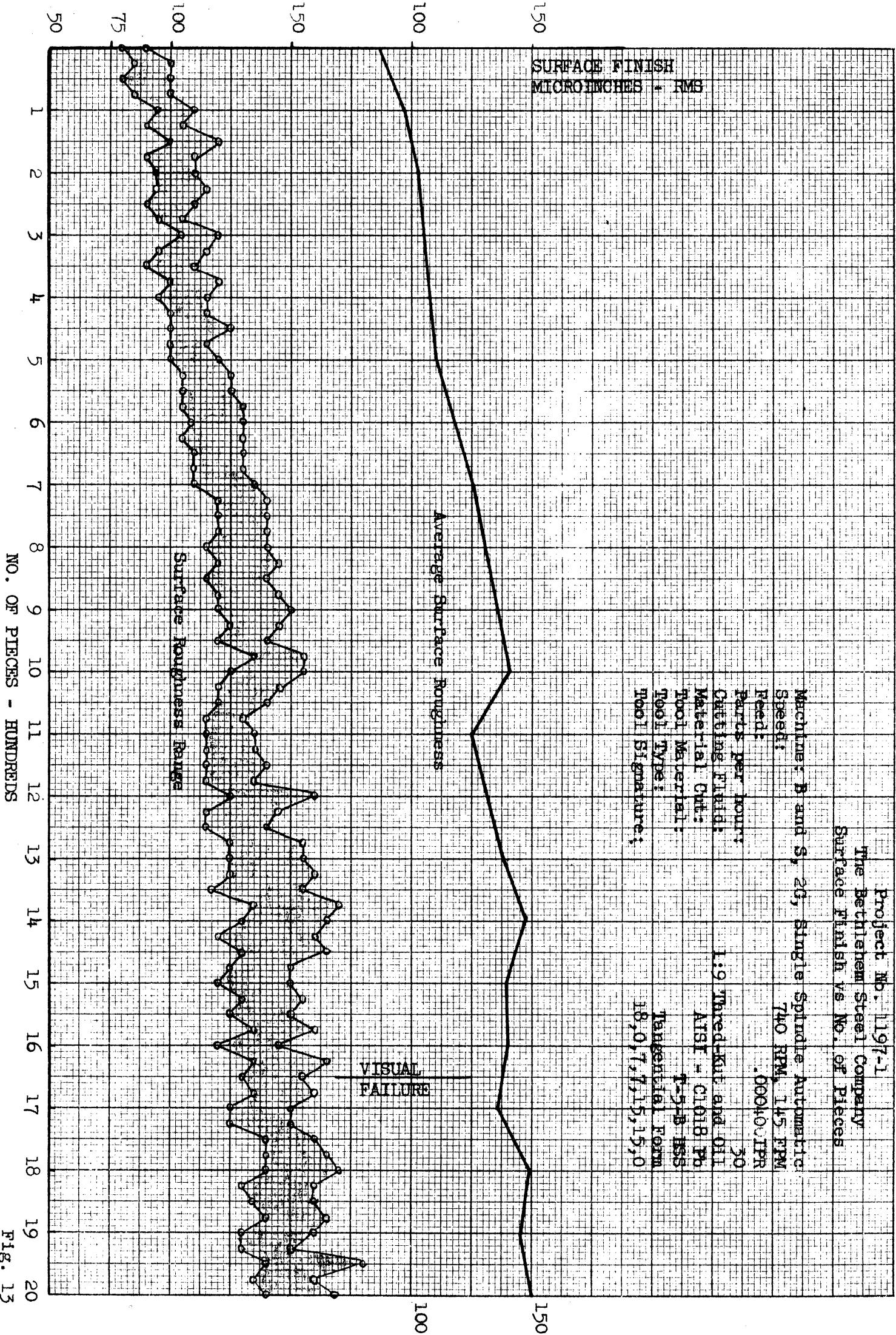

Project No. 1197-1
 The Bethlehem Steel Company
 Surface Finish vs No. of Pieces

Machine: B and S, 26, Single Spindle Automatic
 Speed: 740 RPM, 145 FPM
 Feed: .000400 IPR
 Parts Per Hour: 30
 Cutting Fluid: 1:9 Tared-Kut and Oil
 Material Cut: AISI - C1018, P6
 Tool Material: T-9-B HSS
 Tool Type: Tangential Form
 Tool Signature: 18,0,7,7,15,15,0

NO. OF PIECES - HUNDREDS

Fig. 13

**SURFACE FINISH
MICROINCHES - RMS**

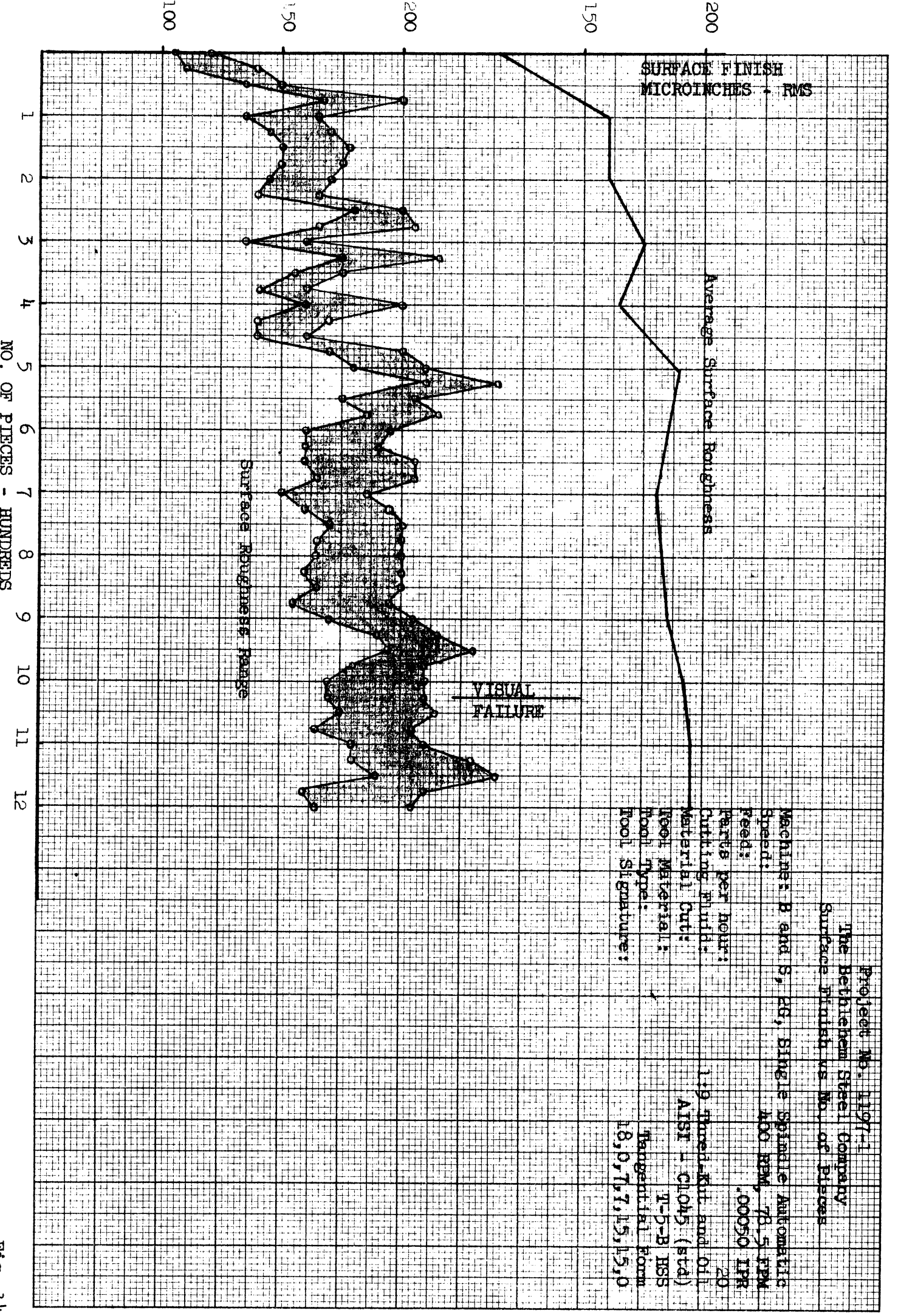

Project No. 1197-1
The Bethlehem Steel Company
Surface Finish vs No. of Pieces

Machiner: B and S, 20, SINGLE Spindle Automatic
Speed: 400 RPM, 78.5 RPM
Feeds: .00050 IPR
Revs per hour: 20
Cutting Fluid: 1:19 Thred-Kit and Oil
Material Cut: AISI - C1045 (std)
Tool Material: T-5-B HSS
Tool Type: Tangential Form
Tool Signature: 18,0,7,7,15,15,0

Surface Roughness Range

VISUAL FAILURE

NO. OF PIECES - HUNDREDS

FIG. 14

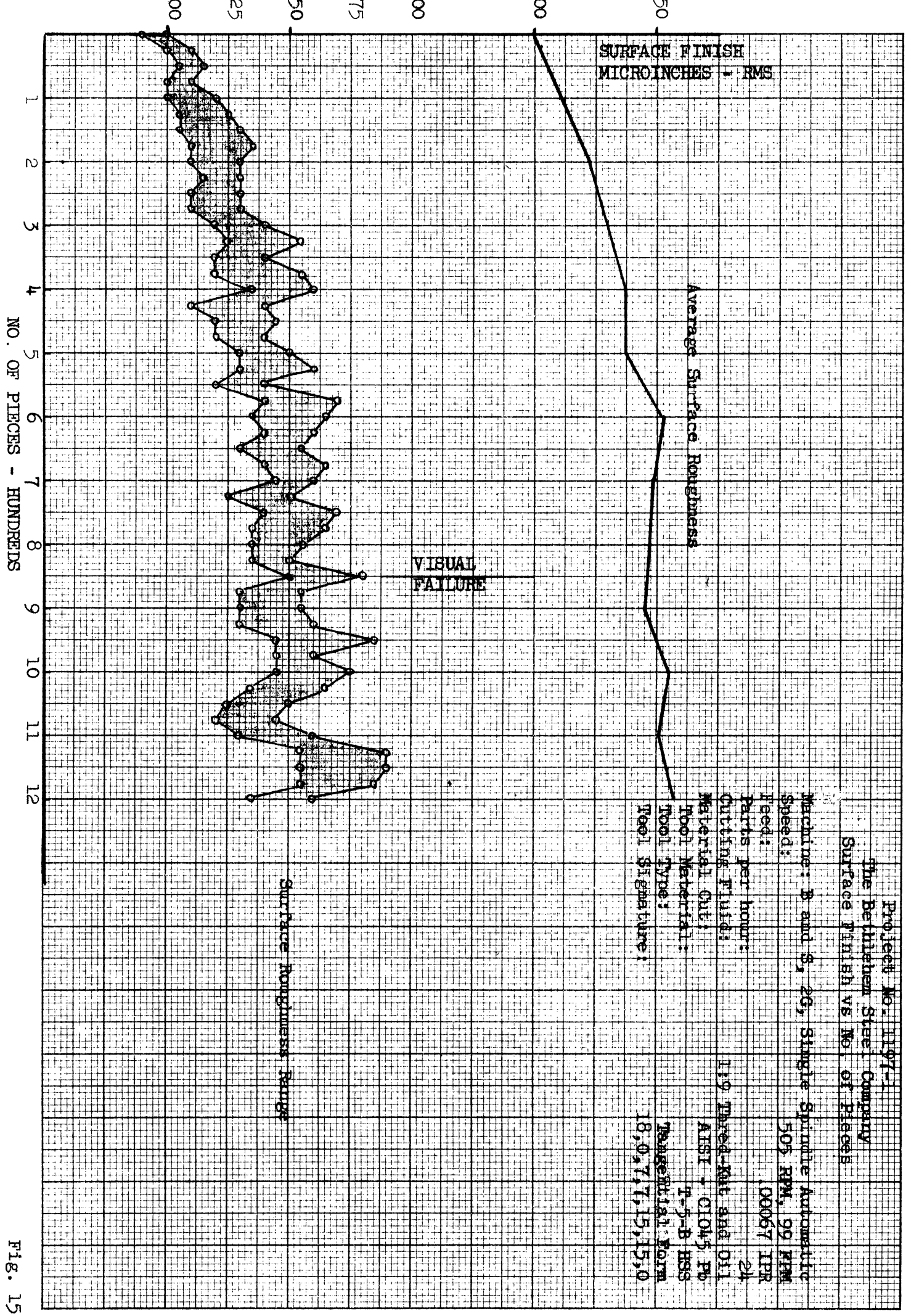

Fig. 15

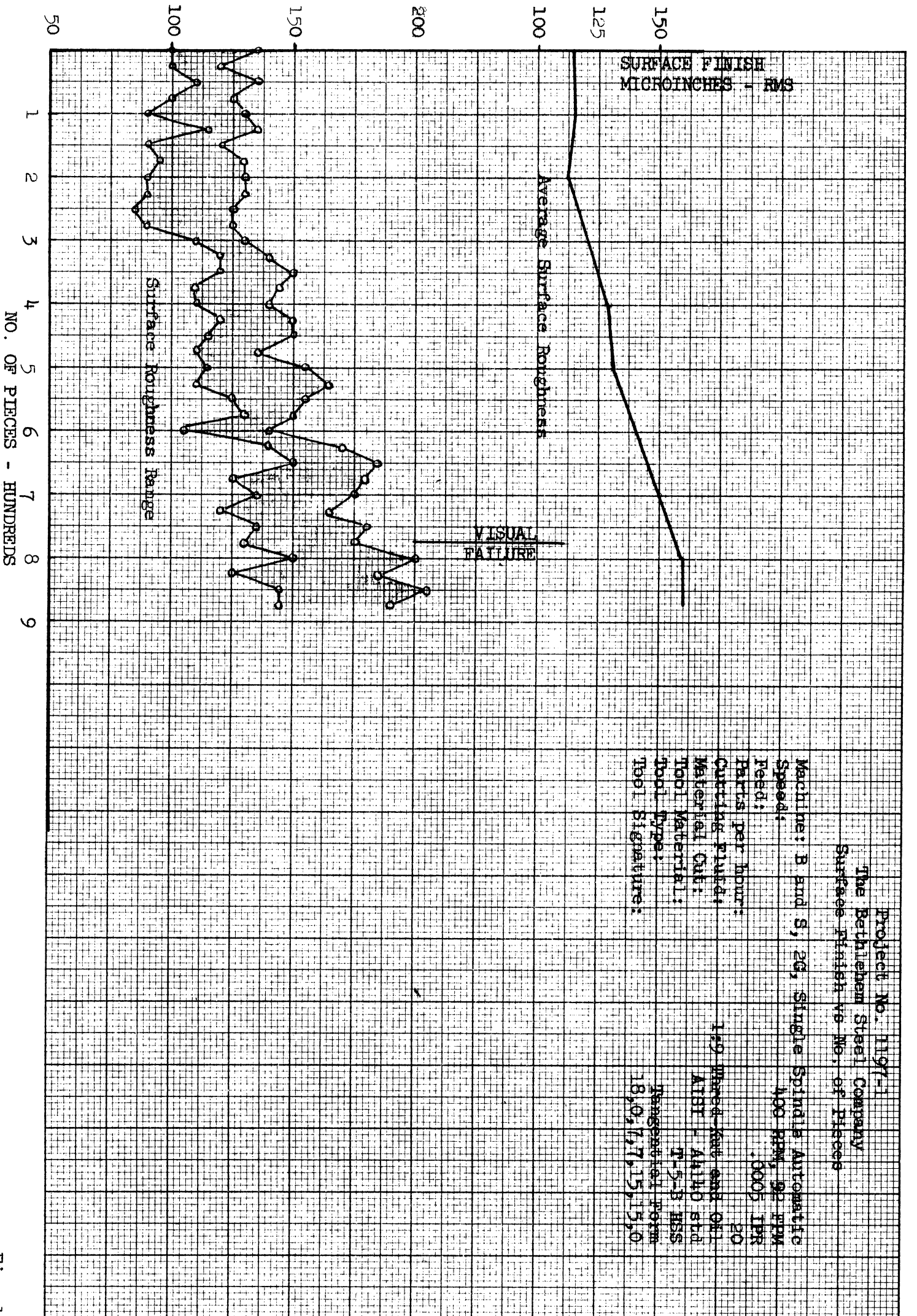

Fig. 16

Surface Finish
MICROINCHES RMS

Average Surface Roughness

VISUAL FAILURE

Surface Roughness Range

Project No. 1197-1
 The Bethlehem Steel Company
 Surface Finish vs. No. of Pieces

Machine: B and S, 2G, Single Spindle Automatic	
Speed: 175 RPM, 109 FPM	
Feed: 0.0005 IPR	
Parts per hour: 24	
Cutting fluid: 1:9 Thru-Kut and Oil	
Material Cut: AISI - A1140 PD	
Tool Material: T-5-B HSS	
Tool Type: Tangential Form	
Tool Signature: 18, 0, 7, 7, 15, 15, 0	

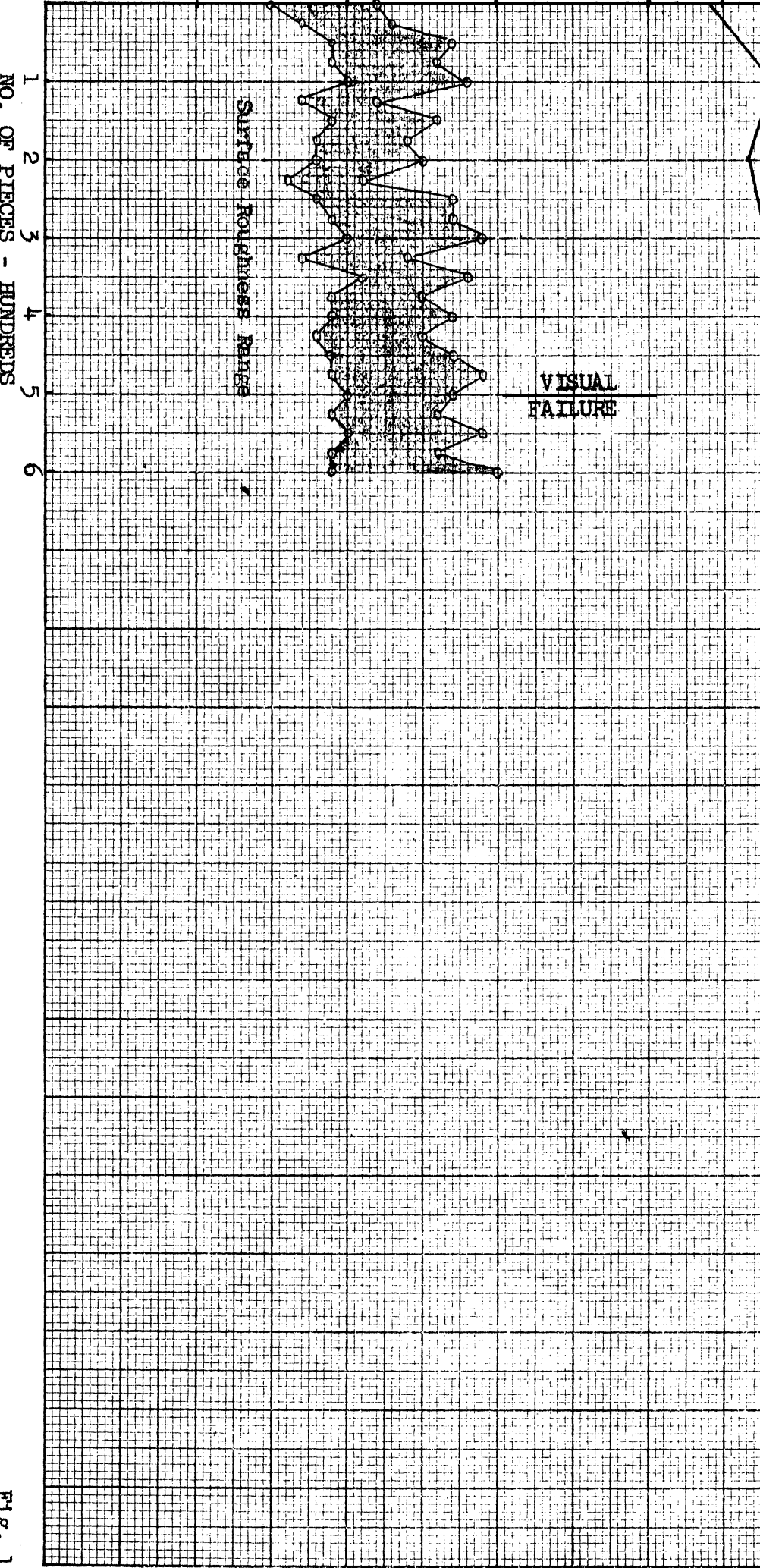

NO. OF PIECES - HUNDREDS

FIG. 17

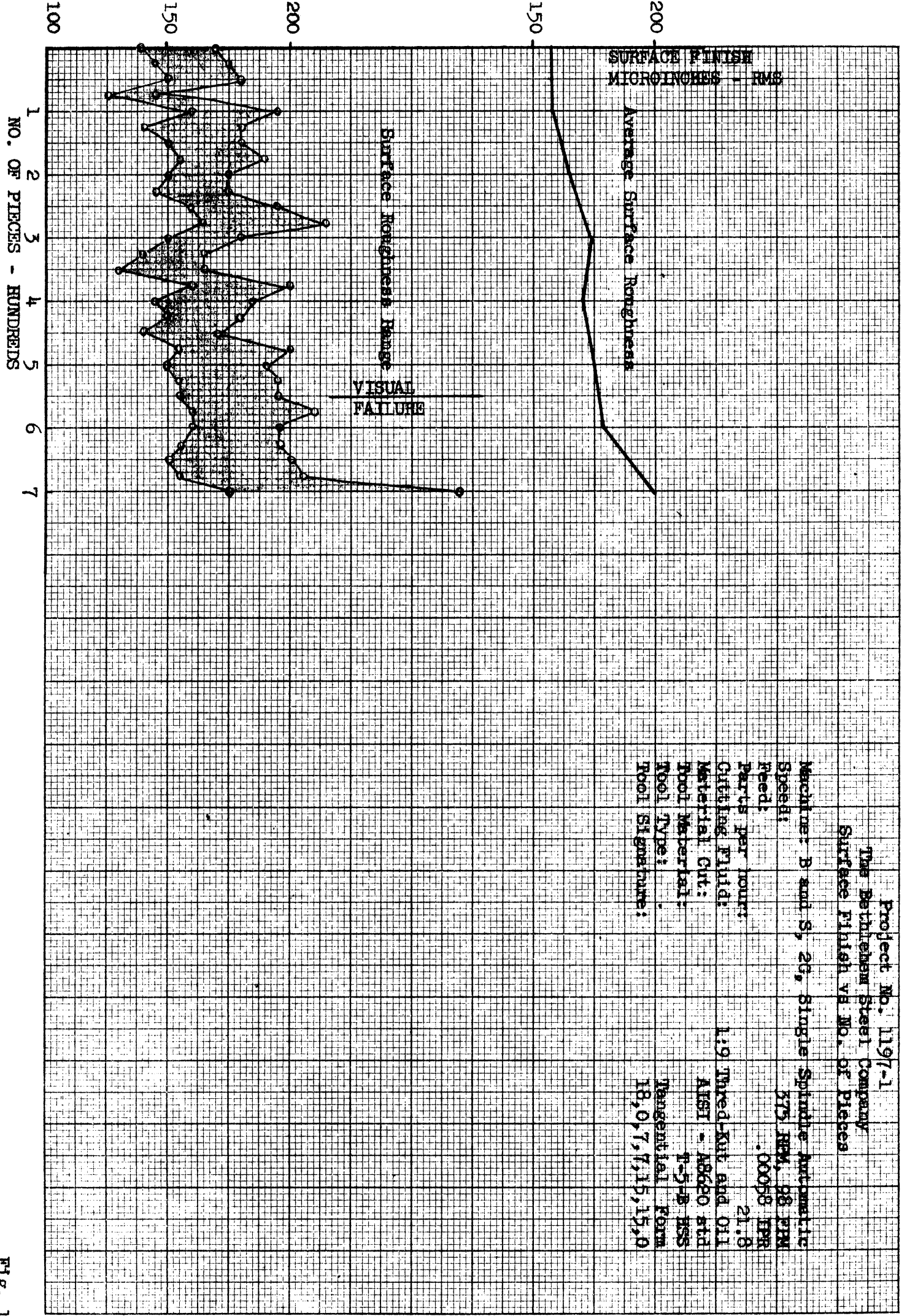

Project No. 1197-1
 The Bethlehem Steel Company
 Surface Finish vs No. of Pieces

Machiner: B and S, 26, Single Spindle Automatic
 Speed: 575 RPM, 98 FPM
 Feed: .00058 IPM
 Parts per hour: 21.8
 Cutting Fluid: 1:9 Thred-Kut and Oil
 Material Cut: AISI - A6620 Std
 Tool Material: T-5-H8 HSS
 Tool Type: Tangential Form
 Tool Signature: 18,0,7,7,15,15,0

Fig. 18

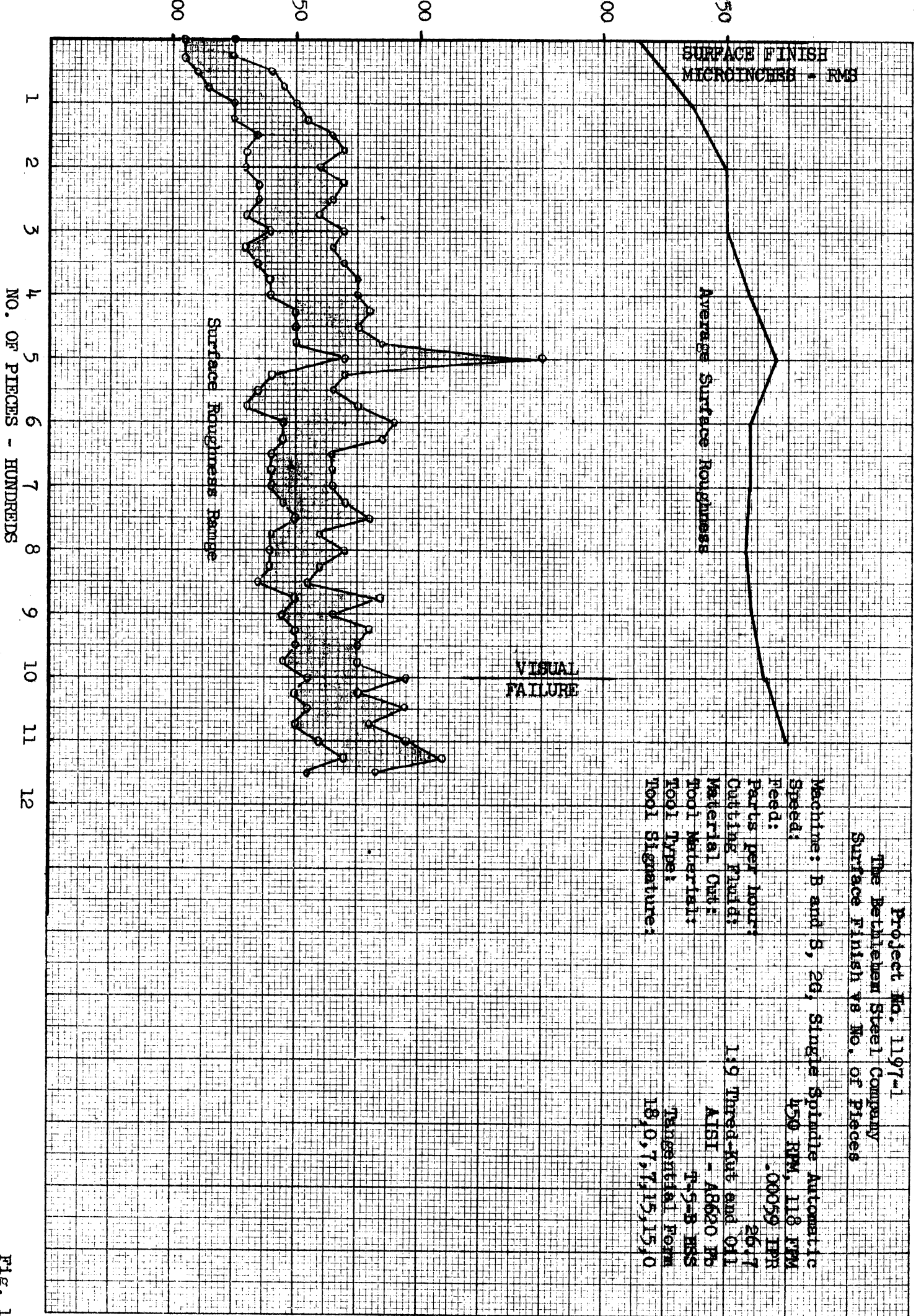
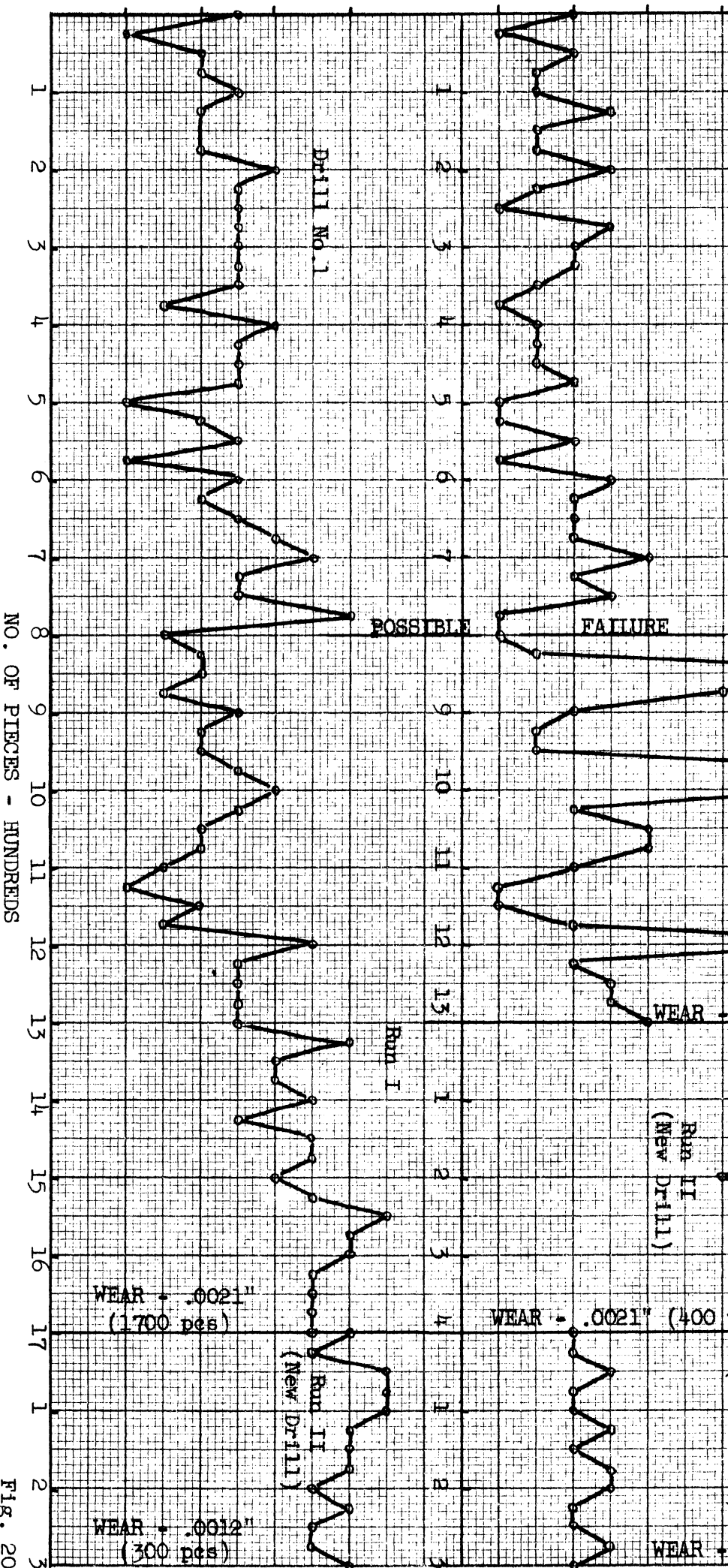

FIG. 19

DRILLED DIAM.
in.

Project No. 1197-1
The Bethlehem Steel Company
Dimensional Stability vs No. of Pieces

Machine: B and S, 2G, Single Spindle Automatic
Speed: 740 RPM, 85 FPM
Feed: No. 1-.0057 IPR, No. 2-.0041 IPR
Parts per hour: 40
Cutting Fluid: 1:9 Speed-Mix and Oil
Material Cut: AISI - C1117
Tool Material: Moly HSS
Tool Type: Drilling
Flute Signature: 135° Point angle
11° Relief angle



NO. OF PIECES - HUNDREDS

FIG. 20

DRILLED DIAM.
in.

Project No. 1197-1
The Bethlehem Steel Company
Dimensional Stability vs No. of Pieces

Machine: B and S, 2C, Single Spindle Automatic
Speed: 740 RPM, 25 FPM
Feed: No. 1-.0028 IPR, No. 2-.0051 IPR
Parts per hour: 30
Cutting Fluid: 1:9 Thred-Kut and Oil
Material Cut: AISI - C1018 Pb
Cool Material: Mils MSS
Tool Type: Drilling
Tool Signature: 135° Point angle
11° Relief angle

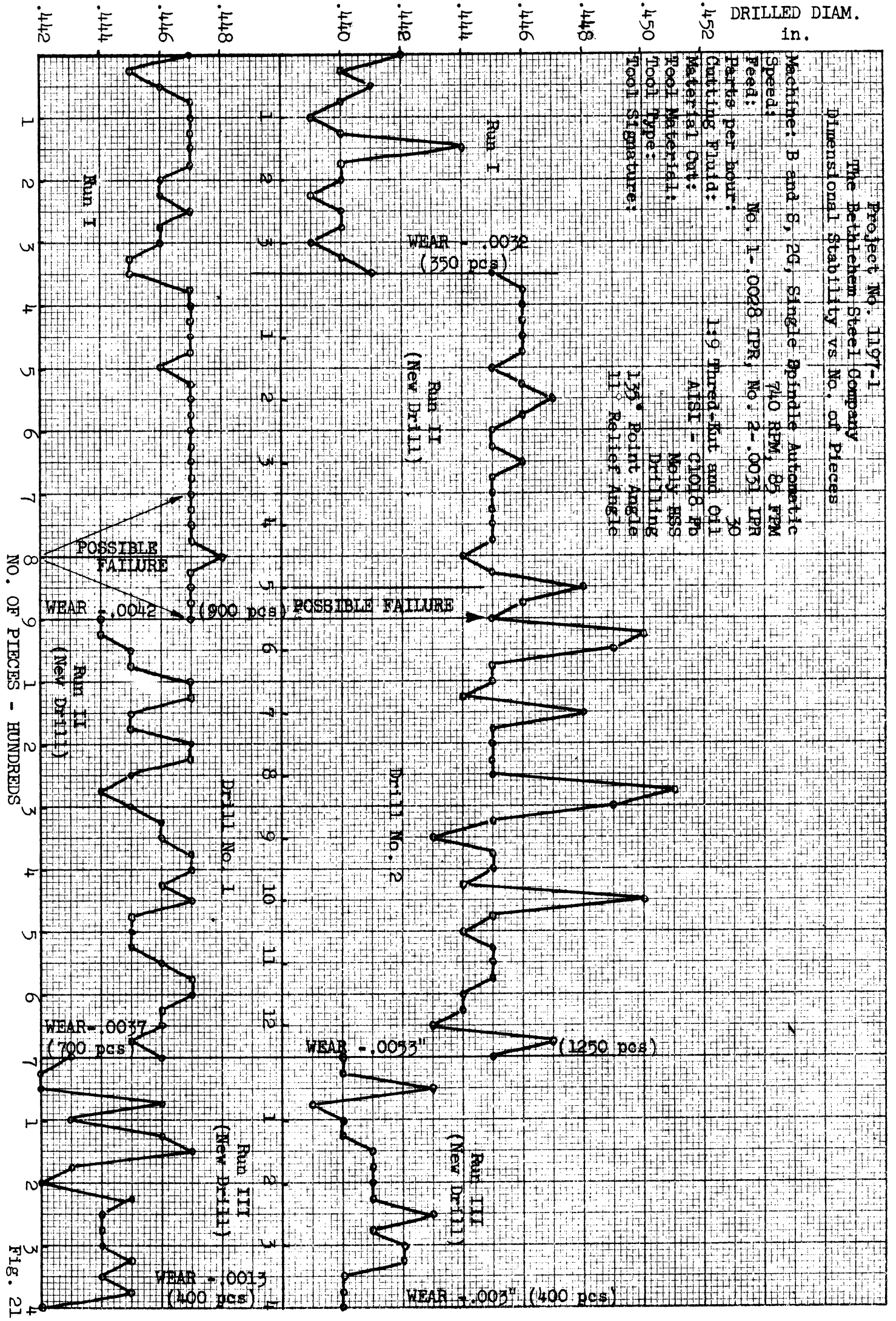
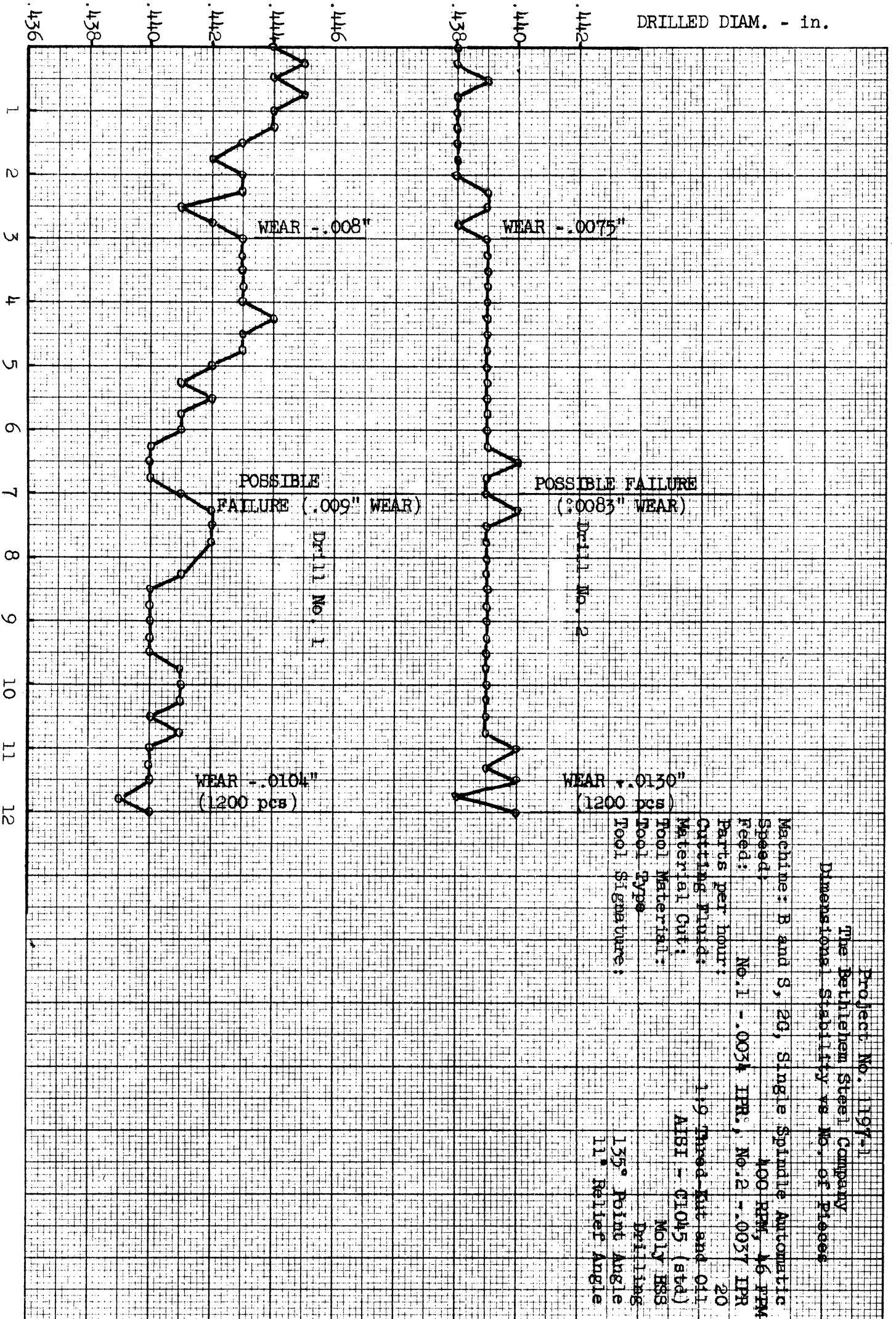

Fig. 21



Project No. 1197-1
 The Bethlehem Steel Company
 Dimensions - Stability vs. No. of Pieces

Machine: B and S, 20, Single Spindle Automatic
 Speed: 400 RPM, 16 FPM
 Feed: No. 1 - .0037 IPR, No. 2 - .0037 IPR
 Parts per hour: 20
 Cutting Fluid: 1% Thred-Kut and Oil
 Material Cut: AISI - 01045 (std)
 Tool Material: Moly HSS
 Tool Type: Drilling
 Tool Signature: 135° Point Angle
 11° Relief Angle

NO. OF PIECES - HUNDREDS

Fig. 22

NO. OF PIECES - HUNDREDS

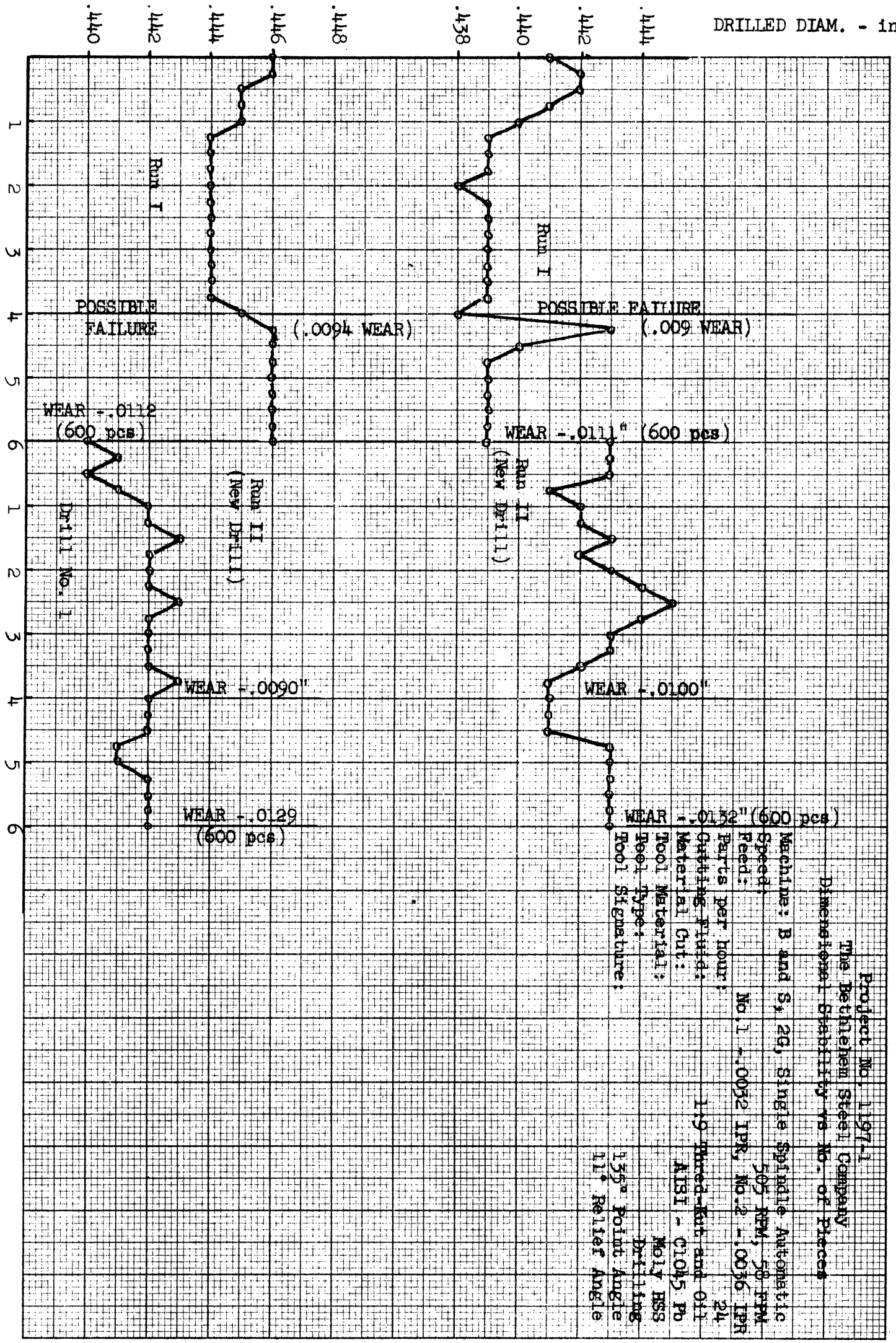

Project No. 1197-1
 The Bethlehem Steel Company
 Dimensional Stability vs. No. of Pieces

Machines: B and S, 20, Single Spindle Automatic
 Speed: 505 RPM, 50 RPM
 Feed: No. 1 -.0032 IPK, No. 2 -.0036 IPK
 Parts per hour: 24
 Cutting Fluid: 19 Incred-Kut and Oil
 Material Cut: A181 - C1045 Pb
 Tool Material: Moly HSS
 Tool Type: Drilling
 Tool Signature: 135° Point Angle
 11° Relief Angle

Fig. 23

DRILLED DIAM. - in.

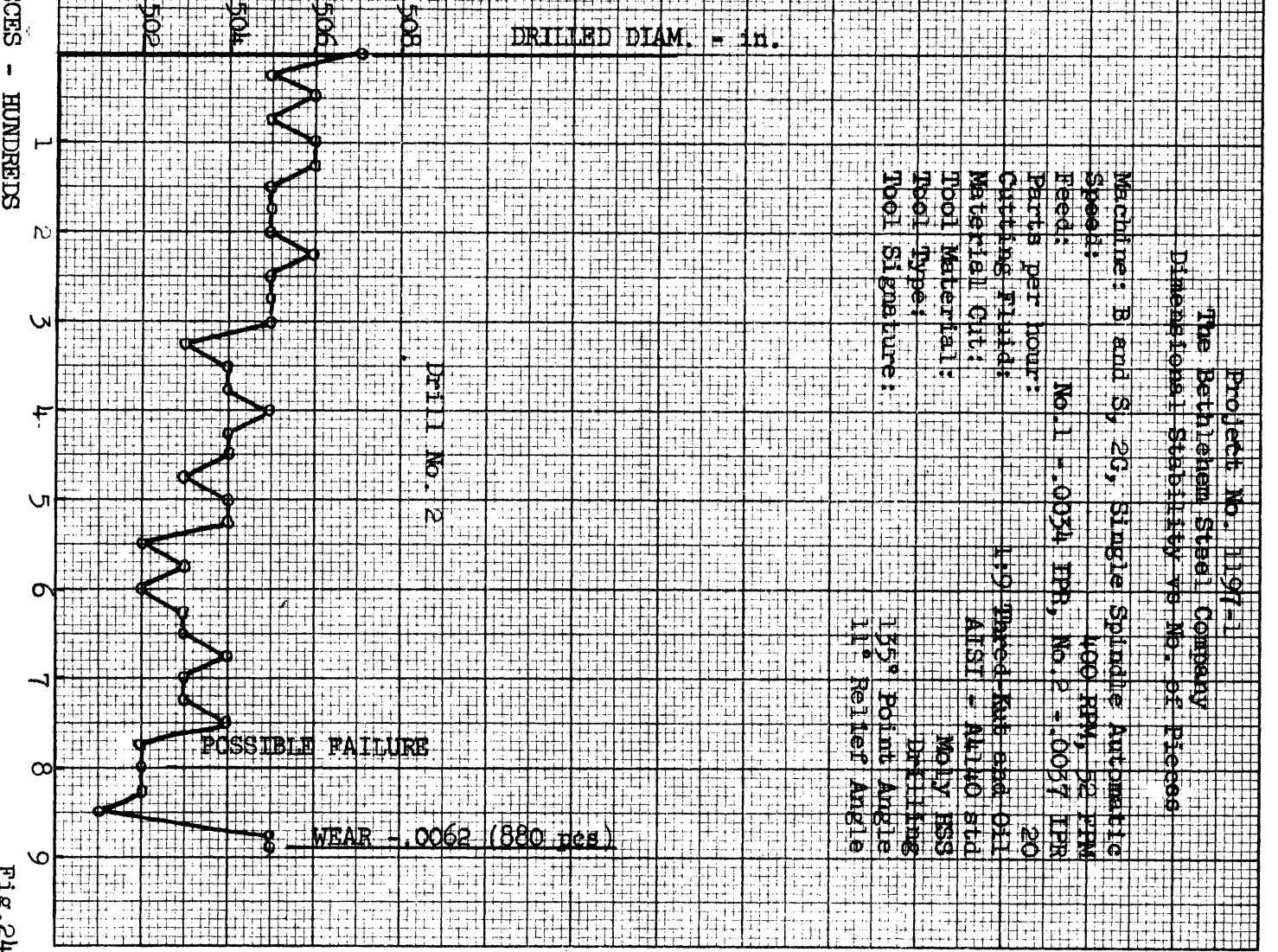
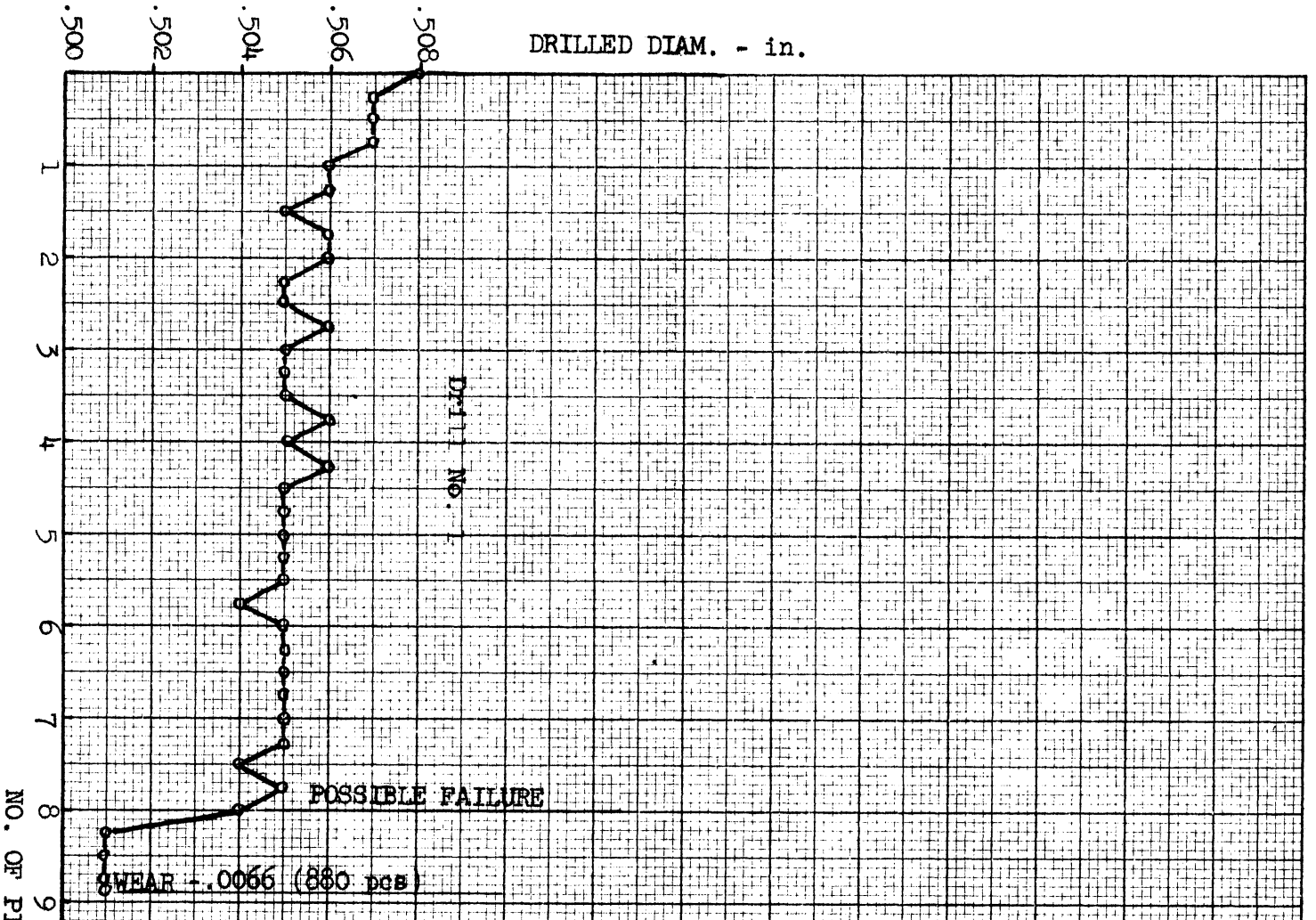

Project No. 1197-1
 The Bethlehem Steel Company
 Dimensional Stability vs No. of Pieces

Machine: B and S, 2G, Single Spindle Automatic
 Speed: 100 RPM, 52 RPM
 Feed: No. 1 - .0034 IPH, No. 2 - .0037 IPH
 Parts per hour: 20
 Cutting Fluids: 119 Traced-Kut and Oil
 Material Cut: AISI - A1140 Std
 Tool Material: Moly HSS
 Tool Type: Drillings
 Tool Signature: 135° Point Angle
 11° Relief Angle

Fig. 24

DRILLED DIAM. - in.

510
508
506
504
502
500

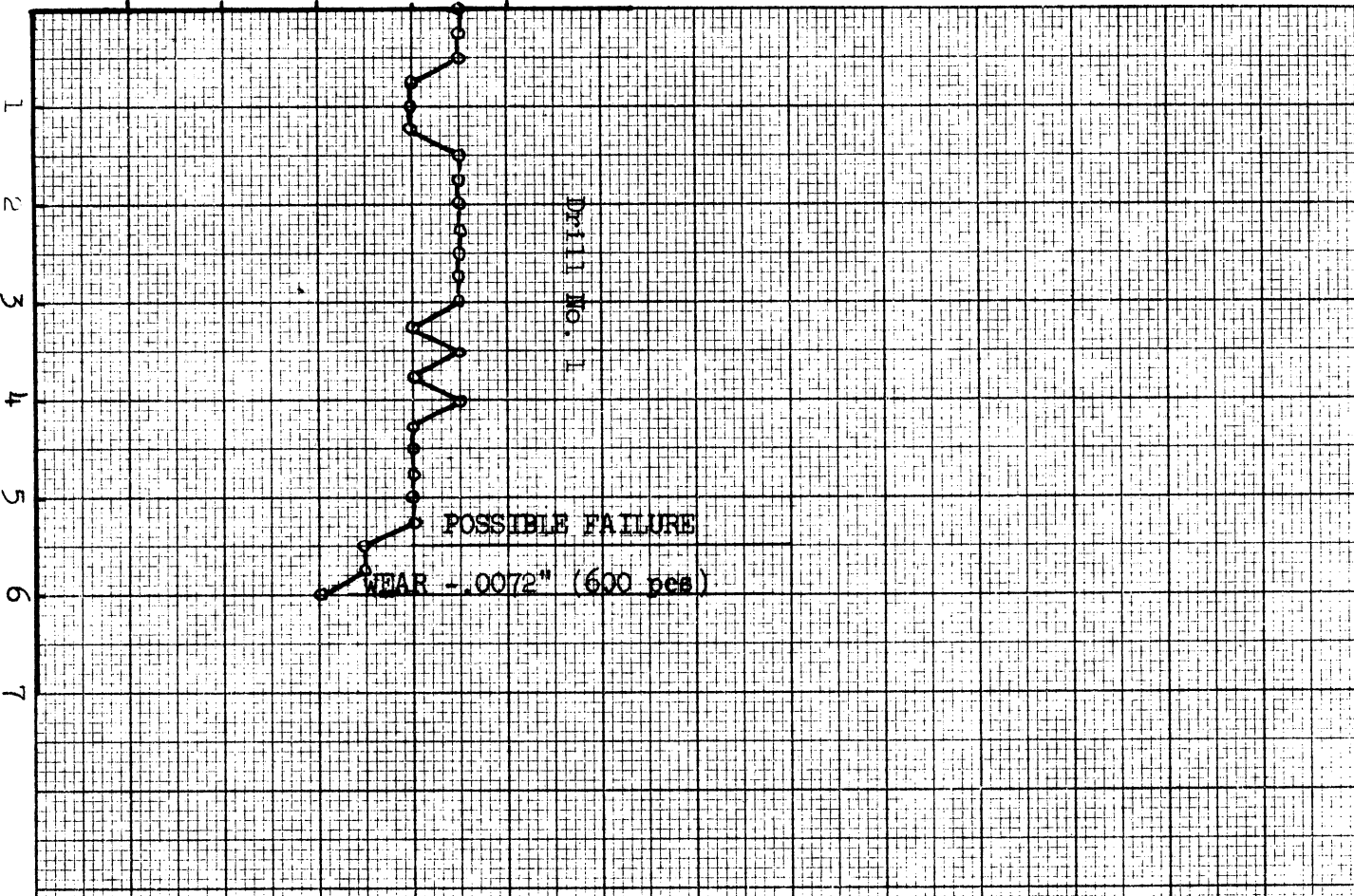

DRILLED DIAM. - in.

508
506
504
502

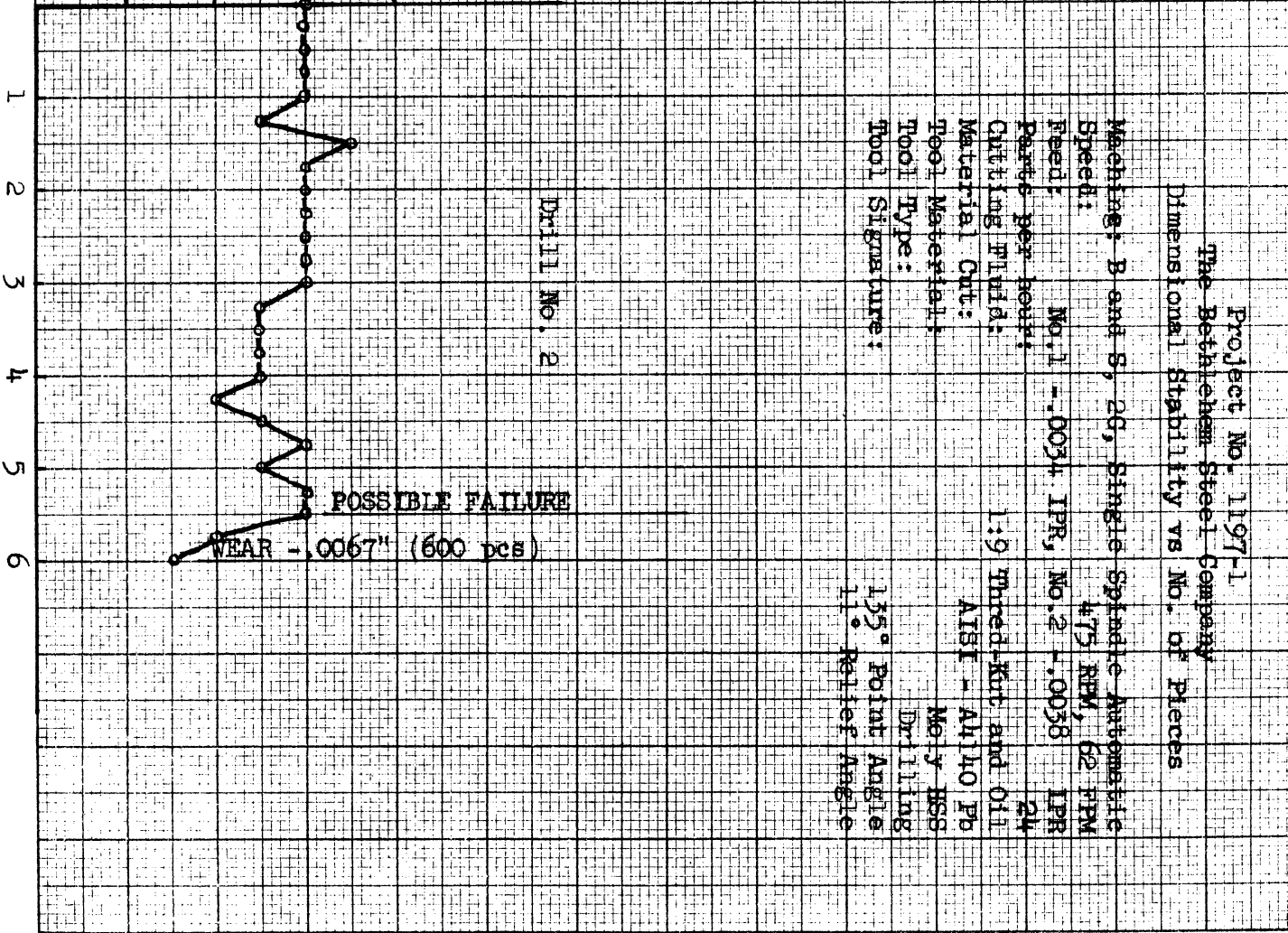

Project No. 1197-1
The Bethlehem Steel Company
Dimensional Stability vs No. of Pieces

Machining: B and S, 26, Single Spindle Automatic
Steel: S75 RPM, 62 RPM
Feed: No. 1 - .0034 IPR, No. 2 - .0038 IPR
RPMs per hour: 24
Cutting Fluid: 1:9 Thred-Kut and Oil
Material Cut: AISI - A1140 Pp
Tool Material: Moly HSS
Tool Type: Drilling
Tool Signature: 135° Point Angle
11° Relief Angle

NO. OF PIECES - HUNDREDS

FIG. 25

DRILLED DIAM. - in.

.584
.586
.588
.590

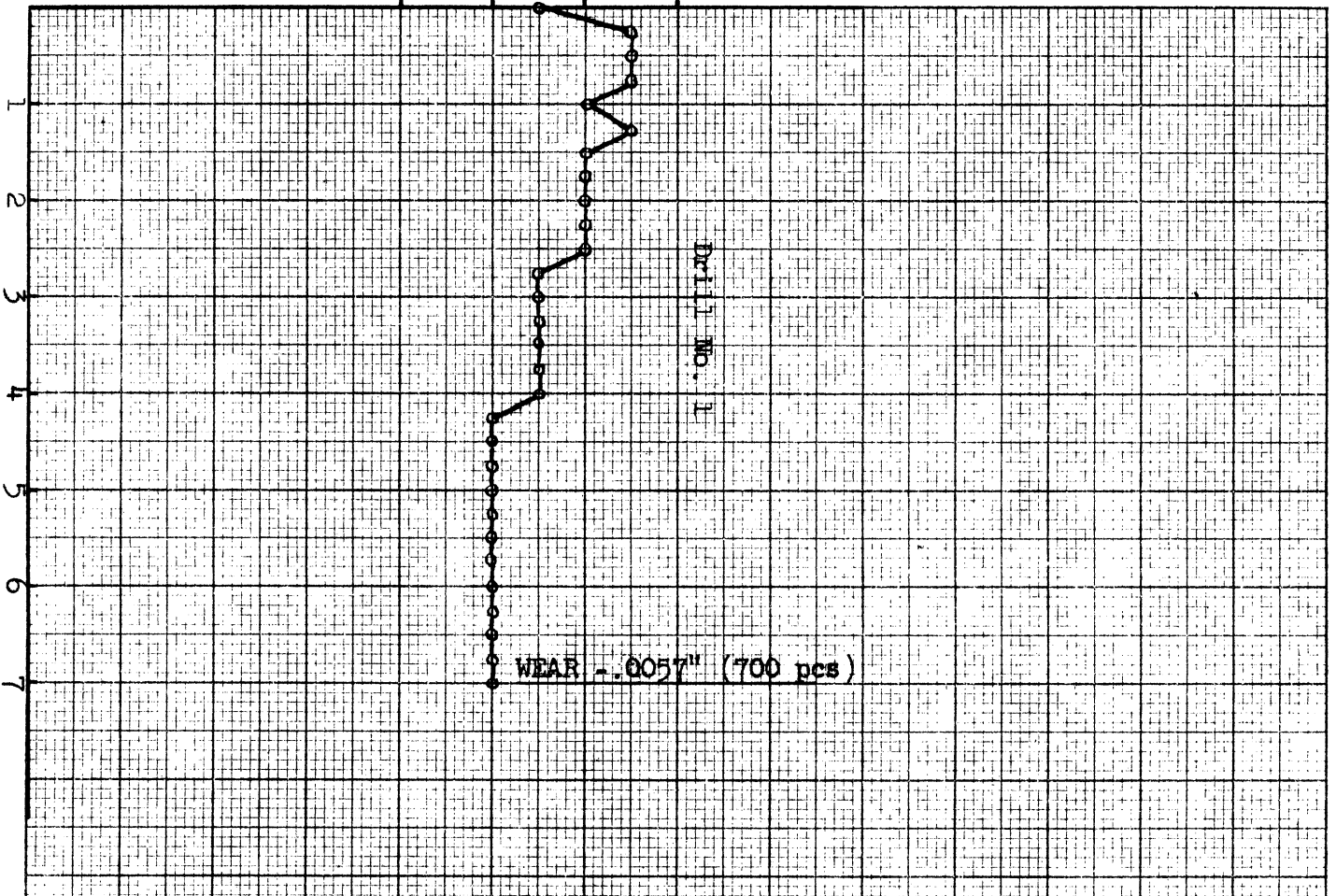

DRILLED DIAM. - in.

.586
.588
.590
.592

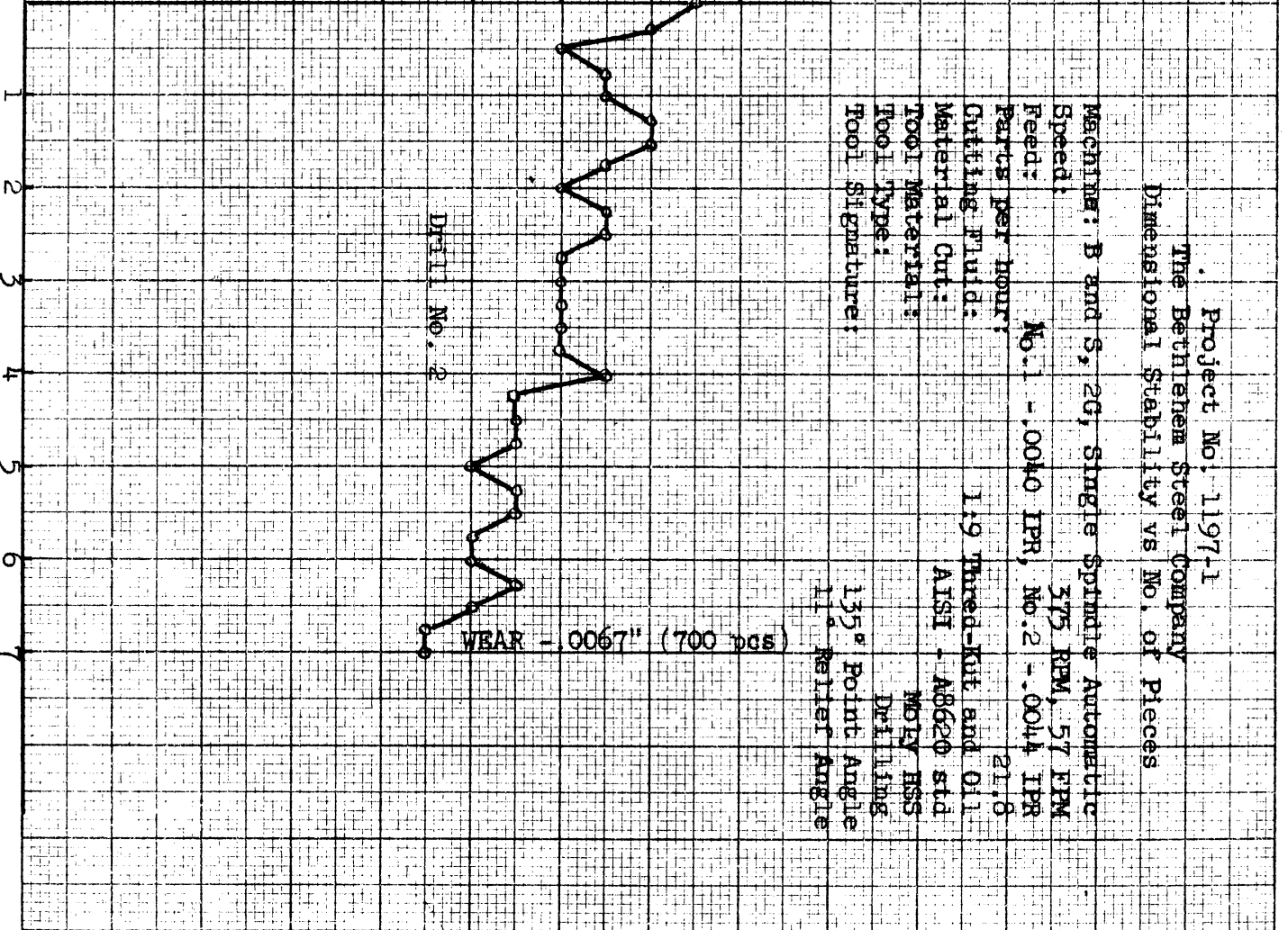

Project No. 1197-1
 The Bethlehem Steel Company
 Dimensional Stability vs No. of Pieces

Machine: B and S, 20, Single Spindle Automatic
 Speed: 375 RPM, 57 FPM
 Feed: No. 1 - .0040 IPR, No. 2 - .0044 IPR
 Parts per hour: 21.8
 Cutting Fluid: 1:9 Thred-Kut and Oil
 Material Cut: AISI - A8620 std
 Tool Material: Moly HSS
 Tool Type: Drillings
 Tool Signature: 135° Point Angle
 11° Relief Angle

NO. OF PIECES - HUNDREDS

Fig. 26

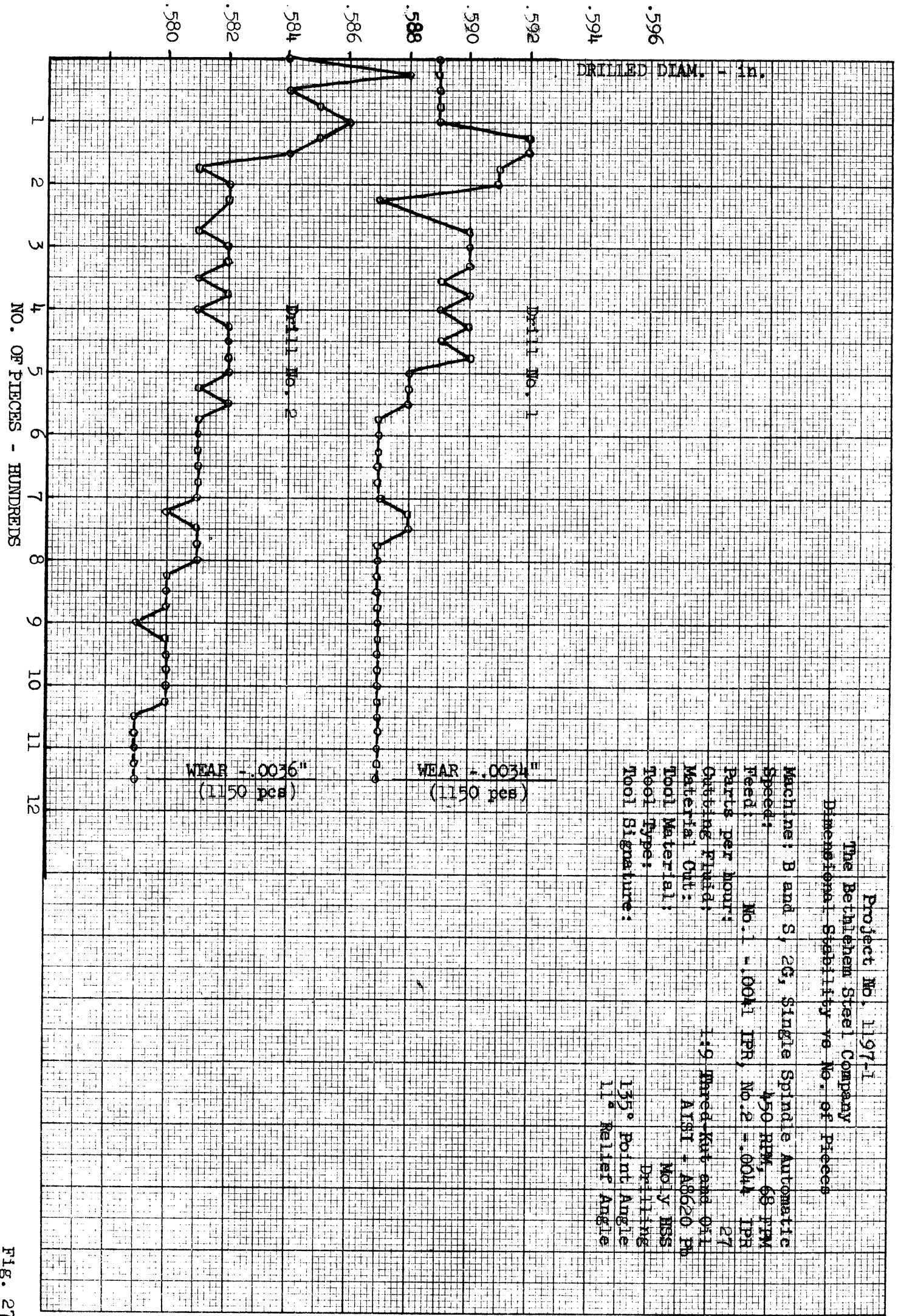

DRILLED DIAM. - in.

NO. OF PIECES - HUNDREDS

Project No. 1197-1
 The Bethlehem Steel Company
 Dimensional Stability vs. No. of Pieces

Machine: B and S, 20, Single Spindle Automatic
 Speed: 450 RPM, 68 RPM
 Feed: No. 1 = .0041 IPR, No. 2 = .0044 IPR
 Parts per hour: 27
 Cutting Fluid: 1:9 pared-Kut emul Oil
 Material Cut: AISI - A8620 Pt
 Tool Material: Moly HSS
 Tool Type: Drilling
 Tool Signature: 135° Point Angle
 11° Relief Angle

WEAR = .0034"
 (1150 pcs)

Drill No. 1

Drill No. 2

WEAR = .0036"
 (1150 pcs)

FIG. 27