

UNIVERSITY OF
MICHIGAN

ENGINEERING
COLLEGE

INDUSTRY
PROGRAM

STUDY OF THE FEASIBILITY OF AQUEOUS RECOVERY OF SPENT FUELS

*Part 3. Calculated Distribution of
Fission Product Nuclides*

J. V. NEHEMIAS
R. C. DENNIS
EUGENE AMBO

January, 1955
IP-109



ANN ARBOR

mu - ECIP - Nehemias - IP-109

We wish to express our appreciation
to the Detroit Edison Company for
permission to issue this report
under the College of Engineering
Industry Program.

ENGINEERING RESEARCH INSTITUTE
UNIVERSITY OF MICHIGAN
ANN ARBOR

STUDY OF THE FEASIBILITY
OF
AQUEOUS RECOVERY OF SPENT FUELS

Part 3
CALCULATED DISTRIBUTION
OF
FISSION PRODUCT NUCLIDES

John V. Nehemias

Ralph C. Dennis

Eugene Ambo

Project No. 2240

CONSUMERS POWER COMPANY (JACKSON COUNTY)

FOR THE DOW CHEMICAL - DETROIT EDISON AND ASSOCIATES

ATOMIC-POWER DEVELOPMENT PROJECT

June, 1954

PREFACE

The investigation reported here was undertaken at the request of Professor Harold A. Ohlgren as part of Engineering Research Institute Project 2240, conducted for Consumers Power Company (Jackson County) for the Dow Chemical - Detroit Edison and Associates Atomic-Power Development Project.

Table of Contents

	Page
Preface	iii
List of Tables	vii
List of Figures	ix
INTRODUCTION	1
ASSUMPTIONS	4
SAMPLE CALCULATION	4
GAMMA RADIATION LEVELS	10
BETA PARTICLE ABSORPTION	95
DECAY CHARACTERISTICS	95
NUMERICAL METHODS	103
REFERENCES	104

List of Tables

	Page
TABLE I. Modifications and Extensions of Engelder's Work Incorporated in This Report	2
TABLE II. Summary of Calculations Involved in Determining Mass and Activity of Each Nuclide at Time of Removal	11
TABLE III. Data Derived from Decay Schemes for Calculation of Radiation Level and Rate of Heat Formation	97
TABLE IV. Survival Ratios for Mass Number 127	106
TABLE V. Calculated Mass, Activity, Radiation Level and Rate of Heat Formation of Each Nuclide of Mass Number 127 for $t = 0, 1, 2, 4, 8, 16$ Days after Shutdown	107
TABLE VI. Calculated Mass, Activity, Radiation Level and Rate of Heat Formation of Fission Nuclides, by Element, for $t = 0, 1, 2, 4, 8, 16$ Days after Shutdown	109

List of Figures

	Page
Fig. 1. Total Activity, Radiation Level, and Rate of Heat Formation for All Fission Product Nuclides as a Function of Time after Shutdown	3
Fig. 2. Fast Fission Yields for U-235 as Estimated by Engelder.	5
Fig. 3. Decay Chain for Mass Number 127.	7
Fig. 4. Chart of the Fission Product Nuclides	(follows p. 10)
Fig. 5. Roentgens per Hour per Millicurie at One Centimeter from a Point Gamma Emitter as a Function of Photon Energy, Assuming One Photon per Disintegration	10a
Fig. 6. Disintegration Scheme for Mass Number 127.	10
Fig. 7. Schematic Diagram of a Typical Program for the Analog Computer and Its Associated Solution	105

STUDY OF THE FEASIBILITY
OF
AQUEOUS RECOVERY OF SPENT FUELS

PART 3

CALCULATED DISTRIBUTION OF FISSION PRODUCT NUCLIDES

INTRODUCTION

In the course of reactor operation, fissionable materials generally divide into two fragment nuclides. The radioactive species among these then decay by the emission of beta particles and gamma radiation to the stable state.

In any plant designed to process spent reactor fuel, consideration must be given to the amount of this radioactivity present, by element, in the fission products. The primary interest is in predicting radiation levels for shielding calculations and the rate of formation of heat at each processing stage. It is also of interest to know the mass of each element present, including stable nuclides, in designing separation processes.

The calculation reported here is an evaluation of the mass and the activity of each fission product nuclide present in the spent fuel of a 500 Mw reactor operating on a 42 day cycle, at the time of removal from the reactor and as a function of time thereafter. These quantities have been expressed in terms of grams and curies per 10 kilograms of fissioned material, respectively. The calculations represent some modification and extension of the work of Moteff ¹ and Engelder ². The major modifications are summarized in Table I. The data are presented in final form, by element, in Table VI at 0, 1, 2, 4, 8, and 16 days after removal from the reactor.

The effect of the calculated activities, in terms of roentgens per hour at one meter from a point source, and B.T.U.'s per hour of heat generated from beta particle absorption, has also been calculated. Because of its dependence upon absorber material, absorber thickness and geometry, calculation of heat generation from gamma absorption has been deferred to future calculations when these quantities will be better known. The several calculations discussed above appear in summary in Fig. 1.

The calculation of the number of grams and curies present is a separate problem for each nuclide. To each mass number corresponds a decay chain,

Table I

Modifications and Extensions of Engelder's Work

Incorporated in This Report

Modification	Engelder	Nehemias
Minimum fission yield	1%	0.01%
Minimum half life	5 hr	1 hr
Reactor operation time	1000 hr	42 d
Steady state power	550 Mw	500 Mw
Time after shutdown	1 d	0,1,2,4, 8,16 d
Calculation of decay chains	none past 2nd generation	all chains complete

FIGURE 1
SUMMARY OF RADIATION CHARACTERISTICS
OF FISSION PRODUCT
NUCLIDES

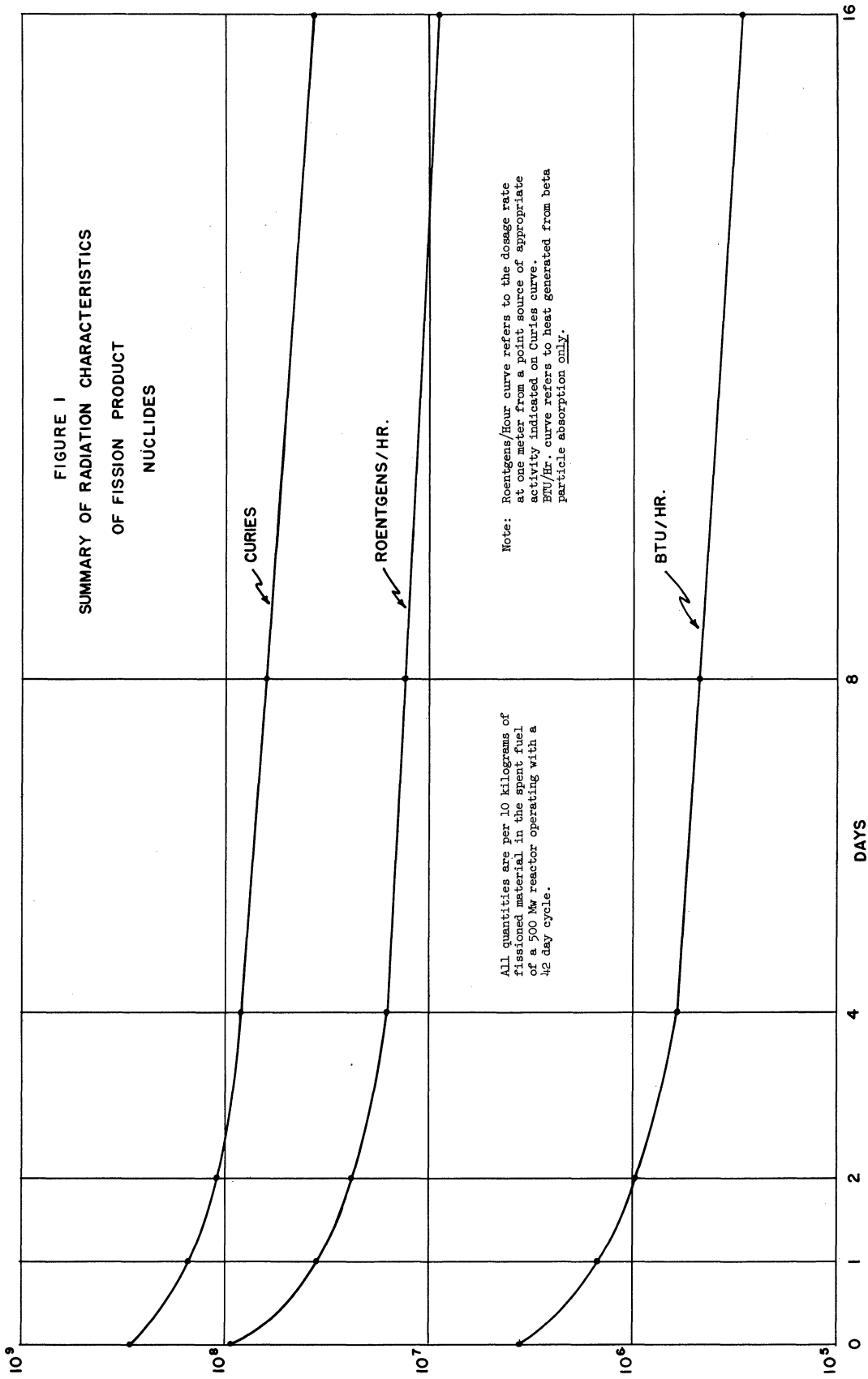

although in some cases the decay chain consists merely of a single stable nuclide. It will be assumed that the first nuclide in each decay chain is formed at the total yield rate for that mass number, that its daughter products are formed only through the radioactive decay of the parent nuclide.

Many of these results can be obtained by various methods. In these calculations, a particular format has been selected and maintained throughout for ease of calculation.

ASSUMPTIONS

Reactor operation time, $T = 42$ days.

Steady state reactor power = 500 Mw.

Time after removal from reactor, $t = 0, 1, 2, 4, 8, 16$ days.

Radioactive decay schemes taken from "Nuclear Data", NBS Circular-499, or reasonable values assumed when no data is available.

Fission yields greater than 0.01% are used.

Species with half lives less than one hour which have precursors with half lives less than one hour are not considered.

Fission yields for fast fission of U-235 are not well known. The curve of fast fission yields for U-235, estimated by Engelder, has been used in these calculations, see Fig. 2. Modification of the results will be undertaken when better, more detailed data become available. The calculations presented here are somewhat more sensitive to such modifications than Engelder's because yields down to 0.01% are used. Thus, yield values are assumed throughout the highly conjectural central trough region.

Neutron capture by fission products while residing in the reactor has not been considered because of the extreme paucity of cross section data at the neutron energies involved.

Secondary processes, such as the low energy spectrum of bremsstrahlung produced during the absorption of beta particles in matter, and the production of internal conversion and secondary electrons during the absorption of gamma radiation, have not been taken into account. In future calculations of detailed shielding requirements, these effects will be considered when necessary.

SAMPLE CALCULATION

For every mass number, including those which yield only stable nuclides, the rate of formation in grams per second and the total yield in grams

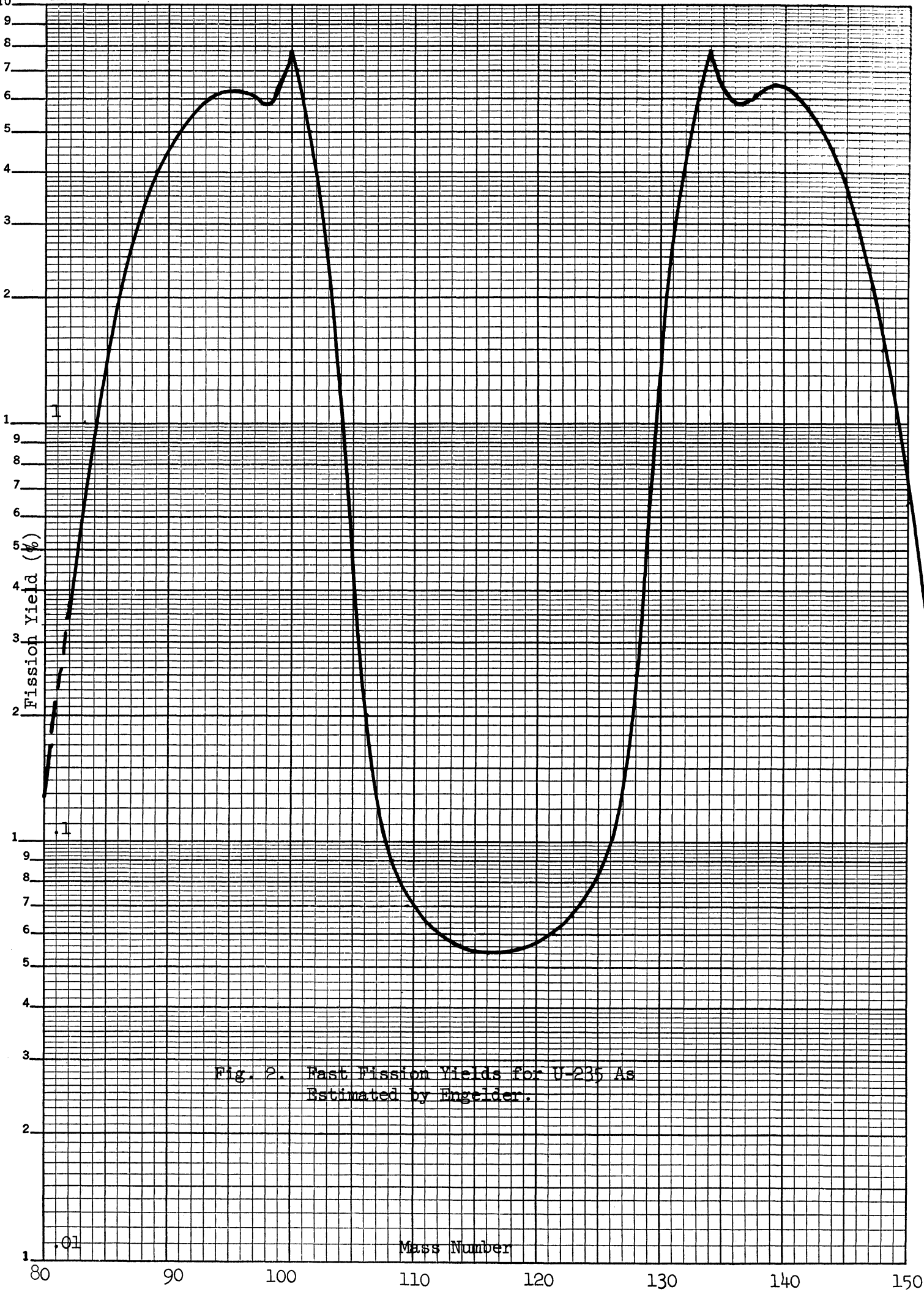

Fig. 2. Fast Fission Yields for U-235 As Estimated by Engelder.

have been calculated. To calculate the rate of formation for each mass number one uses the relationship:

$$\text{grams/second} = \frac{yWfA}{N}$$

where,

y = fission yield,

W = reactor power level in watts,

f = fission rate, in fissions per watt-second

(f = 3.25×10^{10} , assuming 192 Mev/fission),

A = atomic number,

N = Avogadro's number, 6.023×10^{23} .

For mass number 127,

$$\begin{aligned} \text{grams/second} &= \frac{0.0015(5 \times 10^8)(3.25 \times 10^{10})127}{6.023 \times 10^{23}} \\ &= 0.0515 \times 10^{-4}. \end{aligned}$$

The total number of grams of mass number 127 produced in the reactor core after 42 days of steady state operation at 500 Mw is simply:

$$\begin{aligned} &= 0.0515 \times 10^{-4}(42)24(3600) \\ &= 18.5. \end{aligned}$$

This quantity and those that follow in this sample calculation may be expressed as quantity present per 10 kilograms of fissioned material by dividing by 2.31, since total mass of fissioned material after 42 days

$$\begin{aligned} &= \frac{(5 \times 10^8)(3.25 \times 10^{10})(235)42(24)3600}{6.025 \times 10^{23}} \\ &= 23,100 \text{ grams.} \end{aligned}$$

The decay chain for mass number 127 is shown in Fig. 3.

At the end of 42 days of steady state reactor operation, the buildup of this parent nuclide (Sb-127) approaches saturation; i.e., the rate of decay has increased to approximately equal the rate of formation. The fraction of saturation for a parent nuclide after T days of reactor operation is (Motteff):

$$F_1 = (1 - e^{-\lambda_1 T}),$$

where λ_1 is the decay constant in reciprocal time and T is the reactor operation time in days.

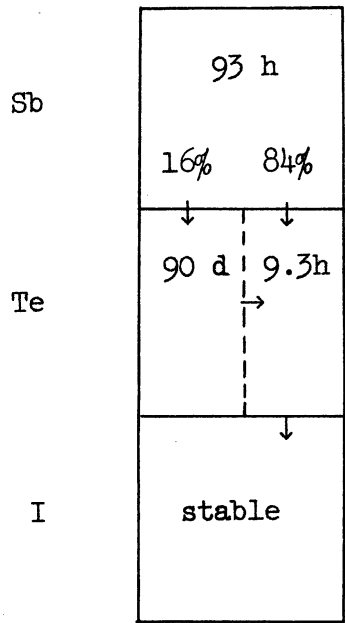

Fig. 3. Decay Chain for Mass Number 127.

For Sb-127,

$$F_1 = (1 - e^{-0.179(42)}),$$

$$= (1 - 0.00054),$$

$$= 0.99946,$$

$$= 1.$$

The activity at saturation is calculated according to the relationship

$$\text{curies} = \frac{yWf}{3.7 \times 10^{10}},$$

where,

y = fission yield

W = reactor power level

and

f = fission rate, in fission/watt-second

(3.25×10^{10} assuming 192 Mev/fission)

For mass number 127,

$$\text{curies} = \frac{0.0015(5 \times 10^8)(3.25 \times 10^{10})}{3.7 \times 10^{10}},$$

= 0.638×10^8 curies in the entire reactor core
in the entire reactor core after 42 days of operation.

The decay rate is directly proportional to the amount of material, M, present; i.e.,

$$\frac{dM}{dt} = -\lambda M.$$

As M is desired in grams, and dM/dt has been computed in grams per second (at saturation),

$$M(\text{grams}) = \frac{\text{grams/second}}{\lambda}$$

$$= 0.015 \times 10^{-4} \frac{3600(93)}{0.693},$$

$$= 2.46.$$

ENGINEERING RESEARCH INSTITUTE • UNIVERSITY OF MICHIGAN

The fraction of saturation for a daughter nuclide after T days of operation is (Motteff)

$$F_2 = \frac{\lambda_1 \lambda_2}{\lambda_1 - \lambda_2} \left[\frac{1 - e^{-\lambda_2 T}}{\lambda_2} - \frac{1 - e^{-\lambda_1 T}}{\lambda_1} \right].$$

For 90-day Te-127,

$$F_2 = \frac{0.179(0.0077)}{0.179 - 0.0077} \left[\frac{1 - e^{-0.0077(42)}}{0.0077} - \frac{1 - e^{-0.179(42)}}{0.179} \right],$$

$$= 0.263.$$

The number of curies of 90-day Te-127 present after 42 days of reactor operation is thus,

$$= 0.638 \times 10^6 (0.263) 0.16 = 0.027 \times 10^6 \text{ curies,}$$

and, as before, the number of grams

$$= \frac{0.0515 \times 10^{-4} (90) 24 (3600) 0.263 (0.16)}{0.693},$$

$$= 2.43 \text{ grams.}$$

A total of $(18.5 - 2.46)(0.16) = 2.56$ grams of the 90-day isomer of Te-127 has been formed. Of this, only 0.13 grams has decayed to the 9.3 hour isomer in the entire 42 day period. On this basis, one may consider that essentially the only source of the 9.3 hour isomer is direct decay of Sb-127. From this, calculating as before for a daughter nuclide,

$$F_2 \approx 1,$$

$$\text{curies} = 0.638 \times 10^6 (0.84) = 0.546 \times 10^6,$$

and,

$$\text{grams} = \frac{0.0515 \times 10^{-4} (9.3) 3600 (0.84)}{0.693} = 0.206$$

The total number of grams formed at mass number 127 has been computed (18.5 grams). The mass of each of the radioactive nuclides has also been computed at the time of removal from the reactor. It follows that the mass of stable I-127 is

$$18.5 - (2.46 + 2.43 + 0.206) = 13.4 \text{ grams}$$

The preceding calculations are presented in Table II for each mass number with a fission yield in excess of 0.01%. The fold-in chart (Fig. 4) presents the results of these calculations of mass and activity level for each nuclide, per 10 kilograms of fissioned material, at the time of removal from the reactor.

GAMMA RADIATION LEVELS

Marinelli, et al (3) have published a curve of roentgens per hour per millicurie point source at one centimeter distance as a function of photon energy as shown in Fig. 5. This assumes one photon, at the energy in question, per disintegration. If the disintegration scheme is known, the radiation level at a particular position may be calculated.

The disintegration scheme used for mass number 127 is shown in Fig. 6.

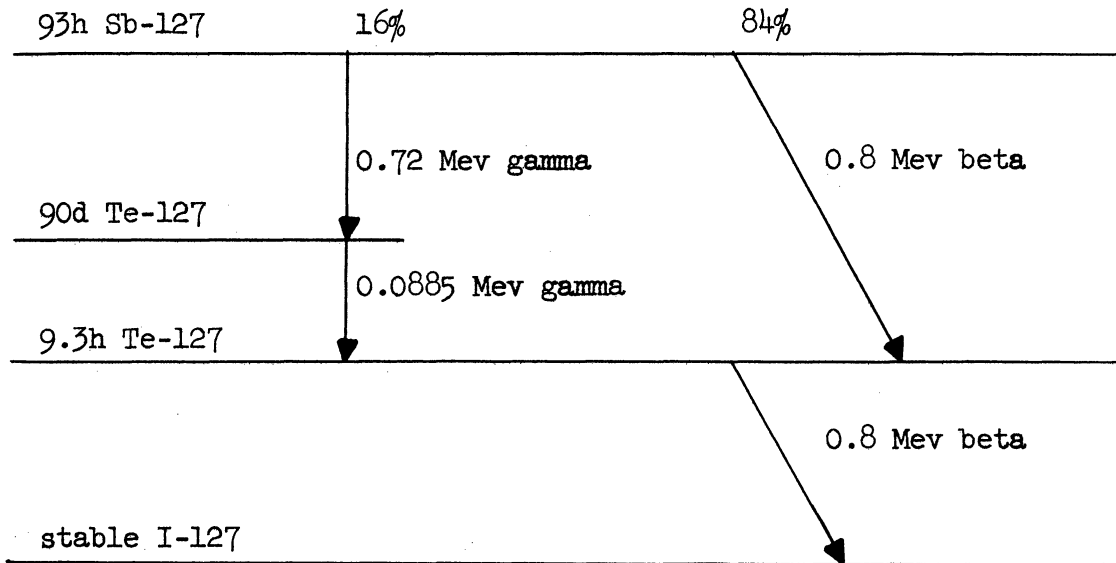

Fig. 6. Disintegration Scheme for Mass Number 127.

In the decay of Sb-127, there are 0.16 photons per disintegration of 0.72 Mev energy. As shown in Fig. 5, such a photon yields 0.42 roentgens per hour per curie at one meter. Therefore, for Sb-127,

$$\frac{(0.16)0.638 \times 10^6 (0.42)}{2.31} = 1.85 \times 10^4$$

roentgens per hour at one meter for 10 kilograms of fissioned material.

Similarly for 90-day Te-127,

$$\frac{0.027 \times 10^6 (0.045)}{2.31} = 5.26 \times 10^2$$

Table III lists the constants required for these calculations, by element. "g" is the number of gammas per disintegration, "r" is the dosage rate in roentgens per hour at one meter from a one curie point source of photons at the particular energy.

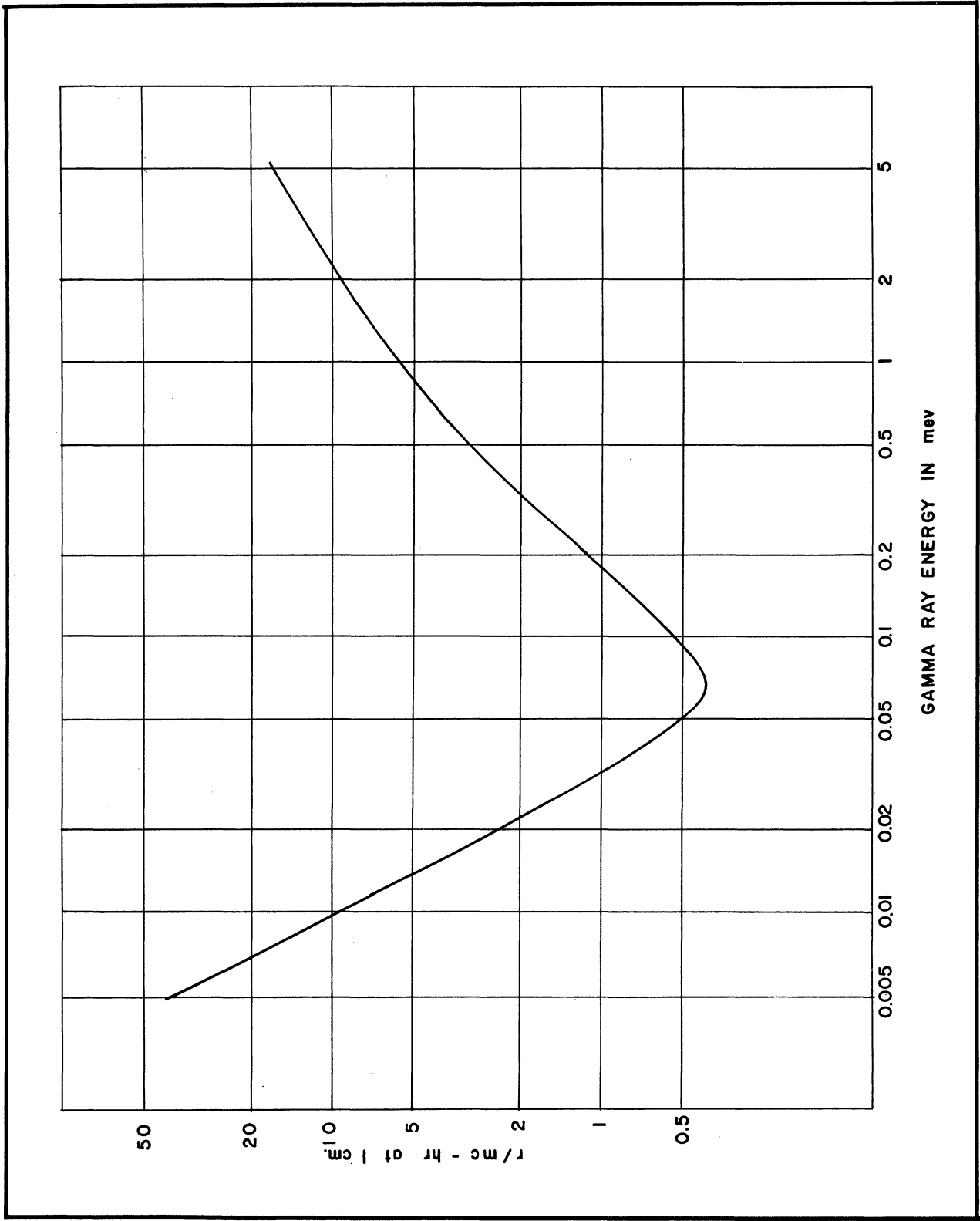

Fig. 5. Roentgens per hour per milligram at one centimeter from a point gamma emitter as a function of photon energy, assuming one photon per disintegration.

Table II

Summary of Calculations Involved in Determining Mass
and Activity of Each Nuclide at Time of
Removal

One page has been devoted to each mass number, indicating the steps involved in each calculation. A typical calculation (mass number 127) has been exemplified in detail in the preceding text.

Mass number 77 (Yield 0.0001)

$$\text{Grams/second} = \frac{0.0001(5 \times 10^8)(3.25 \times 10^{10})77}{6.023 \times 10^{23}}$$

$$= 0.00207 \times 10^{-4} \text{ gm/sec.}$$

$$\text{Total grams} = 0.00207 \times 10^{-4}(42)24(3600),$$

$$= 0.752 \text{ gm.}$$

$$\text{Curies at saturation} = \frac{0.0001(5 \times 10^8)(3.25 \times 10^{10})}{3.7 \times 10^{10}},$$

$$= 4.4 \times 10^4 \text{ curies.}$$

$$4.4 \times 10^4 (.02) = 880 \text{ curies}$$

Ge	59 s	12 h	4.4 × 10 ⁴ curies (F = 1)
	↓		
As	40 h		4.4 × 10 ⁴ curies (F = 1)
	↓		
Se	.02	.98	.752 - .013 - .043 = 0.696 gm.
	↓		
	17.5 m	stable	
	↓		

Mass number 78 (Yield 0.00017)

$$\begin{aligned} \text{Grams/second} &= \frac{0.00017(5 \times 10^8)(3.25 \times 10^{10})78}{6.023 \times 10^{23}} \\ &= 0.00356 \times 10^{-4} \text{ gm/sec.} \end{aligned}$$

$$\begin{aligned} \text{Total grams} &= 0.00356 \times 10^{-4} (42)24(3600), \\ &= 1.295 \text{ gm.} \end{aligned}$$

$$\begin{aligned} \text{Curies at saturation} &= \frac{0.00017(5 \times 10^8)(3.25 \times 10^{10})}{3.7 \times 10^{10}}, \\ &= 7.5 \times 10^4 \text{ curies.} \end{aligned}$$

Ge	2.1 h	7.5×10^4 curies (F = 1)
As	90 m	7.5×10^4 curies (F = 1)
Se	stable	1.295 gm.

Mass number 79 (Yield 0.00056)

$$\begin{aligned} \text{Grams/second} &= \frac{0.00056(5 \times 10^8)(3.25 \times 10^{10})79}{6.023 \times 10^{23}} \\ &= 0.0122 \times 10^{-4} \text{ gm/sec.} \end{aligned}$$

$$\begin{aligned} \text{Total grams} &= 0.0122 \times 10^{-4} (42) 24 (3600), \\ &= 3.98 \text{ gm.} \end{aligned}$$

$$\begin{aligned} \text{Curies at saturation} &= \frac{0.00056(5 \times 10^8)(3.25 \times 10^{10})}{3.7 \times 10^{10}}, \\ &= 0.247 \times 10^6 \text{ curies.} \end{aligned}$$

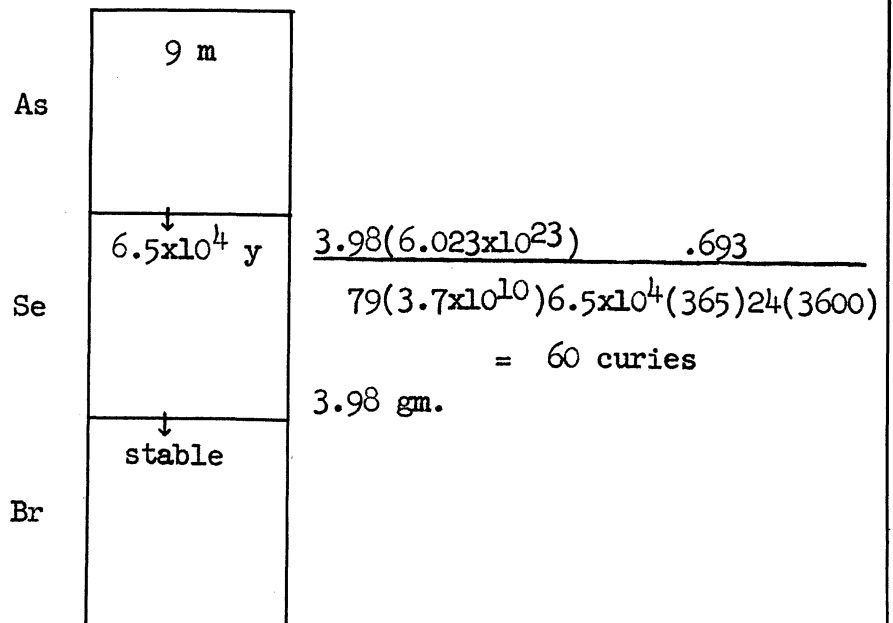

Mass number 80 (Yield 0.001)

$$\begin{aligned} \text{Grams/second} &= \frac{0.001(5 \times 10^8)(3.25 \times 10^{10})80}{6.023 \times 10^{23}} \\ &= 0.0215 \times 10^{-4} \text{ gm/sec.} \\ \text{Total grams} &= 0.0215 \times 10^{-4} (42) 24 (3600), \\ &= 7.81 \text{ gm.} \end{aligned}$$

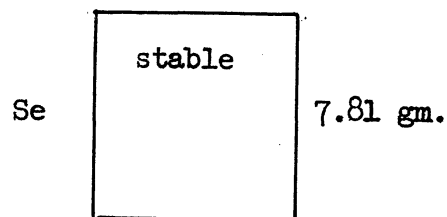

Mass number 81 (Yield 0.002)

$$\begin{aligned} \text{Grams/second} &= \frac{0.002(5 \times 10^8)(3.25 \times 10^{10})81}{6.023 \times 10^{23}} \\ &= 0.0435 \times 10^{-4} \text{ gm/sec.} \\ \text{Total grams} &= 0.0435 \times 10^{-4} (42)24(3600), \\ &= 15.7 \text{ gm.} \end{aligned}$$

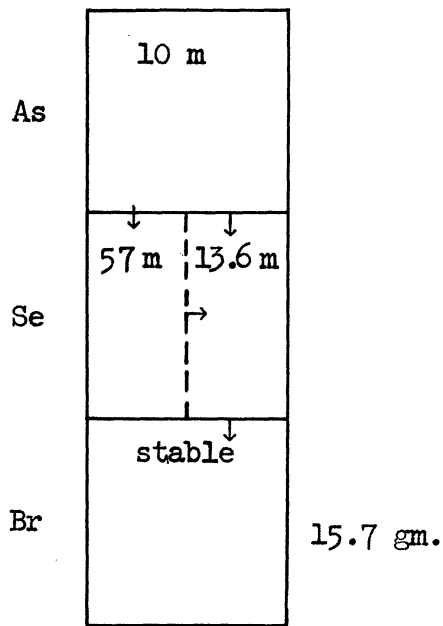

Mass number 82 (Yield 0.0034)

$$\begin{aligned} \text{Grams/second} &= \frac{0.0034(5 \times 10^8)(3.25 \times 10^{10})82}{6.023 \times 10^{23}} \\ &= 0.075 \times 10^{-4} \text{ gm/sec.} \end{aligned}$$

$$\begin{aligned} \text{Total grams} &= 0.075 \times 10^{-4}(42)24(3600), \\ &= 27.3 \text{ gm.} \end{aligned}$$

$$\begin{aligned} \text{Curies at saturation} &= \frac{0.0034(5 \times 10^8)(3.25 \times 10^{10})}{3.7 \times 10^{10}}, \\ &= 1.49 \times 10^6 \text{ curies} \end{aligned}$$

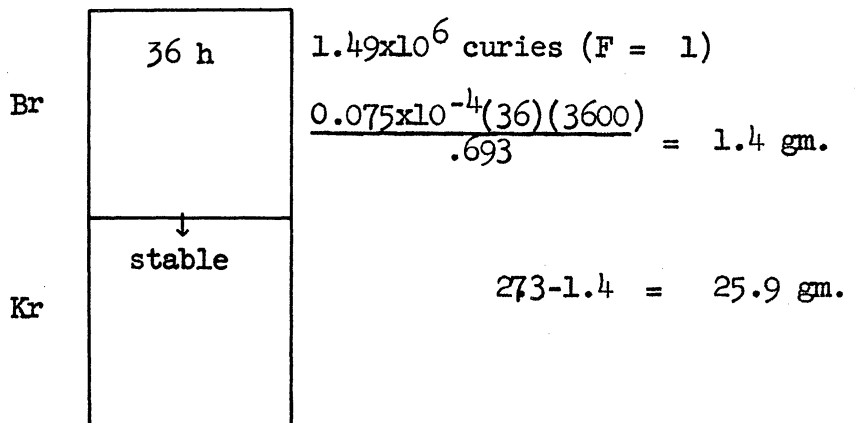

Mass number 83 (Yield 0.0055)

$$\begin{aligned} \text{Grams/second} &= \frac{0.0055(5 \times 10^8)(3.25 \times 10^{10})83}{6.023 \times 10^{23}} \\ &= 0.1225 \times 10^{-4} \text{ gm/sec.} \end{aligned}$$

$$\begin{aligned} \text{Total grams} &= 0.1225 \times 10^{-4} (42) 24 (3600), \\ &= 44.5 \text{ gm.} \end{aligned}$$

$$\begin{aligned} \text{Curies at saturation} &= \frac{0.0055(5 \times 10^8)(3.25 \times 10^{10})}{3.7 \times 10^{10}}, \\ &= 2.42 \times 10^6 \text{ curies.} \end{aligned}$$

2.42×10^6 curies

$$\frac{0.1225 \times 10^{-4} (2.4) 3600}{.693} = 0.153 \text{ gm.}$$

2.42×10^6 curies

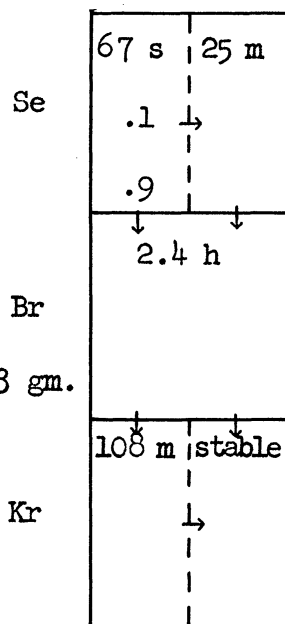

$$44.5 - .15 = 44.35 \text{ gm.}$$

Mass number 84 (Yield 0.009)

$$\begin{aligned} \text{Grams/second} &= \frac{0.009(5 \times 10^8)(3.25 \times 10^{10})84}{6.023 \times 10^{23}} \\ &= 0.204 \times 10^{-4} \text{ gm/sec.} \end{aligned}$$

$$\begin{aligned} \text{Total grams} &= 0.204 \times 10^{-4}(42)24(3600), \\ &= 74 \text{ gm.} \end{aligned}$$

$$\begin{aligned} \text{Curies at saturation} &= \frac{0.009(5 \times 10^8)(3.25 \times 10^{10})}{3.7 \times 10^{10}}, \\ &= 3.95 \times 10^6 \text{ curies.} \end{aligned}$$

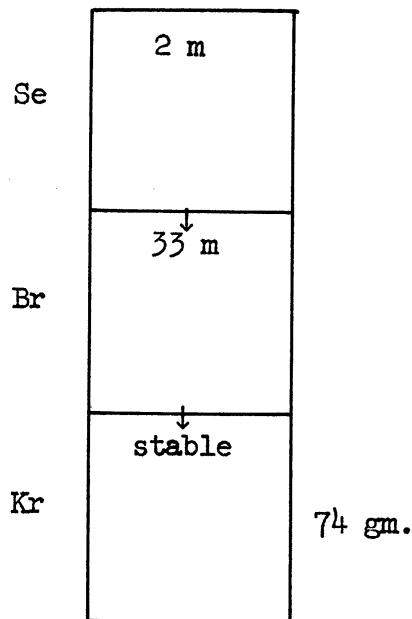

Mass number 85 (Yield 0.014)

$$\begin{aligned} \text{Grams/second} &= \frac{0.014(5 \times 10^8)(3.25 \times 10^{10})85}{6.023 \times 10^{23}} \\ &= 0.322 \times 10^{-4} \text{ gm/sec.} \end{aligned}$$

$$\begin{aligned} \text{Total grams} &= 0.322 \times 10^{-4}(42)24(3600), \\ &= 117 \text{ gm.} \end{aligned}$$

$$\begin{aligned} \text{Curies at saturation} &= \frac{0.014(5 \times 10^8)(3.25 \times 10^{10})}{3.7 \times 10^{10}}, \\ &= 6.15 \times 10^6 \text{ curies.} \end{aligned}$$

$$\begin{aligned} &3.08 \times 10 \text{ curies} \\ &\frac{0.322 \times 10}{2} \frac{(4.36)3600(.5)}{.693} \\ &= 0.182 \end{aligned}$$

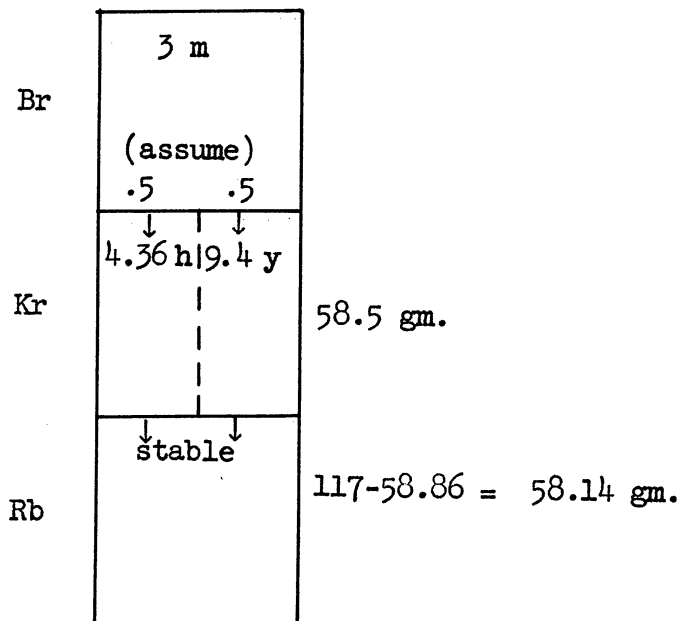

Mass number 86 (Yield 0.02)

$$\begin{aligned} \text{Grams/second} &= \frac{0.02(5 \times 10^8)(3.25 \times 10^{10})86}{6.023 \times 10^{23}} \\ &= 0.464 \times 10^{-4} \text{ gm/sec.} \end{aligned}$$

$$\begin{aligned} \text{Total grams} &= 0.464 \times 10^{-4}(42)24(3600), \\ &= 168.5 \text{ gm.} \end{aligned}$$

$$\begin{aligned} \text{Curies at saturation} &= \frac{0.02(5 \times 10^8)(3.25 \times 10^{10})}{3.7 \times 10^{10}}, \\ &= 8.8 \times 10^6 \text{ curies.} \end{aligned}$$

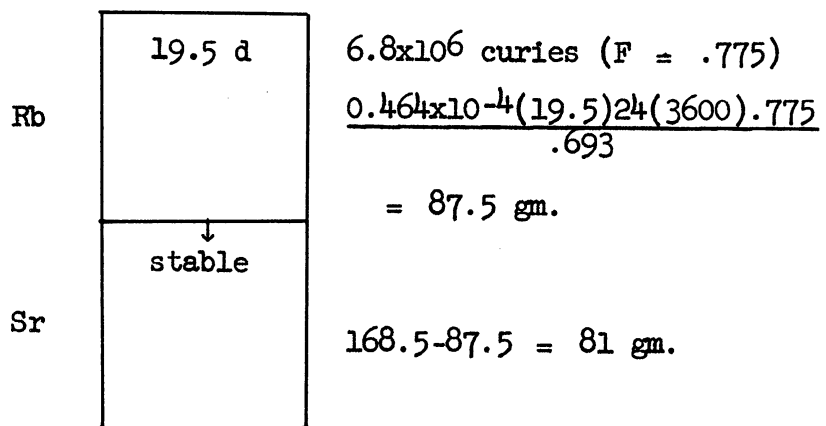

Mass number 87 (Yield 0.027)

$$\begin{aligned} \text{Grams/second} &= \frac{0.027(5 \times 10^8)(3.25 \times 10^{10})87}{6.023 \times 10^{23}} \\ &= 0.634 \times 10^{-4} \text{ gm/sec.} \end{aligned}$$

$$\begin{aligned} \text{Total grams} &= 0.634 \times 10^{-4}(42)24(3600), \\ &= 230 \text{ gm.} \end{aligned}$$

$$\begin{aligned} \text{Curies at saturation} &= \frac{0.027(5 \times 10^8)(3.25 \times 10^{10})}{3.7 \times 10^{10}}, \\ &= 11.9 \times 10^6 \text{ curies.} \end{aligned}$$

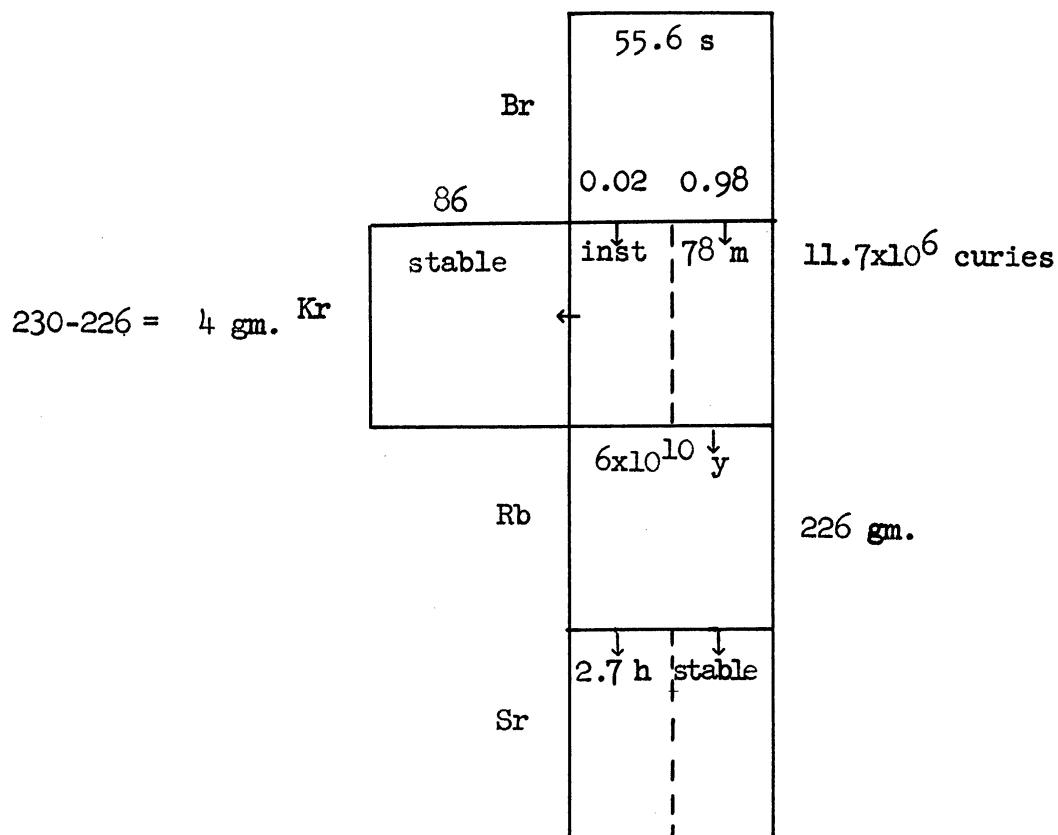

Mass number 88 (Yield 0.034)

$$\begin{aligned} \text{Grams/second} &= \frac{0.034(5 \times 10^8)(3.25 \times 10^{10})88}{6.023 \times 10^{23}} \\ &= 0.806 \times 10^{-4} \text{ gm/sec.} \end{aligned}$$

$$\begin{aligned} \text{Total grams} &= 0.806 \times 10^{-4}(42)24(3600), \\ &= 292 \text{ gm.} \end{aligned}$$

$$\begin{aligned} \text{Curies at saturation} &= \frac{0.034(5 \times 10^8)(3.25 \times 10^{10})}{3.7 \times 10^{10}}, \\ &= 14.95 \times 10^6 \text{ curies.} \end{aligned}$$

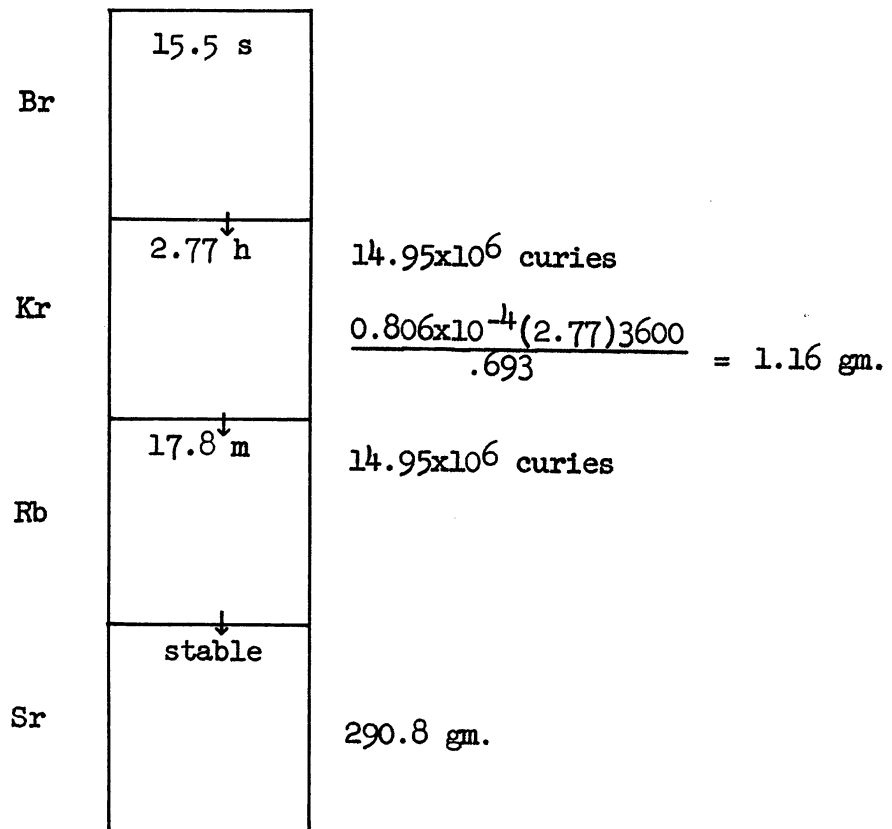

Mass number 89 (Yield 0.040)

$$\begin{aligned} \text{Grams/second} &= \frac{0.040(5 \times 10^8)(3.25 \times 10^{10})89}{6.023 \times 10^{23}} \\ &= 0.96 \times 10^{-4} \text{ gm/sec.} \end{aligned}$$

$$\begin{aligned} \text{Total grams} &= 0.96 \times 10^{-4}(42)24(3600), \\ &= 348 \text{ gm.} \end{aligned}$$

$$\begin{aligned} \text{Curies at saturation} &= \frac{0.040(5 \times 10^8)(3.25 \times 10^{10})}{3.7 \times 10^{10}}, \\ &= 17.6 \times 10^6 \text{ curies.} \end{aligned}$$

Br	4.51 s	
	↓	
Kr	2.6 m	
	↓	
Rb	15.4 m	
	↓	
Sr	53 d	$7.4 \times 10^6 \text{ curies (F = 0.42)}$ $\frac{0.96 \times 10^{-4}(53)24(3600)(.42)}{.693}$ $= 267 \text{ gm.}$
	↓	
Y	stable	$358 - 267 = 81 \text{ gm.}$

Mass number 90 (Yield 0.046)

$$\begin{aligned} \text{Grams/second} &= \frac{0.046(5 \times 10^8)(3.25 \times 10^{10})90}{6.023 \times 10^{23}} \\ &= 1.12 \times 10^{-4} \text{ gm/sec.} \end{aligned}$$

$$\begin{aligned} \text{Total grams} &= 1.12 \times 10^{-4}(42)24(3600), \\ &= 407 \text{ gm.} \end{aligned}$$

$$\begin{aligned} \text{Curies at saturation} &= \frac{0.046(5 \times 10^8)(3.25 \times 10^{10})}{3.7 \times 10^{10}}, \\ &= 20.4 \times 10^6 \text{ curies.} \end{aligned}$$

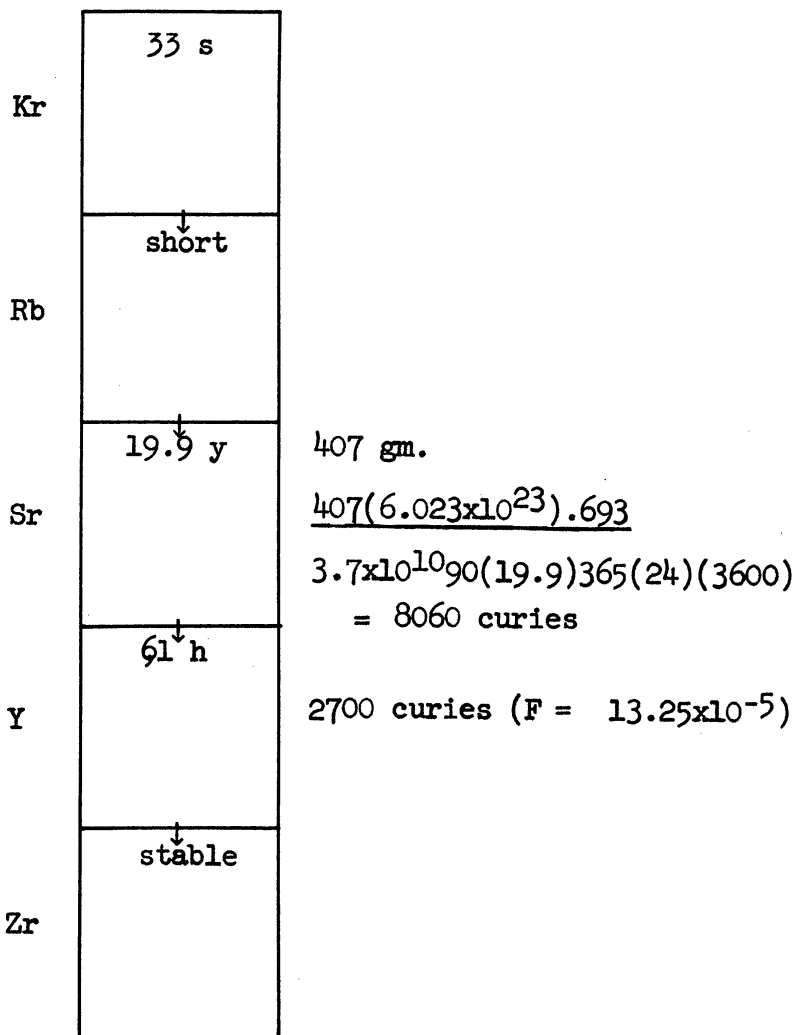

Mass number 91 (Yield 0.05)

Grams/second $\frac{0.05(5 \times 10^8)(3.25 \times 10^{10})91}{6.023 \times 10^{23}}$

1.23×10^{-4} gm/sec.

Total grams $1.23 \times 10^{-4}(42)24(3600)$,
446 gm.

Curies at saturation $\frac{0.05(5 \times 10^8)(3.25 \times 10^{10})}{3.7 \times 10^{10}}$,
 22×10^6 curies.

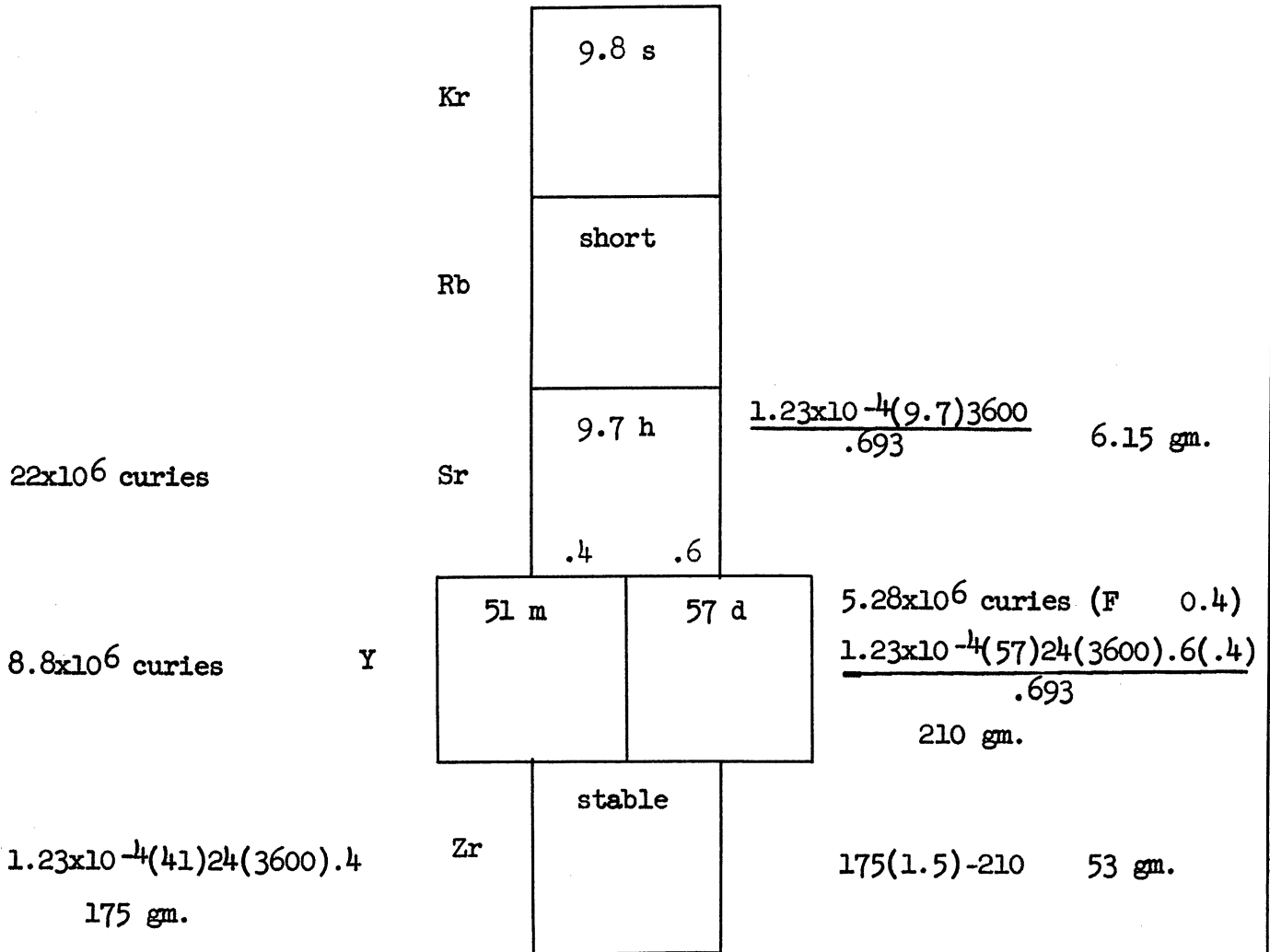

Mass number 92 (Yield 0.055)

$$\begin{aligned} \text{Grams/second} &= \frac{0.055(5 \times 10^8)(3.25 \times 10^{10})92}{6.023 \times 10^{23}} \\ &= 1.36 \times 10^{-4} \text{ gm/sec.} \end{aligned}$$

$$\begin{aligned} \text{Total grams} &= 1.36 \times 10^{-4}(42)24(3600), \\ &= 495 \text{ gm.} \end{aligned}$$

$$\begin{aligned} \text{Curies at saturation} &= \frac{0.055(5 \times 10^8)(3.25 \times 10^{10})}{3.7 \times 10^{10}}, \\ &= 24.4 \times 10^6 \text{ curies.} \end{aligned}$$

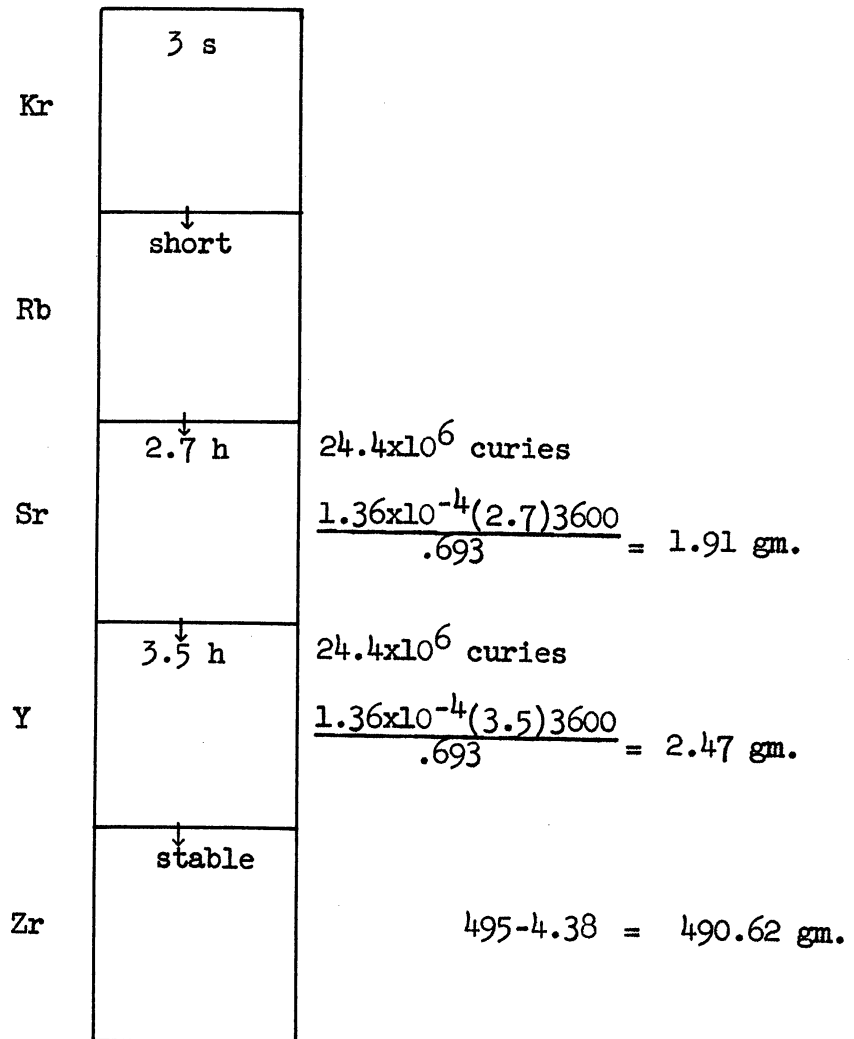

Mass number 93 (Yield 0.06)

$$\begin{aligned} \text{Grams/second} &= \frac{0.06(5 \times 10^8)(3.25 \times 10^{10})93}{6.023 \times 10^{23}} \\ &= 1.51 \times 10^{-4} \text{ gm/sec.} \end{aligned}$$

$$\begin{aligned} \text{Total grams} &= 1.51 \times 10^{-4}(42)24(3600), \\ &= 546 \text{ gm.} \end{aligned}$$

$$\begin{aligned} \text{Curies at saturation} &= \frac{0.06(5 \times 10^8)(3.25 \times 10^{10})}{3.7 \times 10^{10}}, \\ &= 26.6 \times 10^6 \text{ curies.} \end{aligned}$$

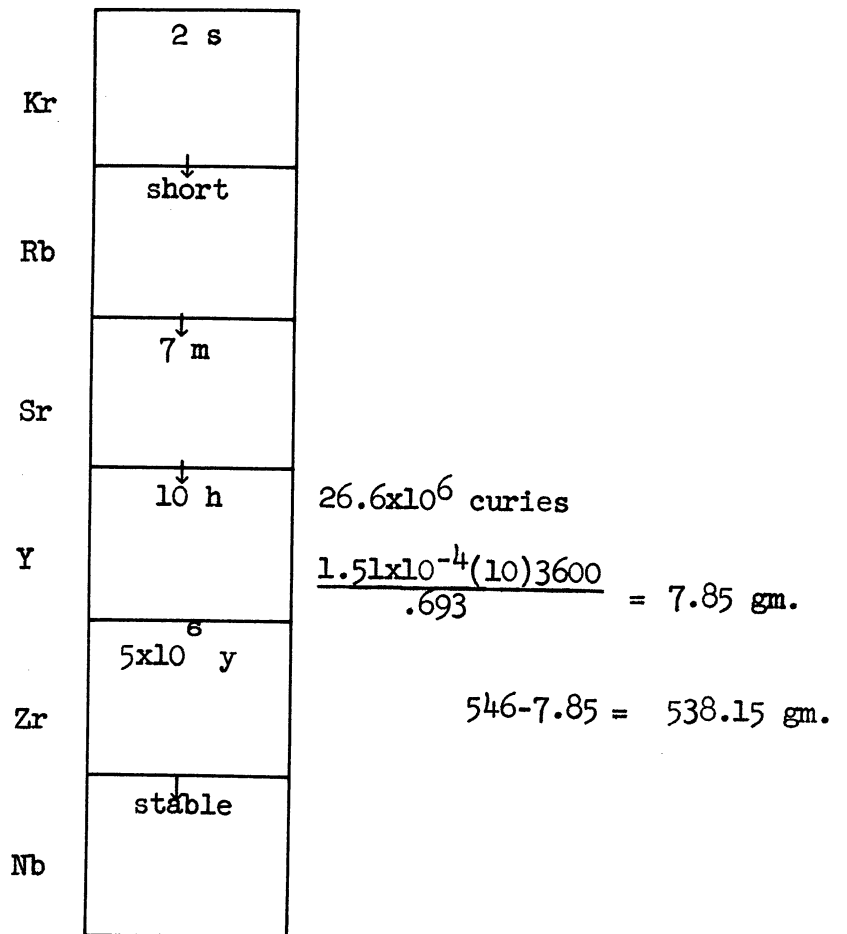

Mass number 94 (Yield 0.063)

$$\begin{aligned} \text{Grams/second} &= \frac{0.063(5 \times 10^8)(3.25 \times 10^{10})94}{6.023 \times 10^{23}} \\ &= 1.6 \times 10^{-4} \text{ gm/sec.} \end{aligned}$$

$$\begin{aligned} \text{Total grams} &= 1.6 \times 10^{-4}(42)24(3600), \\ &= 579 \text{ gm.} \end{aligned}$$

$$\begin{aligned} \text{Curies at saturation} &= \frac{0.063(5 \times 10^8)(3.25 \times 10^{10})}{3.7 \times 10^{10}}, \\ &= 27.9 \times 10^6 \end{aligned}$$

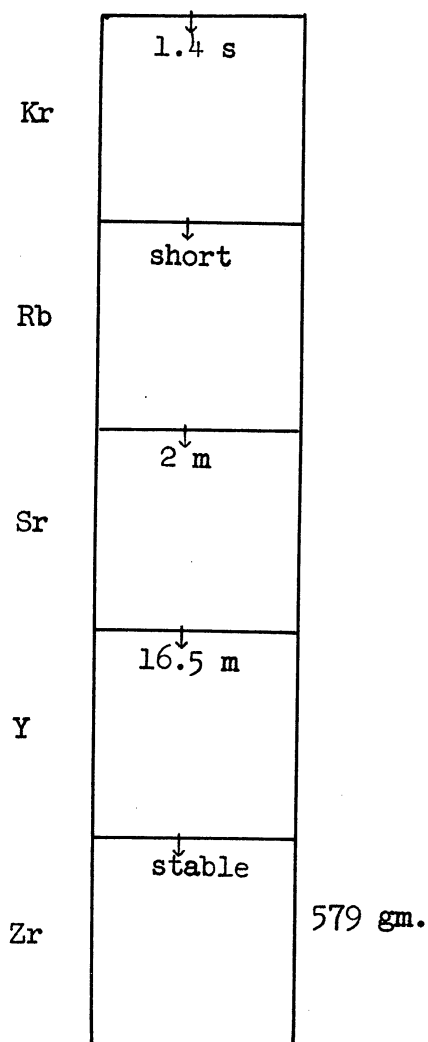

Mass number 95 (Yield 0.064)

$$\begin{aligned} \text{Grams/second} &= \frac{0.064(5 \times 10^8)(3.25 \times 10^{10})95}{6.023 \times 10^{23}} \\ &= 1.64 \times 10^{-4} \text{ gm/sec.} \end{aligned}$$

$$\begin{aligned} \text{Total grams} &= 1.64 \times 10^{-4}(42)24(3600), \\ &= 594 \text{ gm.} \end{aligned}$$

$$\begin{aligned} \text{Curies at saturation} &= \frac{0.064(5 \times 10^8)(3.25 \times 10^{10})}{3.7 \times 10^{10}}, \\ &= 28.4 \times 10^6 \text{ curies.} \end{aligned}$$

Kr	short	
	↓	
Rb	short	
	↓	
Sr	short	
	↓	
Y	10.5 m	
	↓	
Zr	65 d	$10.35 \times 10^6 \text{ curies (F = .365)}$
	.01 .99	$\frac{1.65 \times 10^{-4}(65)24(3600) \cdot 365}{.693} = 496 \text{ gm.}$
	90 h 35 d	$3.7 \times 10^6 \text{ curies (F = 0.13)}$
Nb	↓	$\frac{1.64 \times 10^{-4}(35)24(3600) \cdot 365 \cdot (.99) \cdot 13}{.693}$
	↓	$= 34.4 \text{ gm.}$
Mo	stable	

594 - 530.5 = 63.5 gm.

Mass number 96 (Yield 0.063)

$$\begin{aligned} \text{Grams/second} &= \frac{0.063(5 \times 10^8)(3.25 \times 10^{-10})96}{6.023 \times 10^{23}} \\ &= 1.63 \times 10^{-4} \text{ gm/sec.} \\ \text{Total grams} &= 1.63 \times 10^{-4}(42)24(3600), \\ &= 590 \text{ gm.} \end{aligned}$$

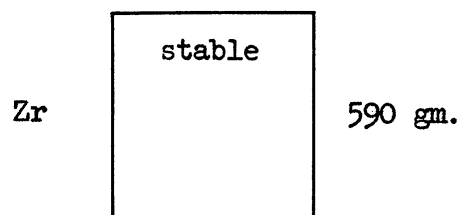

Mass number 97 (Yield 0.06)

$$\begin{aligned} \text{Grams/second} &= \frac{0.06(5 \times 10^8)(3.25 \times 10^{10})97}{6.023 \times 10^{23}} \\ &= 1.565 \times 10^{-4} \text{ gm/sec.} \end{aligned}$$

$$\begin{aligned} \text{Total grams} &= 1.565 \times 10^{-4}(42)24(3600), \\ &= 566 \text{ gm.} \end{aligned}$$

$$\begin{aligned} \text{Curies at saturation} &= \frac{0.06(5 \times 10^8)(3.25 \times 10^{10})}{3.7 \times 10^{10}}, \\ &= 26.6 \times 10^6 \text{ curies} \end{aligned}$$

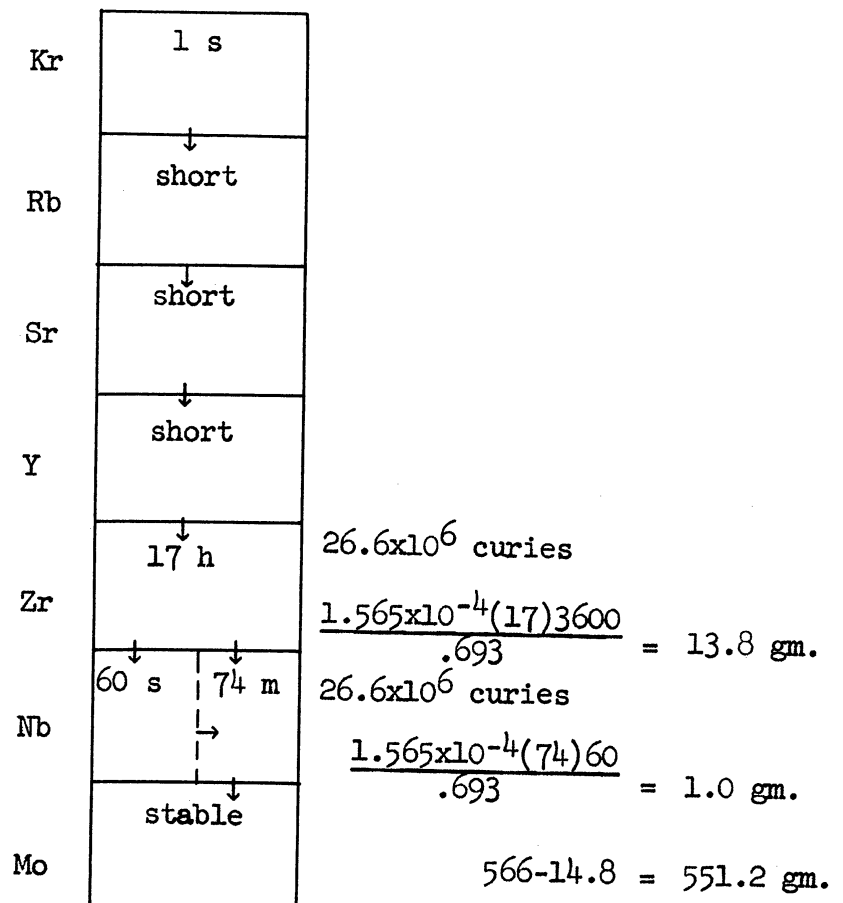

Mass number 98 (Yield 0.058)

$$\begin{aligned} \text{Grams/second} &= \frac{0.058(5 \times 10^8)(3.25 \times 10^{10})98}{6.023 \times 10^{23}} \\ &= 1.527 \times 10^{-4} \text{ gm/sec.} \\ \text{Total grams} &= 1.527 \times 10^{-4}(42)24(3600), \\ &= 552 \text{ gm.} \end{aligned}$$

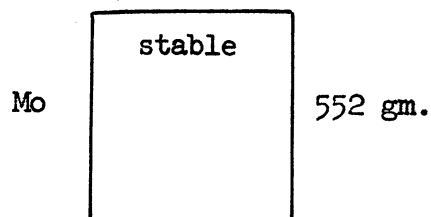

Mass number 100 (Yield 0.078)

$$\begin{aligned} \text{Grams/second} &= \frac{0.078(5 \times 10^8)(3.25 \times 10^{10})100}{6.023 \times 10^{23}} \\ &= 2.1 \times 10^{-4} \text{ gm/sec.} \\ \text{Total grams} &= 2.1 \times 10^{-4}(42)^{24}(3600), \\ &= 759 \text{ gm.} \end{aligned}$$

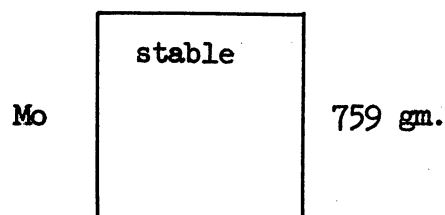

Mass number 101 (Yield 0.06)

$$\begin{aligned} \text{Grams/second} &= \frac{0.06(5 \times 10^8)(3.25 \times 10^{10})101}{6.023 \times 10^{23}} \\ &= 1.635 \times 10^{-4} \text{ gm/sec.} \end{aligned}$$

$$\begin{aligned} \text{Total grams} &= 1.635 \times 10^{-4}(42)24(3600), \\ &= 591 \text{ gm.} \end{aligned}$$

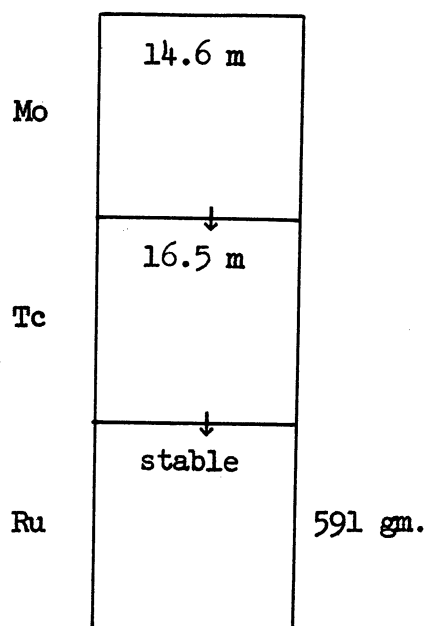

Mass number 102 (Yield 0.04)

$$\begin{aligned} \text{Grams/second} &= \frac{0.04(5 \times 10^8)(3.25 \times 10^{10})102}{6.023 \times 10^{23}} \\ &= 1.1 \times 10^{-4} \text{ gm/sec.} \end{aligned}$$

$$\begin{aligned} \text{Total grams} &= 1.1 \times 10^{-4}(42)24(3600), \\ &= 399 \text{ gm.} \end{aligned}$$

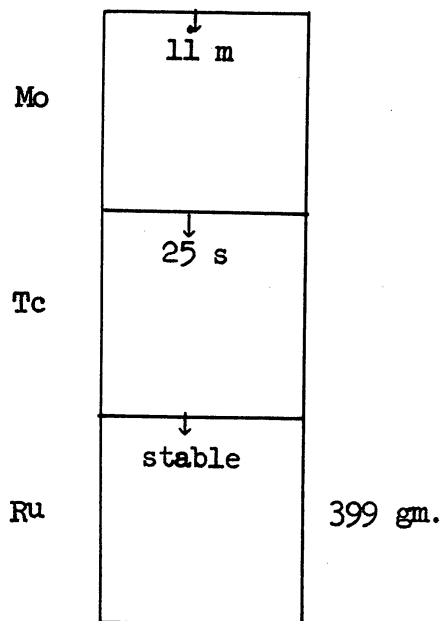

Mass number 103 (Yield 0.022)

$$\begin{aligned} \text{Grams/second} &= \frac{0.022(5 \times 10^8)(3.25 \times 10^{10})103}{6.023 \times 10^{23}} \\ &= 0.612 \times 10^{-4} \text{ gm/sec.} \end{aligned}$$

$$\begin{aligned} \text{Total grams} &= 0.612 \times 10^{-4}(42)24(3600), \\ &= 221.6 \text{ gm.} \end{aligned}$$

$$\begin{aligned} \text{Curies at saturation} &= \frac{0.022(5 \times 10^8)(3.25 \times 10^{10})}{3.7 \times 10^{10}}, \\ &= 9.75 \times 10^6 \text{ curies.} \end{aligned}$$

4.65 × 10⁶ curies

$$\begin{aligned} &\frac{.612 \times 10^{-4}(57)60(.95)(.5)}{.693} \\ &= 0.137 \text{ gm.} \end{aligned}$$

Ru

42 d	
.95	.05
57 m	stable

Rh

4.88 × 10⁶ curies (F = 0.5)

$$\begin{aligned} &\frac{0.612 \times 10^{-4}(42)24(3600)0.5}{.693} \\ &= 160 \text{ gm.} \end{aligned}$$

$$221.6 - 160 = 61.5 \text{ gm.}$$

Mass number 104 (Yield 0.011)

$$\begin{aligned} \text{Grams/second} &= \frac{0.011(5 \times 10^8)(3.25 \times 10^{10})104}{6.023 \times 10^{23}} \\ &= 0.309 \times 10^{-4} \text{ gm/sec.} \\ \text{Total grams} &= 0.309 \times 10^{-4}(42)24(3600), \\ &= 111.8 \text{ gm.} \end{aligned}$$

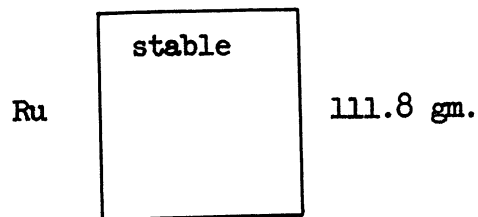

Mass number 105 (Yield 0.005)

$$\begin{aligned} \text{Grams/second} &= \frac{0.005(5 \times 10^8)(3.25 \times 10^{10})105}{6.023 \times 10^{23}} \\ &= 0.142 \times 10^{-4} \text{ gm/sec.} \end{aligned}$$

$$\begin{aligned} \text{Total grams} &= 0.1421 \times 10^{-4} (42)24(3600), \\ &= 51.3 \text{ gm.} \end{aligned}$$

$$\begin{aligned} \text{Curies at saturation} &= \frac{0.005(5 \times 10^8)(3.25 \times 10^{10})}{3.7 \times 10^{10}}, \\ &= 2.22 \times 10^6 \text{ curies.} \end{aligned}$$

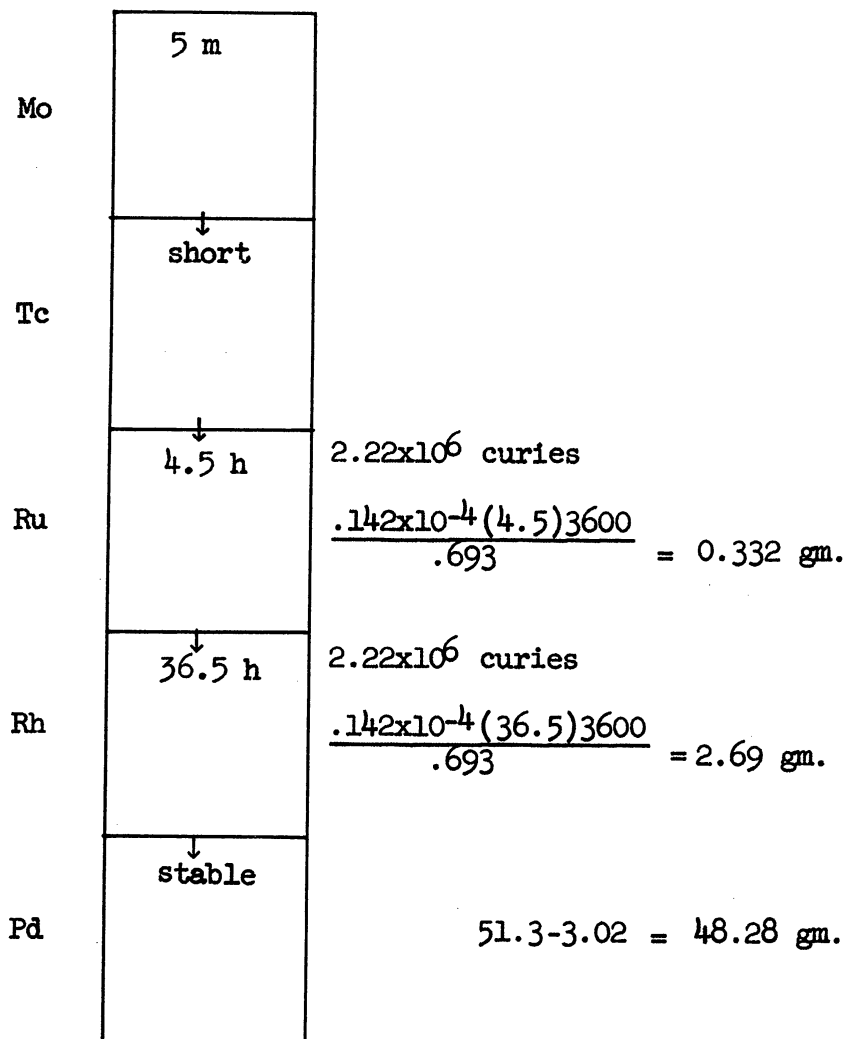

Mass number 106 (Yield 0.0023)

$$\begin{aligned} \text{Grams/second} &= \frac{0.0023(5 \times 10^8)(3.25 \times 10^{10})106}{6.023 \times 10^{23}} \\ &= 0.066 \times 10^{-4} \text{ gm/sec.} \end{aligned}$$

$$\begin{aligned} \text{Total grams} &= 0.066 \times 10^{-4} (42) 24 (3600), \\ &= 23.8 \text{ gm.} \end{aligned}$$

$$\begin{aligned} \text{Curies at saturation} &= \frac{0.0023(5 \times 10^8)(3.25 \times 10^{10})}{3.7 \times 10^{10}}, \\ &= 1.04 \times 10^6 \text{ curies.} \end{aligned}$$

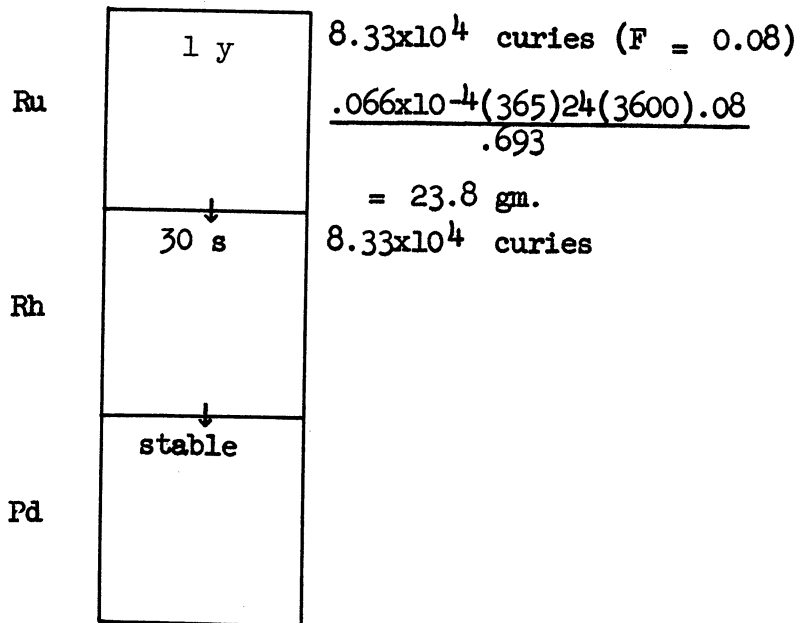

Mass number 107 (Yield 0.0014)

$$\begin{aligned} \text{Grams/second} &= \frac{0.0014(5 \times 10^8)(3.25 \times 10^{10})107}{6.023 \times 10^{23}} \\ &= 0.0406 \times 10^{-4} \text{ gm/sec.} \end{aligned}$$

$$\begin{aligned} \text{Total grams} &= 0.0406 \times 10^{-4} (42) 24 (3600), \\ &= 14.65 \text{ gm.} \end{aligned}$$

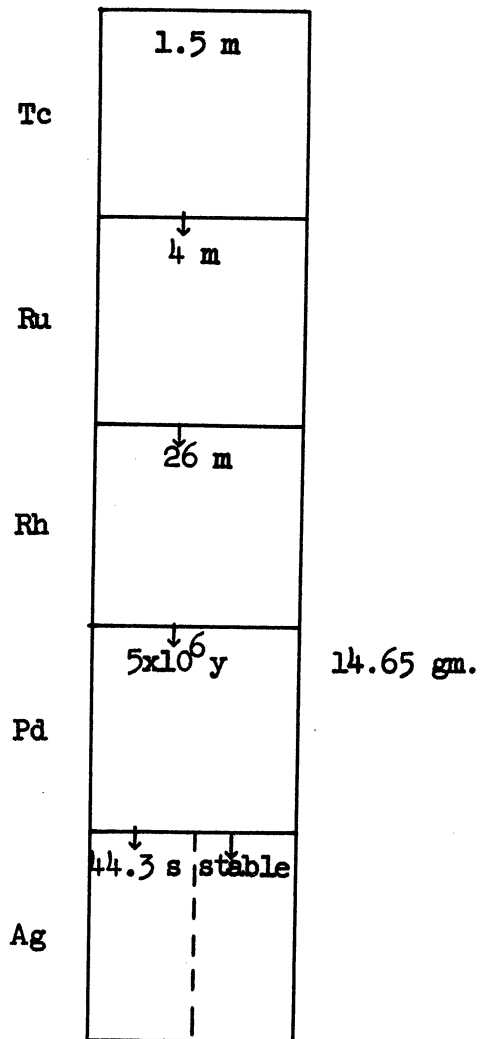

Mass number 108 (Yield 0.00092)

$$\begin{aligned} \text{Grams/second} &= \frac{0.00092(5 \times 10^8)(3.25 \times 10^{10})108}{6.023 \times 10^{23}} \\ &= 0.0269 \times 10^{-4} \text{ gm/sec.} \end{aligned}$$

$$\begin{aligned} \text{Total grams} &= 0.0269 \times 10^{-4} (42) 24 (3600), \\ &= 9.72 \text{ gm.} \end{aligned}$$

$$\begin{aligned} \text{Curies at saturation} &= \frac{0.00092(5 \times 10^8)(3.25 \times 10^{10})}{3.7 \times 10^{10}} \\ &= 0.416 \times 10^6 \text{ curies.} \end{aligned}$$

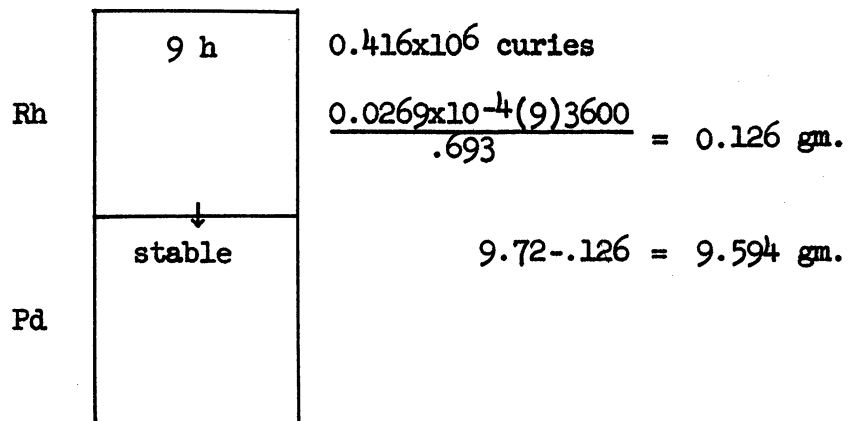

Mass number 109 (Yield 0.00074)

$$\begin{aligned} \text{Grams/second} &= \frac{0.00074(5 \times 10^8)(3.25 \times 10^{10})109}{6.023 \times 10^{23}} \\ &= 0.0219 \times 10^{-4} \text{ gm/sec.} \end{aligned}$$

$$\begin{aligned} \text{Total grams} &= 0.0219 \times 10^{-4} (42) 24 (3600), \\ &= 7.9 \text{ gm.} \end{aligned}$$

$$\begin{aligned} \text{Curies at saturation} &= \frac{0.00074(5 \times 10^8)(3.25 \times 10^{10})}{3.7 \times 10^{10}}, \\ &= 0.335 \times 10^6 \text{ curies.} \end{aligned}$$

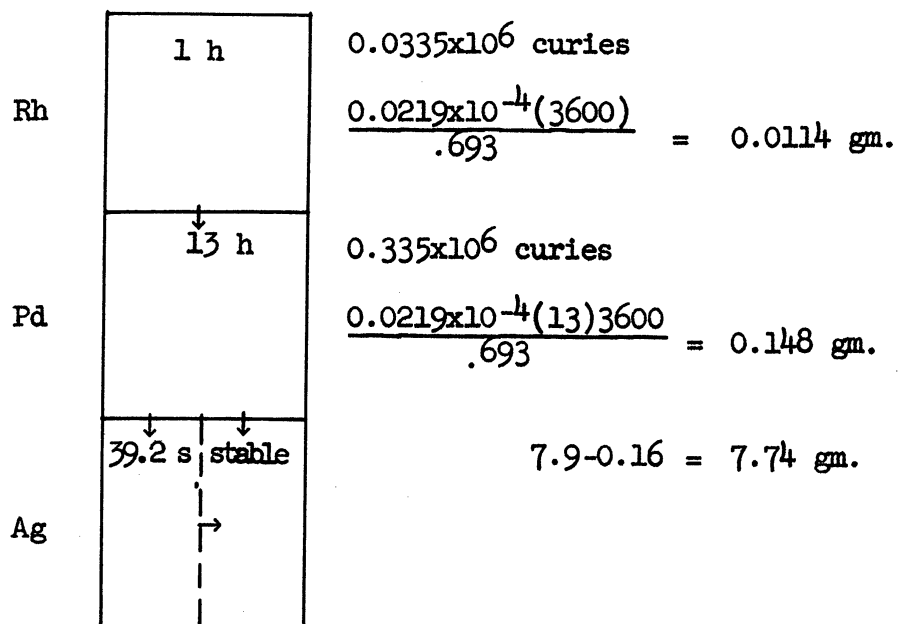

Mass number 110 (Yield 0.00067)

$$\text{Grams/second} = \frac{0.00067(5 \times 10^8)(3.25 \times 10^{10})110}{6.023 \times 10^{23}}$$

$$= 0.020 \times 10^{-4} \text{ gm/sec.}$$

$$\text{Total grams} = 0.020 \times 10^{-4}(42)24(3600),$$

$$= 7.26 \text{ gm.}$$

Pd

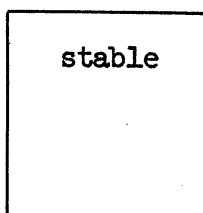

7.26 gm.

Mass number 111 (Yield 0.00063)

$$\begin{aligned} \text{Grams/second} &= \frac{0.00063(5 \times 10^8)(3.25 \times 10^{10})111}{6.023 \times 10^{23}} \\ &= 0.019 \times 10^{-4} \text{ gm/sec.} \end{aligned}$$

$$\begin{aligned} \text{Total grams} &= 0.019 \times 10^{-4} (42) 24 (3600), \\ &= 6.9 \text{ gm.} \end{aligned}$$

$$\begin{aligned} \text{Curies at saturation} &= \frac{0.00063(5 \times 10^8)(3.25 \times 10^{10})}{3.7 \times 10^{10}}, \\ &= 0.285 \times 10^6 \text{ curies} \end{aligned}$$

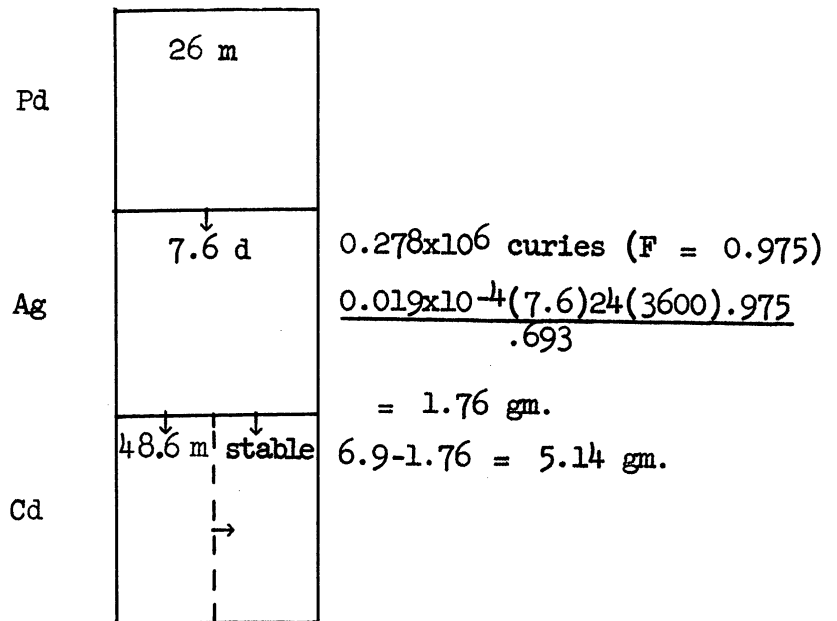

Mass number 112 (Yield 0.00060)

$$\text{Grams/second} = \frac{0.00060(5 \times 10^8)(3.25 \times 10^{10})112}{6.023 \times 10^{23}}$$

$$= 0.0183 \times 10^{-4} \text{ gm/sec.}$$

$$\text{Total grams} = 0.0183 \times 10^{-4}(42)24(3600),$$

$$= 6.65 \text{ gm.}$$

$$\text{Curies at saturation} = \frac{0.00060(5 \times 10^8)(3.25 \times 10^{10})}{3.7 \times 10^{10}},$$

$$= 0.272 \times 10^6 \text{ curies.}$$

Pd	21 h	0.272×10^6 curies	
	↓		
Ag	3.2 h	0.272×10^6 curies	
	↓		
Cd	stable		$6.65 - 0.23 = 6.42 \text{ gm.}$

Mass number 113 (Yield 0.00058)

$$\begin{aligned} \text{Grams/second} &= \frac{0.00058(5 \times 10^8)(3.25 \times 10^{10})113}{6.023 \times 10^{23}} \\ &= 0.0177 \times 10^{-4} \text{ gm/sec.} \end{aligned}$$

$$\begin{aligned} \text{Total grams} &= 0.0177 \times 10^{-4} (42) 24 (3600), \\ &= 6.36 \text{ gm.} \end{aligned}$$

$$\begin{aligned} \text{Curies at saturation} &= \frac{0.00058(5 \times 10^8)(3.25 \times 10^{10})}{3.7 \times 10^{10}} \\ &= 0.263 \times 10^6 \text{ curies.} \end{aligned}$$

Ag	5.3 h	
	<div style="display: flex; justify-content: space-around;"> ↓ ↓ </div> <div style="display: flex; justify-content: space-between;"> 2.3 m stable </div>	
Cd		

0.263×10^6 curies

$\frac{0.0177 \times 10^{-4} (5.3) 3600}{.693} = 0.0488 \text{ gm.}$

$6.36 - 0.049 = 6.311 \text{ gm.}$

Mass number 114 (Yield 0.00056)

$$\begin{aligned} \text{Grams/second} &= \frac{0.00056(5 \times 10^8)(3.25 \times 10^{10})114}{6.023 \times 10^{23}} \\ &= 0.0173 \times 10^{-4} \text{ gm/sec.} \\ \text{Total grams} &= 0.0173 \times 10^{-4} (42)24(3600), \\ &= 6.21 \text{ gm.} \end{aligned}$$

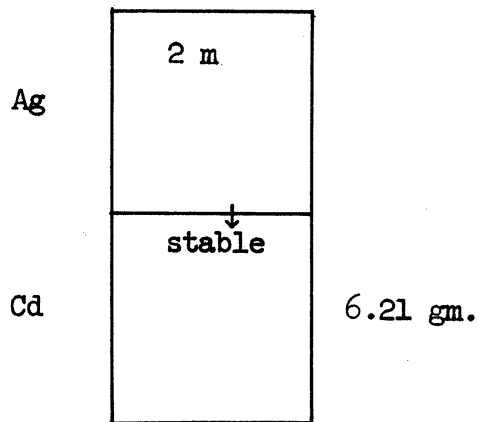

Mass number 115 (Yield 0.00055)

$$\begin{aligned} \text{Grams/second} &= \frac{0.00055(5 \times 10^8)(3.25 \times 10^{10})115}{6.023 \times 10^{23}} \\ &= 0.0171 \times 10^{-4} \text{ gm/sec.} \end{aligned}$$

$$\begin{aligned} \text{Total grams} &= 0.0171 \times 10^{-4} (42)24(3600), \\ &= 6.15 \text{ gm.} \end{aligned}$$

$$\begin{aligned} \text{Curies at saturation} &= \frac{0.00055(5 \times 10^8)(3.25 \times 10^{10})}{3.7 \times 10^{10}}, \\ &= 0.249 \times 10^6 \text{ curies.} \end{aligned}$$

$$0.125 \times 10^6 \text{ curies}$$

$$\frac{0.0171 \times 10^{-4} (2.33)24(3600) \cdot 5}{.693} \text{ Cd}$$

$$= 0.27 \text{ gm.}$$

$$0.125 \times 10^6 \text{ curies}$$

Ag

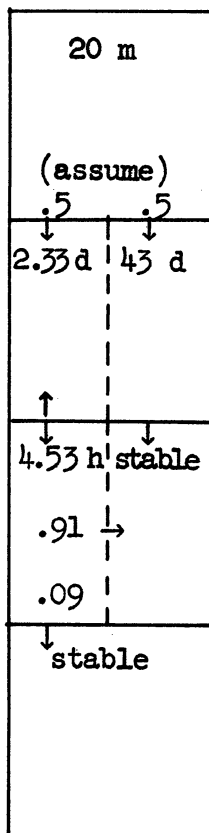

$$0.0625 \times 10^6 \text{ curies (F = 0.5)}$$

$$\frac{0.0171 \times 10^{-4} (43)24(3600) \cdot 5 \cdot (.5)}{.693}$$

$$= 2.3 \text{ gm.}$$

$$(3.075) - 2.3 + (3.075 - 0.27) \cdot 91$$

$$= 3.35 \text{ gm.}$$

In

Sn

$$(3.075 - 0.27) \cdot 0.09 = 0.253 \text{ gm.}$$

Mass number 116 (Yield 0.00054)

$$\text{Grams/second} = \frac{0.00054(5 \times 10^8)(3.25 \times 10^{10})116,}{6.023 \times 10^{23}}$$

$$= 0.0169 \times 10^{-4} \text{ gm/sec.}$$

$$\text{Total grams} = 0.0169 \times 10^{-4}(42)24(3600),$$

$$= 6.09 \text{ gm.}$$

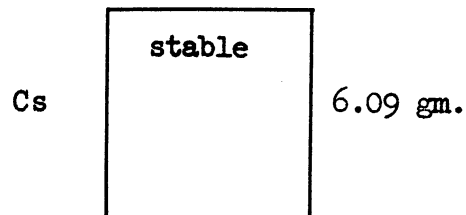

Mass number 118 (Yield 0.00054)

$$\begin{aligned} \text{Grams/second} &= \frac{0.00054(5 \times 10^8)(3.25 \times 10^{10})118}{6.023 \times 10^{23}} \\ &= 0.0172 \times 10^{-4} \text{ gm/sec.} \end{aligned}$$

$$\begin{aligned} \text{Total grams} &= 0.0172 \times 10^{-4}(42)24(3600), \\ &= 6.19 \text{ gm.} \end{aligned}$$

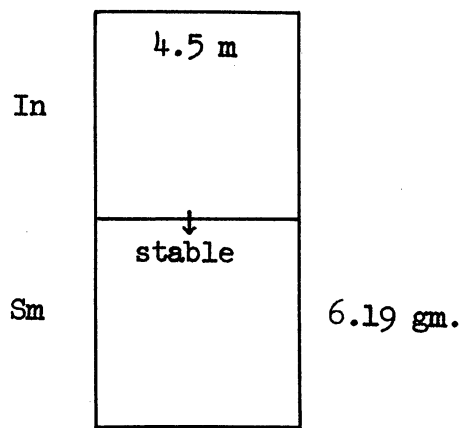

Mass number 119 (Yield 0.00056)

$$\begin{aligned} \text{Grams/second} &= \frac{0.00056(5 \times 10^8)(3.25 \times 10^{10})119}{6.023 \times 10^{23}} \\ &= 0.018 \times 10^{-4} \text{ gm/sec.} \end{aligned}$$

$$\begin{aligned} \text{Total grams} &= 0.018 \times 10^{-4}(42)24(3600), \\ &= 6.47 \text{ gm.} \end{aligned}$$

$$\begin{aligned} \text{Curies at saturation} &= \frac{0.00056(5 \times 10^8)(3.25 \times 10^{10})}{3.7 \times 10^{10}}, \\ &= 0.254 \times 10^6 \text{ curies.} \end{aligned}$$

$$\begin{aligned} &0.0317 \times 10^6 \text{ curies (F = .25)} \\ &\frac{0.018 \times 10^{-4}(100)24(3600) \cdot 5(.25)}{.693 \quad \text{Sm}} \\ &= 0.28 \text{ gm.} \end{aligned}$$

In

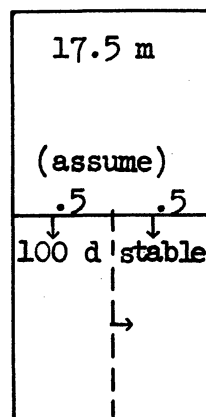

$$6.47 - 0.28 = 6.19 \text{ gm.}$$

Mass number 120 (Yield 0.00057)

$$\text{Grams/second} = \frac{0.00057(5 \times 10^8)(3.25 \times 10^{10})120}{6.023 \times 10^{23}}$$

$$= 0.0185 \times 10^{-4} \text{ gm/sec.}$$

$$\text{Total grams} = 0.0185 \times 10^{-4}(42)24(3600),$$

$$= 6.62 \text{ gm.}$$

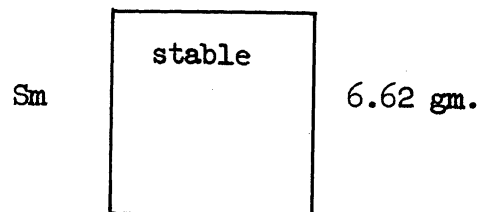

Mass number 121 (Yield 0.00059)

$$\begin{aligned} \text{Grams/second} &= \frac{0.00059(5 \times 10^8)(3.25 \times 10^{10})^{121}}{6.023 \times 10^{23}} \\ &= 0.0193 \times 10^{-4} \text{ gm/sec.} \end{aligned}$$

$$\begin{aligned} \text{Total grams} &= 0.0193 \times 10^{-4} (42) 24 (3600), \\ &= 6.94 \text{ gm.} \end{aligned}$$

$$\begin{aligned} \text{Curies at saturation} &= \frac{0.00059(5 \times 10^8)(3.25 \times 10^{10})}{3.7 \times 10^{10}}, \\ &= 0.268 \times 10^6 \text{ curies.} \end{aligned}$$

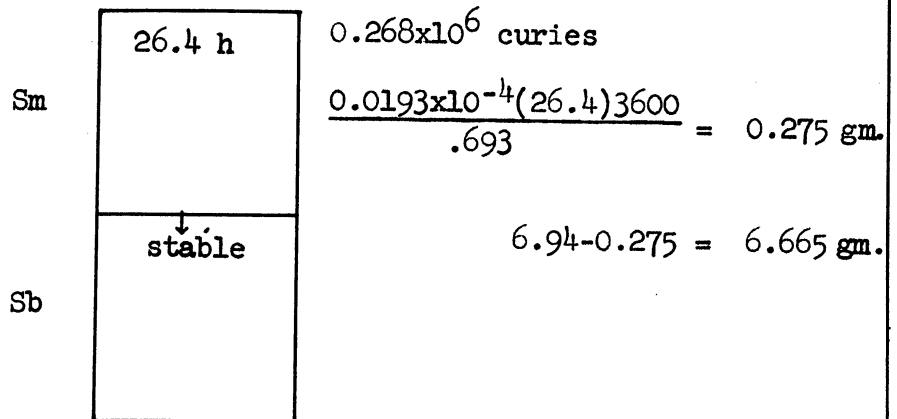

Mass number 122 (Yield 0.00062)

$$\begin{aligned} \text{Grams/second} &= \frac{0.00062(5 \times 10^8)(3.25 \times 10^{10})122,}{6.023 \times 10^{23}} \\ &= 0.0205 \times 10^{-4} \text{ gm/sec.} \\ \text{Total grams} &= 0.0205 \times 10^{-4}(42)24(3600), \\ &= 7.36 \text{ gm.} \end{aligned}$$

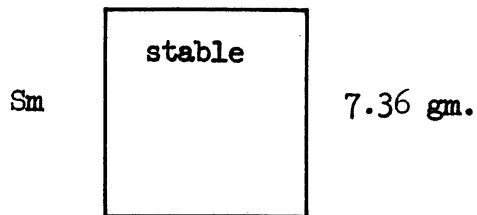

Mass number 123 (Yield 0.00066)

$$\begin{aligned} \text{Grams/second} &= \frac{0.00066(5 \times 10^8)(3.25 \times 10^{10})123,}{6.023 \times 10^{23}} \\ &= 0.0219 \times 10^{-4} \text{ gm/sec.} \end{aligned}$$

$$\begin{aligned} \text{Total grams} &= 0.0219 \times 10^{-4} (42)24(3600), \\ &7.89 \text{ gm.} \end{aligned}$$

$$\begin{aligned} \text{Curies at saturation} &= \frac{0.00066(5 \times 10^8)(3.25 \times 10^{10}),}{3.7 \times 10^{10}} \\ &= 0.299 \times 10^6 \text{ curies.} \end{aligned}$$

$$\begin{aligned} &0.0299 \times 10^6 \text{ curies (F = .2)} \\ &\frac{0.0219 \times 10^{-4} (130)24(3600) \cdot 2(.5)}{.693} \text{ Sm} \\ &= 3.56 \text{ gm.} \end{aligned}$$

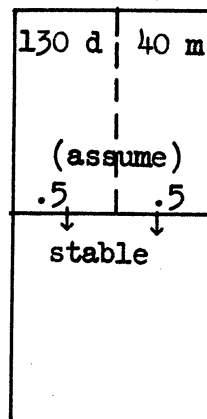

Sb

$$7.89 - 3.56 = 4.33 \text{ gm.}$$

Mass number 124 (Yield 0.00072)

$$\begin{aligned} \text{Grams/second} &= \frac{0.00072(5 \times 10^8)(3.25 \times 10^{10})124}{6.023 \times 10^{23}} \\ &= 0.0242 \times 10^{-4} \text{ gm/sec.} \\ \text{Total grams} &= 0.0242 \times 10^{-4}(42)24(3600), \\ &= 8.7 \text{ gm.} \end{aligned}$$

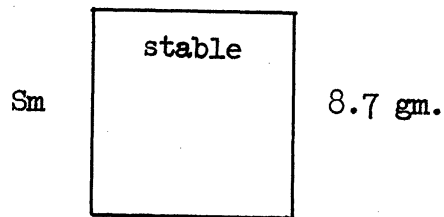

Mass number 125 (Yield 0.00084)

$$\begin{aligned} \text{Grams/second} &= \frac{0.00084(5 \times 10^8)(3.25 \times 10^{10})125}{6.023 \times 10^{23}} \\ &= 0.0284 \times 10^{-4} \text{ gm/sec.} \end{aligned}$$

$$\begin{aligned} \text{Total grams} &= 0.0284 \times 10^{-4} (42) 24 (3600), \\ &= 10.2 \text{ gm.} \end{aligned}$$

$$\begin{aligned} \text{Curies at saturation} &= \frac{0.00084(5 \times 10^8)(3.25 \times 10^{10})}{3.7 \times 10^{10}}, \\ &= 0.38 \times 10^6 \text{ curies.} \end{aligned}$$

$$\begin{aligned} &0.180 \times 10^6 \text{ curies (F = 0.95)} \\ &\frac{0.0284 \times 10^{-4} (10) 24 (3600) .95 (.5)}{.693} \text{ Sm} \\ &= 1.68 \text{ gm.} \end{aligned}$$

$$\begin{aligned} &0.0585 \times 10^6 \text{ curies (F = 0.308)} \\ &\frac{.0284 \times 10^{-4} (50) 24 (3600) .308 (.5)}{.693} \text{ Sb} \\ &= 2.72 \text{ gm.} \end{aligned}$$

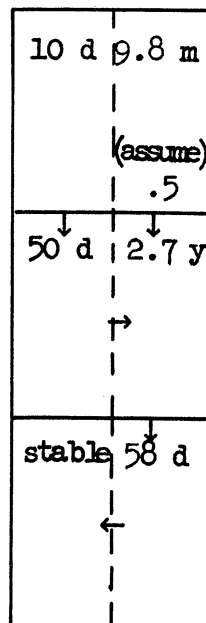

$$10.2 - 4.4 = 5.8 \text{ gm.}$$

Te

Mass number 126 (Yield 0.001)

$$\begin{aligned} \text{Grams/second} &= \frac{0.001(5 \times 10^8)(3.25 \times 10^{10})126}{6.023 \times 10^{10}} \\ &= 0.034 \times 10^{-4} \text{ gm/sec.} \end{aligned}$$

$$\begin{aligned} \text{Total grams} &= 0.034 \times 10^{-4} (42) 24 (3600), \\ &= 12.2 \text{ gm.} \end{aligned}$$

$$\begin{aligned} \text{Curies at saturation} &= \frac{0.001(5 \times 10^8)(3.25 \times 10^{10})}{3.7 \times 10^{10}}, \\ &= 0.439 \times 10^6 \text{ curies.} \end{aligned}$$

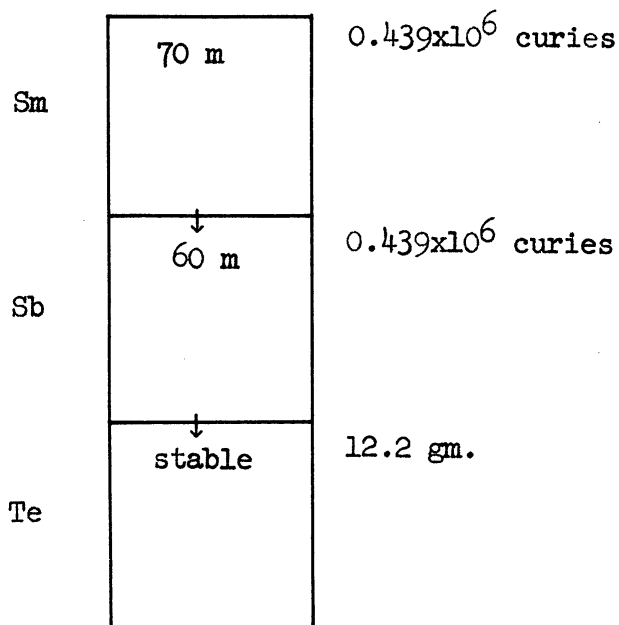

Mass number 128 (Yield 0.0026)

$$\text{Grams/second} = \frac{0.0026(5 \times 10^8)(3.25 \times 10^{10})128}{6.023 \times 10^{23}}$$

$$\begin{aligned} \text{Total grams} &= 0.09 \times 10^{-4} \text{ gm/sec.} \\ &= 0.09 \times 10^{-4} (42)24(3600), \\ &= 32.3 \text{ gm.} \end{aligned}$$

Te

stable

32.3 gm.

ENGINEERING RESEARCH INSTITUTE • UNIVERSITY OF MICHIGAN

Mass number 129 (Yield 0.0064)

$$\begin{aligned} \text{Grams/second} &= \frac{0.0064(5 \times 10^8)(3.25 \times 10^{10})129}{6.023 \times 10^{23}} \\ &= 0.223 \times 10^{-4} \text{ gm/sec.} \end{aligned}$$

$$\begin{aligned} \text{Total grams} &= 0.223 \times 10^{-4}(42)24(3600) \\ &= 80.3 \text{ gm.} \end{aligned}$$

$$\begin{aligned} \text{Curies at saturation} &= \frac{0.0064(5 \times 10^8)(3.25 \times 10^{10})}{3.7 \times 10^{10}} \\ &= 2.72 \times 10^6 \text{ curies.} \end{aligned}$$

$$\begin{aligned} &0.815 \times 10^6 \text{ curies (F = .60)} \\ &\frac{0.223 \times 10^{-4}(32)24(3600) \cdot 6(.5)}{.693} \\ &= 26.8 \text{ gm.} \end{aligned}$$

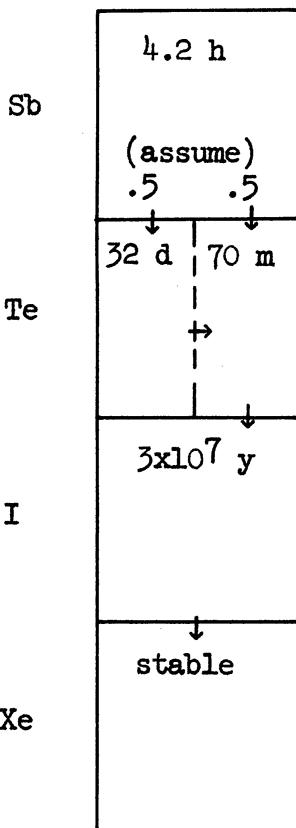

$$\begin{aligned} &2.72 \times 10^6 \text{ curies} \\ &\frac{0.223 \times 10^{-4}(4.2)3600}{.693} = 0.49 \text{ gm.} \end{aligned}$$

$$\frac{1.36 \times 10^6 \text{ curies}}{0.815} = 2.18 \times 10^6 \text{ curies}$$

$$80.3 - 27.29 = 53.01 \text{ gm.}$$

ENGINEERING RESEARCH INSTITUTE • UNIVERSITY OF MICHIGAN

Mass number 130 (Yield 0.015)

$$\begin{aligned}\text{Grams/second} &= \frac{0.015(5 \times 10^8)(3.25 \times 10^{10})130,}{6.023 \times 10^{23}} \\ &= 0.527 \times 10^{-4} \text{ gm/sec.} \\ \text{Total grams} &= 0.527 \times 10^{-4}(42)24(3600) \\ &= 192 \text{ gm.}\end{aligned}$$

Te

stable

 192 gm.

ENGINEERING RESEARCH INSTITUTE • UNIVERSITY OF MICHIGAN

Mass number 131 (Yield 0.028)

$$\begin{aligned} \text{Grams/second} &= \frac{0.028(5 \times 10^8)(3.25 \times 10^{10})131}{6.023 \times 10^{23}} \\ &= 0.99 \times 10^{-4} \text{ gm/sec.} \end{aligned}$$

$$\begin{aligned} \text{Total grams} &= 0.99 \times 10^{-4}(42)24(3600), \\ &= 360 \text{ gm.} \end{aligned}$$

$$\begin{aligned} \text{Curies at saturation} &= \frac{0.028(5 \times 10^8)(3.25 \times 10^{10})}{3.7 \times 10^{10}}, \\ &= 12.3 \times 10^6 \text{ curies.} \end{aligned}$$

12.3×10^6 curies

$$\frac{0.99 \times 10^{-4}(30)3600}{.693} = 15.5 \text{ gm. Te}$$

I

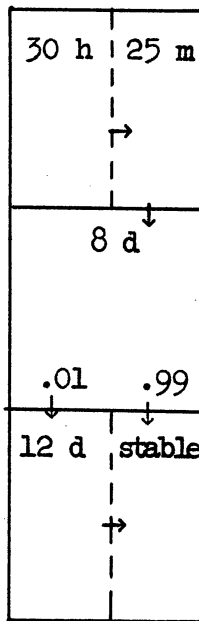

11.9×10^6 curies (F = 0.97)

$$\frac{0.99 \times 10^{-4}(8)24(3600).97}{.693} = 95.9 \text{ gm.}$$

$$\begin{aligned} &\frac{.693(2.4)6.023 \times 10^{23}}{1.2(2.4)3600(13.1)3.7 \times 10^{10}} \text{ Xe} \\ &= 0.20 \times 10^6 \text{ curies} \\ &(360 - 15.5 - 95.9)0.01 = 2.4 \text{ gm.} \end{aligned}$$

$$(360 - 15.5 - 95.9).99 = 246.2 \text{ gm.}$$

Mass number 132 (Yield 0.045)

$$\begin{aligned} \text{Grams/second} &= \frac{0.045(5 \times 10^8)(3.25 \times 10^{10})132,}{6.023 \times 10^{23}} \\ &= 1.6 \times 10^{-4} \text{ gm/sec.} \end{aligned}$$

$$\begin{aligned} \text{Total grams} &= 1.6 \times 10^{-4}(42)24(3600), \\ &= 582 \text{ gm.} \end{aligned}$$

$$\begin{aligned} \text{Curies at saturation} &= \frac{0.045(5 \times 10^8)(3.25 \times 10^{10}),}{3.7 \times 10^{10}} \\ &= 19.8 \times 10^6 \text{ curies.} \end{aligned}$$

Sb	5 m	
Te	77 h	$19.8 \times 10^6 \text{ curies}$ $\frac{1.6 \times 10^{-4}(77)3600}{.693} = 64.1 \text{ gm.}$
I	2.4 h	$19.8 \times 10^6 \text{ curies}$ $\frac{1.6 \times 10^{-4}(2.4)3600}{.693} = 2.0 \text{ gm.}$
Xe	stable	$582 - 66.1 = 515.9 \text{ gm.}$

Mass number 133 (Yield 0.060)

$$\begin{aligned} \text{Grams/second} &= \frac{0.060(5 \times 10^8)(3.25 \times 10^{10})133}{6.023 \times 10^{23}} \\ &= 2.15 \times 10^{-4} \text{ gm/sec.} \end{aligned}$$

$$\begin{aligned} \text{Total grams} &= 2.15 \times 10^{-4}(42)24(3600), \\ &= 772 \text{ gm.} \end{aligned}$$

$$\begin{aligned} \text{Curies at saturation} &= \frac{0.060(5 \times 10^8)(3.25 \times 10^{10})}{3.7 \times 10^{10}}, \\ &= 26.4 \times 10^6 \text{ curies.} \end{aligned}$$

Sb	10 m	
Te	66 m	26.5 × 10 ⁶ curies $\frac{2.15 \times 10^{-4}(66)60}{.693} = 1.23 \text{ gm.}$
I	22.4 h	26.5 × 10 ⁶ curies $\frac{2.15 \times 10^{-4}22.4(3600)}{.693} = 25.1 \text{ gm.}$
Xe	5.27 d	26.5 × 10 ⁶ curies $\frac{5.27(24)3600(2.15 \times 10^{-4})}{.693} = 141 \text{ gm.}$
Cs	stable	792 - 167.33 = 604.67 gm

ENGINEERING RESEARCH INSTITUTE • UNIVERSITY OF MICHIGAN

Mass number 134 (Yield 0.078)

$$\text{Grams/second} = \frac{0.078(5 \times 10^8)(3.25 \times 10^{10})134}{6.023 \times 10^{23}}$$

$$= 2.79 \times 10^{-4} \text{ gm/sec.}$$

$$\text{Total grams} = 2.79 \times 10^{-4}(42)24(3600),$$

$$= 1016 \text{ gm.}$$

$$\text{Curies at saturation} = \frac{0.078(5 \times 10^8)(3.25 \times 10^{10})}{3.7 \times 10^{10}},$$

$$= 34.3 \times 10^6 \text{ curies.}$$

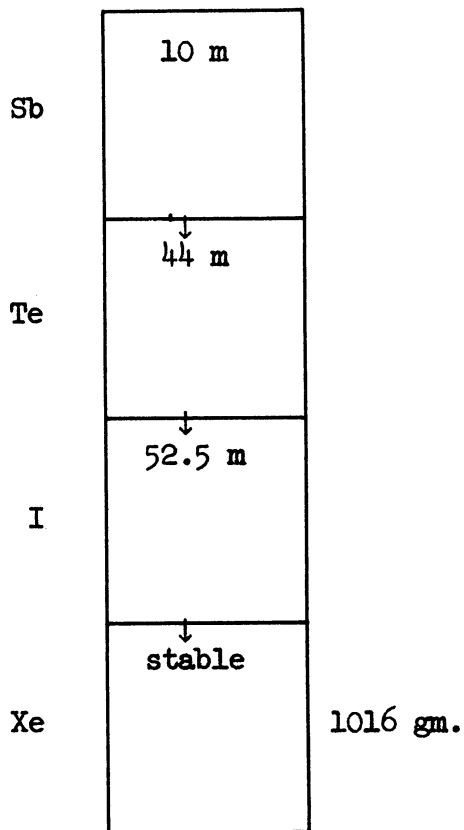

ENGINEERING RESEARCH INSTITUTE • UNIVERSITY OF MICHIGAN

Mass number 135 (Yield 0.064)

$$\text{Grams/second} = \frac{0.064(5 \times 10^8)(3.25 \times 10^{10})^{135}}{6.023 \times 10^{23}}$$

$$2.31 \times 10^{-4} \text{ gm/sec.}$$

$$\text{Total grams} = 2.31 \times 10^{-4}(42)24(3600),$$

$$840 \text{ gm.}$$

$$\text{Curies at saturation} = \frac{0.064(5 \times 10^8)(3.25 \times 10^{10})}{3.7 \times 10^{10}}$$

$$28.2 \times 10^6 \text{ curies.}$$

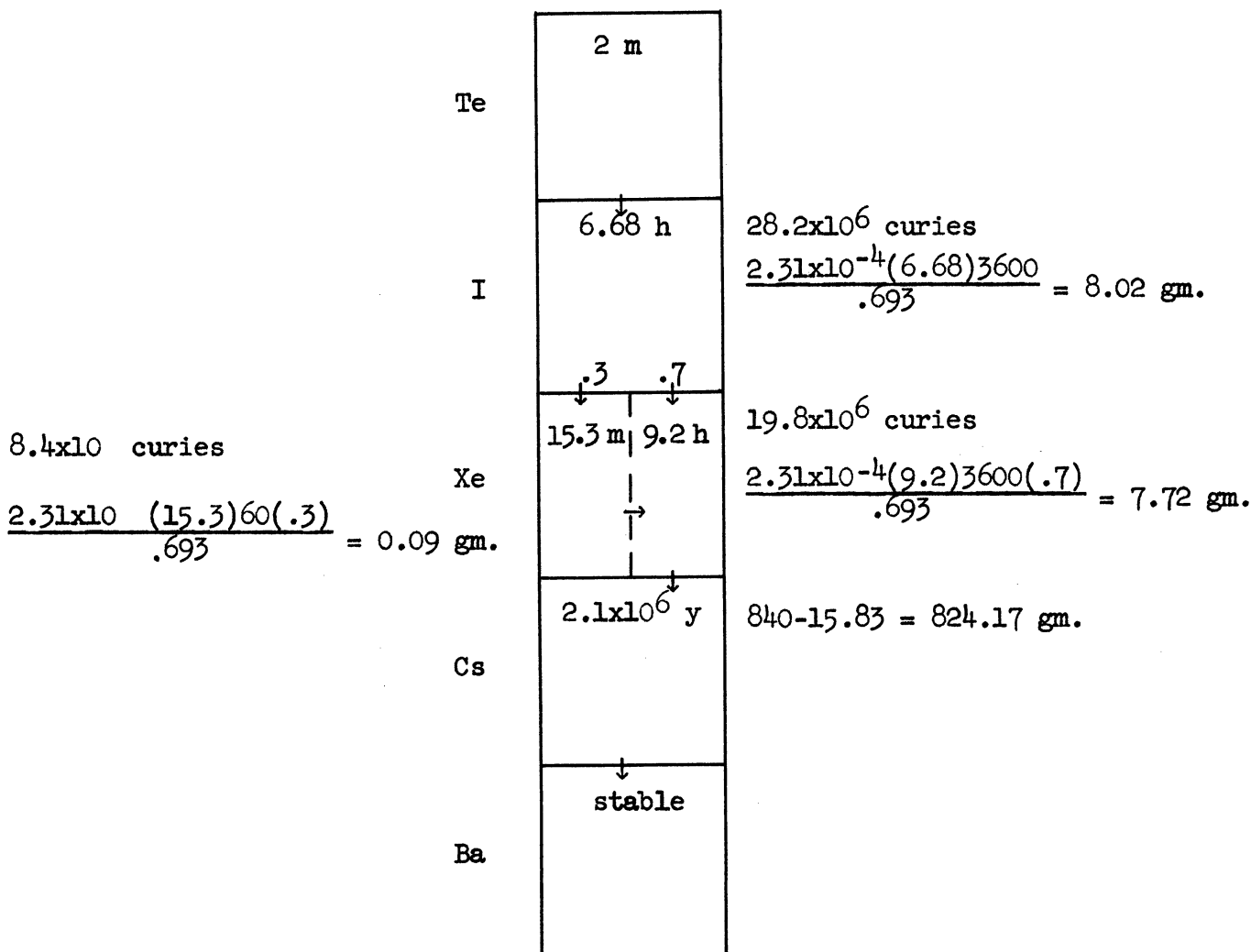

ENGINEERING RESEARCH INSTITUTE • UNIVERSITY OF MICHIGAN

Mass number 136 (Yield 0.059)

$$\begin{aligned} \text{Grams/second} &= \frac{0.059(5 \times 10^8)(3.25 \times 10^{10})136,}{6.023 \times 10^{23}} \\ &= 2.15 \times 10^{-4} \text{ gm/sec.} \end{aligned}$$

$$\begin{aligned} \text{Total grams} &= 2.15 \times 10^4 (42) 24 (3600), \\ &= 781 \text{ gm.} \end{aligned}$$

$$\begin{aligned} \text{Curies at saturation} &= \frac{0.059(5 \times 10^8)(3.25 \times 10^{10}),}{3.7 \times 10^7} \\ &= 26 \times 10^6 \text{ curies.} \end{aligned}$$

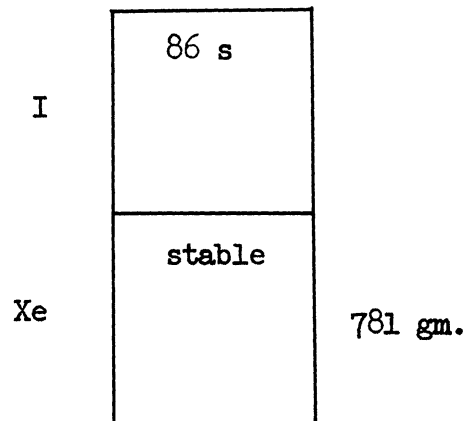

Mass number 137 (Yield 0.058)

$$\begin{aligned} \text{Grams/second} &= \frac{0.058(5 \times 10^8)(3.25 \times 10^{10})137}{6.023 \times 10^{23}} \\ &= 2.13 \times 10^{-4} \text{ gm/sec.} \end{aligned}$$

$$\begin{aligned} \text{Total grams} &= 2.13 \times 10^{-4}(42)24(3600), \\ &= 775 \text{ gm.} \end{aligned}$$

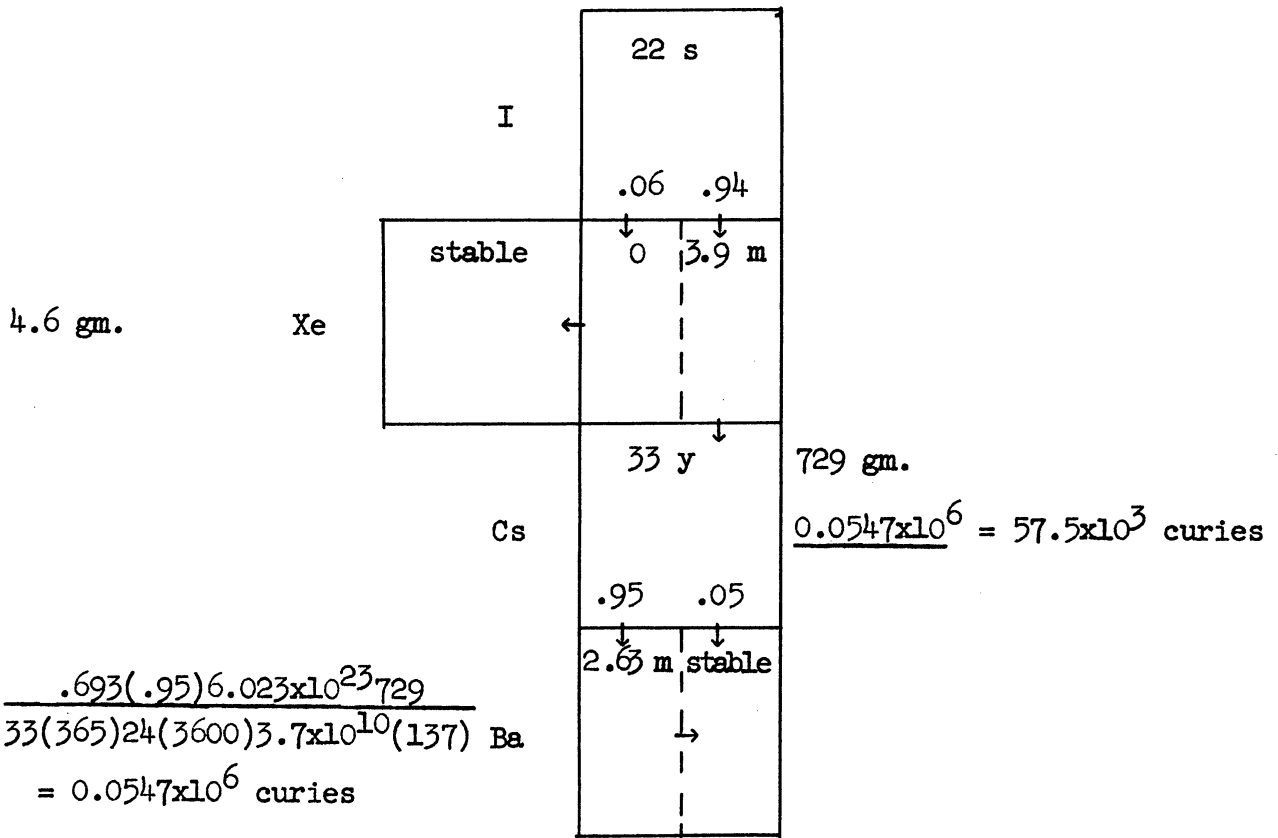

Mass number 138 (Yield 0.062)

$$\begin{aligned} \text{Grams/second} &= \frac{0.062(5 \times 10^8)(3.25 \times 10^{10})138}{6.023 \times 10^{23}} \\ &= 2.31 \times 10^{-4} \text{ gm/sec.} \end{aligned}$$

$$\begin{aligned} \text{Total grams} &= 2.31 \times 10^{-4} (42) 24 (3600), \\ &= 840 \text{ gm.} \end{aligned}$$

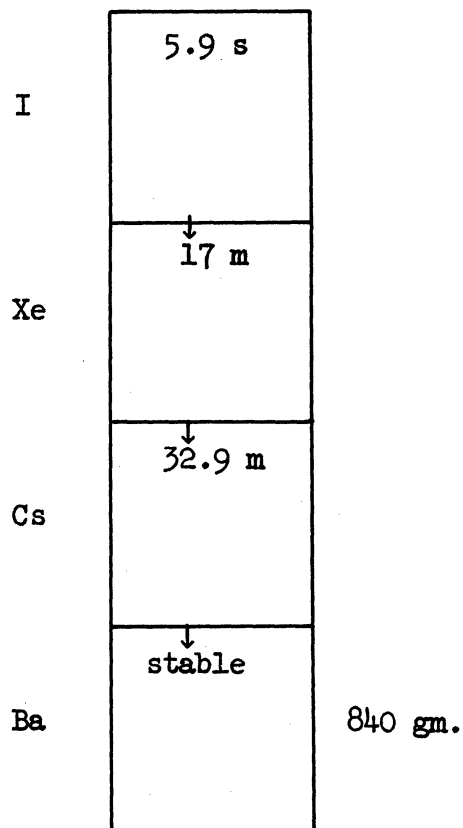

ENGINEERING RESEARCH INSTITUTE • UNIVERSITY OF MICHIGAN

Mass number 139 (Yield 0.064)

$$\begin{aligned} \text{Grams/second} &= \frac{0.064(5 \times 10^8)(3.25 \times 10^{10})139}{6.023 \times 10^{23}} \\ &= 2.4 \times 10^{-4} \text{ gm/sec.} \end{aligned}$$

$$\begin{aligned} \text{Total grams} &= 2.4 \times 10^{-4}(42)24(3600), \\ &= 872 \text{ gm.} \end{aligned}$$

$$\begin{aligned} \text{Curies at saturation} &= \frac{0.064(5 \times 10^8)(3.25 \times 10^{10})}{3.7 \times 10^{10}}, \\ &= 28.2 \times 10 \text{ curies.} \end{aligned}$$

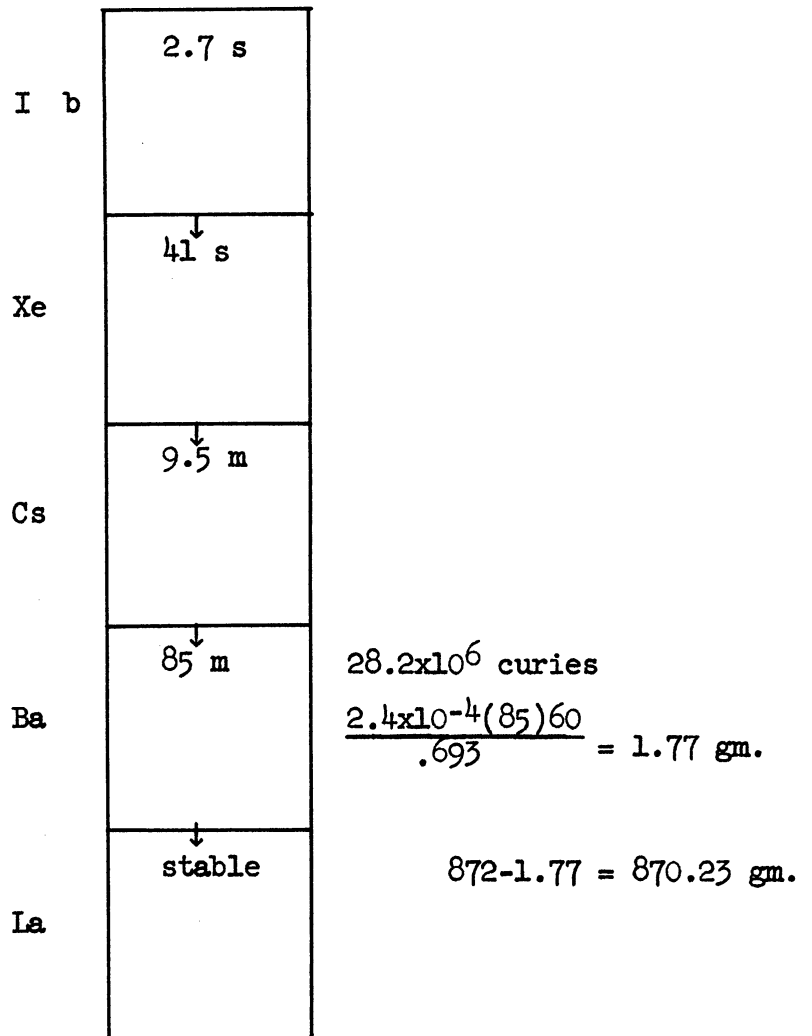

ENGINEERING RESEARCH INSTITUTE • UNIVERSITY OF MICHIGAN

Mass number 140 (Yield 0.063)

$$\begin{aligned} \text{Grams/second} &= \frac{0.063(5 \times 10^8)(3.25 \times 10^{10})140}{6.023 \times 10^{23}} \\ &= 2.38 \times 10^{-4} \text{ gm/sec.} \end{aligned}$$

$$\begin{aligned} \text{Total grams} &= 2.38 \times 10^{-4} (42) 24) 3600, \\ &= 865 \text{ gm.} \end{aligned}$$

$$\begin{aligned} \text{Curies at saturation} &= \frac{0.063(5 \times 10^8)(3.25 \times 10^{10})}{3.7 \times 10^{10}}, \\ &= 27.8 \times 10^6 \text{ curies.} \end{aligned}$$

Xe	16 s	
	↓	
Cs	66 s	
	↓	
Ba	12.8 d	$24.6 \times 10^6 \text{ curies (F = .885)}$ $\frac{2.38 \times 10^{-4} (12.8) 24 (3600) (.885)}{.693}$ $= 337 \text{ gm.}$
	↓	
La	40 h	$24.5 \times 10^6 \text{ curies (F = .88)}$ $\frac{2.38 \times 10^{-4} (40) 3600}{.693} = 43.5 \text{ gm.}$
	↓	
Ce	stable	$865 - 380.5 = 484.5 \text{ gm.}$

ENGINEERING RESEARCH INSTITUTE • UNIVERSITY OF MICHIGAN

Mass number 141 (Yield 0.060)

$$\begin{aligned} \text{Grams/second} &= \frac{0.060(5 \times 10^8)(3.25 \times 10^{25})141,}{6.023 \times 10^{23}} \\ &= 2.28 \times 10^{-4} \text{ gm/sec.} \end{aligned}$$

$$\begin{aligned} \text{Total grams} &= 2.28 \times 10^{-4}(42)24(3600), \\ &= 830 \text{ gm.} \end{aligned}$$

$$\begin{aligned} \text{Curies at saturation} &= \frac{0.060(5 \times 10^8)(3.25 \times 10^{10}),}{3.7 \times 10^{10}} \\ &= 26.5 \times 10^6 \text{ curies.} \end{aligned}$$

Xe	3 s	
Cs	short	
Ba	18 m	
Ia	3.7 h	26.5×10^6 curies
Ce	30 d	$\frac{2.28 \times 10^{-4}(3.7)3600}{.693} = 4.39 \text{ gm.}$
Pr	stable	16.4×10^6 curies (F = .62)
		$\frac{2.28 \times 10^{-4}(30)24(3600)(.62)}{.693} = 530 \text{ gm.}$
		$830 - 534.39 = 295.61 \text{ gm.}$

Mass number 142 (Yield 0.055)

$$\begin{aligned} \text{Grams/second} &= \frac{0.055(5 \times 10^8)(3.25 \times 10^{10})142}{6.023 \times 10^{23}} \\ &= 2.1 \times 10^{-4} \text{ gm/sec.} \end{aligned}$$

$$\begin{aligned} \text{Total grams} &= 2.1 \times 10^{-4}(42)24(3600), \\ &= 766 \text{ gm.} \end{aligned}$$

$$\begin{aligned} \text{Curies at saturation} &= \frac{0.055(5 \times 10^8)(3.25 \times 10^{10})}{3.7 \times 10^{10}}, \\ &= 24.3 \times 10^6 \text{ curies.} \end{aligned}$$

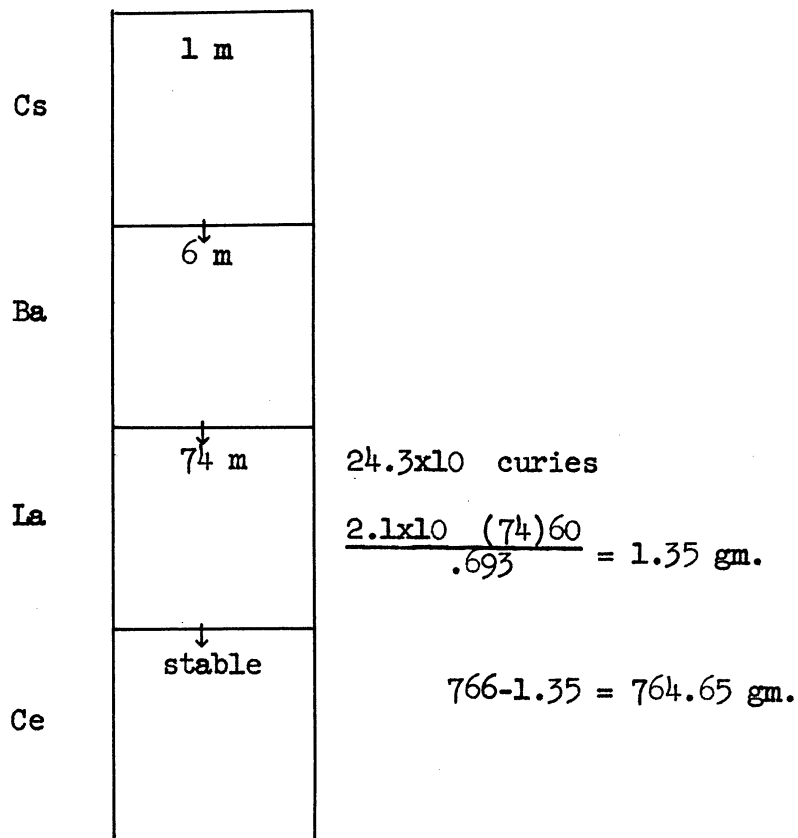

ENGINEERING RESEARCH INSTITUTE • UNIVERSITY OF MICHIGAN

Mass number 143 (Yield 0.050)

$$\begin{aligned} \text{Grams/second} &= \frac{0.050(5 \times 10^8)(3.25 \times 10^{10})143}{6.023 \times 10^{23}} \\ &= 1.92 \times 10^{-4} \text{ gm/sec.} \end{aligned}$$

$$\begin{aligned} \text{Total grams} &= 1.92 \times 10^{-4}(42)24(3600), \\ &= 702 \text{ gm.} \end{aligned}$$

$$\begin{aligned} \text{Curies at saturation} &= \frac{0.050(5 \times 10^8)(3.25 \times 10^{10})}{3.7 \times 10^{10}}, \\ &= 22.1 \times 10^6 \text{ curies.} \end{aligned}$$

Xe	1 s	
	↓	
Cs	short	
	↓	
Ba	.5 m	
	↓	
La	19 m	
	↓	
Ce	33 h	$\frac{22.1 \times 10^6 \text{ curies}}{.693} = 33 \text{ gm.}$
	↓	
Pr	13.7 d	$19.2 \times 10^6 \text{ curies (F = .869)}$ $\frac{1.92 \times 10^{-4}(13.7)(24)3600(.869)}{.693} = 285 \text{ gm.}$
	↓	
Nd	stable	702 - 318 = 384 gm.

ENGINEERING RESEARCH INSTITUTE • UNIVERSITY OF MICHIGAN

Mass number 144 (Yield 0.043)

$$\begin{aligned} \text{Grams/second} &= \frac{0.043(5 \times 10^8)(3.25 \times 10^{10})^{144}}{6.023 \times 10^{23}} \\ &= 1.66 \times 10^{-4} \text{ gm/sec.} \end{aligned}$$

$$\begin{aligned} \text{Total grams} &= 1.66 \times 10^{-4} (42)^{24} (3600), \\ &= 608 \text{ gm.} \end{aligned}$$

$$\begin{aligned} \text{Curies at saturation} &= \frac{0.043(5 \times 10^8)(3.25 \times 10^{10})}{3.7 \times 10^{10}}, \\ &= 1.9 \times 10^6 \text{ curies.} \end{aligned}$$

Xe	1 s	
Cs	short	
Ba	short	
La	short	
Ce	275 d	1.9×10^6 curies (F = 0.1) $\frac{1.66 \times 10^{-4} (275)^{24} (3600) 0.1}{.693} = 570 \text{ gm.}$
Pr	17.5 m	1.9×10^6 curies
Nd	stable	608-570 = 38 gm.

ENGINEERING RESEARCH INSTITUTE • UNIVERSITY OF MICHIGAN

Mass number 145 (Yield 0.036)

$$\begin{aligned} \text{Grams/second} &= \frac{0.036(5 \times 10^8)(3.25 \times 10^{10})^{145}}{6.023 \times 10^{23}} \\ &= 1.4 \times 10^{-4} \text{ gm/sec.} \end{aligned}$$

$$\begin{aligned} \text{Total grams} &= 1.4 \times 10^{-4} (42) 24 (3600), \\ &= 513 \text{ gm.} \end{aligned}$$

$$\begin{aligned} \text{Curies at saturation} &= \frac{0.036(5 \times 10^8)(3.25 \times 10^{10})}{3.7 \times 10^{10}}, \\ &= 15.9 \times 10^6 \text{ curies.} \end{aligned}$$

Xe	.8 s	
	↓	
Cs	short	
	↓	
Ba	short	
	↓	
La	short	
	↓	
Ce	1.8 h	$\frac{15.9 \times 10^6 \text{ curies}}{1.4 \times 10^{-4} (1.8) 3600} = 1.31 \text{ gm.}$
	↓	
Pr	4.5 h	$\frac{15.9 \times 10^6 \text{ curies}}{1.4 \times 10^{-4} (4.5) 3600} = 3.27 \text{ gm.}$
	↓	
Nd	stable	$513 - 4.58 = 508.42 \text{ gm.}$

Mass number 146 (Yield 0.028)

$$\begin{aligned} \text{Grams/second} &= \frac{0.028(5 \times 10^8)(3.25 \times 10^{10})146}{6.023 \times 10^{23}} \\ &= 1.095 \times 10^{-4} \text{ gm/sec.} \end{aligned}$$

$$\begin{aligned} \text{Total grams} &= 1.095 \times 10^{-4}(42)24(3600) \\ &= 402 \text{ gm.} \end{aligned}$$

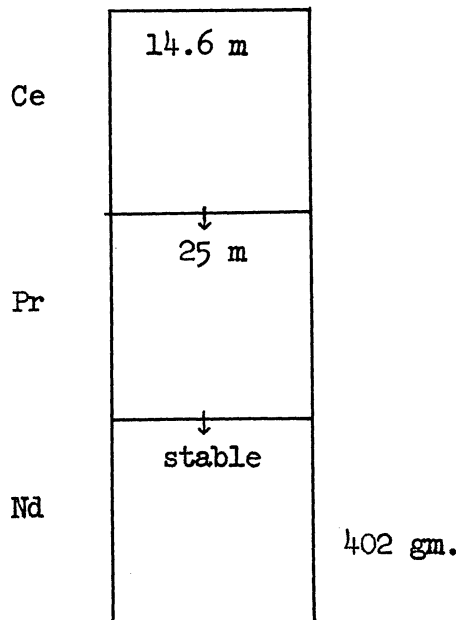

Mass number 147 (Yield 0.021)

$$\begin{aligned} \text{Grams/second} &= \frac{0.021(5 \times 10^8)(3.25 \times 10^{10})147}{6.023 \times 10^{23}} \\ &= 0.828 \times 10^{-4} \text{ gm/sec.} \end{aligned}$$

$$\begin{aligned} \text{Total grams} &= 0.828 \times 10^{-4}(42)24(3600), \\ &= 304 \text{ gm.} \end{aligned}$$

$$\begin{aligned} \text{Curies at saturation} &= \frac{0.021(5 \times 10^8)(3.25 \times 10^{10})}{3.7 \times 10^{10}}, \\ &= 9.28 \times 10^6 \text{ curies.} \end{aligned}$$

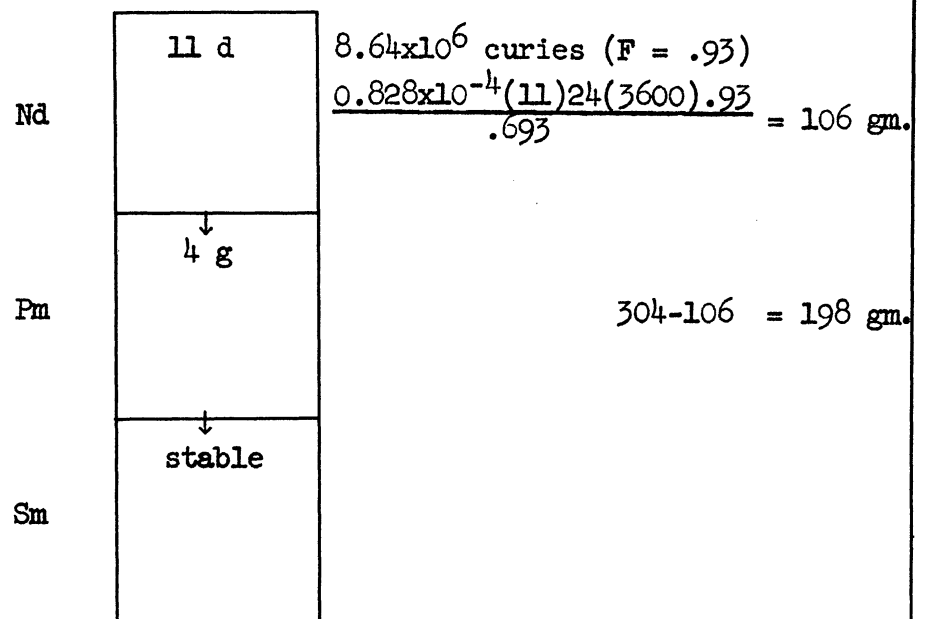

Mass number 148 (Yield 0.015)

$$\text{Grams/second} = \frac{0.015(5 \times 10^8)(3.25 \times 10^{10})148,}{6.023 \times 10^{23}}$$

$$= 0.595 \times 10^{-4} \text{ gm/sec.}$$

$$\text{Total grams} = 0.595 \times 10^{-4}(42)24(3600)$$

$$= 218.5 \text{ gm.}$$

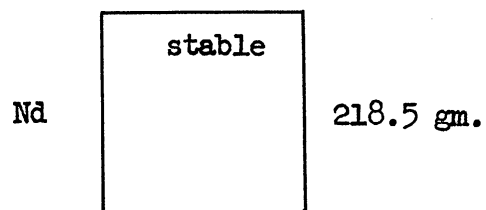

Mass number 149 (Yield 0.01)

$$\begin{aligned} \text{Grams/second} &= \frac{0.01(5 \times 10^8)(3.25 \times 10^{10})149}{6.023 \times 10^{23}} \\ &= 0.4 \times 10^{-4} \text{ gm/sec.} \end{aligned}$$

$$\begin{aligned} \text{Total grams} &= 0.4 \times 10^{-4} (42) 24 (3600) \\ &= 147 \text{ gm.} \end{aligned}$$

$$\begin{aligned} \text{Curies at saturation} &= \frac{0.01(5 \times 10^8)(3.25 \times 10^{10})}{3.7 \times 10^{10}}, \\ &= 4.44 \times 10^6 \text{ curies.} \end{aligned}$$

Nd	2 h	4.44×10^6 curies $\frac{0.4 \times 10^{-4} (2) 3600}{.693}$
	↓	
Pm	47 h	4.44×10^6 curies $\frac{0.4 \times 10^{-4} (47) 3600}{.693}$
	↓	
Sm	stable	$147 - 10.196 = 136.804 \text{ gm.}$

Mass number 150 (Yield 0.0064)

$$\begin{aligned} \text{Grams/second} &= \frac{0.0064(5 \times 10^8)(3.25 \times 10^{10})150,}{6.023 \times 10^{23}} \\ &= 0.258 \times 10^{-4} \text{ gm/sec.} \end{aligned}$$

$$\begin{aligned} \text{Total grams} &= 0.258 \times 10^{-4}(42)24(3600), \\ &= 94.7 \text{ gm.} \end{aligned}$$

Nd stable 94.7 gm.

Mass number 151 (Yield 0.0041)

$$\begin{aligned} \text{Grams/second} &= \frac{0.0041(5 \times 10^8)(3.25 \times 10^{10})151}{6.023 \times 10^{23}} \\ &= 0.166 \times 10^{-4} \text{ gm/sec.} \end{aligned}$$

$$\begin{aligned} \text{Total grams} &= 0.166 \times 10^{-4}(42)24(3600), \\ &= 61.1 \text{ gm.} \end{aligned}$$

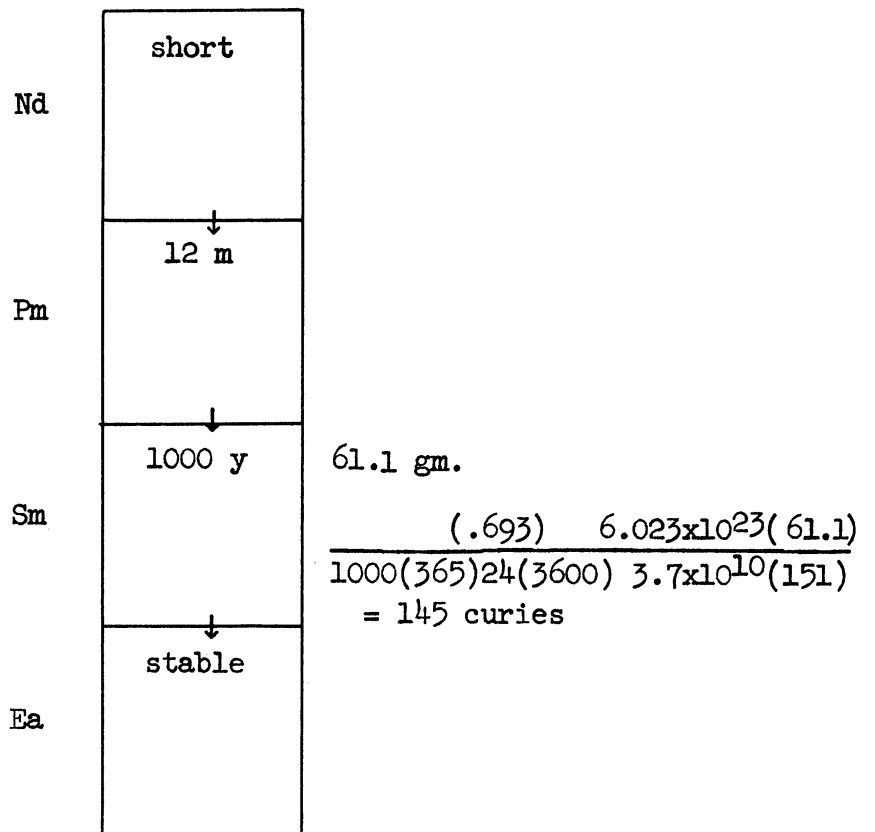

ENGINEERING RESEARCH INSTITUTE • UNIVERSITY OF MICHIGAN

Mass number 152 (Yield 0.0025)

$$\text{Grams/second} = \frac{0.0025(5 \times 10^8)(3.25 \times 10^{10})152}{6.023 \times 10^{23}}$$

$$= 0.1016 \times 10^{-4} \text{ gm/sec.}$$

$$\text{Total grams} = 0.1016 \times 10^{-4}(42)24(3600)$$

$$= 37.4 \text{ gm.}$$

Sm

stable

37.4 gm.

ENGINEERING RESEARCH INSTITUTE • UNIVERSITY OF MICHIGAN

Mass number 153 (Yield 0.0014)

$$\begin{aligned} \text{Grams/second} &= \frac{0.0014(5 \times 10^8)(3.25 \times 10^{10})153}{6.023 \times 10^{23}} \\ &= 0.0573 \times 10^{-4} \text{ gm/sec.} \end{aligned}$$

$$\begin{aligned} \text{Total grams} &= 0.0573 \times 10^{-4} (42) 24 (3600), \\ &= 21.1 \text{ gm.} \end{aligned}$$

$$\begin{aligned} \text{Curies at saturation} &= \frac{0.0014(5 \times 10^8)(3.25 \times 10^{10})}{3.7 \times 10^{10}}, \\ &= 0.615 \times 10^6 \text{ curies.} \end{aligned}$$

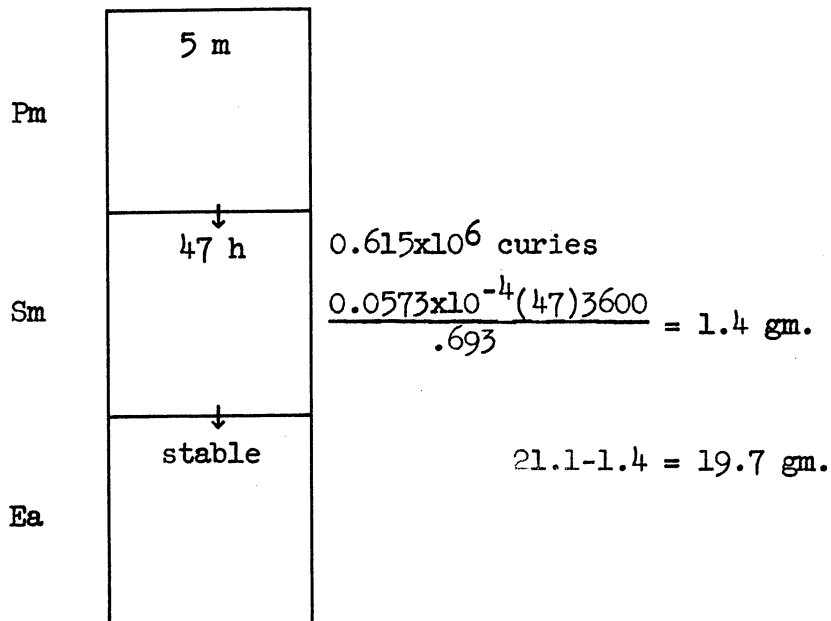

Mass number 154 (Yield 0.0008)

$$\begin{aligned} \text{Grams/second} &= \frac{0.0008(5 \times 10^8)(3.25 \times 10^{10})154}{6.023 \times 10^{23}} \\ &= 0.033 \times 10^{-4} \text{ gm/sec.} \end{aligned}$$

$$\begin{aligned} \text{Total grams} &= 0.033 \times 10^{-4} (42)24(3600), \\ &= 12.15 \text{ gm.} \end{aligned}$$

Sm

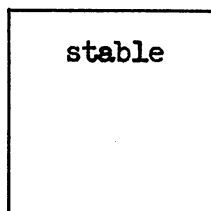

12.15 gm.

ENGINEERING RESEARCH INSTITUTE • UNIVERSITY OF MICHIGAN

Mass number 155 (Yield 0.00035)

$$\begin{aligned} \text{Grams/second} &= \frac{0.00035(5 \times 10^8)(3.25 \times 10^{10})155,}{6.023 \times 10^{23}} \\ &= 0.01465 \times 10^{-4} \text{ gm/sec.} \end{aligned}$$

$$\begin{aligned} \text{Total grams} &= 0.01465 \times 10^{-4} (42) 24 (3600), \\ &= 5.33 \text{ gm.} \end{aligned}$$

Pm	5 m	
Sm	25 m	
Ea	2 y	5.33 gm.
Gd	stable	$\frac{.693 \quad 6.023 \times 10^{23} (5.33)}{2(365) 24(3600) 3.7 \times 10^{10} (155)}$ $= 6150 \text{ curies}$

ENGINEERING RESEARCH INSTITUTE • UNIVERSITY OF MICHIGAN

Mass number 156 (Yield 0.0001)

$$\begin{aligned} \text{Grams/second} &= \frac{0.0001(5 \times 10^8)(3.25 \times 10^{10})156,}{6.023 \times 10^{23}} \\ &= 0.00418 \times 10^{-4} \text{ gm/sec.} \end{aligned}$$

$$\begin{aligned} \text{Total grams} &= 0.00418 \times 10^{-4} (42)24(3600), \\ &= 1.54 \text{ gm.} \end{aligned}$$

$$\begin{aligned} \text{Curies at saturation} &= \frac{0.0001(5 \times 10^8)(3.25 \times 10^{10}),}{3.7 \times 10^{10}} \\ &= 0.044 \times 10 \text{ curies.} \end{aligned}$$

Pm	5 m	
Sm	10 h	$0.044 \times 10^6 \text{ curies}$ $\frac{0.00418 \times 10^{-4} (10)3600}{.693} = .022 \text{ gm.}$
Ea	15.4 d	$0.037 \times 10^6 \text{ curies (F = 0.84)}$ $\frac{0.00418 \times 10^{-4} (15.4)24(3600) \cdot 84}{.693}$ $= .674 \text{ gm.}$
Gd	stable	$1.54 - .696 = .844 \text{ gm.}$

BETA PARTICLE ABSORPTION

As discussed by Engelder, it is probable that beta particles emitted by fission product nuclides within a typical piece of chemical processing equipment will be totally absorbed; therefore all the emitted energy would be absorbed within the equipment as thermal energy.

In the decay of Sb-127, there are 0.84 beta particles per disintegration with a maximum energy of 0.8 Mev. A satisfactory conversion factor from maximum energy to average energy over the range of energies involved is 0.4. The conversion factor from Mev to BTU is 1.517×10^{-16} , and 3600 (3.7×10^{10}) converts curies into particles per hour. Thus for Sb-127,

$$\frac{(1.517 \times 10^{-16}) 3600 (3.7 \times 10^{10}) 0.84 (0.8) 0.4 (0.638 \times 10^6)}{2.31} = 1.50 \times 10^3$$

BTU per hour per 10 kilograms of fissioned material.

Similarly for 9.3 hour Te-127,

$$\frac{(1.517 \times 10^{-16}) 3600 (3.7 \times 10^{10}) 0.8 (0.4) 0.546 \times 10^6}{2.31} = 1.52 \times 10^3$$

Table III lists the constants required for these calculations. "b" is the number of beta particles per disintegration, "w" is maximum beta particle energy in Mev.

DECAY CHARACTERISTICS

The number of grams and curies of each nuclide, and the resulting rates of beta energy absorption and gamma radiation levels have been calculated at the time of removal from the reactor, for each mass number, according to the processes just outlined. It is now of interest to evaluate the variation in these quantities with time after removal from the reactor. For purposes of this calculation, the various nuclides were partitioned into three groups: first generation (parent) nuclides, second generation (daughter) nuclides, and third generation (grand-daughter) nuclides.

Rutherford has developed explicit expressions directly applicable to this problem. As stated by Rutherford, the situation is as follows: ". . . a primary source has supplied (a particular) matter A at a constant rate for any time T and is then suddenly removed. Required the amount of A, B, C at any subsequent time," the following nomenclature is pertinent:

- 1) B and C are daughter and grand-daughter of A, respectively.
- 2) $\lambda_1, \lambda_2, \lambda_3$ are the decay constants of A, B, C respectively.

3) T is the operation time of the reactor, in this case, 42 days.

4) t is the independent variable, time.

5) P_T, P
 Q_T, Q
 R_T, R } refer to the amounts of A, B, and C present at time of shutdown, $t = 0$, and after an arbitrary time t , respectively.

The ratios $P/P_T, Q/Q_T, R/R_T$, i.e., the ratios of the amount present at time t after removal from the reactor to the amount present at shutdown, are given by Equations 1, 2, and 3, respectively. These ratios shall henceforth be referred to as survival ratios.

$$1) P/P_T = e^{-\lambda_1 t};$$

$$2) Q/Q_T = \frac{ae^{-\lambda_2 t} - be^{-\lambda_1 t}}{a-b},$$

where

$$a = \frac{1 - e^{-\lambda_2 T}}{\lambda_2},$$

$$b = \frac{1 - e^{-\lambda_1 T}}{\lambda_1},$$

and,

$$3) R/R_T = \frac{fe^{-\lambda_1 t} + ge^{-\lambda_2 t} + he^{-\lambda_3 t}}{f+g+h},$$

where

$$f = \frac{\lambda_2}{(\lambda_2 - \lambda_1)(\lambda_3 - \lambda_1)} (1 - e^{-\lambda_1 T}),$$

$$g = \frac{\lambda_1}{(\lambda_1 - \lambda_2)(\lambda_3 - \lambda_2)} (1 - e^{-\lambda_2 T}),$$

$$h = \frac{\lambda_1 \lambda_2}{\lambda_3 (\lambda_1 - \lambda_3)(\lambda_2 - \lambda_3)} (1 - e^{-\lambda_3 T}).$$

Table III

Data Derived from Decay Schemes for Calculation
of Radiation Level and Rate of
Heat Formation

The third column, g , lists the fraction: *gammas* per disintegration. The fourth column, r , is the dosage rate in Roentgens per hour at one meter from a point source of one curie at the particular energy. The fifth column, b , lists the fraction: *betas* per disintegration. The sixth column, w , is the average beta particle energy in Mev.

ENGINEERING RESEARCH INSTITUTE • UNIVERSITY OF MICHIGAN

Elt.	Mass #	g	r	b	w	Elt.	Mass #	g	r	b	w
Ge	77	1.000	0.300	1.000	1.740	Rb	85	-	-	-	-
	78	-	-	1.000	0.900		86	0.300	0.600	0.700	1.800
As	77	-	-	1.000	0.700		86	-	-	0.300	0.600
	78	1.000	0.145	0.700	1.400		87	-	-	-	-
	78	-	-	0.300	4.100		88	-	-	1.000	5.000
Se	77	1.000	0.067	-	-	Sr	86	-	-	-	-
	78	-	-	-	-		88	-	-	-	-
	79	-	-	1.000	0.030		89	-	-	1.000	1.500
	80	-	-	-	-		90	-	-	1.000	0.540
Br	81	-	-	-	-		91	0.400	0.700	0.400	1.300
	82	1.000	0.320	1.000	0.465		91	0.400	0.350	0.600	3.200
	82	0.500	0.450	-	-		92	-	-	1.000	0.100
	82	0.500	0.720	-	-	Y	89	-	-	-	-
	82	0.500	0.960	-	-		90	-	-	1.000	2.250
	83	-	-	1.000	1.000		91	-	-	1.000	1.540
Kr	82	-	-	-	-		92	1.000	0.400	1.000	3.500
	83	1.000	0.070	-	-		93	1.000	0.400	1.000	3.100
	84	-	-	-	-	Zr	91	-	-	-	-
	85	1.000	0.140	1.000	1.000		92	-	-	-	-
	86	-	-	-	-		93	-	-	-	-
	87	-	-	1.000	3.200		94	-	-	-	-
	88	-	-	1.000	2.400		95	0.020	0.115	0.20	0.887

ENGINEERING RESEARCH INSTITUTE • UNIVERSITY OF MICHIGAN

Elt.	Mass #	g	r	b	w	Elt.	Mass #	g	r	b	w
Zr	95	0.980	0.410	0.980	0.400	Rh	103	-	-	1.000	0.030
	96	-	-	-	-		105	1.000	0.190	1.000	0.600
	97	1.000	0.450	1.000	1.500		106	0.170	0.360	0.180	2.300
Nb	95	1.000	0.115	1.000	0.146		106	0.010	0.670	0.820	3.550
	95	1.000	0.440	-	-		108	1.000	0.460	1.000	1.300
	97	1.000	0.450	1.000	1.400		109	-	-	1.000	0.100
Mo	95	-	-	-	-	Pd	105	-	-	-	-
	97	-	-	-	-		107	-	-	-	-
	98	-	-	-	-		108	-	-	-	-
	99	1.000	0.140	0.250	0.240		109	-	-	1.000	0.950
	99	-	-	1.000	1.200		110	-	-	-	-
	100	-	-	-	-		112	-	-	1.000	0.200
Tc	99	1.000	0.070	-	-	Ag	109	-	-	-	-
Ru	101	-	-	-	-		111	-	-	1.000	1.060
	102	-	-	-	-		112	1.000	0.490	1.000	3.600
	103	1.000	0.150	0.500	0.350		113	-	-	1.000	2.100
	103	1.000	0.320	0.500	0.665	ca	111	-	-	-	-
	103	-	-	0.970	0.200		112	-	-	-	-
	103	-	-	0.300	0.800		113	-	-	-	-
	104	-	-	-	-		114	-	-	-	-
	105	1.000	0.430	1.000	1.400		115	1.000	0.290	1.000	1.670
	106	-	-	1.000	0.041		115	0.600	0.30	0.600	0.460

ENGINEERING RESEARCH INSTITUTE • UNIVERSITY OF MICHIGAN

Elt.	Mass #	g	r	b	w	Elt.	Mass #	g	r	b	w
Cd	115	1.000	0.090	0.400	1.100	Sb	125	1.000	0.350	-	-
	116	-	-	-	-		126	-	-	-	-
	117	-	-	1.000	1.500		127	0.160	0.420	0.840	0.800
In	115	0.940	0.190	0.940	0.490		129	-	-	1.000	0.100
	115	-	-	0.060	0.830	Te	126	-	-	-	-
	117	-	-	1.000	1.950		127	0.160	0.045	1.000	0.800
Sn	115	-	-	-	-		128	-	-	-	-
	117	1.000	0.090	-	-		129	1.000	0.055	-	-
	118	-	-	-	-		130	-	-	-	-
	119	1.000	0.040	-	-		131	1.000	0.090	1.000	1.800
	120	-	-	-	-		132	1.000	0.120	1.000	0.280
	121	-	-	1.000	0.383		133	-	-	1.000	0.100
	122	-	-	-	-	I	127	-	-	-	-
	123	0.010	0.230	1.000	1.420		129	-	-	-	-
	124	-	-	-	-		131	0.150	0.390	0.150	0.320
	125	-	-	1.000	2.380		131	0.850	0.220	0.850	0.600
	126	1.000	0.650	0.600	0.700		132	0.500	0.350	0.500	0.900
	126	-	-	0.400	2.700		132	0.500	0.750	0.500	2.200
Sb	121	-	-	-	-		133	0.060	0.490	0.060	0.500
	123	-	-	-	-		133	0.940	0.320	0.940	1.400
	125	1.000	0.090	0.350	0.621		135	1.000	0.700	0.350	0.470
	125	1.000	0.250	0.650	0.288		135	1.000	0.850	0.400	1.000

ENGINEERING RESEARCH INSTITUTE • UNIVERSITY OF MICHIGAN

Elt.	Mass #	g	r	b	w	Elt.	Mass #	g	r	b	w
La	142	1.000	0.100	1.000	0.100	I	135	-	-	0.250	1.400
Ce	140	-	-	-	-	Xe	131	1.000	0.086	-	-
	141	-	-	0.300	0.560		132	-	-	-	-
	142	-	-	-	-		133	1.000	0.044	1.000	0.315
	143	1.000	0.320	1.000	1.360		134	-	-	-	-
	144	-	-	1.000	0.348		135	1.00	0.310	1.000	0.930
	145	-	-	1.000	0.100		135	1.000	0.140	-	-
Pr	141	-	-	-	-		136	-	-	-	-
	143	-	-	1.000	0.932	Cs	133	-	-	-	-
	144	1.000	0.068	1.000	3.070		135	-	-	-	-
	145	-	-	1.000	3.200		137	0.950	0.380	0.950	0.510
Nd	143	-	-	-	-		137	-	-	0.050	1.200
	144	-	-	-	-	Ba	137	1.000	0.320	-	-
	145	-	-	-	-		138	-	-	-	-
	146	-	-	-	-		139	0.260	0.086	1.000	2.270
	147	0.400	0.340	0.400	0.400		140	0.400	0.310	0.600	1.022
	147	-	-	0.600	0.900		140	-	-	0.400	0.480
	148	-	-	-	-	La	139	-	-	-	-
	149	-	-	1.000	1.500		140	0.770	0.720	0.700	1.320
	150	-	-	-	-		140	0.150	0.470	0.200	1.670
Pm	147	-	-	-	-		140	0.070	0.350	0.100	2.260
	149	0.100	0.140	1.000	1.100		141	-	-	1.000	2.800

ENGINEERING RESEARCH INSTITUTE • UNIVERSITY OF MICHIGAN

<i>Elt.</i>	<i>Mass #</i>	<i>g</i>	<i>r</i>	<i>b</i>	<i>w</i>	<i>Elt.</i>	<i>Mass #</i>	<i>g</i>	<i>r</i>	<i>b</i>	<i>w</i>
Sm	149	-	-	-	-	Eu	153	-	-	-	-
	151	-	-	1.000	0.074		155	0.600	0.044	0.800	0.154
	152	-	-	-	-		155	0.400	0.051	0.200	0.243
	153	1.000	0.040	1.000	0.780		156	1.000	0.960	0.600	0.500
	153	1.000	0.053	-	-		156	-	-	0.400	2.500
	154	-	-	-	-	Gd	156	-	-	-	-
	156	-	-	1.000	0.800						

NUMERICAL METHODS

The various calculations described below were performed with "slide rule accuracy."

The calculation of the first generation cases (Eq. 1) were performed with a slide rule.

The analog computer of the Electrical Engineering department of the University of Michigan was used to obtain the solution of 19 of the 35 second generation cases. For this, Equation 2 was obtained as the solution of the differential equation

$$\ddot{F} + (\lambda_1 + \lambda_2) \dot{F} + \lambda_1 \lambda_2 F = 0,$$

with the initial values

$$F = 1,$$

$$\dot{F} = \frac{\lambda_1 b - \lambda_2 a}{a - b}.$$

A schematic diagram of a typical program and its associated solution is shown in Fig. 7.

The remaining 16 second generation cases (those with non-zero first derivatives at $t = 0$) were solved directly from Equation 2 with the aid of a desk calculator. The third generation cases were also obtained by means of a desk calculator.

A considerable savings in time could have been effected if a machine such as the I.B.M. Card-Programmed Electronic Computer had been available. The time spent in "table look-up" and transcription of intermediate results would have been considerably reduced.

In the case of the mass number 127, both isomers of Te-127 may be considered daughter products, as previously discussed. The survival ratios for the three radioactive members of the sample decay chain for 0, 1, 2, 4, 8, and 16 days after shutdown are presented in Table IV. These multiplicative factors are then applied to the four quantities of interest as calculated at time of shutdown. The mass of the stable nuclide increases directly with the loss of mass of the radioactive members of the chain. The resultant information for mass number 127 is presented in Table V. Table VI contains these data for all the mass numbers arranged by elements.

REFERENCES

- (1) Moteff, J., "Fission Product Decay Gamma Energy Spectrum",
General Electric Company.
- (2) Engelder, T. C., "Heat Generation by Elements in the Fission Products
Products, A Preliminary Report", Dow Chemical Company, Dec. 1953.
- (3) Marinelli, et al, American Journal of Roentgenology, 59:260.
- (4) Rutherford, Sir Ernest, et al, "Radiations from Radioactive
Substances", pp 15-18, 1930.

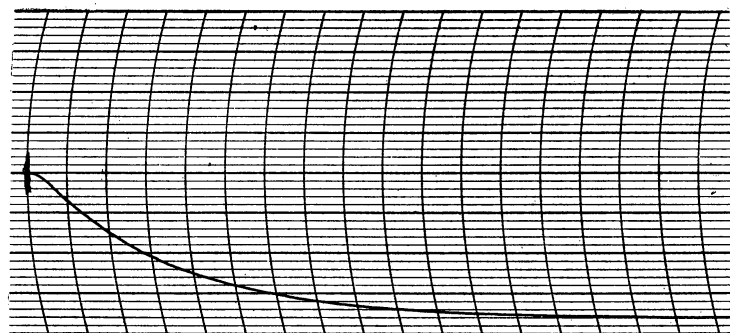
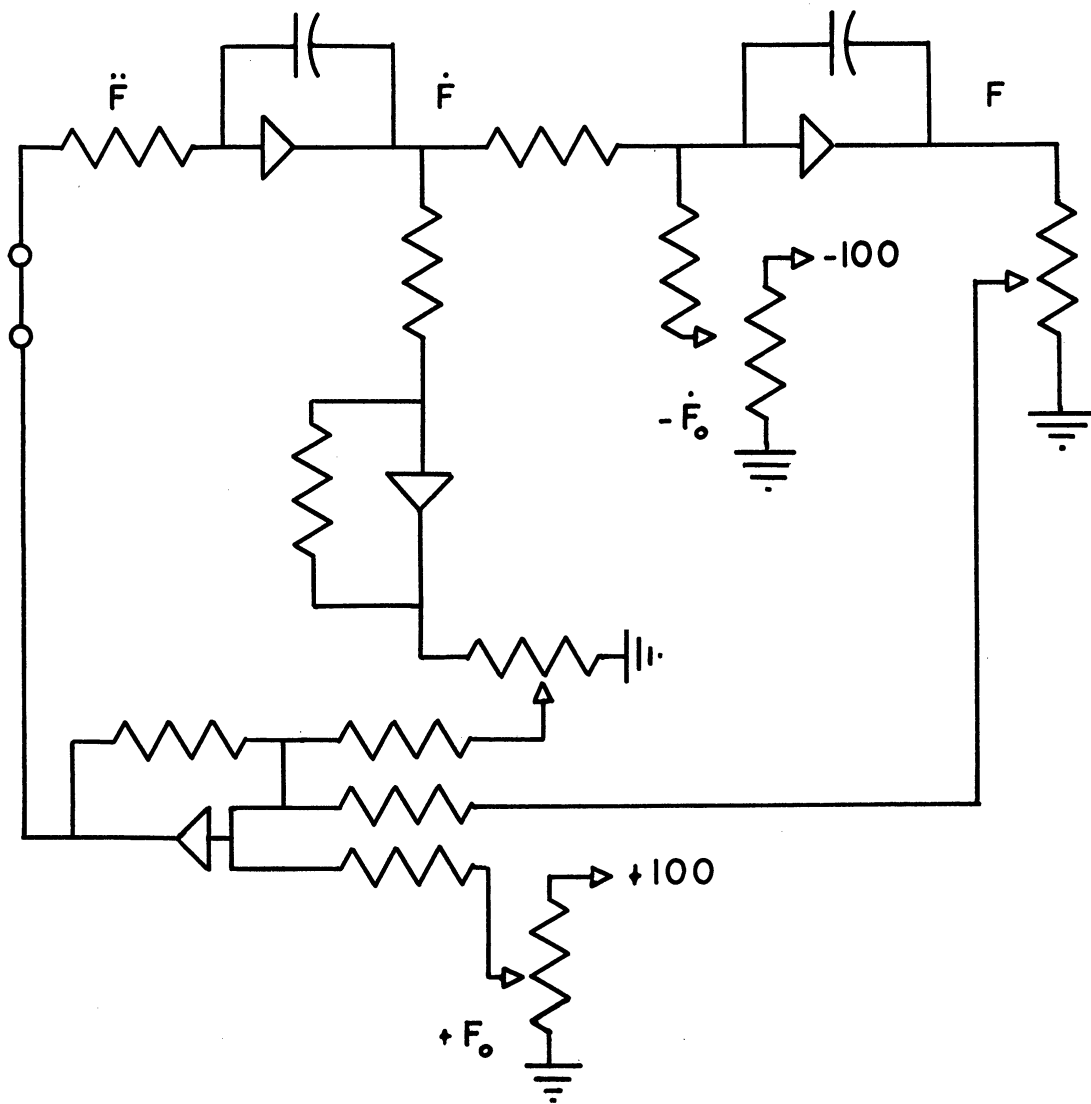

Fig. 7. Schematic Diagram of a Typical Program for the Analog Computer and Its Associated Solution.

Table IV

Survival Ratios for Mass Number 127

The ratios of quantity present at a given time after shutdown to quantity present initially are tabulated for each radioactive nuclide (including isomers) of mass number 127, for $t = 0, 1, 2, 4, 8, 16$ days after shutdown.

Days after shutdown	Sb 127	90 d Te 127	9.3 h Te 127
0	1	1	1
1	0.836	1.062	0.905
2	0.700	1.062	0.759
4	0.489	1.110	0.538
8	0.249	1.128	0.261
16	0.057	1.099	0.063

Table V

Calculated Mass, Activity, Radiation Level and Rate
of Heat Formation of Each Nuclide
of Mass Number 127 for
 $t = 0, 1, 2, 4, 8, 16$ days
after Shutdown

The first column, G, is mass in grams. The second column, C, is activity in curies. The third column, R, is radiation level in Roentgens per hour at one meter from a point source of the particular curie level and energy. The fourth column, W, is the rate of formation of heat from beta particle absorption in BTU's per hour. All quantities are expressed per 10 kilograms of fissioned material.

Mass Number 127

G	C	R	W
---	---	---	---

Sb

1.04	2.76×10^5	1.85×10^4	1.50×10^3
0.89	2.31×10^5	1.55×10^4	1.25×10^3
0.74	1.93×10^5	1.30×10^5	1.05×10^3
0.51	1.35×10^5	9.07×10^3	7.33×10^2
0.25	6.60×10^4	4.44×10^3	3.58×10^2
0.06	1.57×10^4	1.05×10^3	8.52×10^1

Te

1.55	2.48×10^5	5.26×10^2	1.52×10^3
1.20	2.26×10^5	5.56×10^2	1.38×10^3
1.19	1.93×10^5	5.56×10^2	1.16×10^3
1.22	1.43×10^5	5.76×10^2	8.18×10^2
1.21	8.09×10^4	5.93×10^2	1.80×10^2
1.16	3.52×10^4	5.77×10^2	4.30×10^1

I

5.80	-	-	-
5.93	-	-	-
6.06	-	-	-
6.27	-	-	-
6.53	-	-	-
7.27	-	-	-

TABLE VI

Calculated Mass, Activity, Radiation Level and Rate
of Heat Formation of Fission Product
Nuclides, by Element, for
 $t = 0, 1, 2, 4, 8, 16$ days
after Shutdown

The columns G, C, R, W have the same significance as corresponding columns in Table V. These nuclide characteristics are sub-totaled by element; final totals are also tabulated. All quantities are expressed per 10 kilograms of fissioned material.

GERMANIUM Ge

G	C	R	W
---	---	---	---

G	C	R	W
---	---	---	---

77

0.01	1.90×10^4	5.70×10^3	2.67×10^2
-	4.80×10^3	1.40×10^3	6.72×10
-	1.20×10^3	3.60×10^2	1.67×10
-	7.4×10	2.20×10	1.04
-	0.29	0.09	-
-	-	-	-

78

-	3.25×10^4	-	2.37×10^2
-	2.27×10	-	0.10
-	0.02	-	-
-	-	-	-
-	-	-	-
-	-	-	-

TOTAL

0.01	5.15×10^4	5.70×10^3	5.04×10^2
-	4.76×10^3	1.40×10^3	6.72×10
-	1.19×10^3	3.60×10^2	1.67×10
-	7.45×10	2.24×10	1.04
-	0.29	0.09	-
-	-	-	-

ARSENIC As

G	C	R	W
---	---	---	---

G	C	R	W
---	---	---	---

77

0.02	1.90×10^4	-	1.07×10^2
0.02	1.71×10^4	-	9.64×10
0.01	1.20×10^4	-	6.76×10
-	5.00×10^3	-	2.82×10
-	1.00×10^3	-	5.88
-	-	-	-

78

-	3.25×10^4	4.71×10^4	8.40×10^2
-	1.30×10	1.89	-
-	-	-	-
-	-	-	-
-	-	-	-
-	-	-	-

TOTAL

0.02	5.15×10^4	4.71×10^4	9.48×10^2
0.02	1.72×10^4	1.89	9.64×10
0.01	1.20×10^4	-	6.76×10
-	5.00×10^3	-	2.82×10
-	1.04×10^3	-	5.88
-	-	-	-

SELENIUM Se

G	C	R	W
---	---	---	---

G	C	R	W
---	---	---	---

77

0.30	3.81×10^2	2.55×10	-
0.31	3.41×10^2	2.28×10	-
0.31	2.41×10^2	1.60×10	-
0.32	1.00×10^2	6.70	-
0.33	2.00×10	1.30	-
0.33	-	-	-

80

3.38	-	-	-
"	-	-	-
"	-	-	-
"	-	-	-
"	-	-	-
"	-	-	-

78

0.56	-	-	-
"	-	-	-
"	-	-	-
"	-	-	-
"	-	-	-
"	-	-	-

79

1.72	2.60	-	-
"	"	-	-
"	"	-	-
"	"	-	-
"	"	-	-
"	"	-	-

TOTAL

5.97	4.07×10^2	2.55×10	-
5.98	3.67×10^2	2.28×10	-
5.98	2.67×10^2	1.61×10	-
5.99	1.26×10^2	6.70	-
5.99	4.60×10	1.30	-
5.99	2.60×10	-	-

BROMINE Br

G	C	R	W
---	---	---	---

G	C	R	W
---	---	---	---

81

6.80	-	-	-
"	-	-	-
"	-	-	-
"	-	-	-
"	-	-	-
"	-	-	-

82

0.61	6.45×10^5	8.93×10^5	2.42×10^4
0.38	4.07×10^5	5.64×10^5	1.53×10^4
0.24	2.55×10^5	3.53×10^5	9.56×10^3
0.10	9.96×10^4	1.38×10^5	3.74×10^3
0.01	1.56×10^4	2.16×10^4	5.84×10^2
-	3.88×10^2	5.37×10^2	1.46×10^1

83

0.07	1.05×10^6	-	8.48×10^3
-	9.43×10^2	-	7.60
-	-	-	-
-	-	-	-
-	-	-	-
-	-	-	-

TOTAL

7.47	1.69×10^6	8.93×10^5	3.27×10^4
7.18	4.08×10^5	5.64×10^5	1.53×10^4
7.04	2.55×10^5	3.53×10^5	9.56×10^3
6.89	9.96×10^4	1.38×10^5	3.74×10^3
6.81	1.56×10^4	2.16×10^4	5.84×10^2
6.80	3.88×10^2	5.37×10^2	1.46×10^1

KRYPTON Kr

G	C	R	W
---	---	---	---

82

1.12x10	-	-	-
1.14x10	-	-	-
1.15x10	-	-	-
1.17x10	-	-	-
1.18x10	-	-	-
1.18x10	-	-	-

G	C	R	W
---	---	---	---

85

2.54x10	1.33x10 ⁶	1.86x10 ⁵	1.08x10 ⁴
2.53x10	2.94x10 ⁴	4.12x10 ³	2.38x10 ²
2.53x10	4.33x10	6.06	0.35
2.53x10	-	-	-
2.53x10	-	-	-
2.53x10	-	-	-

G	C	R	W
---	---	---	---

88

0.50	6.48x10 ⁶	-	1.26x10 ⁵
-	1.56x10 ⁴	-	3.03x10 ²
-	3.75x10	-	0.73
-	-	-	-
-	-	-	-
-	-	-	-

83

1.92x10	1.05x10 ⁶	7.35x10 ⁴	-
1.90x10	9.40x10 ²	6.58x10	-
1.90x10	-	-	-
1.90x10	-	-	-
1.90x10	-	-	-
1.90x10	-	-	-

86

1.73	-	-	-
"	-	-	-
"	-	-	-
"	-	-	-
"	-	-	-
"	-	-	-

84

3.20x10	-	-	-
"	-	-	-
"	-	-	-
"	-	-	-
"	-	-	-
"	-	-	-

87

-	5.07x10 ⁶	-	1.31x10 ⁵
-	1.52	-	-
-	-	-	-
-	-	-	-
-	-	-	-
-	-	-	-

TOTAL

9.00x10	1.39x10 ⁷	2.60x10 ⁵	2.68x10 ⁵
8.98x10	4.60x10 ⁴	4.19x10 ³	5.40x10 ²
8.99x10	8.08x10	6.06	2.69
9.01x10	-	-	-
9.01x10	-	-	-
9.01x10	-	-	-

RUBIDIUM Rb

G	C	R	W
---	---	---	---

G	C	R	W
---	---	---	---

85			
2.52x10	-	-	-
2.53x10	-	-	-
"	-	-	-
"	-	-	-
"	-	-	-
"	-	-	-

88			
-	6.47x10 ⁶	-	2.62x10 ⁵
-	1.59x10 ⁴	-	6.44x10 ²
-	3.75x10	-	1.52
-	-	-	-
-	-	-	-
-	-	-	-

86			
3.78x10	2.90x10 ⁶	5.22x10 ⁵	3.38x10 ⁴
3.65x10	2.84x10 ⁶	5.11x10 ⁵	3.30x10 ⁴
3.52x10	2.74x10 ⁶	4.93x10 ⁵	3.19x10 ⁴
3.29x10	2.55x10 ⁶	4.59x10 ⁵	2.97x10 ⁴
2.86x10	2.22x10 ⁶	4.00x10 ⁵	2.58x10 ⁴
2.14x10	1.67x10 ⁶	3.01x10 ⁵	1.94x10 ⁴

87			
9.79x10	-	-	-
"	-	-	-
"	-	-	-
"	-	-	-
"	-	-	-
"	-	-	-

TOTAL			
1.61x10 ²	9.42x10 ⁶	5.22x10 ⁵	2.92x10 ⁵
1.60x10 ²	2.85x10 ⁶	5.11x10 ⁵	3.37x10 ⁴
1.58x10 ²	2.74x10 ⁶	4.93x10 ⁵	3.19x10 ⁴
1.56x10 ²	2.55x10 ⁶	4.59x10 ⁵	2.97x10 ⁴
1.52x10 ²	2.22x10 ⁶	4.00x10 ⁵	2.58x10 ⁴
1.45x10 ²	1.67x10 ⁶	3.01x10 ⁵	1.94x10 ⁴

STRONTIUM Sr

G	C	R	W
---	---	---	---

86			
3.51x10	-	-	-
3.64x10	-	-	-
3.77x10	-	-	-
4.00x10	-	-	-
4.44x10	-	-	-
5.15x10	-	-	-

G	C	R	W
---	---	---	---

90			
1.76x10 ²	3.49x10 ³	-	1.52x10
"	"	-	"
"	"	-	"
"	"	-	"
"	"	-	"
"	"	-	"

G	C	R	W
---	---	---	---

88			
1.26x10 ²	-	-	-
"	-	-	-
"	-	-	-
"	-	-	-
"	-	-	-
"	-	-	-

91			
2.66	9.53x10 ⁶	4.00x10 ⁶	1.88x10 ⁵
0.48	1.72x10 ⁶	7.22x10 ⁵	1.42x10 ⁴
0.09	3.16x10 ⁵	1.33x10 ⁵	2.62x10 ³
-	9.53x10 ³	4.00x10 ³	7.88x10
-	1.19x10	5.00	-
-	-	-	-

89			
1.15x10 ²	3.20x10 ⁶	-	3.88x10 ⁴
1.14x10 ²	3.18x10 ⁶	-	3.86x10 ⁴
1.12x10 ²	3.12x10 ⁶	-	3.78x10 ⁴
1.10x10 ²	3.04x10 ⁶	-	3.68x10 ⁴
1.04x10 ²	2.88x10 ⁶	-	3.49x10 ⁴
9.40x10	2.60x10 ⁶	-	3.15x10 ⁴

92			
0.83	1.06x10 ⁷	-	8.56x10 ³
-	2.22x10 ⁴	-	1.79x10
-	-	-	-
-	-	-	-
-	-	-	-
-	-	-	-

TOTAL			
4.56x10 ²	2.33x10 ⁷	4.00x10 ⁶	2.35x10 ⁵
4.54x10 ²	4.92x10 ⁶	7.22x10 ⁵	5.28x10 ⁴
4.53x10 ²	3.44x10 ⁶	1.33x10 ⁵	4.04x10 ⁴
4.53x10 ²	3.04x10 ⁶	4.00x10 ³	3.68x10 ⁴
4.51x10 ²	2.90x10 ⁶	5.00	3.49x10 ⁴
4.48x10 ²	2.60x10 ⁶	-	3.15x10 ⁴

YTTTRIUM Y

G	C	R	W
---	---	---	---

G	C	R	W
---	---	---	---

89

3.51x10	-	-	-
3.64x10	-	-	-
3.85x10	-	-	-
4.07x10	-	-	-
4.68x10	-	-	-
5.67x10	-	-	-

92

1.07	1.06x10 ⁷	4.24x10 ⁶	1.20x10 ⁵
-	2.22x10 ⁴	8.88x10 ³	2.50x10 ²
-	-	-	-
-	-	-	-
-	-	-	-
-	-	-	-

90

-	1.17x10 ³	-	2.12x10
-	"	-	"
-	"	-	"
-	"	-	"
-	"	-	"
-	"	-	"

93

3.40	1.15x10 ⁷	4.60x10 ⁶	2.88x10 ⁴
0.65	2.19x10 ⁶	8.76x10 ⁵	2.19x10 ⁴
0.12	4.16x10 ⁵	1.66x10 ⁵	4.16x10 ³
-	1.50x10 ⁴	6.00x10 ³	1.50x10 ²
-	2.13x10	8.52	-
-	-	-	-

91

9.09x10	6.10x10 ⁶	-	7.60x10 ⁴
9.09x10	2.97x10 ⁶	-	3.70x10 ⁴
9.01x10	2.39x10 ⁶	-	2.97x10 ⁴
8.83x10	2.23x10 ⁶	-	2.77x10 ⁴
8.40x10	2.11x10 ⁶	-	2.62x10 ⁴
8.10x10	1.92x10 ⁶	-	2.39x10 ⁴

TOTAL

1.30x10 ²	2.82x10 ⁷	8.84x10 ⁶	2.25x10 ⁵
1.28x10 ²	5.18x10 ⁶	8.85x10 ⁵	5.92x10 ⁴
1.29x10 ²	2.81x10 ⁶	1.66x10 ⁵	3.39x10 ⁴
1.29x10 ²	2.24x10 ⁶	6.00x10 ³	2.79x10 ⁴
1.31x10 ²	2.12x10 ⁶	8.52	2.62x10 ⁴
1.38x10 ²	1.92x10 ⁶	-	2.39x10 ⁴

ZIRCONIUM Zr

G	C	R	W
---	---	---	---

91			
9.87x10 ²	-	-	-
1.02x10 ²	-	-	-
1.03x10 ²	-	-	-
1.05x10 ²	-	-	-
1.09x10 ²	-	-	-
1.11x10 ²	-	-	-

G	C	R	W
---	---	---	---

94			
2.51x10 ²	-	-	-
"	-	-	-
"	-	-	-
"	-	-	-
"	-	-	-
"	-	-	-

G	C	R	W
---	---	---	---

97			
5.98	1.15x10 ⁷	5.18x10 ⁶	1.39x10 ³
2.24	4.31x10 ⁶	1.94x10 ⁶	5.24x10 ⁴
0.84	1.61x10 ⁶	7.24x10 ⁵	1.95x10 ⁴
-	3.22x10 ⁴	1.45x10 ⁴	3.90x10 ²
-	9.18x10	4.13x10	1.11
-	-	-	-

92			
2.12x10 ²	-	-	-
"	-	-	-
"	-	-	-
"	-	-	-
"	-	-	-
"	-	-	-

95			
2.15x10 ²	4.48x10 ⁶	1.81x10 ⁶	1.48x10 ⁴
2.13x10 ²	4.44x10 ⁶	1.79x10 ⁶	1.46x10 ⁴
2.10x10 ²	4.37x10 ⁶	1.77x10 ⁶	1.44x10 ⁴
2.06x10 ²	4.30x10 ⁶	1.74x10 ⁶	1.42x10 ⁴
1.97x10 ²	4.12x10 ⁶	1.66x10 ⁶	1.36x10 ⁴
1.81x10 ²	3.77x10 ⁶	1.52x10 ⁶	1.24x10 ⁴

93			
2.33x10 ²	-	-	-
2.36x10 ²	-	-	-
2.36x10 ²	-	-	-
2.36x10 ²	-	-	-
2.36x10 ²	-	-	-
2.36x10 ²	-	-	-

96			
2.55x10 ²	-	-	-
"	-	-	-
"	-	-	-
"	-	-	-
"	-	-	-
"	-	-	-

TOTAL			
1.27x10 ²	1.60x10 ⁷	6.99x10 ⁶	1.53x10 ⁵
1.27x10 ²	8.75x10 ⁶	3.73x10 ⁶	6.72x10 ⁴
1.27x10 ²	5.98x10 ⁶	2.49x10 ⁶	3.39x10 ⁴
1.26x10 ²	4.33x10 ⁶	1.75x10 ⁶	1.46x10 ⁴
1.26x10 ²	4.20x10 ⁶	1.66x10 ⁶	1.36x10 ⁴
1.25x10 ²	3.77x10 ⁶	1.52x10 ⁶	1.24x10 ⁴

NIOBIUM Nb

G	C	R	W
---	---	---	---

G	C	R	W
---	---	---	---

95

1.49x10 ³	1.64x10 ⁶	9.10x10 ⁵	1.94x10 ³
1.56x10 ³	1.71x10 ⁶	9.49x10 ⁵	2.02x10 ³
1.66x10 ³	1.82x10 ⁶	1.01x10 ⁶	2.15x10 ³
1.69x10 ³	1.86x10 ⁶	1.03x10 ⁶	2.20x10 ³
1.86x10 ³	2.04x10 ⁶	1.13x10 ⁶	2.41x10 ³
2.20x10 ³	2.40x10 ⁶	1.33x10 ⁶	2.88x10 ³

97

0.43	1.15x10 ⁷	5.18x10 ⁶	1.30x10 ⁵
0.16	4.31x10 ⁶	1.94x10 ⁶	4.88x10 ⁴
0.06	1.61x10 ⁶	7.24x10 ⁵	1.82x10 ⁴
-	3.23x10 ⁴	1.45x10 ⁴	3.66x10 ²
-	9.18x10	4.13x10	1.04
-	-	-	-

TOTAL

1.54x10 ³	1.32x10 ⁷	6.09x10 ⁶	1.32x10 ⁵
1.58x10 ³	6.02x10 ⁶	2.89x10 ⁶	5.08x10 ⁴
1.67x10 ³	3.43x10 ⁶	1.73x10 ⁶	2.04x10 ⁴
1.69x10 ³	1.88x10 ⁶	1.04x10 ⁶	2.56x10 ³
1.86x10 ³	2.04x10 ⁶	1.13x10 ⁶	2.77x10 ³
2.20x10 ³	2.40x10 ⁶	1.33x10 ⁶	2.83x10 ³

MOLYBDENUM Mo

G	C	R	W
---	---	---	---

G	C	R	W
---	---	---	---

95

2.75x10	-	-	-
2.90x10	-	-	-
3.06x10	-	-	-
3.46x10	-	-	-
4.16x10	-	-	-
5.46x10	-	-	-

99

2.41x10	1.15x10 ⁷	1.61x10 ⁶	1.17x10 ⁵
1.90x10	9.05x10 ⁶	1.26x10 ⁶	9.24x10 ⁴
1.50x10	7.10x10 ⁶	9.94x10 ⁵	7.24x10 ⁴
9.18	4.37x10 ⁶	6.12x10 ⁵	4.44x10 ⁴
3.51	1.67x10 ⁶	2.34x10 ⁵	1.70x10 ⁴
0.51	2.42x10 ⁵	3.39x10 ⁴	2.47x10 ³

97

2.39x10 ²	-	-	-
2.43x10 ²	-	-	-
2.44x10 ²	-	-	-
2.44x10 ²	-	-	-
2.45x10 ²	-	-	-
2.45x10 ²	-	-	-

100

3.29x10 ²	-	-	-
-	"	-	-
-	"	-	-
-	"	-	-
-	"	-	-
-	"	-	-

98

2.39x10 ²	-	-	-
"	-	-	-
"	-	-	-
"	-	-	-
"	-	-	-
"	-	-	-

TOTAL

8.58x10 ²	1.15x10 ⁷	1.61x10 ⁶	1.17x10 ⁵
8.59x10 ²	9.05x10 ⁶	1.26x10 ⁶	9.24x10 ⁴
8.57x10 ²	7.10x10 ⁶	9.94x10 ⁵	7.24x10 ⁴
8.57x10 ²	4.37x10 ⁶	6.12x10 ⁵	4.44x10 ⁴
8.58x10 ²	1.67x10 ⁶	2.34x10 ⁵	1.70x10 ⁴
8.68x10 ²	2.42x10 ⁵	3.39x10 ⁴	2.47x10 ³

TECHNETIUM Tc

G	C	R	W
---	---	---	---

G	C	R	W
---	---	---	---

99			
2.27×10^2	1.15×10^7	8.05×10^5	-
2.31×10^2	1.03×10^7	7.21×10^5	-
2.36×10^2	7.84×10^6	5.49×10^5	-
2.42×10^2	4.83×10^6	3.38×10^5	-
2.47×10^2	1.82×10^6	1.27×10^5	-
2.50×10^2	3.06×10^5	2.14×10^4	-

TOTAL			
2.27×10^2	1.15×10^7	8.05×10^5	-
2.31×10^2	1.03×10^7	7.21×10^5	-
2.36×10^2	7.84×10^6	5.49×10^5	-
2.42×10^2	4.83×10^6	3.38×10^5	-
2.47×10^2	1.82×10^6	1.27×10^5	-
2.50×10^2	3.06×10^5	2.14×10^4	-

RUTHENIUM Ru

G	C	R	W
---	---	---	---

101			
2.62×10^2	-	-	-
"	-	-	-
"	-	-	-
"	-	-	-
"	-	-	-
"	-	-	-

G	C	R	W
---	---	---	---

104			
4.95×10	-	-	-
"	-	-	-
"	-	-	-
"	-	-	-
"	-	-	-
"	-	-	-

G	C	R	W
---	---	---	---

102			
1.77×10^2	-	-	-
"	-	-	-
"	-	-	-
"	-	-	-
"	-	-	-
"	-	-	-

105			
0.15	9.83×10^5	4.23×10^5	1.11×10^4
-	2.43×10^4	1.04×10^4	2.75×10^2
-	5.22×10^2	2.24×10^2	5.90
-	-	-	-
-	-	-	-
-	-	-	-

103			
7.09×10	2.16×10^6	1.02×10^6	3.48×10^4
6.96×10	2.13×10^6	1.00×10^6	3.43×10^4
6.82×10	2.10×10^6	9.87×10^5	3.38×10^4
6.64×10	2.07×10^6	9.73×10^5	3.33×10^4
6.20×10	1.90×10^6	8.93×10^5	3.06×10^4
5.45×10	1.67×10^6	7.85×10^5	2.69×10^4

106			
1.05×10	3.69×10^4	-	1.21×10
"	"	-	"
"	"	-	"
"	"	-	"
"	"	-	"
"	"	-	"

TOTAL			
5.70×10^2	3.18×10^6	1.44×10^6	4.59×10^4
5.68×10^2	2.18×10^6	1.01×10^6	3.45×10^4
5.67×10^2	2.13×10^6	9.87×10^5	3.38×10^4
5.65×10^2	2.10×10^6	9.73×10^5	3.33×10^4
5.61×10^2	1.93×10^6	8.93×10^5	3.06×10^4
5.53×10^2	1.70×10^6	7.85×10^5	2.69×10^4

RHODIUM Rh

G	C	R	W
---	---	---	---

G	C	R	W
---	---	---	---

103			
2.73x10	5.10x10 ⁵	-	1.24x10 ²
2.86x10	5.00x10 ⁵	-	1.22x10 ²
2.99x10	4.98x10 ⁵	-	1.20x10 ²
3.17x10	4.83x10 ⁵	-	1.17x10 ²
3.61x10	4.52x10 ⁵	-	1.09x10 ²
4.37x10	3.97x10 ⁵	-	9.60x10

108			
0.06	1.84x10 ⁵	8.46x10 ⁴	1.93x10 ³
0.01	3.01x10 ⁴	1.38x10 ⁴	3.16x10 ²
-	4.61x10 ³	2.12x10 ³	4.84x10
-	1.11x10 ²	5.11x10	1.17
-	-	-	-
-	-	-	-

105			
1.19	9.83x10 ⁶	1.87x10 ⁶	4.77x10 ⁴
0.90	7.44x10 ⁶	1.41x10 ⁶	3.61x10 ⁴
0.58	4.78x10 ⁶	9.08x10 ⁵	2.32x10 ⁴
0.26	2.12x10 ⁵	4.03x10 ⁴	1.03x10 ⁴
0.03	2.66x10 ⁴	5.05x10 ³	1.29x10 ³
-	-	-	-

109			
-	1.48x10 ⁵	-	1.20x10 ²
-	-	-	-
-	-	-	-
-	-	-	-
-	-	-	-
-	-	-	-

106			
-	3.69x10 ⁴	2.51x10 ³	8.67x10 ²
-	"	"	"
-	"	"	"
-	"	"	"
-	"	"	"
-	"	"	"

TOTAL			
2.85x10	2.38x10 ⁶	1.96x10 ⁶	5.09x10 ⁴
2.95x10	1.79x10 ⁶	1.43x10 ⁶	3.75x10 ⁴
3.03x10	1.48x10 ⁶	9.10x10 ⁵	2.43x10 ⁴
3.20x10	1.18x10 ⁶	4.28x10 ⁴	1.13x10 ⁴
3.62x10	9.30x10 ⁵	7.56x10 ³	2.35x10 ³
4.37x10	7.93x10 ⁵	2.51x10 ³	1.06x10 ³

PALLADIUM Pd

G	C	R	W
---	---	---	---

G	C	R	W
---	---	---	---

G	C	R	W
---	---	---	---

105

2.14x10	-	-	-
2.18x10	-	-	-
2.21x10	-	-	-
2.25x10	-	-	-
2.27x10	-	-	-
2.27x10	-	-	-

109

0.07	1.48x10 ⁵	-	1.14x10 ³
0.02	4.12x10 ⁴	-	3.16x10 ²
-	1.14x10 ⁴	-	8.76x10
-	8.90x10 ²	-	6.83
-	2.67	-	-
-	-	-	-

107

6.49	-	-	-
"	-	-	-
"	-	-	-
"	-	-	-
"	-	-	-
"	-	-	-

110

3.22	-	-	-
"	-	-	-
"	-	-	-
"	-	-	-
"	-	-	-
"	-	-	-

108

4.25	-	-	-
4.30	-	-	-
4.31	-	-	-
4.31	-	-	-
4.31	-	-	-
4.31	-	-	-

112

0.09	1.20x10 ⁵	-	1.94x10 ²
0.04	5.44x10 ⁴	-	8.81x10
0.02	2.48x10 ⁴	-	4.02x10
-	5.05x10 ³	-	8.18
-	2.17x10 ²	-	-
-	0.42	-	-

TOTAL

3.55x10	2.69x10 ⁵	-	1.33x10 ³
3.59x10	9.57x10 ⁴	-	9.04x10 ²
3.62x10	3.59x10 ⁴	-	1.28x10 ²
3.65x10	5.76x10 ³	-	1.50x10
3.67x10	2.17x10 ²	-	-
3.67x10	0.42	-	-

SILVER Ag

G	C	R	W
---	---	---	---

G	C	R	W
---	---	---	---

109

3.35	-	-	-
3.40	-	-	-
3.42	-	-	-
3.42	-	-	-
3.42	-	-	-
3.42	-	-	-

113

0.02	1.14×10^5	-	1.94×10^3
-	4.89×10^3	-	8.31×10
-	2.16×10^2	-	3.67
-	0.44	-	-
-	-	-	-
-	-	-	-

111

0.76	1.20×10^5	-	1.03×10^3
0.70	1.10×10^5	-	9.41×10^2
0.64	1.00×10^5	-	8.56×10^2
0.53	8.31×10^4	-	7.11×10^2
0.37	5.76×10^4	-	4.93×10^2
0.18	2.77×10^4	-	2.37×10^2

112

0.01	1.18×10^5	5.78×10^4	3.93×10^3
0.01	5.33×10^4	2.61×10^4	1.55×10^3
-	2.42×10^4	1.19×10^4	7.04×10^2
-	4.94×10^3	2.42×10^4	1.44×10^2
-	2.12×10^2	1.04×10^2	6.17
-	0.40	0.20	-

TOTAL

4.14	3.52×10^5	5.18×10^4	6.90×10^3
4.10	1.63×10^5	2.61×10^4	2.57×10^3
4.06	1.25×10^5	1.19×10^4	1.56×10^3
3.95	8.79×10^4	2.42×10^3	8.55×10^2
3.79	5.76×10^4	1.04×10^2	5.00×10^2
3.60	2.77×10^4	0.20	2.37×10^2

CADMIUM Cd

G	C	R	W
---	---	---	---

111

2.23	-	-	-
2.29	-	-	-
2.35	-	-	-
2.50	-	-	-
2.62	-	-	-
2.81	-	-	-

G	C	R	W
---	---	---	---

114

2.69	-	-	-
"	-	-	-
"	-	-	-
"	-	-	-
"	-	-	-
"	-	-	-

G	C	R	W
---	---	---	---

117

0.01	1.06×10^5	-	2.83×10^3
-	2.87×10^2	-	3.47
-	0.90	-	-
-	-	-	-
-	-	-	-
-	-	-	-

112

2.78	-	-	-
2.84	-	-	-
2.86	-	-	-
2.88	-	-	-
2.88	-	-	-
2.88	-	-	-

115

1.12	8.12×10^4	2.25×10^4	6.92×10^2
1.07	6.69×10^4	1.86×10^4	6.03×10^2
1.03	5.61×10^4	1.57×10^4	5.35×10^2
0.97	4.18×10^4	1.18×10^4	4.42×10^2
0.88	2.88×10^4	8.26×10^3	3.51×10^2
0.77	2.15×10^4	7.34×10^3	2.86×10^2

113

2.73	-	-	-
2.75	-	-	-
2.75	-	-	-
2.75	-	-	-
2.75	-	-	-
2.75	-	-	-

116

2.64	-	-	-
"	-	-	-
"	-	-	-
"	-	-	-
"	-	-	-
"	-	-	-

TOTAL

1.44×10^5	1.87×10^5	2.25×10^4	3.52×10^3
1.43×10^4	6.75×10^4	1.86×10^4	6.06×10^2
1.43×10^4	5.63×10^4	1.57×10^4	5.35×10^2
1.43×10^4	4.20×10^4	1.18×10^4	4.42×10^2
1.44×10^4	2.90×10^4	8.26×10^3	3.51×10^2
1.19×10^4	2.15×10^4	7.34×10^3	2.86×10^2

INDIUM In

G	C	R	W
---	---	---	---

G	C	R	W
---	---	---	---

115

1.45	7.49×10^4	1.34×10^4	3.09×10^2
1.49	4.37×10^4	7.82×10^3	1.80×10^2
1.52	2.99×10^4	5.35×10^3	1.23×10^2
1.58	1.65×10^4	2.95×10^3	6.80×10
1.66	4.50×10^3	8.06×10^2	1.85×10
1.77	-	-	-

117

0.01	1.06×10^5	-	1.67×10^3
-	2.87×10^2	-	4.53
-	0.90	-	-
-	-	-	-
-	-	-	-
-	-	-	-

TOTAL

1.46	1.81×10^5	1.34×10^4	2.00×10^3
1.49	4.42×10^4	7.82×10^3	1.85×10^2
1.52	2.99×10^4	5.35×10^3	1.23×10^2
1.58	1.65×10^4	2.95×10^3	6.80×10
1.66	4.50×10^3	8.06×10^2	1.85×10
1.77	-	-	-

G	C	R	W
---	---	---	---

115

0.11	-	-	-
0.11	-	-	-
0.11	-	-	-
0.12	-	-	-
0.12	-	-	-
0.12	-	-	-

G	C	R	W
---	---	---	---

119

2.80	1.37x10 ⁴	5.48x10 ²	-
"	1.36x10 ⁴	5.44x10 ²	-
"	1.35x10 ⁴	5.40x10 ²	-
"	1.33x10 ⁴	5.32x10 ²	-
"	1.29x10 ⁴	5.16x10 ²	-
"	1.22x10 ⁴	4.88x10 ²	-

G	C	R	W
---	---	---	---

122

3.18	-	-	-
"	-	-	-
"	-	-	-
"	-	-	-
"	-	-	-
"	-	-	-

G	C	R	W
---	---	---	---

125

0.73	7.79x10 ⁴	-	1.50x10 ³
0.68	7.27x10 ⁴	-	1.40x10 ³
0.59	6.79x10 ⁴	-	1.30x10 ³
0.55	5.93x10 ⁴	-	1.14x10 ³
0.42	4.71x10 ⁴	-	9.04x10 ²
0.24	2.59x10 ⁴	-	4.97x10 ²

117

2.68	4.54x10 ⁴	4.09x10 ³	-
2.66	4.33x10 ⁴	3.90x10 ³	-
2.66	4.13x10 ⁴	3.72x10 ³	-
2.66	3.76x10 ⁴	3.38x10 ³	-
2.66	3.10x10 ⁴	2.79x10 ³	-
2.66	2.12x10 ⁴	1.91x10 ³	-

120

2.86	-	-	-
"	-	-	-
"	-	-	-
"	-	-	-
"	-	-	-
"	-	-	-

123

1.54	1.29x10 ⁴	2.97x10 ²	1.48x10 ²
1.54	1.29x10 ⁴	2.97x10 ²	1.48x10 ²
1.52	1.28x10 ⁴	2.94x10 ²	1.47x10 ²
1.48	1.26x10 ⁴	2.90x10 ²	1.45x10 ²
1.48	1.24x10 ⁴	2.85x10 ²	1.43x10 ²
1.41	1.19x10 ⁴	2.74x10 ²	1.37x10 ²

126

-	1.90x10 ⁵	1.24x10 ⁵	2.30x10 ³
-	-	-	-
-	-	-	-
-	-	-	-
-	-	-	-
-	-	-	-

118

2.68	-	-	-
"	-	-	-
"	-	-	-
"	-	-	-
"	-	-	-
"	-	-	-

122

0.12	1.19x10 ⁵	-	3.68x10 ²
0.06	6.19x10 ⁴	-	1.91x10 ²
0.03	3.29x10 ⁴	-	1.01x10 ²
-	9.26x10 ³	-	2.86x10
-	7.32x10 ²	-	2.26
-	-	-	-

124

3.76	-	-	-
"	-	-	-
"	-	-	-
"	-	-	-
"	-	-	-
"	-	-	-

TOTAL

2.04x10	4.58x10 ⁵	1.29x10 ⁵	4.32x10 ³
2.03x10	2.04x10 ⁵	4.74x10 ³	1.74x10 ³
1.70x10	1.68x10 ⁵	4.55x10 ³	1.55x10 ³
2.01x10	1.32x10 ⁵	4.20x10 ³	1.31x10 ³
2.00x10	9.41x10 ⁴	3.59x10 ³	1.05x10 ³
1.97x10	7.12x10 ⁴	2.67x10 ³	6.34x10 ²

ANTIMONY Sb

G	C	R	W
---	---	---	---

G	C	R	W
---	---	---	---

G	C	R	W
---	---	---	---

121

2.88	-	-	-
2.91	-	-	-
2.97	-	-	-
2.99	-	-	-
3.00	-	-	-
3.00	-	-	-

126

-	1.90×10^5	-	1.54×10^2
-	-	-	-
-	-	-	-
-	-	-	-
-	-	-	-
-	-	-	-

123

1.87	-	-	-
1.87	-	-	-
1.89	-	-	-
1.90	-	-	-
1.93	-	-	-
2.00	-	-	-

127

1.04	2.76×10^5	1.85×10^4	1.50×10^3
0.89	2.31×10^5	1.55×10^4	1.25×10^3
0.74	1.93×10^5	1.30×10^4	1.05×10^3
0.51	1.35×10^5	9.07×10^3	7.33×10^2
0.25	6.60×10^4	4.44×10^3	3.58×10^2
0.06	1.57×10^4	1.05×10^3	8.52×10^1

125

3.69	2.53×10^4	1.75×10^4	8.20×10^1
3.73	2.61×10^4	1.80×10^4	8.46×10^1
3.82	2.67×10^4	1.84×10^4	8.65×10^1
3.86	2.77×10^4	1.91×10^4	8.97×10^1
3.99	2.90×10^4	2.00×10^4	9.40×10^1
4.17	2.98×10^4	2.06×10^4	9.66×10^1

129

0.21	1.17×10^6	-	9.45×10^2
-	2.25×10^4	-	1.82×10^1
-	4.71×10^2	-	-
-	-	-	-
-	-	-	-
-	-	-	-

TOTAL

9.69	1.61×10^6	1.34×10^5	3.26×10^3
9.40	2.79×10^5	1.15×10^5	2.14×10^3
9.42	2.20×10^5	9.95×10^4	1.64×10^3
9.16	1.37×10^5	7.58×10^4	1.18×10^3
9.17	9.50×10^4	4.77×10^4	6.27×10^2
9.27	4.55×10^4	2.72×10^4	2.24×10^2

TELLURIUM Te

G	C	R	W
---	---	---	---

126

5.28	-	-	-
"	-	-	-
"	-	-	-
"	-	-	-
"	-	-	-
"	-	-	-

G	C	R	W
---	---	---	---

129

1.16x10	8.20x10 ⁵	4.51x10 ⁴	-
1.14x10	7.90x10 ⁵	4.34x10 ⁴	-
1.12x10	7.70x10 ⁵	4.24x10 ⁴	-
1.07x10	3.20x10 ⁵	1.76x10 ⁴	-
9.78	2.90x10 ⁵	1.60x10 ⁴	-
8.27	2.50x10 ⁵	1.38x10 ⁴	-

G	C	R	W
---	---	---	---

132

2.78x10	8.57x10 ⁶	1.02x10 ⁶	1.94x10 ⁴
2.24x10	6.92x10 ⁶	8.30x10 ⁵	1.56x10 ⁴
1.80x10	5.54x10 ⁶	6.65x10 ⁵	1.25x10 ⁴
1.20x10	3.61x10 ⁶	4.33x10 ⁵	8.16x10 ³
4.89	1.51x10 ⁶	1.81x10 ⁵	3.41x10 ³
0.86	2.66x10 ⁵	3.19x10 ⁴	6.01x10 ²

127

1.55	2.48x10 ⁵	5.26x10 ²	1.52x10 ³
1.20	2.26x10 ⁵	5.56x10 ²	1.38x10 ³
1.19	1.93x10 ⁵	5.56x10 ²	1.16x10 ³
1.22	1.43x10 ⁵	5.76x10 ²	8.18x10 ²
1.21	8.09x10 ⁴	5.93x10 ²	1.80x10 ²
1.16	3.52x10 ⁴	5.77x10 ²	4.30

130

8.31x10	-	-	-
"	-	-	-
"	-	-	-
"	-	-	-
"	-	-	-
"	-	-	-

133

0.53	1.14x10 ⁷	-	9.24x10 ³
0.13	2.85	-	-
-	-	-	-
-	-	-	-
-	-	-	-
-	-	-	-

128

1.40x10	-	-	-
"	-	-	-
"	-	-	-
"	-	-	-
"	-	-	-
"	-	-	-

131

6.71	1.06x10 ⁷	9.55x10 ⁵	1.54x10 ⁵
3.85	6.10x10 ⁶	5.49x10 ⁵	8.84x10 ⁴
2.20	3.50x10 ⁶	3.15x10 ⁵	5.08x10 ⁴
0.73	1.16x10 ⁶	1.04x10 ⁵	1.68x10 ⁴
0.08	1.20x10 ⁵	1.88x10 ⁴	1.74x10 ³
-	-	-	-

TOTAL

1.51x10 ²	2.13x10 ⁷	2.03x10 ⁶	1.84x10 ⁵
1.41x10 ²	1.40x10 ⁷	1.43x10 ⁶	1.05x10 ⁵
1.35x10 ²	1.00x10 ⁷	1.03x10 ⁶	6.45x10 ⁴
1.27x10 ²	5.23x10 ⁶	5.61x10 ⁵	2.58x10 ⁴
1.29x10 ²	2.00x10 ⁶	2.11x10 ⁵	5.33x10 ³
1.12x10 ²	3.11x10 ⁵	4.73x10 ⁴	6.05x10 ²

IODINE I

G	C	R	W
---	---	---	---

127

5.80	-	-	-
5.93	-	-	-
6.06	-	-	-
6.27	-	-	-
6.53	-	-	-
7.23	-	-	-

G	C	R	W
---	---	---	---

132

0.86	8.59×10^6	3.22×10^6	1.07×10^5
0.73	7.18×10^6	2.69×10^6	$8.98 \cdot 10^4$
0.58	5.80×10^6	2.18×10^6	7.25×10^5
0.35	3.48×10^6	1.30×10^6	4.35×10^4
0.14	1.38×10^6	5.18×10^5	1.72×10^4
0.02	2.31×10^5	8.66×10^4	$2.89 \cdot 10^3$

G	C	R	W
---	---	---	---

129

2.29×10	-	-	-
2.25×10	-	-	-
2.27×10	-	-	-
2.31×10	-	-	-
2.41×10	-	-	-
2.56×10	-	-	-

133

1.08×10	1.14×10^7	3.76×10^6	1.24×10^5
5.75	5.88×10^6	1.94×10^6	6.41×10^4
2.58	2.72×10^6	8.98×10^5	2.96×10^4
0.58	6.19×10^5	2.04×10^5	6.75×10^3
-	2.29×10^5	7.56×10^4	2.50×10^3
-	-	-	-

131

4.15×10	5.15×10^6	1.27×10^6	2.32×10^4
3.98×10	4.93×10^6	1.21×10^6	2.22×10^4
3.75×10	4.63×10^6	1.14×10^6	2.09×10^4
3.24×10	4.02×10^6	9.89×10^5	4.46×10^3
2.35×10	2.91×10^6	7.16×10^5	3.23×10^3
1.17×10	1.45×10^6	3.57×10^5	6.54×10^2

135

3.47	1.22×10^7	1.89×10^7	9.01×10^5
0.28	1.40×10^6	2.17×10^6	1.03×10^5
-	8.18×10^4	1.27×10^5	6.04×10^4
-	6.10×10^2	9.46×10^2	4.51×10
-	-	-	-
-	-	-	-

TOTAL

8.54×10	3.72×10^7	2.72×10^7	1.16×10^6
7.50×10	1.92×10^7	8.01×10^6	2.79×10^5
6.94×10	1.34×10^7	4.86×10^6	1.83×10^5
6.27×10	8.18×10^6	2.49×10^6	5.47×10^4
5.42×10	4.51×10^6	1.31×10^6	2.29×10^4
4.46×10	3.76×10^6	4.44×10^5	3.54×10^3

XENON Xe

G	C	R	W
---	---	---	---

G	C	R	W
---	---	---	---

G	C	R	W
---	---	---	---

131

1.07×10^2	8.68×10^4	7.46×10^3	-
1.12×10^2	7.83×10^4	6.73×10^3	-
1.16×10^2	7.10×10^4	6.11×10^3	-
1.22×10^2	5.75×10^4	4.94×10^3	-
1.32×10^2	3.72×10^4	3.20×10^3	-
1.44×10^2	1.38×10^4	1.19×10^3	-

134

4.39×10^2	-	-	-
4.39×10^2	-	-	-
4.39×10^2	-	-	-
4.39×10^2	-	-	-
4.39×10^2	-	-	-
4.39×10^2	-	-	-

132

2.23×10^2	-	-	-
2.28×10^2	-	-	-
2.33×10^2	-	-	-
2.39×10^2	-	-	-
2.46×10^2	-	-	-
2.51×10^2	-	-	-

135

3.47	1.22×10^7	5.49×10^6	9.16×10^4
0.28	1.00×10^6	4.50×10^5	7.51×10^3
-	8.18×10^4	3.68×10^4	6.14×10^2
-	6.12×10^2	2.75×10^2	4.60
-	-	-	-
-	-	-	-

133

6.10×10	1.14×10^7	5.02×10^5	2.90×10^4
5.86×10	1.10×10^7	4.84×10^5	2.79×10^4
5.41×10	1.01×10^7	4.84×10^5	2.79×10^4
4.37×10	8.14×10^6	3.58×10^5	2.07×10^4
2.59×10	4.84×10^6	2.13×10^5	1.23×10^4
9.00	1.68×10^6	7.39×10^4	4.27×10^2

136

3.58×10^2	-	-	-
"	-	-	-
"	-	-	-
"	-	-	-
"	-	-	-
"	-	-	-

TOTAL

1.19×10^3	2.36×10^7	6.00×10^6	1.21×10^5
1.19×10^3	1.20×10^7	9.40×10^5	3.44×10^4
1.20×10^3	1.01×10^7	5.27×10^5	2.85×10^4
1.20×10^3	8.27×10^6	3.63×10^5	2.87×10^4
1.20×10^3	4.87×10^6	2.16×10^5	1.23×10^4
1.20×10^3	1.69×10^6	7.50×10^4	4.27×10^3

CESIUM Cs

G	C	R	W
---	---	---	---

G	C	R	W
---	---	---	---

133

2.61×10^2	-	-	-
2.69×10^2	-	-	-
2.77×10^2	-	-	-
2.89×10^2	-	-	-
3.08×10^2	-	-	-
3.25×10^2	-	-	-

135

3.56×10^2	-	-	-
3.63×10^2	-	-	-
3.63×10^2	-	-	-
3.63×10^2	-	-	-
3.63×10^2	-	-	-
3.63×10^2	-	-	-

137

3.15×10	2.48×10^5	8.95×10^4	1.09×10^3
"	"	"	"
"	"	"	"
"	"	"	"
"	"	"	"
"	"	"	"

TOTAL

9.34×10^2	2.48×10^5	8.95×10^4	1.09×10^3
9.48×10^2	"	"	"
9.56×10^2	"	"	"
9.69×10^2	"	"	"
9.87×10^2	"	"	"
1.00×10^3	"	"	"

BARIUM Ba

G	C	R	W
---	---	---	---

G	C	R	W
---	---	---	---

137

-	2.36×10^4	7.55×10^3	-
-	"	"	-
-	"	"	-
-	"	"	-
-	"	"	-
-	"	"	-

140

1.46×10^2	1.06×10^7	1.31×10^6	6.89×10^4
1.38×10^2	1.00×10^7	1.24×10^6	6.50×10^4
1.31×10^2	9.17×10^6	1.14×10^6	5.96×10^4
1.12×10^2	8.18×10^6	1.01×10^6	5.32×10^4
1.07×10^2	6.88×10^6	8.53×10^5	4.47×10^4
6.19×10	4.78×10^6	5.93×10^5	3.11×10^4

138

3.63×10^2	-	-	-
"	-	-	-
"	-	-	-
"	-	-	-
"	-	-	-
"	-	-	-

139

0.77	1.22×10^7	4.32×10^4	-
-	3.90×10	-	-
-	-	-	-
-	-	-	-
-	-	-	-
-	-	-	-

TOTAL

5.10×10^2	1.38×10^7	1.36×10^6	6.89×10^4
5.02×10^2	1.01×10^7	1.29×10^6	6.50×10^4
4.96×10^2	9.18×10^6	1.19×10^6	5.96×10^4
4.76×10^2	8.20×10^6	1.06×10^6	5.32×10^4
4.71×10^2	6.90×10^6	9.03×10^5	4.47×10^4
4.26×10^2	4.80×10^6	6.43×10^5	3.11×10^4

LANTHANUM La

G	C	R	W
---	---	---	---

G	C	R	W
---	---	---	---

139

3.77×10^2	-	-	-
3.78×10^2	-	-	-
3.78×10^2	-	-	-
3.78×10^2	-	-	-
3.78×10^2	-	-	-
3.78×10^2	-	-	-

142

0.58	1.05×10^7	1.05×10^6	8.48×10^3
-	1.57×10	1.57	-
-	-	-	-
-	-	-	-
-	-	-	-
-	-	-	-

140

1.88×10	1.06×10^7	6.88×10^6	1.27×10^5
1.87×10	1.05×10^7	6.81×10^6	1.26×10^5
1.84×10	1.03×10^7	6.68×10^6	1.24×10^5
1.71×10	9.61×10^6	6.24×10^6	1.15×10^5
1.41×10	7.96×10^6	5.17×10^6	9.55×10^4
9.30	5.23×10^6	3.39×10^6	6.28×10^4

141

2.45	1.14×10^7	-	2.58×10^5
-	1.26×10^5	-	2.85×10^5
-	1.37×10^3	-	3.10×10
-	-	-	-
-	-	-	-
-	-	-	-

TOTAL

4.00×10^2	3.25×10^7	7.93×10^6	3.93×10^5
3.96×10^2	1.06×10^7	6.81×10^6	4.11×10^5
3.96×10^2	1.04×10^7	6.68×10^6	1.24×10^5
3.95×10^2	9.61×10^6	6.24×10^6	1.15×10^5
3.92×10^2	7.96×10^6	5.17×10^6	9.55×10^4
3.87×10^2	5.23×10^6	3.39×10^6	6.28×10^4

CERIUM Ce

G	C	R	W
---	---	---	---

140

2.10×10^2	-	-	-
2.18×10^2	-	-	-
2.25×10^2	-	-	-
2.45×10^2	-	-	-
2.66×10^2	-	-	-
3.02×10^2	-	-	-

G	C	R	W
---	---	---	---

143

1.43×10	9.56×10^6	3.06×10^6	1.05×10^5
8.61	5.75×10^6	1.84×10^6	6.32×10^4
4.84	3.24×10^6	1.04×10^6	3.56×10^4
1.64	1.82×10^6	5.82×10^5	2.00×10^4
0.19	1.21×10^5	3.87×10^4	1.33×10^3
0.02	1.72×10^4	5.50×10^3	1.89×10^2

G	C	R	W
---	---	---	---

141

2.29×10^2	7.10×10^6	3.58×10^5	2.61×10^4
2.26×10^2	6.92×10^6	3.49×10^5	2.55×10^4
2.21×10^2	6.79×10^6	3.42×10^5	2.50×10^4
2.11×10^2	6.45×10^6	3.25×10^5	2.37×10^4
1.92×10^2	5.88×10^6	2.96×10^5	2.16×10^4
1.59×10^2	4.89×10^6	2.46×10^5	1.80×10^4

144

2.47×10^2	8.22×10^5	-	2.31×10^3
2.47×10^2	8.22×10^5	-	2.31×10^3
2.46×10^2	8.18×10^5	-	2.30×10^3
2.44×10^2	8.14×10^5	-	2.29×10^3
2.41×10^2	8.05×10^5	-	2.26×10^3
2.36×10^2	7.88×10^5	-	2.21×10^3

142

3.31×10^2	-	-	-
3.32×10^2	-	-	-
3.32×10^2	-	-	-
3.32×10^2	-	-	-
3.32×10^2	-	-	-
3.32×10^2	-	-	-

145

0.57	8.61×10^6	-	6.96×10^3
-	1.16×10^2	-	-
-	-	-	-
-	-	-	-
-	-	-	-
-	-	-	-

TOTAL

1.03×10^3	2.60×10^7	3.42×10^6	1.40×10^5
"	1.34×10^7	2.19×10^6	9.10×10^4
"	1.08×10^7	1.38×10^6	6.29×10^4
"	9.08×10^6	9.07×10^5	4.60×10^4
"	6.80×10^6	3.35×10^5	2.52×10^4
"	5.68×10^6	2.52×10^5	2.04×10^4

PRASEODYMIUM Pr

G	C	R	W
---	---	---	---

G	C	R	W
---	---	---	---

141

1.28×10^2	-	-	-
1.34×10^2	-	-	-
1.39×10^2	-	-	-
1.48×10^2	-	-	-
1.68×10^2	-	-	-
2.00×10^2	-	-	-

145

1.41	6.90×10^6	-	1.79×10^4
0.04	1.73×10^5	-	4.48×10^4
-	4.32×10^3	-	1.12×10^4
-	1.08×10^2	-	2.80
-	2.71	-	-
-	-	-	-

143

1.24×10^2	8.33×10^6	-	6.27×10^4
1.25×10^2	8.42×10^6	-	6.34×10^4
1.21×10^2	8.15×10^6	-	6.14×10^4
1.13×10^2	7.64×10^6	-	5.75×10^4
9.37×10^1	6.29×10^6	-	4.74×10^4
6.25×10^1	4.23×10^6	-	3.19×10^4

144

-	8.25×10^5	5.61×10^4	2.05×10^4
-	8.25×10^5	5.61×10^4	2.05×10^4
-	8.20×10^5	5.58×10^4	2.03×10^4
-	8.15×10^5	5.54×10^4	2.02×10^4
-	8.07×10^5	5.49×10^4	2.00×10^4
-	7.89×10^5	5.36×10^4	1.96×10^4

TOTAL

2.53×10^2	1.60×10^7	5.61×10^4	1.01×10^5
2.99×10^2	9.41×10^6	5.61×10^4	1.29×10^5
2.60×10^2	9.01×10^6	5.58×10^4	8.17×10^4
2.62×10^2	8.45×10^6	5.54×10^4	7.77×10^4
2.61×10^2	7.09×10^6	5.49×10^4	6.74×10^4
2.63×10^2	5.01×10^6	5.36×10^4	5.15×10^4

NEODYMIUM Na

G	C	R	W
---	---	---	---

143

1.67×10^2	-	-	-
1.34×10^2	-	-	-
1.79×10^2	-	-	-
1.90×10^2	-	-	-
2.11×10^2	-	-	-
2.42×10^2	-	-	-

G	C	R	W
---	---	---	---

146

1.74×10^2	-	-	-
"	-	-	-
"	-	-	-
"	-	-	-
"	-	-	-
"	-	-	-

G	C	R	W
---	---	---	---

149

0.18	1.93×10^6	-	2.34×10^4
-	3.85×10^2	-	4.66
-	-	-	-
-	-	-	-
-	-	-	-
-	-	-	-

144

1.65×10	-	-	-
1.65×10	-	-	-
1.78×10	-	-	-
1.91×10	-	-	-
2.21×10	-	-	-
2.73×10	-	-	-

147

4.60×10	3.75×10^6	5.10×10^5	4.84×10^3
4.34×10	3.56×10^6	4.84×10^5	4.59×10^3
4.08×10	3.34×10^6	4.54×10^5	4.31×10^3
3.56×10	2.95×10^6	4.01×10^5	3.81×10^3
2.78×10	2.26×10^6	3.07×10^5	2.92×10^3
1.69×10	1.34×10^6	1.82×10^5	1.73×10^3

150

4.11×10	-	-	-
"	-	-	-
"	-	-	-
"	-	-	-
"	-	-	-
"	-	-	-

145

2.23×10^2	-	-	-
"	-	-	-
"	-	-	-
"	-	-	-
"	-	-	-
"	-	-	-

148

9.48×10	-	-	-
"	-	-	-
"	-	-	-
"	-	-	-
"	-	-	-
"	-	-	-

TOTAL

7.62×10^2	5.68×10^6	5.10×10^5	2.82×10^4
7.27×10^2	3.56×10^6	4.84×10^5	4.59×10^3
7.71×10^2	3.34×10^6	4.54×10^5	4.31×10^3
7.78×10^2	2.95×10^6	4.01×10^5	3.81×10^3
7.94×10^2	2.26×10^6	3.07×10^5	2.92×10^3
8.20×10^2	1.34×10^6	1.82×10^5	1.73×10^3

PROMETHIUM Pm

G	C	R	W
---	---	---	---

G	C	R	W
---	---	---	---

147

8.16x10	-	-	-
8.85x10	-	-	-
9.11x10	-	-	-
9.64x10	-	-	-
1.04x10 ²	-	-	-
1.15x10 ²	-	-	-

149

4.24	1.92x10 ⁶	2.69x10 ⁴	1.71x10 ⁴
3.35	1.51x10 ⁶	2.11x10 ⁴	1.34x10 ⁴
2.57	1.16x10 ⁶	1.62x10 ⁴	1.03x10 ⁴
1.11	5.03x10 ⁵	7.04x10 ³	4.47x10 ³
0.22	9.98x10 ⁴	1.40x10 ³	8.87x10 ²
-	-	-	-

TOTAL

8.58x10	1.92x10 ⁶	2.69x10 ⁴	1.71x10 ⁴
9.19x10	1.51x10 ⁶	2.11x10 ⁴	1.34x10 ⁴
9.37x10	1.16x10 ⁶	1.62x10 ⁴	1.03x10 ⁴
9.75x10	5.03x10 ⁵	7.04x10 ³	4.47x10 ³
1.04x10 ²	9.98x10 ⁴	1.40x10 ³	8.87x10 ²
1.15x10 ²	-	-	-

SAMARIUM Sm

G	C	R	W
---	---	---	---

149			
5.94x10	-	-	-
6.04x10	-	-	-
6.12x10	-	-	-
6.27x10	-	-	-
6.36x10	-	-	-
6.38x10	-	-	-

G	C	R	W
---	---	---	---

153			
0.61	2.66x10 ⁵	1.06x10 ⁴	-
0.46	1.86x10 ⁵	7.44x10 ³	-
0.32	1.33x10 ⁵	5.32x10 ³	-
0.16	6.07x10 ⁴	2.43x10 ³	-
0.04	1.38x10 ⁴	5.52x10 ²	-
-	8.24x10 ²	3.30x10	-

G	C	R	W
---	---	---	---

151			
2.65x10	6.29x10	-	-
"	"	-	-
"	"	-	-
"	"	-	-
"	"	-	-
"	"	-	-

154			
5.27	-	-	-
"	-	-	-
"	-	-	-
"	-	-	-
"	-	-	-
"	-	-	-

152			
1.62x10	-	-	-
"	-	-	-
"	-	-	-
"	-	-	-
"	-	-	-
"	-	-	-

156			
0.01	1.90x10 ⁴	-	1.23x10 ²
-	3.62x10 ³	-	2.34x10
-	6.94x10 ²	-	4.48
-	2.48x10	-	-
-	-	-	-
-	-	-	-

TOTAL			
1.08x10 ²	2.85x10 ⁵	1.06x10 ⁴	1.23x10 ²
1.09x10 ²	1.89x10 ⁵	7.44x10 ³	2.34x10
1.10x10 ²	1.39x10 ⁵	5.32x10 ³	4.48
1.11x10 ²	6.13x10 ⁴	2.43x10 ³	-
1.12x10 ²	1.39x10 ⁴	5.52x10 ²	-
1.12x10 ²	8.86x10 ²	3.30x10	-

EUROPIUM Eu

G	C	R	W
---	---	---	---

G	C	R	W
---	---	---	---

153

8.53	-	-	-
8.68	-	-	-
8.82	-	-	-
8.98	-	-	-
9.09	-	-	-
9.13	-	-	-

155

2.30	2.66×10^3	1.25×10^2	3.70
"	"	"	"
"	"	"	"
"	"	"	"
"	"	"	"
"	"	"	"

156

0.29	1.60×10^4	1.54×10^4	1.68×10^2
0.29	1.57×10^4	1.51×10^4	1.65×10^2
0.28	1.51×10^4	1.45×10^4	1.59×10^2
0.25	1.38×10^4	1.32×10^4	1.45×10^2
0.21	1.16×10^4	1.11×10^4	1.22×10^2
0.15	8.09×10^3	7.77×10^3	8.49×10^1

TOTAL

1.11×10^1	1.84×10^4	1.55×10^4	1.72×10^2
1.13×10^1	1.83×10^4	1.52×10^4	1.69×10^2
1.14×10^1	1.77×10^4	1.46×10^4	1.63×10^2
1.15×10^1	1.64×10^4	1.33×10^4	1.49×10^2
1.16×10^1	1.42×10^4	1.12×10^4	1.26×10^2
1.16×10^1	1.06×10^4	7.89×10^3	8.86×10^1

GADOLINIUM Gd

G	C	R	W
---	---	---	---

G	C	R	W
---	---	---	---

156

0.36	-	-	-
0.38	-	-	-
0.39	-	-	-
0.42	-	-	-
0.45	-	-	-
0.52	-	-	-

TOTAL

0.36	-	-	-
0.38	-	-	-
0.39	-	-	-
0.42	-	-	-
0.45	-	-	-
0.52	-	-	-

G	C	R	W
---	---	---	---

GRAND
TOTAL

8.28×10^3	2.99×10^8	9.46×10^7	3.79×10^6
8.28×10^3	1.46×10^8	3.52×10^7	1.58×10^6
8.29×10^3	1.20×10^8	2.48×10^7	9.26×10^5
8.28×10^3	8.78×10^7	1.67×10^7	6.19×10^5
8.11×10^3	6.28×10^7	1.31×10^7	4.32×10^5
8.30×10^3	4.37×10^7	9.21×10^7	2.99×10^5

UNIVERSITY OF MICHIGAN



3 9015 03483 4302