

2948-36-F

# AN INSTRUMENTATION SYSTEM FOR THE MEASUREMENT OF TERRAIN PROFILE

IRVIN J. SATTINGER  
SIDNEY STERNICK

December 1961

Special Projects Group  
*Institute of Science and Technology*  
THE UNIVERSITY OF MICHIGAN  
Ann Arbor, Michigan

## NOTICES

Sponsorship. The work reported herein was conducted by the Institute of Science and Technology for the U. S. Army, Contract DA-20-018 ORD-20815. Contracts and grants to The University of Michigan for the support of sponsored research by the Institute of Science and Technology are administered through the Office of the Vice-President for Research.

ASTIA Availability. Qualified requesters may obtain copies of this document from:

Armed Services Technical Information Agency  
Arlington Hall Station  
Arlington 12, Virginia

Final Disposition. After this document has served its purpose, it may be destroyed. Please do not return it to the Institute of Science and Technology.

**CONTENTS**

|   |    |
|---|----|
| Notices . . . . .   | ii |
| List of Figures . . . . .                                       | iv |
| Abstract . . . . .  | 1  |
| 1. Introduction . . . . .                                       | 1  |
| 2. Required Characteristics of Instrumentation System . . . . . | 2  |
| 2.1. Types of Information Required . . . . .                    | 2  |
| 2.2. Performance and Operating Characteristics . . . . .        | 3  |
| 3. System Design and Operation . . . . .                        | 4  |
| 3.1. Theory of Operation . . . . .                              | 4  |
| 3.2. Detailed Description of System Design . . . . .            | 5  |
| 4. Error Analysis . . . . .                                     | 8  |
| 4.1. Instrumentation Errors . . . . .                           | 8  |
| 4.2. Errors Due to Mathematical Approximations . . . . .        | 12 |
| 5. Possibilities of System Refinement . . . . .                 | 13 |
| 5.1. Reduction of Wheel Bounce . . . . .                        | 13 |
| 5.2. Alternative Methods of Profile Computation . . . . .       | 14 |
| 5.3. Correction of Vehicle Roll . . . . .                       | 17 |
| 5.4. Measurement along Parallel Tracks . . . . .                | 17 |
| 6. Conclusions . . . . .  | 17 |
| Appendix: Data-Recording and Conversion System . . . . .        | 19 |
| References . . . . .  | 21 |
| Distribution List . . . . .                                     | 22 |

**FIGURES**

Frontispiece. Field Equipment for Terrain Measurement . . . . . vi

1. Terrain-Measuring Assembly . . . . . 5

2. Field-Equipment Block Diagram . . . . . 7

3. Data-Processing Facility . . . . . 7

4. Representation of Terrain Sample . . . . .13

5. Measurement Geometry . . . . .14

6. Alternative Computation Method . . . . .16

7. Test Data on V-Ramp Profile . . . . .18



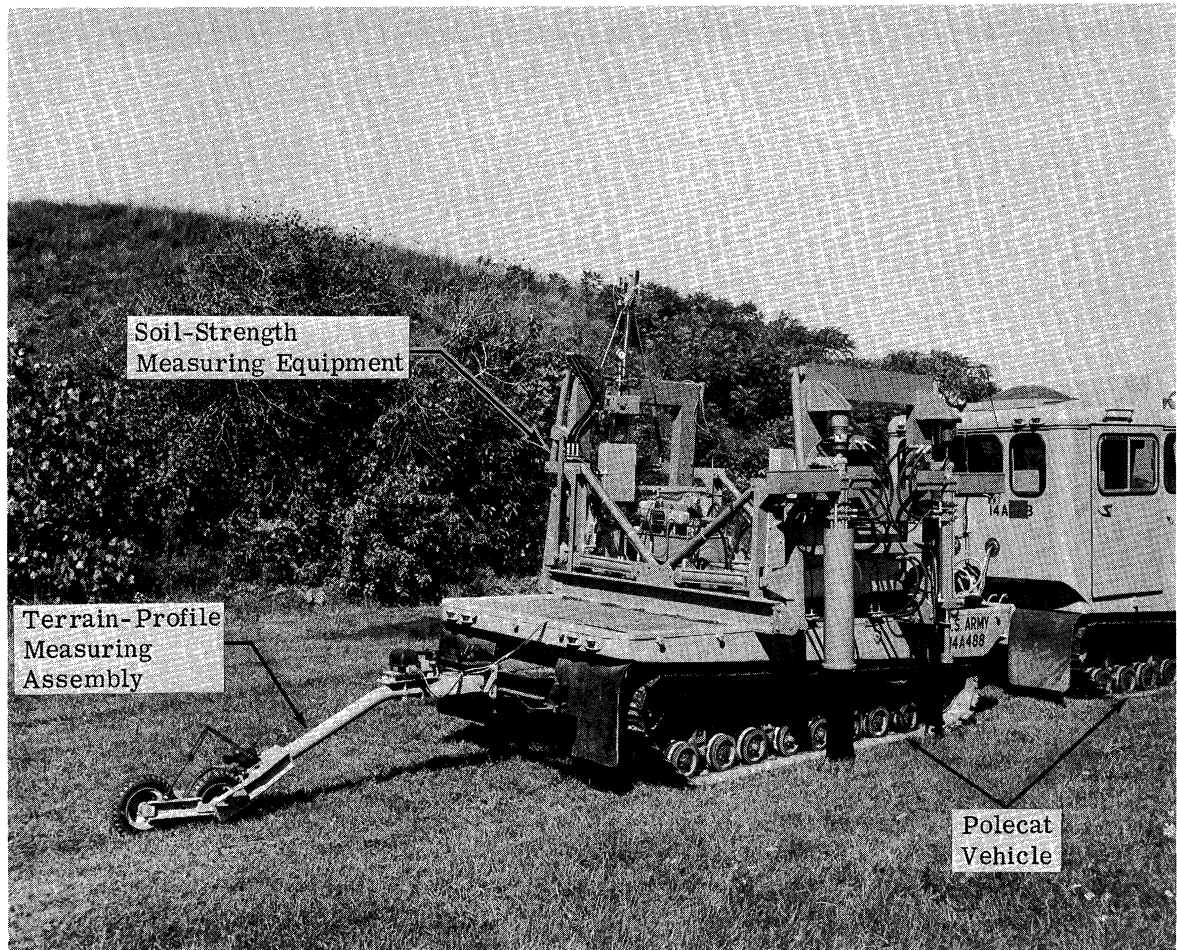

FRONTISPIECE. FIELD EQUIPMENT FOR TERRAIN MEASUREMENT

---

# AN INSTRUMENTATION SYSTEM FOR THE MEASUREMENT OF TERRAIN PROFILE

## ABSTRACT

An instrumentation system for the measurement of terrain profile has been developed and tested. Its purpose is to provide a means for the rapid and accurate collection of terrain-profile data useful in analyzing the rough-ground performance of cross-country vehicles. The field equipment consists of a two-wheeled measuring assembly which is towed across the ground at a speed not exceeding 5 mph. Electrical instruments mounted on the assembly continuously measure the slope of the ground and the distance traveled along the surface. These quantities are recorded on magnetic tape. The magnetic tape is then returned to a laboratory data-processing system which obtains the profile data by integrating the slope of the ground with respect to surface travel. Preliminary analysis and tests indicate that the system is capable of obtaining terrain profile with an error having a standard deviation of not more than 4 inches in 100 feet.

---

## 1

### INTRODUCTION

An important factor in the performance of a military vehicle is its mobility during off-the-road operation. One aspect of the mobility of a vehicle is its rough-ground performance, an indication of which is the speed at which it can move across rough terrain. Allowable speeds tend to be limited by the effects of motion on passengers and equipment.

To improve the rough-ground performance of military vehicles, methods for analyzing and predicting such performance must be developed and implemented (References 1 and 2). In addition to experimental field testing, considerable work has been done on theoretical analysis of vehicle dynamics. The early methods of analysis were based primarily on the assumption that the suspension system is linear. These methods are at present being extended to permit the analysis of vehicle performance by representing terrain profile and vehicle motion in terms of power spectral density distributions (References 3, 4, and 5). Also, analog-computer simulation methods have been developed which take into account the important nonlinearities of the suspension system as well as the irregularity of the ground surface (References 6 and 7).

Applying such methods of vehicle dynamic analysis requires an organized body of information on the geometrical characteristics of terrain over which off-the-road vehicles travel.

Since large amounts of data are needed, it is advisable to adopt measurement methods suitable for rapid and accurate collection of data. This report describes an instrumentation system developed for the purpose by the Institute of Science and Technology, under Contract DA-20-018 ORD-20815 with the Land Locomotion Laboratory of the Ordnance Tank-Automotive Command. The Frontispiece is a photograph of the resulting field equipment. The soil-strength measuring equipment also shown was developed under the same contract; it is discussed in Reference 3.

A detailed statement of the requirements placed on the design of the terrain-profile measurement system described in this report is given in Section 2. The measurement technique uses a slope integration method of profile computation, the theory of which is described in Section 3.1. A detailed description of the design and operation of the equipment follows in Section 3.2. Since the accuracy of the system is of primary concern, the various types of error and the expected magnitude of each are analyzed in Section 4. Possibilities of refining the system further by adding special features, modifying components, or using alternative methods of data processing are taken up in Section 5. Section 6 contains samples of test data and briefly presents conclusions concerning the equipment and its performance.

## 2

### REQUIRED CHARACTERISTICS OF INSTRUMENTATION SYSTEM

#### 2.1. TYPES OF INFORMATION REQUIRED

The profile of a particular section of ground consists of the elevation of each point along a selected route as a function of the horizontal distance along the route. Methods of analyzing the ground-wave performance of cross-country vehicles use either a ground-profile record or some other form of data derived from it. Profile data are thus the basic information required in terrain measuring.

If the data are to be used to determine the dynamic response of the vehicle in pitch and bounce only, the profile along a single line is sufficient. More comprehensive studies which include the roll response would require data collected along two parallel lines separated by the track width of a vehicle.

Since studies of mobility may be expected to cover entire areas, it is desirable to supplement the profile data collected along specific paths with information on the general area. A plan view should be provided to show the natural and man-made features. Such data may already be available either on topographic maps similar to those prepared by the U. S. Geological Survey or in aerial photographs available from civilian or military agencies.



## 2.2. PERFORMANCE AND OPERATING CHARACTERISTICS

A profile-measurement system must be accurate, economical, reliable, and mobile, and must provide an output in usable form. The degree of accuracy required of the data depends on how errors in profile measurement affect the calculation of the pitch, bounce, and roll of a number of types of wheeled and track-laying vehicles as they travel over terrain at various speeds. In terms of response to a sinusoidal terrain profile of a given amplitude, the vehicle body moves only slightly for ground wavelengths less than half the wheelbase or ground-contact length of the vehicle, or more than five times that length. Wheelbases of interest range from 4 to 20 feet; therefore, reasonably accurate measurements of sinusoidal components with wavelengths greater than 2 feet and less than 100 feet should be sufficient. To obtain such accuracy, a horizontal resolution (i.e., horizontal spacing of individual measurements) equal to about 1 foot is adequate. However, a greater degree of horizontal resolution is useful, since it permits detailed measurement of individual nonsinusoidal irregularities. With respect to vertical accuracy required, errors of 1 inch over horizontal distances of the order of a wheelbase length and errors of 4 inches over distances of 100 feet result in errors in calculation of body motions small enough to be ignored. In determining the accuracy of a system, systematic errors, which accumulate in only one direction, appear as a difference in average slope and are therefore of no significance in vehicle studies.

If it is considered desirable for any reason to eliminate the accumulation of errors over long distances, an independent set of data on the elevation of points spaced along the route could be provided by conventional surveying methods or topographic maps. The data from the terrain measuring system could then be corrected to pass through the independently determined points.

The operation of a system depending on highly trained personnel is likely to be expensive and subject to interruptions of service. For this reason, ruggedness of construction, simplicity of operation, and ease of maintenance are important characteristics.

The instrumentation vehicle must have good off-the-road mobility. It may have to go over difficult routes to take measurements in areas which contain obstacles of various sizes and shapes, varying widely in composition or consistency, and possibly covered with snow or vegetation.

Since large amounts of terrain data are required, it is advisable to develop measurement methods which can collect data rapidly and accurately, and in a form convenient for subsequent use. Two specific uses for terrain-geometry data are anticipated: they can be used to provide

road-function inputs to an analog simulation of a vehicle suspension system, or they can be subjected to harmonic analysis techniques to characterize each road sample in terms of its spectral density (i.e., the amplitude of each sinusoidal component as a function of ground wavelength). In either case, a record of elevation,  $y$ , as a function of the horizontal component of distance,  $x$ , provides the necessary data in a form adaptable to the intended use.

### 3

## SYSTEM DESIGN AND OPERATION

### 3.1. THEORY OF OPERATION

The measurement technique adopted in the system described herein makes use of a slope-integration method. This basic method was selected after study of various possible methods of measuring terrain geometry (Reference 9). A device which integrates the slope of the ground mechanizes the equations:

$$y - y_0 = \int_0^s \sin \theta \, ds \quad (1)$$

$$x = \int_0^s \cos \theta \, ds \quad (2)$$

where  $s$  is the total distance traveled along the surface of the ground

$x$  is the horizontal component of distance along the ground for total travel,  $s$

$y$  is the elevation of the ground at horizontal distance,  $x$

$y_0$  is the elevation of the ground at the beginning of the run

$\theta$  is the slope angle of the ground under the vehicle at the distance  $s$  from the origin

For these equations, the two quantities which must be measured continuously are the distance traveled by the measuring vehicle and the slope of the ground over which it is traveling. To determine these two quantities, a trailer towed by a powered vehicle supports a measuring assembly consisting of two wheels mounted in tandem so as to follow a common track (Figure 1). An angular reference device carried by the trailer provides a continuous indication of the pitch angle of the wheel frame, assumed to be the same as the slope of the ground over which the wheels are traveling. The forward travel of the vehicle is measured by an odometric device connected to the front trailer wheel. The electrical outputs of the angular reference and the distance indicator are fed through a data-recording and conversion system to a digital computer which performs the computation indicated in Equations 1 and 2.

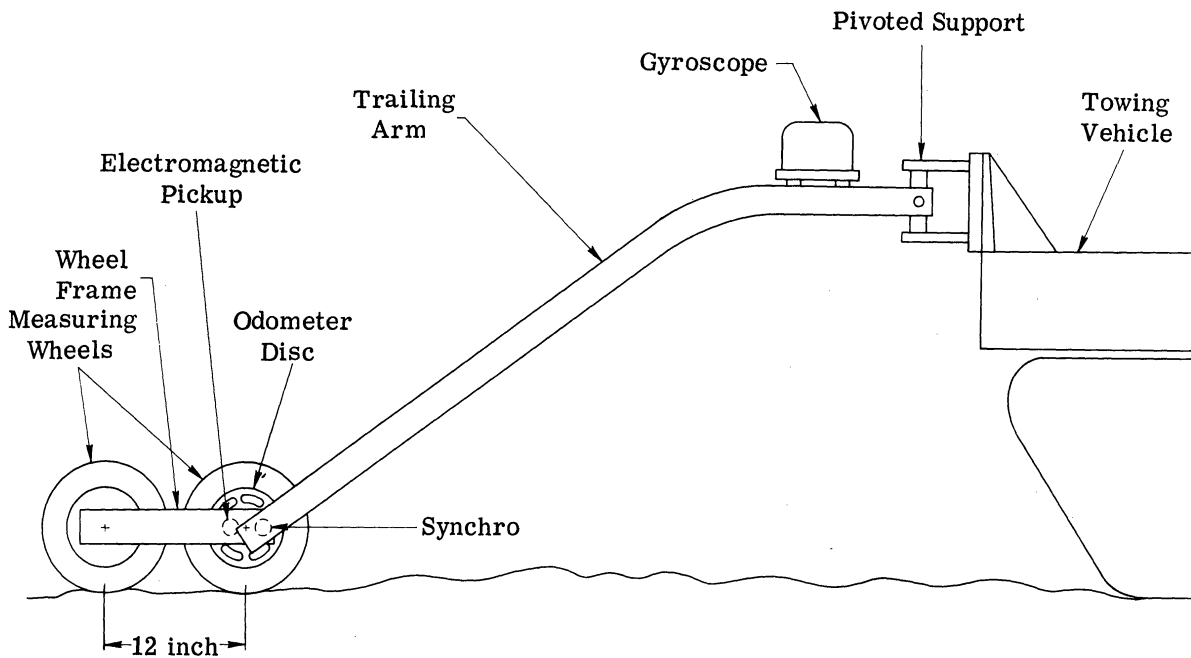

FIGURE 1. TERRAIN-MEASURING ASSEMBLY

### 3.2. DETAILED DESCRIPTION OF SYSTEM DESIGN

A preliminary design of an instrumentation system using the slope-integration method is described in Reference 9. The system actually constructed, as described in the present report, differs from the original design in certain details, particularly with respect to the methods of data recording and processing and to the type of instrumentation vehicle used. The modified recording methods make the instrumentation device simpler, more reliable, and compatible with data-conversion and processing equipment now available at the Ordnance Tank-Automotive Command. The field instrumentation system is to be mounted on a Polecat vehicle rather than an M-43 ambulance, as originally proposed. The Polecat, a track-laying vehicle, has greater mobility in all types of cross-country terrain.

The measuring assembly of the terrain-geometry measurement system is shown in Figure 1, and a block diagram of the electrical equipment in the vehicle is shown in Figure 2. The measuring assembly is attached to the rear unit of the Polecat vehicle by a pivoted support, which allows the trailing arm to rotate in both yaw and pitch. The slope of the ground is sensed by a pair of 11-inch-diameter wheels, mounted in tandem on a frame of 12-inch wheelbase at the rear of the assembly.

An odometer system measures the travel of the wheel along the surface. In this system, a series of voltage pulses, each representing a constant increment of travel,  $\Delta s$ , is produced

in the following manner. A metal disc mounted on the axle of the front measuring wheel contains 10 evenly spaced slots which pass in front of an electromagnetic pickup as the wheel rotates. The pickup is part of an oscillator circuit, which starts oscillating as the metal surface recedes from the pickup and stops as it approaches. When the oscillation ceases, an output stage of an electronic amplifier is allowed to conduct, energizing a hermetically sealed relay. A voltage transmitted through the relay contact is recorded on one channel of an Ampex AR-200 magnetic-tape recorder. Thus, each closure represents an increment of travel of the front measuring wheel. Field tests indicate that the relay operates fast enough to allow a forward vehicle speed as high as 8 mph.

The pitch angle of the measuring frame is sensed by a vertical gyroscope mounted on the trailing arm, total allowable range being from  $-90^{\circ}$  to  $+90^{\circ}$ . A synchro system is used to indicate continuously the angle between the wheel frame and the vertical. One synchro is attached to the front measuring wheel in such a manner as to indicate the angle between the wheel frame and the trailing arm. A second synchro is attached to the pitch gimbal of the gyroscope, so that in the absence of vehicle roll it measures the angle between the trailing arm and the vertical spin axis of the gyroscope. The stator windings of the two synchros are electrically connected so that the voltage of the output rotor winding is proportional to the sine of the angle between the longitudinal axis of the wheel frame and the vertical. This output signal consists of a 400-cps carrier voltage whose amplitude and phase correspond to the sine of the angle. A demodulator converts this carrier voltage to a varying d-c voltage, having a magnitude and sign also corresponding to the sine of the angle. This voltage is recorded on a second channel of the Ampex AR-200 tape recorder, in parallel with the odometer voltage.

In addition to the measuring assembly and magnetic-tape recorder described above, the terrain-measurement system includes power supplies to generate electrical power for the system. The primary source of this power is a gasoline engine which operates a 115-volt, 60-cps a-c generator. Auxiliary power supplies use the 60-cps power to produce 115-volt, 400-cps a-c required by the synchros and the gyroscope motor, and 28-volt d-c for the tape recorder.

In order to obtain terrain-geometry data in its final form, the raw data, as originally recorded on magnetic tape, must be processed in a digital computer. This is accomplished by a data-processing facility at the Ordnance Tank-Automotive Command (Figure 3). This facility contains a magnetic-tape reproducer which reproduces the recorded electrical outputs of the measuring instruments in analog form. A multiplexer sequentially samples the individual channels of the tape reproducer. The sampled data are converted into digital form by an analog-

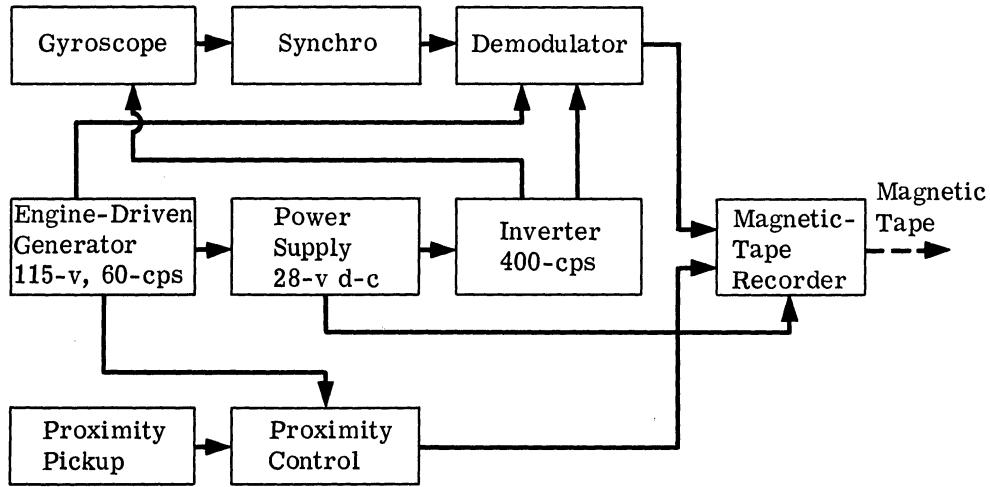

FIGURE 2. FIELD-EQUIPMENT BLOCK DIAGRAM

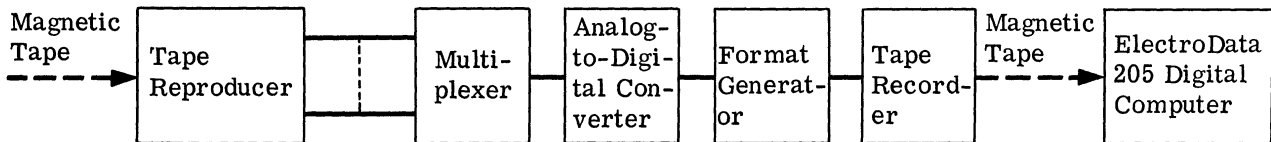

FIGURE 3. DATA-PROCESSING FACILITY

to-digital converter. The format generator then organizes the numerical data into a format compatible for use with an ElectroData 205 digital computer. The modified data are again recorded on magnetic tape. The resulting tape is then inserted into the tape system of the computer, so that the original data are available for further processing. This further processing is accomplished in accordance with a set of computer instructions inserted along with the data. Since the computer processing can be modified by preparing and inserting a new set of instructions, maximum flexibility can be obtained in the data-processing operation. The considerations involved in the selection and purchase of the data-recording and conversion equipment of Figure 3 are discussed in the Appendix.

In this section, one particular method of obtaining profile data from the raw data is described. Alternative methods are possible; some of them are discussed in Section 5.

In the data-processing operation the increments of distance  $\Delta y$  and  $\Delta x$  of the ground profile are computed for constant increments  $\Delta s$  along the ground surface. For each increment

$\Delta s$  amounting to 3.7 inches, the following computations occur:

$$\Delta x_i = \Delta s (\sin \theta)_i \quad (3)$$

$$\Delta y_i = \Delta s (\cos \theta)_i \quad (4)$$

$$x_i = \sum_0^i \Delta x_i \quad (5)$$

$$y_i = \sum_0^i \Delta y_i \quad (6)$$

The computed values of  $x_i$  and  $y_i$  can be plotted by a digital plotter, or the values can be stored within the computer for subsequent analysis.

#### 4

### ERROR ANALYSIS

This section analyzes various possible sources of error in the measurement of the terrain profile, the expected magnitude of the individual errors, and the total combined effect of these errors on the overall accuracy of the system.

Generally speaking, errors fall into two categories, referred to here as instrumentation errors (both mechanical and electrical) and mathematical approximations. Instrumentation errors may be caused by mechanical limitations of the system, such as wheel bounce or wheel slip, or by the characteristics of the electrical instrumentation measurement and recording devices. The second type of error is inherent in the nature of the mathematical process used in the reduction of the data. The most important error of this type results from the use of a measuring assembly of finite wheelbase length.

#### 4.1. INSTRUMENTATION ERRORS

This section discusses first the frequency characteristics of instrumentation errors in terms of their effect on total error. Estimates are then developed for the total error expected in the system.

Certain types of error, such as that due to high-frequency electrical noise, may be considered as superimposing a random variation on the true profile. Such errors may be assumed to have a normal distribution and are most easily expressed in terms of the standard deviation of the total discrepancy built up in the profile over a specified distance. Other errors (e.g., a

deviation of the gyroscope spin axis from the vertical) have a relatively slow variation in comparison with the speed of the vehicle and would introduce components of error having wavelengths much longer than the significant wavelengths. For relatively short distances, such as 100 feet, this type of error will appear as a fairly constant slope superimposed on the true profile. This type of discrepancy would have little effect on the motion of the vehicle in the frequency ranges affecting human comfort or performance. Nevertheless, it is desirable to keep such errors to a minimum. Still other errors might correspond to profile wavelengths intermediate between the very short and very long values mentioned above, but it is believed that these are relatively small. The various types of error will be discussed individually, after which an estimate will be made of their combined effects.

If the measurement wheel bounces off the ground, errors will be introduced into the individual readings of slope angle  $\theta$ . The front measurement wheel is kept on the ground by the weight of the trailing arm, the rear wheel by gravity and by a device providing both spring and damping forces. With this design, it has been found that speeds up to about 5 mph do not cause serious wheel bouncing. Higher speeds would probably be feasible if stronger spring and shock-absorber attachments, were used. Random differences in the sinkage of the front and rear measuring wheels would have the same effect on accuracy as wheel bounce. Since exact data on the amount of wheel bounce cannot easily be determined, an estimate will be used in this analysis. It will be assumed that the magnitude of the bounce at 5 mph has a standard deviation of  $2^\circ$  (0.035 radian), and that the bounce frequency is high enough to make the errors in each 3.7-inch increment substantially independent of each other. For small slope angles, the random error introduced into each measurement interval amounts to 0.035 of the measurement increment of 3.7 inches, or 0.13 inch. For larger slope angles, the error would decrease in proportion to the cosine of the angle.

Errors introduced into the system by the demodulator are given below in terms of the maximum rated output voltage of 2.5 volts:

linearity: 0.5% of full scale  
ripple: 1.0% of instantaneous output voltage  
drift: 0.1% of full scale per hour

Full scale may be assumed to correspond to a slope angle  $\theta$  of  $45^\circ$ .

The gyroscope is assumed to introduce an error with a standard deviation of  $0.25^\circ$ , this error being in the nature of a long-term drift. In addition, the gyroscope synchro and the wheel synchro will each have a nonlinearity. The error for each of the two units is assumed to have a standard deviation of  $0.1^\circ$ .

Another type of error associated with the synchro system is that due to variations in the 400-cps supply voltage. These variations will appear as variations in the scale factor of the synchro system, affecting both positive and negative values of  $\Delta y$ . No serious difficulty is introduced by considering the resulting errors random in nature. A standard deviation of 1% of the normal applied voltage is assumed. This will result in a 1% variation of the scale factor of the synchro system.

The tape recording and reproduction equipment also introduce errors. In terms of the maximum output voltage of 1 volt, the components of error are:

linearity: 1% of full scale  
 noise: 2% of full scale

The computation of profile is based on the assumption that the odometer system indicates constant increments of distance along the ground. In practice, these increments may vary slightly with measuring vehicle speed and terrain roughness. In one set of test data, taken on firm ground, the actual increments varied as follows:

| Speed<br>(fps) | Length of Increment<br>(inches) |
|----------------|---------------------------------|
| 3              | 3.67                            |
| 6              | 3.70                            |
| 13.5           | 3.77                            |

For very soft or rough ground, greater variation would be expected. For the purpose of this analysis, a variation of increment length having a standard deviation of 5% will be assumed.

The error components described above can now be combined to give an estimate of overall error in the system due to mechanical and electrical causes. The errors caused by high-frequency noise, nonlinearities, and long-term drift will be considered separately.

Where an error is quoted in terms of percent of full scale, the full scale is assumed to correspond to the sine of a slope angle of  $45^\circ$ , or 0.707. Thus a noise error of 1% of full scale corresponds to an error in the  $\sin \theta$  of 0.007. For a 3.7-inch increment, this produces a vertical error of 0.026 inch.

The contribution of certain types of error during a specific increment of forward motion is proportional to the value of  $\sin \theta$  during that increment. Variations in length of increment can be treated in the same manner. In order to estimate the error, it will be assumed that the absolute magnitude of slope has an average value of  $10^\circ$ , for which the sine is 0.174. The corresponding vertical increment  $\Delta y$  is 0.65 inch; hence, 1% of this increment is 0.0065.



The noise components of the total error and their magnitudes are given in Table I.

Since the individual errors of Table I are assumed to be randomly distributed, they can be combined by an rms process. The resulting standard deviation for the error in a single increment is found to be 0.144 inch. The primary contribution to this total error is that estimated for the wheel bounce.

The build-up of vertical error over a horizontal distance of 100 feet can now be determined. Since the errors occurring during individual increments are normally distributed about zero, the standard deviation of the total error accumulated over a given horizontal distance would be proportional to the square root of the number of measuring increments. Thus, for individual increments of error amounting to 0.144 inch, the standard deviation for a 100-foot run would be

$$\epsilon_y = 0.144 \sqrt{1200/3.7} = 2.6 \text{ inches}$$

In addition to the random errors discussed above, there will be a set of errors having very slow variation with time. These will appear in the terrain profile as a superimposed variation of elevation containing wavelengths too long to be of major interest. Thus, the demodulator may accumulate a drift of 0.1% of full scale in 1 hour. This amount of drift introduces a slope in the terrain profile amounting to 0.84 inch per 100 feet. The gyroscope also introduces an error with a standard deviation of  $0.25^\circ$ , corresponding to a slope in the terrain profile of 5.2 inches per 100 feet.

TABLE I. CONTRIBUTIONS TO RANDOM ERROR

| <u>Type of Error*</u>                         | <u>Error in 3.7-inch<br/>Increment<br/>(in.)</u> |
|---|--|
| Wheel bounce                                  | 0.13   |
| Demodulator                                   |  |
| Linearity (0.5% F.S.)                         | 0.013  |
| Ripple (1.0% S.F.)                            | 0.007  |
| Tape recorder                                 |  |
| Linearity (1% F.S.)                           | 0.026  |
| Noise (2% F.S.)                               | 0.052  |
| Synchronizer                                  |  |
| Linearity, Synchronizer No. 1 ( $0.1^\circ$ ) | 0.007  |
| Linearity, Synchronizer No. 2 ( $0.1^\circ$ ) | 0.007  |
| Inverter voltage (1% S.F.)                    | 0.007  |
| Odometer                                      |  |
| Increment length (5% S.F.)                    | 0.035  |

\*F.S. = full scale; S.F. = scale factor.

#### 4.2. ERRORS DUE TO MATHEMATICAL APPROXIMATIONS

Two types of inaccuracy result from mathematical approximations used in collecting and handling terrain-profile data. One type results from ignoring the effect of roll of the measuring vehicle on the orientation of the measuring assembly. The second type is due to the fact that the wheel assembly which determines the slope of the ground has a finite wheelbase. The effect of each type of inaccuracy upon the measured profile will be described here, after which methods of reducing or eliminating the effect will be indicated.

If the measuring assembly were continuously maintained at zero roll angle, the output of the synchros would correctly measure the angle between the wheel frame and the vertical. However, because of irregularities of the ground, the vehicle and its measuring assembly will tend to take up a roll angle approximating the side slope of the terrain. Under these conditions, the angle measured by the synchros is that between the wheel frame and an axis tilted from the vertical by the roll angle. It can be shown that the relation between the desired and the actual measurement is given by the equation

$$\sin \theta_d = \sin \theta_m \cos \phi_r \quad (7)$$

where  $\theta_d$  is the desired angle

$\theta_m$  is the measured angle

$\phi_r$  is the roll angle

Thus, a multiplying factor equal to  $\cos \phi_r$  is theoretically required to correct for the roll of the vehicle. Ignoring this correction has the effect of a variation of scale factor, occurring in synchronism with the changing roll angle. If the absolute magnitude of the slope in the direction of travel has an average value of  $10^\circ$ , and if the side slope is  $5^\circ$ , the elevation error for each 3.7-inch increment amounts to 0.0032 inch.

As indicated in Section 5, it is possible to record the roll angle and use it to correct the synchro data. However, if studies of the dynamics of vehicle motion on substantial side slopes are to be attempted, further detailed analysis would be desirable to establish what characteristics of the profile data are actually required for such studies.

Ideally, the measuring assembly should use a sensing device of infinitesimal dimensions to determine the slope of the ground as a continuous function of distance traveled along the surface. For practical reasons, however, the system is designed to use a sensing device with a 12-inch wheelbase and to substitute a sampling process for the continuous-measurement process. It is believed that the finite wheelbase results in the more important of these limitations; consequently, further discussion will be confined to this aspect of the problem.

The effect of using a finite wheelbase has been discussed at some length in Reference 9. It is indicated there that if the method of data reduction represented by Equations 3-6 is adopted, the 12-inch wheelbase will attenuate sinusoidal components of terrain profile having wavelengths of less than about 3 feet with little or no response for wavelengths of less than about 1.5 feet. Reference 9 discusses a technique for emphasizing the short-wavelength response by passing the elevation data through a frequency-selective filter. With this filter the magnitude of all components of the profile data down to about 1.1 feet can be measured with less than 10% error.

Figure 4 is an example of the effect of this corrective technique on the representation of a terrain irregularity consisting of a V-ramp 4 feet long and 8 inches high. Curve A shows the profile obtained by the original computation process, curve B the effect of emphasizing the short-wavelength components. Generally speaking, curve B shows slightly increased accuracy in registering the amplitude of the irregularity and the discontinuities of slope.

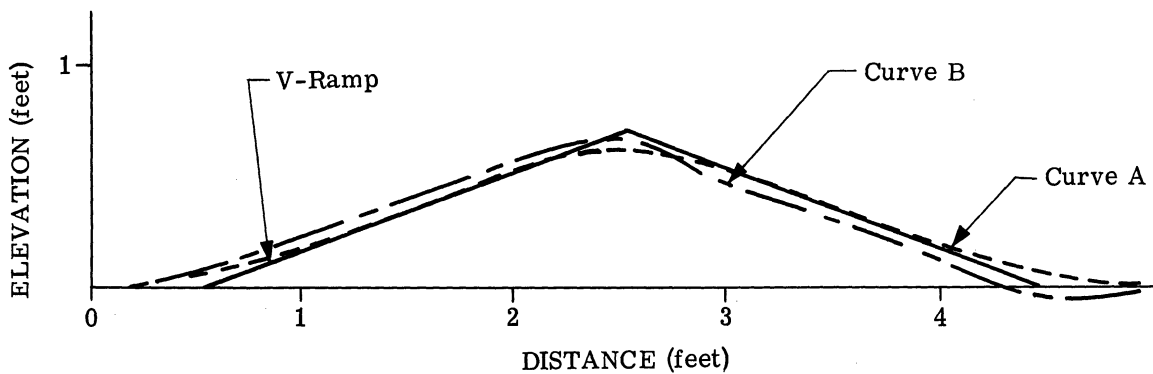

FIGURE 4. REPRESENTATION OF TERRAIN SAMPLE

## 5

### POSSIBILITIES OF SYSTEM REFINEMENT

One of the primary objectives in the designing of the terrain-profile measurement system was to make it flexible enough to permit further improvement and elaboration. Most of the features discussed below can be added without major modification of the present design. These features provide for increased accuracy, higher measurement-vehicle speed, faster or more direct data processing, and more extensive data output.

#### 5.1. REDUCTION OF WHEEL BOUNCE

The maximum speed at which the measurement wheels can be moved along the ground without seriously affecting system accuracy is at present in the neighborhood of 5 mph. The

primary limitation on speed is the tendency of the measurement wheels to bounce. The wheel bounce at a given speed could be reduced by adding stronger spring and shock-absorption devices. The increased vertical loading of the wheels would also be advantageous in that it would compact vegetation and loose soil along the measured path. The mechanism should maintain continuous downward forces on both wheels and at the same time dissipate the kinetic energy introduced by the vertical motion of the trailing arm. Conventional springs and shock absorbers might be used, or, alternatively, power-operated hydraulic or pneumatic cylinders.

Another limitation on speed is the response time of the relay used in the amplifier of the odometer system. A minor modification of the odometer amplifier could eliminate the relay from the circuit.

### 5.2. ALTERNATIVE METHODS OF PROFILE COMPUTATION

Several alternatives to the method of computing profile described in the body of the report are presented in this section. Each has one or more of the potential advantages of increased accuracy, decreased computation time, and direct recording of profile in the field vehicle.

One method of processing the field-recorded data by digital computation is somewhat more complex than that discussed in Section 3.2, but appears to be more accurate. In this method, the x and y components of the position of point B with respect to point A (Figure 5) are determined from the equations

$$x_B = x_A + W \cos \theta \tag{8}$$

$$y_B = y_A + W \sin \theta \tag{9}$$

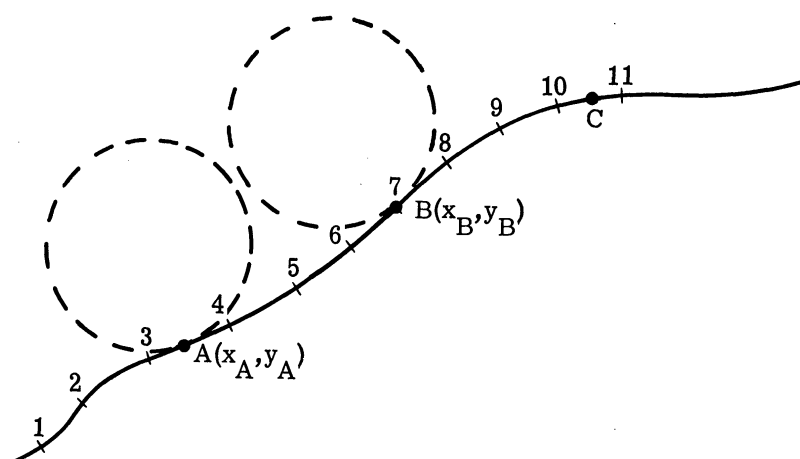

FIGURE 5. MEASUREMENT GEOMETRY

where  $W$  is the wheelbase length. The coordinates  $x_A$  and  $y_A$  can be computed by interpolation from previously determined coordinates of points 3 and 4. The computation described above is repeated for each increment of distance indicated by the odometer system. The position of A with respect to 3 and 4 may be computed by assuming that distances along the ground surface beneath the wheels can be represented by a straight line. A more accurate determination can be made, if necessary, by using the known  $x$  and  $y$  components of the numbered points to determine the position of point A relative to them.

An extension of this general method of data reduction would be to use measurement increments equal to the wheelbase of the measuring device rather than to a small fraction of this distance. Use of this technique would provide the terrain profile as a series of individual points along the ground, separated by a distance of one wheelbase length. Essentially, the data reduction consists of determining the elevation of point B with respect to point A, then determining the position of point C with respect to point B, and so on. The major difficulty in this method of data reduction is that of aligning the rear wheel with the previous position of the front wheel, i.e., making the measurement to determine point C when the rear wheel is exactly at point B. This can probably best be done by making the measurement interval distance increment along the surface of the ground slightly greater than the wheelbase length, to allow for the average curvature of the ground.

No exact comparison between the accuracy of this method and that of the method outlined in Section 3.2 can be made here, since it would require a detailed analysis of the performance of each method on representative samples of terrain profile. In theory, the wheelbase-increment system is more accurate since it avoids the approximation inherent in determining the first derivative of the ground profile with a measuring device of finite length. On the other hand, some error results from the difficulty of aligning the end of one increment with the beginning of the next. The short-increment system has the additional advantage that high-frequency random noise causes less total buildup of error over a given distance, because of the greater sampling rate.

The method of converting field data to the final profile data described in this report uses a digital computer for processing of the data. Methods of converting the data by analog-computation techniques are also possible and potentially have the advantages of (a) reducing the time and cost required for laboratory processing of the data collected in the field, and (b) permitting the installation of the computation equipment in the field vehicle so as to produce an immediate output of the final profile data.

A circuit diagram of a specific technique for accomplishing this type of processing is shown in Figure 6. The circuit results in a direct plot of the profile  $[y = f(x)]$  on a graphic

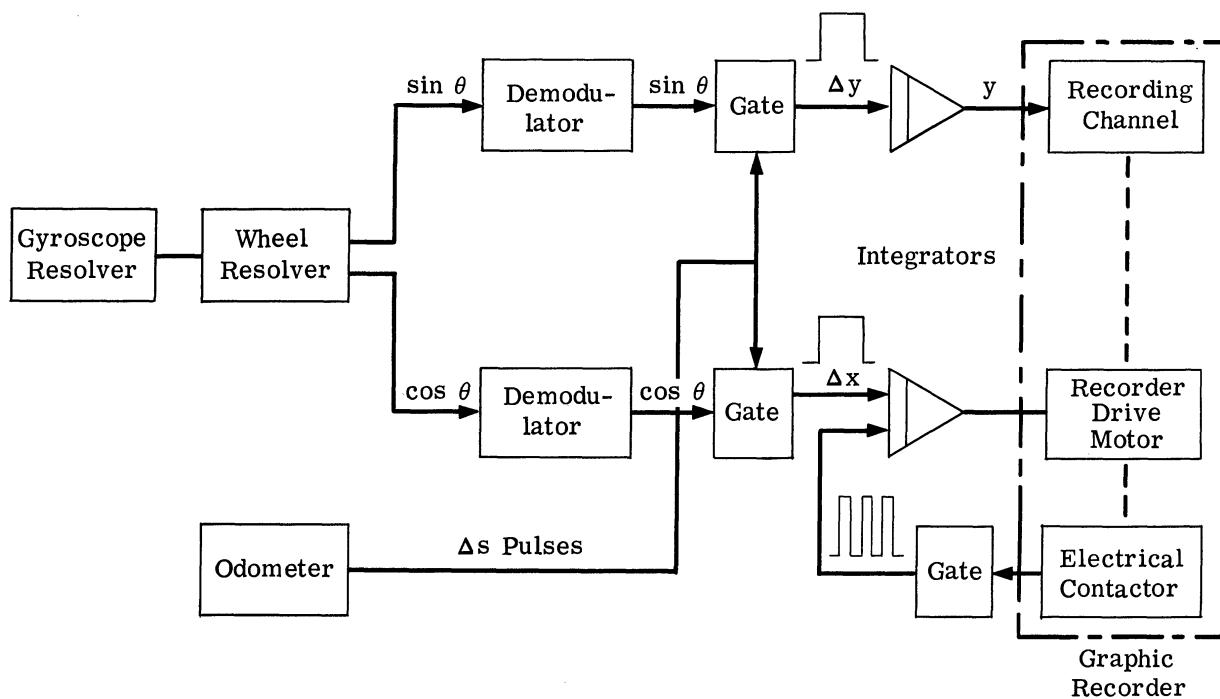

FIGURE 6. ALTERNATIVE COMPUTATION METHOD

recorder. In this technique, a-c resolvers are used to measure the gyroscope-gimbal and wheel-deflection angles. The use of resolvers permits the output of a 400-cps a-c signal corresponding to  $\cos \theta$ , as well as one corresponding to  $\sin \theta$ . This output voltage for  $\sin \theta$  is converted to varying d-c by a demodulator, as in the present system. The output of the demodulator passes through a gating circuit controlled by pulses from the odometer. Each pulse, corresponding to a constant increment  $\Delta s$ , opens the gate for an accurately controlled period of time. The width of the output pulse is proportional to  $\Delta s$ , the height to  $\sin \theta$ . The area under the pulse is therefore equivalent to a constant increment of  $\Delta y$ , which can be either positive or negative. The integrator algebraically sums all incoming  $\Delta y$  pulses, so that its output represents the elevation  $y$ . This output is fed to a recording channel of a graphic recorder.

The paper in the graphic recorder, controlled by the recorder drive motor, is moved forward a constant distance for each increment of  $\Delta x$ . To accomplish this, the 400-cps a-c signal representing  $\cos \theta$ , which is taken from the wheel resolver, is demodulated to a varying d-c voltage, also representing  $\cos \theta$ . A gating circuit similar to that for the  $y$  channel produces voltage pulses, the total area of each one corresponding to a constant increment of horizontal motion along the ground,  $\Delta x$ . The integrator in the  $x$  channel serves to compare the total forward motion of the vehicle with that of the recorder drive motor. The incoming  $\Delta x$  pulses are

compared to a series of pulses fed back from an electrical contactor attached to the motor. Each contactor pulse represents a constant increment of forward motion of the motor.

Modifications of this circuit can be devised for recording the final profile in digital form, for example, on punched paper tape.

### 5.3. CORRECTION FOR VEHICLE ROLL

No provision has been made to correct the profile data for the effect of roll of the instrumentation vehicle. This effect is not appreciable unless measurements are to be made on side slopes of substantial angles, say  $10^\circ$  or greater. Correction can be made by recording the roll angle as obtained by the gyroscope now used in the system and using this to correct the pitch-angle measurement data in accordance with Equation 7.

### 5.4. MEASUREMENT ALONG PARALLEL TRACKS

The present system was constructed to provide terrain-profile data along a single track rather than along parallel tracks. Single-track profile data are sufficient for studies of vehicle motion in the pitch plane. Also, single-track data for an area collected along several different azimuths can be analyzed to give terrain characteristics similar to those which would be collected along parallel tracks. For certain purposes, however, such as the use of profile data in analog-computer simulation of three-dimensional motion, parallel-track data would be preferable. The system can be extended to the measurement of parallel tracks by duplicating the measuring-arm assembly and adding further instrumentation channels.

## 6

### CONCLUSIONS

The measurement system described in this report provides a method for the rapid and accurate collection of terrain-profile data for dynamic analysis of off-the-road vehicle motion. Preliminary analysis indicates that system inaccuracies are of two general types, those due to electronic and mechanical instrumentation, and those due to the use of mathematical approximations. The instrumentation characteristics superimpose errors on the true profile which are primarily of very short wavelength or of great wavelength approaching a constant change in slope. The accumulation of high-frequency error over a distance of 100 feet is expected to have a standard deviation of 3 inches or less. The change in slope, primarily due to gyroscope drift, would have a standard deviation of 5.2 inches per 100 feet. In addition, the use of a finite wheelbase for slope measurement limits the fidelity with which terrain wavelengths of less

than about 1.5 feet can be determined. The above accuracies can be maintained for measurements made at speeds up to 5 mph.

Figure 7 shows two samples of the profile of a V-ramp, 4 inches high, based on data obtained by the measuring system during one of the initial field tests and processed by the data-reduction method of Equations 3 to 6. Curve A shows the representation of the ramp when measured by a vehicle traveling at 4 mph. Curve B is the corresponding result for a vehicle speed of 10 mph. The variation of elevation beyond the ramp in curve B is caused primarily by wheel bounce. The accuracy of reproduction of the original irregularity appears to be consistent with the results of the error analysis of Section 4.

The system can be further improved by the modifications described in Section 5. They can improve system accuracy, increase the speed of field measurement, reduce data-processing time, and provide for collection of data along parallel tracks. Some of the modifications require changes only in the data-reduction process, and not in equipment design.

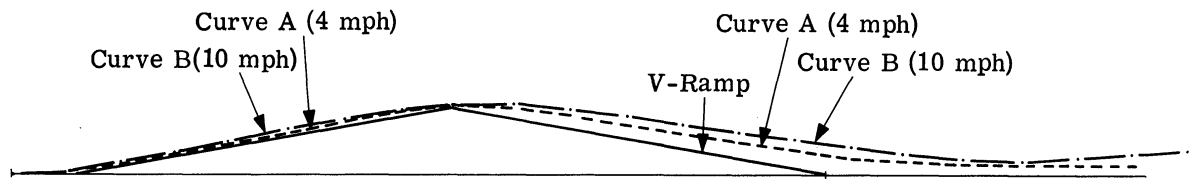

FIGURE 7. TEST DATA ON V-RAMP PROFILE



**Appendix**  
**DATA-RECORDING AND CONVERSION SYSTEM**

In developing an instrumentation system to measure terrain profile, it was necessary to provide as a subsystem certain electronic equipment to record the electrical outputs of angle- and distance-measuring devices and to amplify and convert these signals for insertion into an ElectroData 205 computer for further data processing. It was considered desirable to supply a data-recording and conversion system applicable not only to the terrain-measurement problem, but also to many other field or laboratory test programs requiring data processing. One of the tasks performed under this project consisted of analyzing the requirements for a general purpose data-recording and conversion system, purchasing suitable equipment, following up the production, delivery, and acceptance of the equipment, and providing technical liaison with the Ordnance Tank-Automotive Command for a period after its delivery.

During the analysis and selection of this data-processing equipment a number of system configurations were studied. One of the system choices concerned whether to convert the analog data to a digital format in the field equipment or in a laboratory system. Although a self-contained field system which would produce magnetic tape in the proper format for insertion directly into the computer would result in the most compact complete system of equipment, it was decided that such a system would be less flexible, was not as well developed for field requirements, and would be more costly to extend later to include more than one field system. Consequently the alternative system was chosen, in which a multichannel magnetic-tape recorder expressly designed for field use was provided, a magnetic-tape reproducer was used for playback purposes in the laboratory, and a data-conversion and format-generation system was used to accept the analog inputs from the magnetic-tape reproducer. This system provides the additional advantage that each part of the system may be used not only for the purpose described, but independently for other applications.

The section of the system which performs analog-to-digital conversion and computer-format generation is the largest and most complex component of the data-recording and processing subsystem. Hence, the major effort in this phase of the program was devoted to the analysis, purchase, and checkout of this component. Two major alternative configurations of this part of the system were considered, and quotations were obtained for both. One would use a conventional design for converting from analog to digital form and generating a computer format. The other would incorporate a digital computer as a part of the data-conversion sys-

tem itself. This configuration was considered because it could have the possible advantages of permitting detailed editing and partial reduction of the data by a computer before providing the data in a form suitable for insertion into the main computer. Although these would be substantial advantages, the configuration was finally rejected because of its additional cost.

The system finally selected thus consisted of an Ampex AR-200 14-channel magnetic-tape recorder, a Consolidated Electrodynamics Corporation GR-2800 magnetic-tape reproducer, and an Epsco data-conversion system. These components of the complete subsystem were purchased, and after receipt and acceptance were turned over to the Ordnance Tank-Automotive Command for installation in test vehicles and for laboratory use. The complete system has been found to meet the requirements of the original specifications, and provides a flexible, accurate, and rapid method of processing a considerable number of channels of field and laboratory data for reduction in a digital computer. The individual components can also be used for other purposes than those originally considered.

## REFERENCES

1. I. J. Sattinger, "Methods of Evaluating the Effects of Terrain Geometry on Vehicle Mobility," Proceedings of Interservice Vehicle Mobility Symposium, Office of Ordnance Research, U. S. Army, 18-20 April 1955.
2. M. G. Bekker, Theory of Land Locomotion—The Mechanics of Vehicle Mobility, The University of Michigan Press, Ann Arbor, Mich., 1957.
3. M. G. Bekker, Off-the-Road Locomotion, The University of Michigan Press, Ann Arbor, Mich., 1960.
4. J. L. Bogdanoff and F. Kozin, "On the Statistical Analysis of Linear Vehicle Dynamics," presented at the First International Conference on The Mechanics of Soil-Vehicle Systems, Turin, Italy, 12-16 June 1961 (UNCLASSIFIED).
5. F. Kozin and J. L. Bogdanoff, "On the Statistical Properties of the Ground Contour and Its Relation to the Study of Land Locomotion," presented at the First International Conference on The Mechanics of Soil-Vehicle Systems, Turin, Italy, 12-16 June 1961 (UNCLASSIFIED).
6. I. J. Sattinger and E. B. Therkelsen, "Simulation of Military Vehicle Suspension Systems," Proceedings of IRE National Simulation Conference, 19-21 January 1956, pp. 1.1-1.6 (UNCLASSIFIED).
7. I. J. Sattinger and D. F. Smith, Computer Simulation of Vehicle Motion in Three Dimensions, Report Number 2901-10-T, Willow Run Laboratories, The University of Michigan, Ann Arbor, Mich., May 1960 (UNCLASSIFIED).
8. I. J. Sattinger and S. Sternick, "An Instrumentation System for Measuring Stress-Strain Relationships of Soil," Report Number 2948-35-F, Institute of Science and Technology, The University of Michigan, December 1961 (UNCLASSIFIED).
9. I. J. Sattinger, Terrain Geometry Measurement: Final Engineering Report, Report Number 2384-13-F, Engineering Research Institute, The University of Michigan, April 1956 (UNCLASSIFIED).



DISTRIBUTION LIST

Copy No. Addressee

- 1-11 Contracting Officer, Detroit Ordnance District  
(for Detroit for Ordnance Tank-Automotive Command)  
1580 East Grand Blvd.  
Detroit 11, Michigan  
ATTN: Research & Development Div.
- 12-21 Armed Services Technical Information Agency  
Arlington Hall Station  
Arlington 12, Virginia  
ATTN: TIPCA