

# The *comP* locus of *Neisseria gonorrhoeae* encodes a type IV prepilin that is dispensable for pilus biogenesis but essential for natural transformation

Matthew Wolfgang,<sup>1</sup> Jos P. M. van Putten,<sup>2</sup> Stanley F. Hayes<sup>3</sup> and Michael Koomey<sup>1,4\*</sup>

<sup>1</sup>Department of Microbiology and Immunology, University of Michigan Medical School, Ann Arbor, MI 48109-0620, USA.

<sup>2</sup>Laboratory of Microbial Structure and Function, and

<sup>3</sup>Microscopy Branch, Rocky Mountain Laboratories, NIAID, NIH, Hamilton, MT, USA.

<sup>4</sup>Biotechnology Centre of Oslo, University of Oslo, 0316 Oslo, Norway.

## Summary

The expression of type IV pili (Tfp) by *Neisseria gonorrhoeae* has been shown to be essential for natural genetic transformation at the level of sequence-specific uptake of DNA. All previously characterized mutants defective in this step of transformation either lack Tfp or are altered in the expression of Tfp-associated properties, such as twitching motility, autoagglutination and the ability to bind to human epithelial cells. To examine the basis for this relationship, we identified potential genes encoding polypeptides sharing structural similarities to PilE, the Tfp subunit, within the *N. gonorrhoeae* genome sequence database. We found that disruption of one such gene, designated *comP* (for competence-associated prepilin), leads to a severe defect in the capacity to take up DNA in a sequence-specific manner, but does not alter Tfp biogenesis or expression of the Tfp-associated properties of autoagglutination, twitching motility and human epithelial cell adherence. Indirect evidence based on immunodetection suggests that ComP is expressed at very low levels relative to that of PilE. The process of DNA uptake in gonococci, therefore, is now known to require the expression of at least three distinct components: Tfp, the recently identified PilT protein and ComP.

## Introduction

Natural transformation plays a central role in horizontal exchange of genetic information for many bacterial species of medical, environmental and industrial interest. Although the potential selective advantages of this form of genetic exchange remain open to debate, its biological significance is attested to by the widespread distribution of this property throughout eubacterial species. Further evidence of its relevance can be found in studies of selected Gram-positive species which indicate that competence for transformation is a highly regulated and environmentally responsive event that involves the co-ordinated expression of many genes (Dubnau, 1997). The situation is even more complex in Gram-negative species in which the presence of an outer membrane appears to act as a barrier not only to translocation of the uptake machinery to the cell surface, but also to the import of DNA. Despite much work, natural transformation remains one of the most poorly understood forms of DNA metabolism because the molecules directly engaged in DNA binding and uptake have yet to be identified in any species.

*Neisseria gonorrhoeae*, the Gram-negative aetiological agent of gonorrhoea, is one of large number of mucosal pathogens of man that express competence for natural transformation. Transformation in neisserial species is particularly important to genetic exchange and diversity because it accounts for all cell-to-cell transmissions of chromosomal loci (Catlin, 1982). Gonococcal mutants incapable of expressing Tfp are reduced over a 1000-fold in their capacity to be transformed for chromosomal markers (Drake and Koomey, 1995; Freitag *et al.*, 1995; Tønjum *et al.*, 1995). Recent work has shown that the defect in these mutants is at the level of DNA uptake, to date the earliest definable step in the transformation pathway (Wolfgang *et al.*, 1998). In light of these findings, a strong correlation appears to exist between Tfp expression and the initial phase of the transformation process. Recently, defined mutations at the gonococcal *pilT* locus have been shown to lead to gross defects in DNA uptake, although Tfp in these backgrounds appear quantitatively and qualitatively normal (Wolfgang *et al.*, 1998). These mutants do, however, show a concurrent defect in the expression of twitching motility (Wolfgang *et al.*, 1998), a non-flagellar-mediated form of surface translocation that

Abbreviations: Tfp, type IV pili; ORF, open reading frame; MBP, maltose-binding protein.

Received 1 September, 1998; revised 17 November, 1998; accepted 19 November, 1998. \*For correspondence. E-mail johnk@biotek.uio.no; Tel. (+47) 22 958461; Fax (+47) 22 694130.

has been proposed to be a consequence of pilus retraction (Bradley, 1980).

The potential significance of the association between gonococcal Tfp and DNA uptake is strengthened considerably by the knowledge that transformation mutants in *Bacillus subtilis*, *Haemophilus influenzae* and *Acinetobacter* sp. strain BD413 that fail to express orthologues of Tfp biogenesis components are also blocked at the step of DNA binding and uptake (Dubnau, 1991; Tomb *et al.*, 1991; Porstendorfer *et al.*, 1997; Link *et al.*, 1998). However, Tfp have not been detected in *B. subtilis* or *H. influenzae*, although competence mutants of *Acinetobacter* sp. strain BD413 retain expression of apparently normal Tfp.

Tfp biogenesis in *Pseudomonas aeruginosa* requires expression of the pilus subunit (PilA) as well as multiple proteins that possess a hydrophobic N-terminus characteristic of prepilin-like proteins (Alm and Mattick, 1997). The competence machinery of *B. subtilis* and the type II secretion systems of Gram-negative bacteria likewise utilize multiple prepilin-like molecules (Pugsley, 1993a; Dubnau, 1997; Pugsley *et al.*, 1997). To determine whether gonococci possess prepilin-like molecules in addition to PilE, the pilus subunit, the nearly completed DNA sequence of the gonococcal genome, was examined for the presence of open reading frames (ORFs) sharing identity to the N-terminus of the PilE prepilin protein. We report here the existence of gonococcal ORFs whose deduced polypeptides bear striking similarities to type IV prepilins and demonstrate that one corresponds to a gene designated *comP*, whose product is dedicated to transformation and functions in DNA uptake. Furthermore, we identify the *comP* gene product in both *Escherichia coli* and *N. gonorrhoeae* using antibodies raised against a synthetic peptide based on its primary structure, and we provide evidence that this molecule is expressed at low levels.

## Results

### Identification of type IV prepilin-like ORFs in the FA1090 genome sequence database

The first 50 residues of unprocessed PilE were used to probe the gonococcal genome sequence database assembled at the University of Oklahoma for the presence of related ORFs. Using the TBLASTN algorithm (Altschul *et al.*, 1990), three ORFs with what appeared to be significant relatedness to the query sequence were found (Fig. 1). Further inspection showed that two of these hits were located at the beginning of extended ORFs (ORFA and ORFB) with a reasonable likelihood of corresponding to expressed proteins. In the case of ORFC, the DNA sequence beyond that encoding the residue corresponding to 29 of unprocessed PilE was not available. In the context of this report, the studies described will focus on ORFB.

```

PIL E 5 QKGFLLIELMIVIAIVGILAAVALPAYQDYTARAQVSE 42
      QKGFLLIE+MIV+ I+GI++ +A+P+YQ Y + S+
ORFA  QKGFLLIEMMIVVTILGIISVIAIPSYQSYIEKGYQSQ

PIL E 3 TLQKGFLLIELMIVIAIVGILAAVALPAYQDYTARAQVS 41
      T +GFLL+EL+ V+ I+ +LA + P+Y++Y +A+++
ORFB  TDNRGFLLVELISVVLILSVLALIVYPSYRNYVEKAKIN

PIL E 5 QKGFLLIELMIVIAIVGILAAVALP 29
      Q+GFLL EL+IV+AI I+A +ALP
ORFC  QKGFLLTELLIVMAIAAIMATIALP

```

**Fig. 1.** The gonococcal strain FA1090 genome sequence database contains three type IV prepilin-like ORFs. The TBLASTN (Basic logic alignment search tool) algorithm was used to search the database for ORFs with significant homology to the N-terminal 50 amino acids of unprocessed PilE. Hits with significant identity to the query sequence are shown, with (+) indicating conserved residues.

The genome sequence database was derived from strain FA1090, although the majority of work carried out on gonococcal Tfp biology has used strain MS11 or its derivatives. To study the potential relevance of ORFB, oligonucleotide primers derived from the FA1090 sequence were used in PCR to amplify the ORFB-containing locus from strain N400 (an MS11 derivative expressing the *recA6* allele). Direct DNA sequencing of the 0.9 kb PCR product revealed that the N400 locus was identical to the FA1090 sequence except for a few single base substitutions. It is not clear whether these differences reflect true polymorphisms or errors in the reported database sequence.

### Characterization of ORFB and flanking regions

The N400 ORFB was predicted to encode a 149 residue polypeptide with a pI of 9.5 and molecular weight of 16.8 kDa (Fig. 2A). When used in a BLASTP search of the GenBank databases (Altschul *et al.*, 1997), it was seen to possess the highest degree of identity to the Tfp subunits, including PilA of *P. aeruginosa*, pilins of *Moraxella* species and *Eikenella corrodens*, FimA of *Dichelobacter nodosus* and gonococcal PilE (Fig. 2B). The domains shared by these molecules were limited to the N-terminus. The primary basis for discrimination between this family of molecules and the prepilin-like molecules engaged in type II secretion systems was the presence of tyrosine residues at +24 and +27, which have been implicated in pilin subunit-subunit interaction (Watts *et al.*, 1983). Examination of the sequences immediately upstream of ORFB failed to reveal any obvious similarities to characterized promoters or ribosome binding sites. Based on its prepilin-like structure and findings detailed below, ORFB was designated *comP* (for competence associated prepilin).

To determine which genes and ORFs might be linked to *comP*, the DNA sequence from FA1090 encompassing this locus was used in a BLASTX search of the GenBank databases (Altschul *et al.*, 1997). Surprisingly, the hits with the highest likelihood of representing significant identities were



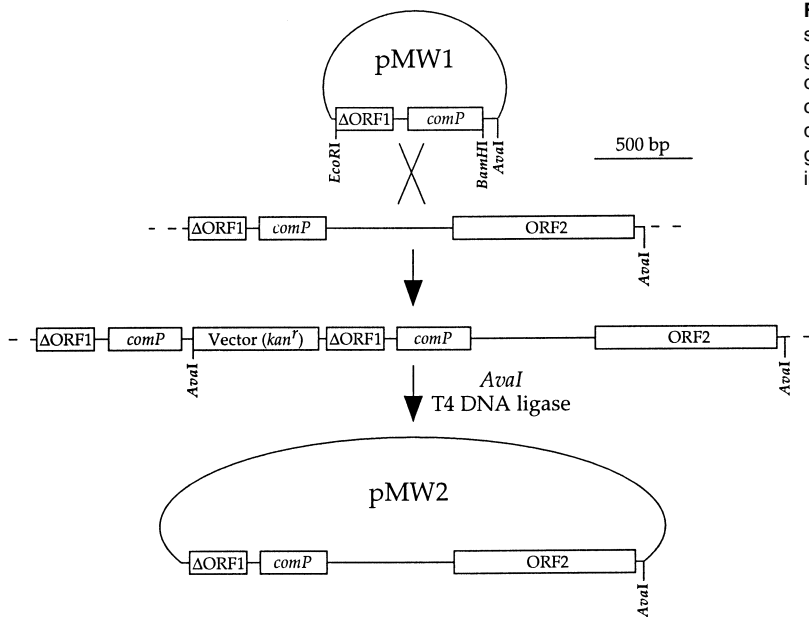

**Fig. 4.** *In situ* cloning of *comP* and flanking sequence. Plasmid pMW1 was integrated onto the gonococcal chromosome resulting in a duplication of the *comP* locus. A clone of the *comP* locus containing 2.6 kb of additional downstream sequence, designated pMW2, was generated by digesting genomic DNA from this strain with *AvaI* followed by intramolecular ligation and transformation into *E. coli*.

ΔORF1 (Figs 3 and 5, Table 1), related to the C-terminal domain of *B. subtilis* ComEA, had no influence on transformability, because deletion mutations in the corresponding region of the *B. subtilis* gene result in a transformation defect at the level of DNA binding (Inamine and Dubnau, 1995).

*Identification of the comP gene product in E. coli*

To assess whether *comP* encoded a polypeptide and whether it corresponded in size to that predicted from the nucleotide sequence, a PCR-generated DNA fragment encompassing the *comP* ORF and the sequences immediately 5' to it was cloned into the T7 promoter plasmid pT7-6. Samples of cells containing the vector control and *comP* construct grown with and without T7 RNA polymerase induction were then examined by immunoblotting using polyclonal rabbit serum raised against a synthetic peptide representing residues 58–77 of ComP (Fig. 2A). As seen in Fig. 6, two proteins with approximate molecular weights

of 16000 and 15800 were detected in the uninduced *comP* constructs. After T7 RNA polymerase induction, the levels of these two species were increased and a third reactive species with a molecular weight of ≈13900 was detected. Because previous studies of PIIe expression in *E. coli* have shown that type IV prepilins are susceptible to cleavage by endogenous prepilin peptidase activity(ies) (Koomey *et al.*, 1991; Francetic *et al.*, 1998), it appears that the doublet species corresponded to unprocessed and processed ComP. The appearance of the much faster migrating form after induction presumably represents a proteolytic breakdown product.

*Prepilin processing of ComP appears to be required for full function*

Type IV prepilins and prepilin-like molecules require processing by members of the PII family of peptidases for function. Mutagenesis studies have shown that the presence of a glycine at position –1 of the prepilins (relative

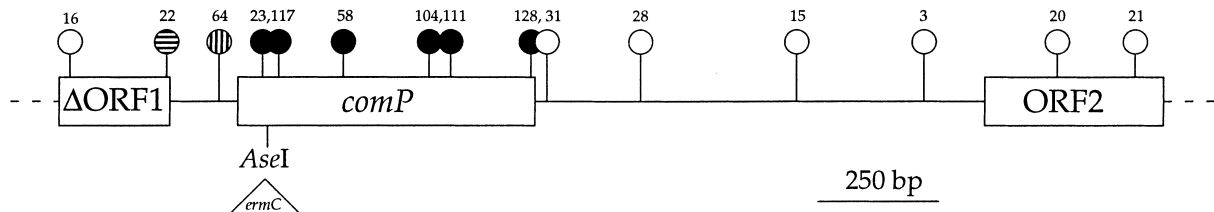

**Fig. 5.** Physical map of the gonococcal *comP* locus and mutations. Transposon insertions are indicated by circles (precise position of insertions are available from authors). ●, Transposon insertions that resulted in a 10000-fold reduction in transformation frequency; ○, insertions that had no effect on transformation. The circle filled with horizontal lines represents a transposon insertion that resulted in a sixfold reduction in transformation frequency (15% relative to the wild-type strain), whereas the circle with vertical lines represent an insertion causing a 5000-fold reduction in transformation frequency (0.02% relative to the wild-type strain).

**Table 1.** *N. gonorrhoeae* strains used in this study with genotypes/phenotypes.

Strain <sup>a</sup>	Relevant genotype	DNase-resistant DNA uptake <sup>b</sup> (%)	Transformation efficiency <sup>c</sup> (%)	Reference
N400	<i>recA6</i> <sup>d</sup>	100	100	Tønjum <i>et al.</i> (1995)
GF2	<i>pilF::mTnerm</i>	<5	<0.01	Freitag <i>et al.</i> (1995)
MW101	$\Delta$ ORF1::mTnerm16	100	100	This work
MW102	$\Delta$ ORF1::mTnerm22	30	15	This work
MW103	mTncm64	<5	0.02	This work
MW104	<i>comP::mTnerm23</i>	<5	<0.01	This work
MW105	<i>comP::mTnerm117</i>	<5	<0.01	This work
MW106	<i>comP::mTnerm58</i>	<5	<0.01	This work
MW107	<i>comP::mTnerm104</i>	<5	<0.01	This work
MW108	<i>comP::mTnerm111</i>	<5	<0.01	This work
MW109	<i>comP::mTnerm128</i>	<5	<0.01	This work
MW110	mTncm31	100	100	This work
MW111	mTncm28	ND	100	This work
MW112	mTncm15	ND	100	This work
MW113	mTncm3	ND	100	This work
MW114	ORF2::mTnerm20	ND	100	This work
MW115	ORF2::mTncm21	ND	100	This work
MW116	<i>comP::ermC</i>	ND	<0.01	This work
MW117	<i>comP</i> <sub>G-1→S</sub>	<5	2	This work
MW118	<i>comP</i> <sub>G-1→S, F1fs</sub>	<5	<0.01	This work
MW119	<i>comP</i> <sub>G-1→S, F1Opal</sub>	<5	<0.01	This work
MW120	<i>pilE::comP</i>	ND	100	This work

a. N400 is a derivative of MS11 that carries the inducible *recA6* allele. All mutants used in this study were constructed in N400.

b. Values are relative to the wild-type parent strain and represent cell-associated DNA that becomes protected from DNase I treatment.

c. Values represent the frequency of transformation to nalidixic acid resistance relative to wild type.

d. *recA6* is an IPTG-inducible allele of *recA* (Seifert, 1997).

to the cleavage site) is critical for cleavage and thus function (Strom and Lory, 1991). For example, a substitution of serine for glycine at this position in gonococcal Pile blocks processing and Tfp expression (Koohey *et al.*, 1991). Given the presence of the consensus cleavage motif in ComP (Fig. 2B) and its apparent ability to be processed in *E. coli* (Fig. 6), we asked what effect a substitution of serine for glycine at the -1 position might have on competence for transformation. The codon at this position was changed from GGG to TCC by site-directed mutagenesis, and the altered allele was introduced into N400 using a non-selective transformation technique. The ComP G<sub>-1</sub> to S<sub>-1</sub> substitution mutant, designated MW117, was defective in transformation. However, it showed a transformation proficiency that was 2% of that seen for the wild-type strain (Fig. 7, Table 1), a level that was still 200-fold higher than what was found for the *comP* ORF insertion mutations. To examine the basis for residual transformability seen in this background, a frameshift mutation and a nonsense mutation were engineered separately into the adjacent phenylalanine codon. N400 transformants carrying these secondary alterations in the context of the original serine substitution (strains MW118 and MW119 respectively) showed transformation defects identical to those found for the *comP* ORF insertion mutants (Fig. 7, Table 1). These results suggest that prepilin processing of ComP is required

for full function with regard to competence for natural transformation.

#### The transformation defect of *comP* mutants is at the level of DNA uptake

Natural transformation involves sequential events in which DNA is taken up into a DNase-resistant state, translocated across the membranes, processed and integrated into the

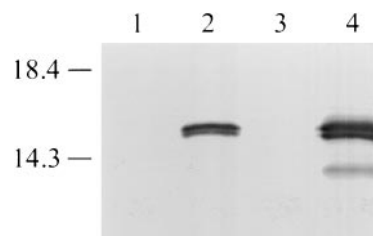

**Fig. 6.** Detection of ComP expression in *E. coli*. Plasmid-encoded *comP* was expressed from the T7 promoter and detected in whole-cell lysates immunoblotted and probed with anti-ComP rabbit polyclonal serum raised against a synthetic ComP peptide. Samples used were from *E. coli* strain BL2 carried either the pT7-6 vector control or pT7-*comP*, which expresses *comP* from the T7 promoter, grown in the absence (lanes 1–2) or presence (lanes 3–4) of T7 RNA polymerase. Lane 1, pT7-6; lane 2, pT7-*comP*; lane 3, pT7-6; lane 4, pT7-*comP*.

		<div style="text-align: center;">           ↓            +1            ▼         </div>	Transformation efficiency
N400	MTDNRG	FTLVEL..	100%
MW117	MTDNRS	FTLVEL..	2%
MW118	MTDNRS	LRWLN*	<0.01%
MW119	MTDNRS	*	<0.01%

**Fig. 7.** Alteration of the predicted prepilin processing site of *ComP* results in a transformation defect. The primary structure of the predicted *ComP* prepilin processing site is shown for the wild-type strain (N400) and site-specific mutants. The effects of these mutations on transformation frequency relative to the wild-type strain are indicated. An arrow indicates the predicted prepilin processing site. Strain MW117 carries a missense mutation at position 6 (-1 relative to the processing site) of *ComP*, resulting in serine for glycine substitution. MW118 carries the missense mutation at position 6 and a frameshift mutation in the adjacent codon (+1), whereas MW119 carries a nonsense (Opal) mutation at position 7 (+1) in addition to the missense mutation.

genome. Because a defect at any one of these steps could account for the diminished transformation capability of *comP* mutants, a DNA uptake assay was used to assess the immediate fate of transforming DNA in these backgrounds. Approximately 4% of a radioactively labelled PCR product containing the neisserial 10bp uptake

sequence was taken up into a DNase-resistant state by the wild-type strain N400 as well as by a selected subset of insertion mutants that display normal values for transformability (Table 1). In contrast, all but one of the insertion mutants with reduced transformability had values of cell-associated, DNase-resistant DNA that were below the limits of detection of the assay (<5%). The one exception was strain MW102, which took up DNA into a DNase-resistant state at a level which was 30% of that seen in the wild-type strain. This mutant that carries a transposon insertion upstream of the *comP* ORF had a transformation proficiency which was 15% of that seen in the wild-type strain (Table 1). This particular insertion mutation appears to reveal a linear relationship between the level of transformability and the capacity to take up DNA into a DNase inaccessible state.

*ComP* is dispensable for normal Tfp expression, autoagglutination, twitching motility and adherence for human epithelial cells

Because gonococcal mutants deficient in Tfp biogenesis show transformation defects remarkably similar to those

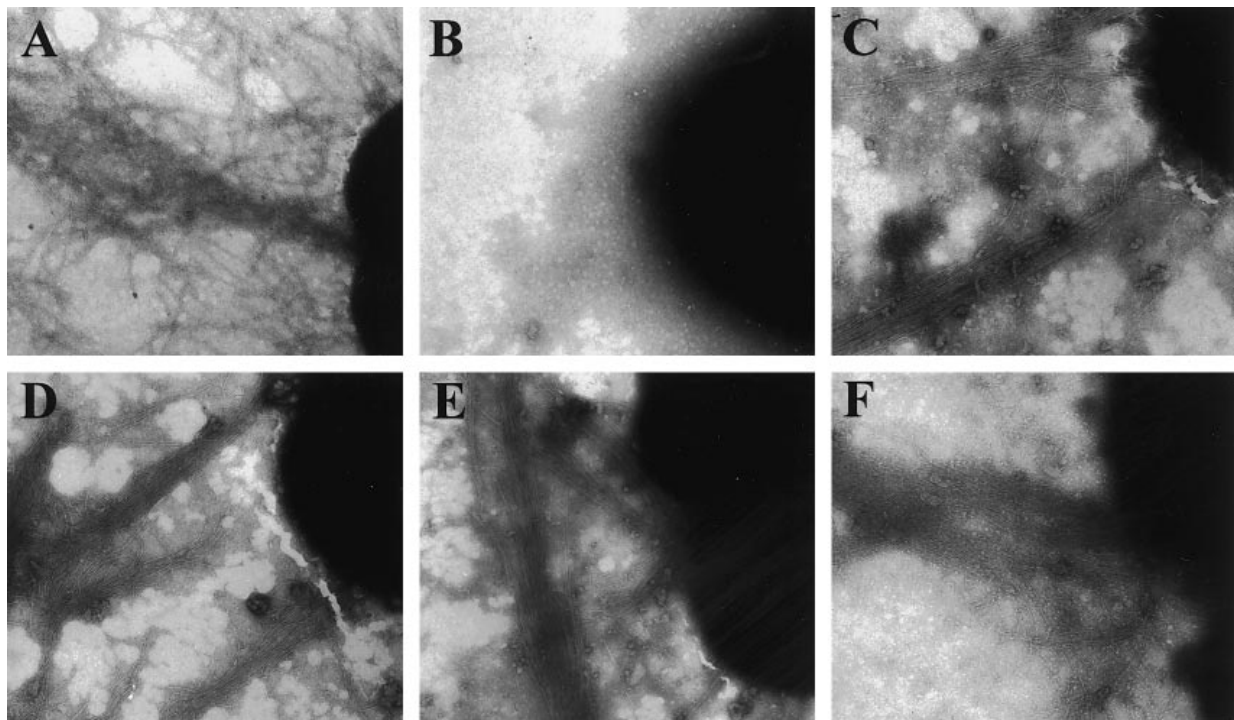

**Fig. 8.** Transmission electron micrographs of wild-type and *comP* mutant strains of *N. gonorrhoeae* show no quantitative or qualitative differences in pilus expression.

- A. N400 (wild type).
  - B. GF2 (*pilF*::mTnrm, non-piliated control).
  - C. MW101 ( $\Delta$ ORF1::mTnrm16).
  - D. MW104 (*comP*::mTnrm23).
  - E. MW110 (mTncm31).
  - F. MW117 (*comP*<sub>E-1-s</sub>).
- Magnification 90 000 $\times$ .

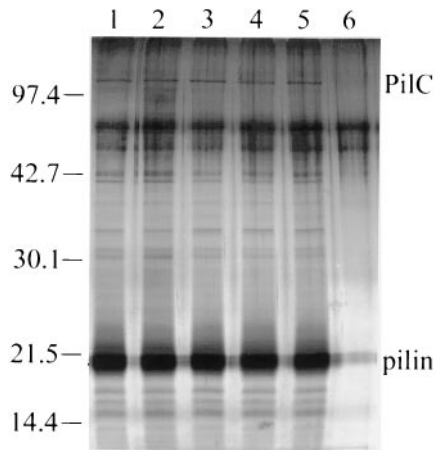

**Fig. 9.** Pilin and pilus-associated polypeptides are not altered in *comP* mutants. Silver staining of purified pilus preparations analysed by SDS-PAGE. Lane 1, N400; lane 2, MW101 ( $\Delta$ ORF1::mTnerm16); lane 3, MW104 (*comP*::mTnerm23); lane 4, MW110 (mTncm31); lane 5, MW117 (*comP*<sub>G-1→S</sub>); lane 6, GF2 (*pilF*::mTnerm, non-piliated control).

seen in *comP* mutants, we asked whether Tfp expression was detectably altered by the mutations at this locus. When negative-stained preparations of whole cells were examined by electron microscopy, no differences in gross filament morphology or abundance were apparent between the wild-type strain and any of the mutants (Fig. 8). As a complementary approach, the status of pilin and other proteins that co-purify with Tfp in these backgrounds was assessed. Silver staining of representative preparations of purified Tfp and associated molecules fractionated by SDS-PAGE failed to detect any differences (Fig. 9), as did immunoblotting of whole-cell lysates from these strains

using pilus-specific antibodies (data not shown). Based on these results and the limits of resolution in the techniques used, ComP does not influence Tfp expression.

Piliated mutants failing to express functional forms of the PilT protein are defective in transformability, twitching motility, and show increased autoagglutination. The transformation defect in this class of mutants was shown to be at the level of sequence-specific DNA uptake (Wolfgang *et al.*, 1998), the same step at which piliated *comP* mutants are defective. Based on this similarity, *comP* mutants were examined microscopically for the expression of twitching motility and in all cases, zones of spreading cells at the periphery of colonies were seen. Even when examined at higher resolution with the more sensitive slide culture technique, cell movement was indistinguishable from that seen for the isogenic wild-type strain. In addition, *comP* mutants showed no alteration in autoagglutination, as assessed by colony morphology and aggregate formation in broth culture, when compared with an isogenic wild-type strain (data not shown).

Rudel *et al.* (1995) have presented data to suggest that the association of PilC with pili is essential for DNA uptake. As detected by silver staining, no differences in the level or migration of PilC were seen in any of the mutants constructed here (Fig. 9). Because the capacity of piliated gonococci to adhere to epithelial cells provides an indirect readout of both pilin and PilC functionality, this phenotype was examined in the *comP* strains. As seen in Fig. 10, the levels of adherence and the patterns of bacterial binding to primary human corneal epithelial cells were identical to that of the wild-type parent strain. In addition, adherent bacteria were recovered and no difference in viable counts, compared with wild type, were detected (data not shown). Thus, despite their defect in DNA uptake, *comP* mutants are unaltered in other Tfp-associated phenotypes.

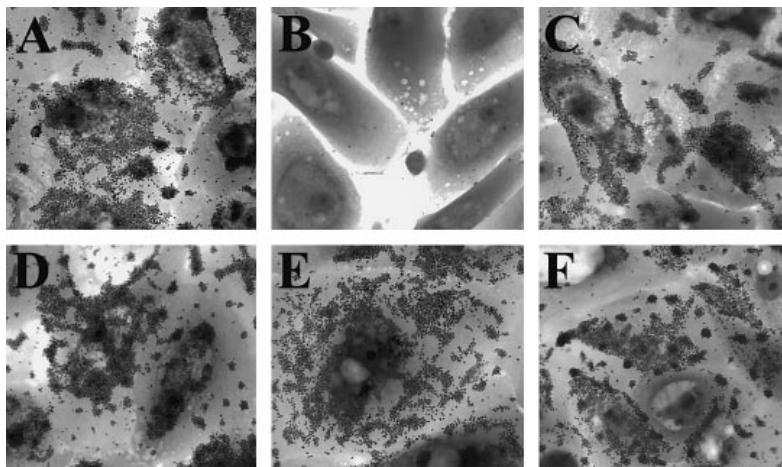
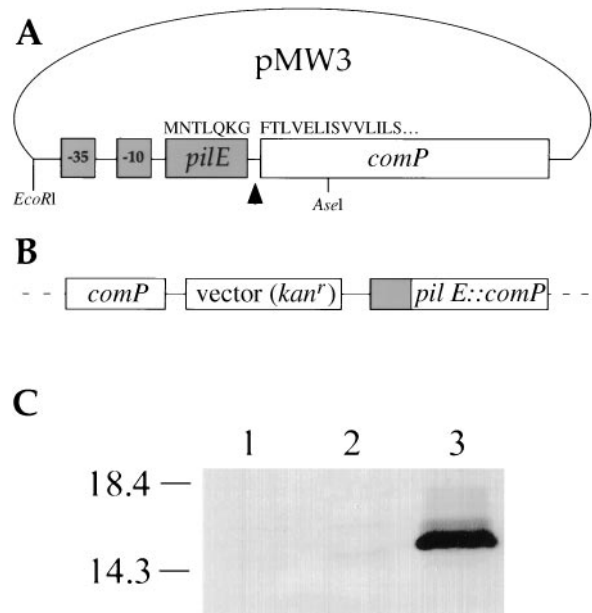

**Fig. 10.** Adherence of genetically defined gonococcal mutants to human corneal epithelial cells. A. N400 (wild type). B. GF2 (*pilF*::mTnerm, non-piliated control). C. MW101 ( $\Delta$ ORF1::mTnerm16). D. MW104 (*comP*::mTnerm23). E. MW110 (mTncm31). F. MW117 (*comP*<sub>G-1→S</sub>).

### Construction of a gonococcal strain that overexpresses mature ComP

Based on the result found using the *E. coli* expression system, we examined whole-cell lysates derived from gonococcal strain N400 and the isogenic *comP* mutants by immunoblotting using the same anti-peptide rabbit serum. However, a ComP-specific signal (unique to the wild-type strain but missing or altered in the mutants) could not be detected. Similar inconclusive results were found when purified Tfp samples from those same strains were tested by immunoblotting (data not shown). Given the possibility that the epitopes recognized by the anti-peptide serum might be masked or otherwise inaccessible when the molecule was expressed in gonococci, the immunoblotting experiments were repeated with rabbit polyclonal serum generated against a purified fusion protein, in which the maltose-binding protein (MBP) was translationally fused to ComP. As with the anti-peptide serum, no ComP-specific signal could be detected in either whole-cell lysates or purified Tfp samples (data not shown).

The simplest explanation for these findings was that ComP might be expressed at low levels in gonococci. To examine this possibility and insure that the antisera did indeed react with ComP synthesized in gonococci, we developed a means for overexpression of the molecule in that background. To achieve this, we adapted the technique previously used by Nunn and Lory (1993) to overexpress the export prepilins XcpT-W by fusing the transcriptional and translational signals present in the highly expressed *pilE* (pilin subunit gene) to the *comP* ORF. The *pilE* gene promoter, ribosome binding site and first seven residues of the PilE ORF were translationally fused to the ComP phenylalanine residue predicted to be the mature N-terminal residue following prepilin peptidase processing (Fig. 11A). The plasmid pMW3 carrying this gene fusion was then integrated into the gonococcal genome at the *comP* locus creating strain MW120. The genetic organization of the *comP* locus of this strain is shown in Fig. 11B. When examined by immunoblotting using either form of ComP antibodies, this strain expressed a strongly reactive polypeptide whose mobility was identical to that found for the molecule when expressed in *E. coli* (Fig. 11C). Immunoblotting of lysates containing decreasing amounts of MW120 cells mixed with a constant amount of wild-type cells revealed that ComP could be detected out to a dilution end point of greater than 1:500. If the antigenicities and basic properties of the mature molecules derived from both the normal and hybrid alleles are equivalent, the level of ComP expressed in a wild-type strain is, in fact, extremely low. We then examined the capacity of strain MW120 to undergo genetic transformation and found it to be indistinguishable from the wild-type parent for this phenotype (Table 1). Taken together, these findings indicate



**Fig. 11.** Construction of a gonococcal strain that overexpresses the mature ComP protein.

A. The ComP overexpressing plasmid pMW3 was constructed by fusing the highly expressed *pilE* gene to the ComP ORF as described in the *Experimental procedures*.

B. Chromosomal organization of the *comP* locus in the overexpressing gonococcal strain.

C. Detection of the mature processed ComP protein in gonococci. Whole-cell lysates of gonococcal strains were analysed by immunoblotting with anti-ComP rabbit polyclonal serum generated against a synthetic ComP peptide. Lanes 1, N400 (wild type); lane 2, MW104 (*comP::mTnerm23*); lane 3, MW120 (*pilE::comP*).

that overexpression of mature ComP as a hybrid protein does not have a discernible effect on transformability.

### Discussion

There is an increasing awareness of the distribution of natural transformation systems among Gram-negative organisms and the importance of this means of genetic exchange to genome variability and polymorphism. Despite this situation, very little is known about the components required for the earliest events of transformation in these species, that being the binding of DNA and its uptake across the outer membrane. In the past few years, *N. gonorrhoeae* has become a particularly intriguing model system because mutants defective in Tfp biogenesis are blocked in transformation at the step of uptake of DNA into a DNase-resistant state (Wolfgang *et al.*, 1998). In this system, the uptake process requires the expression of a relatively well-characterized surface organelle. Nonetheless, expression of these appendages is not sufficient for DNA uptake because *pilT* mutants that fail to take up DNA retain piliation (Wolfgang *et al.*, 1998). The findings here for *comP* mutants further validate that conclusion.



A remarkably consistent theme in natural genetic transformation is the involvement of prepilin-like molecules and sets of orthologues thought to be required for morphogenesis of a polymeric structure related to Tfp. As noted elsewhere (Wolfgang *et al.*, 1998), the major point to be resolved is whether Tfp themselves are engaged directly in DNA uptake or whether other molecules that parasitize the biogenesis pathway to achieve proper localization or activation are responsible. It has been previously shown that all gonococcal mutants that are transformation defective at the level of DNA uptake fail to express Tfp or are altered in at least one Tfp-associated property, such as adherence for epithelial cells, twitching motility or auto-agglutination (Wolfgang *et al.*, 1998). In the case of *comP* mutants, however, no alterations other than the inability to take up DNA could be found. This would be consistent with the pathway parasitism model noted above because one could reasonably envision that ComP might require the Tfp biogenesis factors to form a structure. Thus, mutants in any of the ancillary molecules would lack not only Tfp but also a putative ComP structure. This is almost certainly true in the case of mutants lacking functional PilD, because it is the sole active prepilin peptidase found in gonococci (Freitag *et al.*, 1995).

The above scenario would not, however, readily explain the DNA uptake defect found in mutants failing to express functional forms of PilE, the pilus subunit. Perhaps, PilE and ComP do in fact form a composite structure. Alternatively, this situation may be similar to the case in *P. aeruginosa*, where mutants in the *pilA* gene, encoding the Tfp subunit, were recently shown to be partially defective in protein export. It was further demonstrated that PilA was capable of forming heterodimers with XcpT, one of the four prepilin-like molecules required for the export pathway (Lu *et al.*, 1997). It is plausible then that gonococcal PilE might influence ComP function by virtue of a similar interaction.

The findings here are reminiscent of those made for the *comP* gene required for genetic transformation in *Acinetobacter* sp. strain BD413 and predicted to encode a prepilin-like molecule (Porstendorfer *et al.*, 1997). Although *comP* mutants in that species were unaltered in expression of pilus fibres characteristic of Tfp, they were found to be defective at the level of DNA binding. Attempts to define a defect in gonococcal competence mutants at this step of transformation are complicated because it has been reported that DNA binding is not sequence-specific (Rudel *et al.*, 1995) and that non-piliated mutants still bind DNA (although they do not take it up into a DNase-resistant state) (Biswas *et al.*, 1977). It would be premature to assume that ComP functions similarly in each of these species, especially because the competence of *Acinetobacter* Tfp mutants has not been examined. A second finding made here, which has a relationship to competence systems in

other species, is the linkage between gonococcal *comP* and an upstream partial ORF that bears striking resemblance to the corresponding domain of the ComEA protein of *Bacillus subtilis*. Mutants in *comEA* are defective in DNA binding and based on the C-terminal sequence similarities with other DNA binding proteins, ComEA has been proposed to be an integral part of the DNA-binding apparatus (Inamine and Dubnau, 1995). It was somewhat surprising then that the gonococcal mutant with an insertion disrupting the integrity of the conserved motif within the ORF showed no transformation defect. More work is required to determine whether this ORF is actually expressed as a polypeptide and whether the region 5' of this sequence encodes a contiguous ORF sharing identity with the equivalent N-terminal segment of ComEA. Currently, the sequence of this region is not yet identifiable within the gonococcal genome database.

It is particularly noteworthy that the *comP*<sub>G-1→S</sub> allele-containing strain retained partial transformability and DNA uptake proficiency. Substitution of the glycine residue at the -1 position (relative to the cleavage site) in the pilin subunits of *N. gonorrhoeae* and *P. aeruginosa* results in the inability to be cleaved by PilD and blocks Tfp expression, whereas the presence of glycine at this position of prepilin-like PulG is absolutely required for processing and secretion of pullulanase (Pugsley, 1993b). The ability to detect partial function of the *comP*<sub>G-1→S</sub> allele may reflect the exquisite sensitivity of the transformation assay, which as shown here can quantitatively discriminate over a 10 000- to 100 000-fold range. We envision that low levels of mature ComP might be expressed from the *comP*<sub>G-1→S</sub> allele by virtue of residual activity of PilD for the missense polypeptide or perhaps even by translational misincorporation of glycine at this position of the molecule. Formally, one cannot rule out that non-processed ComP may in fact retain some functionality. Nonetheless, if the former model were true, ComP would have to function at extremely low concentrations, which would be consistent with the finding that wild-type ComP appears to function at levels below that detectable by standard immunoblotting techniques. In this context, it is important to note that genetic data have defined an essential role for the prepilin-like molecule PilV in *P. aeruginosa* Tfp biogenesis, although expression of *pilV* mRNA could not be detected (Alm and Mattick, 1995). In both instances, it will be of considerable interest to reconcile how prepilin-like molecules can play essential roles in Tfp-related biology when present at such low levels relative to that of the corresponding pilin subunit. The discovery that ComP can be expressed at levels equivalent to that of the pilin subunit (as a fusion protein) without disrupting the process of DNA uptake creates a unique opportunity to explore the relationship between Tfp and the early events of genetic transformation. Although strains expressing the PilE::ComP hybrid protein cannot be considered

physiologically normal, they do make it possible to determine whether processed ComP can form a pilus or visible surface organelle, to assess what influence PilE might have on ComP localization or stability and examine what alterations might be seen when other components of the gonococcal Tfp biogenesis machinery are absent or altered.

In summary, the current gonococcal genome sequence database and molecular genetics were used to identify the *comP* gene and its product as a critical factor in the DNA uptake phase of competence for natural transformation. Having established that the gonococcal sequence-specific DNA uptake pathway requires at least the expression of Tfp, the PilT protein and ComP, it is clear that any comprehensive model for the mechanisms behind this process must account for the roles of each. Our ongoing studies are focused on identifying and understanding the complex interactions that exist between these essential components. These studies may be relevant not only to the early steps of genetic transformation but also to the two other avenues for horizontal gene transfer based on recent findings. First, the thin pili of IncI1 conjugal plasmids, required for liquid mating, belong to the type IV family of pili (Kim and Komano, 1997). Secondly, Tfp are required for lysogenic conversion of *Vibrio cholerae* by a filamentous phage encoding cholera toxin (Waldor and Mekalanos, 1996). How these highly related, surface organelles contribute to such diverse forms of DNA translocation across the outer membrane remains to be seen.

## Experimental procedures

### Cloning of *comP*

The region encompassing  $\Delta$ ORF1 and all of *comP* was PCR amplified with Vent DNA polymerase (New England Biolabs) from strain N400 (a derivative of MS11) using primers *comP*-5' (5'-GGAATTCGGCGGTAACATCAATGCG) and *comP*-3' (5'-CGGATCCATGCACCATAAATCCACGG) derived from the FA1090 sequence. The primers contained the *Eco*RI and *Bam*HI restriction sites, are underlined. The resulting 950 bp PCR product was digested with *Eco*RI and *Bam*HI and force cloned into the polylinker of pUP6 to yield pMW1. pUP6 is a derivative of the shuttle mutagenesis/integration vector pHSS6 (Seifert *et al.*, 1990), which carries two gonococcal DNA uptake sequences inserted into the *Eco*RI site. The uptake sequence carrying fragment was generated by hybridizing two oligonucleotides, up-link 1 (5'-AATTCGCCGTCTG-AATATCTTTCAGACGGC) and up-link 2 (5'-AATTGCCG-TCTGAAAGATATTCAGACGGC). The resulting fragment has *Eco*RI-compatible 5' overhangs but reconstitutes only a single *Eco*RI site such that it can still be used for cloning. Gonococcal uptake sequences are in bold and underlined nucleotides reconstitute a single *Eco*RI half-site. DNA sequencing was performed to identify clones in which the fragment was positioned between the reconstituted *Eco*RI site and the proximal *Not*I site.

### In situ cloning and mutagenesis of the *comP* locus

Strain N400 was transformed with pMW1 and whole-plasmid integration was selected for on Gc agar plates containing  $50 \mu\text{g ml}^{-1}$  kanamycin. The resulting transformants carry a duplication of *comP*. To clone additional sequences 3' of *comP*, *in situ* cloning was performed as outlined in Fig. 4. Genomic DNA was prepared from the gonococcal *comP* duplication strain and digested to completion with *Ava*I, which cleaves at a unique restriction site in the pUP6 polylinker. A second *Ava*I site was predicted to occur 3.5 kb downstream of the site of vector integration based on analysis of the strain FA1090 sequence. The digested genomic DNA was ligated and transformed into *E. coli* strain HB101 and transformants selected on kanamycin ( $50 \mu\text{g ml}^{-1}$ ). The resulting clones were found to be 5.8 kb, corresponding to a 3.5 kb fragment of genomic sequence and the 2.3 kb pUP6 vector. One such clone was designated pMW2. Transposon mutagenesis was performed on pMW2 as described previously (Seifert *et al.*, 1990). Transposon insertions were isolated, sequenced, and transformed into the gonococcal strain N400 as previously described (Freitag *et al.*, 1995).

### DNA sequencing

To ensure that no changes had occurred in the pilin subunit of the gonococcal mutants used in this study, *pilE* genes were sequenced and compared with the wild type. This was accomplished by amplifying *pilE* by PCR from chromosomal DNA using Vent DNA polymerase and primers Gc-PCI (5'-CTCGAATTCGACCCAATCAACACAC-3') and Gc-PCIV (5'-GCGGCCGTGGAAAATCACTTACCG-3'). The plus strand of the resulting PCR product was sequenced using primers Gc-B (5'-ACCCTTATCGAGCTGATG-3') and Gc-C (5'-GTAAAGAGGTTGAAGTT-3'). The minus strand was sequenced using primers Gc-PCIV (5'-GCGGCCGTGGAAAATCACTTACCG-3') and Gc-F (5'-GGATGCCACGCCGGC-3').

PCR products and plasmids were sequenced using the Thermo Sequenase radiolabelled terminator cycle sequencing kit (Amersham Life Science) according to the manufacturer's protocol.

### Measurement of transformation frequency and DNA uptake

Transformation assays were carried out as previously described using  $1 \mu\text{g ml}^{-1}$  plasmid pSY6 DNA (Stein *et al.*, 1991). Transformants were selected on Gc agar containing  $1 \mu\text{g ml}^{-1}$  nalidixic acid. DNA uptake was assessed using a  $^{32}\text{P}$ -labelled PCR fragment that carried two copies of the Gc DNA uptake sequence. The source of the PCR template and the radiolabelling procedure have been described previously (Wolfgang *et al.*, 1998). Uptake assays were performed by adding 300 ng of  $^{32}\text{P}$ -labelled PCR product to 1 ml suspensions containing  $10^9$  colony-forming units of Gc supplemented with 7 mM  $\text{MgCl}_2$ . Suspensions were tumbled for 30 min at 37°C, placed on ice and DNase I added to a final concentration of  $100 \mu\text{g ml}^{-1}$  and incubated for 5 min. Cells were washed 4× in 1 ml of ice-cold Gc broth and counted in 3 ml of scintillation cocktail in a Beckman LS3801 liquid scintillation counter.

### T7 expression of *comP* in *E. coli*

*comP* was PCR amplified from the wild-type strain using primers *comP*-T7-5' (5'-CGGGATCCGGTGCTGCCTGCGG-3') and *comP*-T7-3' (5'-AACTGCAGATCCACGGCTAAAGAT-AATTGGG-3'). The primers containing the *Bam*HI and *Pst*I restriction sites are underlined. The PCR product was digested with *Bam*HI, cloned into the T7 expression vector pT7-6 (Tabor and Richardson, 1985), digested with *Sma*I and *Bam*HI to produce pT7-*comP*. The *Pst*I site was not used because of the presence of a second *Pst*I site in the PCR fragment. Expression of *comP* in *E. coli* under the control of the T7 RNA polymerase was carried out as described (Tabor and Richardson, 1985).

### Construction of *ComP* prepilin processing mutants

Site-specific mutations were generated by PCR. Mutagenesis primers were designed to overlap a unique *Ase*I site located 16 bp 3' of the *ComP* -1 glycine codon. These primers were used in combination with the primer *comP*-5' to generate PCR fragments corresponding to the 5' region of *comP*. PCR fragments were digested with *Eco*RI and *Ase*I and used to replace the *Eco*RI/*Ase*I fragment of pMW1. Primer *comP*-G<sub>-1</sub>S-3' (5'-CTGATATTAATTCAACCAGCGTAAAGGACC-GATTATCAGTCATT-3') changes the -1 codon from GGG to TCC resulting in a G<sub>-1</sub> to S substitution. Primer *comP*-F<sub>1</sub>S-3' (5'-CTGATATTAATTCAACCAGCGTAAAGGACC-GATTATCAGTCATT-3') causes a G<sub>-1</sub> to S change and deletes a nucleotide from the +1 codon causing a reading frameshift. Primer *comP*-F<sub>1</sub>Opal-3' (5'-CTGATATTAATTCAACCAGC-GTT**CAGGACC**GATTATCAGTCATT-3') results in a G<sub>-1</sub> to S substitution and changes the +1 phenylalanine codon from TTT to TGA, resulting in an Opal nonsense mutation. Underlined nucleotides represent the *Ase*I (ATTAAT) site and a newly created *Av*all (GGACC) restriction site. Bold nucleotides represent altered codons. The altered alleles were introduced into the wild-type strain by a non-selective transformation procedure as previously described (Gunn and Stein, 1996). Incorporation of the site-specific mutations onto the gonococcal chromosome was verified by the presence of a new *Av*all restriction site in PCR products generated from the *comP* locus followed by DNA sequencing.

### Construction of a MBP::ComP fusion protein

A MBP::ComP hybrid protein was constructed by generating a translational fusion of MBP to residue 35 of unprocessed *ComP*. The sequence corresponding to the C-terminus of *ComP*, beginning at the codon for glutamate 35, was PCR amplified from strain N400 using primers *comP*-malE-5' (5'-CGGAATTCGAGAAAGCAAAGATAAATGCAGTGC-3') and *comP*-malE-3' (5'-ACGCGTTCGACGAAAACCGCACAAAT-ACTGAAACAC-3'). Underlined nucleotides represent the *Eco*RI and *Sal*I sites. The resulting product was digested with *Eco*RI and *Sal*I and cloned into the polylinker of pMAL-c2 (New England Biolabs) to produce pMW4. The clone was verified by DNA sequencing as described. Expression and purification of the fusion protein was carried out according to the instructions provided with the pMAL Protein Fusion and Purification System Kit (New England Biolabs). A polypeptide

of the correct size was purified and detected by SDS-PAGE and staining with Coomassie brilliant blue (Bio-Rad) as described (Sambrook *et al.*, 1989).

### SDS-PAGE, immunoblotting and silver staining

Procedures for SDS-PAGE and immunoblotting have been described previously (Freitag *et al.*, 1995). Rabbit polyclonal antiserum was generated against a synthetic peptide (LQNGRFKQTSTKWPSLPIKE) corresponding to *ComP* amino acid residues 58-77 and to the purified MBP::ComP fusion protein. The *ComP* synthetic peptide was synthesized by the University of Michigan Protein and Carbohydrate Structure Facility. *ComP* was detected by immunoblotting whole-cell lysates of *E. coli* and Gc using rabbit polyclonal antibodies and alkaline phosphatase-coupled goat anti-rabbit antibodies (Tago). Pilus purification and silver staining procedures have been described previously (Wolfgang *et al.*, 1998). Stained gels were air dried using the Easy Breeze gel drying system (Hoefer). Prestained molecular-weight markers (Gibco BRL) were used as standards.

### Characterization of twitching motility

Twitching motility was assessed by direct visualization of cells at the periphery of colonies observed with a Stereozoom 7 (Bausch and Lomb) stereomicroscope as described (Swanson, 1978) as well as by the slide culture method (Darzins, 1993), when cells are inoculated onto Gc agar slices on microscope slides, covered with a coverslip and visualized under a Zeiss phase microscope using the 40× objective.

### Electron microscopy

Colonies of bacteria grown on Gc agar plates (12 h, 37°C, 5% CO<sub>2</sub>) were gently touched with pioloform-coated grids and air dried. Grids were subsequently stained with 1% ammonium molybdate in water for 2 min, rinsed once with water, air dried, and viewed in a Hitachi HU-11E-1 electron microscope.

### Bacterial adherence assay

Primary cultures of human corneal epithelial cells were established as described (van Putten and Paul, 1995). For use in adherence assays, epithelial cells were grown on 12 mm circular glass or thermanox coverslips in 1 ml of medium. Before the start of the infection, the medium was replaced with 1 ml of Dulbecco's modified Eagle medium (DMEM) supplemented with 5% FCS. Gonococci were grown on Gc agar plates (14 h, 5% CO<sub>2</sub>), suspended in tissue culture medium, and added to the cells (2 × 10<sup>7</sup> per well). After 4-6 h of incubation (37°C, 10% CO<sub>2</sub>), the infection was stopped by rinsing the cells three times with 1 ml of Dulbecco's phosphate-buffered saline (DPBS) to remove unbound microorganisms, followed by fixation (at least 30 min, room temperature) in 0.1% glutaraldehyde/1% paraformaldehyde in DPBS. Specimens were stained with crystal violet (0.007% in distilled water) and bacterial adherence was scored with an Olympus BH-2 microscope.

### Construction of a gonococcal strain overexpressing mature ComP

An overexpressing *comP* allele was generated by fusing the transcriptional and translational signals present in the highly expressed *pilE* to the *comP* ORF. Specifically, the *pilE* gene promoter, ribosome binding site and first seven residues of the PilE ORF were translationally fused to the ComP phenylalanine residue predicted to be the mature N-terminal residue following prepilin peptidase processing (Fig. 11A). This was accomplished by PCR amplification of the *pilE* promoter region and nucleotides coding for the first seven residues of the prepilin of N400 using primers pilE-5' (5'-CTCGAATTCCGACC-CAATCAACACAC-3') and pilE-*comP*-3' (5'-**CTGATATTA-ATTCAACCAGCGTAAAGCCTTTTTGAAGGGTATTC**-3'). Primer pilE-5' creates an *EcoRI* restriction site (underlined). The 5' end of primer pilE-*comP*-3' (bold) is complementary to the *comP* sequence coding for residues +1 to +8 and overlaps the *AseI* site (underlined). The 3' portion of this primer is designed to amplify the first seven codons of *pilE* and the upstream promoter region. The resulting PCR product was digested with *EcoRI* and *AseI* and used to replace the *EcoRI/AseI* fragment containing the *comP* 5' region of plasmid pMW1. The resulting plasmid pMW3 was integrated into the genome of the wild-type strain N400 to create the genomic organization depicted in Fig. 11B.

### Acknowledgements

This work was supported by Public Health Service Grant A127837 (M.K.) and National Institutes of Health (NIH) Clinical Research Center (CRC) grant M01 RR 00042. Human corneas were generously provided by Dr P. Buck, Montana Eye Bank, Missoula, MT, USA. The gonococcal strain FA1090 genome sequence database was assembled and provided by the Gonococcal Genome Sequencing Project, and B. A. Roe, S. P. Lin, L. Song, X. Yuan, S. Clifton and D.W. Dyer at the University of Oklahoma.

### References

Alm, R.A., and Mattick, J.S. (1995) Identification of a gene, *pilV*, required for type 4 fimbrial biogenesis in *Pseudomonas aeruginosa*, whose product possesses a prepilin-like leader sequence. *Mol Microbiol* **16**: 485–496.

Alm, R.A., and Mattick, J.S. (1997) Genes involved in the biogenesis and function of type-4 fimbriae in *Pseudomonas aeruginosa*. *Gene* **192**: 89–98.

Altschul, S.F., Gish, W., Miller, W., Myers, E.W., and Lipman, D.J. (1990) Basic local alignment search tool. *J Mol Biol* **215**: 403–410.

Altschul, S.F., Madden, T.L., Schaffer, A.A., Zhang, J., Zhang, Z., Miller, W., and Lipman, D.J. (1997) Gapped BLAST and PSI-BLAST: a new generation of protein database search programs. *Nucleic Acids Res* **25**: 3389–3402.

Biswas, G.D., Sox, T., Blackman, E., and Sparling, P.F. (1977) Factors affecting genetic transformation of *Neisseria gonorrhoeae*. *J Bacteriol* **129**: 983–992.

Bradley, D.E. (1980) A function of *Pseudomonas aeruginosa* PAO polar pili: twitching motility. *Can J Microbiol* **26**: 146–154.

Catlin, B.W. (1982) Cell-to-cell transmission of chromosomal loci in *Neisseria gonorrhoeae*. In *Genetic Exchange*. Streips, U.N., Guild, W.R., Goodgal, S.H., and Wilson, G.A. (eds). New York: Marcel Dekker, pp. 311–321.

Darzins, A. (1993) The *pilG* gene product, required for *Pseudomonas aeruginosa* pilus production and twitching motility, is homologous to the enteric single-domain response regulator CheY. *J Bacteriol* **175**: 5934–5944.

Drake, S.L., and Koomey, M. (1995) The product of the *pilQ* gene is essential for the biogenesis of type IV pili in *Neisseria gonorrhoeae*. *Mol Microbiol* **18**: 975–986.

Dubnau, D. (1991) Genetic competence in *Bacillus subtilis*. *Microbiol Rev* **55**: 395–424.

Dubnau, D. (1997) Binding and transport of transforming DNA by *Bacillus subtilis*: the role of type-IV pilin-like proteins – a review. *Gene* **192**: 191–198.

Francetic, O., Lory, S., and Pugsley, A.P. (1998) A second prepilin peptidase gene in *Escherichia coli* K-12. *Mol Microbiol* **27**: 763–775.

Freitag, N., Seifert, H.S., and Koomey, M. (1995) Characterization of the *pilF-pilD* pilus assembly locus of *Neisseria gonorrhoeae*. *Mol Microbiol* **16**: 575–586.

Gunn, J.S., and Stein, D.C. (1996) Use of a non-selective transformation technique to construct a multiply restriction/modification-deficient mutant of *Neisseria gonorrhoeae*. *Mol Gen Genet* **251**: 509–517.

Inamine, G.S., and Dubnau, D. (1995) ComEA, a *Bacillus subtilis* integral membrane protein required for genetic transformation, is needed for both DNA binding and transport. *J Bacteriol* **177**: 3045–3051.

Kim, S.R., and Komano, T. (1997) The plasmid R64 thin pilus identified as a type IV pilus. *J Bacteriol* **179**: 3594–3603.

Koomey, M., Bergstrom, S., Blake, M., and Swanson, J. (1991) Pilin expression and processing in pilus mutants of *Neisseria gonorrhoeae*: critical role of Gly<sub>-1</sub> in assembly. *Mol Microbiol* **5**: 279–287.

Link, C., Eickernjager, S., Porstendorfer, D., and Averhoff, B. (1998) Identification and characterization of a novel competence gene, *comC*, required for DNA binding and uptake in *Acinetobacter sp.* strain BD413. *J Bacteriol* **180**: 1592–1595.

Lu, H.M., Motley, S.T., and Lory, S. (1997) Interactions of the components of the general secretion pathway: role of *Pseudomonas aeruginosa* type IV pilin subunits in complex formation and extracellular protein secretion. *Mol Microbiol* **25**: 247–259.

Nunn, D.N., and Lory, S. (1993) Cleavage, methylation, and localization of the *Pseudomonas aeruginosa* export proteins XcpT, -U, -V, and -W. *J Bacteriol* **175**: 4375–4382.

Porstendorfer, D., Drotschmann, U., and Averhoff, B. (1997) A novel competence gene, *comP*, is essential for natural transformation of *Acinetobacter sp.* strain BD413. *Appl Env Microbiol* **63**: 4150–4157.

Pugsley, A.P. (1993a) The complete general secretory pathway in Gram-negative bacteria. *Microbiol Rev* **57**: 50–108.

Pugsley, A.P. (1993b) Processing and methylation of PulG, a pilin-like component of the general secretory pathway of *Klebsiella oxytoca*. *Mol Microbiol* **9**: 295–308.

Pugsley, A.P., Francetic, O., Possot, O.M., Sauvonnnet, N.,

- and Hardie, K.R. (1997) Recent progress and future directions in studies of the main terminal branch of the general secretory pathway in Gram-negative bacteria – a review. *Gene* **192**: 13–19.
- van Putten, J.P.M., and Paul, S.M. (1995) Binding of syndecan-like cell surface proteoglycan receptors is required for *Neisseria gonorrhoeae* entry into human mucosal cells. *EMBO J* **14**: 2144–2154.
- Rudel, T., Facius, D., Barten, R., Scheuerpflug, I., Nonnenmacher, E., and Meyer, T.F. (1995) Role of pili and the phase-variable PilC protein in natural competence for transformation of *Neisseria gonorrhoeae*. *Proc Natl Acad Sci USA* **92**: 7986–7990.
- Sambrook, J., Fritsch, E.J., and Maniatis, T. (1989) *Molecular Cloning: a Laboratory Manual*, 2nd edn. Cold Spring Harbor, New York: Cold Spring Harbor Laboratory Press.
- Seifert, H. (1997) Insertionally inactivated and inducible *recA* alleles for use in *Neisseria*. *Gene* **188**: 215–220.
- Seifert, H.S., Ajioka, R.S., Paruchuri, D., Heffron, F., and So, M. (1990) Shuttle mutagenesis of *Neisseria gonorrhoeae*: pilin null mutations lower DNA transformation competence. *J Bacteriol* **172**: 40–46.
- Stein, D.C., Danaher, R.J., and Cook, T.M. (1991) Characterization of a *gyrB* mutation responsible for low-level nalidixic acid resistance in *Neisseria gonorrhoeae*. *Antimicrob Agents Chemother* **35**: 622–626.
- Strom, M.S., and Lory, S. (1991) Amino acid substitutions in pilin of *Pseudomonas aeruginosa*. Effect on leader peptide cleavage, amino-terminal methylation, and pilus assembly. *J Biol Chem* **266**: 1656–1664.
- Swanson, J. (1978) Studies on gonococcus infection XII. Colony color and opacity variants of gonococci. *Infect Immun* **19**: 320–331.
- Swanson, J., and Barrera, O. (1983) Gonococcal pilus subunit size heterogeneity correlates with transitions in colony piliation phenotype, not with changes in colony opacity. *J Exp Med* **158**: 1459–1472.
- Tabor, S., and Richardson, C.C. (1985) A bacteriophage T7 RNA polymerase/promoter system for controlled exclusive expression of specific genes. *Proc Natl Acad Sci USA* **82**: 1074–1078.
- Tomb, J., El-Hajj, H., and Smith, H.O. (1991) Nucleotide sequence of a cluster of genes involved in the transformation of *Haemophilus influenzae* Rd. *Gene* **104**: 1–10.
- Tønjum, T., Freitag, N.E., Normark, E., and Koomey, M. (1995) Identification and characterization of *pilG*, a highly conserved pilus assembly gene in pathogenic *Neisseria*. *Mol Microbiol* **16**: 451–464.
- Waldor, M.K., and Mekalanos, J.J. (1996) Lysogenic conversion by a filamentous phage encoding cholera toxin. *Science* **272**: 1910–1914.
- Watts, T.H., Kay, C.M., and Paranchych, W. (1983) Spectral properties of three quaternary arrangements of *Pseudomonas* pilin. *Biochem* **22**: 3640–3646.
- Wolfgang, M., Lauer, P., Park, H.P., Brossay, L., Hebert, J., and Koomey, M. (1998) PilT mutations lead to simultaneous defects in competence for natural transformation and twitching motility in piliated *Neisseria gonorrhoeae*. *Mol Microbiol* **29**: 321–330.