

No. 119
December 1971

LONGITUDINAL STRENGTH OF THE HULL GIRDER

Jan R. Getz
Translated by: F. C. Michelsen



THE DEPARTMENT OF NAVAL ARCHITECTURE AND MARINE ENGINEERING

THE UNIVERSITY OF MICHIGAN
COLLEGE OF ENGINEERING

REFERENCE ROOM

Naval Architecture & Marine Engineering Bldg.
University of Michigan
Ann Arbor, MI 48109

ACKNOWLEDGEMENT

The cost of typing and reproducing these
notes was covered in part by a grant from Frederic Gibbs

LONGITUDINAL STRENGTH
OF THE
HULL GIRDER

by: Jan R. Getz*

translated by: F.C. Michelsen**

DEPARTMENT OF NAVAL ARCHITECTURE AND MARINE ENGINEERING
COLLEGE OF ENGINEERING
THE UNIVERSITY OF MICHIGAN
ANN ARBOR, MICHIGAN
1971

* Prof. N.T.H. Trondheim, Norway

** Prof. University of Michigan

CONTENTS

	Page
PREFACE	v
<u>1. Introduction</u>	vii
<u>2. The Ship's Hull as a Structural System</u>	1
<u>3. Longitudinal Bending Loads</u>	22
<u>4. Torsion of the Hull Girder</u>	61
<u>5. Superstructures and Deck Houses</u>	76

PREFACE

The loading acting on the ship's hull has been treated in Part I and the objective of Part II is primarily to give an overview of the structural arrangements of the hull girder, its response to loading and the most important conditions and relationships that must be considered in the evaluation of longitudinal strength and allowable stresses.

These lectures do not in detail go into the theoretical background of calculations of stresses and deformations, and neither do they cover the buckling problem. These topics are treated in the notes on "Theory of Elasticity" and "Structural Analysis" and are partially covered in the notes on "Structural Details and Materials."

Trondheim, Jan. 1967

Jan Getz

1. Introduction

These lectures which constitute a chapter of the subject "Ship Structures" have been given the title "Longitudinal Strength." This is not meant to indicate that the structural design problem can be separated into "longitudinal strength analysis," "transverse strength analysis," and "local strength analysis," since the strength of a structure and its effectiveness obviously must depend upon all the forms of loadings simultaneously. Nevertheless, it is convenient to a certain degree to analyze the ship structure within the framework of such a conventional subdivision of the subject as indicated above.

The concept "Transverse Strength" has historical roots in that it was introduced at a time when the shell plating of the hull was almost exclusively stiffened by transverse structures consisting of frames, deck beams, floor plates, web frames, and bulkheads. Today we use longitudinal local stiffening extensively together with main stiffening in both transverse and longitudinal planes, and it is essentially the strength of these plated grillages and frameworks that are of prime interest. Simplified, however, we may say that it is the transverse strength that ensures the integrity of the transverse shape of the hull girder.

The concept "Local Strength" is also somewhat ambiguous but must be considered to primarily include the strength of the plates between the stiffeners and of relatively small local stiffeners. The concept is, furthermore, frequently used in the analysis of entire panels whose loading is primarily local and therefore of little influence to the analysis of longitudinal loads. We may mention transverse bulkheads and lower decks as examples, although in the case of bulkheads these may influence the longitudinal bending moment distribution. A more logical subdivision of the subject of loading is suggested as follows:

- a) Loading on the ship's hull as a beam.
- b) Loading on the main girder system of the hull.

- c) Loading on local stiffeners.
- d) Loading on plates as isolated elements.

The total stress in the material is found by a superposition of the effects of the separate loadings given above. It will not be necessary in modern structural analysis to differentiate between the main girder system (main web frames) and more local stiffeners since in principle there is no difference. It is really only a question of difference in the magnitude of the relative stiffnesses. In simplified methods of analysis it is often advantageous to consider the local stiffeners as being elastically supported by the main girders. (The reverse point of view is also used.)

When analyzing stiffened panels as anisotropic plates (plates possessing different stiffnesses in orthogonal directions) plates and stiffeners are treated as an integral structure which provides no opportunity to study the local stress conditions in the plate.

2. The Ship's Hull as a Structural System

	Page
2.1 Considerations of ship motion characteristics and choice of form and proportion	1
2.2 The watertight function of shell and decks	2
2.3 The hull as a beam	5
2.4 Bulkheads and web frames as member maintaining the hull shape	8
2.5 Superstructures and deck houses	11
2.6 Various stiffening systems	12
2.7 Strength considerations in design of stiffener systems	16
2.8 Corrosion allowance	17
2.9 Production and operational considerations	19

2.1 Considerations of ship motion characteristics and choice of form and proportions.

It is the ship's function to transport cargo and passengers under the premise that it is economically competitive in doing so. As far as sea transport is concerned it is predominantly being performed by displacement ships and it is these that are of concern to us here. The principles are, however, also essentially valid in the design of submarines, air cushion vehicles and hydrofoil craft, although these present some problems uniquely their own.

To achieve economy of propulsion it will be necessary to give the ship somewhat elongated proportions and have it fined at both ends. From a

structural point of view the ship is a floating beam. The stability criterion also gets into the act and influence and limits the ratios between beam depth and draft. We may therefore say that the ship's main dimensions are in the first round dictated by its hydrodynamic characteristics, and the structure must be fitted in to best meet the utility requirements of the ship. In addition to these restrictions, we have to consider constraints on main dimensions imposed by draft limitations at ports of call and at locks, allowable beams permitted at bridges, and maximum length that can be handled by locks and piers.

Strength requirements, however, affect the weight of the ship and cost of construction, and it may pay off to deviate from the optimum proportions arrived at from a minimum resistance point of view and, for instance, reduce ship length.

The displacement of the ship and hence its deadweight capacity must, however, be related to the requirements of volume capacity. The ratio between depth and draft is therefore often determined by requirements other than those presented by the minimum allowable freeboard. Such an increase in volume can be provided at a relatively low construction cost, since the deeper hull girder provides a favorable distribution of material with a high efficiency of deck and bottom flanges. A high freeboard may require an increase in beam, though, to provide for adequate stability.

A complete analysis of all of these design considerations is very costly and time consuming if performed manually, and it is natural that several computer aided methods of design optimization are now in general use.

2.2 The watertight function of shell and decks

The primary demand placed on a ship is that it shall provide a watertight and weathertight shell to protect cargo, passengers, and stores from the elements. This shell shall be as light and inexpensive as possible, and it is then a structural optimization problem to dimension the individual panels such that they can support the many simultaneously occurring loads, and be built at a minimum consumption of materials and at the lowest possible cost.

Initially the requirement of watertightness implies that the shell plating has a sufficient local strength to be able to support the hydrostatic and hydrodynamic pressures exerted by the sea and by the cargo without exhibiting permanent sets, cracks or fractures during the lifetime of the ship. As these loads are largely dynamic in nature will the consideration of fatigue failure also enter into the picture. For the shell plating we can under normal circumstances and load conditions not permit any significant permanent deformations and we must, therefore, base our analysis on the theory of elasticity and allowable stresses which, when all loads are taken into consideration, are still below the yield stress of the material.

For certain highly exposed regions of the hull this requirement may be difficult to meet, and in past years, in particular, it was not such a rare sight to see ships with the "hungry horse" look up forward, where a combination of welding stresses and wave impacts had caused the plating to become dished between the frames. The most severe loading occurs, however, in the bottom region forward during slamming, and damage is still frequently sustained due to this. Scantling rules have gradually made such structural failures less frequent, and the design should seek to prevent that they occur under normal operation of the ship at sea. Pressures due to slamming may become high, but sufficient information on their approximate magnitude are still lacking.

If there are no special requirements presented in regard to any double bottom or double skin from a safety or operational consideration, we will normally use a single shell and deck for tightness. This provides the lightest and least costly structure, since the local bending stresses in the plating between the stiffeners can most easily be kept at the desirable level when the total flange and web material is located in a single plating. Also the buckling load in compression and shear is higher for this type of structure. Furthermore, we can place more material at the maximum distance from the neutral axis and thus obtain maximum effectiveness of the material in longitudinal bending. This is not so important for the ship sides since stresses in horizontal bending are smaller. However, the shear stresses in the shell plating become significant for large ships and a splitting of the material into two thinner webs, may produce a danger of shear buckling and therefore require extra stiffening.

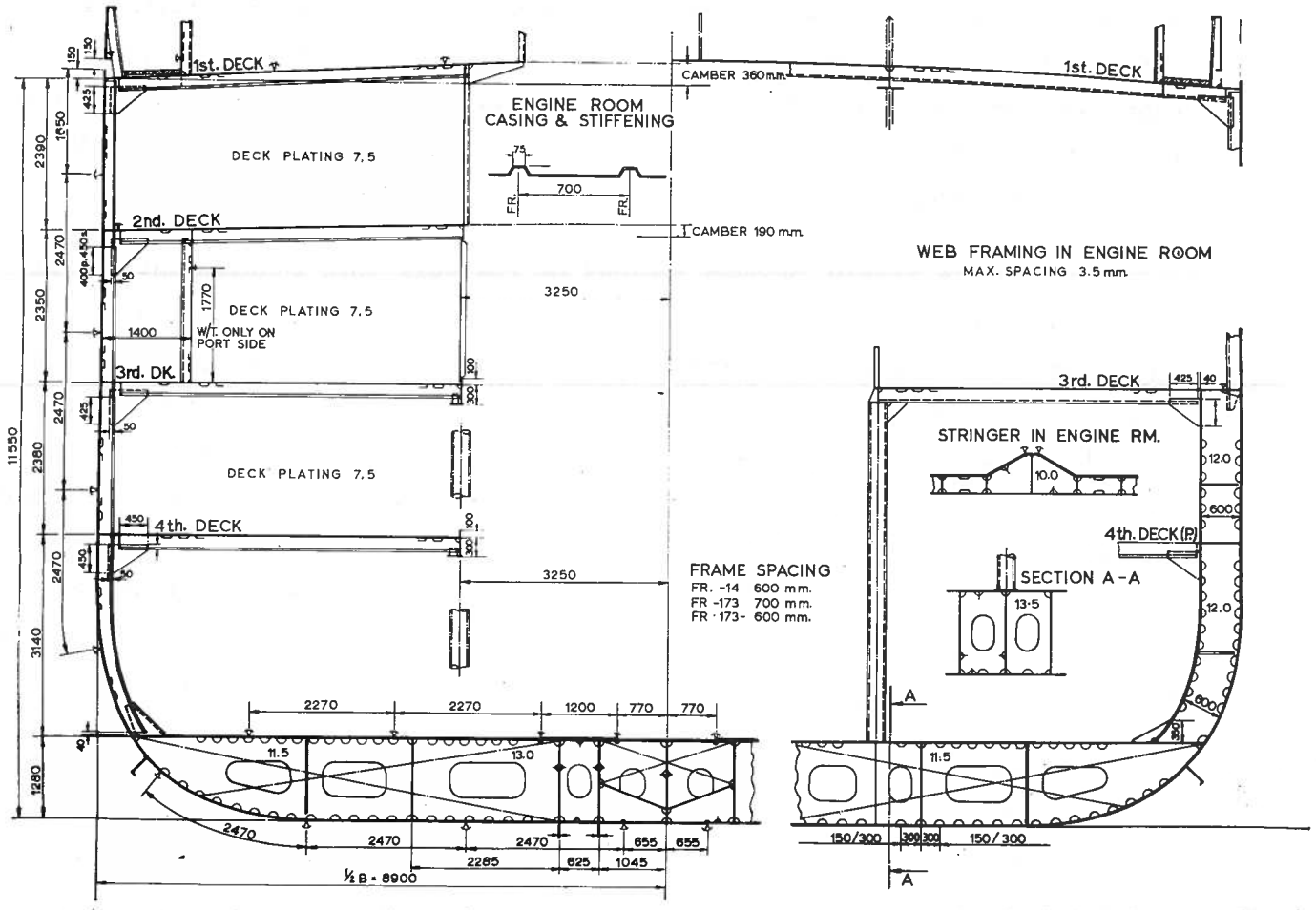


Fig. 2.1 Midship Section of a Refrigerated Cargo Ship. (Conventional Transverse Framing)

Consideration of safety alone will normally not lead to a requirement of double bottom and sides. Other considerations such as cleaning and corrosion may change this. Also there is the question of pollution control after grounding and/or collision. In regard to the bottom it is usually necessary to provide a plane inner bottom in dry cargo ships and bulk carriers. In tankers a double bottom is not usual at this time, although it does offer advantages, as mentioned above, and also better insulation for heated oil cargo.

The subdivision of the hull by longitudinal and transverse bulkheads and between decks is in general dictated by consideration of utility and safety. From a strength point of view these structures are usually not required, since strong web frames could serve as supports for the local stiffeners and to maintain the shape of the hull. As an example we may mention the "automobile carrier".

2.3 The hull as a beam.

The fluid pressure, weights and inertia forces load the hull girder by transferring the forces via plates, stiffeners, main girders and transverse bulkheads to the ship sides and longitudinal bulkheads. The ship sides and longitudinal bulkheads serve as webs of the hull girder and are essentially loaded by concentrated forces that result in shear and normal stresses in the web of the hull girder and its flanges.

The requirements are then that these panels shall be capable of absorbing these stresses without buckling or fracturing, and simultaneously support the local fluid pressures and other local forces. These requirements are in practice met by keeping the individual stress components within prescribed limits. However, if we are to optimize the structure, an integrated approach will have to be followed which normally necessitates the introduction of more advanced methods of analysis.

Usual effective flange theory for thin-walled structures predicts that a shear lag will occur which will reduce the effectiveness of the flanges. It has been found that bottom and deck plating will generally retain close

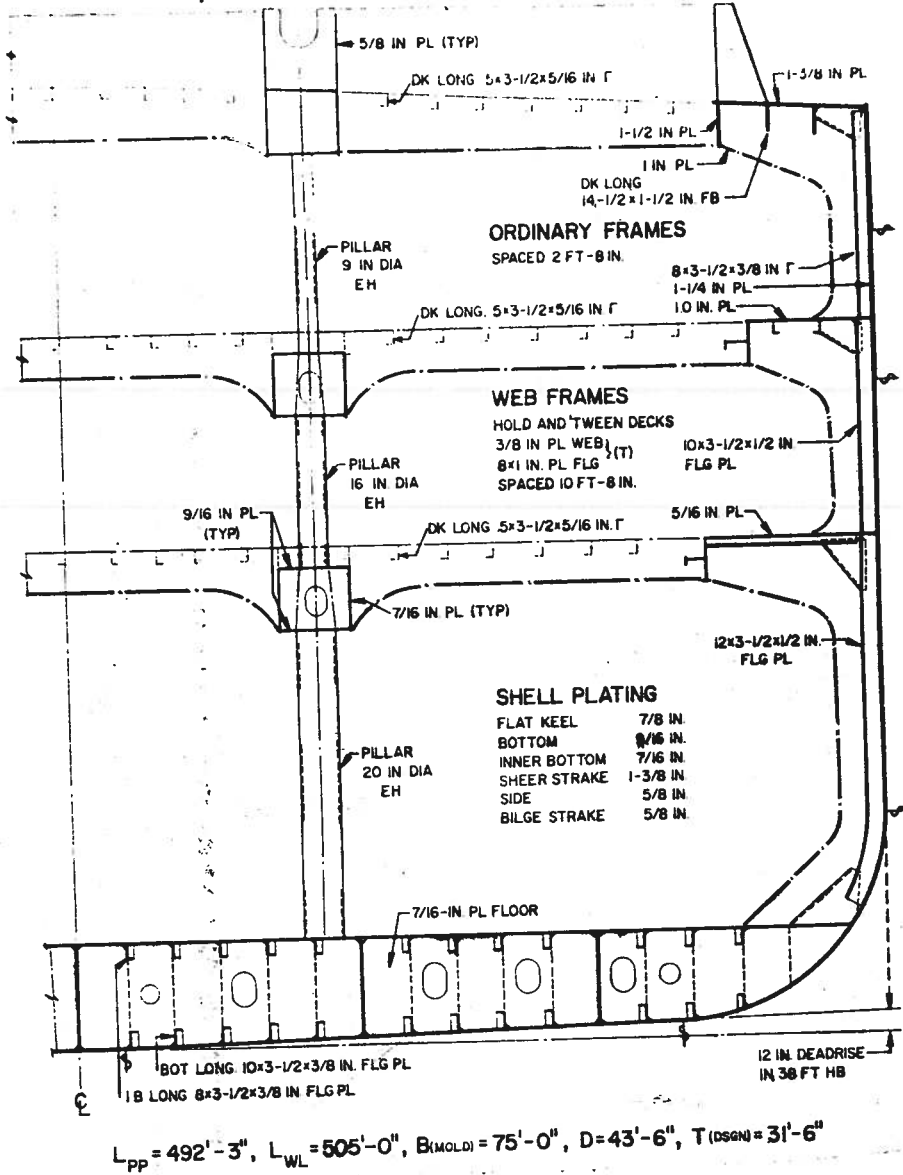
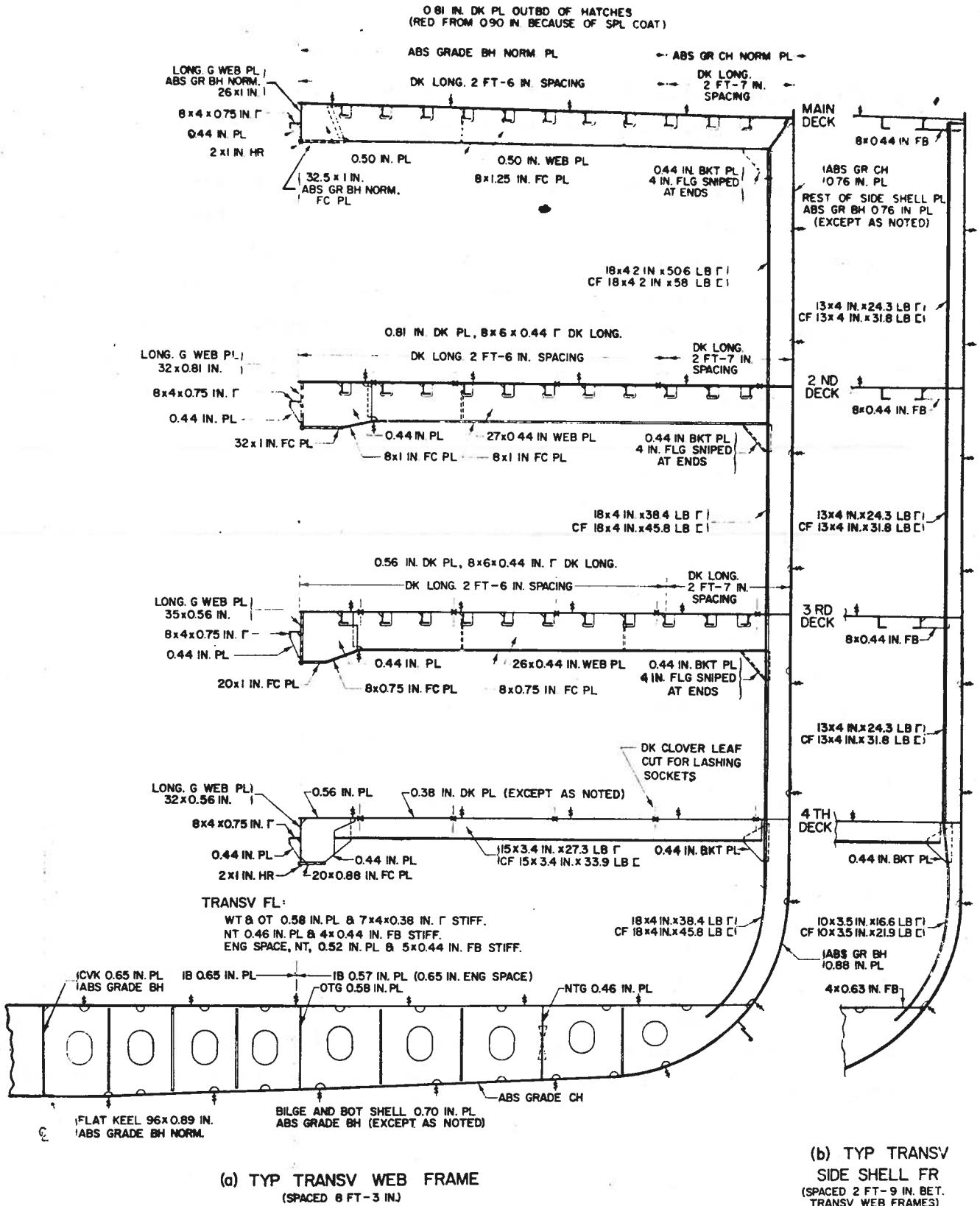


Fig. 2.2 Midship Section of An All-Hatch Cargo Ship.



$L_{OA} = 694'-0"$, $L_{(FOR\ SCANTLG)} = 634'-0"$, $B_{(MOLD.)} = 92'-0"$, $D_{(MIN\ DK\ AT\ SIDE)} = 60'-1-5/8"$, $T_{(FOR\ SCANTLG)} = 29'-0"$, $T_{(DSGN)} = 27'-0"$
 $C_B = 0.529$, FR SPCG III 2'-9"

Fig. 2.3 Longitudinal Frames in Decks; Floors on Each Frame.

to full strength during vertical bending of the hull girder. However, strongly concentrated loads may reduce the effectiveness considerably.

The main deck plating of tankers is for the most part intact, whereas in the case of dry cargo ships we find the deck flange of the hull girder impaired by large deck openings. These do not only lead to a loss of cross-sectional area of the deck but for all normal hatch designs there will also occur a stress concentration in the deck plating of the hatch corners. In the case of extremely large hatches the torsion loads will also give rise to high stresses at the hatch corners and the torsional stiffeners will be greatly reduced. Much effort has been spent on developing structures that reduce stress concentration and it is economically correct to spend extra money for a good hatch design if this will reduce the requirement on the cross-sectional area of the deck.

For modern break-bulk cargo ships, it is now a common practice to install side ports. This means that material is cut away in highly stressed parts of the ship and here we find that considerations of utility and strength are in conflict. However, the benefits derived from a rational cargo handling method are so significant that it is deemed most advantageous to find alternate ways of satisfying the strength requirements although this would increase the steel weight and construction costs.

2.4 Bulkheads and web frames as members maintaining the hull shape.

For thin-walled panel structures, such as found in the hull girder of ships, the shape of the box girder subjected to shear and bending loads, would not be maintained if, in addition to local stiffeners, there had not been fitted bulkheads or strong web frames at suitable spacings. The stiffness of such frames can be determined from the occurring pressure and shear loads, as explained in more details in the chapter on the subject.

The lateral loading on the panels in the form of fluid pressures, deck cargo, etc., will require support similar to those considered above, and

these are usually more than adequate to safeguard the shape of the hull girder.

Bulkheads in tankers and bulk carriers, which are routinely subjected to pressures from one side, must be dimensioned such that no plastic deformations will take place. Plastic deformations would soon lead to cracks and structural failure because of load reversals.

In case of flooding after collision or grounding, a bulkhead may be loaded to a higher level than normal, since the strength reserve after plastic flow has set in can be called for. In dry cargo ships where water tight bulkheads are assumed to be fully loaded only in case of flooding it is common to select scantling which are based on an analysis including both plastic deformations and membrane effects.

2.5 Superstructures and deck houses.

We do not consider here superstructures so designated by the tonnage rules, but we are concerned with superstructures added in a structural sense to the hull girder. According to the usual convention, a superstructure is built flush with the ship's sides whereas a deck house is set in from the deck edge.

Short superstructures and deck houses do not present any serious structural problem, except, of course, the plating of the poop and the fore-castle which become important sections of the shell plating. However, deck houses and superstructures do present problems in that they influence the stress distribution in the hull girder; they are the cause of serious stress concentration at the ends. The sides of superstructures are naturally forced to follow the flexure of the ship's sides in the vertical plane, and the stress distribution in the superstructure is to begin with a stress diffusion problem. The situation is somewhat different in regard to deck houses, since these will behave like separate beams elastically connected to the deck of the ship with "hard points" occurring at the transverse

bulkheads below the deck. Such a beam is loaded by the reaction forces acting between the deck house and the deck and will normally have a different flexure than the side of the ship.

2.6 Various stiffening systems.

When iron and steel ships were first built the framing system previously used in wooden ships was adopted, and common building methods consisting of erecting transverse frames and hanging the shell plating onto these was adhered to. Transverse beams naturally followed, and this has been the generally adopted building method until recent years. Calculations of the buckling strength of panels in compression perpendicular to the stiffeners show that we must use high thickness/(beam spacing) ratios to be able to fully utilize the strength potential of the plate. Traditionally the scantlings of ships were such that the buckling strength was far less than the strength predicted on the yield limit, and a number of ship wrecks can be attributed to the dishing of the plating between the beams (or the beams have also been too weak) which reduced the effectiveness of the compression flange of the hull girder, causing leakage or a broken ship.

The purely transverse frame system has long since been abandoned in tanker designs. Today this is also true to some extent in the case of large dry cargo ships where a mixture of transverse frames in the side shell and longitudinal deck beams and bottom frames are being used (fig. 2.2 - 2.7).

The conventional double bottom construction consists of solid floors located on every third or fourth frame, and open floors located on the remaining frames. In addition there are a center vertical keel (c.v.k.), side girders, tank top and margin plate. It is now fairly common to fit solid floors at every frame and use a horizontal margin plate.

For larger ships it is now common to use longitudinal frames in the double bottom, and the need for side girders is then reduced. (Ships of beams over 21 m. will nevertheless be required to have 2 side girders). The spacing

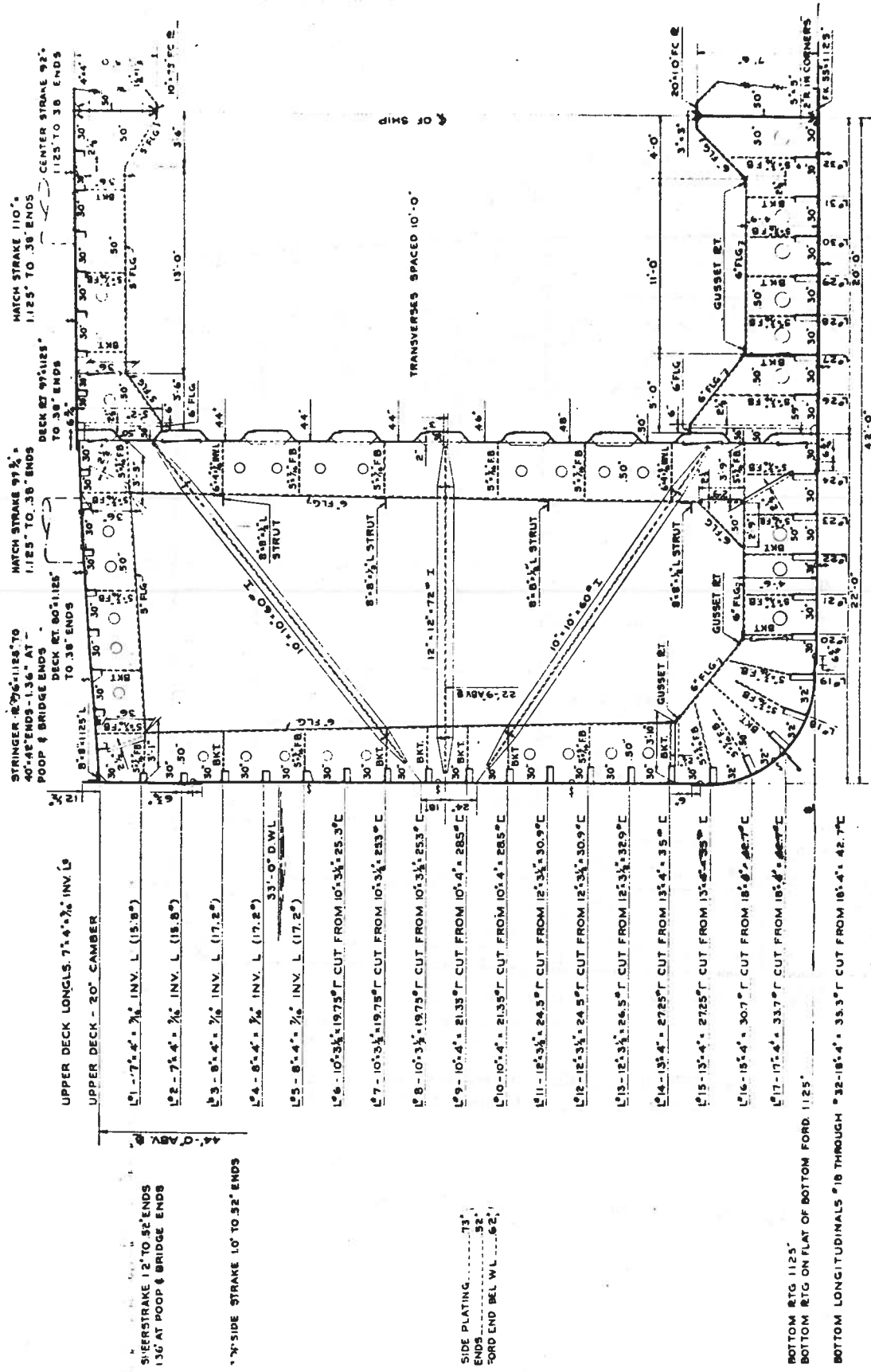


Fig. 2.6 Midship Section of 28,000 TDW. Tanker

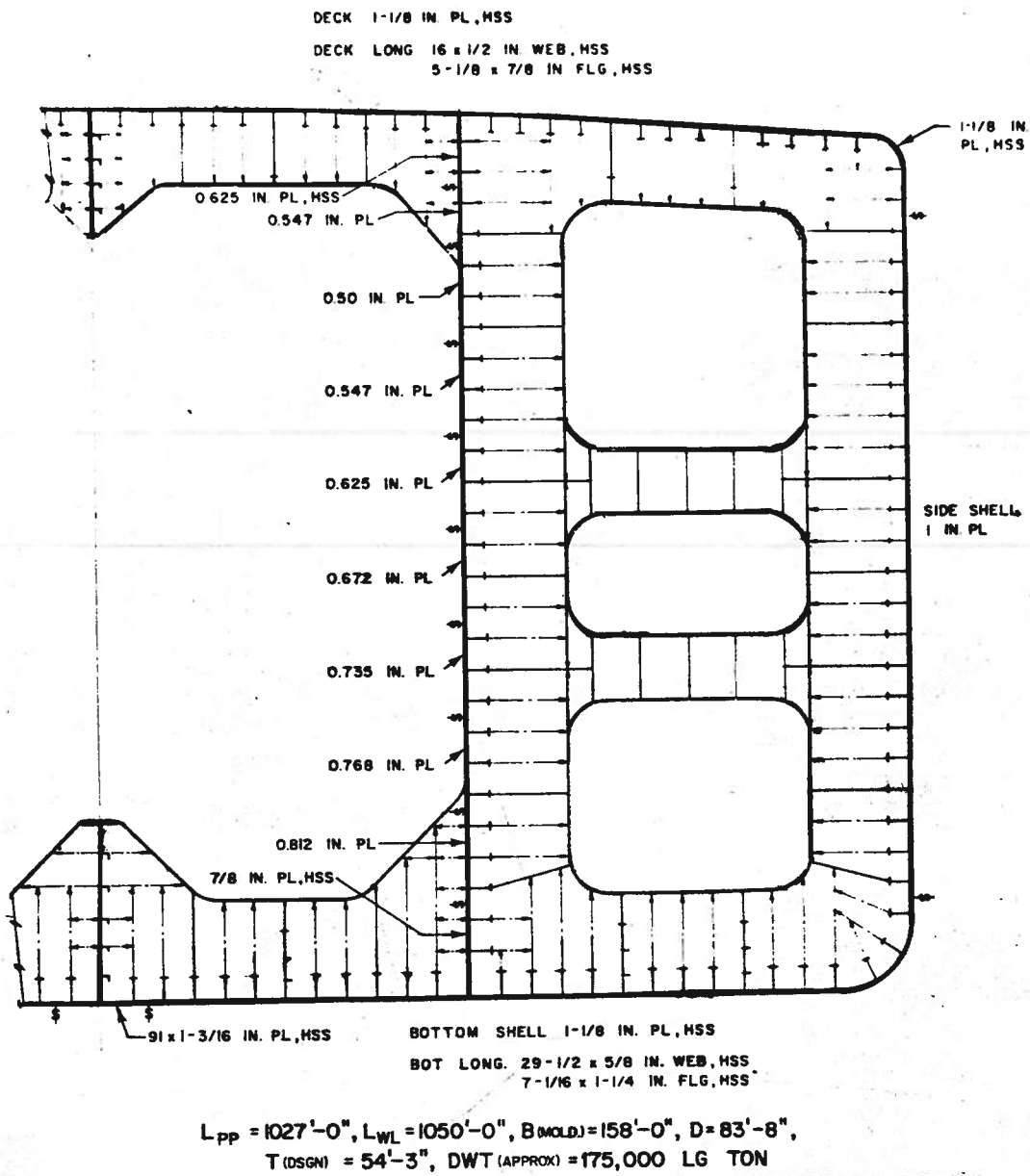
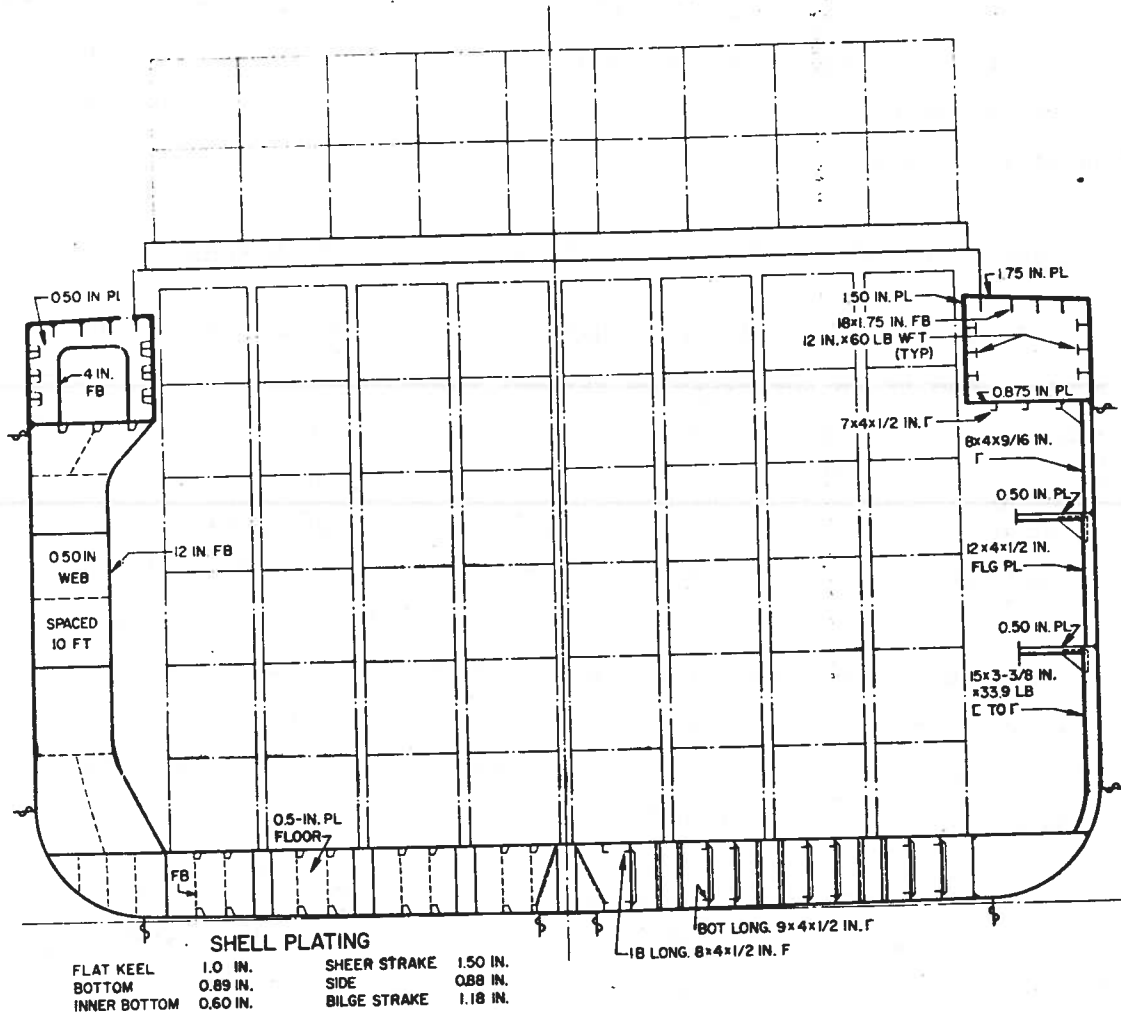


Fig. 2.7 Midship Section of Large Tanker



$L_{OA} = 719'-0''$, $L_{PP} = 675'-0''$, $B_{(MOLD)} = 95'-0''$, $D_{(UP. DK. AT SIDE)} = 54'-0''$
 $T_{(DGN)} = 31'-0''$, $\Delta = 38,800$ LG. TON

Fig. 2.7a Midship Section of Container Ship

between the floors in the cargo hold area is limited to 3m. which, therefore, is the maximum span of the longitudinal frames.

Ships built to carry heavy loads (ore) will use a reduced spacing between the floors. The double bottom will frequently be fitted with more side girders than required by the rules, and the result is a very stiff cellular structure (fig. 2.4).

2.7 Strength considerations in the design of stiffener systems

The largest loads in the hull girder arise from the bending of the hull as a beam, and it is therefore of primary importance to utilize the material in the ship as much as possible in its longitudinal strength. This requires that all longitudinal structural members should be made continuous to the greatest possible extent. Longitudinal stiffening of upper decks, bottom, and inner bottom, is almost mandatory to maintain the effectiveness of the plating at high loading. With longitudinal stiffeners it is easy to achieve a critical buckling stress of the structure which is close to or even above the yield stress of the material. In determining this, we should give due consideration to deformations due to welding and erection and excentricity of loading as well as local buckling and tripping of stiffeners.

In searching for the lightest possible structure with the fewest number of notches and "hard points", it is, however, important also for the transverse strength to provide continuity of the various stiffened elements such that the grillages that support the individual panels form a continuous closed frame, or continuous beam, to a greatest possible extent. We will in this manner obtain a better utilization of the stiffener material through improved end constraints. Stiffeners that are not connected to other stiffeners at the ends will lead to dangerous stress concentrations if they are subjected to axial loads, and give hard working points if they carry heavy lateral loads which produce deflections and rotations at the supports. Due to shear forces it is generally necessary to fit a bracket at the ends, but a crack will easily form if this bracket is attached to a plate field.

It is primarily the danger of brittle and fatigue failures that require good continuous connection with "soft" gradual cross-sectional changes. In practice, it is almost impossible to completely avoid notches introduced in the design and/or production, and consideration of brittle fracture require excellent ductibility properties of the material. To obtain this, without introducing high costs due to the need for special alloys or low milling speeds, it is desirable to limit the plate thicknesses. This leads to a practice where a greater portion of the required cross-sectional area is placed in the stiffeners. It is, furthermore, desirable to avoid heavy concentration of welds and the tri-axial stress conditions that may occur at "hard points".

2.8 Corrosion allowance

The economic life of a ship depends upon many factors, as for instance technical/economical obsolescence. The rapid development we have witnessed during the last decades, not least in regard to size, have often made ships ill suited for the services intended long before they were technically ready for the wrecker. If we disregard this factor, then it is primarily the maintenance costs which determine when to recycle the ship. Wear and repair of machinery and outfitting play a great part in the economy of operation, but also replacement of parts of the hull because of corrosion can become a determining factor. Scantling rules of the classification societies take this into account, based on conventional methods of corrosion protection. It is thus possible to keep ships in service for 20-30 years without having to replace too much of the hull structure. For tankers it may be necessary to replace a substantial amount of structure even as early as 5-10 years after entering service.

To tolerate normal waste of material, ships have been given an addition to the scantlings, thus maintaining sufficient strength until material thicknesses either locally or on the average have reached condemnable dimensions. To retain its class with the classification societies, the ship is inspected thoroughly at regular intervals, when borings or ultra sound tests are conducted to measure thicknesses or remaining material.

Figure 2.8 indicates typical allowable thickness reductions^{*)}.

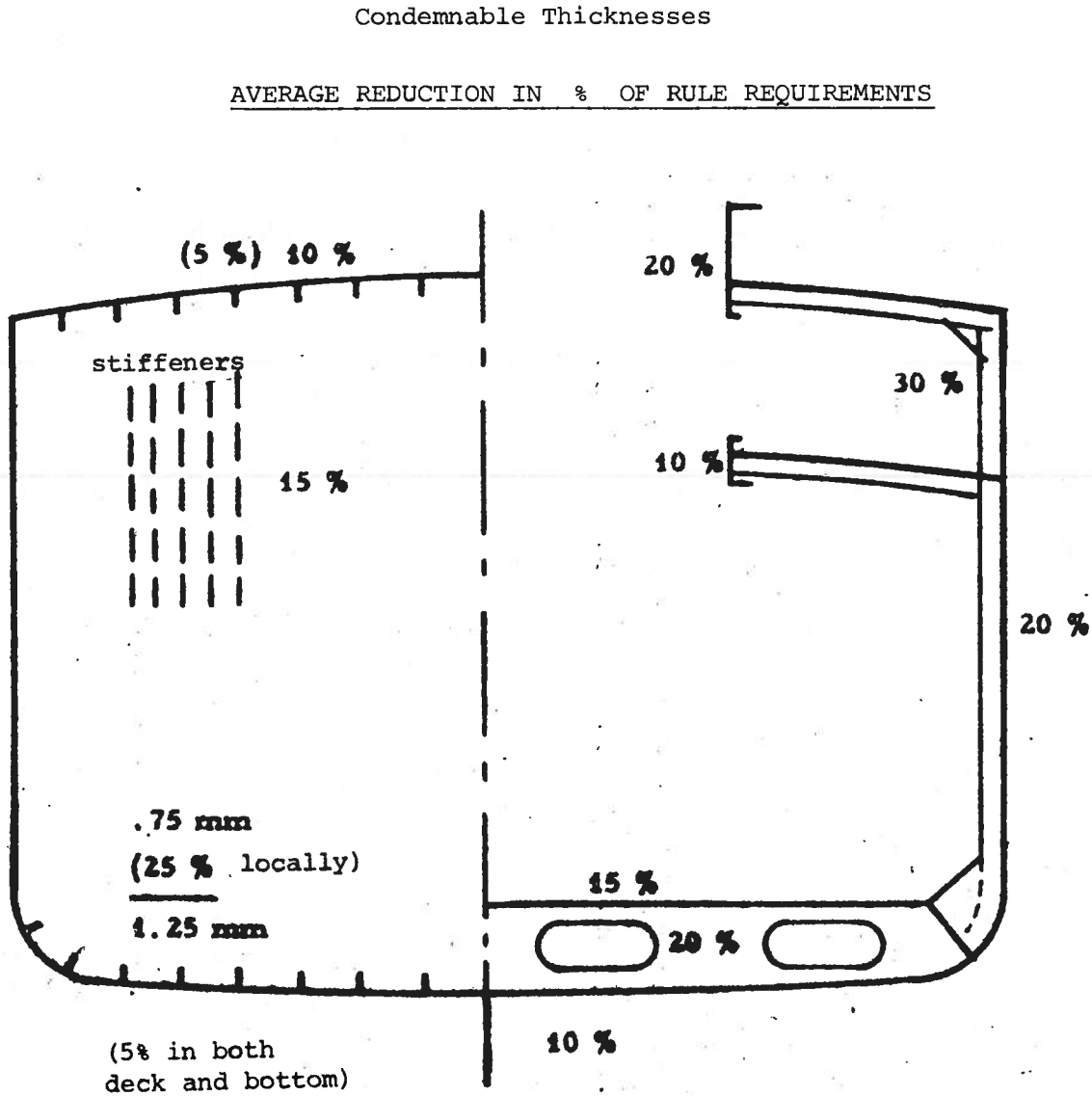


Fig. 2.8

*) Th. Bruland: Rules concerning the corrosion margin in the use of preservatives. Det norske Veritas" Med. No. 35, 1963 and European Shipbuilding No. 1, 1963.

Recent development of new methods of corrosion protection have again raised the question of corrosion allowances. The addition to the scantlings called for is costly in weight and manufacture, and also leads to a reduction of payload. It might indeed be a sound investment to pay for the installation of costly but excellent corrosion protection systems if a reduction of the corrosion allowance is approved. Savings in maintenance will also be realized by such a system as well as reduced fuel costs due to a smoother hull surface.

The classification societies have gradually become accommodating on this issue and have, on a trial basis, permitted the corrosion allowance to be halved provided approved anti-corrosion systems are incorporated. It must be emphasized, however, that the minimum thicknesses required for a ship to maintain its class are unchanged and the reduction in corrosion allowance is completely the responsibility of the owner. Thus it is extremely important to install and maintain a good protection system for both internal and external surface.

2.9 Production and operational considerations.

Technical problems of individual yards which were associated with production played, in years past, an important role in the choice of structural and construction details, and this is one factor influencing the long life of the traditional transversely framed ship. Today practically all yards build the ships in large sub-assemblies, and the arrangement of the main stiffeners are not seen to play any significant role in this production system. In regard to the sectioning of the ship into sub-assemblies and detailing, due attention must be paid to the problems of production and erection. At present there are, for instance, in force certain requirements pertaining to the offset of butt seams in the welded shell and deck plating, as shown in fig. 2.9. These requirements are on occasions relaxed, as, for instance, when lengthening a ship, but the weld must then be carefully inspected.

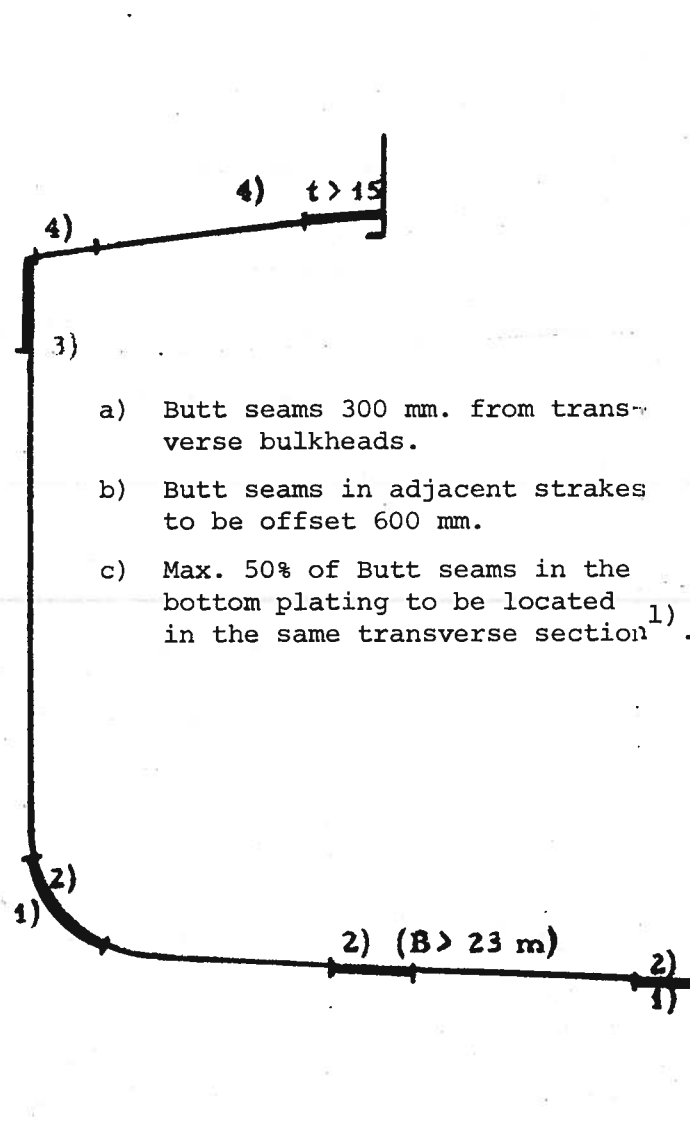
The operational considerations are economic in nature. In tanks for liquid cargo it is important that adequate openings are provided for rapid drainage to the location of the suction piping. Consideration of material waste and cleaning will furthermore make it desirable to avoid horizontal girders on longitudinal bulkheads and ship's sides as much as possible. A smooth inner bottom is attractive from a cleaning point of view, as well as corrosion protection and cargo heating, but a double bottom in tankers has yet to gain general acceptance on account of increased cost and loss of cubic.

For dry-cargo ships, both for break-bulk and bulk cargoes, it is absolutely necessary to have a smooth inner bottom. Furthermore, web frames and horizontal girders fitted to ship's sides are undesirable because these structures interfere with stowage of the cargoes. Horizontal girders are avoided in bulk carriers because they interfere with the unloading. The depths of web frames and girders in the deck play an important role for break bulk carriers since they affect the use of available cubic, and transverse frames are therefore preferable since web frames are not required.

In the engine room it is important that due consideration be given to the machinery arrangement. With the machinery located aft it becomes necessary to provide extra stiffness to the aft body to avoid excessive vibrations.

Currently it is common to use transverse frames in the engine room with some deep web frames and horizontal intercostals to support the normal frames. This design gives a discontinuity of the framing system at the transition between engine room and cargo tanks, but since this transition is located outside of the highly stressed region of the hull girder it has not caused any difficulties provided the details of the transition are well designed. It is not evident, however, that this method of design is the best, and ships are now being built with longitudinal framing also in the engine room.

OFFSETTING OF WELDED BUTT SEAMS



Within $0.4L$ for $L > 110 \text{ m}$.

- 1) If sagging still water bending moment predominates.
- 2) - 4) Free choice of butt location when high strength steel is used.

Fig. 2.9

3. Longitudinal Bending Loads.

	<u>Page</u>
3.1 The Loading	22
3.2 Effects of the pressure against the ends and sides of the ship	24
3.3 Vertical Bending	26
3.4 Horizontal Bending	41
3.5 Shear Stresses	45
3.6 Deflection of the hull girder	51

We shall in the following sections discuss the response of the structure to the loading. Determination of the magnitude of the loading was described in earlier sections but we shall nevertheless here give a short review of the state of our knowledge.

3.1 The loading.

If we disregard local distributions in the cross-section of the hull then we have found that shear forces and bending moments in the hull girder are the results of the differences between hydrostatic and/or hydrodynamic pressures and weights and inertia forces of hull, outfitting and cargo. Loading occurs in both the vertical and the horizontal planes. If we, furthermore, account for angle of heel and refer the loading to the coordinate-system fixed in the ship so that we can use the principal axis of the cross-section, then the horizontal and vertical forces must be decomposed.

In practice we concern ourselves primarily with the loading in the "vertical" plane fixed in the ship and we differentiate between the loading in still water and the relatively slowly varying additional loads in waves. Also we should add higher frequency loads caused by slamming and vibrations.

Selection of the scantlings of the hull girder have traditionally been based on past experiences, and the calculations have been an exercise in comparing scantlings with existing ships. As far as the response of the hull girder to the loading is concerned, we have come far in regard to calculations of stresses and deformations. These can be performed with a high degree of accuracy and confidence. However, when it comes to the magnitudes of the loads we are not quite that well off. A factor which only has been taken into consideration within the last decade in the structural design of ships is the concentrated transfer of the loads from the main girders of the panels and transverse bulkheads to the webs of the hull girder (ship's sides and longitudinal bulkheads). It has been common to draw the buoyancy curve as a continuous curve corresponding to the displacement of the ship, and a similar treatment was given to the weight of dry and liquid cargoes. The pressures against the plates are in reality transferred via local stiffeners to the main girders of the grillage beams and subsequently either directly or via the transverse bulkheads to the longitudinal bulkheads and ship's sides. These webs of the hull girder are therefore loaded by large concentrated forces. Although this will in most normal situations not affect the bending moment distribution to any significant extent, it is possible that some unusual load distributions and/or structural arrangements will produce peaks in the bending moment where the magnitude may be sufficiently higher than the value obtained on the basis of a "smooth" loading curve to warrant consideration. Furthermore, the effective flange of the hull girder is reduced at points where concentrated forces are acting, which results in a reduced section modulus. The bending stresses may therefore be significantly increased at bulkheads.

The local load transfer also plays an important role in the distribution of shear load between the ship's sides and longitudinal bulkheads. For large ships where the web area is critical with respect to shear loads we must take this into consideration, especially where corrugated bulkheads are being used. This we shall return to later.

3.2 The effect of the pressures against the ship's sides and ends.

Normally when we talk about the longitudinal strength of a ship we first consider the bending due to vertical loads. Secondly, we include the effect of horizontal bending. Stresses induced in the hull girder by the fluid pressures acting against the sides and ends are rarely included. The obvious reason for this is the relatively small magnitude of these stresses. However, the closer we get to a rational method of structural analysis the more careful we shall have to be in performing this, and make certain that all contributions to the total magnitude of the stress are accounted for. It is then necessary to keep in mind that horizontal normal pressures against the ship's hull also give rise to an axial load which is eccentric with respect to the neutral axis. These pressures also produce a similar effect in the transverse direction. We shall here merely take a look at the order of magnitude of these stresses, and to do so it is sufficient to consider a box shaped barge. The maximum axial force fully submerged is then

$$T \approx 1/2 BH^2 \text{ (metric tons)}$$

The cross-sectional area of the box girder of constant plate thickness t is

$$A = 2t (B + H) \text{ m}^2$$

and the average axial stress becomes:

$$\sigma = \frac{T}{A} = \frac{BH^2}{4t(B+H)} = \frac{H}{4} \frac{H/t}{1+H/B} \text{ (tons/m}^2\text{)}$$

The ratio H/t is approximately 400 to 600 and the ratio H/B is about 0.4 - 0.6. This gives a stress measured in kp/cm^2 of $7H - 10H$ with H given in meters. The average axial pressure may therefore become 100 - 200 kp/cm^2 depending upon and increasing with respect to ship size.

Naturally the axial stress will be reduced if the ship is fitted with a double bottom and more than one deck.

Since the axial force is excentric with respect to the neutral axis, bending stresses will appear in deck and bottom plating. If we consider the simple box girder with the neutral axis located at half depth, the bending moment becomes

$$M = T \cdot H/6 = BH^3/12 \quad (\text{tons meter})$$

If for the section modulus only deck and bottom plating is included, then

$$Z = tBH \quad (\text{m}^3)$$

and the bending stress becomes

$$\sigma_b = M/Z = H^2/12t \quad (\text{tons/m}^2)$$

assuming here that $H/t = 500$ we get

$$\sigma_b = 4H \quad (\text{kp/cm}^2)$$

Thus for a depth of between 10 and 20 meters the bending stress is between 40 and 80 kp/cm^2 .

From this simple example it becomes evident that the stress in the bottom caused by the pressures acting at the ship's ends may reach a magnitude of 200-300 kp/cm^2 for large ships. This cannot be considered an insignificant contribution, but it is also necessary to evaluate to what degree the stress occurs similtaneous with the maximum bending stress due to cargo distribution along the hull girder.

Maximum axial force will coincide with the sagging condition when the bottom plating is in tension. The stress due to axial force will therefore reduce the total stress in the bottom plating where as the stress in the deck plating has increased. In the hogging condition the effect of the axial force is reversed but the magnitude of the force is less.

Clearly the water pressure will produce similar stresses in the transverse direction. Considering that the ship has some transverse bulkheads, it follows that stresses due to water pressure transversely are of the same order of magnitude as those resulting from axial pressure component. In ships with double bottom and several decks the stress components will of course be reduced.

3.3 Vertical Bending.

In the calculation of longitudinal stresses in the hull girder it is normally assumed that the Navier hypothesis of flexure of beams is valid such that

$$\sigma = \frac{M \cdot z}{I}$$

where

M = external moment loading.

I = area moment of inertia of cross-section.

z = distance from the point under consideration to the neutral axis of the area of the cross-section.

σ = stress due to bending at that point.

The L/D ratio (L = length of ship, D = depth of hull girder) is commonly found to be approximately 14. The Navier hypothesis is sufficiently accurate for beams of such proportions. One should keep in mind, however, that the hull girder is made up from thin webs and flanges. Shear stresses in these will be relatively high, which causes deformations that are not linearly varying with the distance from the neutral axis. A significant deviation from the Navier hypothesis of plane deformation may therefore exist. The effects of shear stresses on the distribution of bending stresses of thin-walled cross-sections - the so-called shear lag effect - will be treated in more detail in connection with the study of effective width of flanges.

occurring over a certain specified area of the cross-section of the hull girder.

The maximum stresses are formed in the uppermost continuous deck and in the bottom. These are given by

$$\begin{aligned}\sigma_d &= \frac{M \cdot z_d}{I} = \frac{M}{Z_d} \\ \sigma_b &= \frac{M \cdot z_b}{I} = \frac{M}{Z_b}\end{aligned}\tag{3.2}$$

where Z_d and Z_b are the section moduli of the hull girder with respect to deck and bottom.

Methods of calculating Z_d and Z_b are assumed to be known. Suffice it to mention here that the neutral axis is normally located from 40-48% of D above the keel. The two section moduli will therefore be of different magnitude.

In calculating the moment of inertia and the section modulus of the hull girder it is of special interest to consider a section through its weakest part amidships, such as a section in the way of a large deck

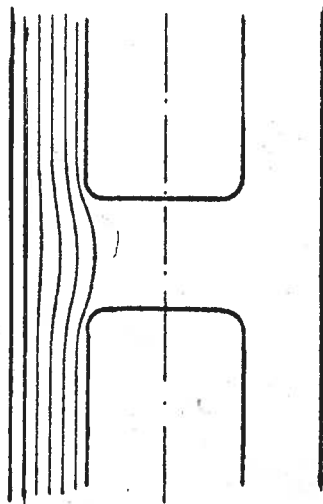


Fig. 3.3a

opening. For a section between openings it would be erroneous to include the total cross-sectional area as being effective. Fig. 3.3a shows a typical stress pattern of a hull. One notes that the stresses in the stringer plate is hardly affected by the existence of the plating between hatches. There is a "shadow" behind deck openings where the stresses are low and the structure in these regions do not contribute much to the longitudinal strength of the hull girder.

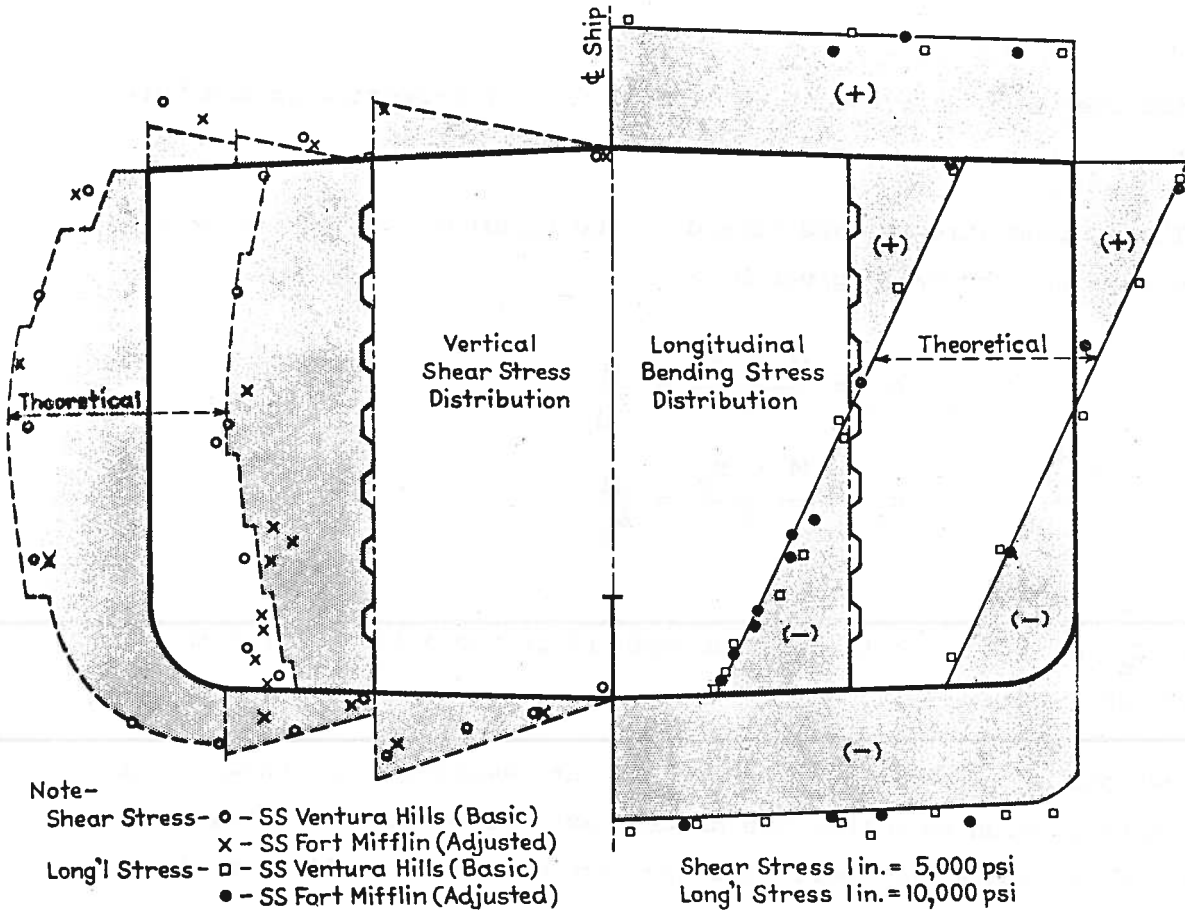


Fig. 3.1

Shear and moment study on the SS Ventura Hills

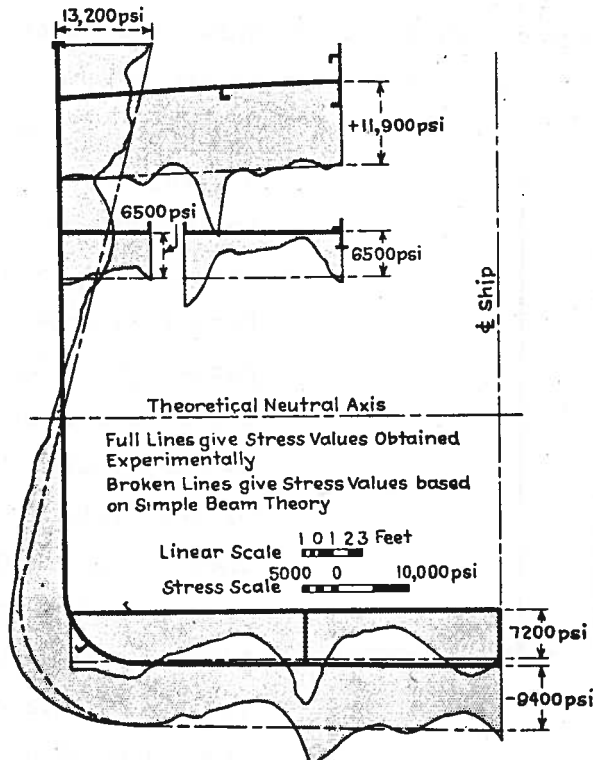


Fig. 3.2

Hog-sag cycle—distribution of longitudinal stresses over test section on the SS Ocean Vulcan. Hogging moment of 120,000 tons-ft

Occurrence of buckling of plates will also influence the stress distribution in the hull girder to a considerable degree. A significant amount of buckling may take place at relatively low stress levels if the plates have received initial deformations due to welding or from other causes. If the buckling load of the plates are exceeded their effectiveness as parts of the cross-section of the hull girder will be further reduced. But even after the theoretical buckling load has been exceeded will the buckled plate elements be active. This will be further discussed in the treatment of buckling of plates.

A considerable number of full scale strength tests of hull girders have been made. Table 3.1 gives some of the more significant results obtained from such tests. The table was prepared by Vasta¹⁾. A fairly complete table covering the period before 1948 is given by the British Admiralty Ship Welding Committee.

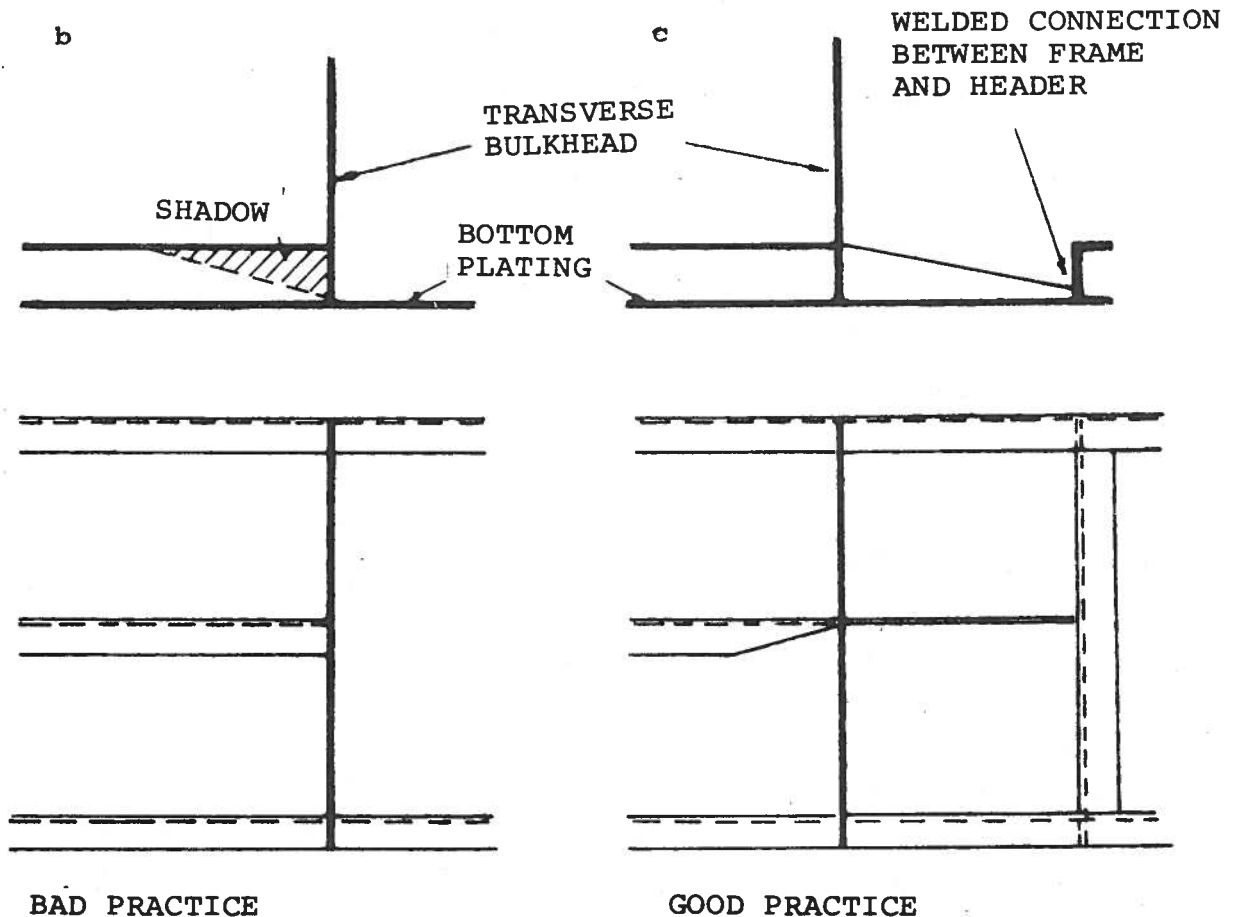
Fig. 3.1 shows to the right the bending stresses and to the left the shear stresses as measured on the SS Ventura Hills. For comparison is also shown the stresses calculated from the simple beam theory. The agreement between theory and test is very good. Fig. 3.2 shows corresponding measured and calculated stresses for SS Ocean Vulcan. Here it is clear that the plates have buckled since the stresses in the plate panels are lower than calculated, whereas the stresses in longitudinal stiffeners and girders are higher. SS Ventura Hills is longitudinally framed and SS Ocean Vulcan is transversally framed. In order to delay buckling, today's larger ships are fitted with longitudinal frames in the bottom and decks.

All discontinuities in the form of hatch openings, changes in the cross-section of girders, etc., also alters the linear stress-distribution and complicates the stress analysis. It is very difficult to obtain a clear picture of the actual stress distribution in all detail, and it is the practice therefore to calculate the stresses from Equation (3.1). However, these stresses only give an approximate picture of the average stresses

1) Vasta, J.: "Lessons Learned from Full-Scale Ship Structural Tests," Trans. S.N.A.M.E., Vol. 66, pp. 165-214, 1958.

Generally, it can be said that all structural elements included in the calculation of the section modulus must be continuous a sufficient distance in both directions from the section under consideration, so that no part of the element's cross-section is located in the "shadow" of discontinuities at the end of the element (see fig. 3.3b).

Local longitudinal stiffeners should never be terminated as shown in fig. 3.3b, at highly loaded section of the ship, since such practice can lead to structural failures. A better arrangement is shown in fig. 3.3c where the area of the stiffeners are gradually reduced. Similarly, a stiffener should not be terminated on an unstiffened plate panel. The bottom plating of fig. 3.3c has therefore been fitted with a transverse stiffener at the end of the longitudinal frame. The end of the frame must be welded into the inserted stiffener to avoid "scissoring" between frame and stiffener, (see fig. 3.3d).



END DETAIL OF LONGITUDINAL FRAMING

Fig. 3.3b and c

Since the maximum bending moment remains fairly constant over a considerable length of the ship amidships it is required by the classification societies that the middle 40% of the length of the hull girder is of sufficient strength to withstand the maximum bending moment. The structural elements included in the determination of longitudinal strength will therefore normally have to be continuous over more than 40% of L .

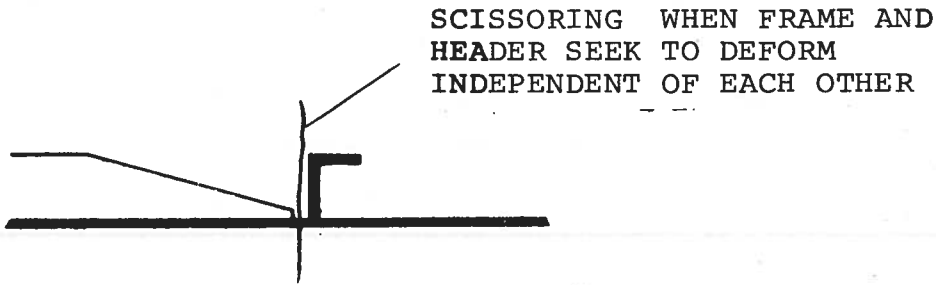


Fig. 3.3d

Such elements are:

- a) Shell plating.
- b) Longitudinal frames in bottom and sides.
- c) C.V.K. and other continuous side girders in the double bottom.
- d) Tanktop, including continuous stiffeners.
- e) Longitudinal bulkheads, plane or horizontally corrugated.
- f) Longitudinal continuous beams of the decks.
- g) Continuous 'tween decks.
- h) Long superstructures.

In regard to the effectiveness of the shell plating it is necessary to consider buckling. In the case of a longitudinally framed ship it is not difficult to provide for full effectiveness. For a transversely framed ship it may, on the other hand, be necessary to use a reduced area of plating to account for the possibility of buckling.

Longitudinal frames can be considered fully effective as long as the penetration of transverse bulkheads is done properly. Such penetrations represent a very important structural detail that demands the closest of attention. Det Norske Veritas Rules of 1962 for large tankers permits the

frames to be cut at transverse bulkheads for ships when $L < 200$ m.

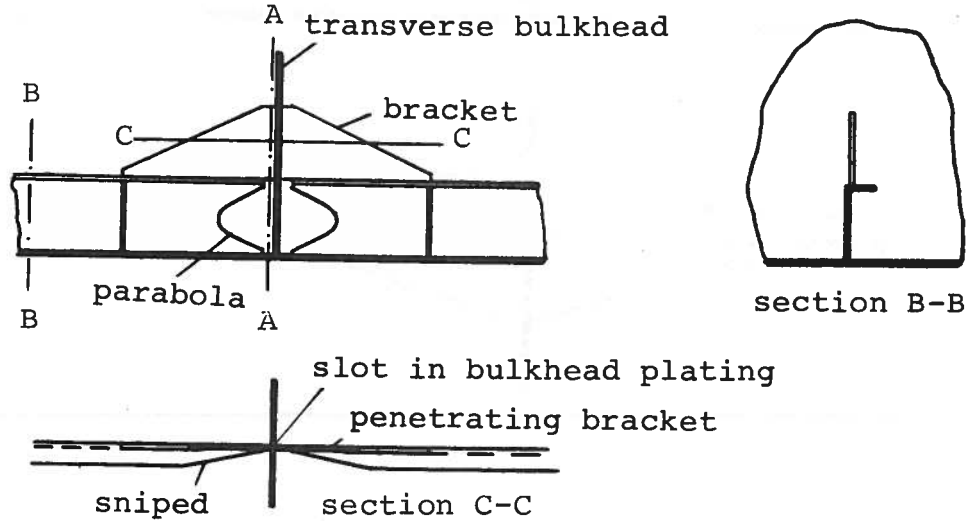


Fig. 3.3e

A detailing as shown in fig. 3.3e has been in use for some time. The bracket is here continuous through a slot in the bulkhead. The area of the bracket must obviously be such that the cross-sectional area of Section V-V in fig. 3.3e is equal to that of section B-B. The flanges must be tapered towards the bulkhead. The frames can not be run up against the bulkhead plating on both sides and welded there. Rolled plates may often have a low tensile strength normal to its plane because of lamination. Furthermore, the connection between frame and bulkhead would, in such a case, consist of fillet welds which are weaker than butt welds and also subject to fatigue failures.

A possible detailing of the intersection of frame and transverse bulkhead is shown in fig. 3.3f. Here the expanded flange plate is continuous through a slot in the bulkhead whereas the frame is cut and welded to the bulkhead on all sides so that shear loading can be transferred from frame to bulkhead. Since the frames are also loaded laterally by fluid pressures on bottom such shear loading can be considerable. The structural detail

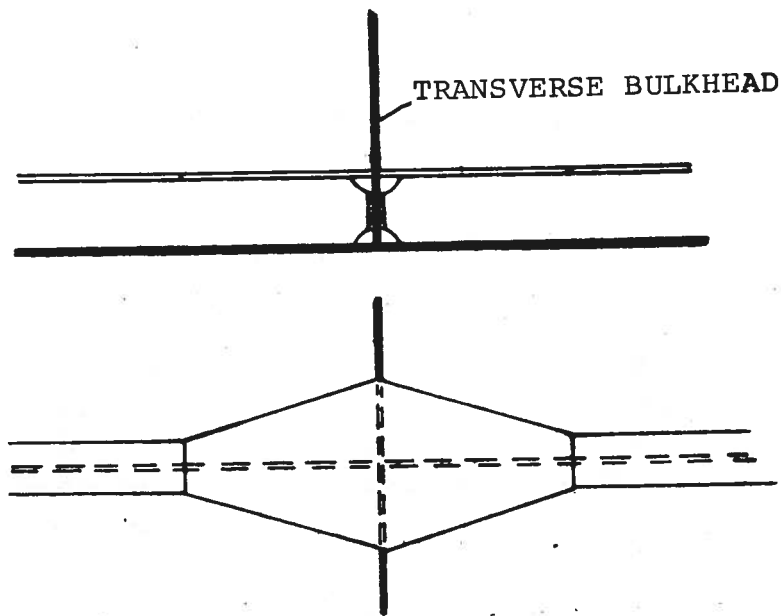


Fig. 3.3f

shown in fig. 3.3f is probably more expensive to manufacture than the one shown in fig. 3.3e. The detail shown in fig. 3.3g also represents good practice in cases where the frames are made from flat bars. The bracket is continuous through the bulkhead and is a part of the bulkhead sub-assembly. The notches in the brackets are desirable for the purpose of drainage, but care must be taken to ensure a smooth stress distribution.

In the larger ships the longitudinal frames must be continuous through the bulkheads and the butts so arranged that an overlap exists to avoid a zone of concentration of butts joints.

A certain degree of reluctance to consider the longitudinal frames as fully effective is expressed in some of the rules of classification societies (A.B.S., Lloyds Register). A.B.S. rules of 1961 require for example that the shell plating and the

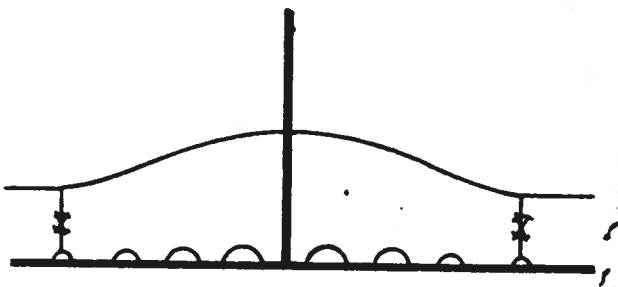


Fig. 3.3g

plating of longitudinal bulkheads contribute at least 75% of the total section modulus when $L < 200$ m and 60% when $L = 300$ m . Det Norske Veritas does not have any corresponding rule. On the contrary, in the 1960 rules, it was specified that a minimum of 0.2L% of the cross-sectional area of the bottom of large tankers was to be placed in the frames ($L =$ length in m) . The requirement was introduced to keep plate dimensions within reasonable thicknesses. The 1962 rules eliminated it and stated only that plate thicknesses should be kept below 35-40 mm on account of the brittleness of thicker plates as well as the welding problems encountered with such plates.

The areas of the frames shall in the calculation of the section modulus be reduced to account for notches and cut-aways. Similar considerations must be made for manholes and lightening holes.

Longitudinal bulkheads are included in the longitudinal strength if they are plane or are corrugated longitudinally.

Longitudinal beams are treated in a manner similar to the frames. Hatch side coaming can usually not be considered effective. Long hatch coamings may be taken account of, however. Also there are cases where the side coamings are continued between openings, and these should therefore be considered fully effective.

'Tween decks in dry cargo ships is often located so close to the natural axis that it does not pay to provide the continuity required to make it effective.

In some cases the strength deck may have a step. If so a careful analysis of the transfer of forces from one level to the other of the deck must be made. A somewhat simplified analysis is shown in the following example.

Example

Approximate the transfer of forces in the transverse and longitudinal bulkheads at the step in the strength deck of a dry cargo ship shown in fig. 3.4a.

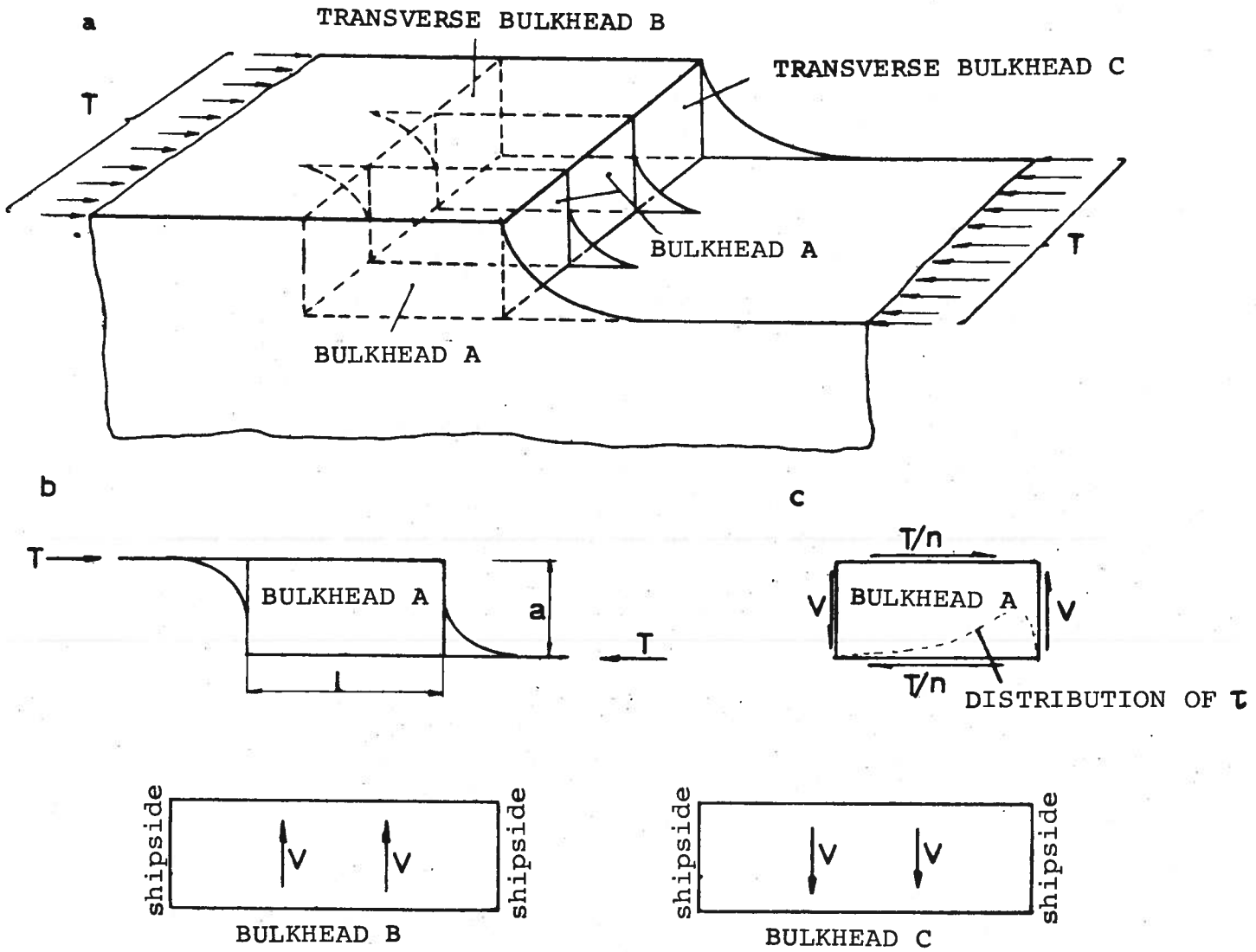


Fig. 3.4

Solution:

If it is assumed that the compressive force in the two deck levels are the same and equal to T then it follows that the bulkheads A will be subjected to vertical forces (V) through bulkheads B and C . With the number of bulkhead A equal to n , V is found from:

$$\frac{T}{n} \cdot a = V \cdot l \quad \text{from which} \quad V = \frac{T \cdot a}{n \cdot l} \quad (3.3)$$

where a = 'tween deck height

l = length of the bulkheads A

The forces V will also produce significant shear load in the transverse bulkheads B and C as well as bending. This must be considered in the design of openings in the bulkheads.

If the stress in the deck is equal to the maximum allowable stress, then

$$\tau_{\text{allowable}} = \frac{\sigma_{\text{allowable}}}{\sqrt{3}} = \frac{1}{\sqrt{3}} \frac{T}{A_d}$$

where A_d is the cross-sectional area of the deck.

Assuming that the shear force T is uniformly distributed between all longitudinal bulkheads and also uniformly distributed lengthwise, we obtain:

$$\tau = \frac{T}{n \cdot l \cdot t} = \tau_{\text{allowable}} = \frac{1}{\sqrt{3}} \frac{T}{A_d}$$

i.e.,

$$t = \frac{\sqrt{3} A_d}{n \cdot l}$$

where t = the required thickness of the A-bulkheads including the shell plating.

The shear stresses will actually not be uniform but more likely distributed as shown in fig. 3.4c. It would therefore be correct to select a somewhat higher value of t than given by the formula above.

Effectiveness of deck cross-section between two rows of hatches.

Whenever a ship is fitted with two or more rows of hatches we find that the plating in the deck area between the hatches is less than fully effective in bending. The reason for this is that the transfer of shear

stresses has been impaired by the hatch openings. However, the strips of deck plating between the hatch openings are also connected to the hull girder at both ends of the hatch region and are, through the transverse rigidity of the vessel, prevented from completely shirking any longitudinal strains that should result from the constraints at the ends of the strips. Thus longitudinal stresses are present in the strips, but these are essentially different from those resulting from the bending of the hull girder as a box beam, since the former are independent of the variations of the moment along the hull.

The reduced effectiveness of the deck plating referred to above has been studied at the "Högskolan" in Stockholm¹⁾. Figure 3.5a shows the effectiveness of the deck plating between the hatches as a function of the spring constant k which is defined in figure 3.5b. The shape of the hull girder and the moment distributions that are investigated are shown in fig. 3.5c. The low effectiveness of plating at low values of the spring constant for moment distribution of type M_3 is the consequence of the elimination of the effect of the end constraints in that case. The designation "with longitudinal bulkhead" refers to a partial bulkhead in the upper part of the cargo hold which does not act as a complete web of the hull girder. This "small depth" beam will nevertheless result in some increase of stresses in the middle strip of plating at small values of k .

Figure 3.6 shows in more detail how the effectiveness of the deck plating varies with the shape of the moment distribution curve. Several distributions are shown and the associated effectiveness at two different values of the spring constant is indicated. We note from this that when the moment is relatively constant over the length of the hatch region the effectiveness of the plating is good and the influence of the spring constant relatively small, whereas large variations in the moment distribution reduce the effectiveness of the deck plating and increase its sensitivity to the magnitude of the spring constant.

1) Civ. Eng. Anders Orje: "Bending Stresses in Ships with Several Rows of Hatches". Kungl. Tekniska Högskolan. Report No. E-18, March 1966.

Effectiveness of Middle Strip

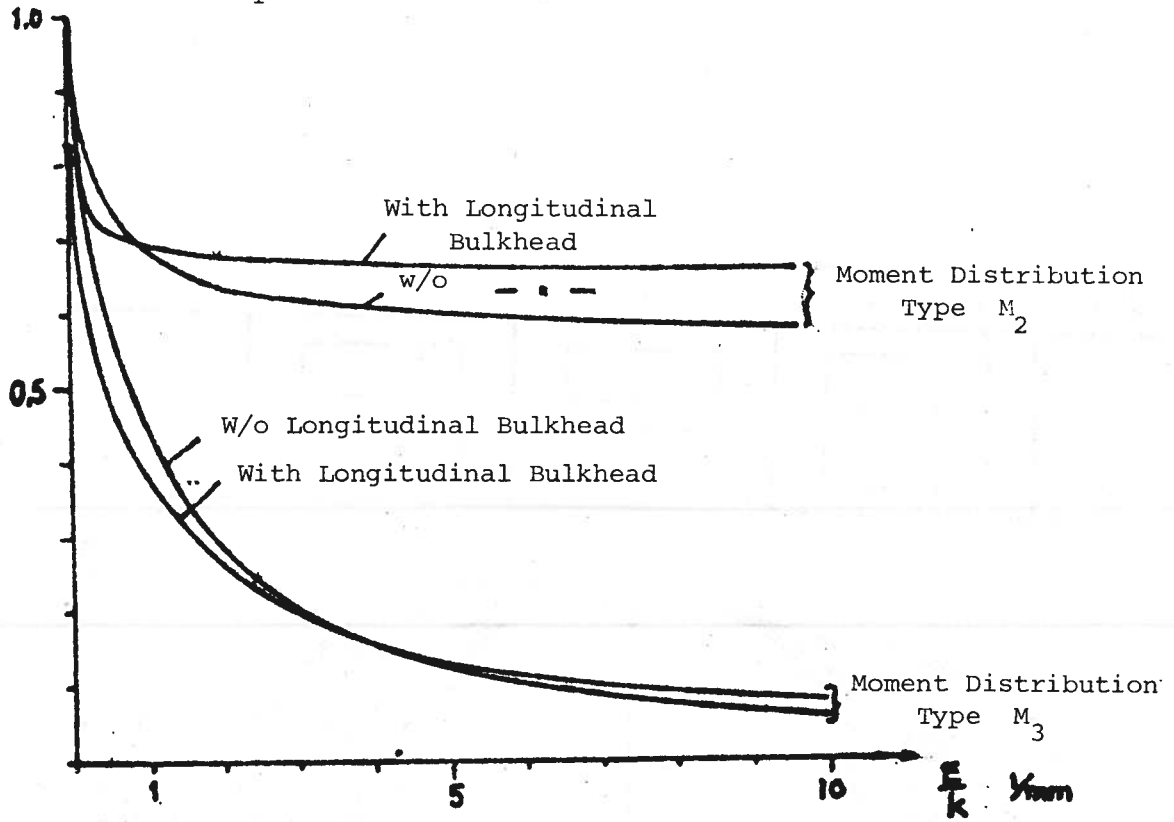


Fig. 3.5 a)

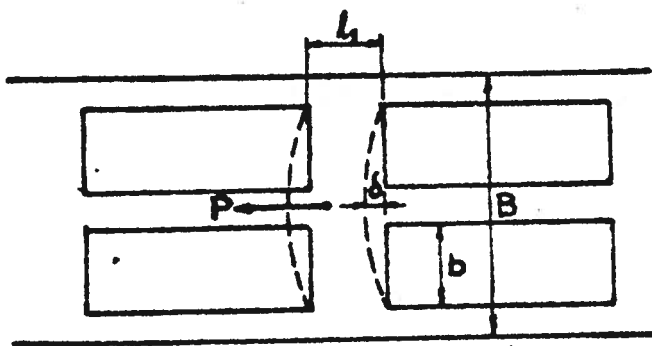


Fig. 3.5 b)

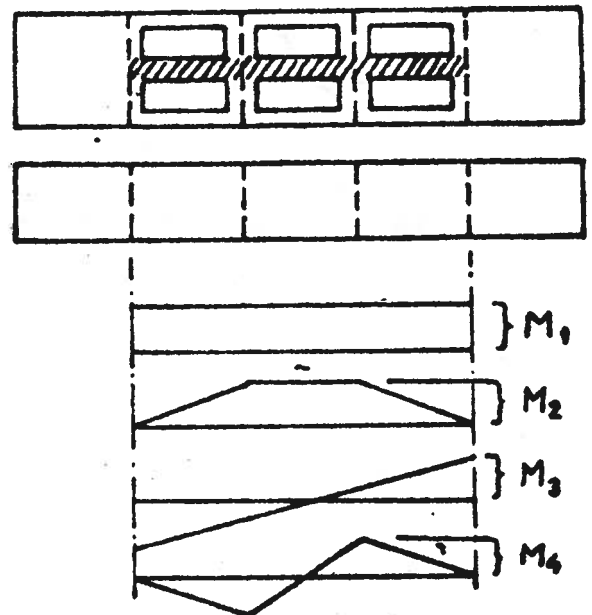
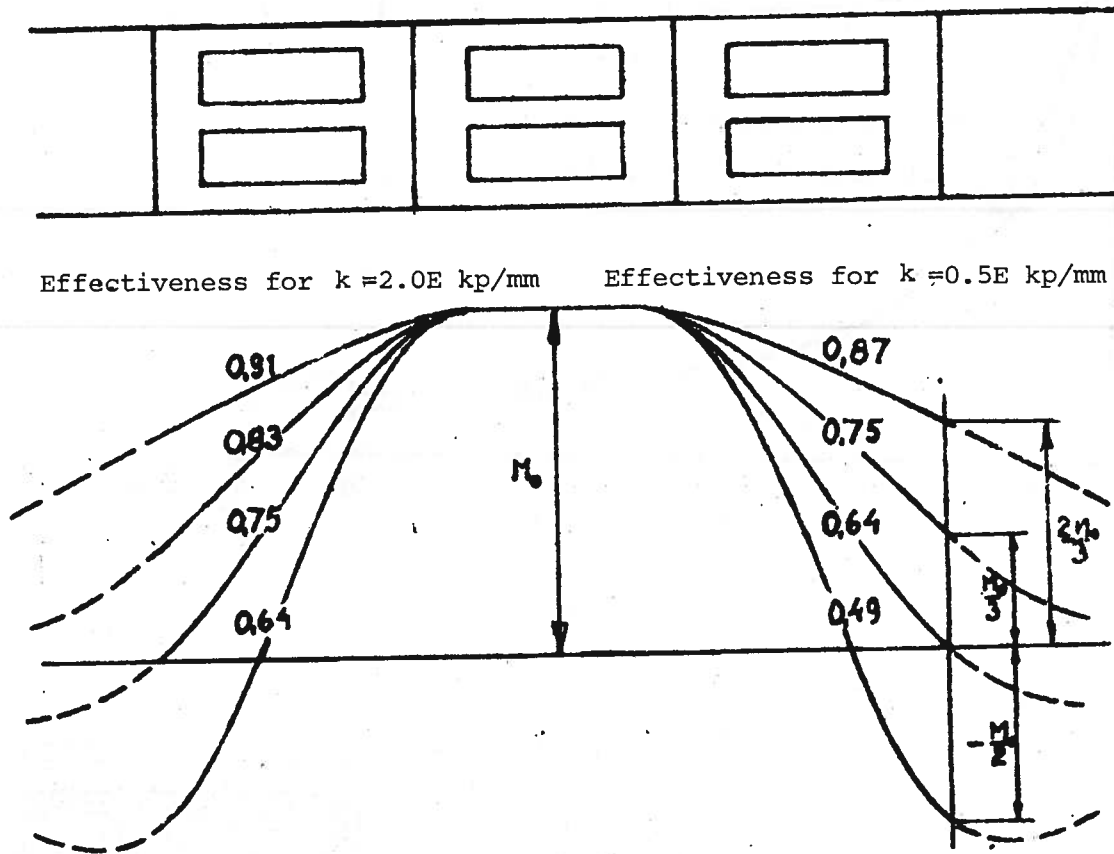


Fig. 3.5 c)



THE INFLUENCE OF THE MOMENT DISTRIBUTION ON THE EFFECTIVENESS OF THE DECK PLATING BETWEEN THE HATCHES FOR THE TESTED MODEL

Fig. 3.6

3.4 Horizontal Bending

When we discuss "horizontal" and "vertical" bending moments we are referring to moments with respect to axis that are afixed in the ships and oriented such that they are horizontal and vertical when the ship is upright in still water. A ship is partially subjected to true horizontal moments due to water pressures acting on the hull in the seaway - particularly in irregular seas. However, the horizontal bending moments referred to the structural horizontal plane are predominantly caused by the heeling of the ship during rolling in the seaway. A component of the real vertical bending moment (still water plus wave bending moment) is thereby carried over to the structural horizontal plane of the ship. The heel will obviously alter the sectional area curve, and therefore the moment curve, but if we neglect this effect we can write for the "horizontal" moment due to heel

$$M_H = M \sin \theta \quad (3.7)$$

where θ is the angle of the heel. For an angle of heel of 30° , M_H , therefore, reaches a magnitude of $0.5 M$.

Horizontal and vertical bending moments will normally not assume maximum values simultaneously. If the ship moves in regular sinusoidal waves at an arbitrary course with respect to their direction of propagation then we can say that

$$M_V = M_{VO} \cos (\omega t + \epsilon_V) \quad (3.8)$$

$$M_H = M_{HO} \cos (\omega t + \epsilon_H)$$

where

$$M_V = \text{vertical bending moment}$$

$$M_H = \text{horizontal bending moment}$$

M_{VO} and M_{HO} = maximum values of moments

ω = frequency of encounter

ϵ_V and ϵ_H = phase angles

The stresses then become

$$\sigma_V = \frac{M_V}{Z_V} = \frac{M_{VO}}{Z_V} \cos (\omega t + \epsilon_V) \quad (3.9)$$

$$\sigma_H = \frac{M_H}{Z_H} = \frac{M_{HO}}{Z_H} \cos (\omega t + \epsilon_H)$$

where

Z_V = section modulus with respect to deck or bottom

Z_H = section modulus with respect to vertical axis

Thus

$$\sigma_V = \sigma_{VO} \cos (\omega t + \epsilon_V) \quad (3.10)$$

$$\sigma_H = \sigma_{HO} \cos (\omega t + \epsilon_H)$$

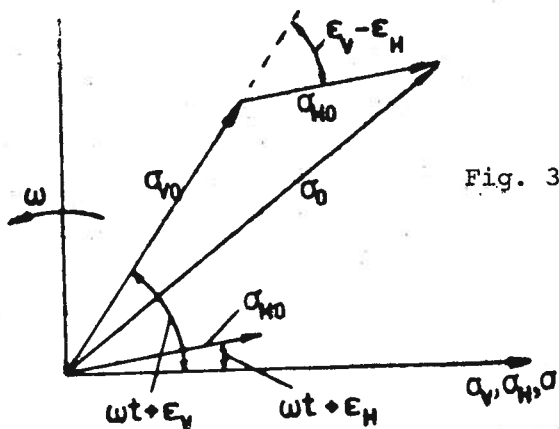


Fig. 3.7a

From fig. 3.7a) can be derived the resultant varying stresses in the corners between the hull sides and deck and bottom. Its maximum value will be

$$\sigma_o = \sqrt{\sigma_{VO}^2 + \sigma_{HO}^2 + 2\sigma_{VO} \sigma_{HO} \cos(\epsilon_V - \epsilon_H)} \quad (3.11)$$

The phase angle will normally be very large. Fig. 3.7b shows vertical and horizontal bending moments measured on a model of the following dimensions:

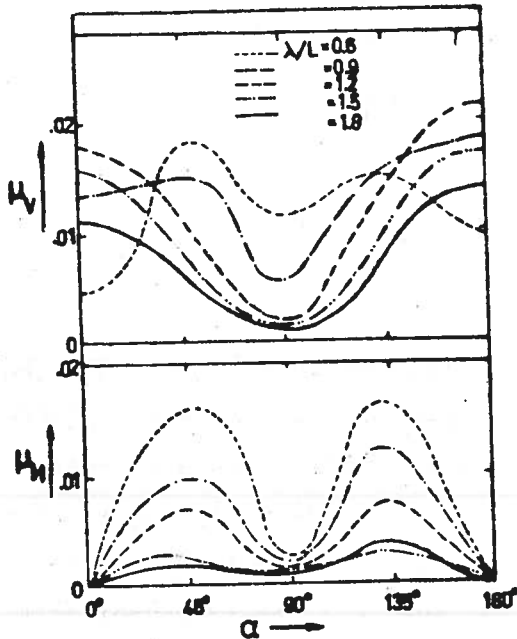


Fig. 3.7b

$$\frac{L}{D} = 17.5$$

$$\frac{L}{B} = 7.0$$

$$C_B = 0.80$$

Wave height was equal to $\frac{L}{50}$ and the speed of the model corresponded to $F_r = \frac{v}{\sqrt{gL}} = .15$.

In the figure are given

$$\mu_V = \frac{M_V}{\gamma h B L^2}; \quad \mu_H = \frac{M_H}{\gamma h B L^2}$$

where

h = wave height

α = angle between the course of the ship and the propagation of the waves.

We note that μ_V has its maximum value (≈ 0.022) in head seas ($\alpha = 180^\circ$) and in waves of $\lambda = 1.2 L$. ($\lambda = 1.0 L$ was not investigated).

We note furthermore that the horizontal moments can become fairly large, μ_H being 0.017 at $\alpha = 135^\circ$ and $\lambda = 0.6 L$. Under this condition μ_V is somewhat smaller.

From the observed phase angle ($\epsilon_V - \epsilon_H$) and the diagram of fig. 3.7b and equation (3.11) we can calculate the maximum stresses in the hull girder. Such a calculation has been made for different values of the ratio $\frac{Z_V}{Z_H}$ and are shown in fig. 3.7c¹⁾. We note here that if $Z_V = Z_H$ then the stresses at the corner of the gunwale will be:

1) Vosser, G., Swan, W.A., Rijken, H.: "Vertical and Lateral Bending Moment Measurements on Series 60 Models". Int. Shib. Progress., Vol. 8, No. 83, 1961.

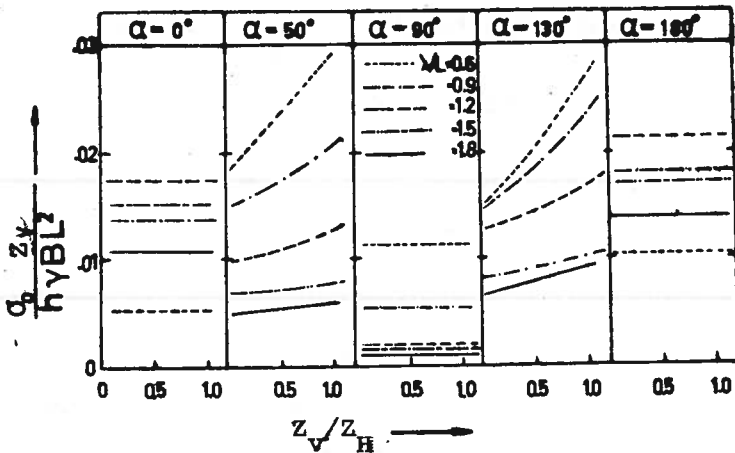
$$\sigma_o = 0.022 \sigma_M \quad \text{for } \alpha = 180^\circ$$

$$\sigma_o = 0.027 \sigma_M \quad \text{for } \alpha = 130^\circ$$

$$\sigma_o = 0.029 \sigma_M \quad \text{for } \alpha = 50^\circ$$

where

$$\sigma_M = \frac{\gamma h B L^2}{Z_V}$$



It follows that lateral bending alone can increase the stresses due to vertical bending only by as much as 30%. The test referred to cover only a limited range of α and $\frac{\lambda}{L}$. It is conceivable that rather adverse conditions could further increase the stress load in the hull girder.

Fig. 3.7c

Abrahamsen refers to the full scale measurements onboard S/S "Ocean Vulcan" where the maximum horizontal moments occurred at $\alpha = 20-25^\circ$. The lateral moments were then as much as 42% of the maximum vertical moment and therefore smaller than indicated in fig. 3.7b, but the phase angle is not given.

On the strength of several references, Getz¹⁾ reports that simultaneous stresses from lateral moments are between 10% and 50% of the stresses due to the maximum vertical bending moment, depending upon ship type, still water moment, sea conditions and motions.

The rules of the classification societies take the effect of the horizontal moment into account by means of the different requirements imposed on the value of Z_H .

1) Getz, J.R. : "Longitudinal Strength and Minimum Weight," S.F.I. Report No. 30, Trondheim. 1960.

Det Norske Veritas rules of 1960 required that for large tankers

$$Z_H \geq 1.15 Z_V$$

The 1962 rules reduced this to

$$Z_H \geq 1.05 Z_V$$

The effects of lateral bending moments are also considered in the requirements on structural details. The thickness of the stringer plates and sheer strake plating are greater than for contiguous material, and frequently of higher quality material.

Dimensions of longitudinal frames are also increased in this region (cfr. Abrahamsen and Vedeler "Strength of Large Tankers," pp. 65). The requirements

$$Z_H \geq 1.05 Z_V$$

can be written approximately as

$$\frac{I_H}{\frac{B}{2}} \approx \frac{I_H}{1.8 \frac{D}{2}} \geq 1.05 \frac{I_V}{1.1 \frac{D}{2}}$$

by which

$$I_H \geq \sim 1.7 I_V$$

3.5 Shear Stresses

Determination of shear stresses (excl. of torsion) will in principle, obviously be the same in both the vertical and horizontal planes. It is, however, the vertical shear stresses that are of greatest concern, in part because the vertical webs of the hull girder are lower and thinner, so that the web area is smaller than for the horizontal webs, even when longitudinal

bulkheads are present. An exception may be the deck with large hatches when the shear stresses due to horizontal shear combined with torsion could become critical.

For approximate estimates of the shear stresses due to bending it may be sufficient to distribute the shear load uniformly over the area of the webs, possibly with a correction for the parabolic stress distribution by calculating the average shear stresses at the top of the webs, disregarding the correct variation of shear load absorbed by the webs.

The well known formula for the shear stress at a section $z = z_1$ (fig. 3.8) can without modifications be used for simple single cell and for multiple cell box girders when these have only two webs and are symmetric with respect to the axis in the direction of the shear load. This is also true for ships with several decks and tank top but without any longitudinal bulkhead

$$\tau = \frac{Q \cdot S}{2I \cdot t}$$

where S is the static moment of the cross-sectional area with respect to the neutral axis and t is the thickness of the shell plating.

For tankers with two longitudinals, for instance, it will be found that the distribution of shear load is statically indeterminate. The solution to this problem will be given elsewhere, suffice it to point out here that the difficulty is really that of establishing where $\tau = 0$ in the deck plating. In practice we often find that $\tau = 0$ somewhere near the longitudinal bulkheads.

The solution to the shear stress distribution is found by first considering a structure which is made statically determinate by means of slots cut in the shell plating along the neutral axis. The shear distribution q_0 is then determined for this structure. This shear distribution, leading

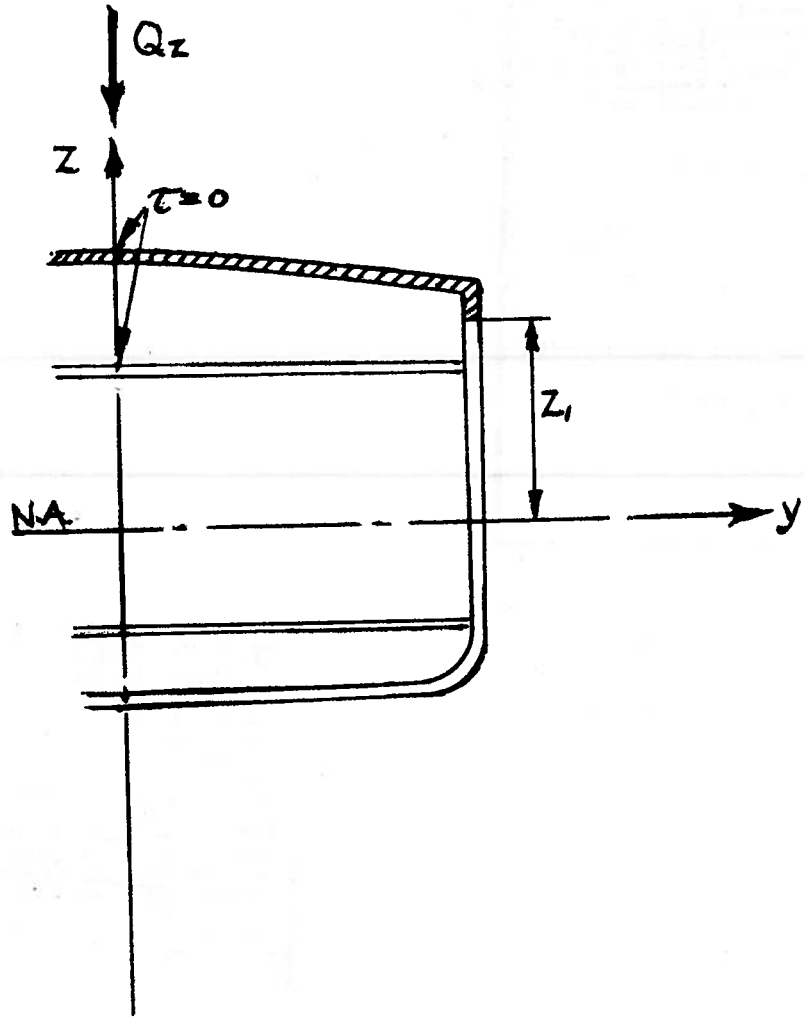
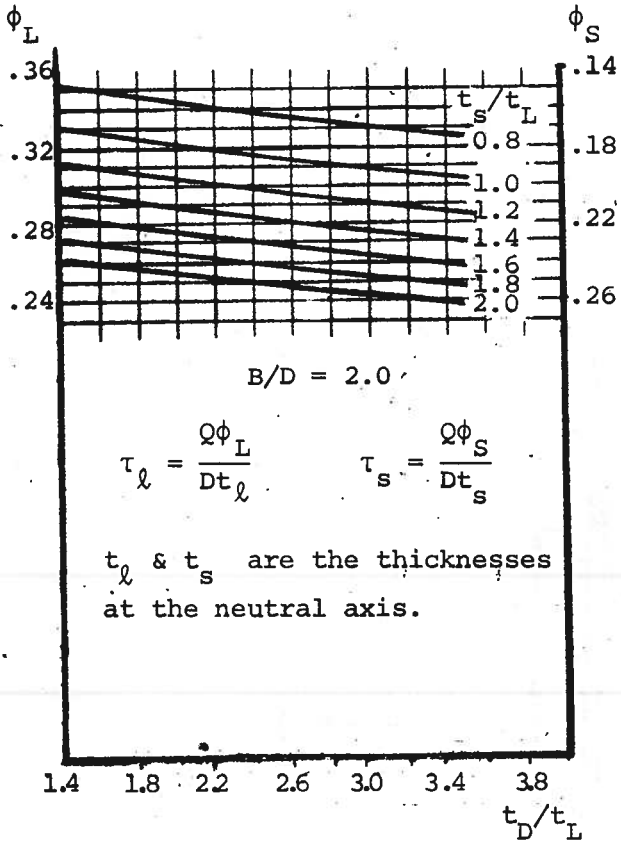
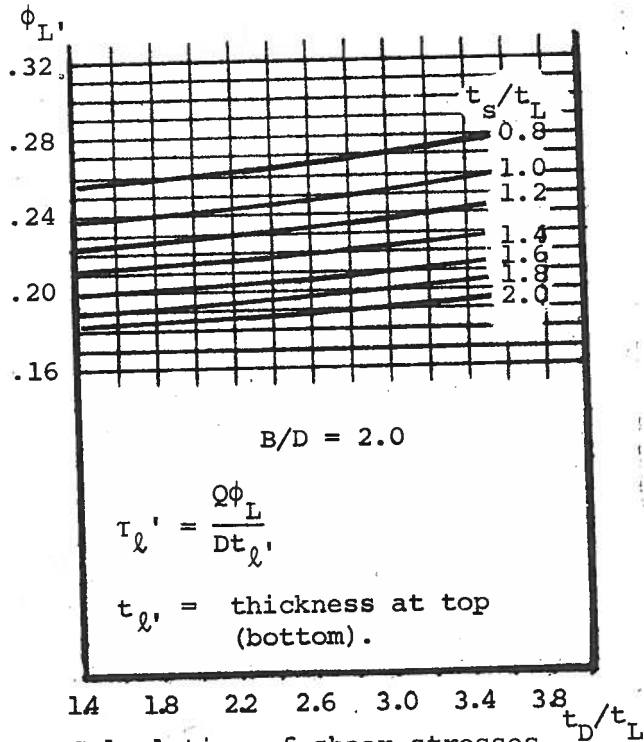


Fig. 3.8



Calculation of shear stresses at the neutral axis in longitudinal bulkheads (τ_l) and shell plating (τ_s).

Fig. 3.9



Calculation of shear stresses ($\tau_{l'}$) at top (bottom) of longitudinal bulkhead.

Fig. 3.10

to a twist of the side tanks, is not compatible with the actual conditions. This twist can be eliminated by the superposition of a constant shear force q_1 around the side tank plating. The magnitude of q_1 is determined from the equation

$$q_1 \oint \frac{ds}{t} = \oint \frac{q_o ds}{t}$$

In Veritas' publication No. 47¹⁾ general results are given for the calculation of shear stresses in the shell plating and in longitudinal bulkheads, depending upon t_D/t_L and t_S/t_L for $B/D = 2.0$ (figs. 3.9 & 3.10). The effects of B/D and the location of the longitudinal bulkheads are indicated to be rather small.

The shear stresses at the neutral axis in the longitudinal bulkheads and shell plating is given respectively by:

$$\tau_\ell = \frac{Q \cdot \phi_L}{D \cdot t_\ell} \quad \text{and} \quad \tau_s = \frac{Q \cdot \phi_S}{D \cdot t_s}$$

Here Q is the shear force at the section, D is molded depth and t_ℓ and t_s are the thicknesses of bulkheads and shell plating at the neutral axis respectively. The values of ϕ_L and ϕ_S are taken from fig. 3.9 where the thicknesses t_S , t_L , and t_D are the "equivalent" average thicknesses. Fig. 3.10 is related to the shear flow at the top of the bulkhead and the shear stress must then be calculated with the plating thickness at that point ($t_{\ell,}$).

More detailed diagrams and monograms can be found in a report from the Italian Classification Society ²⁾. These diagrams show that the effect of the location of the longitudinal bulkheads is negligible and that an increase in B/D above 2.0 only increases the shear flow with 1% for each 0.1 increase of B/D .

-
- 1) P. Lersbryggen: Shear flow in a ship section and shear stresses in longitudinal bulkhead and side plating as a function of plating thickness. (October 1965).
 - 2) Registro Italiano Navale, Bolettino n. 12, Nov. 1966.

When the thickness ratio between the plating in longitudinal bulkhead and shell is varied we find that a thinning of the bulkhead will reduce its shear load, but the shear stress will nevertheless increase some. The shear flow at the neutral axis ($q = \tau t$) of the bulkheads will in practice be approximately 25% of Q/D (Q = total shear force at the section) but since the thickness of the bulkhead is only approx. 2/3 of the thickness of the shell we find that the shear stress will be 22-27% above the mean stress

$$\tau_m = \frac{Q}{2(t_s + t_\ell)D}$$

The horizontal shear load distribution is even more complicated for a ship with several decks and tank top since in this case there is no plane of symmetry where the shear stress is zero.

The same is true for tankers. The lack of symmetry will necessitate the laborious determination of the shear center and the location of the point where $\tau = 0$.

However, such theoretical calculations are based on the assumption that all cells of the cross-section are twisted the same amount, which implies that the cross-section is rigid so that displacements of ship sides and bulkheads are the same.

This assumption is not often well satisfied and it is then necessary to perform a more detailed analysis of the shear load distribution when the shear stress may become critical.

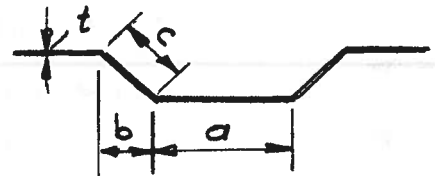
For a tanker with very long cargo tanks we find that the shear loads in the longitudinal bulkheads between the transverse bulkheads are significantly larger than the magnitude given by the theory based on a rigid cross-section. Calculations performed at Norske Veritas¹⁾ has shown that only 10% of the loads on the longitudinal bulkheads are being transferred to the

1) Thv. Bruland: Problems which face the shipbuilders and classification societies the construction of today's large tankers and bulk carriers. European Shipbuilder No. 5, 1965, and Det norske Veritas Publication No. 50.

sides of the ship in spite of deep web frames in the side tanks and swash bulkheads at half length in conjunction with transverse girders and swash bulkheads in the center tanks. Even the "oiltight transverse bulkheads" cannot be considered "rigid" and the thin swash bulkheads with cutouts deform 2-3 times as much as these bulkheads do.¹⁾ This leads to an increase in the shear loads of the longitudinal bulkheads.

The use of corrugated plates for longitudinal bulkheads raise the question whether these are as effective in absorbing shear loads as the plane bulkheads are. This problem has been carefully studied at the Ship Research Institute in Norway and theoretical solutions are available. We can as a first approximation set the effective thickness for a section perpendicular to the corrugated.

$$t_{\text{eff}} = t \frac{a + b}{a + c}$$



In an even simpler form we may say that the effective cross-section is the product of the actual thickness and the depth of the bulkhead. For 45° corrugation and a constant panel width ($a = c$) we then get an efficiency of 0.85.

3.6 Deflection of the Hull Girder.

The calculations of hull girder deflections do not, in principle, present us with any difficult problem. The flexure of the girder follows the Navier hypothesis with good approximation, provided the effective moment of inertia is used. At sections of large openings in the deck and shell plating and where changes in cross-section take place, it may at times be difficult to determine this effective stiffness of the hull girder.

1) B. Skjeggstad: Theory of stresses and deformations in corrugated bulkheads loaded in their plane. Ship Research Institute, Technical note 61.3.20, 62.11.15, 63.4.9, 63.9.30, 64.1.3, 64.6.1, 64.8.5, 65.9.9, and 65.9.20.

According to full scale measurements shear deformations will make up from 10-20% of the total deformation¹⁾. Lately there has been delivered ships from Japanese yards of unusually high D/L ratio. When this is well above the normal value of 1/14 the deformations due to shear must be taken into consideration.

For vertical deflection the simple beam theory gives

$$w(x) = - \int_0^x \int_0^x \frac{M(x)}{EI(x)} dx dx + \int_0^x \frac{\kappa(x) Q(x)}{GA(x)} dx + \phi_0 \cdot x \quad (3.15)$$

where

ϕ_0 = slope of deflection curve at $x = 0$.

$\kappa(x)$ = a factor dependent upon properties of the cross-section as explained below.

Equation (3.15) can more conveniently be written

$$w(x) = \frac{-1}{EI_0} \int_0^x \int_0^x M(x) \eta_1 dx dx + \frac{1}{GA_0} \int_0^x \kappa(x) Q(x) \eta_2(x) dx + \phi_0 x \quad (3.15a)$$

where

$$\eta_1(x) = \frac{I_0}{I(x)}$$

$$\eta_2(x) = \frac{A_0}{A(x)}$$

and

I_0 = moment of inertia of cross-section amidships

A_0 = area of the same.

1) "A Guide for the Analysis of Ship Structures," U.S. Department of Commerce, Washington, D.C., 1960.

In fig. 3.14 is shown how the deflection curve is determined from the reduced moment diagram $(- \frac{M(x)}{EI(x)})$ when the second term of (3.15a) has been neglected.

The deformation due to shear has in (3.15) been set equal to (see fig. 3.15):

$$\frac{dw_s}{dx} = \gamma = \frac{\tau_m}{G} = \frac{\kappa(x) Q(x)}{GA(x)}$$

i.e.,

$$\tau_m = \frac{\kappa(x) Q(x)}{A(x)}$$

where τ_m by definition is the nominal shear stress associated with the shear deformation. As shown under strength of materials $\kappa(x)$ can be determined by energy consideration.

Internal energy in an element of volume due to shear loading has been shown to be

$$dw_i = \frac{\tau^2}{2G} dV$$

External work done by the shear force $Q(x)$ (fig. 3.15) during deformation is equal to

$$dw_e = \frac{1}{2} Q(x) \cdot dw_s = \frac{1}{2} \kappa(x) \frac{Q^2(x)}{GA(x)} dx$$

where w_s = deformation due to shear. Hence

$$\frac{1}{2} \kappa(x) \frac{Q^2(x)}{GA(x)} dx = \int \frac{\tau^2}{2G} dA dx$$

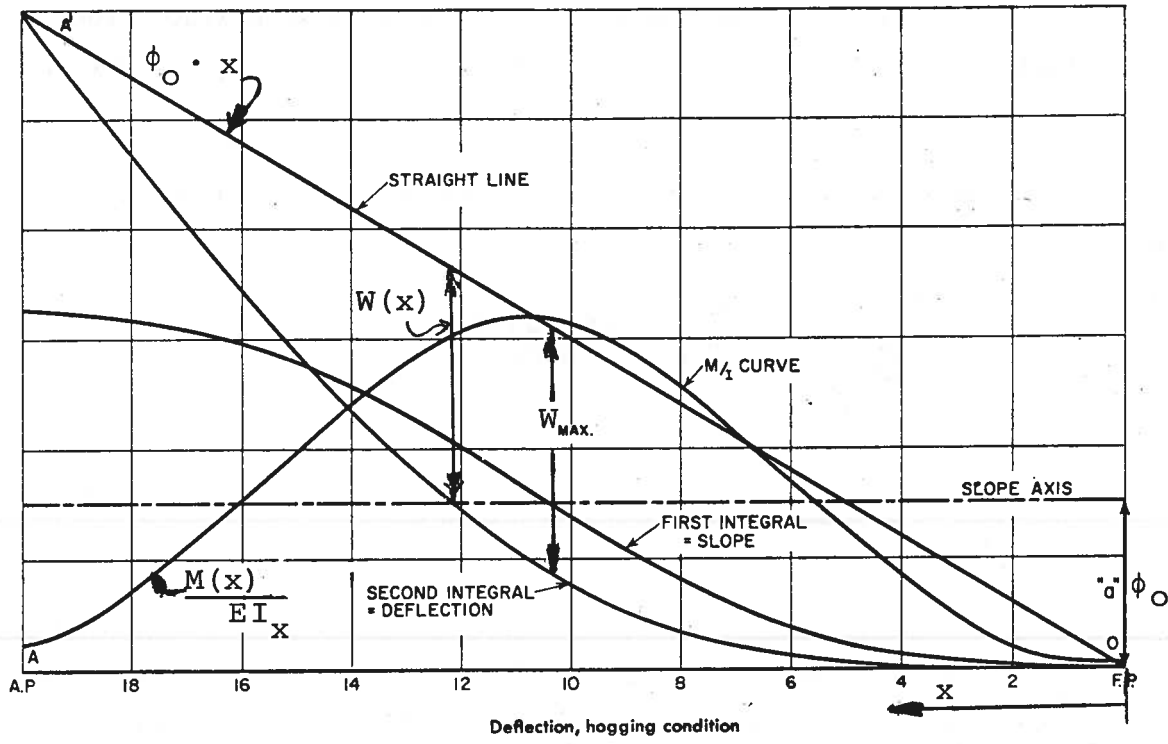


Fig. 3.14

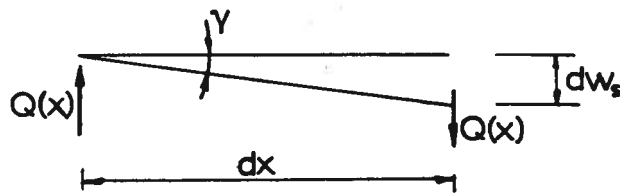


Fig. 3.15

If shear-lag effects are neglected simple beam theory gives

$$\tau = \frac{Q(x) \cdot S}{I(x) \cdot t}$$

where S = static moment of area of cross-section with respect to the neutral axis. If the element of area is written $dA = t \cdot ds$ (t = thickness of plating, ds = elements of arc length measured along cross-section) then the following expression can be derived for $\kappa(x)$

$$\kappa(x) = \frac{A(x)}{I^2(x)} \int \frac{S^2}{t} ds$$

This factor usually varies along the hull, but since shear deformations are relatively small compared to total deflections it is normally satisfactory to use a constant value along the hull (usually $\kappa \approx 1.05$). The value of $\kappa(x)$ is always greater than 1. ($1.0 \leq \kappa \leq 1.2$).

Shear deformations will be of significant magnitude in a vibration analysis. When the ship vibrates in modes with more than 2 nodes the influence of shear deformation on the natural frequency is no longer negligible. The effective flange is small and $\kappa \rightarrow 1.2$.

How large deformations can be allowed? An order of magnitude is given by the example below where the maximum deformation due to bending alone is found to be equal to $L/600$ which for a 300m long trip gives

$$\delta_{\max} \approx .5m.$$

Example

Assume that we have a simple hull girder of length L and depth D . Assume the neutral axis to be located at $D/2$ and that the maximum stresses in deck and bottom is 1500 kp/cm^2 . Assume furthermore that the bending moment and the moment of inertia varies in such a manner that M/EI diagram is triangular as shown in fig. 3.16. This implies that the curvature varies linearly.

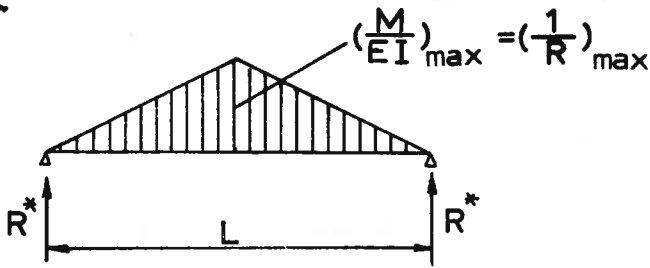


Fig. 3.16

The maximum deflection in the middle can be found by means of Mohr's conjugate beam method. The fictive reaction of this method is

$$R^* = \frac{1}{2} \cdot \frac{L}{2} \cdot \left(\frac{1}{R}\right)_{\max} = \frac{L}{4} \left(\frac{1}{R}\right)_{\max}$$

The effective moment becomes

$$M^* = y_{\max} = R^* \frac{L}{2} - R^* \cdot \frac{1}{3} \cdot \frac{L}{2} = \frac{R^* L}{3}$$

or

$$y_{\max} = \frac{L^2}{12} \left(\frac{1}{R}\right)_{\max}$$

From beam theory

$$\frac{1}{R} = \frac{\epsilon}{D/2} = \frac{2\sigma_{\max}}{ED}$$

where ϵ and σ are the strain and stress at the deck and bottom. Thus

$$\frac{y_{\max}}{L} = \frac{1}{6} \frac{L}{D} \cdot \frac{\sigma_{\max}}{E}$$

For $\sigma_{\max} = 1500 \text{ kp/cm}^2$ and $L/D = 14$ we obtain:

$$y_{\max} = \frac{1}{6} \cdot 14 \cdot \frac{1500}{2.1 \cdot 10^6} = \frac{1}{600}$$

Example

Consider now the same simple hull with M/EI diagram as given in fig. 3.17.

Thus

$$M = 1/2 M_m \left(1 - \cos \frac{2\pi x}{L}\right)$$

The maximum moment at $l/2$ is then

$$M_m = \sigma_{\max} \cdot Z = \frac{\sigma_{\max}}{E} \frac{2EI}{D}$$

The curvature becomes

$$\frac{d^2 y}{dx^2} = \frac{M}{EI} = \frac{\sigma_{\max}}{ED} (1 - \cos \frac{2\pi x}{L})$$

Integrating we obtain:

$$\frac{dy}{dx} = \frac{\sigma_{\max}}{ED} (x - \frac{L}{2\pi} \sin \frac{2\pi x}{L} + C_1)$$

and

$$y = \frac{\sigma_{\max}}{ED} (\frac{x^2}{2} + \frac{L^2}{4\pi^2} \cos \frac{2\pi x}{L} + C_1 x + C_2)$$

The constants of integration C_1 and C_2 are determined from the end conditions $y = 0$, $x = 0$ and $x = L$.

Thus

$$C_2 = -\frac{L^2}{4\pi^2} \quad \text{and} \quad C_1 = -\frac{L}{2}$$

and it follows that:

$$\frac{y}{L} = \frac{L}{D} \frac{\sigma_{\max}}{E} \frac{1}{2} [-\frac{x}{L} + \frac{x^2}{L^2} - \frac{1}{2\pi^2} (1 - \cos \frac{2\pi x}{L})]$$

at $x = \frac{L}{2}$ this gives

$$\begin{aligned} \frac{y_{\max}}{L} &= \frac{L}{D} \frac{\sigma_{\max}}{E} \frac{1}{2} (-\frac{1}{2} + \frac{1}{4} - \frac{1}{\pi^2}) \\ &= -0.175 \frac{L}{D} \frac{\sigma_{\max}}{E} \end{aligned}$$

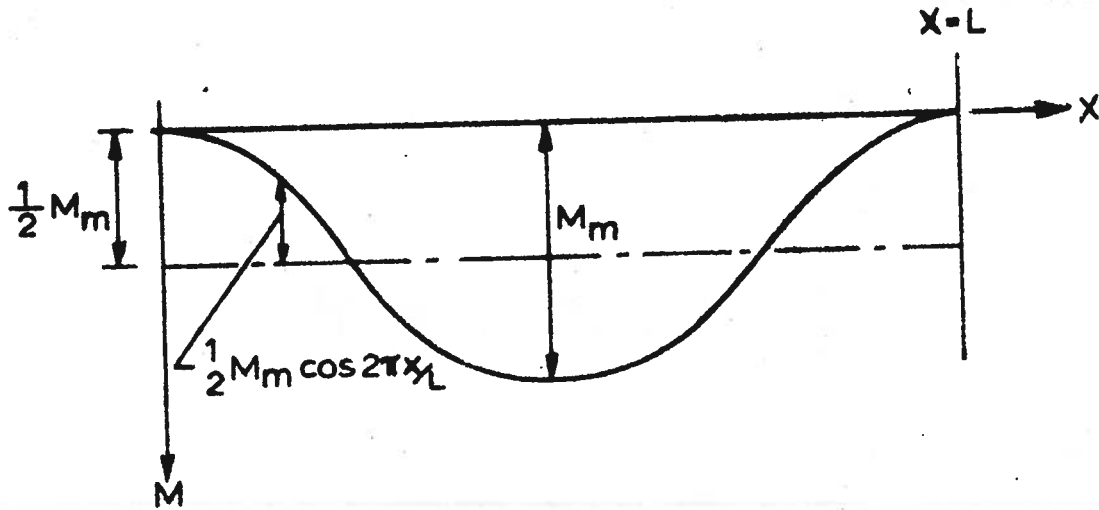


Fig. 3.17

For $\sigma_{\max} = 1500 \text{ kp/cm}^2$, $\frac{\sigma_{\max}}{E} = .71 \times 10^{-3}$, $y_{\max} = -0.125 \cdot 10^{-3} \frac{L}{D}$

Abrahamsen and Vedeler¹⁾ give the following approximate formula for the maximum deflection of tankers when $\sigma_{\max} = 1500 \text{ kp/cm}^2$

$$\frac{y_{\max}}{L} \approx 0.135 \cdot \frac{L}{D}$$

Earlier classification rules were based on $\frac{L}{D} \leq 14$. This limited the deflection to

$$\frac{y_m}{L} = \frac{1}{530}$$

which gives:

$L = 100 \text{ m}$	$y_m = .189 \text{ m}$
$L = 200 \text{ m}$	$y_m = .378 \text{ m}$
$L = 300 \text{ m}$	$y_m = .567 \text{ m}$

1) Abrahamsen, E., Vedeler, G. : "Strenth Criteria for Large Tankers". Tekniske Skrifter, nr. 16N, Oslo 1957. European Shipbuilding No. 6/57 og 1/58. Veritas Med. nr. 6/58.

For larger $\frac{L}{D}$ ratios it is necessary to increase the thicknesses of deck and bottom plating by the factor $\frac{L}{14D}$. This will increase the stiffness almost linearly with $\frac{L}{D}$ such that y_m/L is kept fairly constant. The background for the limitation of the deflection is hardly related to strength conditions. Steneroth¹⁾ has shown that additional stresses caused by slamming and vibrations decrease with increasing $\frac{L}{D}$ ratio. Great flexibility may cause problems with long propeller shafting, but the machinery is today commonly located aft in large ships. The limiting value of maximum deflection is unreasonable where high tensile steel is being used. Veritas has therefore tentatively increased the limit to $\frac{L}{D} = 16$ or $y_{\max} = \frac{L}{463}$.

The contribution of shear loads to the hull girder deflection is given by the following approximate expression, where we have assumed A' to be constant over the length of the ship

$$y_q = - \int_0^x \frac{Q(x)}{GA'} dx = \frac{M(x)}{GA'}$$

at $x = \frac{L}{2}$, $M(x) = \sigma_{\max} Z = 2\sigma_{\max} \frac{I}{D}$ for the example above.

Thus

$$\begin{aligned} y_q &= - \frac{2\sigma_{\max} I}{GA'D} = 2 \cdot \frac{E}{G} \frac{\sigma_{\max}}{E} \frac{1}{A'D} \\ &= - 5.2 \frac{\sigma_{\max}}{E} \frac{1}{A'D} \end{aligned}$$

For the simple cross-section of our example and with $t_1 =$ thickness of deck and bottom and $t_2 =$ thickness of side plating

$$\begin{aligned} A' &= 2t_2 D \\ I &= 2 \left(t_2 \frac{D^3}{12} + t_1 \frac{BD^2}{4} \right) \\ &= \frac{t_1 D^3}{6} \left(\frac{t_2}{t_1} + 3 \frac{B}{D} \right) \end{aligned}$$

1) Steneroth, E.R.: Reflections upon permissible longitudinal stresses in ships. RINA, December 1966.

Thus:

$$y_q = - \frac{5.2}{12} \frac{t_1}{t_2} \left(\frac{t_2}{t_1} + 3 \frac{B}{D} \right) \frac{\sigma_{\max}}{E} \cdot D$$

For $\sigma_{\max} = 1500 \text{ kp/cm}^2$, $\frac{\sigma_{\max}}{E} = .71 \times 10^{-3}$, $\frac{B}{D} = 2$, and $\frac{t_1}{t_2} = 1.5$,

we get $y_q = \frac{-D}{327}$.

And for $\frac{L}{D} = 14$, we get $\frac{y_q}{L} = \frac{-1}{4570}$.

This is 11.6% of the bending deflection.

Generally, for the simple box girder considered above, we can set:

$$\begin{aligned} \frac{y_q}{y_b} &= \frac{.433 \frac{t_1}{t_2} \left(3 \frac{B}{D} + \frac{t_2}{t_1} \right)}{.175 \frac{L}{D}} \cdot \frac{D}{L} \\ &= 2.48 \frac{t_1}{t_2} \left(3 \frac{B}{D} + \frac{t_2}{t_1} \right) \left(\frac{D}{L} \right)^2 \end{aligned}$$

The contribution of the shear load increases with $\left(\frac{D}{L} \right)^2$. The effect of t_1/t_2 follows logically from the fact that the bending deflection decreases approximately linearly with t_1 , whereas the shear deflection decreases with t_2 . The factor t_2/t_1 is usually small compared to $3 \frac{B}{D}$.

4. Torsion of the Hull Girder.

The theory of torsion of open and closed cross-sections is treated in detail in the notes on the analysis of structures and will not be repeated here. However, we shall take a look at the practical consequences of torsion.

The formulae for shear stresses and angle of twist of open and closed single cell cross-sections are simple and are as follows:

For the closed cross-section (fig. 4.1) the shear flow becomes

$$q = \tau t = \frac{T}{2A}$$

and the specific angle of twist:

$$\frac{d\beta}{dx} = \frac{T}{4A^2 G} \oint \frac{ds}{t} = \frac{T}{GI_t}$$

where T is the torsion moment, A the cross-sectional area of the cell and t the wall thickness. The torsional moment of inertia is therefore by definition

$$I_t = \frac{4A^2}{\oint \frac{ds}{t}}$$

Similarly we have for the open cross-section

$$\tau_1 = \frac{T \cdot t_1}{\frac{1}{3} \sum bt^3} = \frac{T \cdot t_1}{I_t}$$

$$I_t \approx \frac{1}{3} \sum bt^3$$

We may point out that this formulae can with sufficient accuracy also be used for cylindrical members, the arc being approximated by straightline segments.

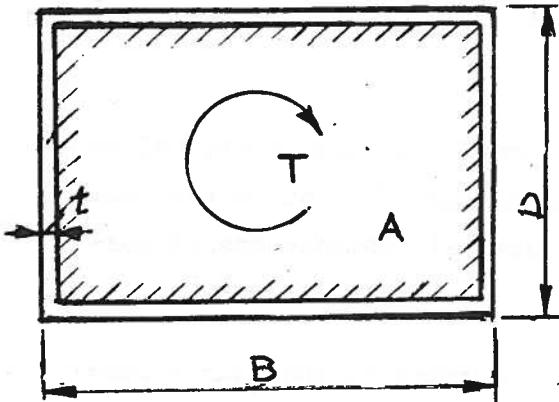


Fig. 4.1

The torsional stiffeners of the hull girder which does not have large hatch openings is so large compared to the external torsion moment that the shear stresses and angle of twist are sufficiently small to cause any serious problems. This does not mean that we in the future may also largely ignore the torsion problem. Presently a number of ships are being built with large hatches, or more than one row of

hatches, and the torsional stiffness has therefore been drastically reduced. Furthermore, as the theoretical foundation of one structural analysis of ship becomes increasingly more rational, it becomes important that all stress components are accounted for.

A fact worth emphasizing is the drastic reduction in torsional stiffness associated with an increase in size and number of hatches. To illustrate this we may compare the torsional rigidities of the rectangular thin-walled section as a closed section and as an open section. The torsional moments of inertia are for these cases:

$$(I_t)_{\text{closed}} = \frac{4B^2D^2t}{2(B+D)} = 2tD^3 \frac{(B/D)^2}{1+B/D}$$

$$(I_t)_{\text{open}} = \frac{2t^3}{3} (B+D)$$

The ratio of the torsional stiffnesses for $B = 2D$ and $D = 400t$ then become

$$\frac{I_{\text{closed}}}{I_{\text{open}}} = \frac{3B^2D^2}{t^2(B+D)^2} = \frac{4}{3} \left(\frac{D}{t}\right)^2 = 2.13 \times 10^5$$

The corresponding ratio of stresses is given by

$$\frac{\tau_{\text{open}}}{\tau_{\text{closed}}} = \frac{2At}{\frac{1}{3} \sum bt^2} = \frac{3BD}{t(B+D)} = \frac{2D}{t} = 800$$

These results indicate that if the hull girder has one continuous hatch opening its torsional stiffness would have been close to zero had it not been for the joining of the two sides of the ship at both ends. It is important to keep this in mind when designing a ship with large hatches.

Let us consider for a moment the deformations which take place in a box girder when this is cut longitudinally and subjected to a torque (fig. 4.2). The difference between the torsional stiffness of the open and closed cross-section is represented by the resistance to any shift along the cut, and for ships this normally depends upon the strength of the deck panels between the hatches and to what degree these prevent such a shift.

If we analyze a box girder with square cross-section in which we have made small intermittent cuts along a longitudinal line we find that with the total length of cuts being 80% of the total length of girder the reduction in torsional stiffness is only 8%. The shear stresses due to torsion have obviously been increased both because of a reduced net cross-sectional area and because of the stress concentration at the ends of the cuts.

The region that is subjected to high stresses will increase as the cuts are widened to a finite width such that they may represent hatches. This will rapidly decrease the torsional stiffness. The panel between the hatches is no longer only subjected to shear. It will to an increasing degree also act as a beam in bending and bending deformations contribute to the relative displacements of hatch sides. We may therefore imagine that the starboard and port sides of the ship are connected by beams that are built-in at both ends to the rest of the deck area. The width of the hatch opening determines the length of these elements and the distance between the hatches and the scantlings determine the stiffness. (Fig. 4.3).

The quantitative effect of different hatch sizes and number of rows of hatches has been studied both theoretically and experimentally by J.P. Bailey¹⁾ and R.W. Clough²⁾. To better get a feel for the magnitudes of the

1) Effect of size of hatches on torsional strength and rigidity, Journal of Ship Research, March 1959.

2) Effect of cargo hatch size on ship girder strength, University of California, 1957.

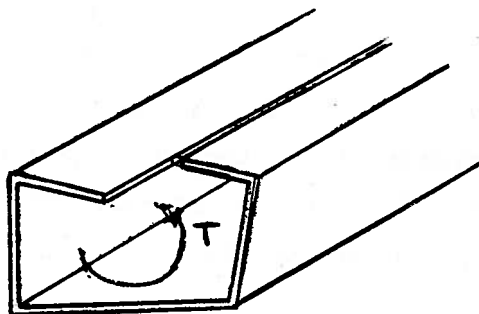


Fig. 4.2

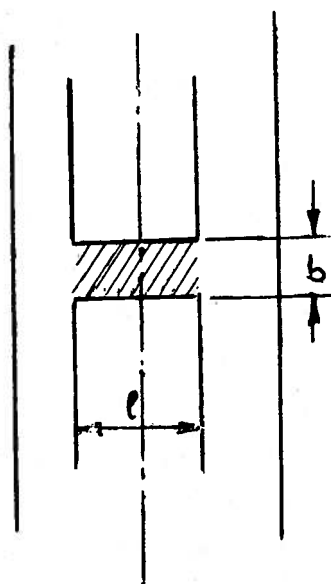


Fig. 4.3

variations in torsional rigidity we shall here take a look at their results. The six models used by Bailey are shown in fig. 4.4 and the angles of twist are given in fig. 4.5. Fig. 4.5a illustrates how the deformations increase as a function of the length and width of the hatches. Length and width are changed simultaneously such that the opening is given as a percentage of the deck area between two bulkheads.

Fig. 4.5b shows the effect of the division of a given hatch opening (52%) into 1, 2, and 3 rows of hatches transversely, simultaneously with the installation of longitudinal bulkheads between the row. The spacing of the hatches is the same in all cases, but we note that the ship becomes "softer" with increasing number of rows. This is caused by the increase in the effective length of the connecting beams between the starboard and port sides.

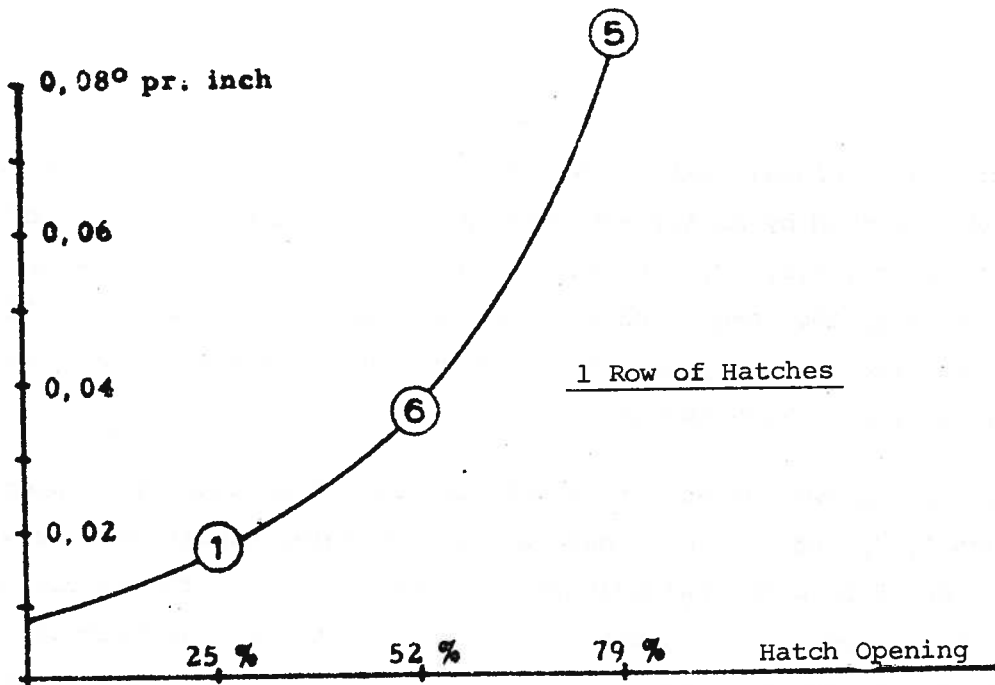
In fig. 4.5c the effect of a shortening of the hatches for the case of 3 rows is shown. The spacing of hatches is kept constant, and since this increases the number of connecting beams we find that the torsional rigidity is increased.

Fig. 4.6 shows the model used by Clough and his results are given in fig. 4.7 together with theoretical calculations based on the principle of virtual work. Fig. 4.8 gives an interesting overview of the dependence of the torsional rigidity upon the hatch length/ship beam ratio and hatch length/cargo hold length ratio over a very wide range of these parameters. In fact the curves cover in the extreme the cases of mere cuts longitudinally or transversely and the case when the hatch covers the entire deck.

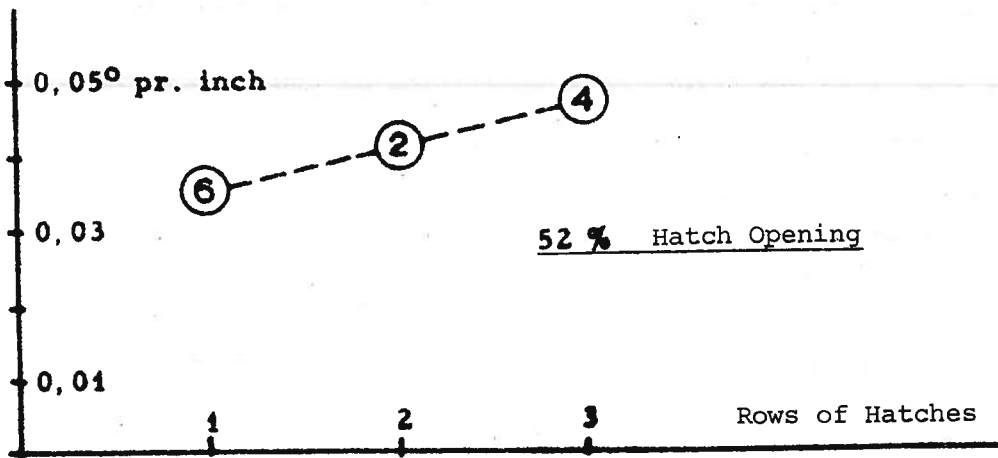
It is considerably more difficult to determine the shear stresses in the deck and the hull girder in general for the different hatch sizes and arrangements. These stresses can be determined by means of the finite element method. Here we shall merely reproduce some of the examples studied by Clough which are shown in fig. 4.9a & b, and 4.10a & b.

When the hatches are becoming so large that the hull girder can no longer be considered as having an effective closed cross-section then it may be of interest to raise the question whether secondary structural members can improve the torsional rigidity. Examples of how the rigidity

a)



b)



c)

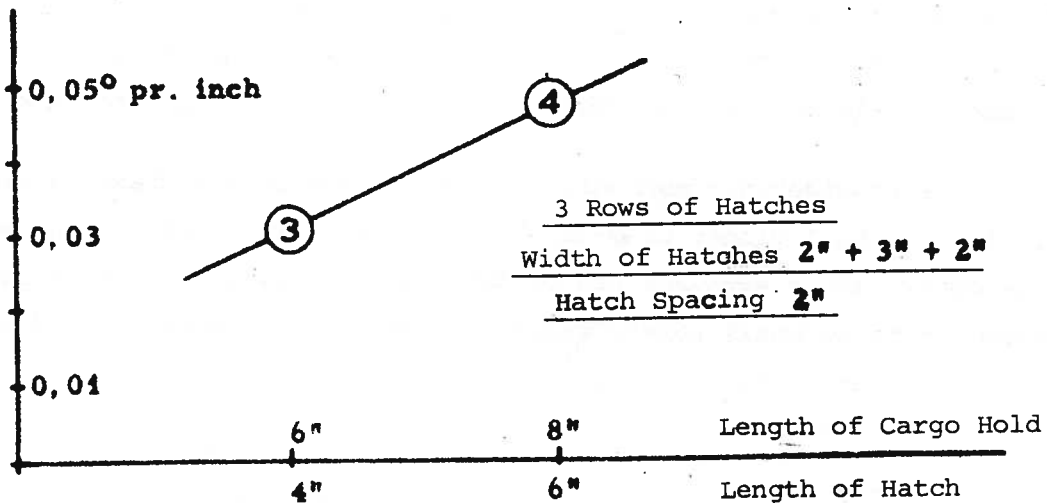
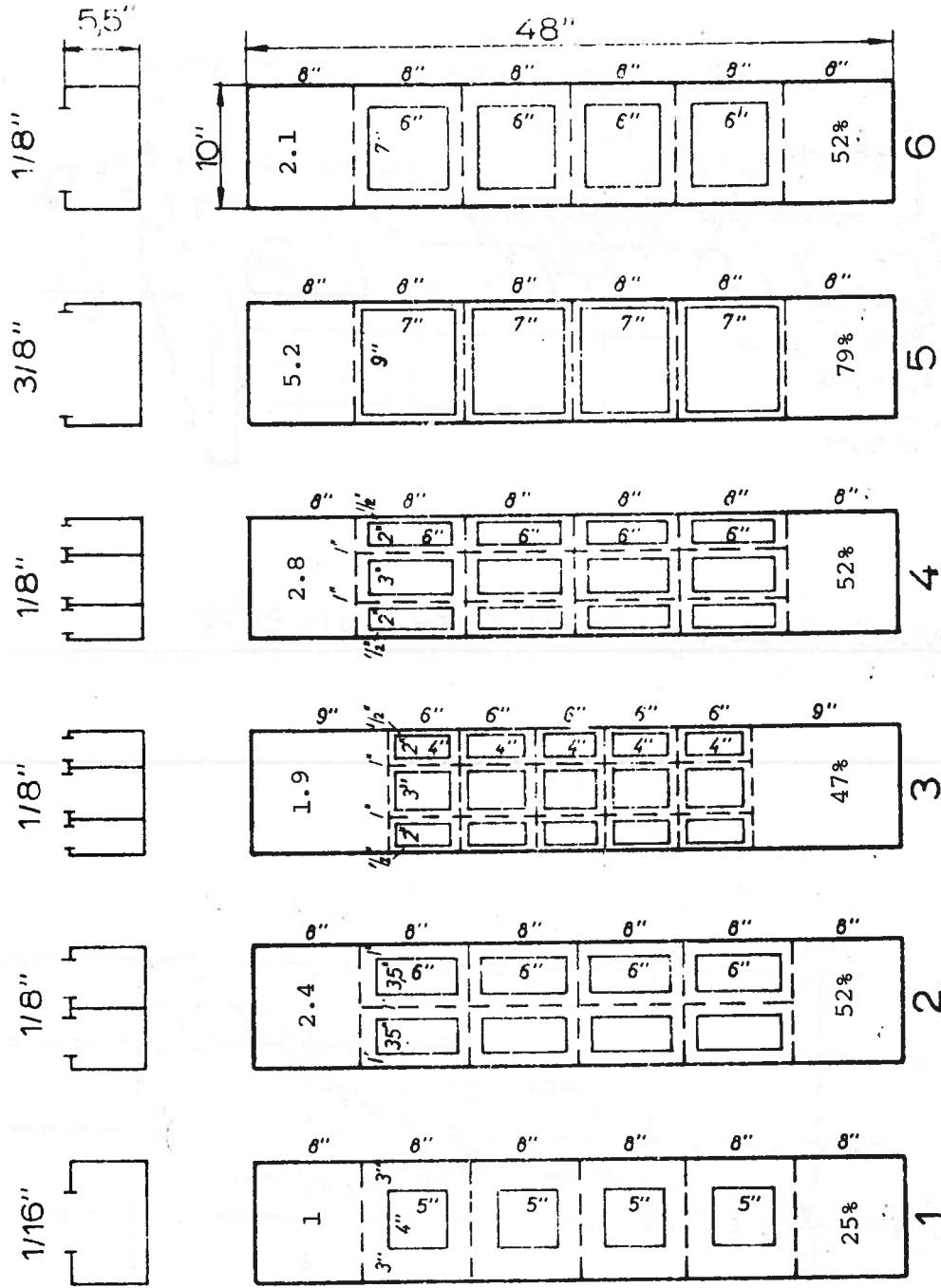


Fig. 4.5

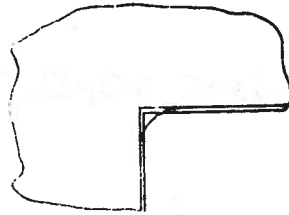


Thickness of Deck Plating

Relative Torsional Rigidity

Hatch Corner

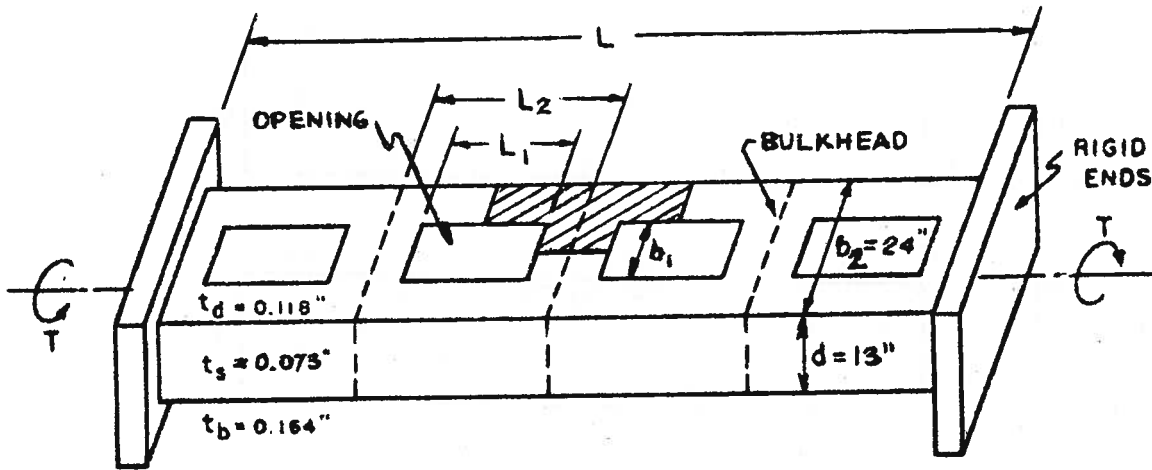
Coaming is slotted for plate of 1/4" rad.



Hatch Opening

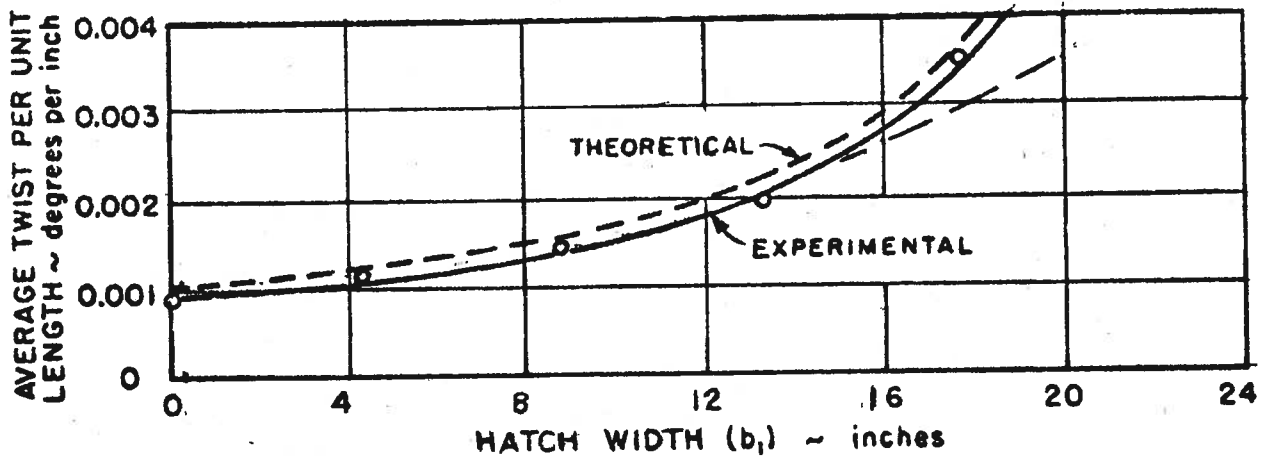
Thickness of plating: Sides & Bulkheads: 1/16"
Bottom: 1/8"
Deck: see sections

Fig. 4.4



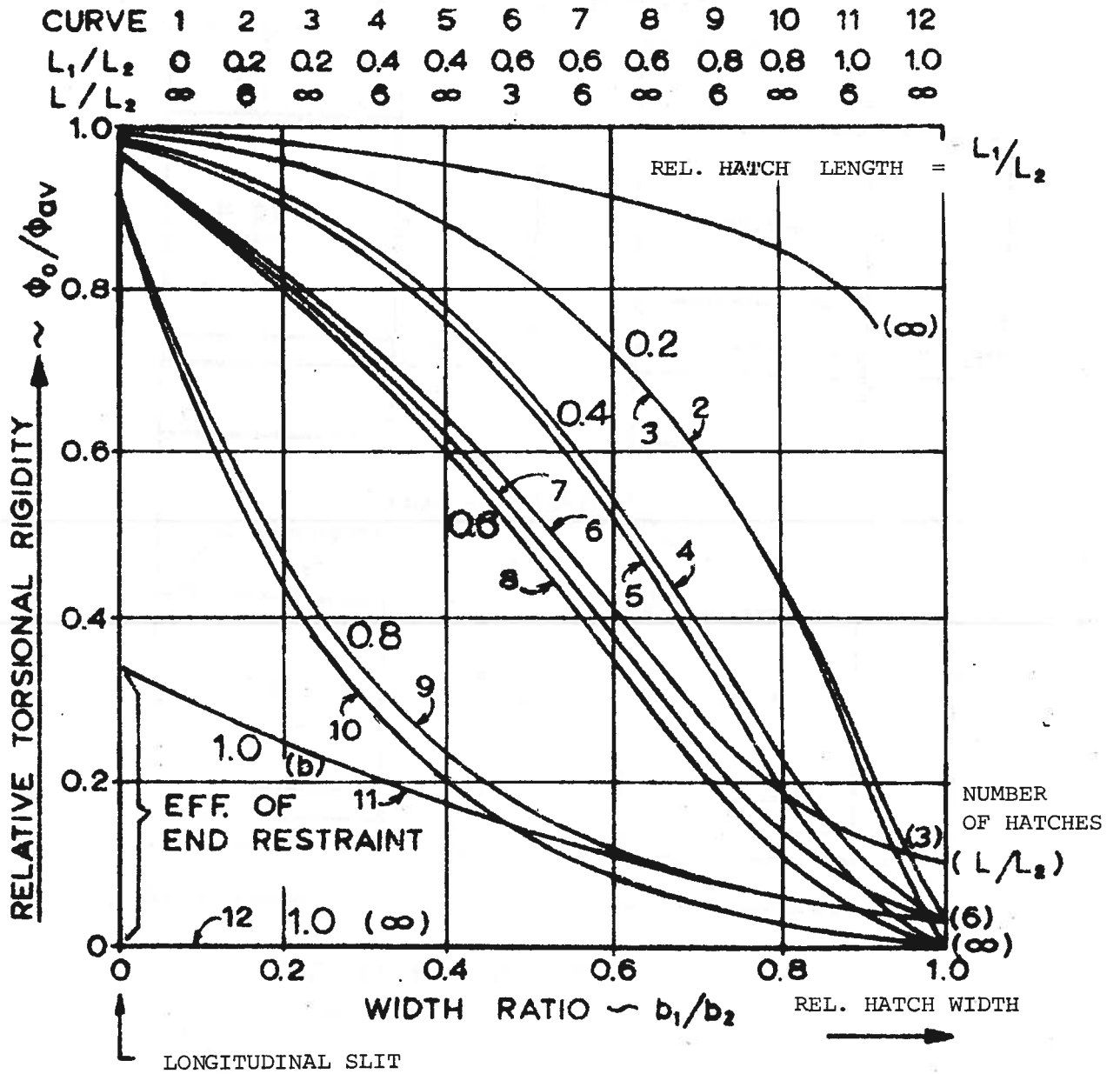
SINGLE CELL BOX BEAM WITH CUT-OUTS

Fig. 4.6



AVERAGE MODEL TWIST vs HATCH WIDTH

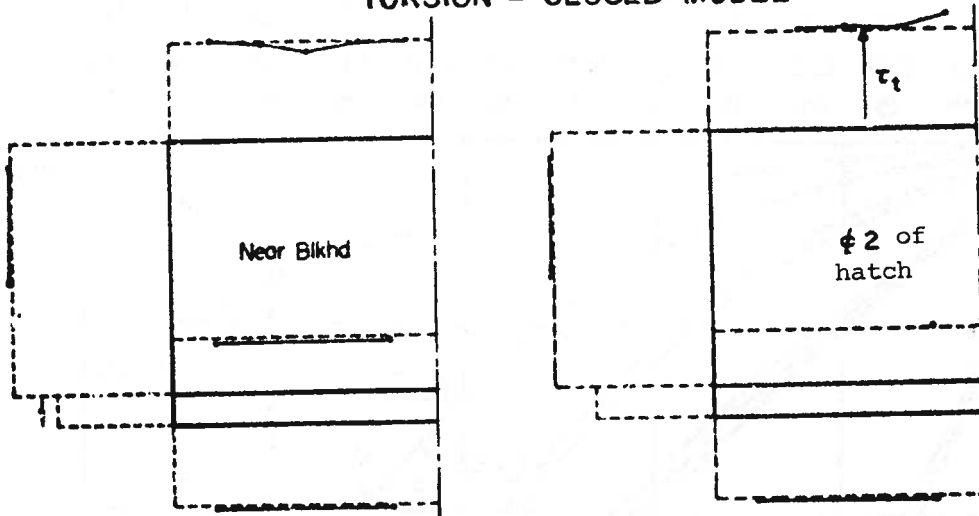
Fig. 4.7



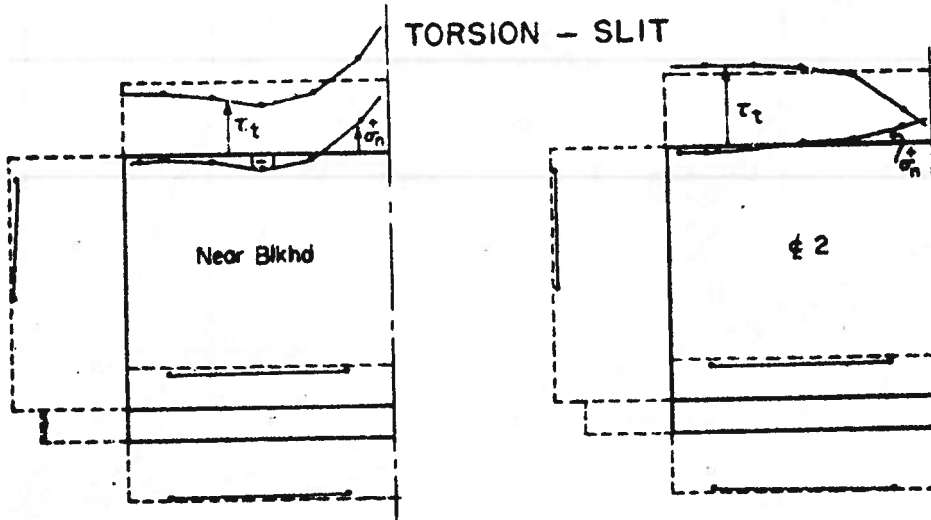
RELATIVE TORSIONAL RIGIDITY OF BOX BEAM HAVING CUT-OUTS

Fig. 4.8

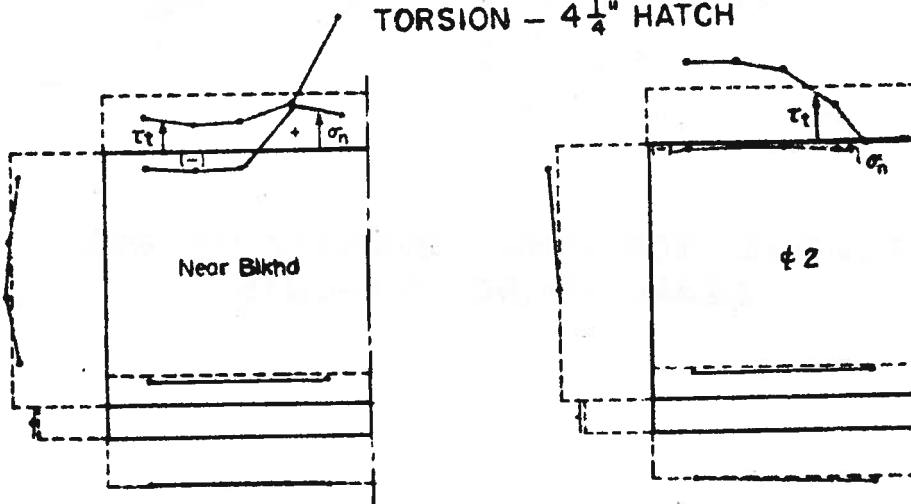
TORSION - CLOSED MODEL



TORSION - SLIT

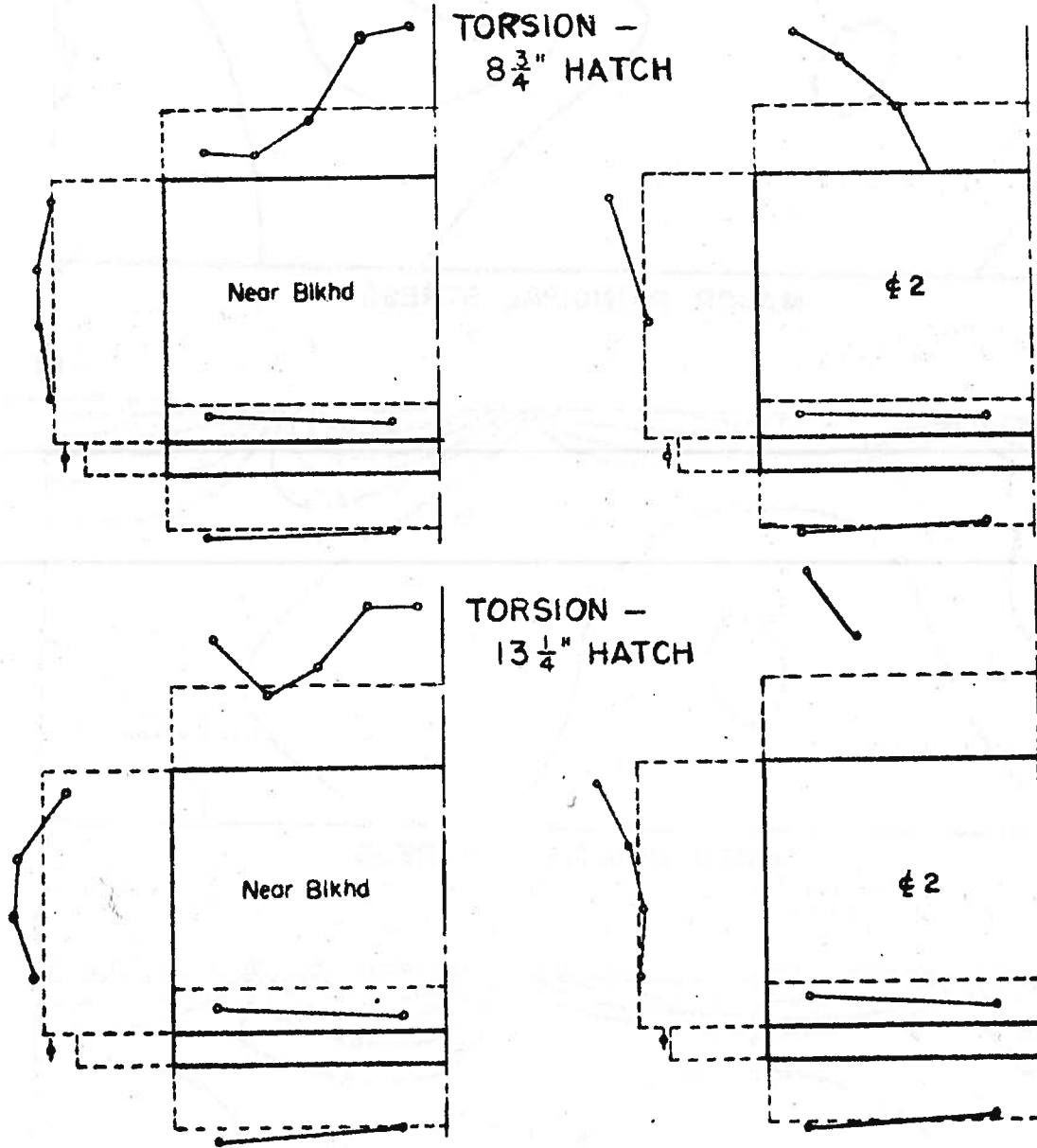


TORSION - 4 1/4" HATCH



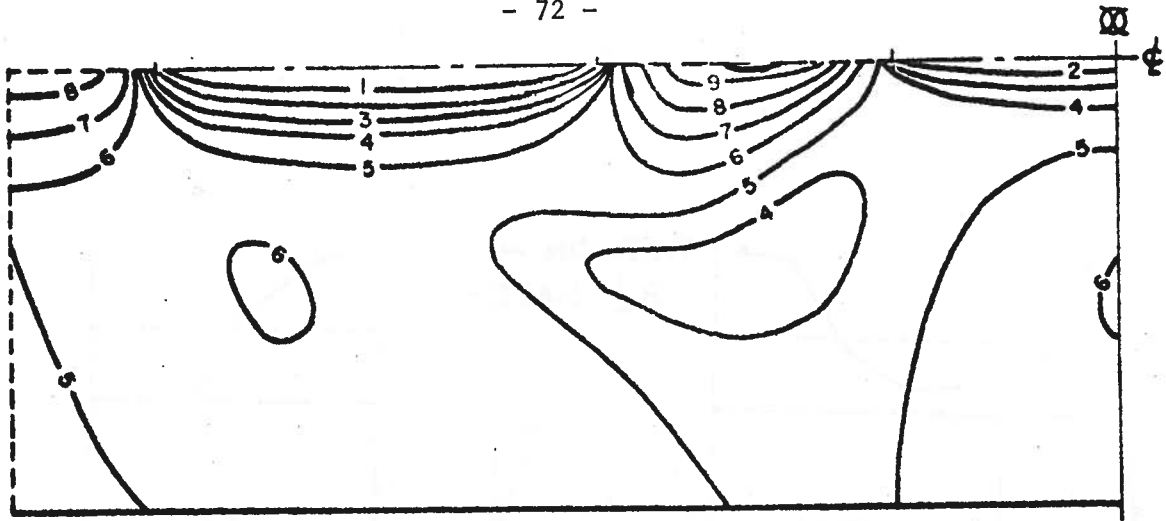
SHEARING STRESS DISTRIBUTION ON TRANSVERSE PLANES UNDER TORSION LOADING CONDITION

Fig. 4.9 a)

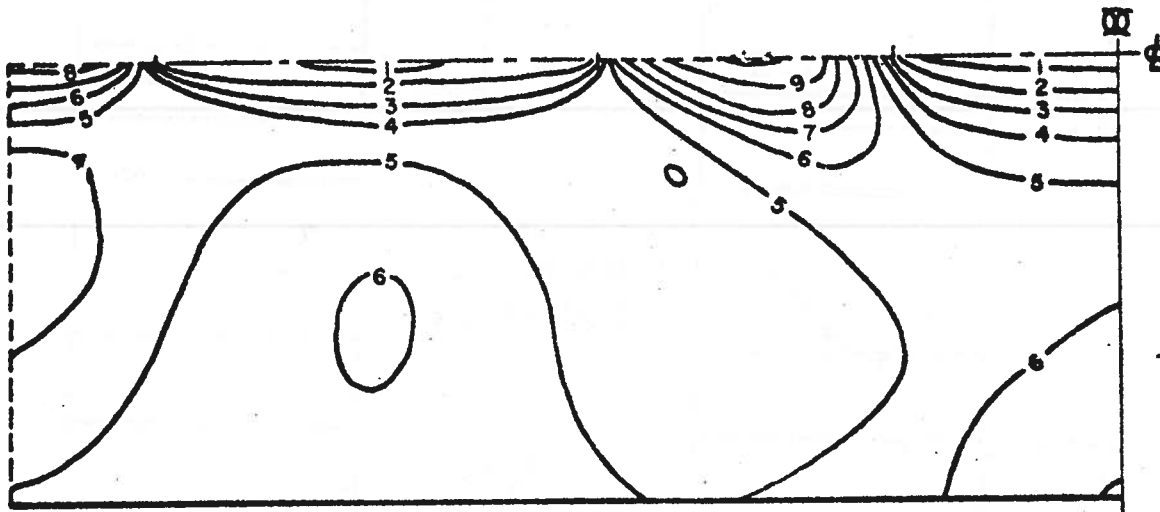


SHEARING STRESS DISTRIBUTION ON TRANSVERSE PLANES UNDER TORSION LOADING CONDITION - SLIT

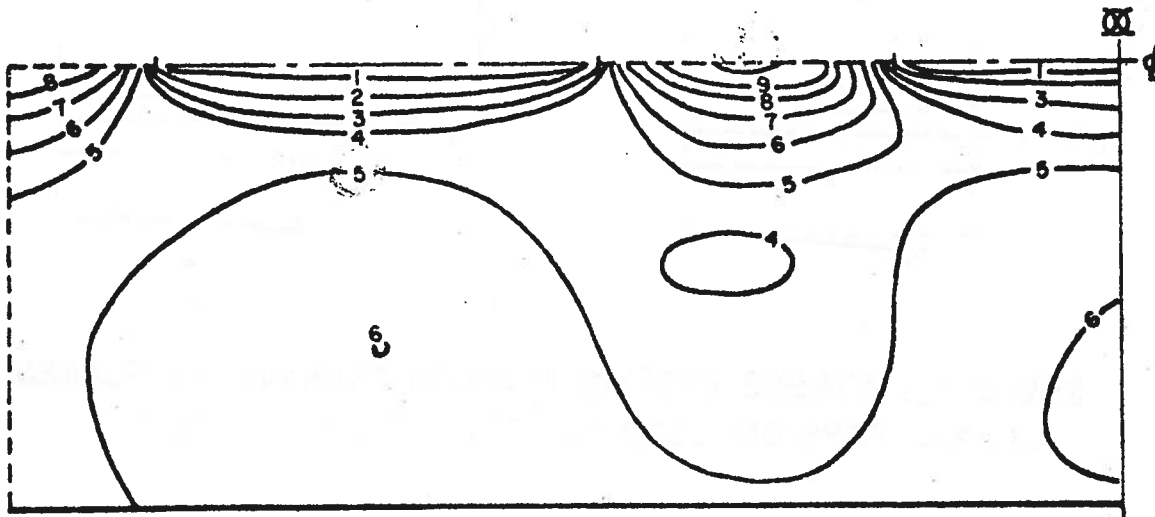
Fig. 4.9b



MAJOR PRINCIPAL STRESS



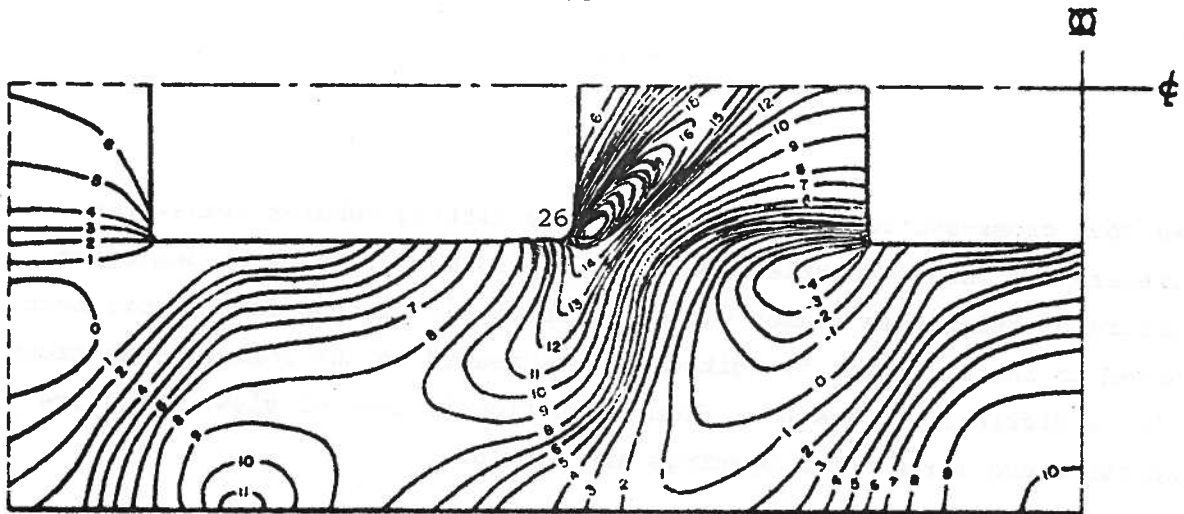
MINOR PRINCIPAL STRESS



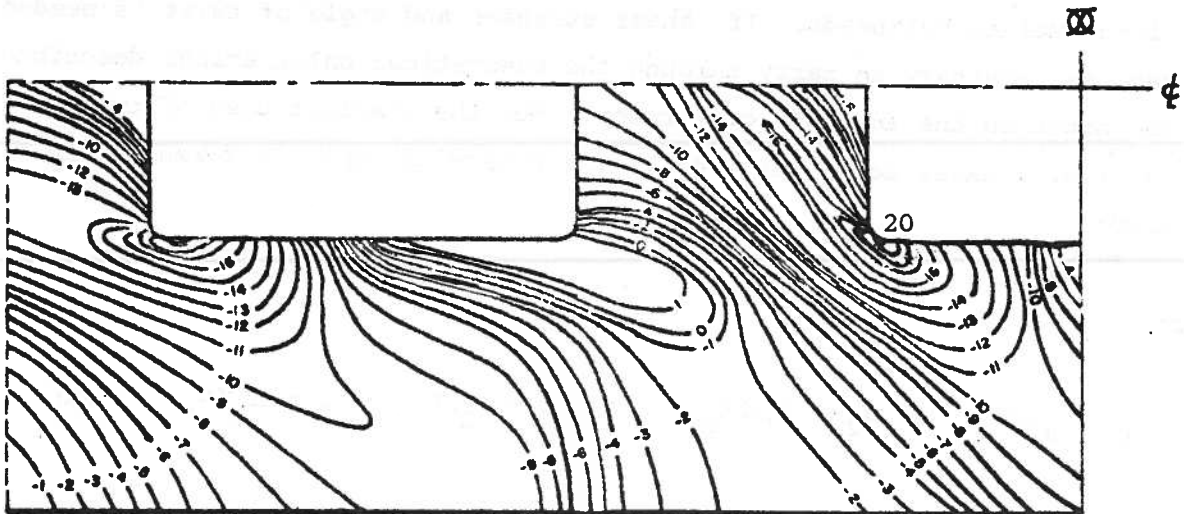
MAXIMUM SHEAR STRESS

STRESS CONTOURS ON DECK UNDER TORSION
LOADING CONDITION - SLIT

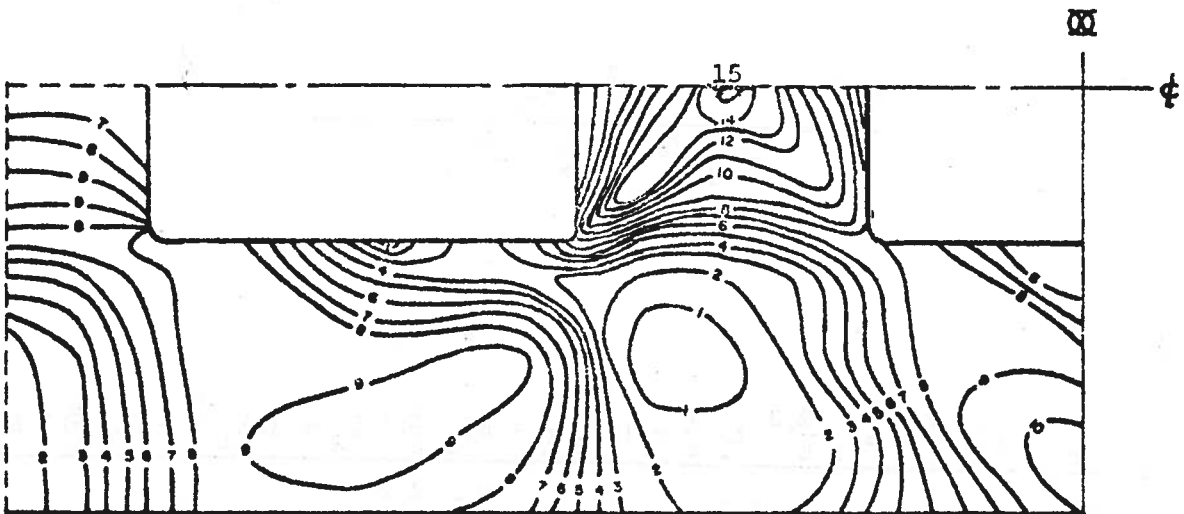
Fig. 4.10 a)



MAJOR PRINCIPAL STRESS



MINOR PRINCIPAL STRESS



MAXIMUM SHEAR STRESS

MAXIMUM STRESS: 4970 psi

STRESS CONTOURS ON DECK UNDER TORSION
LOADING CONDITION - $8\frac{3}{4}$ INCH HATCH B = 24"

Fig. 4.10 b)

of an open cross-section can be increased by fitting tubular transverse stiffeners are known. Carried up to the dimensions of ships an analogous structure of transverse frames could be practical. It has furthermore been proposed to install extra "longitudinal bulkheads" in the form of open trusses but it is difficult to see how, from a functional point of view, these are practical where large hatch openings are needed.

Usually the ship will be divided into several cells by decks, tank top and longitudinal bulkheads. If shear stresses and angle of twist is needed it becomes necessary to carry through the theoretical calculations described in the notes on the analysis of torsion. For the simplest case of two cells (i.e. 1 extra deck - fig. 4.13) the following explicit formulae can be used:

With

$$q_1 = T_1/2A_1 ; \quad q_2 = T_2/2A_2 ; \quad a = 1 + A_2/A_1 ; \quad b = A_2/A_1 , \quad \text{and}$$

$$T = T_1 + T_2, \quad \text{we have that:}$$

$$\frac{T_1}{T} = \frac{\Sigma_2 \frac{\ell}{t} + a \Sigma_3 \frac{\ell}{t}}{b^2 \Sigma_1 \frac{\ell}{t} + \Sigma_2 \frac{\ell}{t} + a^2 \Sigma_3 \frac{\ell}{t}}$$

and

$$\theta = \frac{T}{4GA_1^2} \frac{(\Sigma_2 \frac{\ell}{t} + a \Sigma_3 \frac{\ell}{t})^2 \Sigma_1 \frac{\ell}{t} + (b \Sigma_1 \frac{\ell}{t} + a \Sigma_3 \frac{\ell}{t})^2 \Sigma_2 + (b \Sigma_1 \frac{\ell}{t} - \Sigma_2 \frac{\ell}{t})^2 \Sigma_3 \frac{\ell}{t}}{(b^2 \Sigma_1 \frac{\ell}{t} + \Sigma_2 \frac{\ell}{t} + a^2 \Sigma_3 \frac{\ell}{t})^2}$$

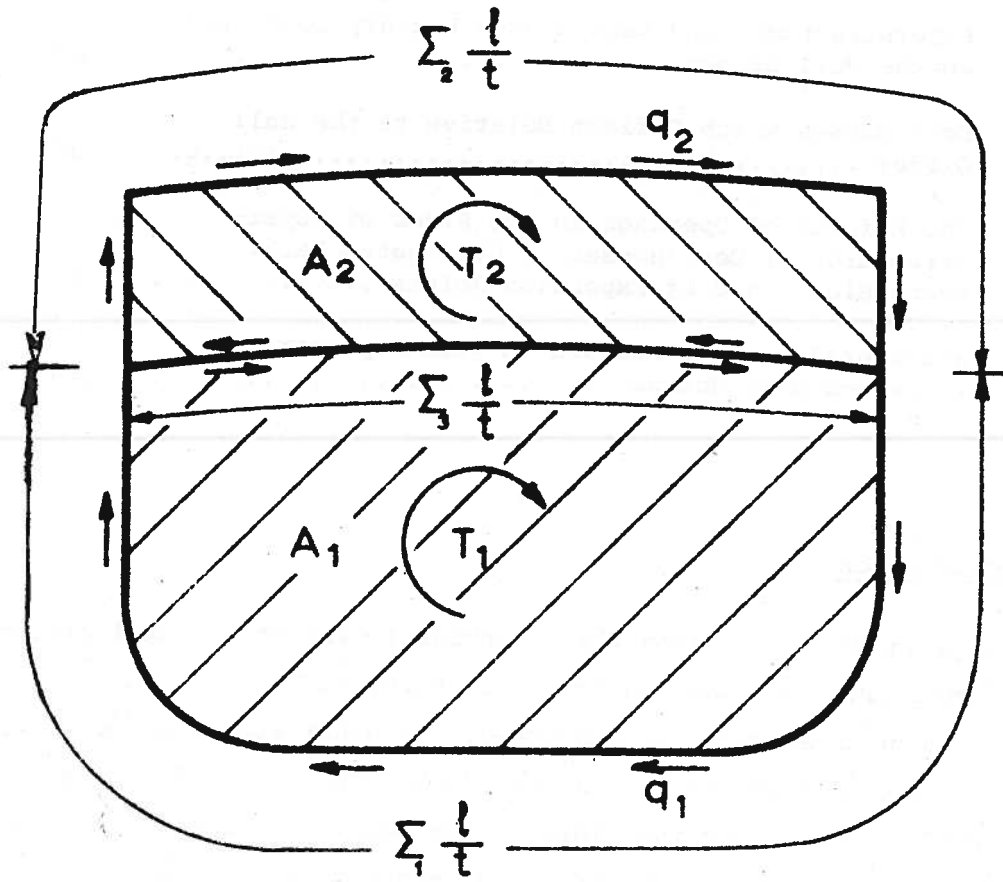


Fig. 4.13

5. Superstructures and Deck Houses.

	Page
5.1 Introduction	80
5.2 Superstructures and Deck Houses Rigidly Connected to the Hull Girder	82
5.3 Deck Houses which Deflect Relative to the Hull Girder	95
5.4 The Effects of Openings in the Sides of Superstructures or Deck Houses of Corrugated Deck, House Sides, and of Expansion Joints	109
5.5 Structural Details Associated with Superstructures and Deck Houses	119

5.1 Introduction

A superstructure is actually an integral part of the hull girder which is not continuous over the length of the ship, at least as far as the following structural analysis is concerned. In other words, we do not include here the superstructure of the shelter deck. The sides of superstructures are natural extensions of the sides of the ship. The sides of the deck houses, on the other hand, are offset from the ship side, and are therefore flexibly connected to the hull girder via the deck.

The contribution of the superstructures and deck houses to the longitudinal strength of the hull girder depends largely upon the length of these structures, and the cross-section some distance away from their ends. As will be shown, the ends do, however, introduce a concentration of forces that call for a careful analysis of structural details of the hull girder and local reinforcements. The contribution of the short superstructure or

deck house to the longitudinal strength is not very great and it is tempting to forego this if, at the same time, we could avoid the problems at the ends. For practical reasons it is difficult, however, to avoid a stiff connection between a deck house and the hull girder, and the problem essentially consists of providing connections aimed at preventing structural failures.

A number of relatively accurate methods of analysis of the interaction between deck house or superstructure and the hull girder can be found in the literature 1), 2), 3), 4), 5), 6), 7), 8), 9). In the following we shall not treat the problem as rigorously as these publications do, in that we shall follow a somewhat simplified approach which, nevertheless, will provide an insight into the nature of the problem. We shall first look at the superstructure that is rigidly connected to the sides of the hull girder and the deck house that is forced to follow the flexure of the hull girder by, for example, a large number of transverse bulkheads. Next we shall analyze the deck house which is elastically connected to the hull

-
- 1) Muckle, W.: "The influence of large side openings on the efficiency of superstructures". TINA, Vol. 104, 1962.
 - 2) Bleich, H.H.: "Report on a study of the structural action of superstructures on ships". U.S. Ship Structure Committee. Report No. 48, 1951.
 - 3) Schade, H.: "The effective breadth concept in ship structure design". TSNAME. Vol. 61, 1953.
 - 4) Nissen, I.H.: "Interaction between deckhouse and main hull girder". Nyt Nordisk Forlag Arnold Busch, Copenhagen, 1955.
 - 5) Chapman, J.C.: "The behaviour of long deckhouses". TINA, Vol. 103, pp. 281, 1961.
 - 6) Johnson, A.J.: "Stresses in deckhouse and superstructures". TINA Vol. 99, s. 634, 1957.
 - 7) Caldwell, J.B.: "The effect of superstructures on the longitudinal strength of ships". TINA, Vol. 99, s. 664, 1957.
 - 8) Terazawa, K. and Yagi, J.: "Review of researches on the strength of ship superstructure". ISSC, 1961.
 - 9) Crawford, L. and Ruby, W.J.: "Model Tests on Hull-Deckhouse Interaction". Report No. 67, Ship Structure Committee, January 1955.

girder via the deck beams, and study the influence of the location and number of bulkheads where the relative displacements between deck house and hull girder must for all practical purposes be equal to zero. Finally we shall, by some examples study the effect of large openings in the sides of the superstructure or deck house and the effect of expansion joints and corrugated house sides.

5.2 Superstructures and Deck Houses Rigidly Connected to the Hull Girder.

As far as determining the distribution of stresses some distance away from the ends of the deck house is concerned, the problem is rather conventional in that the cross-section of the house is included in the calculation of the moment of inertia and section modulus. Disregarding the stress concentrations at the ends of the house the stress distribution will be as indicated in fig. 5.1. If we wish to find the effectiveness of the material in the deck house or superstructure when this is short, or the effectiveness near the ends we may use fig. 5.2, which shows the results of tests performed by Muckle. This curve is valid for the case where there is no extra longitudinal bulkhead between the deck of the hull and the deck of the superstructure to assist in the transfer of forces.

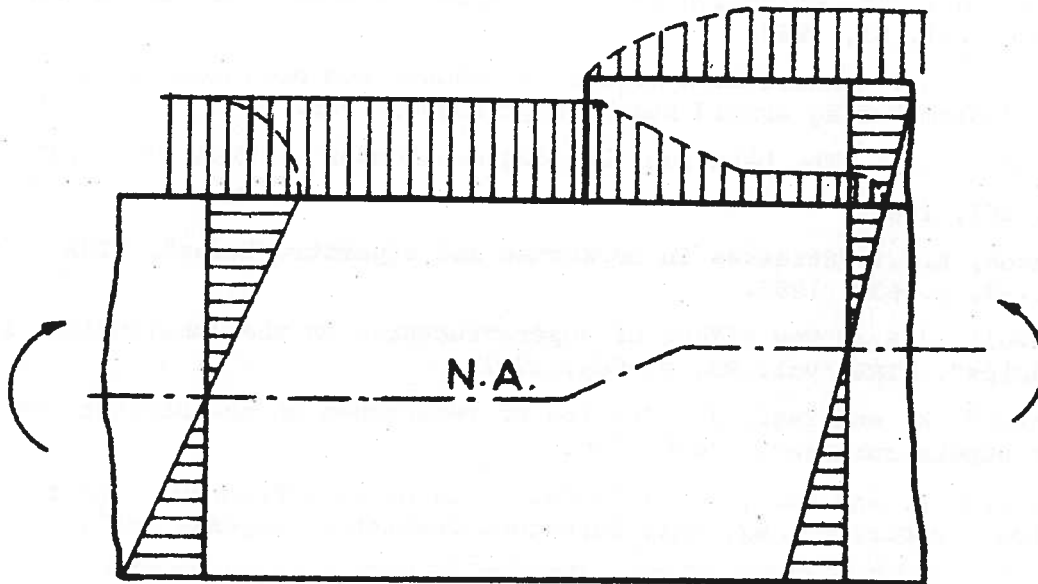
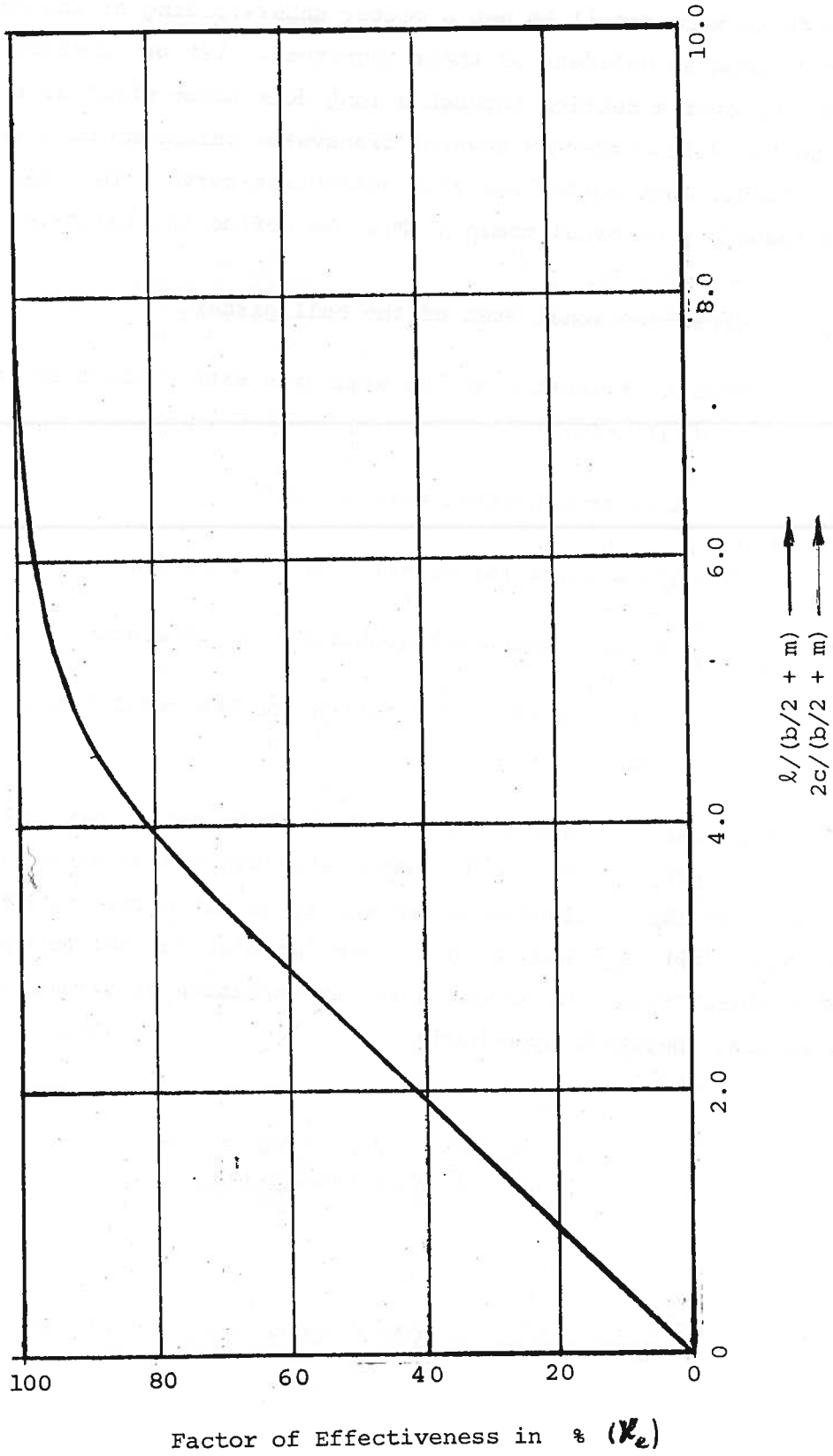


Fig. 5.1

EFFECTIVENESS OF CROSS-SECTIONAL AREA OF DECK HOUSE
WHEN RIGIDLY CONNECTED TO THE HULL GIRDER



l = length of deck house, m = height of house, b = width of house, c = distance from end of house

Fig. 5.2

We are interested in studying the stress picture in the region of the house ends in more detail to get a better understanding of the forces that occur there, and an estimate of their magnitude. Let us consider the stress distribution over a section through a long deck house which is rigidly connected to the hull girder by several transverse bulkheads so that deck house and hull girder must follow the same deflection curve. The hull girder is assumed loaded by external moments (M). We define the following quantities:

A_s = cross-sectional area of the hull girder.

I_s = moment of inertia of the same area with respect to its own neutral axis.

η_s = distance from neutral axis to deck.

E_s = Young's modulus for material of hull girder.

A_o, I_o, η_o, E_o corresponding quantities for the deck house.

$A, I,$ and η corresponding quantities for the total cross-sectional area.

The materials of hull girder and deck house may be dissimilar and we set $K_E = E_o/E_s$. When calculating stresses and deformations differences of the moduli of elasticity can easily be taken care of by substituting $K_E A_o$ for A_o and using the same modulus for the entire modified cross-sectional area. We assume a linear variation of strain over the cross-section (Navier's hypothesis).

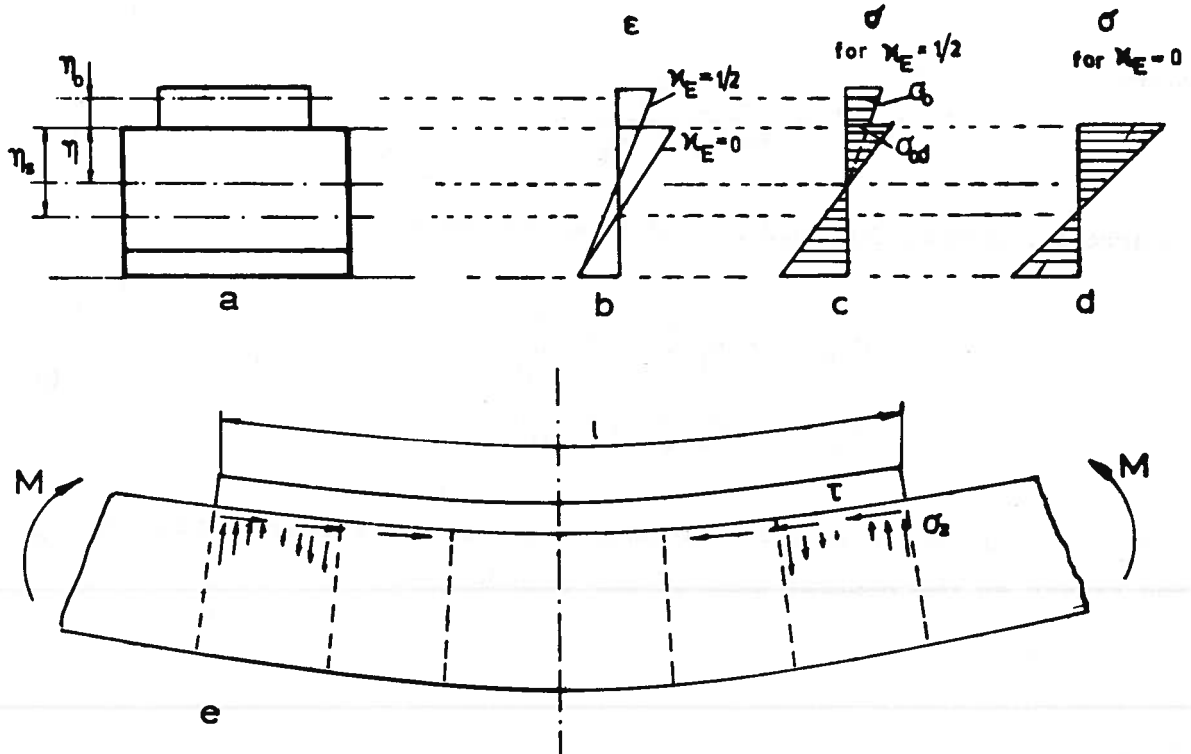


Fig. 5.3

From the elementary theory of strength we obtain

$$\eta_s - \eta = \frac{\kappa_E A_0 (\eta_0 + \eta_s)}{\kappa_E A_0 + A_s}$$

(5.1)

or

$$\eta = \frac{A_s \eta_s - \kappa_E A_0 \eta_0}{A_s + \kappa_E A_0}$$

Furthermore

(5.2)

$$I = \kappa_E I_0 + I_s + \kappa_E A_0 (\eta_0 + \eta_s)^2 - (\kappa_E A_0 + A_s) (\eta_s - \eta)^2$$

$$I = \kappa_E I_0 + I_s + A' (\eta_0 + \eta_s)^2$$

where

$$A' = \frac{\kappa_E A_O A_S}{\kappa_E A_O + A_S}$$

In accordance with fig. 5.3 a) and c) we can write

$$\begin{aligned} \sigma_{od} &= -\kappa_E \frac{M}{I} \eta = \frac{M}{Z_d} \\ \sigma_O &= -\kappa_E \frac{M}{I} (\eta + \eta_O) \end{aligned} \quad (5.3)$$

where σ_{od} is the stress in the deck house at the strength deck and σ_O the stress at the neutral axis of the deck house.

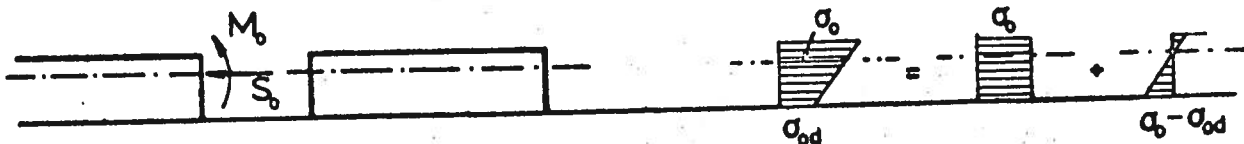


Figure 5.4

Considering now the stress distribution in the deck house separately (fig. 5.4) we note that this can be equated to a normal force (S_O) and a moment (M_O). By equation 5.3 these become:

$$\begin{aligned} S_O &= -\sigma_O A_O = \frac{\kappa_E M A_O}{I} (\eta + \eta_O) \\ M_O &= -(\sigma_O - \sigma_{od}) \frac{I_O}{\eta_O} = \kappa_E M \frac{I_O}{I} \end{aligned} \quad (5.4)$$

S_O is positive in compression.

For these stresses to occur there must exist shear stresses (τ) and normal stresses (σ_z) between hull and deck house as shown in fig. 5.3e. The exact distribution of these is rather difficult to find. We shall here be satisfied with a much simplified analysis.

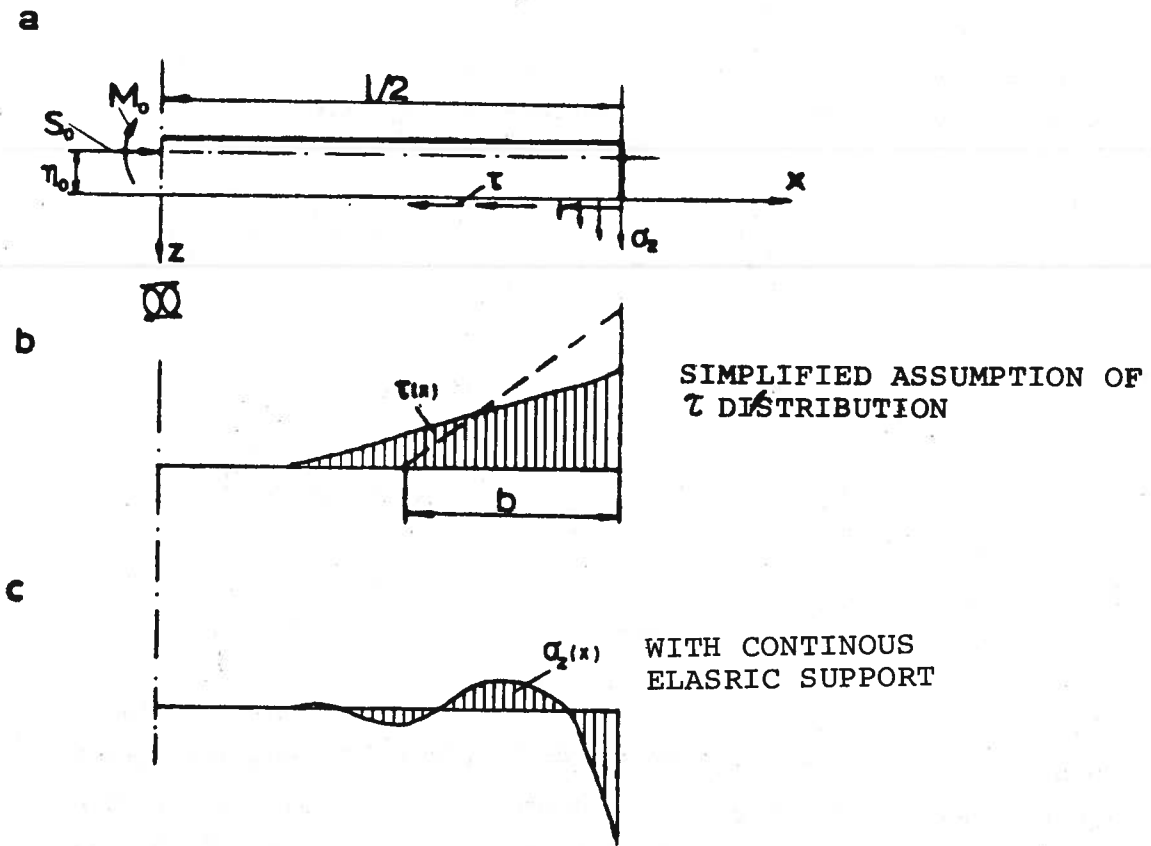


Fig. 5.5

If σ_z and τ are taken to be positive under the loading condition shown in fig. 5.5a, then the following equations of equilibrium are valid. The axial force S_0 gives rise to shear stresses τ such that

$$\Sigma t \cdot \int_0^{l/2} \tau(x) dx = S_0$$

The sum of the vertical stresses must be equal to zero, i.e.,

$$\Sigma t \cdot \int_0^{l/2} \sigma_z(x) dx = 0 \quad (5.5)$$

The moment at the midpoint = moment due to σ_z , i.e.,

$$\Sigma t \cdot \int_0^{l/2} \sigma_z(x) x dx = - (M_0 + S_0 \eta_0)$$

Here we have from equation 5.4 that:

$$-(M_0 + S_0 \eta_0) = -K_E M \frac{I_0 + A_0 \eta_0 (\eta + \eta_0)}{I}$$

Σt = the sum of the thicknesses of all longitudinal bulkheads in the deck house.

If the hull girder as well as the deck house have constant cross-section over the entire length of the house and if the external moment is also constant then it is easy to show that the distribution of τ and σ_z must correspond to a concentrated force $S = S_0$ and a moment $(M_0 + S_0 \eta_0)$ at the ends, as shown in fig. 5.6.

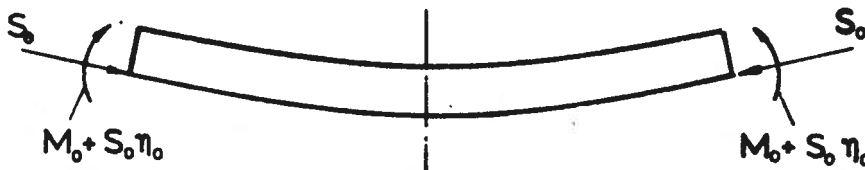


Fig. 5.6

The moments in both the hull girder and the deck house are constant as is the common curvature under these conditions.

The connection between the hull girder and the deck house usually will not be capable of withstanding such a concentrated shear force S_0 . It will therefore be distributed over an area.

The σ_z stresses will also be distributed over some length when the side of the hull and the deck house lie in the same plane.

Very large concentrated forces will, therefore, occur at the ends of the deck house if the sides of the house are located inside the deck edge and if the end of the house rests on a transverse bulkhead, as shown in fig. 5.7.

An approximate estimate of these forces can be obtained if we assume that the forces in the last two bulkheads towards the house end will result in a σ_z -stress distribution such that

$$V \cdot a = M_0 + S_0 \cdot \eta_0$$

$$V = \frac{M_0 + S_0 \cdot \eta_0}{a} \quad (5.6)$$

where a = distance between transverse bulkheads.

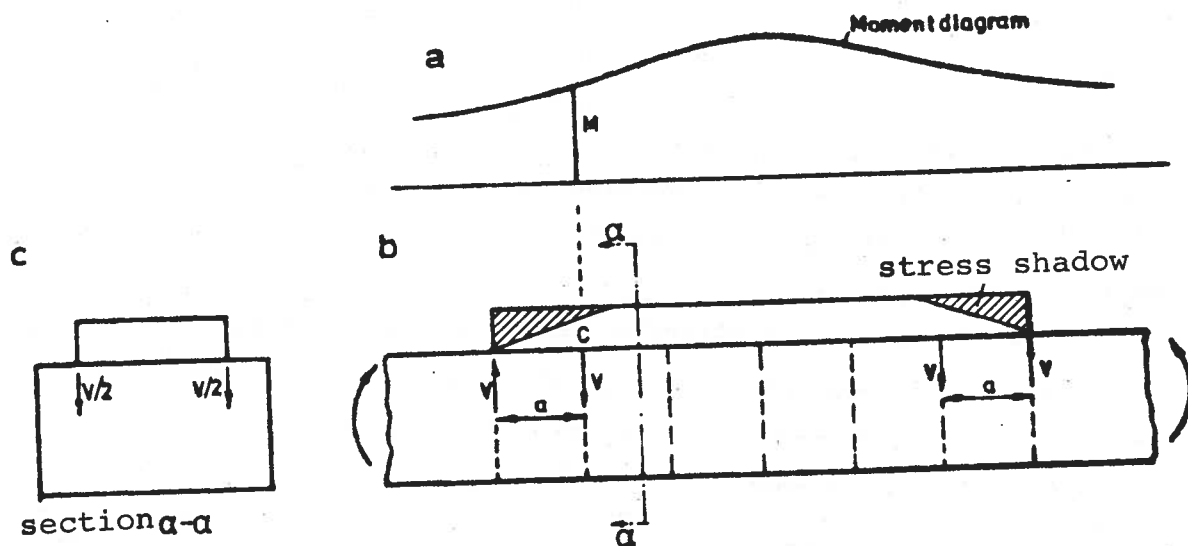


Fig. 5.7

The force V is to be distributed equally between all longitudinal continuous bulkheads in the house, see fig. 5.7 c. If the end of the house is supported by a stansion at the house front then this stansion carries the total force. Note that the direction of the force V will change as the hull girder passes from sagging to hogging. A long series of failures - some rather serious- have taken place because the designer did not take heed of these forces.

The shear stresses can be assumed to vary linearly from zero to τ_{\max} over a length equal to the width¹⁾ of the house, as shown by the dotted line in fig. 5.5b.

We then obtain:

$$\frac{1}{2} \tau_{\max} \cdot b \sum t = S_0$$
$$\tau_{\max} = \frac{2 S_0}{b \sum t} \quad (5.7)$$

A more exact analysis (Chapman) seems to indicate that deck houses whose lengths extend over 4-5 transverse bulkheads or more can be expected to follow the deformation of the hull girder very closely so that the simplified analysis shown above can be applied. In cases where transverse bulkheads are few in number or non-existent the conditions are quite different. Such cases will be treated later.

We have up to this point limited the discussion to the stress distribution over the middle section of a long deck house. Towards the ends of the house the distribution of stresses are a bit more uncertain because, among other effects, a "stress shadow" is formed owing to shear deformations, as indicated in fig. 5.7b. This we can account for approximately by the introduction of a factor of effectiveness of the deck house. In fig. 5.2 is shown how this factor for the middle of the deck house varies as a function of $l/(\frac{b}{2} + m)$, according to tests conducted by Muckle.

1) We note from fig. 5.2 that normal stresses in the deck house do not reach full value until $2c/(b/2 + h) > 4$. If we neglect the height of the house we find that the shear stress can at least be distributed over the length $c \geq b$.

Here

b = width of deck house

m = height of deck house

These values are only approximately correct. If we wish to determine an approximate value of the factor of effectiveness for a section located other than at the midlength this can be done by substituting $2c/(\frac{b}{2} + m)$ for $l/(\frac{b}{2} + m)$. Here c is the distance from the end of the deck house to the section under consideration.

Introducing the effectiveness factor we obtain:

$$\eta = \frac{A_s \eta_s - \kappa_e \kappa_E A_o \eta_o}{A_s + \kappa_e \kappa_E A_o} \quad (5.1a)$$

$$I = \kappa_e \kappa_E I_o + I_s + A'' (\eta_o + \eta_s)^2 \quad (5.2a)$$

where

$$A'' = \frac{\kappa_e \kappa_E A_o A_s}{\kappa_e \kappa_E A_o + A_s}$$

$$\sigma_{od} = -\kappa_E \frac{M}{I} \eta$$
$$\sigma_o = -\kappa_E \frac{M}{I} (\eta + \eta_o) \quad (5.3a)$$

$$S_o = \frac{\kappa_e \kappa_E A_o M}{I} (\eta + \eta_o) \quad (5.4a)$$

$$M_o = \kappa_e \kappa_E M \frac{I_o}{I}$$

Note that the factor $\kappa' = \kappa_E \cdot \kappa_e$ appears in all expressions except in (5.3a) which gives the stresses in the deck house where only κ_E leads to a reduction in stresses.

Example 5.1

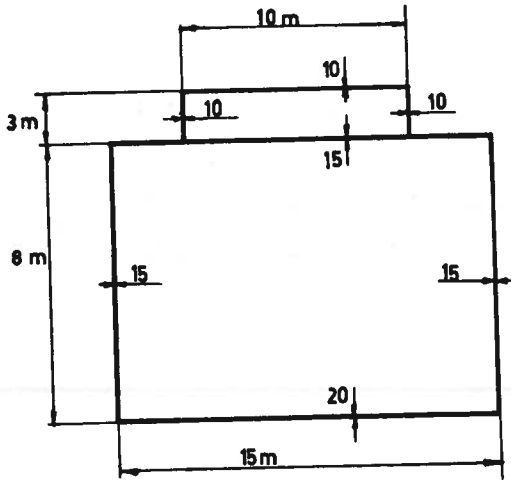


Fig. 5.8a

A simplified hull girder is shown in fig. 5.8a). The deck house is built of aluminum and covers the middle 40% of the length of the ship. Determine the stress distribution in the hull girder near the middle of the deck house subject to a hogging moment. This moment produces a stress of 995 kp/cm^2 in the strength deck if the effect of the deck house is neglected. $L = 120 \text{ m}$ and $\kappa_E = \frac{E_a}{E_s} = \frac{1}{3}$. It is assumed that the deck house rests on several bulkheads and therefore deflects with the hull girder. Plate thicknesses given in fig. 5.8a) are in mm.

a) Hull without deck house (fig. 5.8b).

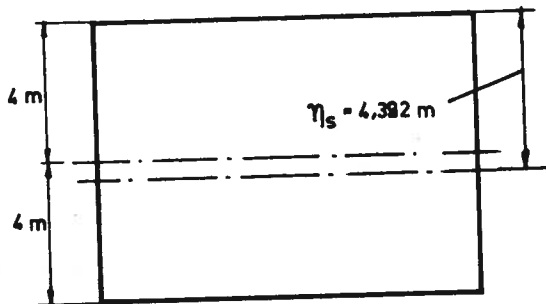


Fig. 5.8b

$$A_s = 2 \cdot 8 \cdot 0.015 + 15 \cdot 0.035 = 0.765 \text{ m}^2$$

$$\eta_s = 4.00 + \frac{4 \cdot 15 \cdot 0.005}{0.765} = \underline{4.392 \text{ m}}$$

$$\begin{aligned} I_s &= 2 \cdot \frac{1}{12} \cdot 0.015 \cdot 8^3 + 15 \cdot 0.035 \cdot 4^2 - \\ &\quad - 0.765 \cdot 0.392^2 \\ &= 1.28 + 8.40 - 0.12 = \underline{9.56 \text{ m}^4} \end{aligned}$$

$$z_{\text{deck}} = \frac{9.56}{4.392} = \underline{2.18 \text{ m}^3}$$

$$\text{Moment: } M = z_{\text{deck}} \cdot \sigma_{\text{deck}} = - 2.18 \cdot 10^6 \cdot 995 \text{ kp.cm} = \underline{-21700 \text{ tm}}$$

b) Deck house.



Fig. 5.8c

$$A_O = (10 + 2 \cdot 3) \cdot 0.01 = 0.16 \text{ m}^2$$

$$\eta_O = \frac{0.10 \cdot 3 + 0.06 \cdot 1.5}{0.16} = 2.44 \text{ m}$$

$$I_O = 2 \cdot \frac{1}{3} \cdot 0.01 \cdot 3^3 - 0.16 \cdot 0.56^2 = 0.13 \text{ m}^4$$

The effectiveness of the deck house is set equal to $\kappa_e = 0.9$. Thus

$$\kappa' = \kappa_e \cdot \kappa_E = 0.9 \cdot \frac{1}{3} = 0.3$$

$$A = \kappa' \cdot A_O + A_S = 0.3 \cdot 0.16 + 0.765 = 0.813 \text{ m}^2$$

$$\eta = \frac{A_S \eta_S - \kappa' A_O \eta_O}{A} = \frac{0.765 \cdot 4.392 - 0.048 \cdot 2.44}{0.813} = \underline{3.99 \text{ m}}$$

$$I = I_S + \kappa' I_O + \frac{\kappa' A_O A_S}{A} (\eta_O + \eta_S)^2$$

$$I = I_S + \kappa' I_O + A'' (\eta_O + \eta_S)^2$$

$$A'' = \frac{\kappa' A_O A_S}{\kappa' A_O + A_S} = \frac{0.048 \cdot 0.765}{0.813} = 0.045 \text{ m}^2$$

$$I = 9.56 + 0.3 \cdot 0.13 + 0.045 (4.392 + 2.44)^2$$

$$= 9.56 + 0.04 + 2.10 = \underline{11.70 \text{ m}^4}$$

Calculation of section moduli $z = \frac{I}{y}$:

		FORMULA	NUMERICAL VALUES	z
At top of the deck house:	z_{ot}	$\frac{I}{(\eta + 3.0)}$	$\frac{11.70}{6.99}$	1.68 m^3
At centroid of deck house:	z_o	$\frac{I}{(\eta + \eta_o)}$	$\frac{11.70}{6.43}$	1.82 m^3
At deck	z_{sd}	$\frac{I}{\eta}$	$\frac{11.70}{3.99}$	2.93 m^3
At bottom	z_{sb}	$\frac{I}{(D - \eta)}$	$\frac{11.70}{4.01}$	2.92 m^3

Calculation of stresses:

	Designation	Formula	Numerical Values	σ (kp/cm ²)
At top of deck house:	σ_{ot}	$\frac{\kappa_E M}{z_{ot}}$	$+\frac{1}{3} \frac{21700}{1.68}$	$+ 430 \text{ kp/cm}^2$
At centroid of deck house:	σ_o	$\frac{\kappa_E M}{z_o}$	$+\frac{1}{3} \frac{21700}{1.82}$	$+ 397 \text{ kp/cm}^2$
At deck (deck house):	σ_{od}	$\frac{\kappa_E M}{z_{od}}$	$+\frac{1}{3} \frac{21700}{2.93}$	$+ 247 \text{ kp/cm}^2$
At deck (hull girder):	σ_{sd}	$\frac{M}{z_{sd}}$	$+\frac{21700}{2.93}$	$+ 741 \text{ kp/cm}^2$
At bottom:	σ_{sb}	$\frac{M}{z_{sb}}$	$-\frac{21700}{2.92}$	$- 743 \text{ kp/cm}^2$

c) Total forces and moments in the deck house

$$S_o = -\kappa_e A_o \sigma_o = -0.16 \cdot 3970 \cdot 0.9 = -573 \text{ tons (tension)}$$

$$M_o = \kappa' \frac{I_o}{I} M = -0.3 \cdot \frac{0.130}{11.70} \cdot 21700 = \underline{-72.4 \text{ tm}}$$

d) The transfer of forces in the deck house to the hull girder at the ends of the deck house.

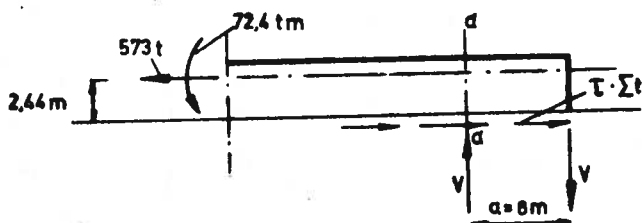


Fig. 5.8d

The deck house is resting on a bulkhead at the end and a second bulkhead is located 8 m from the end. See fig. 5.8d).

We then have

$$V = \frac{1}{8} (72.4 + 573 \cdot 2.44) = \underline{184 \text{ tons}}$$

This force would have been smaller if we had made a special calculation for section a-a of fig. 5.8d). Owing to the lower effectiveness of the deck house here the bending moment would have been lower than the one we have used above.

Assuming the shear stresses to be distributed linearly over a length equal to the width of the deck house, we obtain:

$$\tau_{\max} \cdot \Sigma t = \frac{2S_0}{b} = \frac{2 \cdot 573}{10} = \underline{114.6 \text{ t/m}}$$

Here b = width of deck house.

If there are two continuous longitudinal bulkheads in the deck house then the connection of each of the bulkheads to the main deck should be dimensioned for half of the shear force of 114.6 t/m. The maximum shear stress then becomes 573 kp/cm^2 .

5.3 Deck houses which deflect relative to the hull girder.

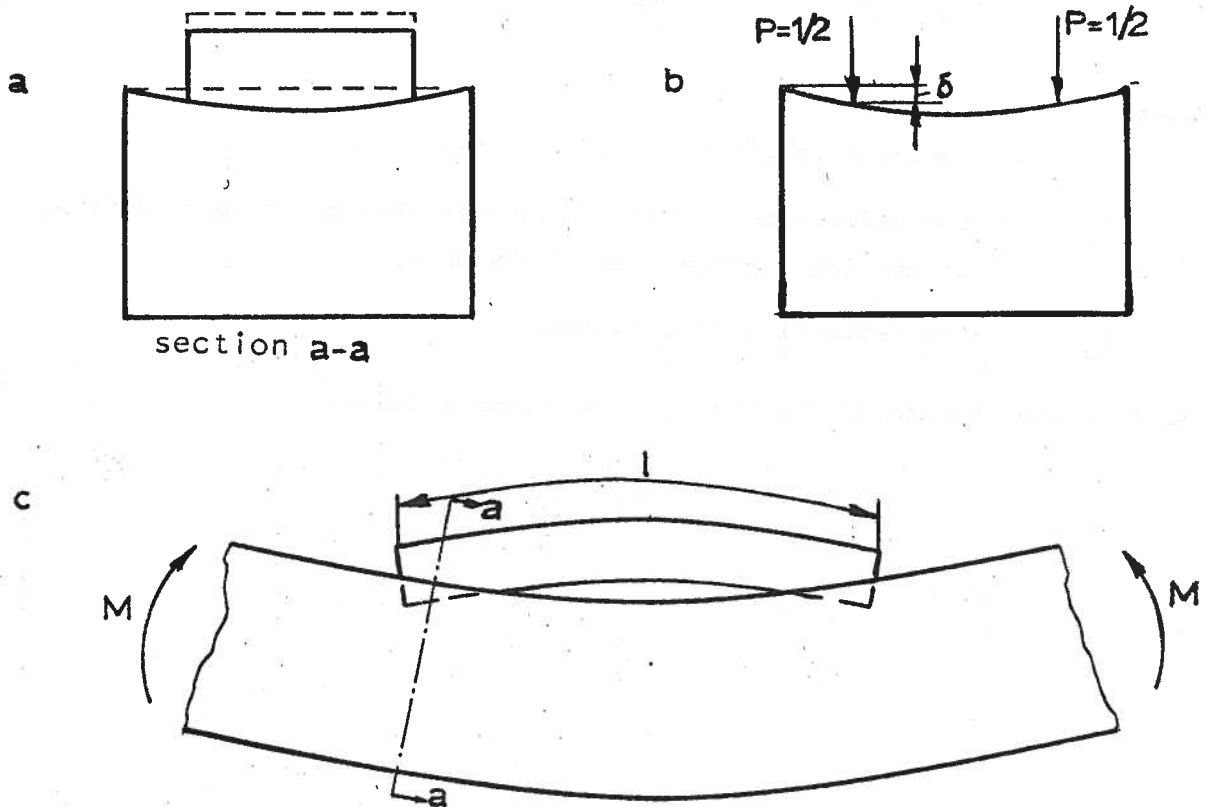


Fig. 5.9

Whenever the deck house rests on relatively flexible beams, or other structures of the strength deck, then the stresses and deflection of the house will be quite different from those calculated in fig. 5.9. We shall now consider this case. Again the treatment will be somewhat simplified. The reader is referred to the literature for a more exact treatment.

The deck house can here be considered as a beam on an elastic foundation. The stiffness of the foundation can be calculated as indicated in fig. 5.9b by replacing the deck house sides by a unit force equally divided between the sides. The deformation δ under this load is calculated in a usual manner for transverse frames and the stiffness (k) is set equal to $\frac{1}{\delta}$. The value of k gives the vertical force acting between deck house and hull girder whenever the relative deflection is equal to unity.

Treating the hull girder and the deck house separately let us consider an element of these of length dx (see fig. 5.10).

The relative vertical displacement between hull girder and house is

$$y_{rel} = y_s - y_o$$

where

y_{rel} = positive if the two elements move apart.

y_s = the deflection of the hull girder when no account is taken of the local deflection of the deck.

y_o = the deflection of deck house.

We then have the following vertical interaction force:

$$V \cdot dx = k (y_s - y_o) dx \quad (5.6)$$

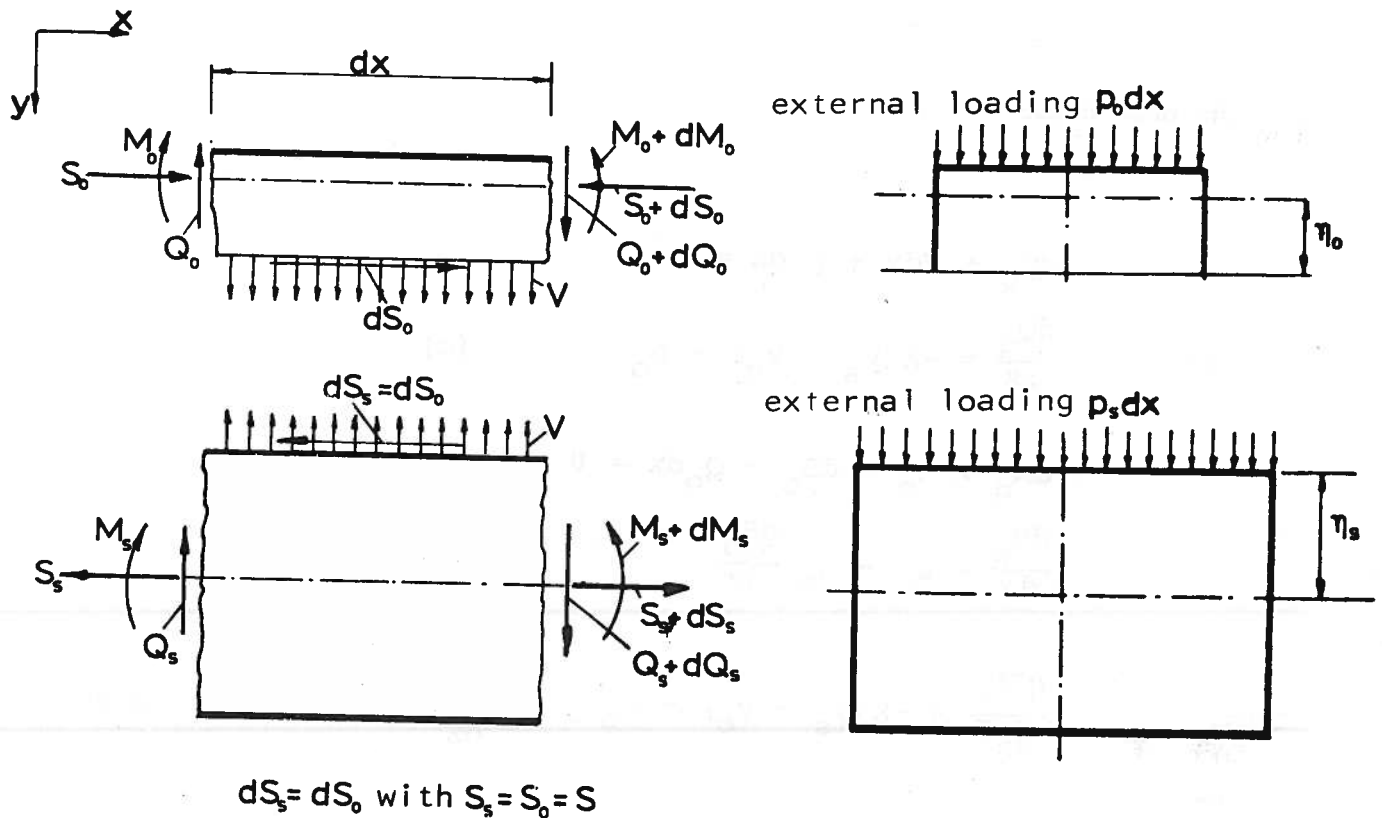


Fig. 5.10

The following equation of equilibrium can then be written:

For the hull girder:

$$dQ_s - V dx + p_s dx = 0$$

or

$$\frac{dQ_s}{dx} = k(y_s - y_o) - p_s \quad (a)$$

$$dM_s + dS_s \cdot \eta_s - Q_s dx = 0$$

or

$$\frac{dM_s}{dx} = Q_s - \eta_s \frac{dS_s}{dx} \quad (b)$$

Thus:

$$\frac{d^2 M_s}{dx^2} = k(y_s - y_o) - p_s - \eta_s \frac{d^2 S}{dx^2} \quad (5.7)$$

For the deck house:

$$dQ_o + Vdx + p_o dx = 0$$

$$\text{or } \frac{dQ_o}{dx} = -k(y_s - y_o) - p_o \quad (c)$$

$$dM_o + \eta_o \cdot dS_o - Q_o dx = 0$$

$$\text{or } \frac{dM_o}{dx} = Q_o - \eta_o \frac{dS_o}{dx} \quad (d)$$

$$\text{Thus: } \frac{d^2 M_o}{dx^2} = -k(y_s - y_o) - p_o - \eta_o \frac{d^2 S}{dx^2} \quad (5.8)$$

We shall now assume that the stress distribution is linear in both girder and house. The bending stresses along the connection between hull girder and deck house can then be calculated from the following equations:

$$\begin{aligned} \sigma_{sd} &= -\frac{M_s}{I_s} \eta_s + \frac{S_s}{A_s} \\ \sigma_{od} &= +\frac{M_o}{I_o} \eta_o - \frac{S_o}{A_o} \end{aligned} \quad (5.9)$$

where the index d is used to indicate that the stresses are referring to the strength deck.

The strains associated with these stresses are:

$$\begin{aligned} \epsilon_{sd} &= \frac{\sigma_{sd}}{E_s} = \frac{1}{E_s} \left(-\frac{M_s}{I_s} \eta_s + \frac{S_s}{A_s} \right) \\ \epsilon_{od} &= \frac{\sigma_{od}}{E_o} = \frac{1}{E_o} \left(\frac{M_o}{I_o} \eta_o - \frac{S_o}{A_o} \right) \end{aligned} \quad (5.10)$$

Deck house and hull girder must have the same strain where they are joined unless slippage is introduced, as was done by Caldwell¹⁾.

In other words, we set:

$$\epsilon_{sd} = \epsilon_{od} \quad (5.11)$$

which after some arithmetic becomes:

$$\frac{S}{A'} = \frac{M_s}{I_s} \eta_s + \frac{1}{\kappa_E} \frac{M_o}{I_o} \eta_o \quad (5.12)$$

where

$$A' = \frac{\frac{E_o}{E_s} A_o A_s}{\frac{E_o}{E_s} A_o + A_s} = \frac{\kappa_E A_o A_s}{\kappa_E A_o + A_s} \quad (5.13)$$

Differentiating (5.12) twice with respect to x and substituting in (5.7) and (5.8) where we also use

$$\begin{aligned} M_s &= -E_s I_s \frac{d^2 y_s}{dx^2} \\ M_o &= -E_o I_o \frac{d^2 y_o}{dx^2} \end{aligned} \quad (5.14)$$

we obtain the following simultaneous differential equations for the solution of the problem:

$$\begin{aligned} (I_s + A' \cdot \eta_s) \frac{d^4 y_s}{dx^4} + \frac{k}{E_s} (y_s - y_o) + A' \eta_o \eta_s \frac{d^4 y_o}{dx^4} - \frac{p_s}{E_s} &= 0 \\ \eta_o \eta_s A' \frac{d^4 y_s}{dx^4} - \frac{k}{E_s} (y_s - y_o) + (\kappa_E I_o + \eta_o^2 A') \frac{d^4 y_o}{dx^4} - \frac{p_o}{E_s} &= 0 \end{aligned} \quad (5.15)$$

1) Caldwell, J.B.: "The Effect of Superstructures on the Longitudinal Strength of Ships," TINA, Vol. 99, pp. 664-689, 1957.

A method of solution of (5.15) is given by Chapman¹⁾. Approximate deformations and stresses can be determined along the deck house except for the region of the ends. The assumption that the stress distribution is linear is not even approximately true there. Shear-lag near the middle of long deck houses can be accounted for by the introduction of $\kappa' = \kappa_e \cdot \kappa_E$ in the equations above in a similar manner as followed in the previous section.

A couple of special cases can be treated in a simple manner. From fig. 5.10 we note that

$$M = M_s + M_o + S(\eta_o + \eta_s) \quad (5.16)$$

where

$M =$ the externally applied moment.

Substituting S from (5.12) we obtain:

(5.17)

$$M = \frac{M_s}{I_s} (I_s + \eta_s(\eta_o + \eta_s)A') + \frac{M_o}{\kappa_E I_o} (\kappa_E I_o + \eta_o(\eta_o + \eta_s)A')$$

1st. Special Case

Let us assume that the deck house remains straight during the deformation of the hull girder caused by an external moment M . Then

$$\frac{d^2 y_o}{dx^2} = -\frac{M_o}{E_o I_o} = 0 \quad \text{in other words } M_o = 0$$

From 5.17 we then get:

$$M_s = \frac{I_s}{I_s + \eta_s(\eta_o + \eta_s)A'} \cdot M = \frac{I_s}{I'} M \quad (5.18)$$

where

$$I' = I_s + \eta_s(\eta_o + \eta_s)A'$$

1) Chapman, J.C.: "The Interaction Between a Ship's Hull Girder and a Long Superstructure," TINA, Vol. 99, pp. 618-633, 1957.

Similarly from (5.12)

$$S = \frac{M_S \eta_S}{I_S} \cdot A' = \frac{M \eta_S}{I'} A' \quad (5.19)$$

In all derivations above $\kappa' = \kappa_e \cdot \kappa_E$ is substituted for κ_E whenever the factor of effectiveness κ_e is less than 1.0.

Example 5.2:

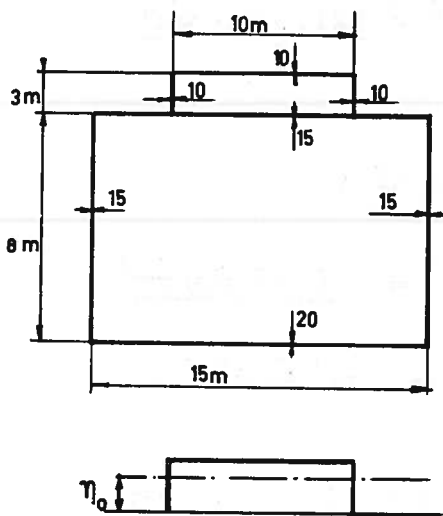


Fig. 5.11

The hull girder is the same as in example 5.1, but here the deck house is assumed to remain straight, see fig. 5.1

Assume $\kappa' = \kappa_e \cdot \kappa_E = 0.3$

Hull girder:

From example above:

$$A_S = 0.765 \text{ m}^2 \quad , \quad A_O = 0.16 \text{ m}^2$$

$$\eta_S = 4.392 \text{ m} \quad , \quad \eta_O = 2.44 \text{ m}$$

$$I_S = 9.56 \text{ m}^4 \quad , \quad I_O = 0.13 \text{ m}^4$$

$$A' = 0.045 \text{ m}^2$$

$$I' = I_S + \eta_S (\eta_O + \eta_S) A' = 9.56 + 4.392 (4.392 + 2.44) \cdot 0.045 = \underline{10.91 \text{ m}^4}$$

$M = -21700 \text{ tm}$ (hogging) and by (5.18) and (5.19)

$$M_S = \frac{I_S}{I'} M = -\frac{9.56}{10.91} \cdot 21700 = \underline{-19000 \text{ tm}}$$

$$S = \frac{\eta_S A'}{I'} M = -\frac{4.392 \cdot 0.045}{10.91} \cdot 21700 = \underline{-394 \text{ tons}}$$

Stresses:

In hull girder:

at deck

$$\begin{aligned}\sigma_{sd} &= +\frac{S}{A_s} - \frac{M \eta_s}{I_s} \\ \sigma_{sd} &= -\frac{394}{0.765} + \frac{19000}{9.56} \cdot 4.392 \\ &= -521 + 8740 = +8219 \text{ t/m}^2 = \underline{821.9 \text{ kp/cm}^2}\end{aligned}$$

at bottom

$$\begin{aligned}\sigma_{sb} &= -\frac{394}{0.756} - \frac{19000}{9.56} (8.00 - 4.392) \\ &= -521 - 7170 = -7691 \text{ t/m}^2 = \underline{-769.1 \text{ kp/cm}^2}\end{aligned}$$

Stresses in the deck house are in this case constant. The numerical value is:

$$\sigma_o = -\frac{S}{\kappa_e \cdot A_o} = +\frac{394}{0.9 \cdot 0.16} = +2730 \text{ t/m}^2 = 273.0 \text{ kp/cm}^2$$

Check:

We must furthermore have that

$$\sigma_o = \kappa_E \cdot \sigma_{sd} = \frac{1}{3} \cdot 821.9 = \underline{274 \text{ kp/cm}^2}$$

2nd. Special Case

Let us assume that the spring constant of the deck k can be set equal to zero, i.e., the deck is very flexible. The vertical forces V are then equal to zero and make no contribution to the bending moment in the deck house. We must then have that

$$M_o = -S \cdot \eta_o \quad (5.20)$$

which together with (5.16) gives:

$$M = M_s + S \cdot \eta_s \quad (5.21)$$

From (5.12)

$$S = \frac{\eta_s A'}{I_s (1 + \frac{A' \eta_o^2}{k' I_o})} M_s = \frac{\beta}{\eta_s} M_s \quad (5.22)$$

Substituting in (5.21) and solving for M_s we obtain:

$$\begin{aligned} M &= M_s (1 + \beta) \\ M_s &= \frac{M}{1 + \beta} \\ S &= \frac{\beta}{1 + \beta} \frac{M}{\eta_s} \end{aligned} \quad (5.23)$$

where

$$\beta = \frac{\eta_s^2 A'}{I_s (1 + \frac{A' \eta_o^2}{k' I_o})} \quad (5.24)$$

Example 5.3

Let us examine the same hull that we analyzed in the first special case under the assumption that $k = 0$. From (5.24) we have that

$$\beta = \frac{(4.392)^2 \cdot 0.045}{9.56 (1 + \frac{0.045 \cdot 2.44^2}{0.3 \cdot 0.13})} = \frac{0.8681}{9.56 \cdot 7.87} = \underline{0.0115}$$

From (5.23)

$$M_s = \frac{-21700}{1.0115} = \underline{-21500 \text{ tm}}$$

$$S = \frac{0.0115}{4.392} \cdot 21500 = \underline{-56.3 \text{ tons}}$$

Thus by (5.20)

$$M_o = -S \eta_o = +56.3 \cdot 2.44 = \underline{+137.2 \text{ tm}}$$

Stresses:

In the hull girder:

at the deck:

$$\begin{aligned} \sigma_{sd} &= \frac{S}{A_s} - \frac{M_s}{I_s} \eta_s = \frac{56.3}{0.756} + \frac{21500}{9.56} \cdot 4.392 \\ &= -75 + 9875 = +9800 \text{ t/m}^2 = \underline{+980.0 \text{ kp/cm}^2} \end{aligned}$$

at the bottom:

$$\begin{aligned} \sigma_{sb} &= -75 - 9875 \cdot \frac{3.608}{4.392} = -75 - 8115 \\ &= 8190 \text{ t/m}^2 = \underline{-819.0 \text{ kp/cm}^2} \end{aligned}$$

In the deck house:

at the deck:

$$\begin{aligned} \sigma_{od} &= -\frac{S}{\kappa_e A_o} + \frac{M_o}{\kappa_e I_o} \eta_o = +\frac{56.3}{0.9 \cdot 0.16} + \frac{137.2}{0.9 \cdot 0.13} \cdot 2.44 \\ &= +391 + 2865 = +3256 \text{ t/m}^2 = \underline{+325.6 \text{ kp/cm}^2} \end{aligned}$$

at the top of the house:

$$\begin{aligned}\sigma_{ot} &= +391 - 2865 \frac{3.0 - 2.44}{2.44} = \\ &= +391 - 656 = -265 \text{ t/m} = \underline{\underline{-26.5 \text{ kp/cm}^2}}\end{aligned}$$

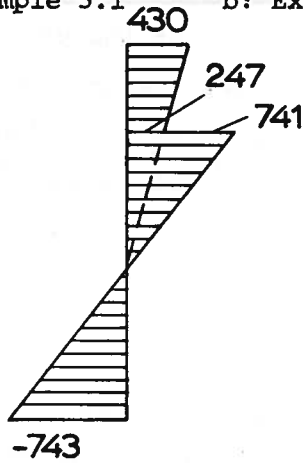
Check:

At the deck:

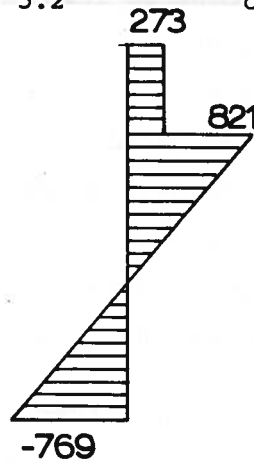
$$\sigma_{od} = \kappa_E \cdot \sigma_{sd} = \frac{1}{3} \cdot 980.0 = \underline{\underline{326.7 \text{ kp/cm}^2}}$$

Concluding remarks about deck houses.

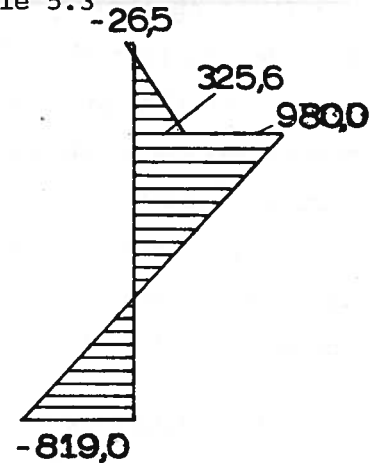
a: Example 5.1



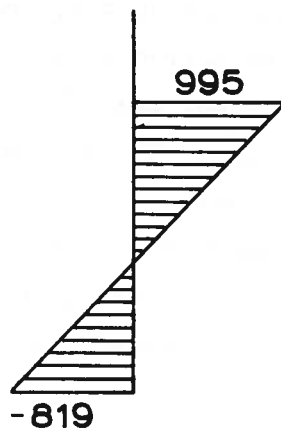
b: Example 5.2



c: Example 5.3



d: HULL GIRDER WITHOUT DECKHOUSE



unit of stress: kp/cm^2

Diagrams of stress distributions of examples 5.1, 5.2, and 5.3

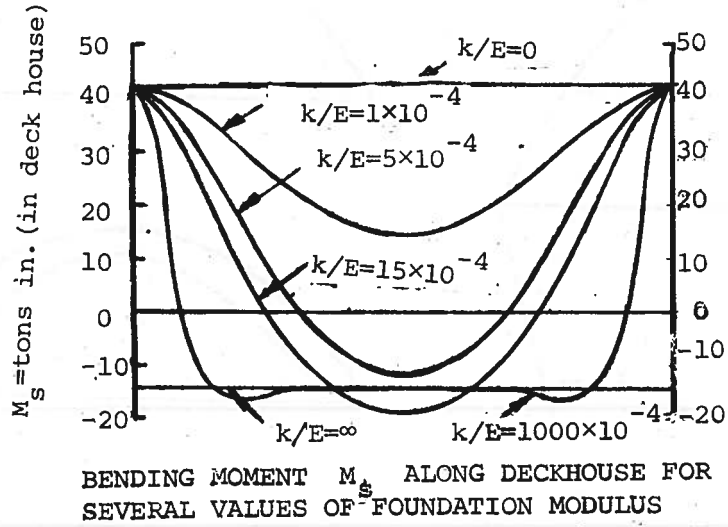
We note from the diagrams on previous page that deck houses that are stiffly connected to the hull girder can reduce considerably the stresses in the hull girder, cfr., diagrams a) and b). When the connection is very flexible, the deck house will, on the other hand, contribute very little towards the total strength of the structure, cfr., diagram c) and d).

A deck house free from stresses is often preferable because we can then design for local strength. At the same time we do not have to give much concern to the problem of transfer of forces between deck house and hull girder.

Experimental and Calculated Results.

It is appropriate at this point to review the literature on the subject in order to provide a better background for an evaluation of the problem as well as design data. Figure 5.12 (Chapman 1961) shows how the bending moment varies along the length of the deck house for several values of the spring constant κ . The ship is here assumed to be without bulkheads and a constant moment acts within the length of the deck house. The curves are calculated from theory which does not provide accurate results near the ends of the deck house for very stiff deck beams.

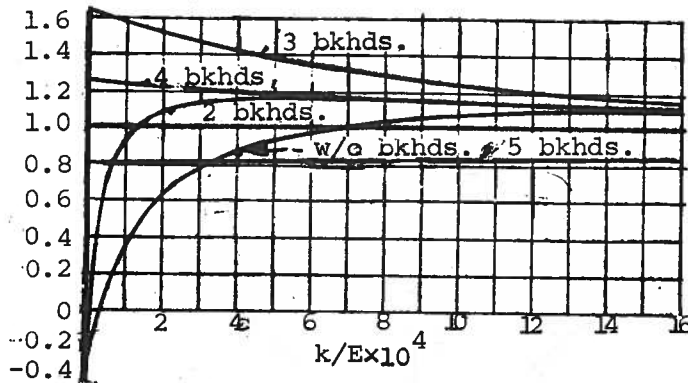
If the ship is fitted with a large number of bulkheads under the deck house, then the action of the deck house is radically different, as mentioned earlier. Figure 5.13 shows the ratios of bending stresses at the top of the deck house, to the bending stress for a fully effective cross-section, including deck house, when the number of bulkheads is changed. Each curve is a function of the spring constant. The influence of the number of bulkheads is small when the spring constant is large. Note that the maximum stress is in many cases larger than that given by the elementary theory of fully effective cross-section. The maximum stress may not occur at the mid-length of the deck house, however. In the case of 5 bulkheads, for instance, the maximum stress occurs at about 30% of the length from the end. The curve of relative displacements of hull girder and deck house is shown in fig. 5.14 for 0 - 5 bulkheads; curves are shown for the spring constant



Box girder without bulkheads. App. moment 1,460 tons in.

Fig. 5.12

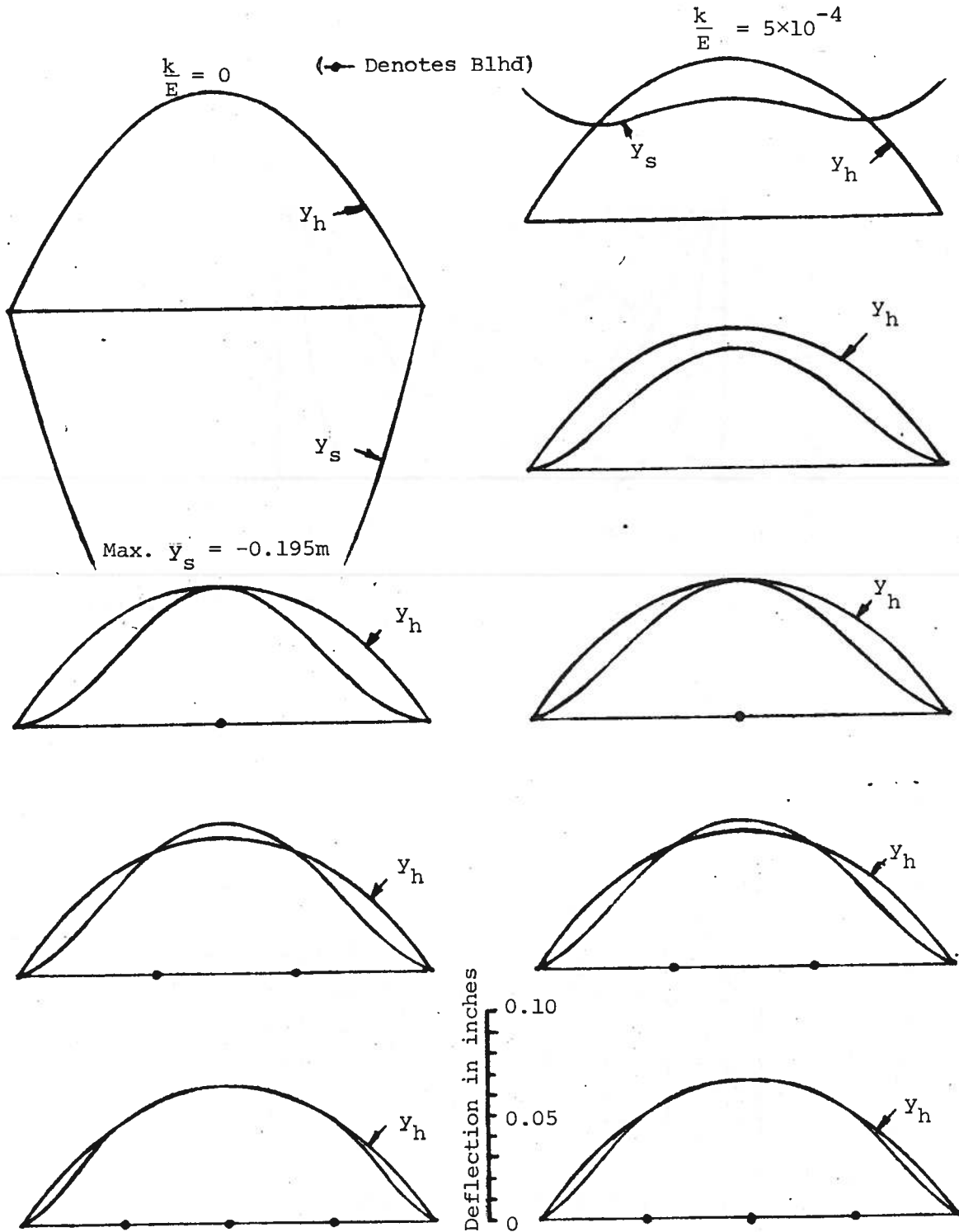
Stress at top of superstruc. of cent. sec.
Simple bending stress at top of superstruc.



VARIATION OF DECKHOUSE STRESS AT $l/2$ WITH FOUNDATION MODULUS

Constant applied bending moment.

Fig. 5.13



Hull and Superstructure Deflections (y_h and y_s) for Five Arrangements of Bulkheads. (Constant $M = 1,460$ in. tons)

Fig. 5.14

equal to zero and 5×10^{-4} (tons/in). Figure 5.15 gives relative deflections at the middle of the deck house for some values of the spring constant.

The reaction forces between deck house and bulkheads will obviously depend upon the spring constant of the deck beams, and fig. 5.16 shows how these forces vary for 3,4, and 5 bulkheads over the length of the deck house.

All the examples referred to above represent a constant bending moment over the length of the deck house. Deviations from this will influence the results. Thus we find that a reduction in bending moment towards the ends of the deck house will reduce the relative displacements there, and the stresses in the deck house will approach the values given by the elementary theory.

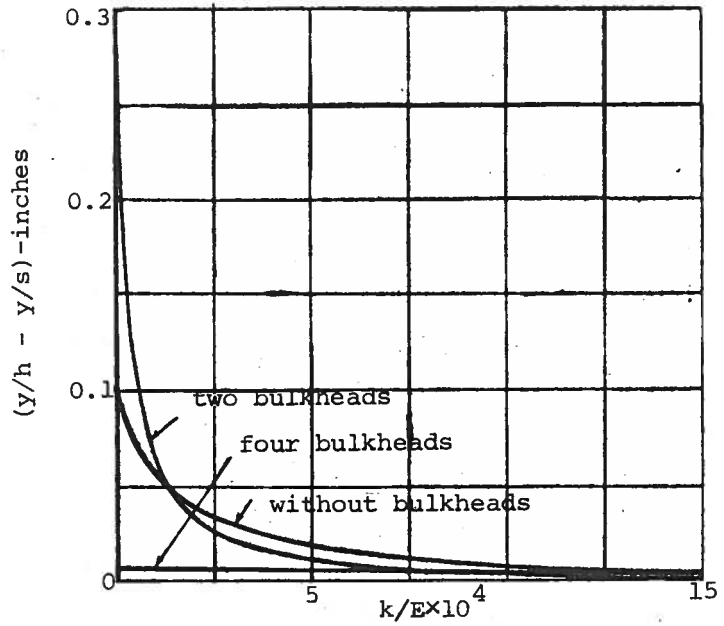
5.4 The Effects of Openings in the Sides of Superstructure or Deck Houses of Corrugated Deck, House Sides, and of Expansion Joints.

The treatment of the superstructure and deck house given above was based on the assumption that the shear stresses in the sides of these structures that occur as a result of the normal stresses in their decks could be absorbed without any difficulties. It will be frequently desirable, however, to cut out large openings in the deck house or superstructure and the transfer of shear stresses will then in many cases be impaired. We may for instance, imagine that the side is replaced by vertical columns. Fig. 5.17 shows how the effectiveness of the deck above is then reduced (Muckle, 1962). If we wish to obtain a high efficiency of the deck then it becomes necessary to make the column very wide (more than 1 m). Tests performed by K. Terazawa¹⁾ illustrates this well, as shown in fig. 5.18. Fig. 5.19 shows that full scale measurements are in good agreement with the theory.

If the sides of the deck house is built from corrugated plates we find that a reduction in the effectiveness of transferring stresses from the hull girder to the deck house top has also in this case taken place. K. Terazawa

1) K. Terazawa: "Stress Distribution in Deckhouse and Superstructure". The Society of Naval Architects of Japan, 1964.

Fig. 5.15



Variation with Foundation Modulus of Relative Deflection ($y_h - y_s$) at center Section of Box Girder.

Applied moment 1,460 tons in.

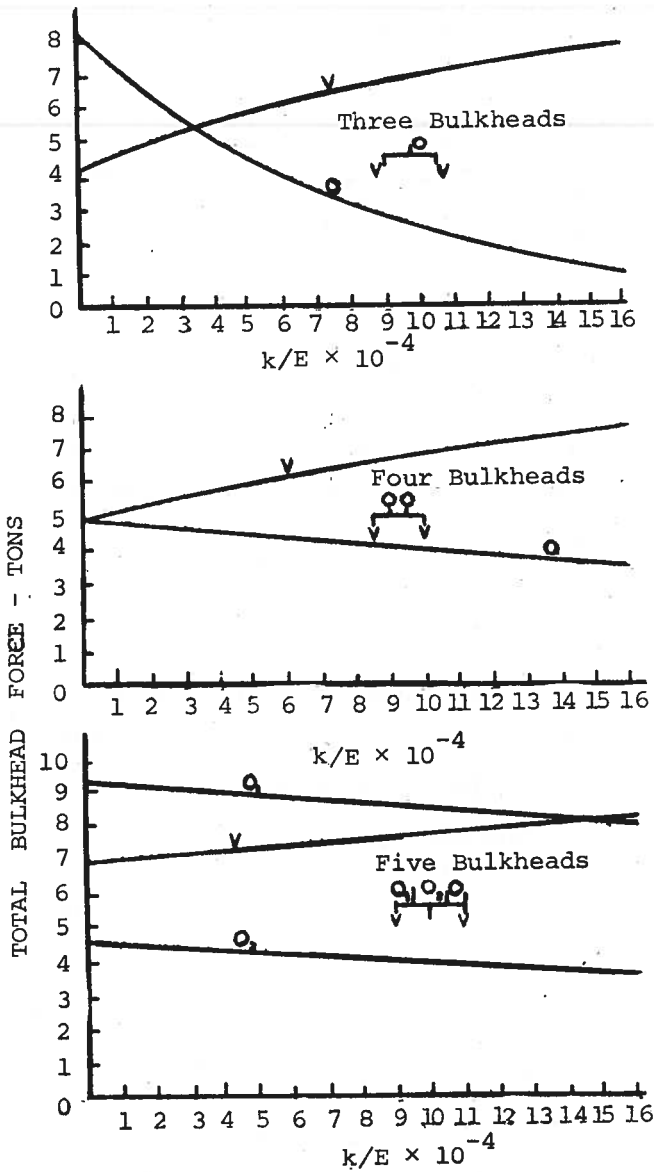


Fig. 5.16

Variation in Bulkhead Force With Foundation Modulus

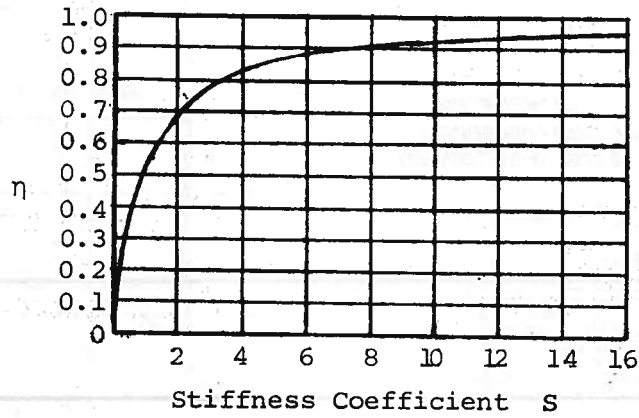


Fig. 5.17

$$\text{Superstructure efficiency} = \frac{\text{Load carried by deck}}{\text{Load carried by deck with rigid verticals}}$$

$$S = \frac{E_{\eta} I_{\eta}}{k h^3} \times 10^{-4}$$

where

E_{η} = Young's modulus for verticals (tons per sq. in.)

I_{η} = Moment of inertia of verticals (in.⁴)

h = Length of verticals (ft.)

k = Coefficient depending upon fixity of verticals and ratio of shear to bending deflection.

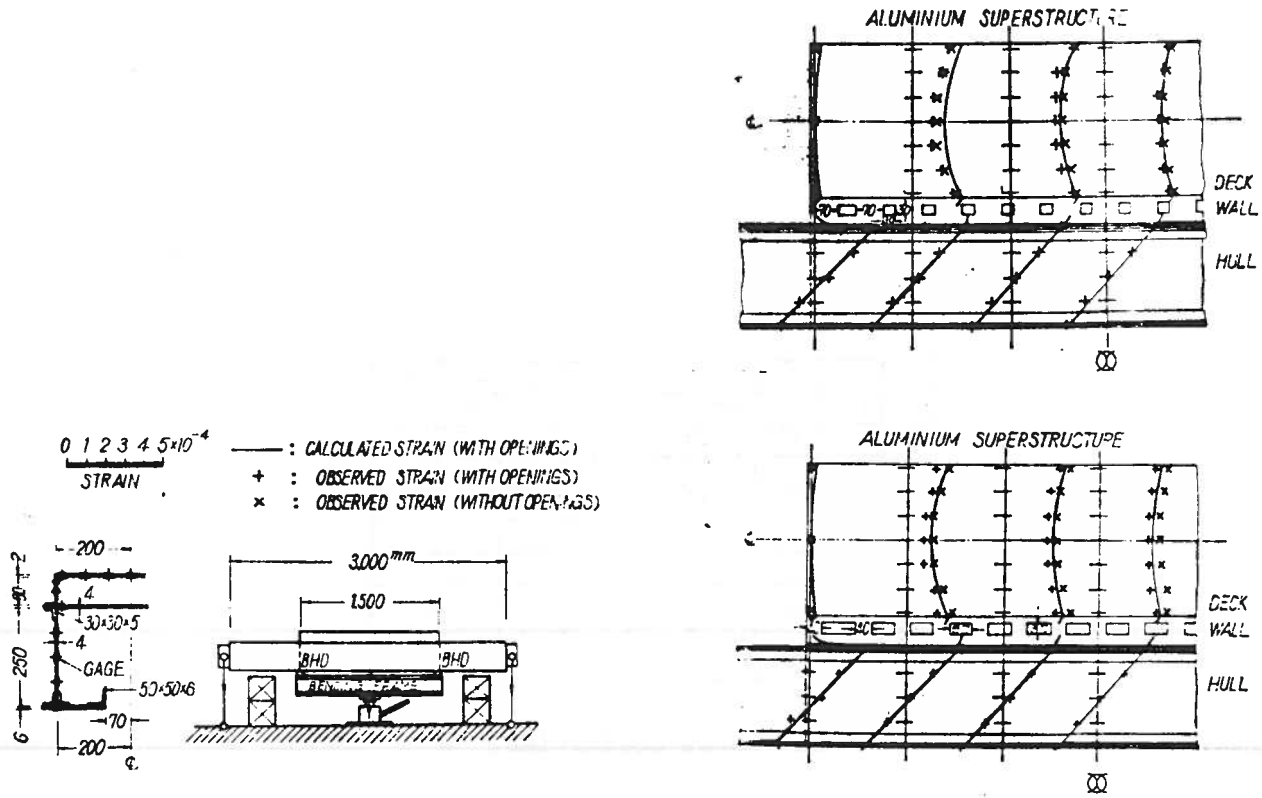


Fig. 5.18

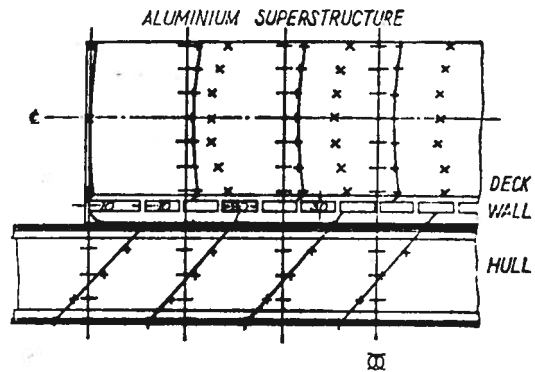
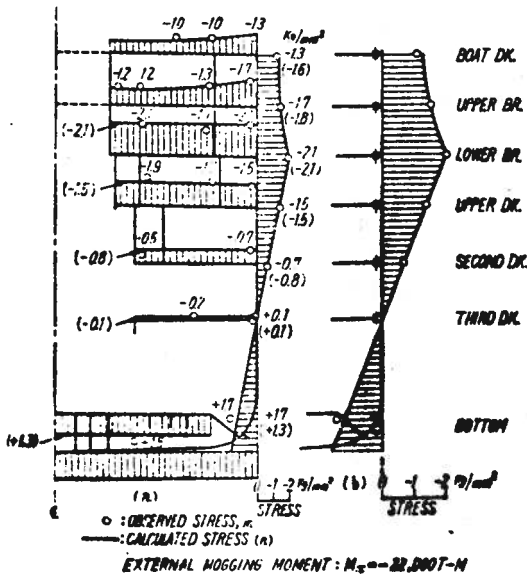


Fig. 5.19 Longitudinal Stress Distribution Obtained by the Theory and the Experiment.

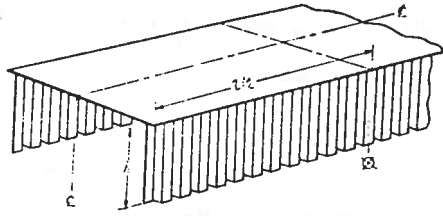


has investigated such designs as well, and fig. 5.20 shows an example of vertical corrugation. The house is here flush with the ship's side and the house is therefore forced to follow the deflection curve of the hull, but the ability of the sides of the deck house to transfer longitudinal forces is very much reduced. Fig. 5.21 shows the stress distribution for the case of horizontal corrugations and vertical stays. In the upper part of the figure it is shown that all stays have been cut away around the corrugations, and neither are they connected to the hull girder. We note that in this case there is a great reduction in the effectiveness of the deck house since it is no longer forced to follow the deflection curve of the hull.

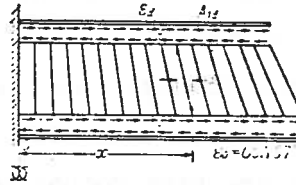
A certain interest exists in building deck houses with corrugated plates in the sides. The spacing between the "depression" in the plating is normally so large, however, that the stiffness of the remaining flat portions of the plating contribute considerably more towards the transfer of forces than indicated by the examples referred to above.

For large passenger ships it has become quite common to use expansion joints in some of the decks topside to reduce the stresses in these. In this way, they can be built lighter without any danger of buckling. Fig. 5.22 shows the effect of a simple expansion joint in the two uppermost decks of a large passenger ship. Clearly, the stresses are considerably reduced in the bridge deck, whereas in the deck below (sun deck) no significant reduction is realized some distance away from the expansion joint. As is apparent from one of the examples of fig. 5.28, it is possible to realize an effective unloading by the use of several expansion joints spaced not too far apart. Problems of a practical nature present themselves, however. These are related to water tightness, possibility of noise, and last, but not least, the presence of stress concentration at the ends of the expansion joints. The expansion joints have in practice led to the formation of cracks even when careful attempts have been made to incorporate details at the ends such as the Japanese tail (fig. 5.23) or the anchor form (fig. 5.24)¹⁾.

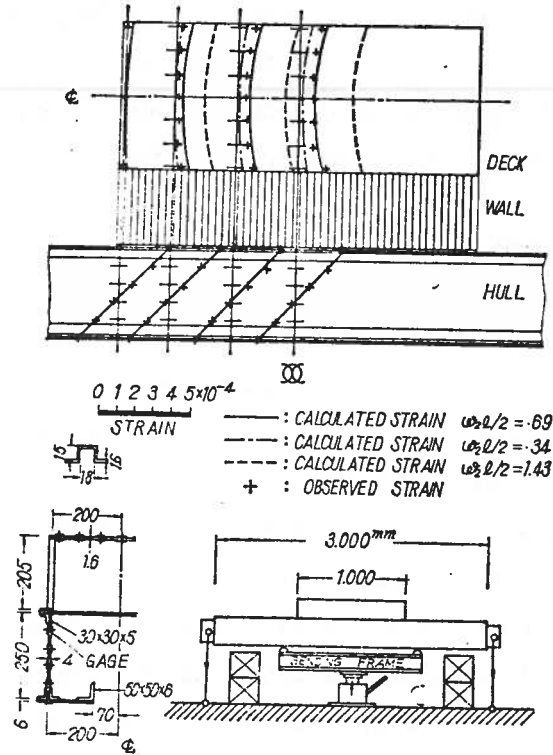
1) These figures are taken from BSRA - Report No. R401, 1962, by Bell.



SUPERSTRUCTURE OF HORIZONTALLY CORRUGATED PLATES

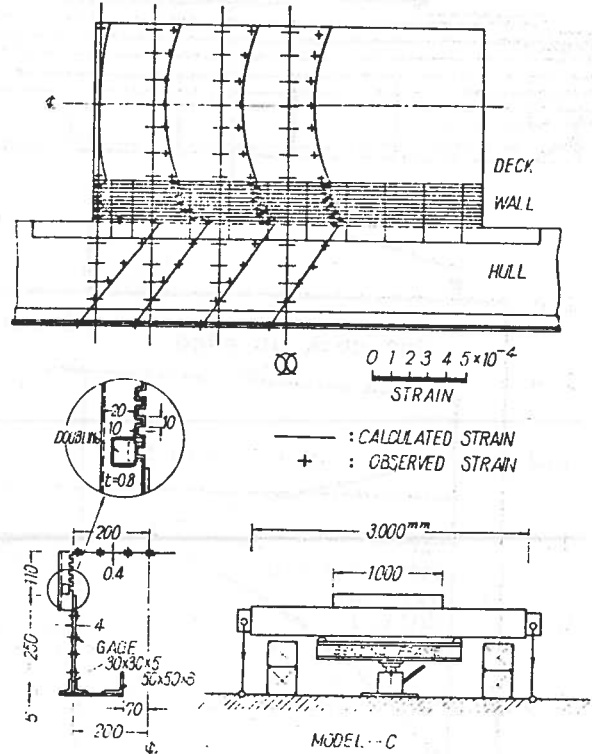
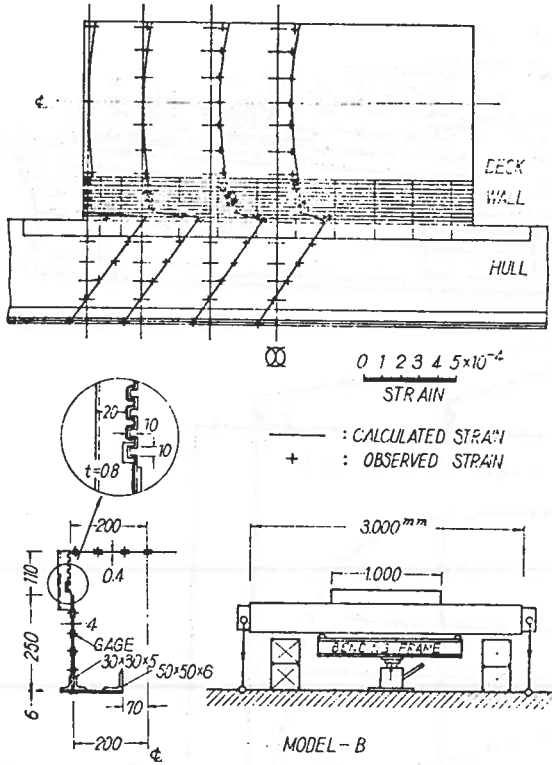


DEFORMATION OF THE SIDE WALL UNDER THE SHEARING ACTION

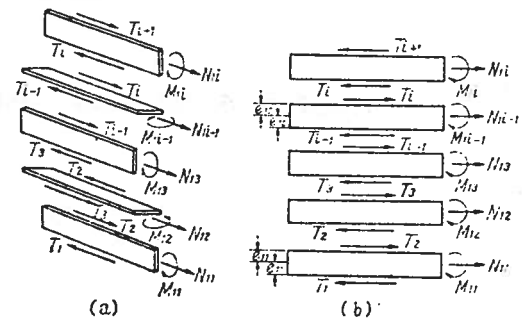
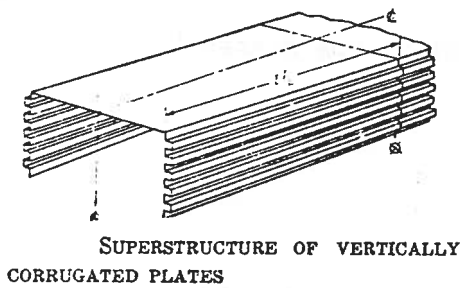


THEORETICAL AND EXPERIMENTAL RESULTS OF THE SUPERSTRUCTURE TYPE MODEL SUBJECTED TO A UNIFORM BENDING MOMENT (SIDE WALLS BEING CONSTRUCTED WITH HORIZONTALLY CORRUGATED PLATES)

Fig. 5.20

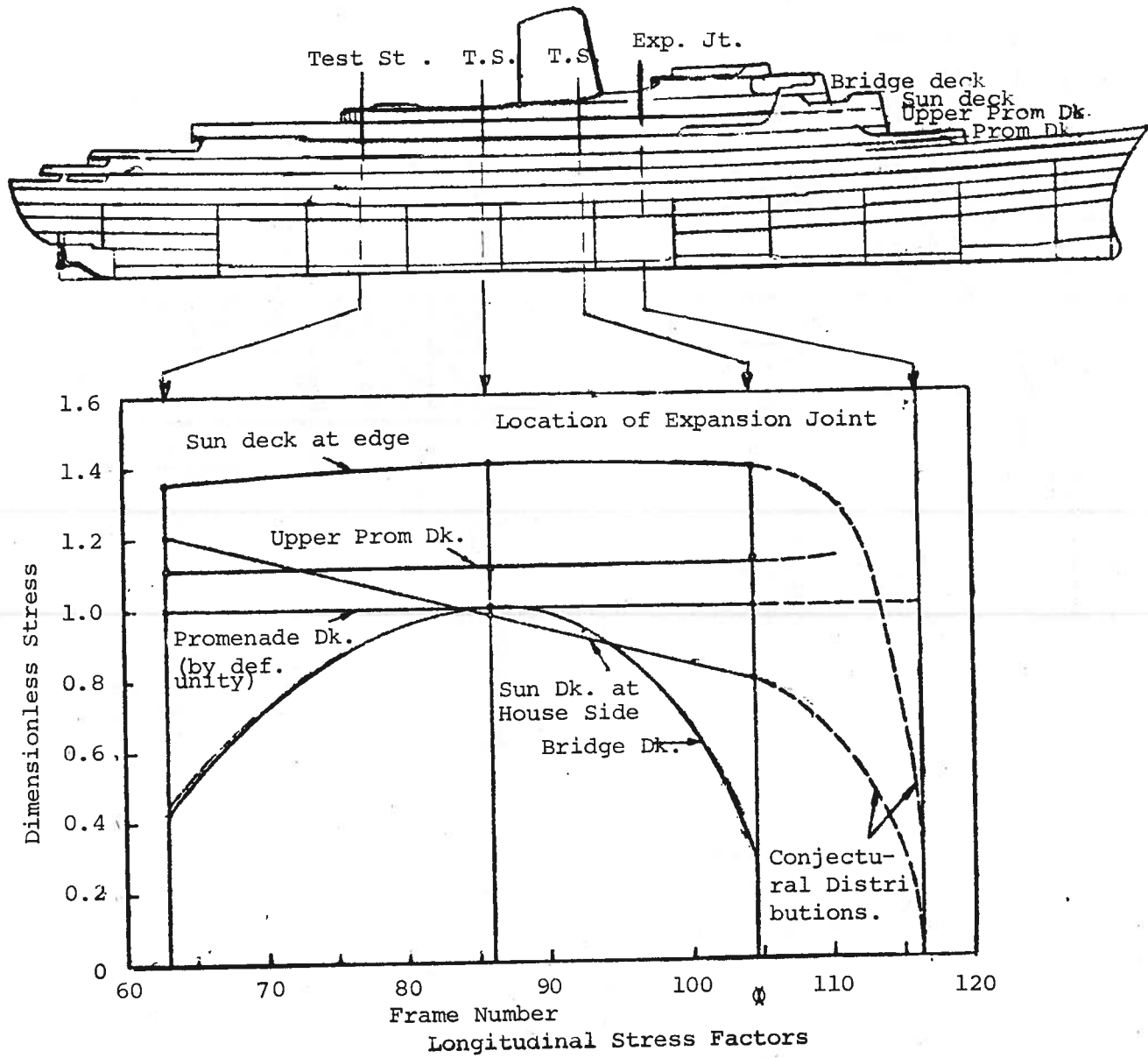


THEORETICAL AND EXPERIMENTAL RESULTS OF THE SUPERSTRUCTURE TYPE MODEL SUBJECTED TO A UNIFORM BENDING MOMENT (SIDE WALLS BEING CONSTRUCTED WITH VERTICALLY CORRUGATED PLATES WITH STIFFENERS)



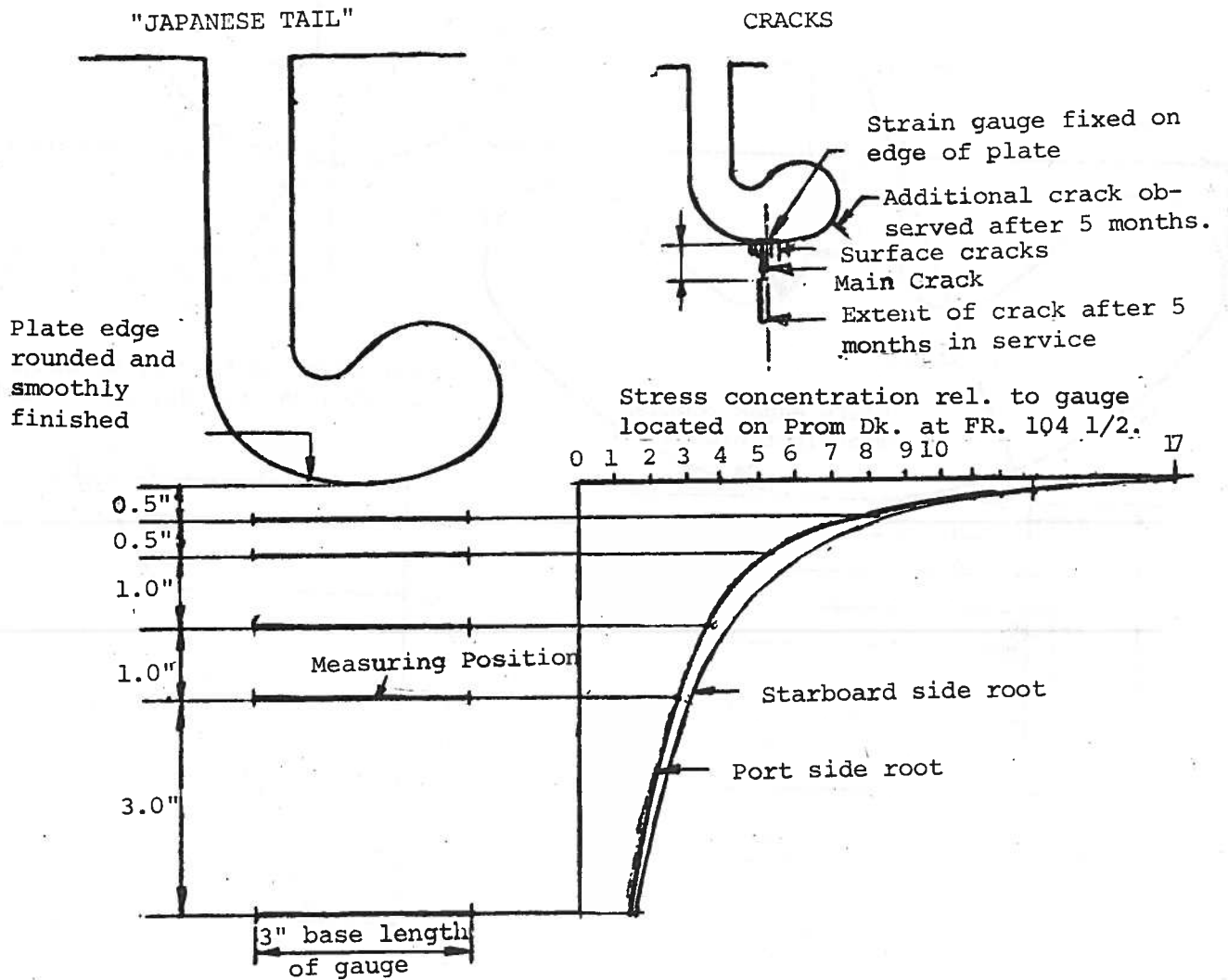
FORCES AND MOMENTS ACTING ON EACH ELEMENT OF THE CORRUGATED PLATE

Fig. 5.21



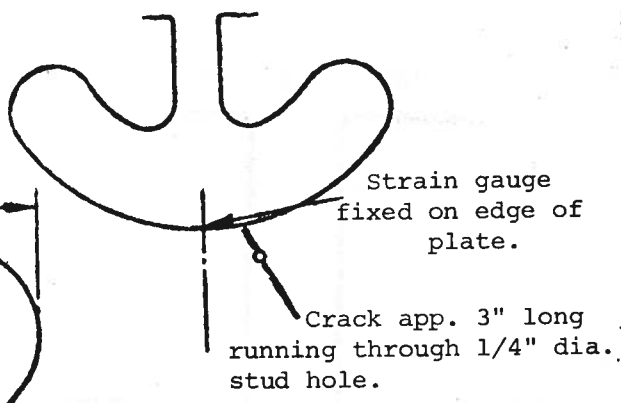
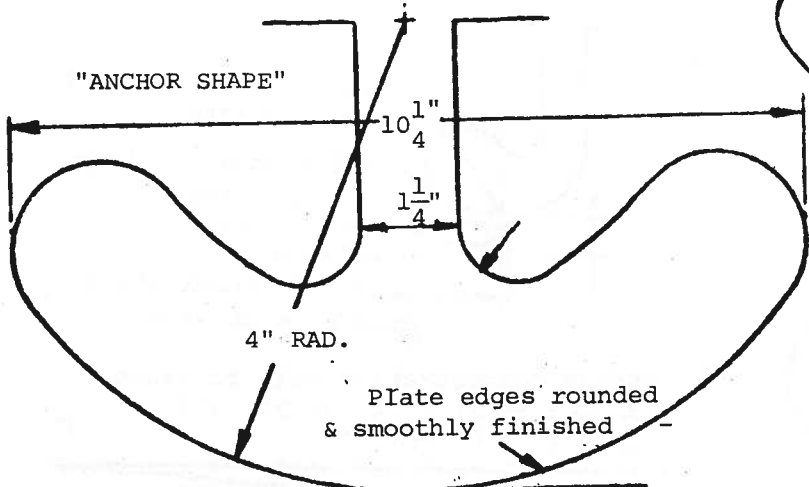
EFFECTS OF THE FIRST EXPANSION JOINT ON THE STRESSES

Fig. 5.22

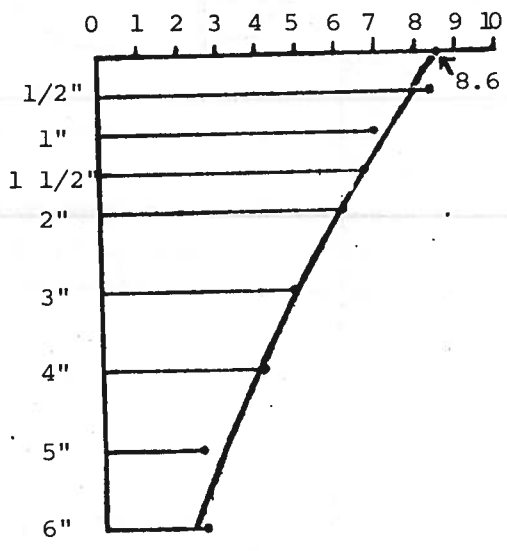
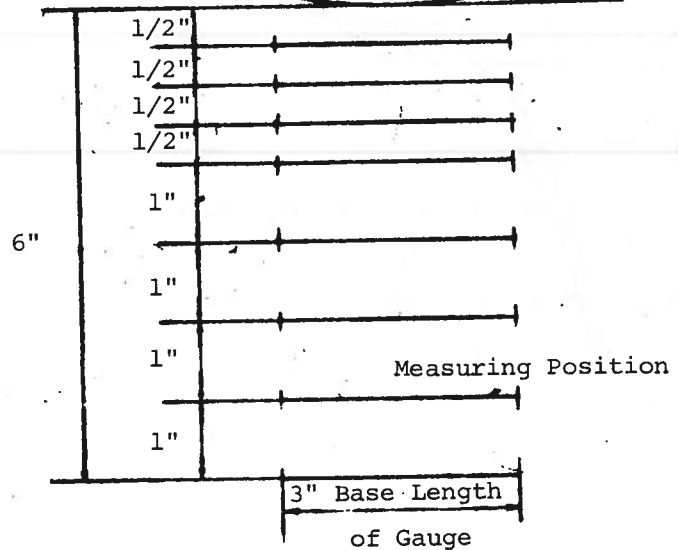


STRESS CONCENTRATIONS AT ROOTS OF EXPANSION JOINT. JAPANESE TAIL.

Fig. 5.23



Stress concentr. rel. to gauge located on prom dk. at FR. $104 \frac{1}{2}$



Stress Concentrations at Root of Expansion Joint. Anchor-Shape Cut Out.

Fig. 5.24

It is of course impossible to avoid completely any stress concentration at the root of such an artificial "crack". Fig. 5.25 shows the theoretical values of the stress concentration factor for various radii at the bottom of the incision as a function of its depth. Evidently very large radii must be used if the value of the factor of stress concentration is to be less than 3, a reasonable aim. Figure 5.26 gives the results of some photoelastic tests performed for the BSRA¹⁾. The same source shows the results of a test with a steel model where the deck house was forced to follow the deflection of the hull girder. These indicate that for a special shape of the anchor form, it has been possible to reach a stress concentration factor as low as 3.

In conclusion we have included fig. 5.28 which gives a summary of full scale measurements of strains and relative deflections obtained from a number of ships²⁾. It may be said that the problems associated with expansion joints are of such a scope that it is tempting to design the superstructures and deck houses as continuous structures, so that they work together with the hull girder as an integral whole. For long structures, this approach will undoubtedly be the most economical.

5.5 Structural Details Associated with Superstructures and Deck Houses.

The transition of the cross-section at the end of the deck house demands special attention so that high stress concentration can be avoided. The sideplates of the superstructure should be shaped as indicated in fig. 5.29.

1) J.C. Chapman: "A new stress-relieving device for super structure expansion joints". BSRA - Report No. 74, 1964.

2) A.J. Johnson and J.C. Chapman: "The Structural Behaviour of Deck Houses and Superstructures". BSRA Report No. 387, 1962.

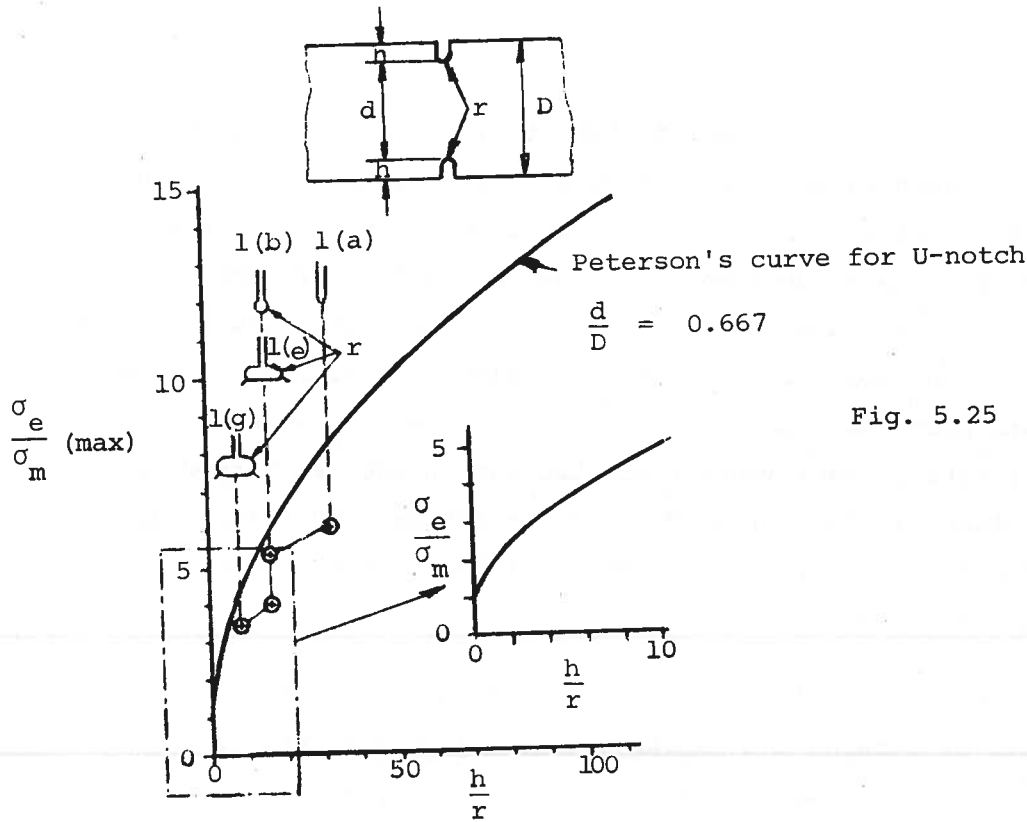
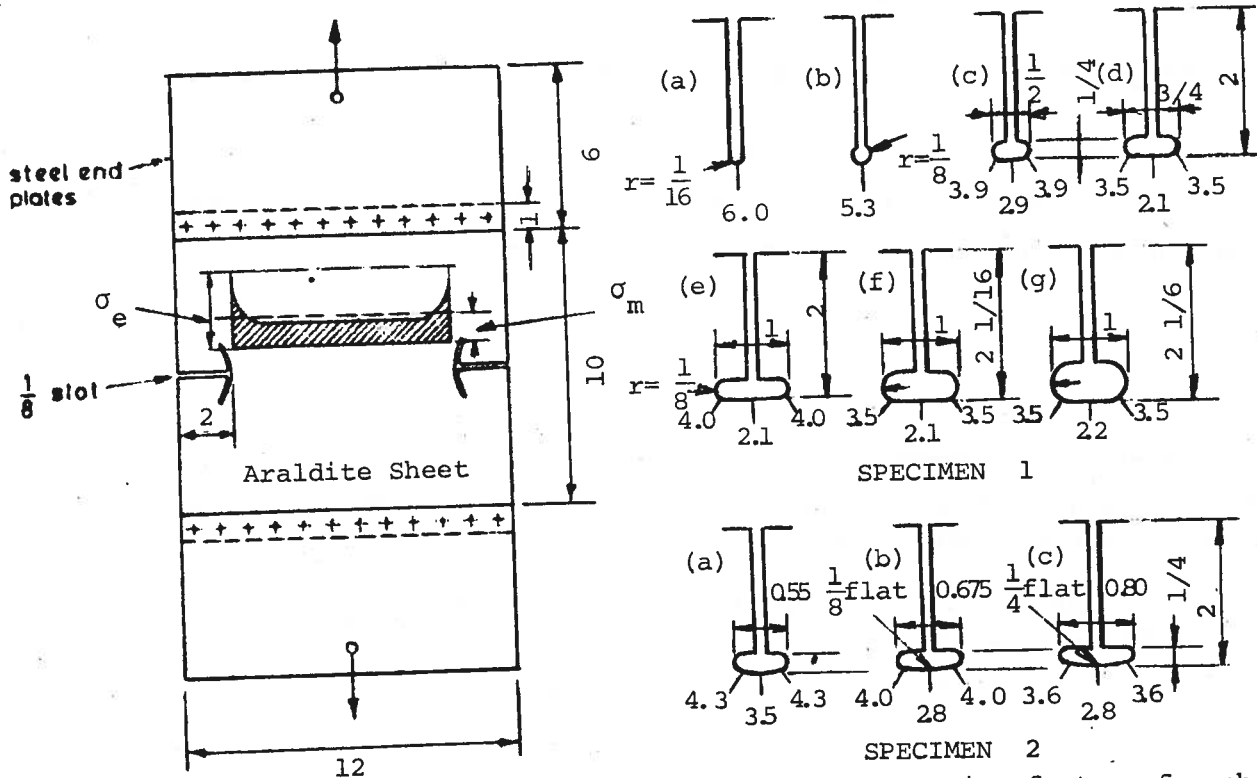


Fig. 5.25

⊕ - results of photoelastic experiments

Variation of stress concentration with h/r .

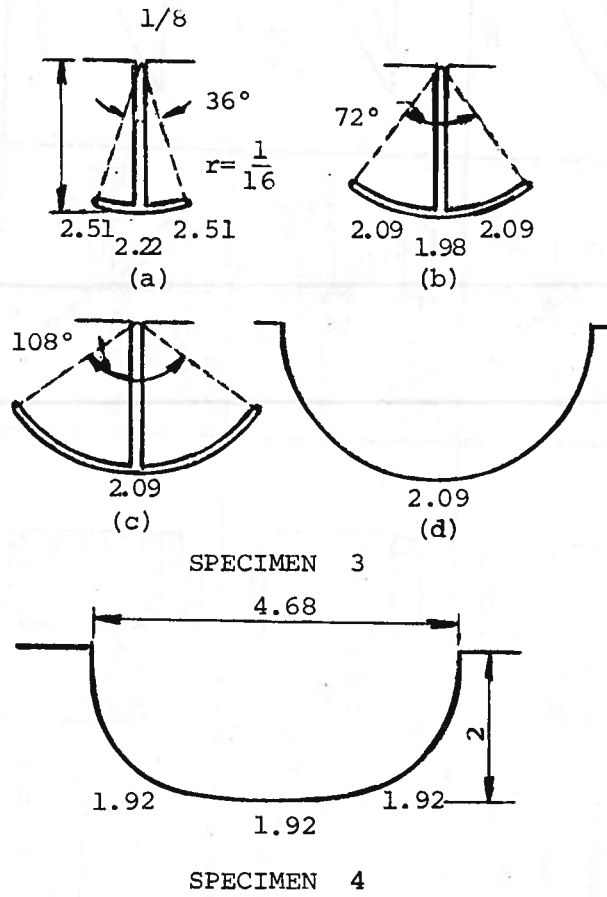


Arrangement of photoelastic specimens (dimensions in inches).

Stress concentration factors for photoelastic specimens 1&2 (in inches)

Fig. 5.26

Fig. 5.26 (continuation)



Stress concentration factors for photoelastic specimens 3 and 4 (Dimensions in inches).

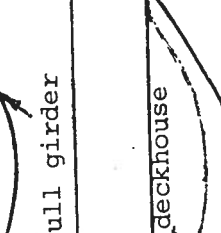
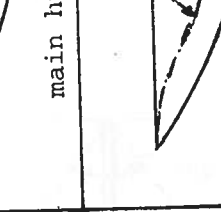
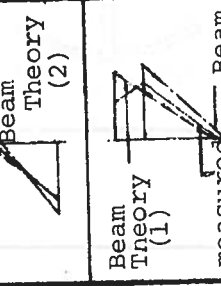
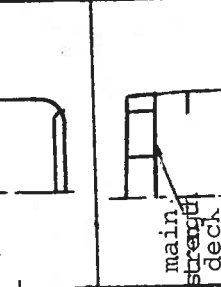
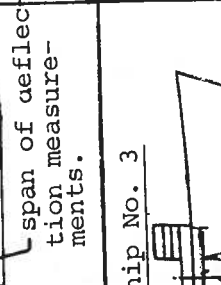
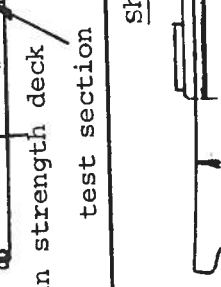
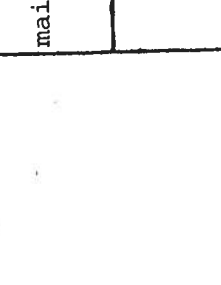
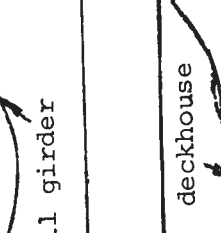
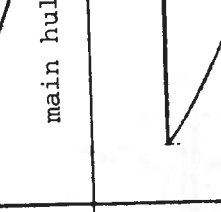
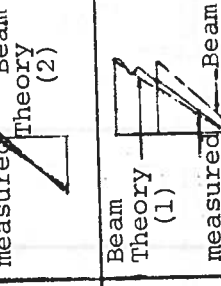
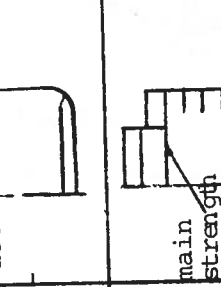
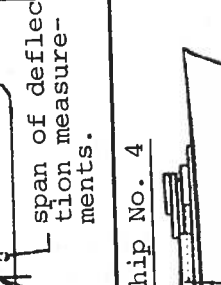
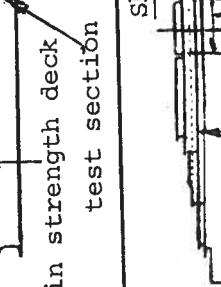
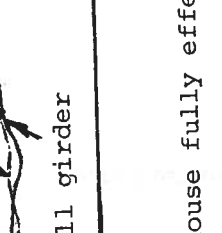
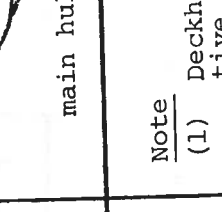
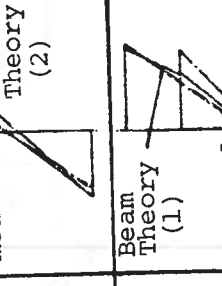
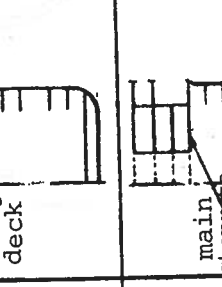
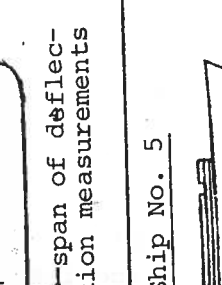
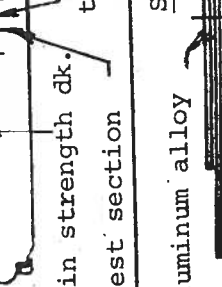
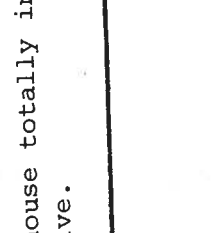
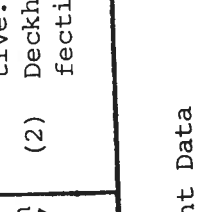
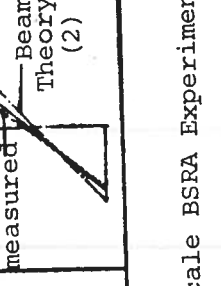
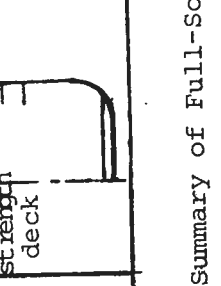
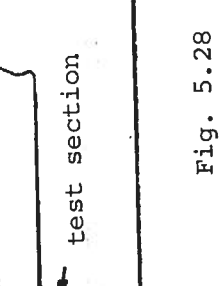
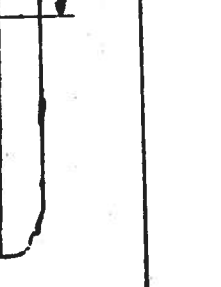

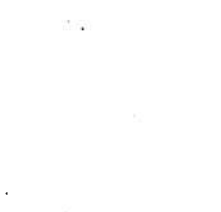


Outline Profile	Outline Section	Strain Distributions	Vertical Deflection of Deck House Relative to Main Hull
<p>Expansion joints main strength dk. test section</p> <p>Ship No. 1</p> <p>span of deflection measurements.</p> 	<p>main strength deck</p> 	<p>Beam theory (1) measured</p> <p>beam theory (2)</p> 	<p>deckhouse</p> <p>Expansion jt. / main hull girder</p>  <p>dk.house</p> <p>main hull girder</p>  <p>deckhouse</p> <p>main hull girder</p>  <p>deckhouse</p> <p>main hull girder</p> 
<p>main strength deck</p> <p>test section</p> <p>Ship No. 2</p> <p>span of deflection measurements.</p> 	<p>main strength deck</p> 	<p>Beam Theory (1) measured</p> <p>Beam Theory (2)</p> 	<p>deckhouse</p> <p>main hull girder</p>  <p>dk.house</p> <p>main hull girder</p>  <p>deckhouse</p> <p>main hull girder</p> 
<p>main strength dk. test section</p> <p>Ship No. 3</p> <p>span of deflection measurements.</p> 	<p>main strength deck</p> 	<p>Beam Theory (1) measured</p> <p>Beam Theory (2)</p> 	<p>deckhouse</p> <p>main hull girder</p>  <p>deckhouse</p> <p>main hull girder</p>  <p>deckhouse</p> <p>main hull girder</p> 
<p>main strength dk. test section</p> <p>Ship No. 4</p> <p>span of deflection measurements.</p> 	<p>main strength deck</p> 	<p>Beam Theory (1) measured</p> <p>Beam Theory (2)</p> 	<p>deckhouse</p> <p>main hull girder</p>  <p>deckhouse</p> <p>main hull girder</p>  <p>deckhouse</p> <p>main hull girder</p> 
<p>aluminum alloy test section</p> <p>Ship No. 5</p> 	<p>main strength deck</p> 	<p>Beam Theory (1) measured</p> <p>Beam Theory (2)</p> 	<p>Note</p> <p>(1) Deckhouse fully effective.</p> <p>(2) Deckhouse totally ineffective.</p> 

Fig. 5.28 Summary of Full-Scale BSRA Experiment Data

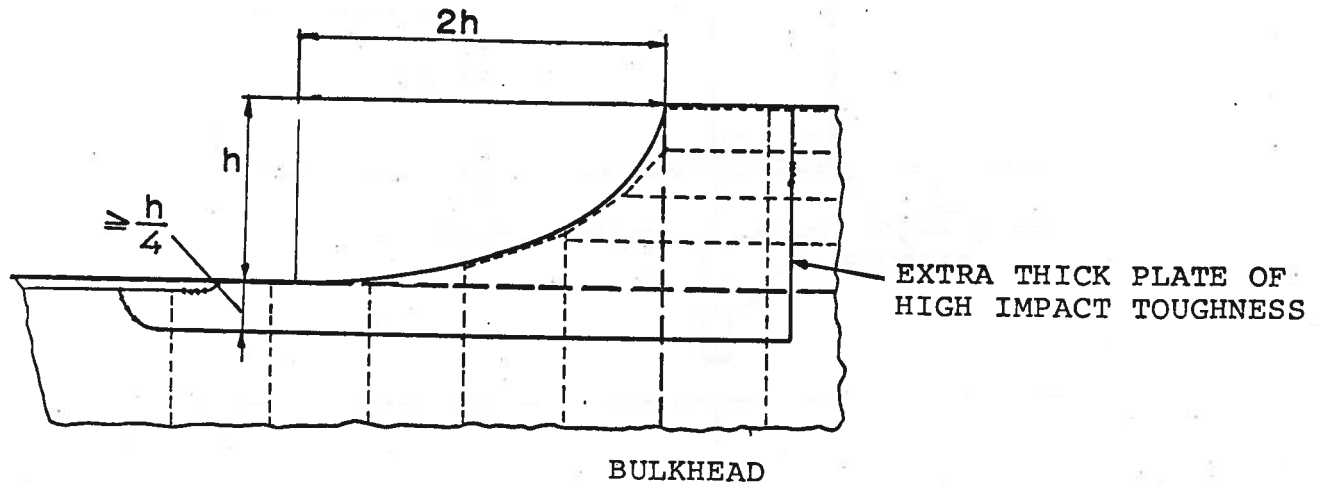


Fig. 5.29

It is recommended that the side plate of the superstructure as well as the shear strake are reinforced in the way of the end of the superstructure. The plate thicknesses could well be increased by as much as 40-50% when the ends are located in a region of large bending moments. Corresponding increase of thicknesses of deck plates must also be made. Opening in the side plating should be avoided.

There is a history of many structural failures which have occurred because the large forces existing at the ends of the deck house have not been considered by the designers. Fig. 5.30 shows a case of failure due to poor design. The front of the deck house should have been placed right over the stanchion and good sized brackets fitted in the plane of the front. The stanchion must, of course, be equally well connected to the structure at its other end (at the tank top). An example of insufficient anchoring at the foot of a stanchion is shown in fig. 5.31.

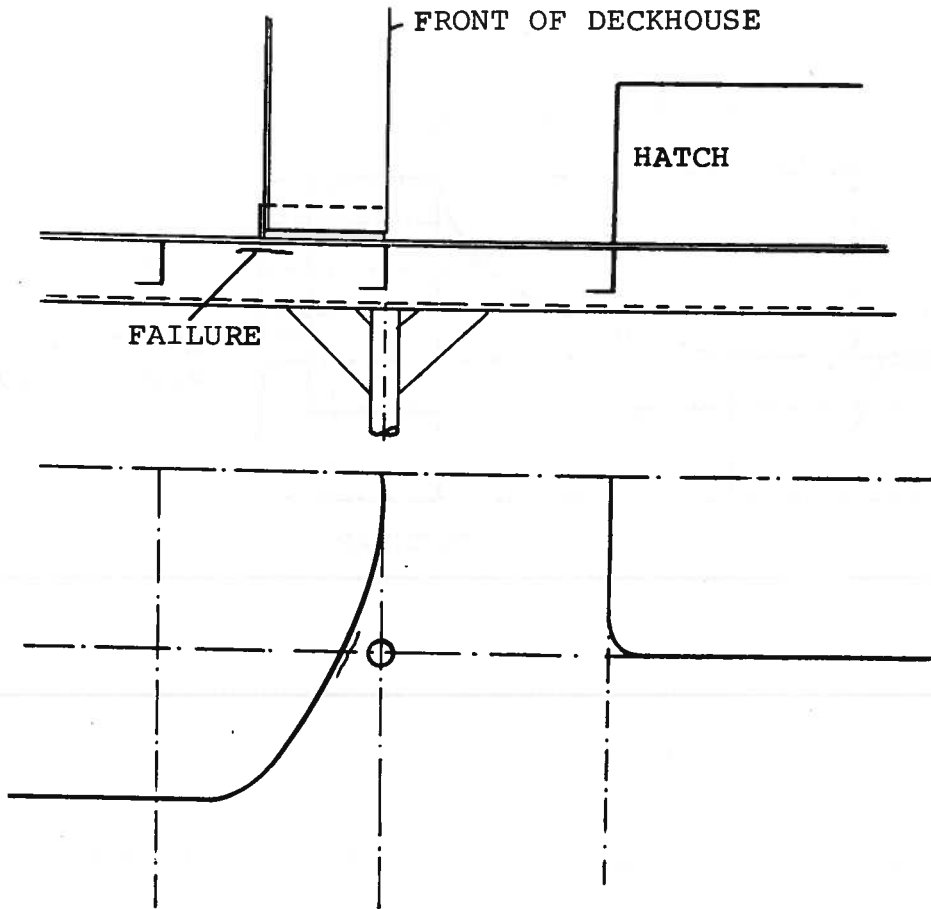


Fig. 5.30

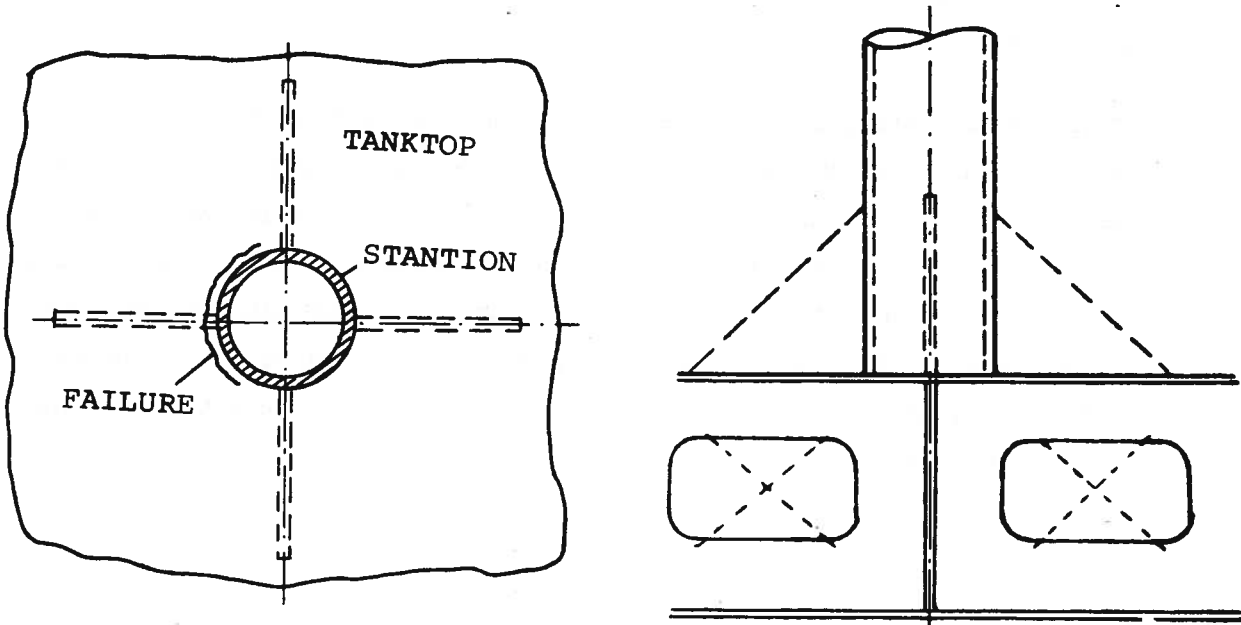


Fig. 5.31

It is not sufficient to fit a doubler plate in the tank top since the stanchion will also be in tension. Brackets can be fitted as indicated. All holes in the floor plates and side girders in the double bottom should also be eliminated in way of stanchion support brackets.

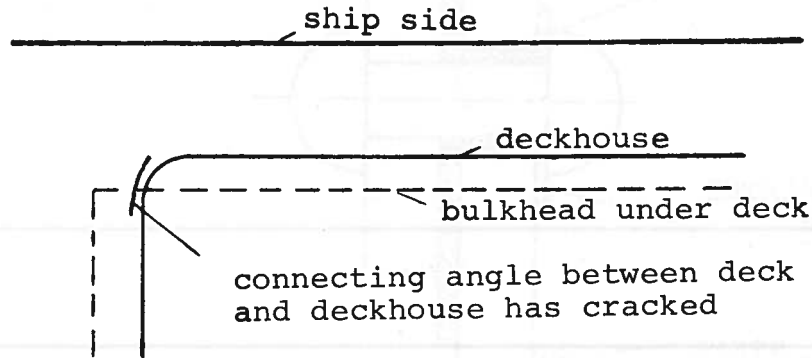


Fig. 5.32

Fig. 5.32 shows an example of poor detailing causing structural failure.

Corrosion by galvanic action must be stopped where aluminum is joined to steel. A connection which has proven to be satisfactory is shown in fig. 5.33.* Aluminum in shipbuilding is on the increase and many new types of connections will appear.

* Steel rivets have also been used with success, but they must remain completely isolated from the aluminum plate.

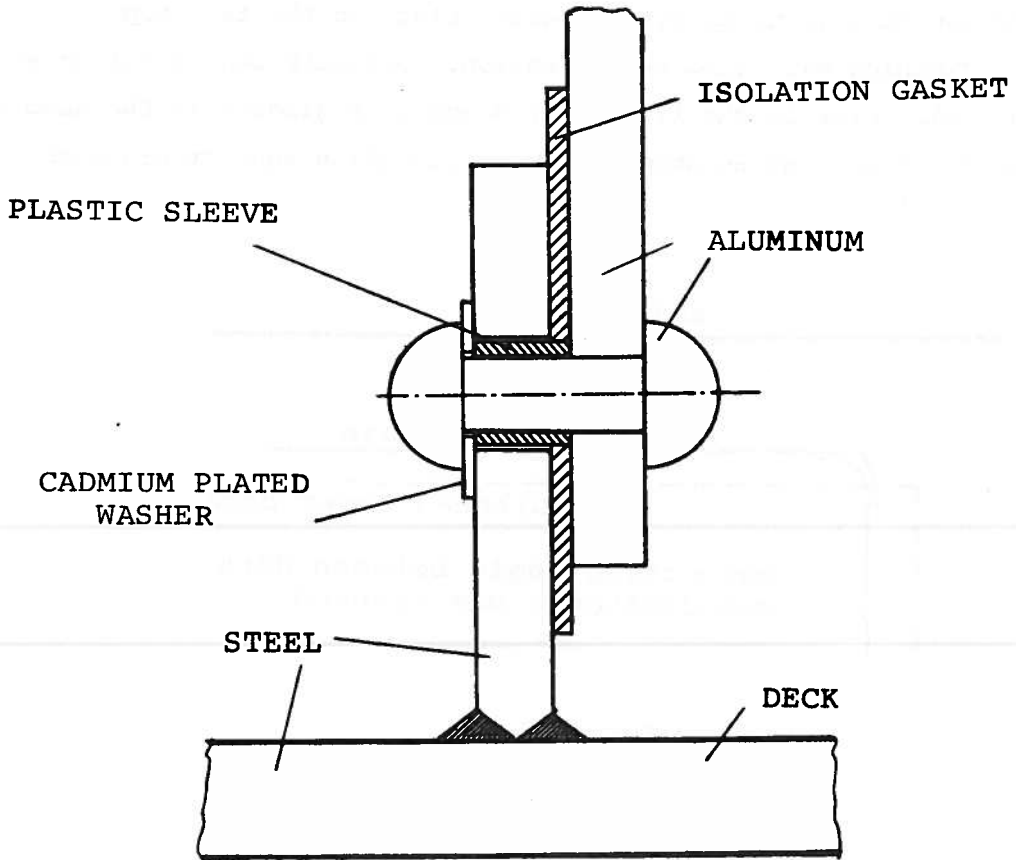


Fig. 5.33