

PASH 10/S-2/
K-9/6

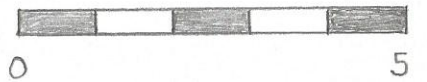

PASH 2013/5-11/
'CU-22/12

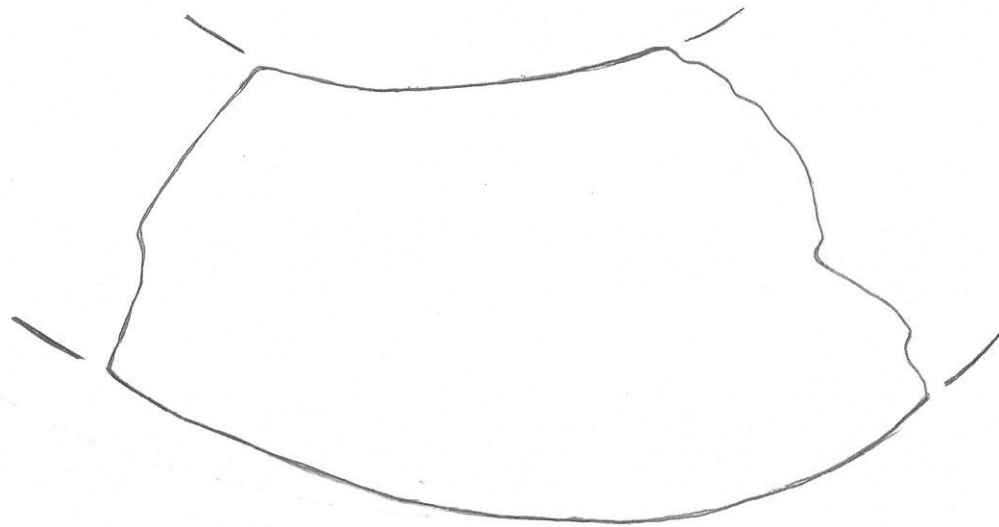
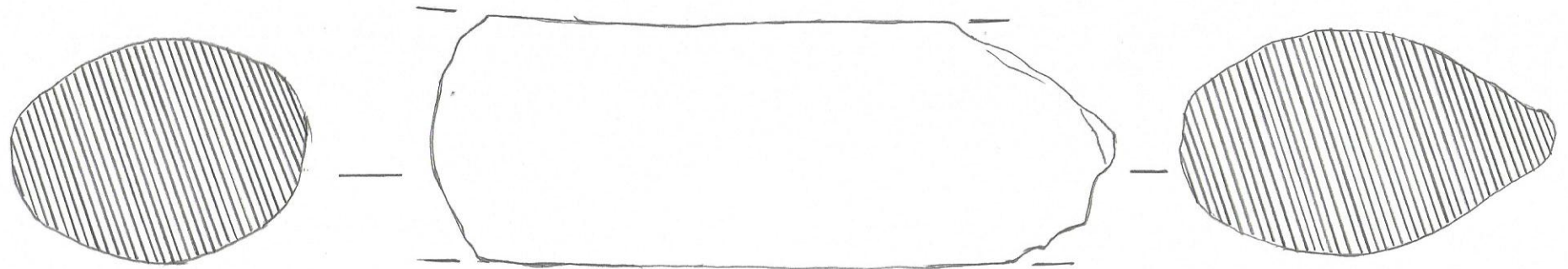
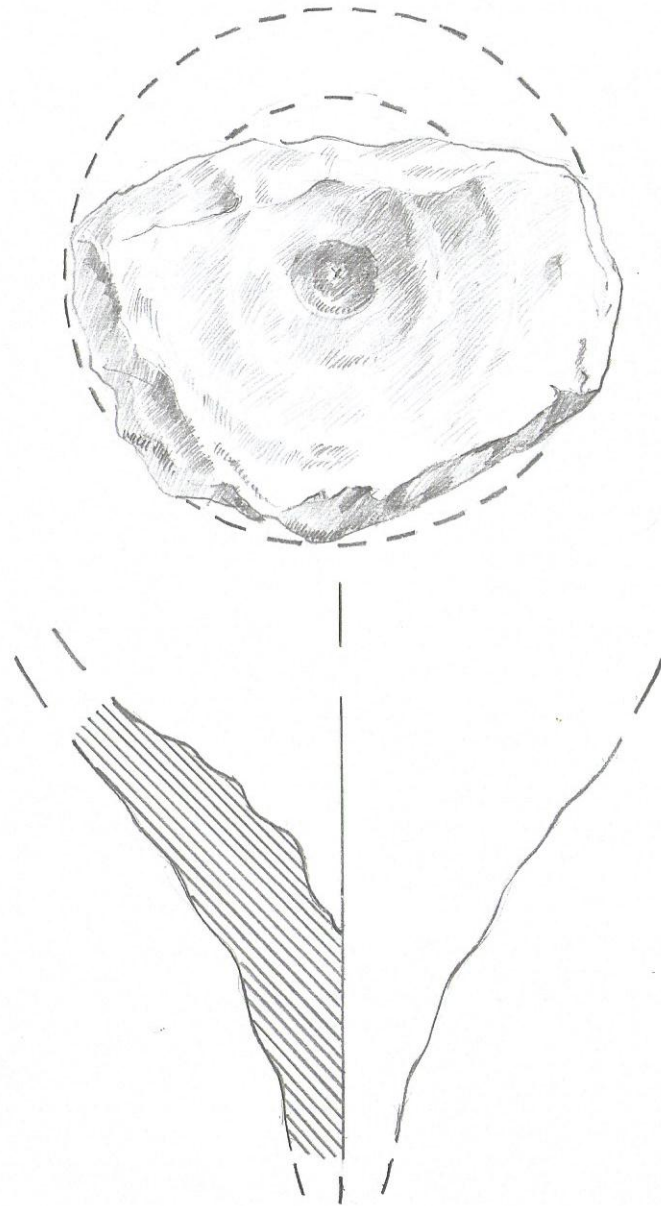

PASH 17[?]
I - 227
40 - 2
?

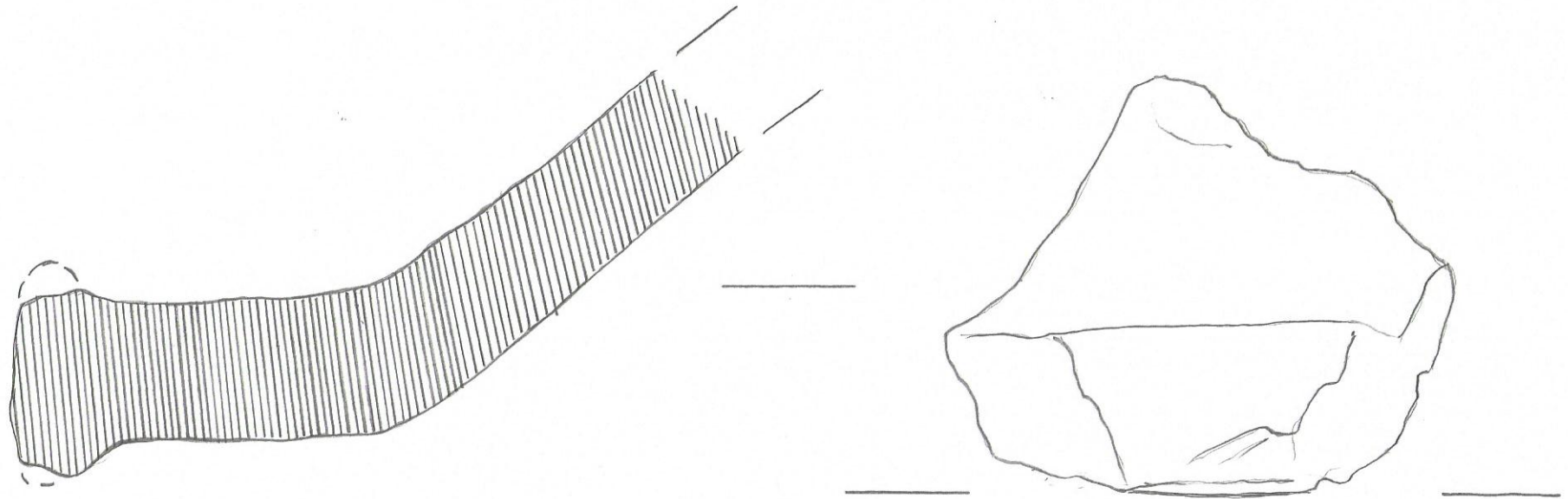

PASH 10/3/5-11/

0-1-22/24

?

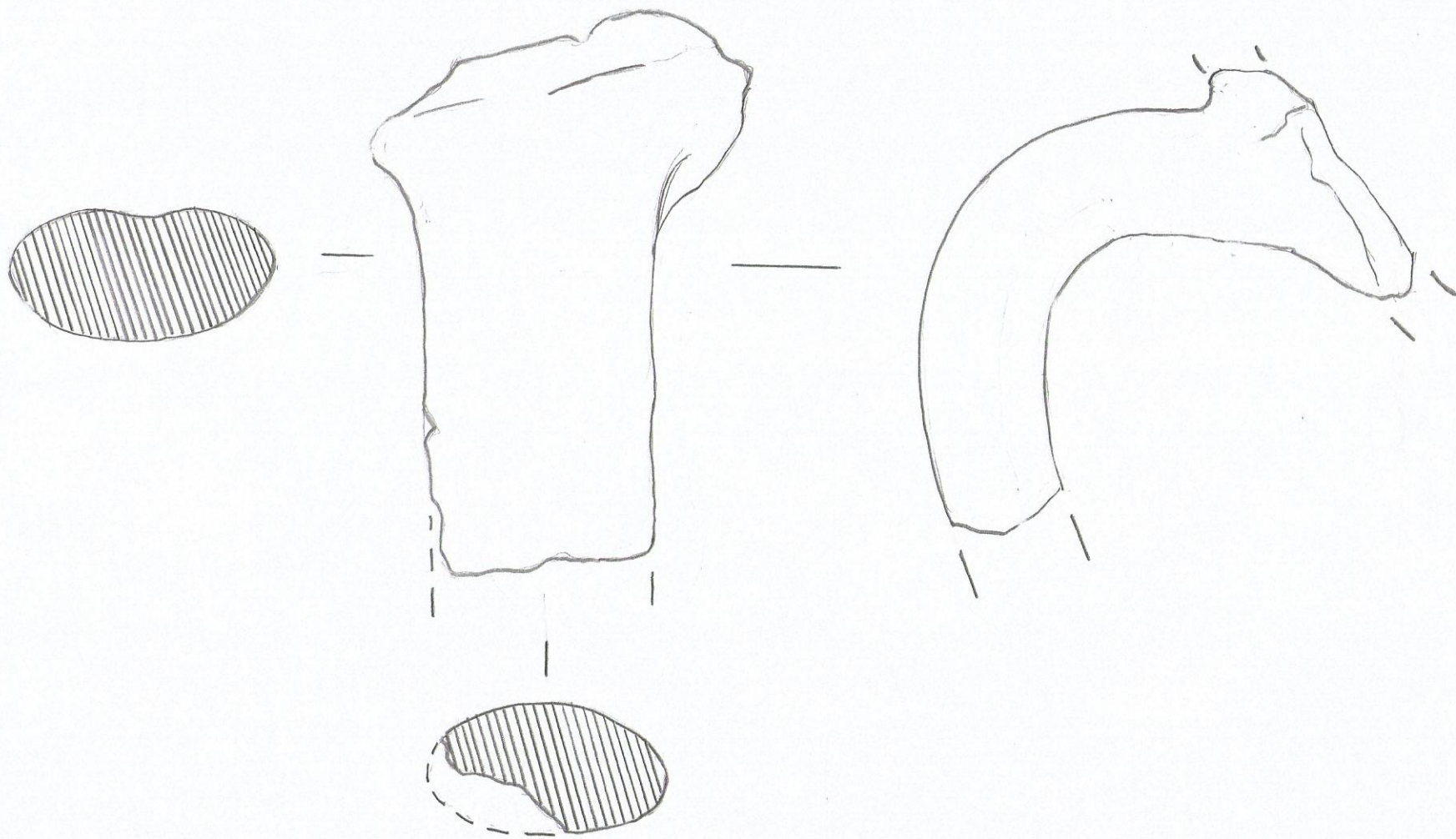

PASH 13
I - 227
40-1

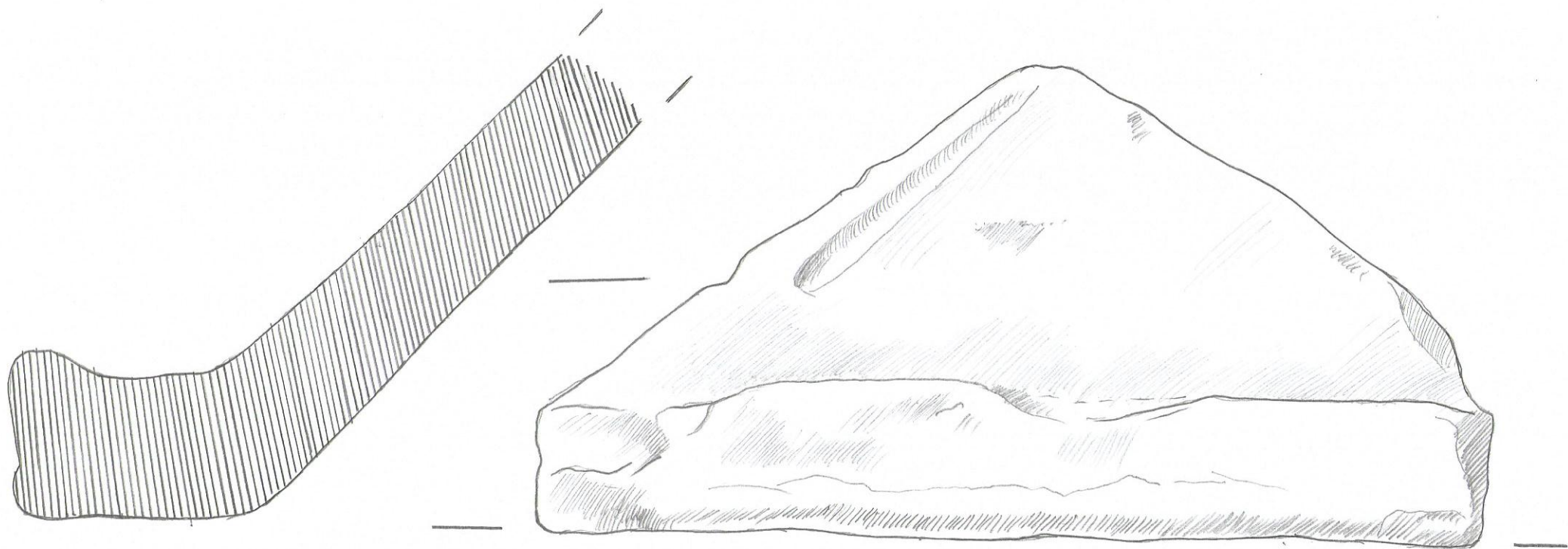

PASH 11/

C-125/1

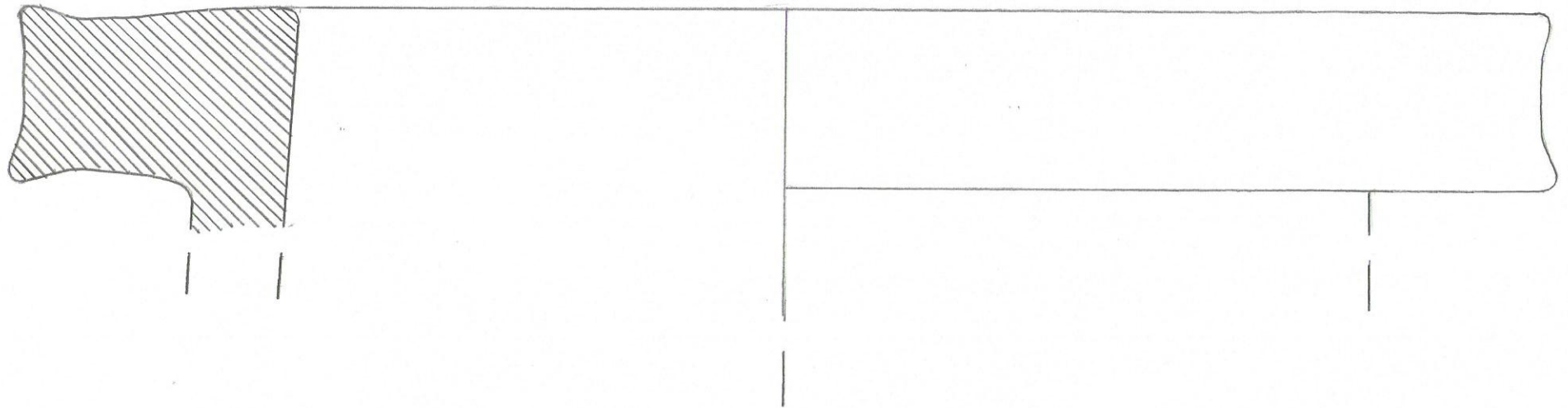

PASH 10/5-2/
.K-9/3



PASH 10/
S-2/K-5/1

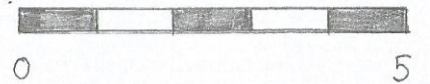
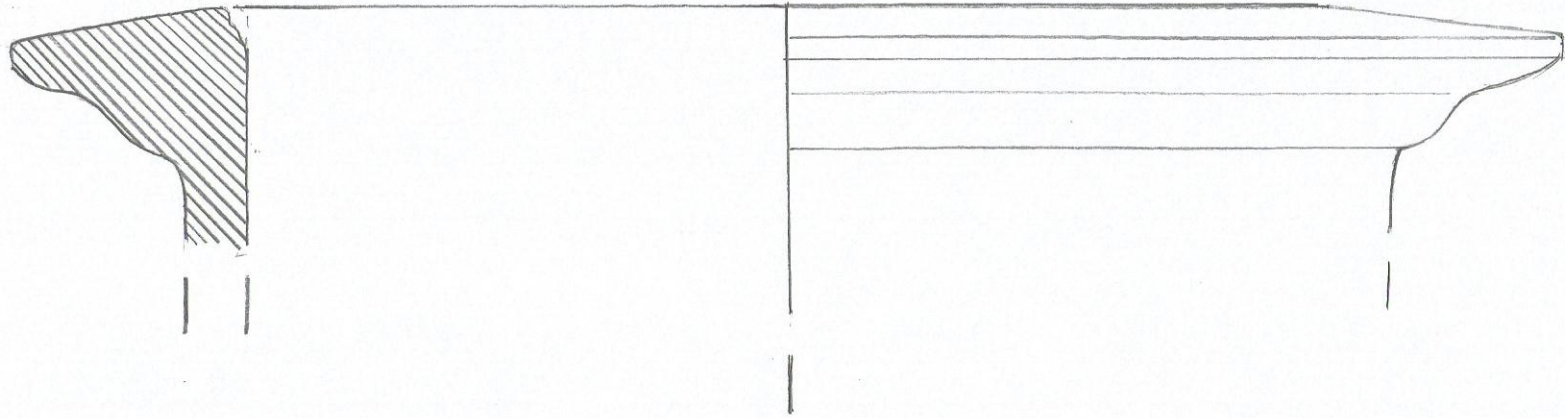

PASH 10/S-2/K-13/4

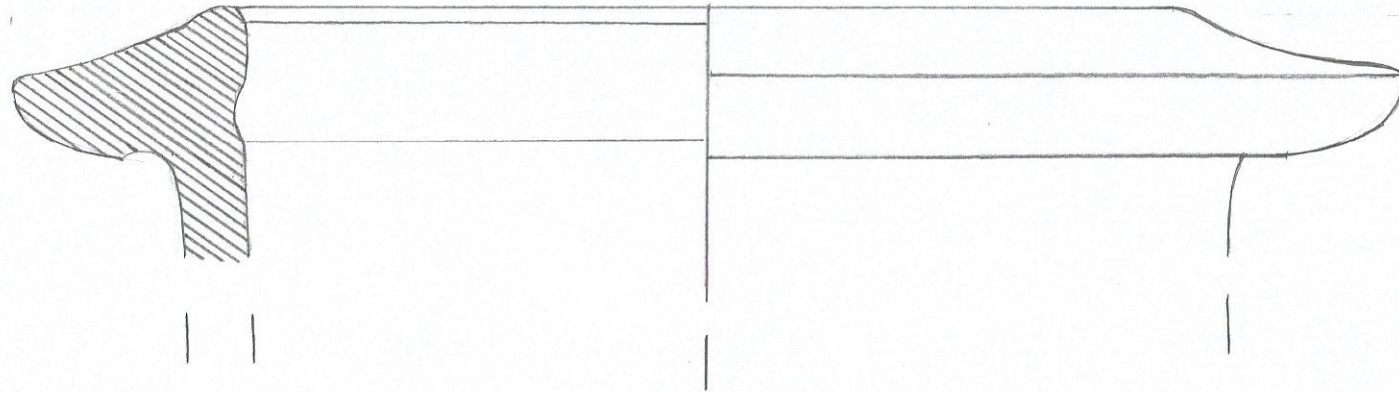

PASH 10
S-2/K-4/
4

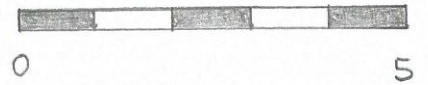
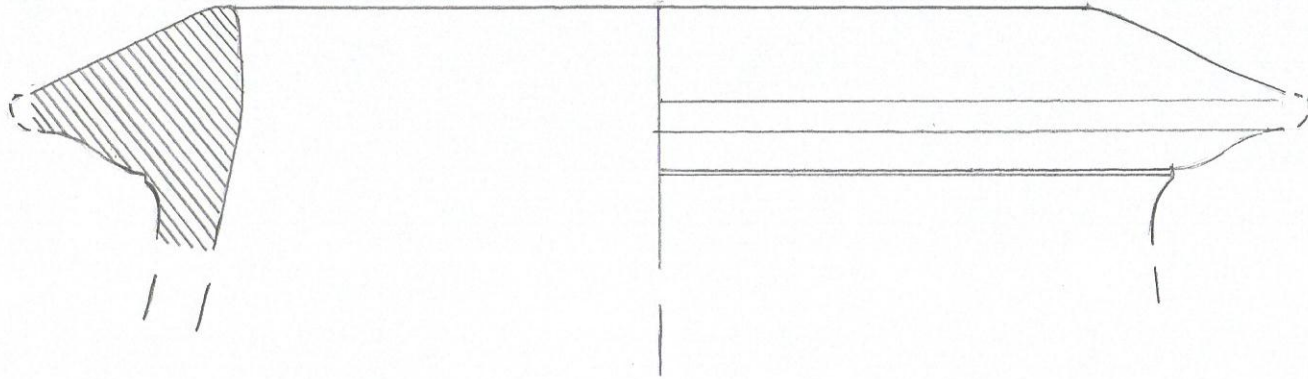

PASH 10/
S-2/K-24/4

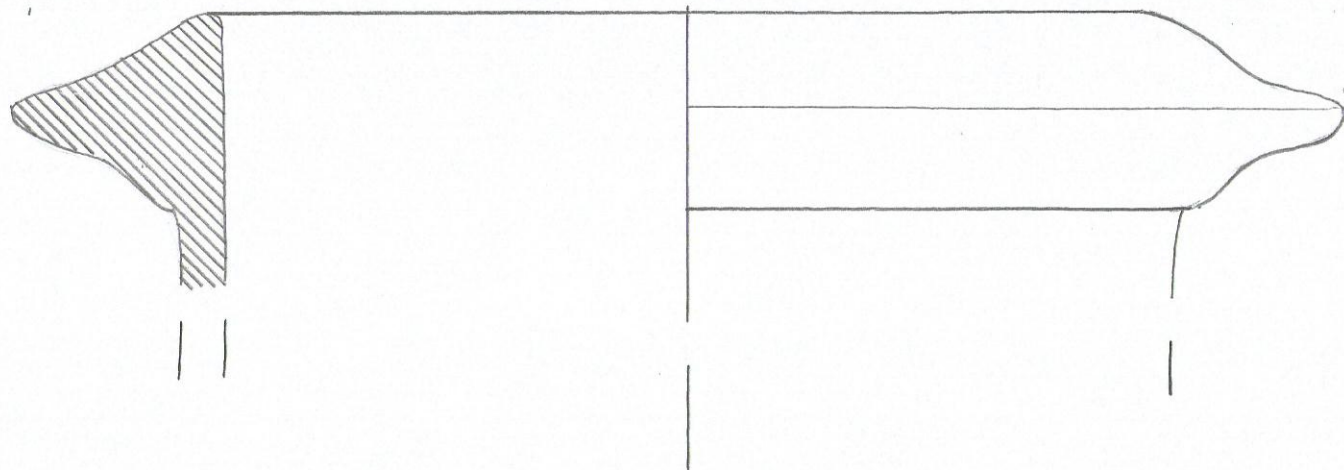

PASH 10/S-2/
K-9/4

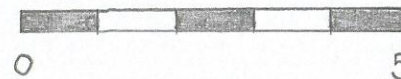
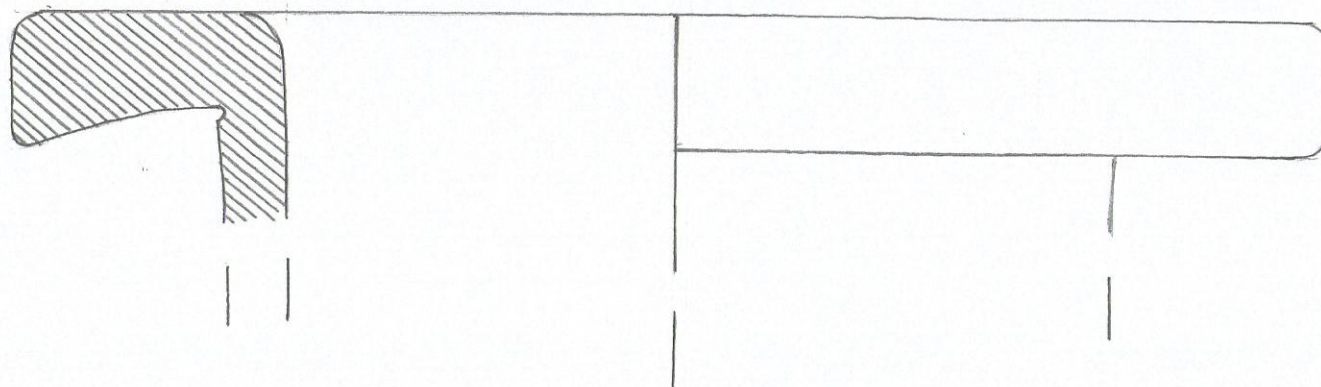

PASH 10/S-2/

K-8/1

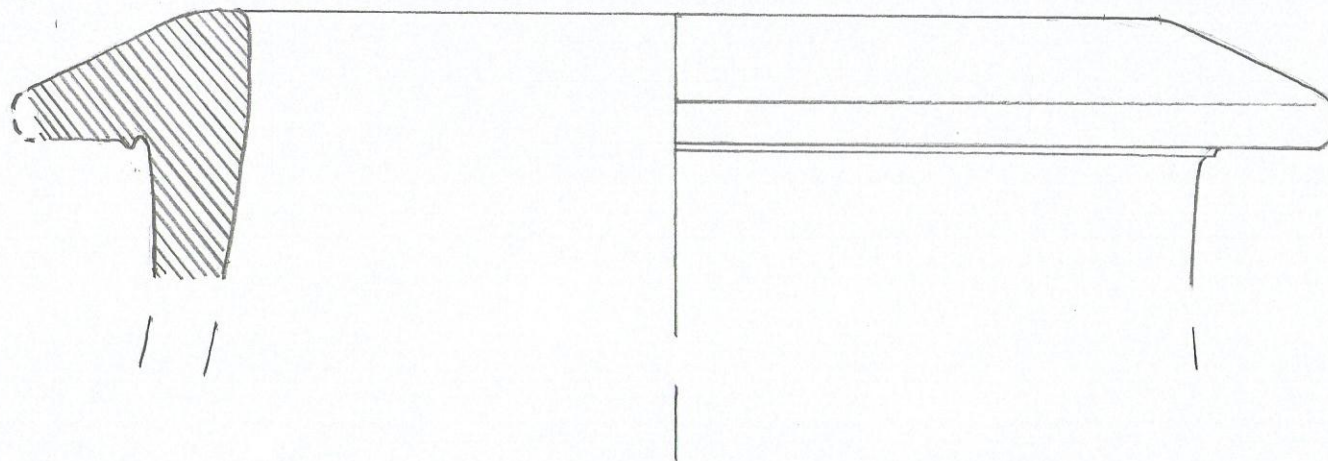

PASH 11/5-3/
K-20/1

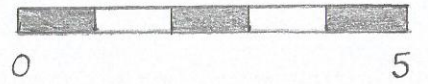
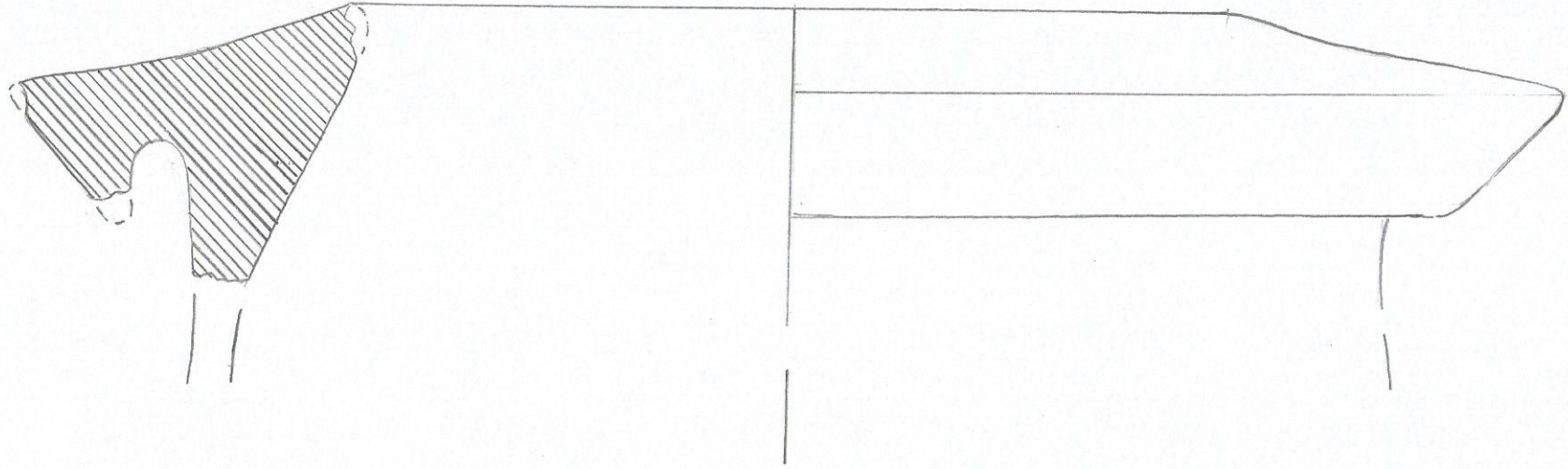

PASH 10/S-2/K-13/1

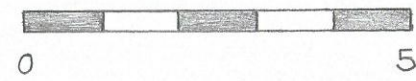
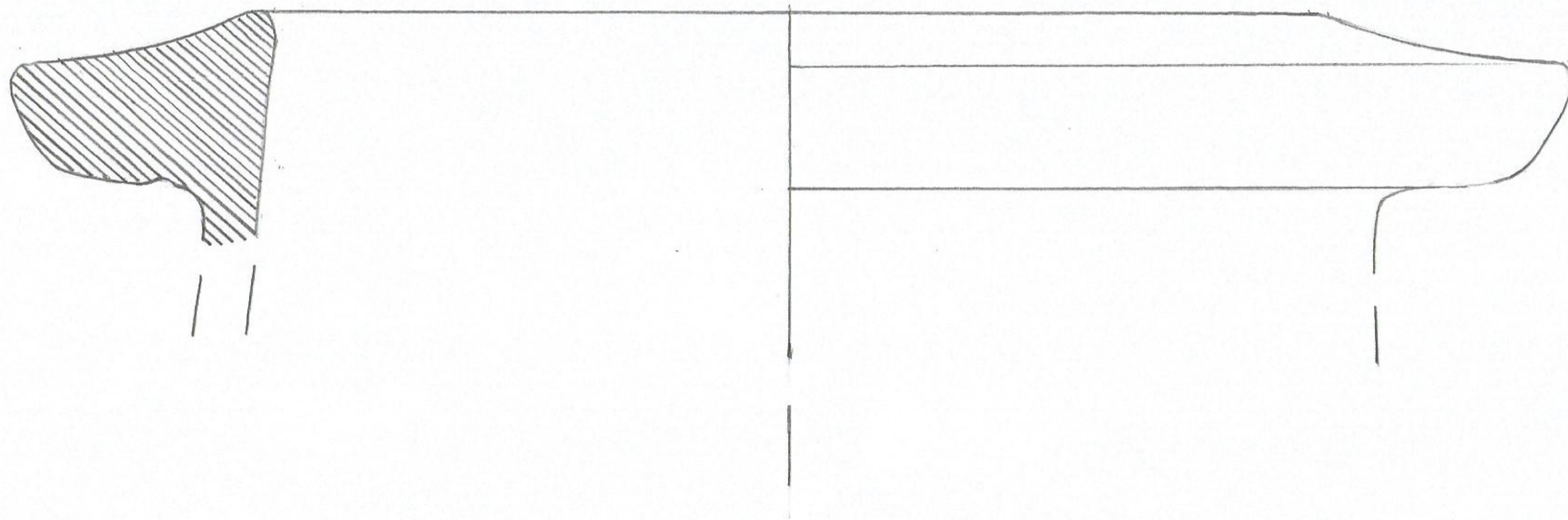

PASH 2014
S-011/ST-04
2

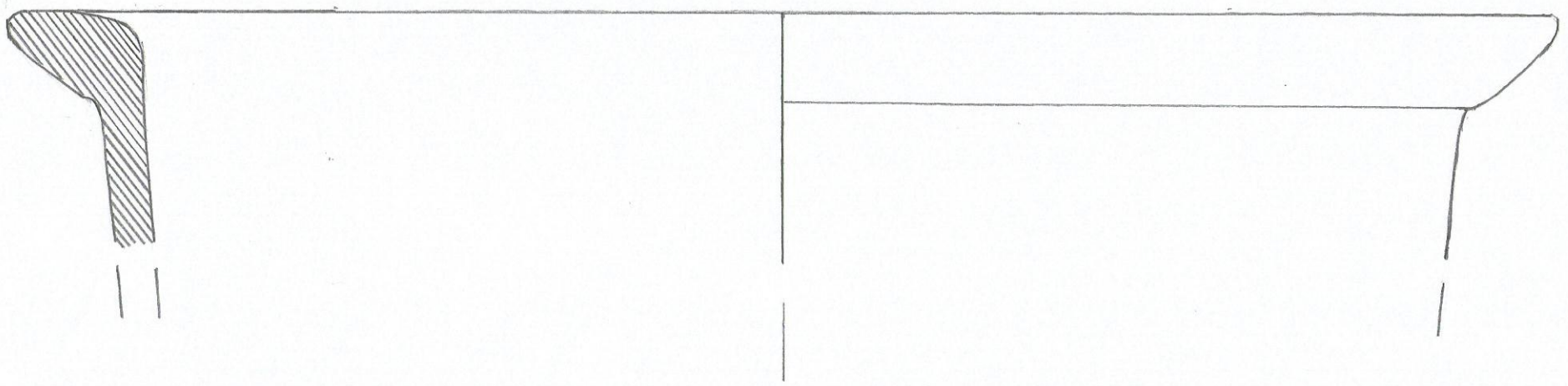

PASH 10/5-2/
K-13/7

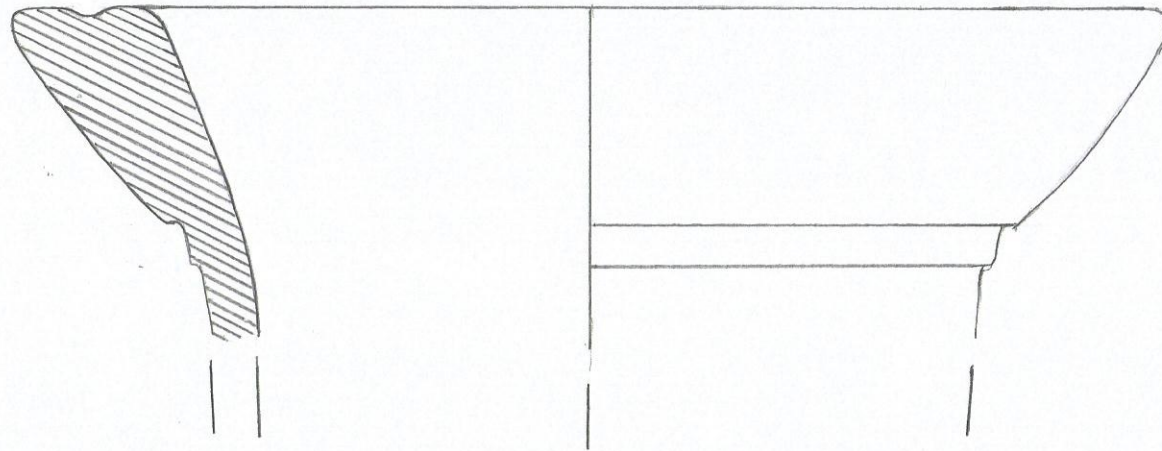

PASH 2013
J-239/6

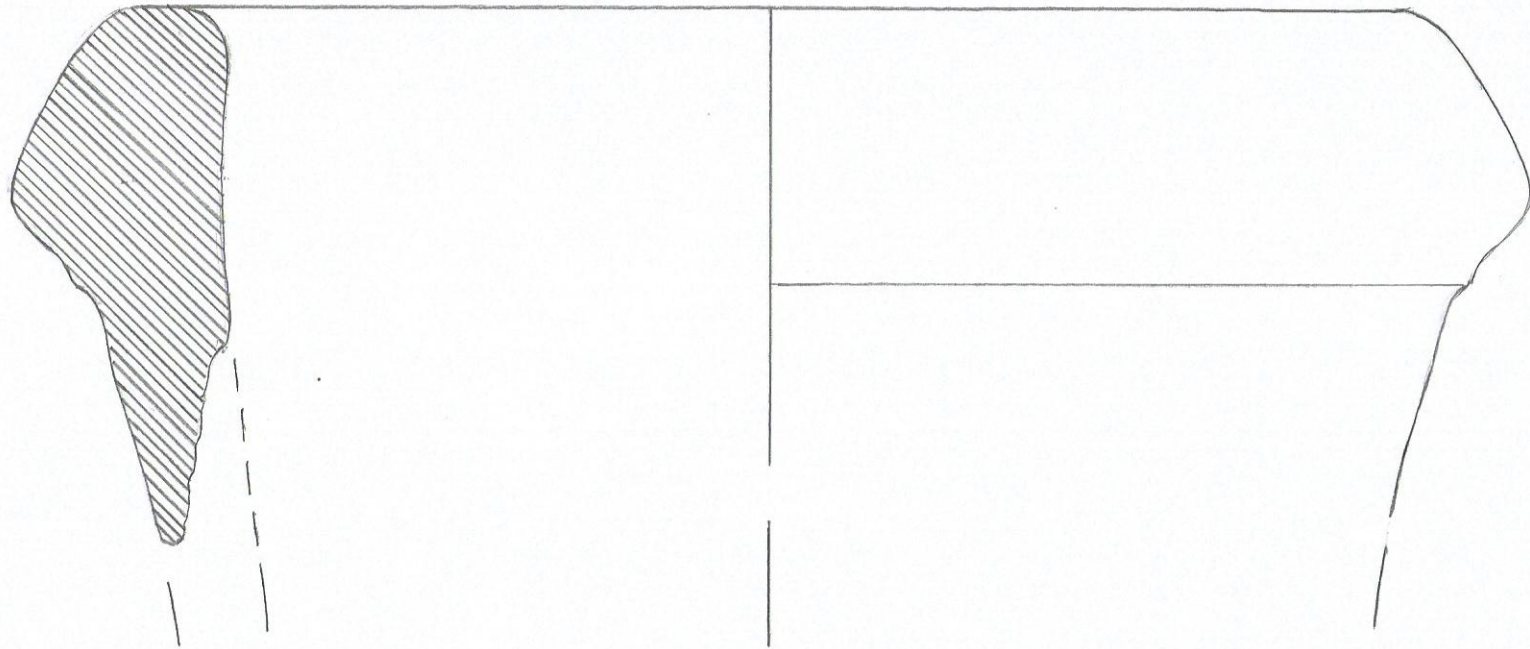

PASH 2013/
S-11/Cu 1974 (?)

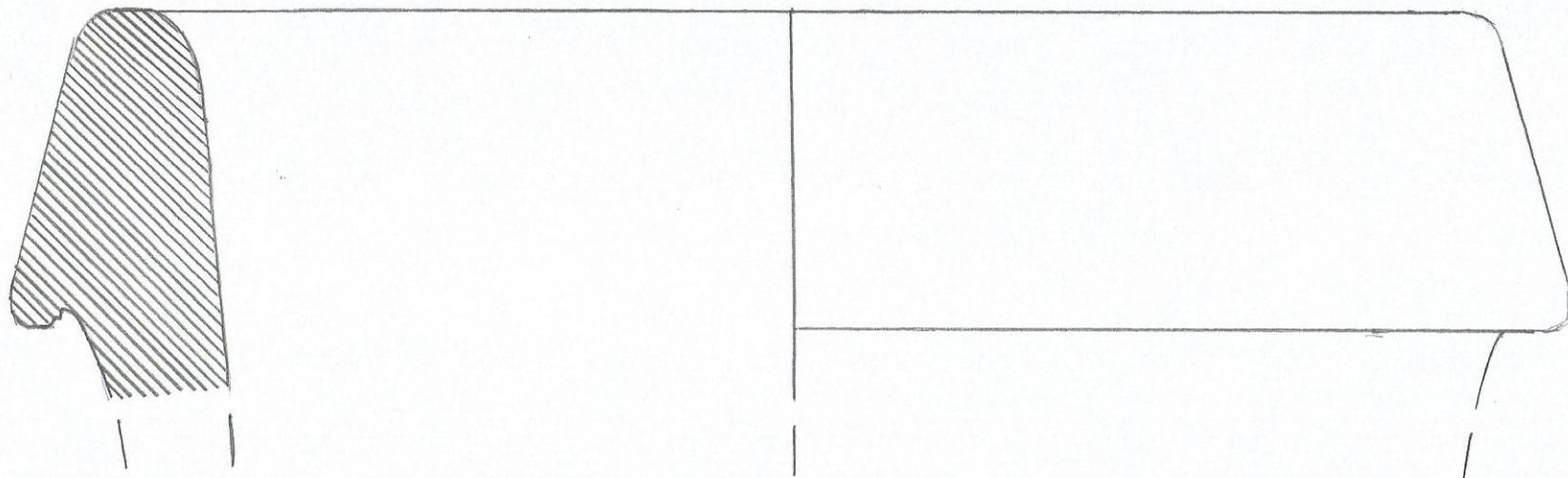

PASH 11/
S-3(?) / K-22/
1



PASH 2013
J 250/31

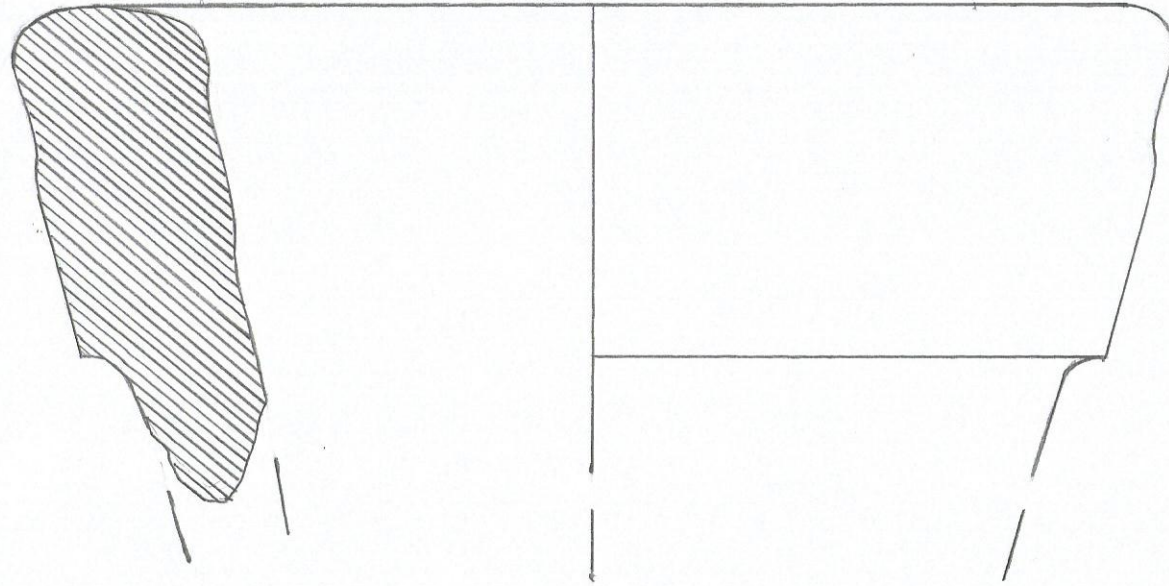

PASH 2013
J250/22

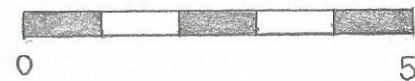
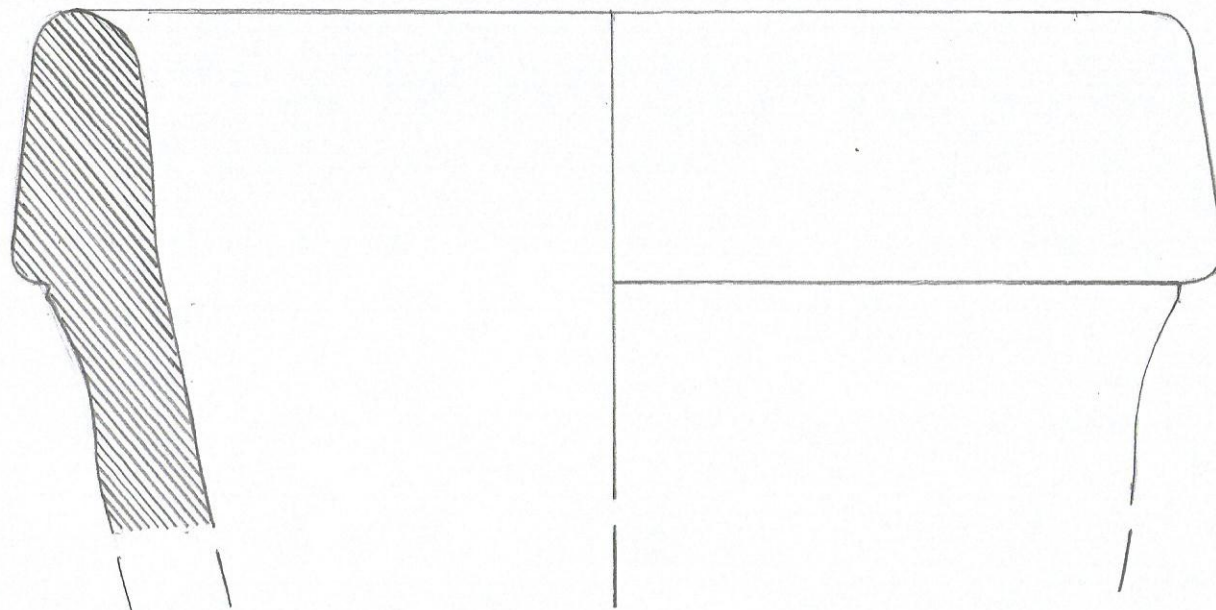

PASH 10/S-1/
K-8/4

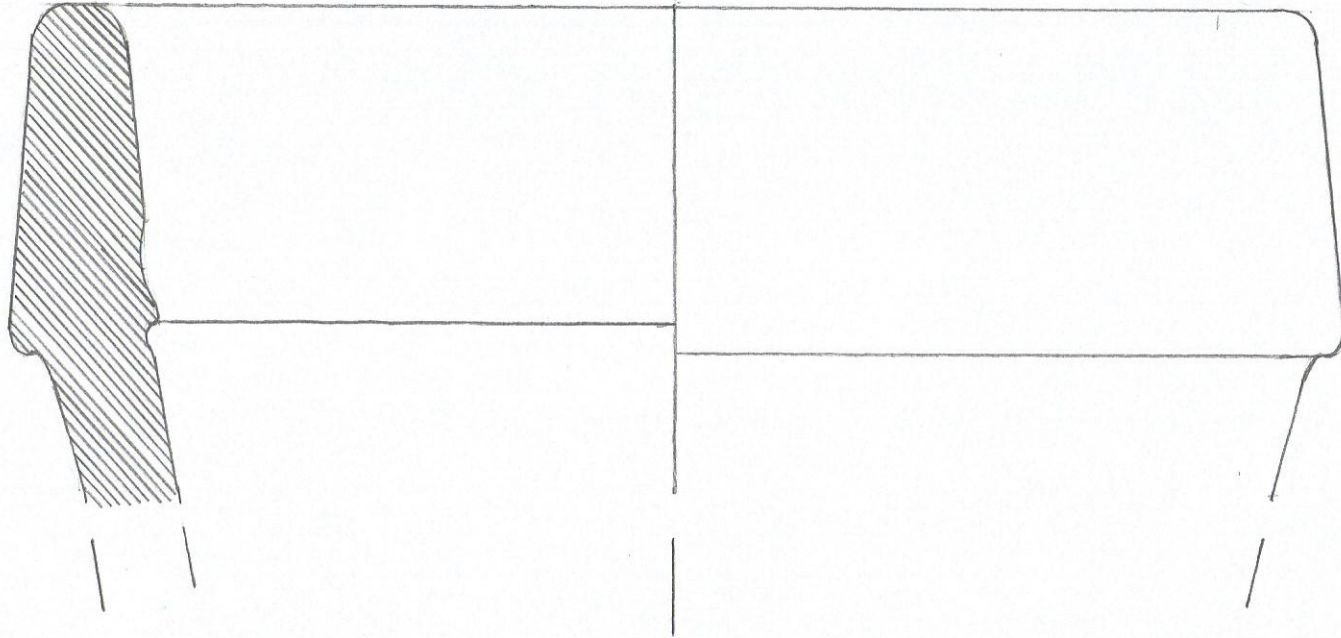

PASH 11/
S-3/K=13/2

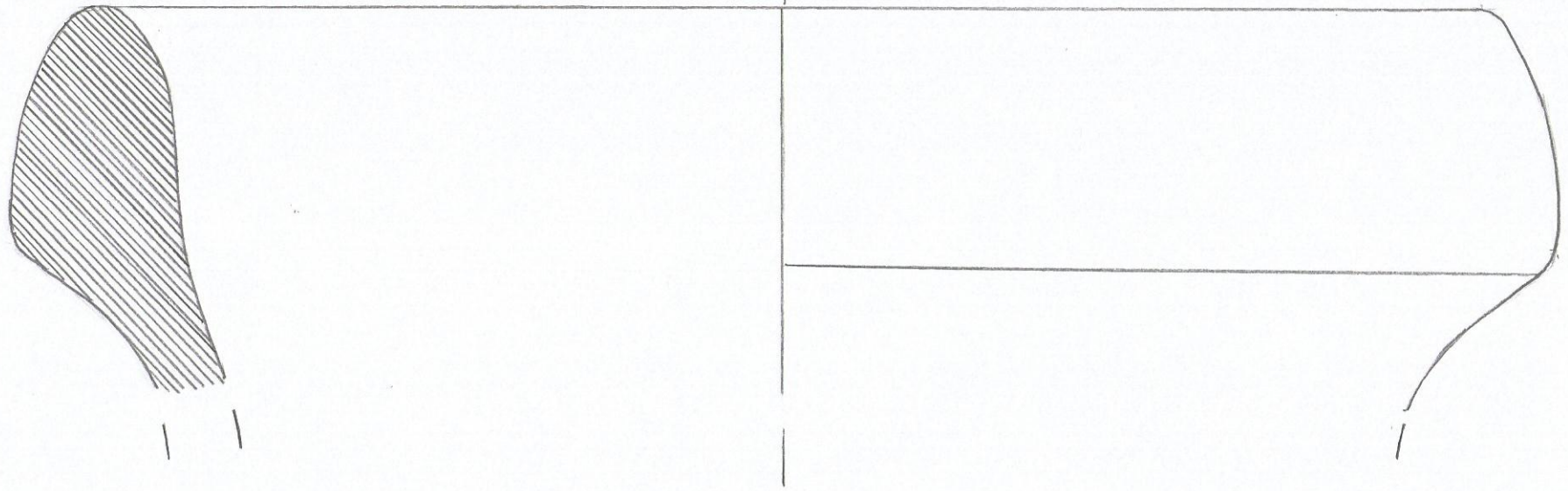

PASH 10/
S-1/K-8/
3

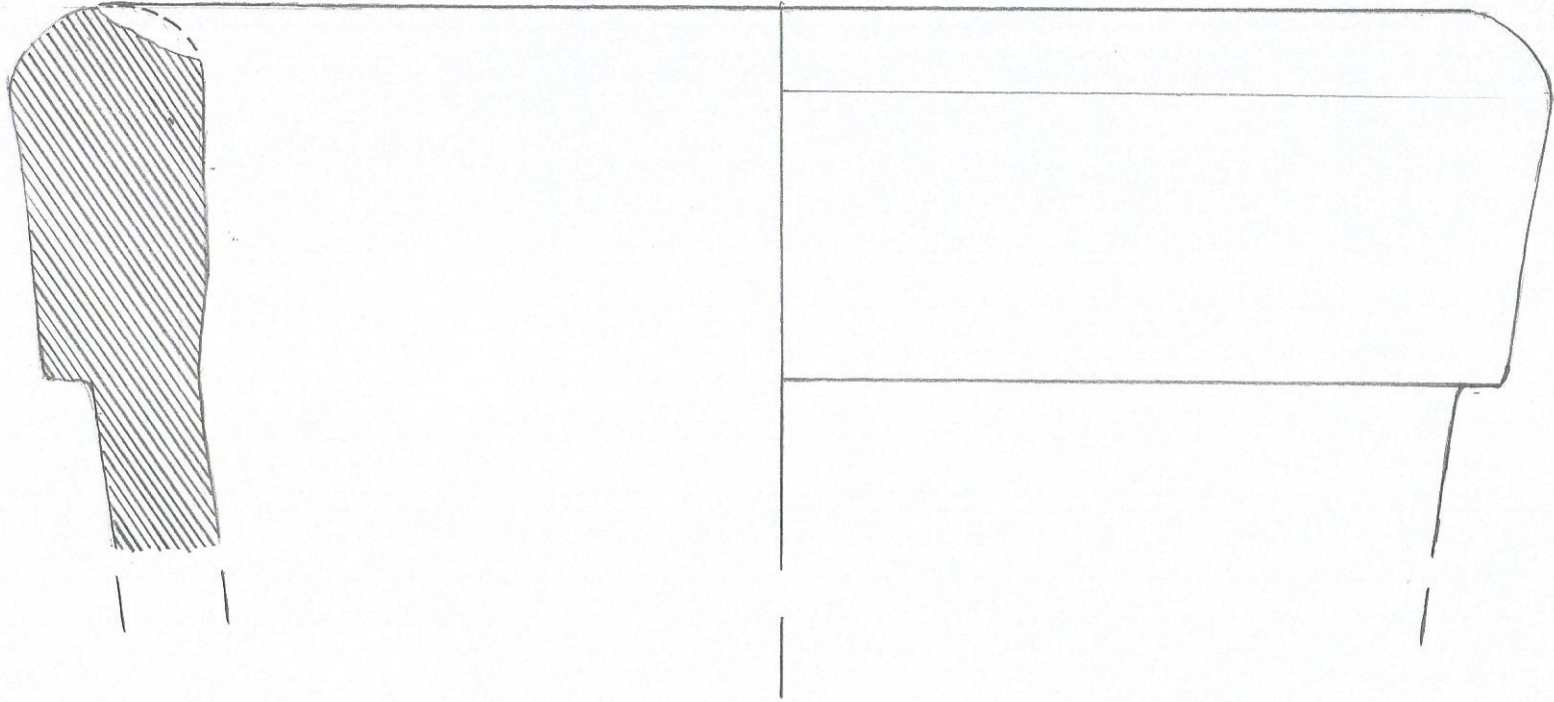

PASH 10/
S-1/
K-8/1 ?

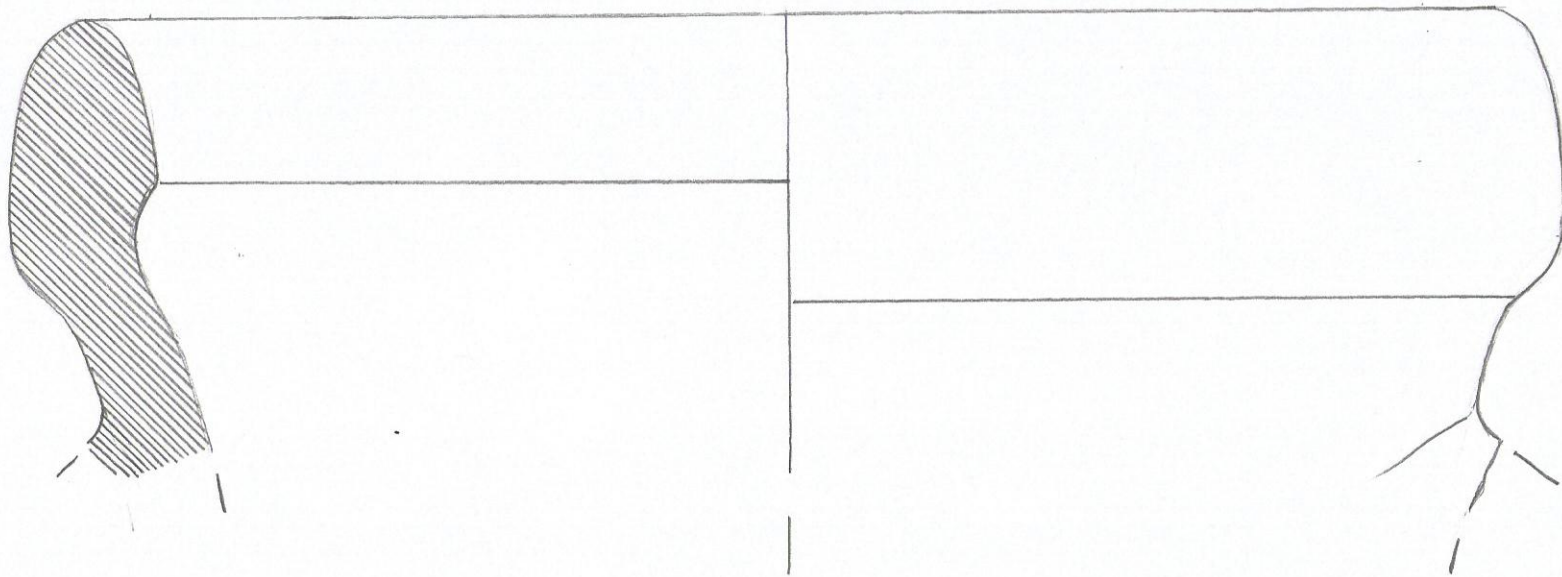

PASH 10/
S-2/K-4/
1

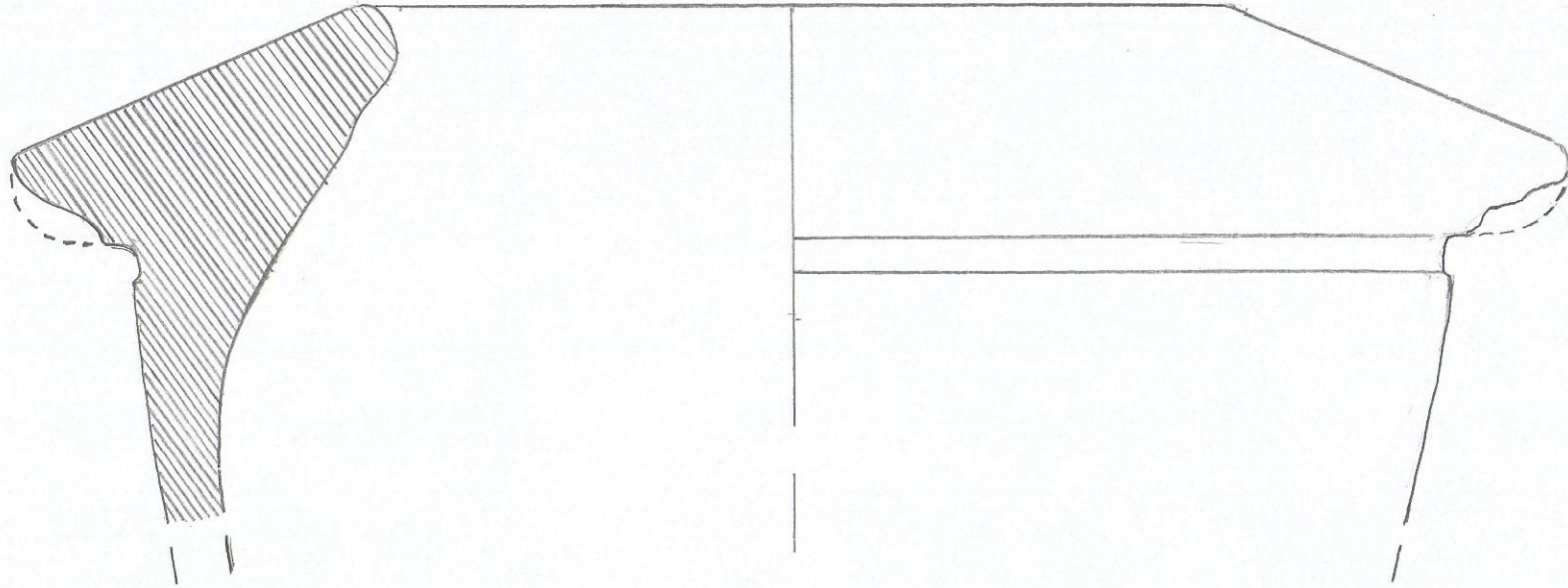

PASH 10/
S-2/K-5/
2

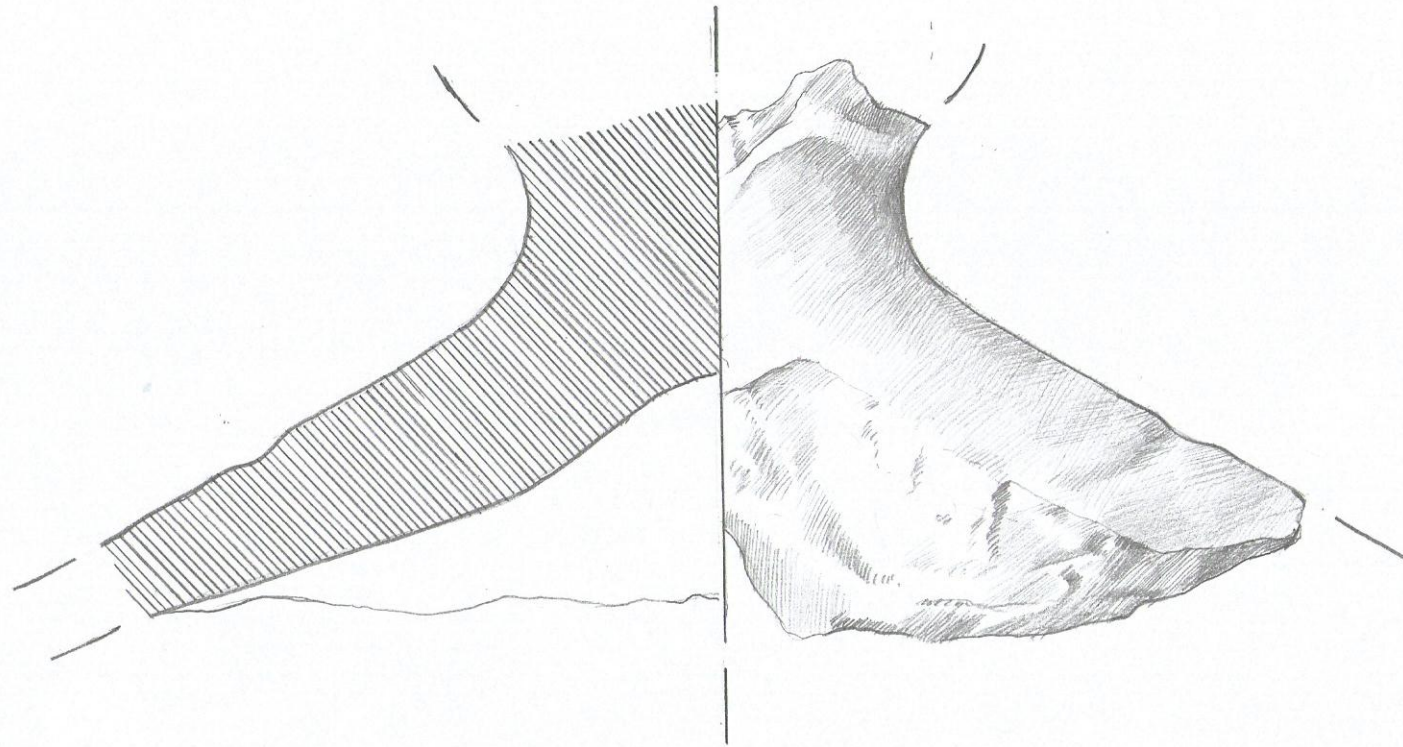

PASH 2013
S-12/I-226/41

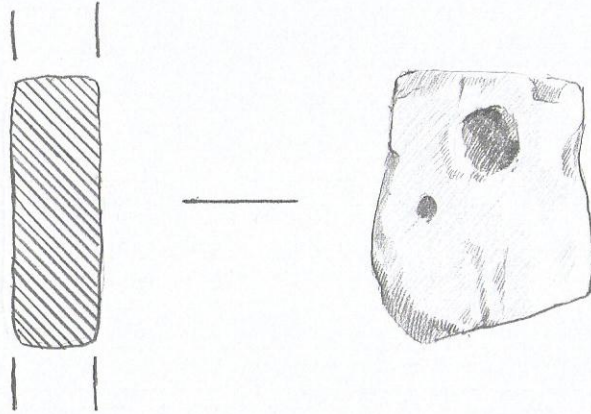

PASH 1457
027-1/8

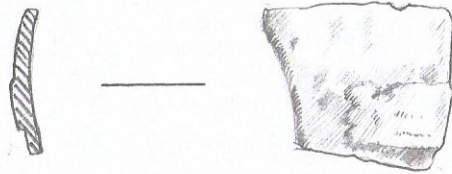

PASH 2013
S-121I-226/42



PASH 14
28/Q4B/4/2

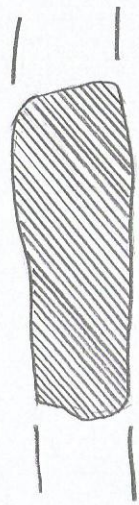

PASH 2014

S-15/17-00278

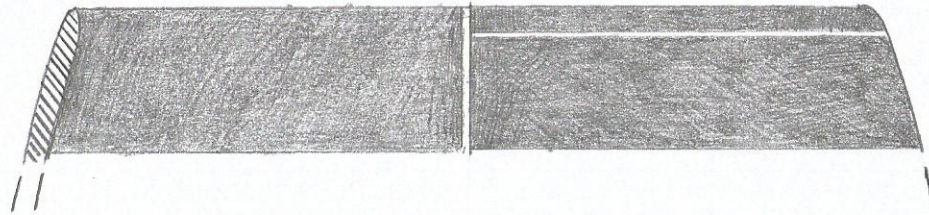

PASH 2013

J-262/34

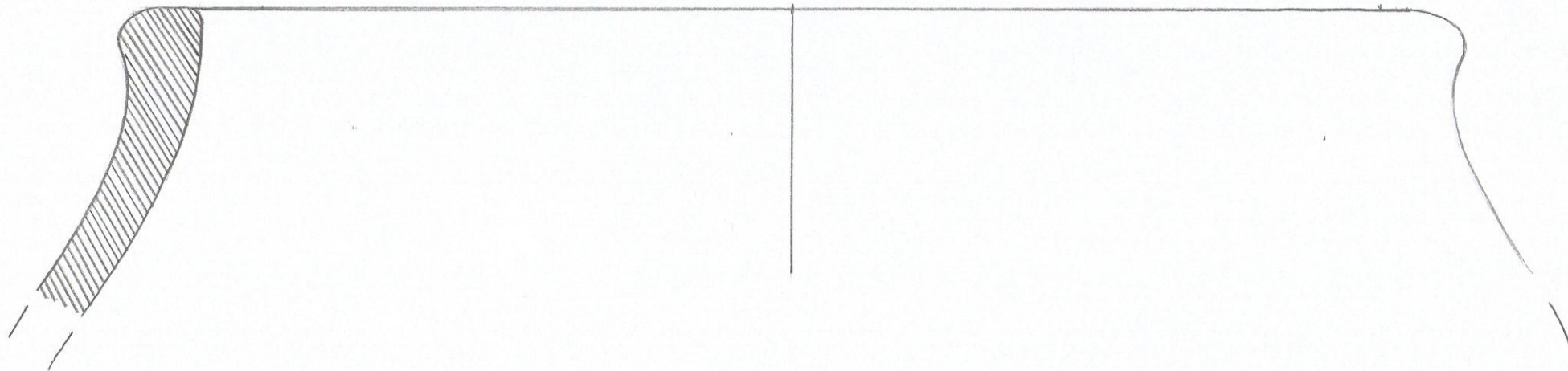

PASH 2013/S. 280/ (11)
40

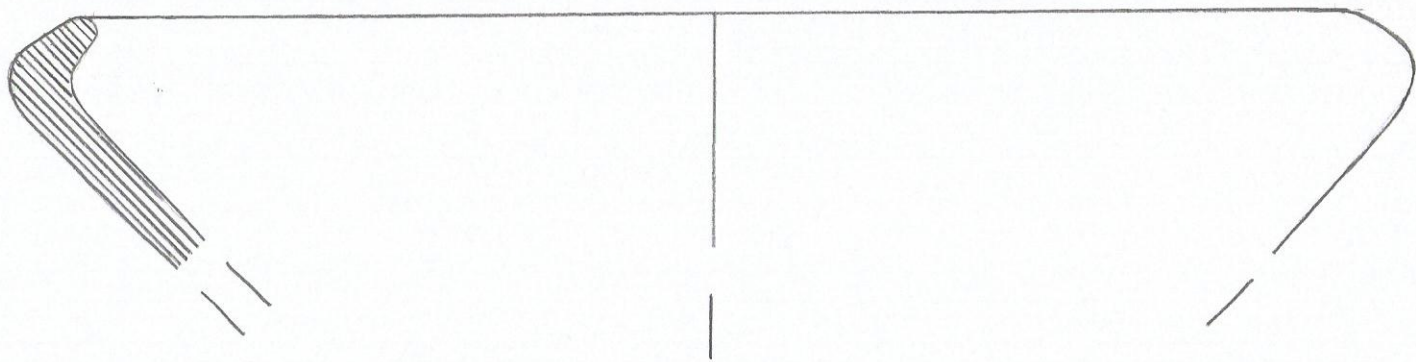

PASH 2013
J-260/57

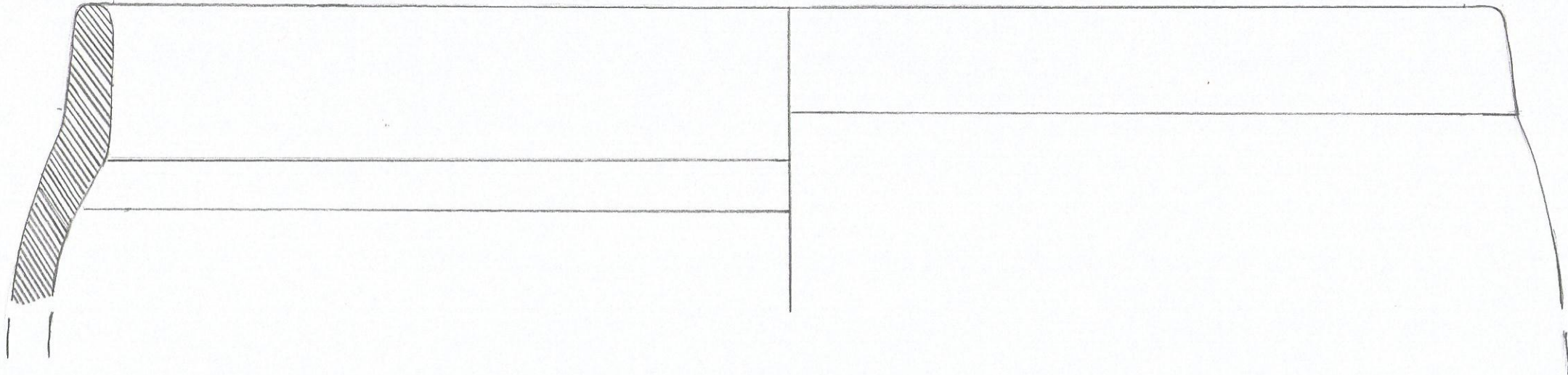

PASH 10/5 -21/
K-8/13

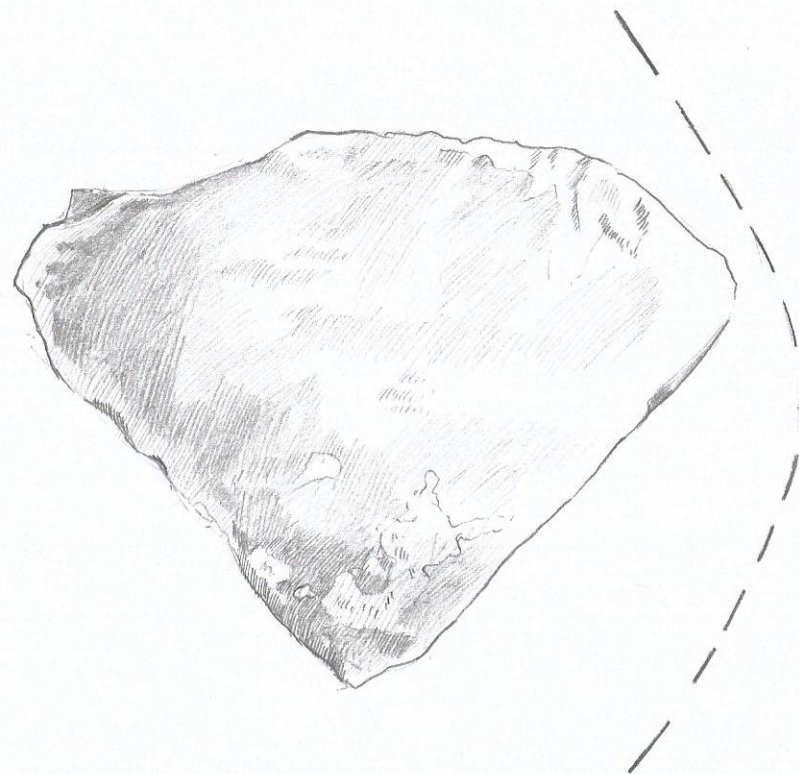
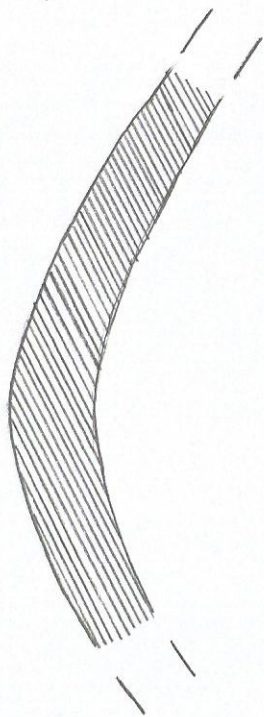

PASH 2013 (nc'qese)
Site - 012
Tract E-227 (1) + (2)

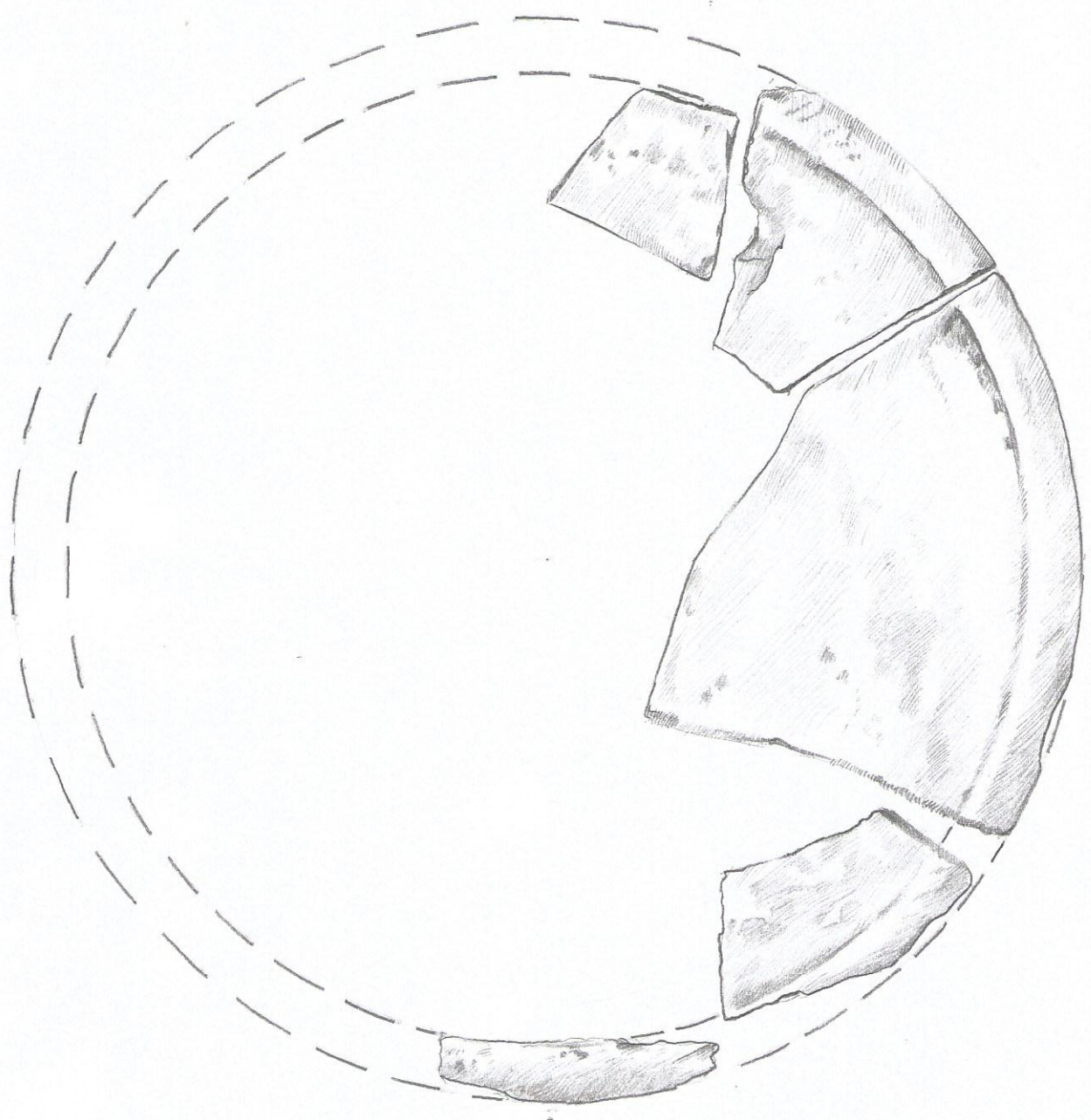
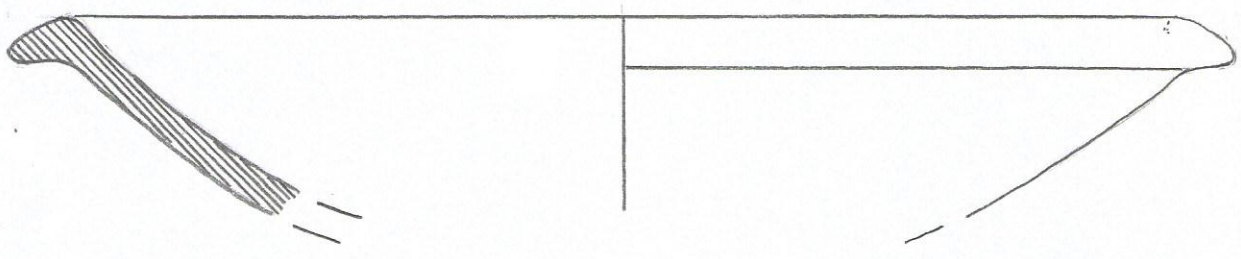

PASH 2014 (no gese)
S 115, U1, L6
5

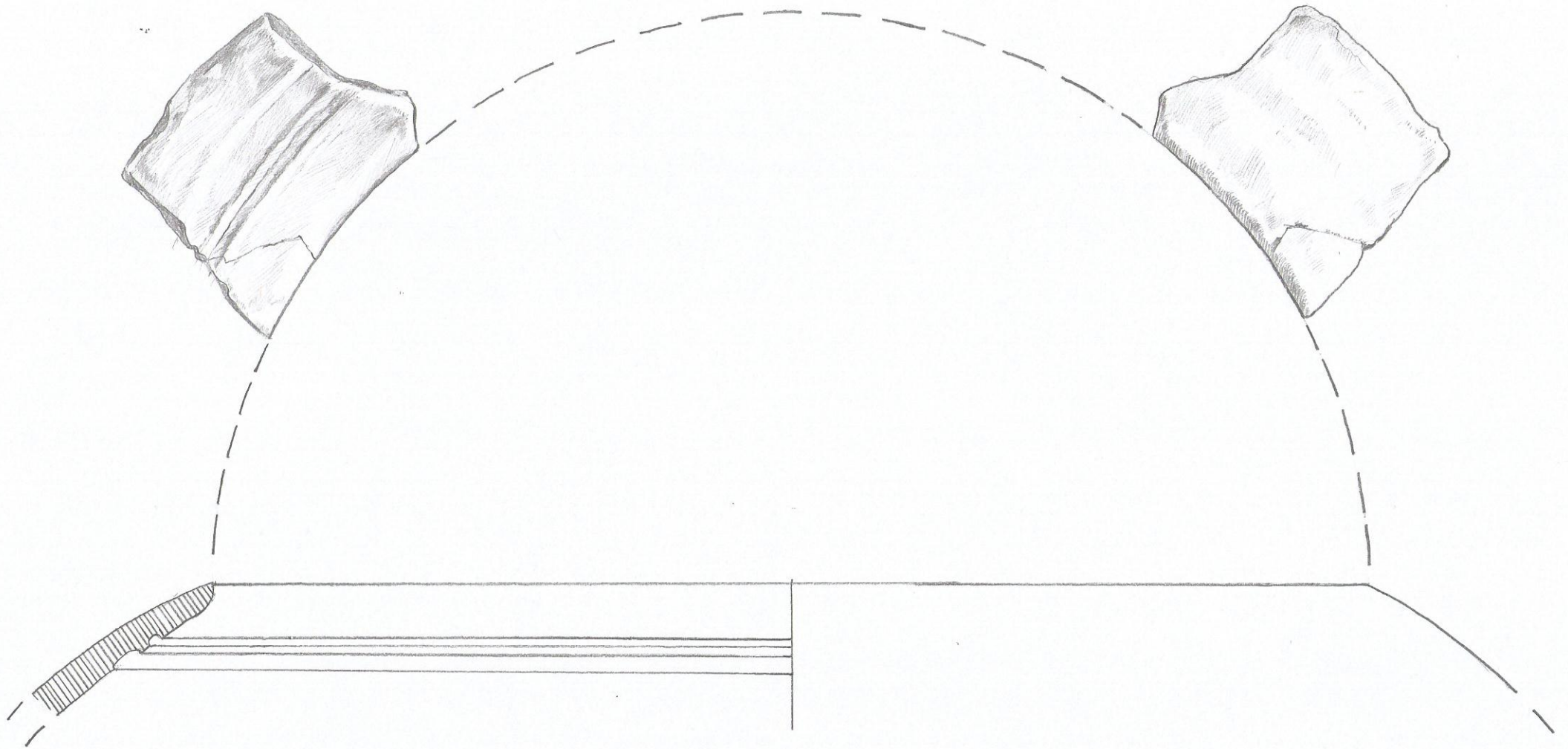

PASH 2014? (néqese)

S-011/5T-00

2

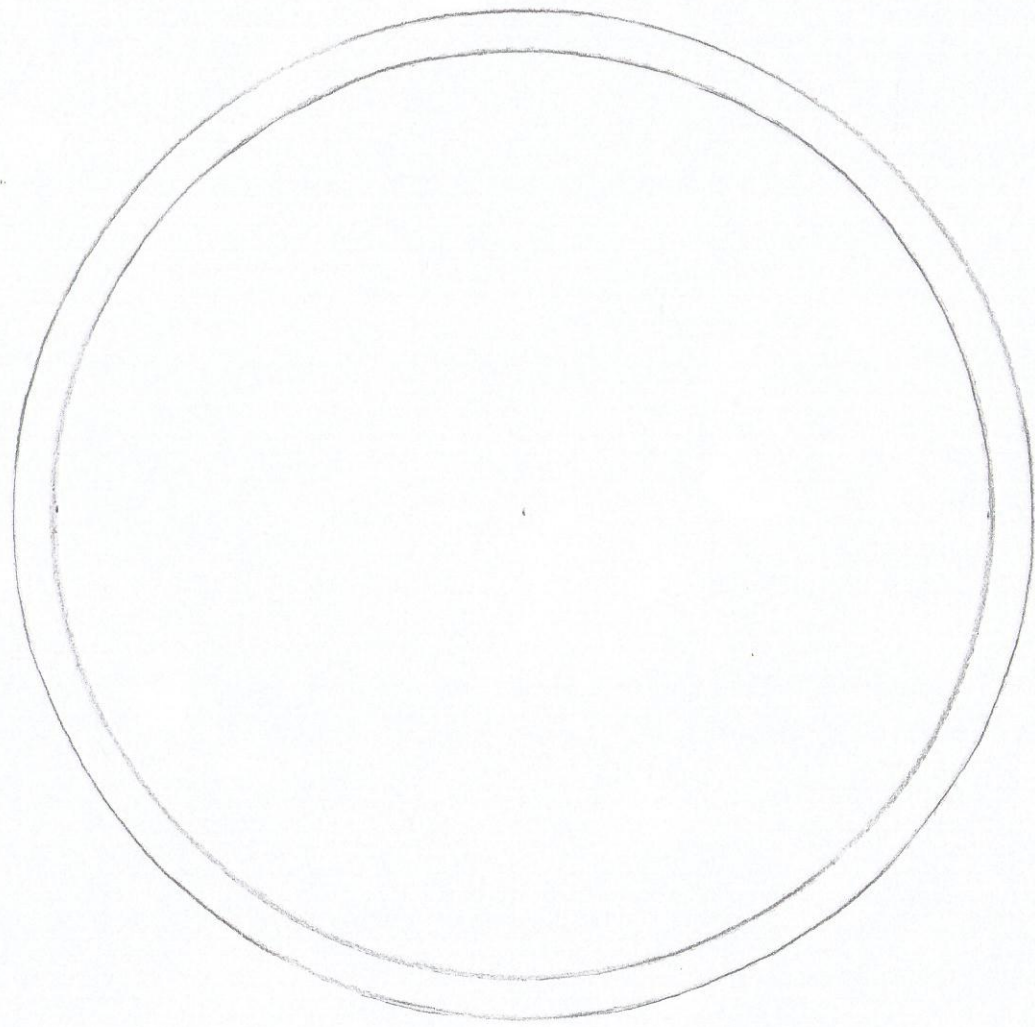
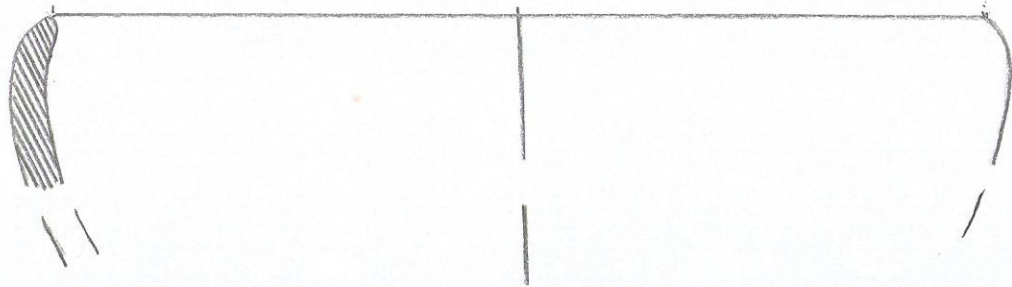

PASH 11 (qese)
S-15/Ur-47/32

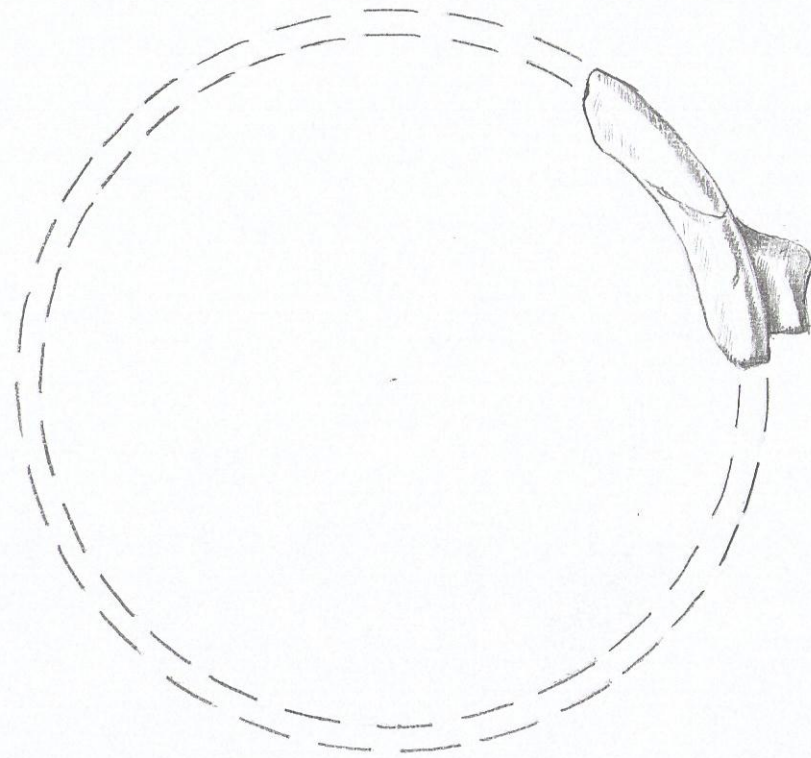
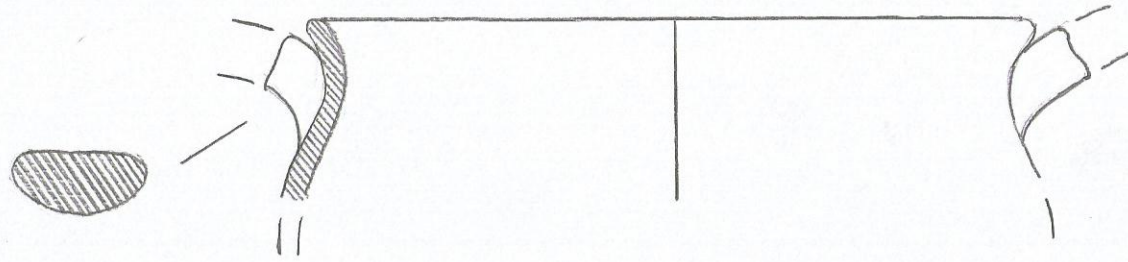

PASH 2014
S-11/5T 05-01

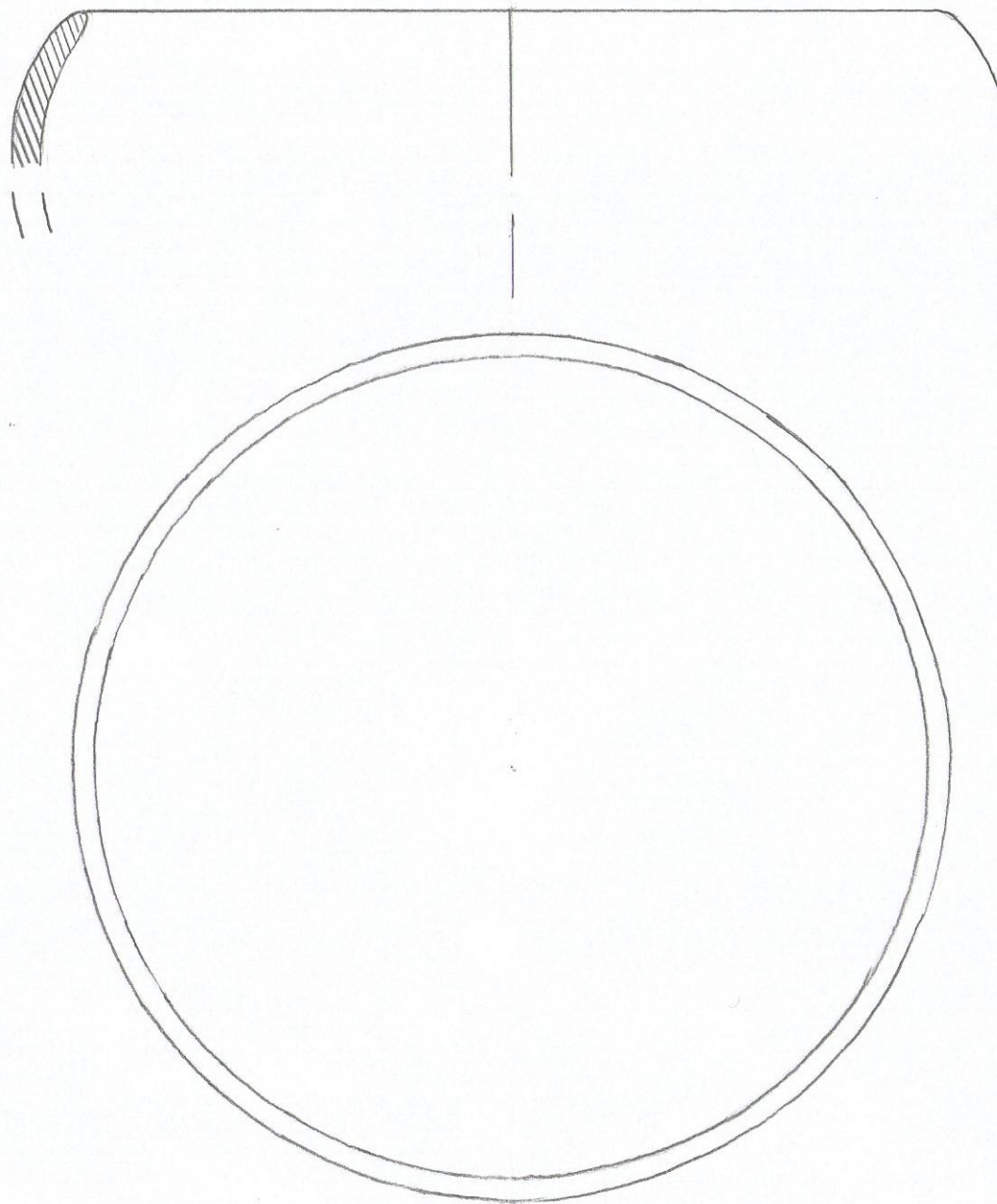

PASH 10/A-4/3

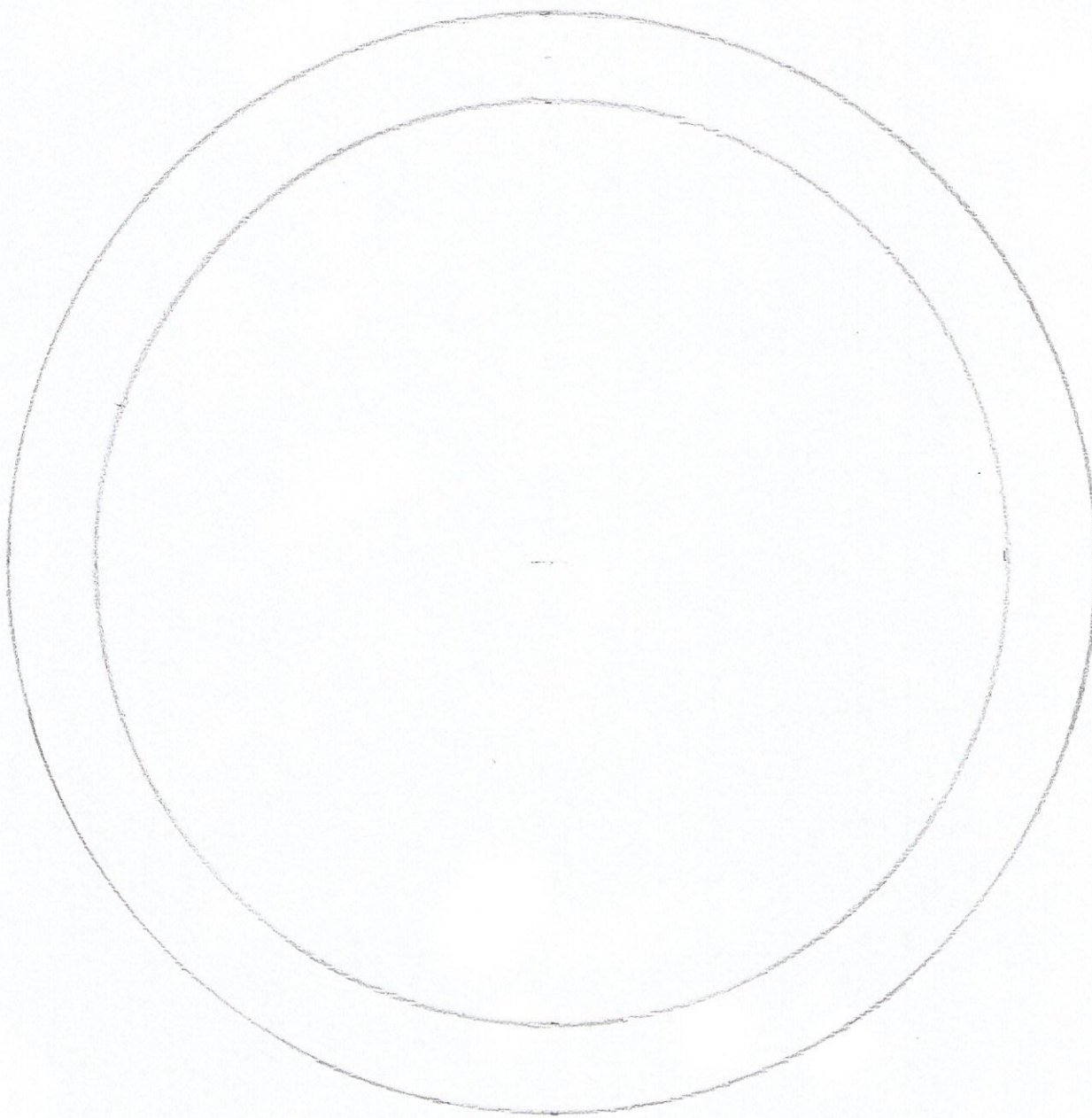
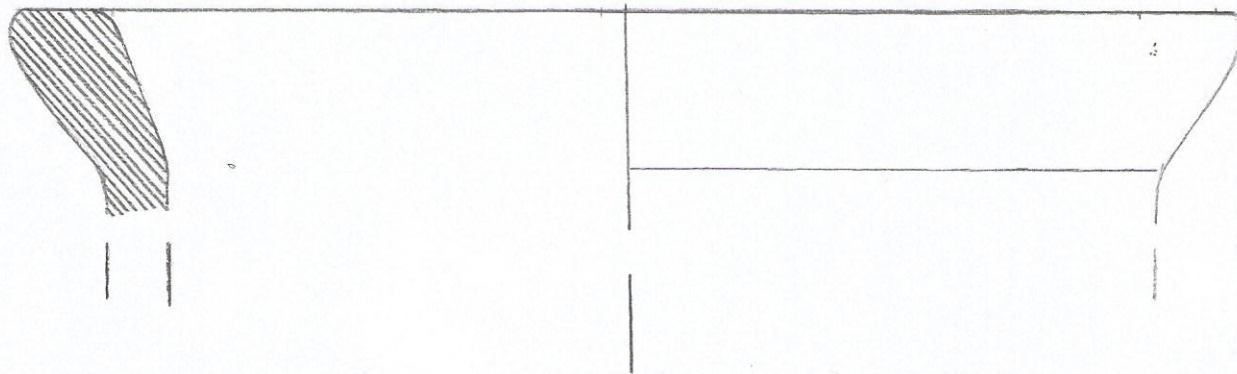

PASH 2014
S-311/57-06
3

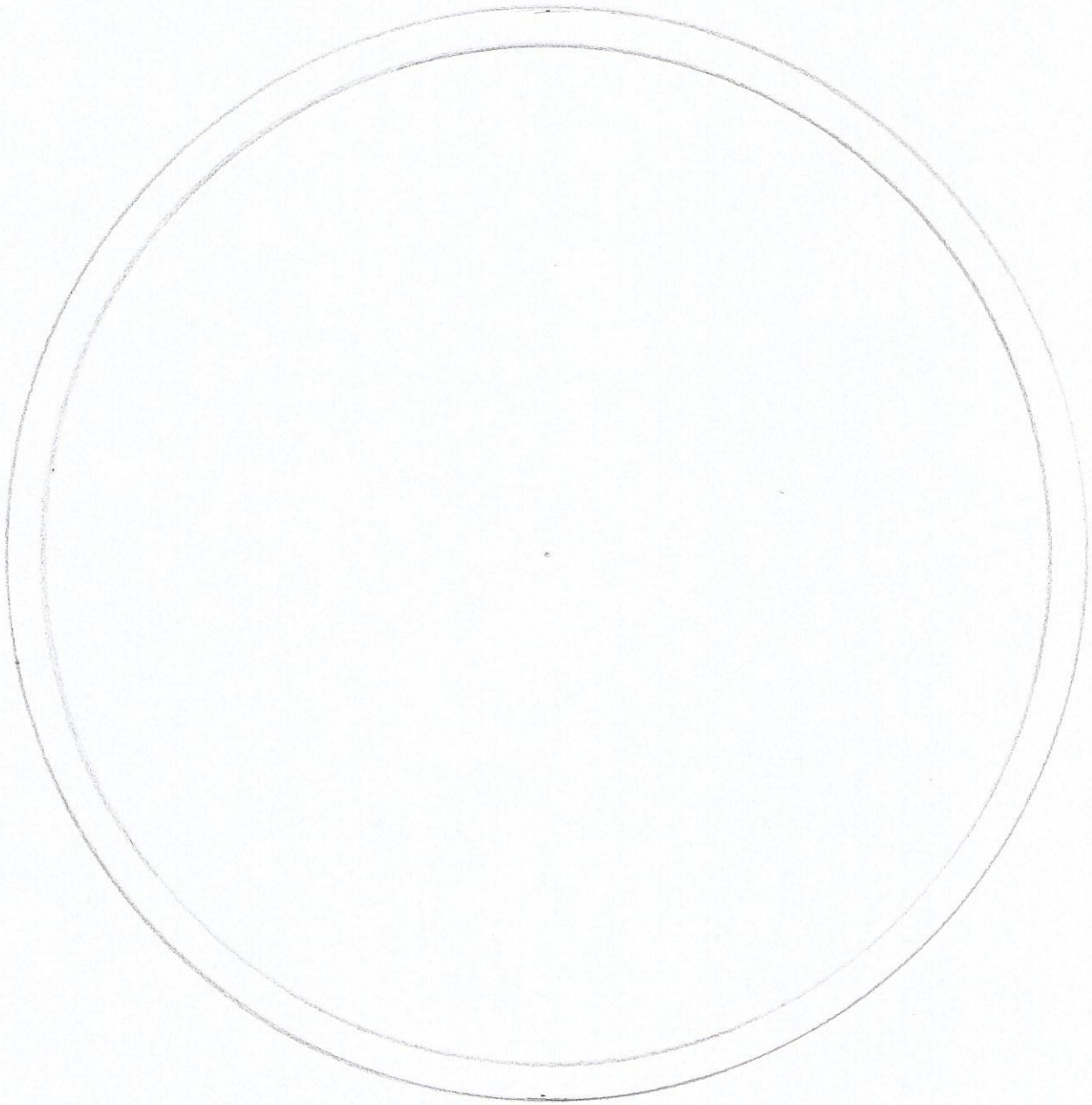
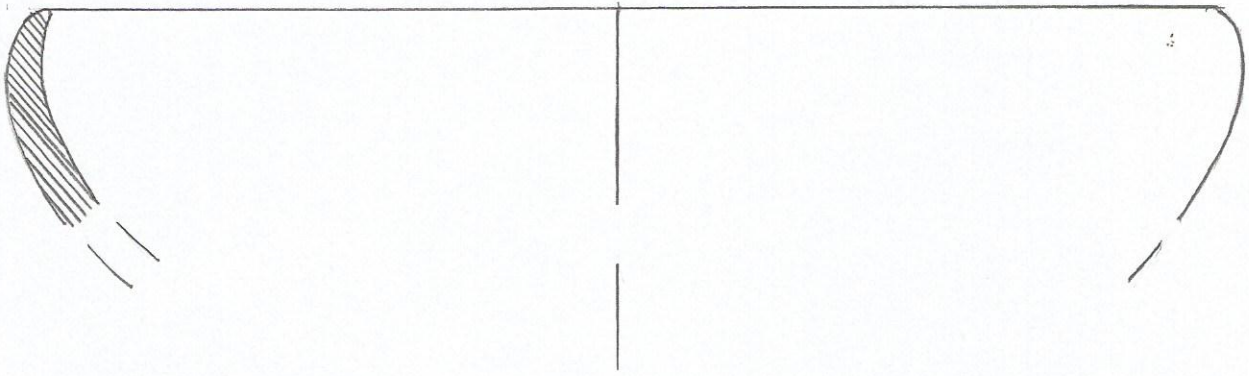

PASH 2014
S 11/1T-02/72

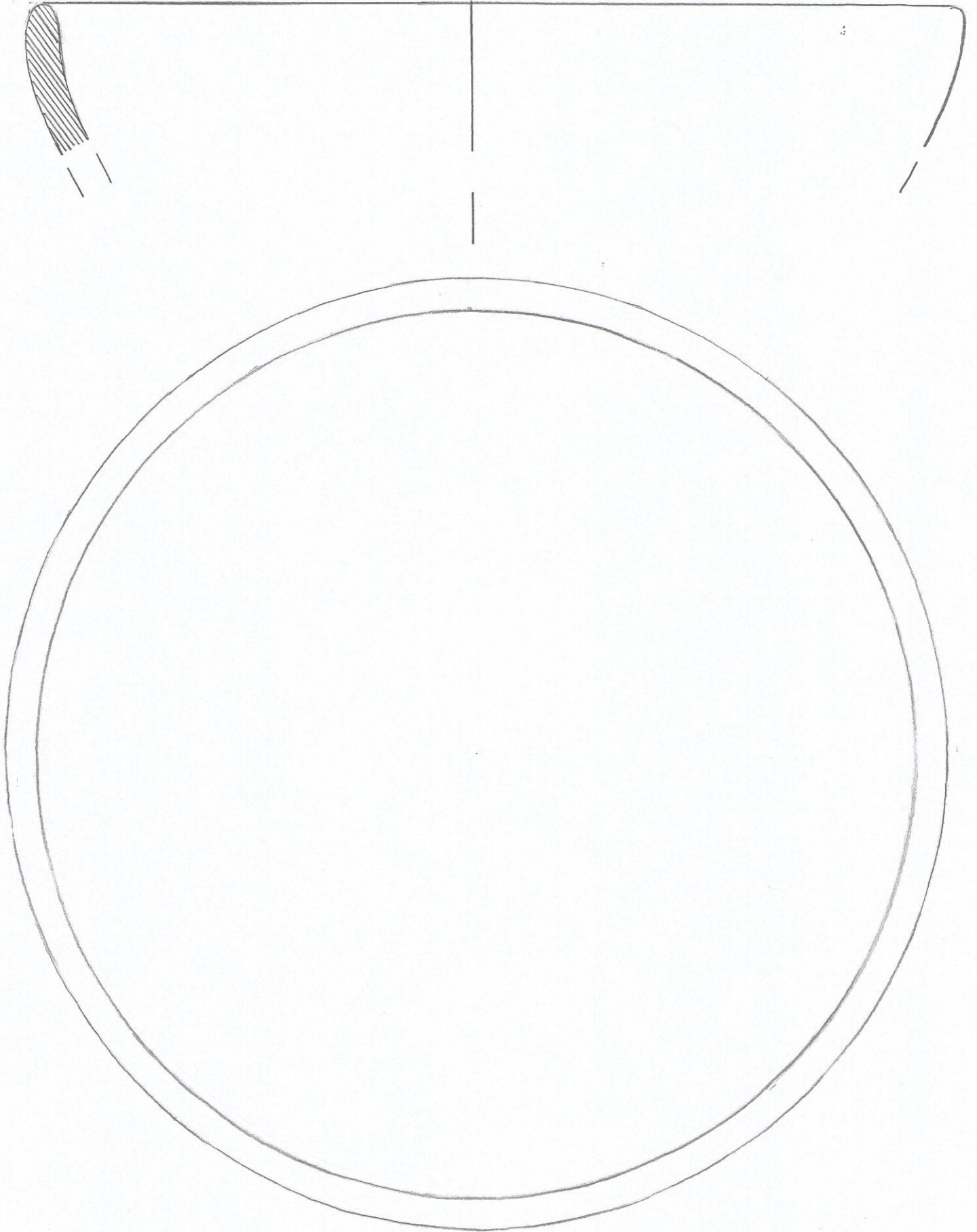

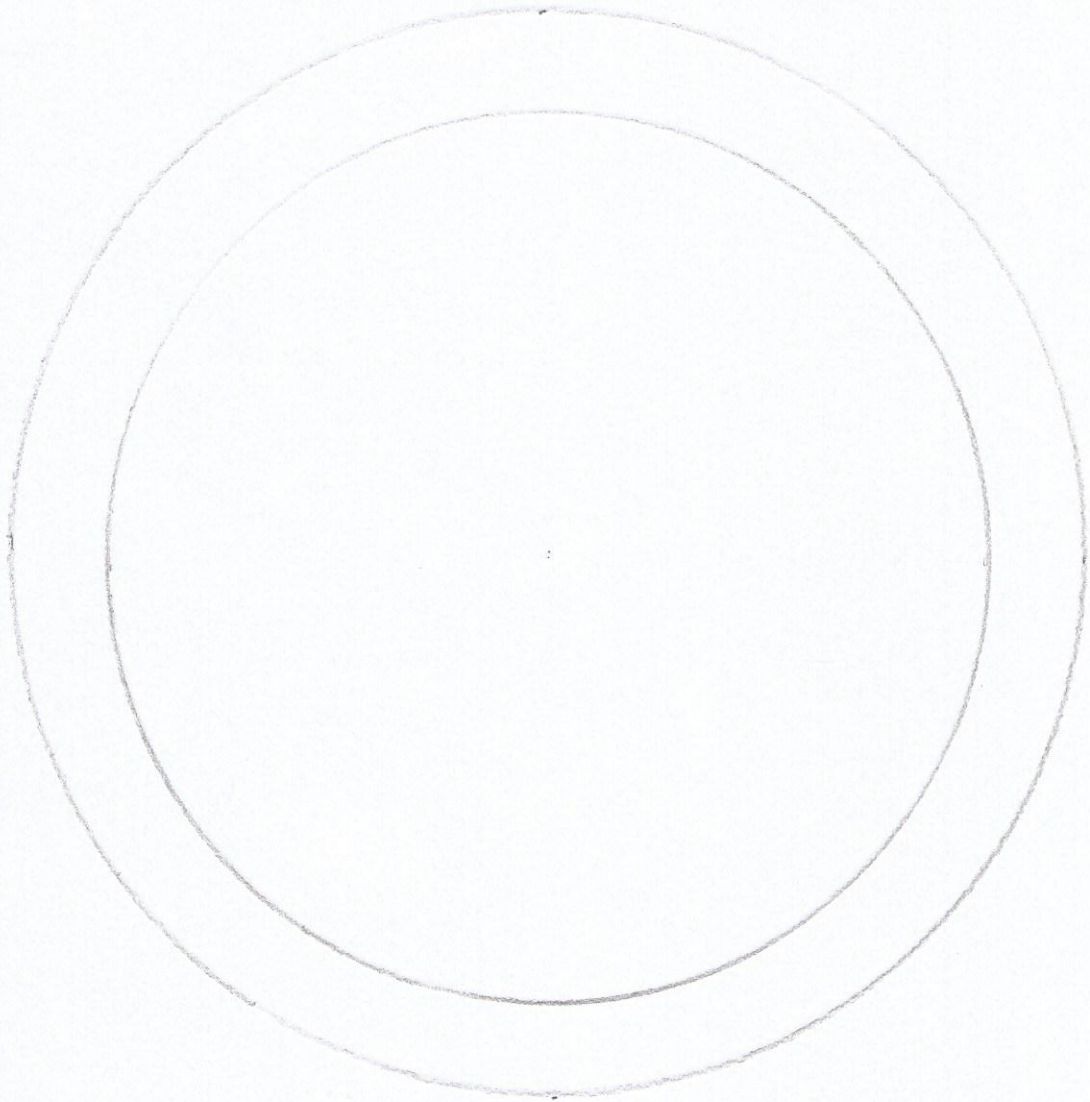
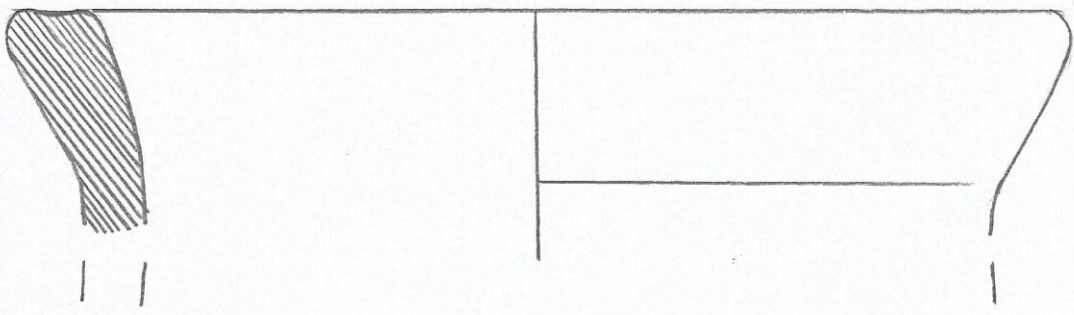

PASH 2014
S-15/41-L6/9!

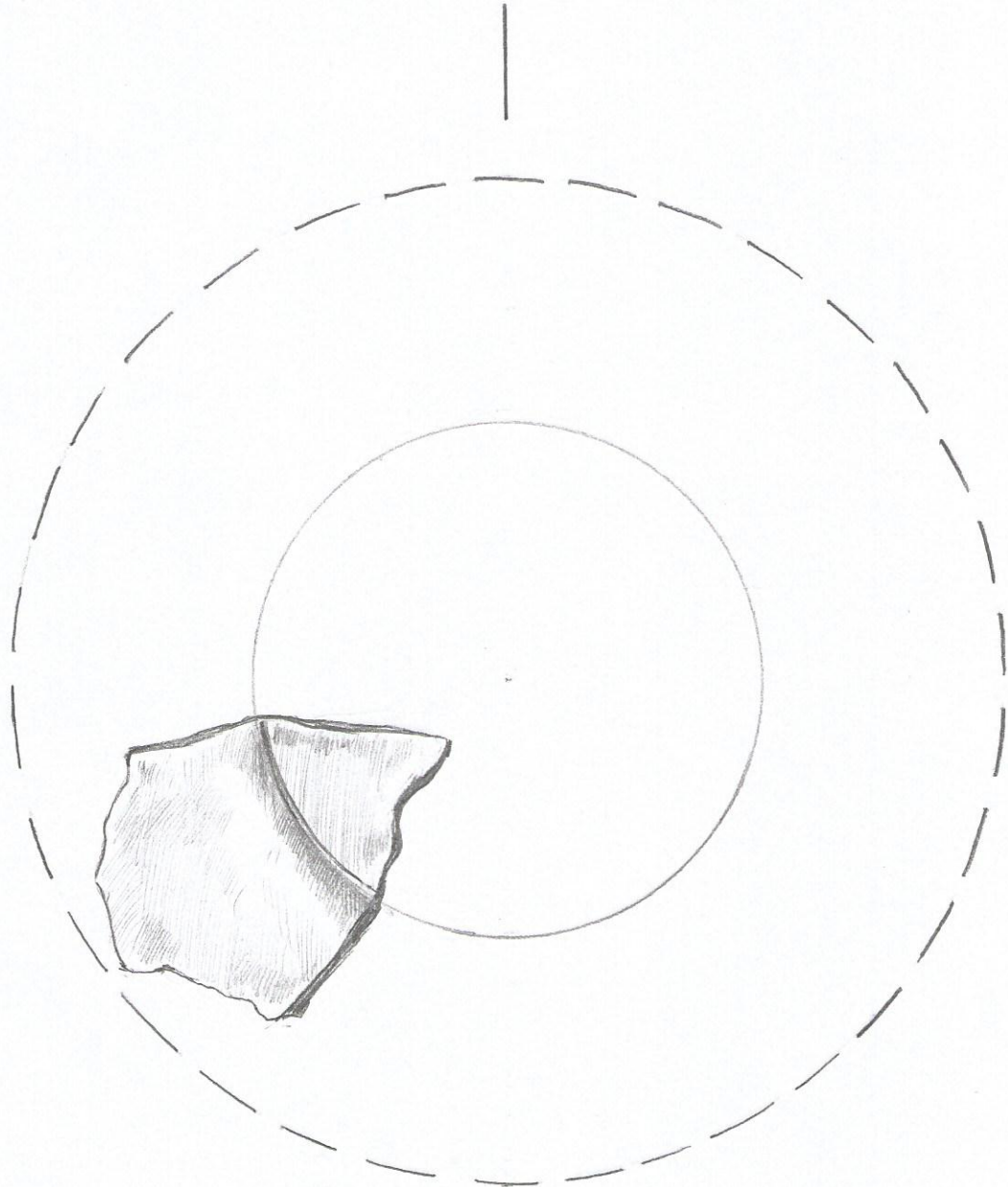
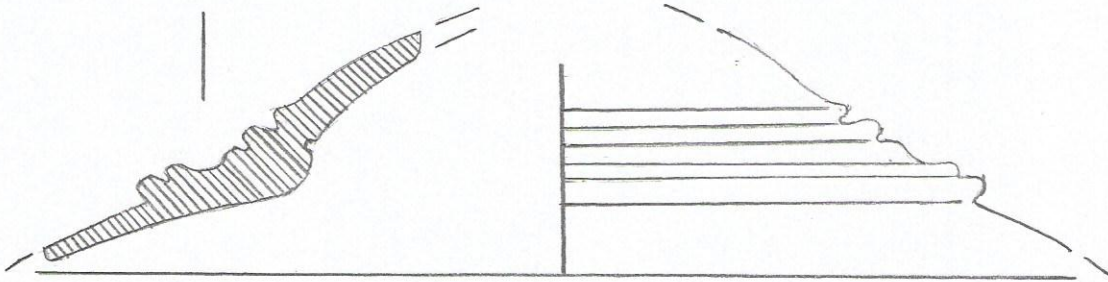
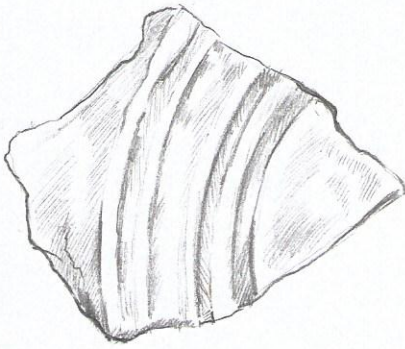

PASH 2014
007-041?
03-23-

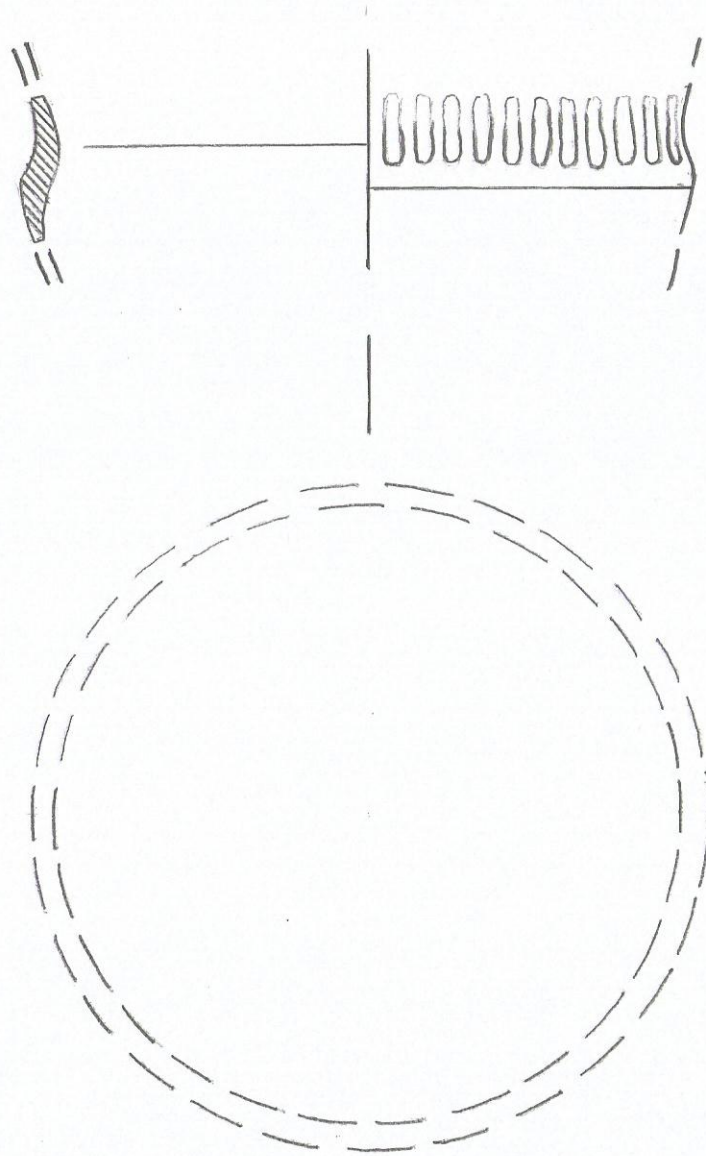

PASH 10/A-4

4

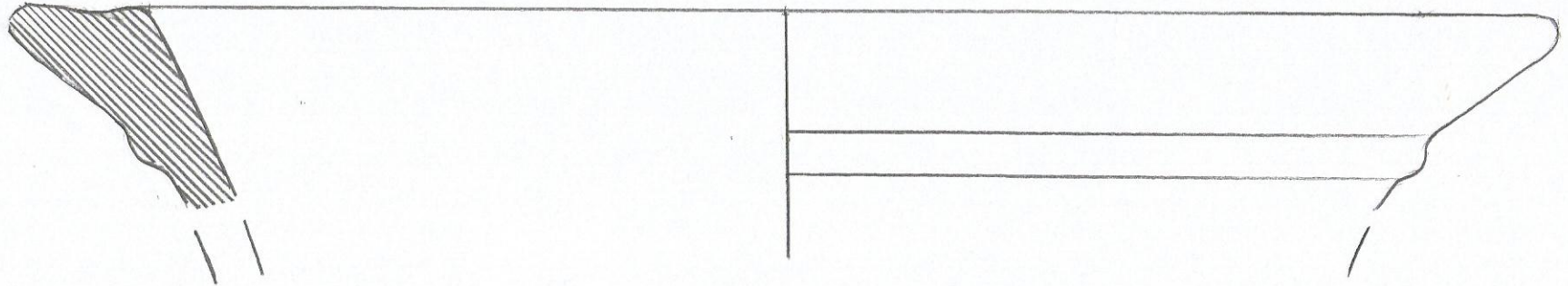

0

5

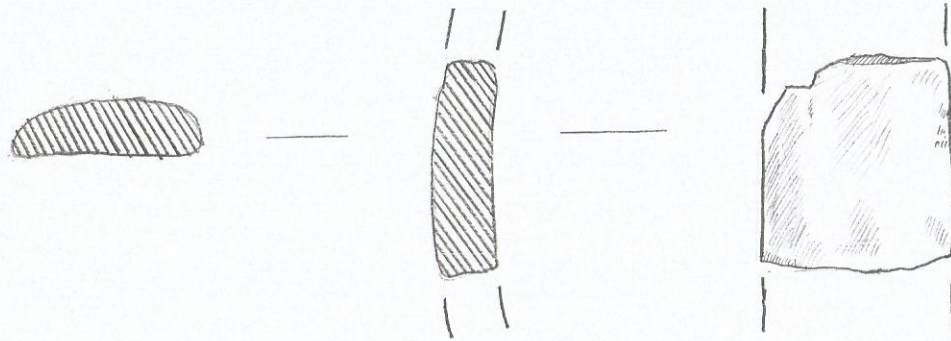

PASH 2013

T-249/22

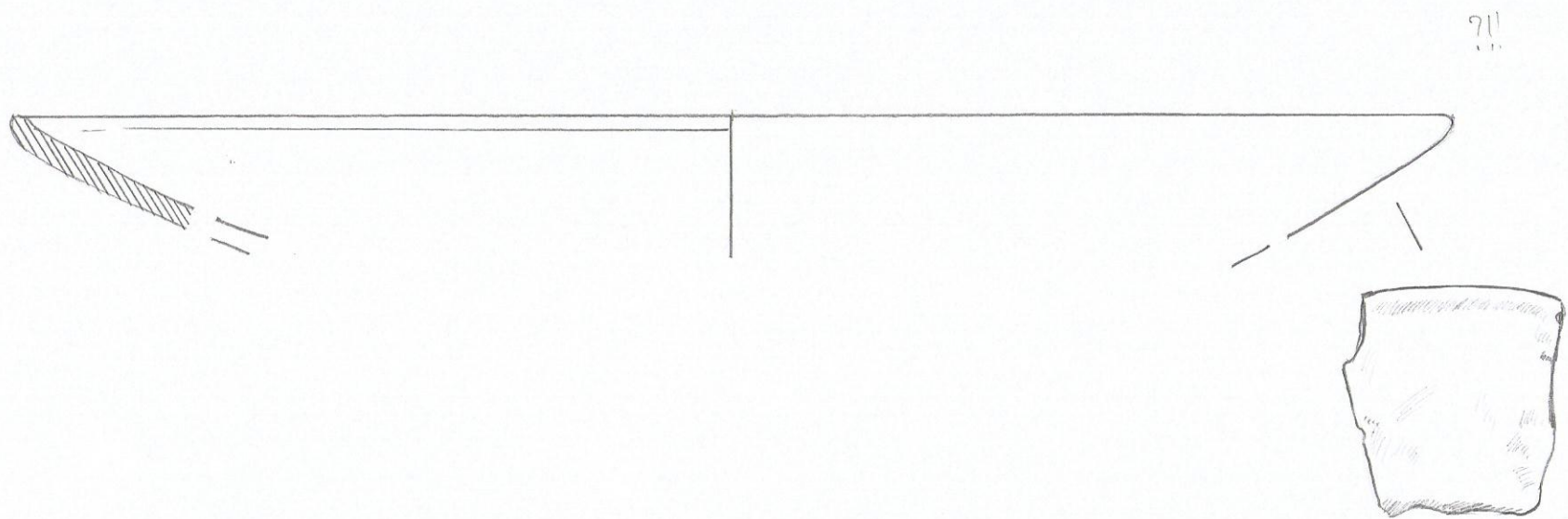

PASH 2013

S-011 Cu-20

192/D

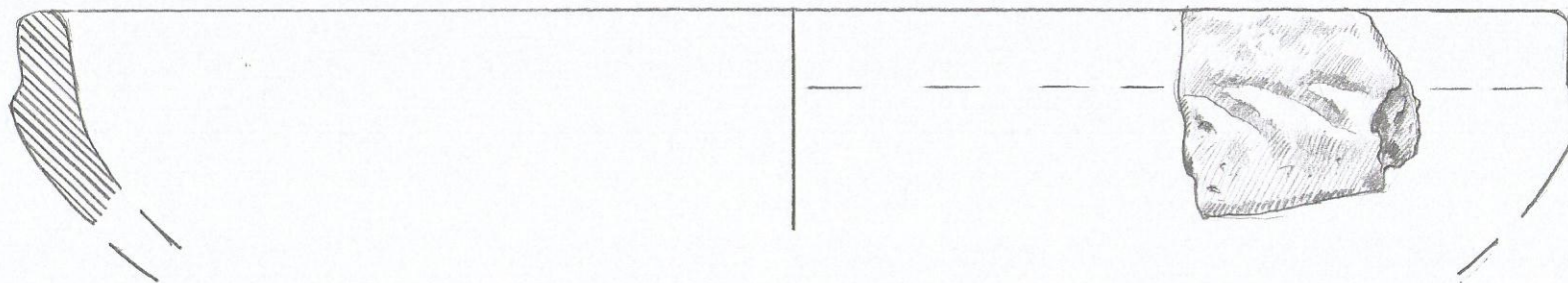

PASH 2014
S-011/57-04
5

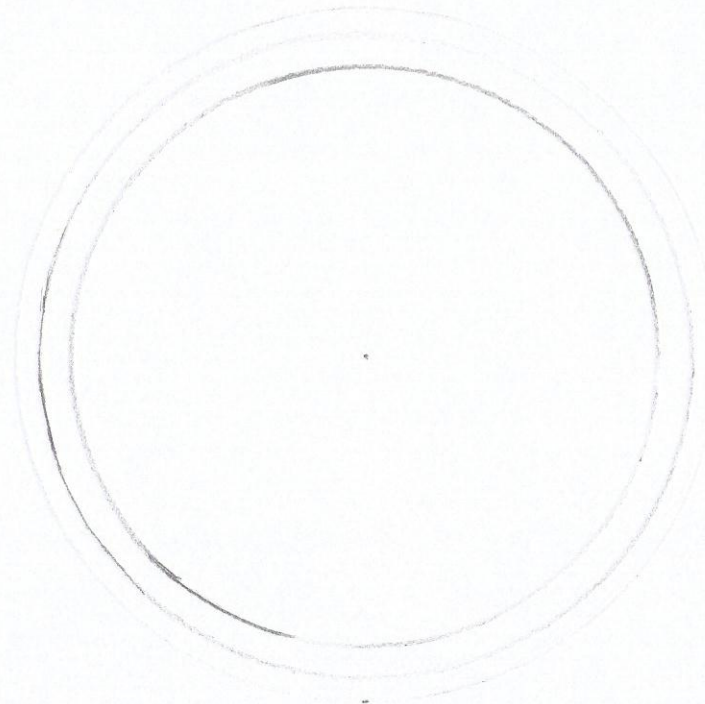
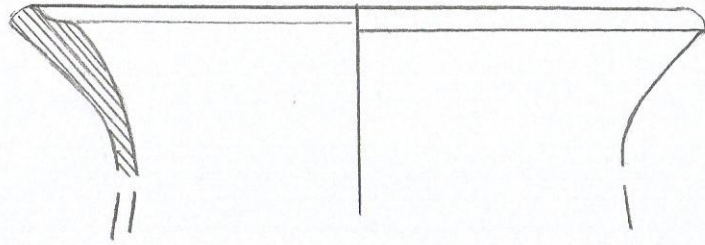

PASH 2013/H-177
/ T-113B/4

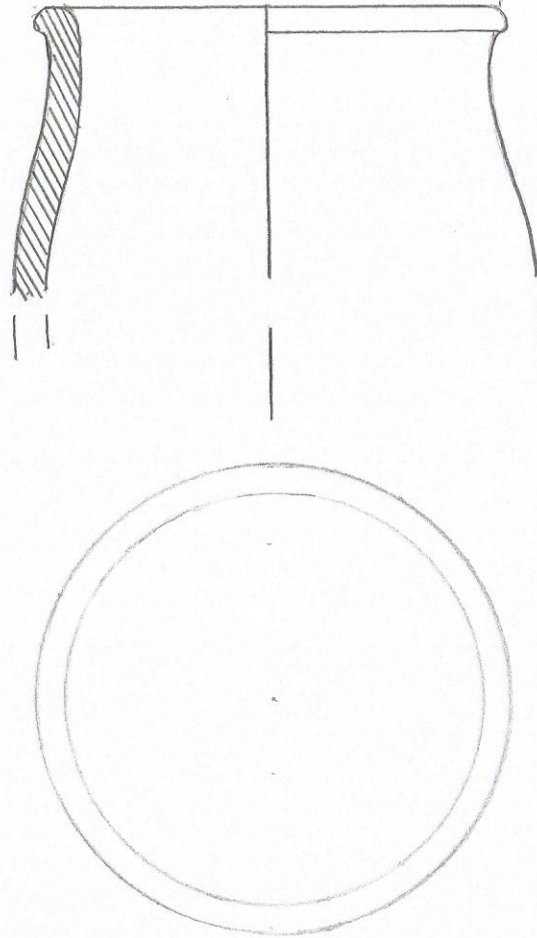

PASH 10/T-71/2

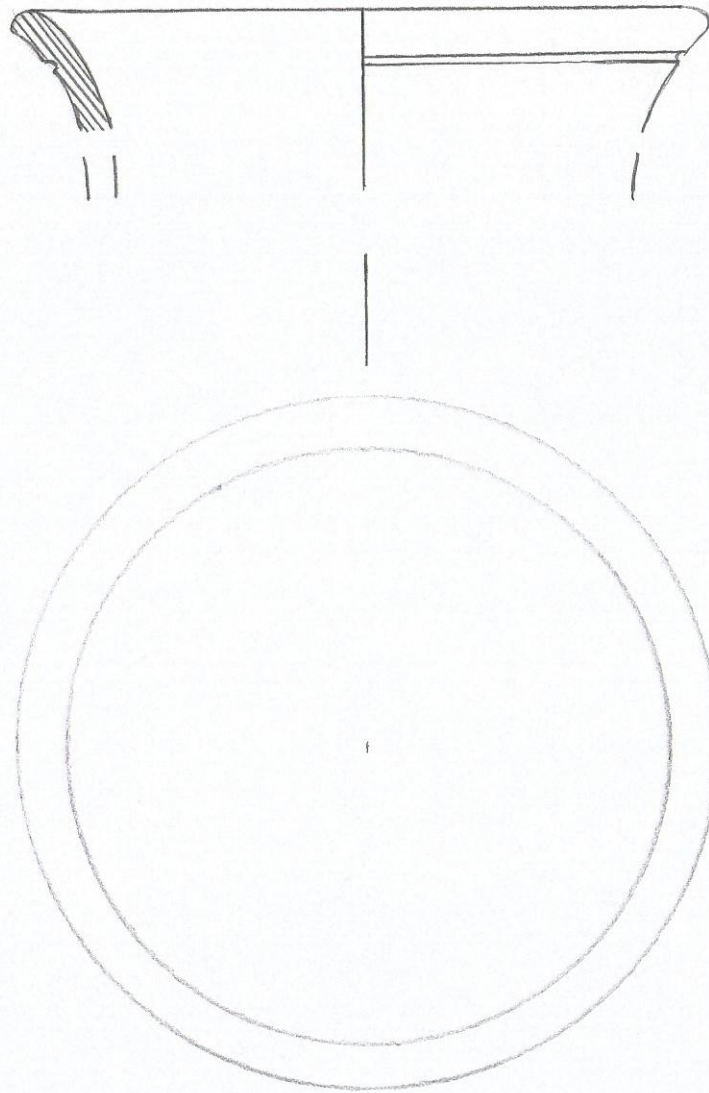

PASH 10/
B-0941
1

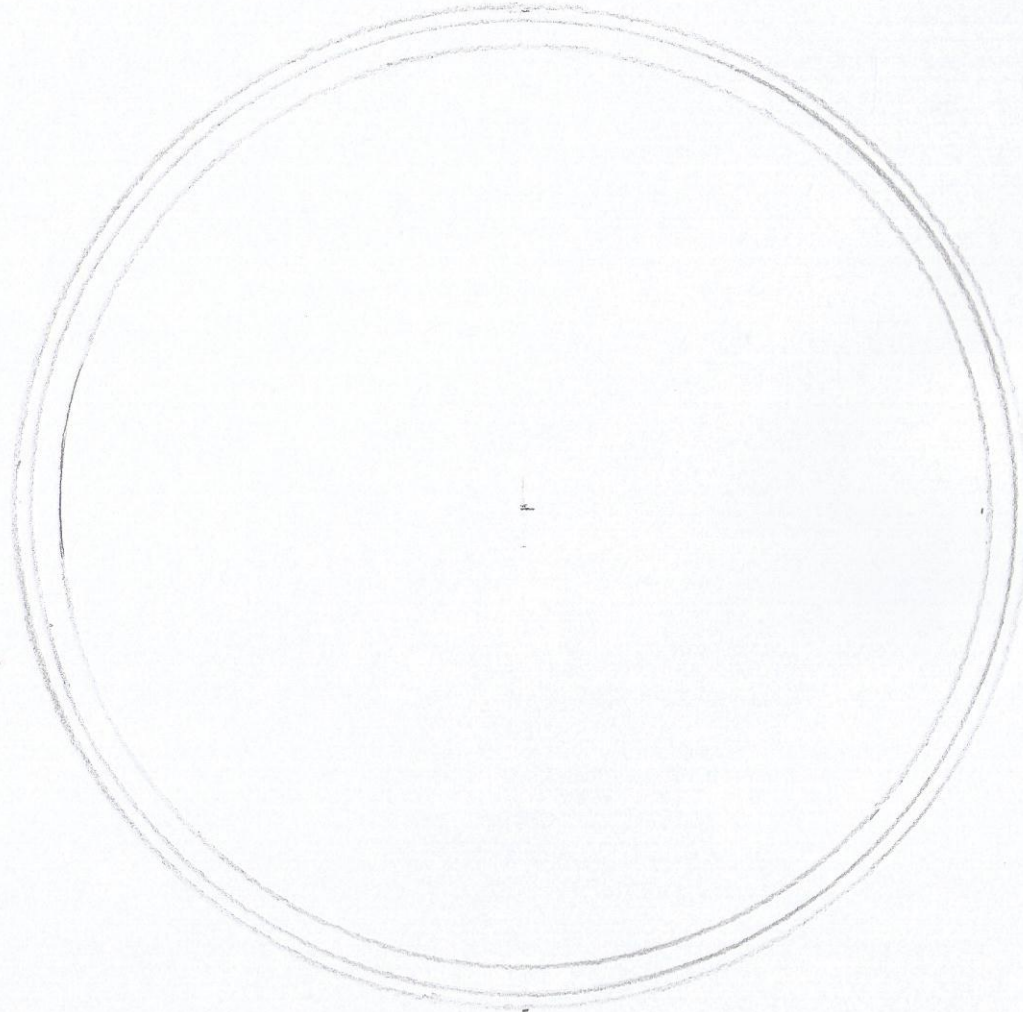
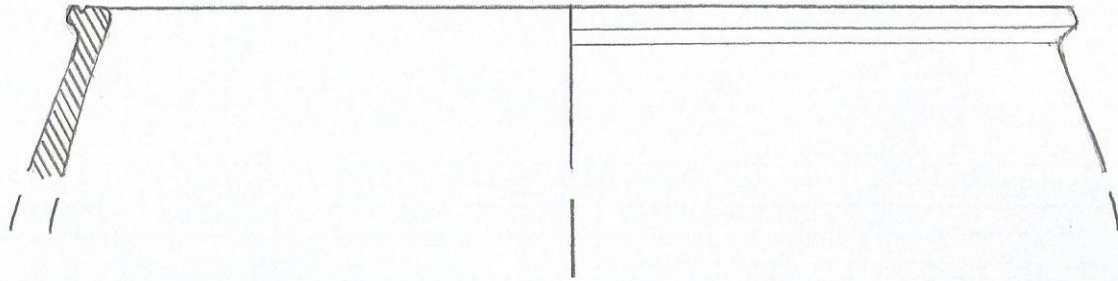

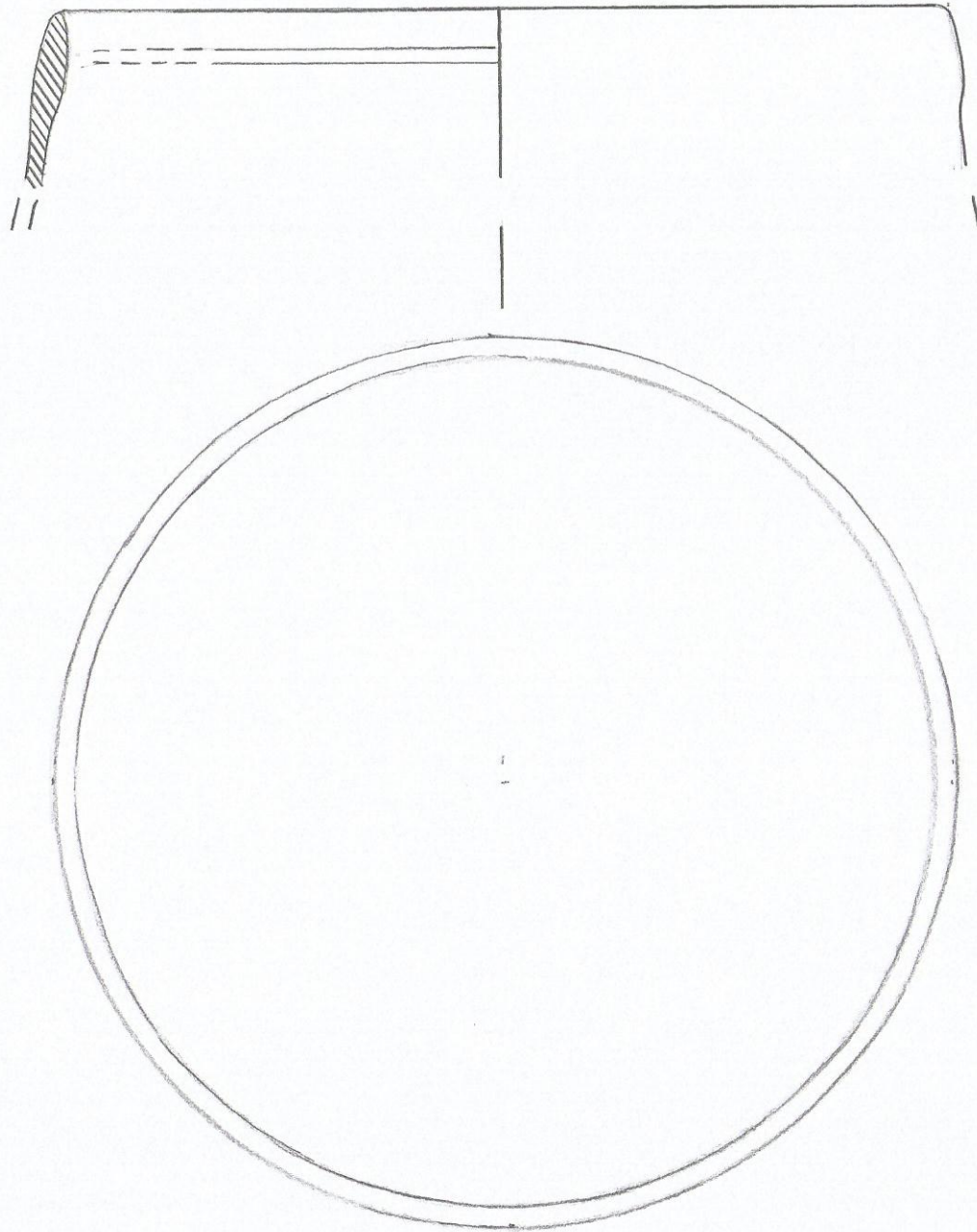

PASH 13
2RV-10/72/1-[Ⓜ]
B

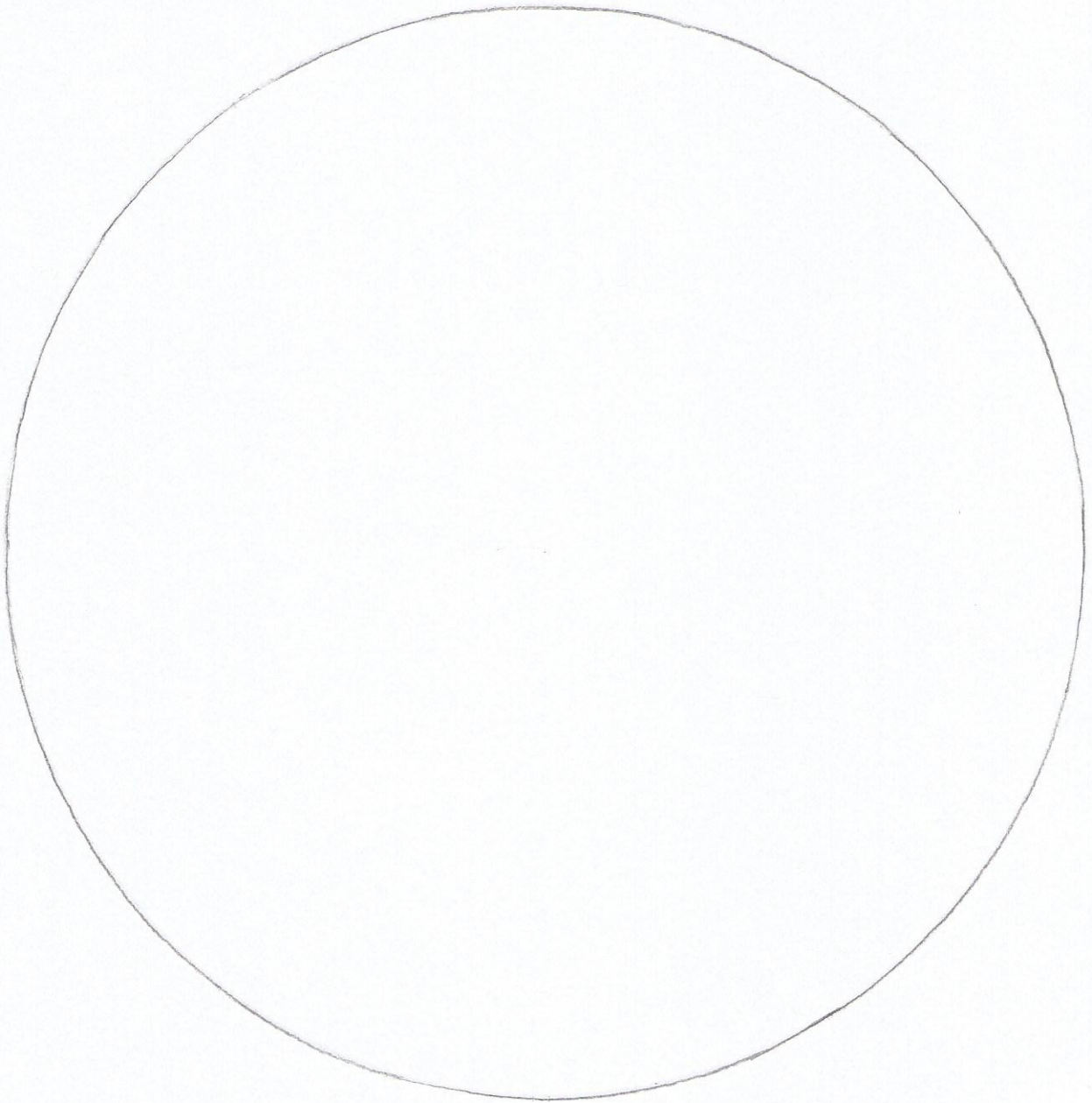
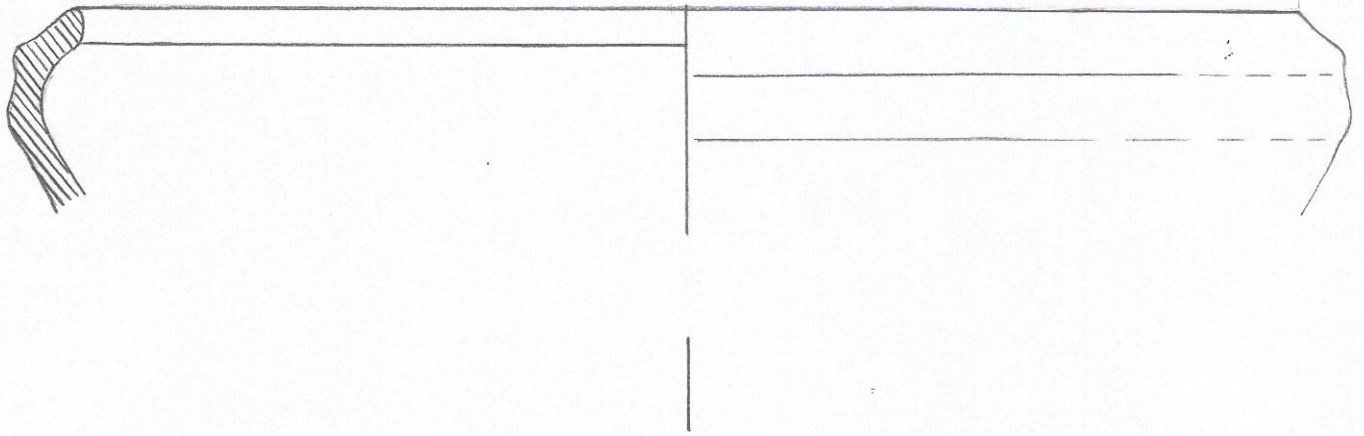

PASH 10/
S-1/K-4/
1

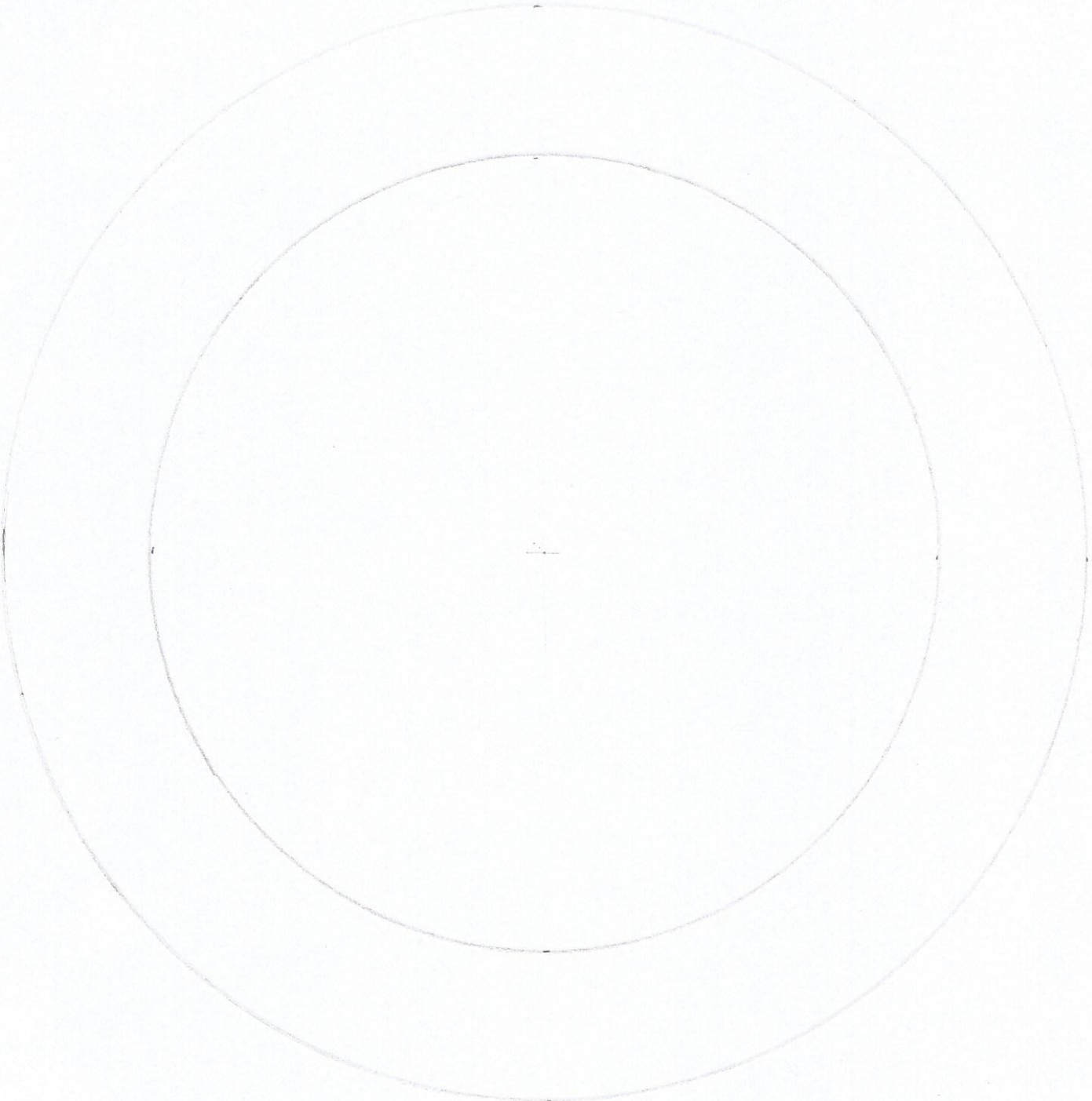
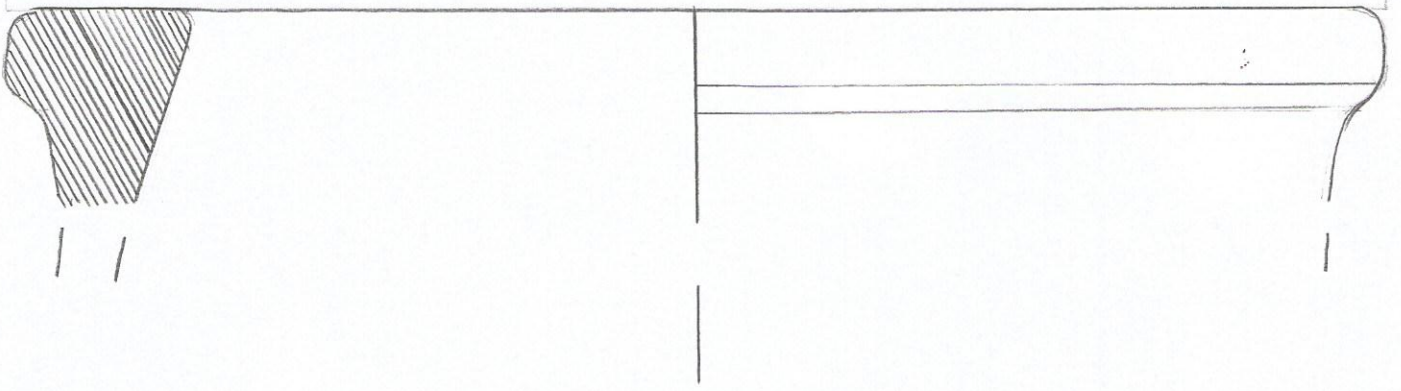

PASH H 5007
02T-3/1

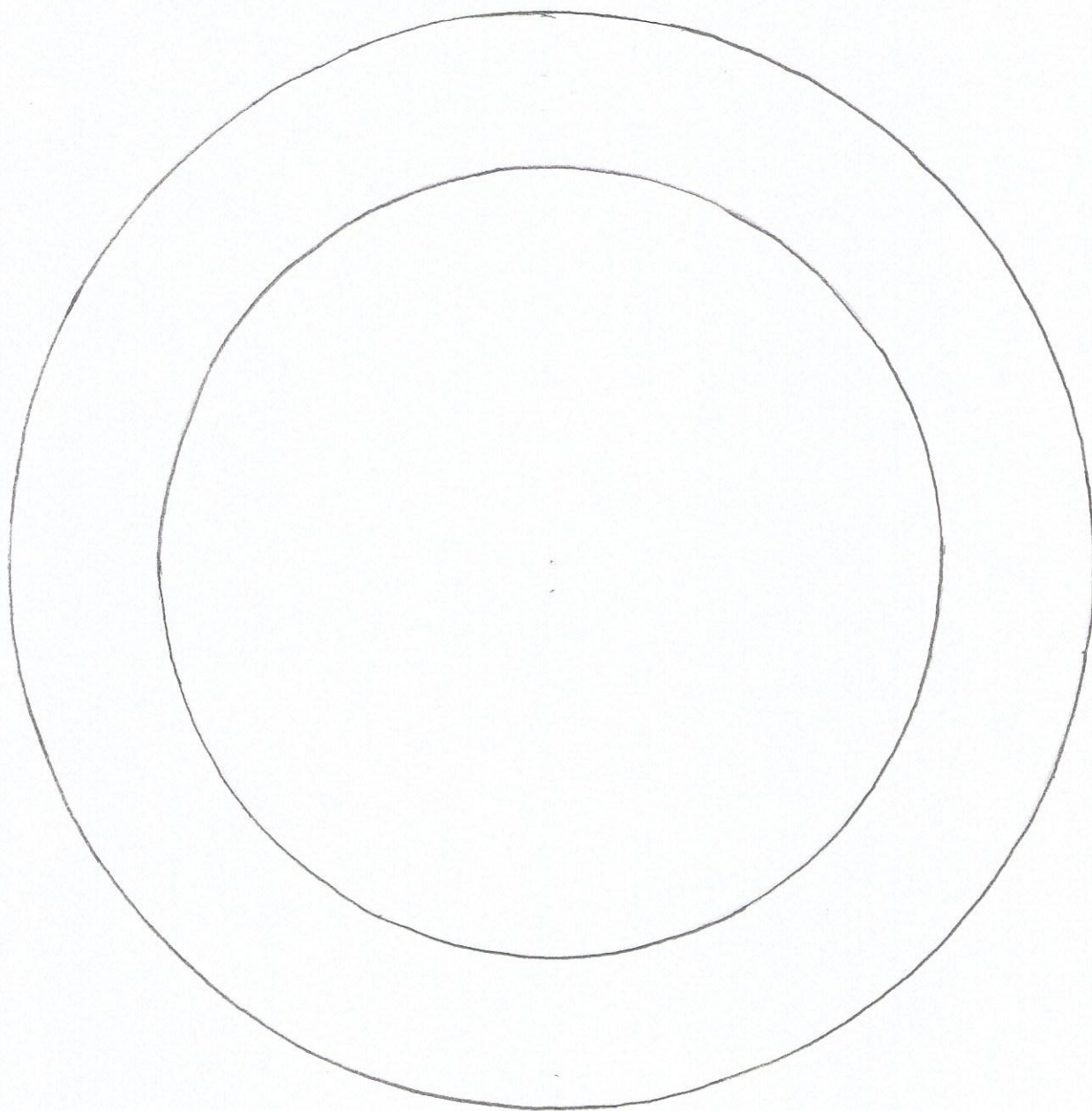
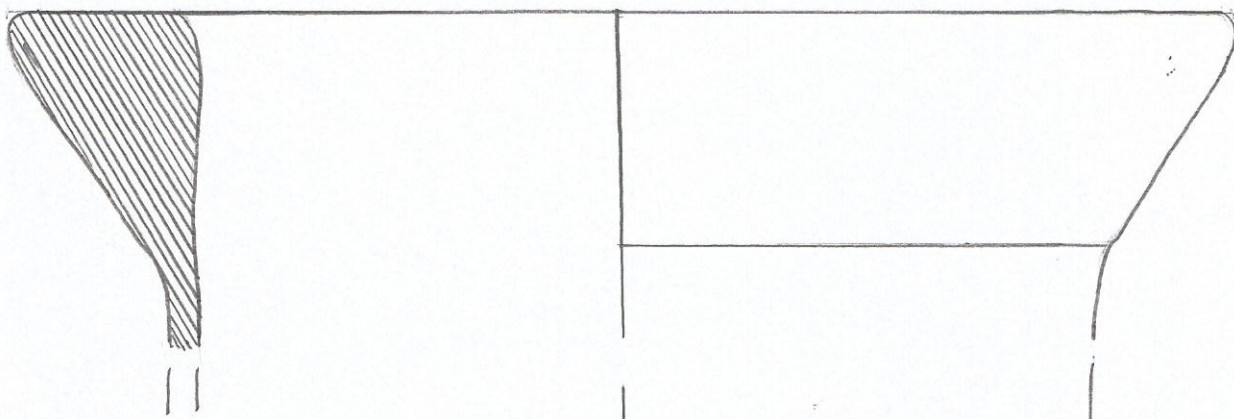

PASH 2013
9-oil Cu-20
193/D

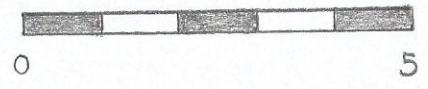
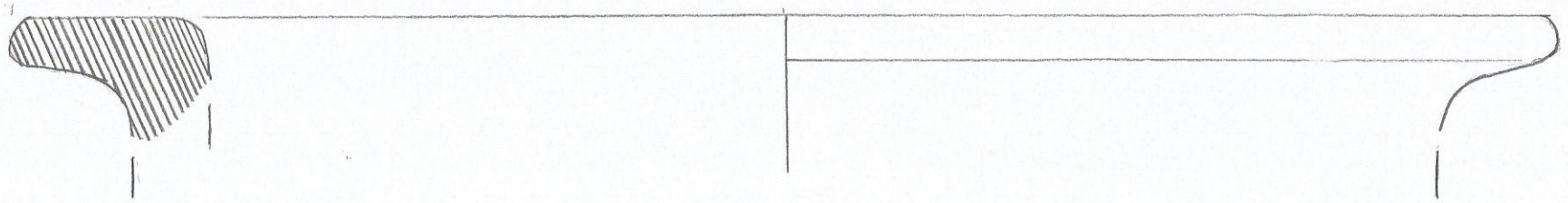

PASH 2013
5-012 I-227

4

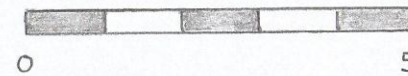
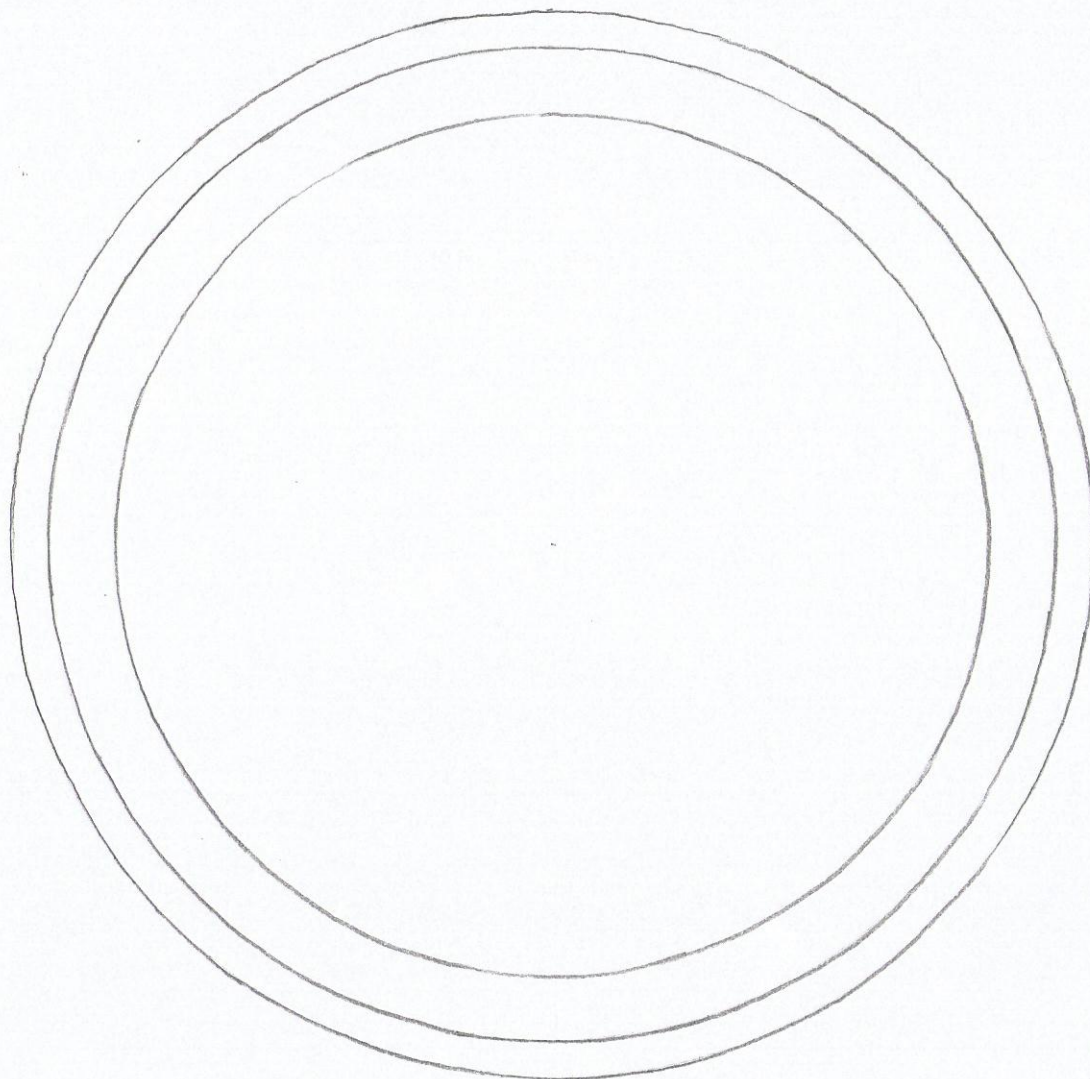
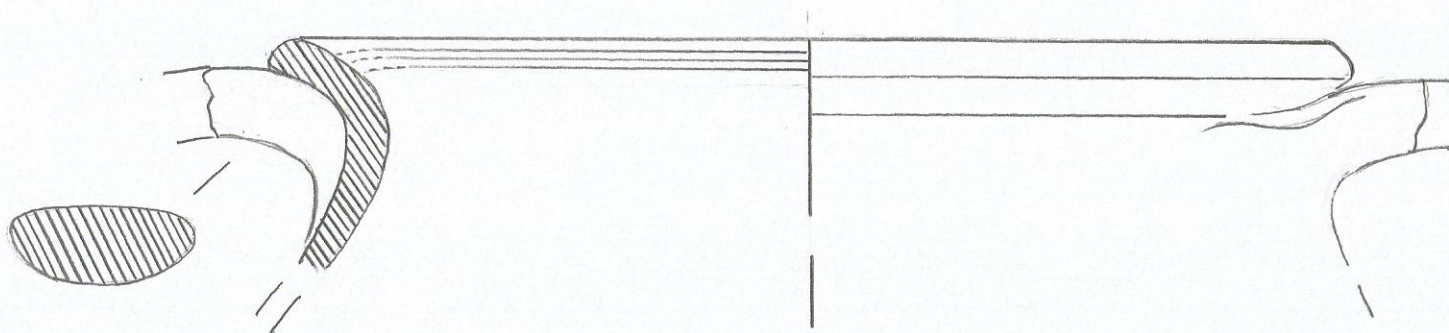

PASH 14
S-15/8T-04/2

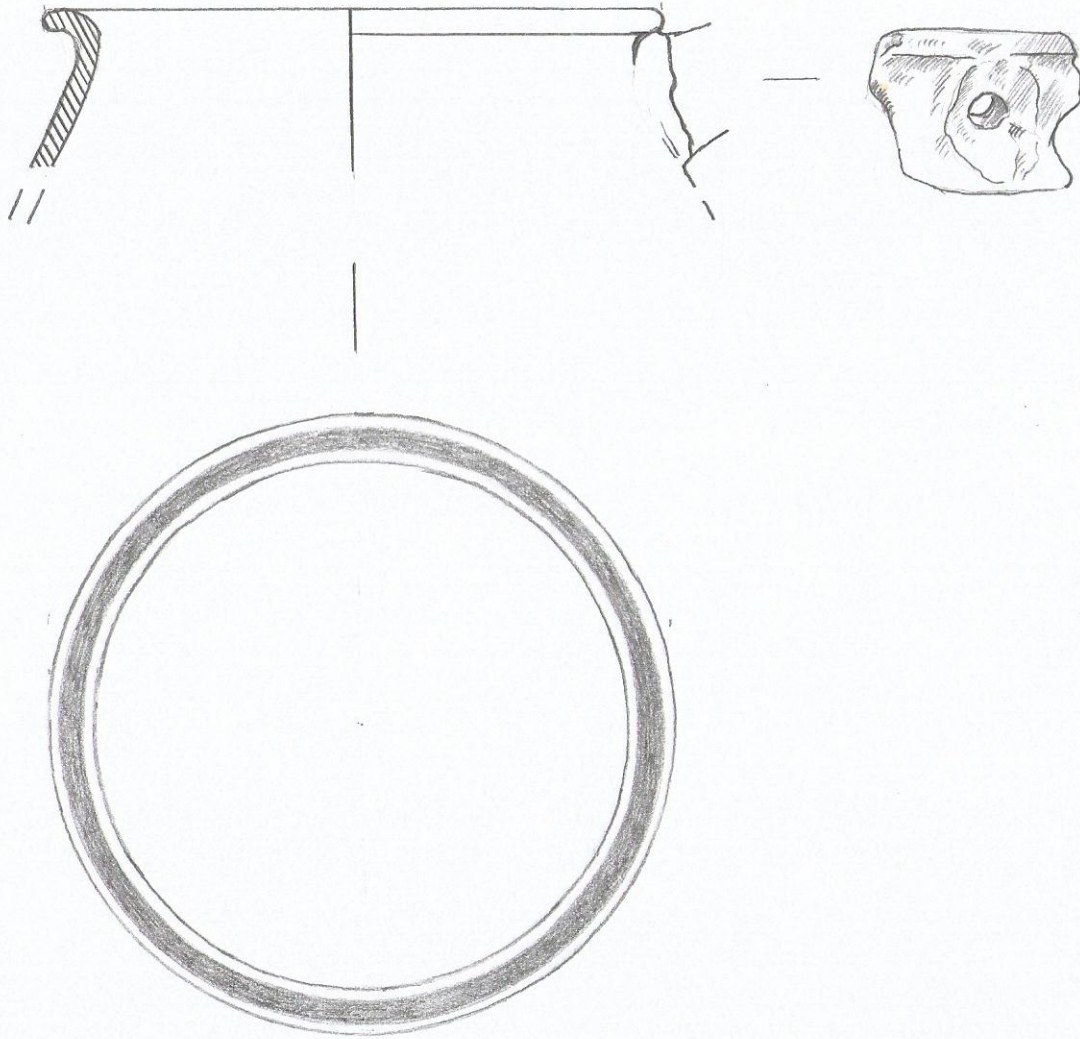

PASH 10/
B-115/
-

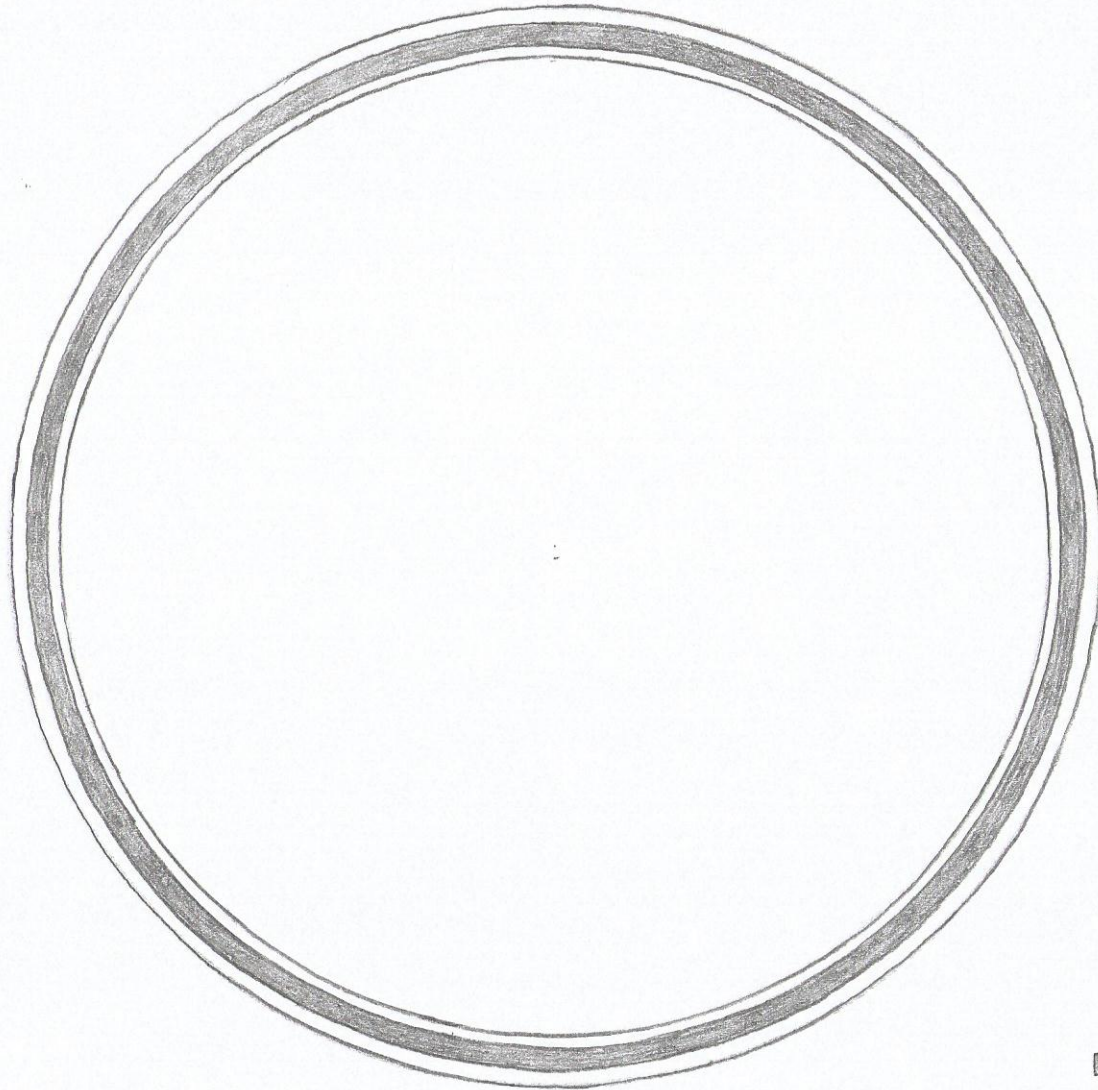
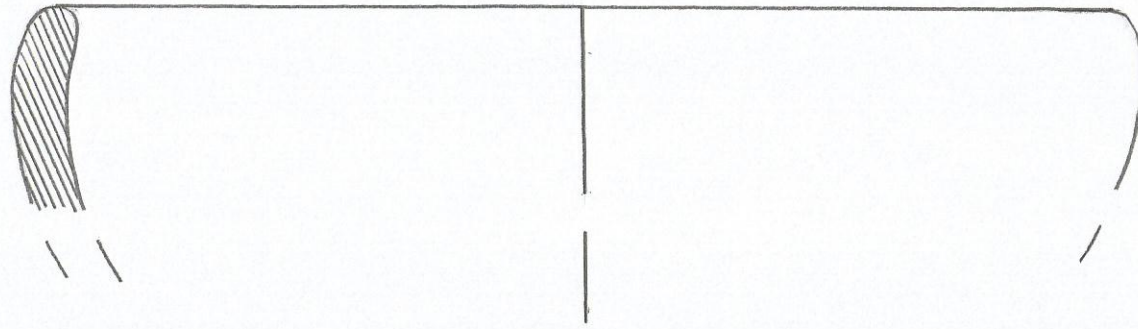

PASH 10/5-2
K-17/2

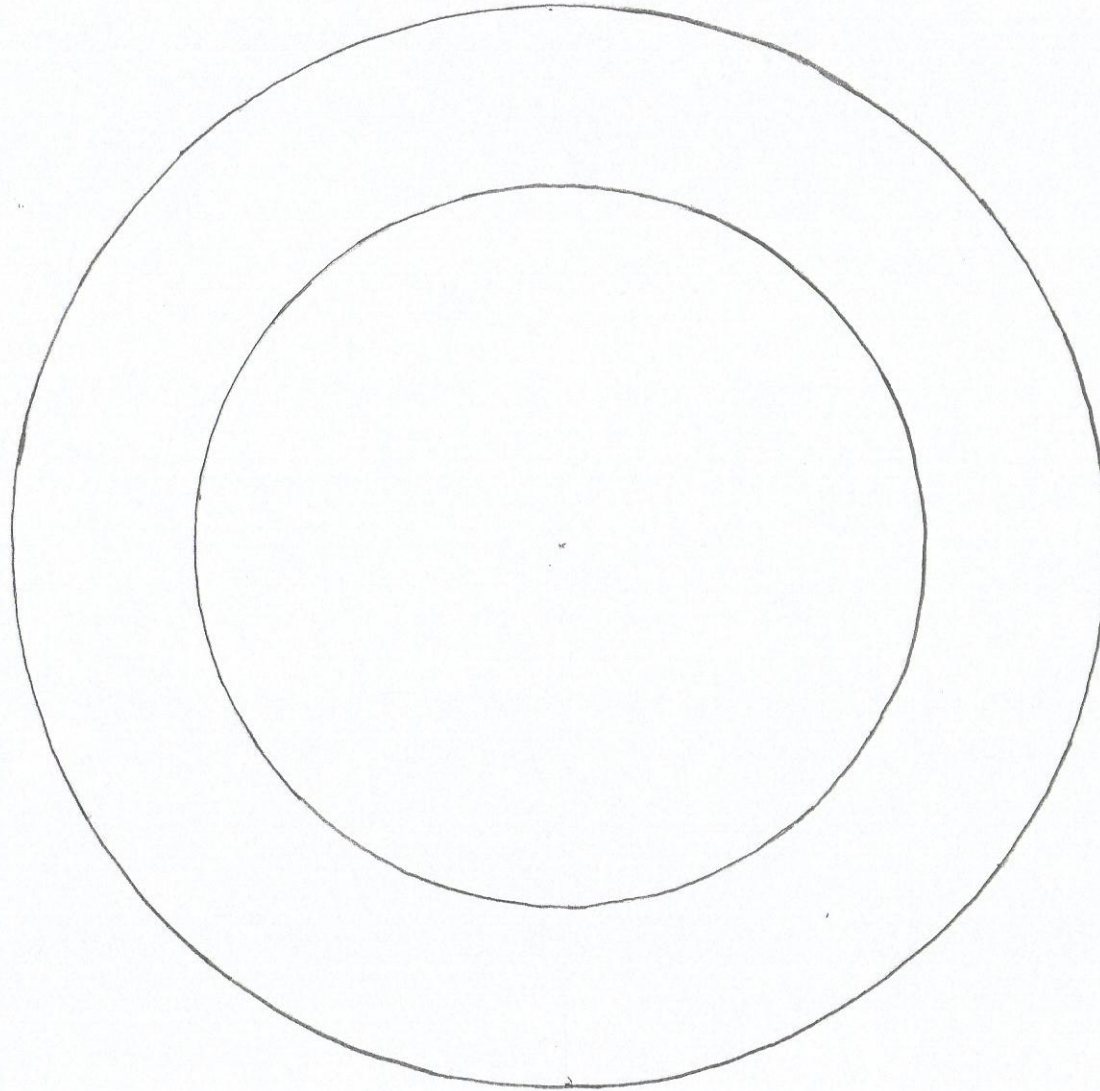
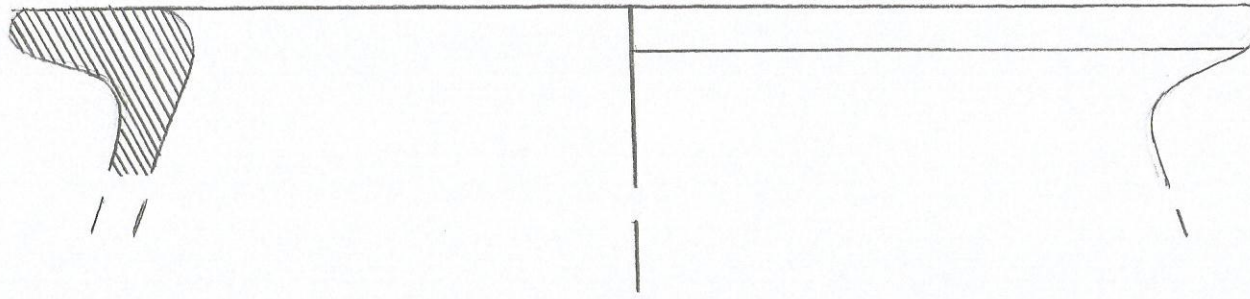

PASH/457-025
4/4

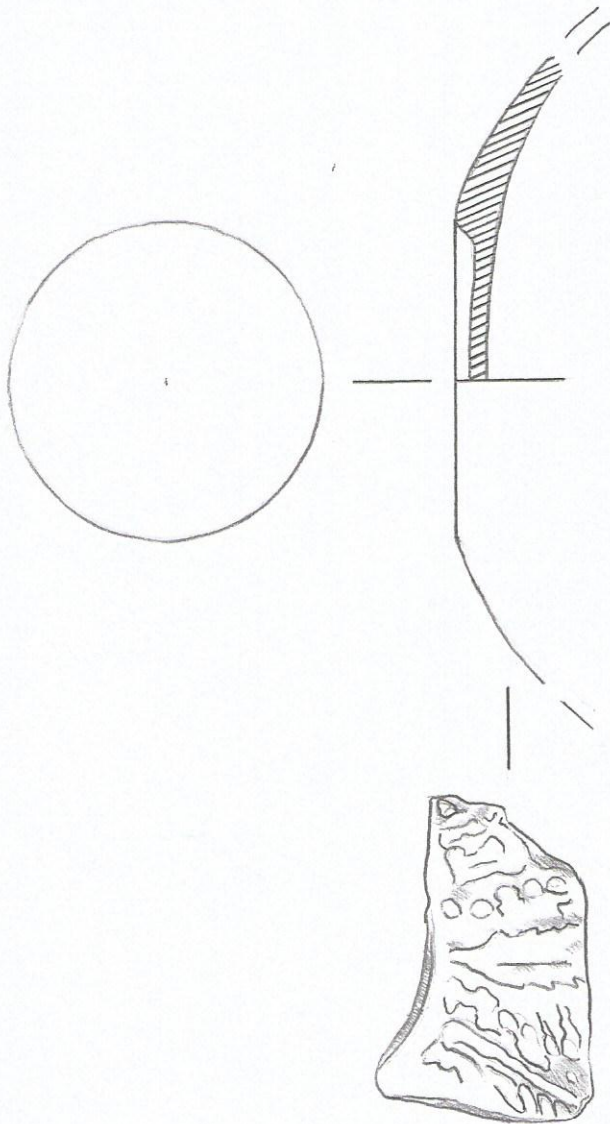

PASH 10/A-4/
2

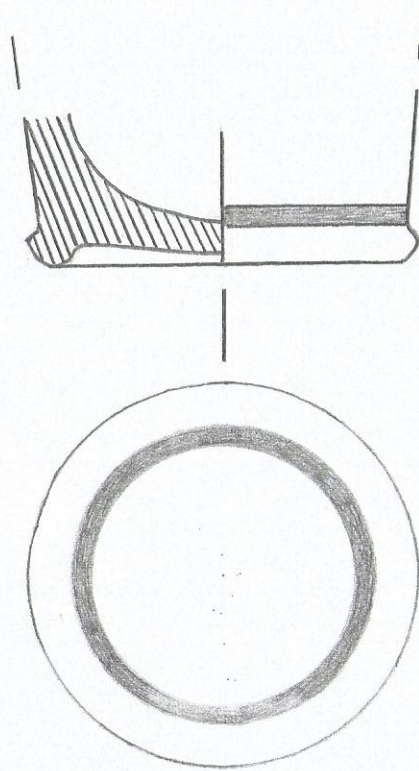

PASH 14
S007-027
002/7

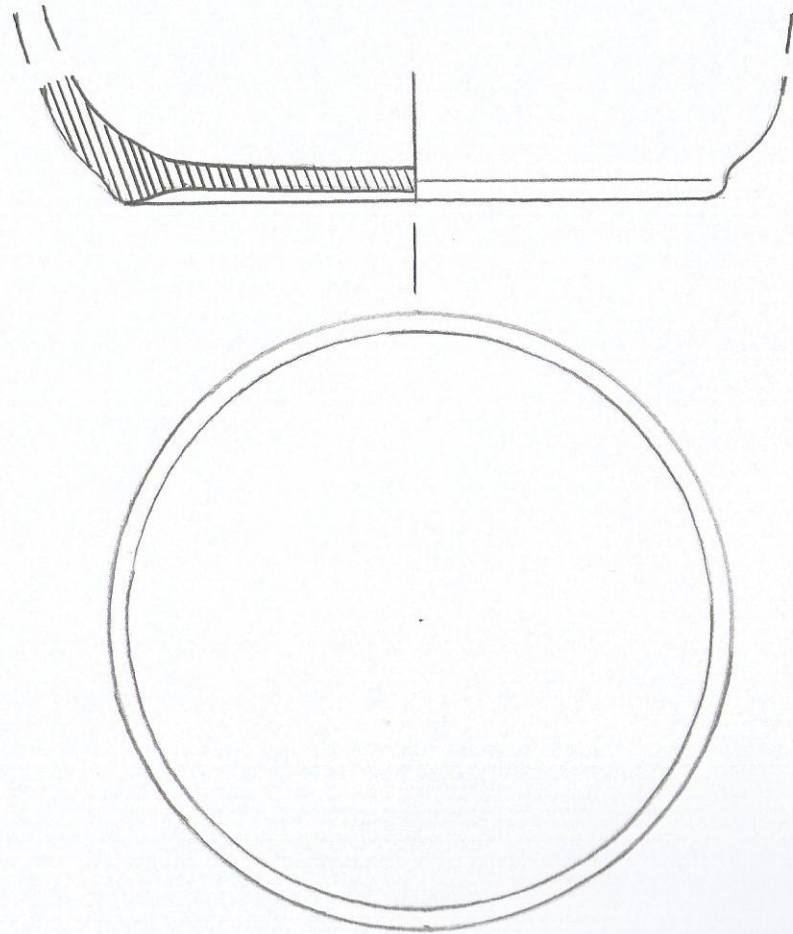

PASH 13 (??)
..... 1/60 3
2

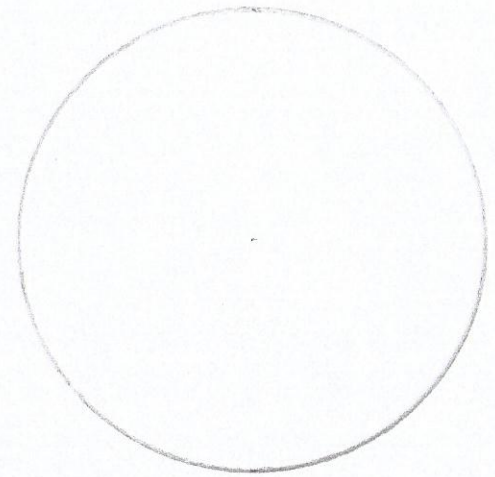
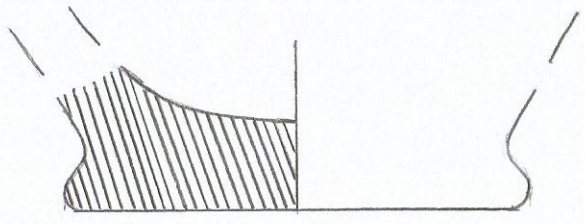

PASH 10/5-2/K-14/19

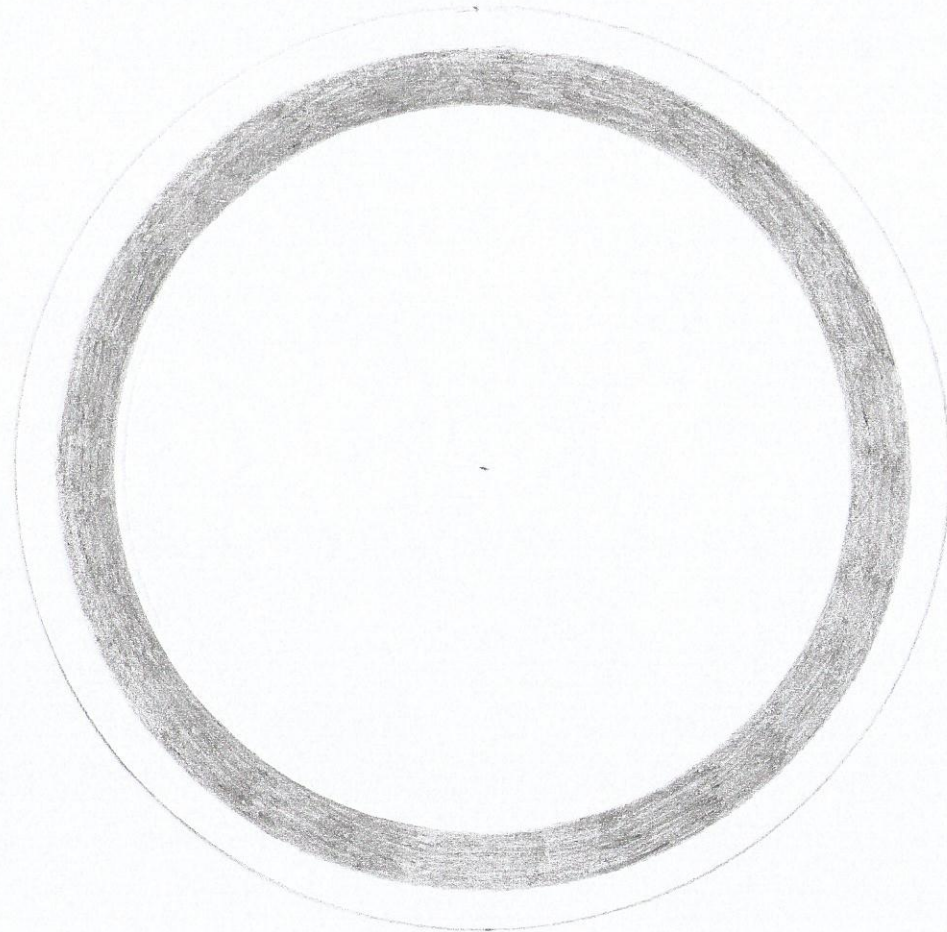
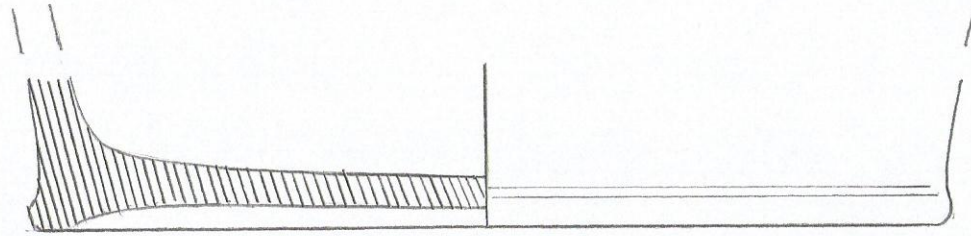

PASH 10/
6-2/K-8/8

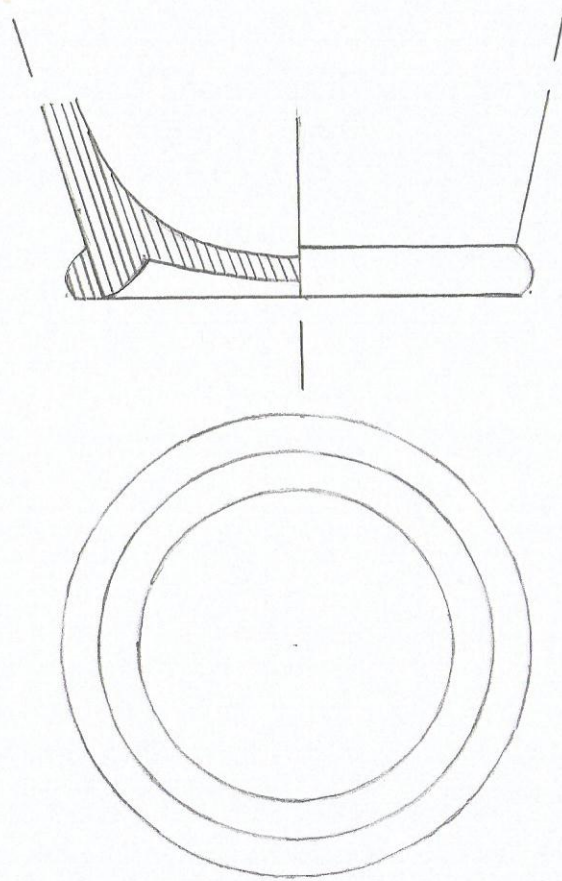

PASH 2014
5007-04T
003-6

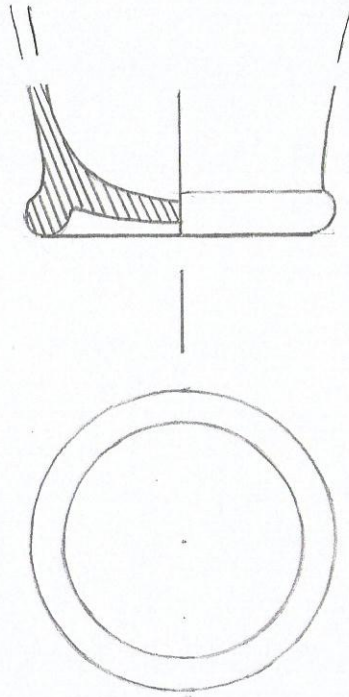

PASH 10
5-2/K-14/17

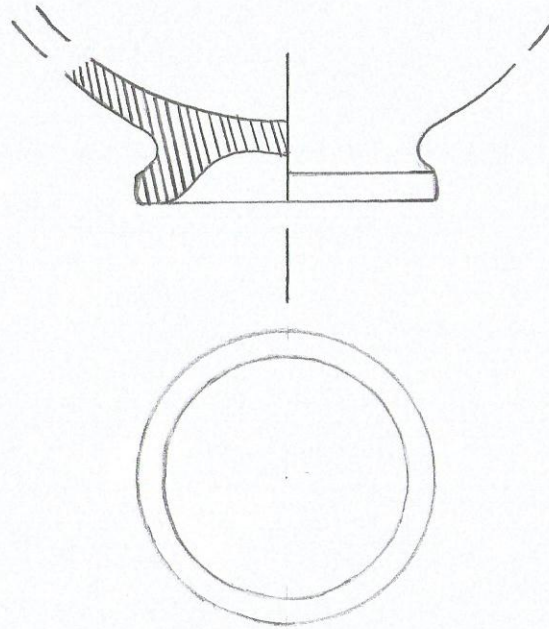

PASH 2013

J-249/14

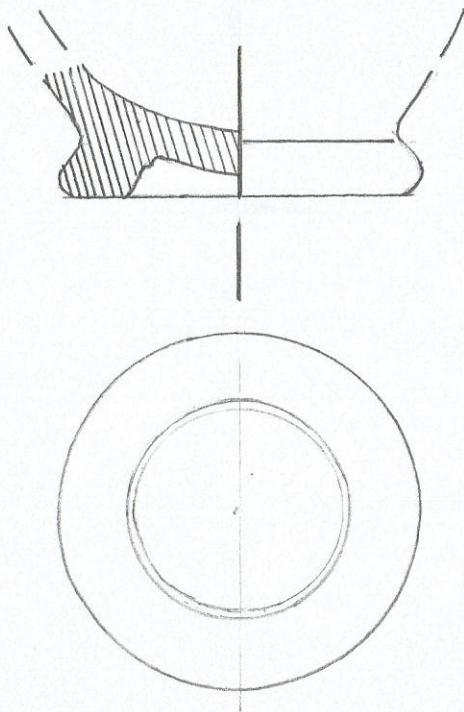

PASH 10/T-71/1

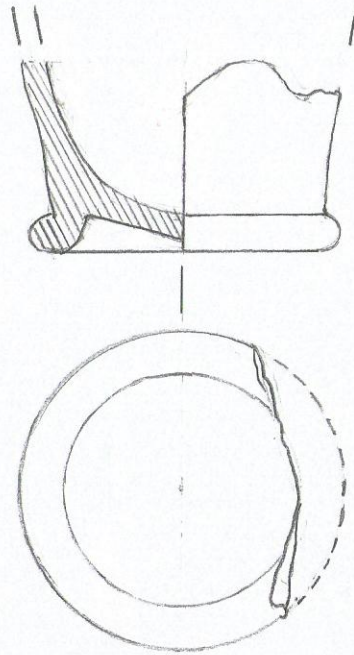

PASH 2013

J-261/16

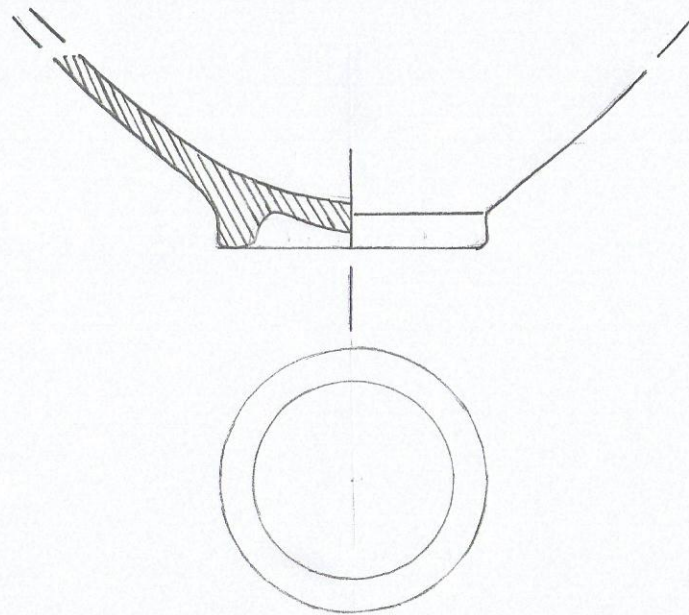

PASH 2013
5-011 Cu 20
186/D

